

AC234 NRG TENDL-2015, AKONING

Principal cross sections

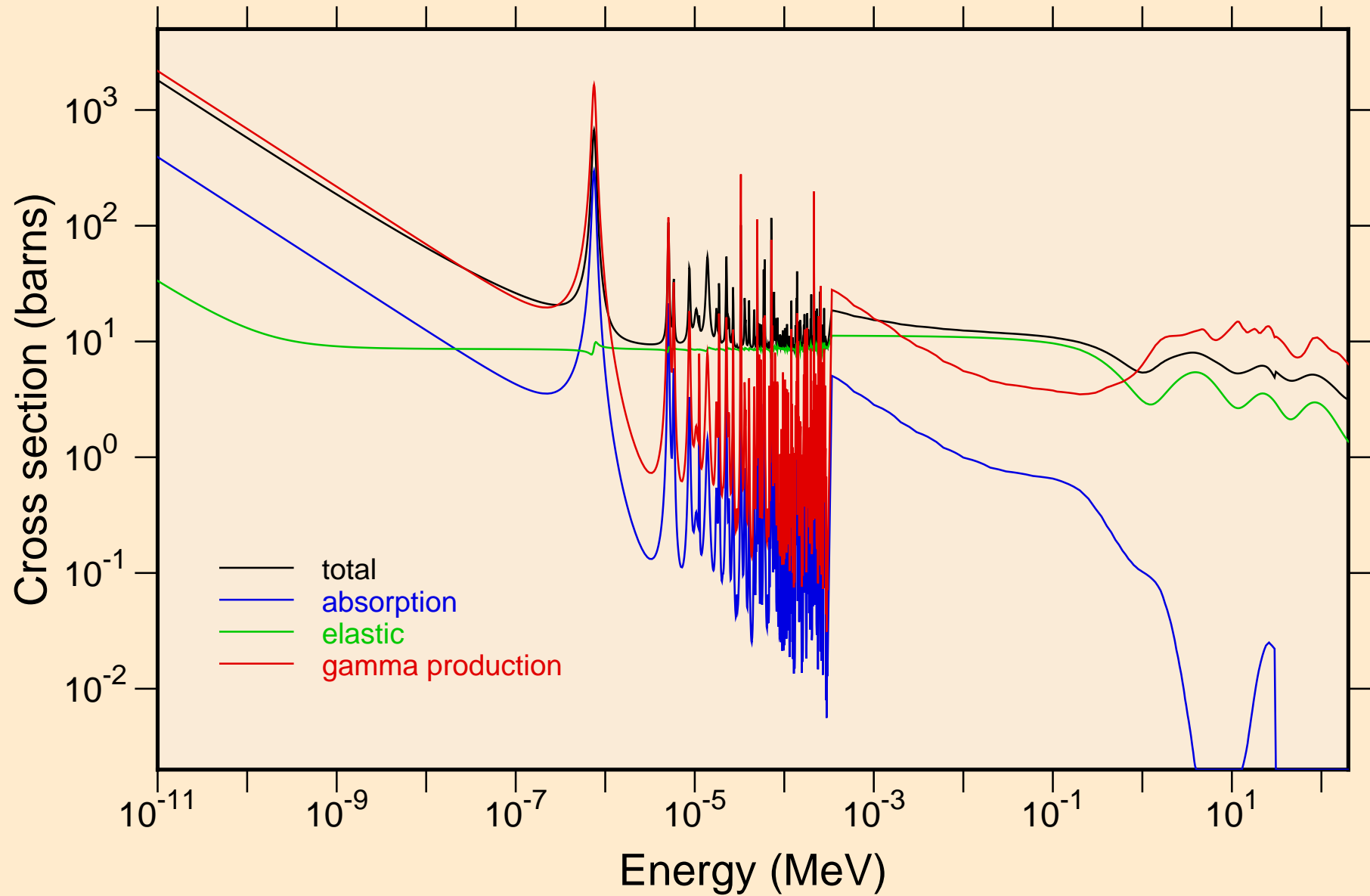

AC234 NRG TENDL-2015, AKONING
resonance total cross section

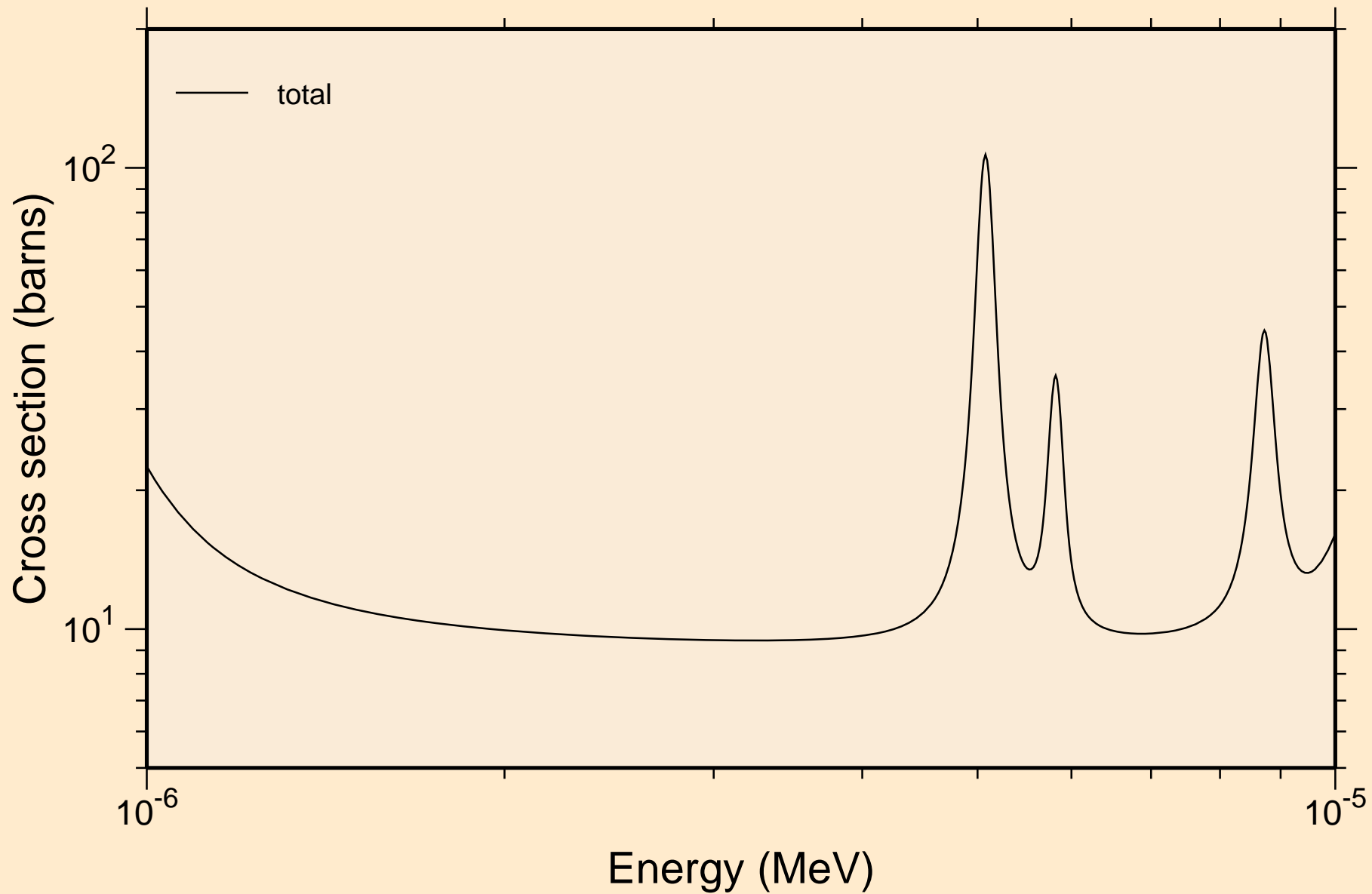

AC234 NRG TENDL-2015, AKONING

resonance total cross section

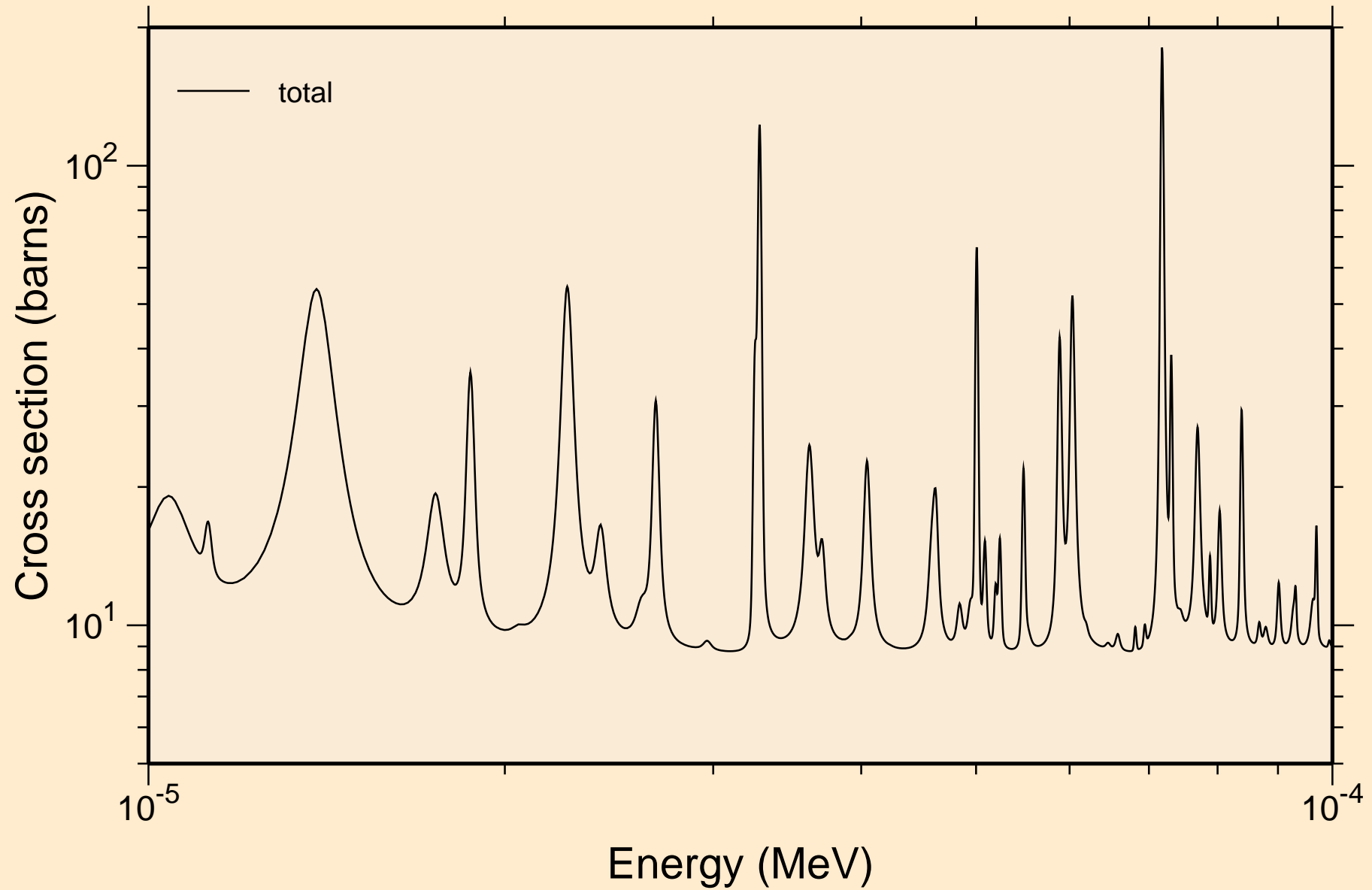

AC234 NRG TENDL-2015, AKONING
resonance total cross section

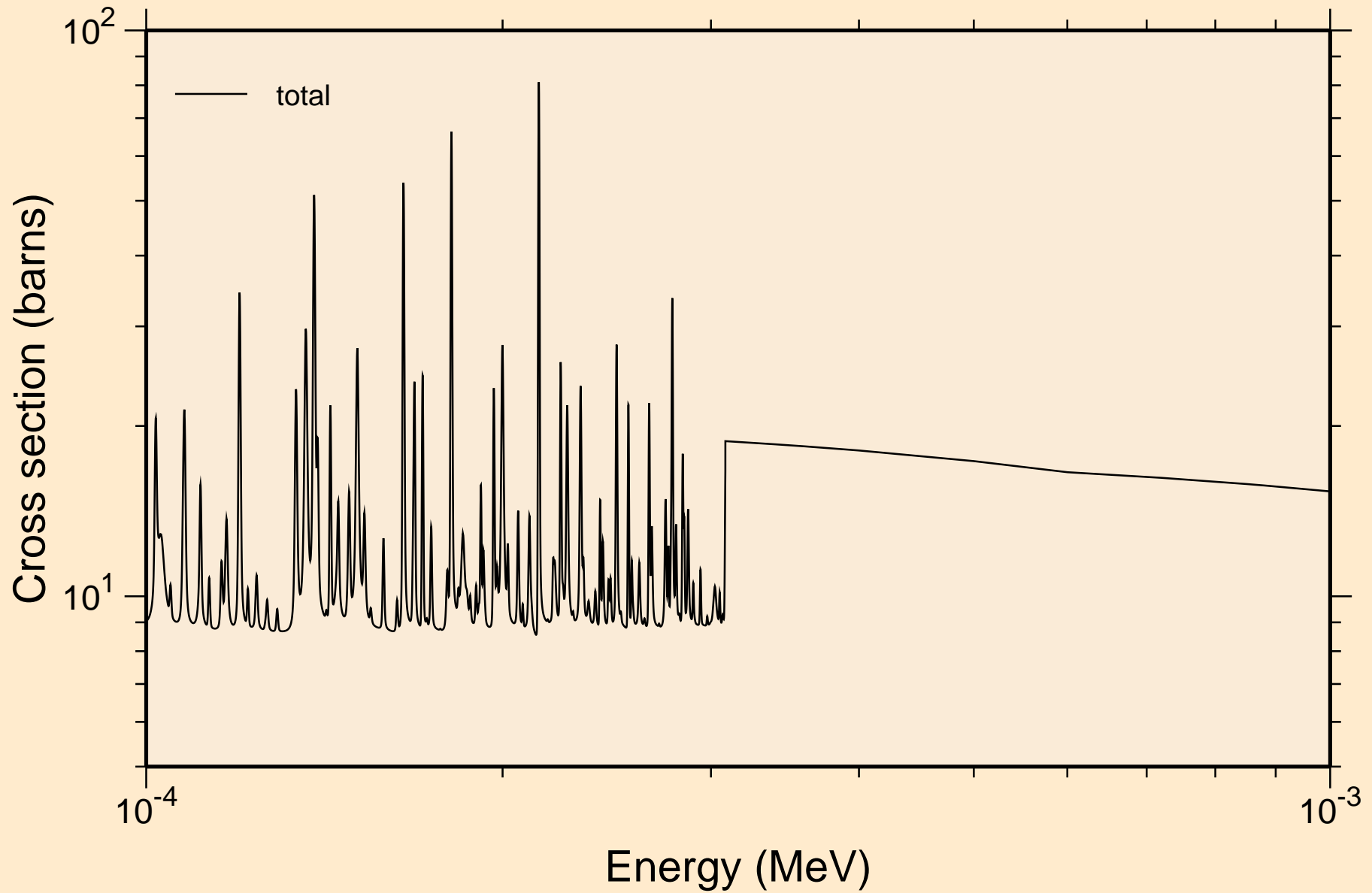

AC234 NRG TENDL-2015, AKONING
resonance total cross section

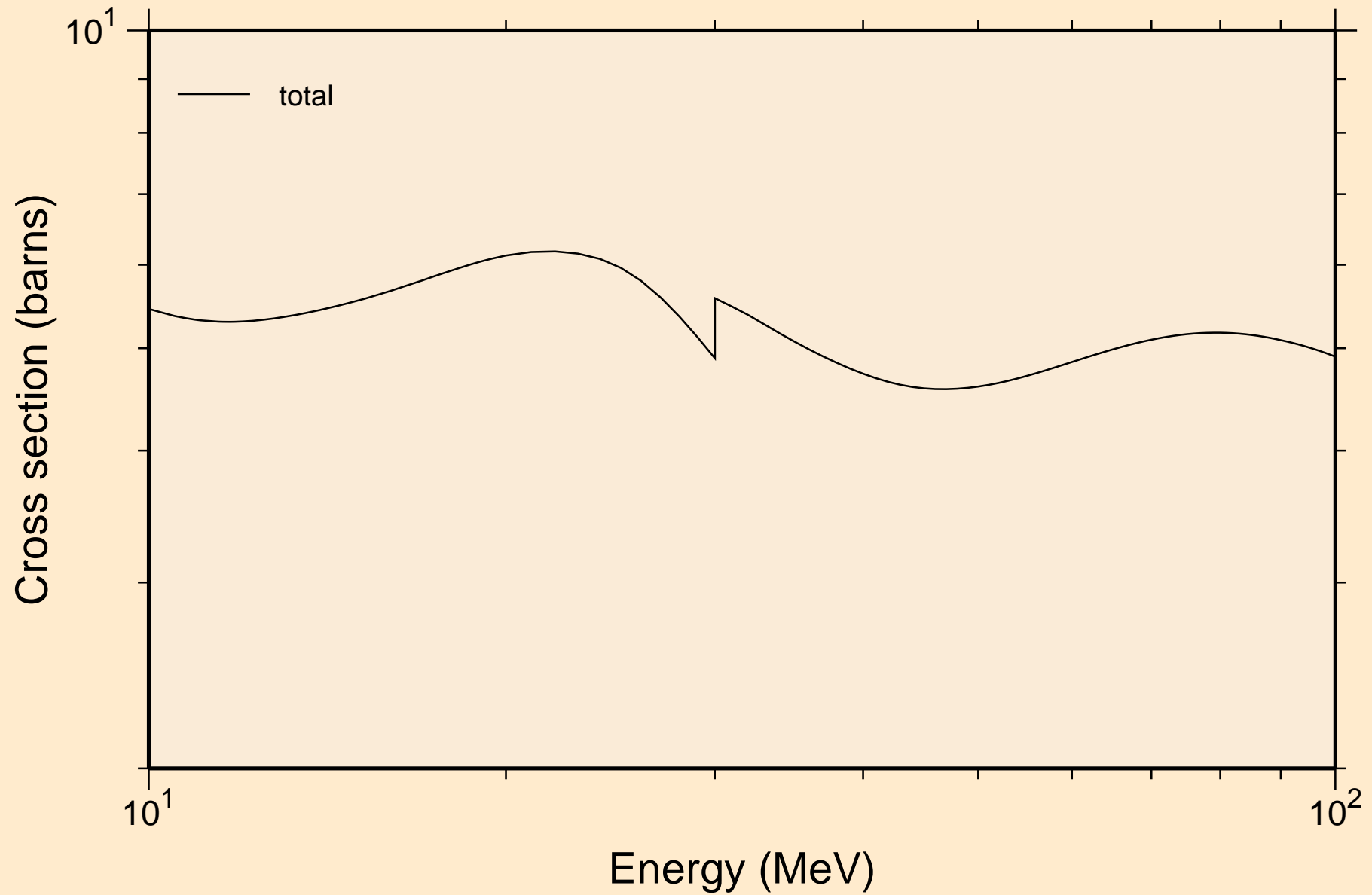

AC234 NRG TENDL-2015, AKONING
resonance absorption cross sections

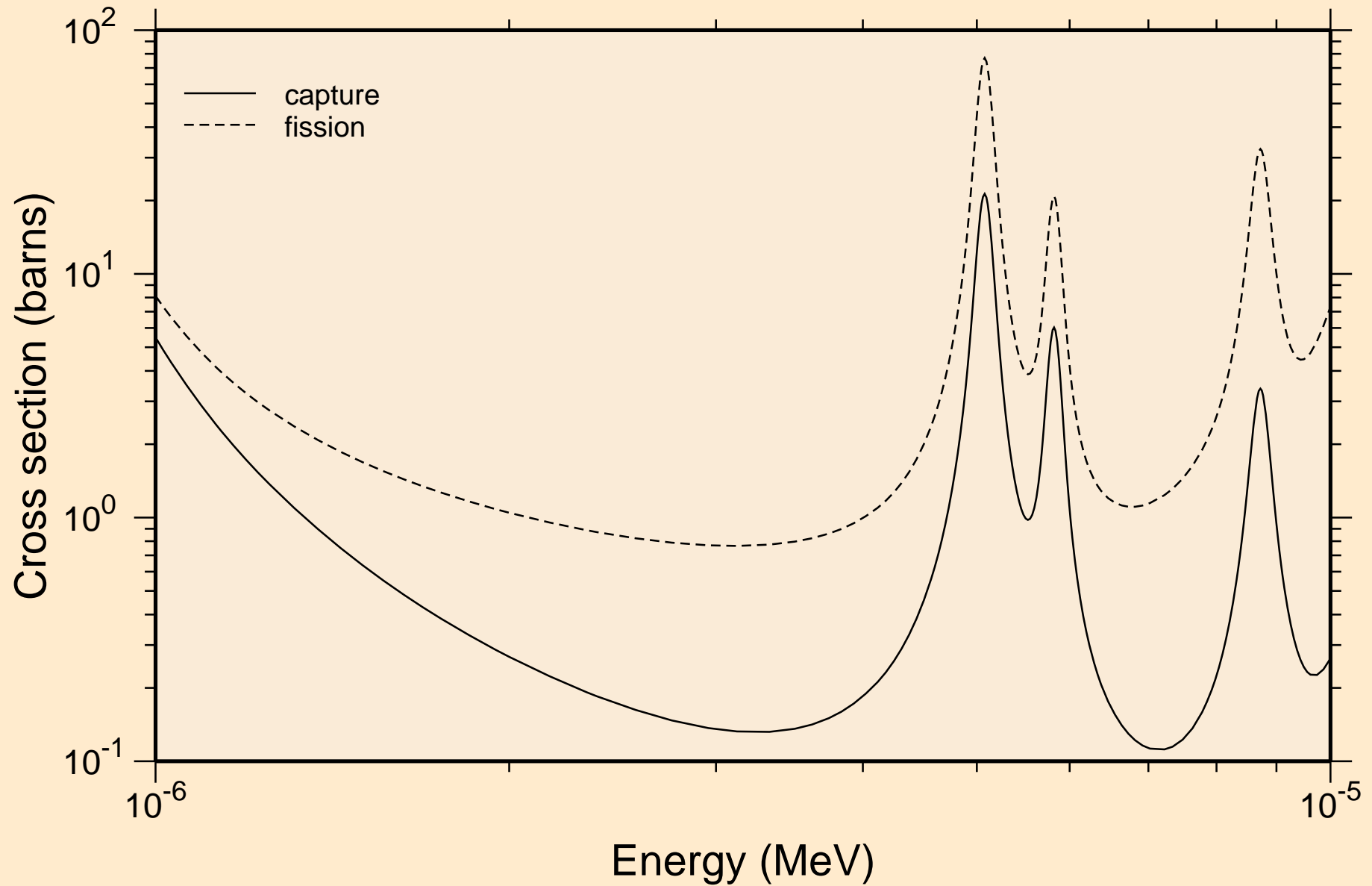

AC234 NRG TENDL-2015, AKONING

resonance absorption cross sections

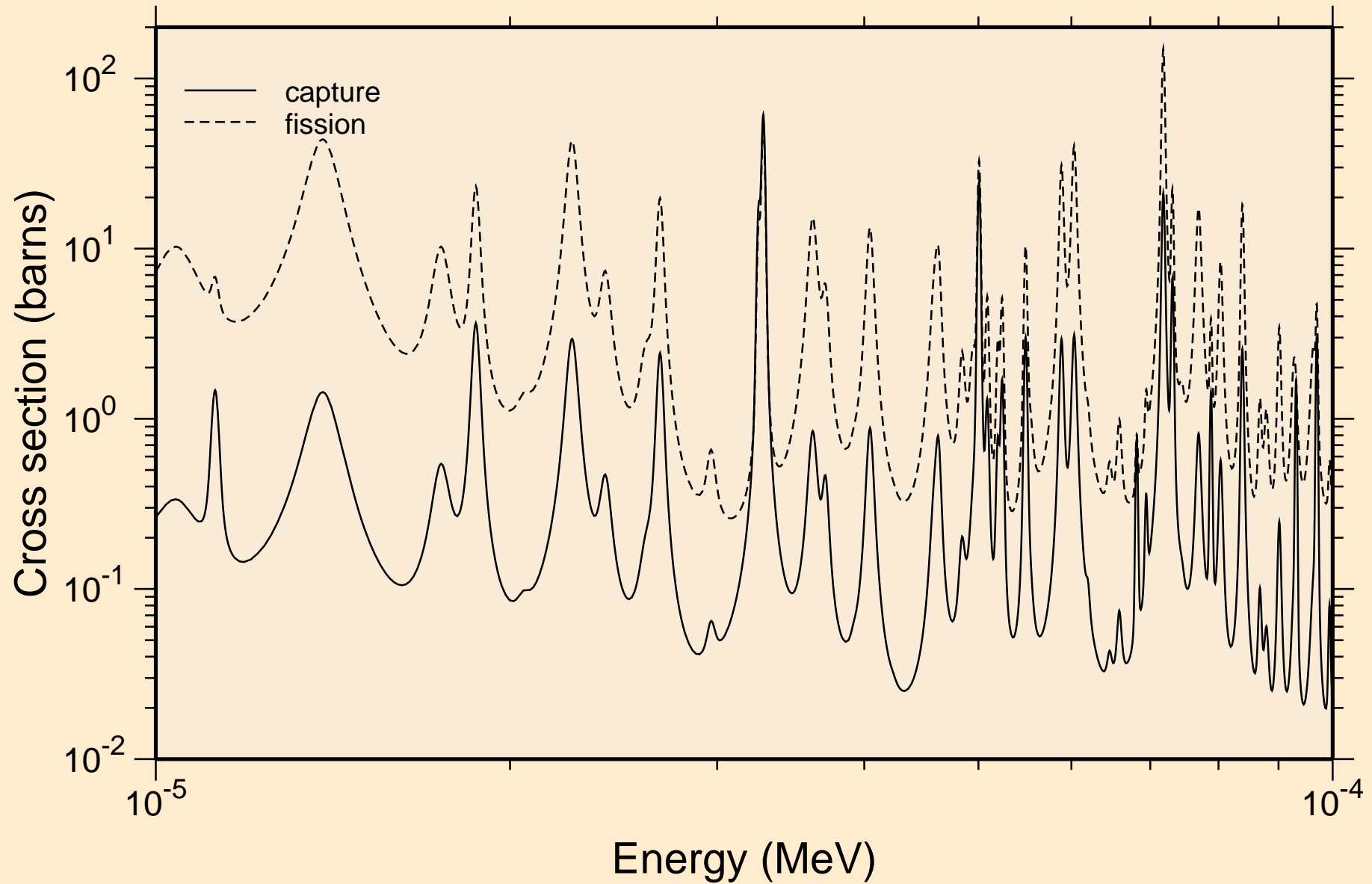

AC234 NRG TENDL-2015, AKONING
resonance absorption cross sections

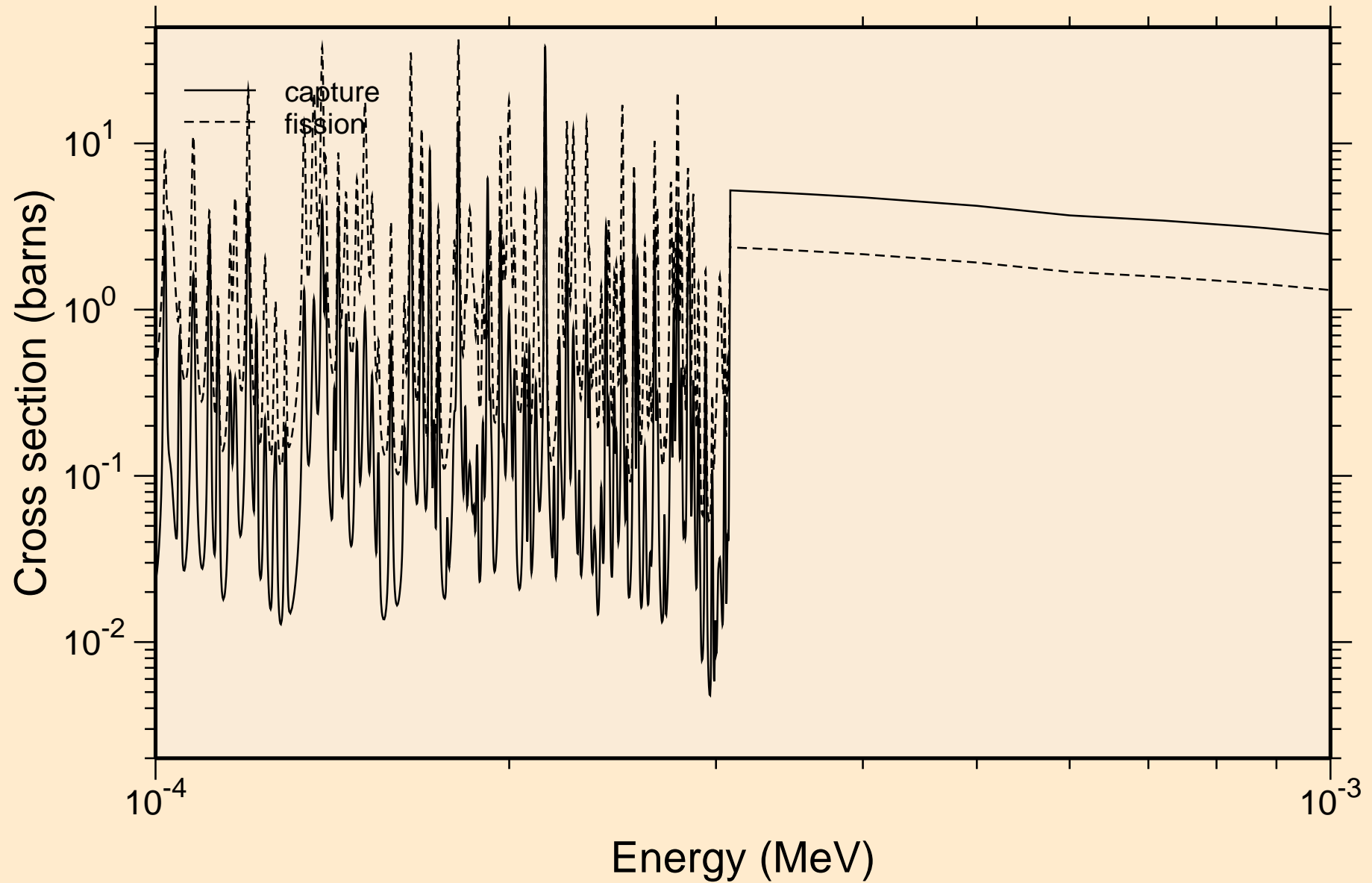

AC234 NRG TENDL-2015, AKONING

resonance absorption cross sections

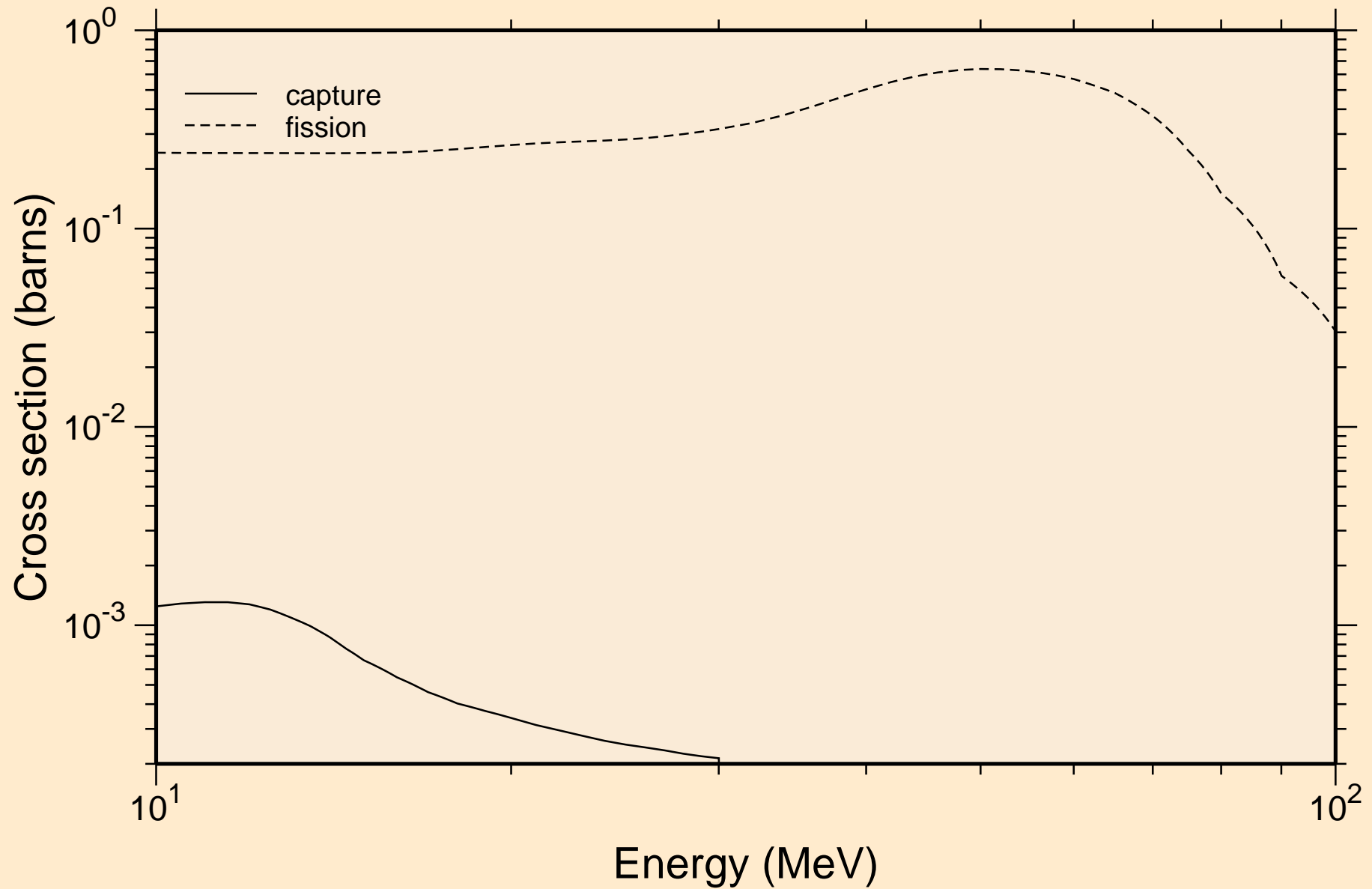

AC234 NRG TENDL-2015, AKONING

Non-threshold reactions

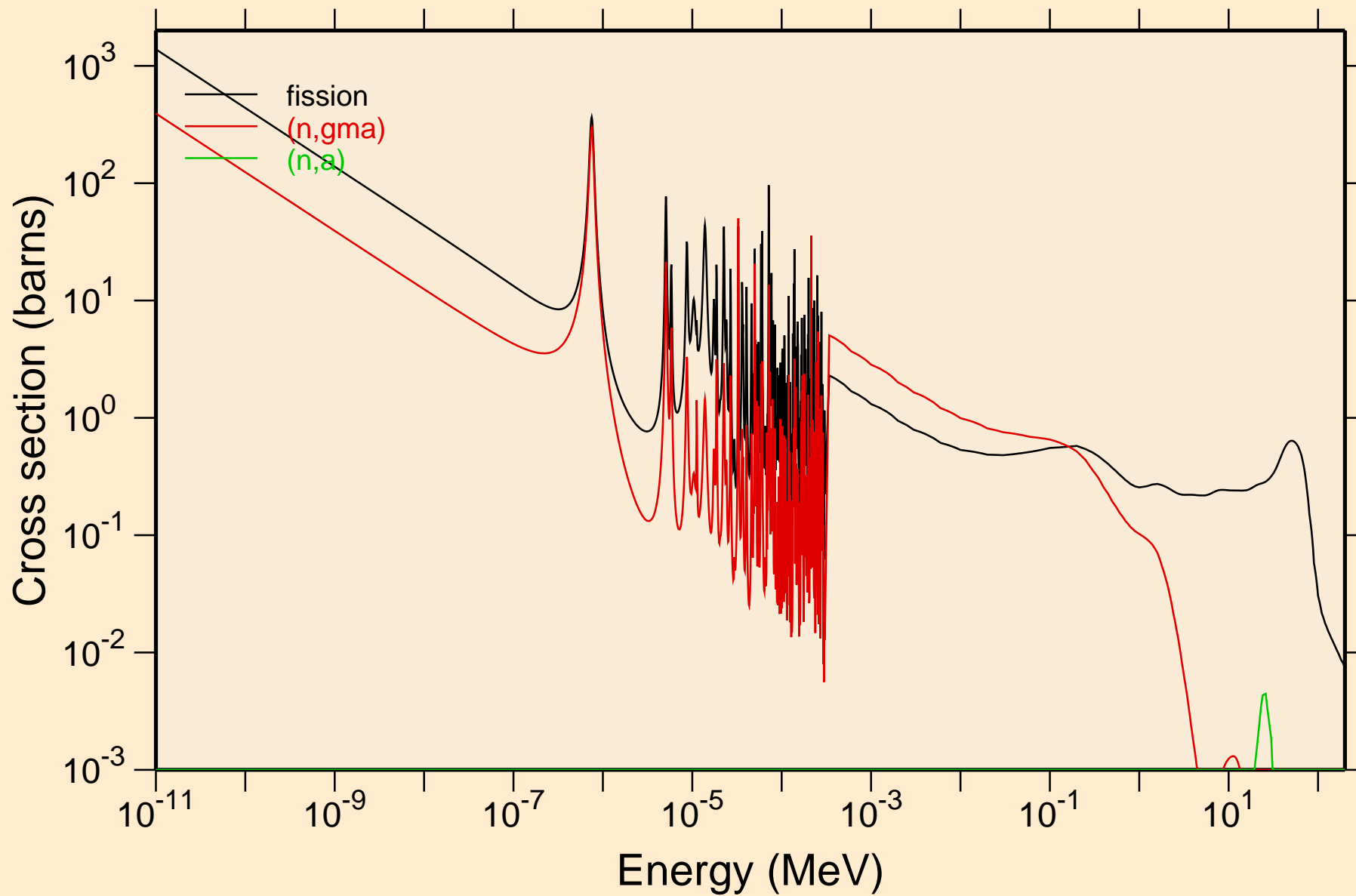

AC234 NRG TENDL-2015, AKONING

Principal cross sections

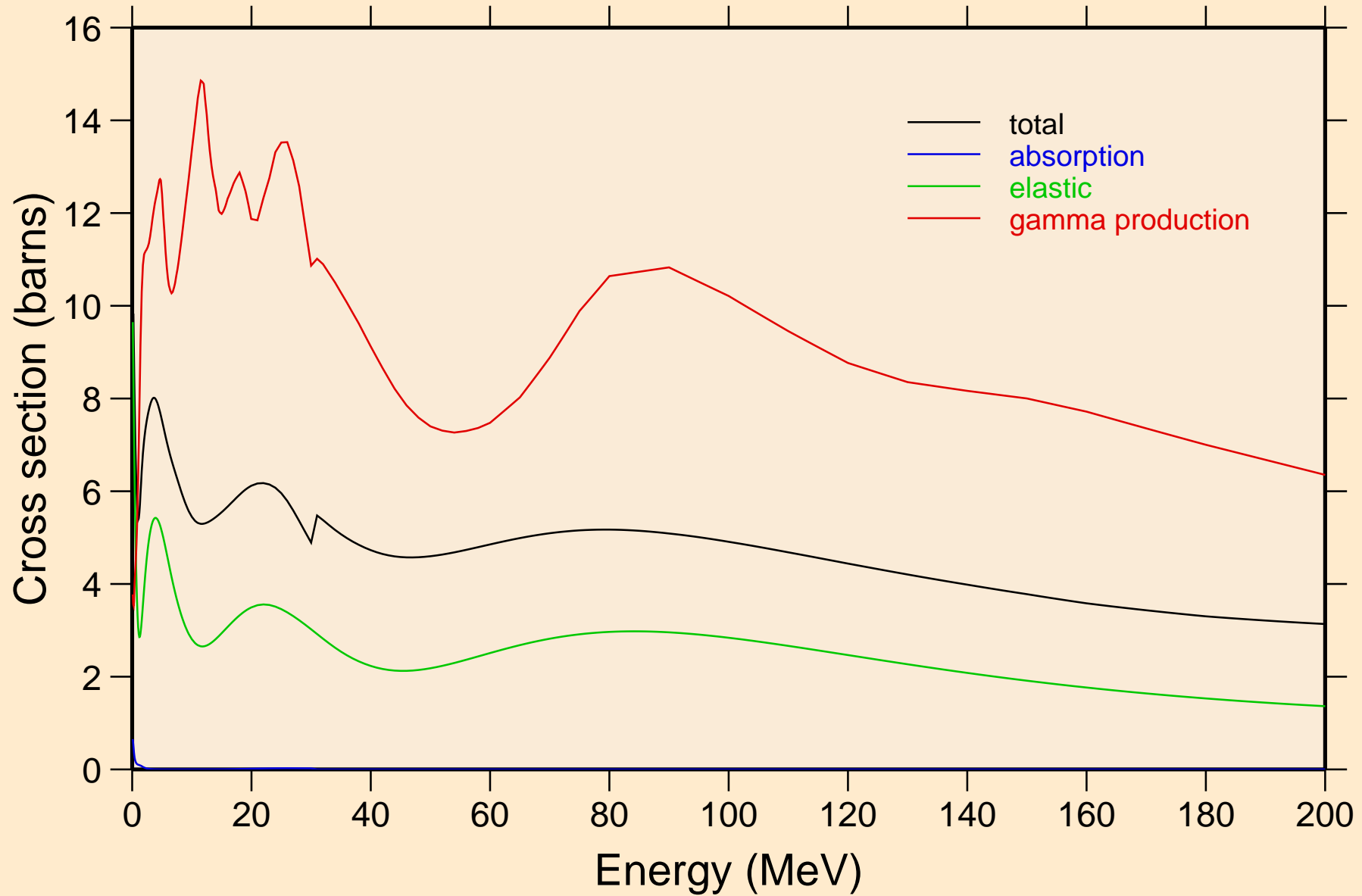

AC234 NRG TENDL-2015, AKONING

Non-threshold reactions

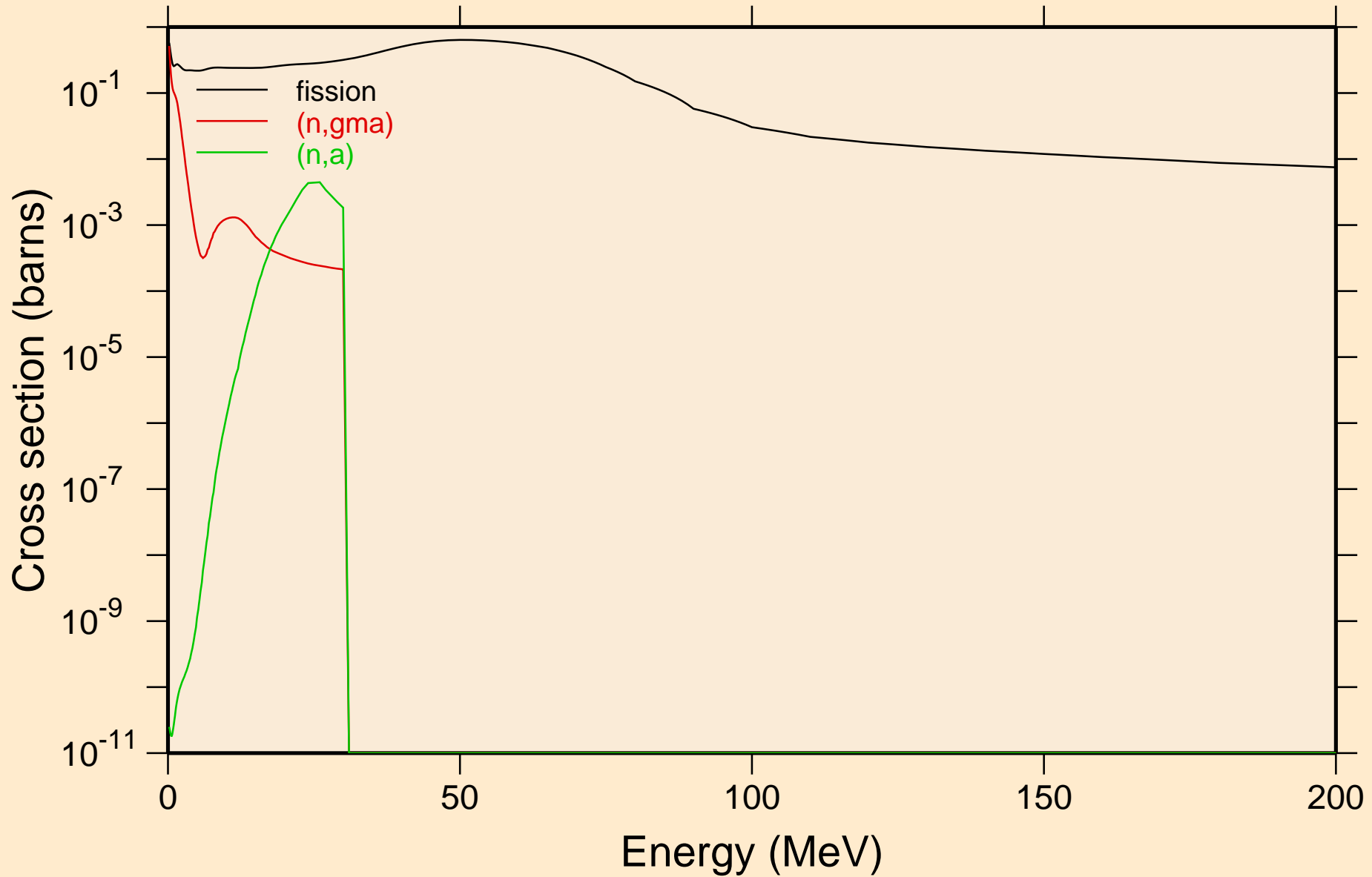

AC234 NRG TENDL-2015, AKONING
Inelastic levels

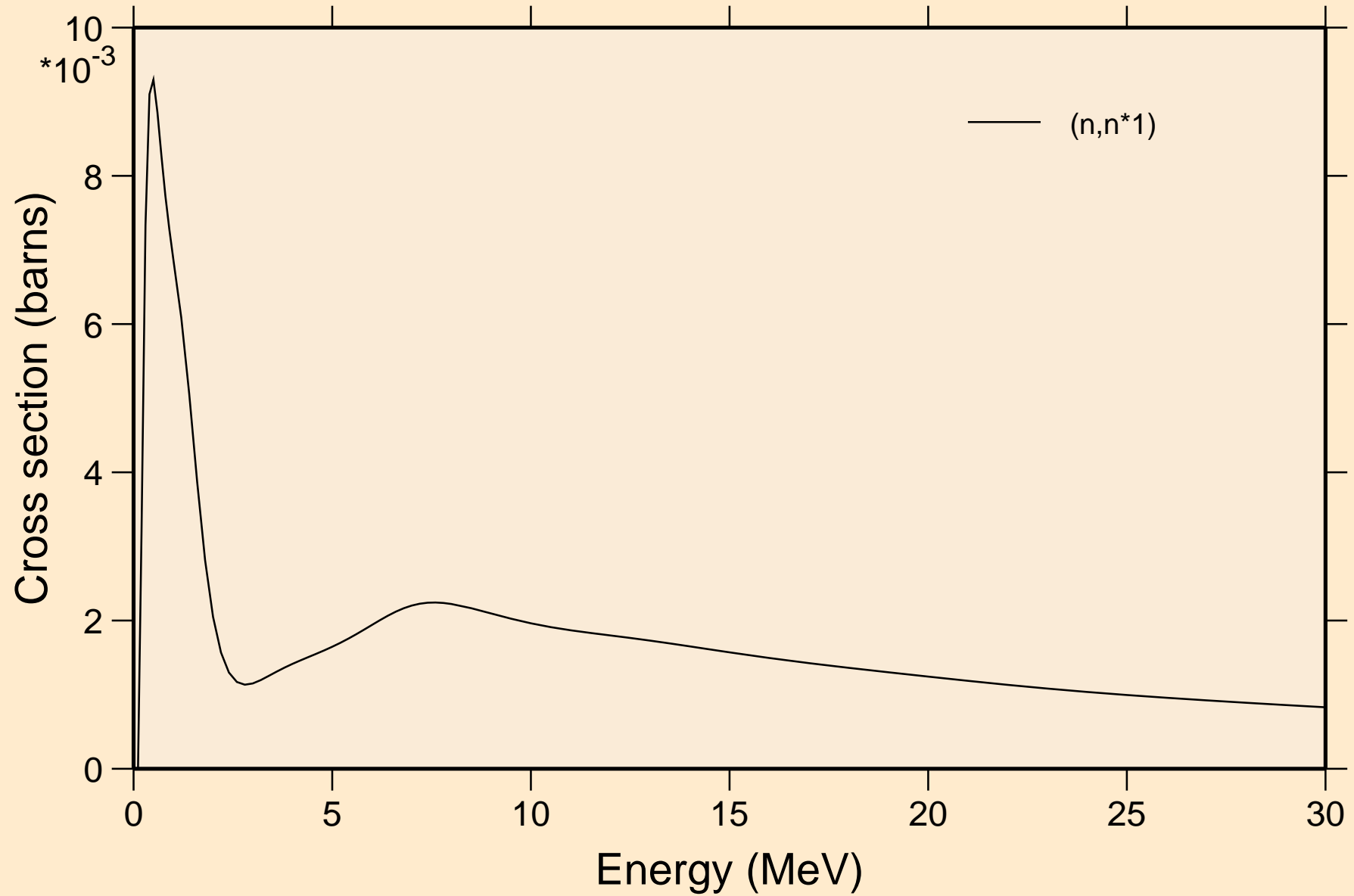

AC234 NRG TENDL-2015, AKONING

Threshold reactions

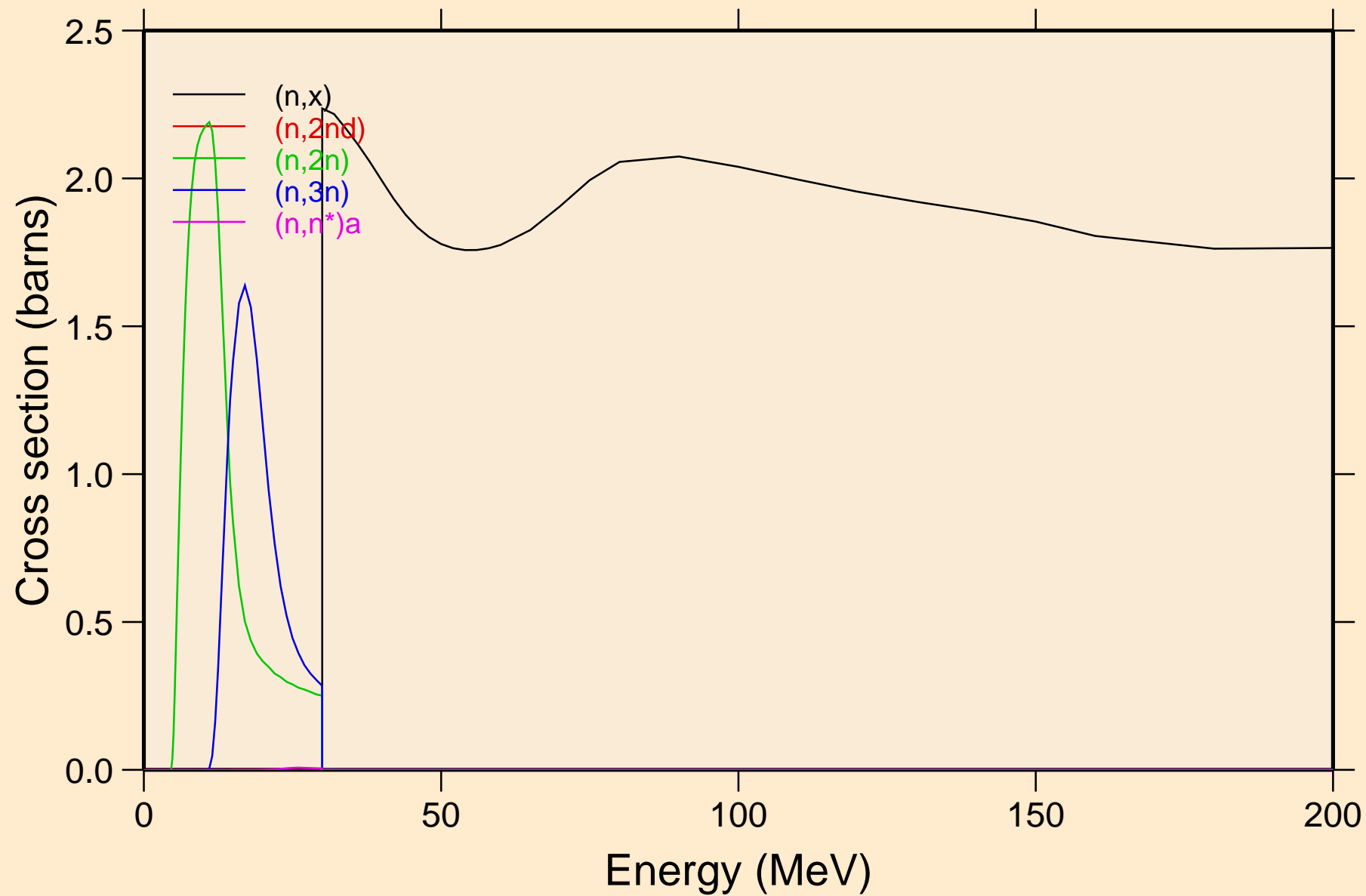

AC234 NRG TENDL-2015, AKONING

Threshold reactions

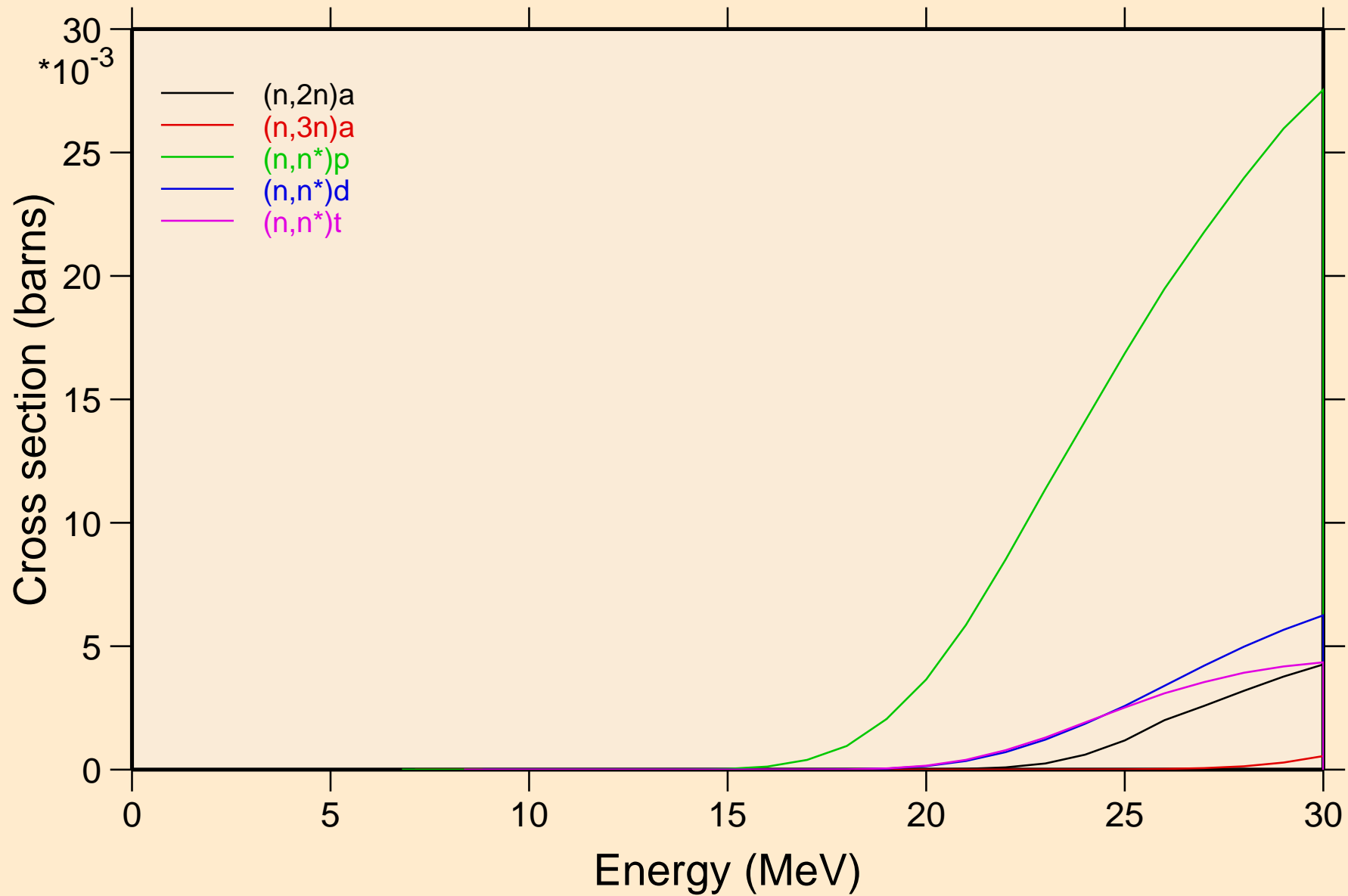

AC234 NRG TENDL-2015, AKONING

Threshold reactions

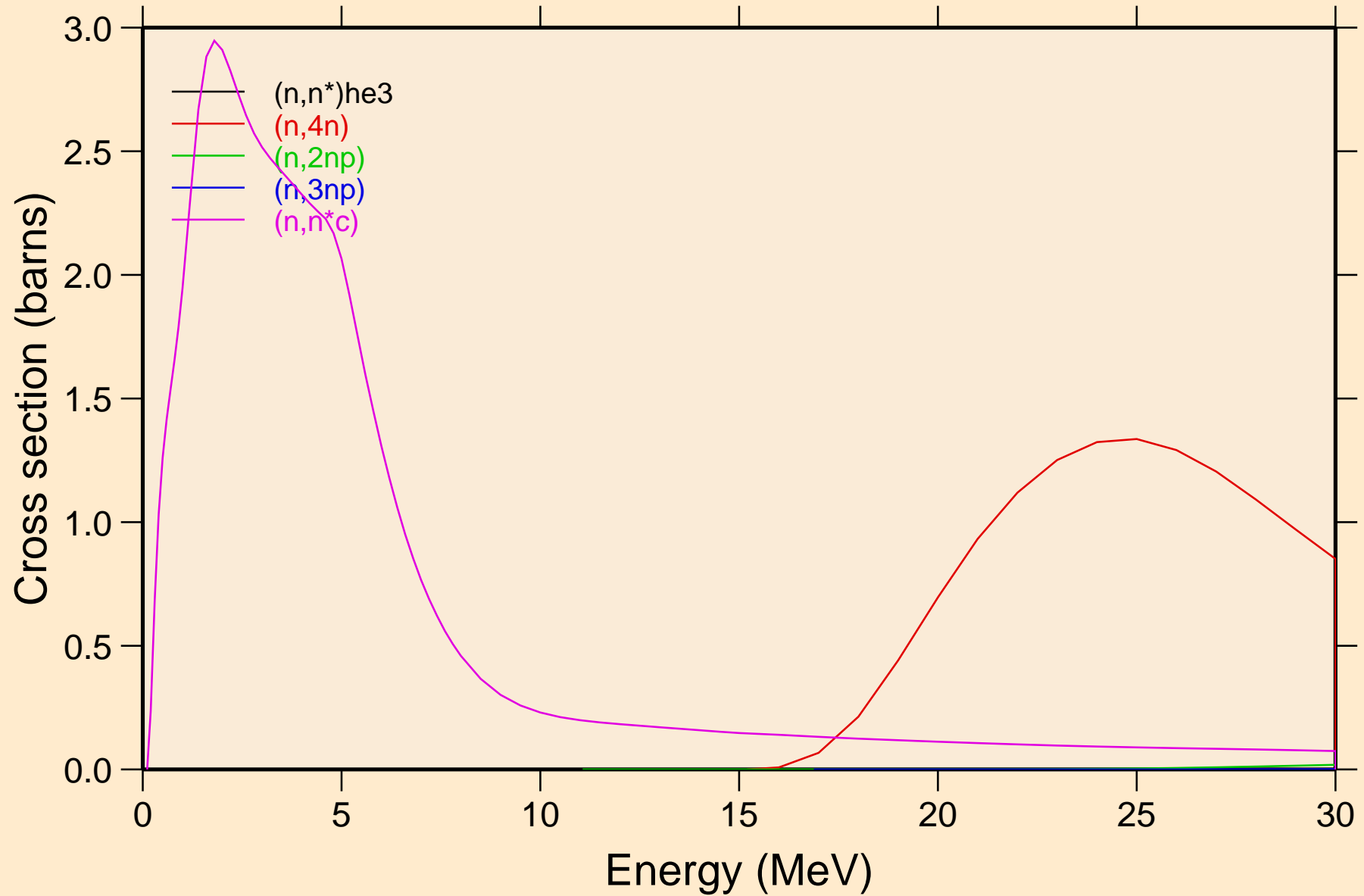

AC234 NRG TENDL-2015, AKONING

Threshold reactions

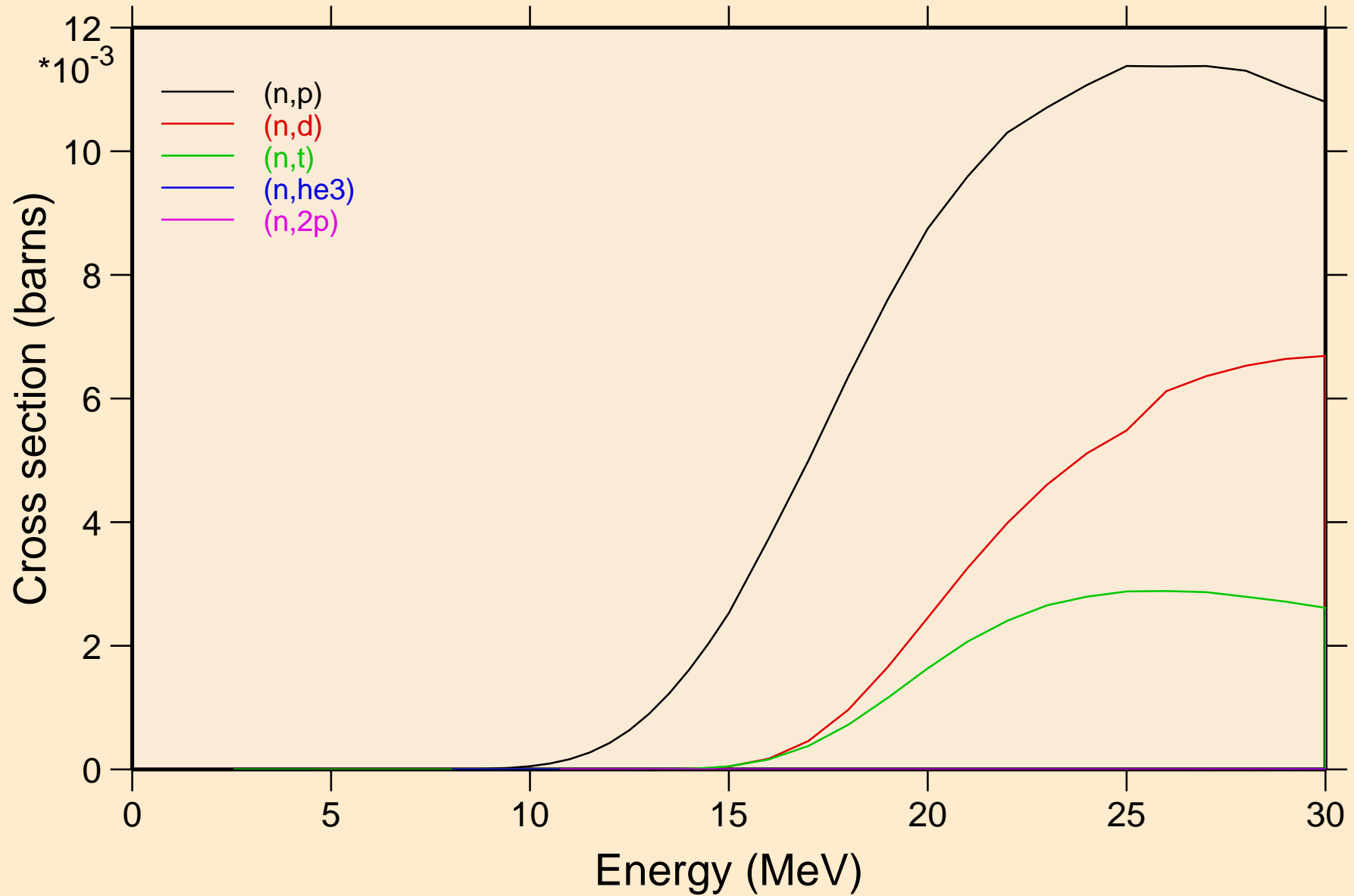

AC234 NRG TENDL-2015, AKONING
angular distribution for elastic

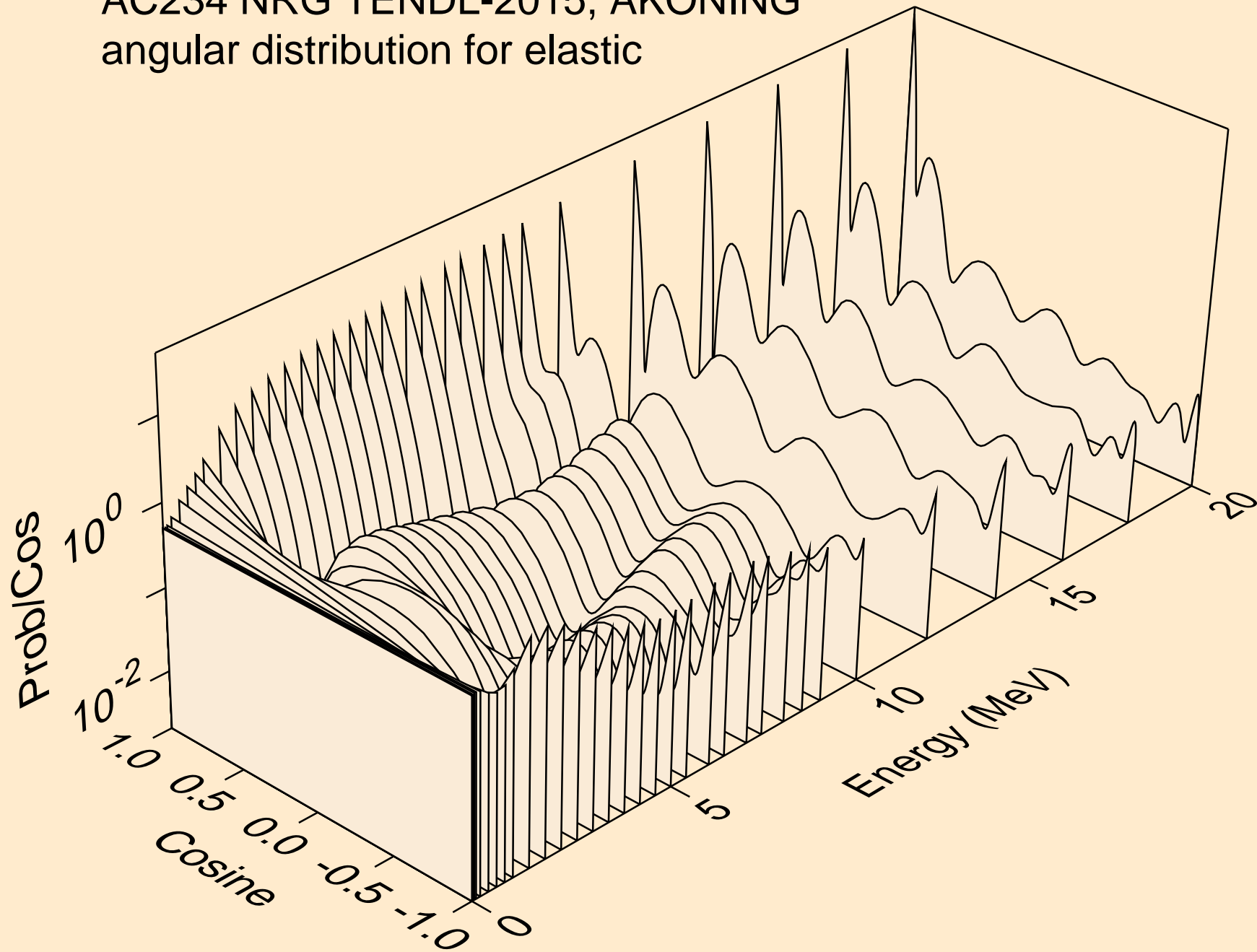

AC234 NRG TENDL-2015, AKONING
angular distribution for elastic

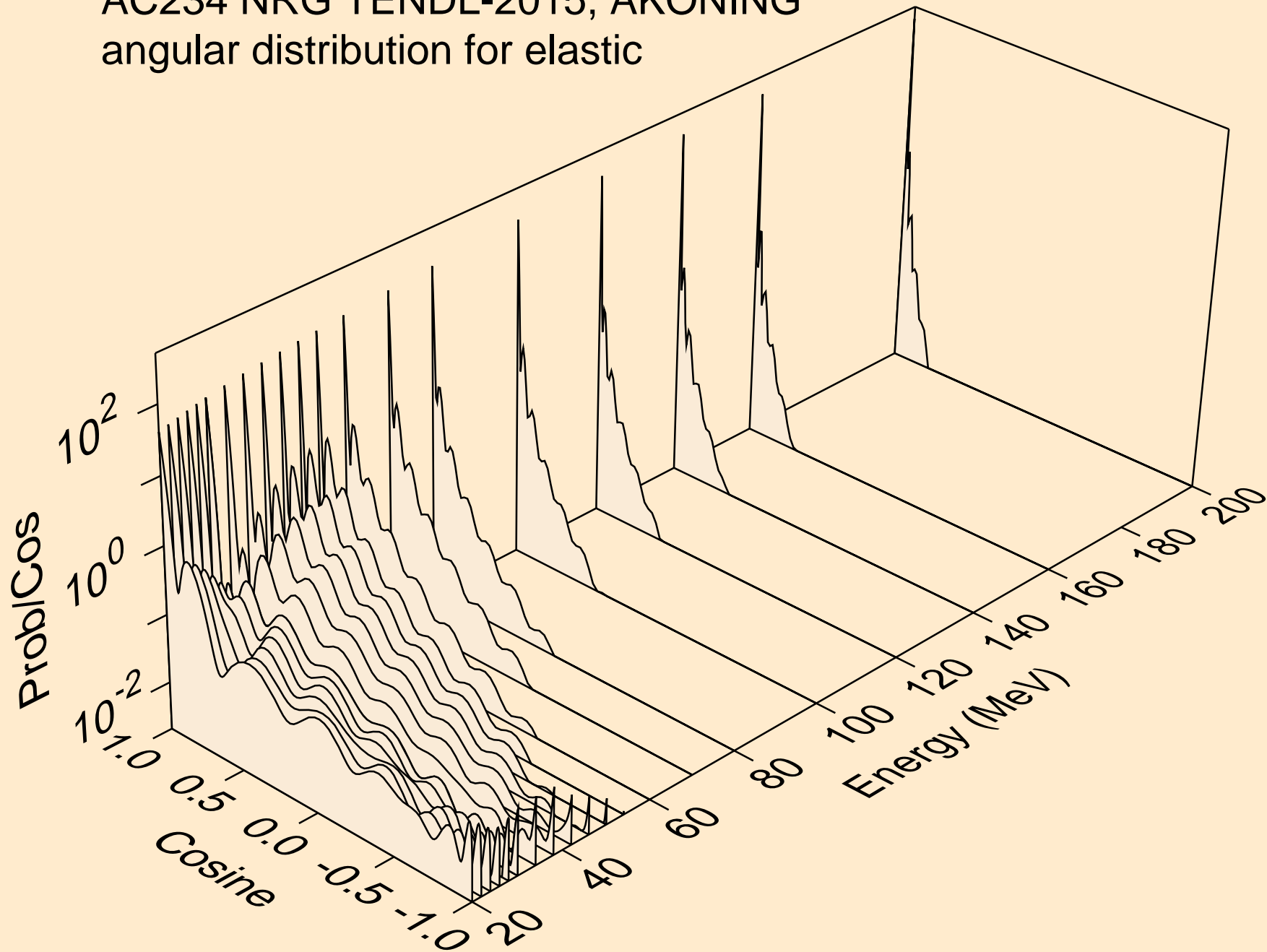

AC234 NRG TENDL-2015, AKONING
angular distribution for (n,n*1)

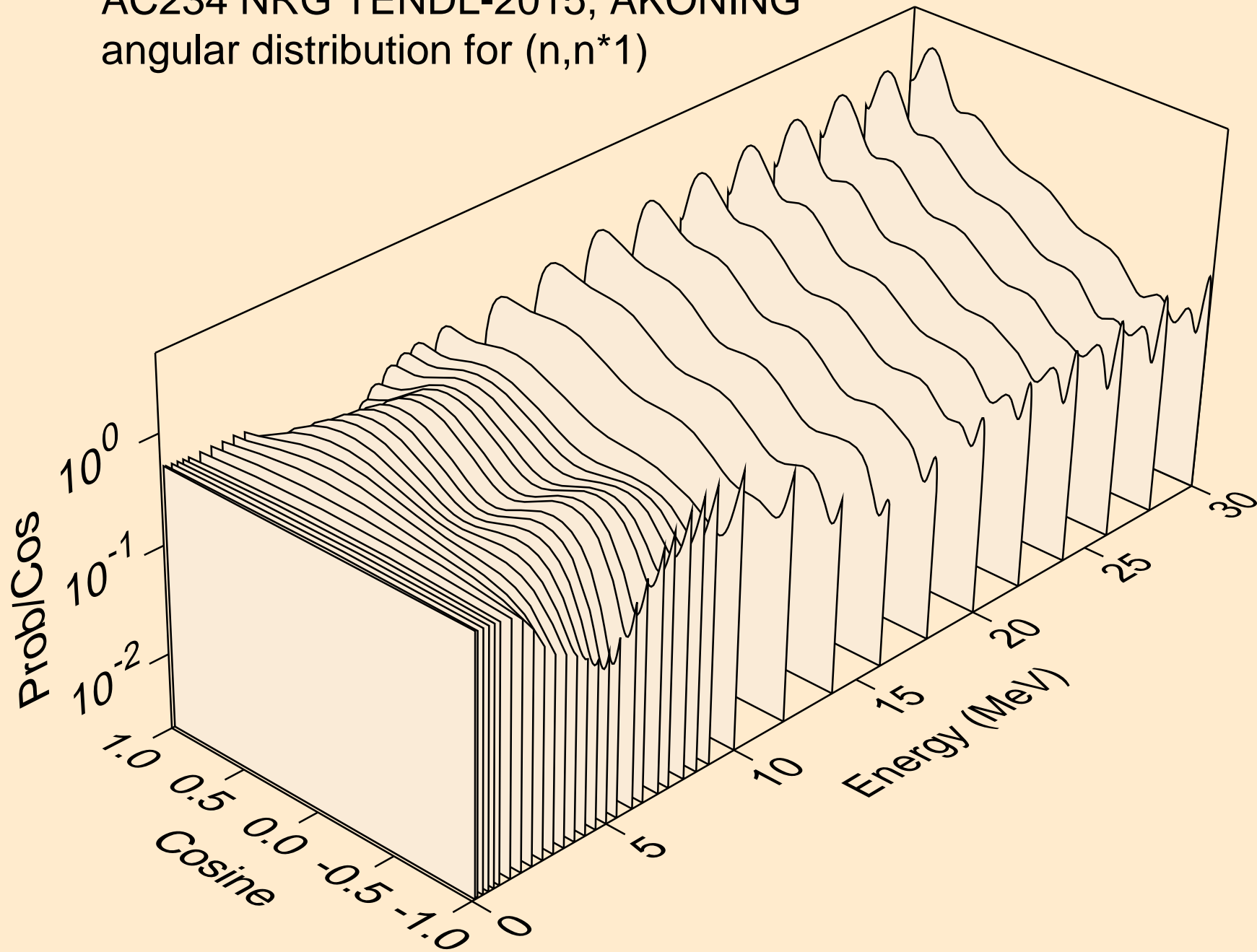

AC234 NRG TENDL-2015, AKONING

Total fission nubar

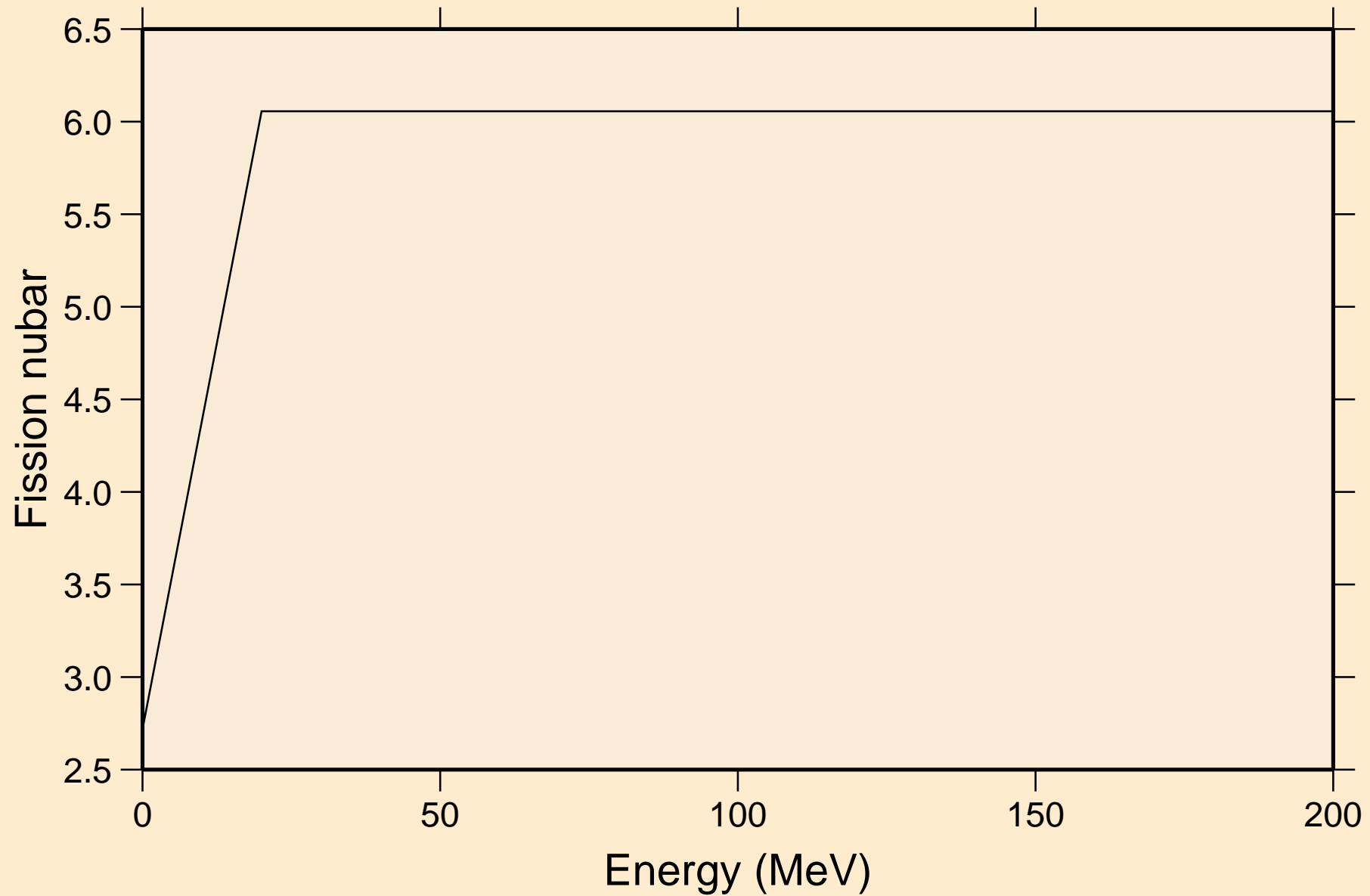

AC234 NRG TENDL-2015, AKONING
Neutron emission for (n,x)

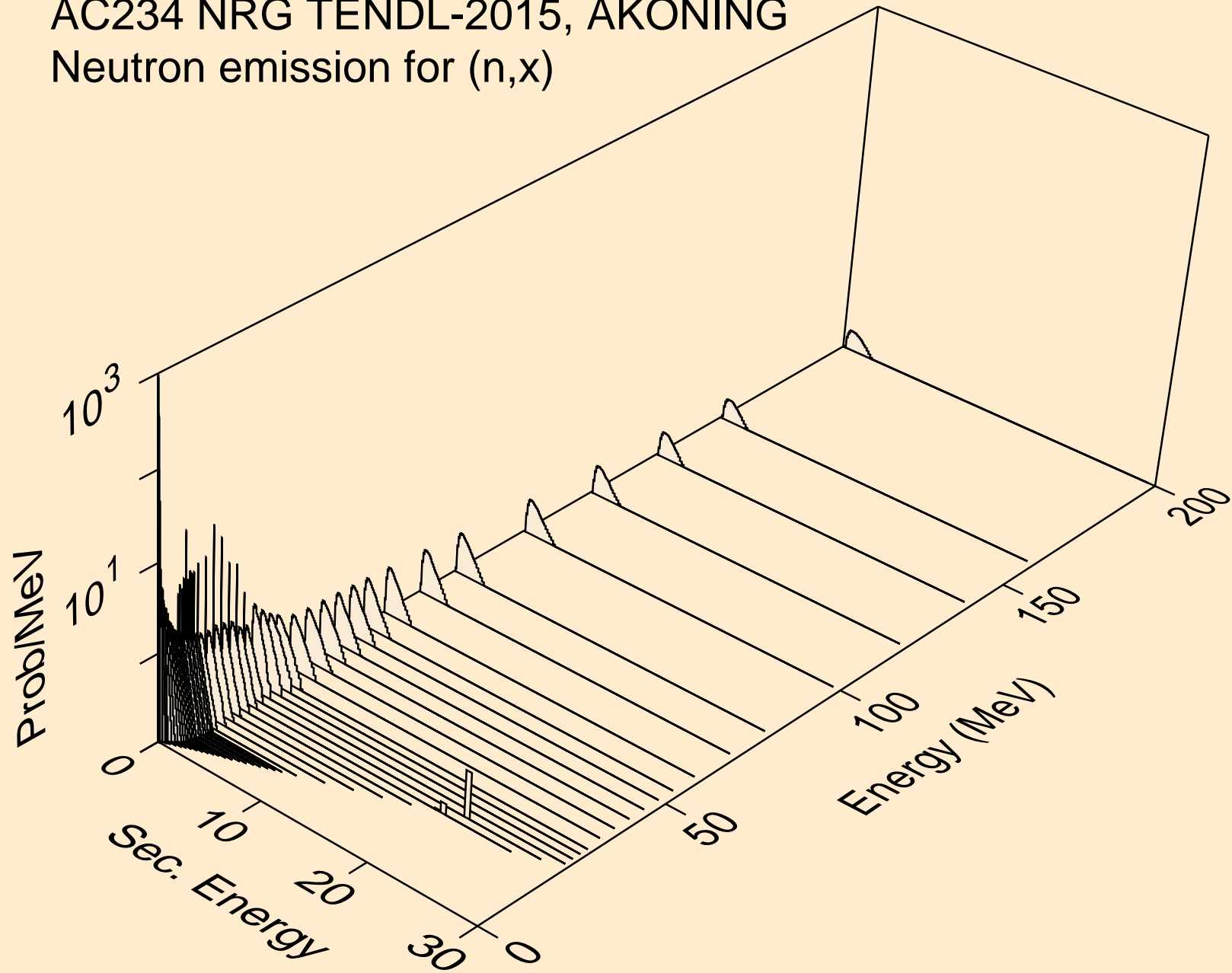

AC234 NRG TENDL-2015, AKONING
Neutron emission for (n,2nd)

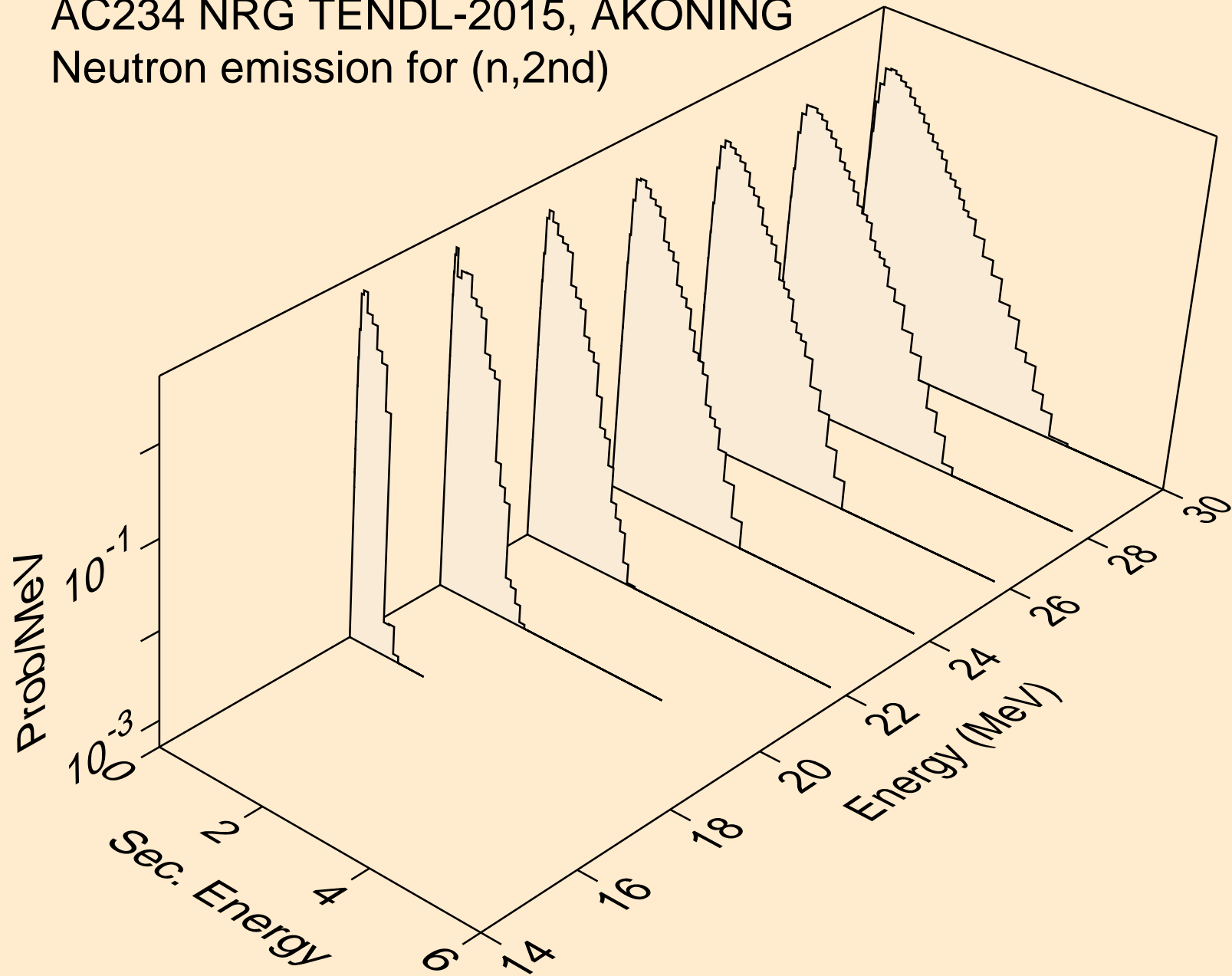

AC234 NRG TENDL-2015, AKONING
Neutron emission for (n,2n)

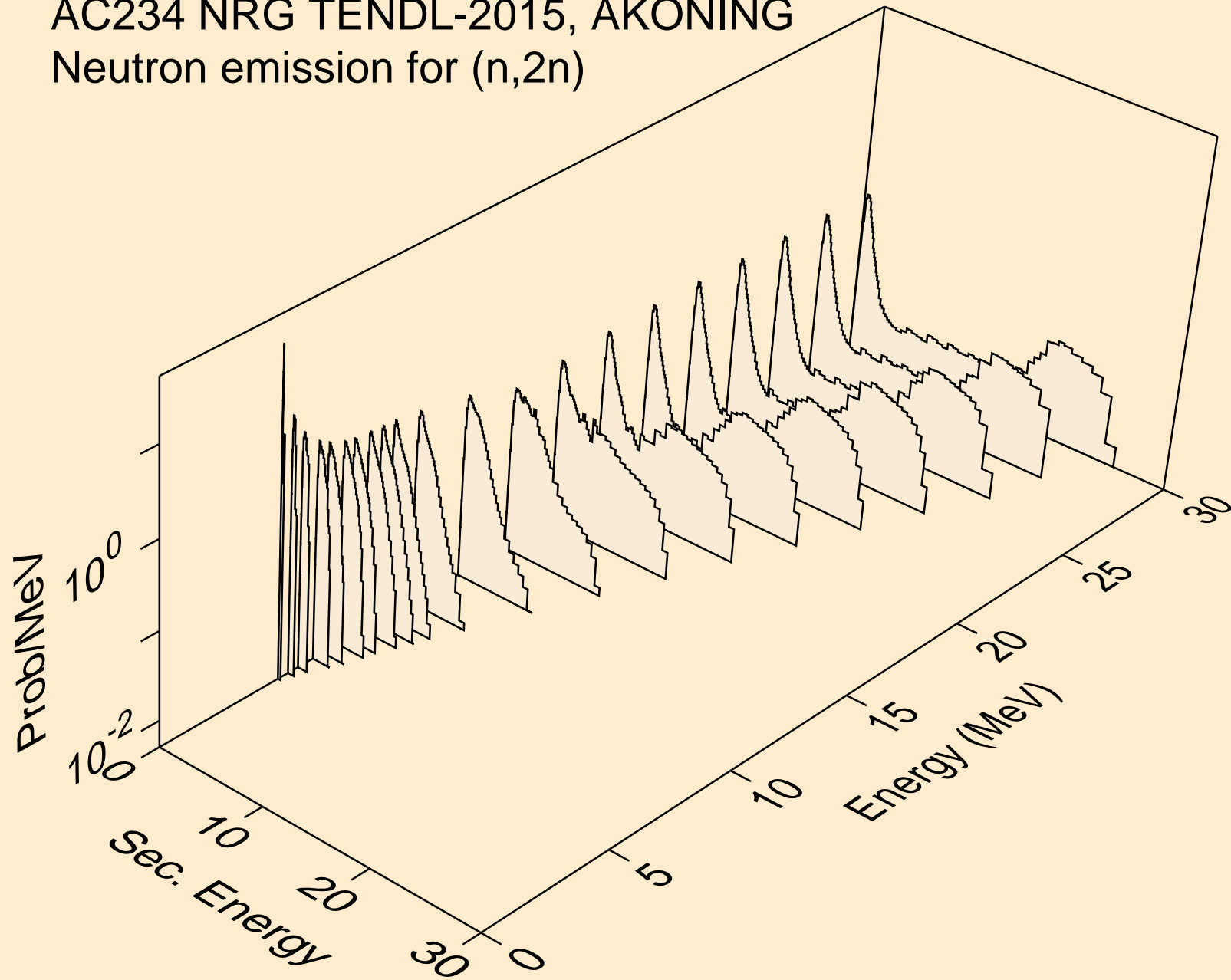

AC234 NRG TENDL-2015, AKONING
Neutron emission for (n,3n)

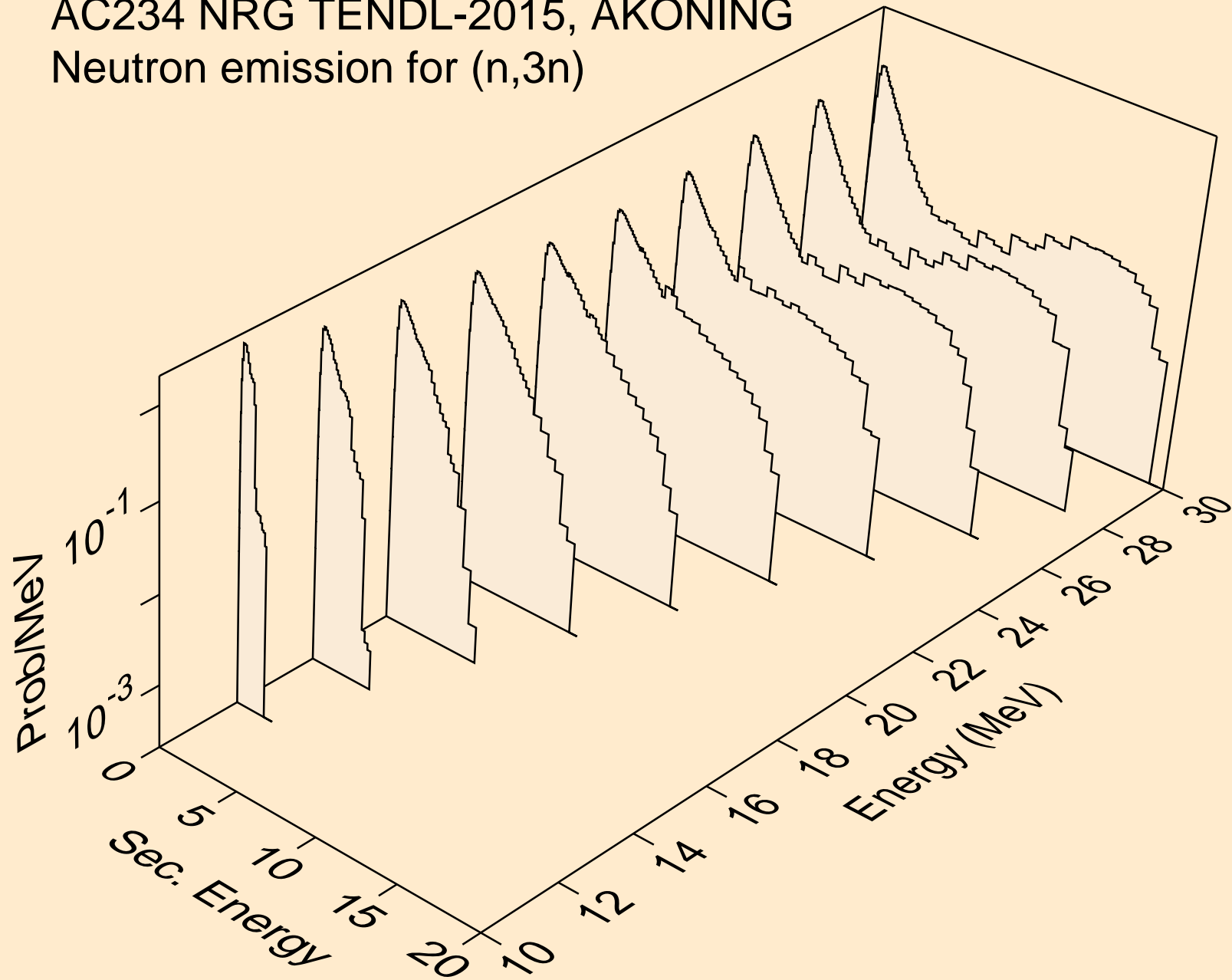

AC234 NRG TENDL-2015, AKONING
Neutron emission for fission

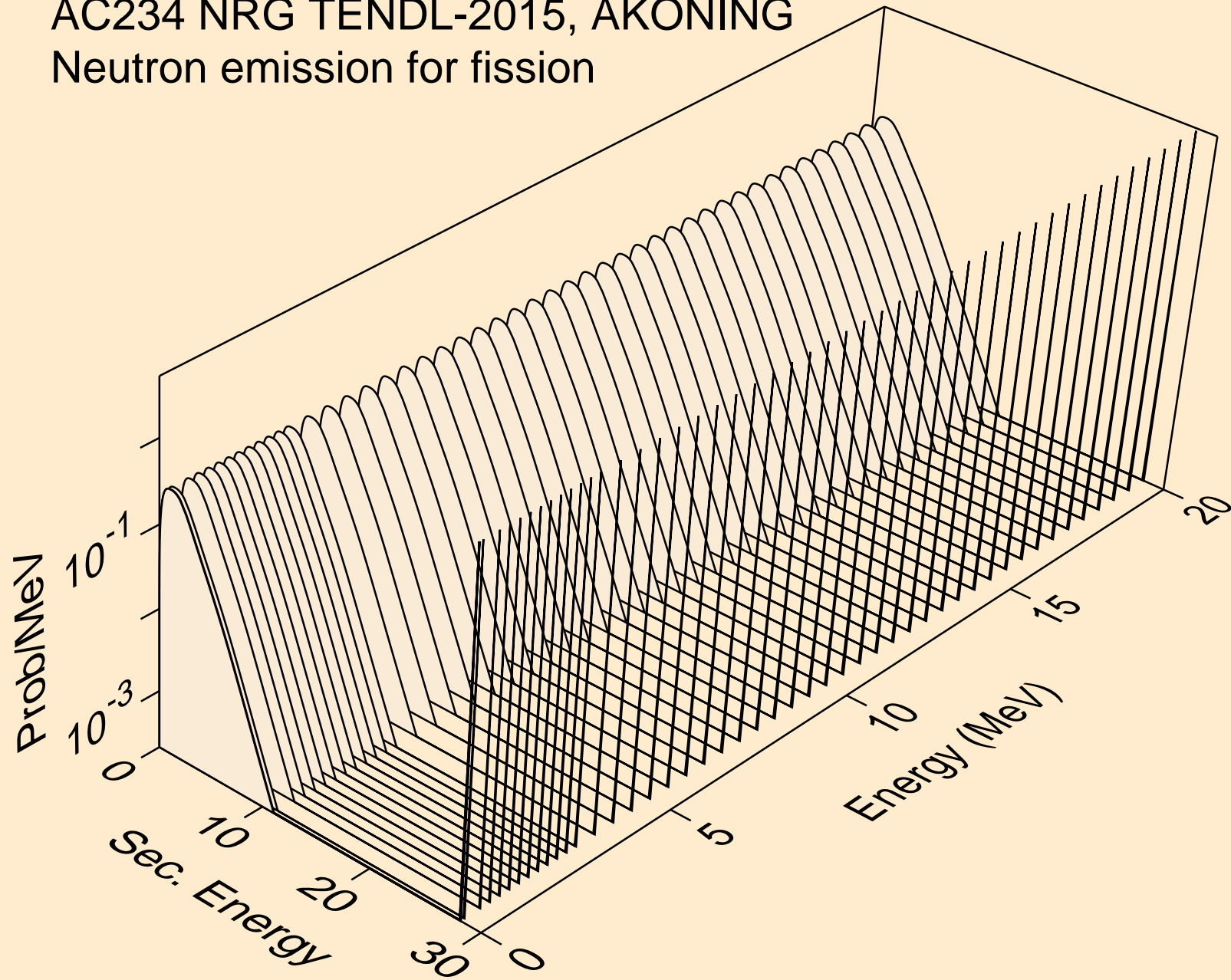

AC234 NRG TENDL-2015, AKONING
Neutron emission for (n,n*)a

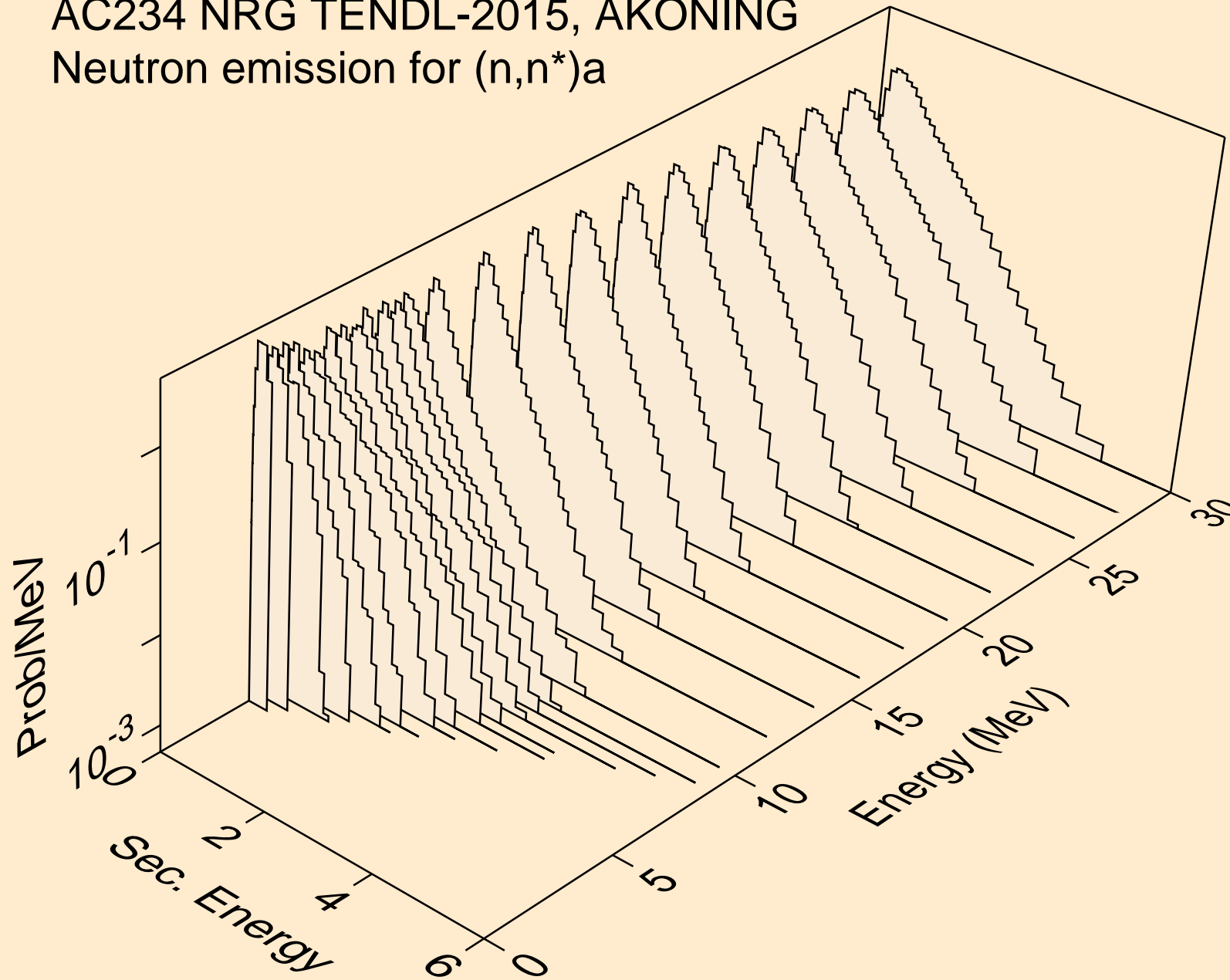

AC234 NRG TENDL-2015, AKONING
Neutron emission for (n,2n)_a

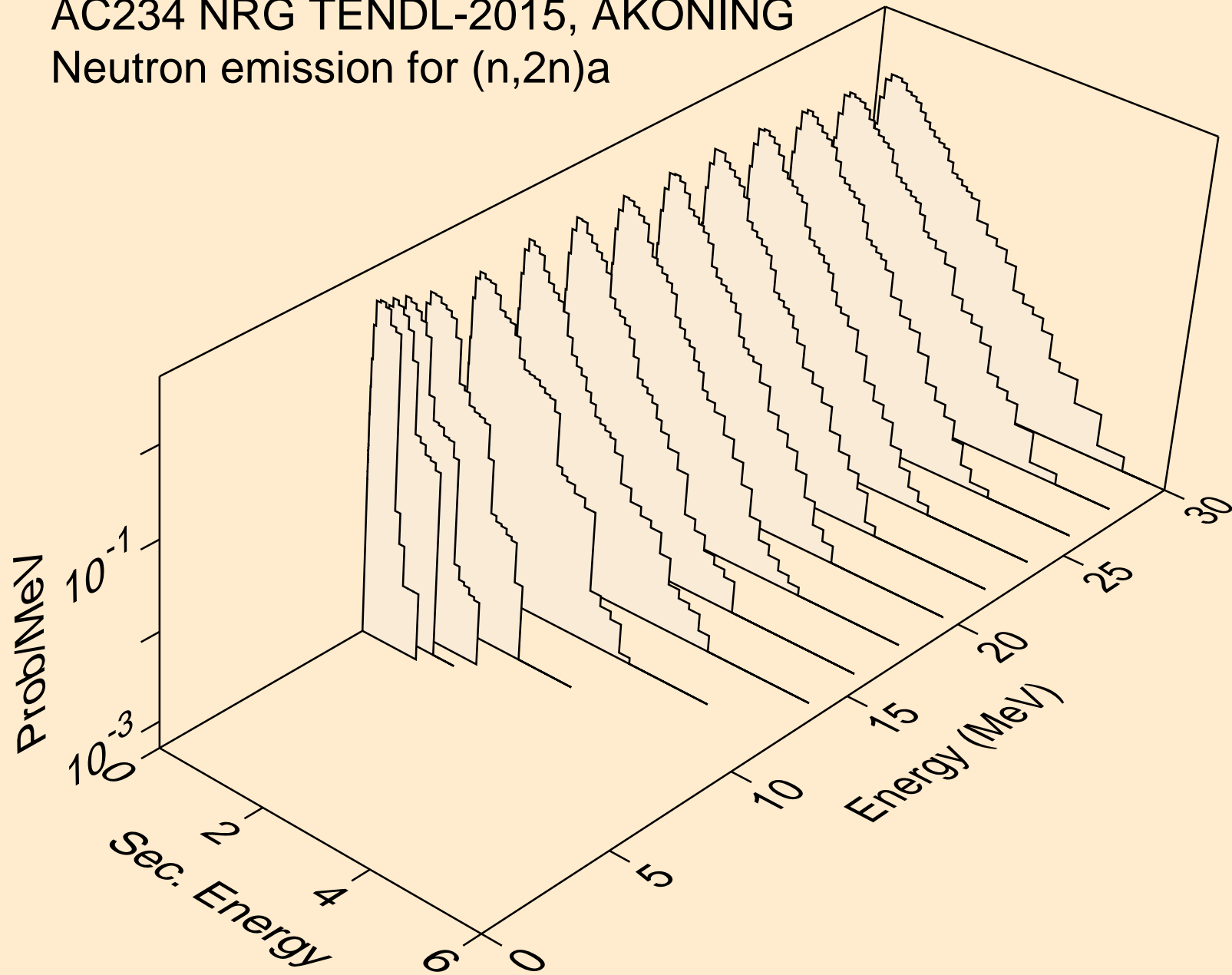

AC234 NRG TENDL-2015, AKONING
Neutron emission for (n,3n)a

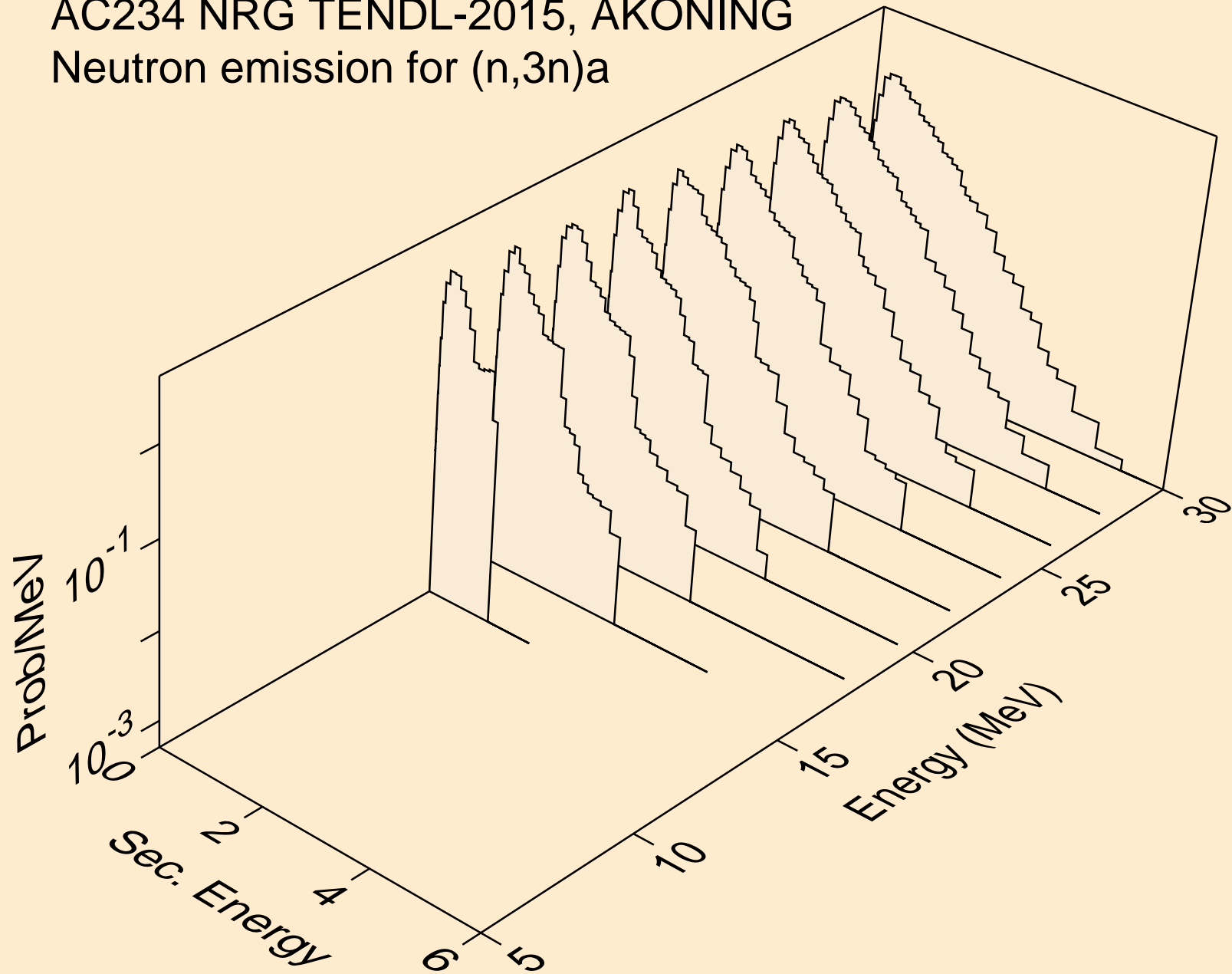

AC234 NRG TENDL-2015, AKONING
Neutron emission for (n,n*)p

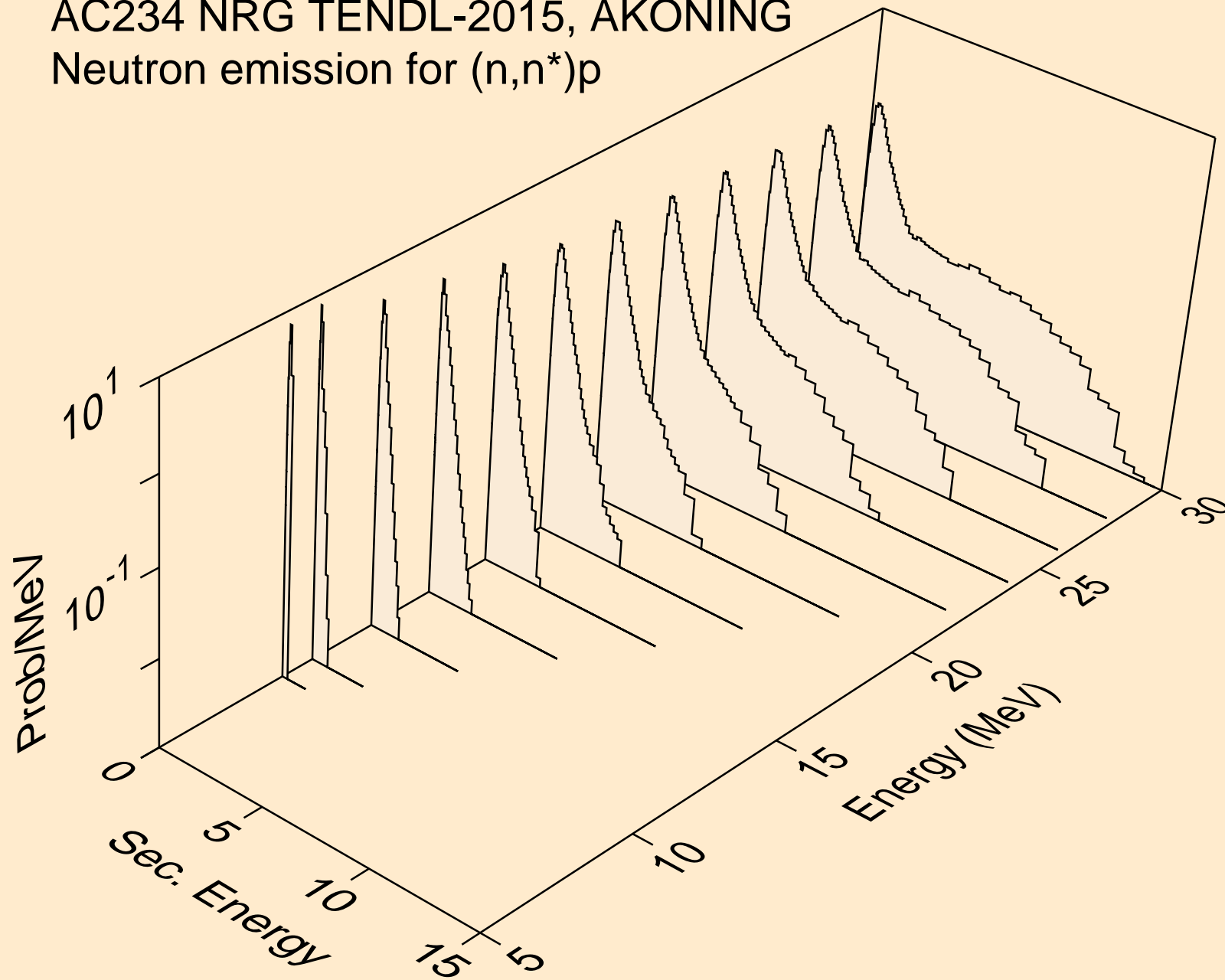

AC234 NRG TENDL-2015, AKONING
Neutron emission for (n,n*)d

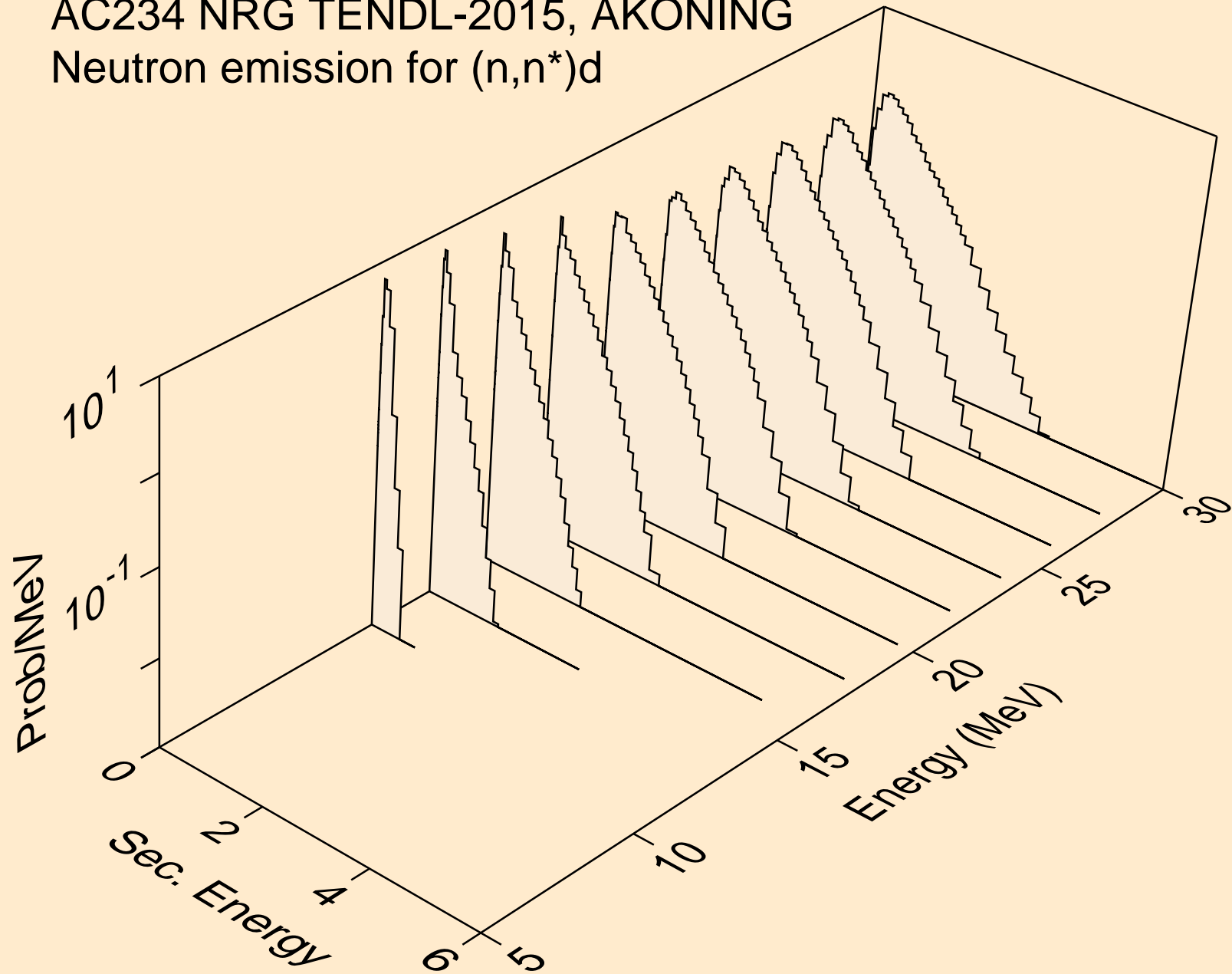

AC234 NRG TENDL-2015, AKONING
Neutron emission for (n,n*)t

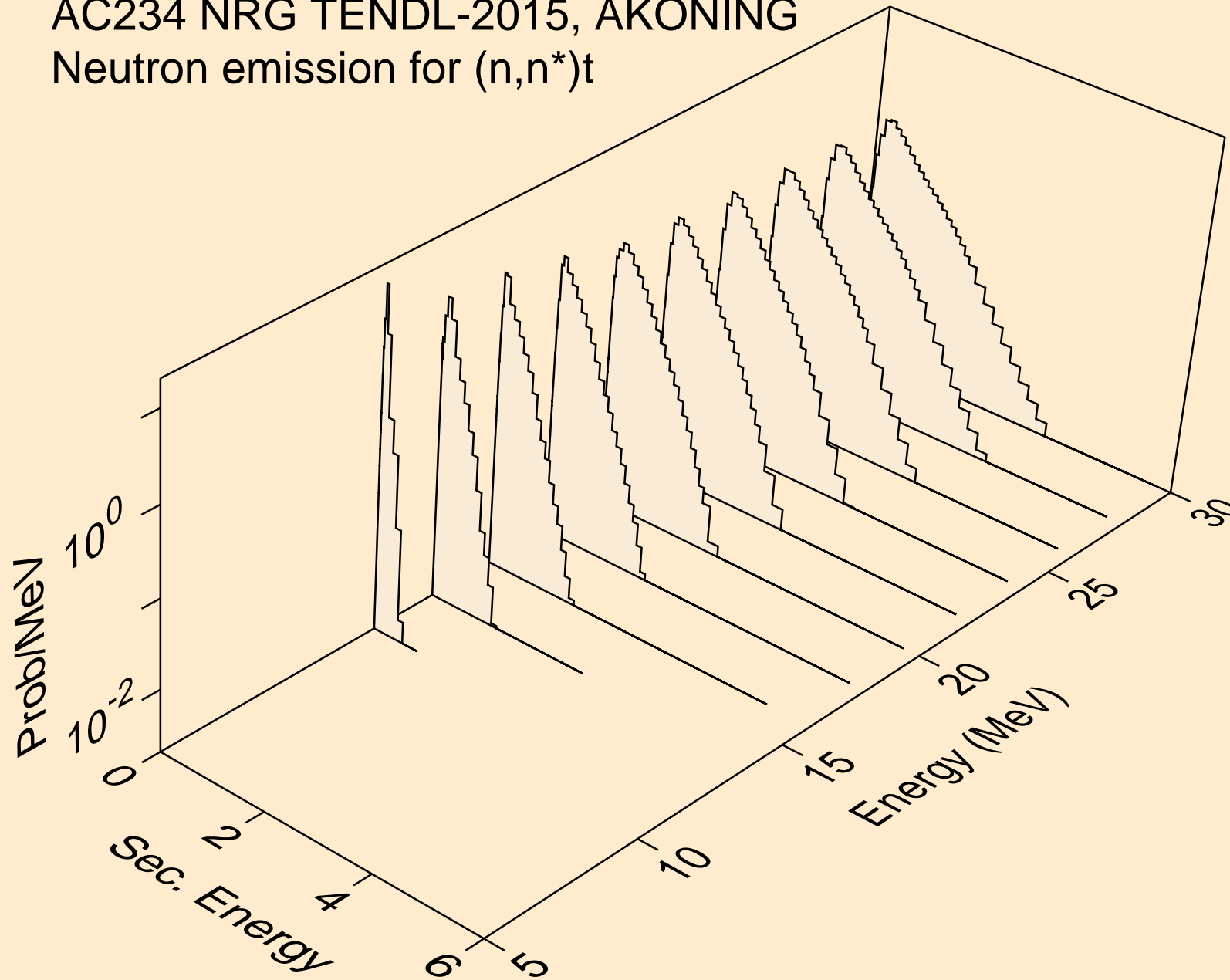

AC234 NRG TENDL-2015, AKONING
Neutron emission for (n,n*)he3

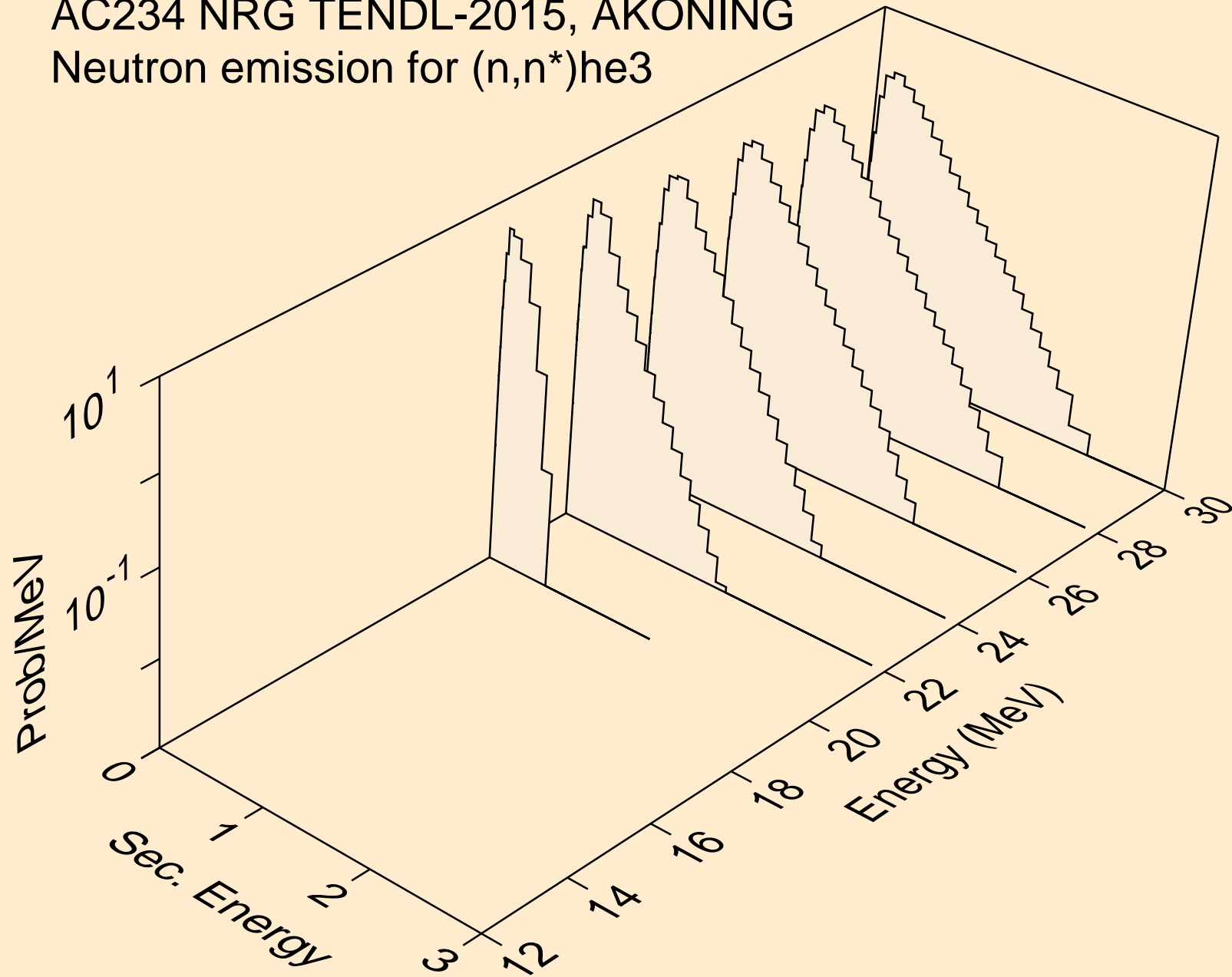

AC234 NRG TENDL-2015, AKONING
Neutron emission for (n,4n)

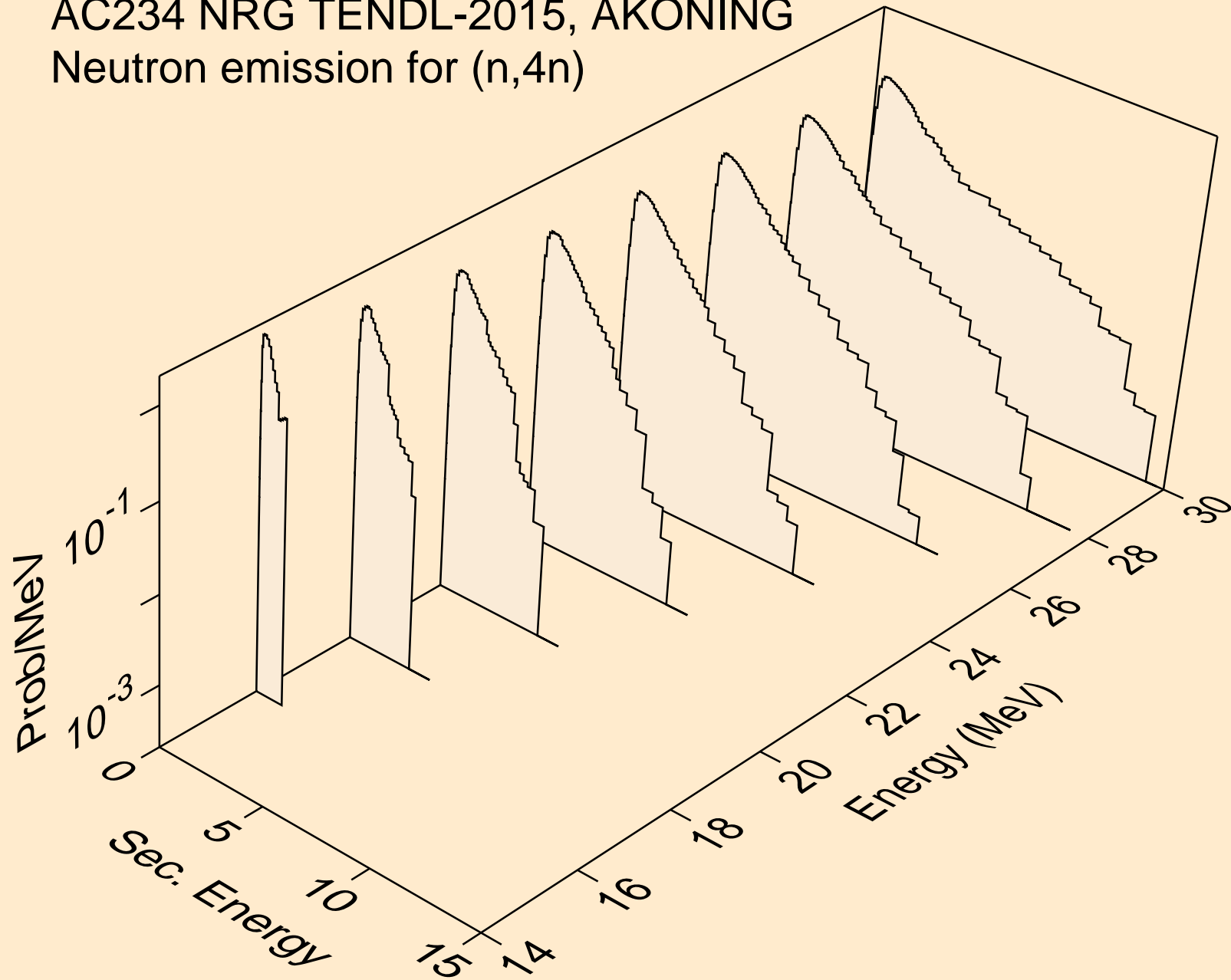

AC234 NRG TENDL-2015, AKONING
Neutron emission for (n,2np)

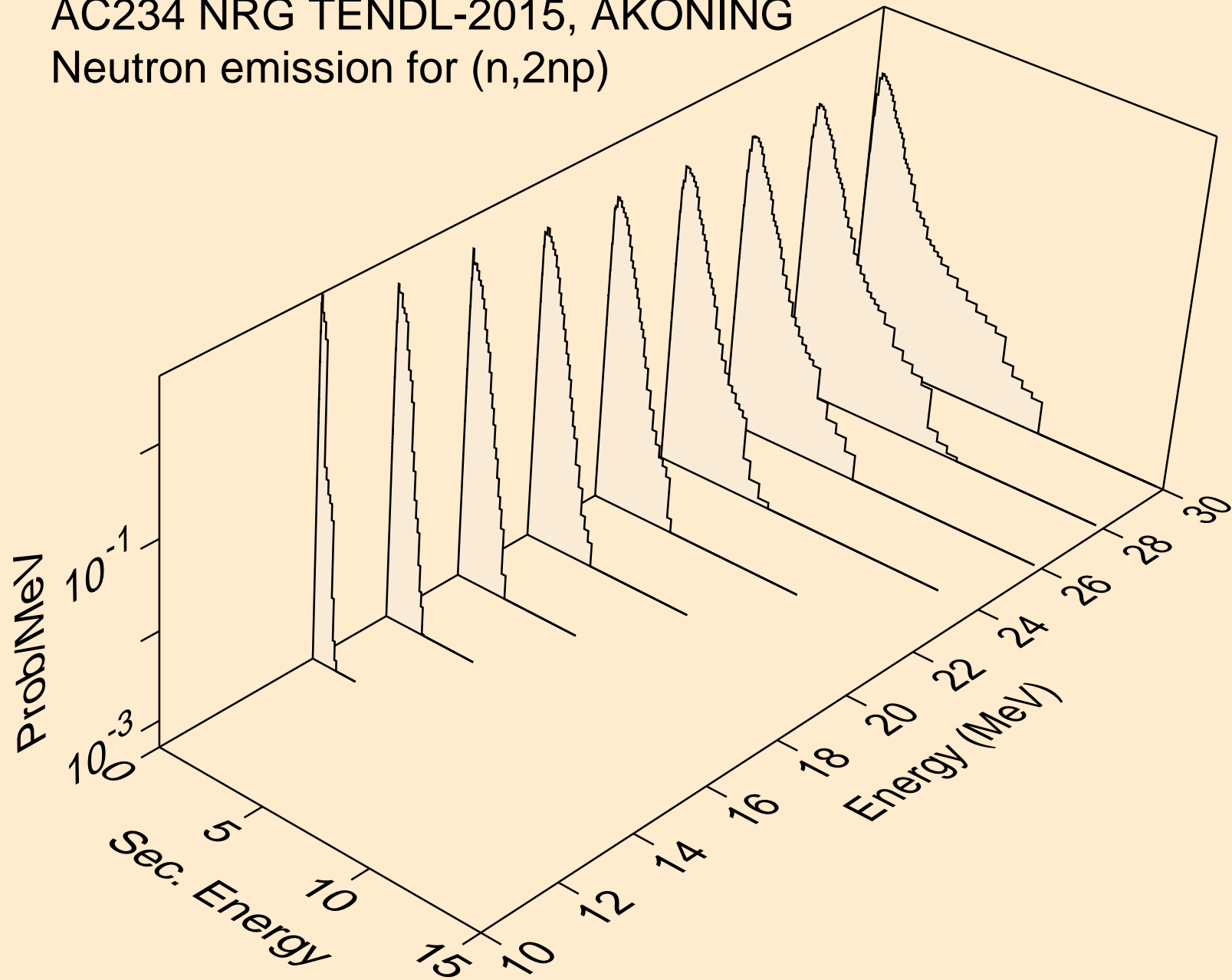

AC234 NRG TENDL-2015, AKONING
Neutron emission for (n,3np)

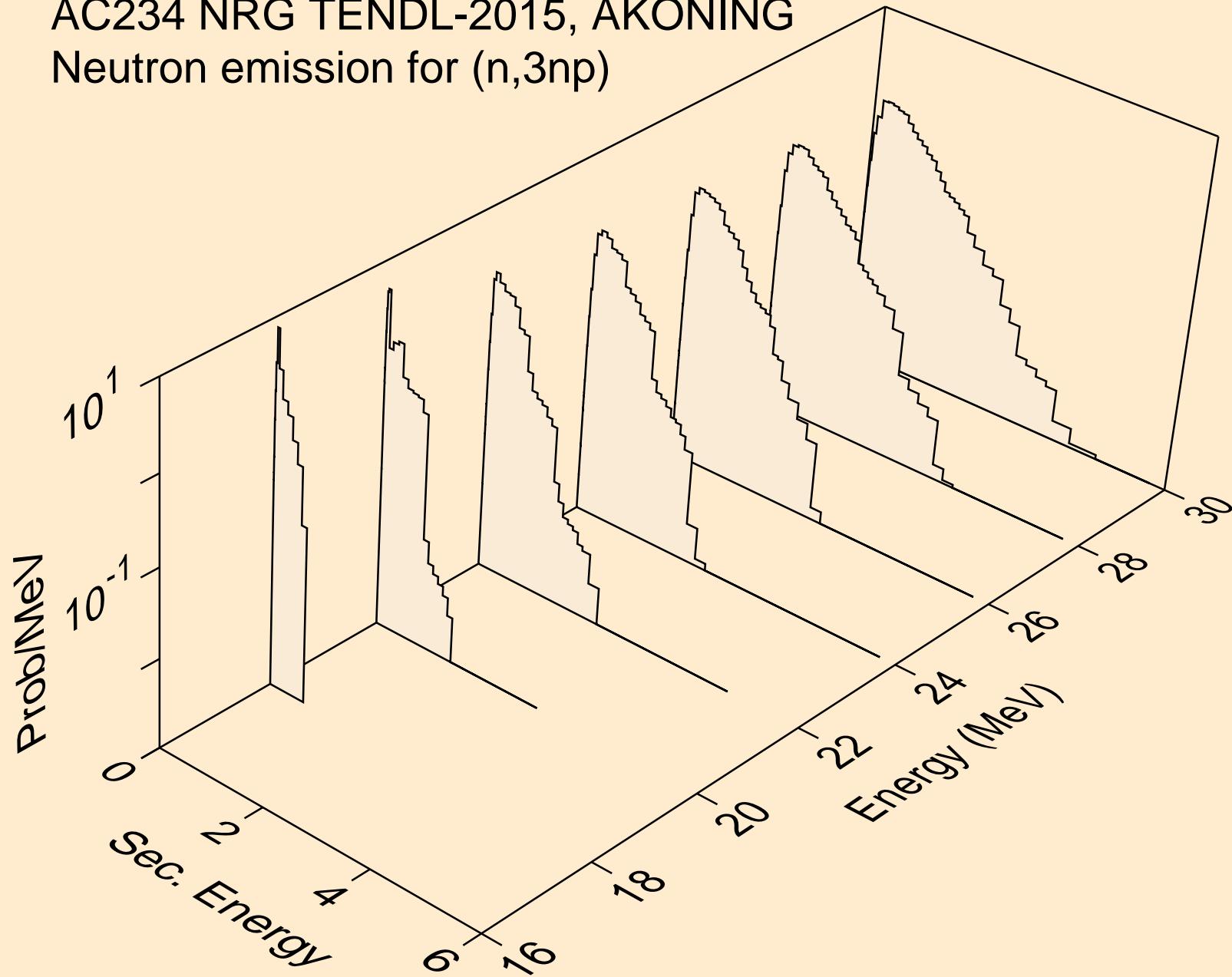

AC234 NRG TENDL-2015, AKONING
Neutron emission for (n,n*c)

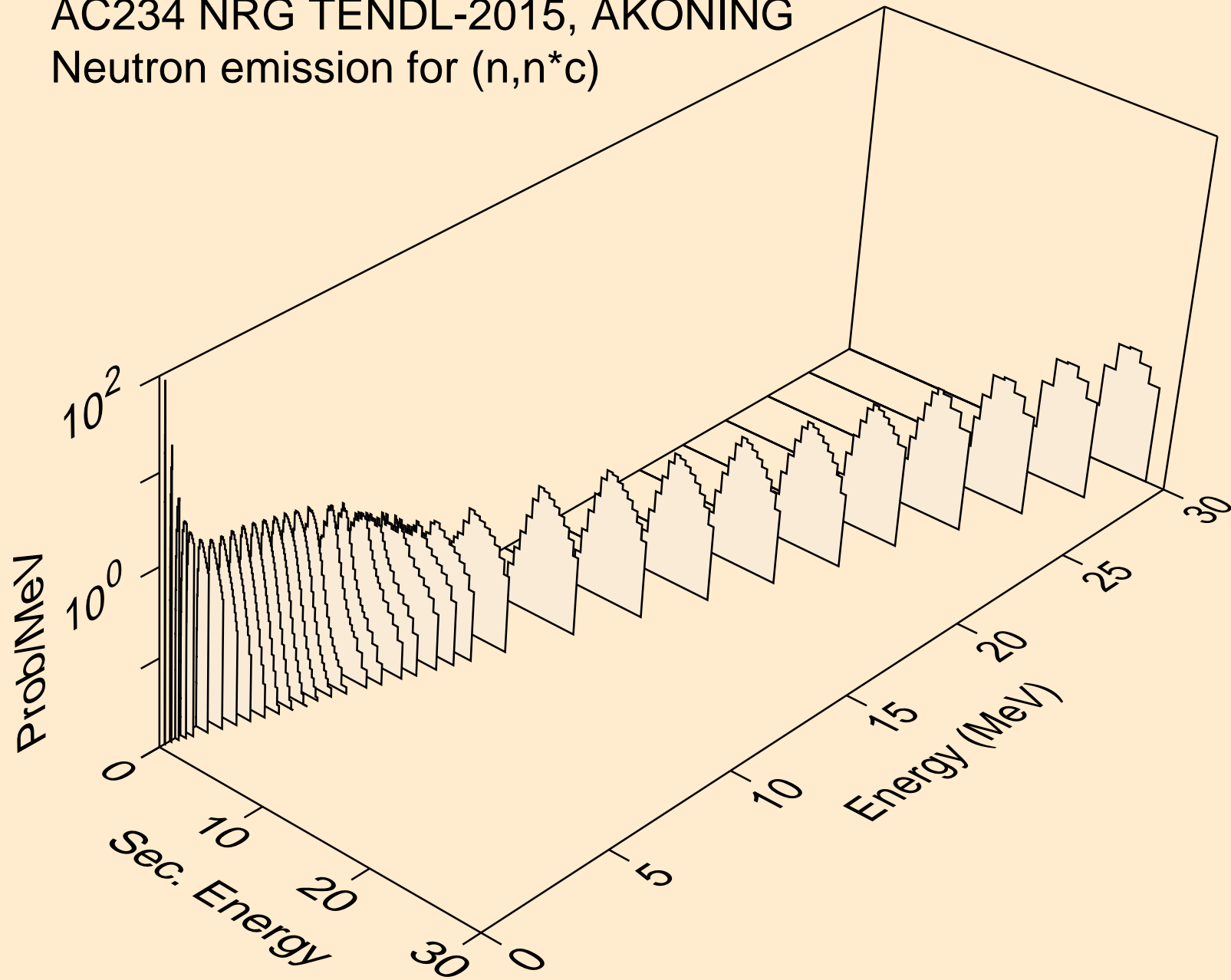

AC234 NRG TENDL-2015, AKONING

Delayed nubar

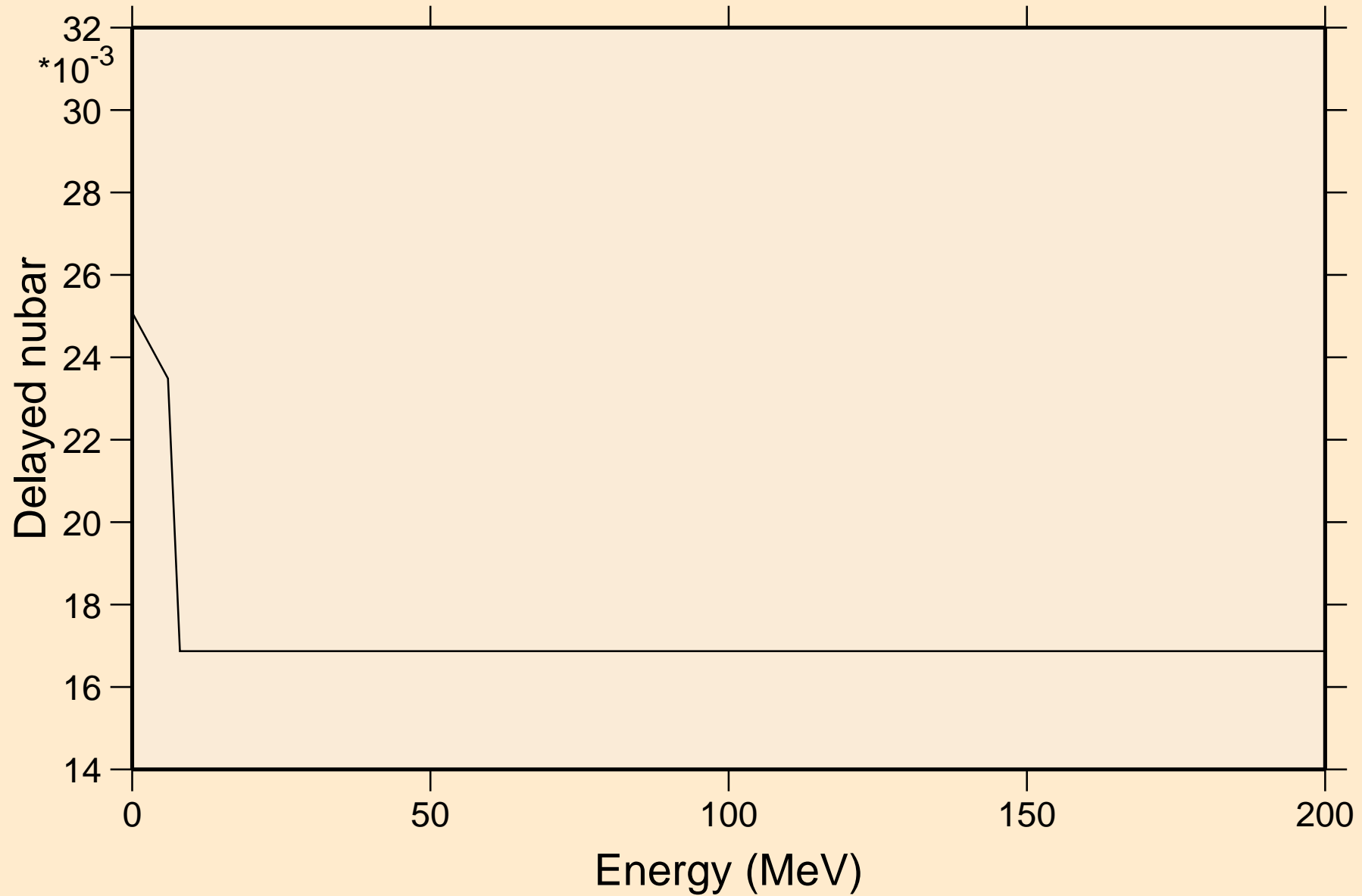

AC234 NRG TENDL-2015, AKONING

Delayed neutron spectra

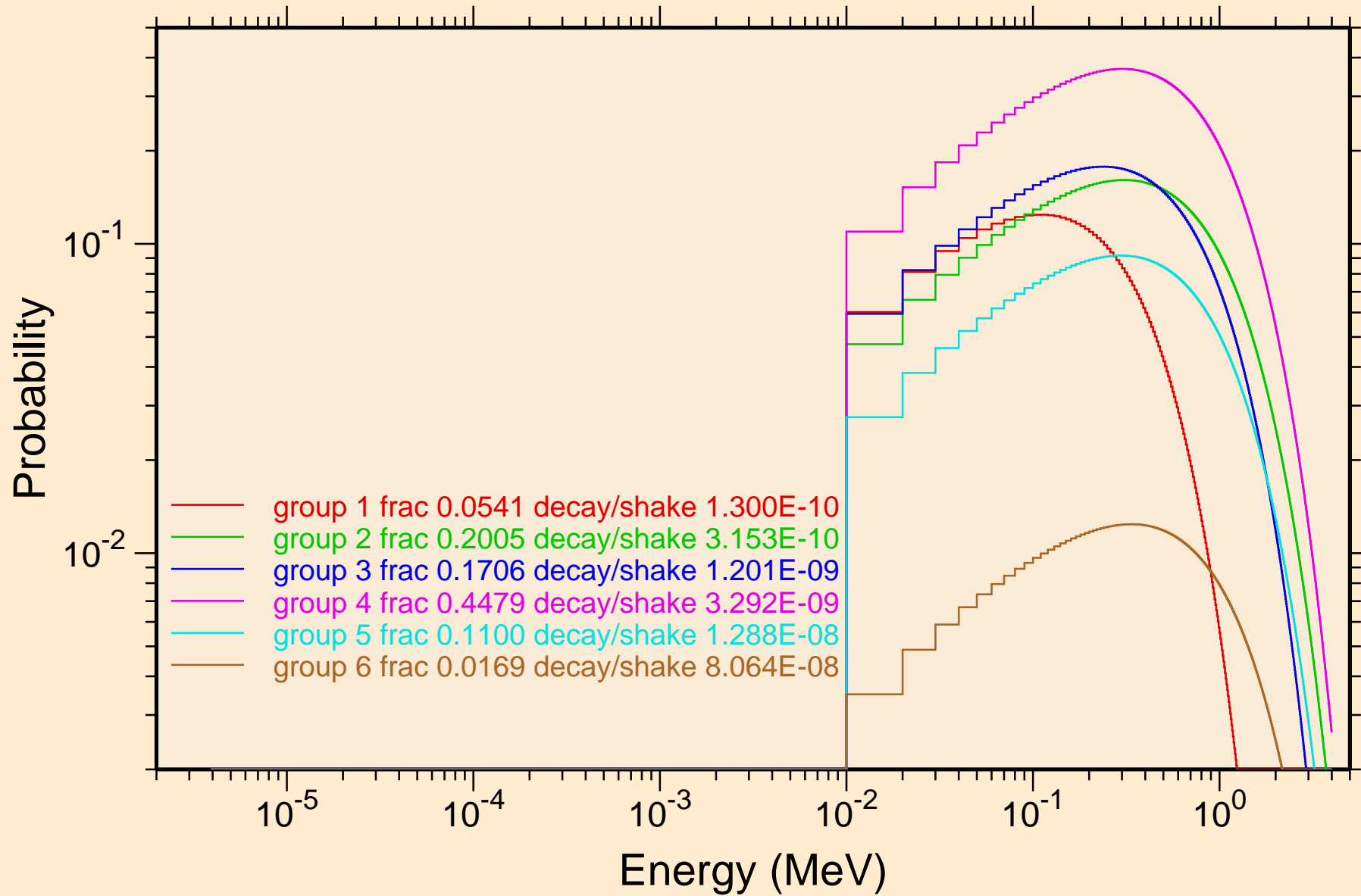

AC234 NRG TENDL-2015, AKONING
Photon emission for (n,x)

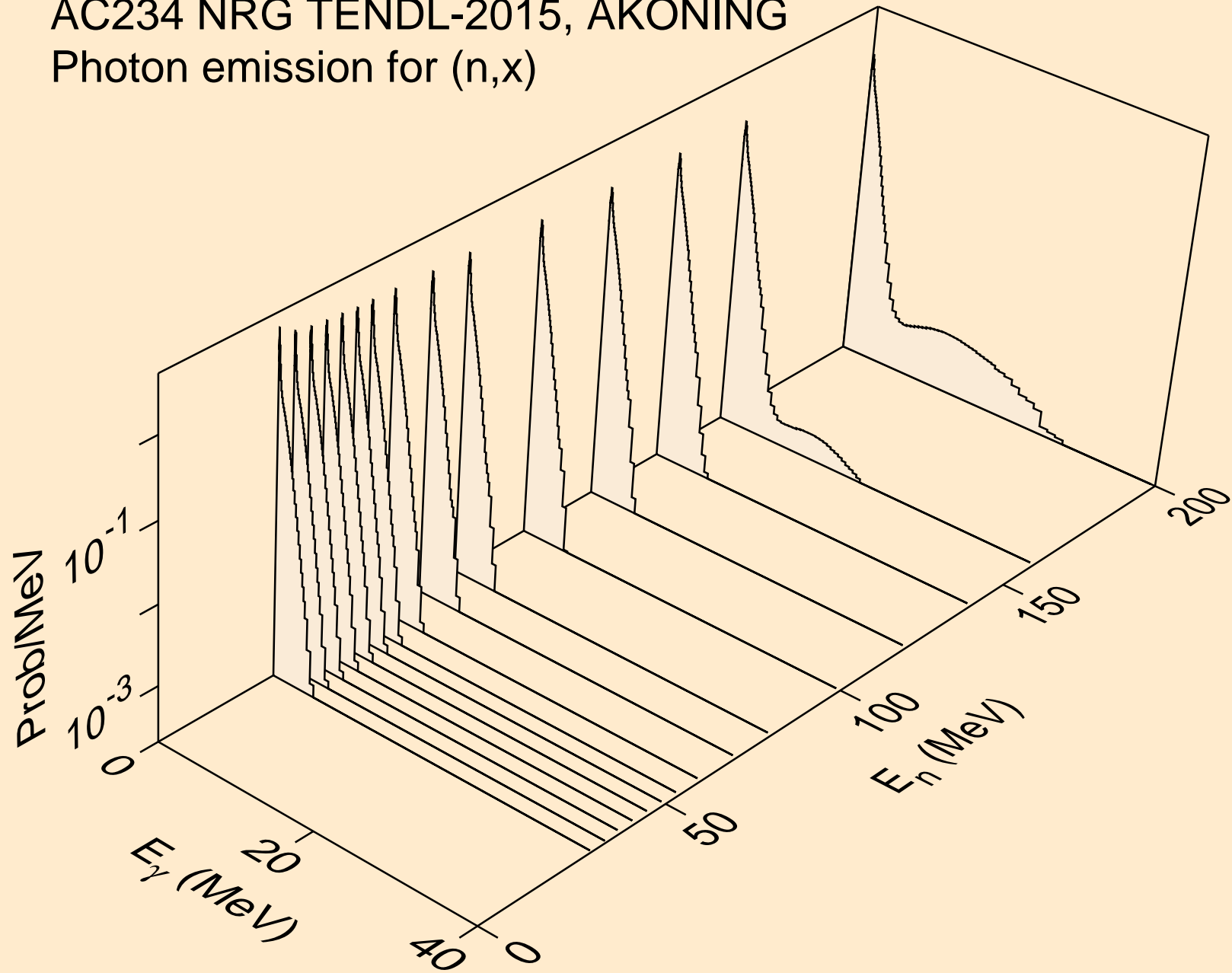

AC234 NRG TENDL-2015, AKONING
Photon emission for (n,2nd)

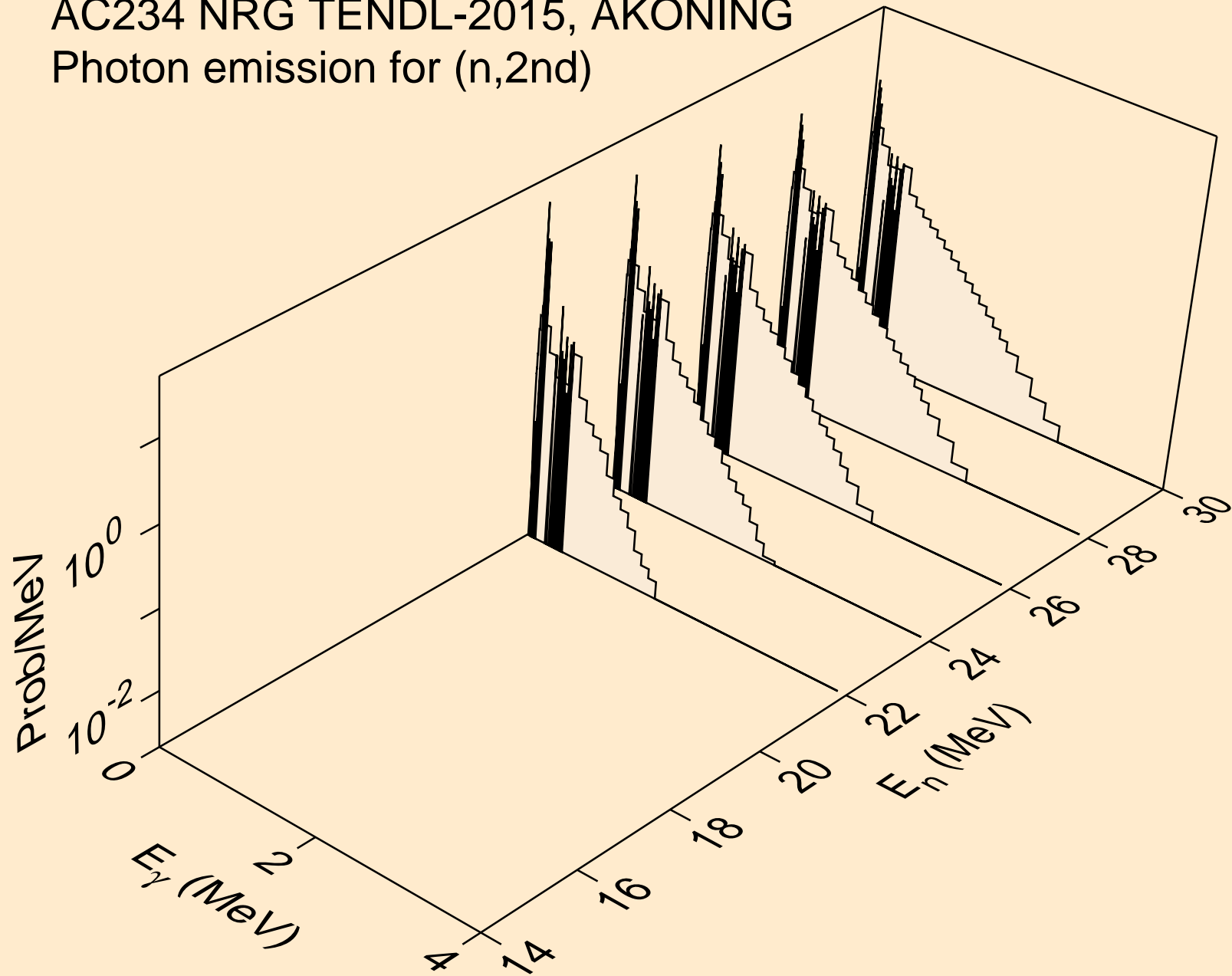

AC234 NRG TENDL-2015, AKONING
Photon emission for (n,2n)

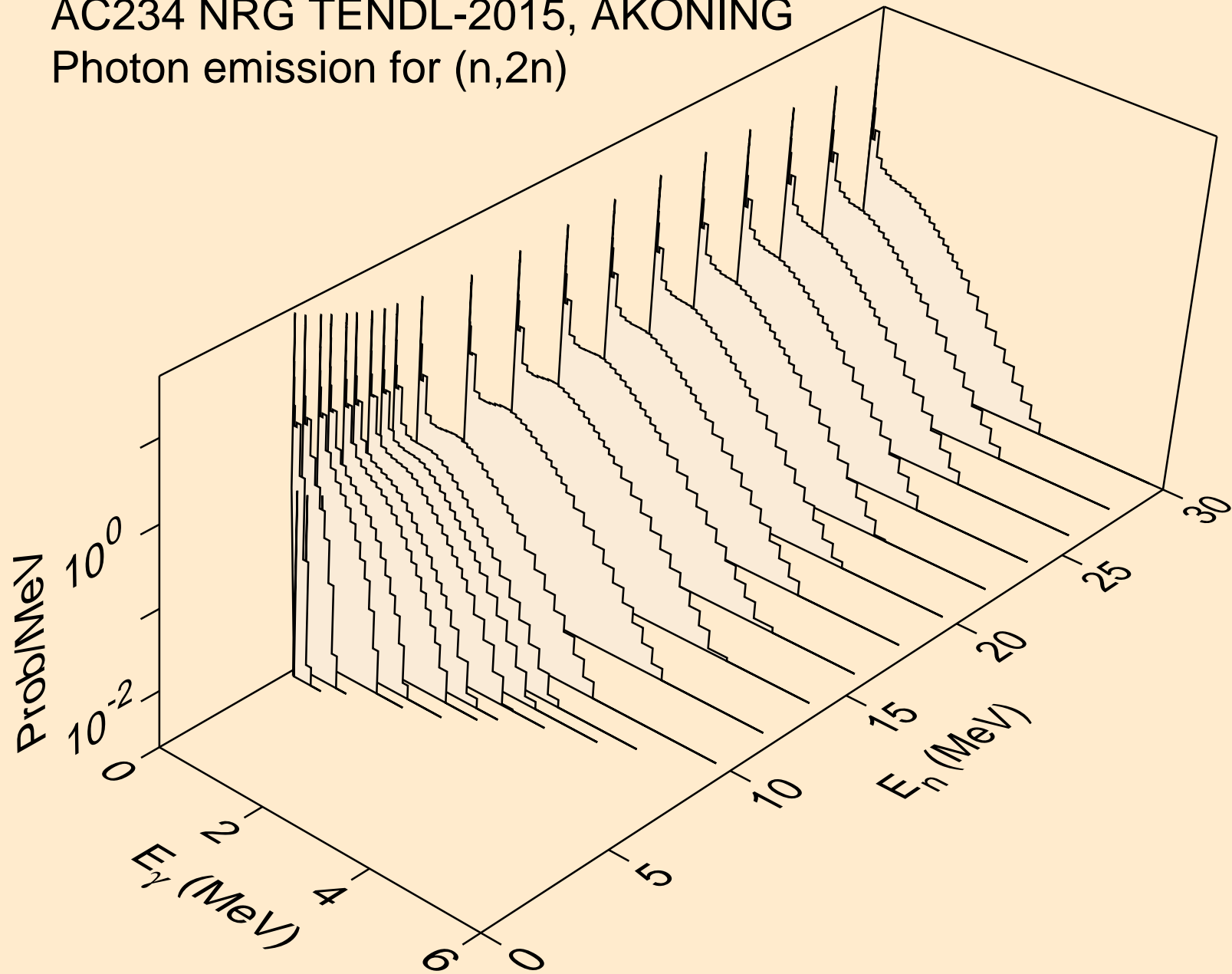

AC234 NRG TENDL-2015, AKONING
Photon emission for (n,3n)

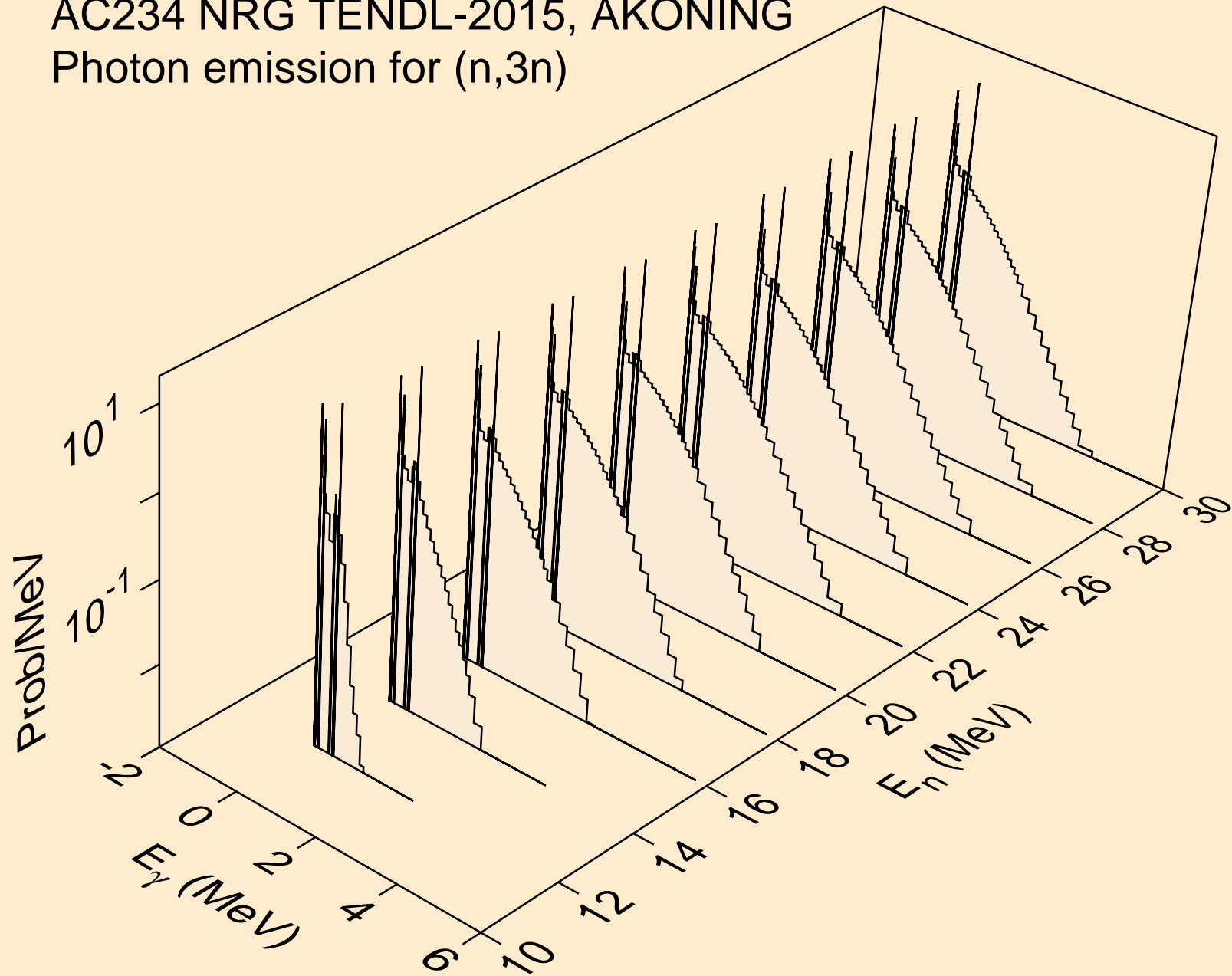

AC234 NRG TENDL-2015, AKONING

Photon emission for (n,n*)a

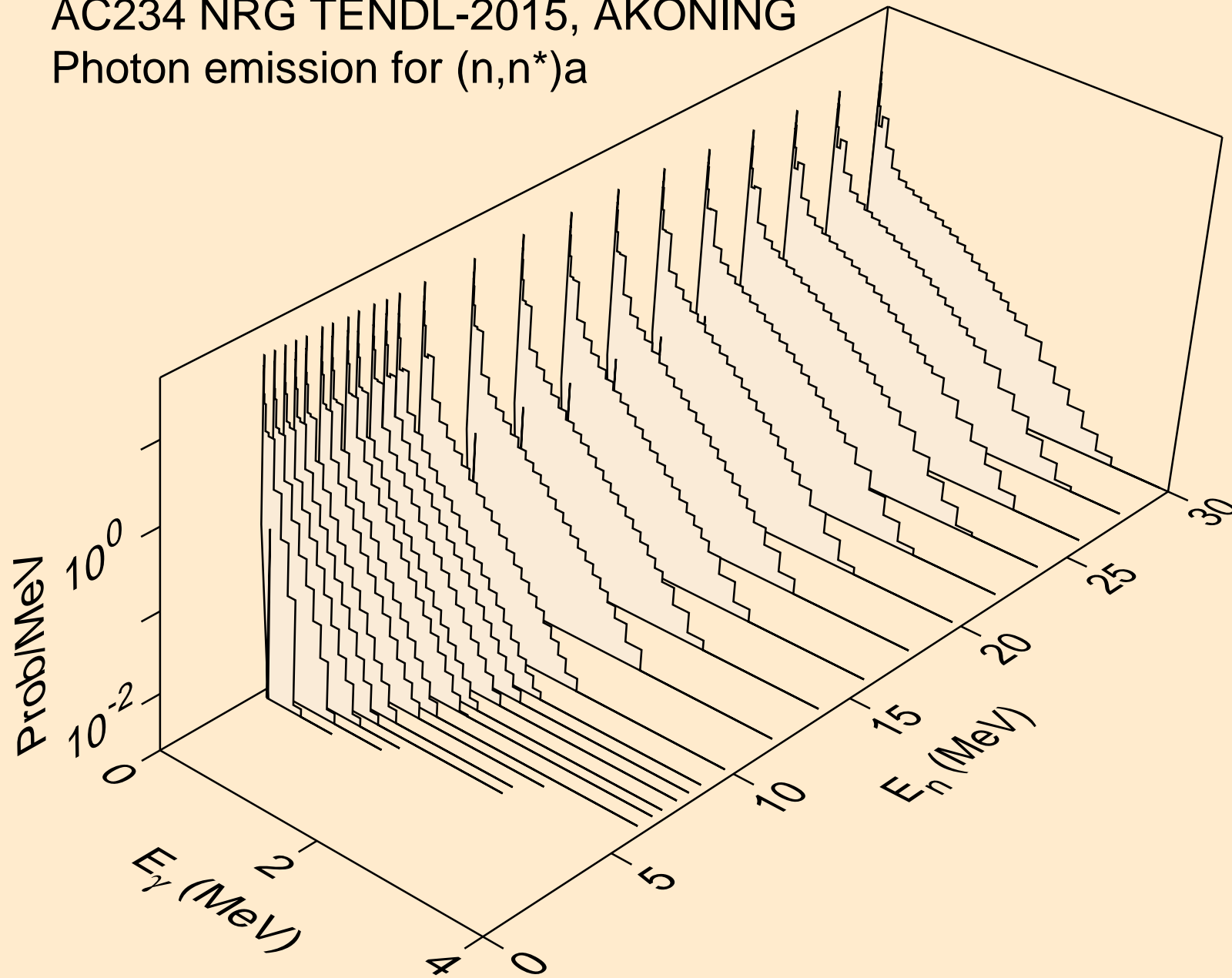

AC234 NRG TENDL-2015, AKONING
Photon emission for (n,2n)_a

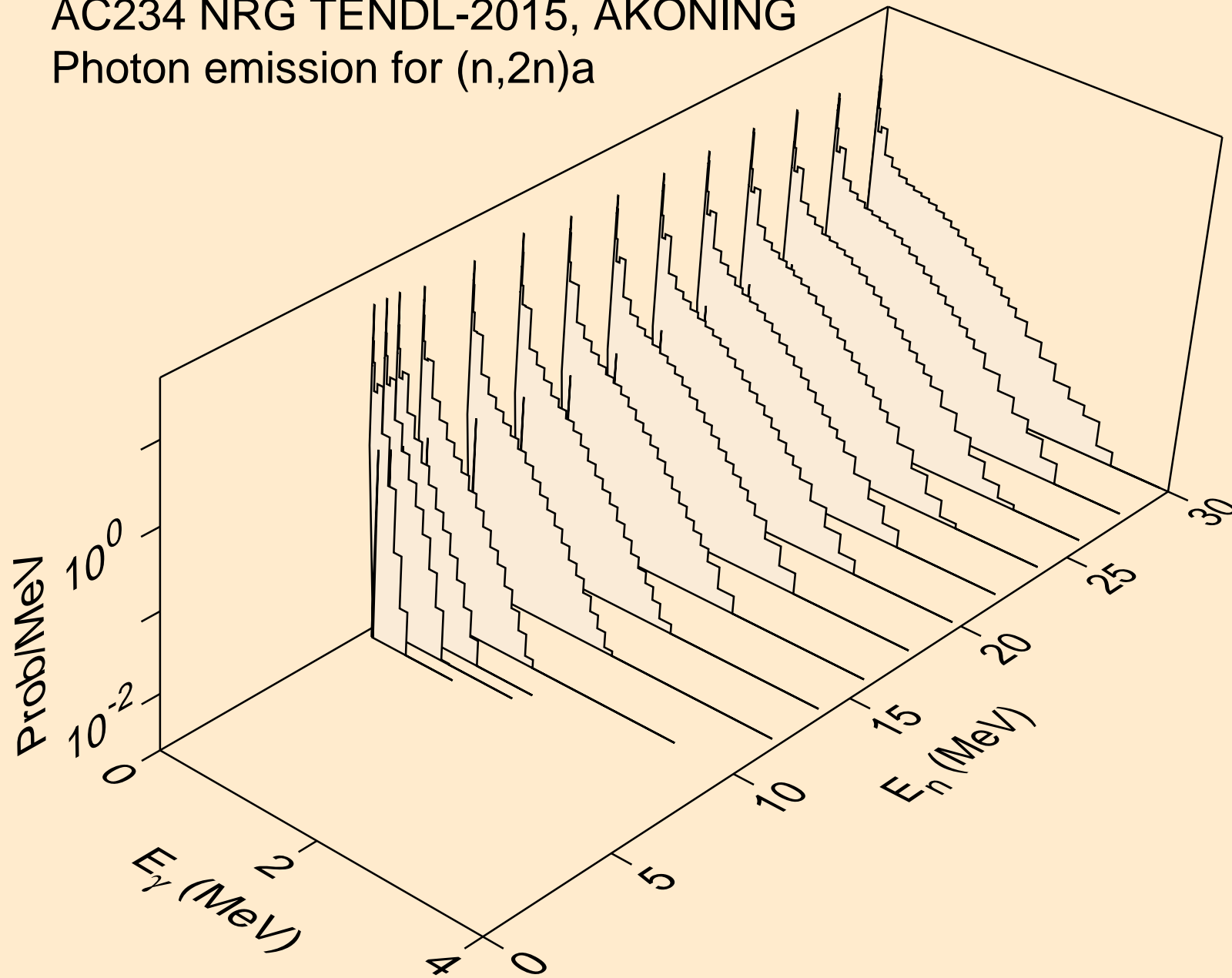

AC234 NRG TENDL-2015, AKONING
Photon emission for (n,3n)a

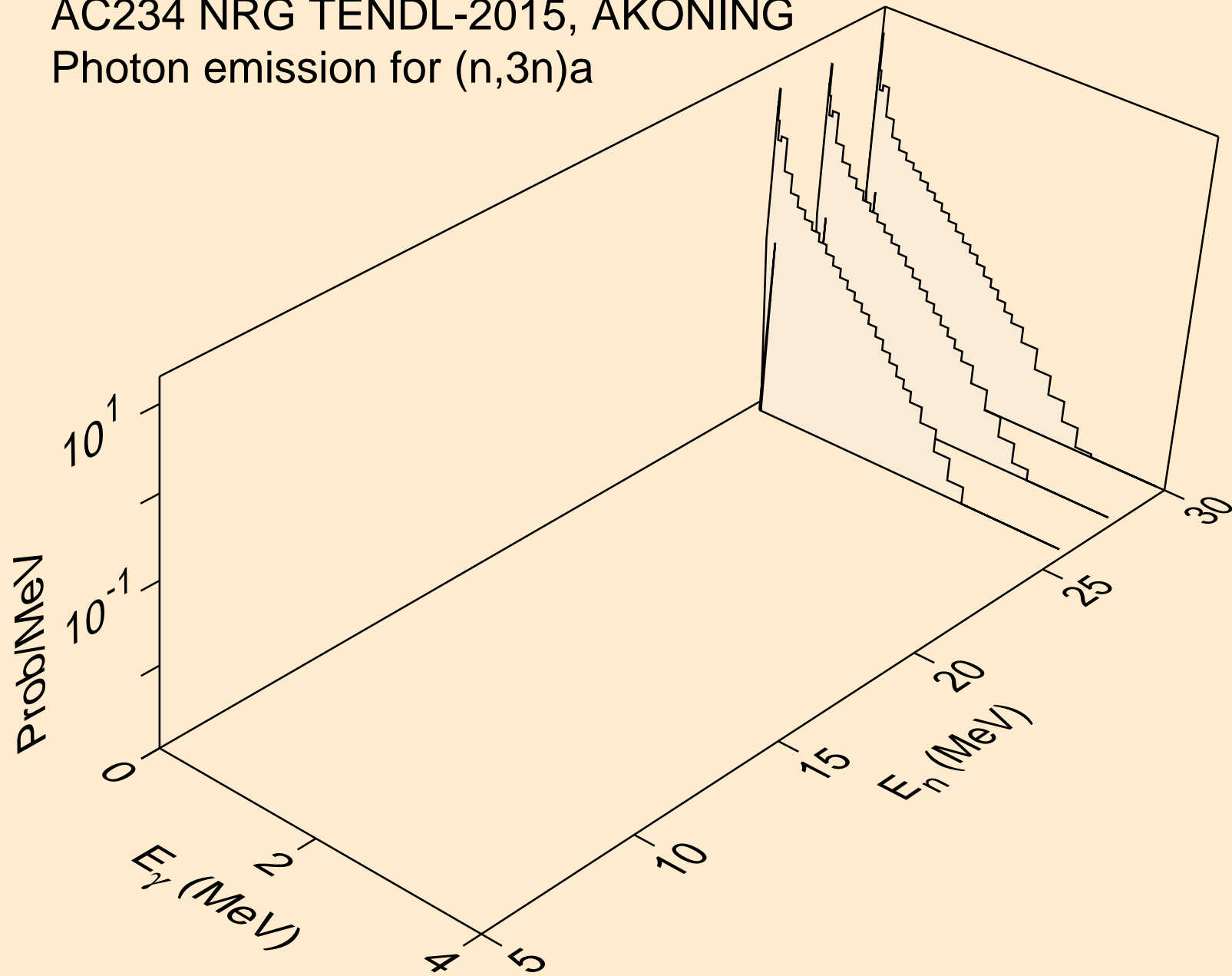

AC234 NRG TENDL-2015, AKONING

Photon emission for (n,n*)p

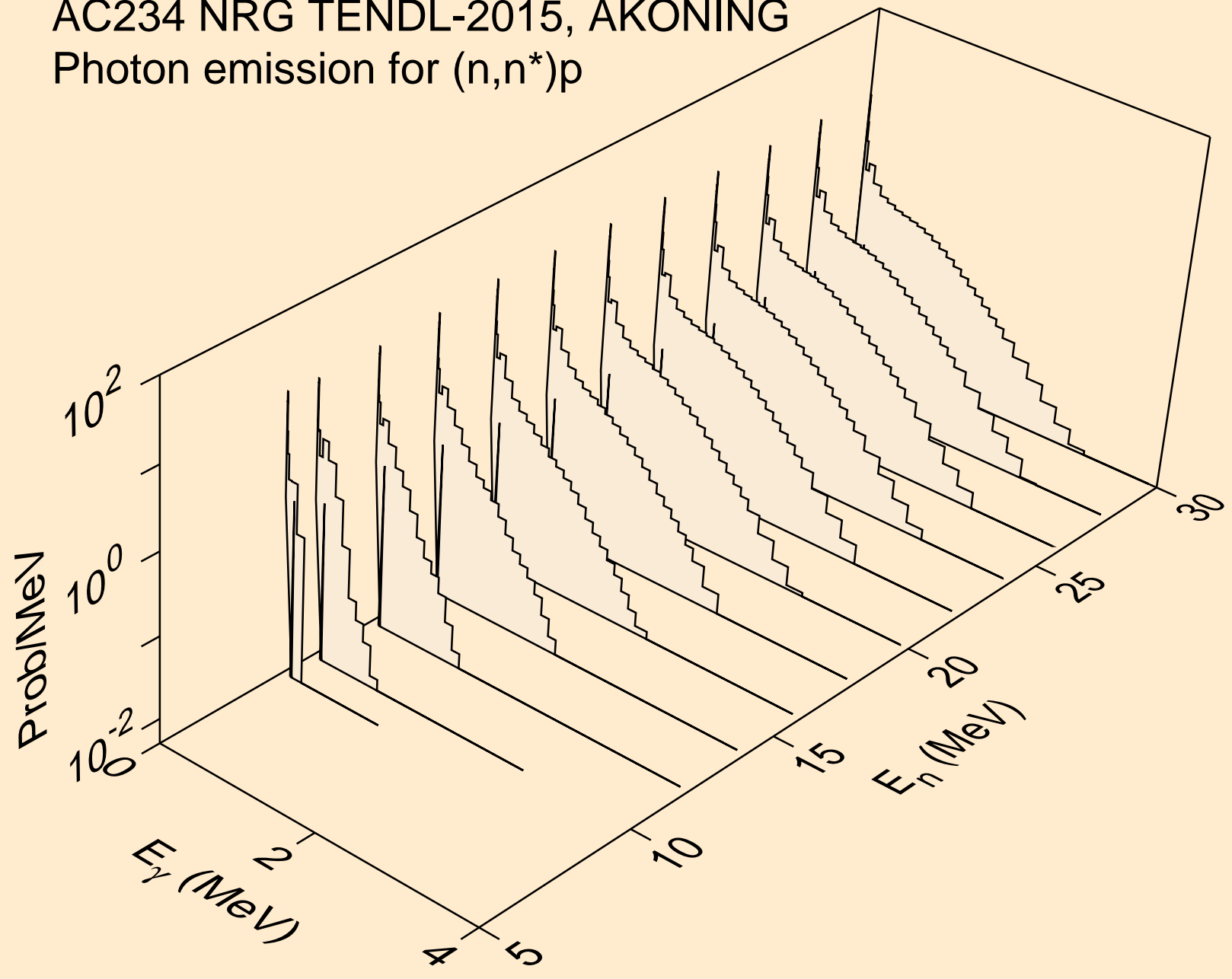

AC234 NRG TENDL-2015, AKONING
Photon emission for (n,n*)d

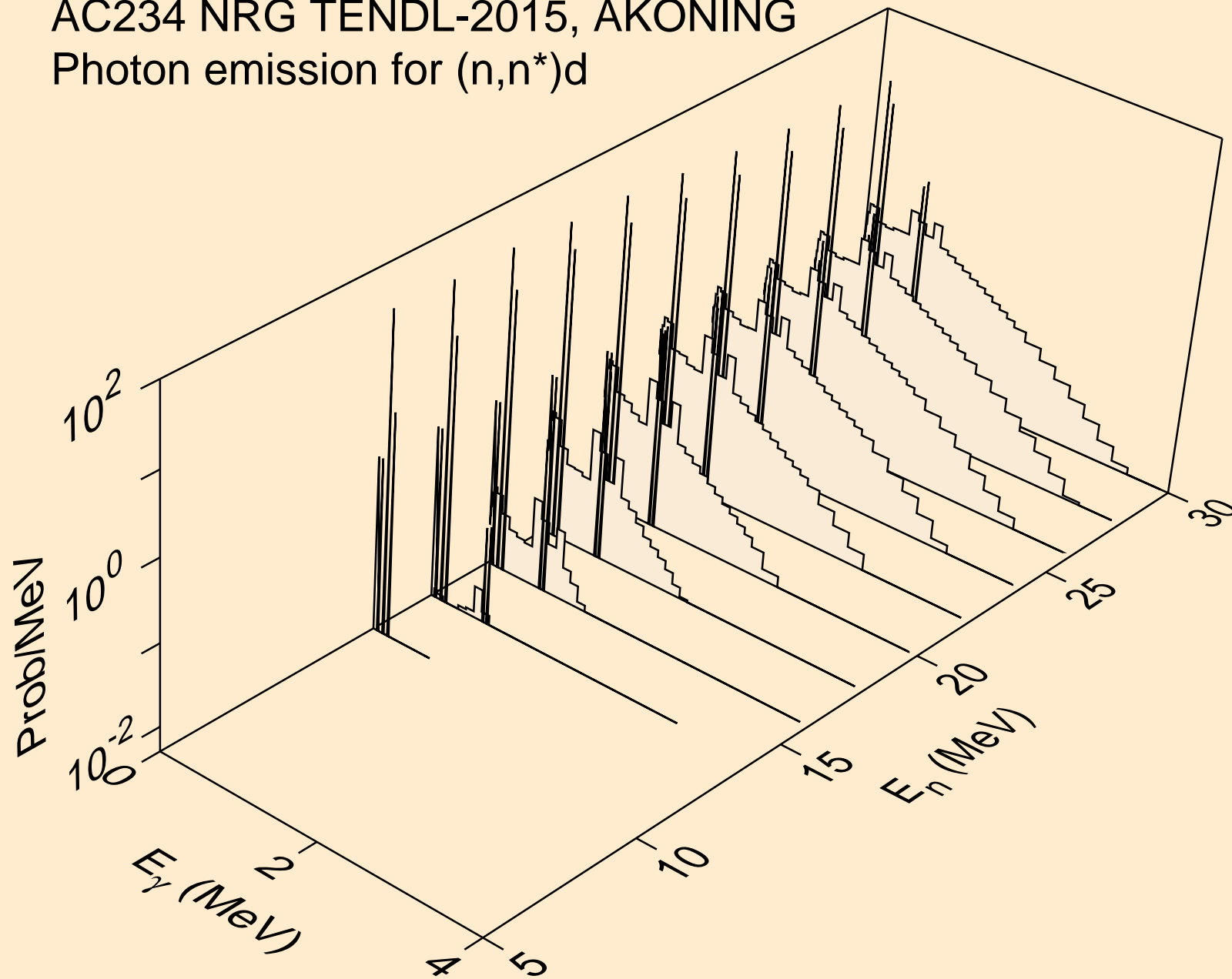

AC234 NRG TENDL-2015, AKONING

Photon emission for (n,n*)t

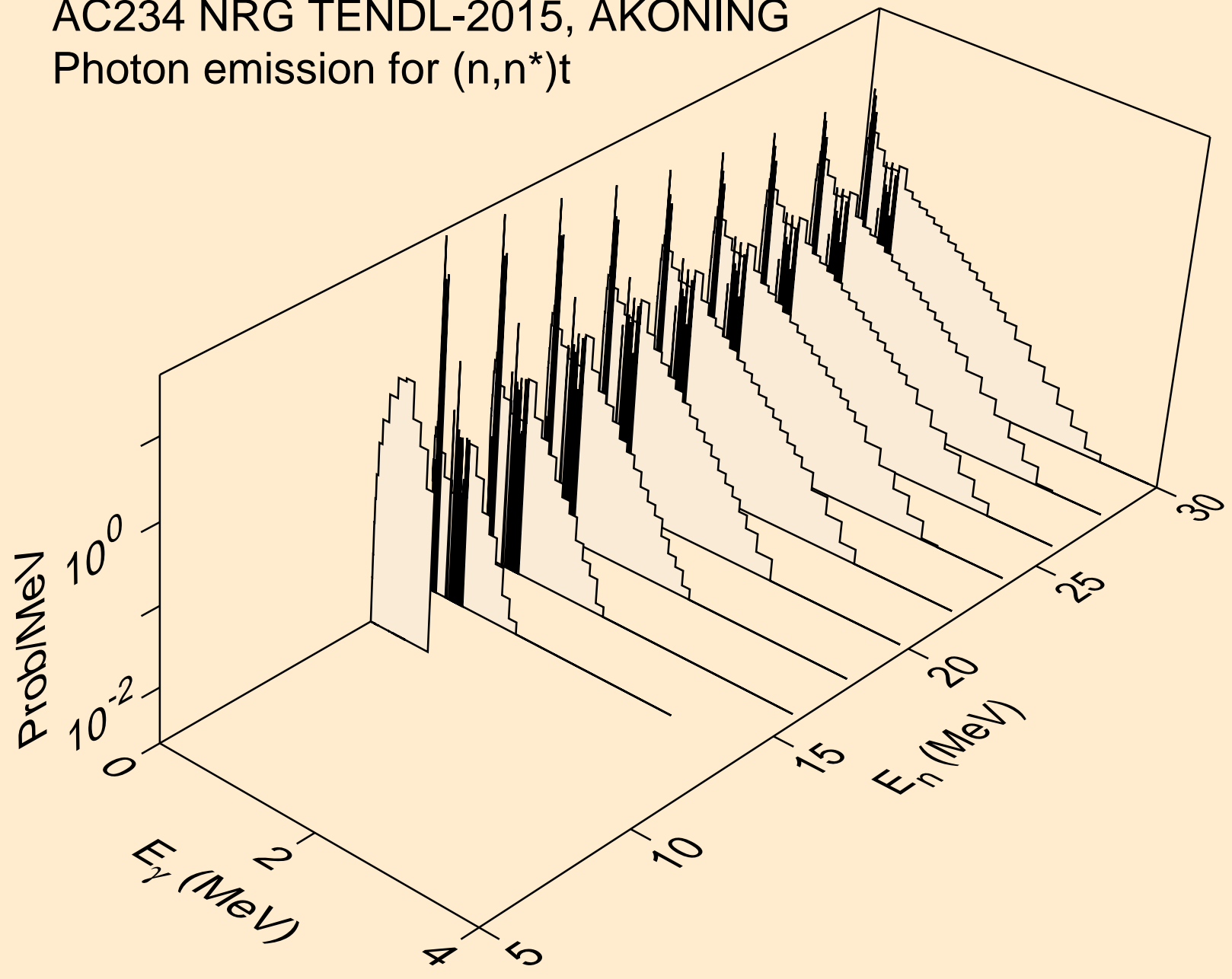

AC234 NRG TENDL-2015, AKONING

Photon emission for (n,n*)he3

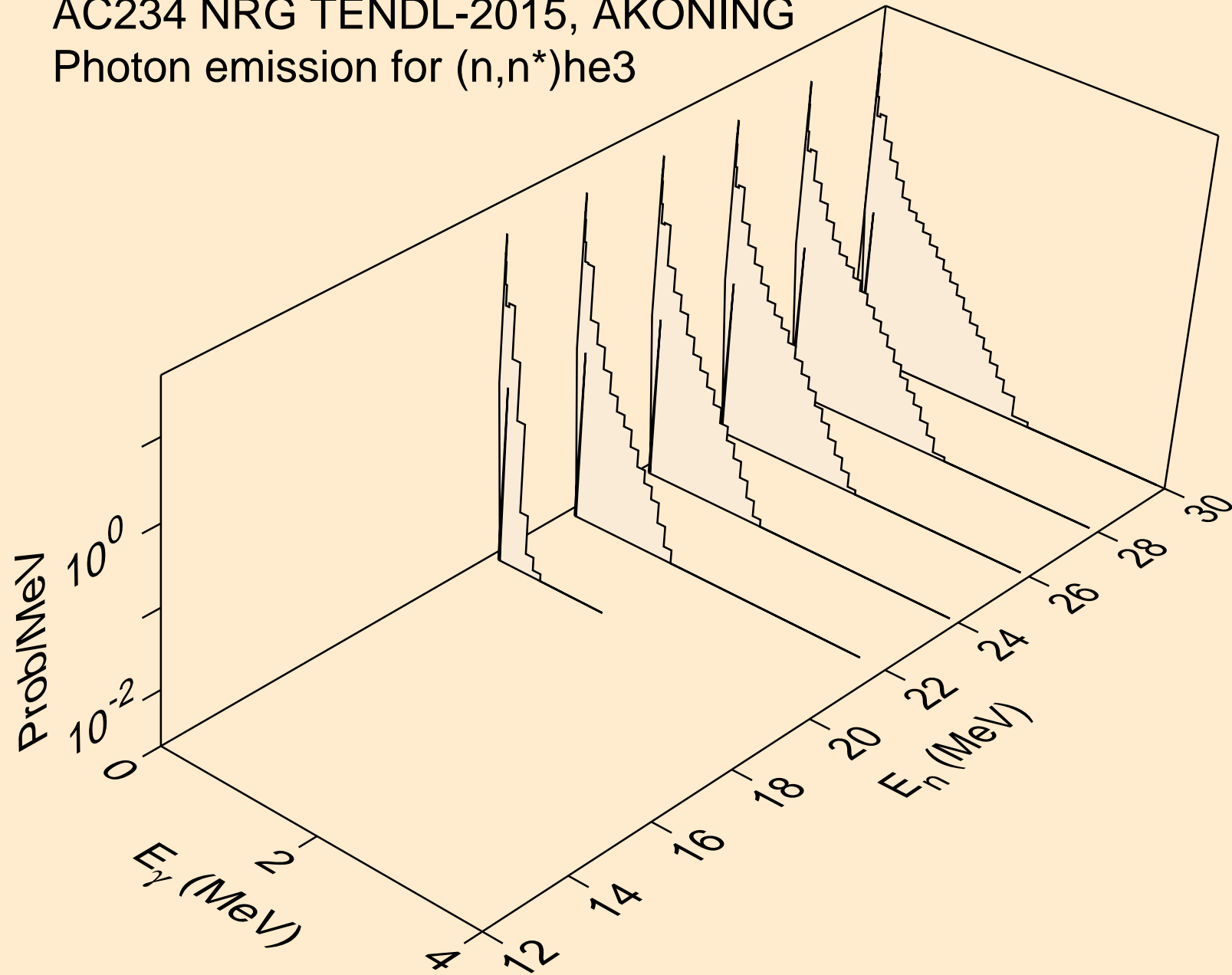

AC234 NRG TENDL-2015, AKONING
Photon emission for (n,4n)

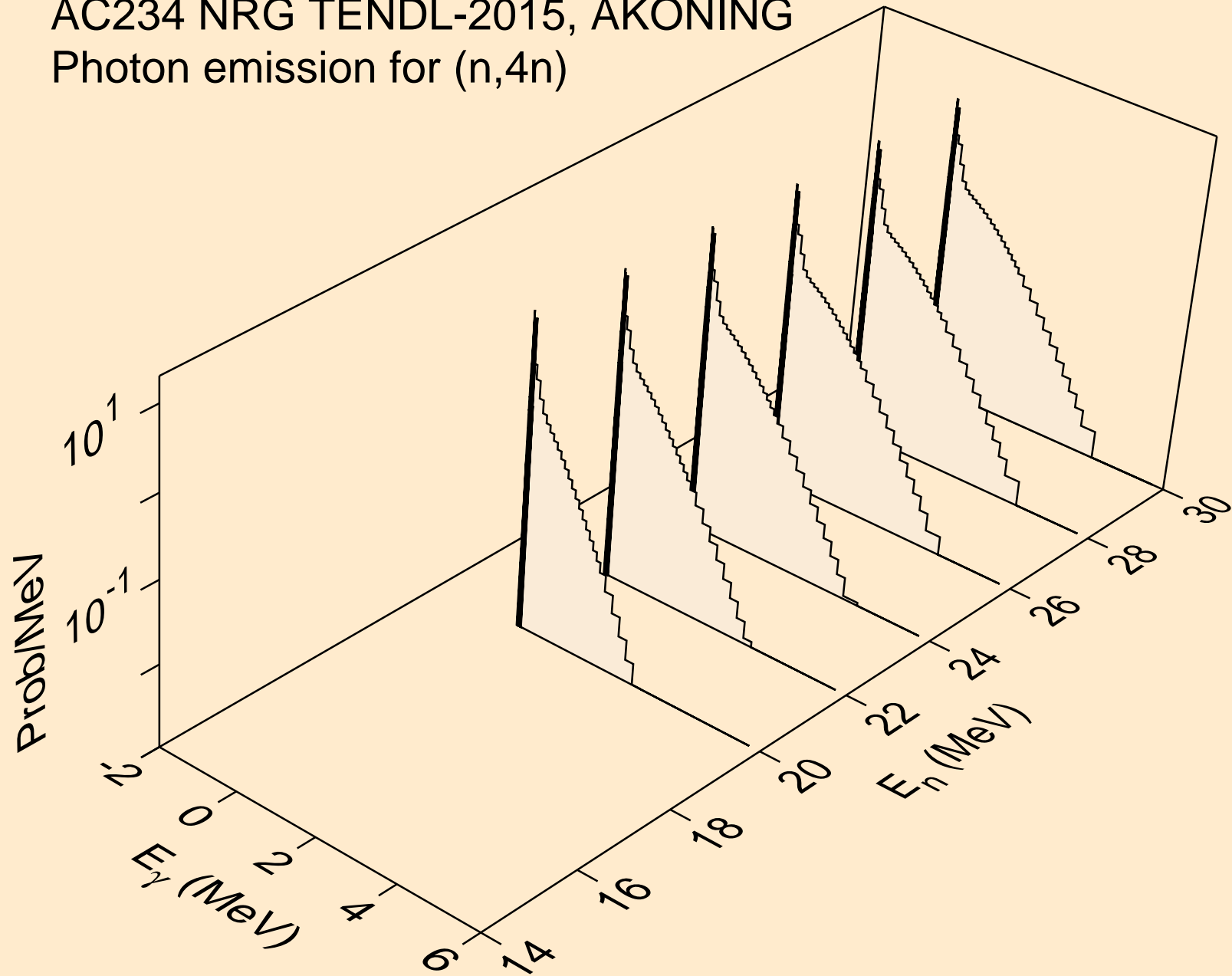

AC234 NRG TENDL-2015, AKONING
Photon emission for (n,2np)

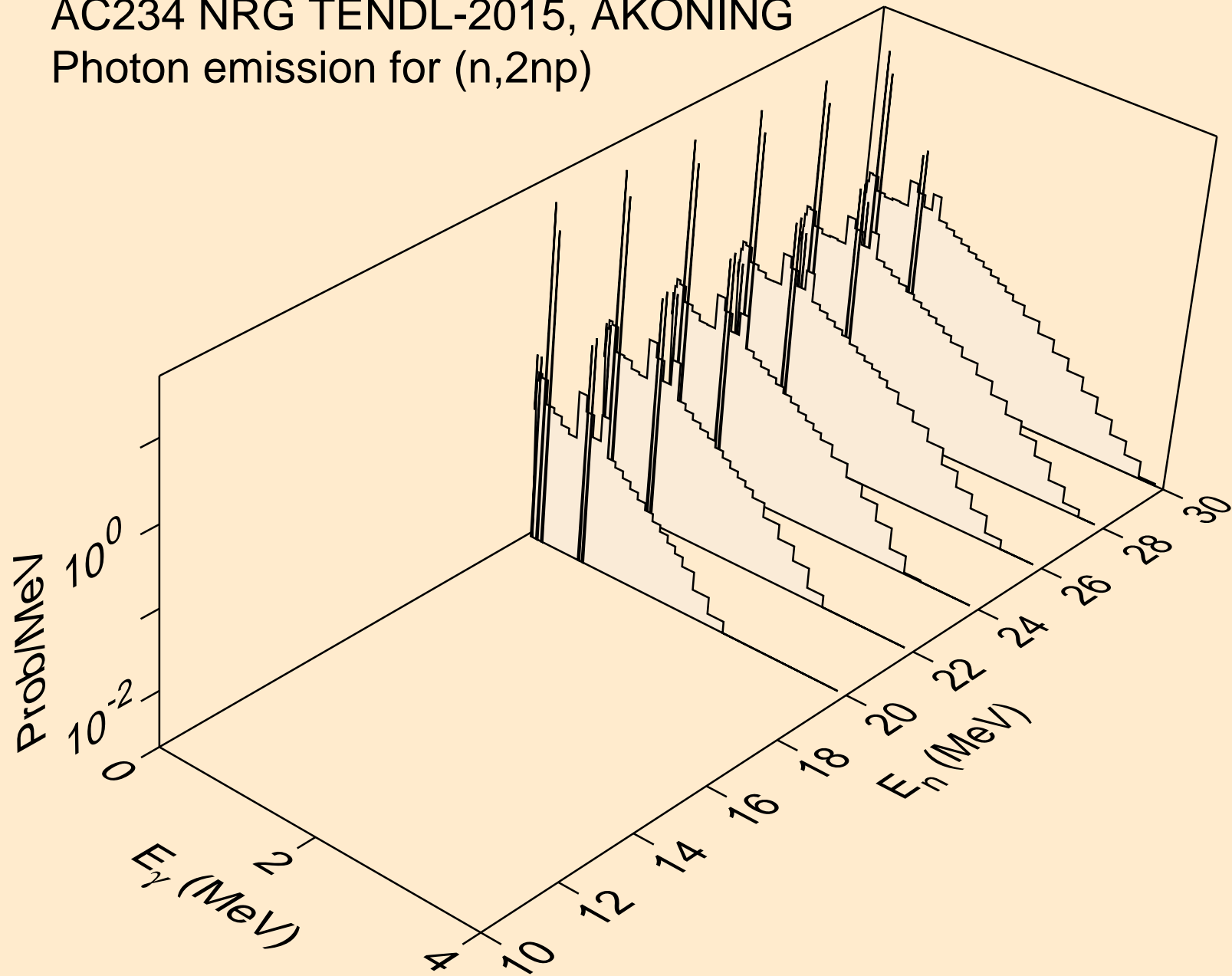

AC234 NRG TENDL-2015, AKONING
Photon emission for (n,3np)

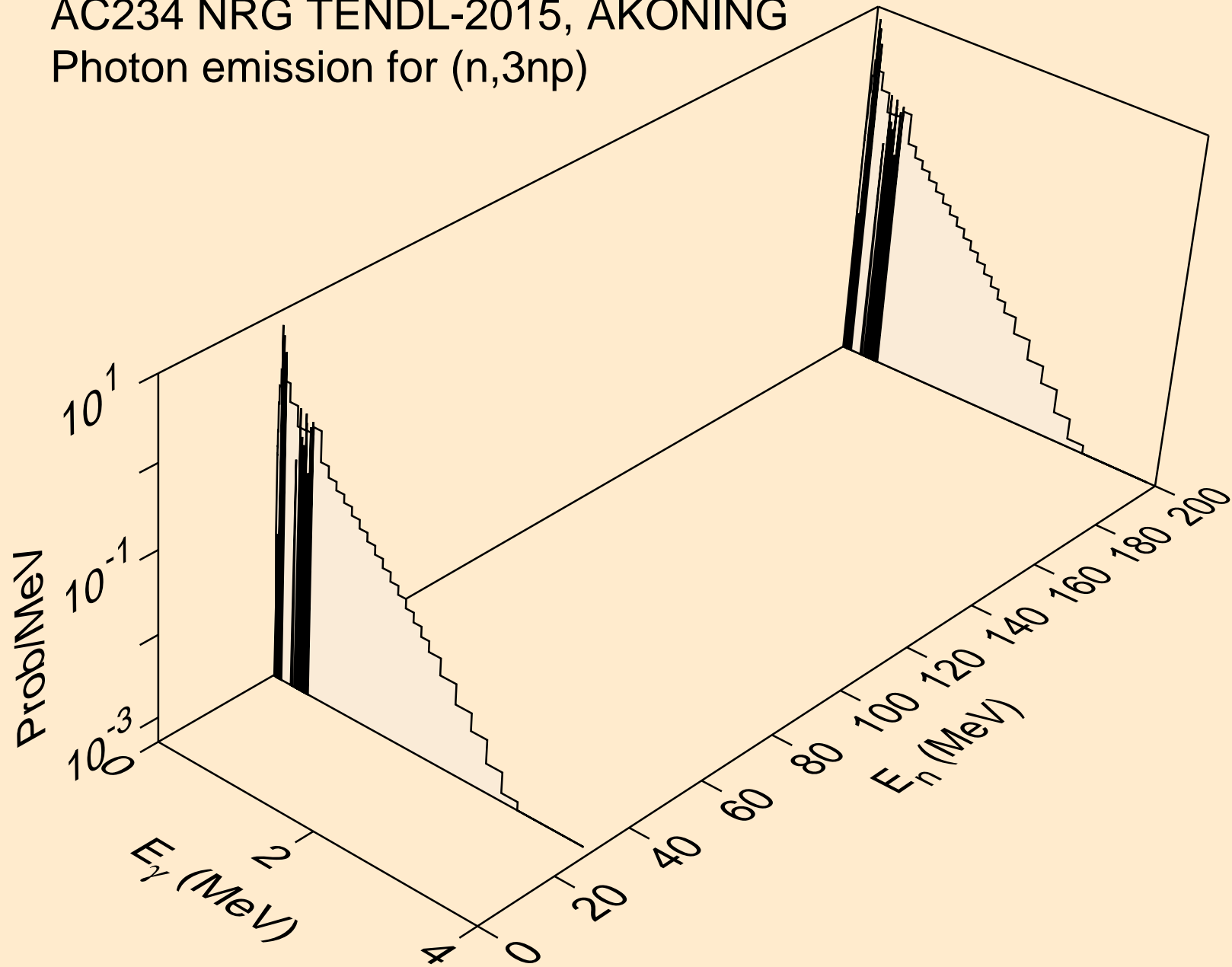

AC234 NRG TENDL-2015, AKONING
Photon emission for (n,n*c)

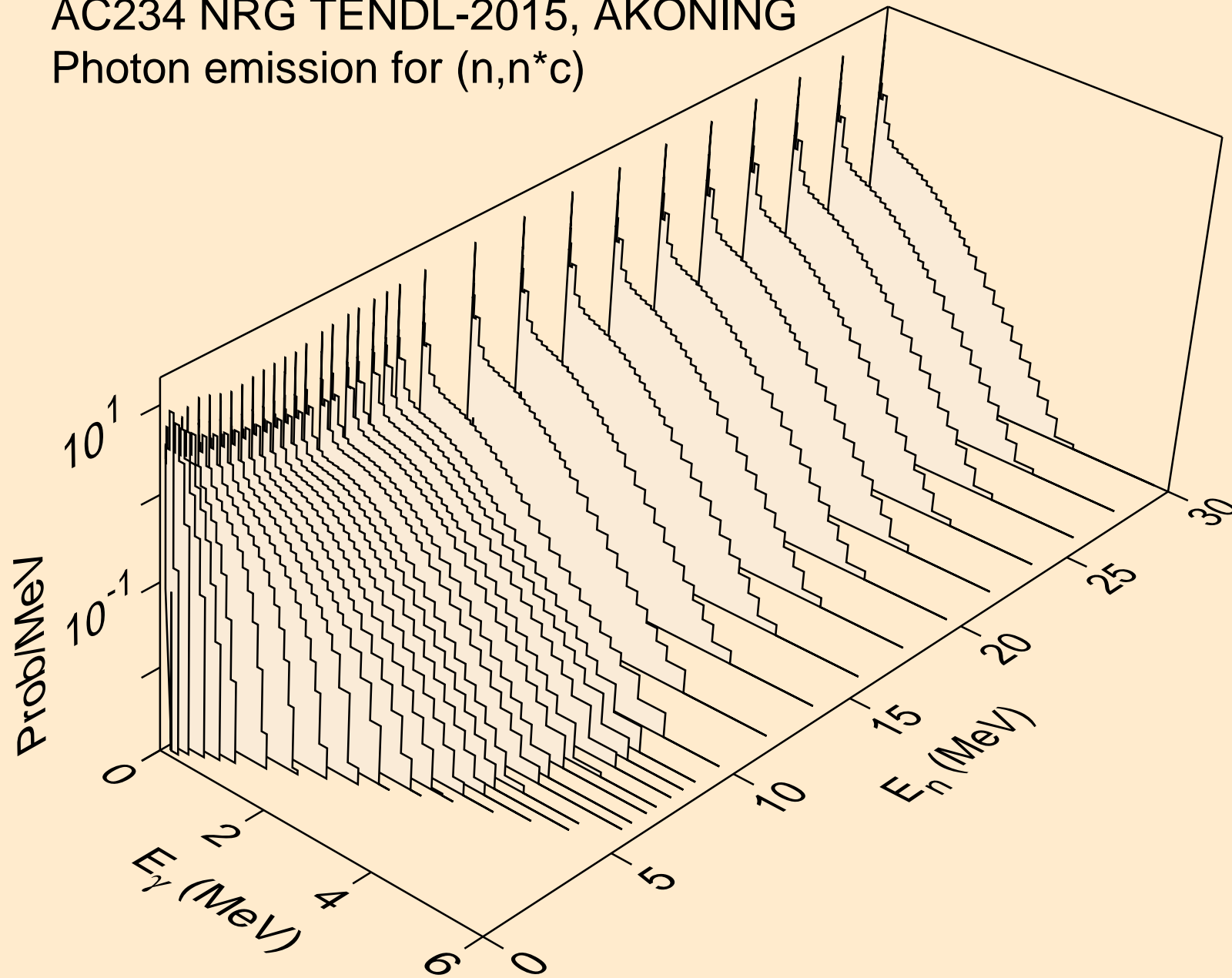

AC234 NRG TENDL-2015, AKONING
Photon emission for (n,gma)

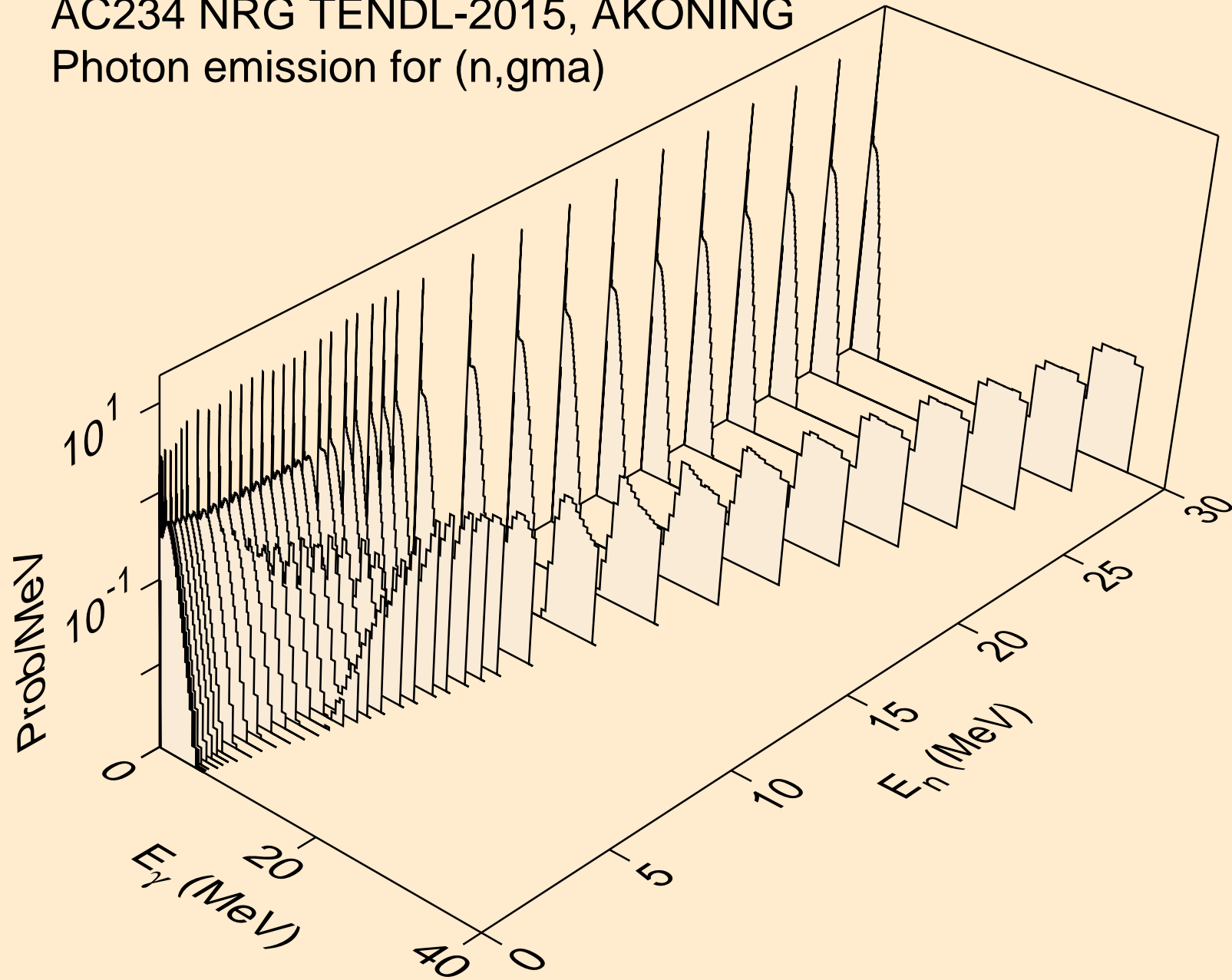

AC234 NRG TENDL-2015, AKONING
Photon emission for (n,p)

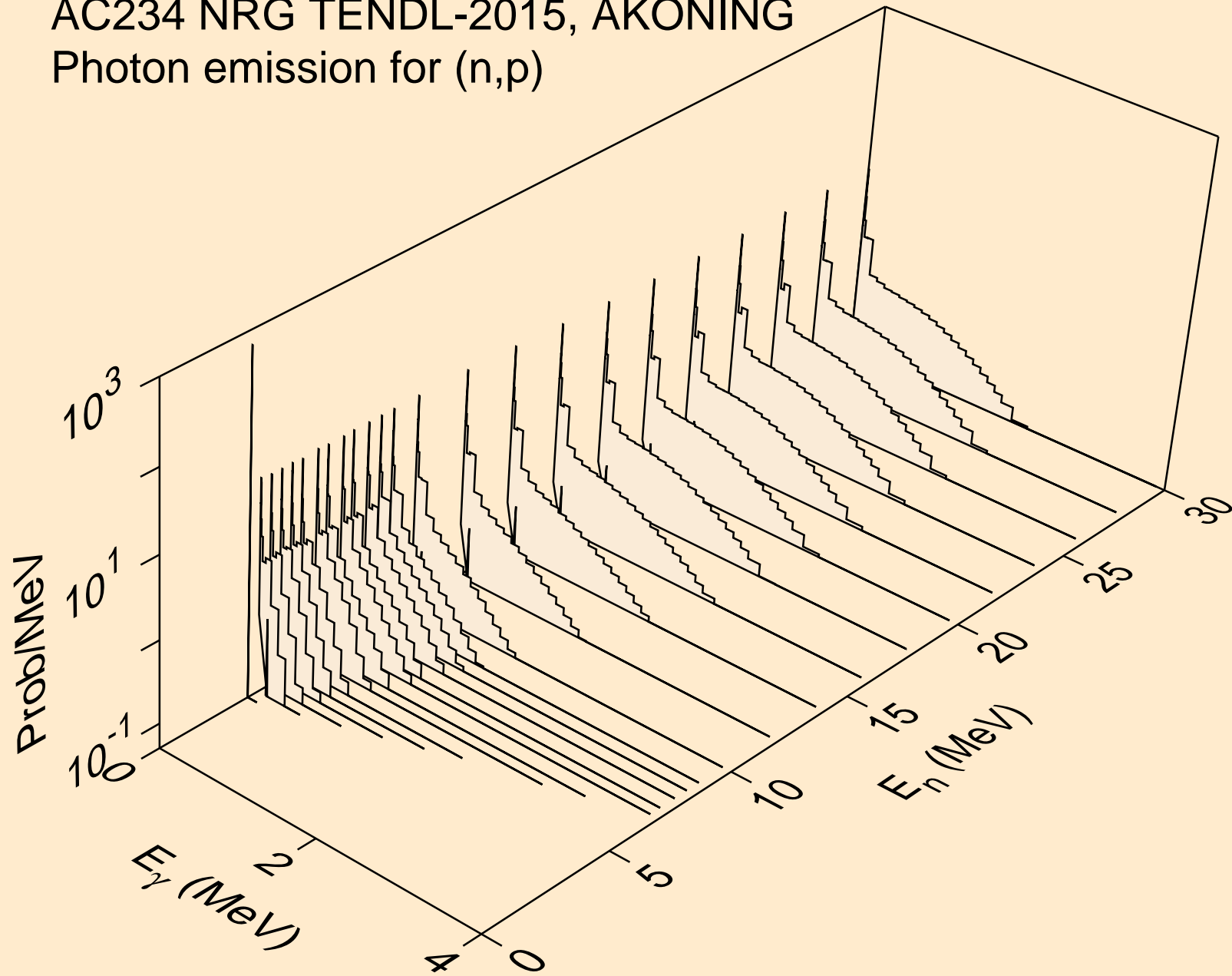

AC234 NRG TENDL-2015, AKONING
Photon emission for (n,d)

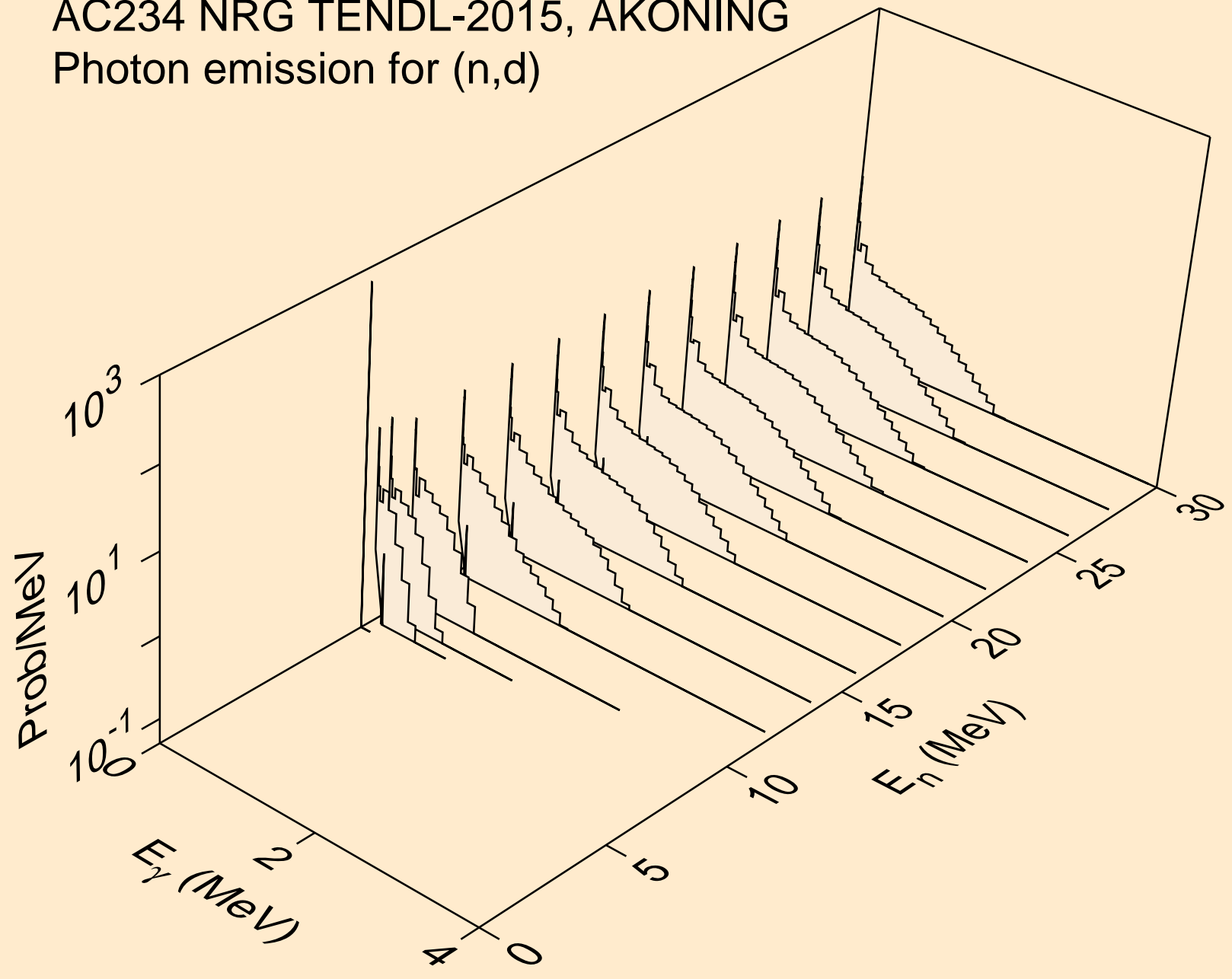

AC234 NRG TENDL-2015, AKONING
Photon emission for (n,t)

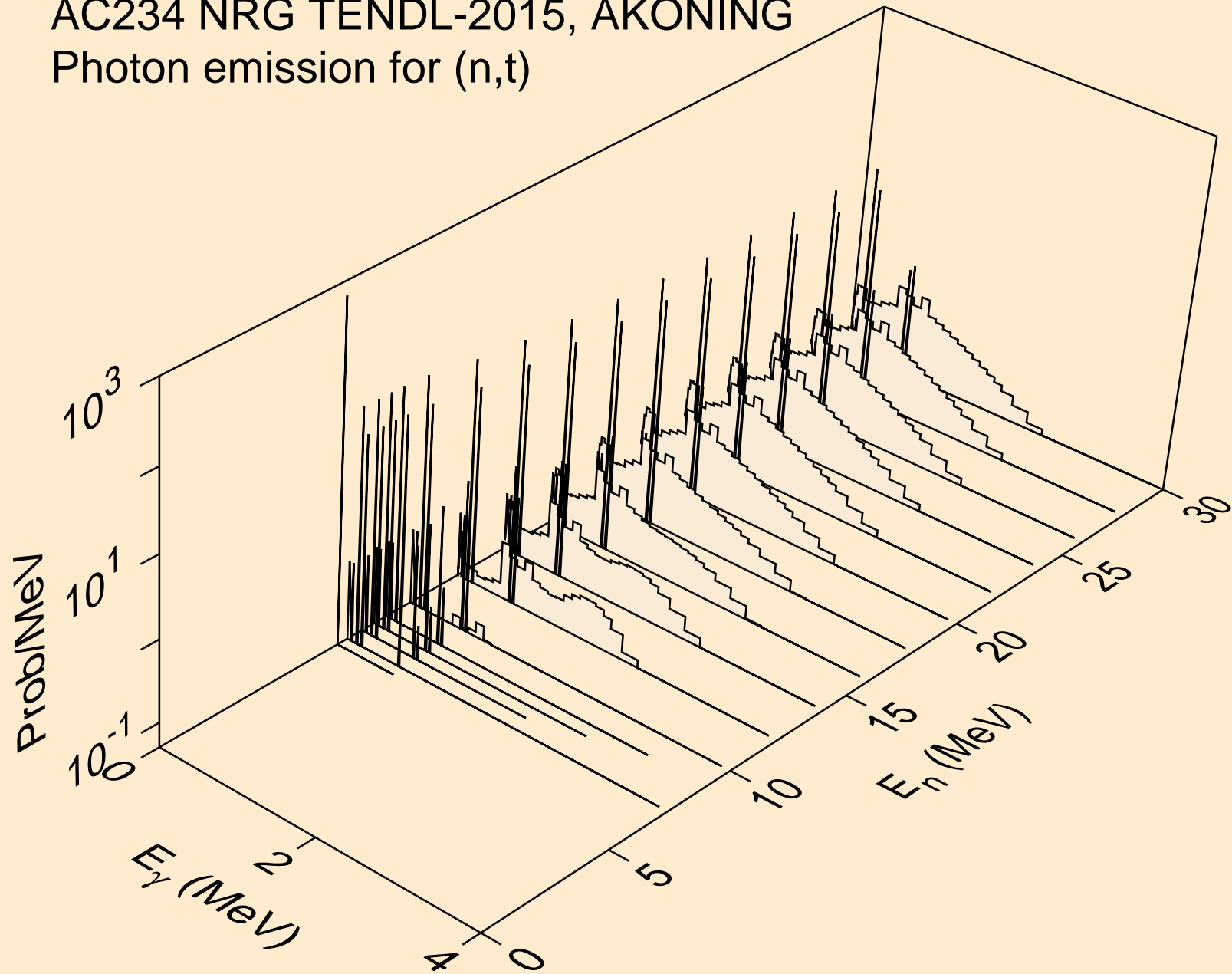

AC234 NRG TENDL-2015, AKONING
Photon emission for (n,he3)

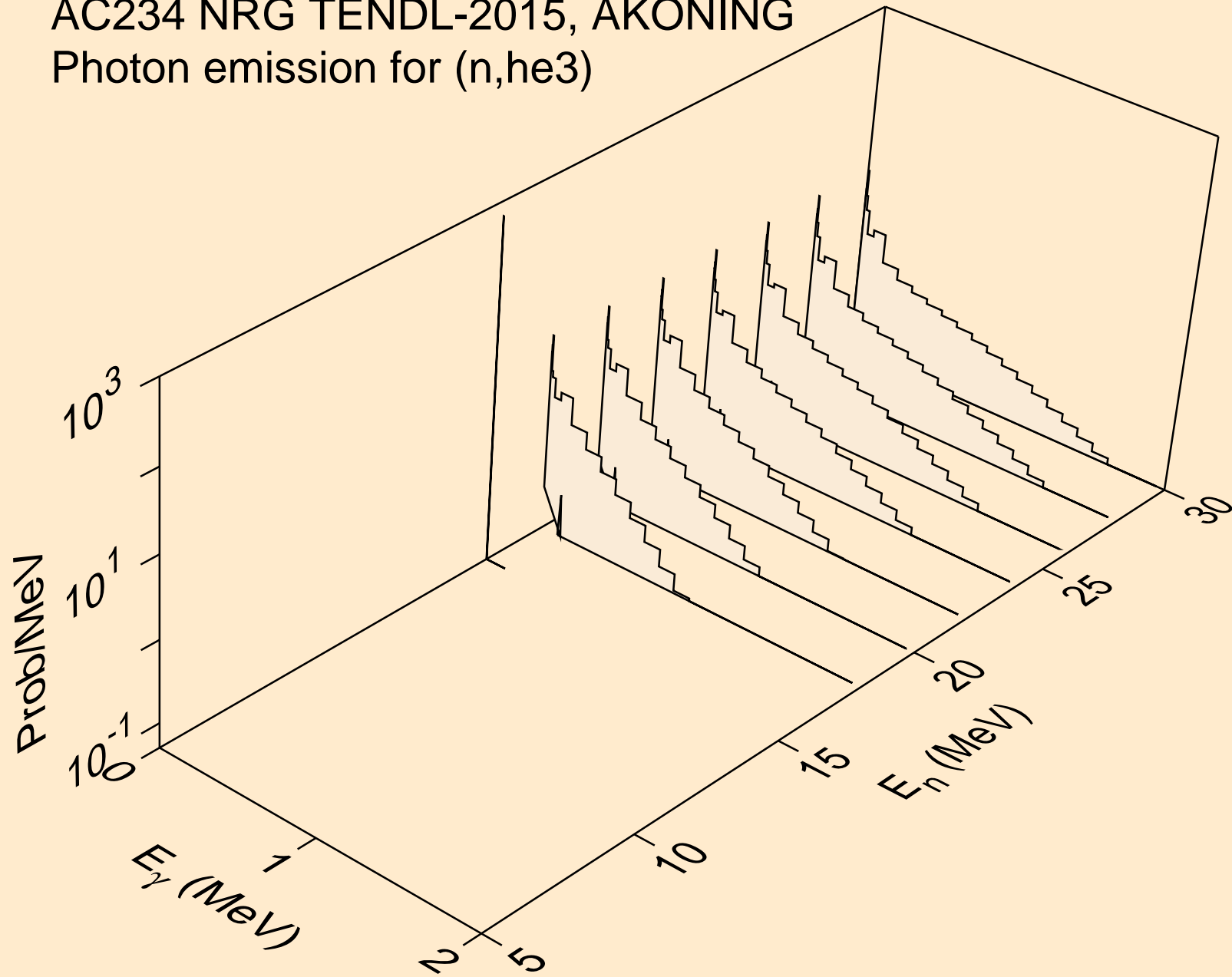

AC234 NRG TENDL-2015, AKONING
Photon emission for (n,a)

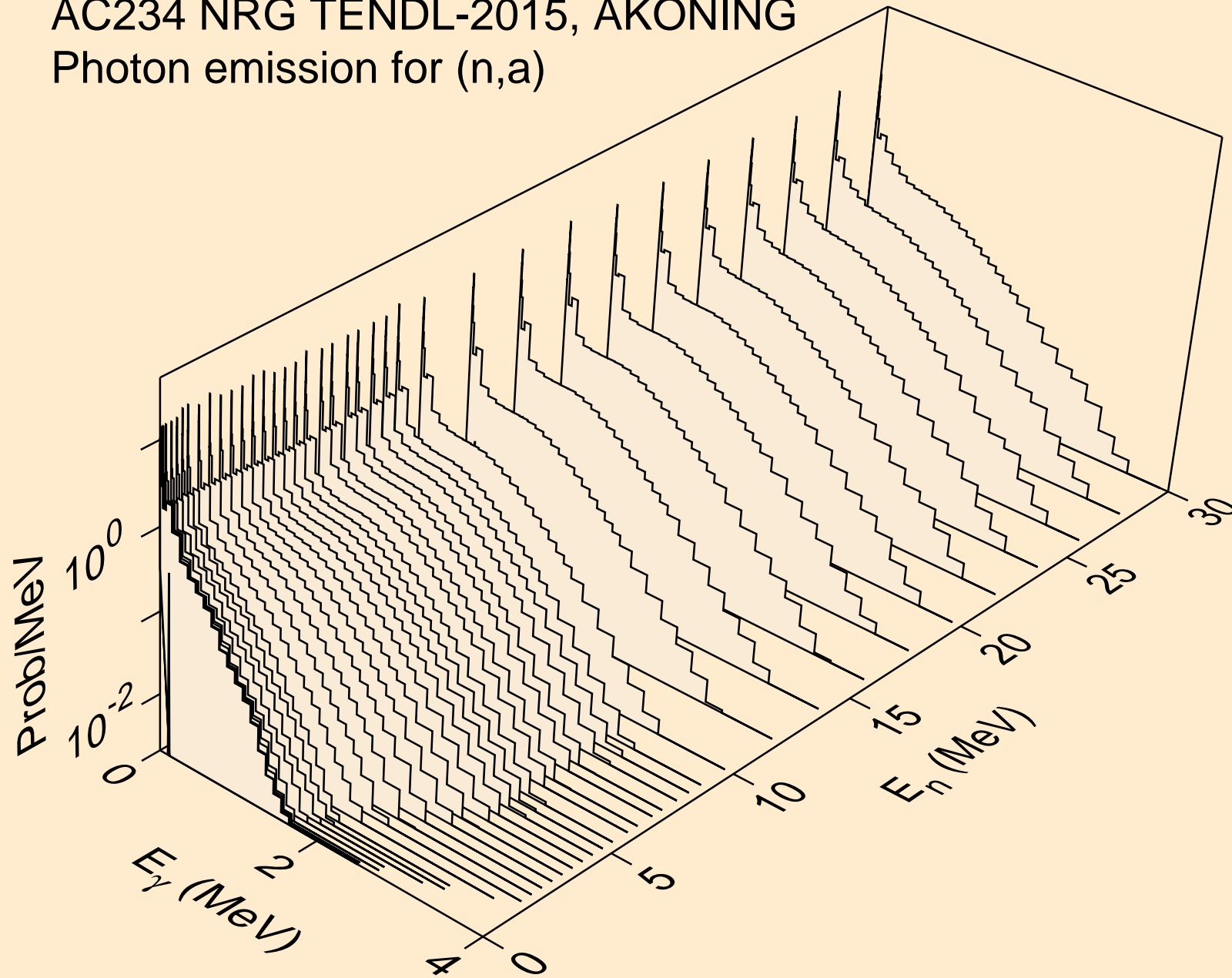

AC234 NRG TENDL-2015, AKONING
Photon emission for (n,2p)

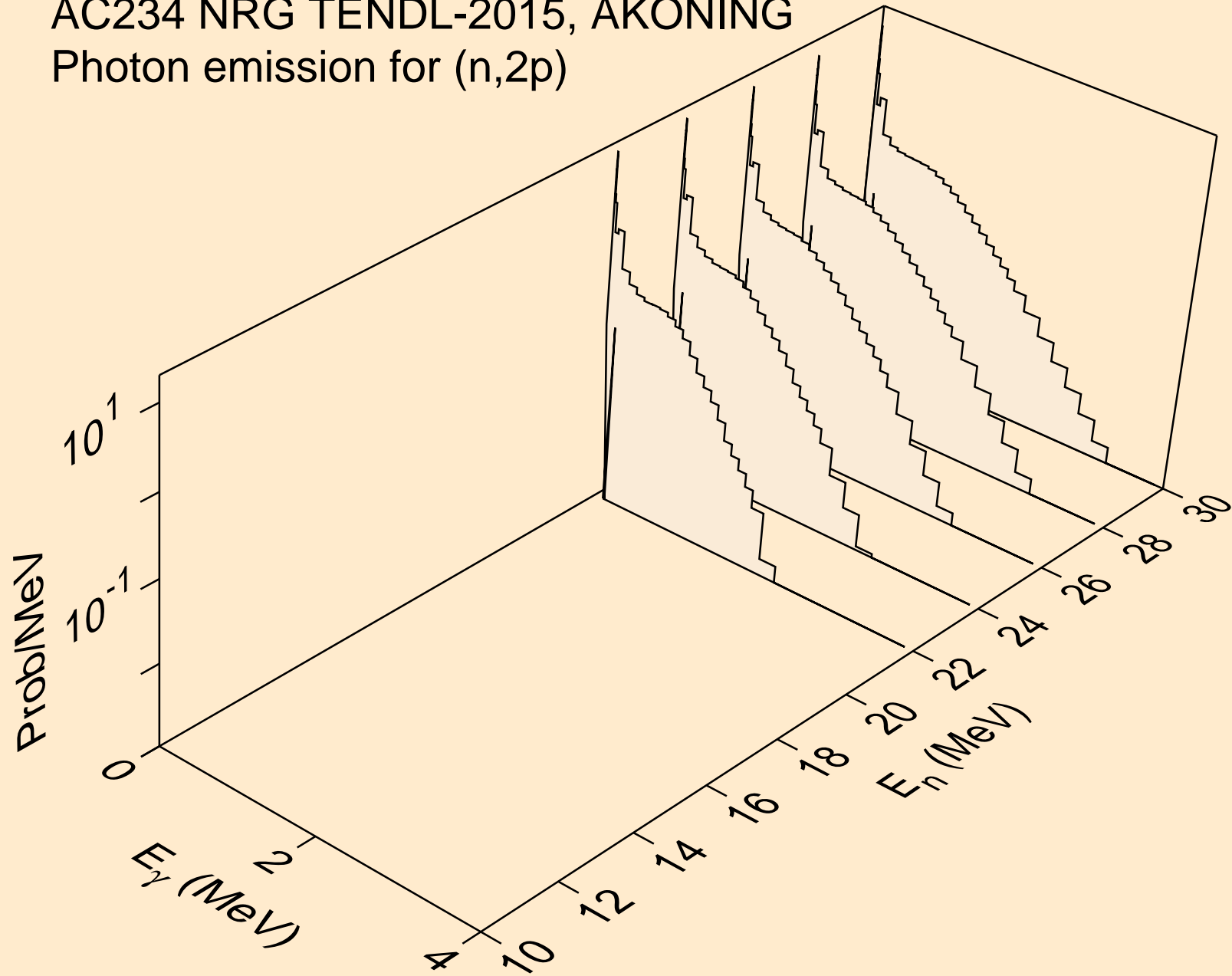

AC234 NRG TENDL-2015, AKONING
thermal capture photon spectrum

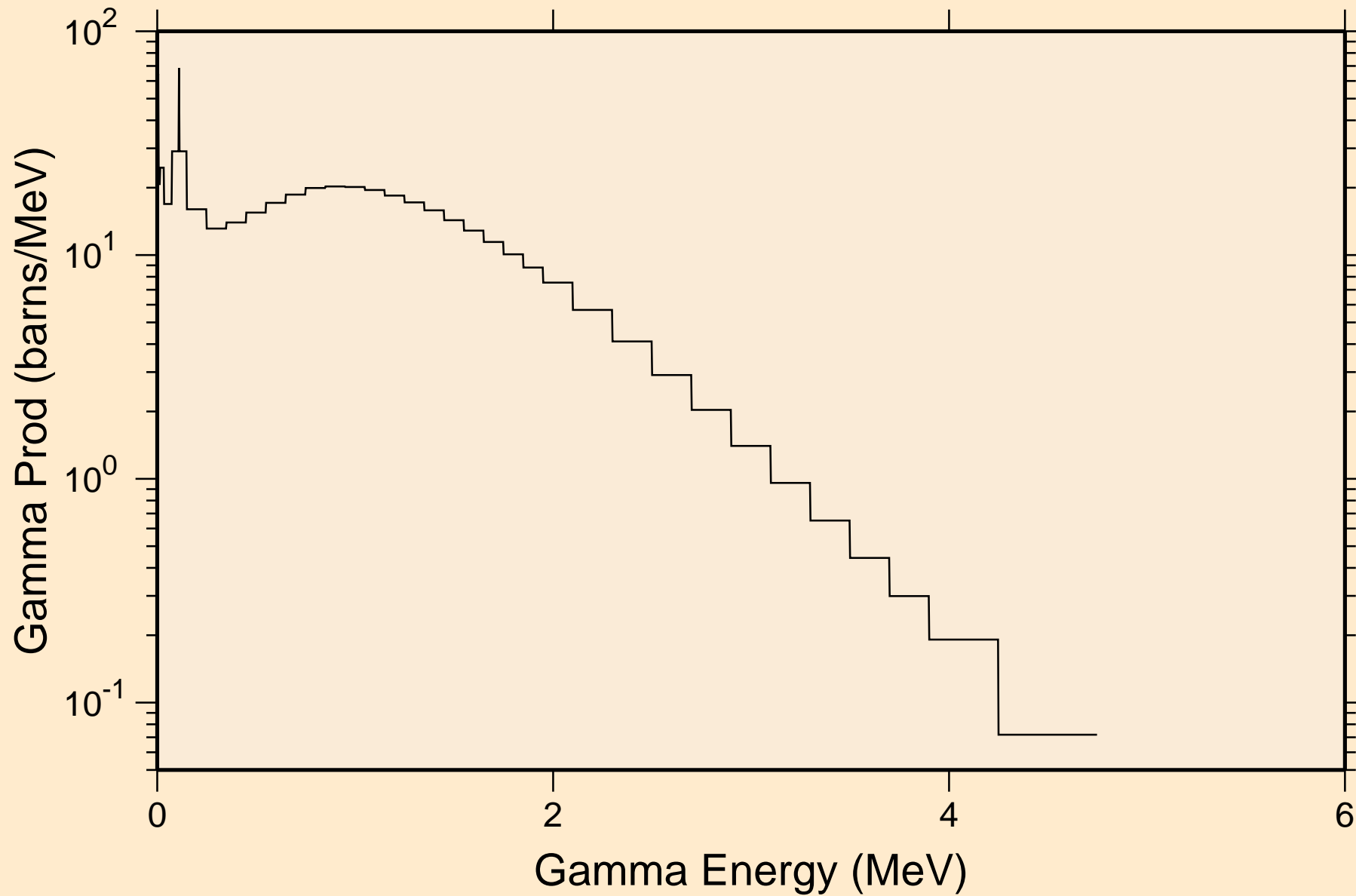

AC234 NRG TENDL-2015, AKONING
14 MeV photon spectrum

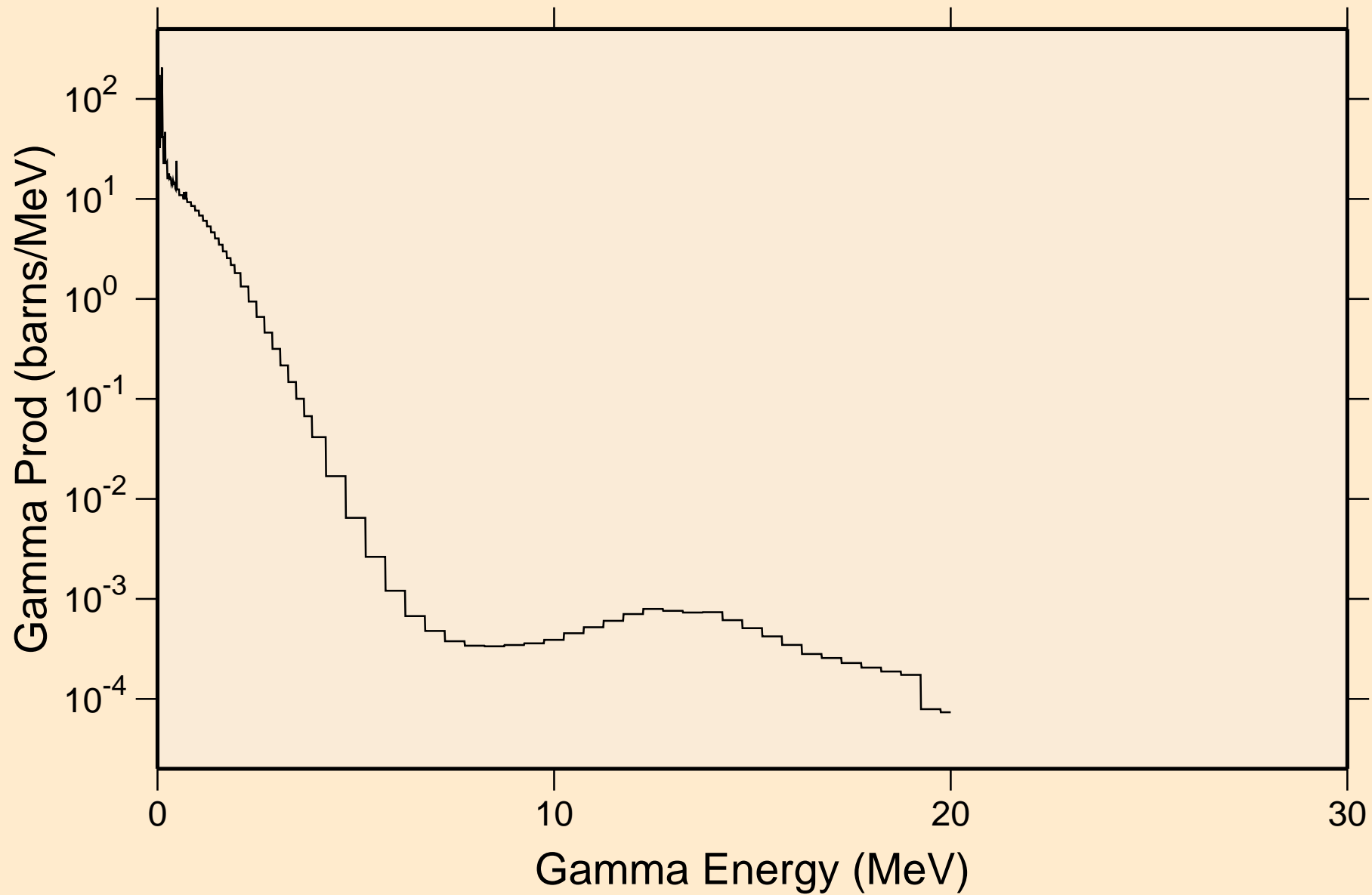

AC234 NRG TENDL-2015, AKONING

Particle heating contributions

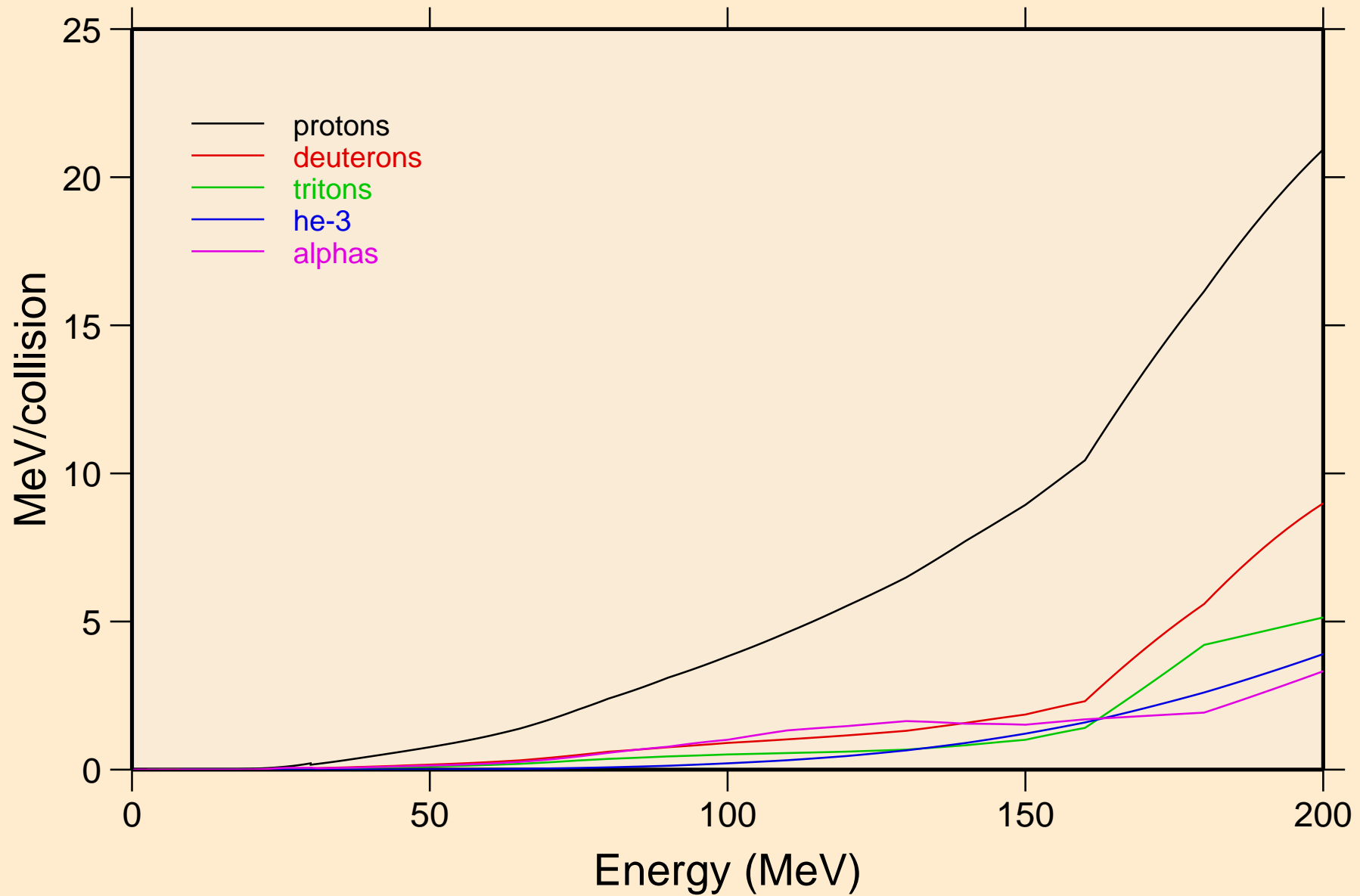

AC234 NRG TENDL-2015, AKONING

Recoil Heating

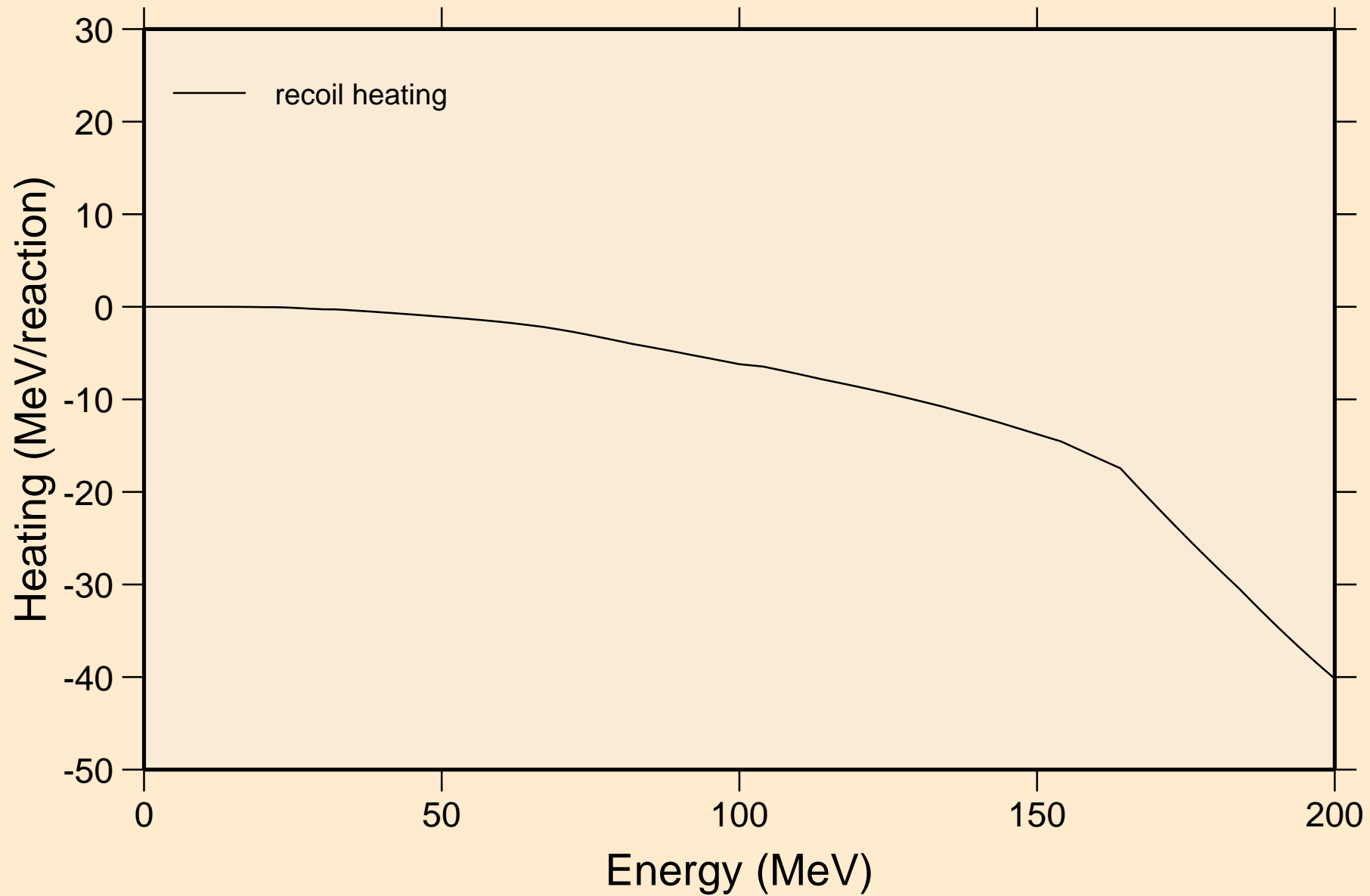

AC234 NRG TENDL-2015, AKONING

Particle production cross sections

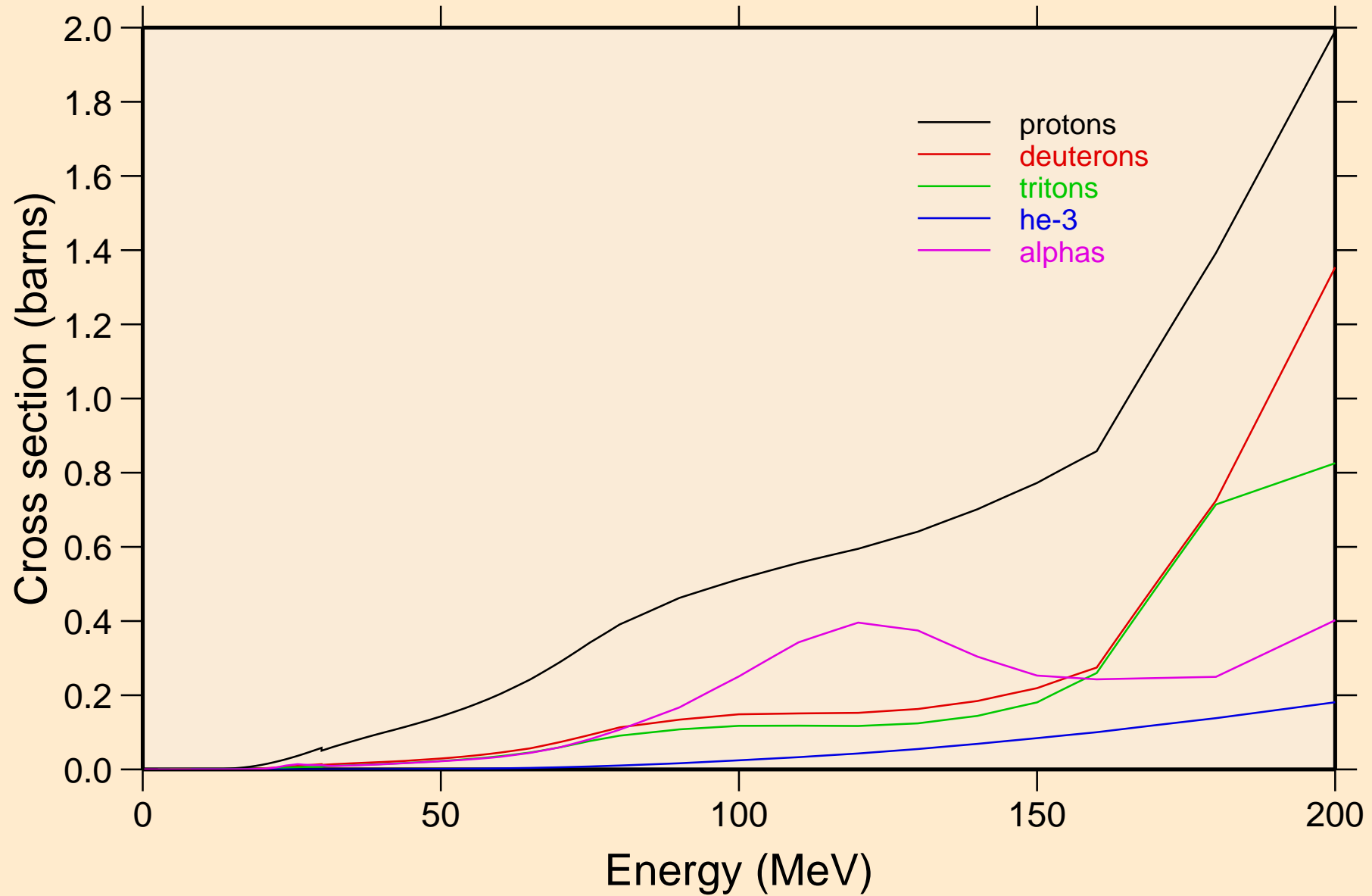

AC234 NRG TENDL-2015, AKONING
protons from (n,x)

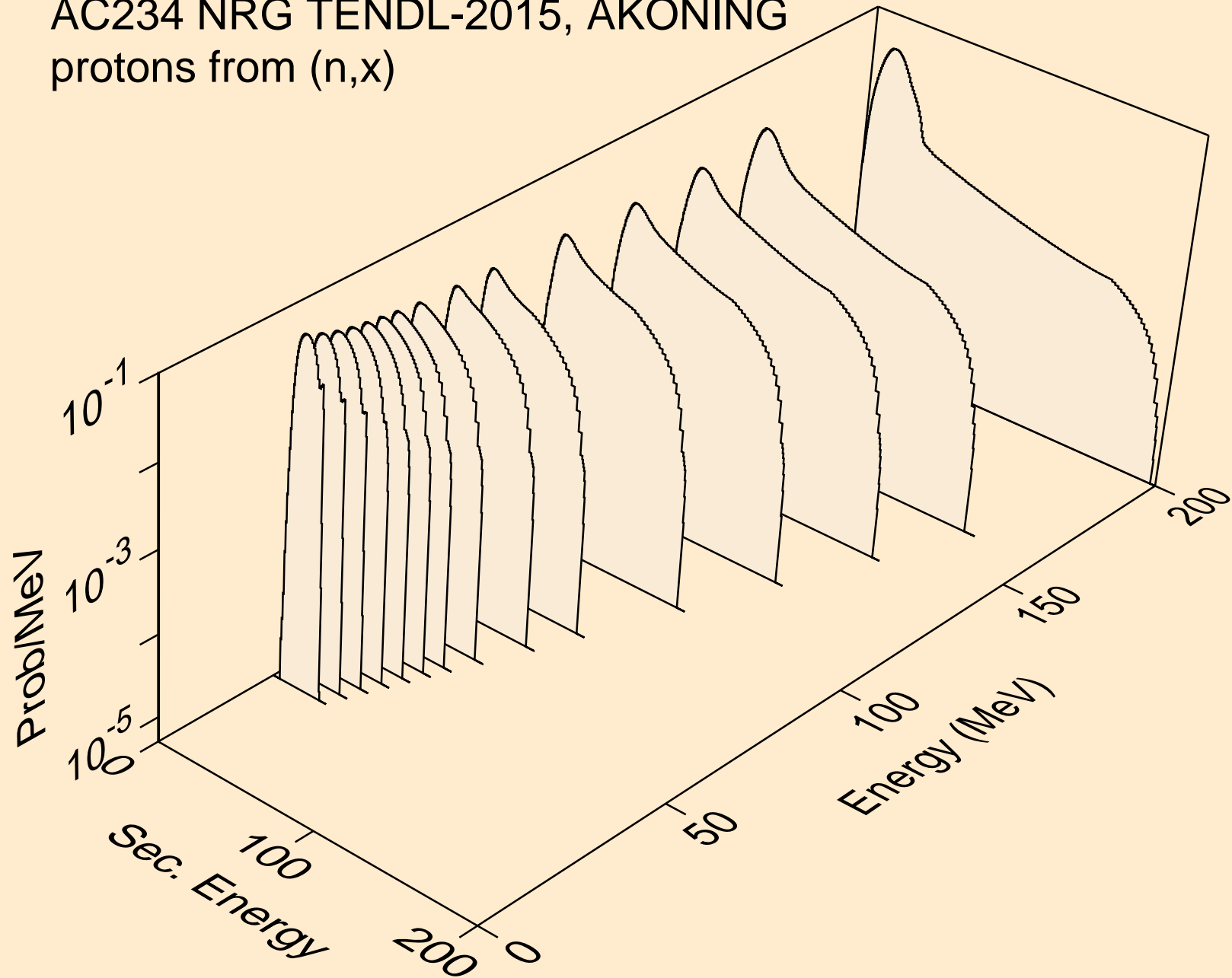

AC234 NRG TENDL-2015, AKONING
protons from (n,n*)p

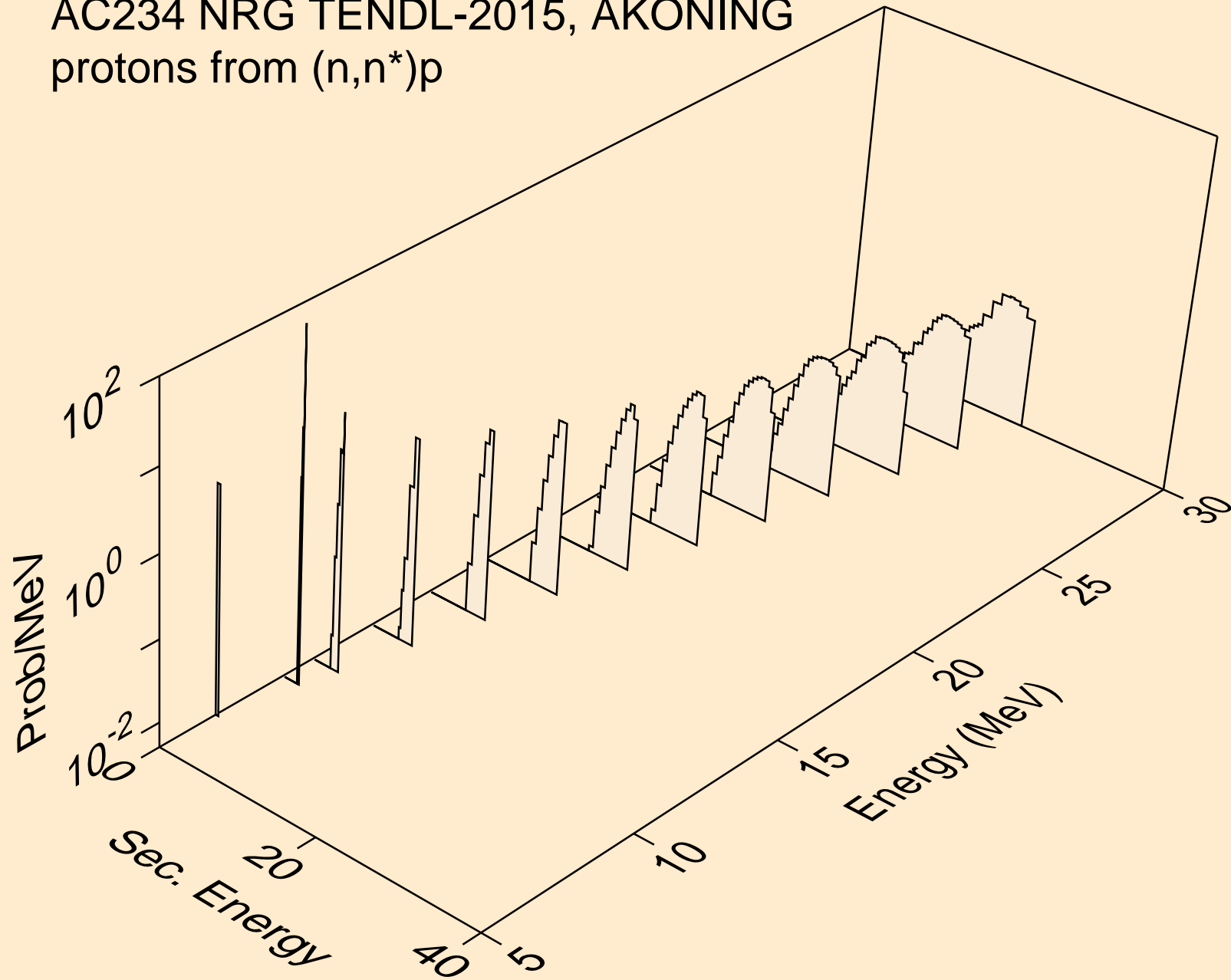

AC234 NRG TENDL-2015, AKONING
protons from (n,2np)

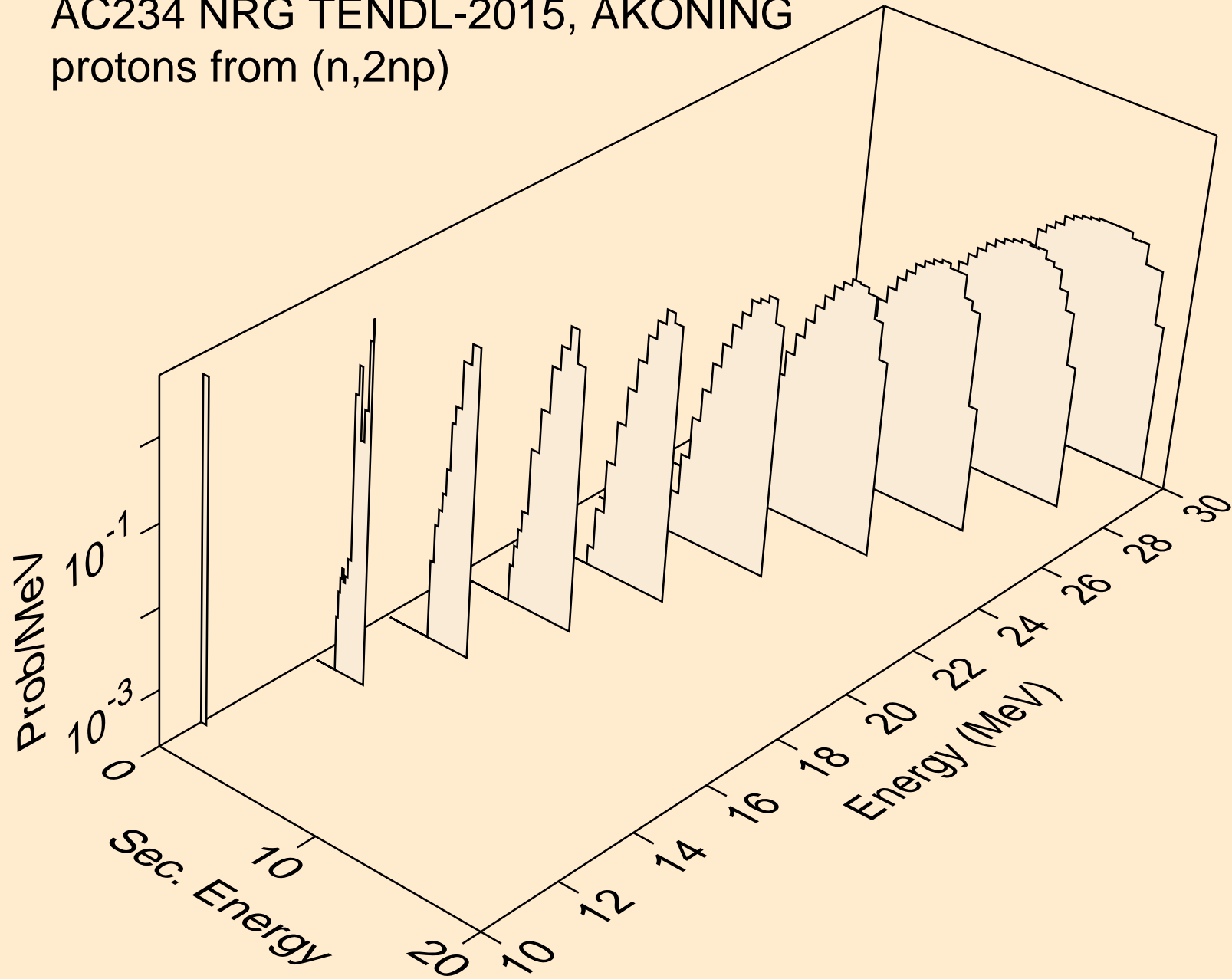

AC234 NRG TENDL-2015, AKONING
protons from (n,3np)

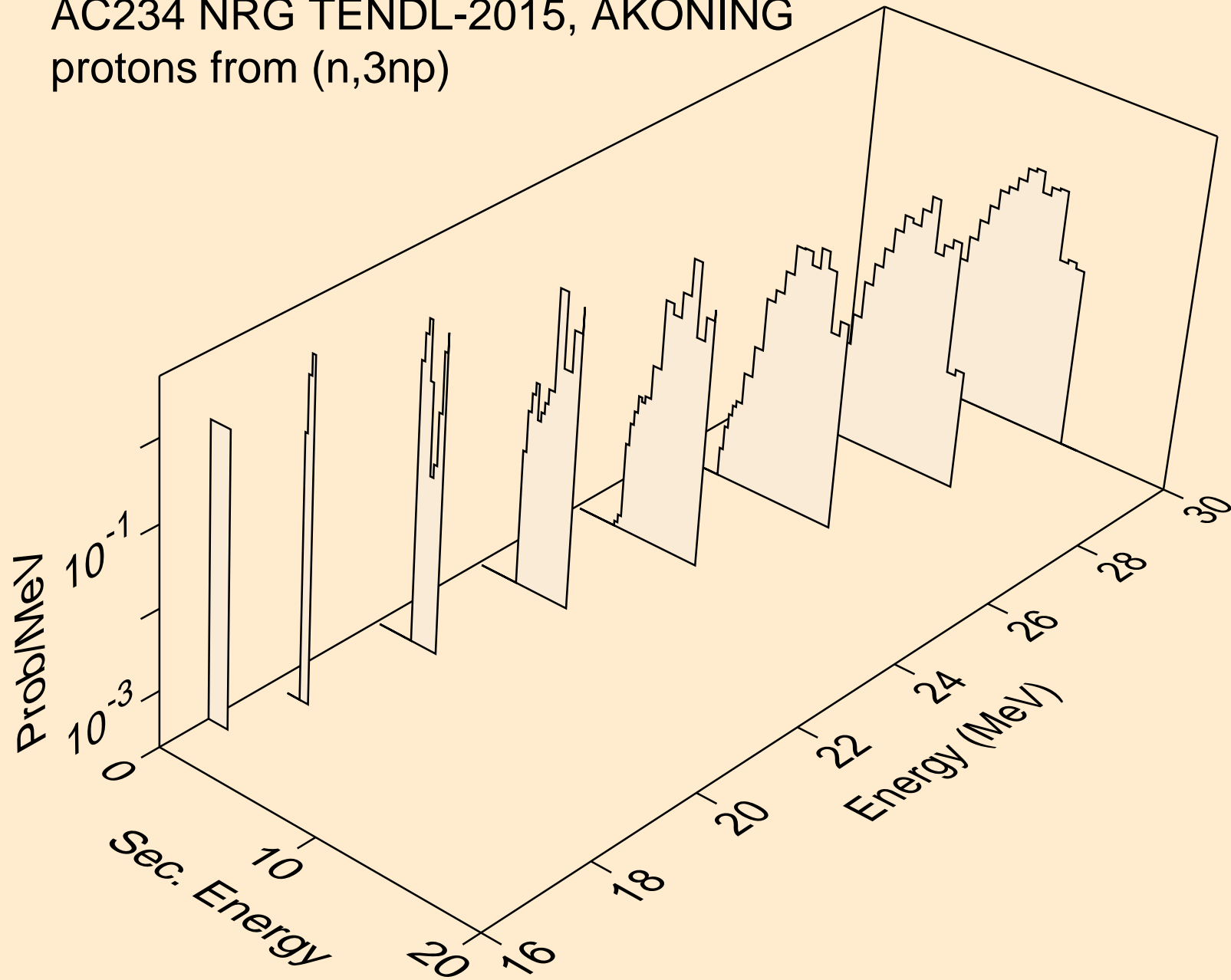

AC234 NRG TENDL-2015, AKONING
protons from (n,p)

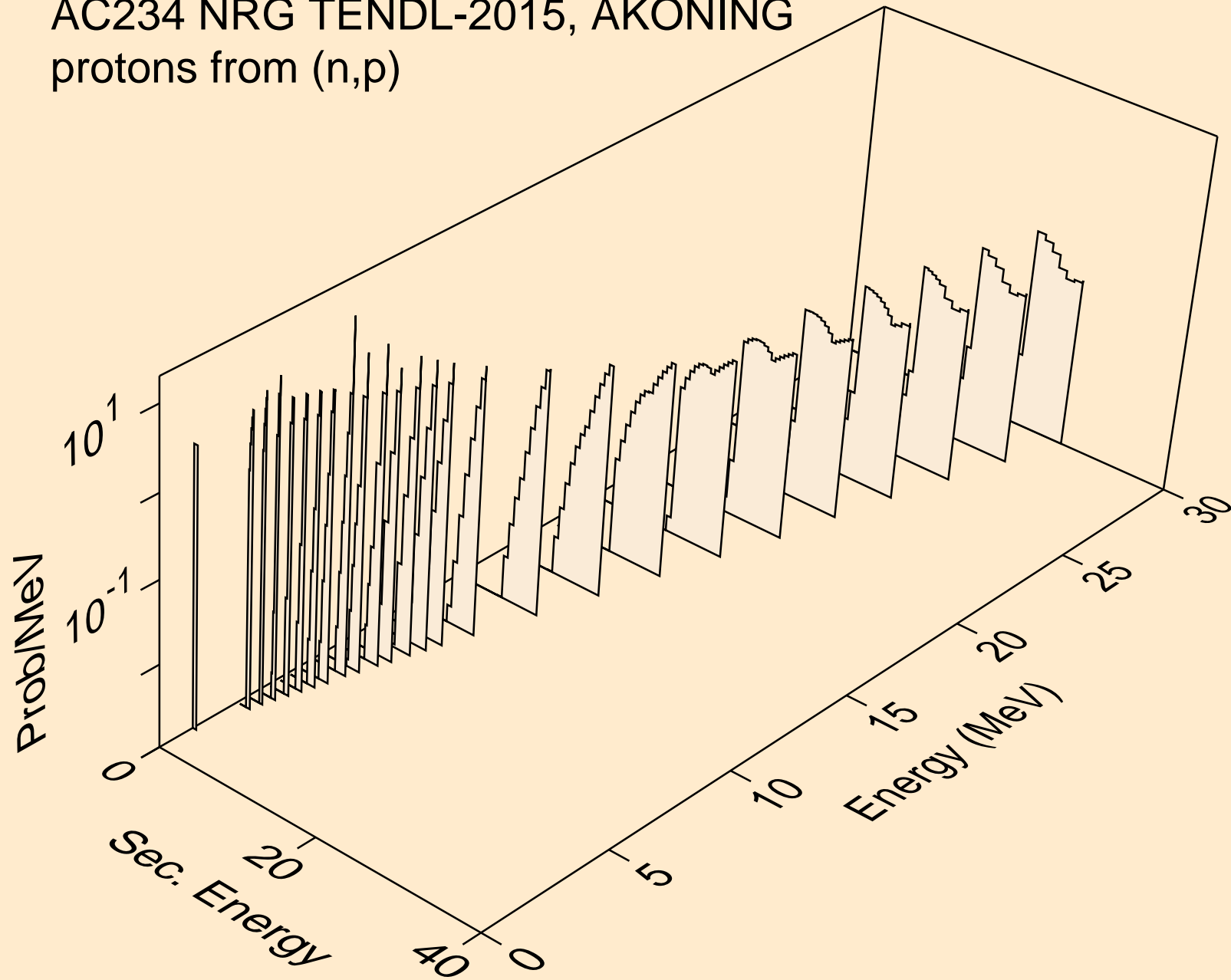

AC234 NRG TENDL-2015, AKONING
protons from (n,2p)

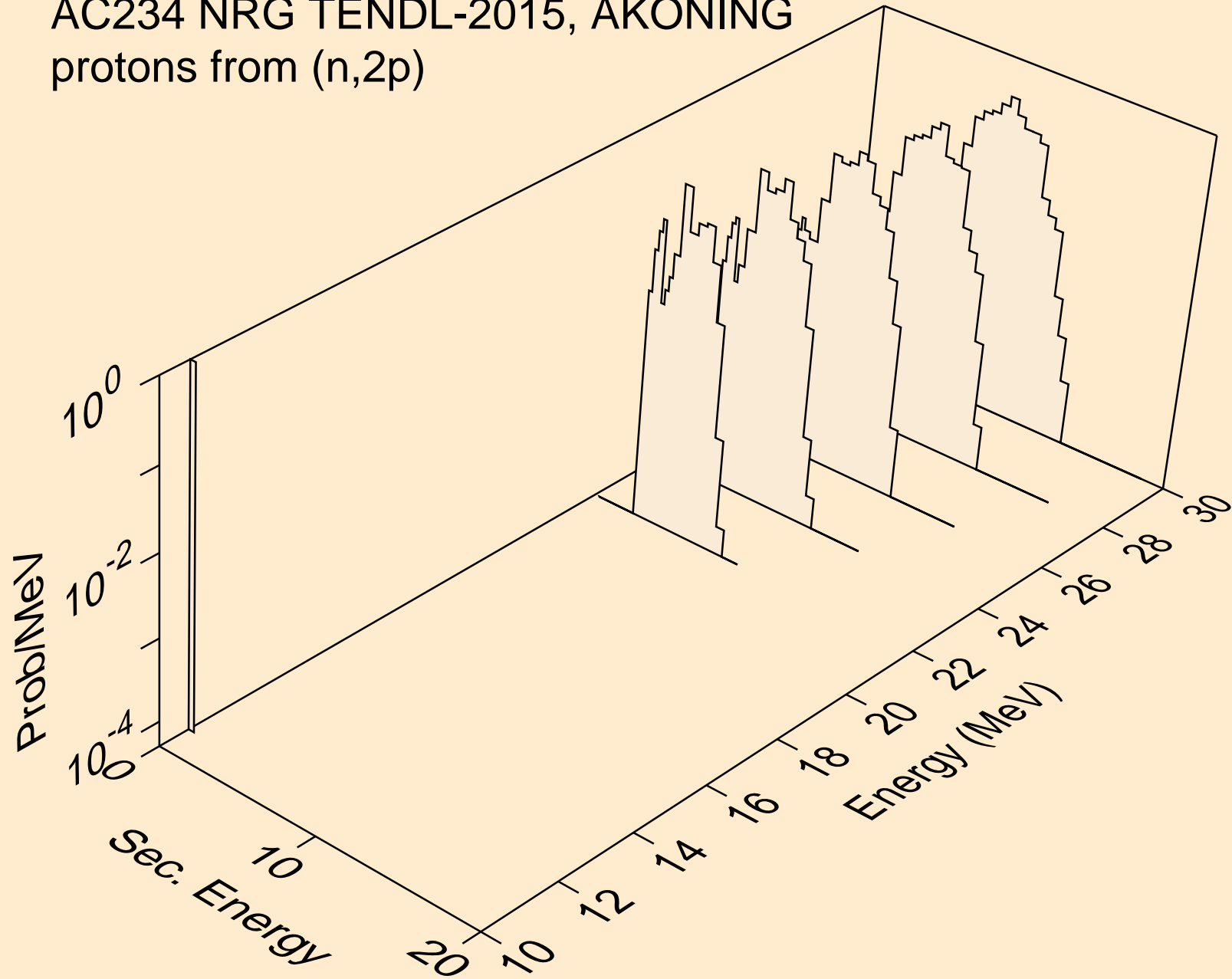

AC234 NRG TENDL-2015, AKONING
deuterons from (n,x)

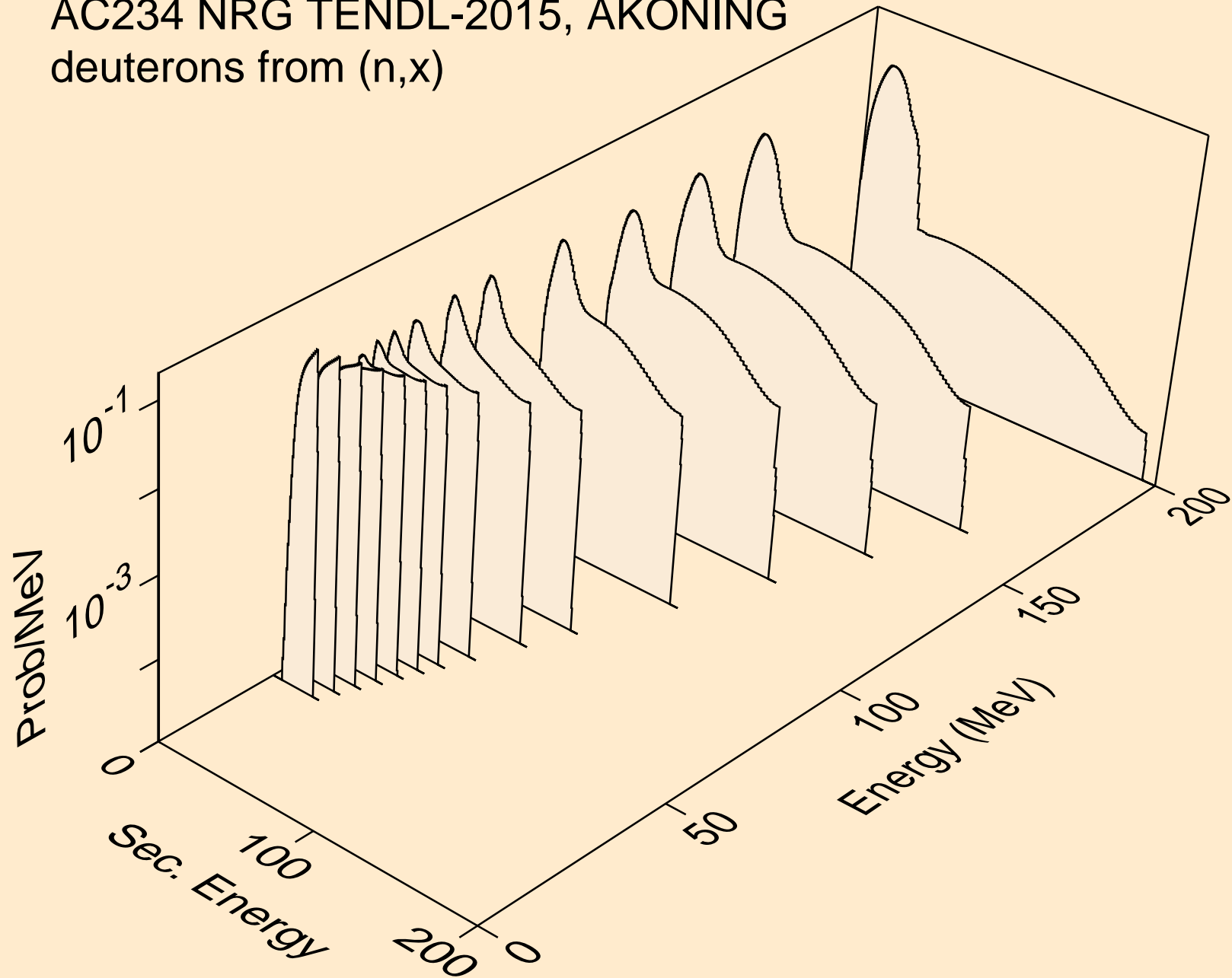

AC234 NRG TENDL-2015, AKONING
deuterons from (n,2nd)

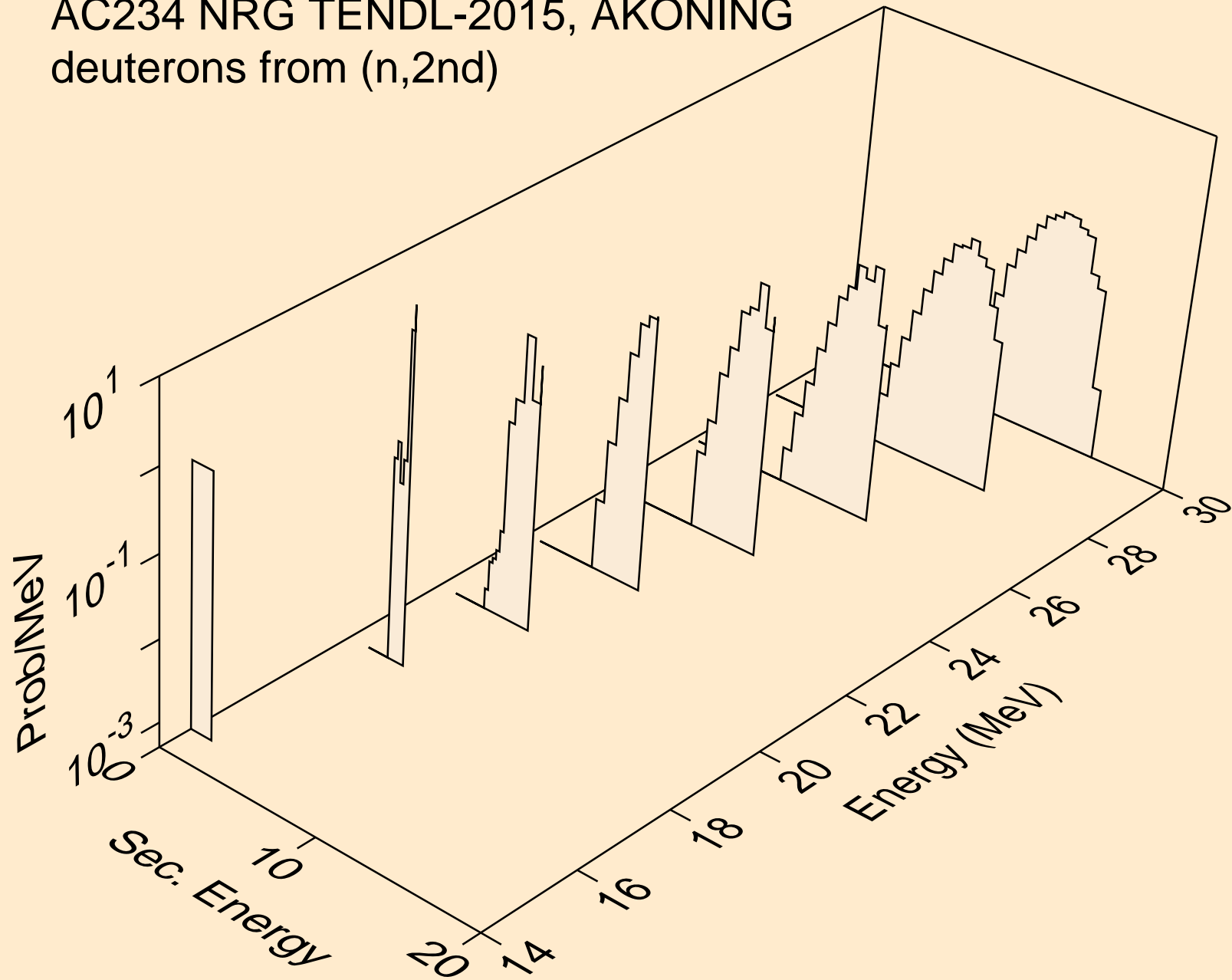

AC234 NRG TENDL-2015, AKONING
deuterons from (n,n*)d

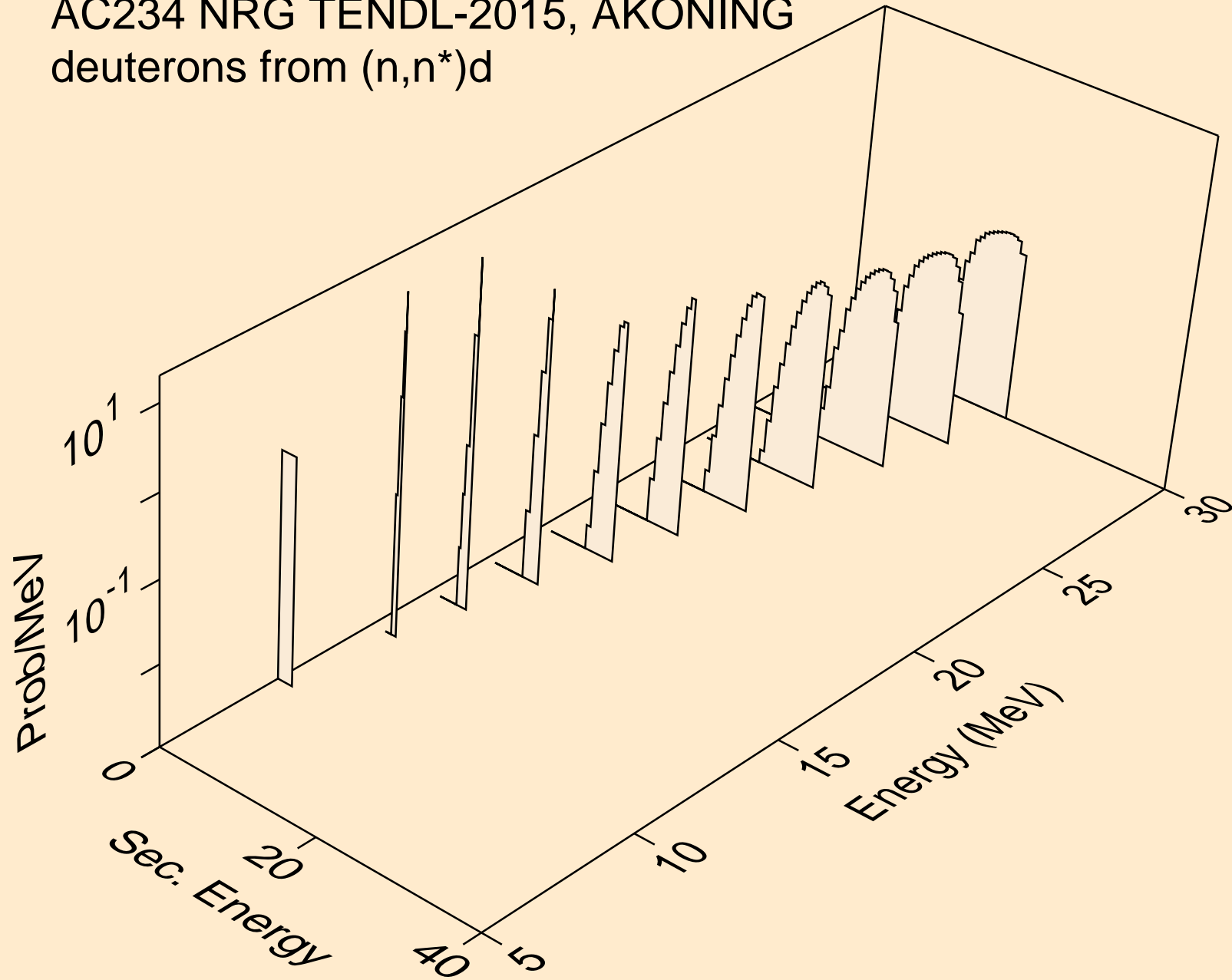

AC234 NRG TENDL-2015, AKONING
deuterons from (n,d)

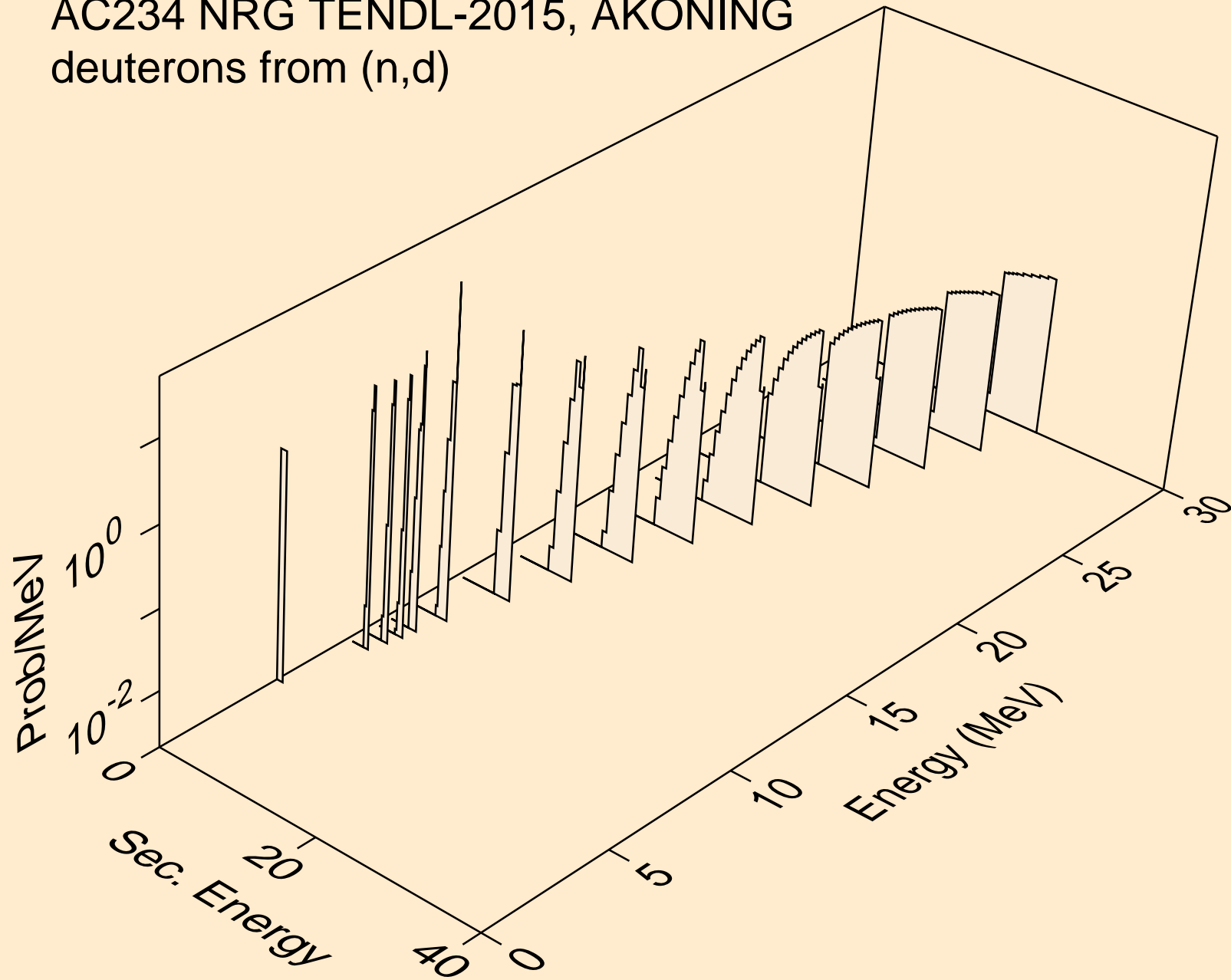

AC234 NRG TENDL-2015, AKONING
tritons from (n,x)

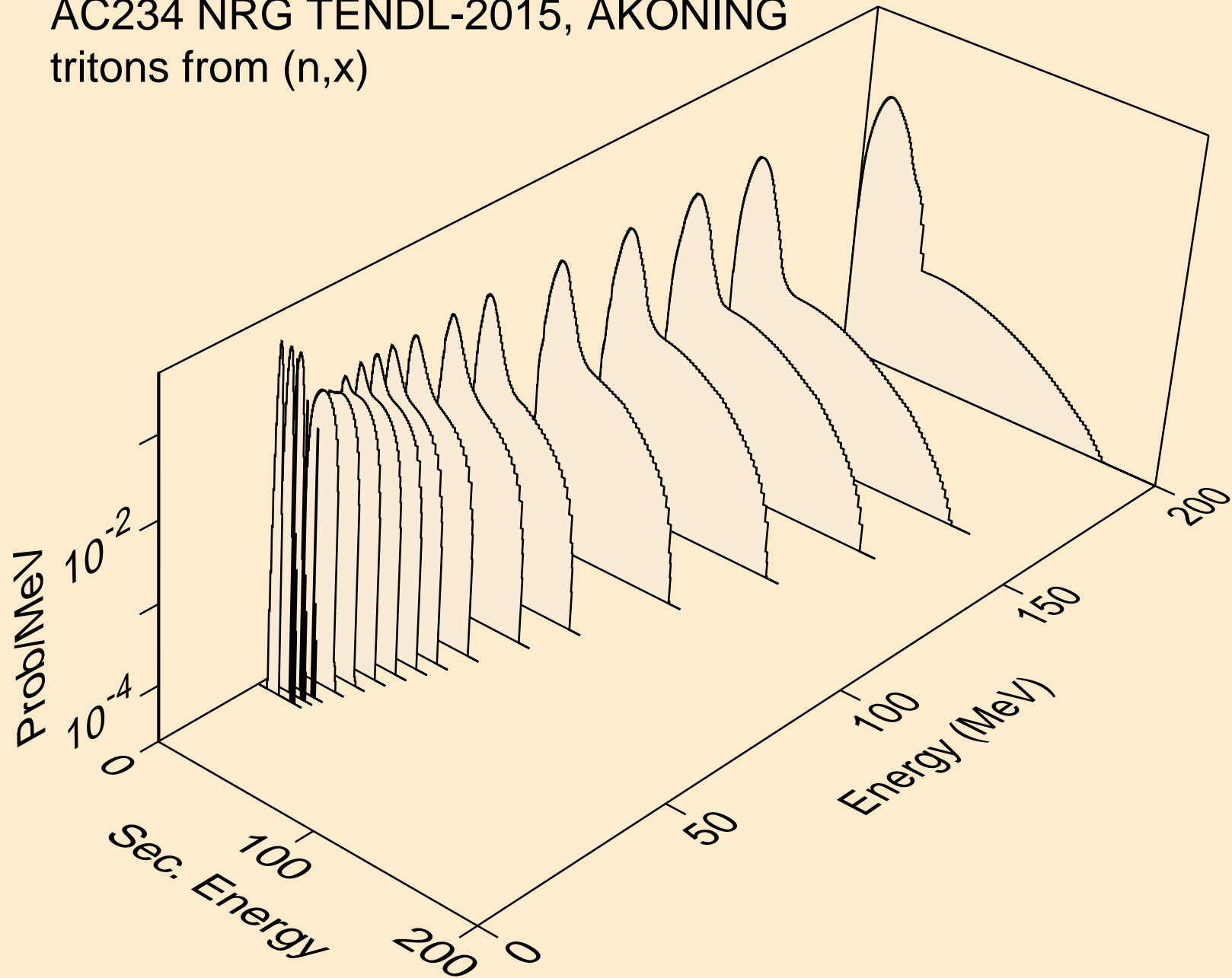

AC234 NRG TENDL-2015, AKONING
tritons from (n,n*)t

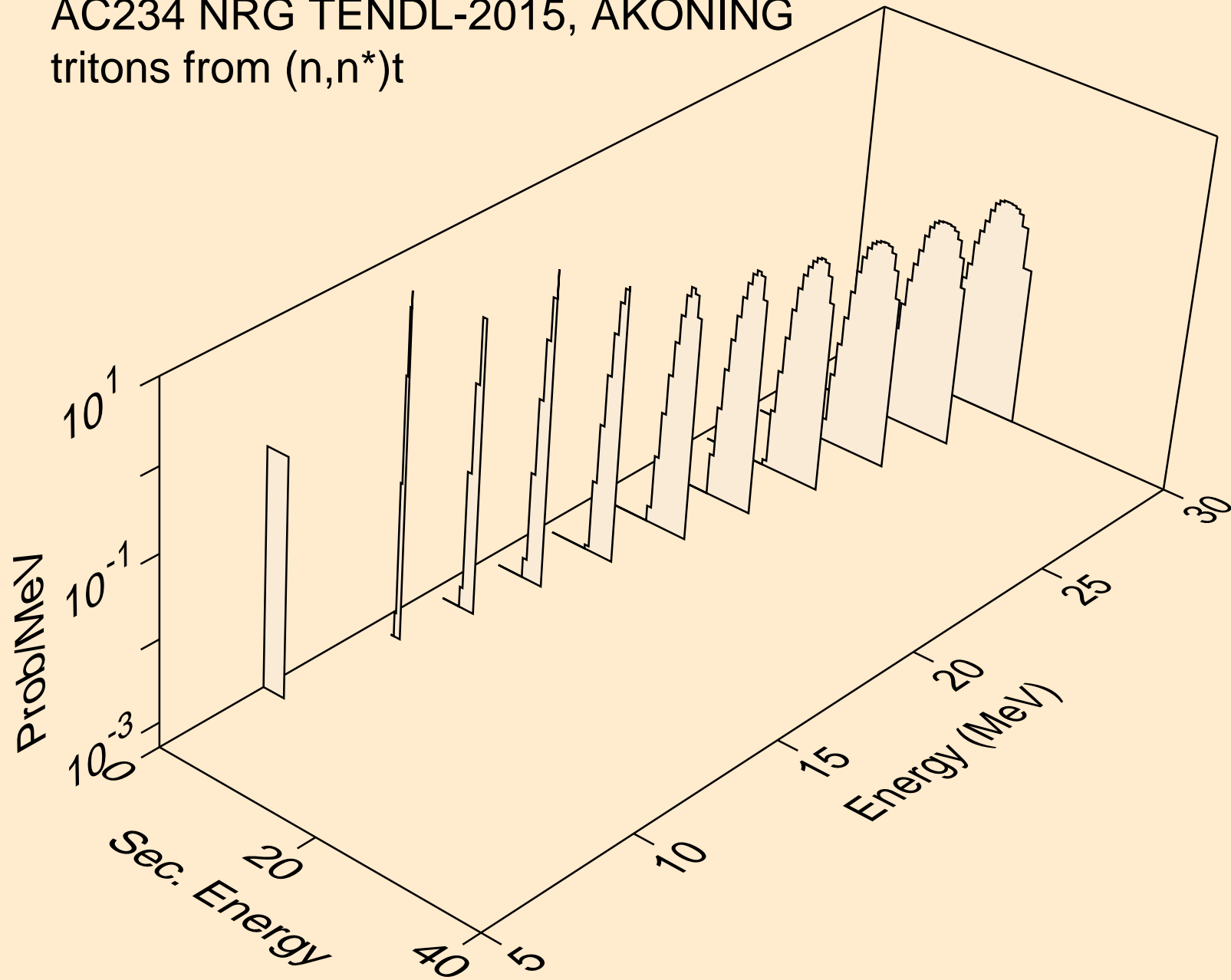

AC234 NRG TENDL-2015, AKONING
tritons from (n,t)

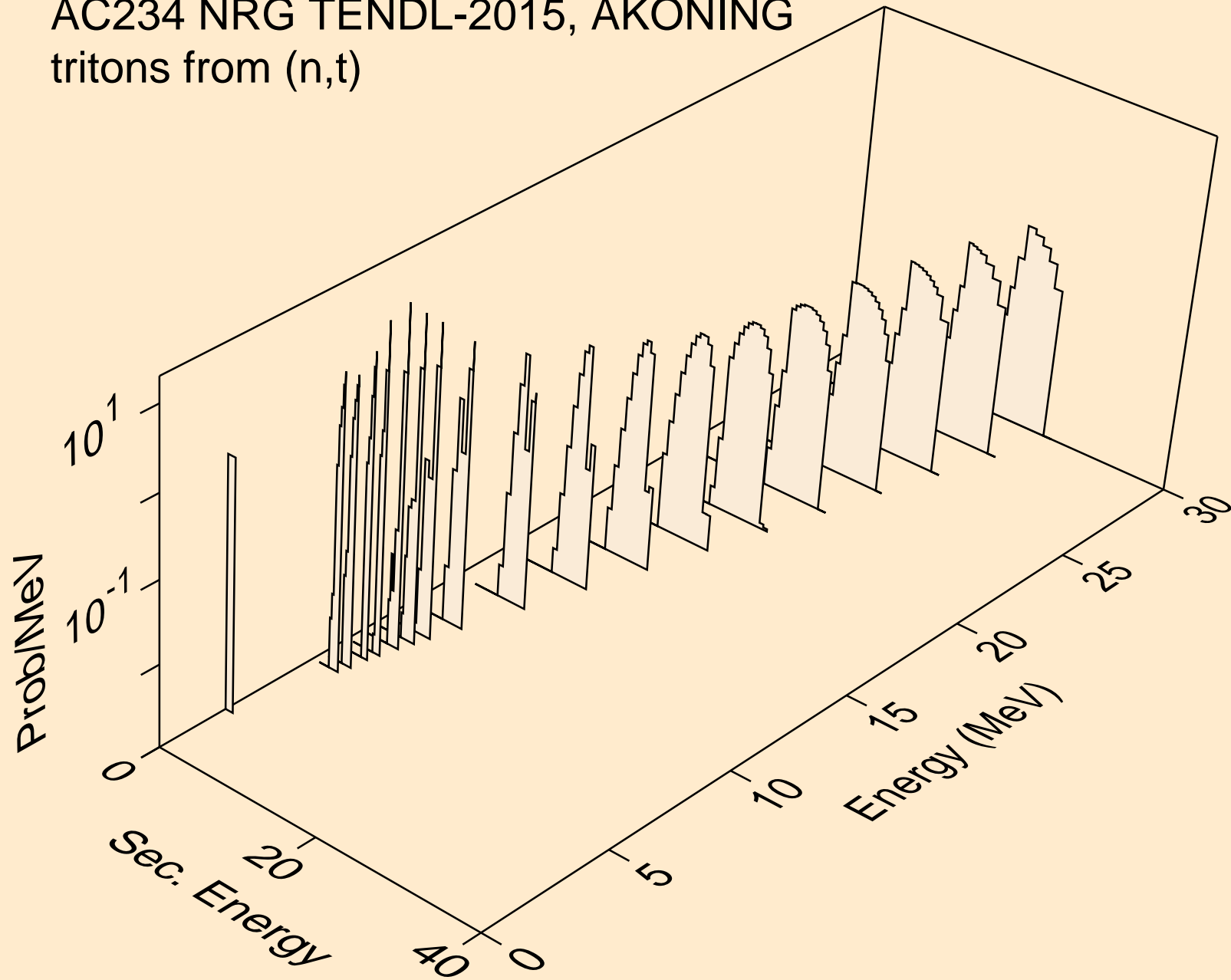

AC234 NRG TENDL-2015, AKONING
he3s from (n,x)

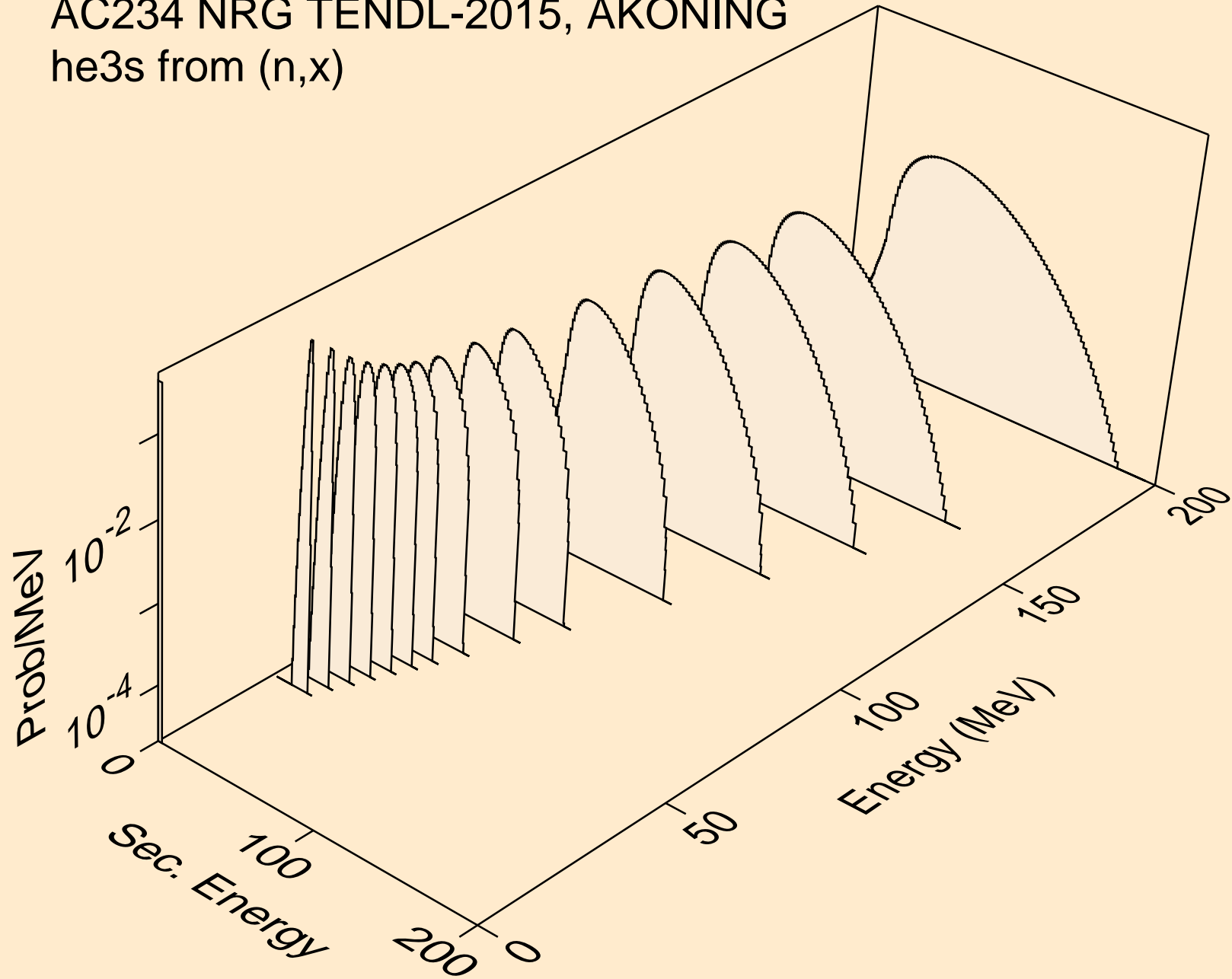

AC234 NRG TENDL-2015, AKONING
he3s from (n,n*)he3

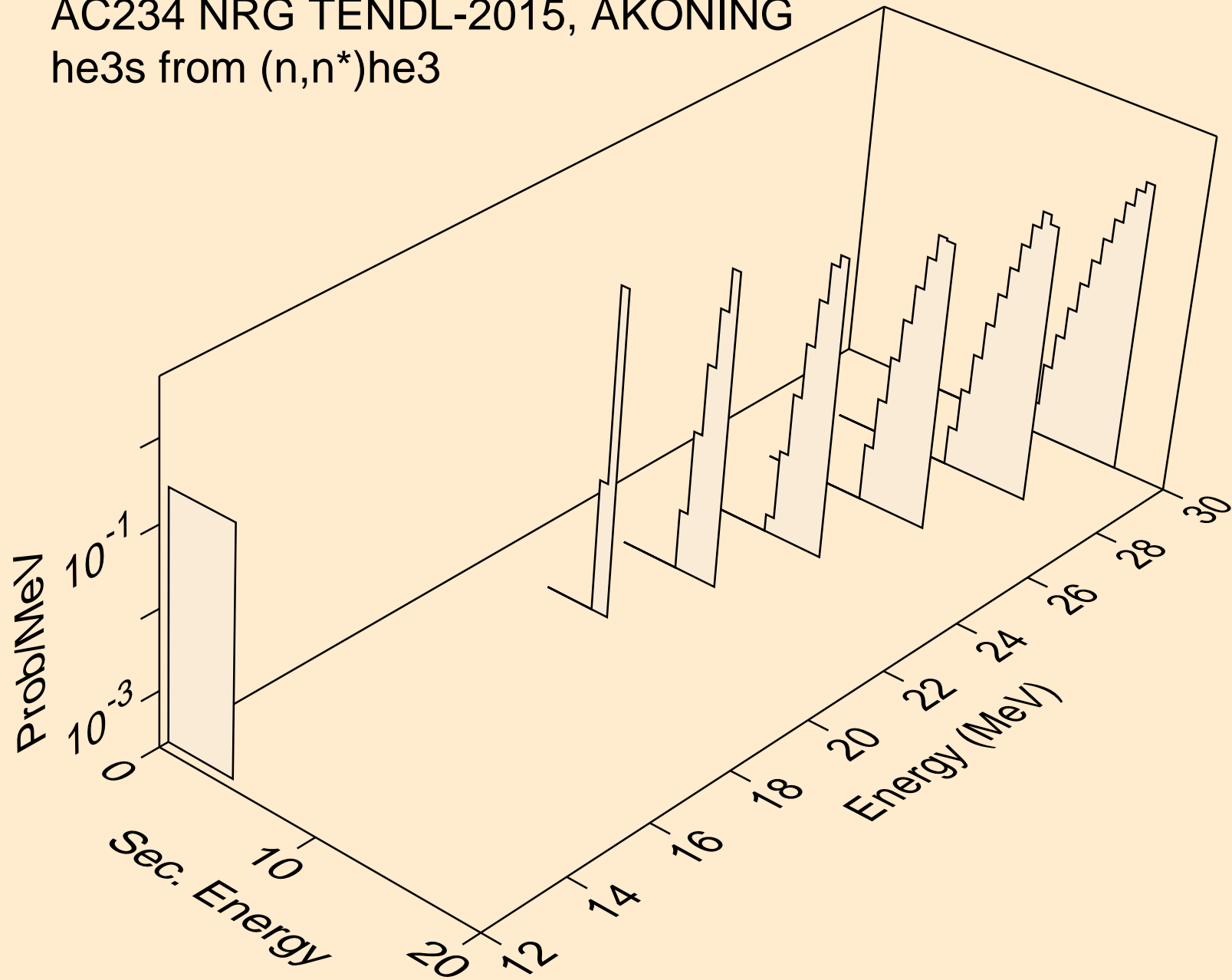

AC234 NRG TENDL-2015, AKONING
he3s from (n,he3)

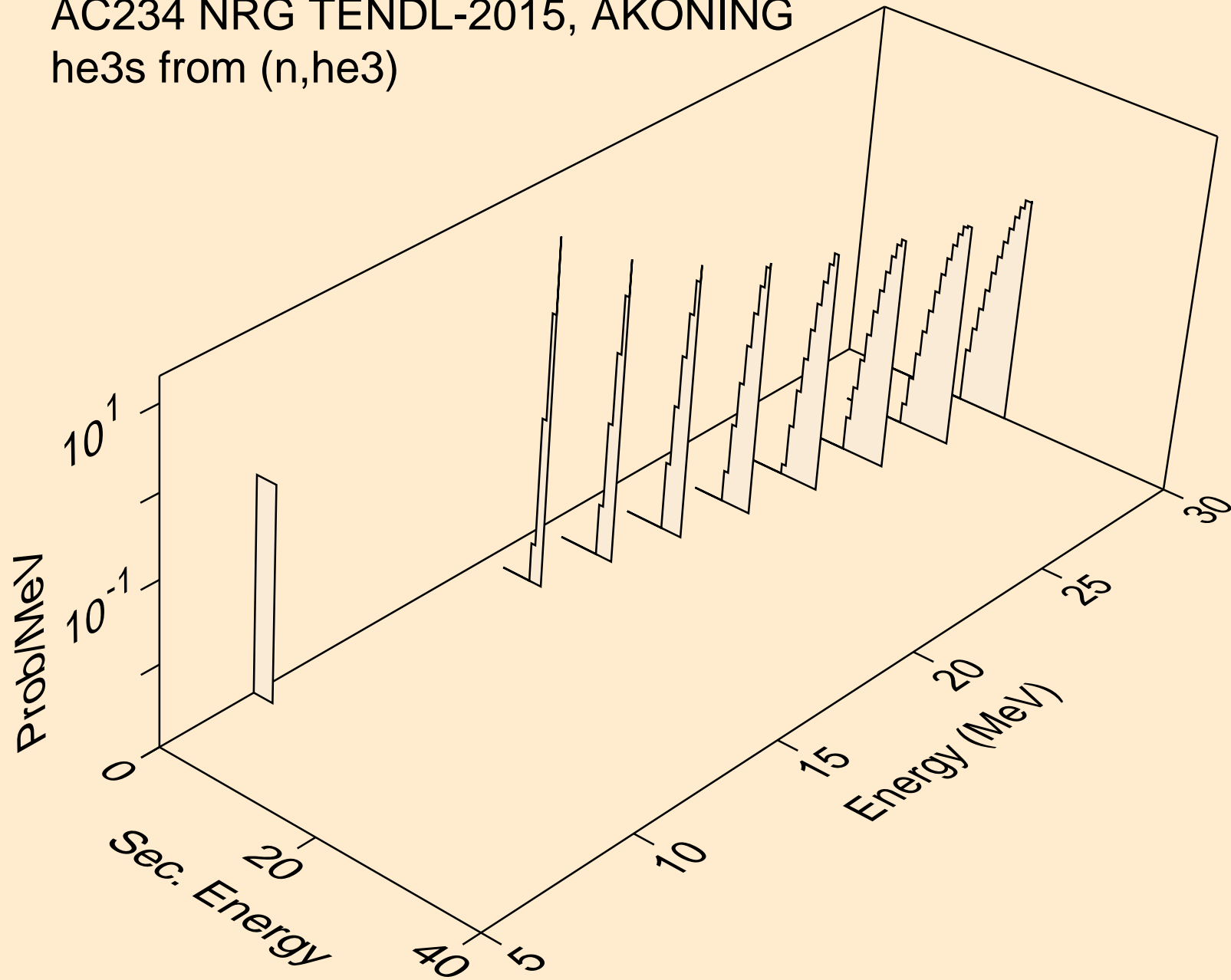

AC234 NRG TENDL-2015, AKONING
alphas from (n,x)

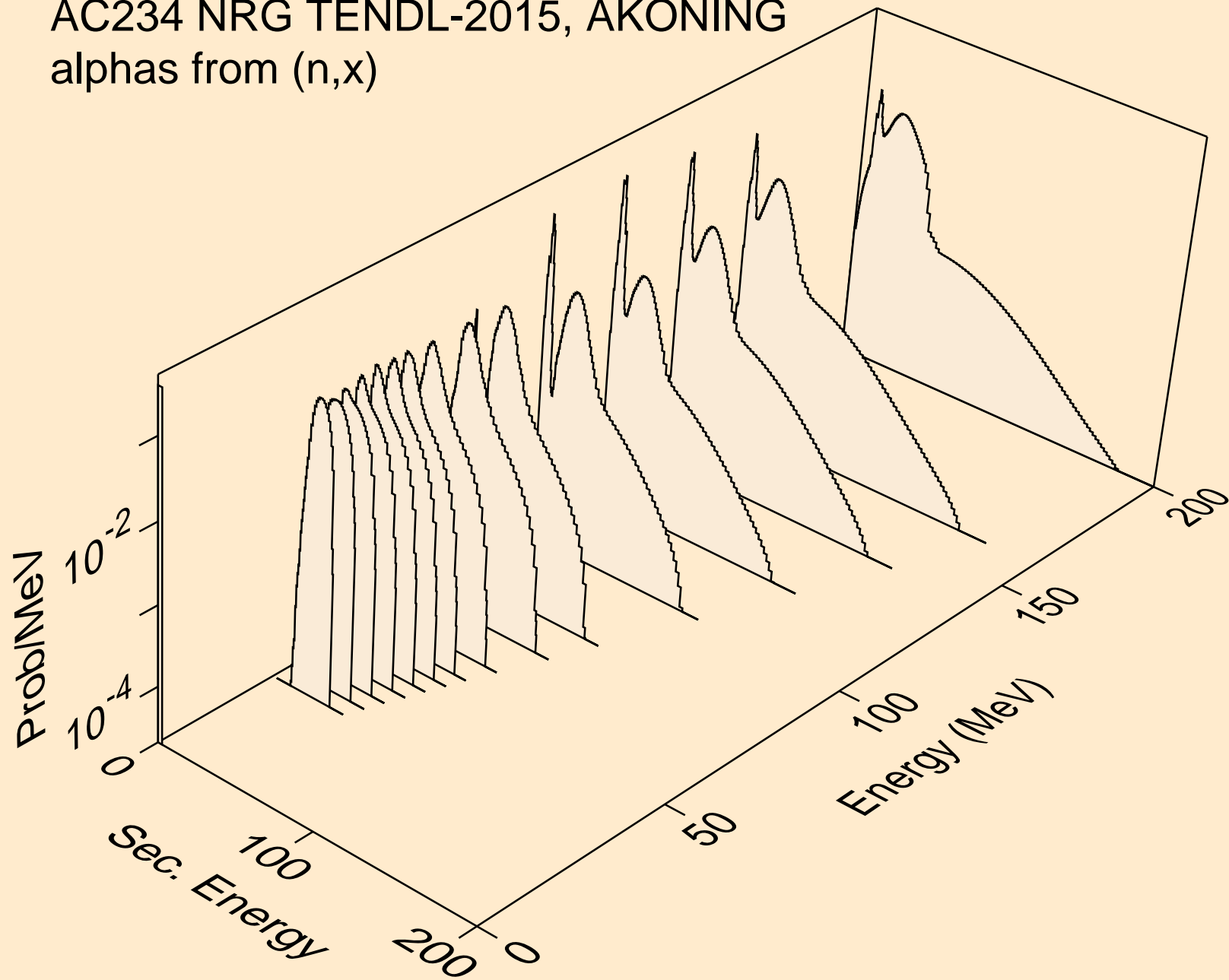

AC234 NRG TENDL-2015, AKONING
alphas from (n,n*)a

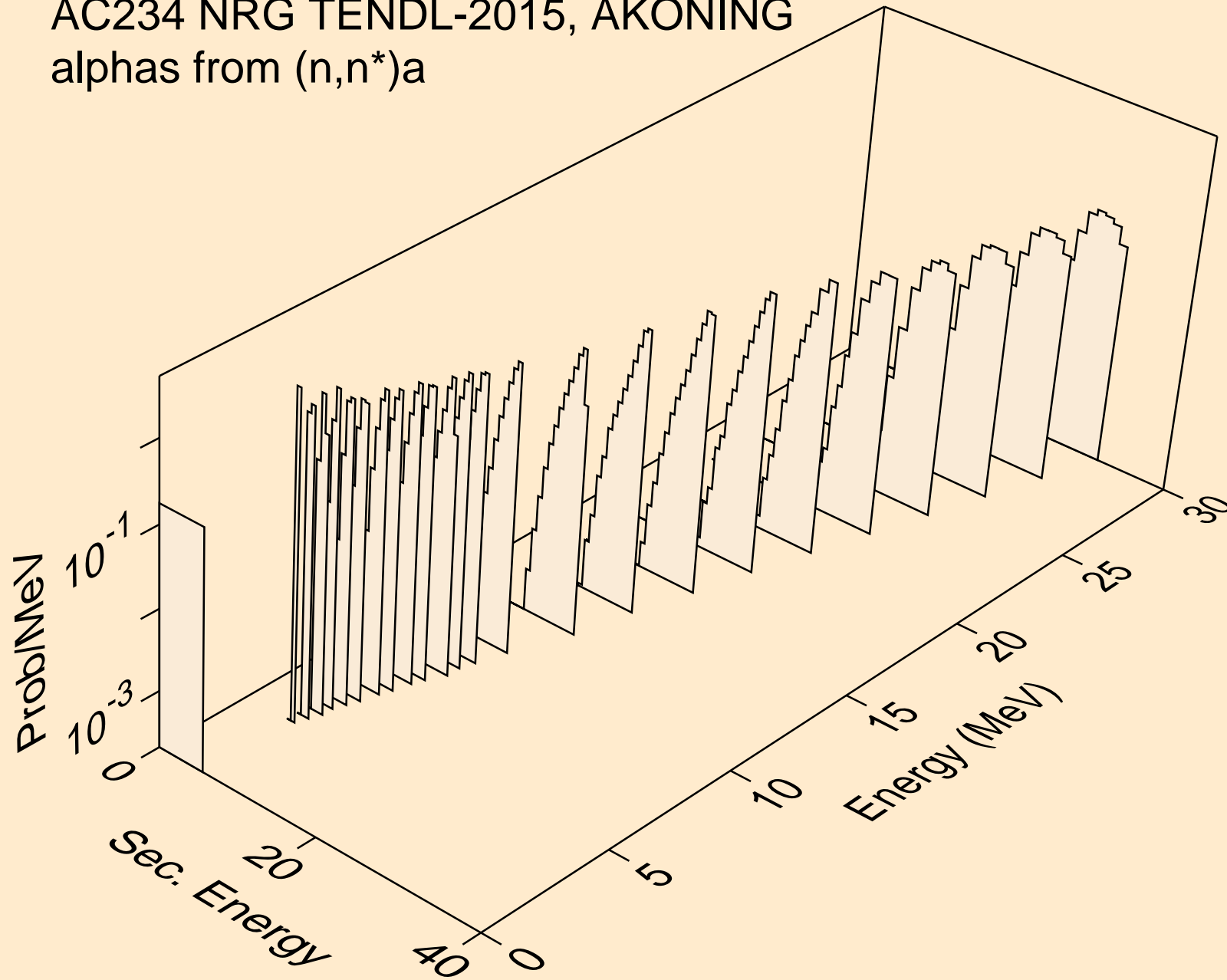

AC234 NRG TENDL-2015, AKONING
alphas from (n,2n)a

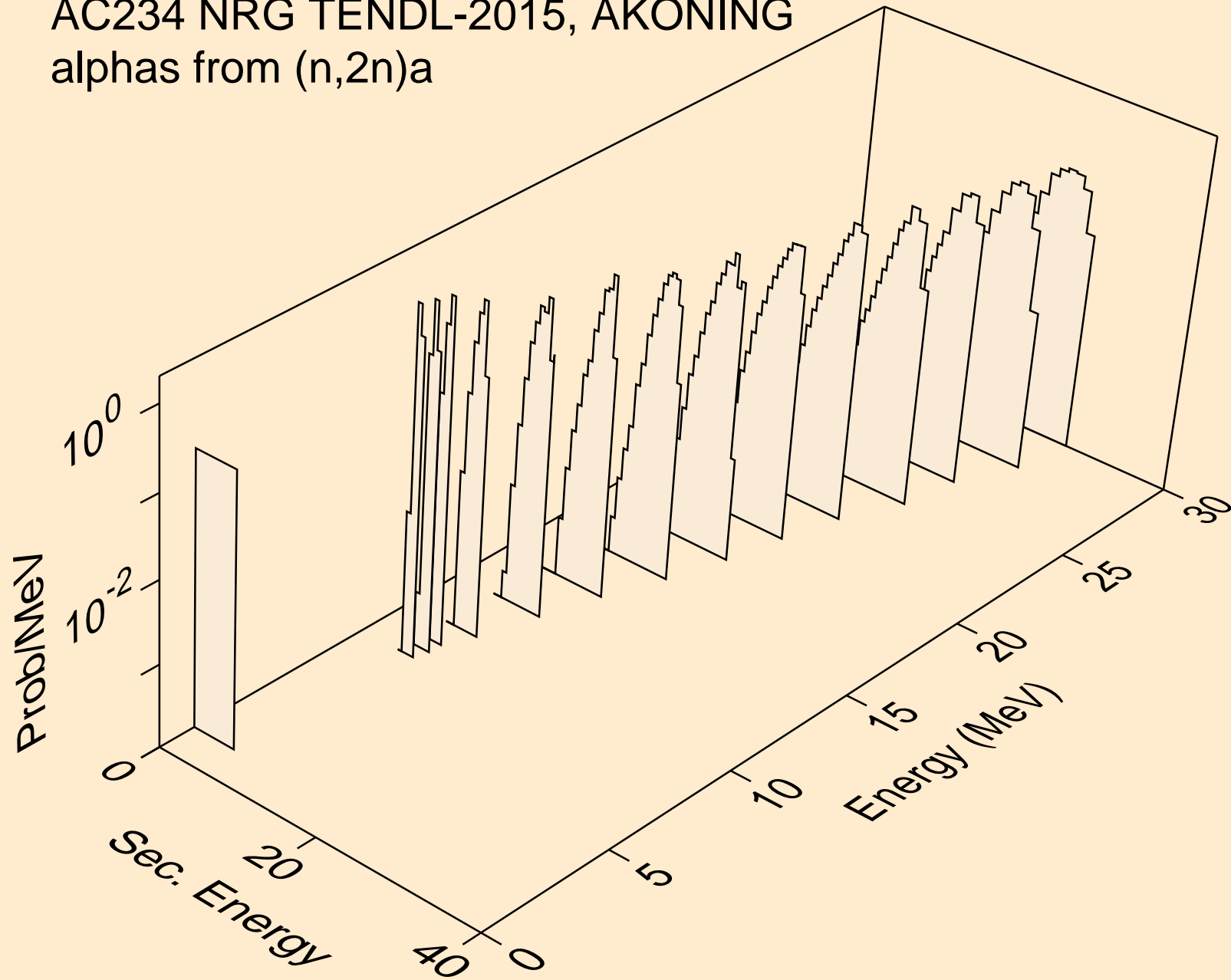

AC234 NRG TENDL-2015, AKONING
alphas from (n,3n)a

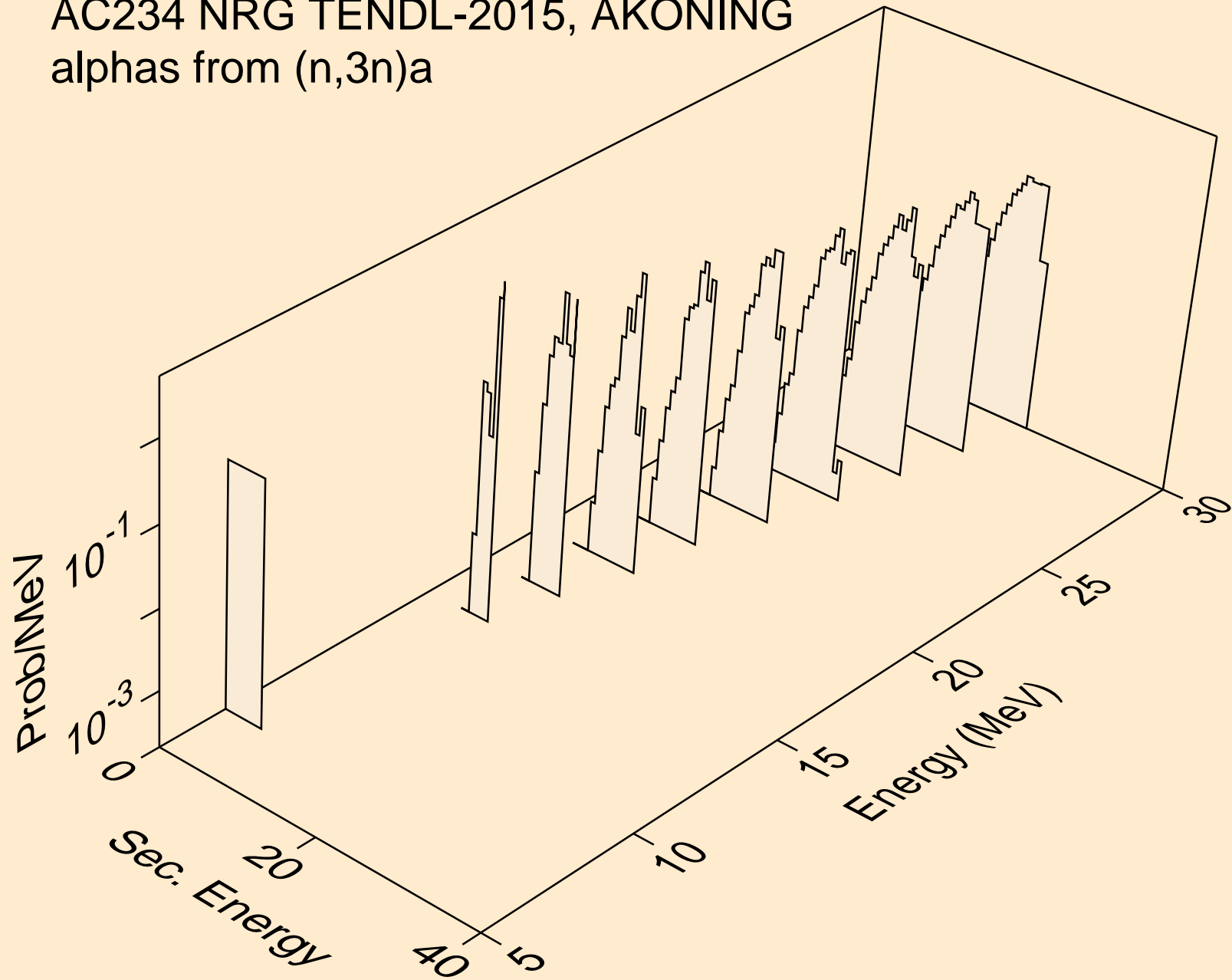

AC234 NRG TENDL-2015, AKONING
alphas from (n,a)

