

AG111M NRG TENDL-2015, AKONING

Principal cross sections

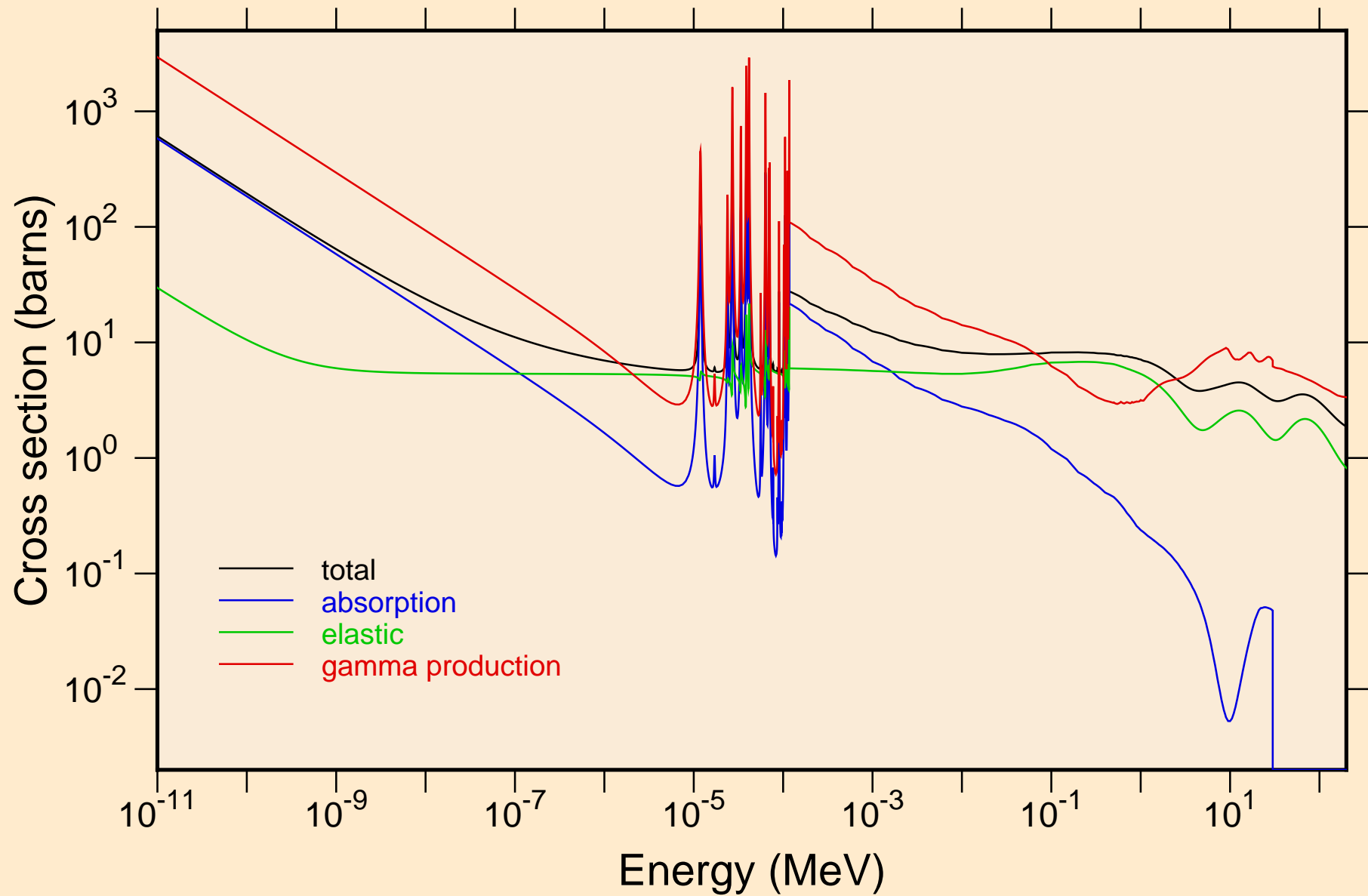

AG111M NRG TENDL-2015, AKONING
Non-threshold reactions

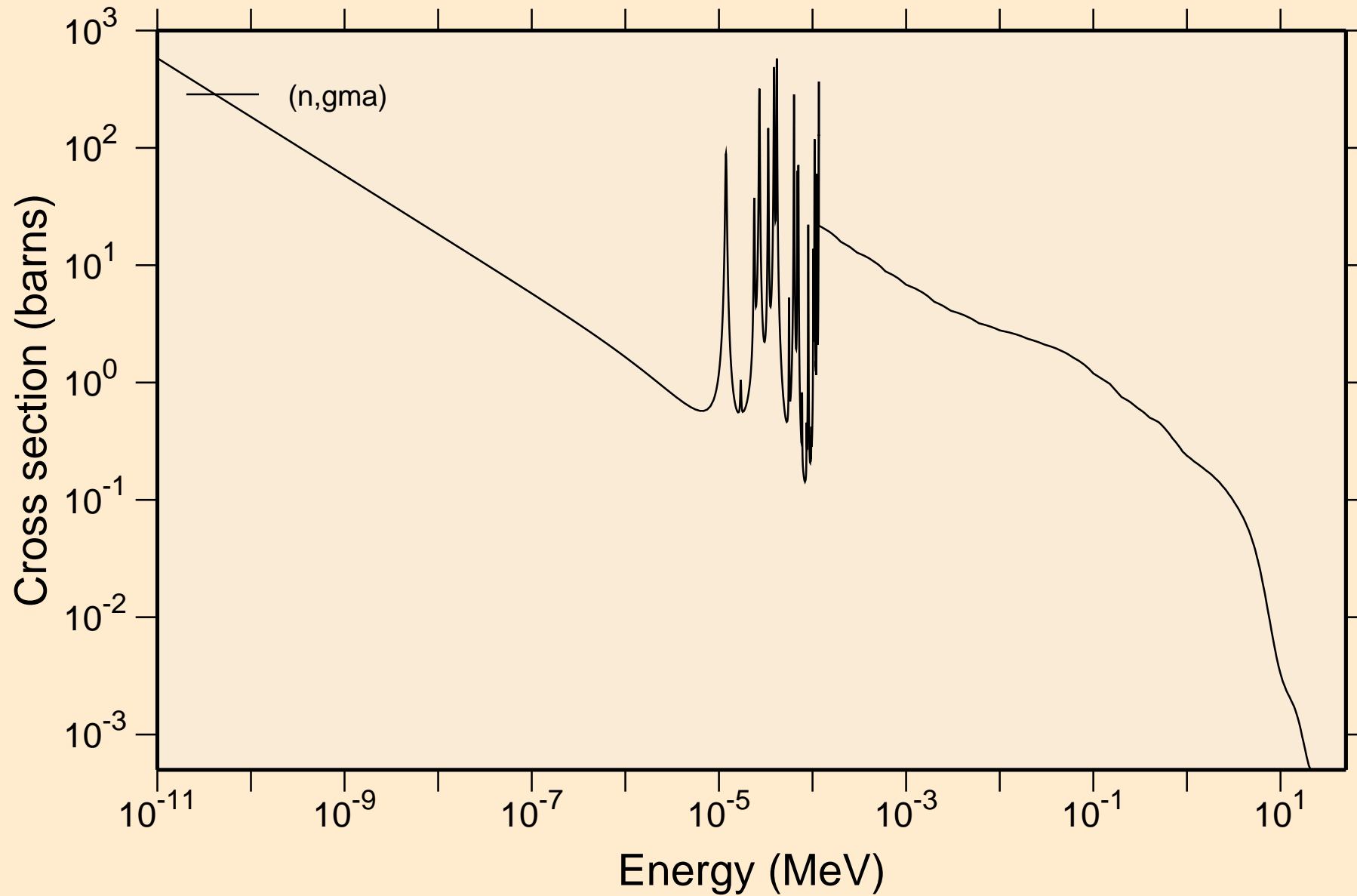

AG111M NRG TENDL-2015, AKONING

Principal cross sections

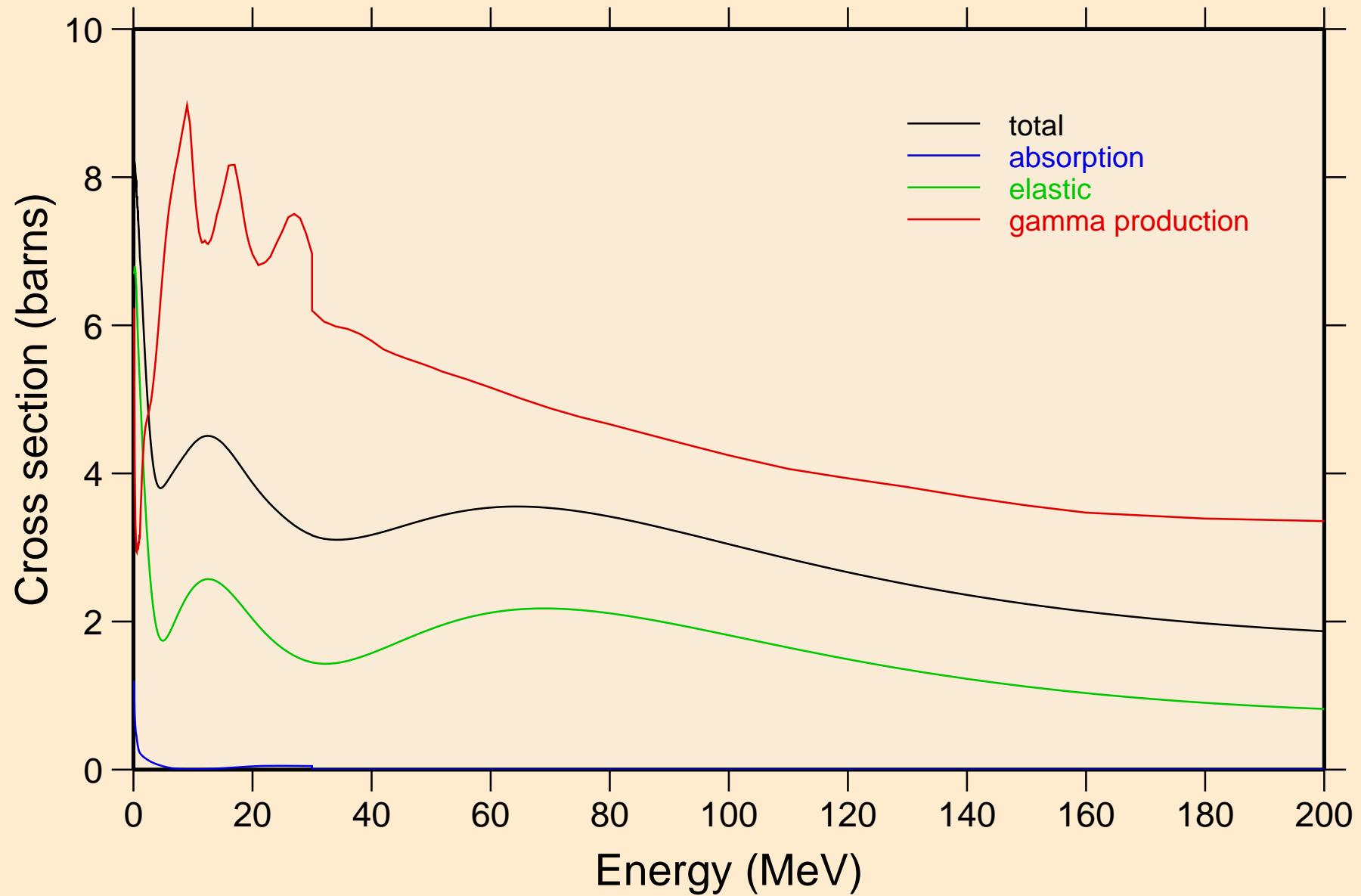

AG111M NRG TENDL-2015, AKONING
Non-threshold reactions

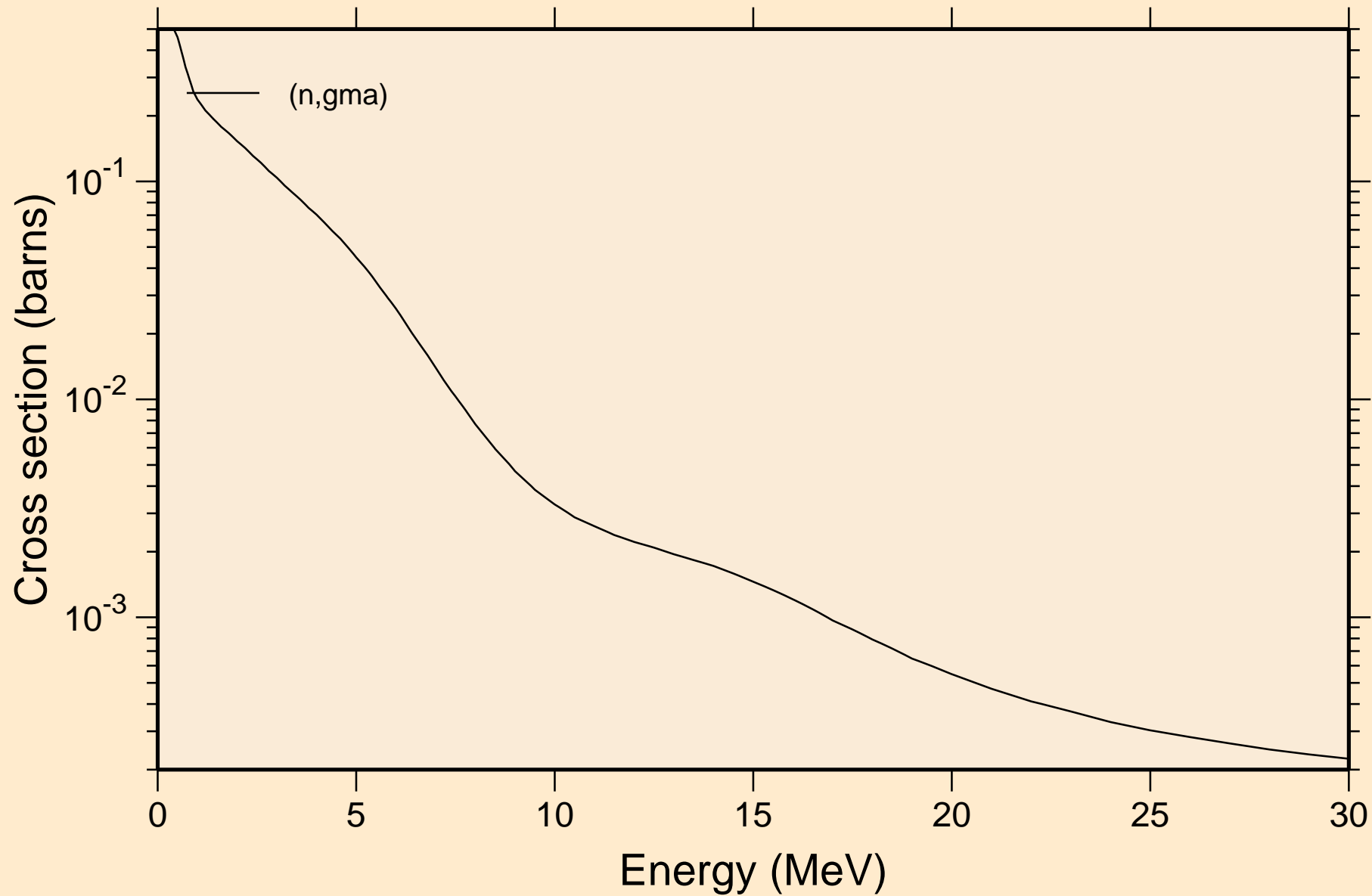

AG111M NRG TENDL-2015, AKONING

Inelastic levels

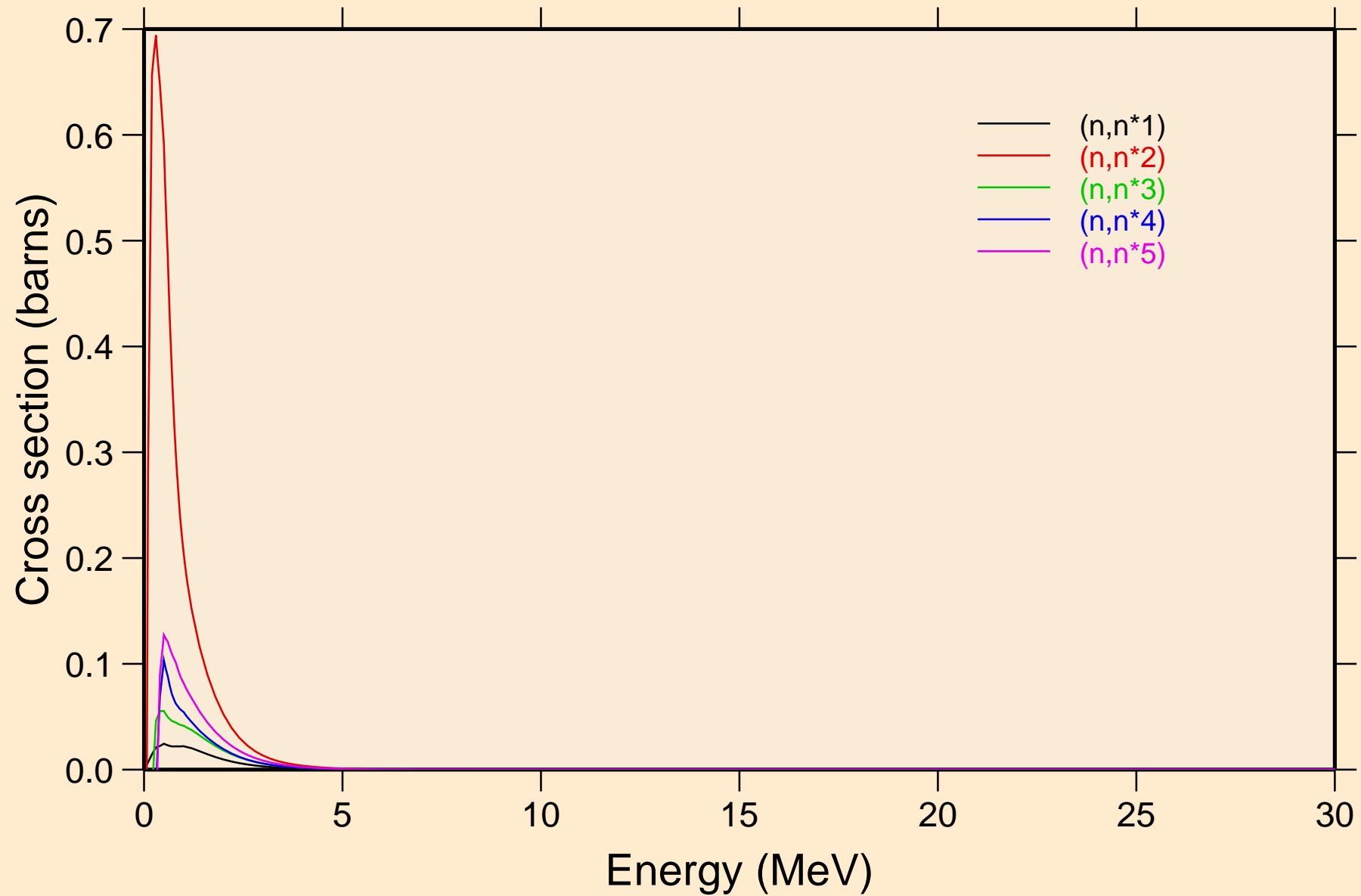

AG111M NRG TENDL-2015, AKONING

Inelastic levels

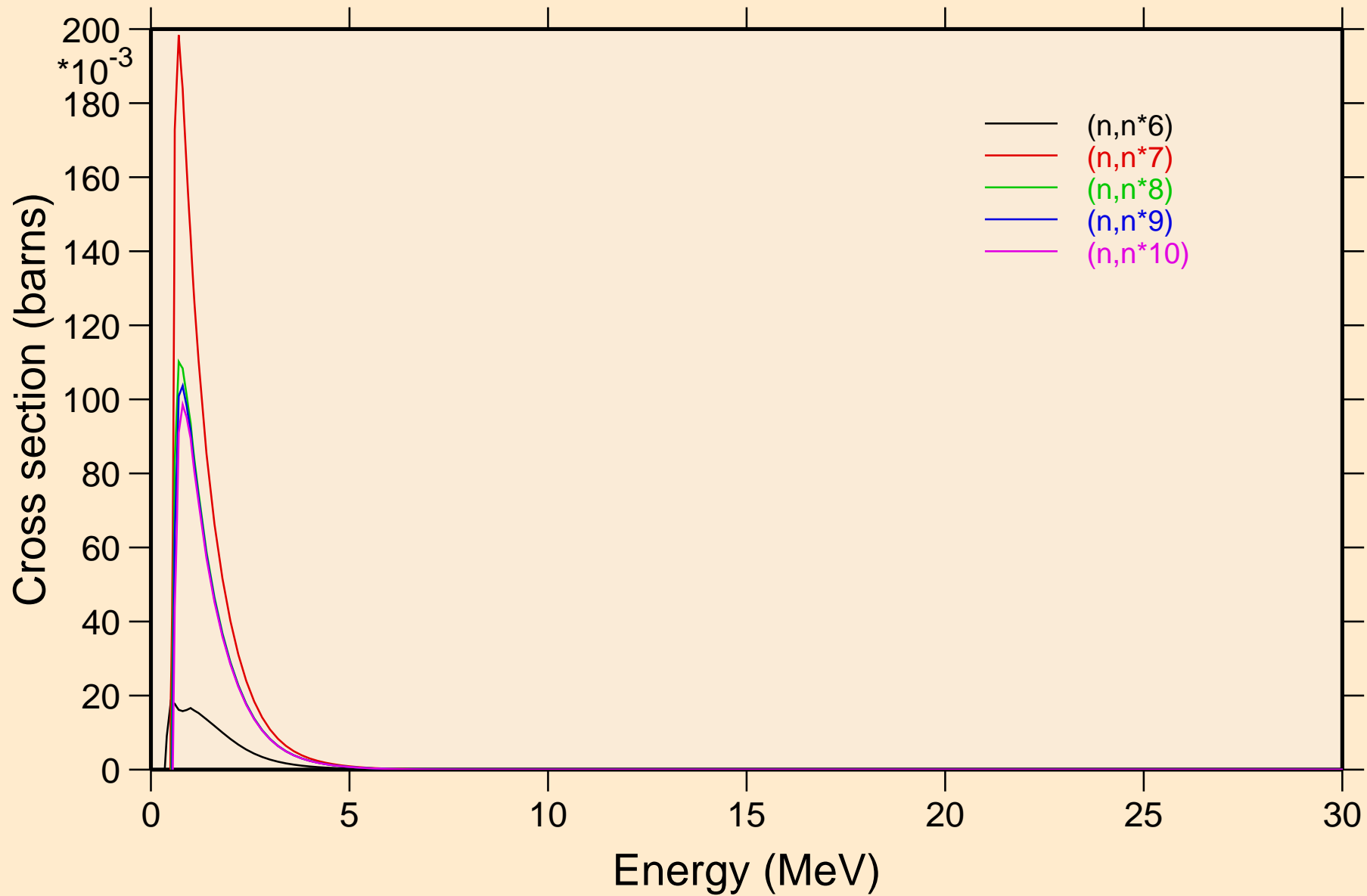

AG111M NRG TENDL-2015, AKONING

Inelastic levels

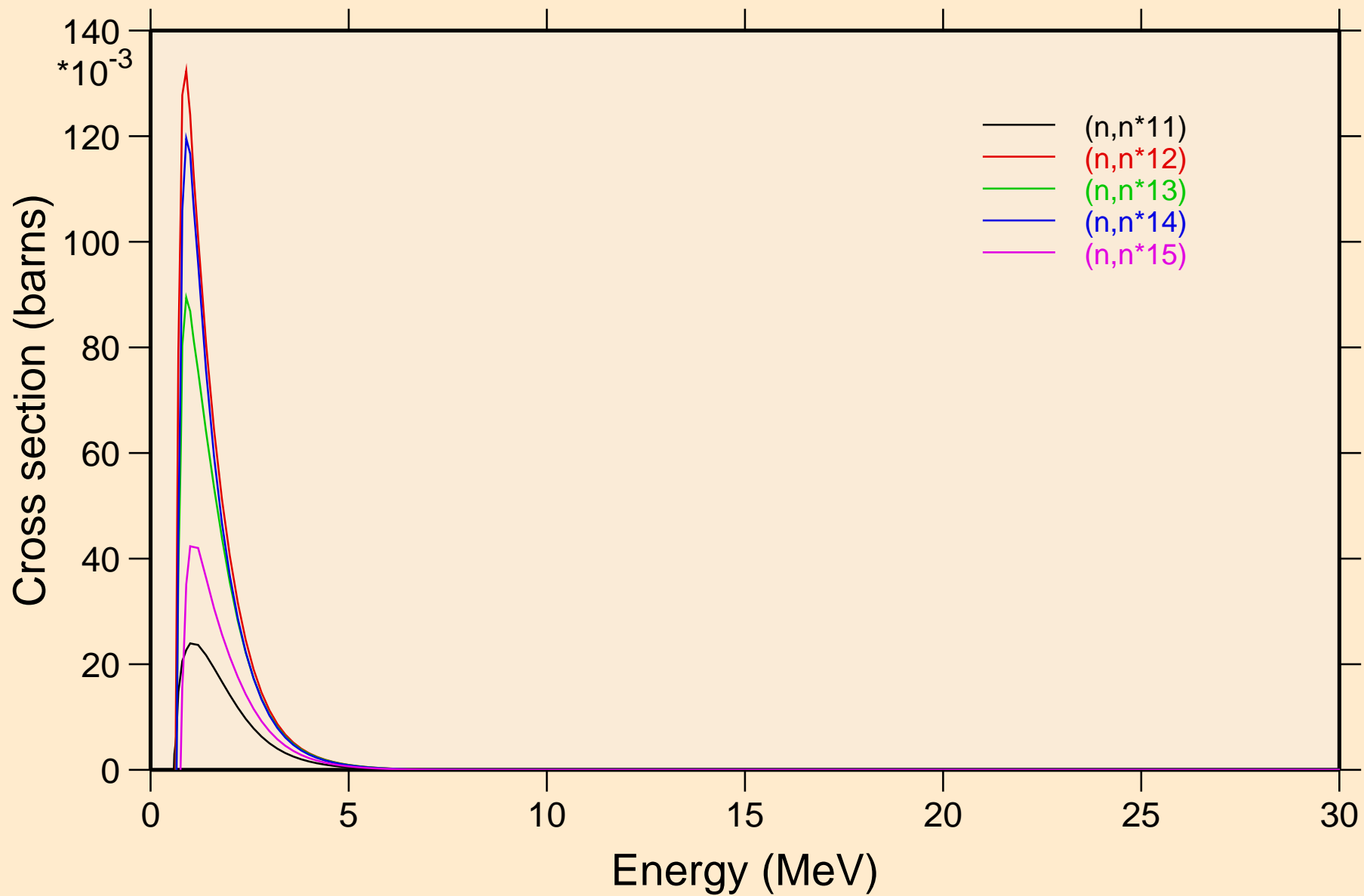

AG111M NRG TENDL-2015, AKONING

Inelastic levels

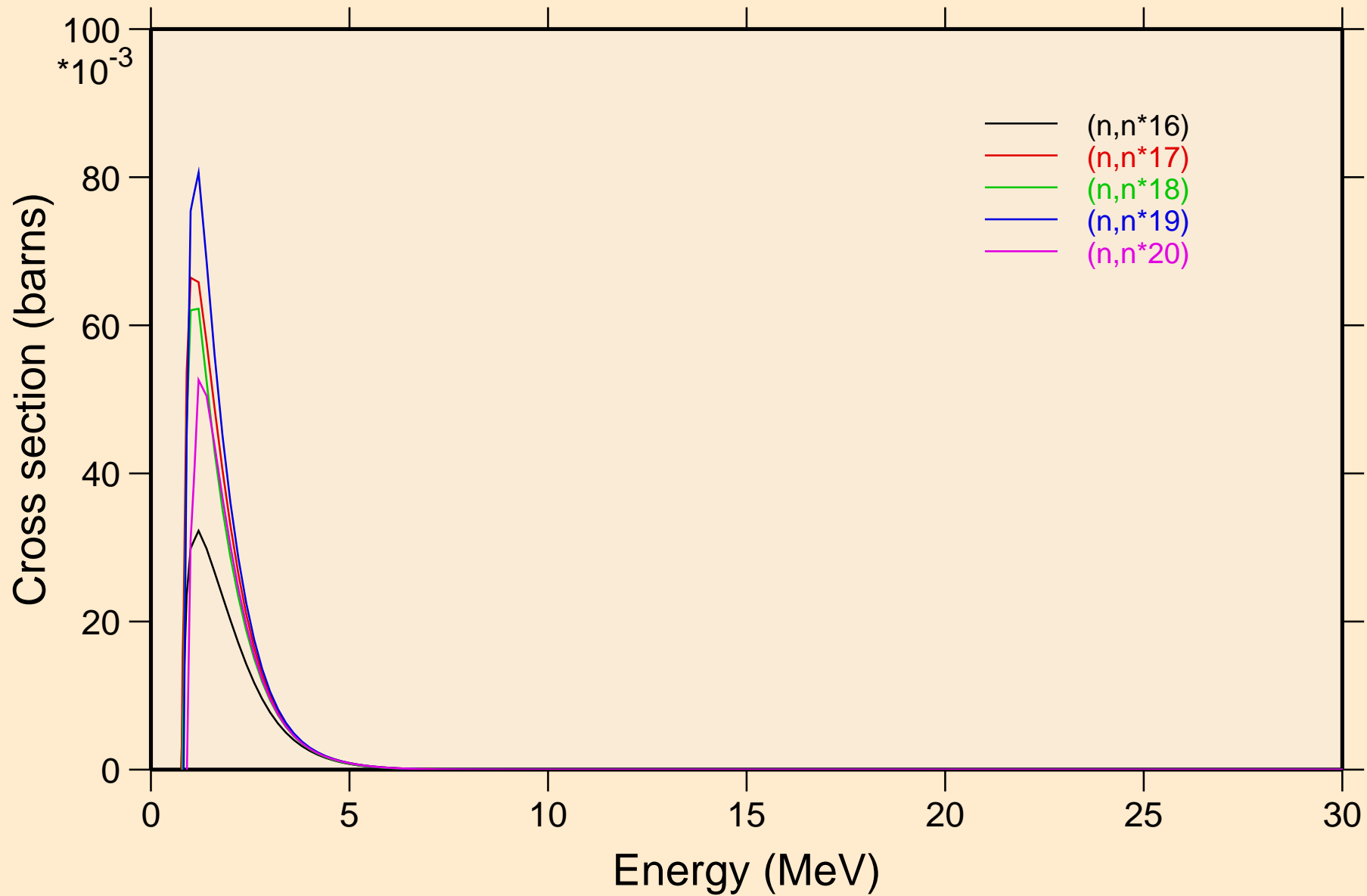

AG111M NRG TENDL-2015, AKONING

Inelastic levels

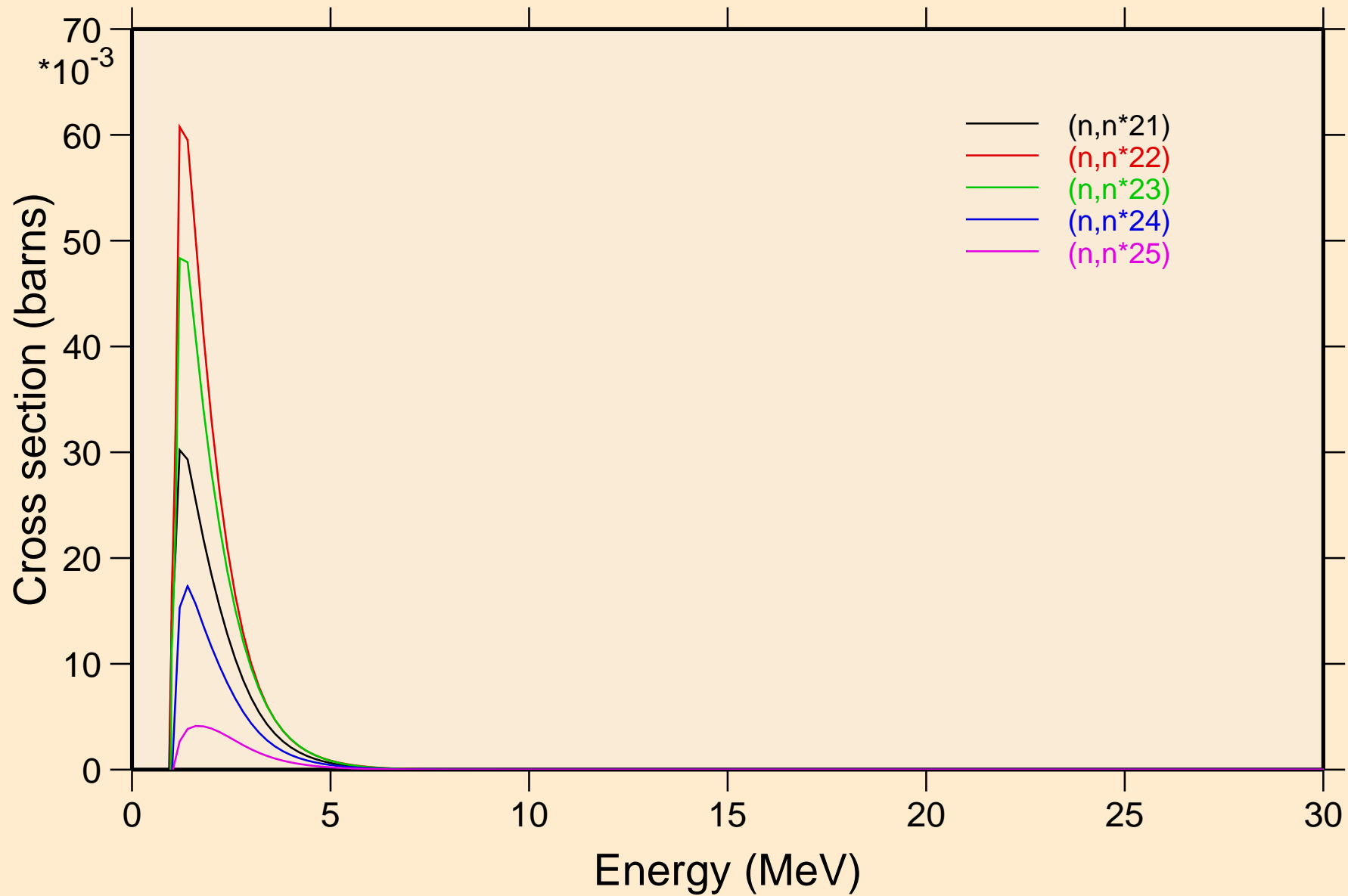

AG111M NRG TENDL-2015, AKONING

Inelastic levels

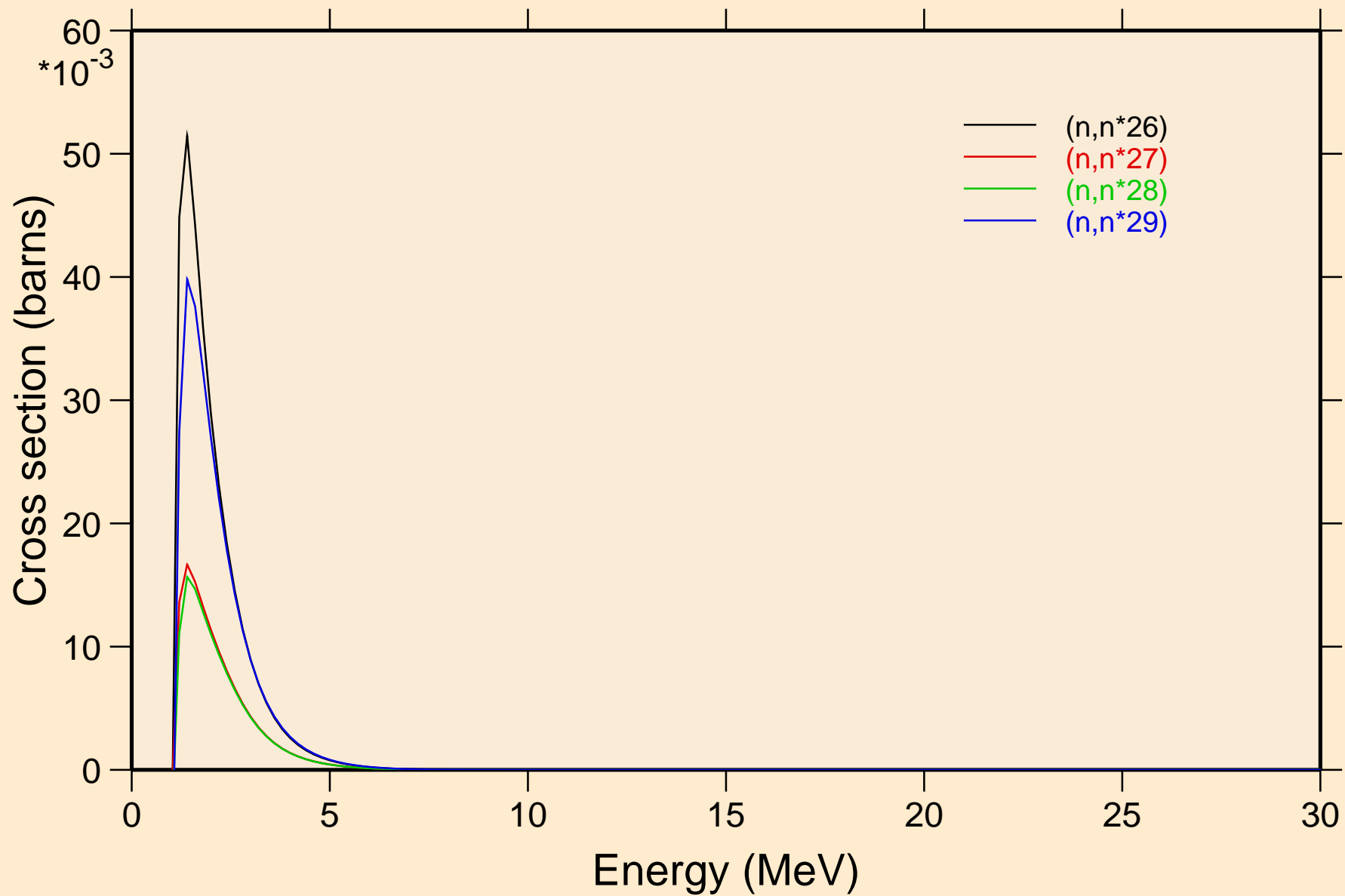

AG111M NRG TENDL-2015, AKONING

Threshold reactions

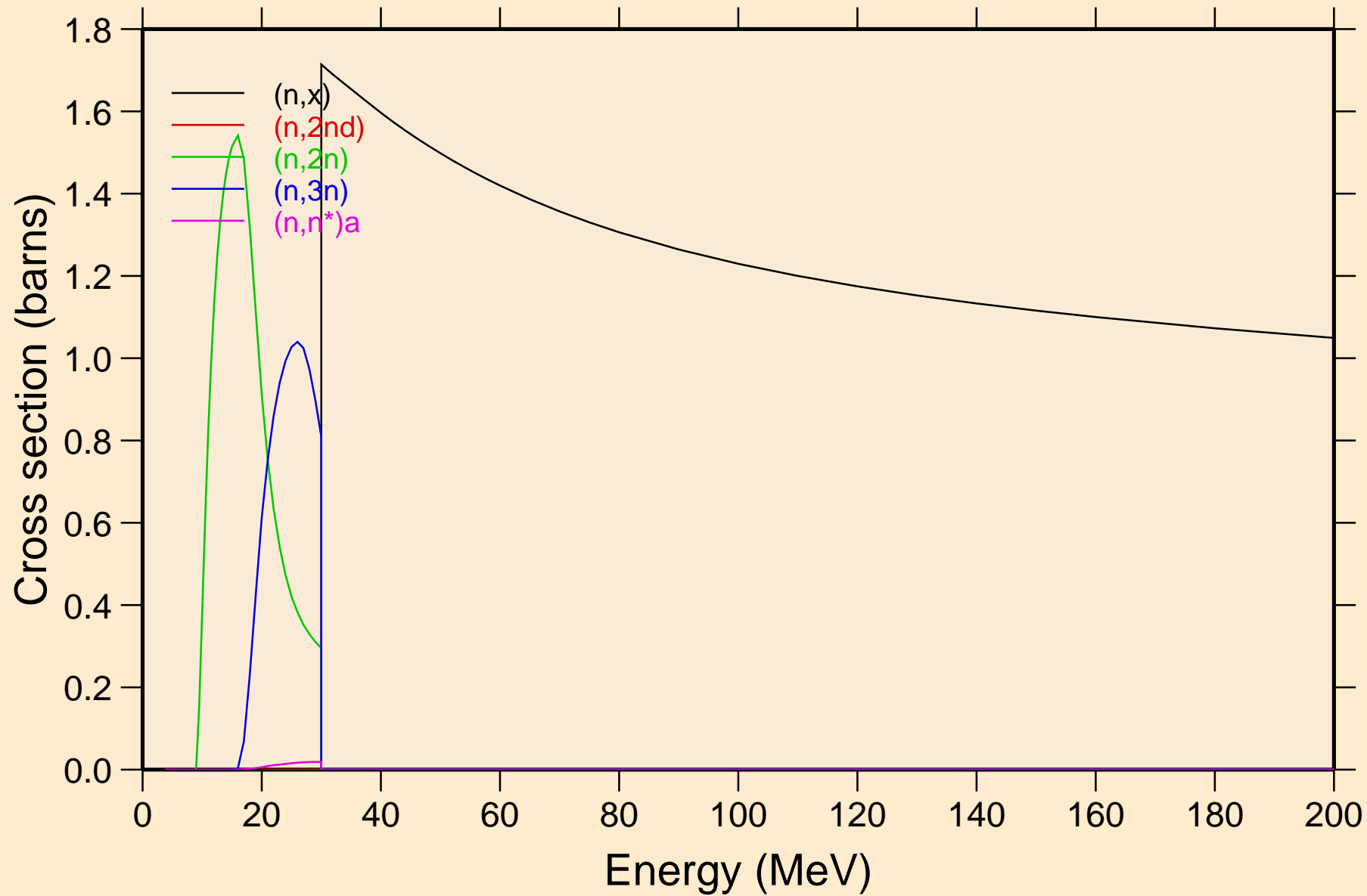

AG111M NRG TENDL-2015, AKONING

Threshold reactions

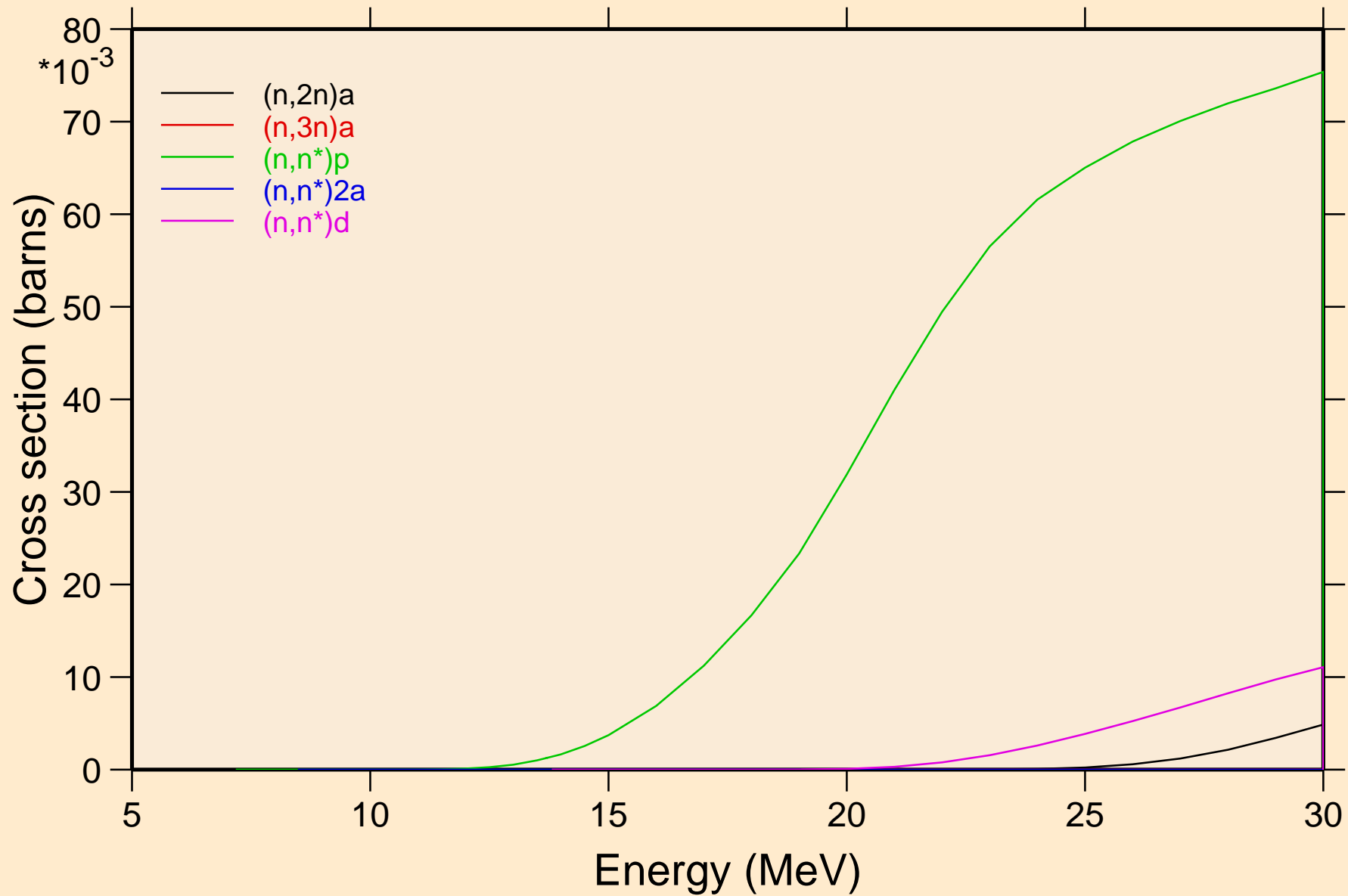

AG111M NRG TENDL-2015, AKONING

Threshold reactions

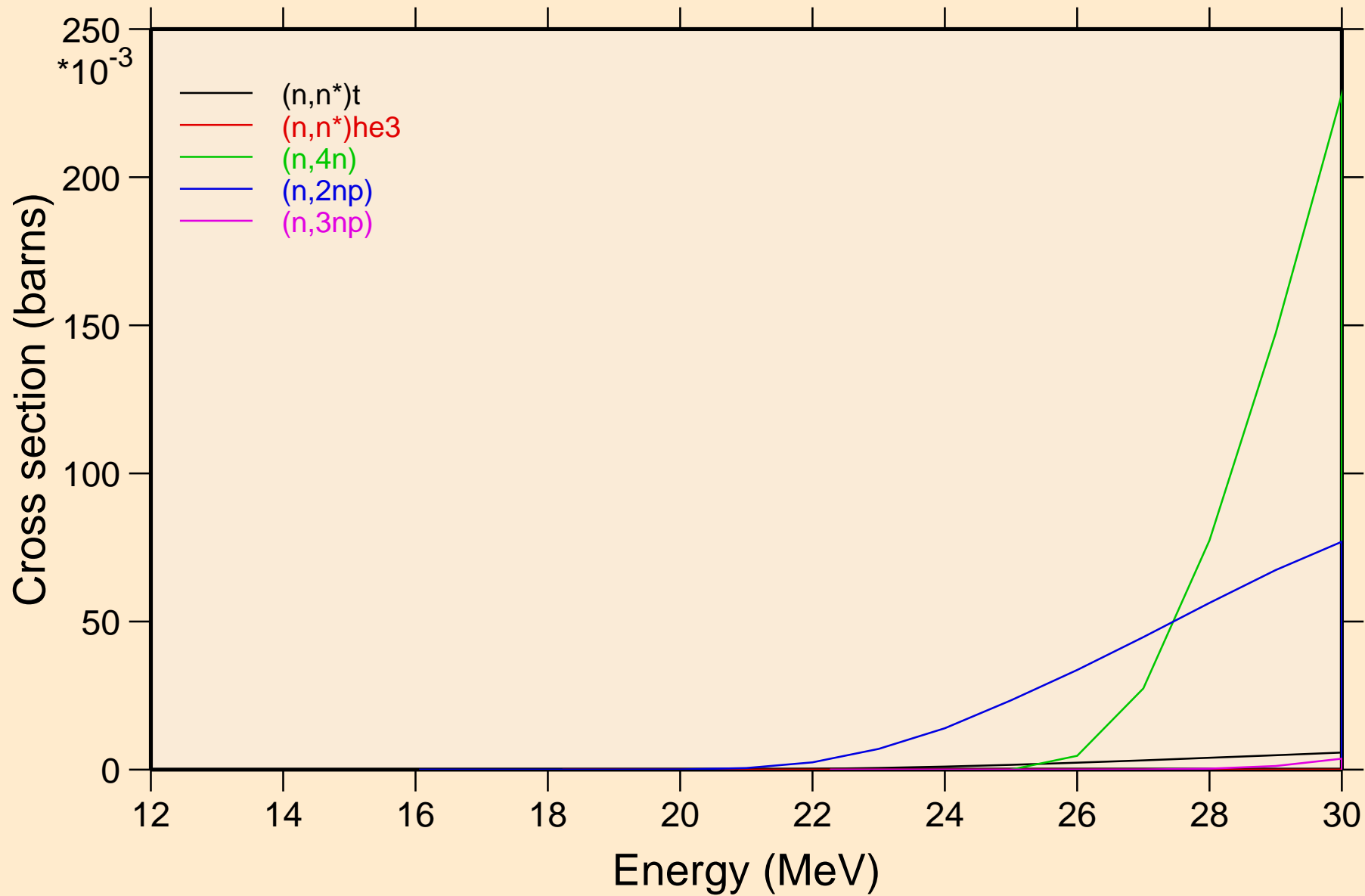

AG111M NRG TENDL-2015, AKONING

Threshold reactions

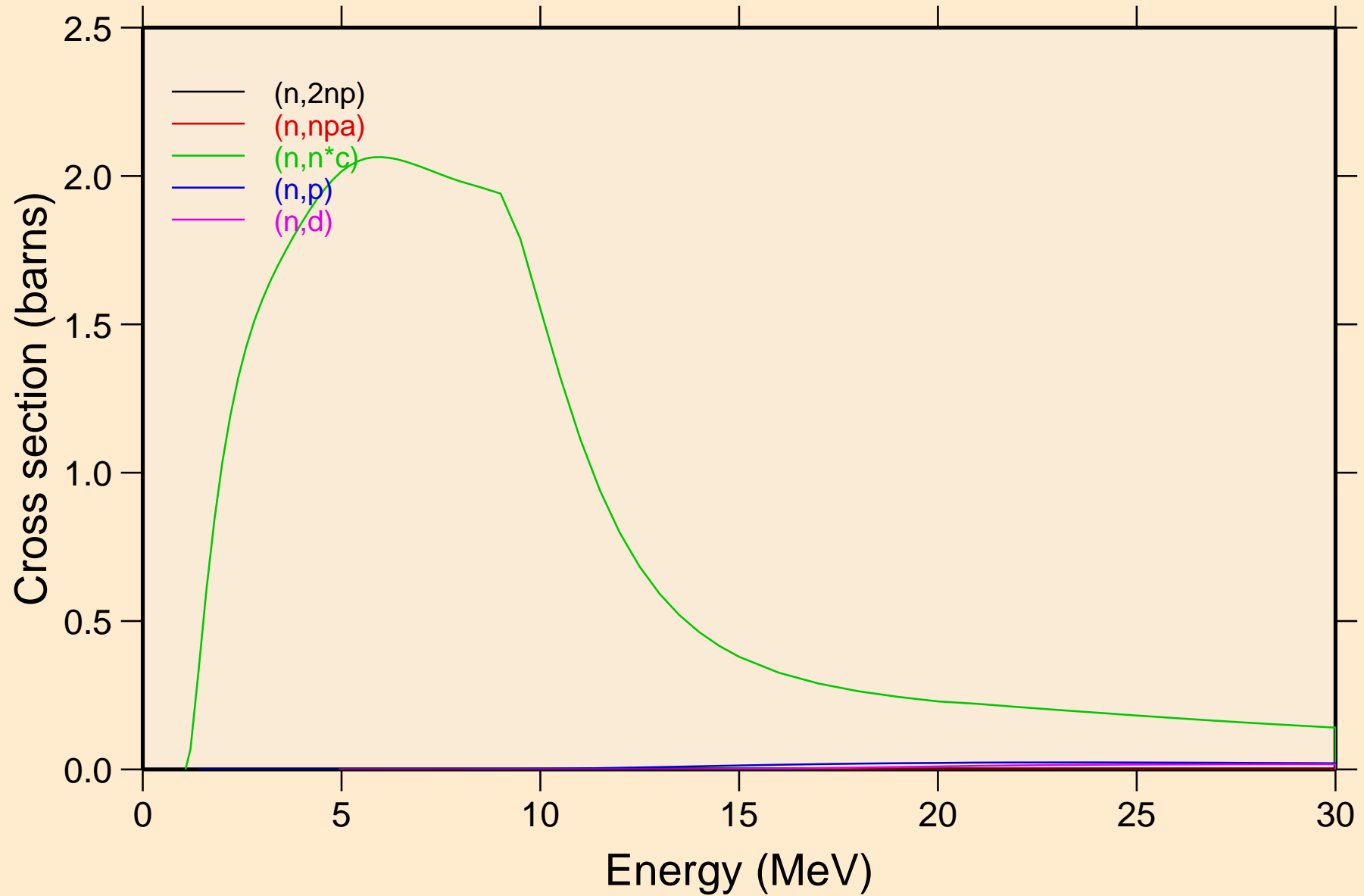

AG111M NRG TENDL-2015, AKONING

Threshold reactions

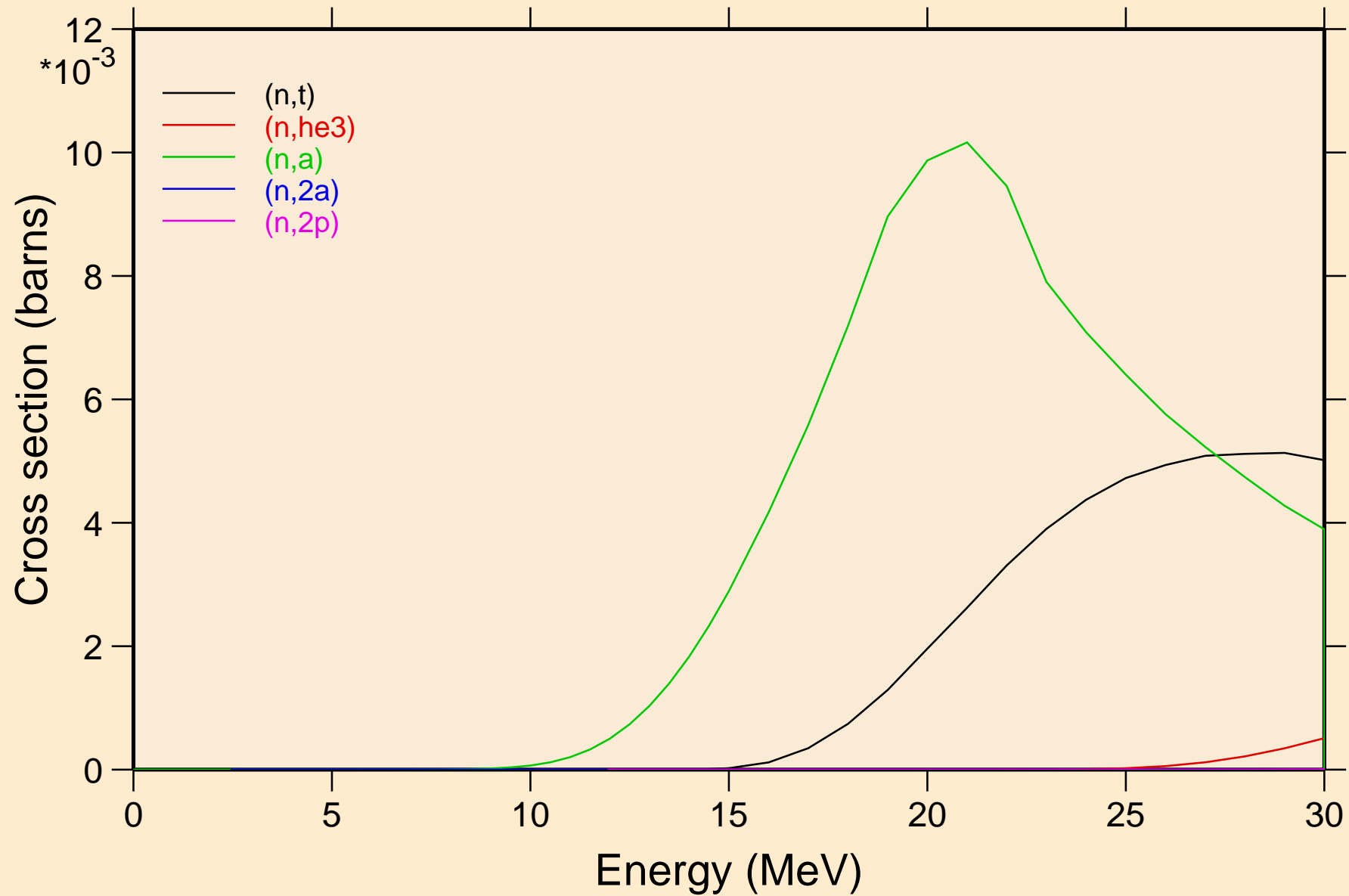

AG111M NRG TENDL-2015, AKONING

Threshold reactions

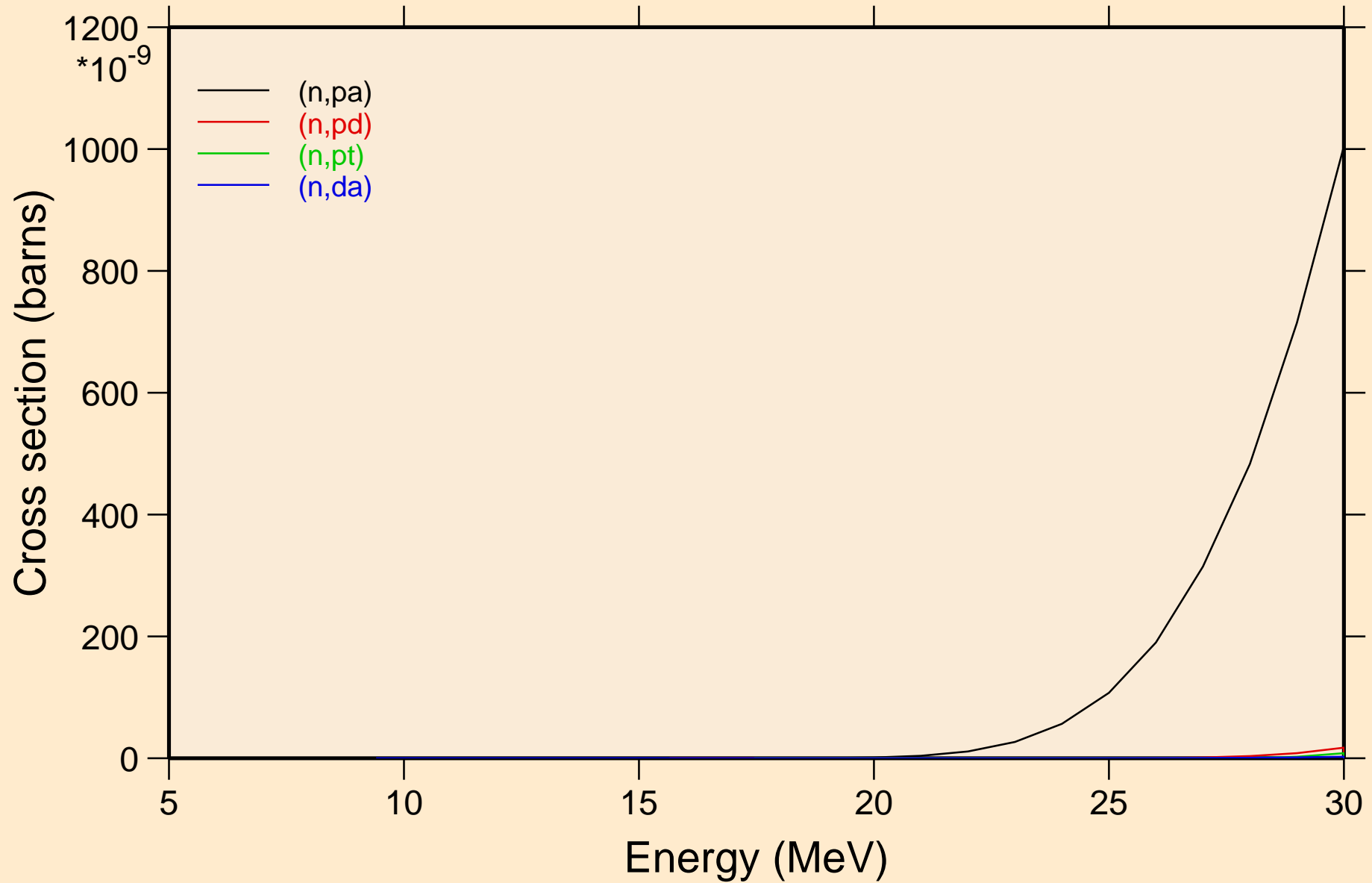

AG111M NRG TENDL-2015, AKONING
angular distribution for elastic

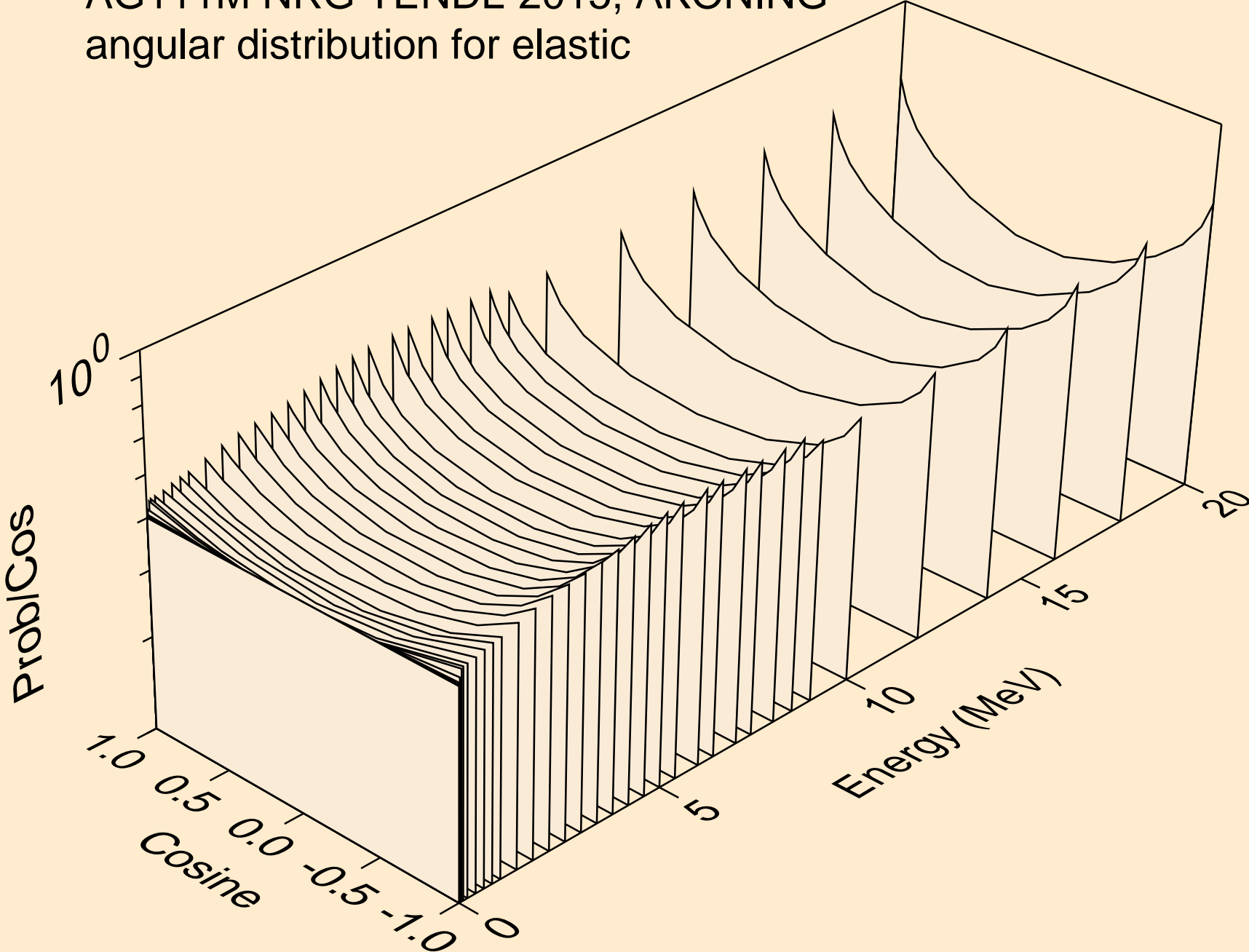

AG111M NRG TENDL-2015, AKONING
angular distribution for elastic

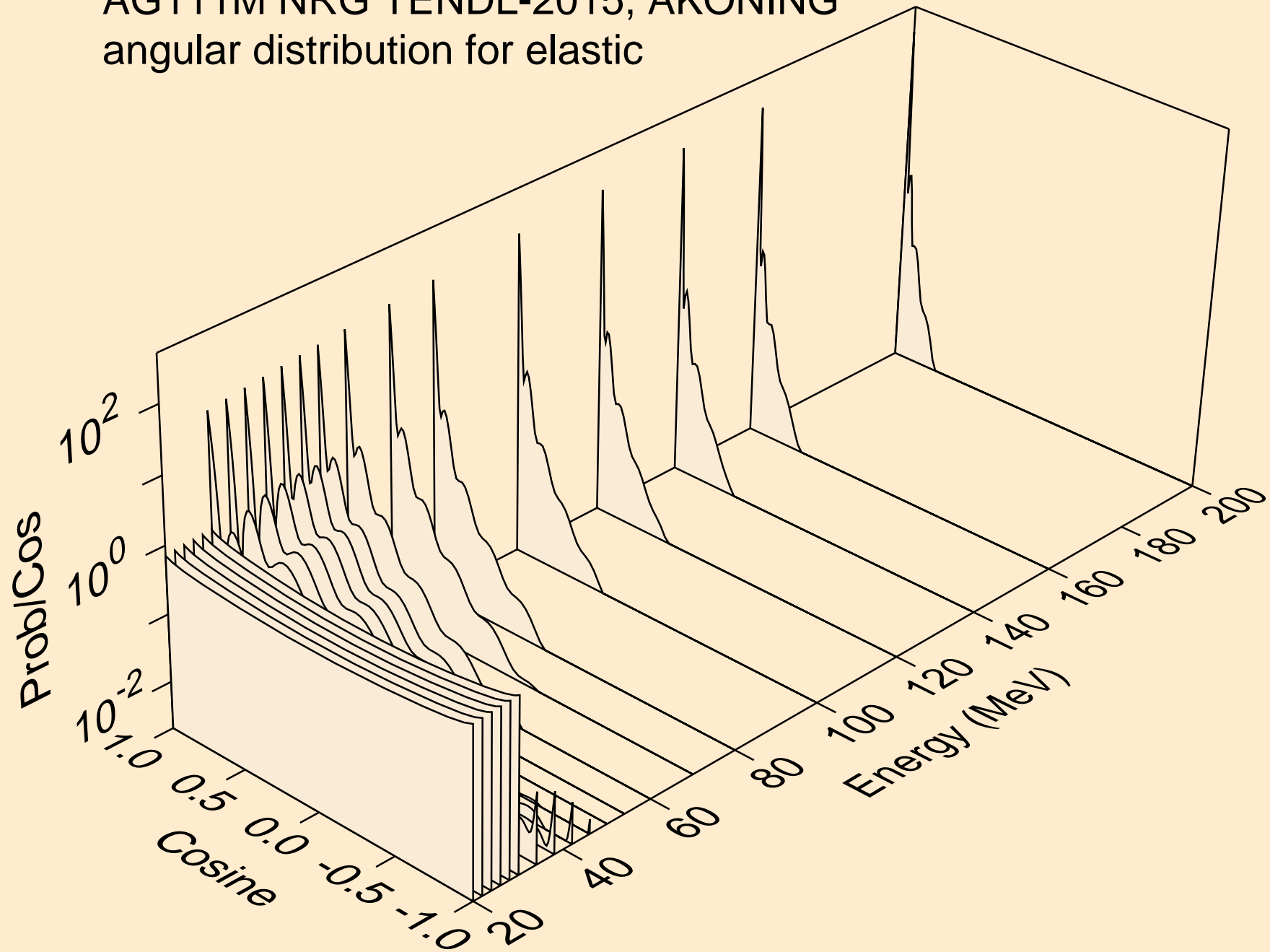

AG111M NRG TENDL-2015, AKONING
angular distribution for (n,n*1)

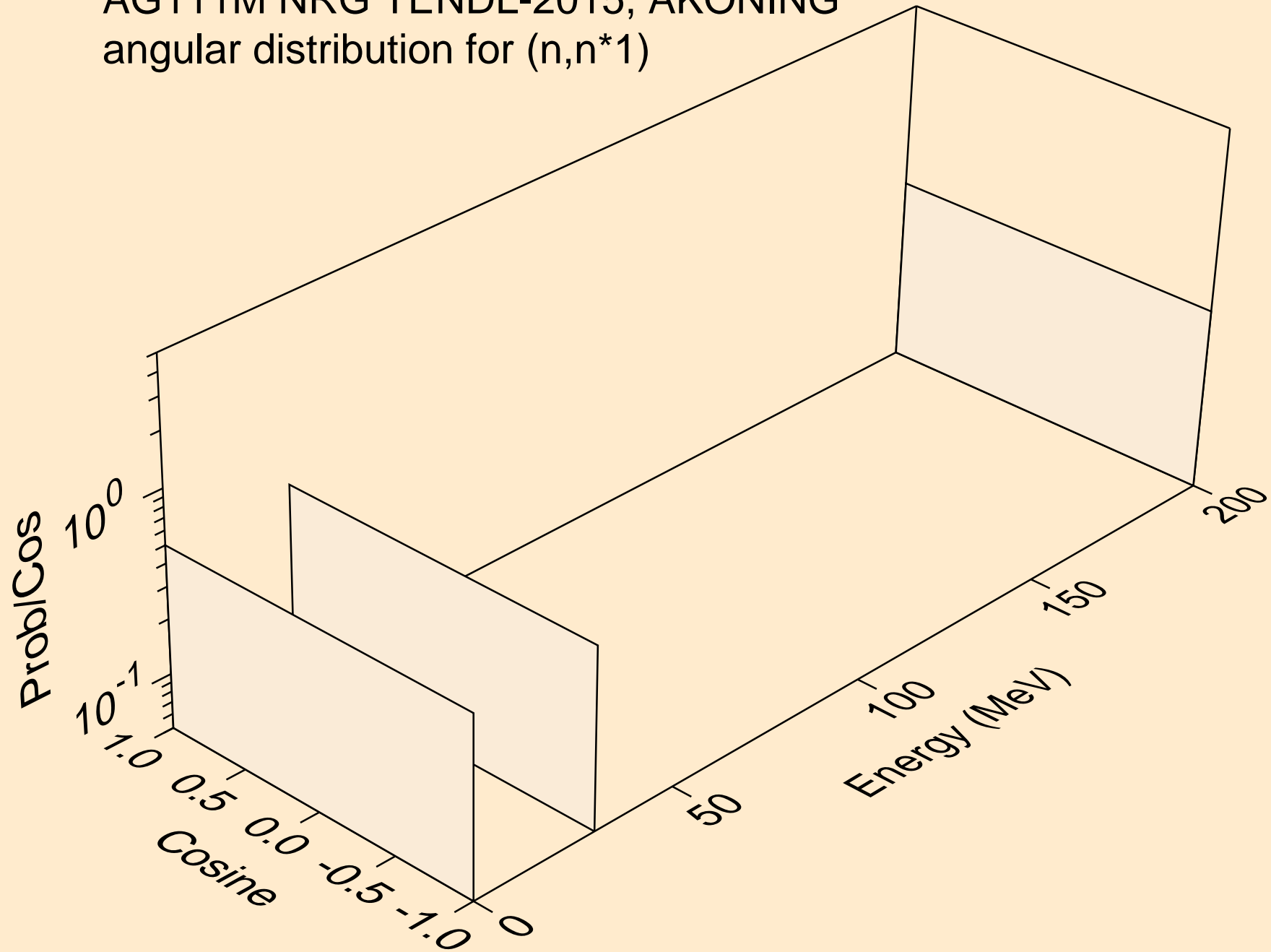

AG111M NRG TENDL-2015, AKONING
angular distribution for (n,n*2)

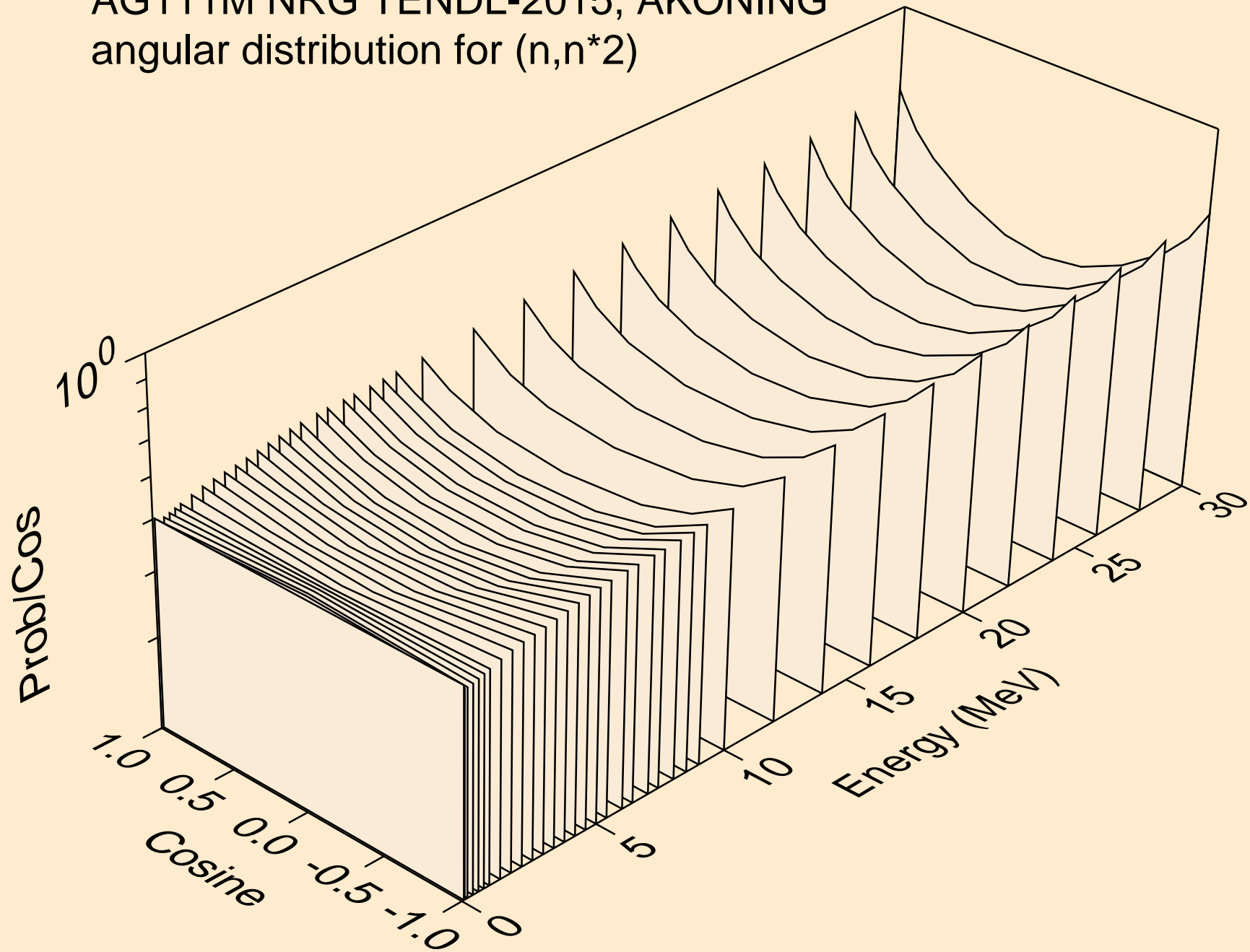

AG111M NRG TENDL-2015, AKONING
angular distribution for (n,n*3)

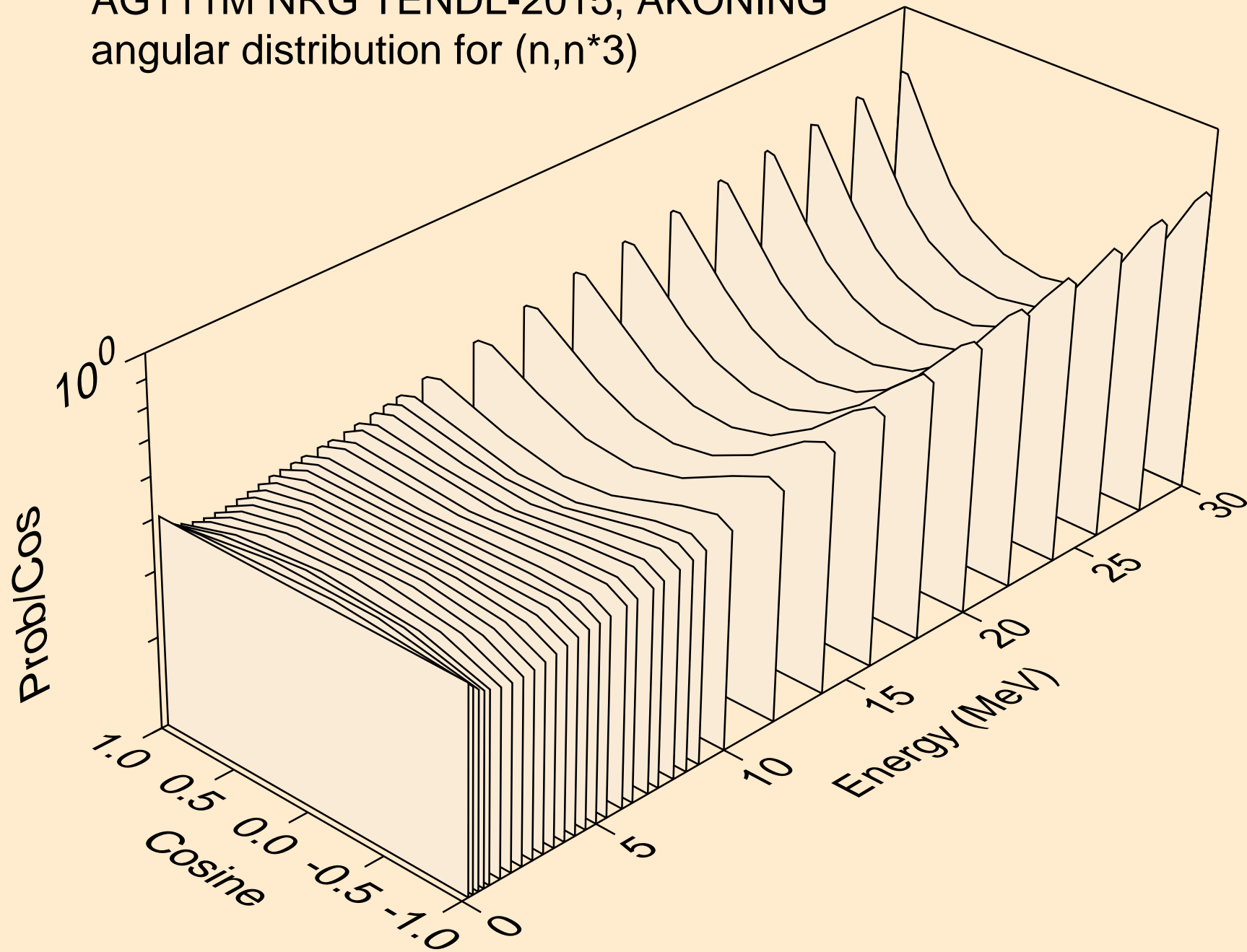

AG111M NRG TENDL-2015, AKONING
angular distribution for (n,n*4)

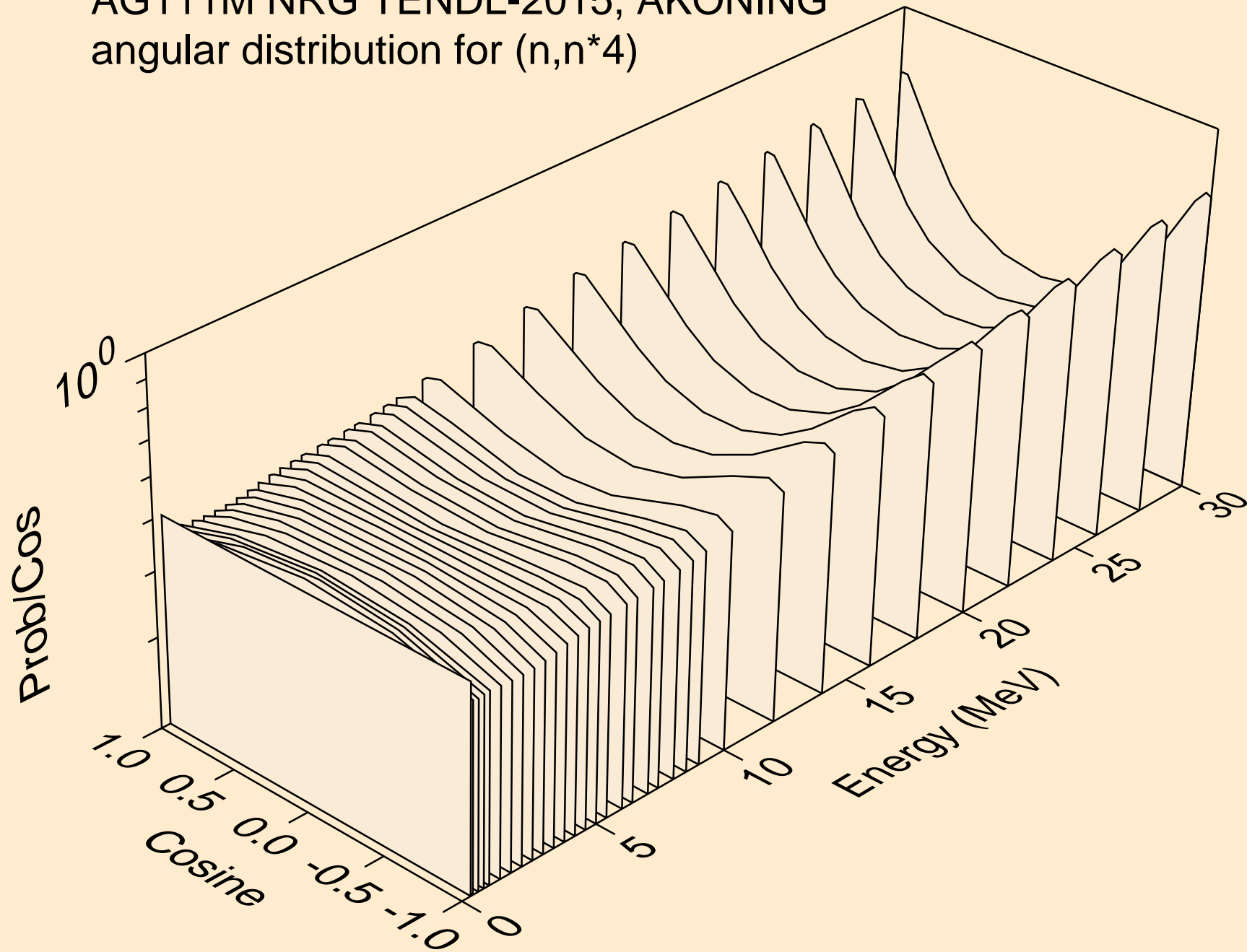

AG111M NRG TENDL-2015, AKONING
angular distribution for (n,n*5)

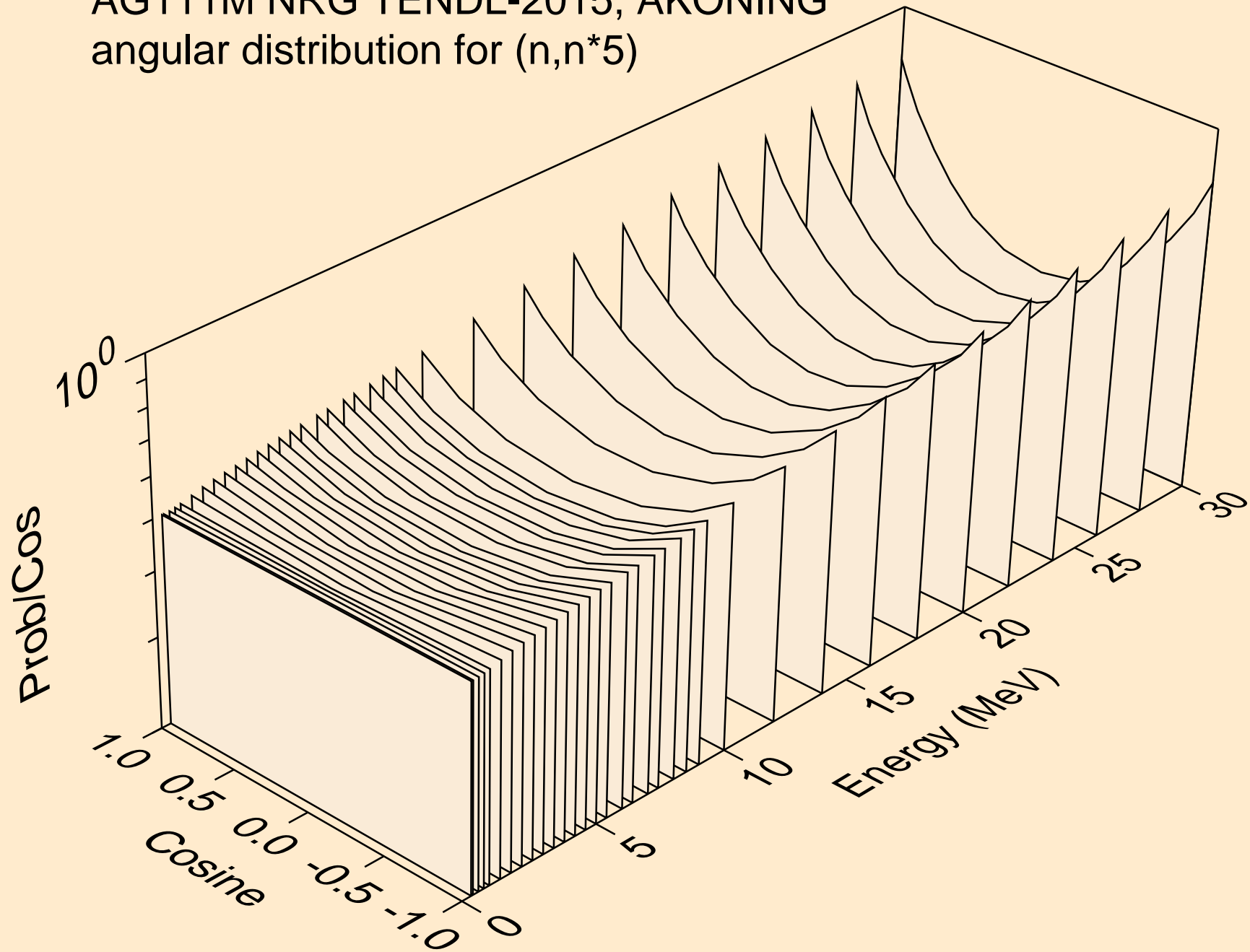

AG111M NRG TENDL-2015, AKONING
angular distribution for (n,n*6)

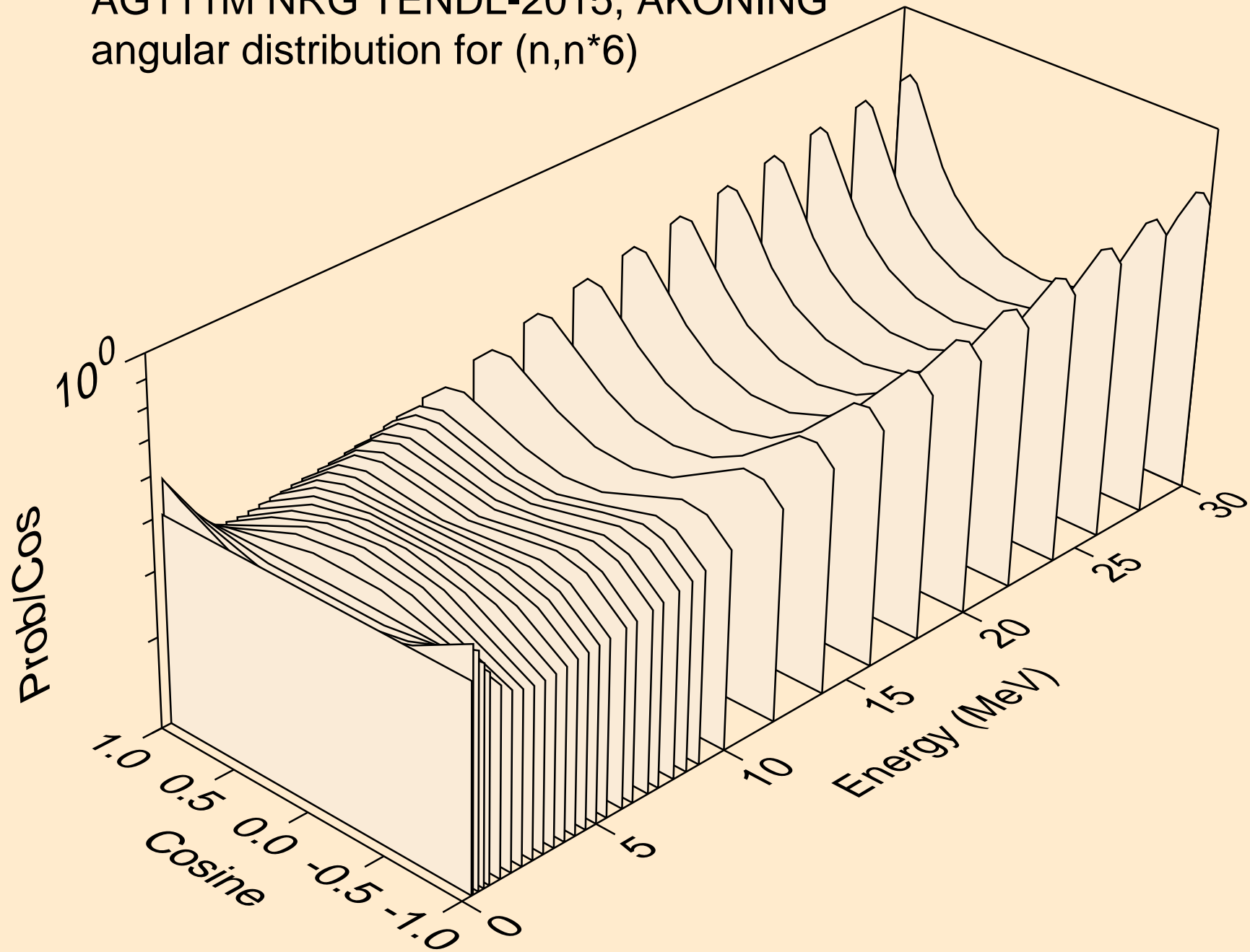

AG111M NRG TENDL-2015, AKONING
angular distribution for (n,n*7)

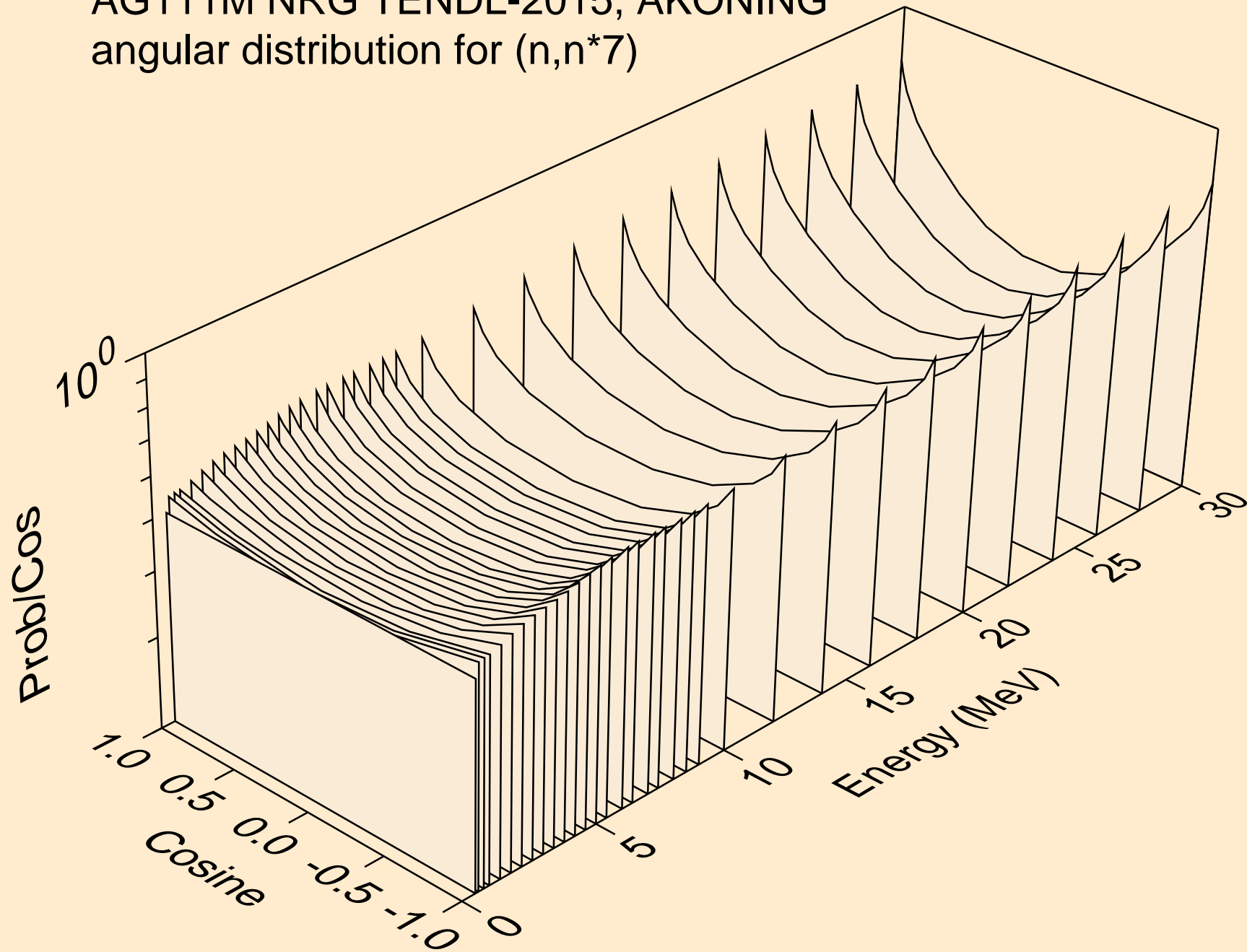

AG111M NRG TENDL-2015, AKONING
angular distribution for (n,n*8)

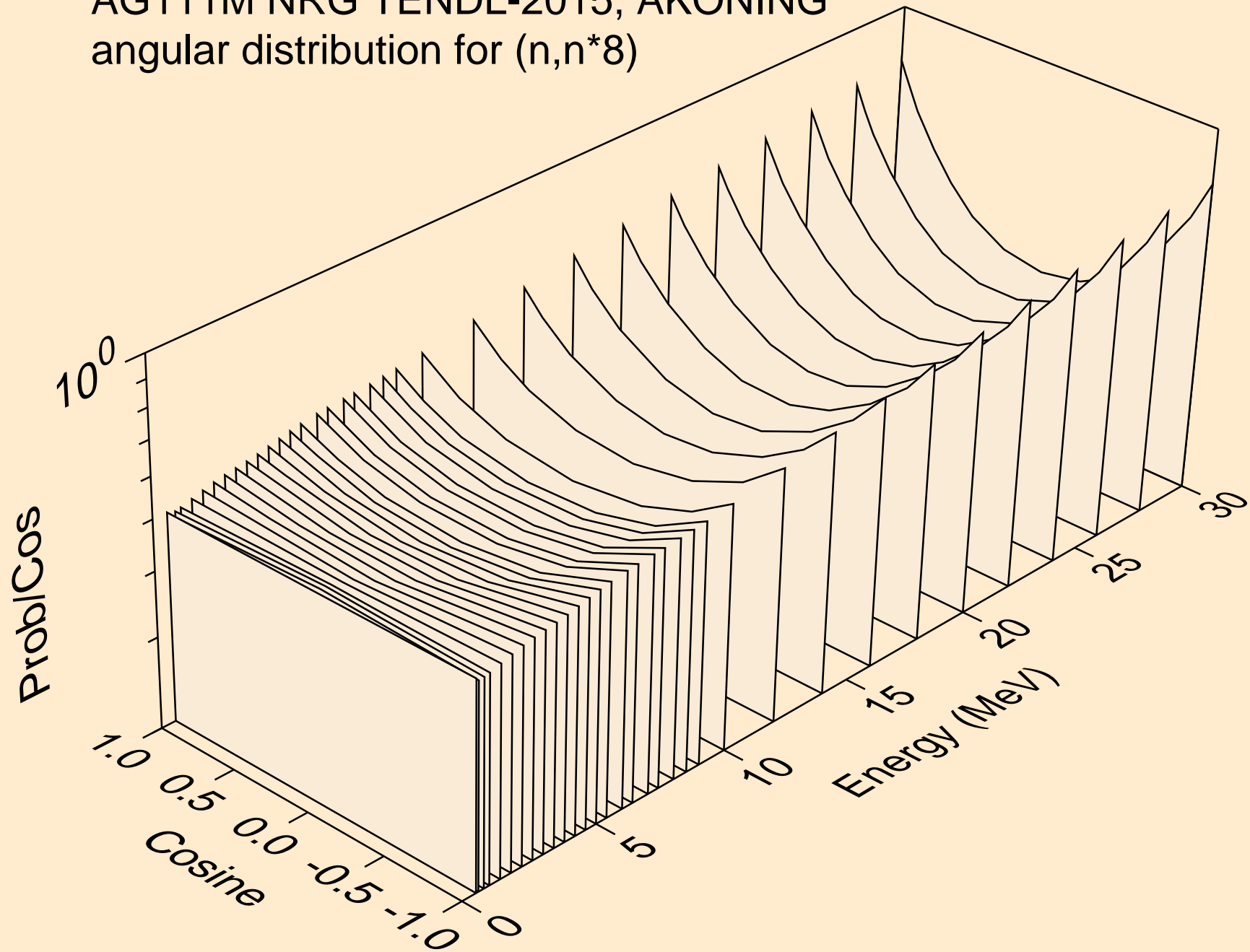

AG111M NRG TENDL-2015, AKONING
angular distribution for (n,n*9)

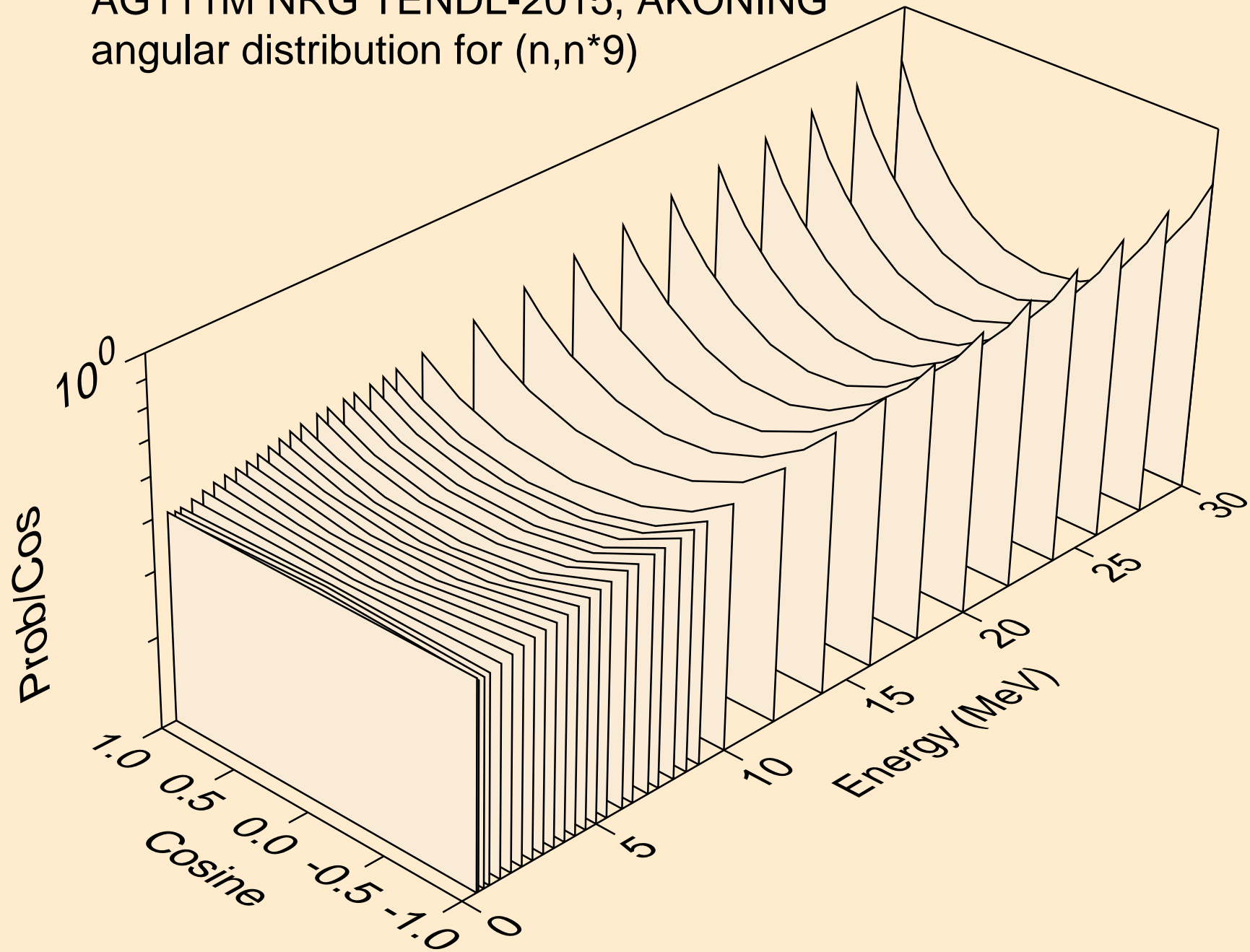

AG111M NRG TENDL-2015, AKONING
angular distribution for (n,n*10)

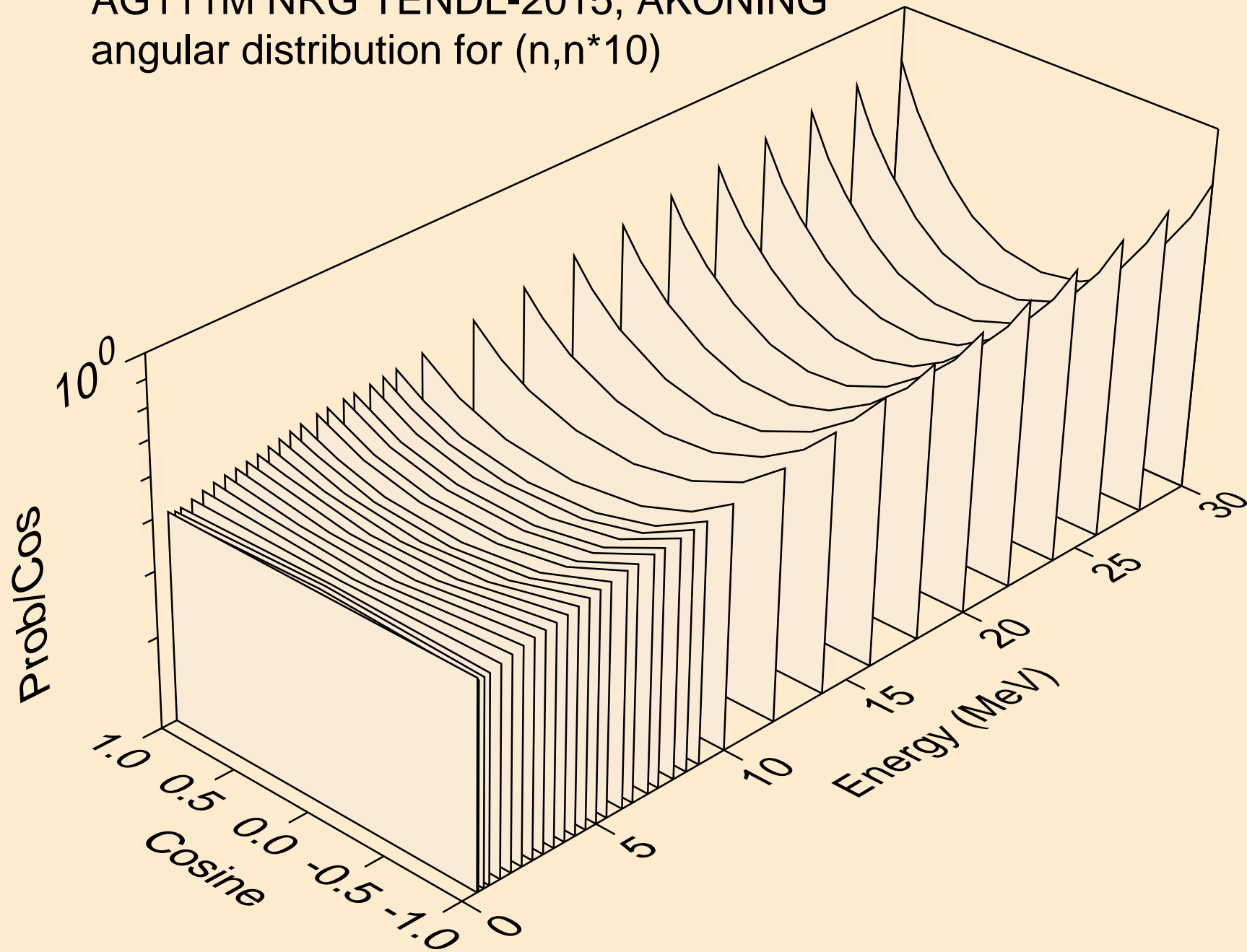

AG111M NRG TENDL-2015, AKONING
angular distribution for (n,n*11)

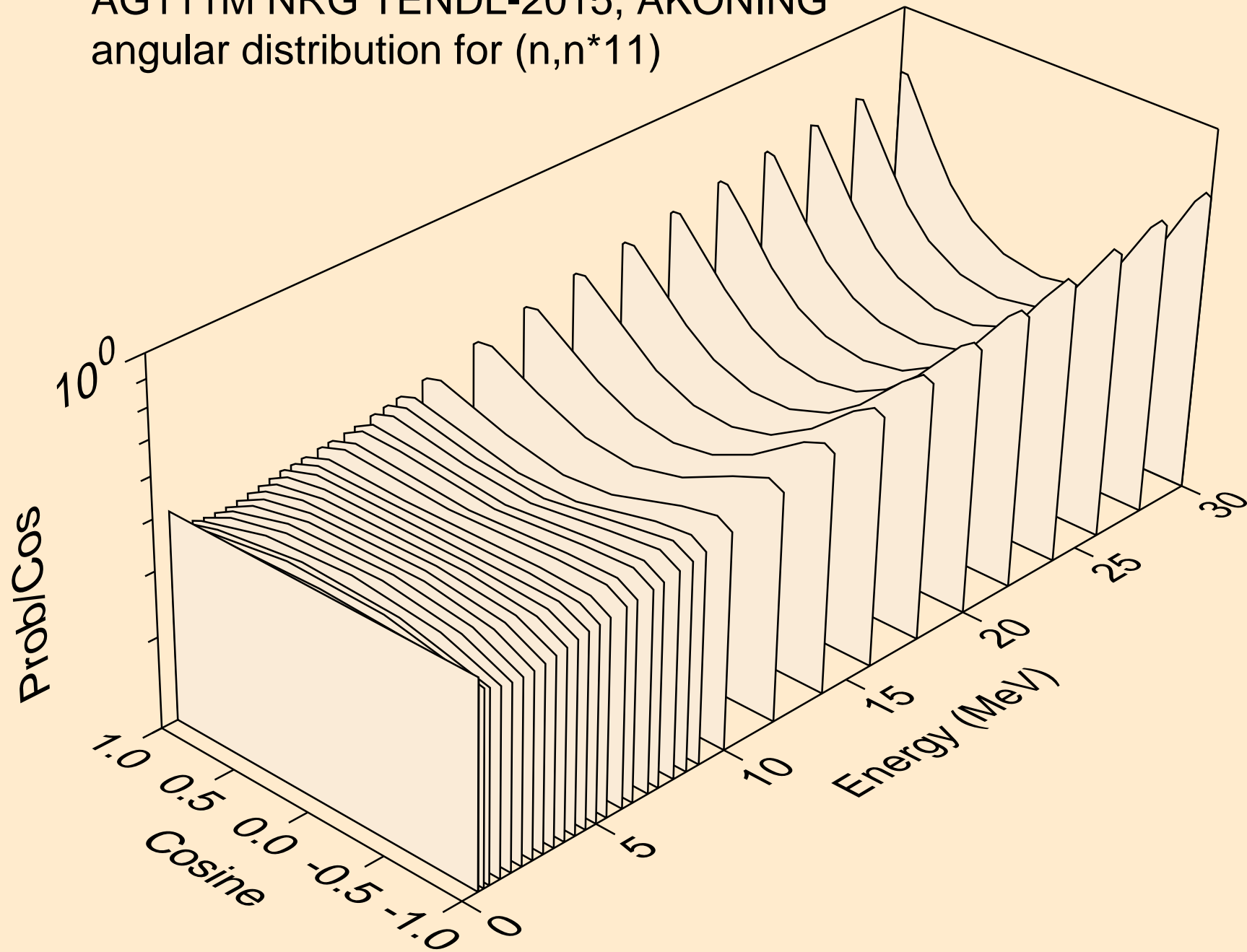

AG111M NRG TENDL-2015, AKONING
angular distribution for (n,n*12)

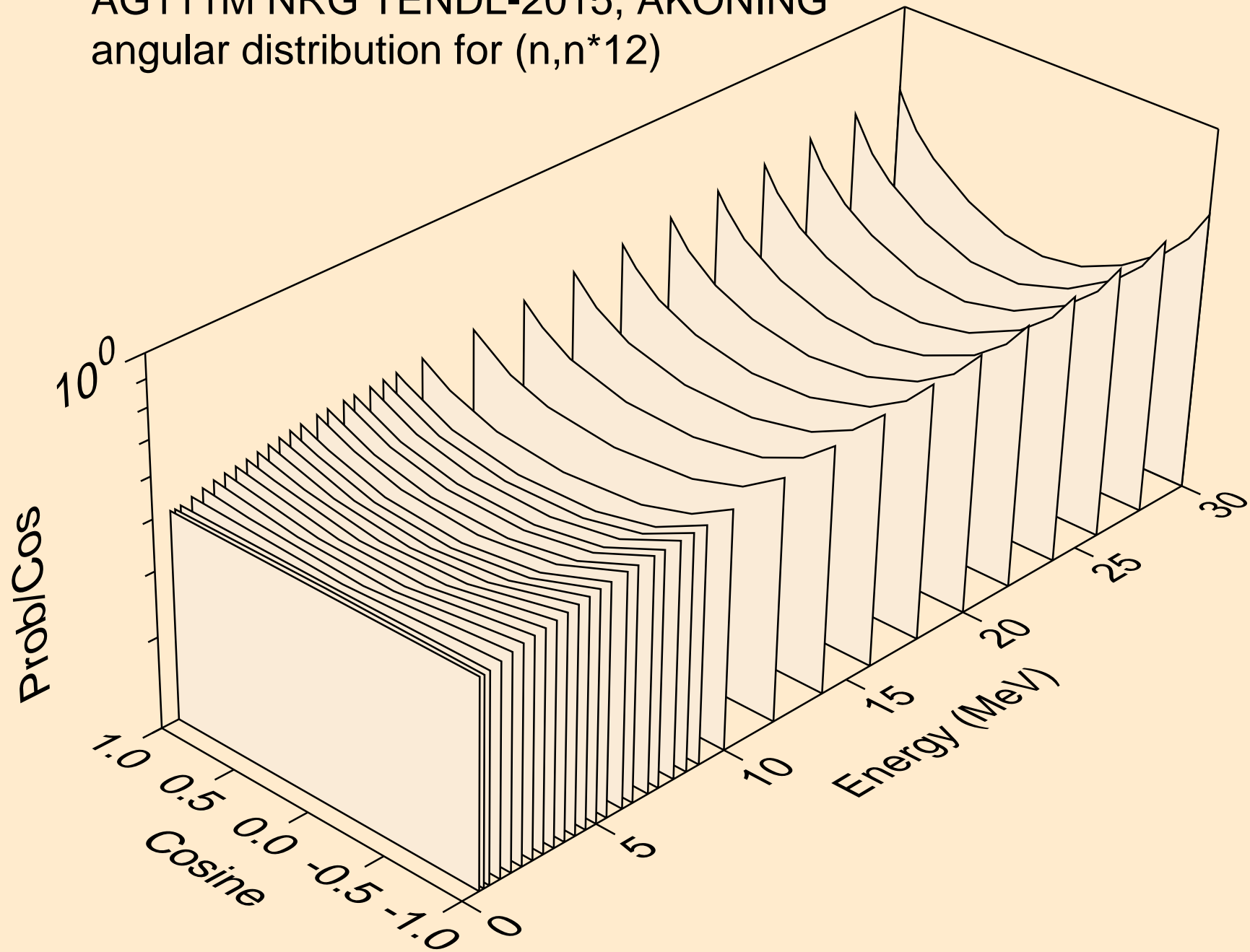

AG111M NRG TENDL-2015, AKONING
angular distribution for (n,n*13)

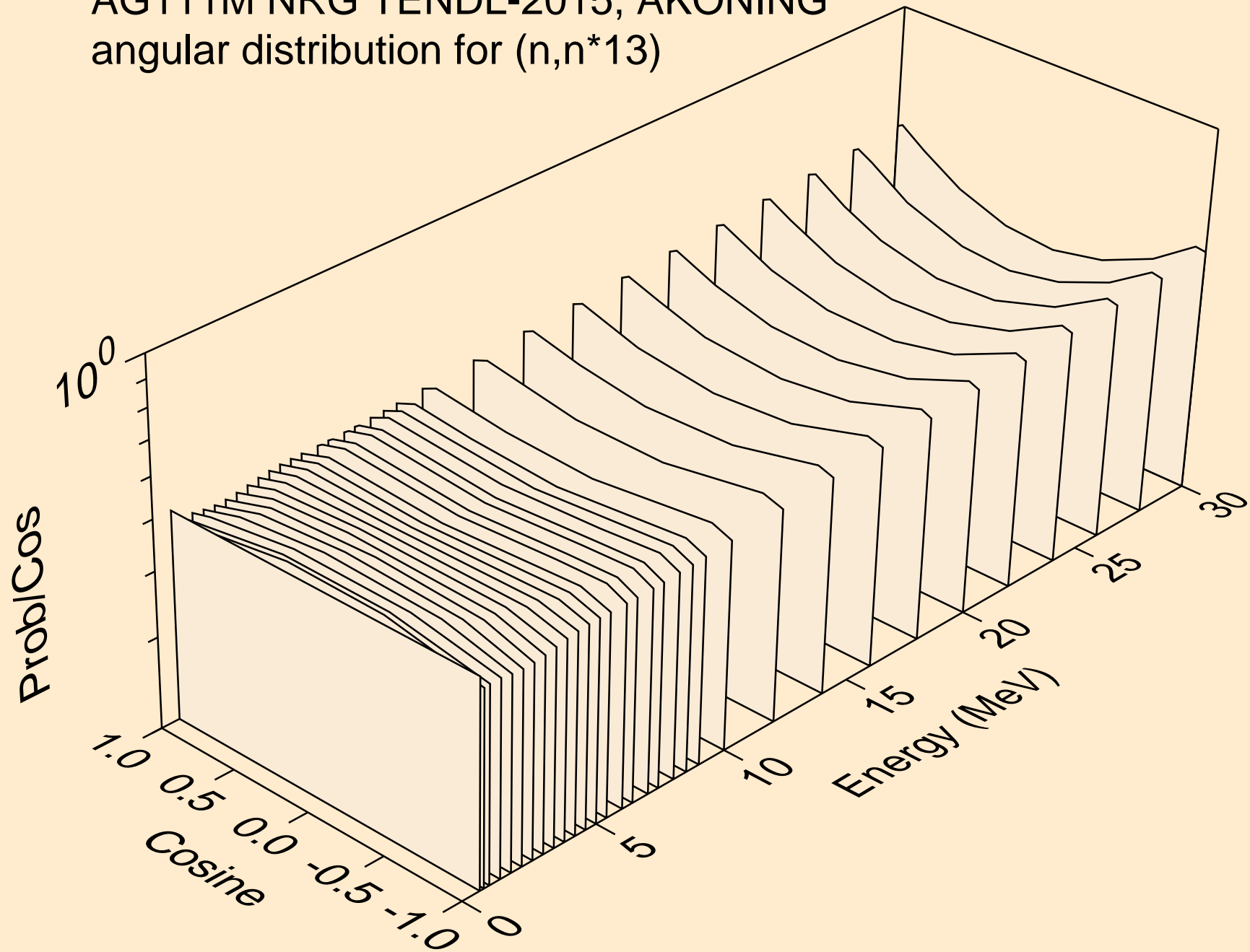

AG111M NRG TENDL-2015, AKONING
angular distribution for (n,n*14)

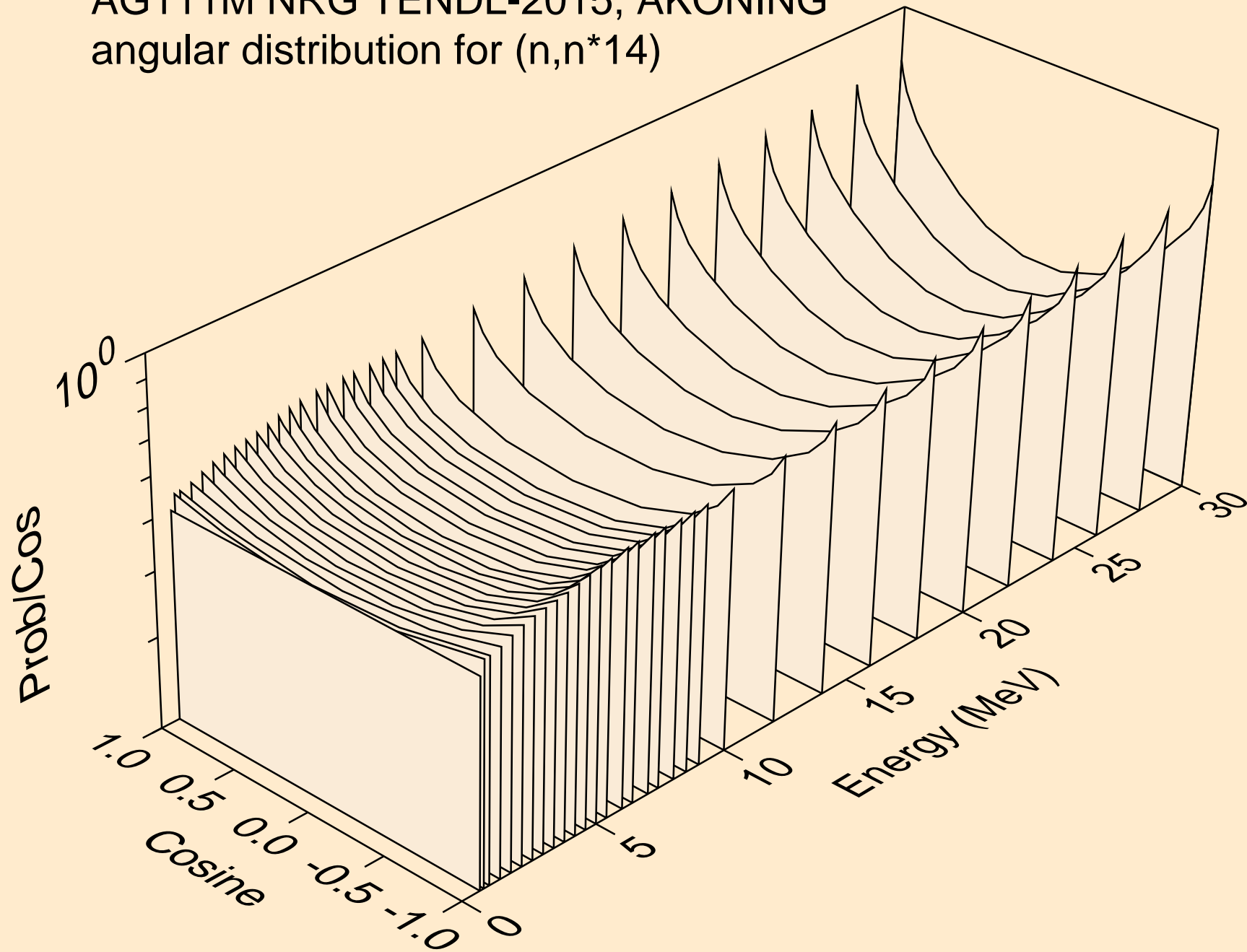

AG111M NRG TENDL-2015, AKONING
angular distribution for (n,n*15)

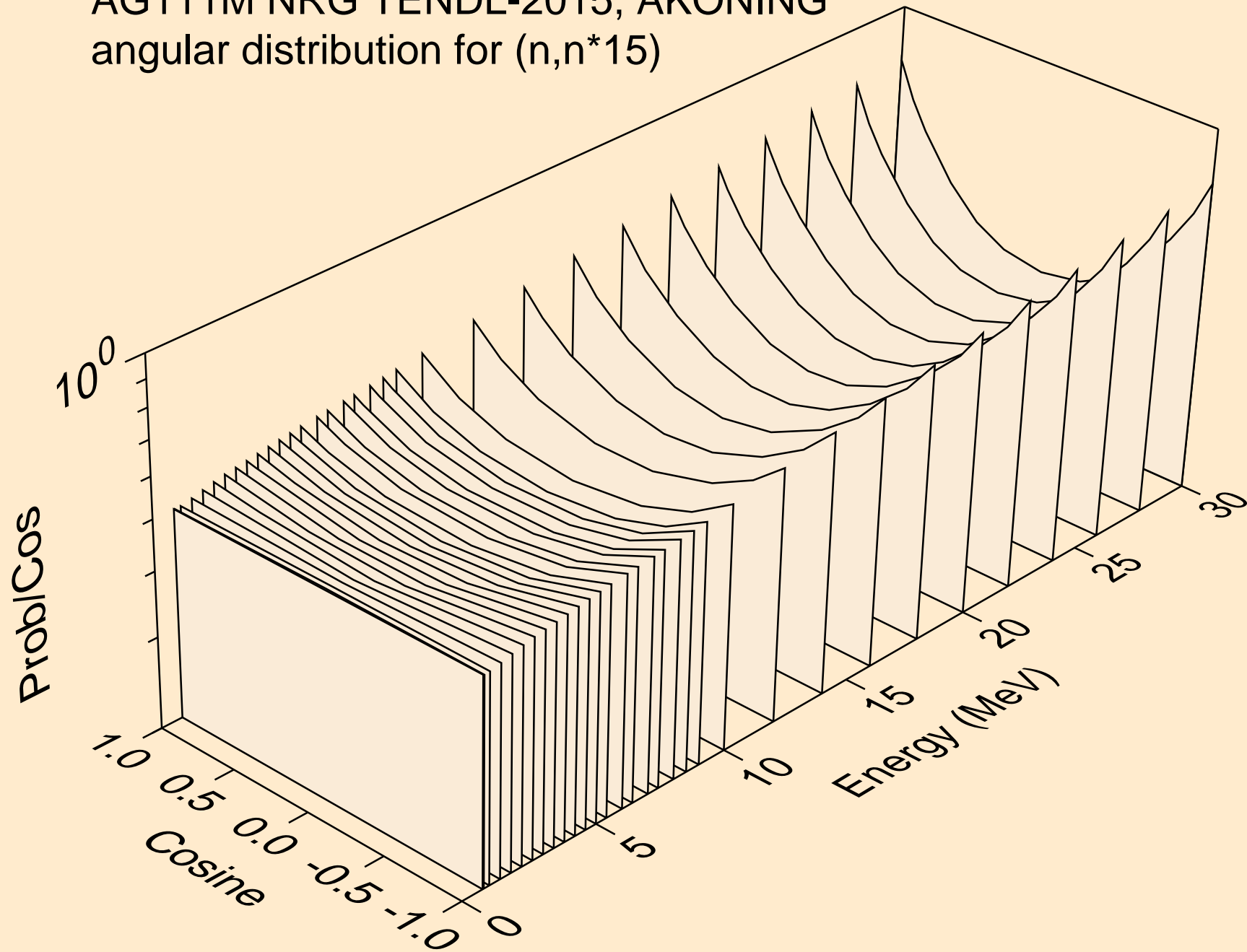

AG111M NRG TENDL-2015, AKONING
angular distribution for (n,n*16)

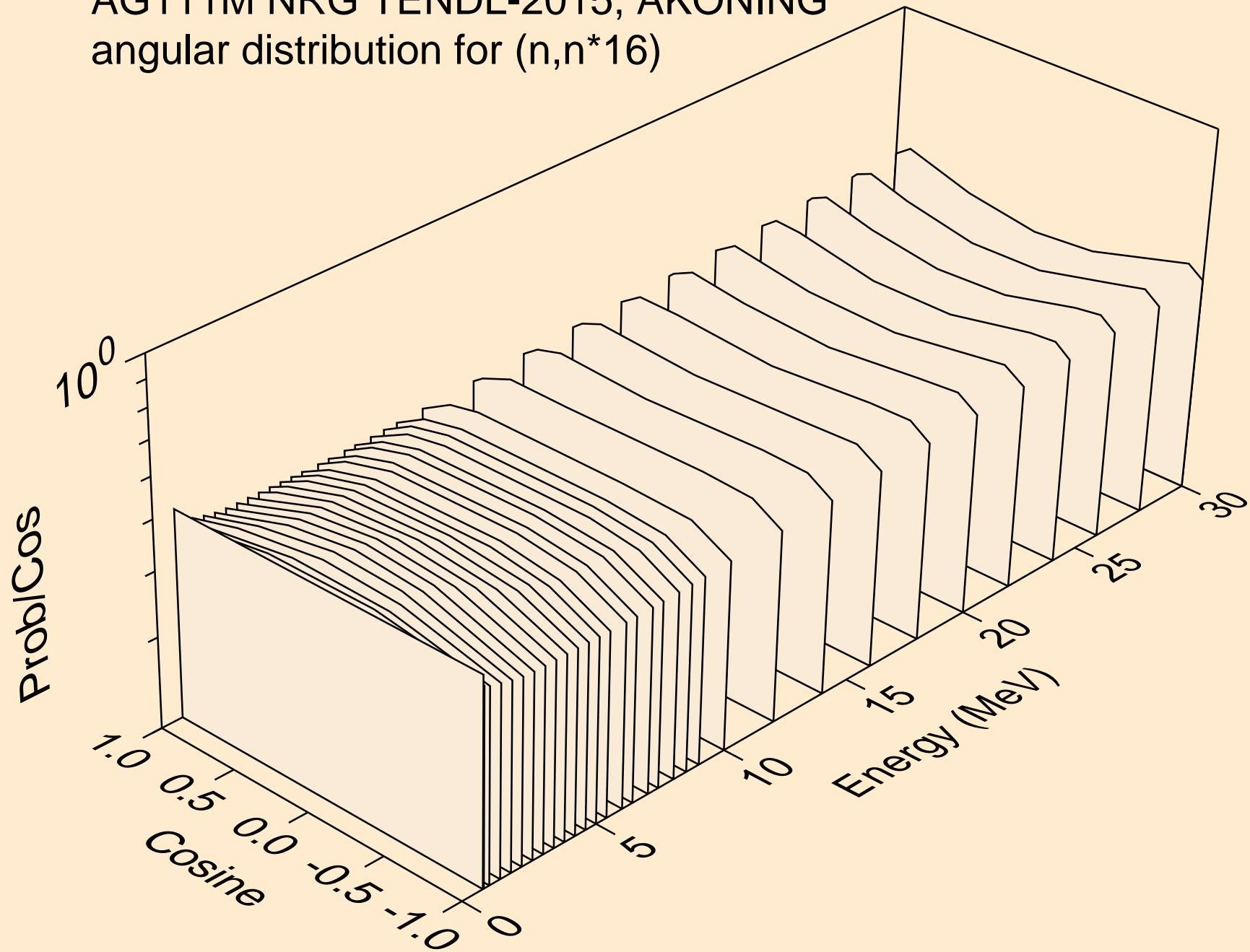

AG111M NRG TENDL-2015, AKONING
angular distribution for (n,n*17)

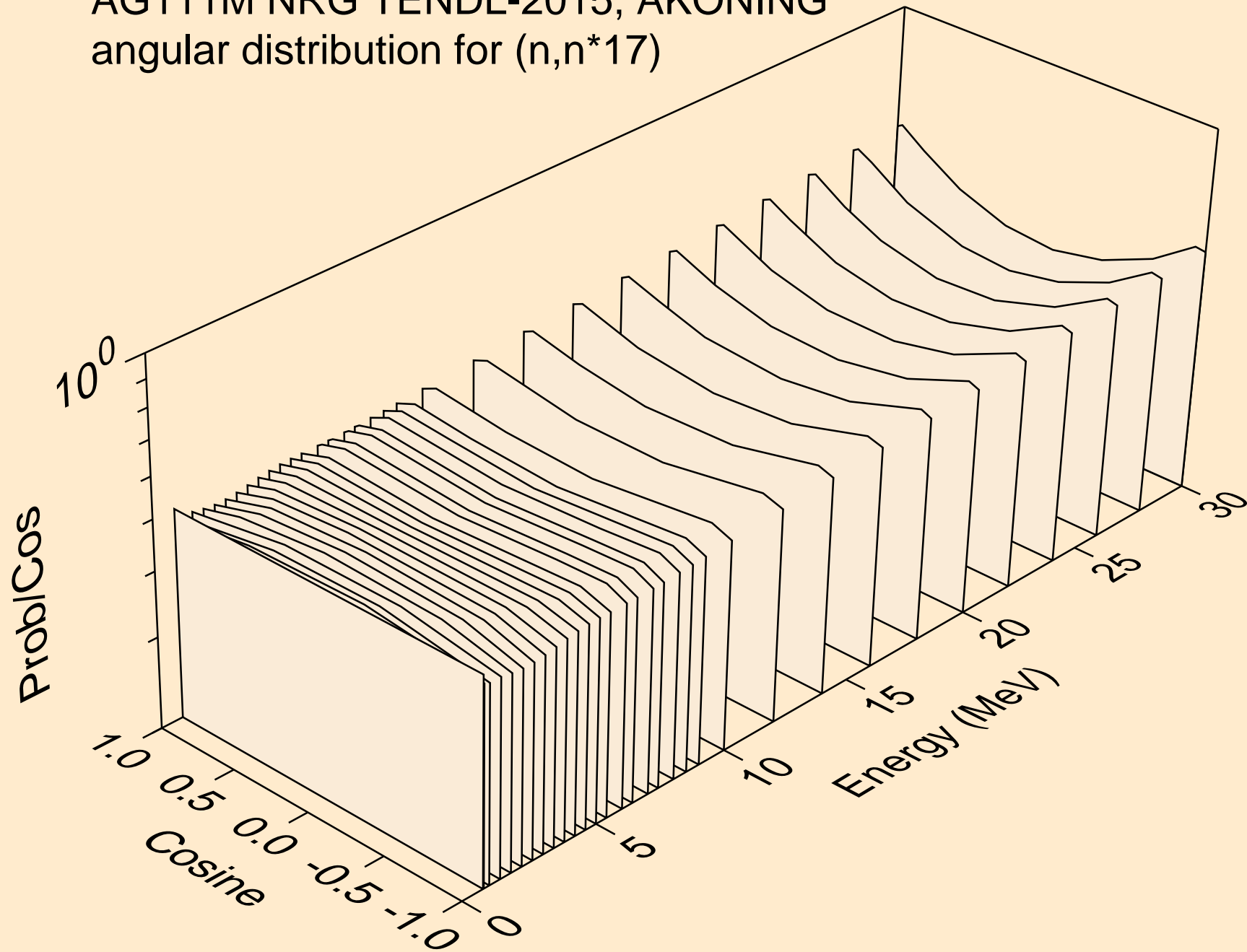

AG111M NRG TENDL-2015, AKONING
angular distribution for (n,n*18)

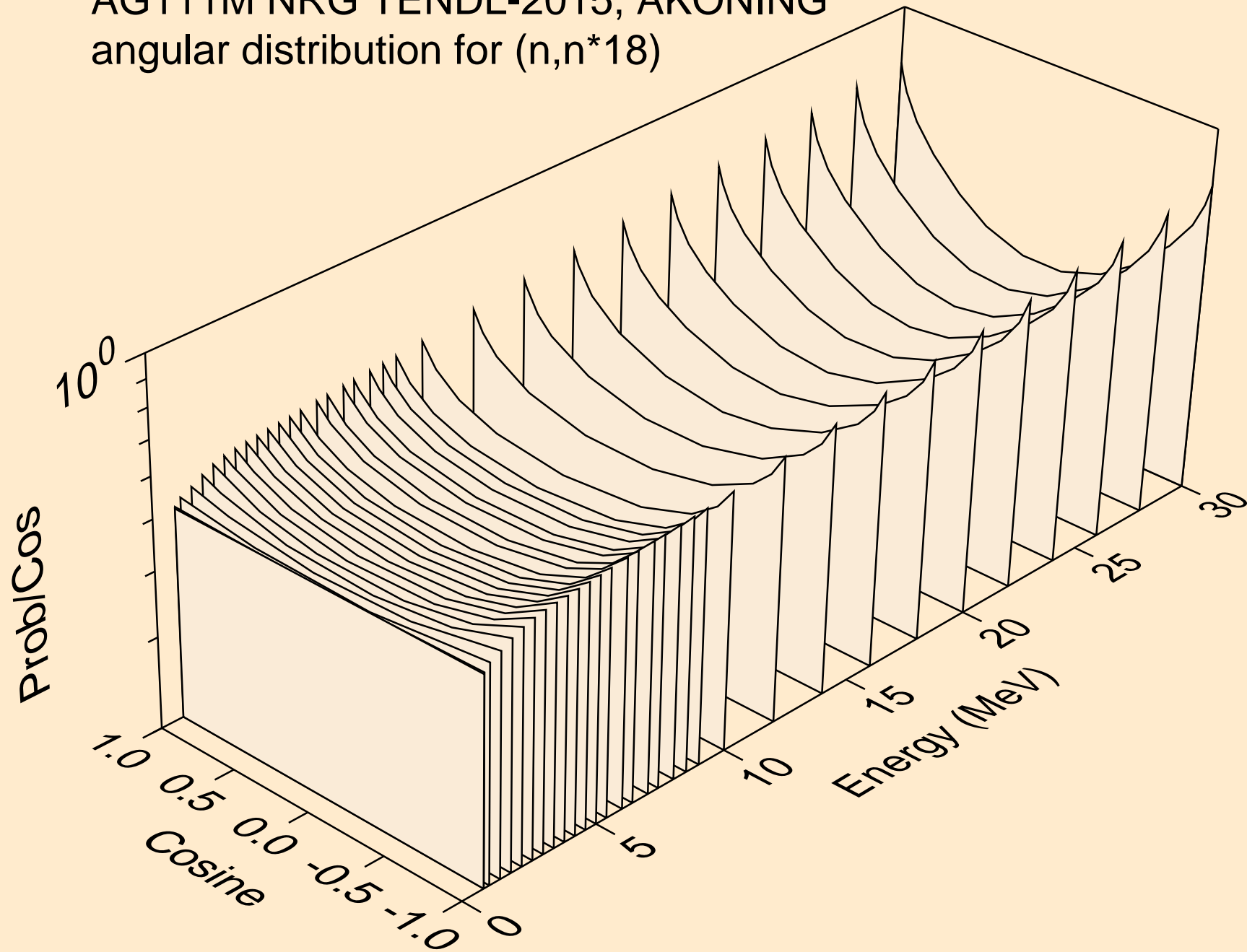

AG111M NRG TENDL-2015, AKONING
angular distribution for (n,n*19)

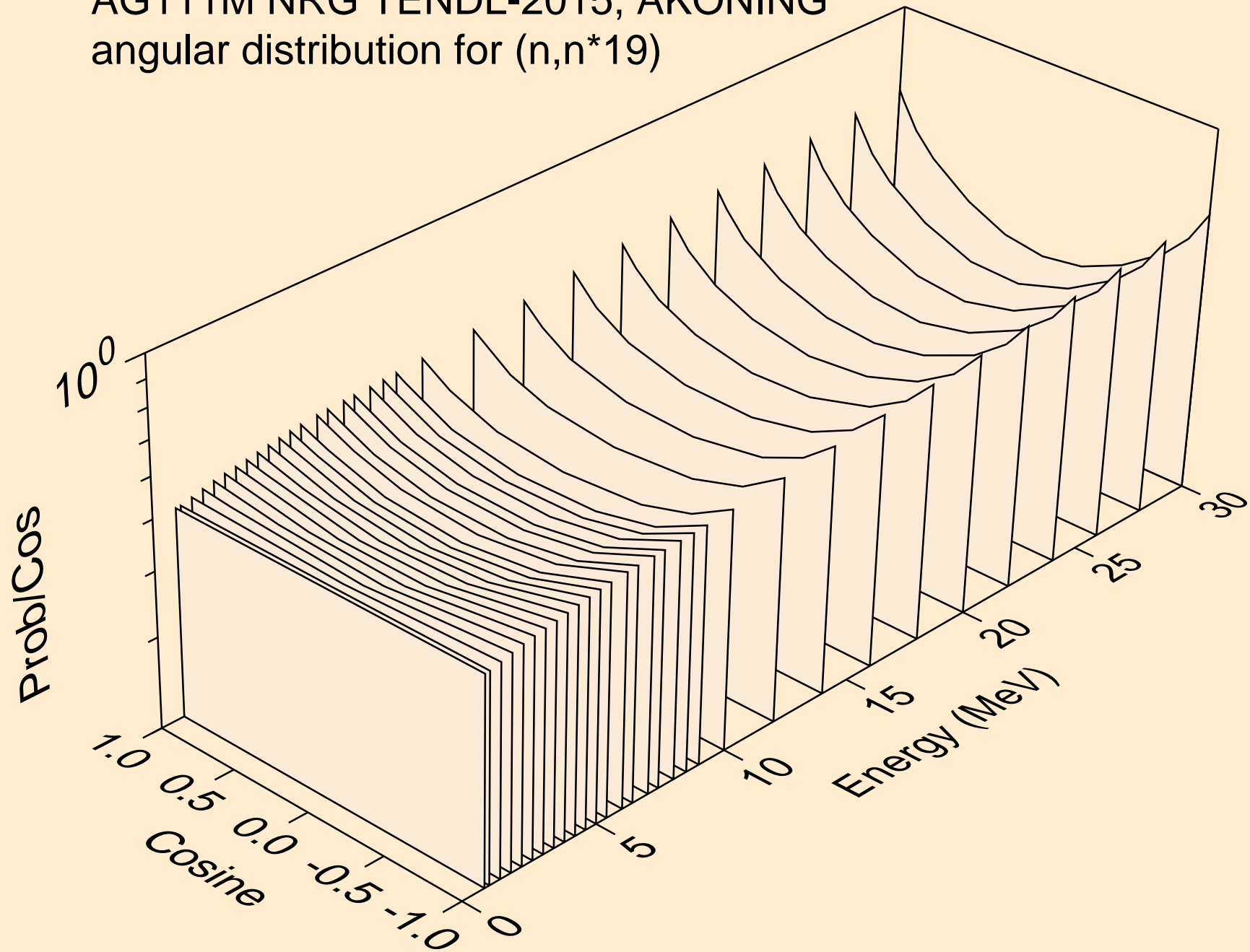

AG111M NRG TENDL-2015, AKONING
angular distribution for (n,n*20)

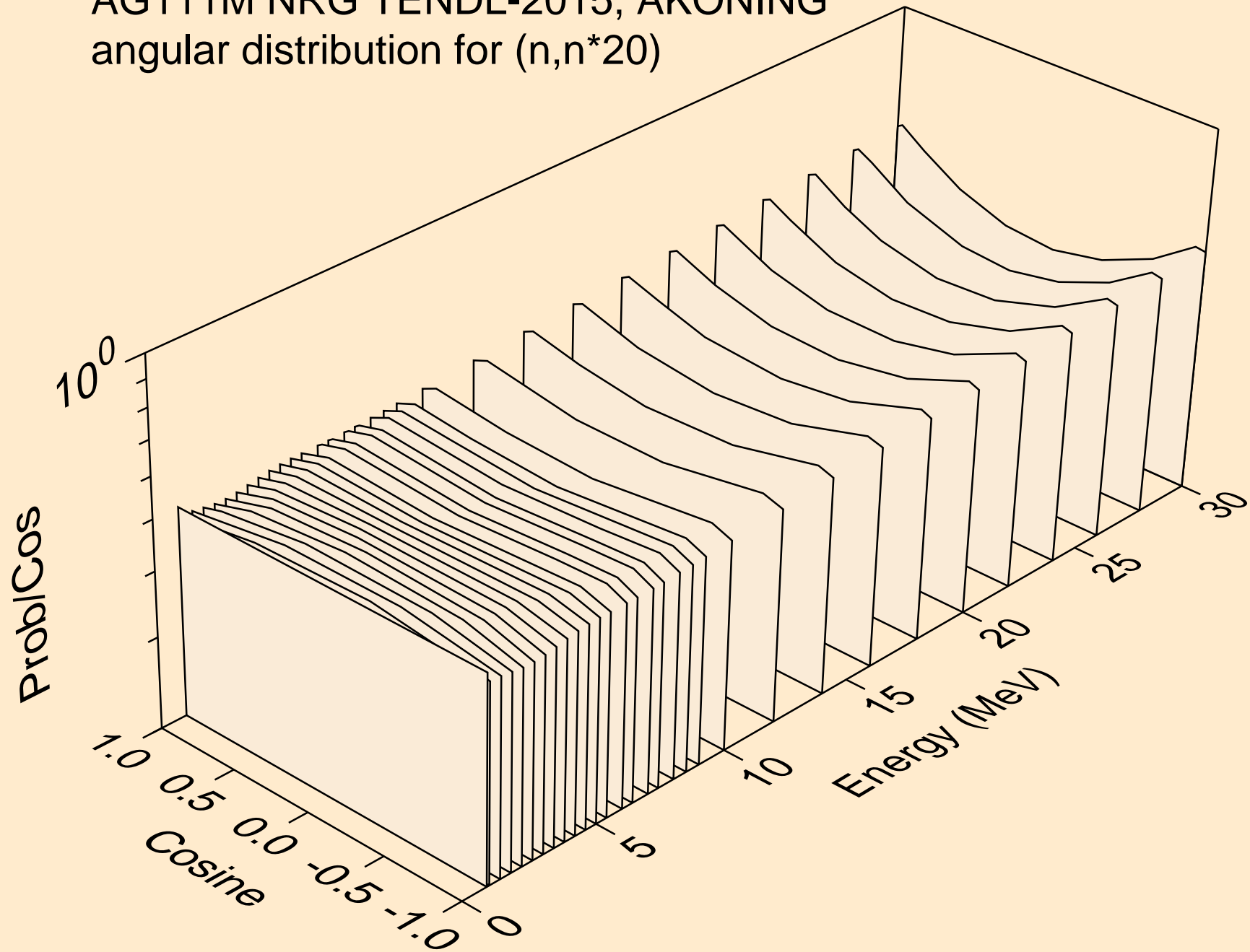

AG111M NRG TENDL-2015, AKONING
angular distribution for (n,n*21)

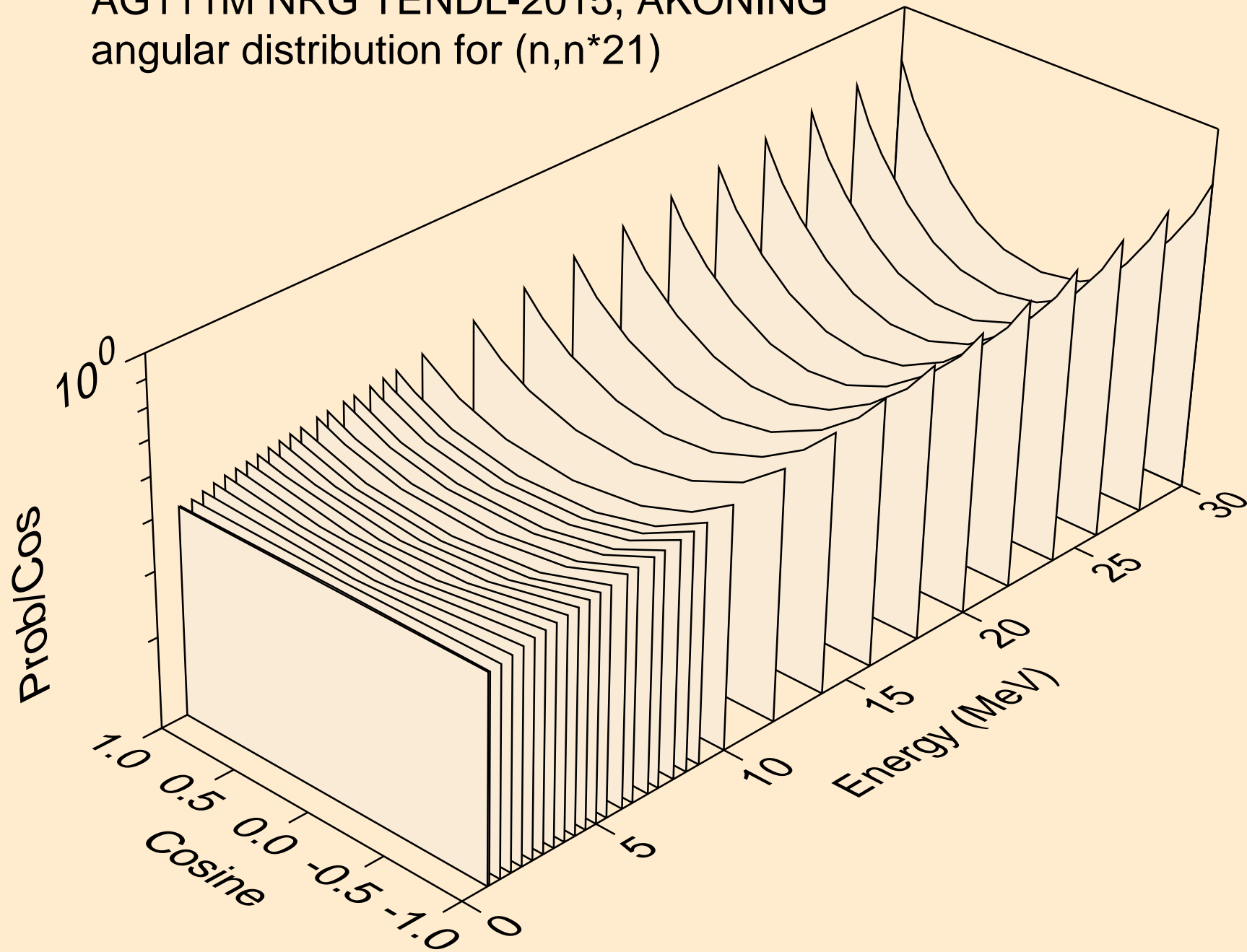

AG111M NRG TENDL-2015, AKONING
angular distribution for (n,n*22)

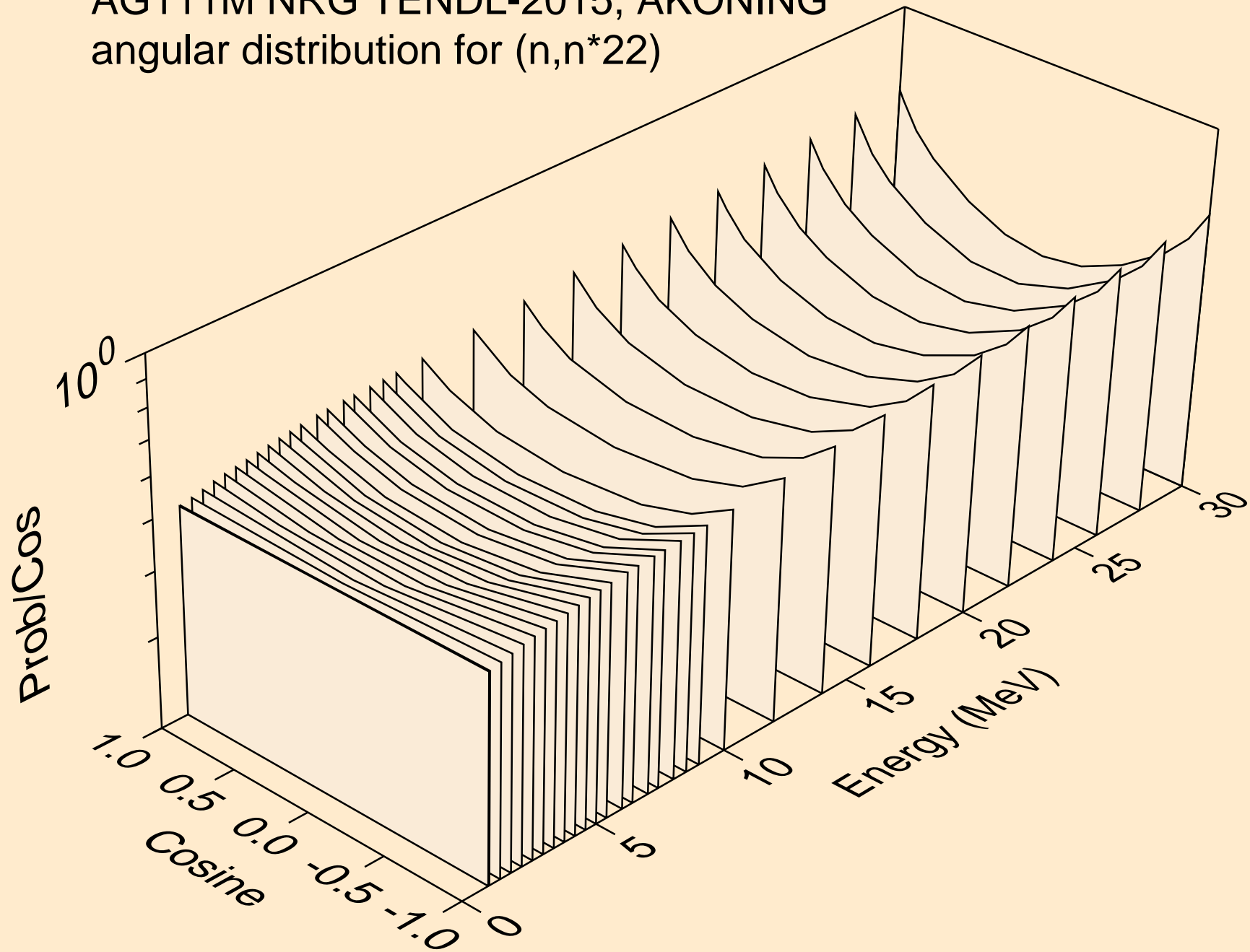

AG111M NRG TENDL-2015, AKONING
angular distribution for (n,n*23)

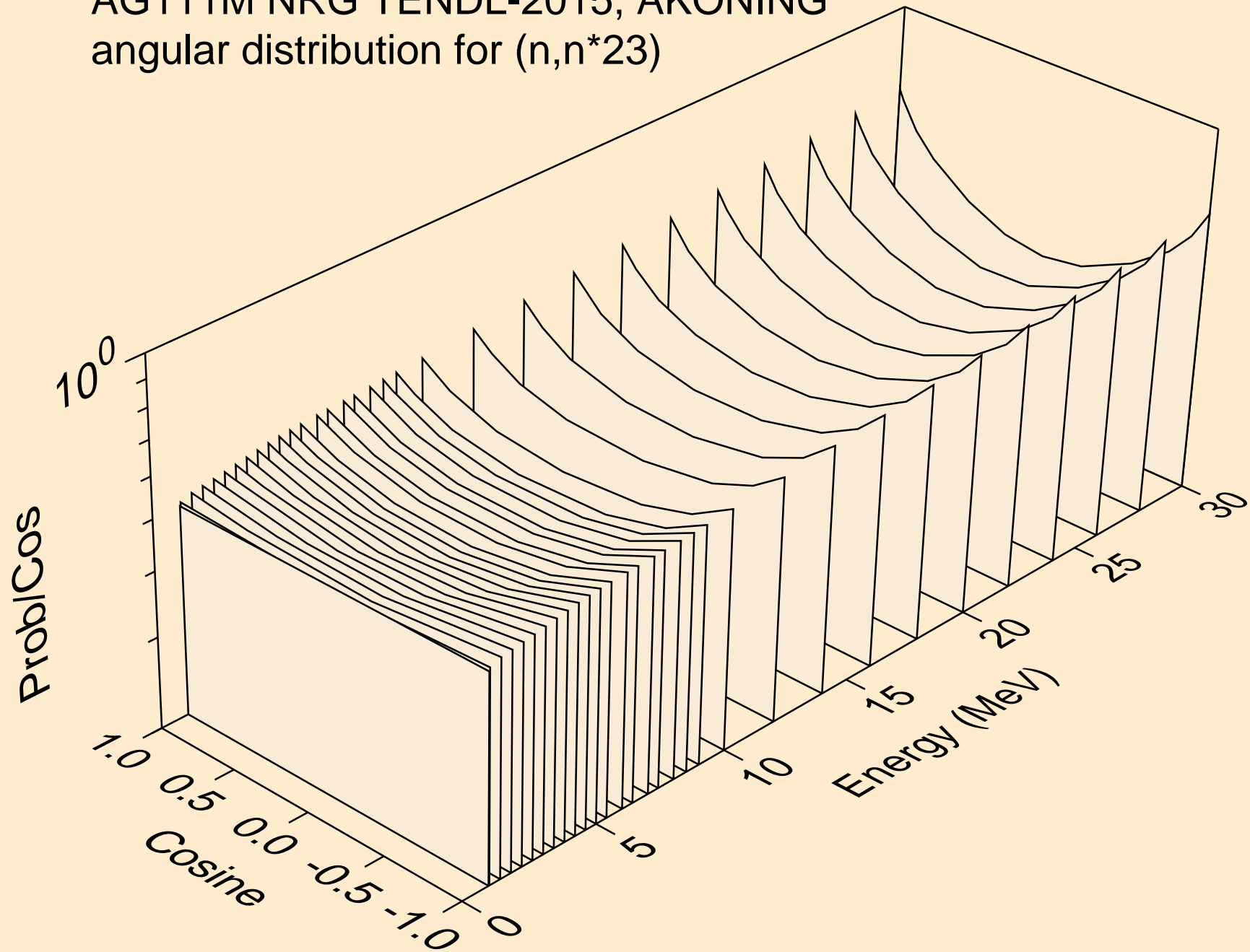

AG111M NRG TENDL-2015, AKONING
angular distribution for (n,n*24)

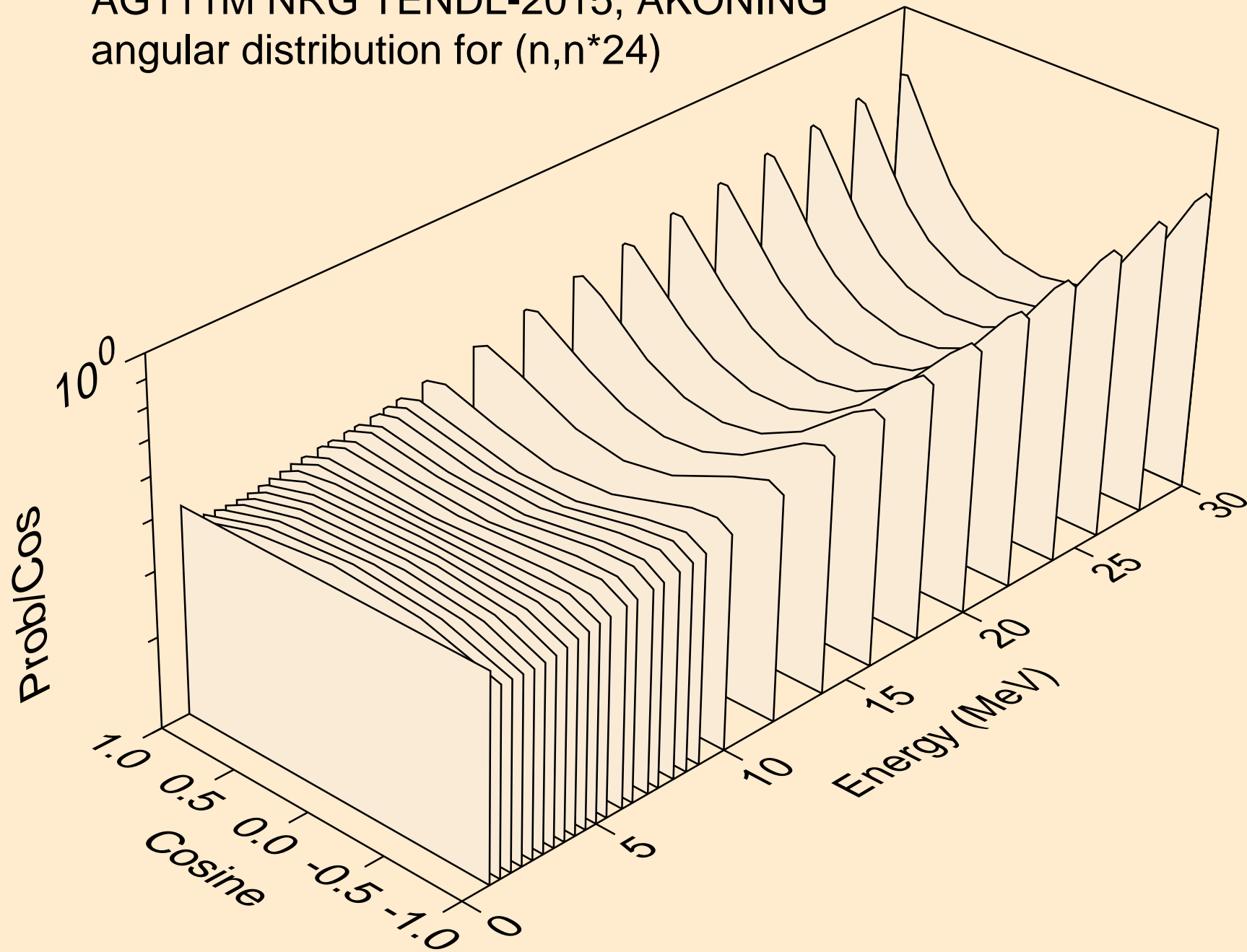

AG111M NRG TENDL-2015, AKONING
angular distribution for (n,n*25)

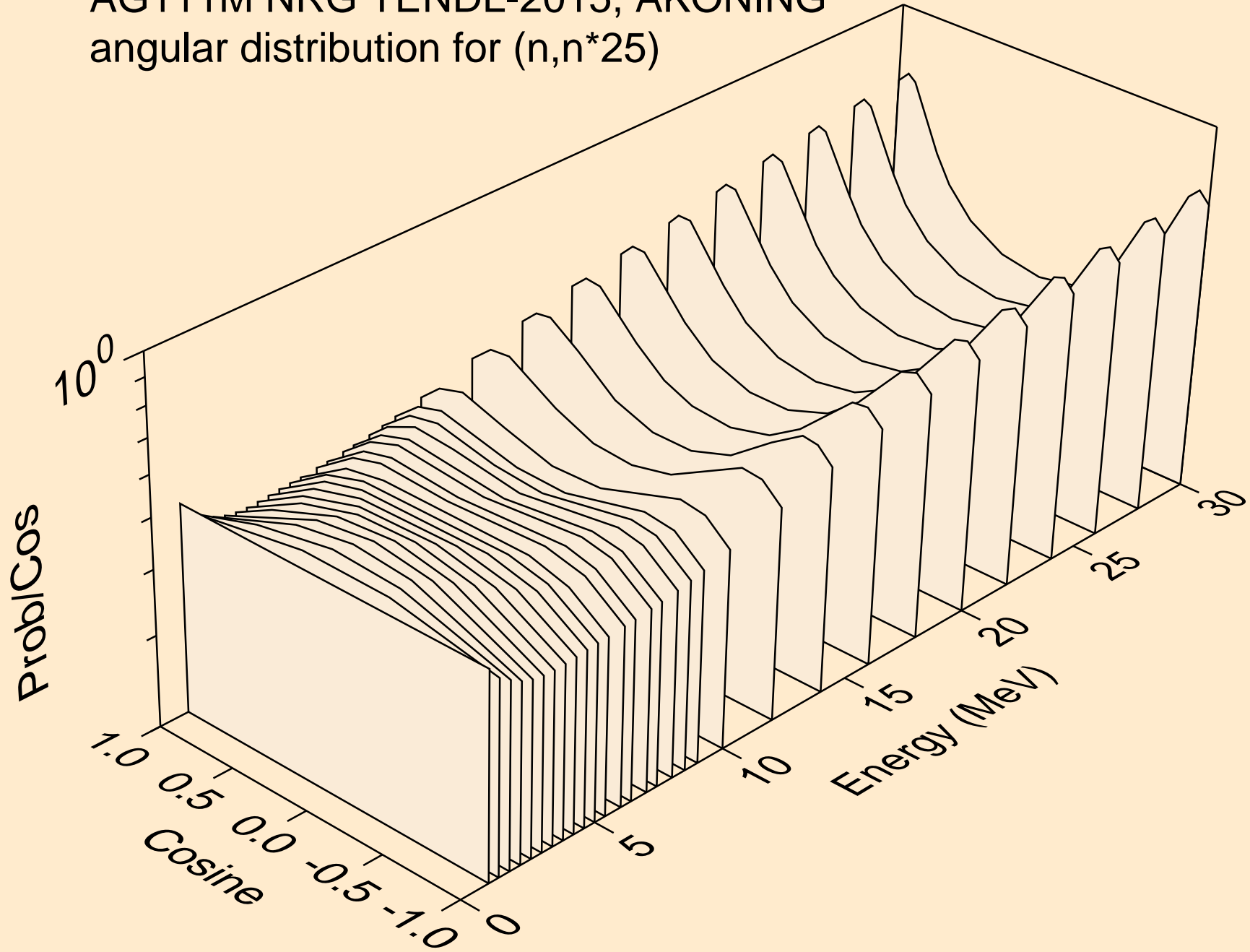

AG111M NRG TENDL-2015, AKONING
angular distribution for (n,n*26)

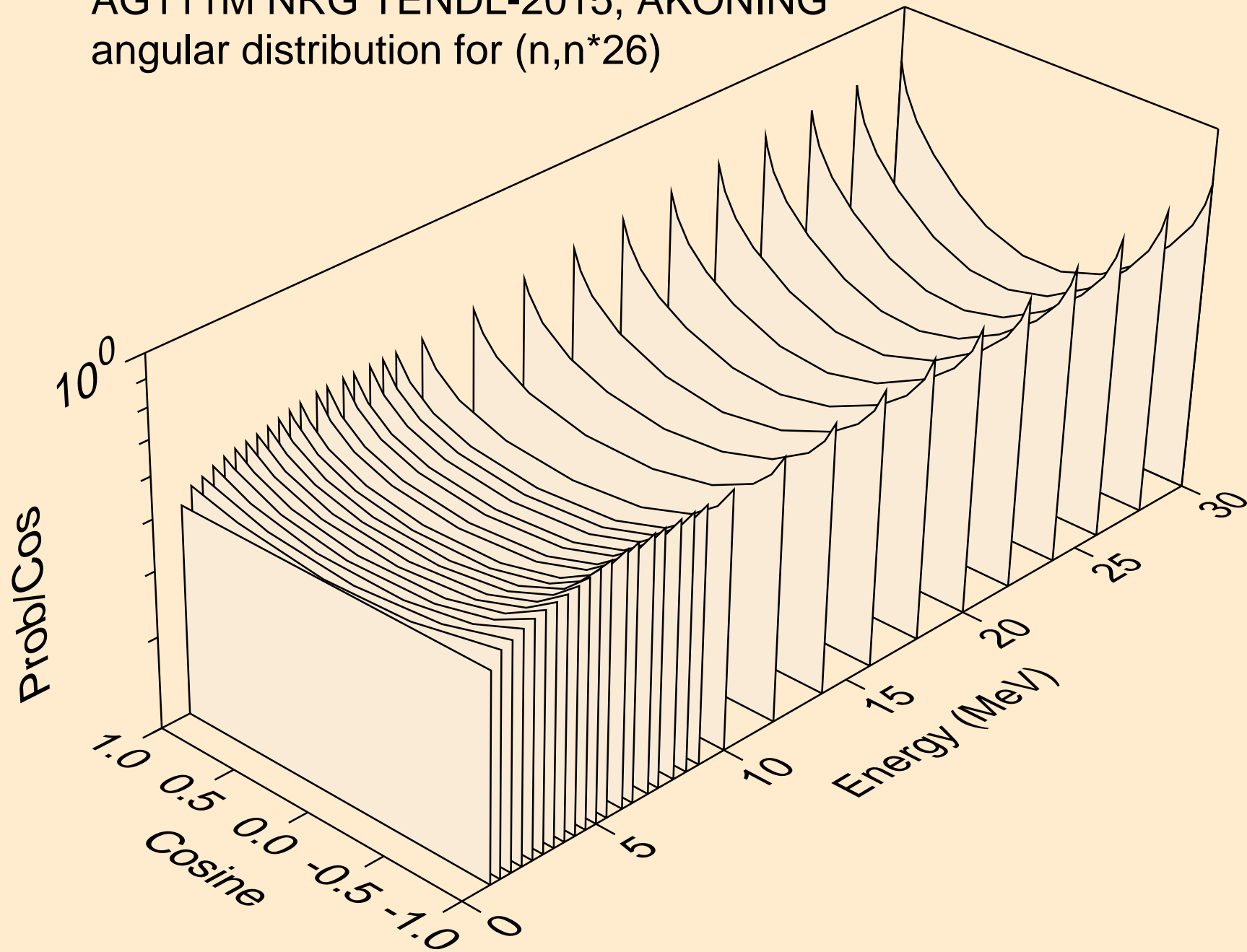

AG111M NRG TENDL-2015, AKONING
angular distribution for (n,n*27)

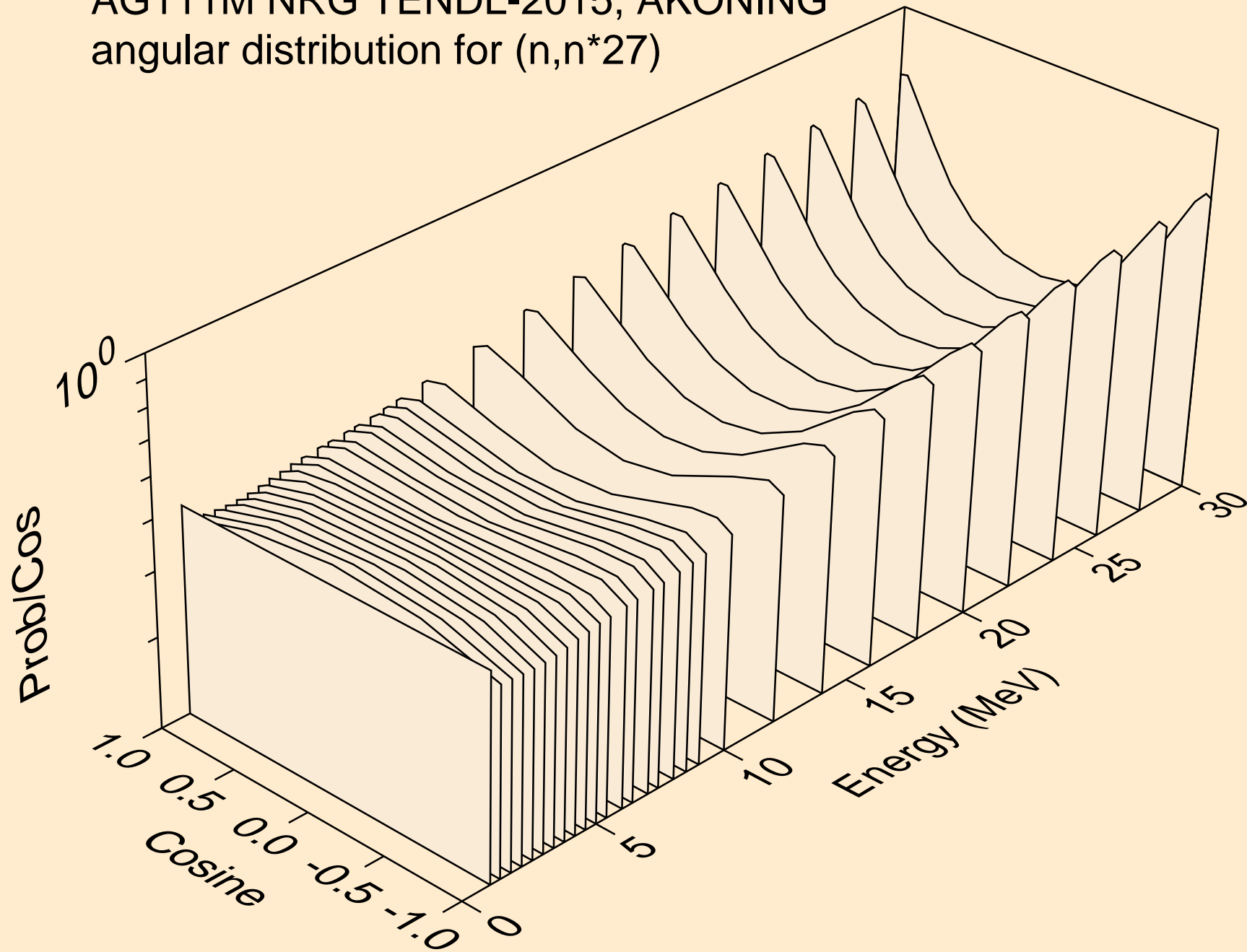

AG111M NRG TENDL-2015, AKONING
angular distribution for (n,n*28)

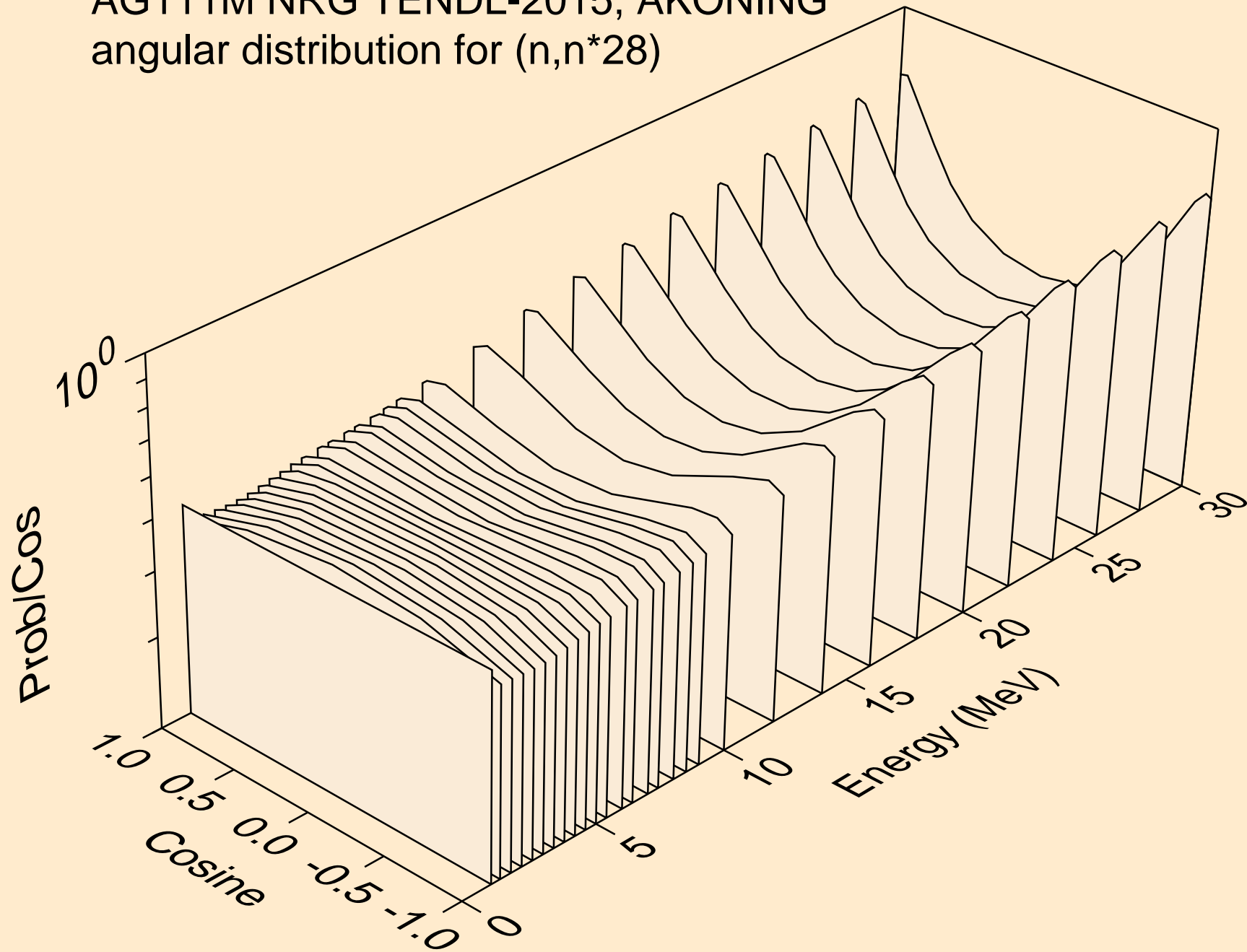

AG111M NRG TENDL-2015, AKONING
angular distribution for (n,n*29)

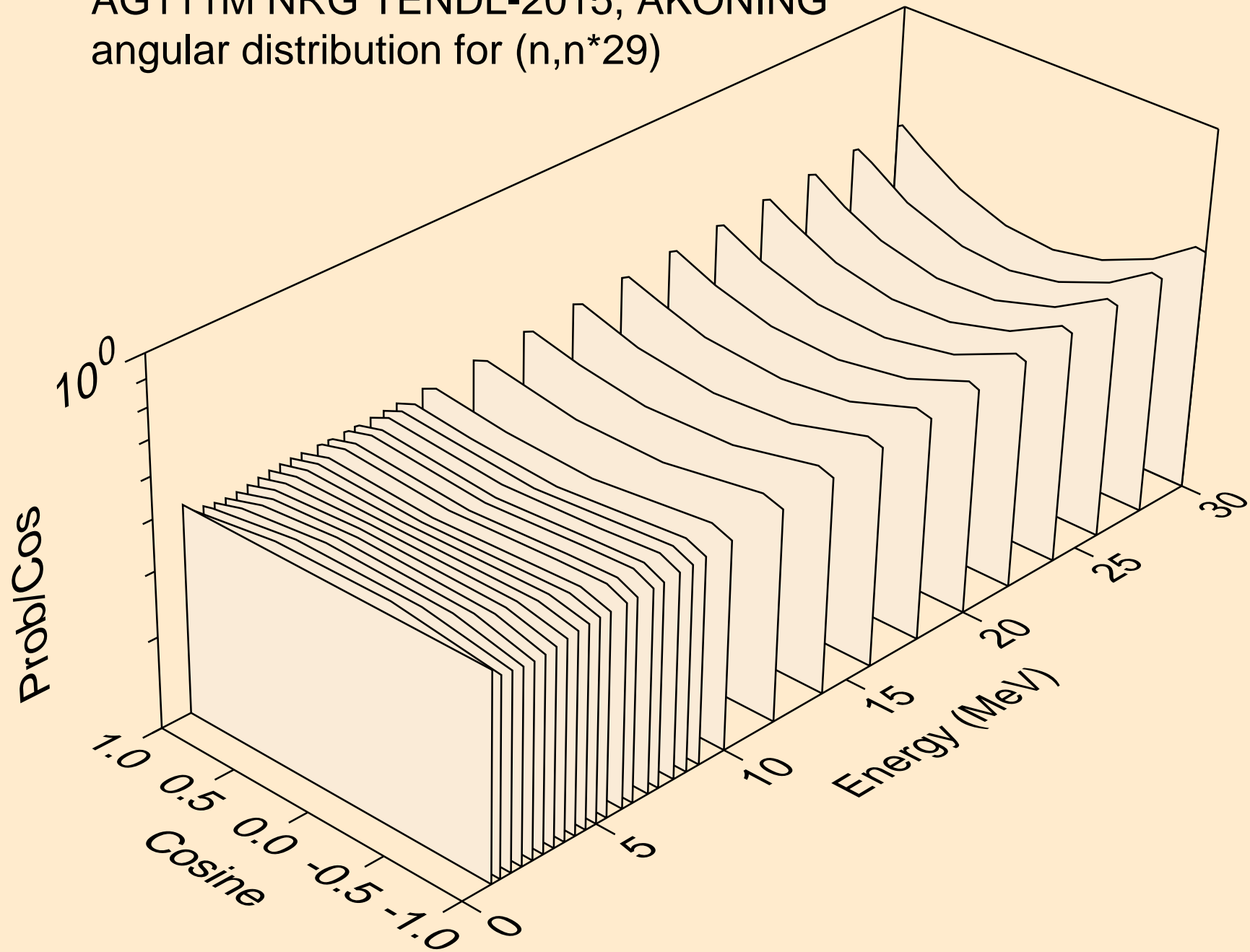

AG111M NRG TENDL-2015, AKONING
Neutron emission for (n,x)

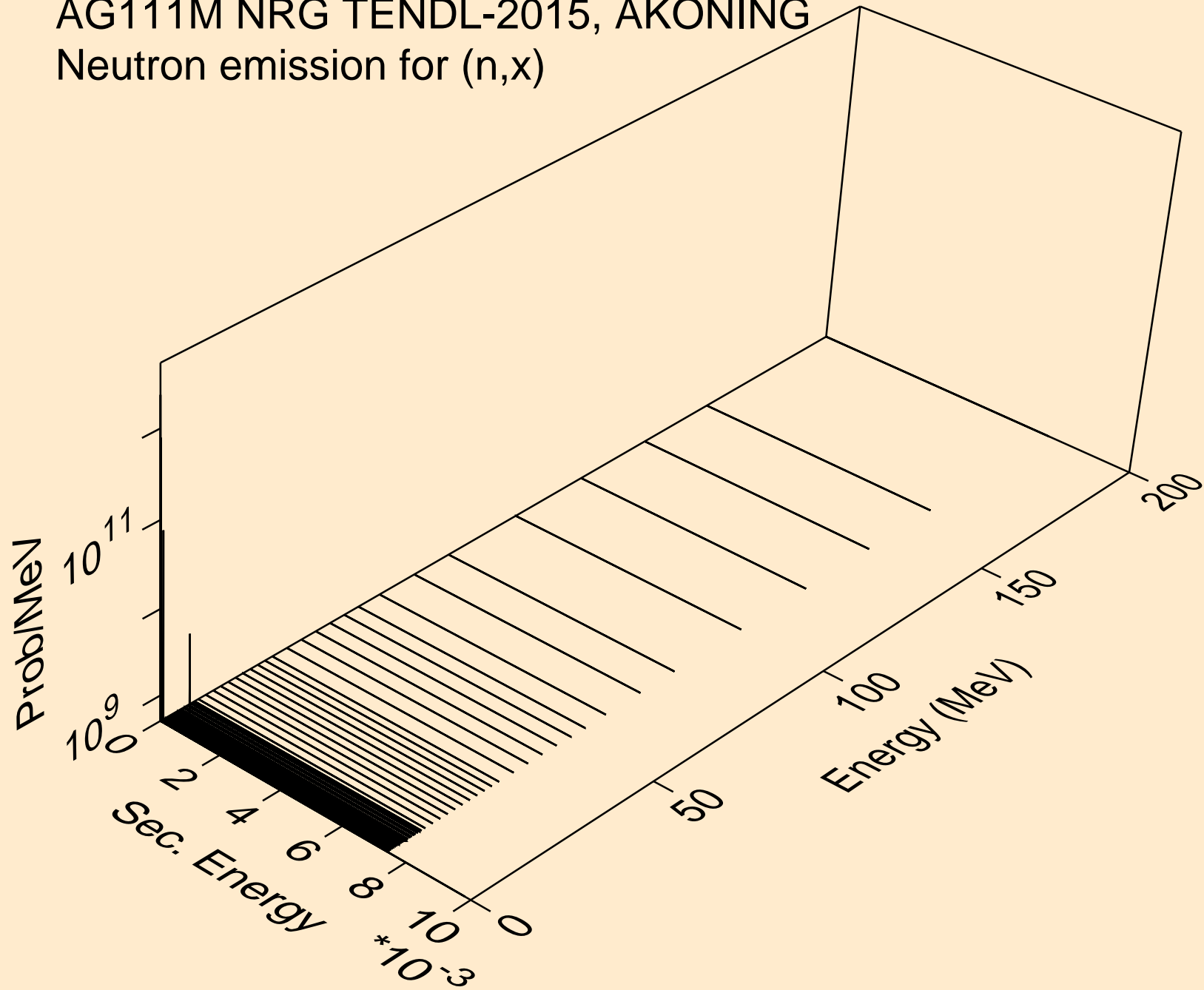

AG111M NRG TENDL-2015, AKONING
Neutron emission for (n,2nd)

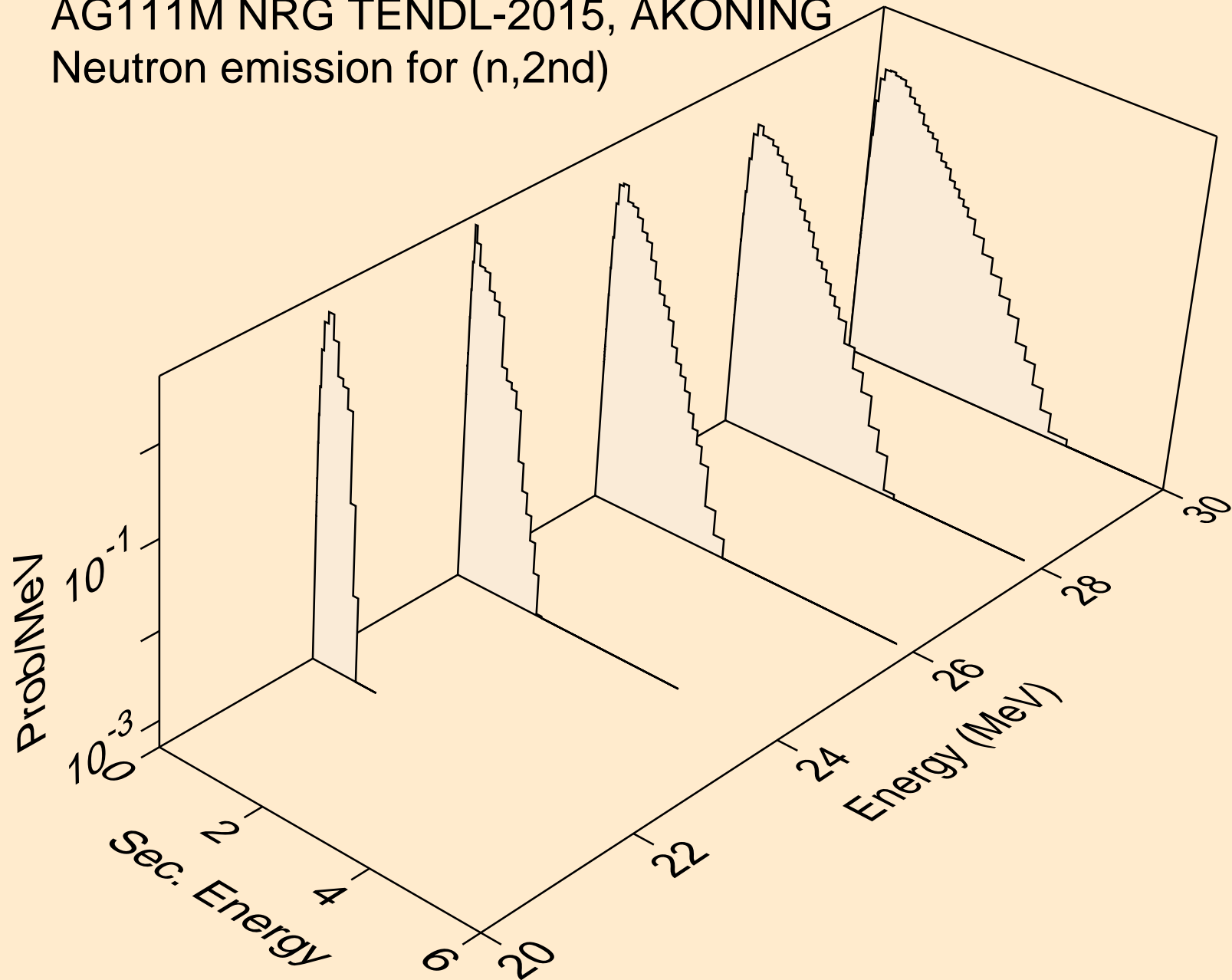

AG111M NRG TENDL-2015, AKONING
Neutron emission for (n,2n)

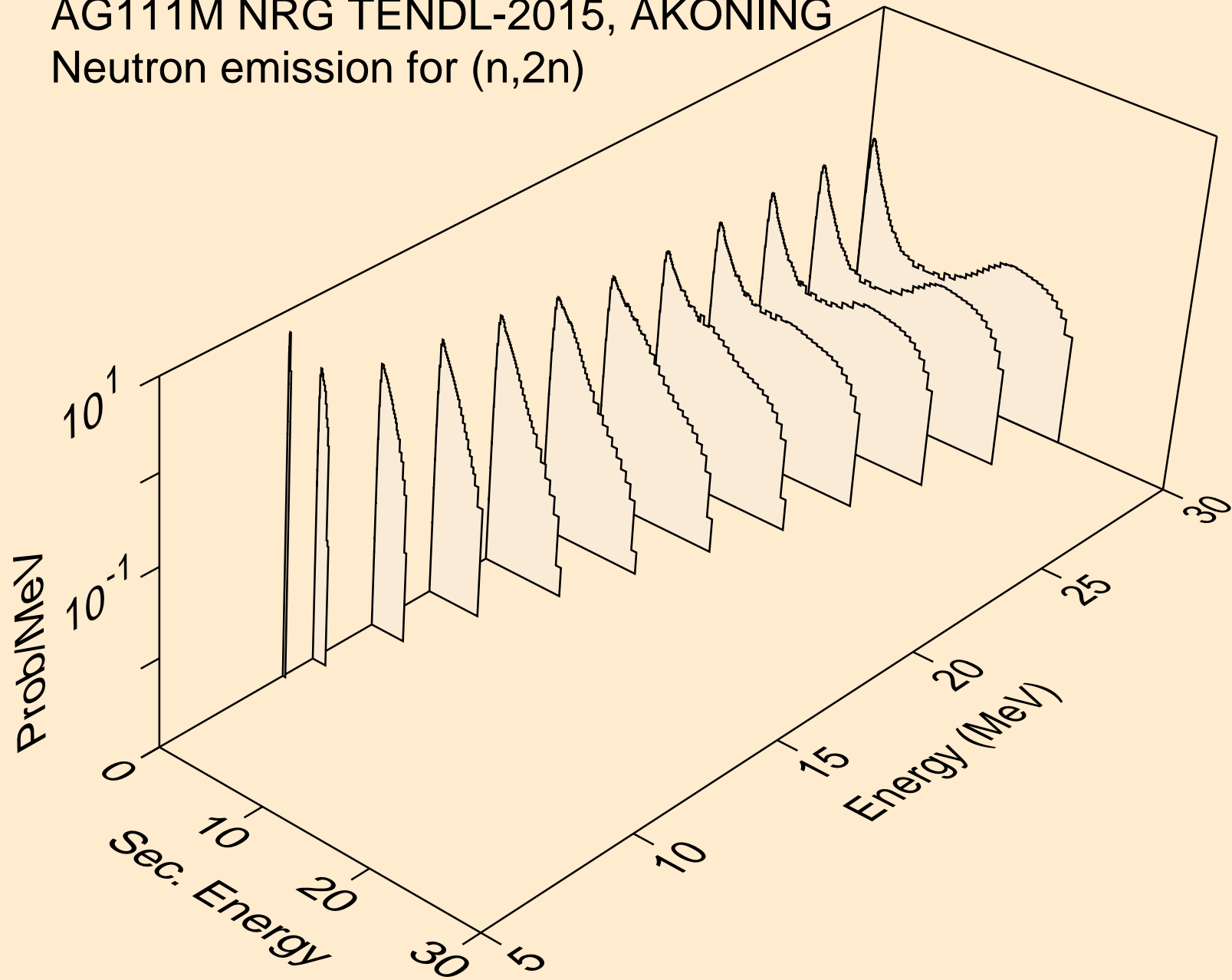

AG111M NRG TENDL-2015, AKONING
Neutron emission for (n,3n)

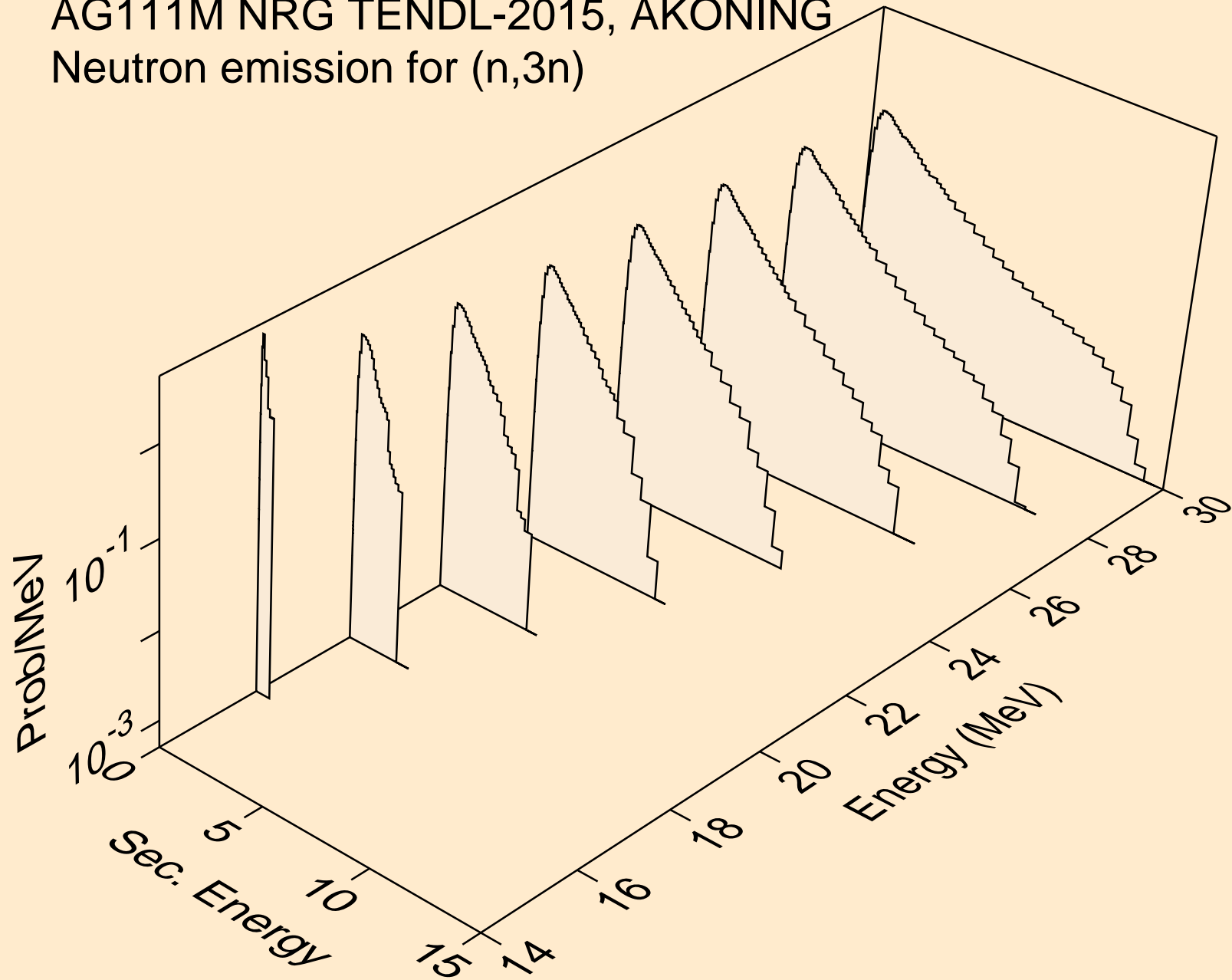

AG111M NRG TENDL-2015, AKONING
Neutron emission for (n,n*)a

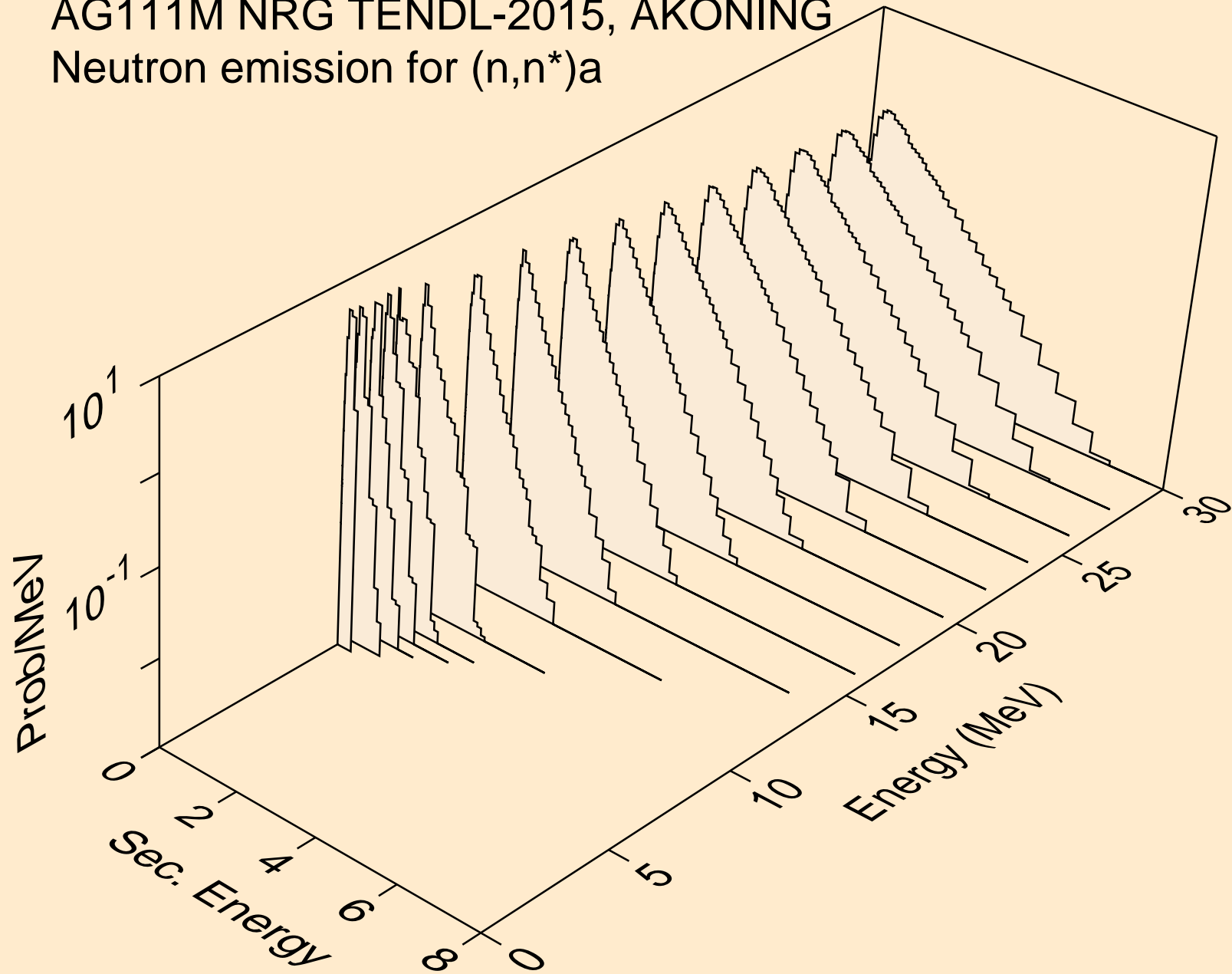

AG111M NRG TENDL-2015, AKONING
Neutron emission for (n,2n)_a

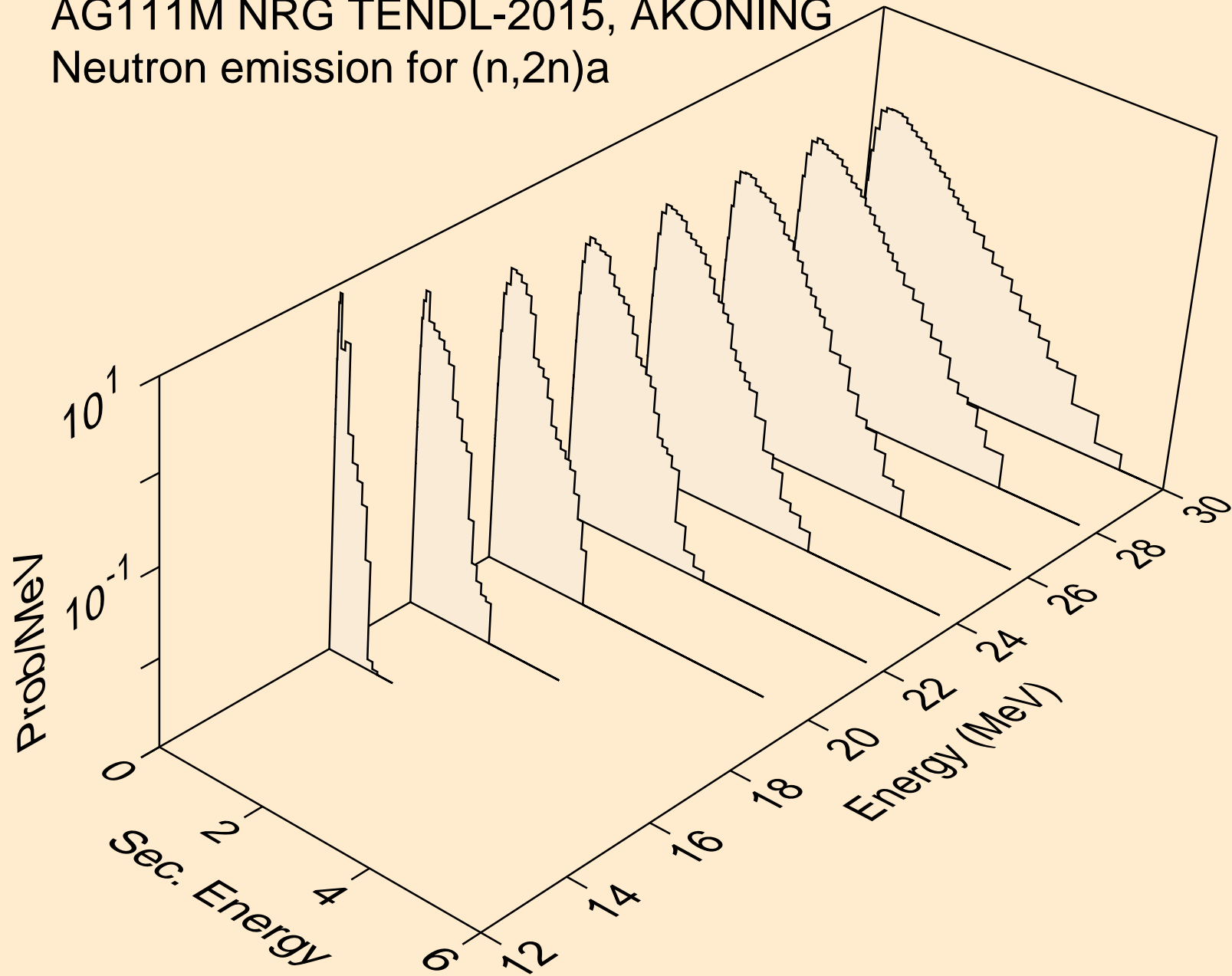

AG111M NRG TENDL-2015, AKONING
Neutron emission for (n,3n)a

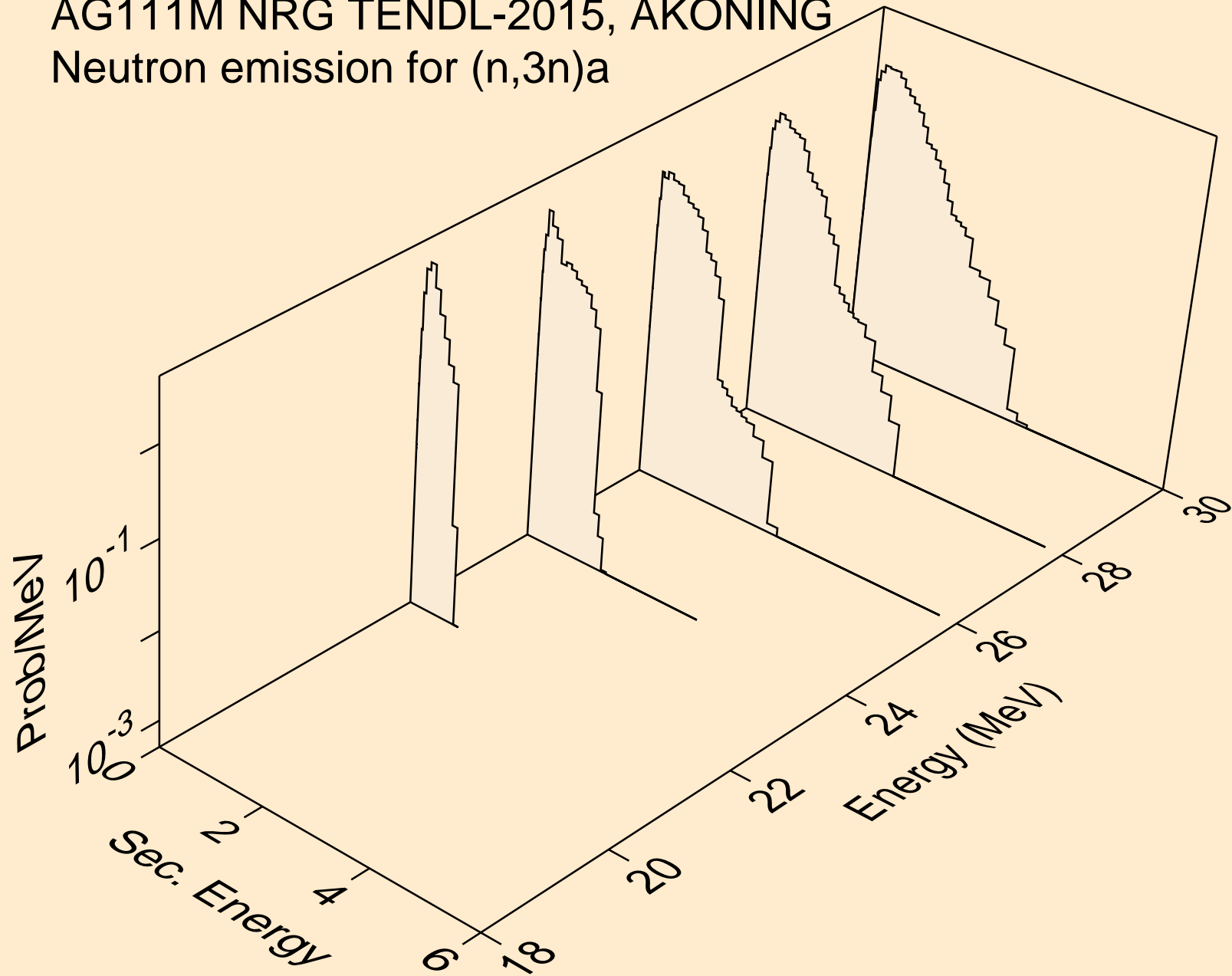

AG111M NRG TENDL-2015, AKONING
Neutron emission for (n,n*)p

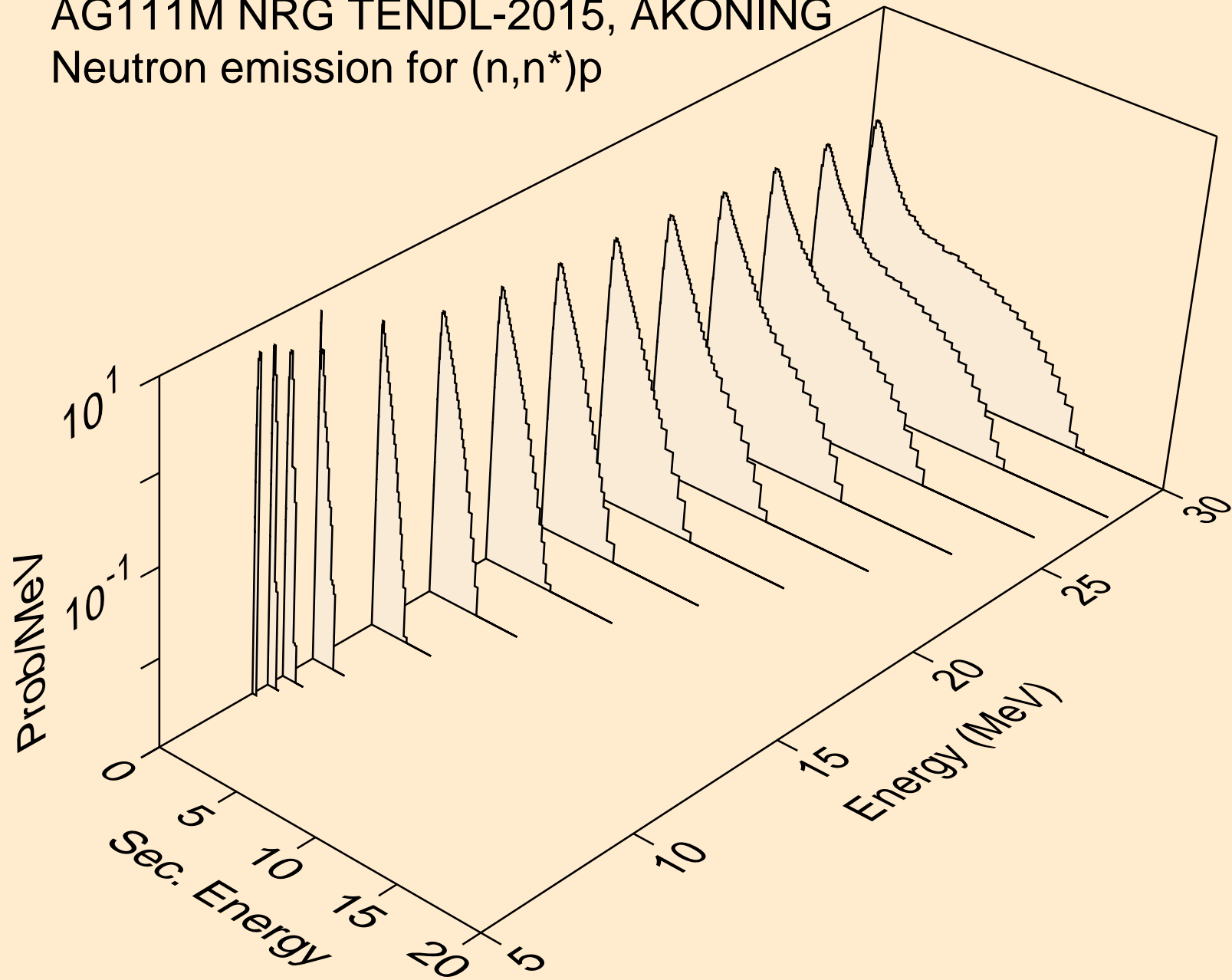

AG111M NRG TENDL-2015, AKONING
Neutron emission for (n,n*)2a

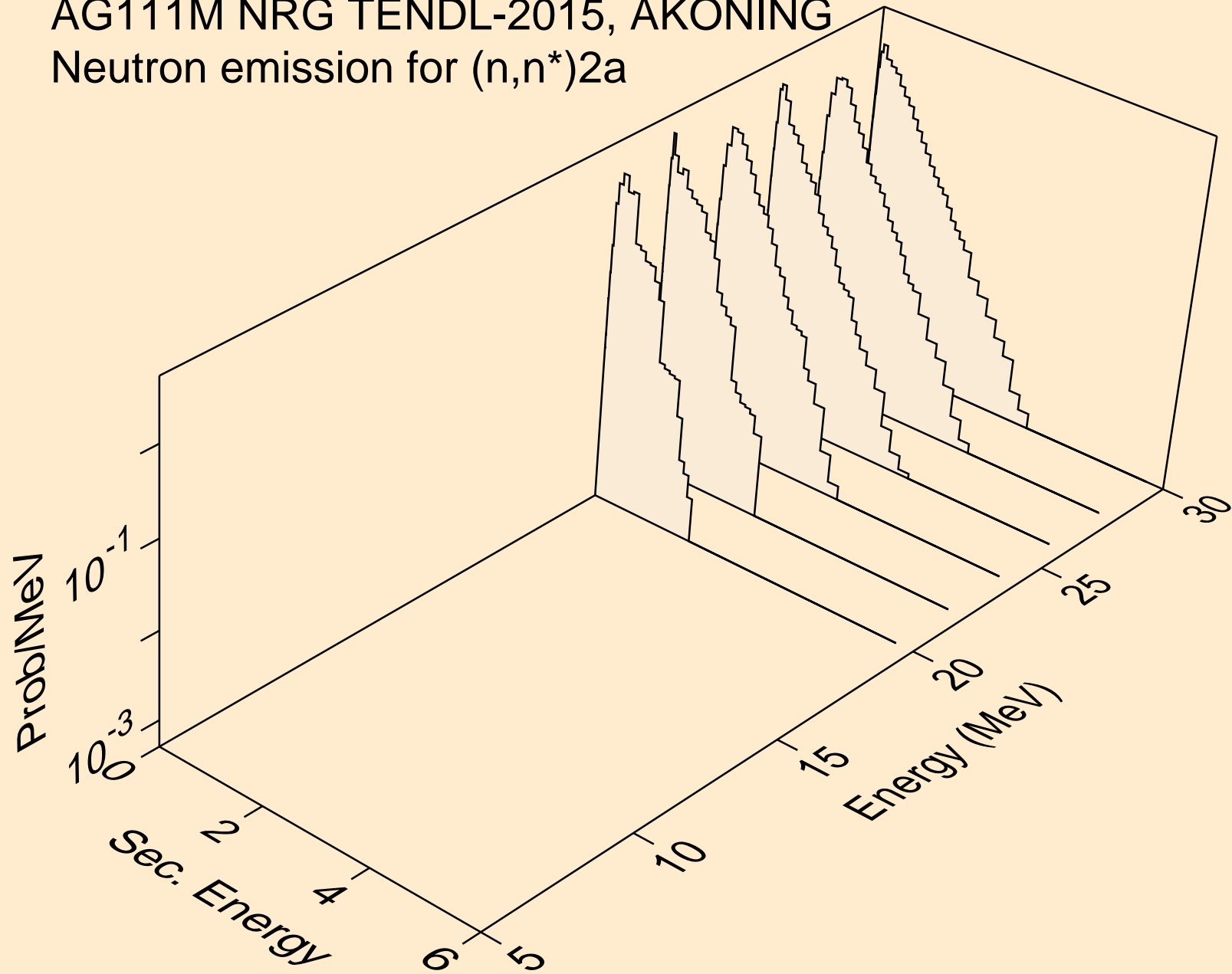

AG111M NRG TENDL-2015, AKONING
Neutron emission for (n,n*)d

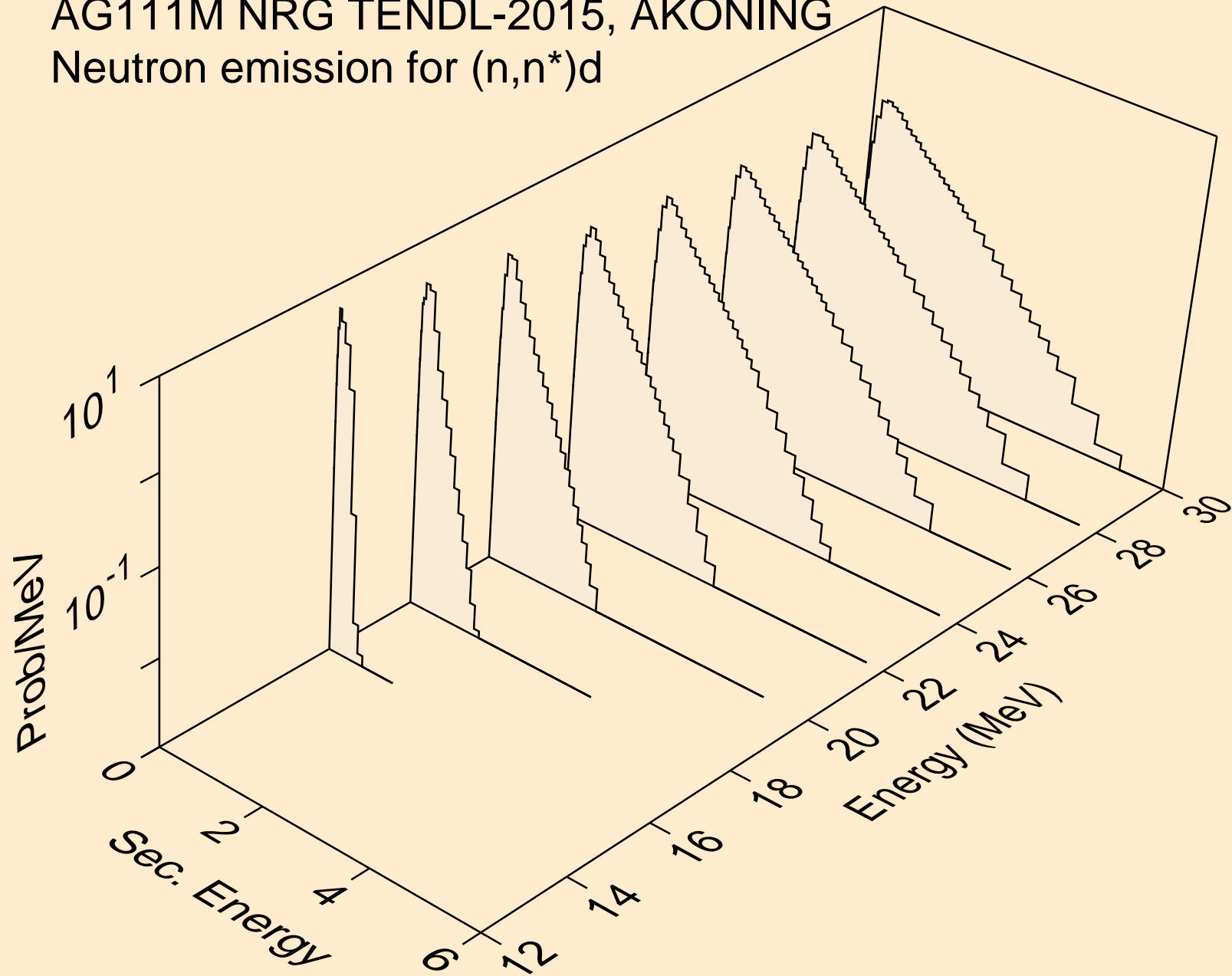

AG111M NRG TENDL-2015, AKONING
Neutron emission for (n,n*)t

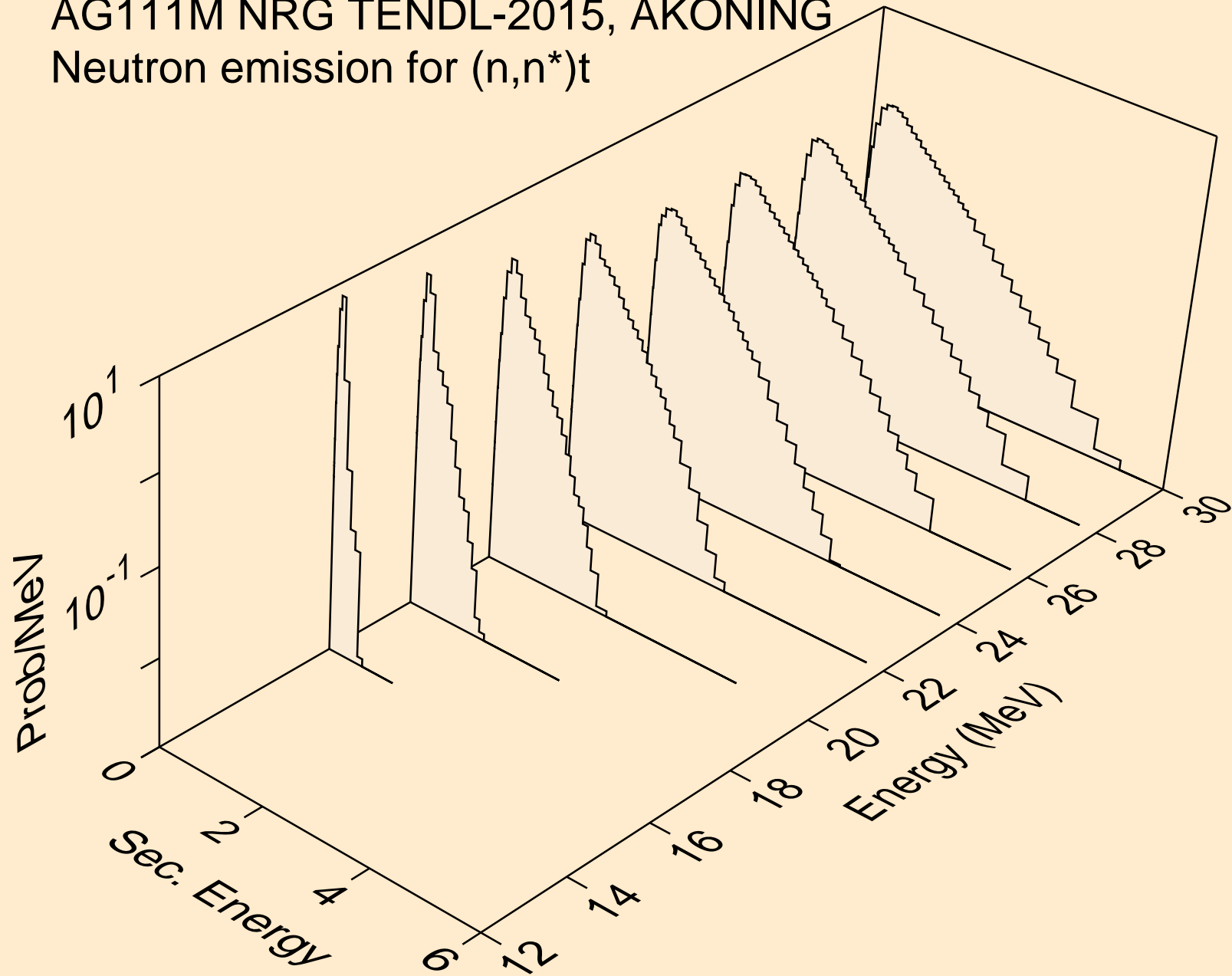

AG111M NRG TENDL-2015, AKONING
Neutron emission for (n,n*)he3

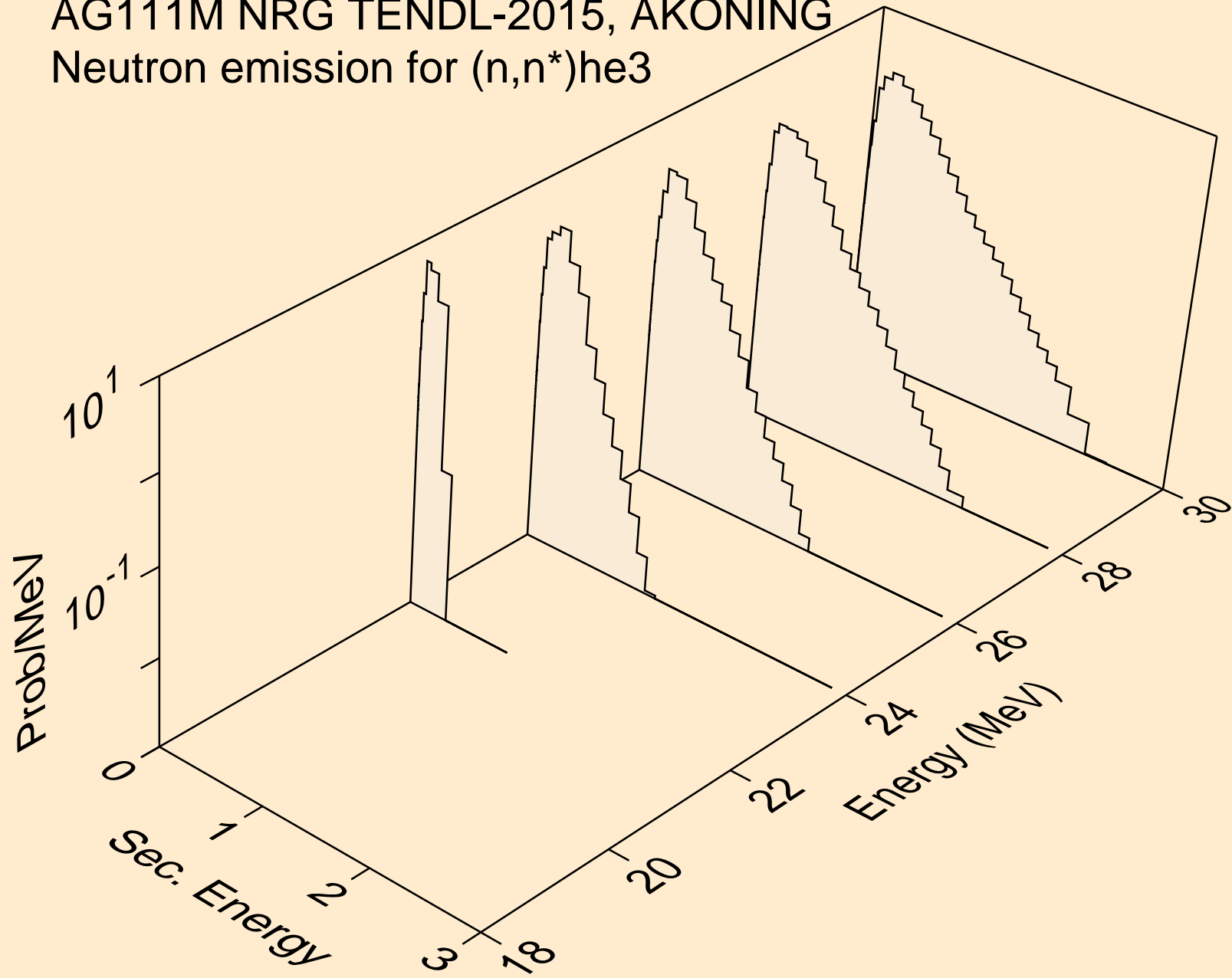

AG111M NRG TENDL-2015, AKONING
Neutron emission for (n,4n)

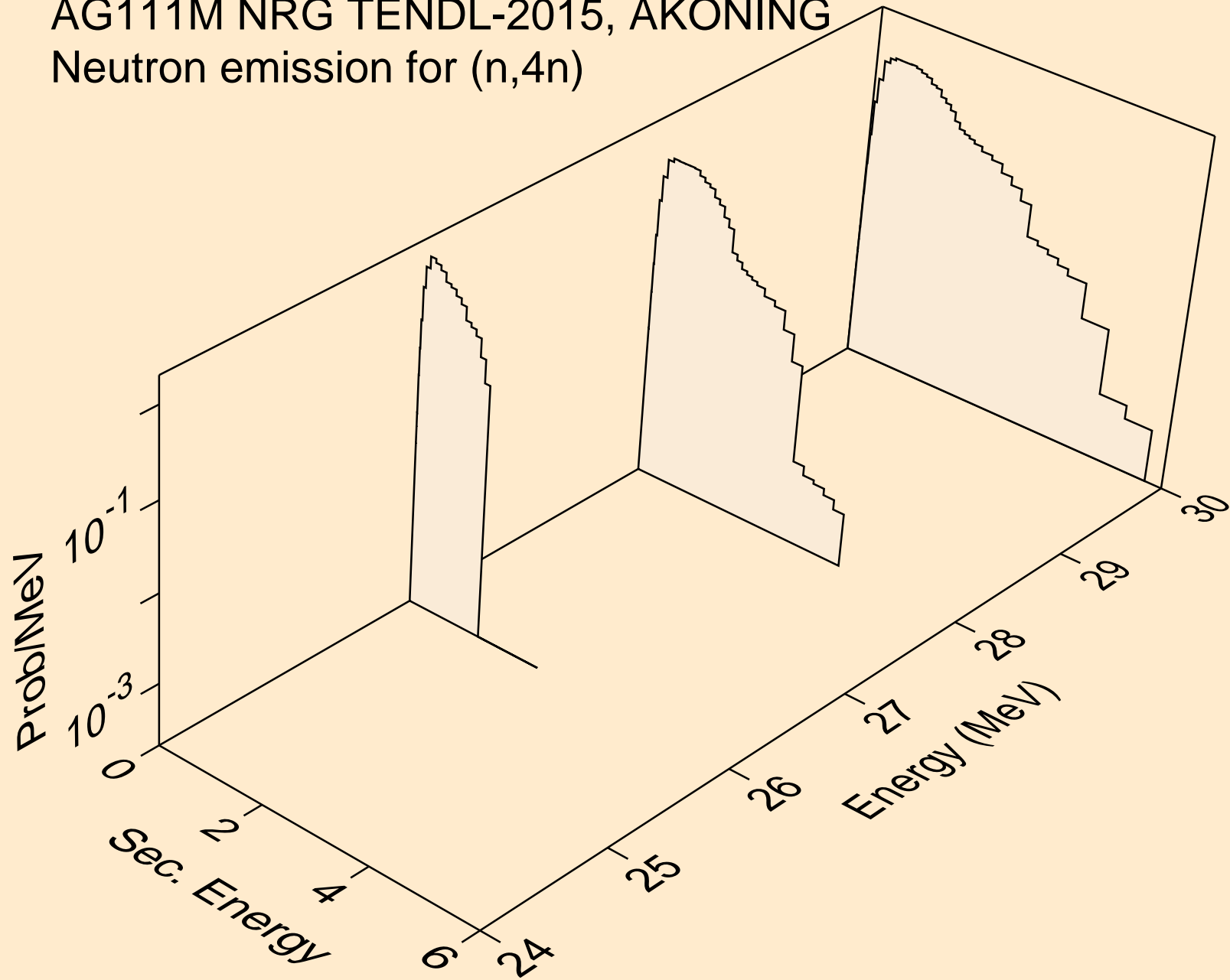

AG111M NRG TENDL-2015, AKONING
Neutron emission for (n,2np)

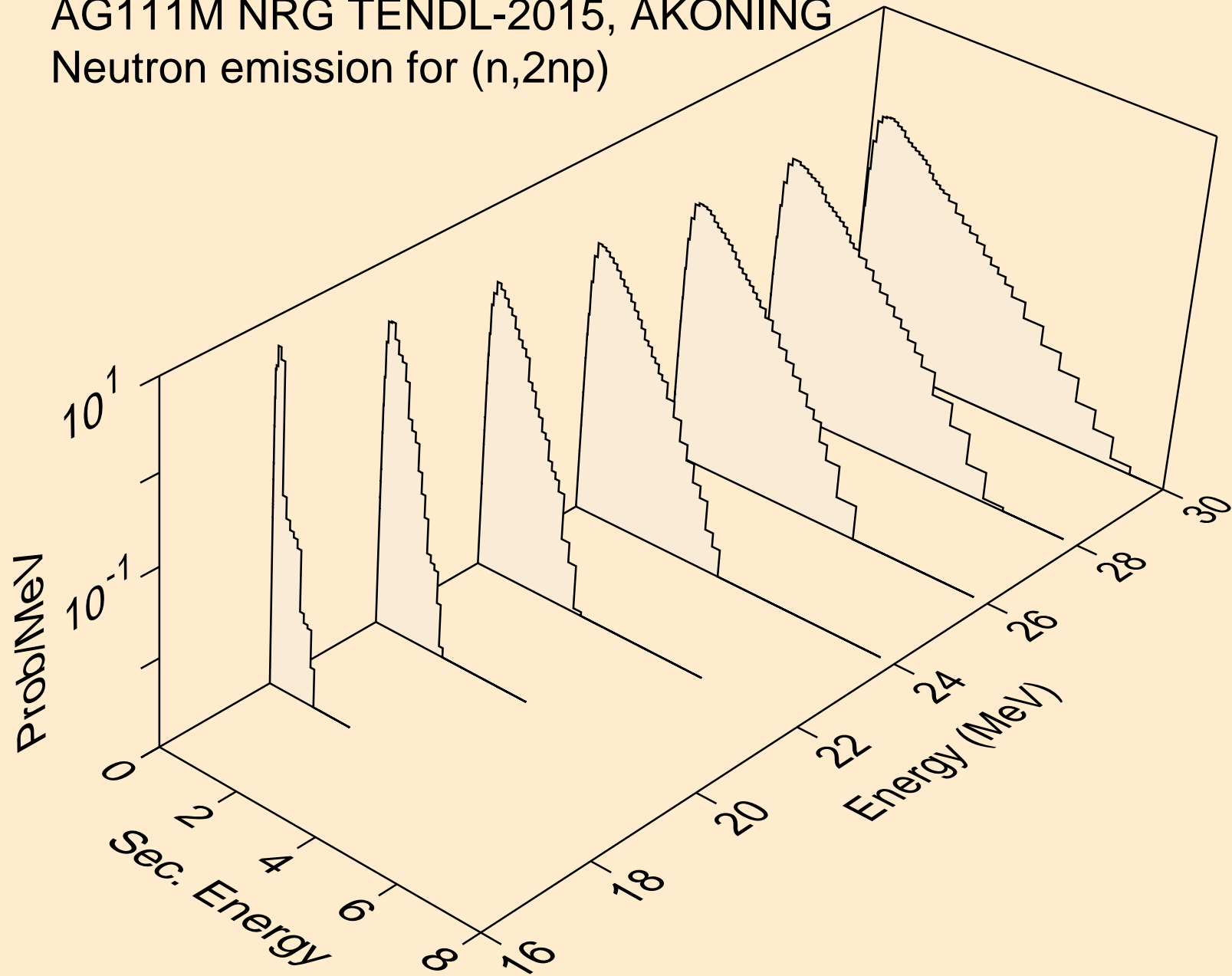

AG111M NRG TENDL-2015, AKONING
Neutron emission for (n,3np)

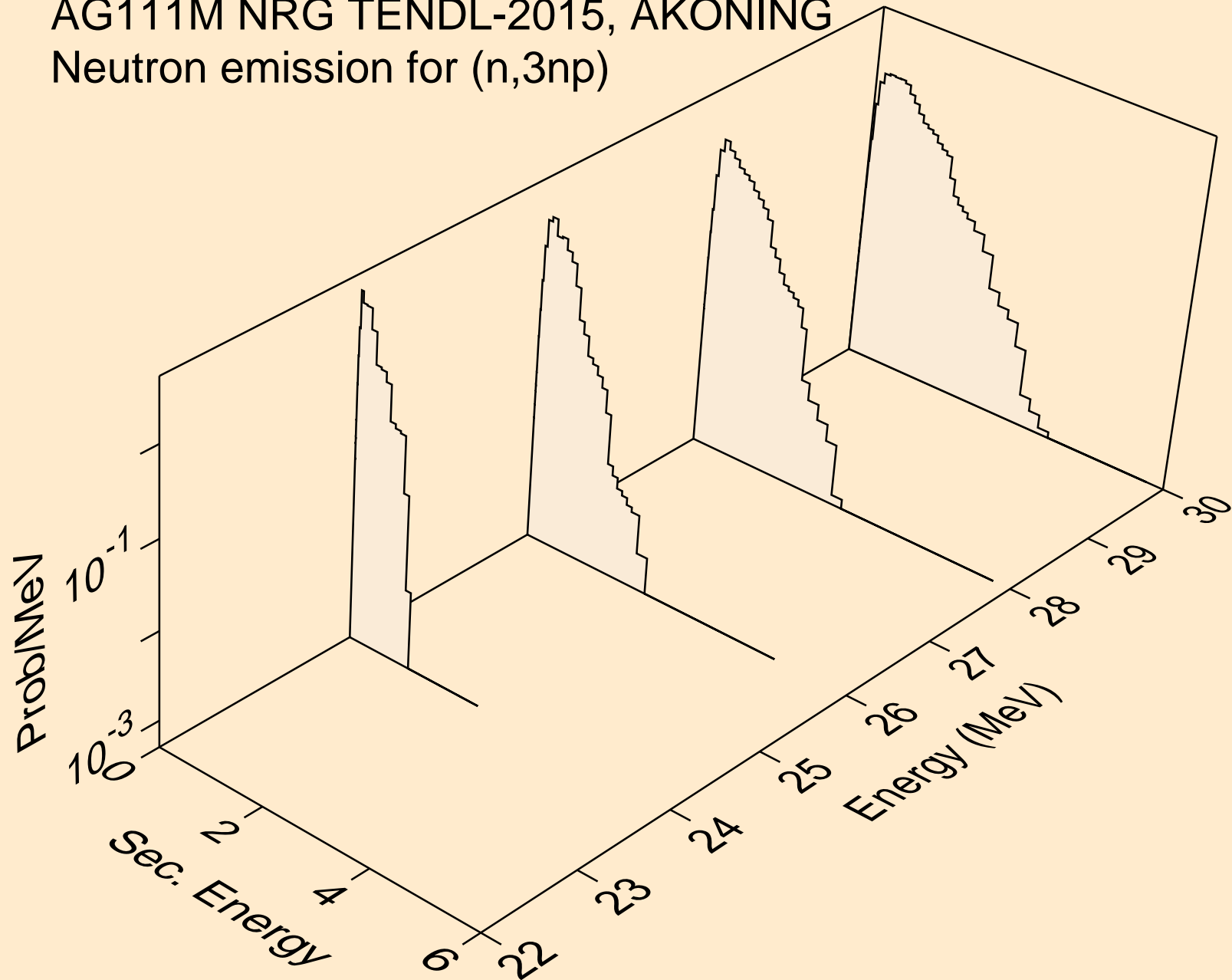

AG111M NRG TENDL-2015, AKONING
Neutron emission for (n,2np)

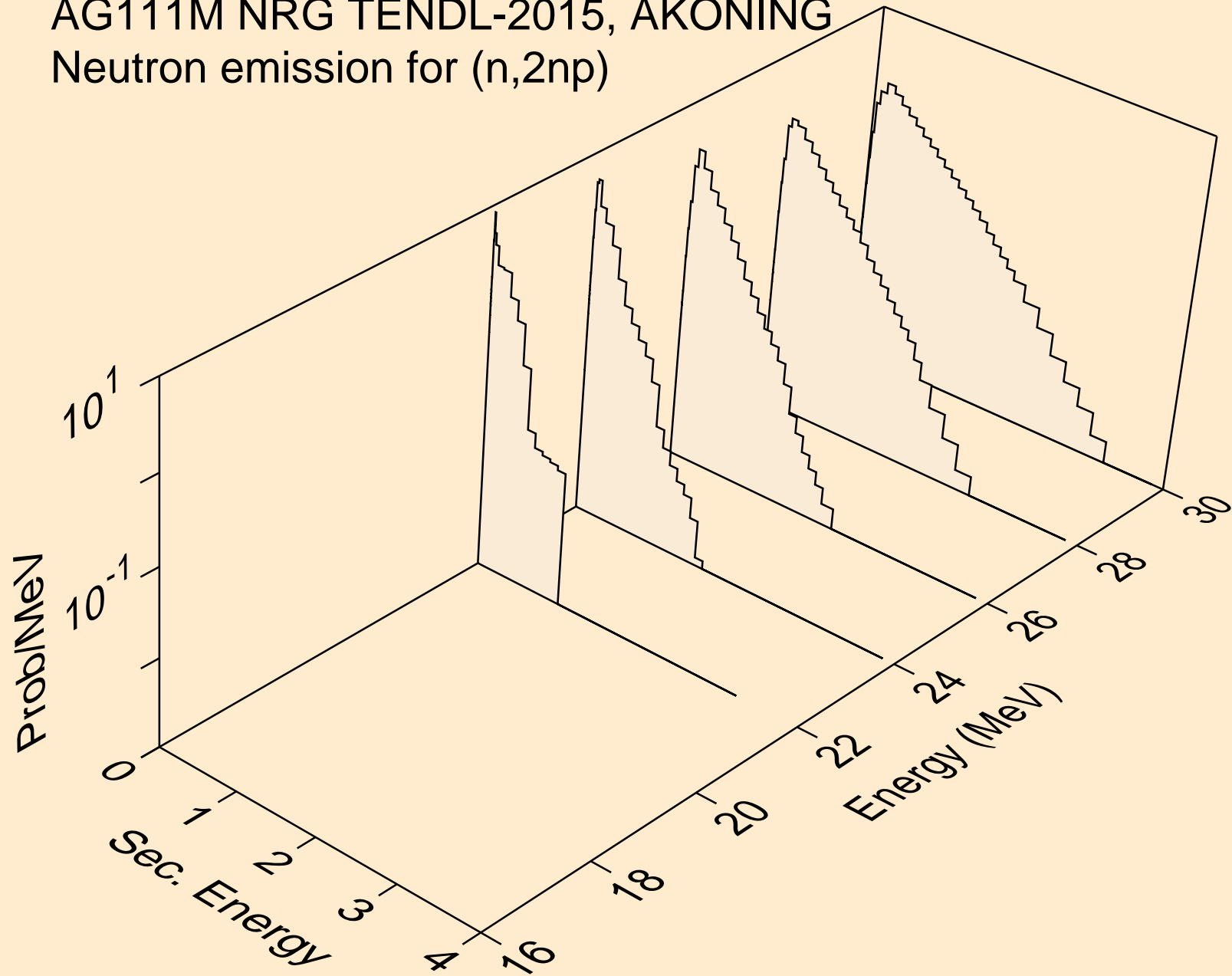

AG111M NRG TENDL-2015, AKONING
Neutron emission for (n,npa)

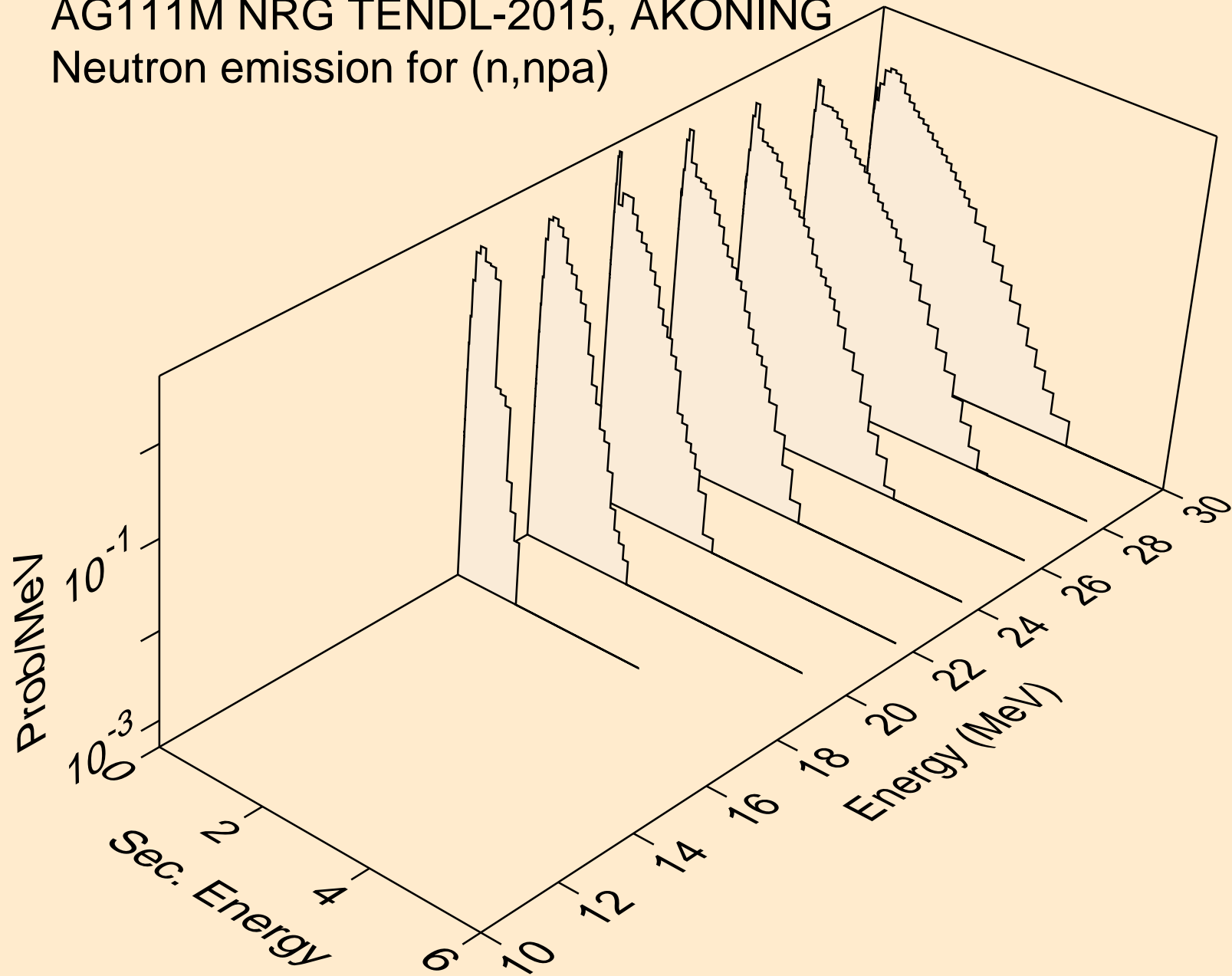

AG111M NRG TENDL-2015, AKONING
Neutron emission for (n,n*c)

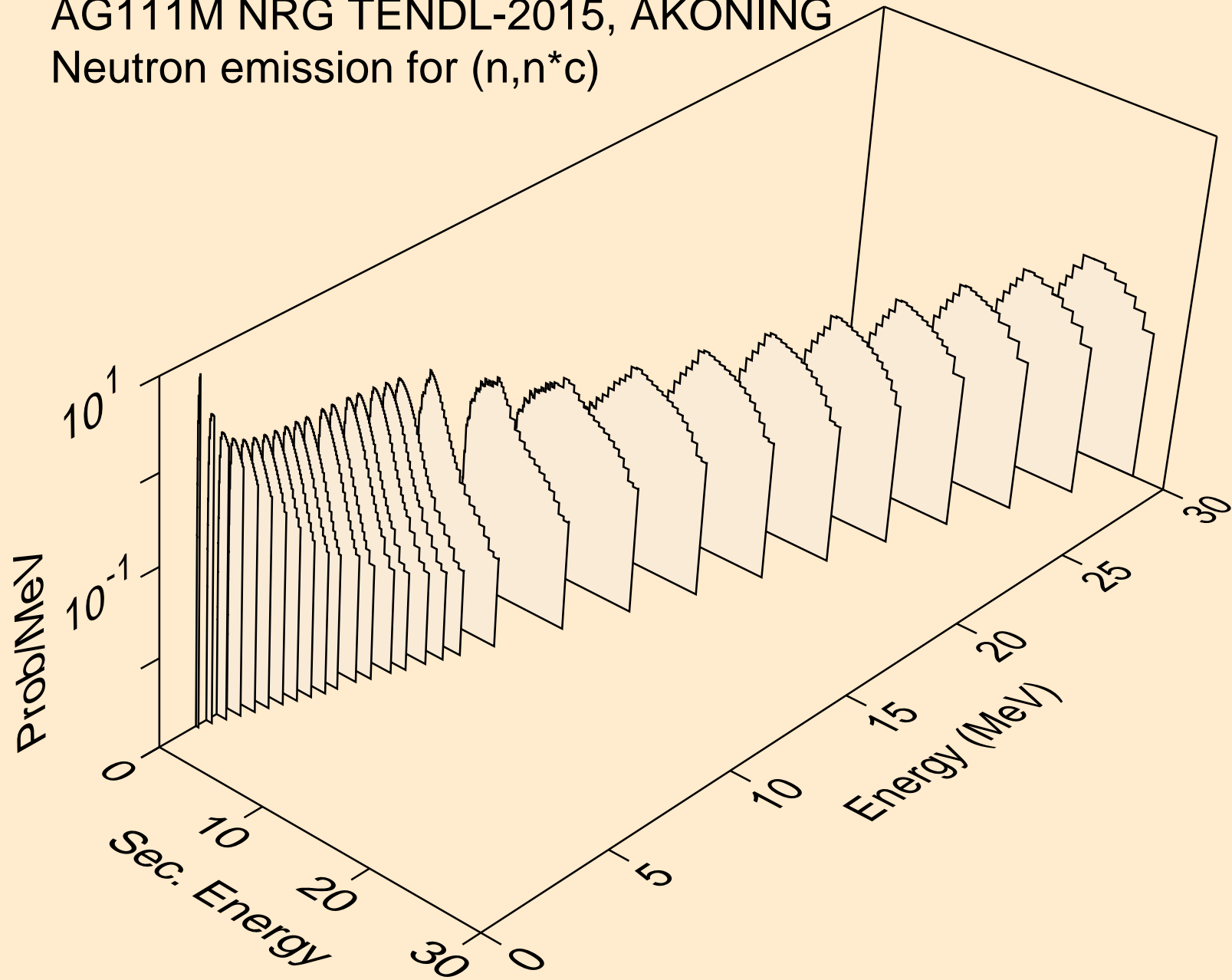

AG111M NRG TENDL-2015, AKONING
Photon emission for (n,x)

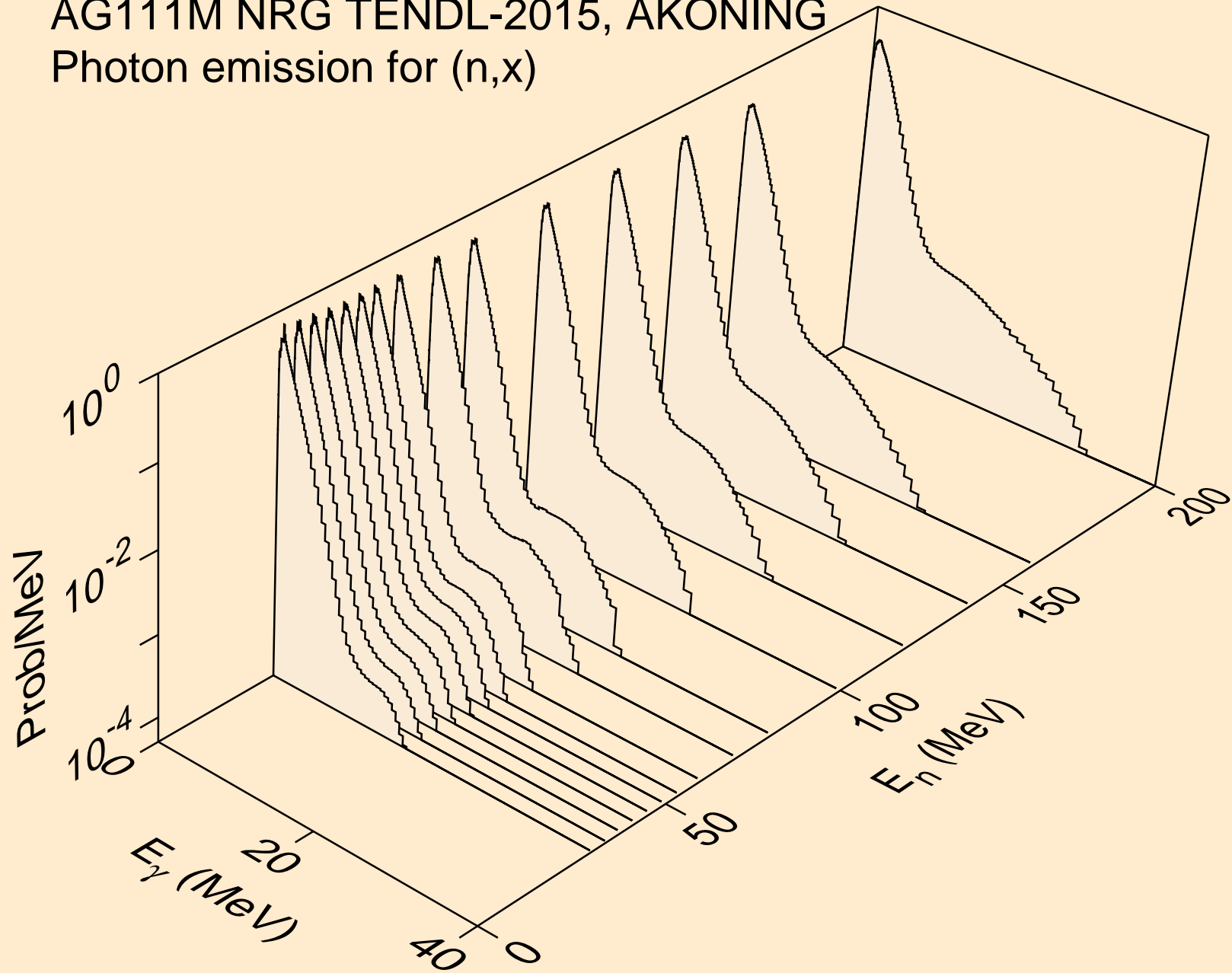

AG111M NRG TENDL-2015, AKONING
Photon emission for (n,2nd)

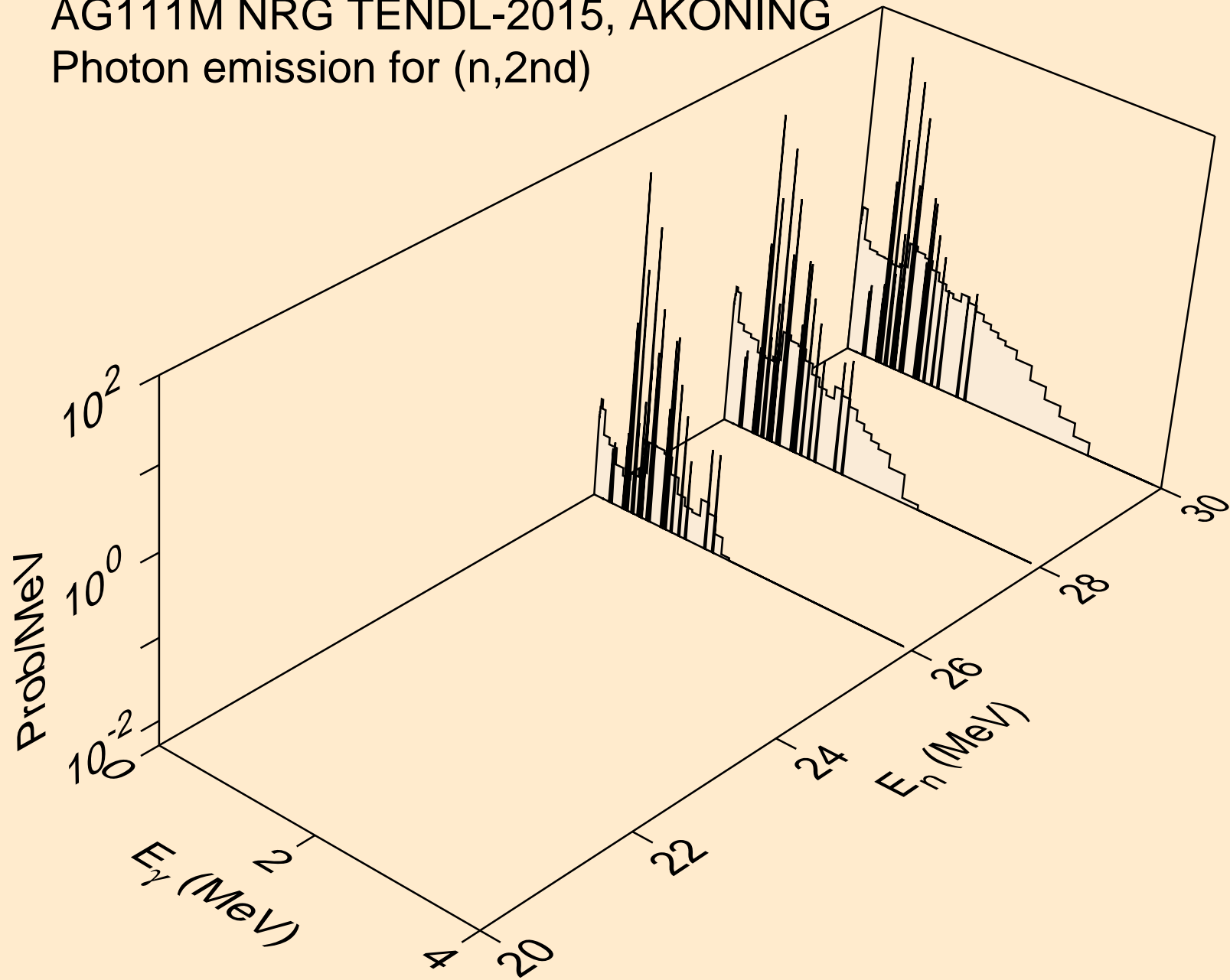

AG111M NRG TENDL-2015, AKONING
Photon emission for (n,2n)

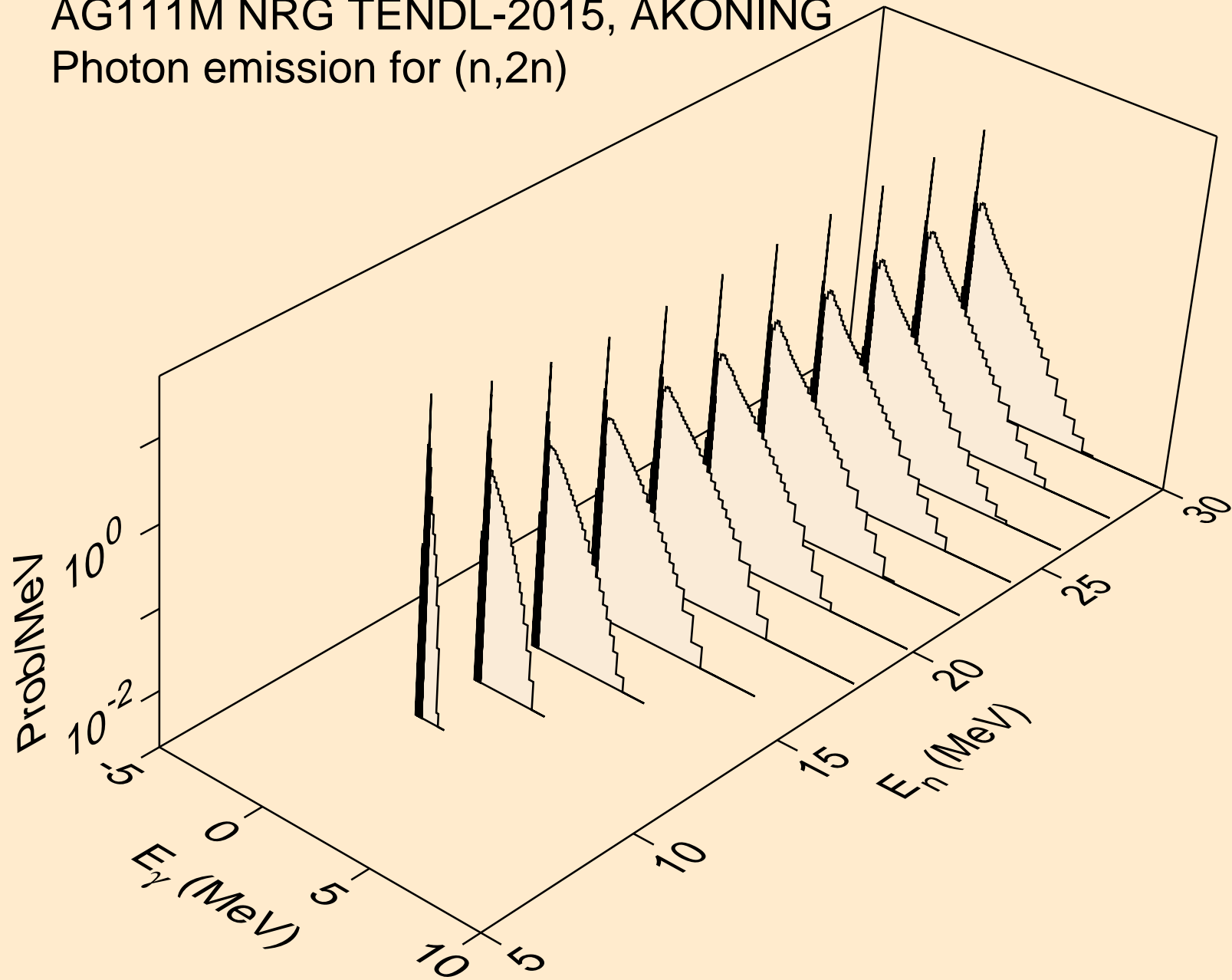

AG111M NRG TENDL-2015, AKONING
Photon emission for (n,3n)

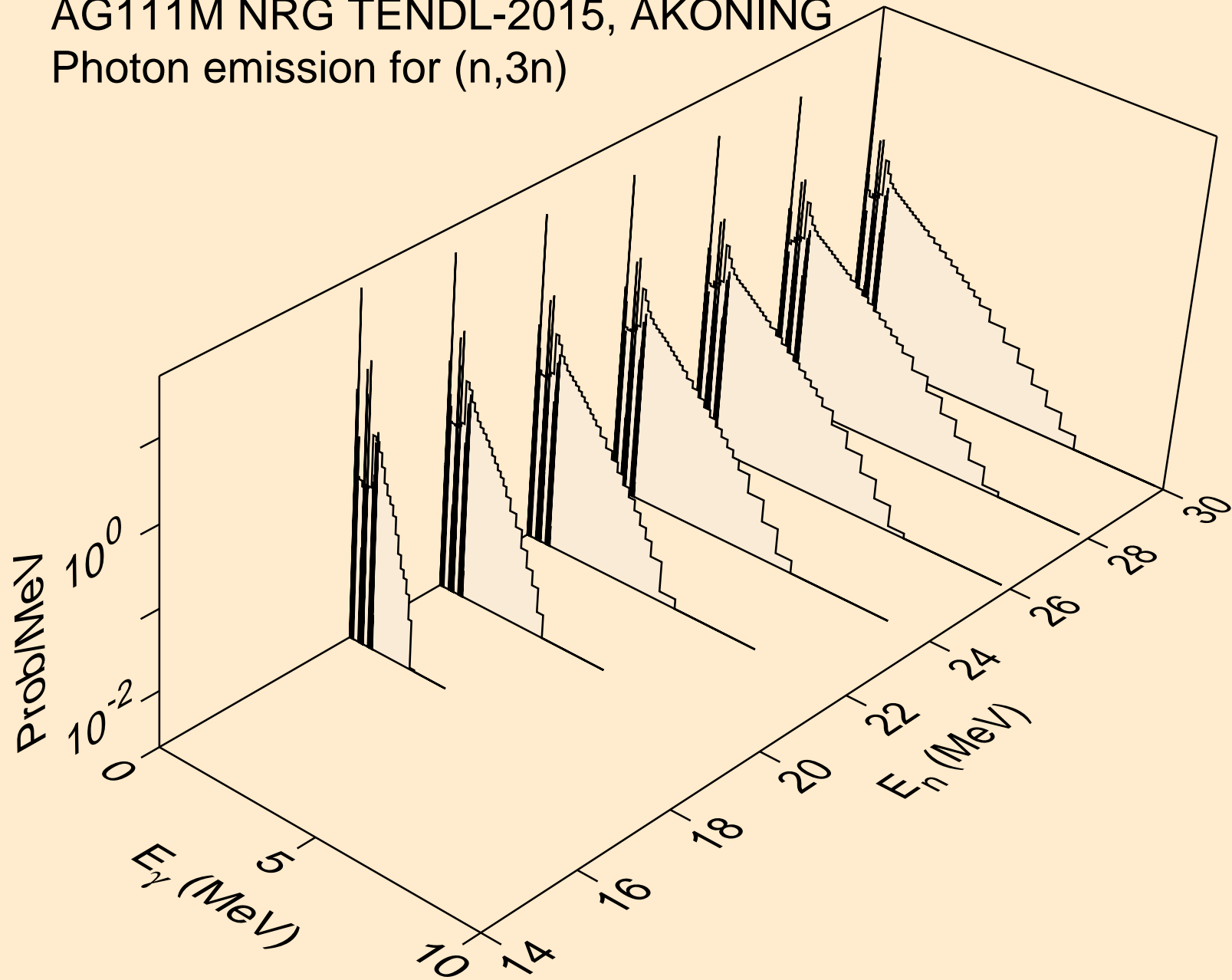

AG111M NRG TENDL-2015, AKONING
Photon emission for (n,n*)a

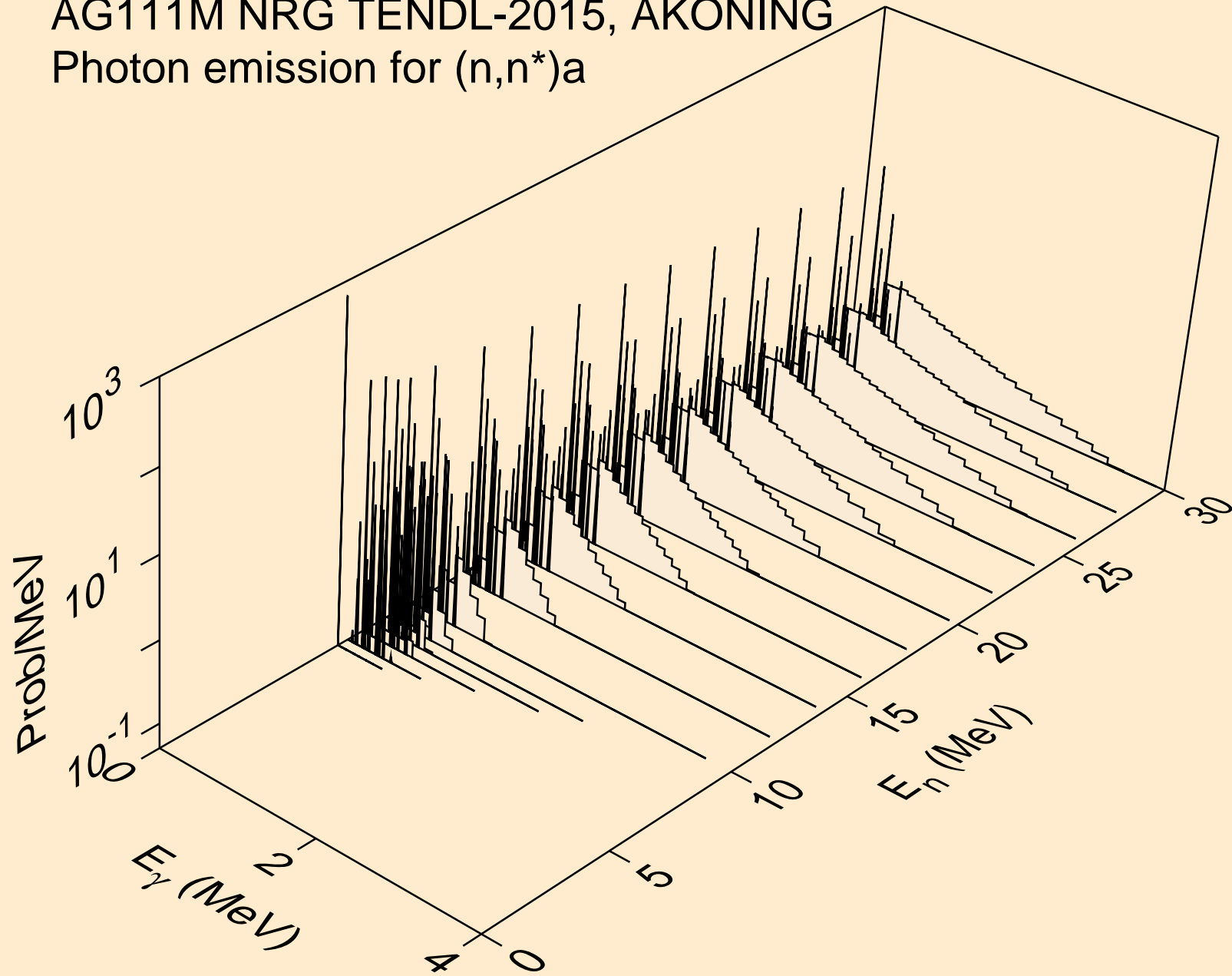

AG111M NRG TENDL-2015, AKONING
Photon emission for (n,2n)a

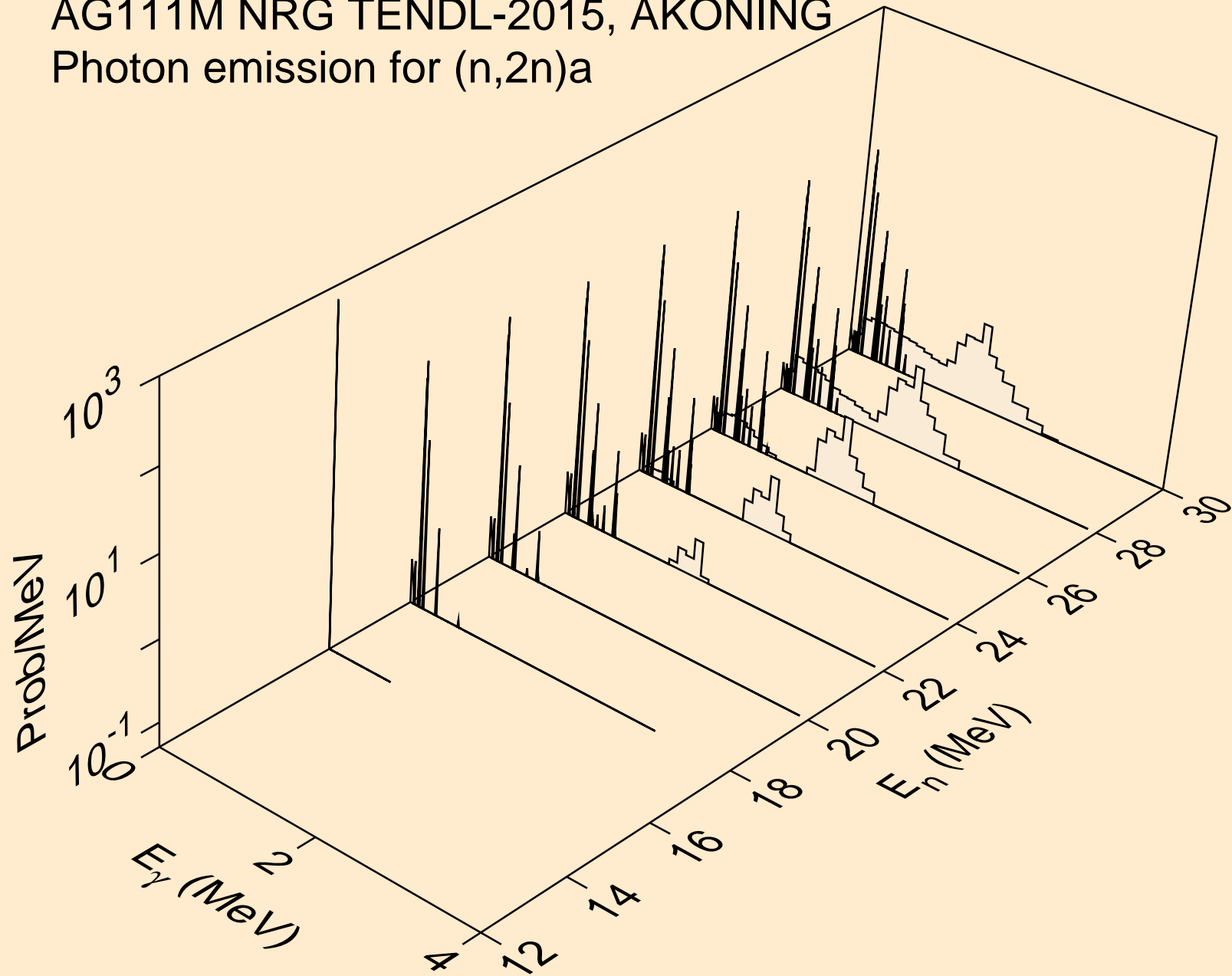

AG111M NRG TENDL-2015, AKONING
Photon emission for (n,3n)a

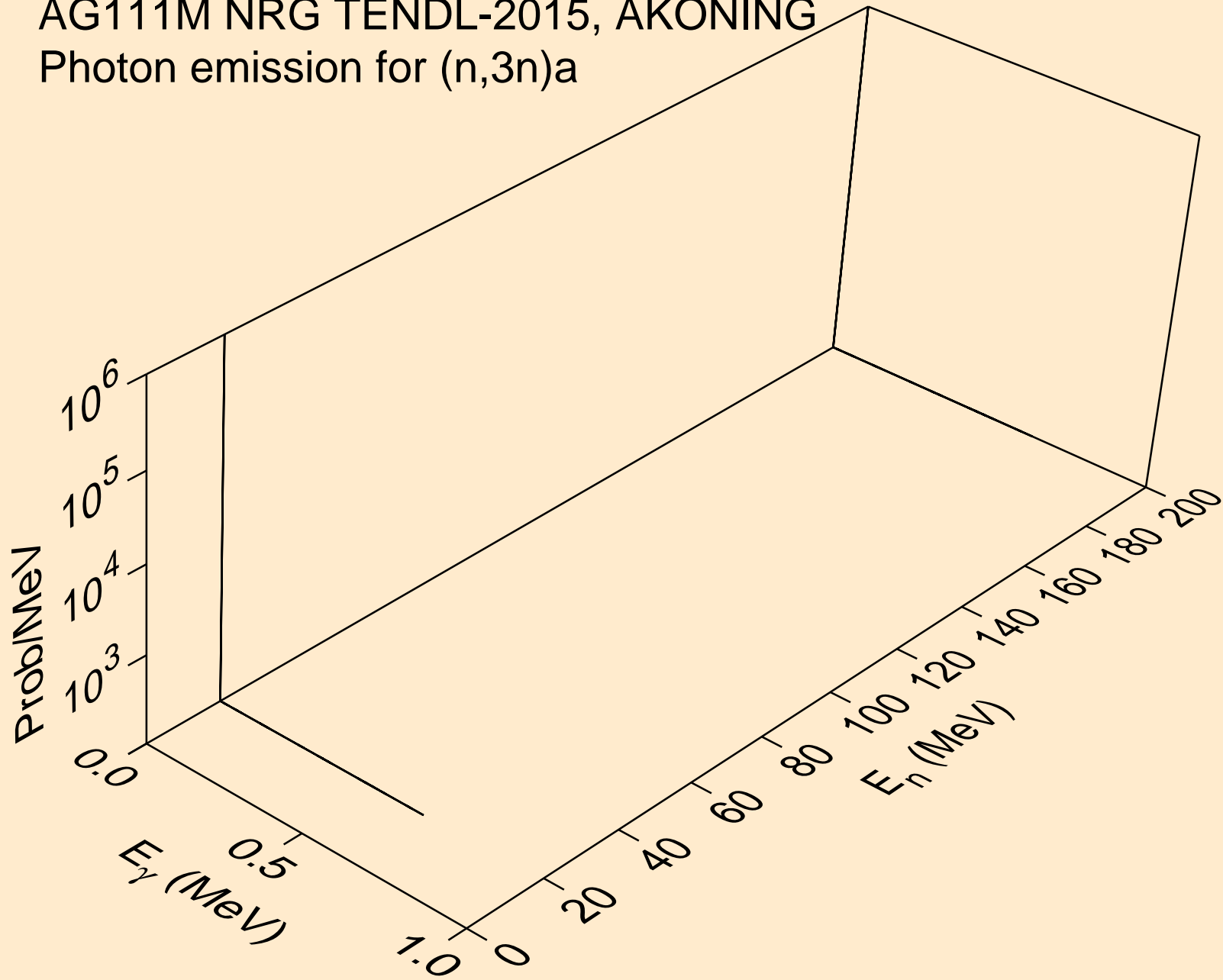

AG111M NRG TENDL-2015, AKONING
Photon emission for (n,n*)p

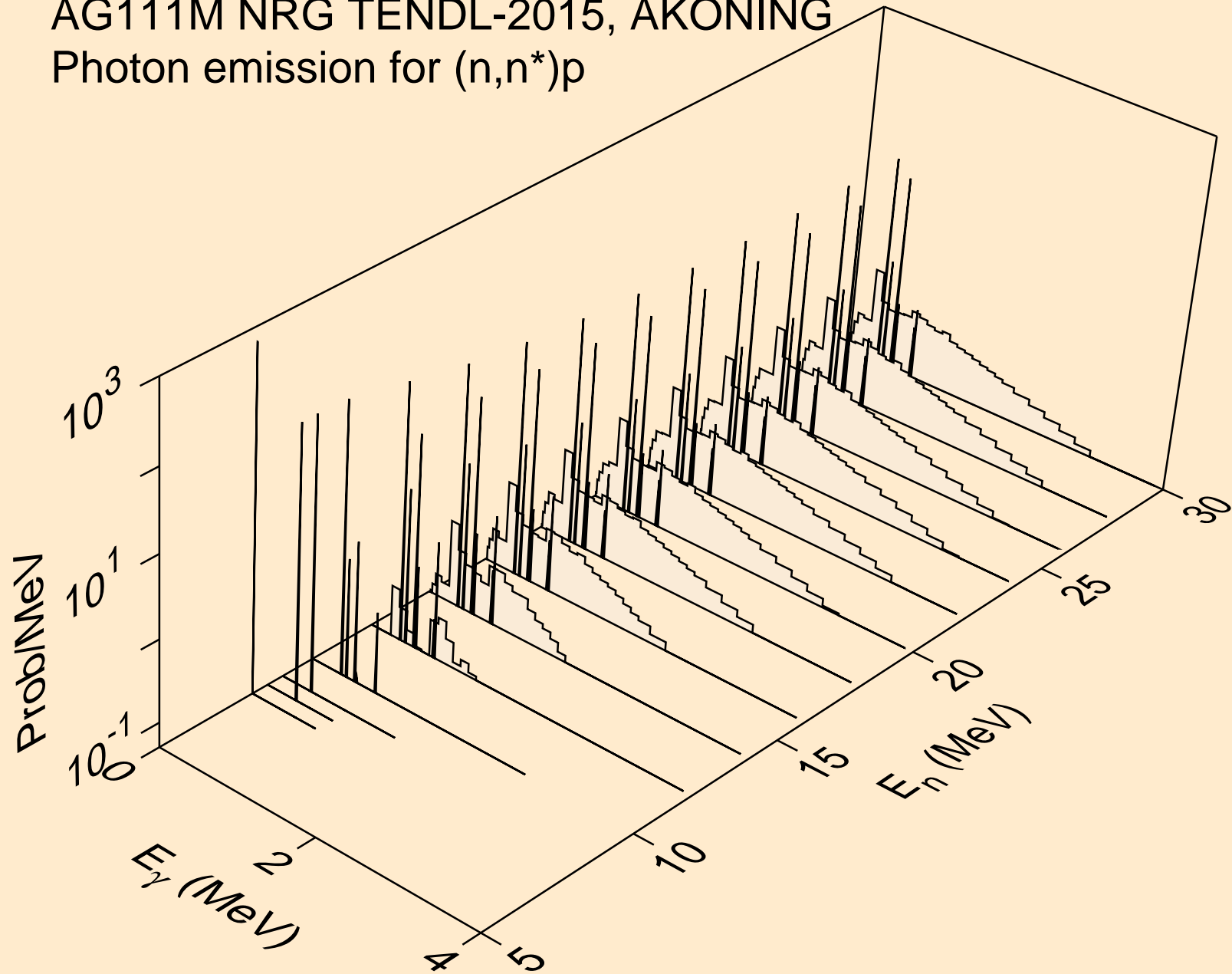

AG111M NRG TENDL-2015, AKONING
Photon emission for (n,n*)2a

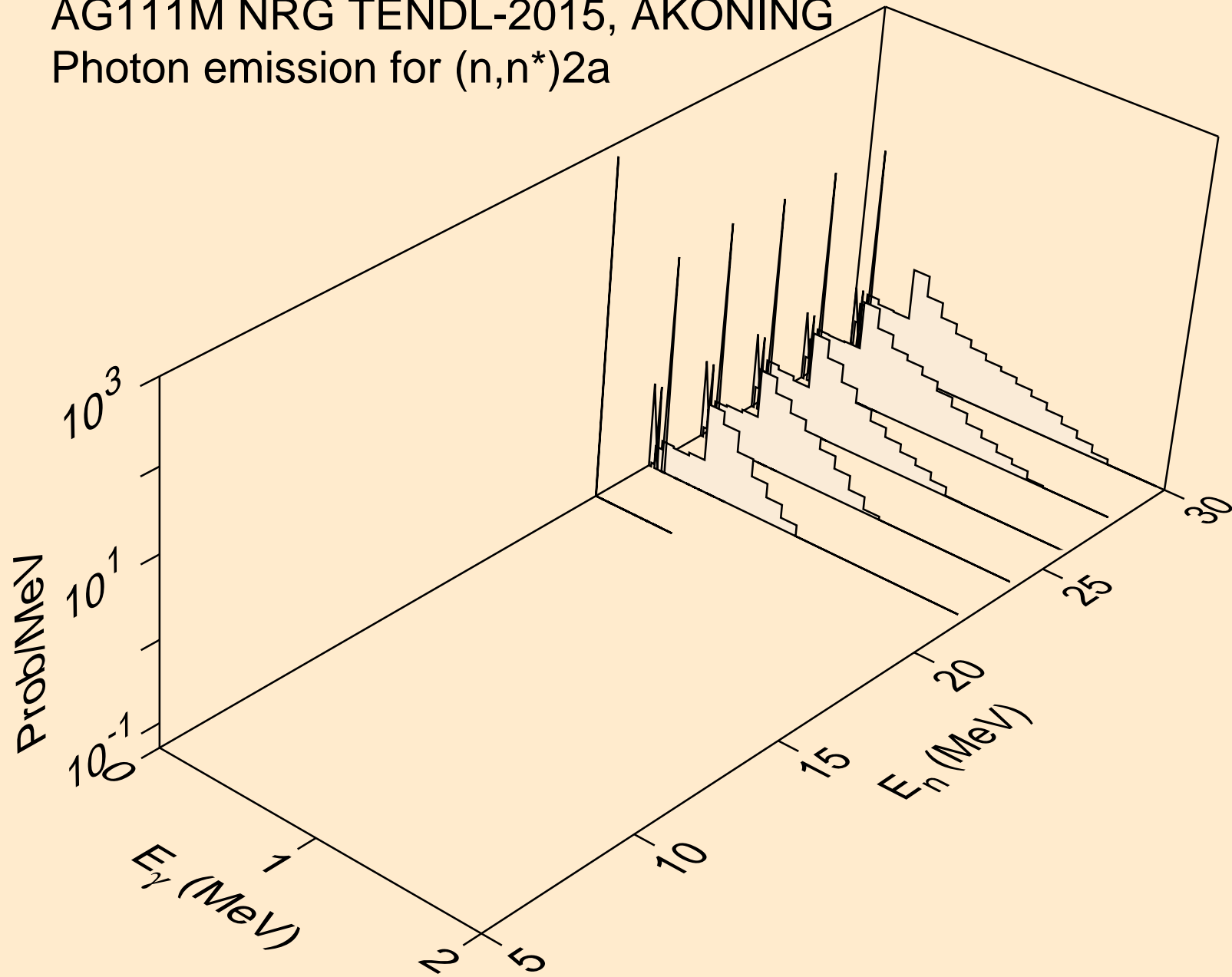

AG111M NRG TENDL-2015, AKONING
Photon emission for (n,n*)d

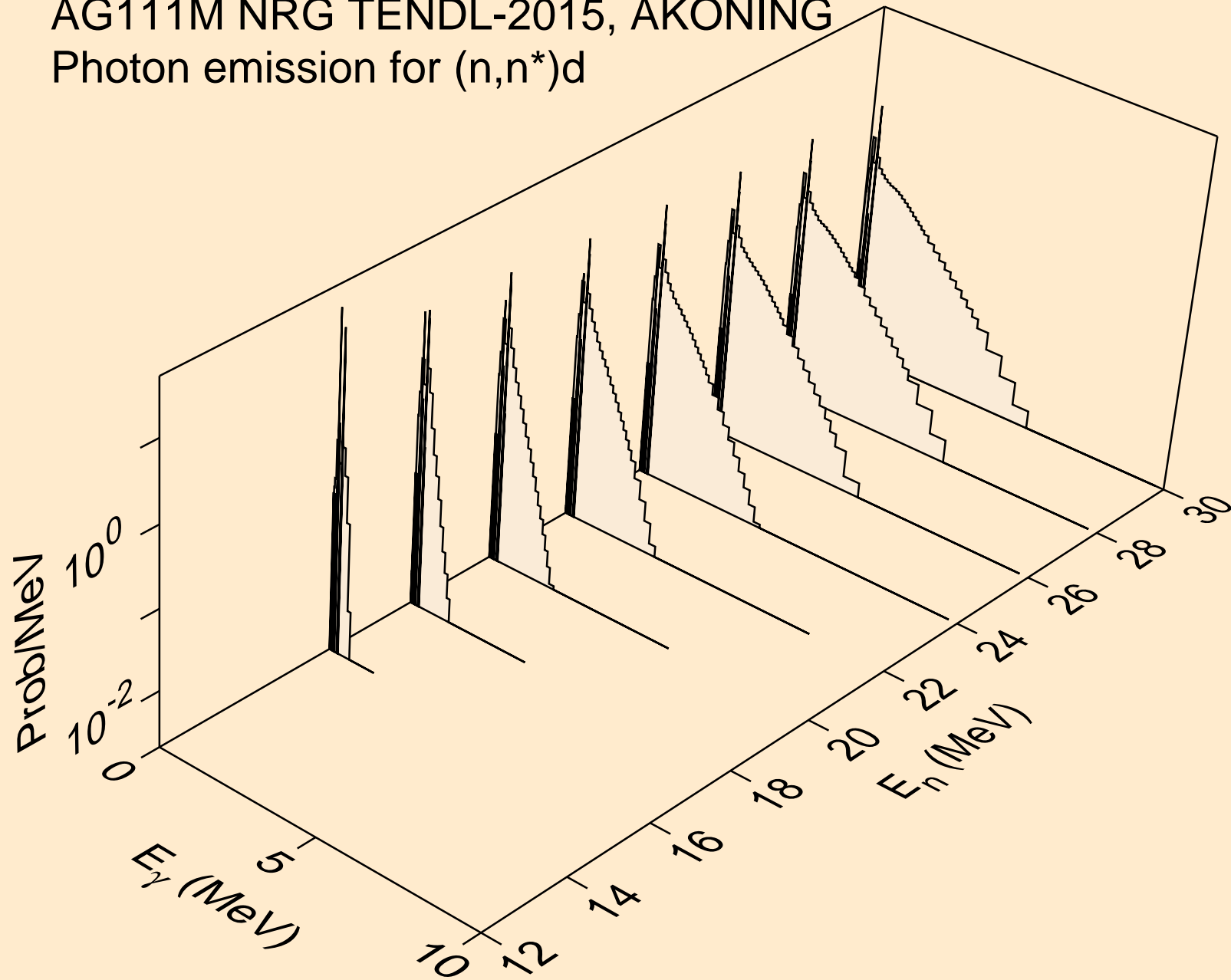

AG111M NRG TENDL-2015, AKONING
Photon emission for (n,n*)t

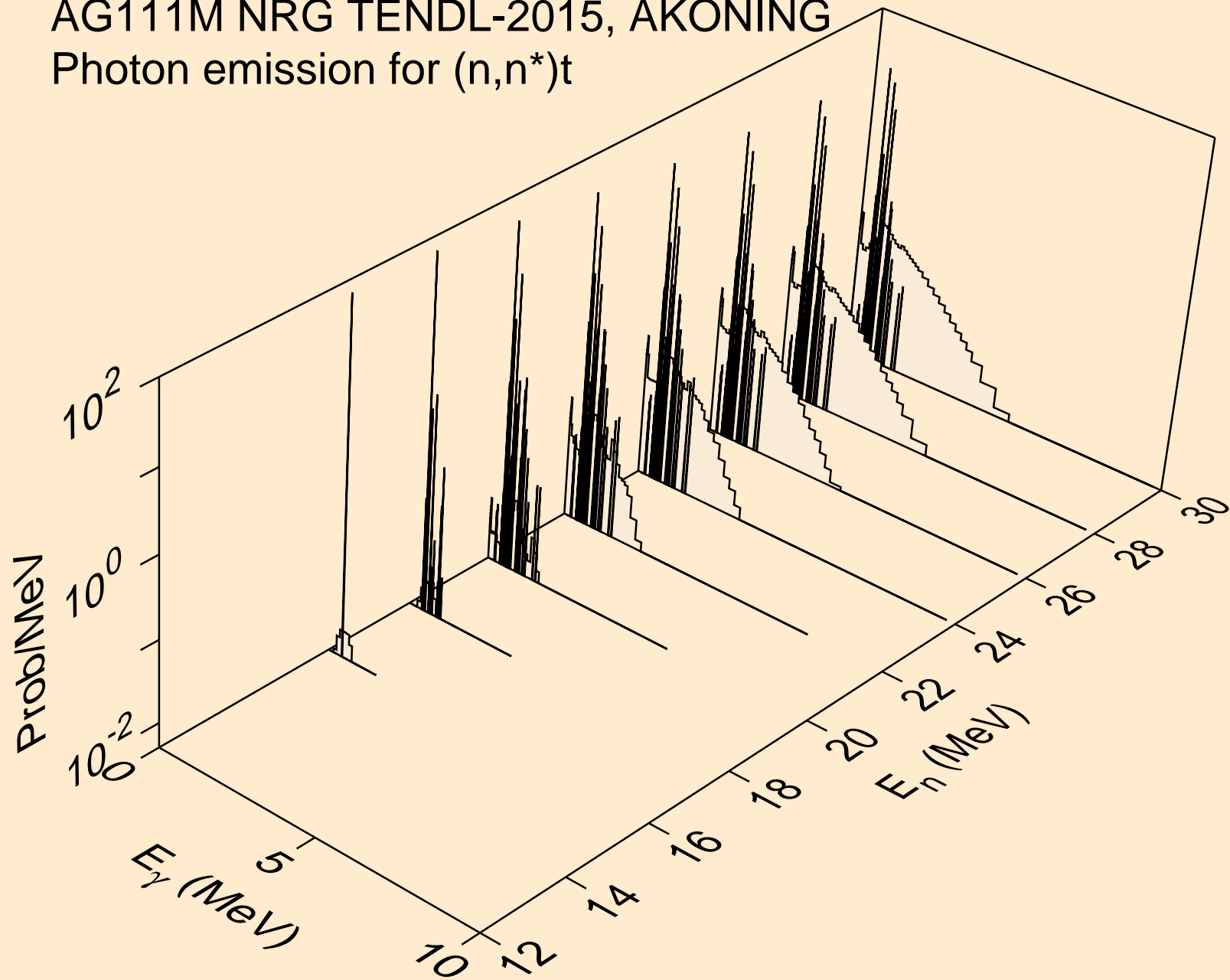

AG111M NRG TENDL-2015, AKONING
Photon emission for (n,n*)he3

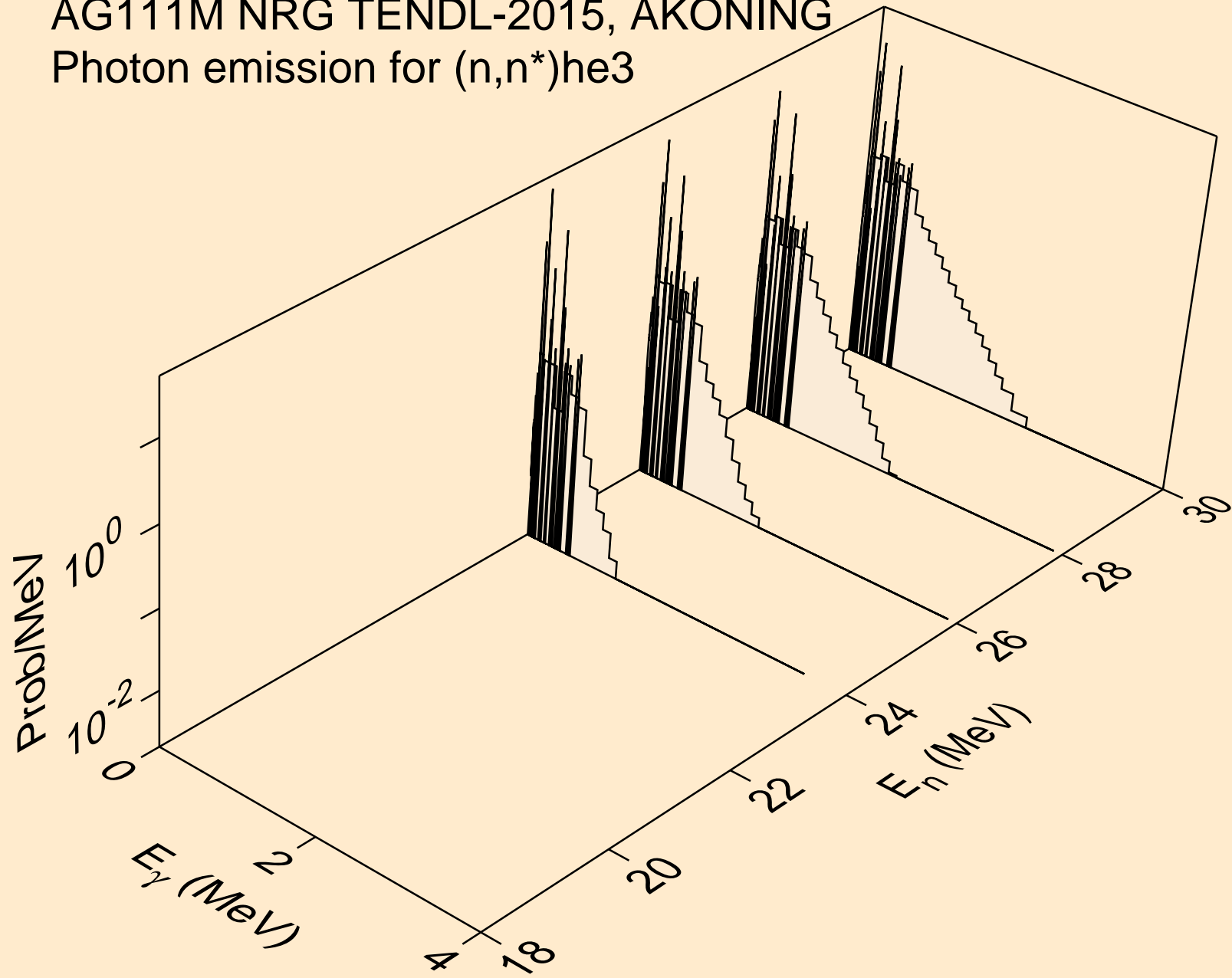

AG111M NRG TENDL-2015, AKONING
Photon emission for (n,4n)

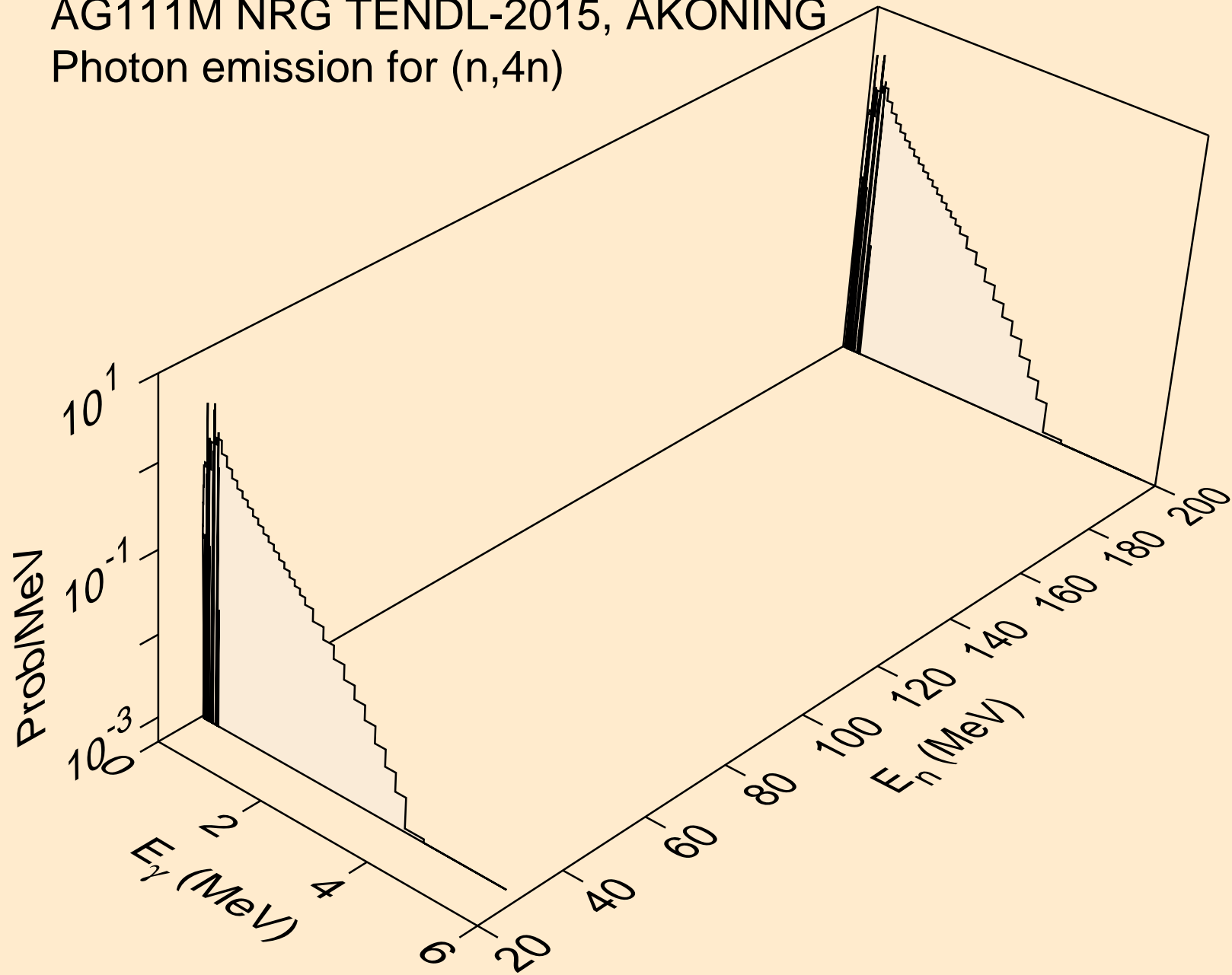

AG111M NRG TENDL-2015, AKONING
Photon emission for (n,2np)

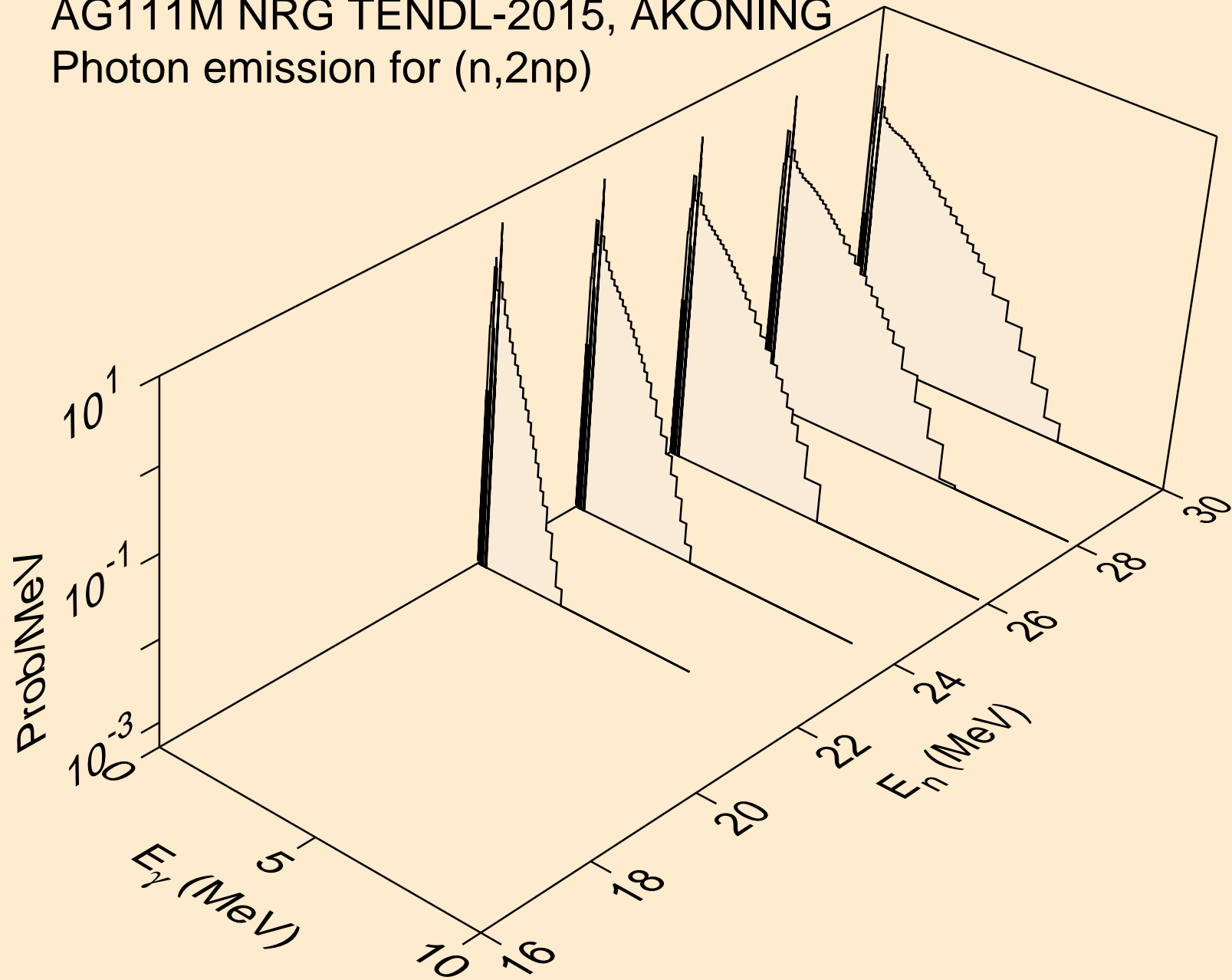

AG111M NRG TENDL-2015, AKONING
Photon emission for (n,3np)

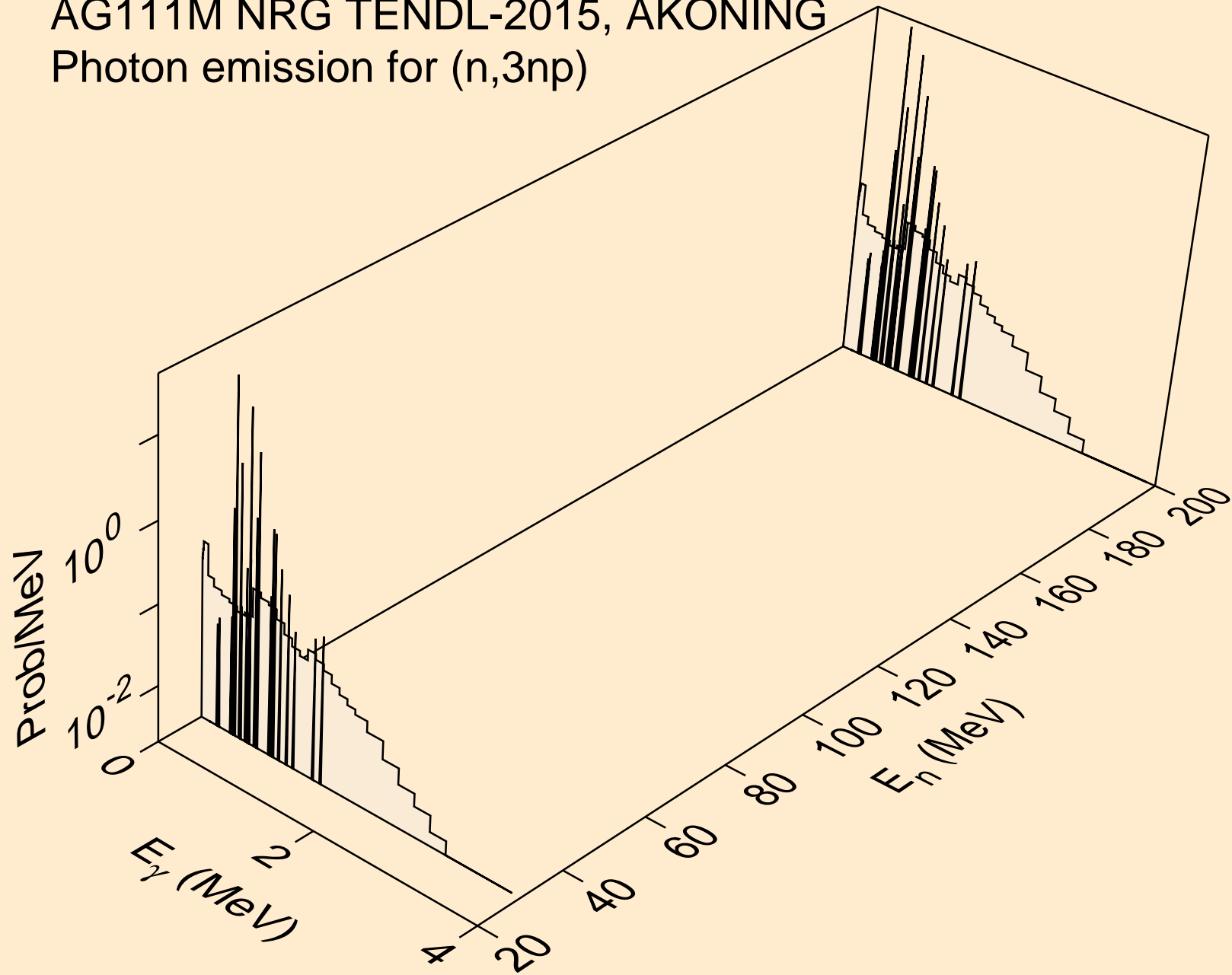

AG111M NRG TENDL-2015, AKONING
Photon emission for (n,2np)

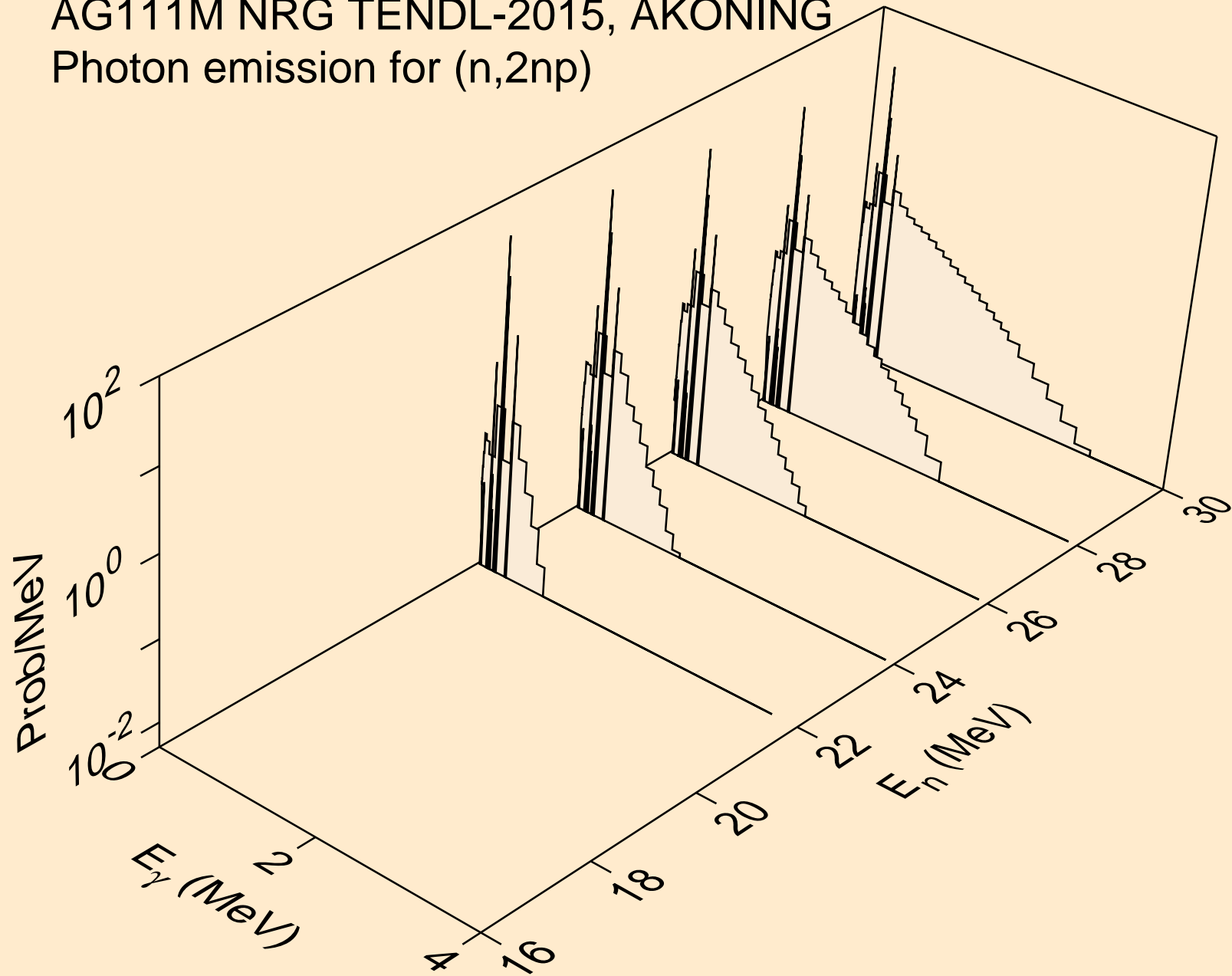

AG111M NRG TENDL-2015, AKONING
Photon emission for (n,npa)

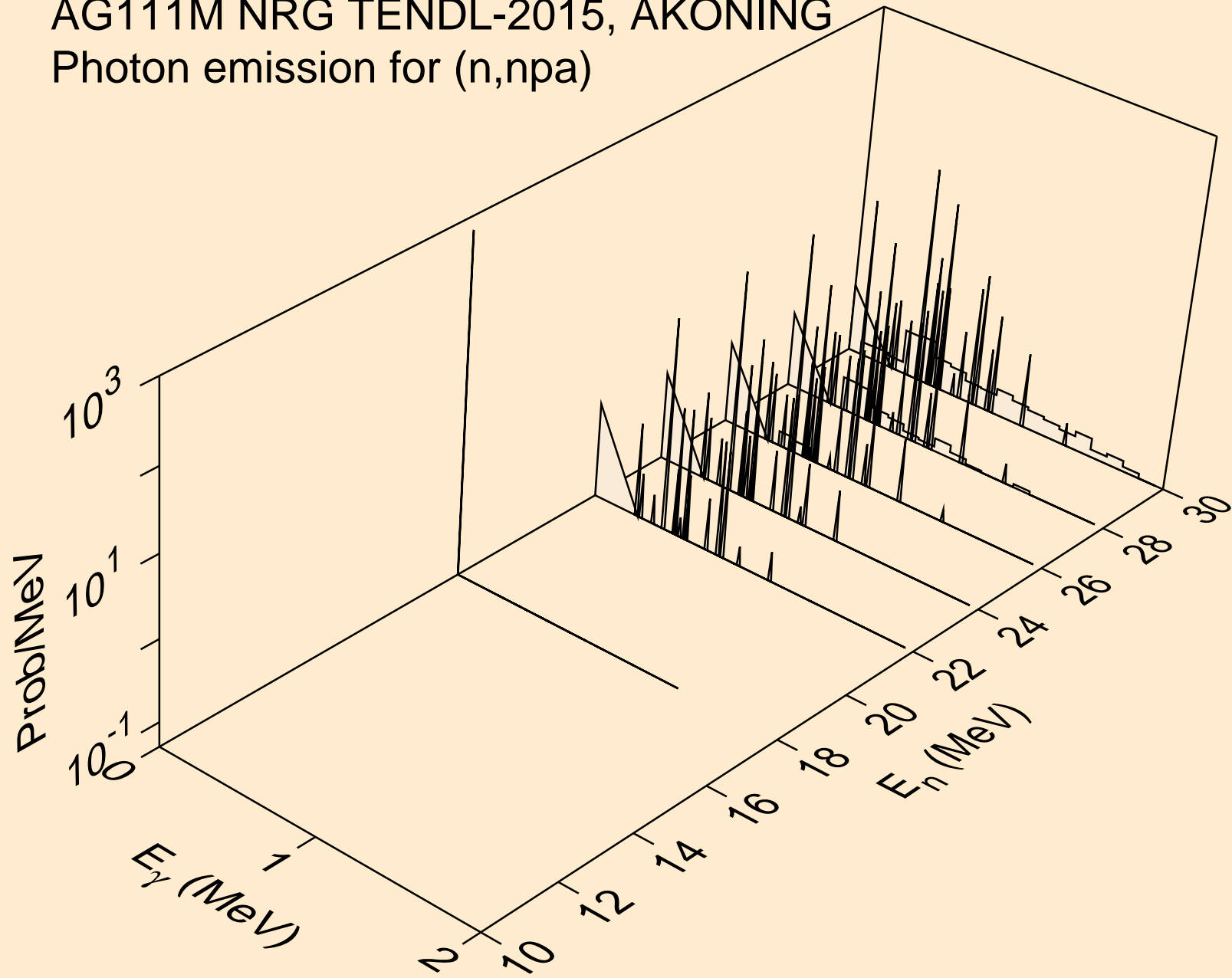

AG111M NRG TENDL-2015, AKONING
Photon emission for (n,n*2)

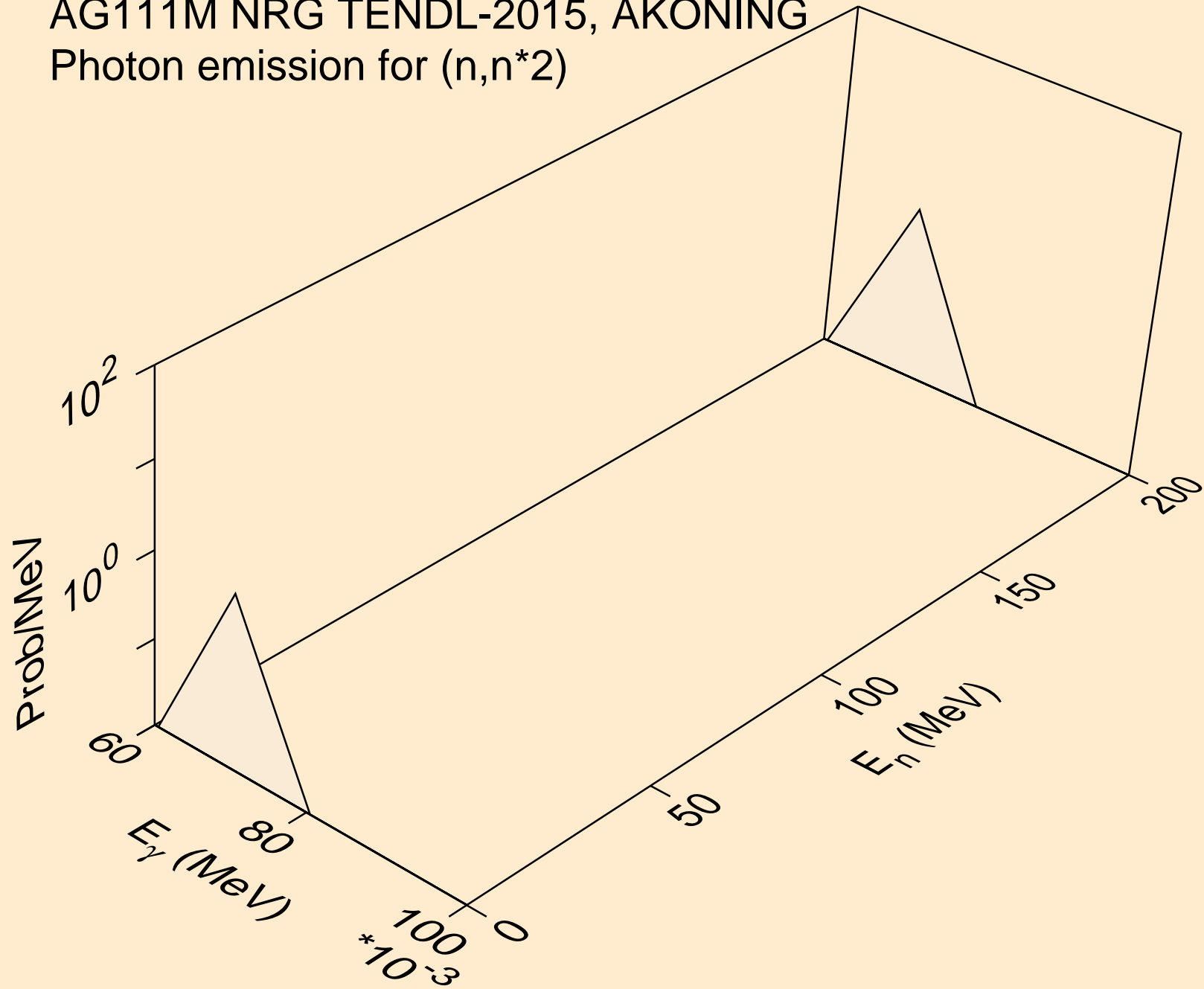

AG111M NRG TENDL-2015, AKONING
Photon emission for (n,n*3)

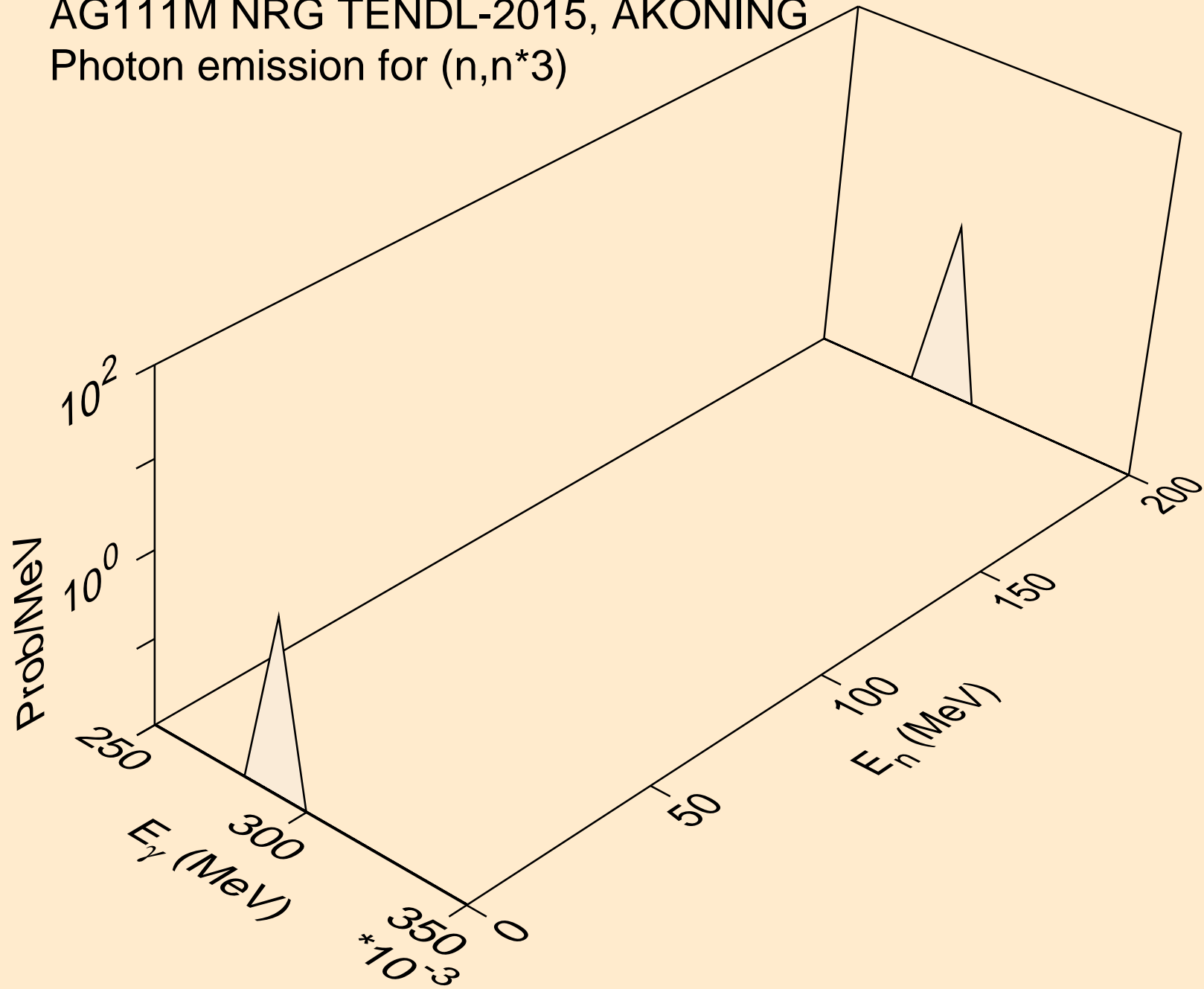

AG111M NRG TENDL-2015, AKONING
Photon emission for (n,n*4)

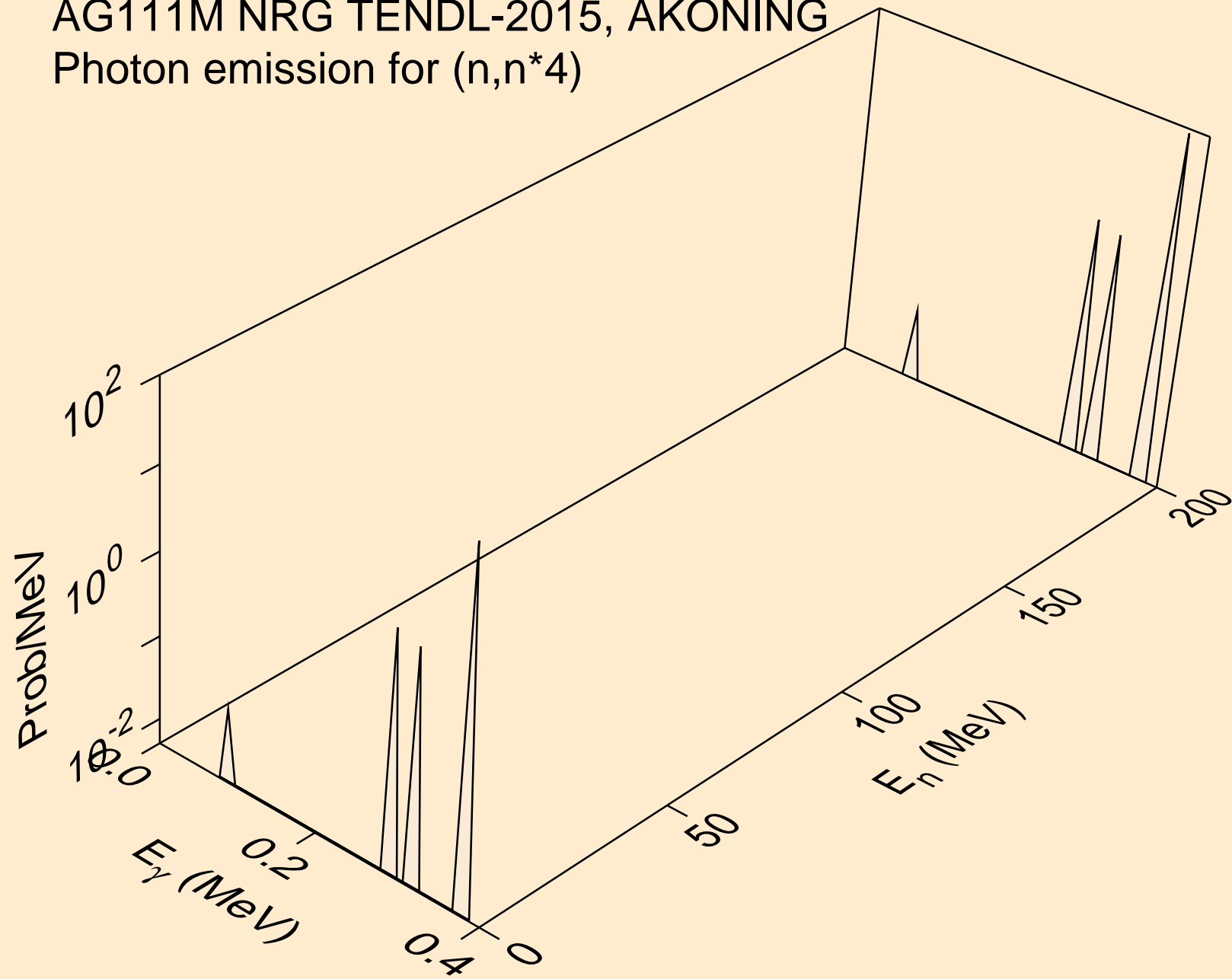

AG111M NRG TENDL-2015, AKONING
Photon emission for (n,n*5)

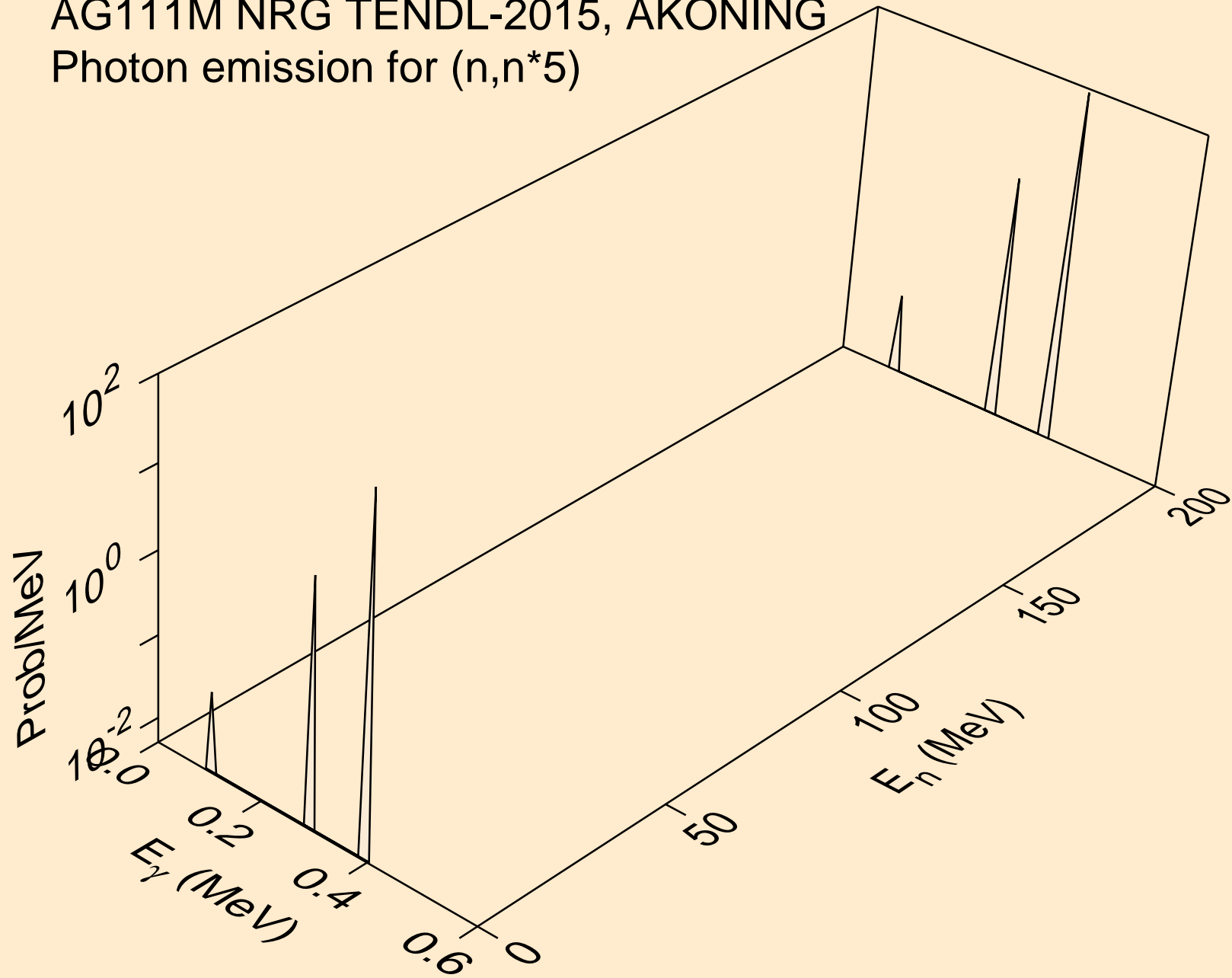

AG111M NRG TENDL-2015, AKONING
Photon emission for (n,n*6)

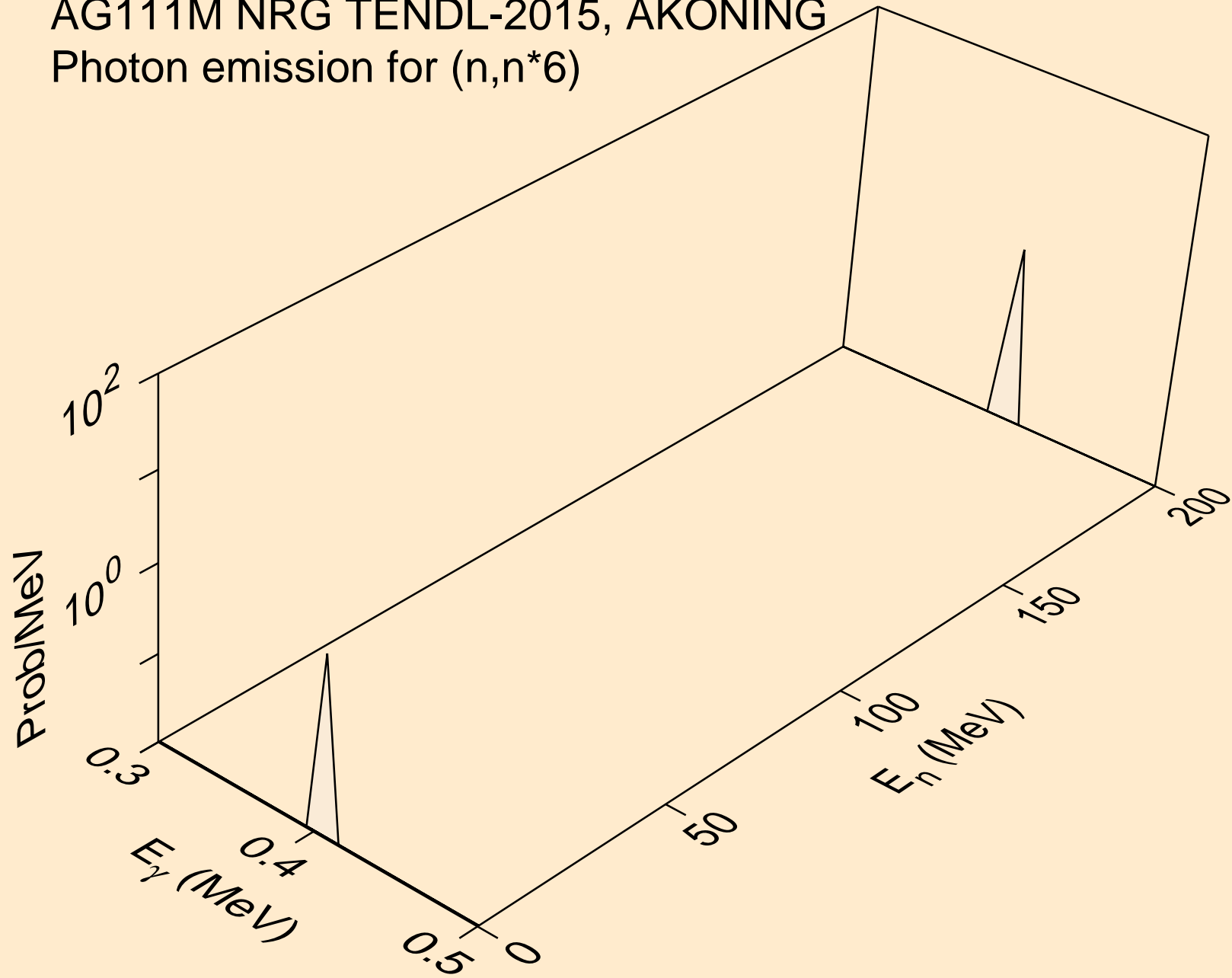

AG111M NRG TENDL-2015, AKONING
Photon emission for (n,n*7)

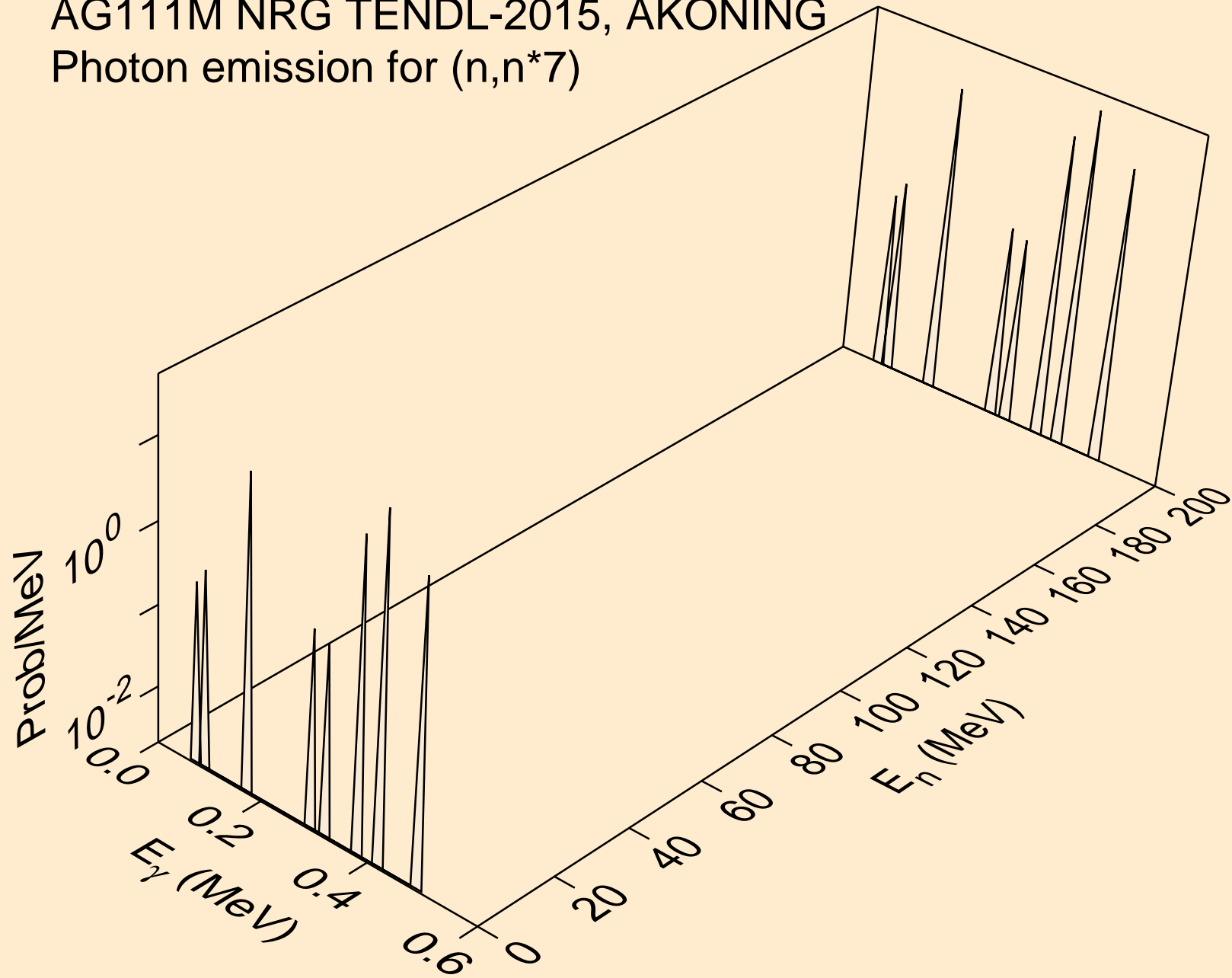

AG111M NRG TENDL-2015, AKONING
Photon emission for (n,n*8)

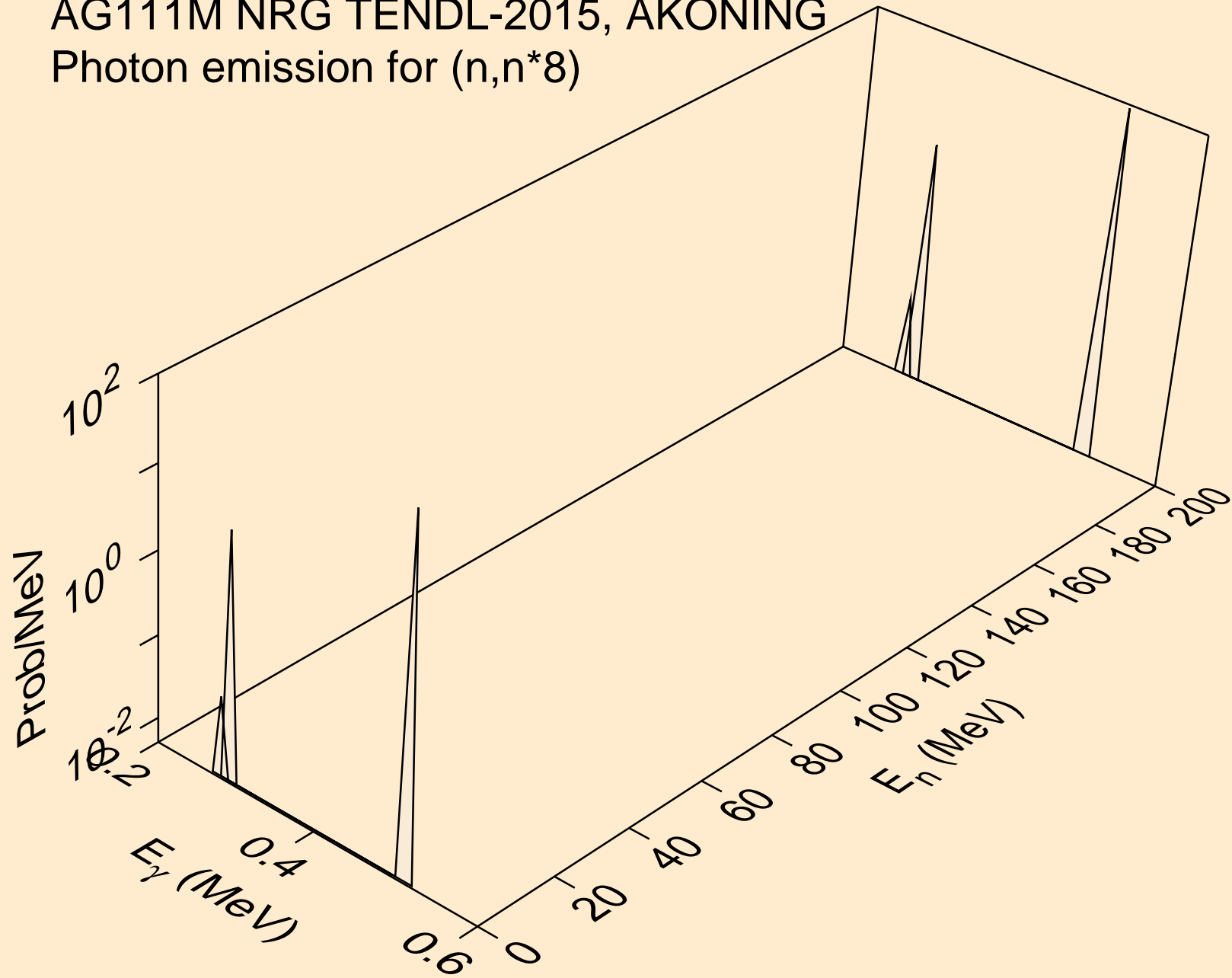

AG111M NRG TENDL-2015, AKONING
Photon emission for (n,n*9)

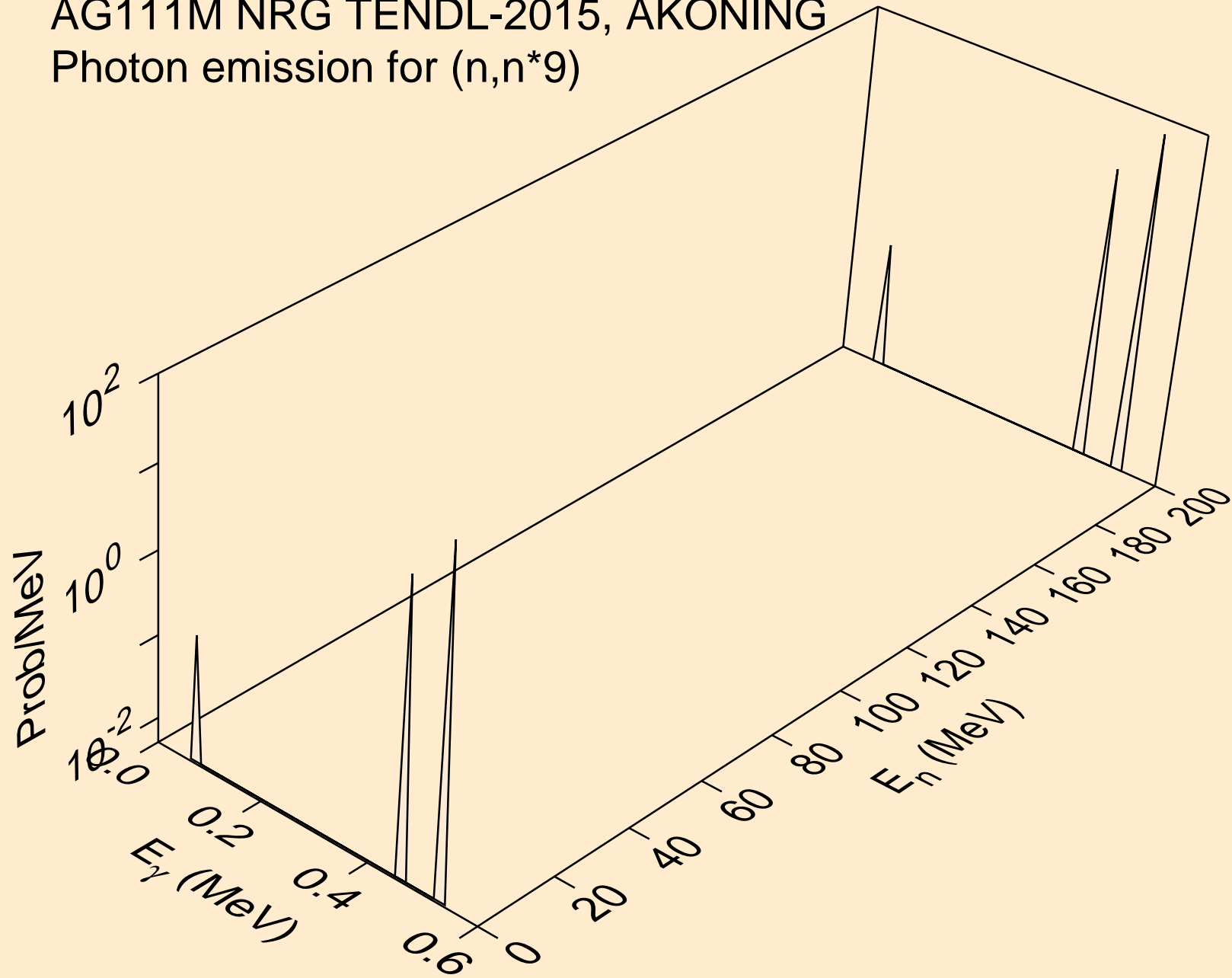

AG111M NRG TENDL-2015, AKONING
Photon emission for (n,n*10)

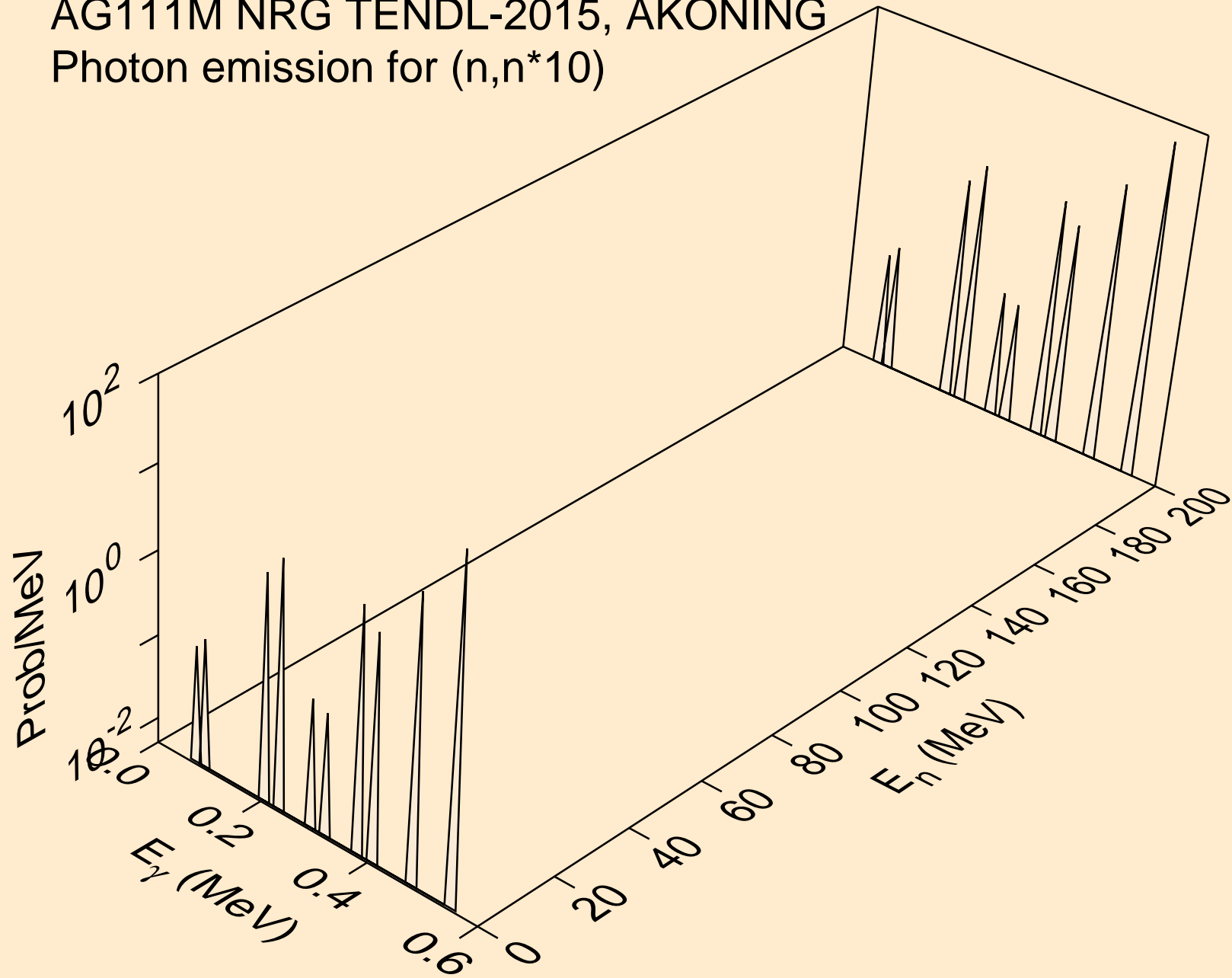

AG111M NRG TENDL-2015, AKONING
Photon emission for (n,n*11)

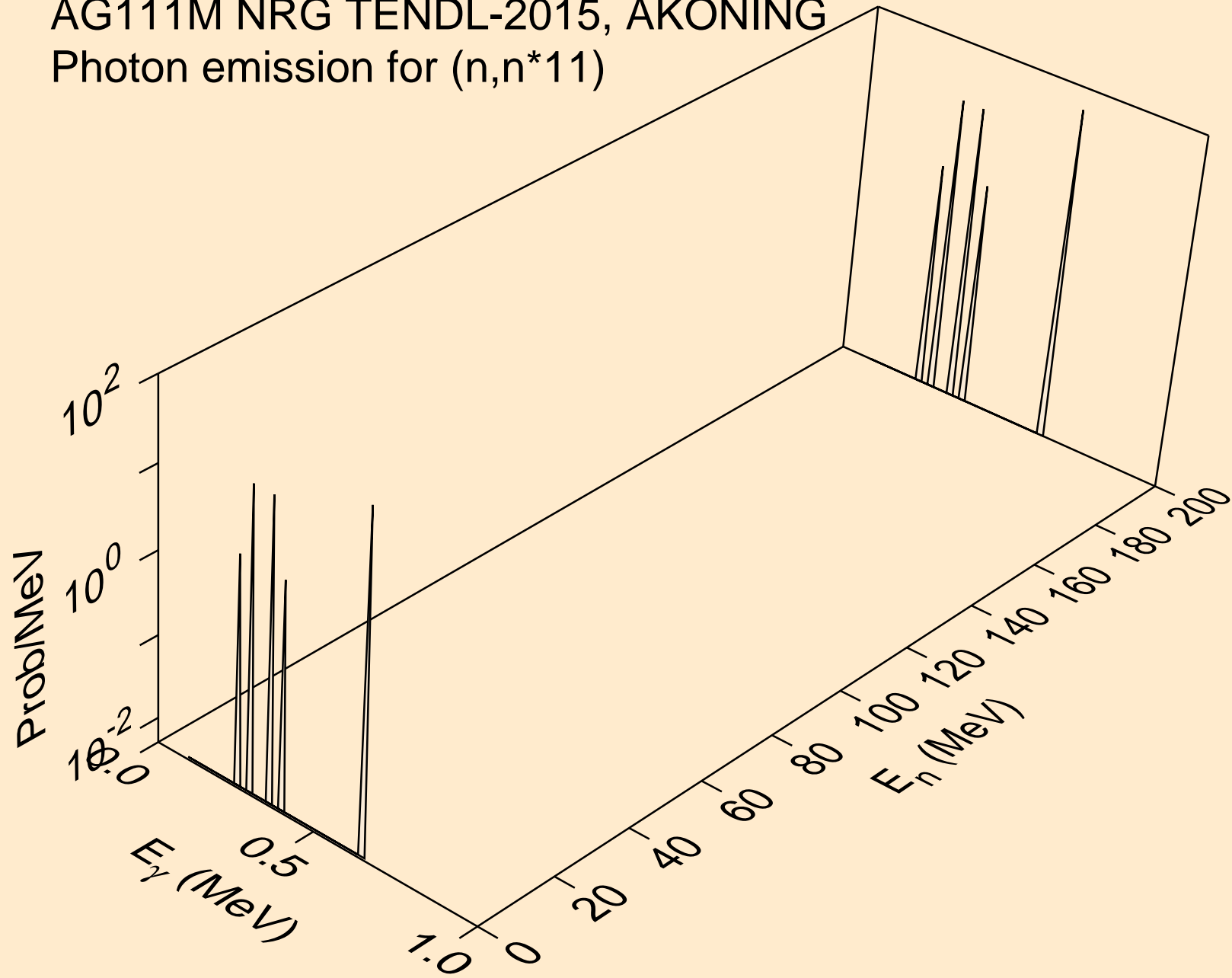

AG111M NRG TENDL-2015, AKONING
Photon emission for (n,n*12)

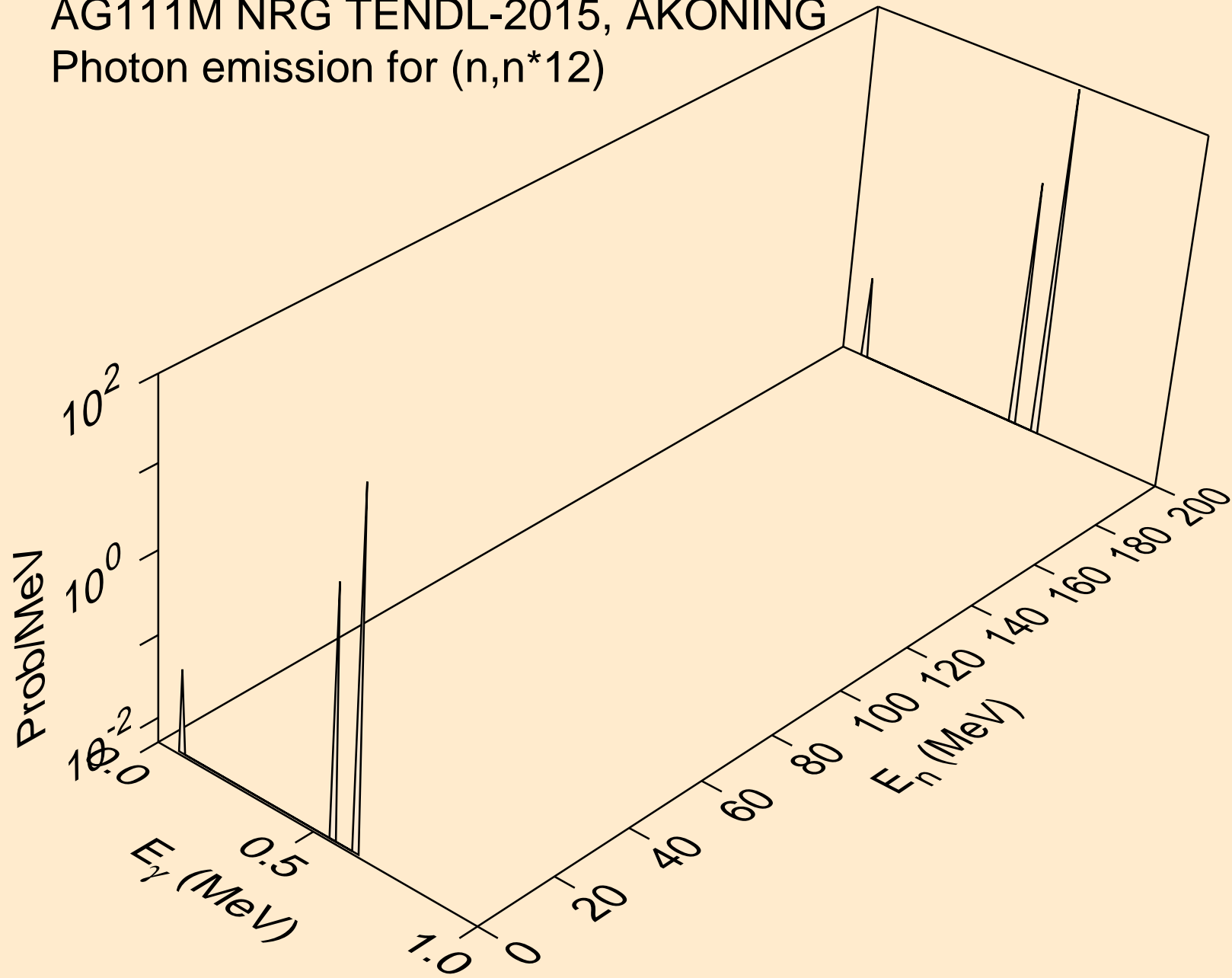

AG111M NRG TENDL-2015, AKONING
Photon emission for (n,n*13)

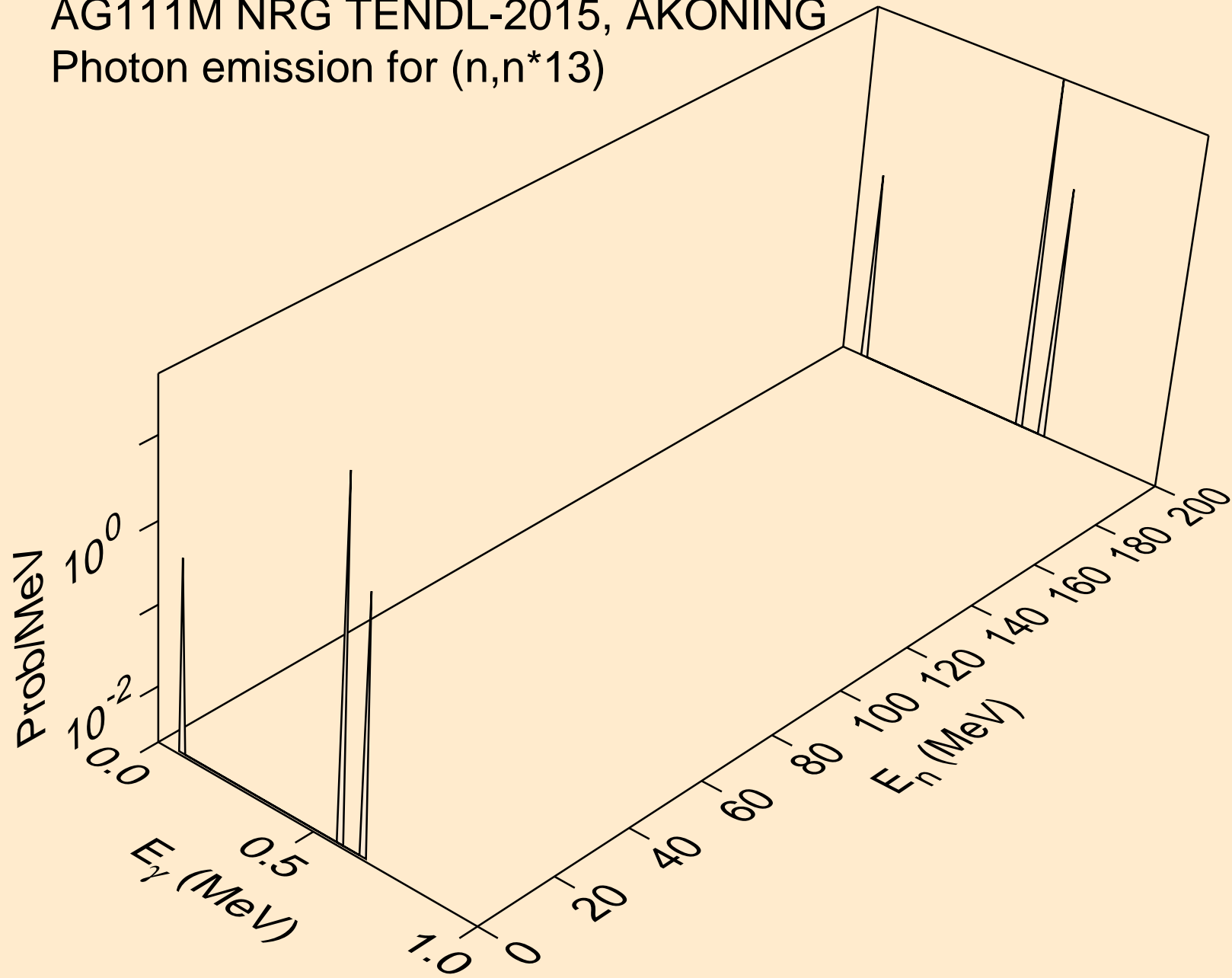

AG111M NRG TENDL-2015, AKONING
Photon emission for (n,n*14)

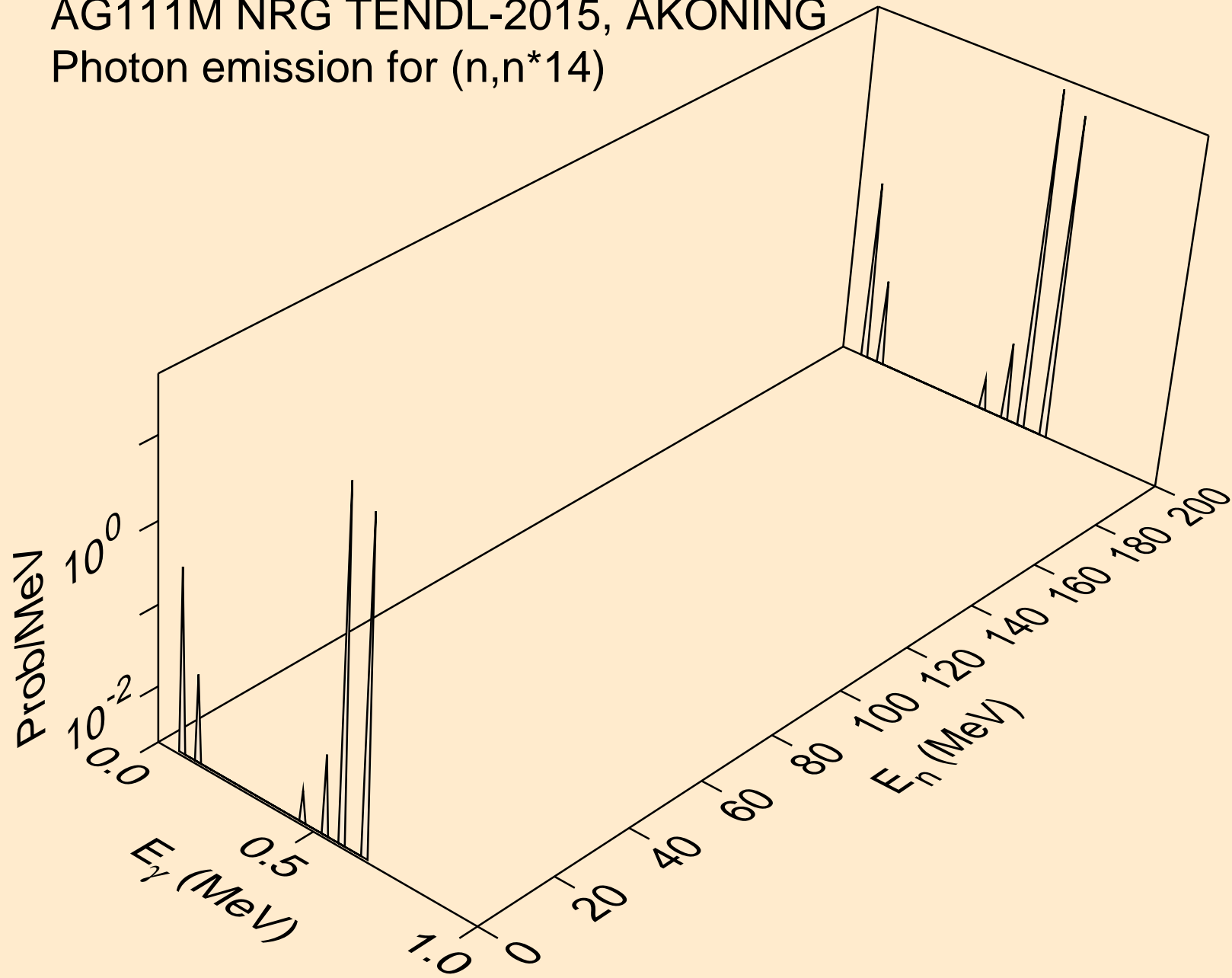

AG111M NRG TENDL-2015, AKONING
Photon emission for (n,n*15)

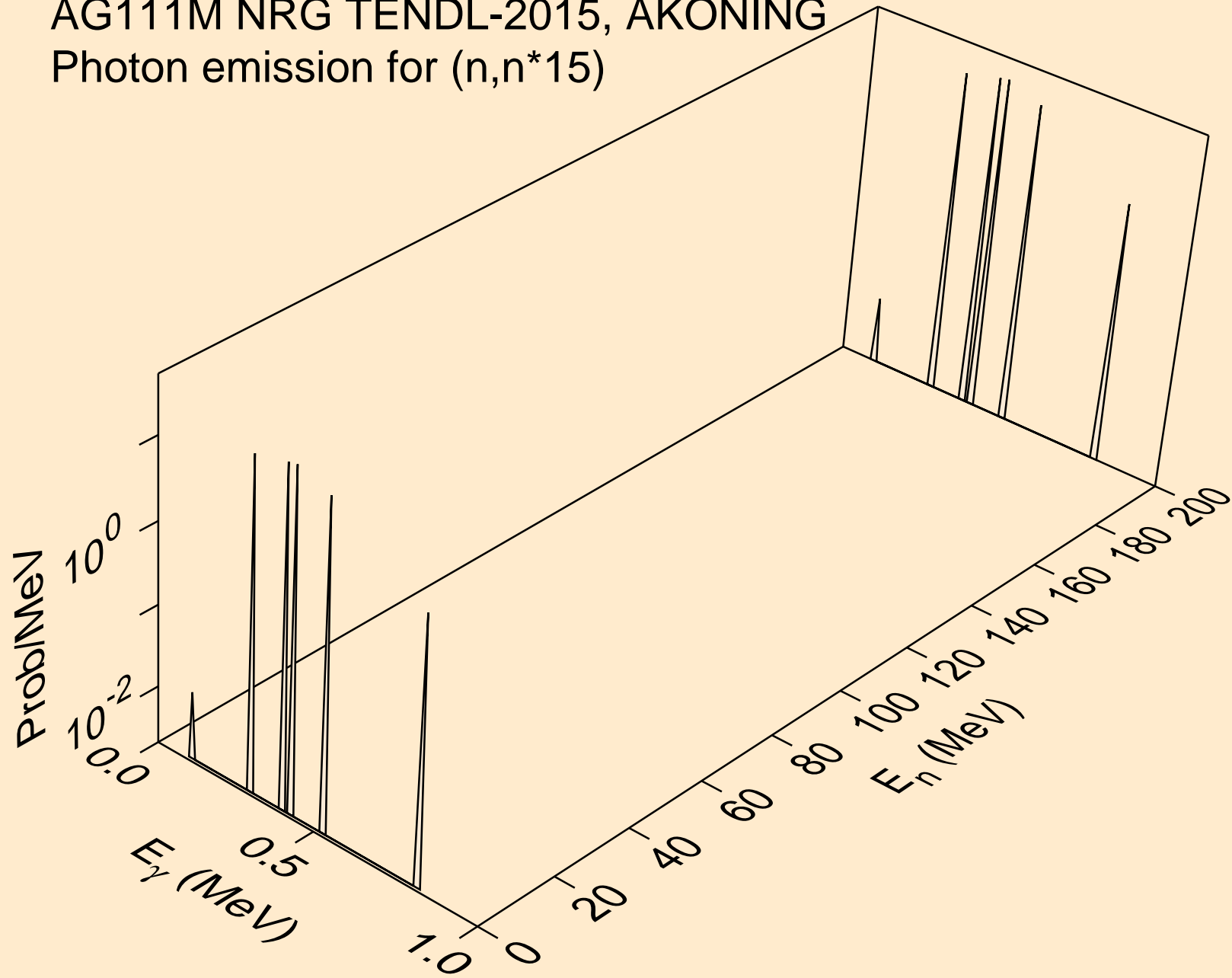

AG111M NRG TENDL-2015, AKONING
Photon emission for (n,n*16)

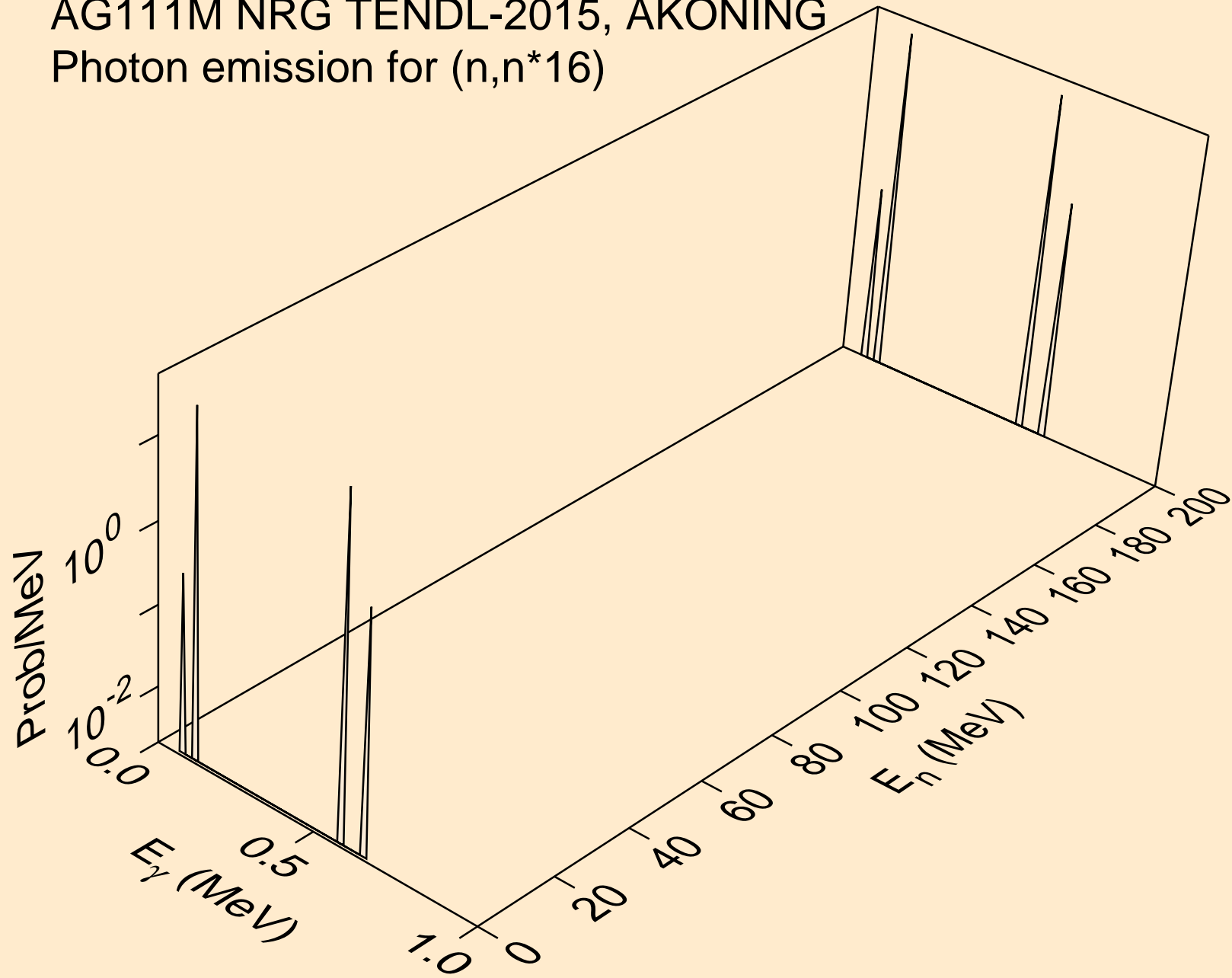

AG111M NRG TENDL-2015, AKONING
Photon emission for (n,n*17)

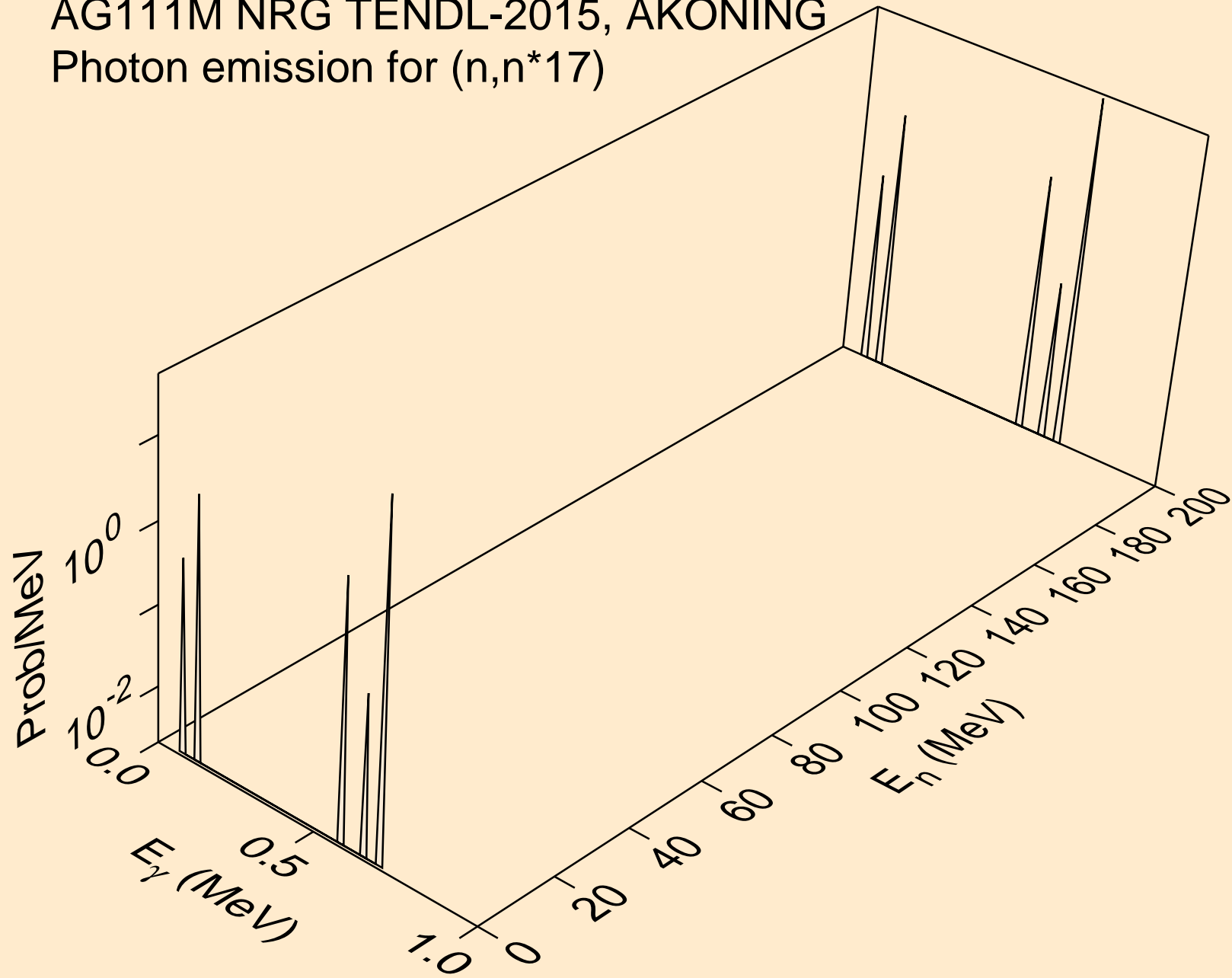

AG111M NRG TENDL-2015, AKONING
Photon emission for (n,n*18)

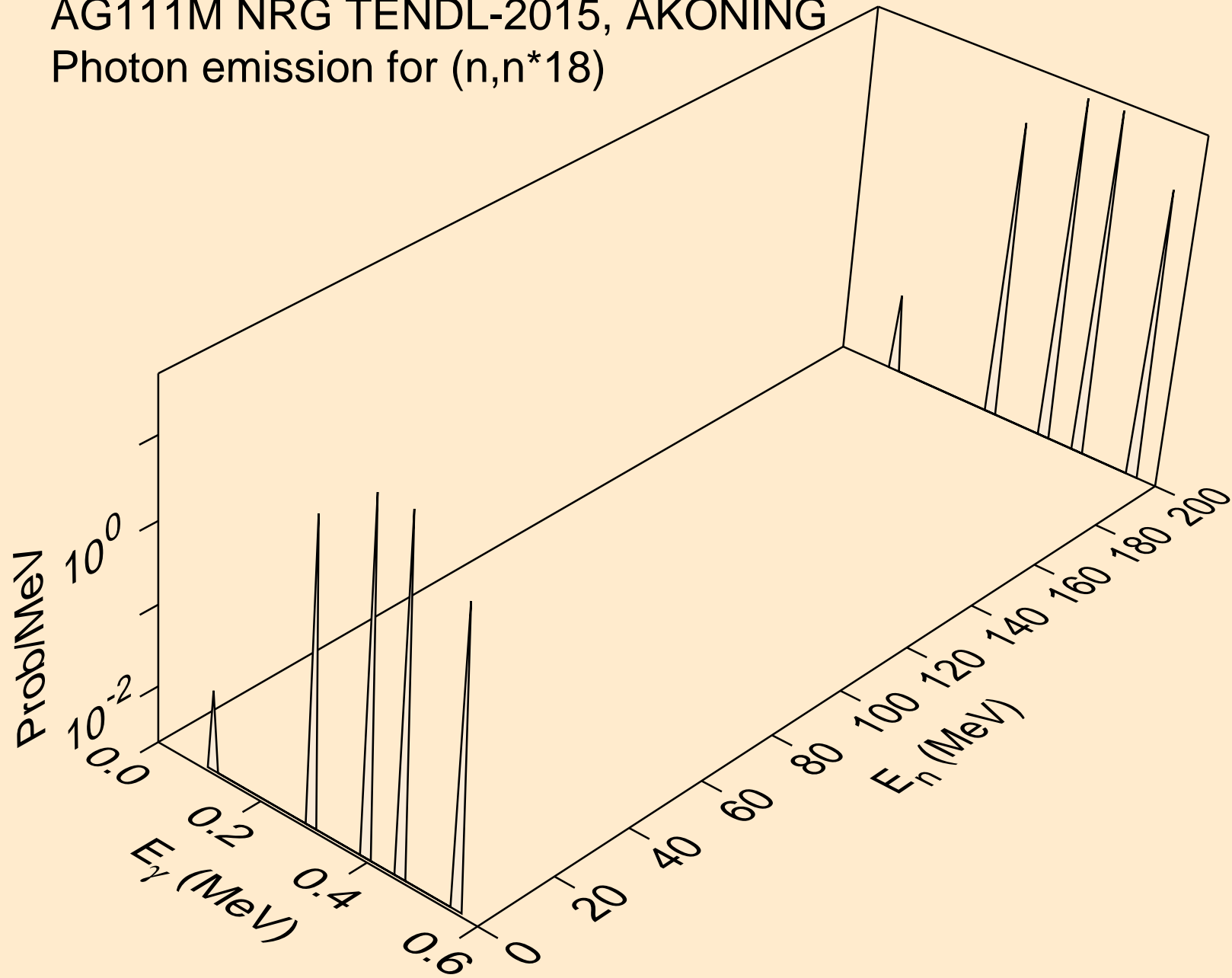

AG111M NRG TENDL-2015, AKONING
Photon emission for (n,n*19)

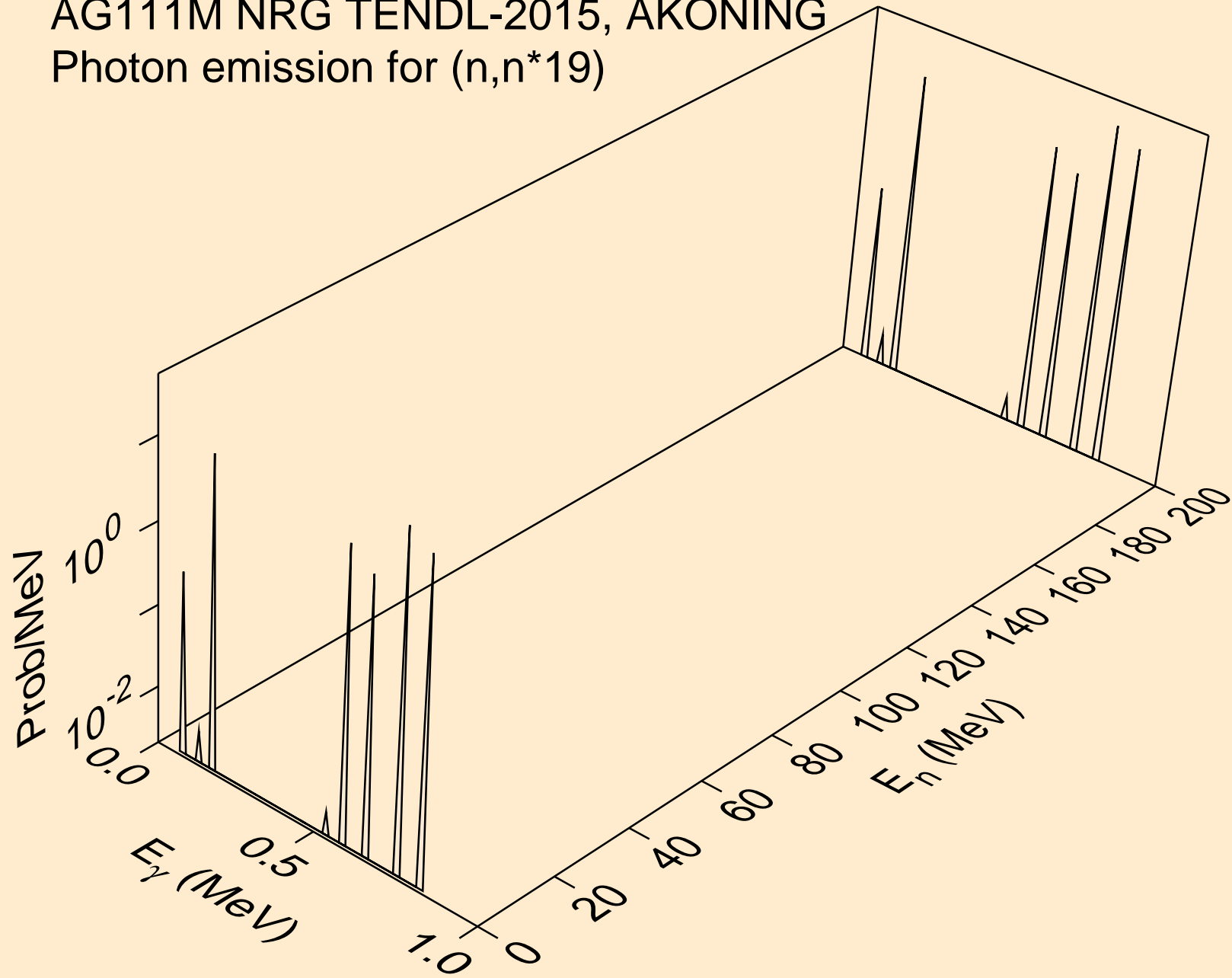

AG111M NRG TENDL-2015, AKONING
Photon emission for (n,n*20)

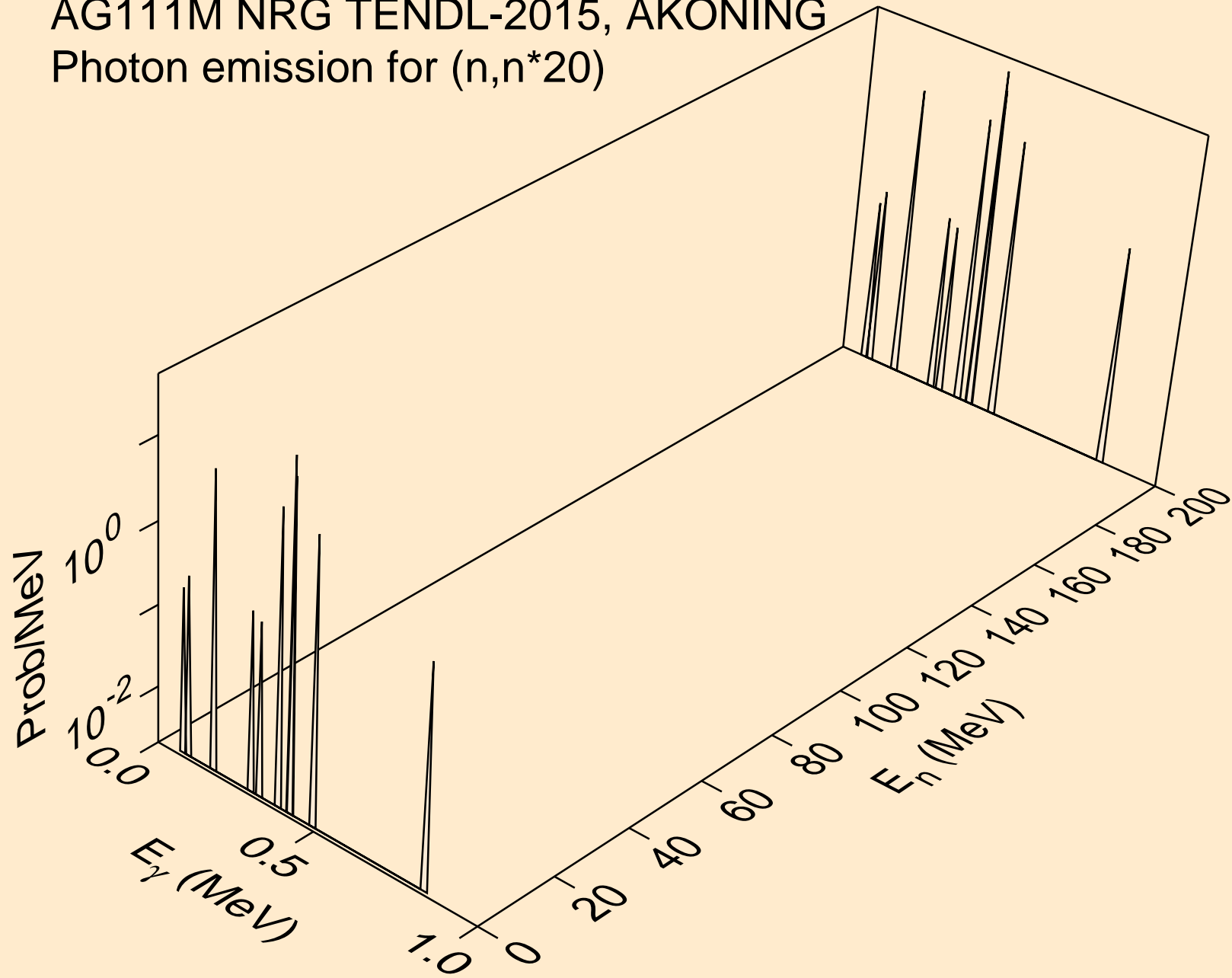

AG111M NRG TENDL-2015, AKONING
Photon emission for (n,n*21)

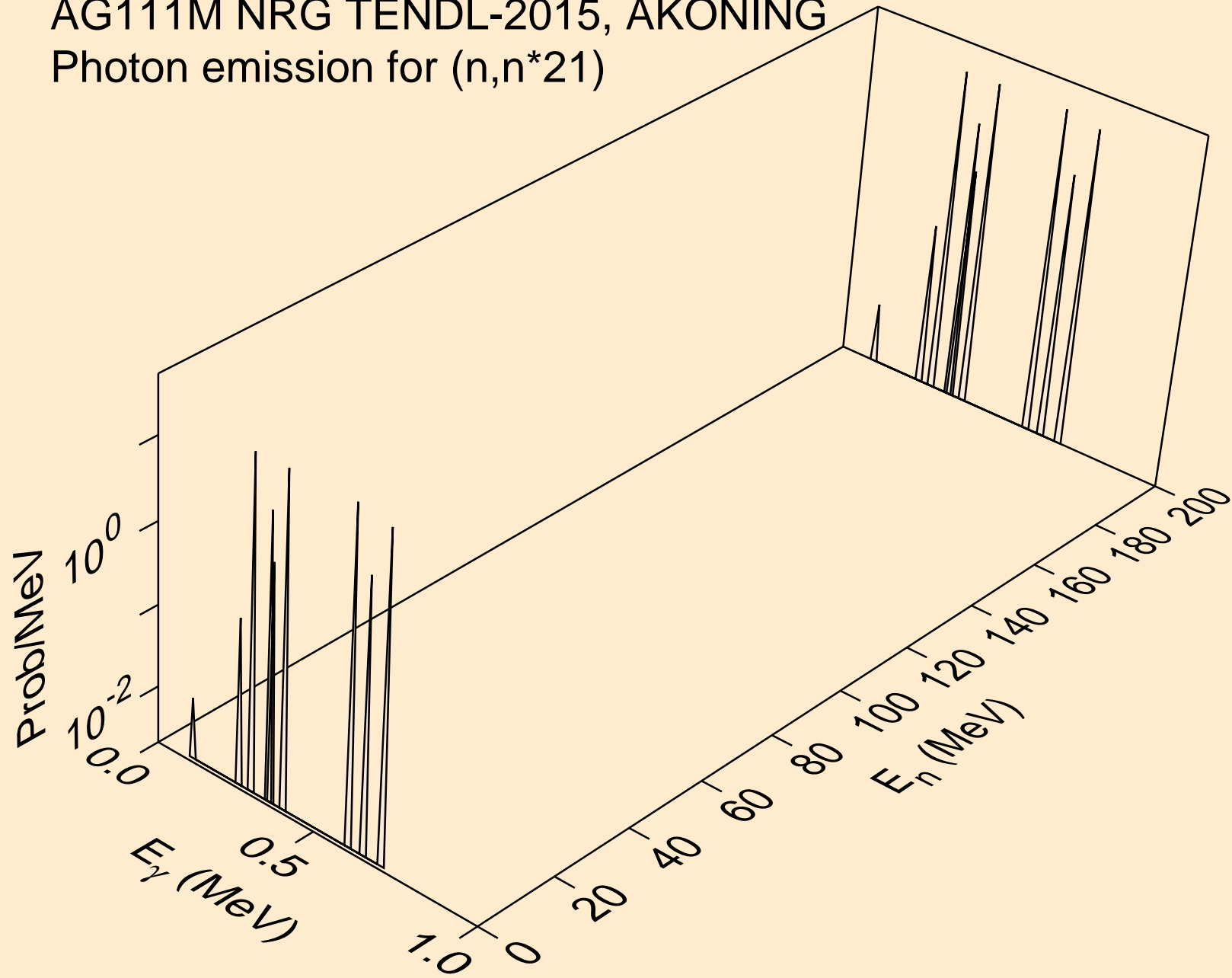

AG111M NRG TENDL-2015, AKONING
Photon emission for (n,n*22)

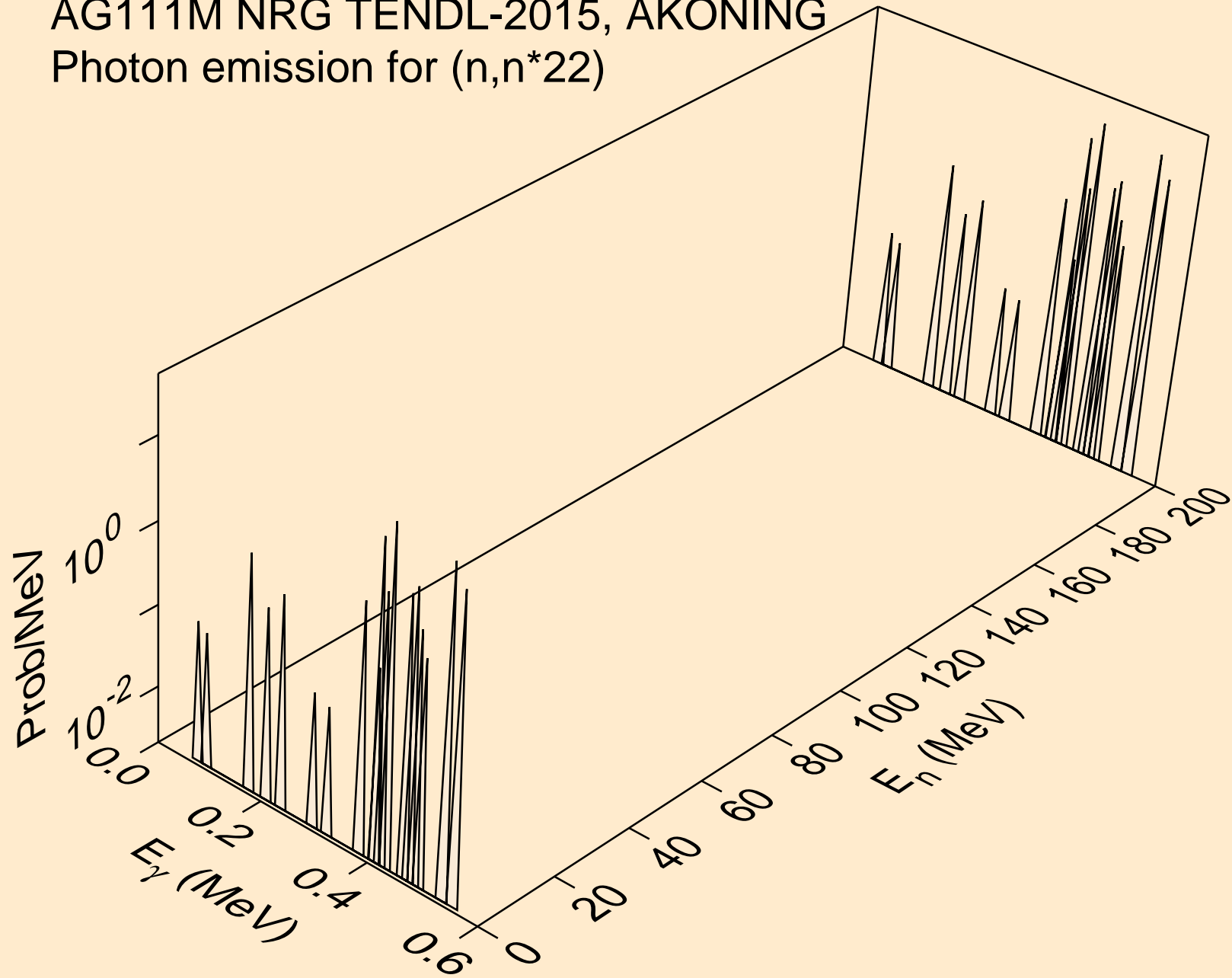

AG111M NRG TENDL-2015, AKONING
Photon emission for (n,n*23)

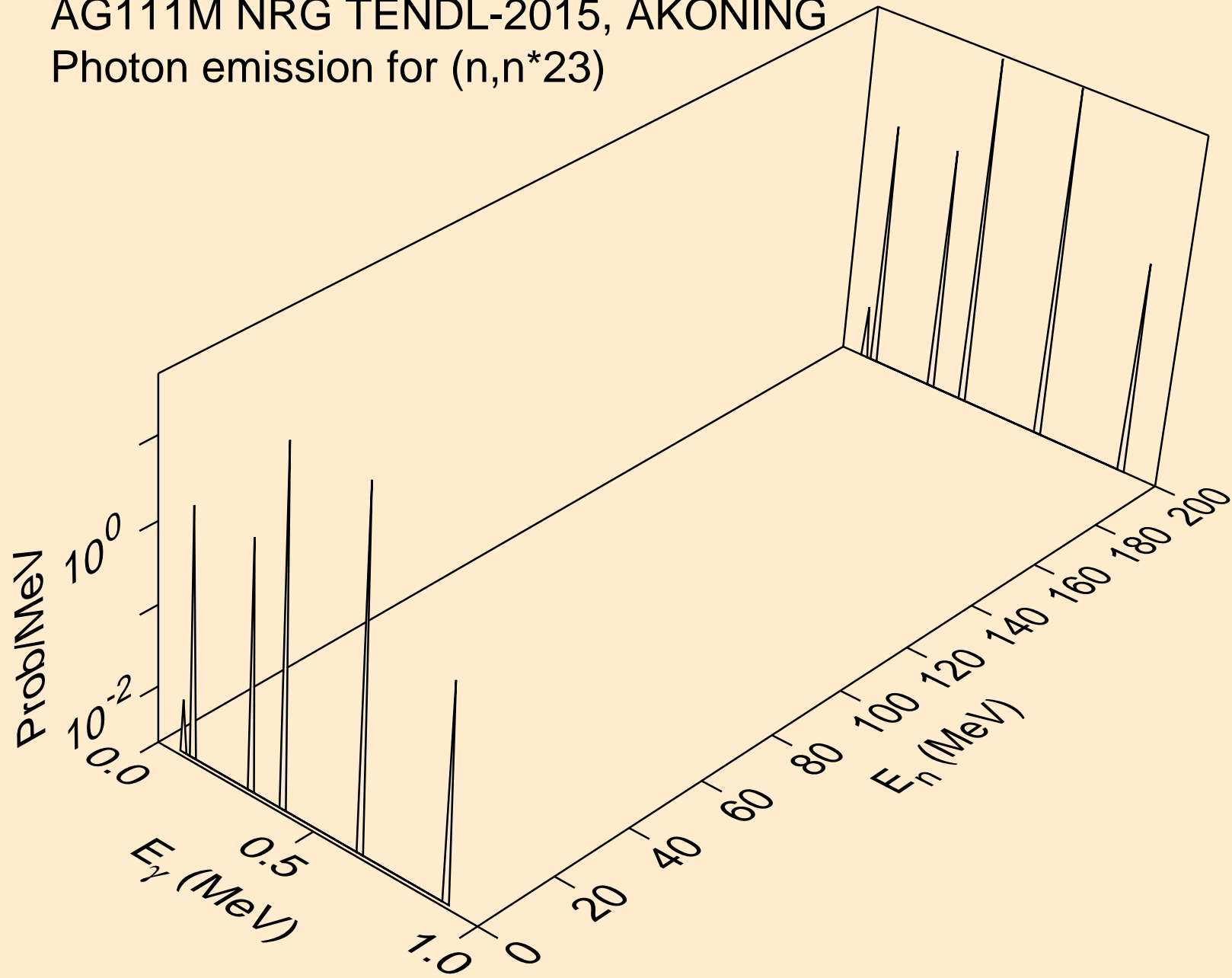

AG111M NRG TENDL-2015, AKONING
Photon emission for (n,n*24)

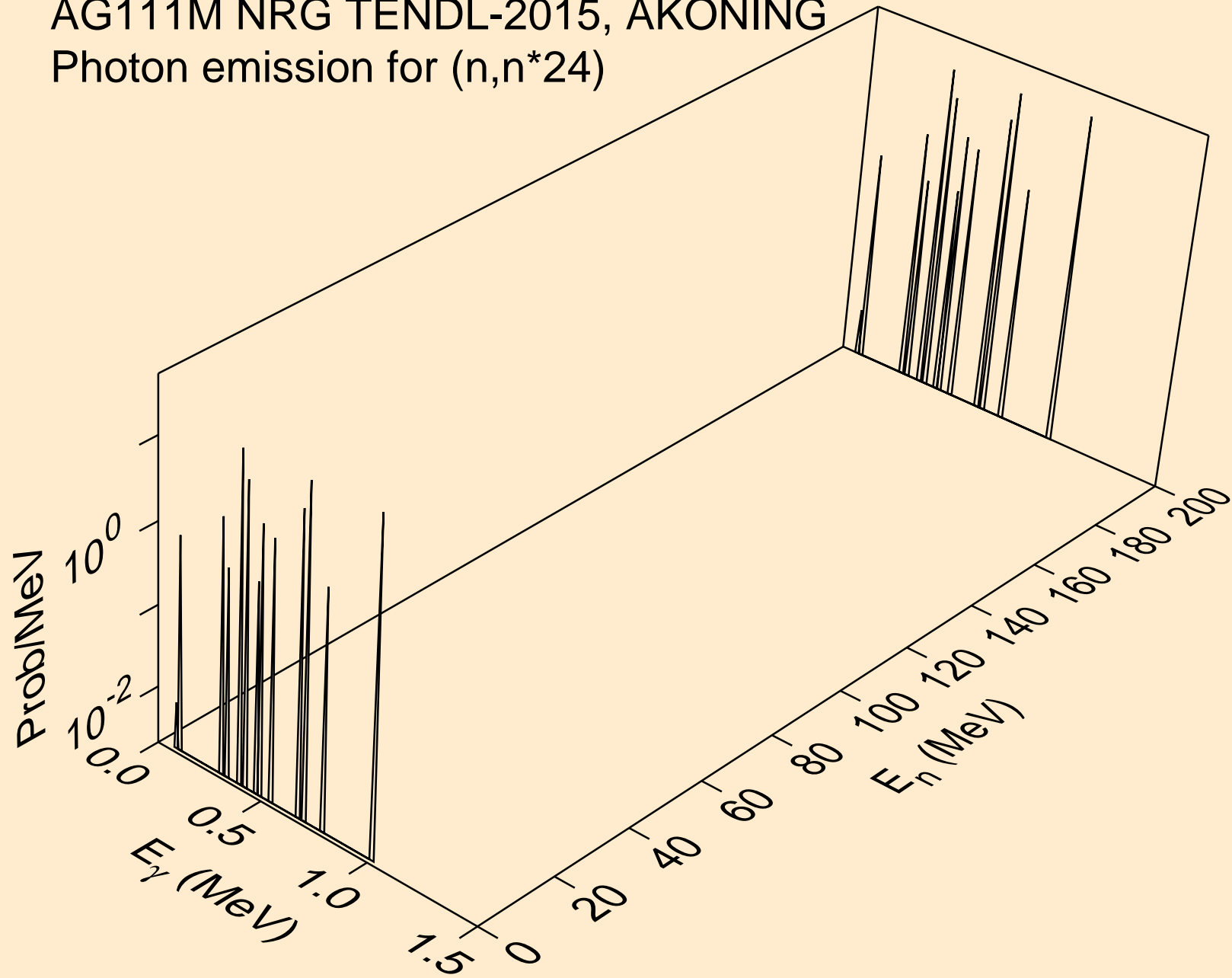

AG111M NRG TENDL-2015, AKONING
Photon emission for (n,n*25)

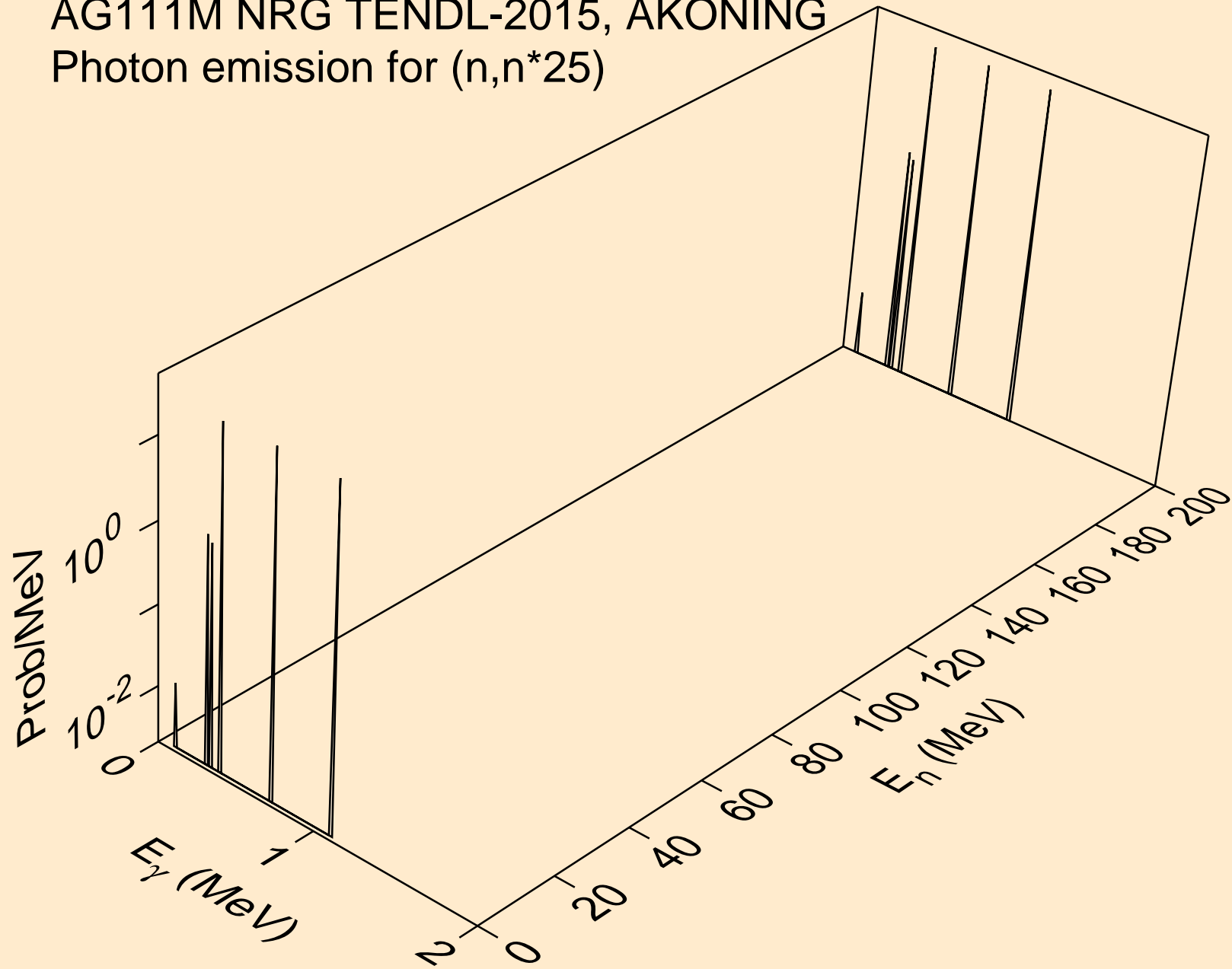

AG111M NRG TENDL-2015, AKONING
Photon emission for (n,n*26)

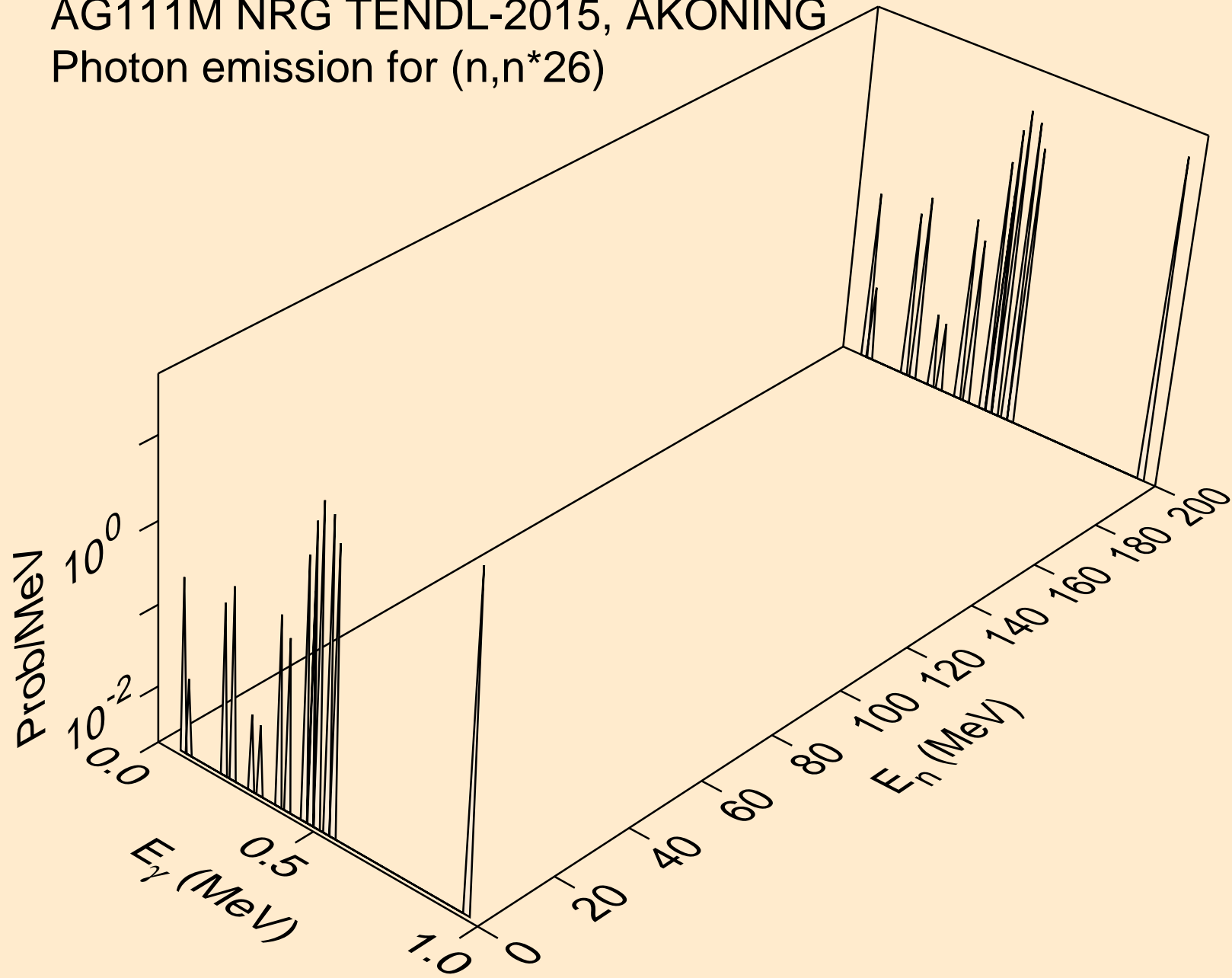

AG111M NRG TENDL-2015, AKONING
Photon emission for (n,n*27)

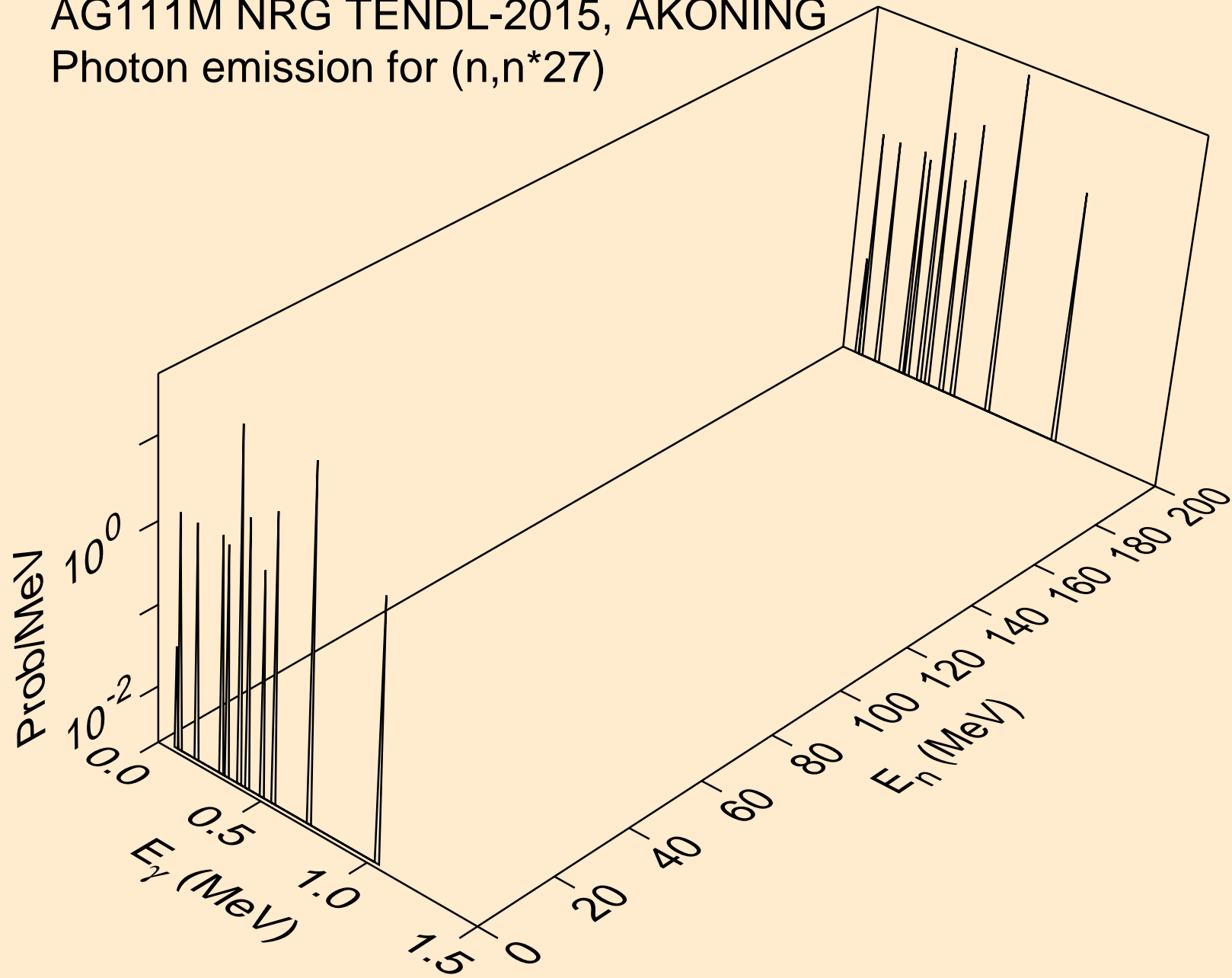

AG111M NRG TENDL-2015, AKONING
Photon emission for (n,n*28)

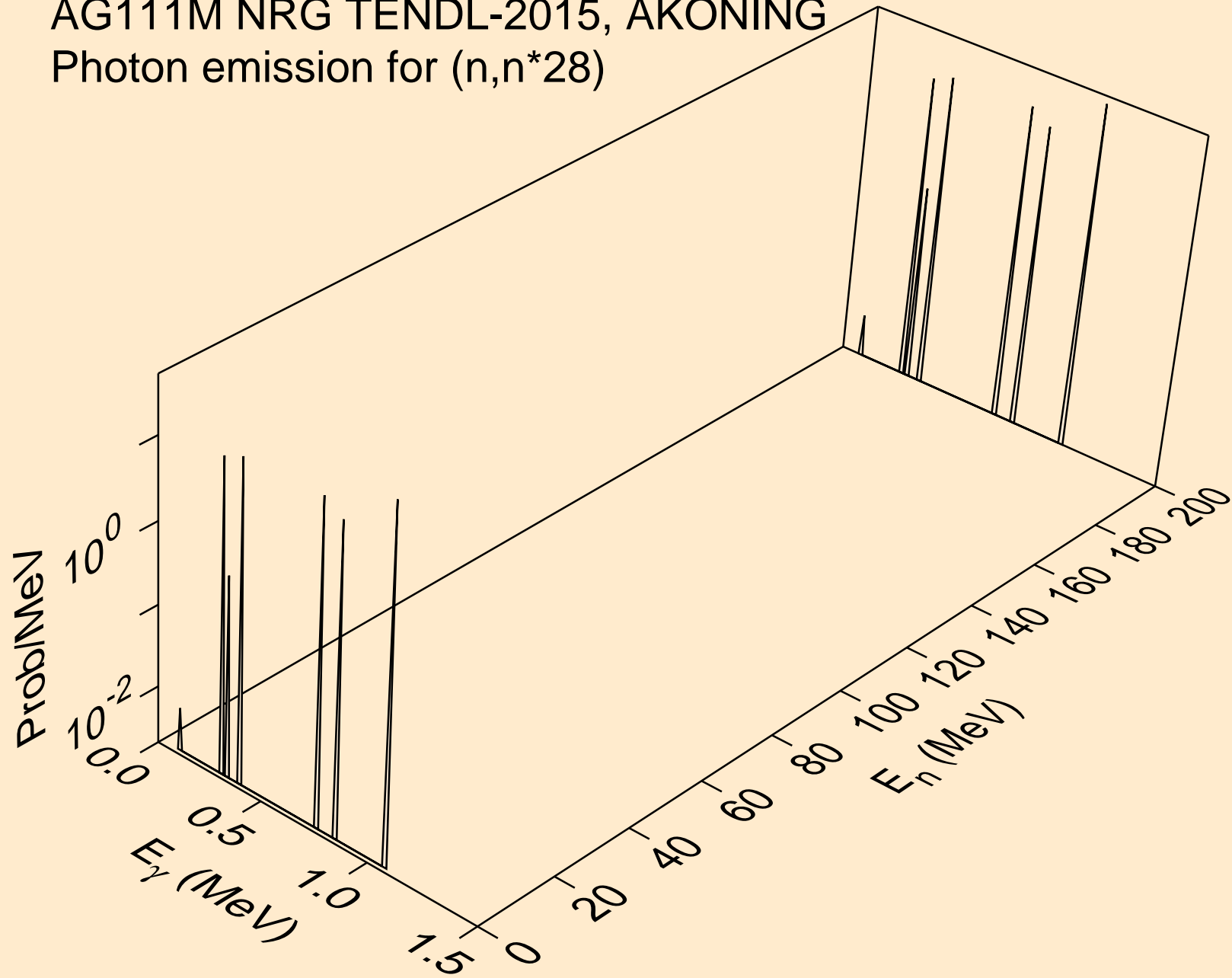

AG111M NRG TENDL-2015, AKONING
Photon emission for (n,n*29)

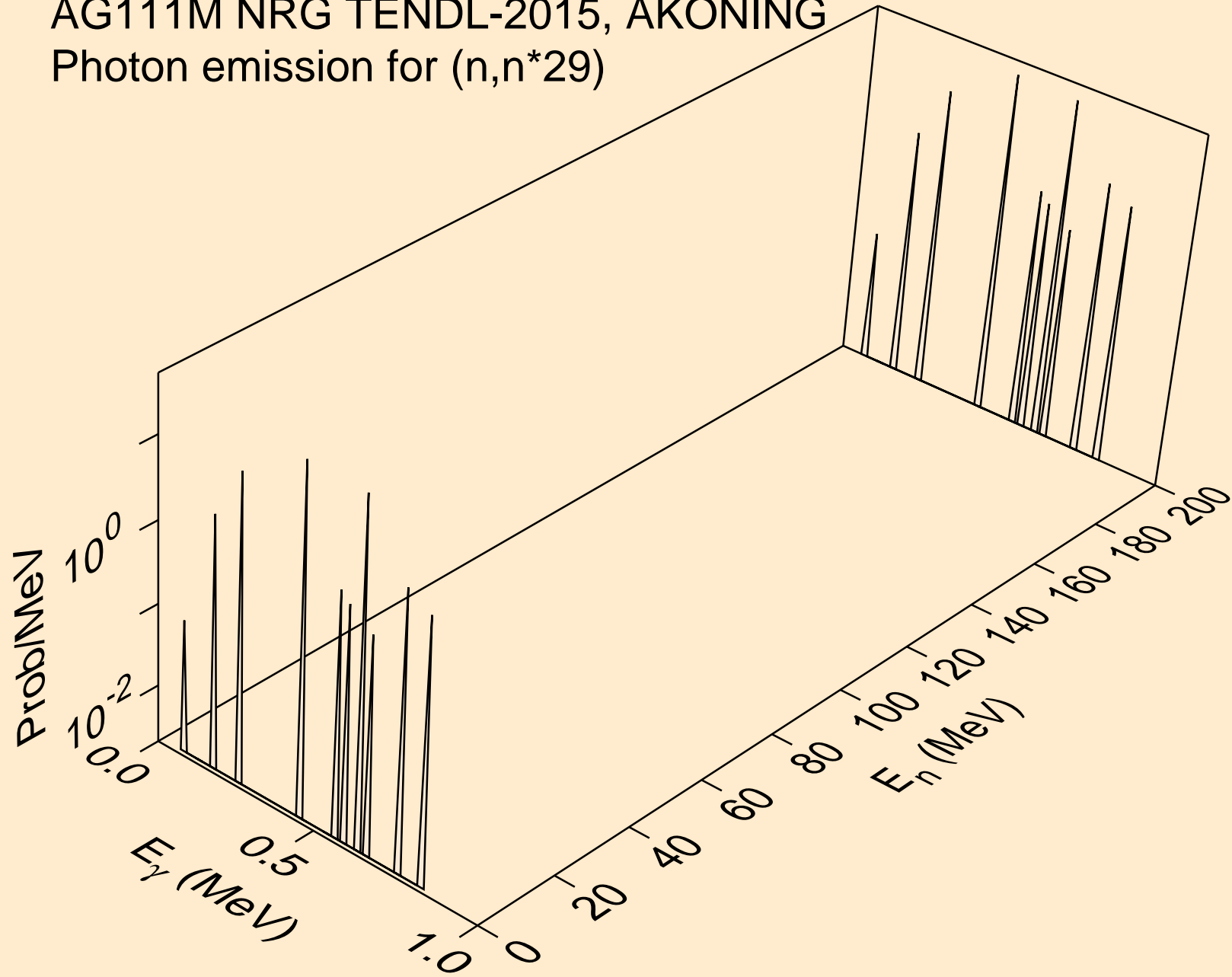

AG111M NRG TENDL-2015, AKONING
Photon emission for (n,n*c)

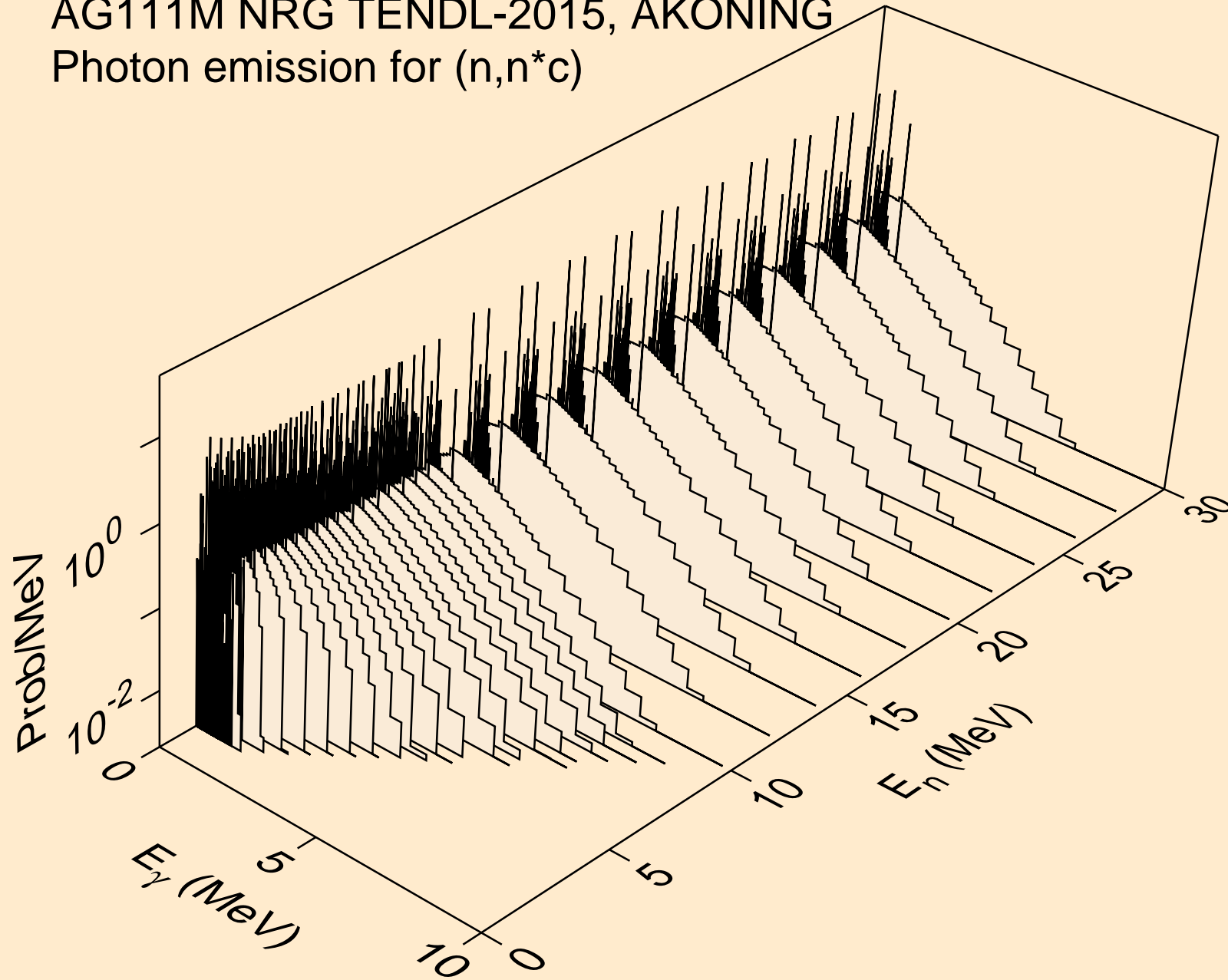

AG111M NRG TENDL-2015, AKONING
Photon emission for (n,gma)

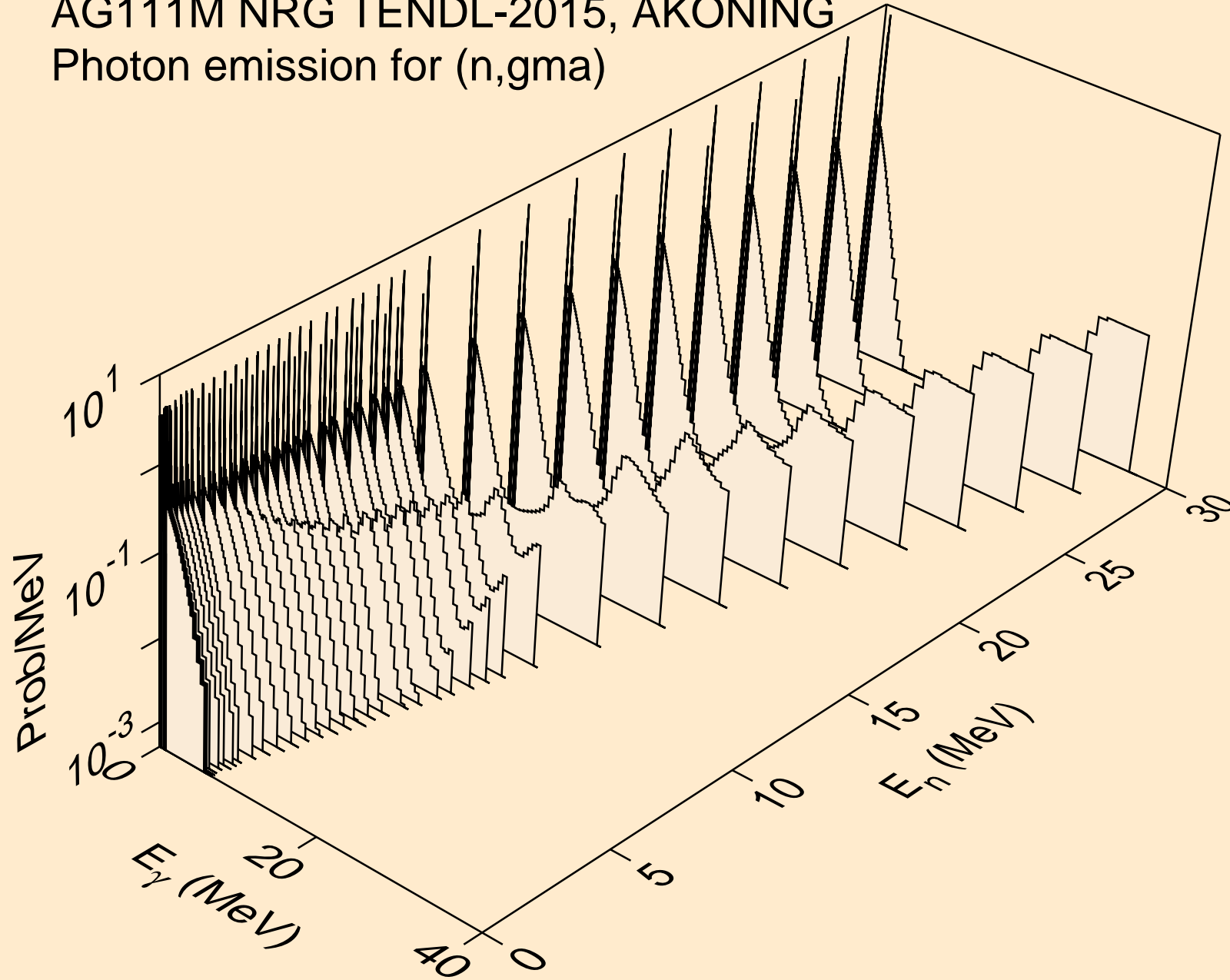

AG111M NRG TENDL-2015, AKONING
Photon emission for (n,p)

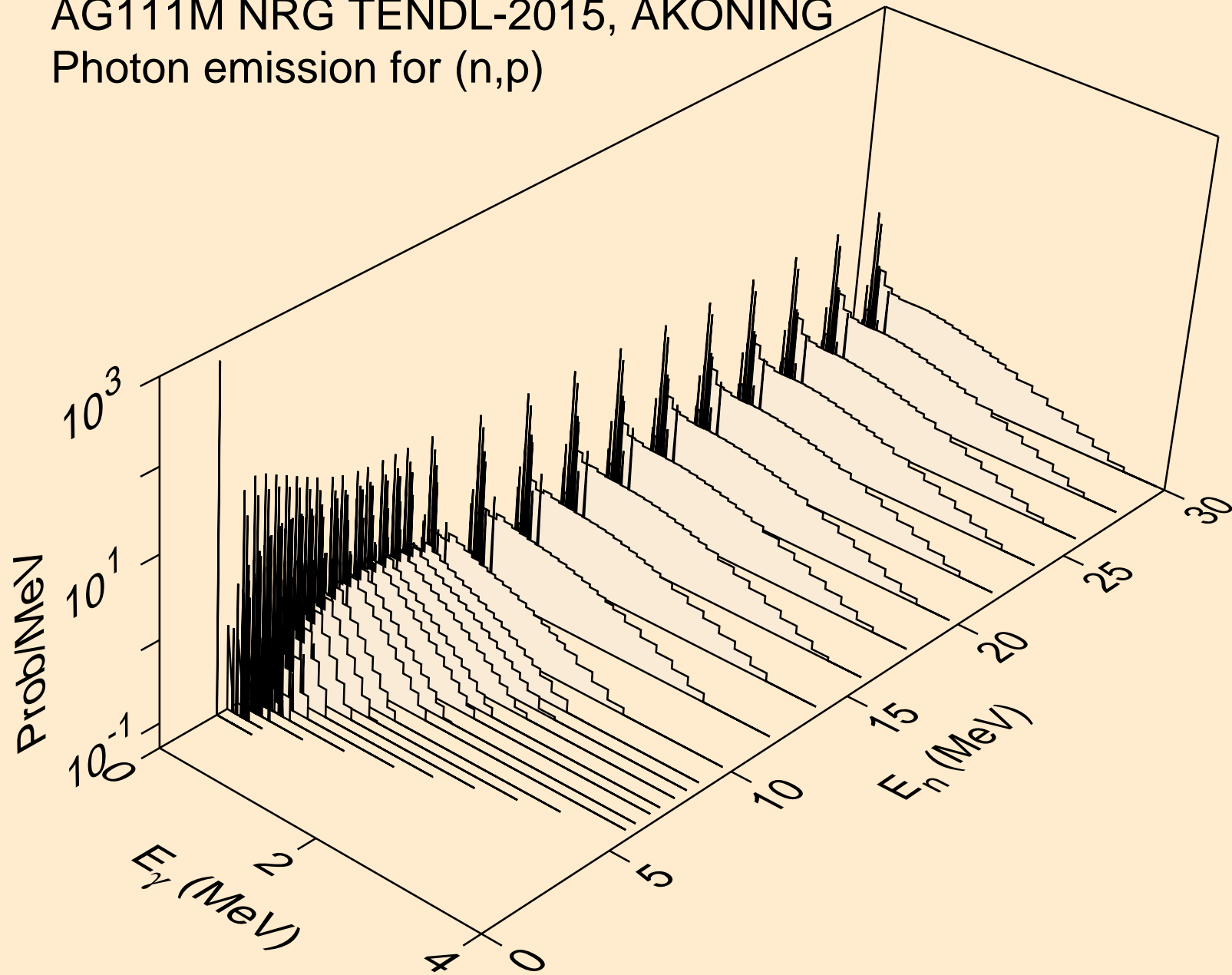

AG111M NRG TENDL-2015, AKONING
Photon emission for (n,d)

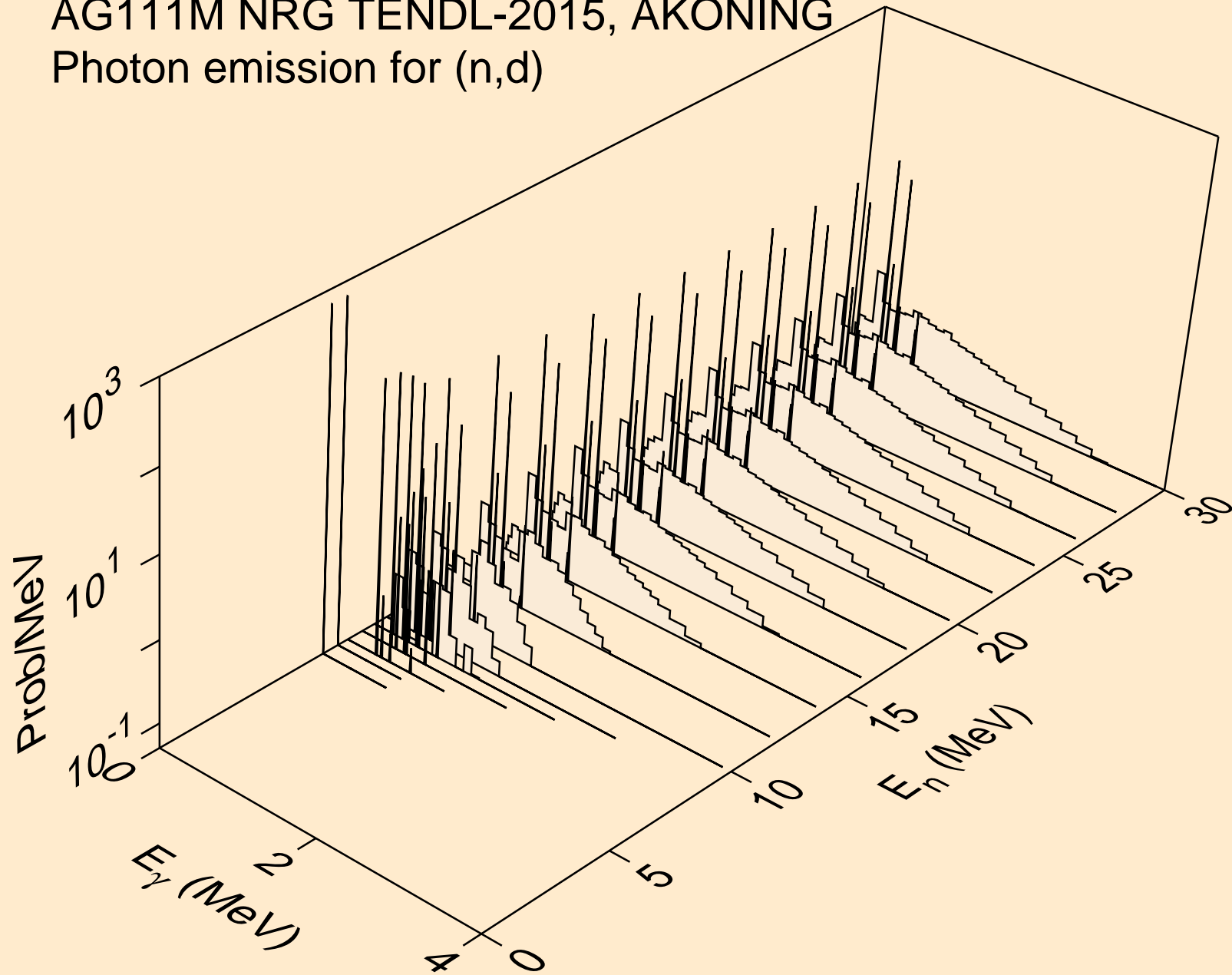

AG111M NRG TENDL-2015, AKONING
Photon emission for (n,t)

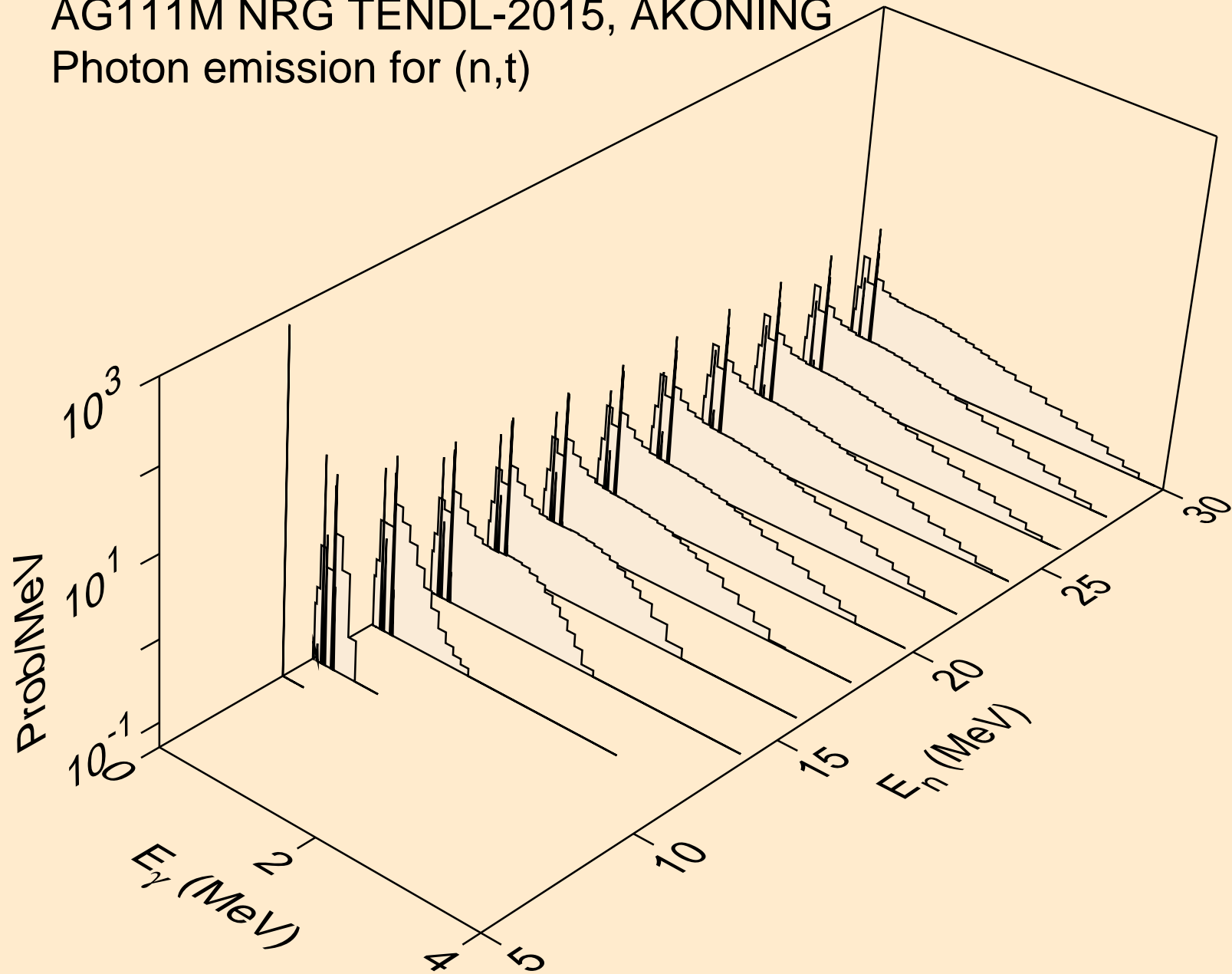

AG111M NRG TENDL-2015, AKONING
Photon emission for (n,he3)

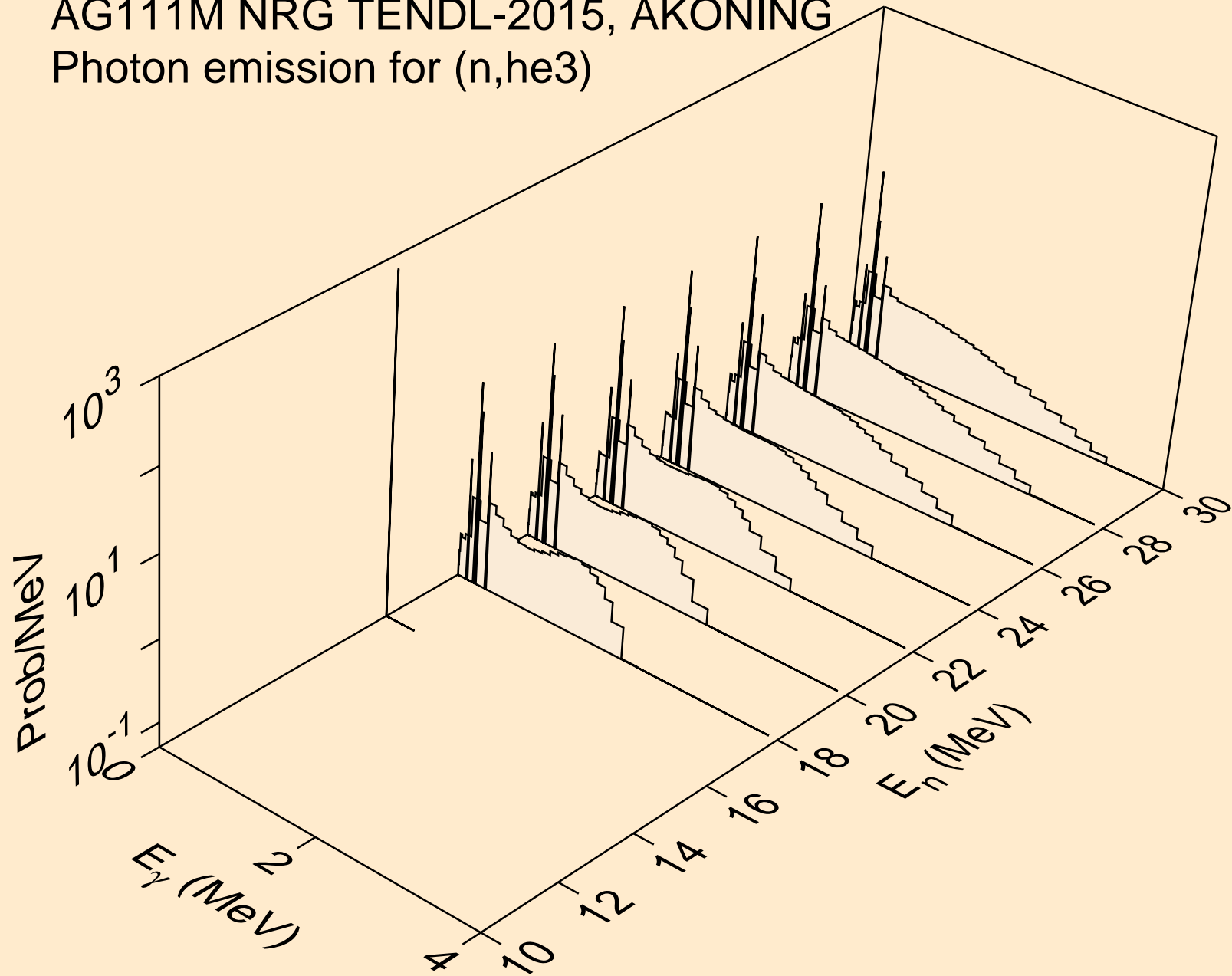

AG111M NRG TENDL-2015, AKONING
Photon emission for (n,a)

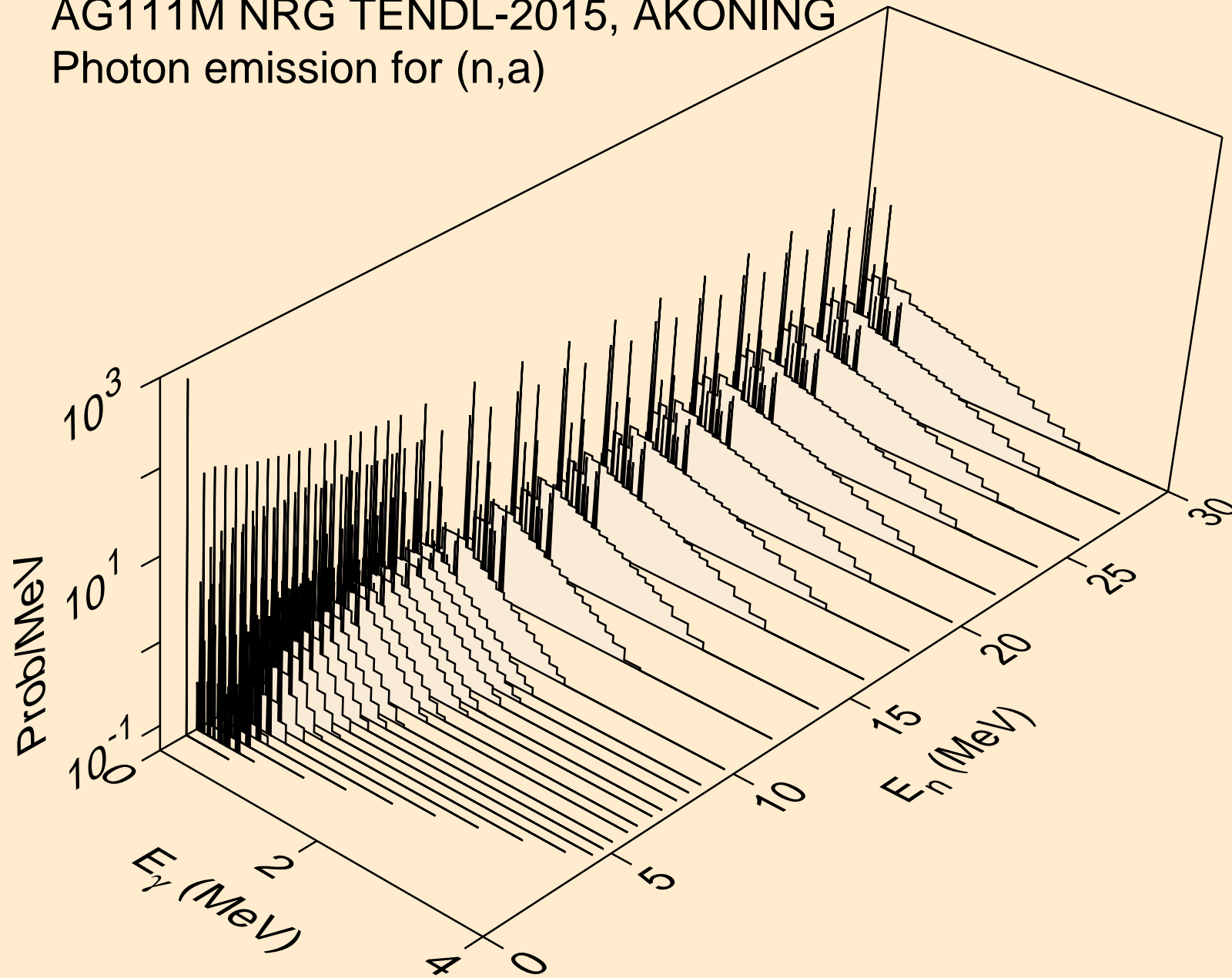

AG111M NRG TENDL-2015, AKONING
Photon emission for (n,2a)

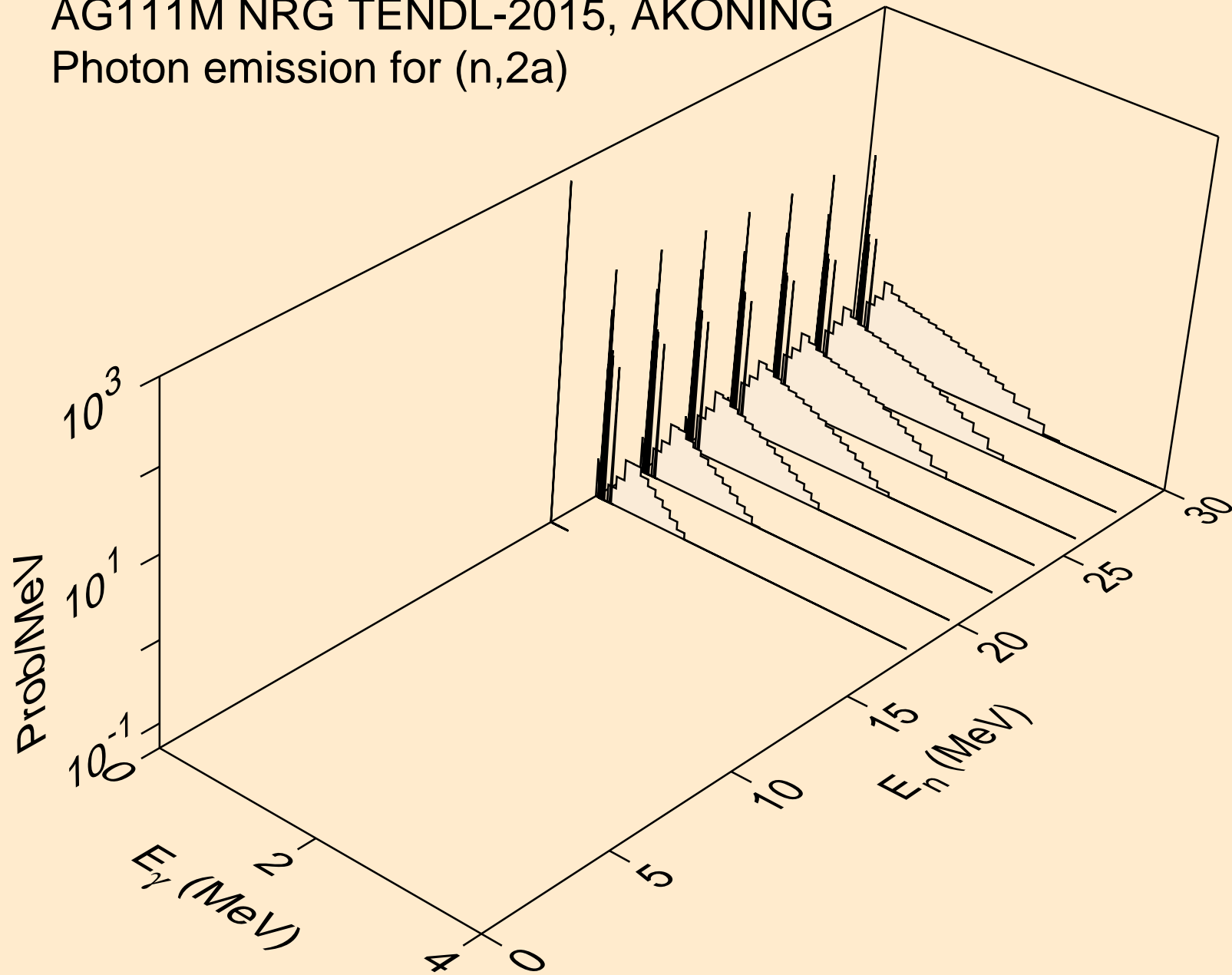

AG111M NRG TENDL-2015, AKONING
Photon emission for (n,2p)

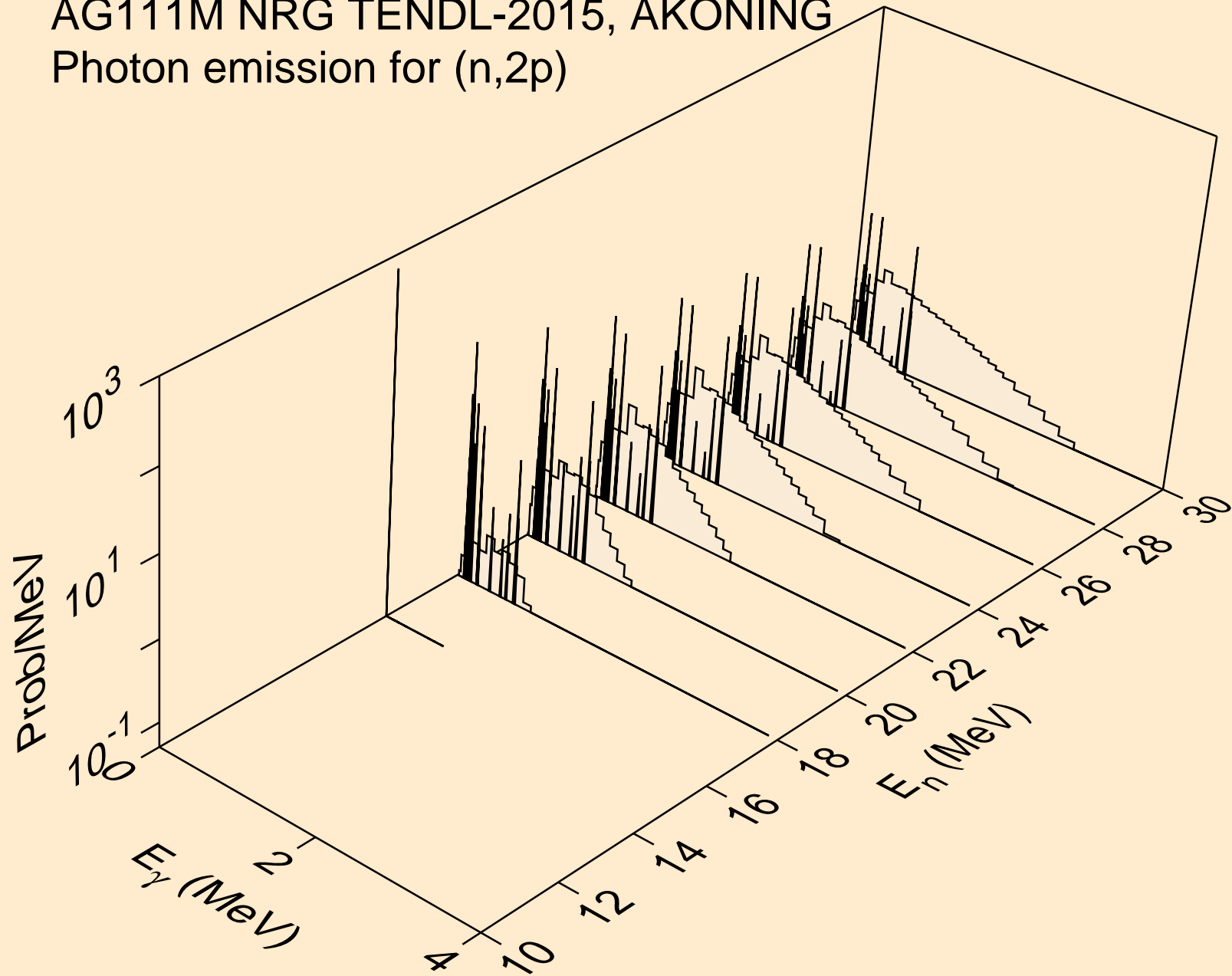

AG111M NRG TENDL-2015, AKONING
Photon emission for (n,pa)

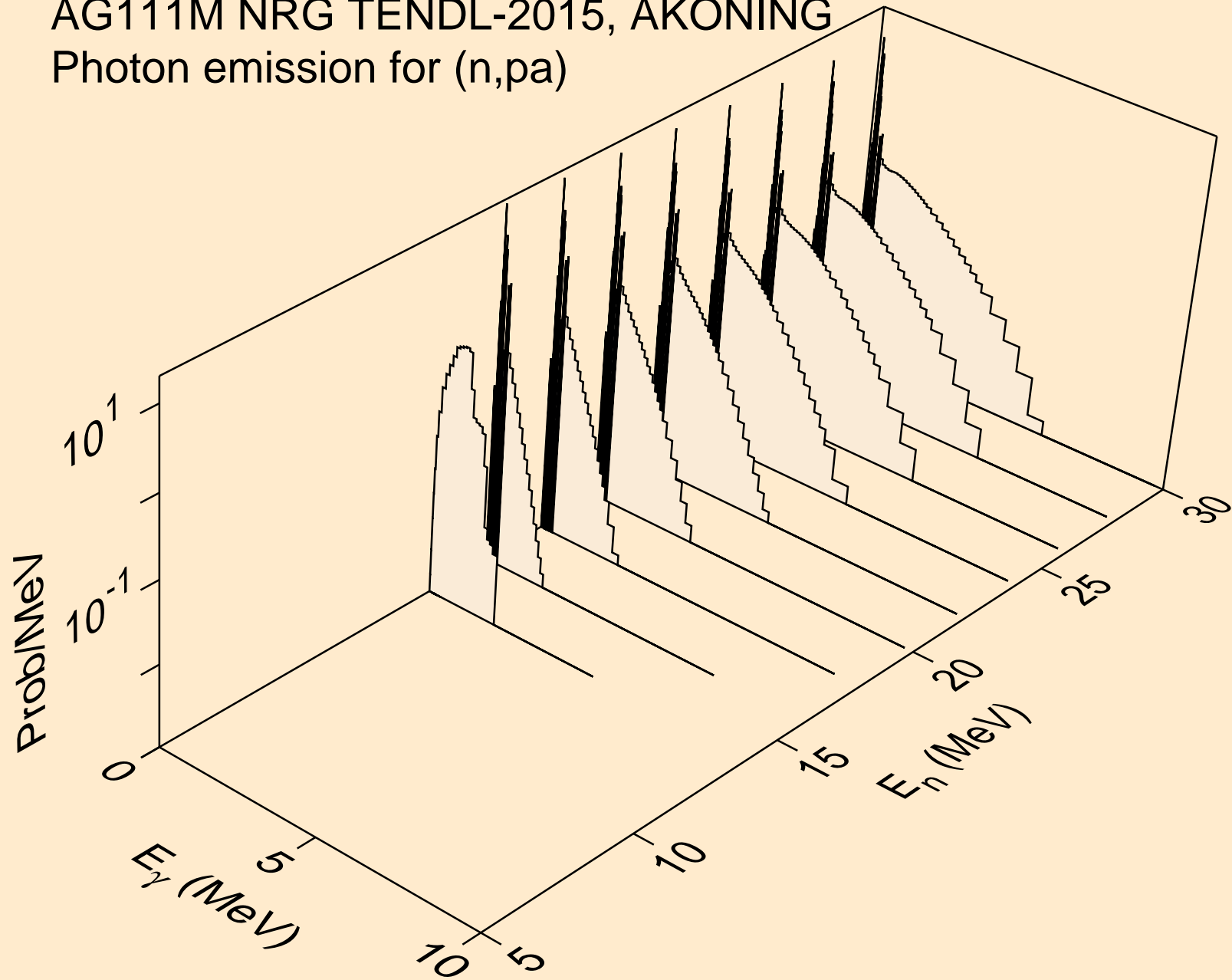

AG111M NRG TENDL-2015, AKONING
Photon emission for (n,pd)

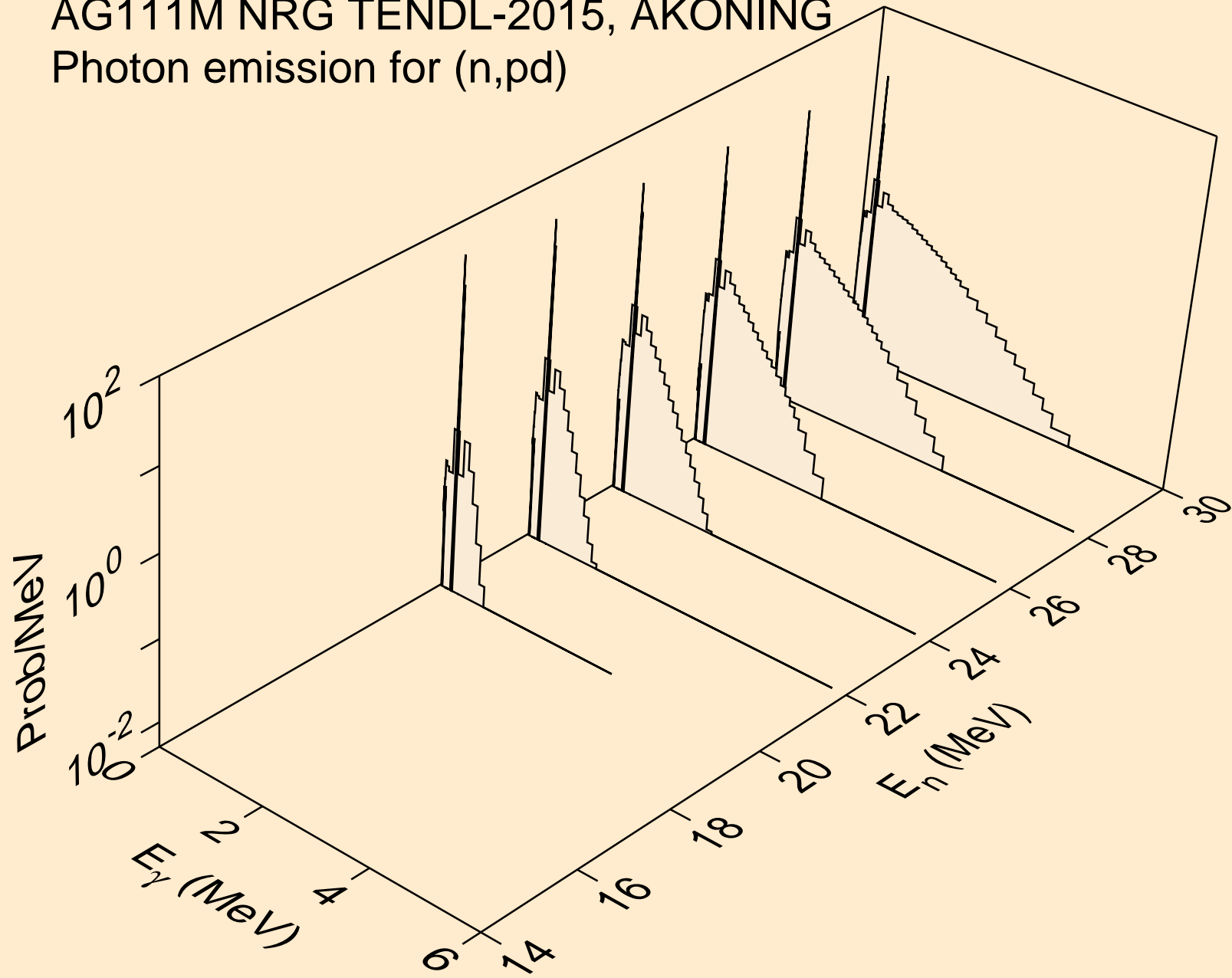

AG111M NRG TENDL-2015, AKONING
Photon emission for (n,pt)

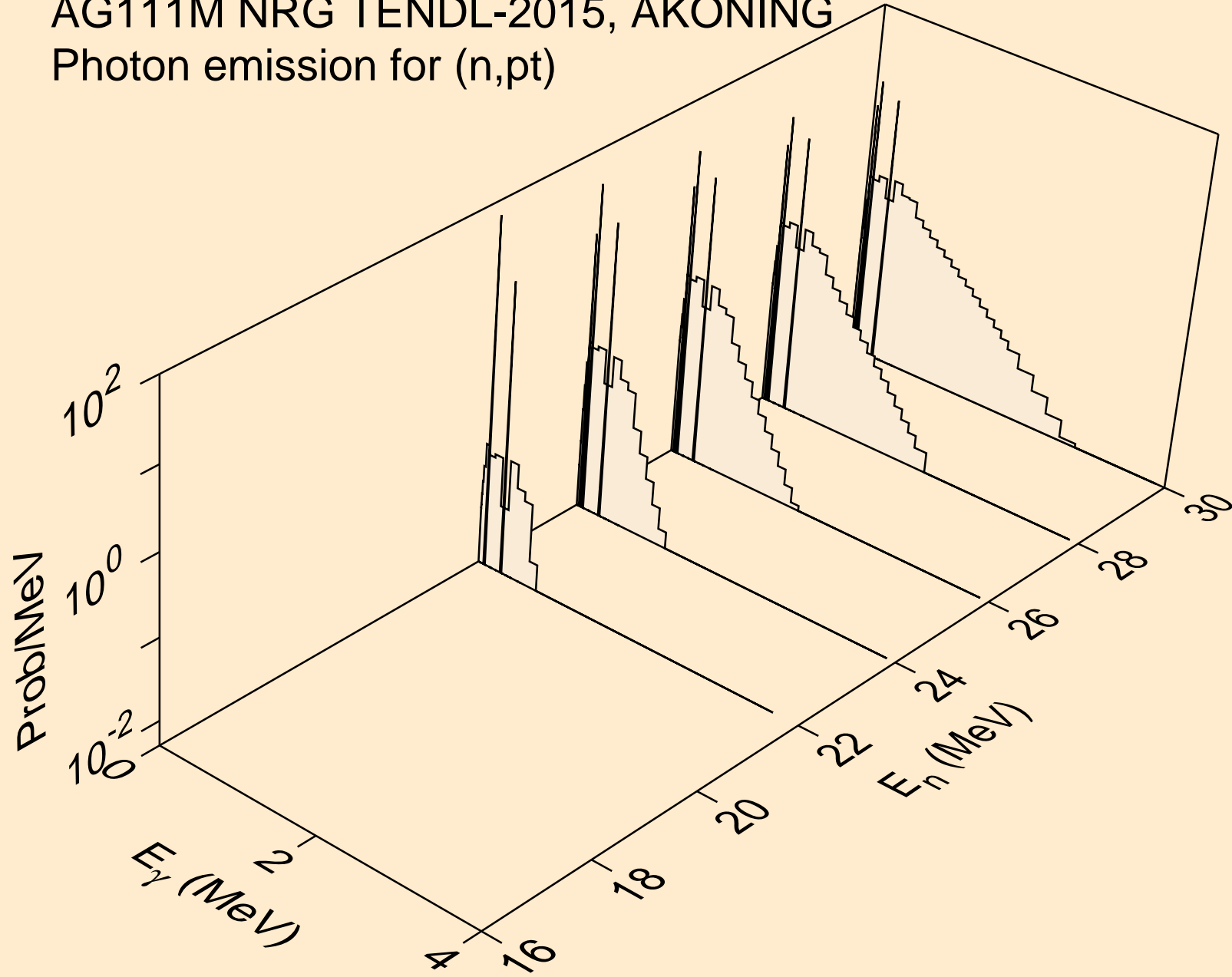

AG111M NRG TENDL-2015, AKONING
Photon emission for (n,da)

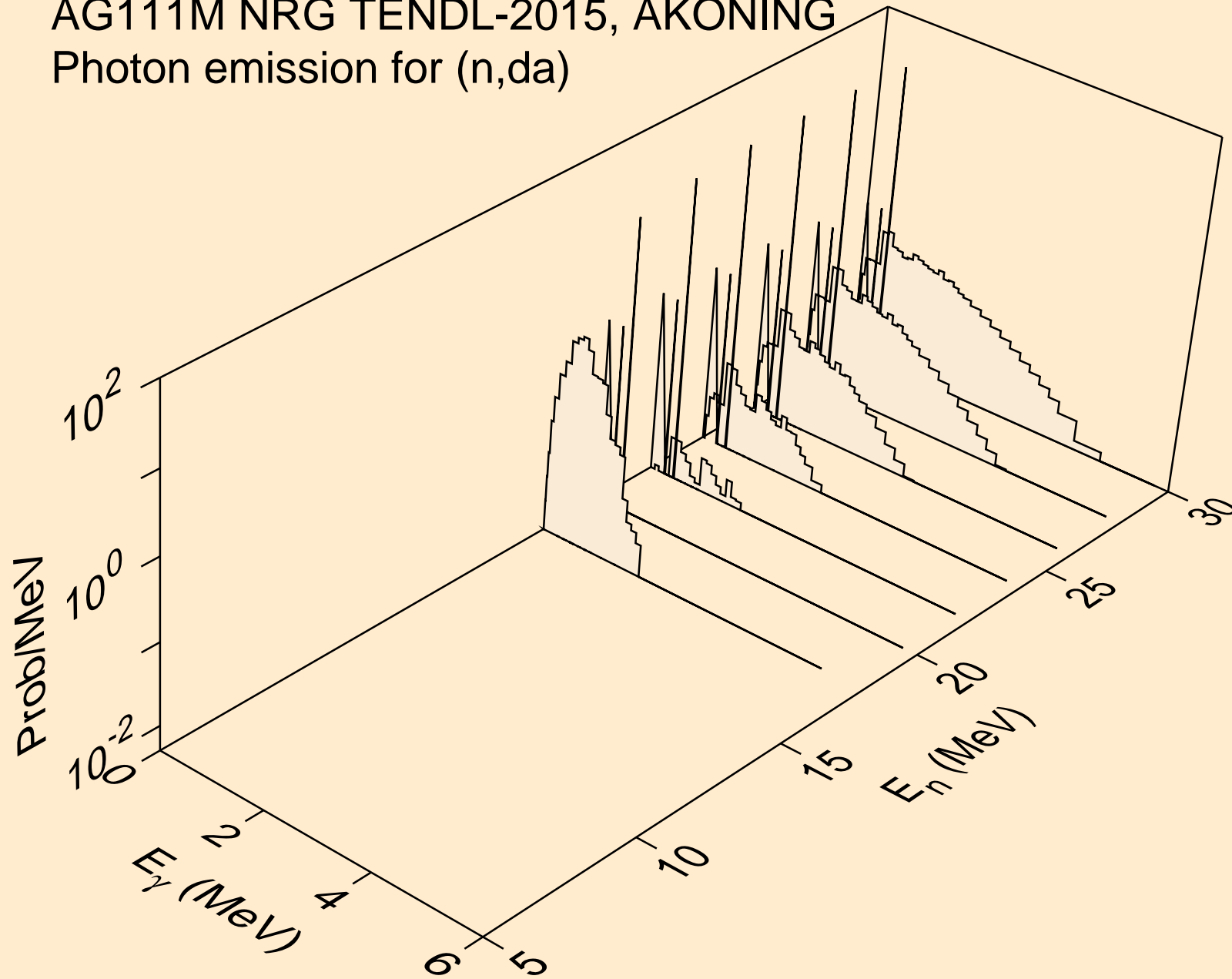

AG111M NRG TENDL-2015, AKONING
thermal capture photon spectrum

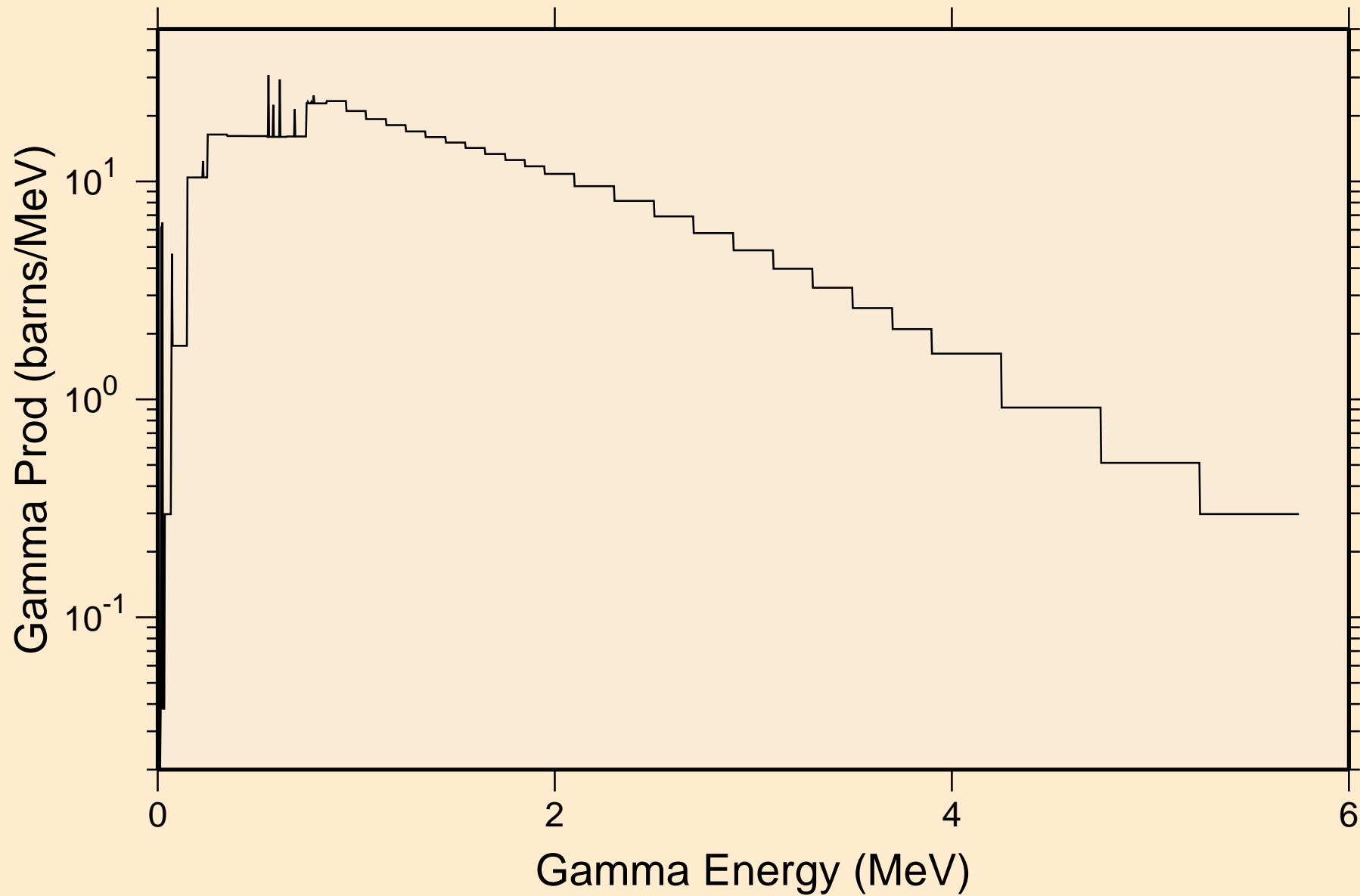

AG111M NRG TENDL-2015, AKONING
14 MeV photon spectrum

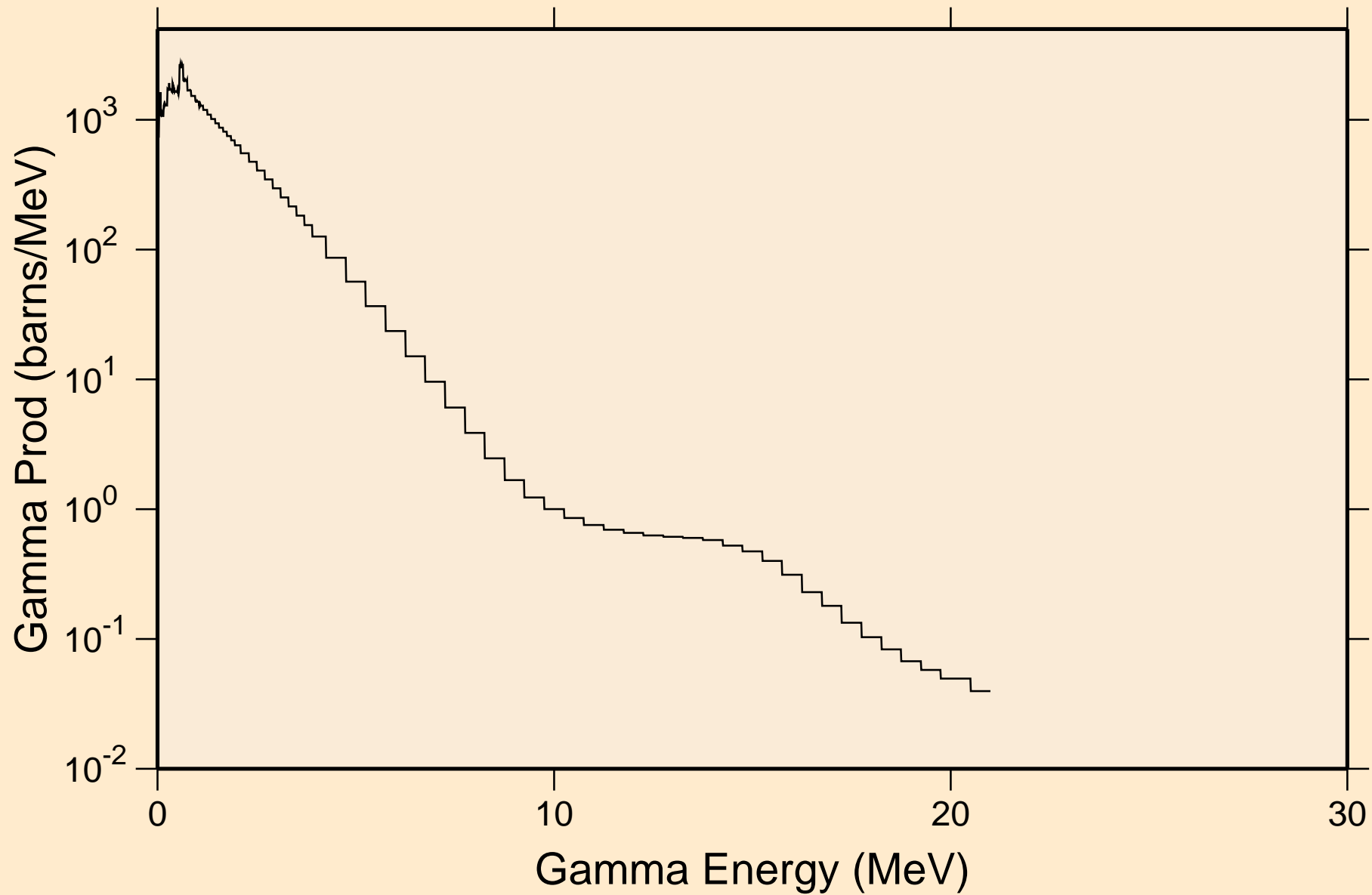

AG111M NRG TENDL-2015, AKONING

Particle heating contributions

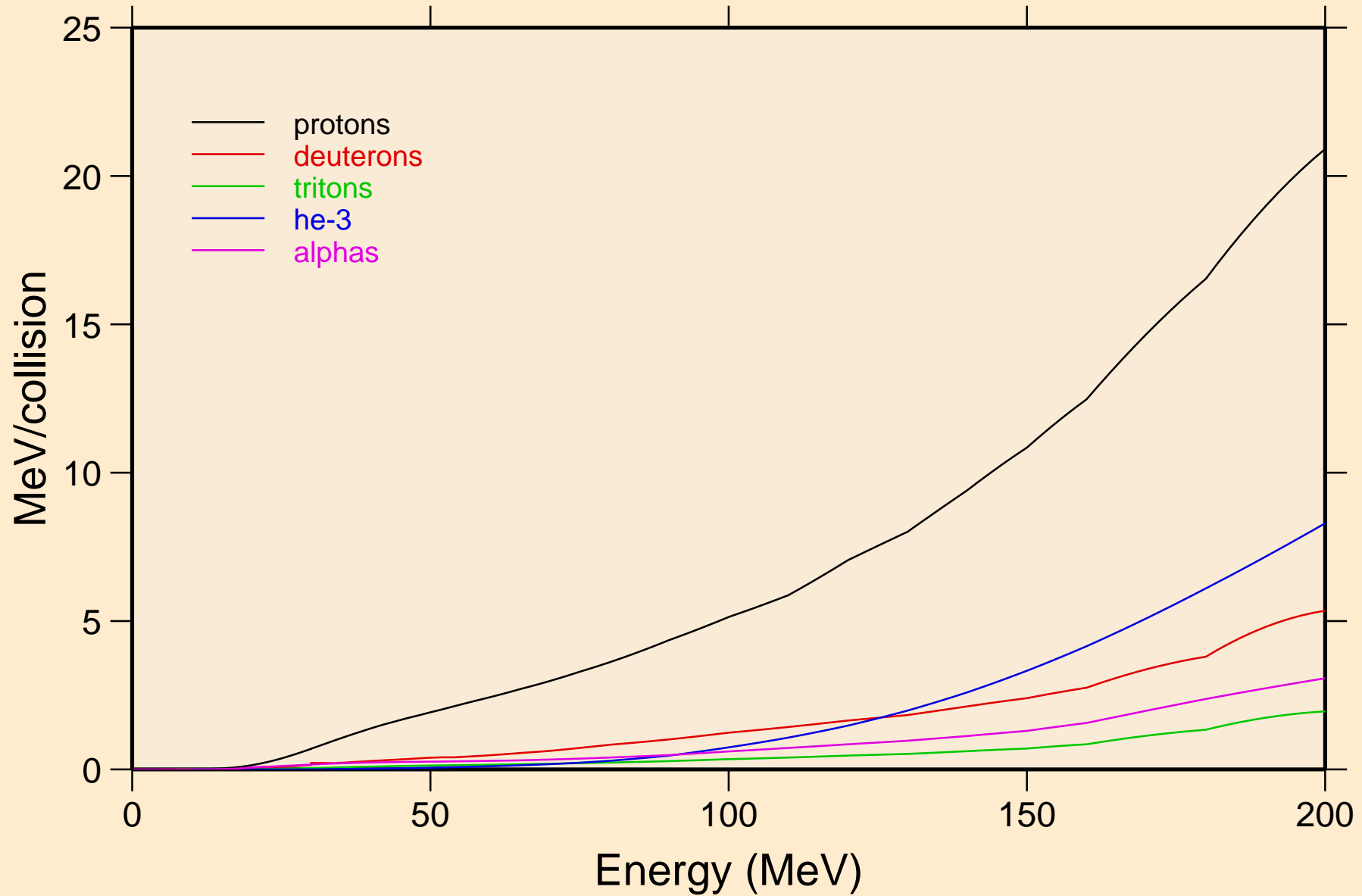

AG111M NRG TENDL-2015, AKONING

Recoil Heating

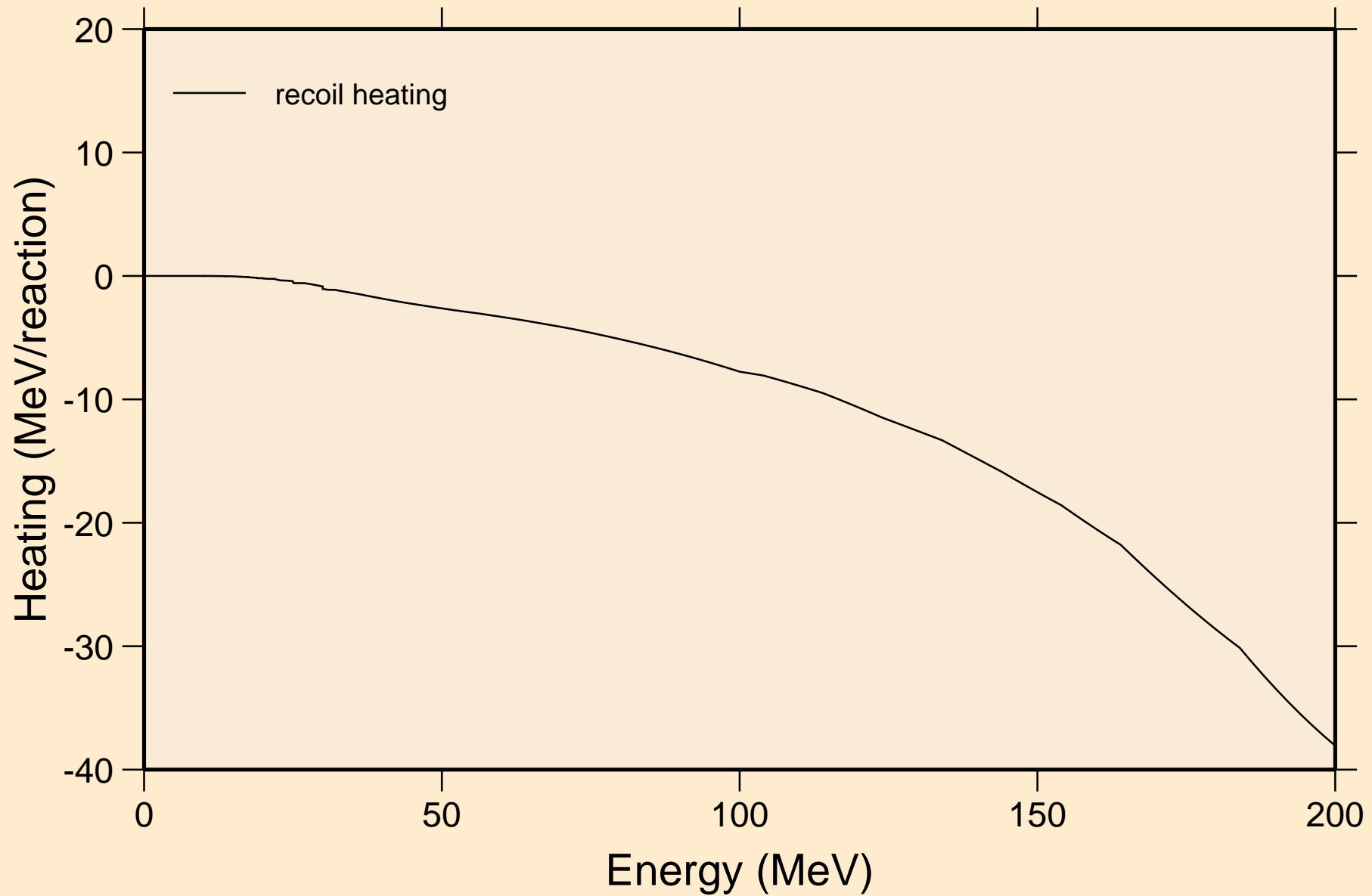

AG111M NRG TENDL-2015, AKONING

Particle production cross sections

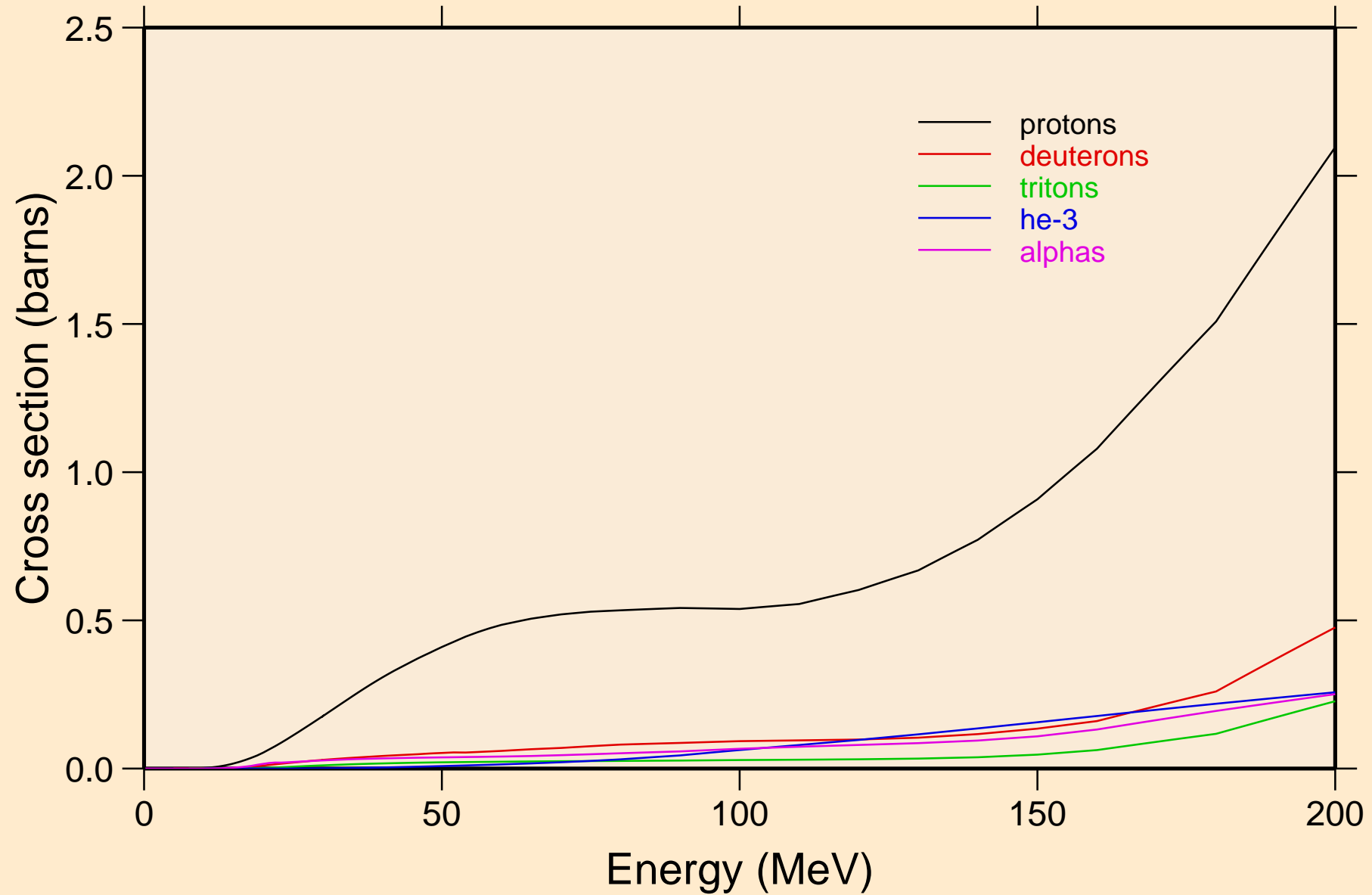

AG111M NRG TENDL-2015, AKONING
protons from (n,x)

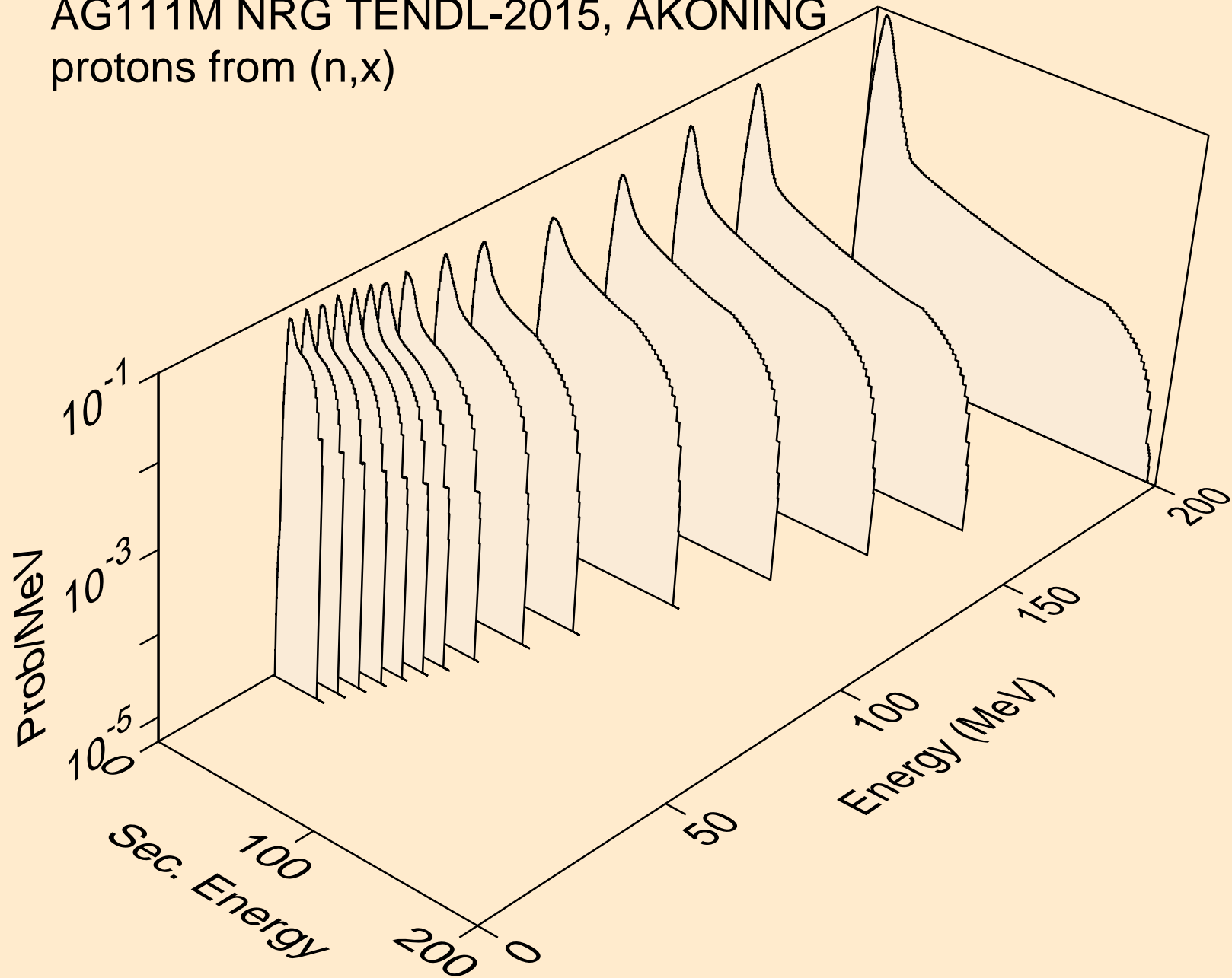

AG111M NRG TENDL-2015, AKONING
protons from (n,n*)p

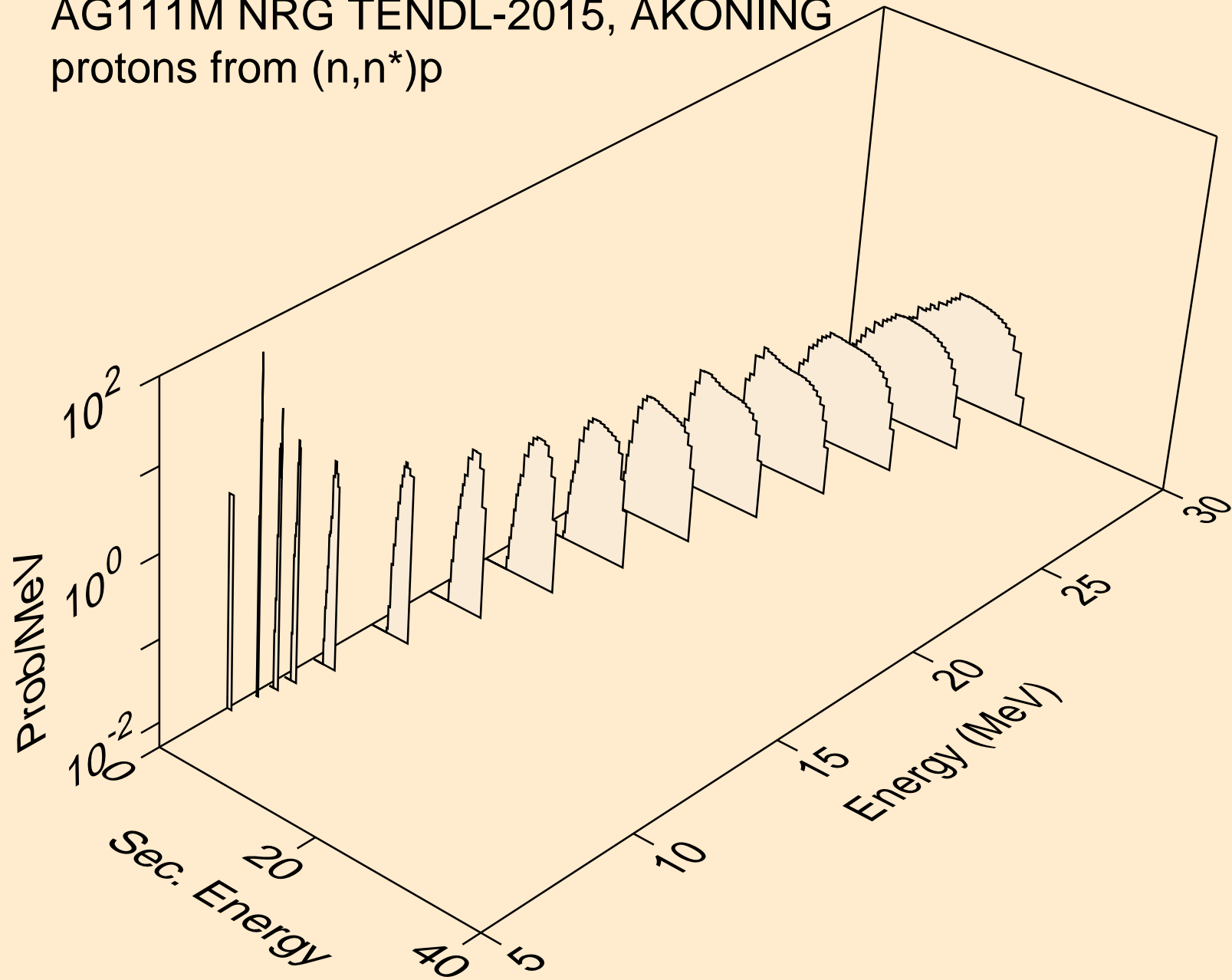

AG111M NRG TENDL-2015, AKONING
protons from (n,2np)

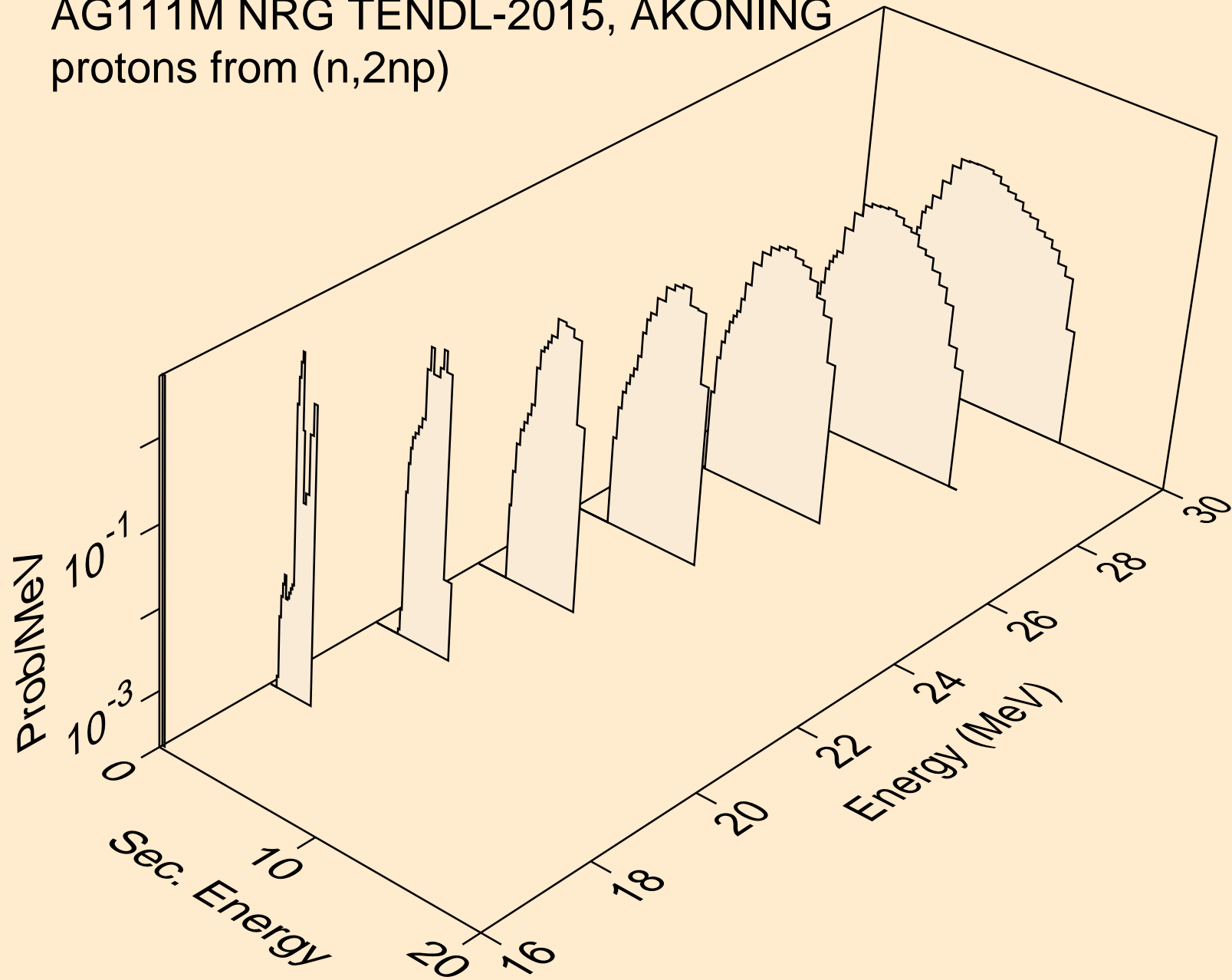

AG111M NRG TENDL-2015, AKONING
protons from (n,3np)

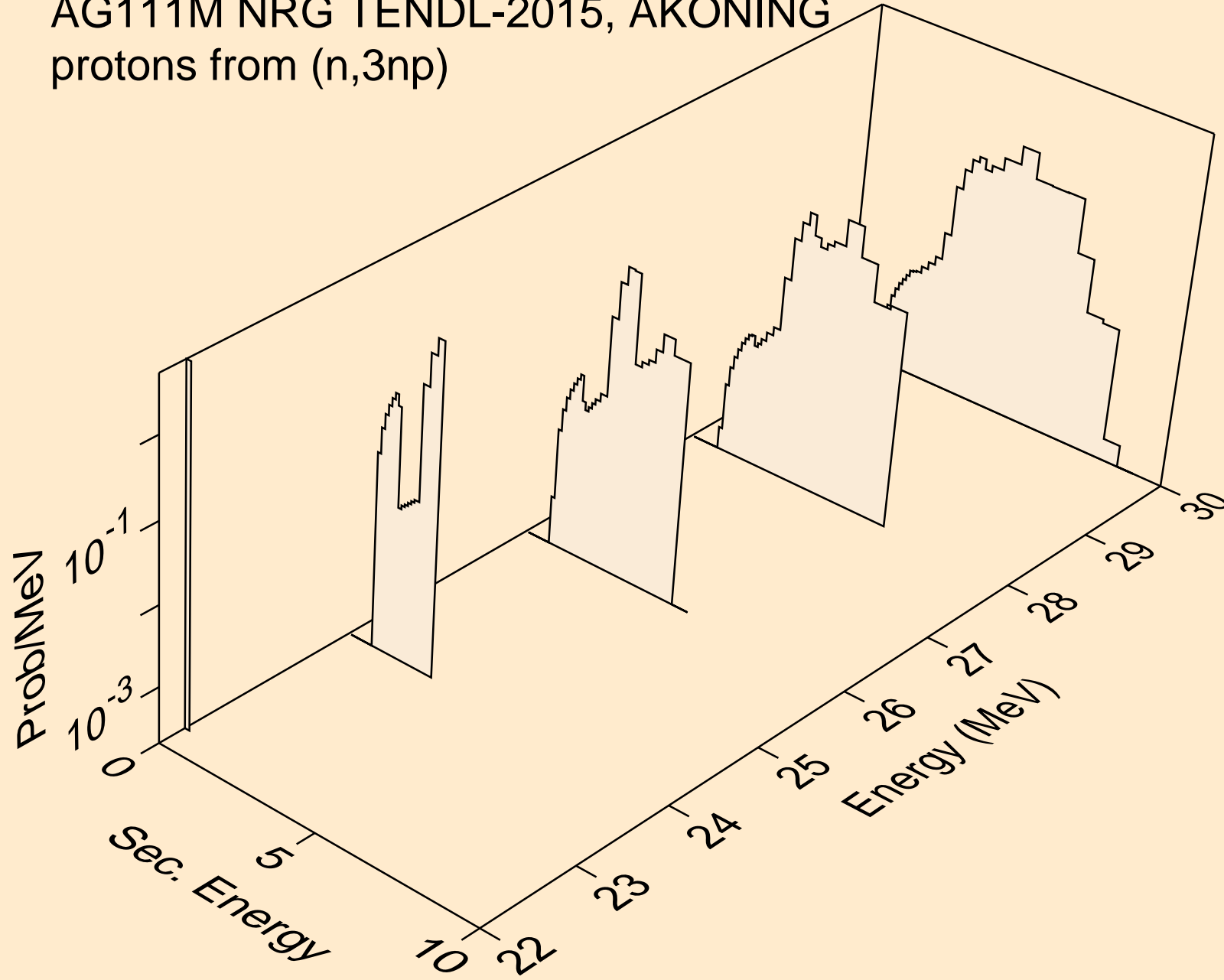

AG111M NRG TENDL-2015, AKONING
protons from (n,2np)

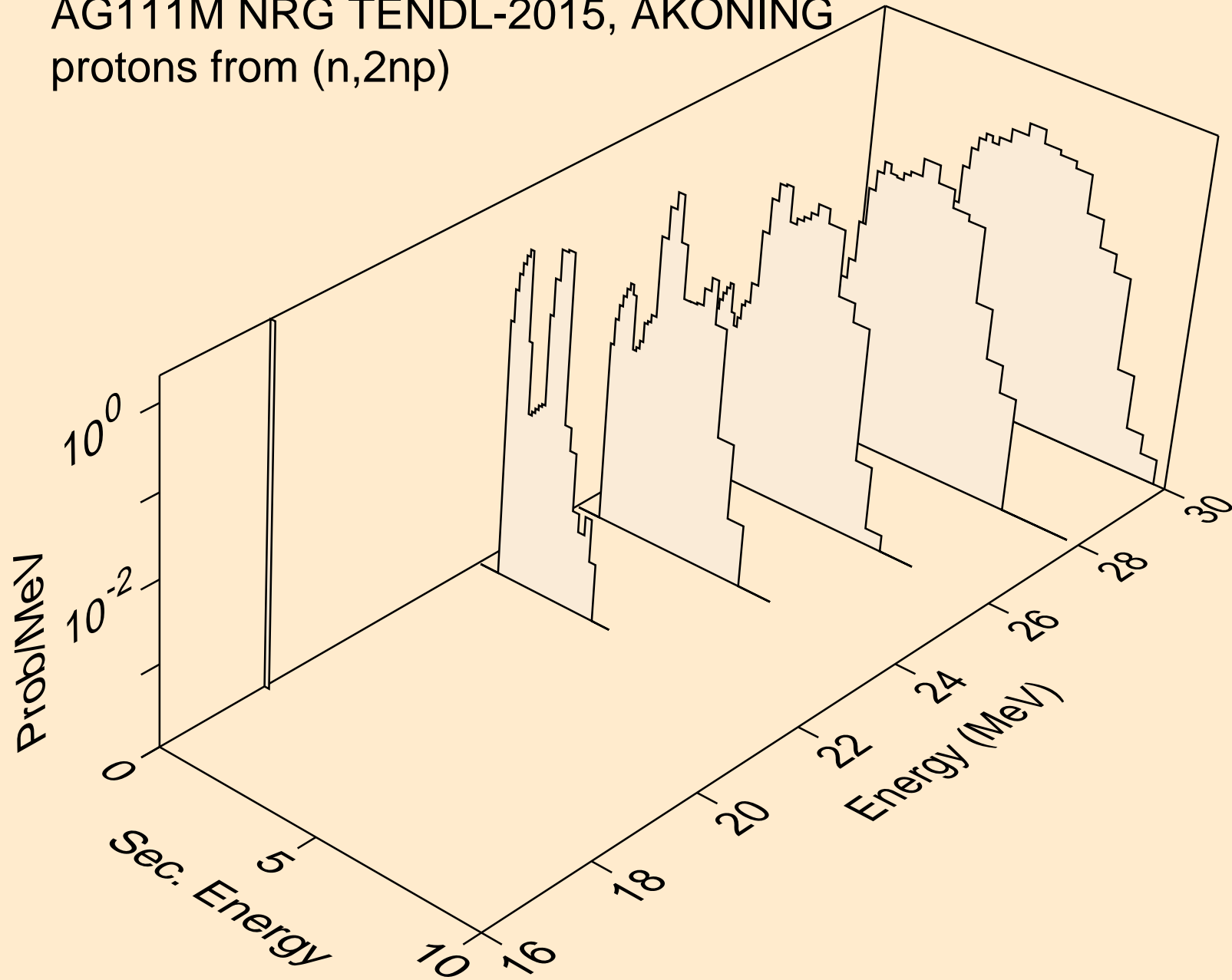

AG111M NRG TENDL-2015, AKONING
protons from (n,npa)

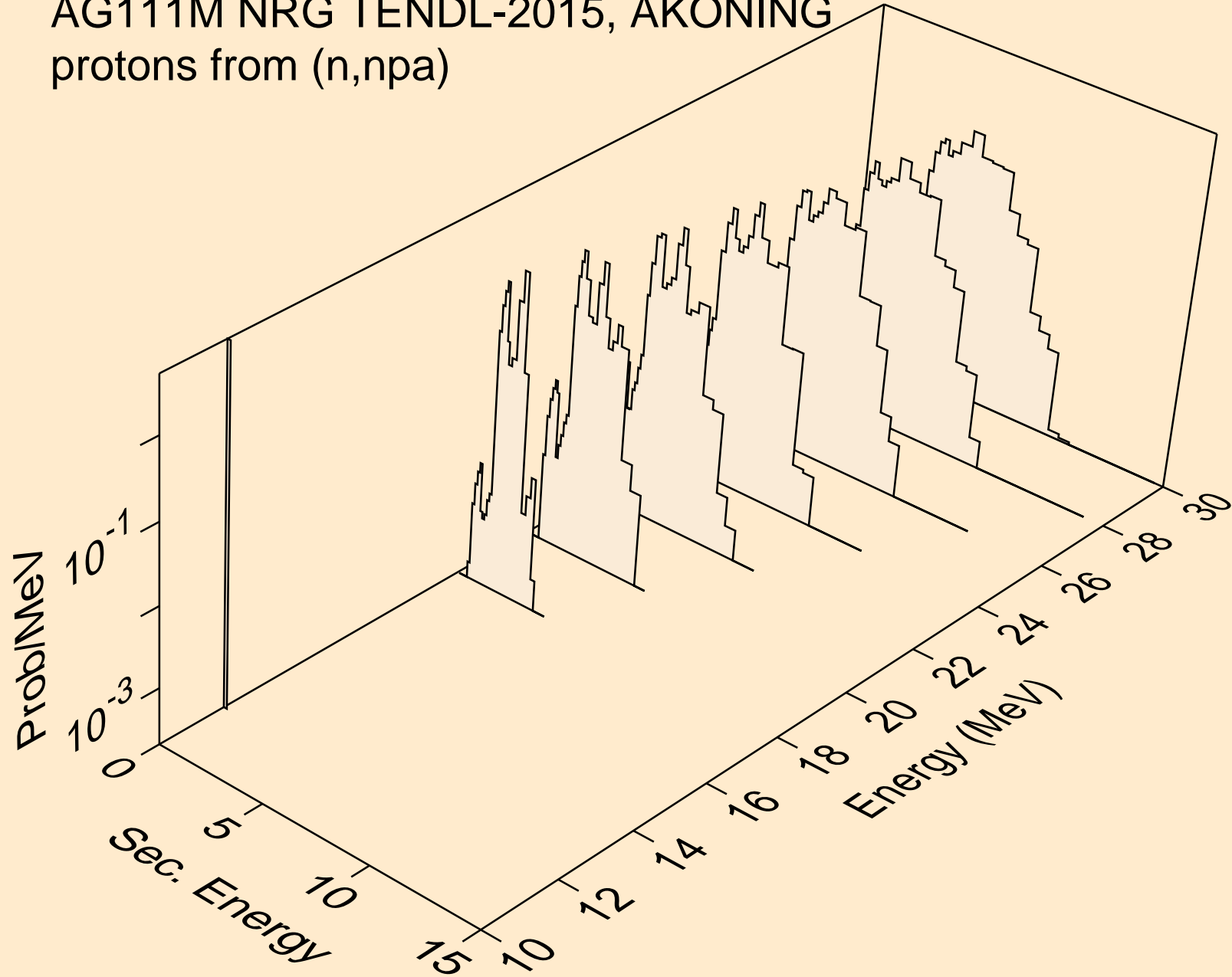

AG111M NRG TENDL-2015, AKONING
protons from (n,p)

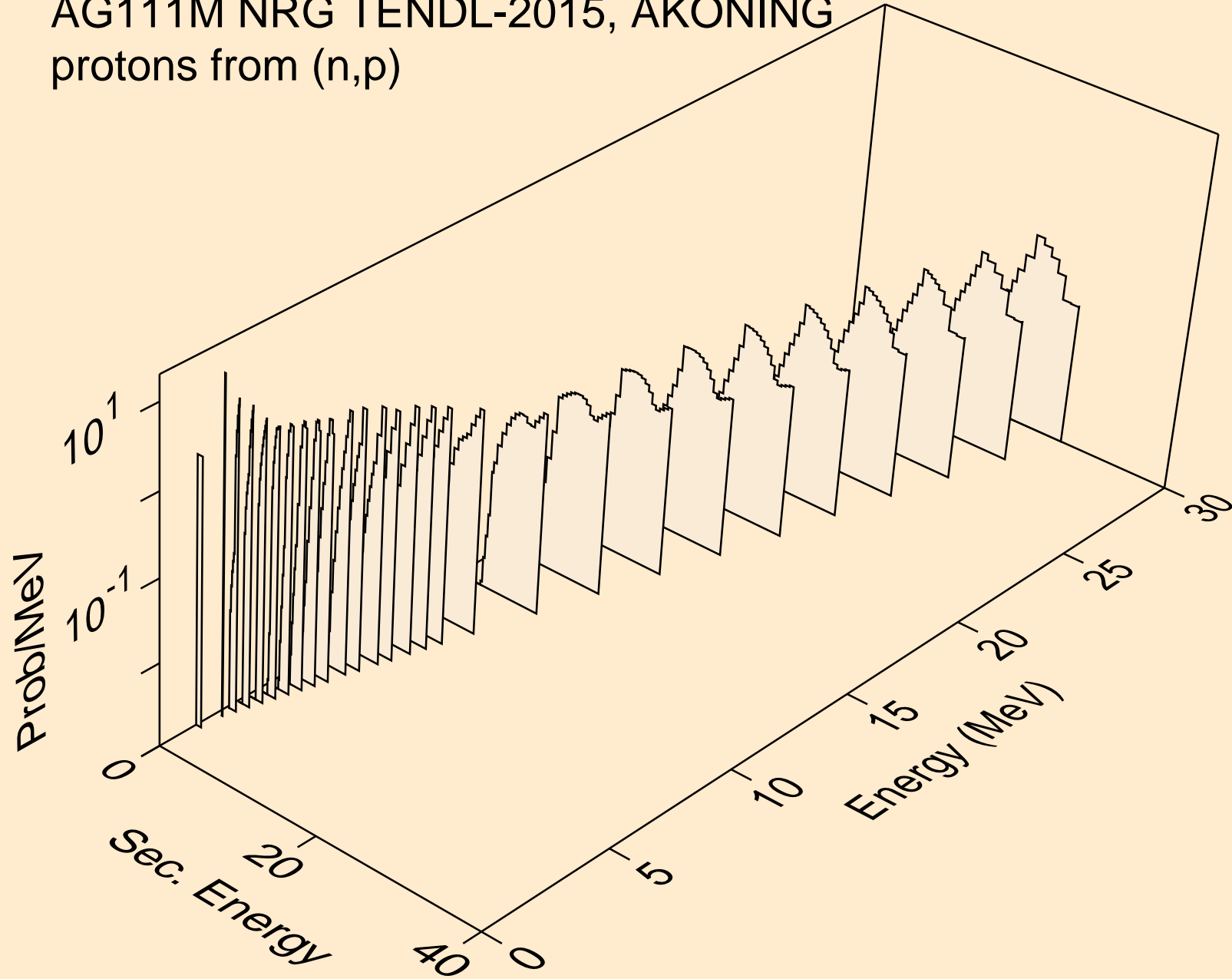

AG111M NRG TENDL-2015, AKONING
protons from (n,2p)

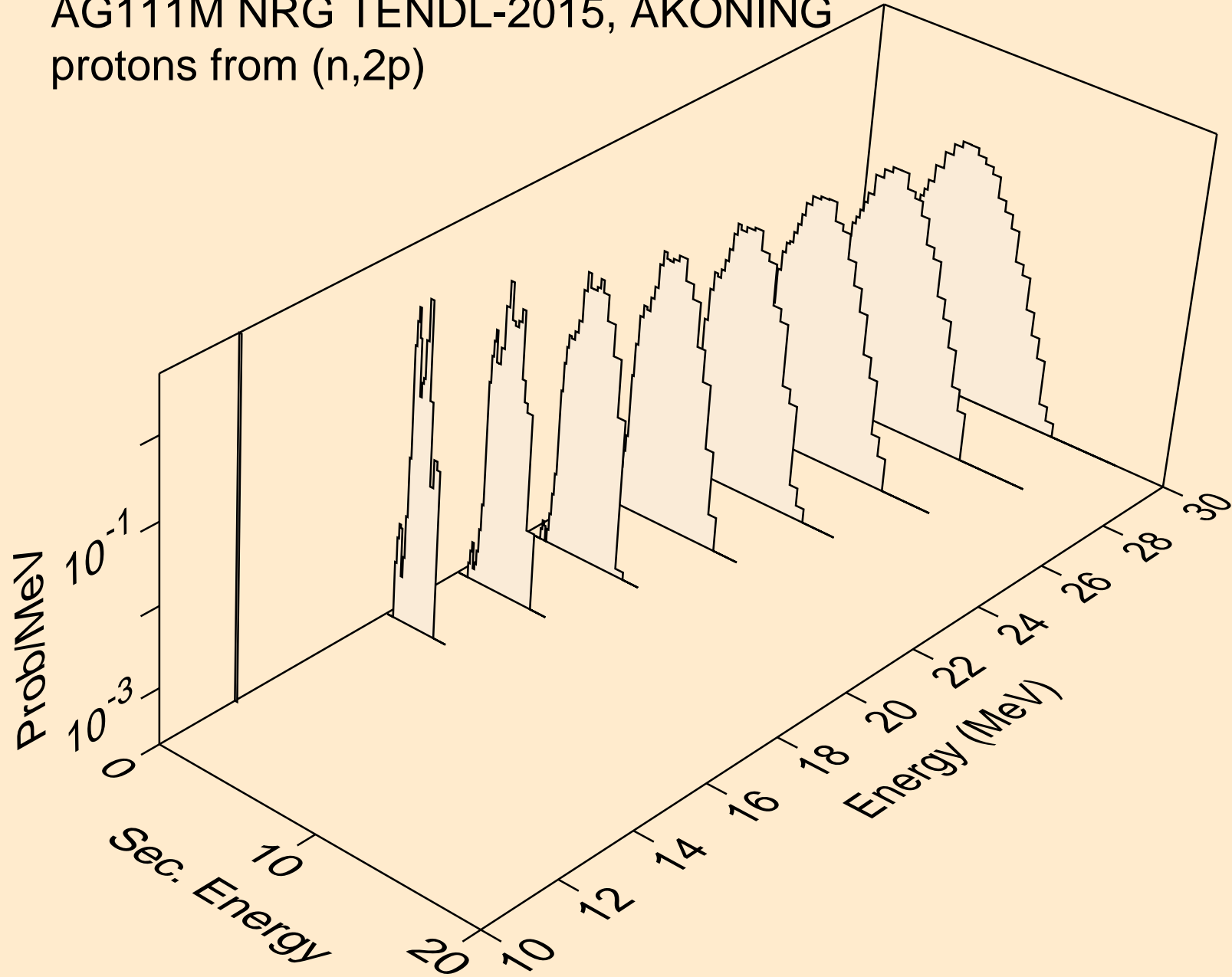

AG111M NRG TENDL-2015, AKONING
protons from (n,pa)

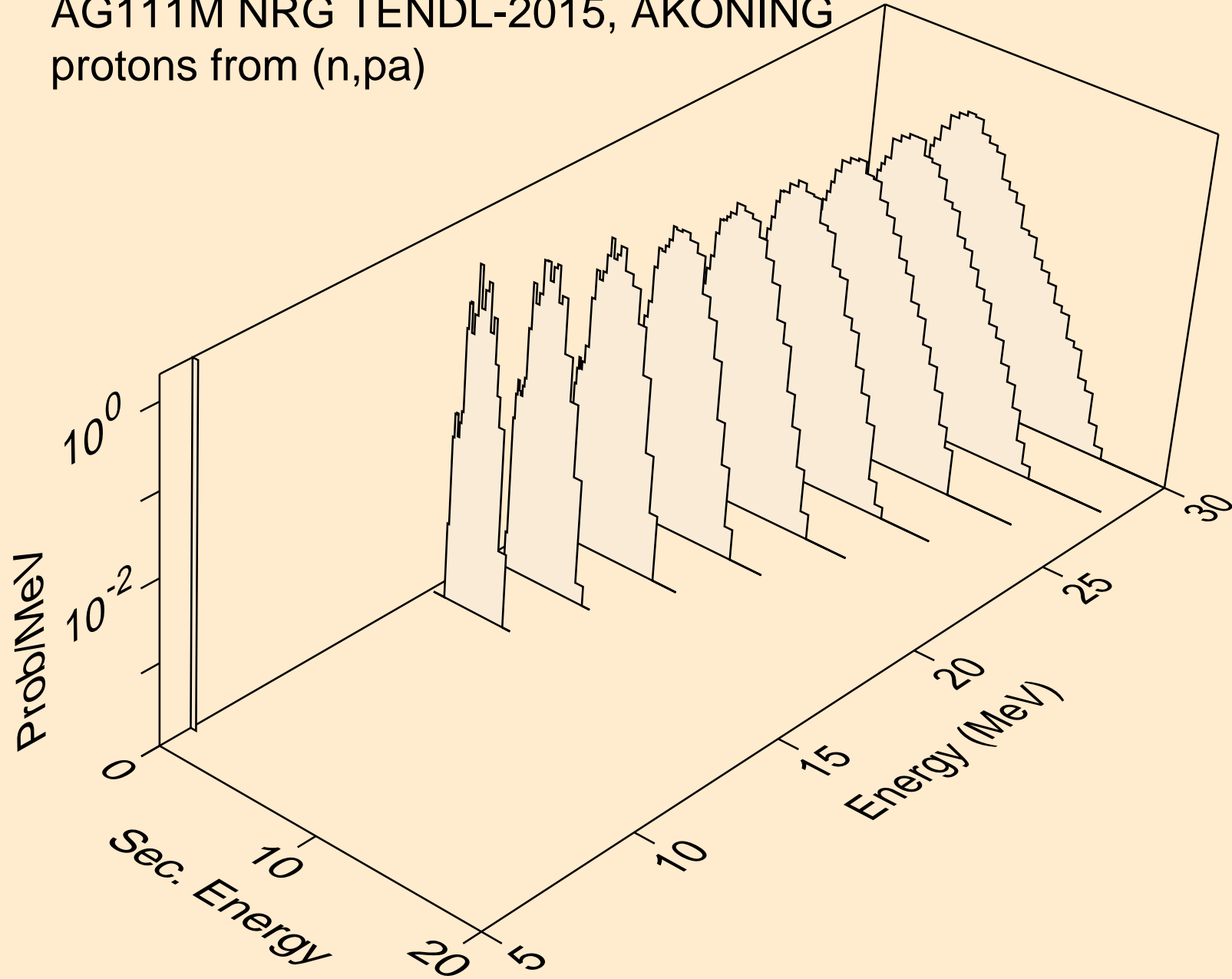

AG111M NRG TENDL-2015, AKONING
protons from (n,pd)

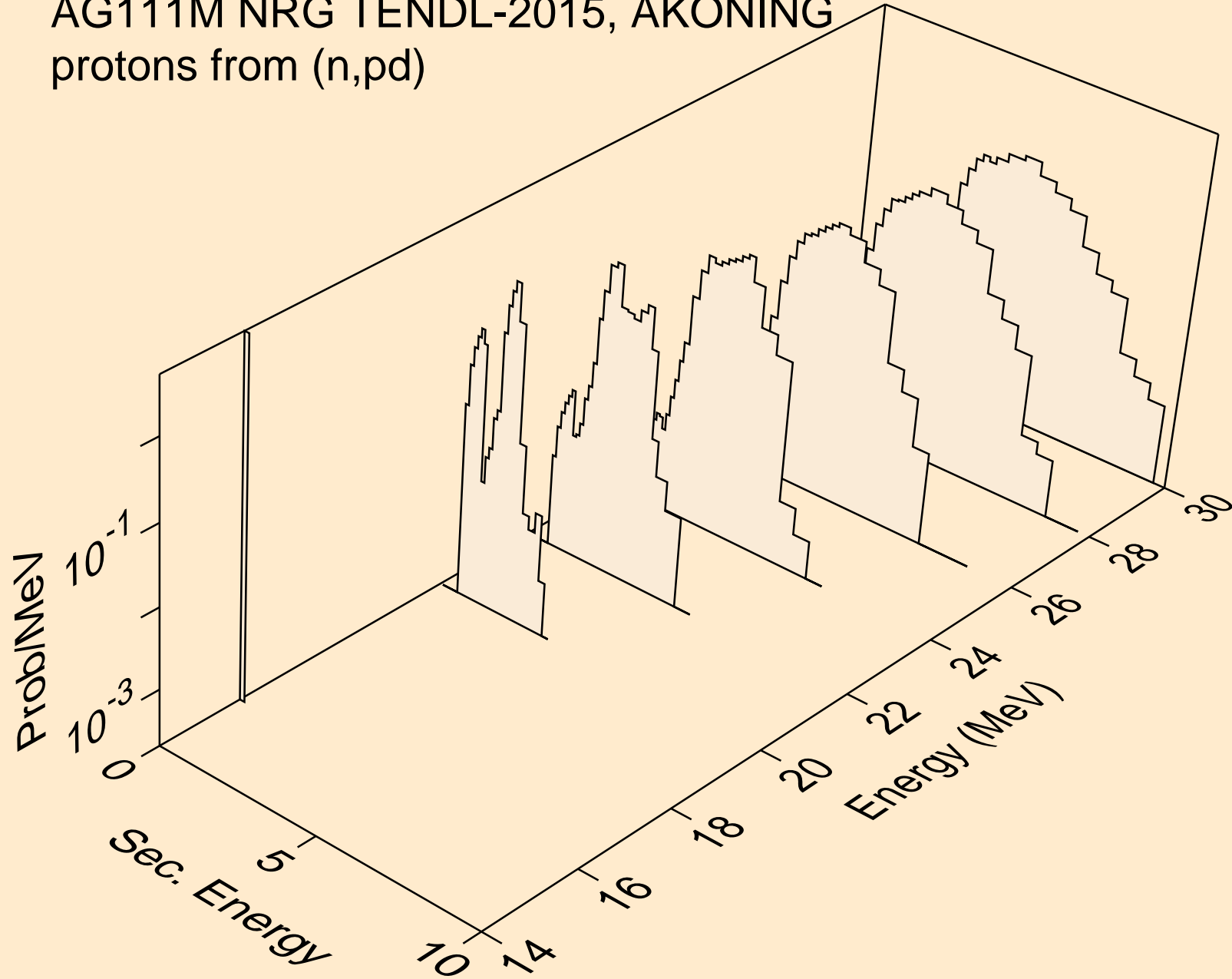

AG111M NRG TENDL-2015, AKONING
protons from (n,pt)

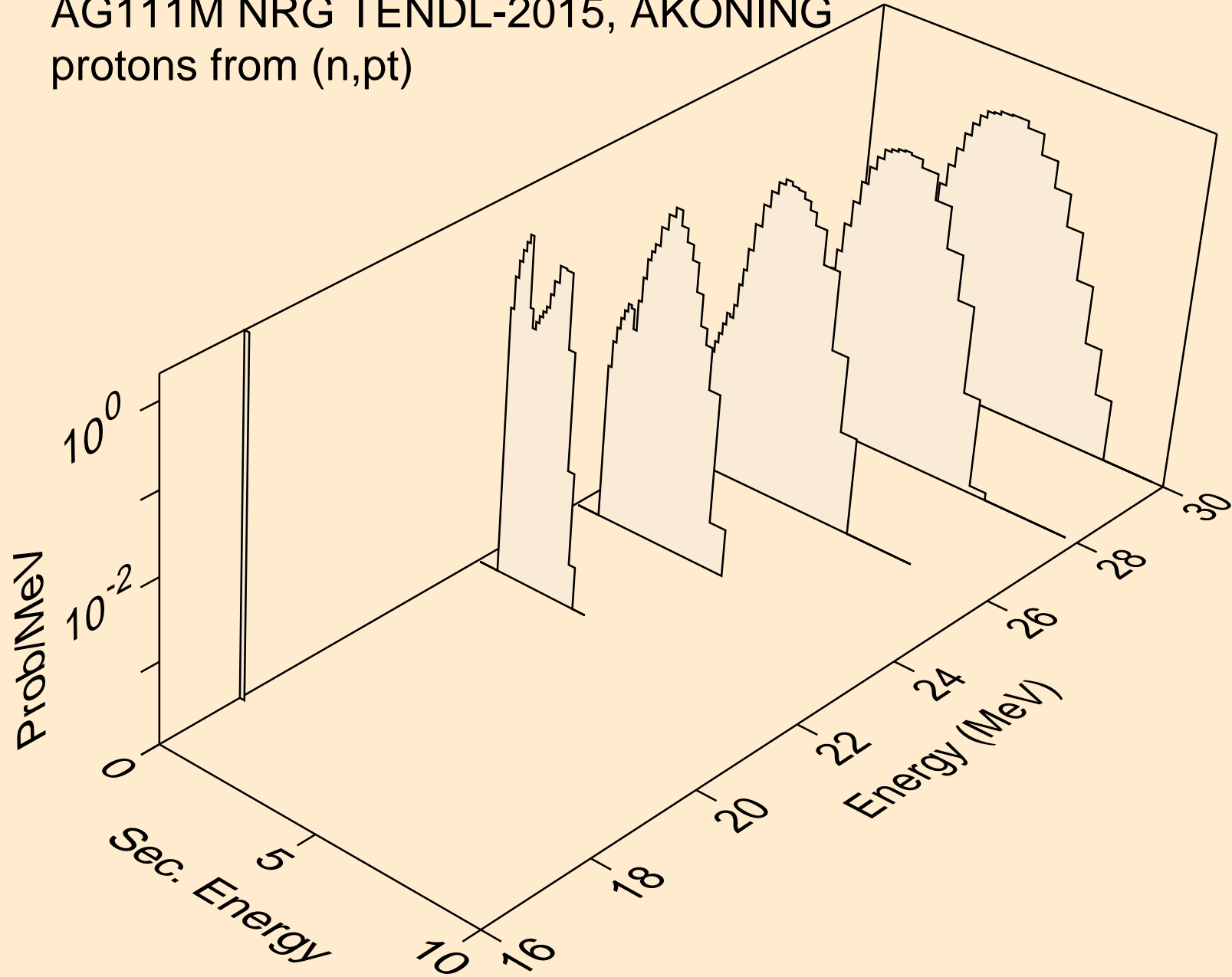

AG111M NRG TENDL-2015, AKONING
deuterons from (n,x)

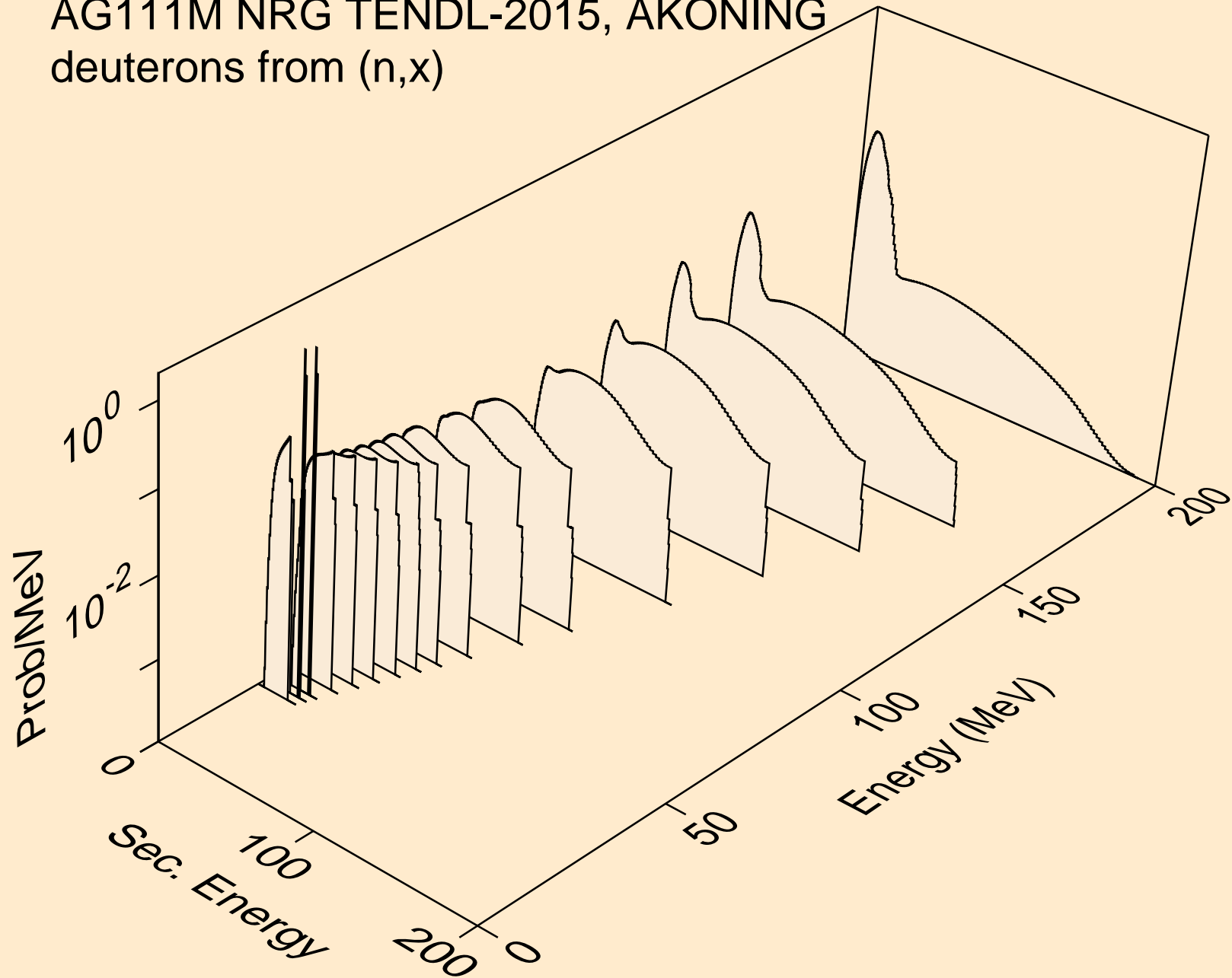

AG111M NRG TENDL-2015, AKONING
deuterons from (n,2nd)

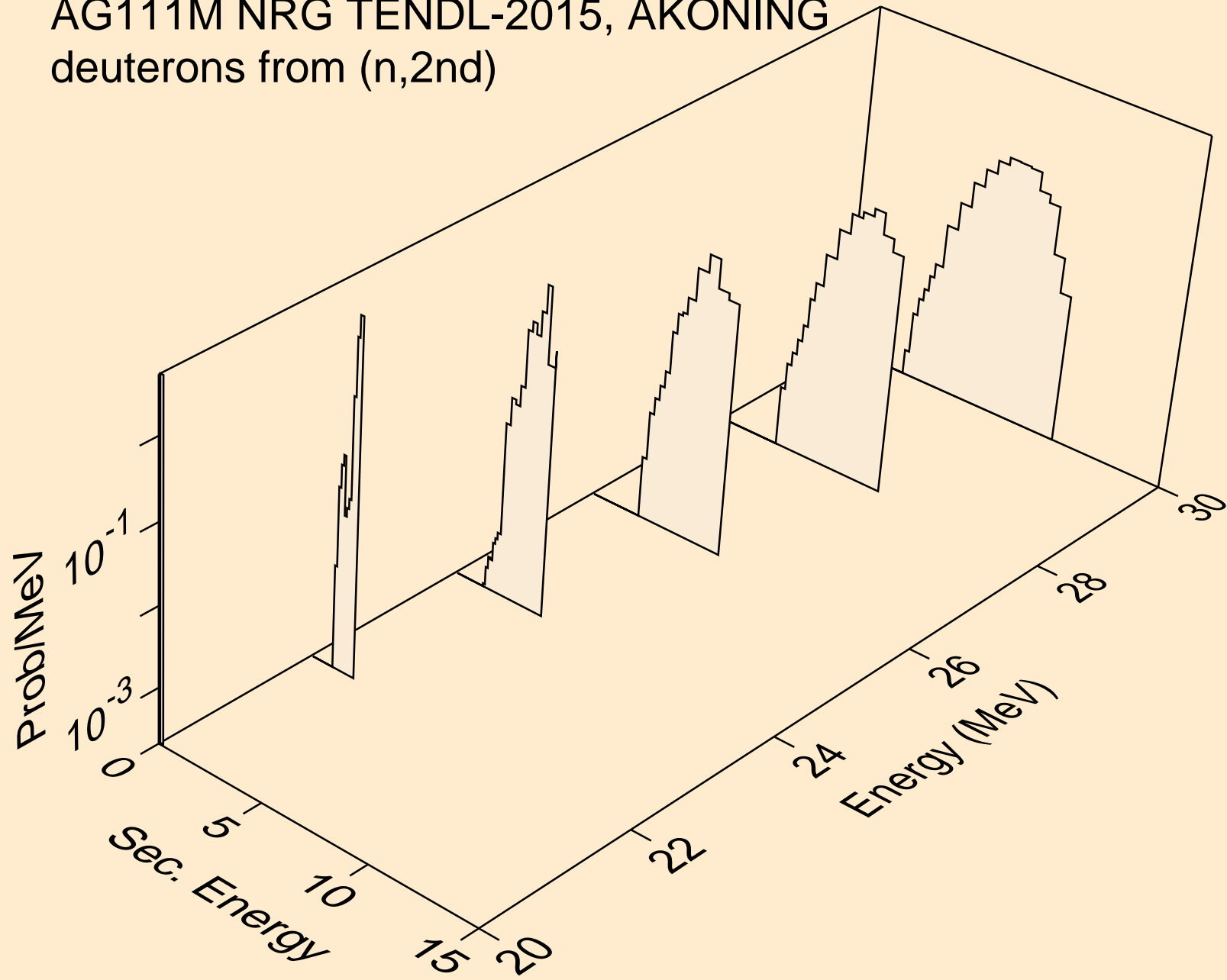

AG111M NRG TENDL-2015, AKONING
deuterons from (n,n*)d

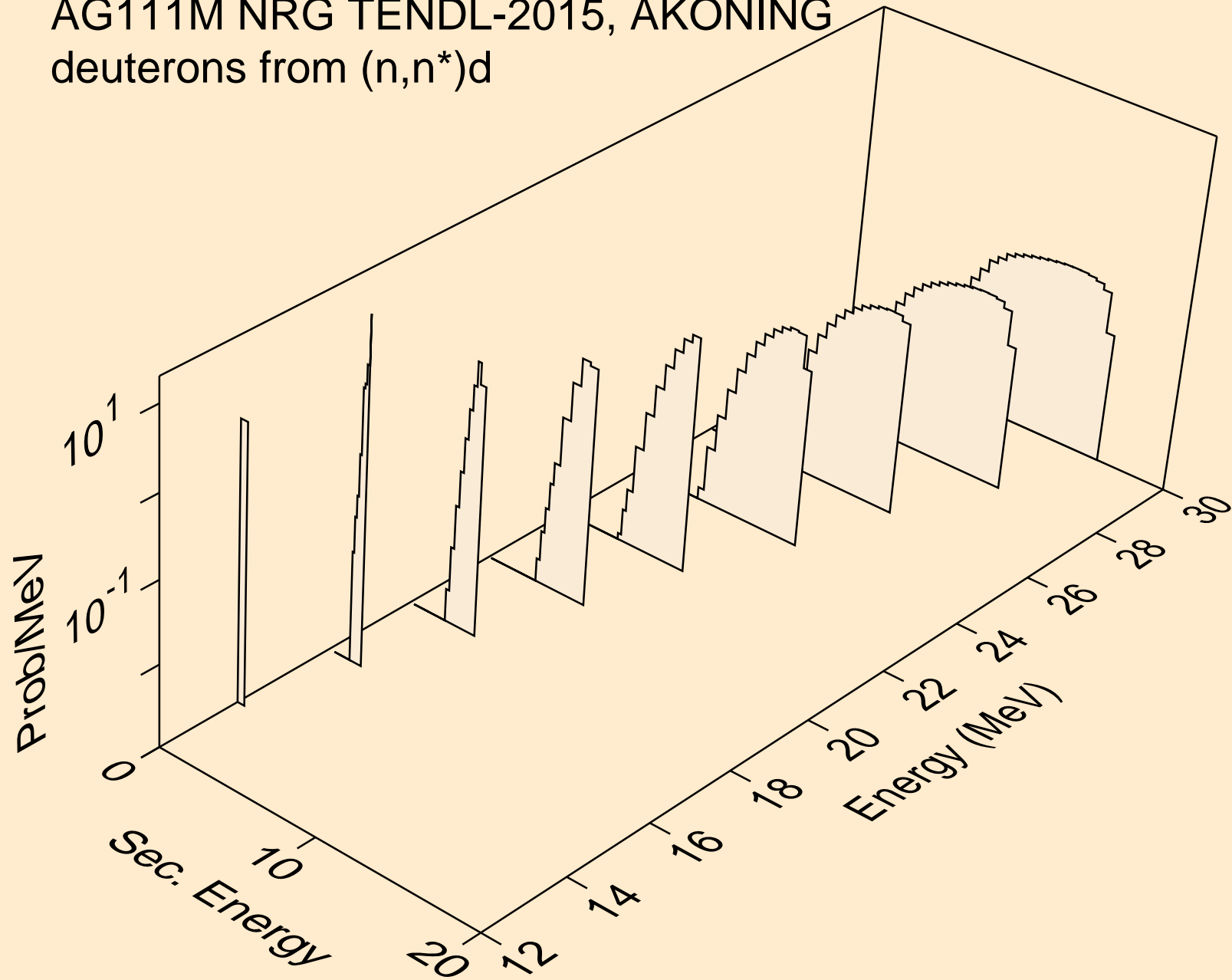

AG111M NRG TENDL-2015, AKONING
deuterons from (n,d)

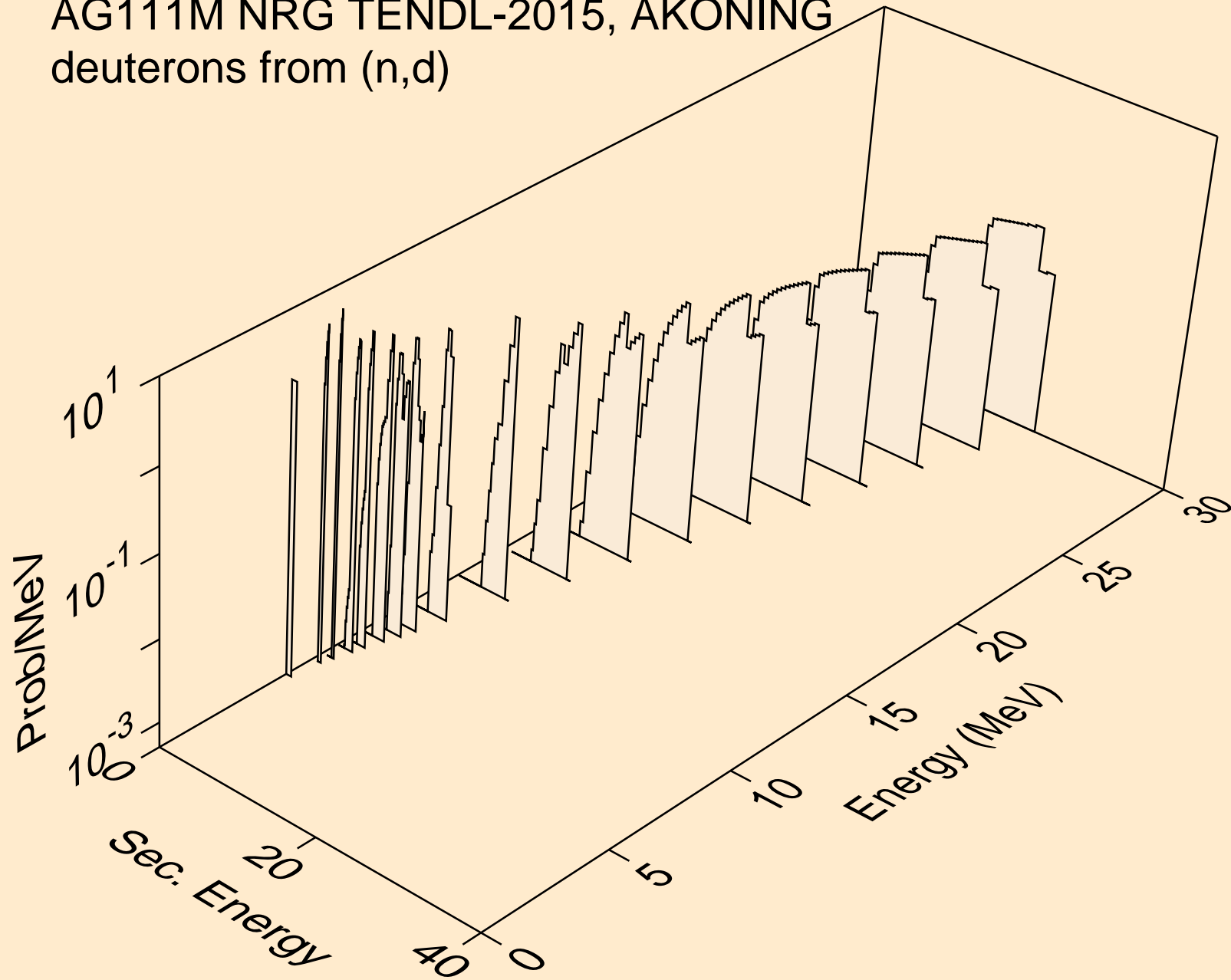

AG111M NRG TENDL-2015, AKONING
deuterons from (n,pd)

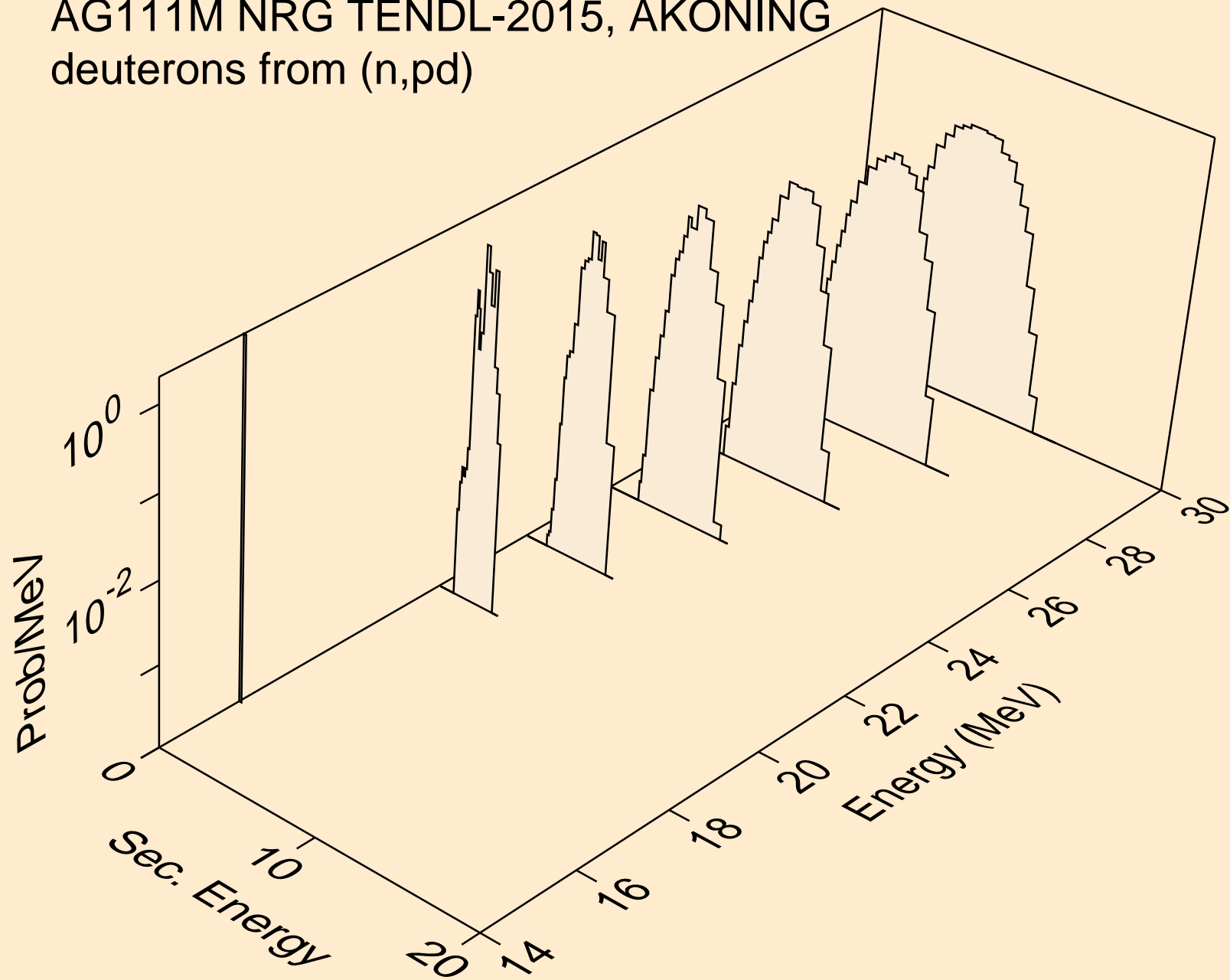

AG111M NRG TENDL-2015, AKONING
deuterons from (n,da)

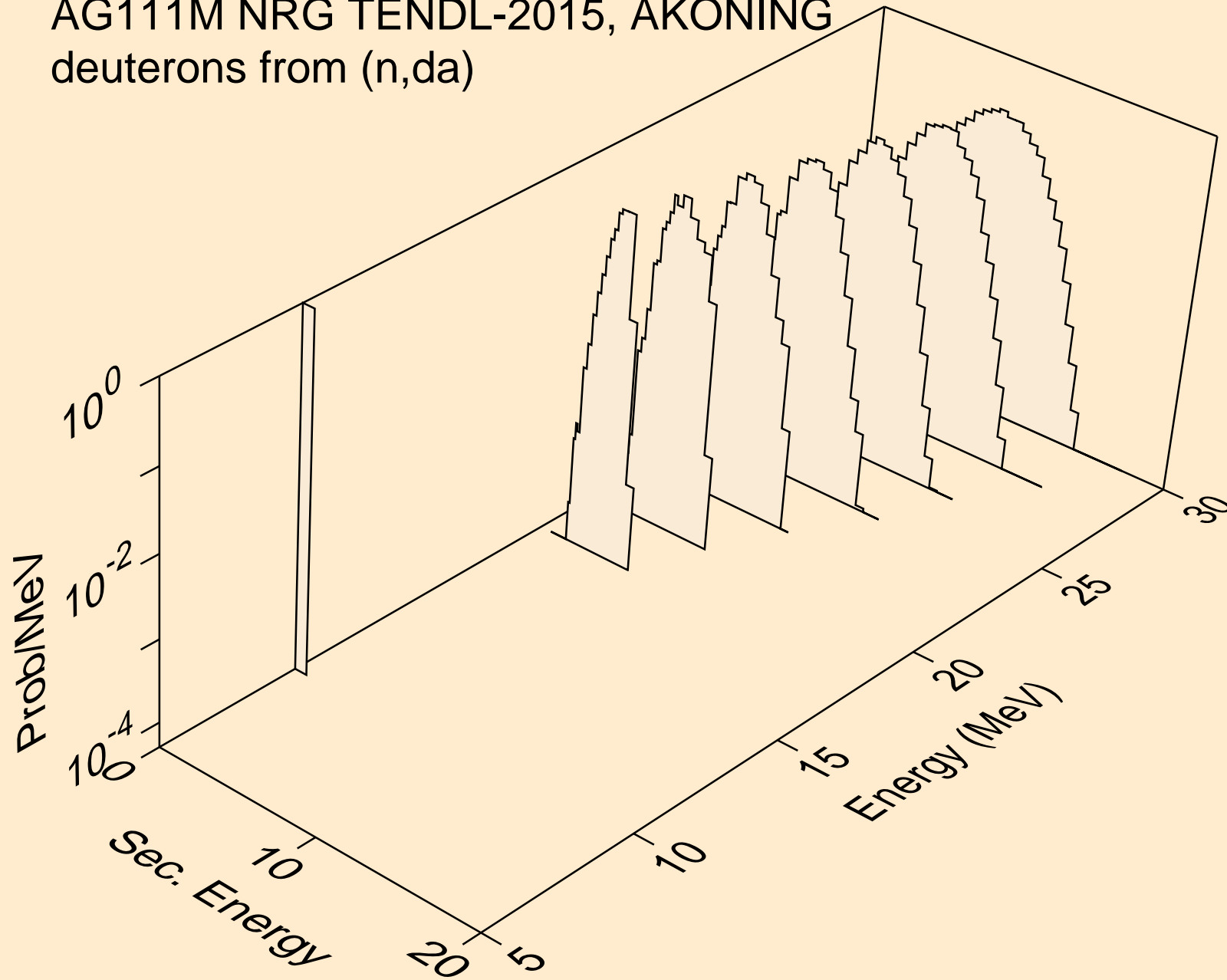

AG111M NRG TENDL-2015, AKONING
tritons from (n,x)

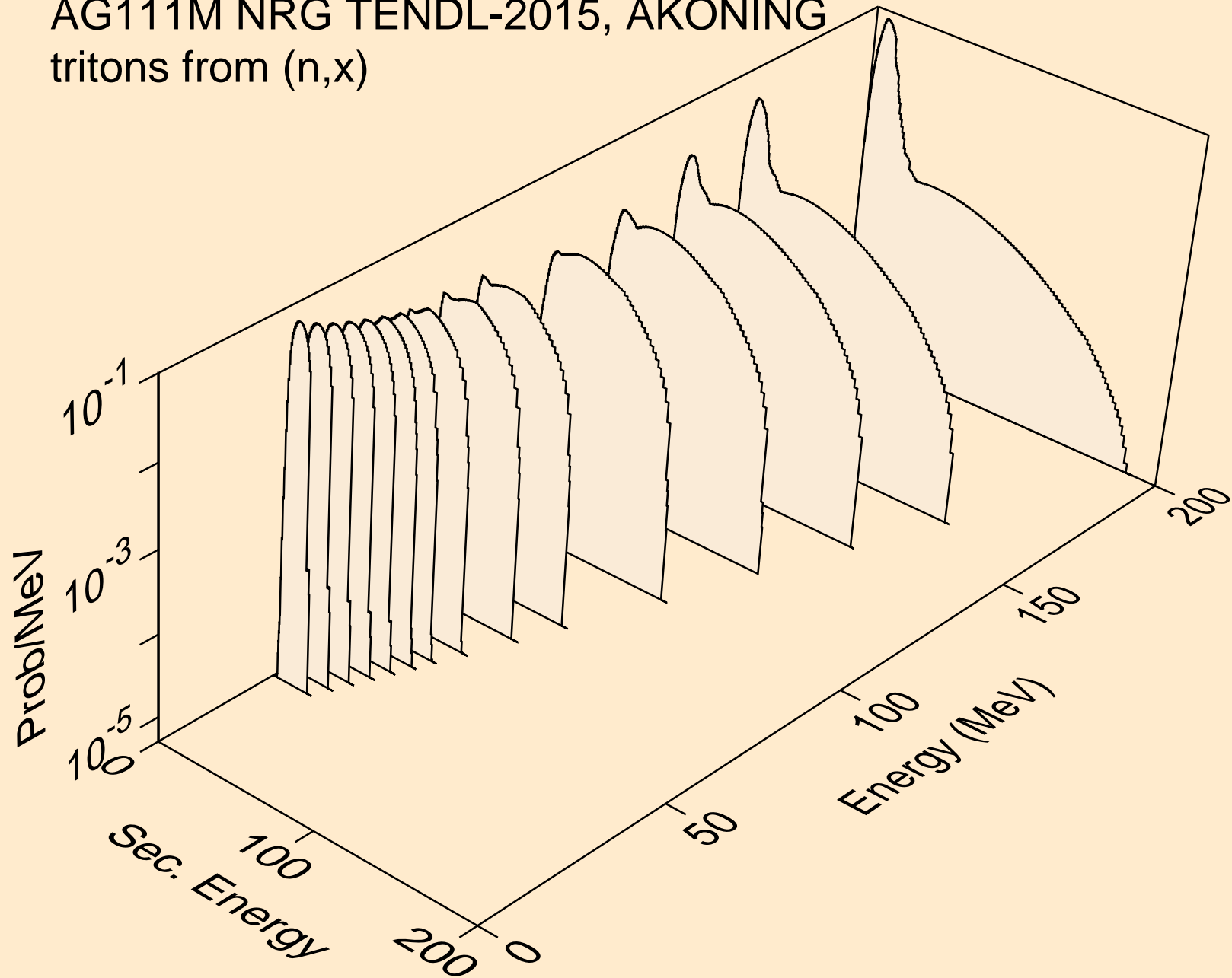

AG111M NRG TENDL-2015, AKONING
tritons from (n,n*)t

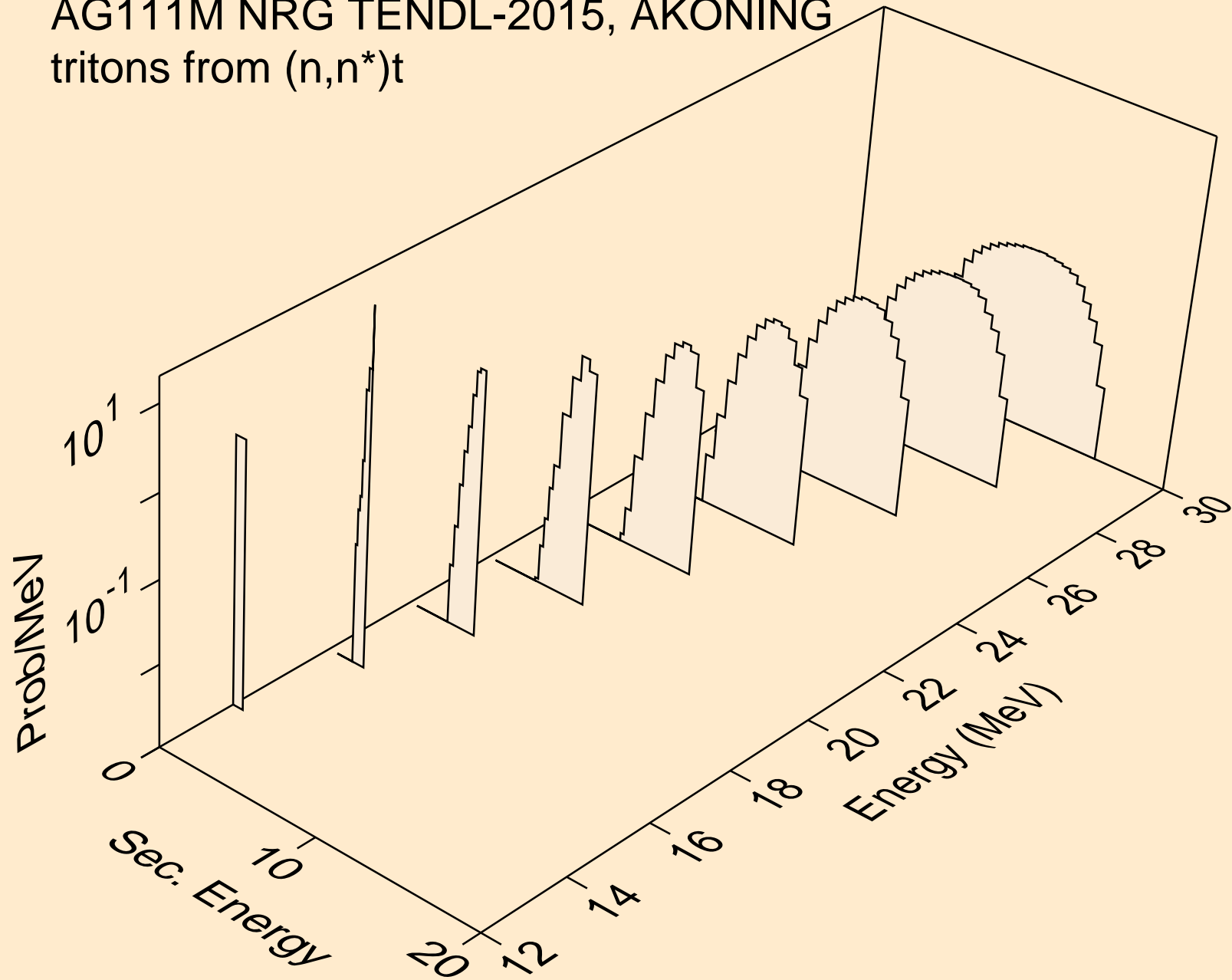

AG111M NRG TENDL-2015, AKONING
tritons from (n,t)

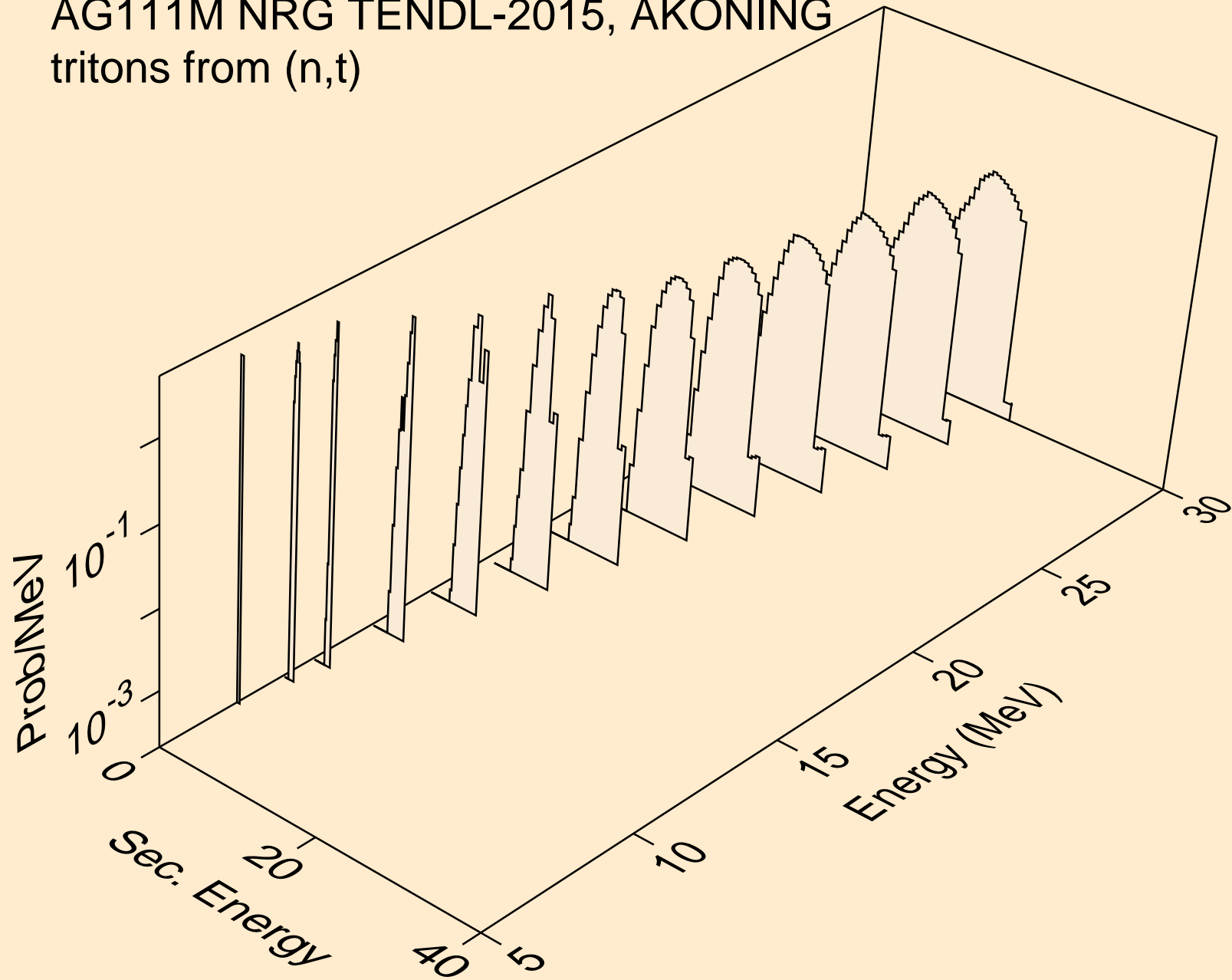

AG111M NRG TENDL-2015, AKONING
tritons from (n,pt)

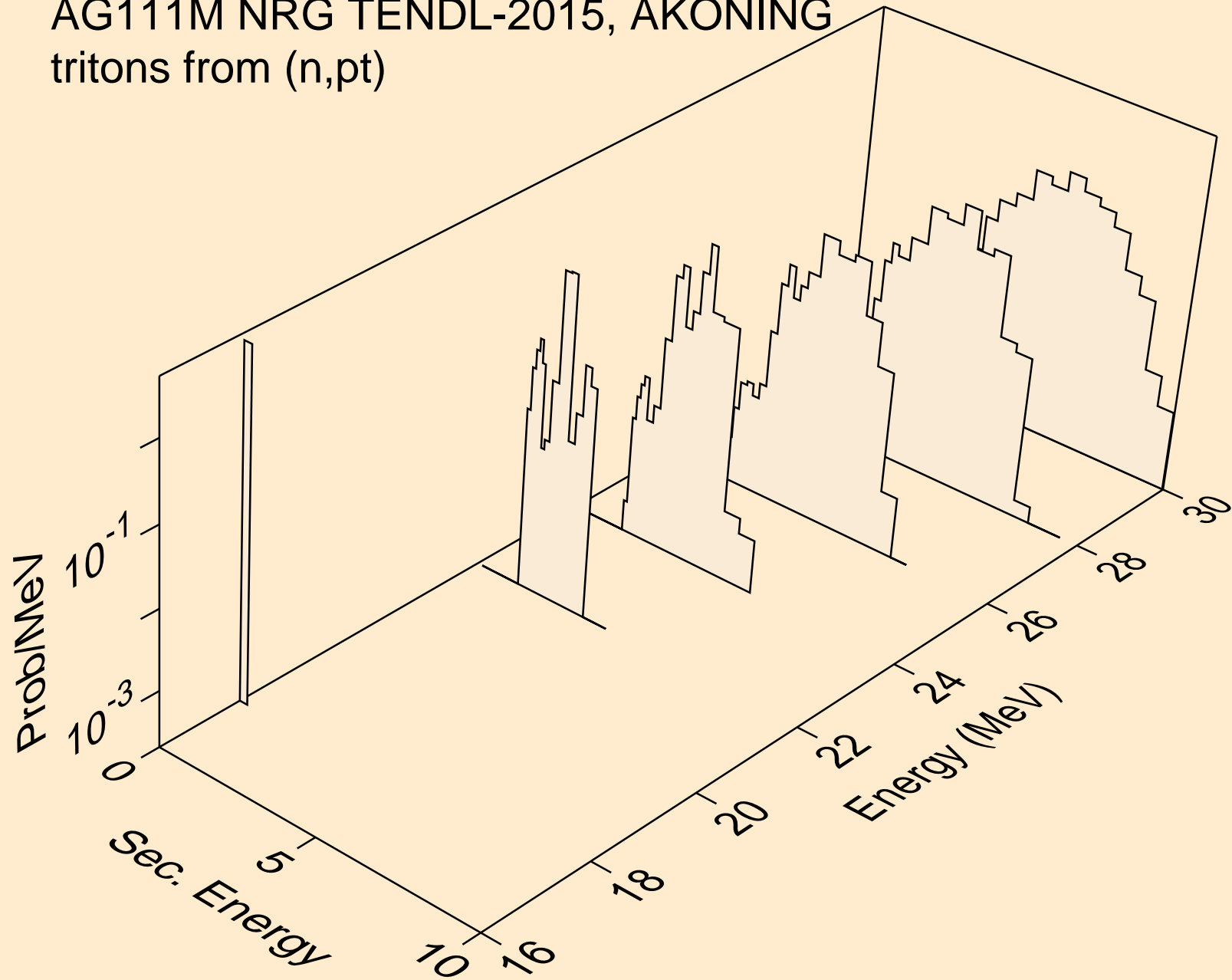

AG111M NRG TENDL-2015, AKONING
he3s from (n,x)

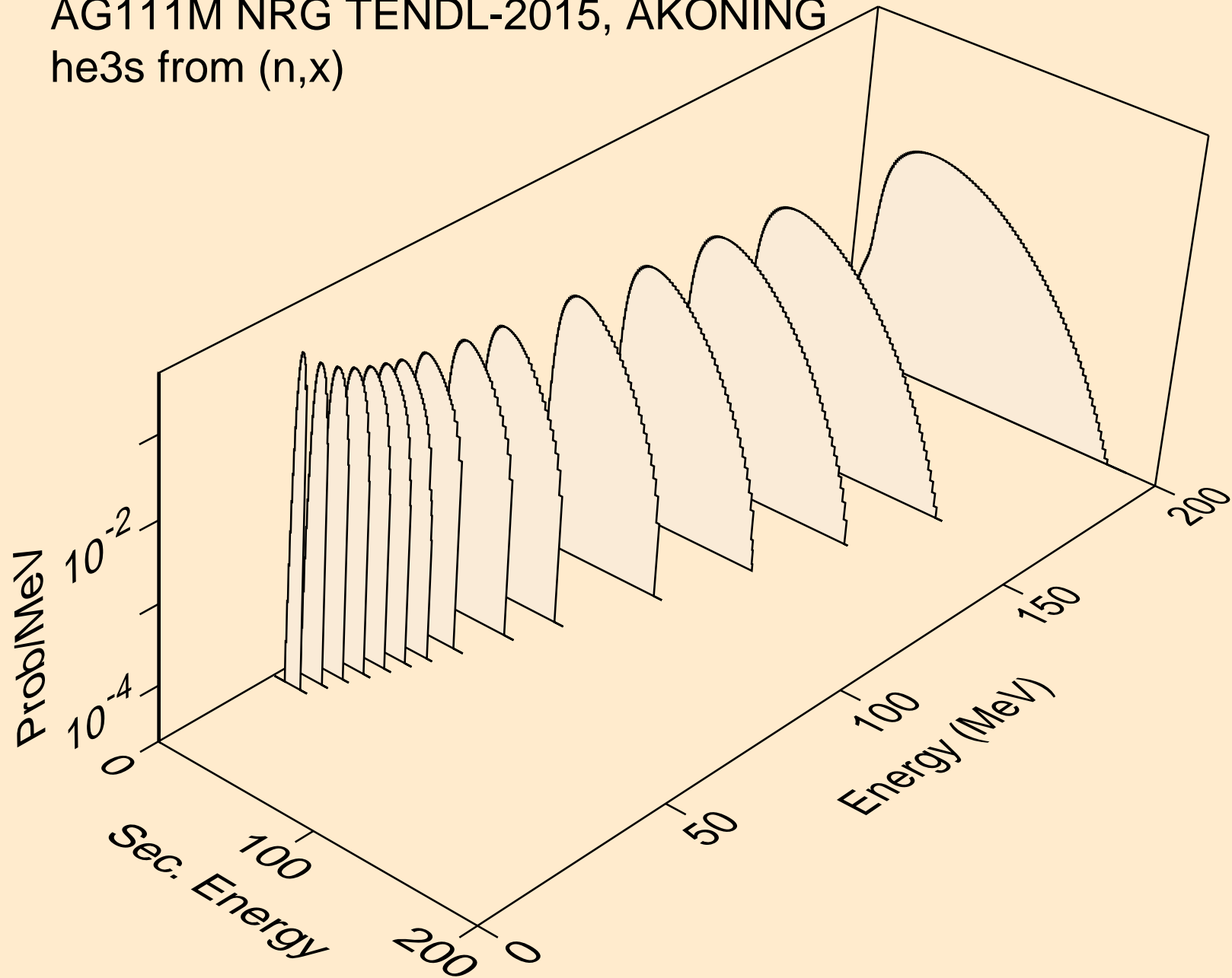

AG111M NRG TENDL-2015, AKONING
he3s from (n,n*)he3

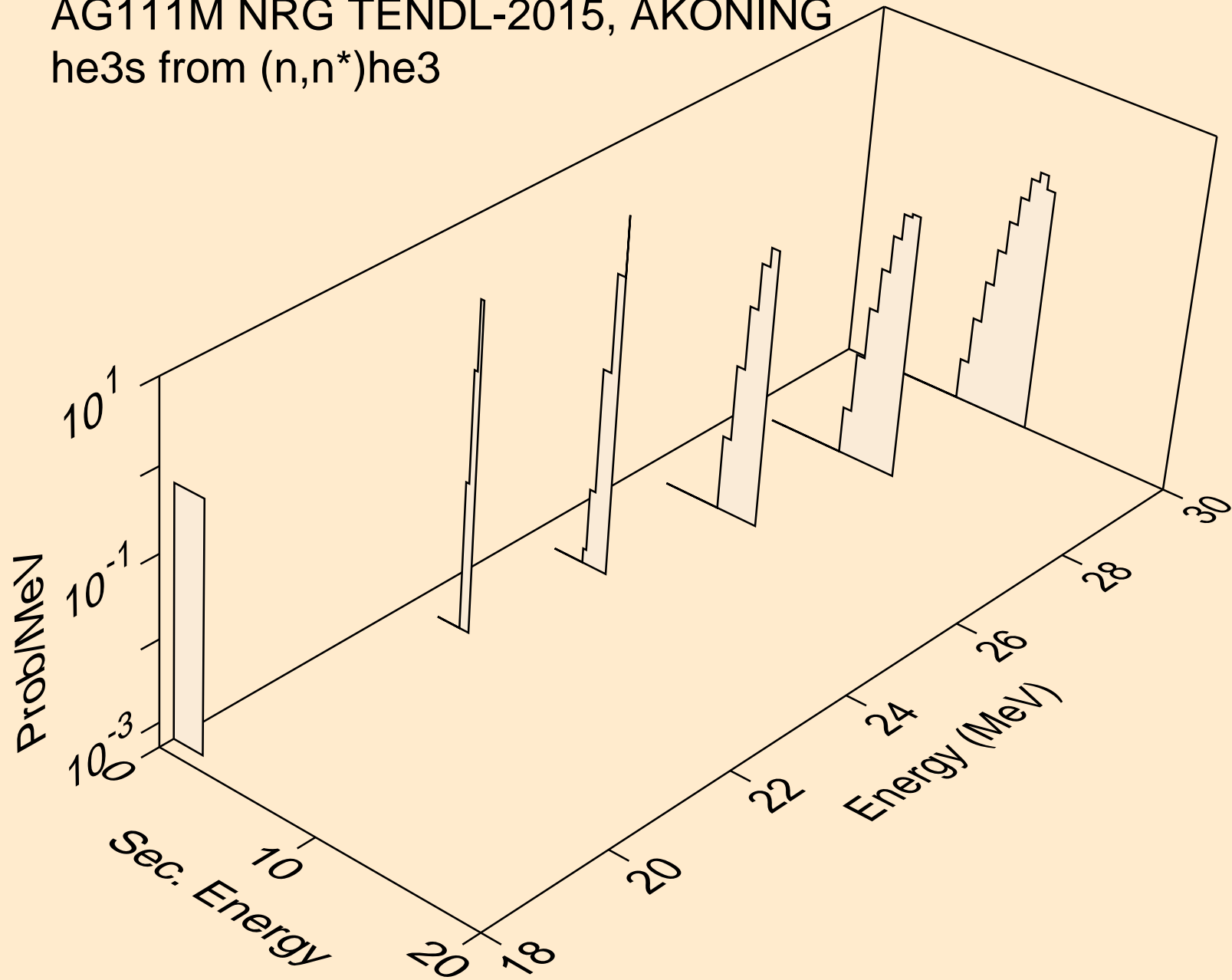

AG111M NRG TENDL-2015, AKONING
he3s from (n,he3)

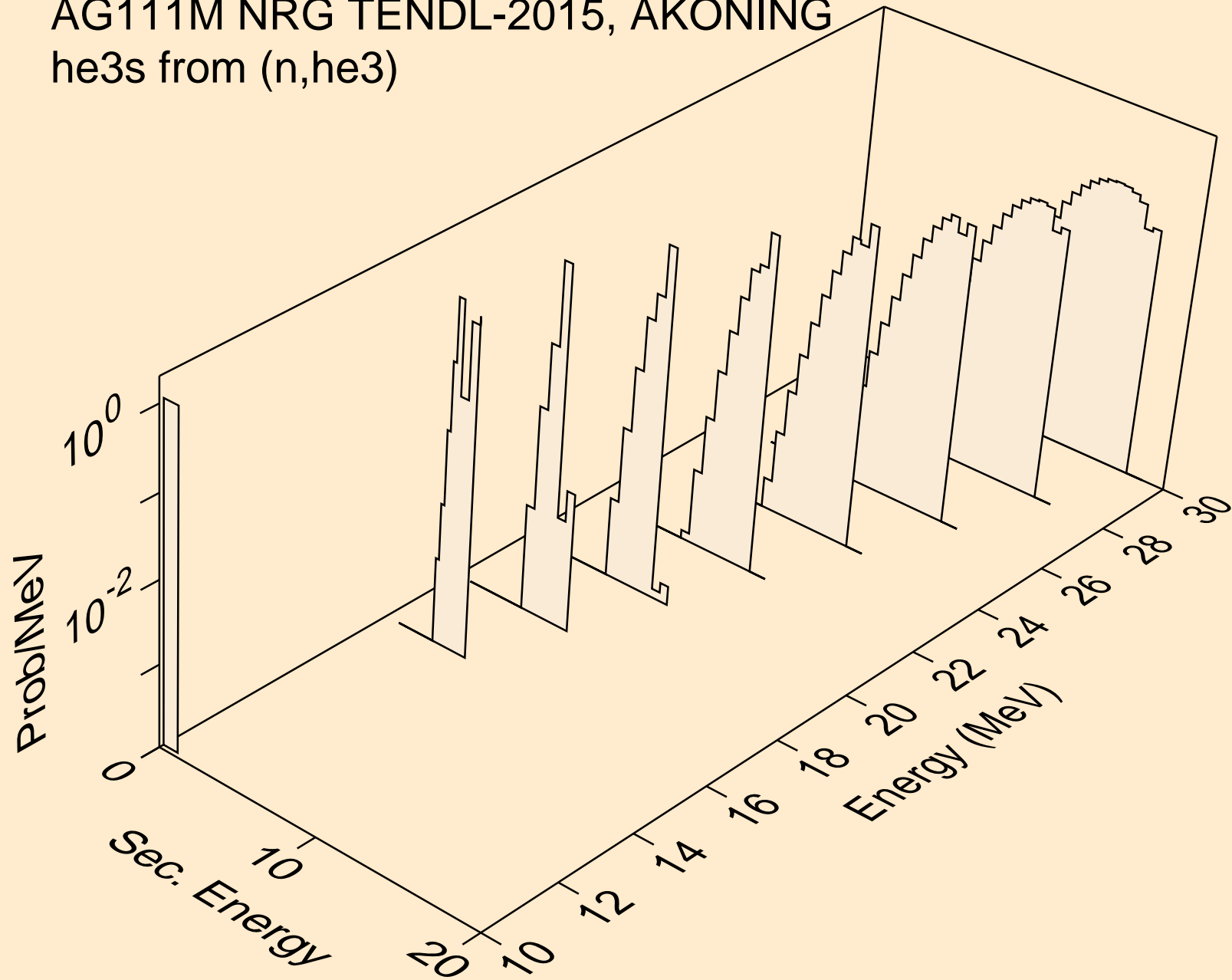

AG111M NRG TENDL-2015, AKONING
alphas from (n,x)

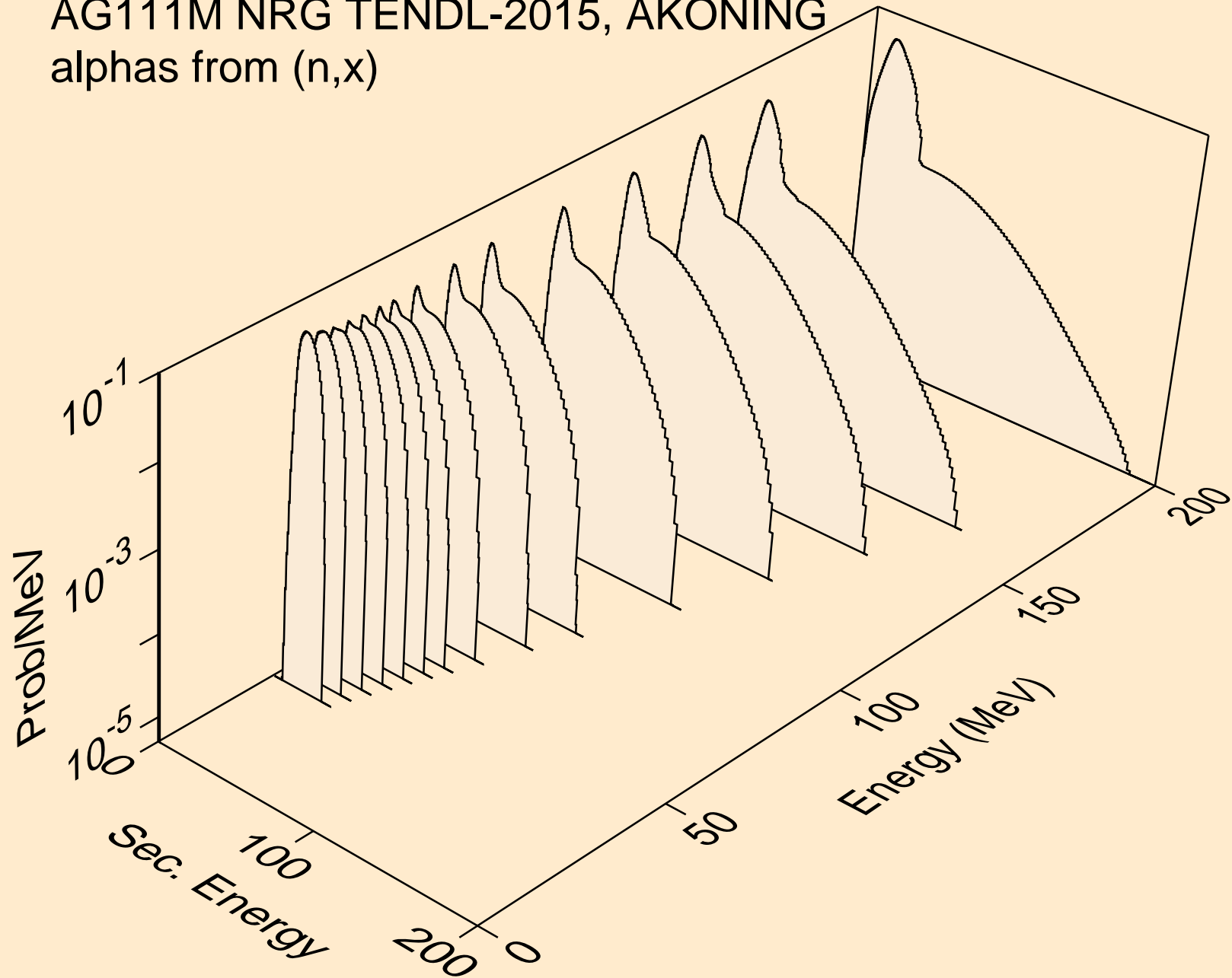

AG111M NRG TENDL-2015, AKONING
alphas from (n,n*)a

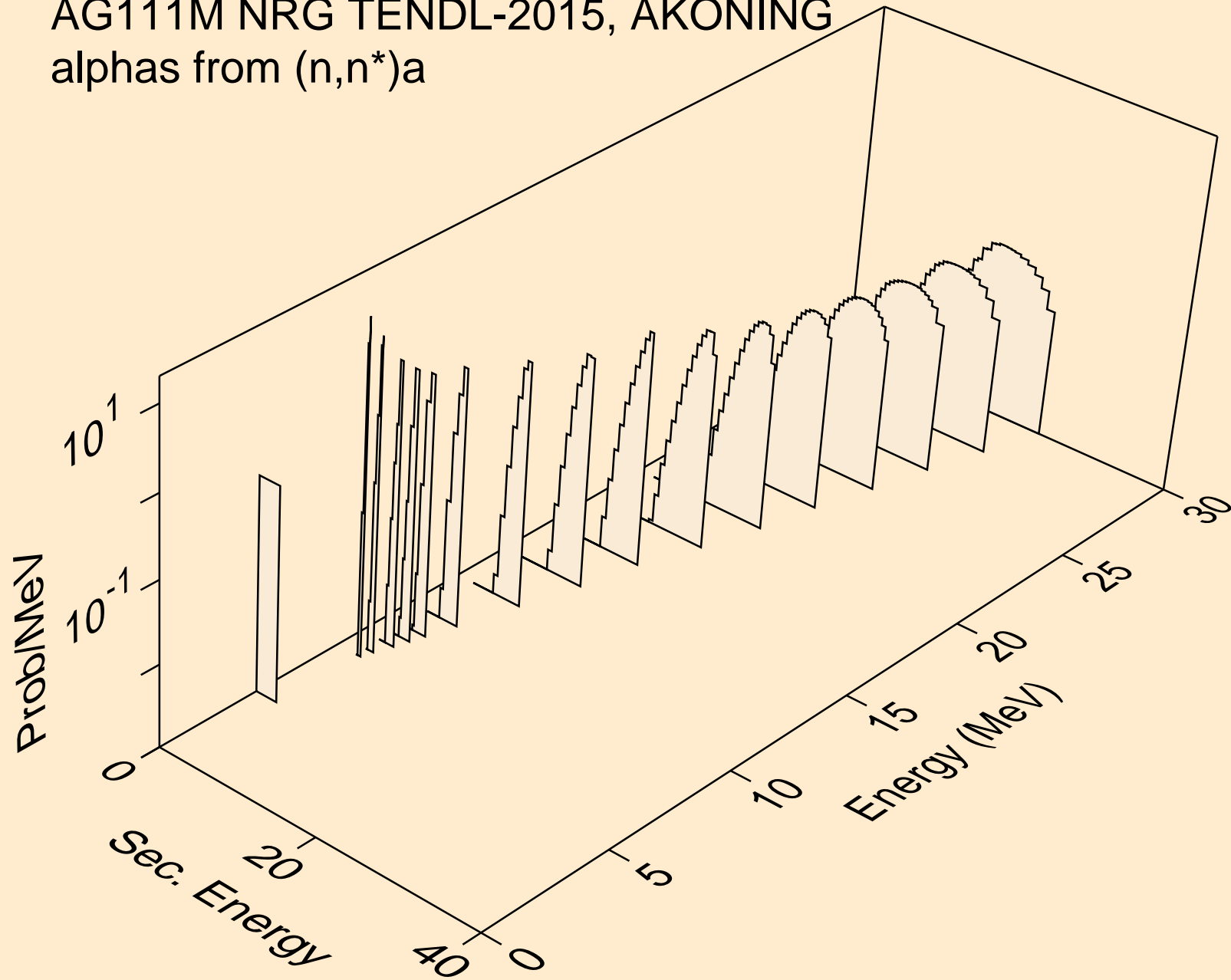

AG111M NRG TENDL-2015, AKONING
alphas from (n,2n)a

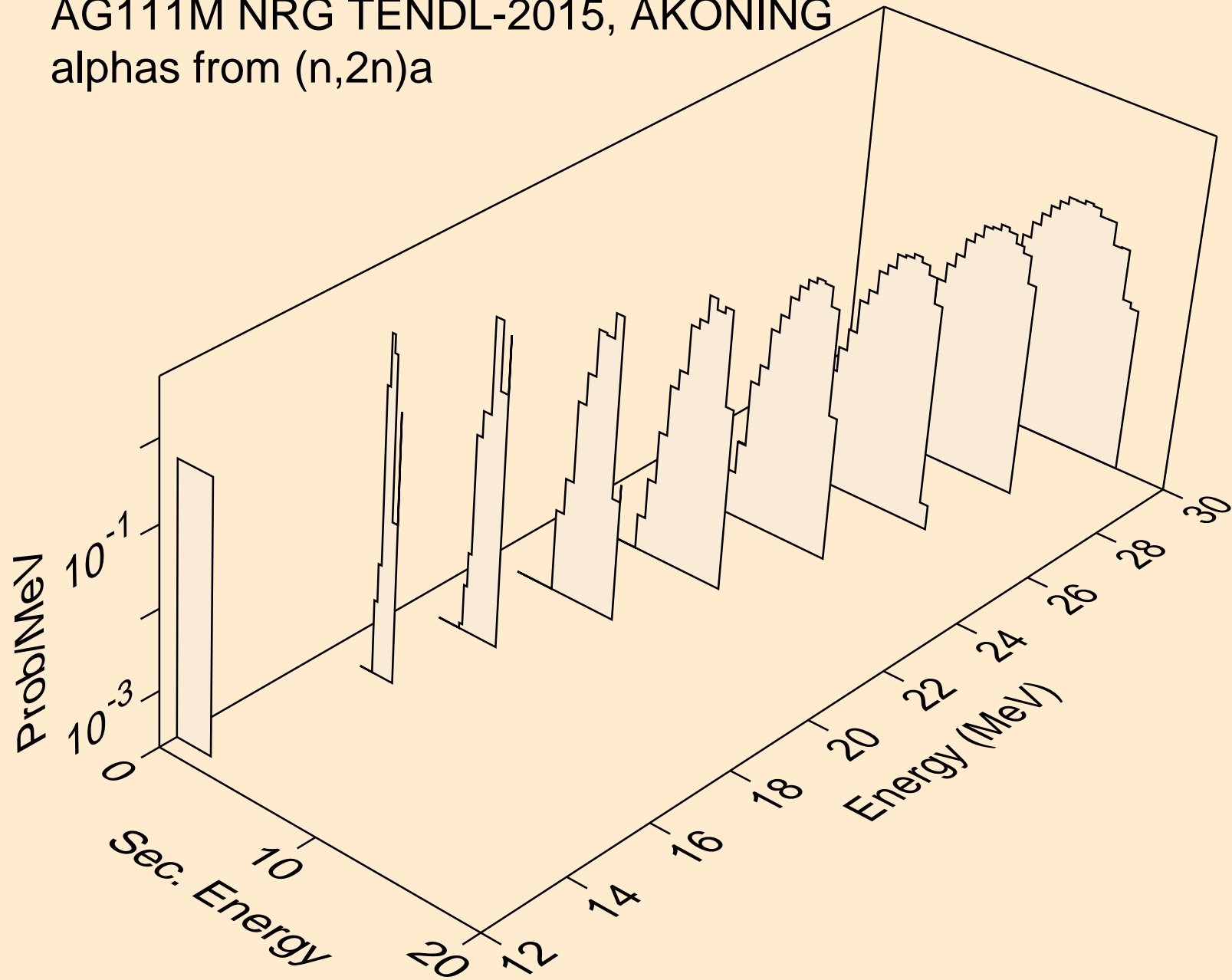

AG111M NRG TENDL-2015, AKONING
alphas from (n,3n)a

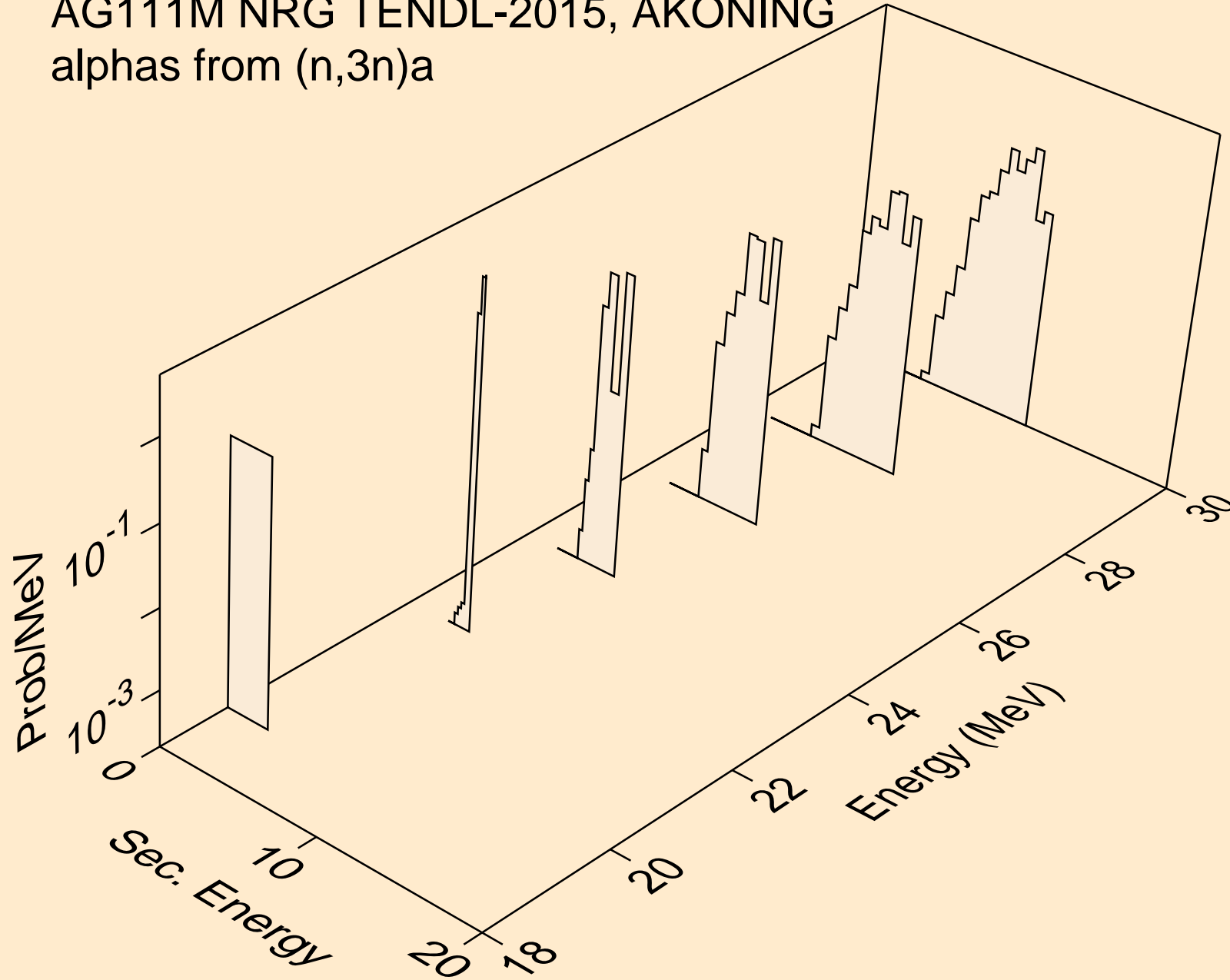

AG111M NRG TENDL-2015, AKONING
alphas from (n,n*)2a

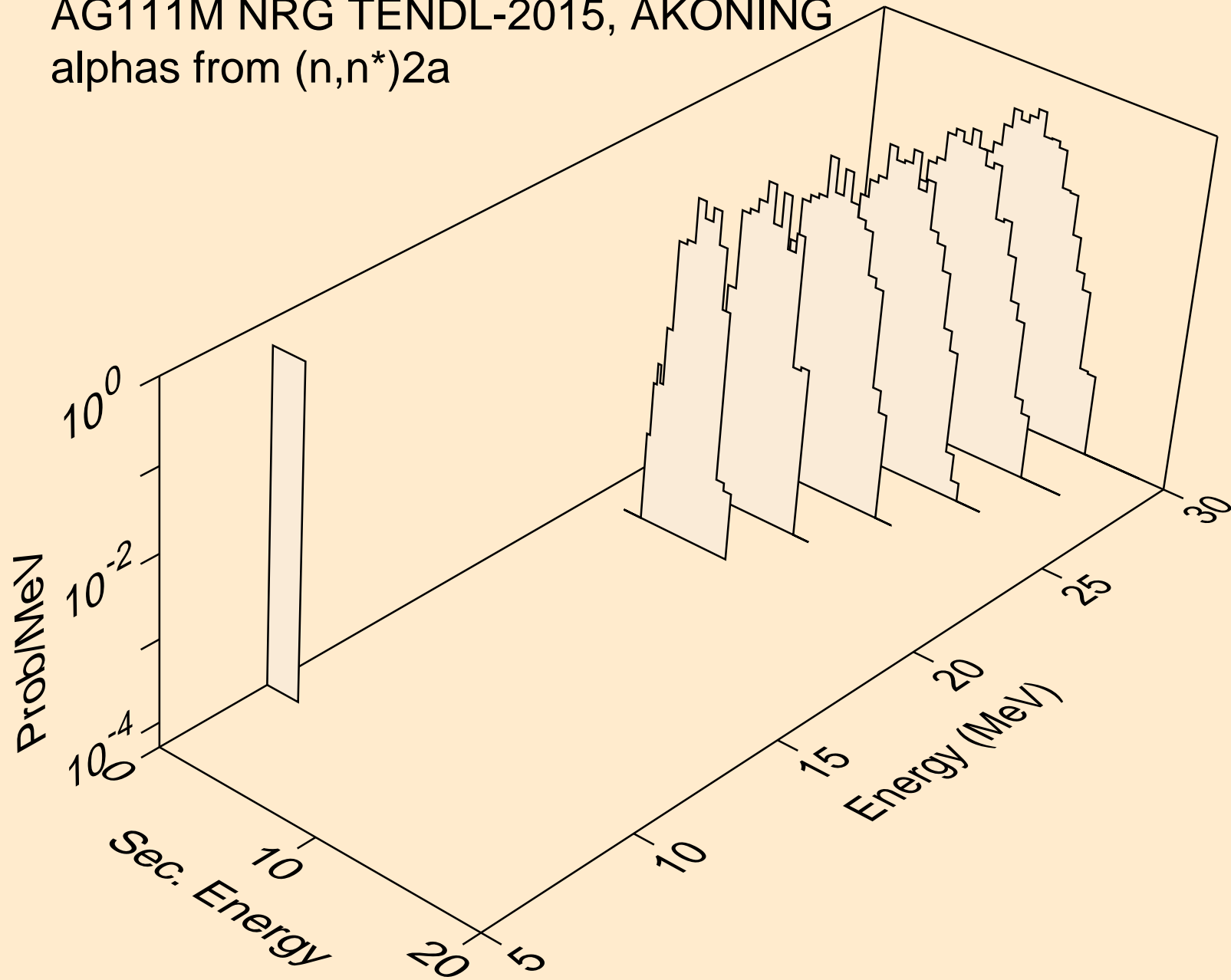

AG111M NRG TENDL-2015, AKONING
alphas from (n,npa)

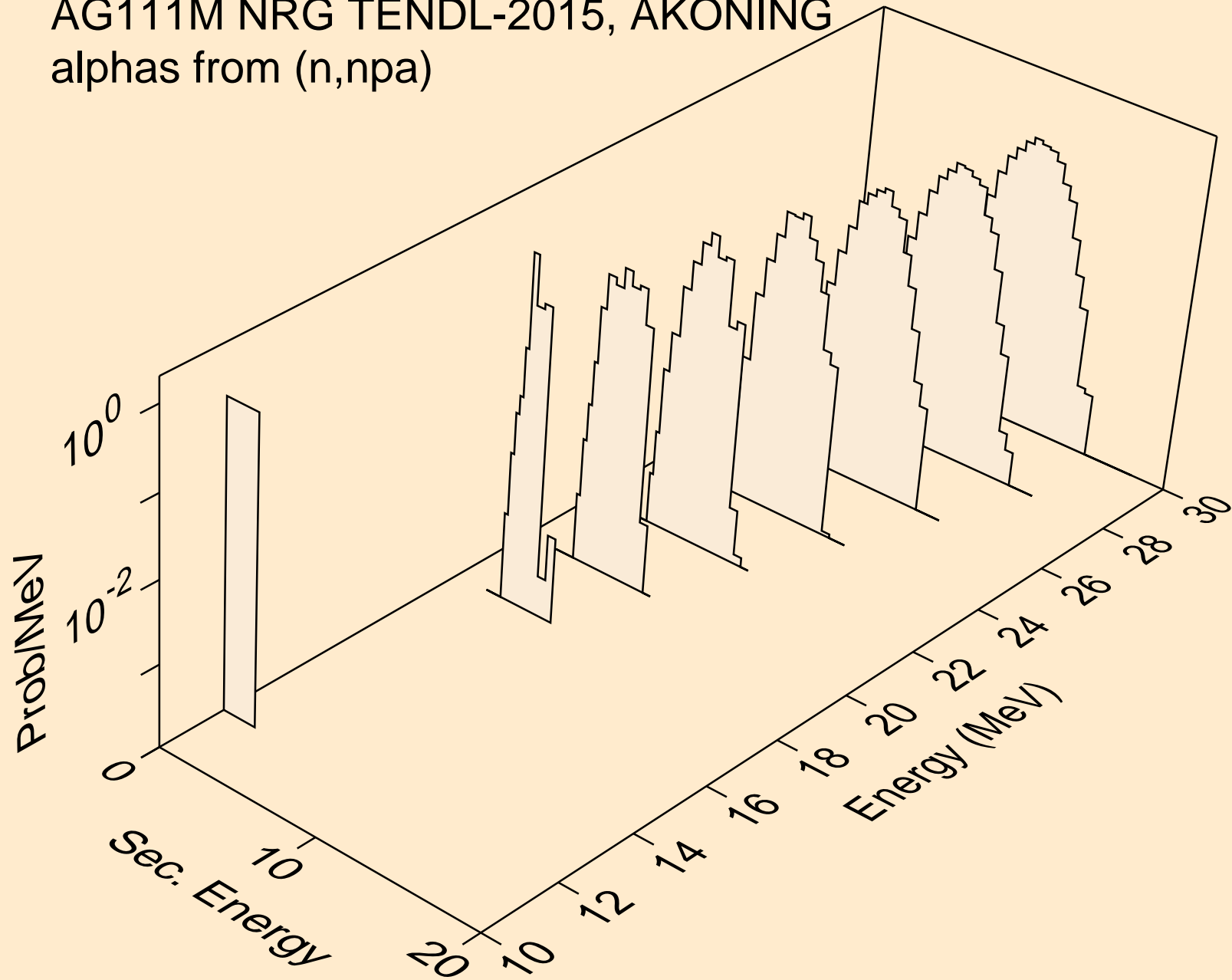

AG111M NRG TENDL-2015, AKONING
alphas from (n,a)

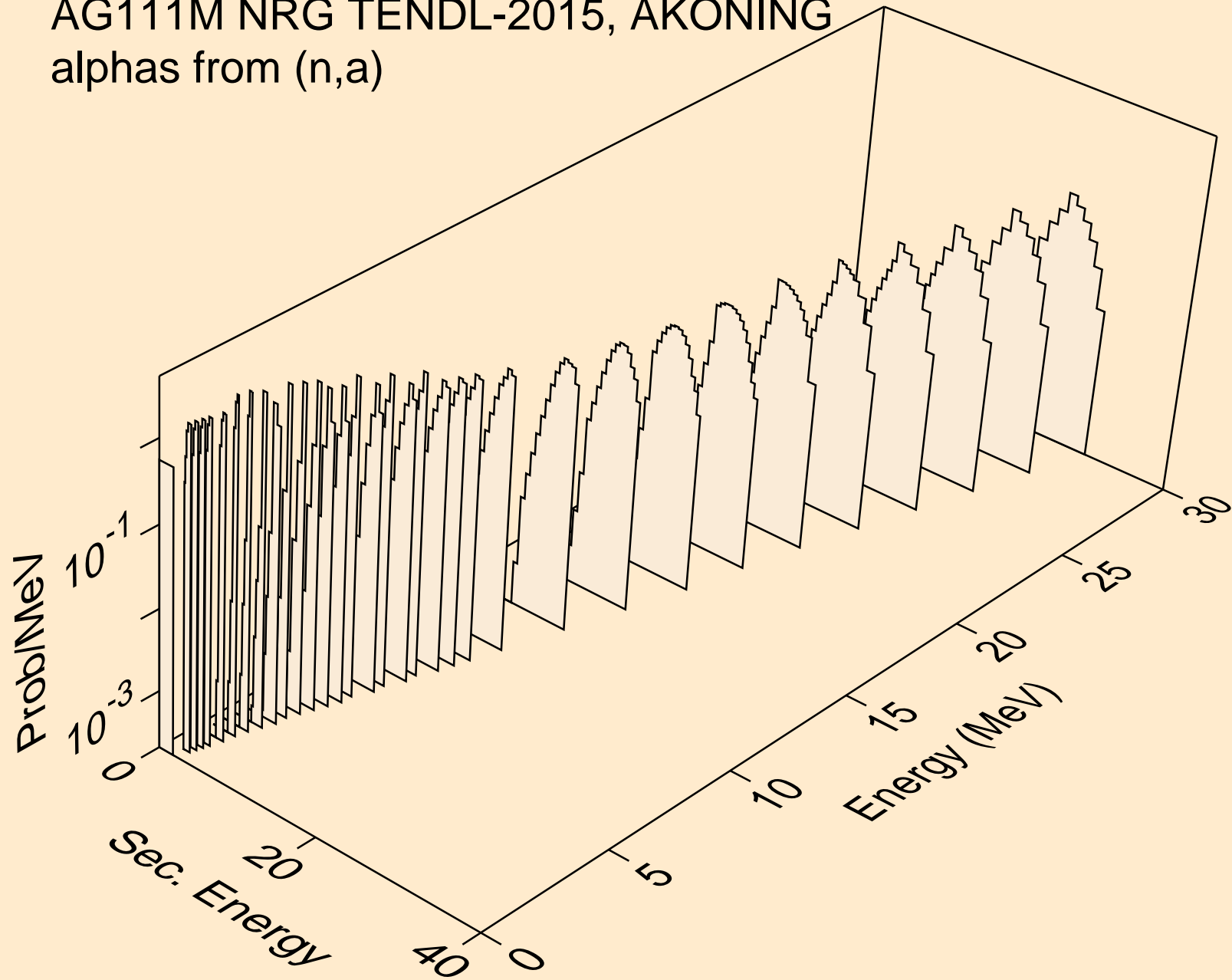

AG111M NRG TENDL-2015, AKONING
alphas from (n,2a)

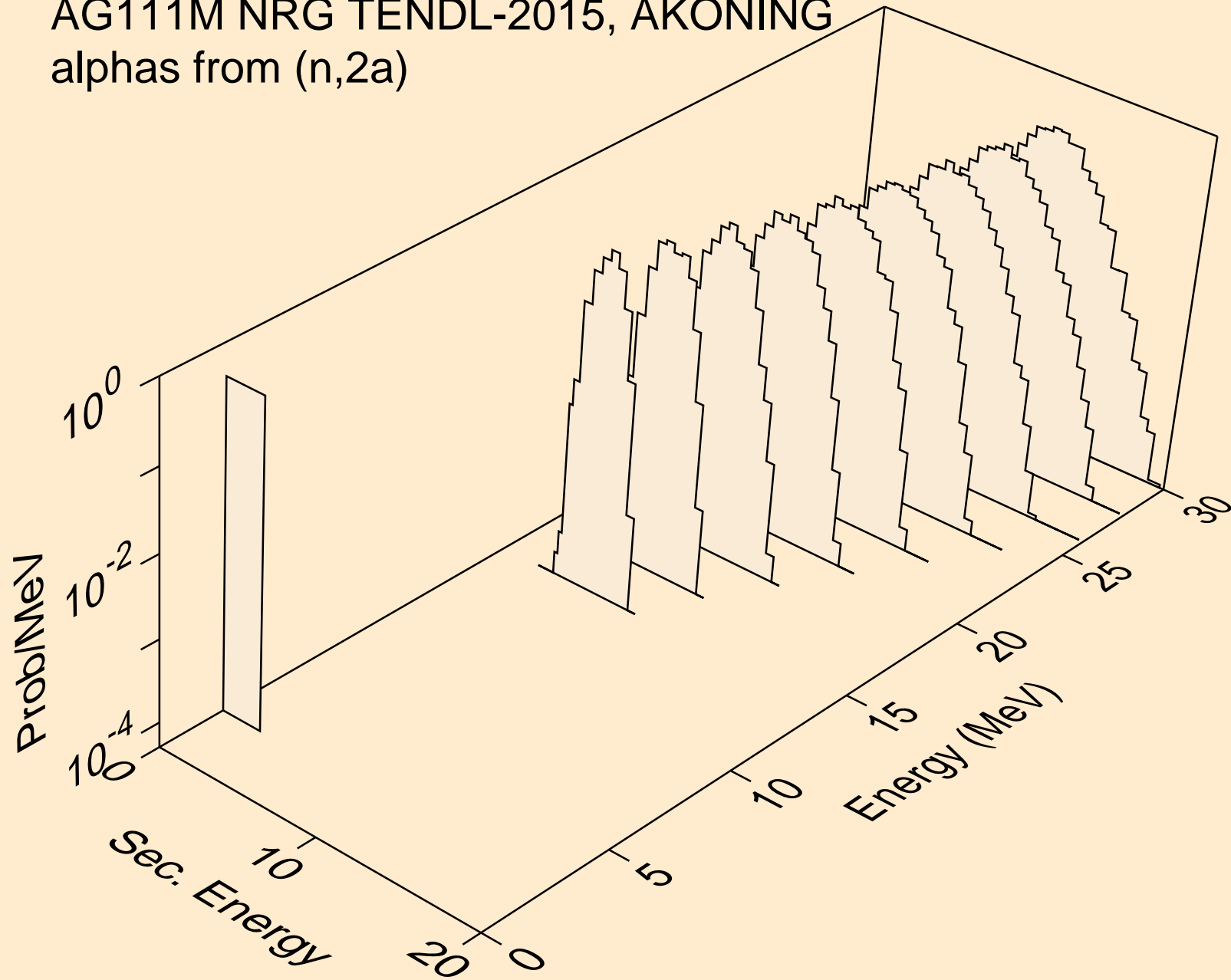

AG111M NRG TENDL-2015, AKONING
alphas from (n,pa)

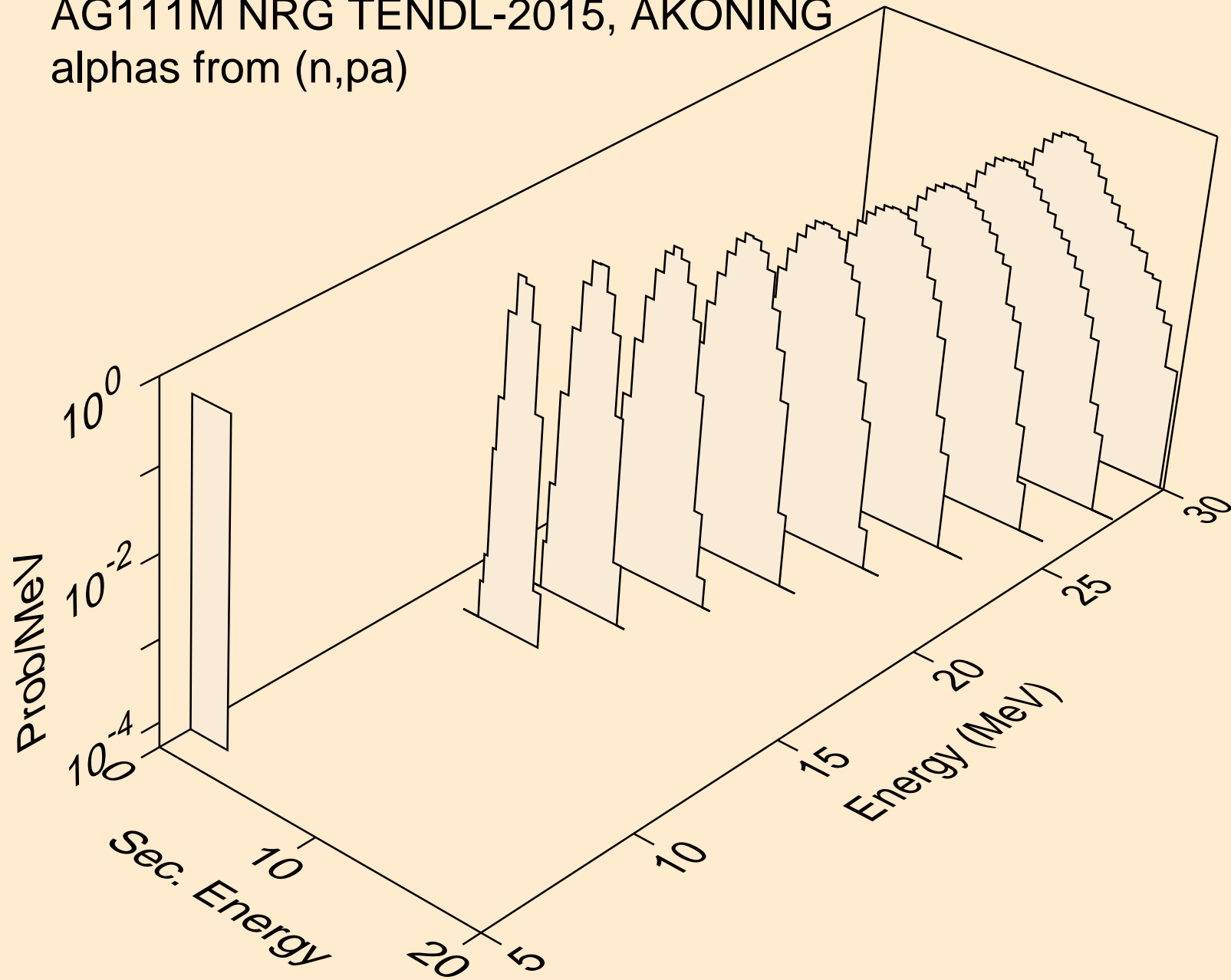

AG111M NRG TENDL-2015, AKONING
alphas from (n,da)

