

AM232 NRG TENDL-2015, AKONING

Principal cross sections

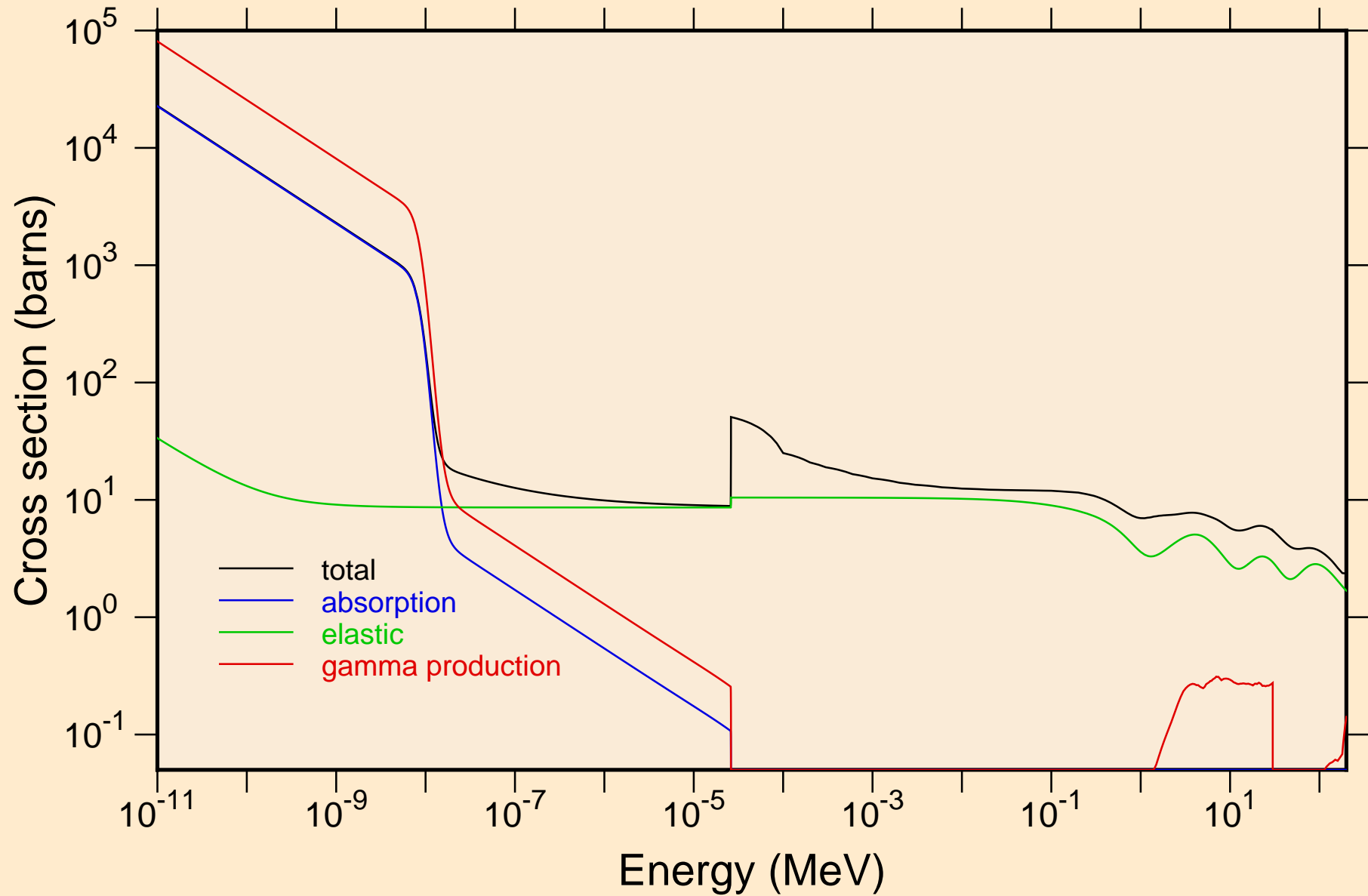

AM232 NRG TENDL-2015, AKONING

Non-threshold reactions

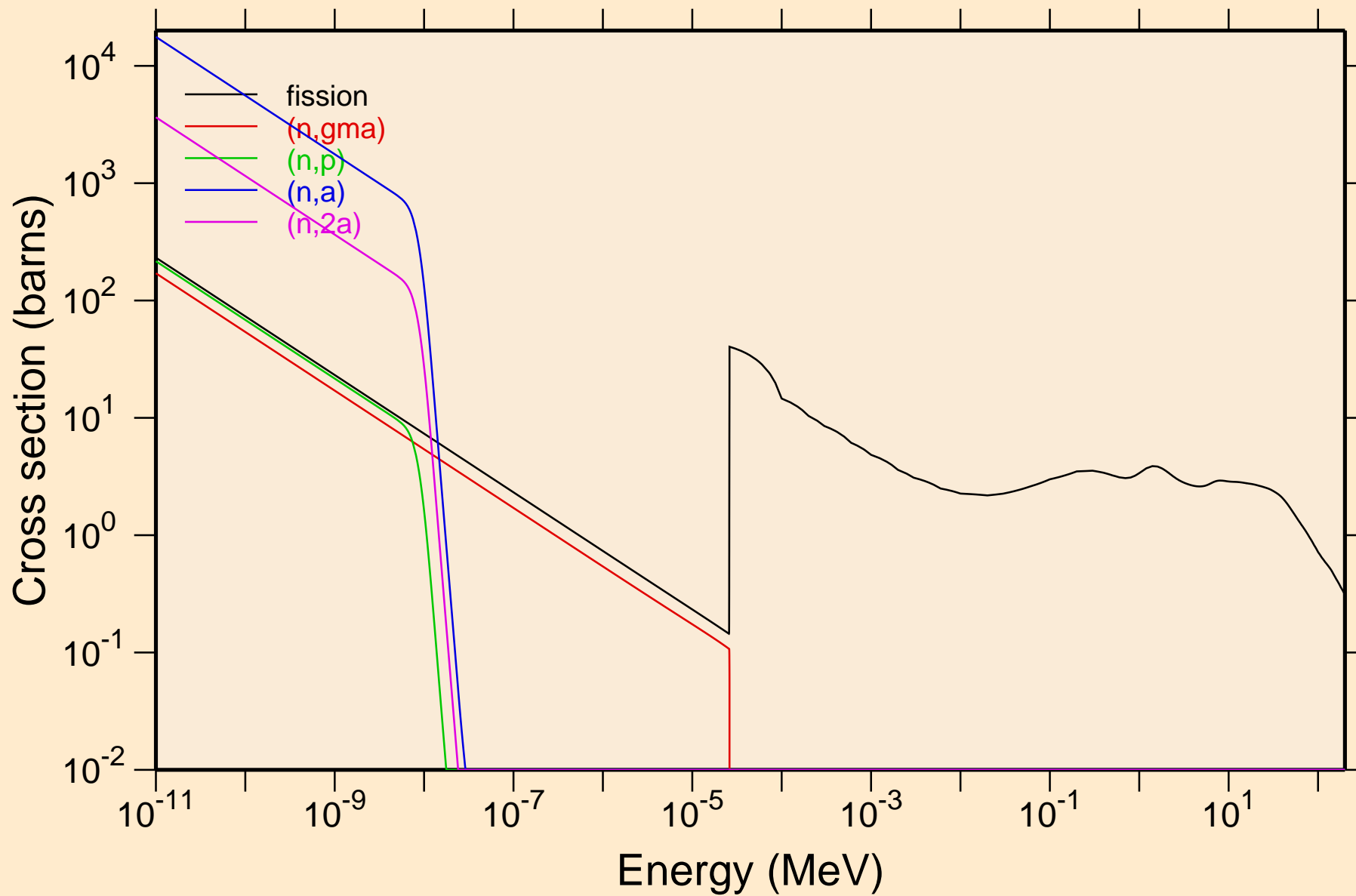

AM232 NRG TENDL-2015, AKONING

Non-threshold reactions

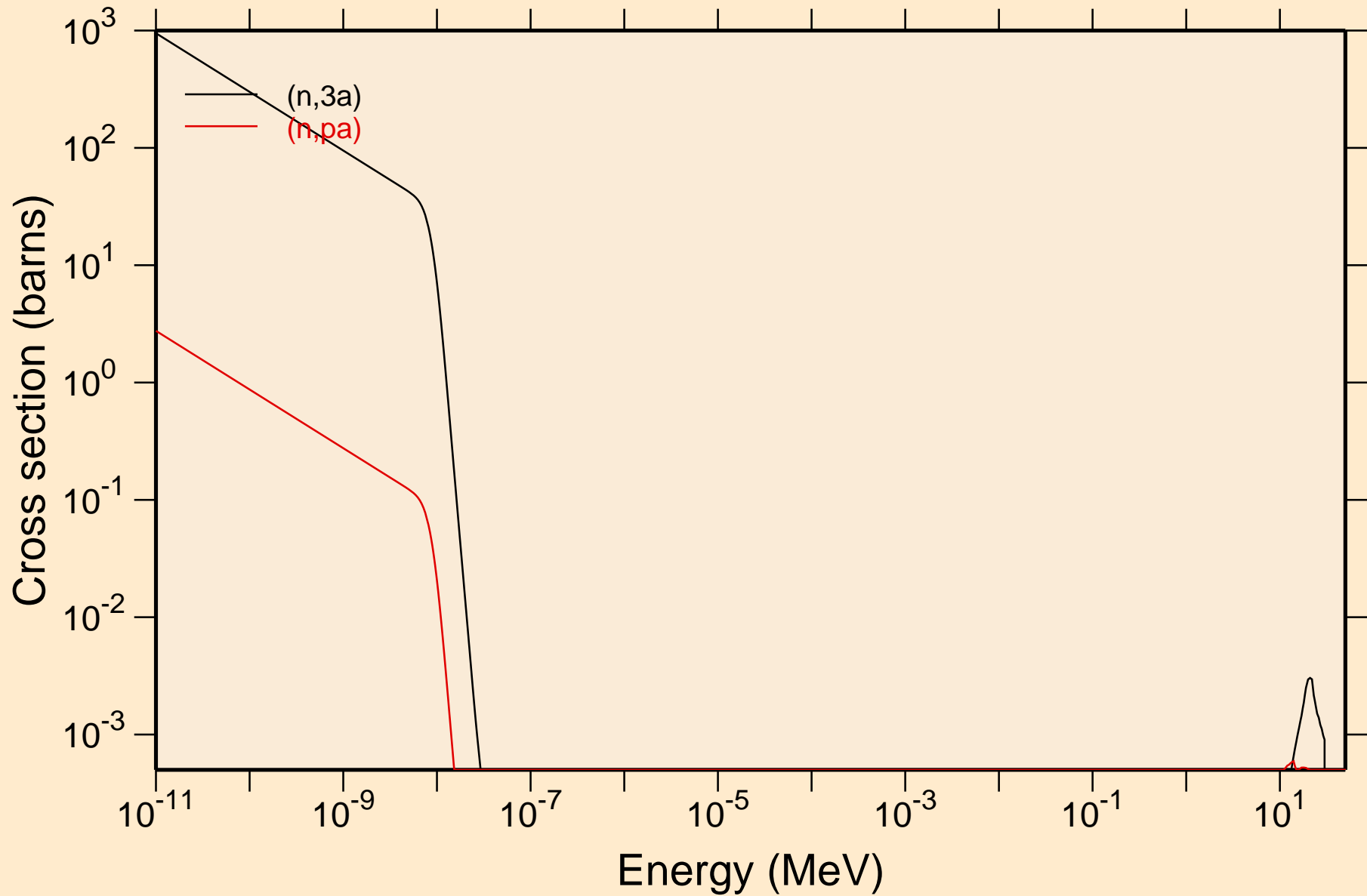

AM232 NRG TENDL-2015, AKONING

Principal cross sections

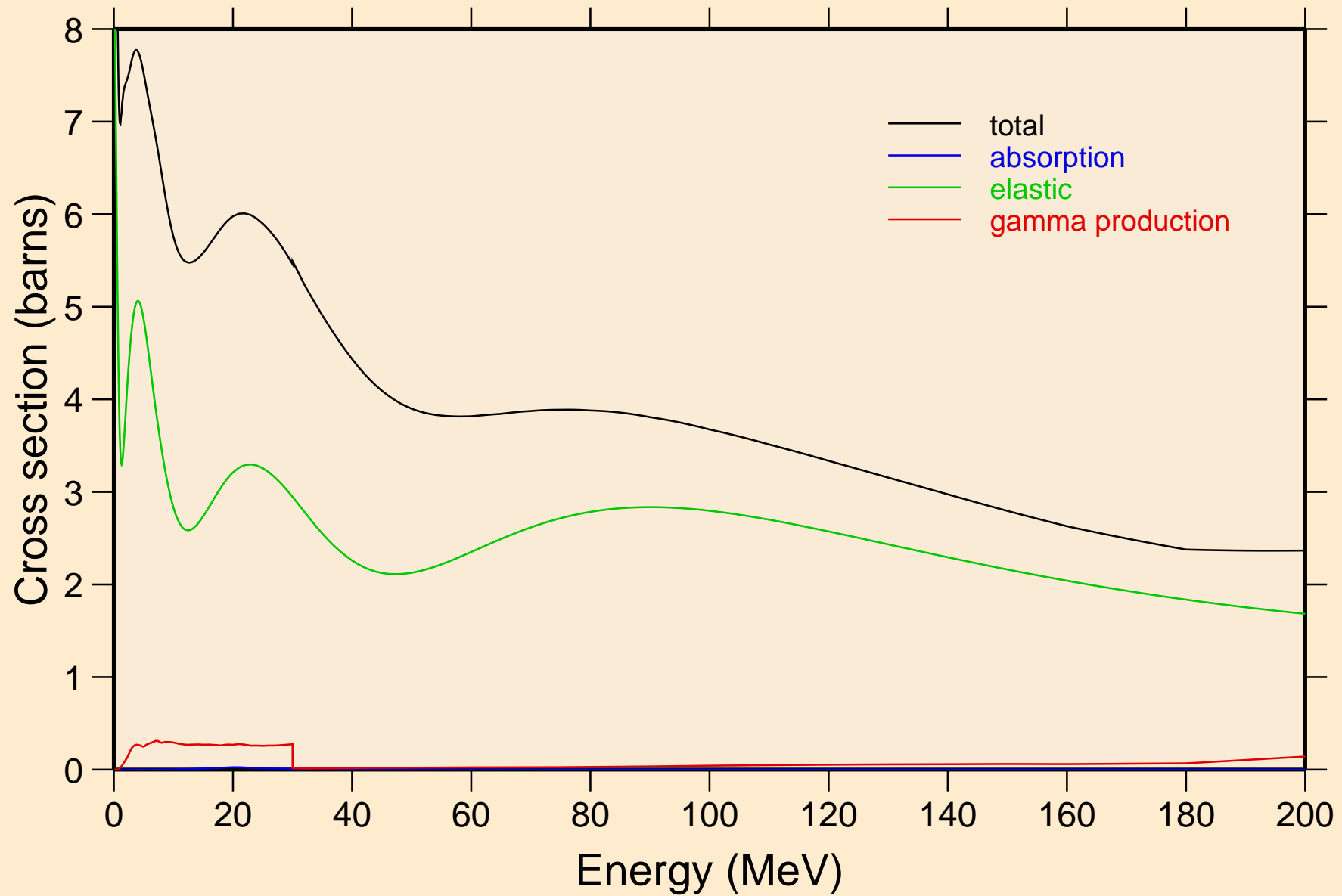

AM232 NRG TENDL-2015, AKONING

Non-threshold reactions

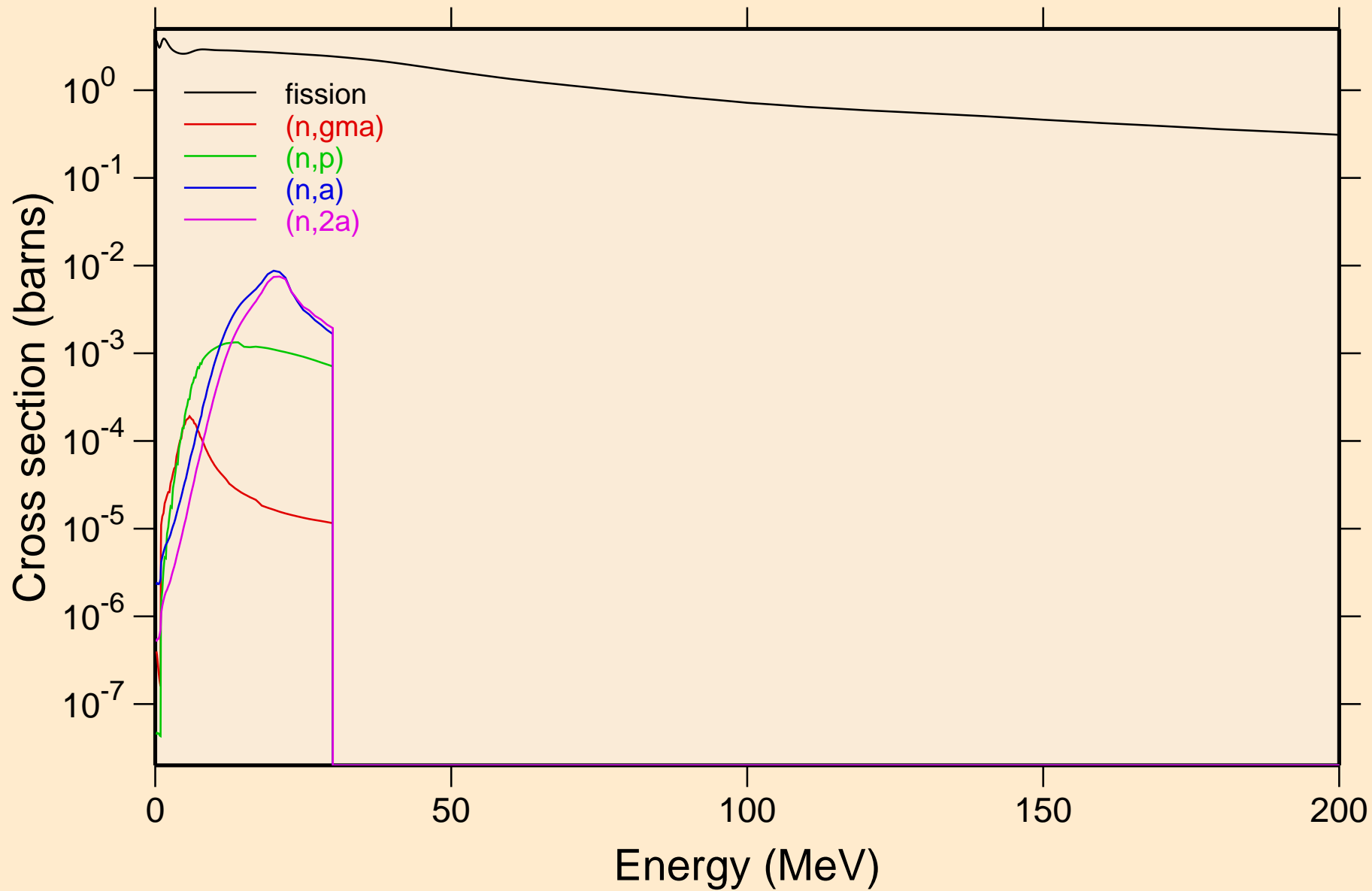

AM232 NRG TENDL-2015, AKONING
Non-threshold reactions

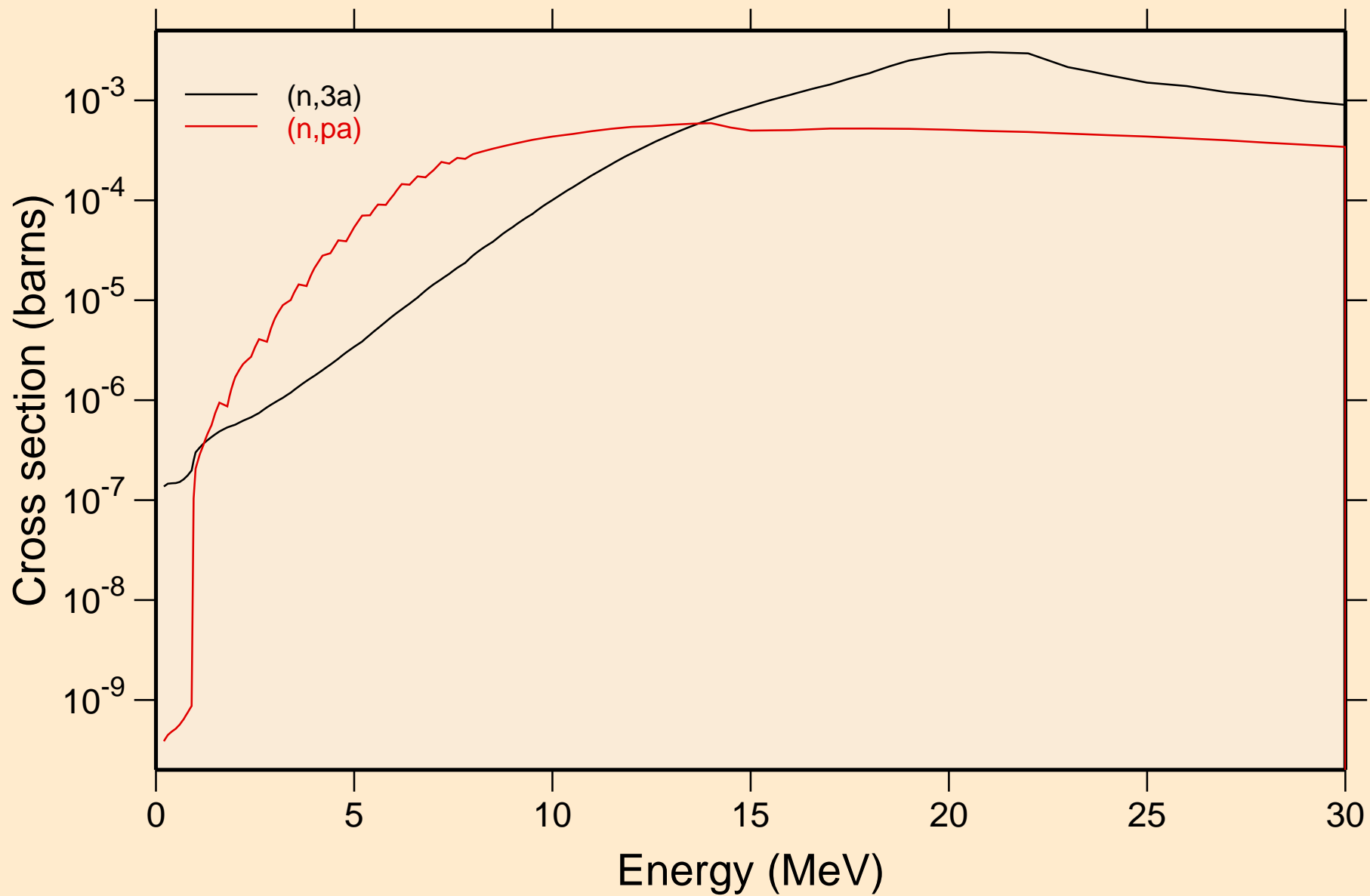

AM232 NRG TENDL-2015, AKONING
Inelastic levels

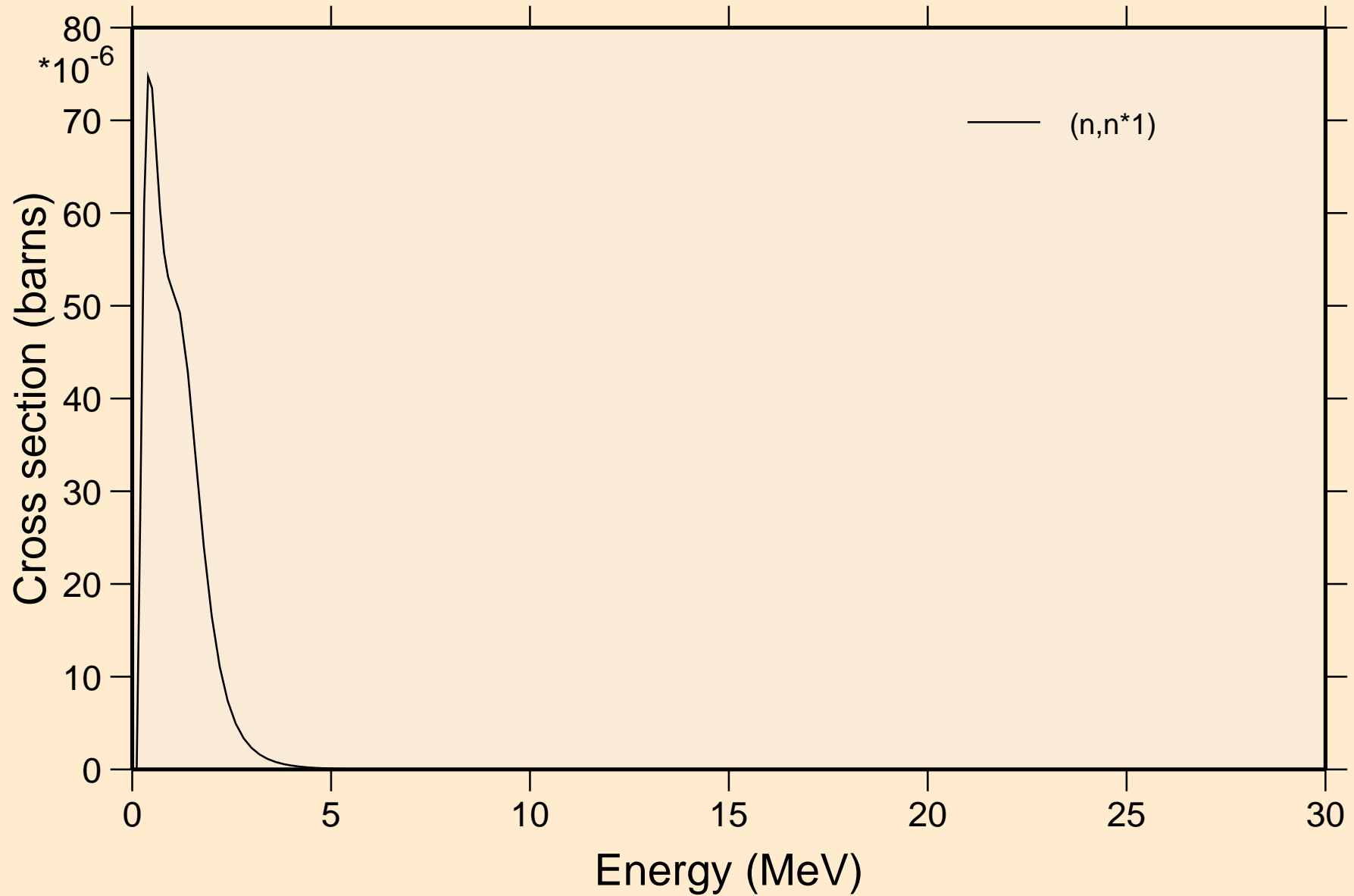

AM232 NRG TENDL-2015, AKONING

Threshold reactions

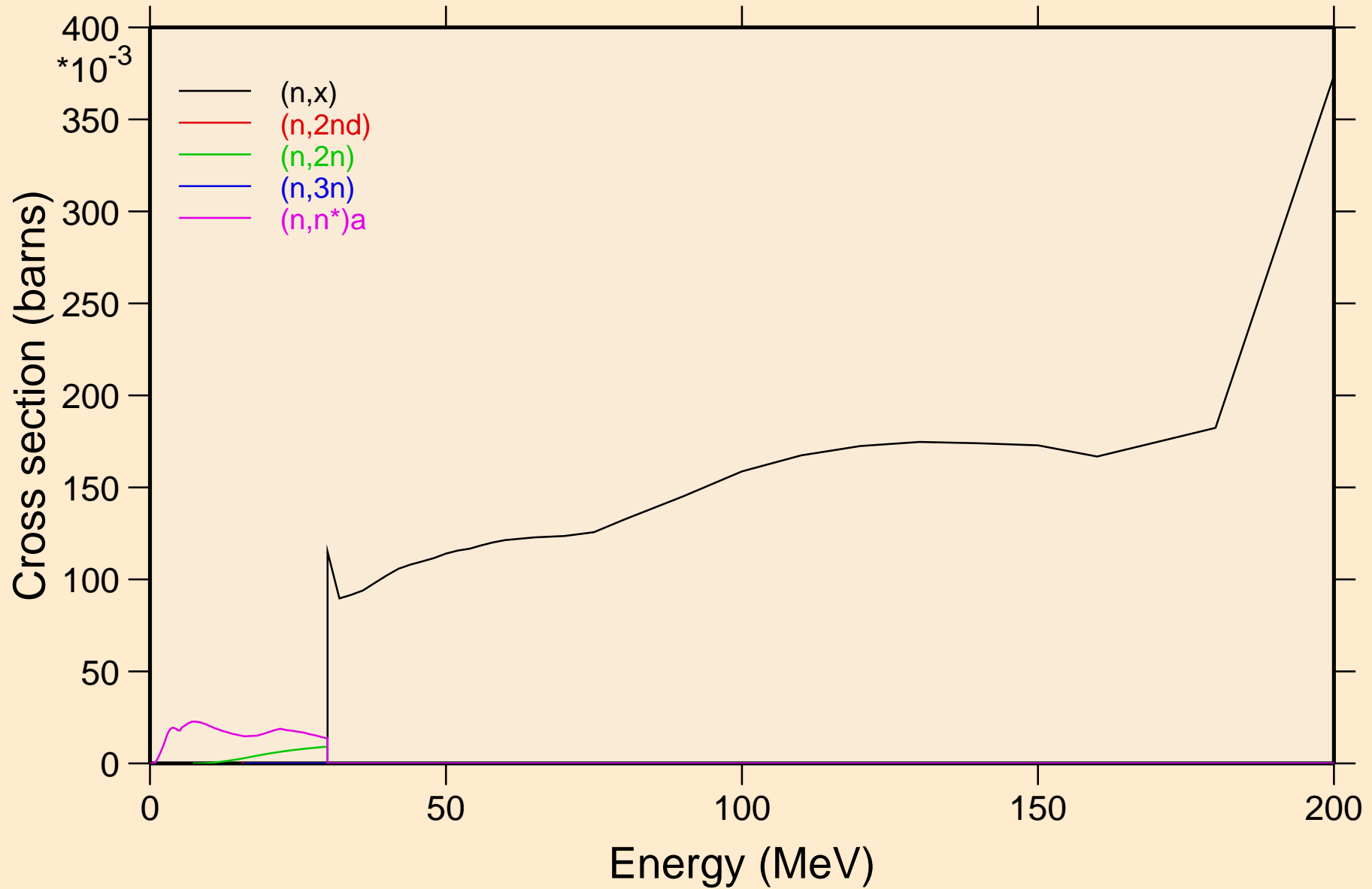

AM232 NRG TENDL-2015, AKONING

Threshold reactions

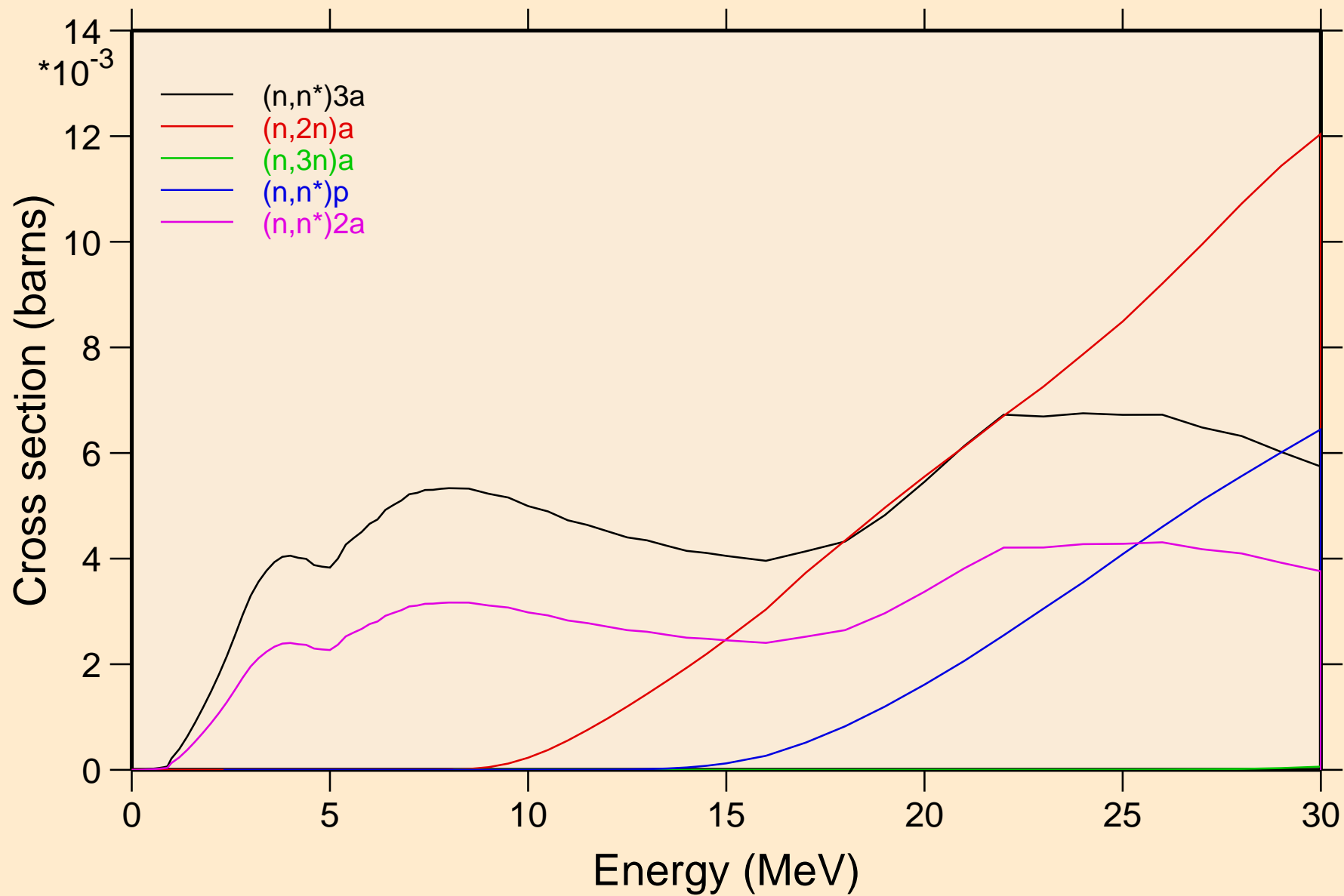

AM232 NRG TENDL-2015, AKONING

Threshold reactions

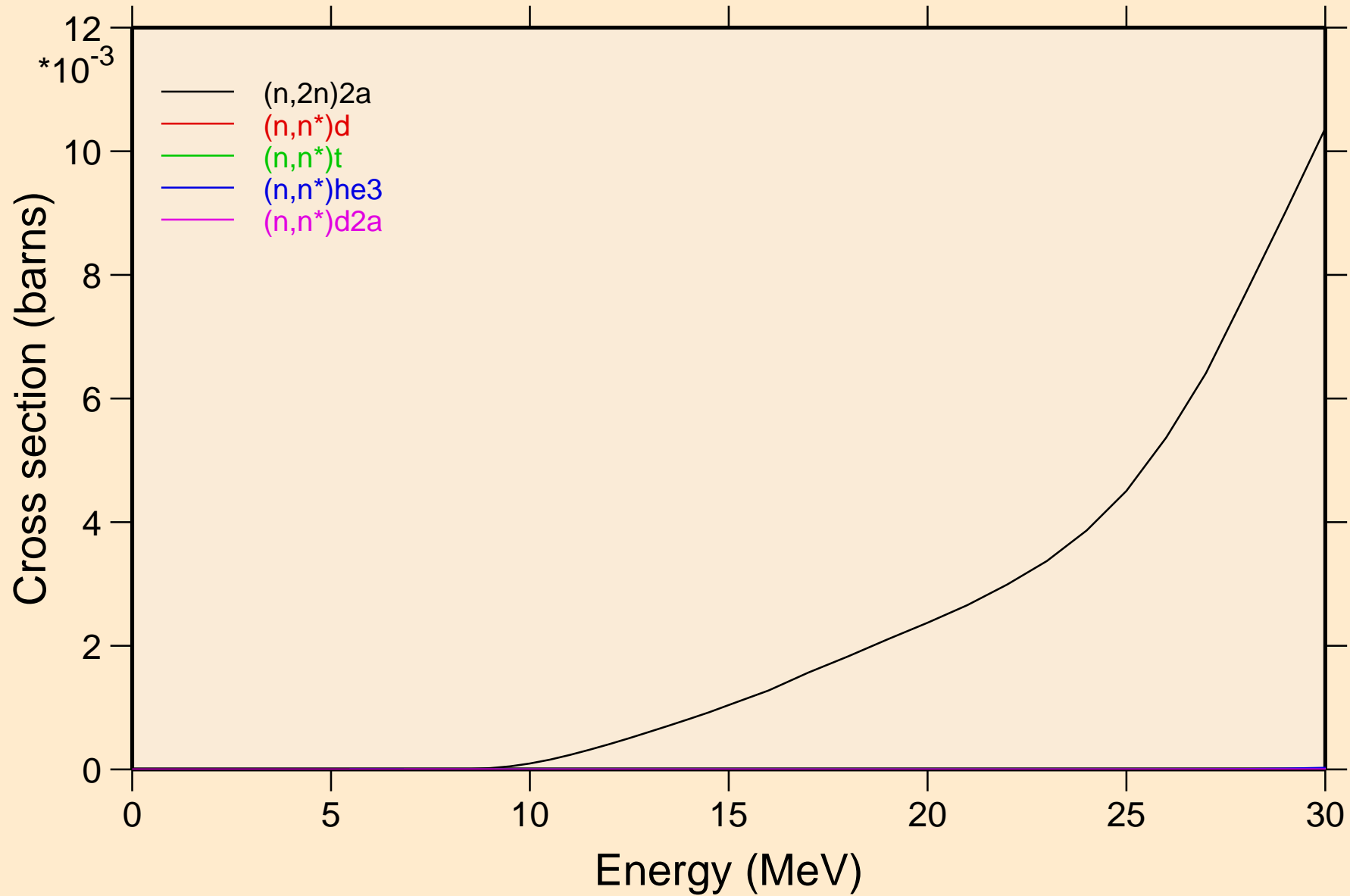

AM232 NRG TENDL-2015, AKONING

Threshold reactions

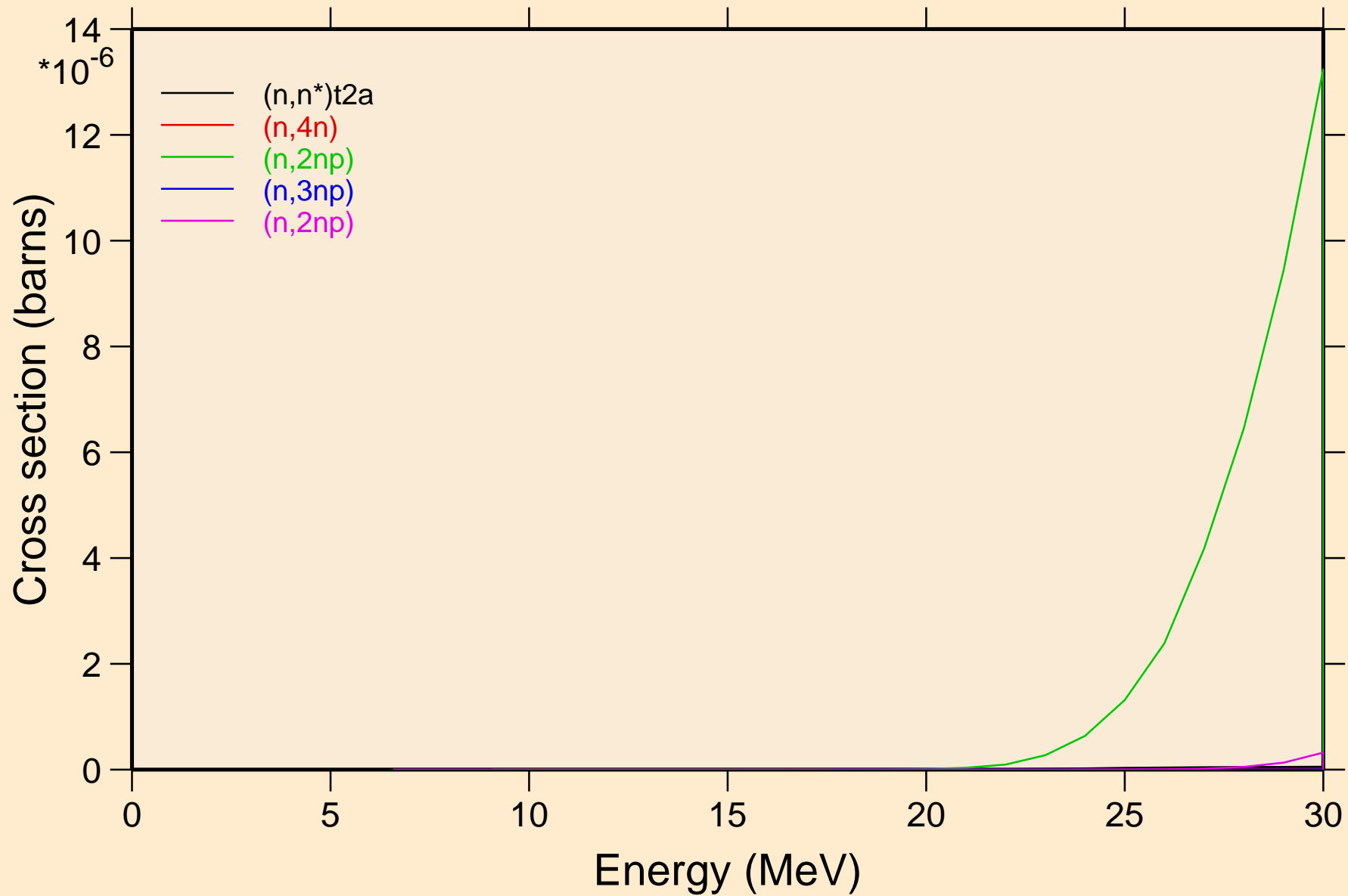

AM232 NRG TENDL-2015, AKONING

Threshold reactions

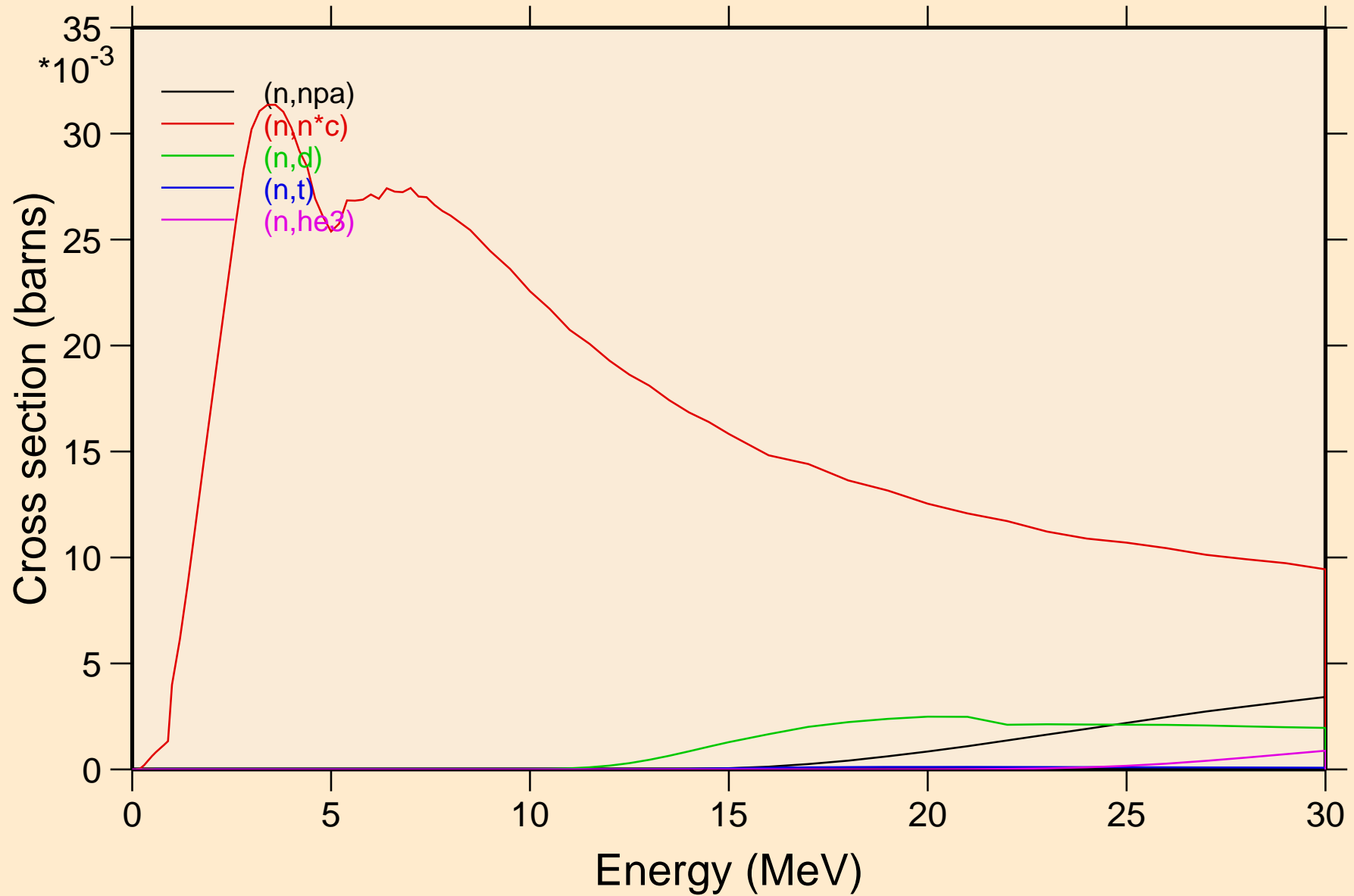

AM232 NRG TENDL-2015, AKONING

Threshold reactions

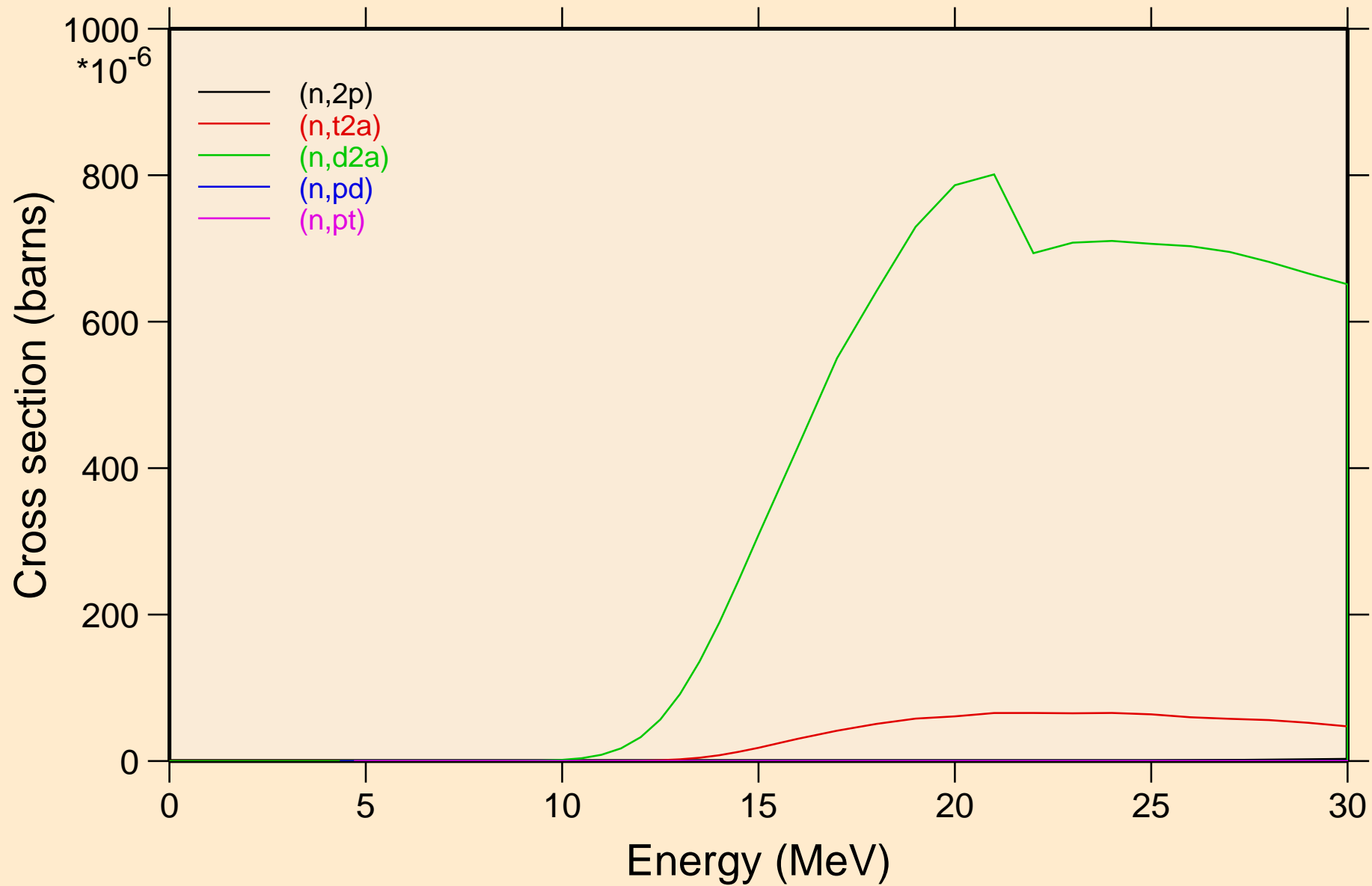

AM232 NRG TENDL-2015, AKONING

Threshold reactions

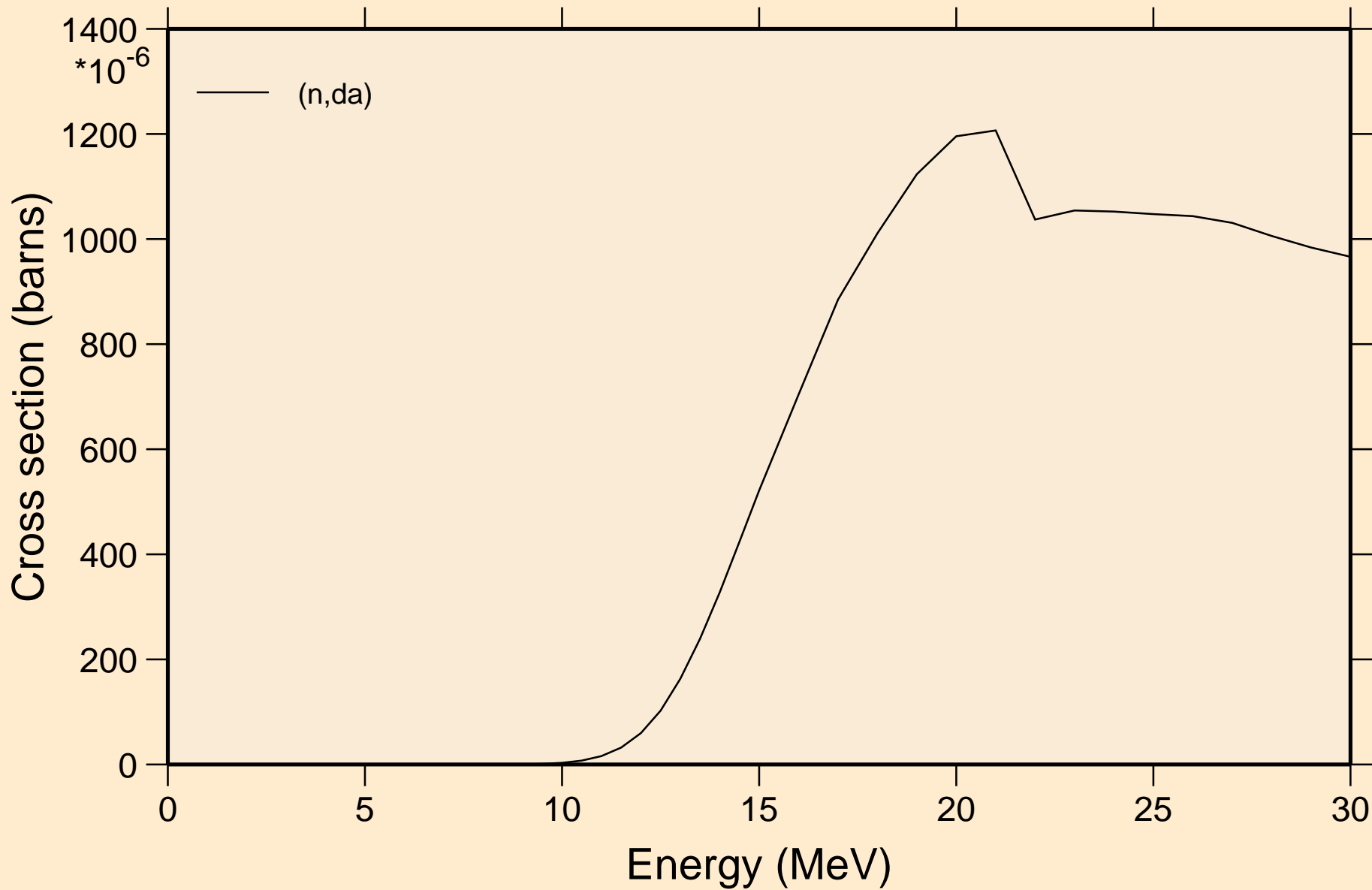

AM232 NRG TENDL-2015, AKONING
angular distribution for elastic

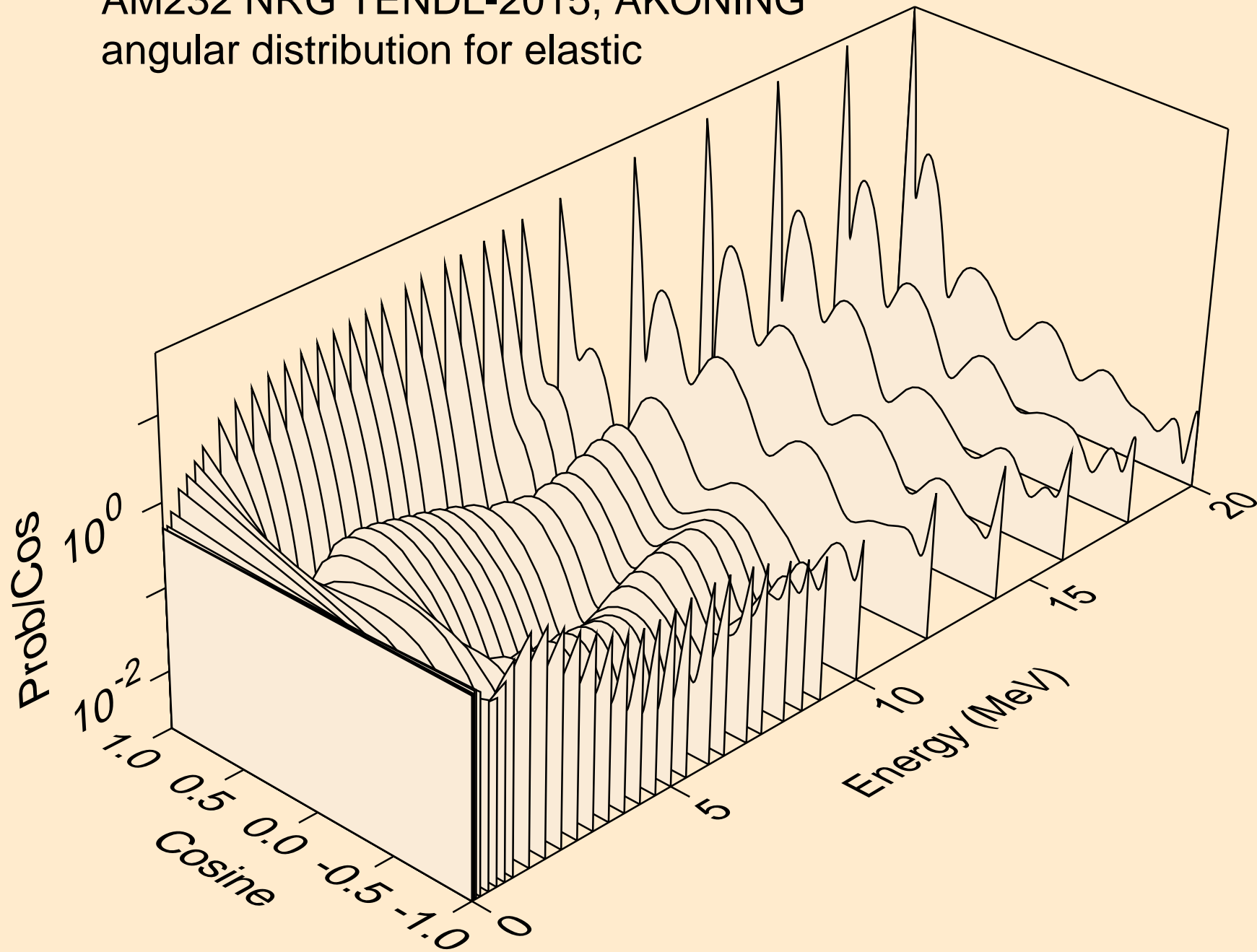

AM232 NRG TENDL-2015, AKONING
angular distribution for elastic

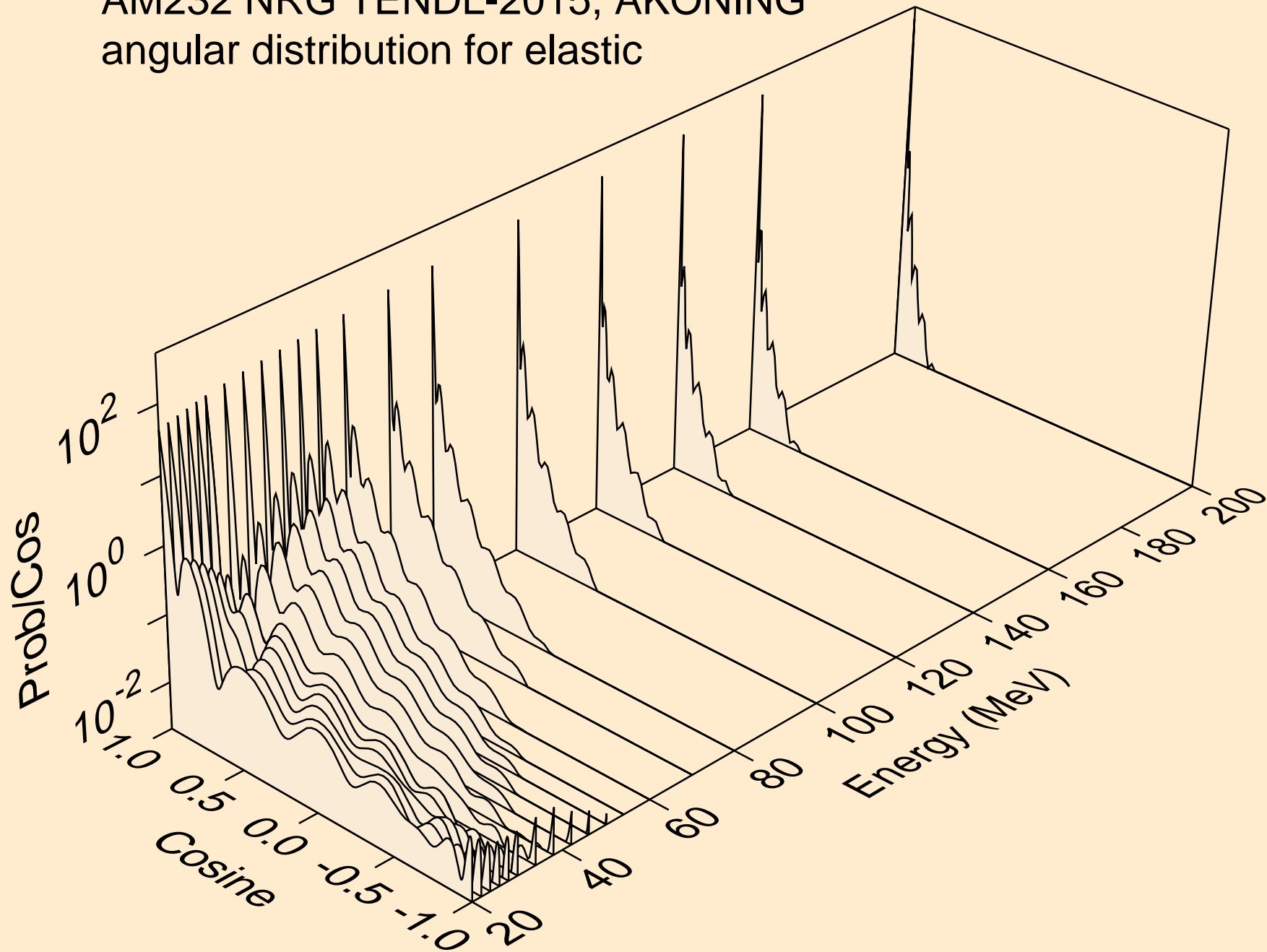

AM232 NRG TENDL-2015, AKONING
angular distribution for (n,n*1)

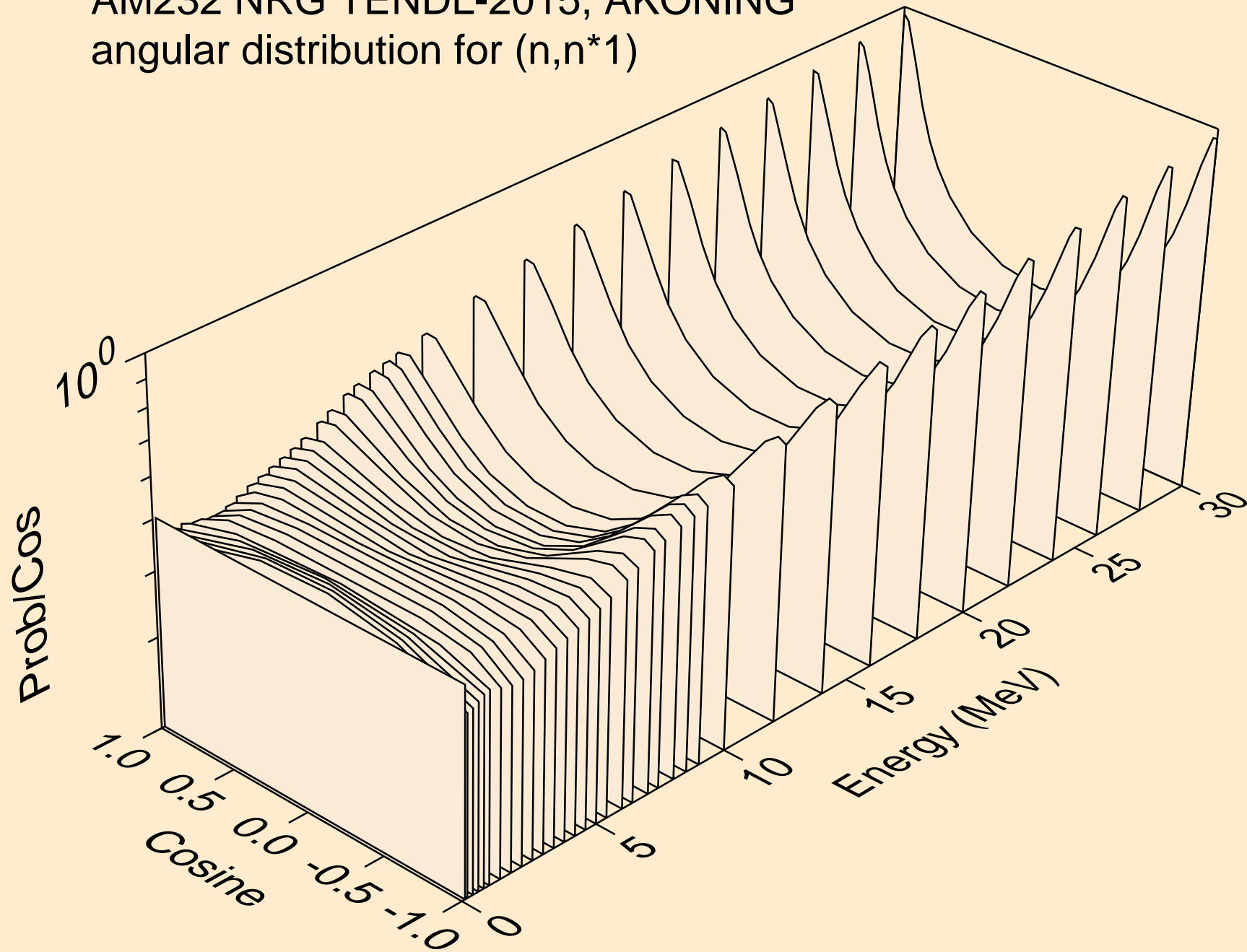

AM232 NRG TENDL-2015, AKONING

Total fission nubar

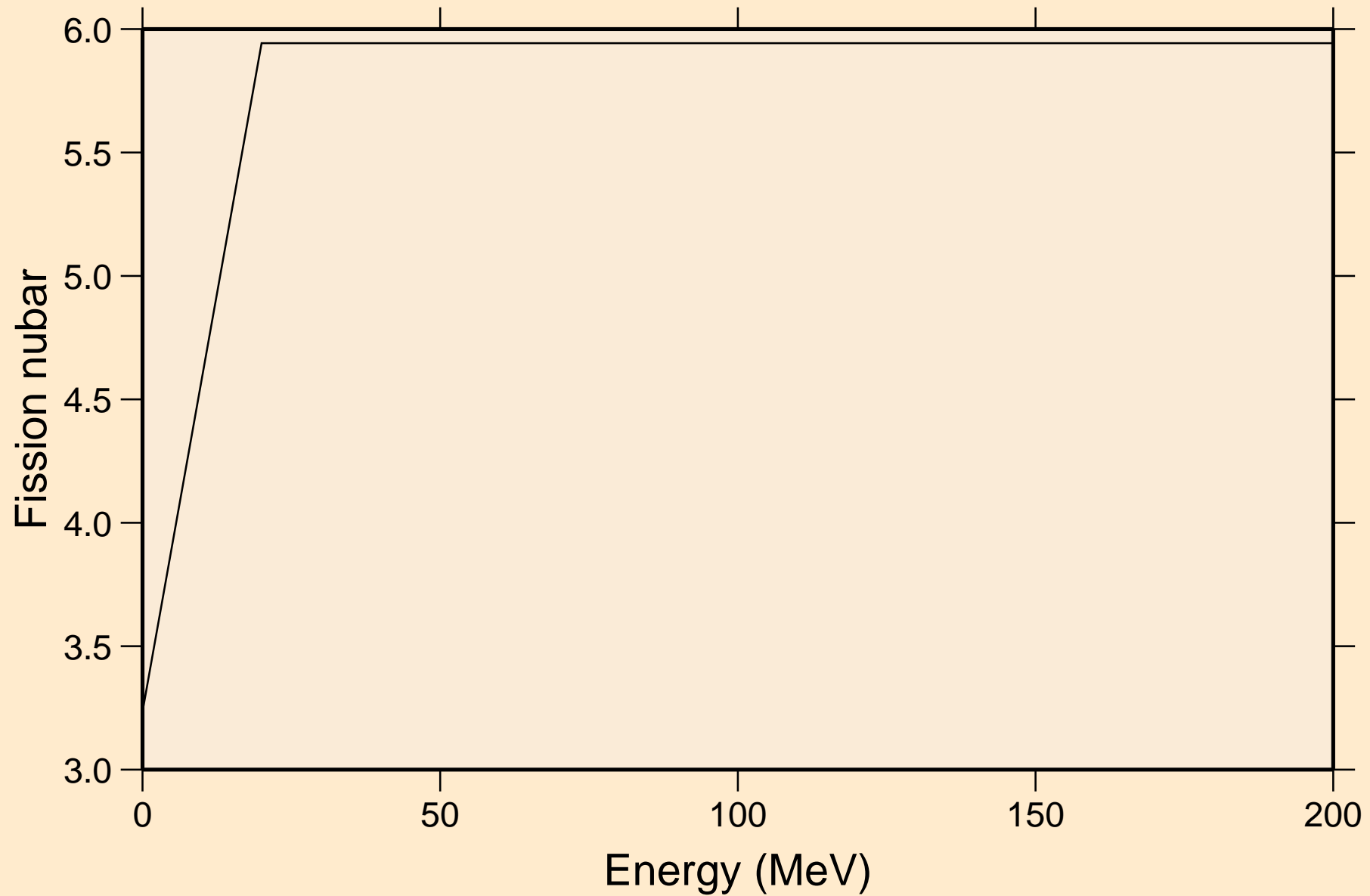

AM232 NRG TENDL-2015, AKONING
Neutron emission for (n,x)

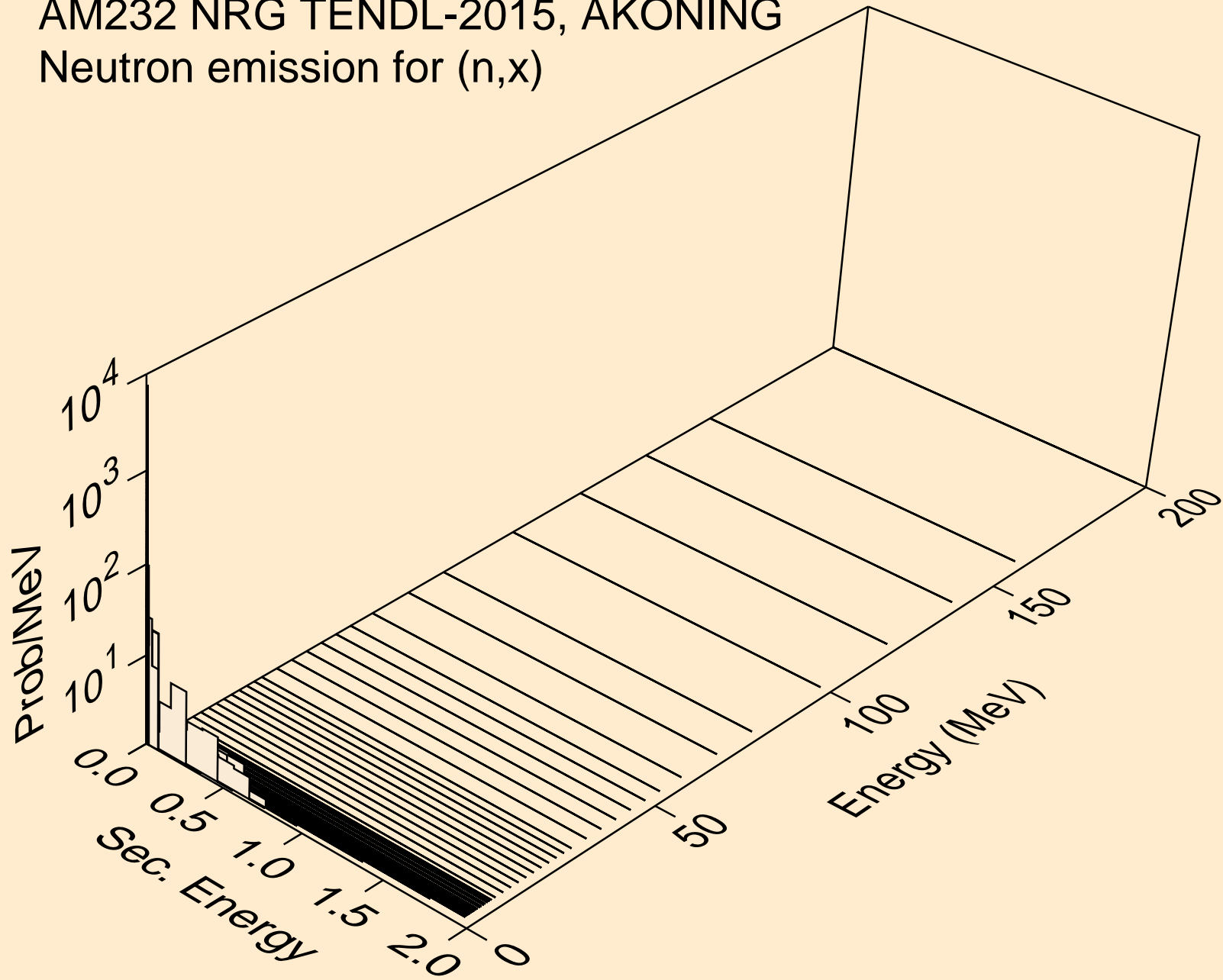

AM232 NRG TENDL-2015, AKONING
Neutron emission for (n,2nd)

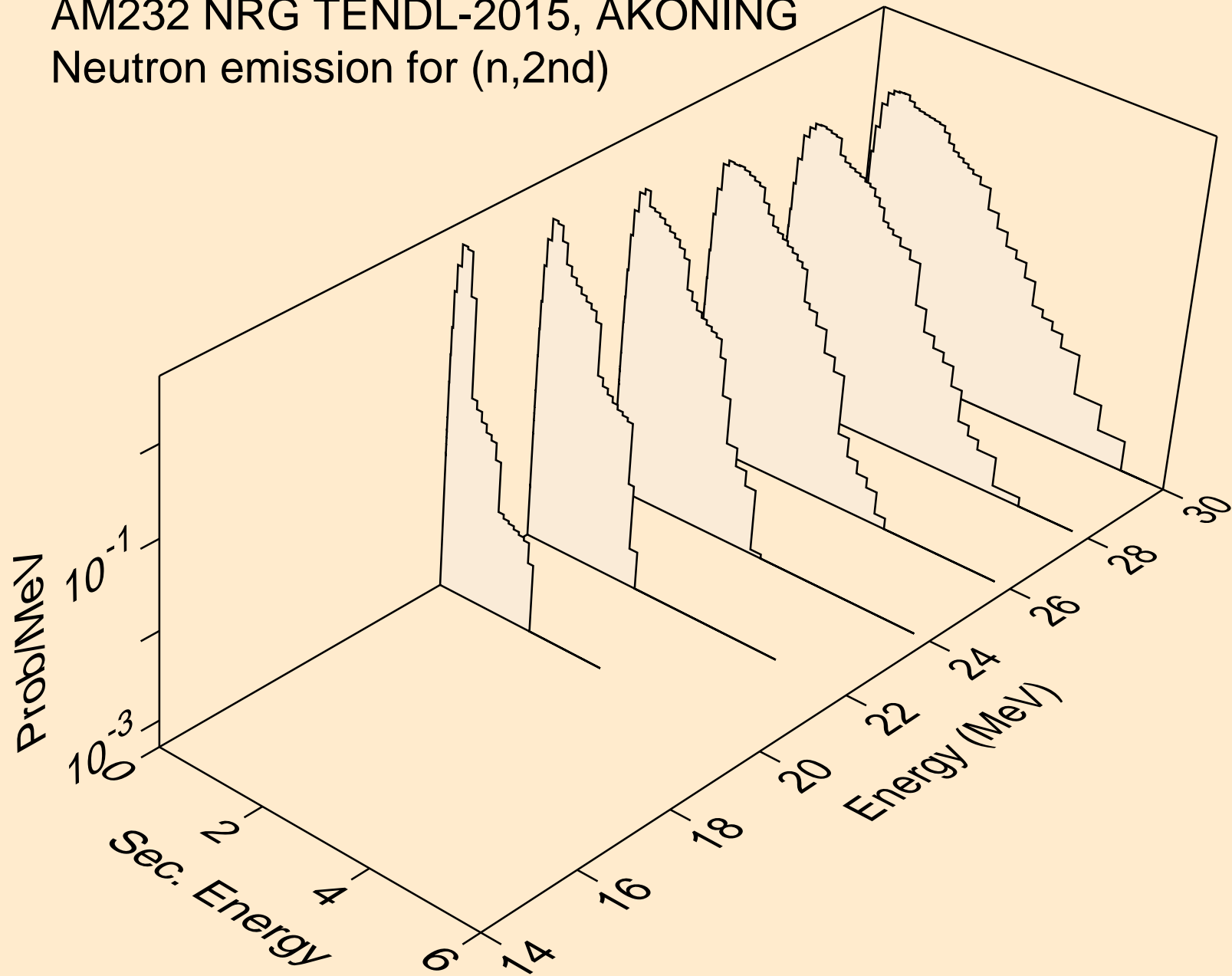

AM232 NRG TENDL-2015, AKONING
Neutron emission for (n,2n)

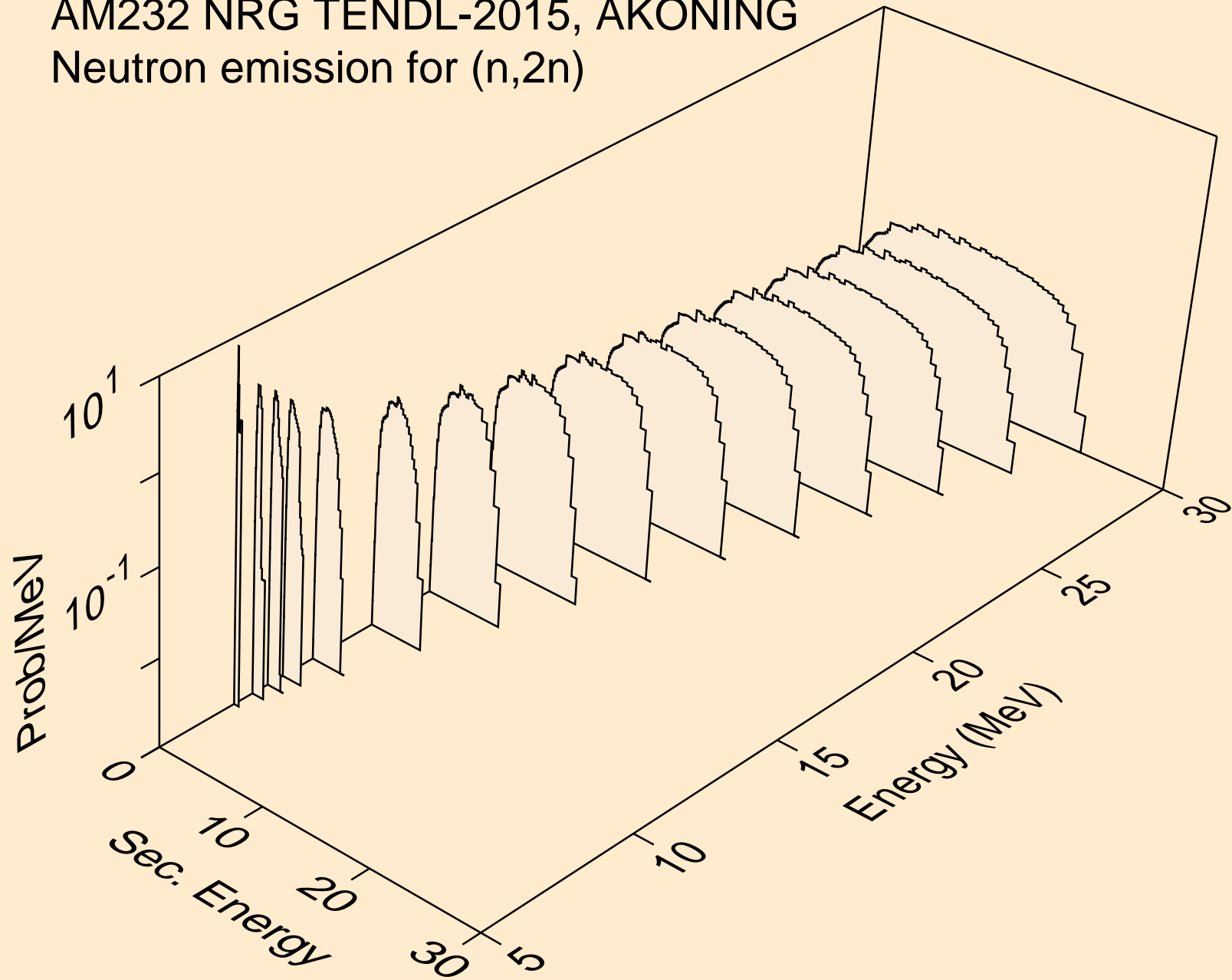

AM232 NRG TENDL-2015, AKONING
Neutron emission for (n,3n)

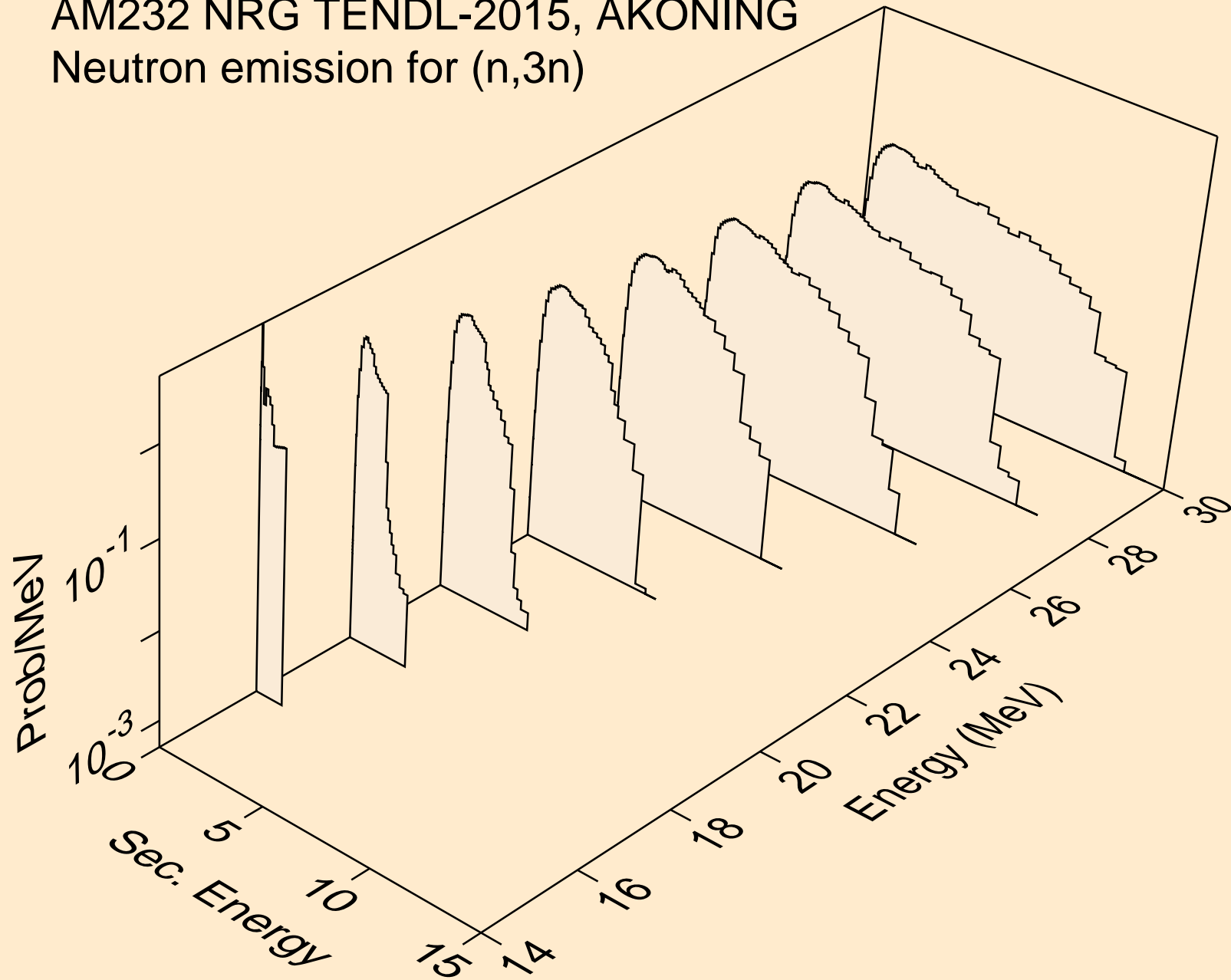

AM232 NRG TENDL-2015, AKONING
Neutron emission for fission

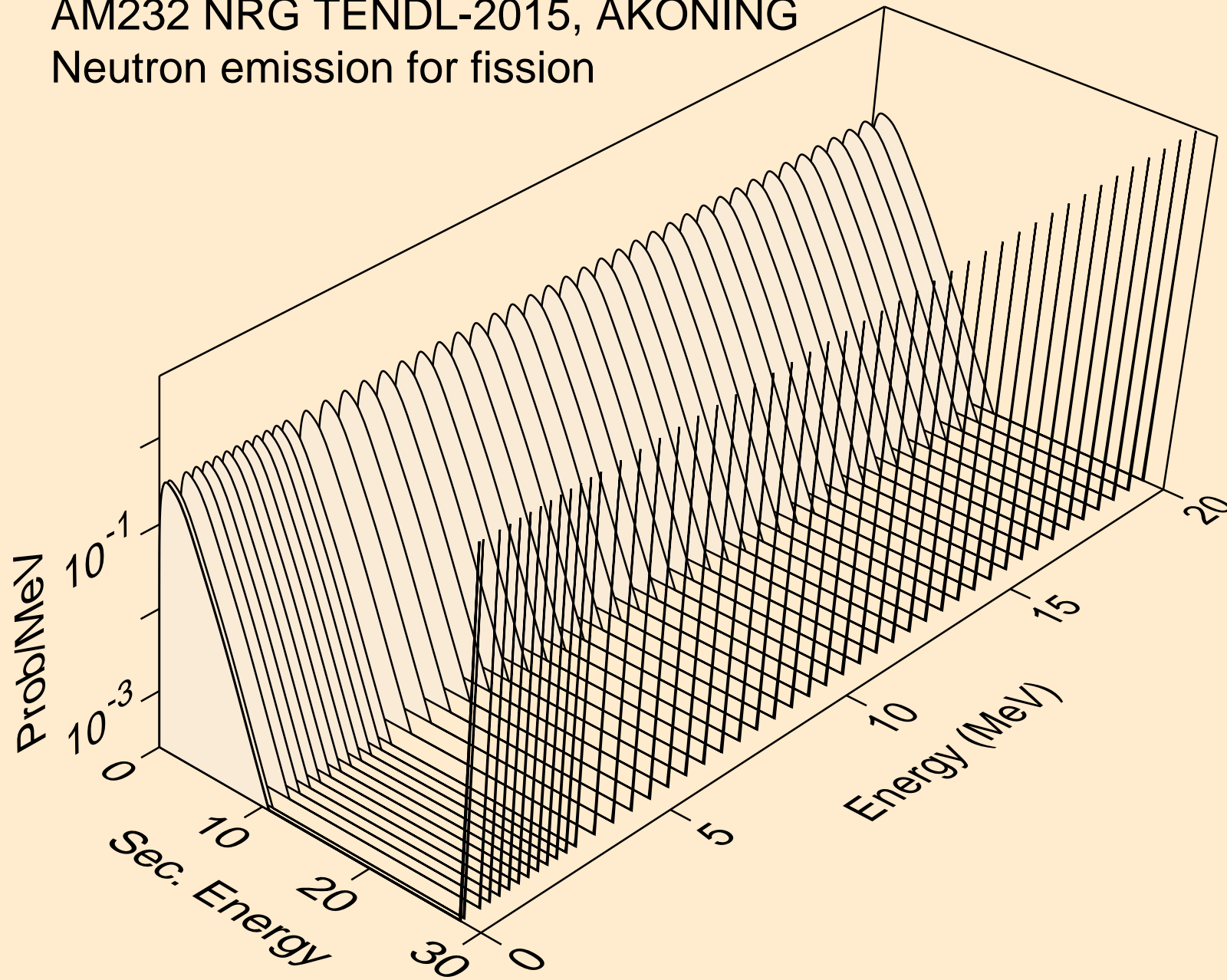

AM232 NRG TENDL-2015, AKONING
Neutron emission for (n,n*)a

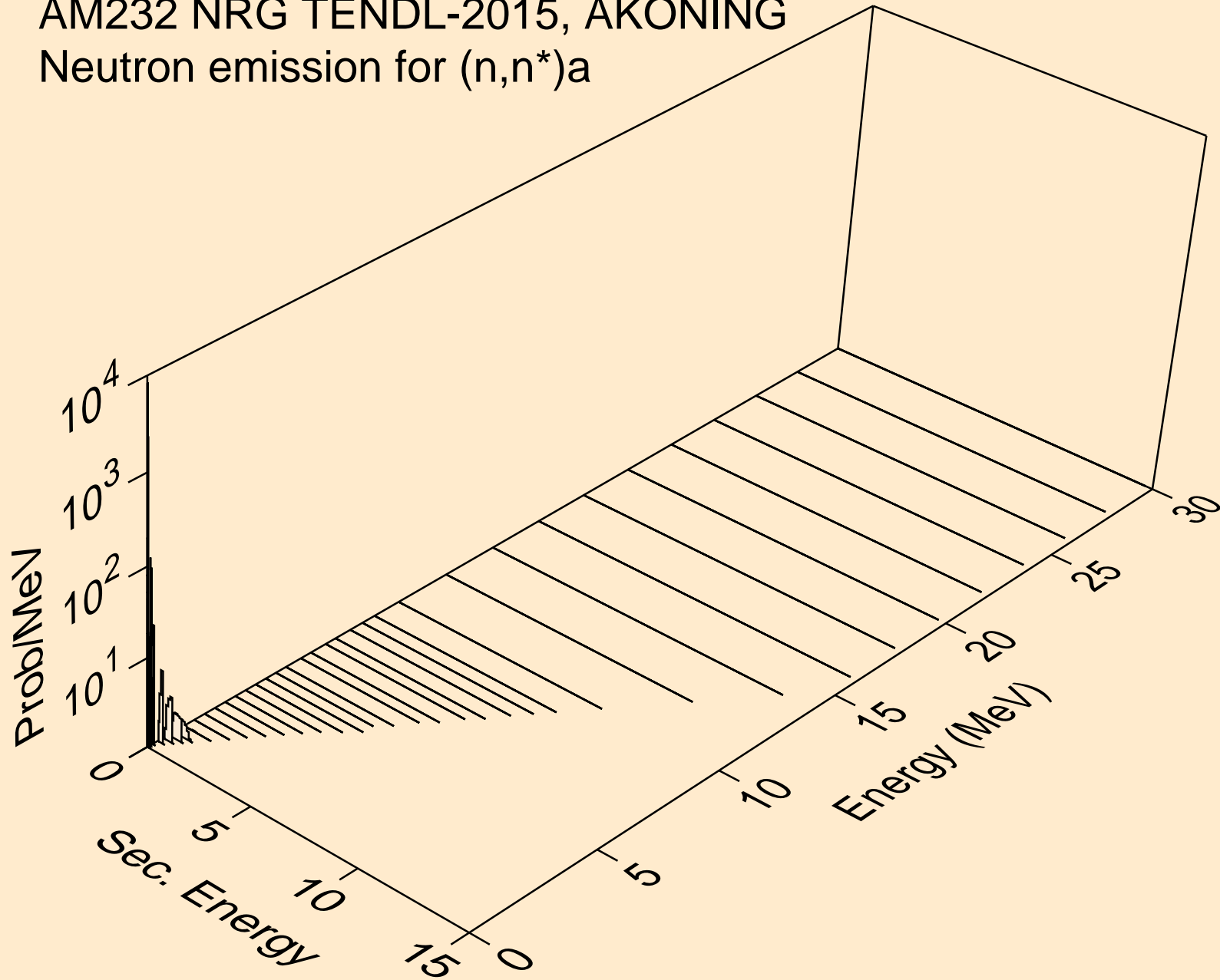

AM232 NRG TENDL-2015, AKONING
Neutron emission for (n,n*)3a

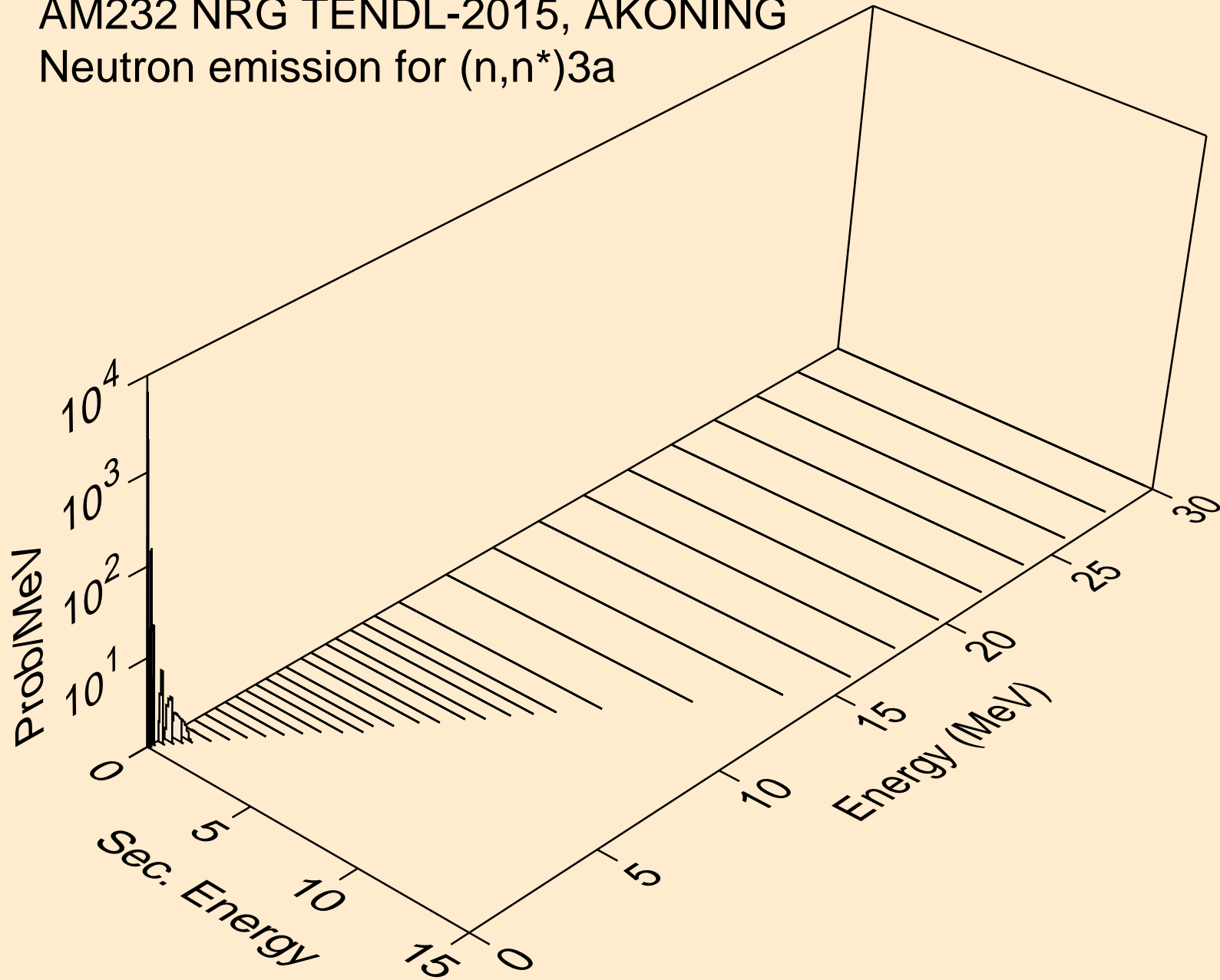

AM232 NRG TENDL-2015, AKONING
Neutron emission for (n,2n)a

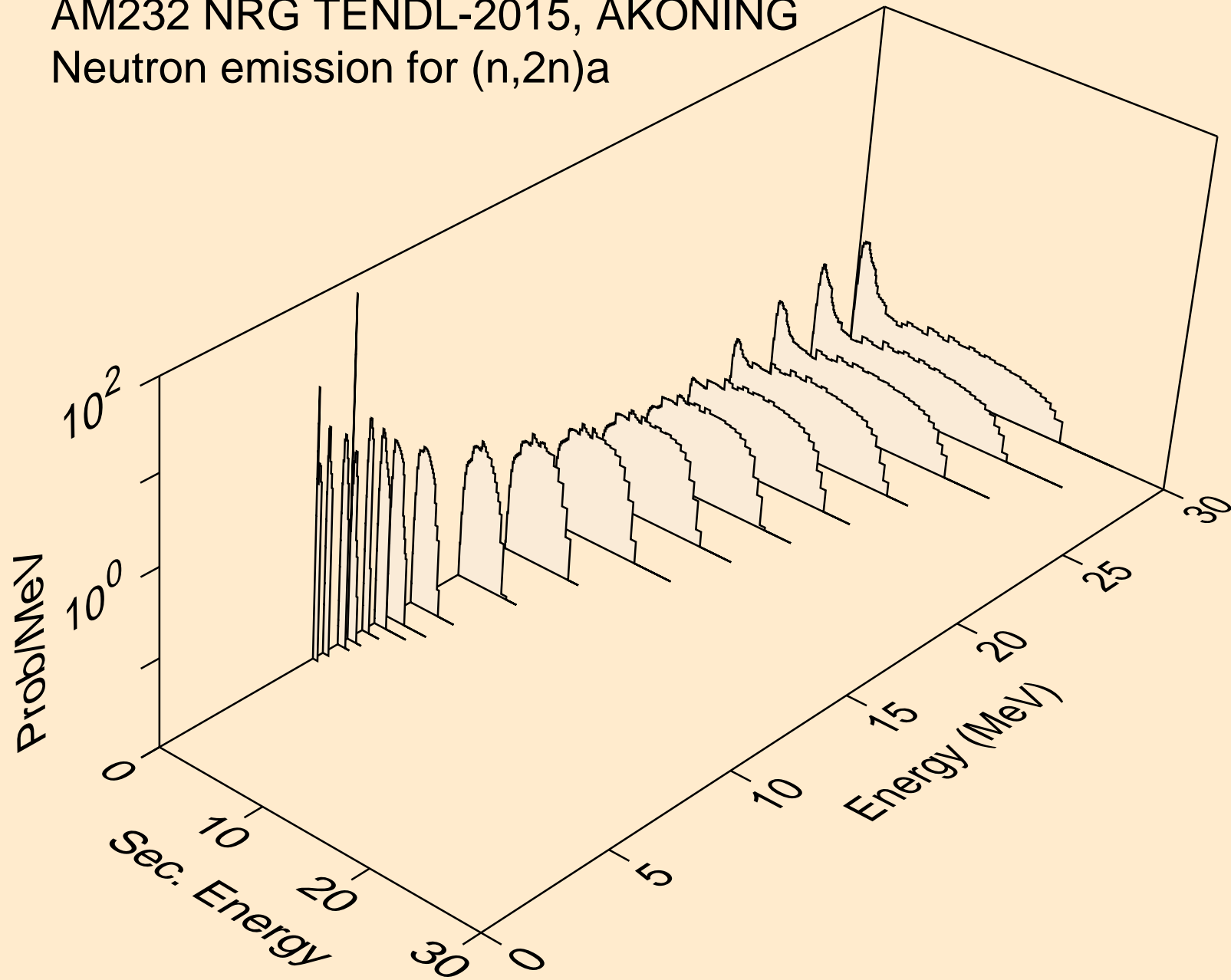

AM232 NRG TENDL-2015, AKONING
Neutron emission for (n,3n)a

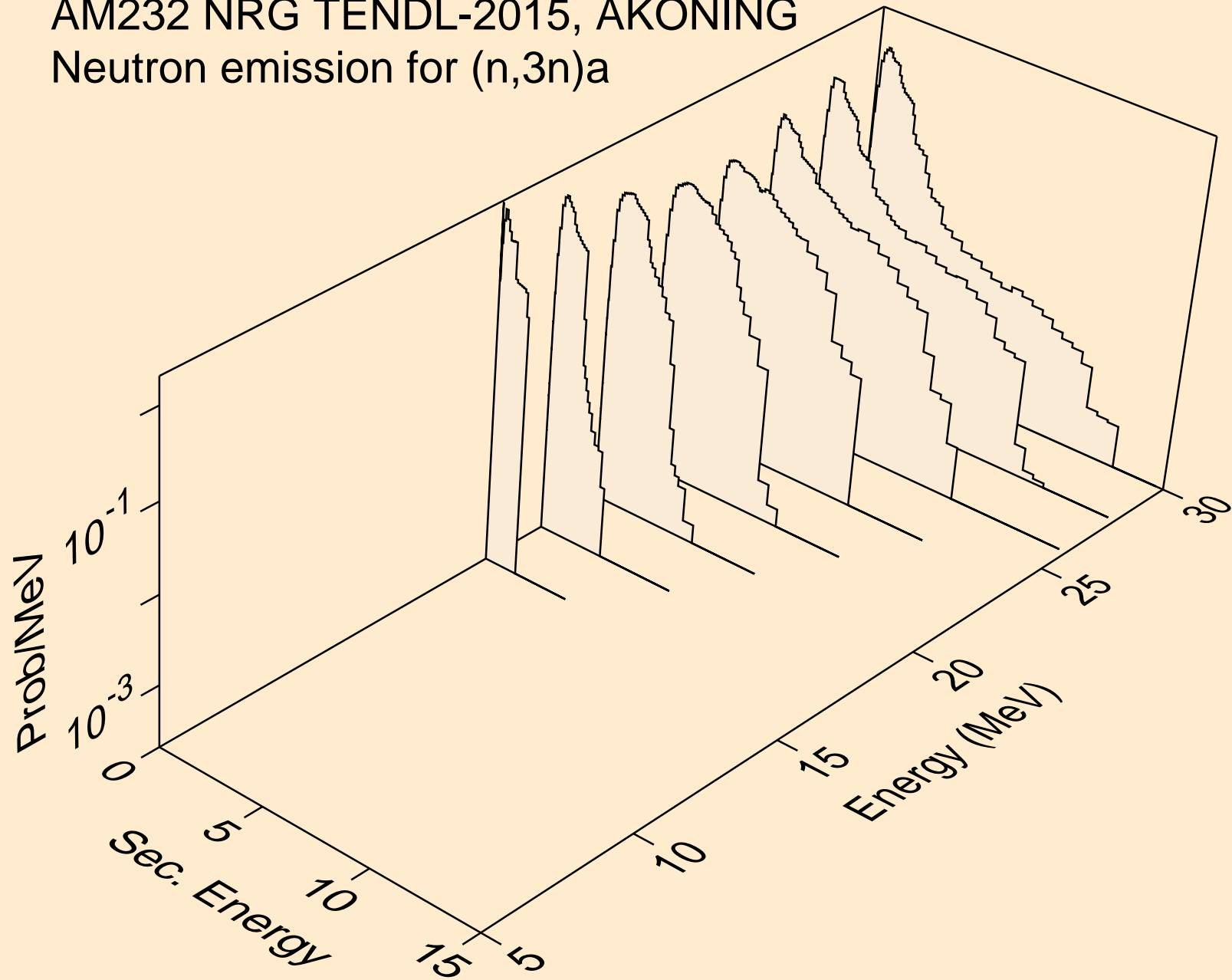

AM232 NRG TENDL-2015, AKONING
Neutron emission for (n,n*)p

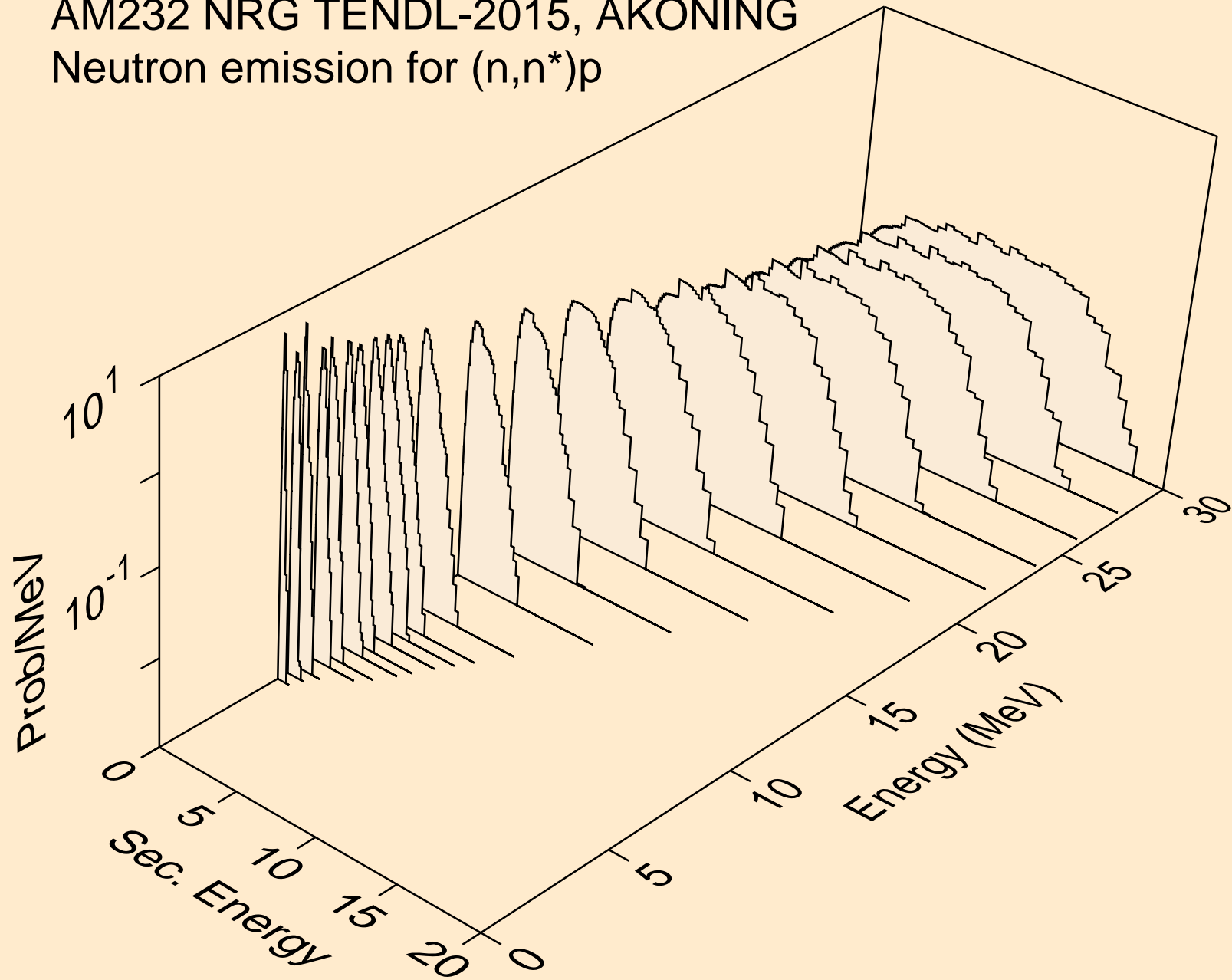

AM232 NRG TENDL-2015, AKONING
Neutron emission for (n,n*)2a

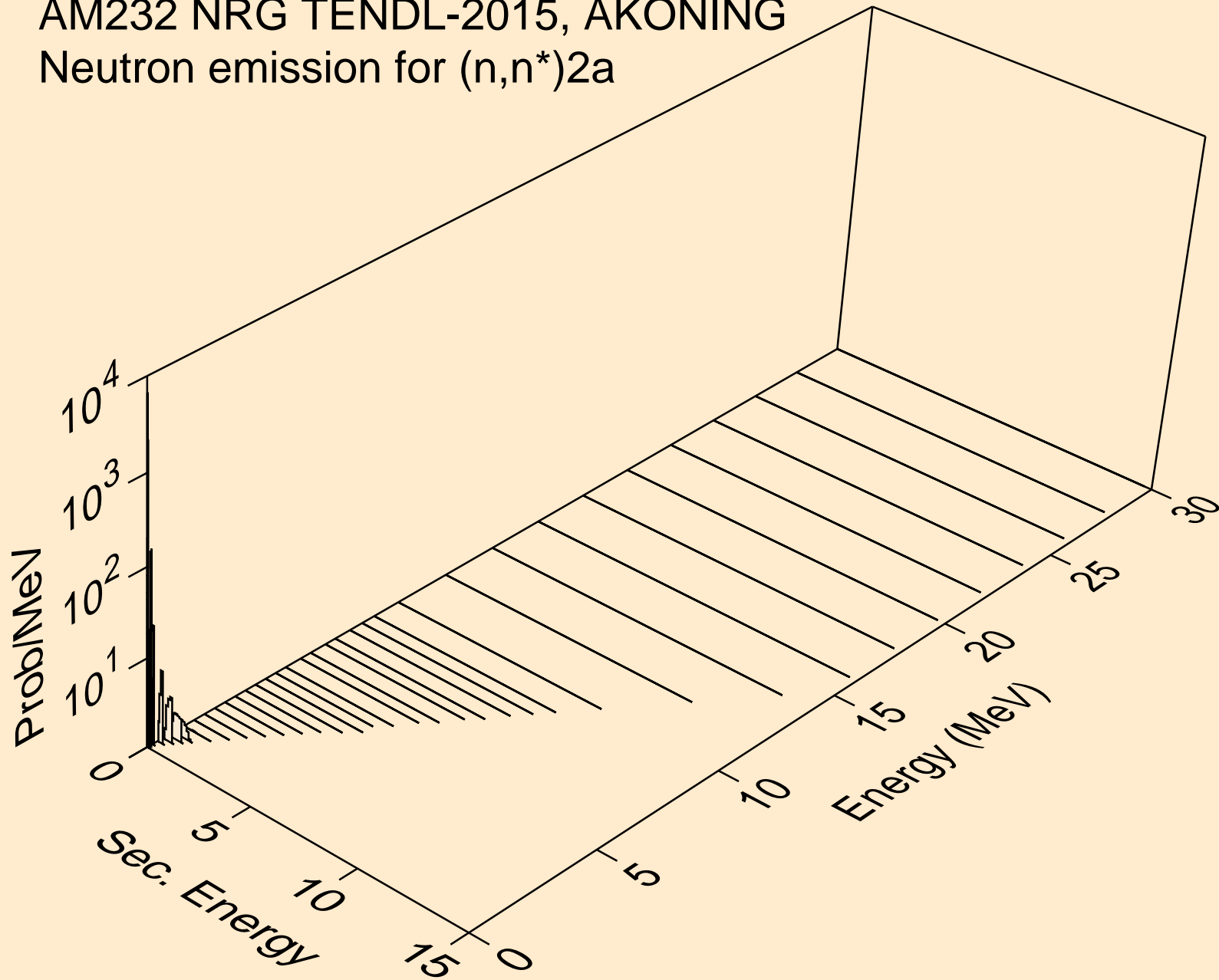

AM232 NRG TENDL-2015, AKONING
Neutron emission for (n,2n)2a

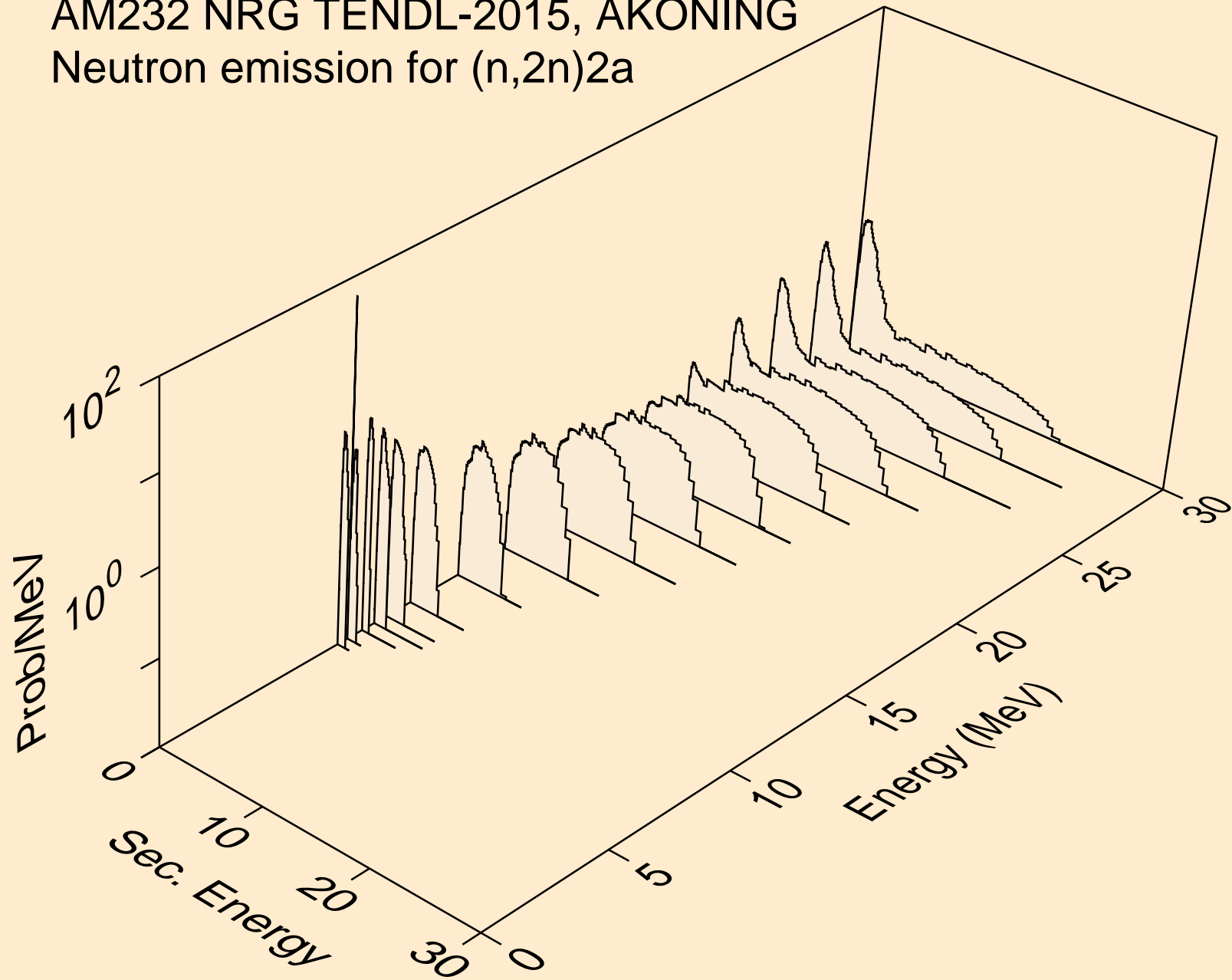

AM232 NRG TENDL-2015, AKONING
Neutron emission for (n,n*)d

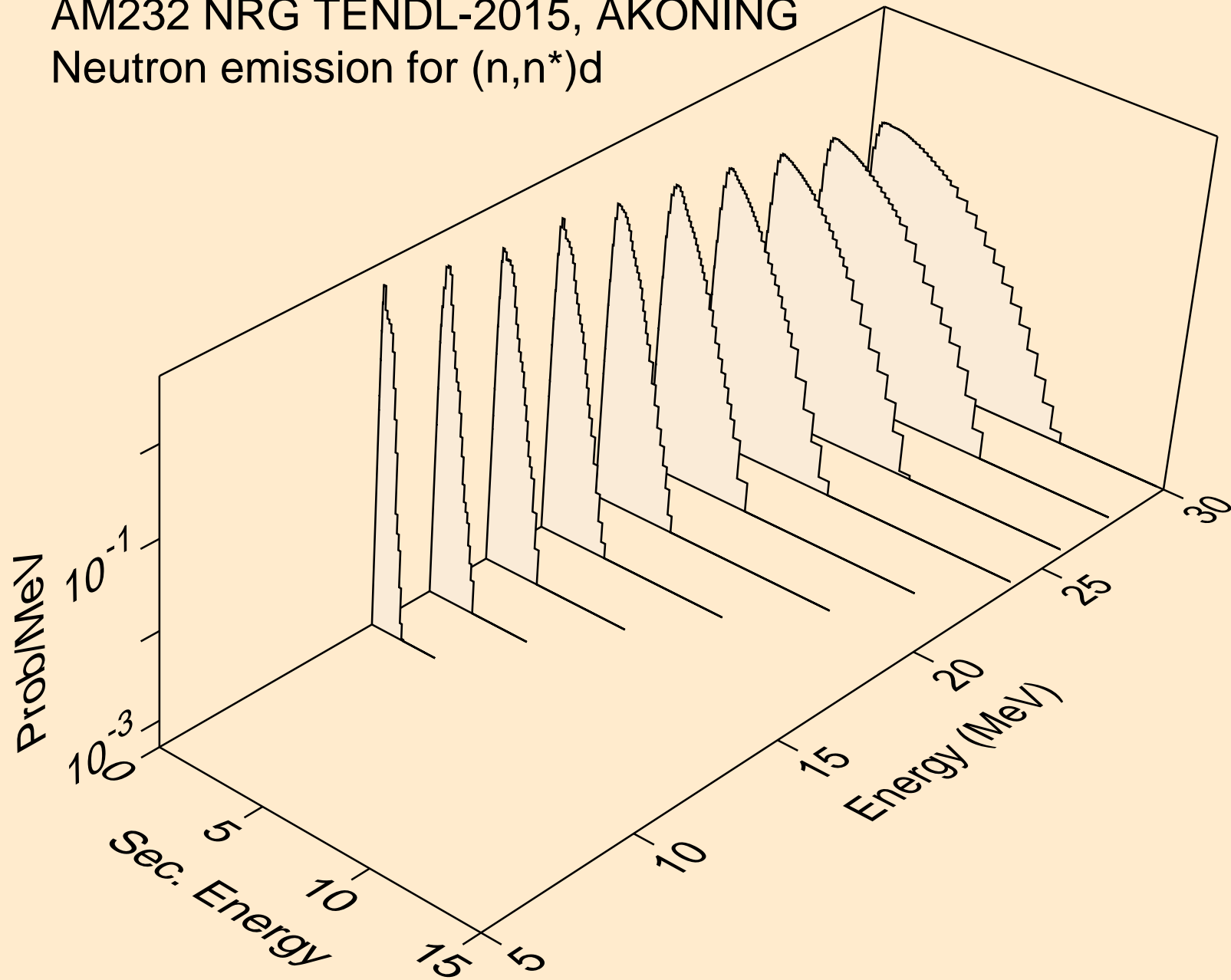

AM232 NRG TENDL-2015, AKONING
Neutron emission for (n,n*)t

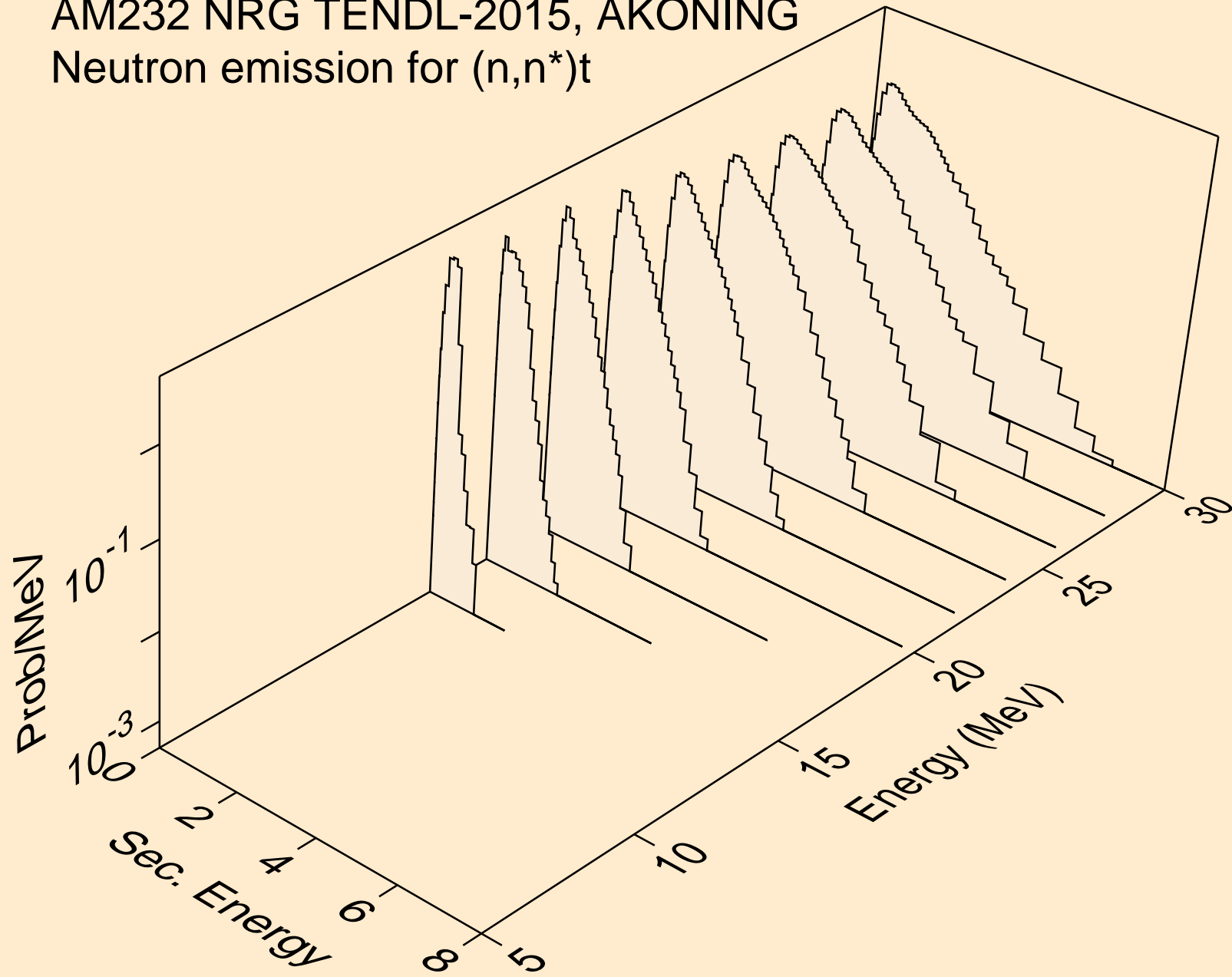

AM232 NRG TENDL-2015, AKONING
Neutron emission for (n,n*)he3

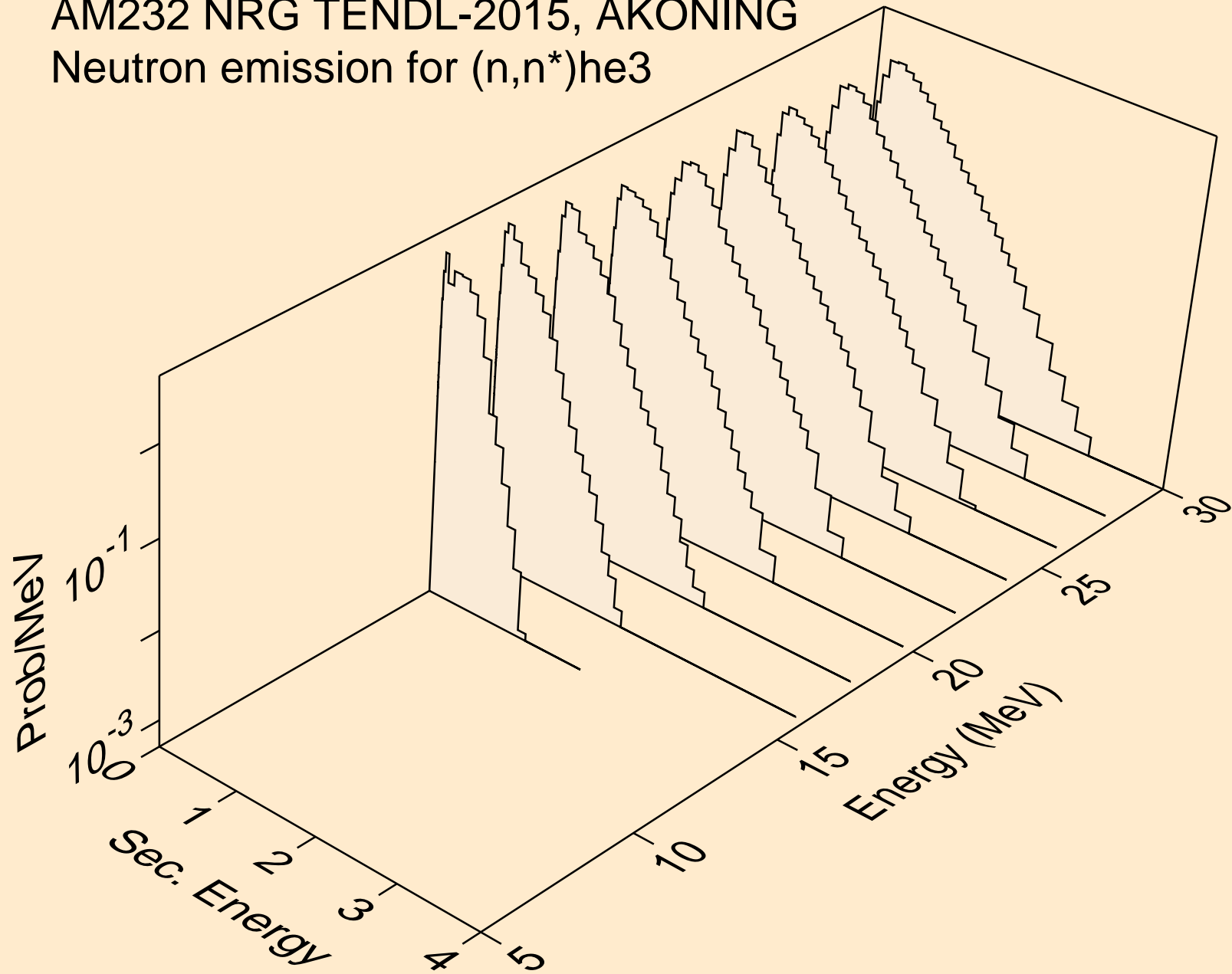

AM232 NRG TENDL-2015, AKONING
Neutron emission for (n,n*)d2a

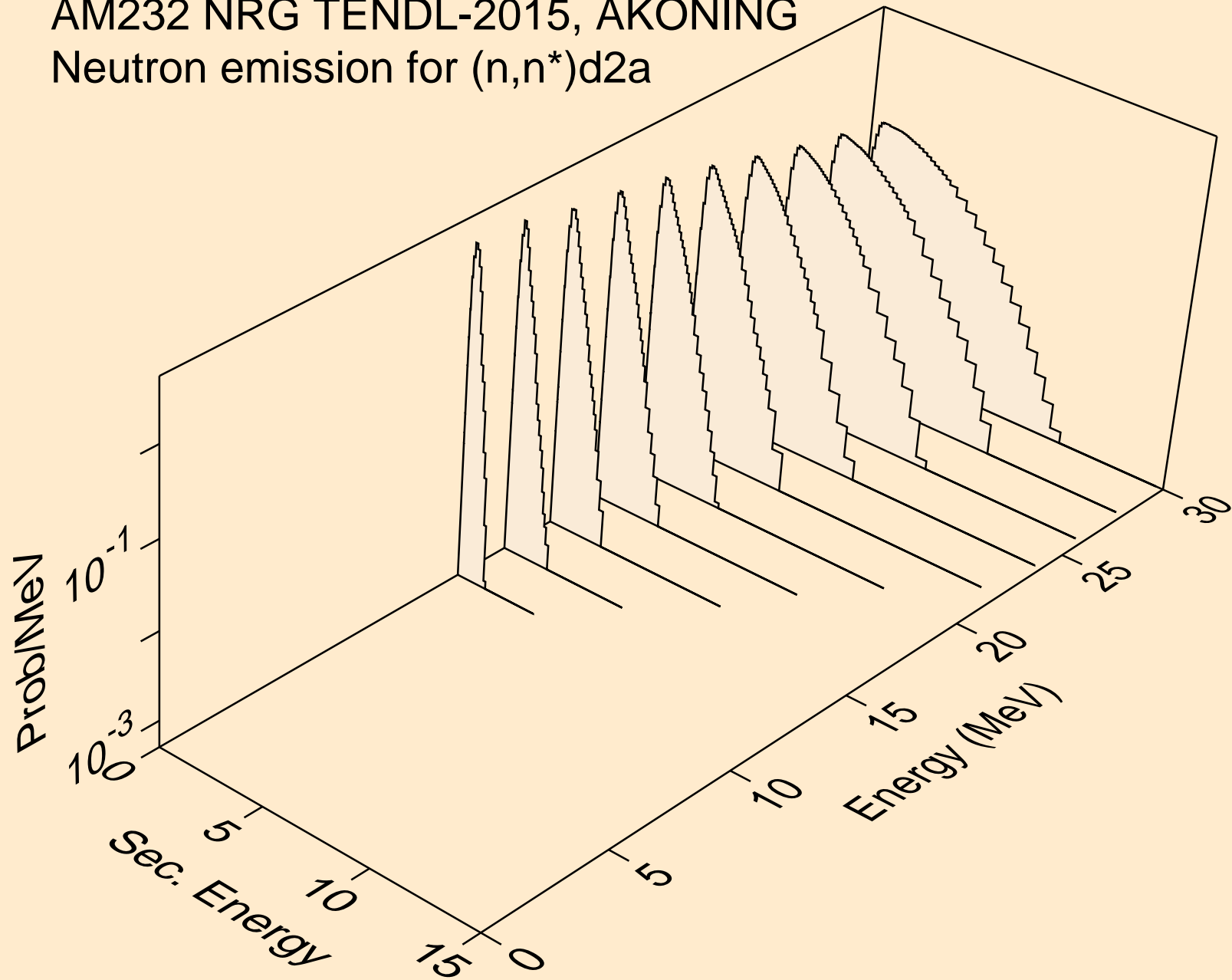

AM232 NRG TENDL-2015, AKONING
Neutron emission for (n,n*)t2a

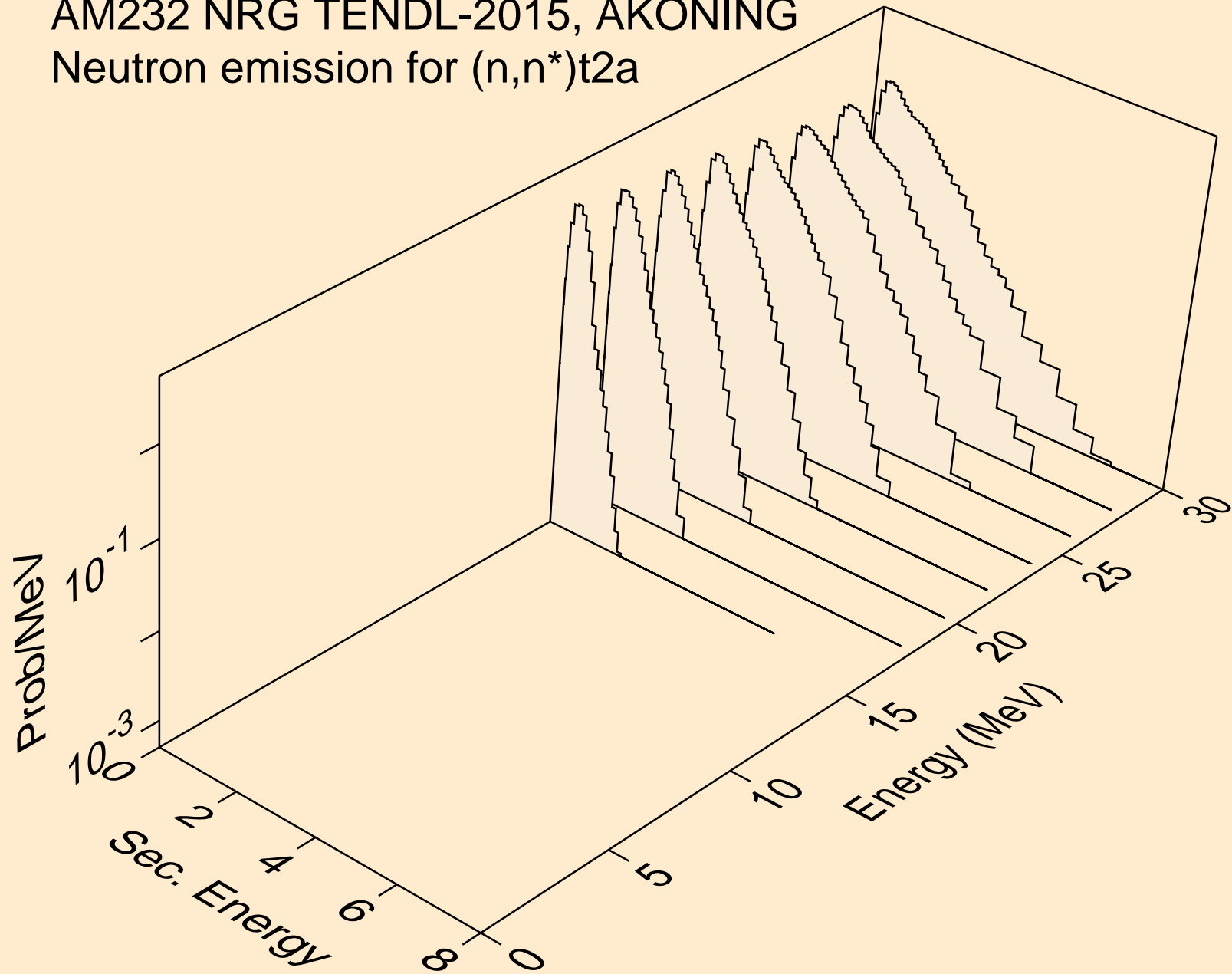

AM232 NRG TENDL-2015, AKONING
Neutron emission for (n,4n)

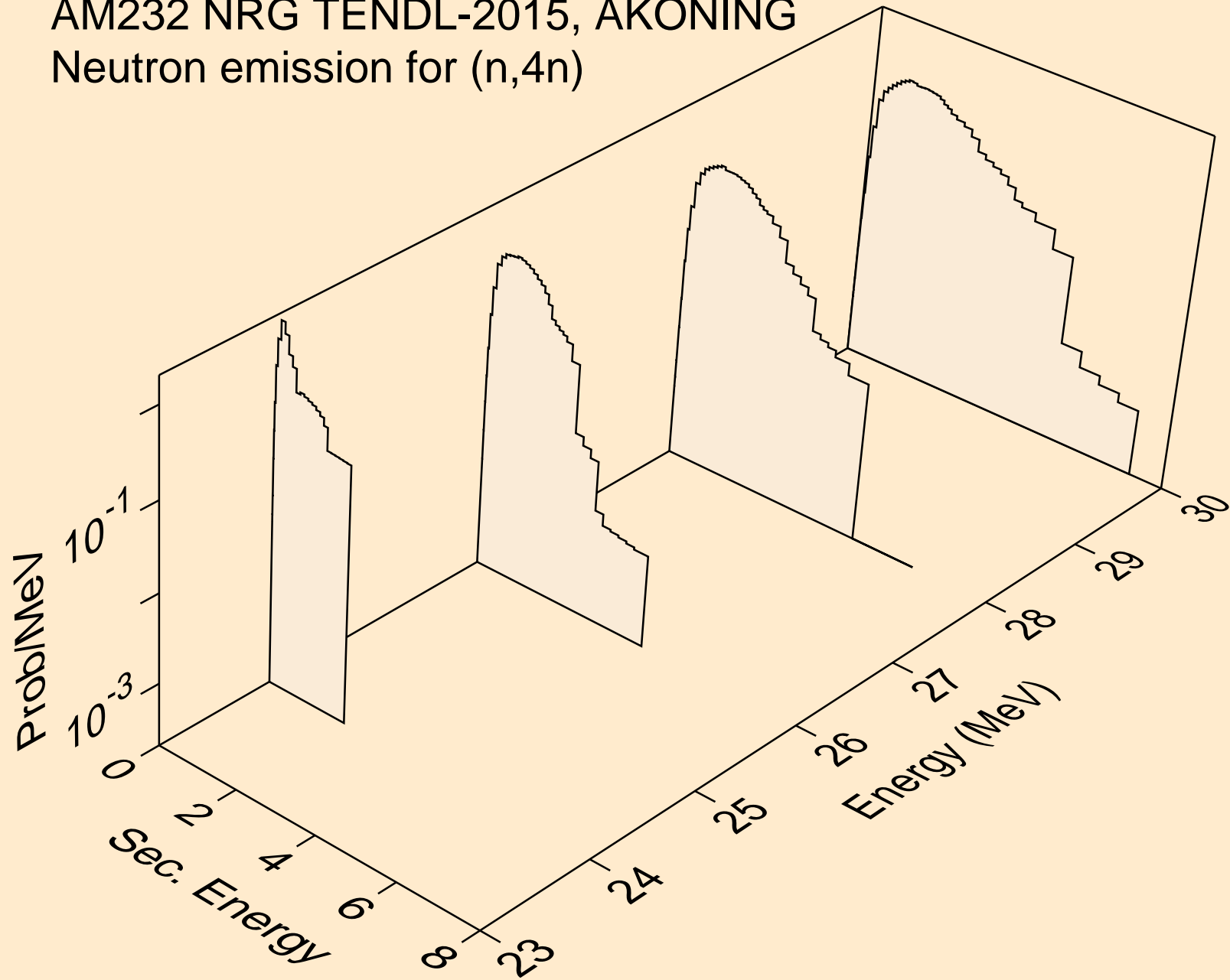

AM232 NRG TENDL-2015, AKONING
Neutron emission for (n,2np)

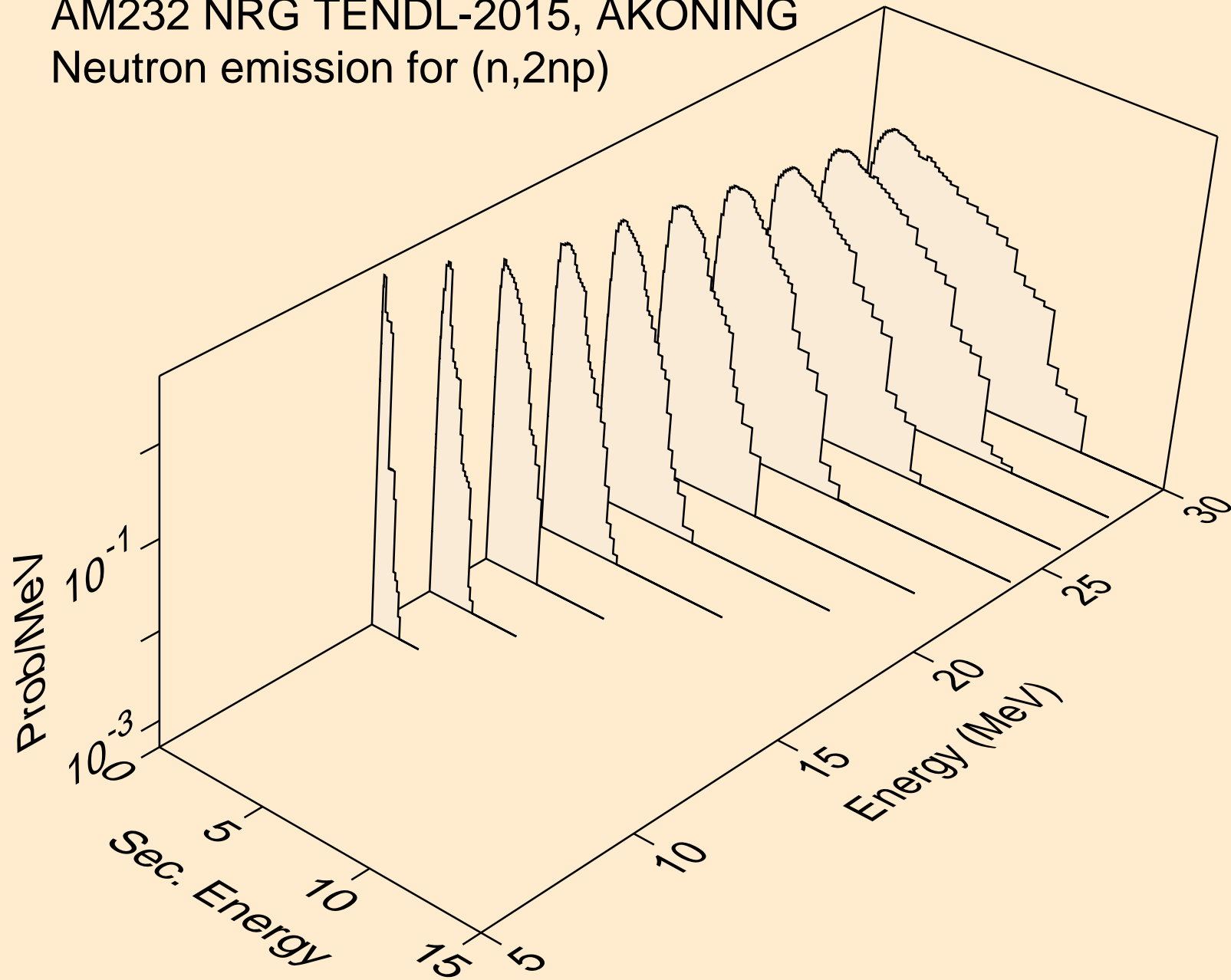

AM232 NRG TENDL-2015, AKONING
Neutron emission for (n,3np)

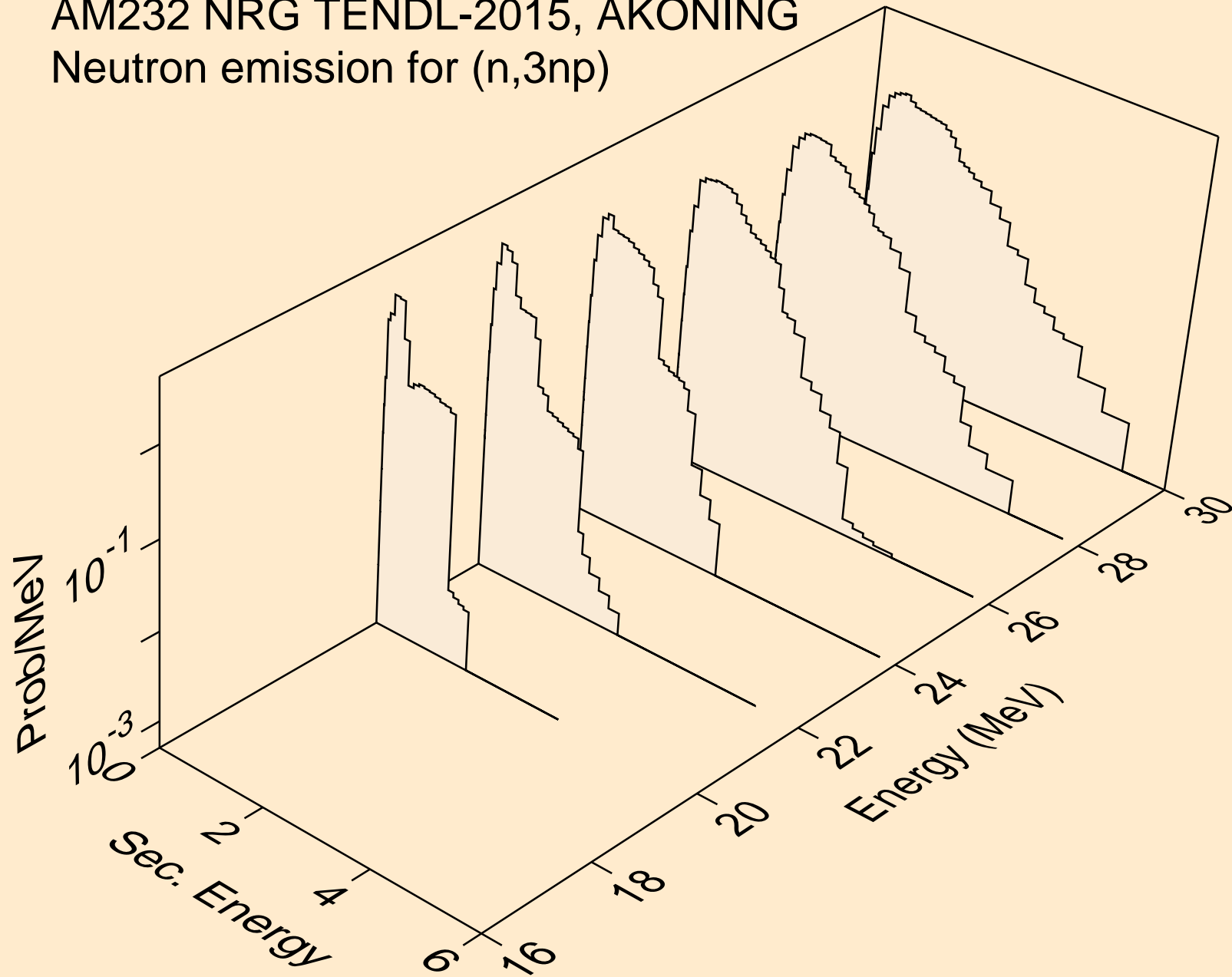

AM232 NRG TENDL-2015, AKONING
Neutron emission for (n,2np)

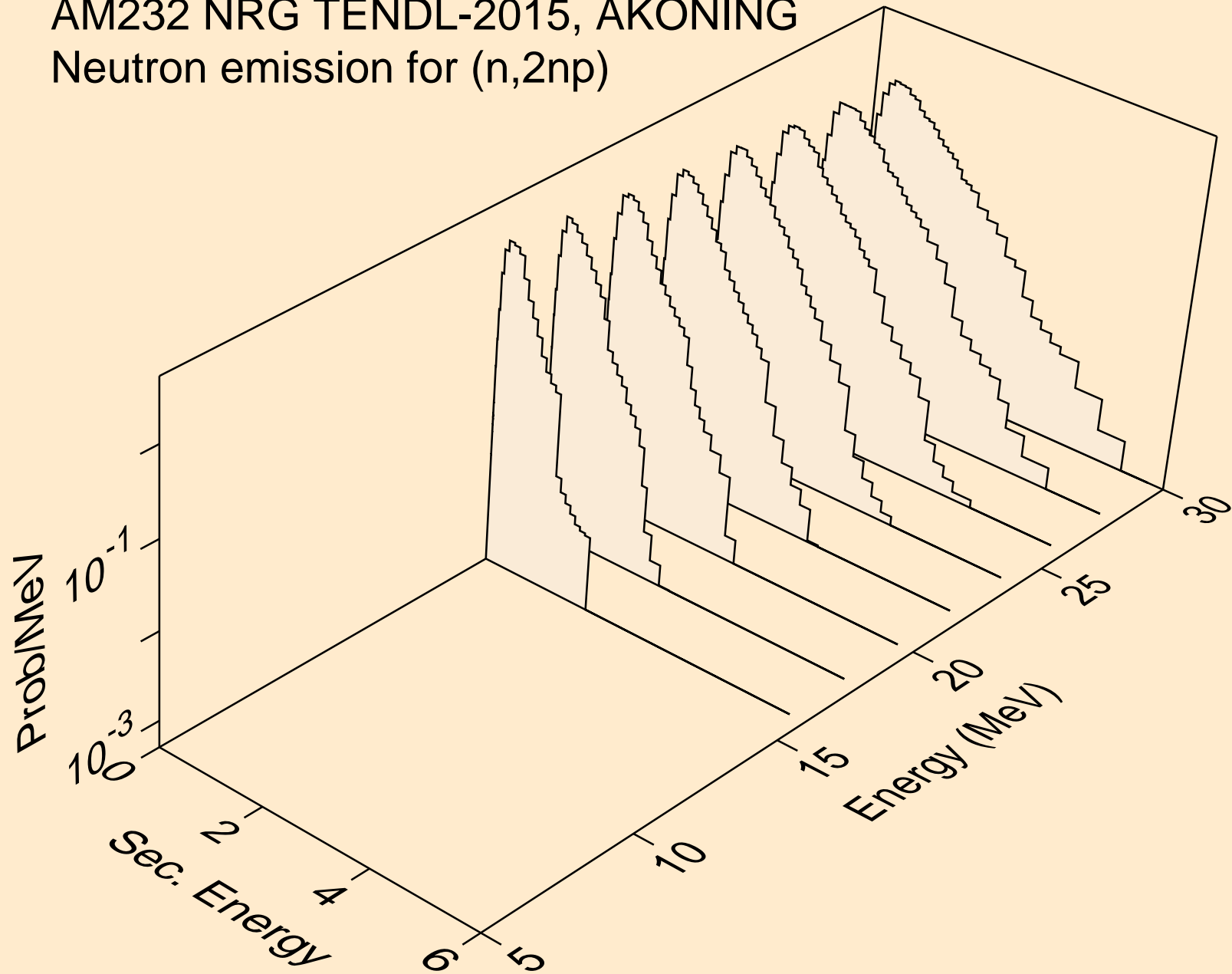

AM232 NRG TENDL-2015, AKONING
Neutron emission for (n,npa)

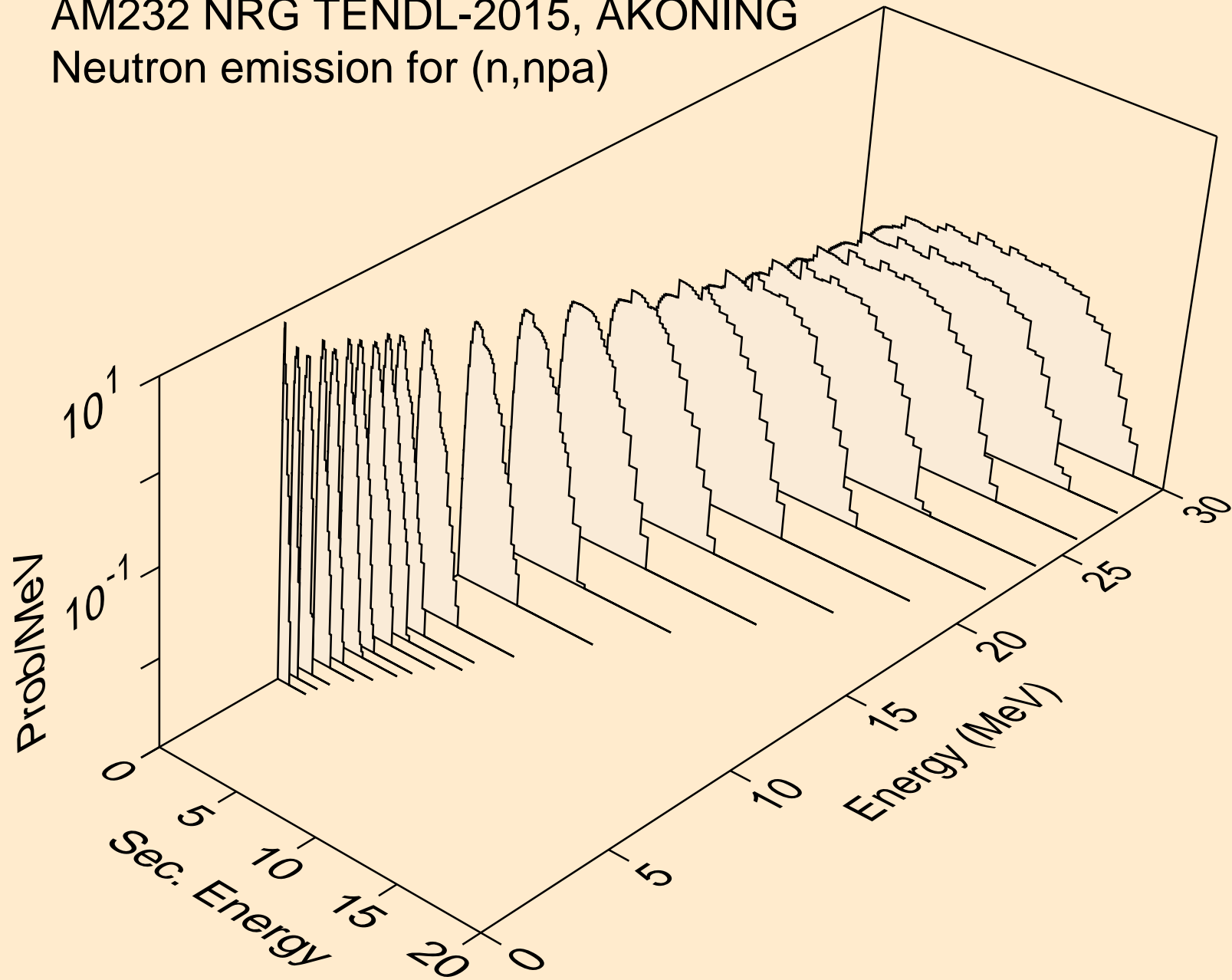

AM232 NRG TENDL-2015, AKONING
Neutron emission for (n,n*c)

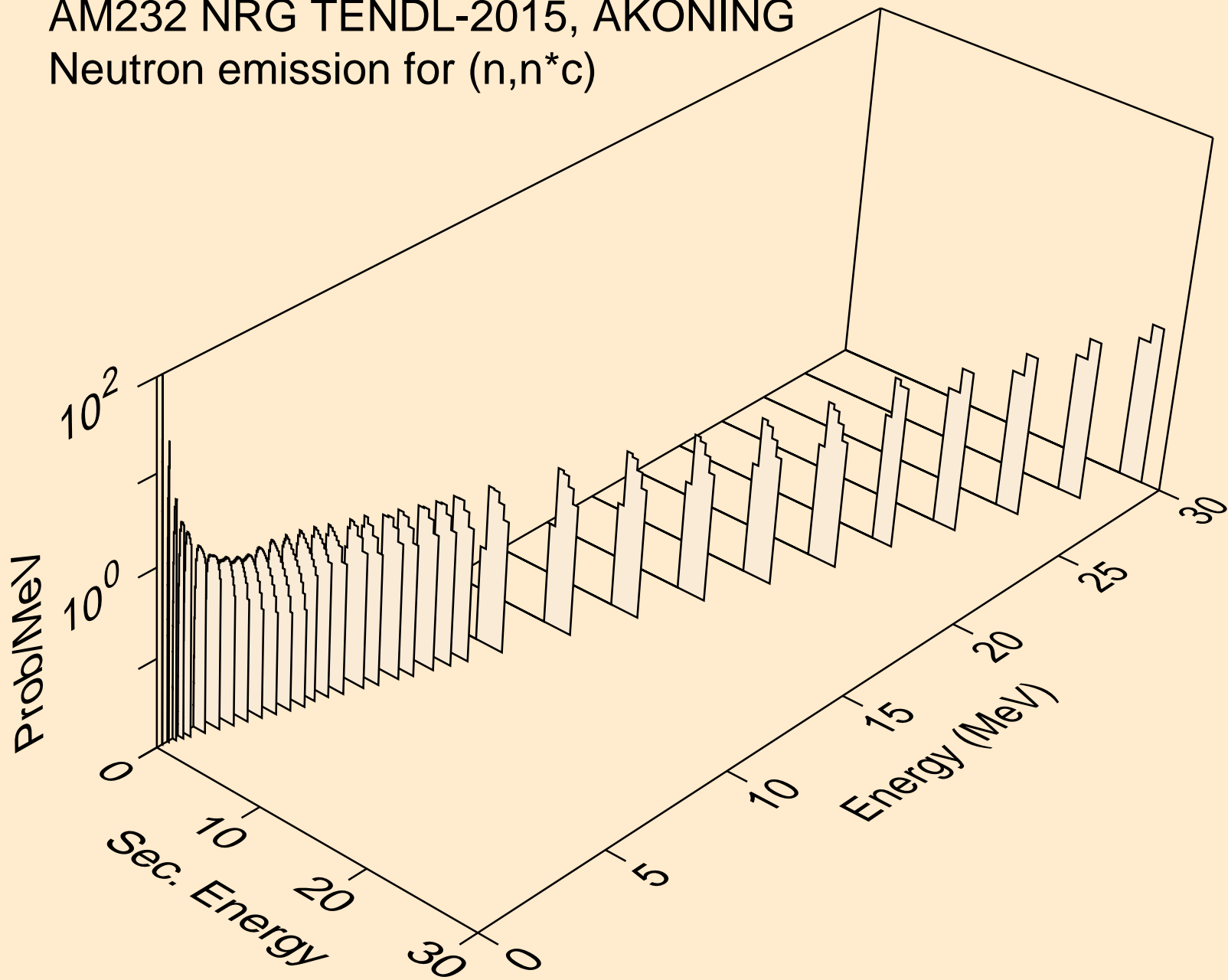

AM232 NRG TENDL-2015, AKONING

Delayed nubar

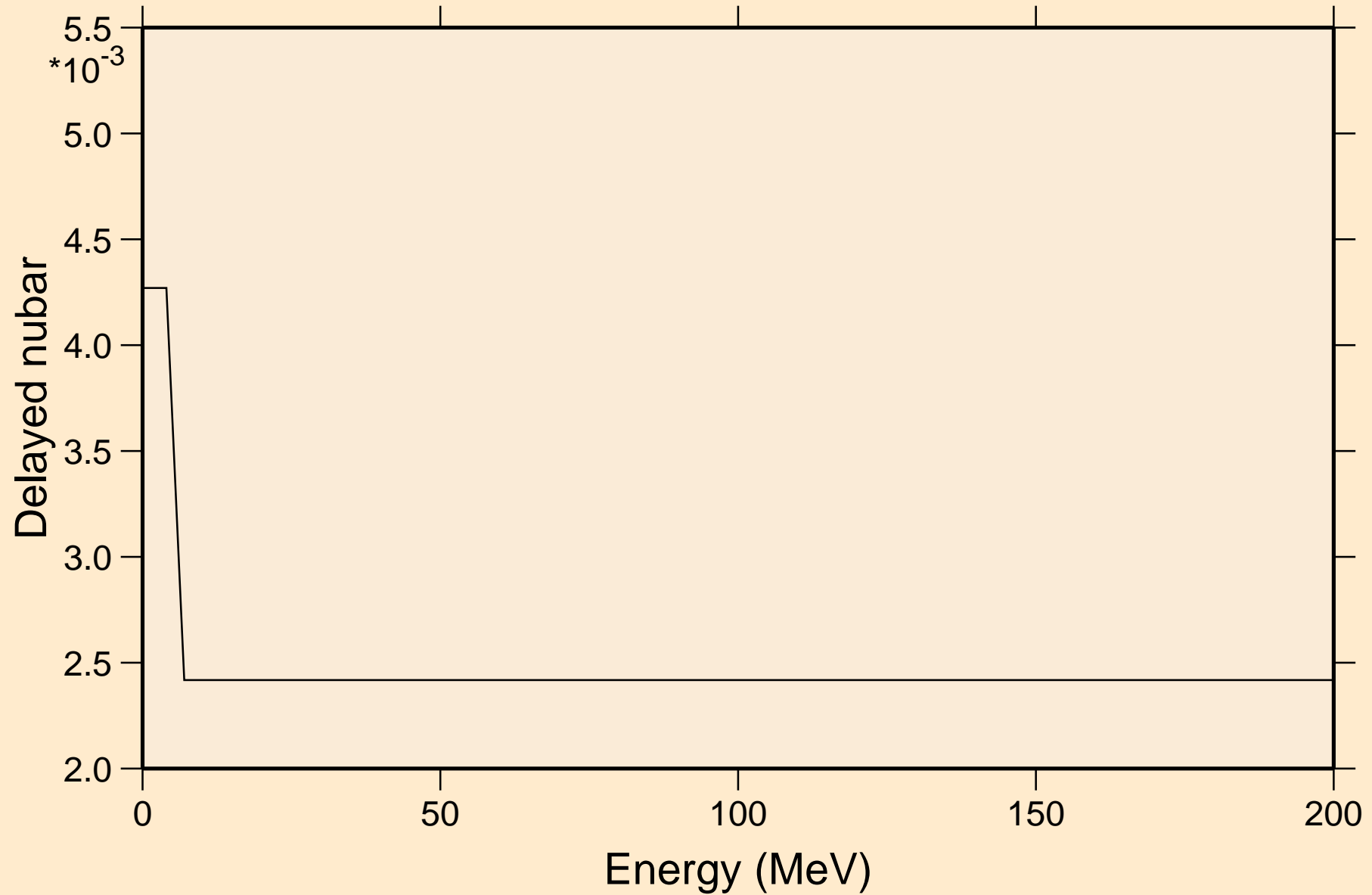

AM232 NRG TENDL-2015, AKONING

Delayed neutron spectra

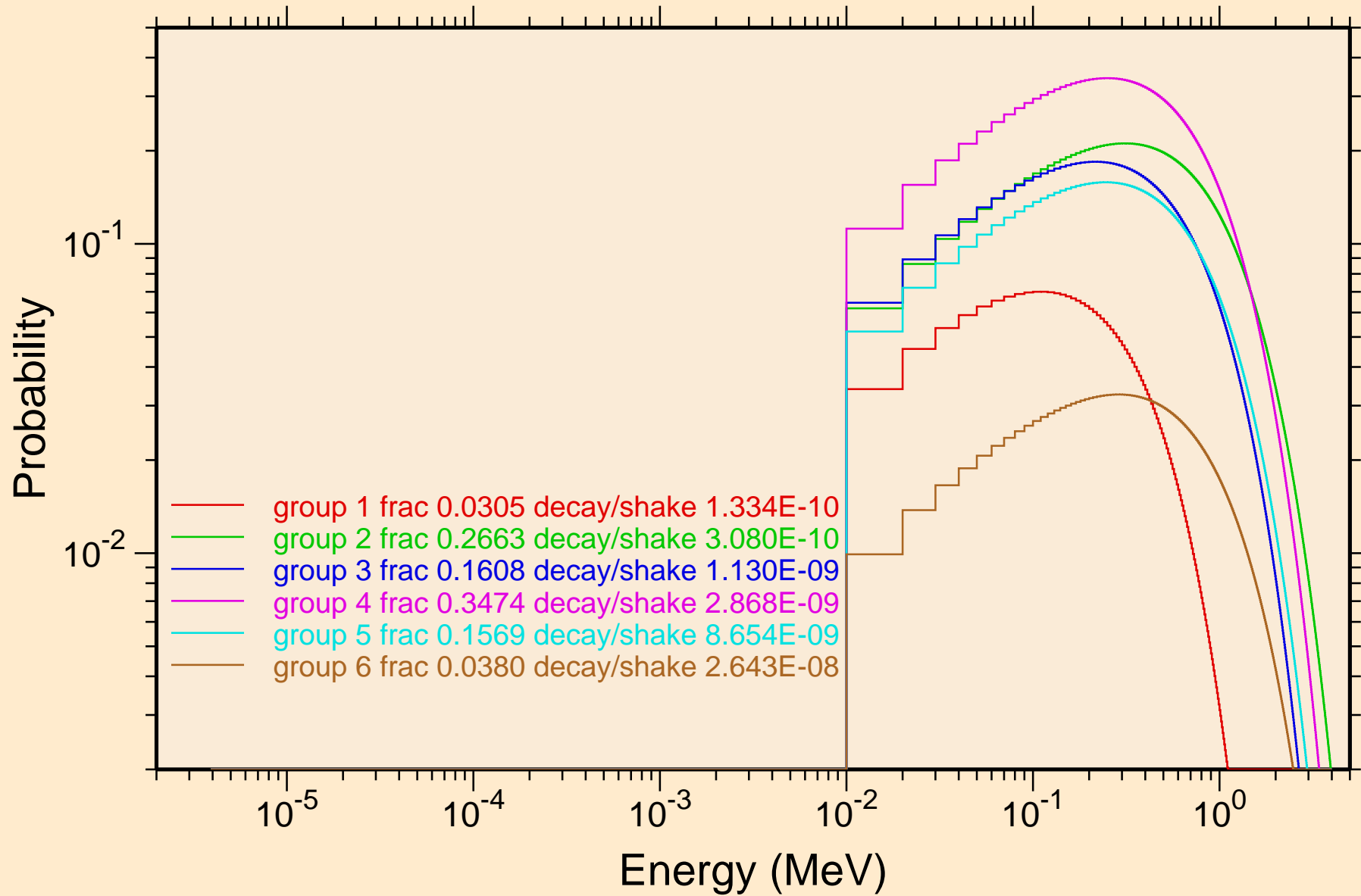

AM232 NRG TENDL-2015, AKONING
Photon emission for (n,x)

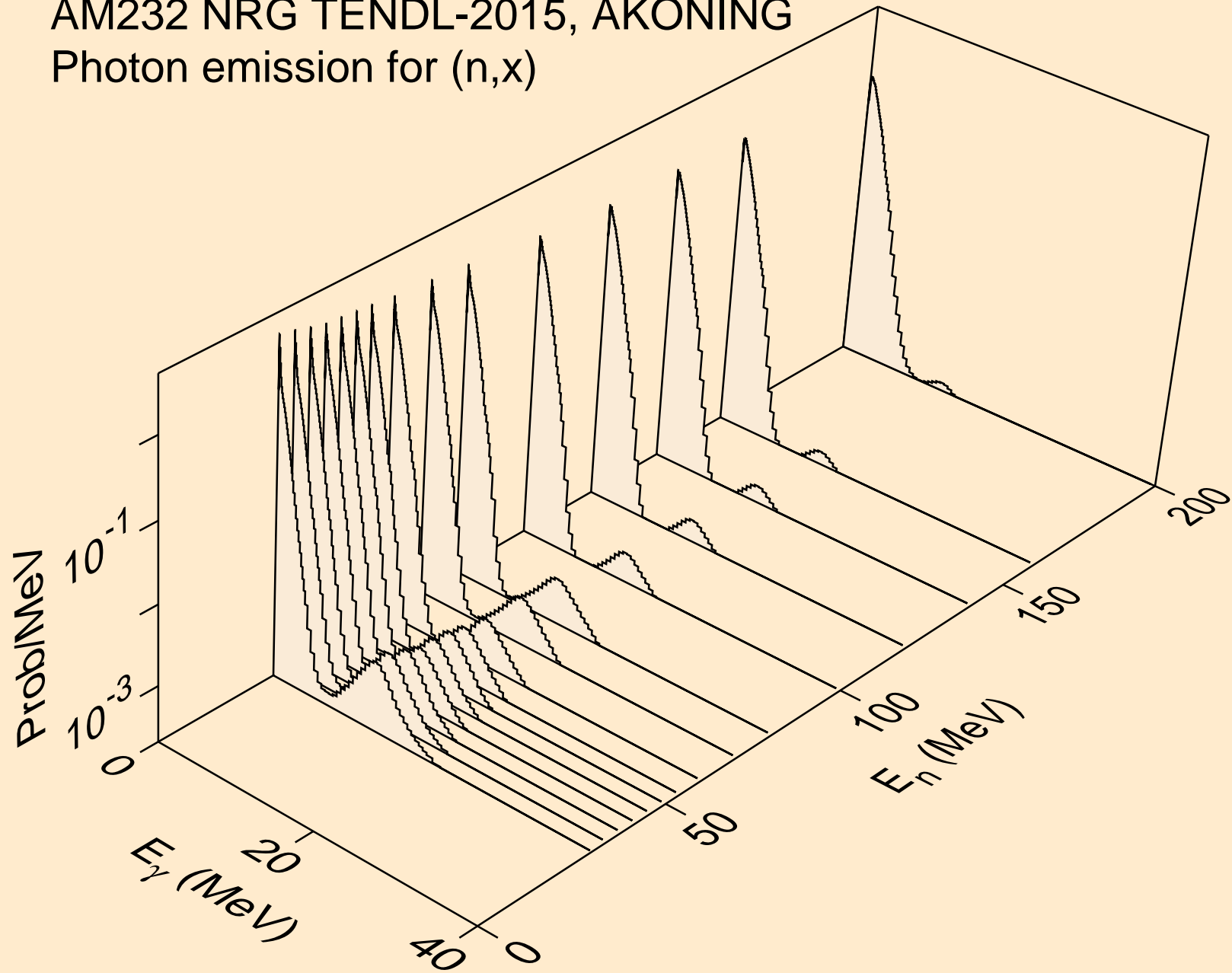

AM232 NRG TENDL-2015, AKONING
Photon emission for (n,2nd)

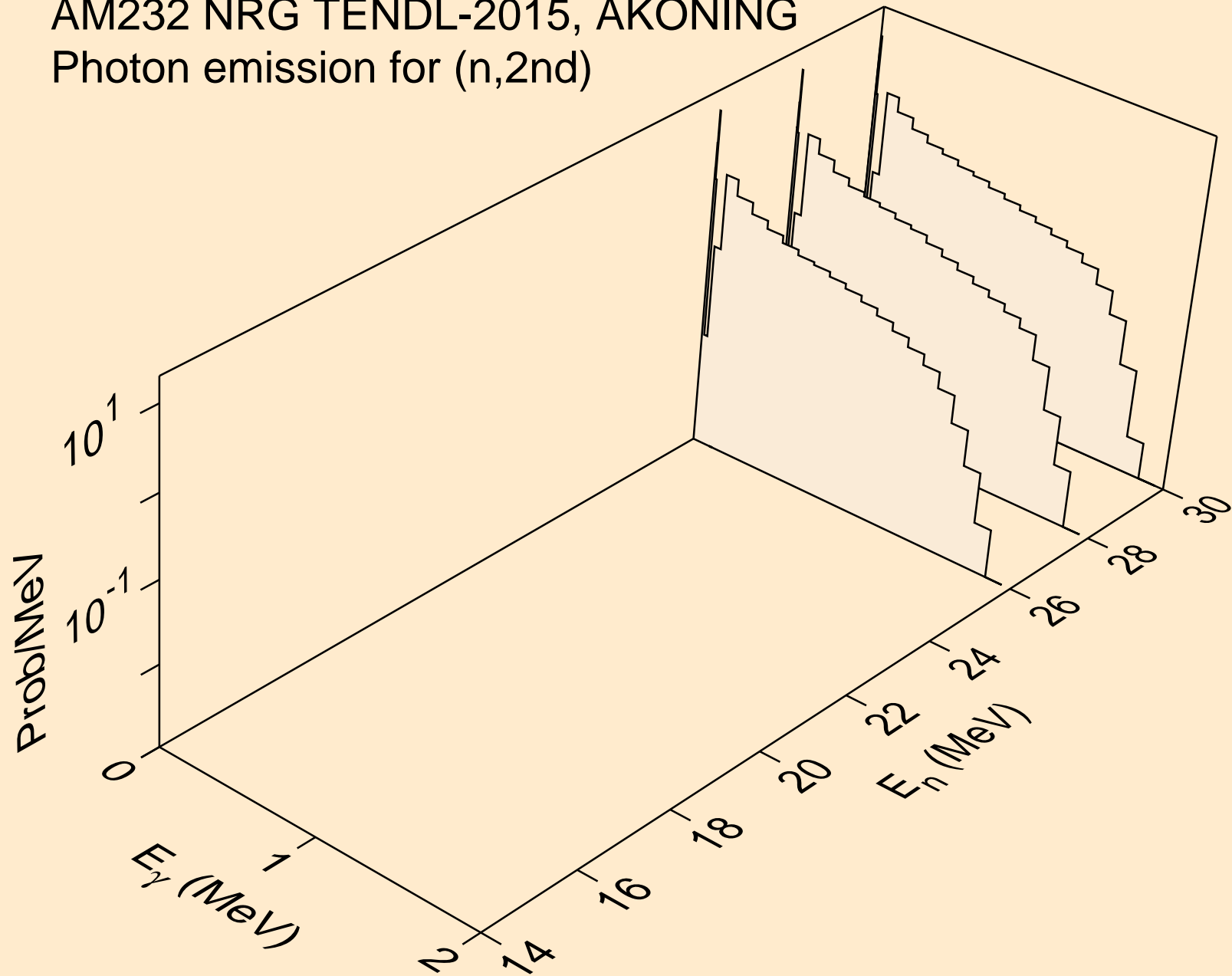

AM232 NRG TENDL-2015, AKONING
Photon emission for (n,2n)

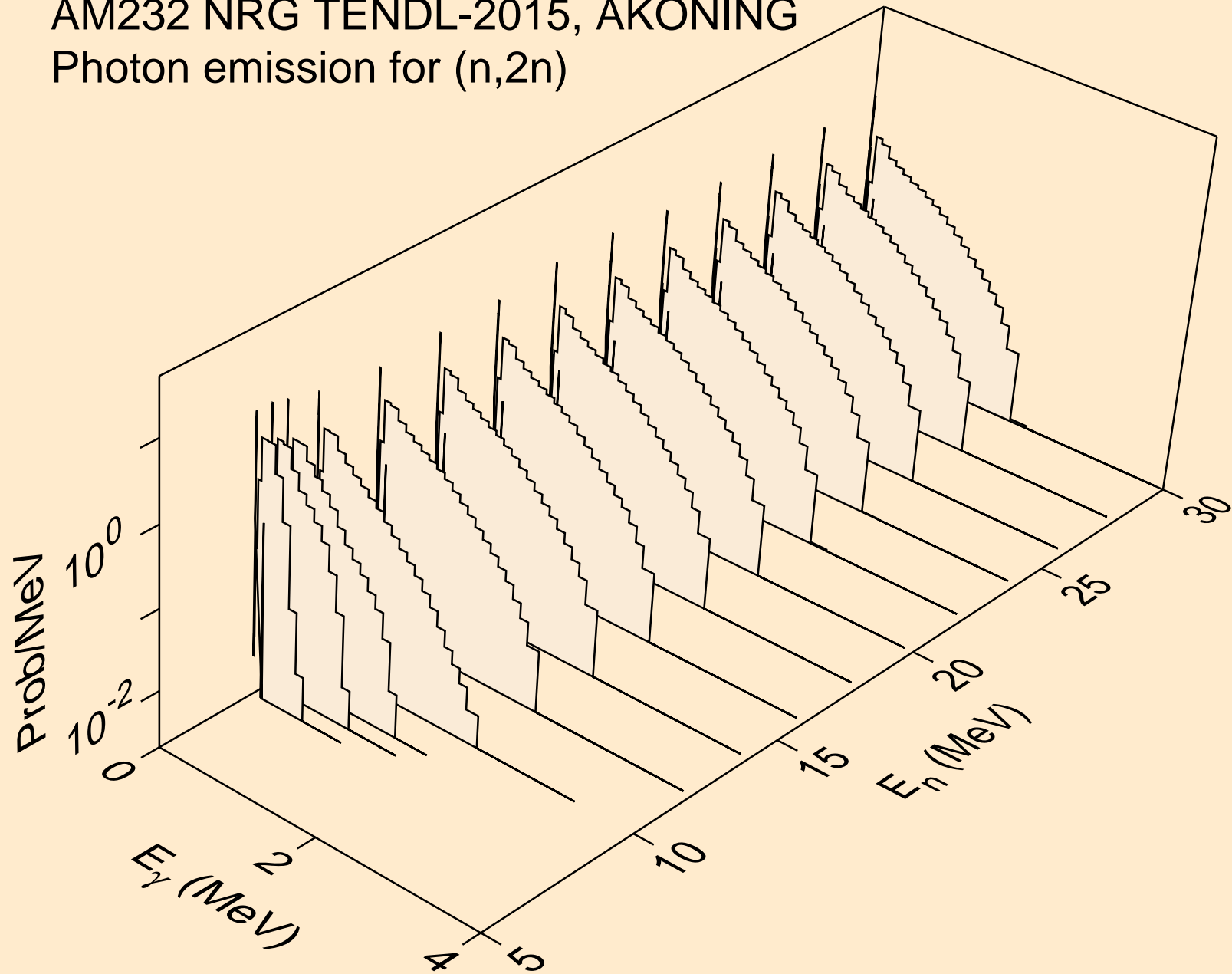

AM232 NRG TENDL-2015, AKONING
Photon emission for (n,3n)

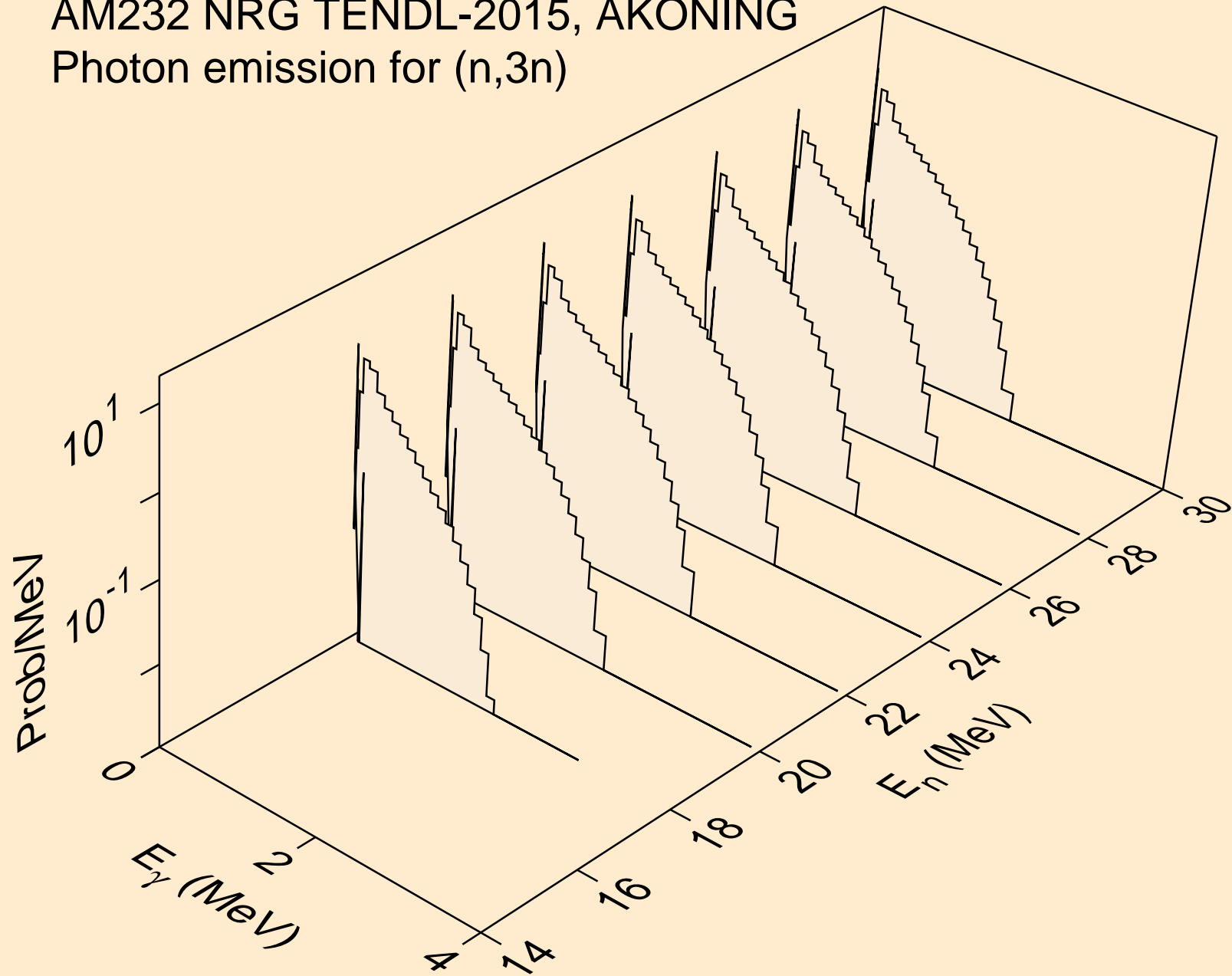

AM232 NRG TENDL-2015, AKONING
Photon emission for (n,n*)a

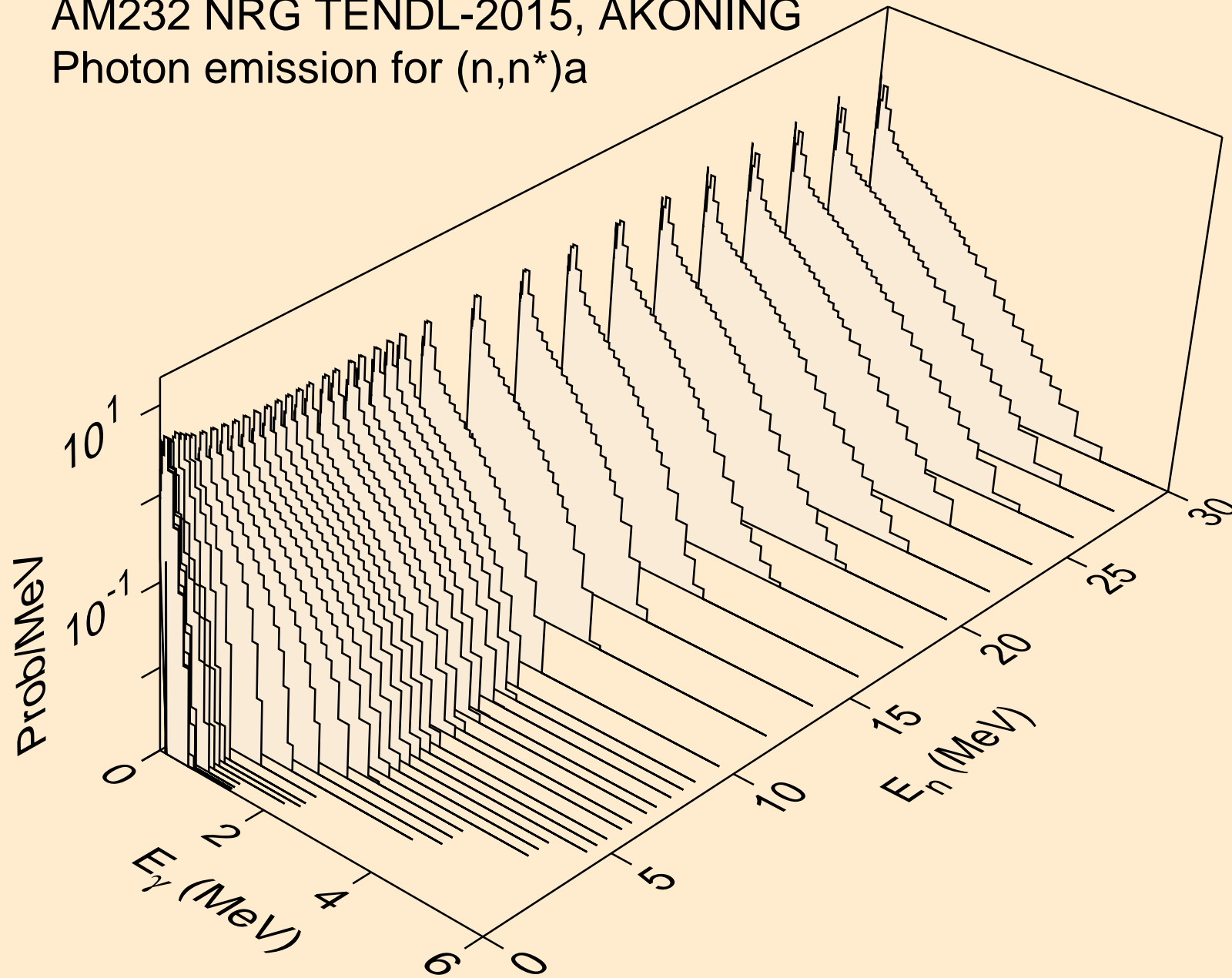

AM232 NRG TENDL-2015, AKONING
Photon emission for (n,n*)3a

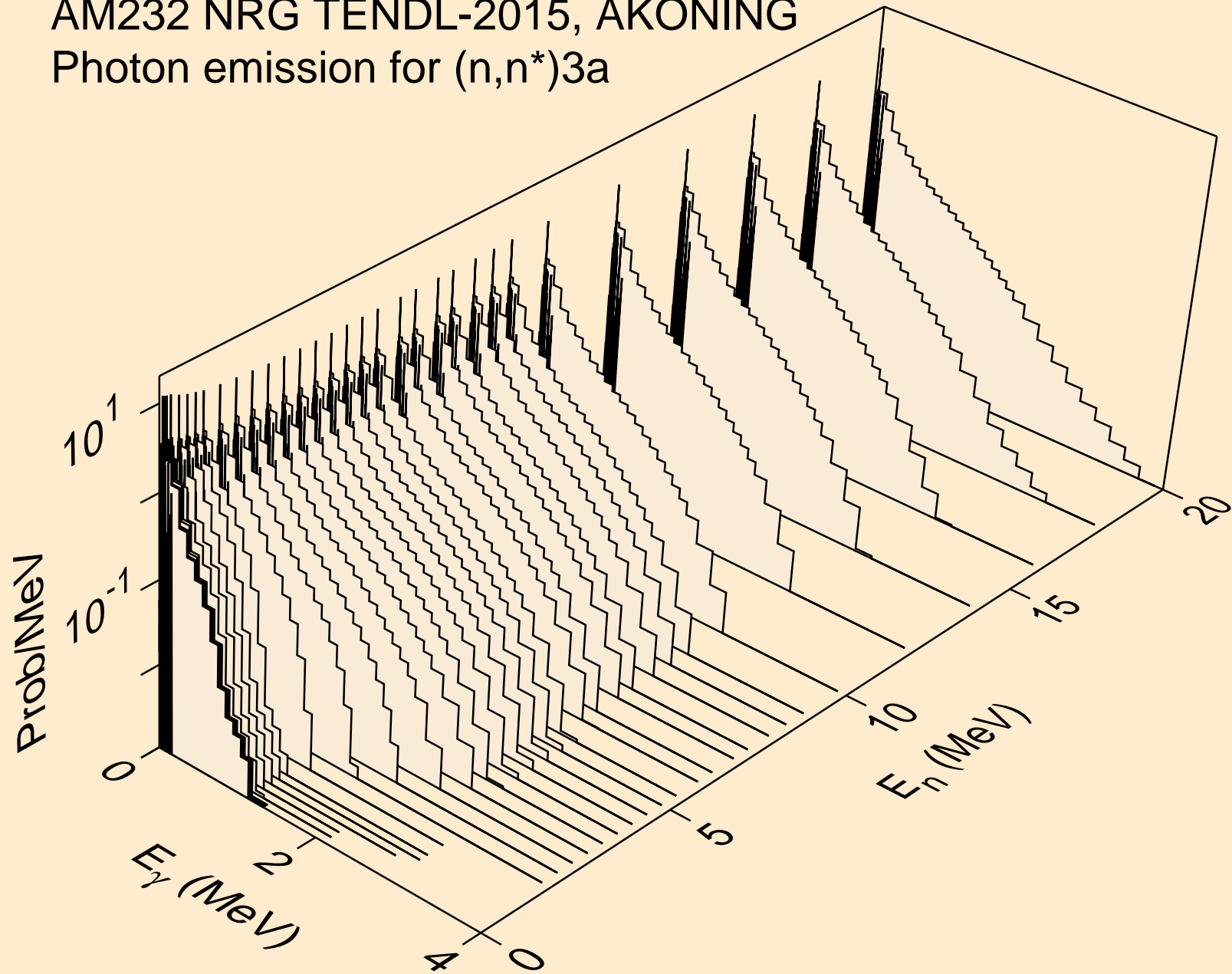

AM232 NRG TENDL-2015, AKONING
Photon emission for (n,2n)a

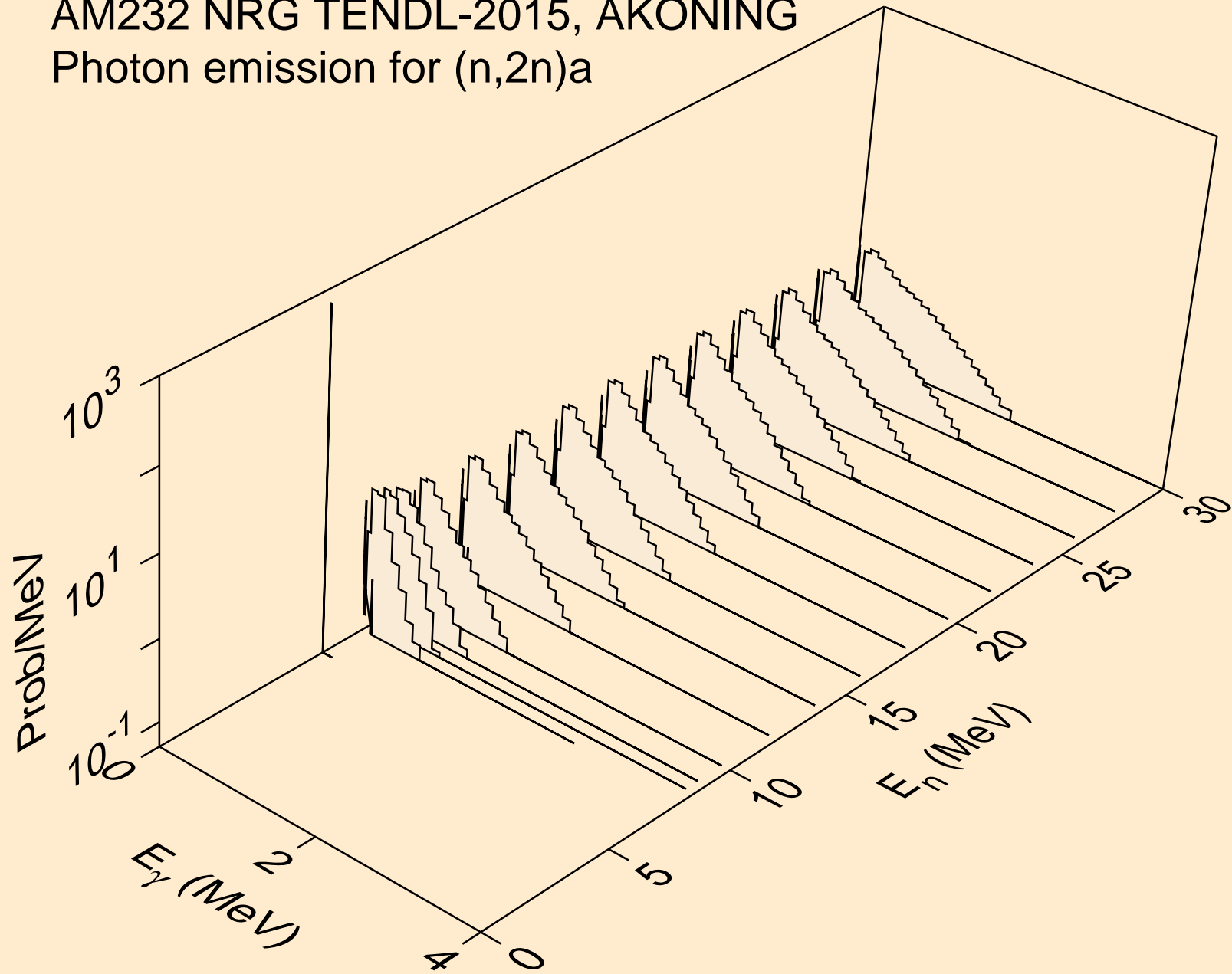

AM232 NRG TENDL-2015, AKONING
Photon emission for (n,3n)a

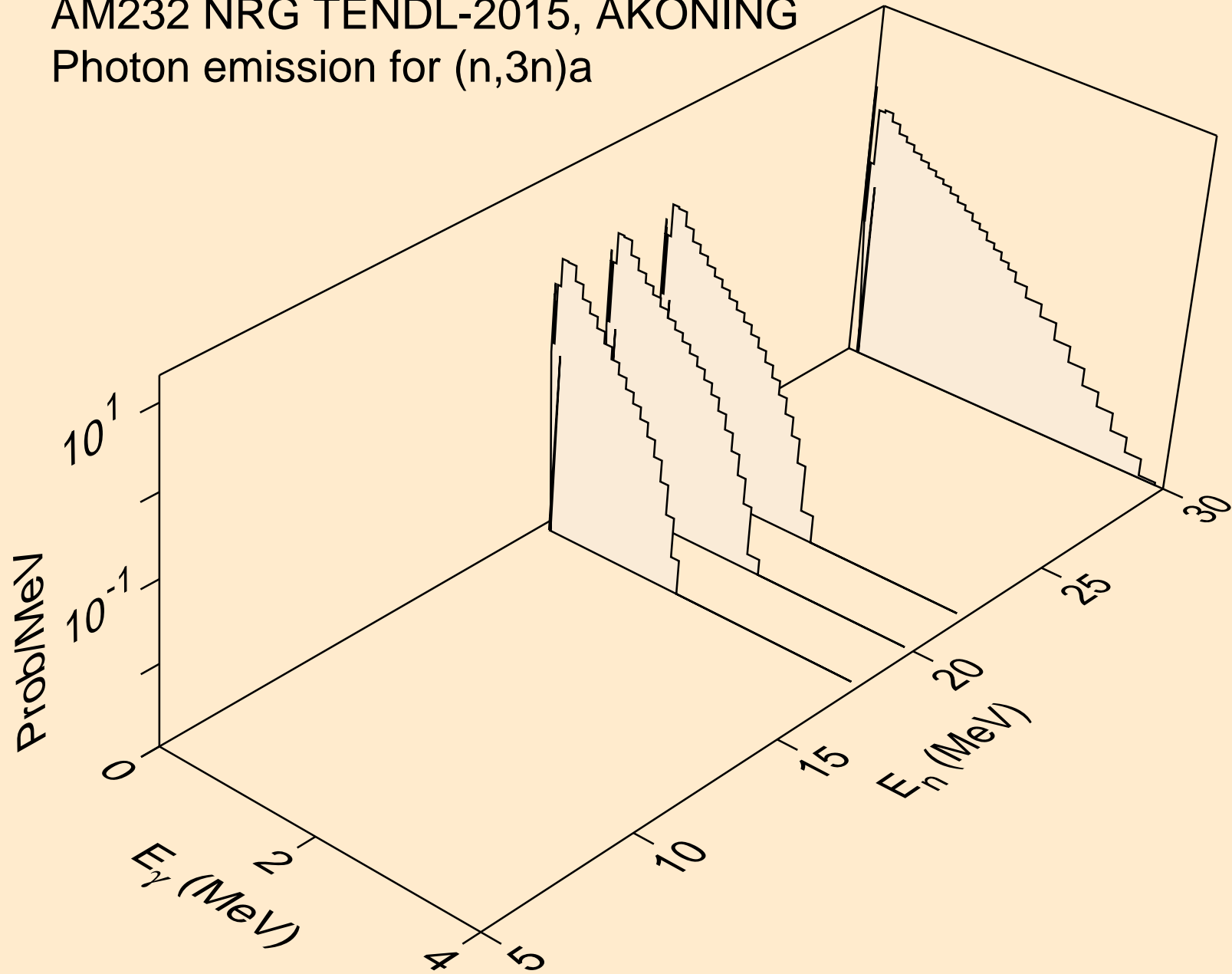

AM232 NRG TENDL-2015, AKONING
Photon emission for (n,n*)p

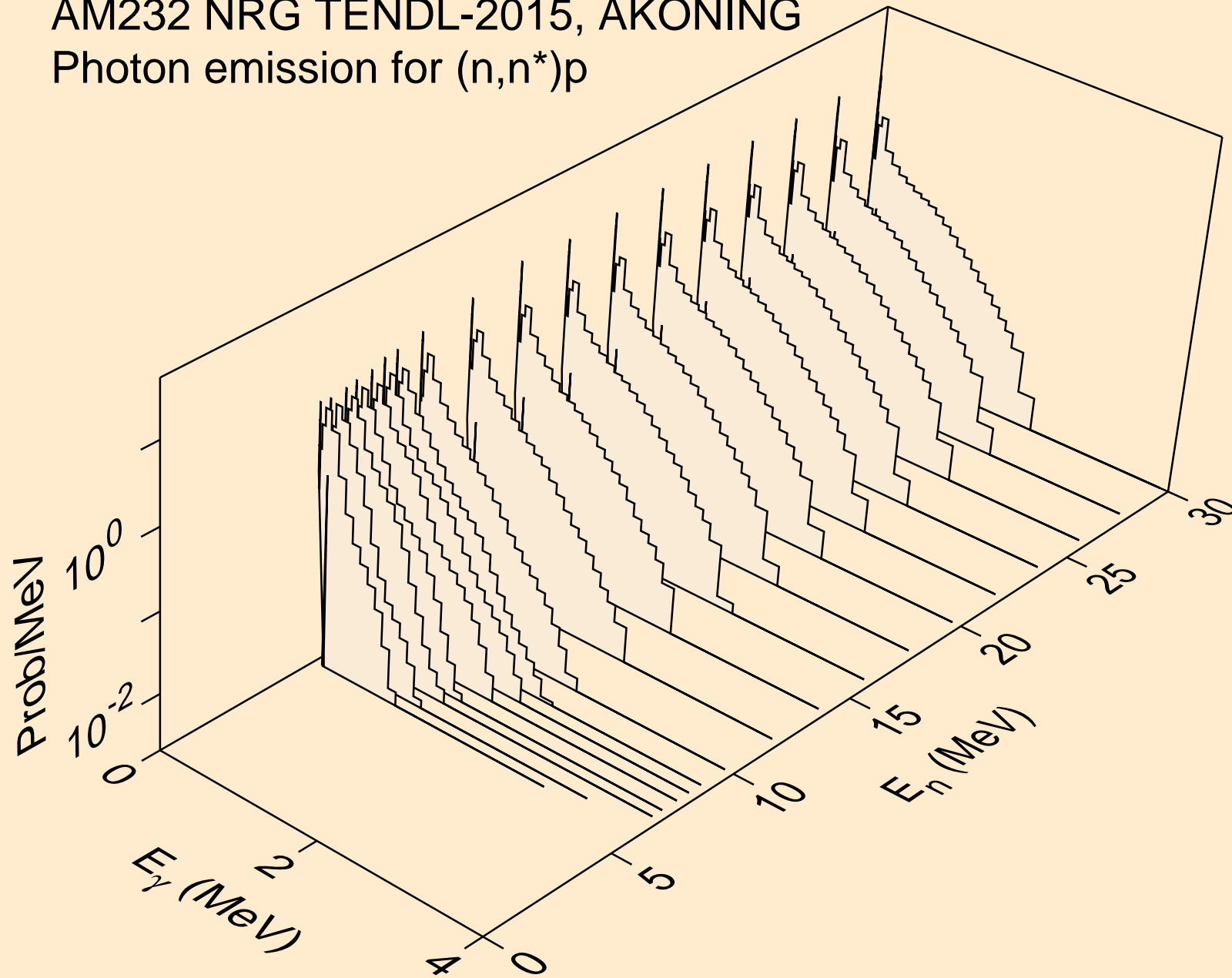

AM232 NRG TENDL-2015, AKONING
Photon emission for (n,n*)2a

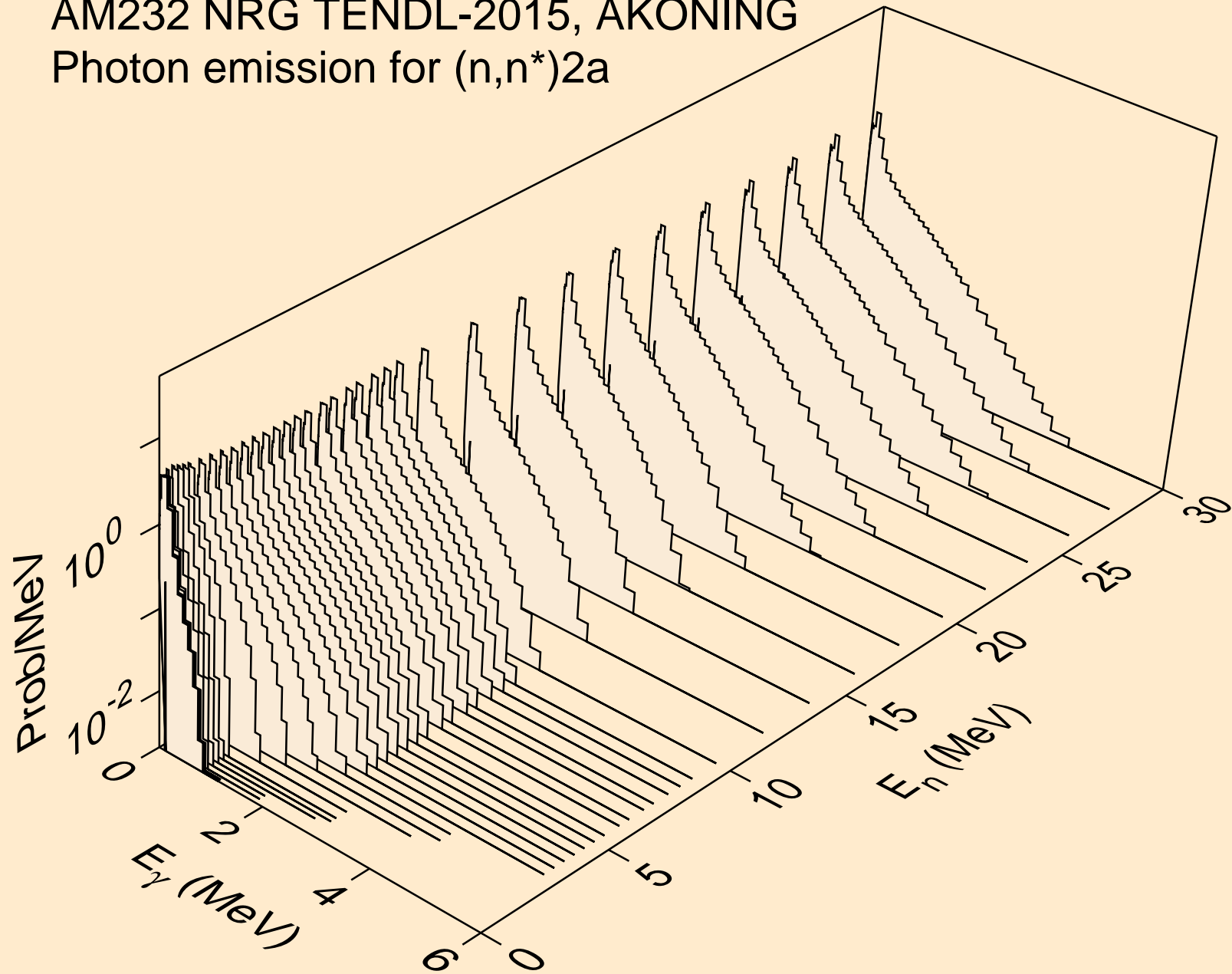

AM232 NRG TENDL-2015, AKONING
Photon emission for (n,2n)2a

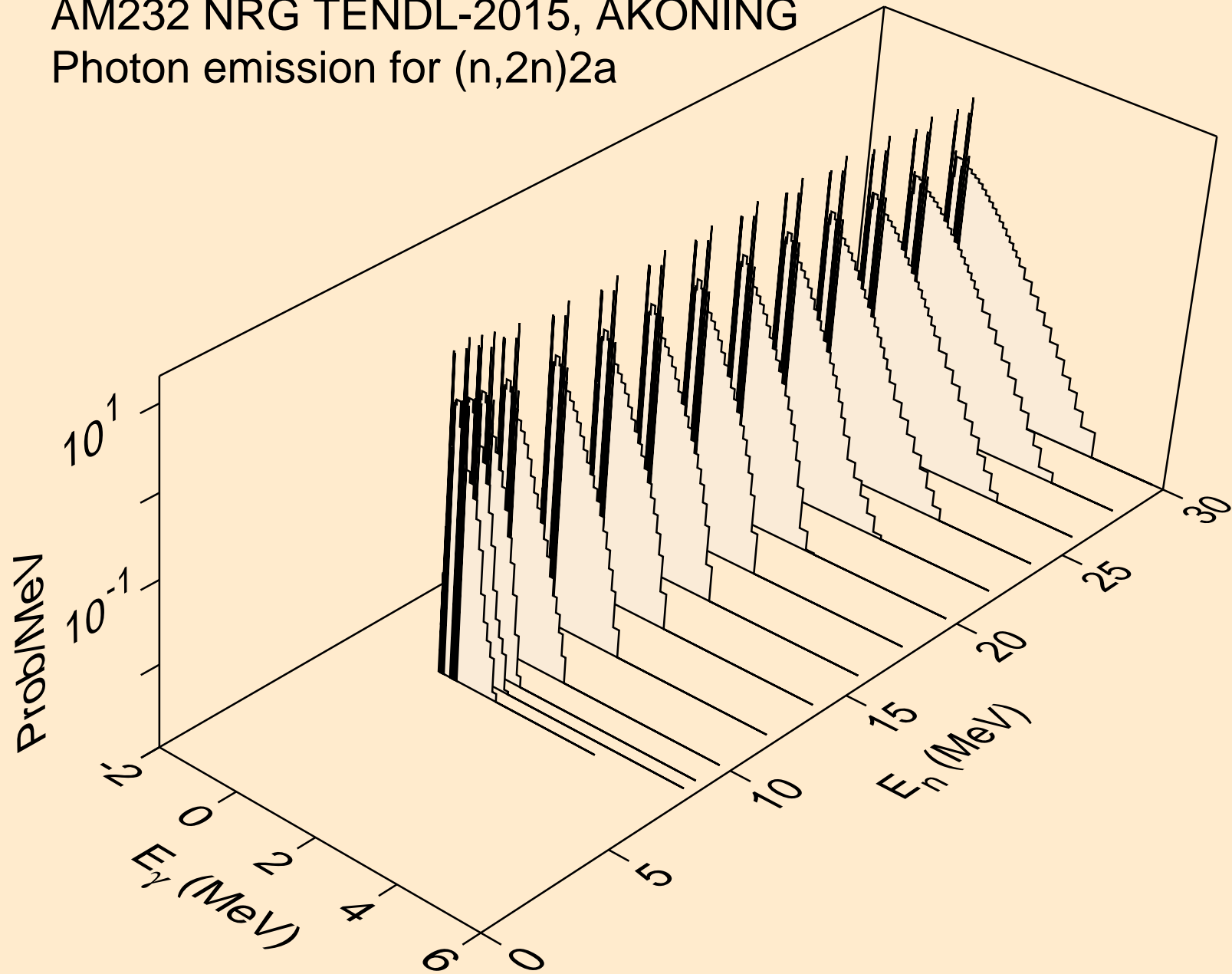

AM232 NRG TENDL-2015, AKONING
Photon emission for (n,n*)d

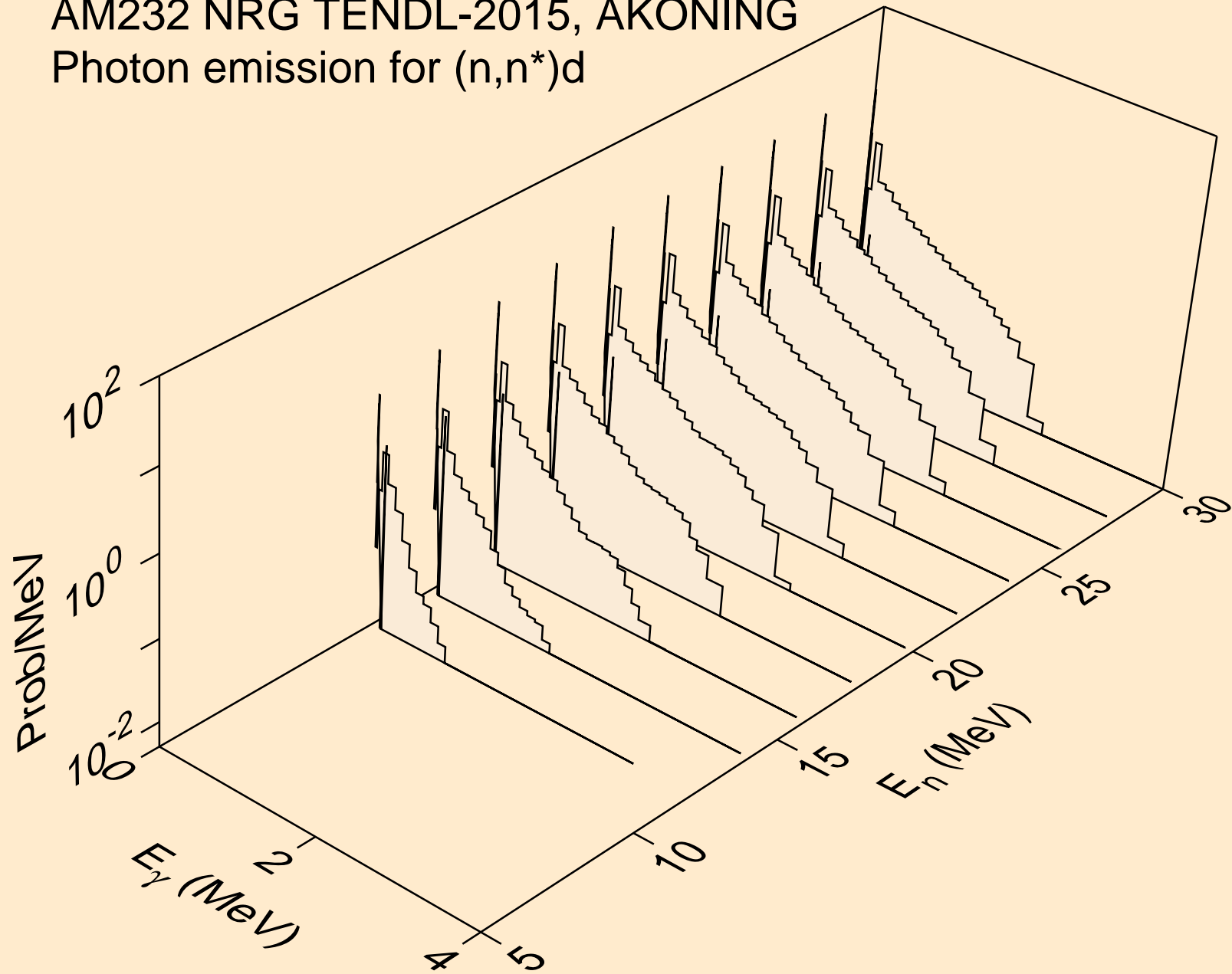

AM232 NRG TENDL-2015, AKONING
Photon emission for (n,n*)t

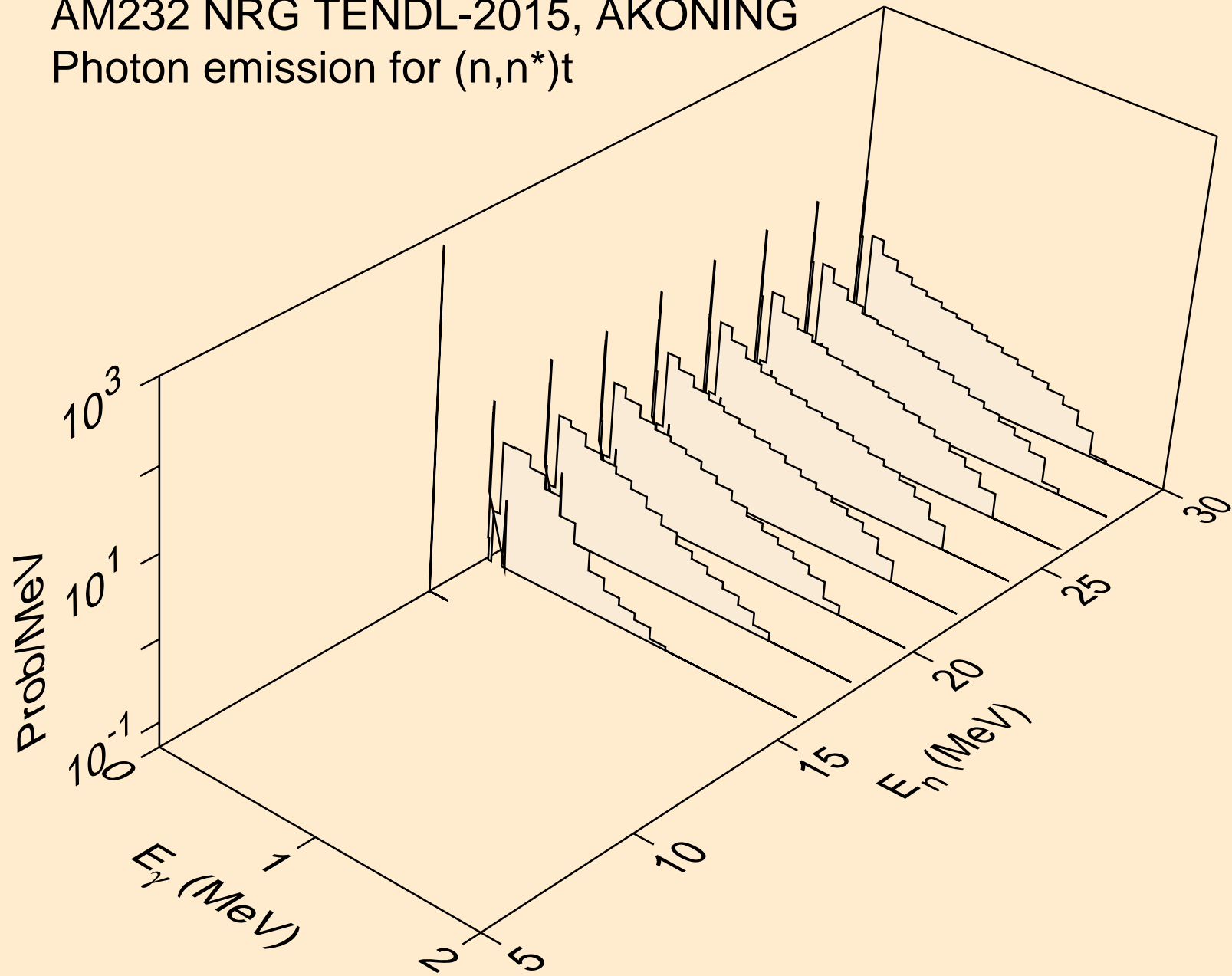

AM232 NRG TENDL-2015, AKONING
Photon emission for (n,n*)he3

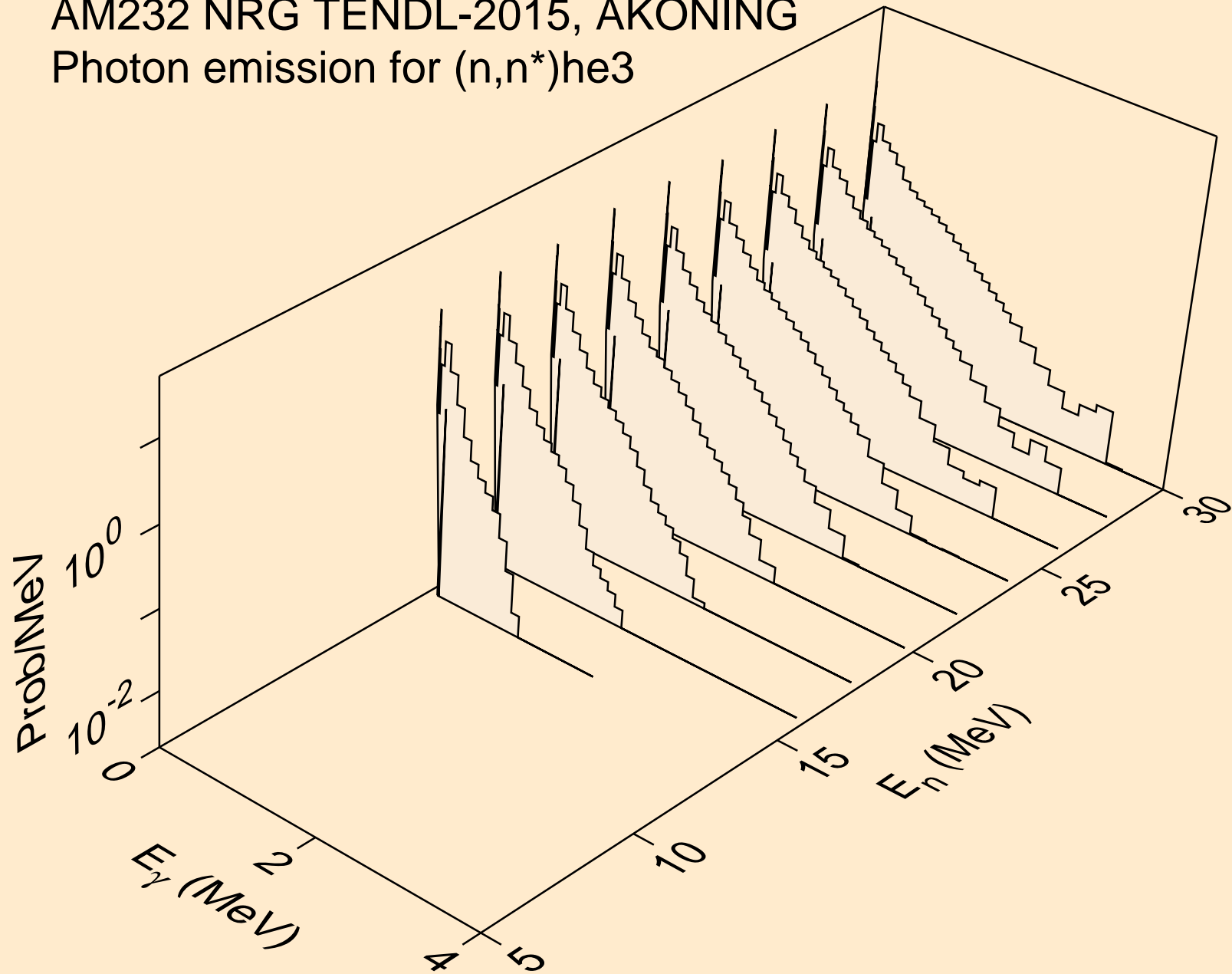

AM232 NRG TENDL-2015, AKONING
Photon emission for (n,n*)d2a

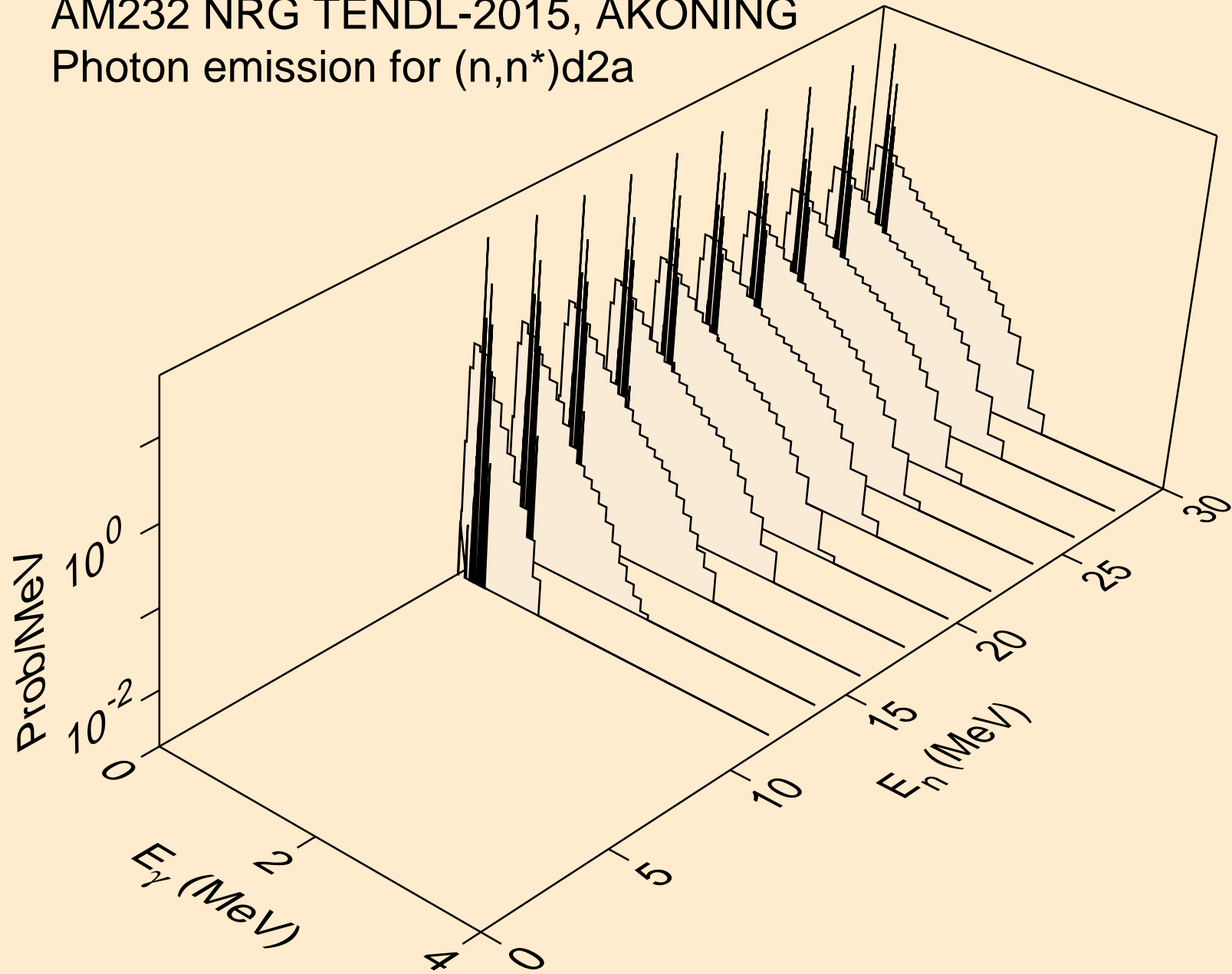

AM232 NRG TENDL-2015, AKONING
Photon emission for (n,n*)t2a

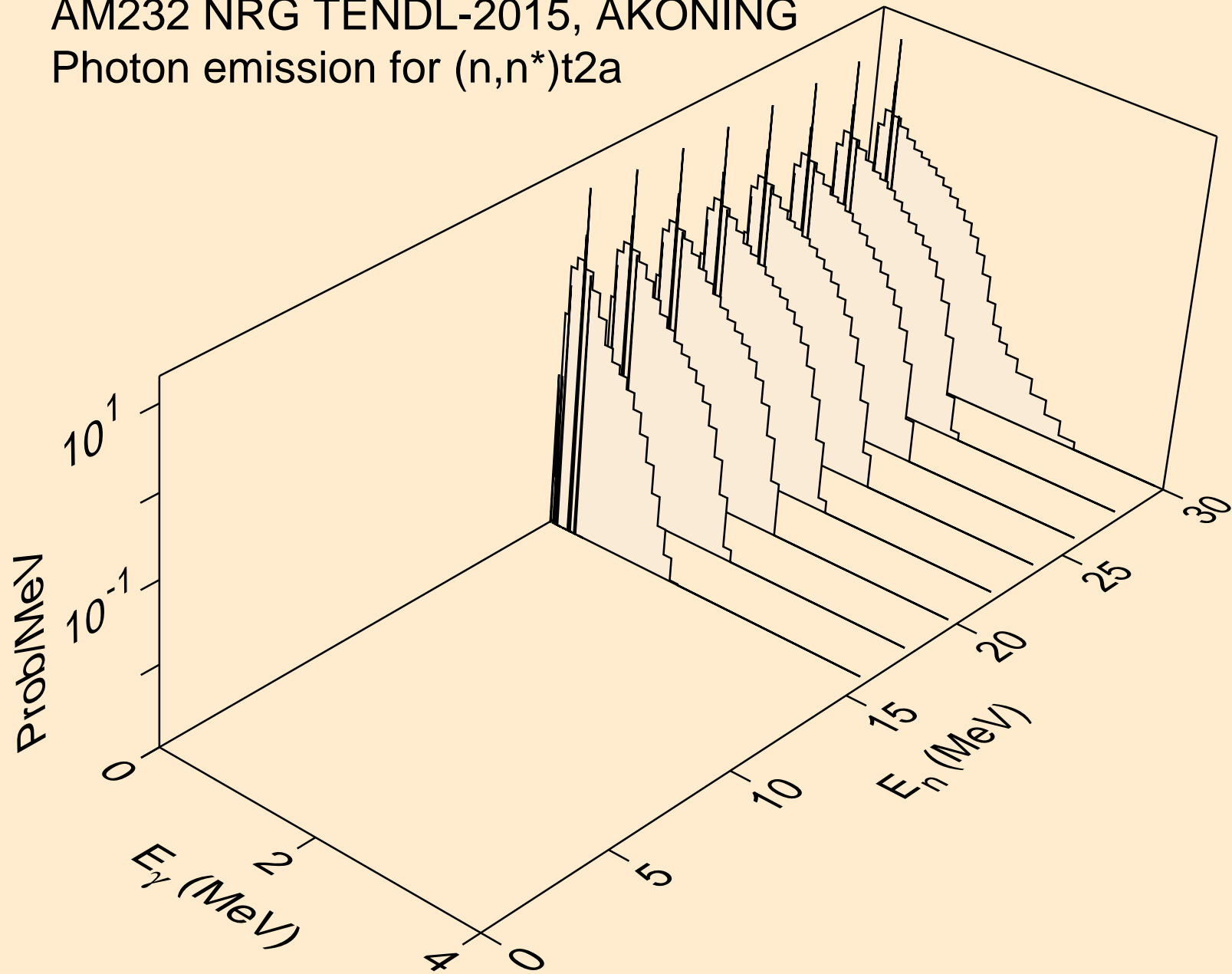

AM232 NRG TENDL-2015, AKONING
Photon emission for (n,4n)

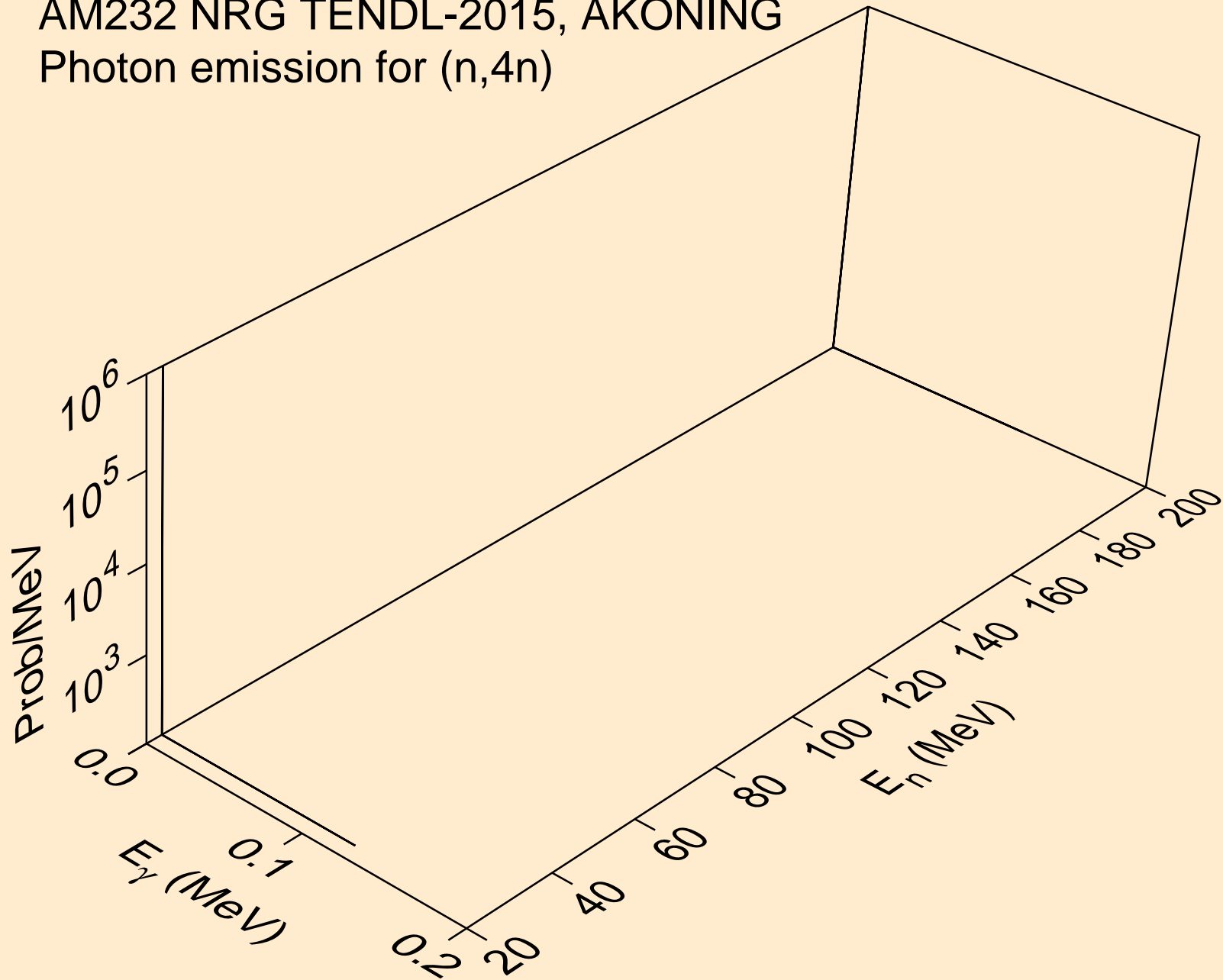

AM232 NRG TENDL-2015, AKONING
Photon emission for (n,2np)

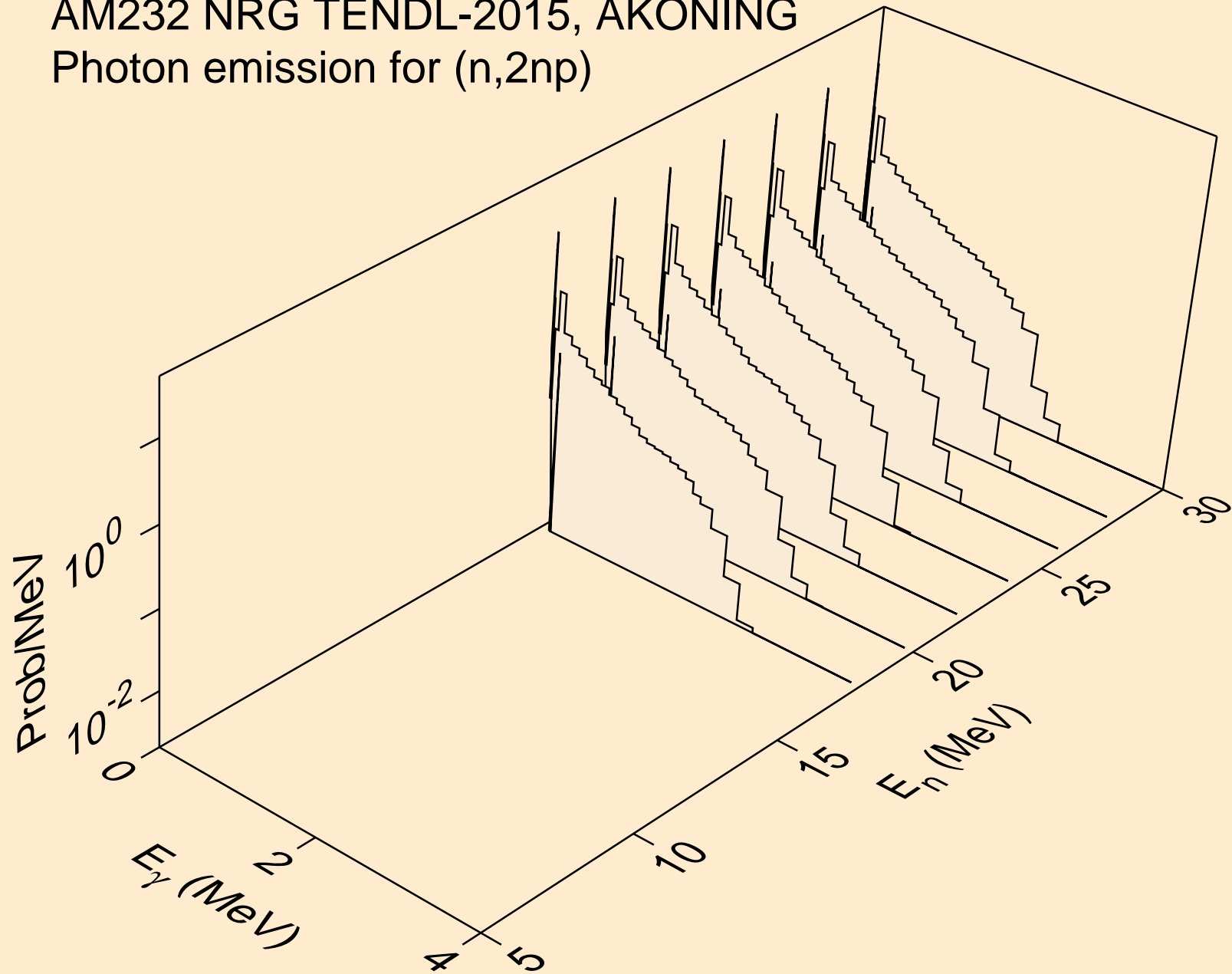

AM232 NRG TENDL-2015, AKONING
Photon emission for (n,3np)

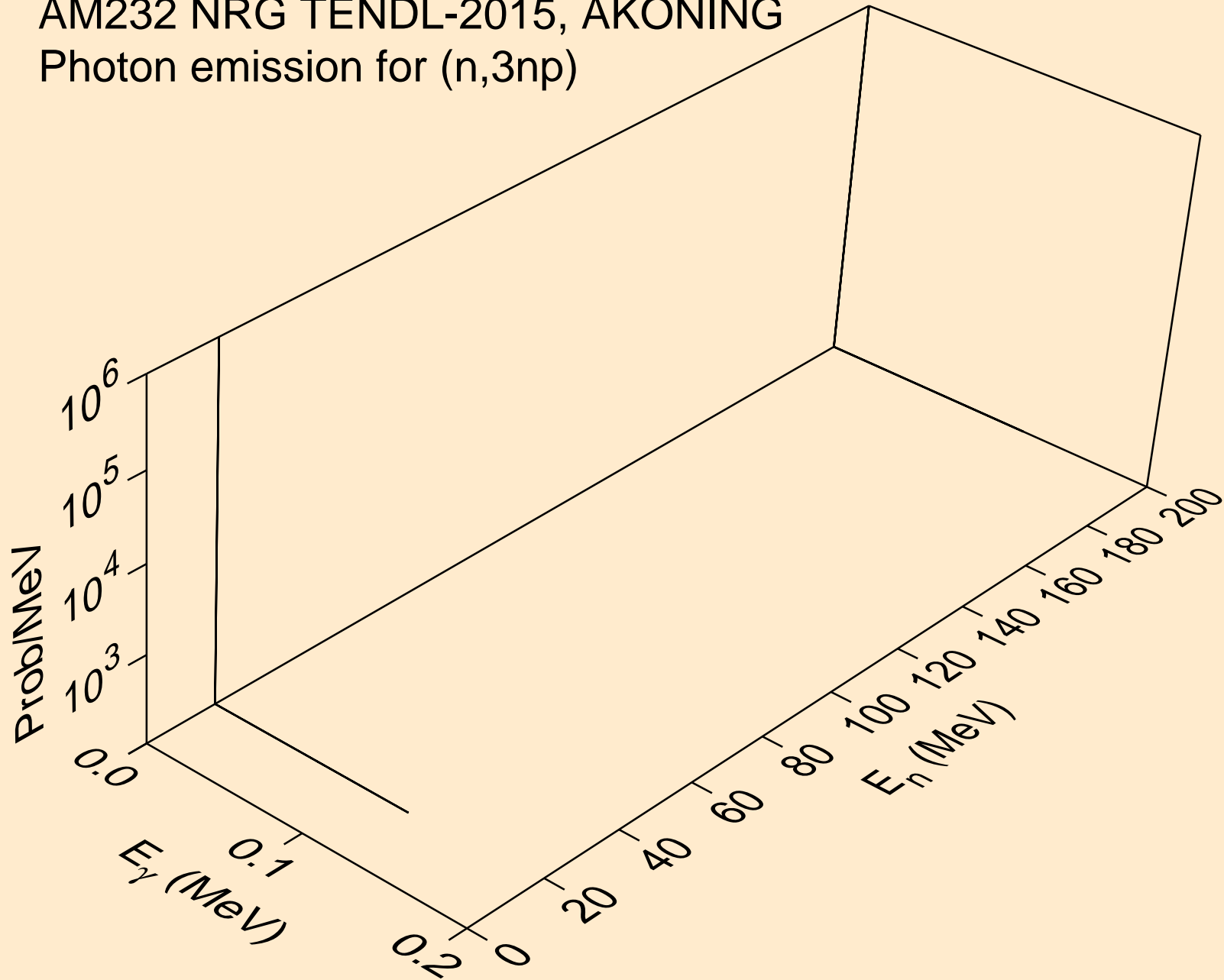

AM232 NRG TENDL-2015, AKONING
Photon emission for (n,2np)

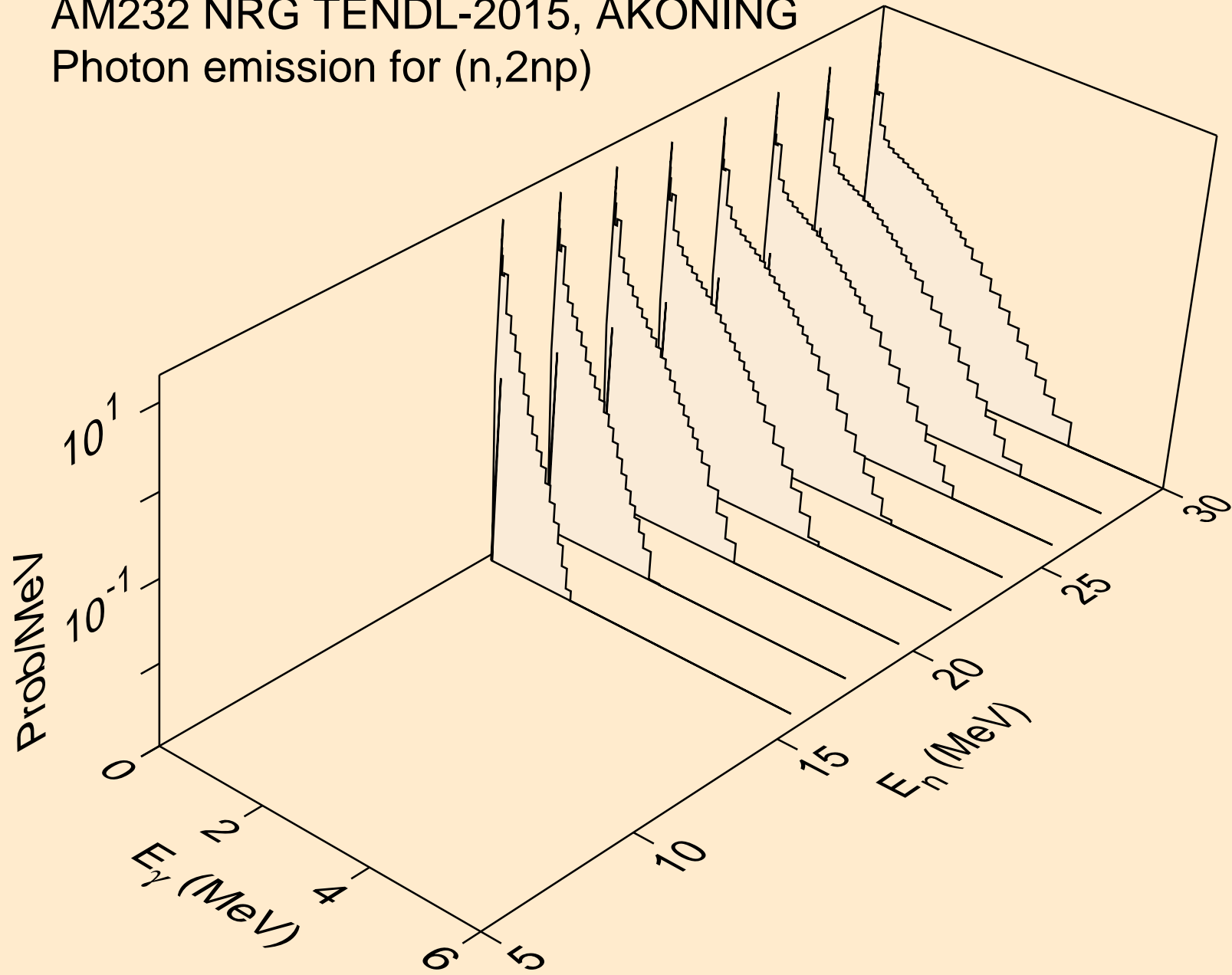

AM232 NRG TENDL-2015, AKONING
Photon emission for (n,npa)

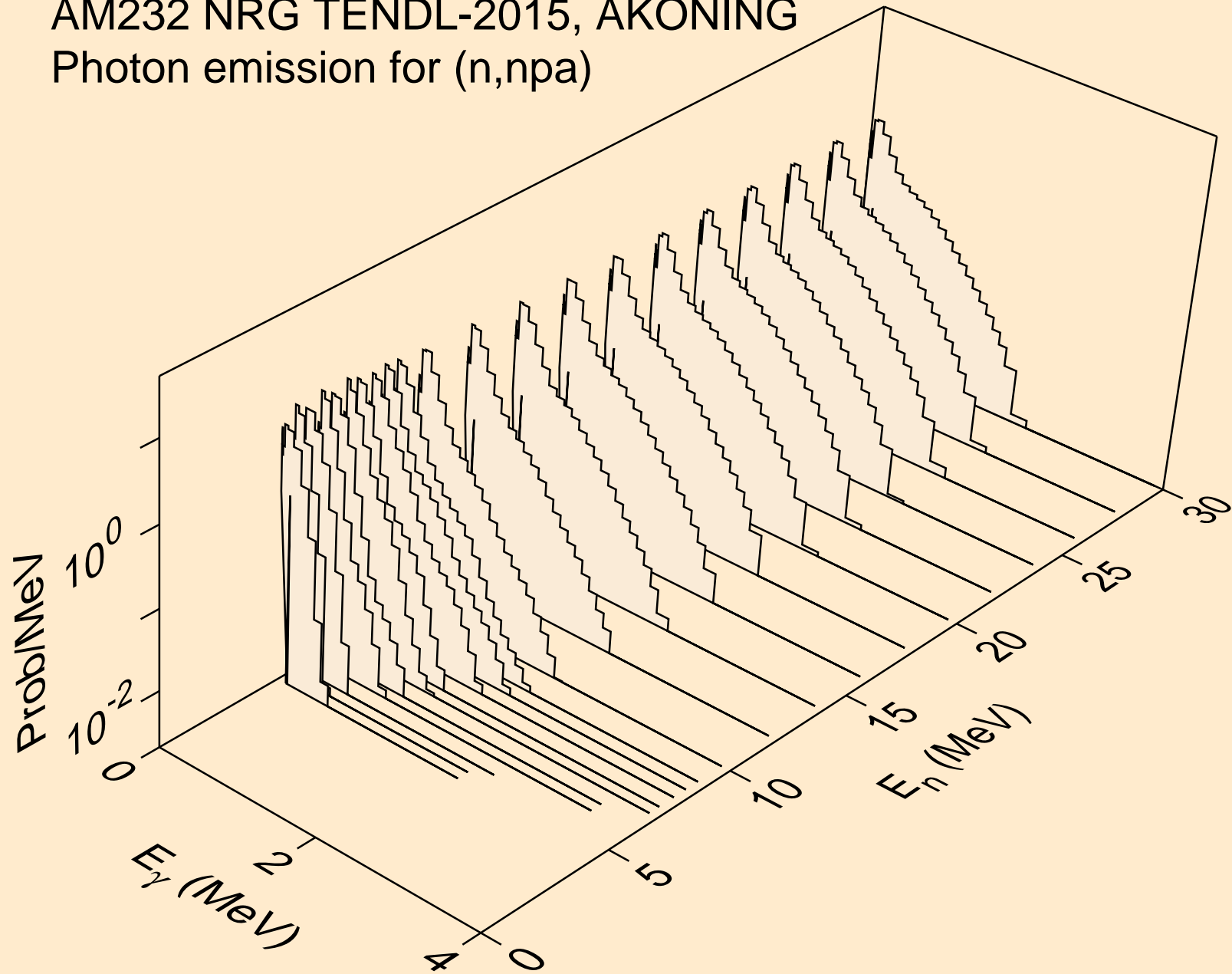

AM232 NRG TENDL-2015, AKONING
Photon emission for (n,n*c)

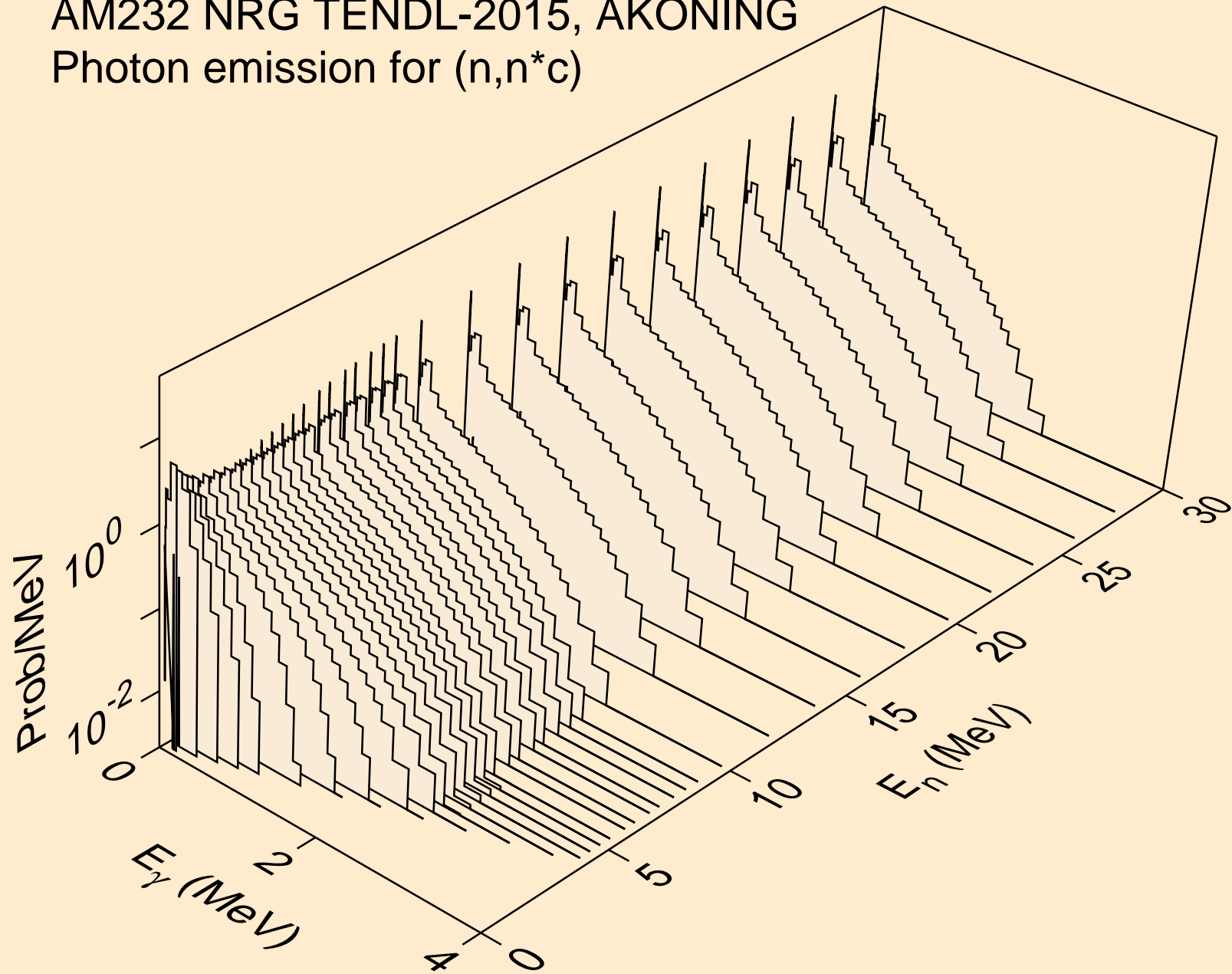

AM232 NRG TENDL-2015, AKONING
Photon emission for (n,gma)

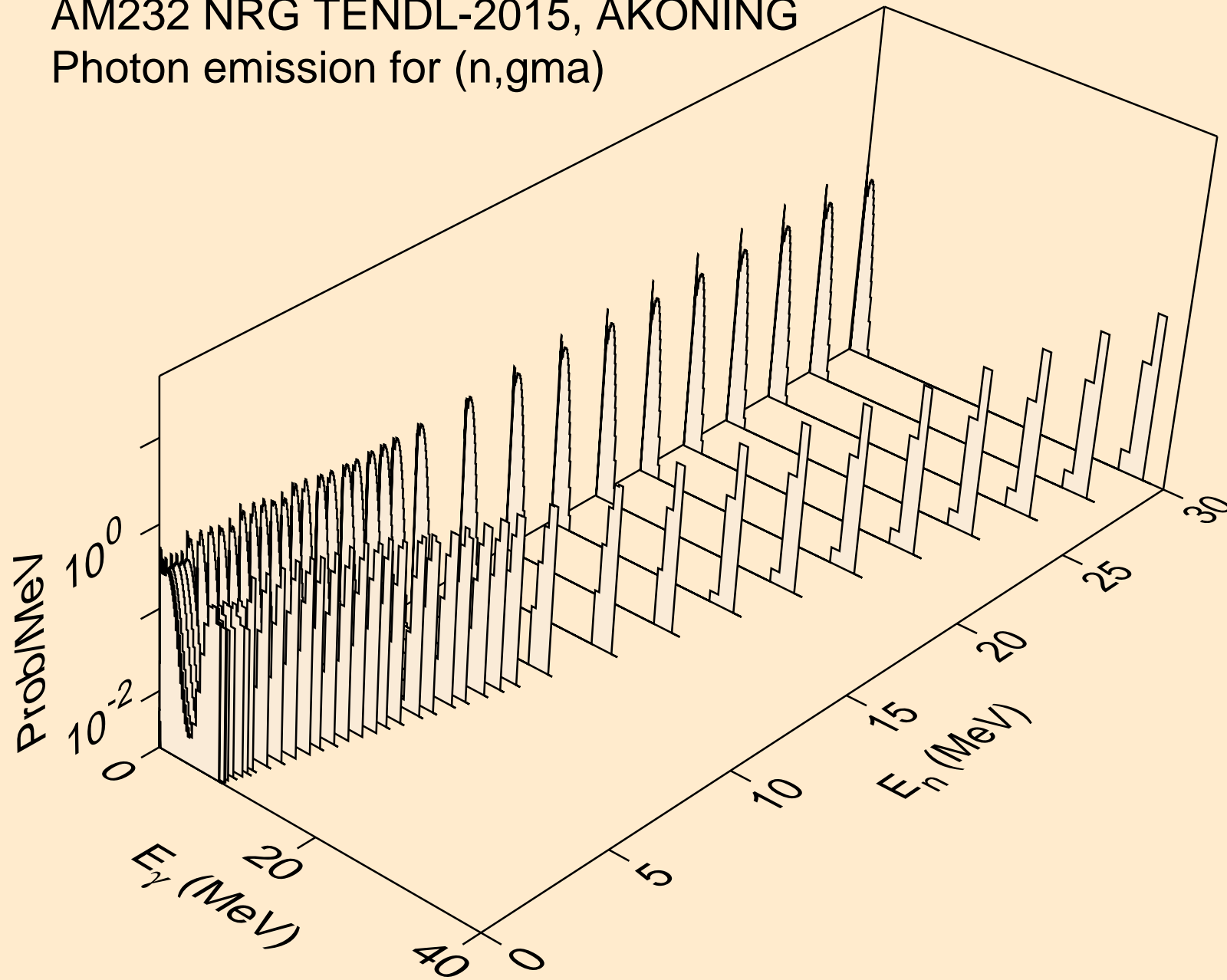

AM232 NRG TENDL-2015, AKONING
Photon emission for (n,p)

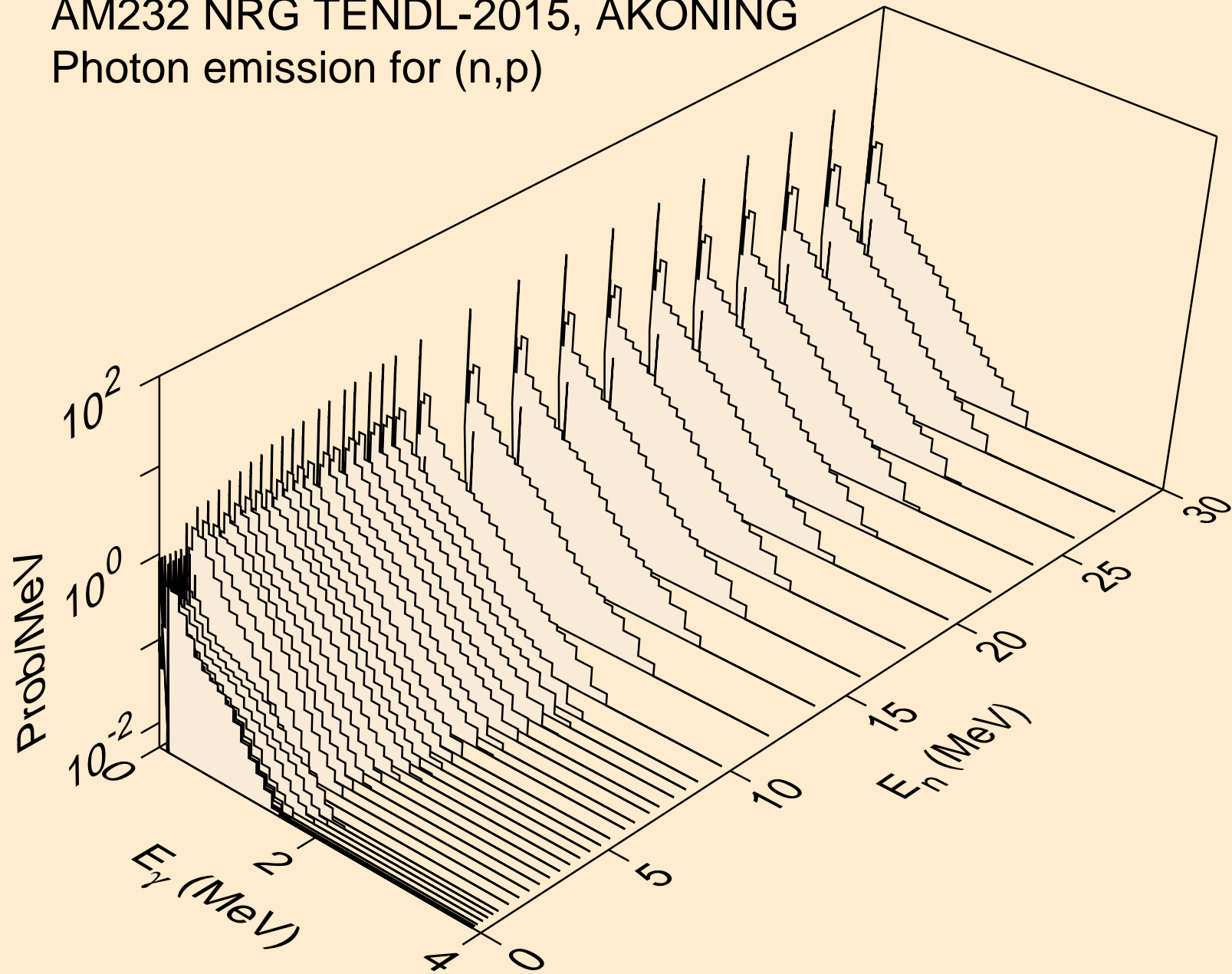

AM232 NRG TENDL-2015, AKONING
Photon emission for (n,d)

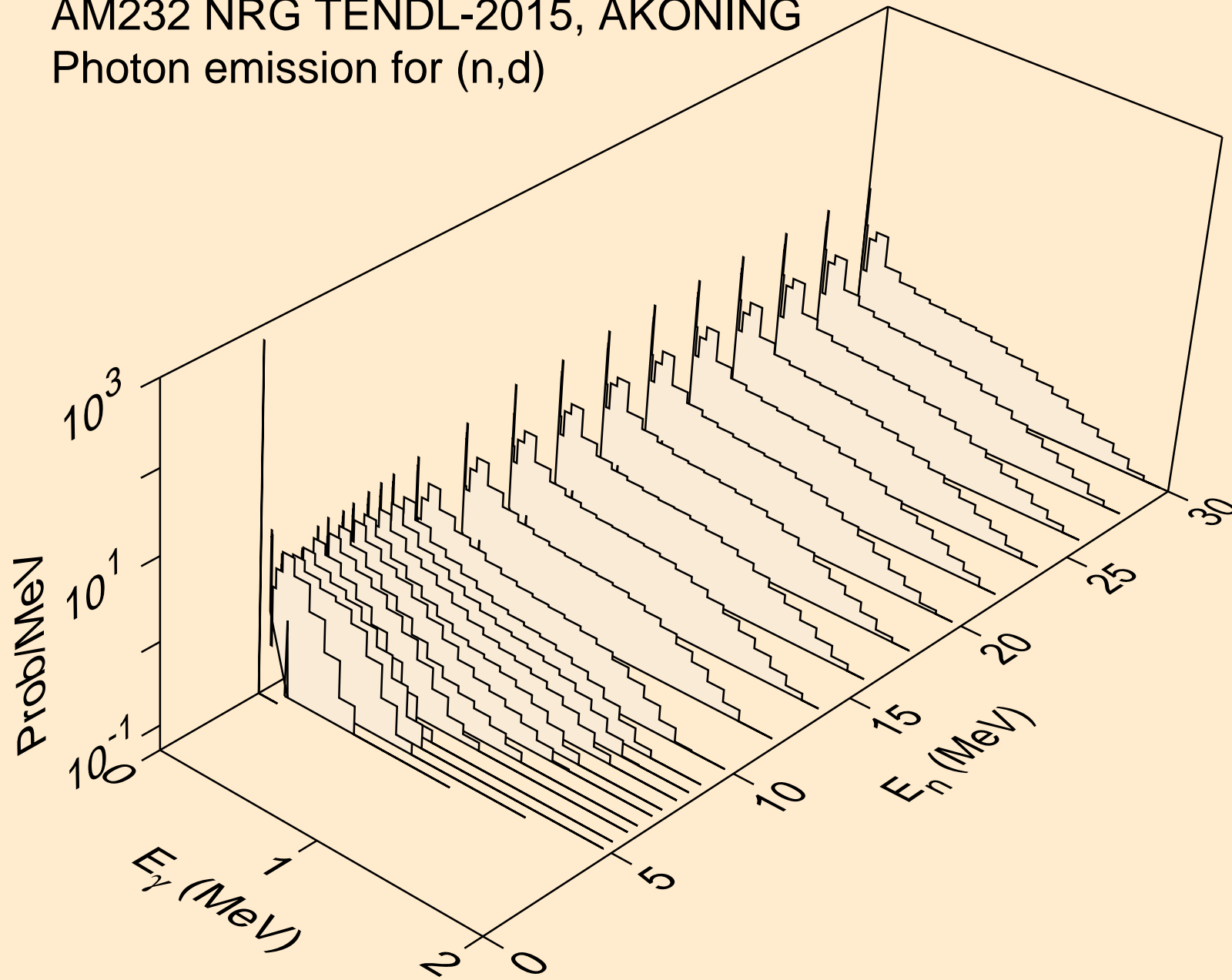

AM232 NRG TENDL-2015, AKONING
Photon emission for (n,t)

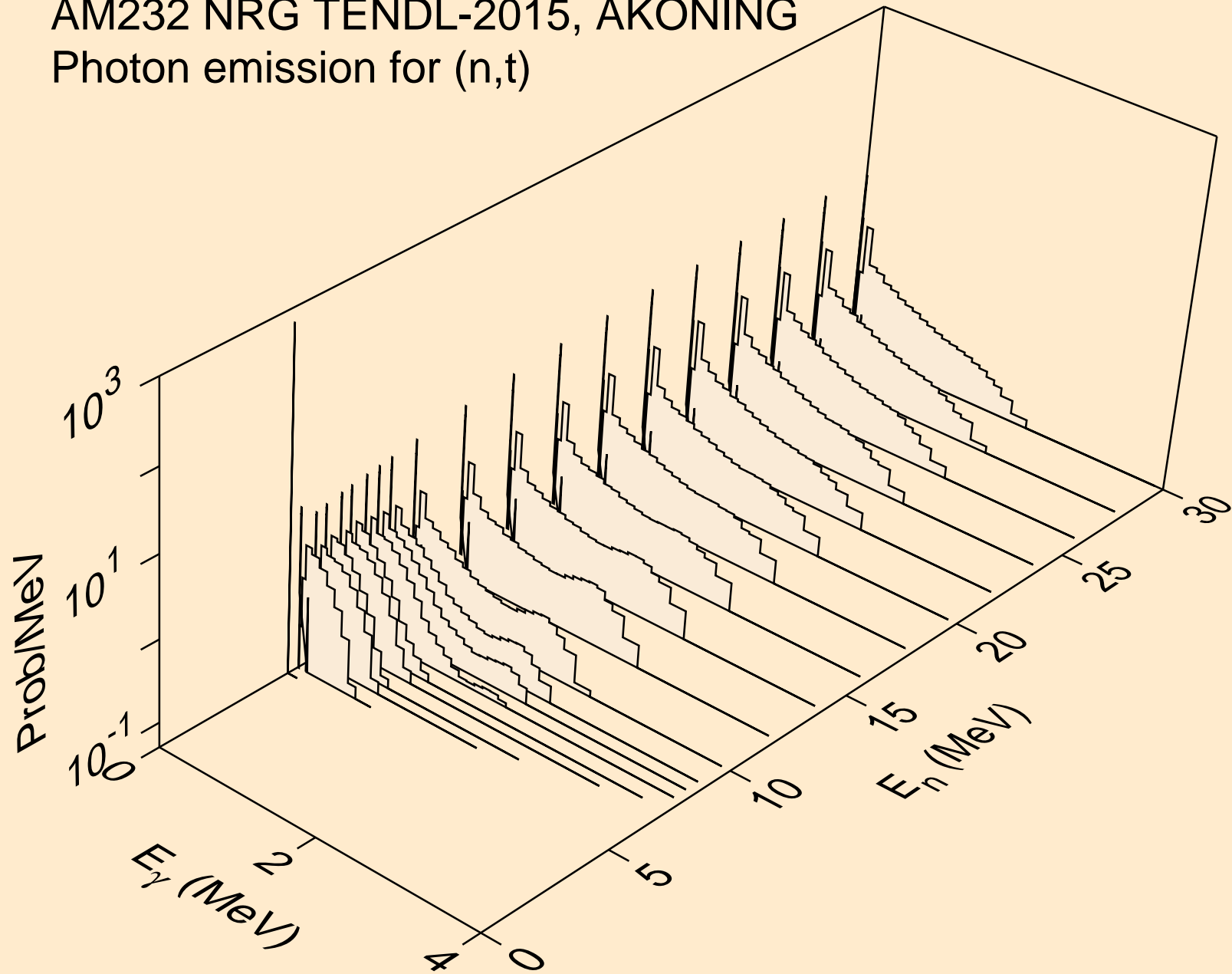

AM232 NRG TENDL-2015, AKONING
Photon emission for (n,he3)

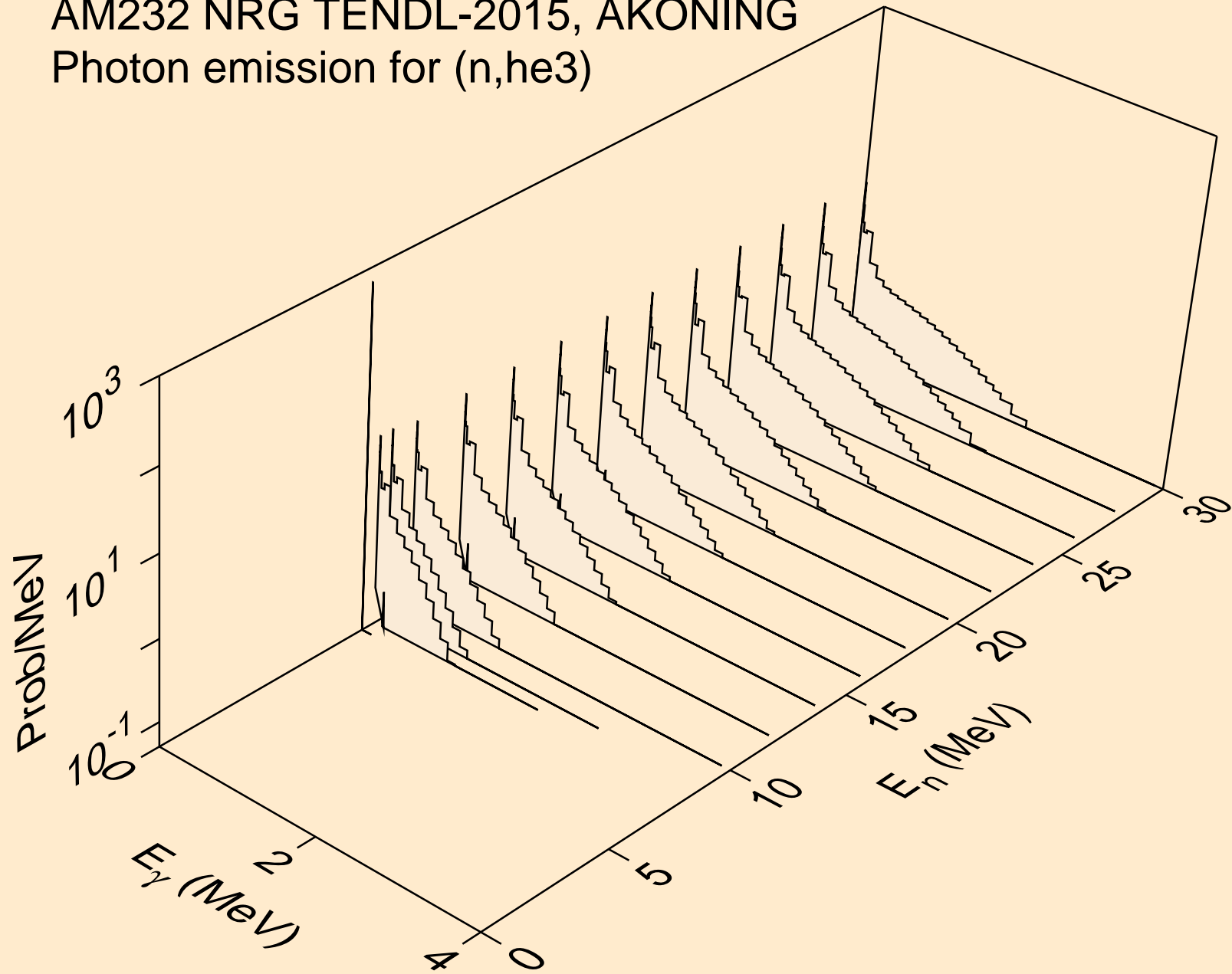

AM232 NRG TENDL-2015, AKONING
Photon emission for (n,a)

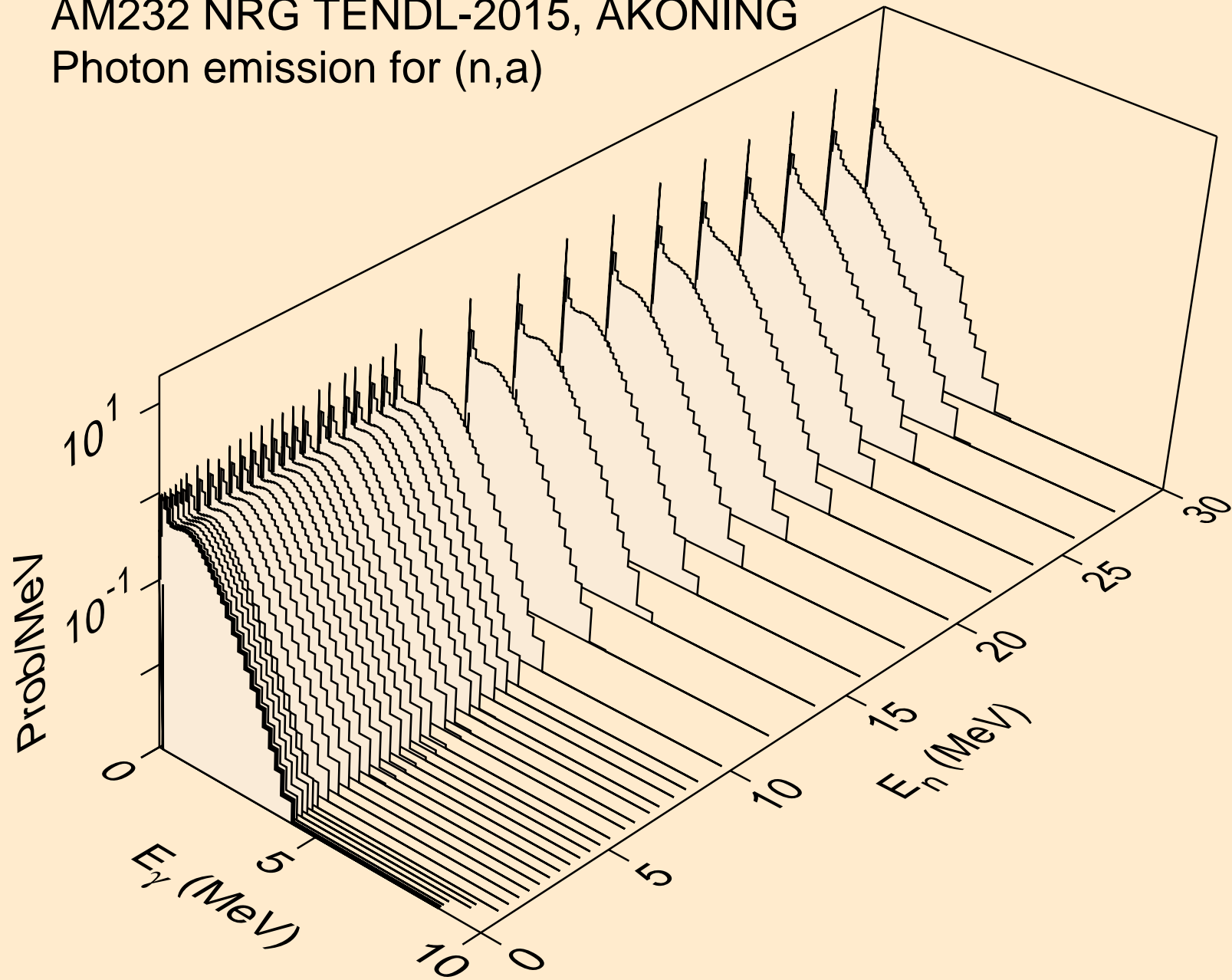

AM232 NRG TENDL-2015, AKONING
Photon emission for (n,2a)

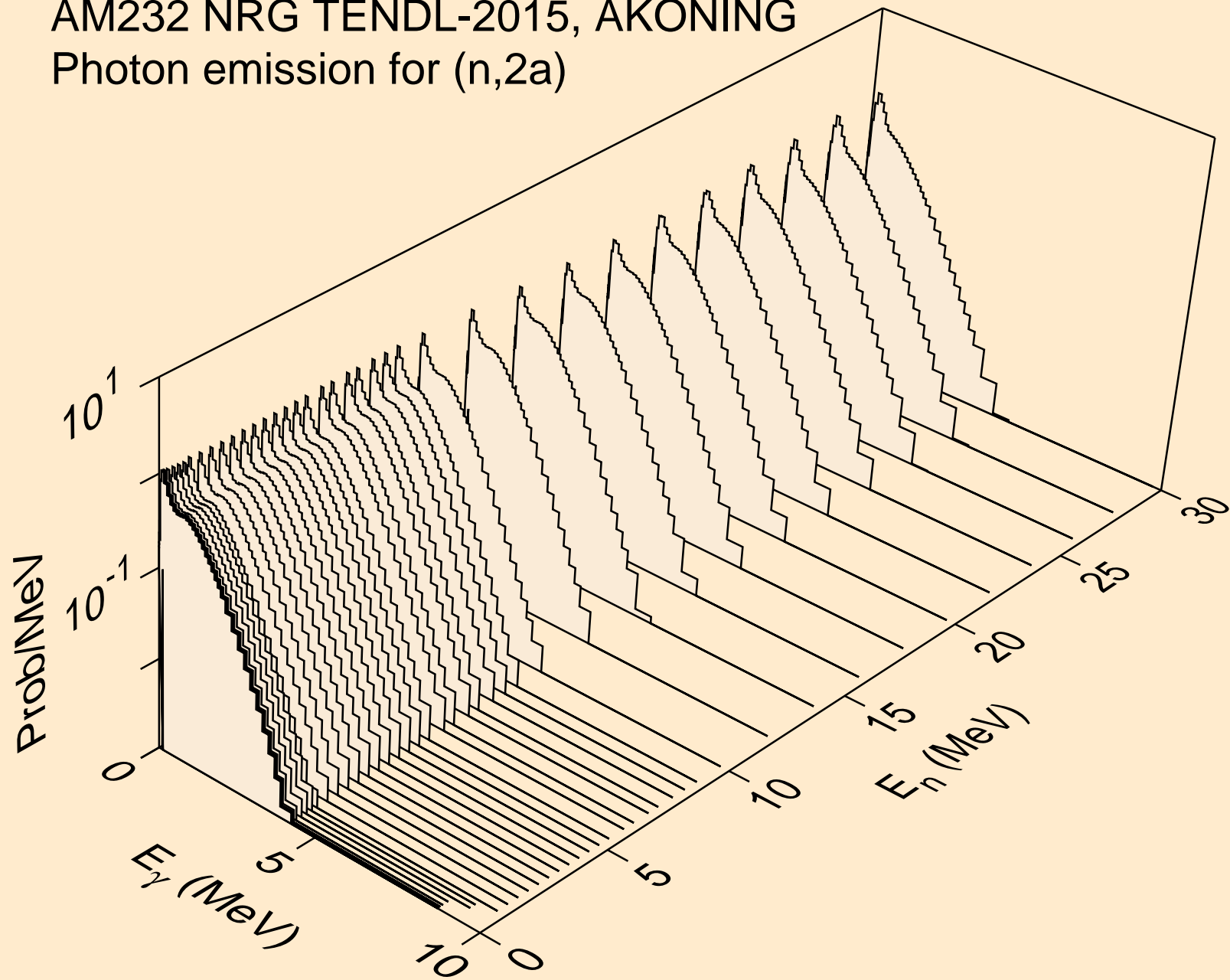

AM232 NRG TENDL-2015, AKONING
Photon emission for (n,3a)

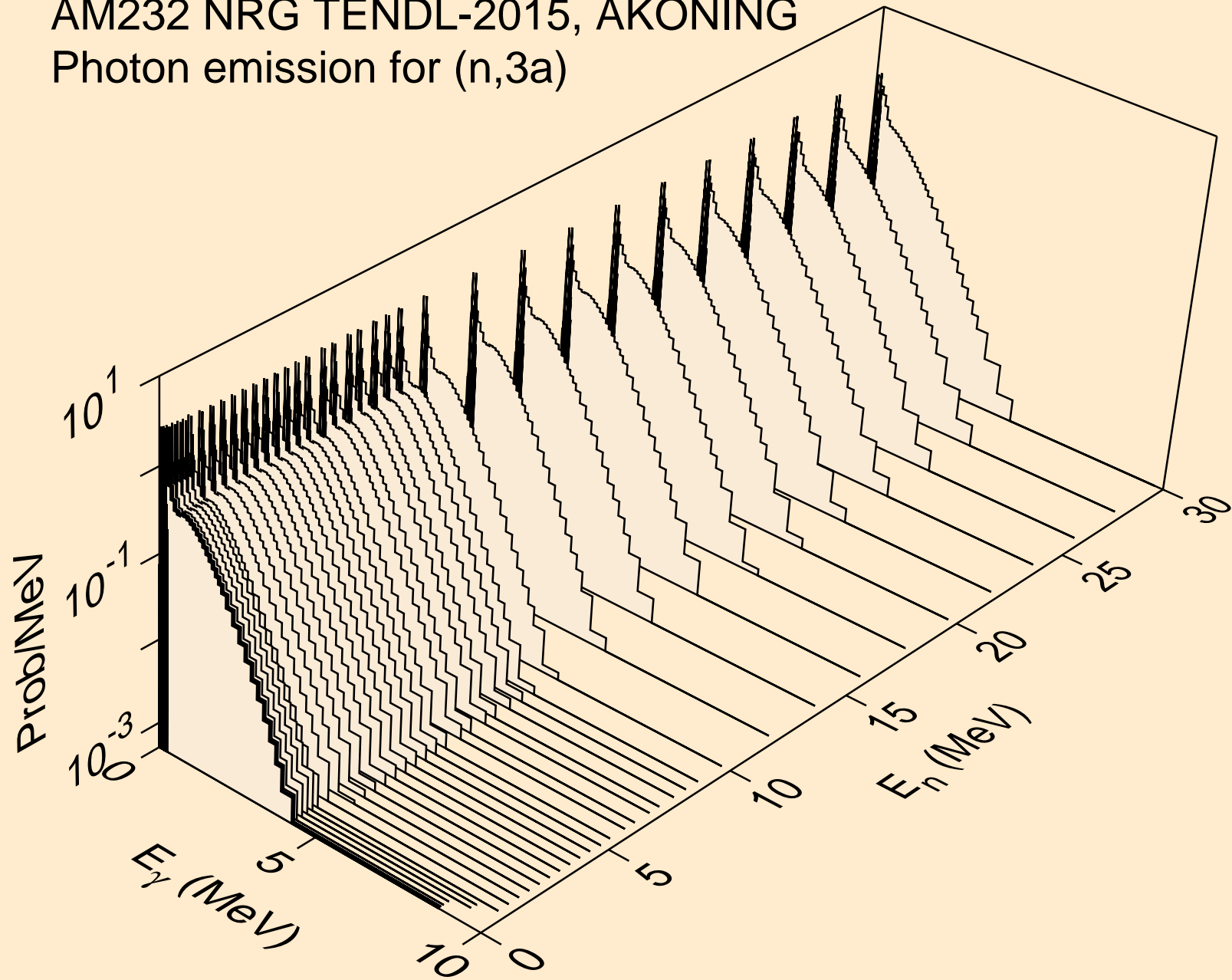

AM232 NRG TENDL-2015, AKONING
Photon emission for (n,2p)

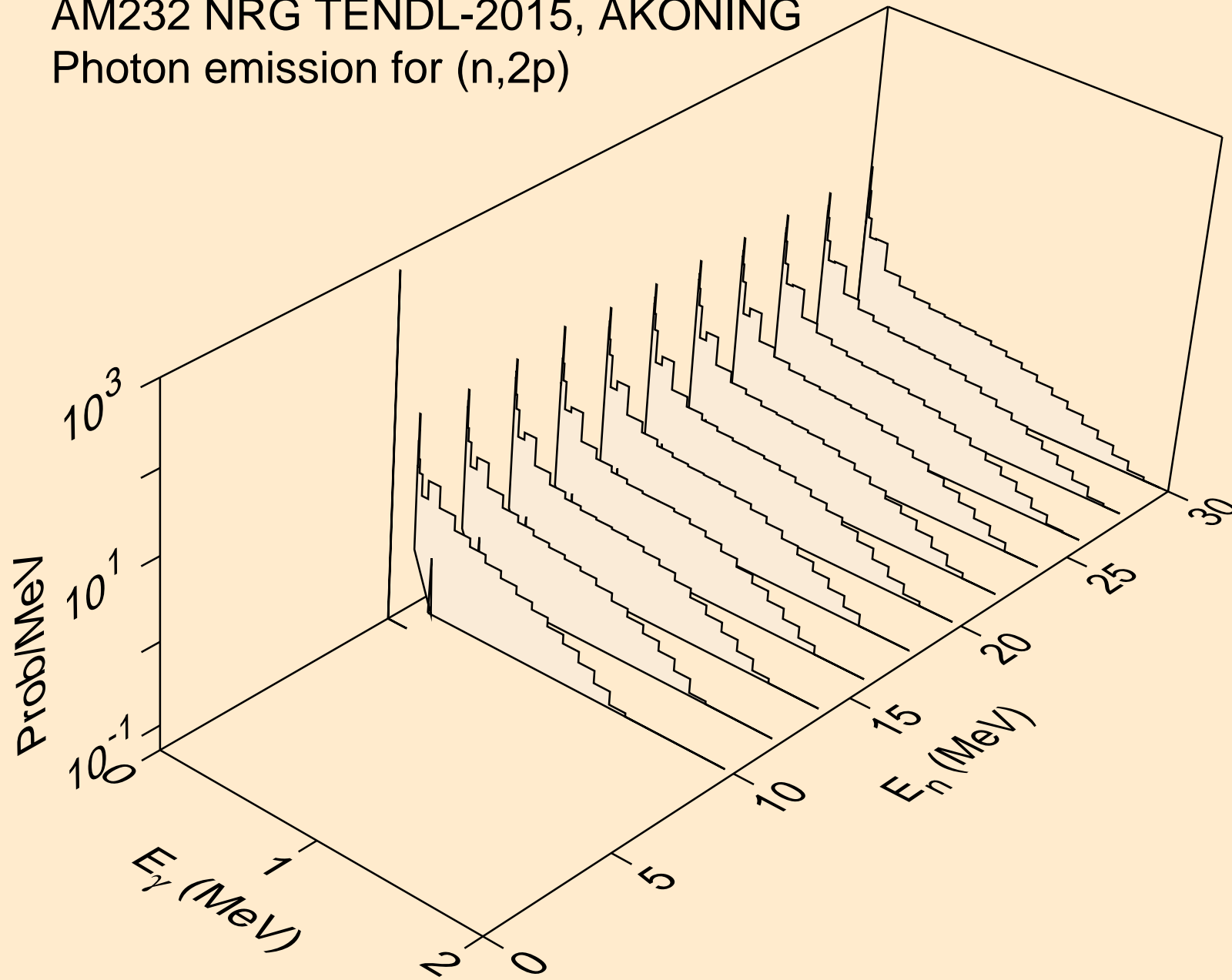

AM232 NRG TENDL-2015, AKONING
Photon emission for (n,p α)

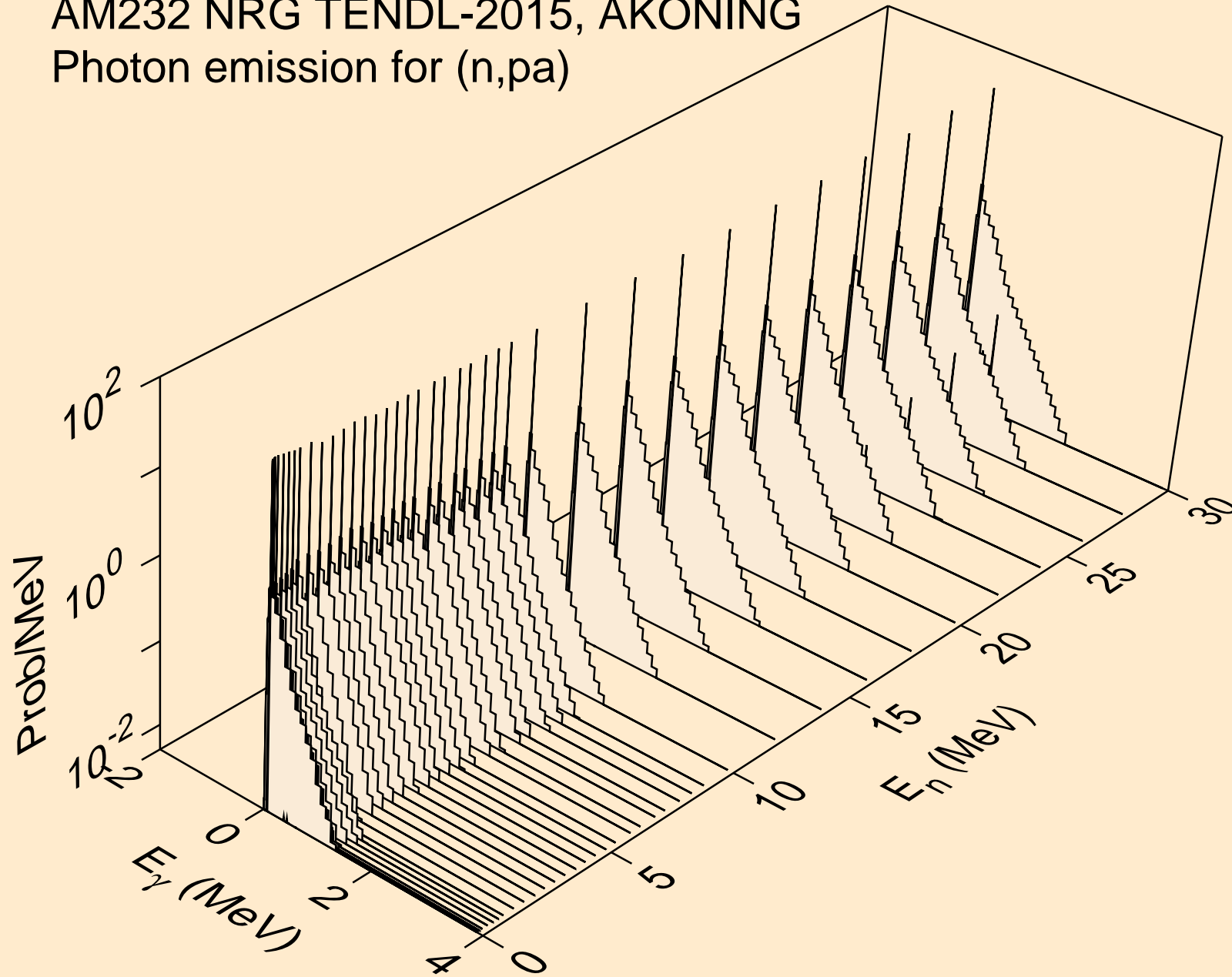

AM232 NRG TENDL-2015, AKONING
Photon emission for (n,t2a)

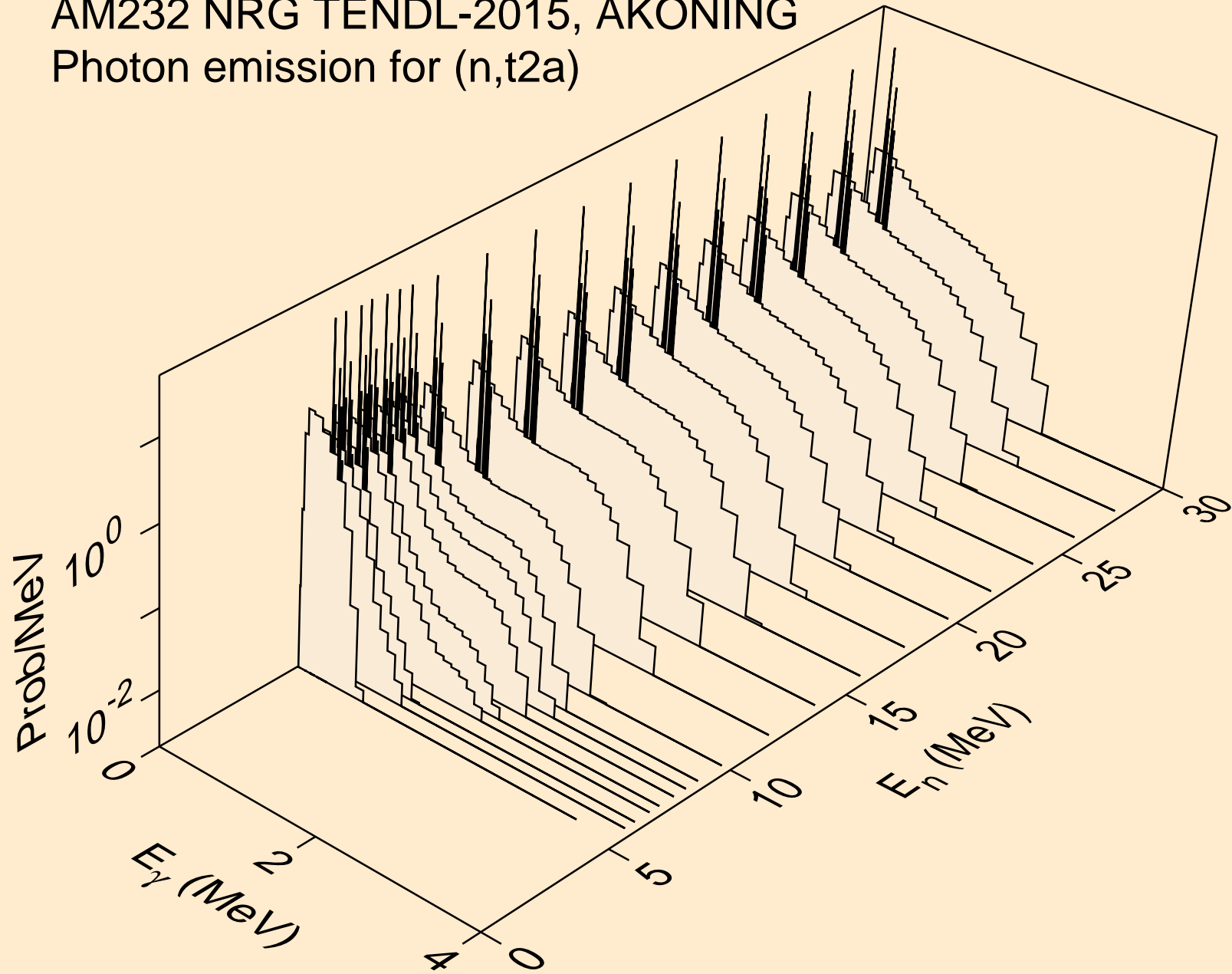

AM232 NRG TENDL-2015, AKONING
Photon emission for (n,d2a)

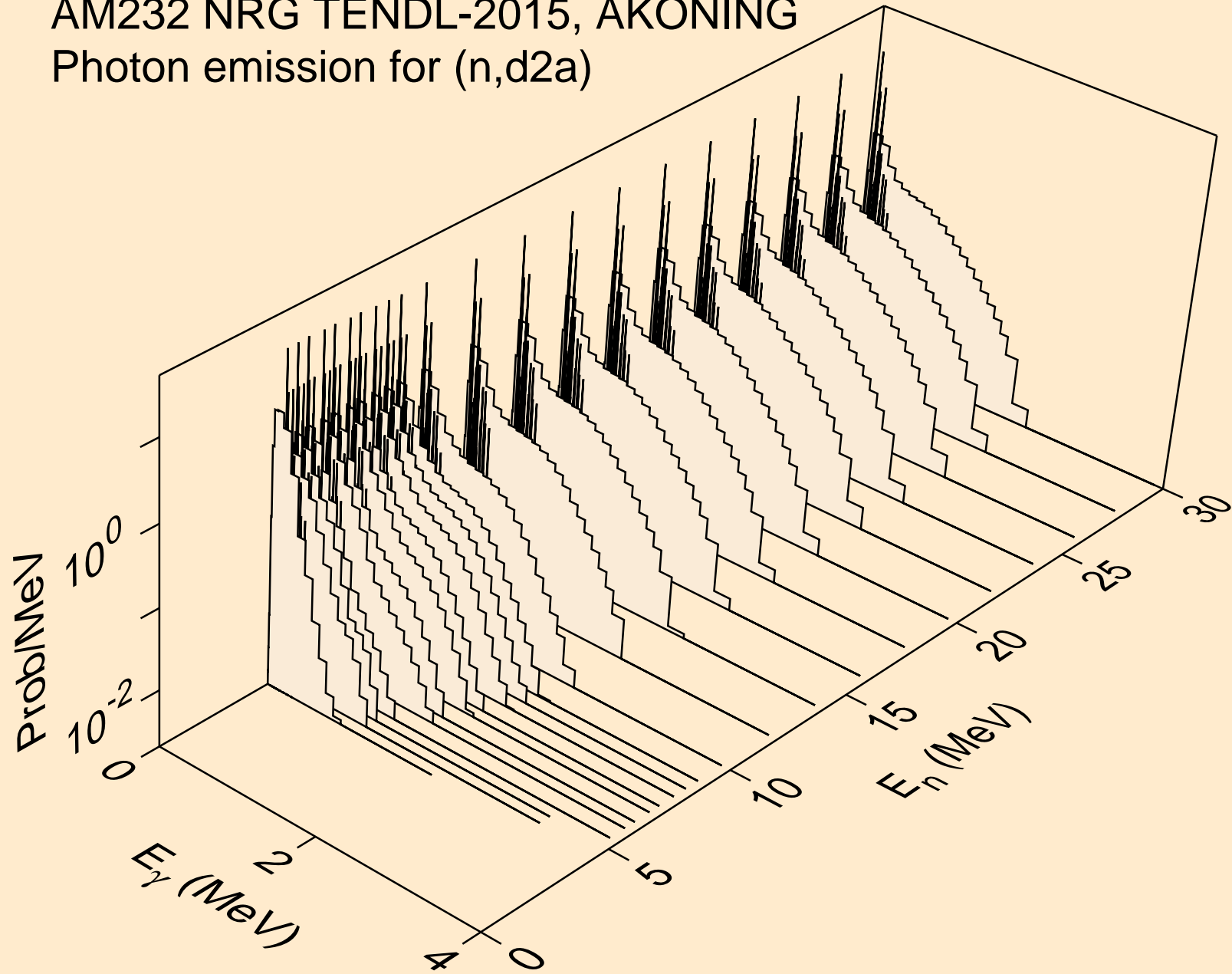

AM232 NRG TENDL-2015, AKONING
Photon emission for (n,pd)

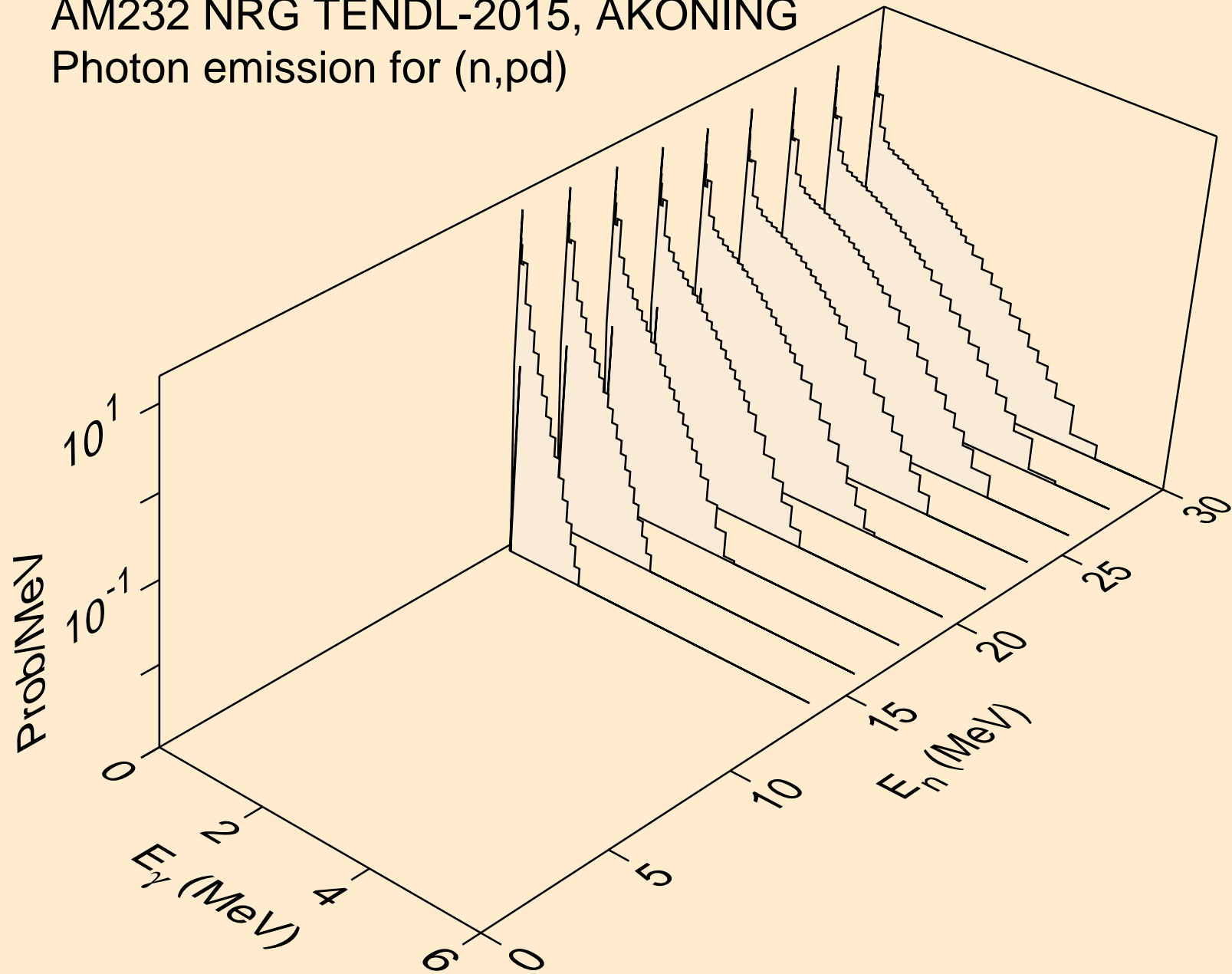

AM232 NRG TENDL-2015, AKONING
Photon emission for (n,pt)

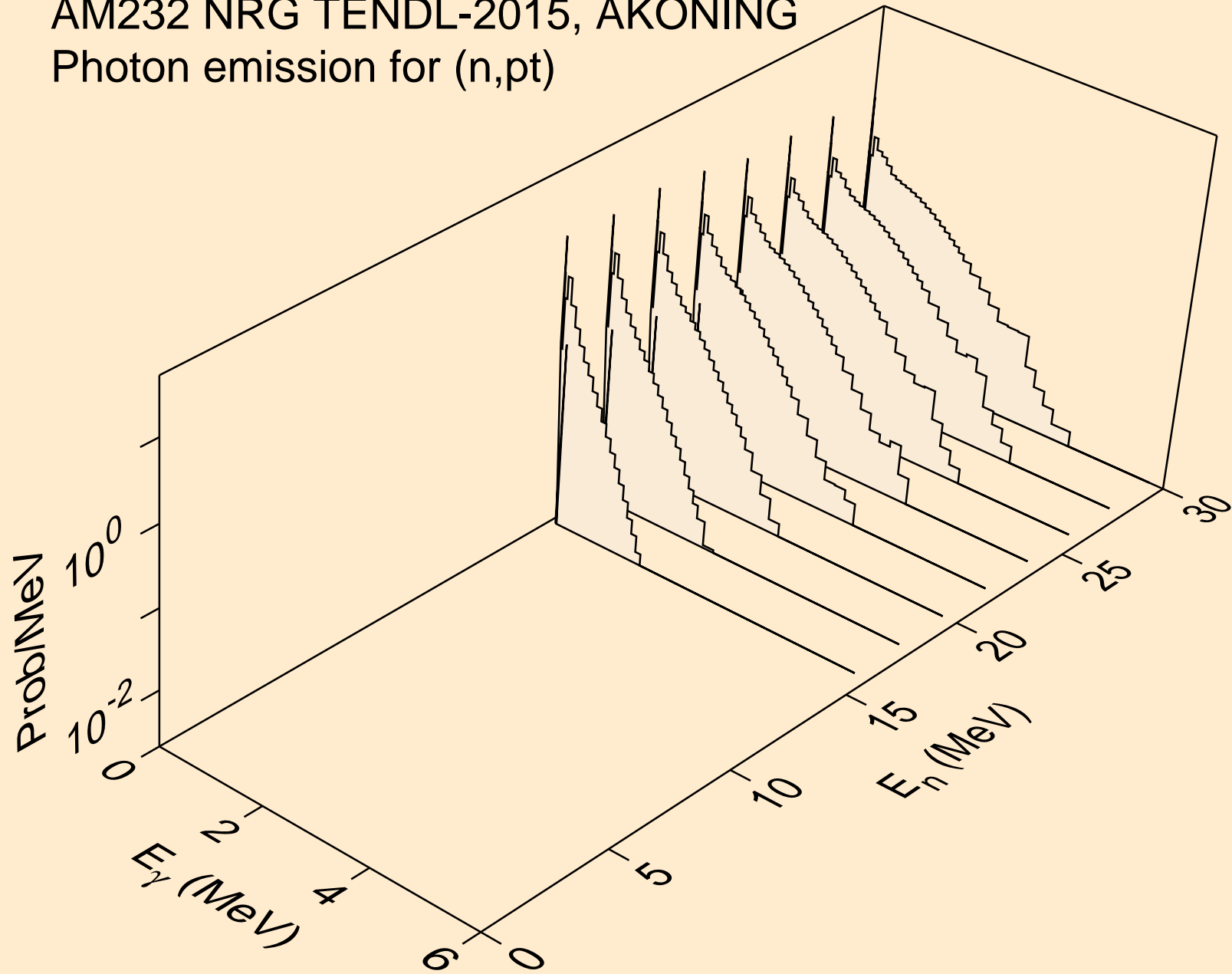

AM232 NRG TENDL-2015, AKONING
Photon emission for (n,da)

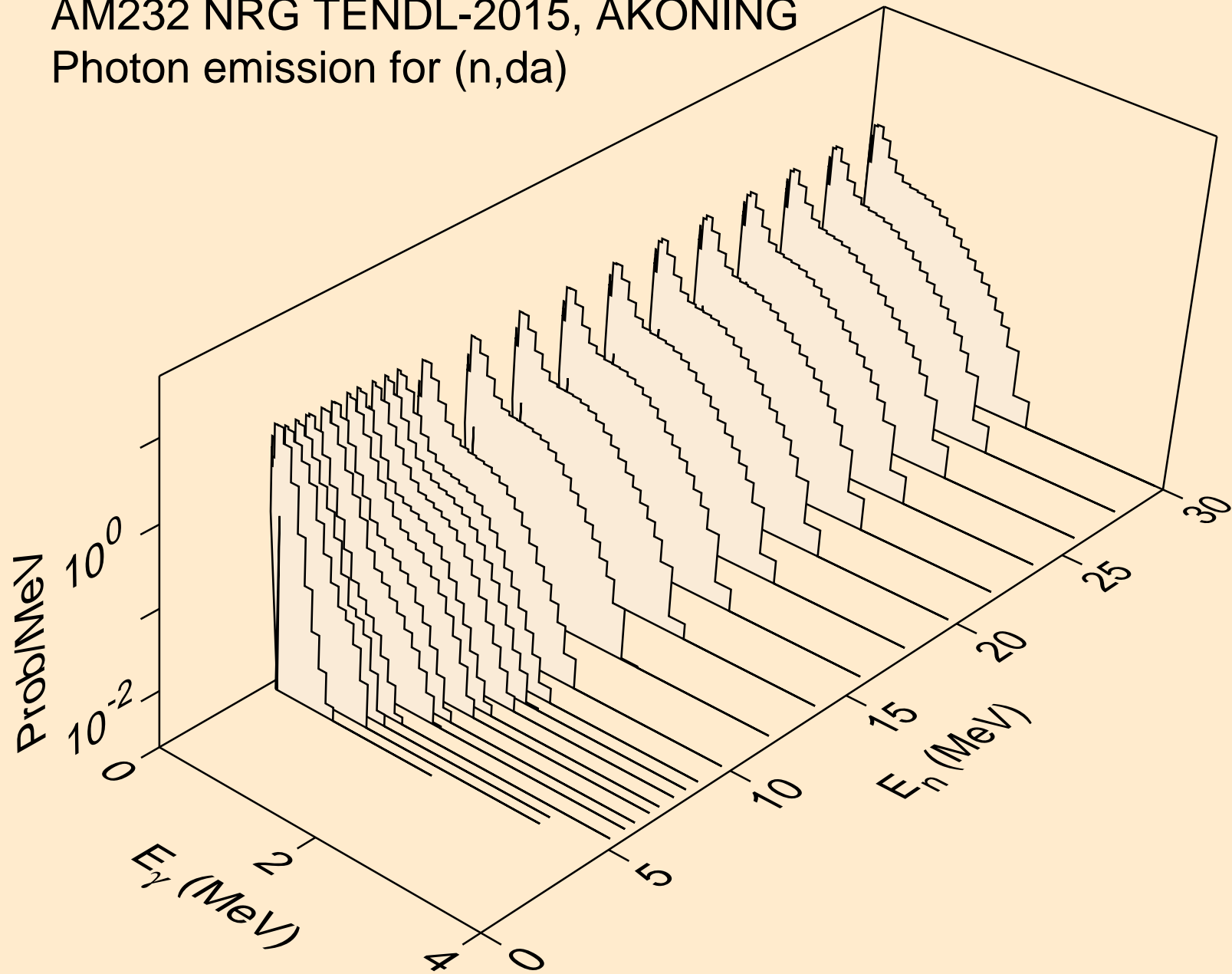

AM232 NRG TENDL-2015, AKONING
thermal capture photon spectrum

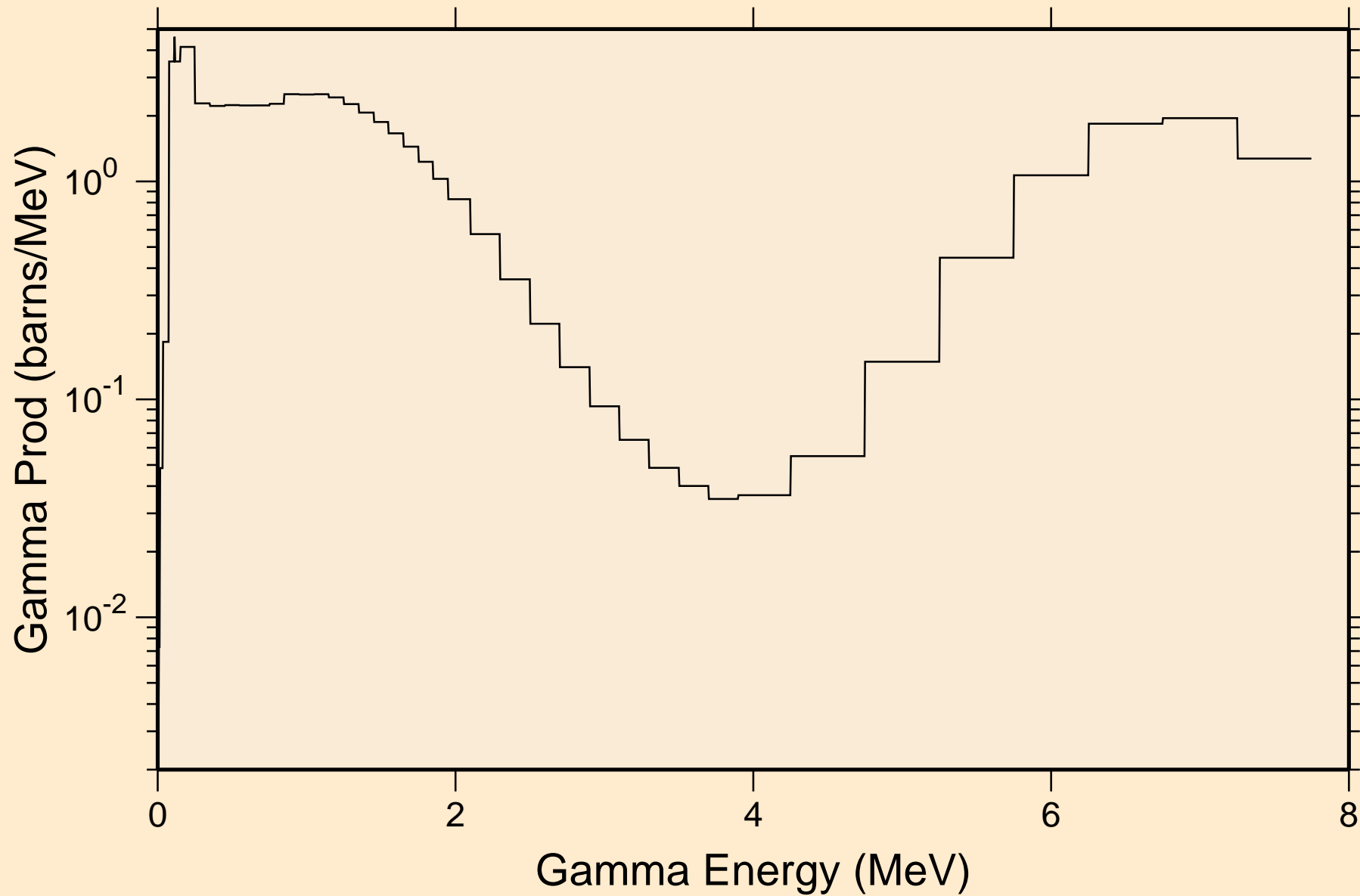

AM232 NRG TENDL-2015, AKONING
14 MeV photon spectrum

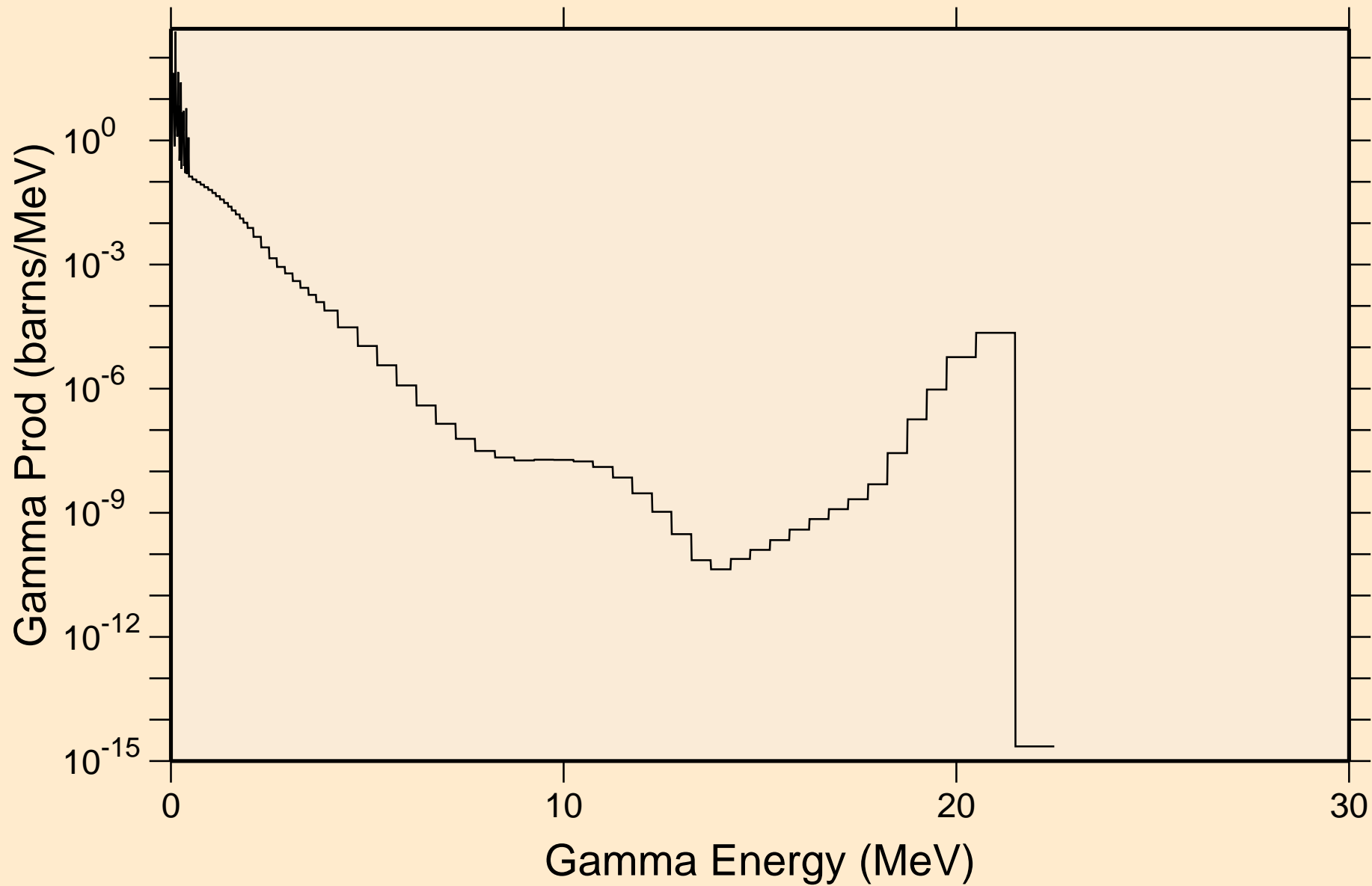

AM232 NRG TENDL-2015, AKONING

Particle heating contributions

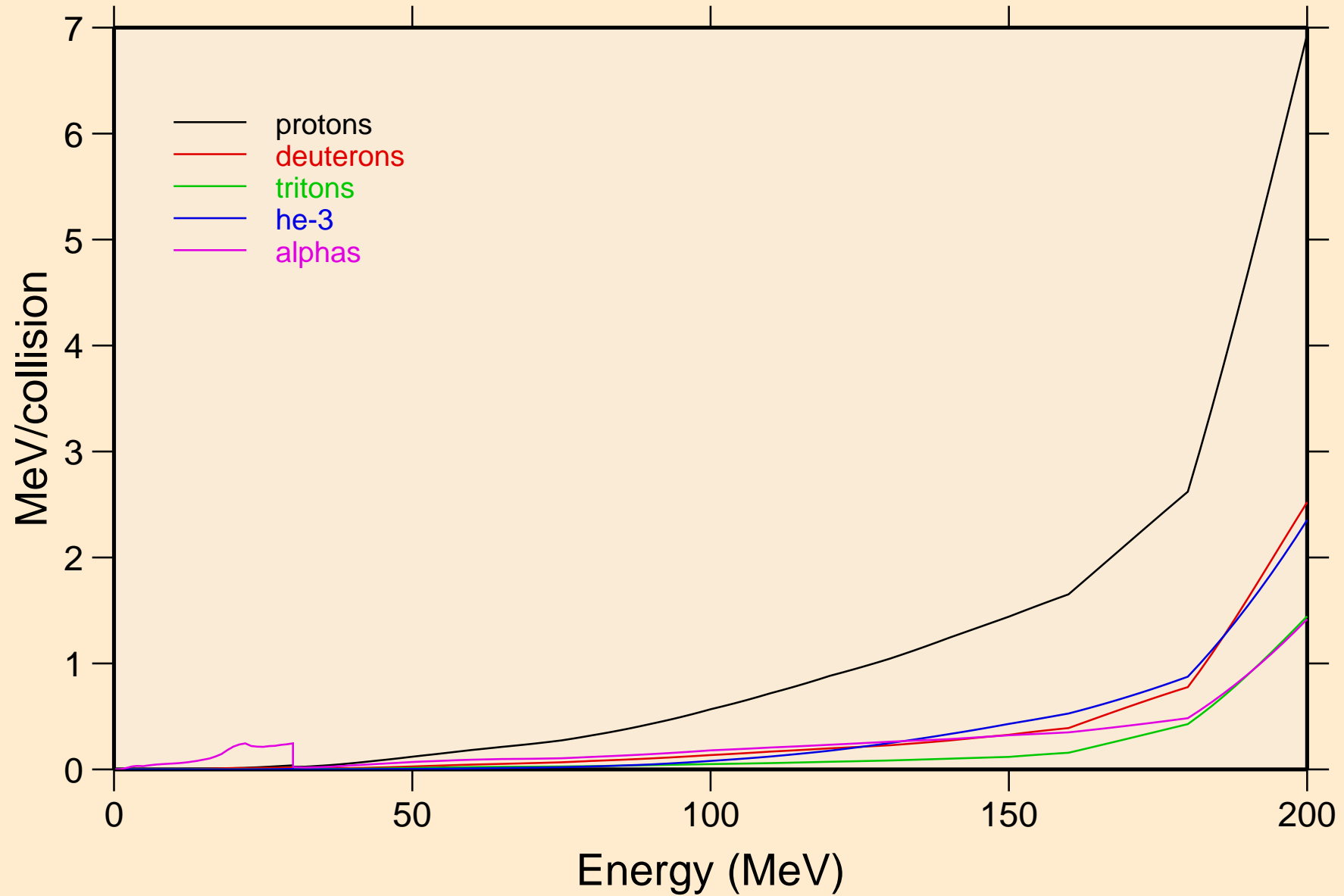

AM232 NRG TENDL-2015, AKONING

Recoil Heating

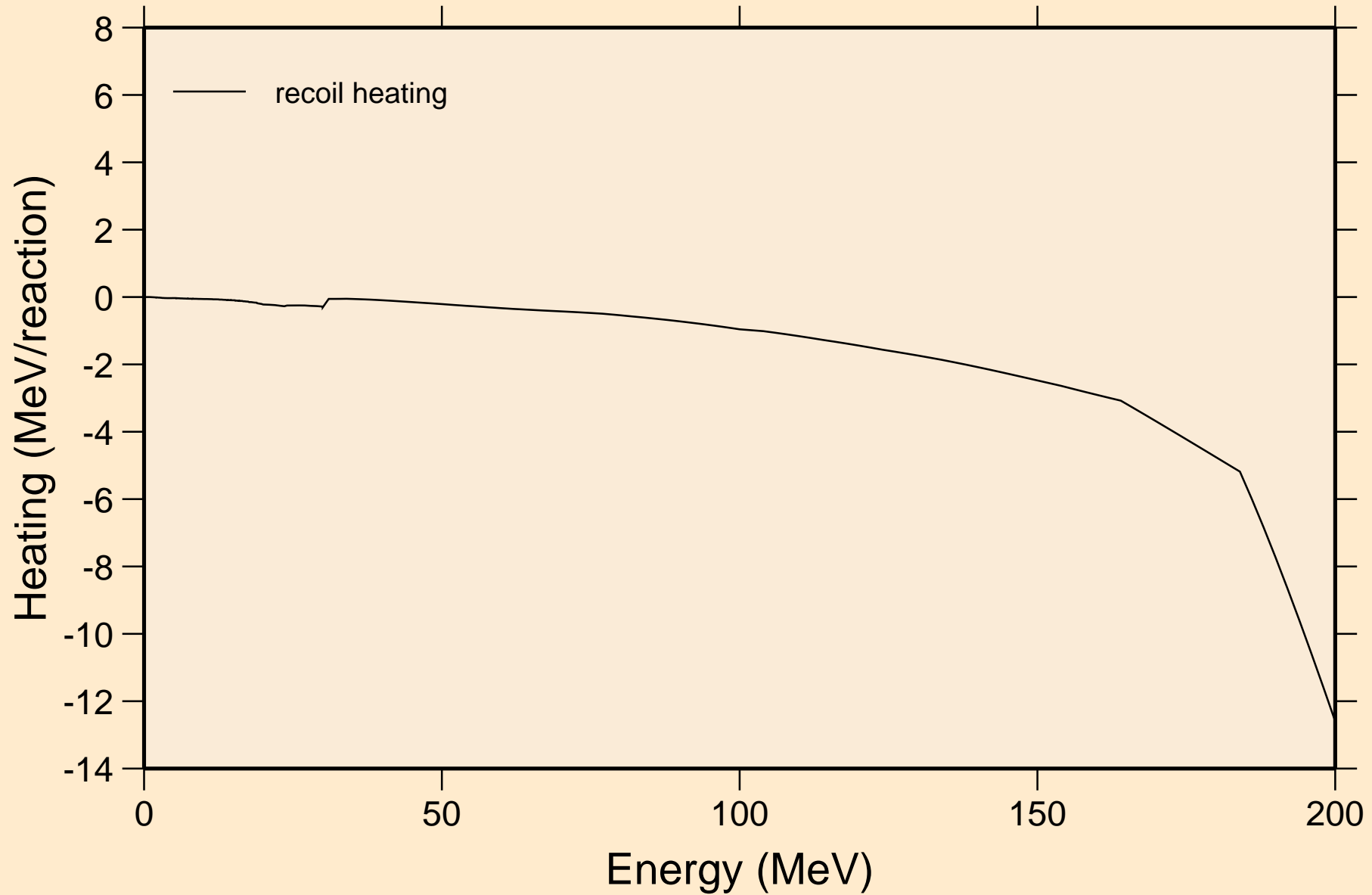

AM232 NRG TENDL-2015, AKONING

Particle production cross sections

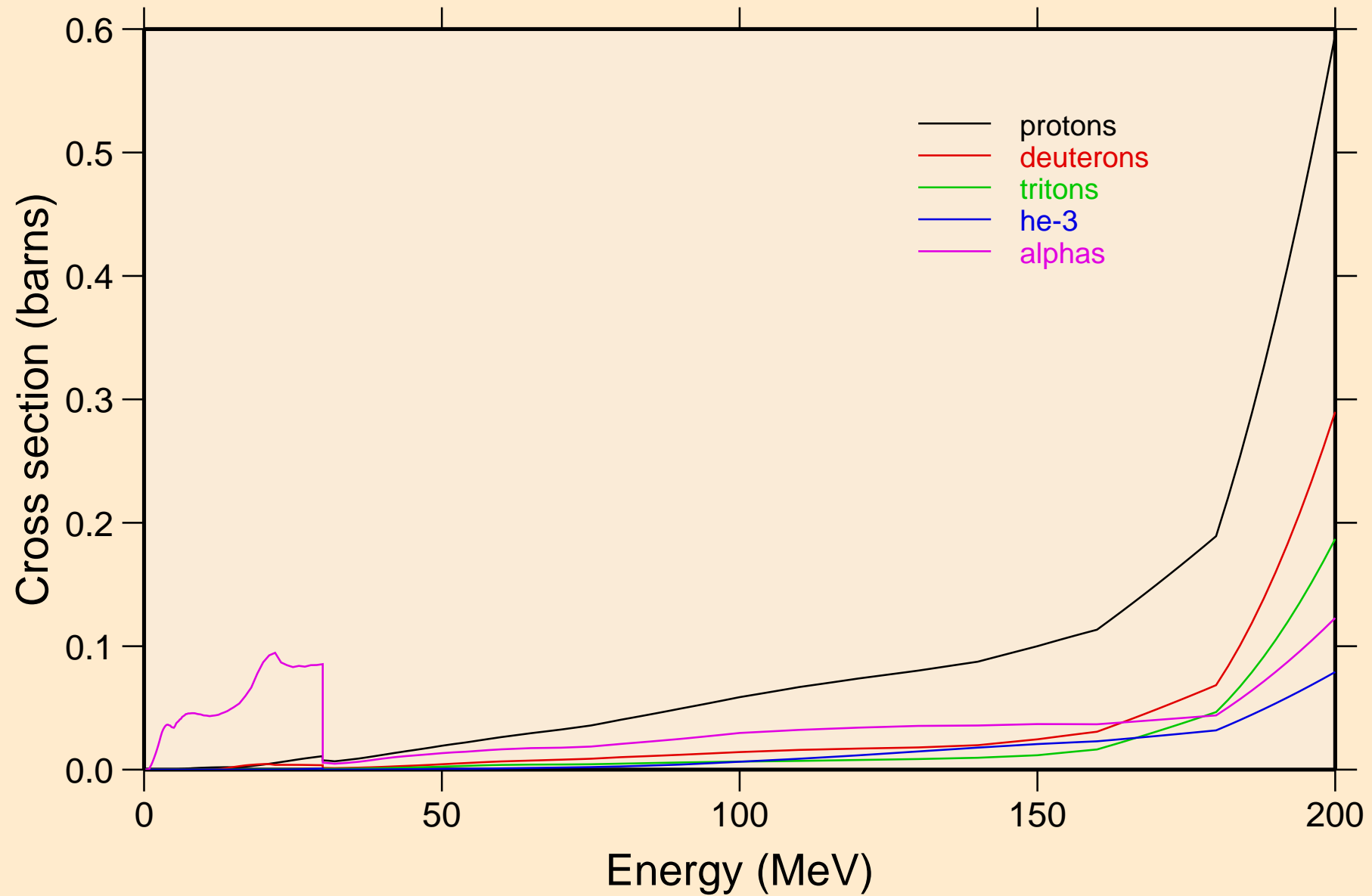

AM232 NRG TENDL-2015, AKONING
protons from (n,x)

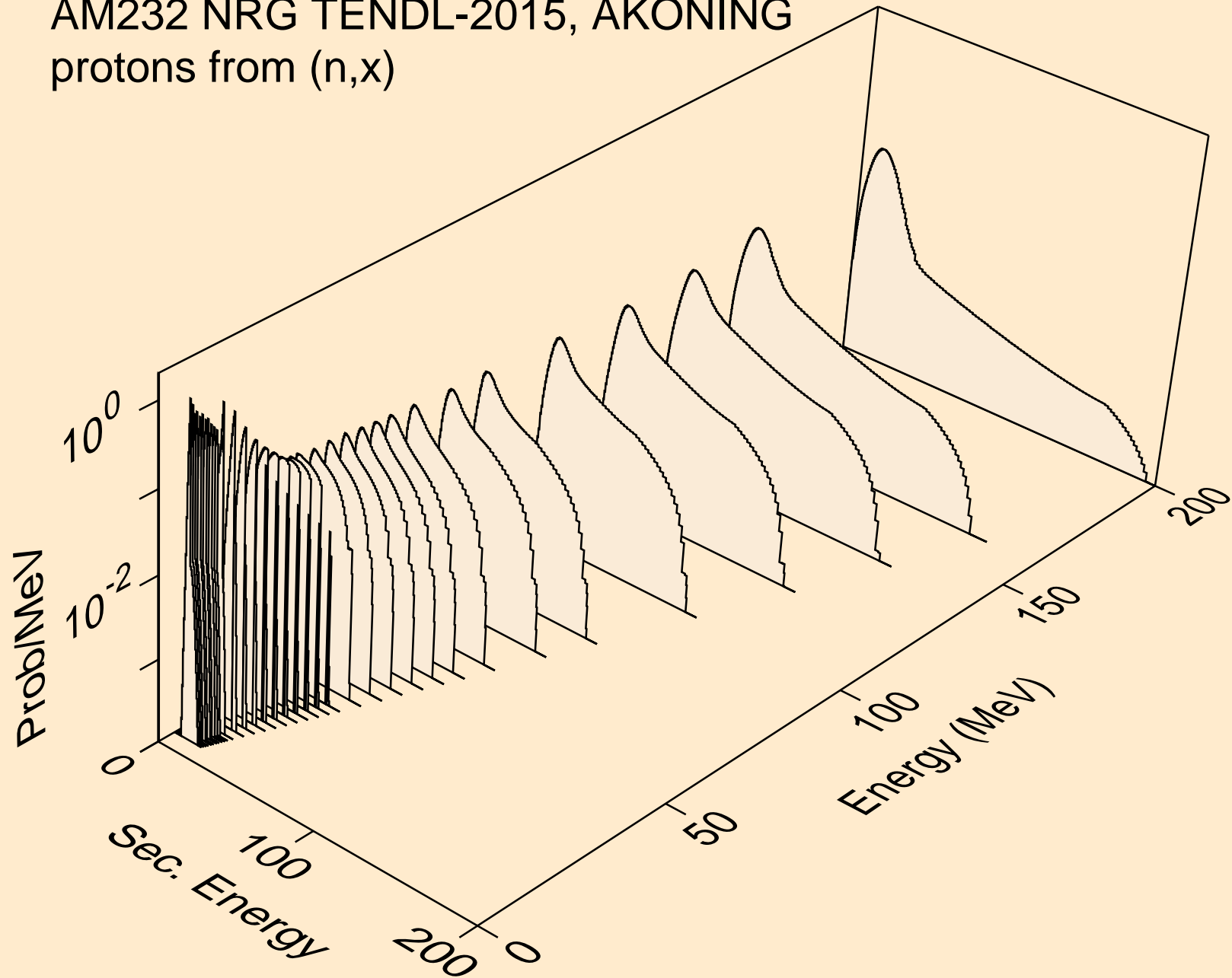

AM232 NRG TENDL-2015, AKONING
protons from (n,n*)p

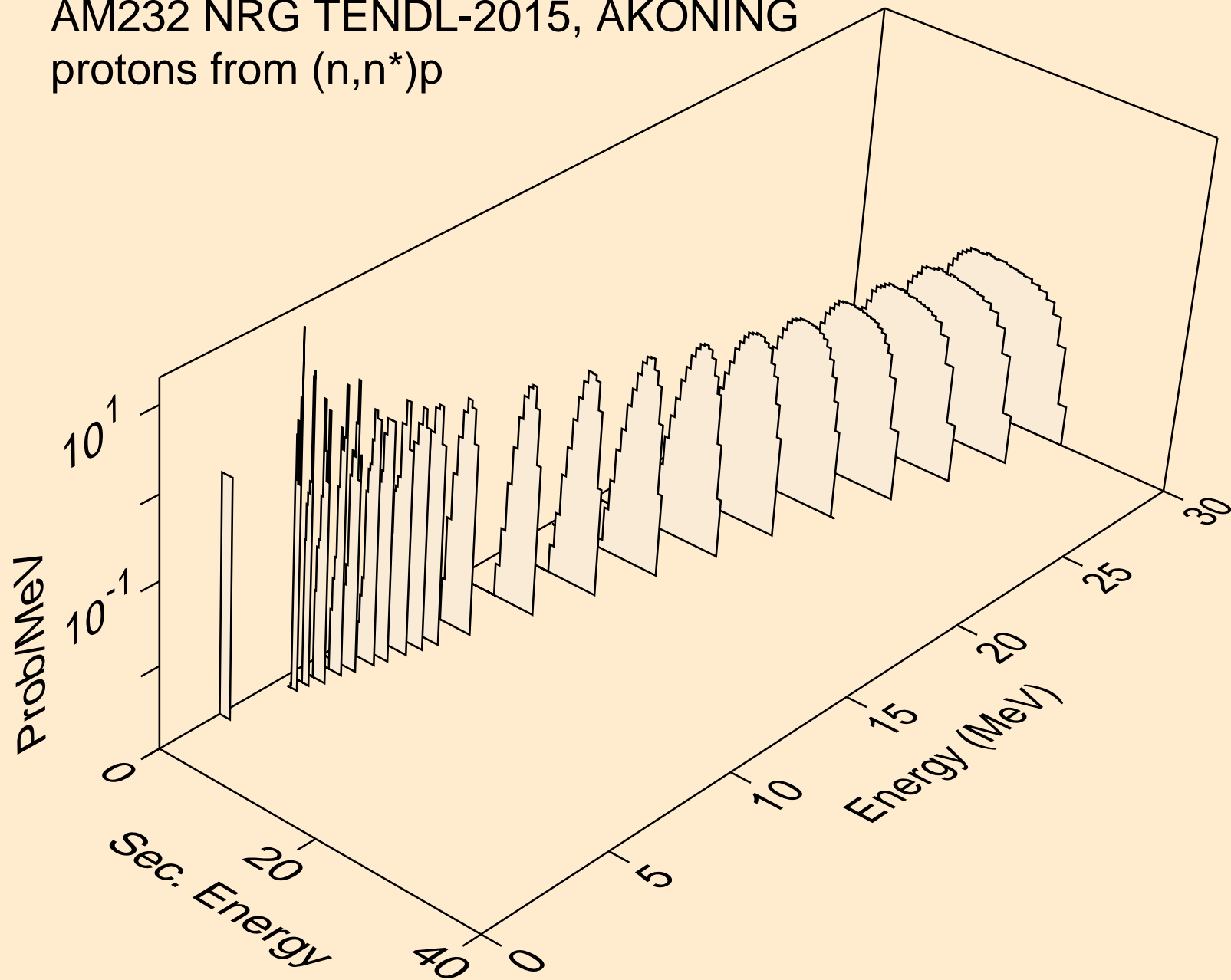

AM232 NRG TENDL-2015, AKONING
protons from (n,2np)

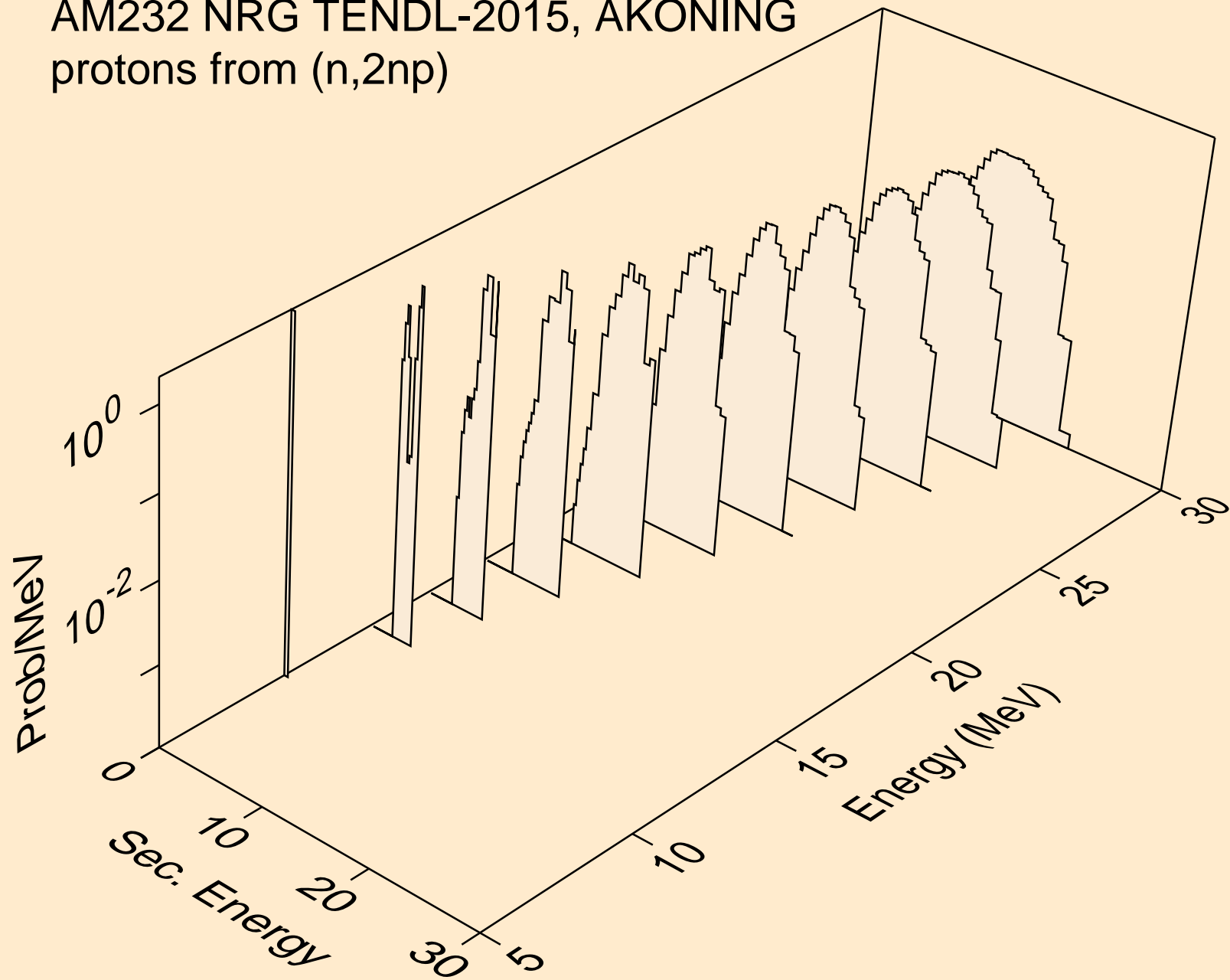

AM232 NRG TENDL-2015, AKONING
protons from (n,3np)

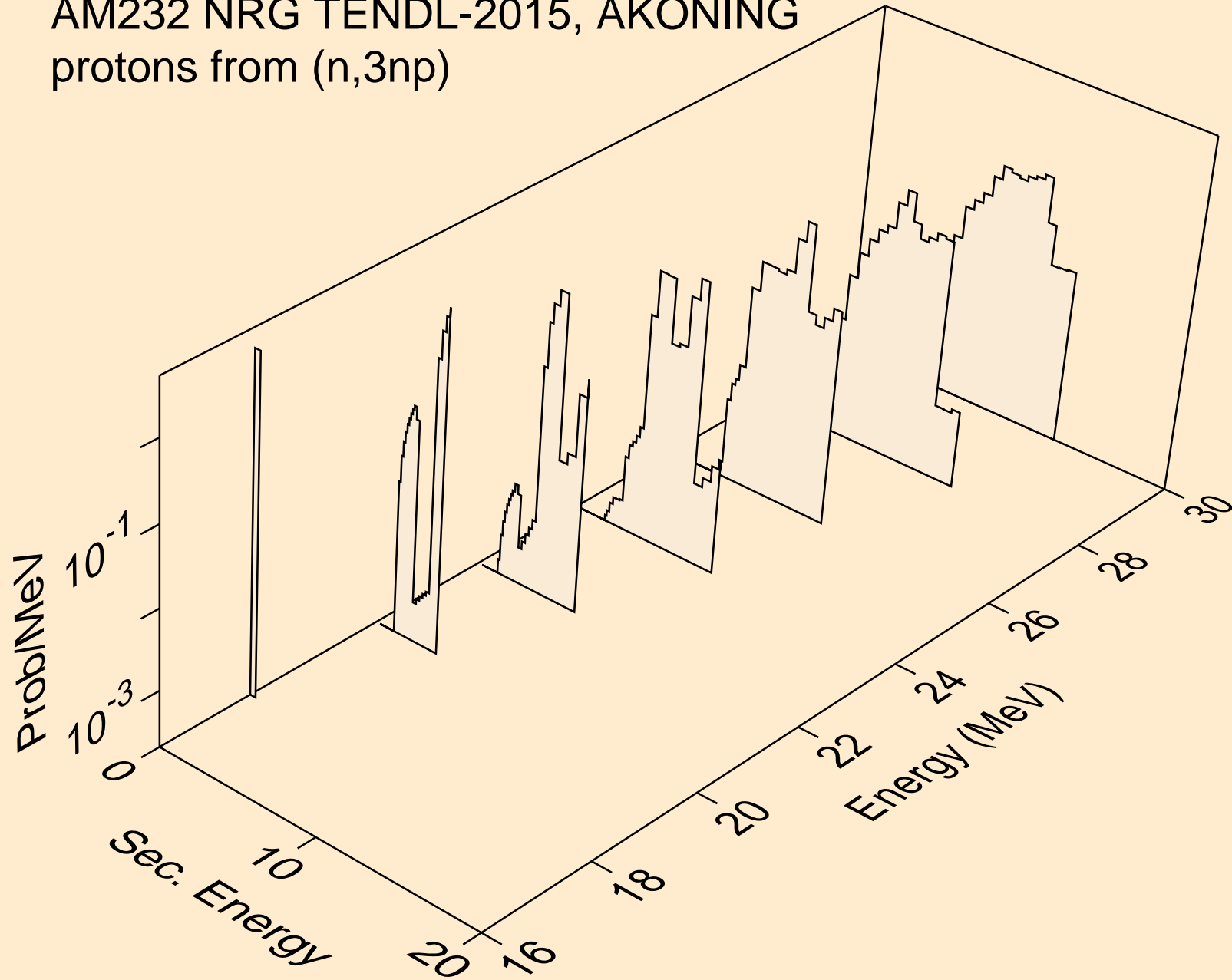

AM232 NRG TENDL-2015, AKONING
protons from (n,2np)

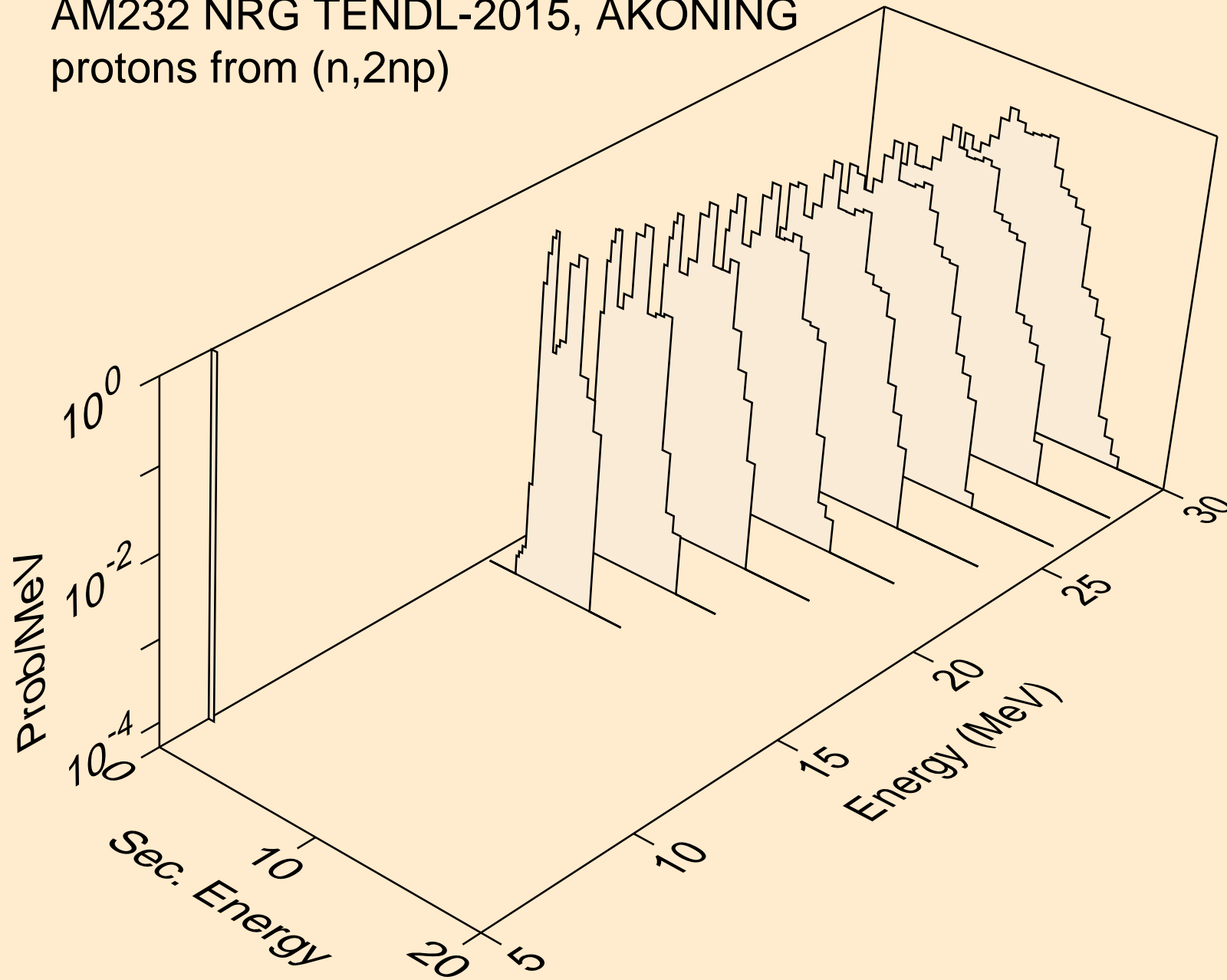

AM232 NRG TENDL-2015, AKONING
protons from (n,npa)

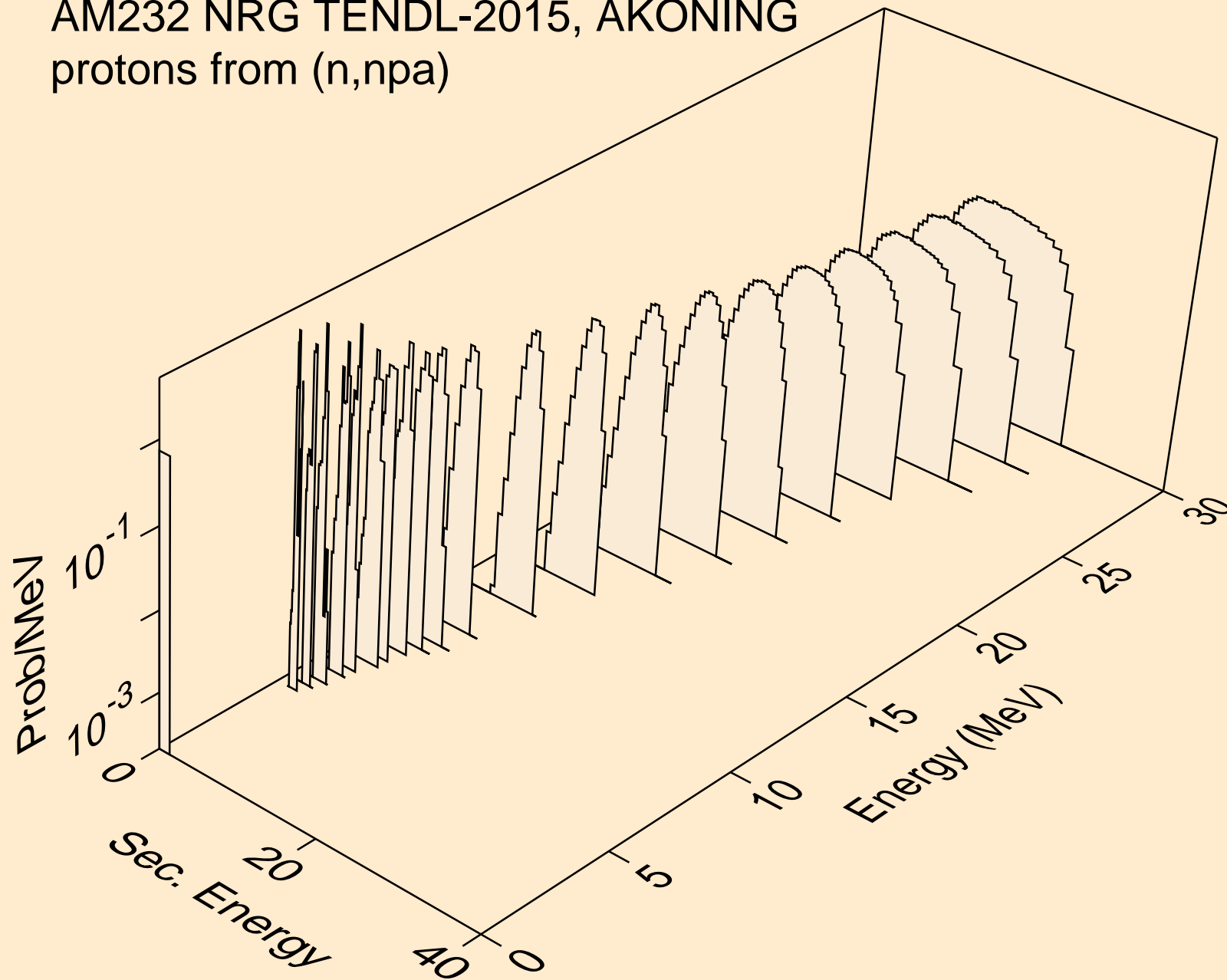

AM232 NRG TENDL-2015, AKONING
protons from (n,p)

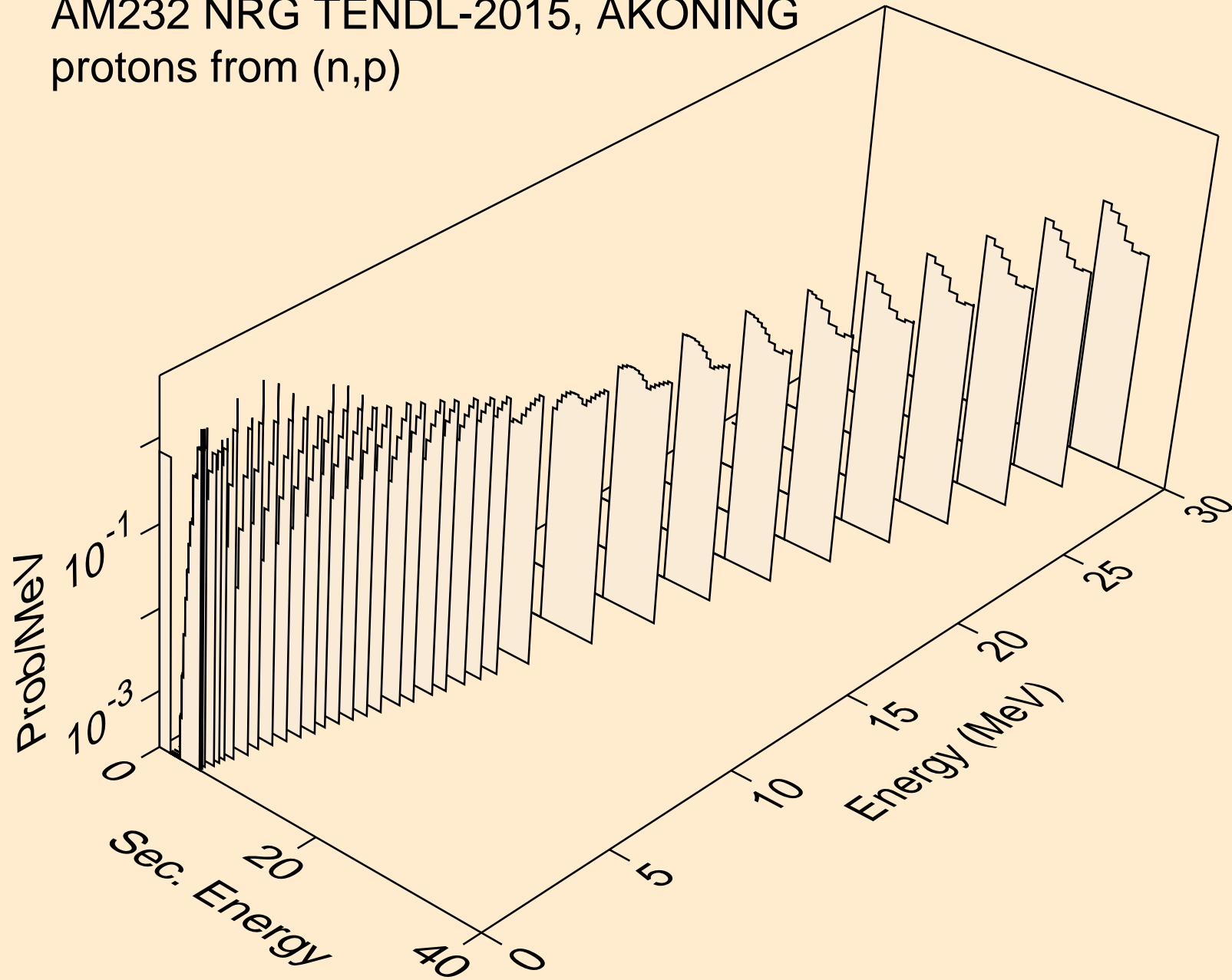

AM232 NRG TENDL-2015, AKONING
protons from (n,2p)

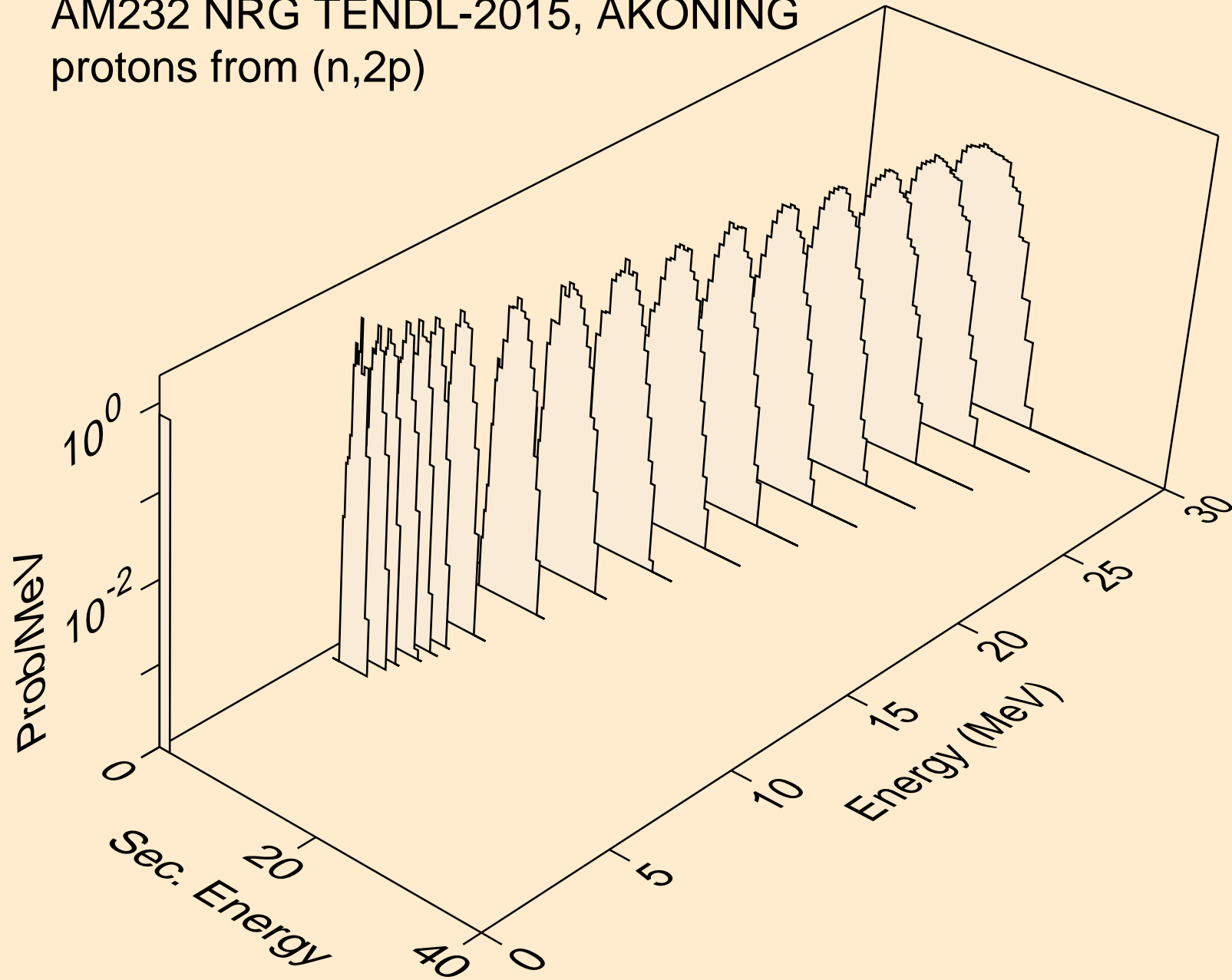

AM232 NRG TENDL-2015, AKONING
protons from (n,pa)

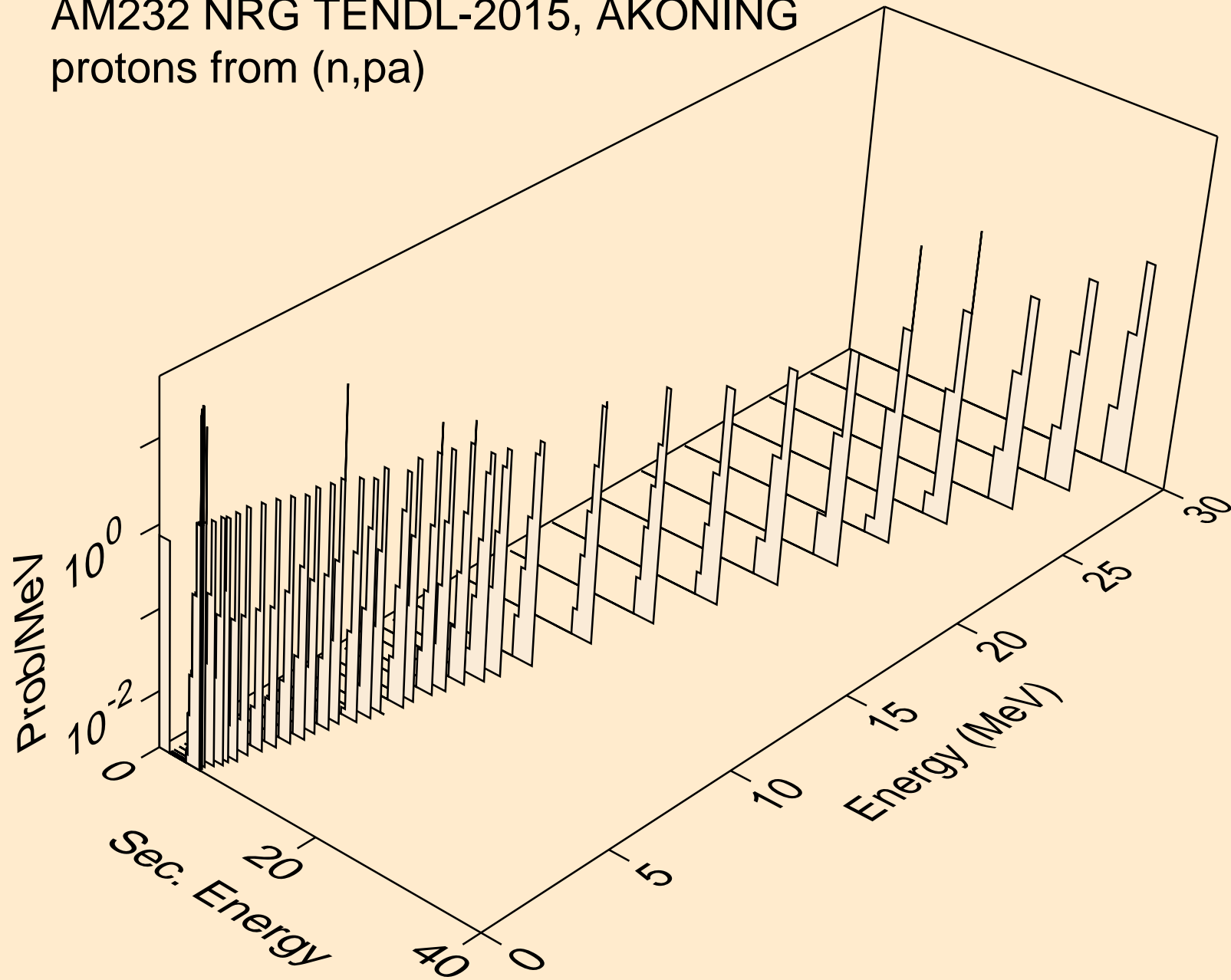

AM232 NRG TENDL-2015, AKONING
protons from (n,pd)

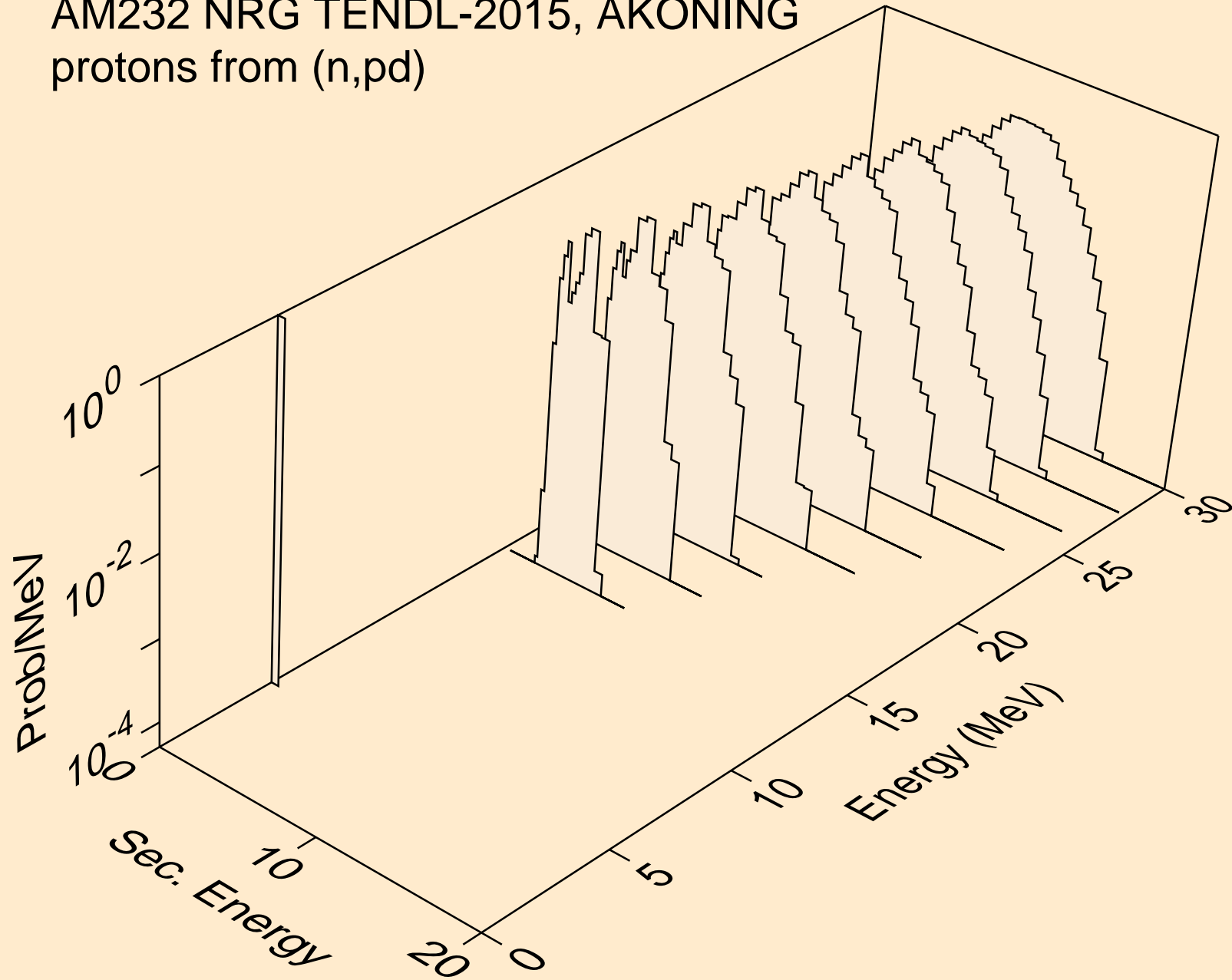

AM232 NRG TENDL-2015, AKONING
protons from (n,pt)

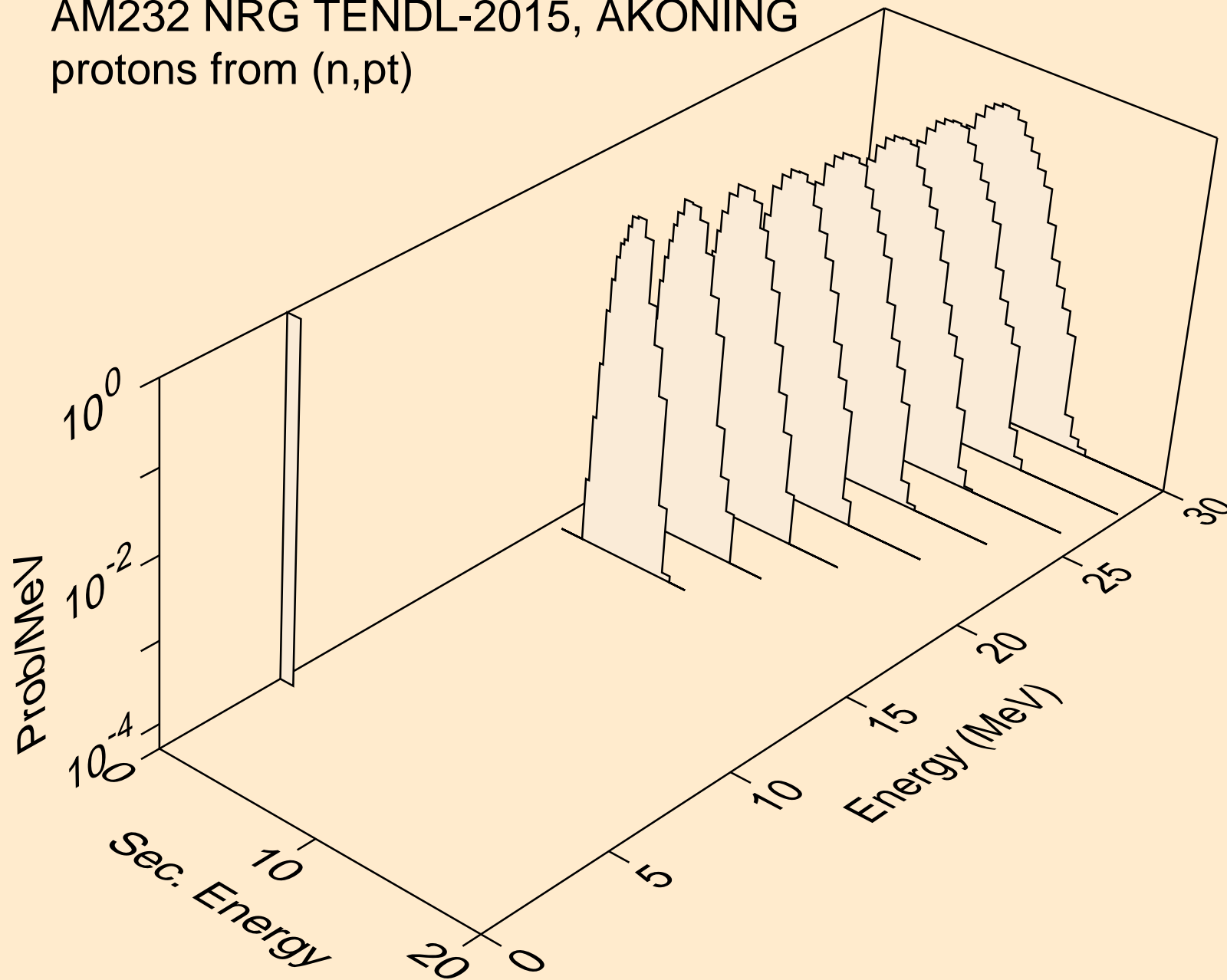

AM232 NRG TENDL-2015, AKONING
deuterons from (n,x)

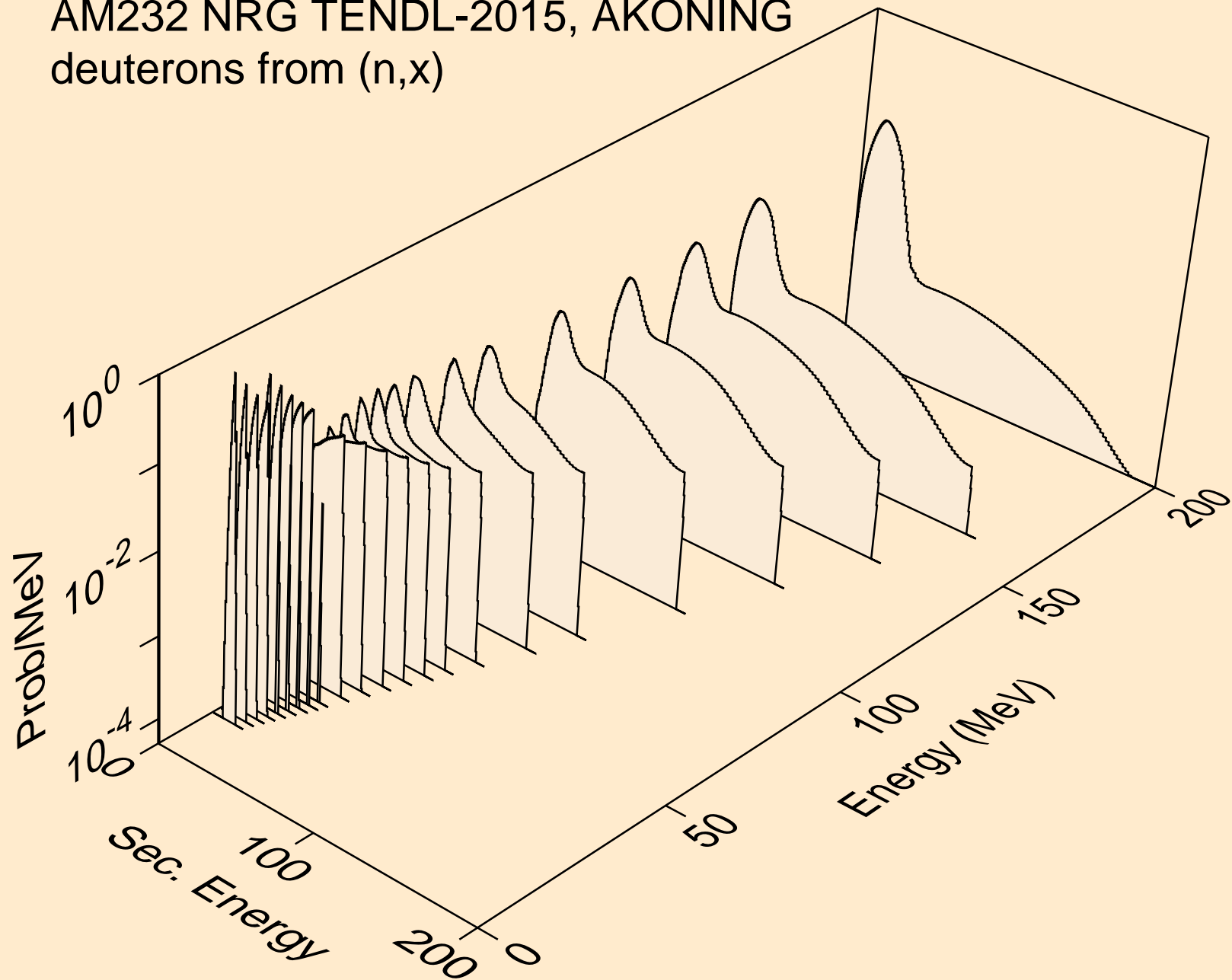

AM232 NRG TENDL-2015, AKONING
deuterons from (n,2nd)

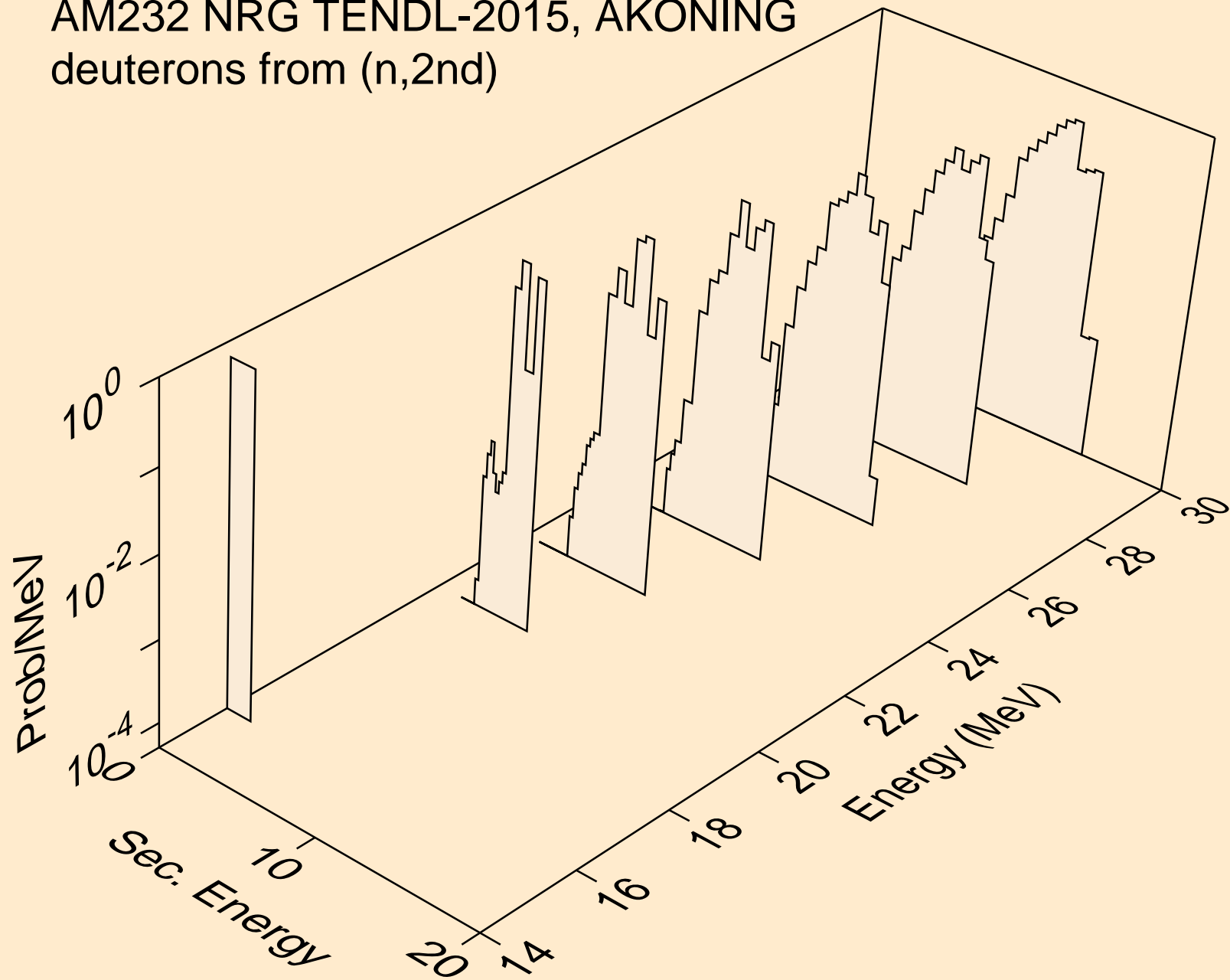

AM232 NRG TENDL-2015, AKONING
deuterons from (n,n*)d

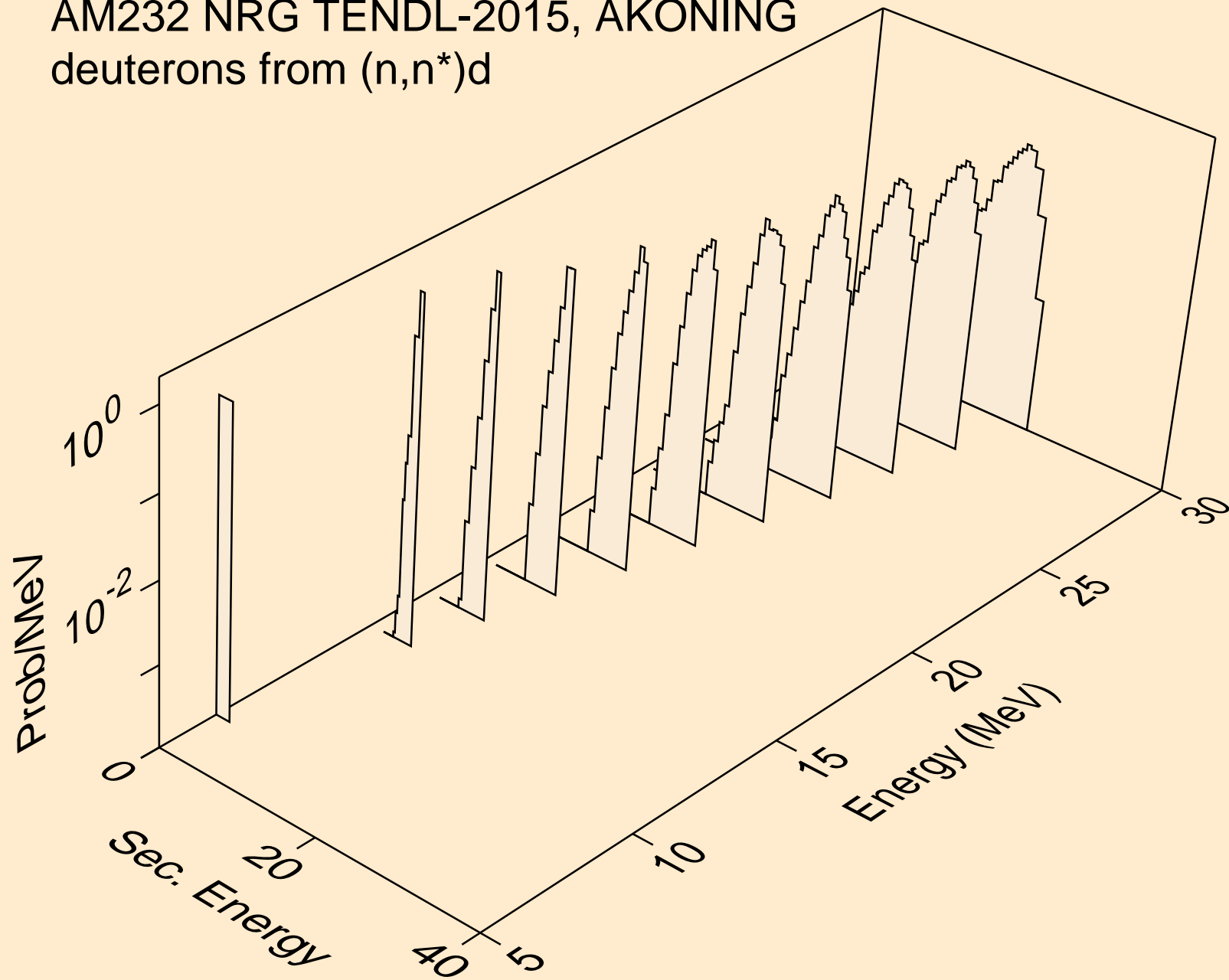

AM232 NRG TENDL-2015, AKONING
deuterons from (n,n*)d2a

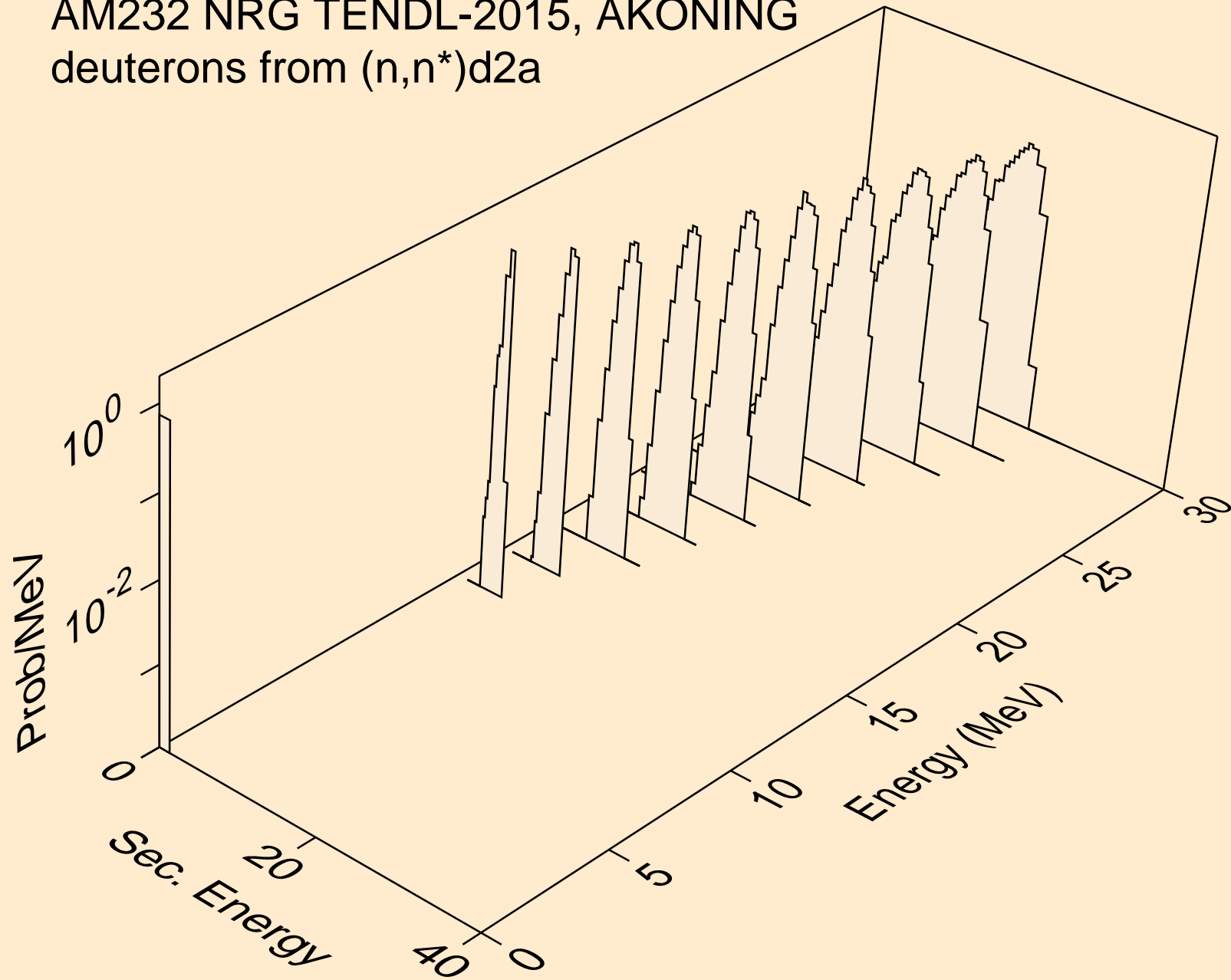

AM232 NRG TENDL-2015, AKONING
deuterons from (n,d)

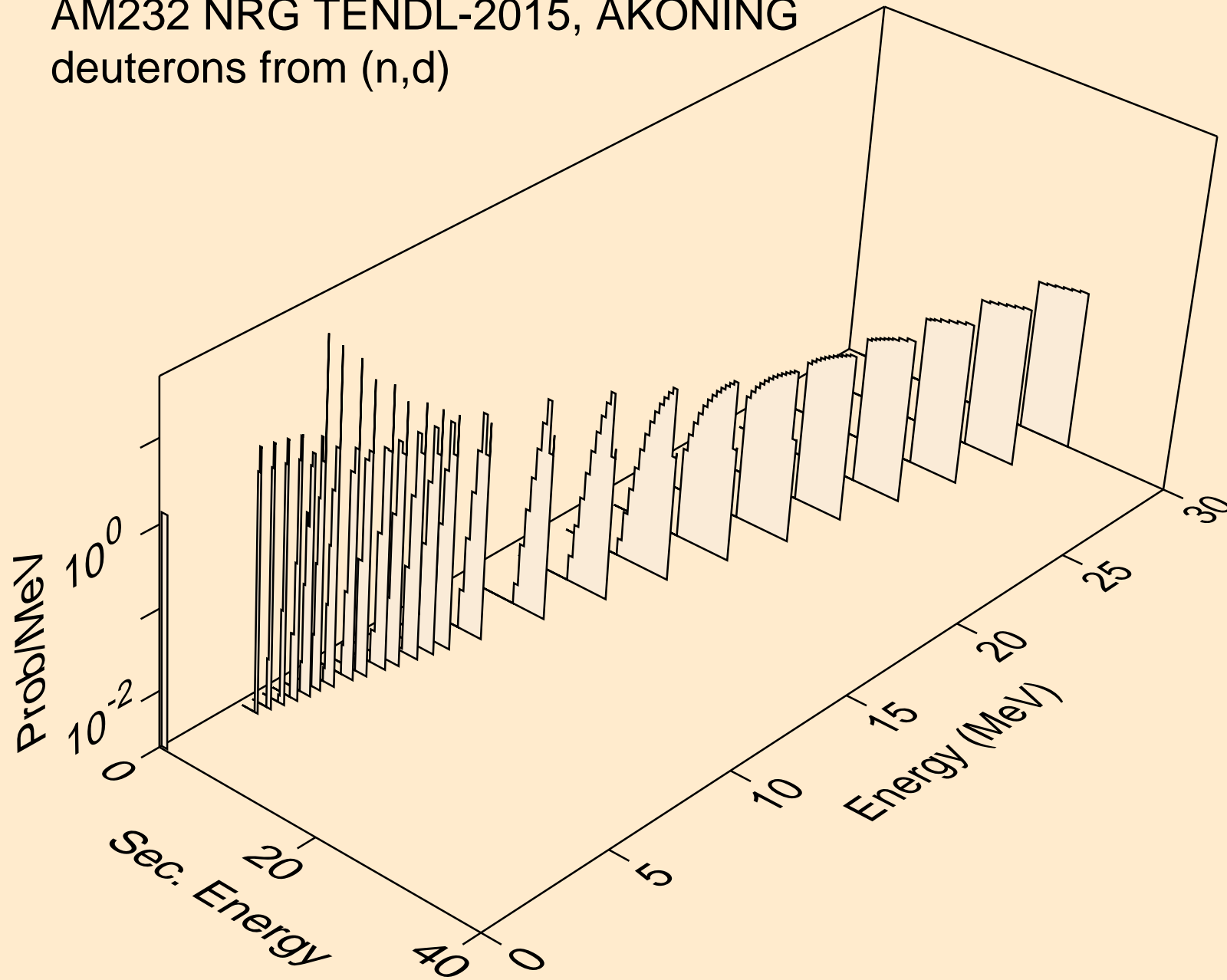

AM232 NRG TENDL-2015, AKONING
deuterons from (n,d2a)

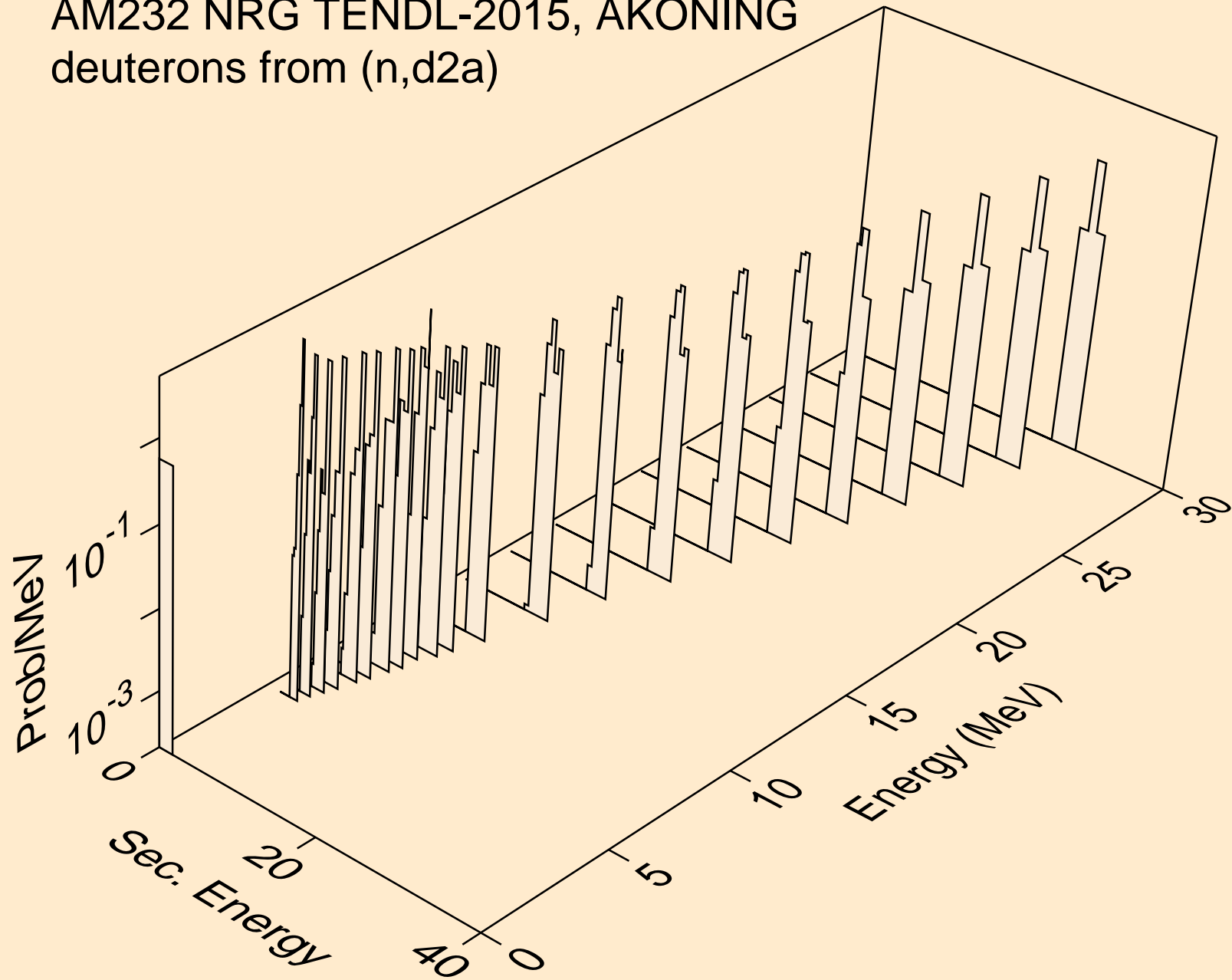

AM232 NRG TENDL-2015, AKONING
deuterons from (n,pd)

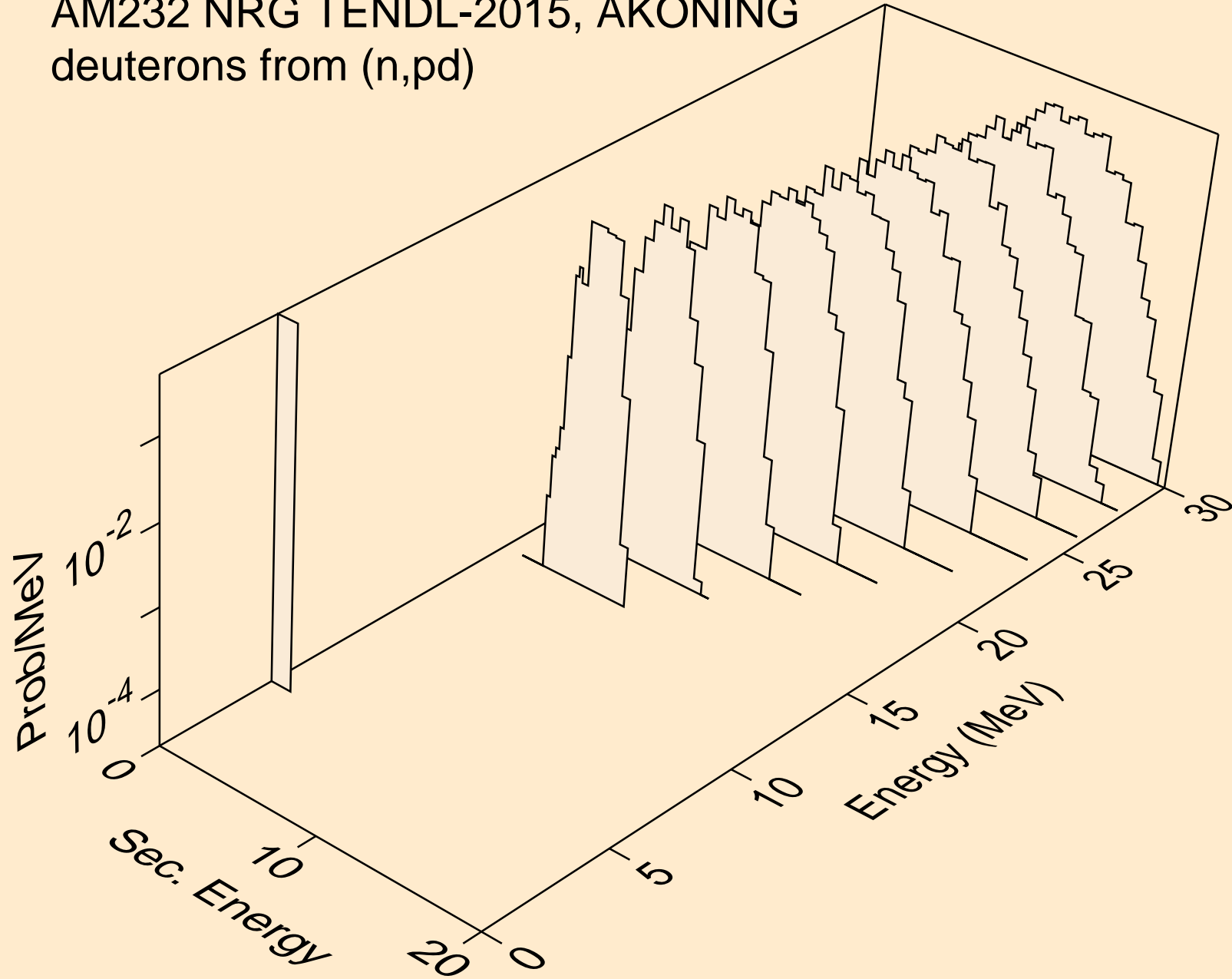

AM232 NRG TENDL-2015, AKONING
deuterons from (n,da)

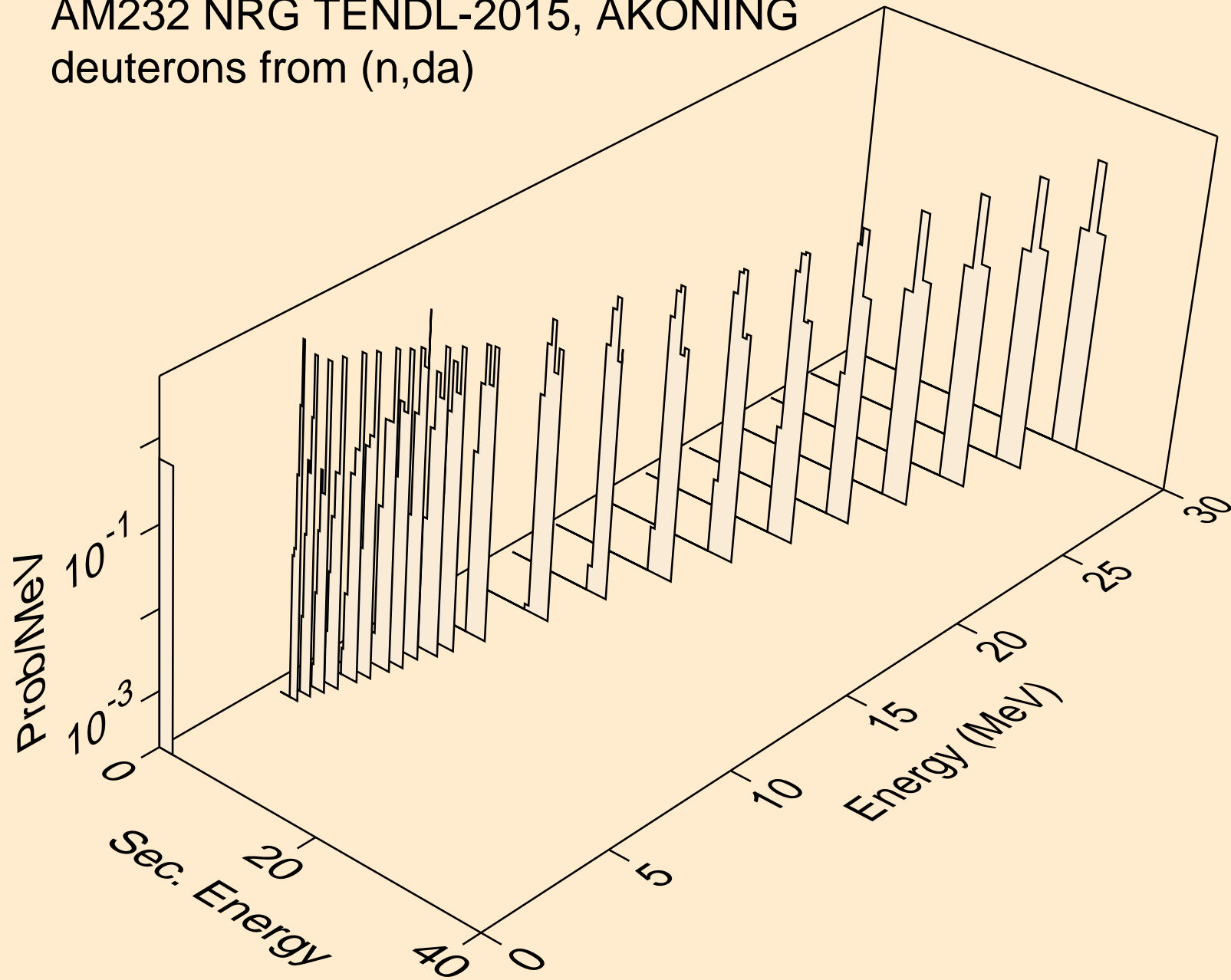

AM232 NRG TENDL-2015, AKONING
tritons from (n,x)

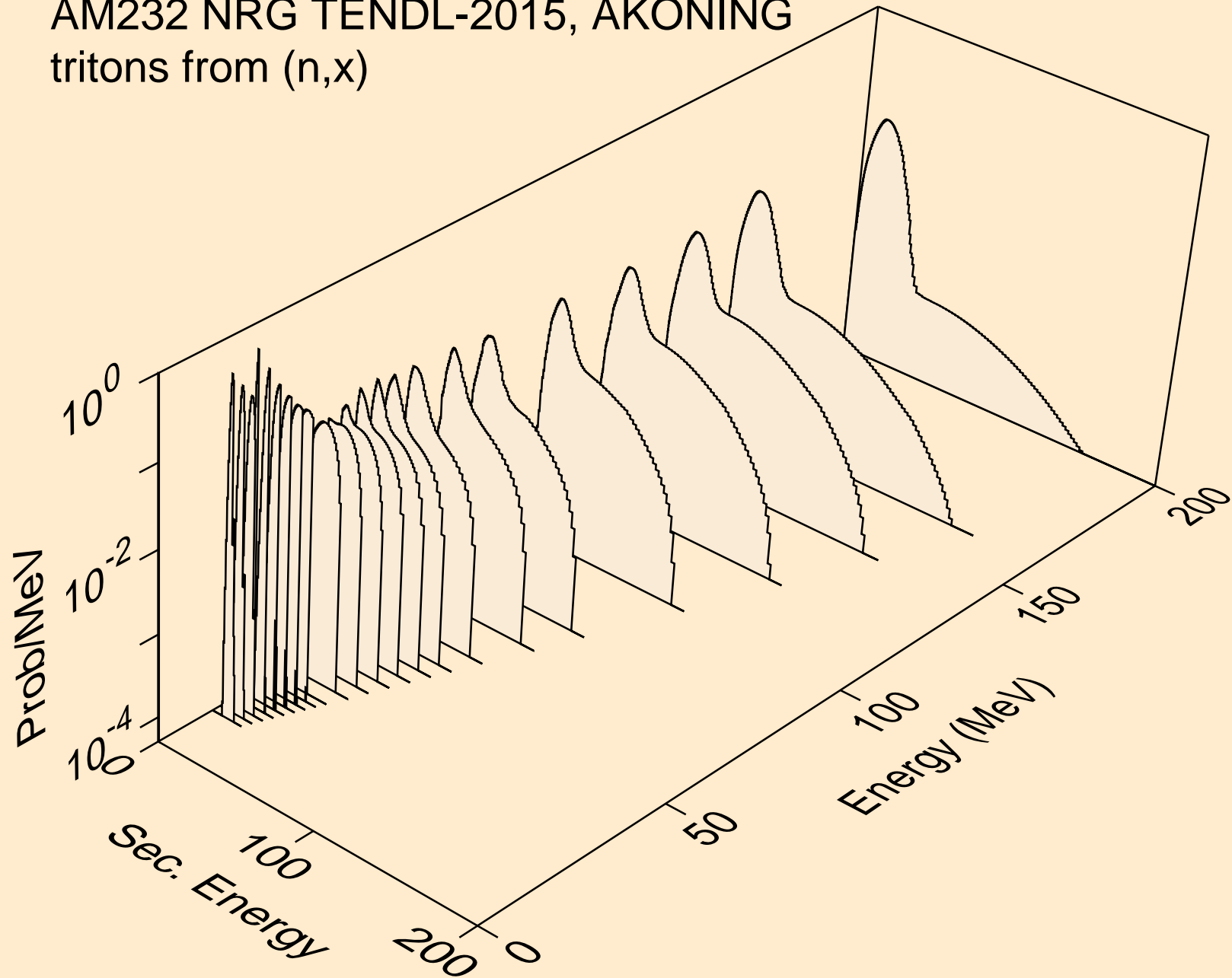

AM232 NRG TENDL-2015, AKONING
tritons from (n,n*)t

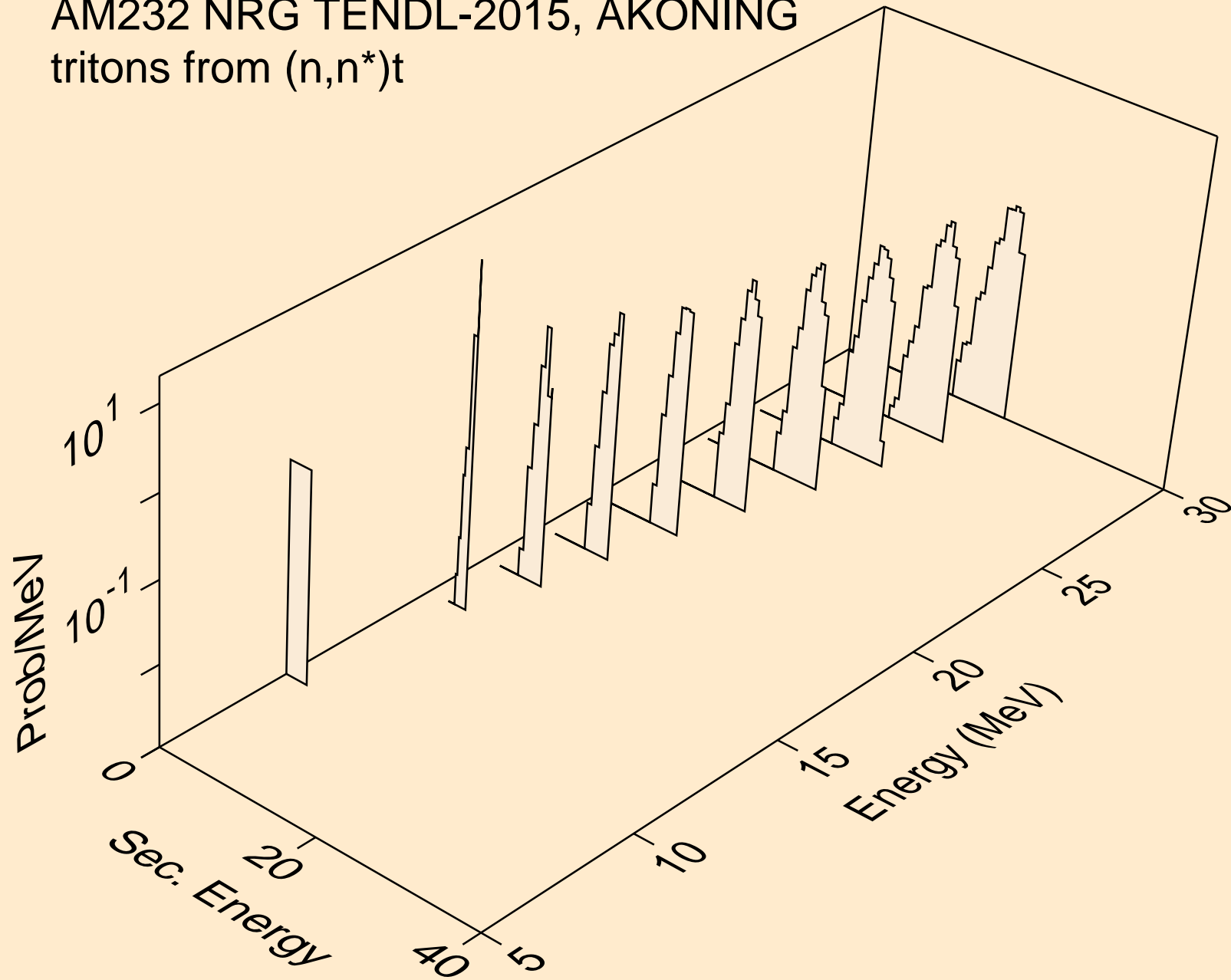

AM232 NRG TENDL-2015, AKONING
tritons from (n,n*)t2a

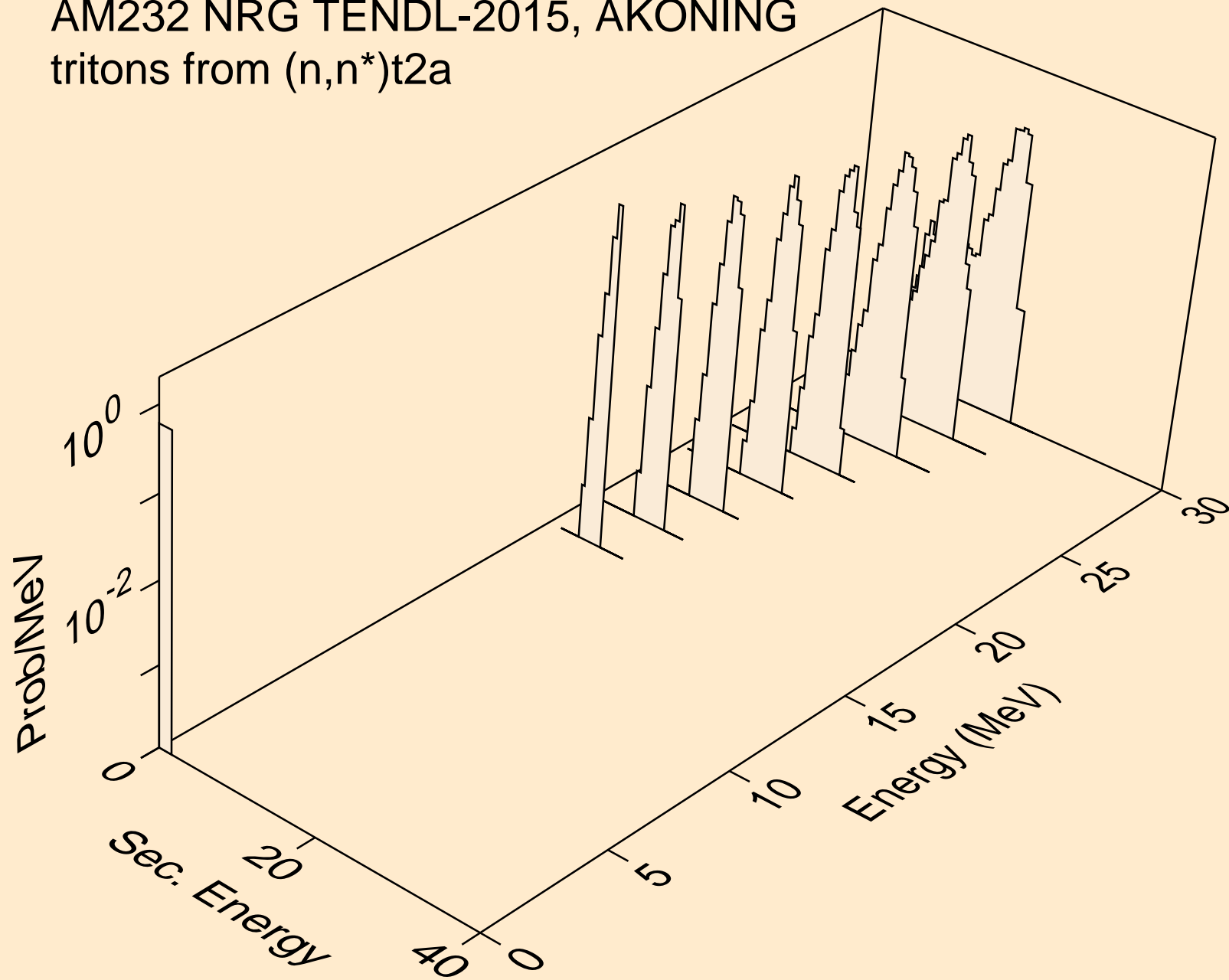

AM232 NRG TENDL-2015, AKONING
tritons from (n,t)

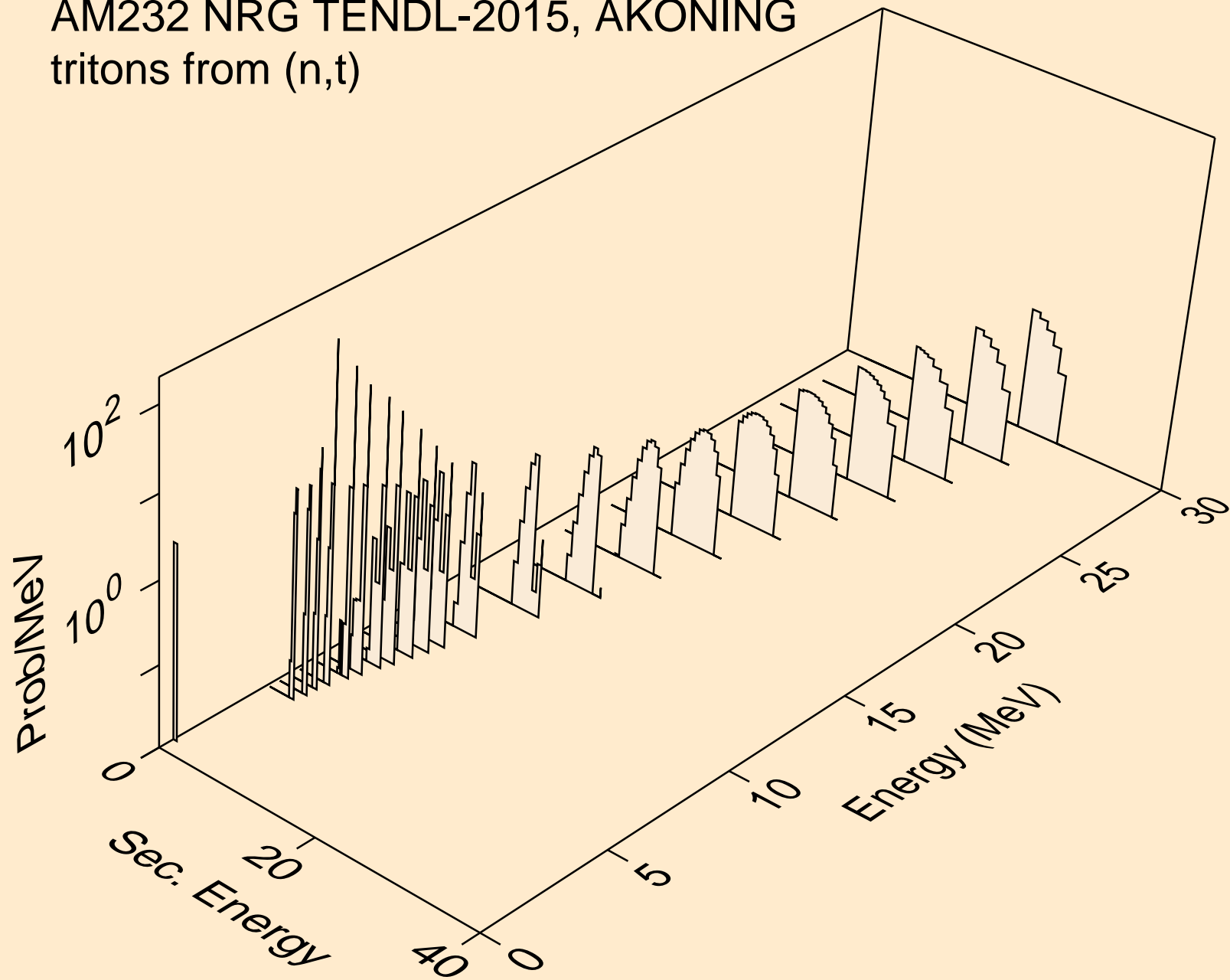

AM232 NRG TENDL-2015, AKONING
tritons from (n,t2a)

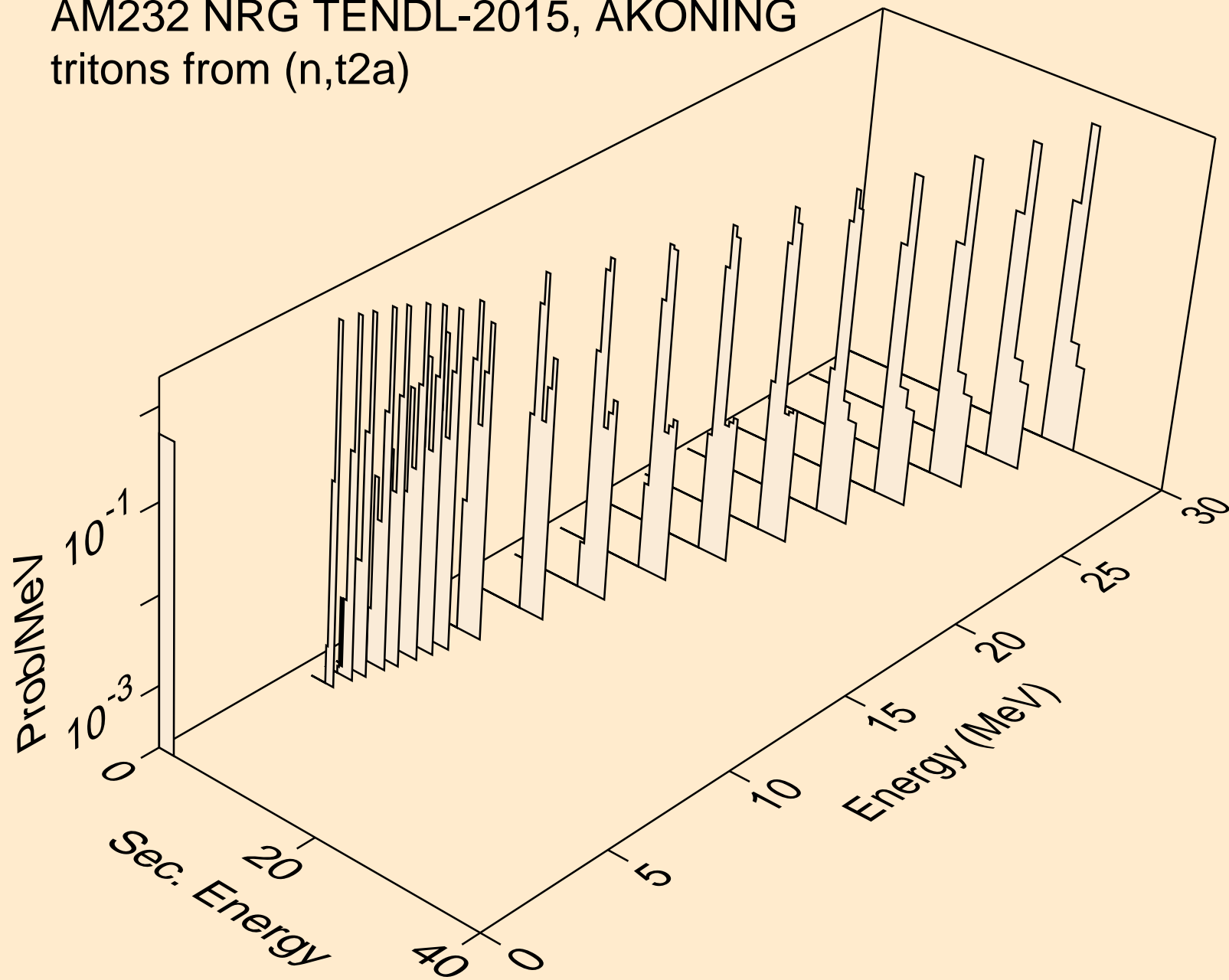

AM232 NRG TENDL-2015, AKONING
tritons from (n,pt)

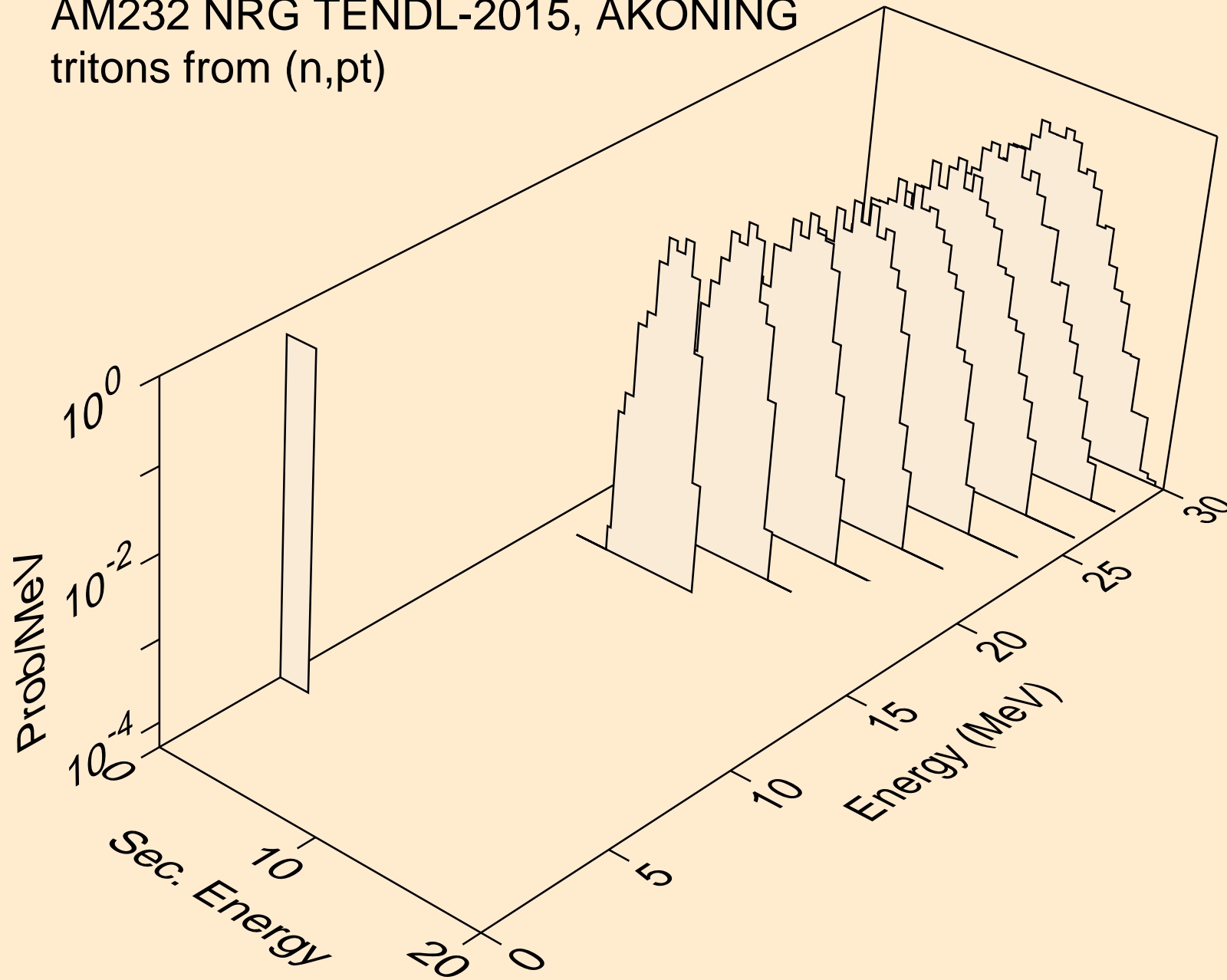

AM232 NRG TENDL-2015, AKONING
he3s from (n,x)

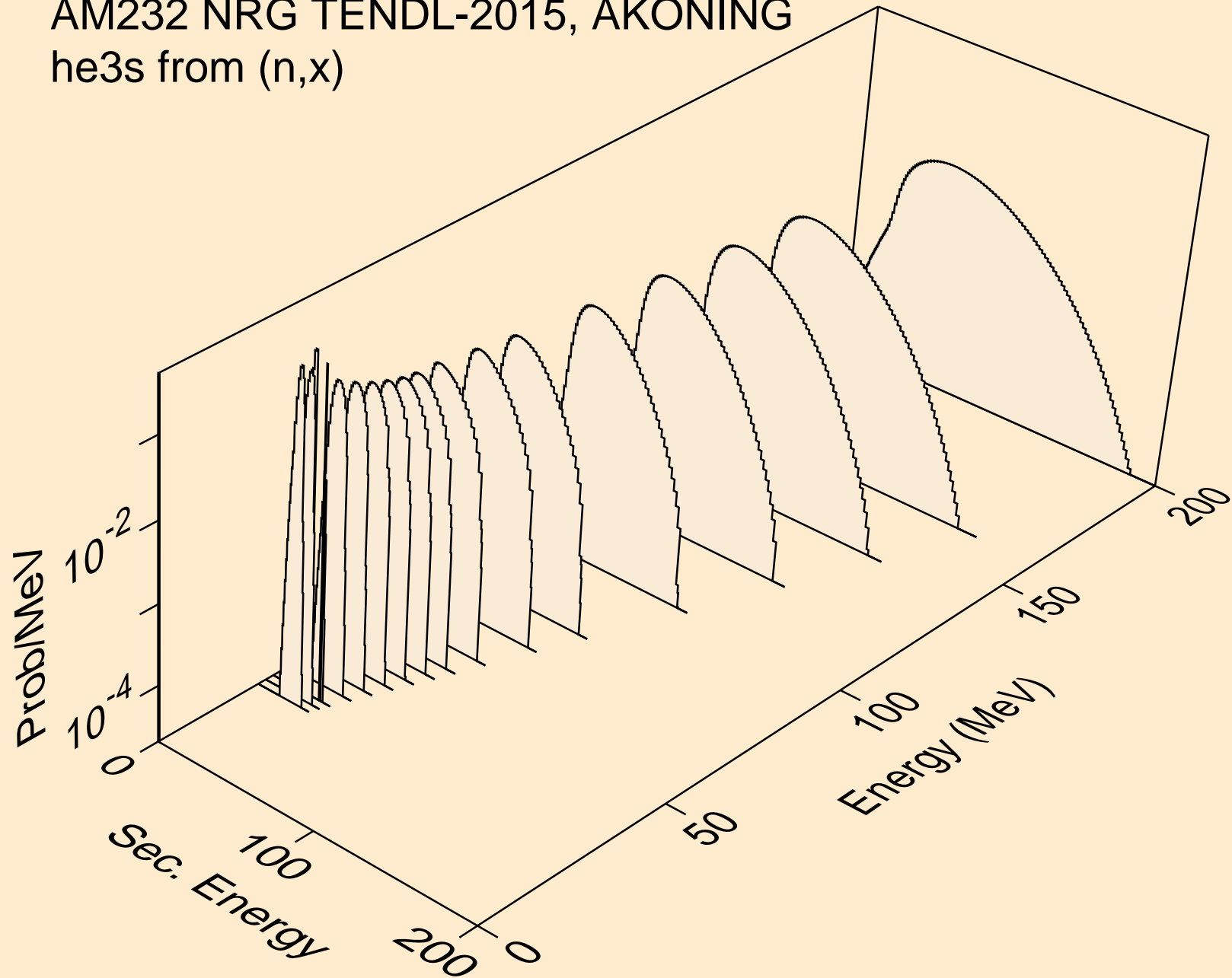

AM232 NRG TENDL-2015, AKONING
he3s from (n,n*)he3

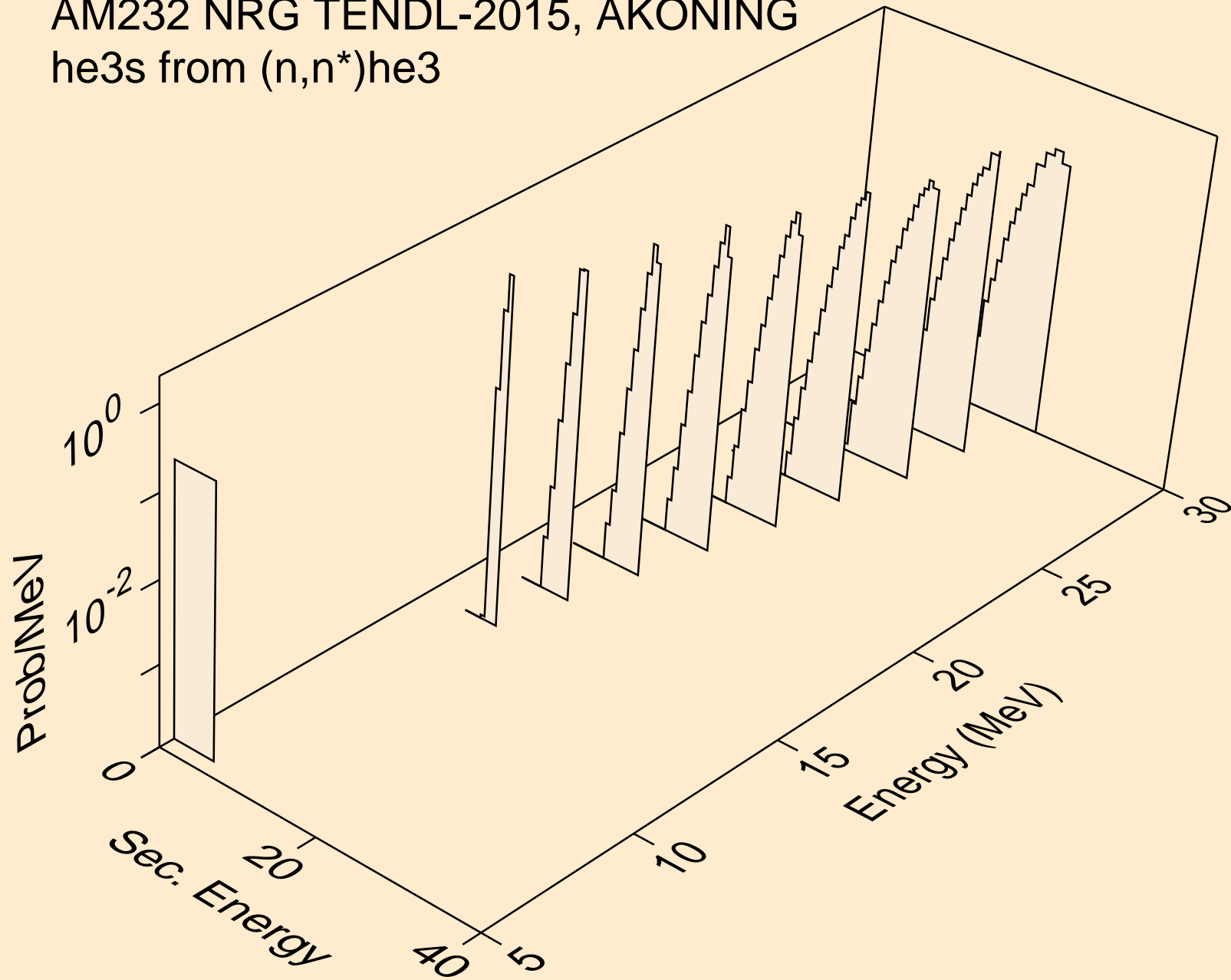

AM232 NRG TENDL-2015, AKONING
he3s from (n,he3)

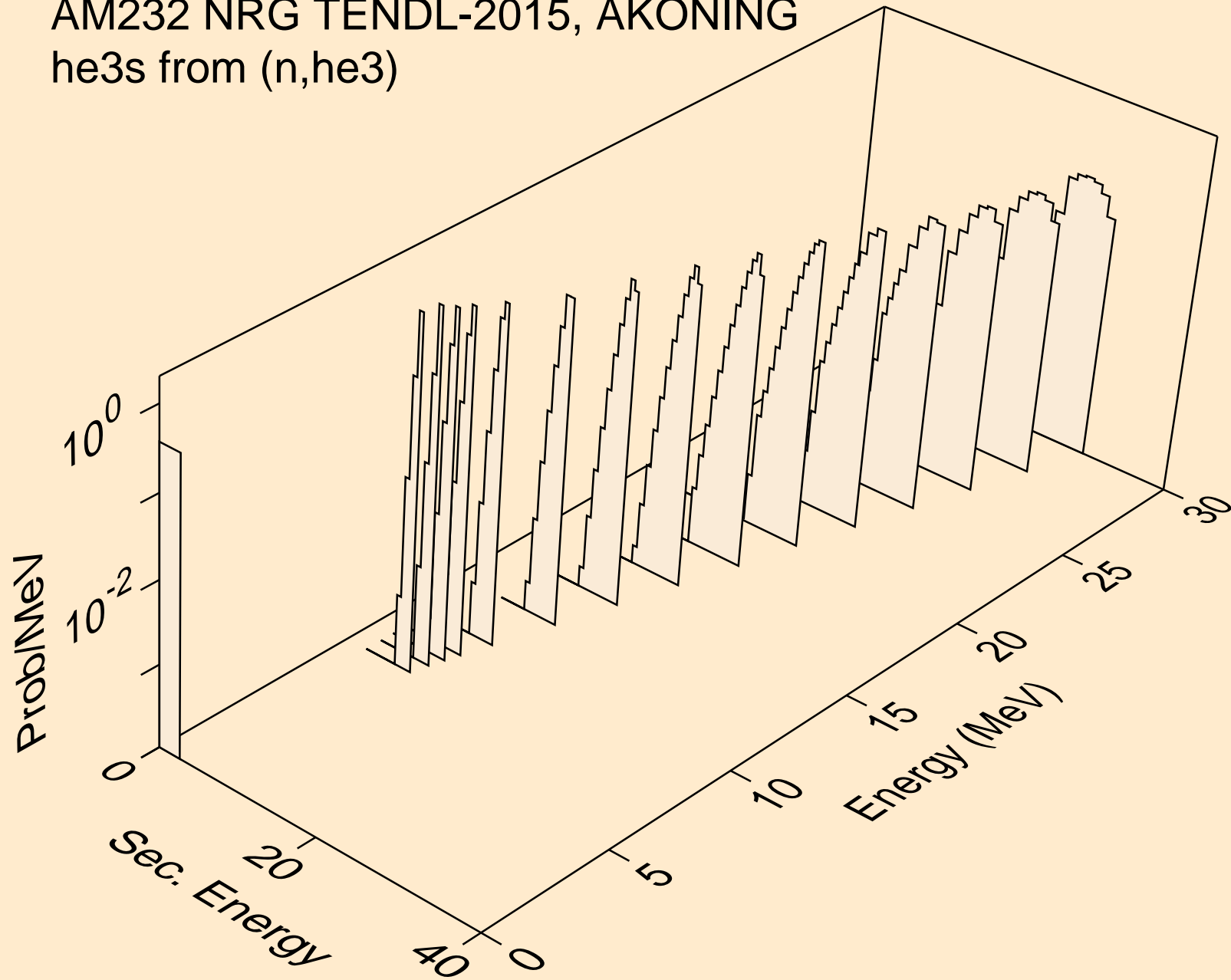

AM232 NRG TENDL-2015, AKONING
alphas from (n,x)

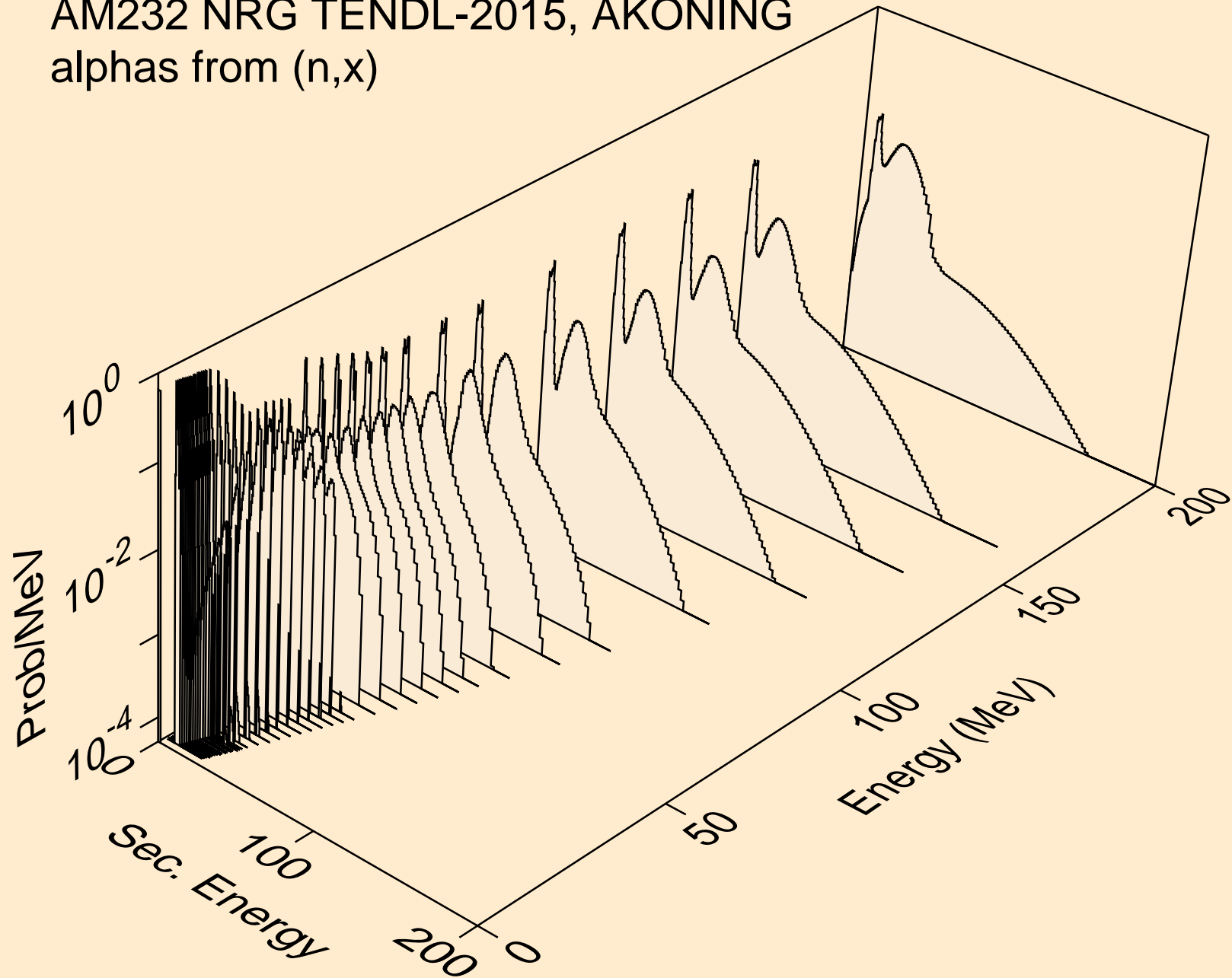

AM232 NRG TENDL-2015, AKONING
alphas from (n,n*)a

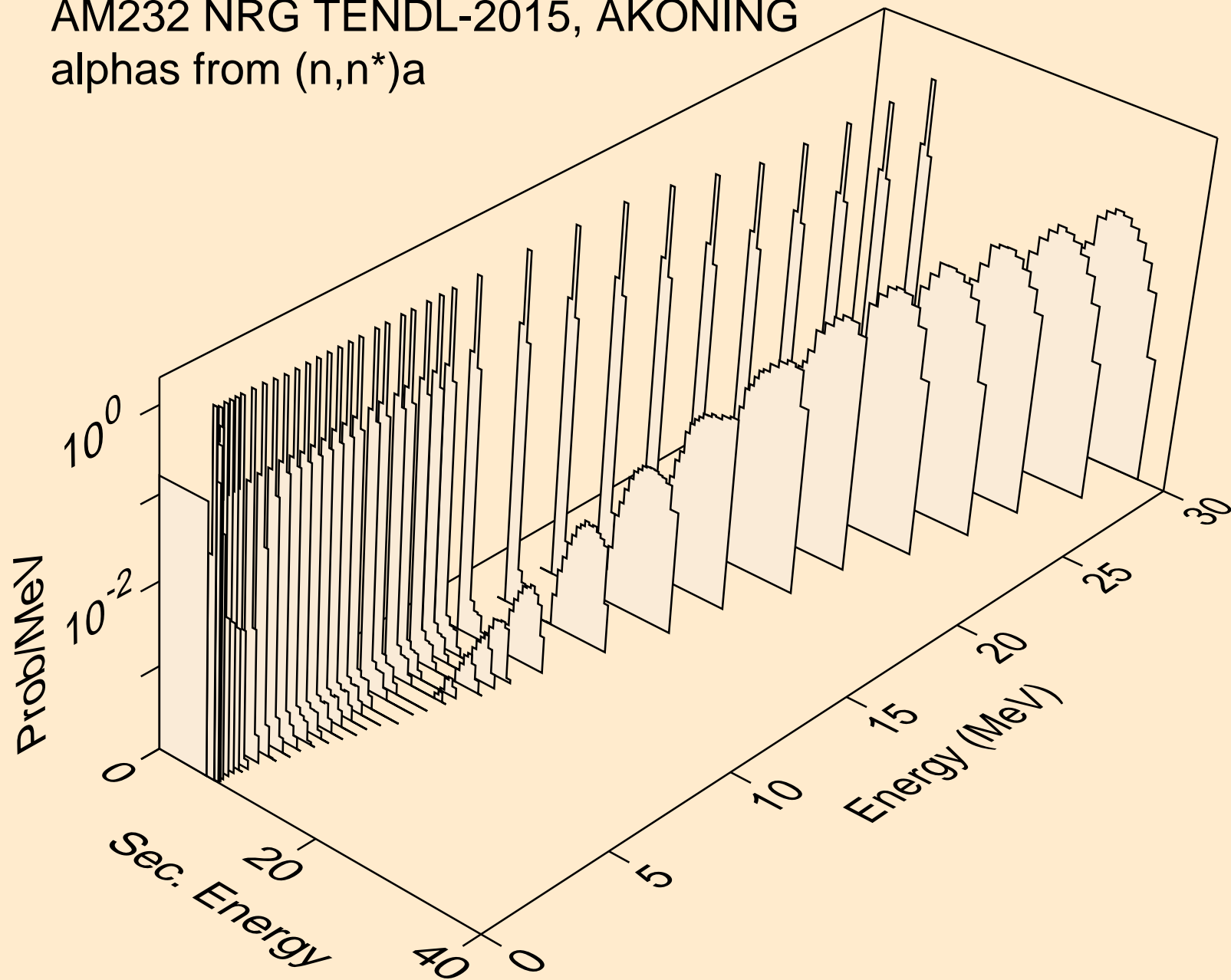

AM232 NRG TENDL-2015, AKONING
alphas from (n,n*)3a

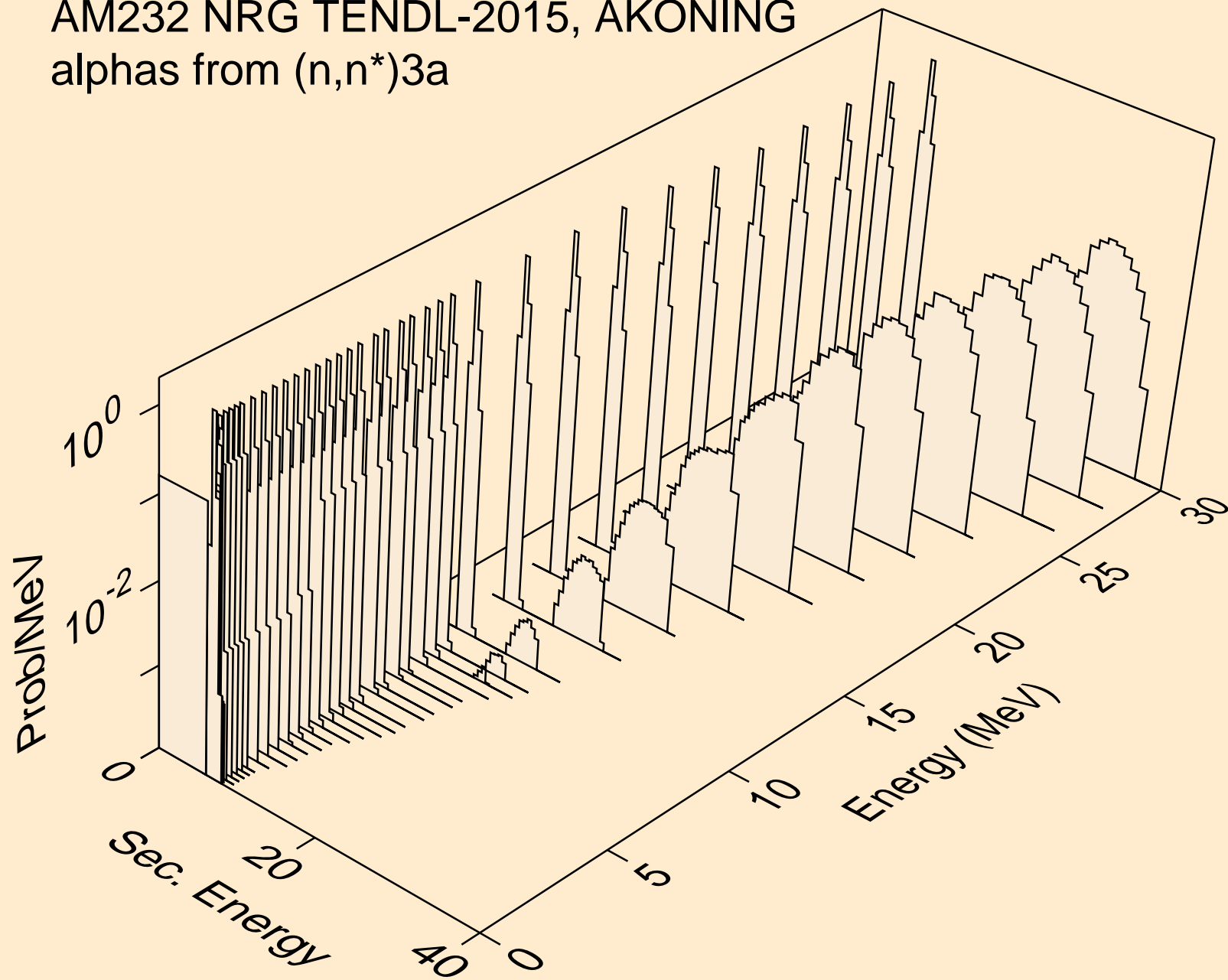

AM232 NRG TENDL-2015, AKONING
alphas from (n,2n)a

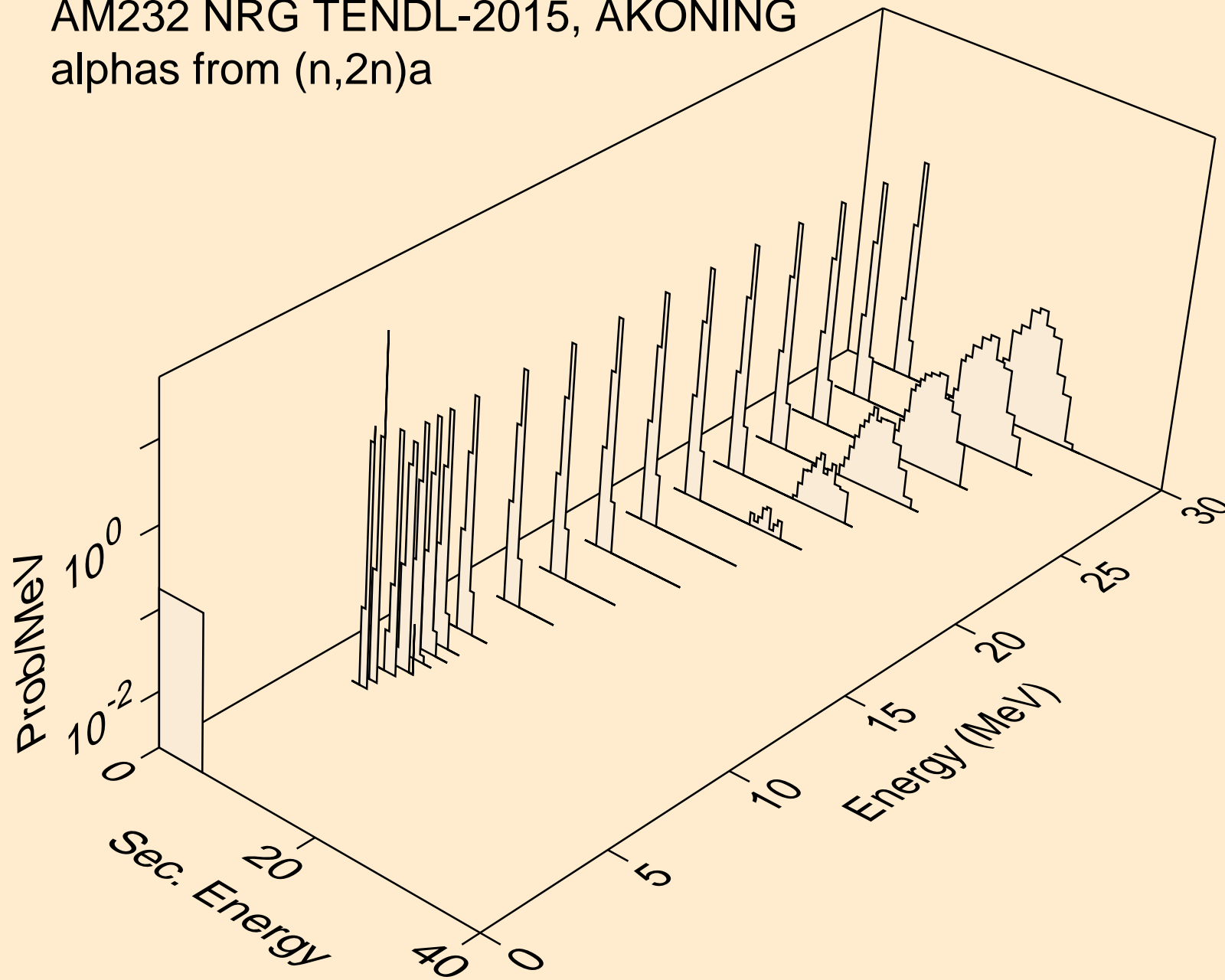

AM232 NRG TENDL-2015, AKONING
alphas from (n,3n)a

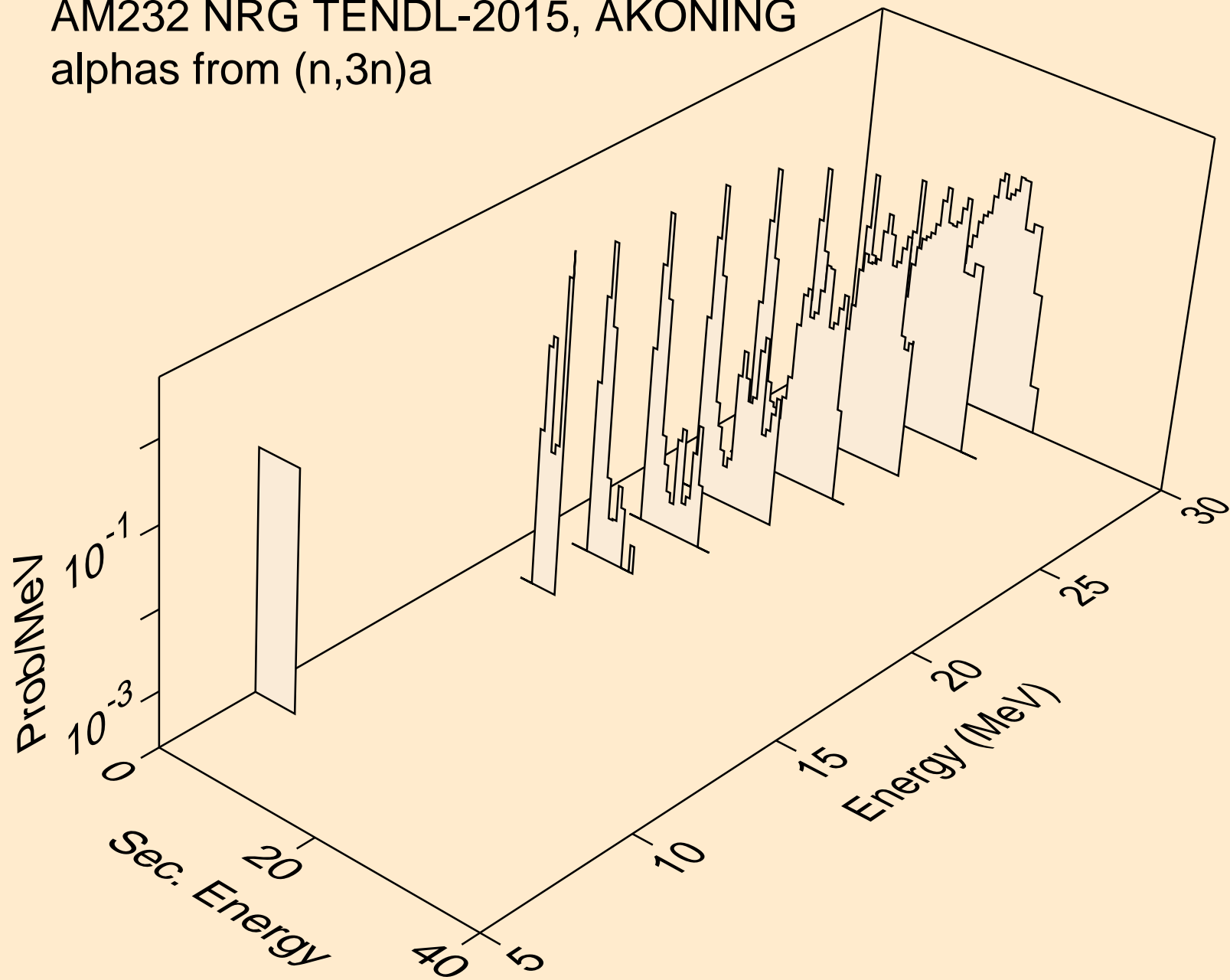

AM232 NRG TENDL-2015, AKONING
alphas from (n,n*)2a

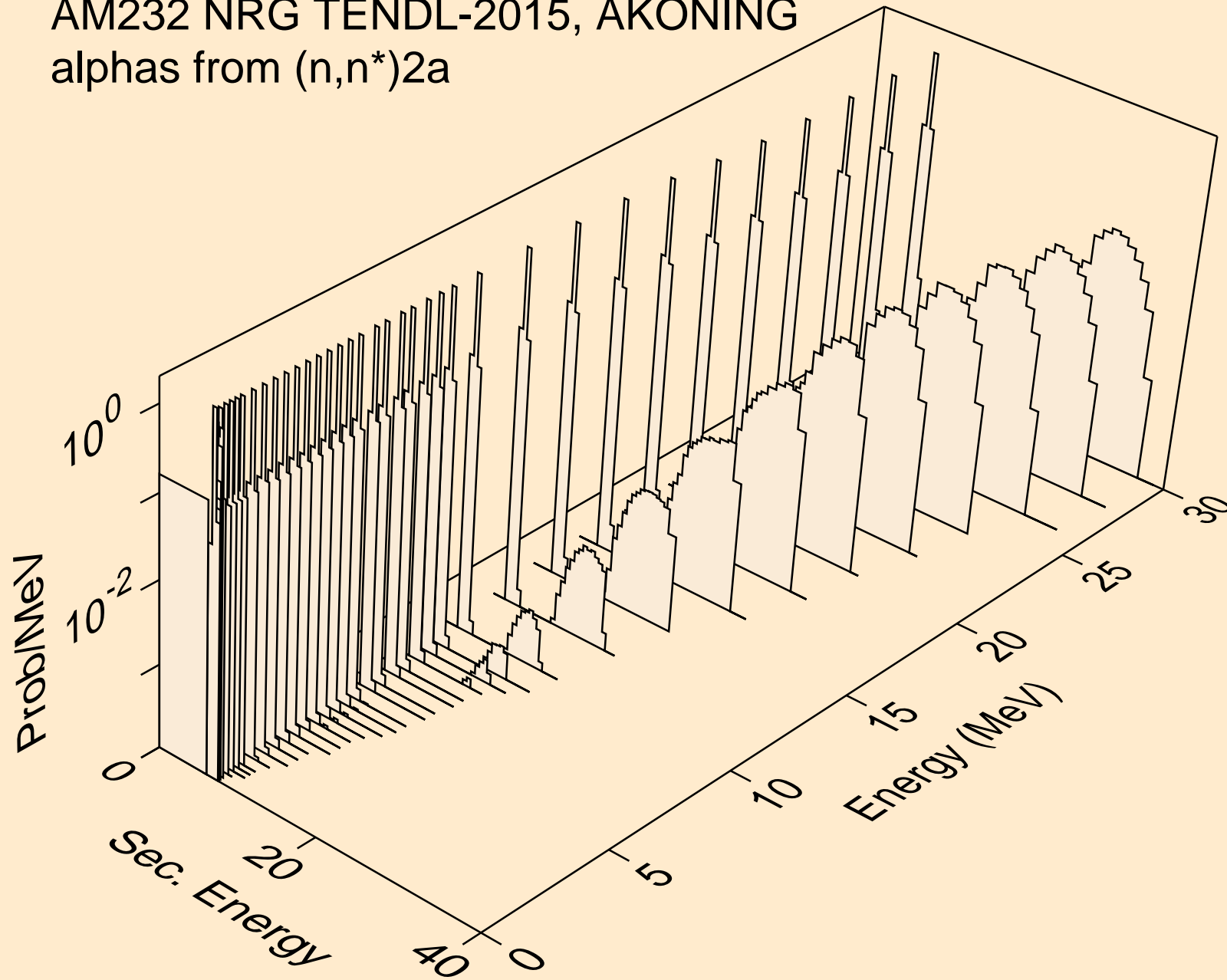

AM232 NRG TENDL-2015, AKONING
alphas from (n,2n)2a

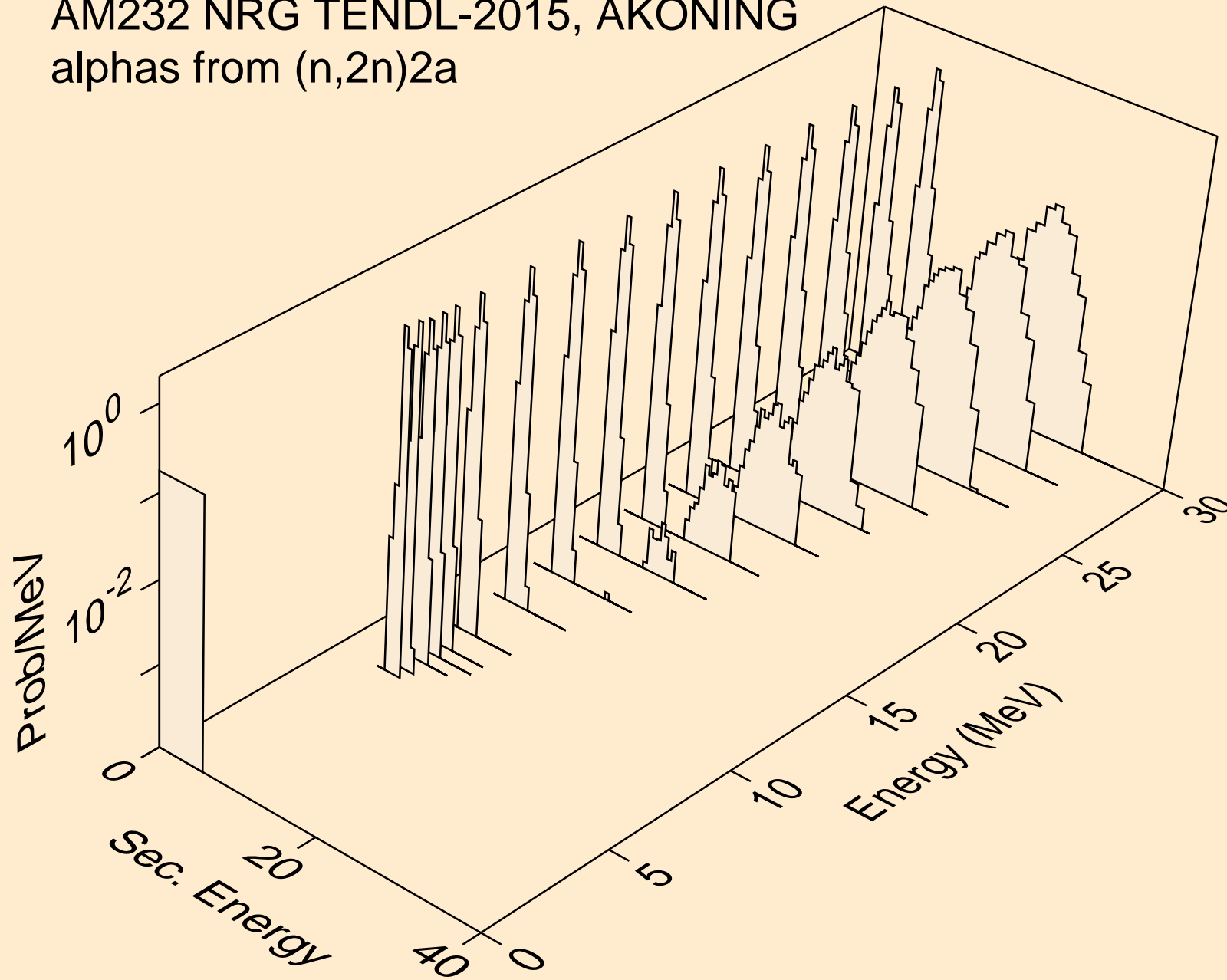

AM232 NRG TENDL-2015, AKONING
alphas from (n,n*)d2a

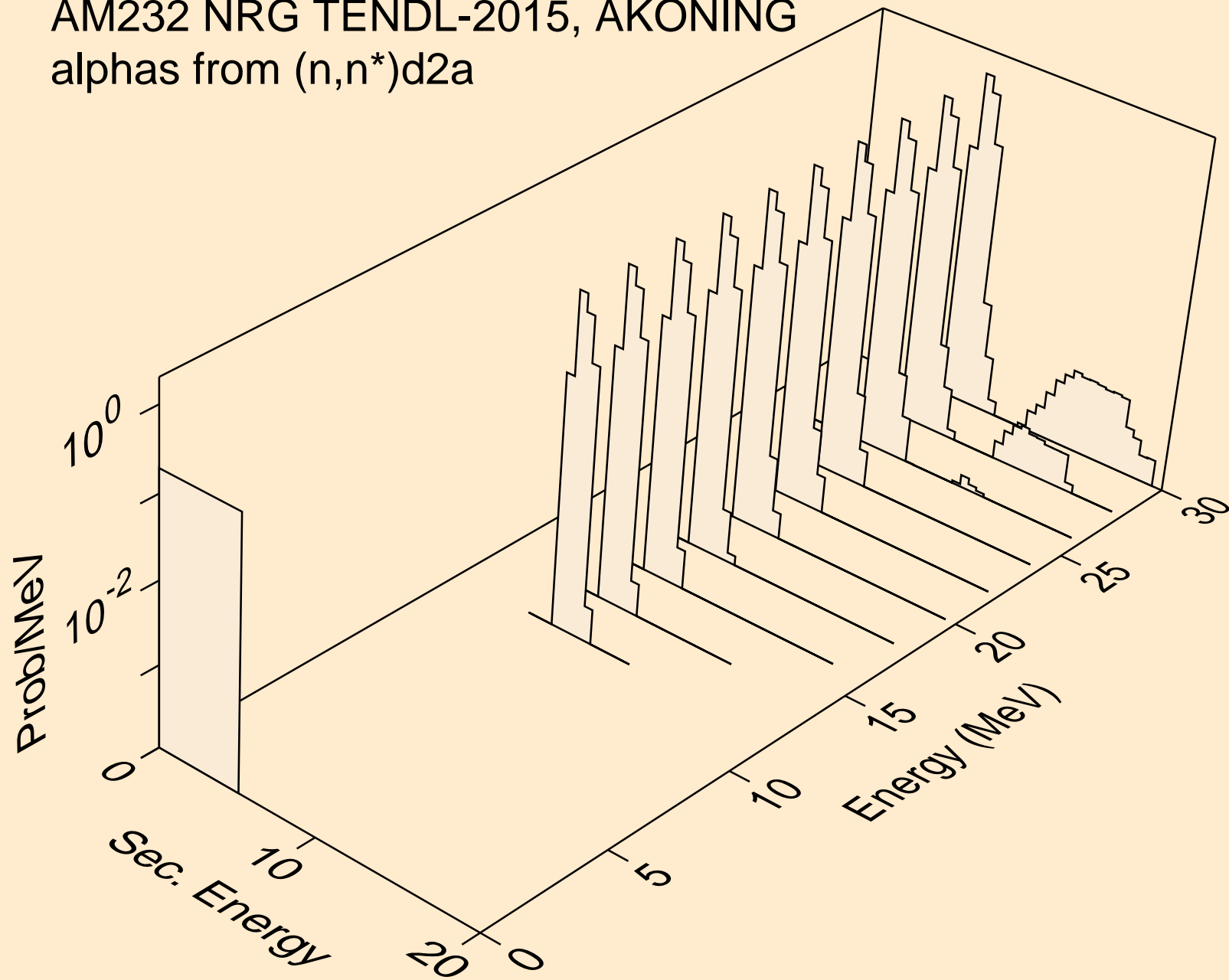

AM232 NRG TENDL-2015, AKONING
alphas from (n,n*)t2a

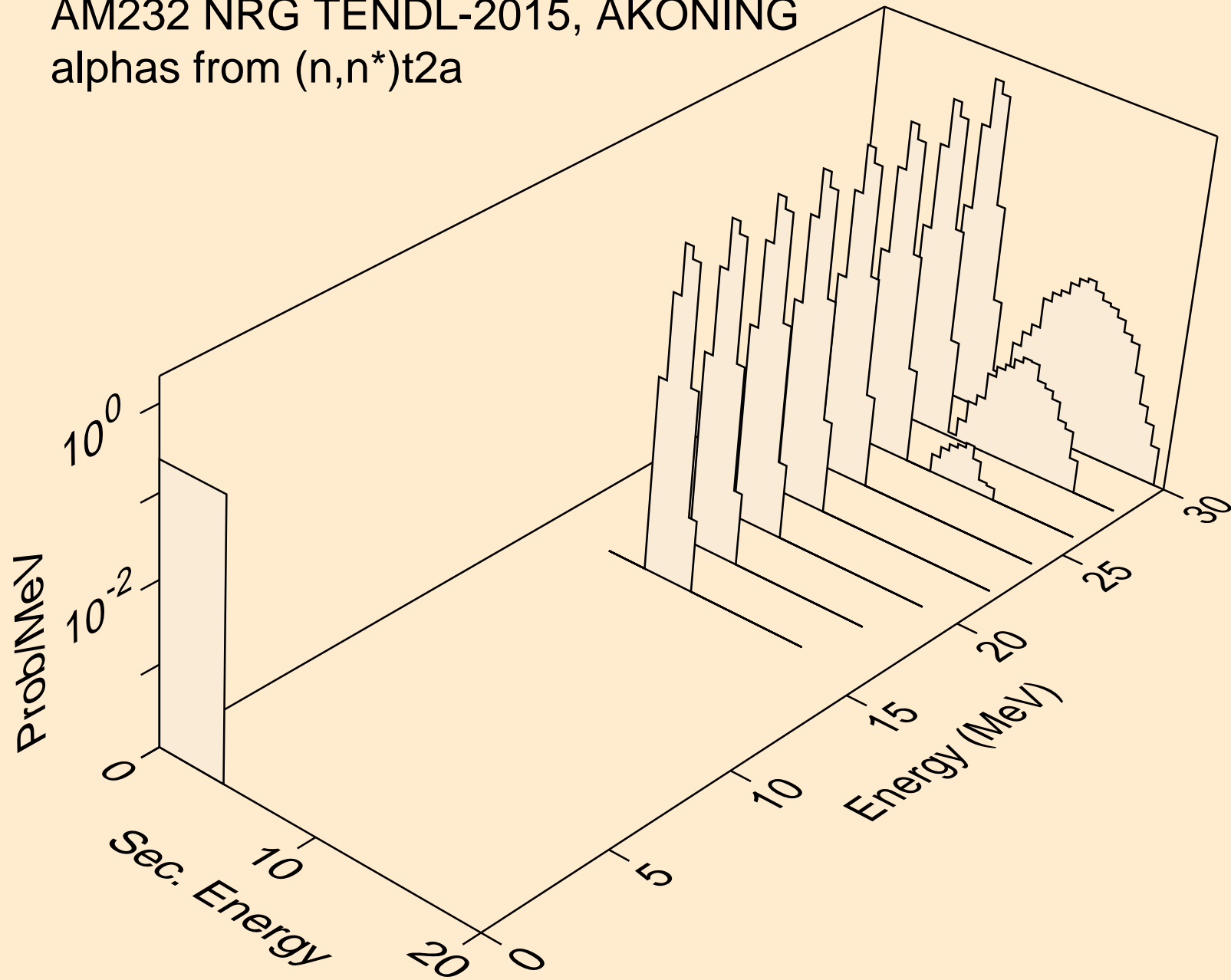

AM232 NRG TENDL-2015, AKONING
alphas from (n,npa)

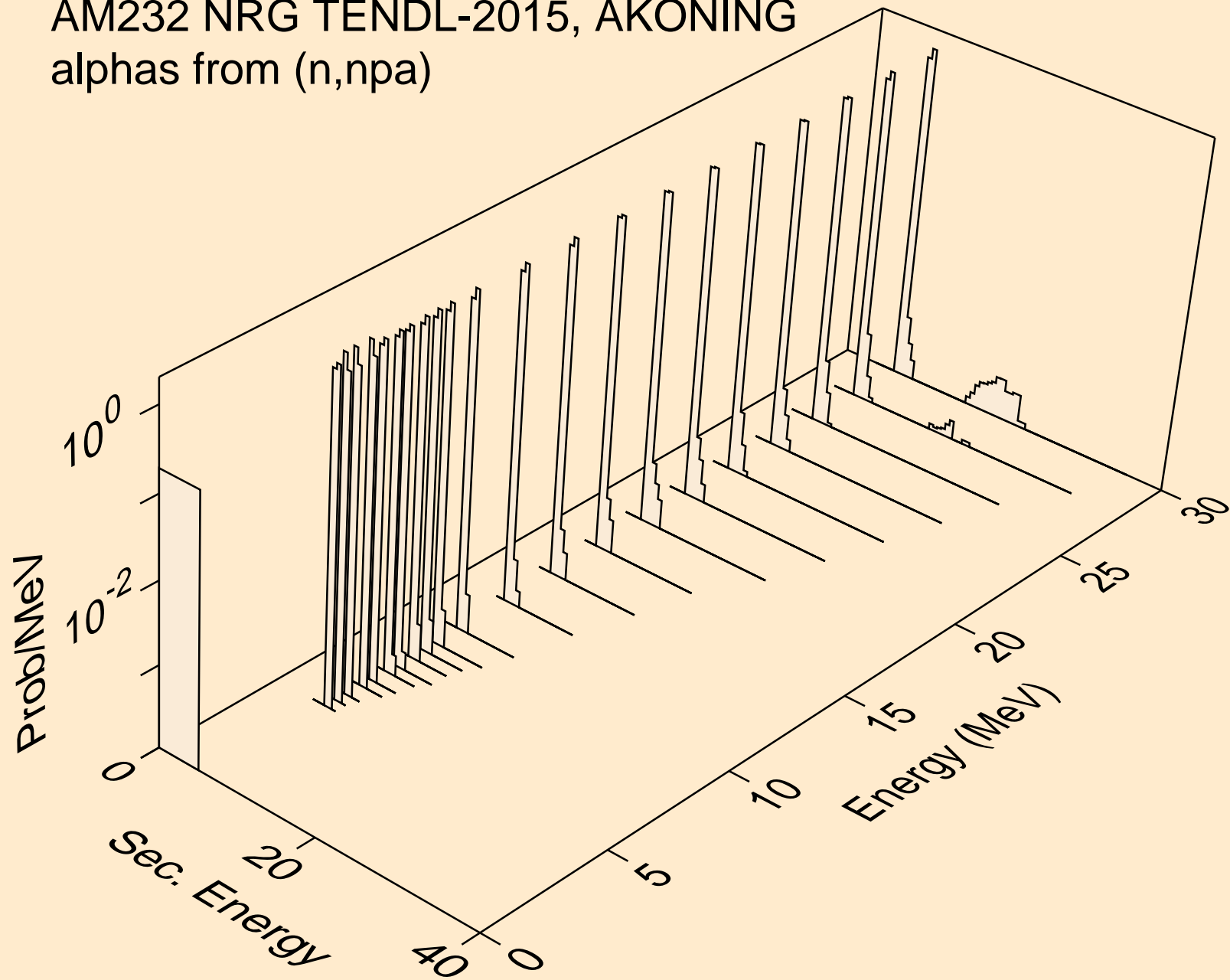

AM232 NRG TENDL-2015, AKONING
alphas from (n,a)

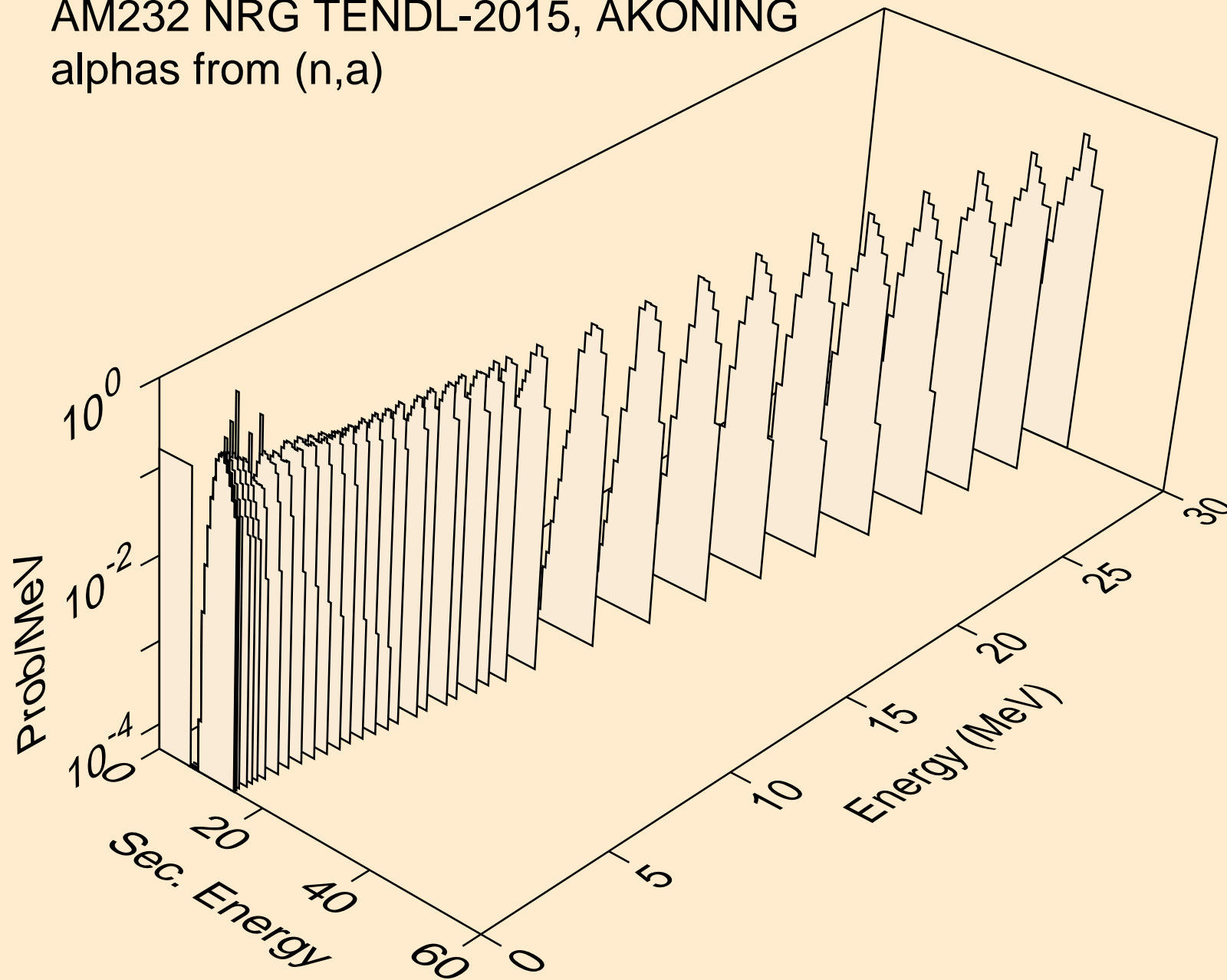

AM232 NRG TENDL-2015, AKONING
alphas from (n,2a)

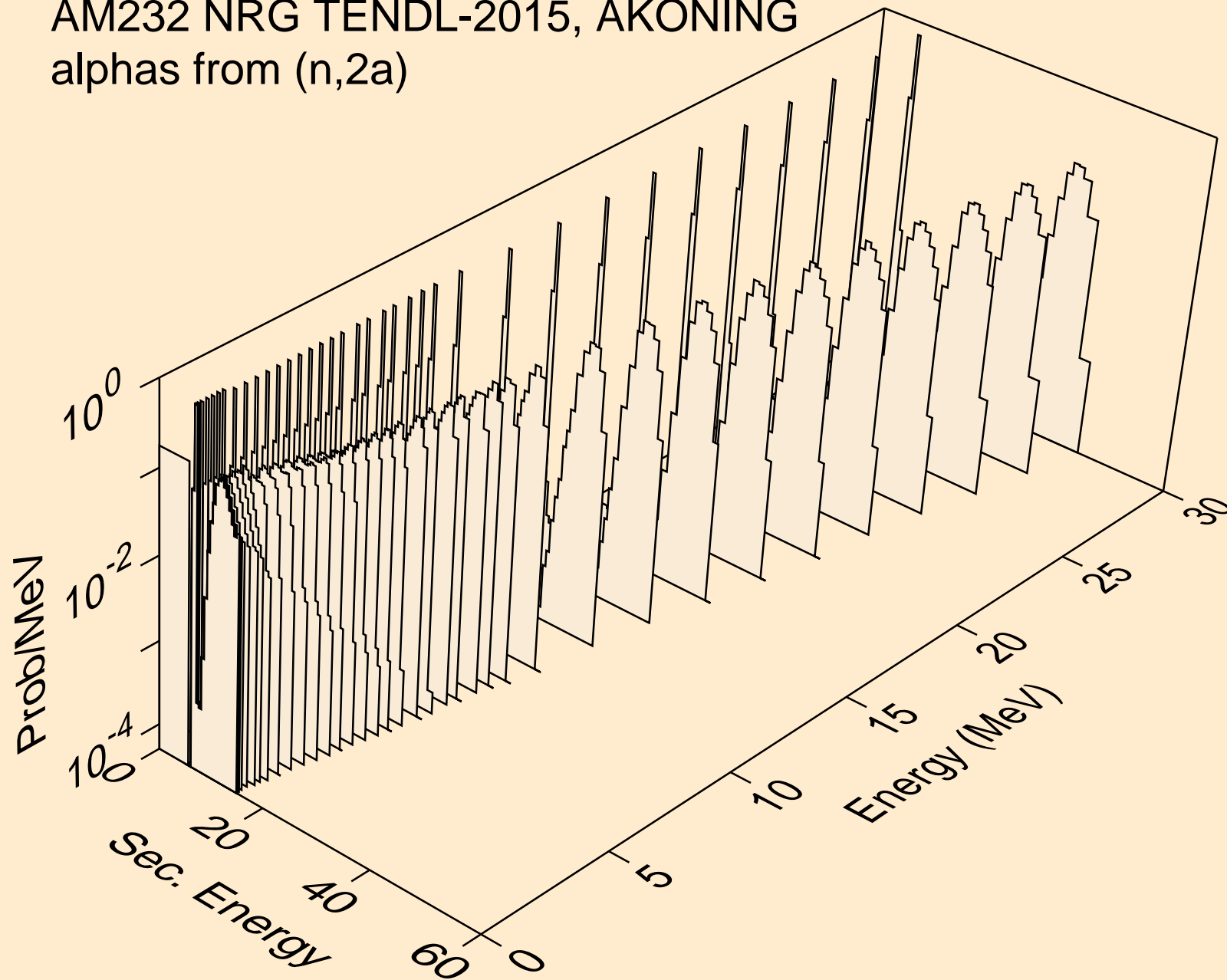

AM232 NRG TENDL-2015, AKONING
alphas from (n,3a)

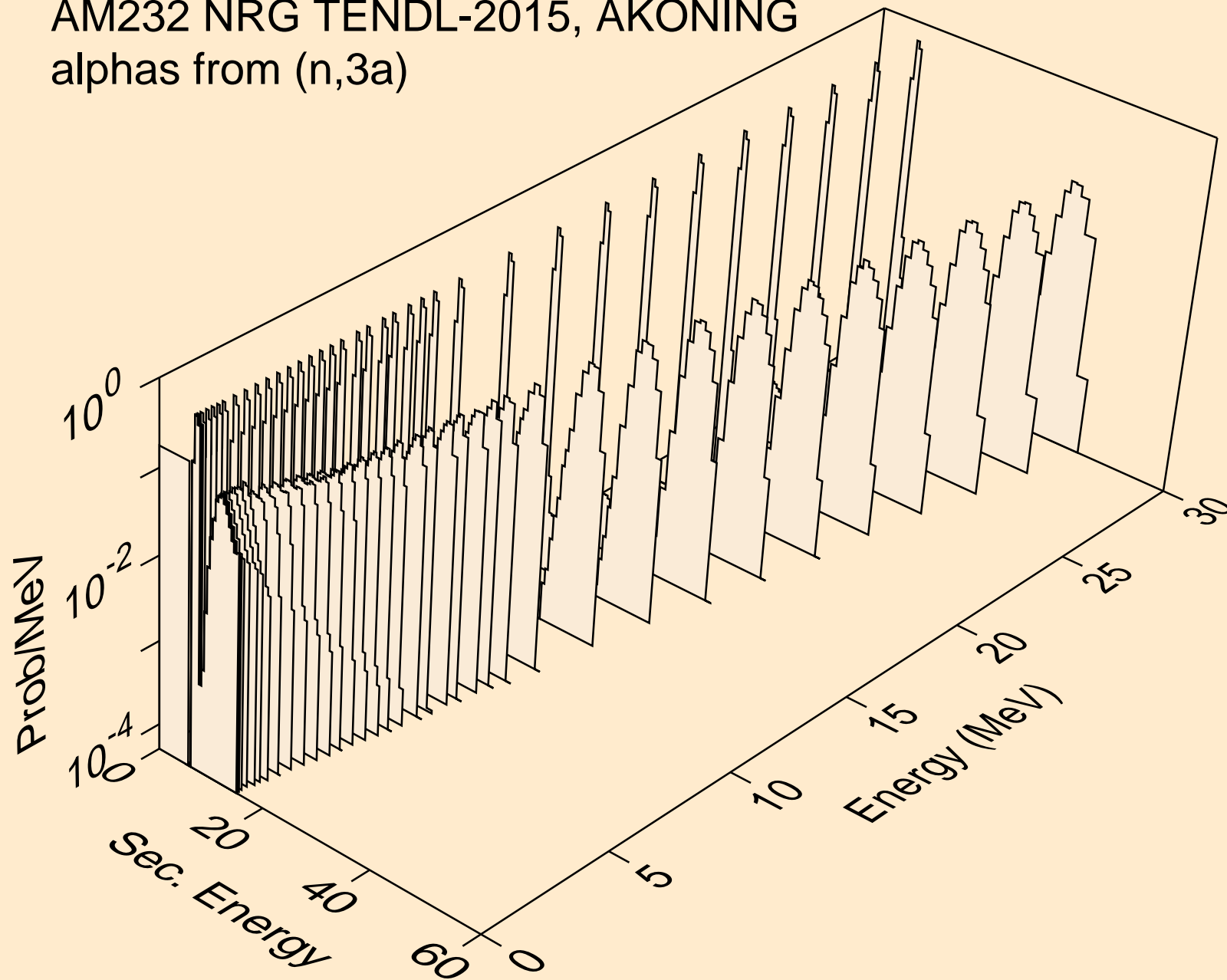

AM232 NRG TENDL-2015, AKONING
alphas from (n,pa)

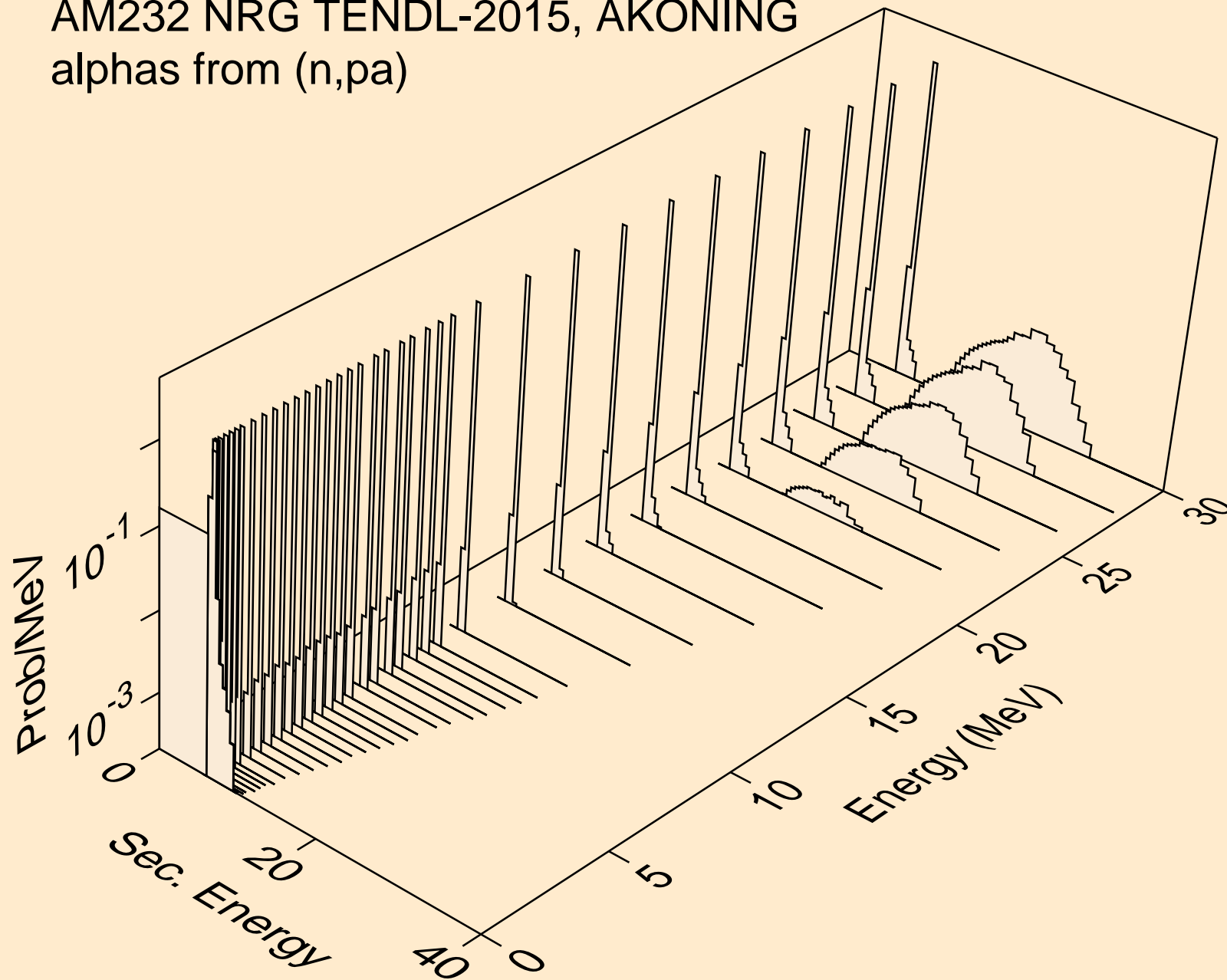

AM232 NRG TENDL-2015, AKONING
alphas from (n,t2a)

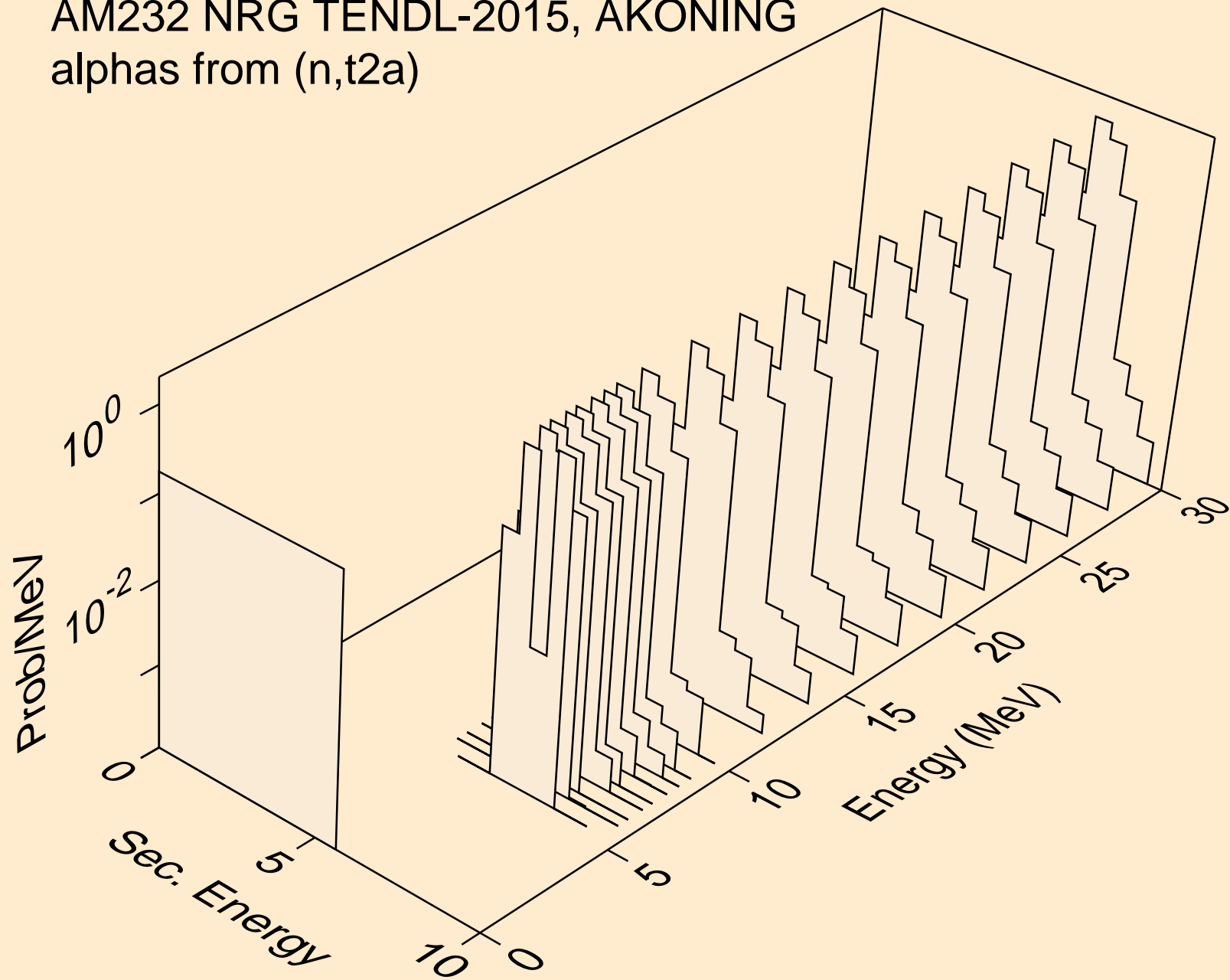

AM232 NRG TENDL-2015, AKONING
alphas from (n,d2a)

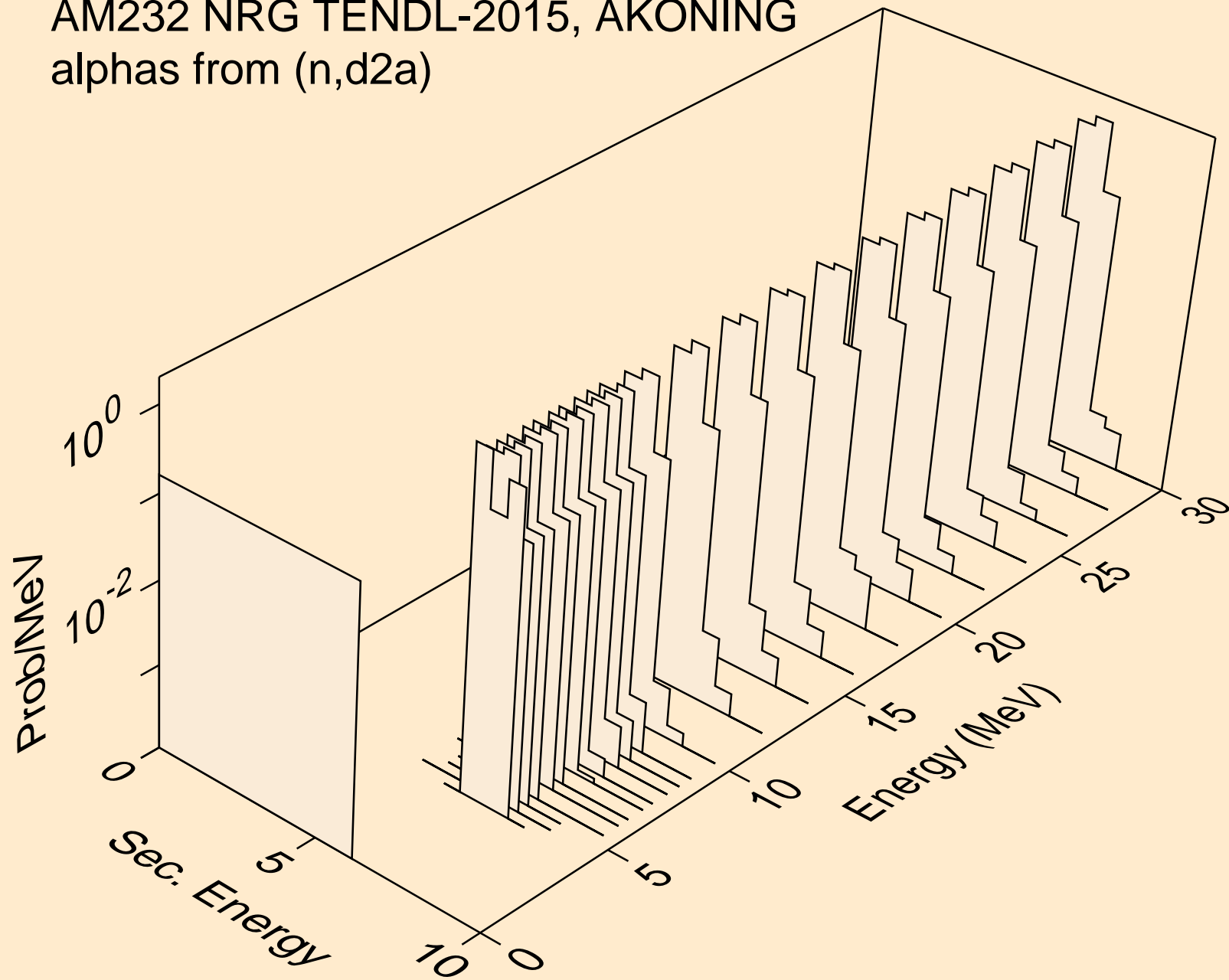

AM232 NRG TENDL-2015, AKONING
alphas from (n,da)

