

# AM235 NRG TENDL-2015, AKONING

## Principal cross sections

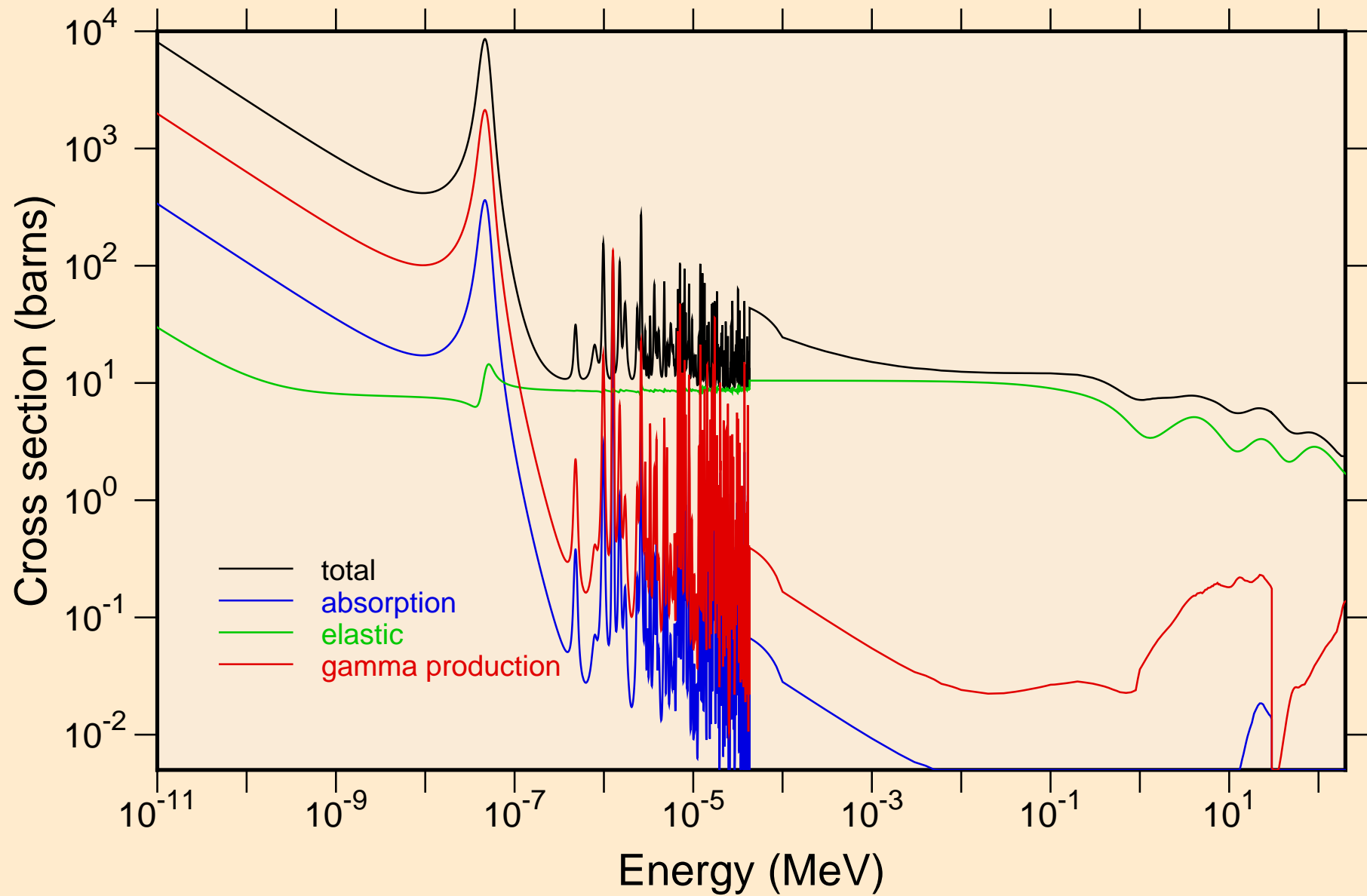

AM235 NRG TENDL-2015, AKONING  
resonance total cross section

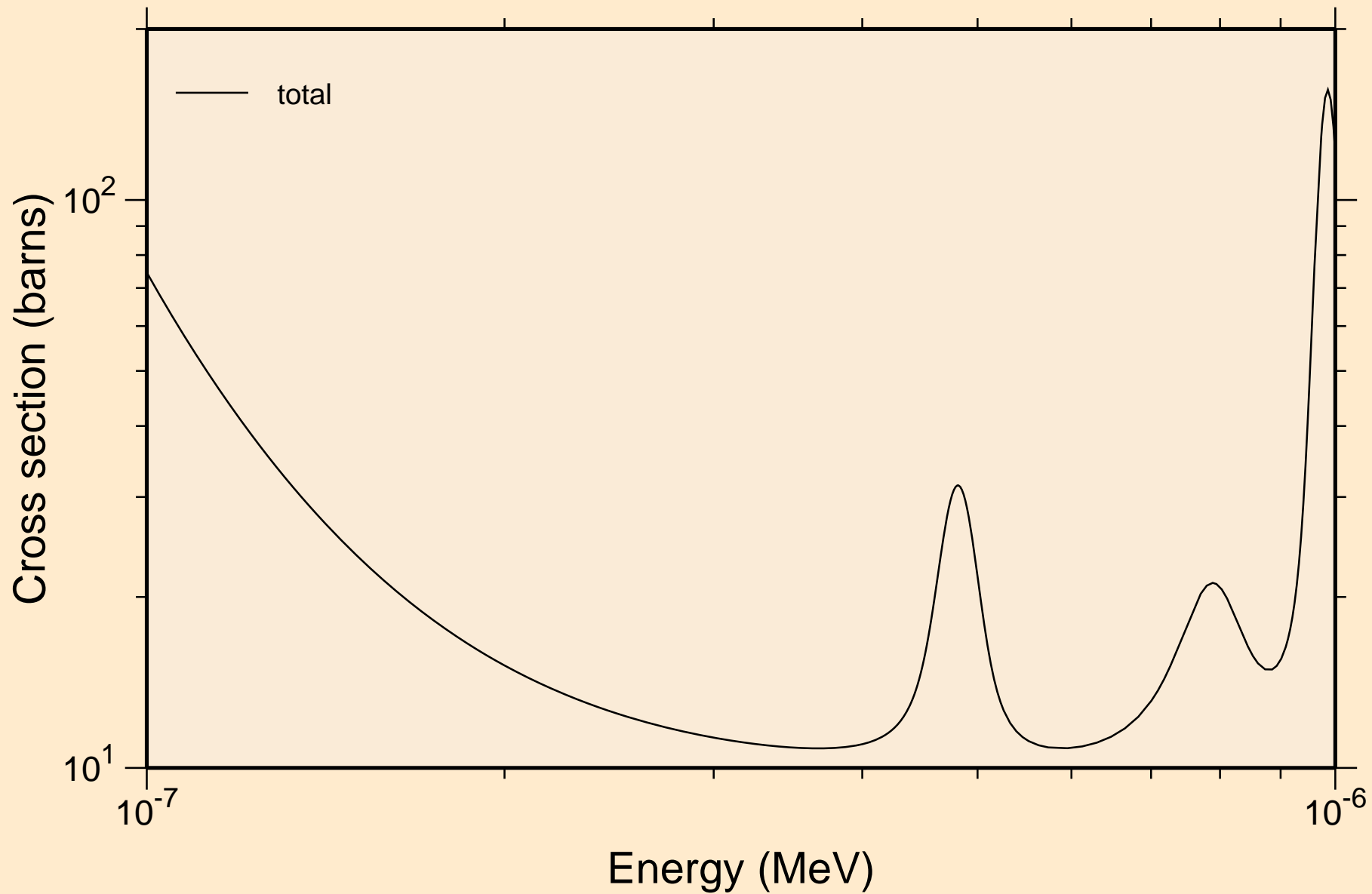

AM235 NRG TENDL-2015, AKONING  
resonance total cross section

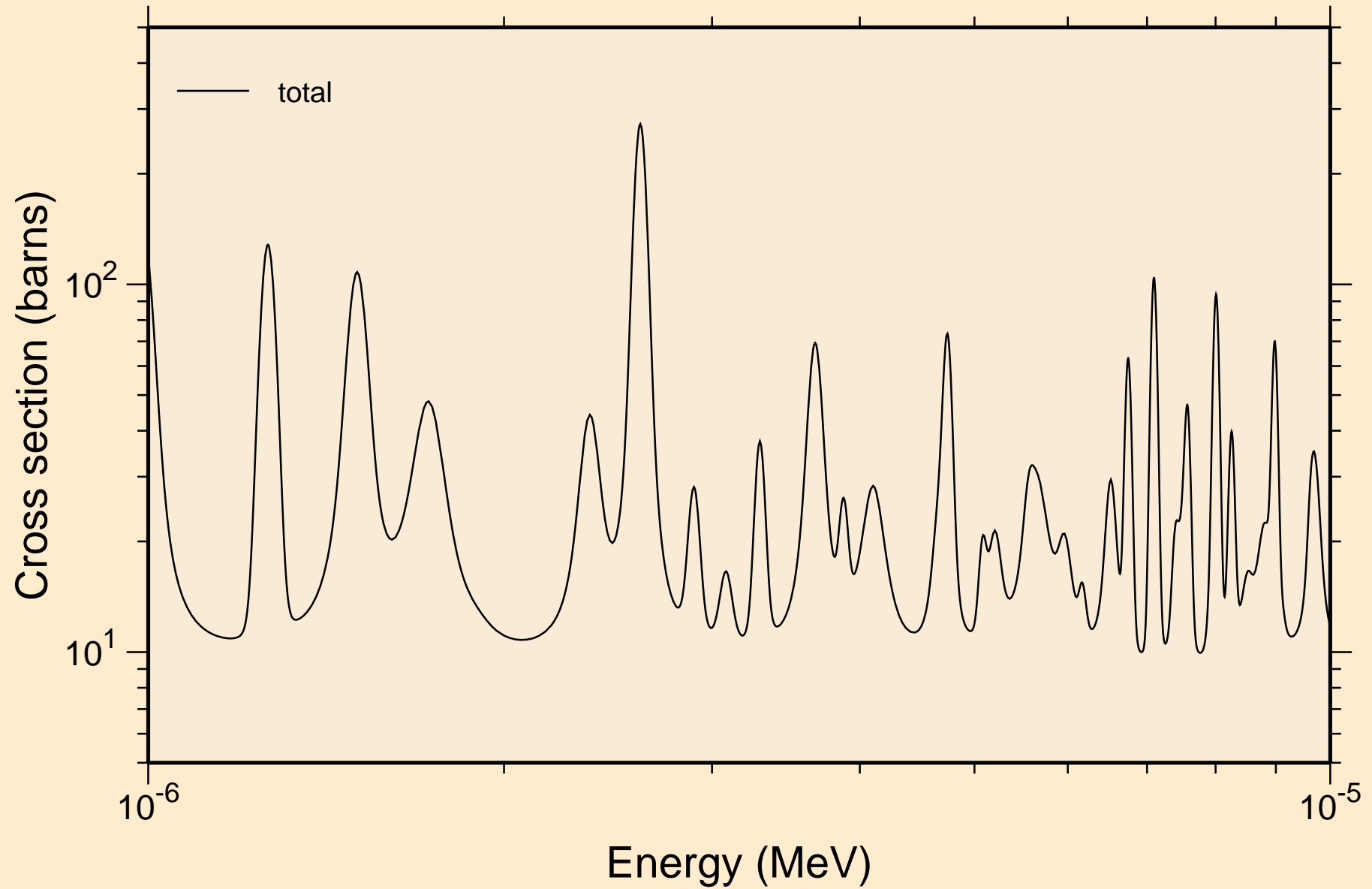

AM235 NRG TENDL-2015, AKONING  
resonance total cross section

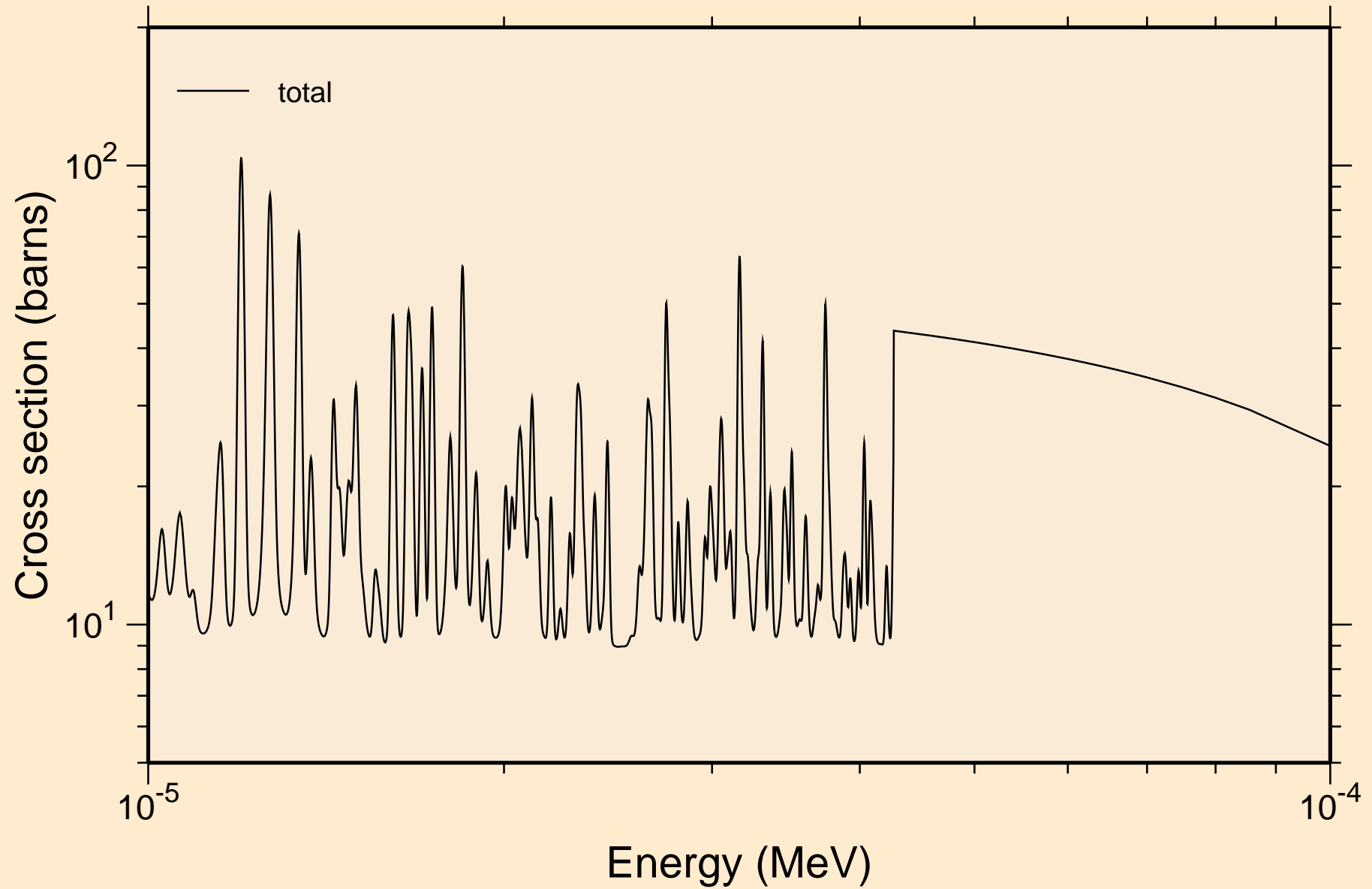

AM235 NRG TENDL-2015, AKONING  
resonance total cross section

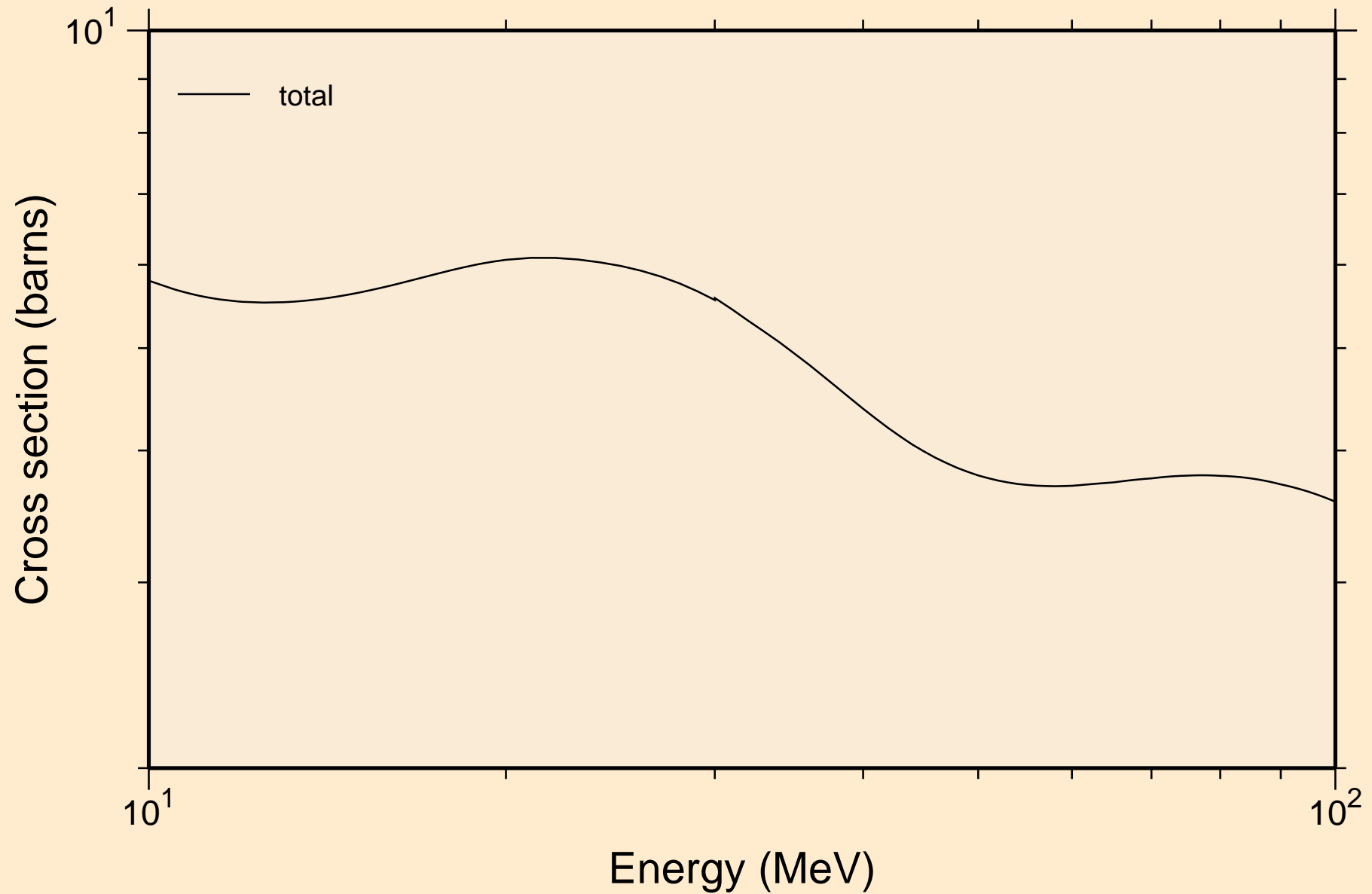

AM235 NRG TENDL-2015, AKONING  
resonance absorption cross sections

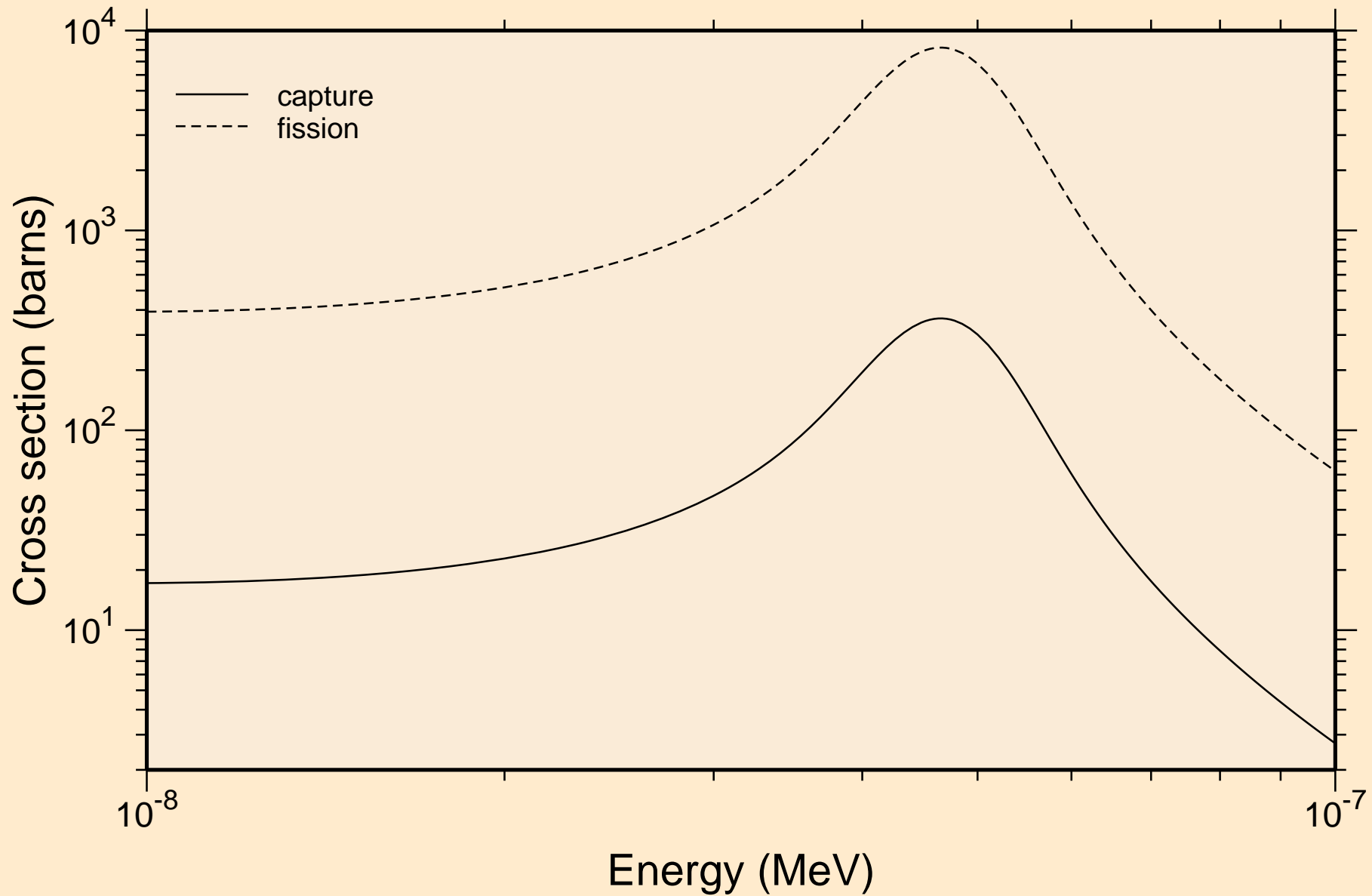

AM235 NRG TENDL-2015, AKONING  
resonance absorption cross sections

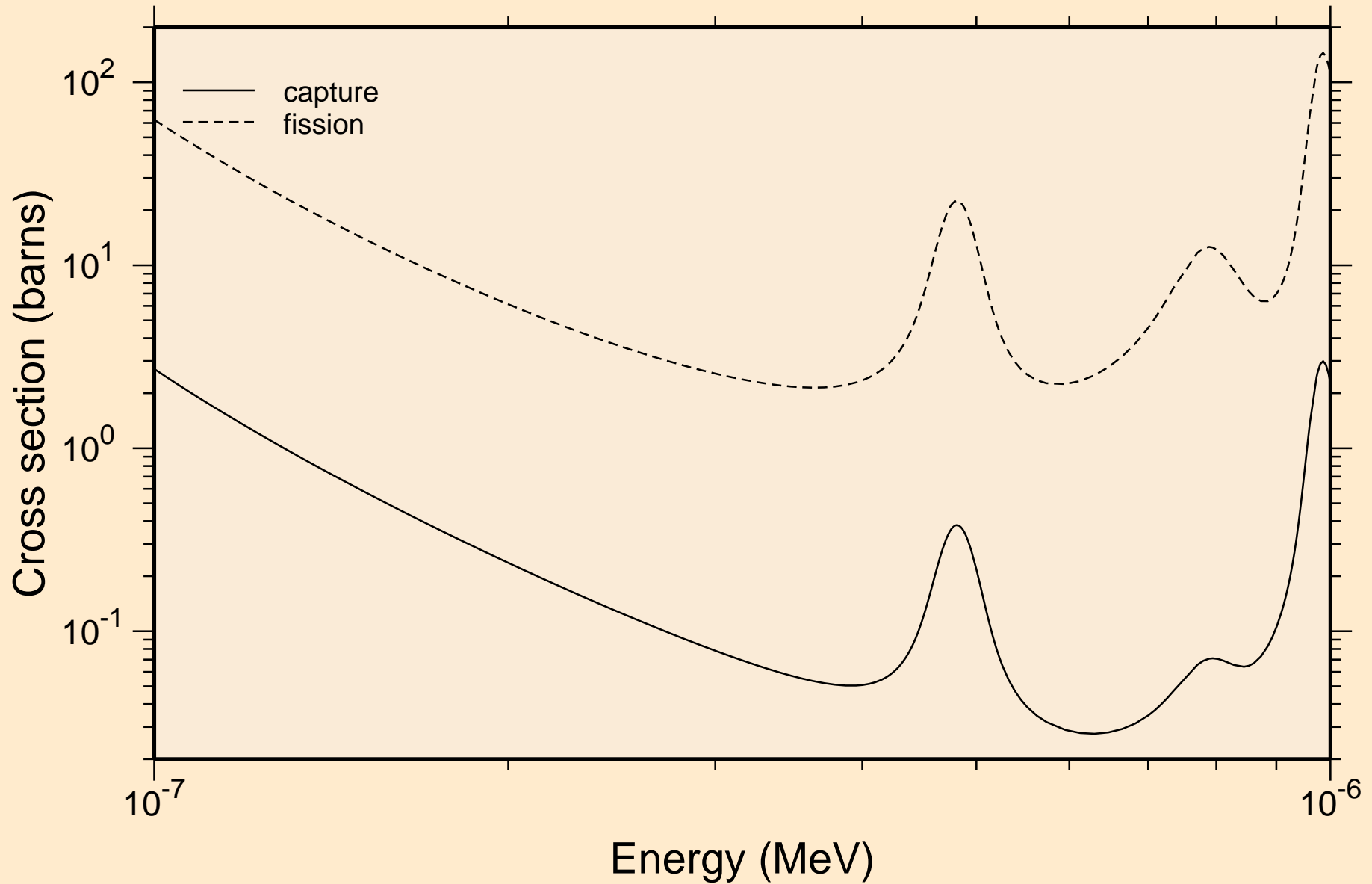

# AM235 NRG TENDL-2015, AKONING resonance absorption cross sections

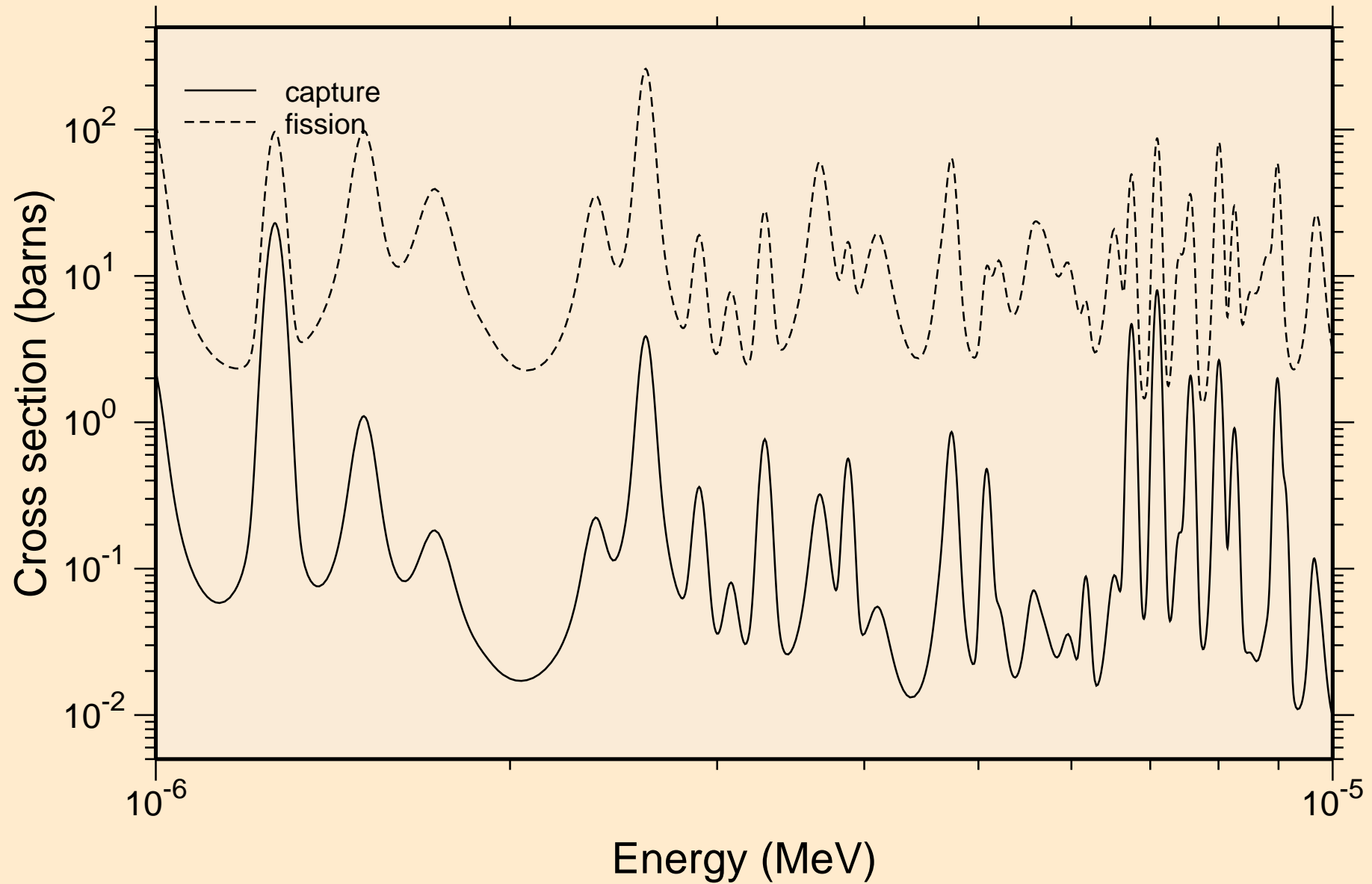



# AM235 NRG TENDL-2015, AKONING resonance absorption cross sections

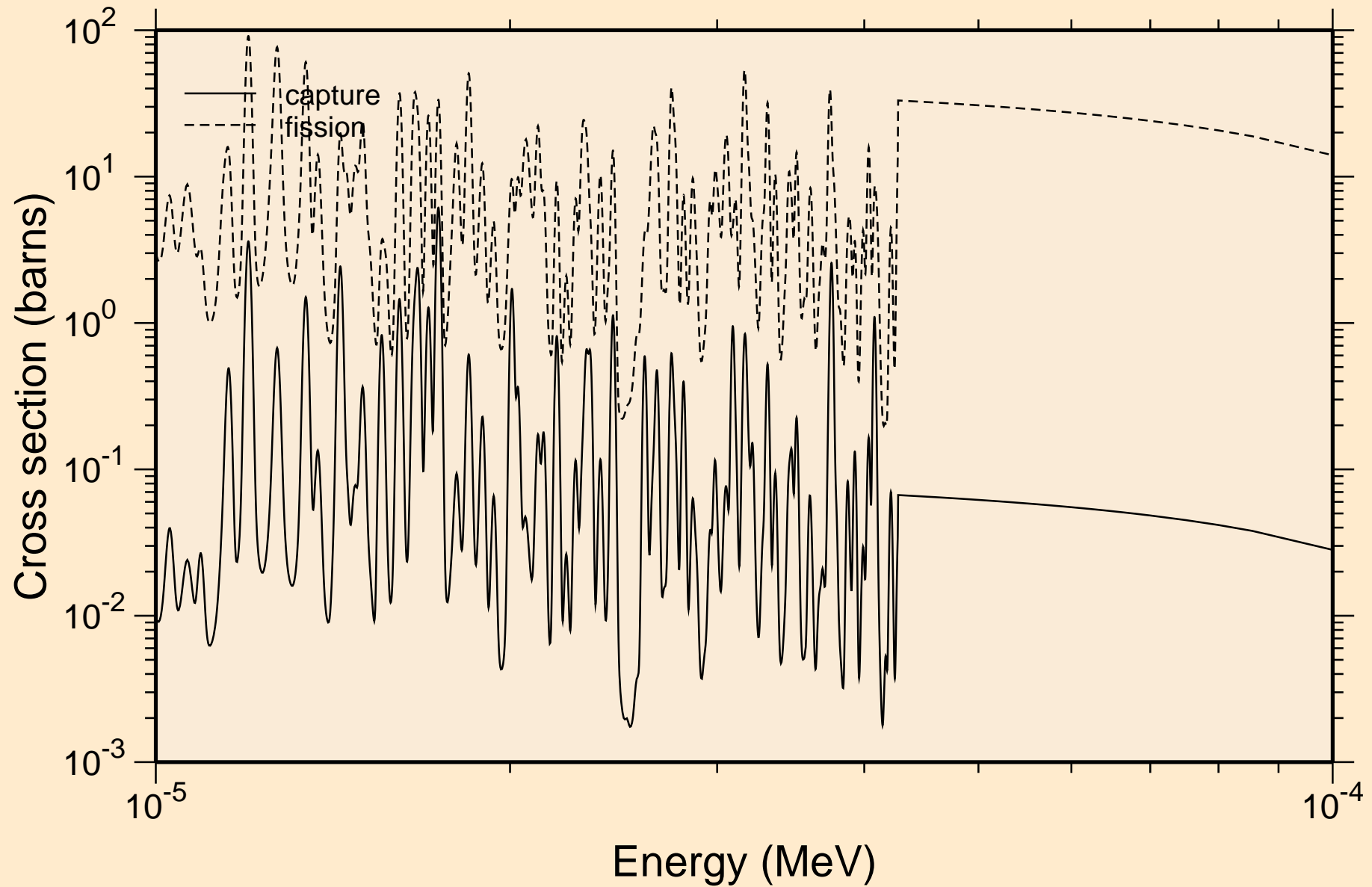

AM235 NRG TENDL-2015, AKONING  
resonance absorption cross sections

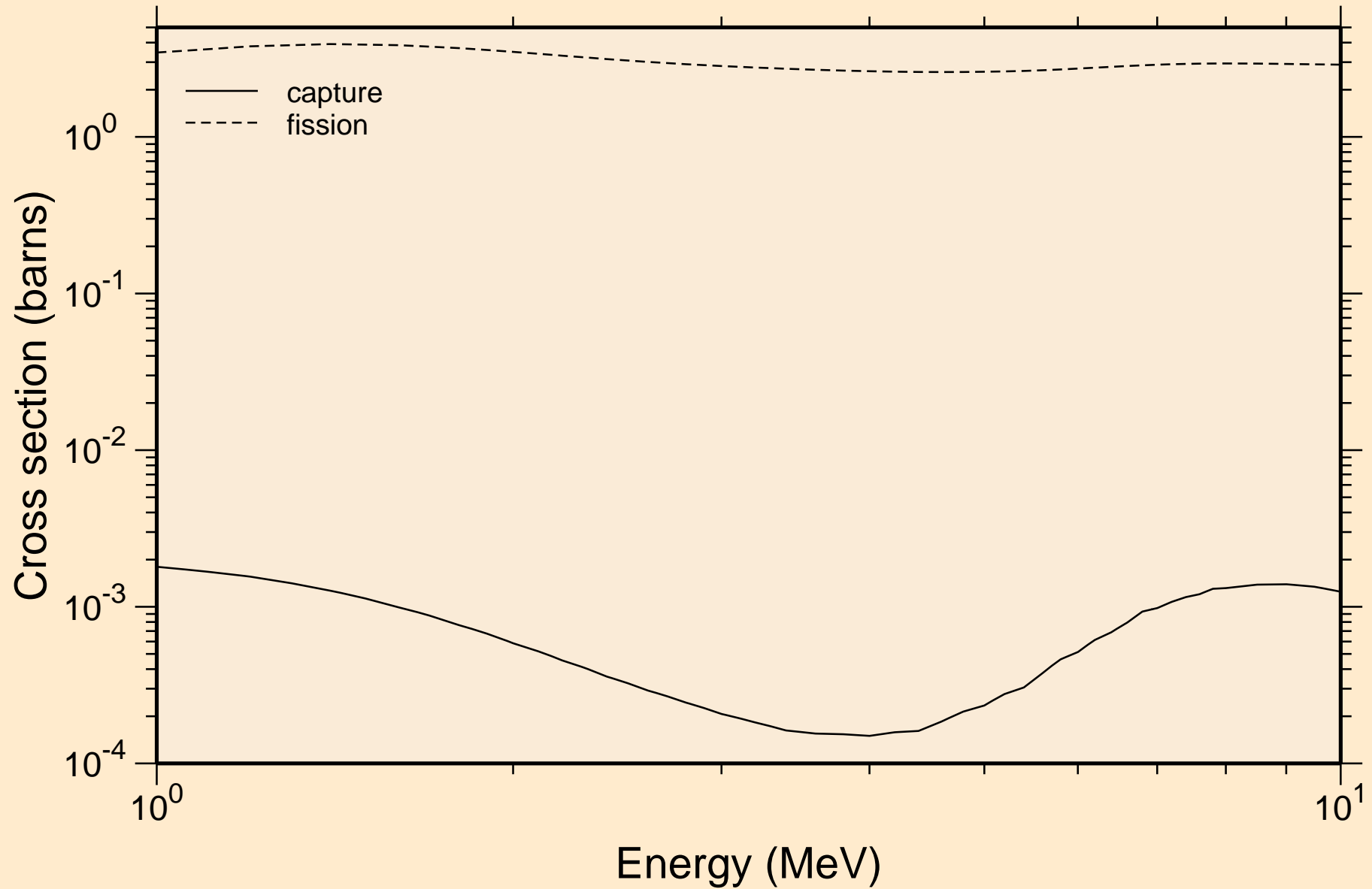

# AM235 NRG TENDL-2015, AKONING

## Non-threshold reactions

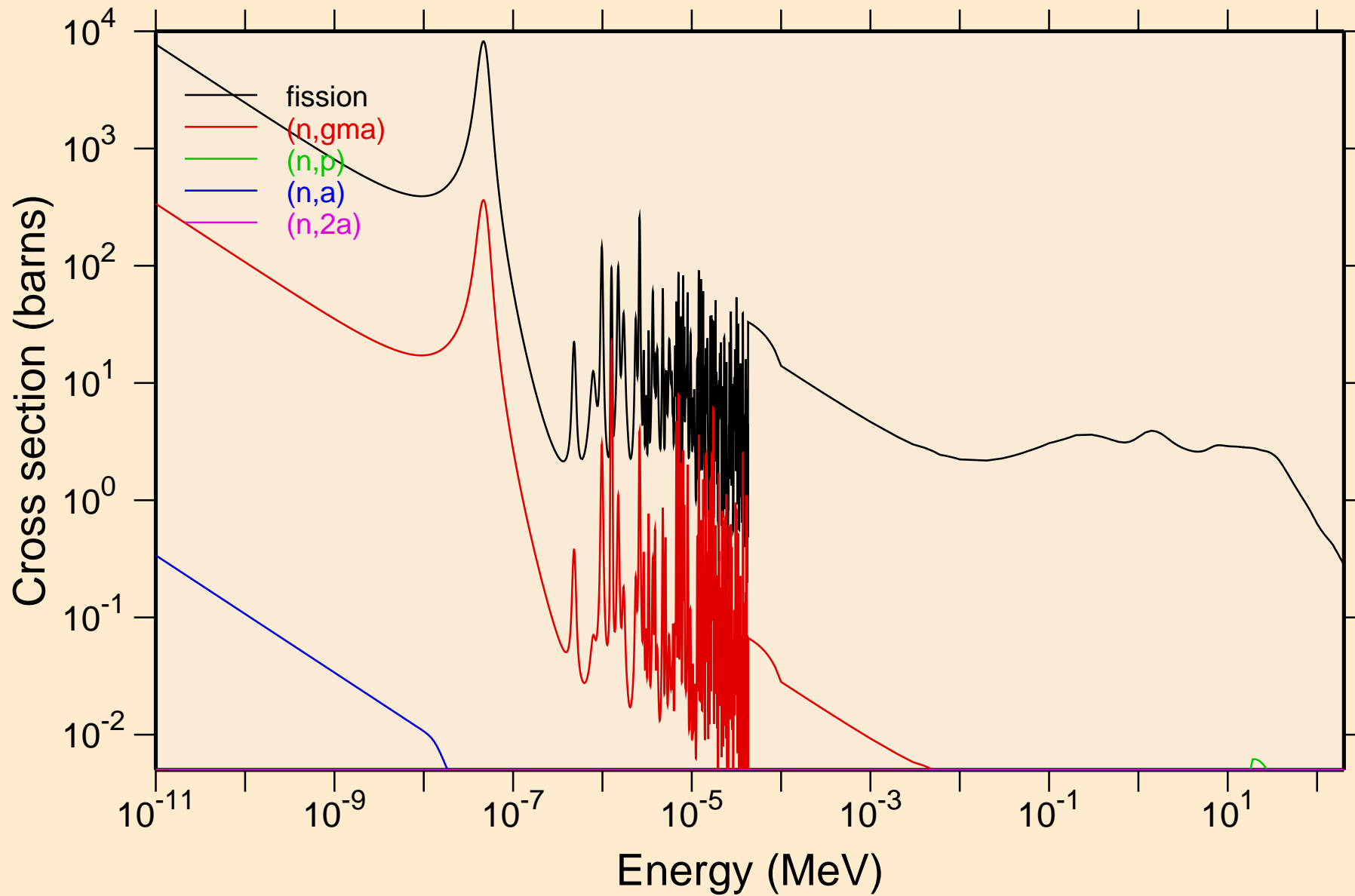

# AM235 NRG TENDL-2015, AKONING

## Principal cross sections

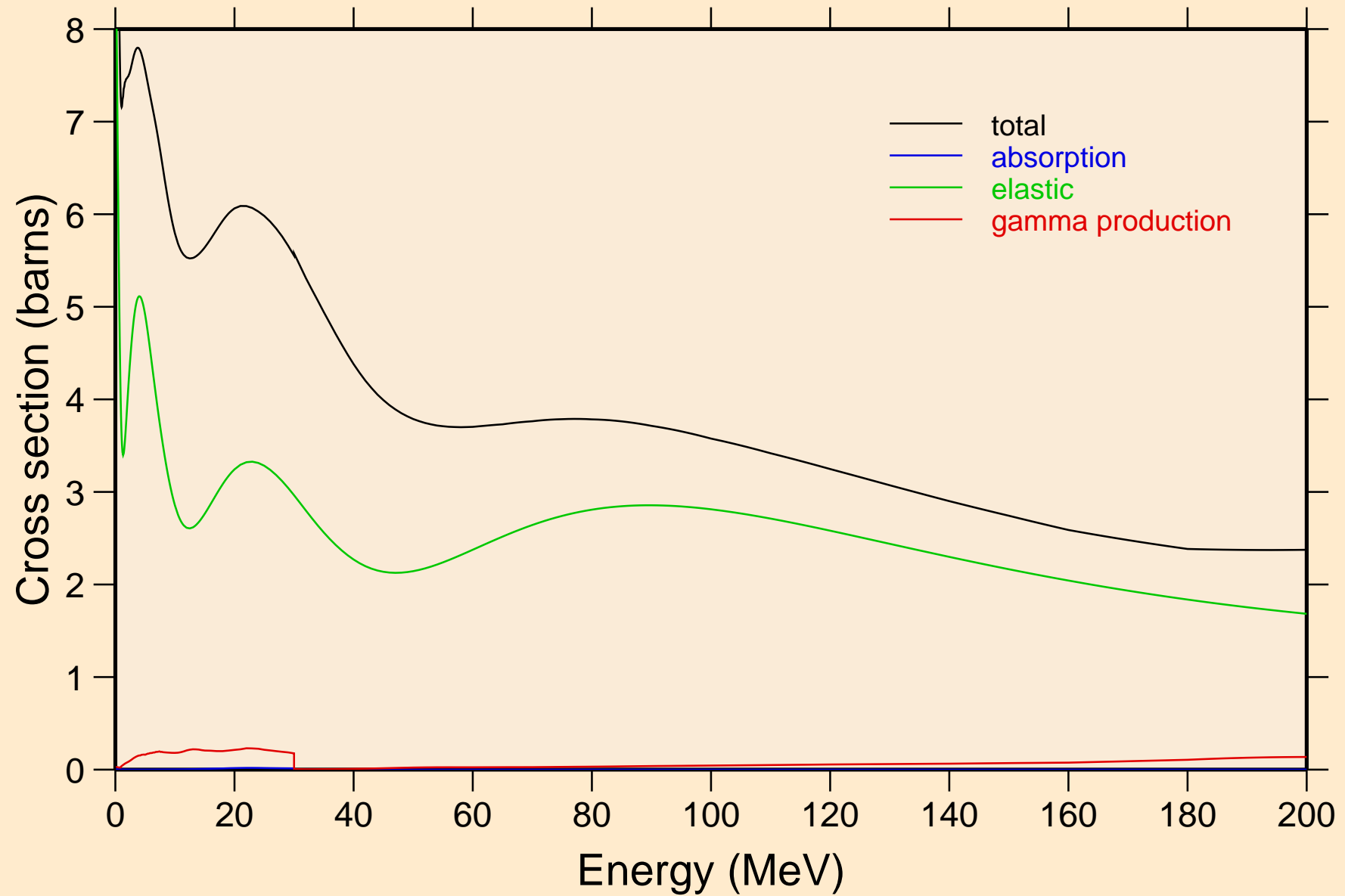

# AM235 NRG TENDL-2015, AKONING

## Non-threshold reactions

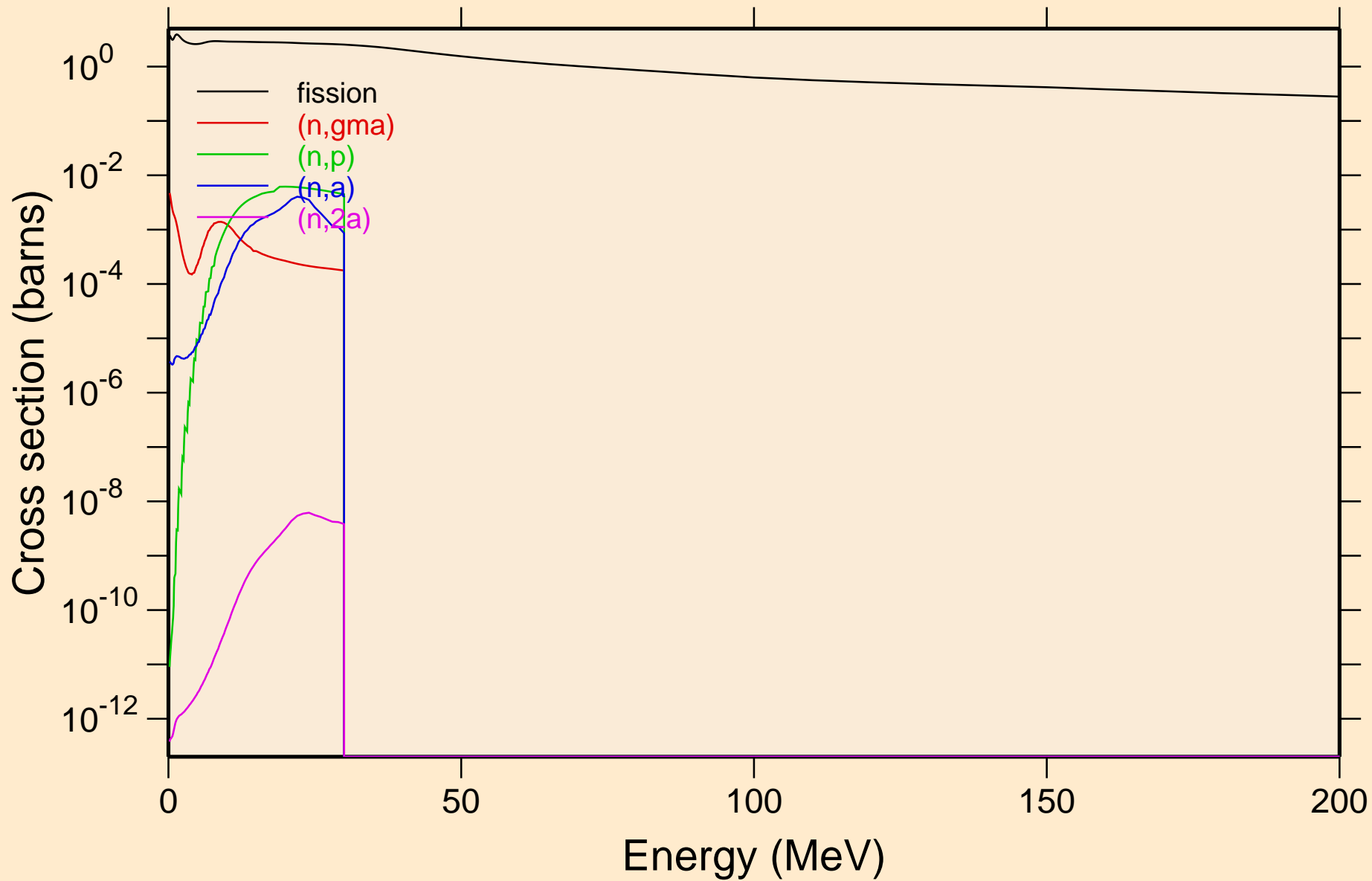

# AM235 NRG TENDL-2015, AKONING

## Inelastic levels

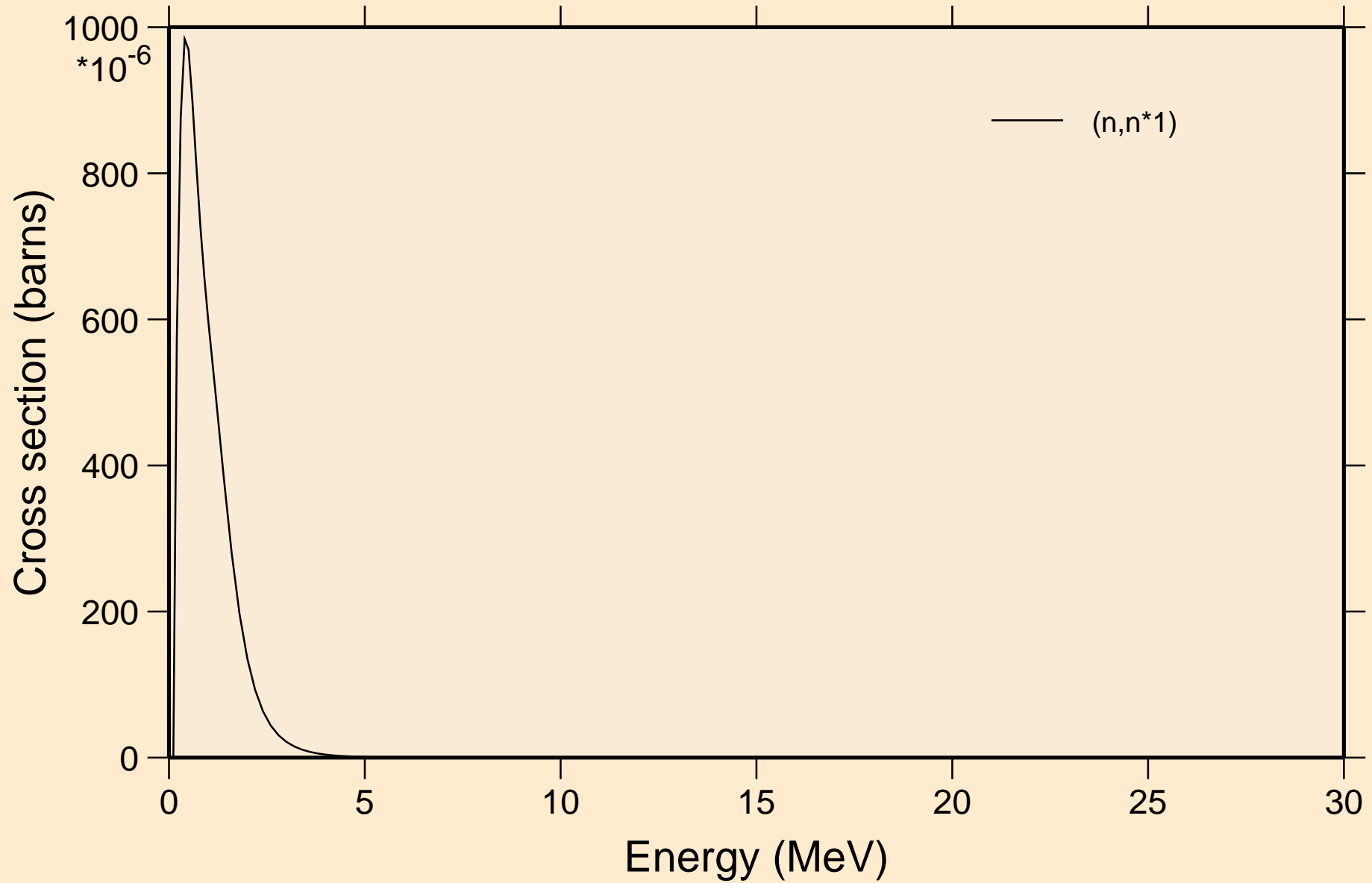

# AM235 NRG TENDL-2015, AKONING

## Threshold reactions

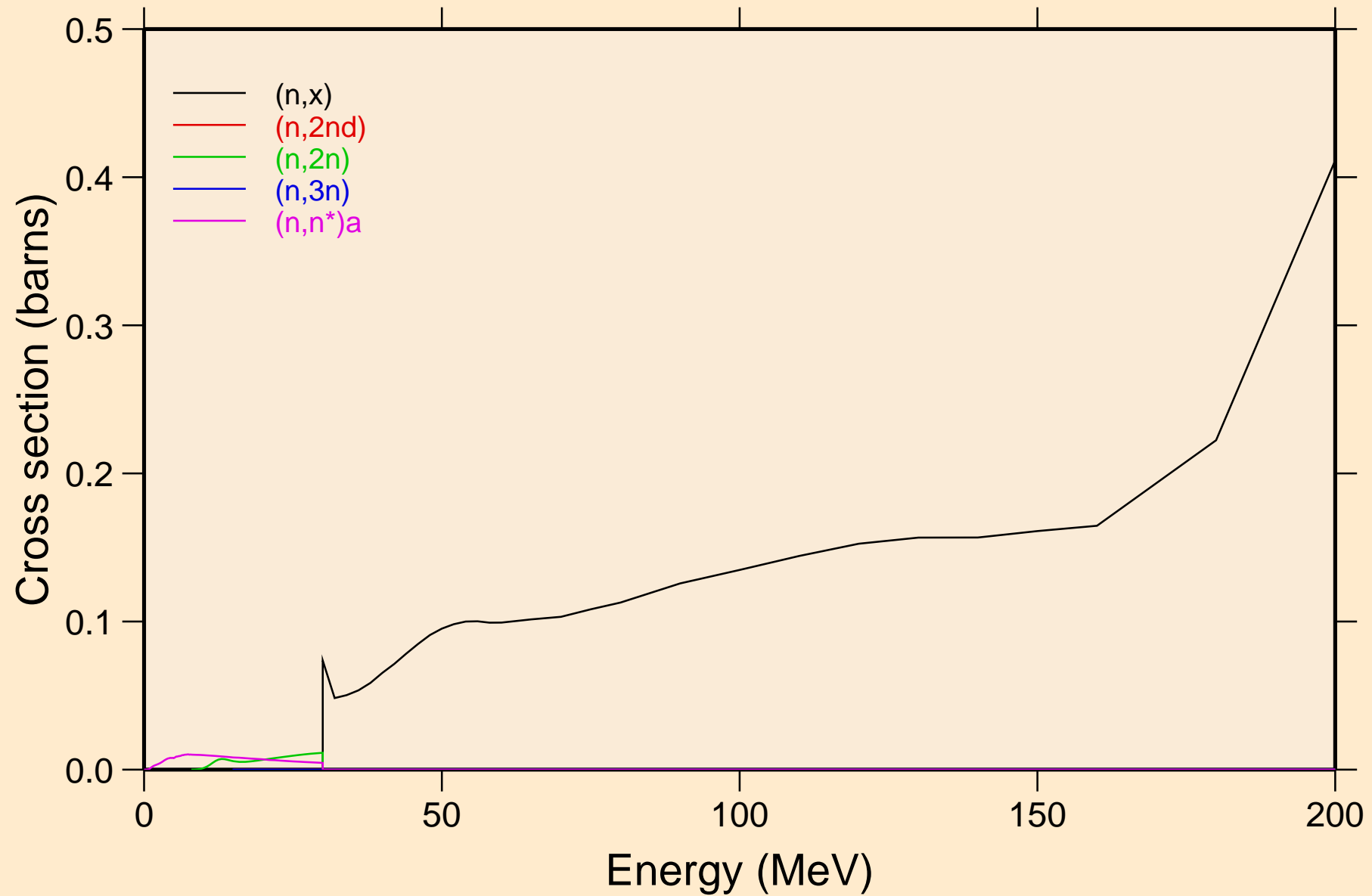

# AM235 NRG TENDL-2015, AKONING

## Threshold reactions

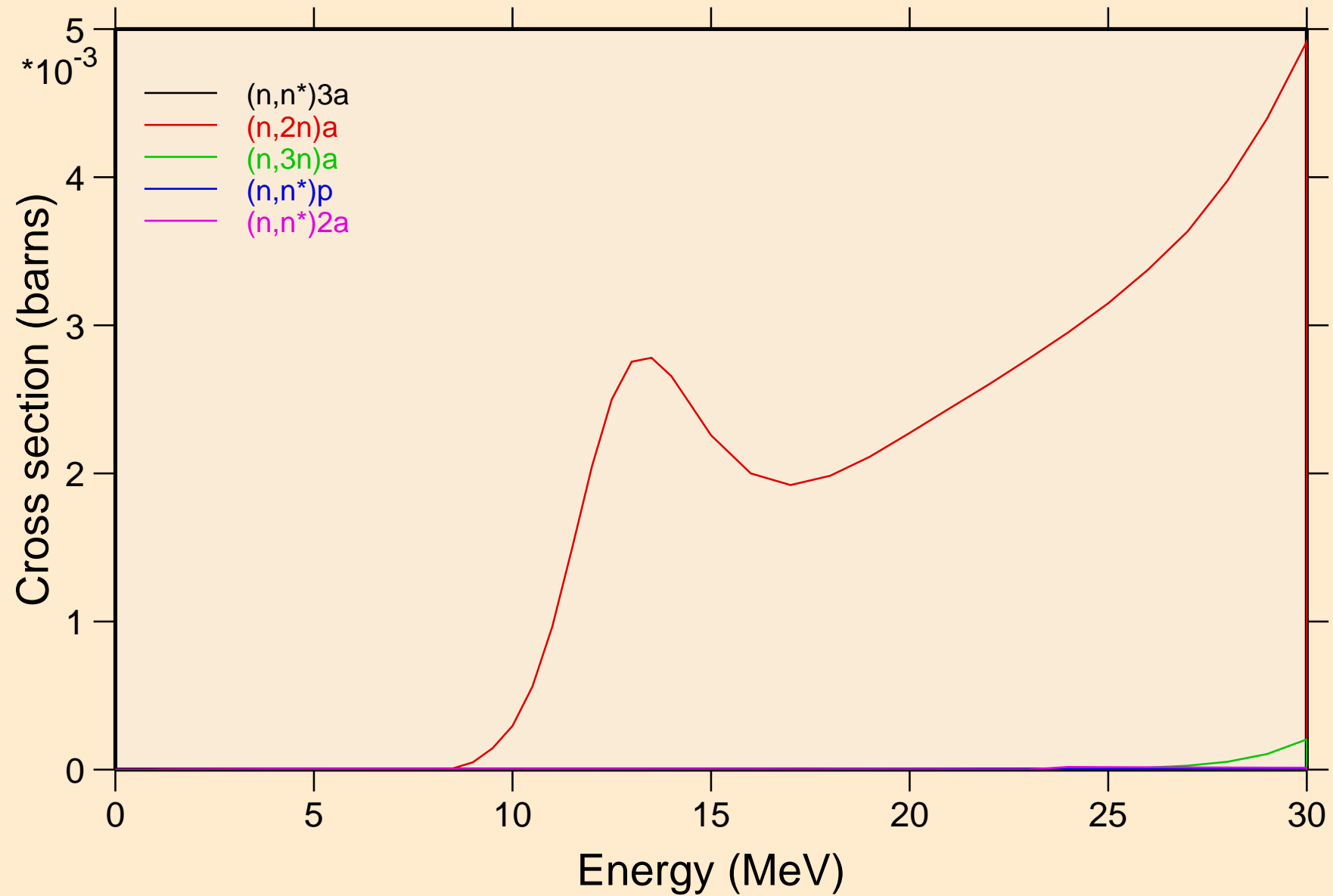



# AM235 NRG TENDL-2015, AKONING

## Threshold reactions

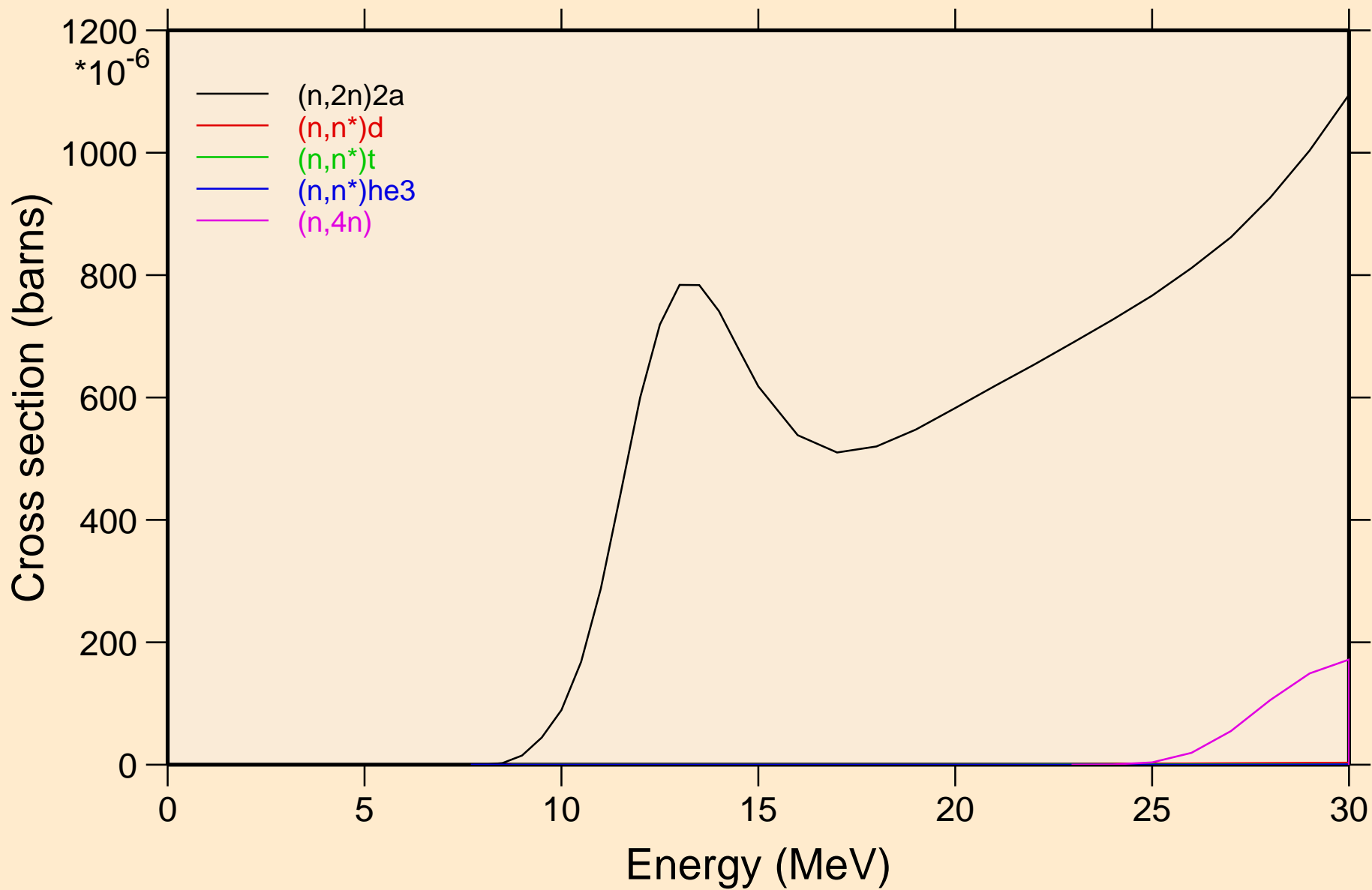

# AM235 NRG TENDL-2015, AKONING

## Threshold reactions

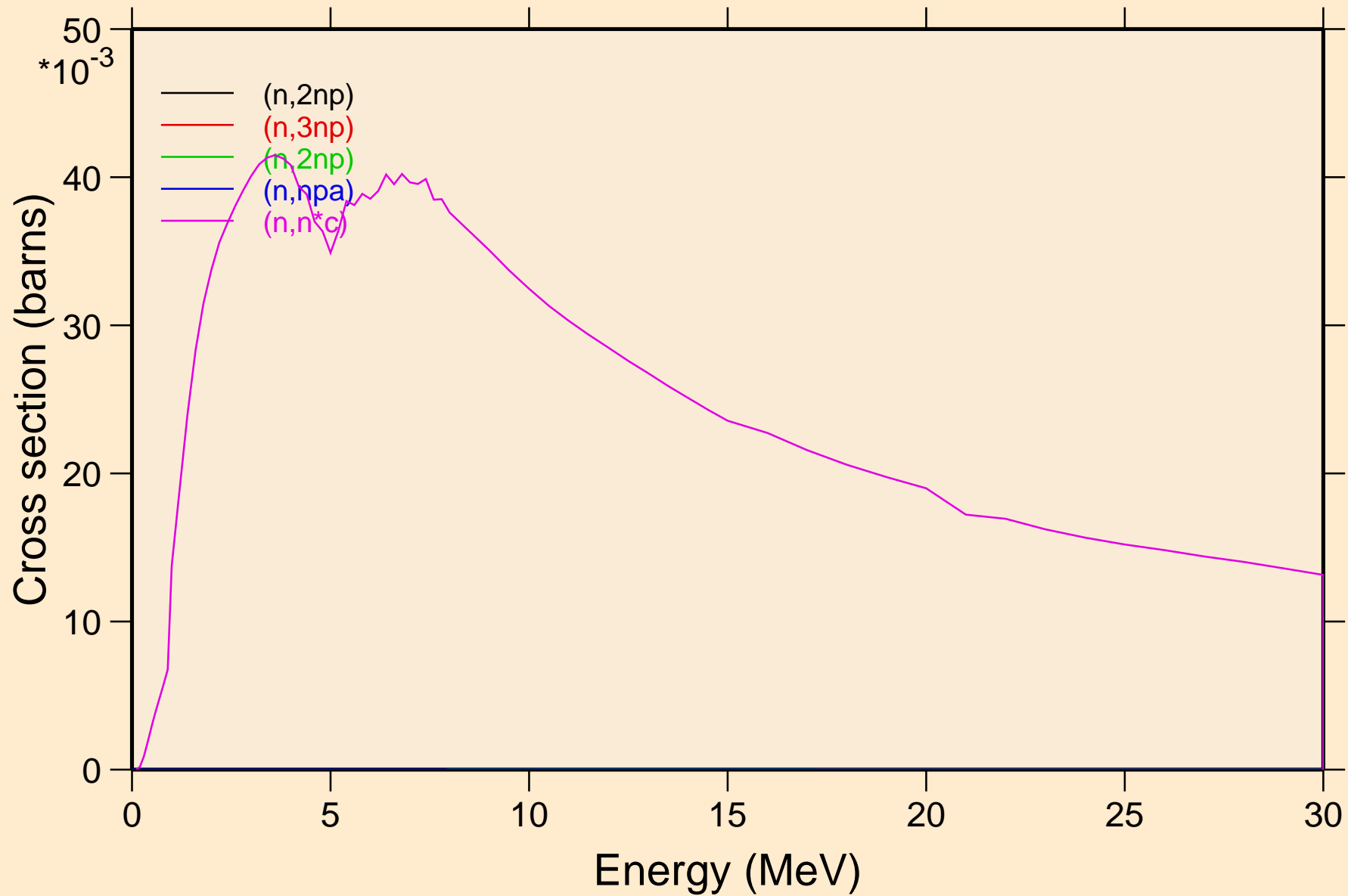

# AM235 NRG TENDL-2015, AKONING

## Threshold reactions

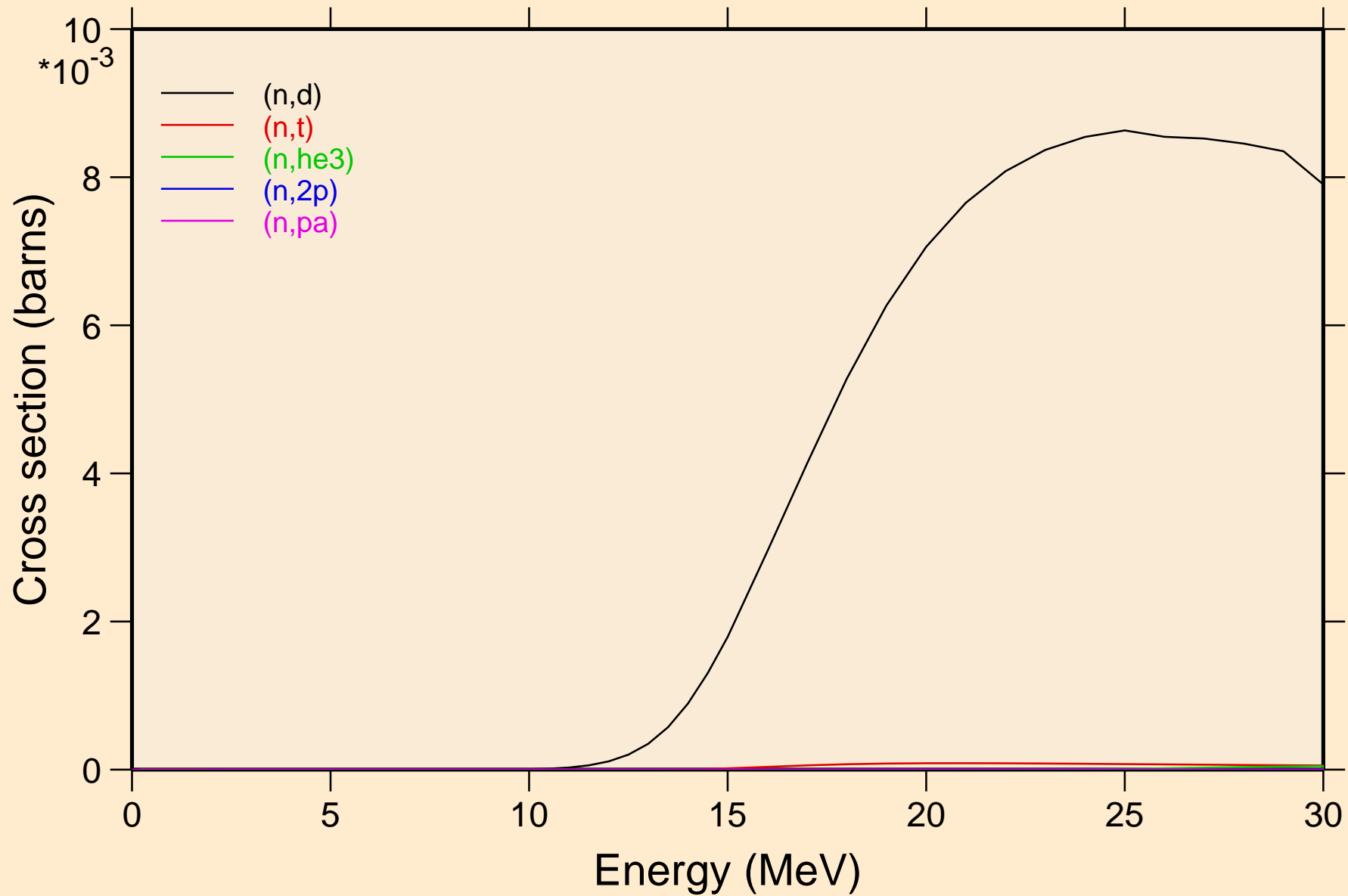

# AM235 NRG TENDL-2015, AKONING

## Threshold reactions

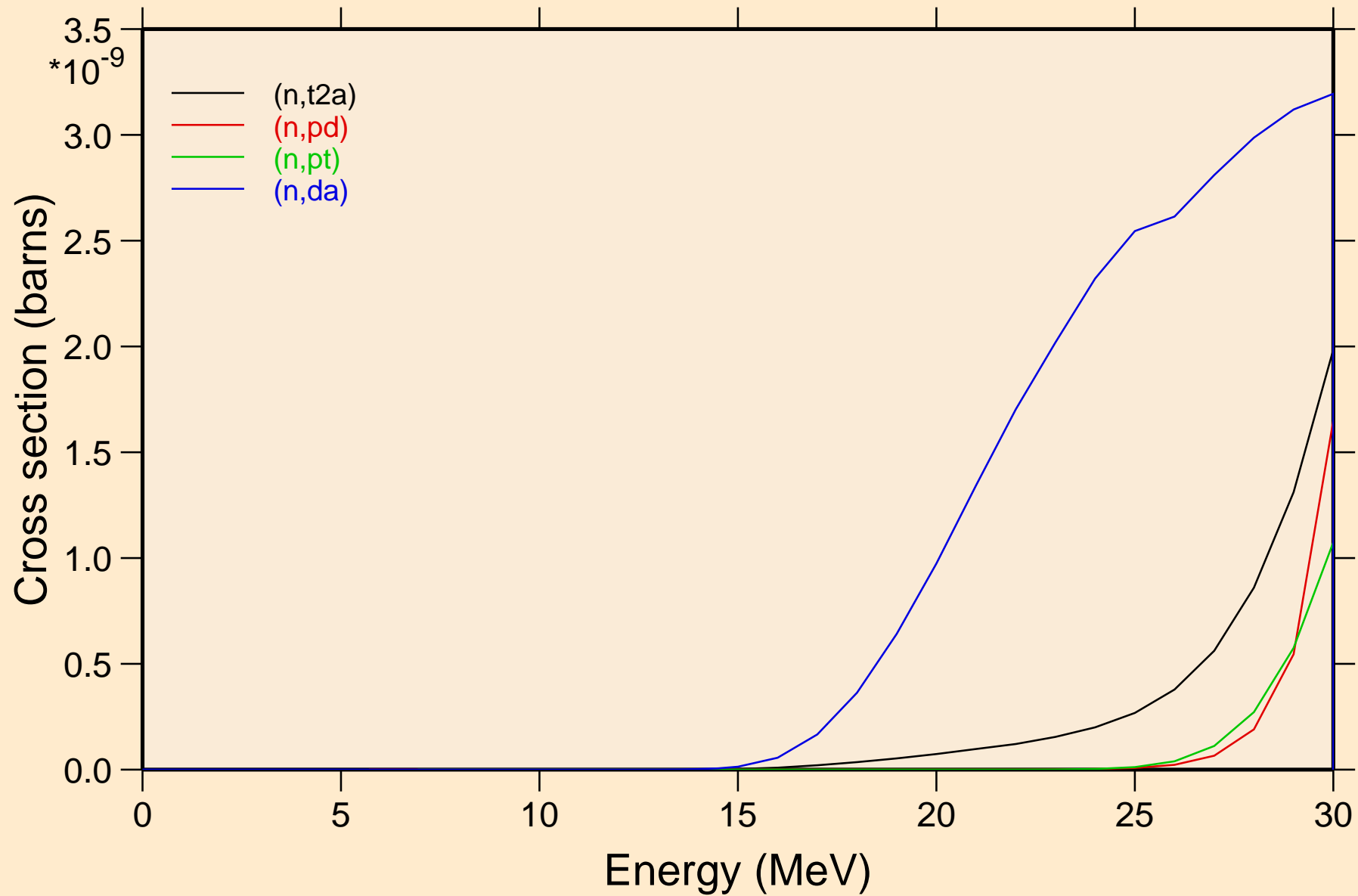

AM235 NRG TENDL-2015, AKONING  
angular distribution for elastic

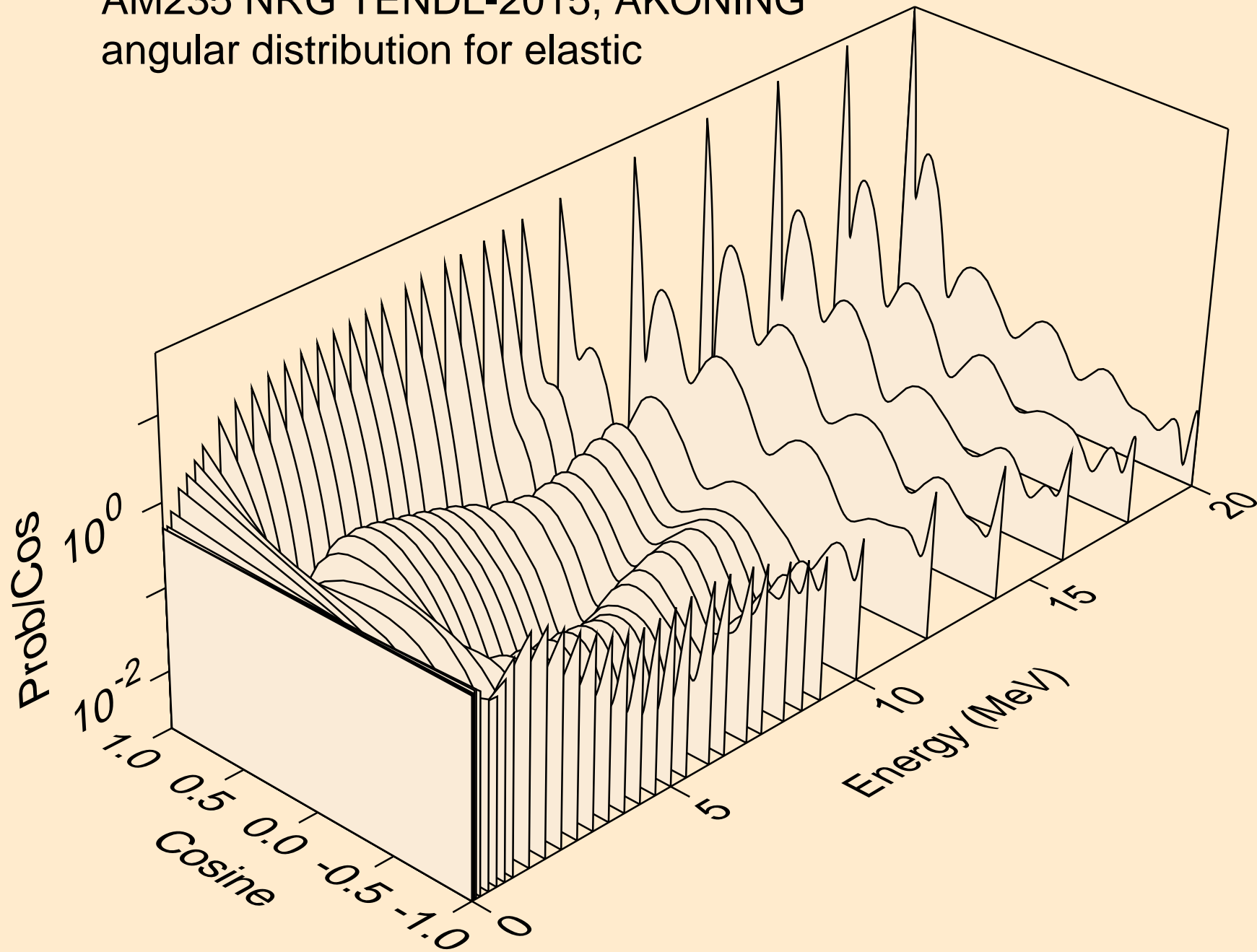

AM235 NRG TENDL-2015, AKONING  
angular distribution for elastic

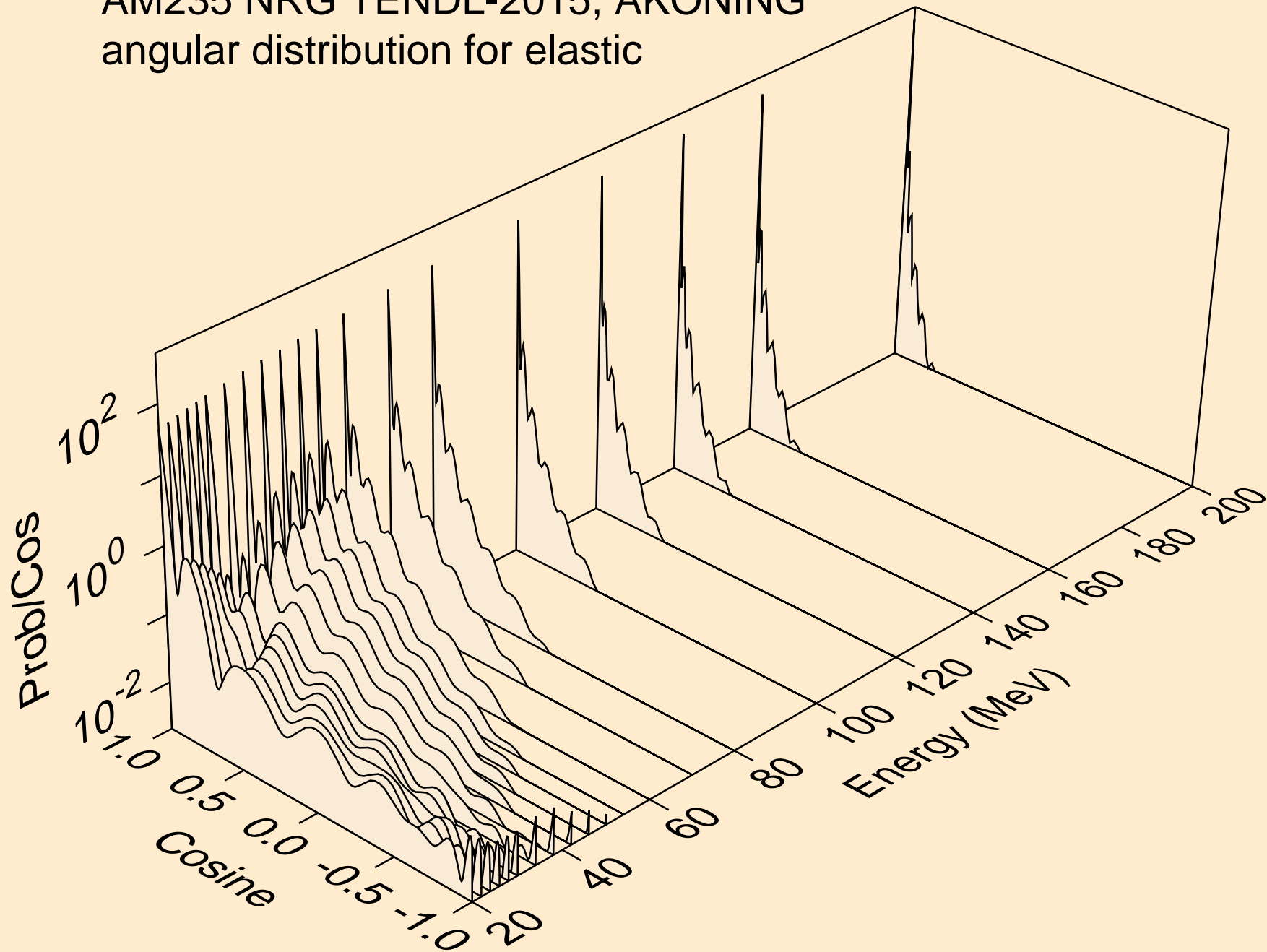

AM235 NRG TENDL-2015, AKONING  
angular distribution for (n,n\*1)

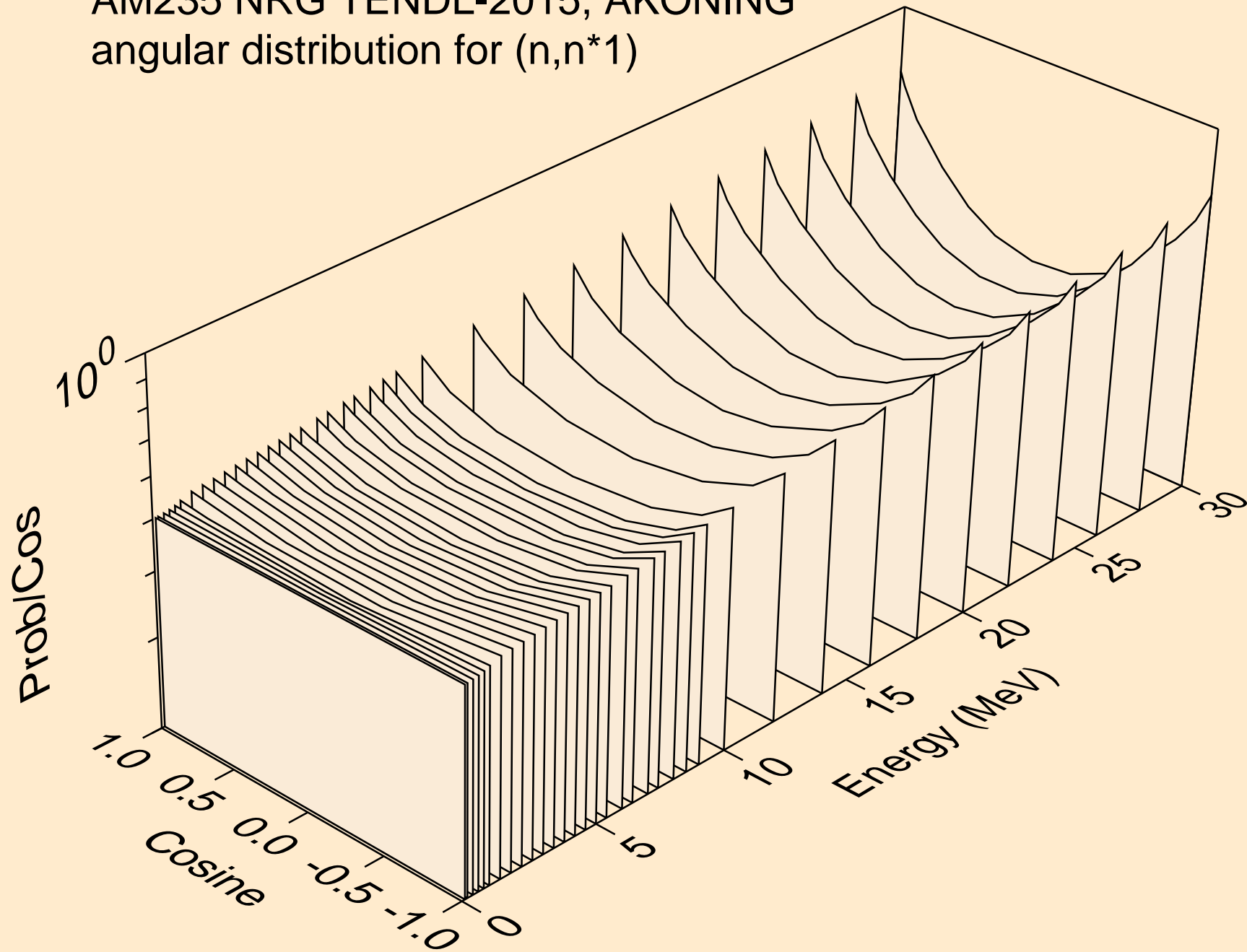

# AM235 NRG TENDL-2015, AKONING

Total fission nubar

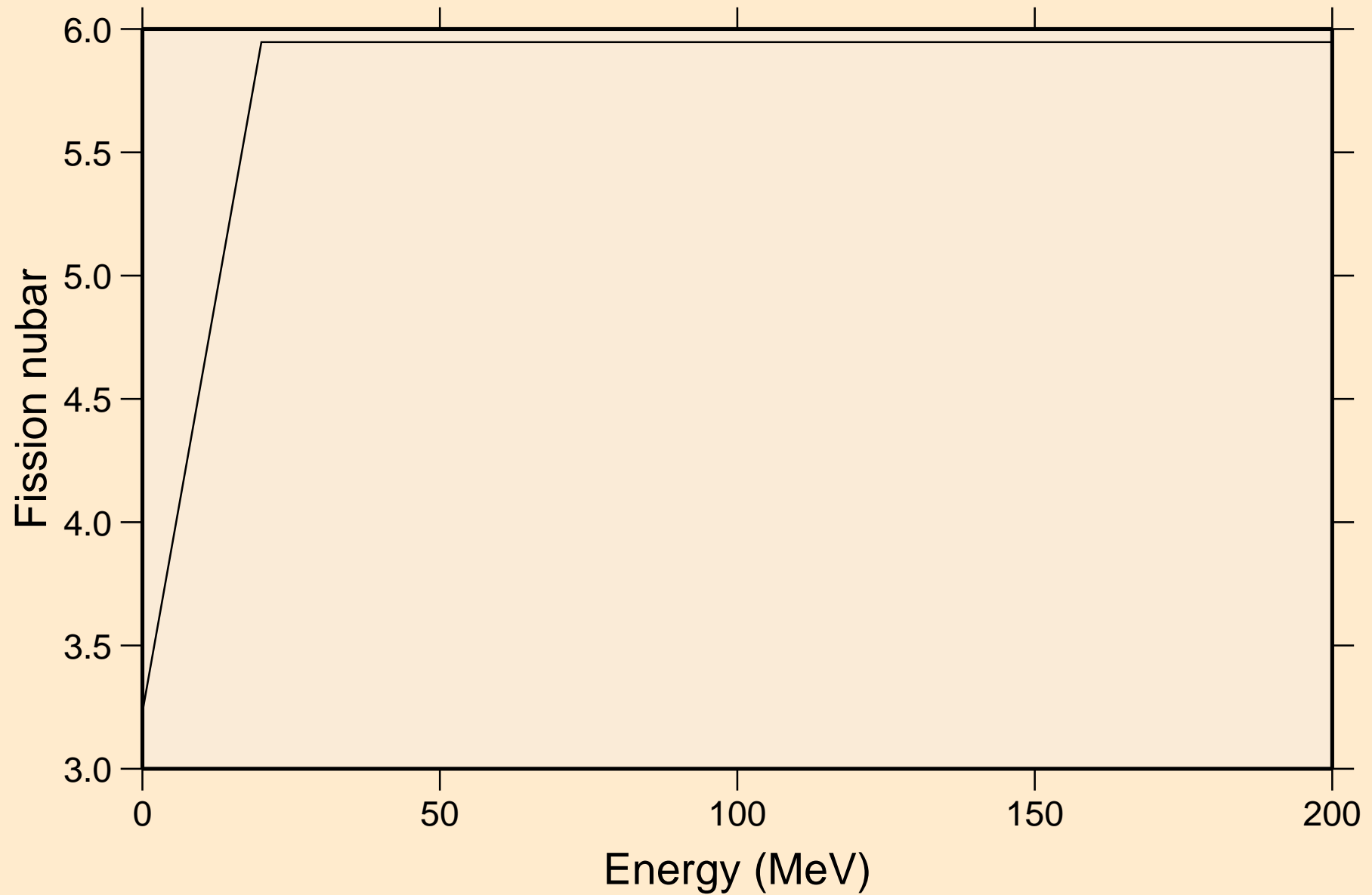



AM235 NRG TENDL-2015, AKONING  
Neutron emission for (n,x)

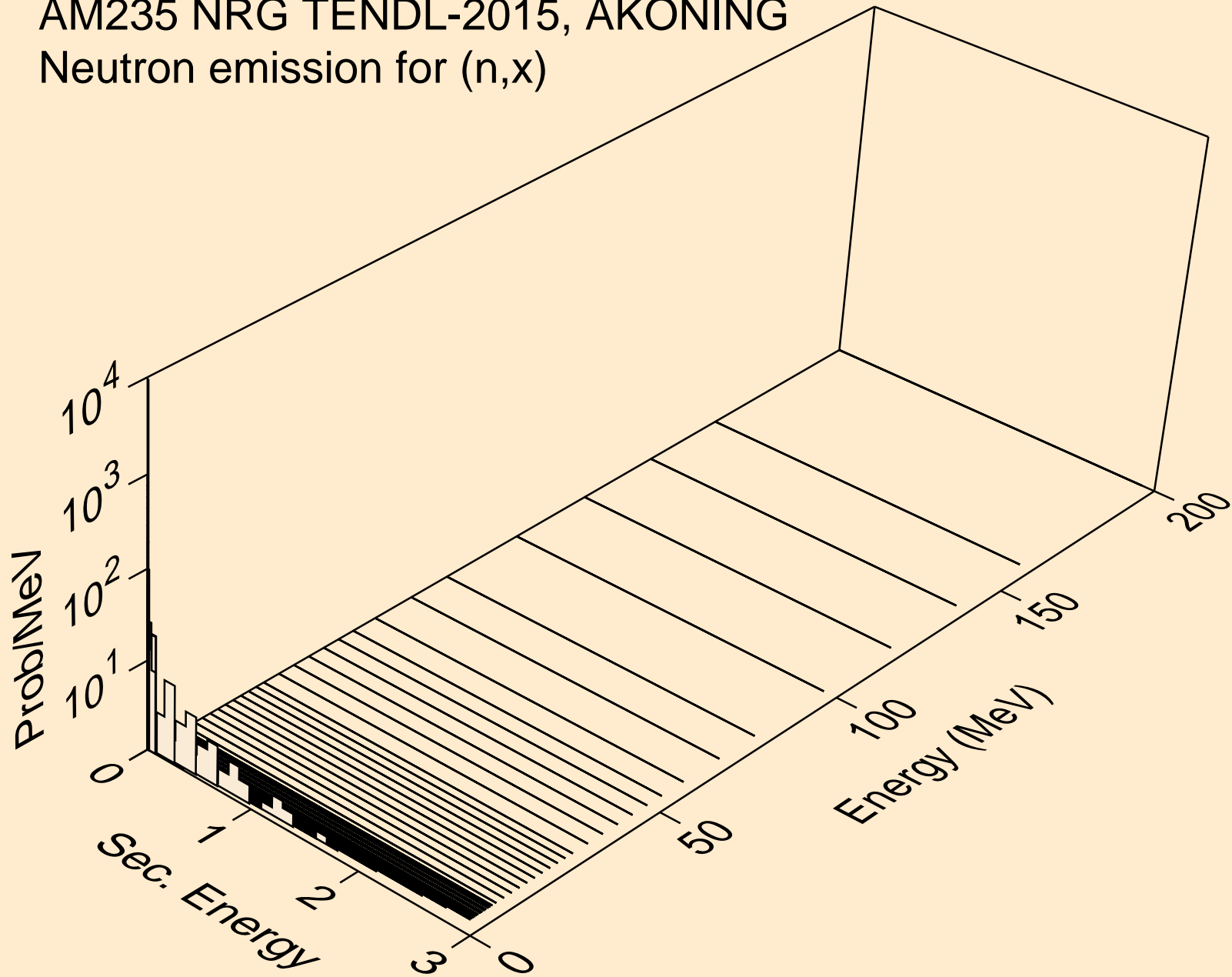

AM235 NRG TENDL-2015, AKONING  
Neutron emission for (n,2nd)

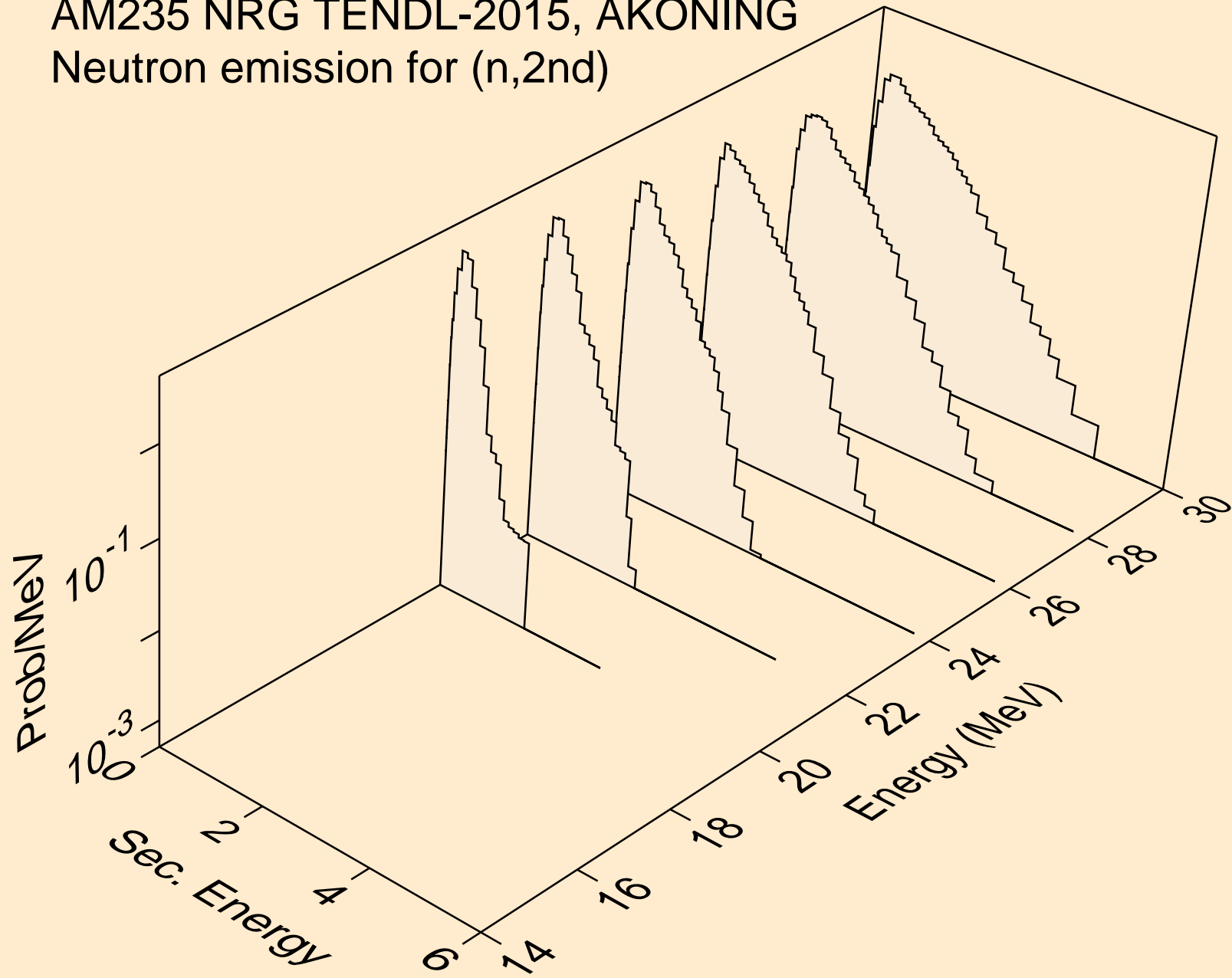

AM235 NRG TENDL-2015, AKONING  
Neutron emission for (n,2n)

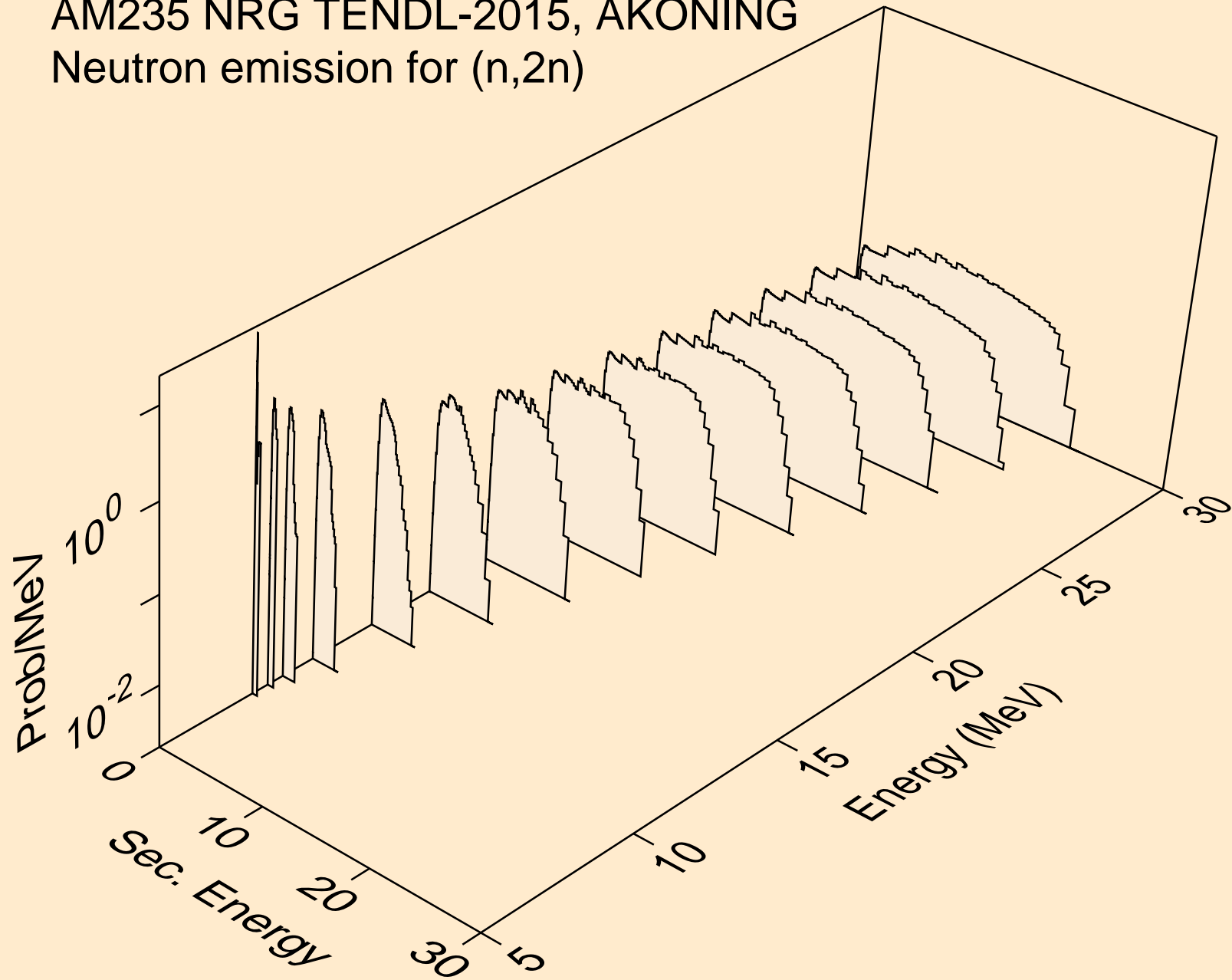

AM235 NRG TENDL-2015, AKONING  
Neutron emission for (n,3n)

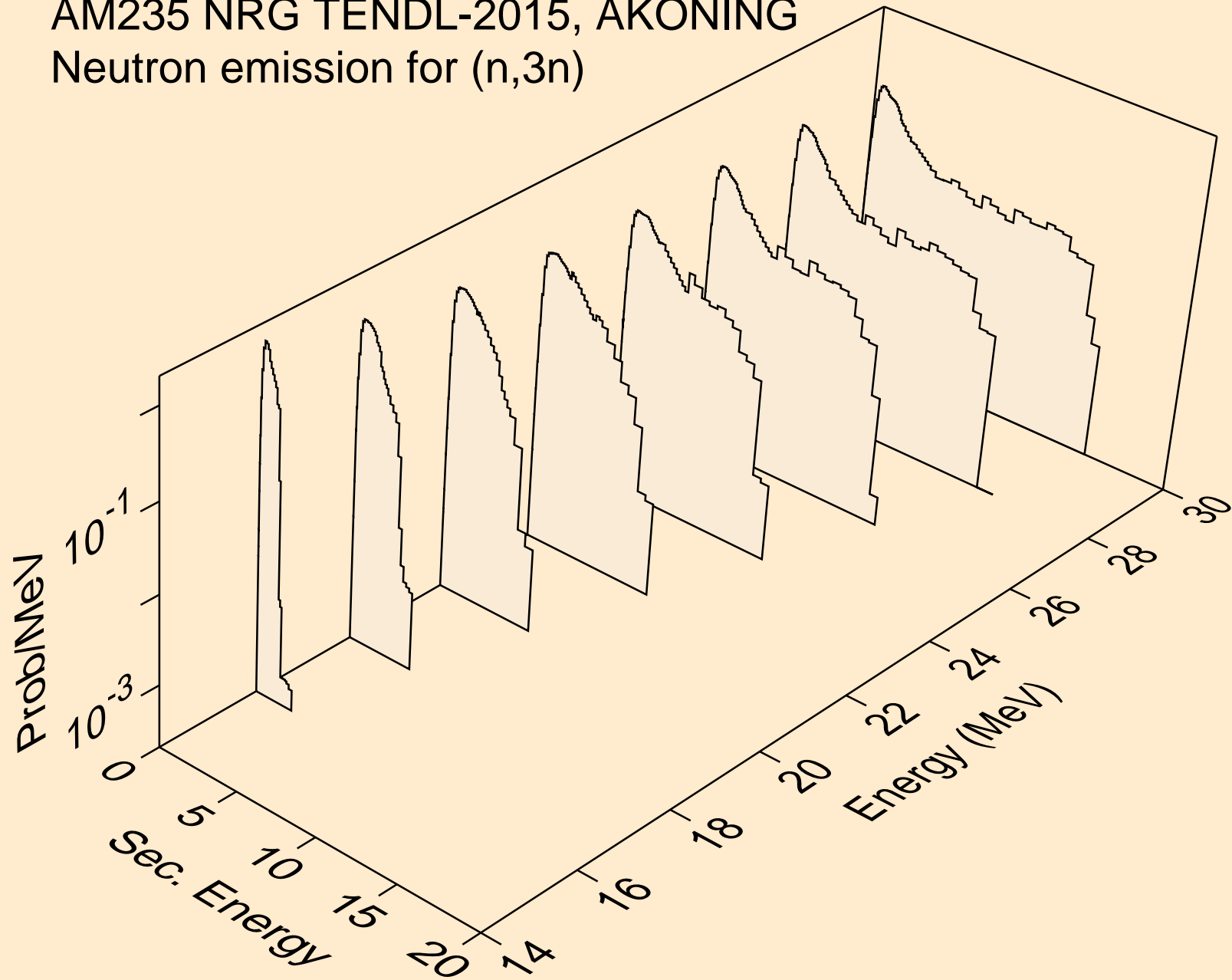

AM235 NRG TENDL-2015, AKONING  
Neutron emission for fission

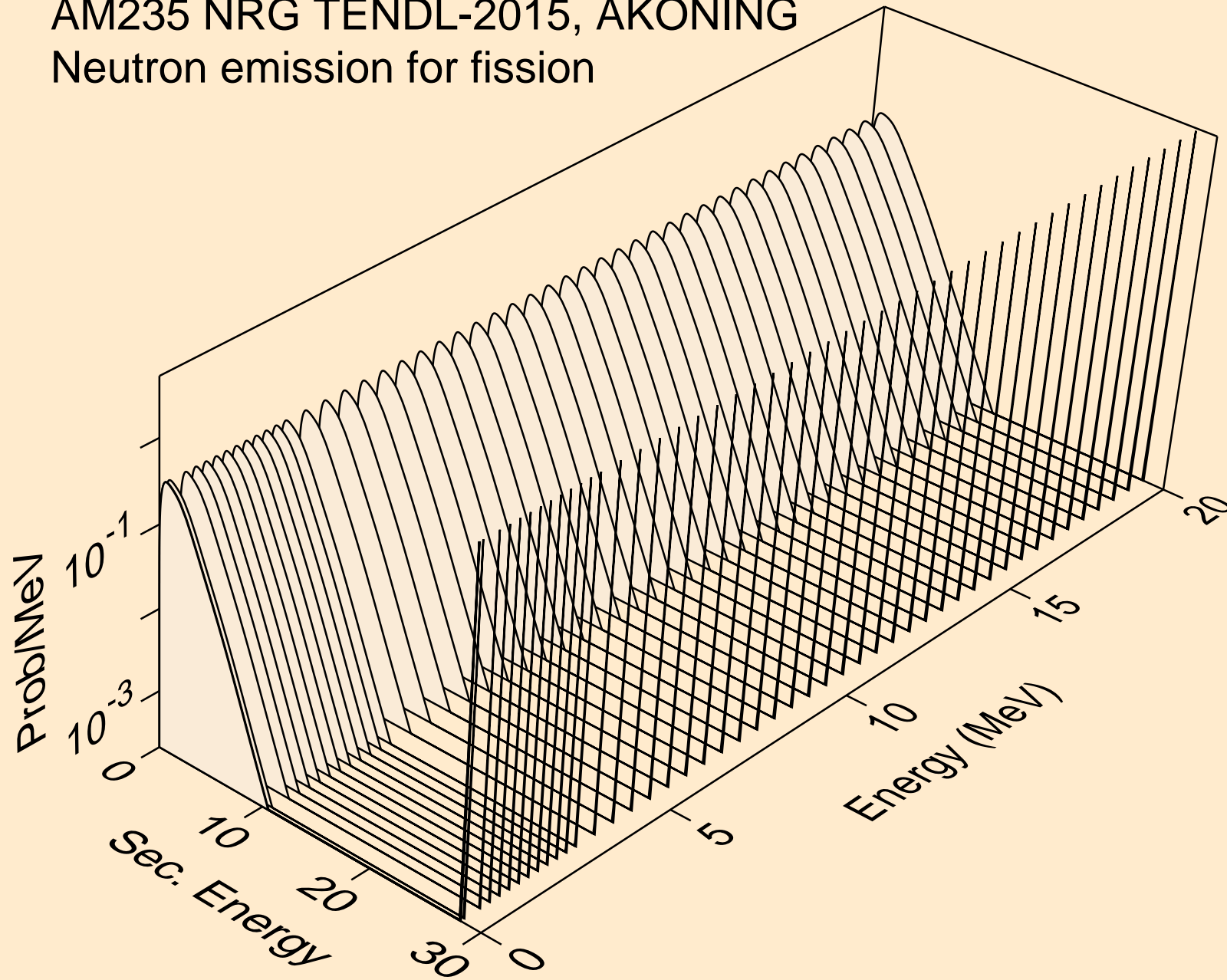

AM235 NRG TENDL-2015, AKONING  
Neutron emission for (n,n\*)a

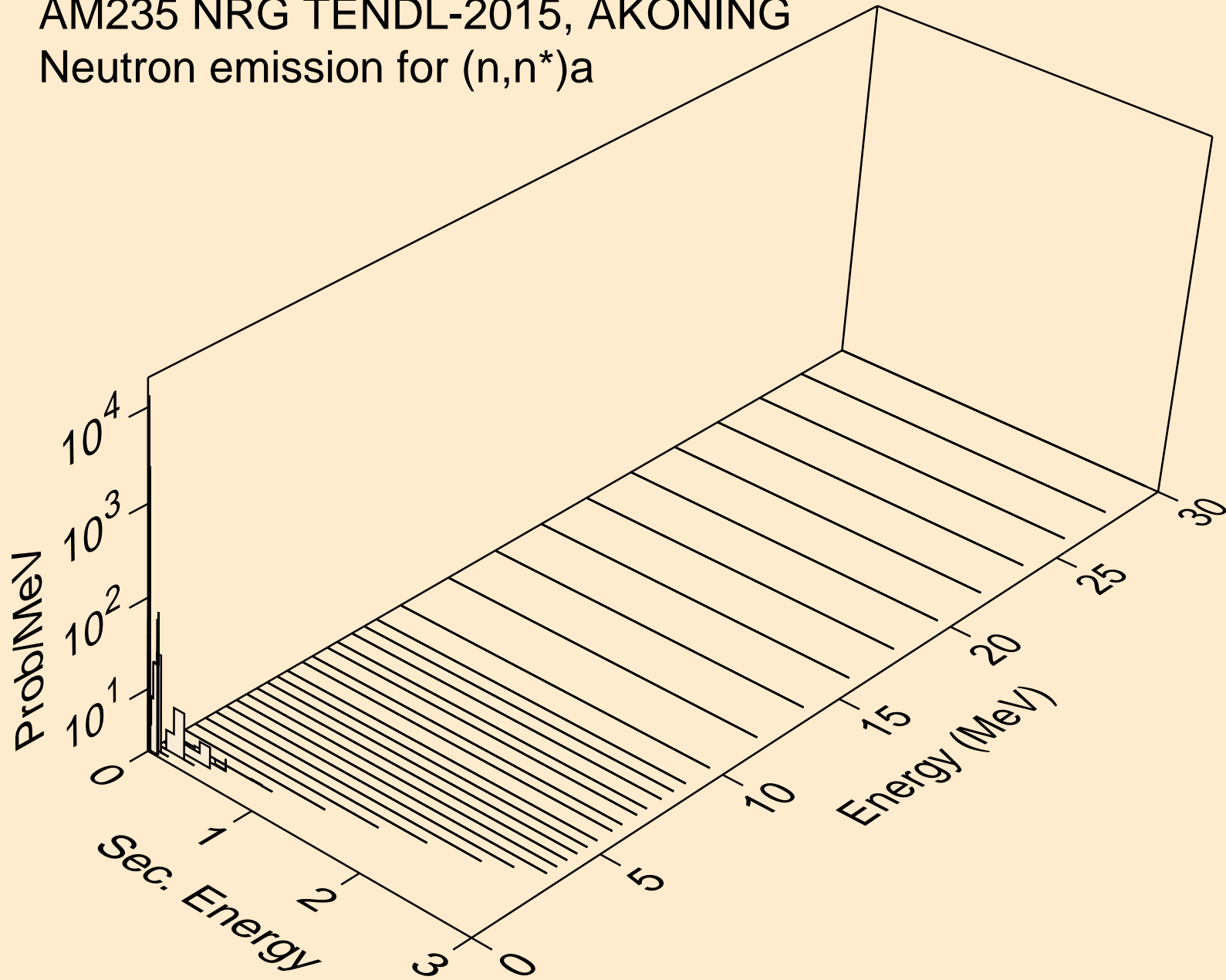

AM235 NRG TENDL-2015, AKONING  
Neutron emission for (n,n\*)3a

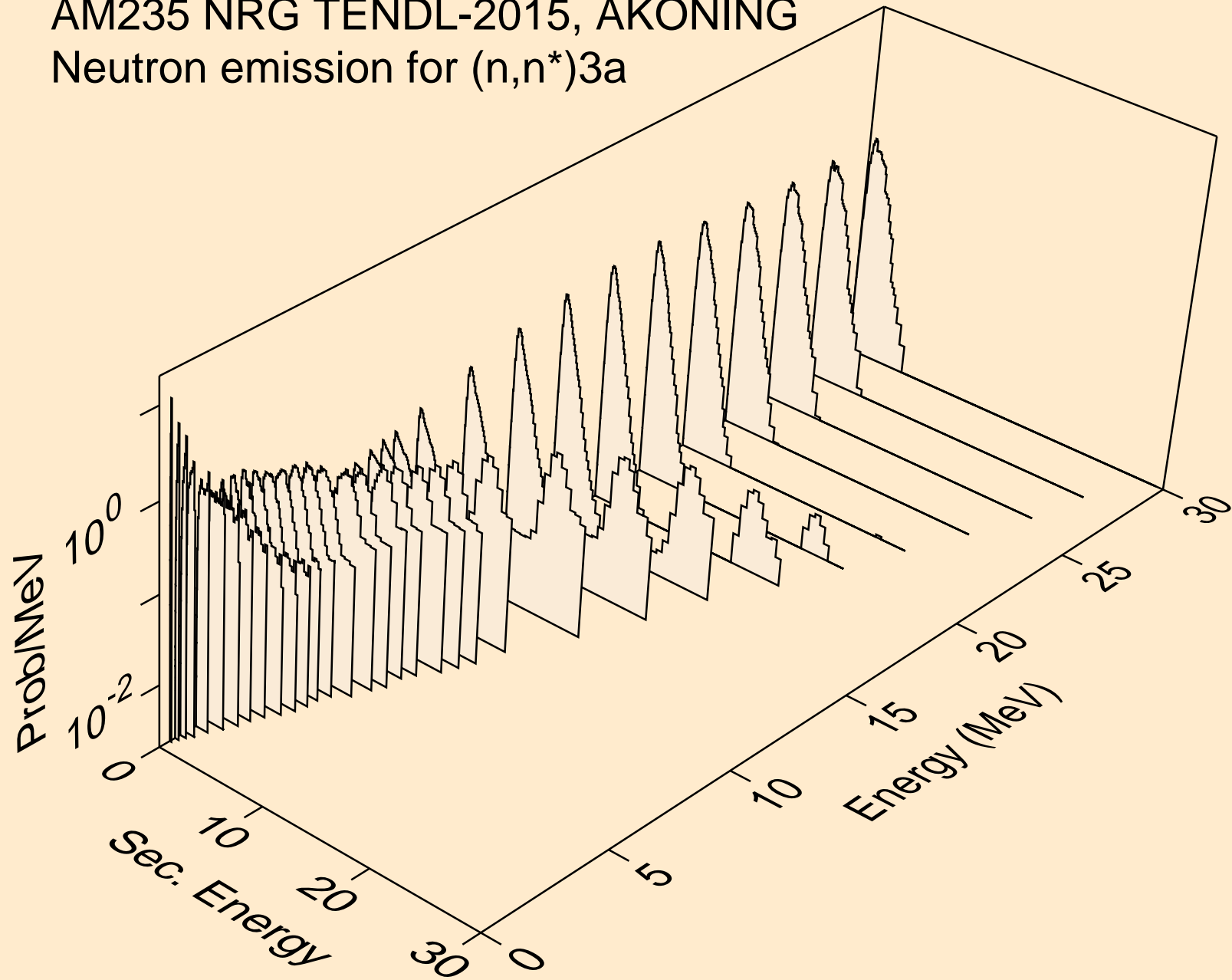

AM235 NRG TENDL-2015, AKONING  
Neutron emission for (n,2n)a

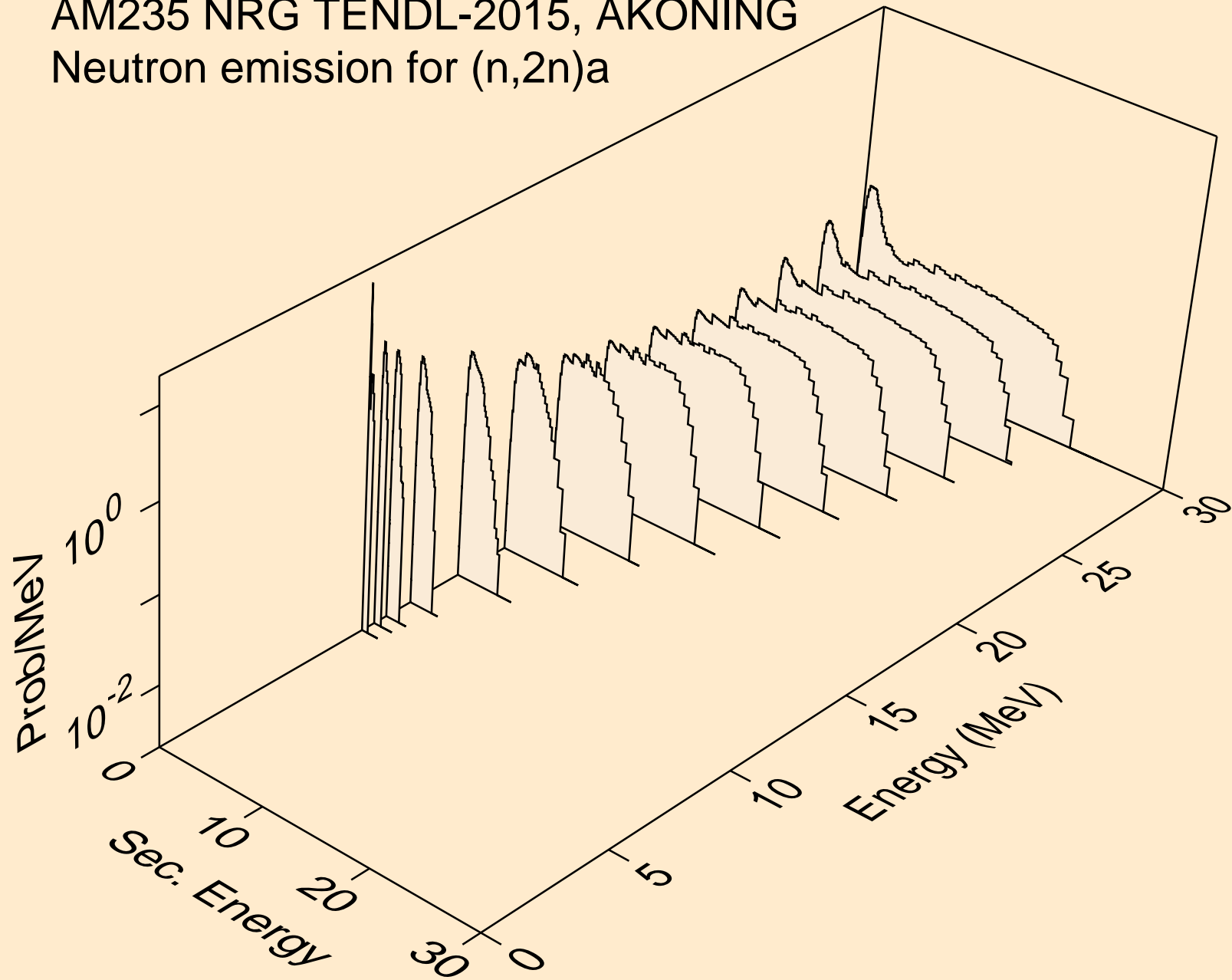



AM235 NRG TENDL-2015, AKONING  
Neutron emission for (n,3n)a

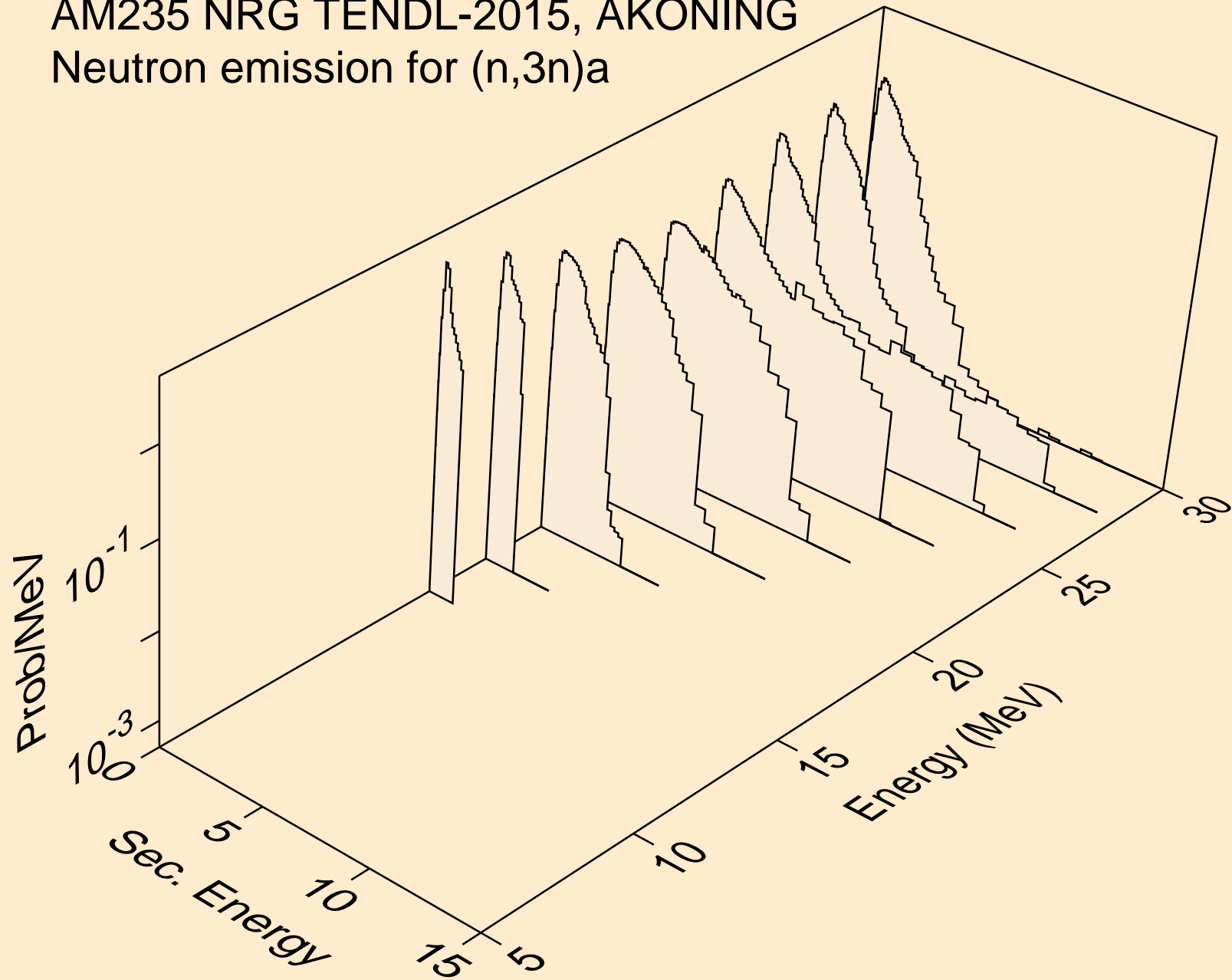

AM235 NRG TENDL-2015, AKONING  
Neutron emission for (n,n\*)p

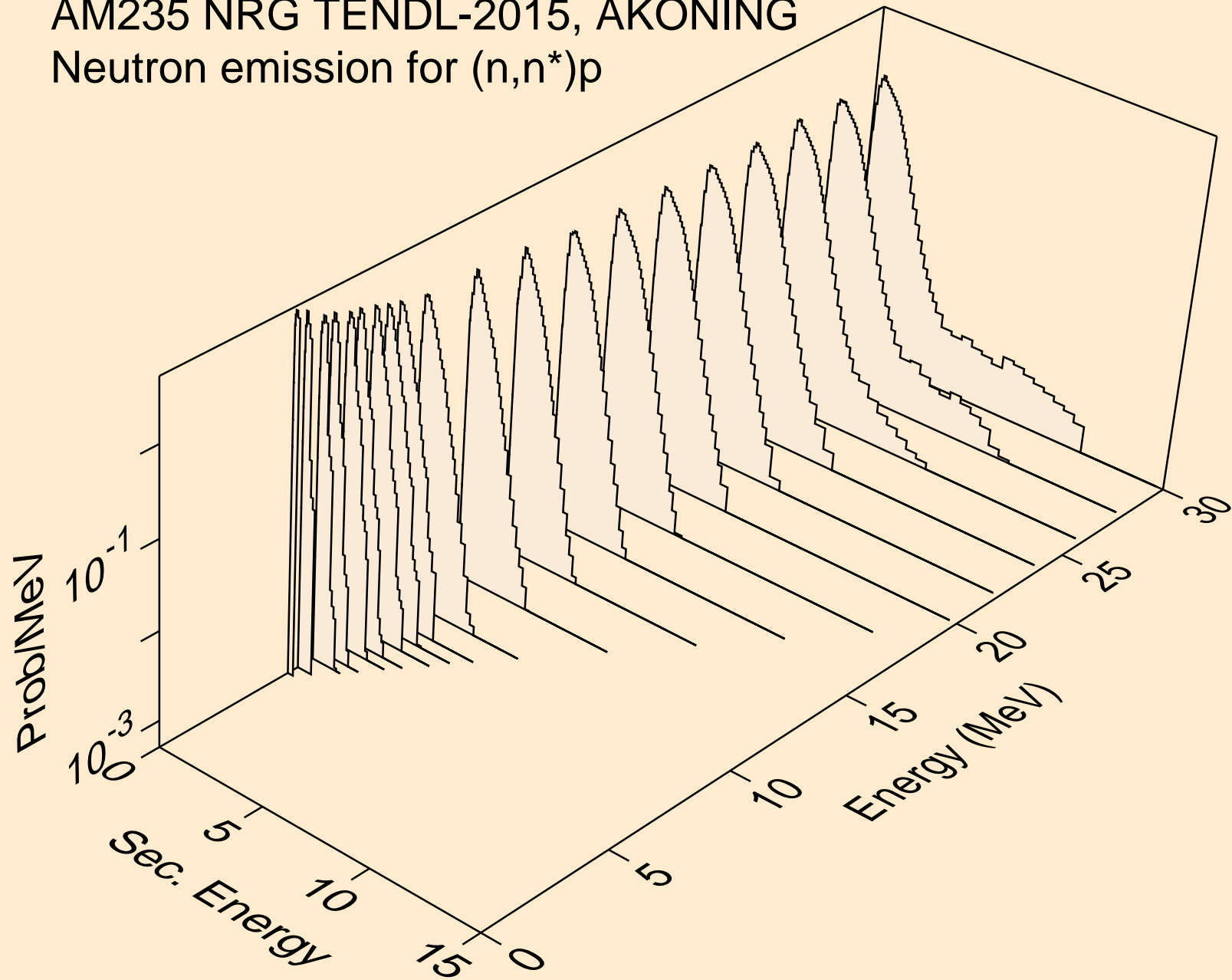

AM235 NRG TENDL-2015, AKONING  
Neutron emission for (n,n\*)2a

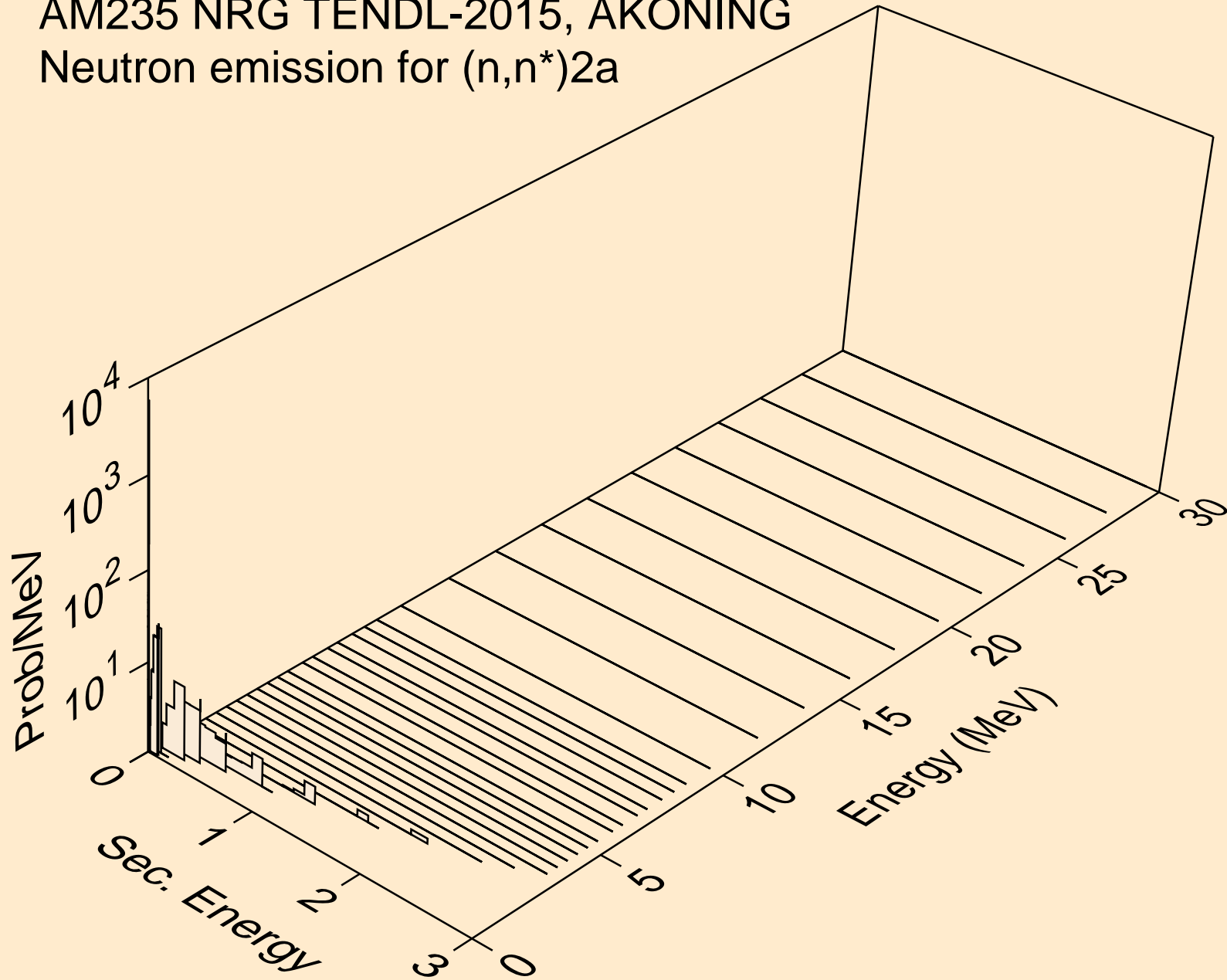

AM235 NRG TENDL-2015, AKONING  
Neutron emission for (n,2n)2a

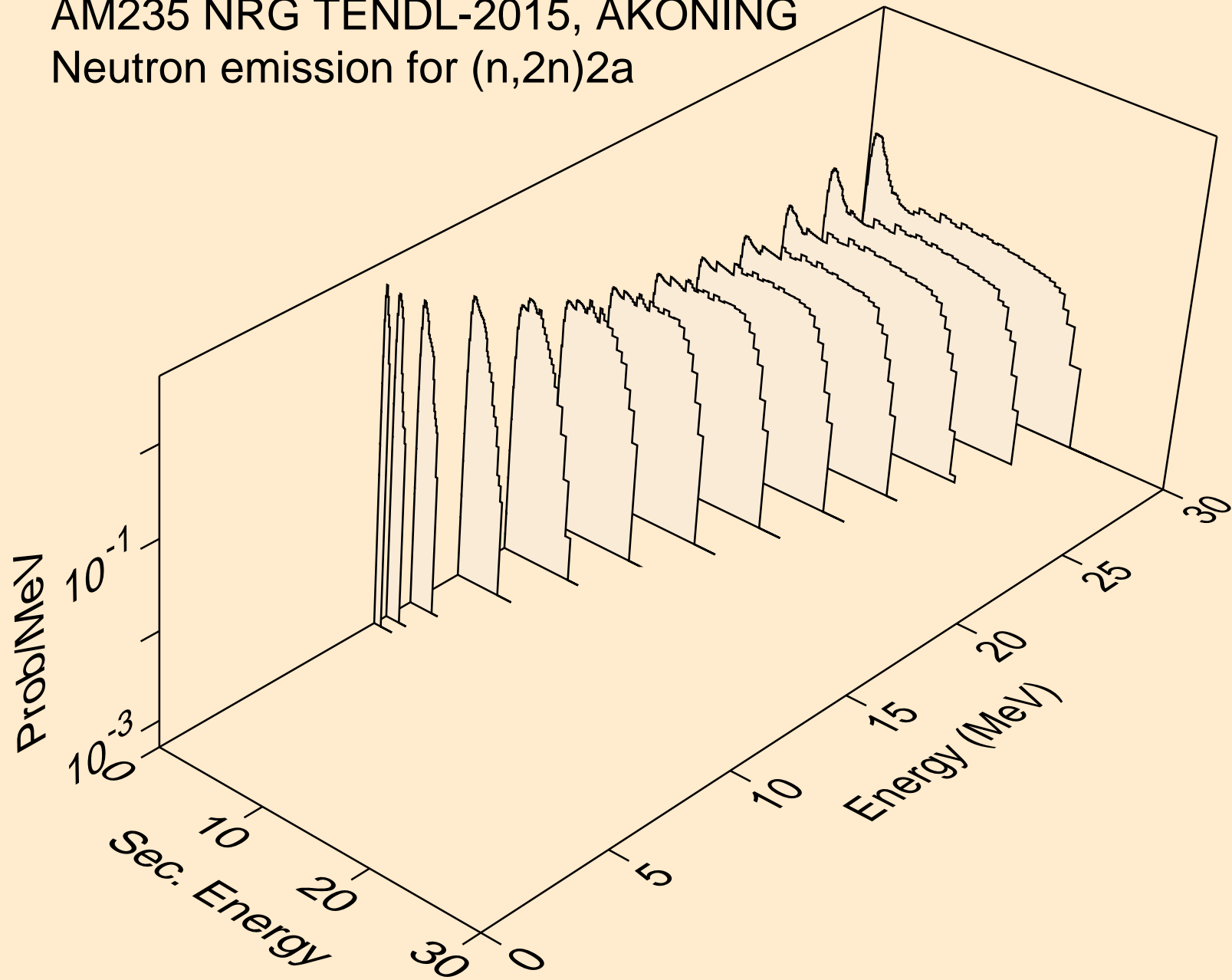

AM235 NRG TENDL-2015, AKONING  
Neutron emission for (n,n\*)d

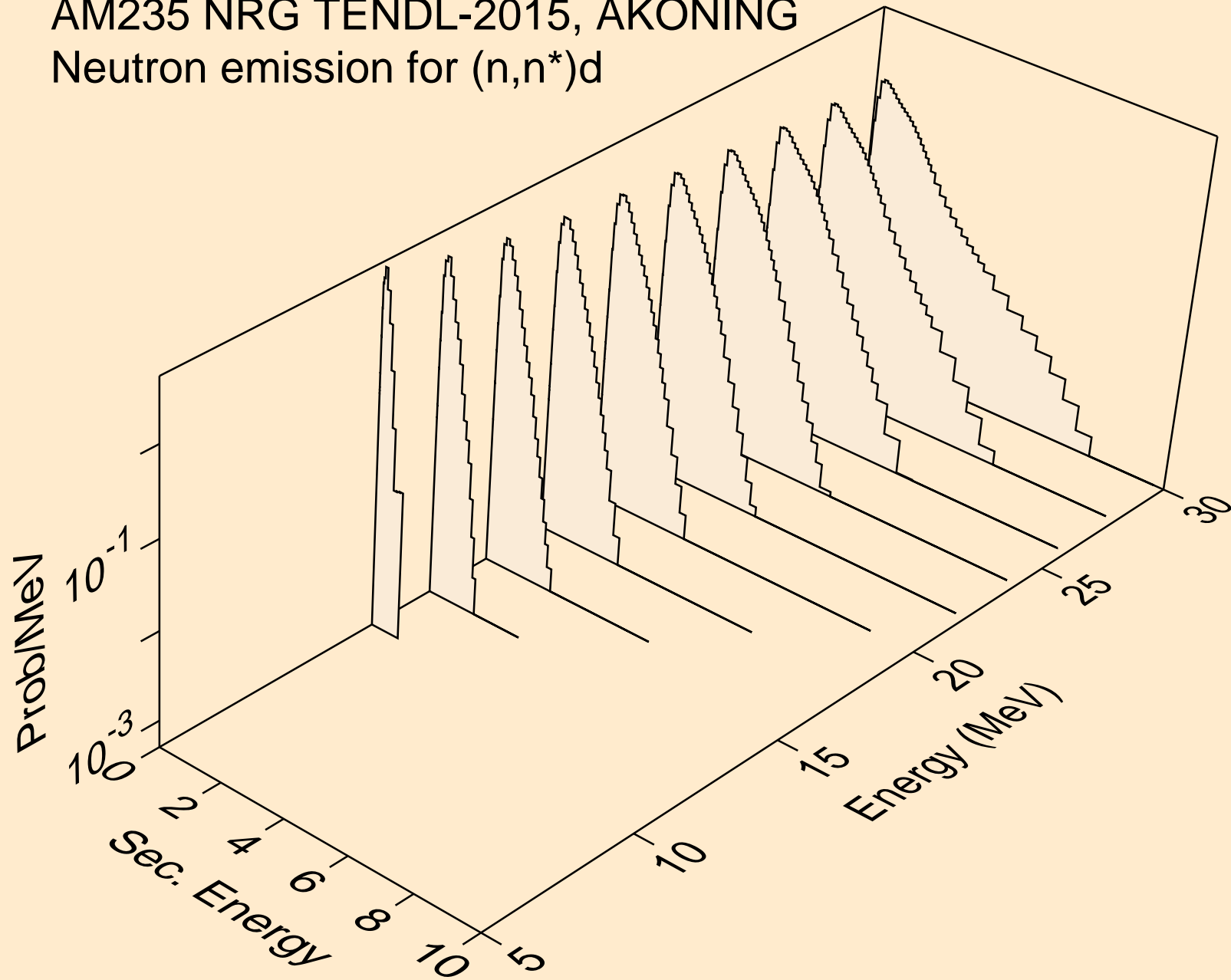

AM235 NRG TENDL-2015, AKONING  
Neutron emission for (n,n\*)t

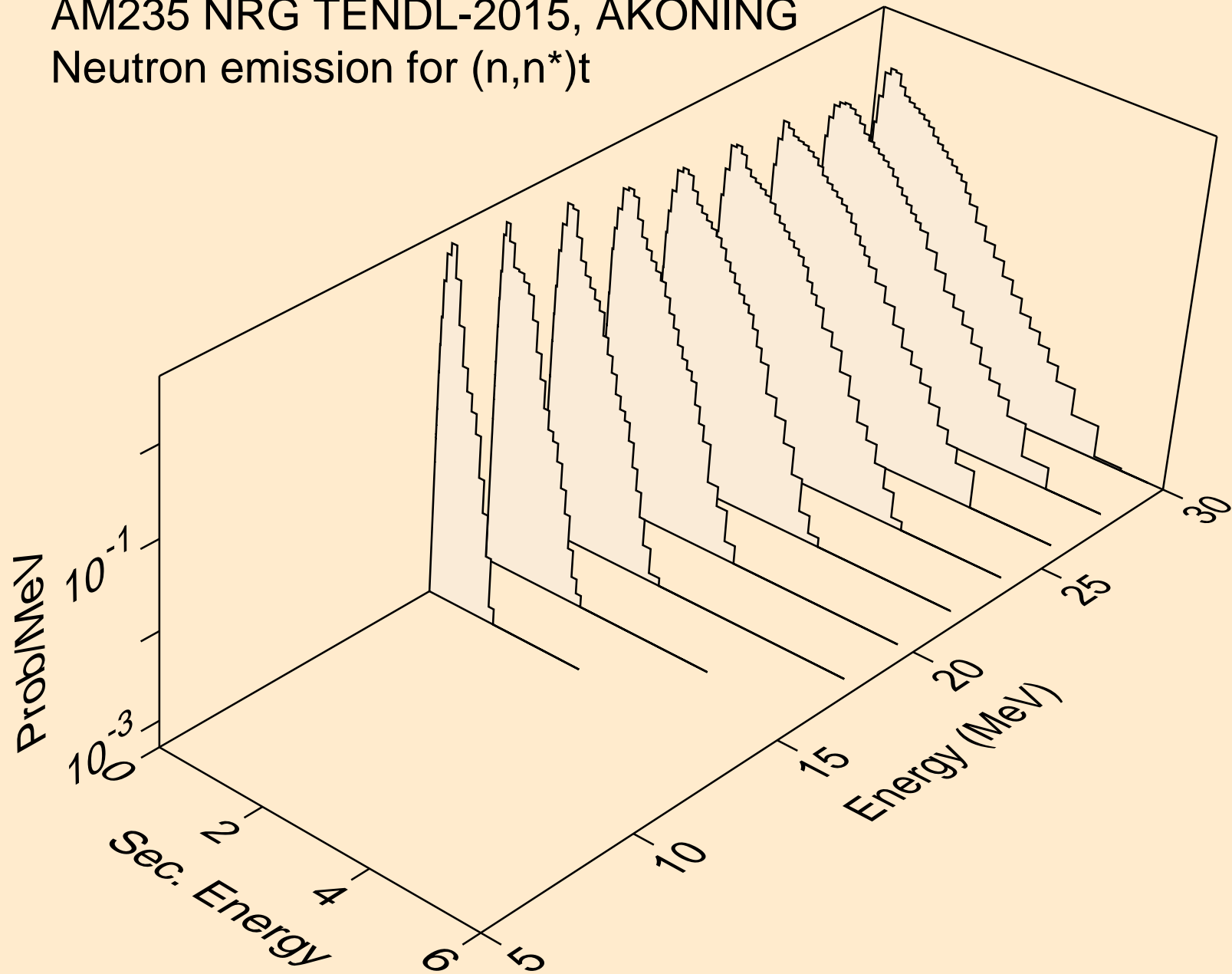

AM235 NRG TENDL-2015, AKONING  
Neutron emission for (n,n\*)he3

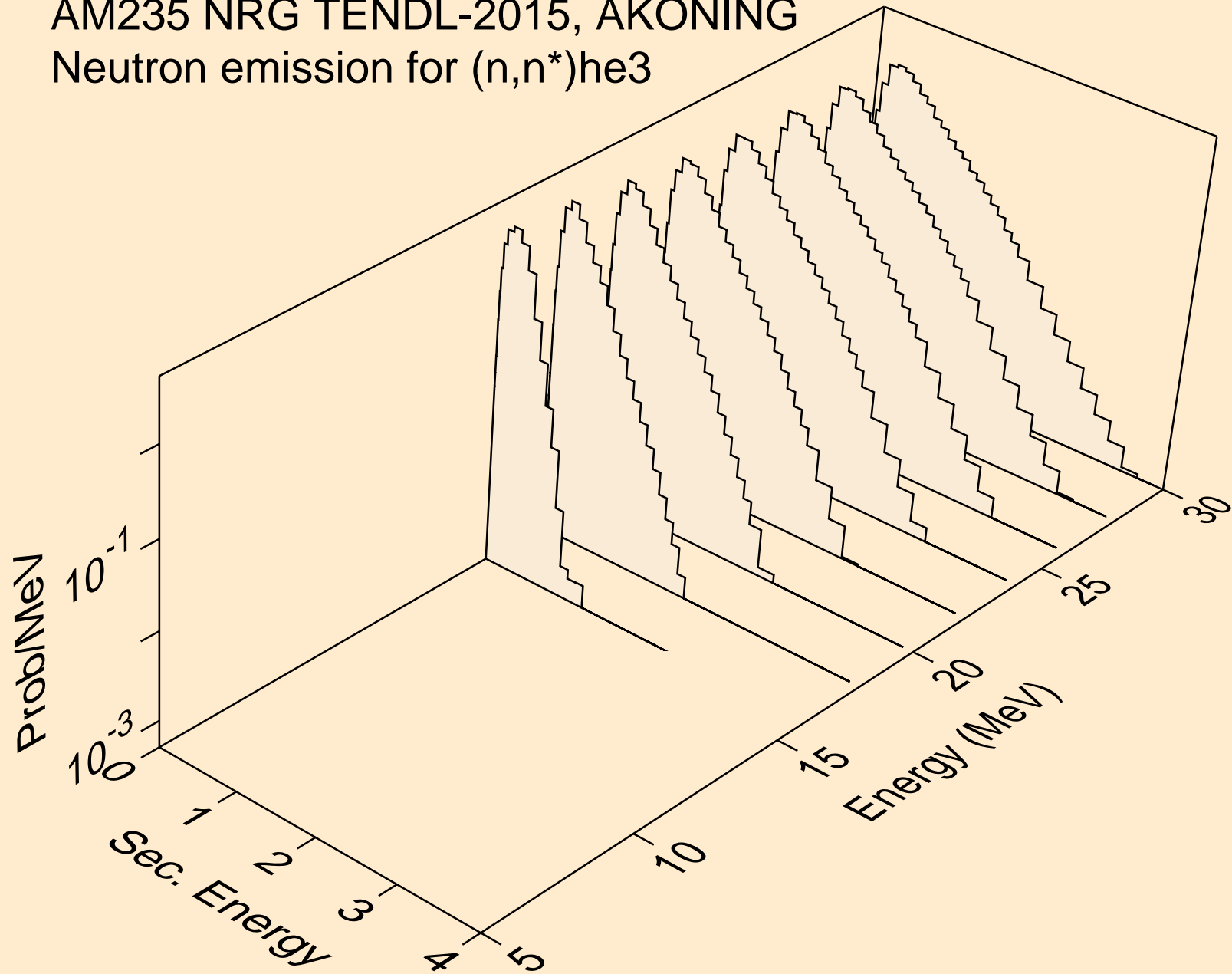

AM235 NRG TENDL-2015, AKONING  
Neutron emission for (n,4n)

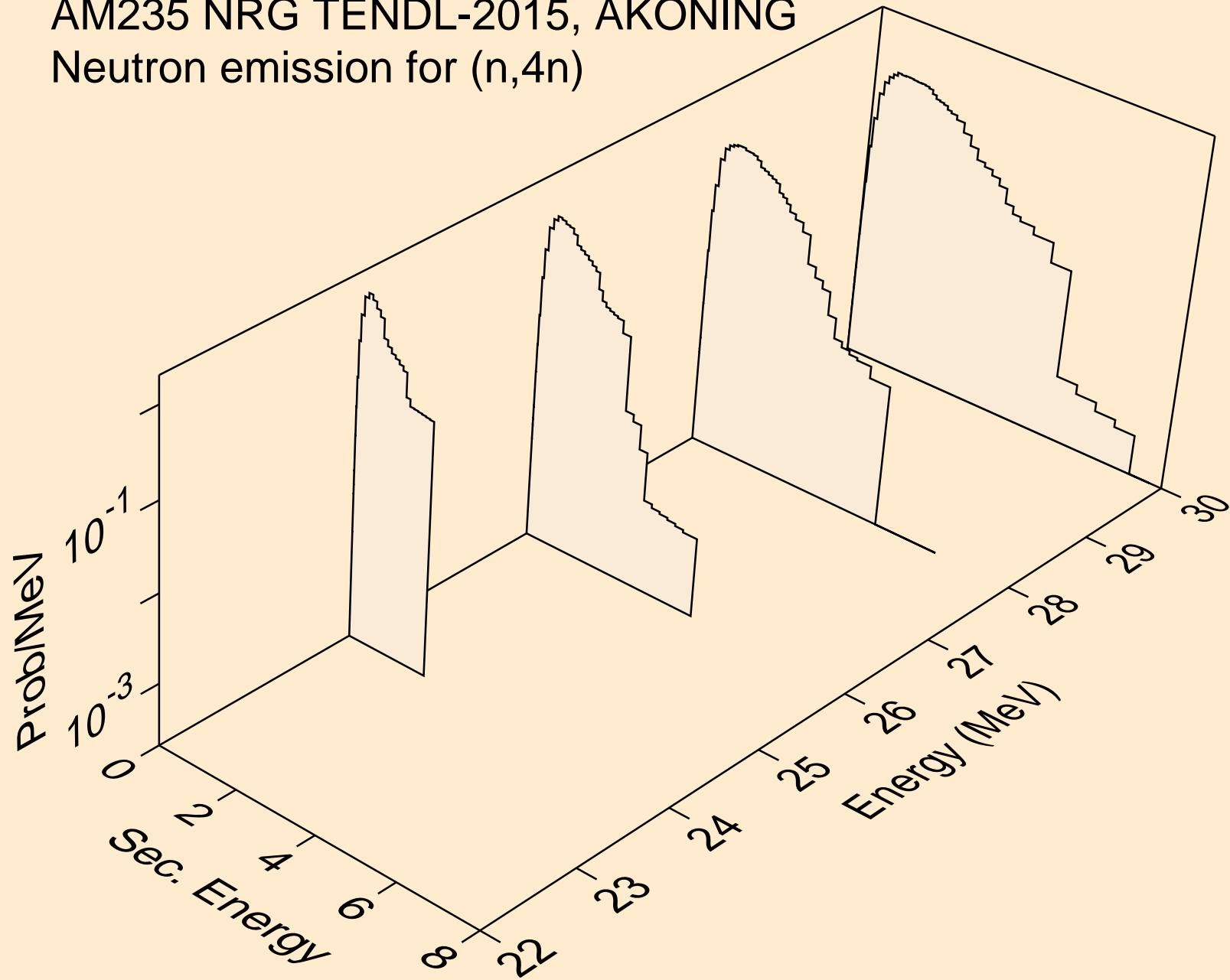



AM235 NRG TENDL-2015, AKONING  
Neutron emission for (n,2np)

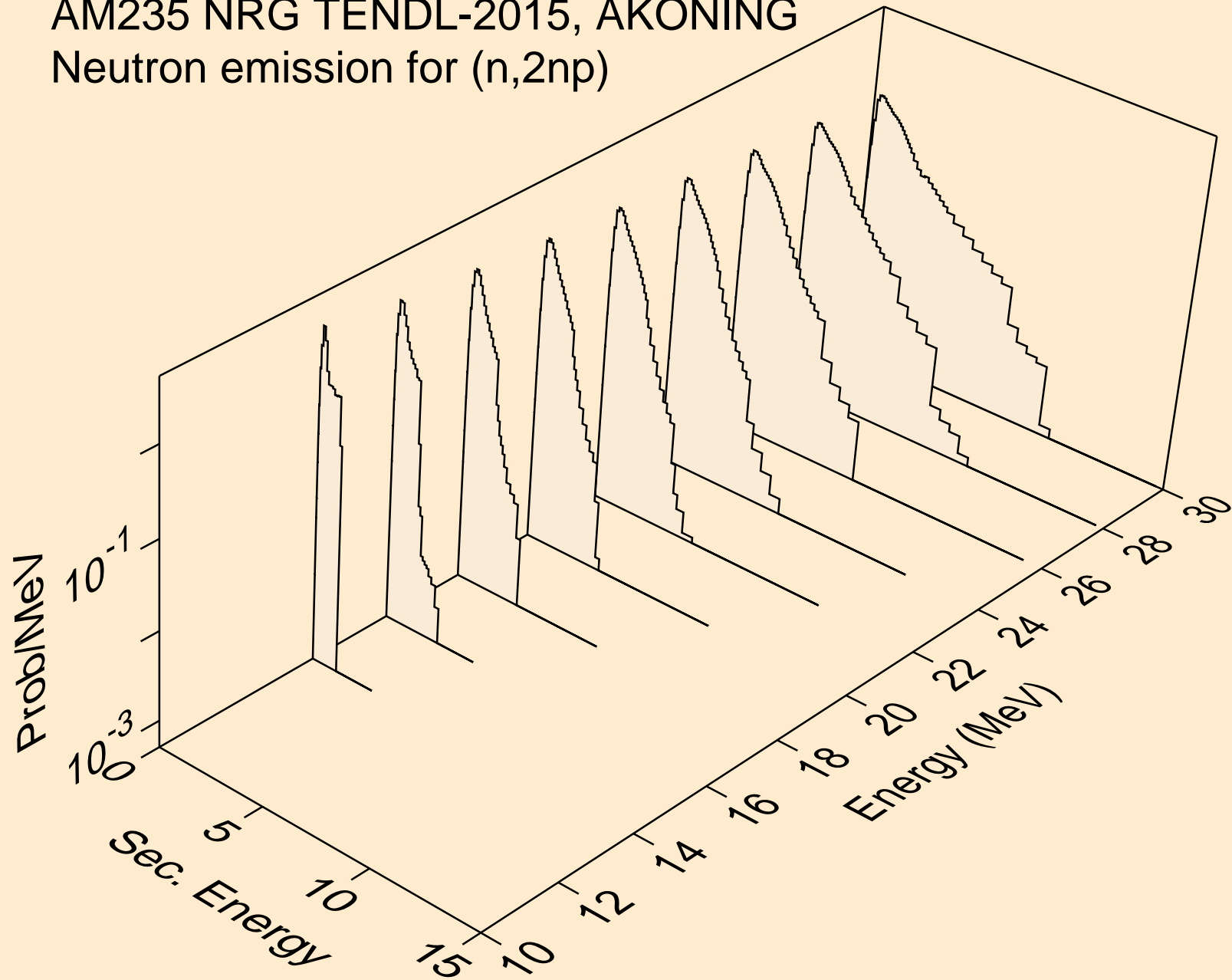

AM235 NRG TENDL-2015, AKONING  
Neutron emission for (n,3np)

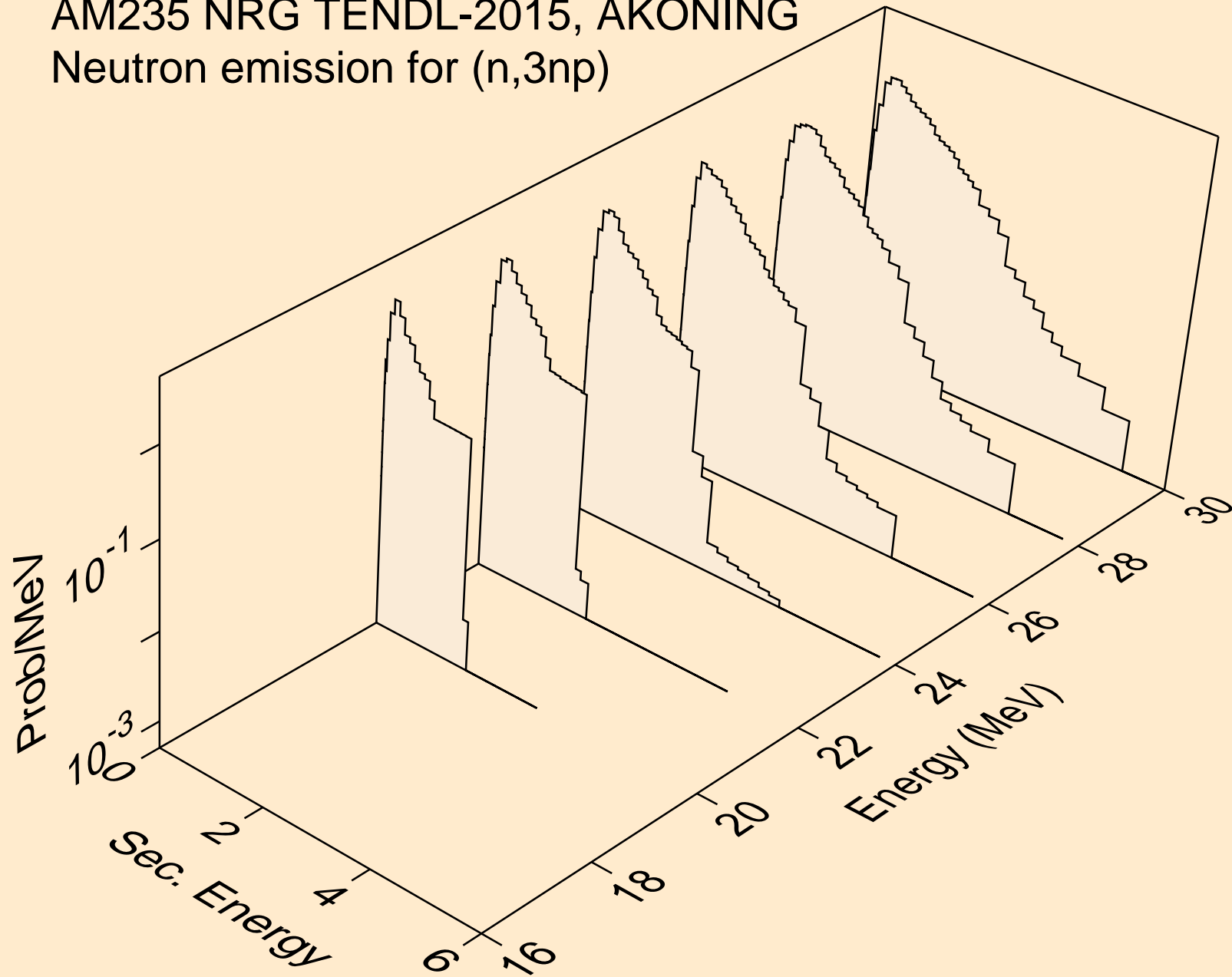

AM235 NRG TENDL-2015, AKONING  
Neutron emission for (n,2np)

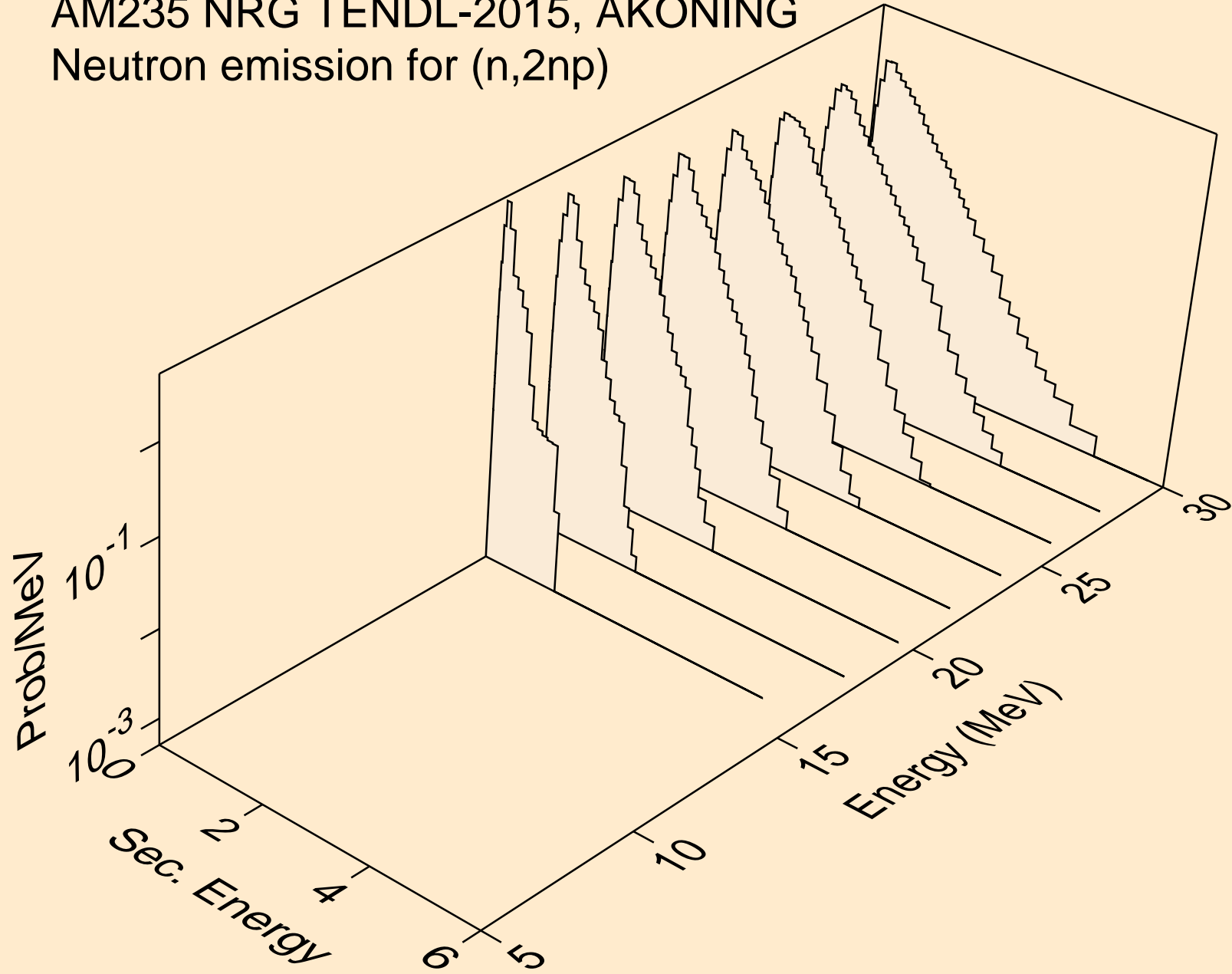

AM235 NRG TENDL-2015, AKONING  
Neutron emission for (n,npa)

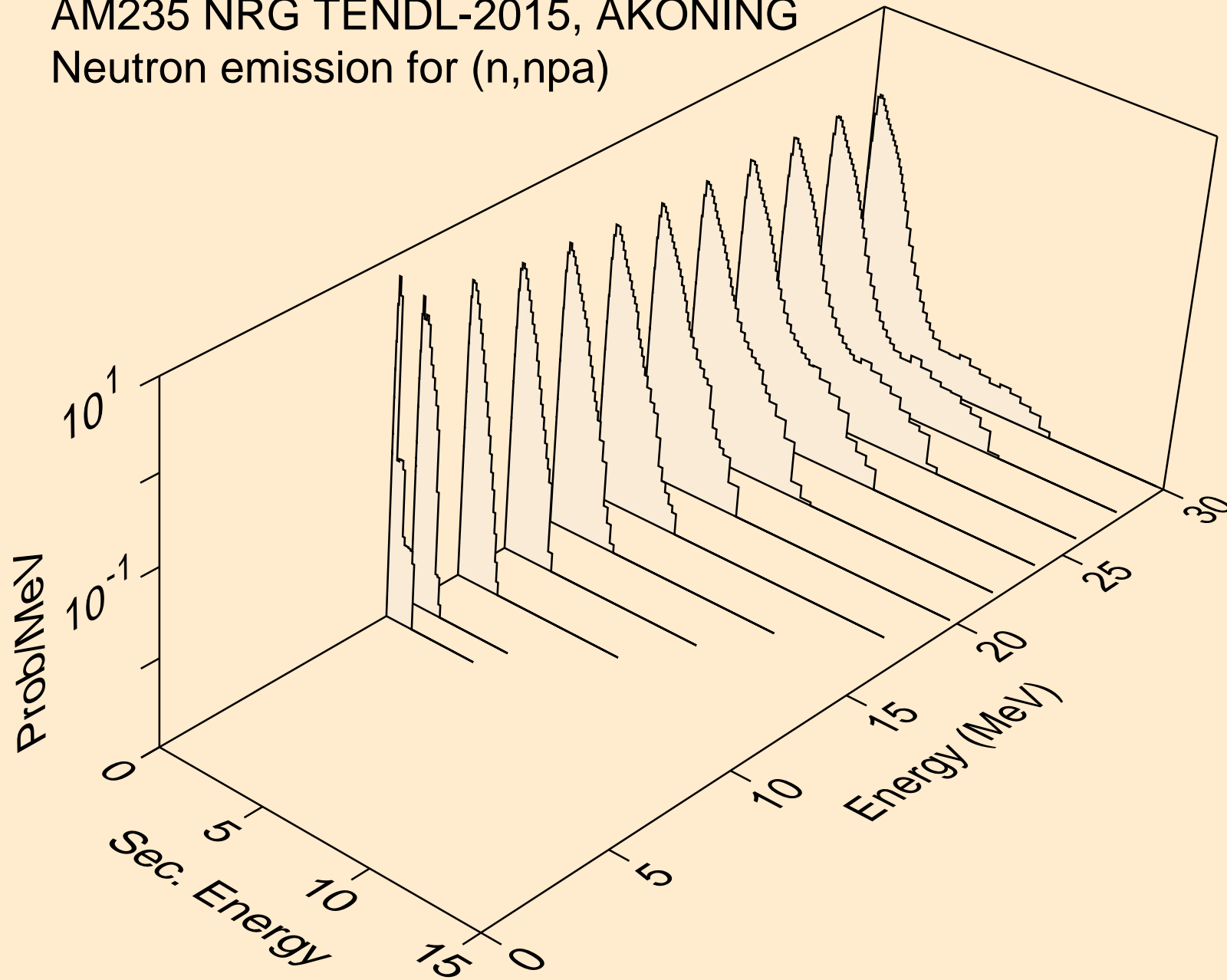

AM235 NRG TENDL-2015, AKONING  
Neutron emission for (n,n\*c)

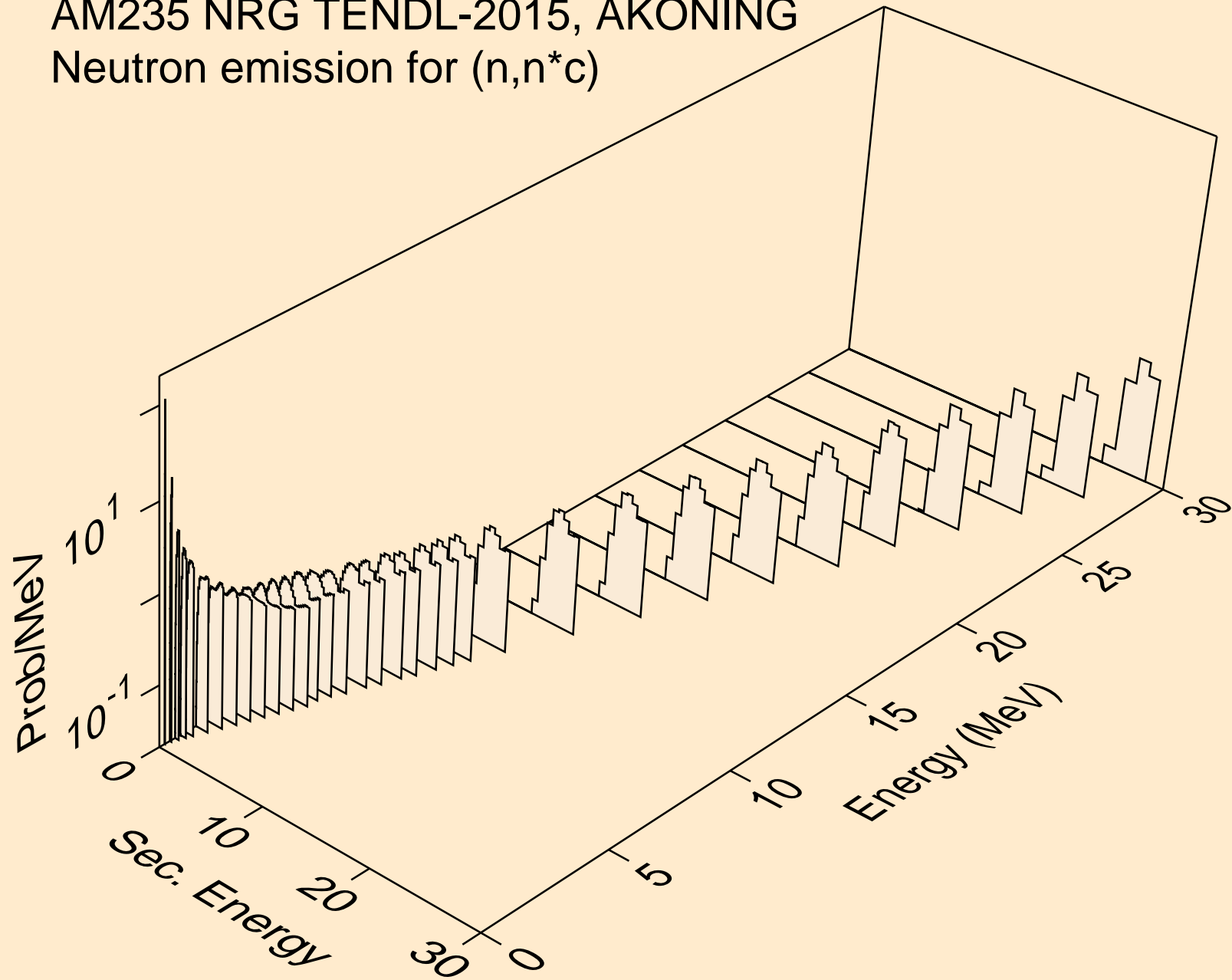

# AM235 NRG TENDL-2015, AKONING

Delayed nubar

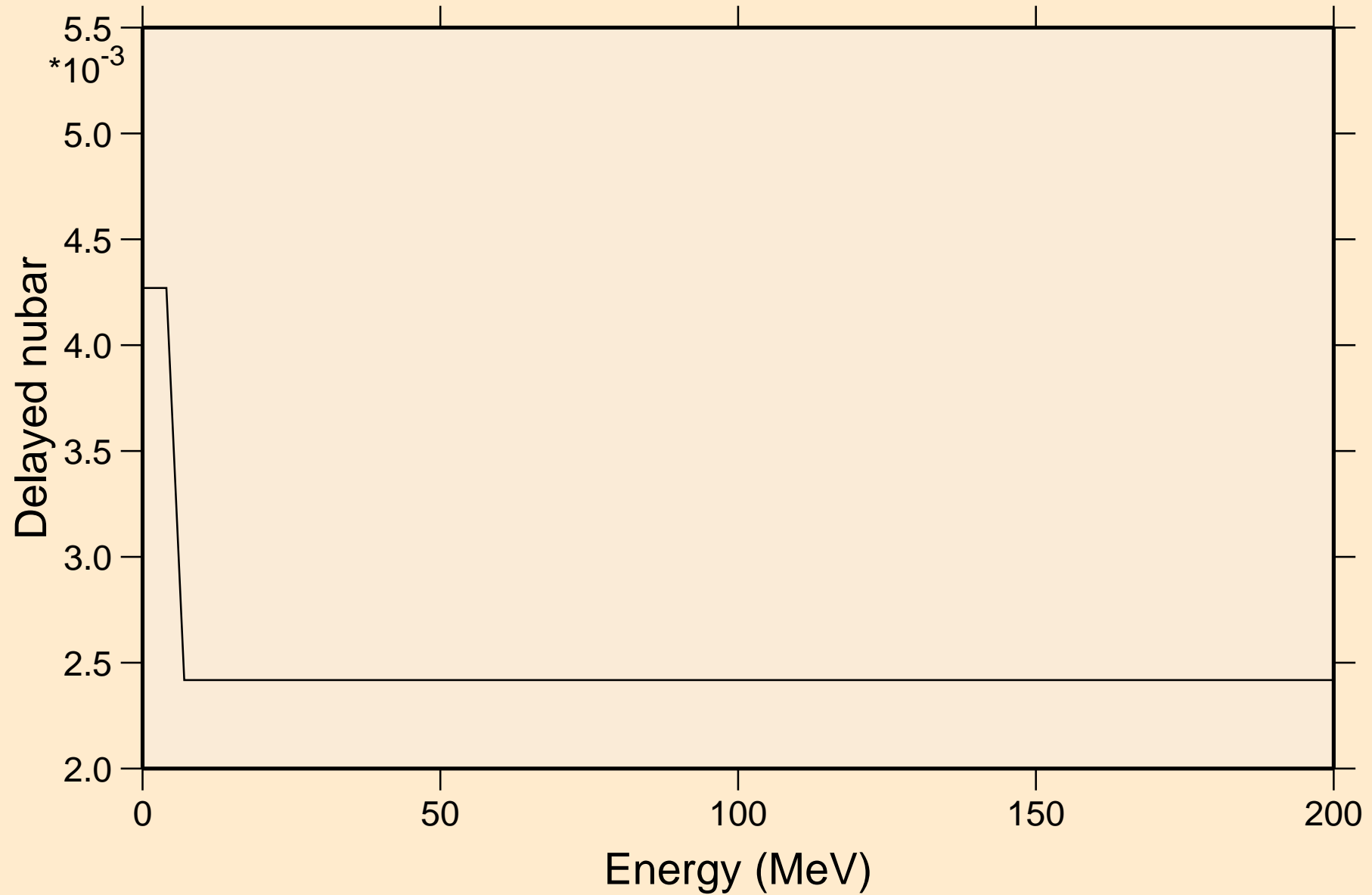

# AM235 NRG TENDL-2015, AKONING

## Delayed neutron spectra

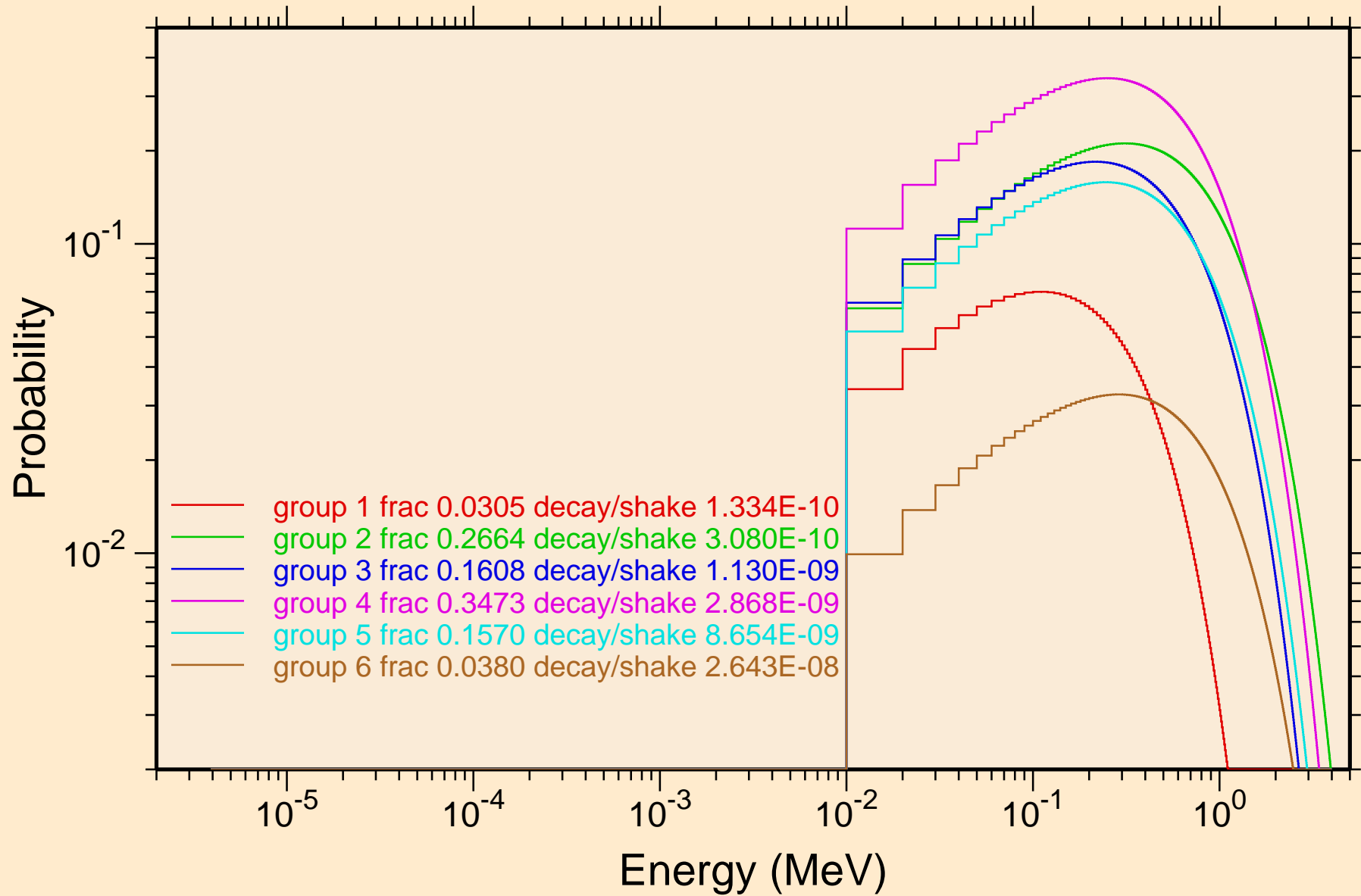

AM235 NRG TENDL-2015, AKONING  
Photon emission for (n,x)

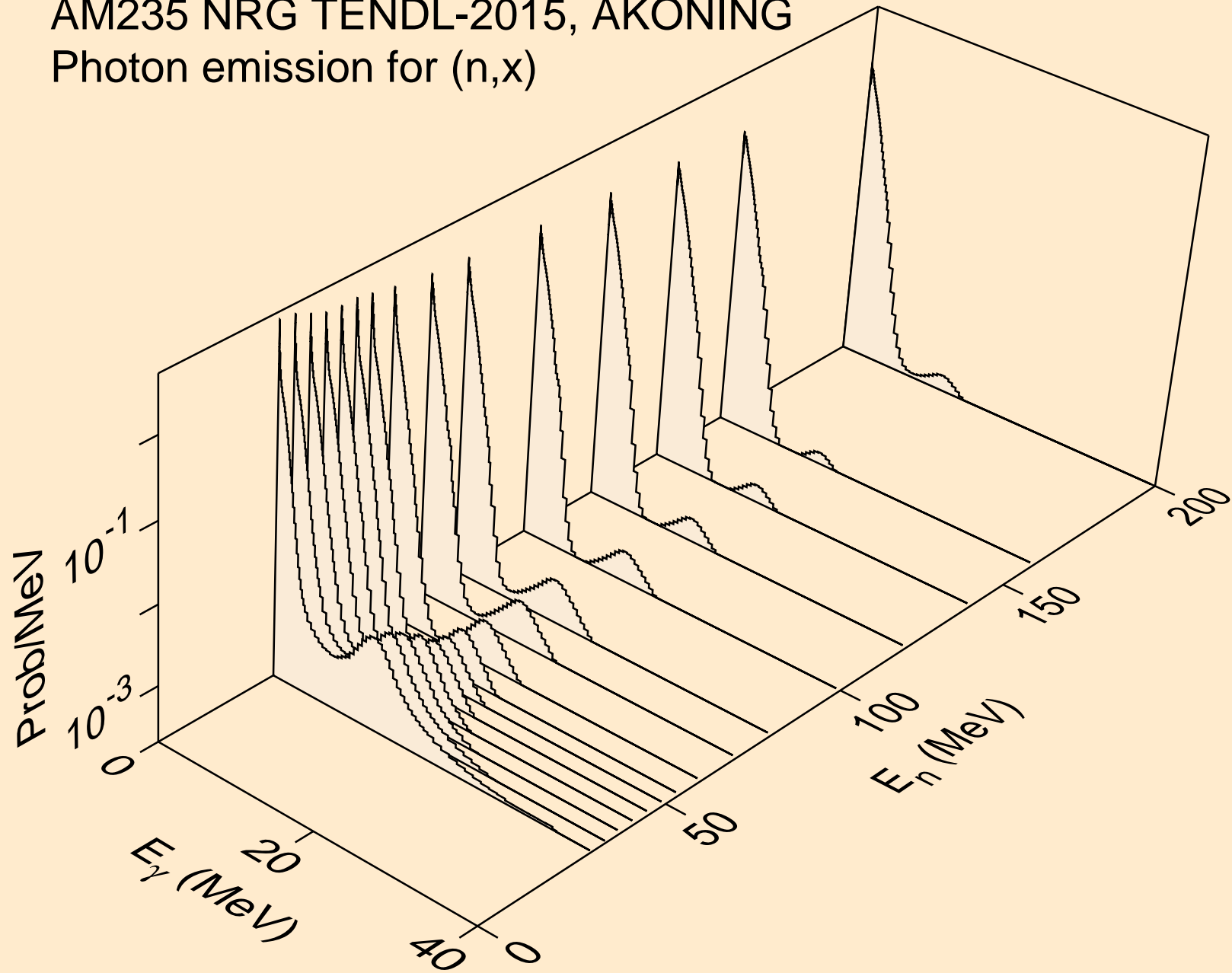



AM235 NRG TENDL-2015, AKONING  
Photon emission for (n,2nd)

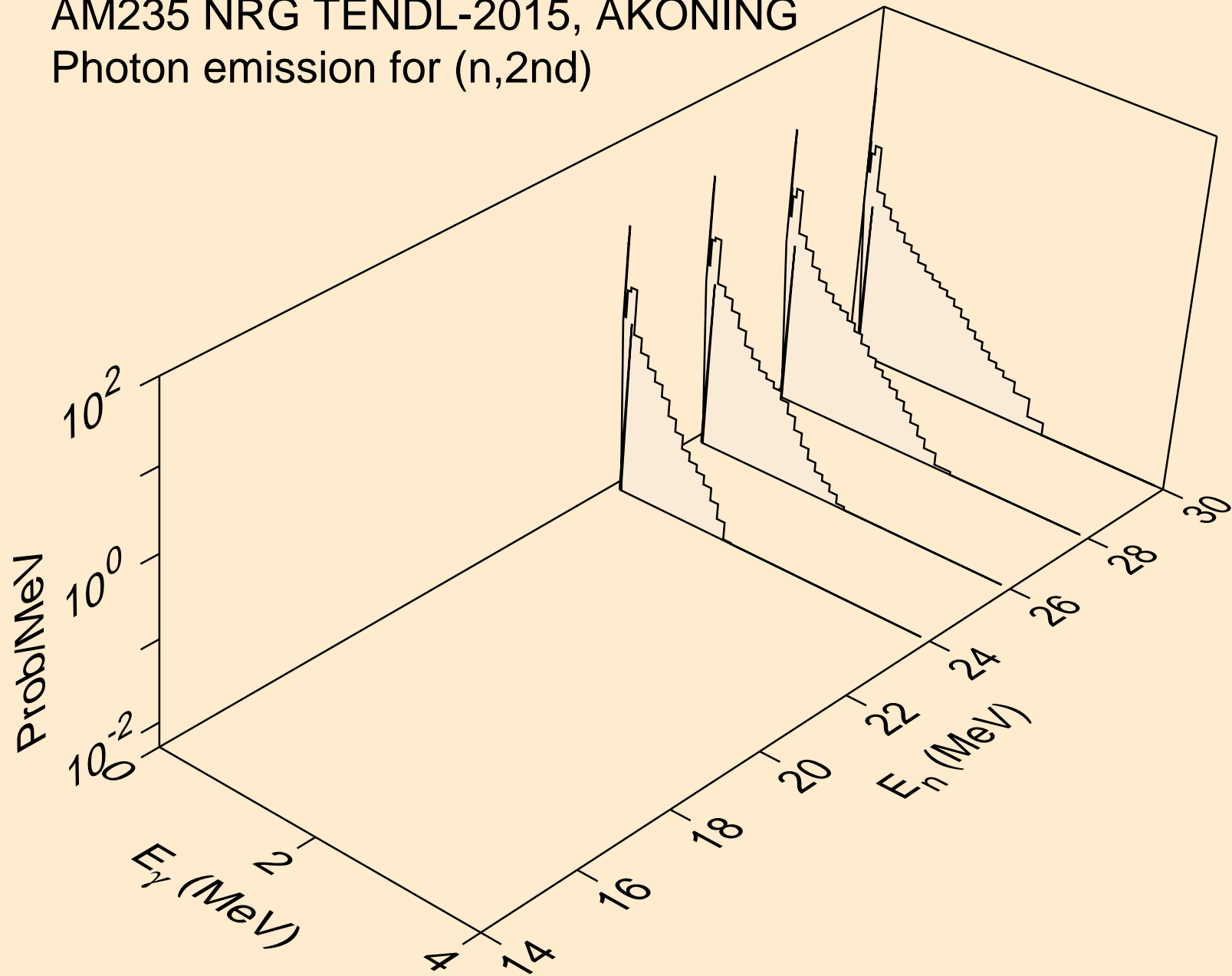

AM235 NRG TENDL-2015, AKONING  
Photon emission for (n,2n)

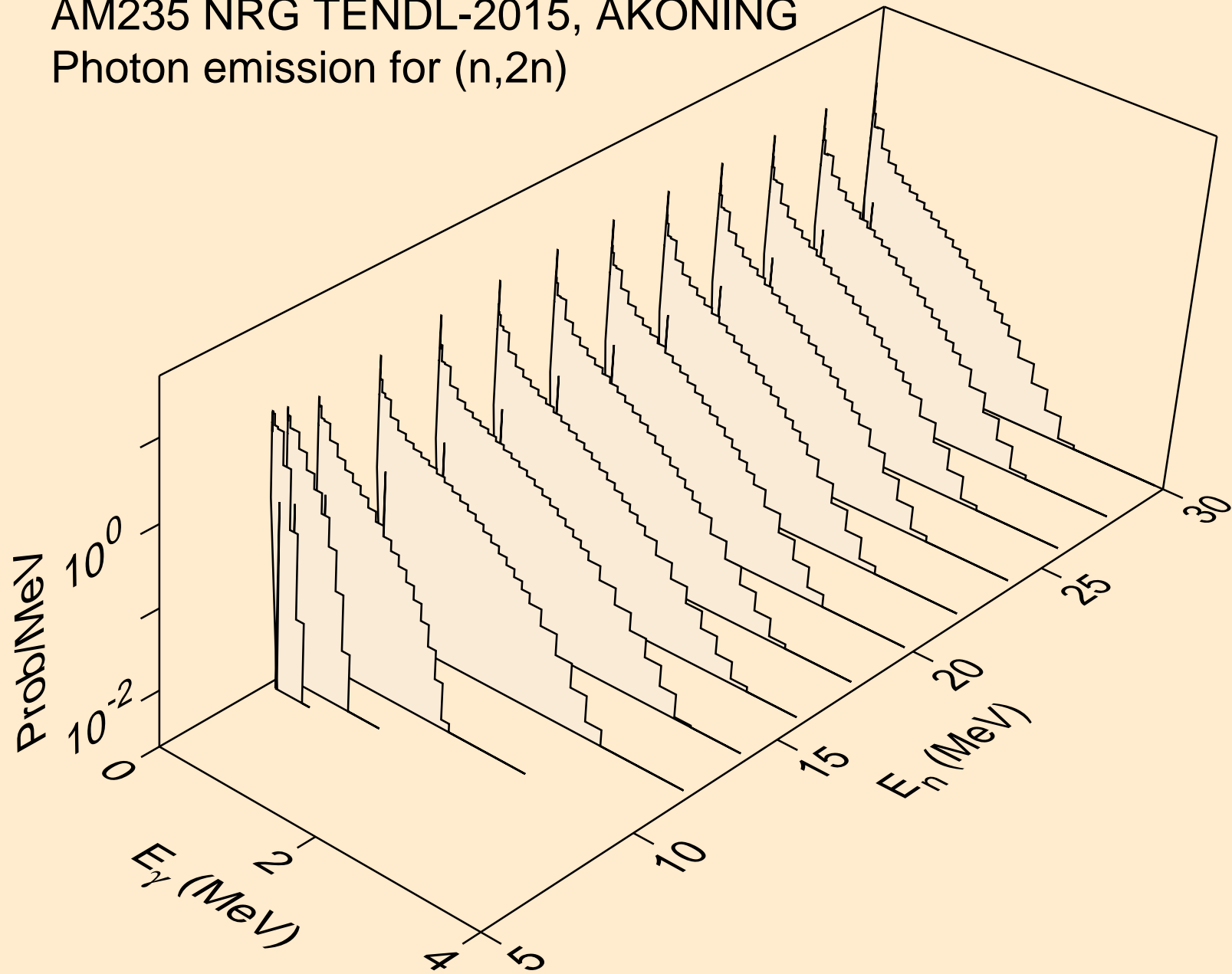

AM235 NRG TENDL-2015, AKONING  
Photon emission for (n,3n)

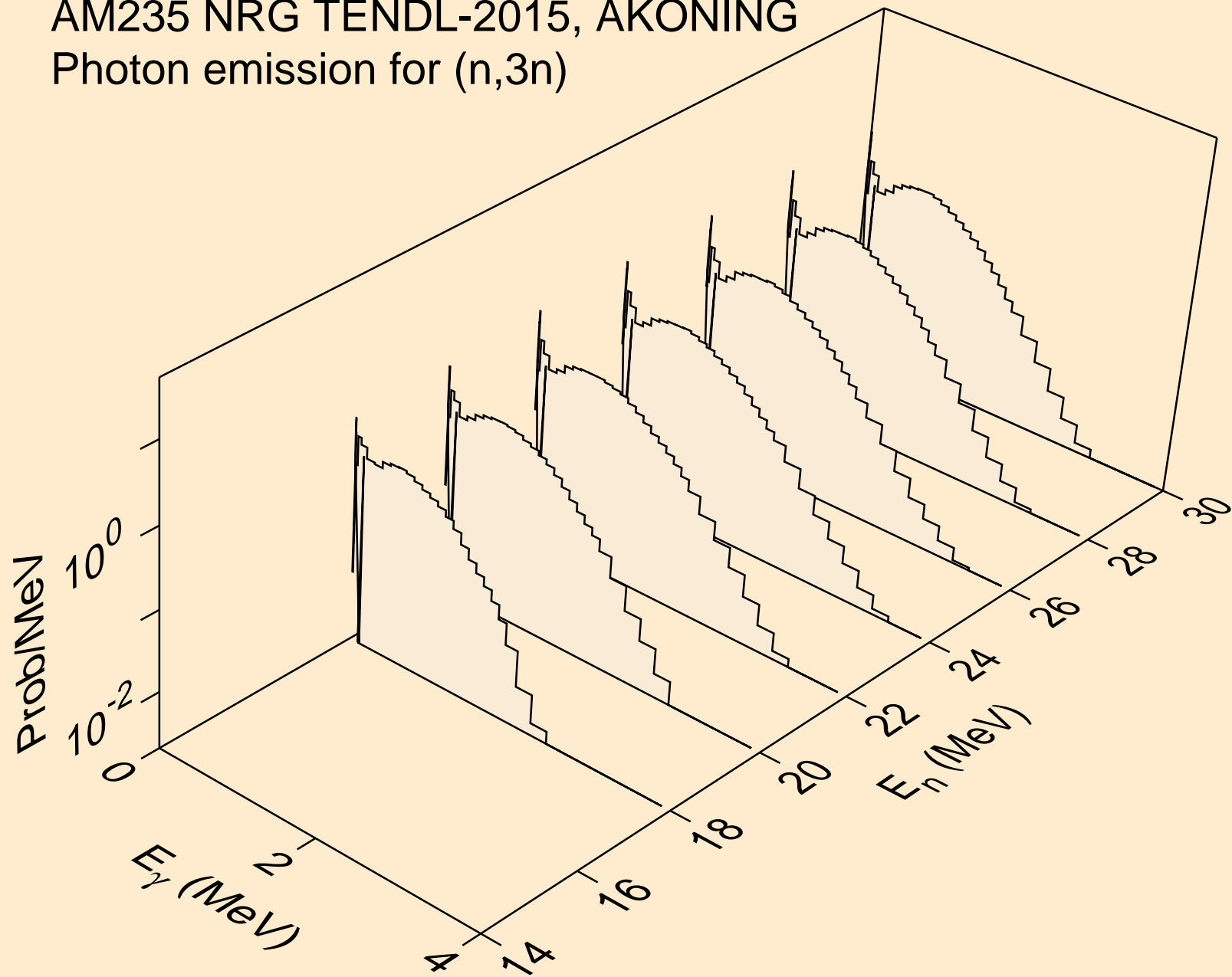

AM235 NRG TENDL-2015, AKONING  
Photon emission for (n,n\*)a

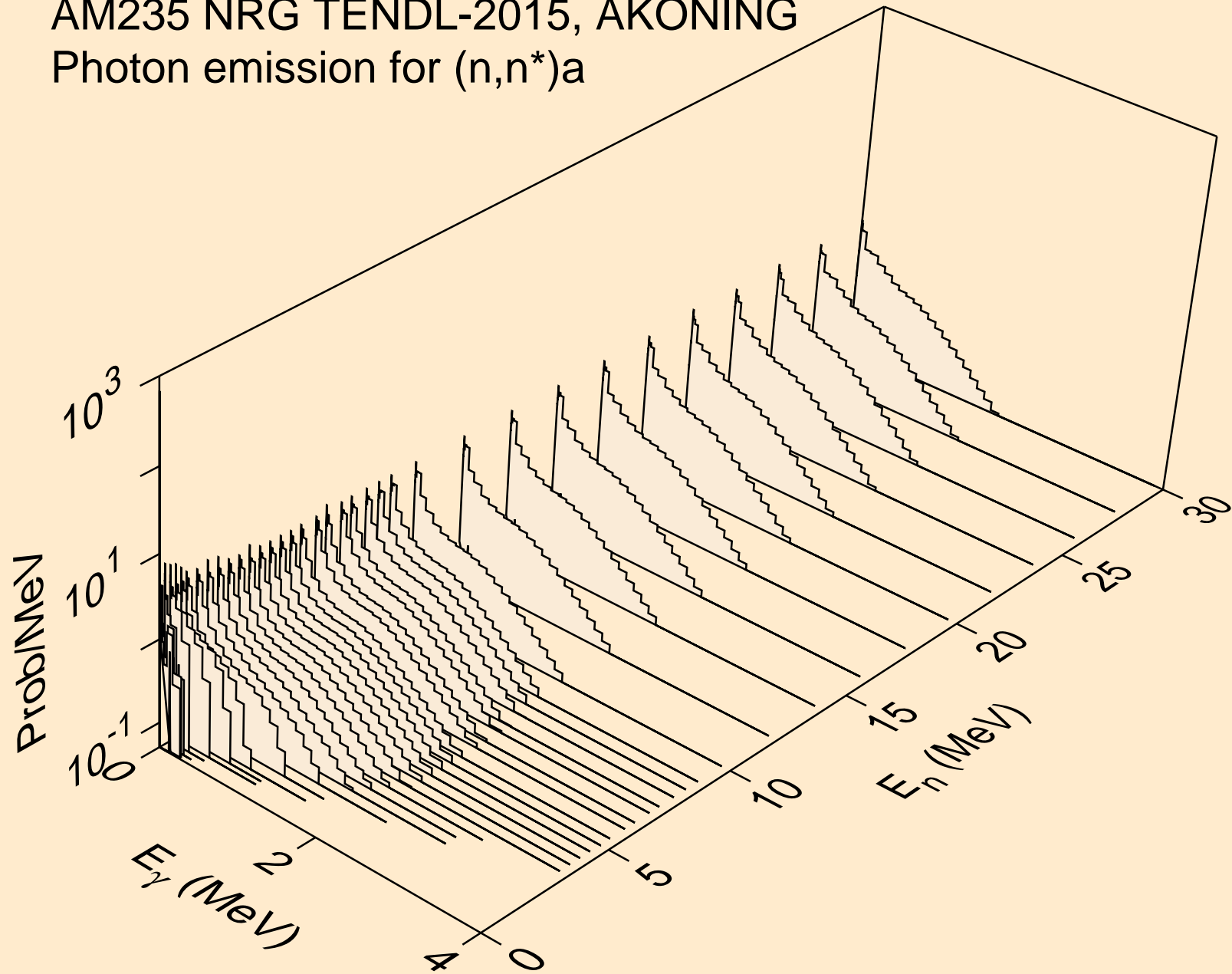

AM235 NRG TENDL-2015, AKONING  
Photon emission for (n,n\*)3a

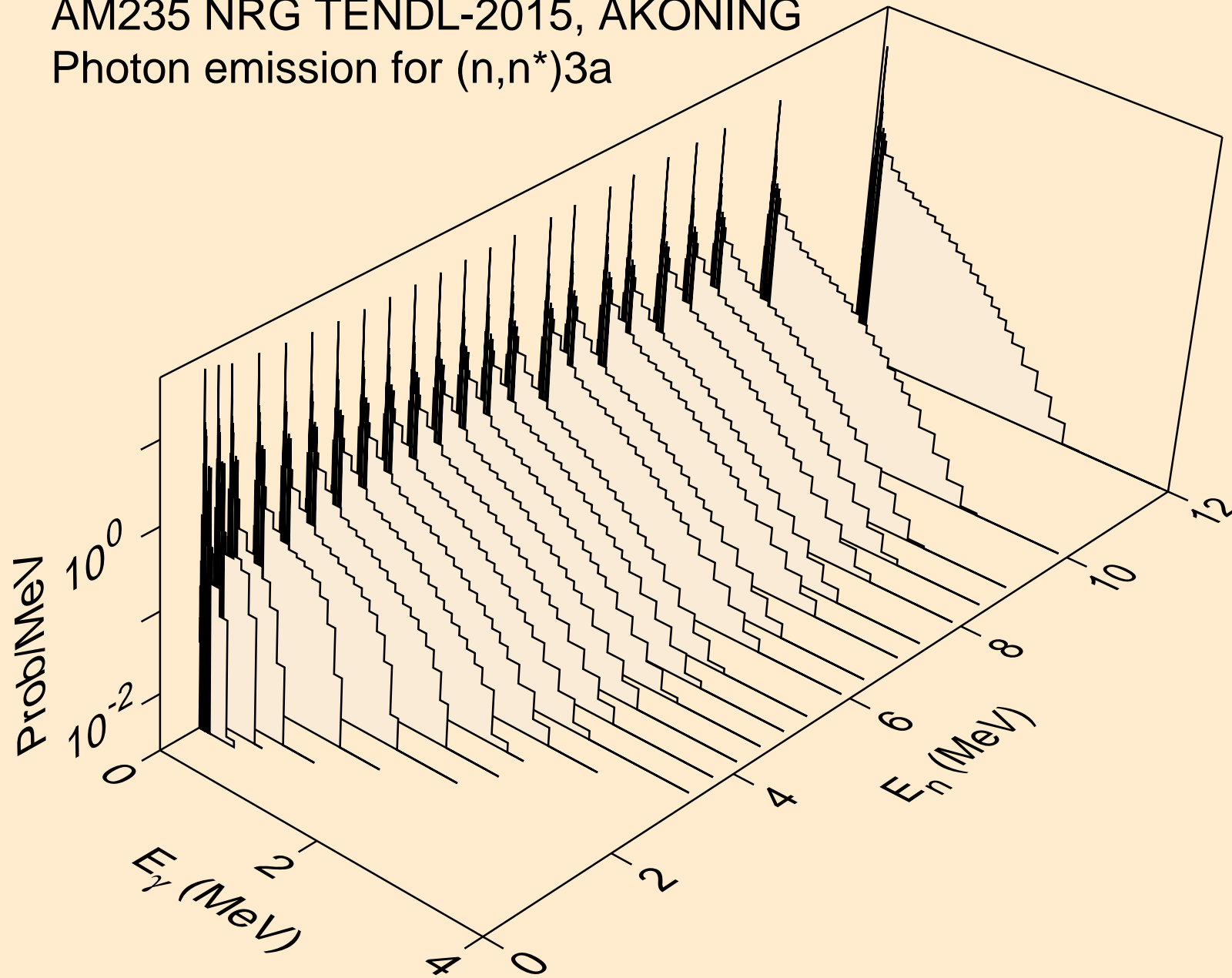

AM235 NRG TENDL-2015, AKONING  
Photon emission for (n,2n)a

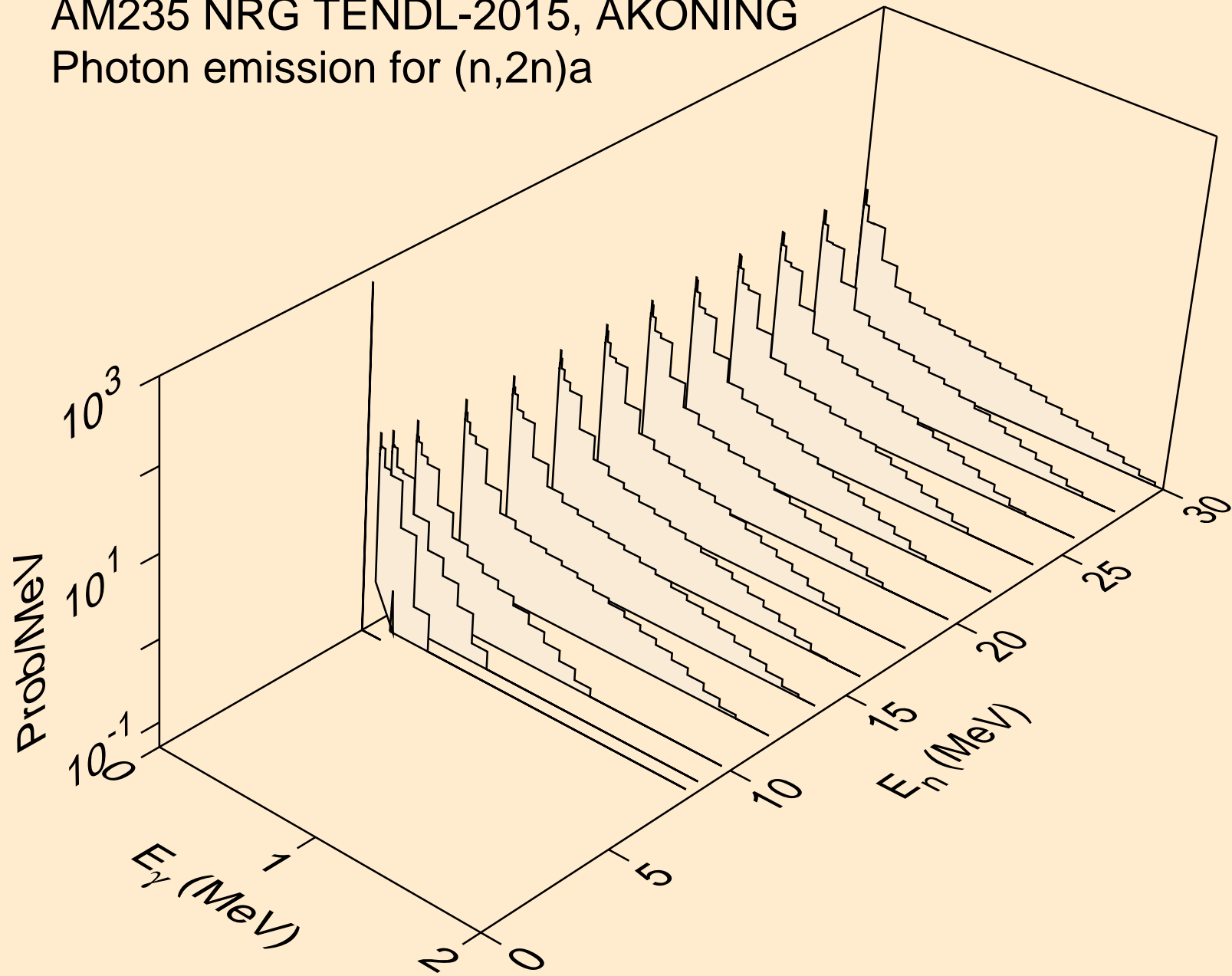

AM235 NRG TENDL-2015, AKONING  
Photon emission for (n,3n)a

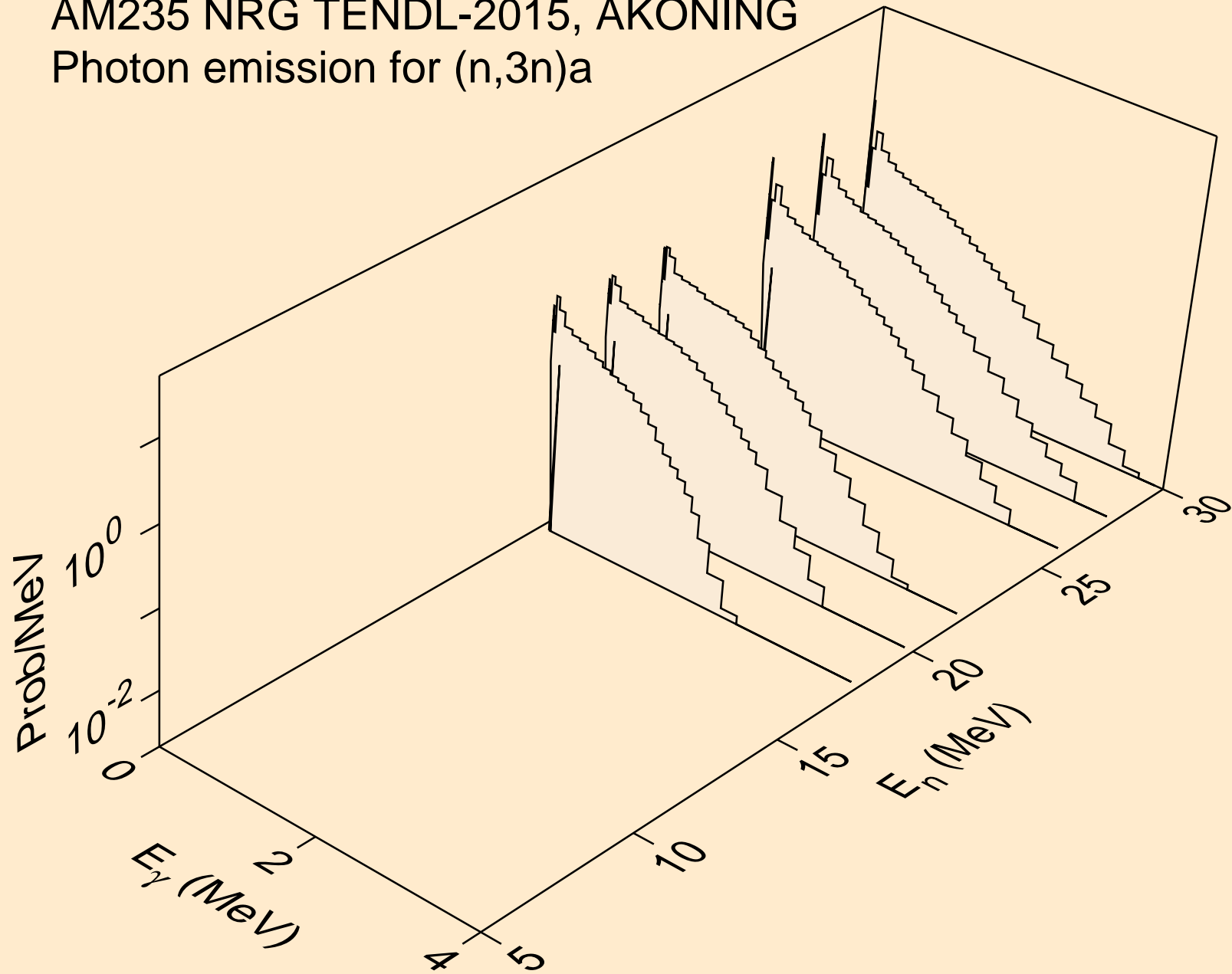

AM235 NRG TENDL-2015, AKONING  
Photon emission for (n,n\*)p

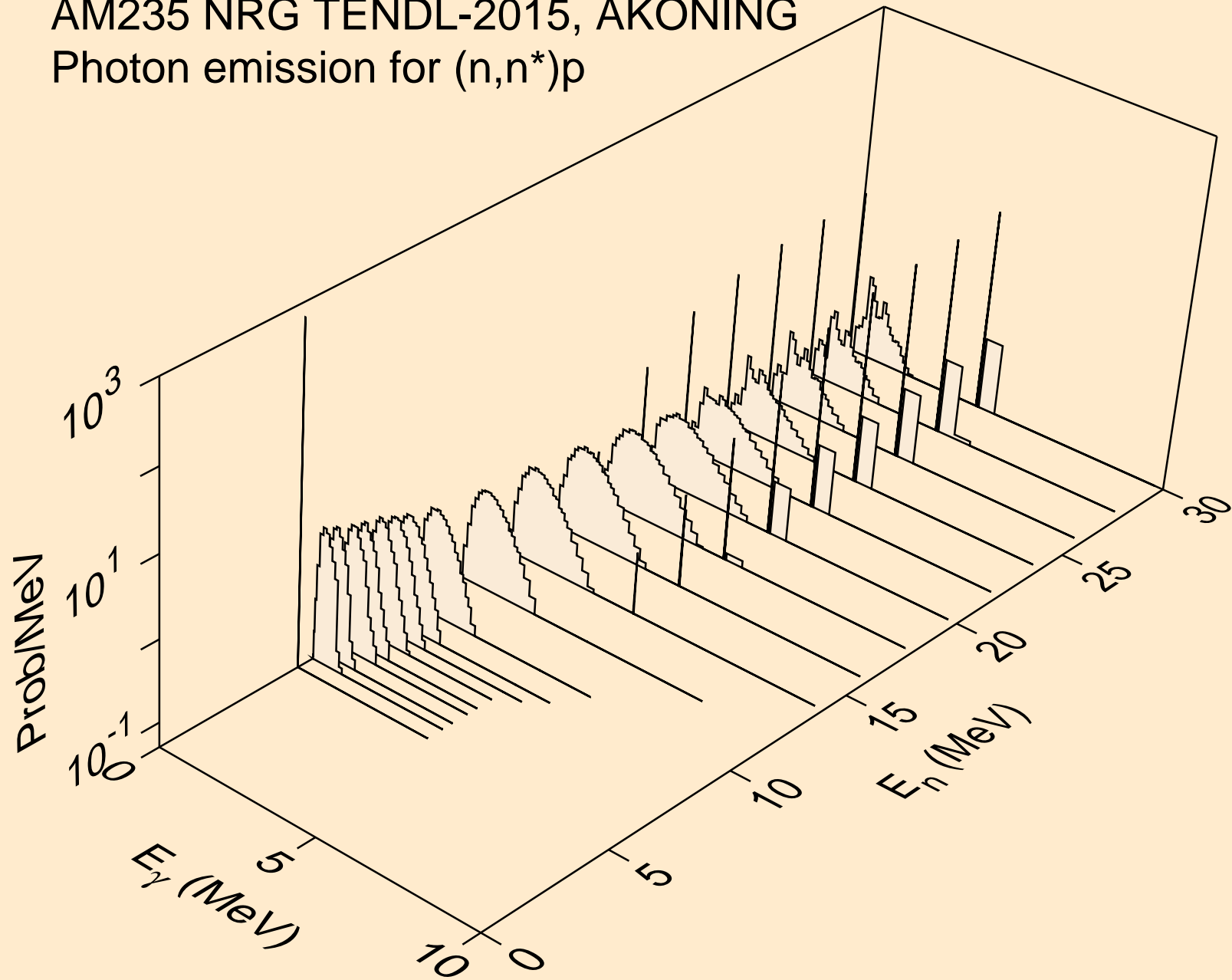



AM235 NRG TENDL-2015, AKONING  
Photon emission for (n,n\*)2a

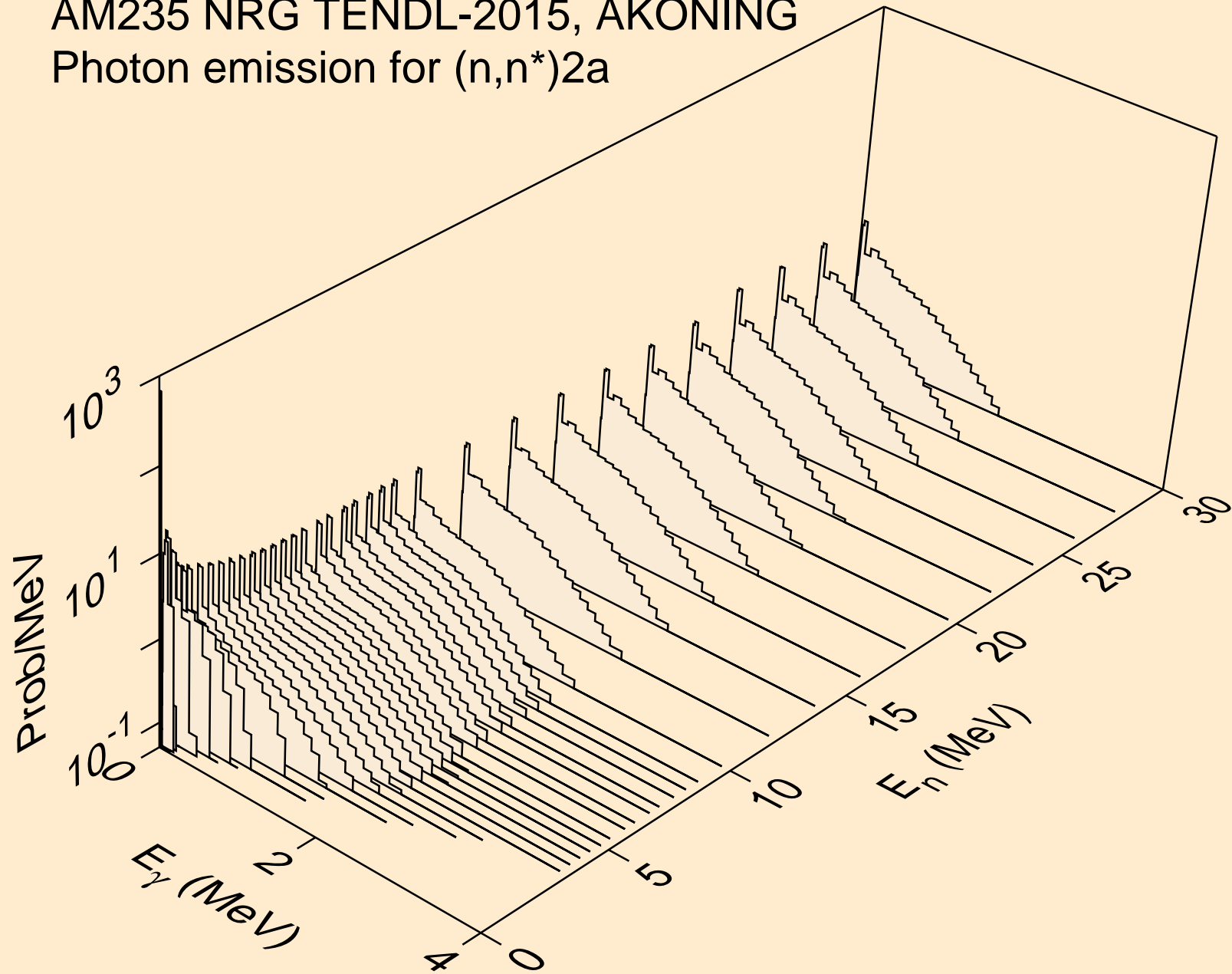

AM235 NRG TENDL-2015, AKONING  
Photon emission for (n,2n)2a

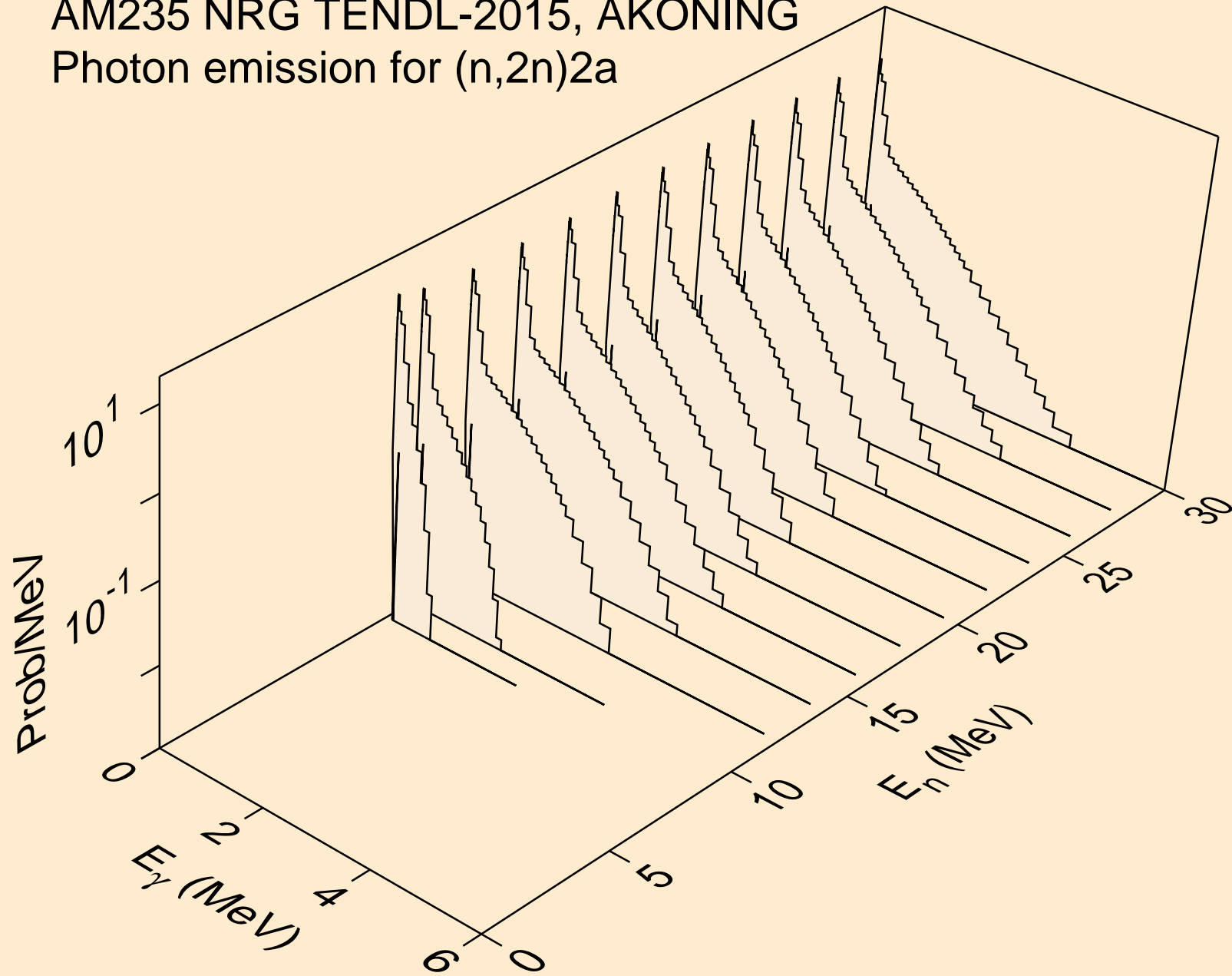

AM235 NRG TENDL-2015, AKONING  
Photon emission for (n,n\*)d

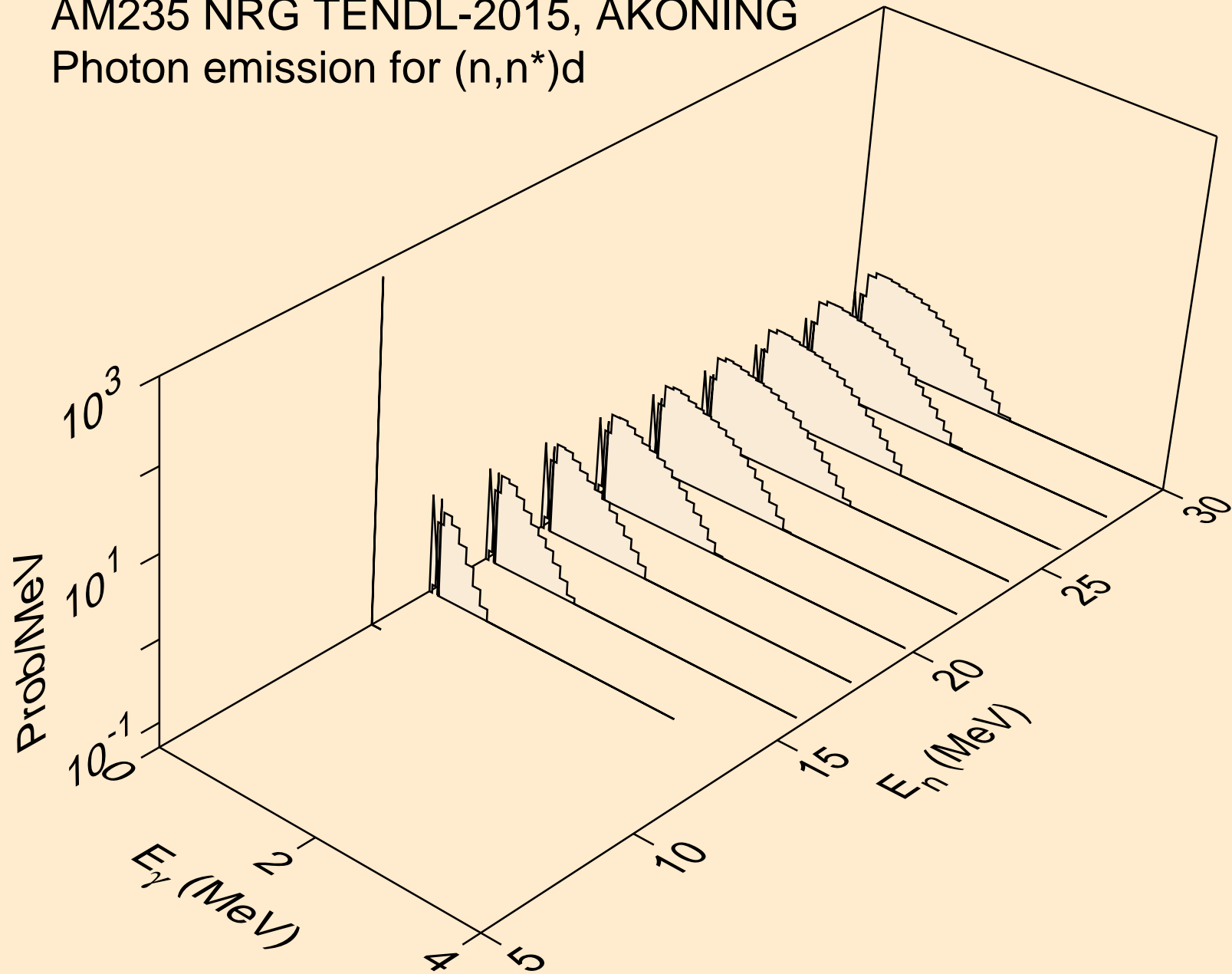

AM235 NRG TENDL-2015, AKONING  
Photon emission for (n,n\*)t

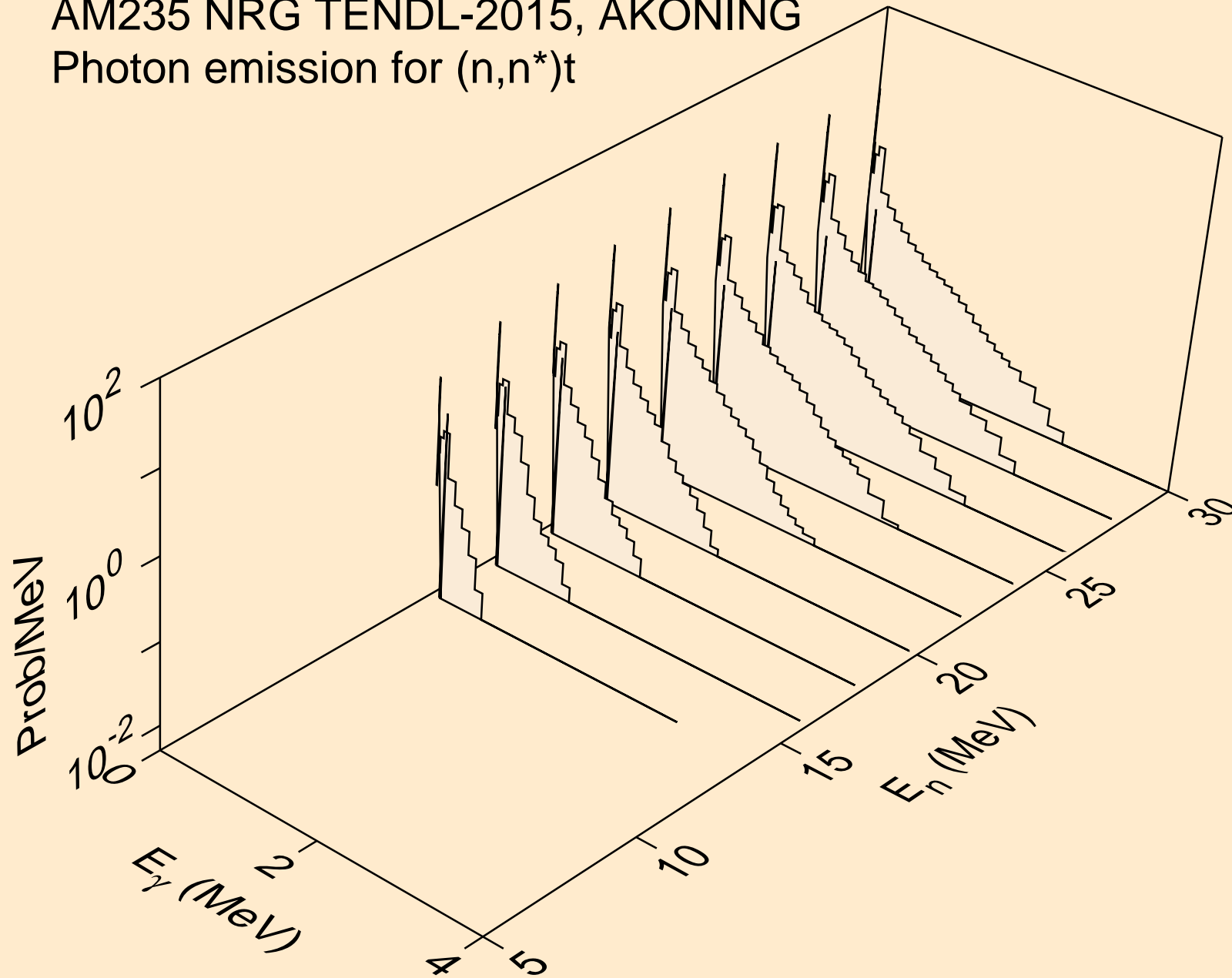

AM235 NRG TENDL-2015, AKONING  
Photon emission for (n,n\*)he3

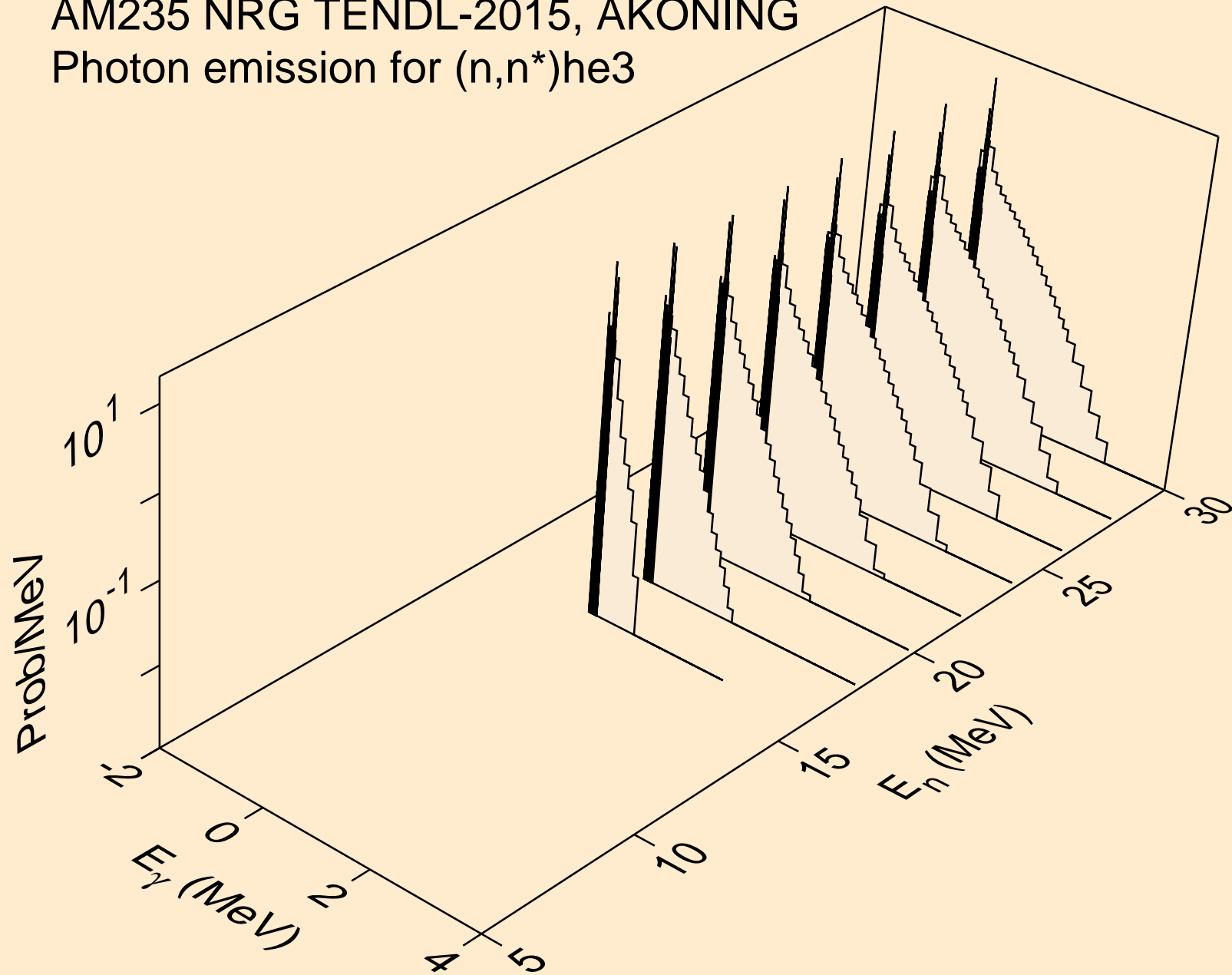

AM235 NRG TENDL-2015, AKONING  
Photon emission for (n,4n)

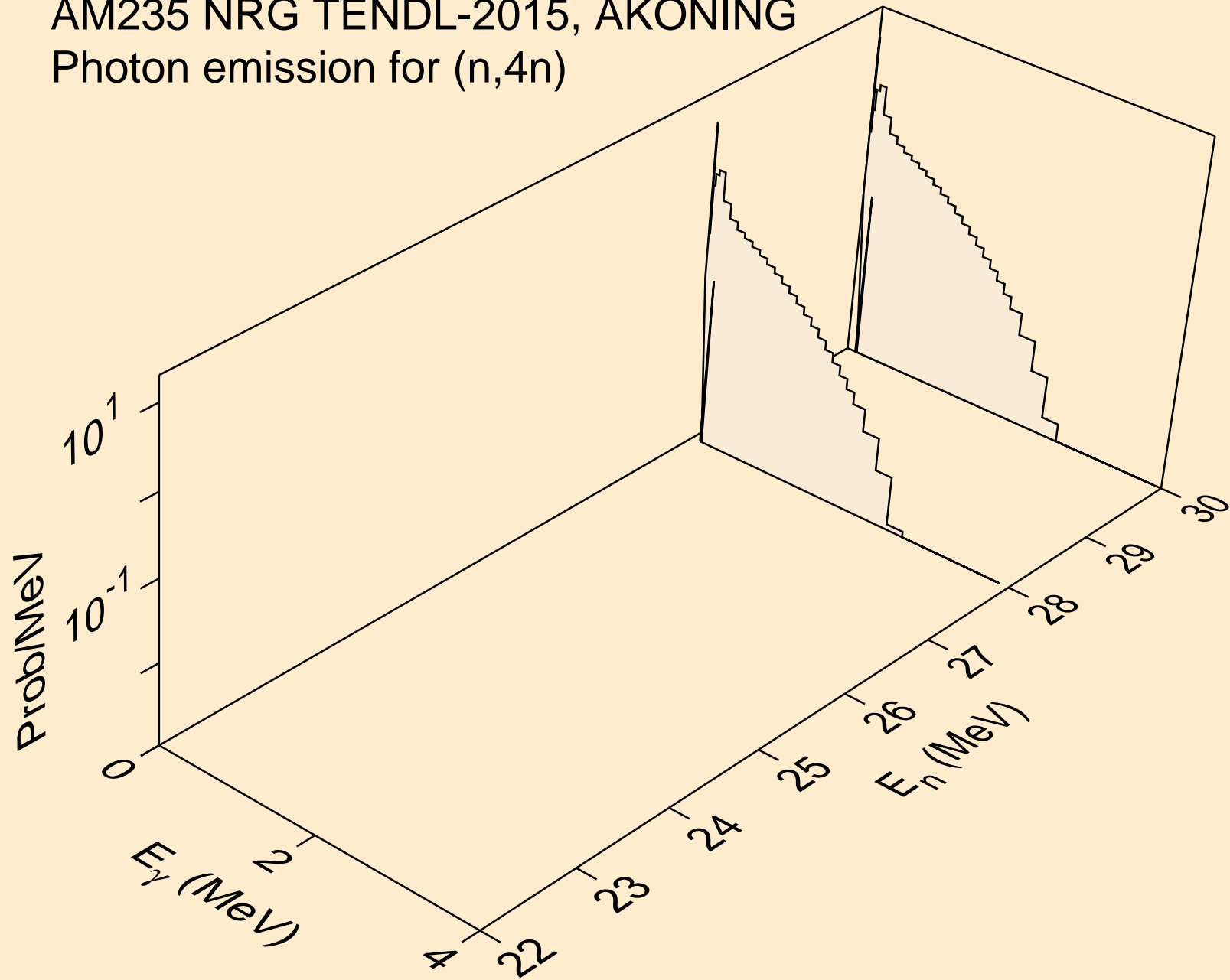

AM235 NRG TENDL-2015, AKONING  
Photon emission for (n,2np)

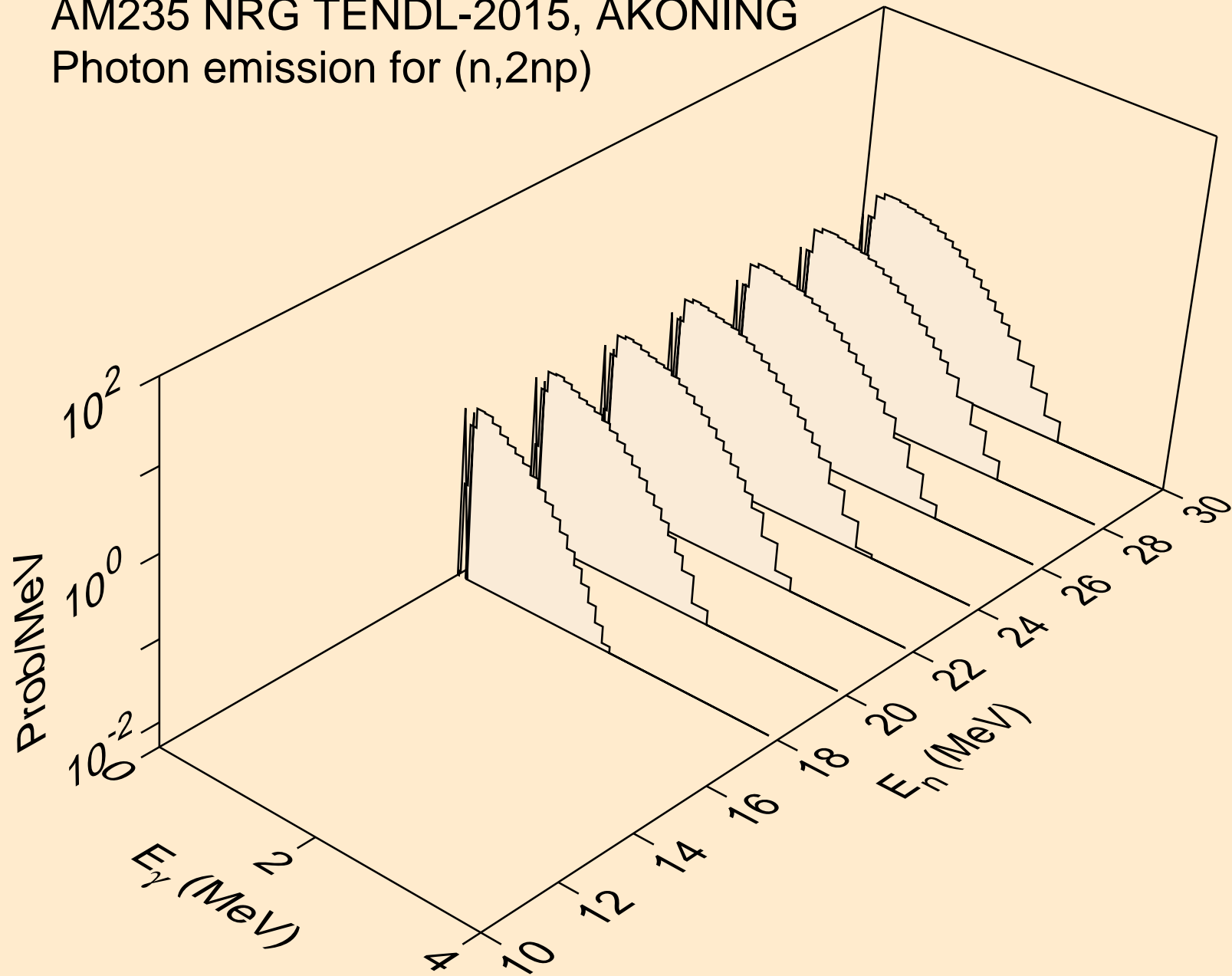

AM235 NRG TENDL-2015, AKONING  
Photon emission for (n,3np)

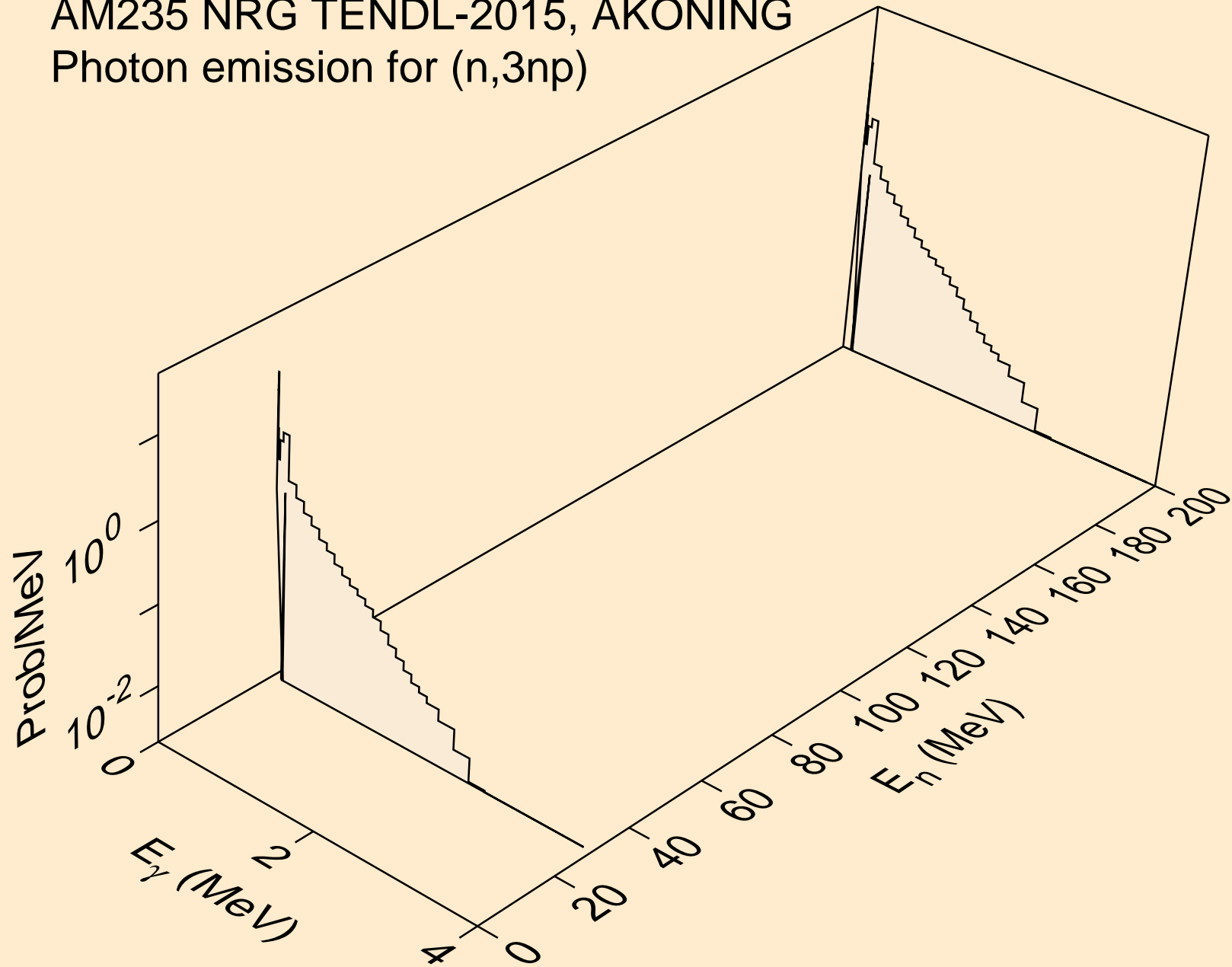



AM235 NRG TENDL-2015, AKONING  
Photon emission for (n,2np)

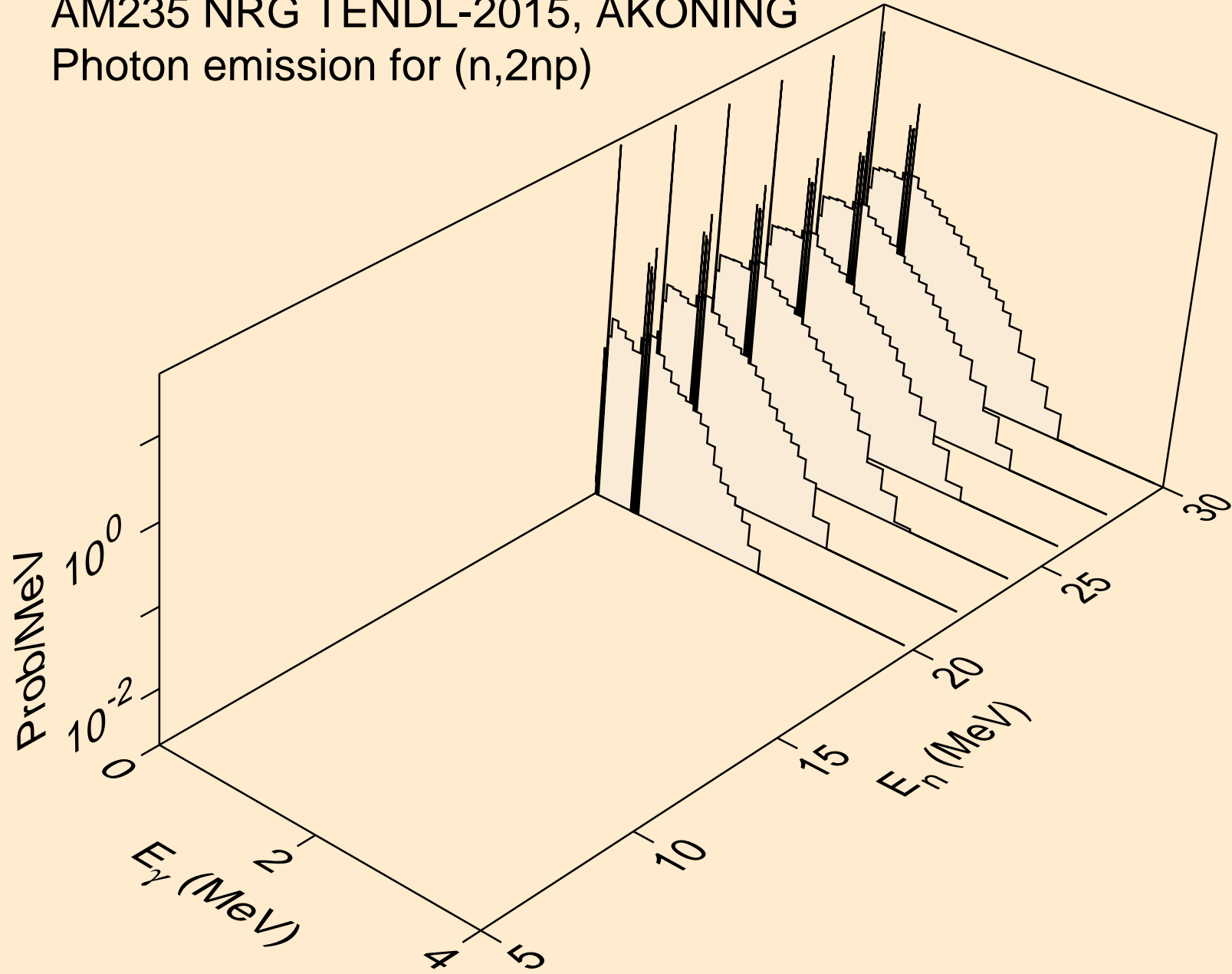

AM235 NRG TENDL-2015, AKONING  
Photon emission for (n,npa)

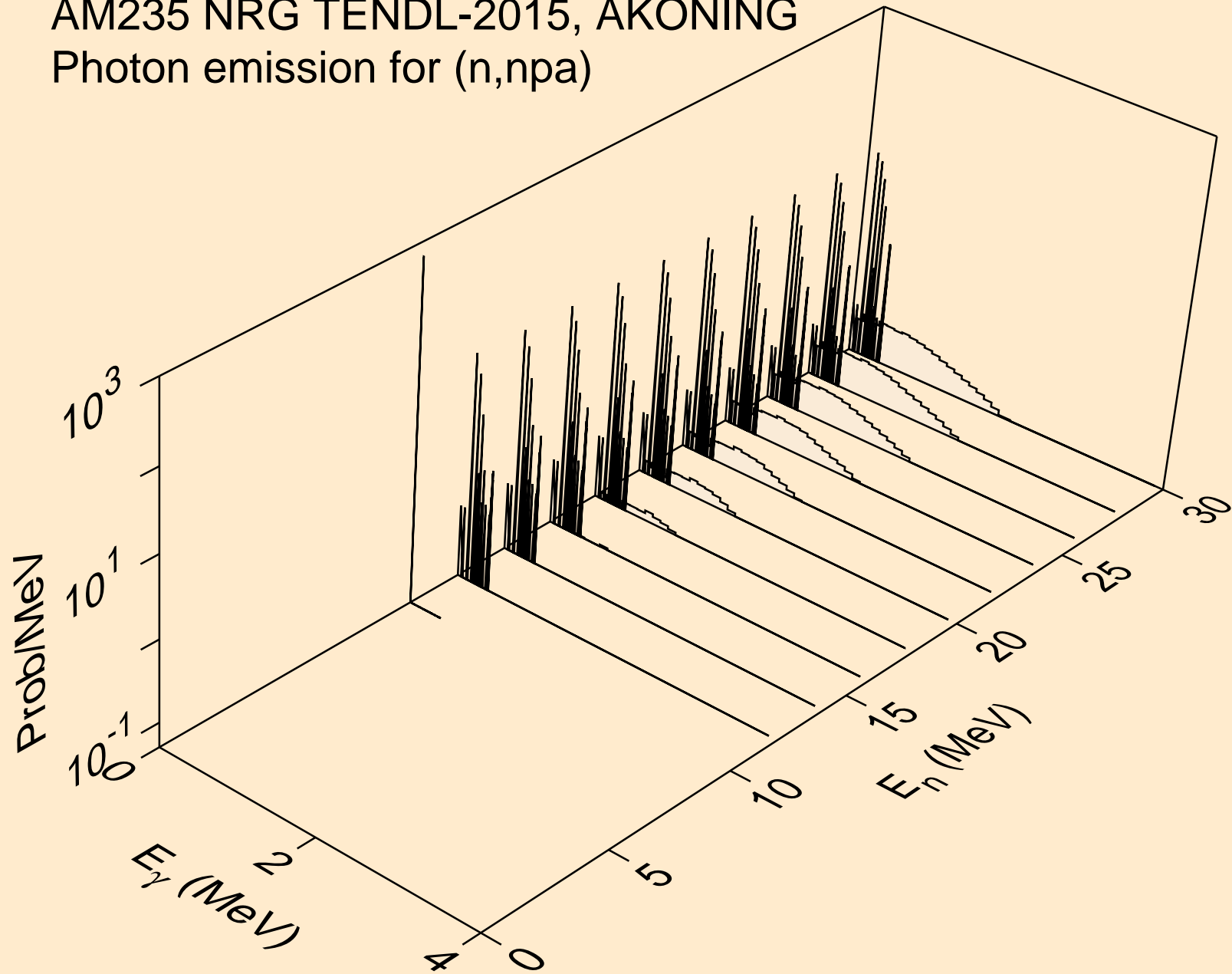

AM235 NRG TENDL-2015, AKONING  
Photon emission for (n,n\*c)

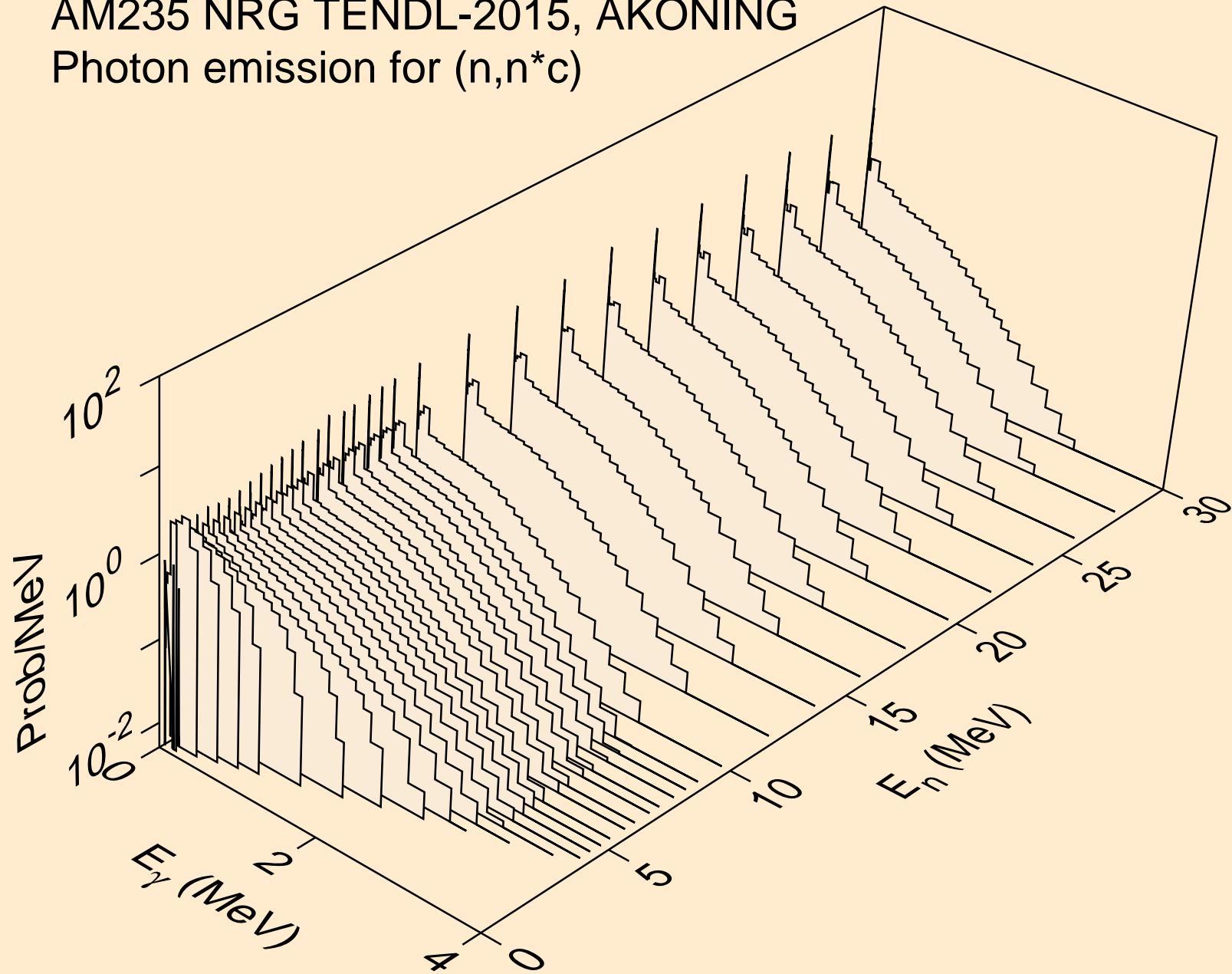

AM235 NRG TENDL-2015, AKONING  
Photon emission for (n,gma)

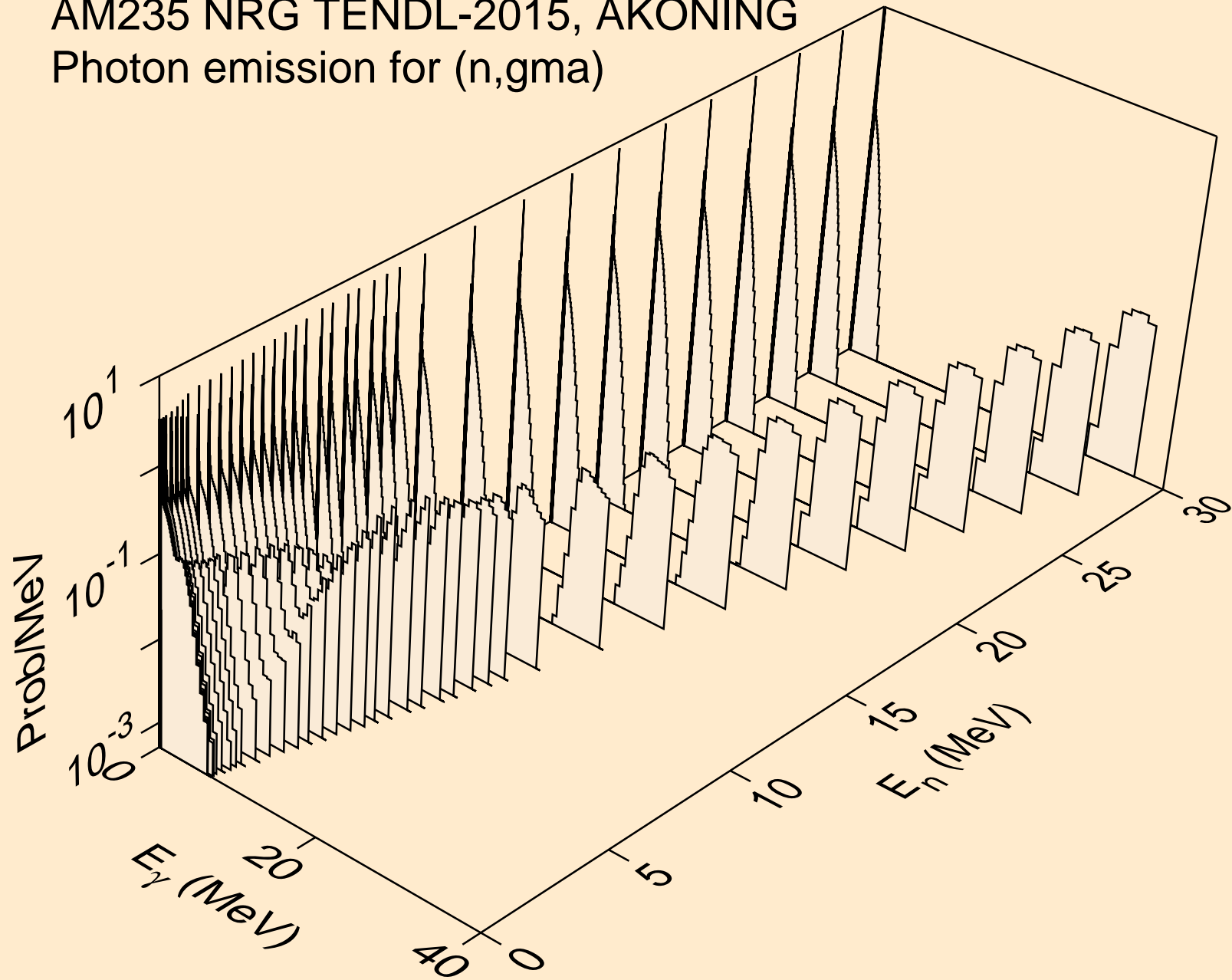

AM235 NRG TENDL-2015, AKONING  
Photon emission for (n,p)

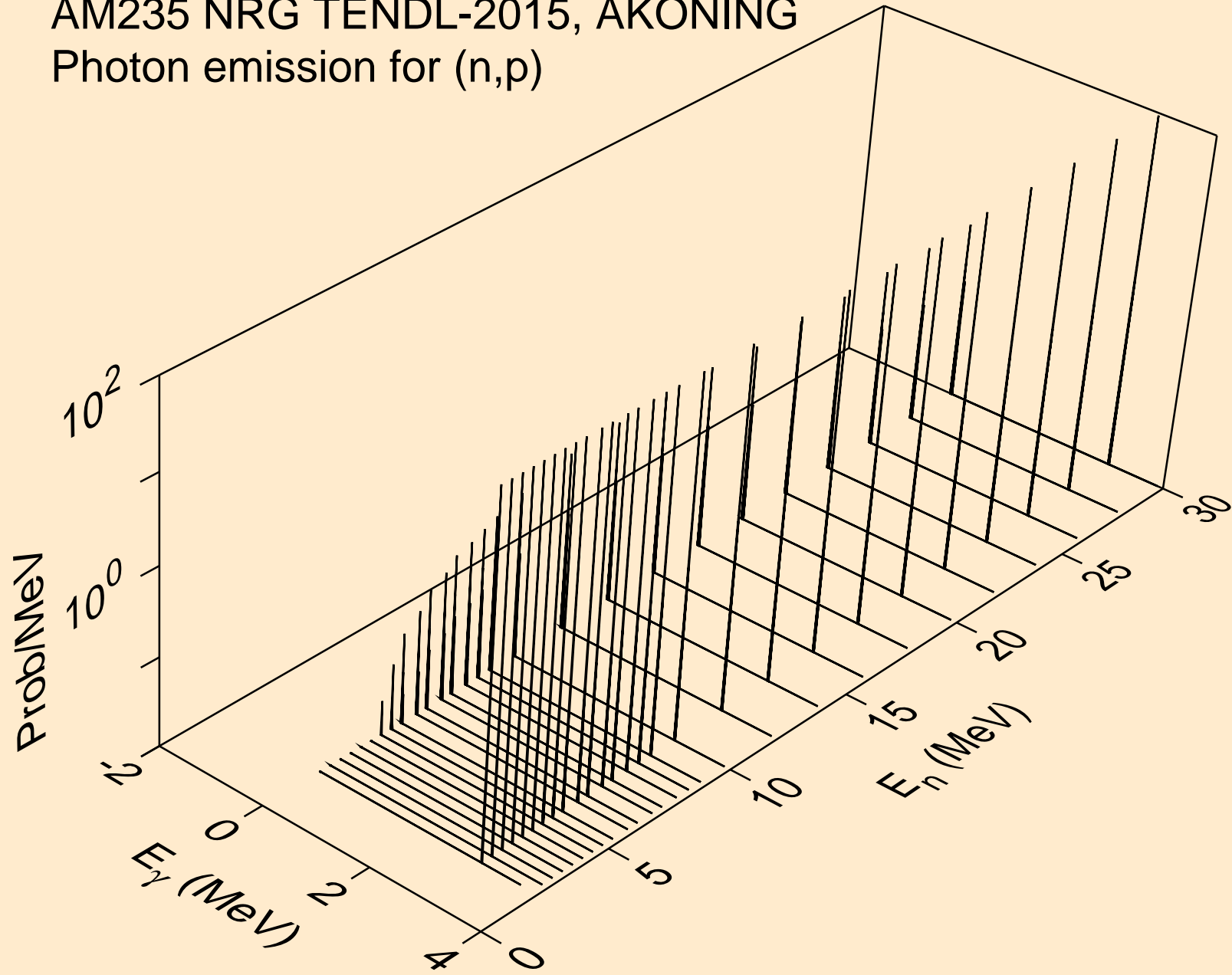

AM235 NRG TENDL-2015, AKONING  
Photon emission for (n,d)

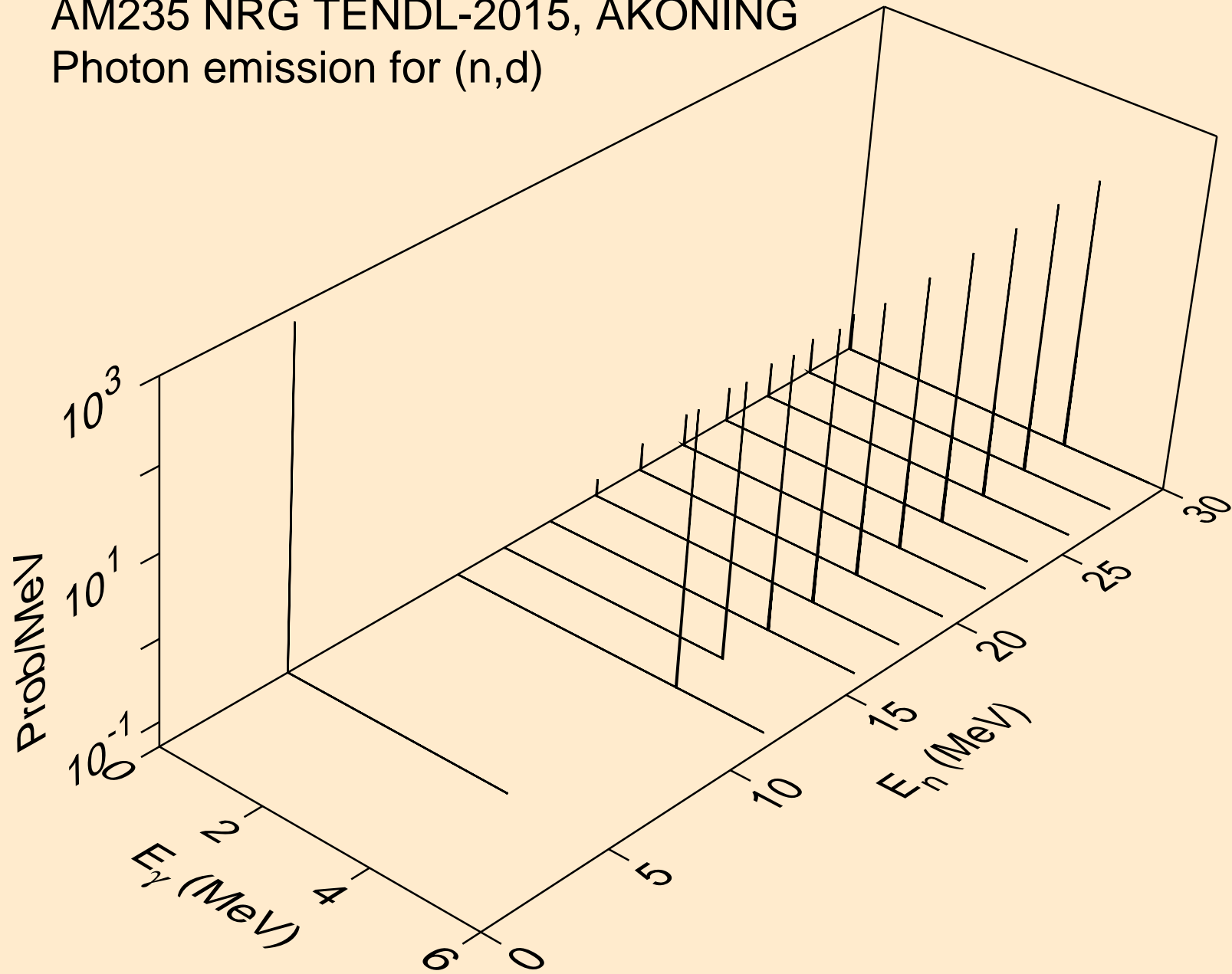

AM235 NRG TENDL-2015, AKONING  
Photon emission for (n,t)

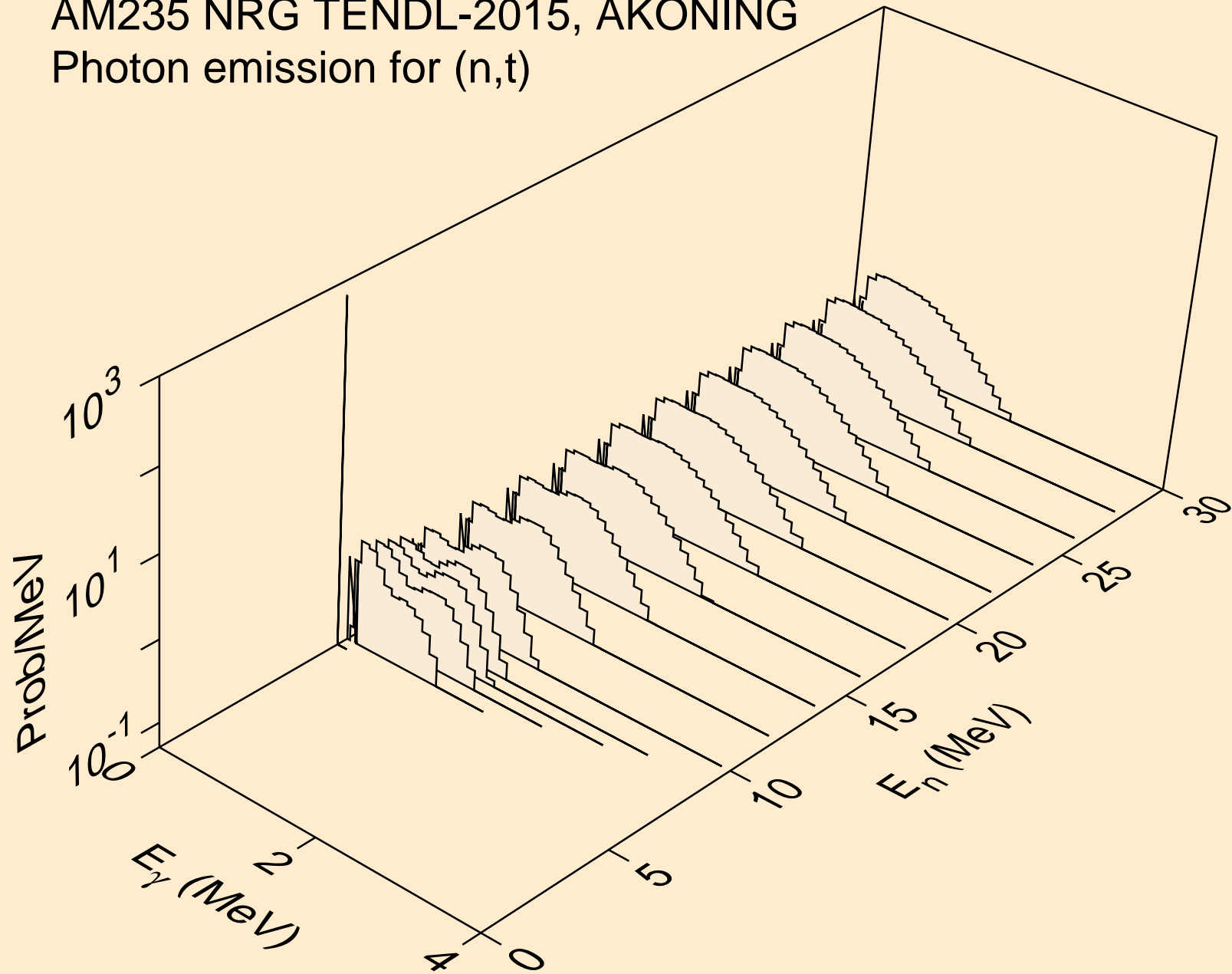

AM235 NRG TENDL-2015, AKONING  
Photon emission for (n,he3)

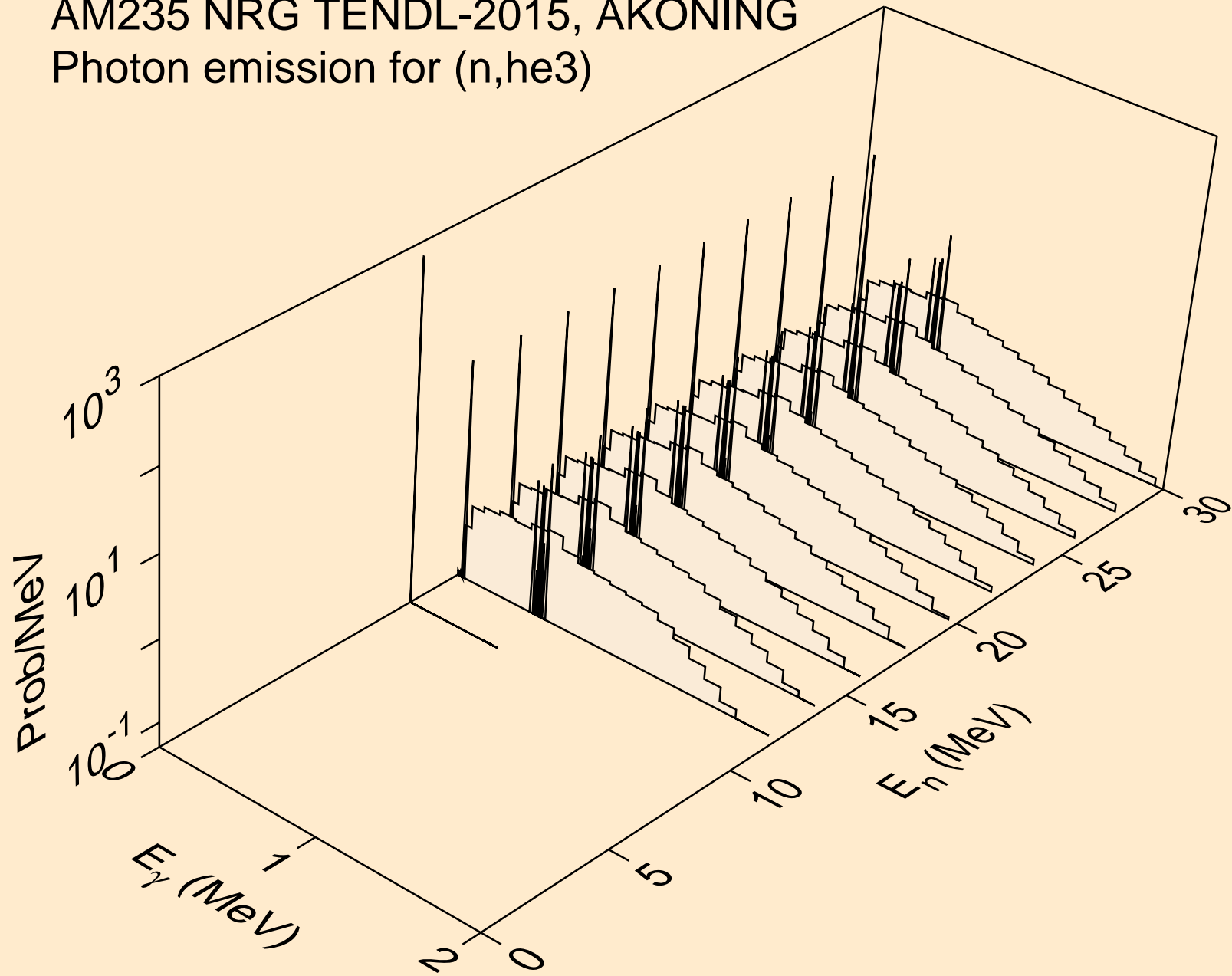



AM235 NRG TENDL-2015, AKONING  
Photon emission for (n,a)

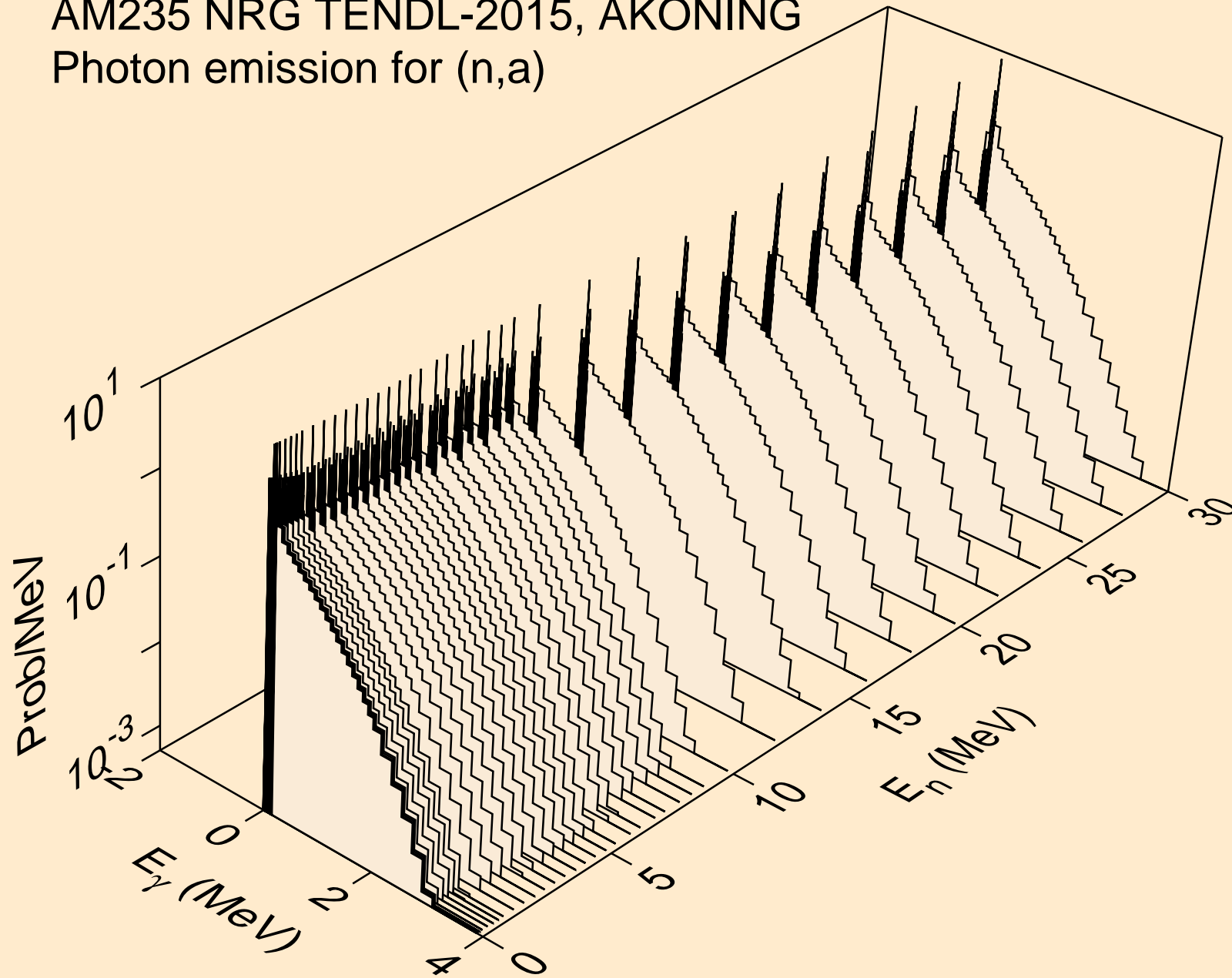

AM235 NRG TENDL-2015, AKONING  
Photon emission for (n,2a)

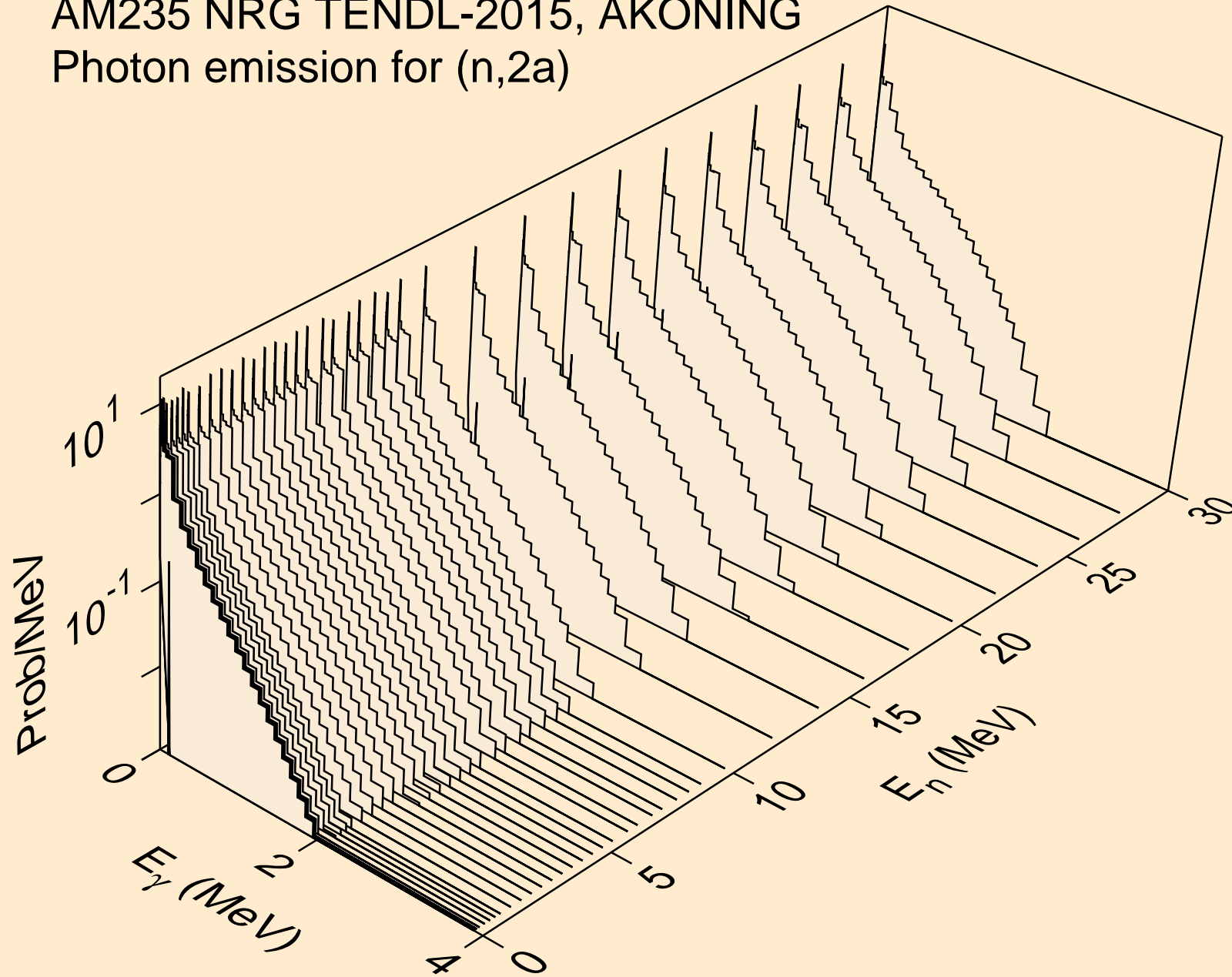

AM235 NRG TENDL-2015, AKONING  
Photon emission for (n,2p)

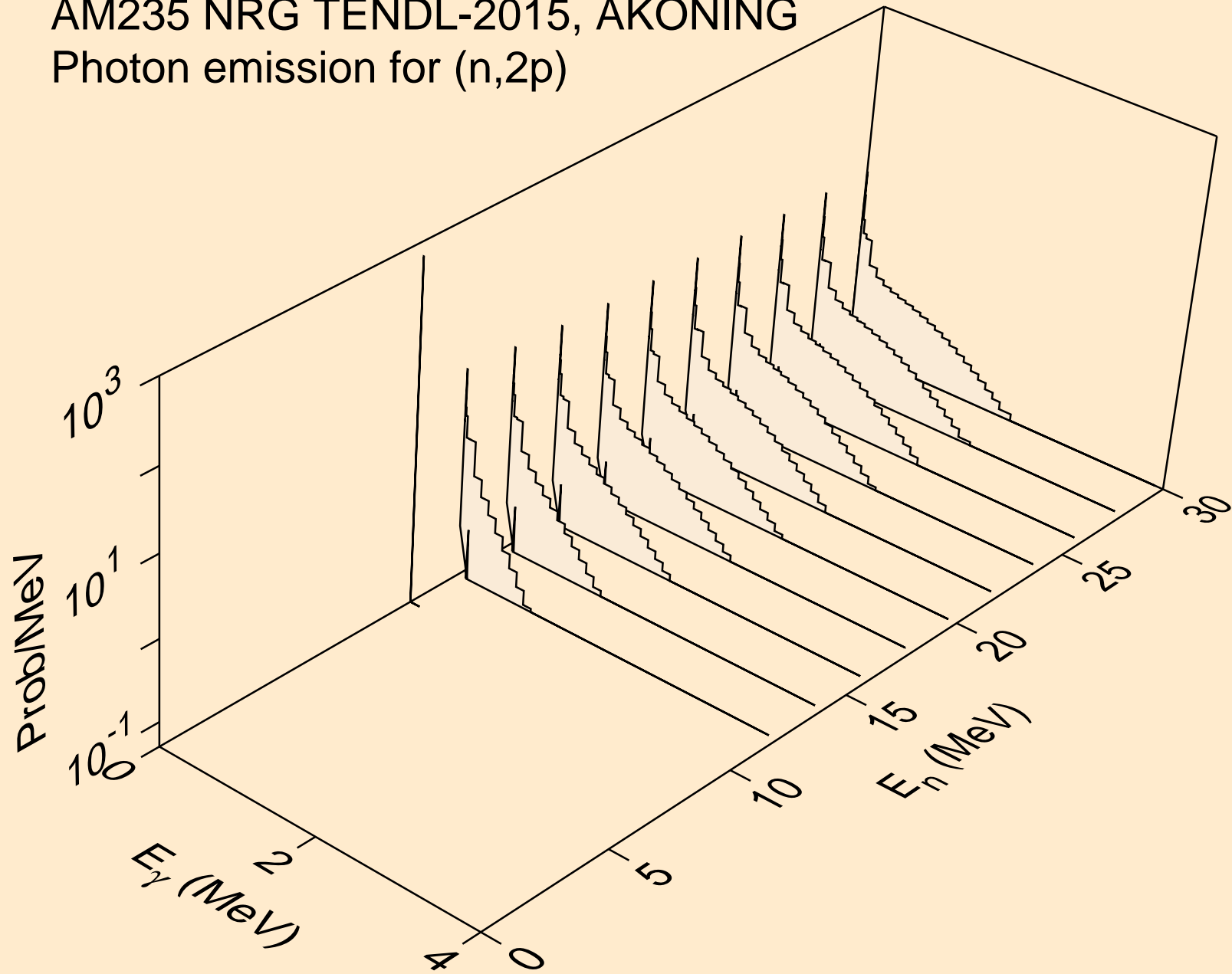

AM235 NRG TENDL-2015, AKONING  
Photon emission for (n,pa)

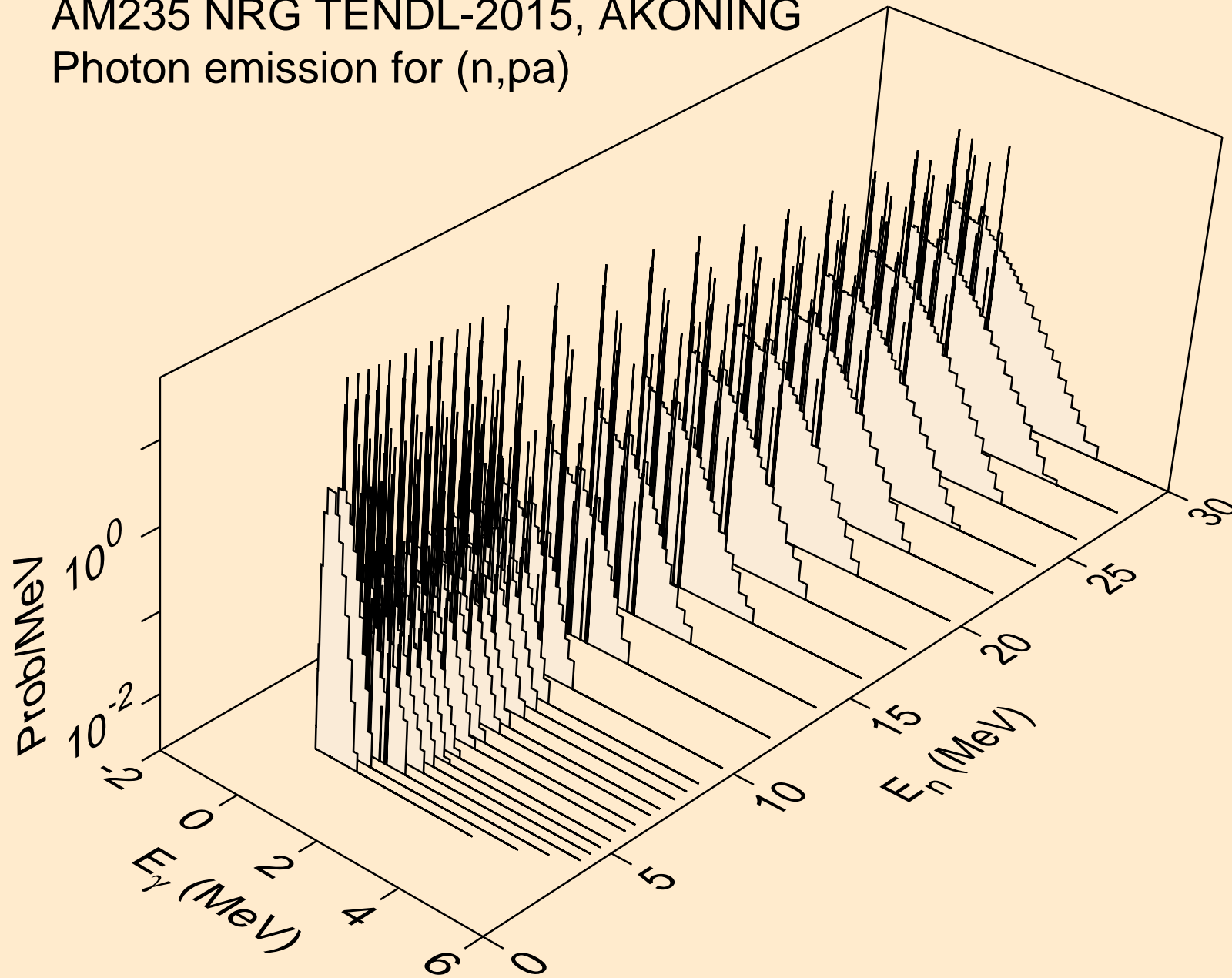

AM235 NRG TENDL-2015, AKONING  
Photon emission for (n,t2a)

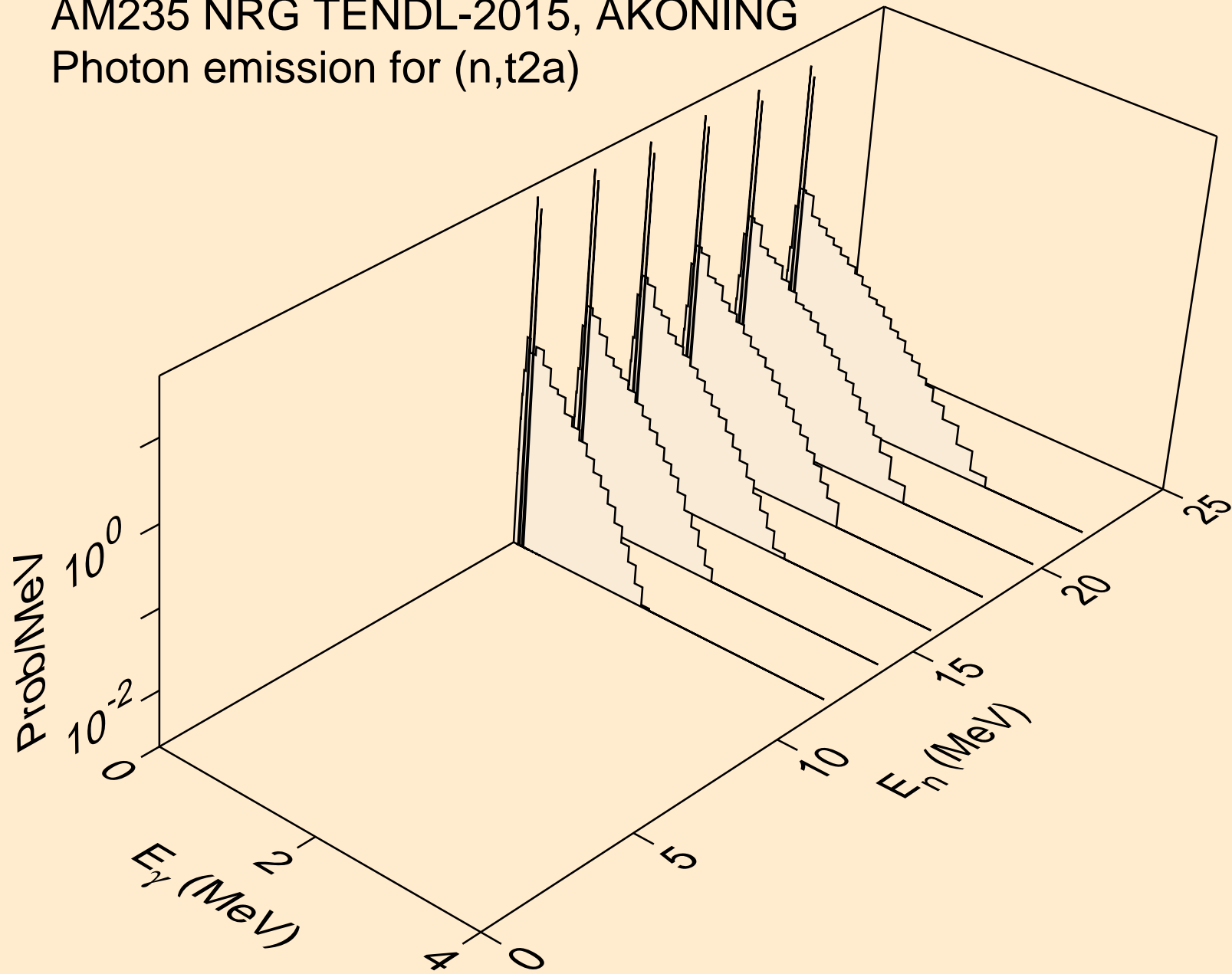

AM235 NRG TENDL-2015, AKONING  
Photon emission for (n,pd)

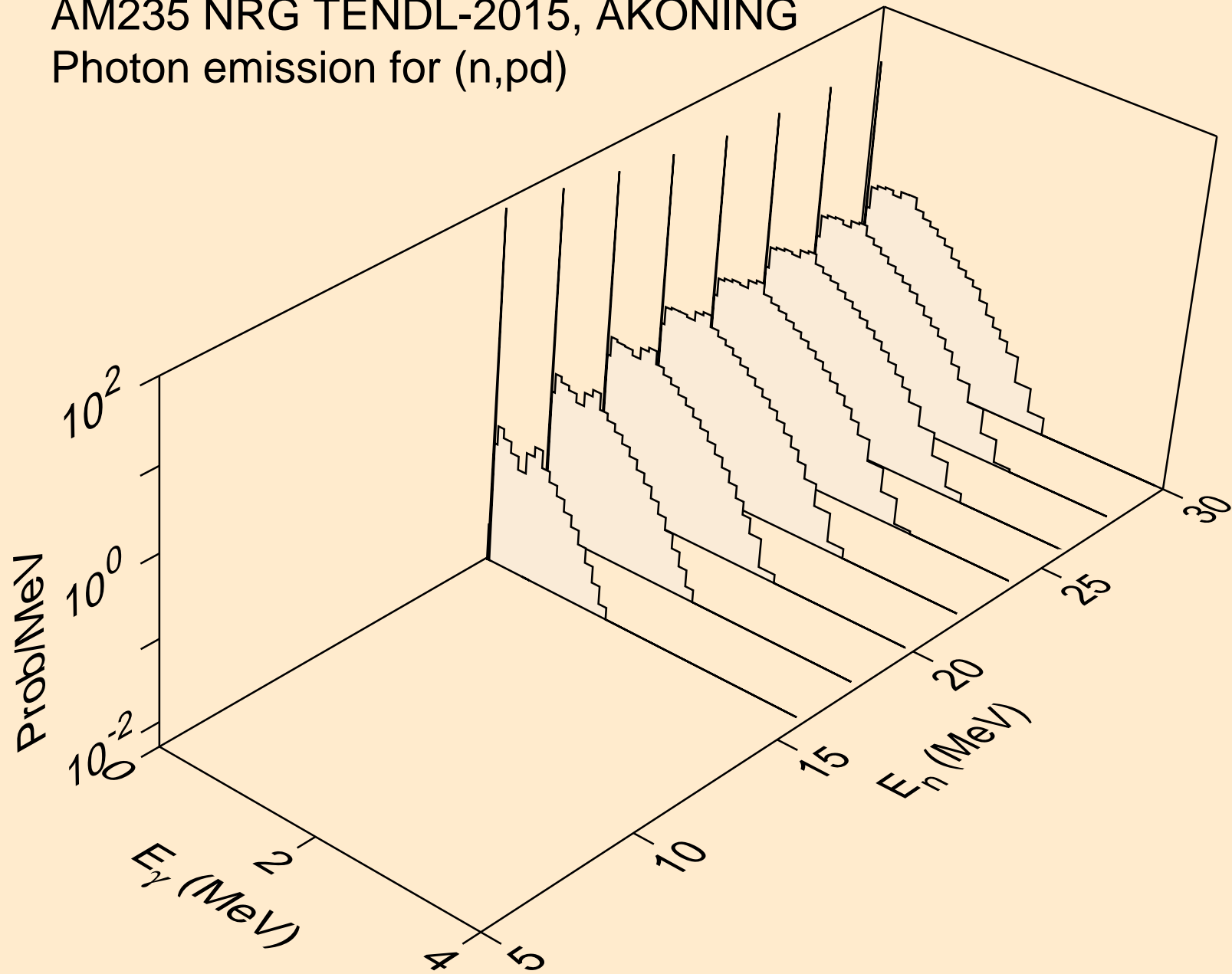

AM235 NRG TENDL-2015, AKONING  
Photon emission for (n,pt)

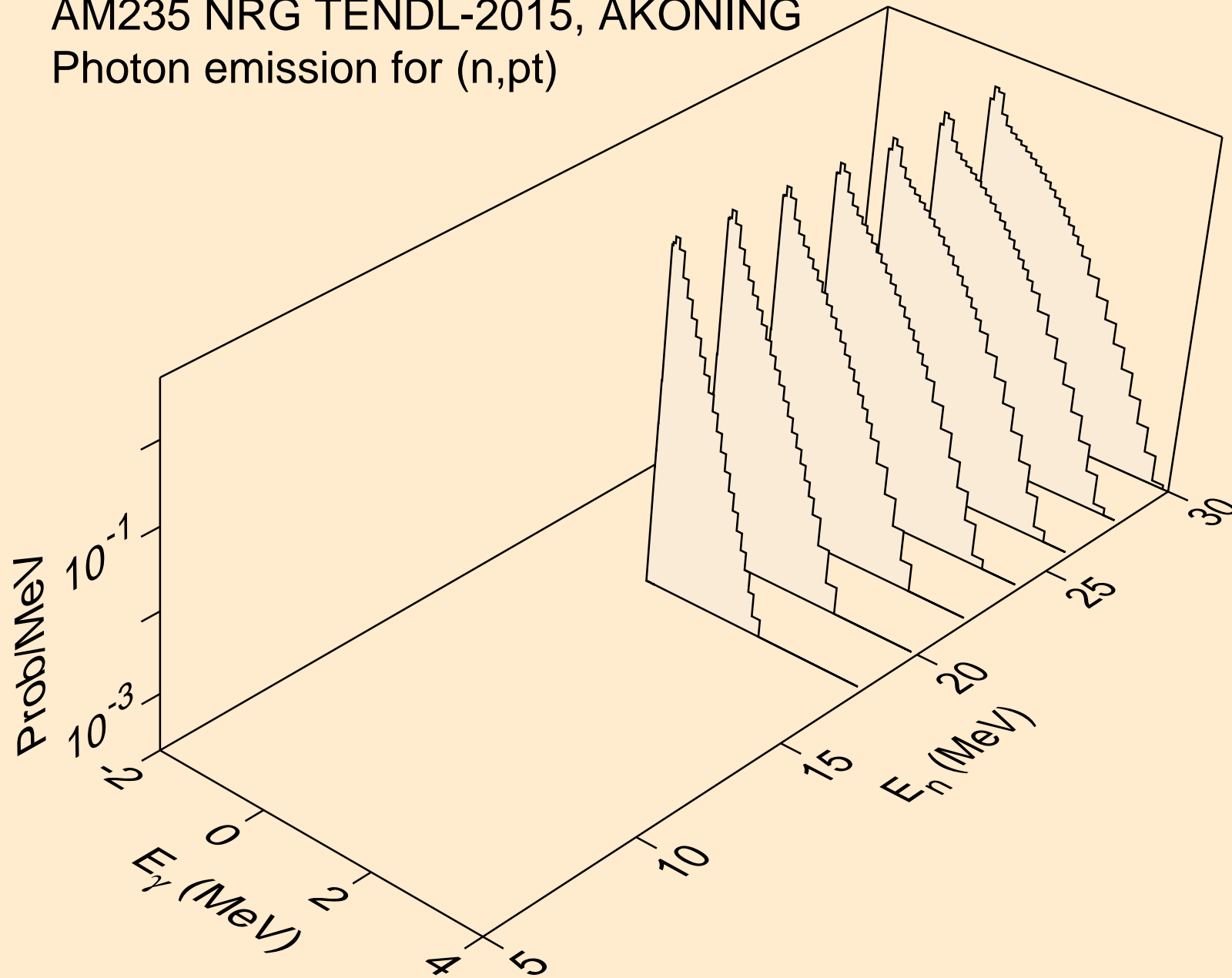

AM235 NRG TENDL-2015, AKONING  
Photon emission for (n,da)

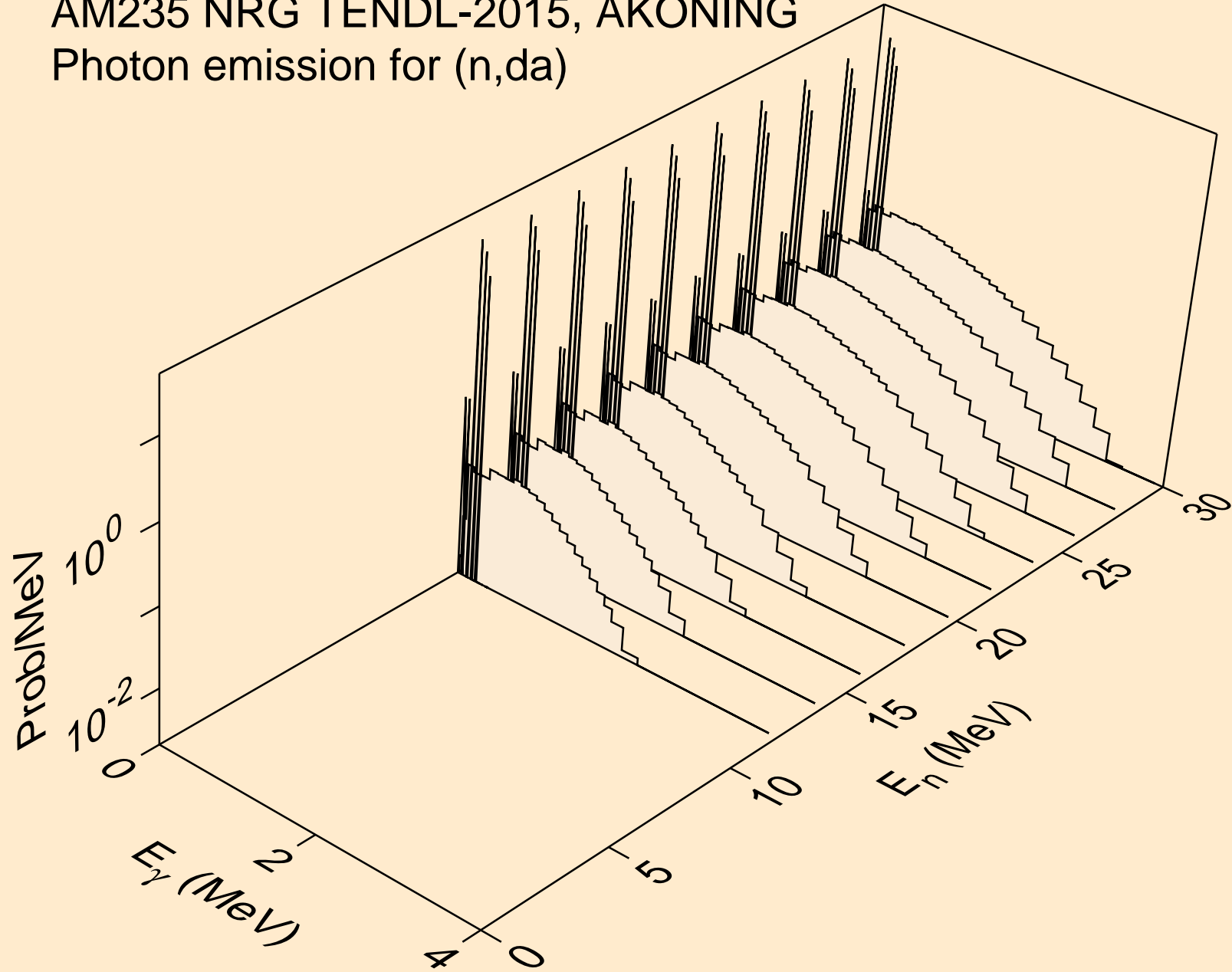



AM235 NRG TENDL-2015, AKONING  
thermal capture photon spectrum

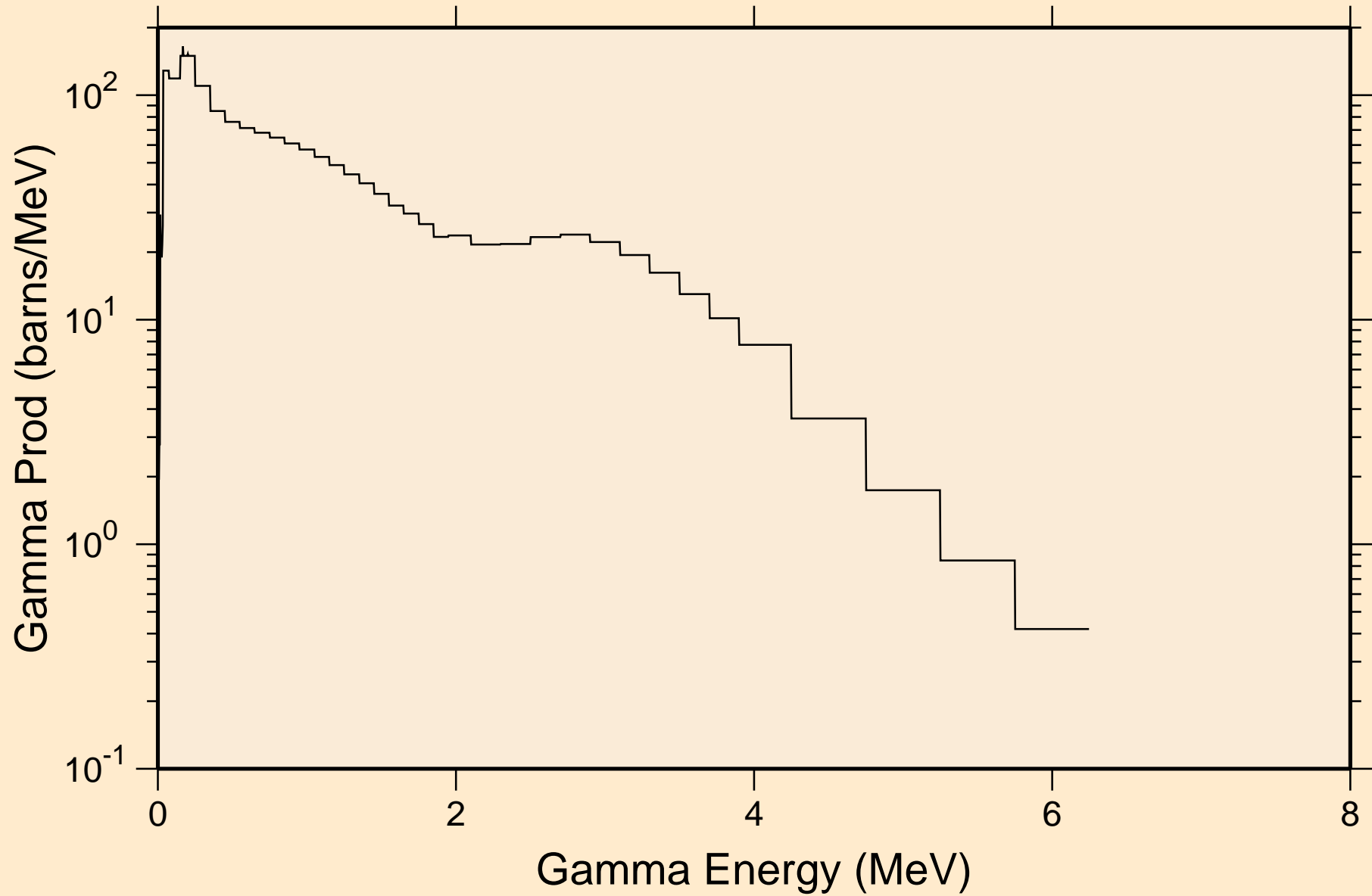

AM235 NRG TENDL-2015, AKONING  
14 MeV photon spectrum

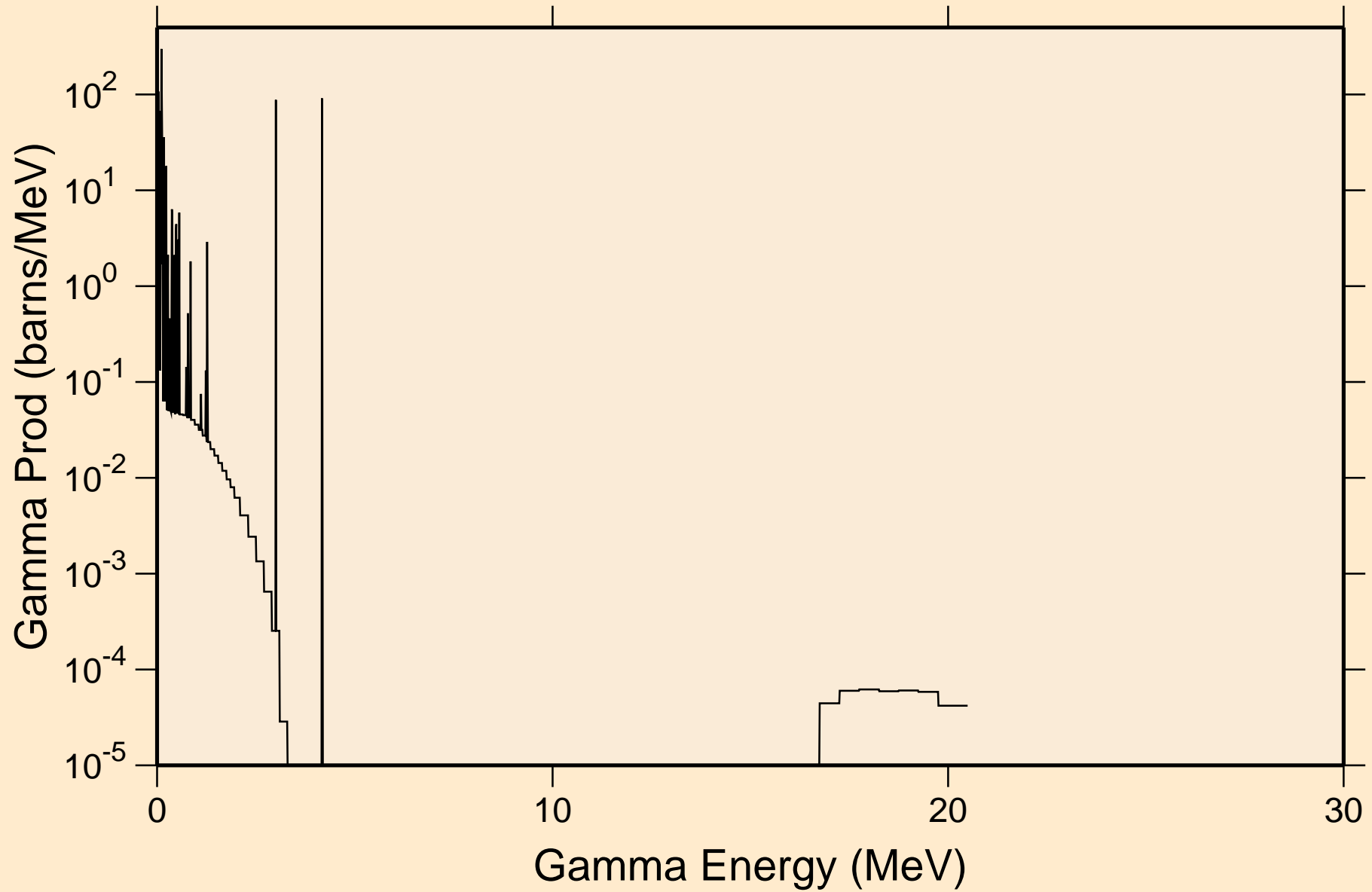

# AM235 NRG TENDL-2015, AKONING

## Particle heating contributions

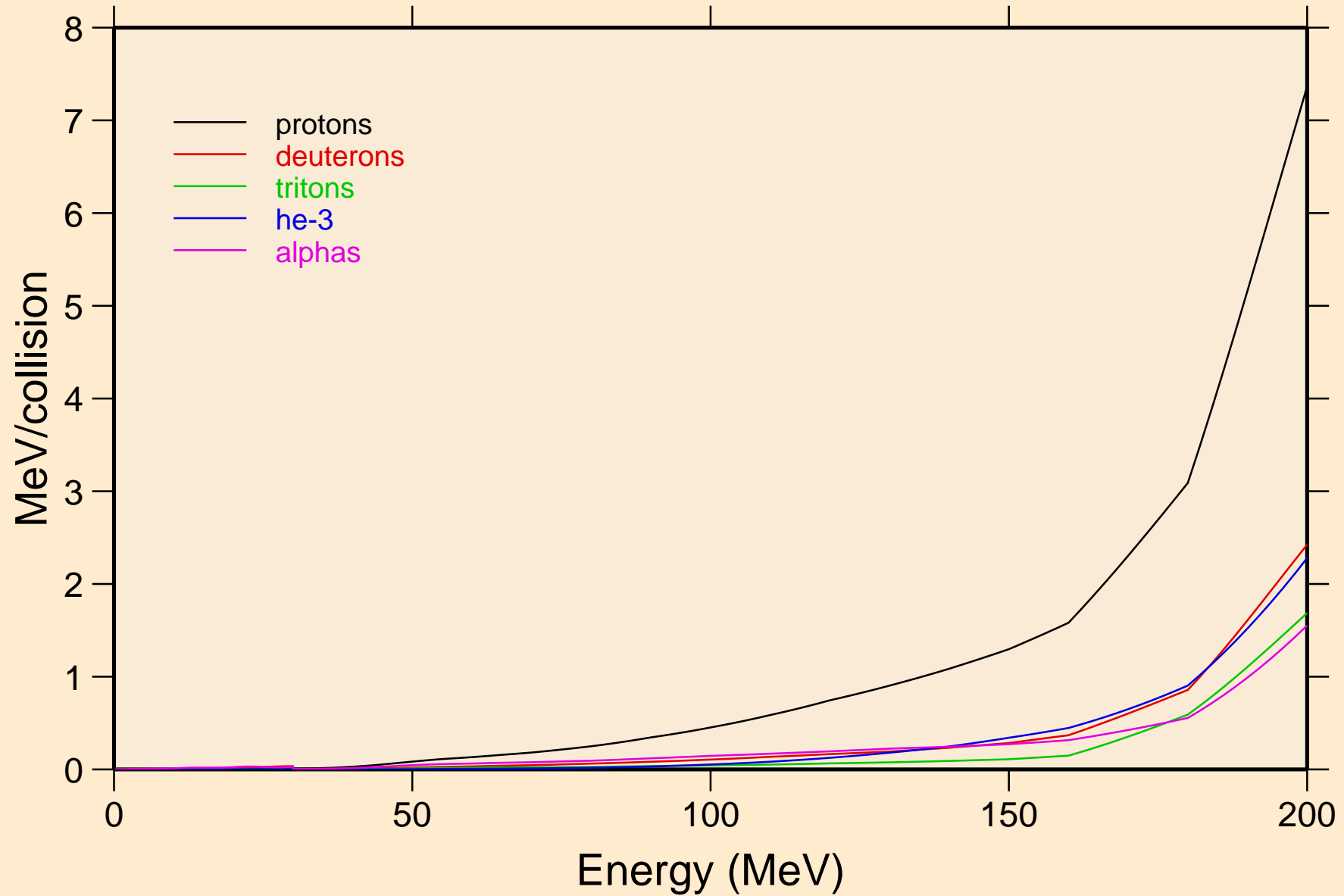

# AM235 NRG TENDL-2015, AKONING

## Recoil Heating

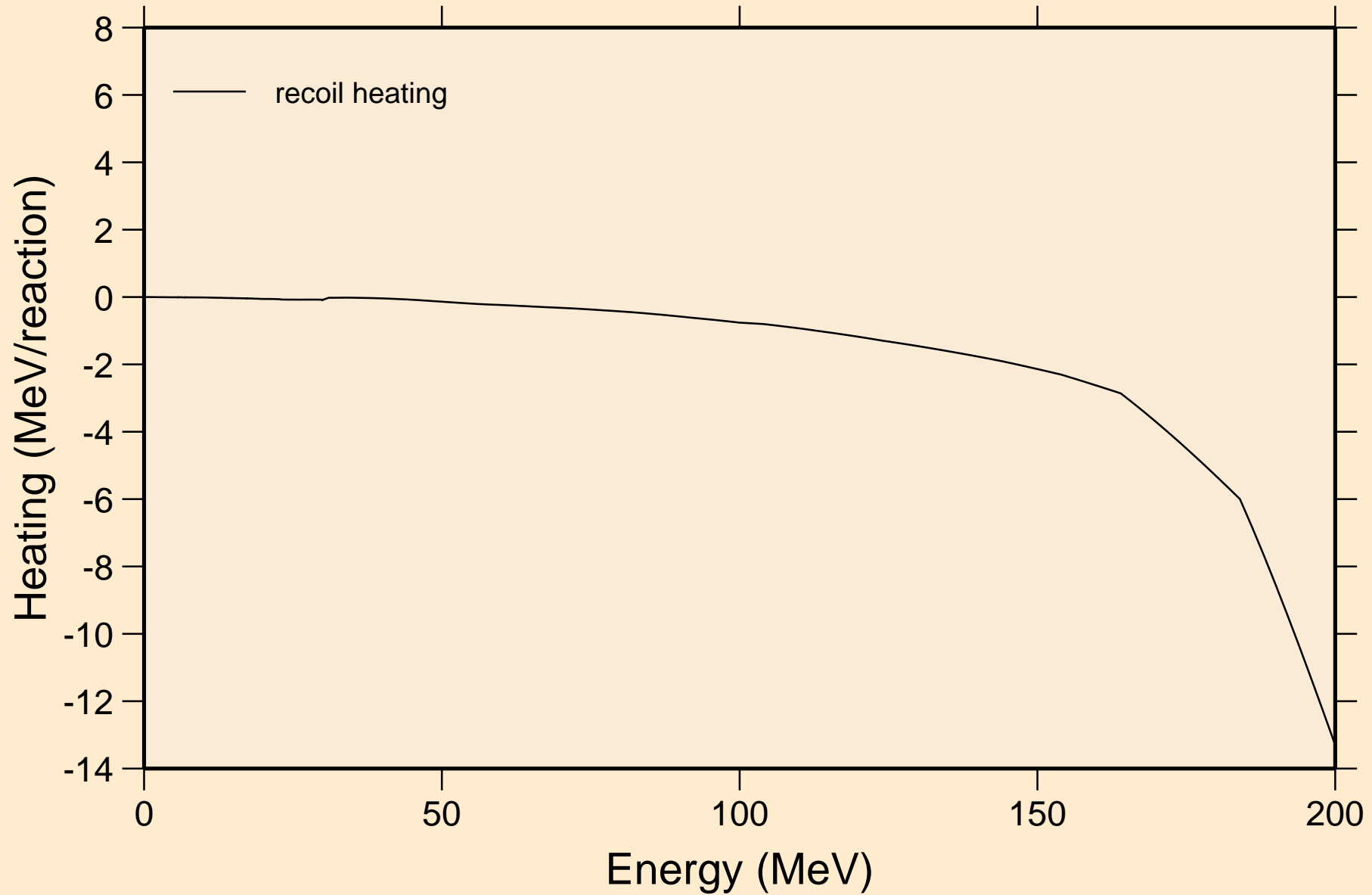

# AM235 NRG TENDL-2015, AKONING

## Particle production cross sections

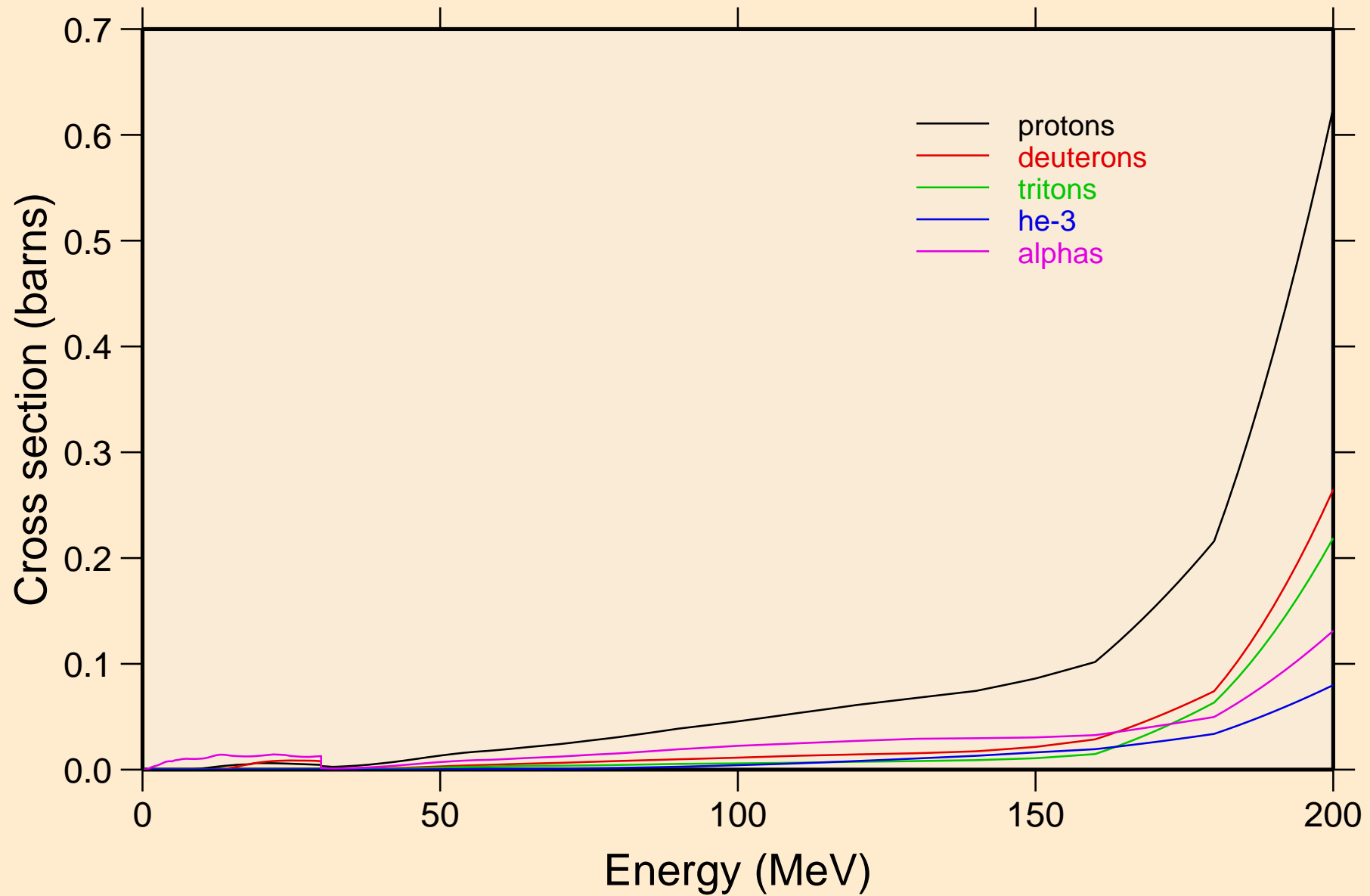

AM235 NRG TENDL-2015, AKONING  
protons from (n,x)

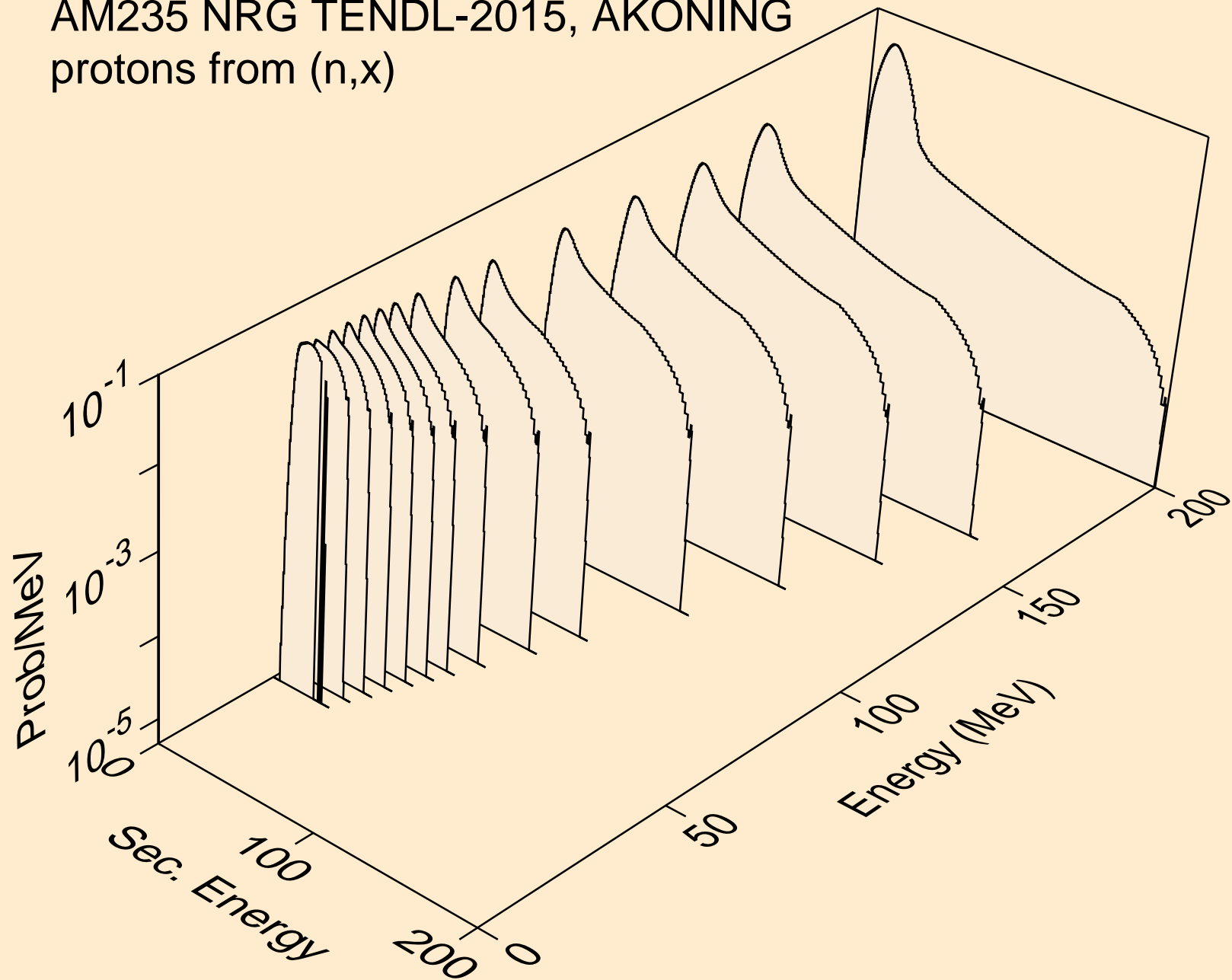

AM235 NRG TENDL-2015, AKONING  
protons from (n,n\*)p

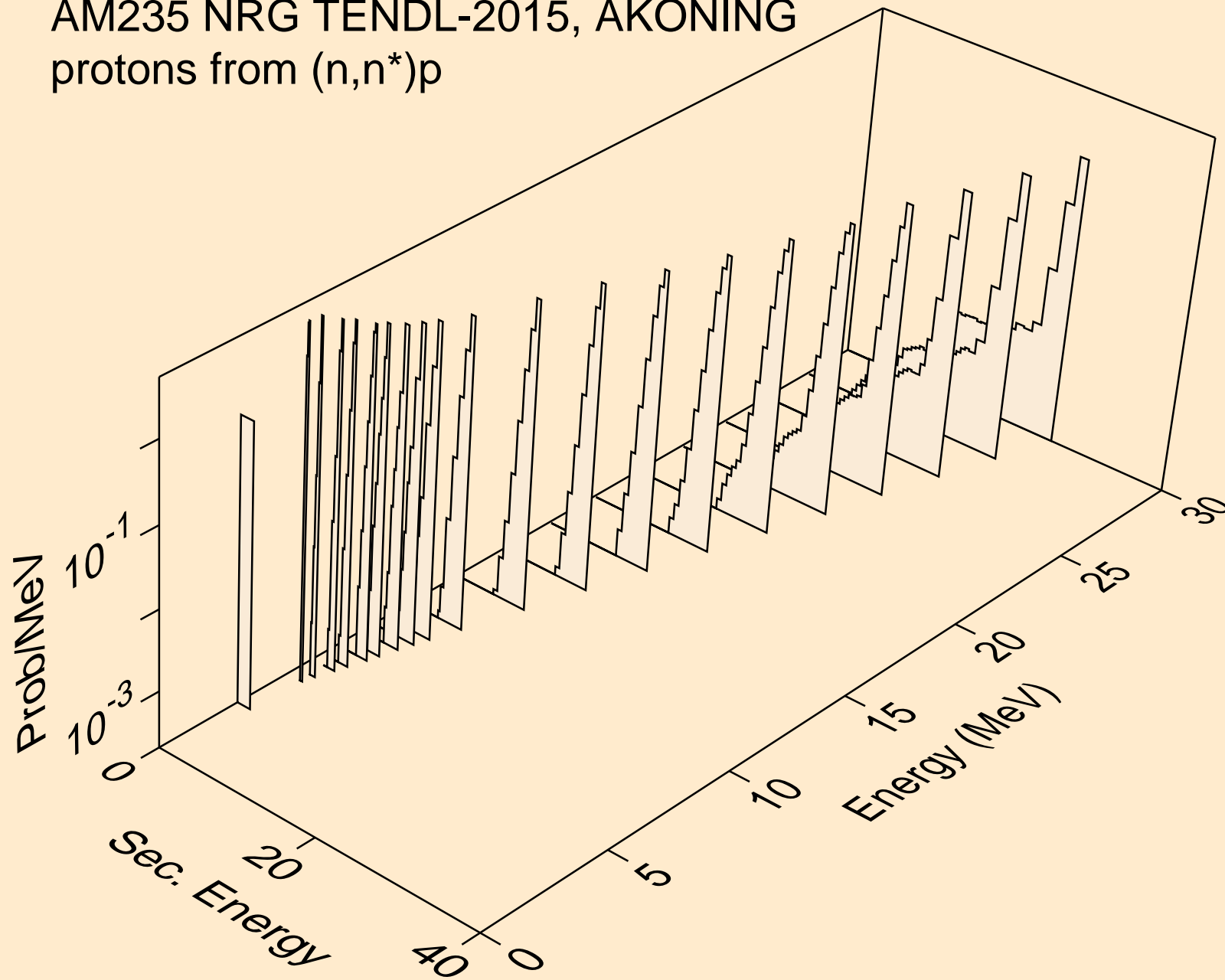

AM235 NRG TENDL-2015, AKONING  
protons from (n,2np)

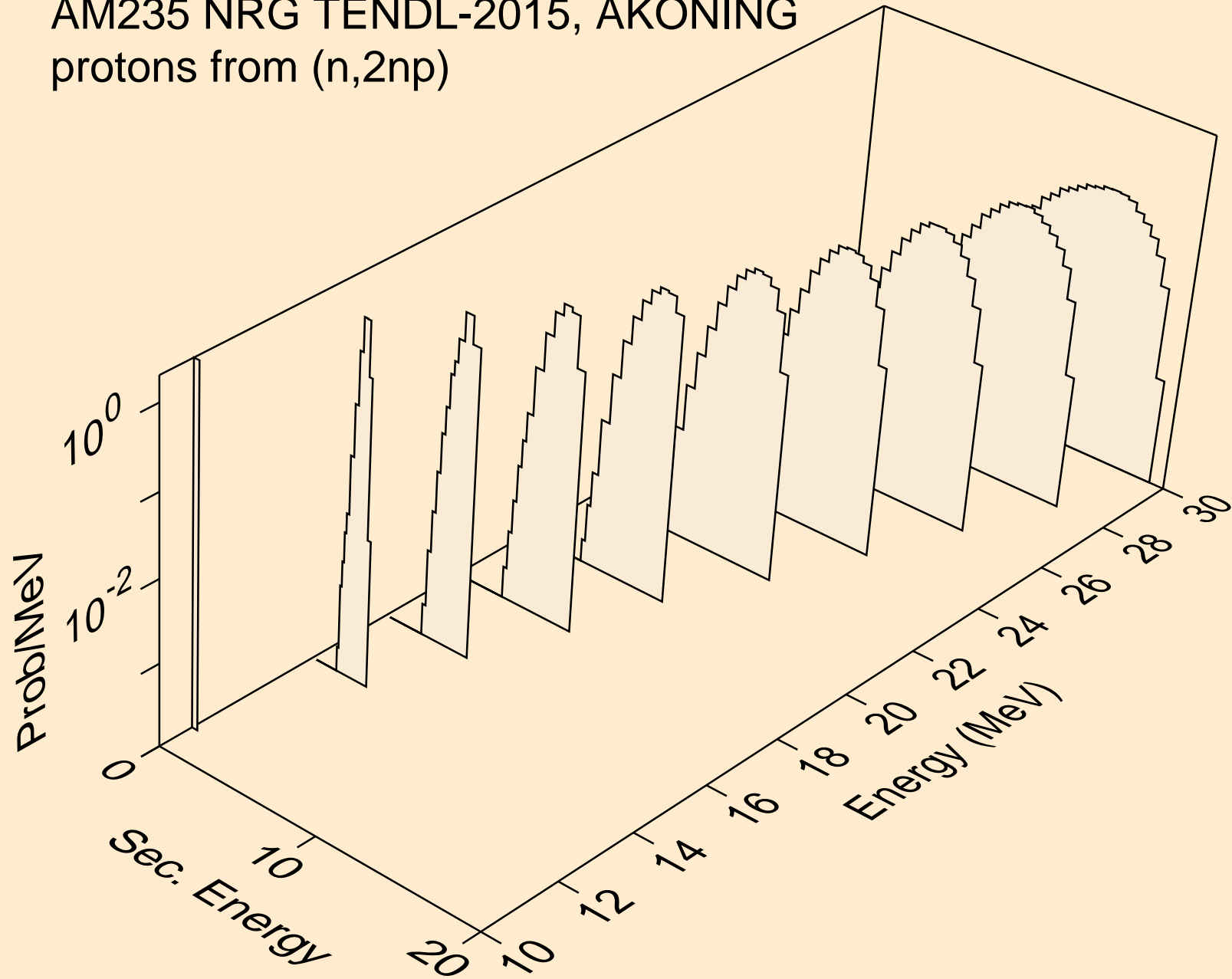



AM235 NRG TENDL-2015, AKONING  
protons from (n,3np)

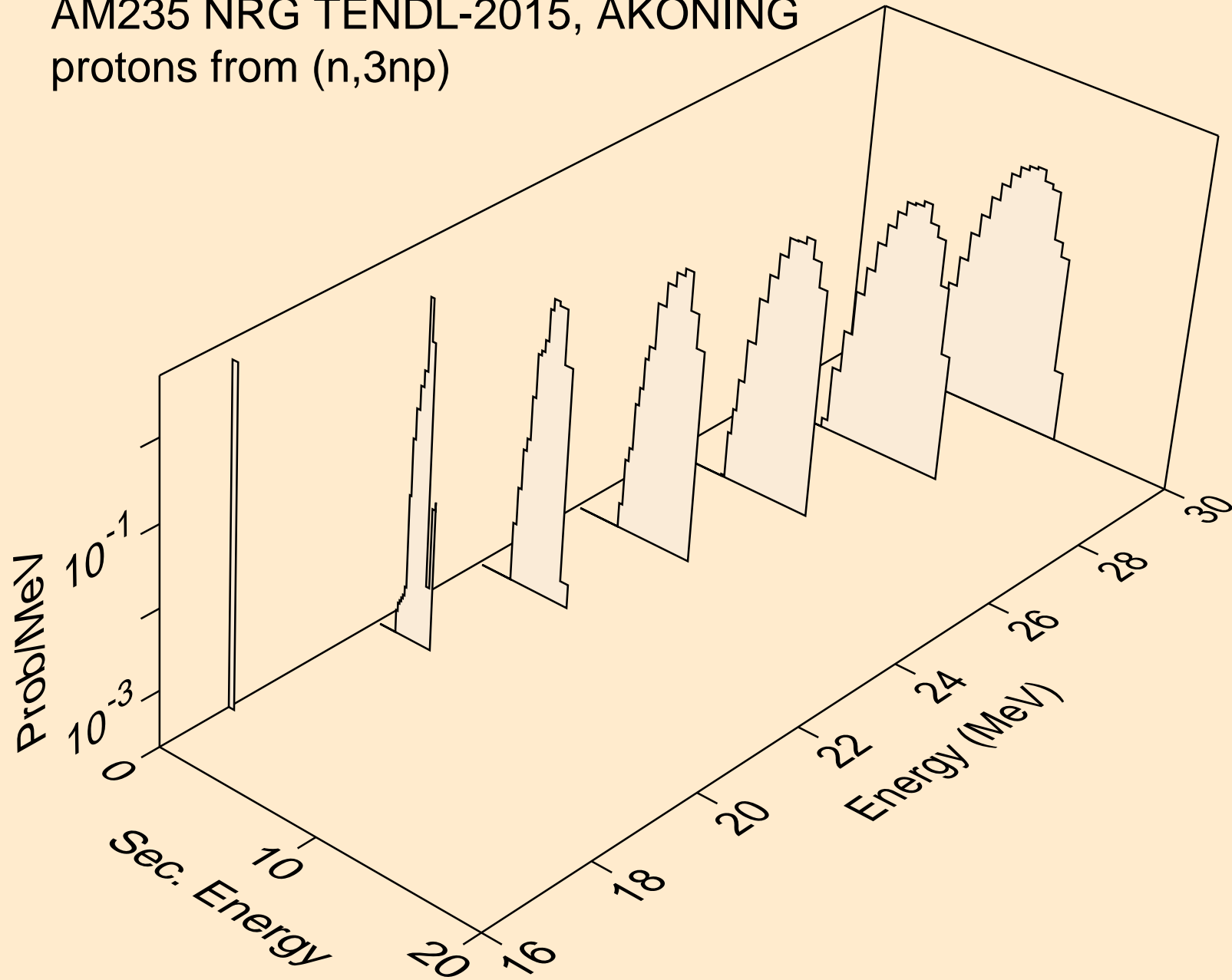

AM235 NRG TENDL-2015, AKONING  
protons from (n,2np)

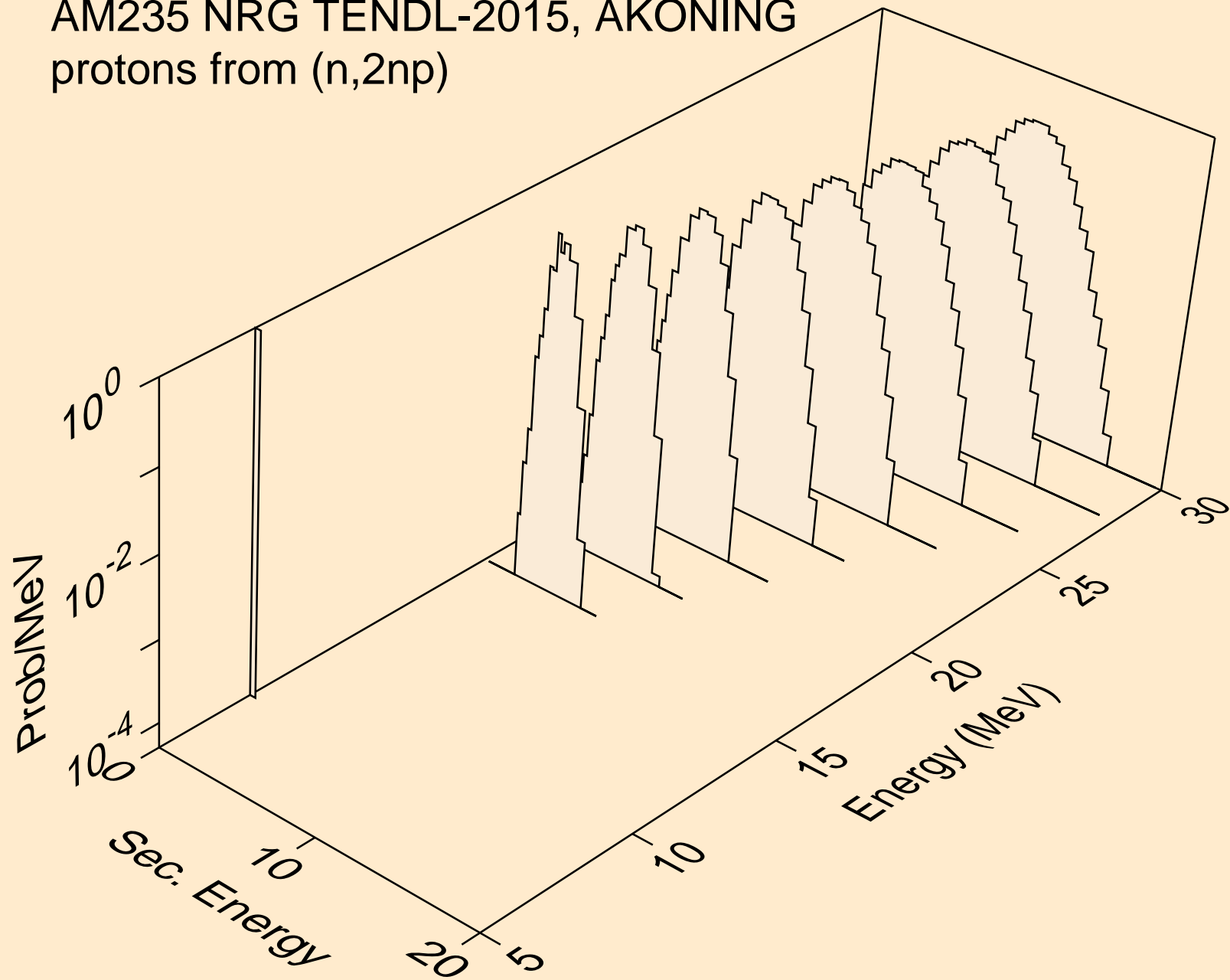

AM235 NRG TENDL-2015, AKONING  
protons from (n,npa)

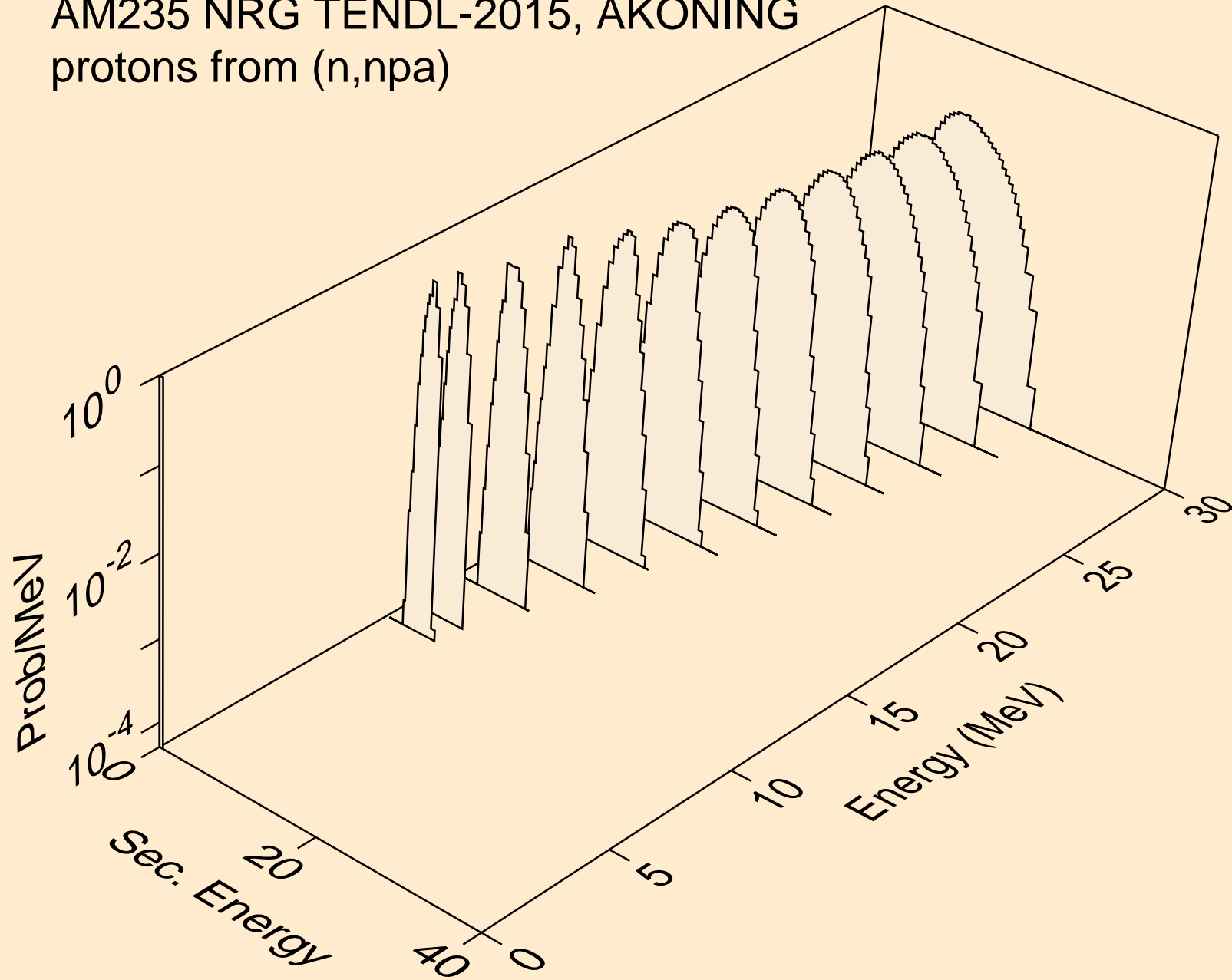

AM235 NRG TENDL-2015, AKONING  
protons from (n,p)

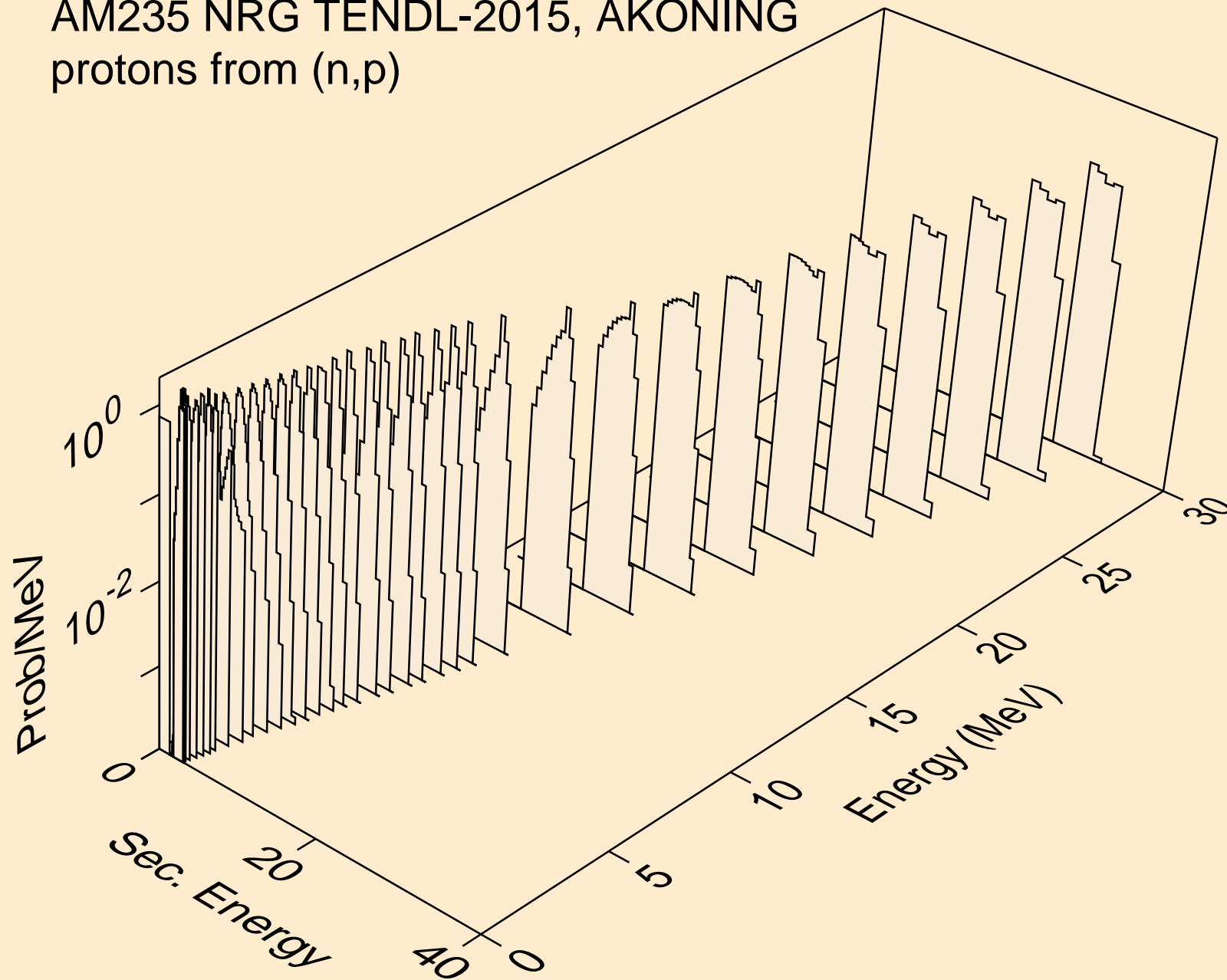

AM235 NRG TENDL-2015, AKONING  
protons from (n,2p)

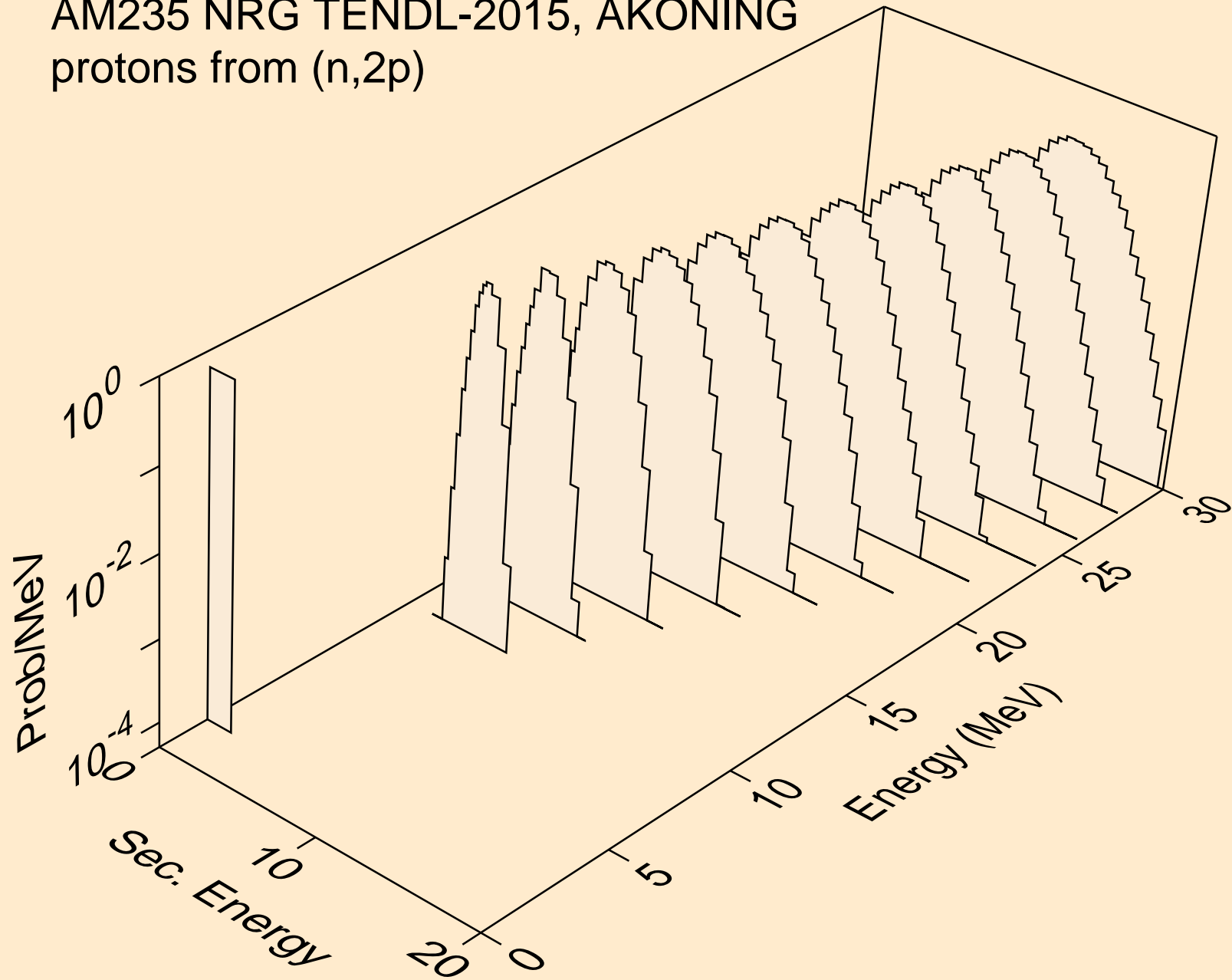

AM235 NRG TENDL-2015, AKONING  
protons from (n,pa)

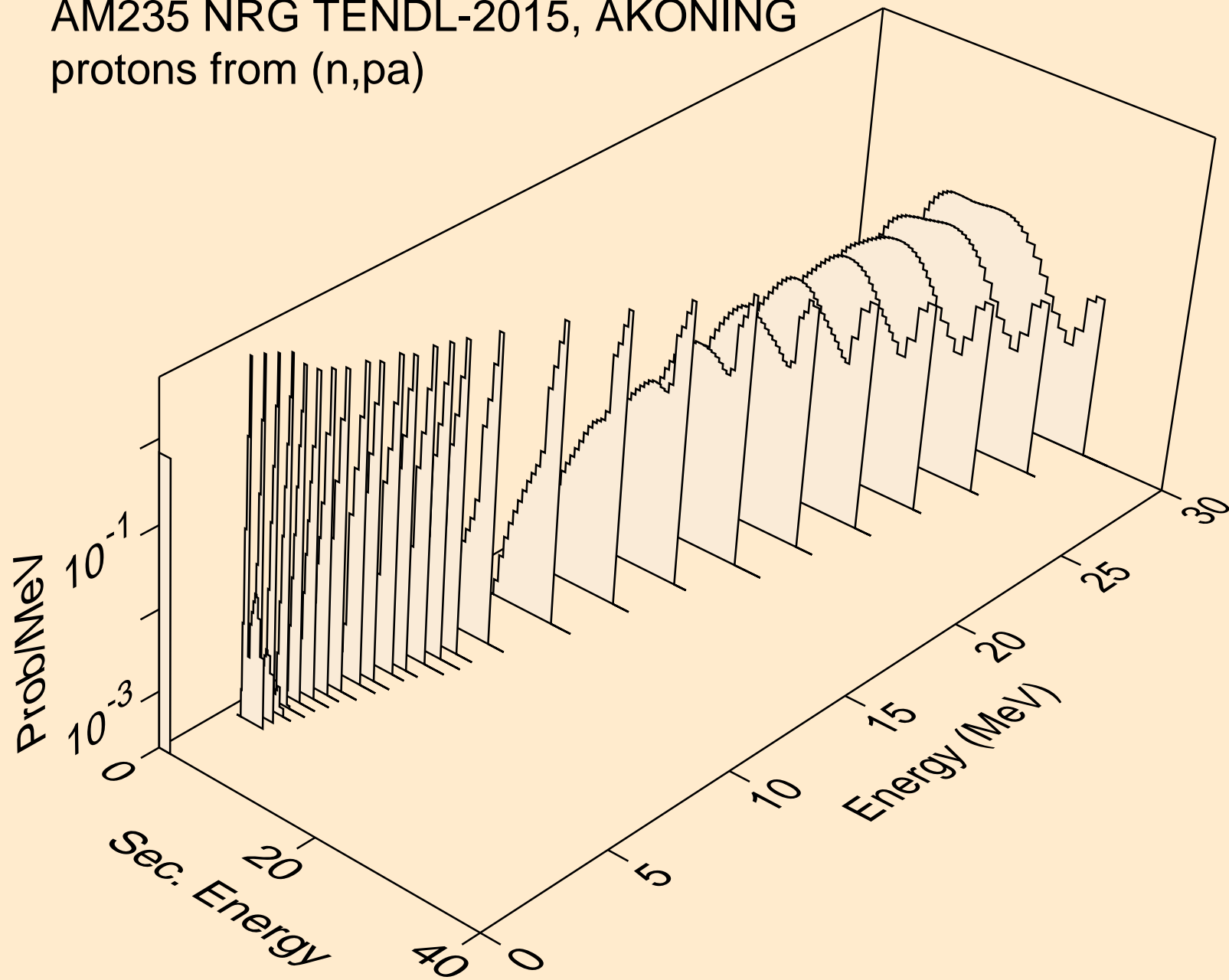

AM235 NRG TENDL-2015, AKONING  
protons from (n,pd)

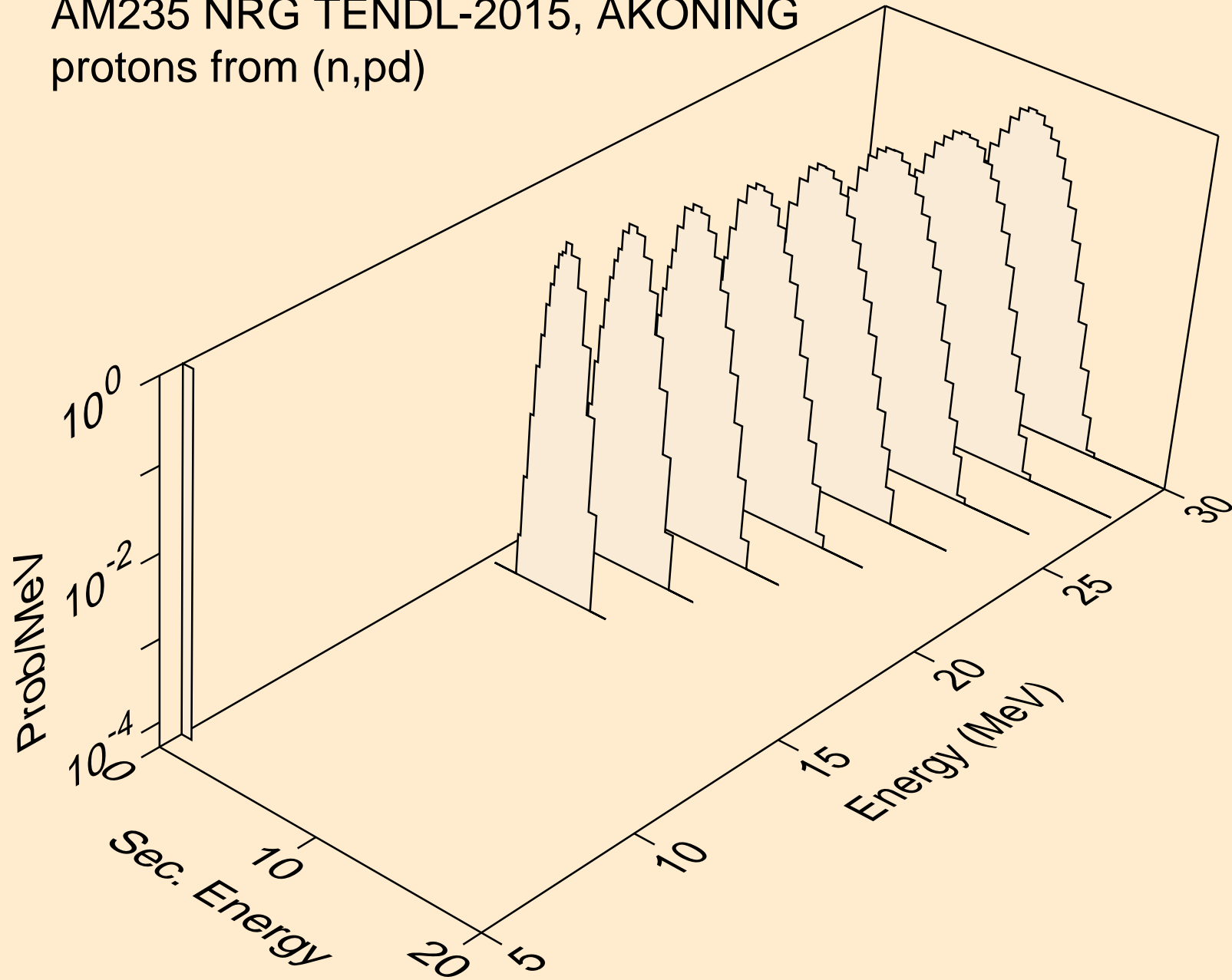

AM235 NRG TENDL-2015, AKONING  
protons from (n,pt)

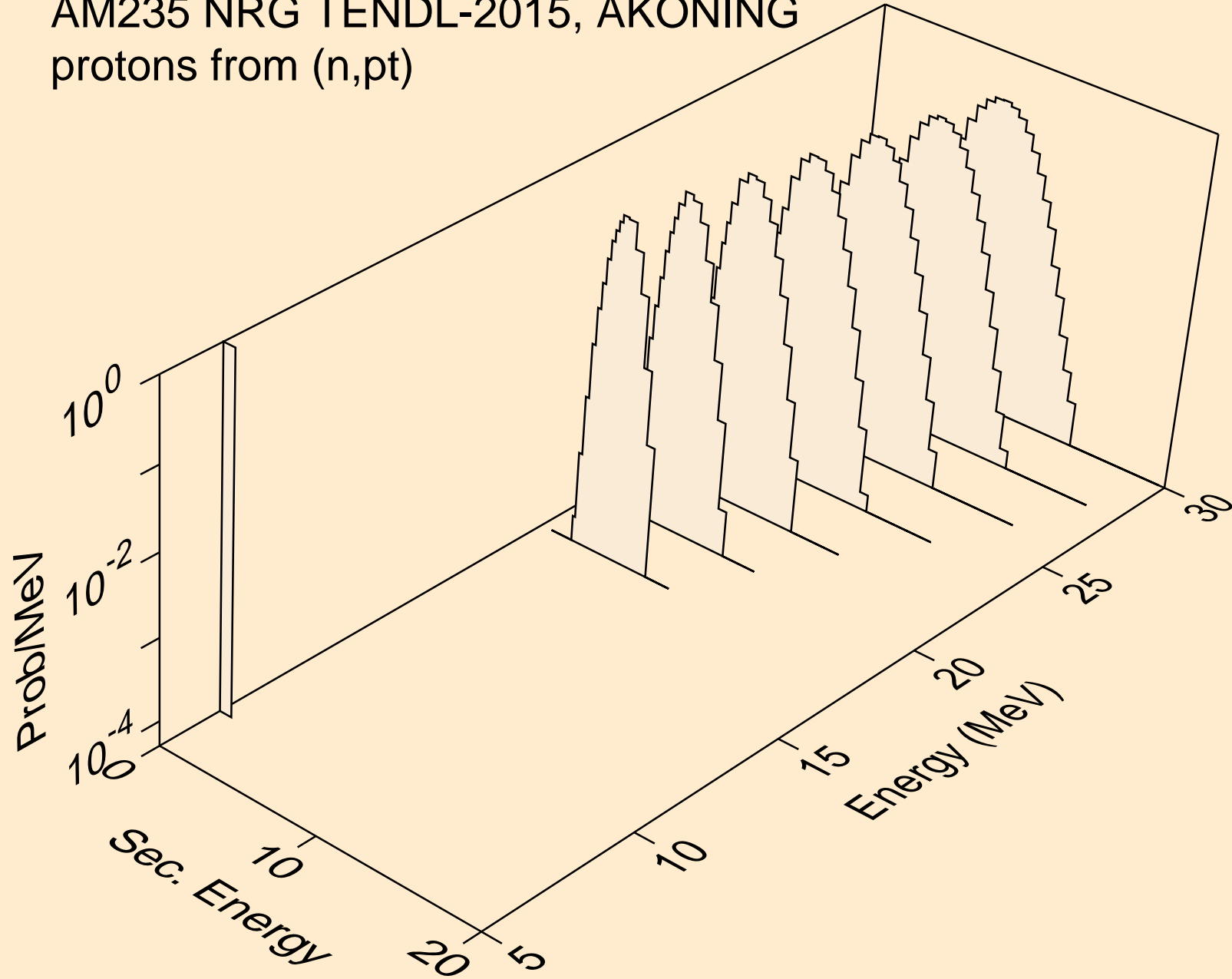



AM235 NRG TENDL-2015, AKONING  
deuterons from (n,x)

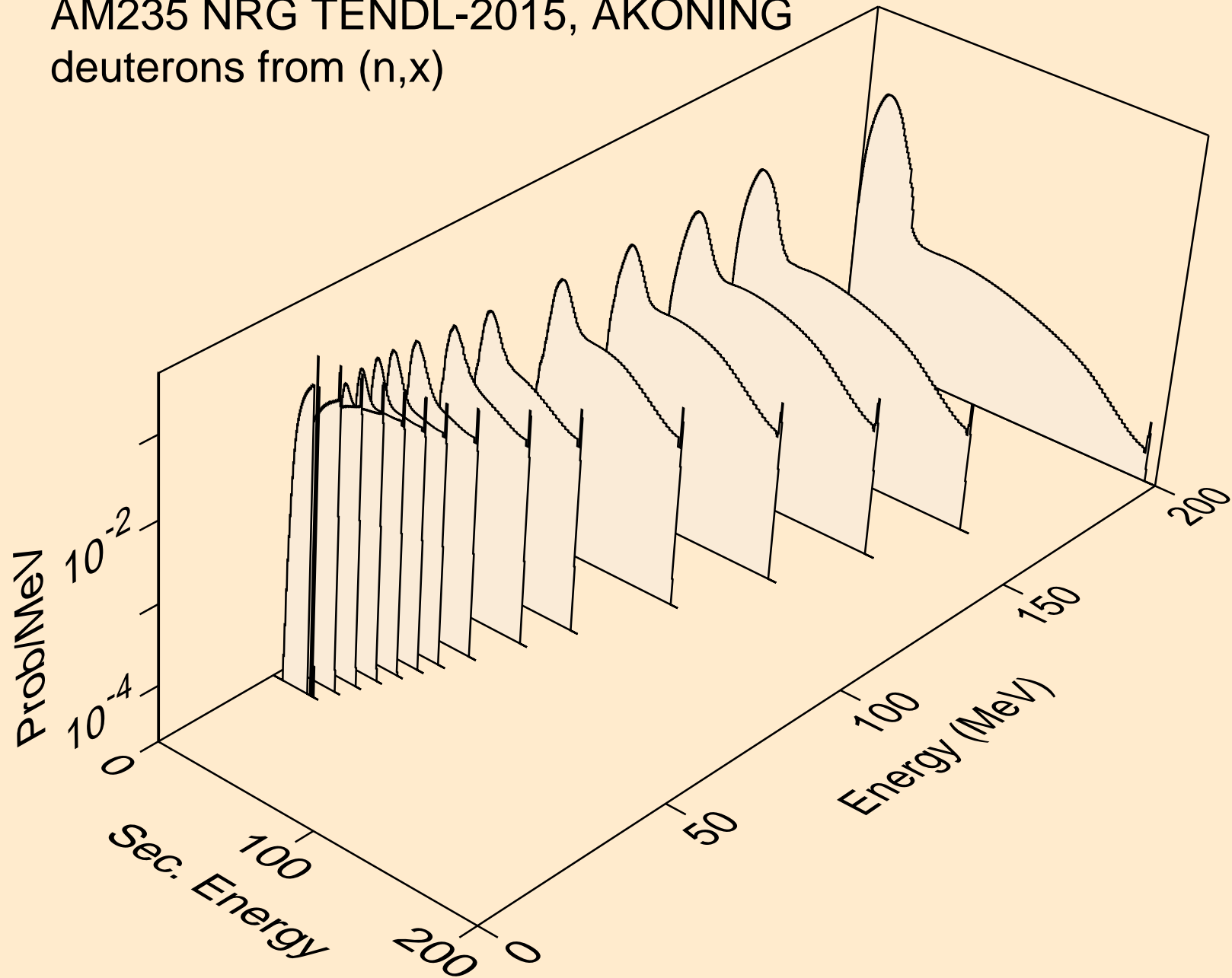

AM235 NRG TENDL-2015, AKONING  
deuterons from (n,2nd)

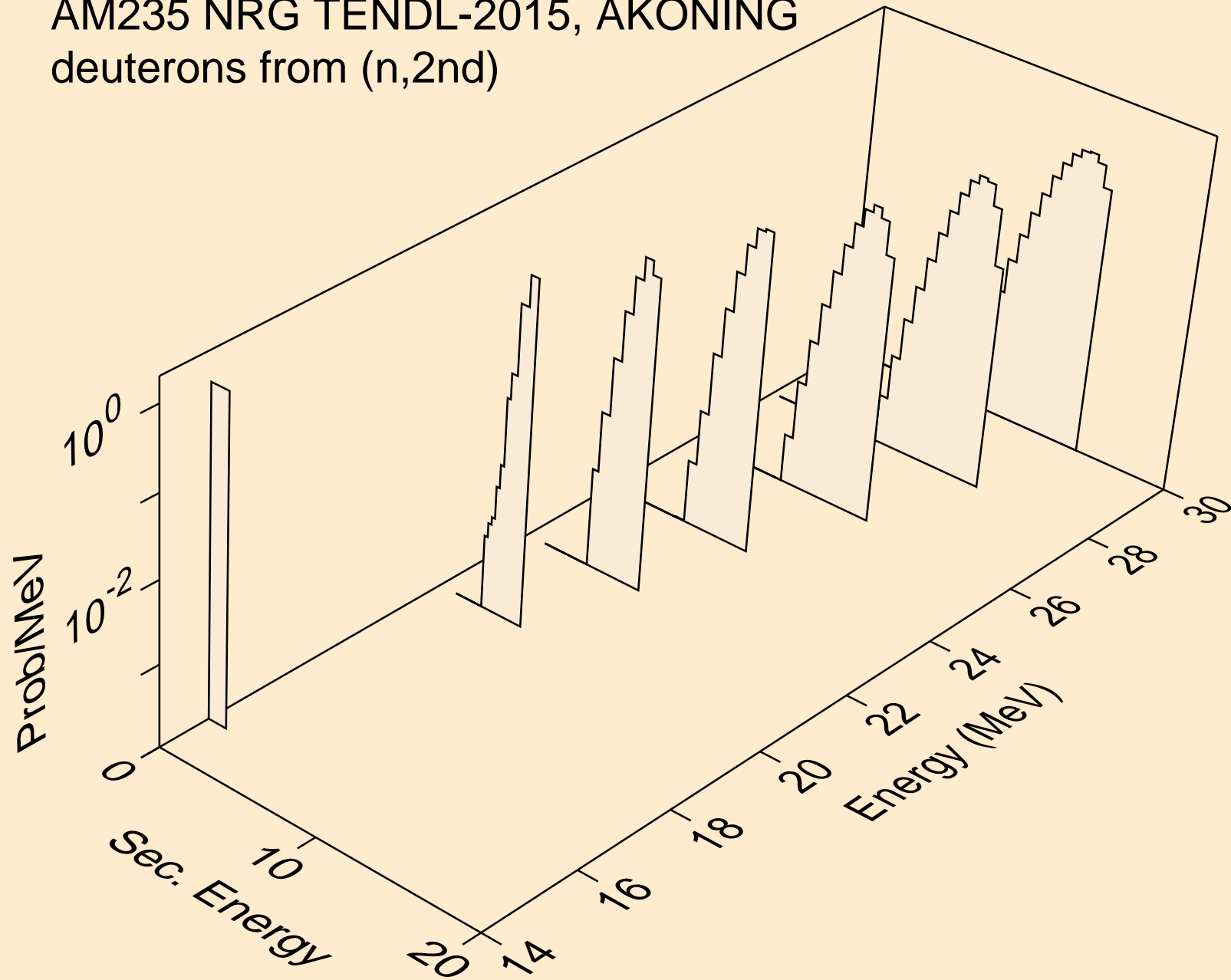

AM235 NRG TENDL-2015, AKONING  
deuterons from (n,n\*)d

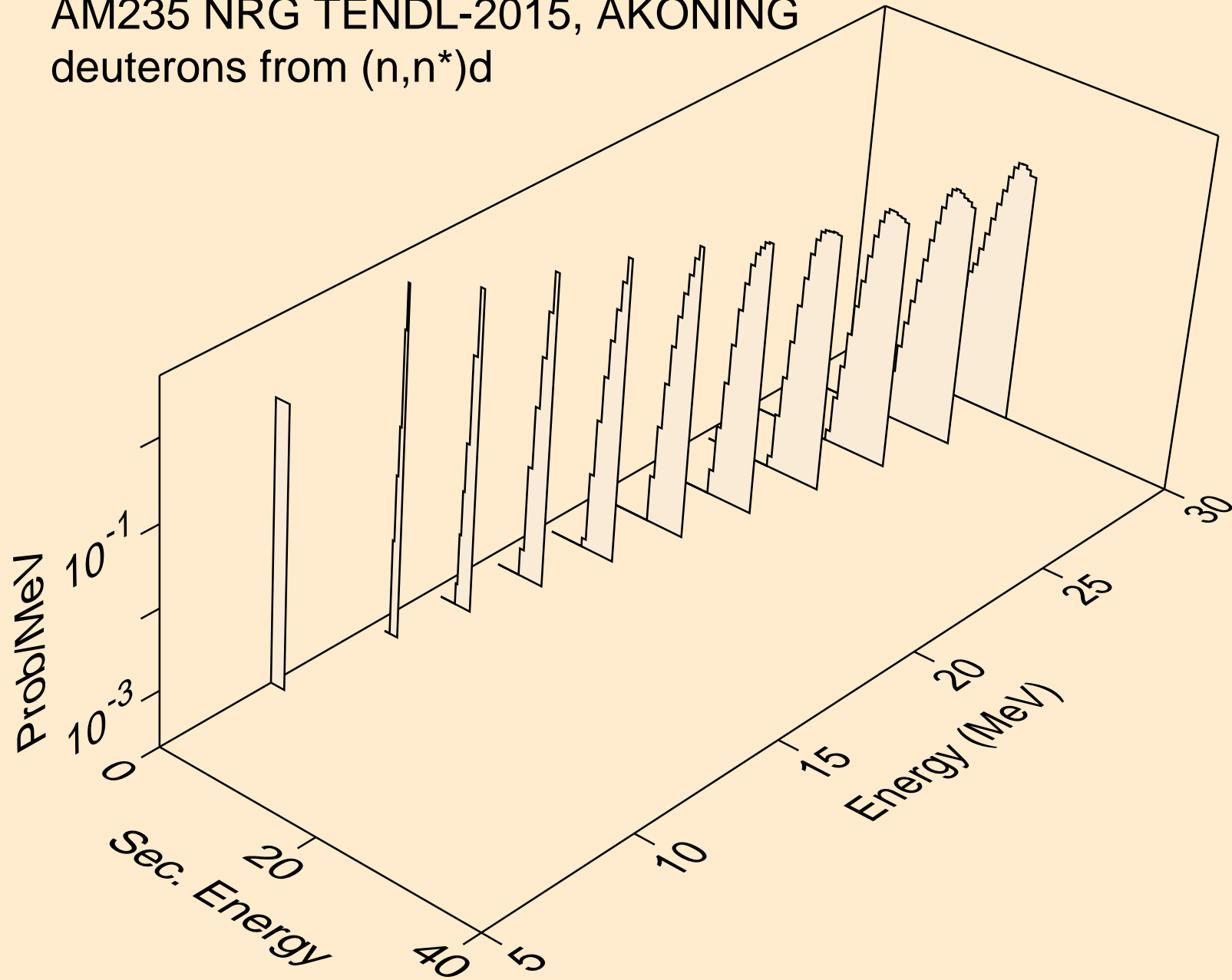

AM235 NRG TENDL-2015, AKONING  
deuterons from (n,d)

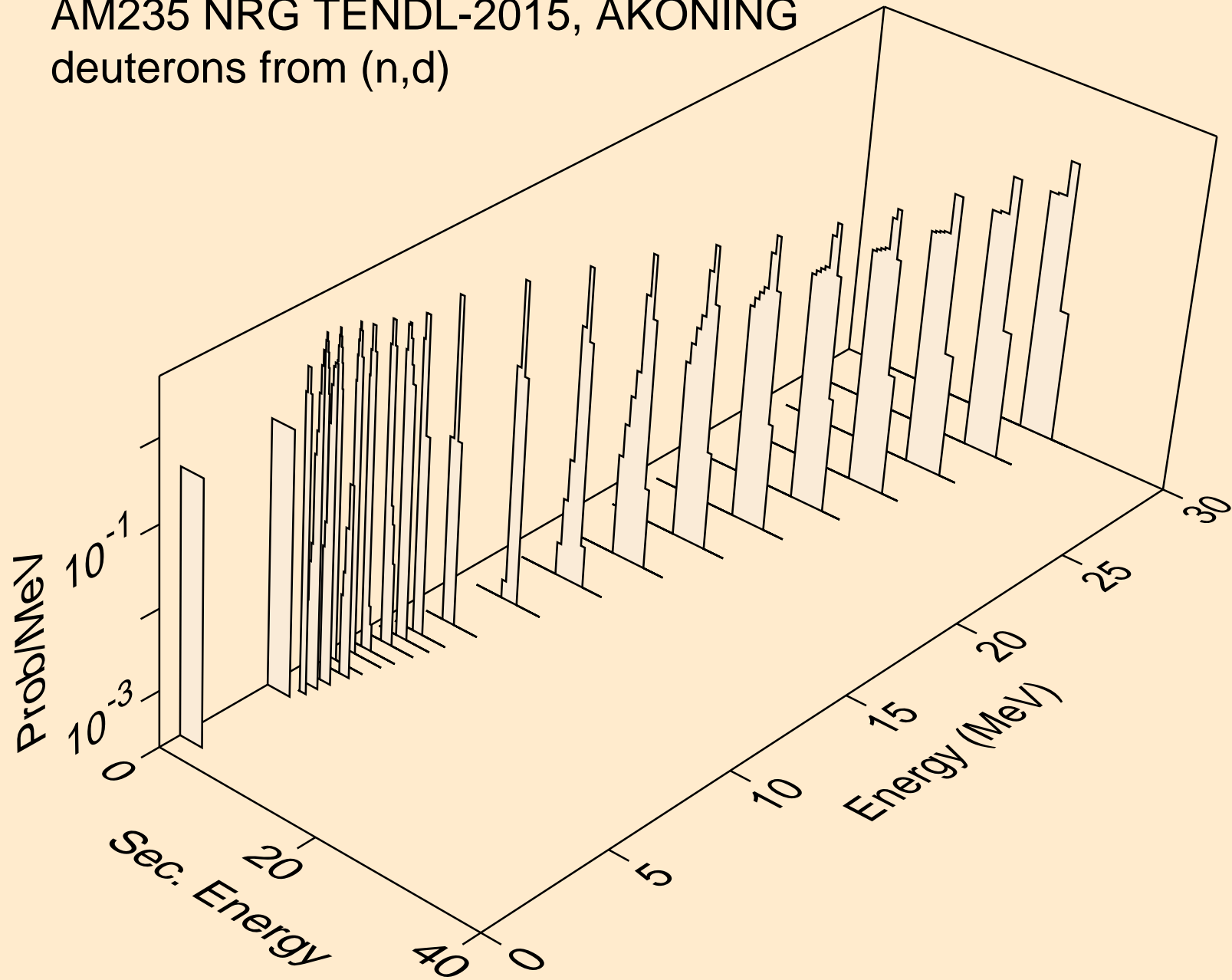

AM235 NRG TENDL-2015, AKONING  
deuterons from (n,pd)

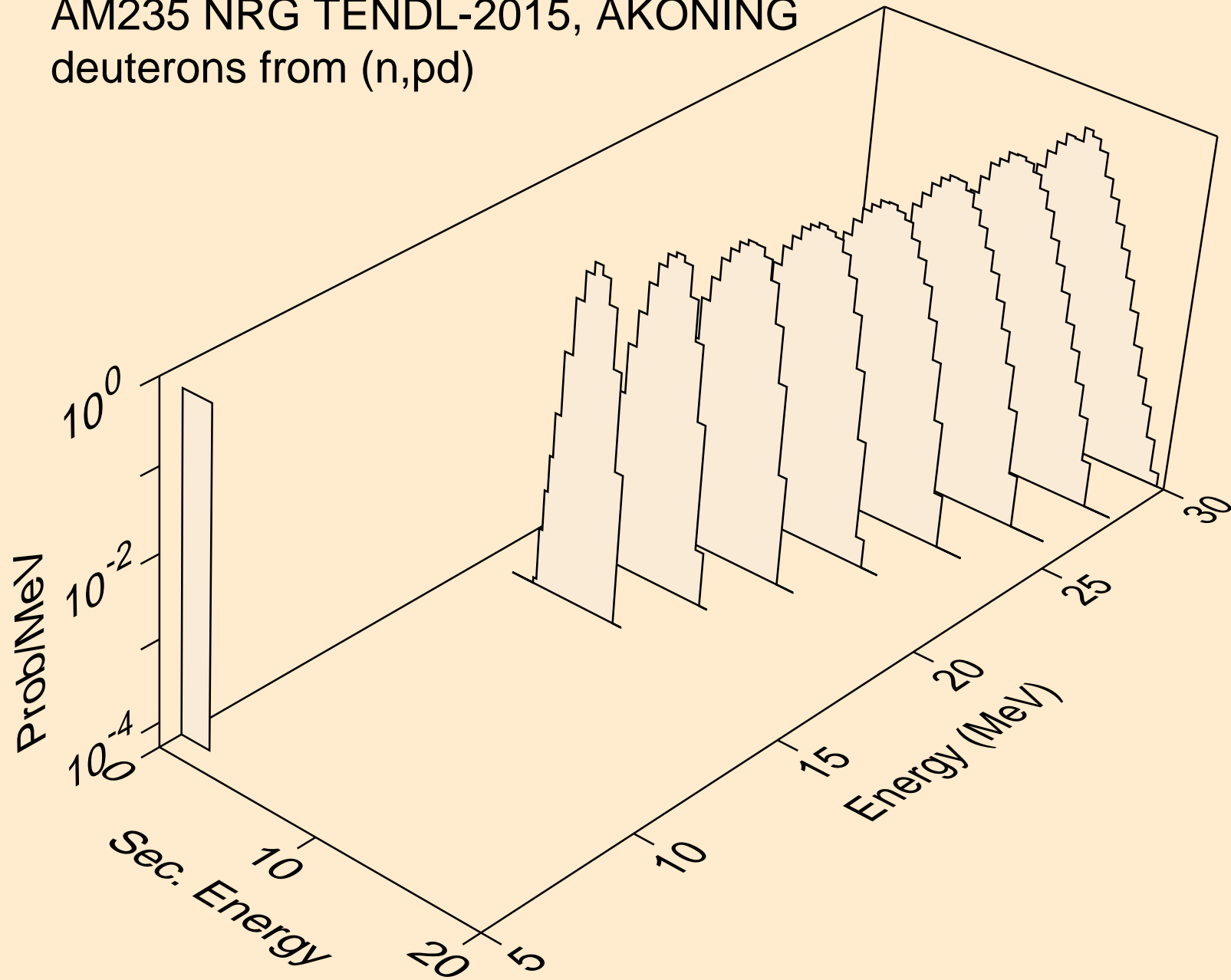

AM235 NRG TENDL-2015, AKONING  
deuterons from (n,da)

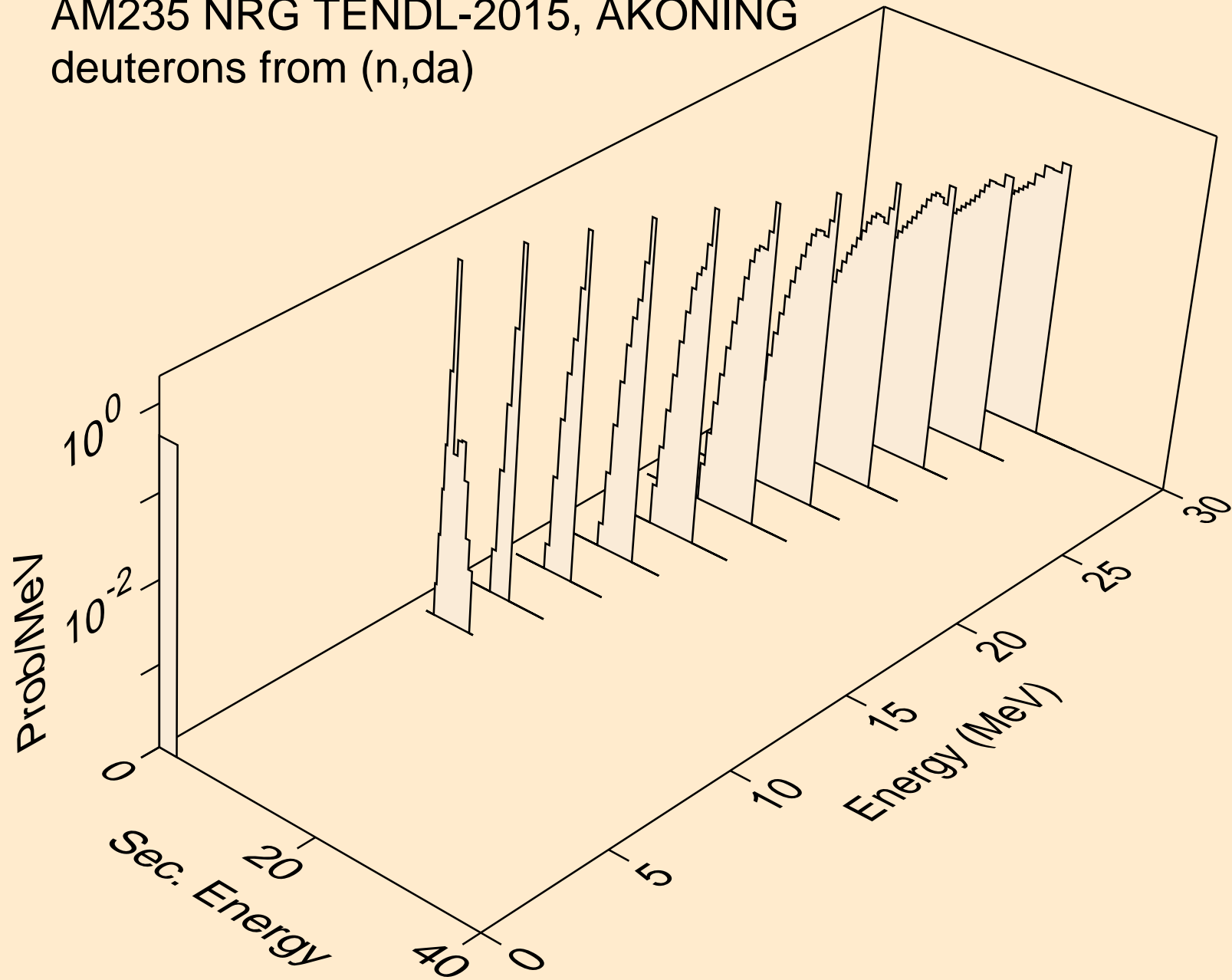

AM235 NRG TENDL-2015, AKONING  
tritons from (n,x)

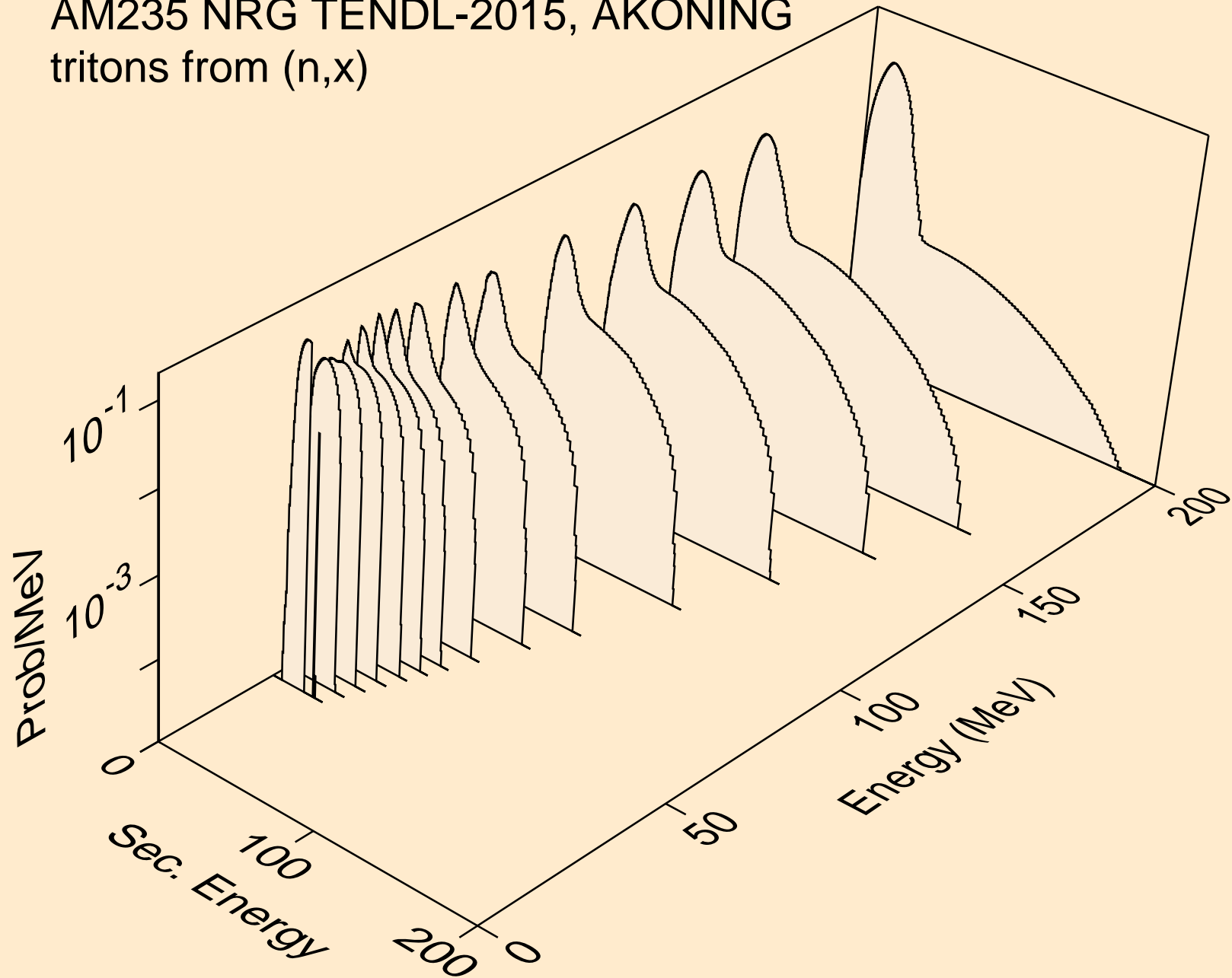

AM235 NRG TENDL-2015, AKONING  
tritons from (n,n\*)t

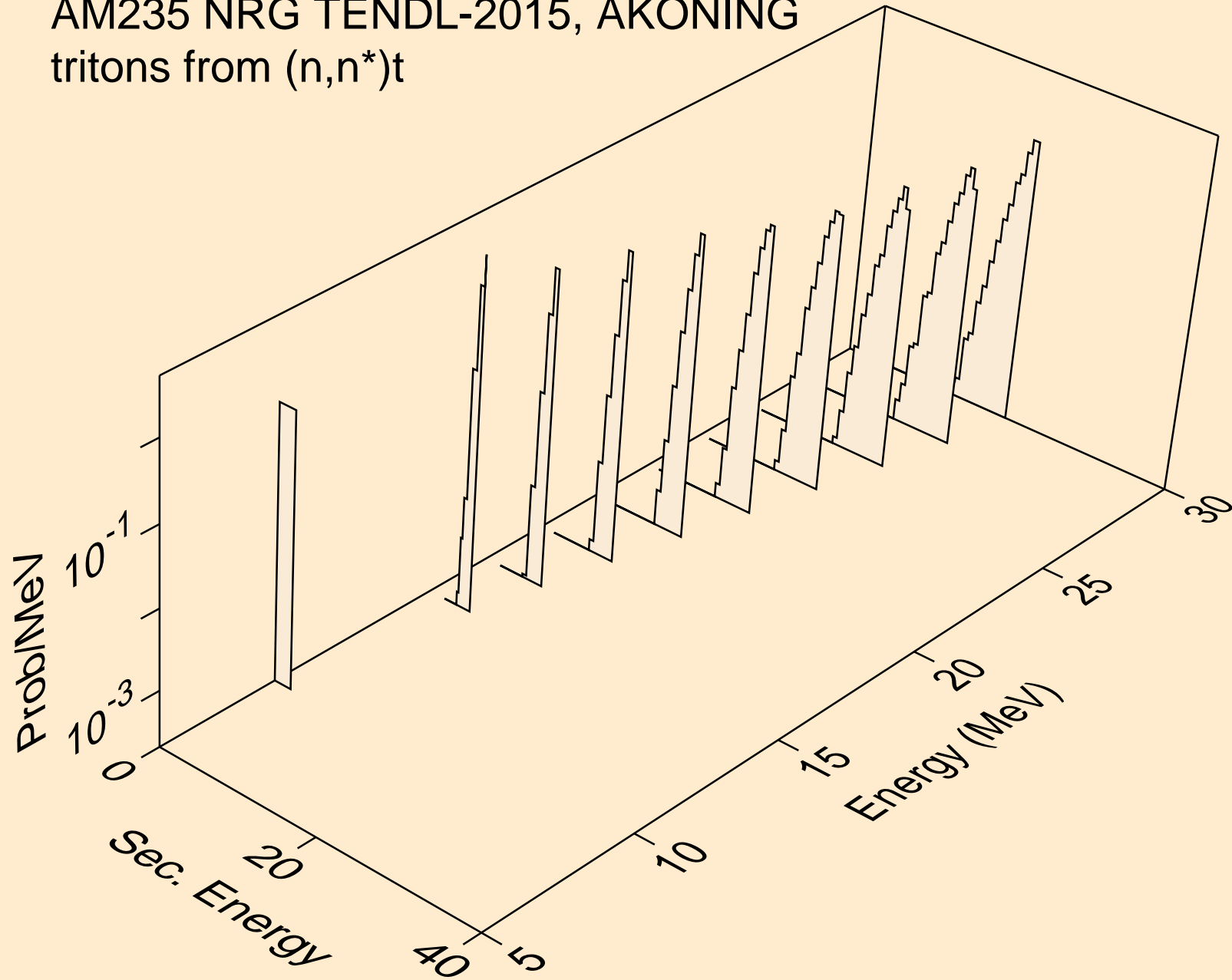



AM235 NRG TENDL-2015, AKONING  
tritons from (n,t)

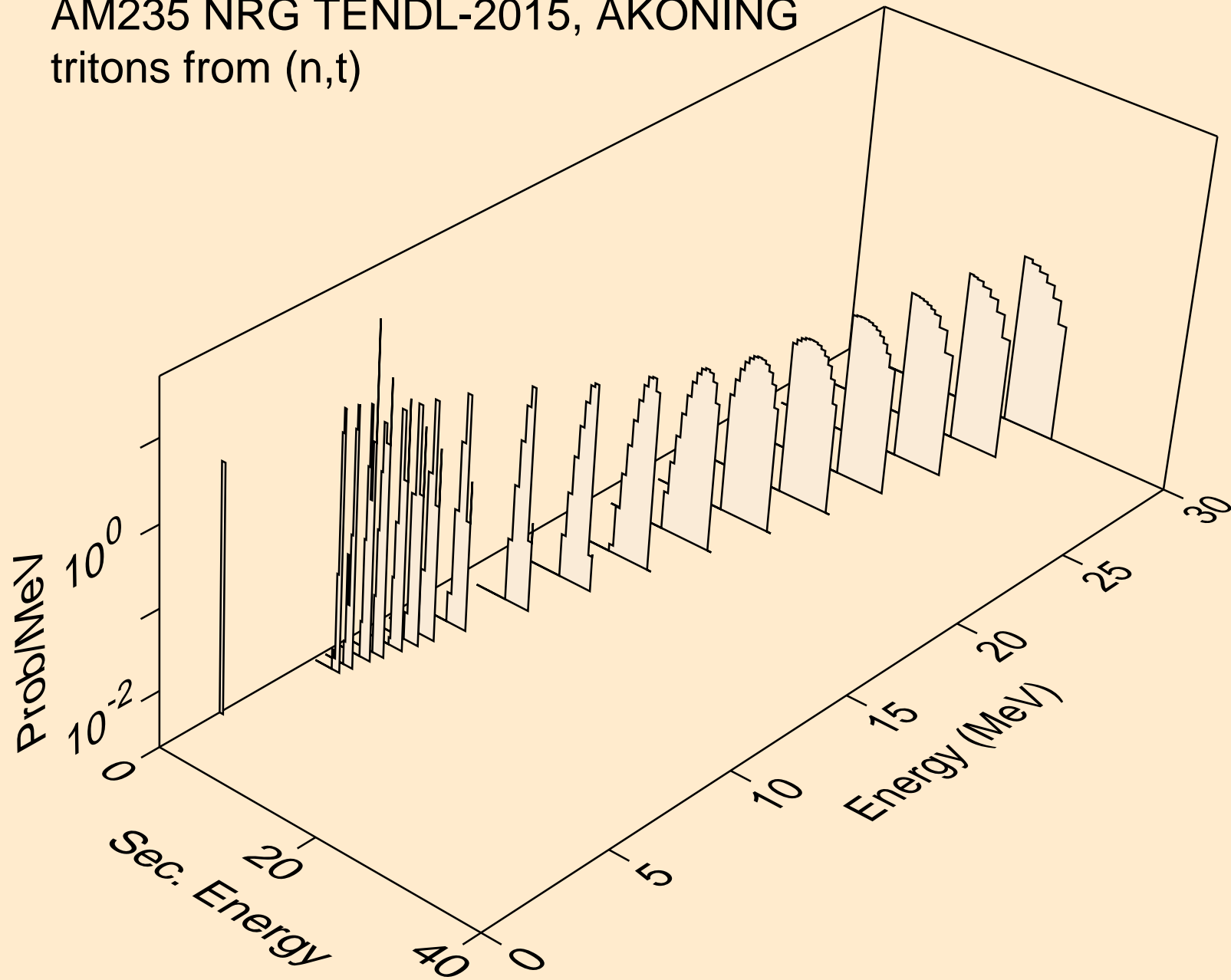

AM235 NRG TENDL-2015, AKONING  
tritons from (n,t2a)

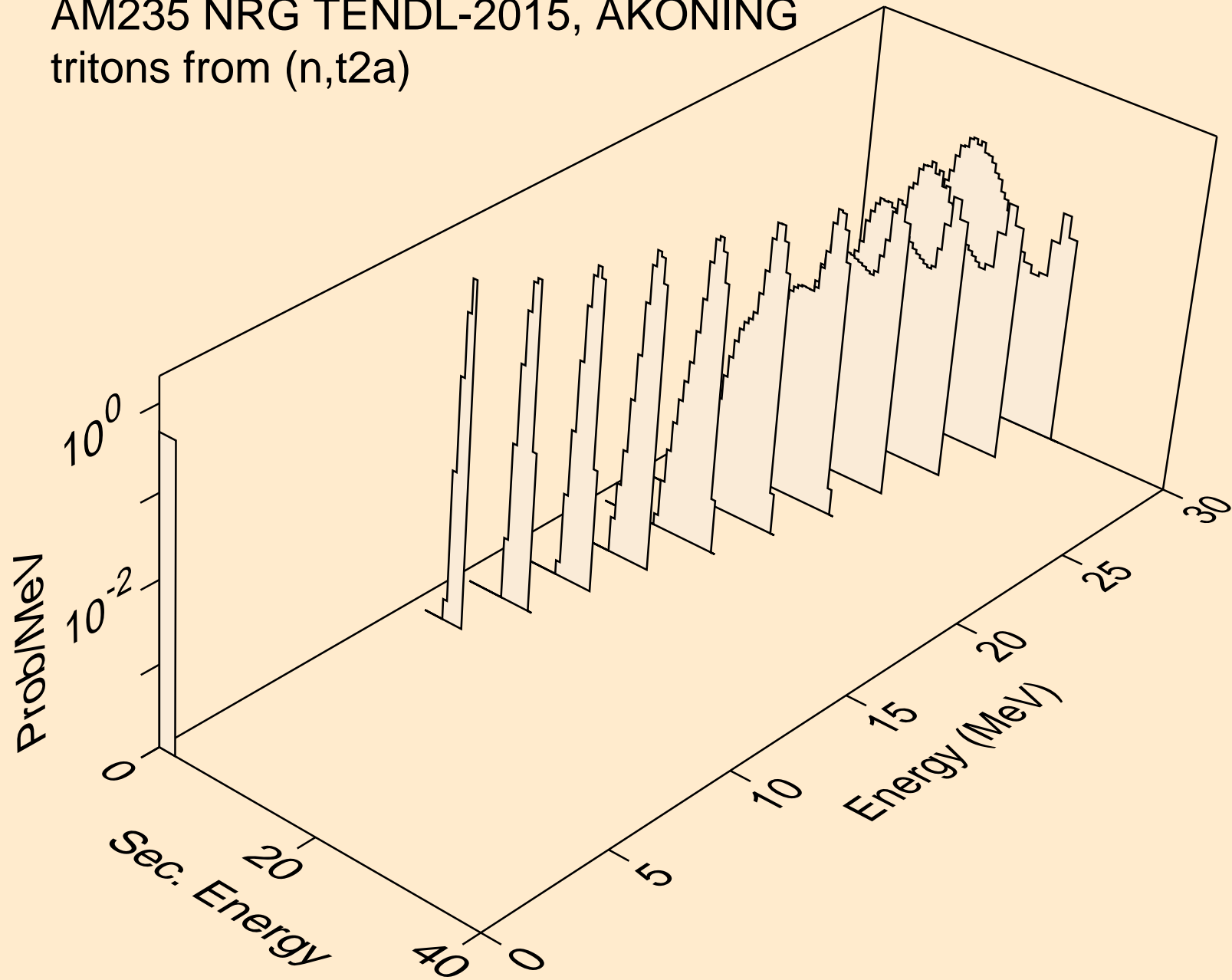

AM235 NRG TENDL-2015, AKONING  
tritons from (n,pt)

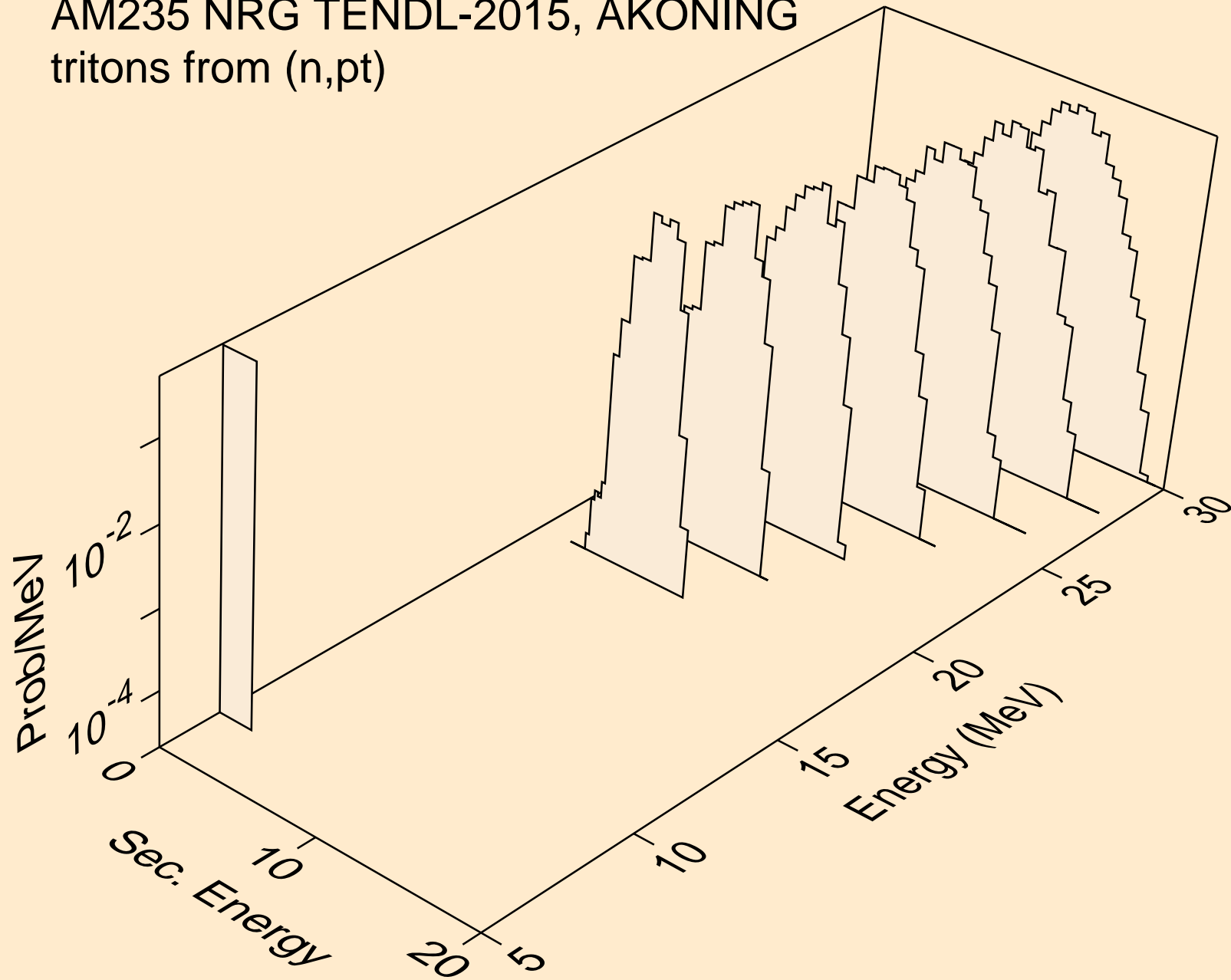

AM235 NRG TENDL-2015, AKONING  
he3s from (n,x)

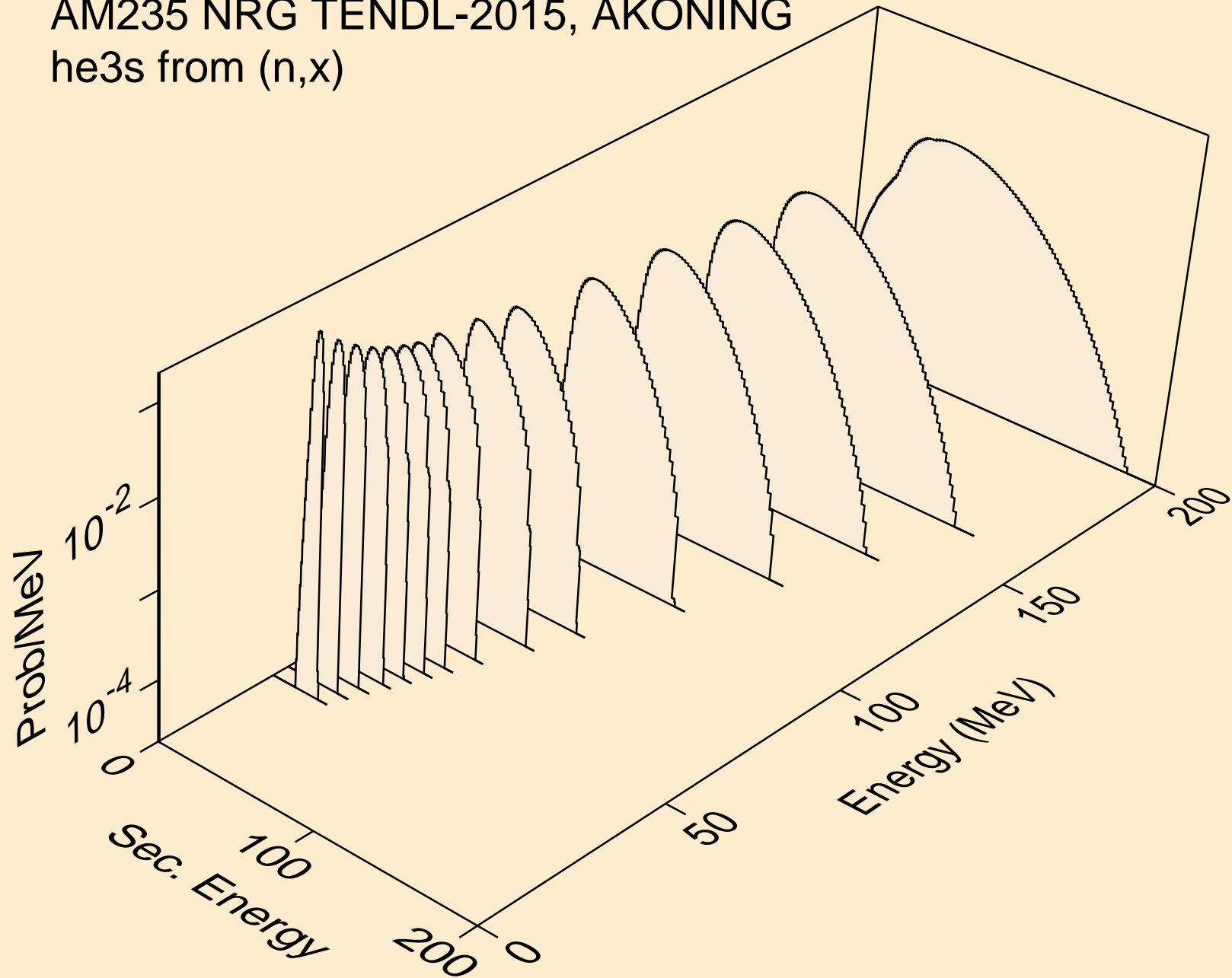

AM235 NRG TENDL-2015, AKONING  
he3s from (n,n\*)he3

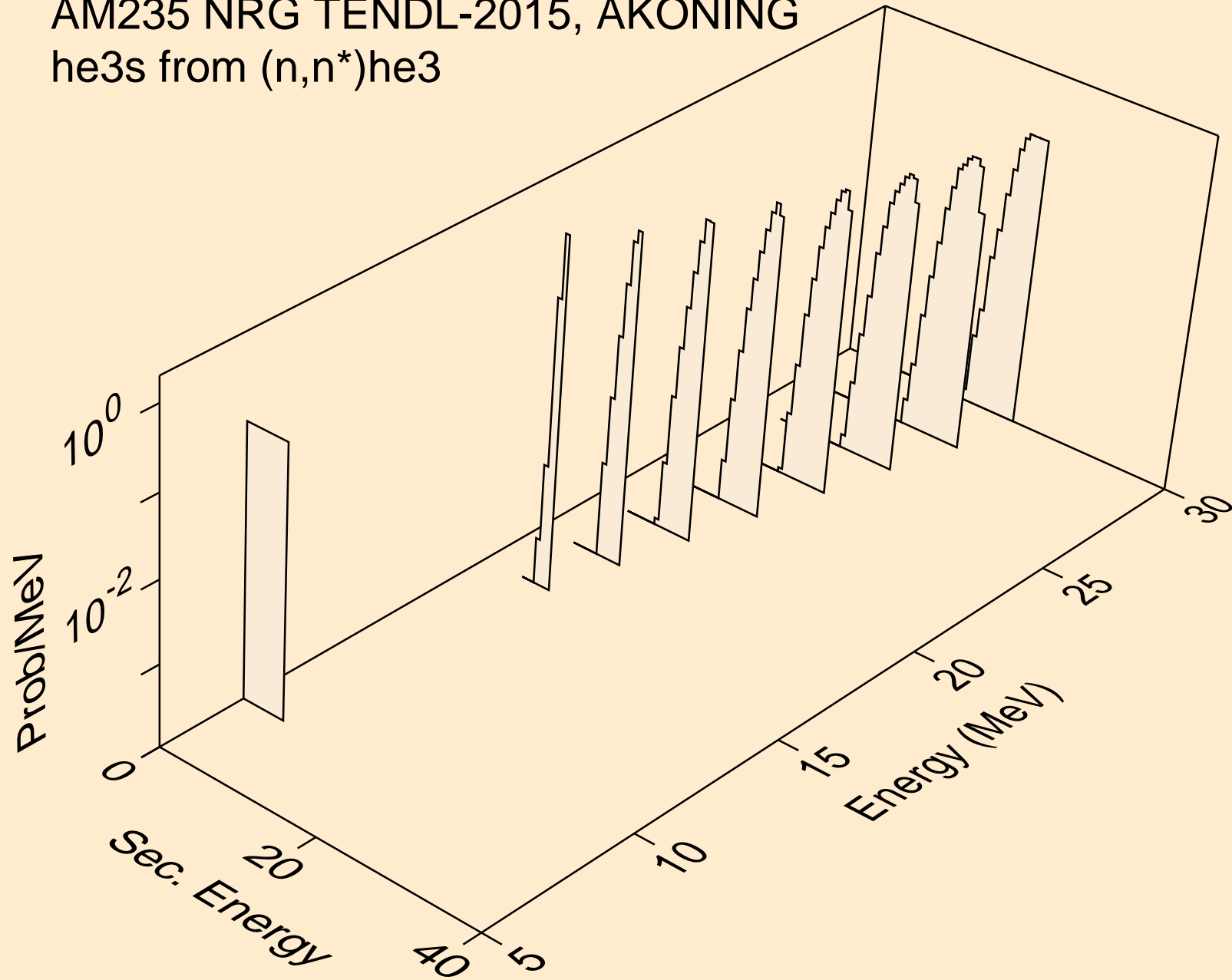

AM235 NRG TENDL-2015, AKONING  
he3s from (n,he3)

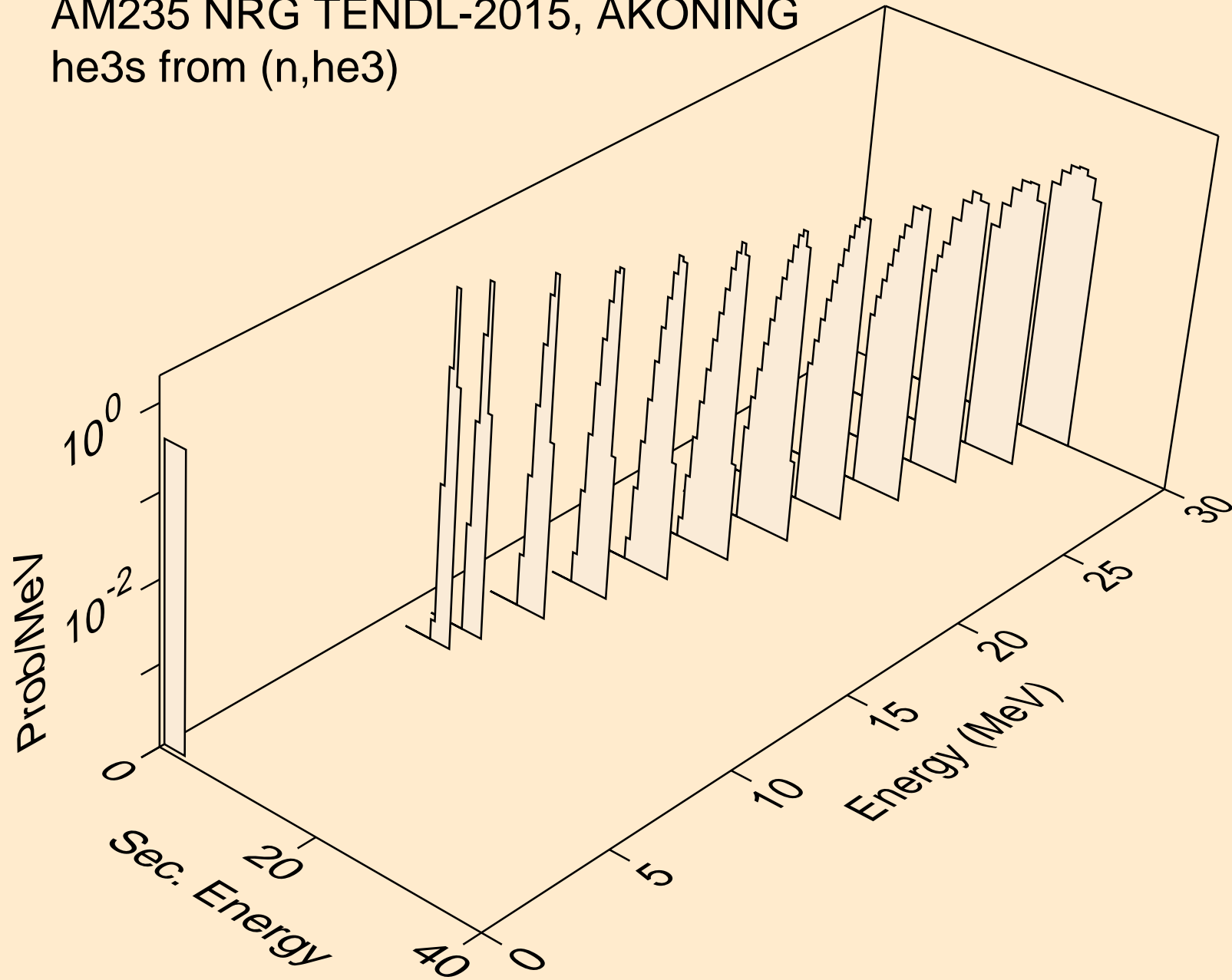

AM235 NRG TENDL-2015, AKONING  
alphas from (n,x)

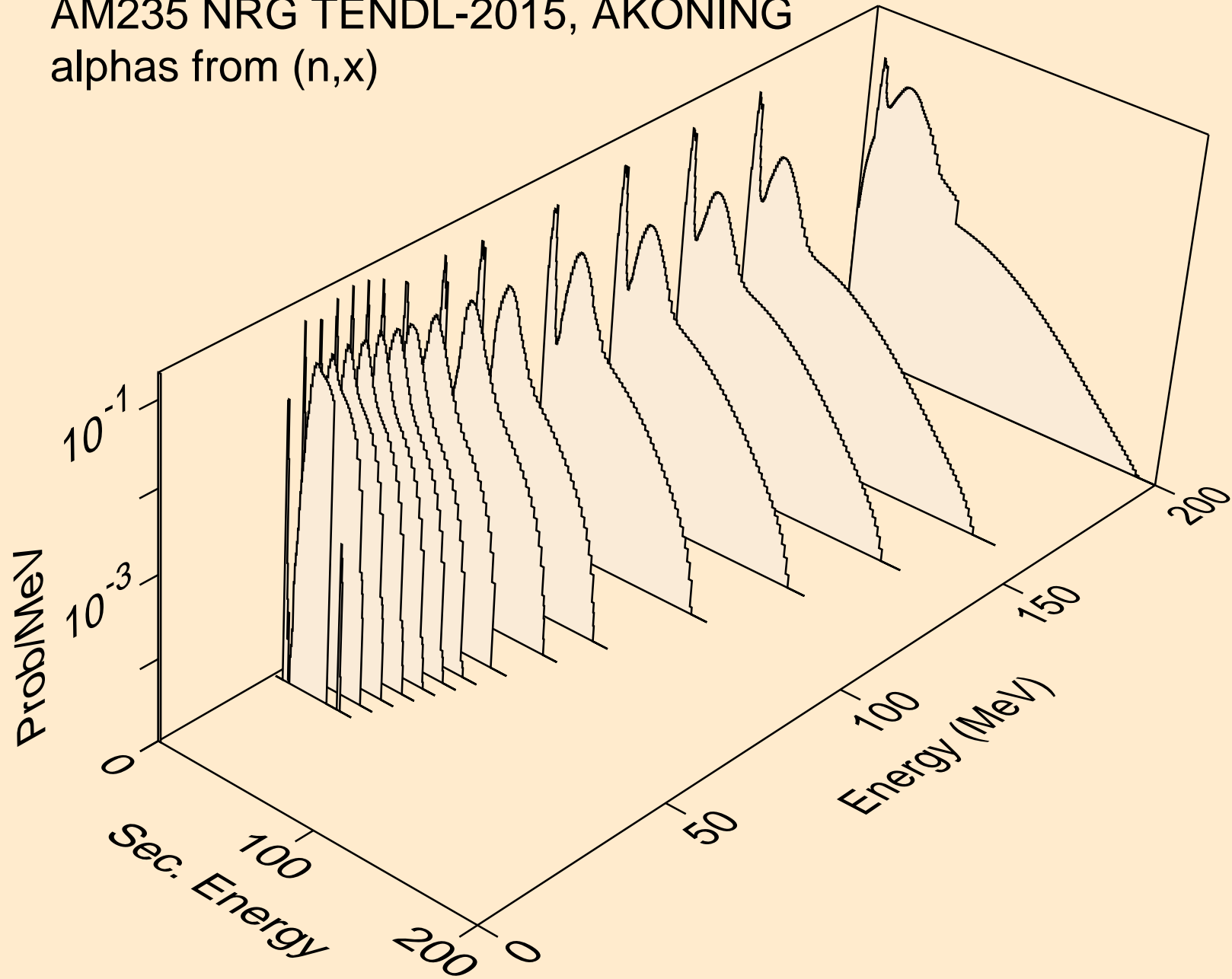

AM235 NRG TENDL-2015, AKONING  
alphas from (n,n\*)a

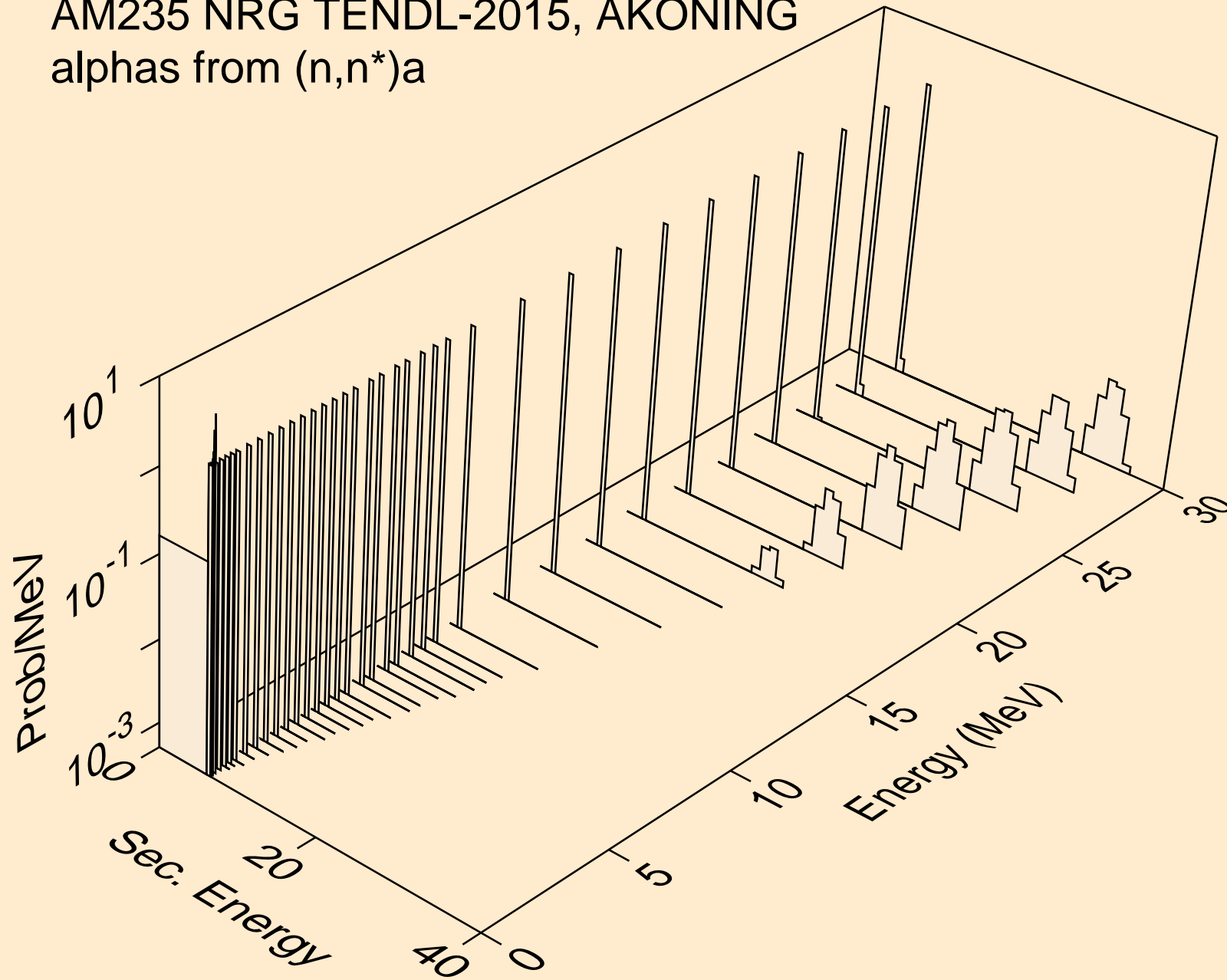



AM235 NRG TENDL-2015, AKONING  
alphas from (n,n\*)3a

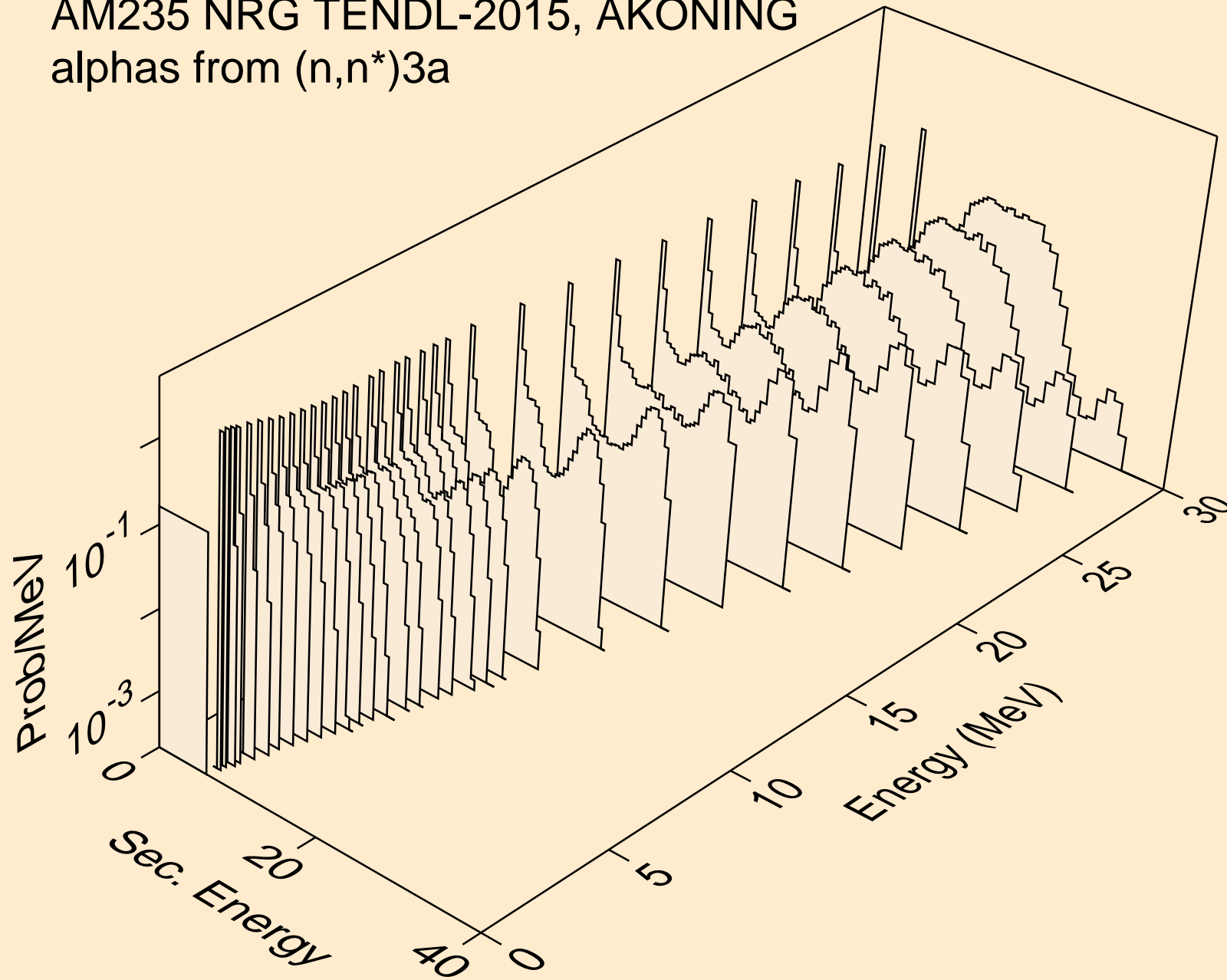

AM235 NRG TENDL-2015, AKONING  
alphas from (n,2n)a

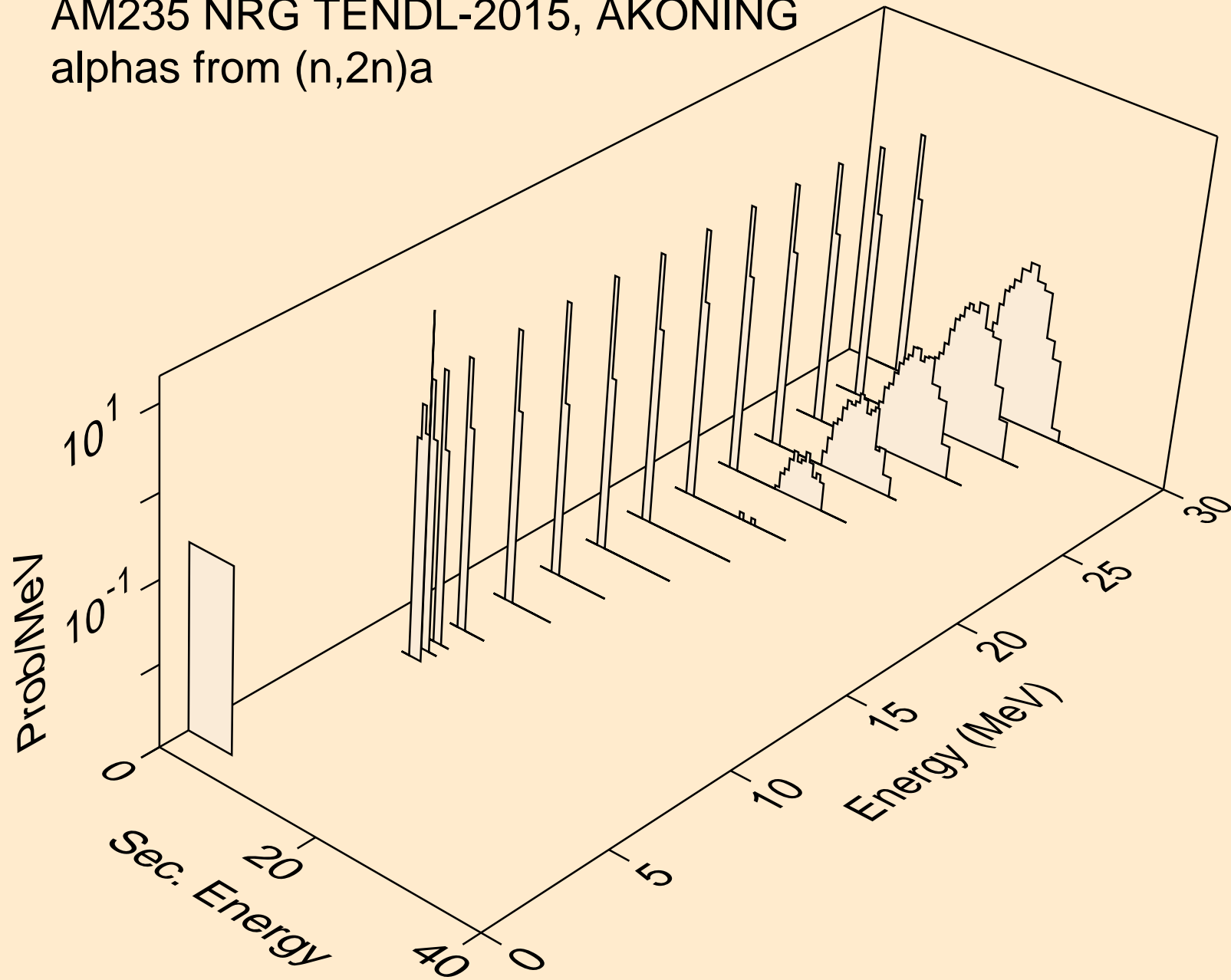

AM235 NRG TENDL-2015, AKONING  
alphas from (n,3n)a

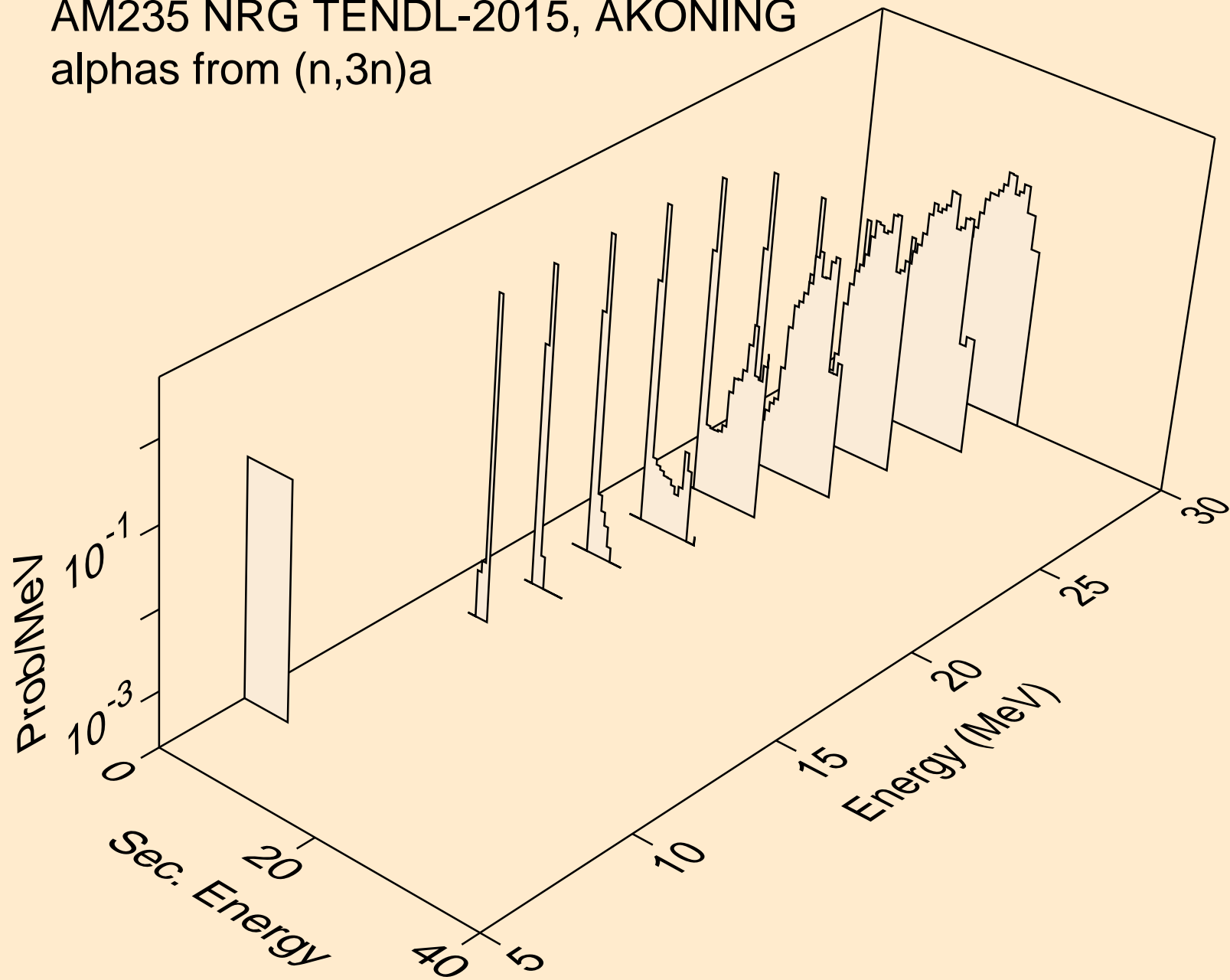

AM235 NRG TENDL-2015, AKONING  
alphas from (n,n\*)2a

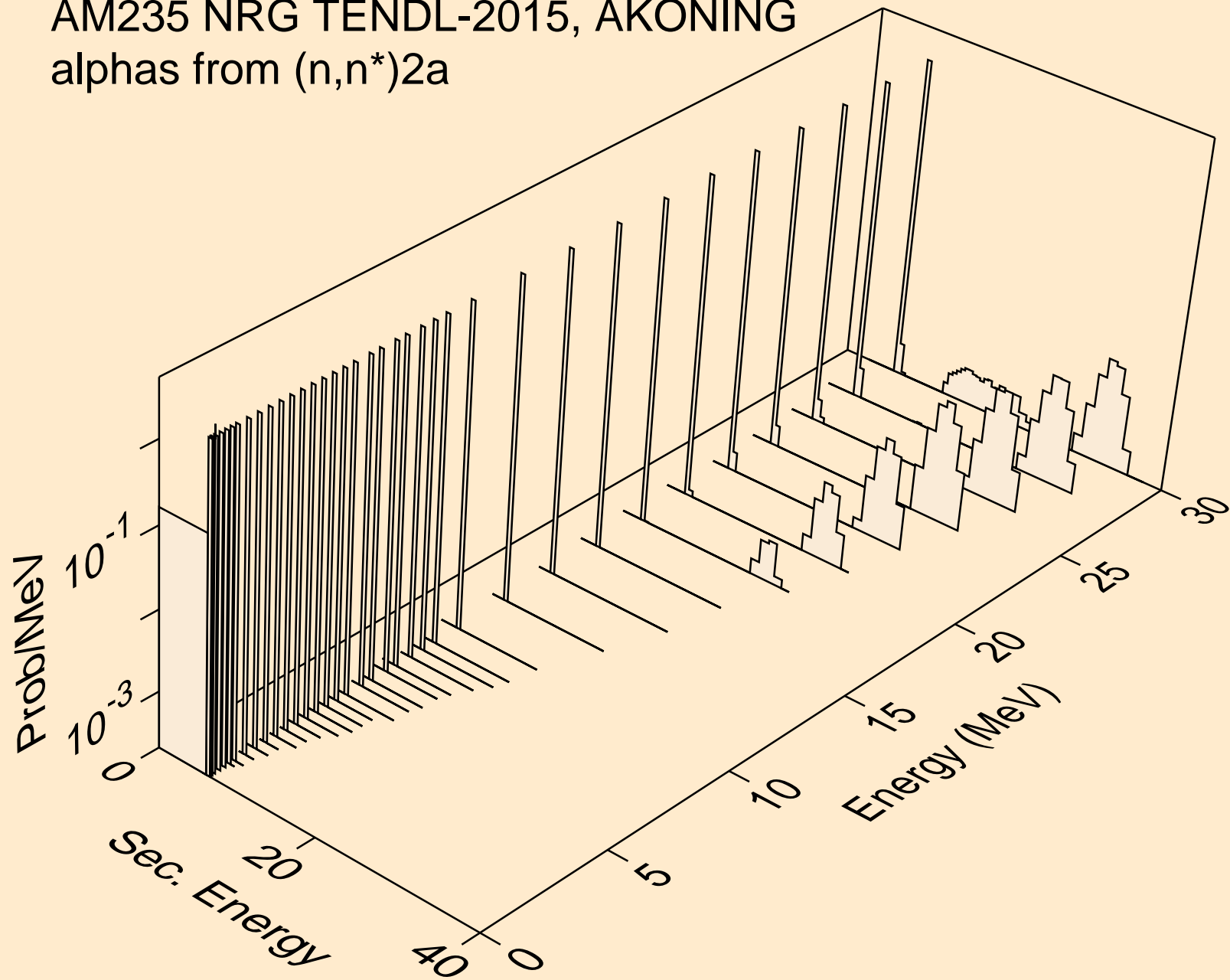

AM235 NRG TENDL-2015, AKONING  
alphas from (n,2n)2a

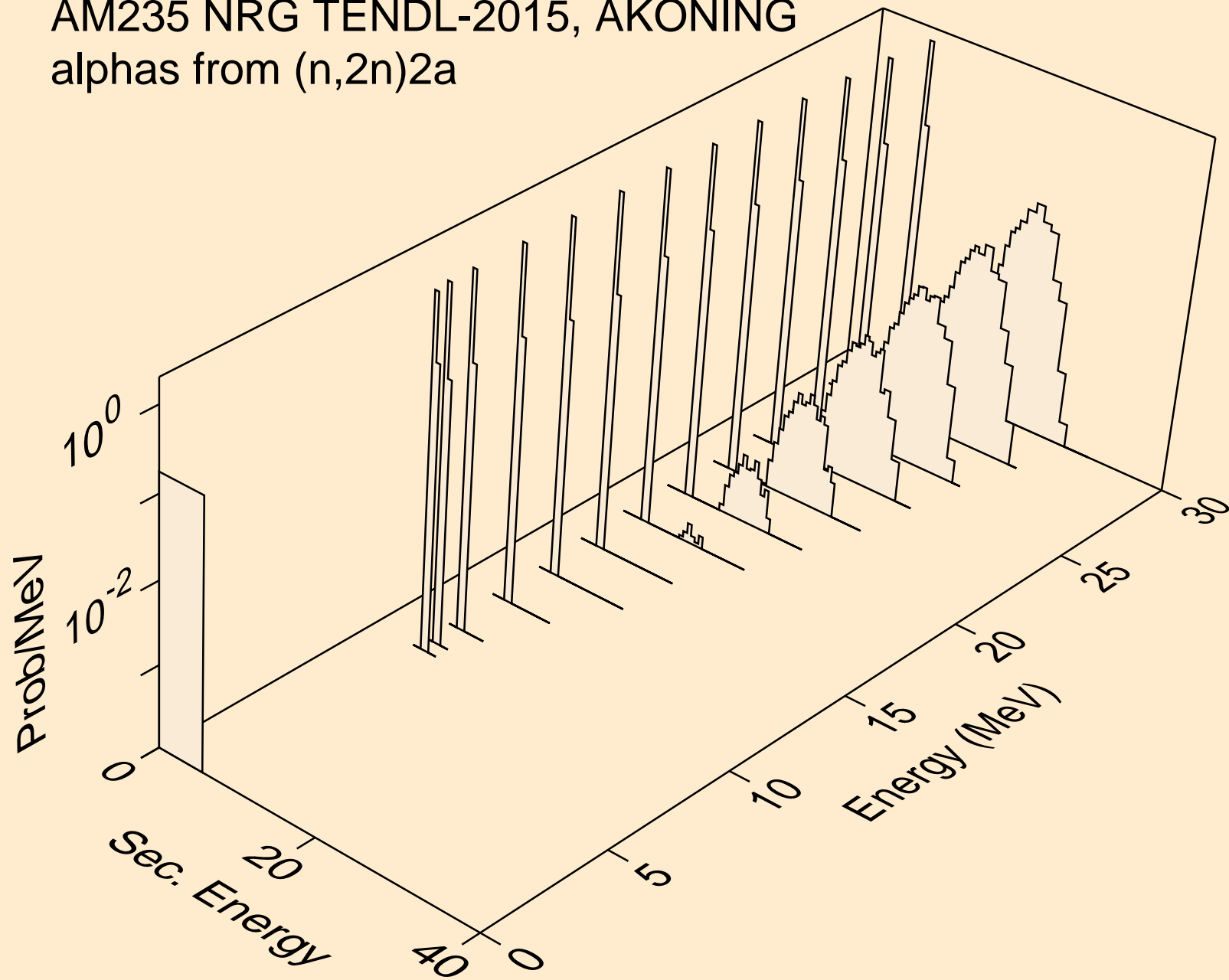

AM235 NRG TENDL-2015, AKONING  
alphas from (n,npa)

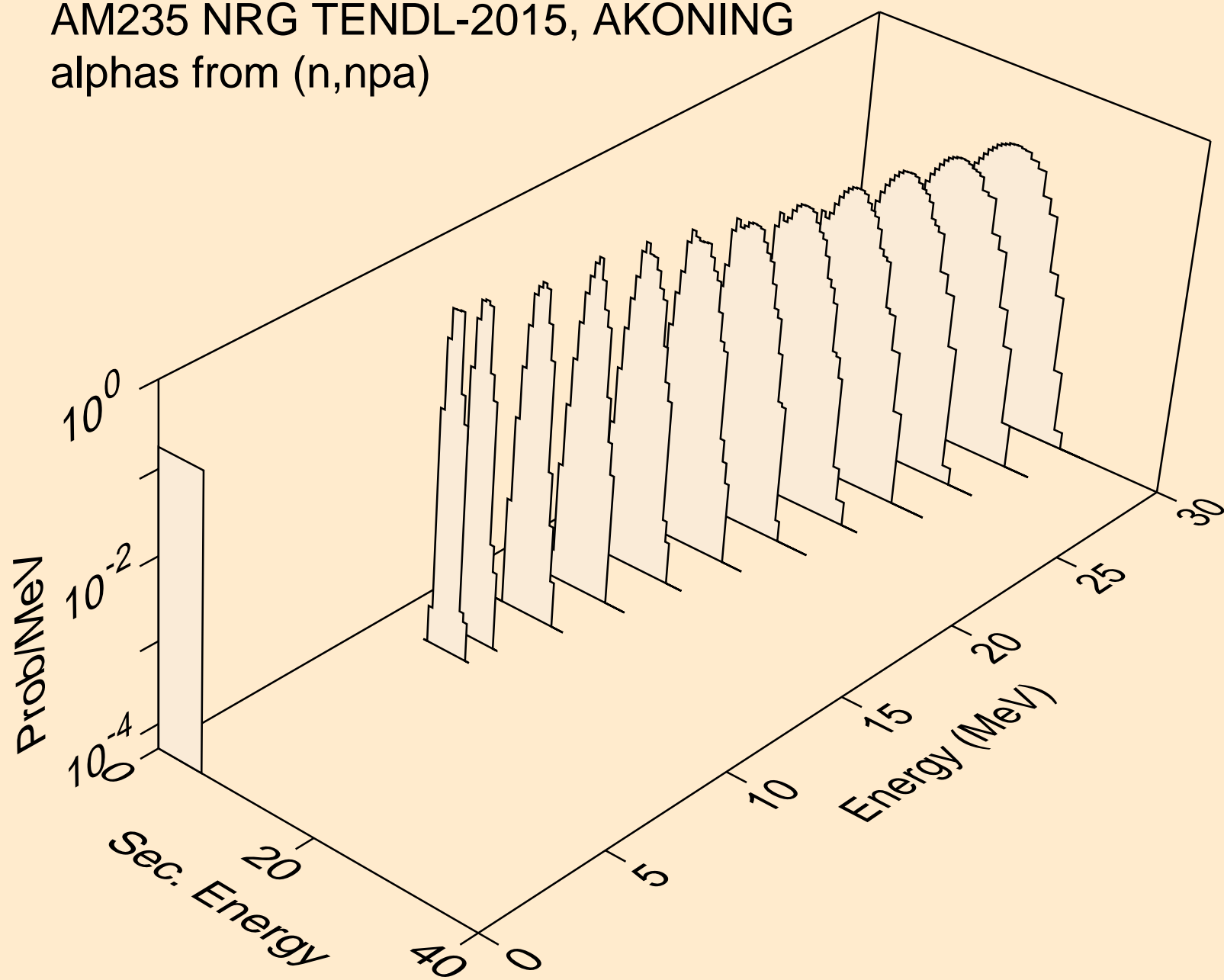

AM235 NRG TENDL-2015, AKONING  
alphas from (n,a)

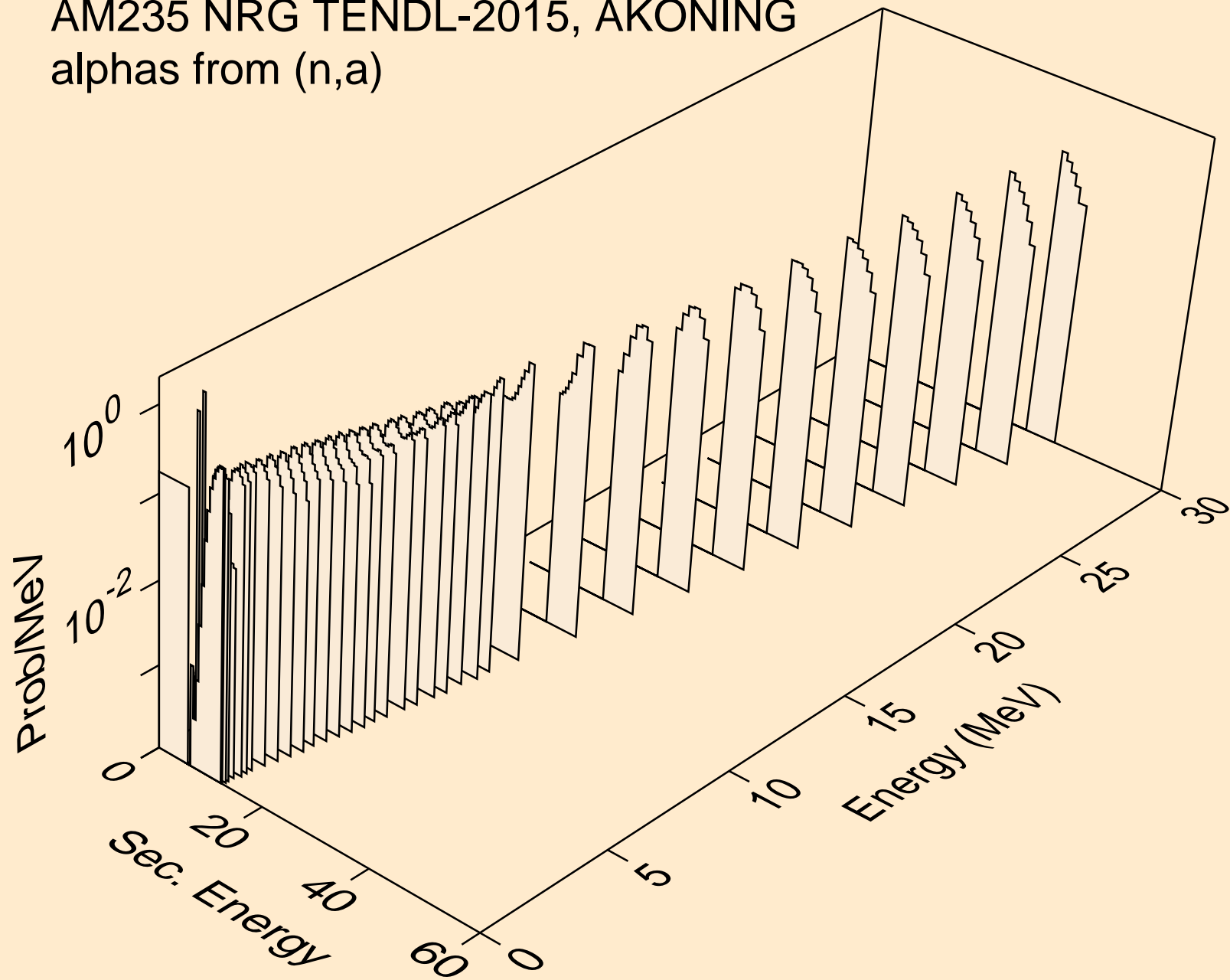

AM235 NRG TENDL-2015, AKONING  
alphas from (n,2a)

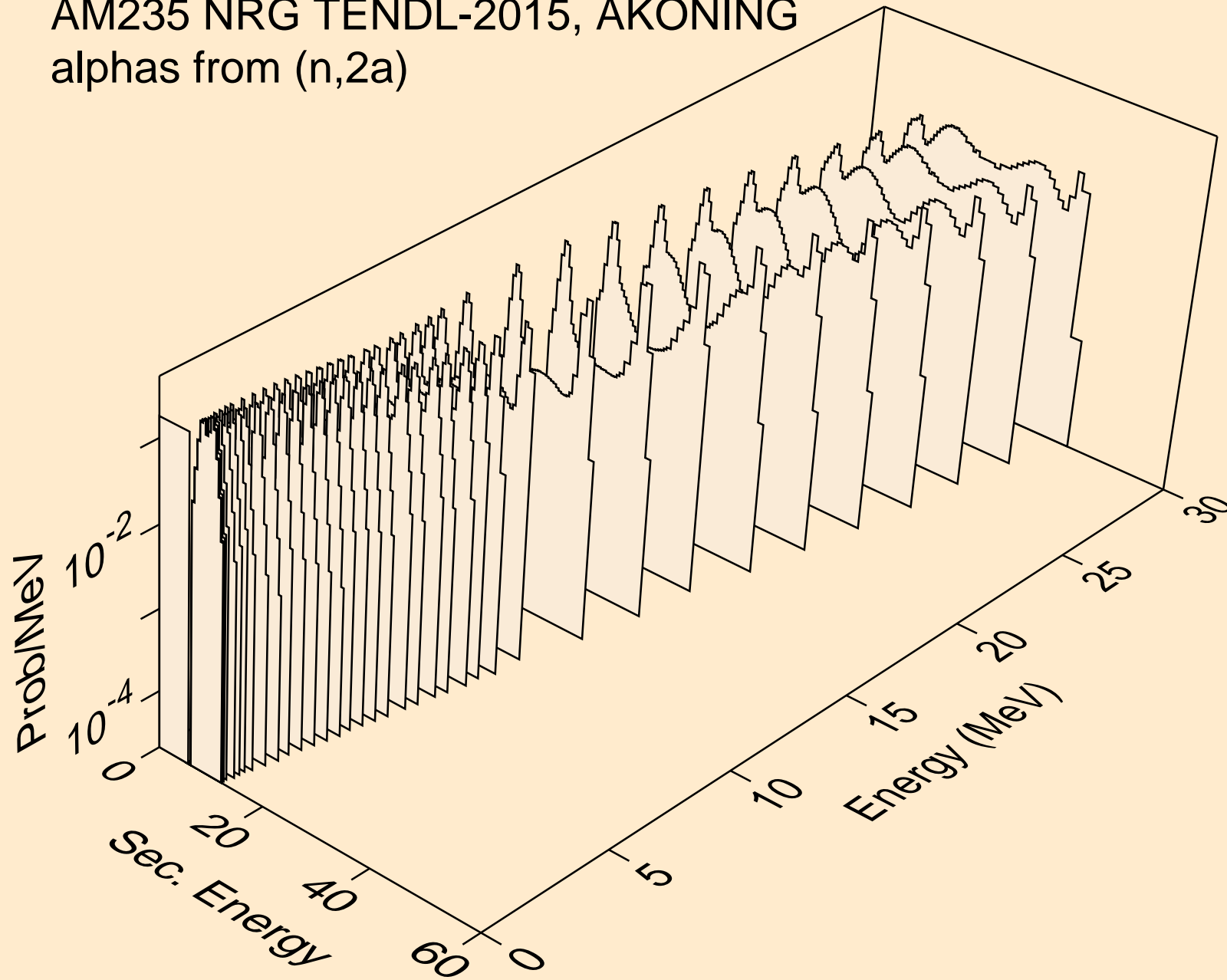



AM235 NRG TENDL-2015, AKONING  
alphas from (n,pa)

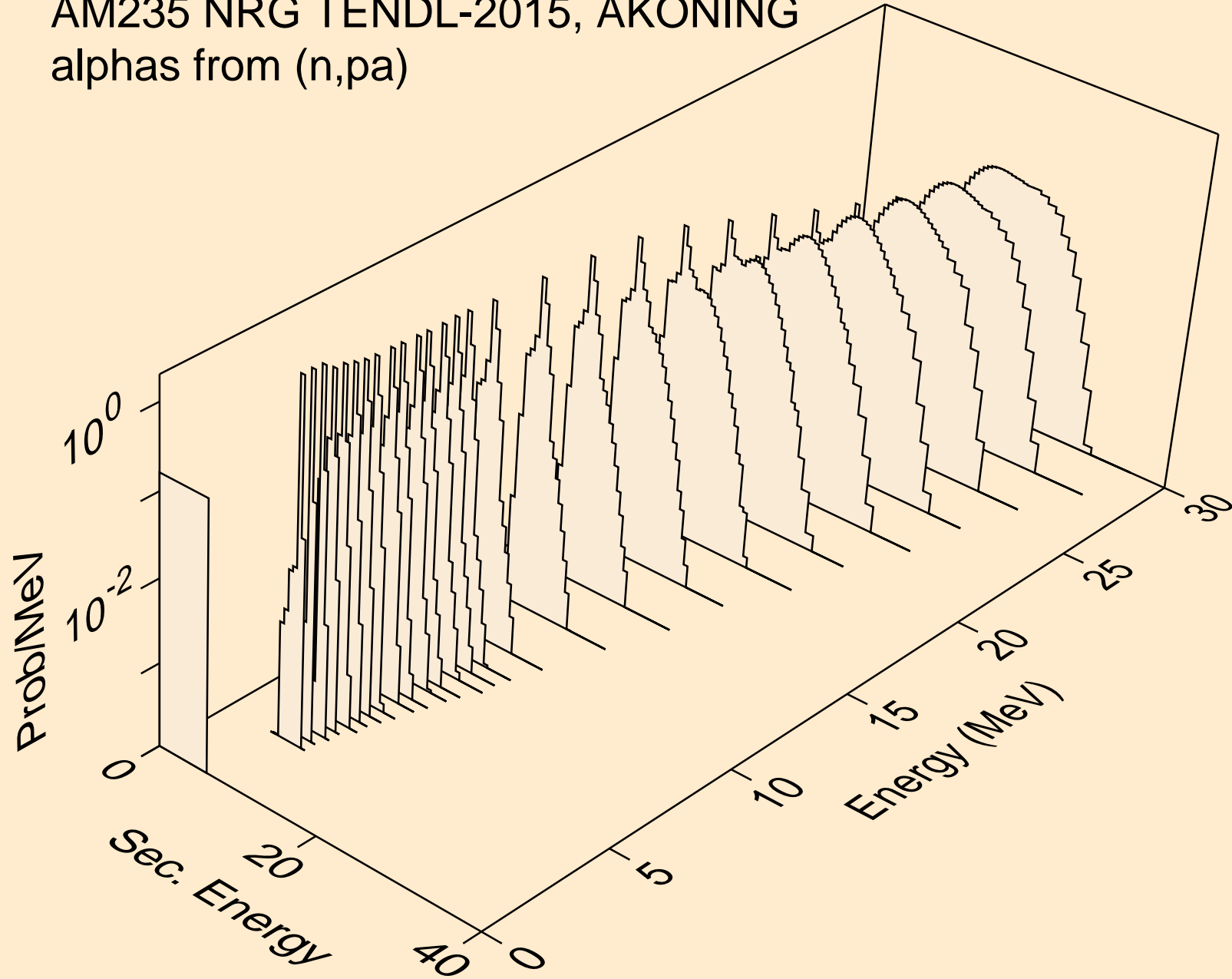

AM235 NRG TENDL-2015, AKONING  
alphas from (n,t2a)

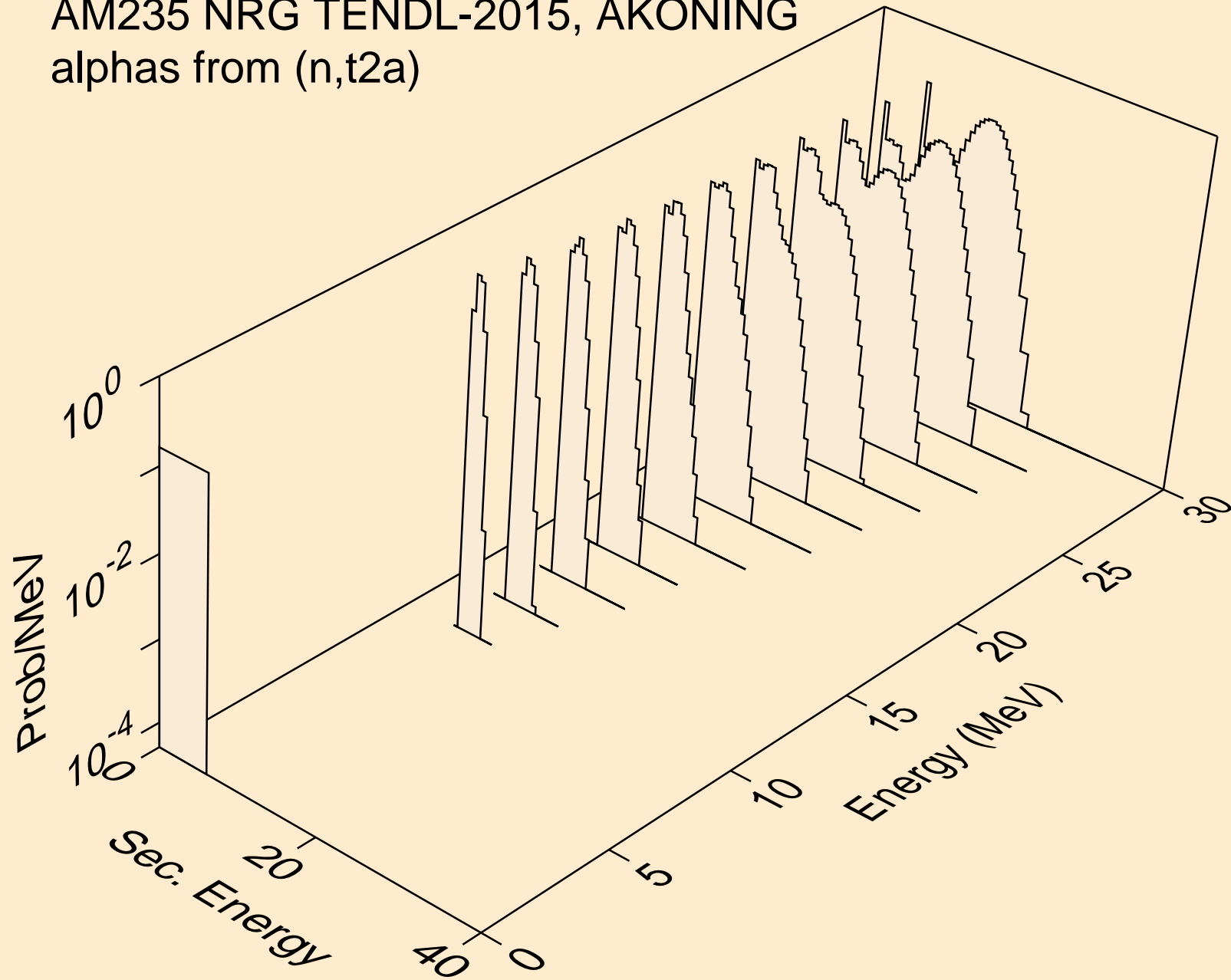

AM235 NRG TENDL-2015, AKONING  
alphas from (n,da)

