

AM236 NRG TENDL-2015, AKONING

Principal cross sections

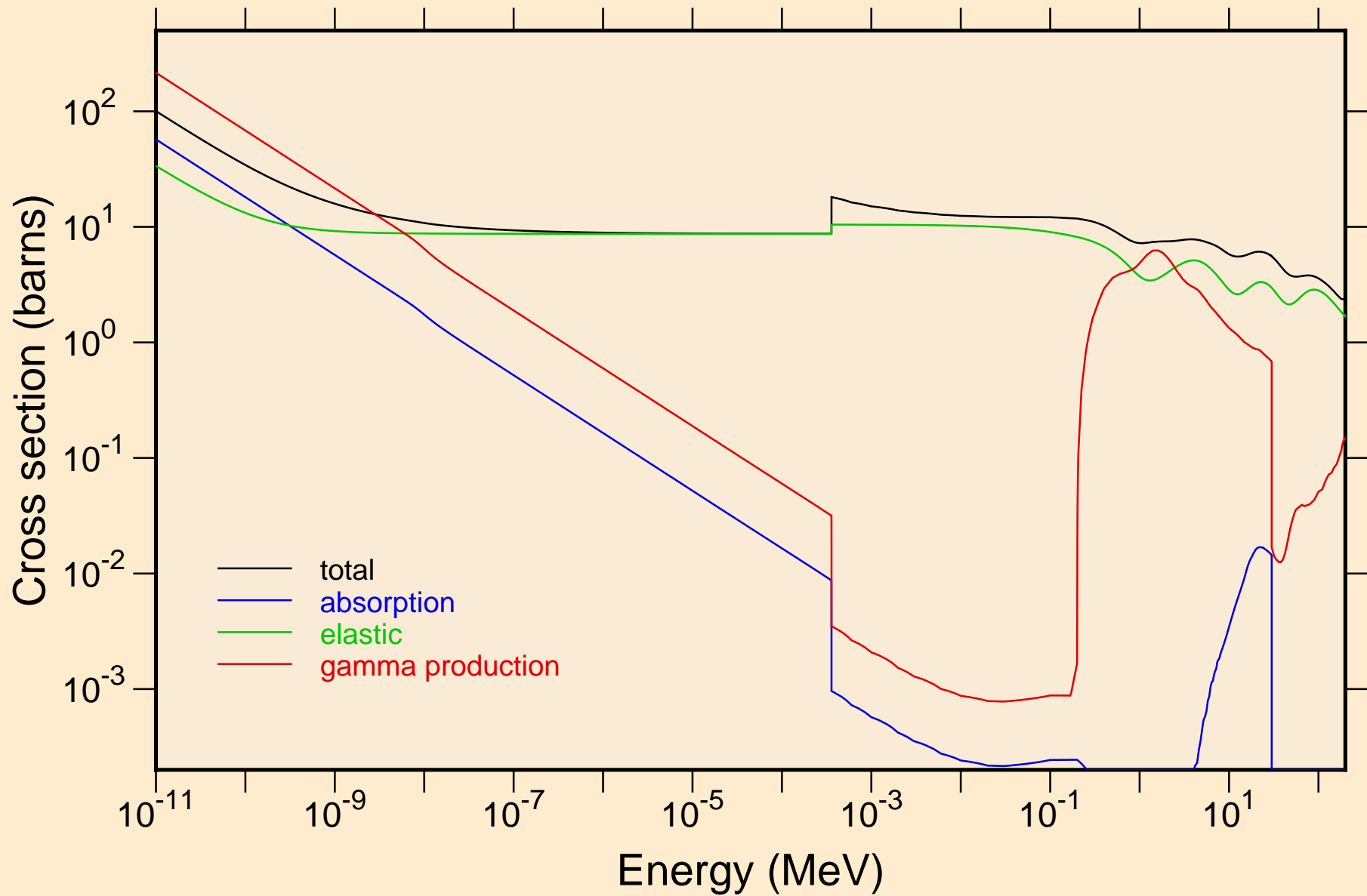

AM236 NRG TENDL-2015, AKONING

Non-threshold reactions

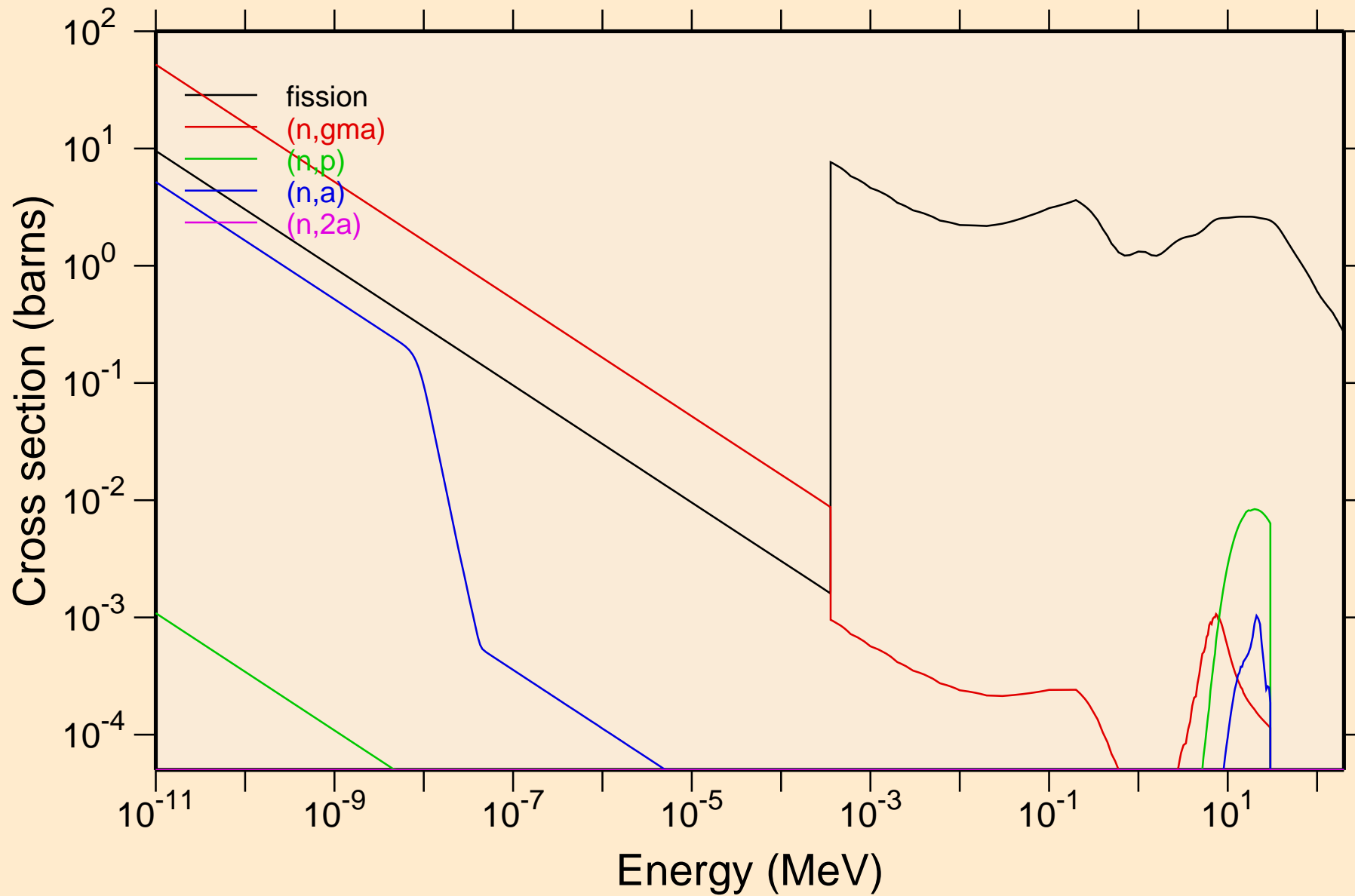

AM236 NRG TENDL-2015, AKONING
Non-threshold reactions

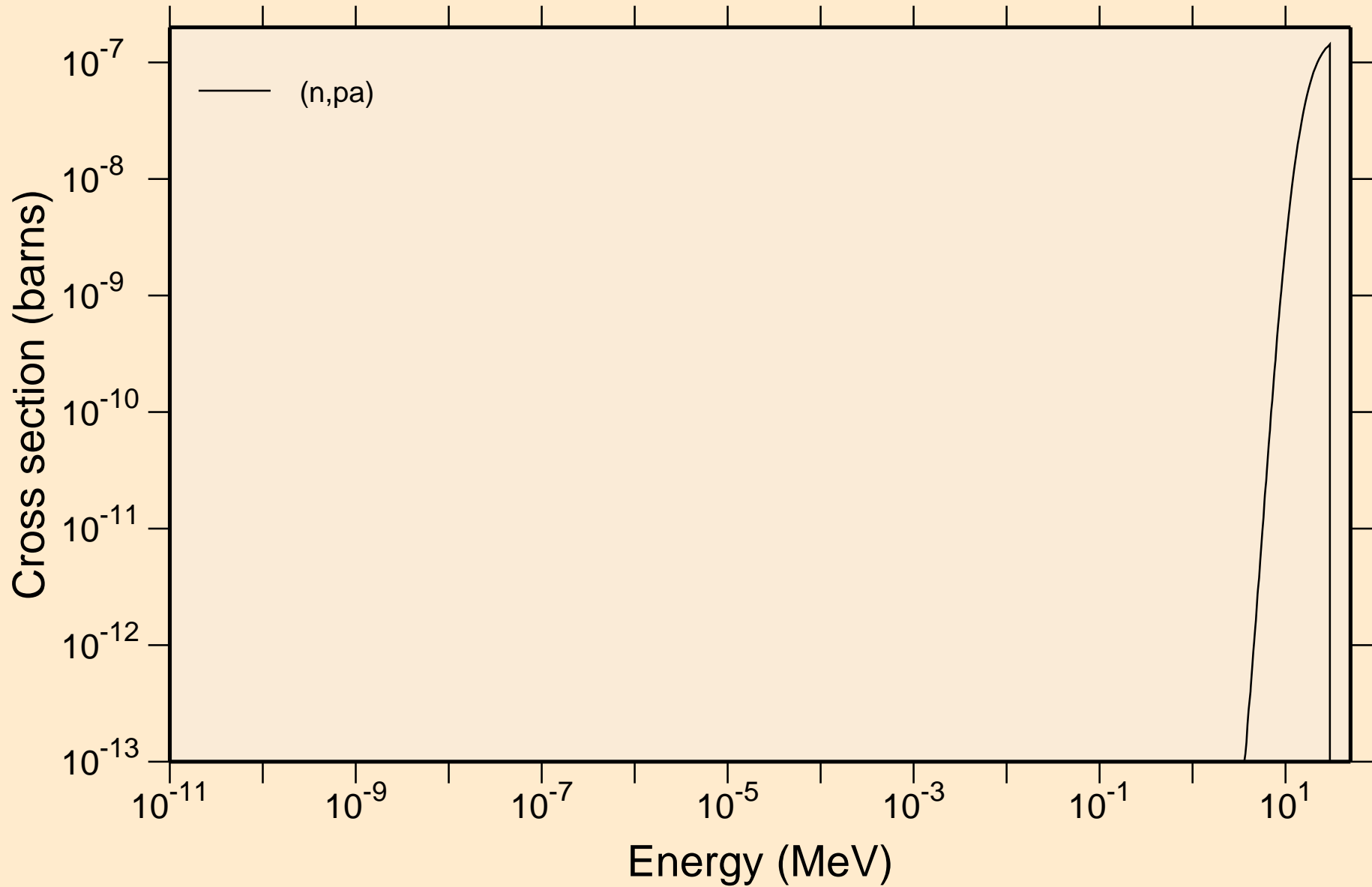

AM236 NRG TENDL-2015, AKONING

Principal cross sections

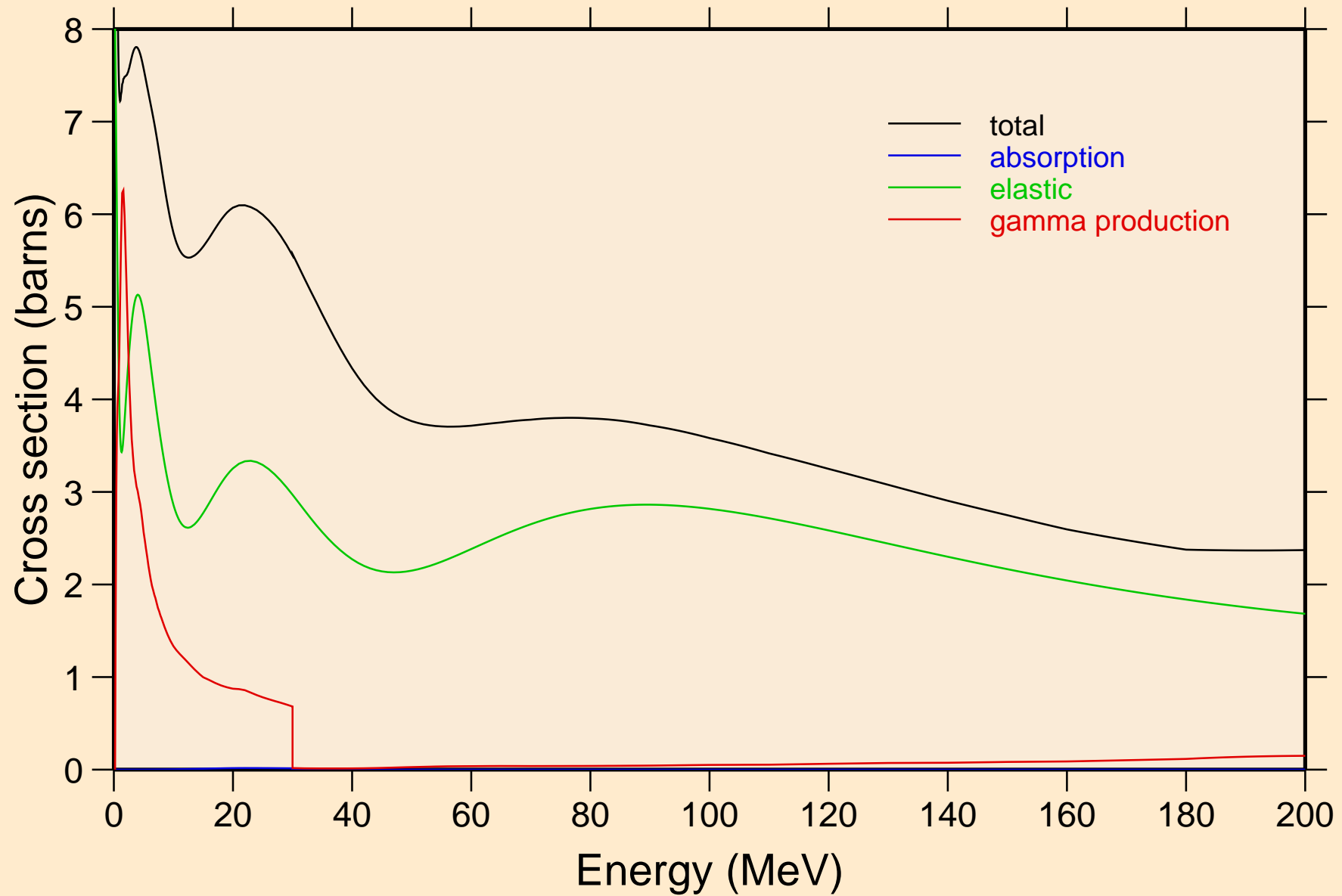

AM236 NRG TENDL-2015, AKONING

Non-threshold reactions

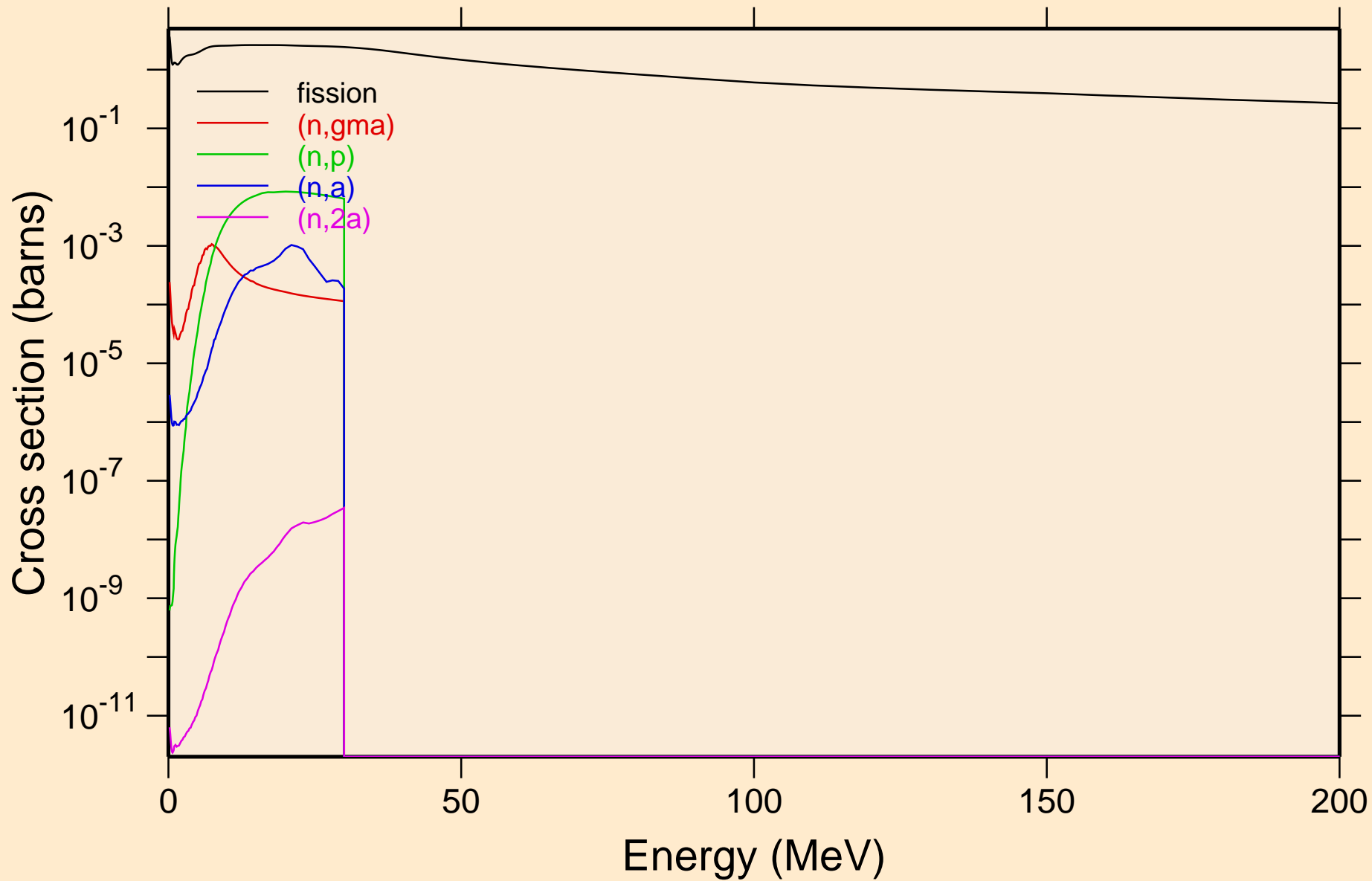

AM236 NRG TENDL-2015, AKONING
Non-threshold reactions

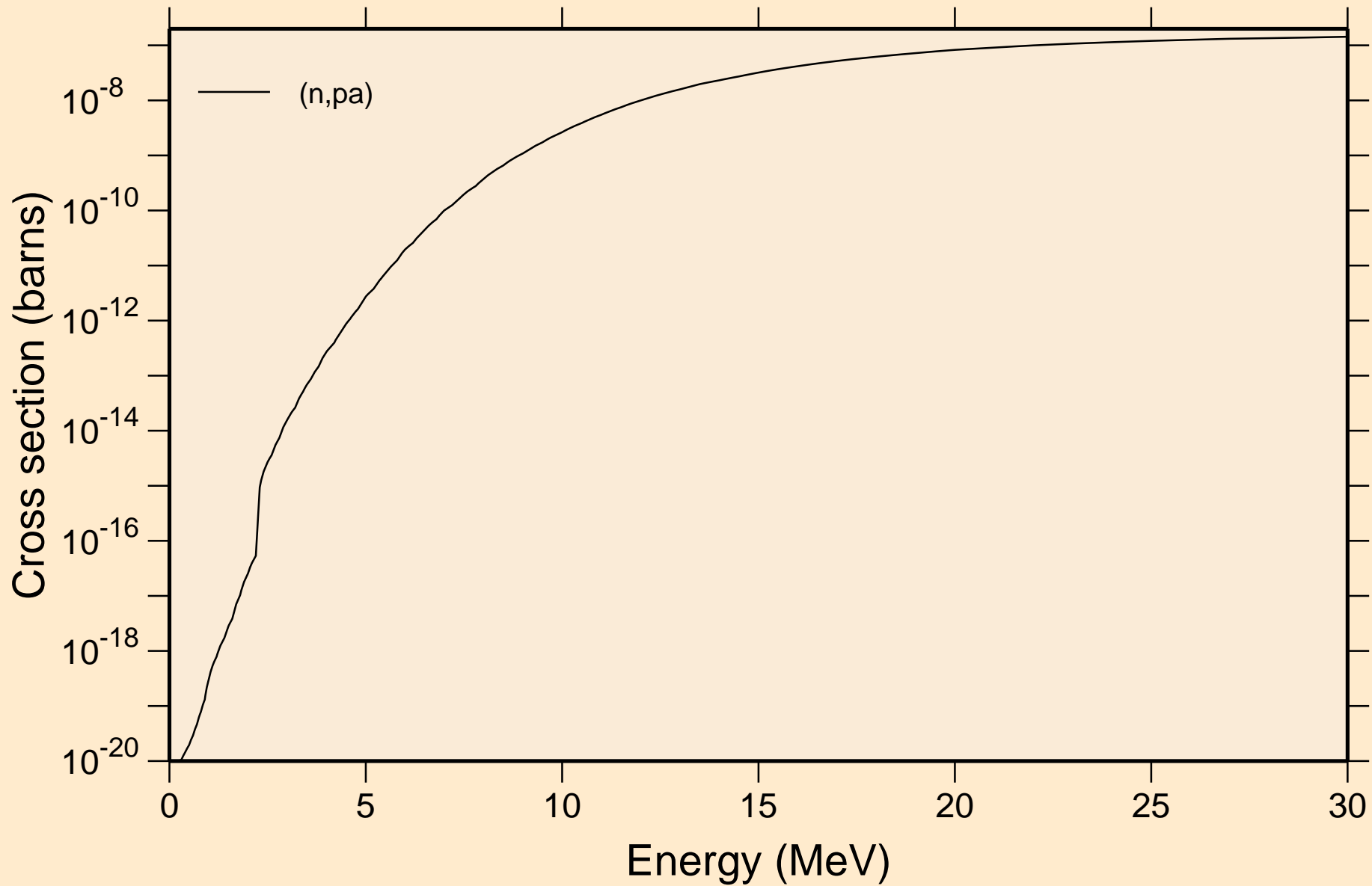

AM236 NRG TENDL-2015, AKONING

Inelastic levels

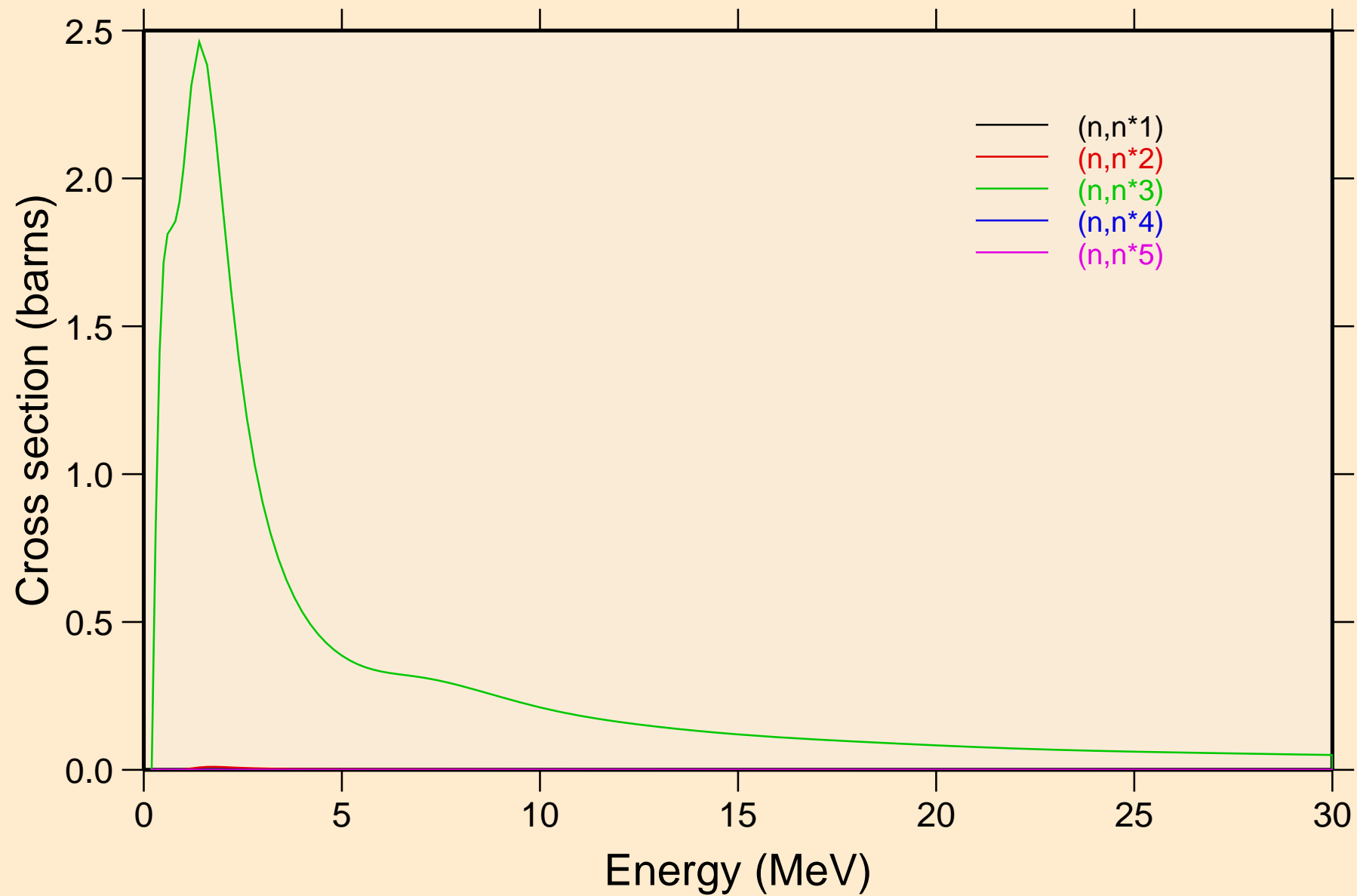

AM236 NRG TENDL-2015, AKONING

Inelastic levels

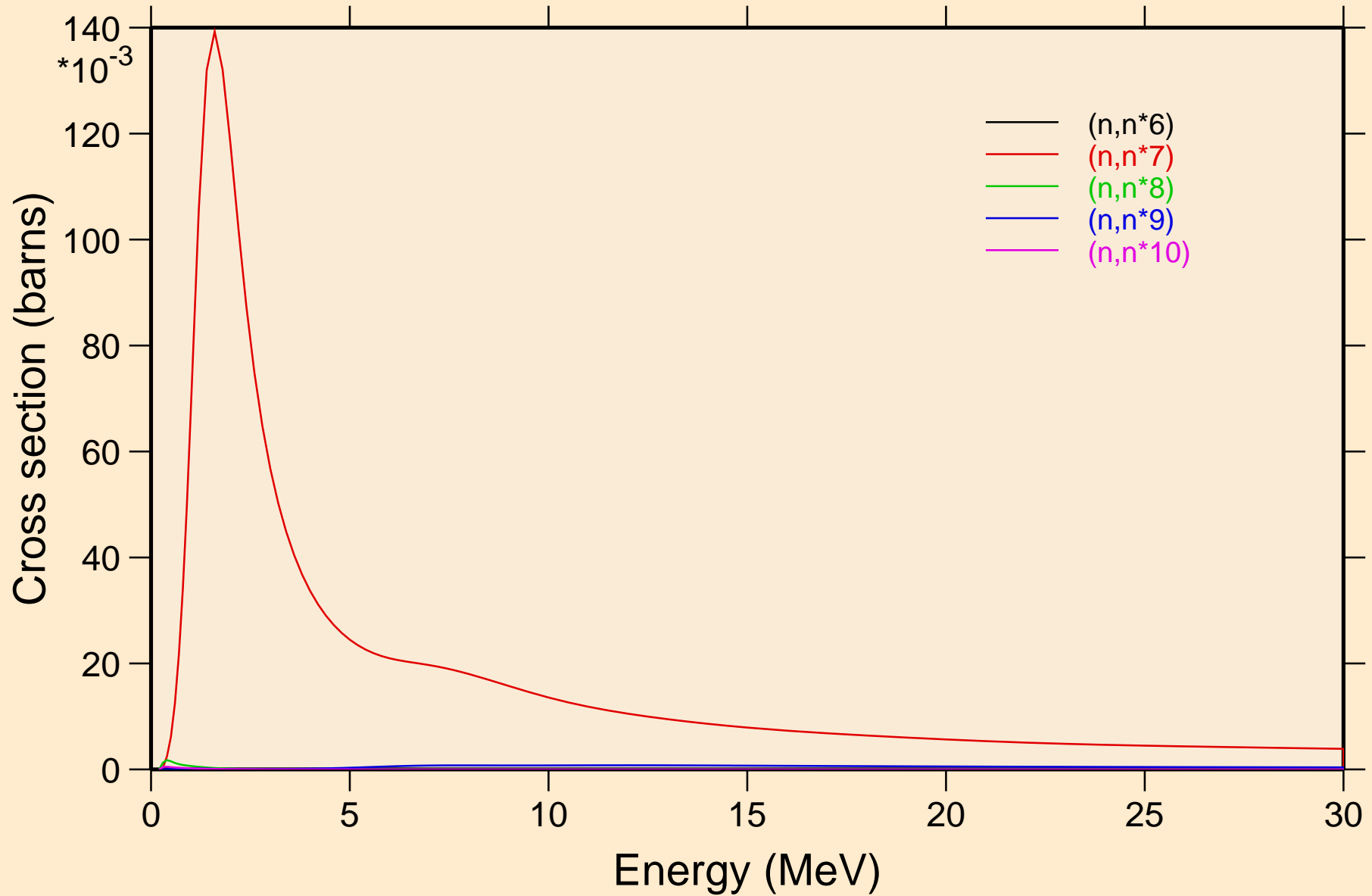

AM236 NRG TENDL-2015, AKONING

Inelastic levels

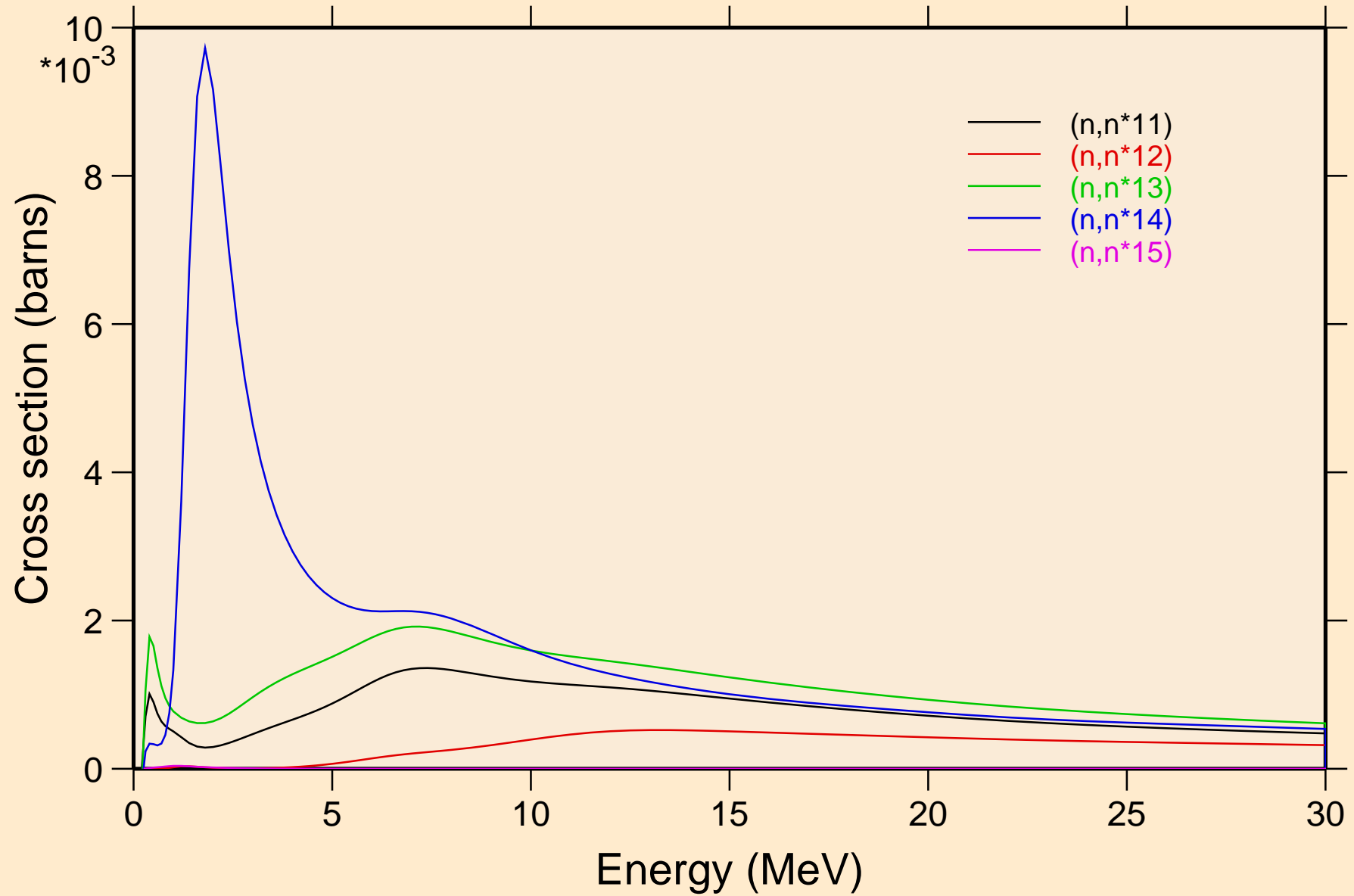

AM236 NRG TENDL-2015, AKONING

Inelastic levels

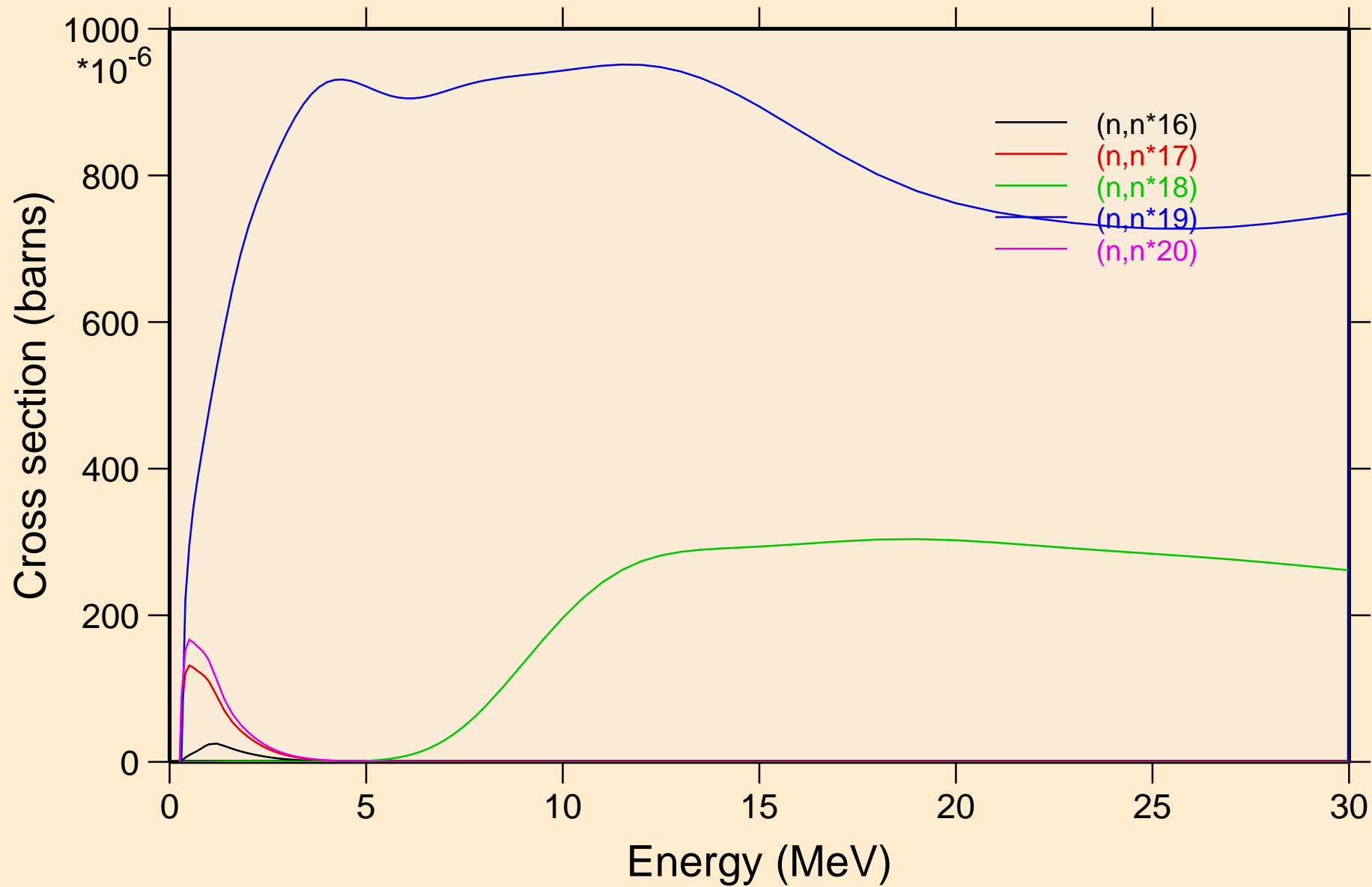

AM236 NRG TENDL-2015, AKONING

Inelastic levels

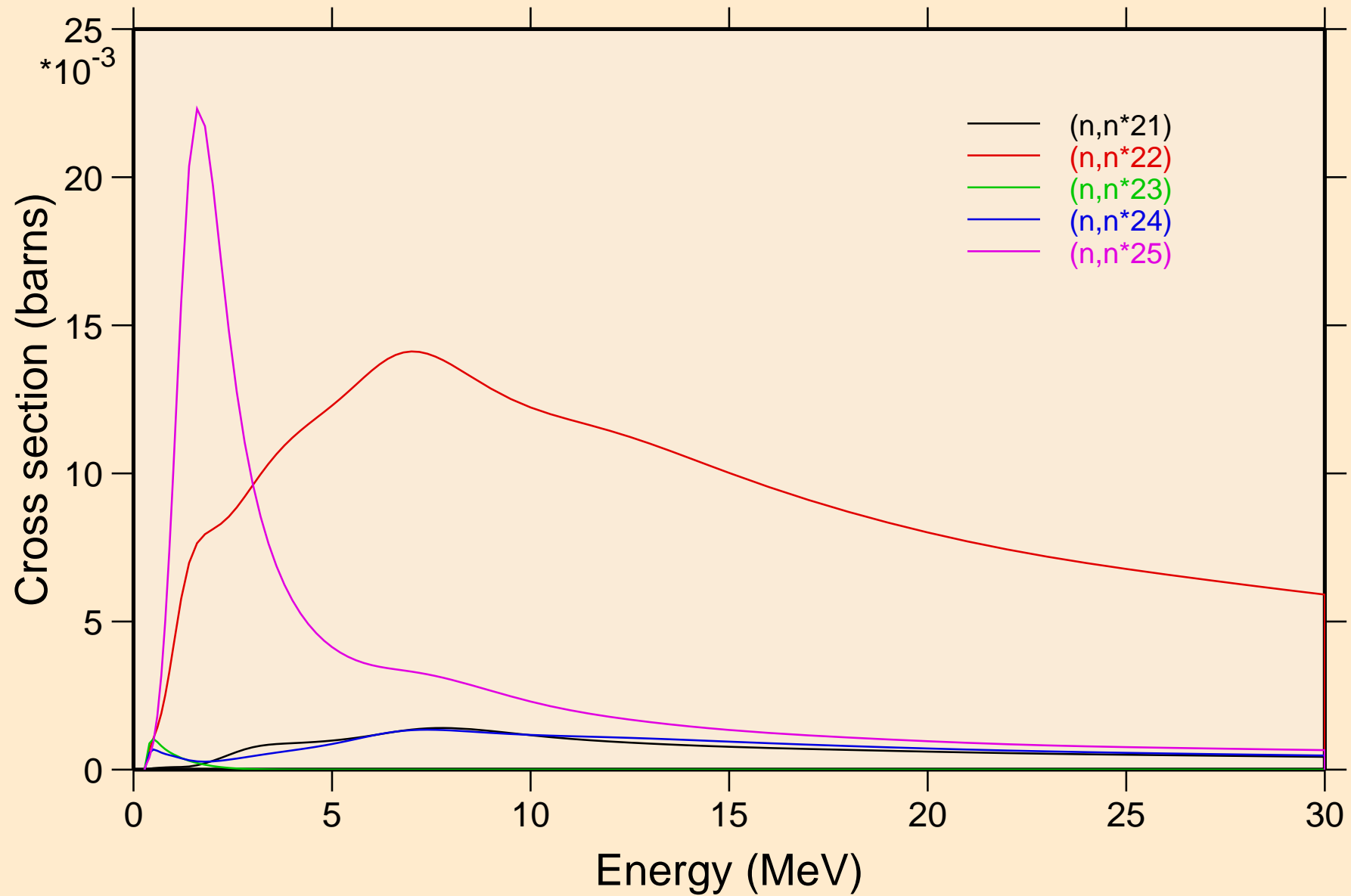

AM236 NRG TENDL-2015, AKONING

Inelastic levels

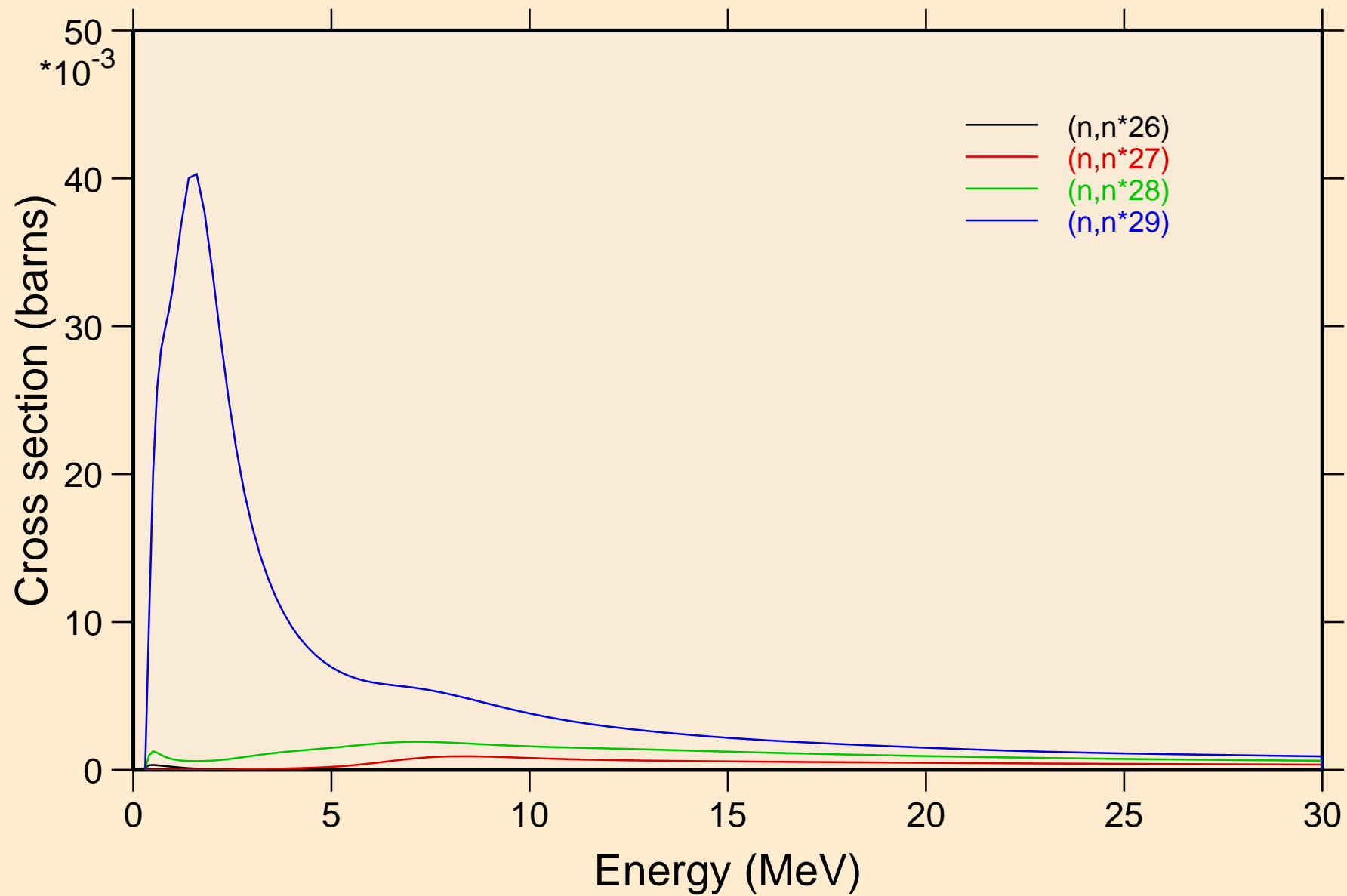

AM236 NRG TENDL-2015, AKONING

Threshold reactions

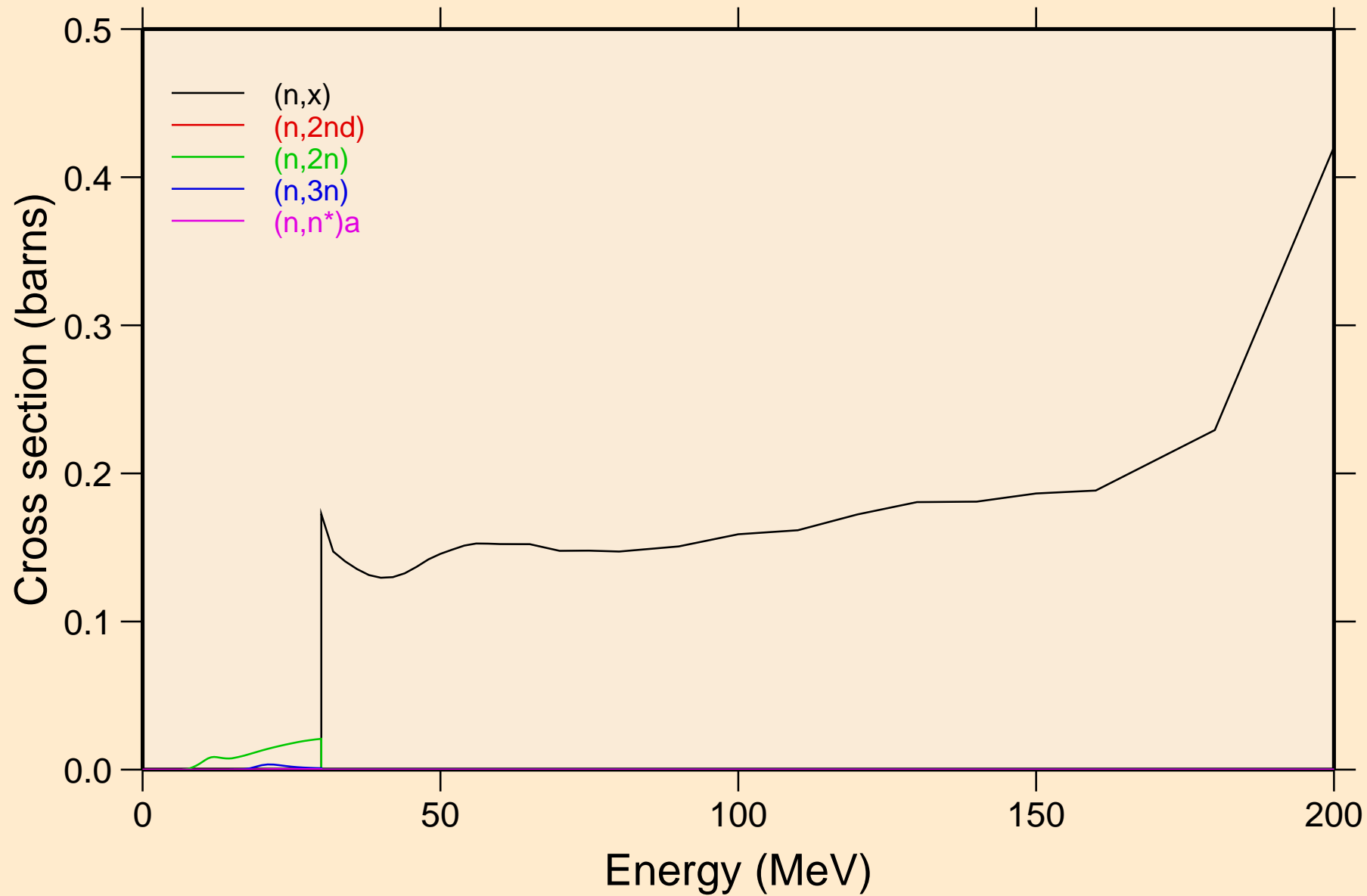

AM236 NRG TENDL-2015, AKONING

Threshold reactions

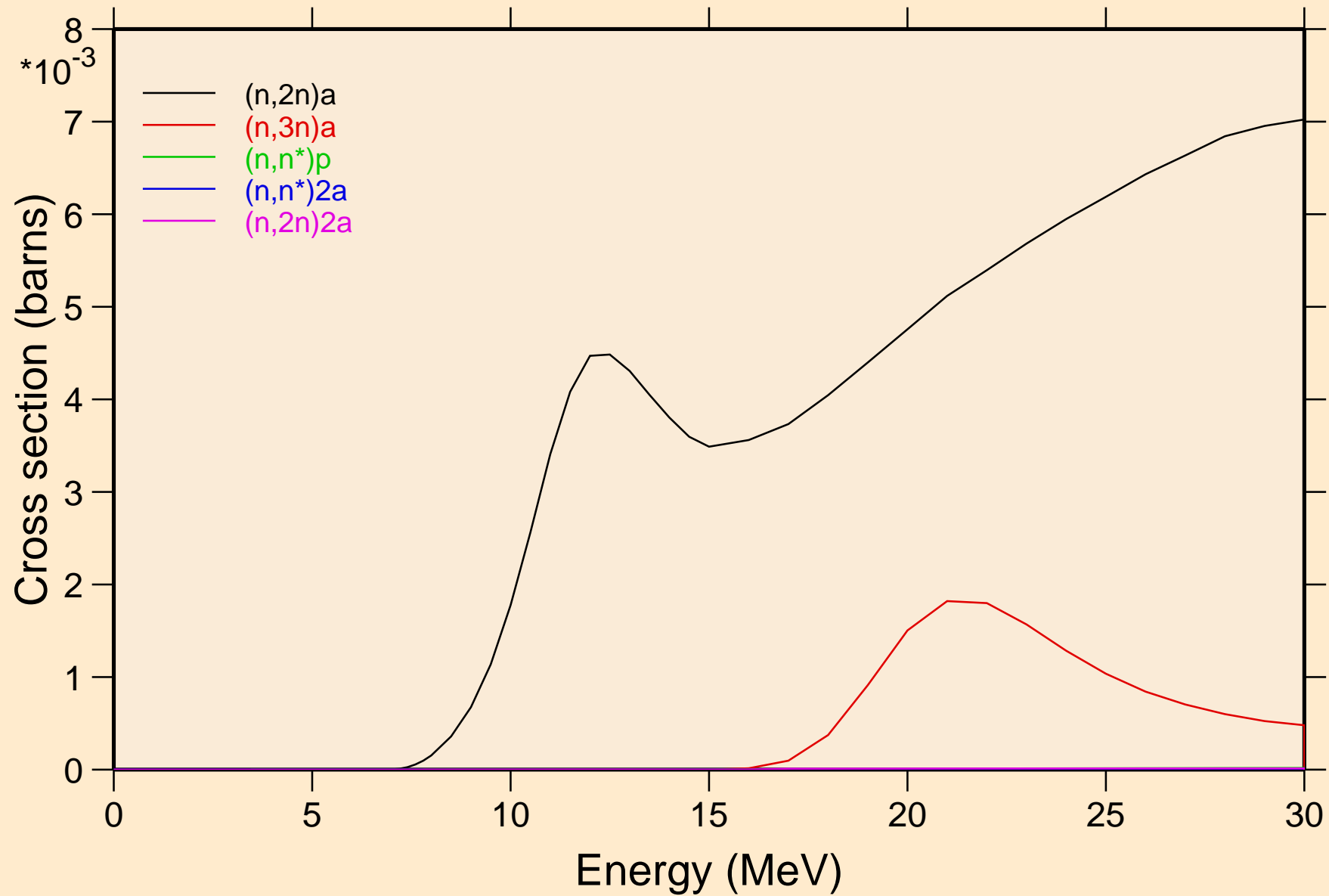

AM236 NRG TENDL-2015, AKONING

Threshold reactions

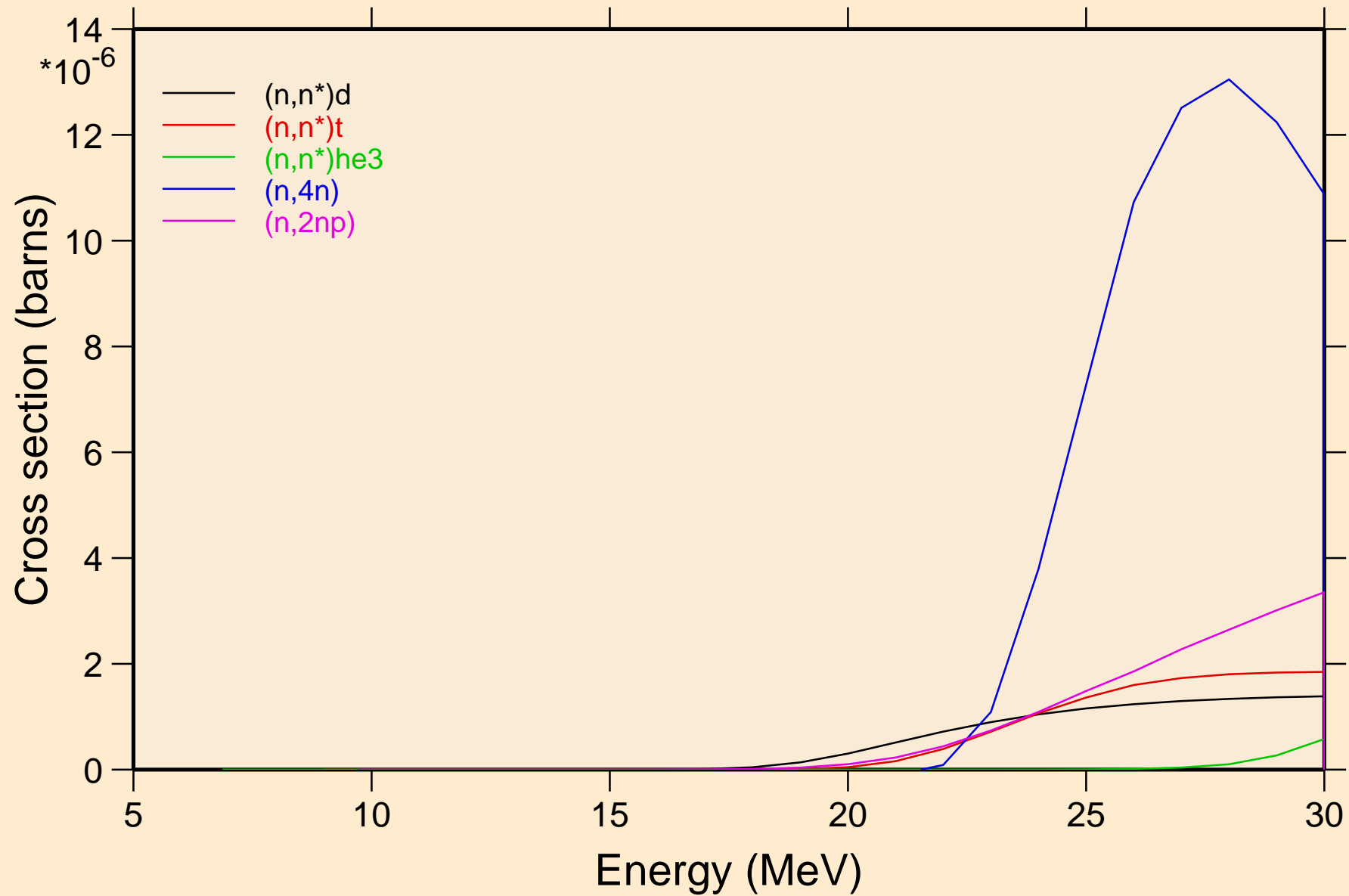

AM236 NRG TENDL-2015, AKONING

Threshold reactions

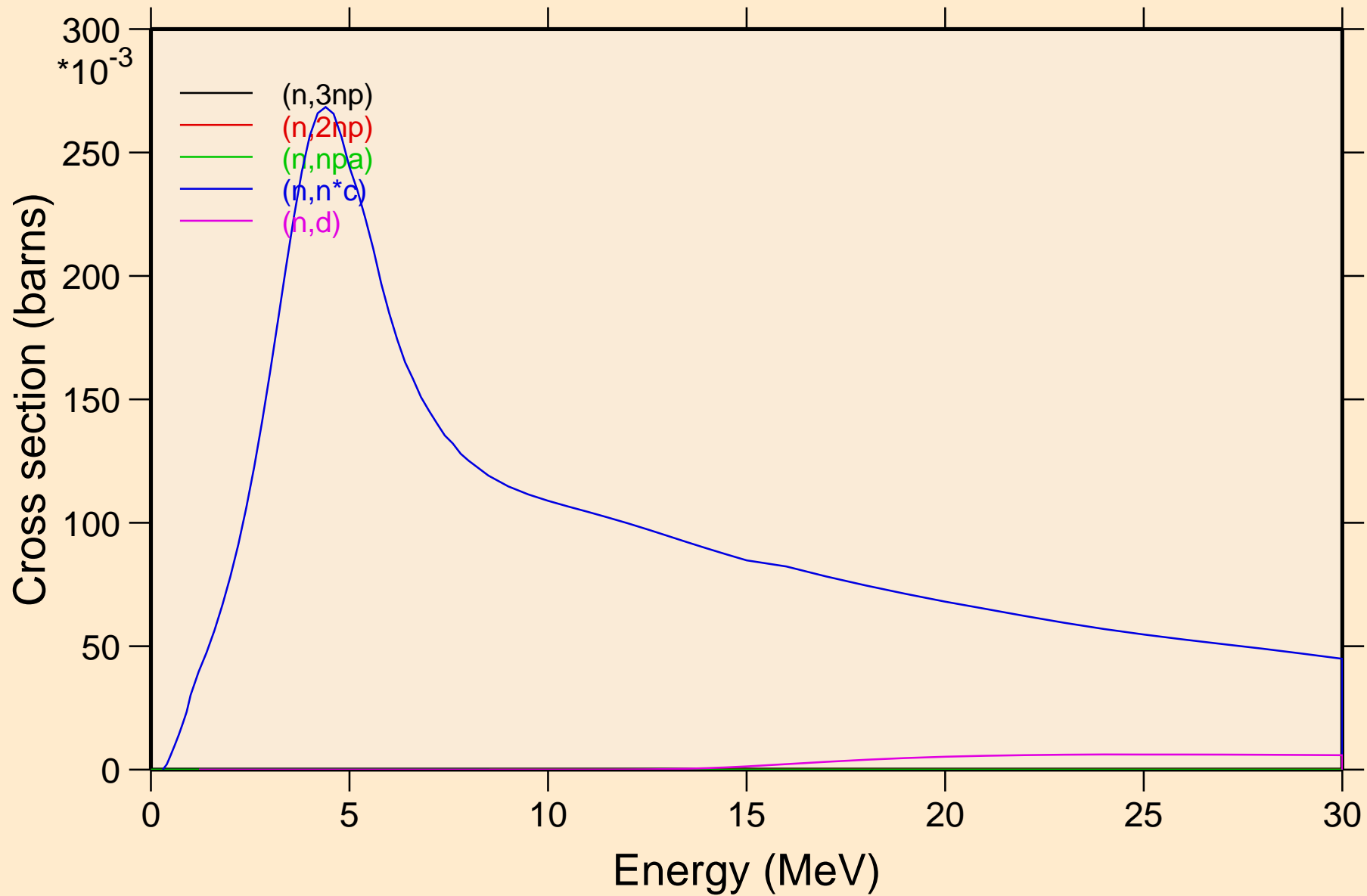

AM236 NRG TENDL-2015, AKONING

Threshold reactions

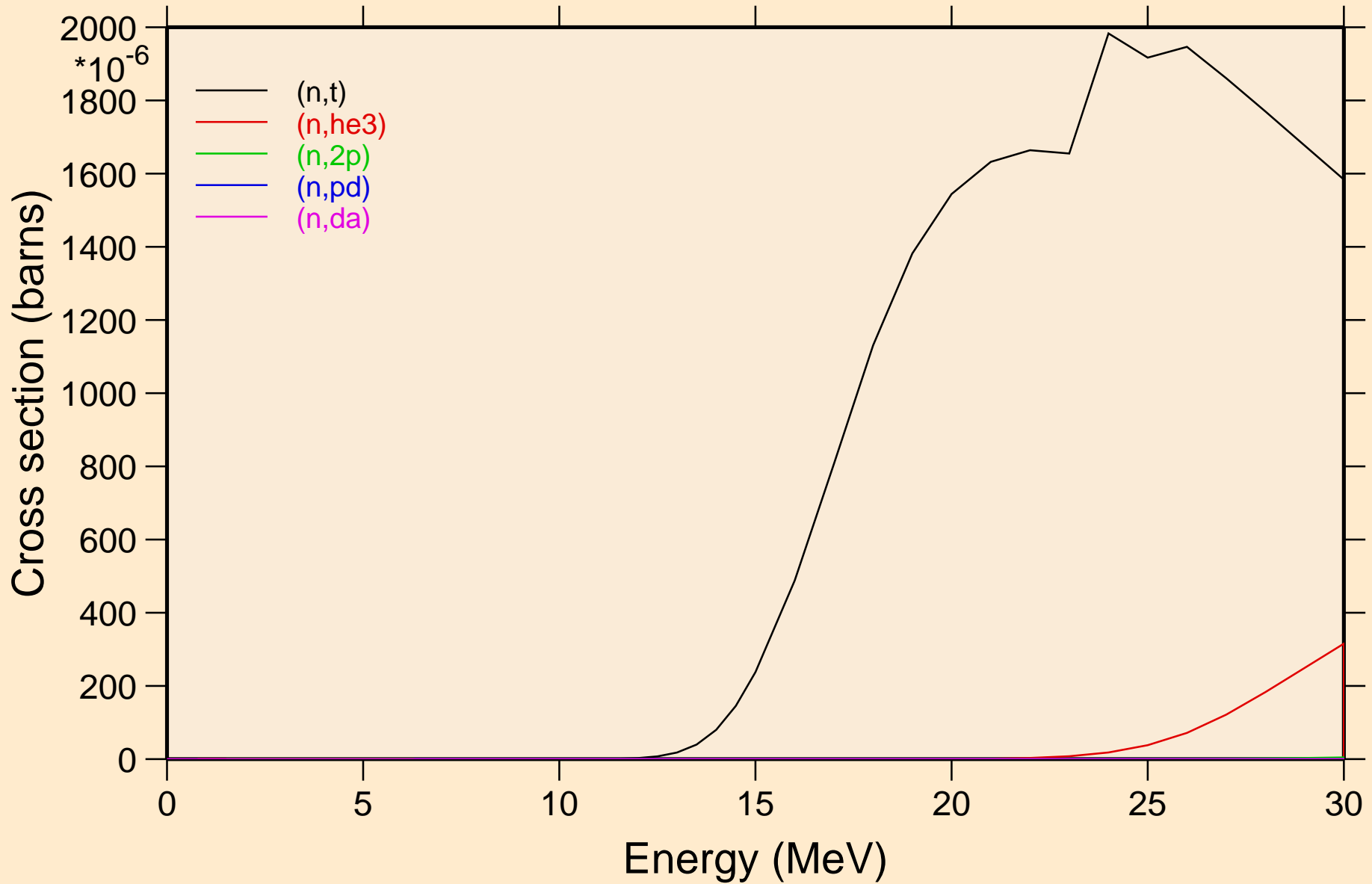

AM236 NRG TENDL-2015, AKONING
angular distribution for elastic

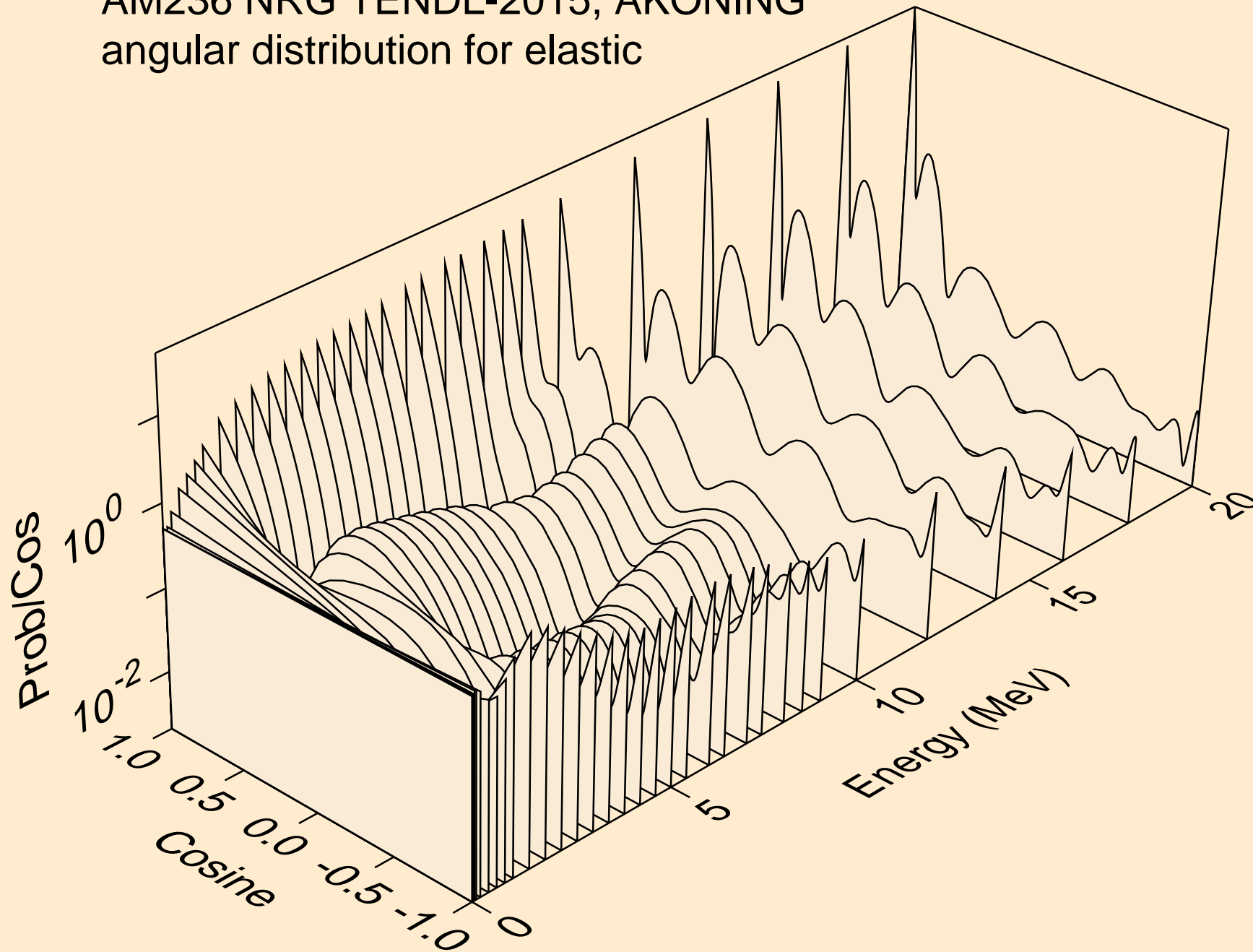

AM236 NRG TENDL-2015, AKONING
angular distribution for elastic

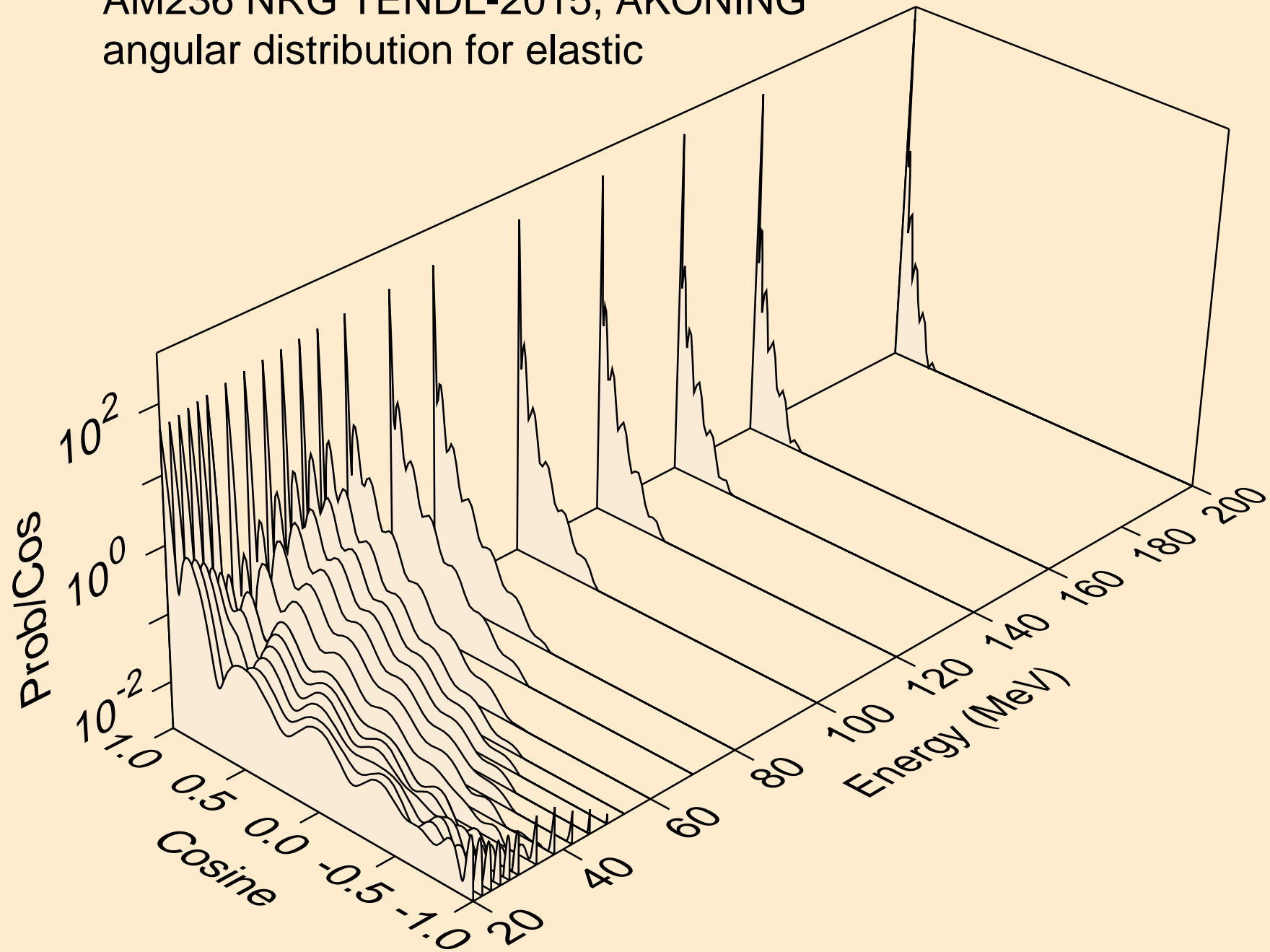

AM236 NRG TENDL-2015, AKONING
angular distribution for (n,n*1)

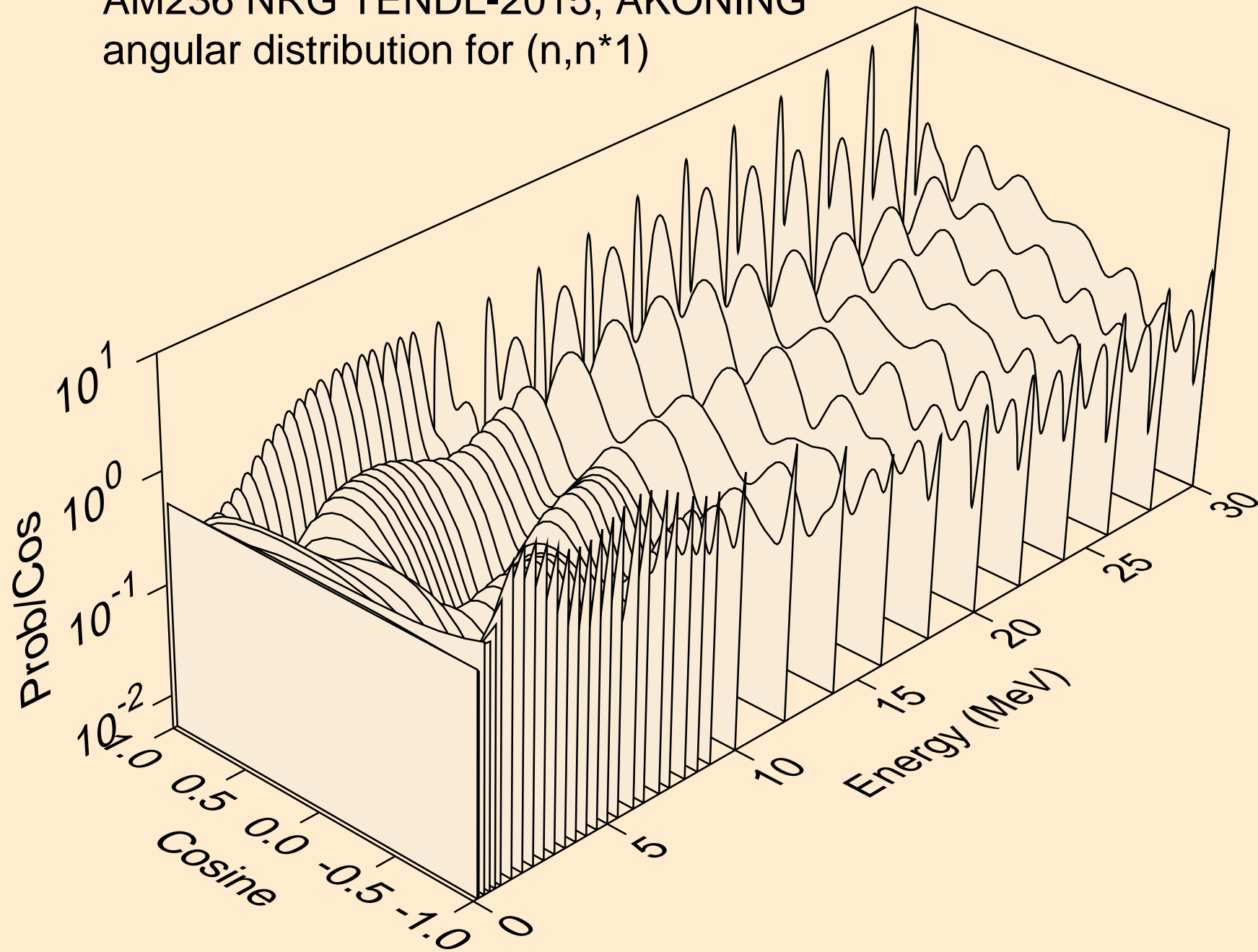

AM236 NRG TENDL-2015, AKONING
angular distribution for (n,n*2)

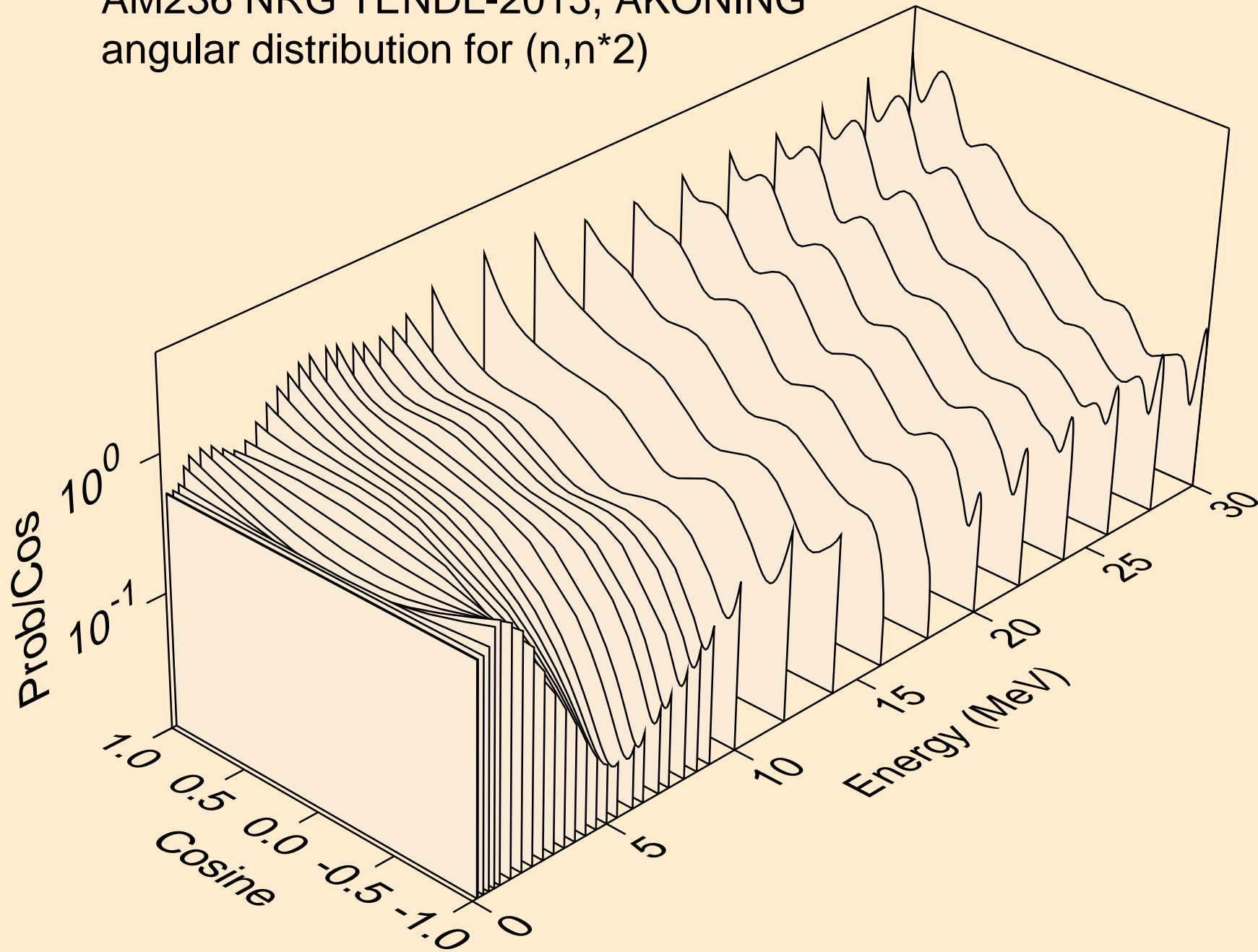

AM236 NRG TENDL-2015, AKONING
angular distribution for (n,n*3)

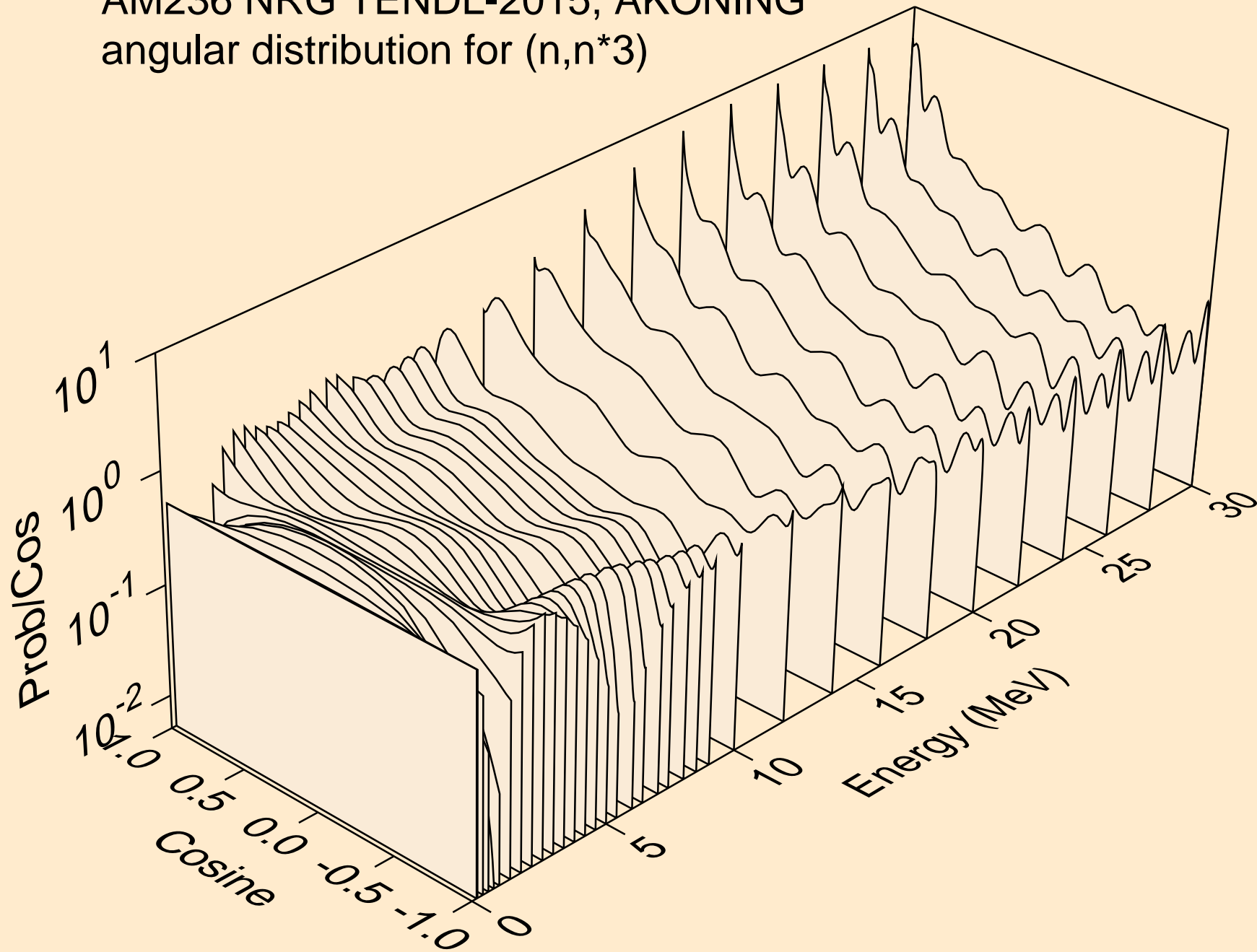

AM236 NRG TENDL-2015, AKONING
angular distribution for (n,n*4)

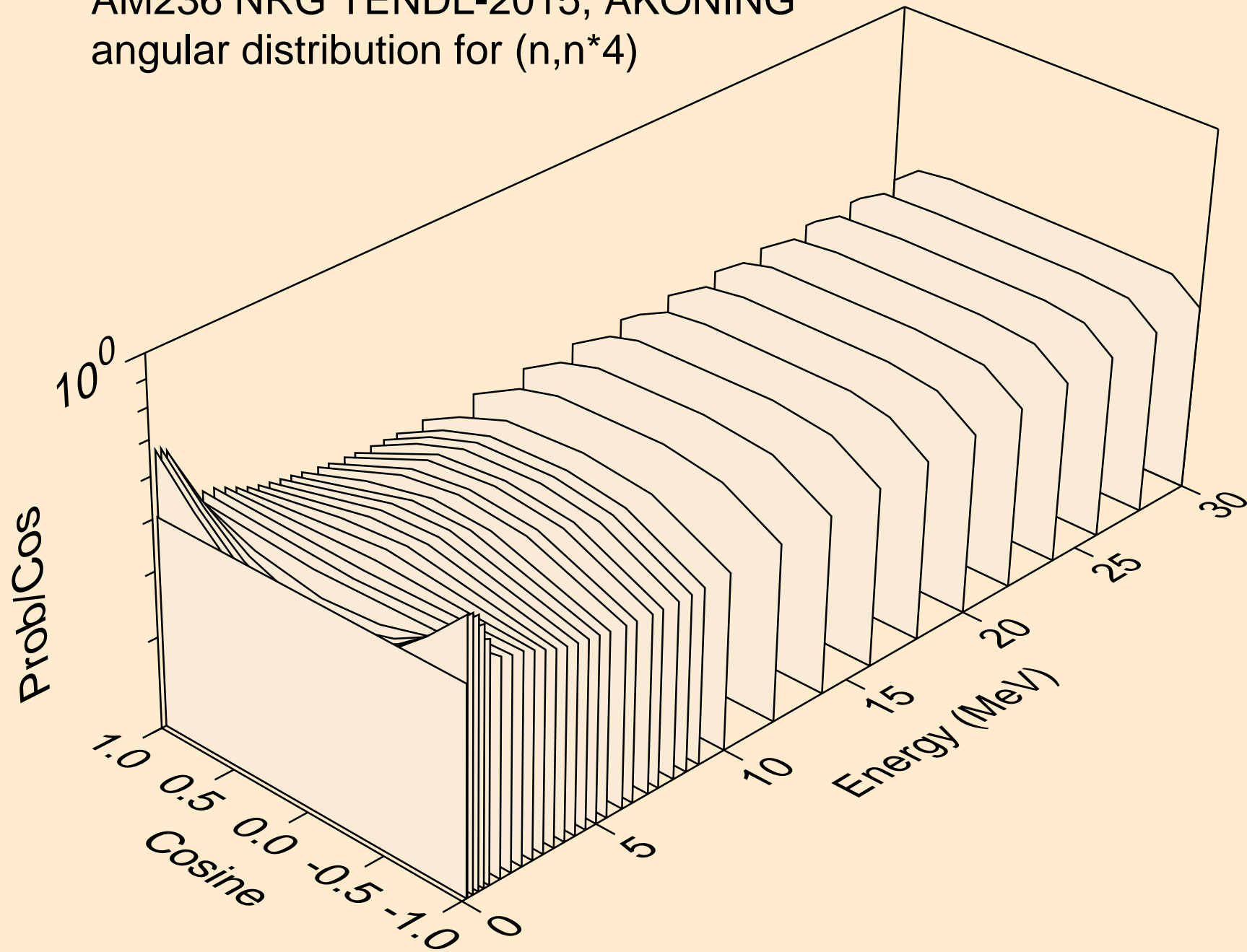

AM236 NRG TENDL-2015, AKONING
angular distribution for (n,n*5)

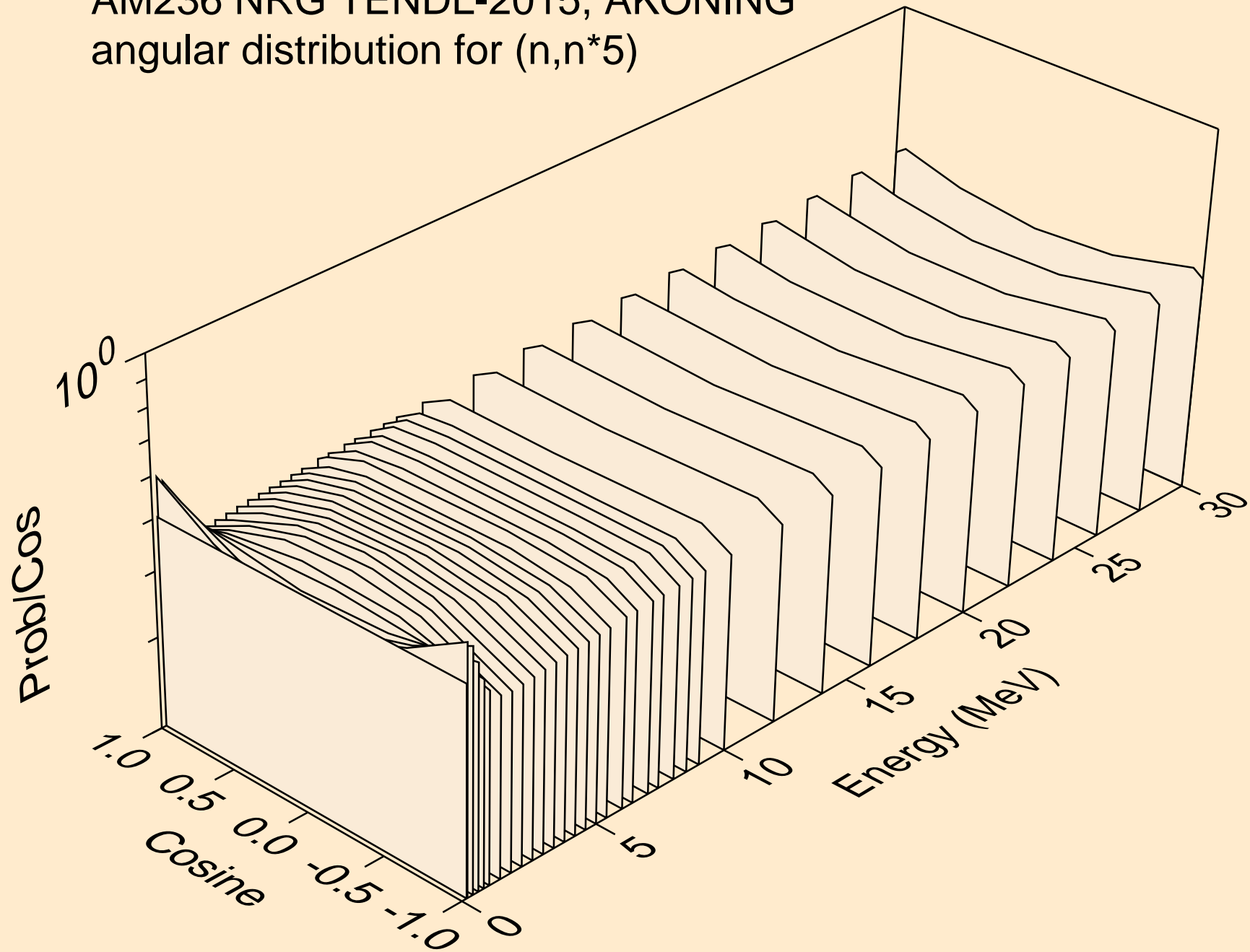

AM236 NRG TENDL-2015, AKONING
angular distribution for (n,n*6)

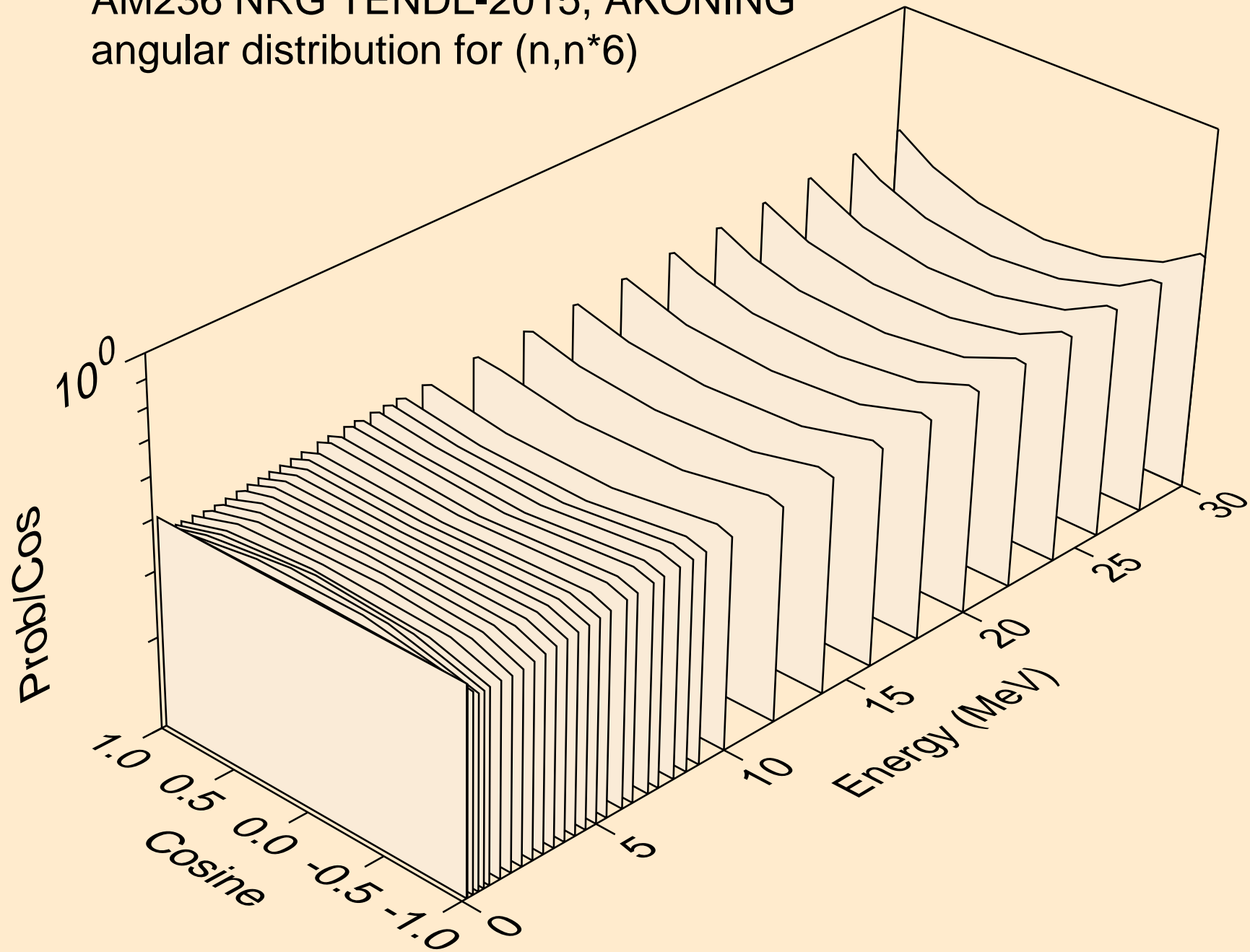

AM236 NRG TENDL-2015, AKONING
angular distribution for (n,n*7)

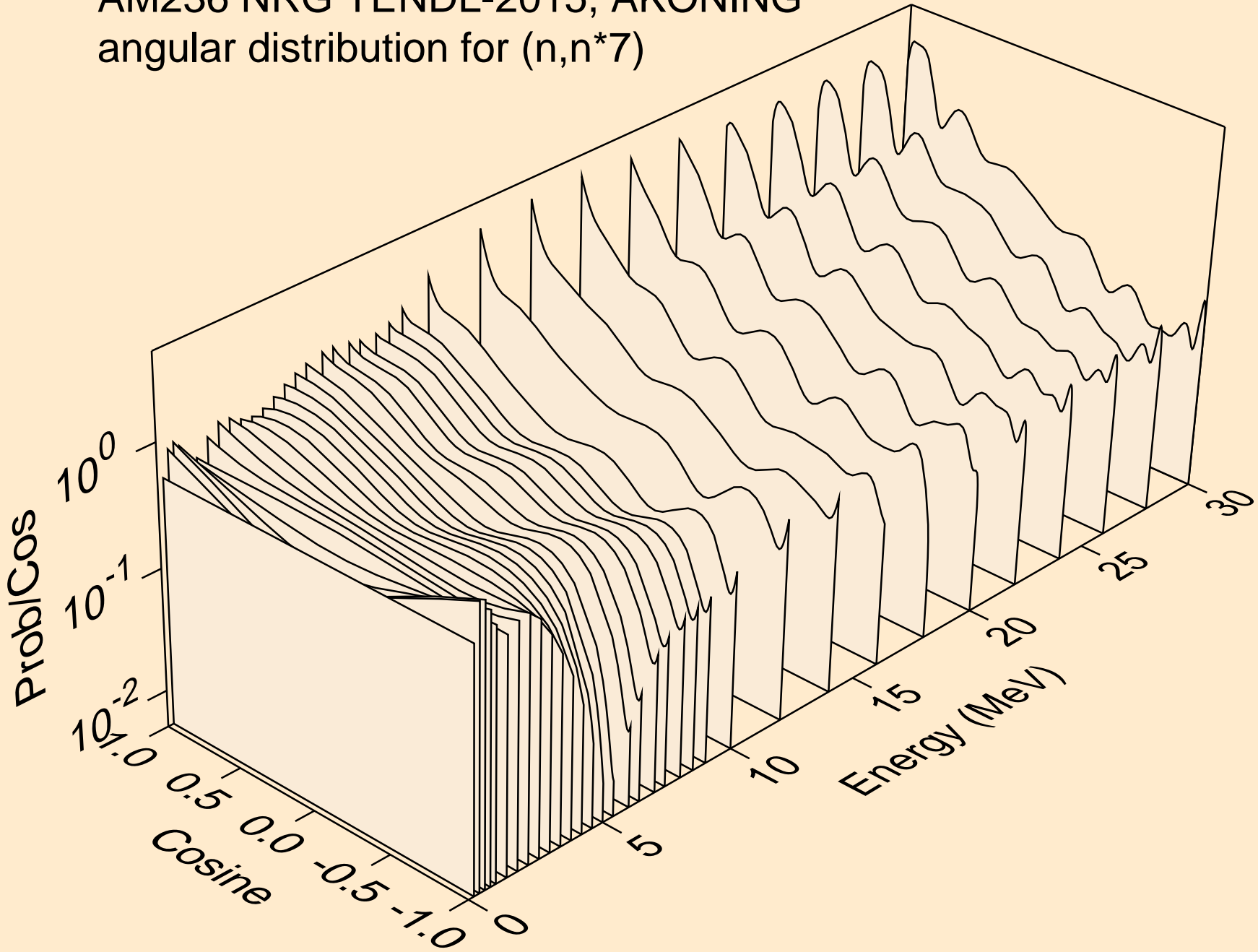

AM236 NRG TENDL-2015, AKONING
angular distribution for (n,n*8)

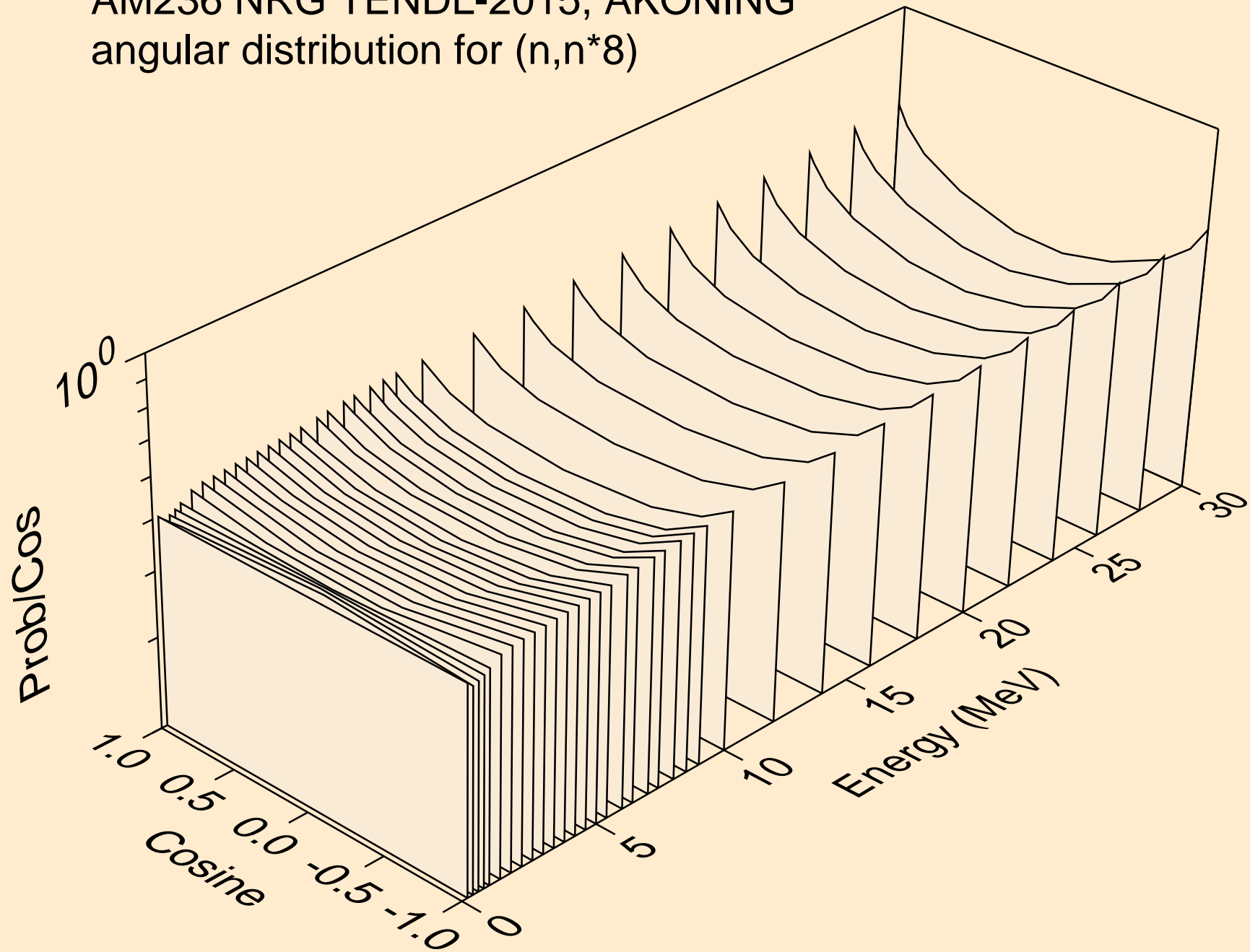

AM236 NRG TENDL-2015, AKONING
angular distribution for (n,n*9)

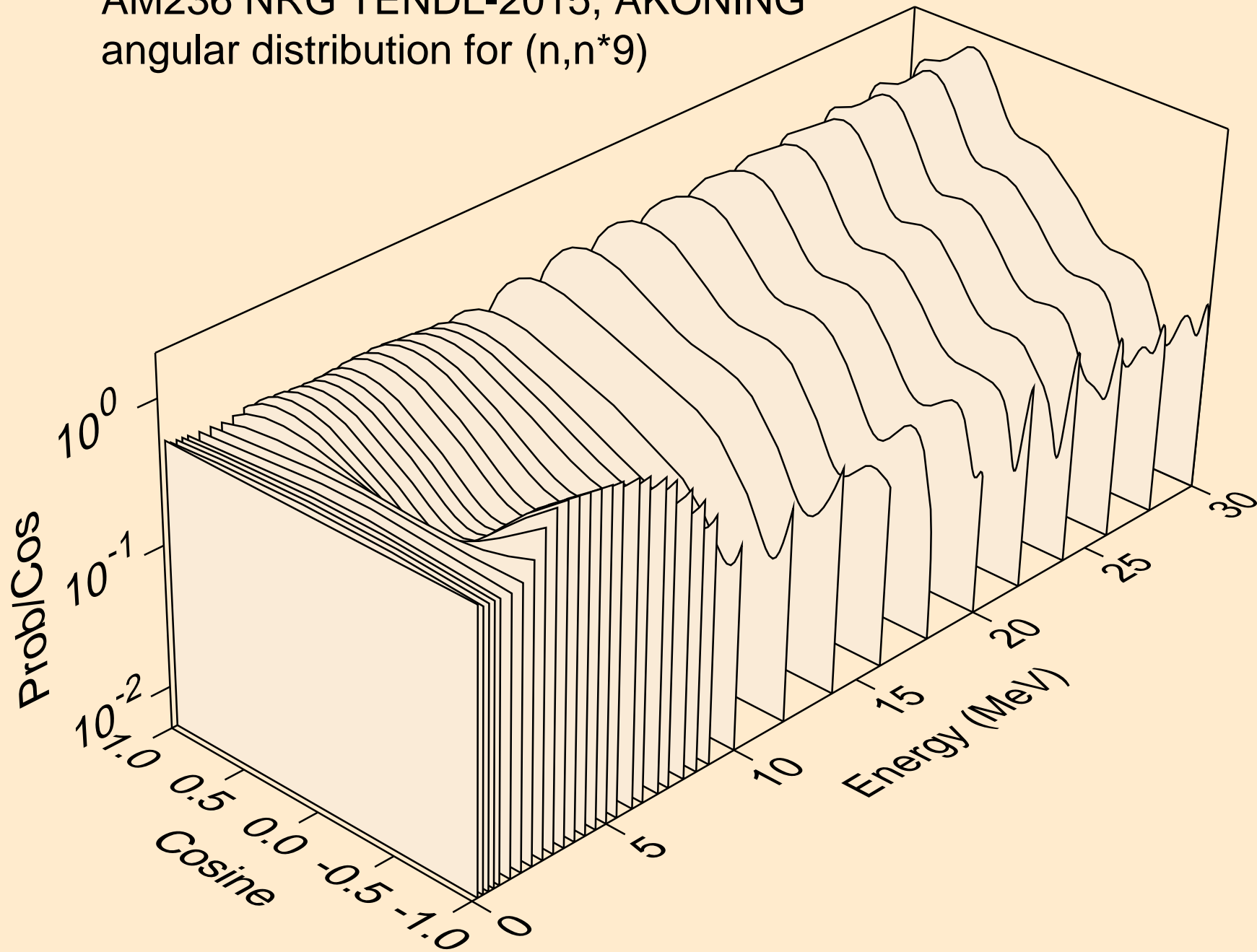

AM236 NRG TENDL-2015, AKONING
angular distribution for (n,n*10)

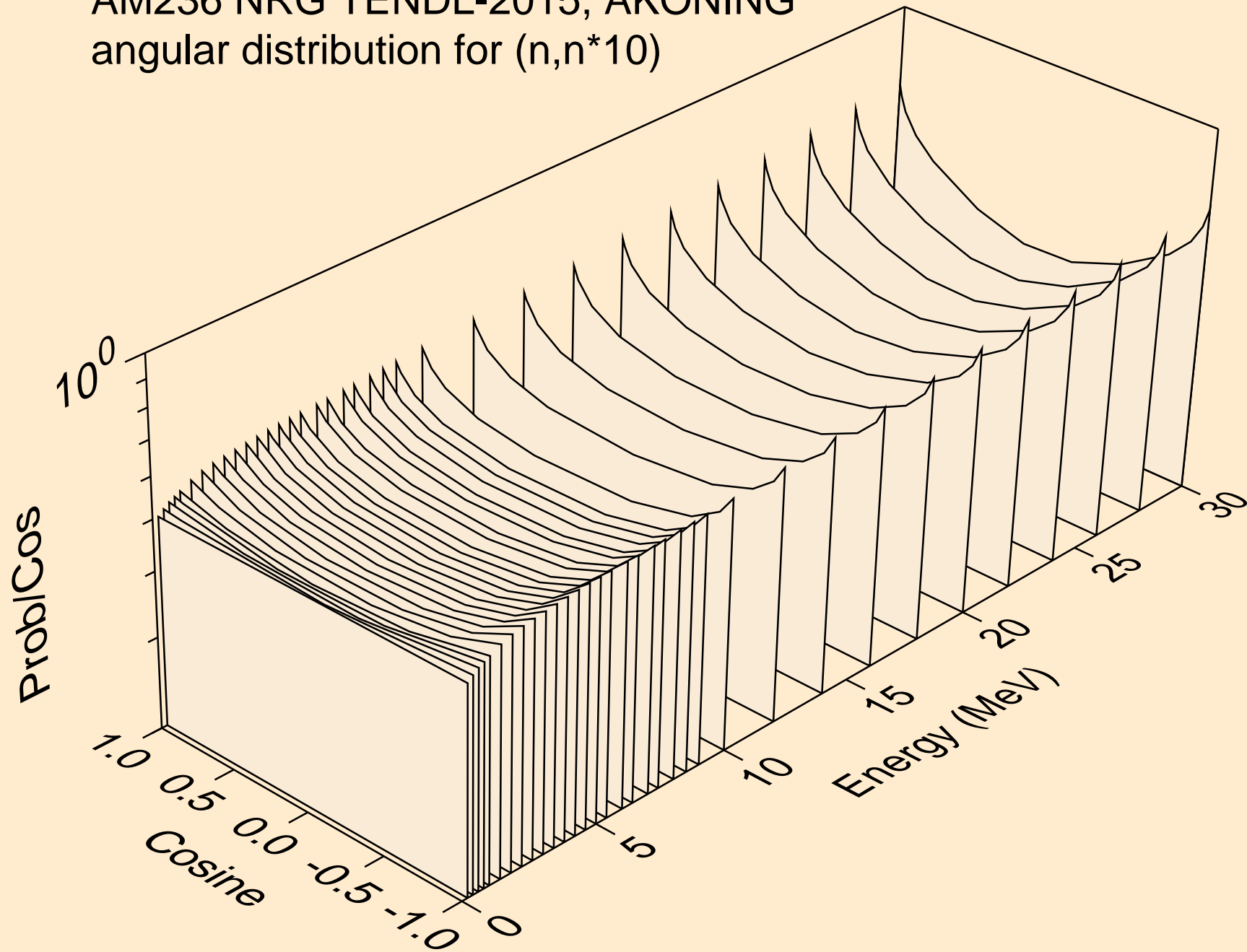

AM236 NRG TENDL-2015, AKONING
angular distribution for (n,n*11)

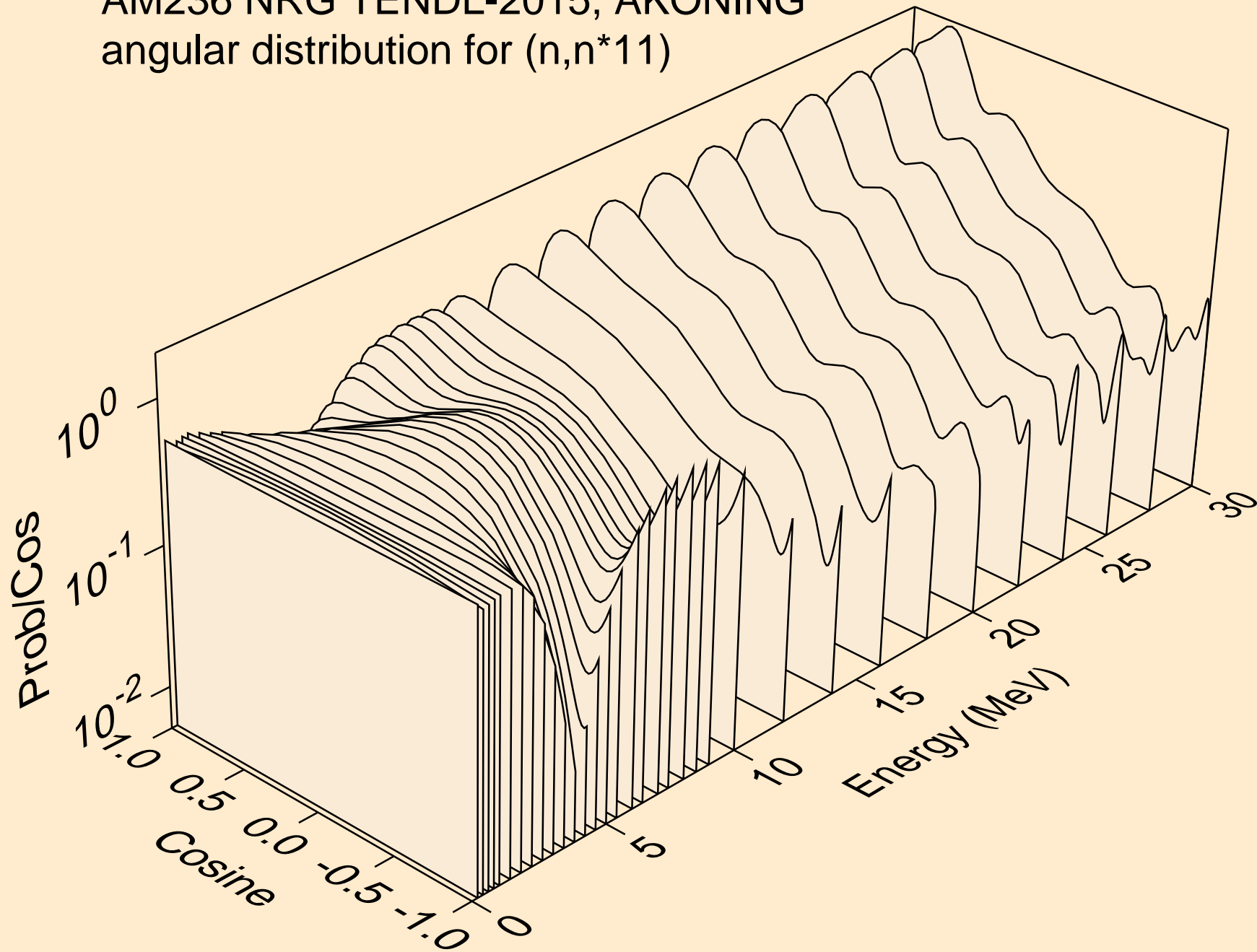

AM236 NRG TENDL-2015, AKONING
angular distribution for (n,n*12)

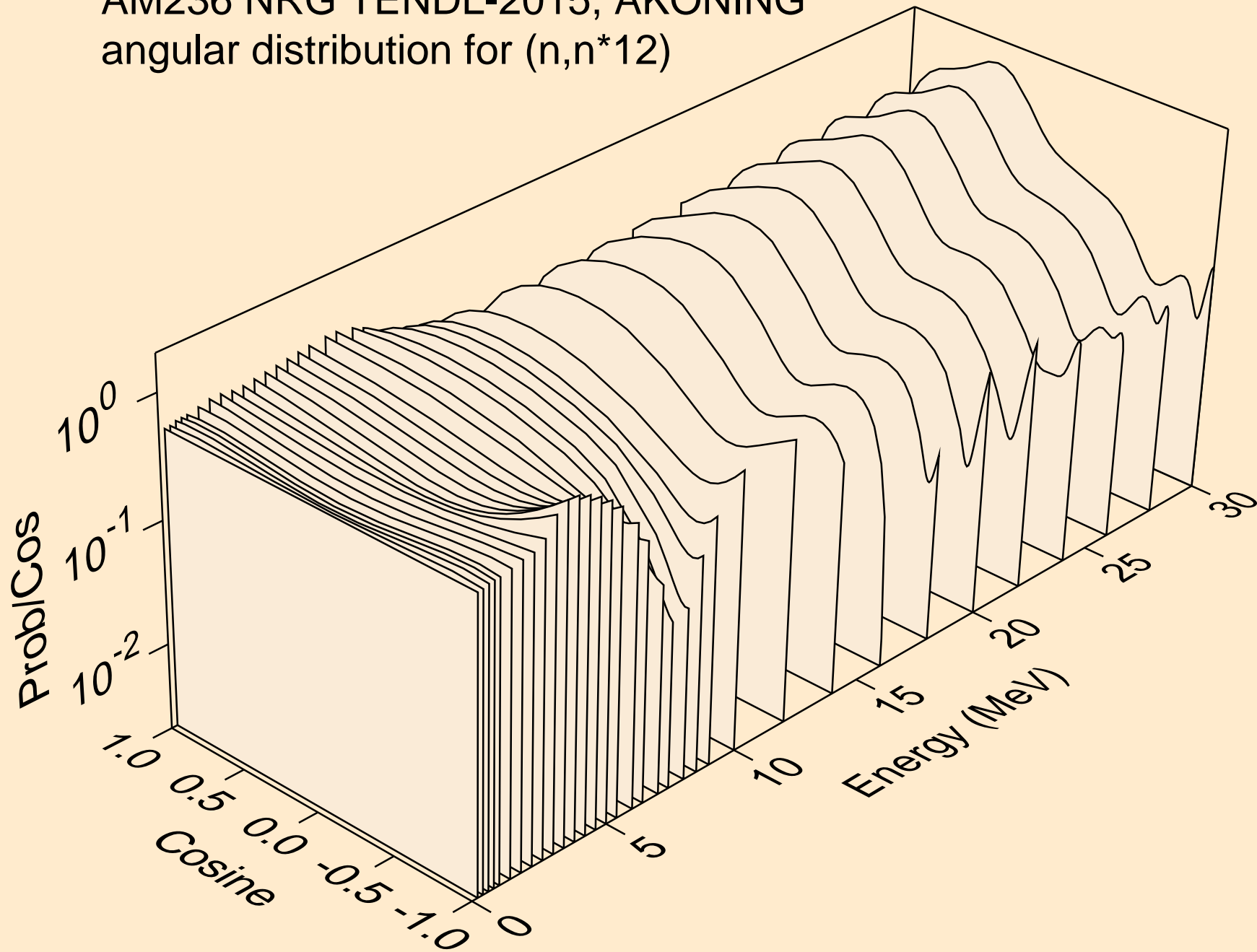

AM236 NRG TENDL-2015, AKONING
angular distribution for (n,n*13)

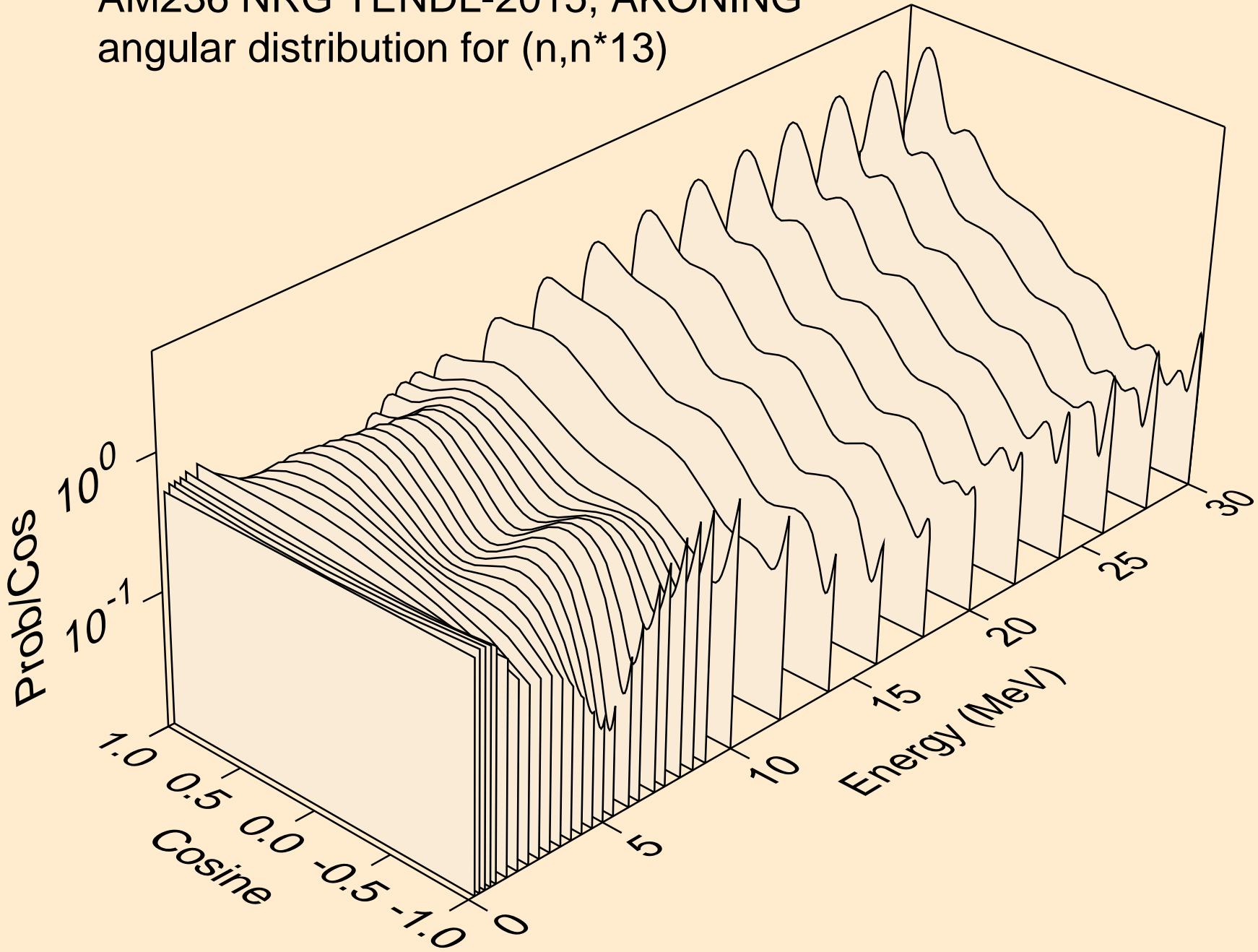

AM236 NRG TENDL-2015, AKONING
angular distribution for (n,n*14)

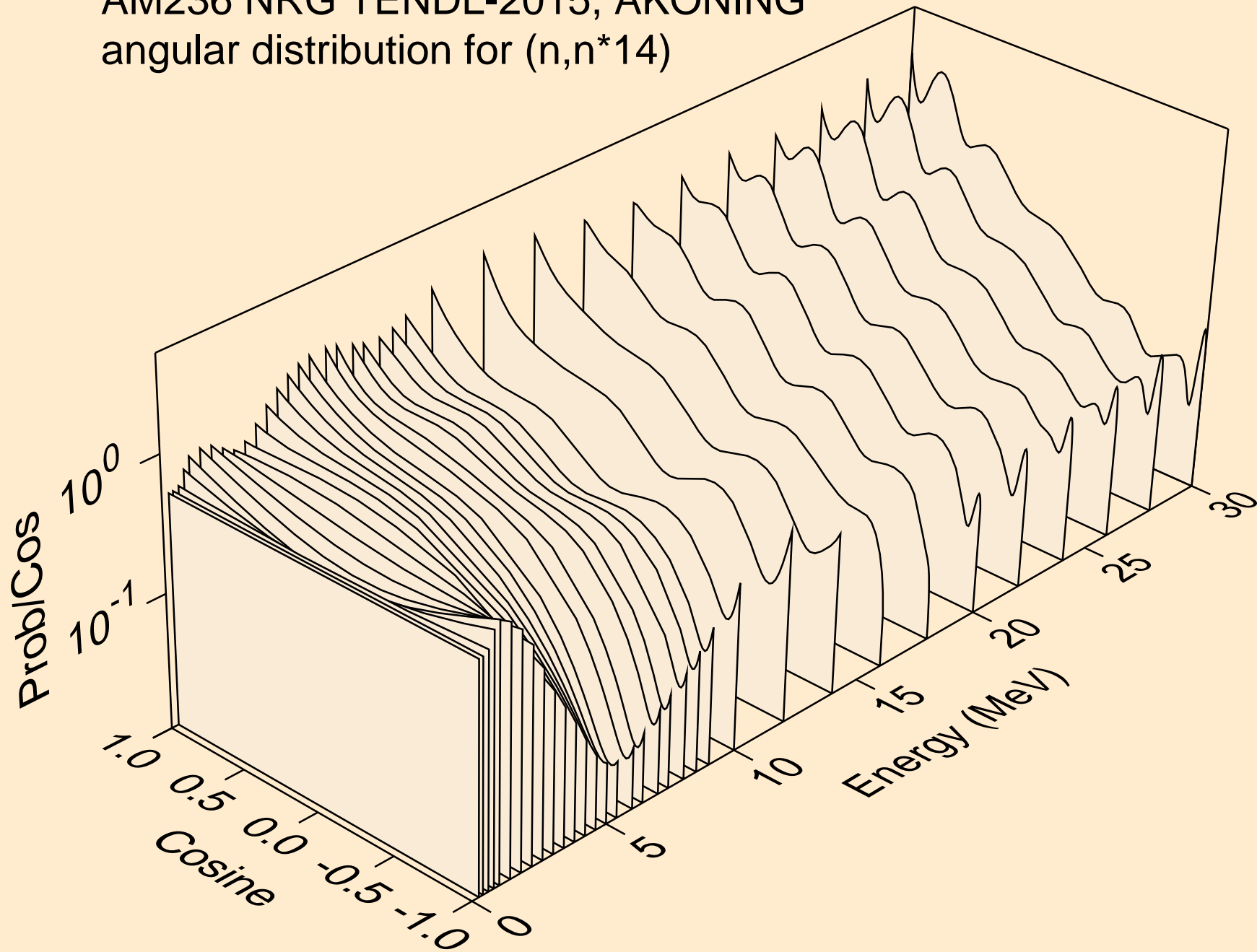

AM236 NRG TENDL-2015, AKONING
angular distribution for (n,n*15)

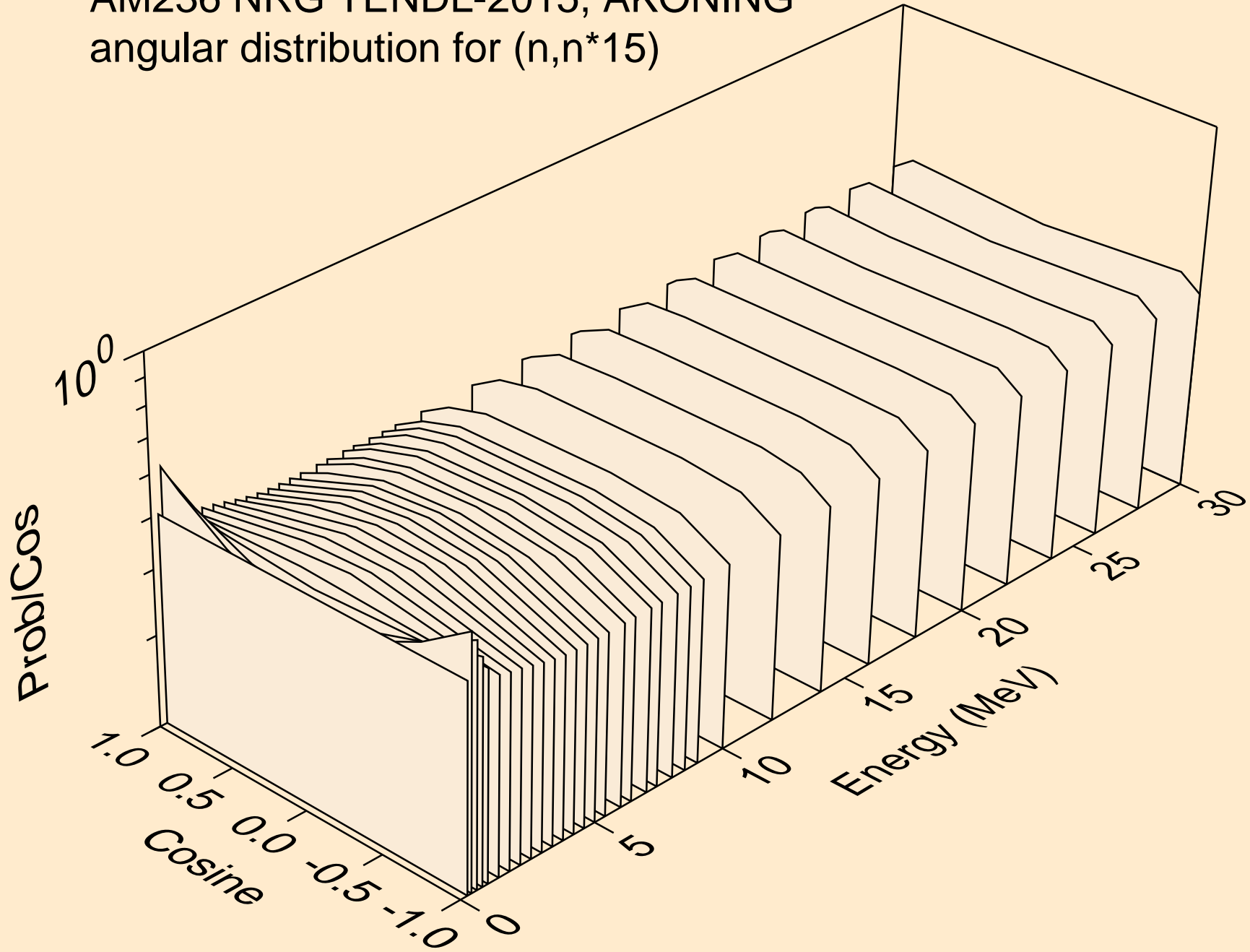

AM236 NRG TENDL-2015, AKONING
angular distribution for (n,n*16)

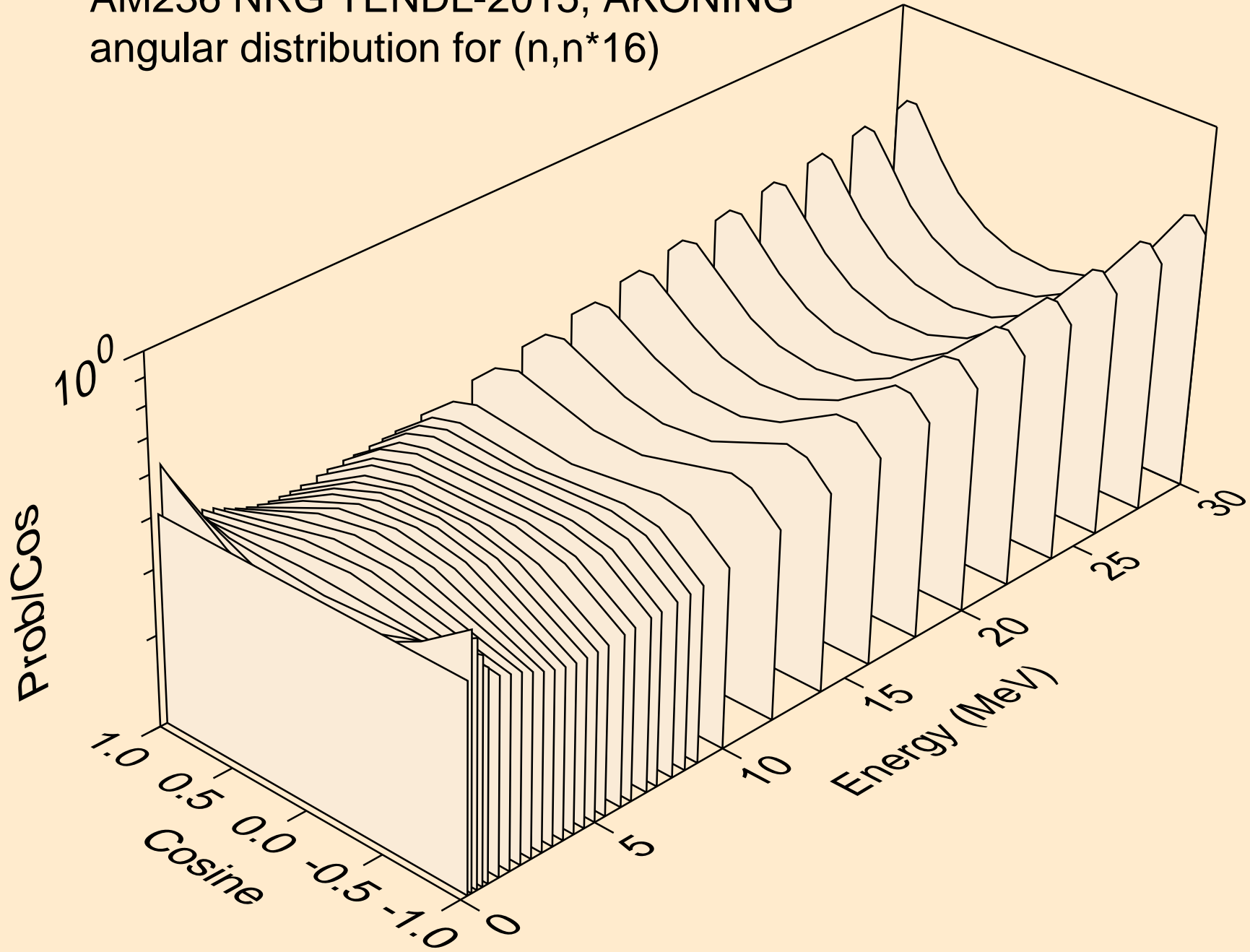

AM236 NRG TENDL-2015, AKONING
angular distribution for (n,n*17)

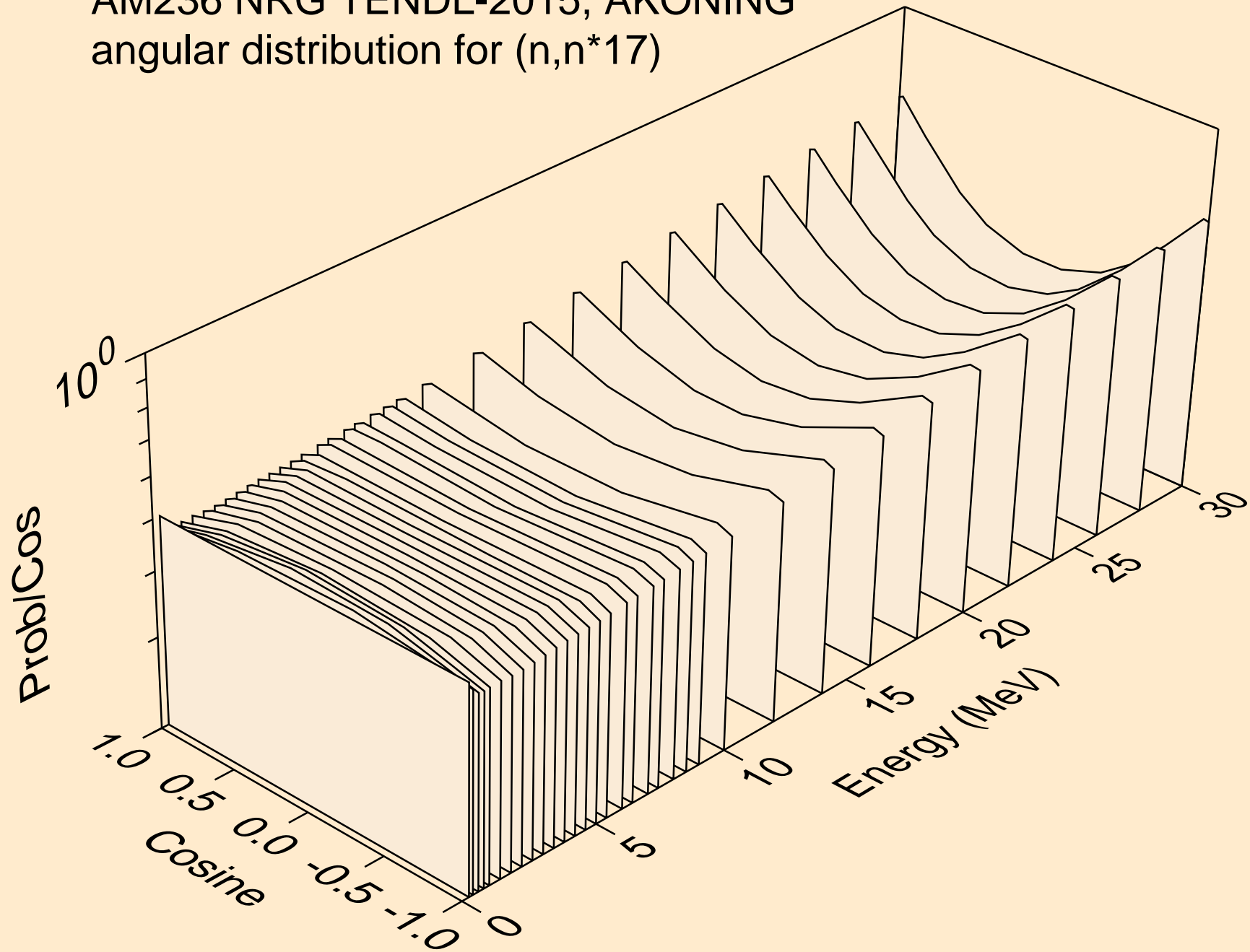

AM236 NRG TENDL-2015, AKONING
angular distribution for (n,n*18)

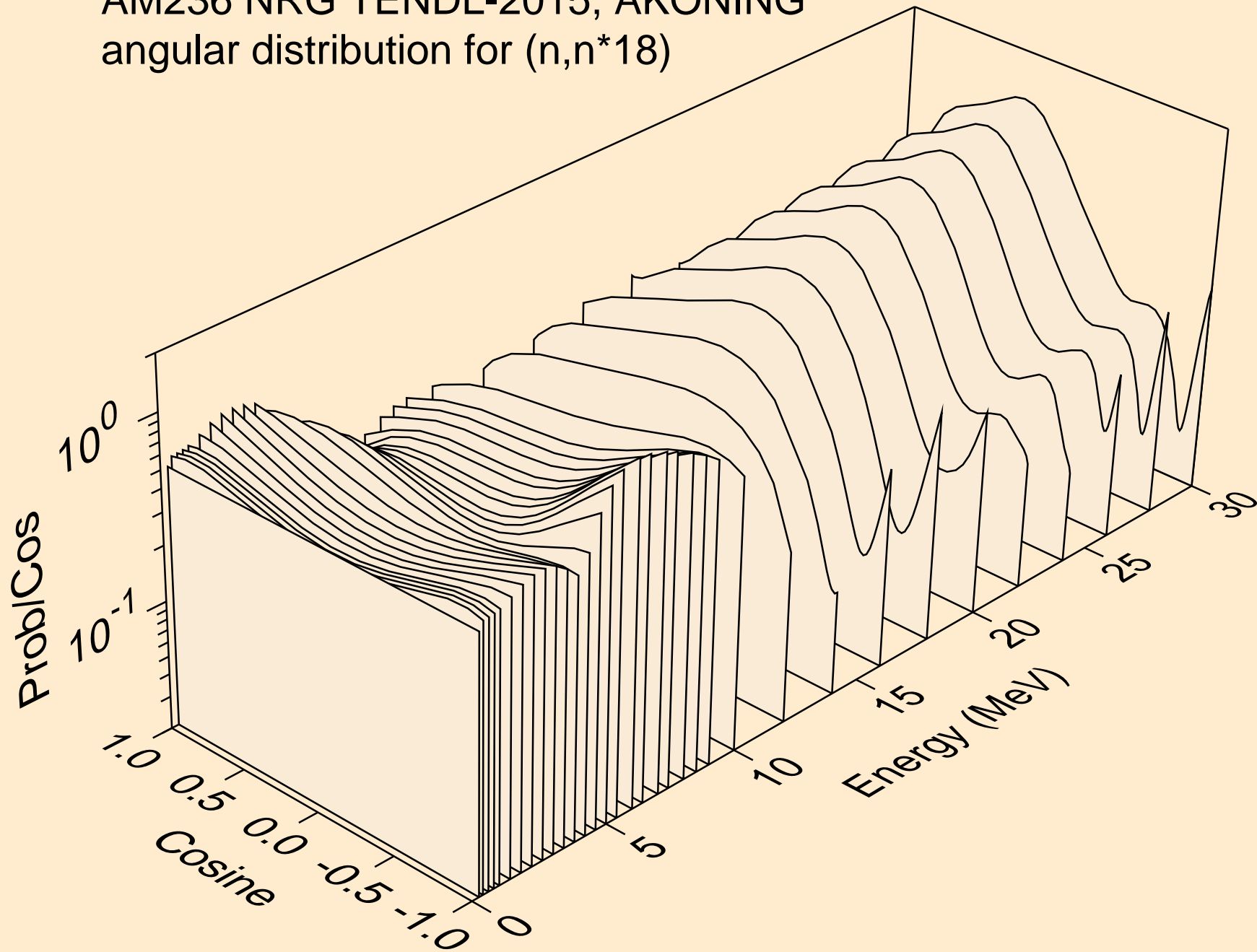

AM236 NRG TENDL-2015, AKONING
angular distribution for (n,n*19)

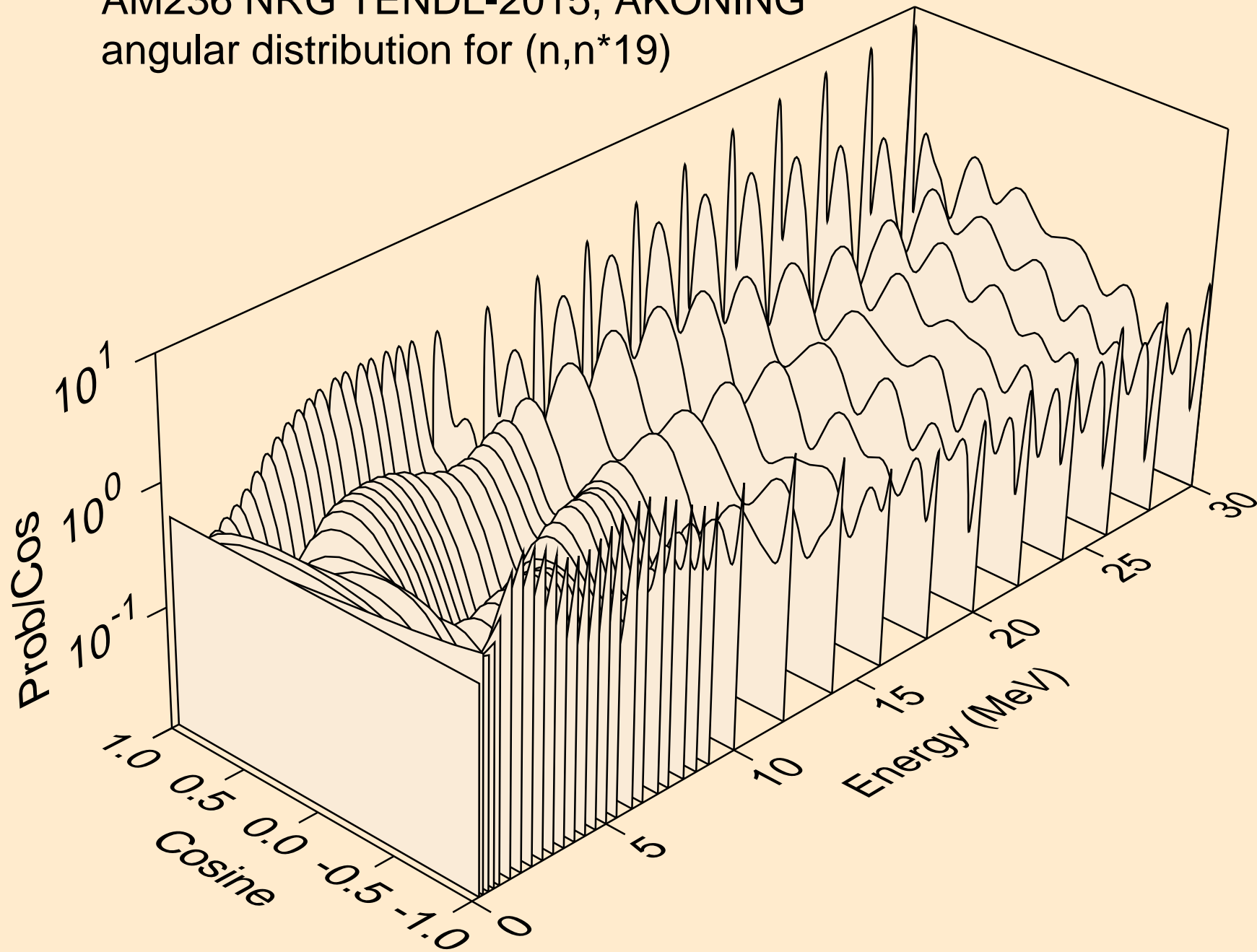

AM236 NRG TENDL-2015, AKONING
angular distribution for (n,n*20)

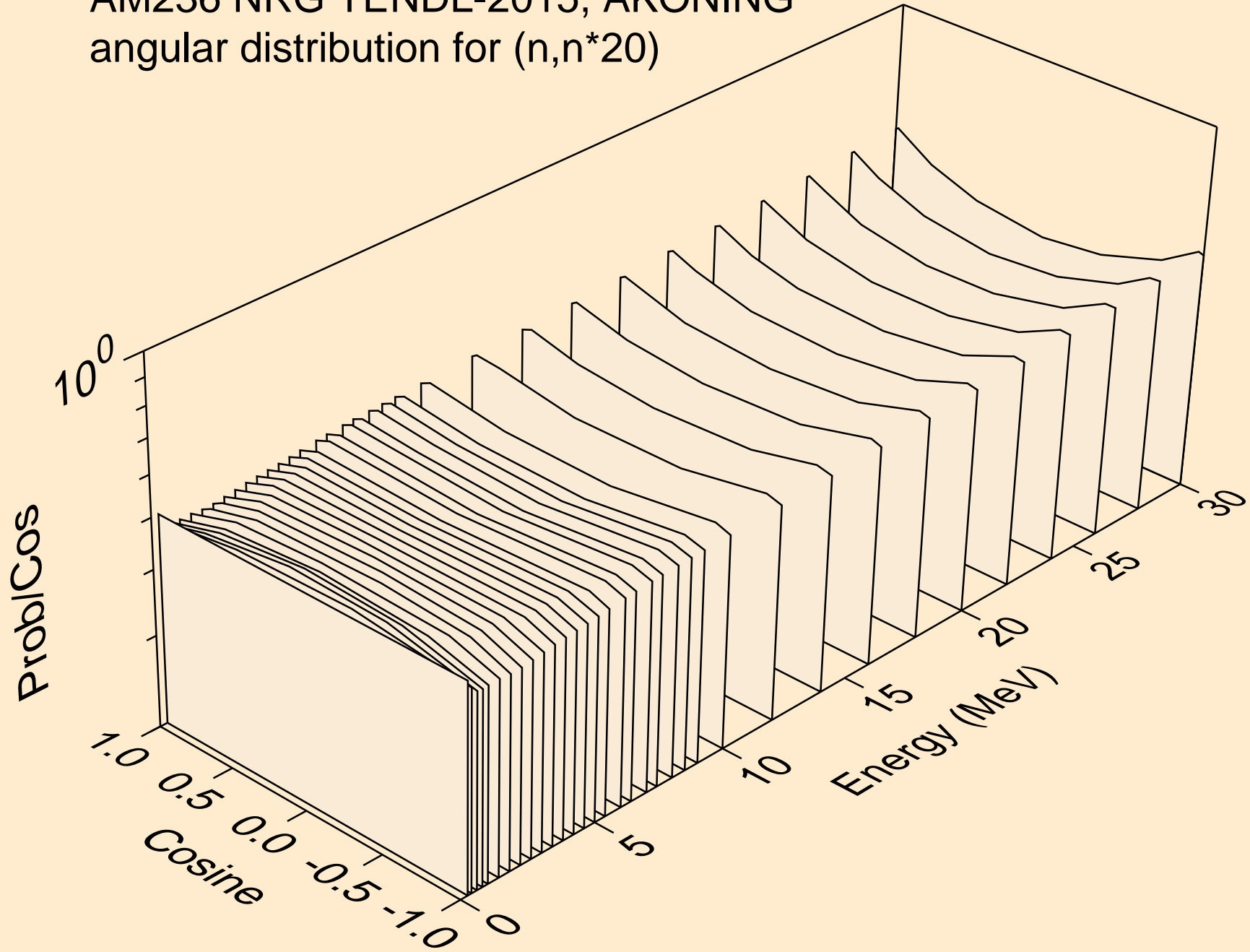

AM236 NRG TENDL-2015, AKONING
angular distribution for (n,n*21)

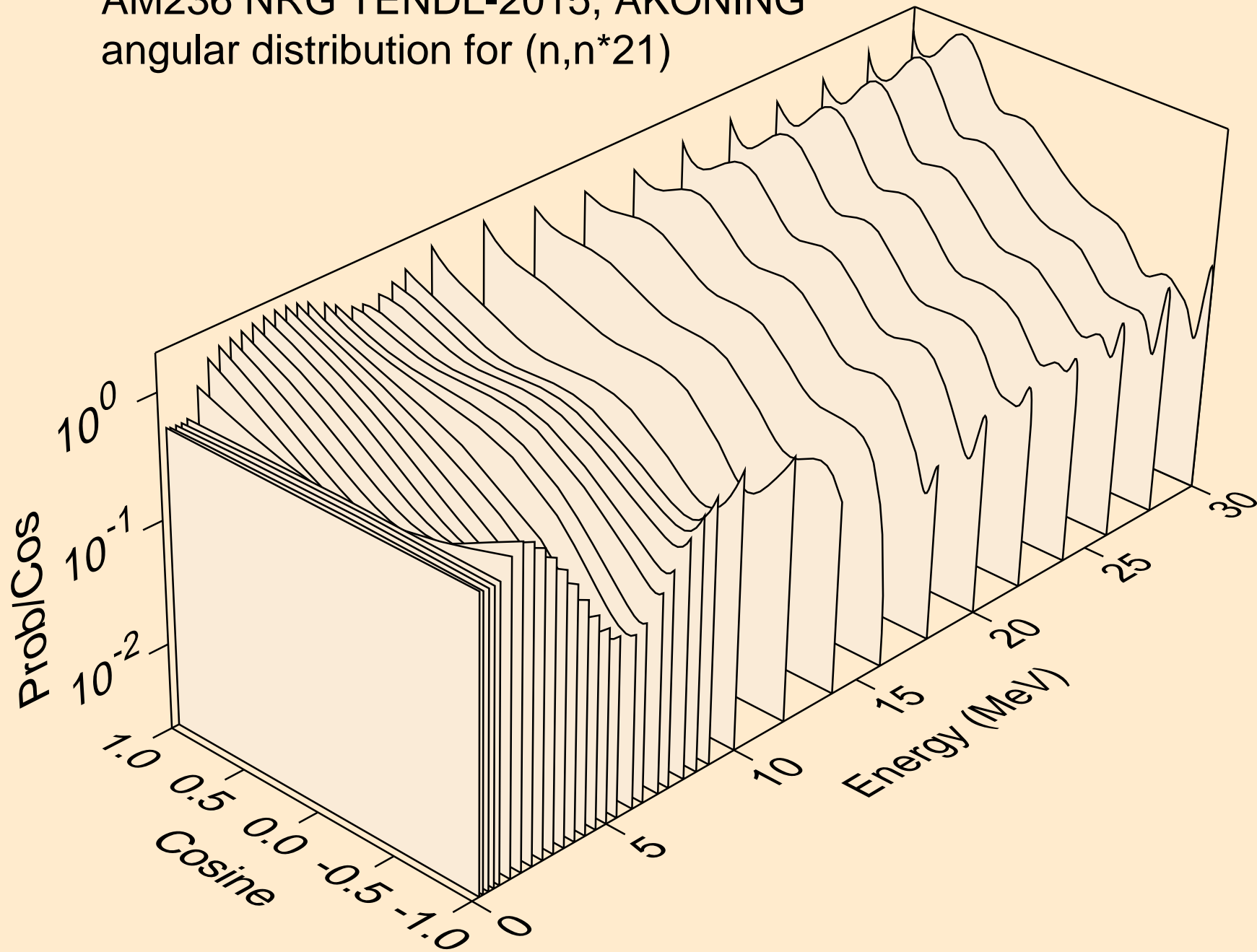

AM236 NRG TENDL-2015, AKONING
angular distribution for (n,n*22)

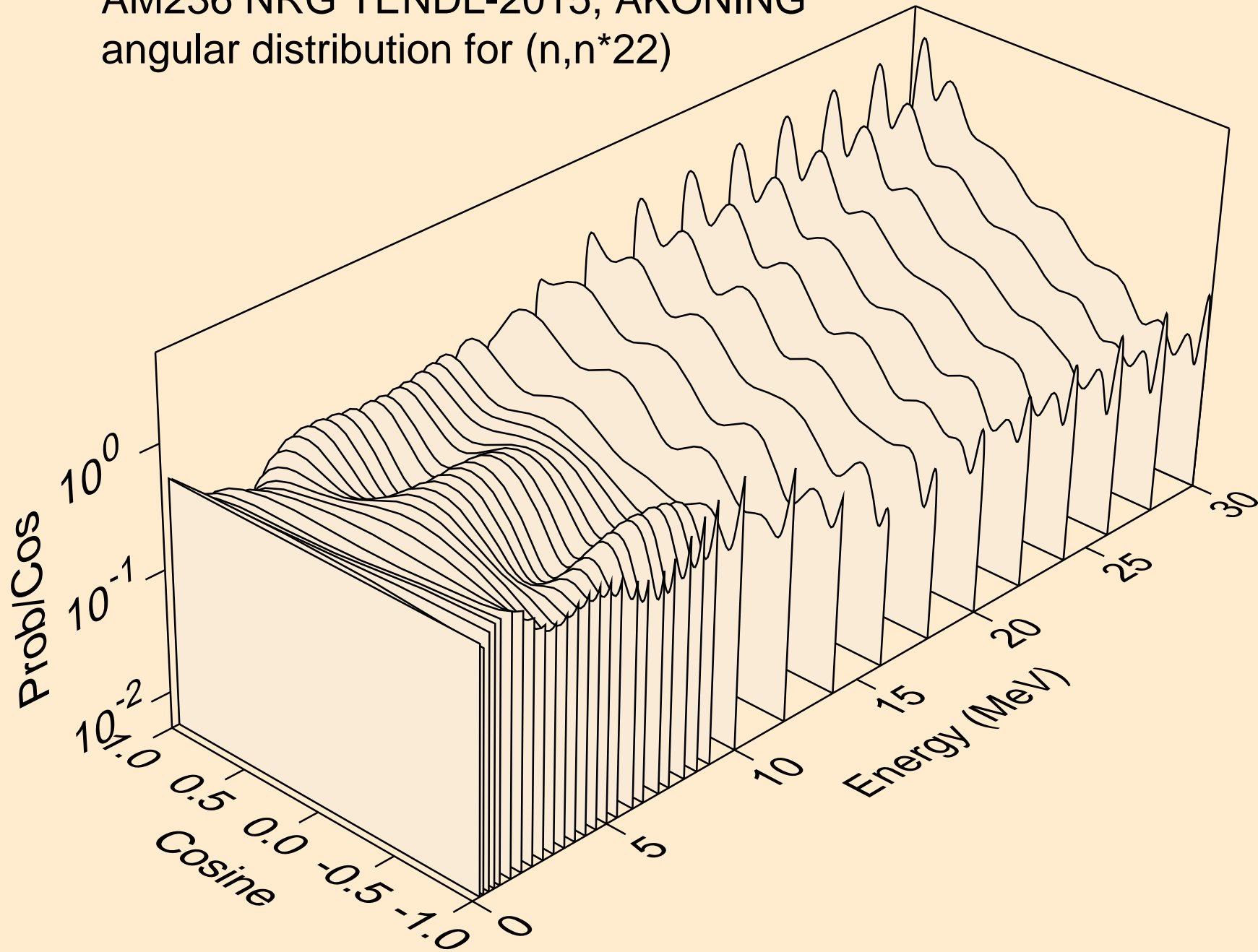

AM236 NRG TENDL-2015, AKONING
angular distribution for (n,n*23)

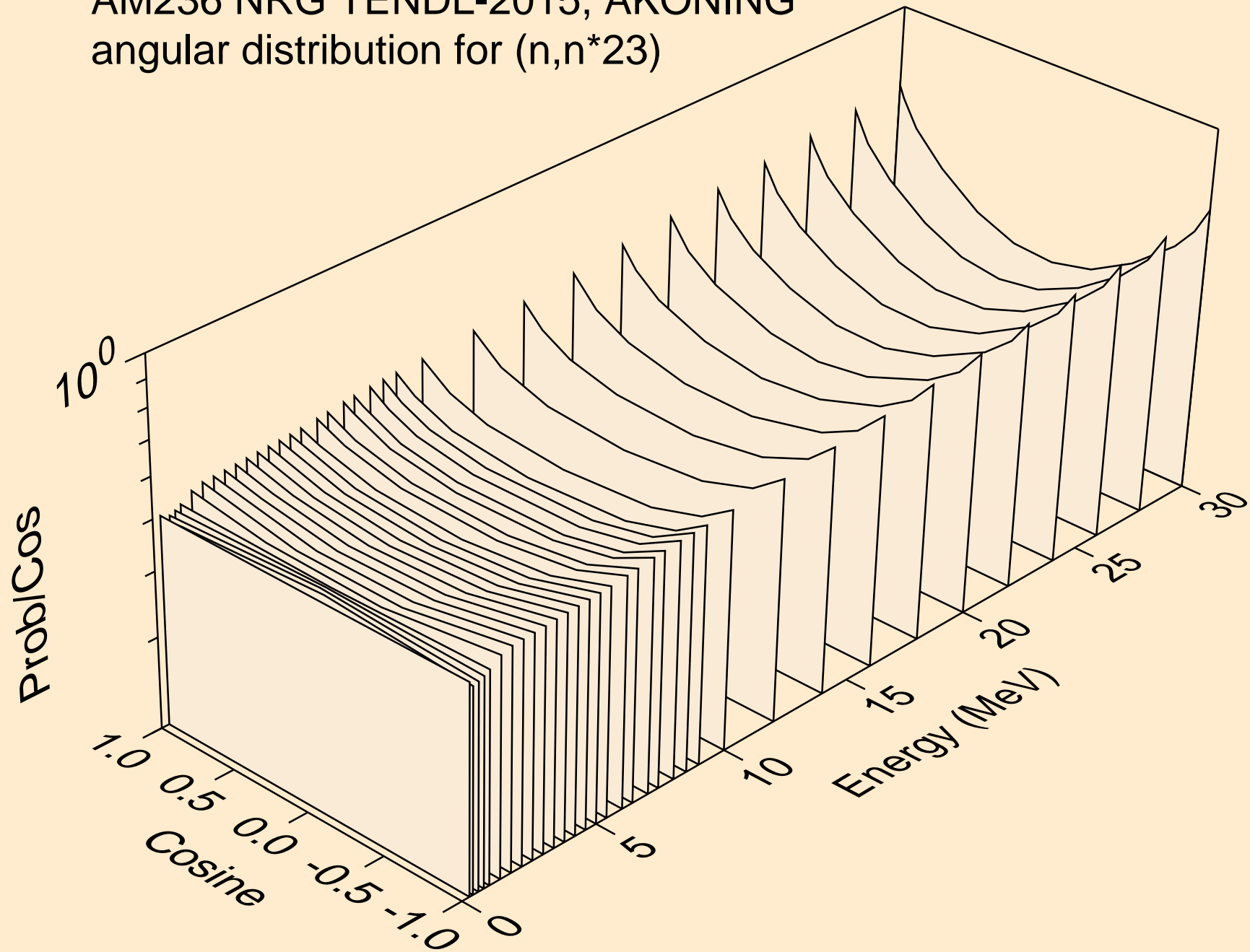

AM236 NRG TENDL-2015, AKONING
angular distribution for (n,n*24)

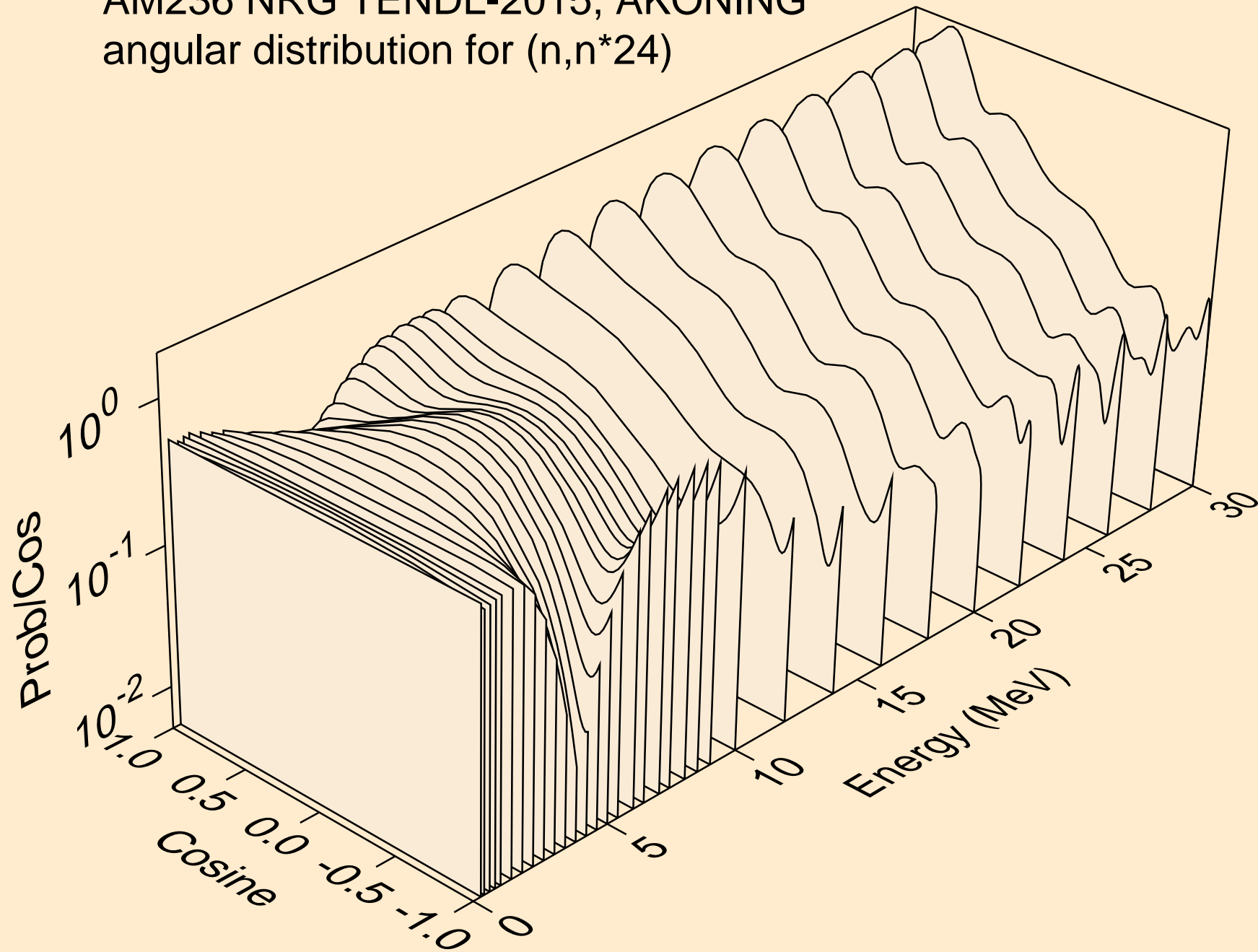

AM236 NRG TENDL-2015, AKONING
angular distribution for (n,n*25)

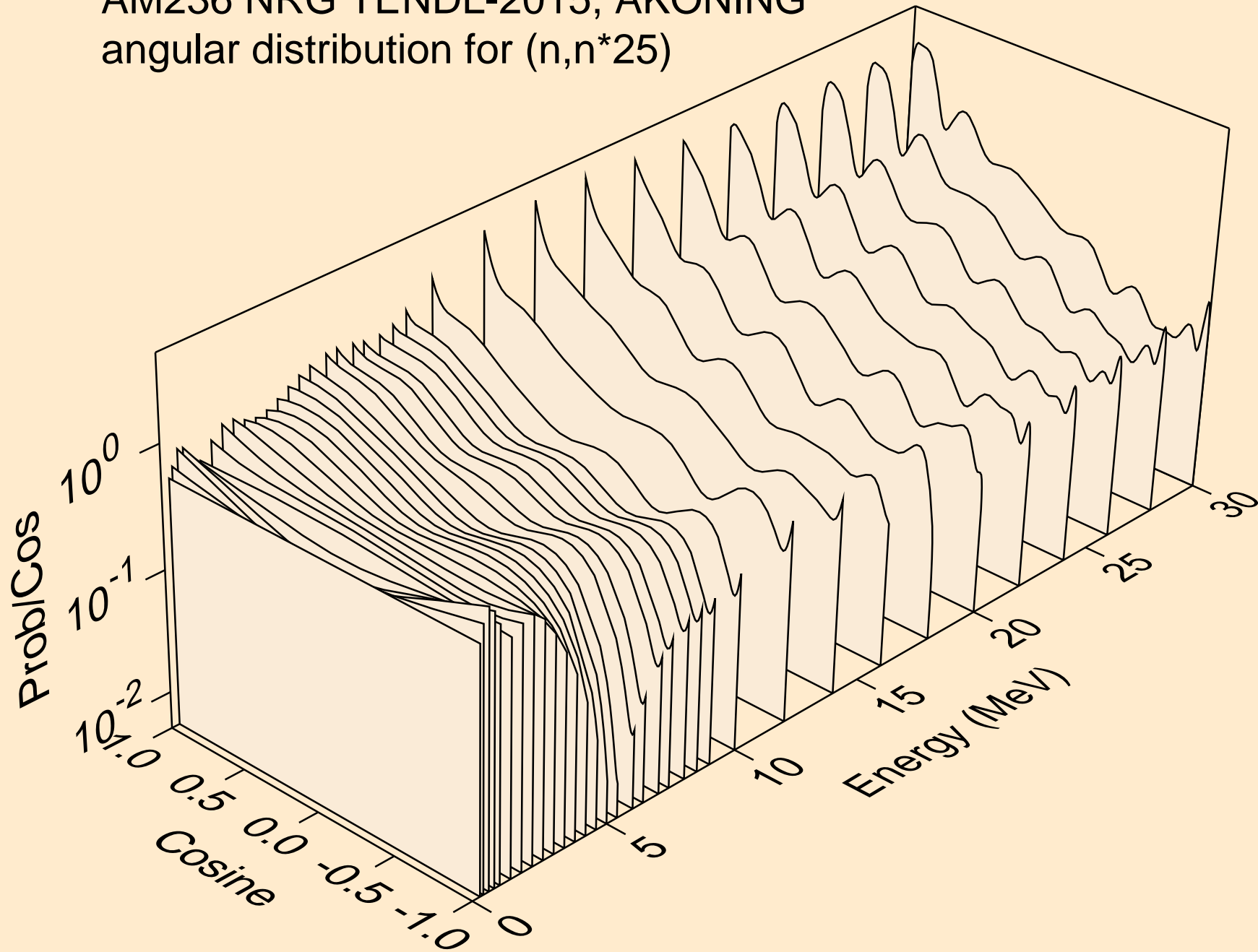

AM236 NRG TENDL-2015, AKONING
angular distribution for (n,n*26)

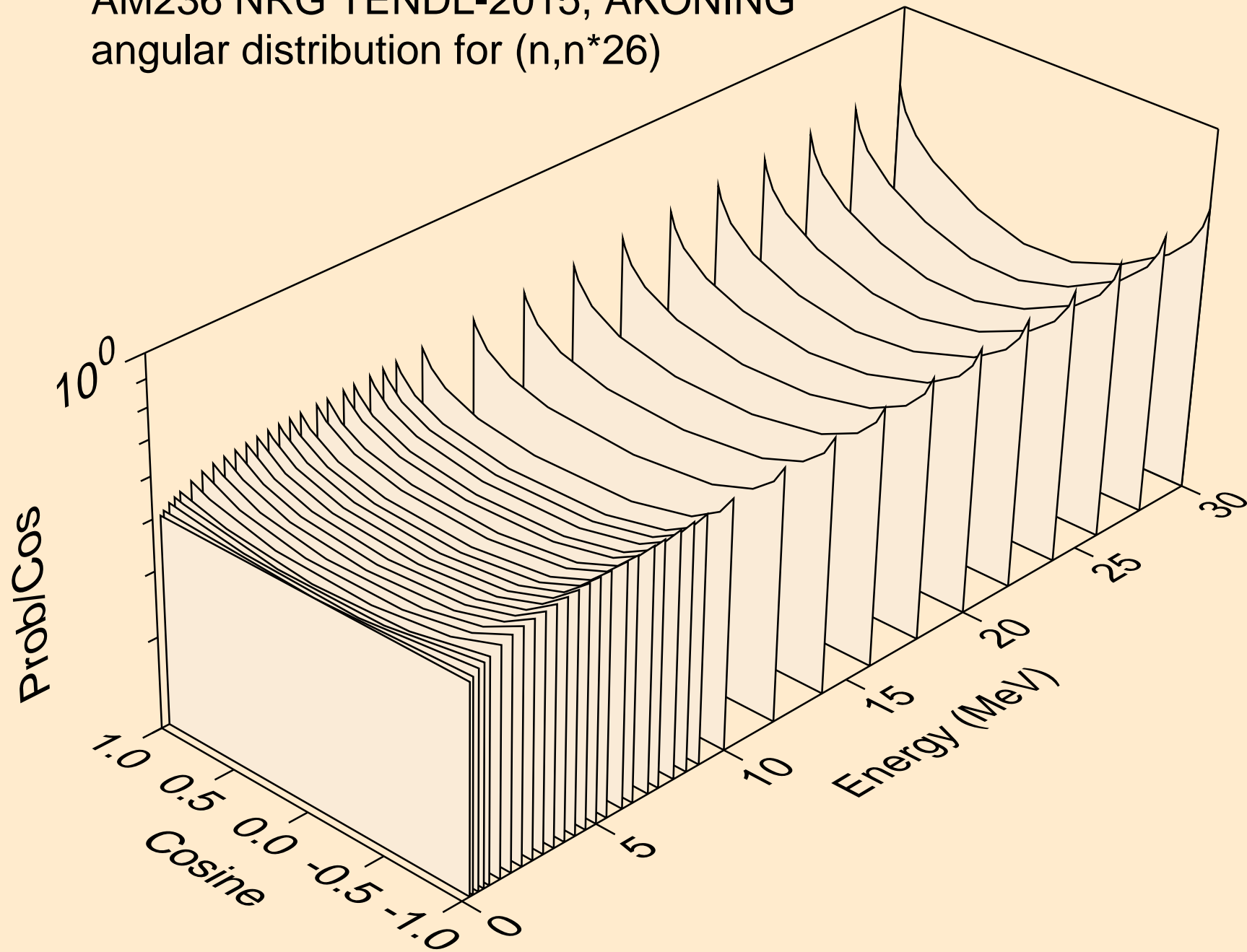

AM236 NRG TENDL-2015, AKONING
angular distribution for (n,n*27)

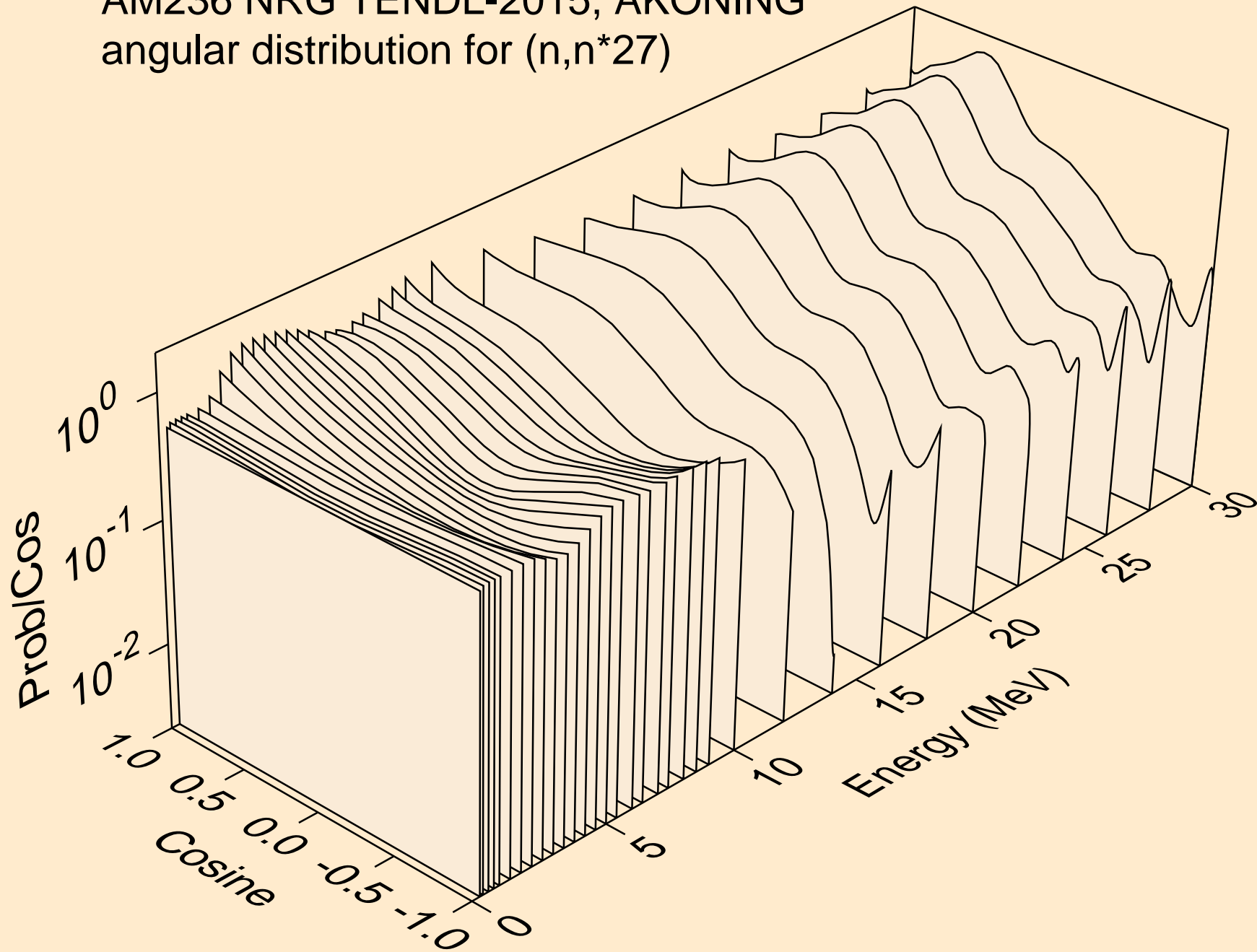

AM236 NRG TENDL-2015, AKONING
angular distribution for (n,n*28)

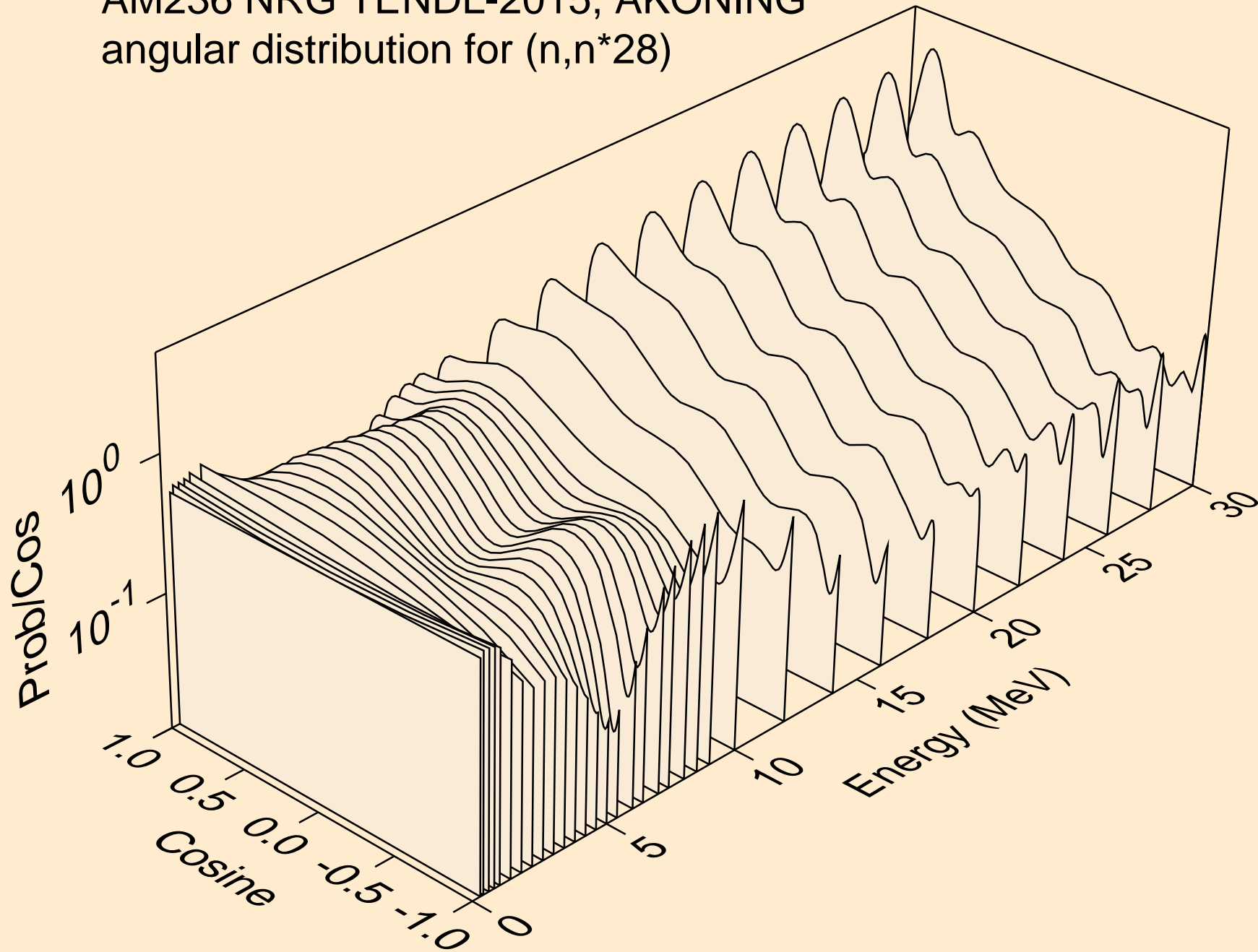

AM236 NRG TENDL-2015, AKONING
angular distribution for (n,n*29)

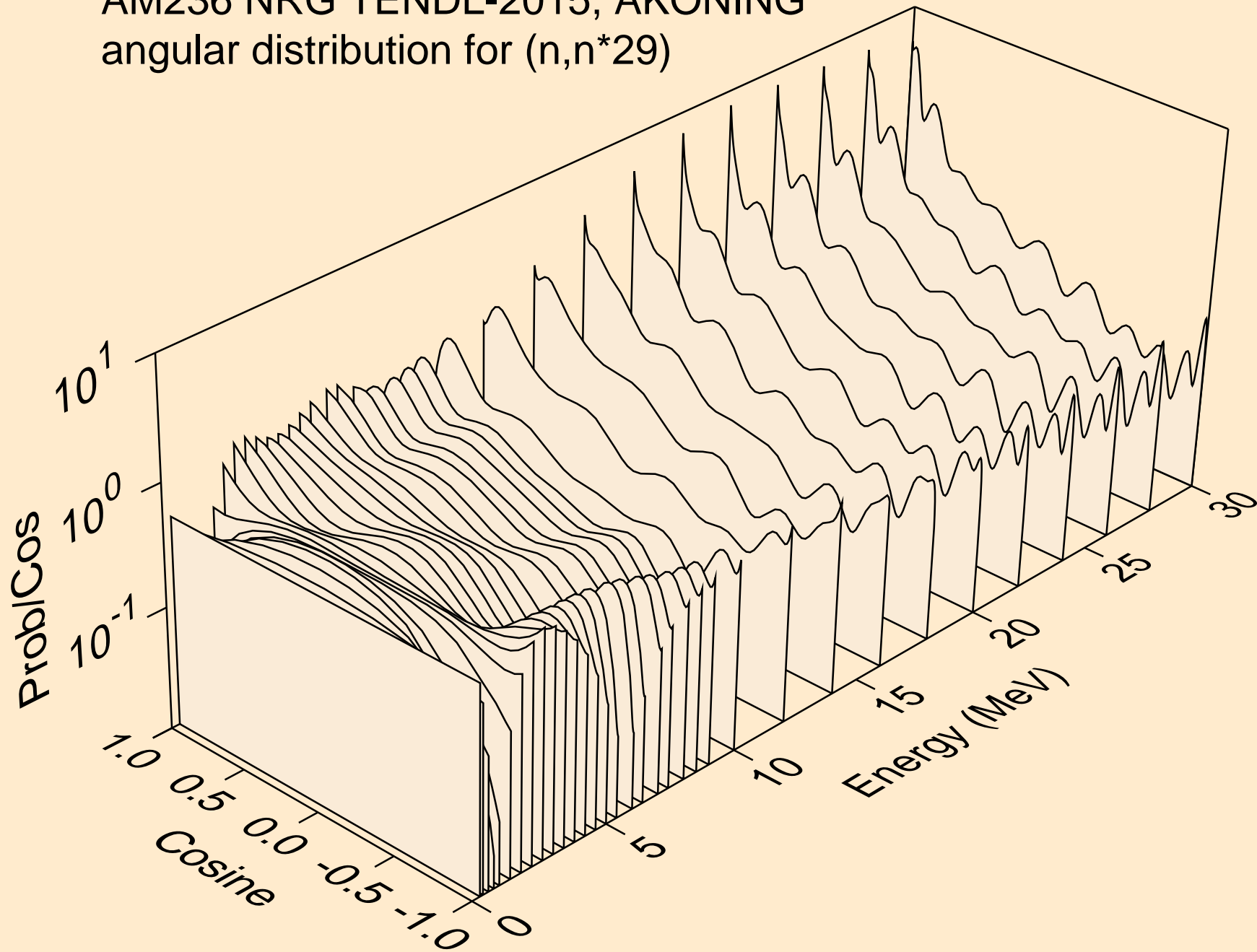

AM236 NRG TENDL-2015, AKONING

Total fission nubar

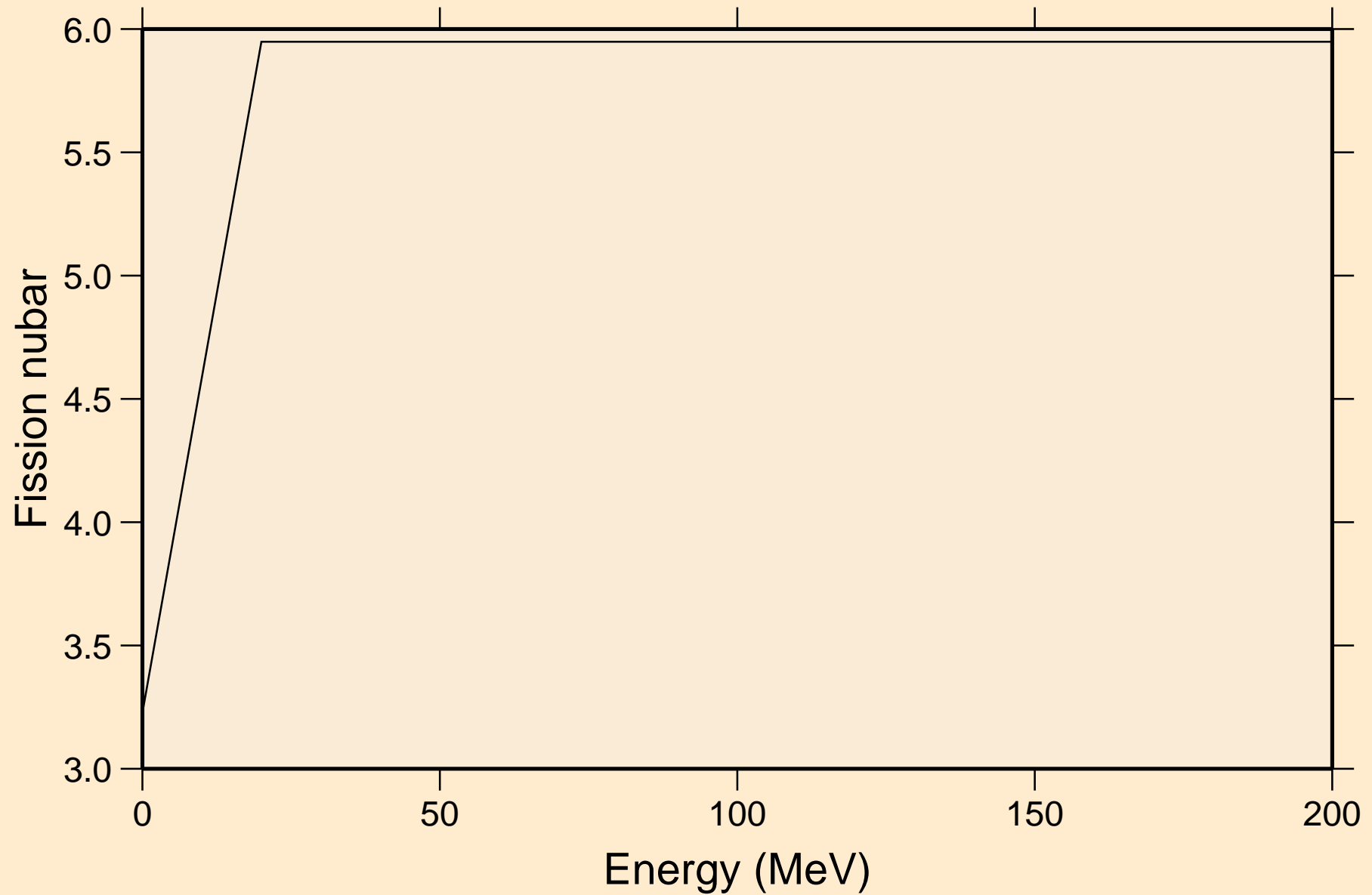

AM236 NRG TENDL-2015, AKONING
Neutron emission for (n,x)

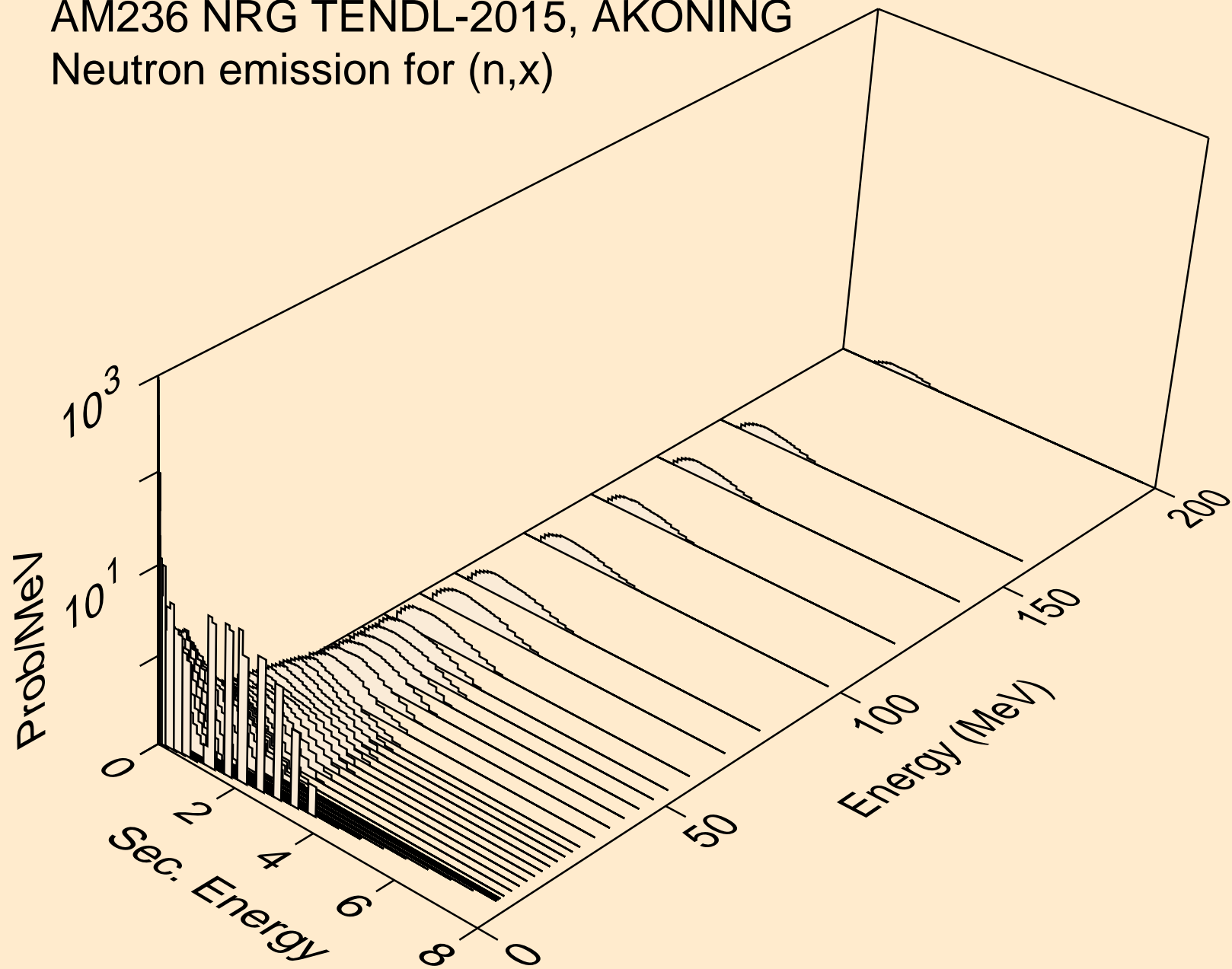

AM236 NRG TENDL-2015, AKONING
Neutron emission for (n,2nd)

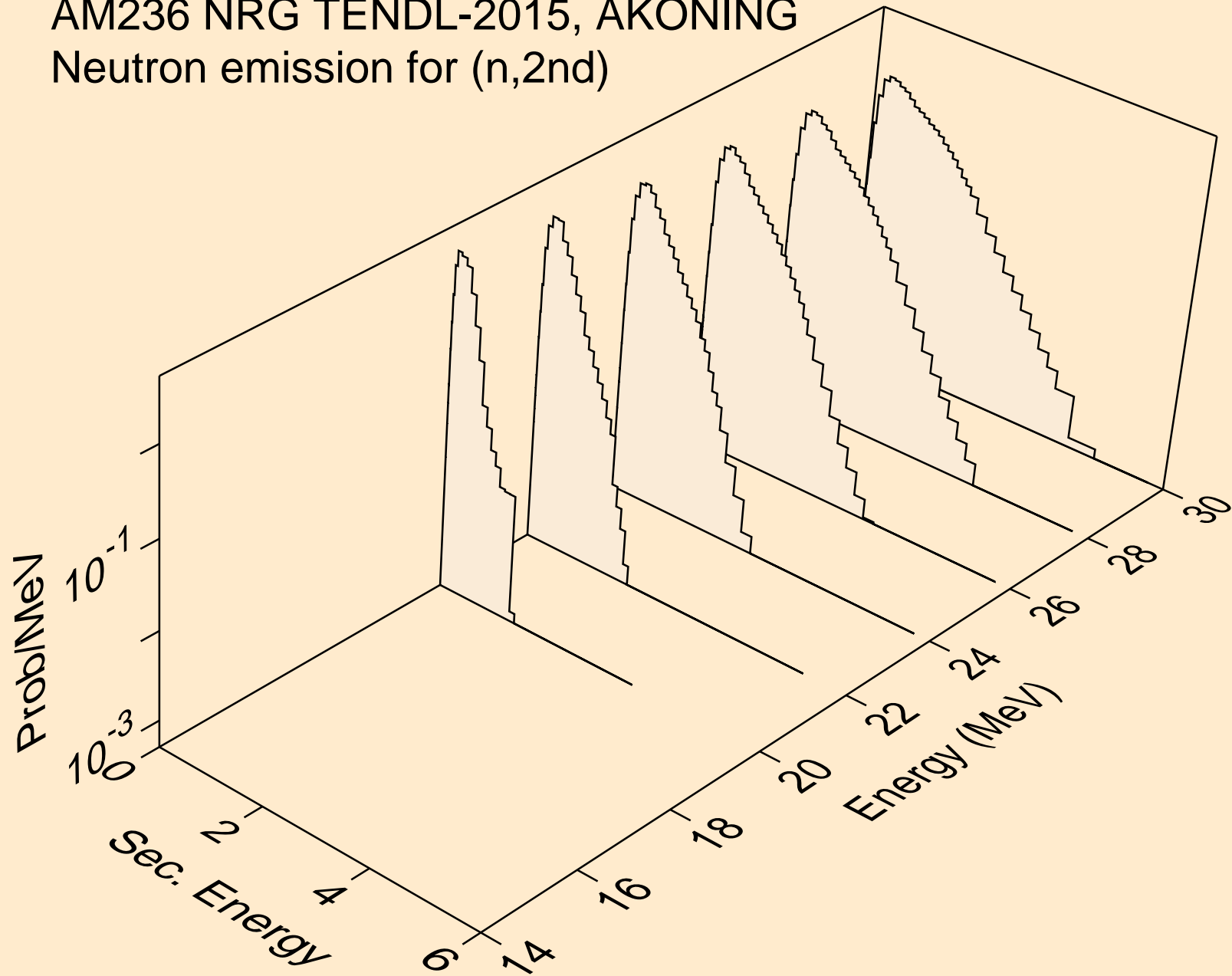

AM236 NRG TENDL-2015, AKONING
Neutron emission for (n,2n)

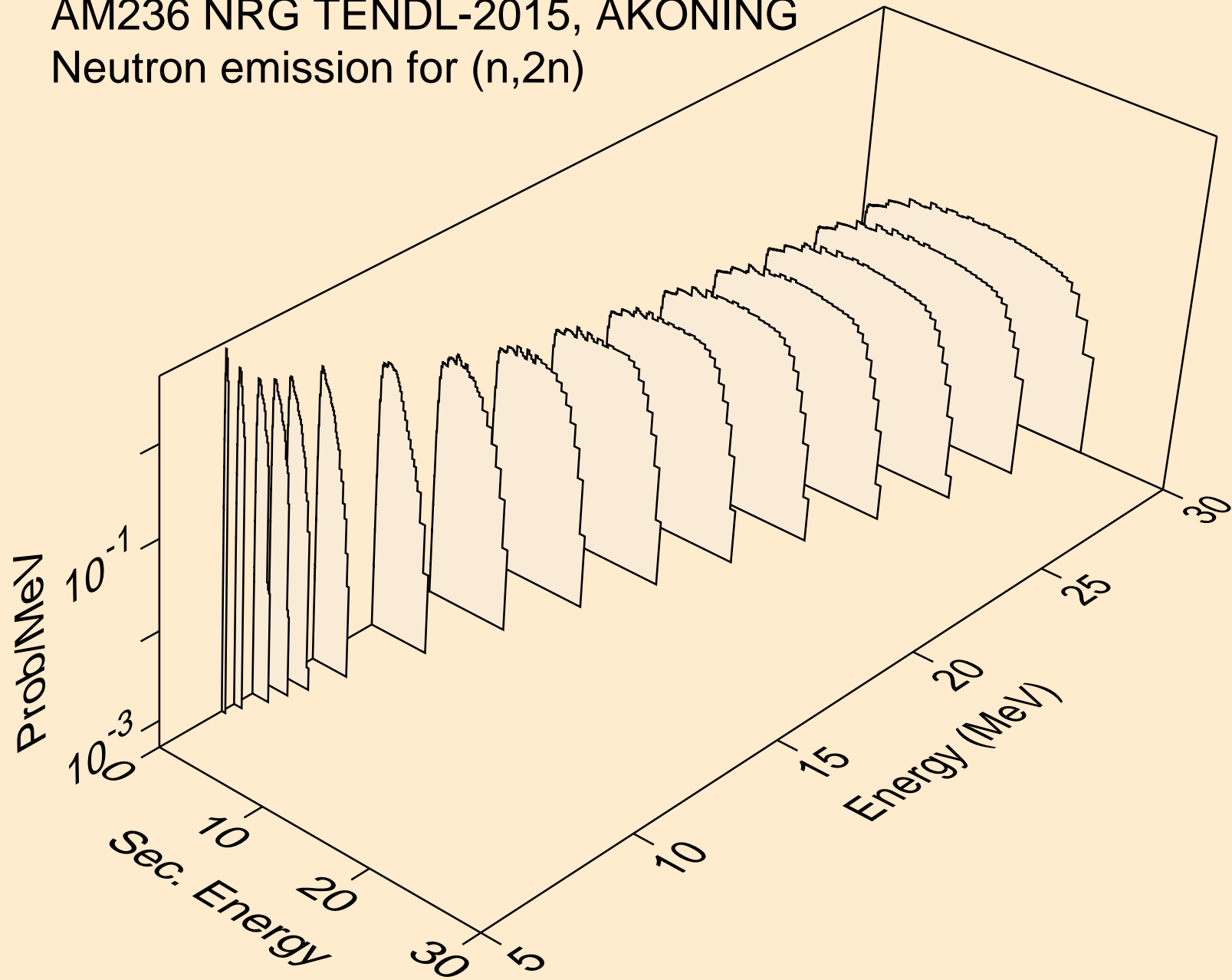

AM236 NRG TENDL-2015, AKONING
Neutron emission for (n,3n)

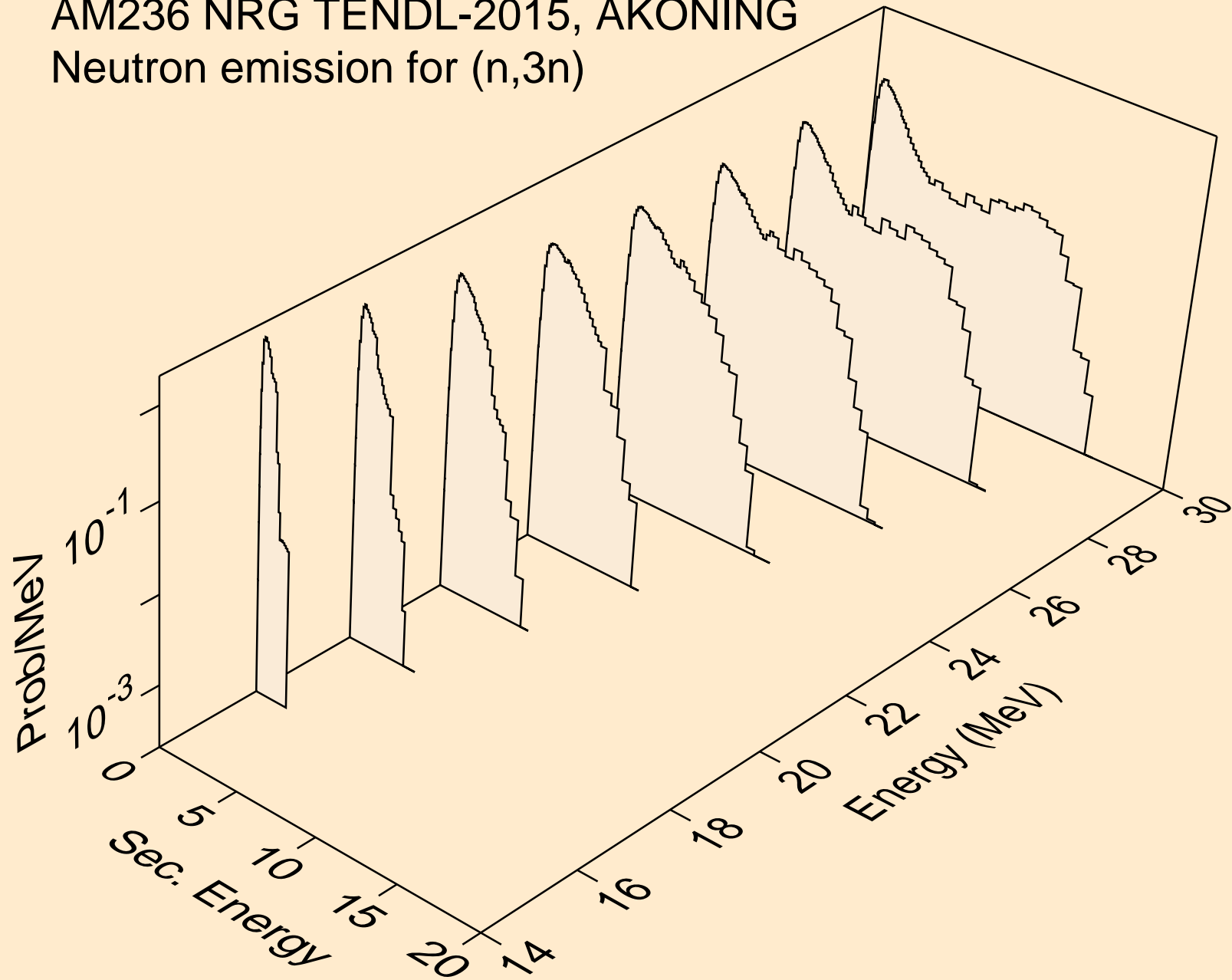

AM236 NRG TENDL-2015, AKONING
Neutron emission for fission

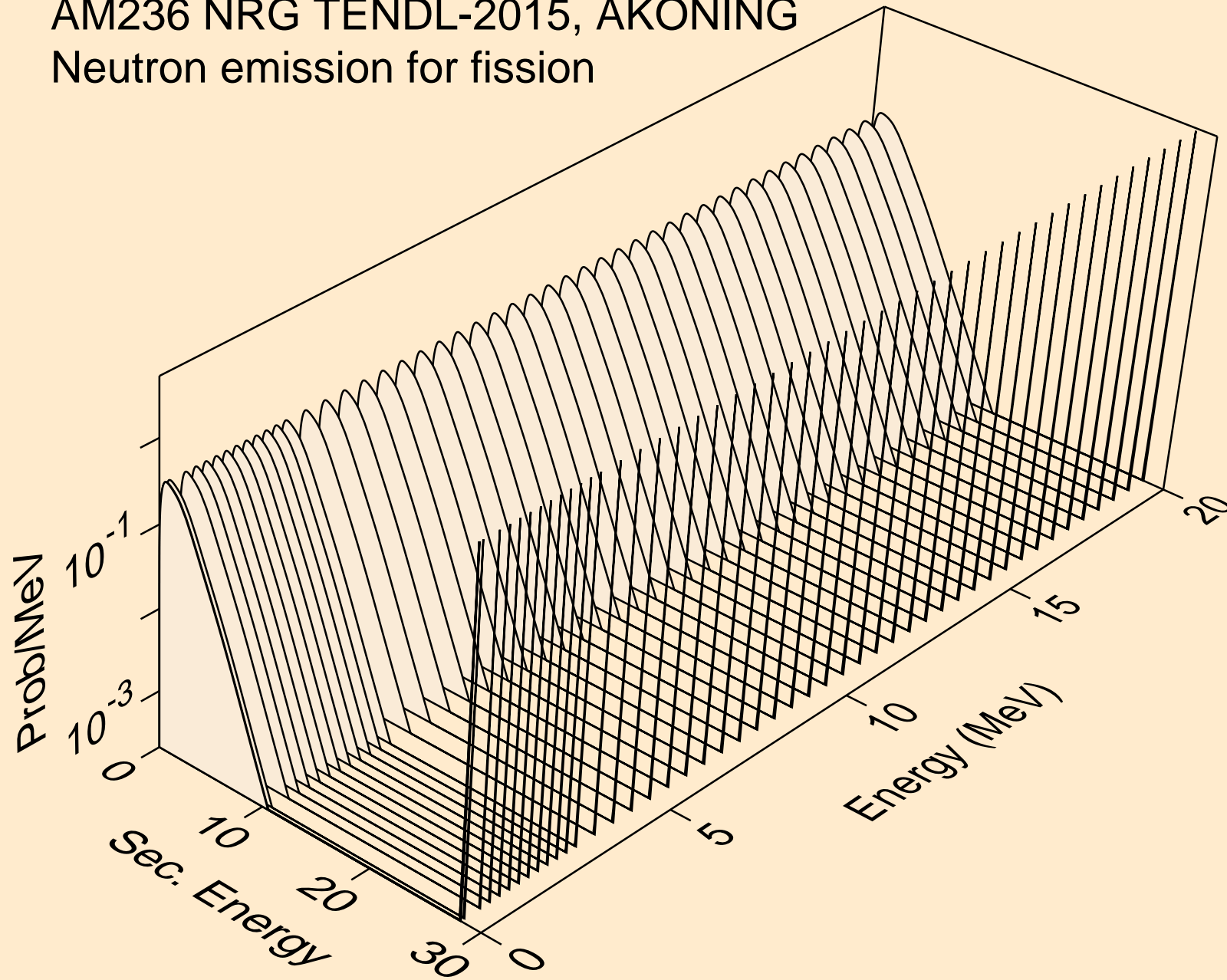

AM236 NRG TENDL-2015, AKONING
Neutron emission for (n,n*)a

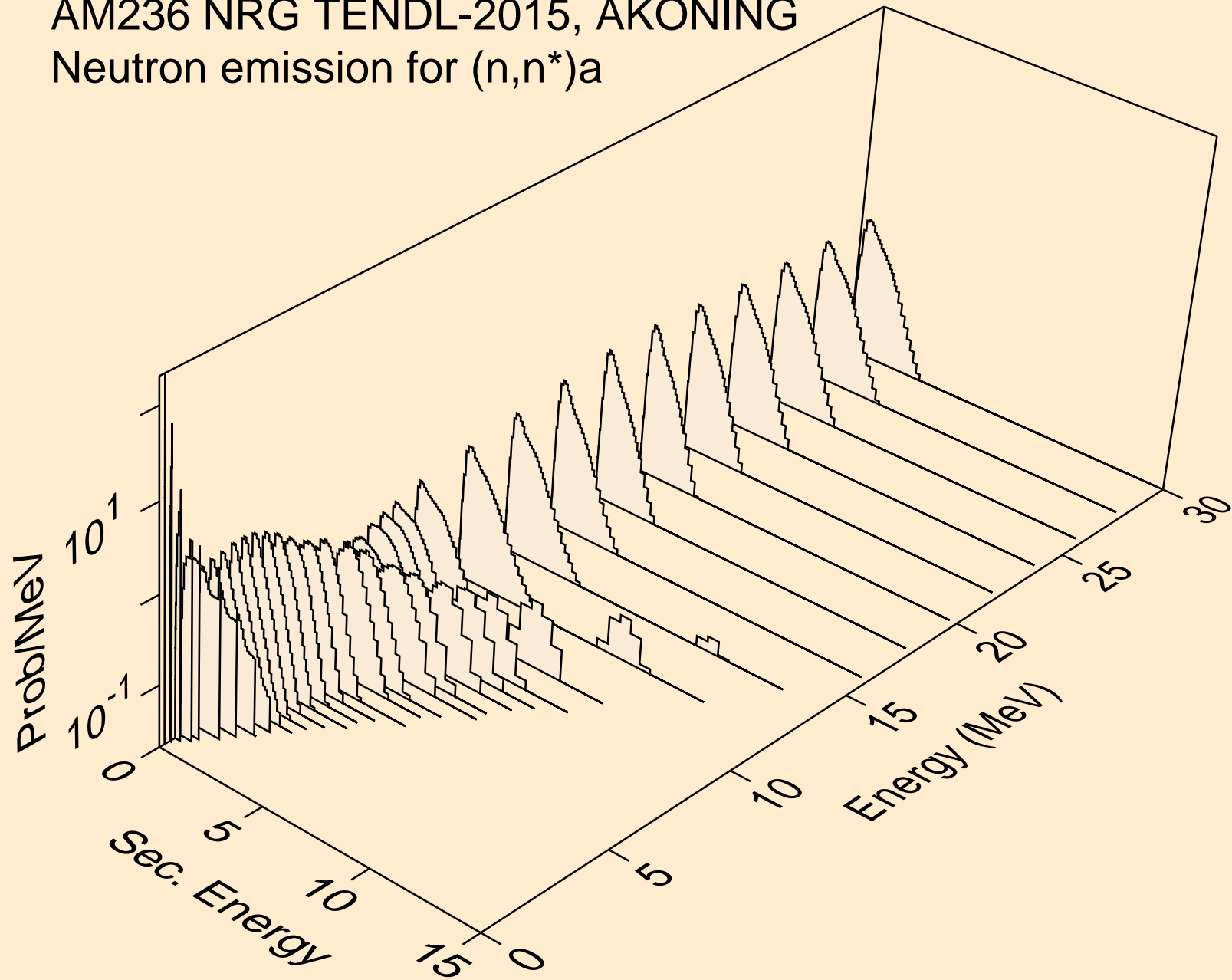

AM236 NRG TENDL-2015, AKONING
Neutron emission for (n,2n)a

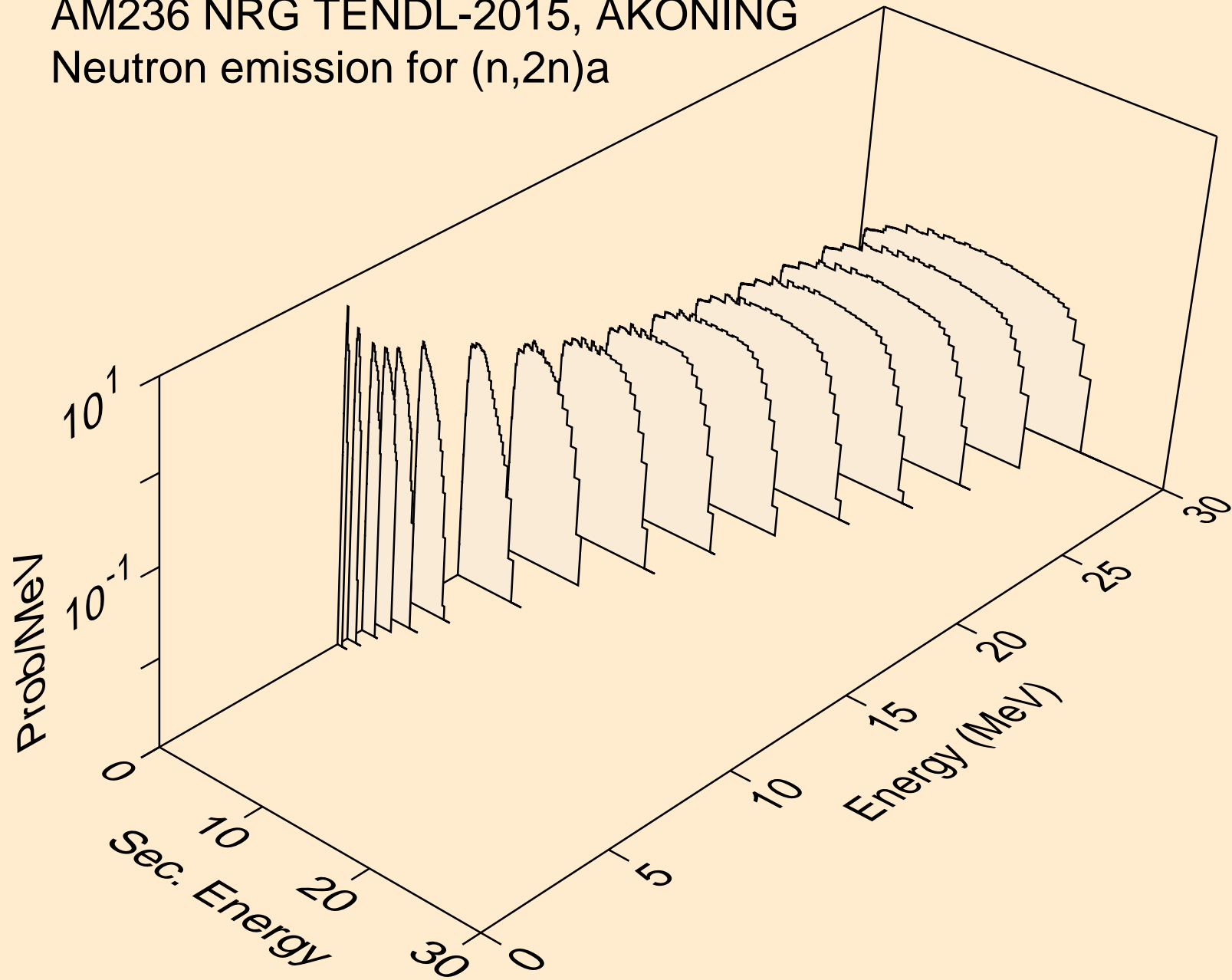

AM236 NRG TENDL-2015, AKONING
Neutron emission for (n,3n)a

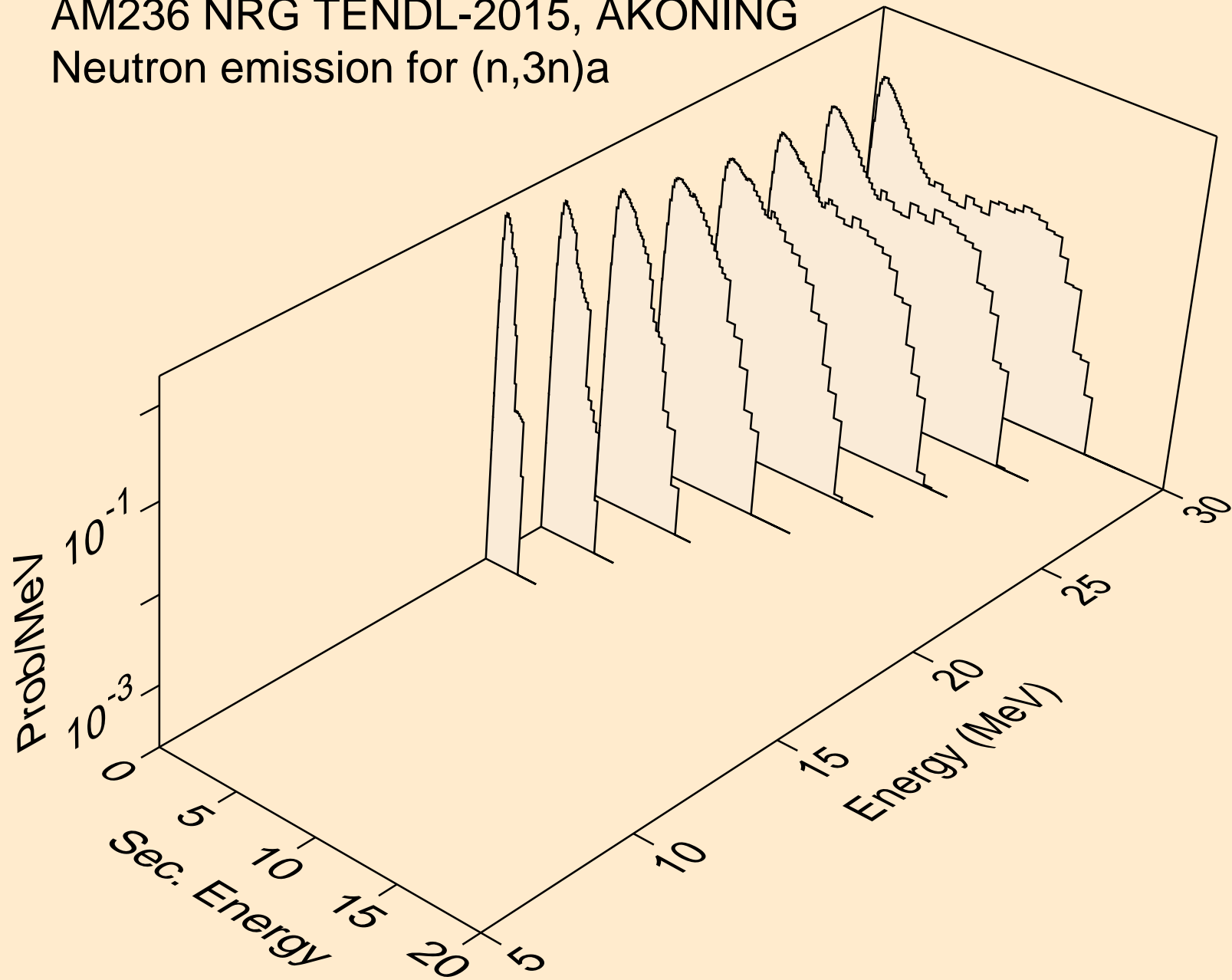

AM236 NRG TENDL-2015, AKONING
Neutron emission for (n,n*)p

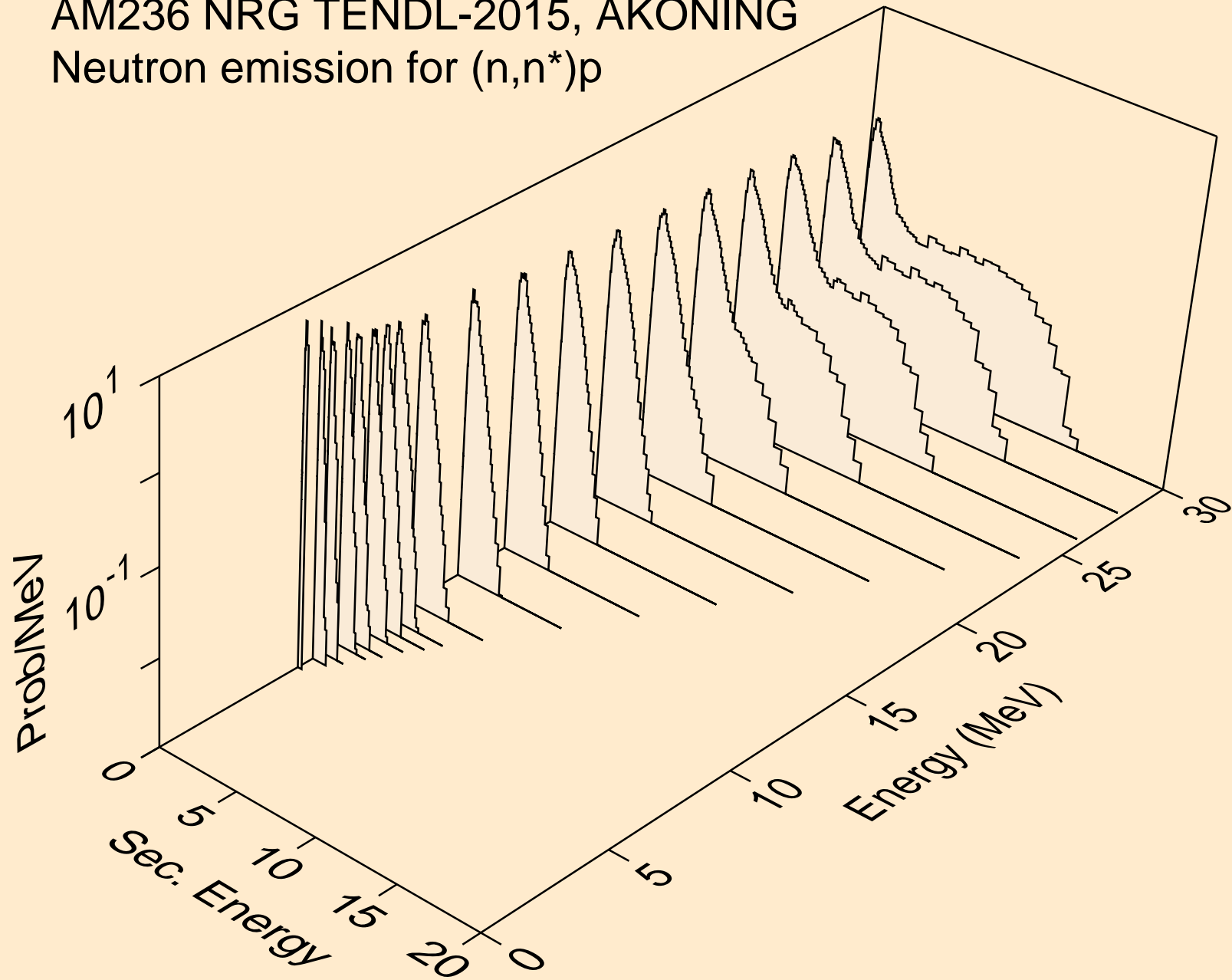

AM236 NRG TENDL-2015, AKONING
Neutron emission for (n,n*)2a

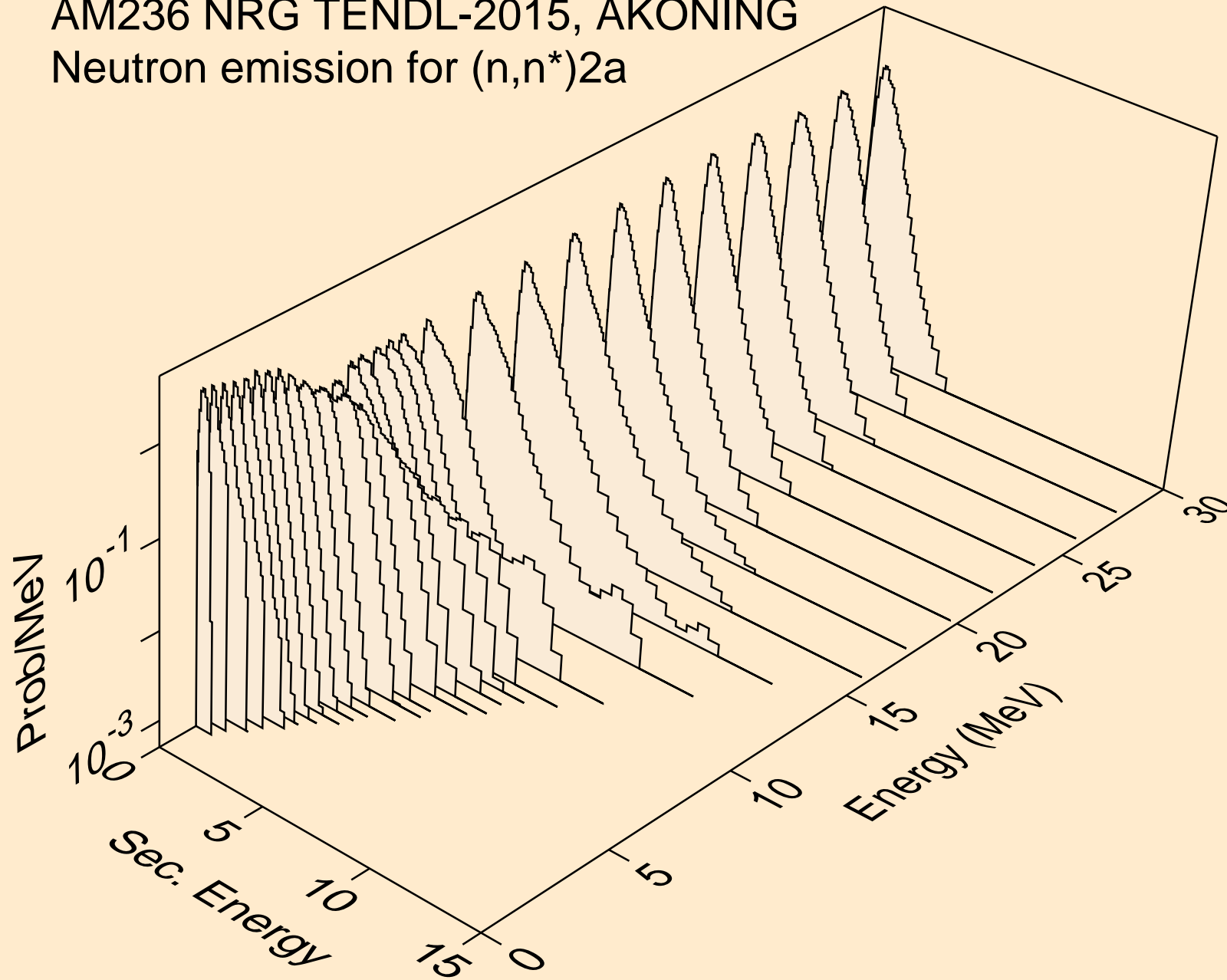

AM236 NRG TENDL-2015, AKONING
Neutron emission for (n,2n)2a

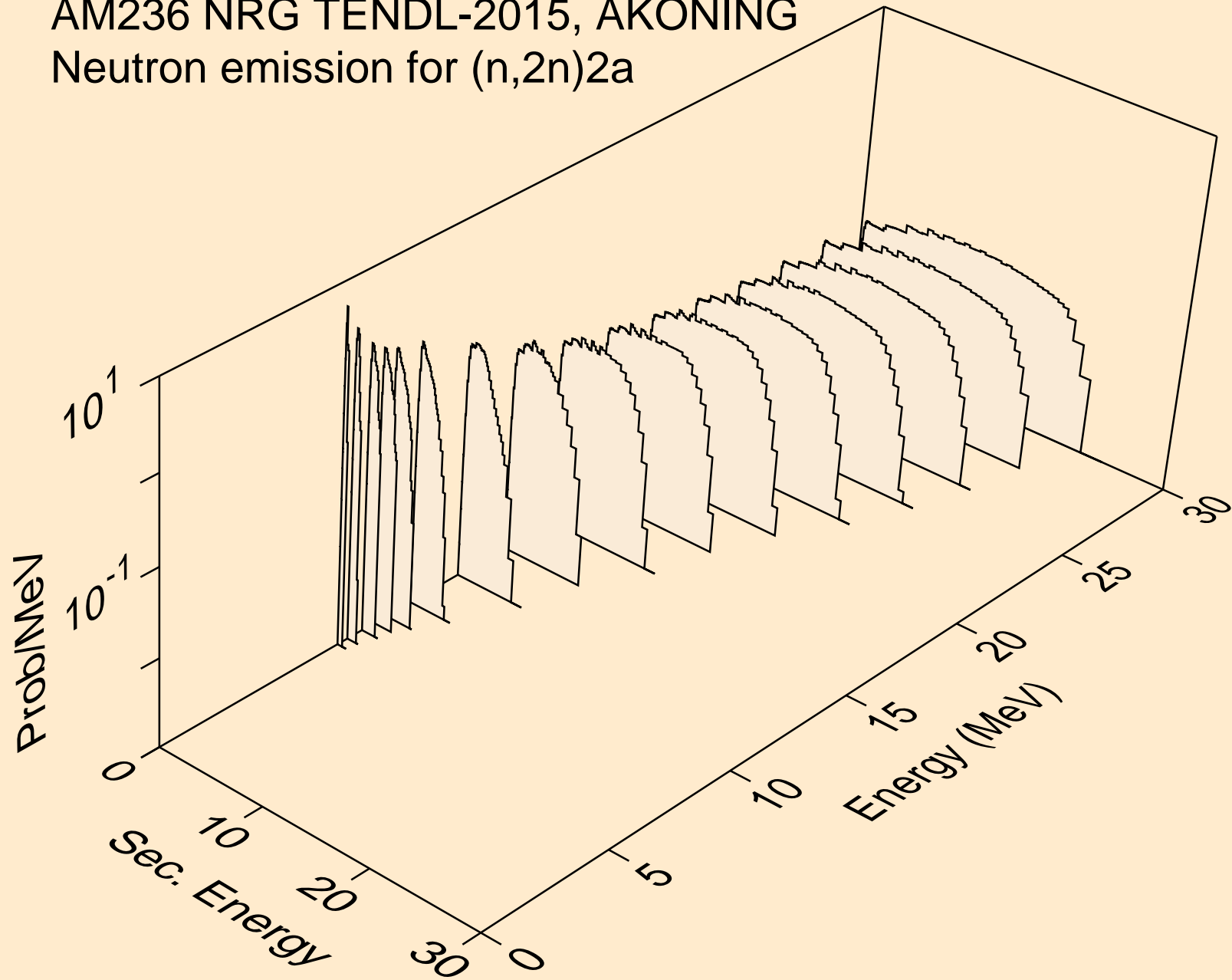

AM236 NRG TENDL-2015, AKONING
Neutron emission for (n,n*)d

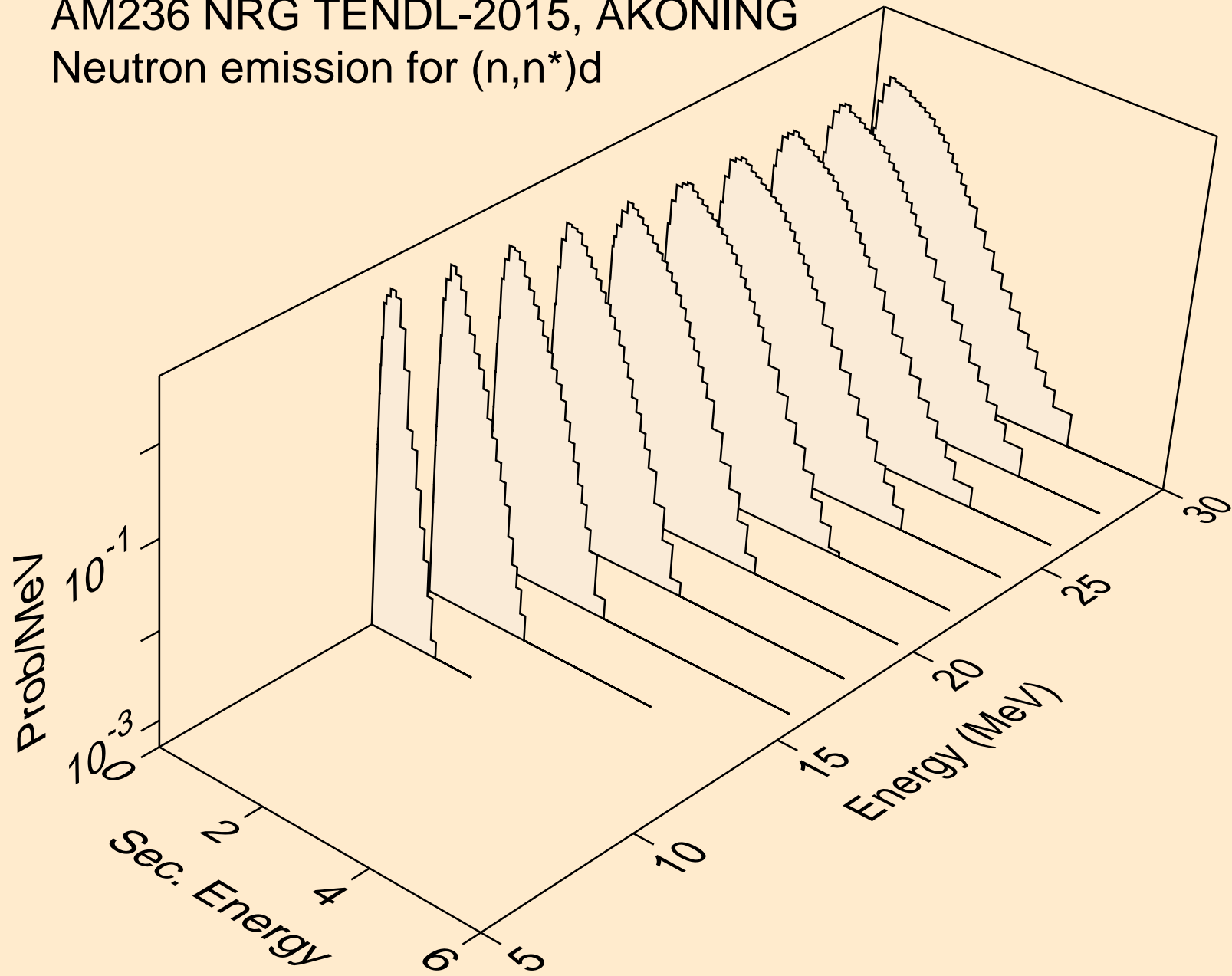

AM236 NRG TENDL-2015, AKONING
Neutron emission for (n,n*)t

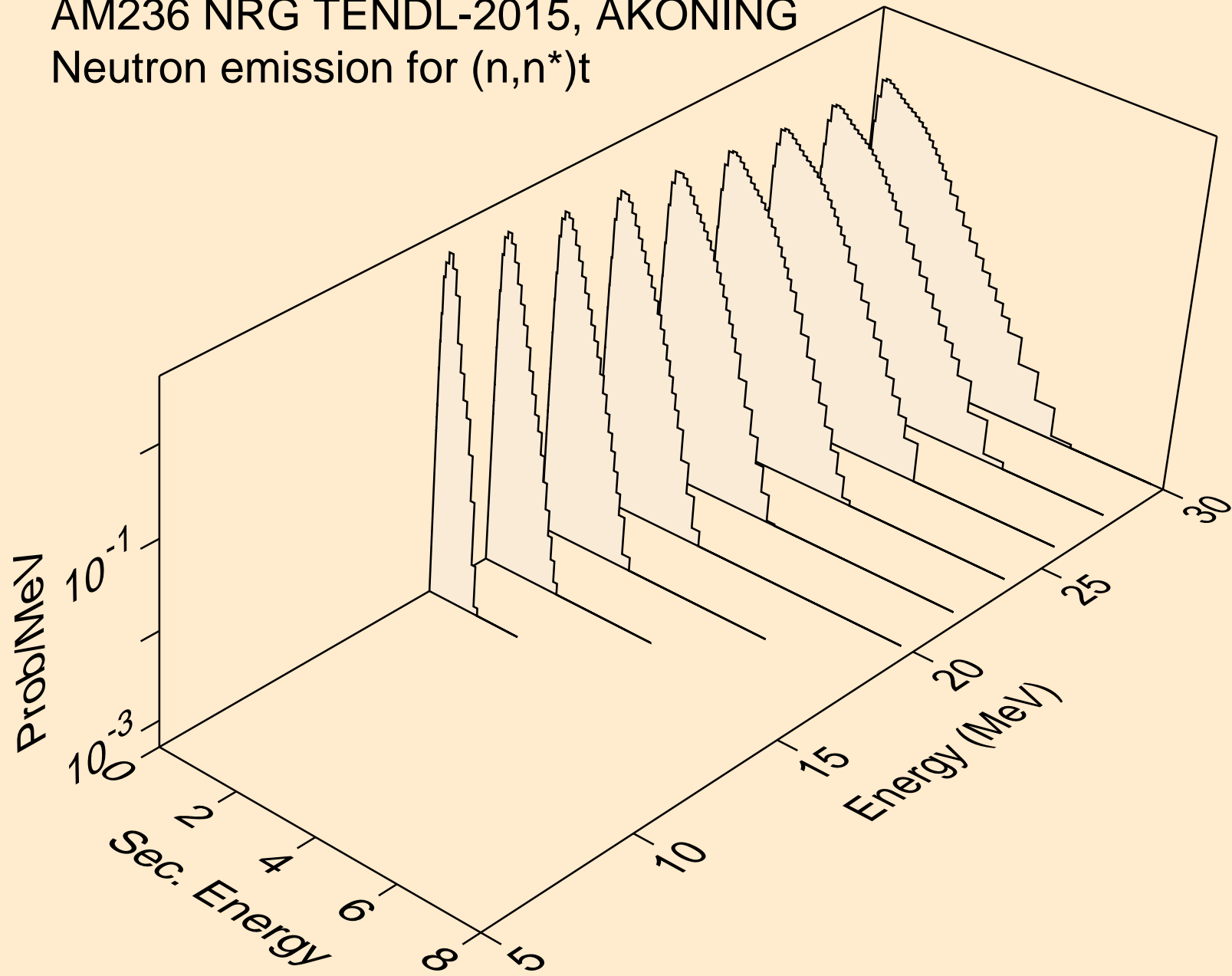

AM236 NRG TENDL-2015, AKONING
Neutron emission for (n,n*)he3

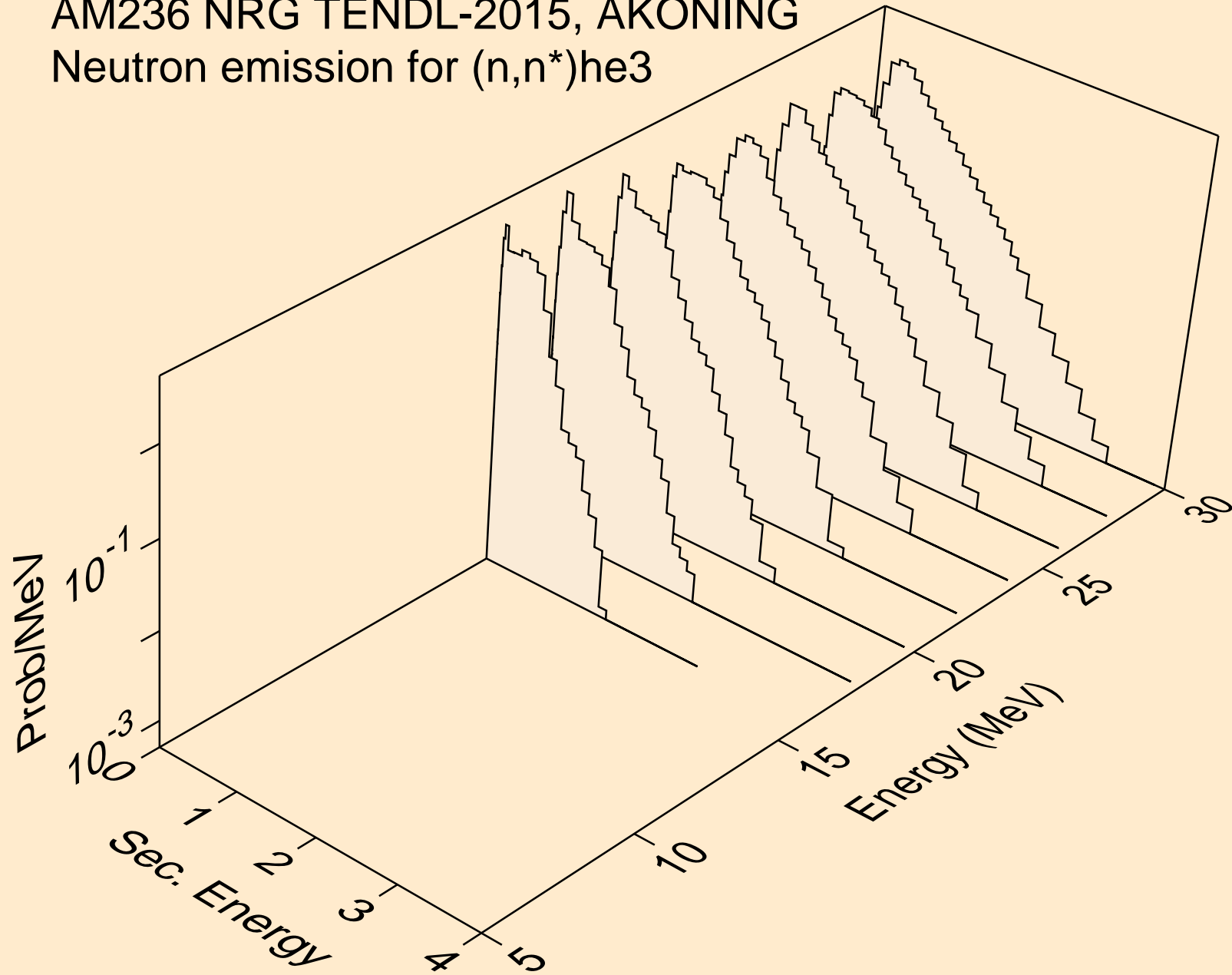

AM236 NRG TENDL-2015, AKONING
Neutron emission for (n,4n)

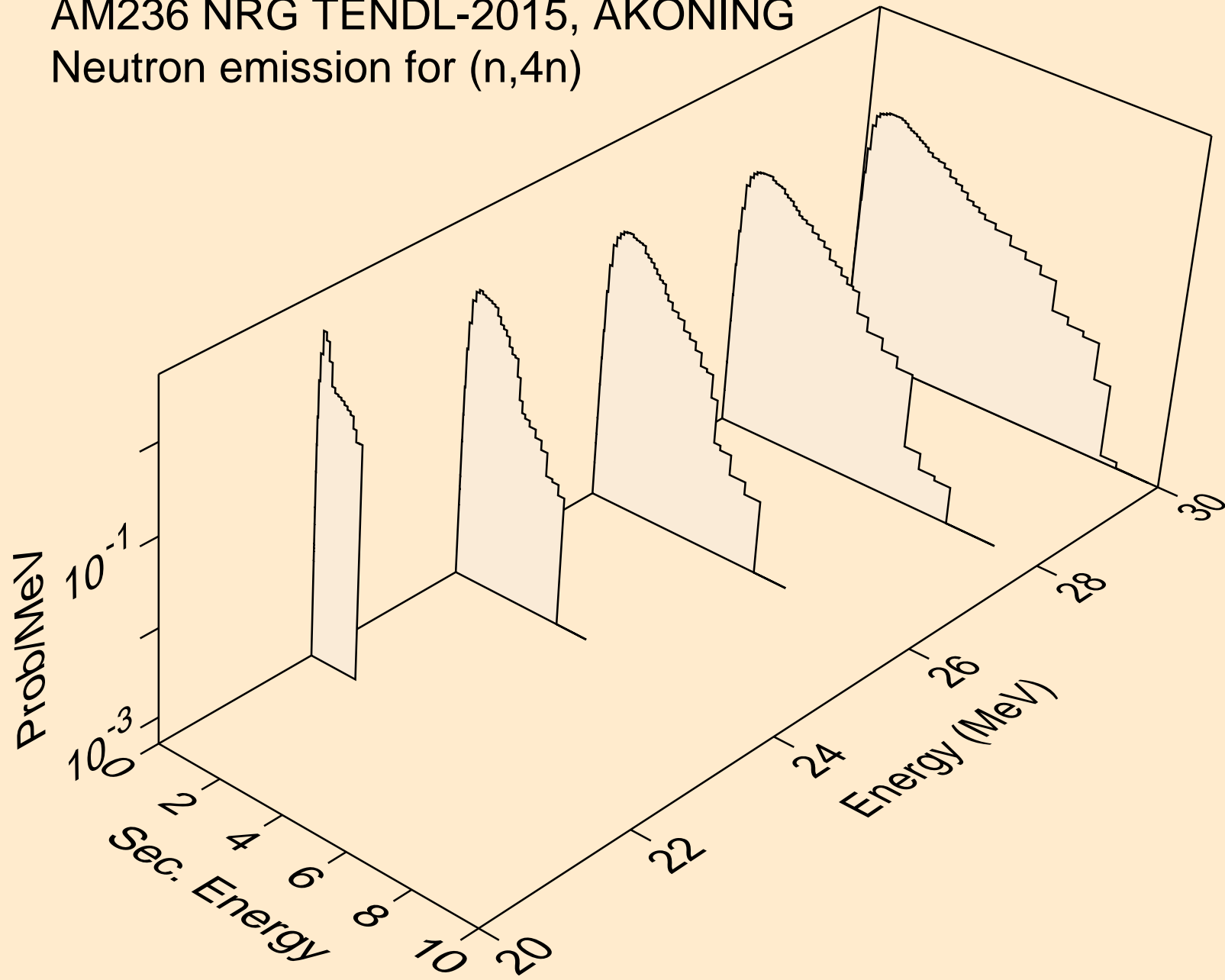

AM236 NRG TENDL-2015, AKONING
Neutron emission for (n,2np)

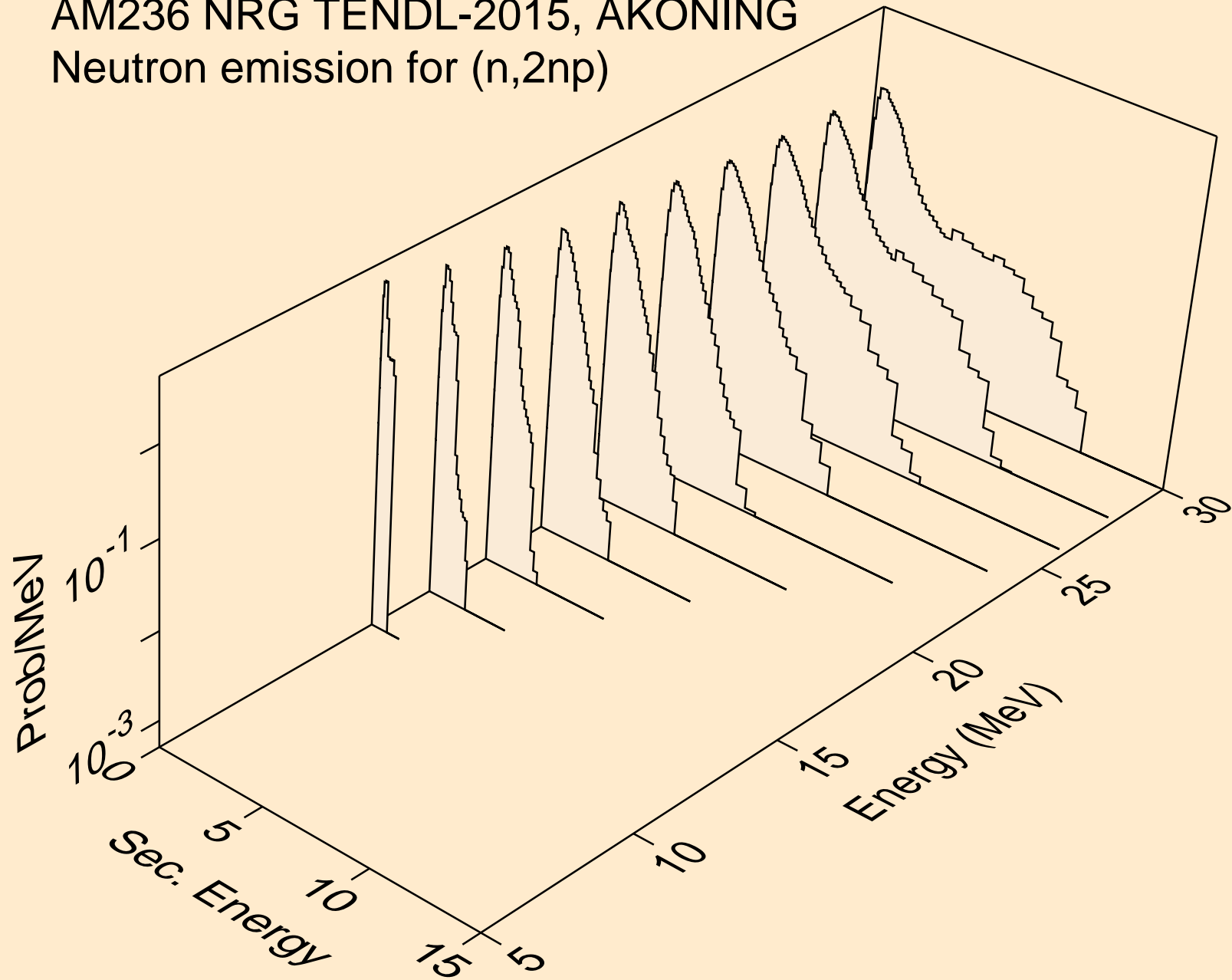

AM236 NRG TENDL-2015, AKONING
Neutron emission for (n,3np)

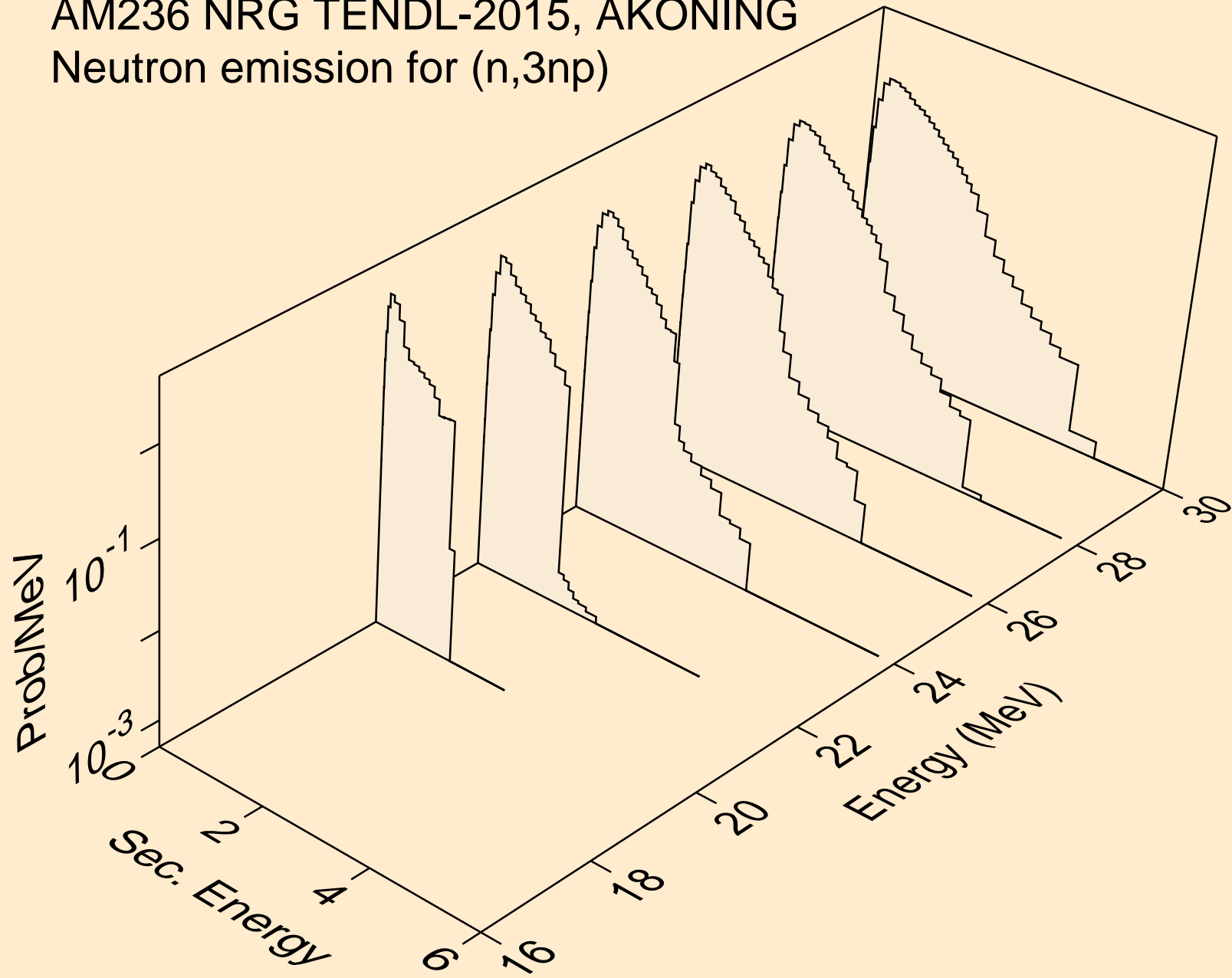

AM236 NRG TENDL-2015, AKONING
Neutron emission for (n,2np)

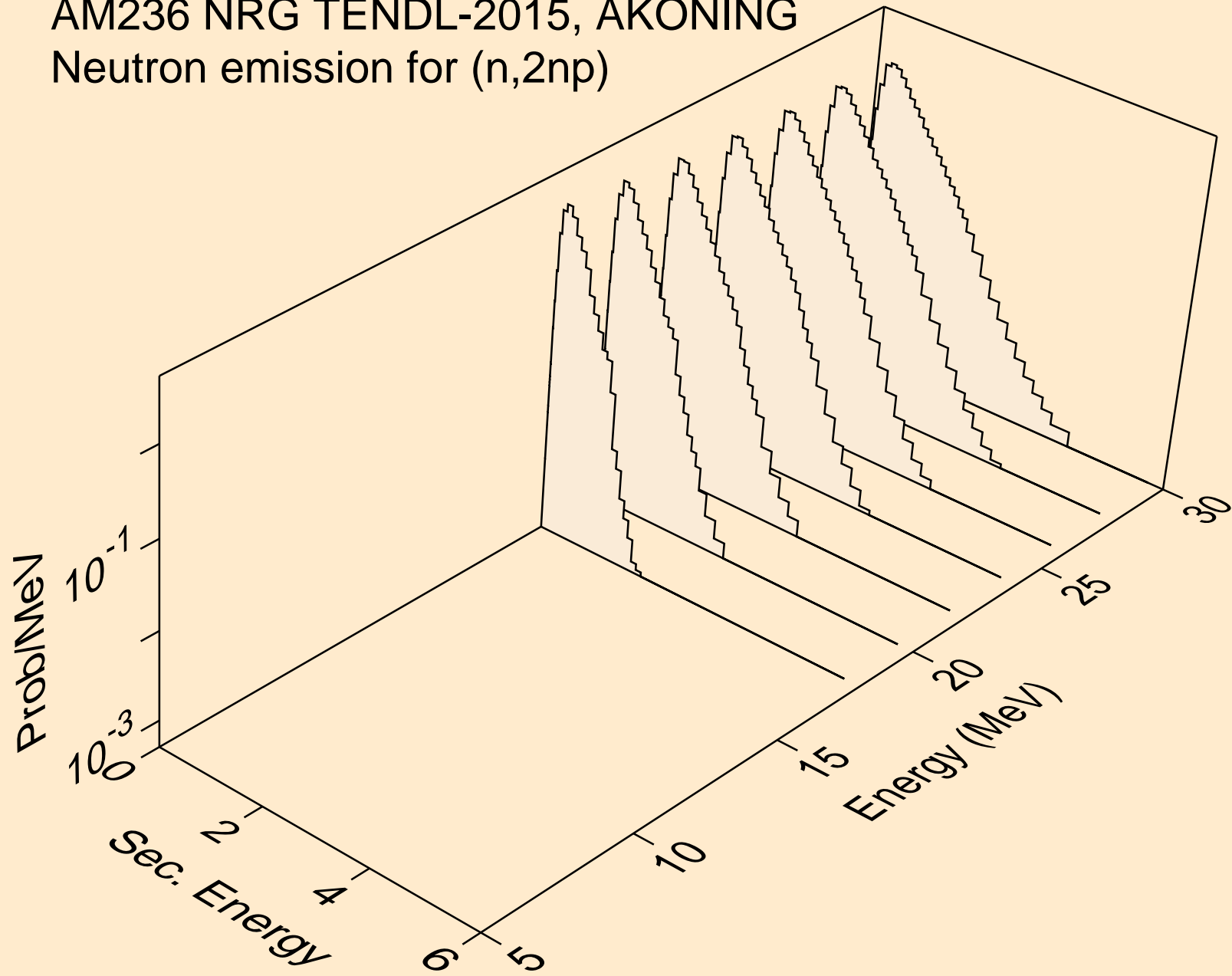

AM236 NRG TENDL-2015, AKONING
Neutron emission for (n,npa)

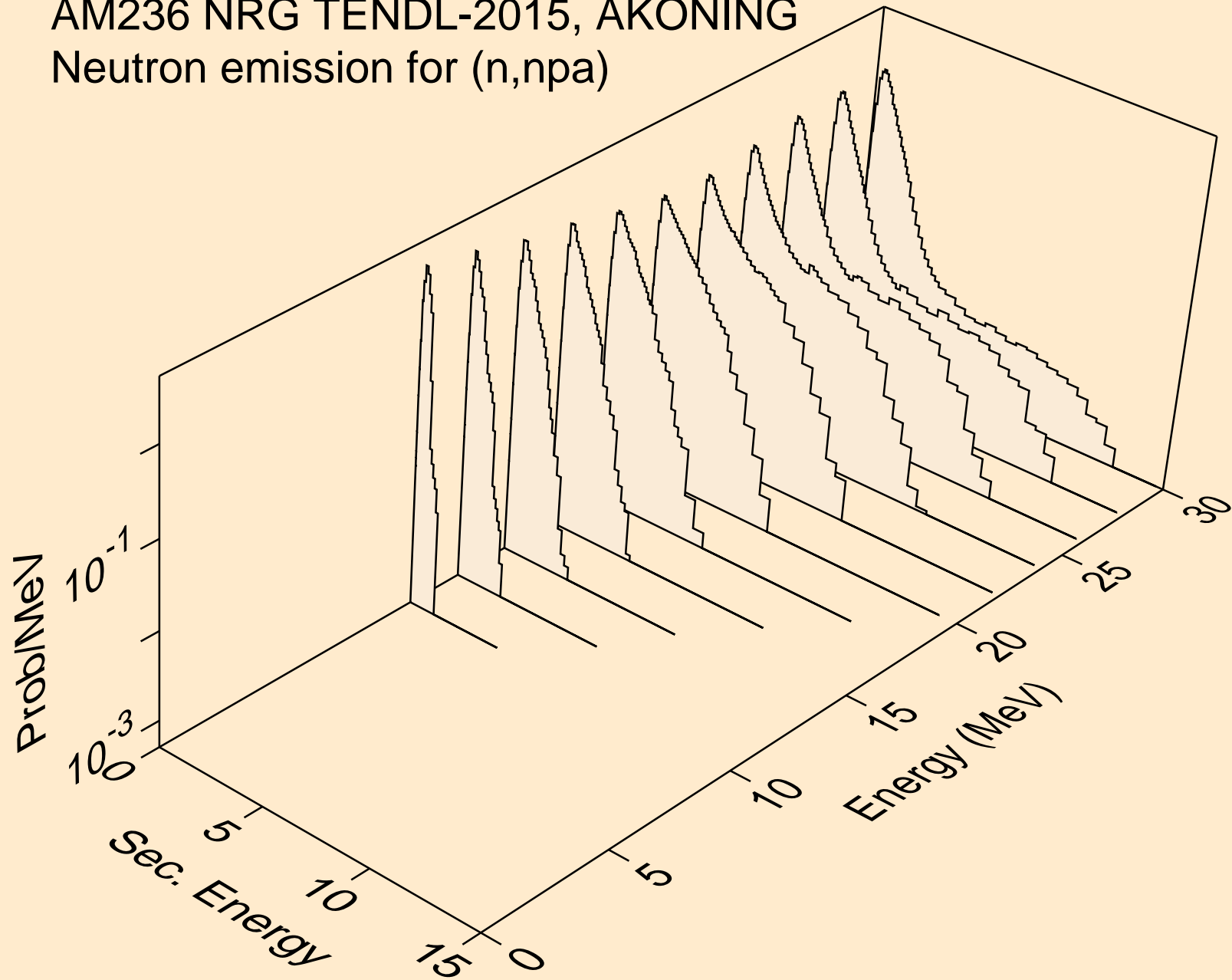

AM236 NRG TENDL-2015, AKONING
Neutron emission for (n,n*c)

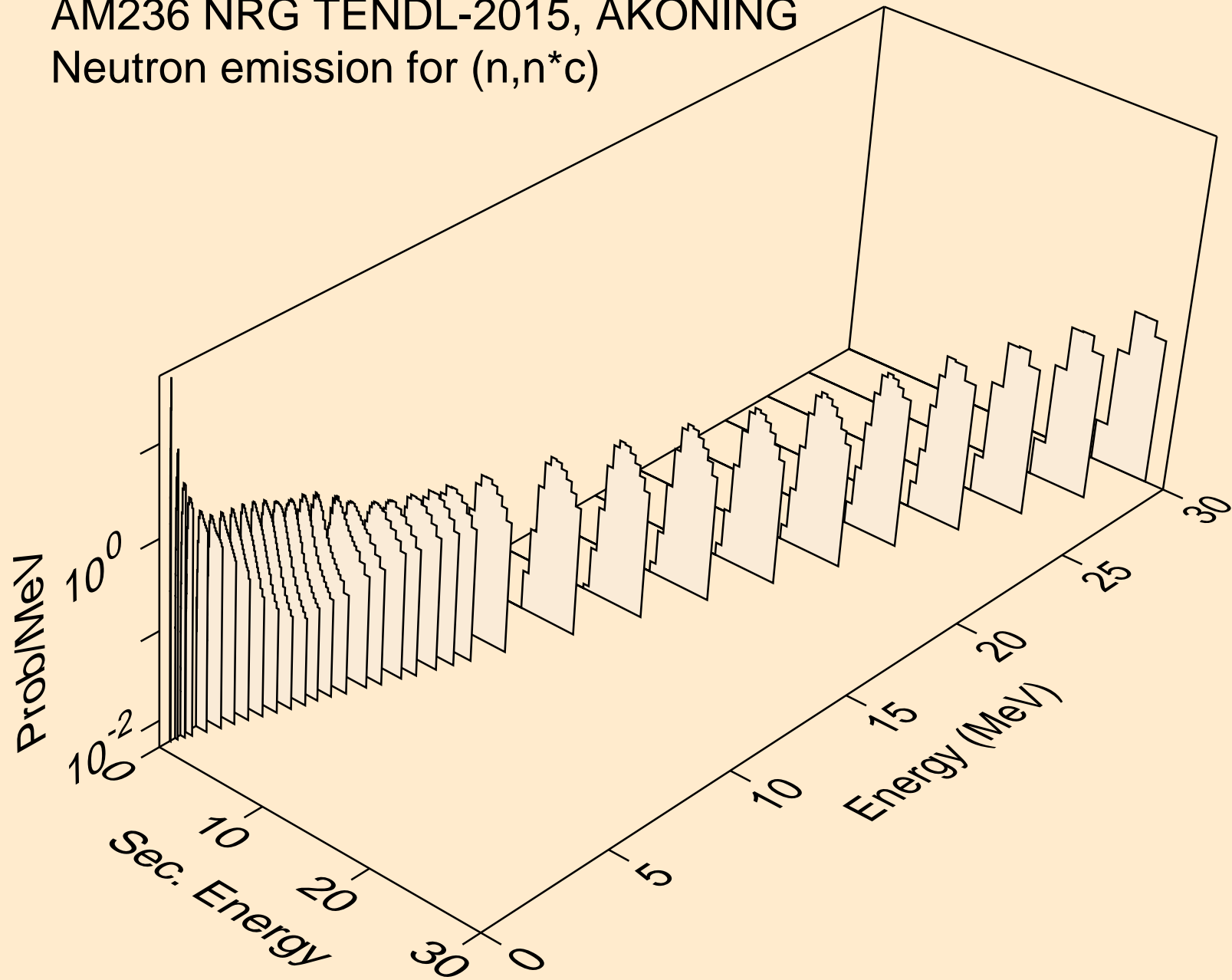

AM236 NRG TENDL-2015, AKONING

Delayed nubar

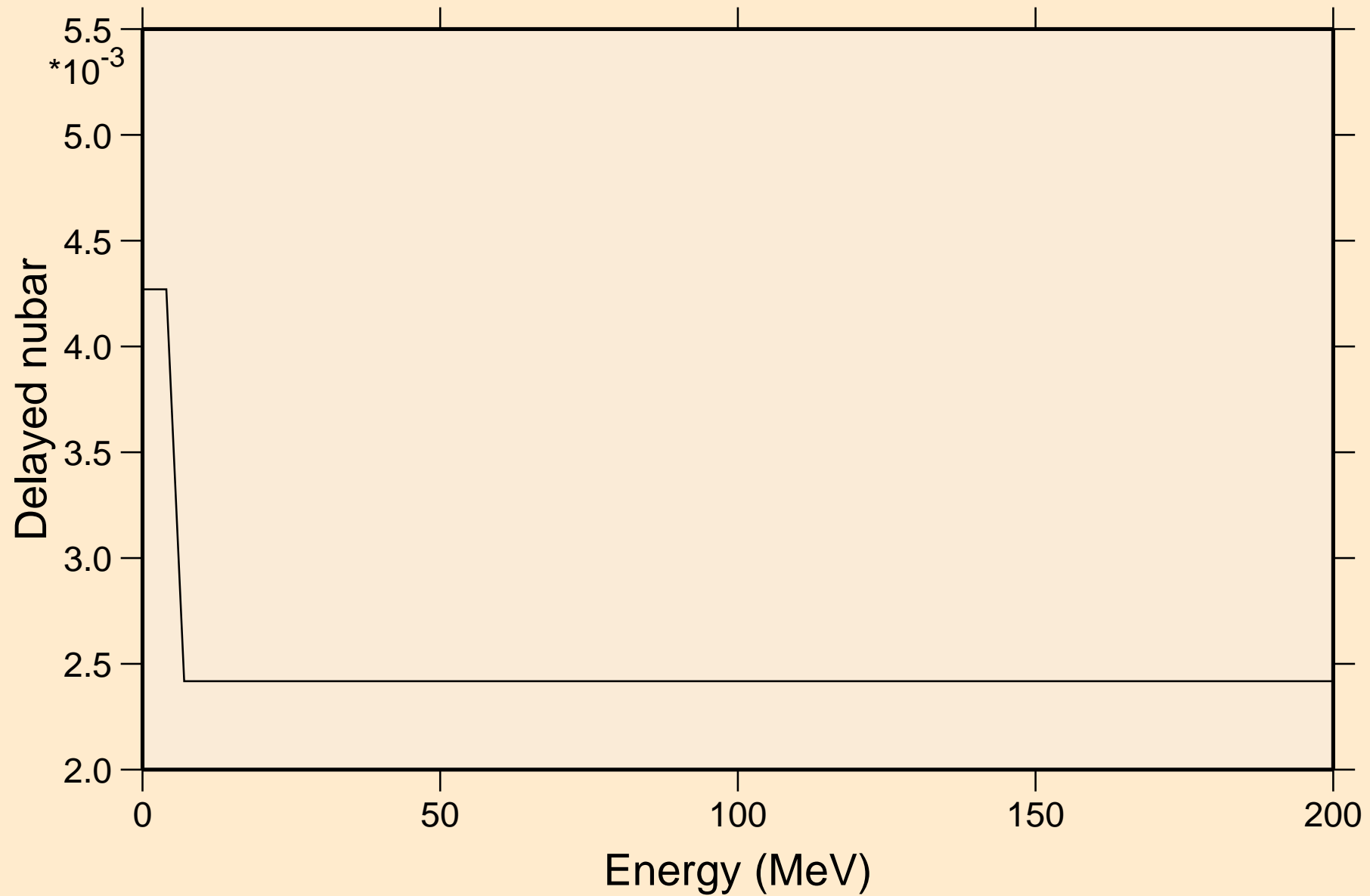

AM236 NRG TENDL-2015, AKONING

Delayed neutron spectra

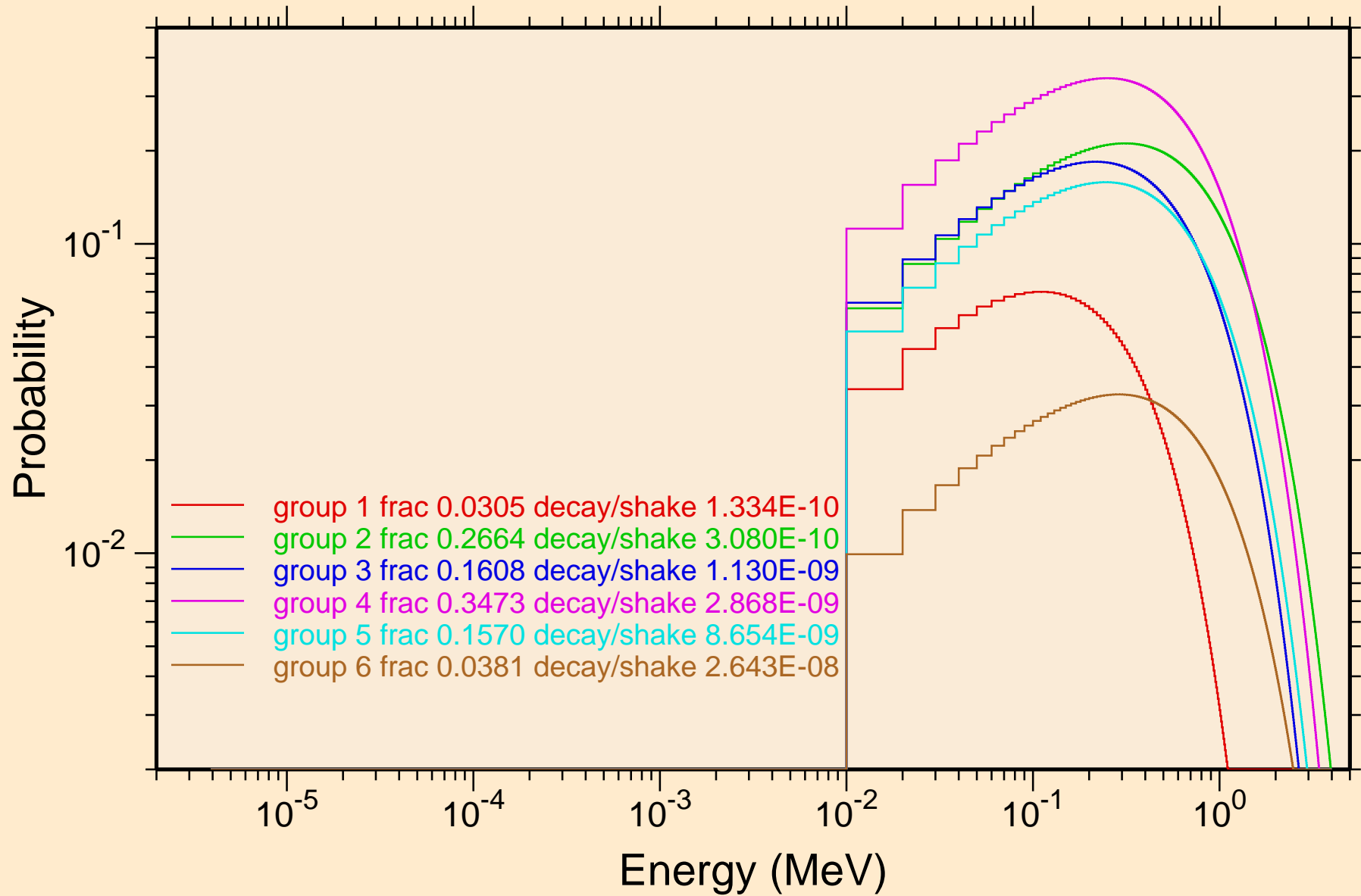

AM236 NRG TENDL-2015, AKONING
Photon emission for (n,x)

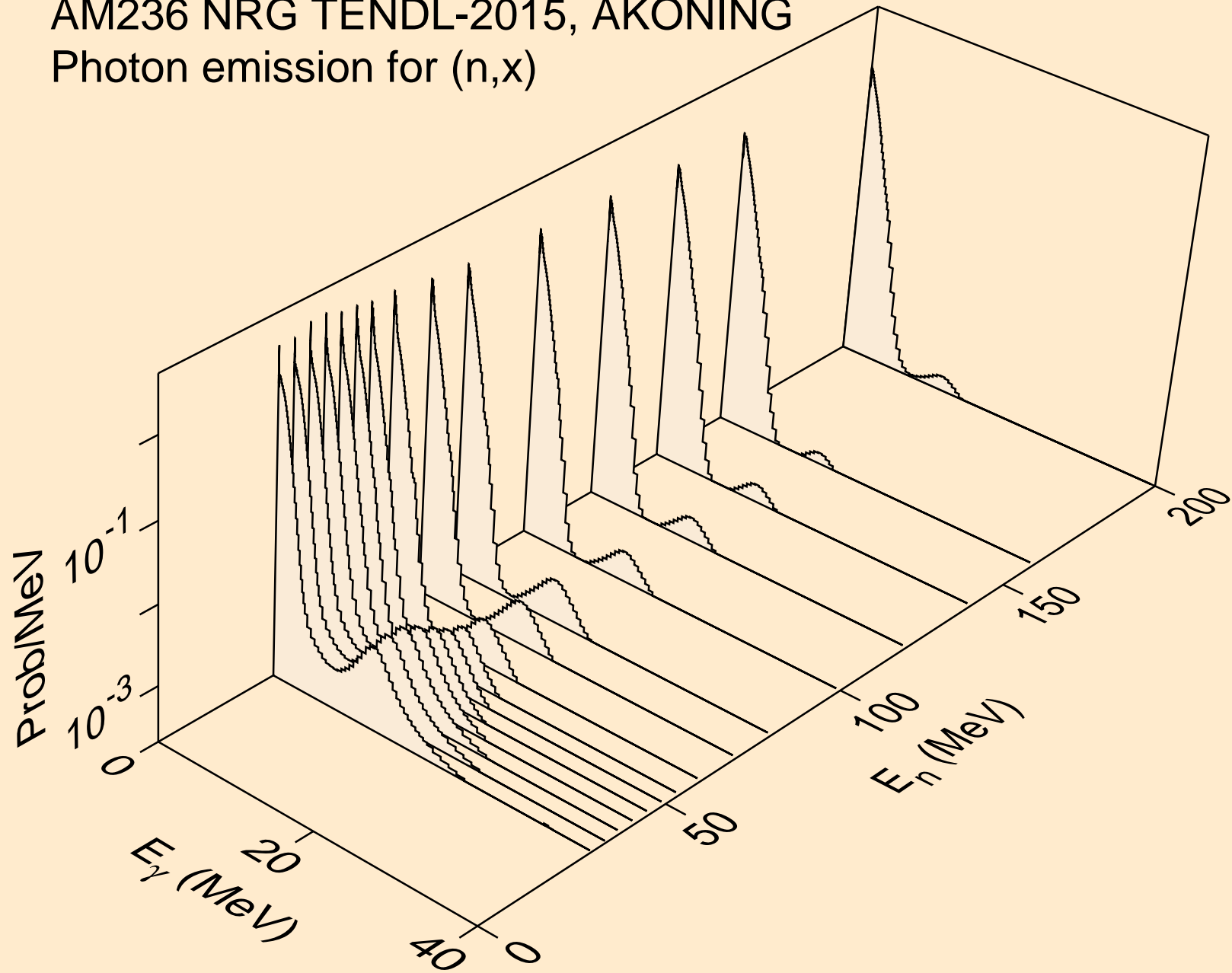

AM236 NRG TENDL-2015, AKONING
Photon emission for (n,2nd)

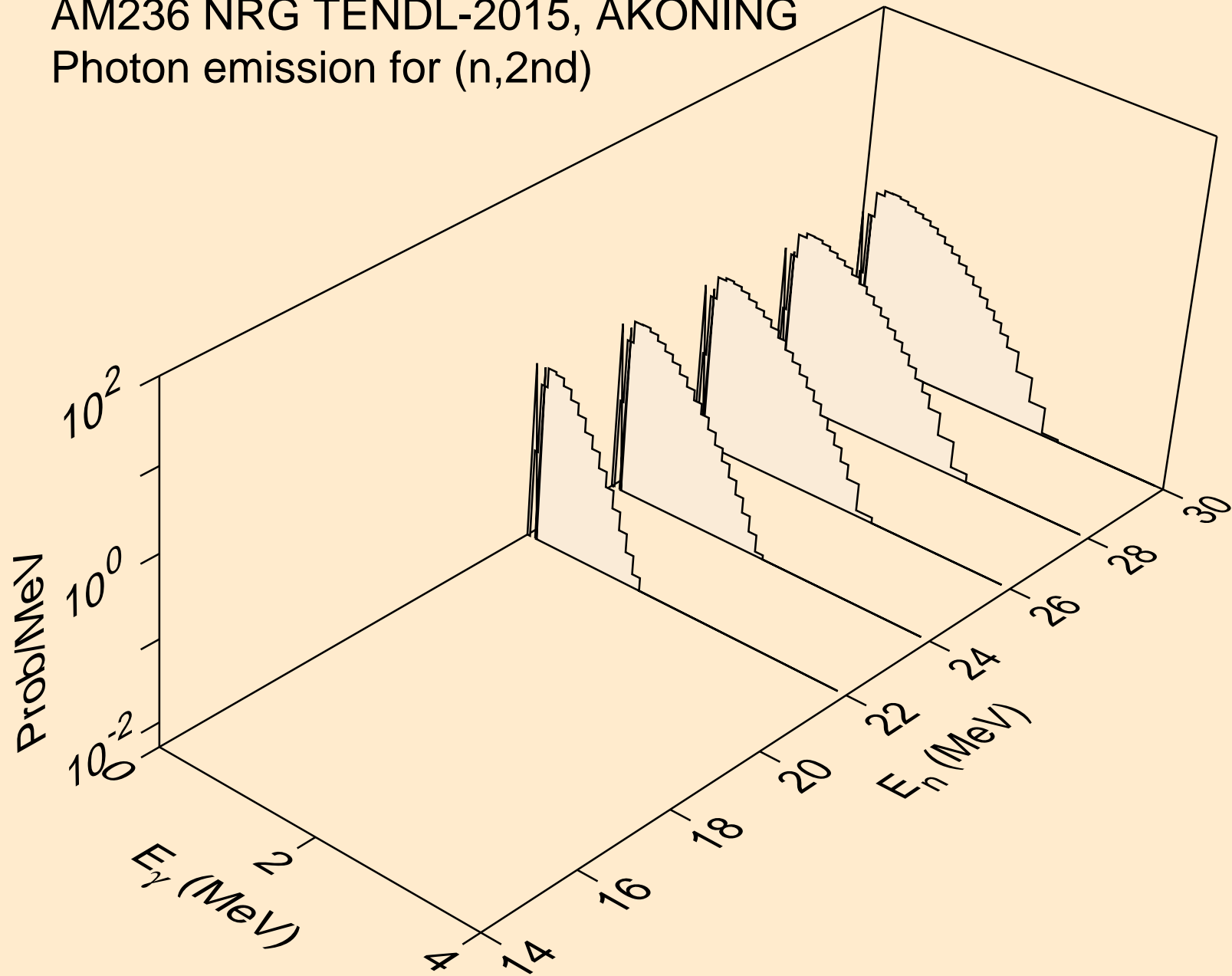

AM236 NRG TENDL-2015, AKONING
Photon emission for (n,2n)

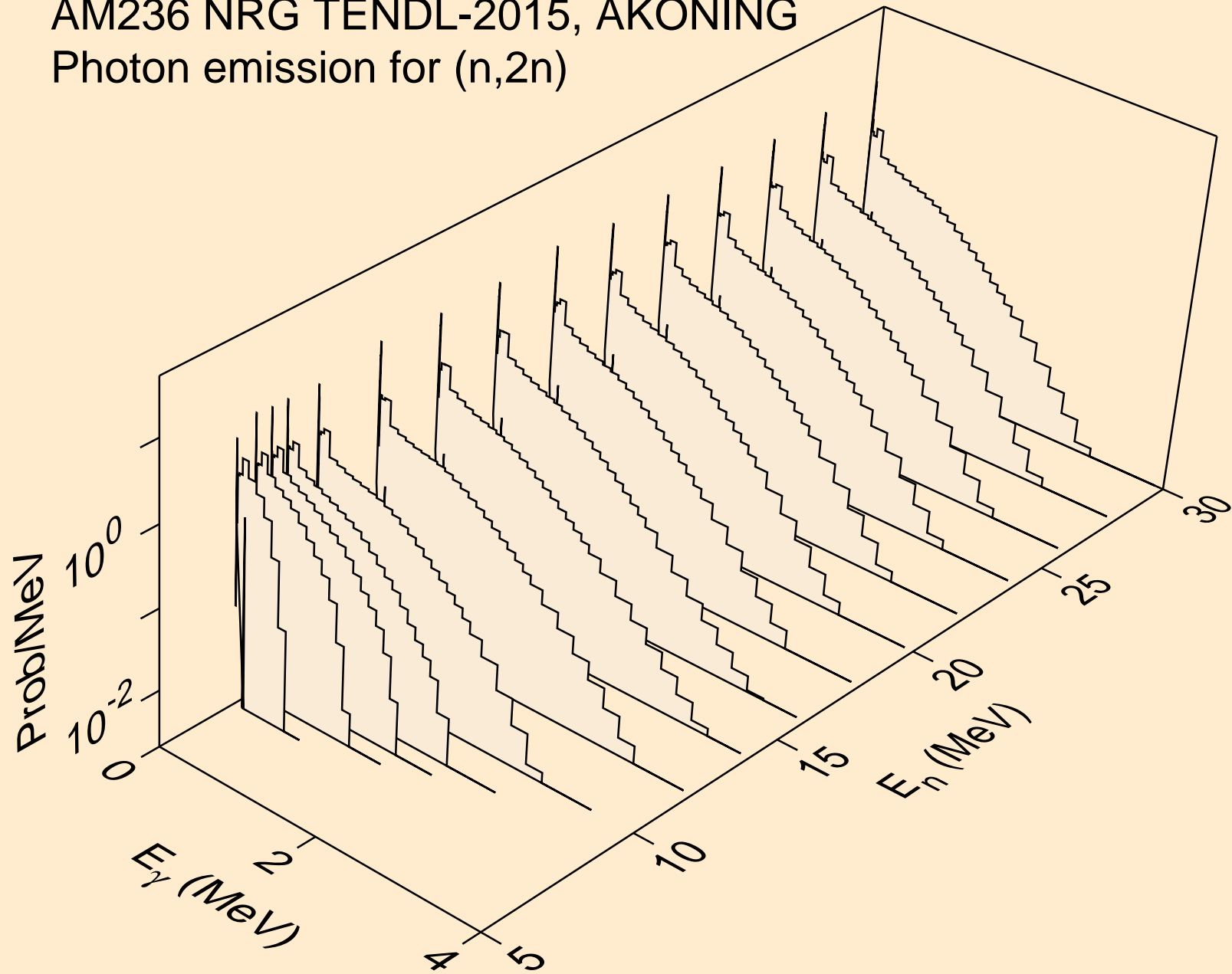

AM236 NRG TENDL-2015, AKONING
Photon emission for (n,3n)

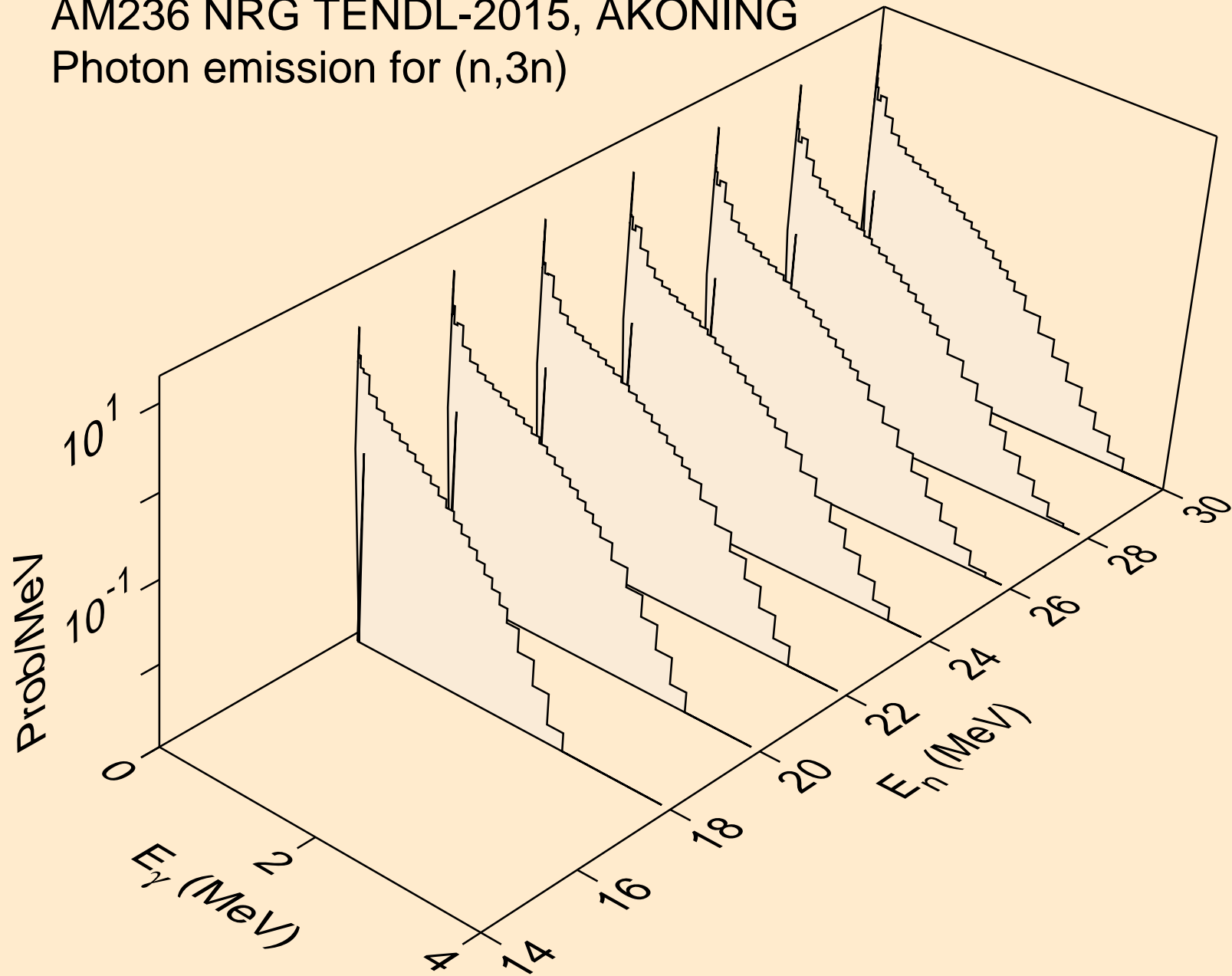

AM236 NRG TENDL-2015, AKONING
Photon emission for (n,n*)a

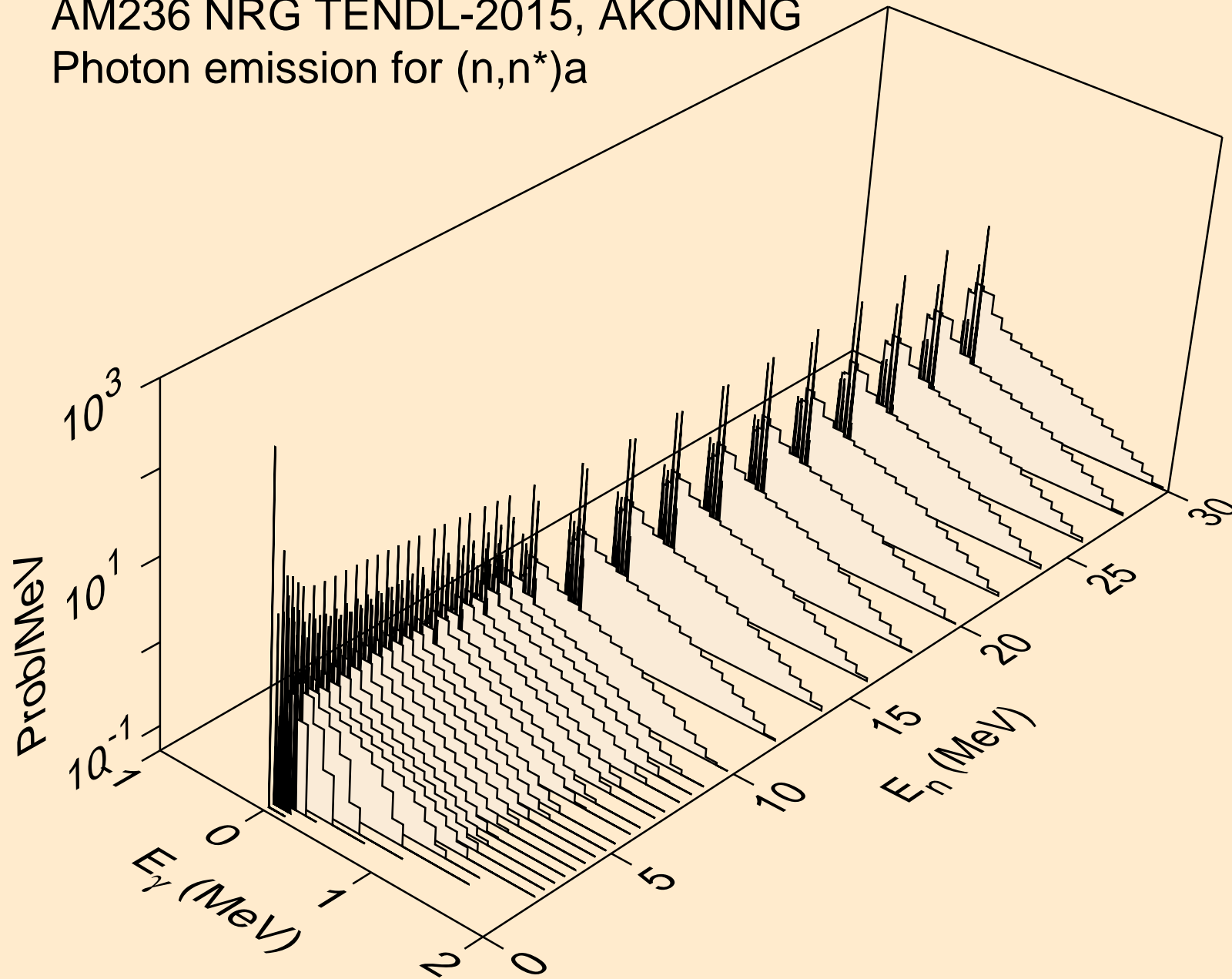

AM236 NRG TENDL-2015, AKONING
Photon emission for (n,2n)a

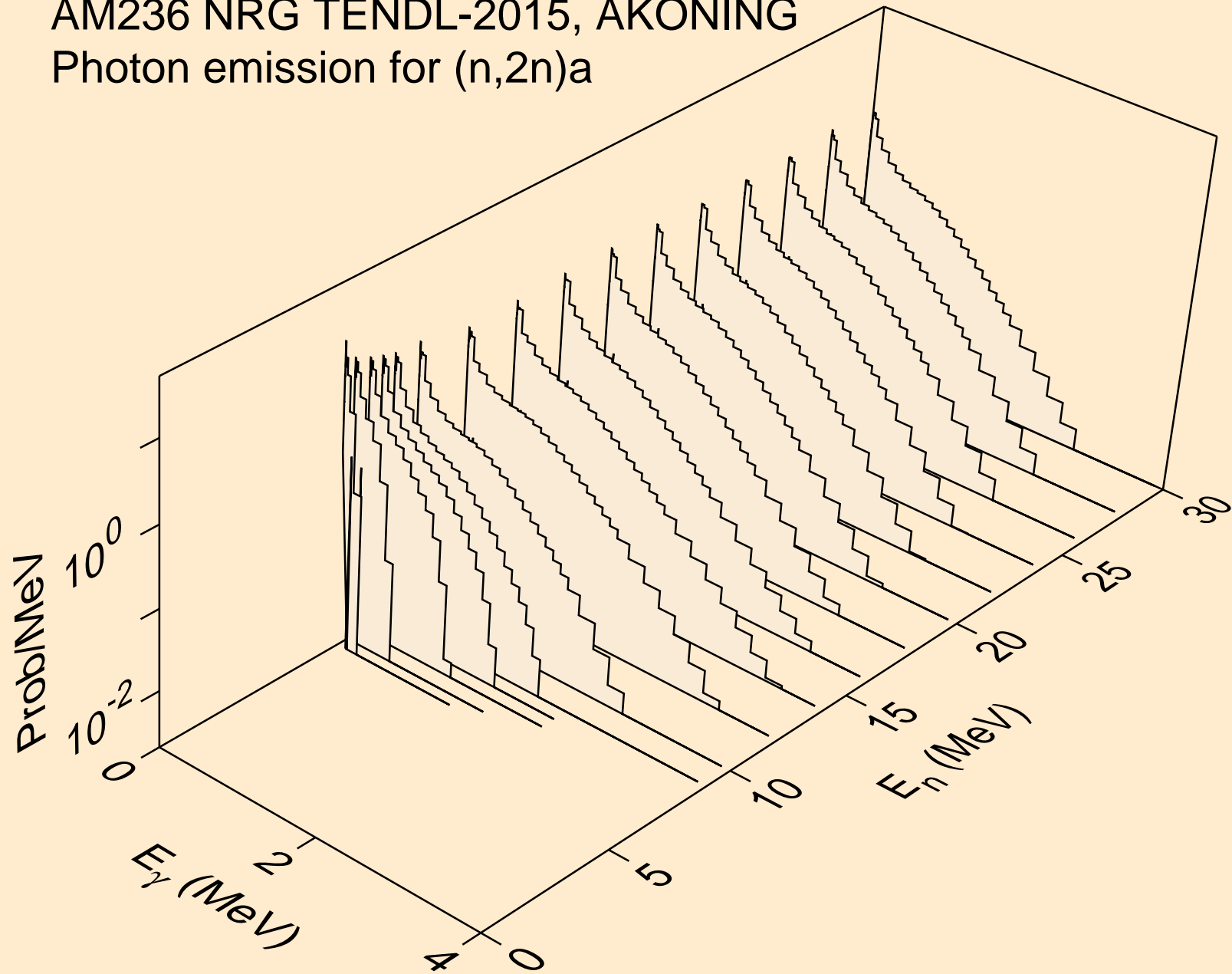

AM236 NRG TENDL-2015, AKONING
Photon emission for (n,3n)a

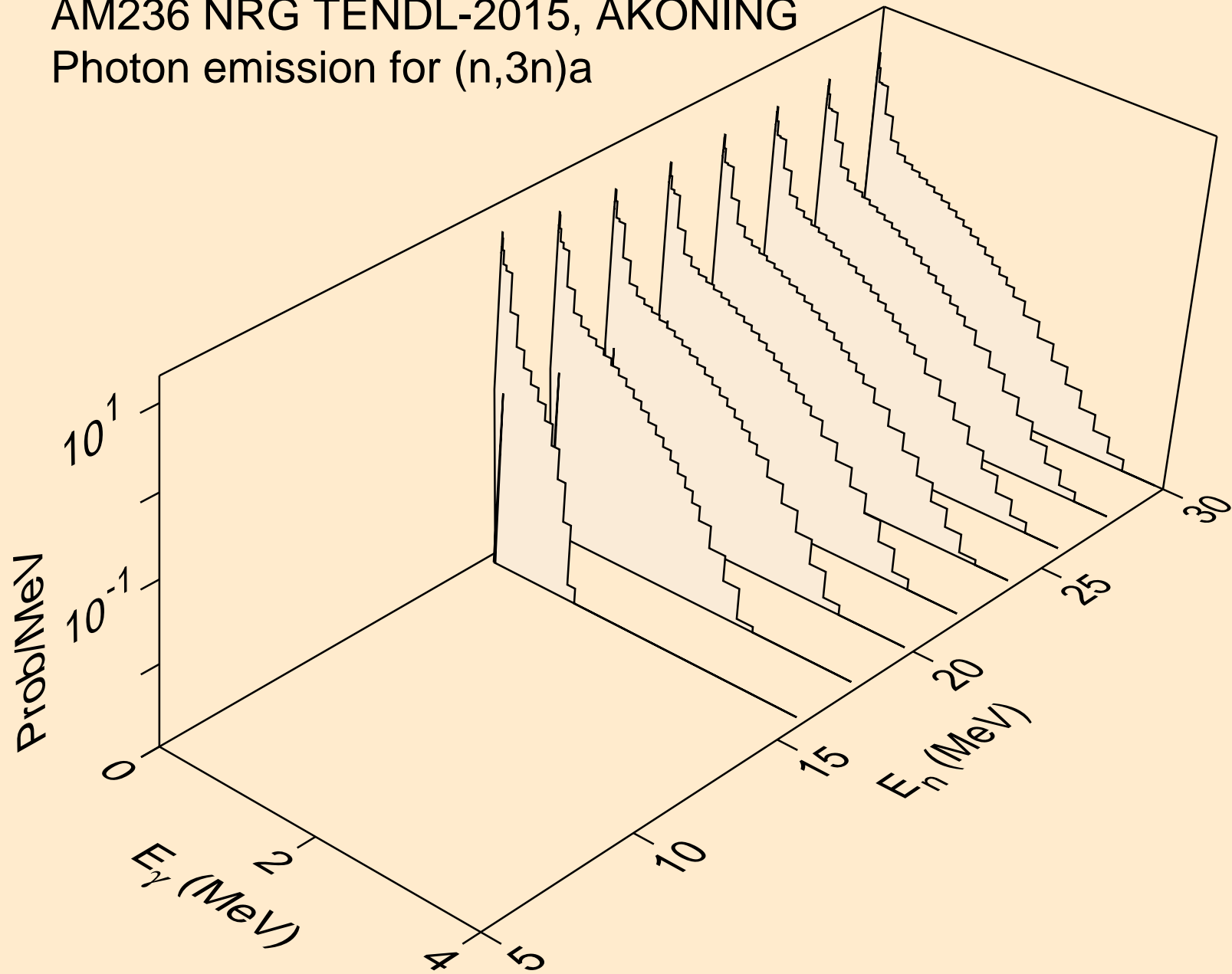

AM236 NRG TENDL-2015, AKONING
Photon emission for (n,n*)p

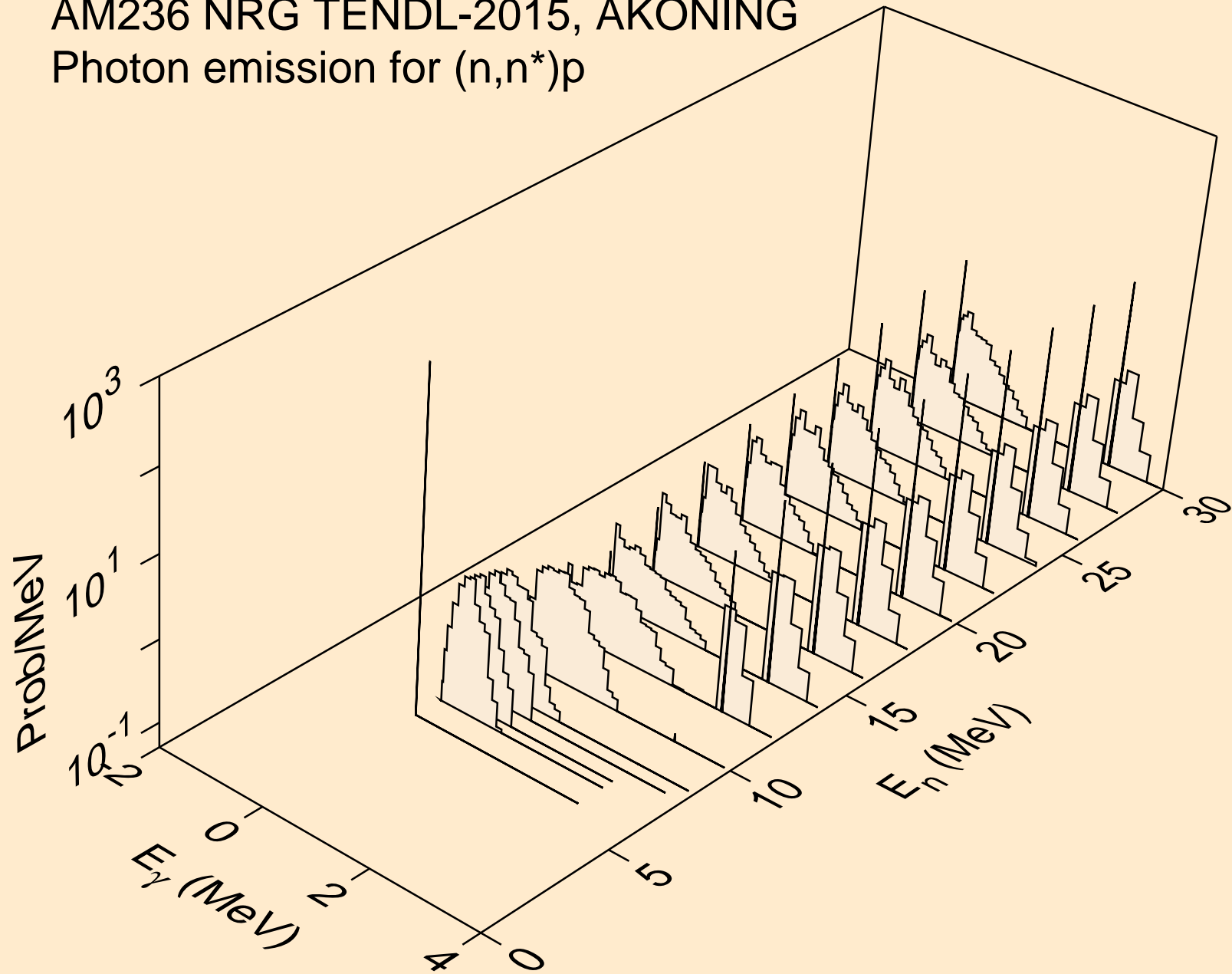

AM236 NRG TENDL-2015, AKONING
Photon emission for (n,n*)2a

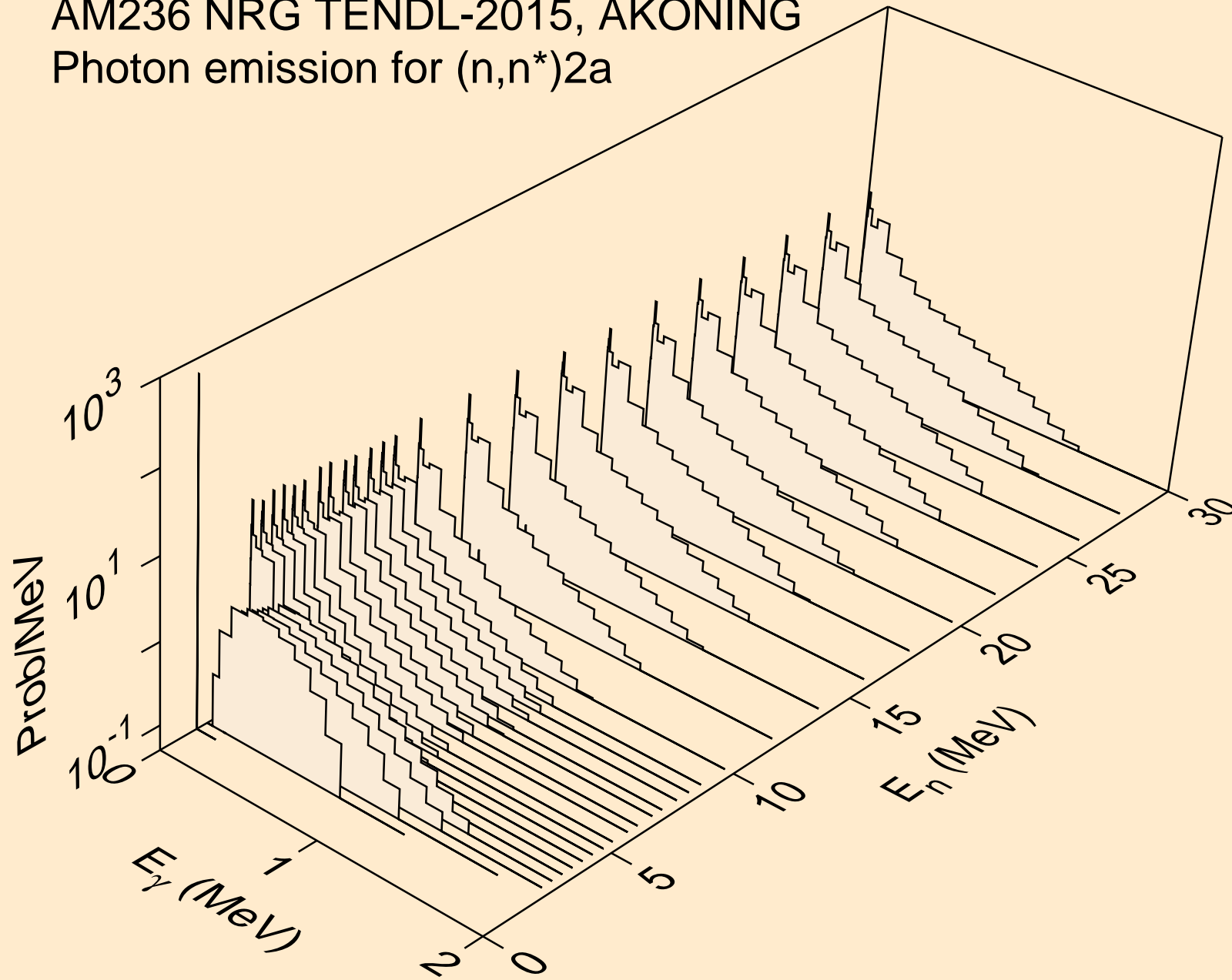

AM236 NRG TENDL-2015, AKONING
Photon emission for (n,2n)2a

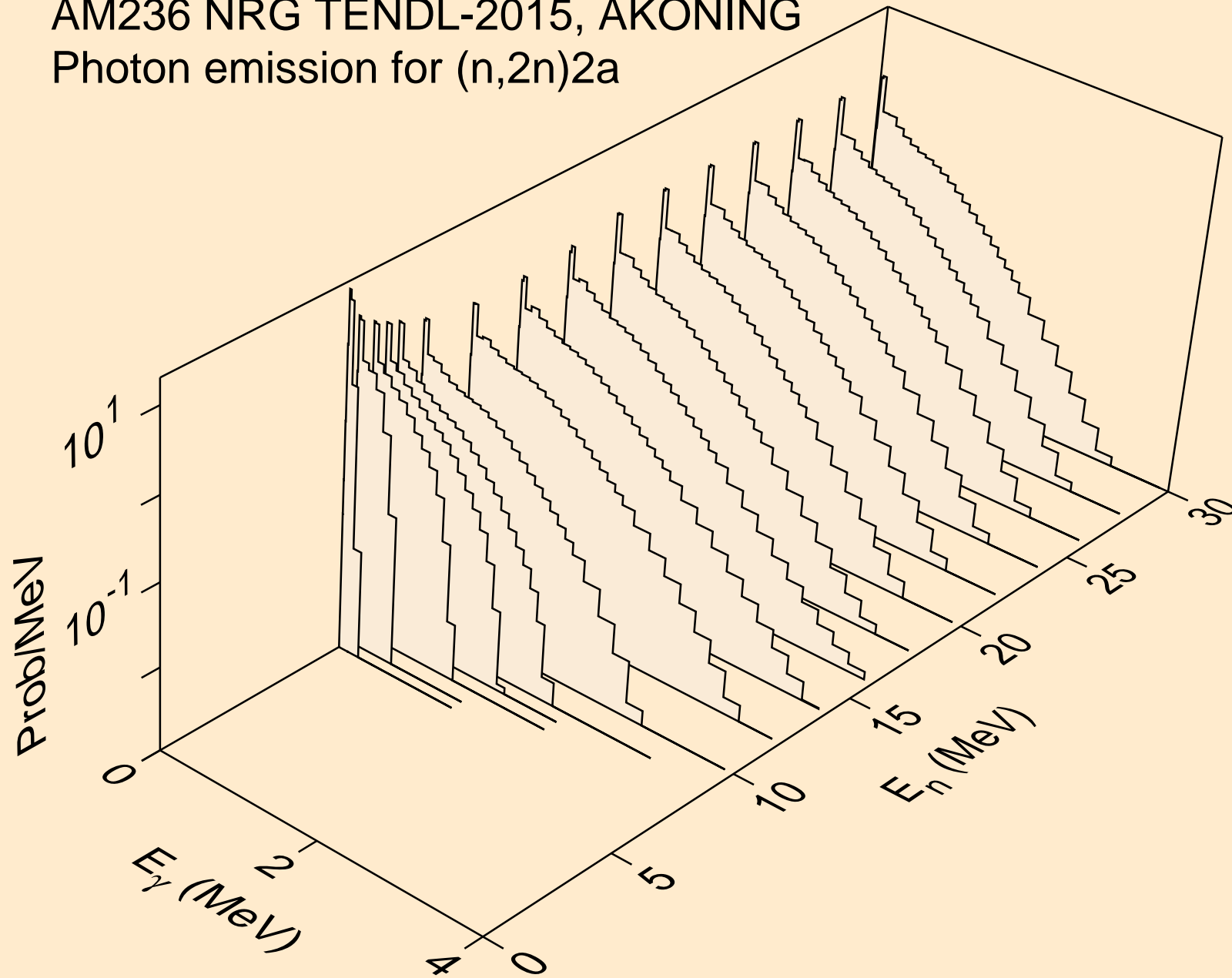

AM236 NRG TENDL-2015, AKONING
Photon emission for (n,n*)d

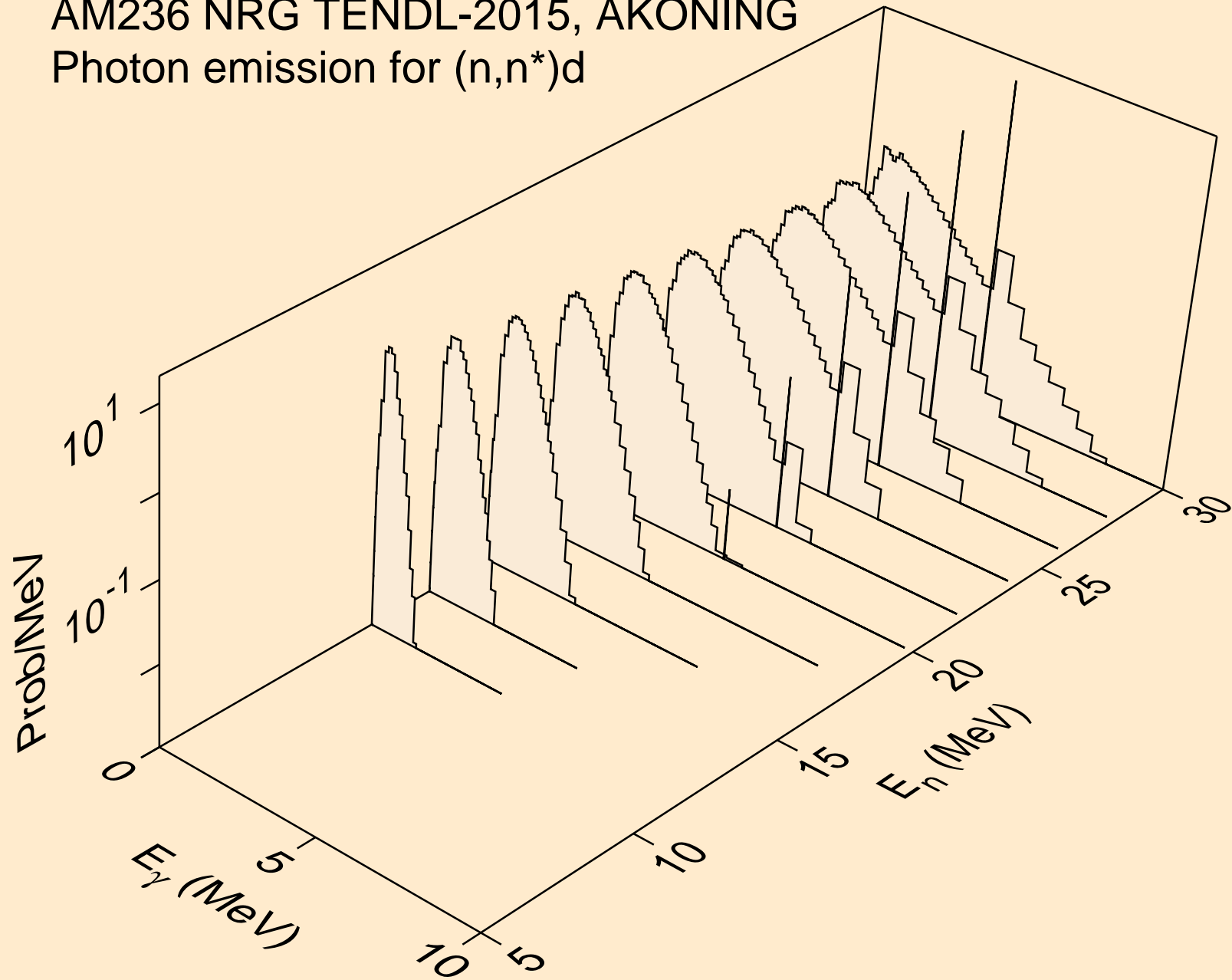

AM236 NRG TENDL-2015, AKONING
Photon emission for (n,n*)t

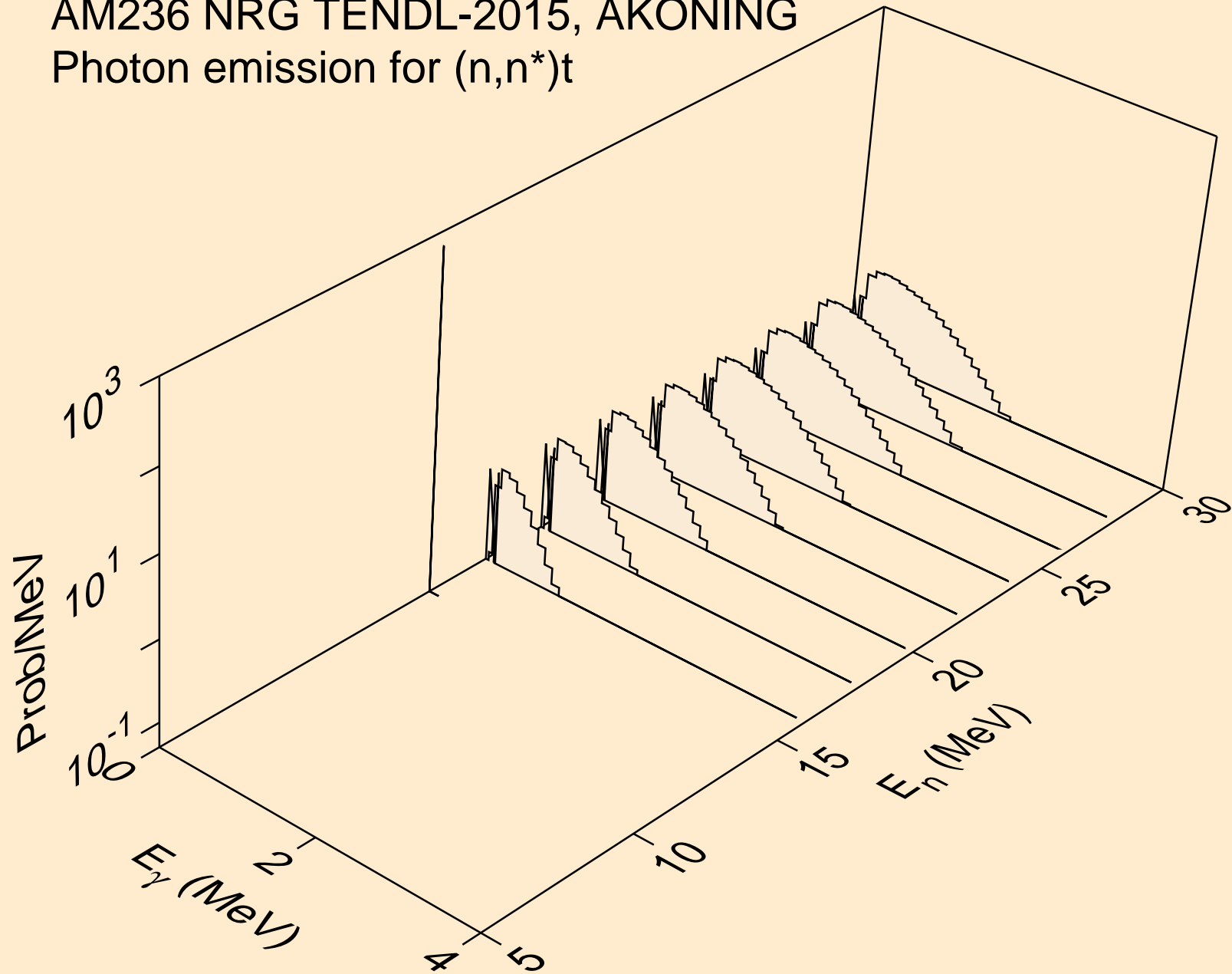

AM236 NRG TENDL-2015, AKONING
Photon emission for (n,n*)he3

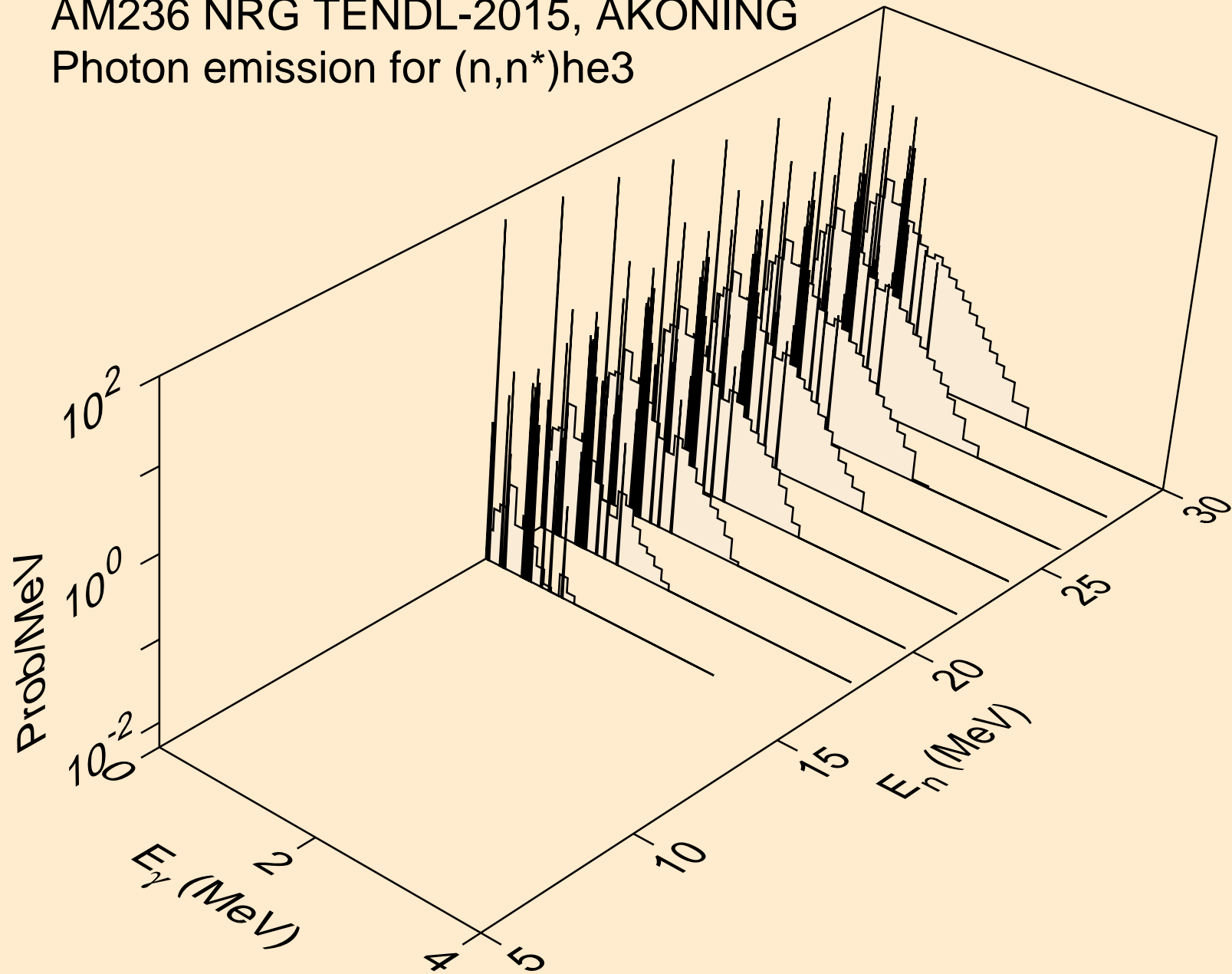

AM236 NRG TENDL-2015, AKONING
Photon emission for (n,4n)

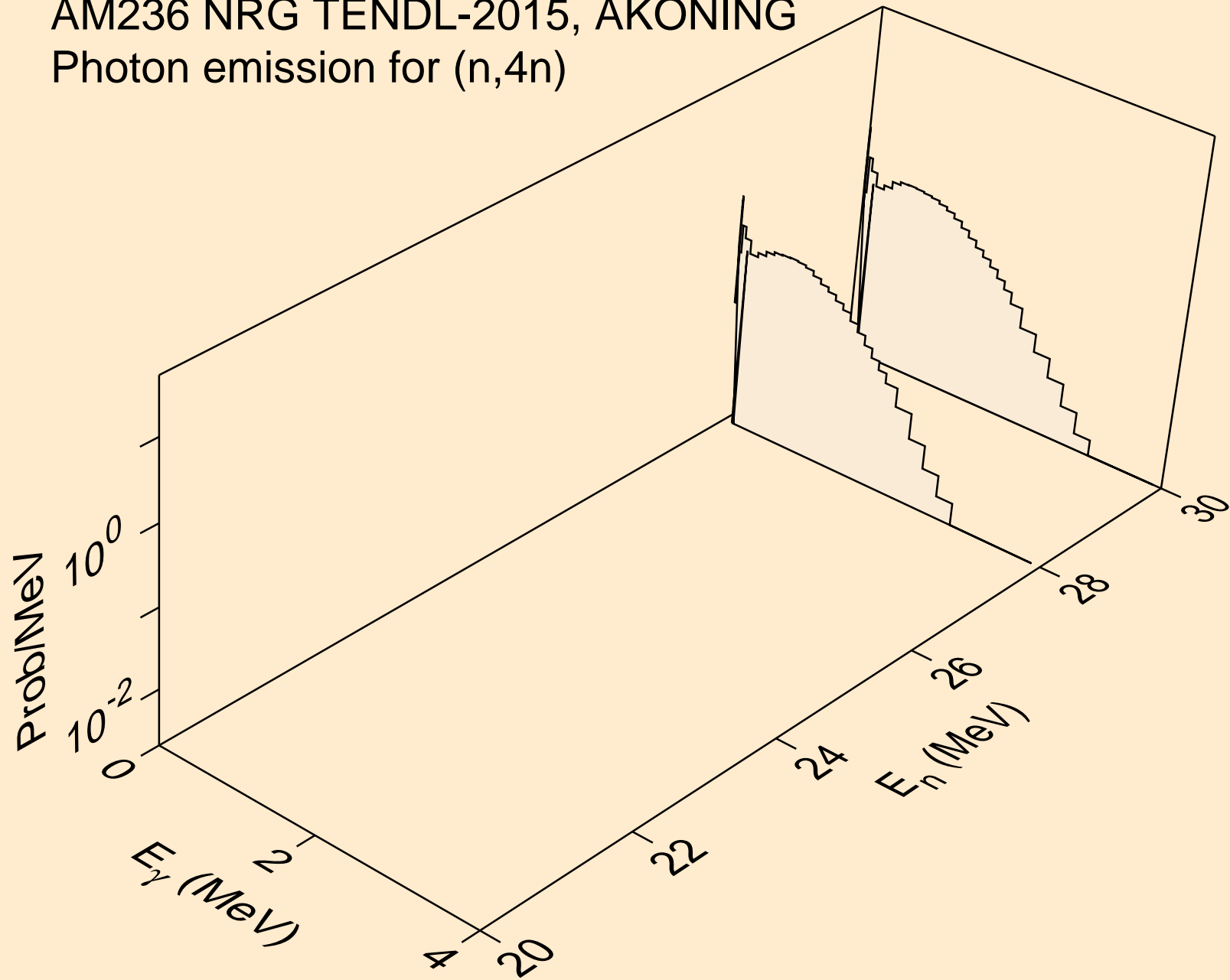

AM236 NRG TENDL-2015, AKONING
Photon emission for (n,2np)

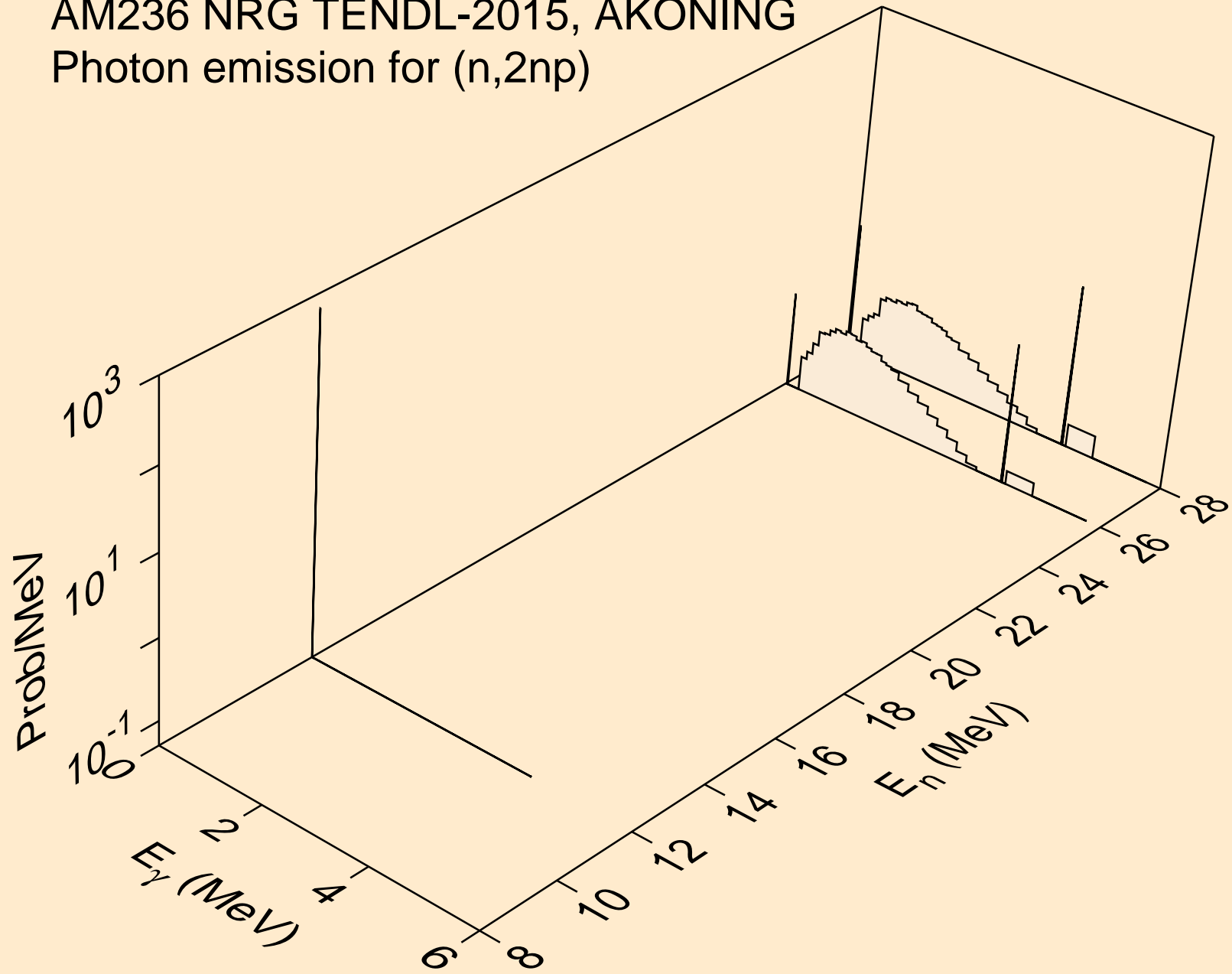

AM236 NRG TENDL-2015, AKONING
Photon emission for (n,3np)

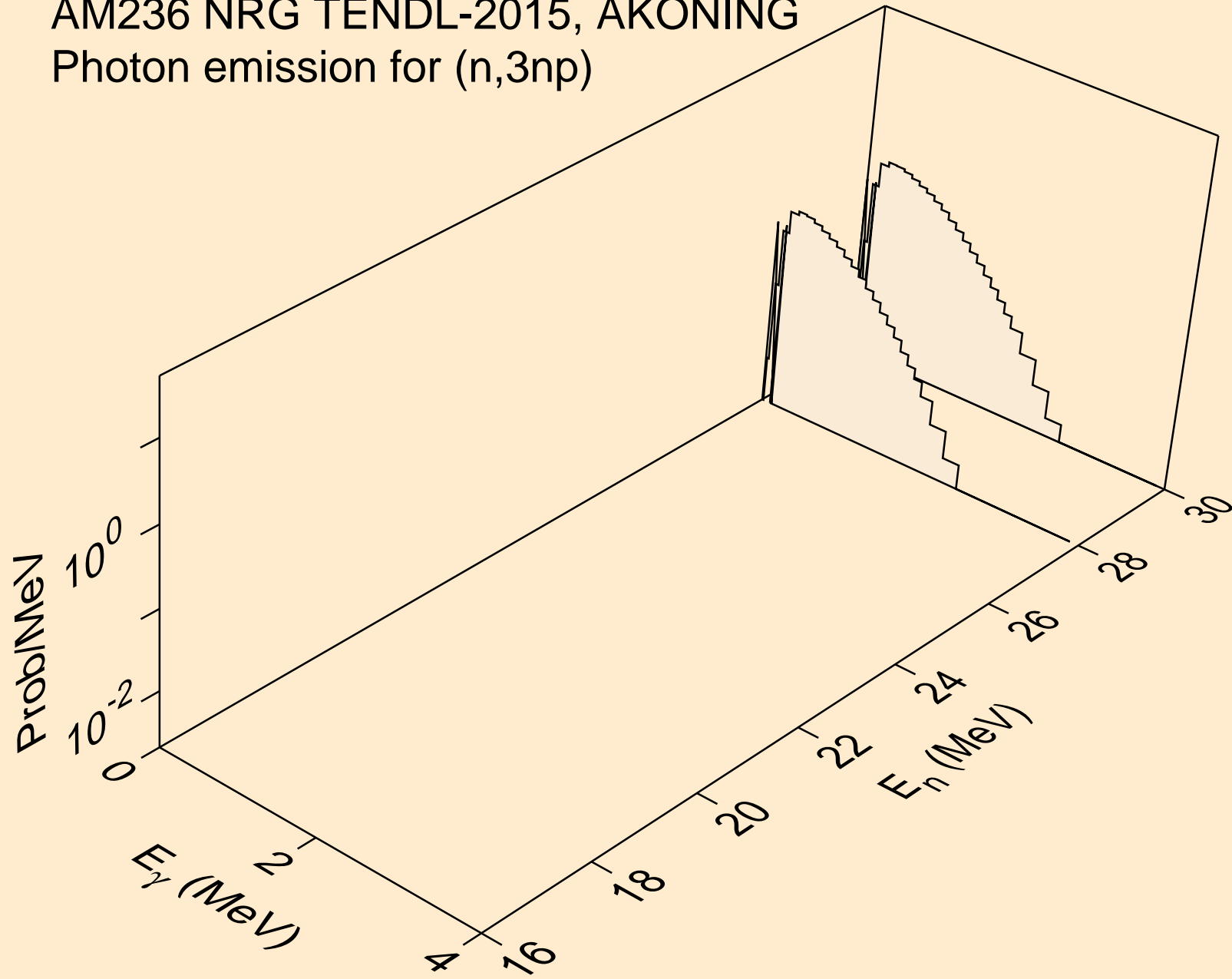

AM236 NRG TENDL-2015, AKONING
Photon emission for (n,2np)

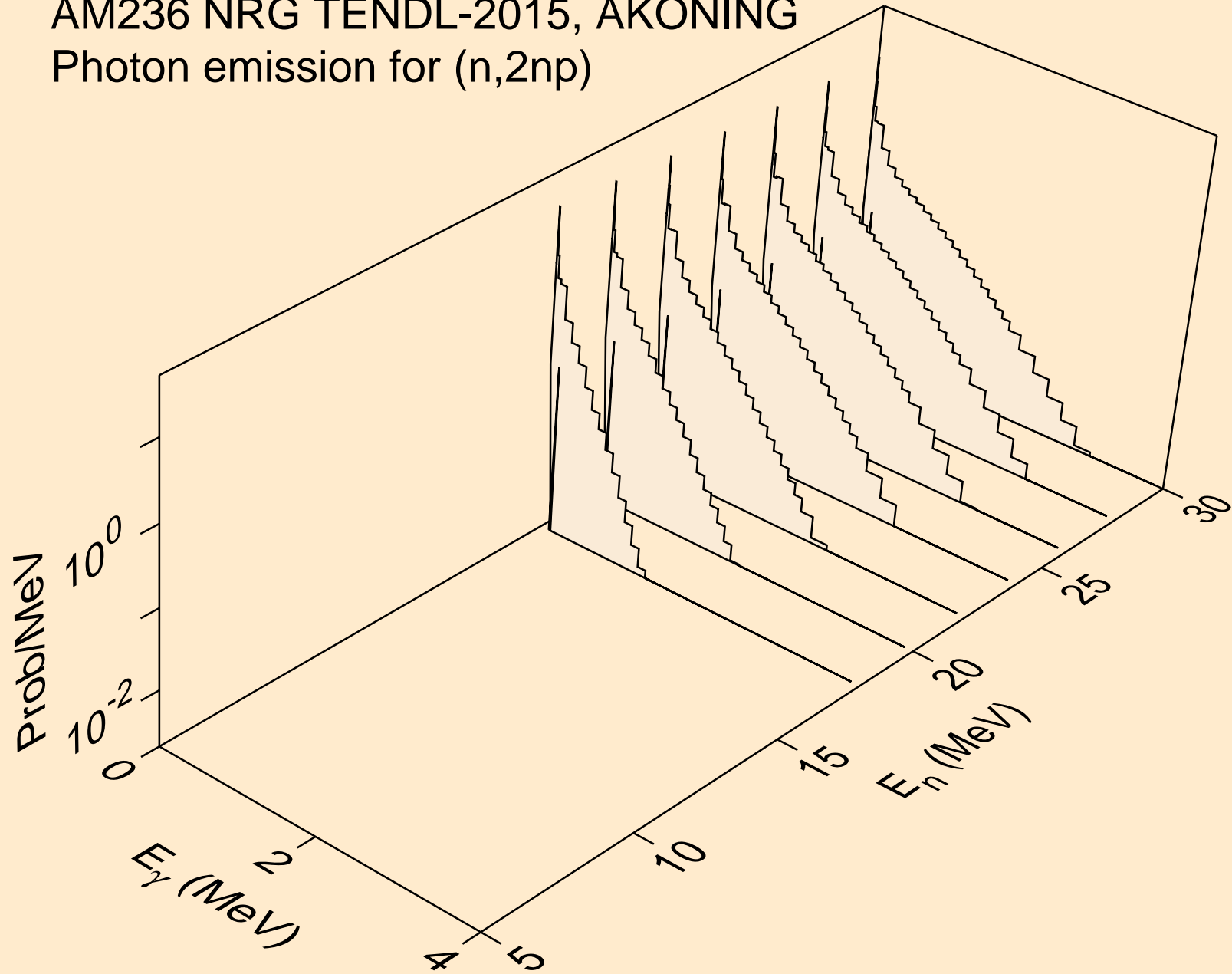

AM236 NRG TENDL-2015, AKONING
Photon emission for (n,npa)

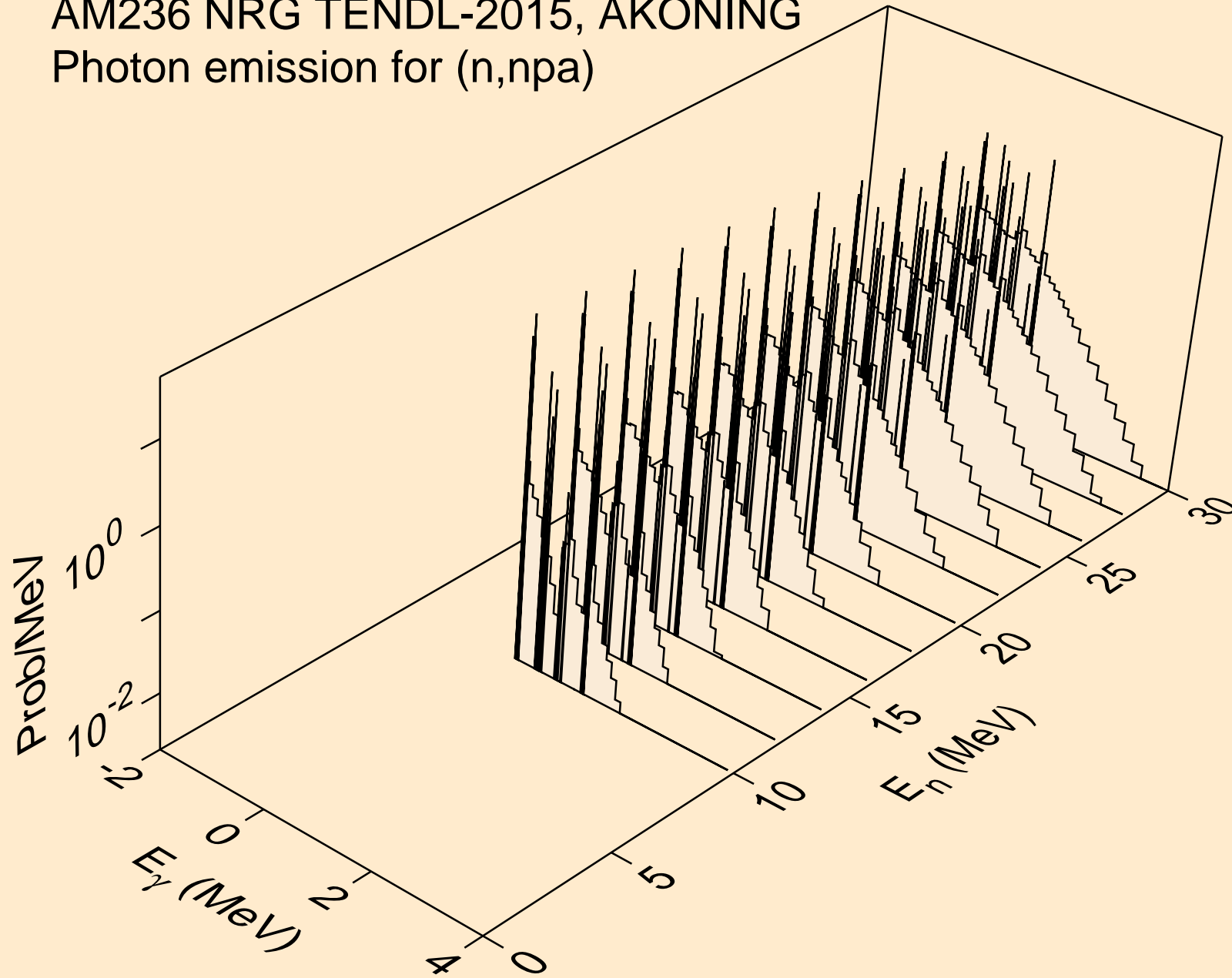

AM236 NRG TENDL-2015, AKONING
Photon emission for (n,n*c)

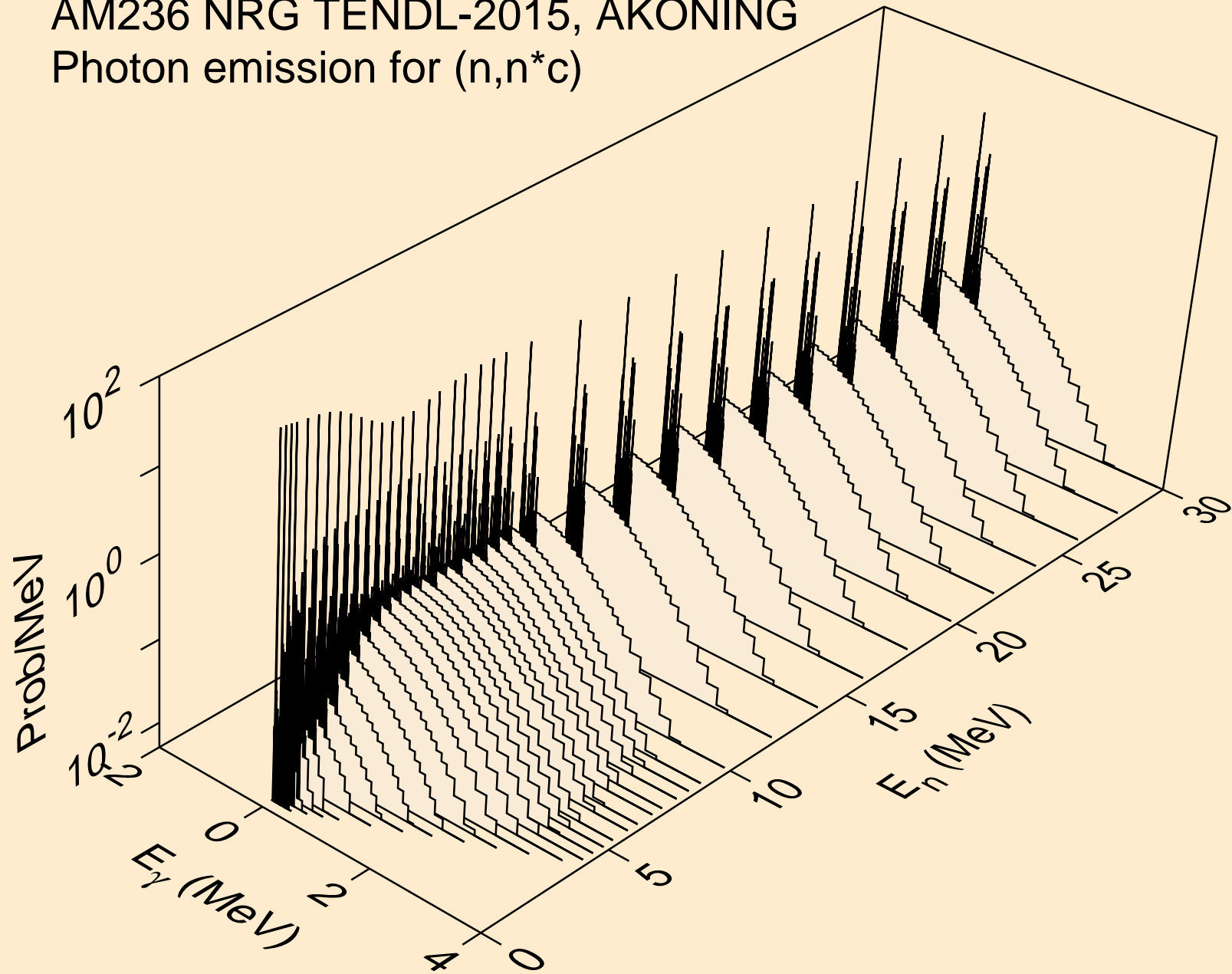

AM236 NRG TENDL-2015, AKONING
Photon emission for (n,gma)

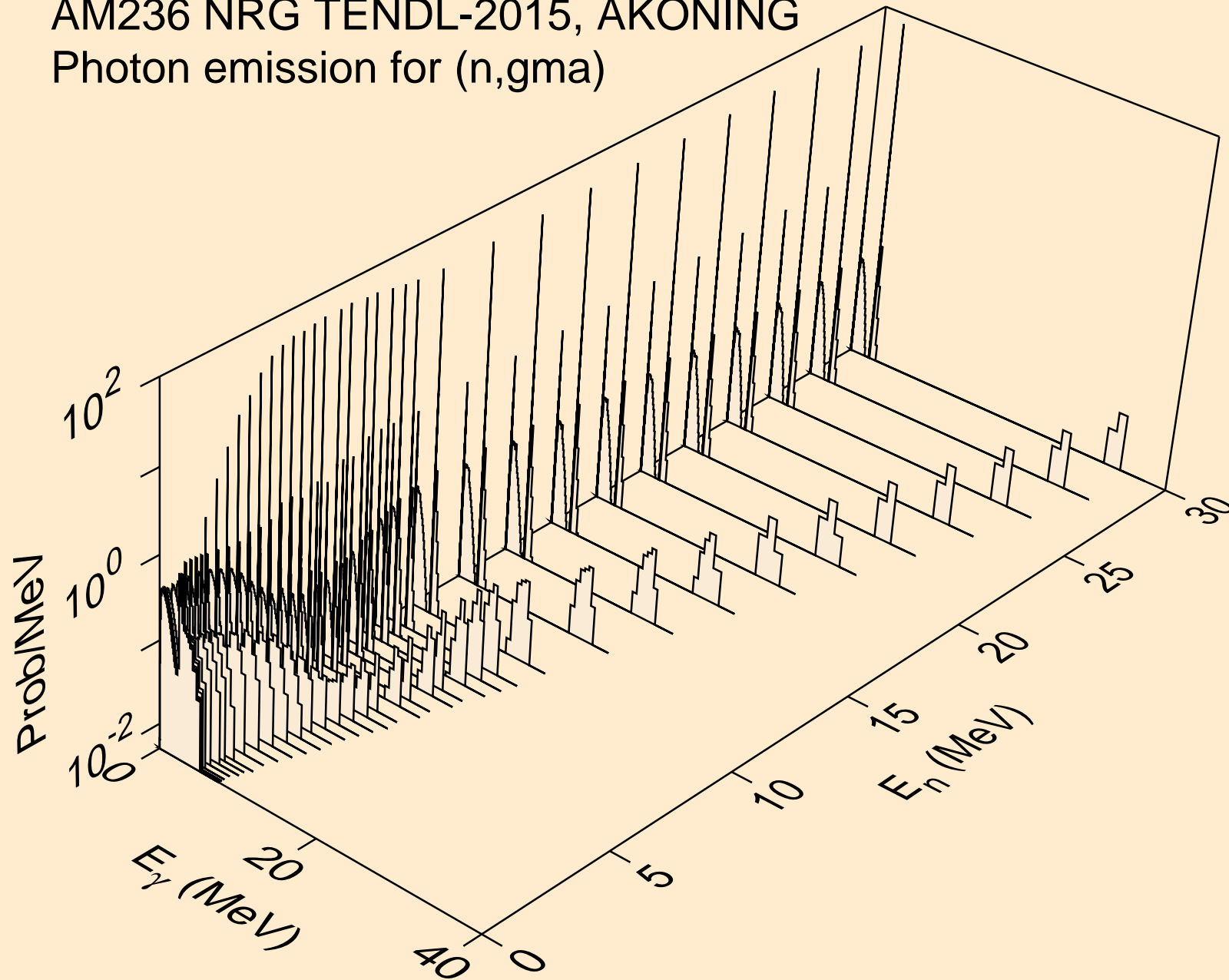

AM236 NRG TENDL-2015, AKONING
Photon emission for (n,p)

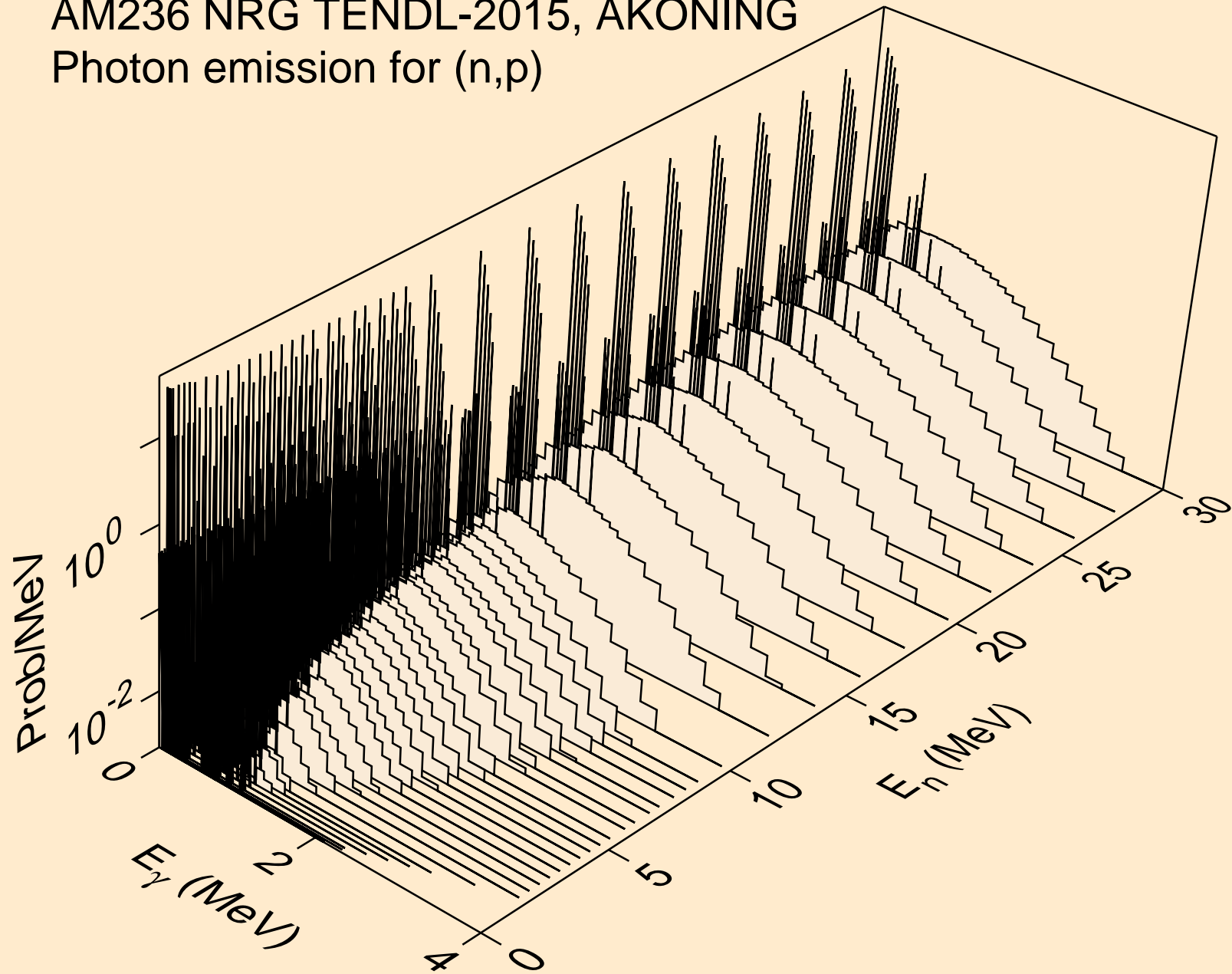

AM236 NRG TENDL-2015, AKONING
Photon emission for (n,d)

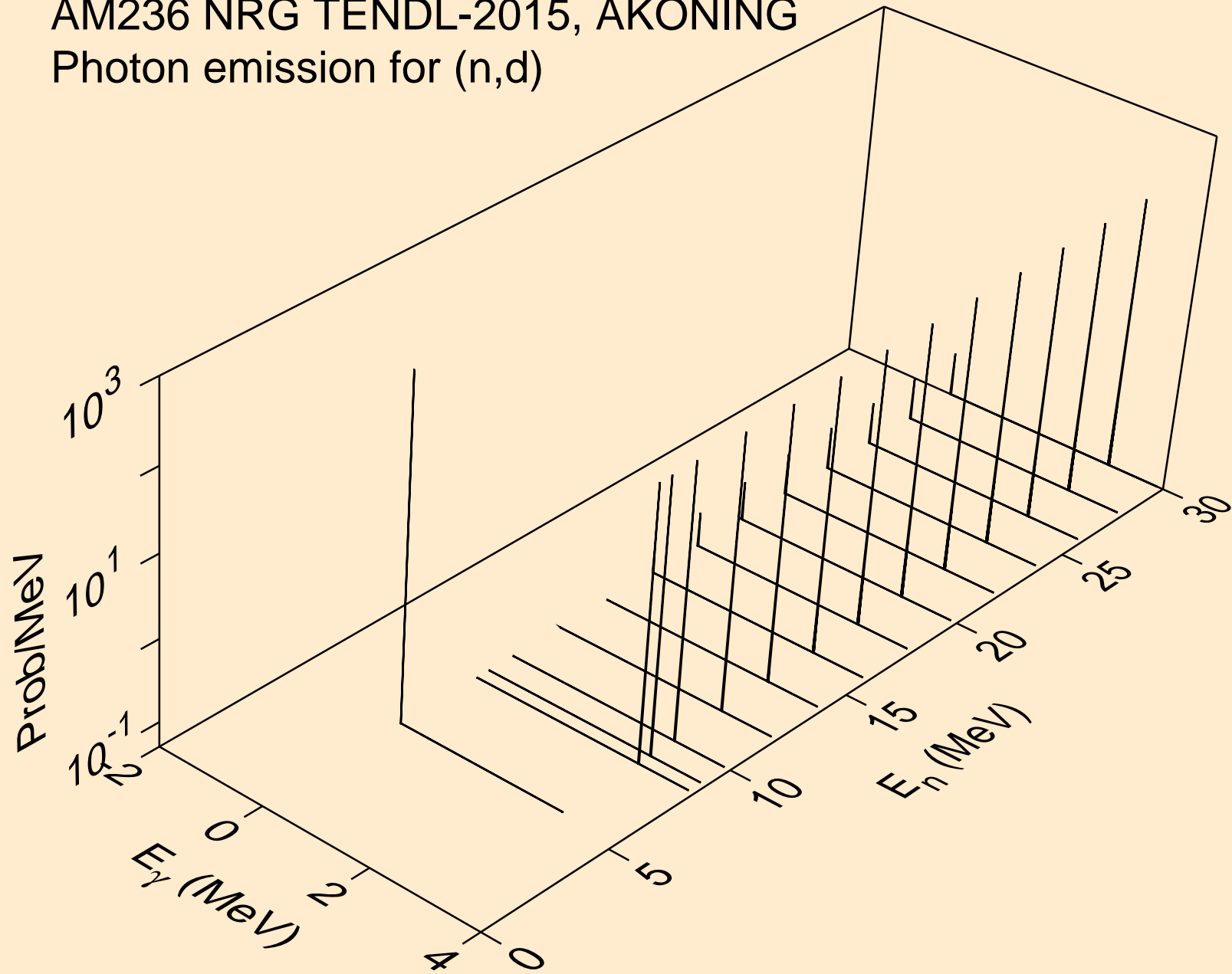

AM236 NRG TENDL-2015, AKONING
Photon emission for (n,t)

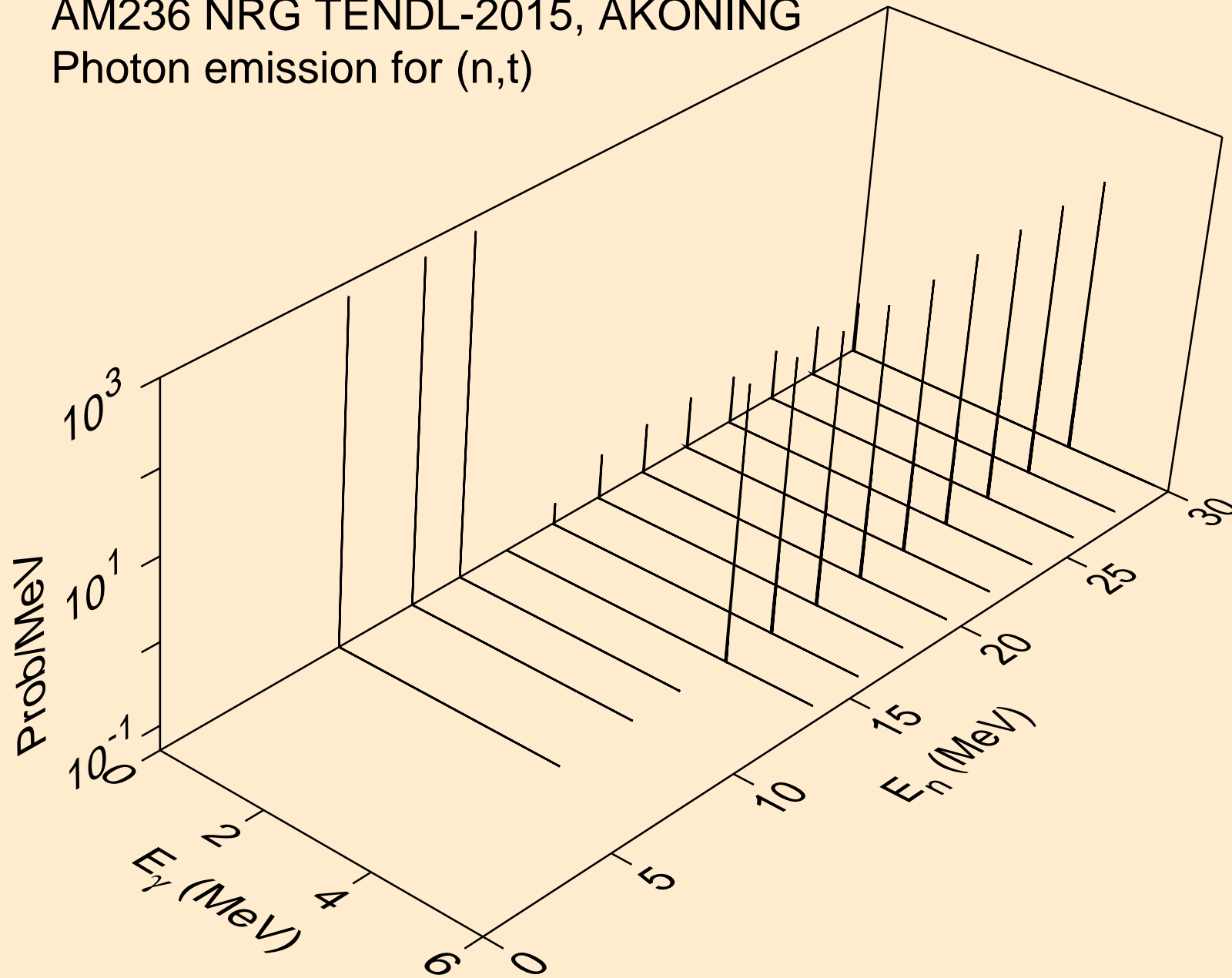

AM236 NRG TENDL-2015, AKONING
Photon emission for (n,he3)

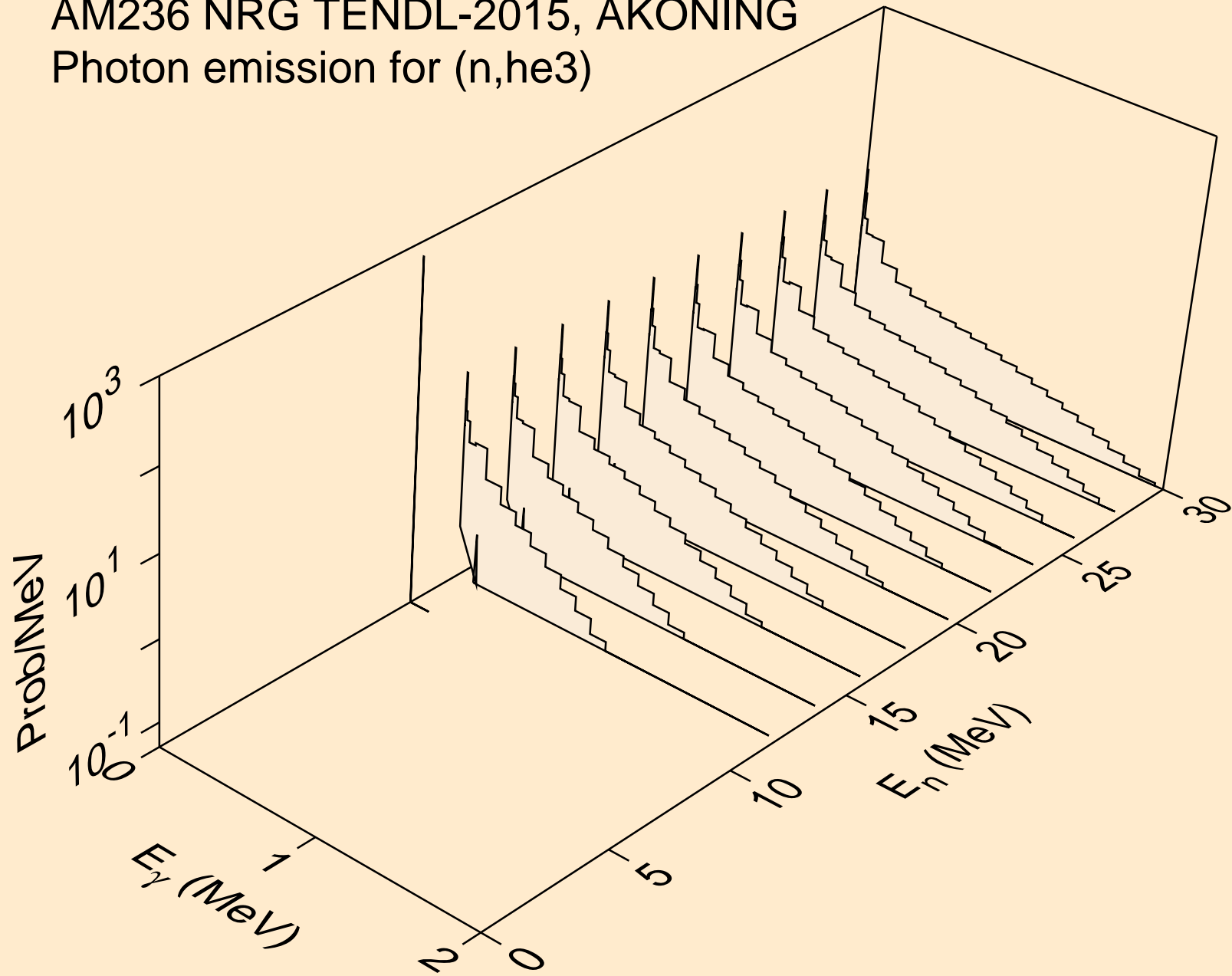

AM236 NRG TENDL-2015, AKONING
Photon emission for (n,a)

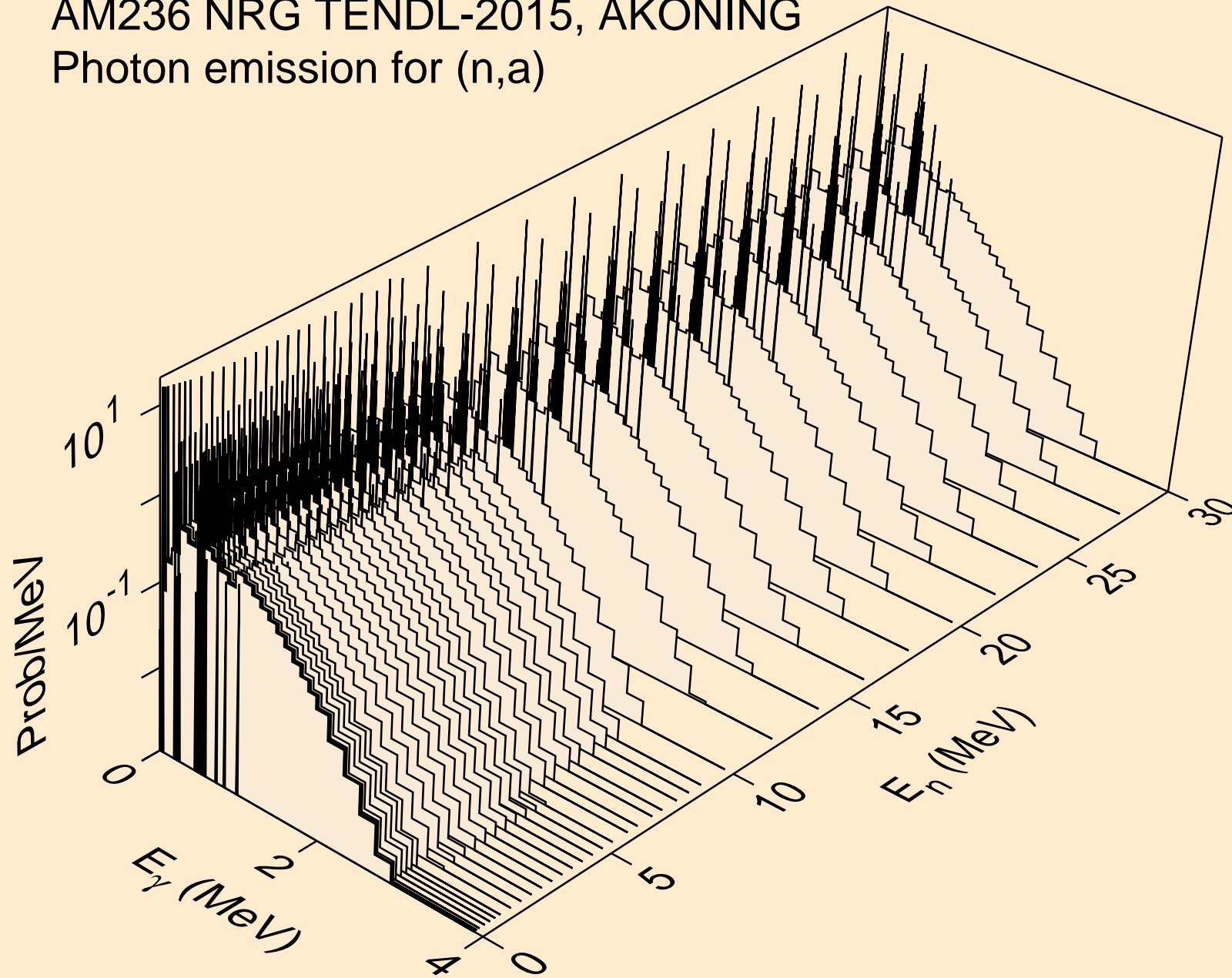

AM236 NRG TENDL-2015, AKONING
Photon emission for (n,2a)

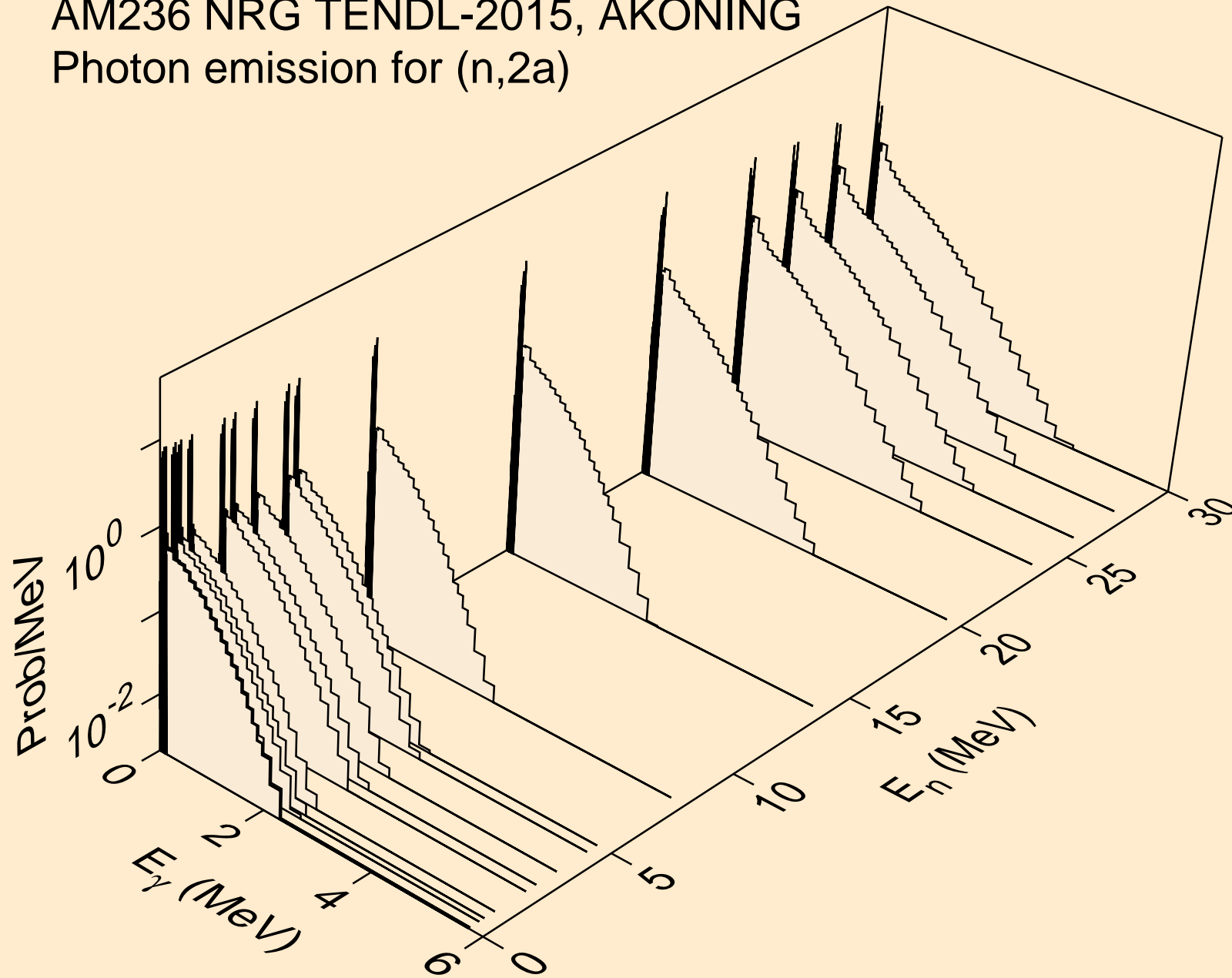

AM236 NRG TENDL-2015, AKONING
Photon emission for (n,2p)

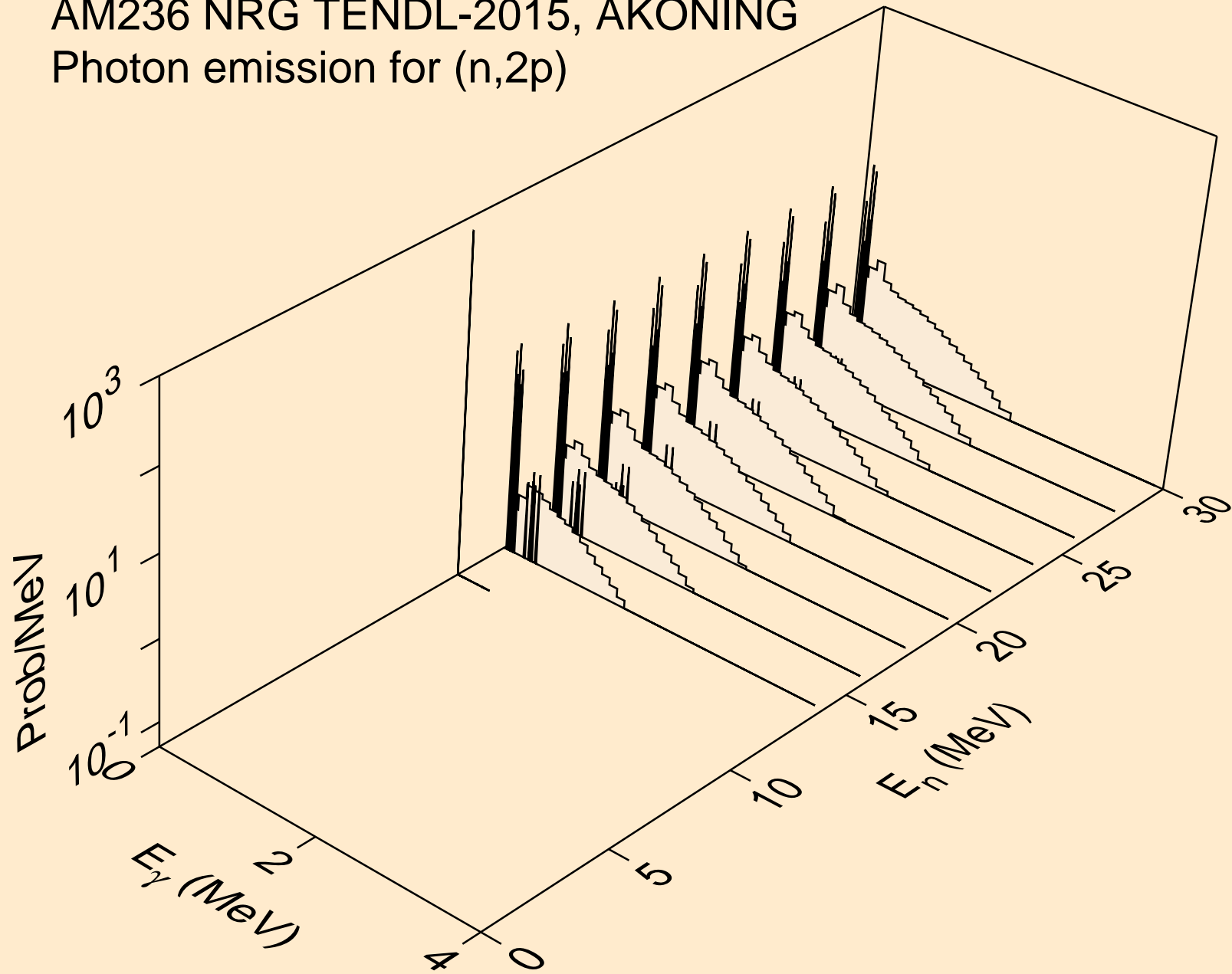

AM236 NRG TENDL-2015, AKONING
Photon emission for (n,p α)

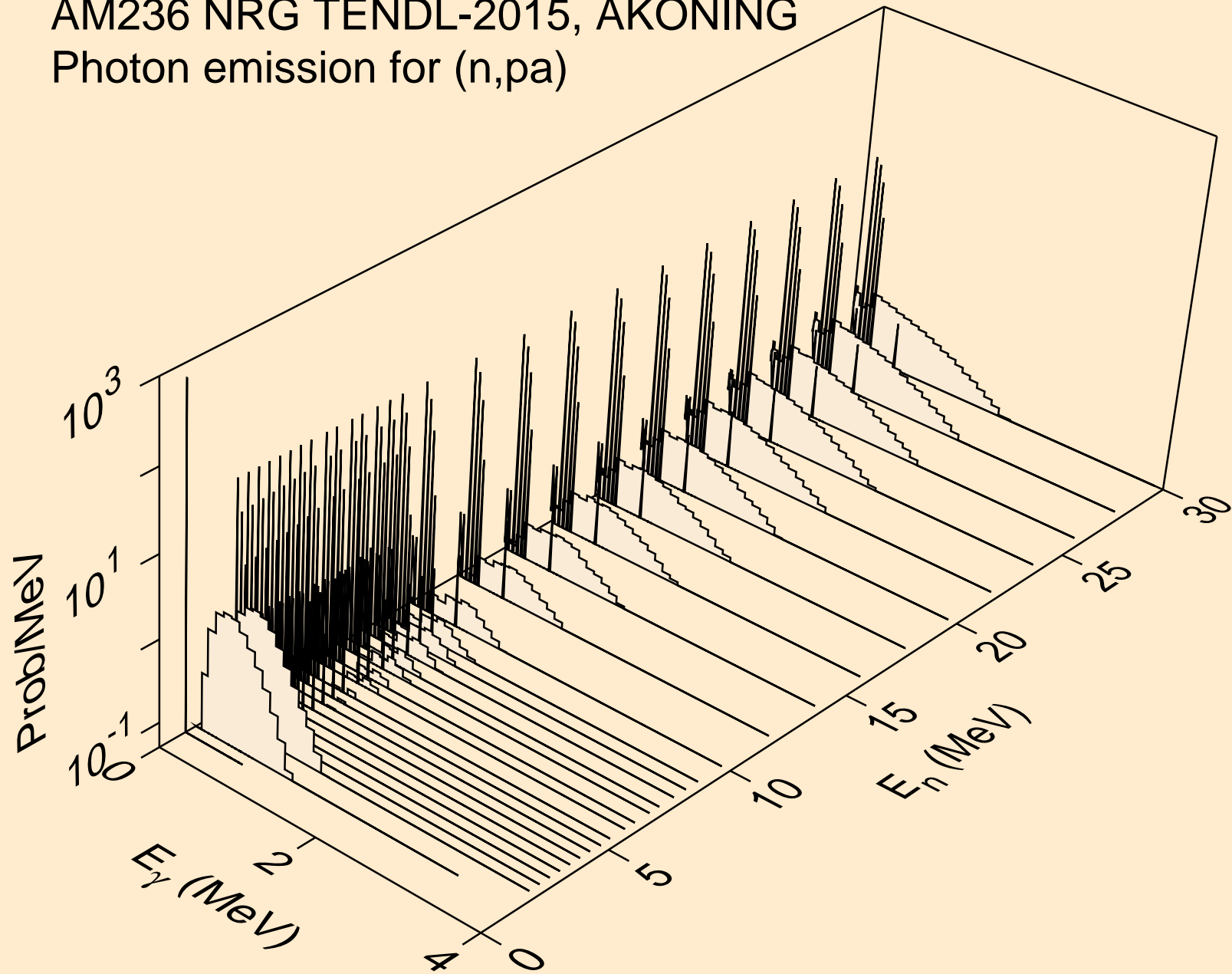

AM236 NRG TENDL-2015, AKONING
Photon emission for (n,pd)

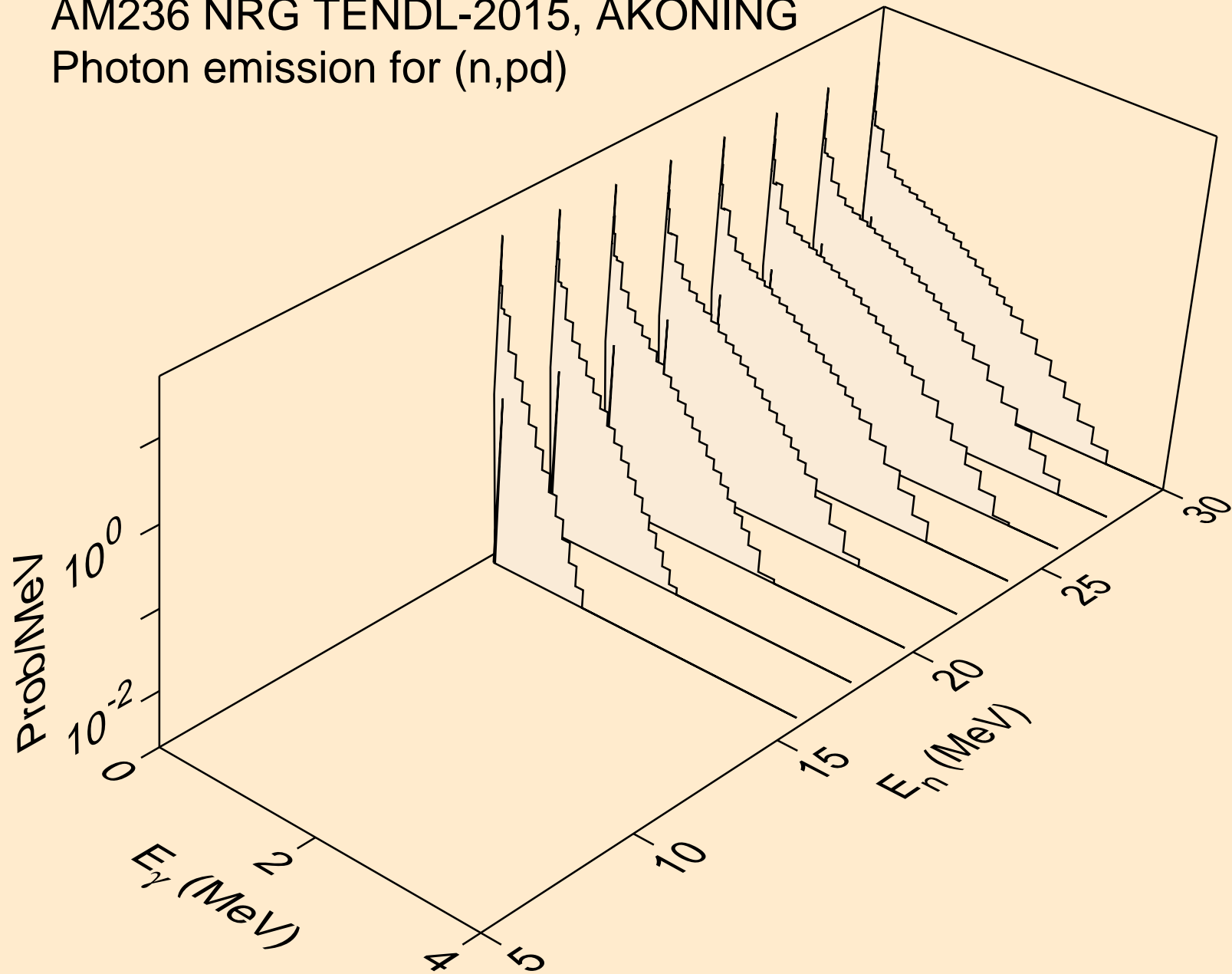

AM236 NRG TENDL-2015, AKONING
Photon emission for (n,da)

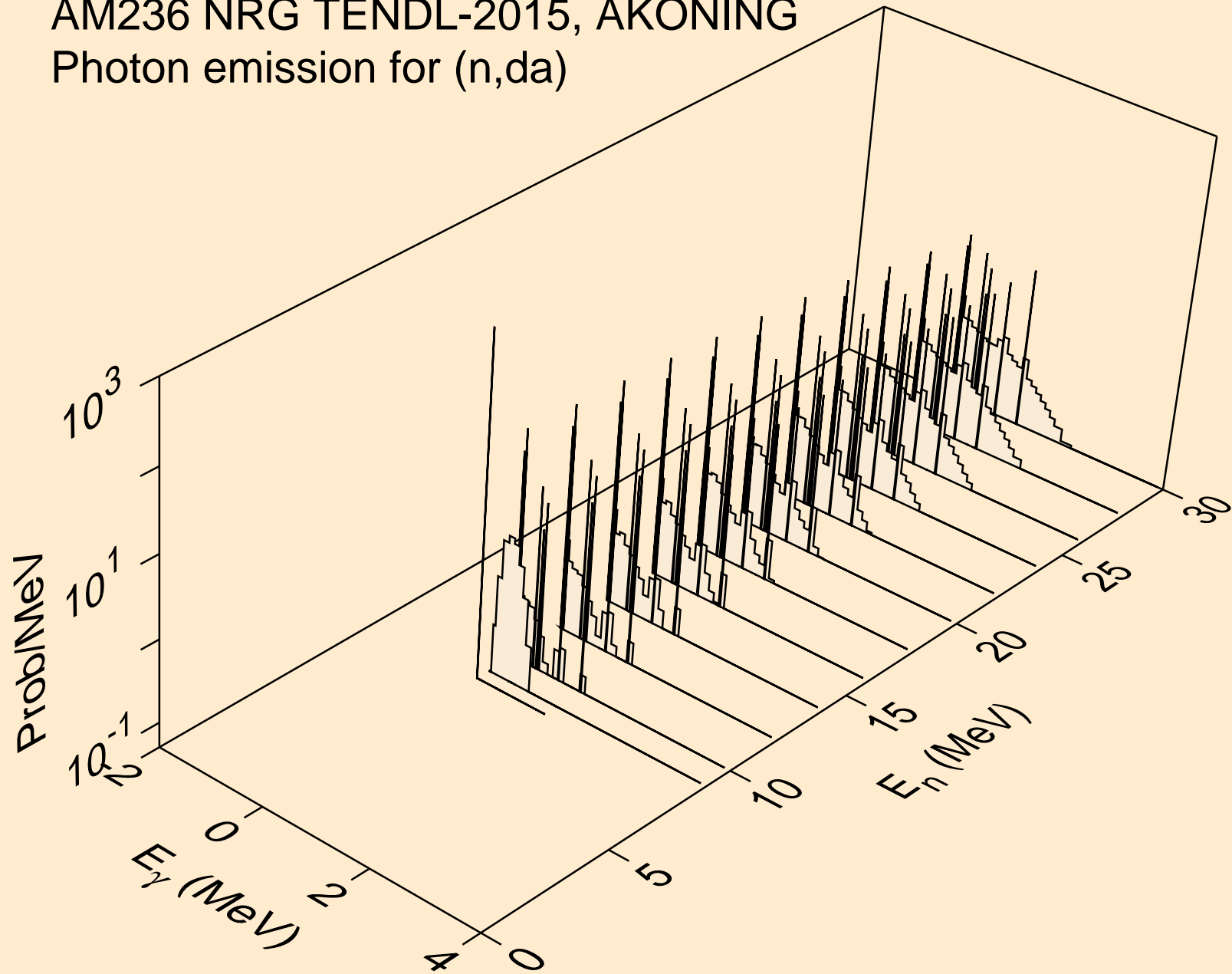

AM236 NRG TENDL-2015, AKONING
thermal capture photon spectrum

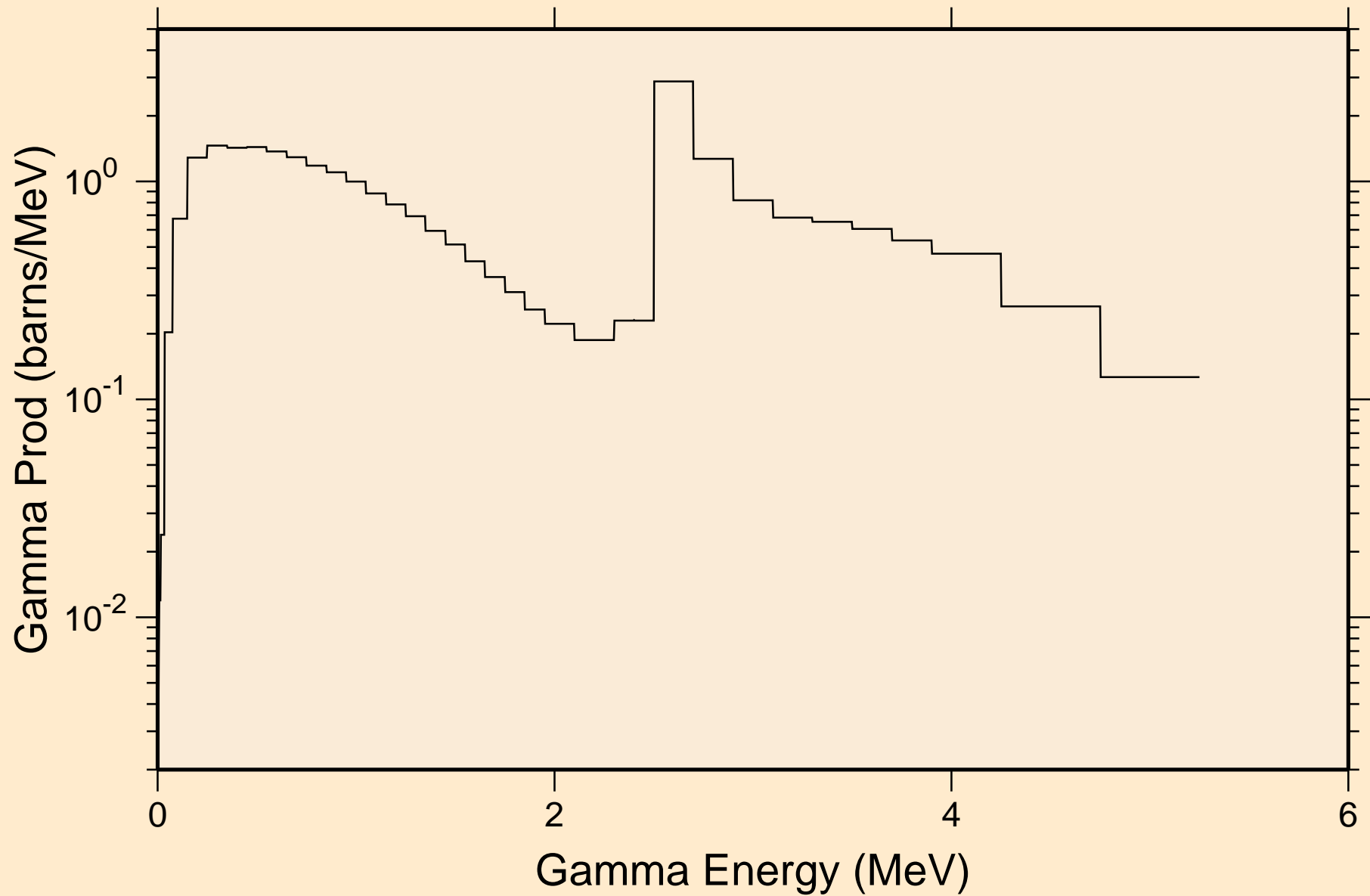

AM236 NRG TENDL-2015, AKONING
14 MeV photon spectrum

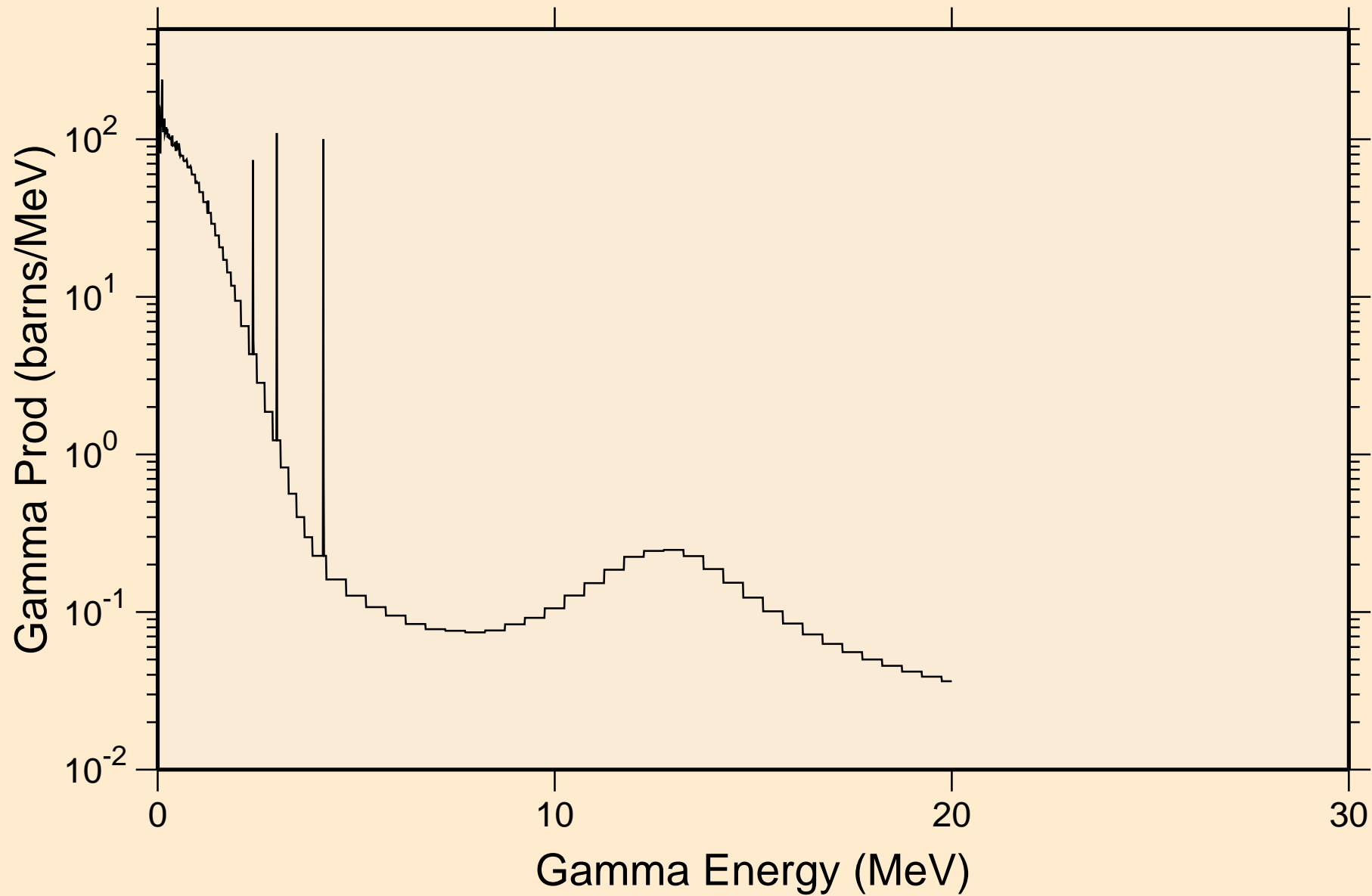

AM236 NRG TENDL-2015, AKONING

Particle heating contributions

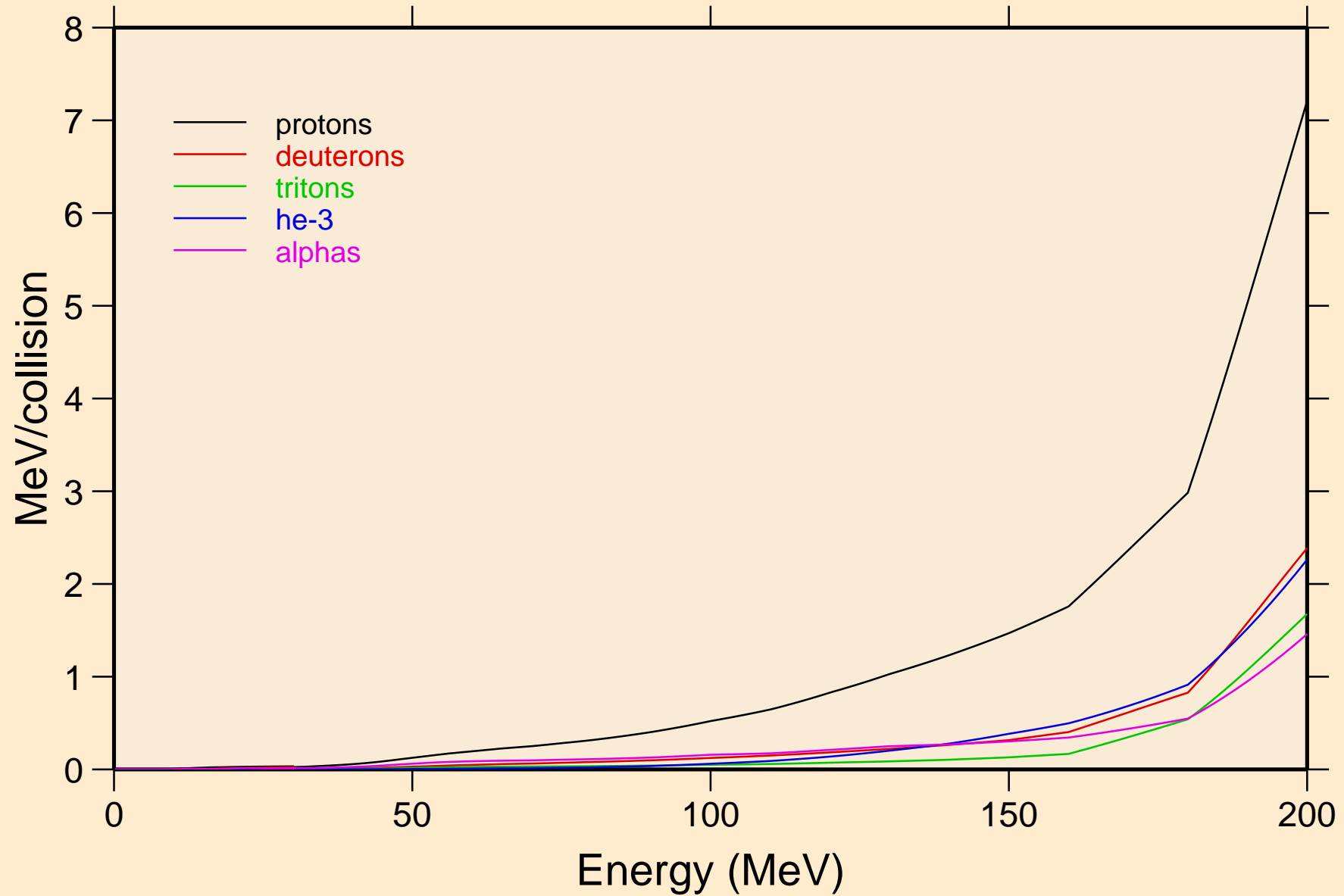

AM236 NRG TENDL-2015, AKONING

Recoil Heating

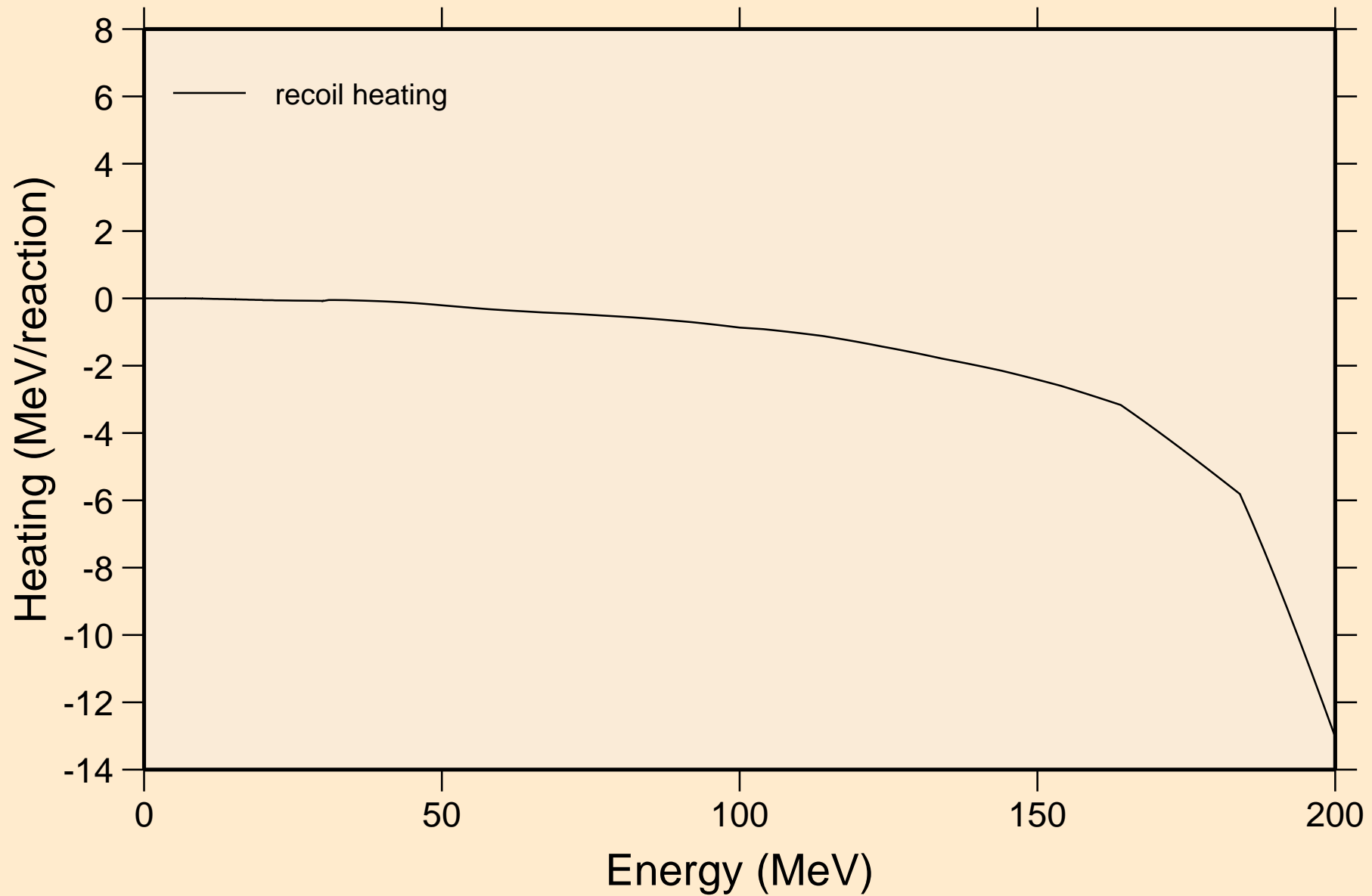

AM236 NRG TENDL-2015, AKONING

Particle production cross sections

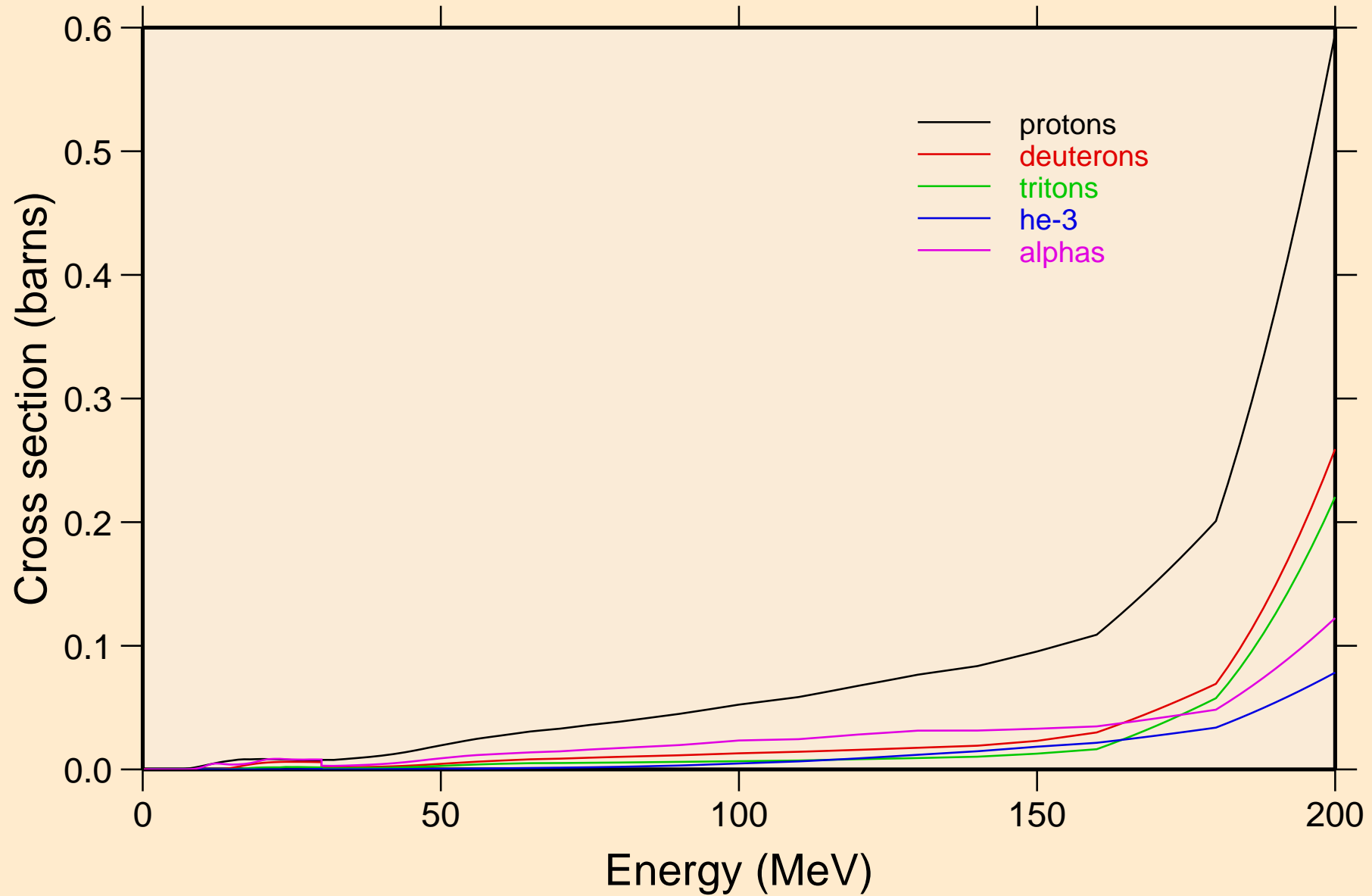

AM236 NRG TENDL-2015, AKONING
protons from (n,x)

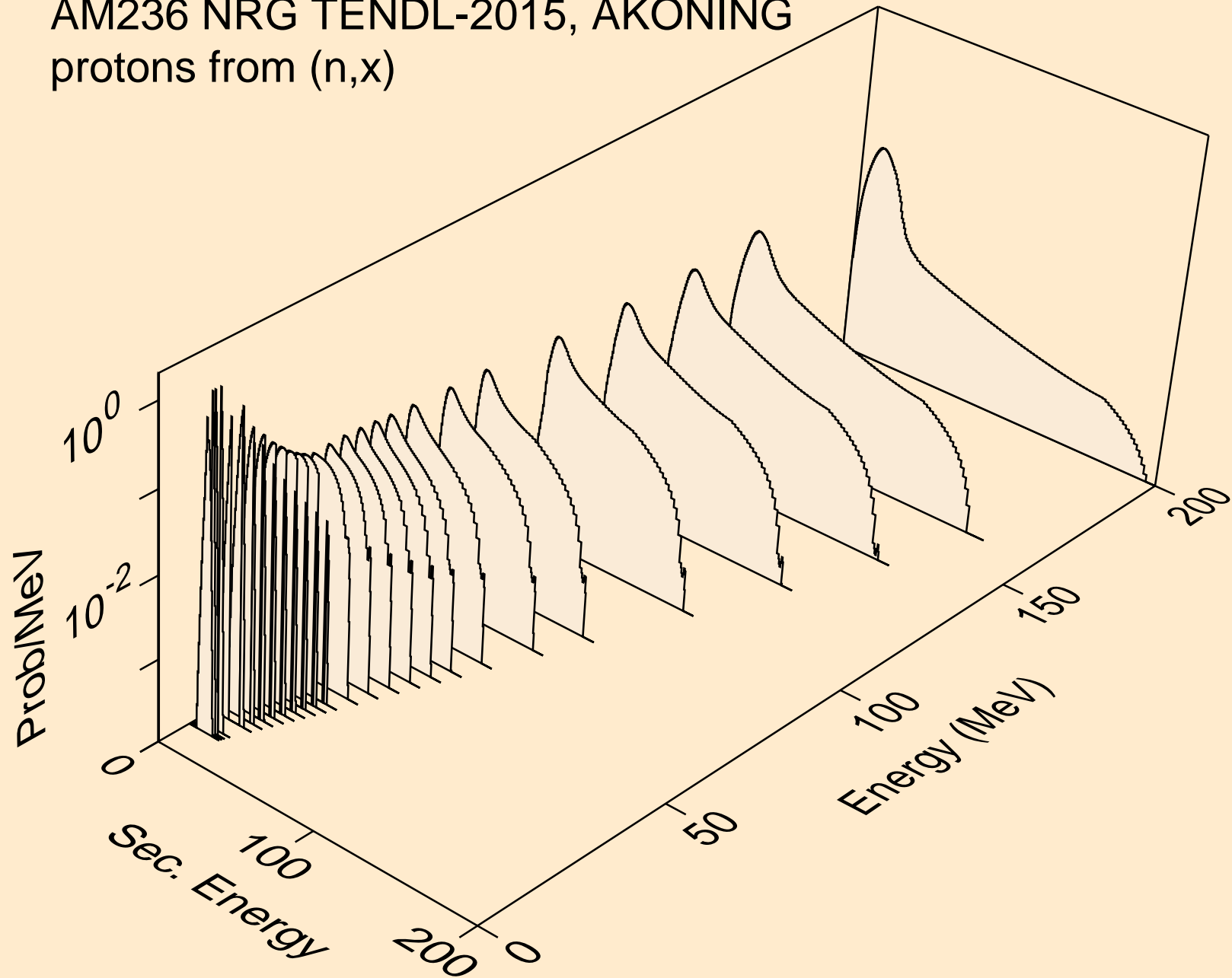

AM236 NRG TENDL-2015, AKONING
protons from (n,n*)p

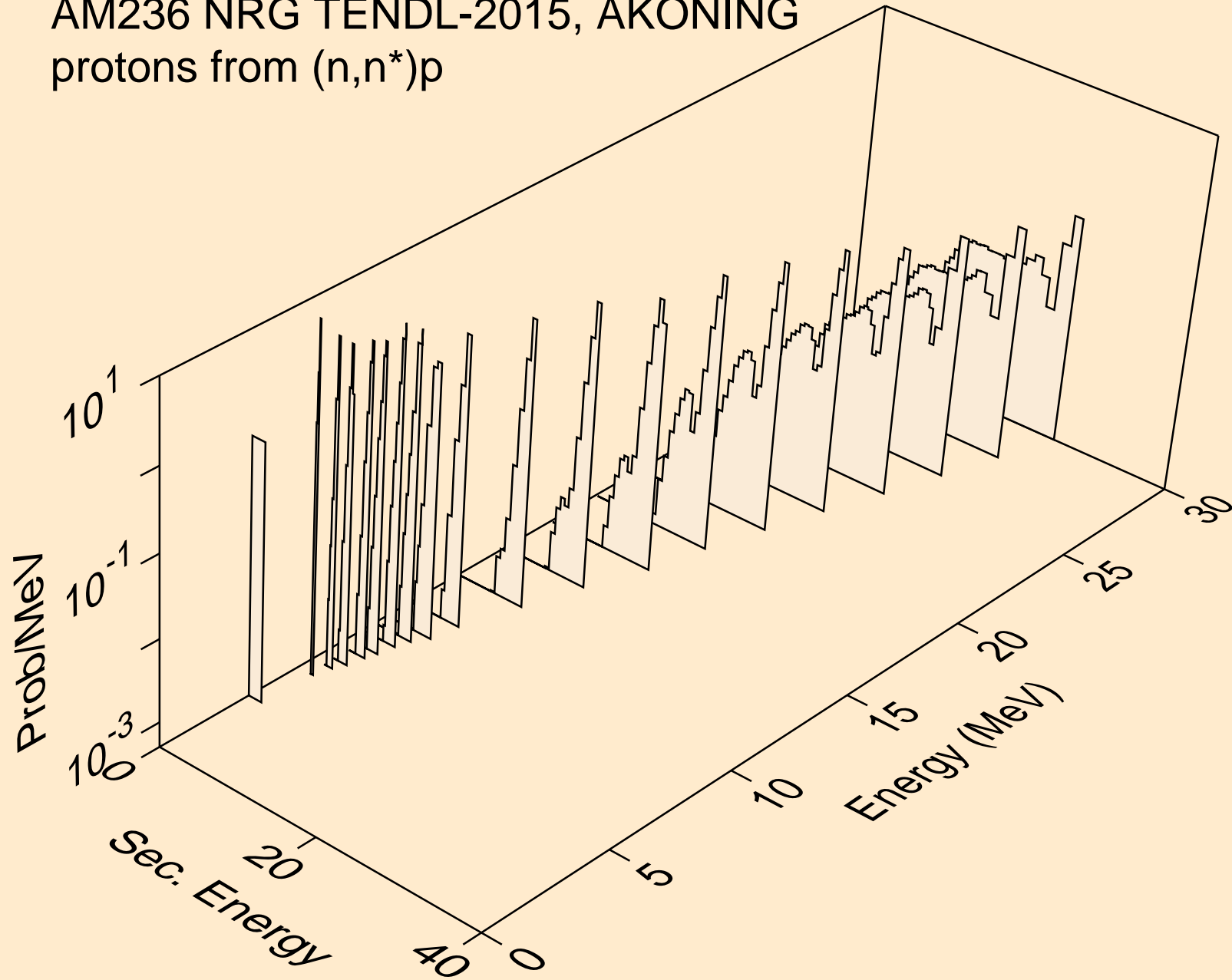

AM236 NRG TENDL-2015, AKONING
protons from (n,2np)

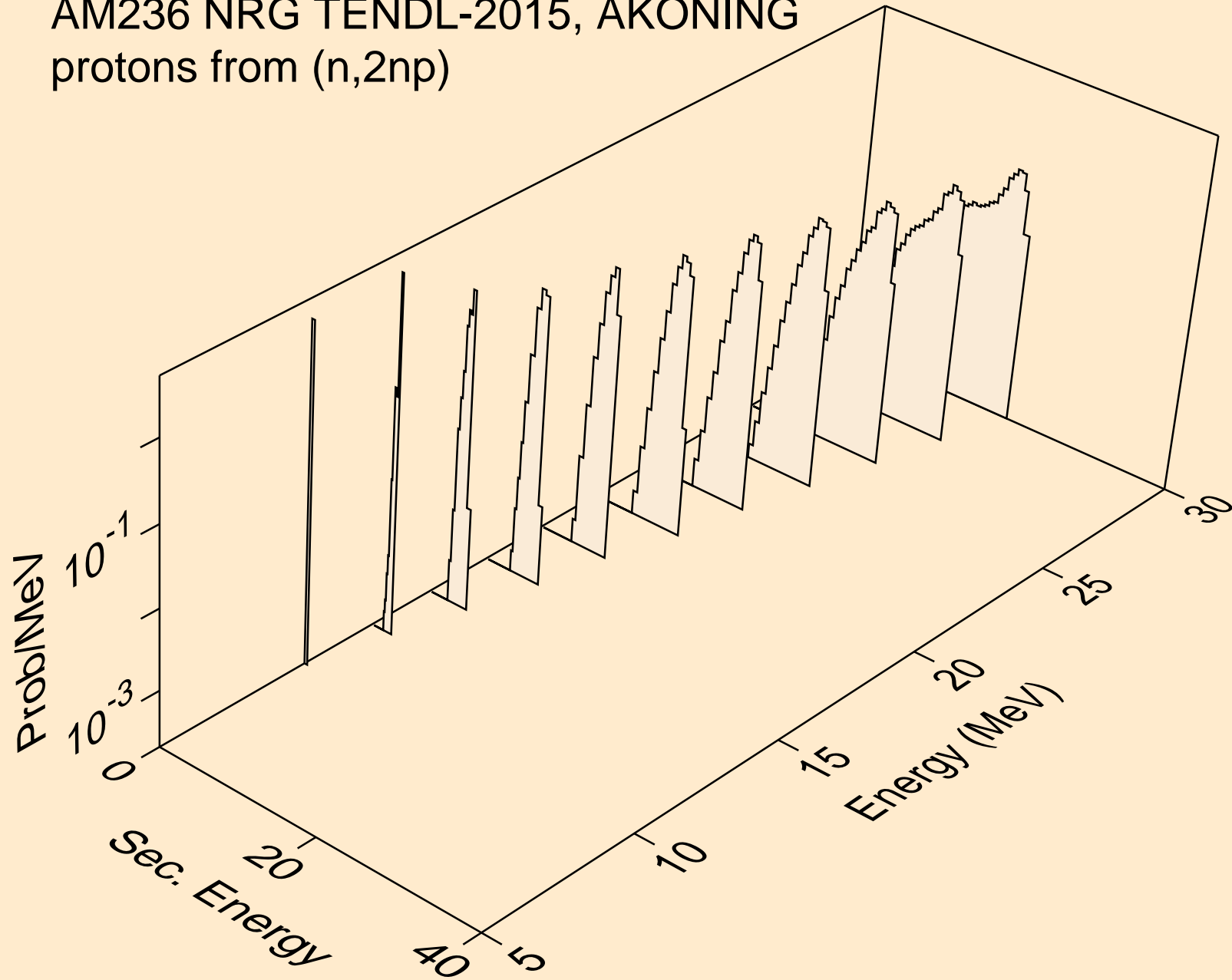

AM236 NRG TENDL-2015, AKONING
protons from (n,3np)

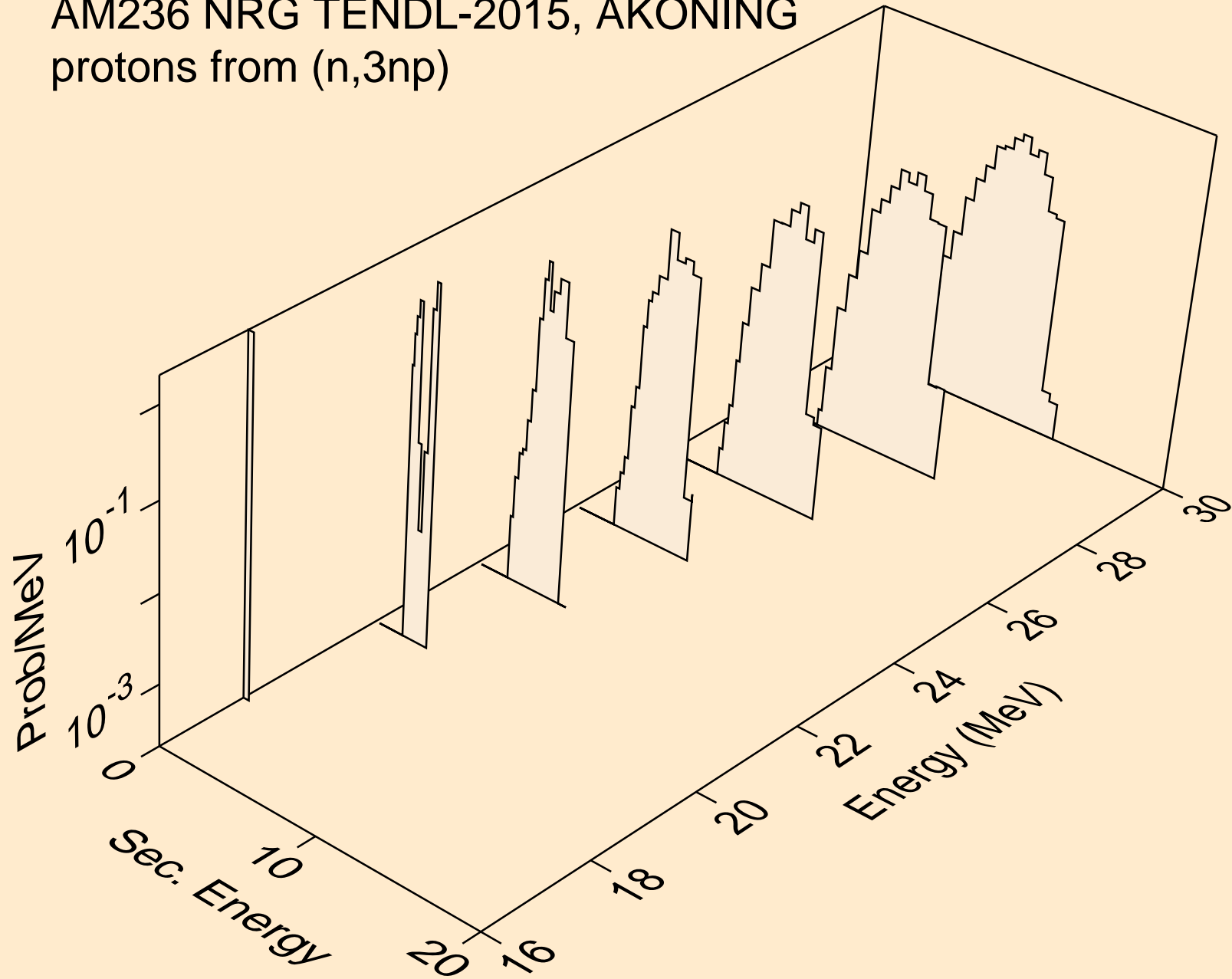

AM236 NRG TENDL-2015, AKONING
protons from (n,2np)

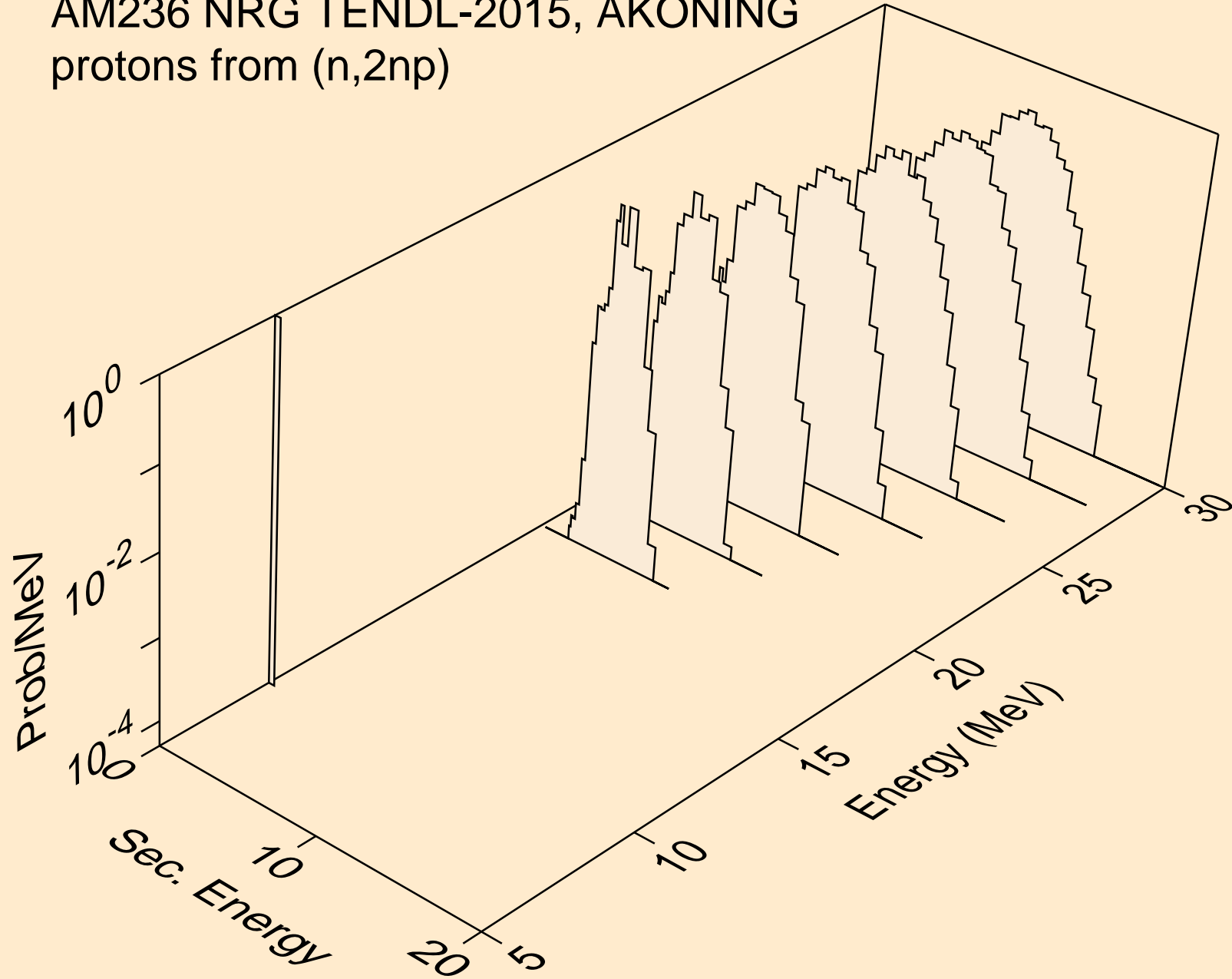

AM236 NRG TENDL-2015, AKONING
protons from (n,npa)

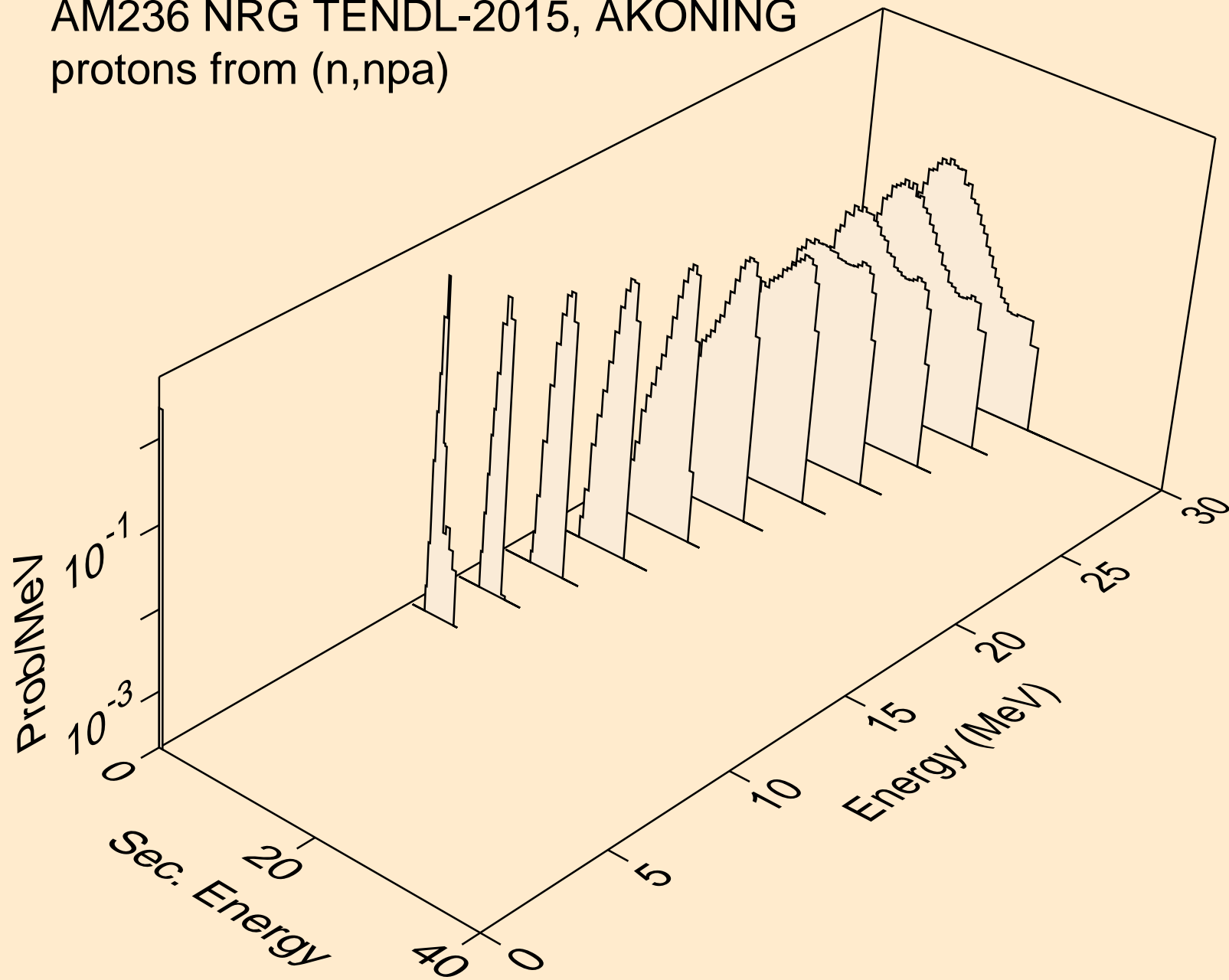

AM236 NRG TENDL-2015, AKONING
protons from (n,p)

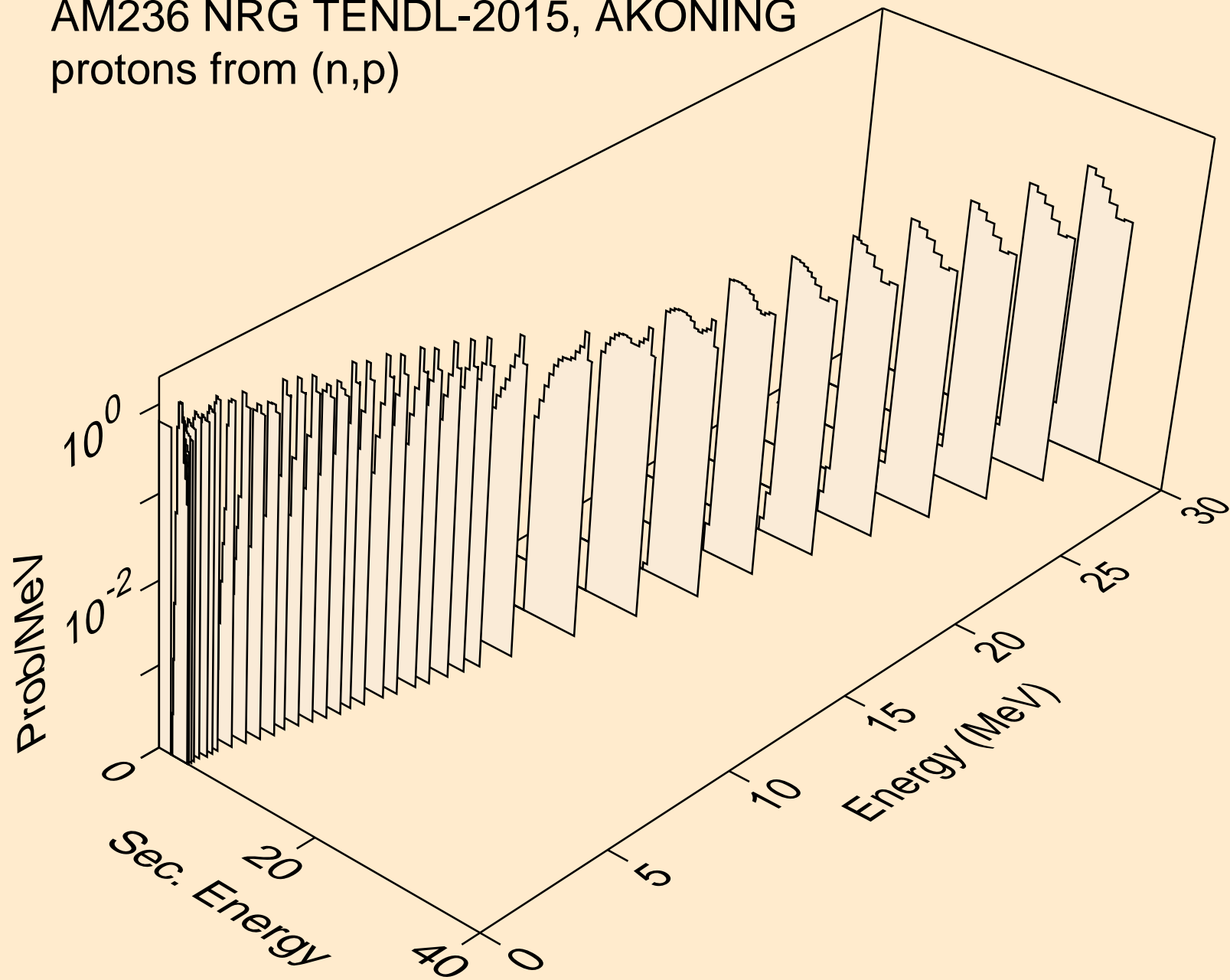

AM236 NRG TENDL-2015, AKONING
protons from (n,2p)

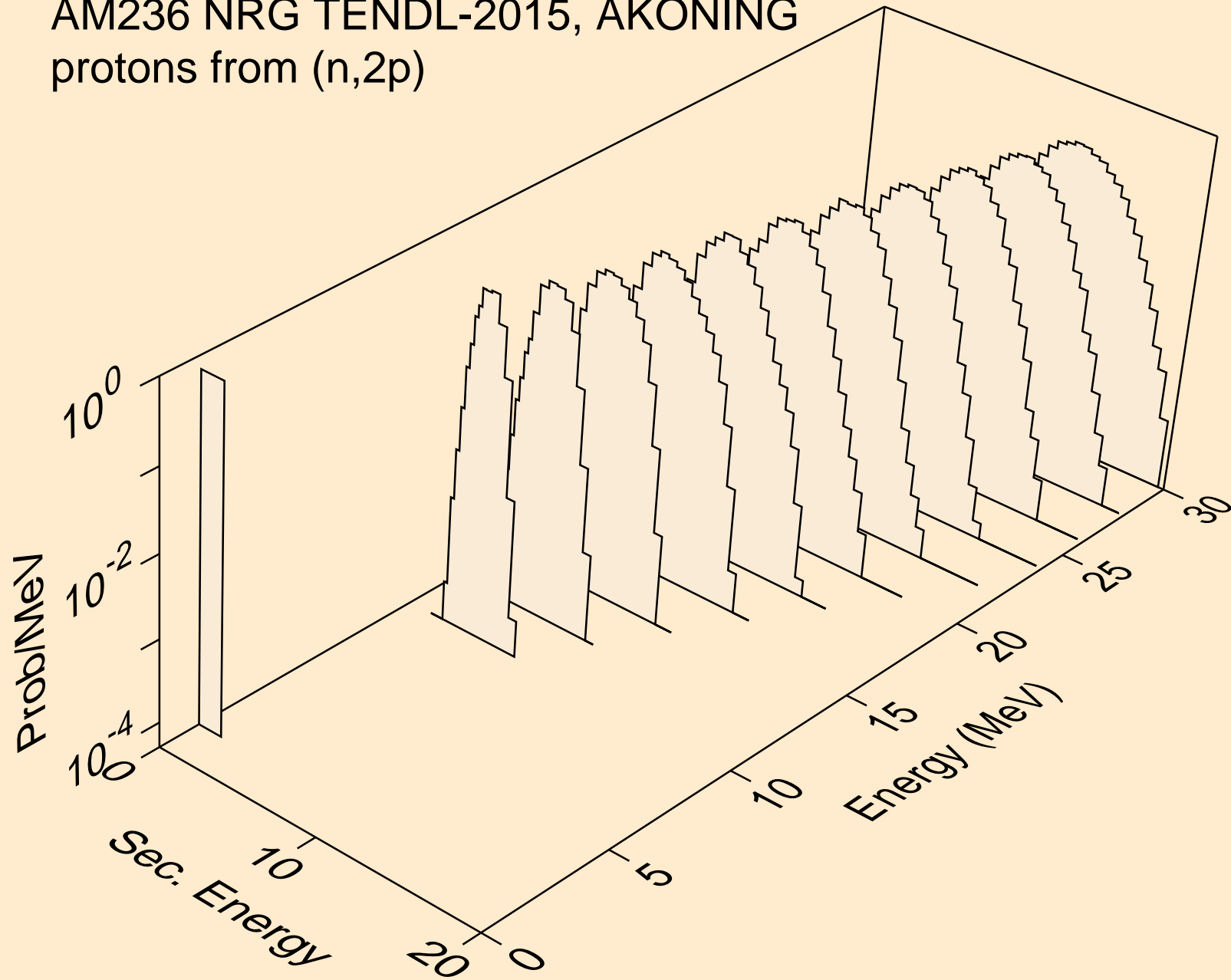

AM236 NRG TENDL-2015, AKONING
protons from (n,pa)

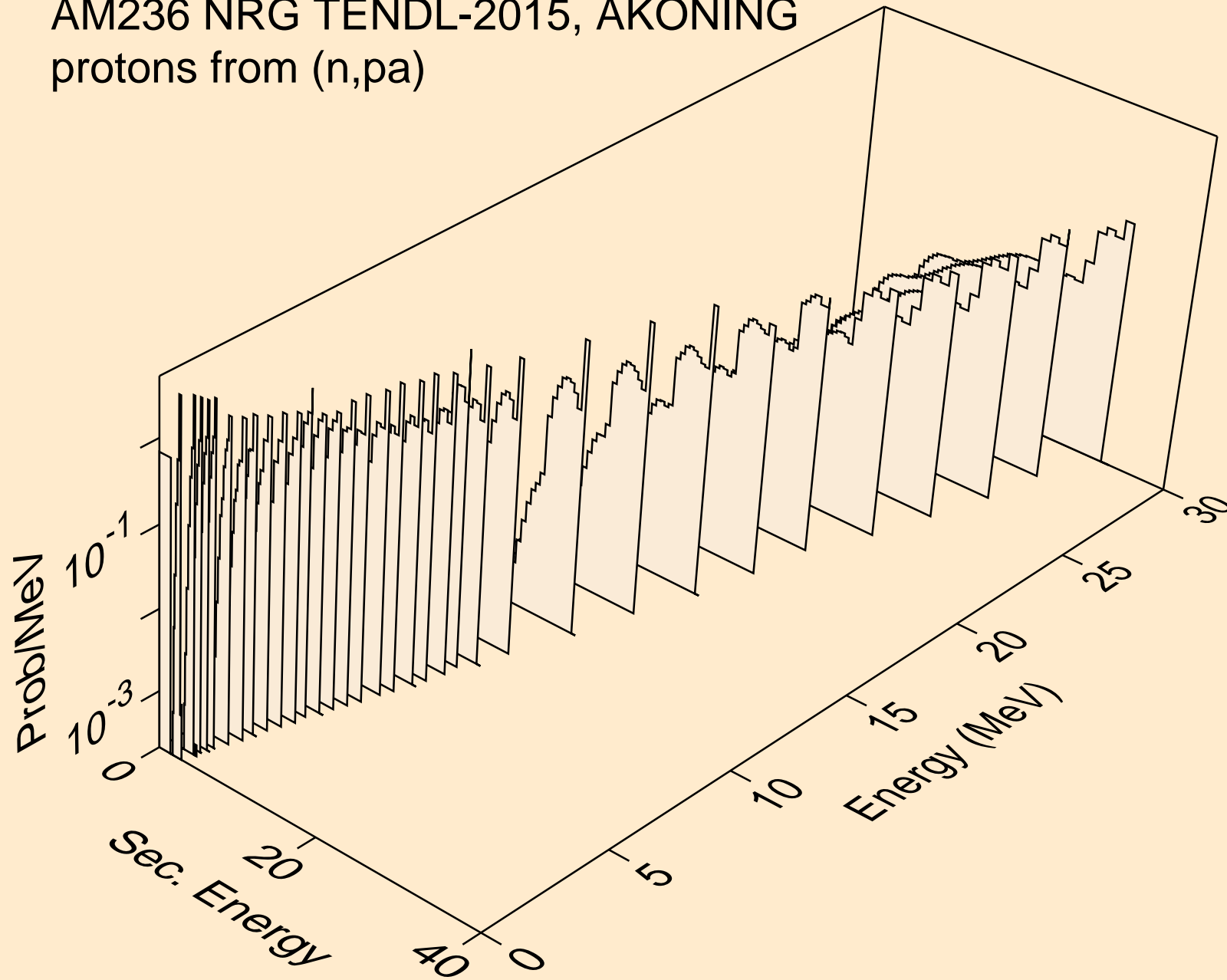

AM236 NRG TENDL-2015, AKONING
protons from (n,pd)

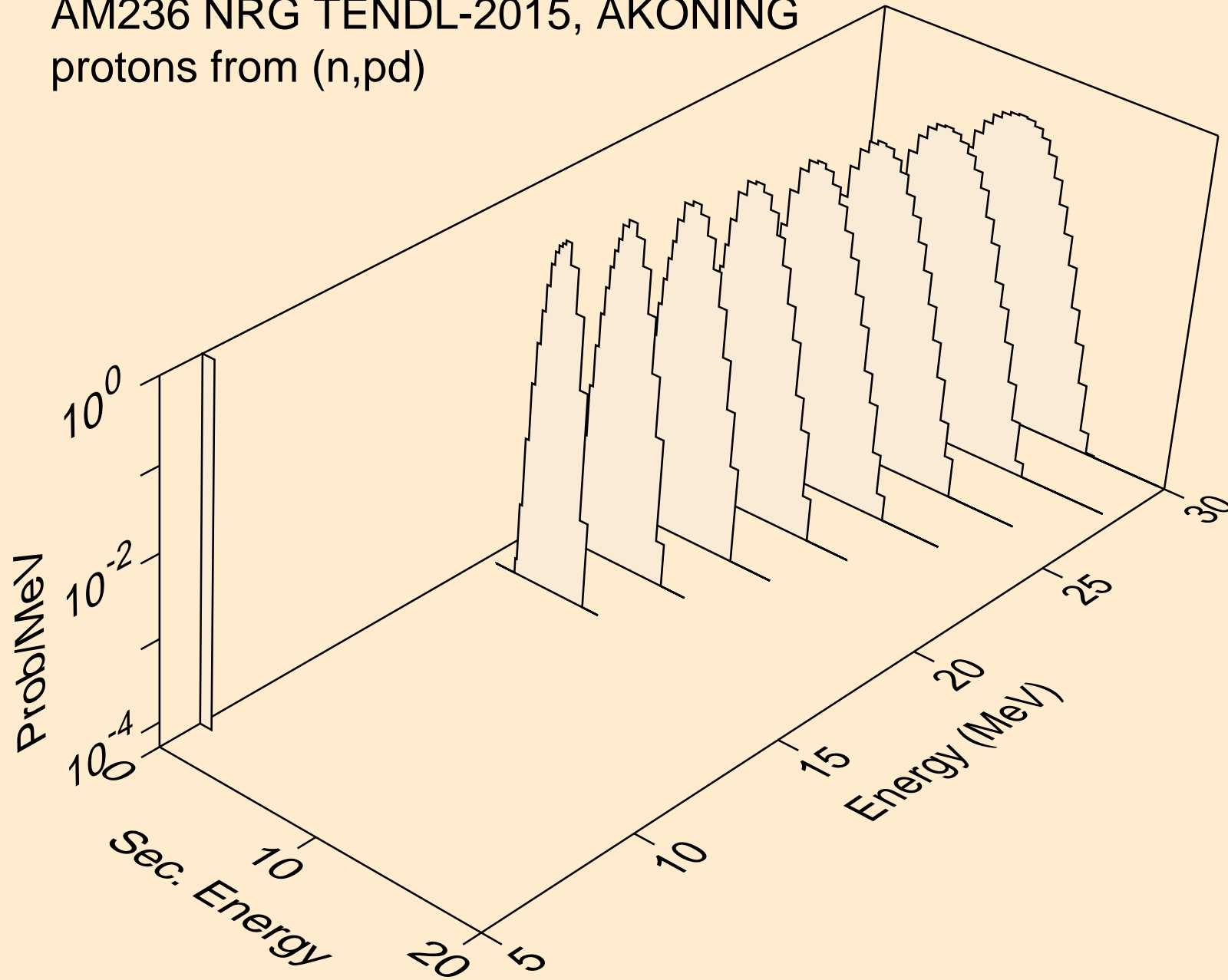

AM236 NRG TENDL-2015, AKONING
deuterons from (n,x)

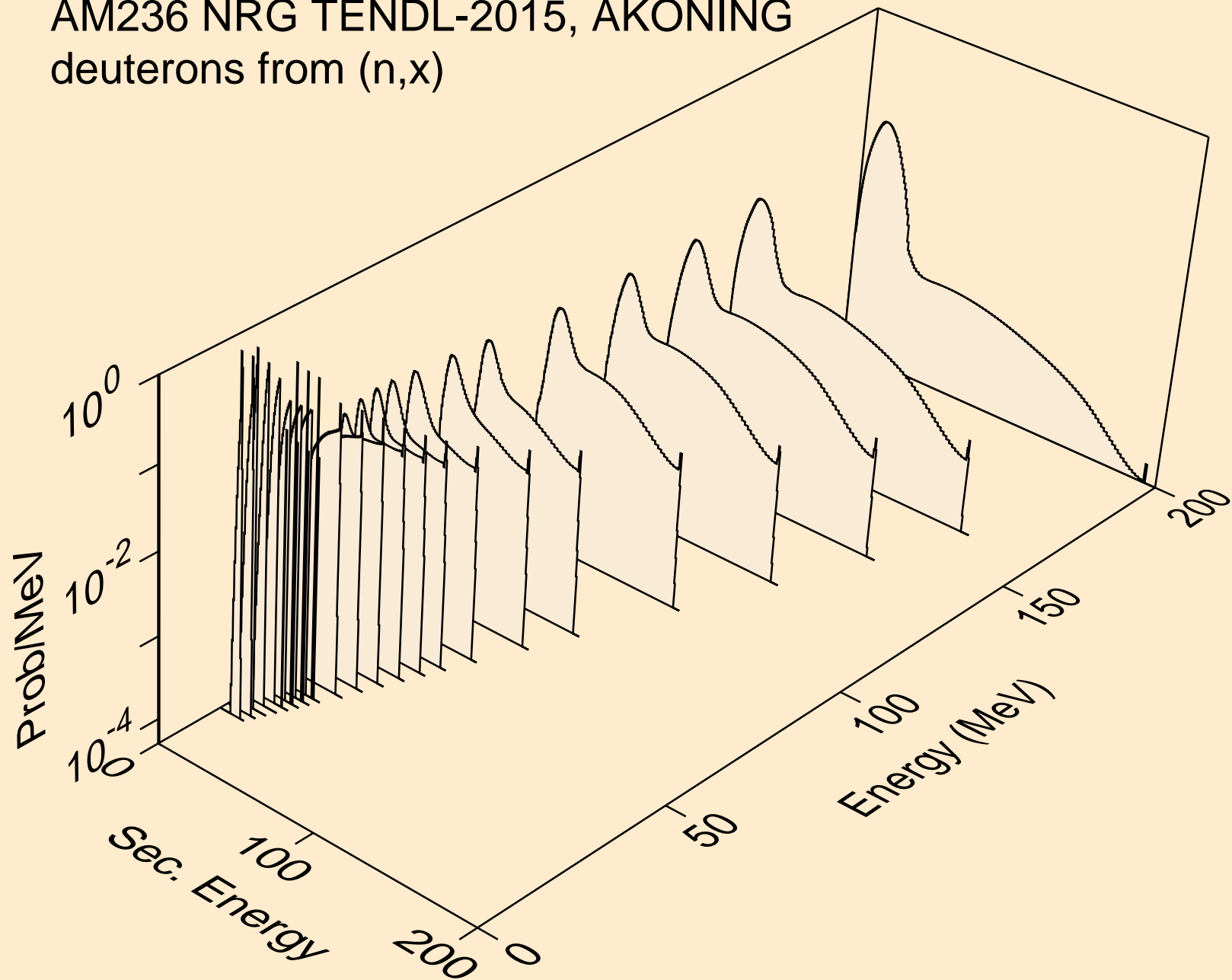

AM236 NRG TENDL-2015, AKONING
deuterons from (n,2nd)

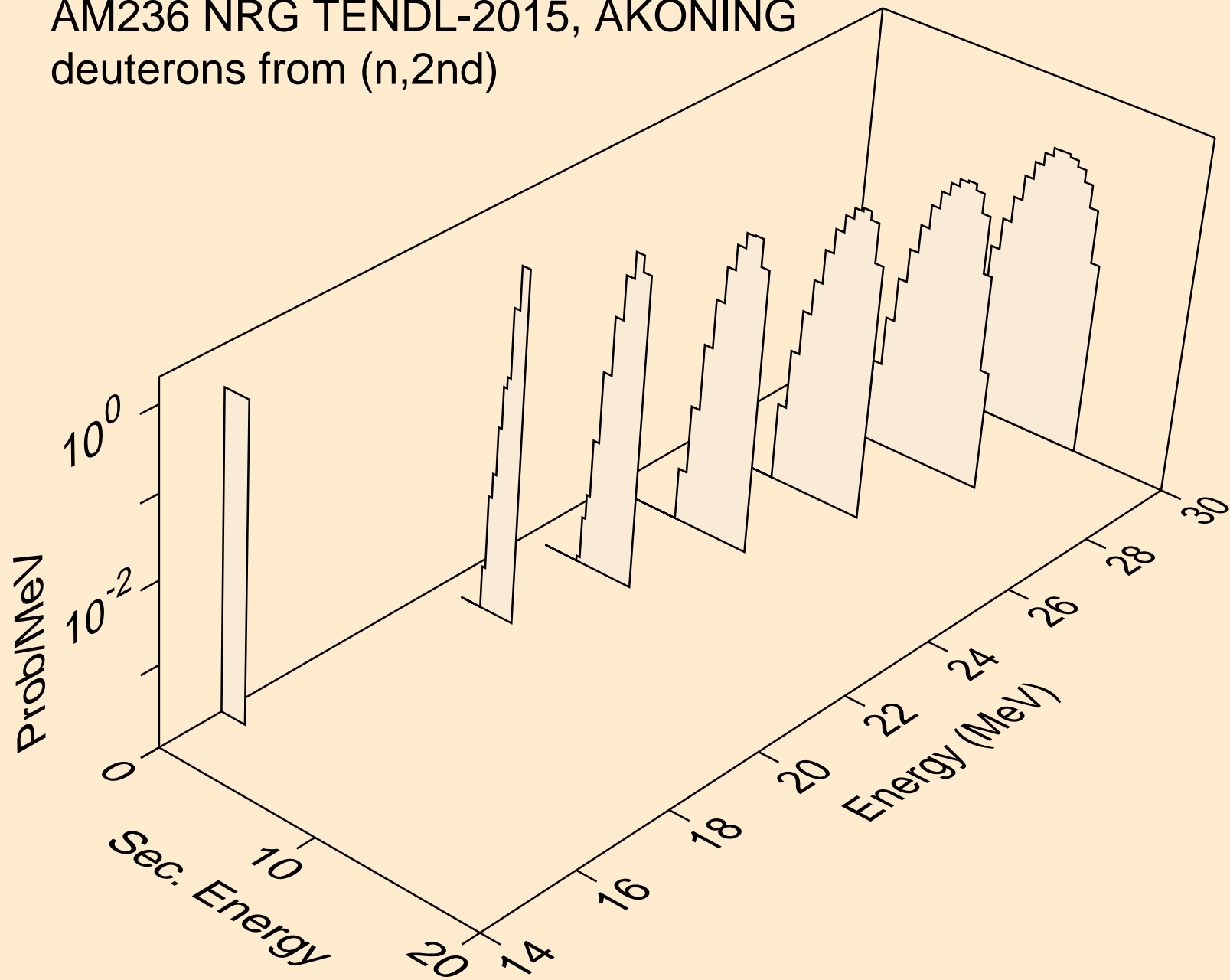

AM236 NRG TENDL-2015, AKONING
deuterons from (n,n*)d

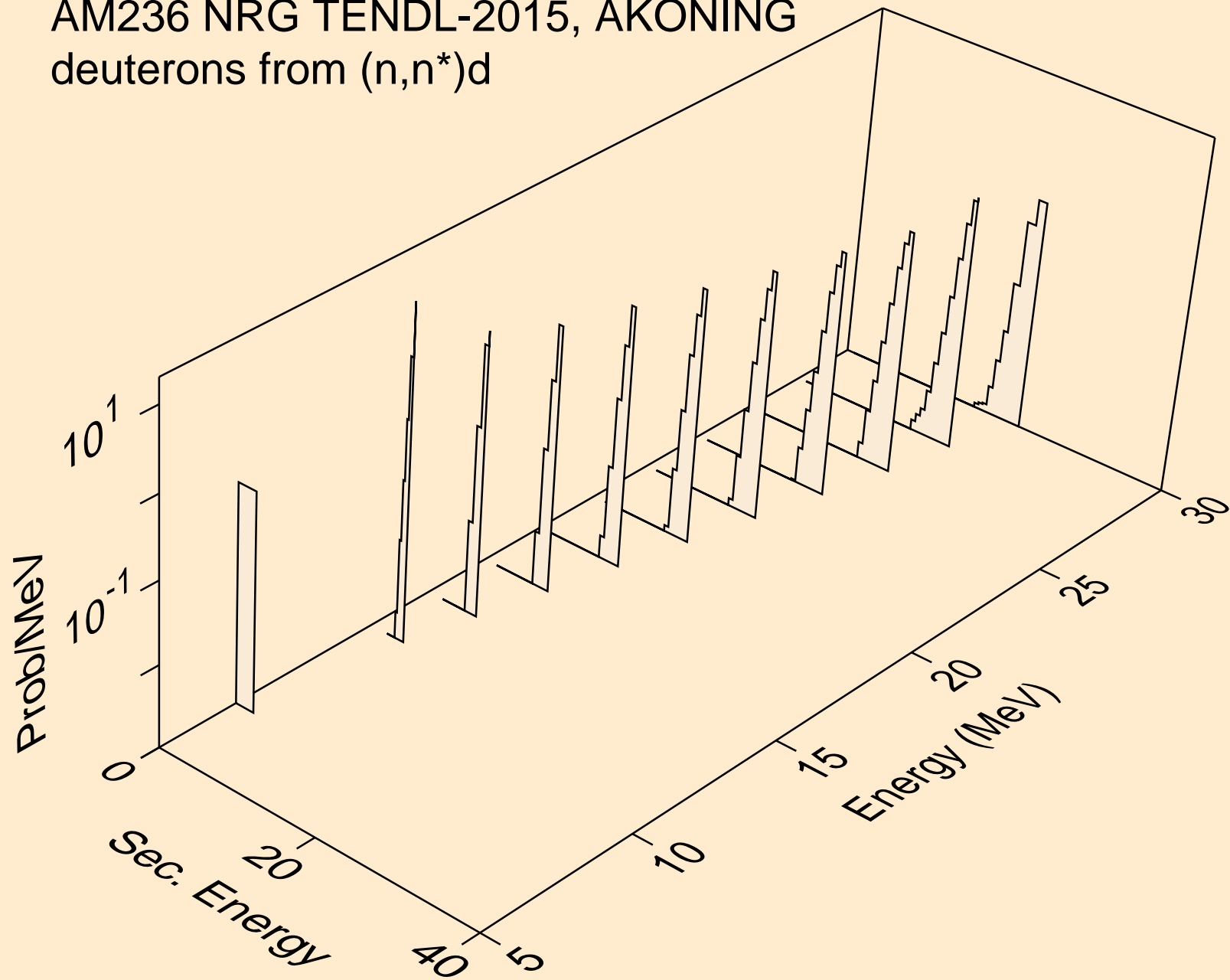

AM236 NRG TENDL-2015, AKONING
deuterons from (n,d)

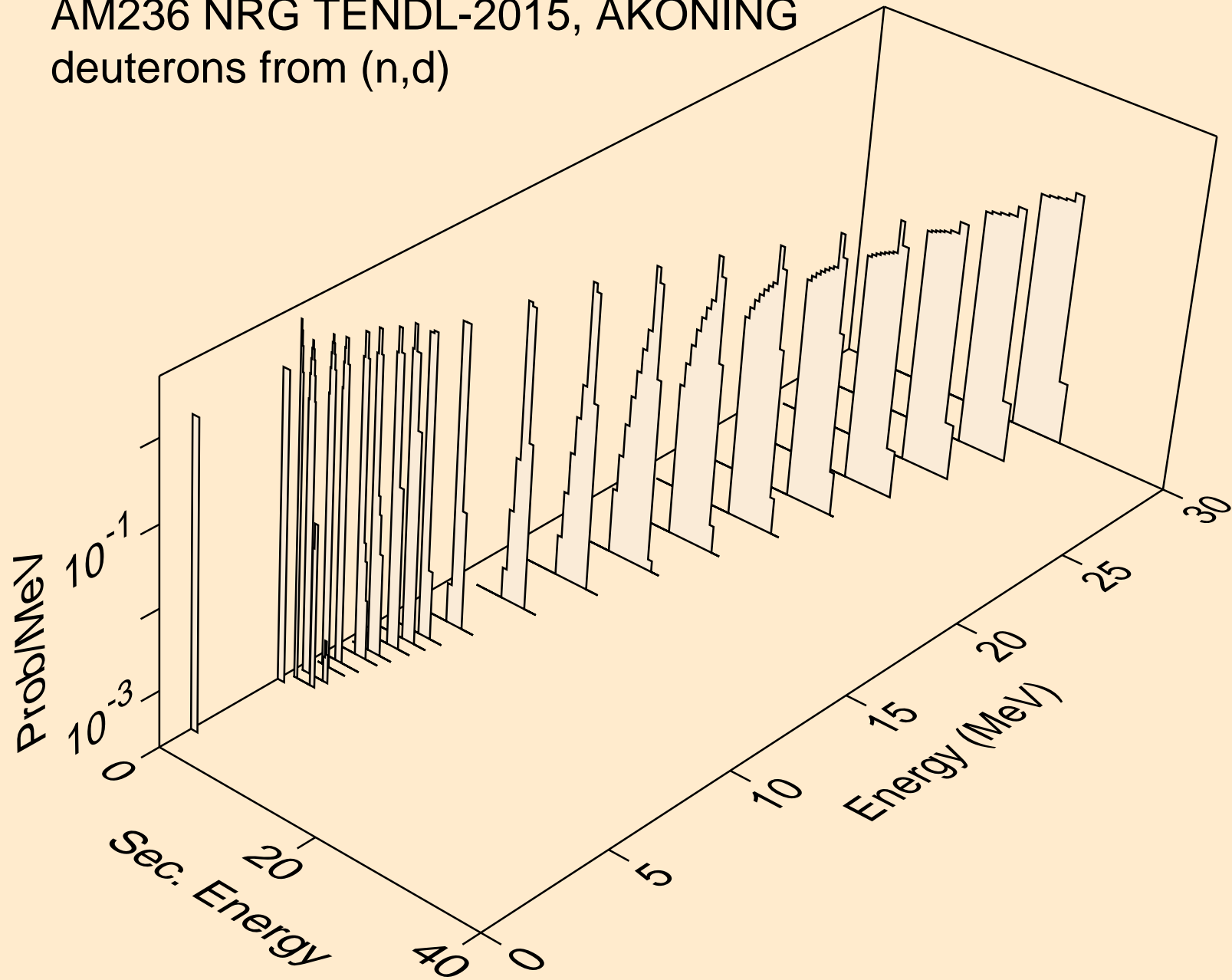

AM236 NRG TENDL-2015, AKONING
deuterons from (n,pd)

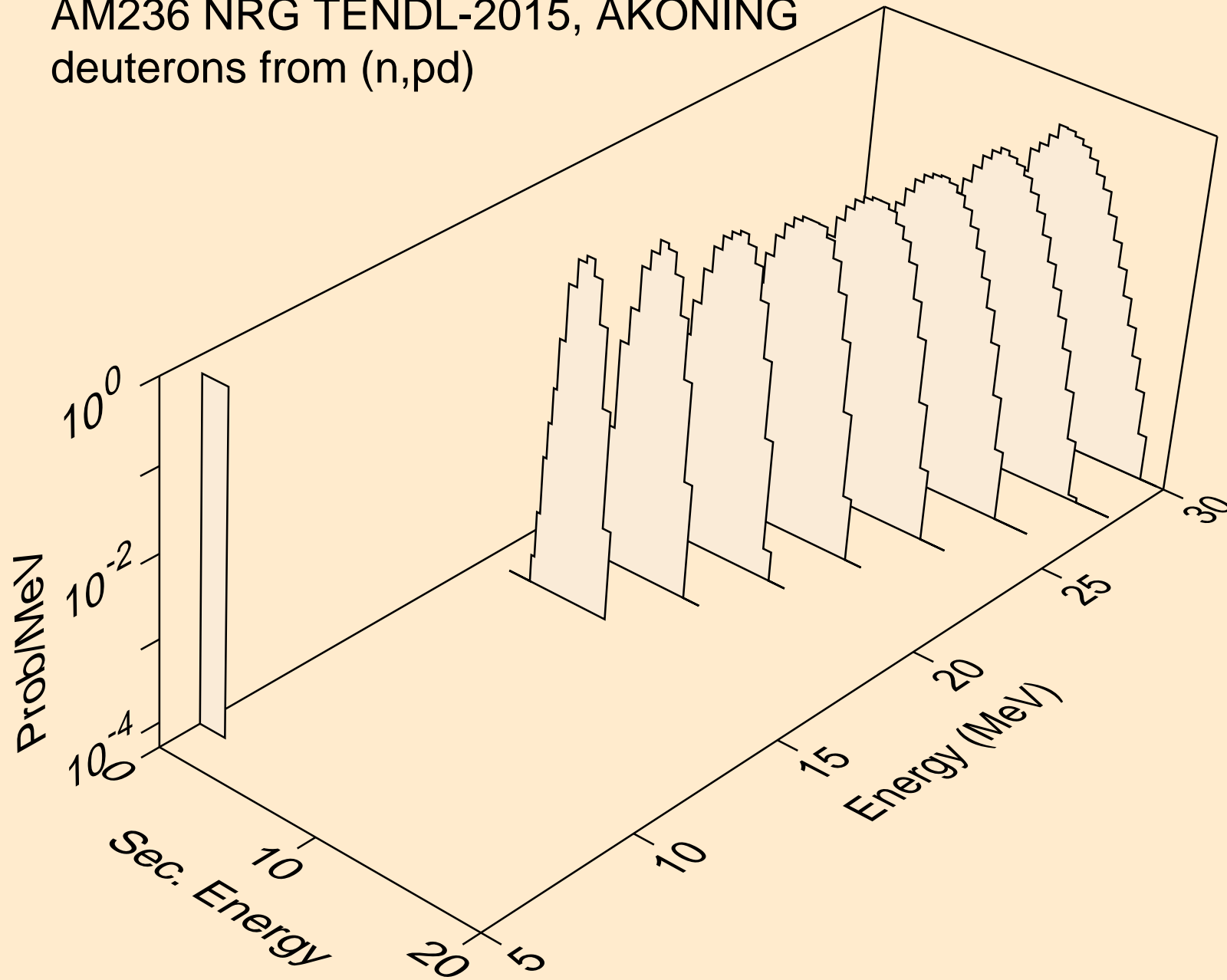

AM236 NRG TENDL-2015, AKONING
deuterons from (n,da)

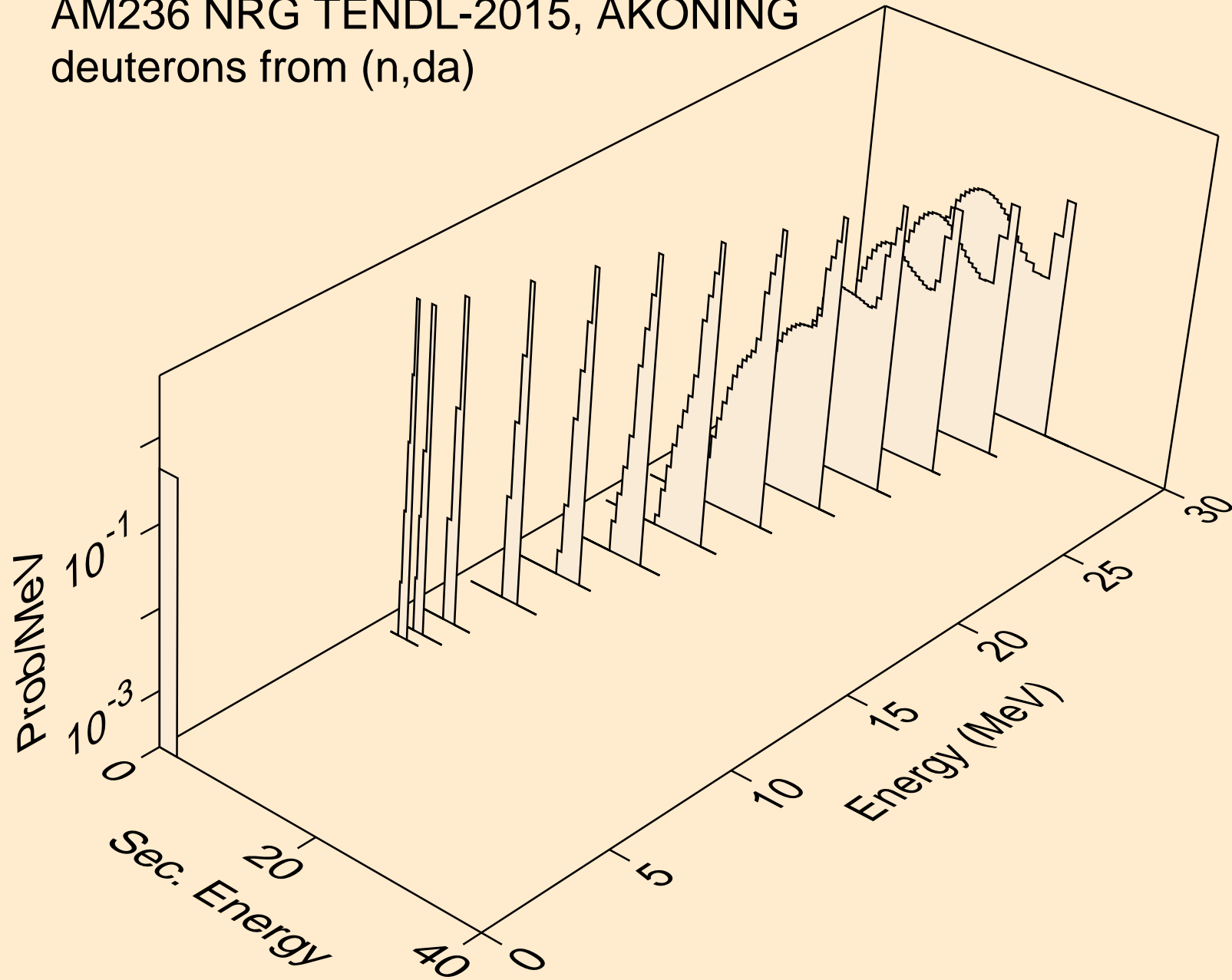

AM236 NRG TENDL-2015, AKONING
tritons from (n,x)

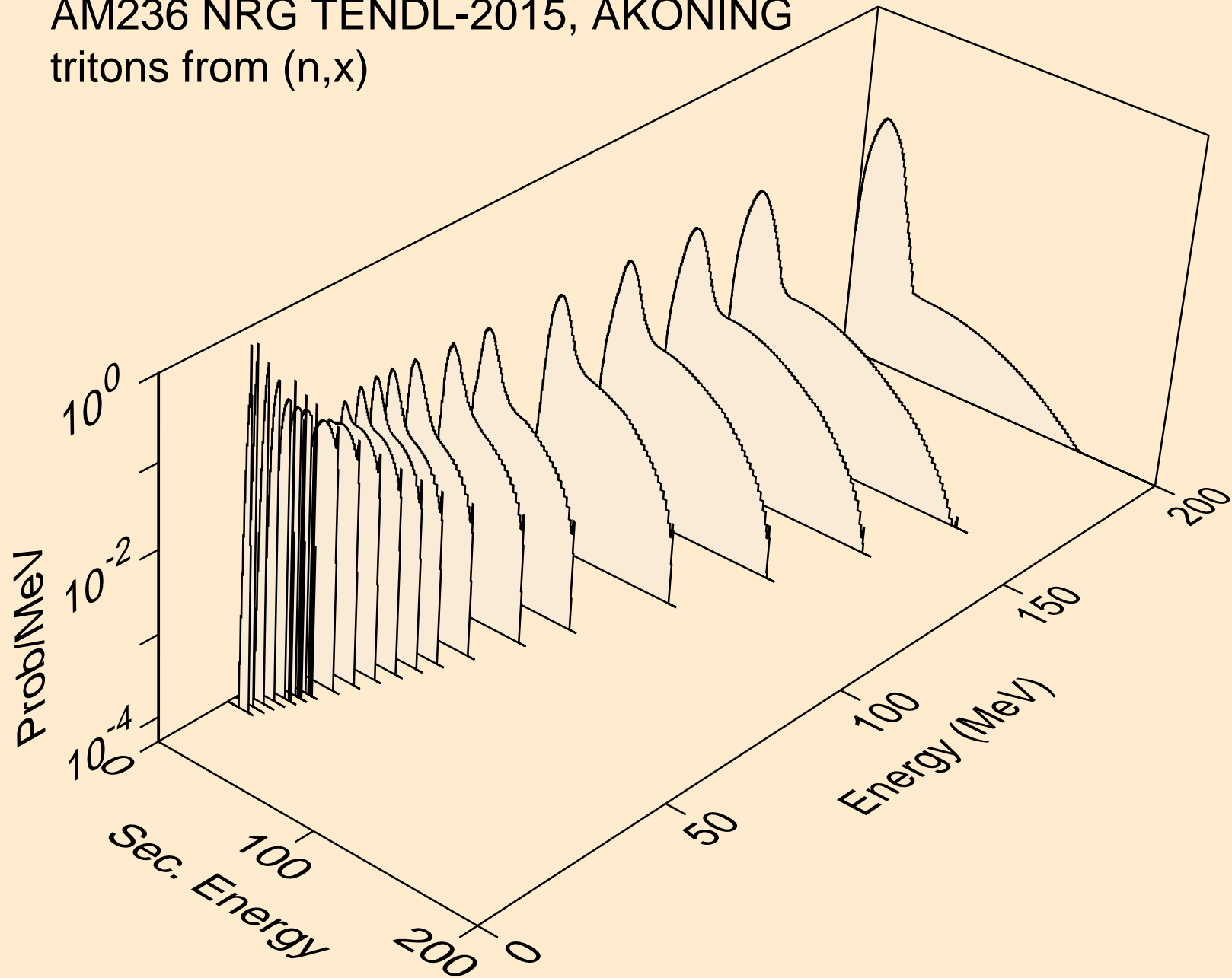

AM236 NRG TENDL-2015, AKONING
tritons from (n,n*)t

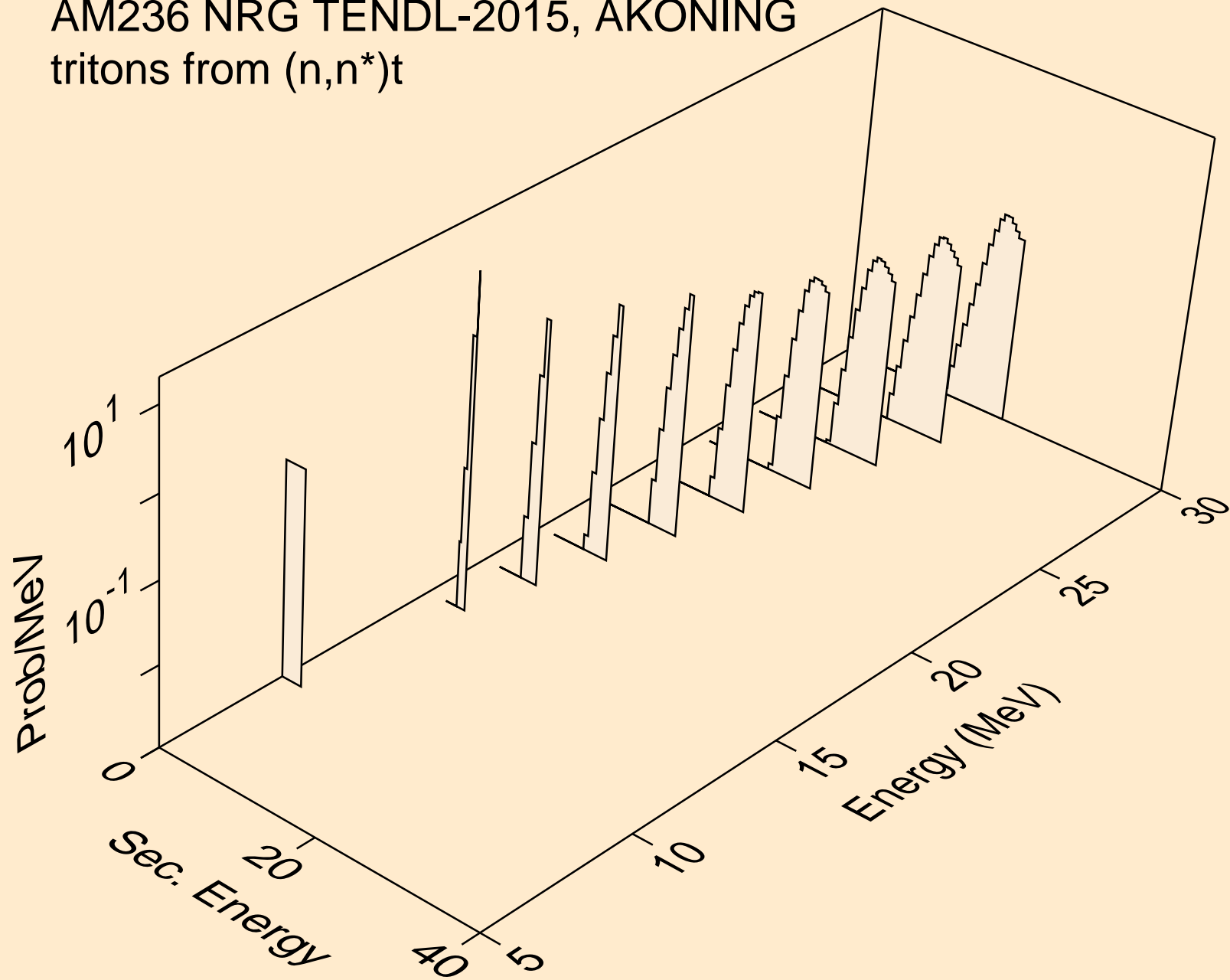

AM236 NRG TENDL-2015, AKONING
tritons from (n,t)

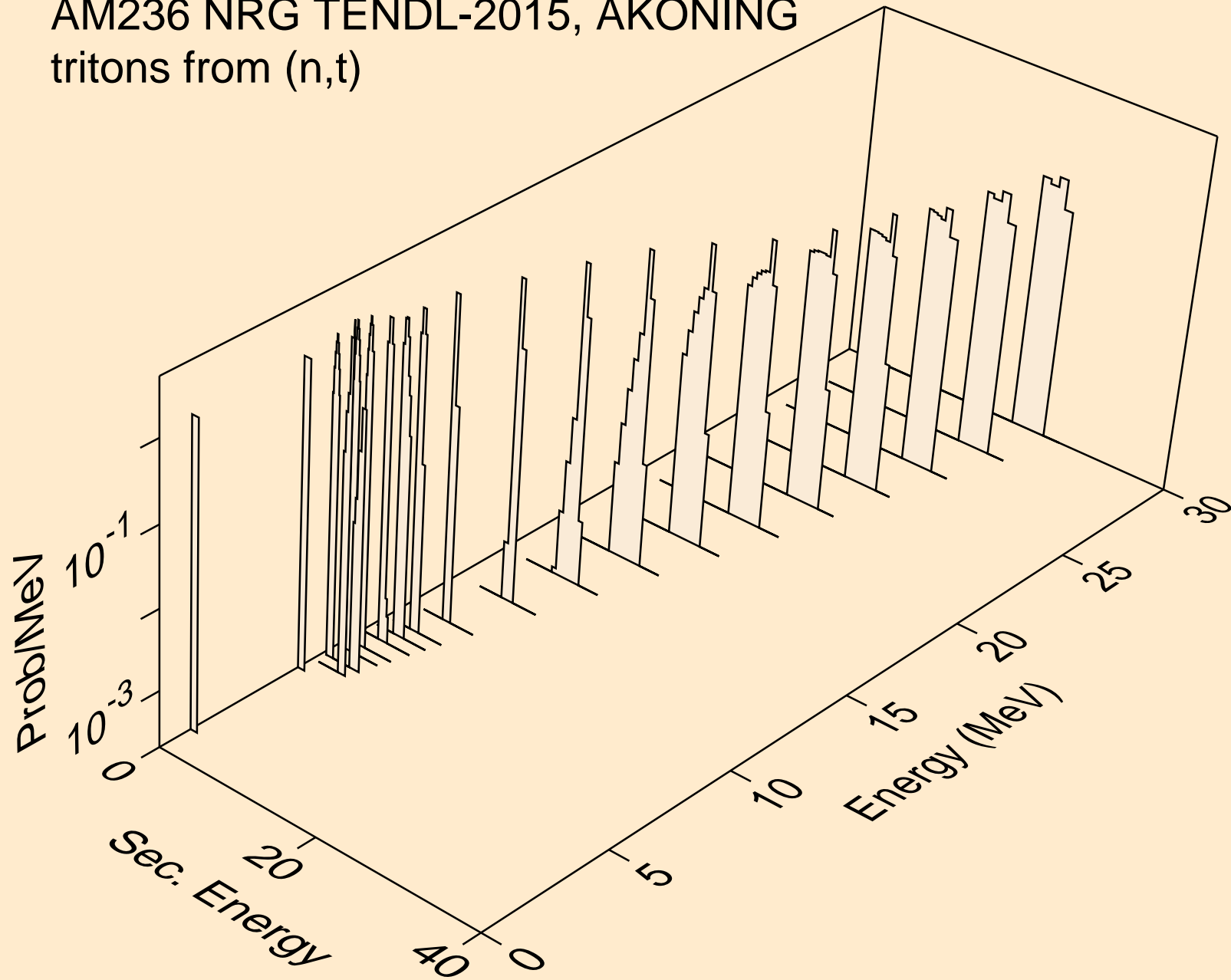

AM236 NRG TENDL-2015, AKONING
he3s from (n,x)

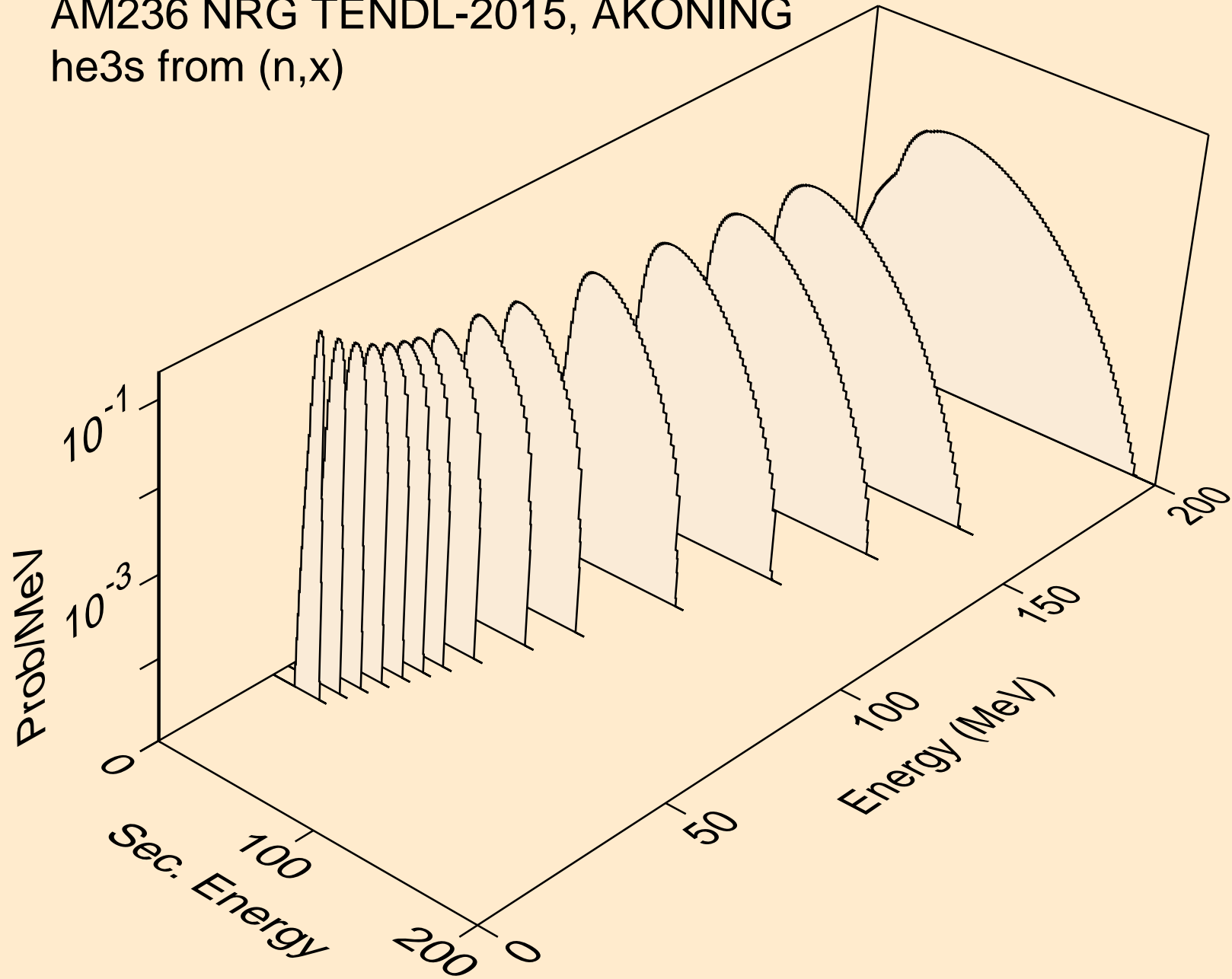

AM236 NRG TENDL-2015, AKONING
he3s from (n,n*)he3

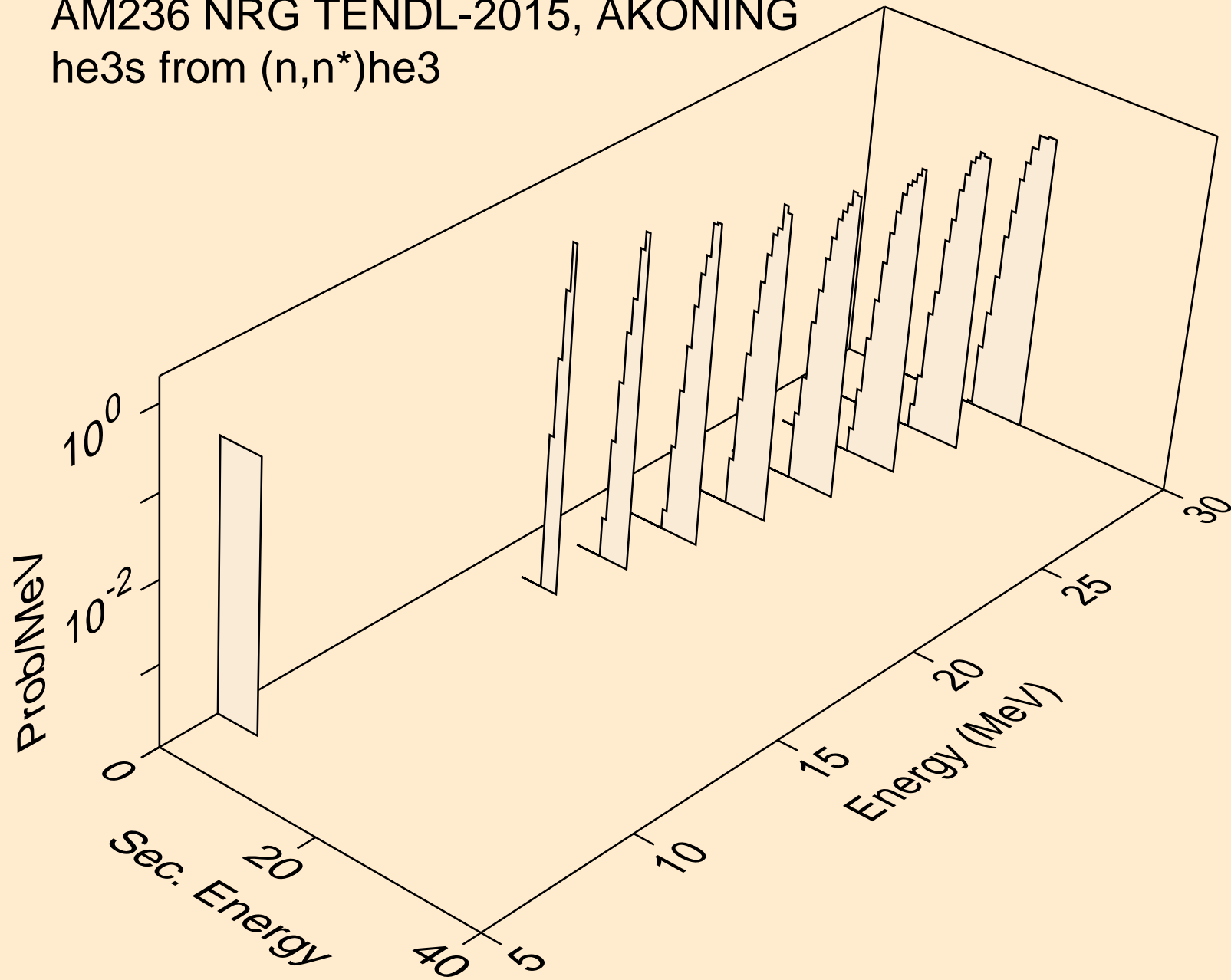

AM236 NRG TENDL-2015, AKONING
he3s from (n,he3)

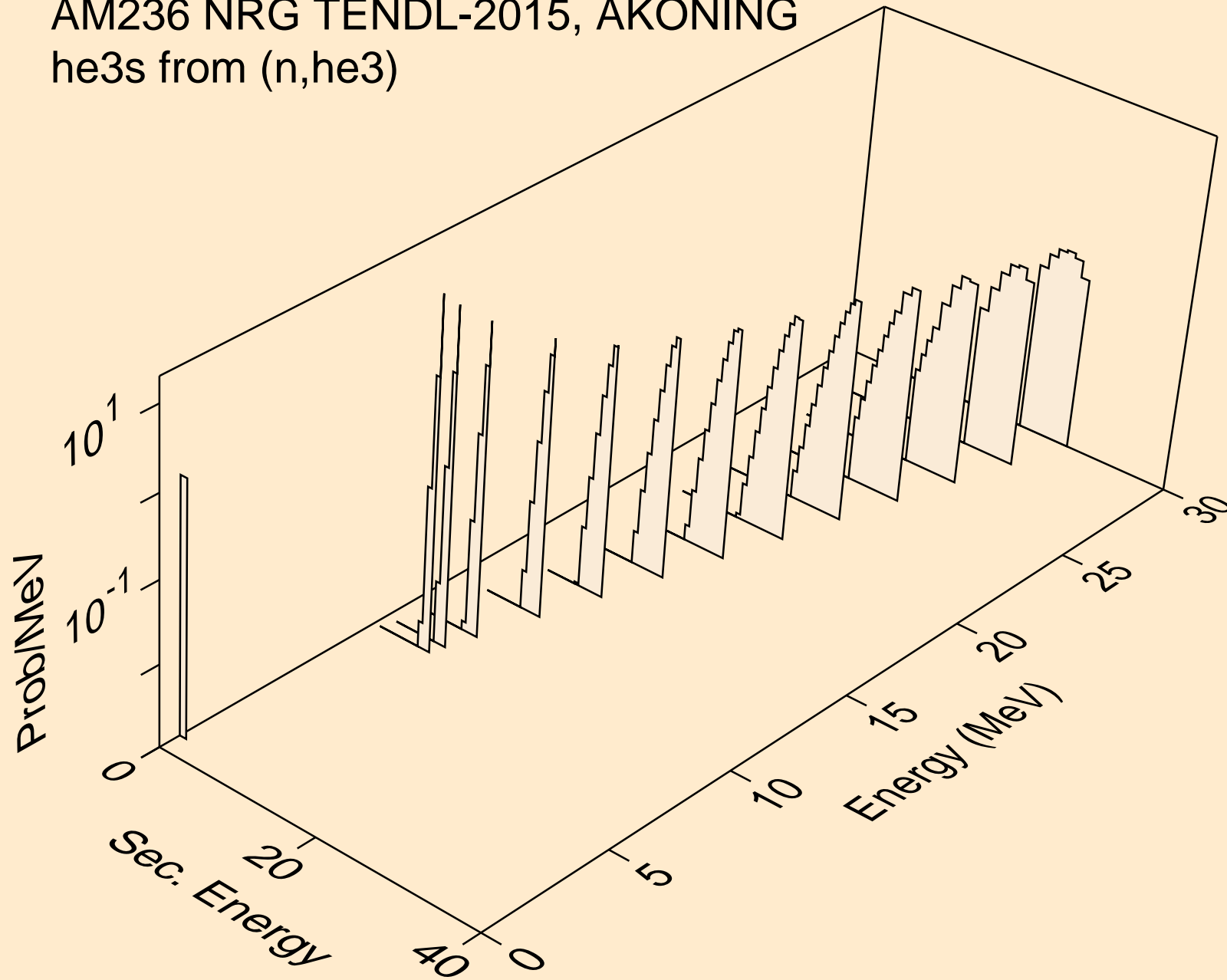

AM236 NRG TENDL-2015, AKONING
alphas from (n,x)

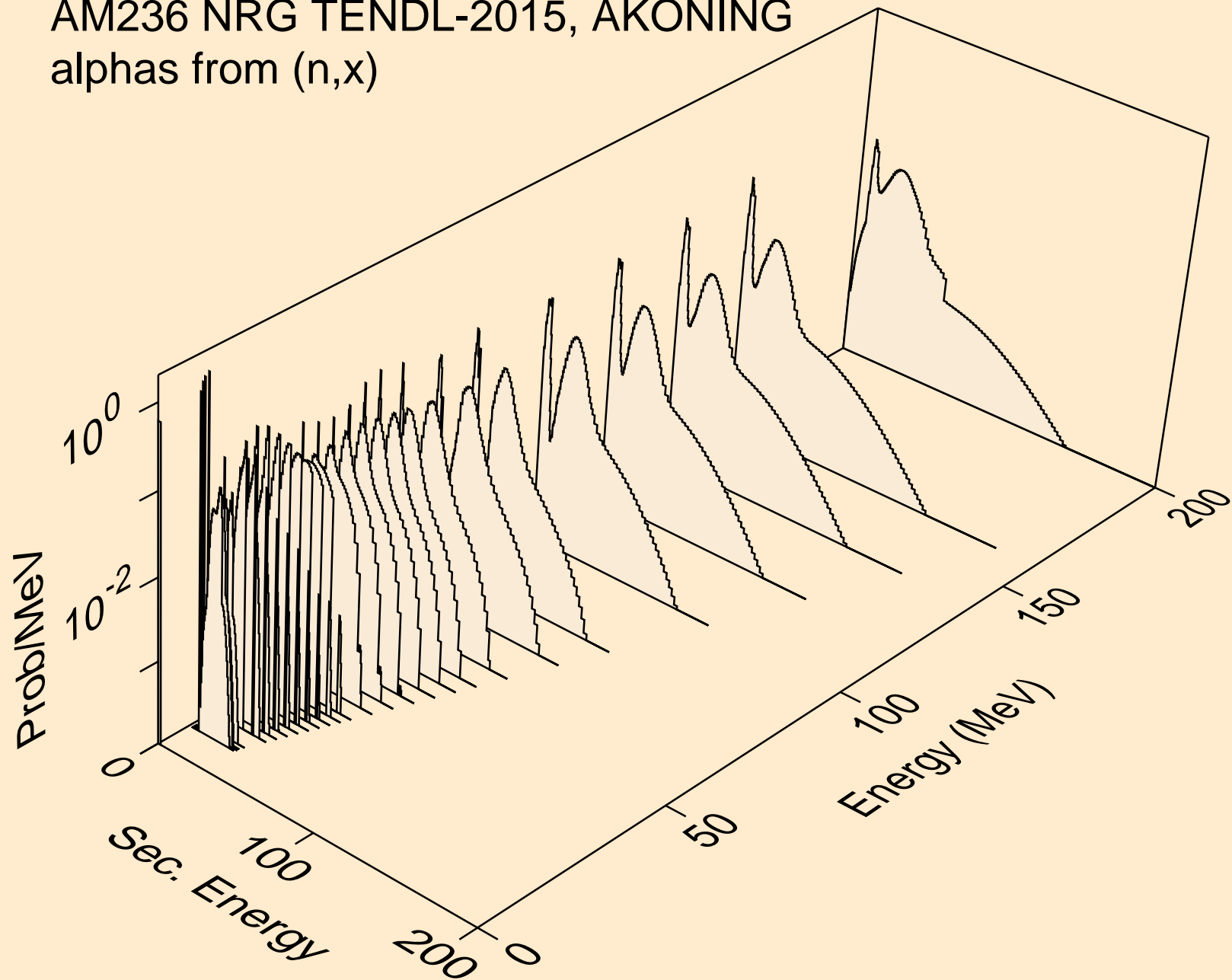

AM236 NRG TENDL-2015, AKONING
alphas from (n,n*)a

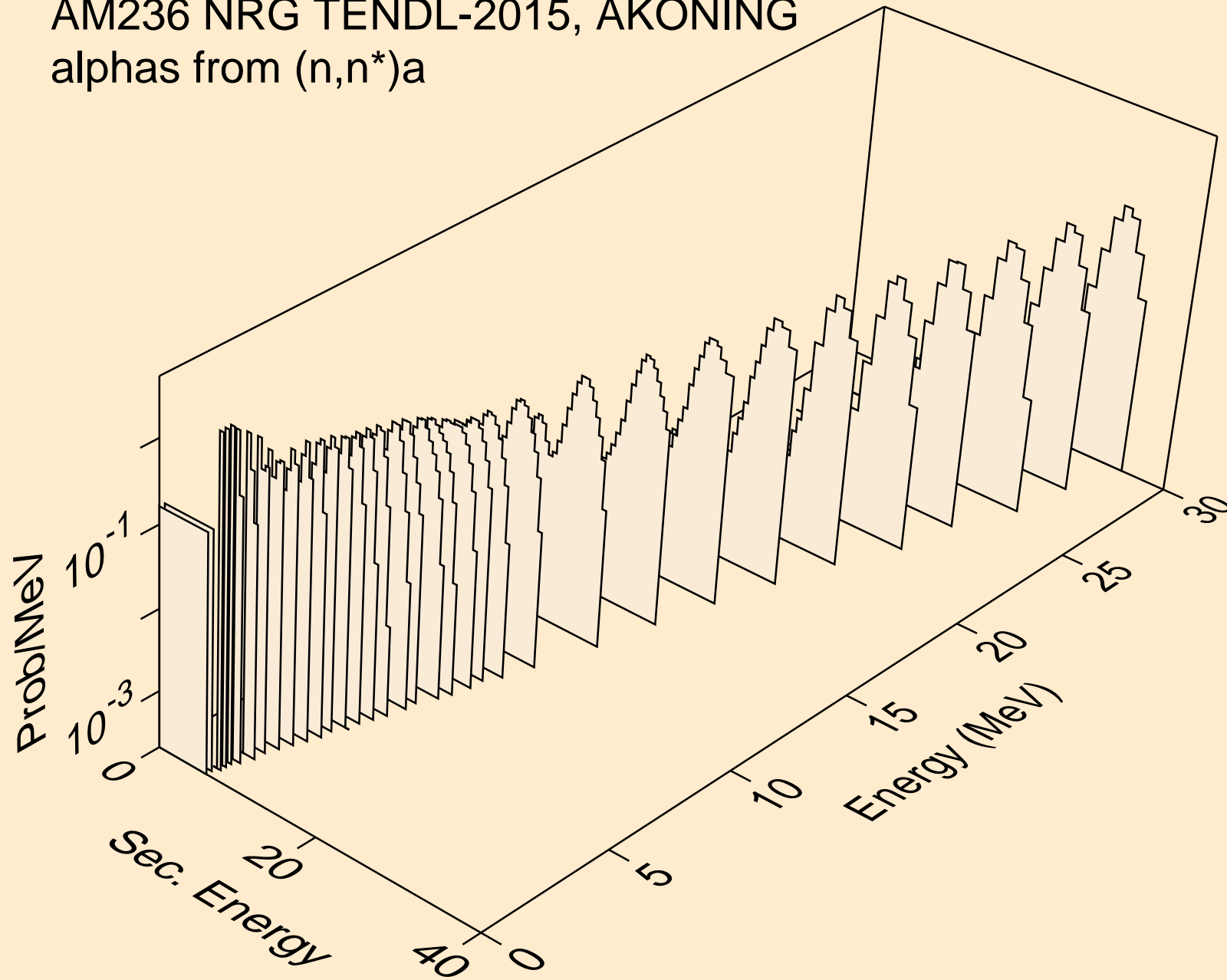

AM236 NRG TENDL-2015, AKONING
alphas from (n,2n)a

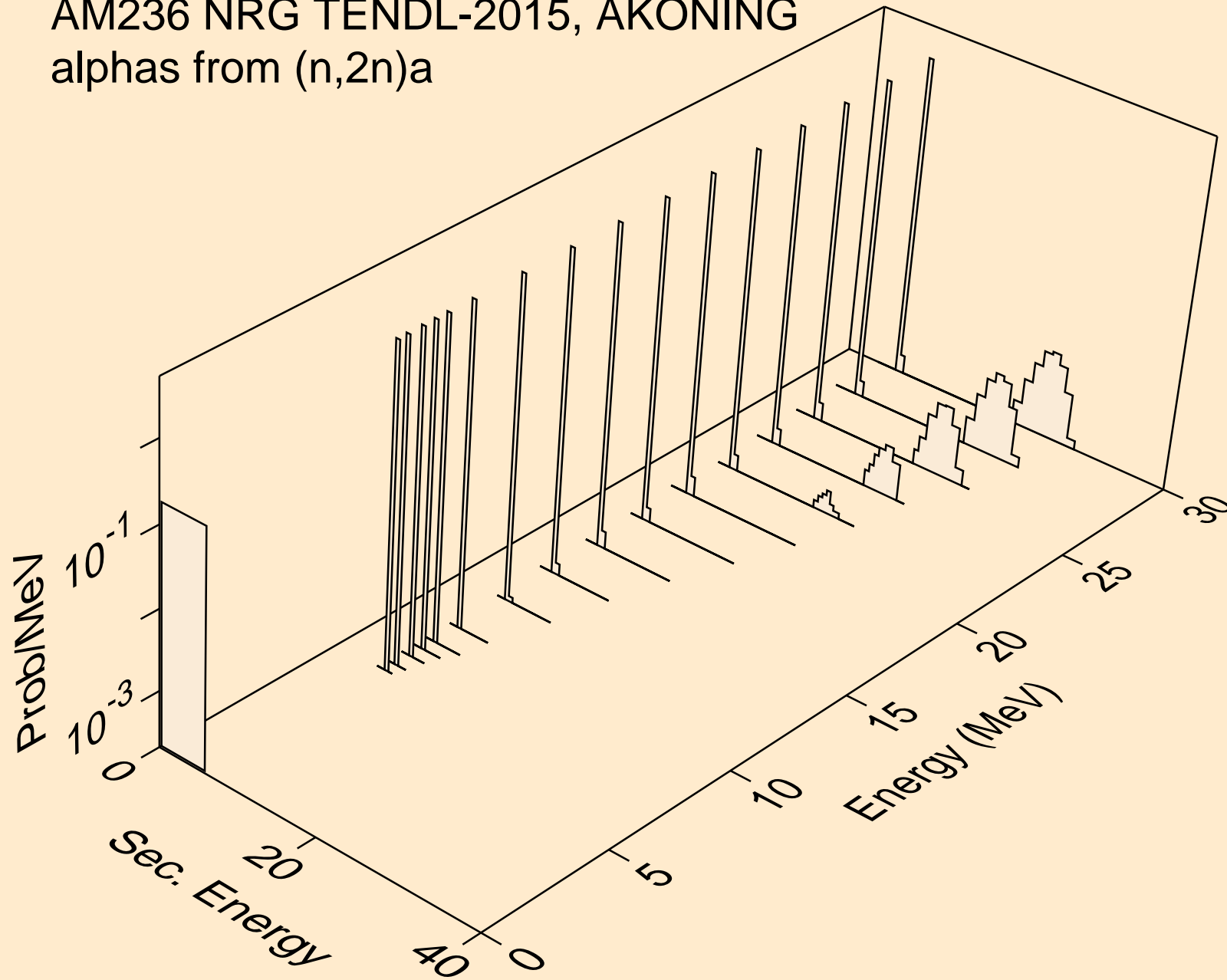

AM236 NRG TENDL-2015, AKONING
alphas from (n,3n)a

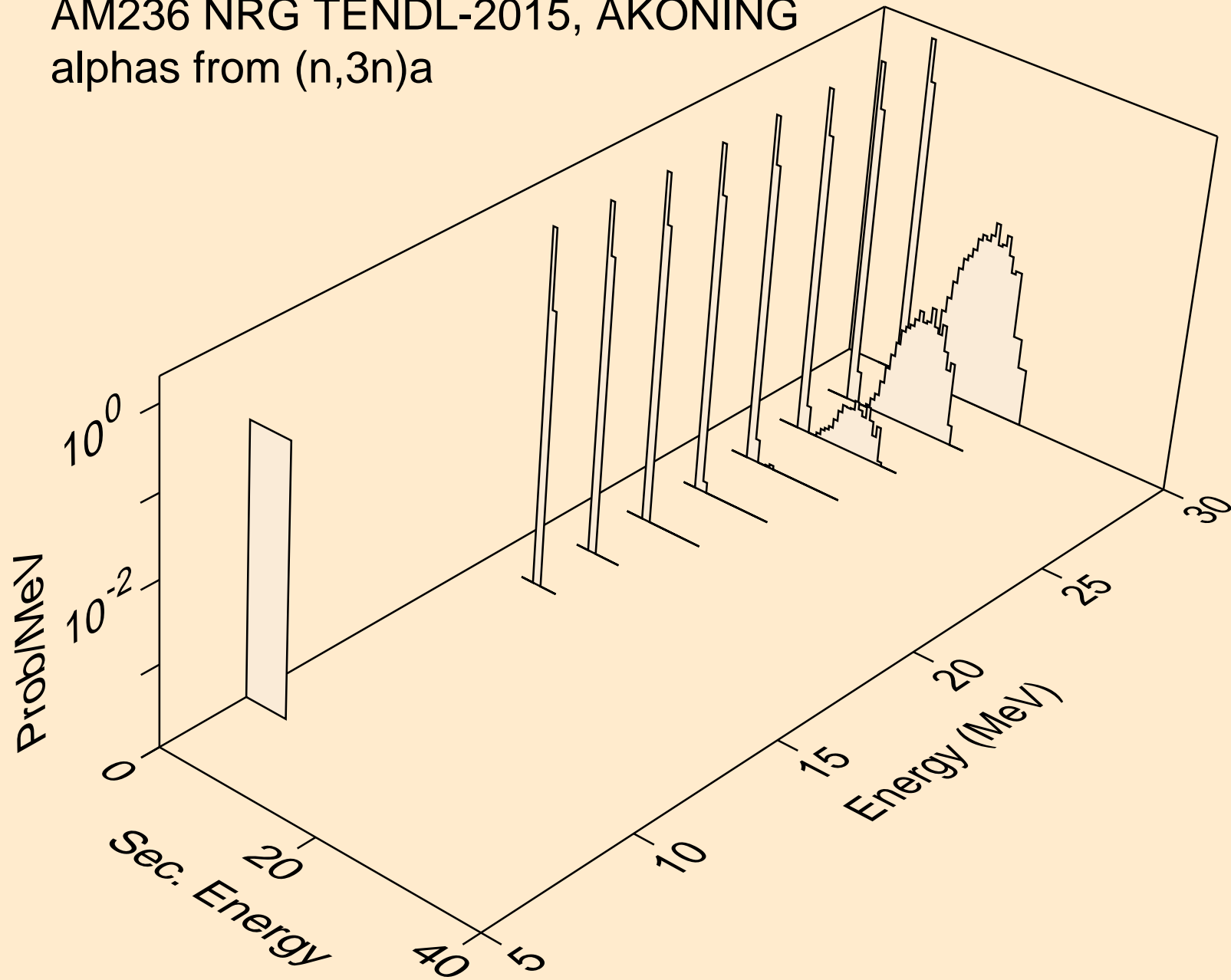

AM236 NRG TENDL-2015, AKONING
alphas from (n,n*)2a

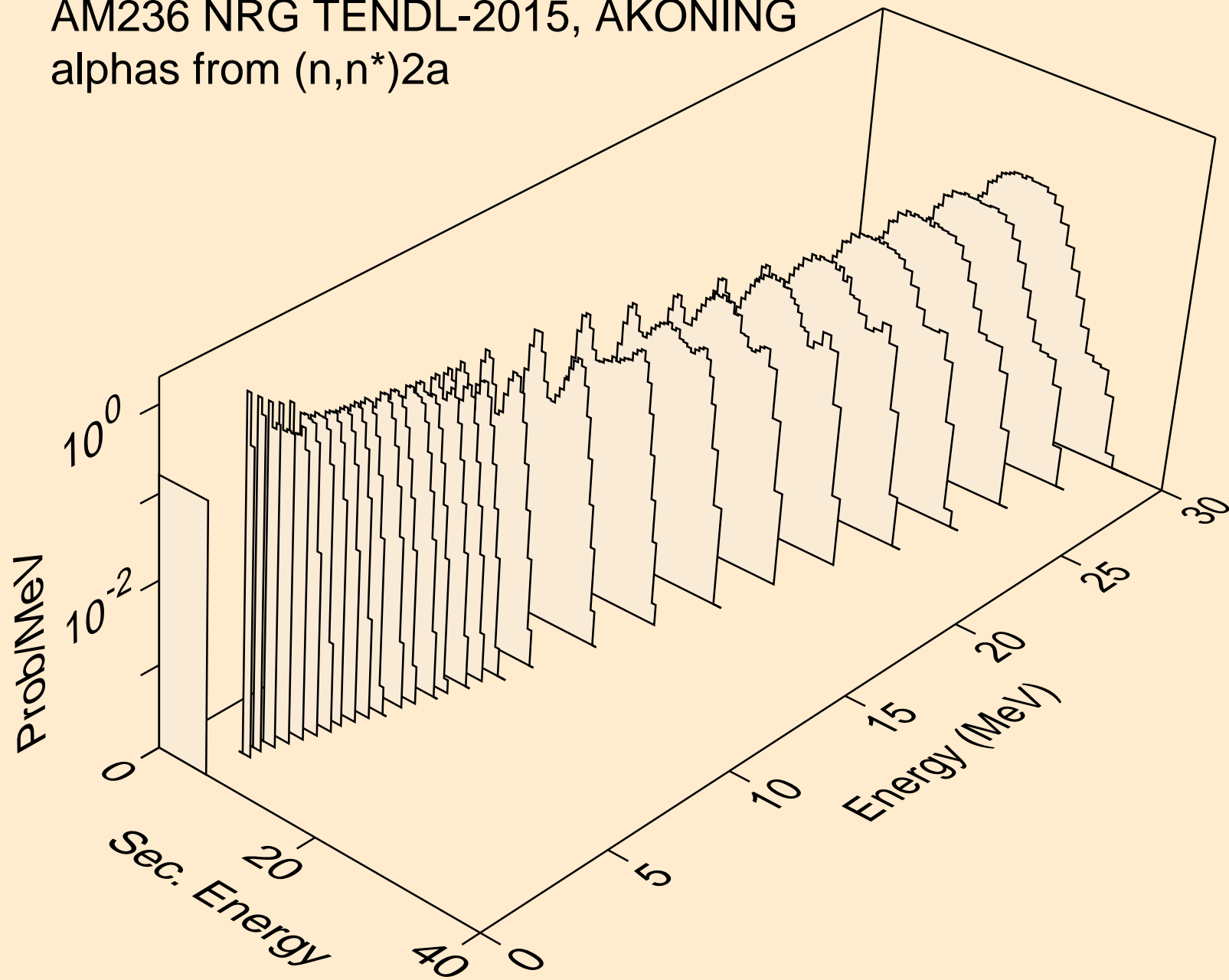

AM236 NRG TENDL-2015, AKONING
alphas from (n,2n)2a

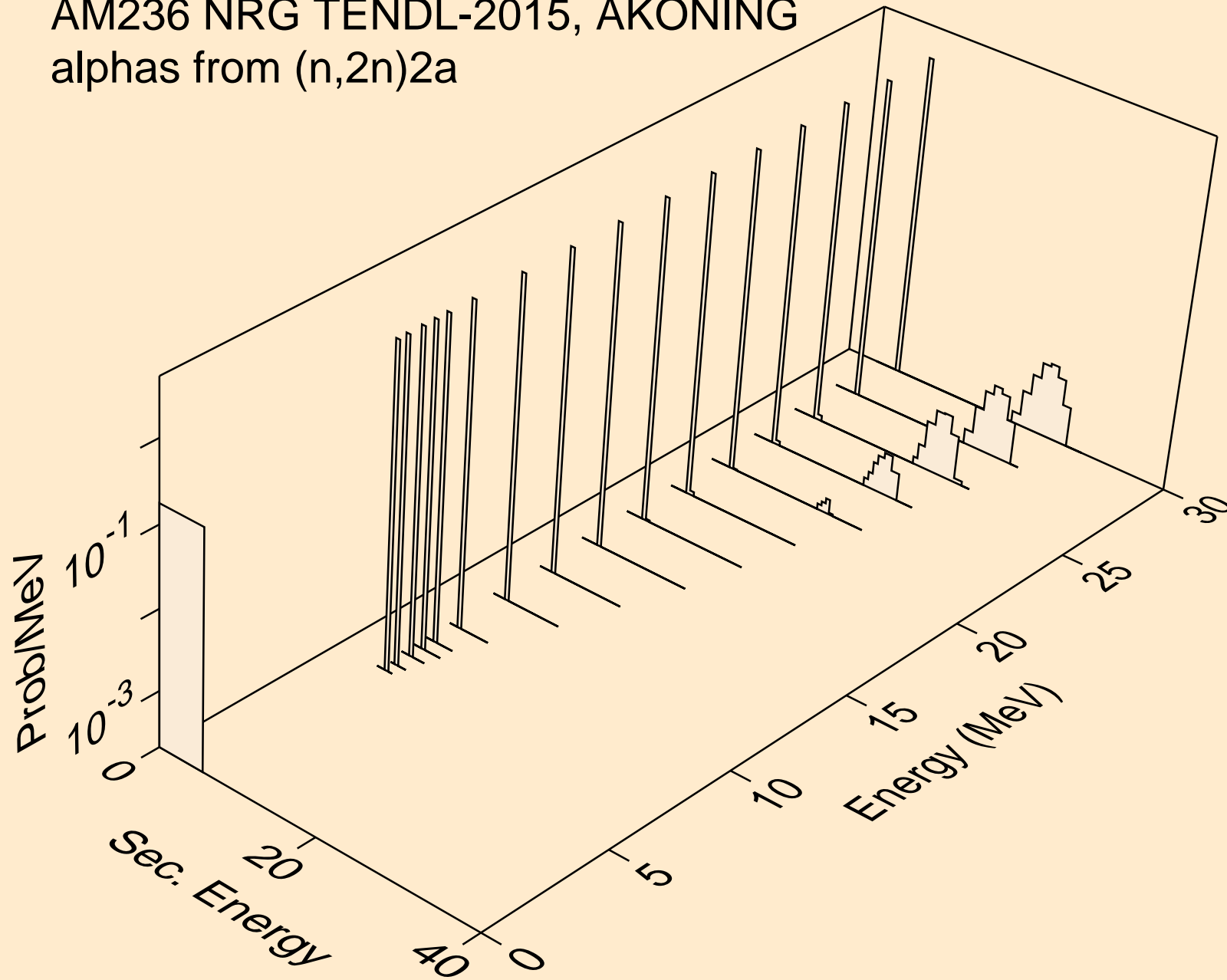

AM236 NRG TENDL-2015, AKONING
alphas from (n,npa)

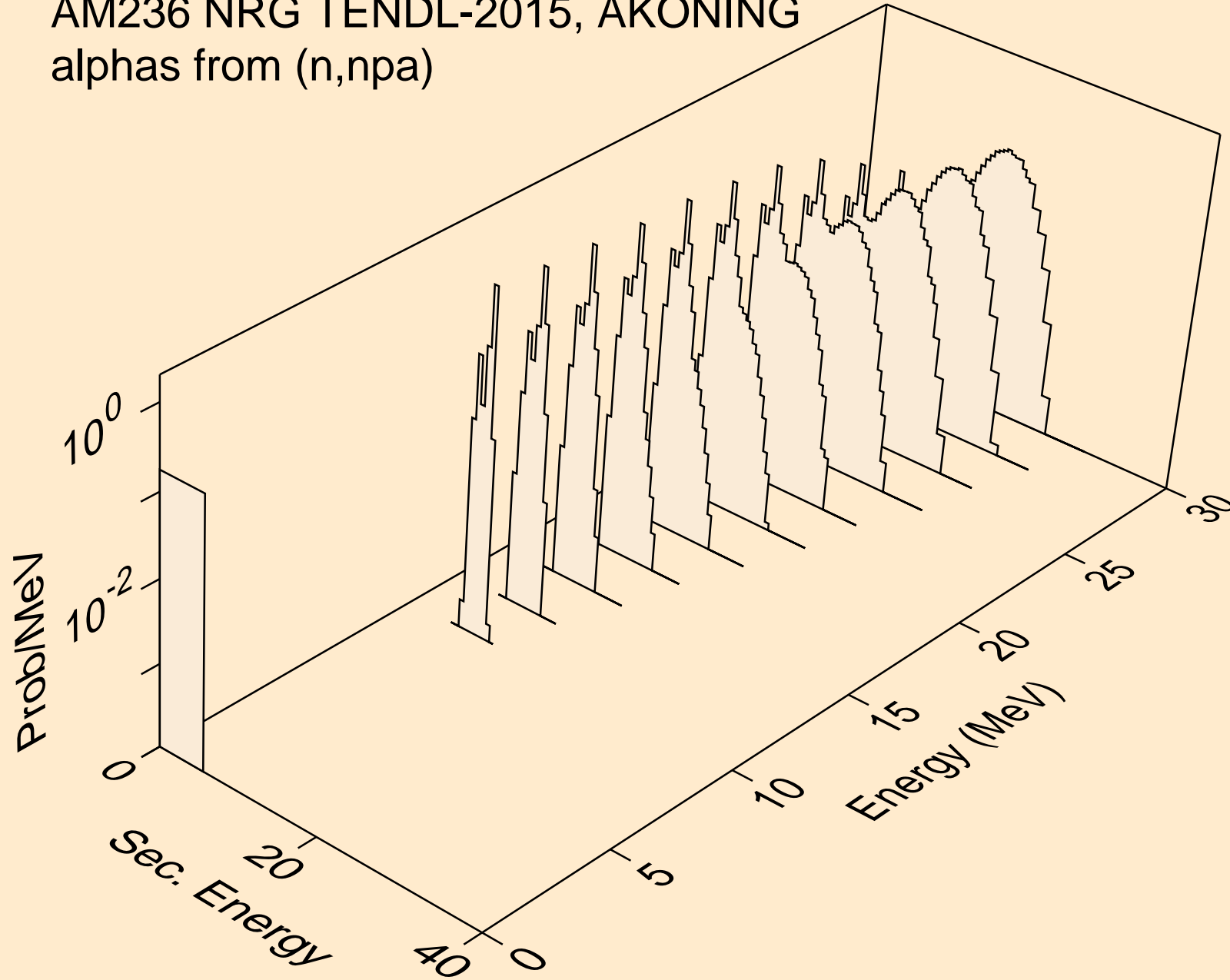

AM236 NRG TENDL-2015, AKONING
alphas from (n,a)

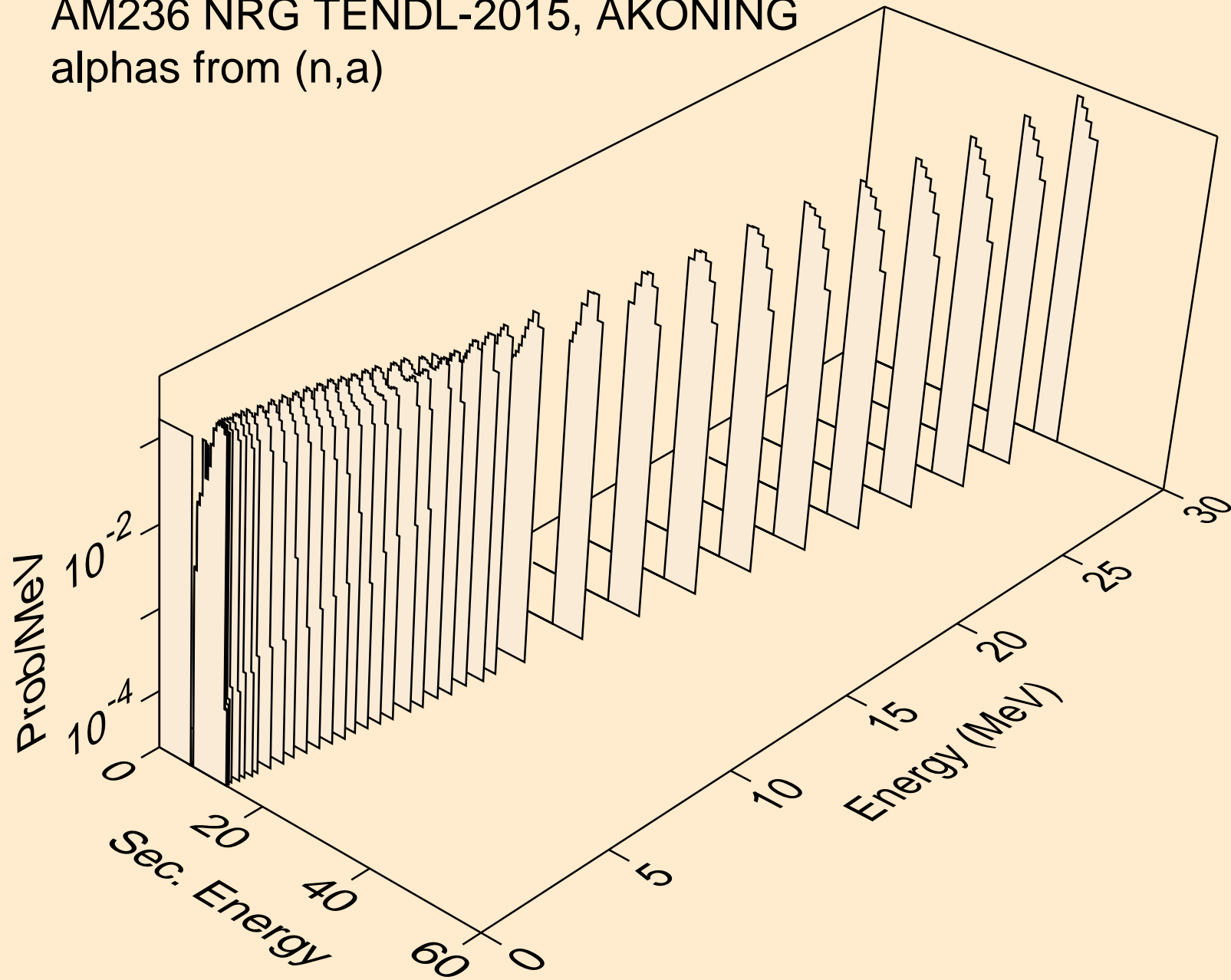

AM236 NRG TENDL-2015, AKONING
alphas from (n,2a)

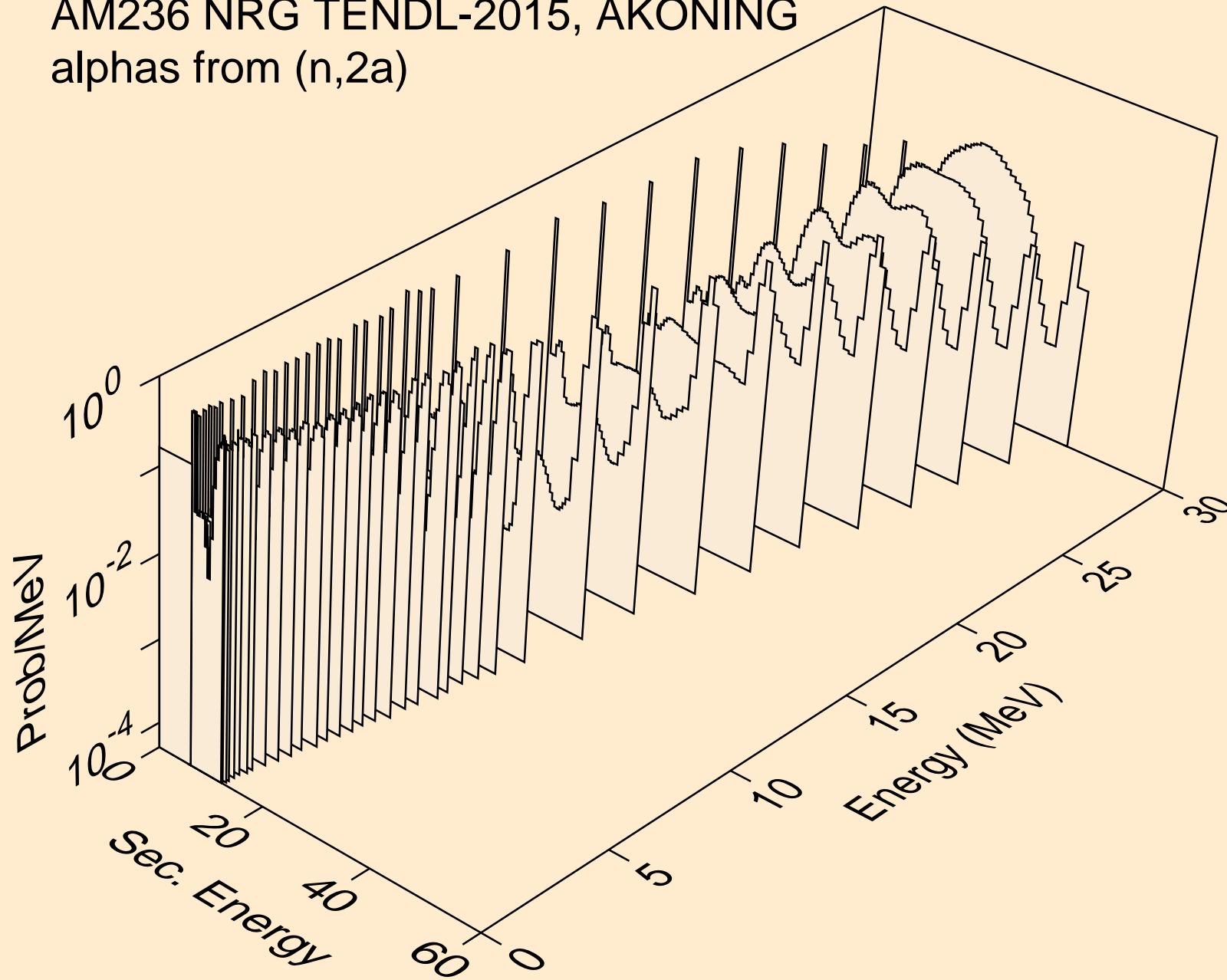

AM236 NRG TENDL-2015, AKONING
alphas from (n,pa)

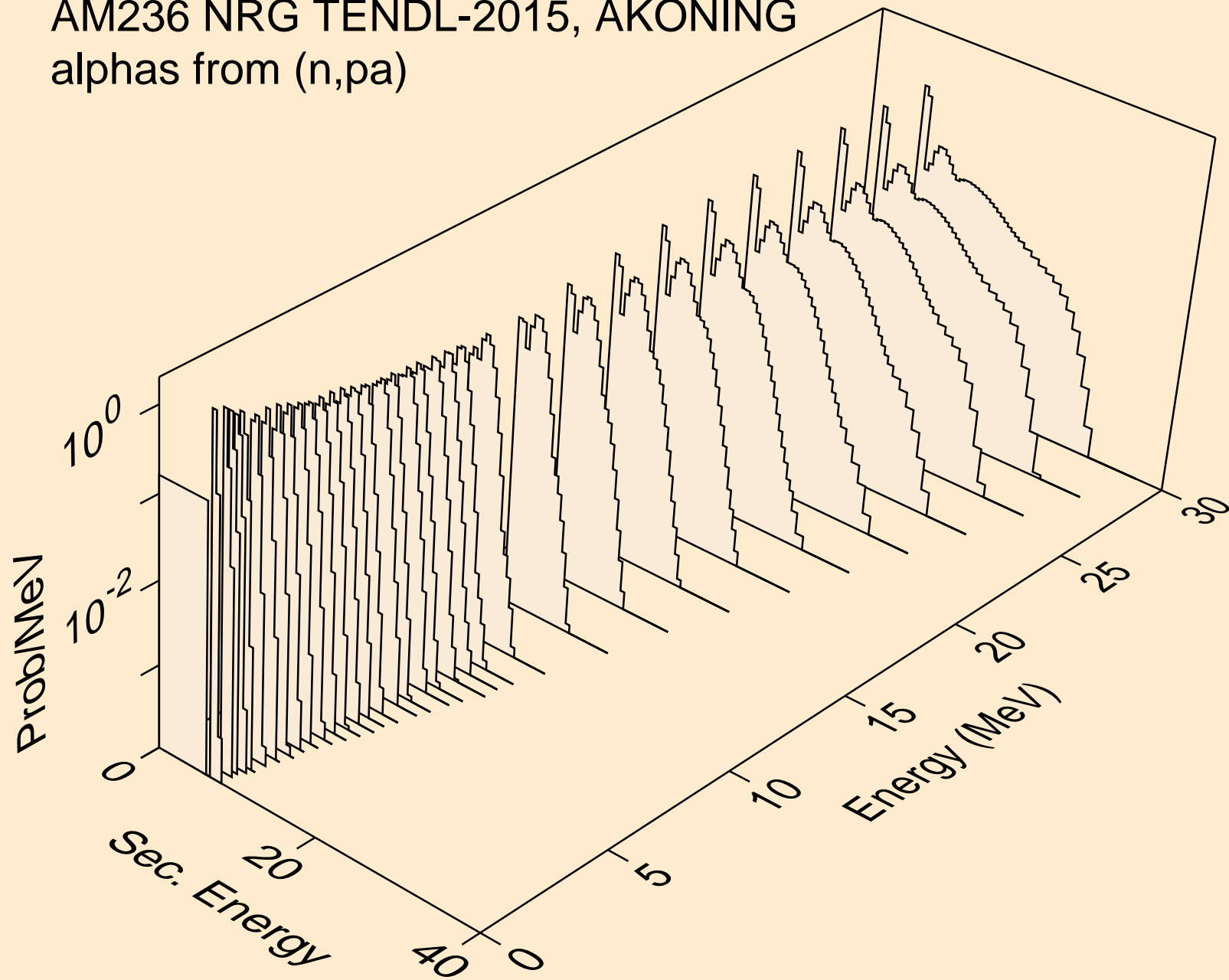

AM236 NRG TENDL-2015, AKONING
alphas from (n,da)

