

AM237 NRG TENDL-2015, AKONING

Principal cross sections

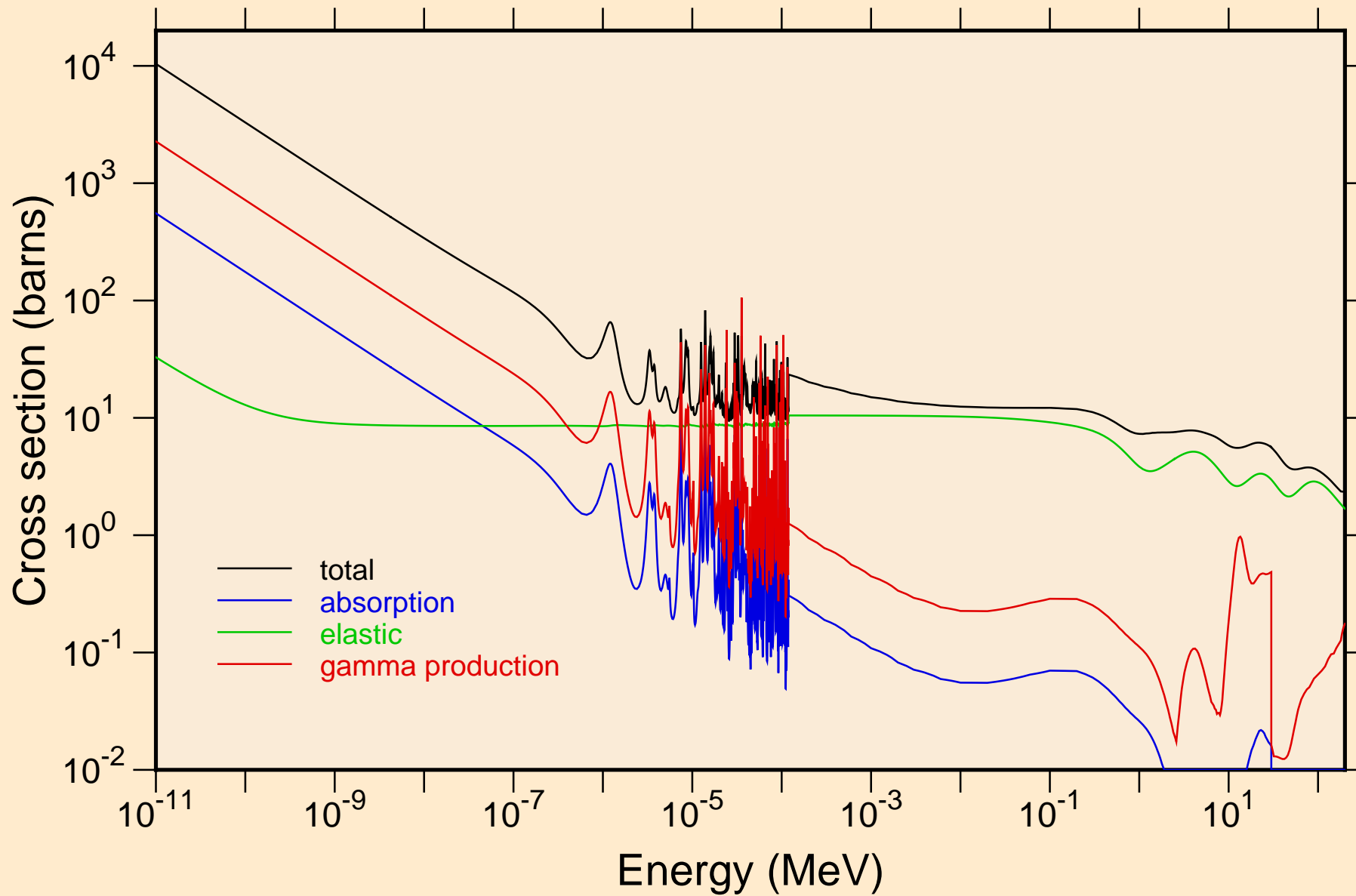

AM237 NRG TENDL-2015, AKONING
resonance total cross section

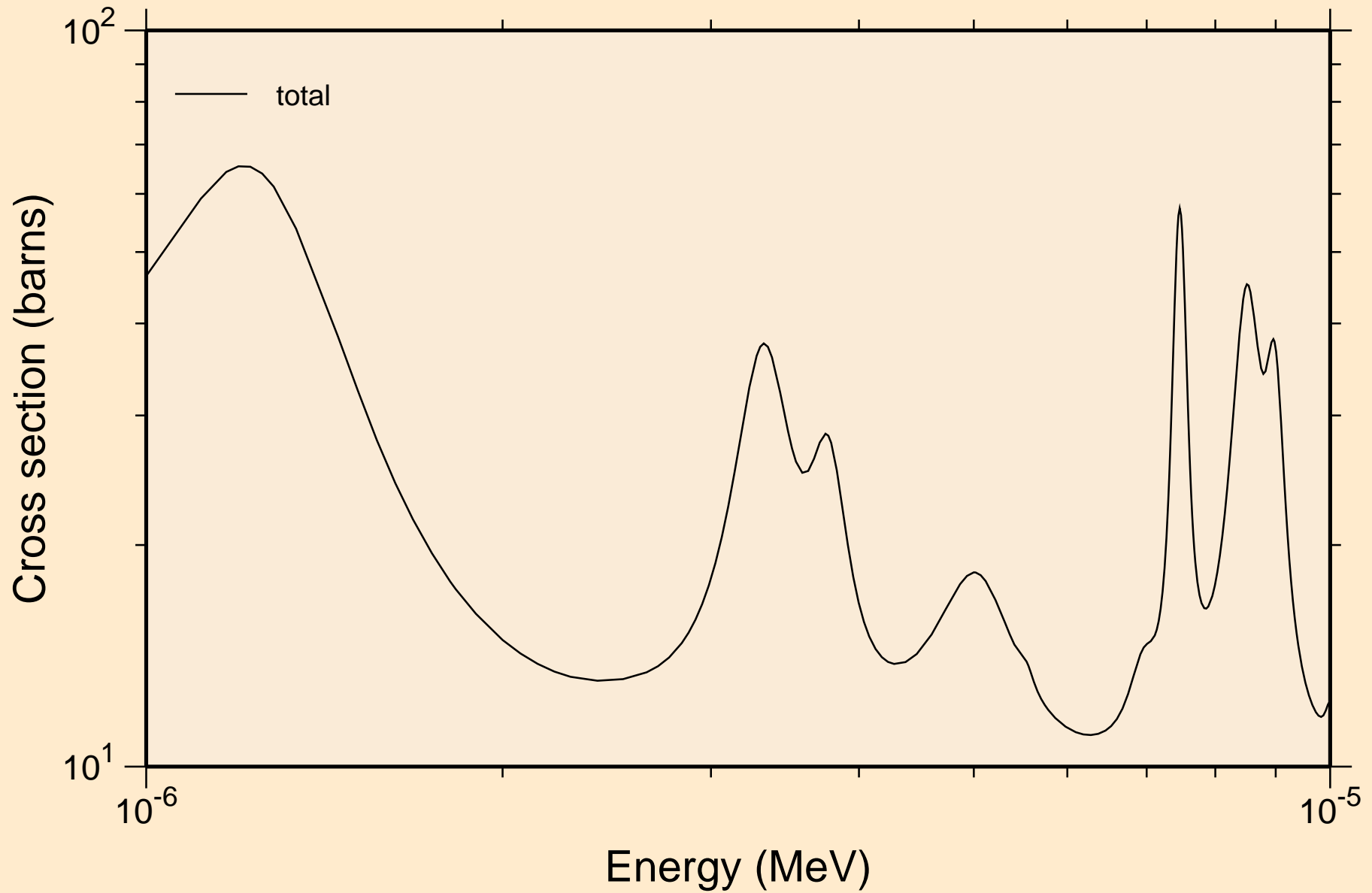

AM237 NRG TENDL-2015, AKONING
resonance total cross section

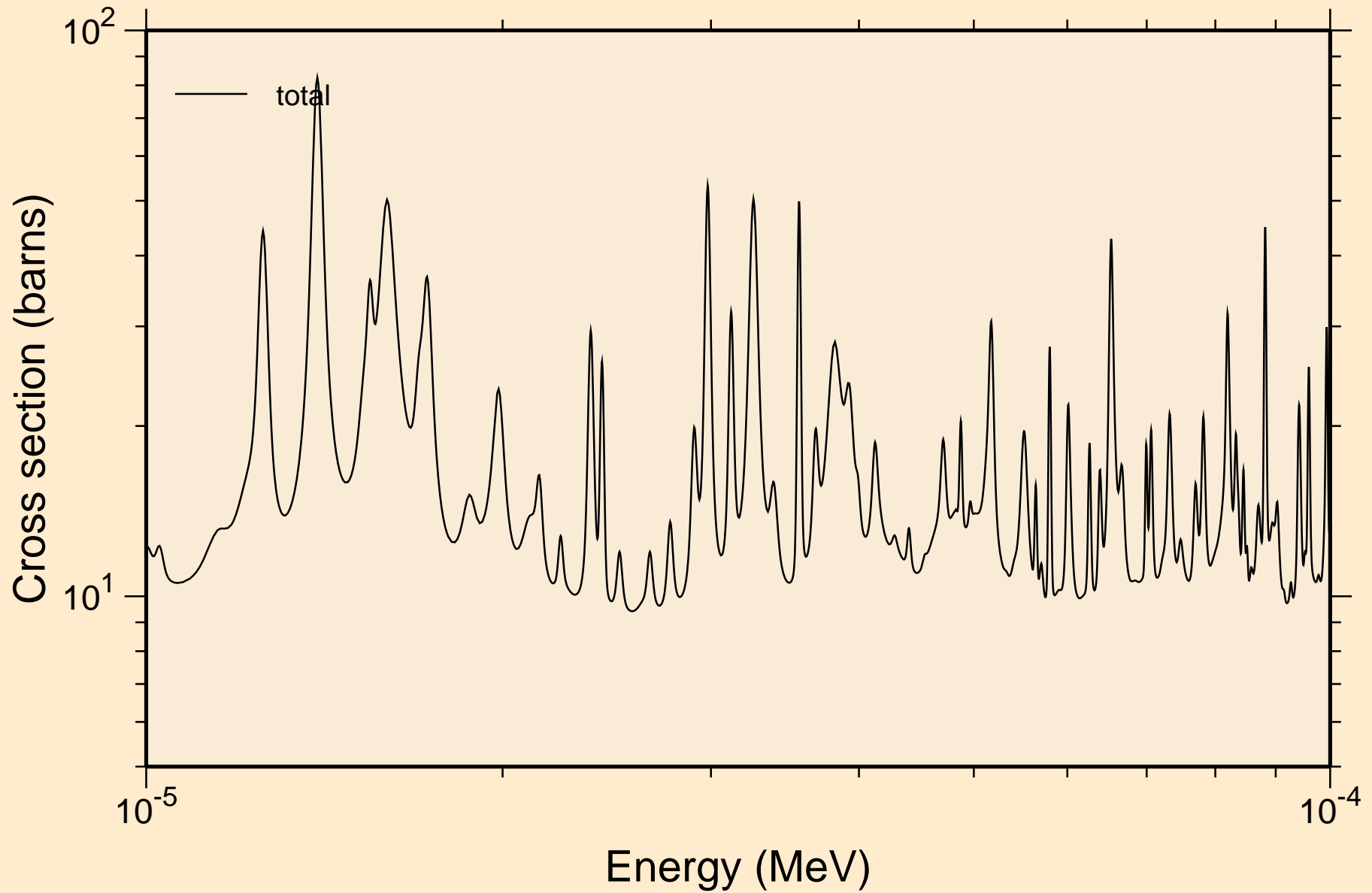

AM237 NRG TENDL-2015, AKONING
resonance total cross section

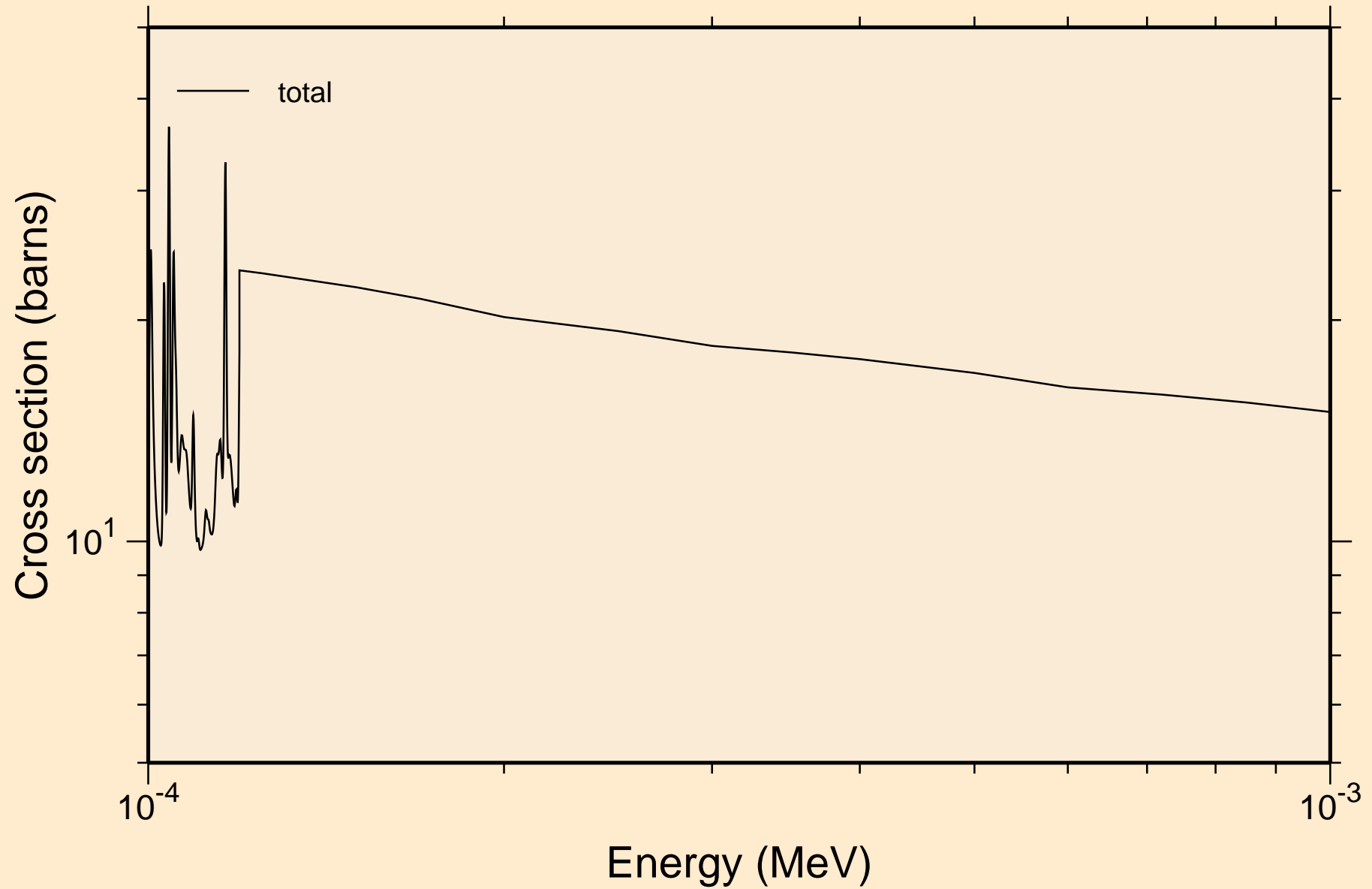

AM237 NRG TENDL-2015, AKONING
resonance total cross section

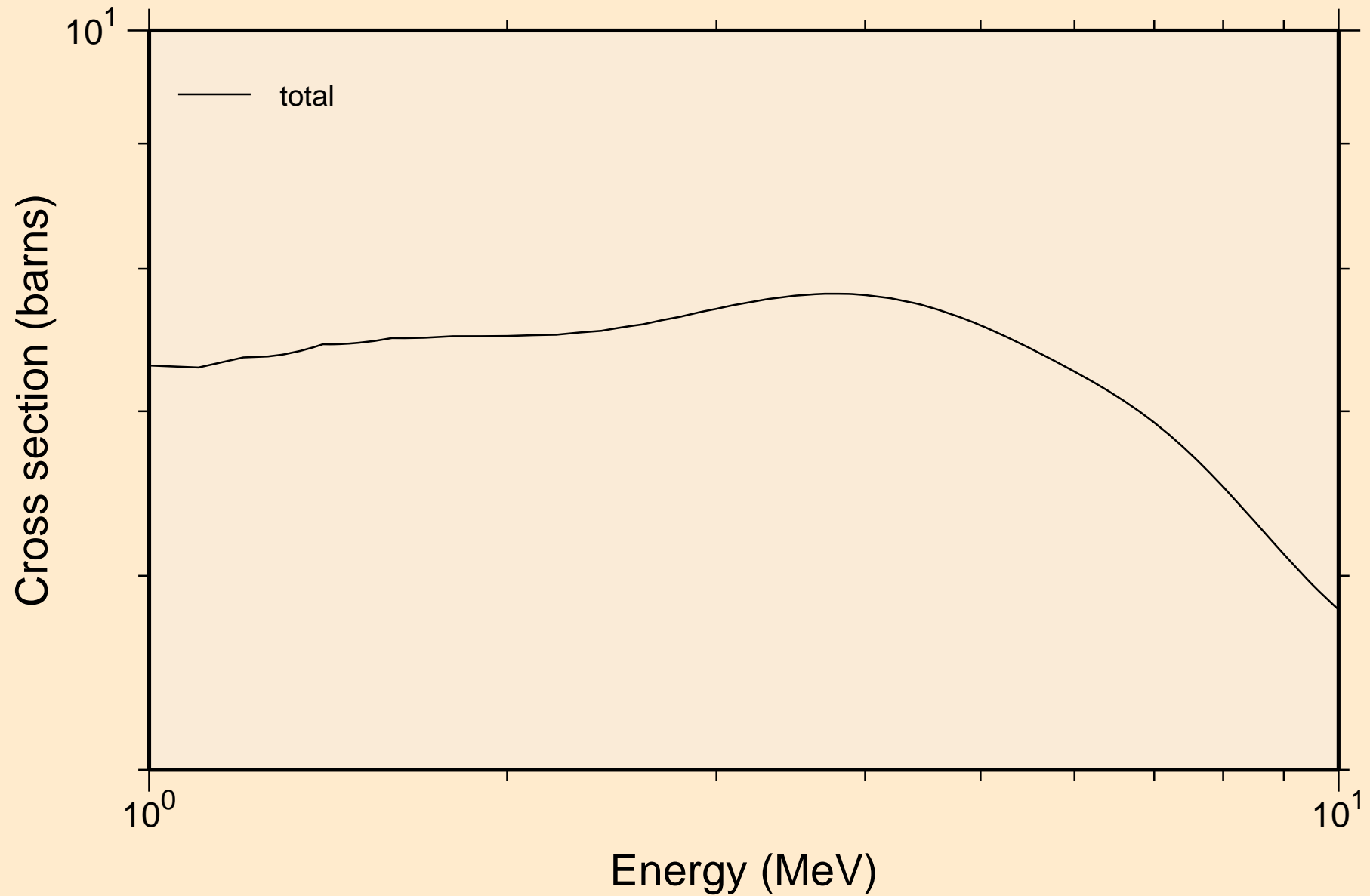

AM237 NRG TENDL-2015, AKONING
resonance absorption cross sections

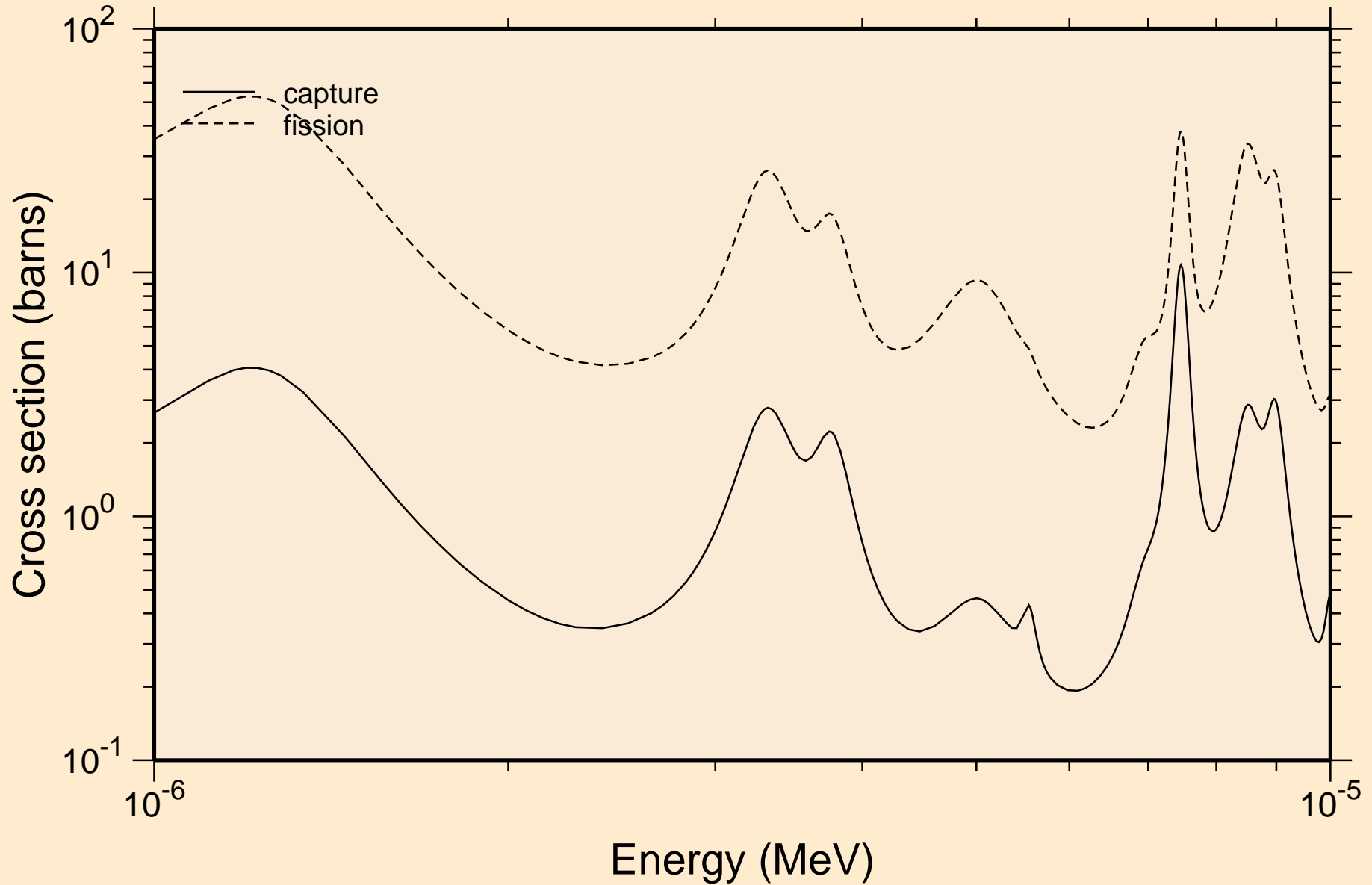

AM237 NRG TENDL-2015, AKONING
resonance absorption cross sections

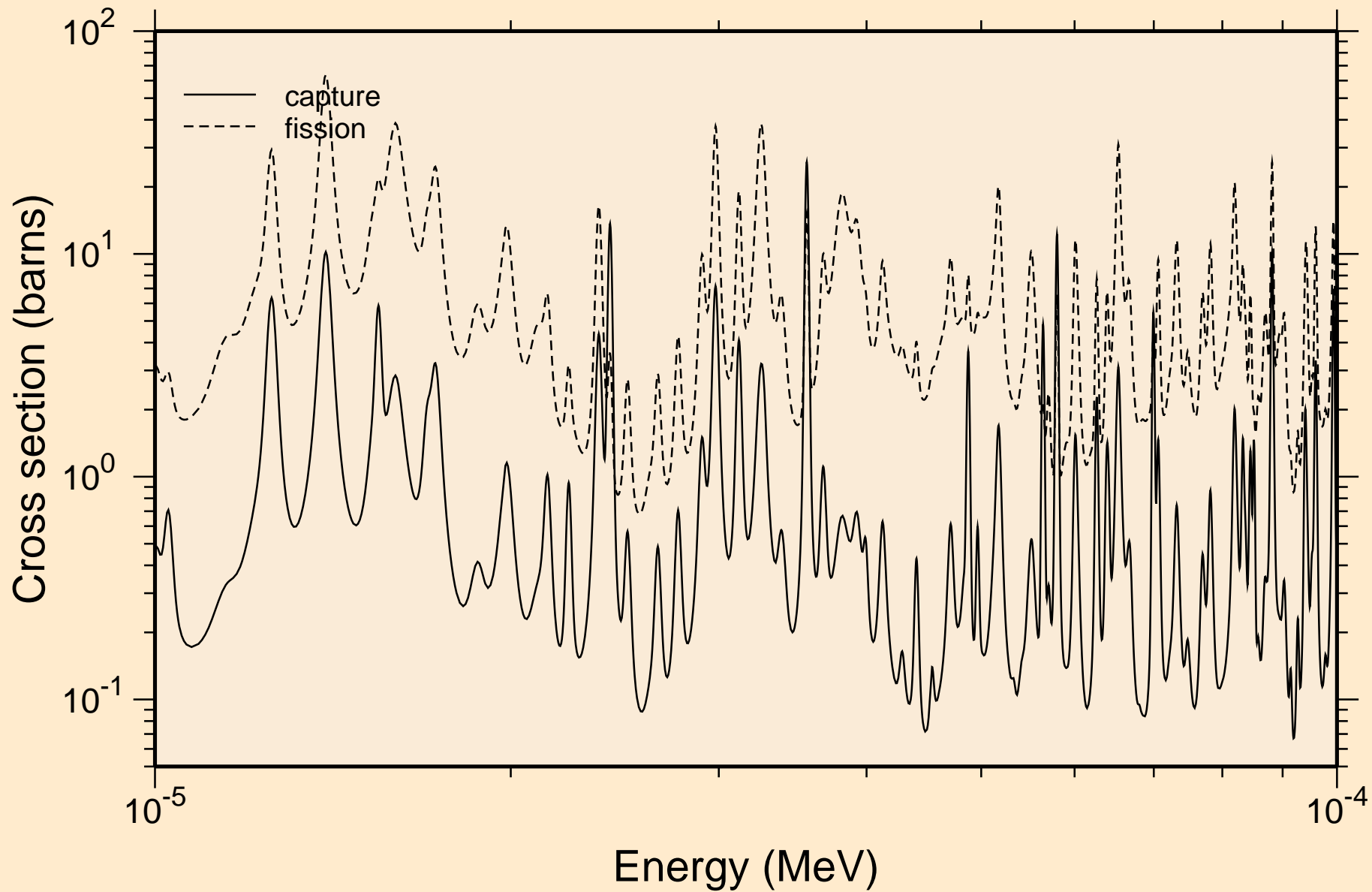

AM237 NRG TENDL-2015, AKONING
resonance absorption cross sections

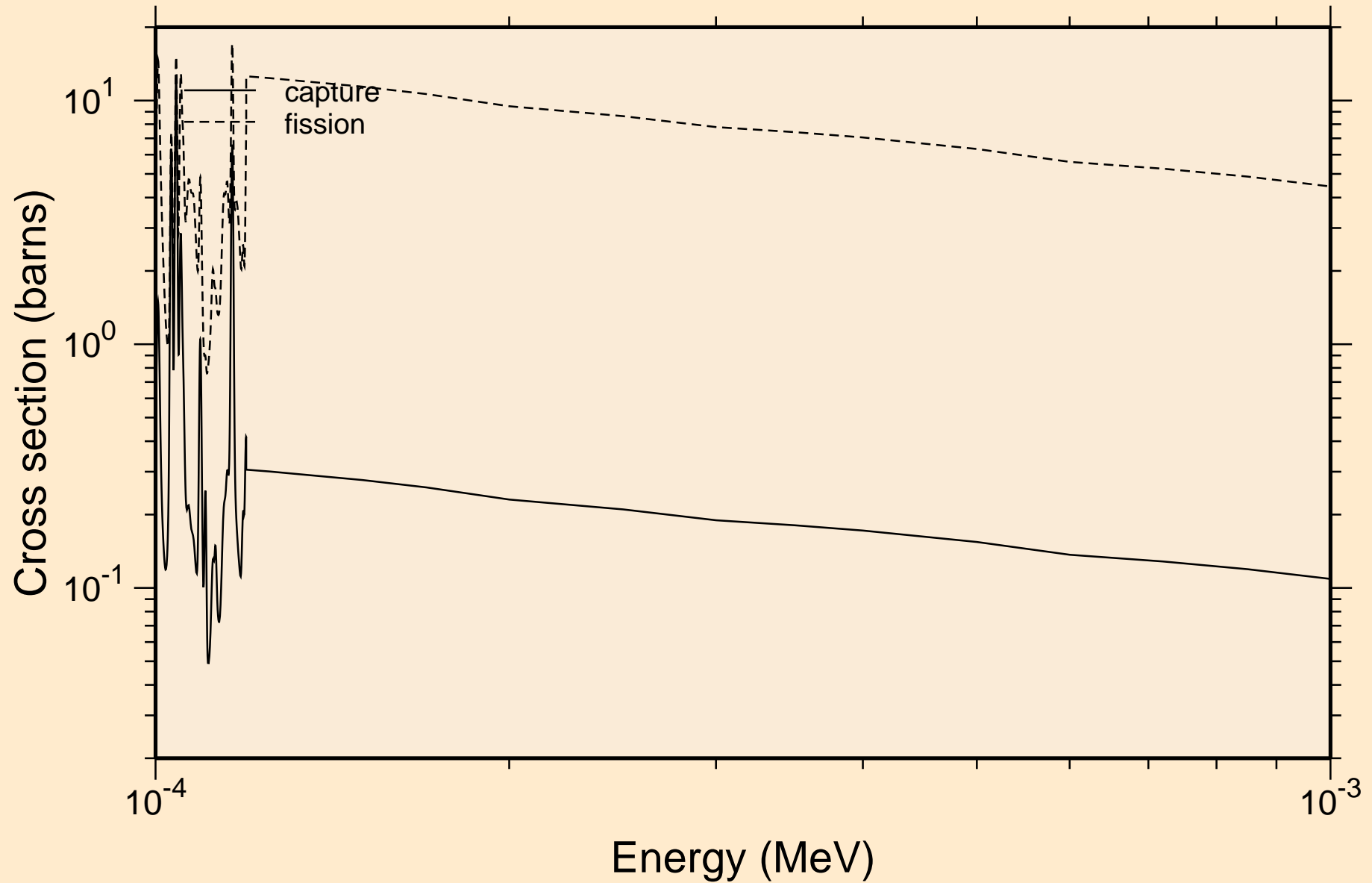

AM237 NRG TENDL-2015, AKONING resonance absorption cross sections

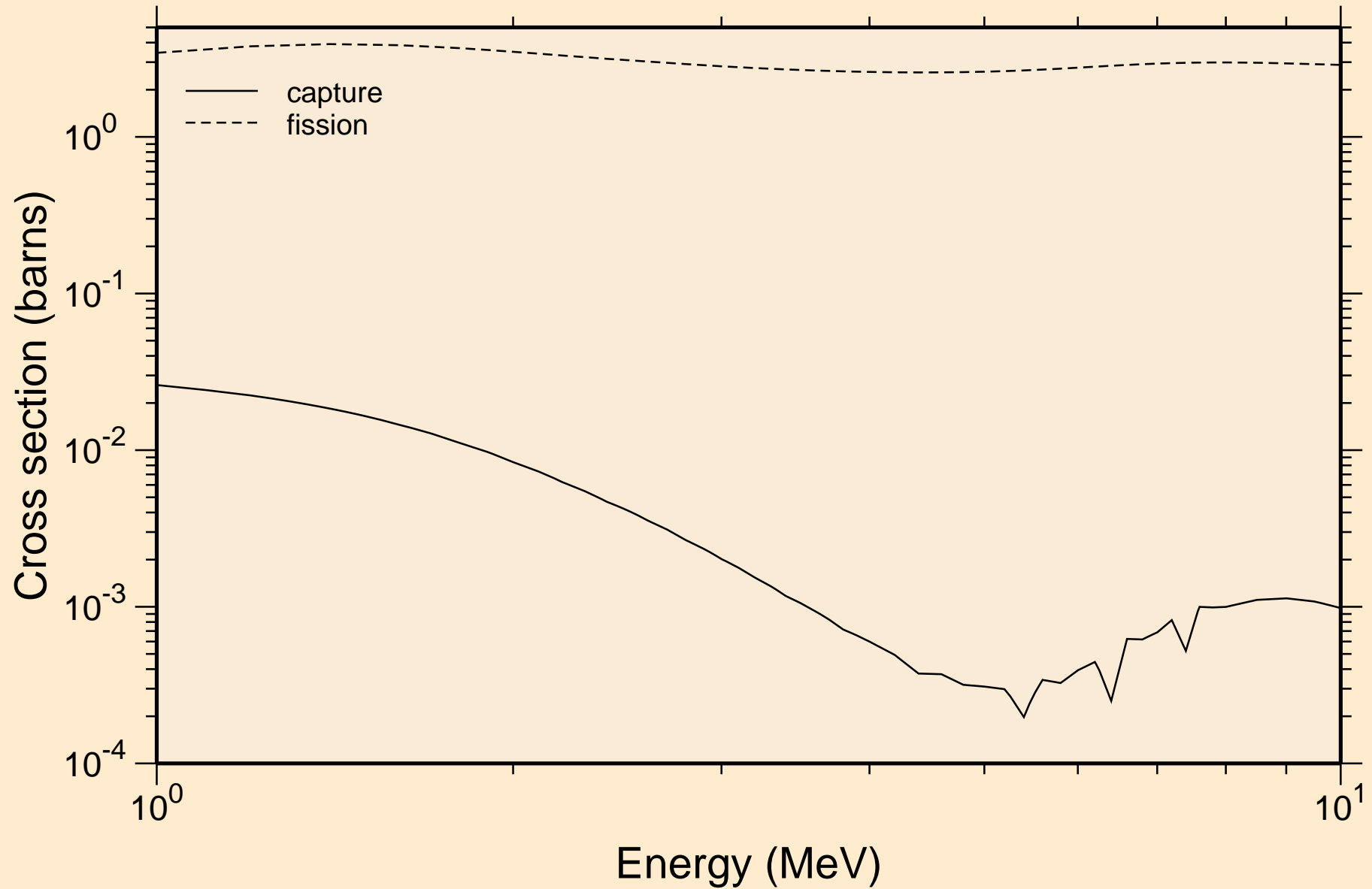

AM237 NRG TENDL-2015, AKONING

Non-threshold reactions

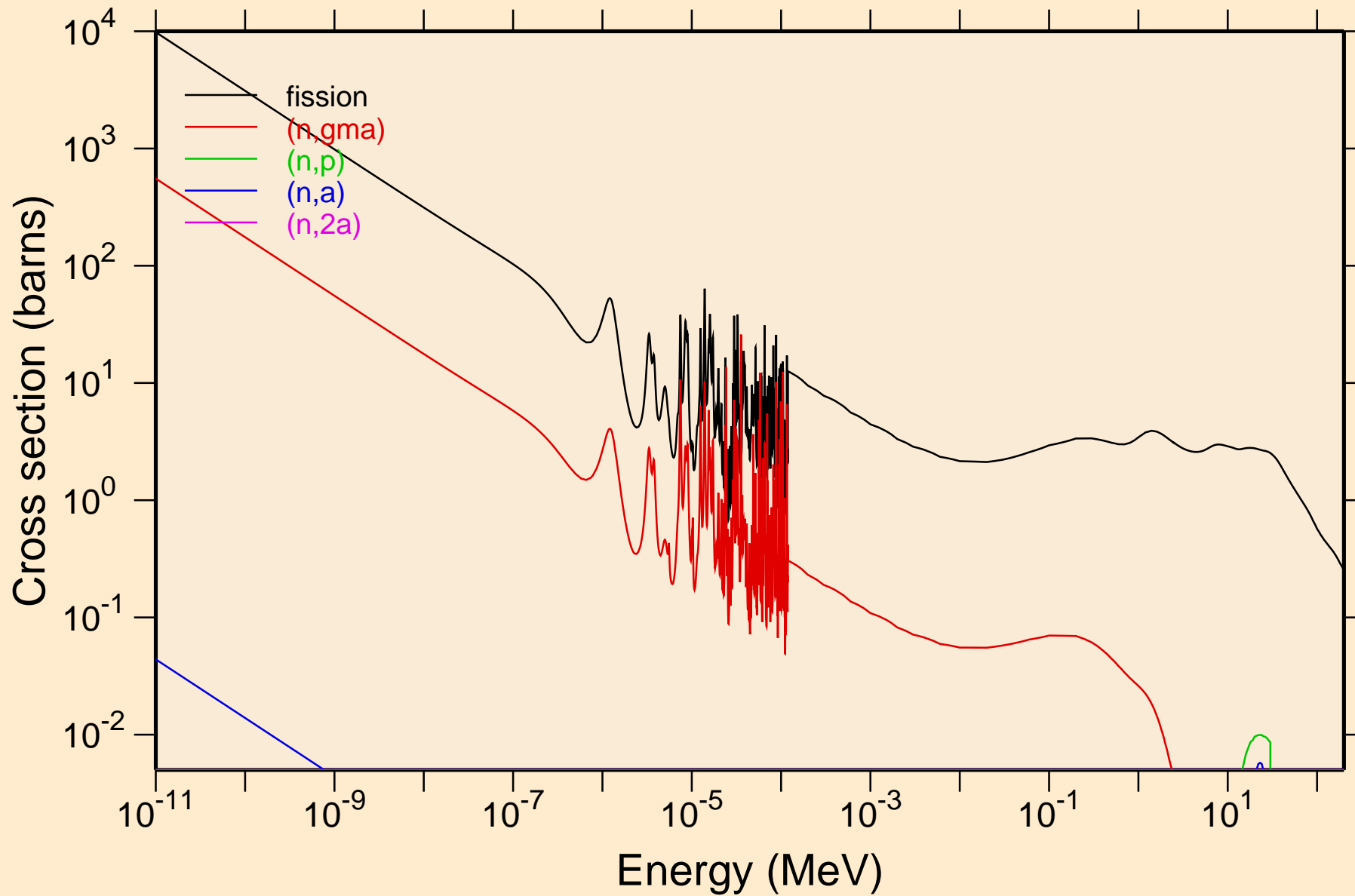

AM237 NRG TENDL-2015, AKONING

Principal cross sections

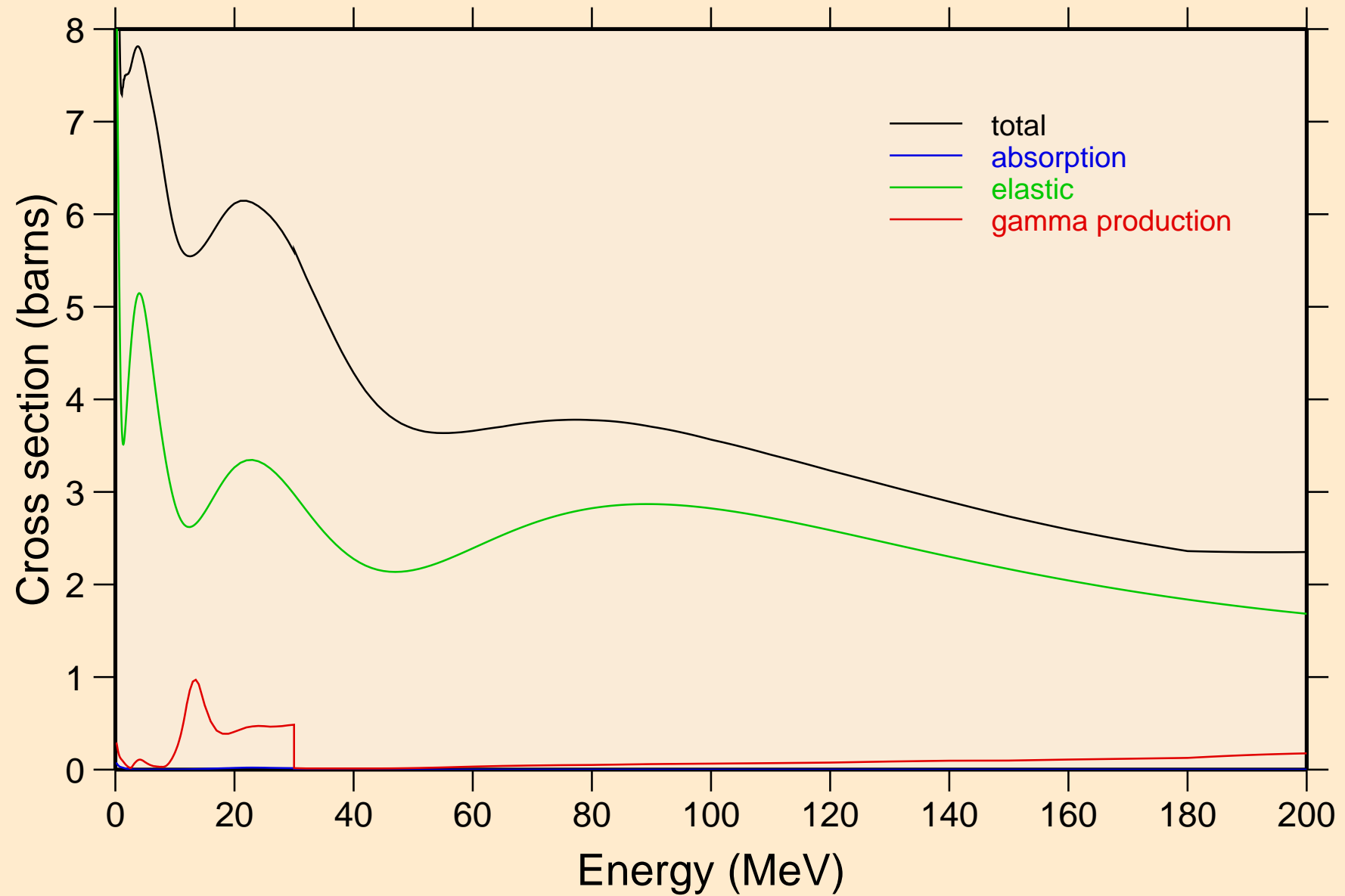

AM237 NRG TENDL-2015, AKONING

Non-threshold reactions

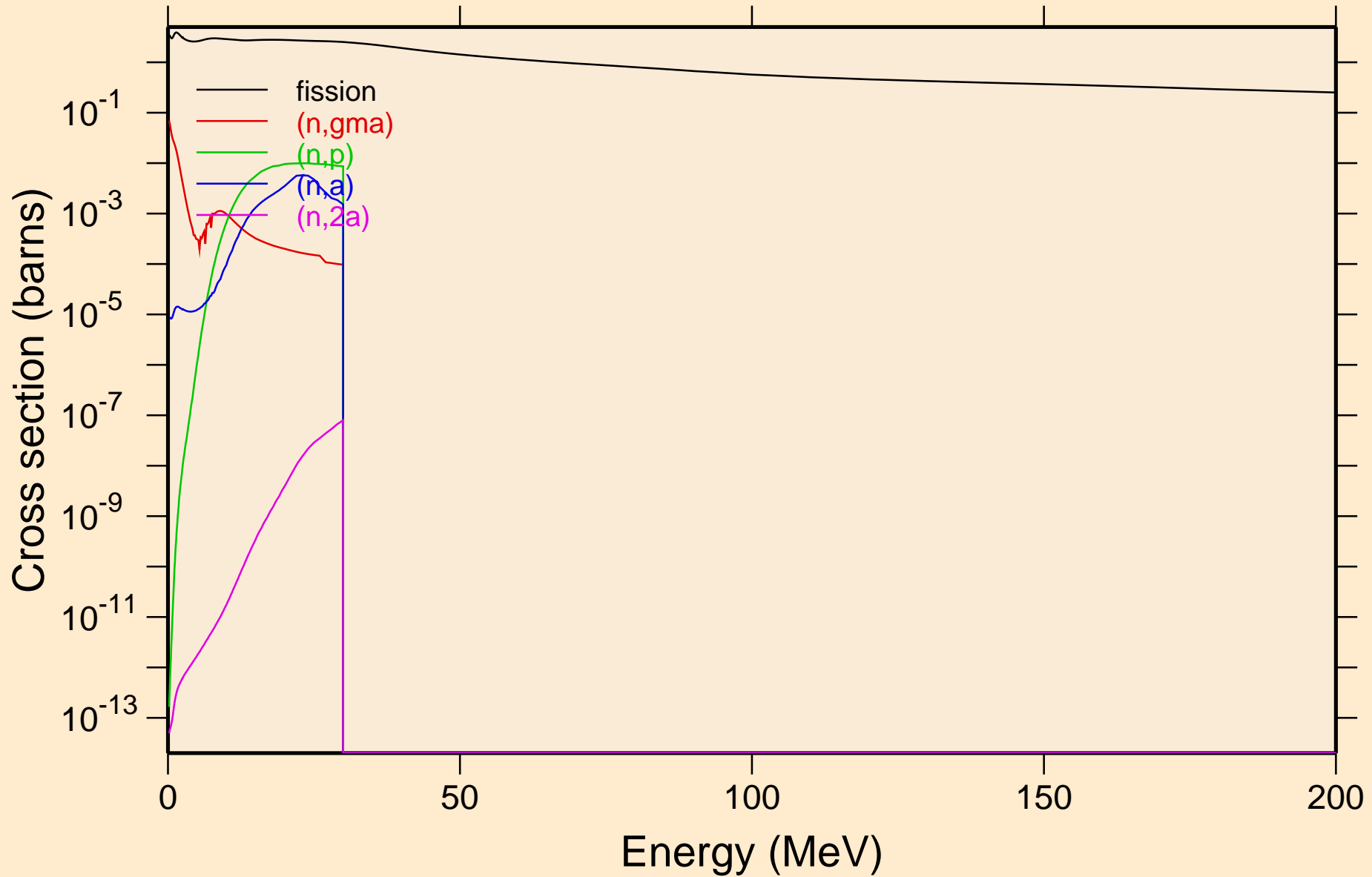

AM237 NRG TENDL-2015, AKONING
Inelastic levels

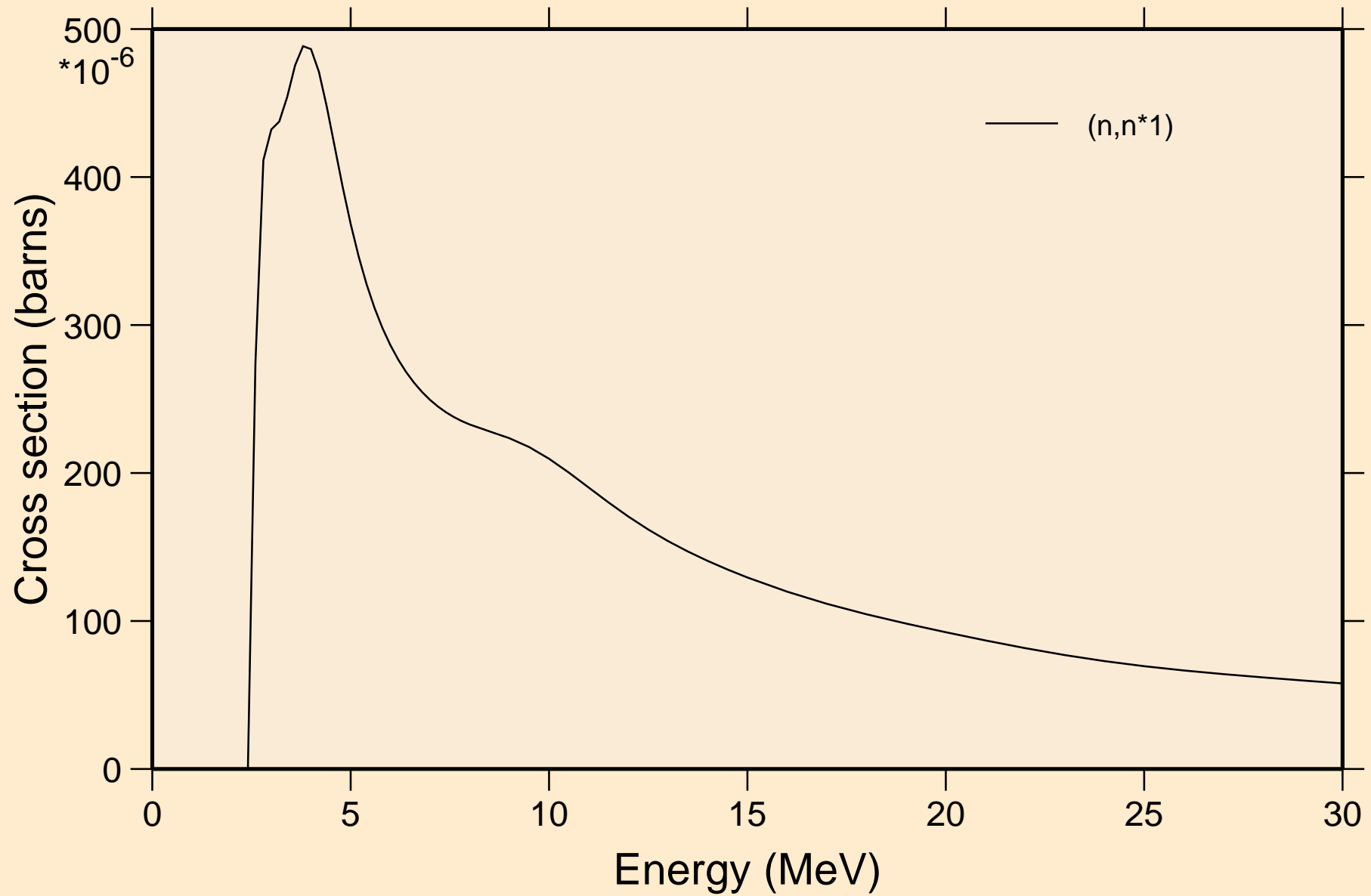

AM237 NRG TENDL-2015, AKONING

Threshold reactions

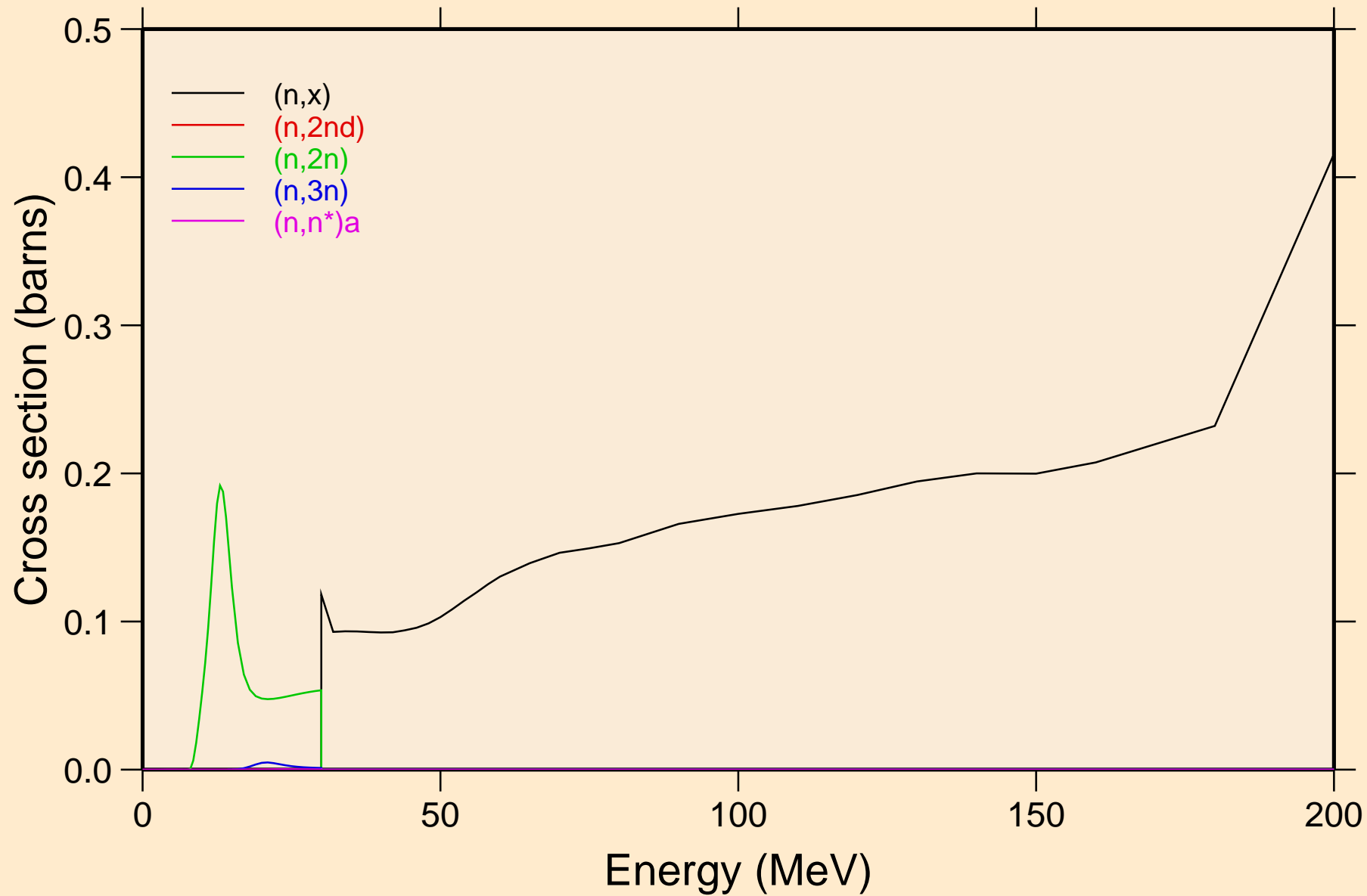

AM237 NRG TENDL-2015, AKONING

Threshold reactions

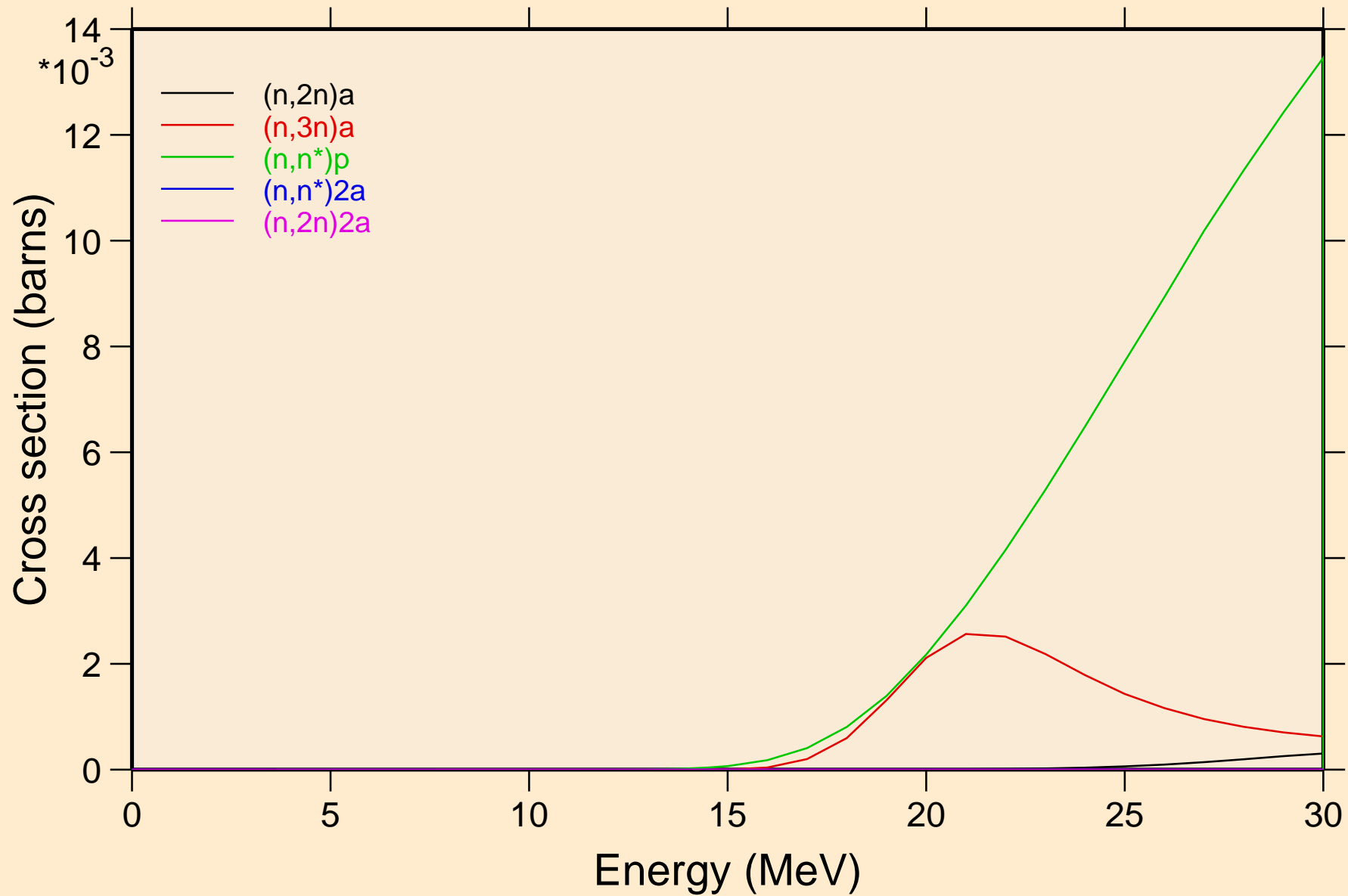

AM237 NRG TENDL-2015, AKONING

Threshold reactions

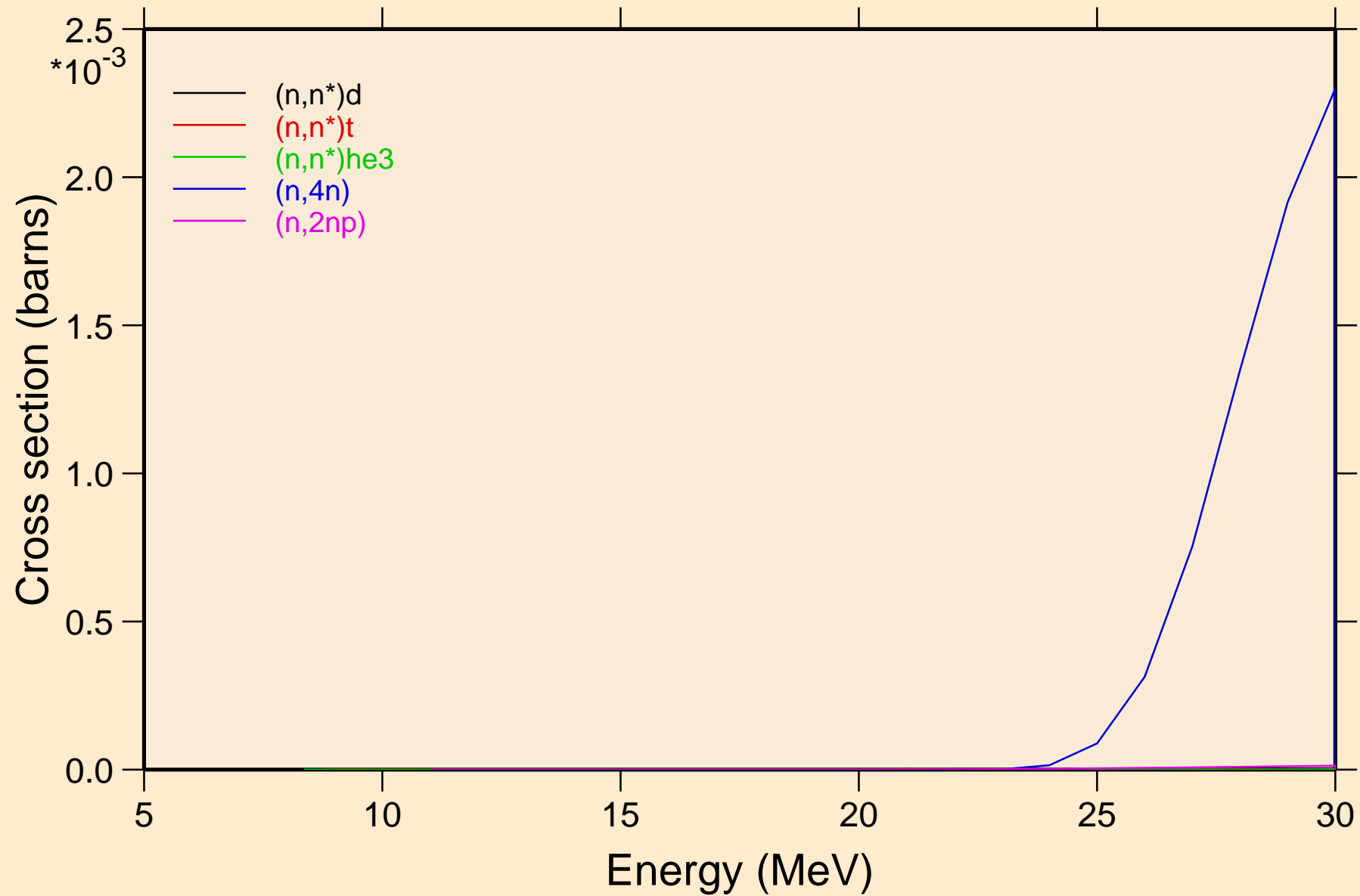

AM237 NRG TENDL-2015, AKONING

Threshold reactions

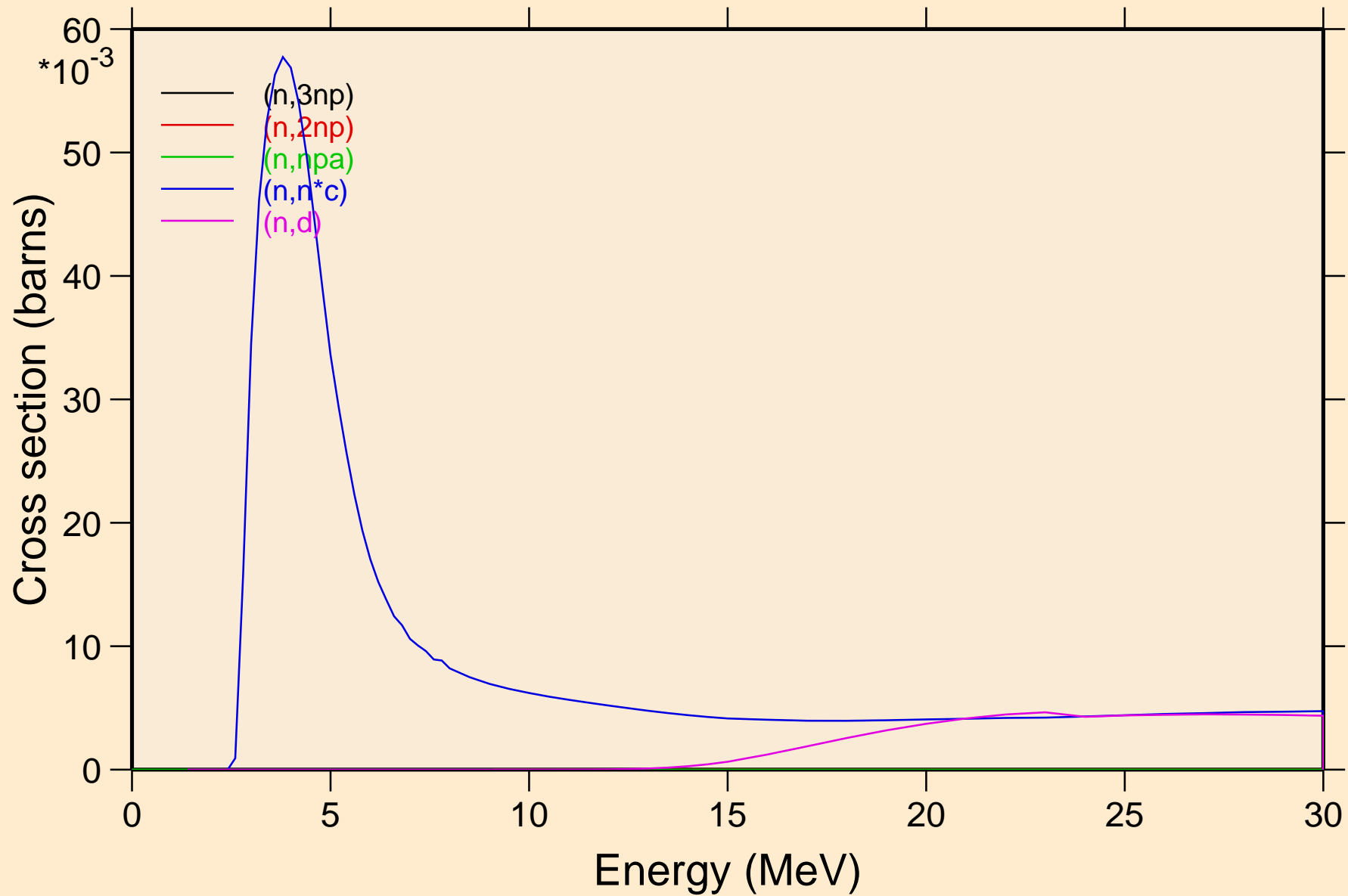

AM237 NRG TENDL-2015, AKONING

Threshold reactions

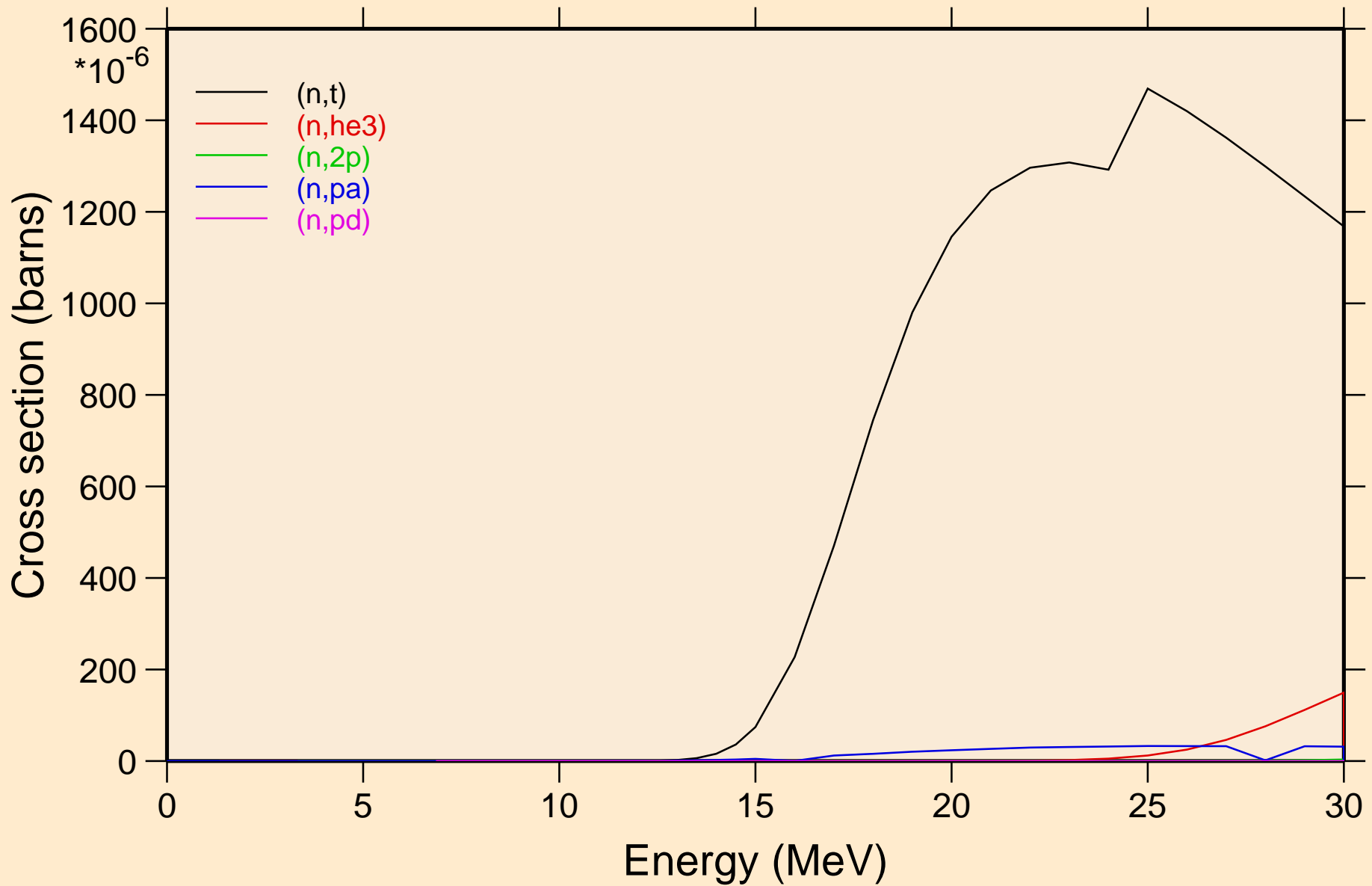

AM237 NRG TENDL-2015, AKONING

Threshold reactions

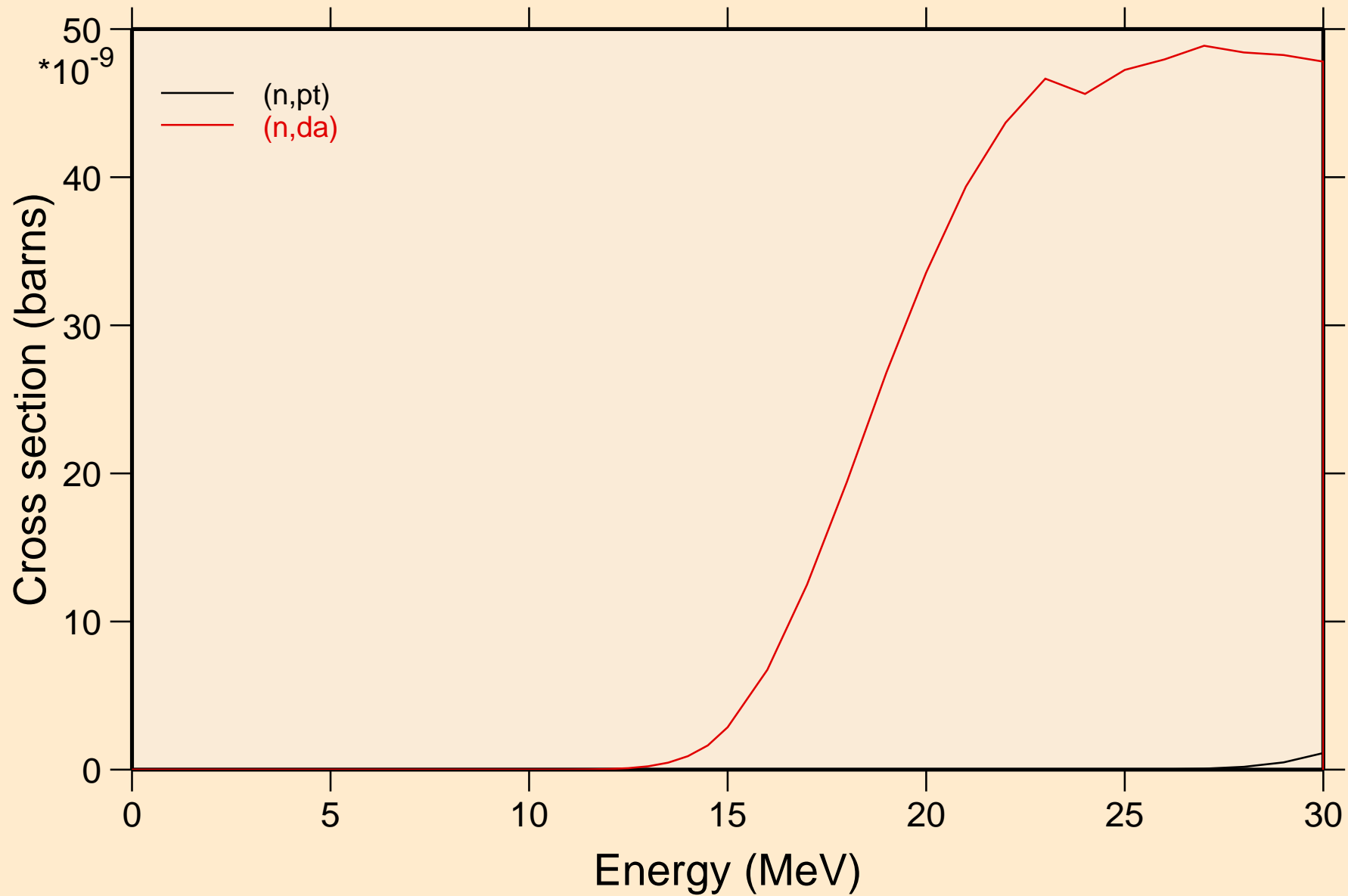

AM237 NRG TENDL-2015, AKONING
angular distribution for elastic

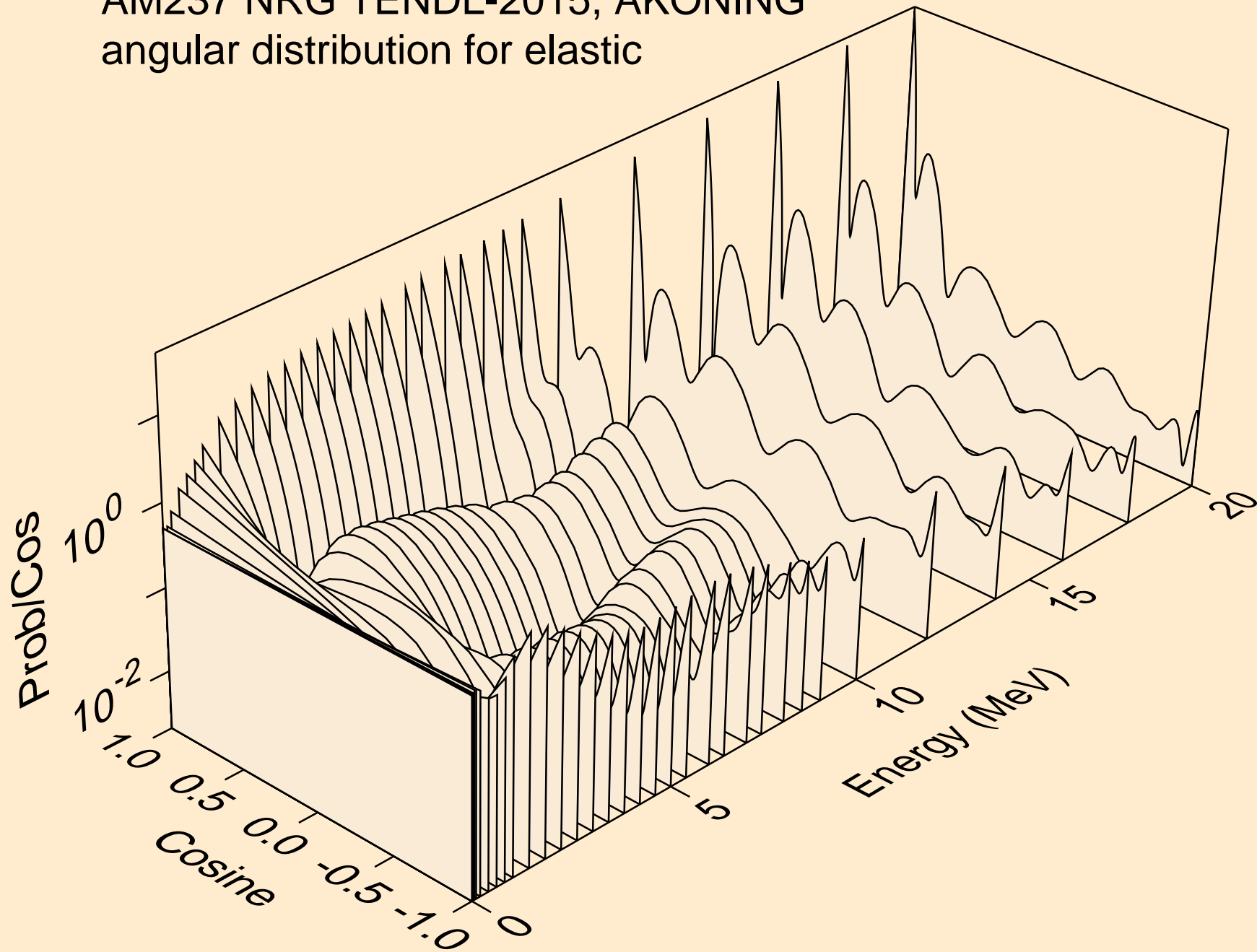

AM237 NRG TENDL-2015, AKONING
angular distribution for elastic

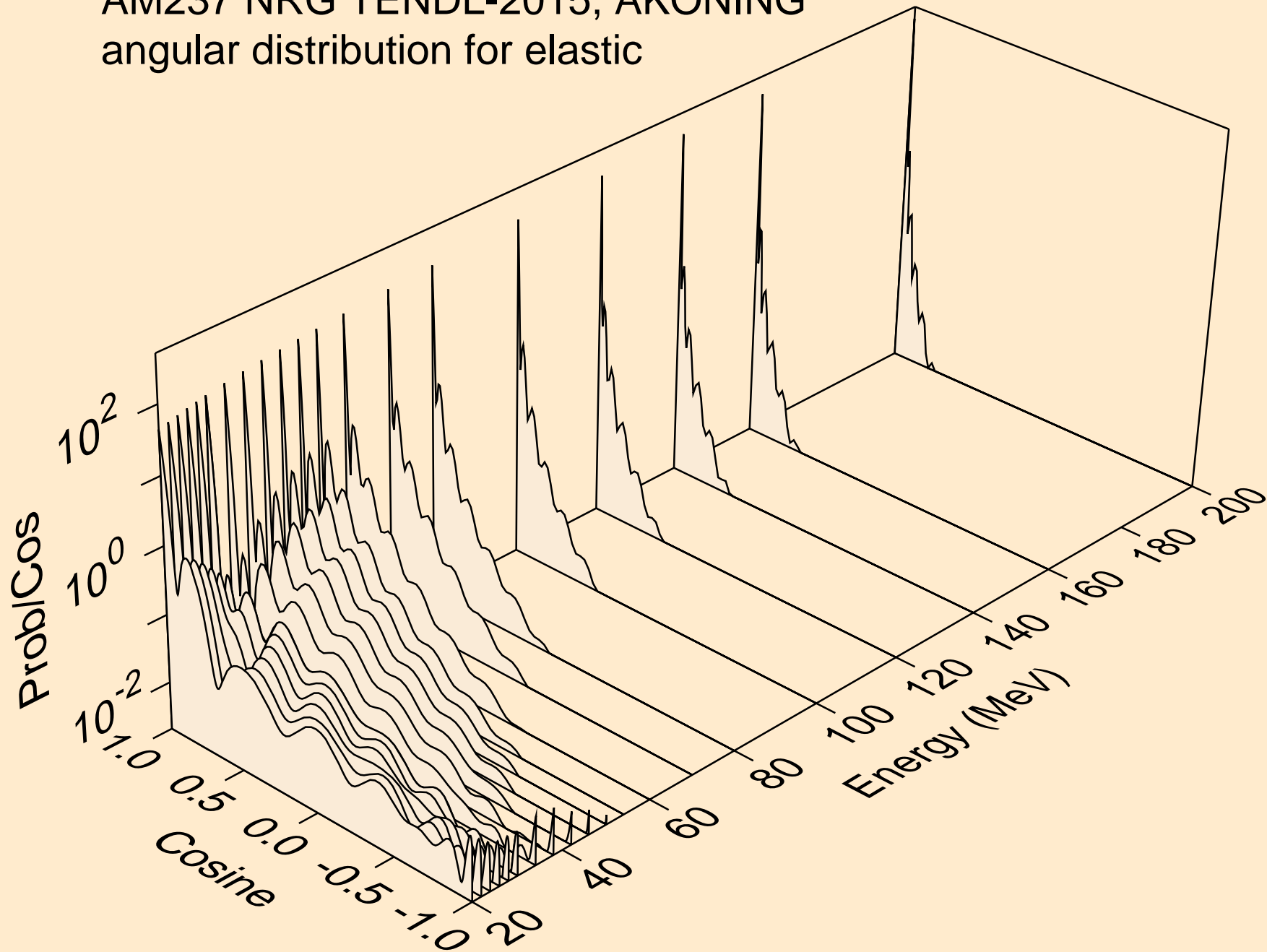

AM237 NRG TENDL-2015, AKONING
angular distribution for (n,n*1)

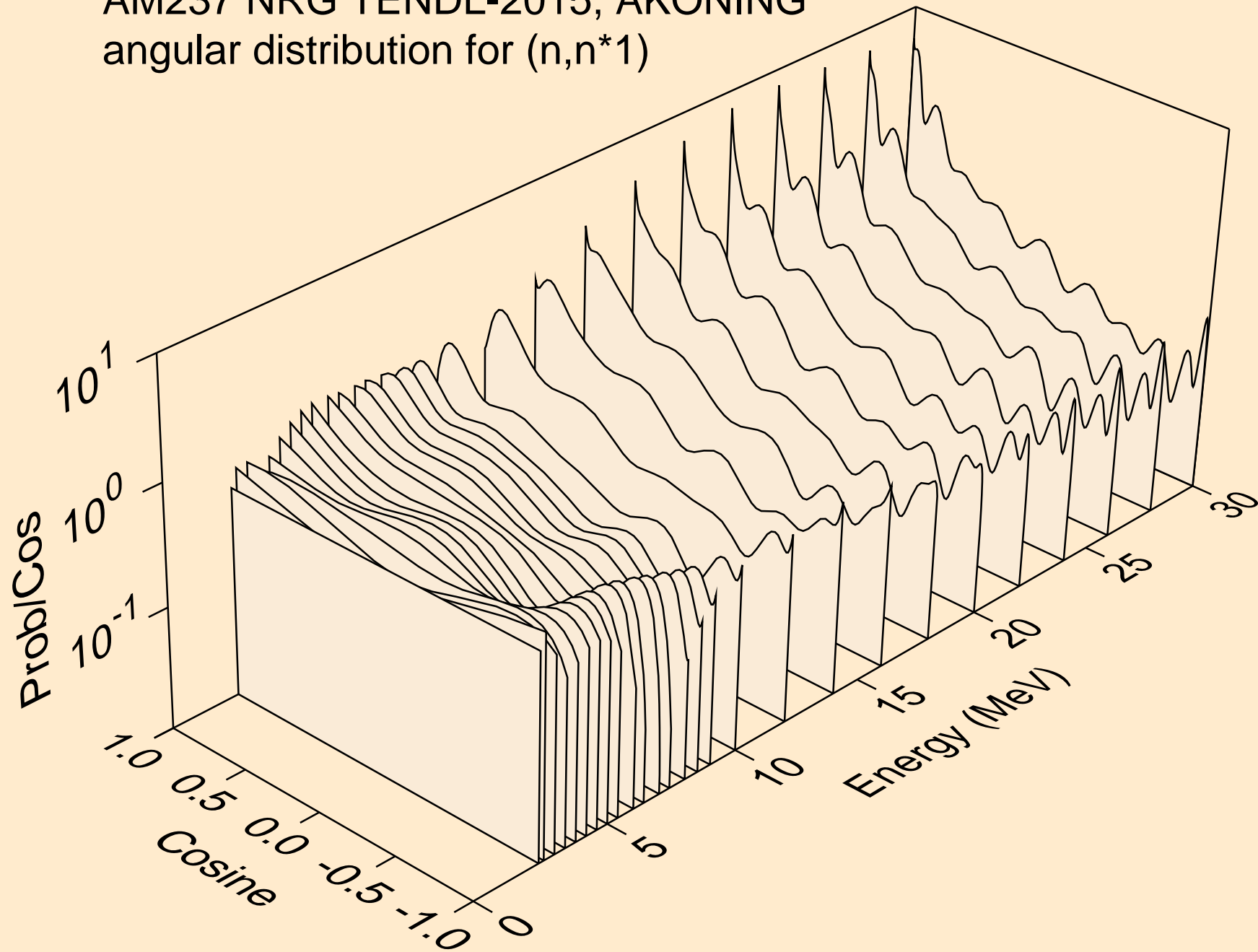

AM237 NRG TENDL-2015, AKONING

Total fission nubar

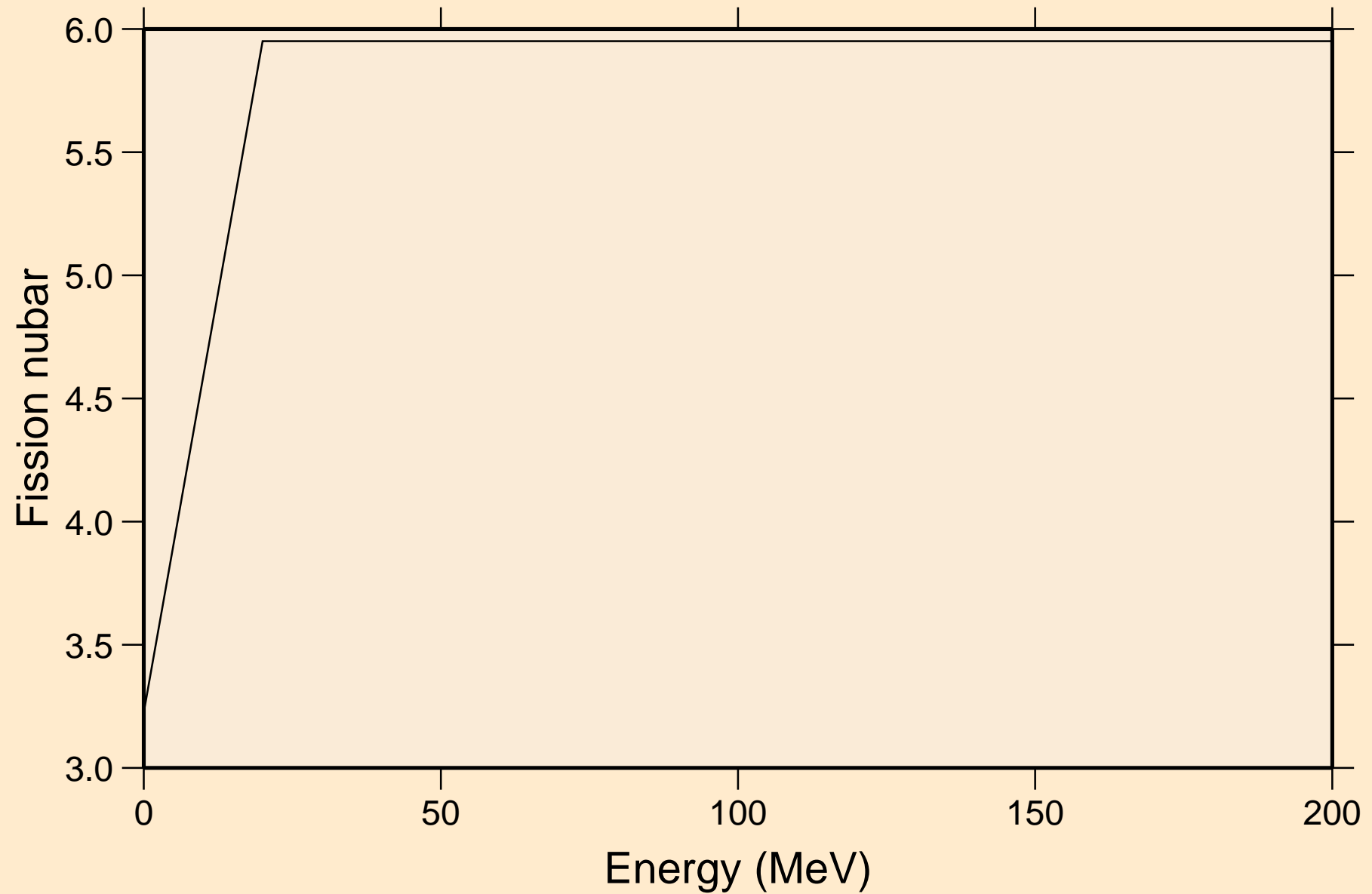

AM237 NRG TENDL-2015, AKONING
Neutron emission for (n,x)

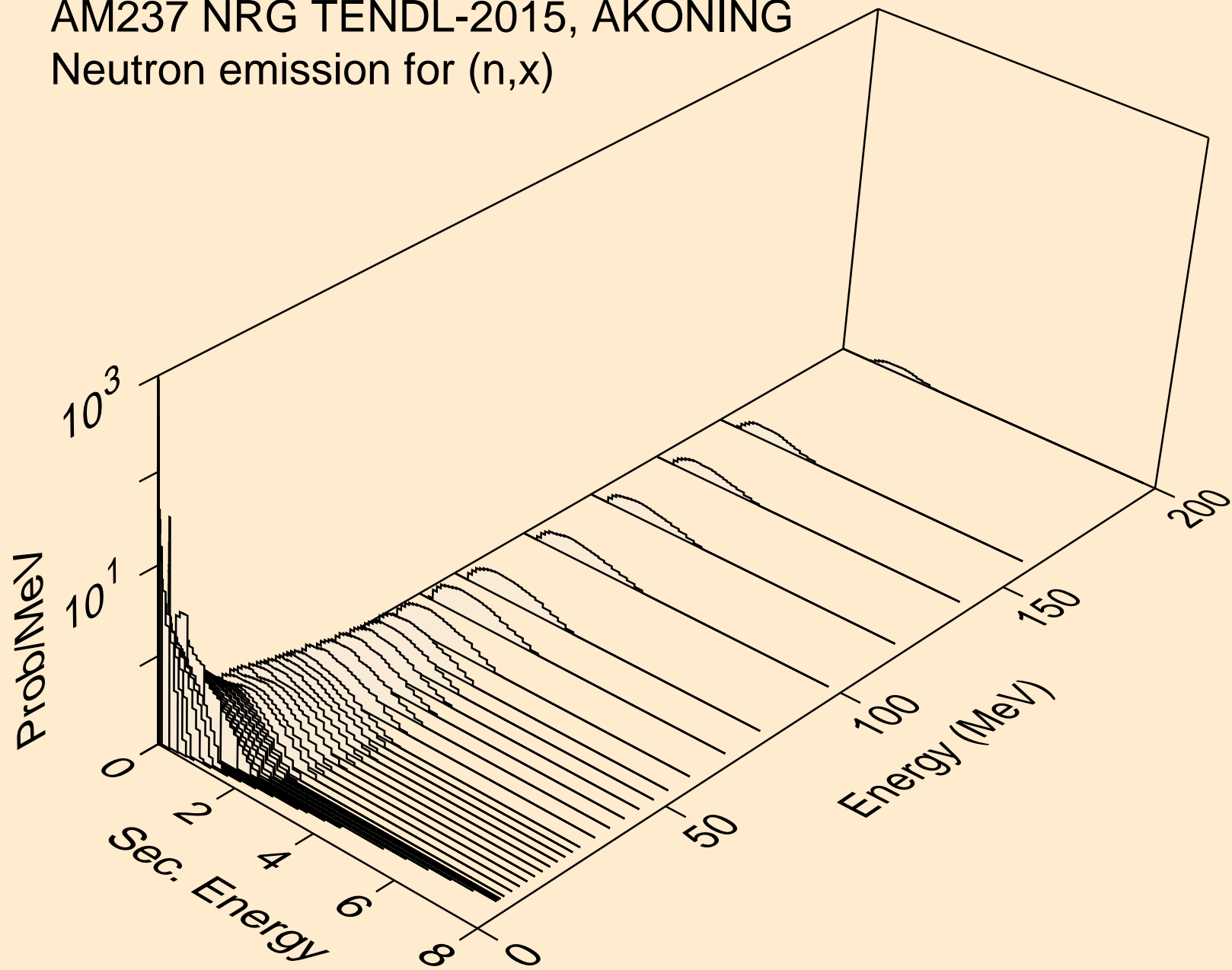

AM237 NRG TENDL-2015, AKONING
Neutron emission for (n,2nd)

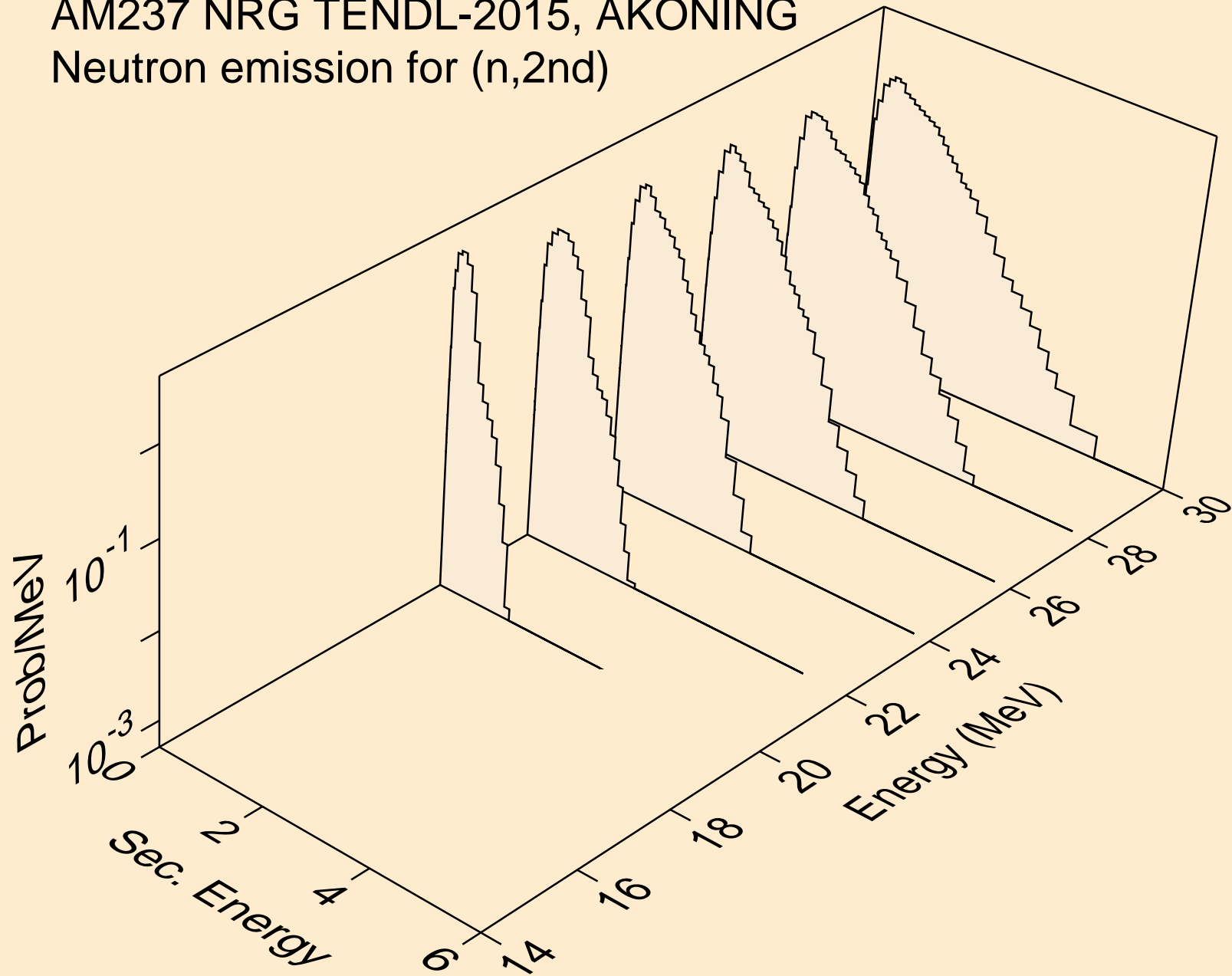

AM237 NRG TENDL-2015, AKONING
Neutron emission for (n,2n)

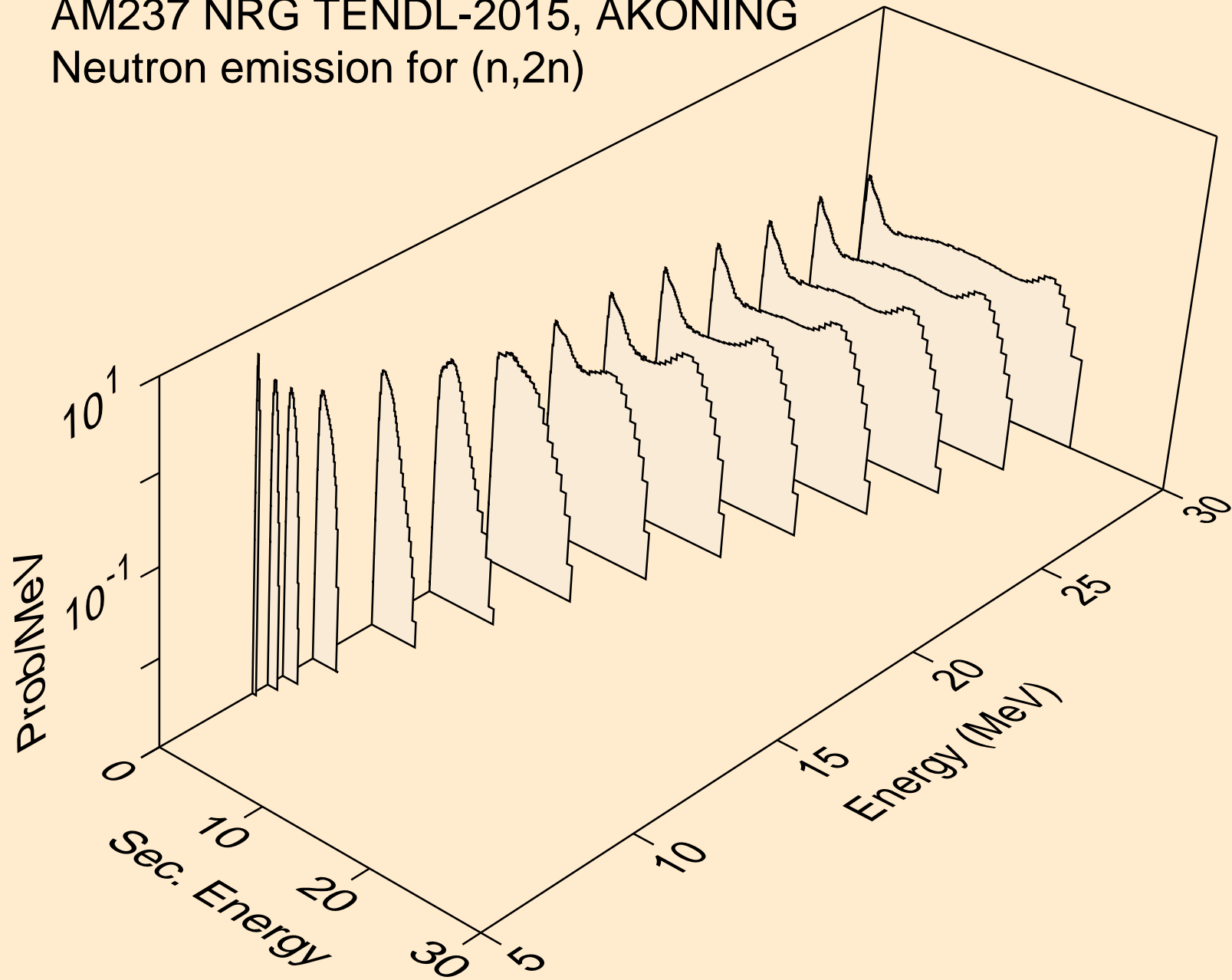

AM237 NRG TENDL-2015, AKONING
Neutron emission for (n,3n)

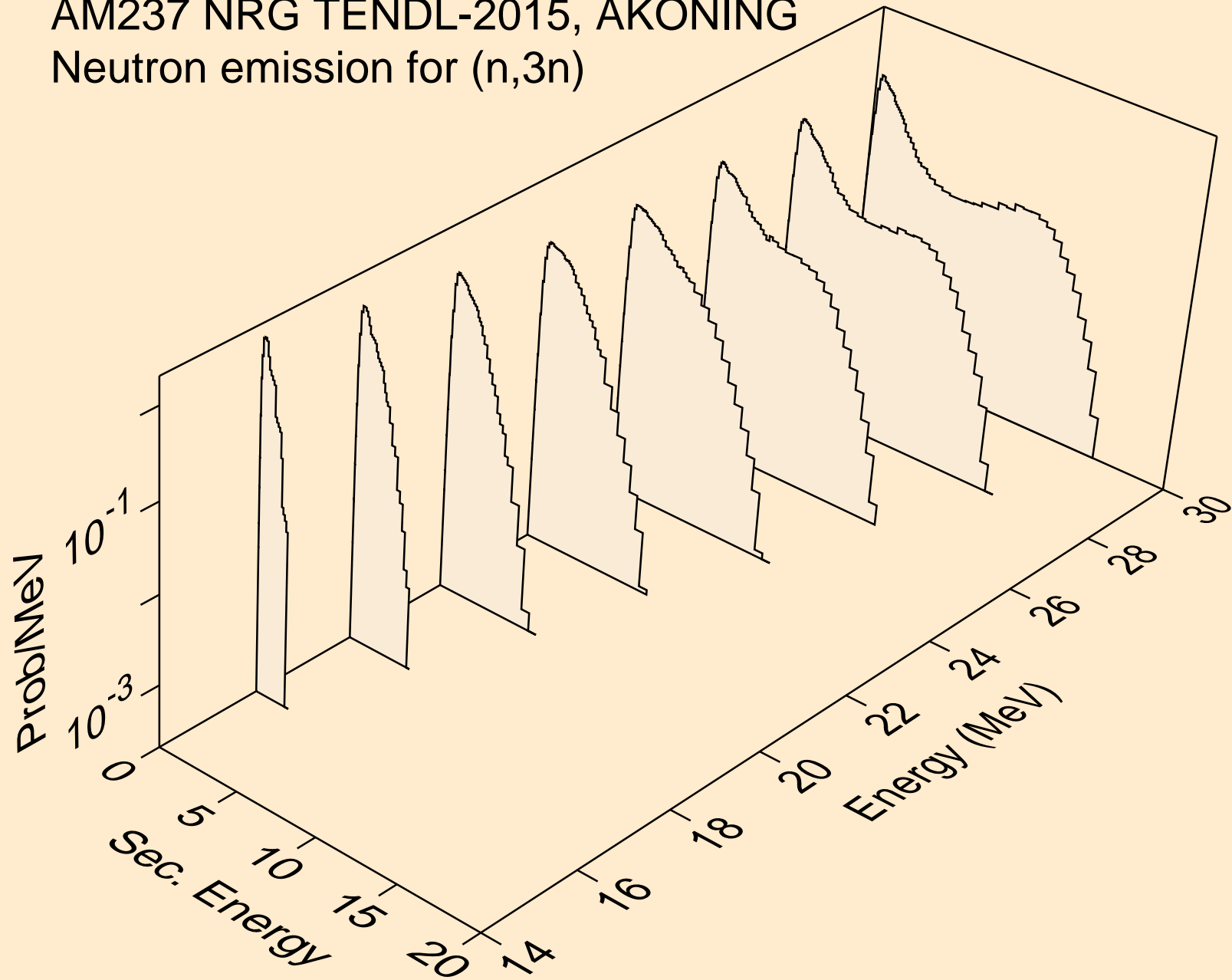

AM237 NRG TENDL-2015, AKONING
Neutron emission for fission

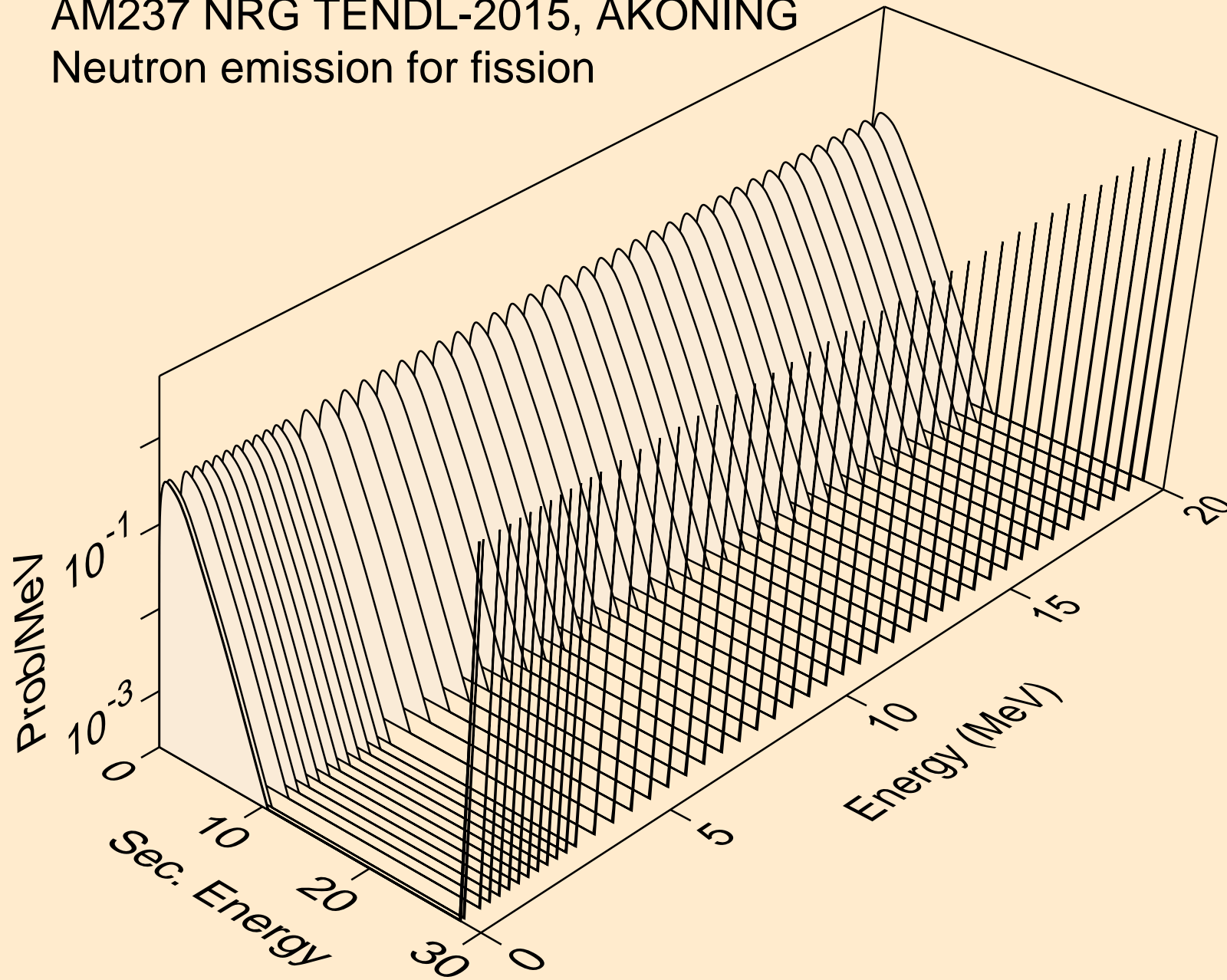

AM237 NRG TENDL-2015, AKONING
Neutron emission for (n,n*)a

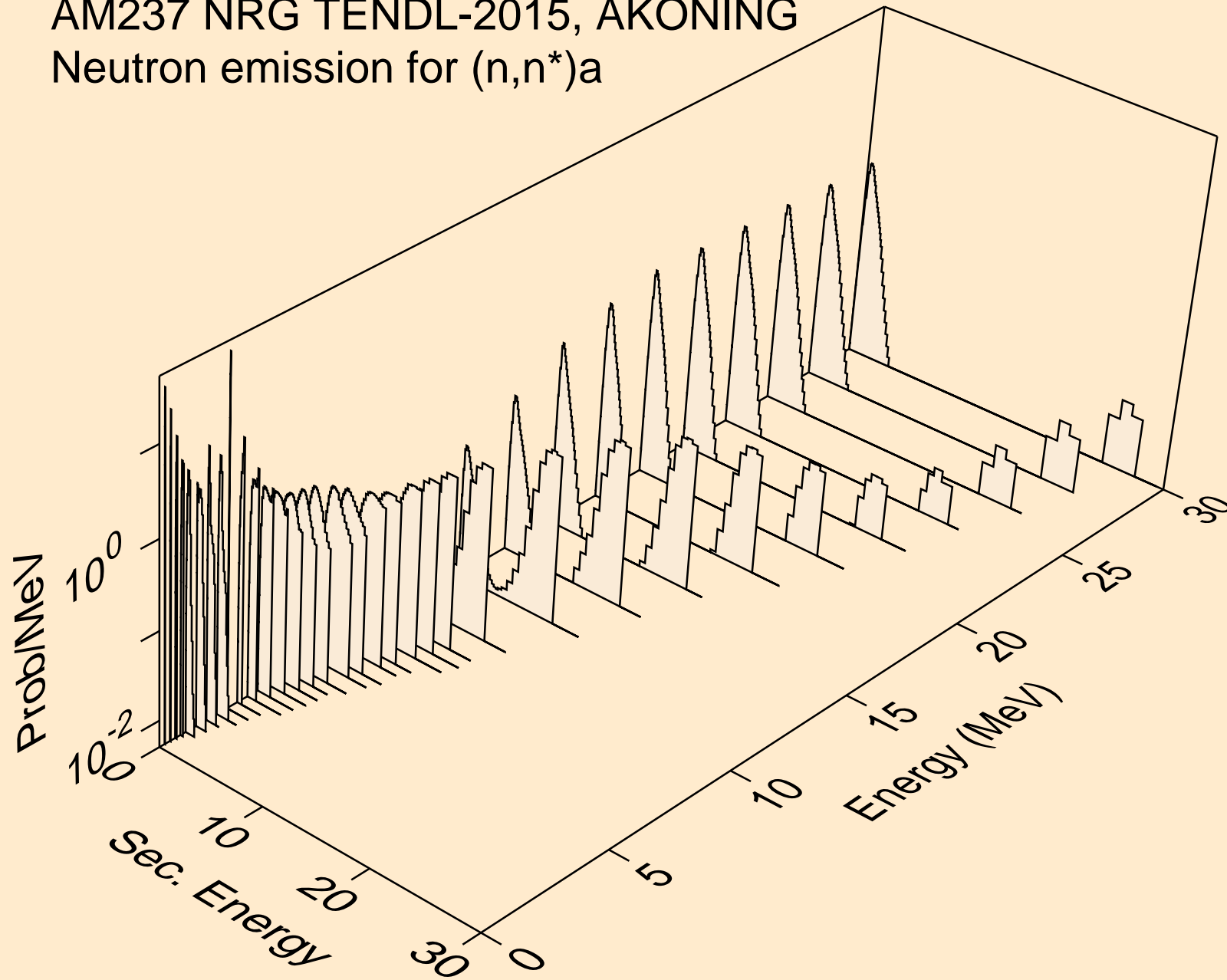

AM237 NRG TENDL-2015, AKONING
Neutron emission for (n,2n)a

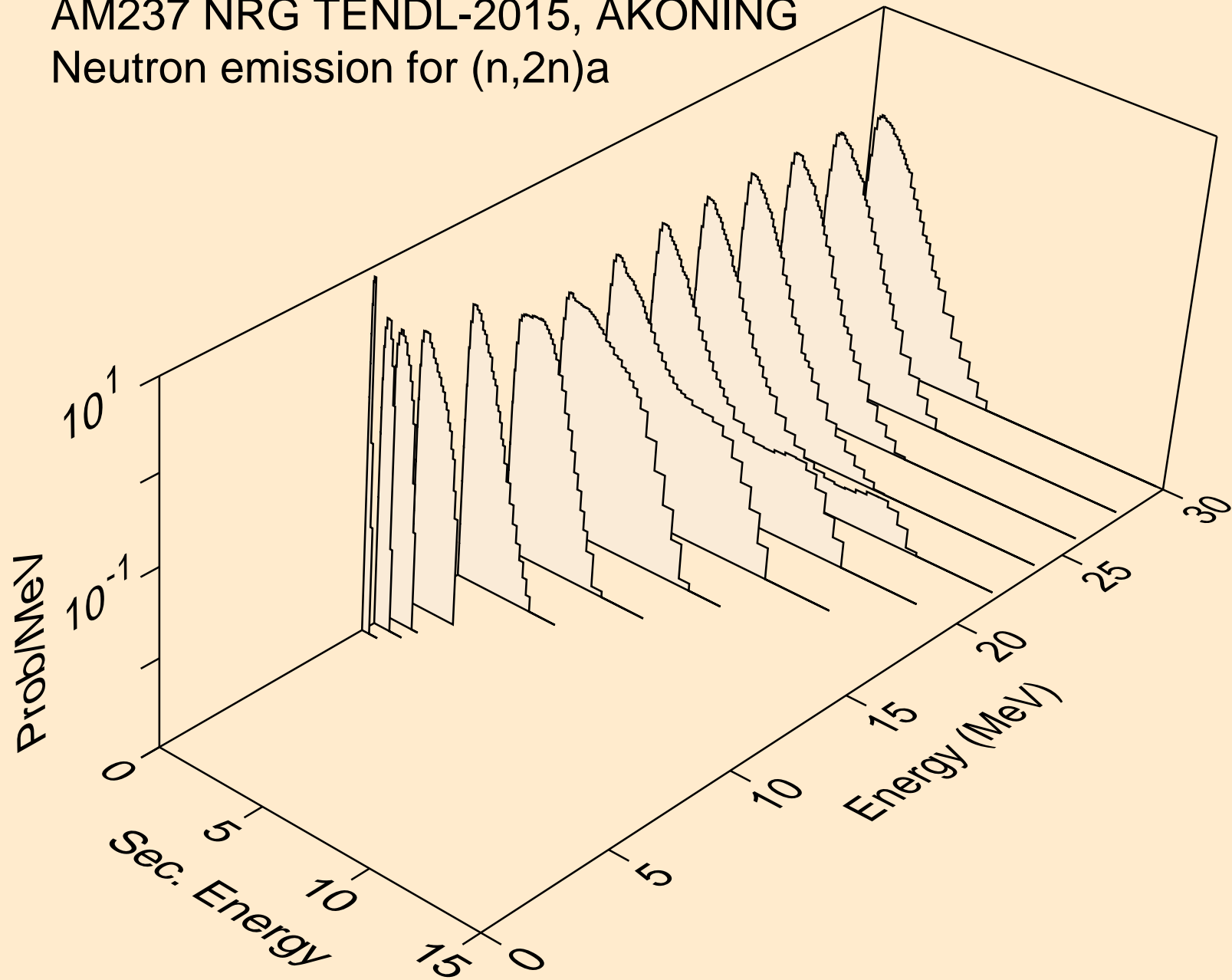

AM237 NRG TENDL-2015, AKONING
Neutron emission for (n,3n)a

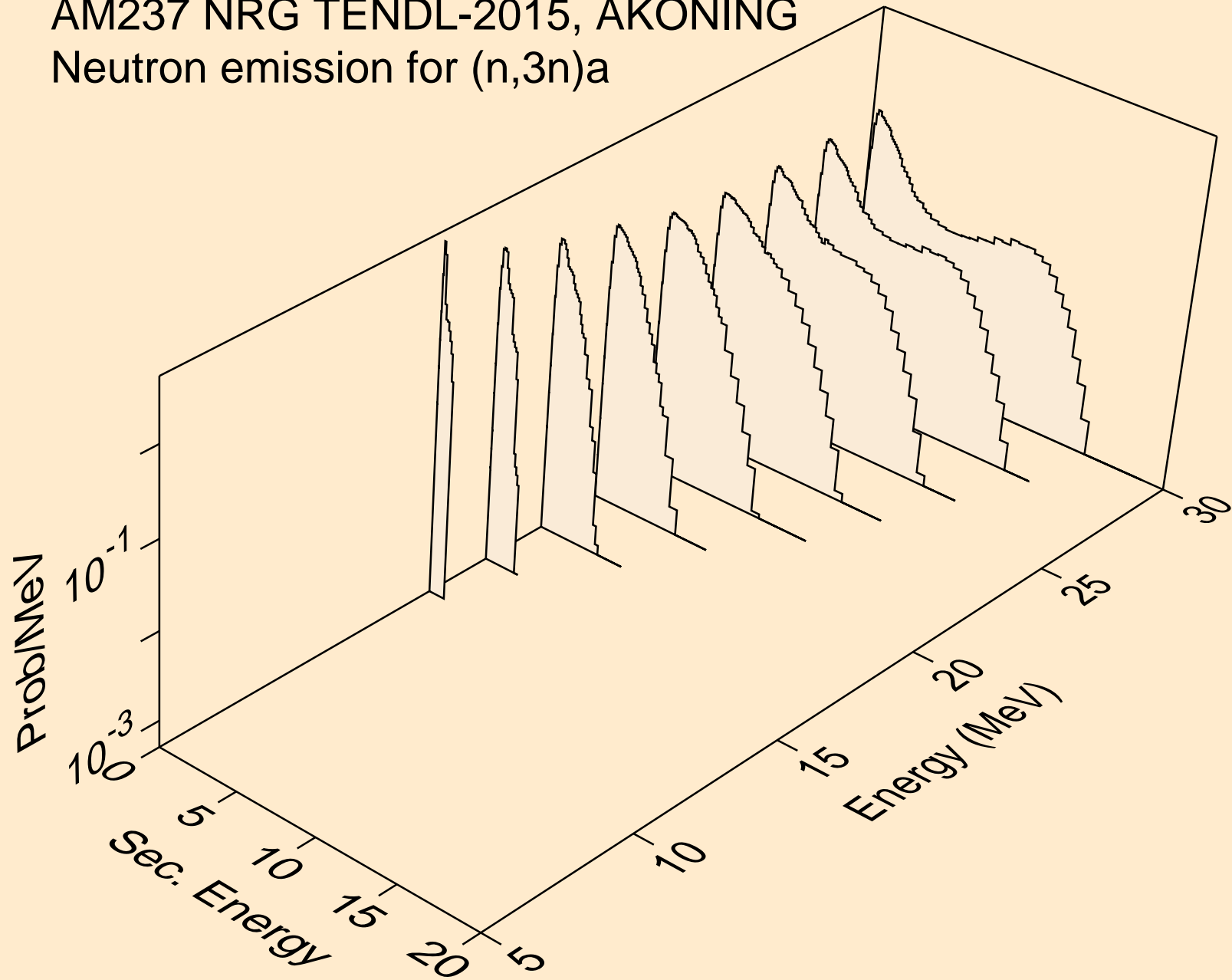

AM237 NRG TENDL-2015, AKONING
Neutron emission for (n,n*)p

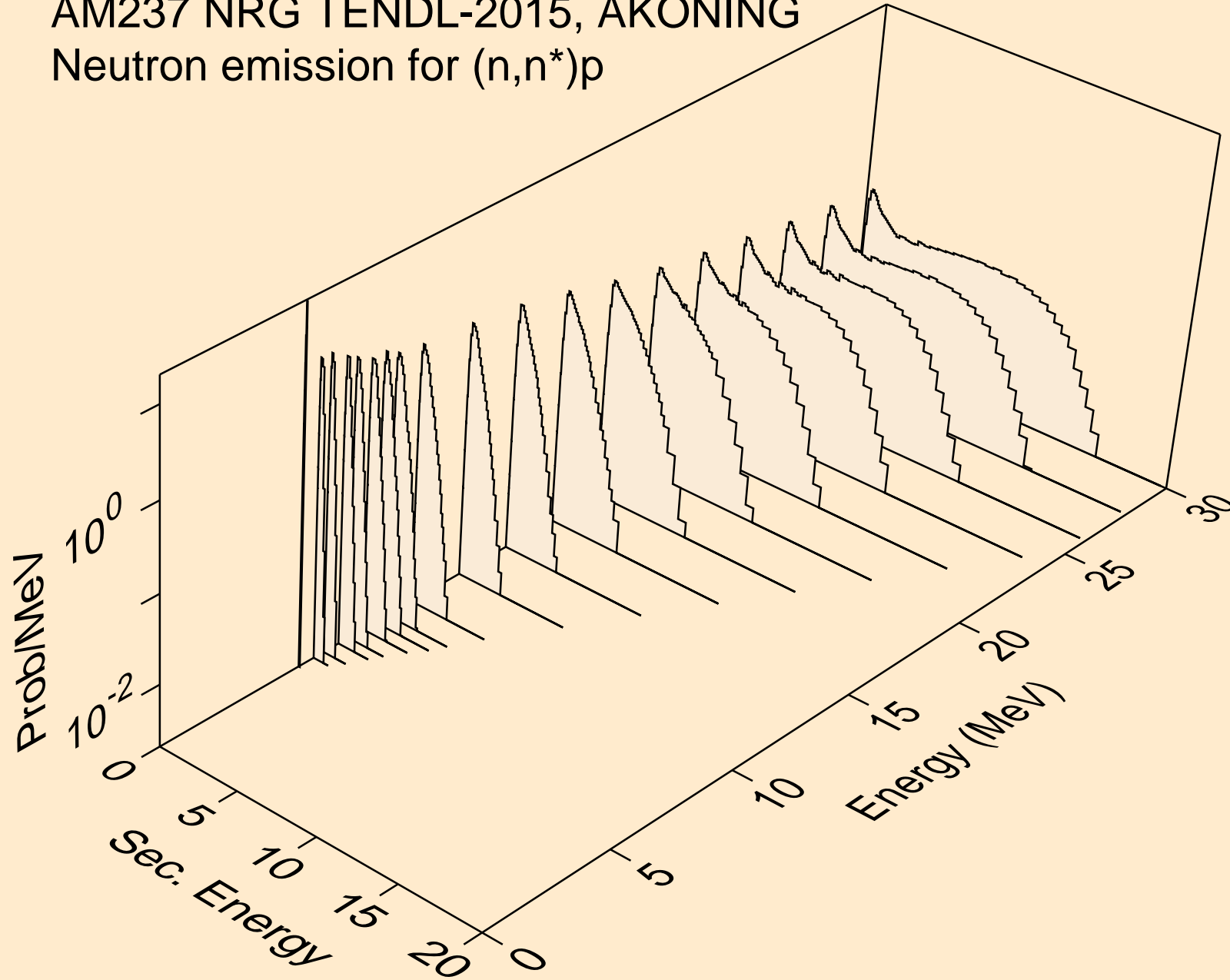

AM237 NRG TENDL-2015, AKONING
Neutron emission for (n,n*)2a

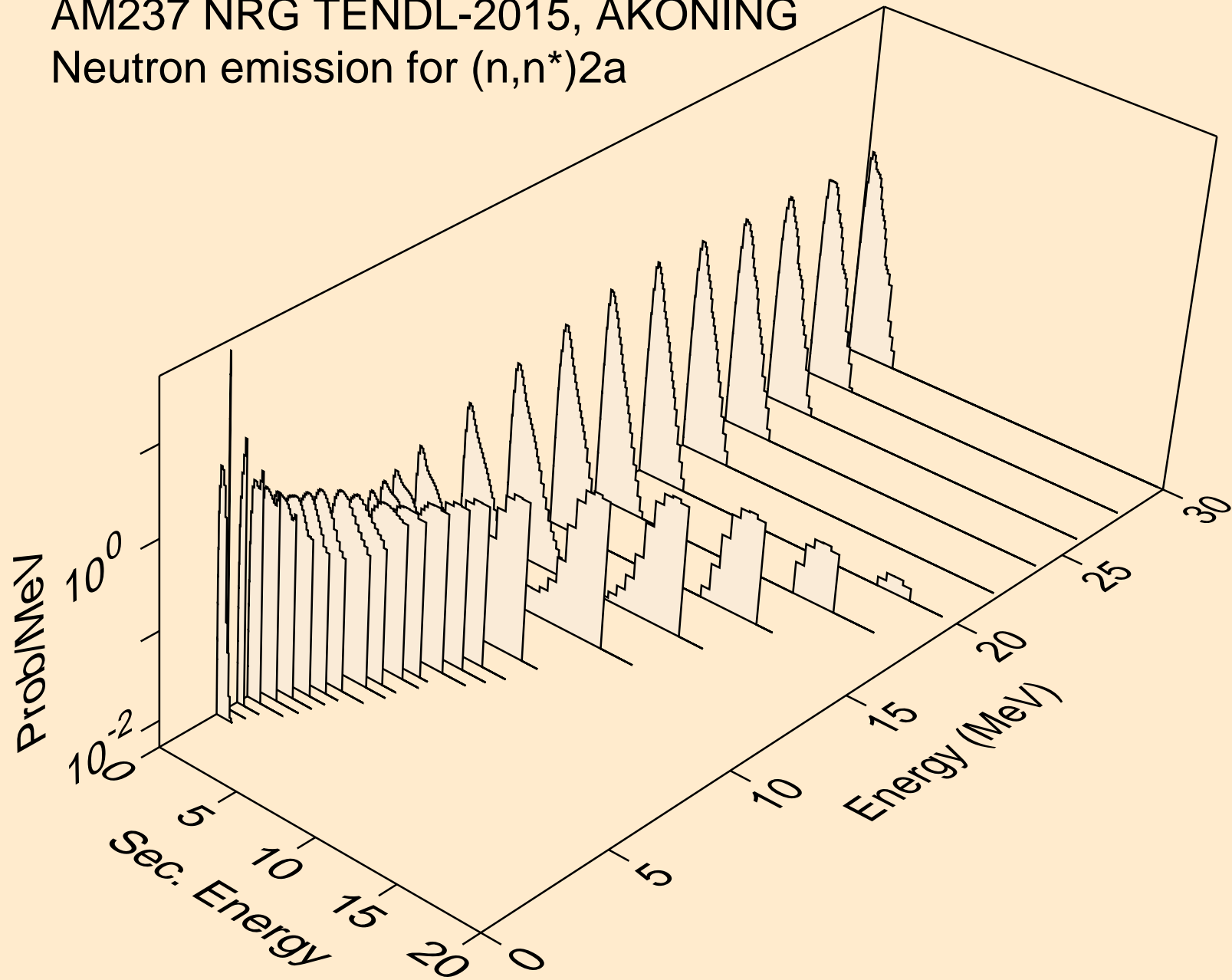

AM237 NRG TENDL-2015, AKONING
Neutron emission for (n,2n)2a

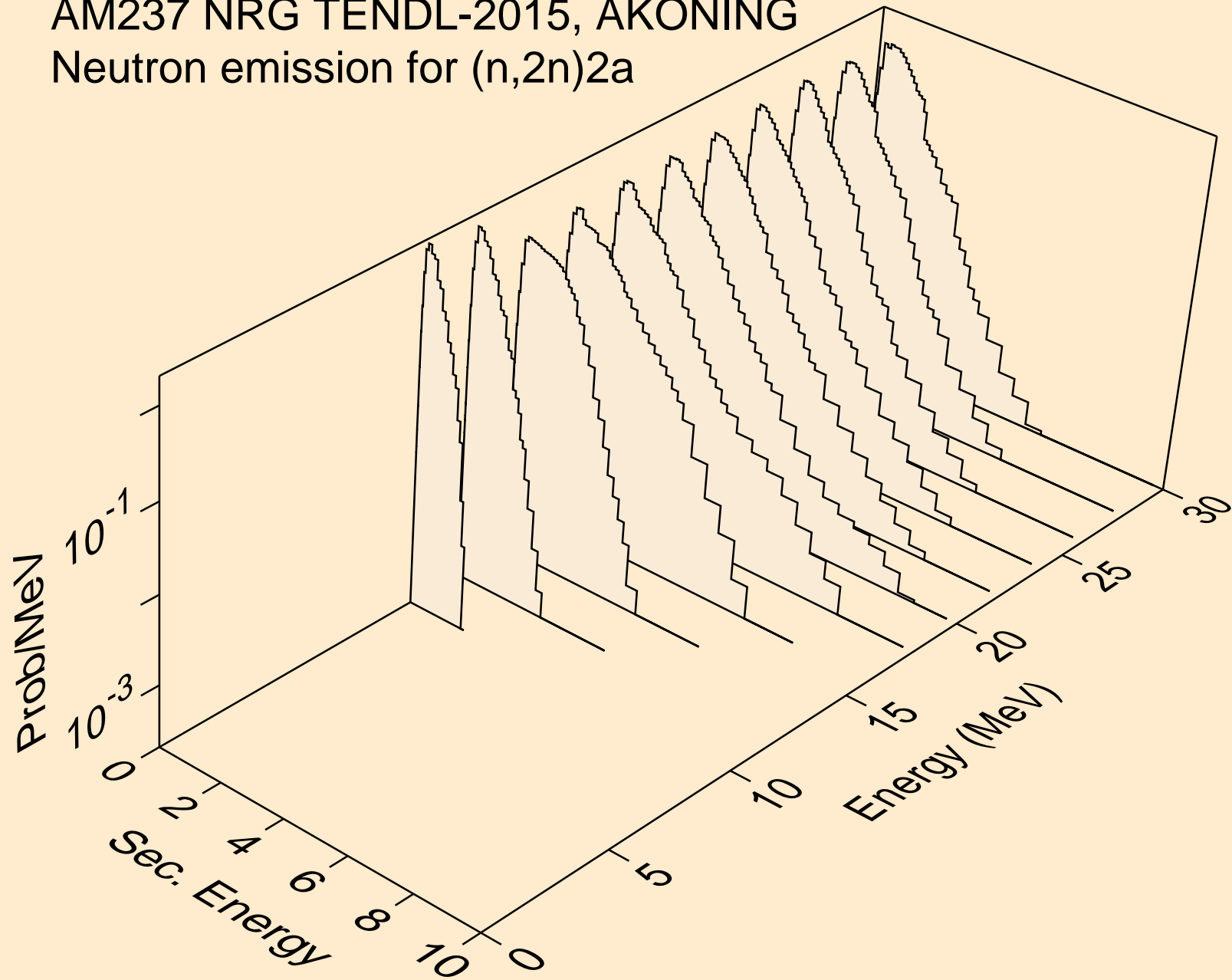

AM237 NRG TENDL-2015, AKONING
Neutron emission for (n,n*)d

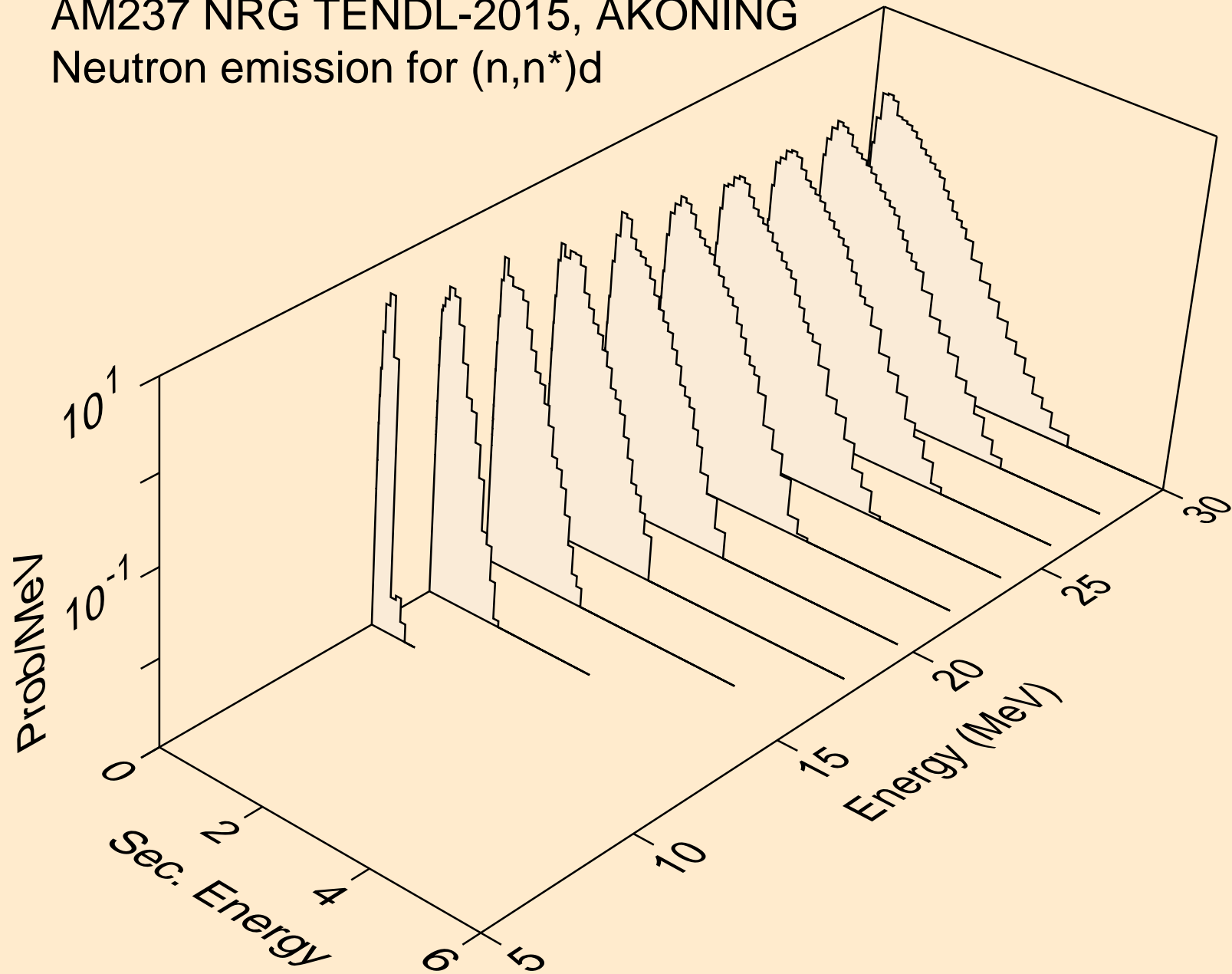

AM237 NRG TENDL-2015, AKONING
Neutron emission for (n,n*)t

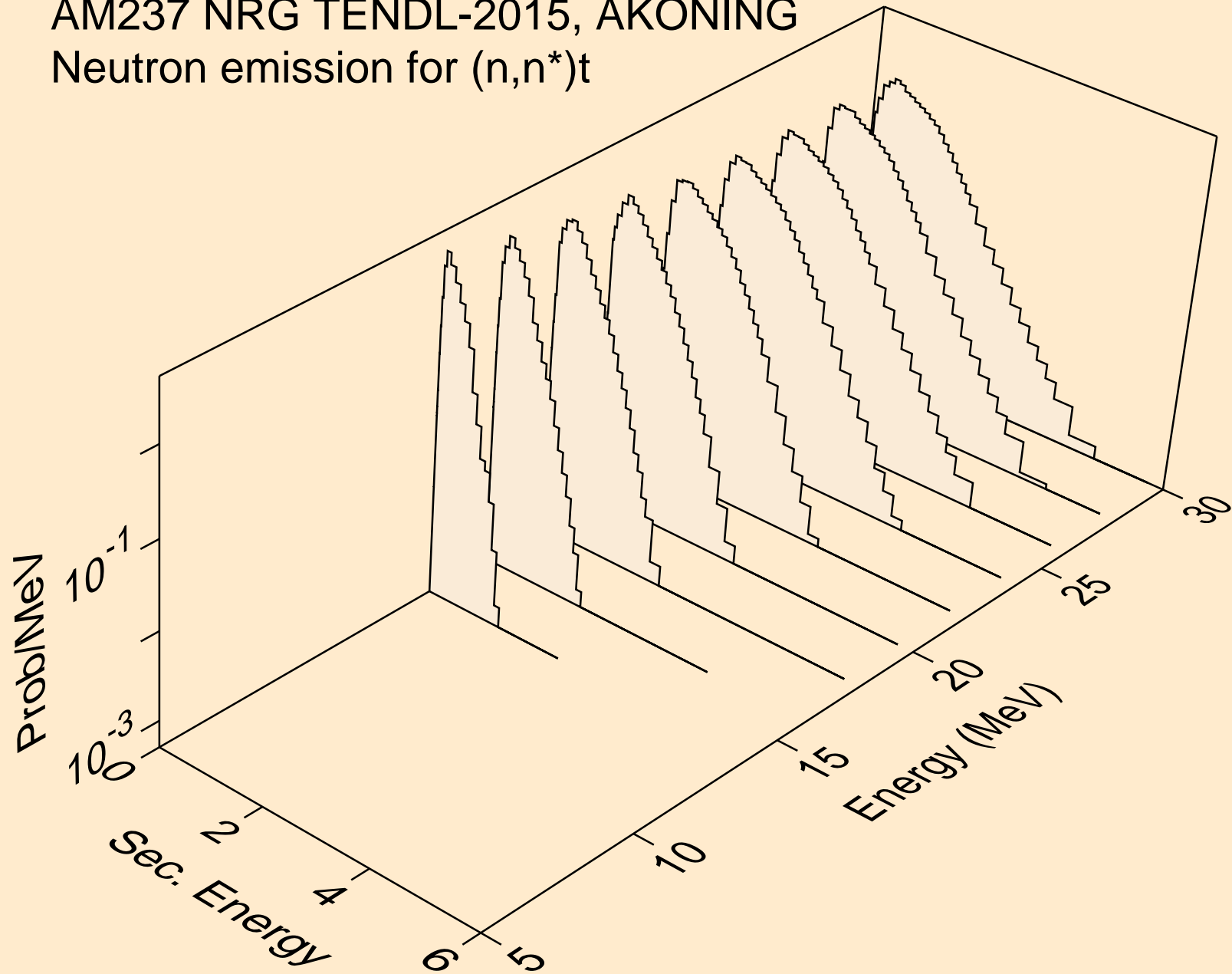

AM237 NRG TENDL-2015, AKONING
Neutron emission for (n,n*)he3

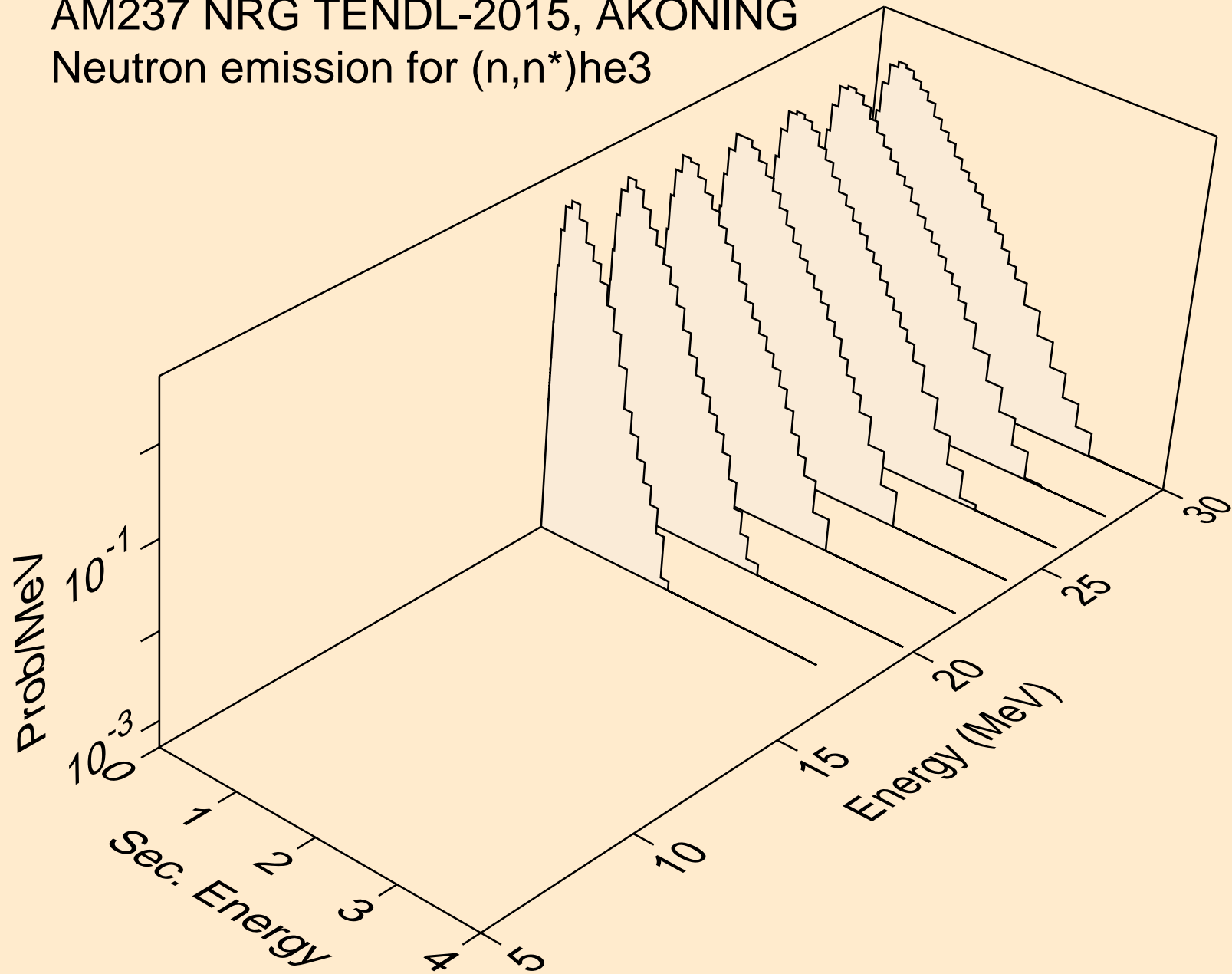

AM237 NRG TENDL-2015, AKONING
Neutron emission for (n,4n)

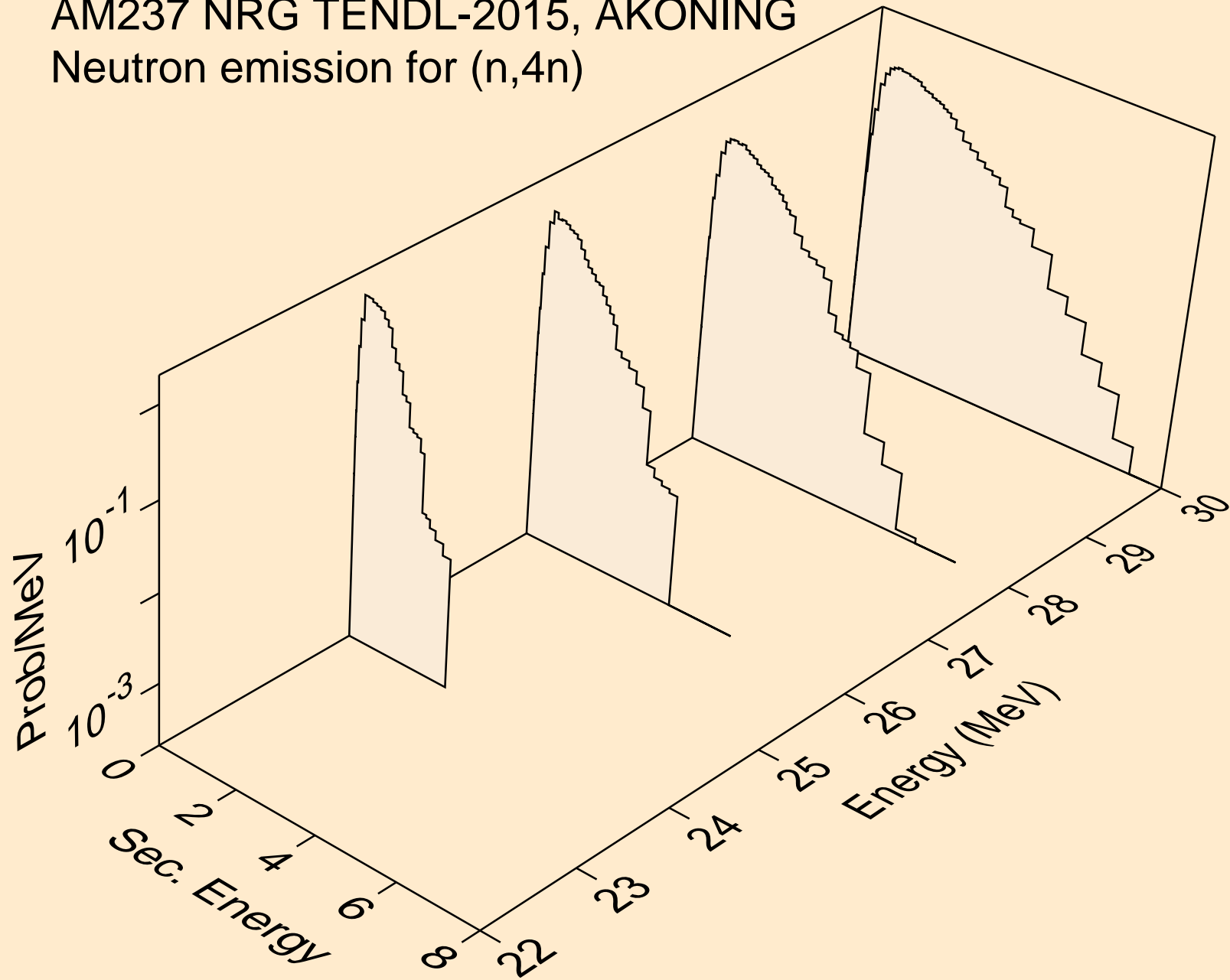

AM237 NRG TENDL-2015, AKONING
Neutron emission for (n,2np)

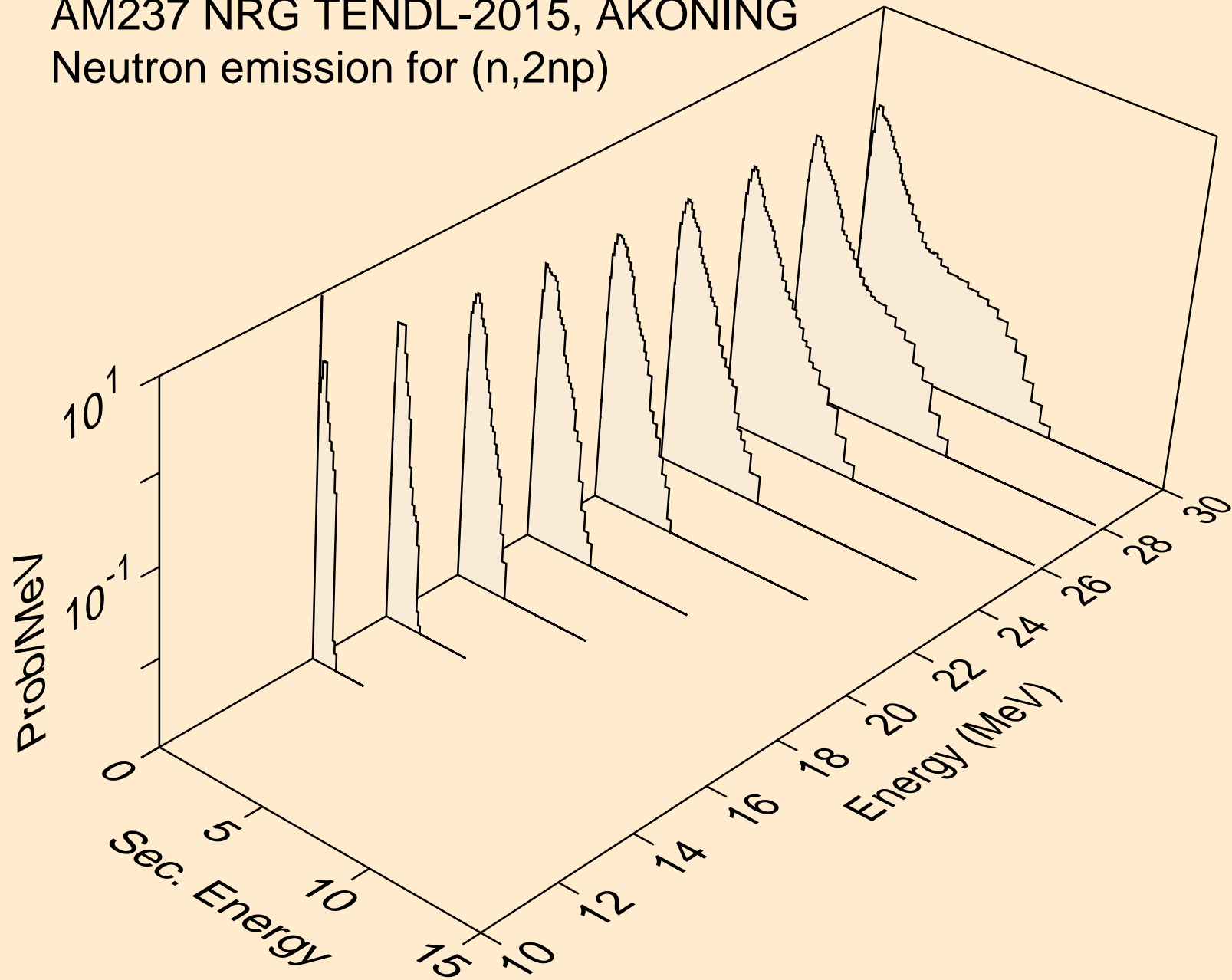

AM237 NRG TENDL-2015, AKONING
Neutron emission for (n,3np)

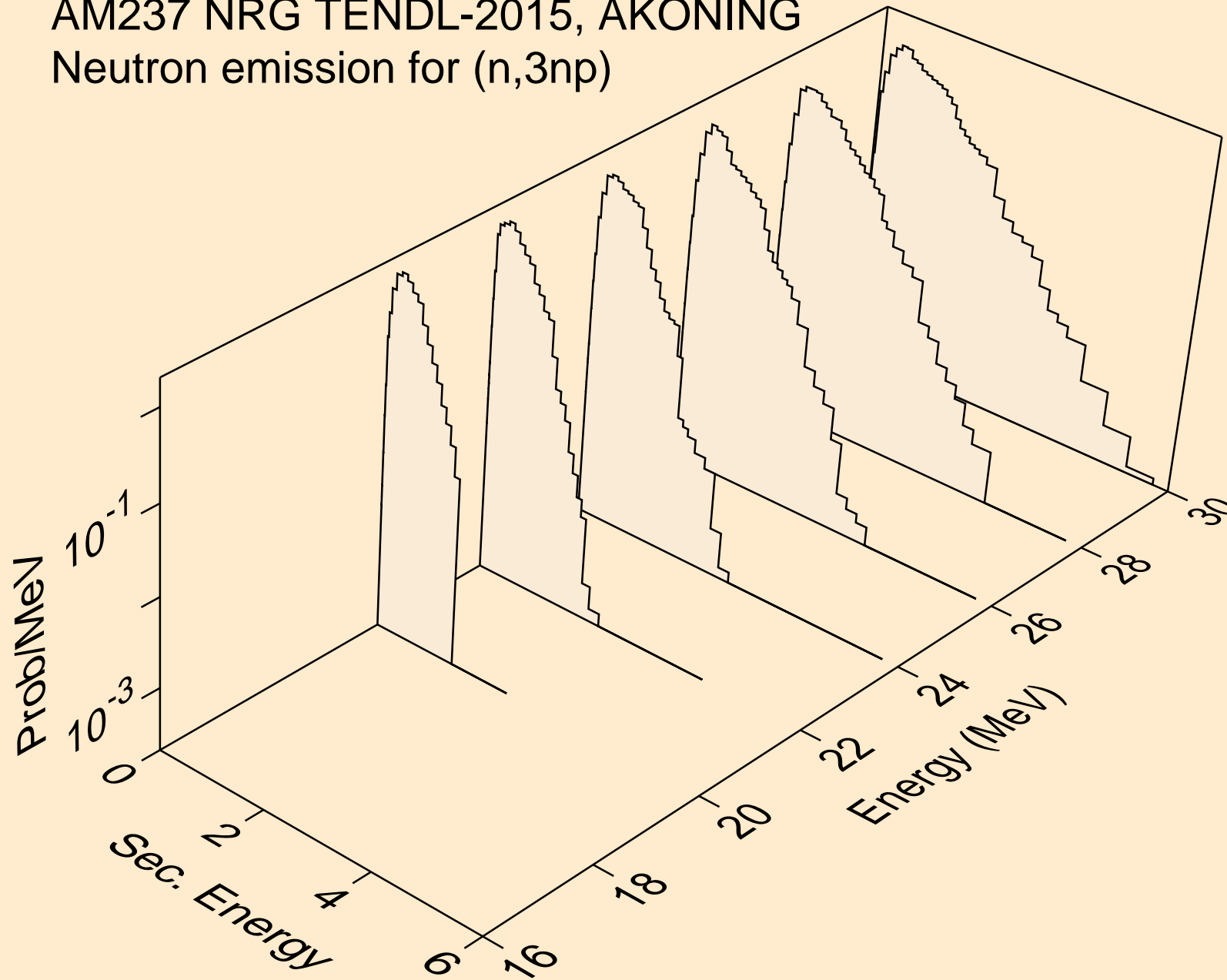

AM237 NRG TENDL-2015, AKONING
Neutron emission for (n,2np)

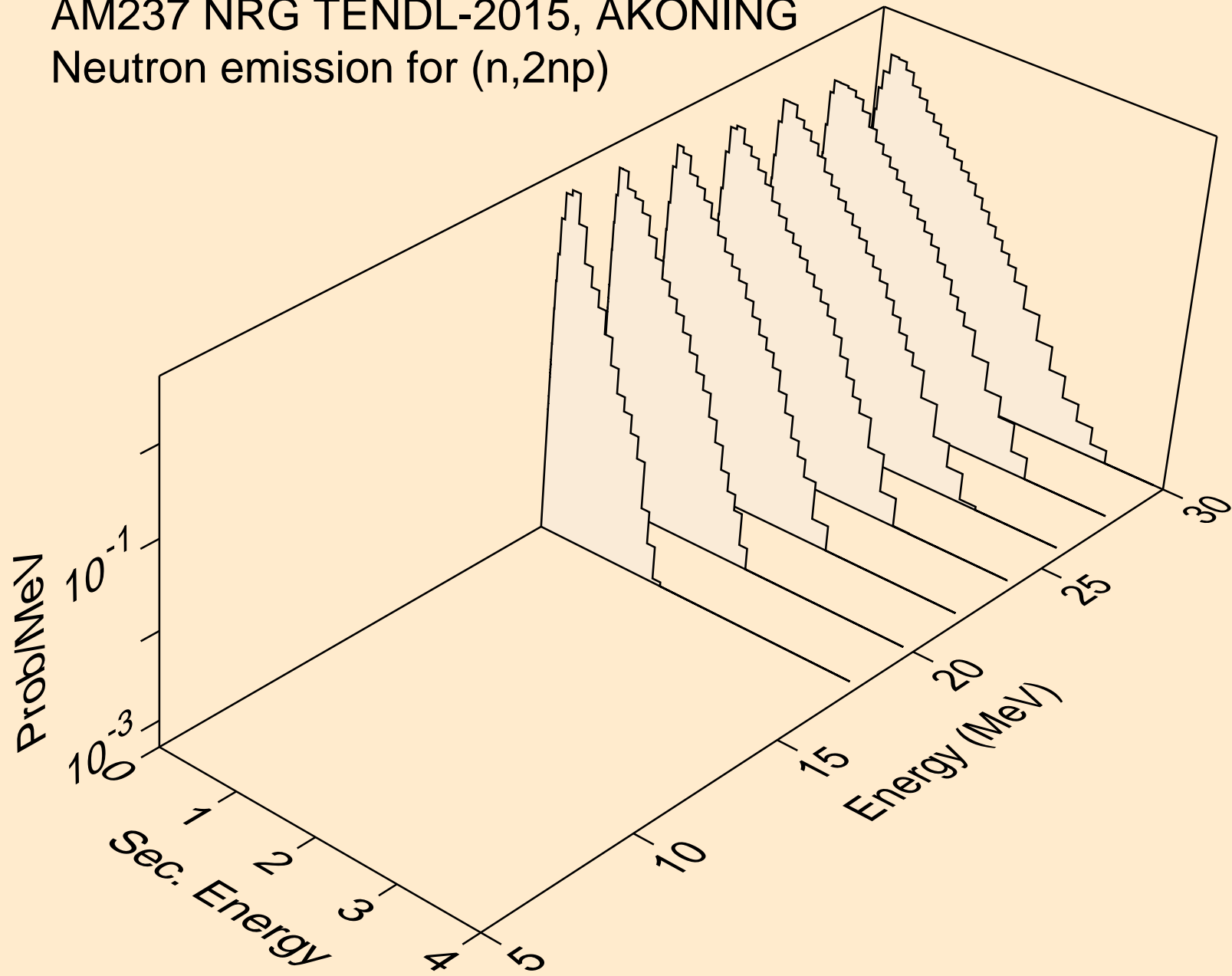

AM237 NRG TENDL-2015, AKONING
Neutron emission for (n,npa)

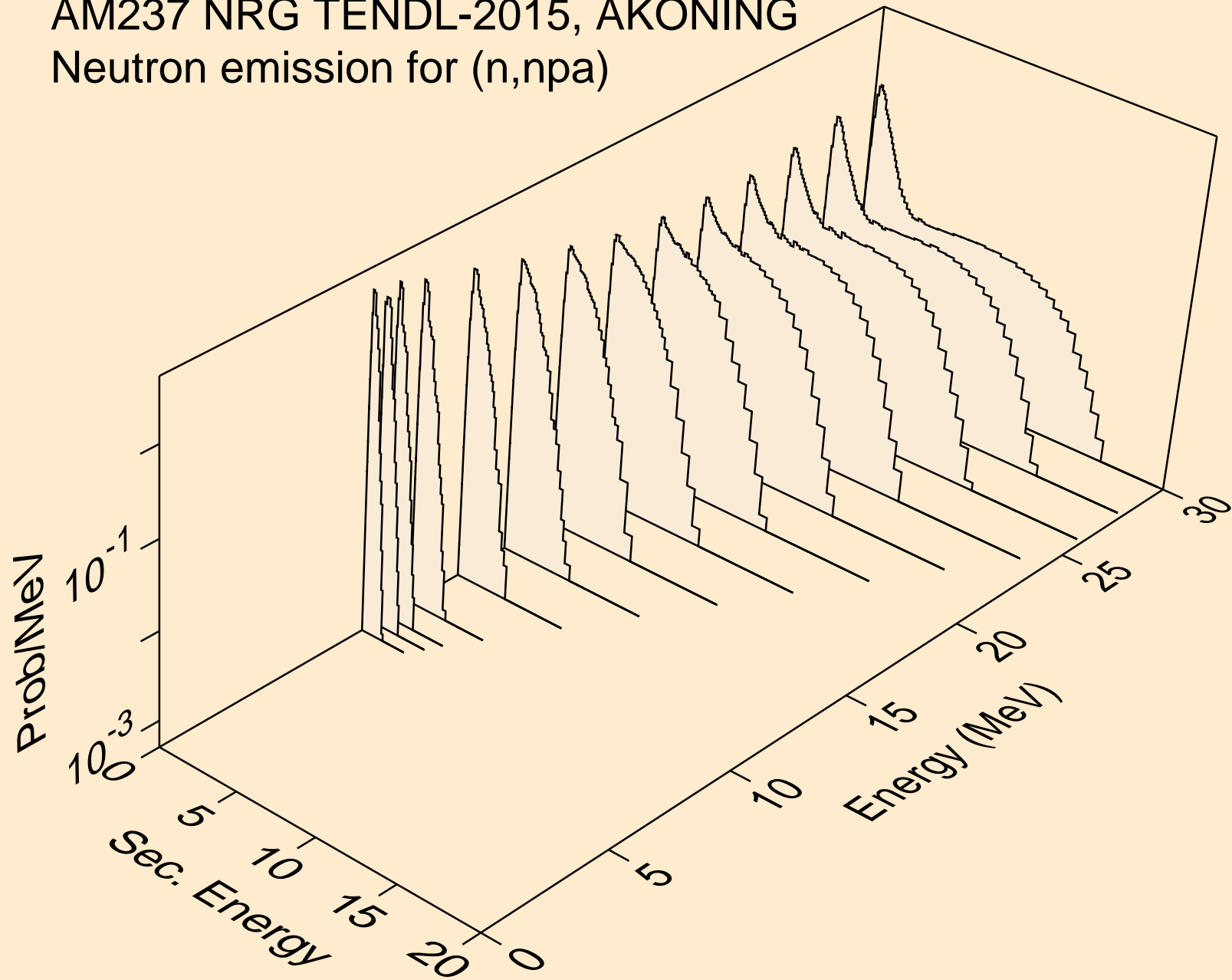

AM237 NRG TENDL-2015, AKONING
Neutron emission for (n,n*c)

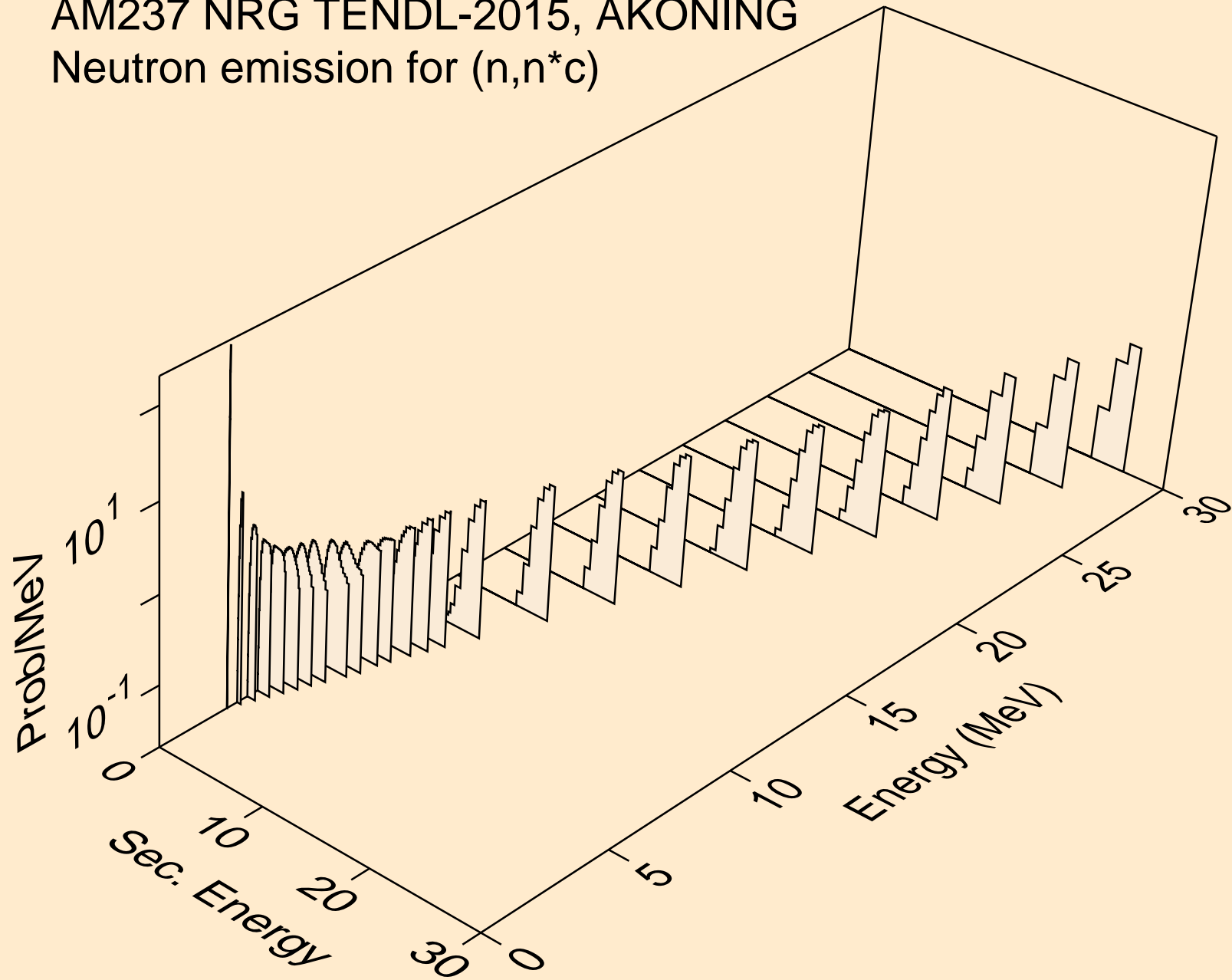

AM237 NRG TENDL-2015, AKONING

Delayed nubar

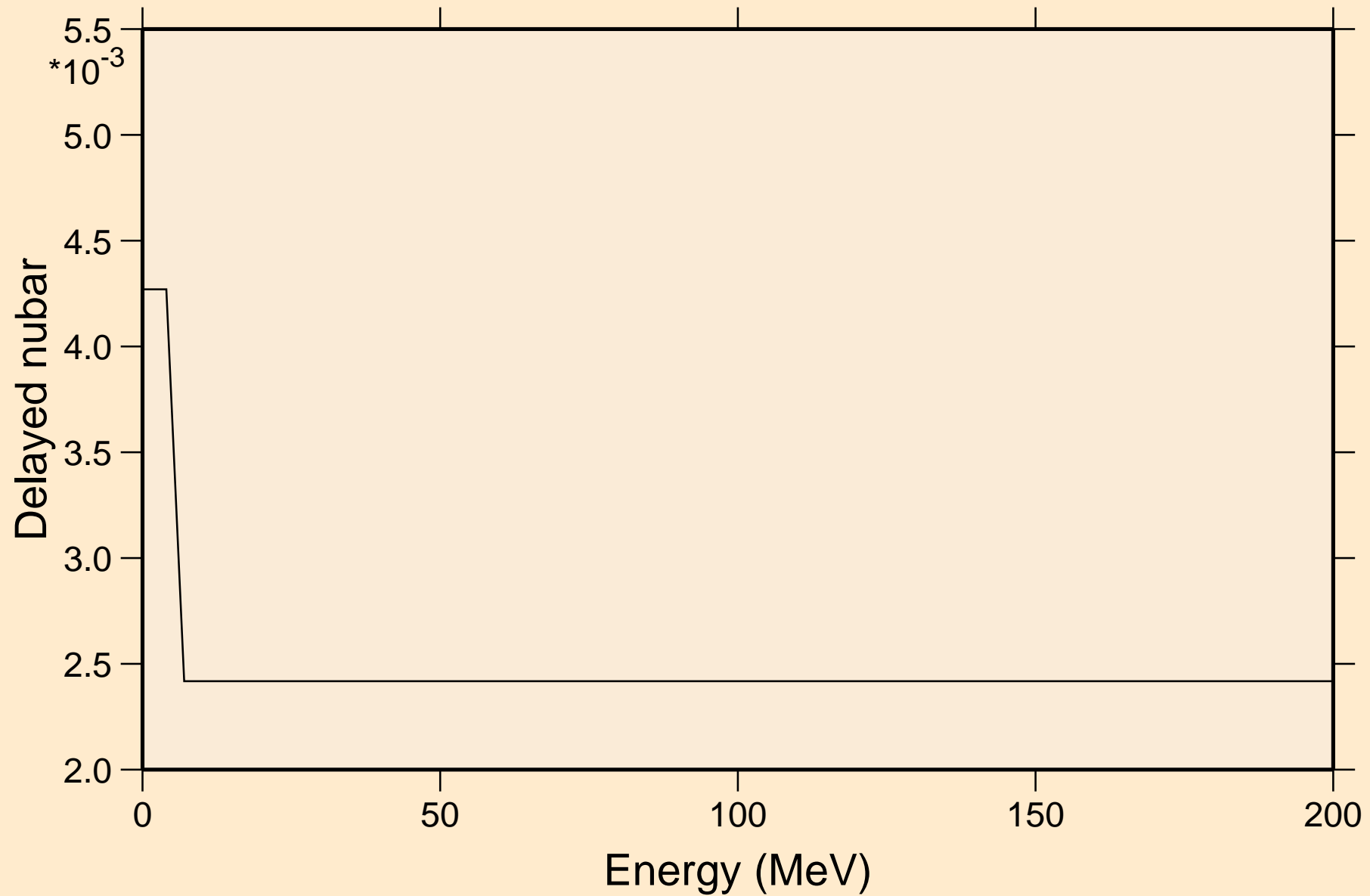

AM237 NRG TENDL-2015, AKONING

Delayed neutron spectra

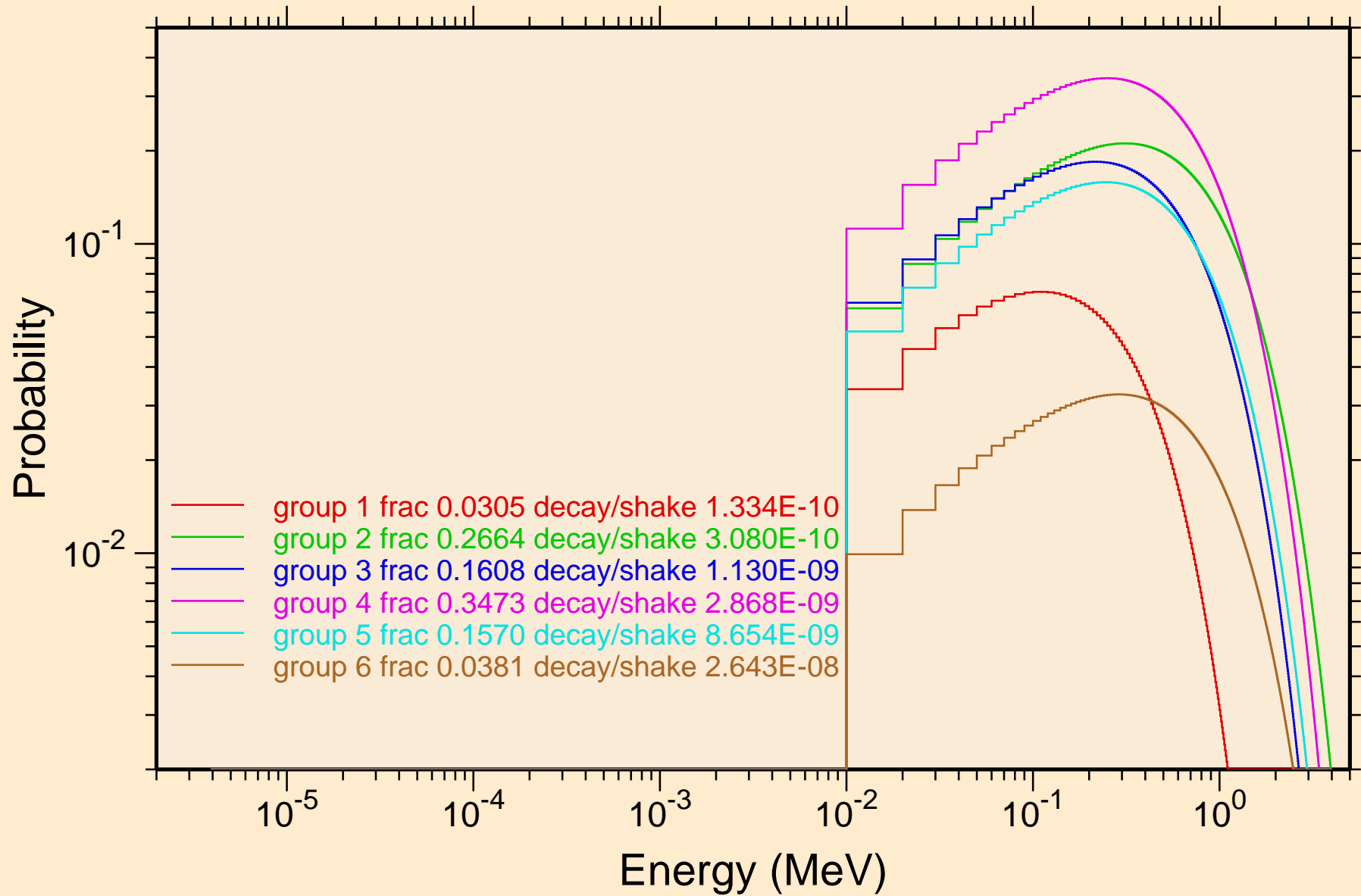

AM237 NRG TENDL-2015, AKONING
Photon emission for (n,x)

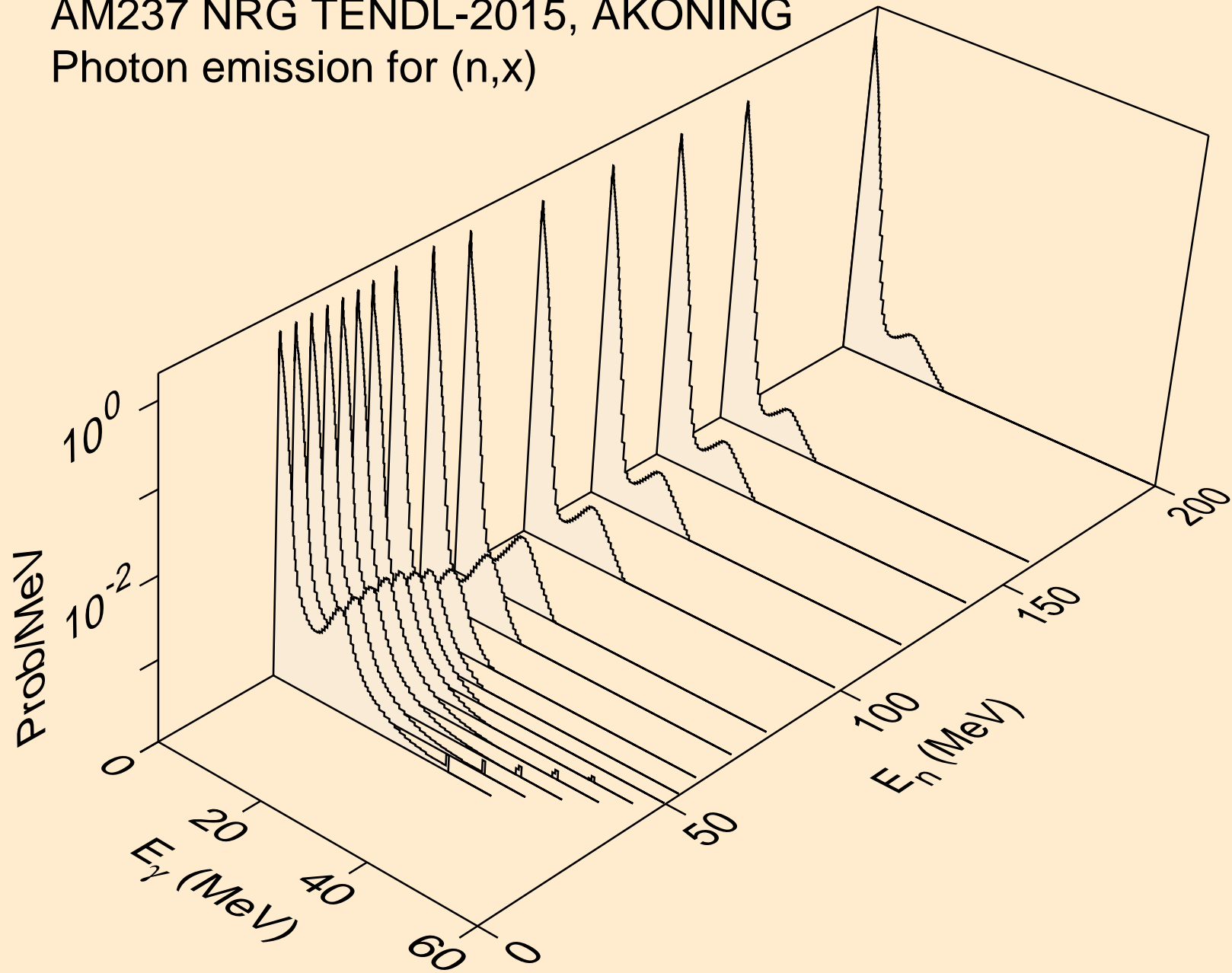

AM237 NRG TENDL-2015, AKONING
Photon emission for (n,2nd)

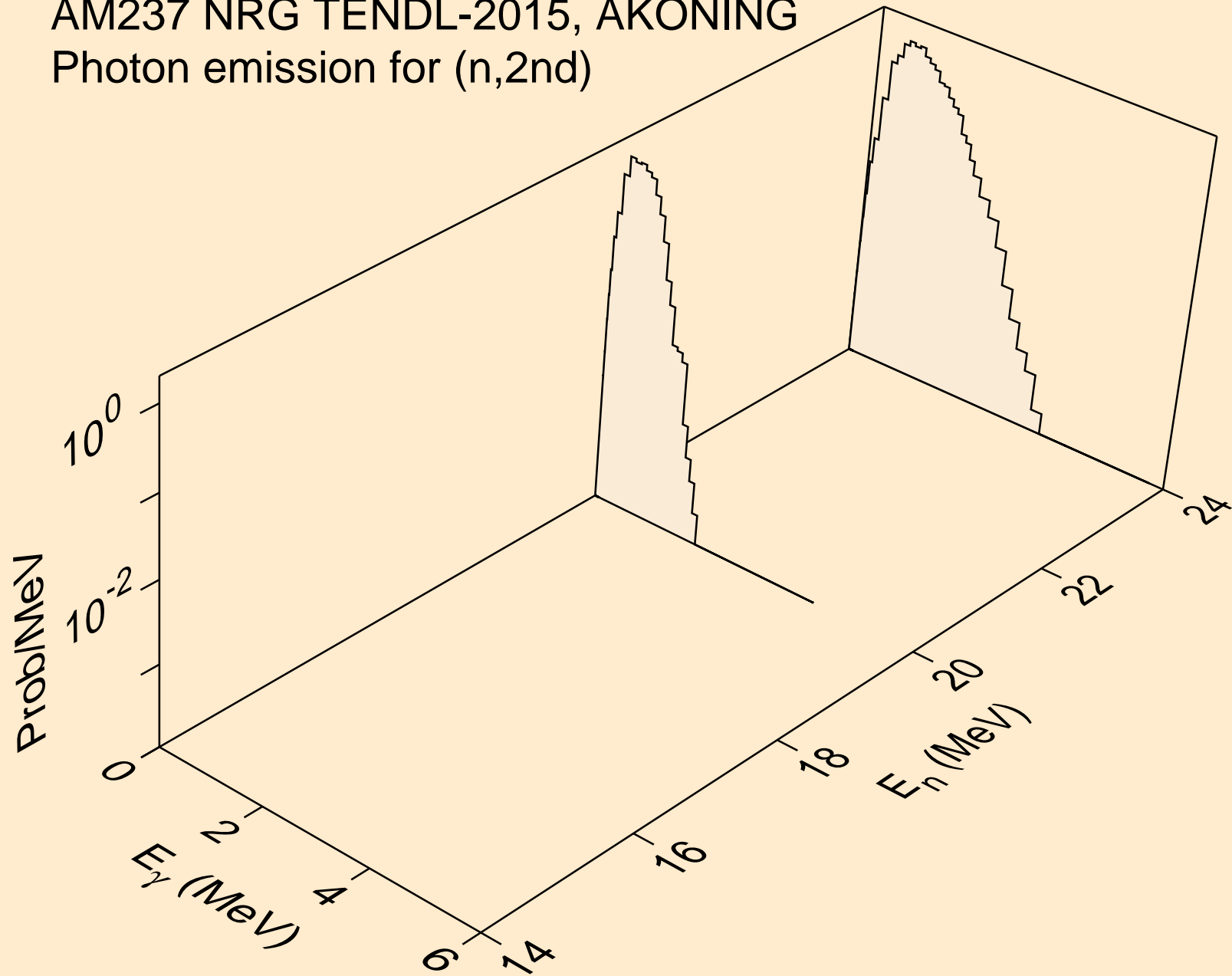

AM237 NRG TENDL-2015, AKONING
Photon emission for (n,2n)

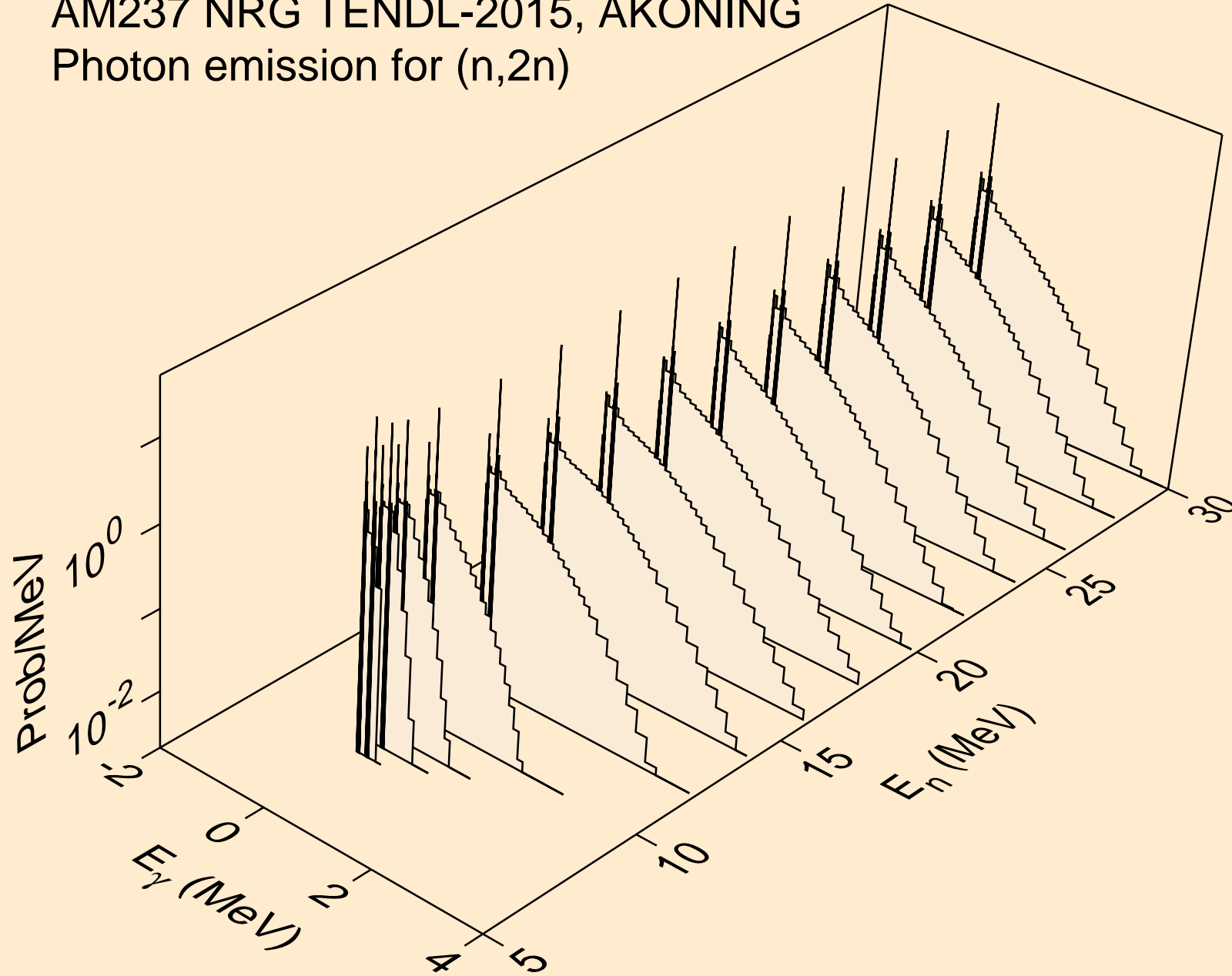

AM237 NRG TENDL-2015, AKONING
Photon emission for (n,3n)

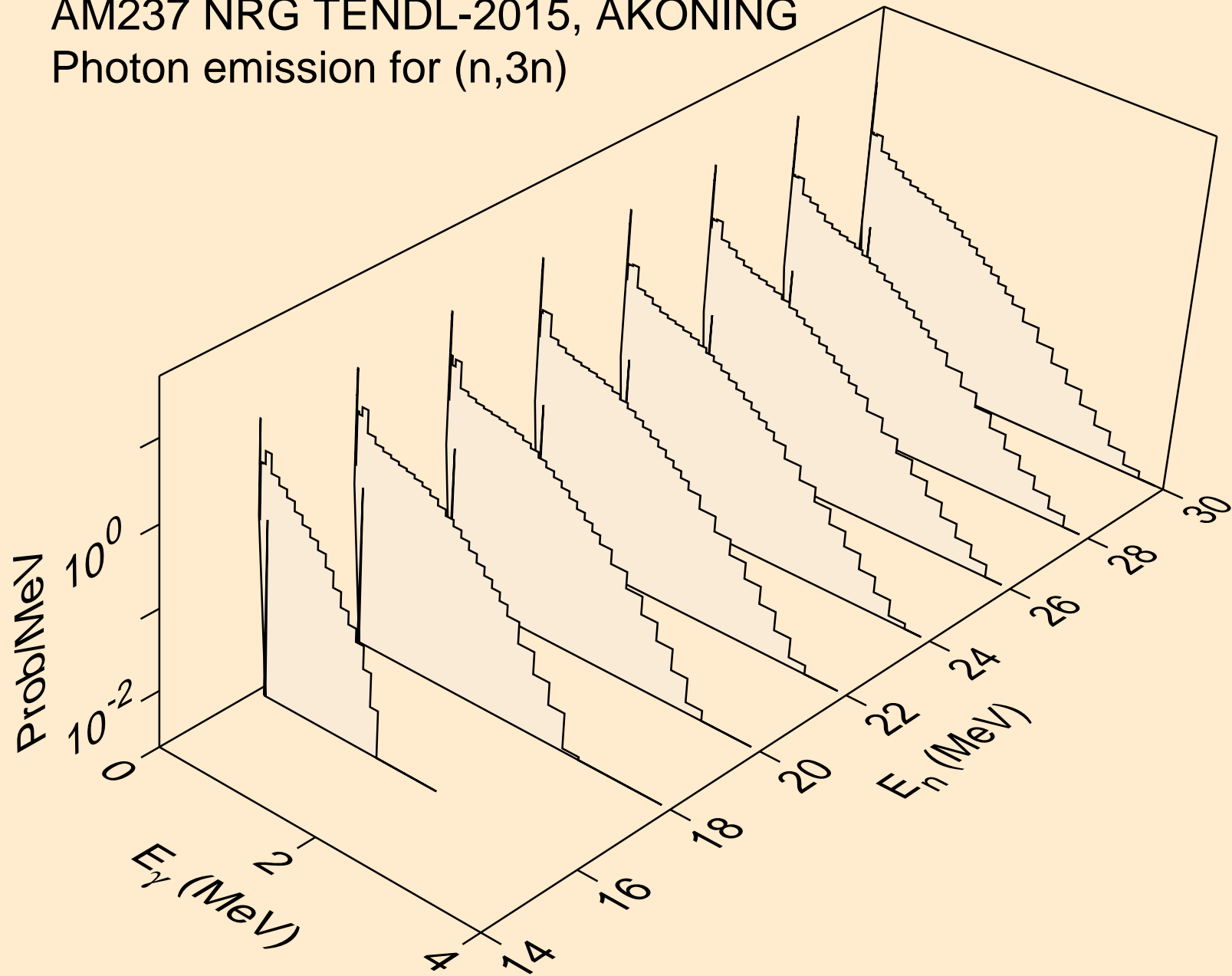

AM237 NRG TENDL-2015, AKONING
Photon emission for (n,n*)a

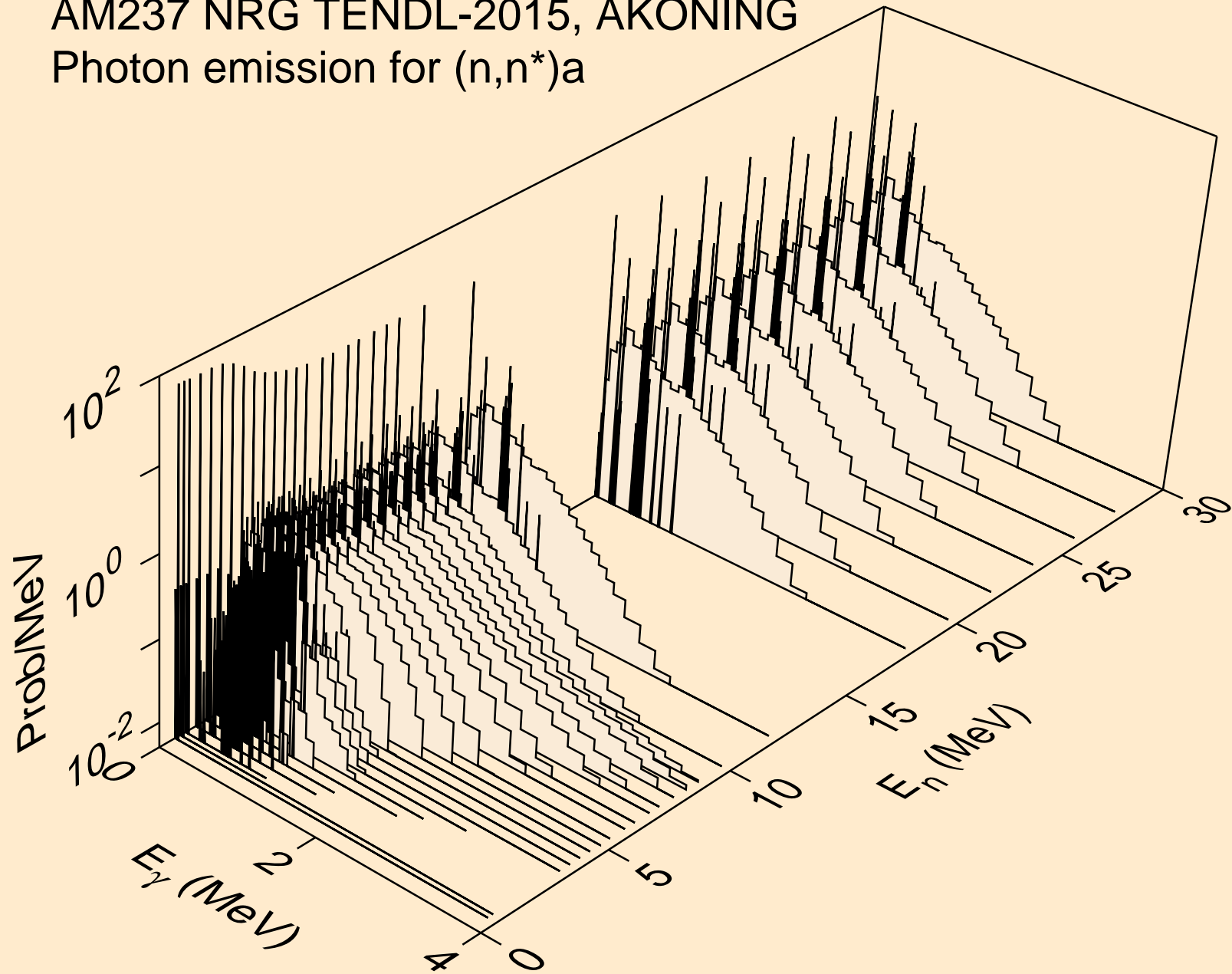

AM237 NRG TENDL-2015, AKONING
Photon emission for (n,2n) α

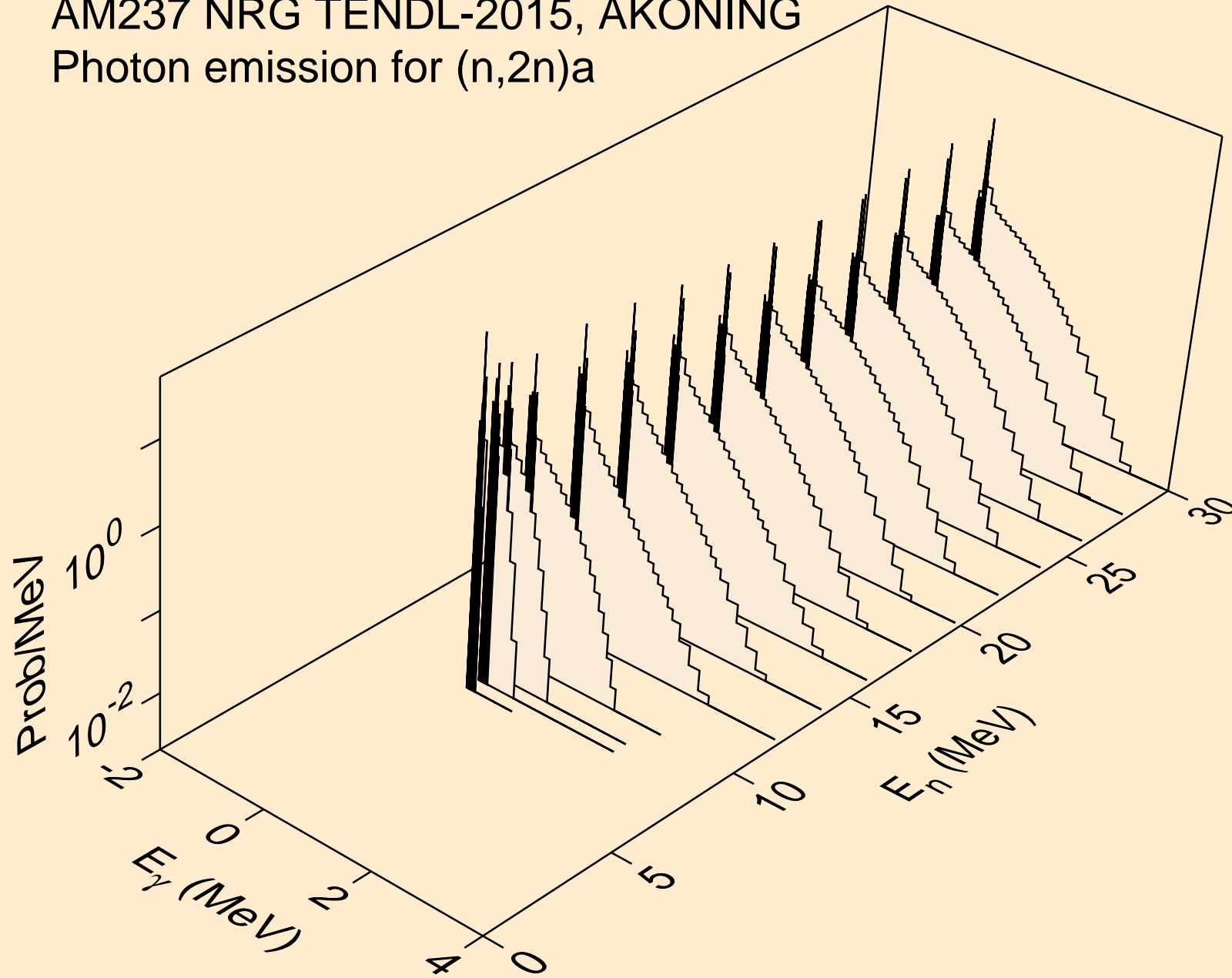

AM237 NRG TENDL-2015, AKONING
Photon emission for (n,3n)a

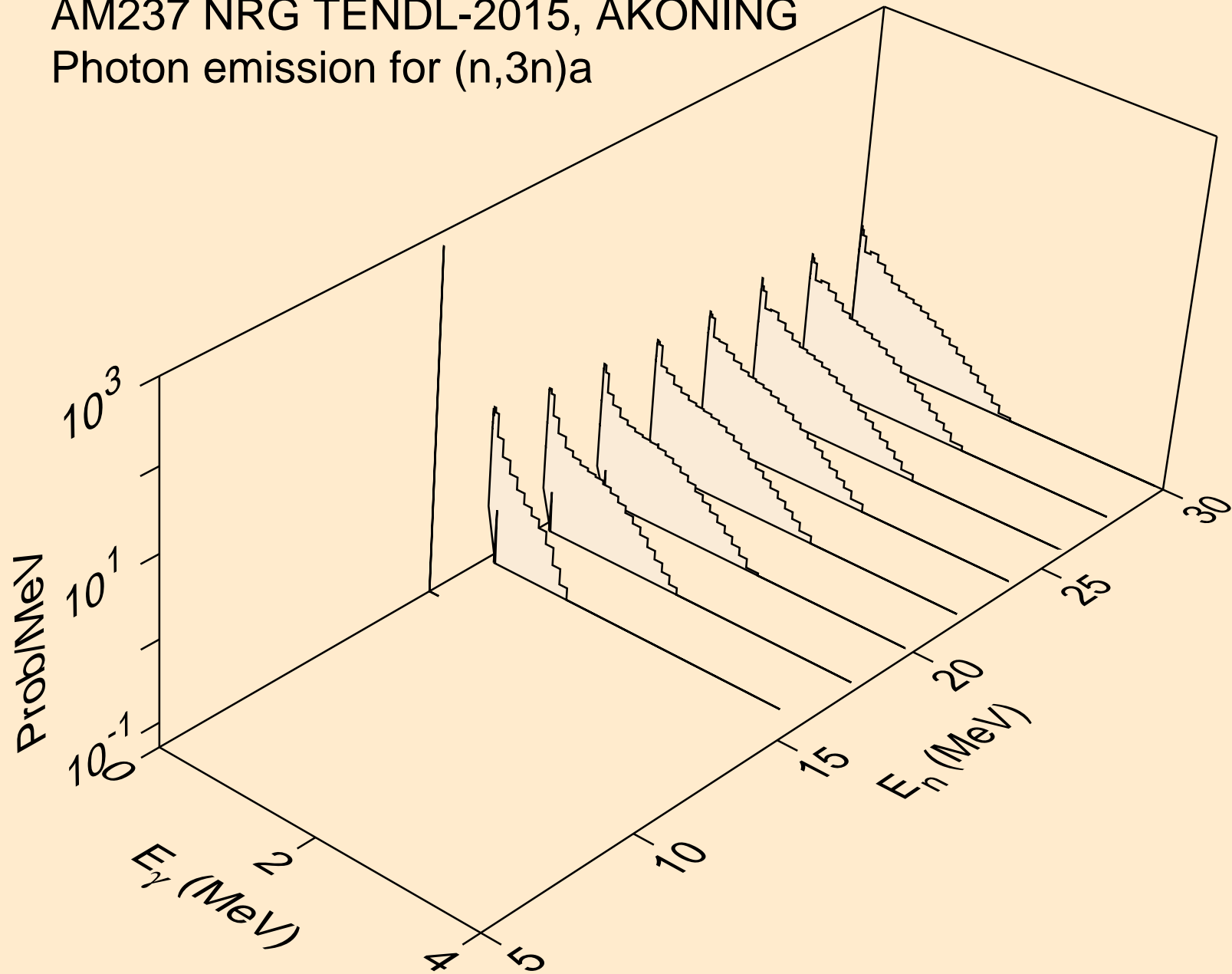

AM237 NRG TENDL-2015, AKONING
Photon emission for (n,n*)p

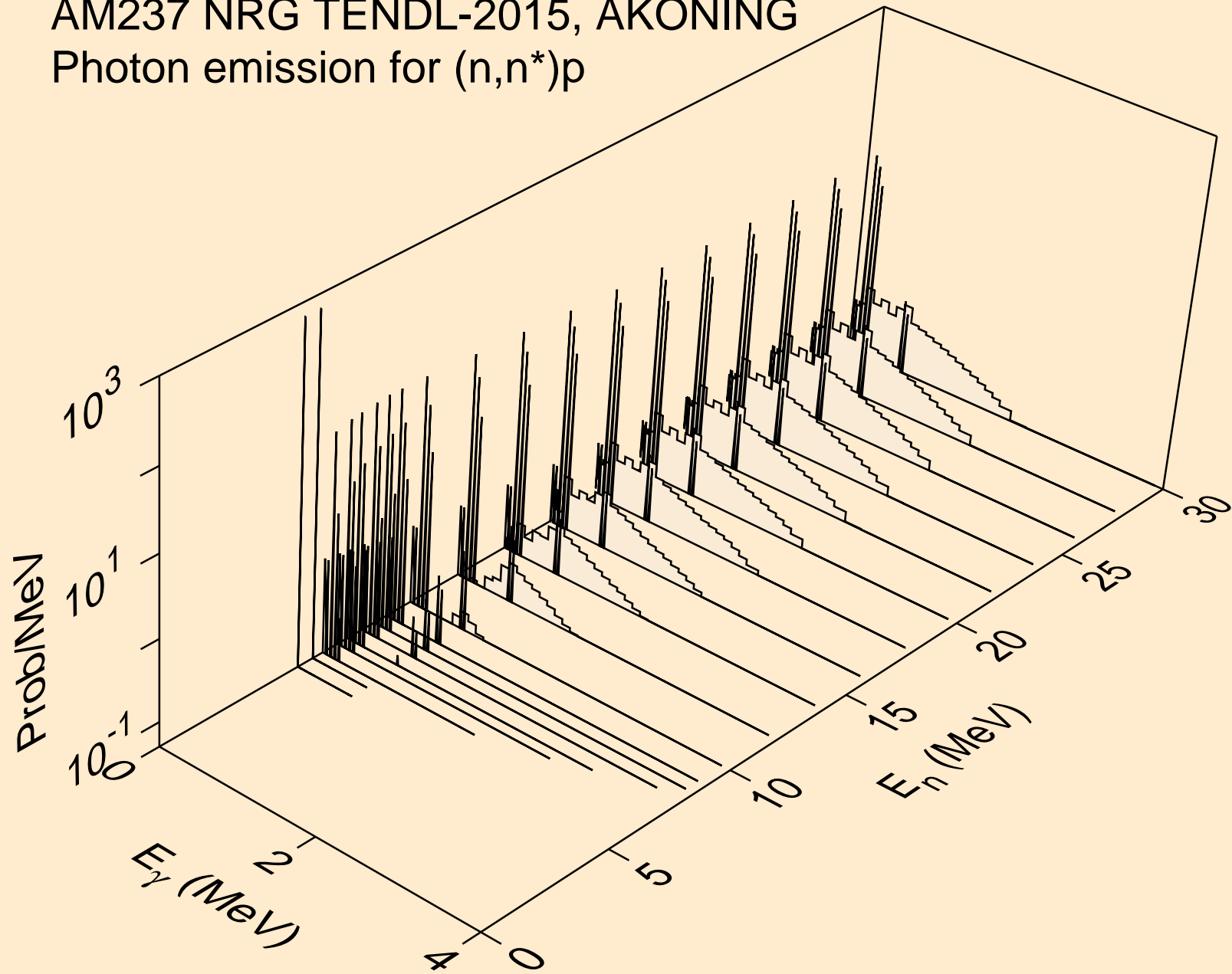

AM237 NRG TENDL-2015, AKONING
Photon emission for (n,n*)2a

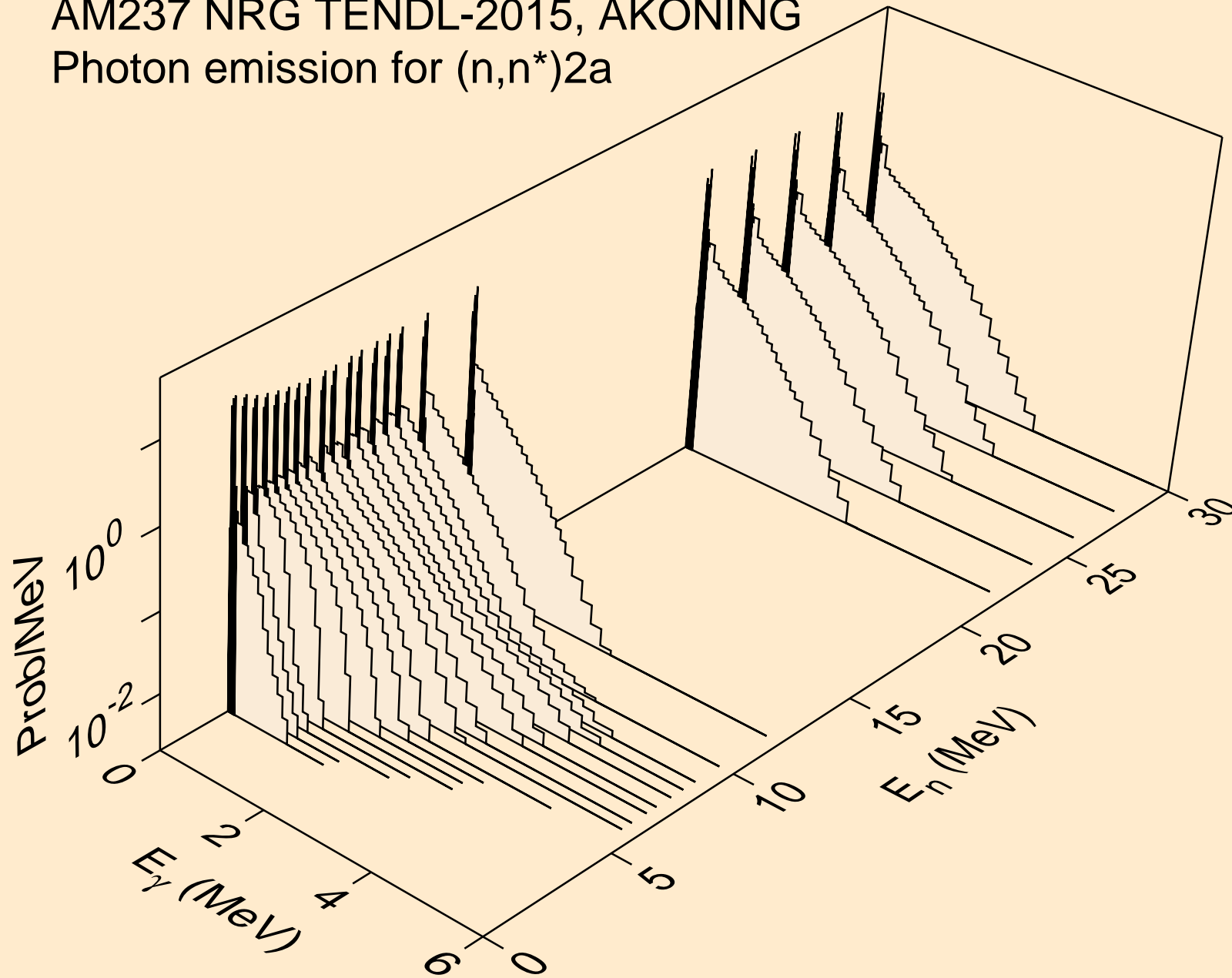

AM237 NRG TENDL-2015, AKONING
Photon emission for (n,2n)2a

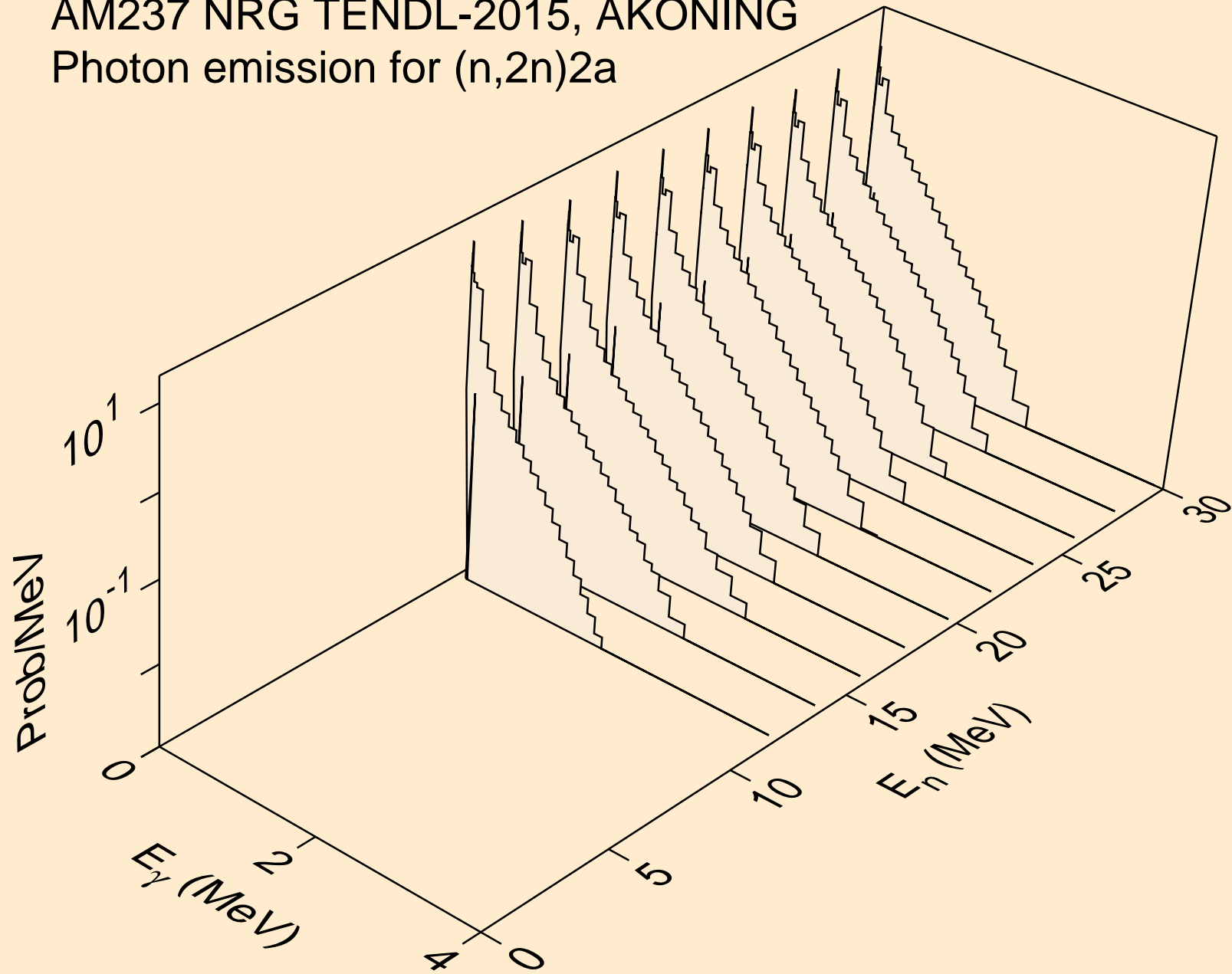

AM237 NRG TENDL-2015, AKONING
Photon emission for (n,n*)d

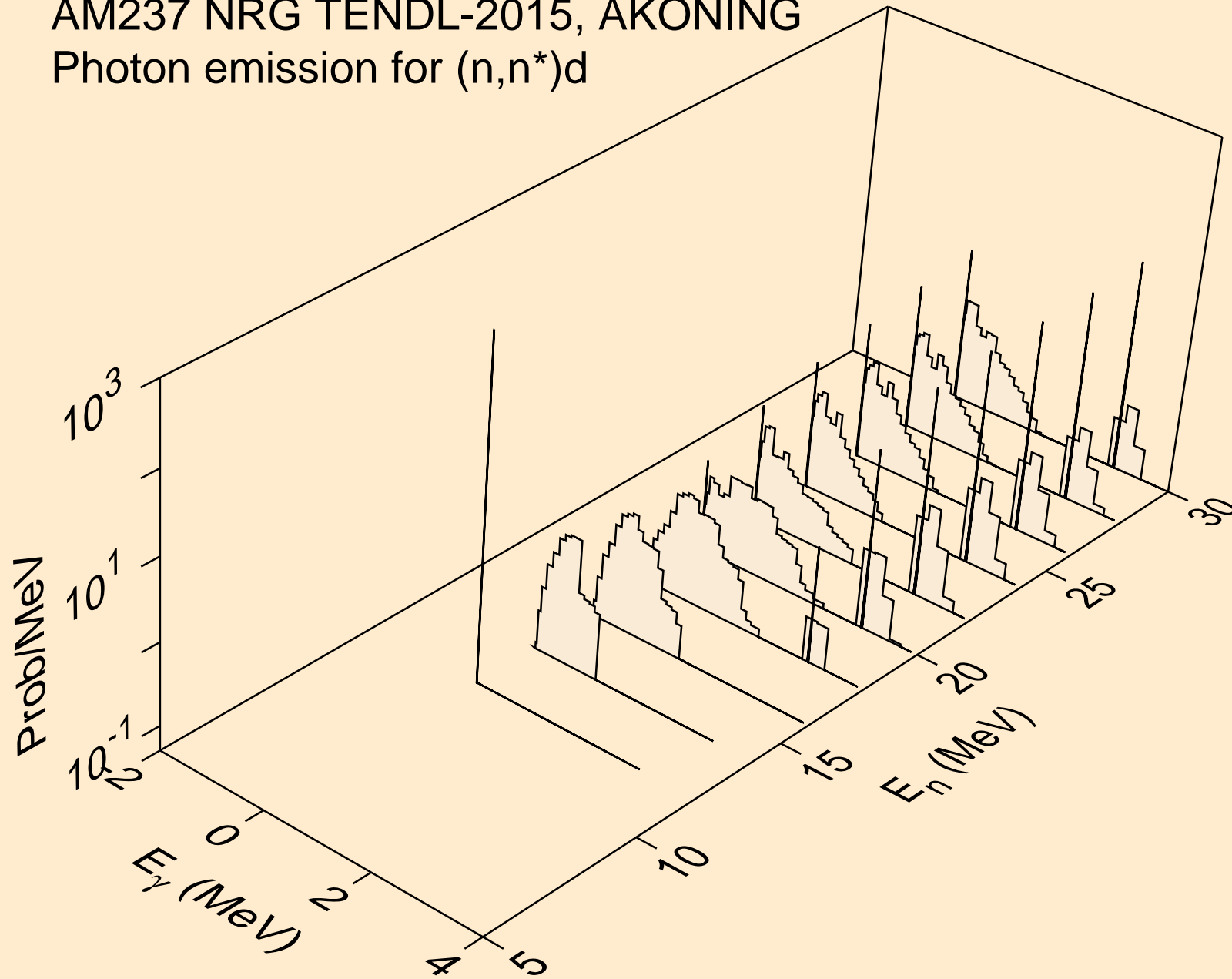

AM237 NRG TENDL-2015, AKONING
Photon emission for (n,n*)t

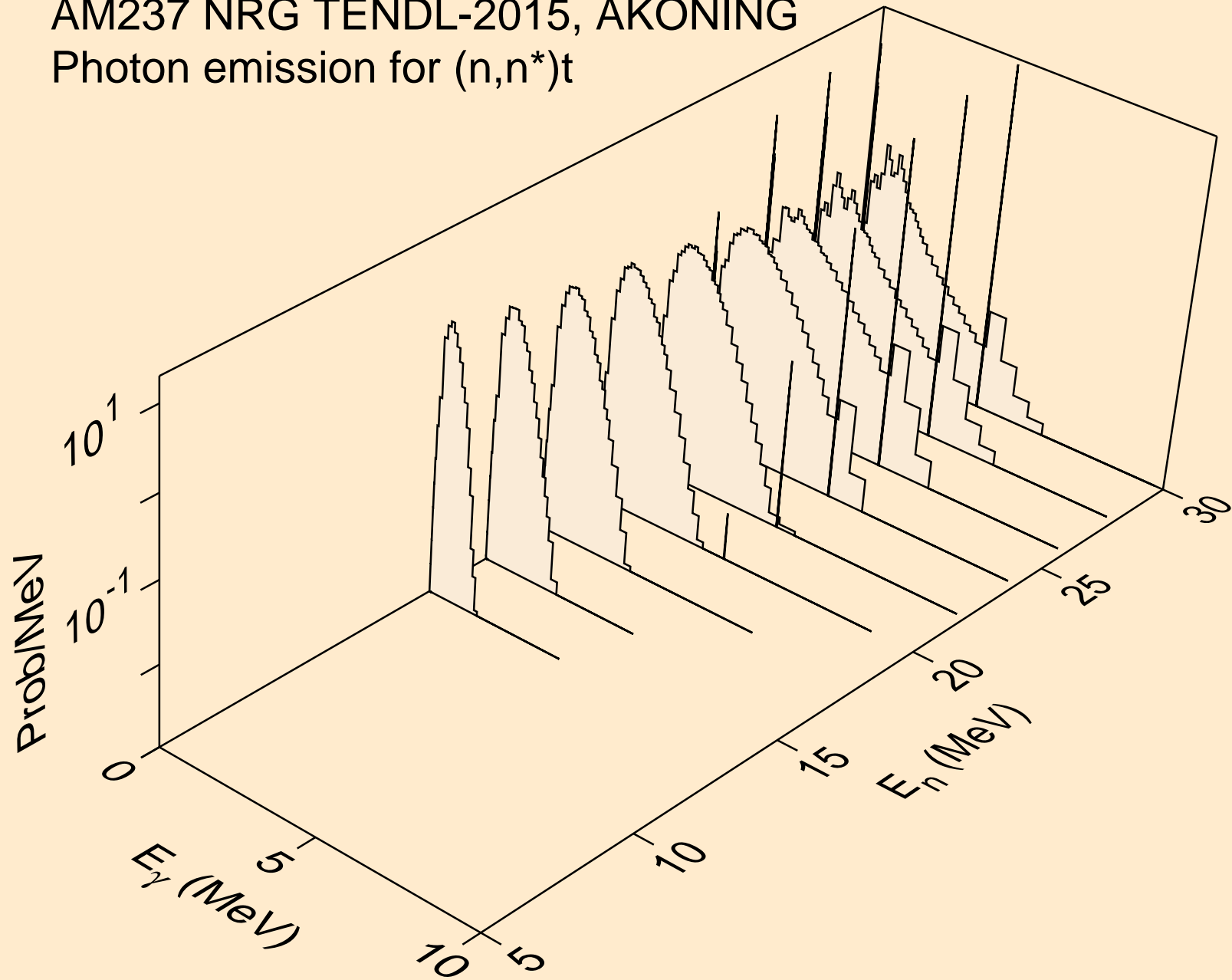

AM237 NRG TENDL-2015, AKONING
Photon emission for (n,n*)he3

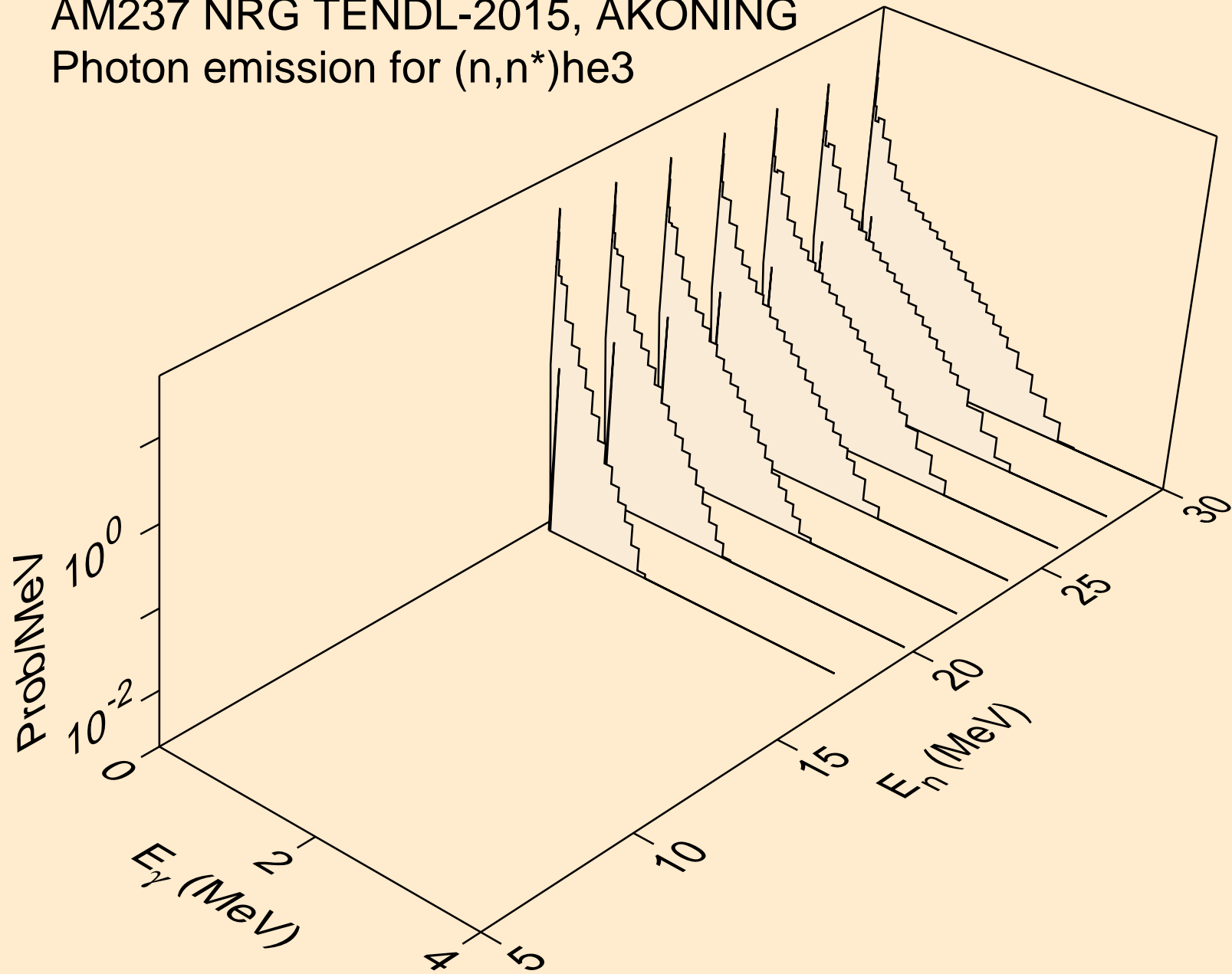

AM237 NRG TENDL-2015, AKONING
Photon emission for (n,4n)

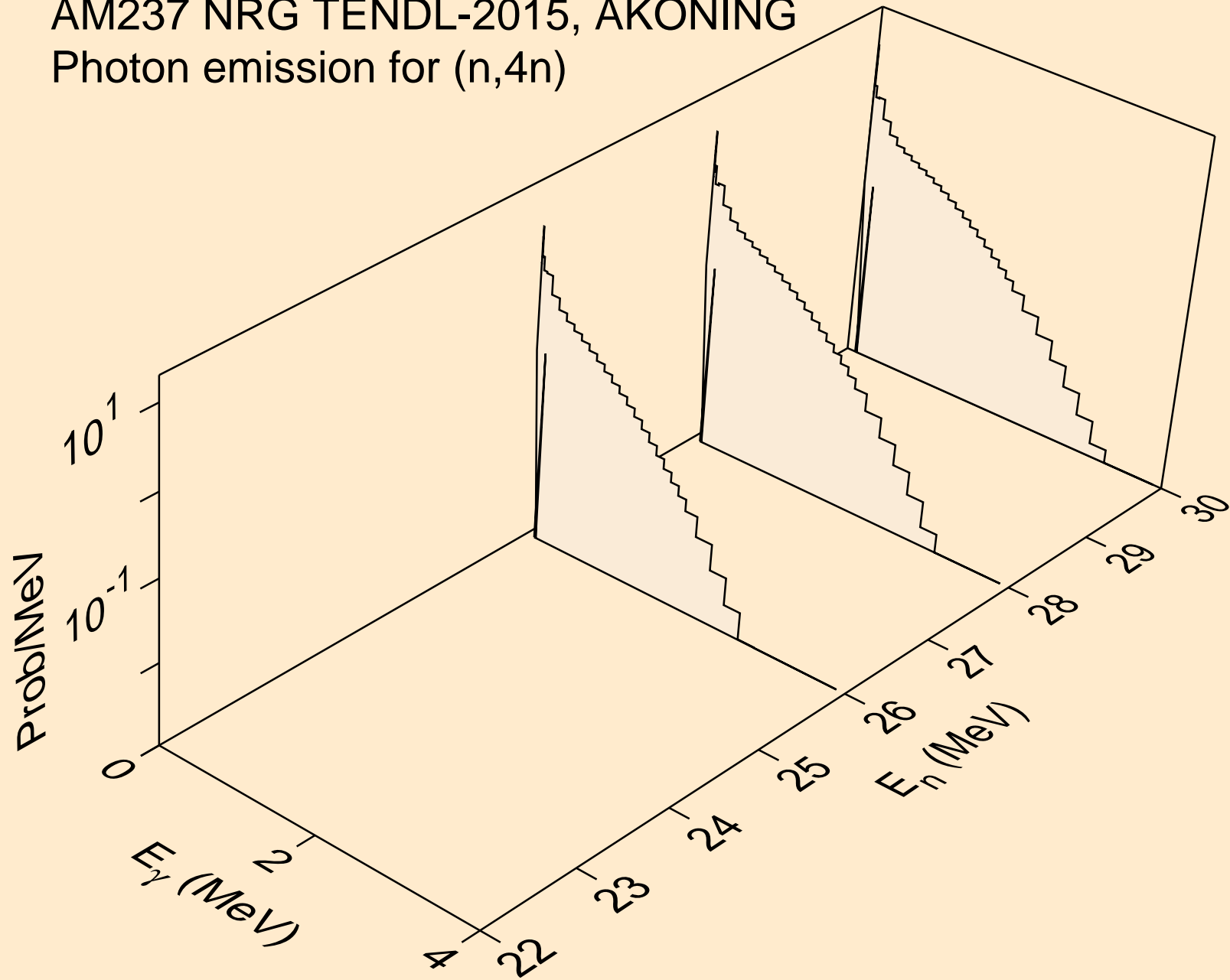

AM237 NRG TENDL-2015, AKONING
Photon emission for (n,2np)

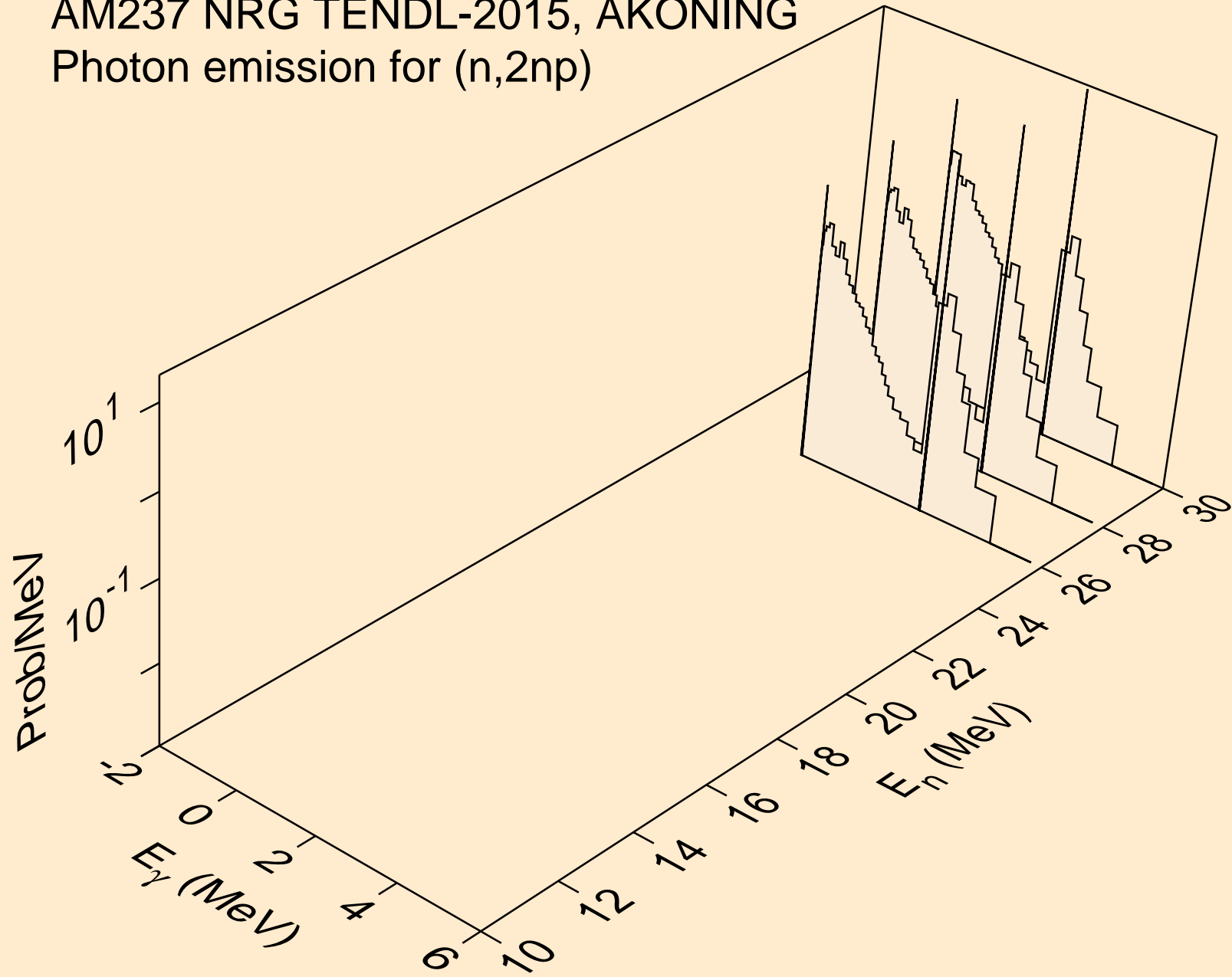

AM237 NRG TENDL-2015, AKONING
Photon emission for (n,3np)

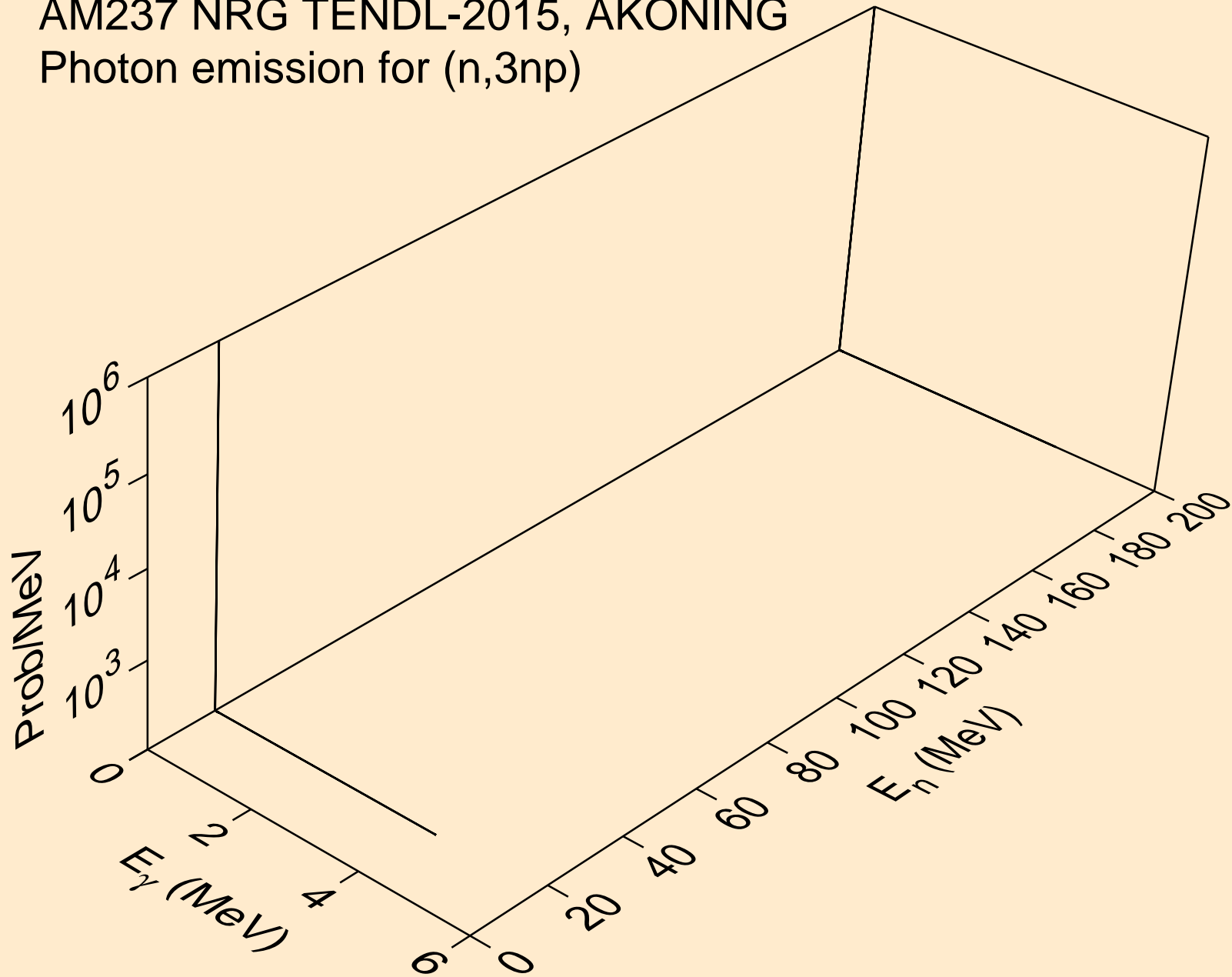

AM237 NRG TENDL-2015, AKONING
Photon emission for (n,2np)

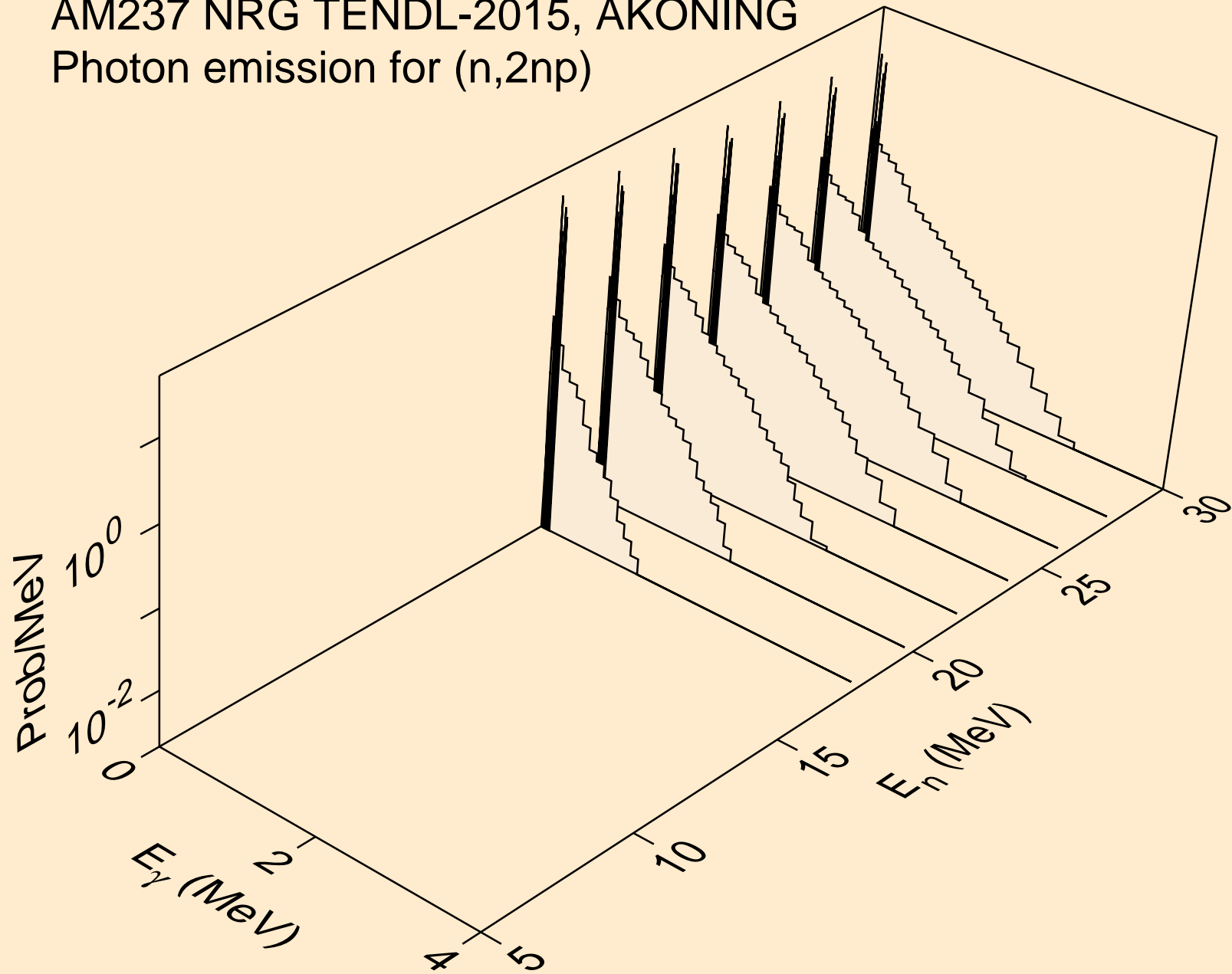

AM237 NRG TENDL-2015, AKONING
Photon emission for (n,npa)

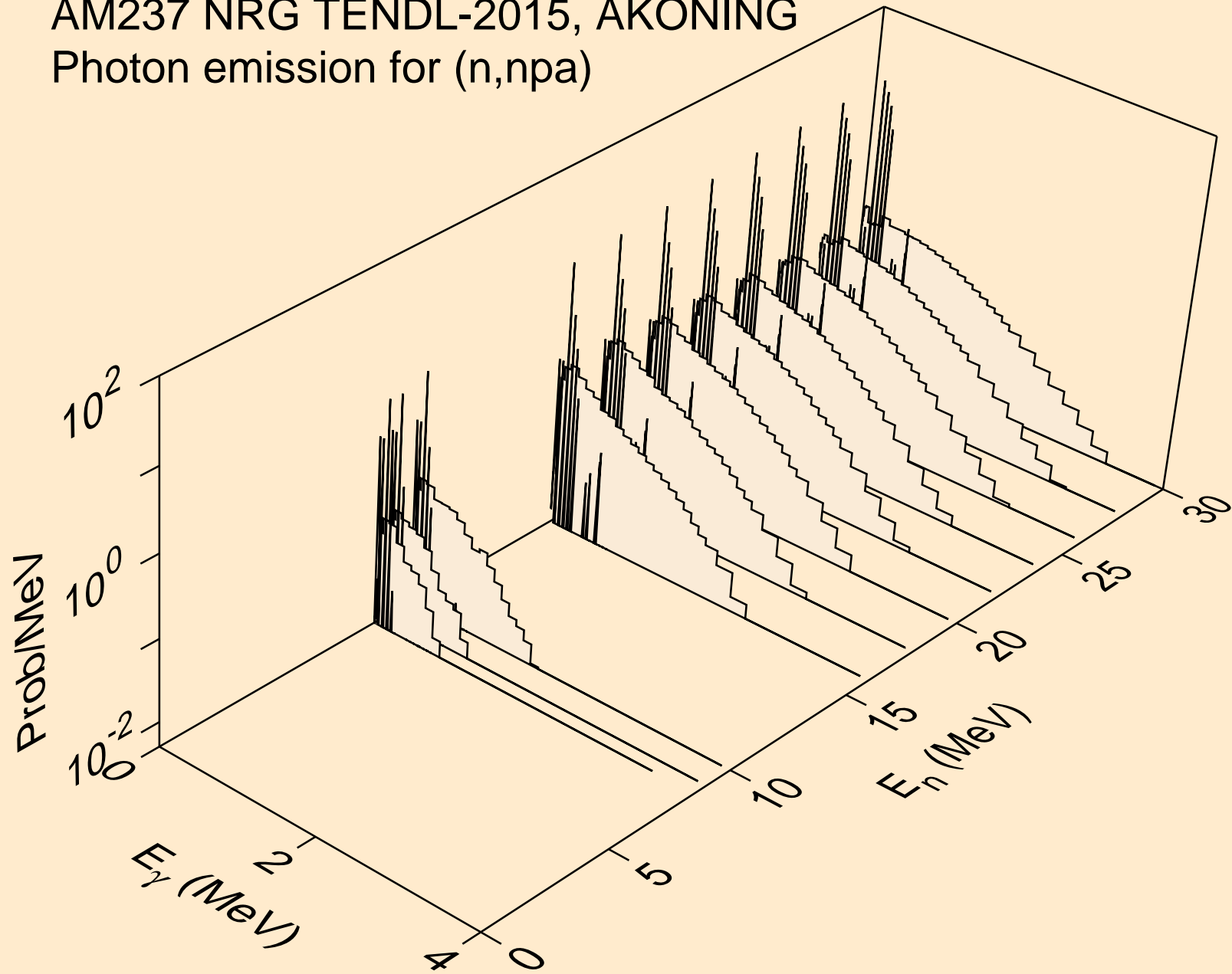

AM237 NRG TENDL-2015, AKONING
Photon emission for (n,n*c)

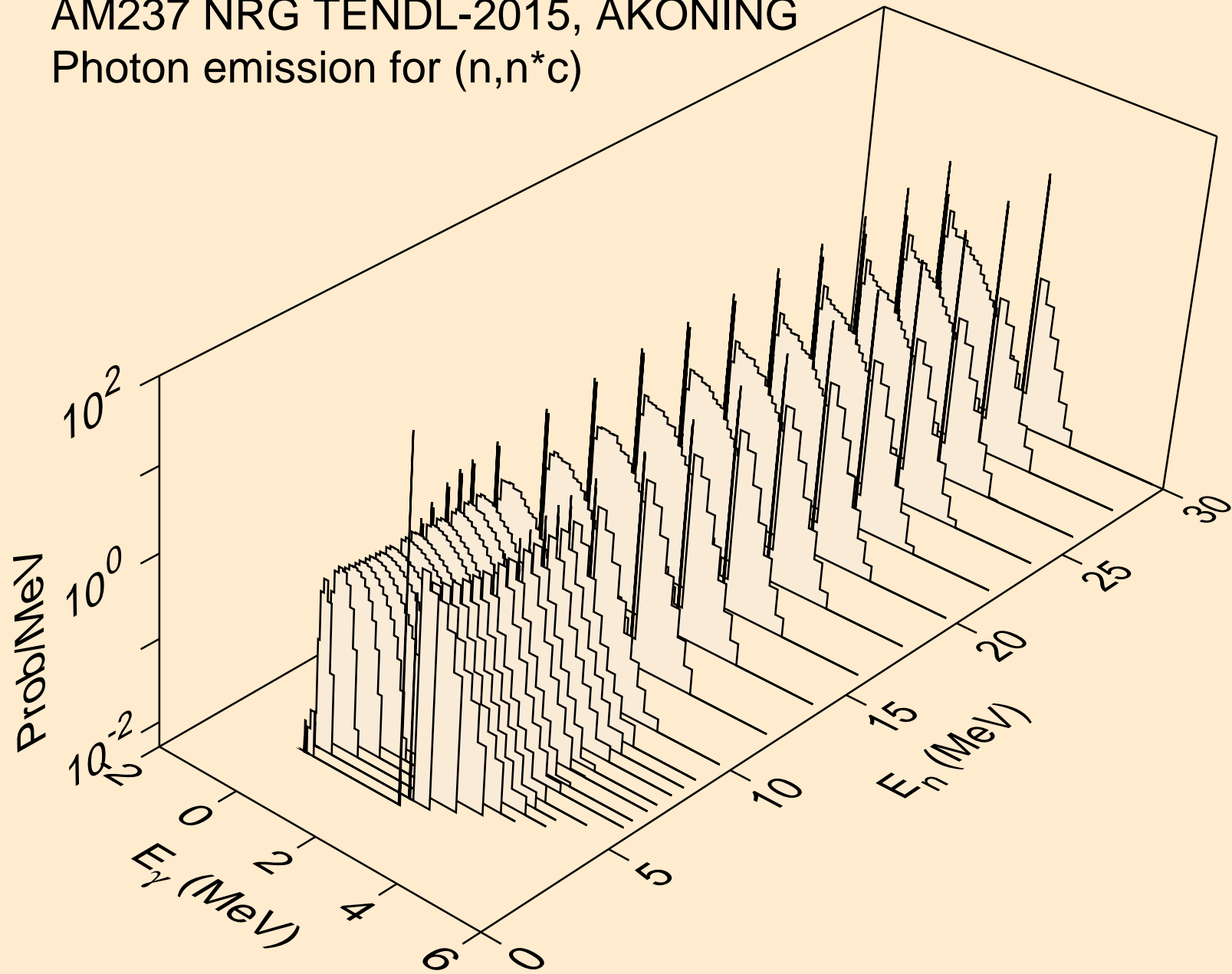

AM237 NRG TENDL-2015, AKONING
Photon emission for (n,gma)

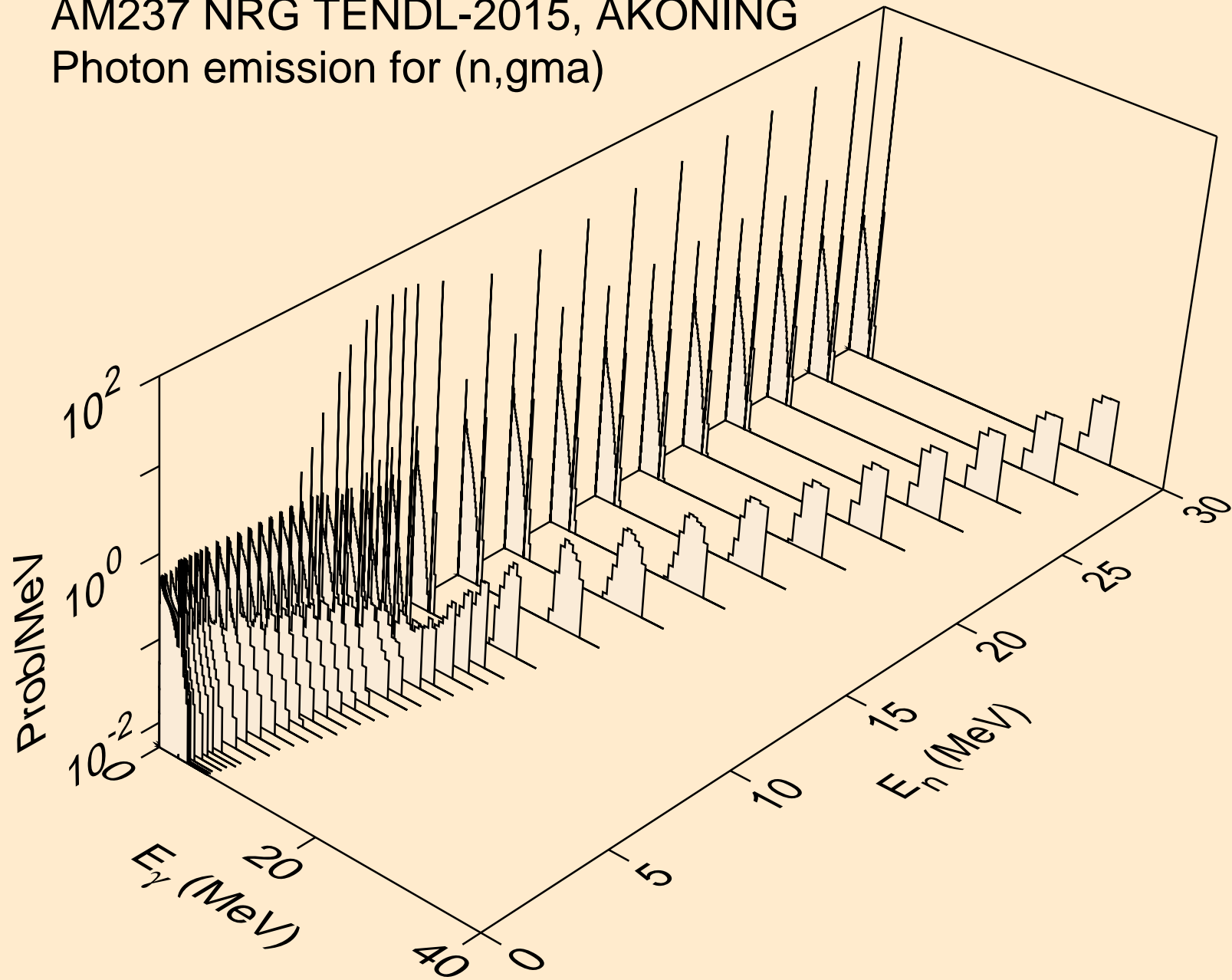

AM237 NRG TENDL-2015, AKONING
Photon emission for (n,p)

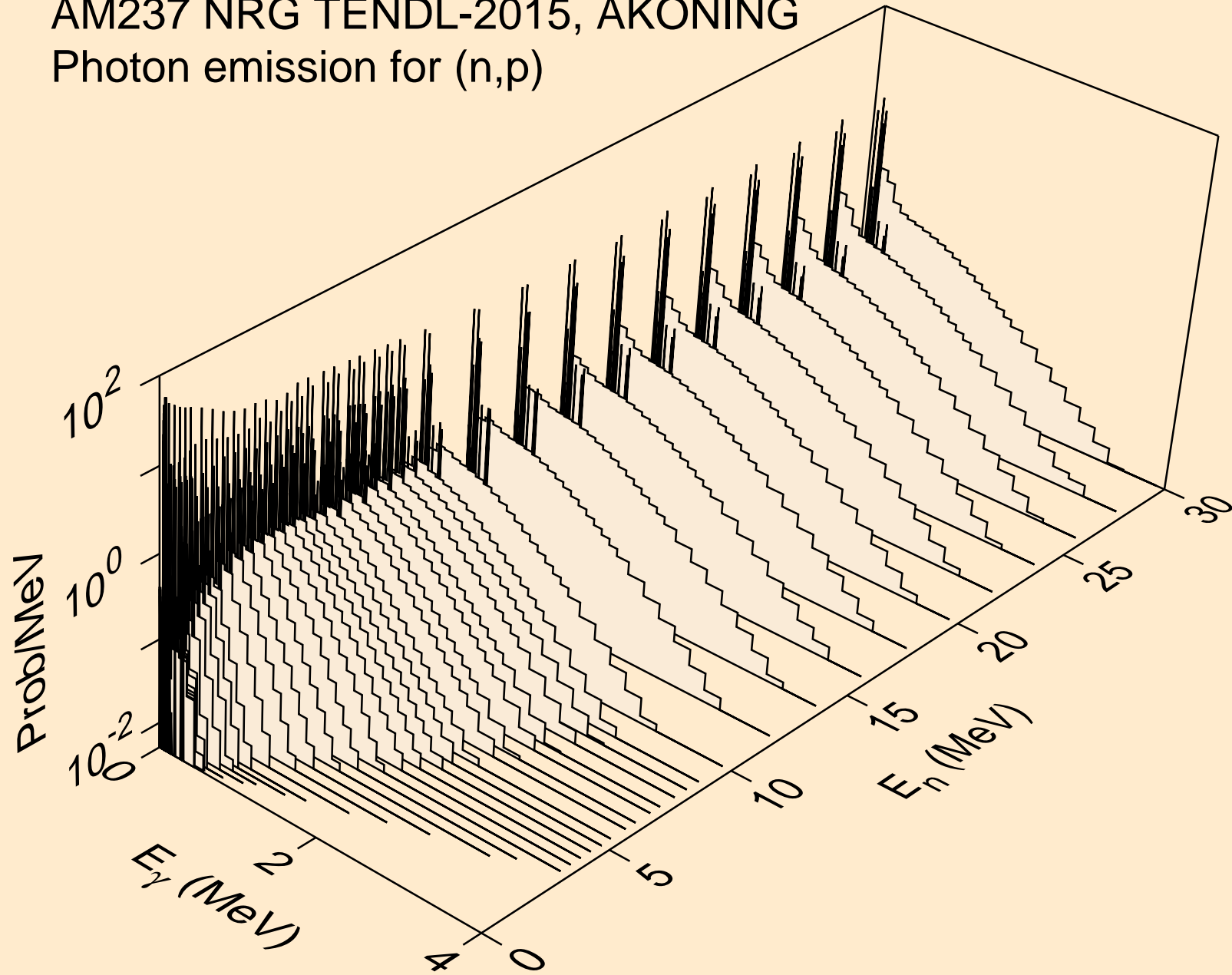

AM237 NRG TENDL-2015, AKONING
Photon emission for (n,d)

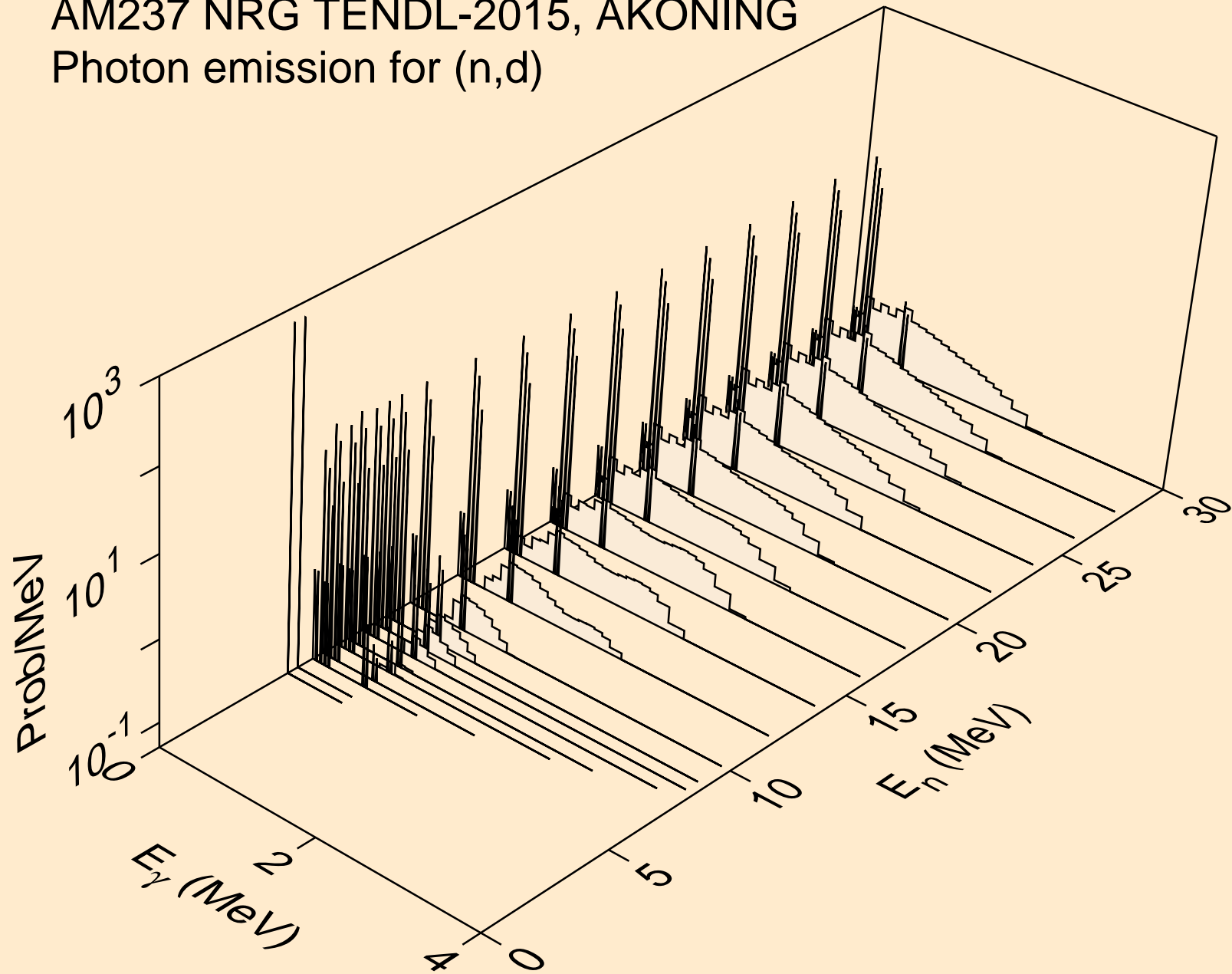

AM237 NRG TENDL-2015, AKONING
Photon emission for (n,t)

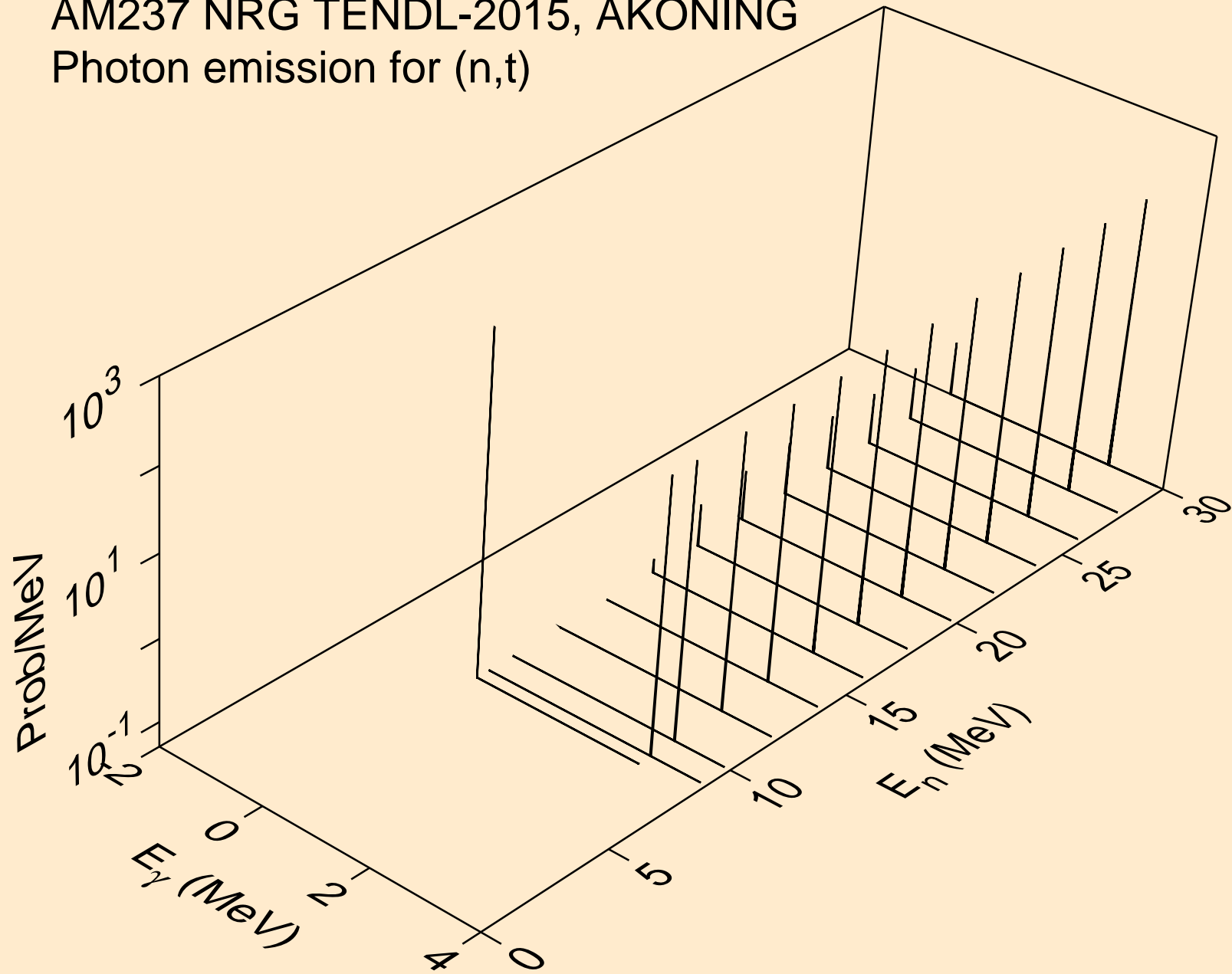

AM237 NRG TENDL-2015, AKONING
Photon emission for (n,he3)

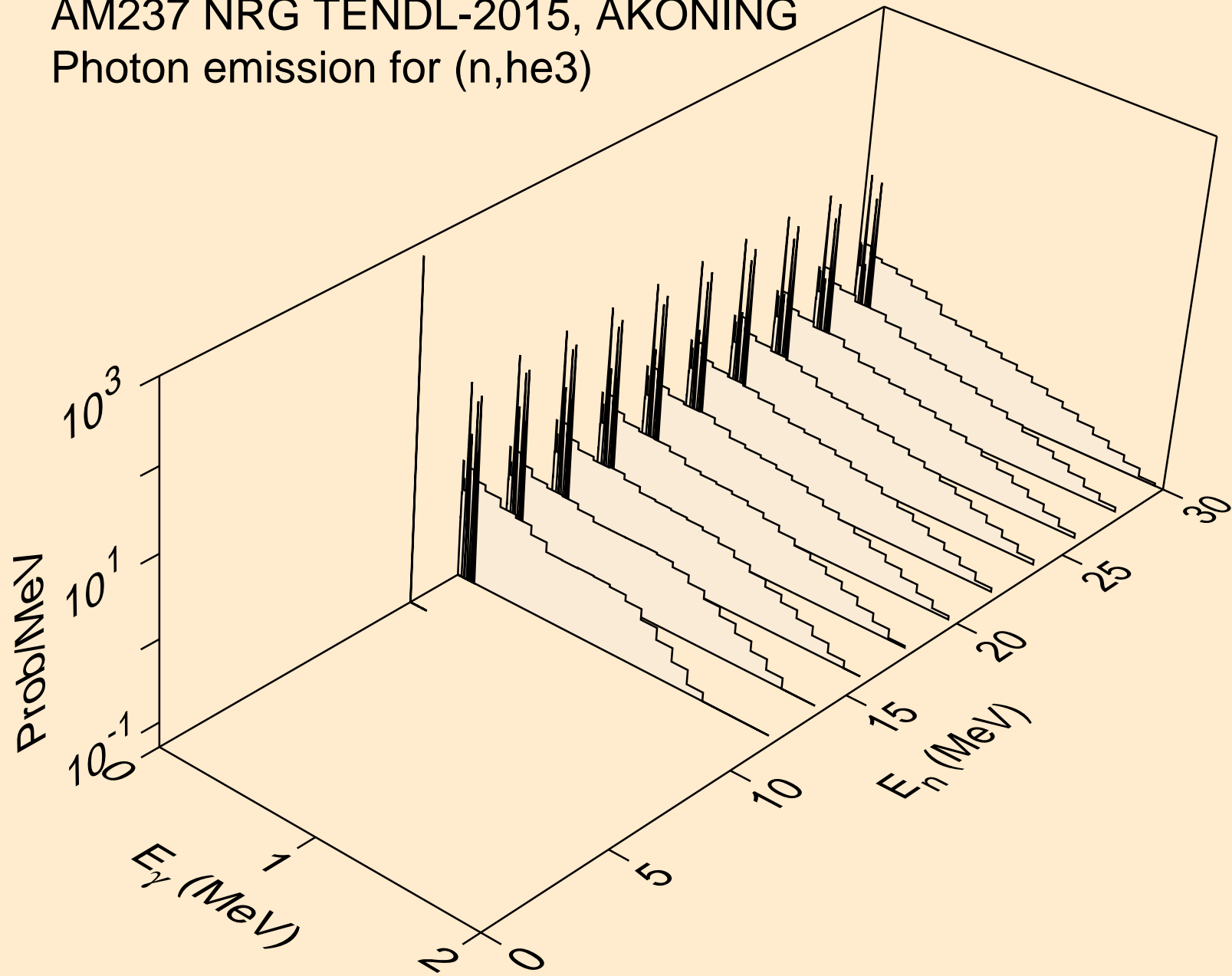

AM237 NRG TENDL-2015, AKONING
Photon emission for (n,a)

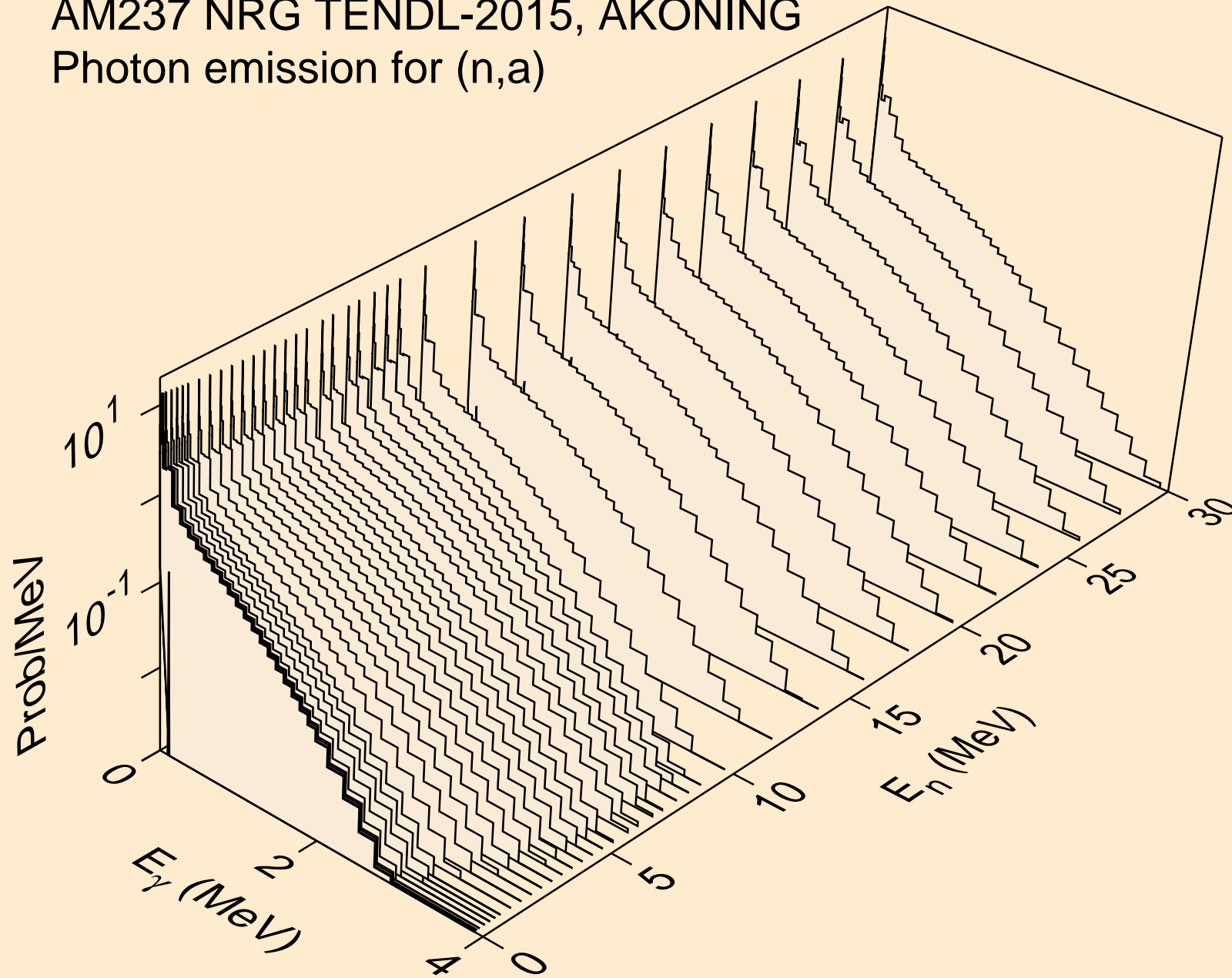

AM237 NRG TENDL-2015, AKONING
Photon emission for (n,2a)

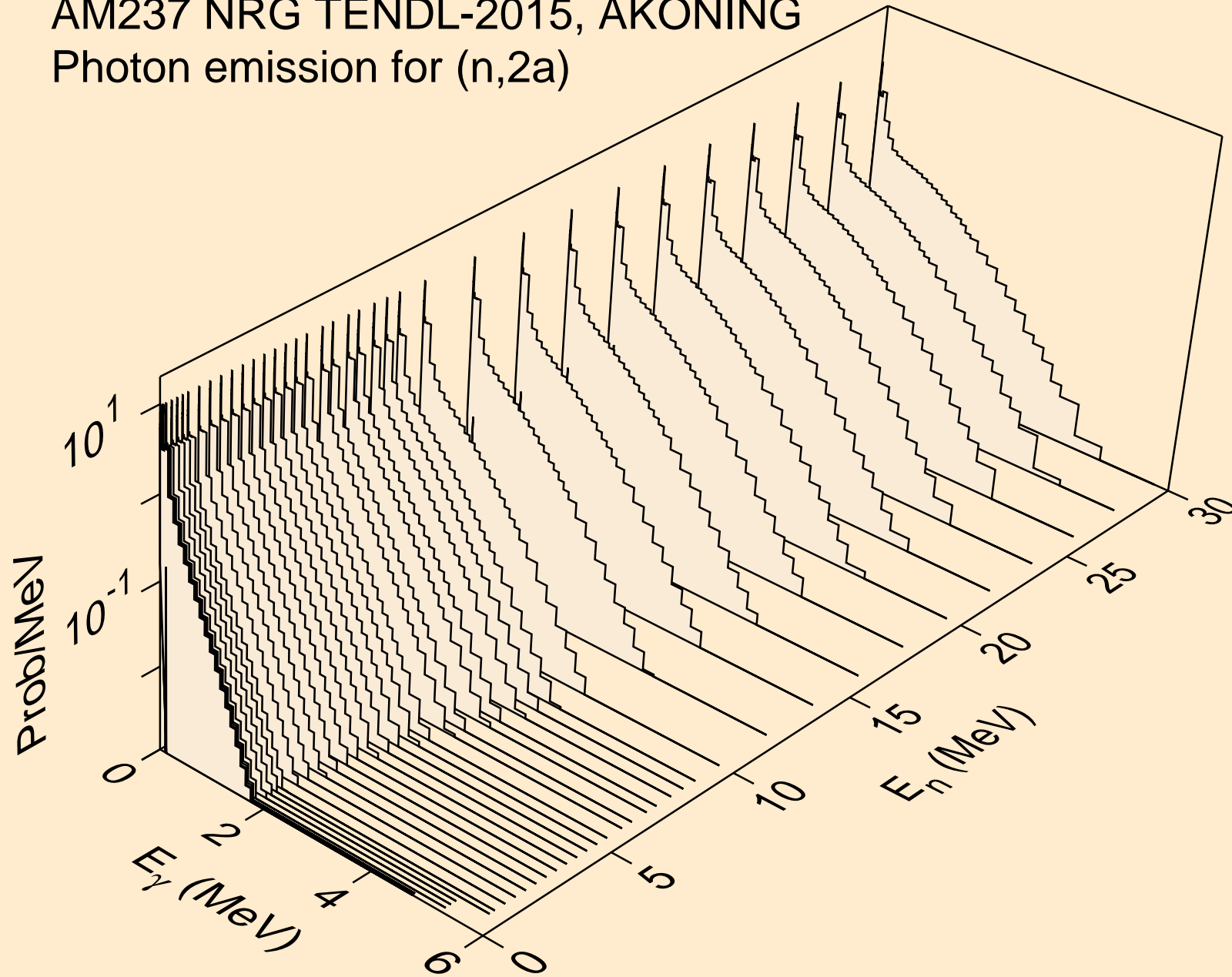

AM237 NRG TENDL-2015, AKONING
Photon emission for (n,2p)

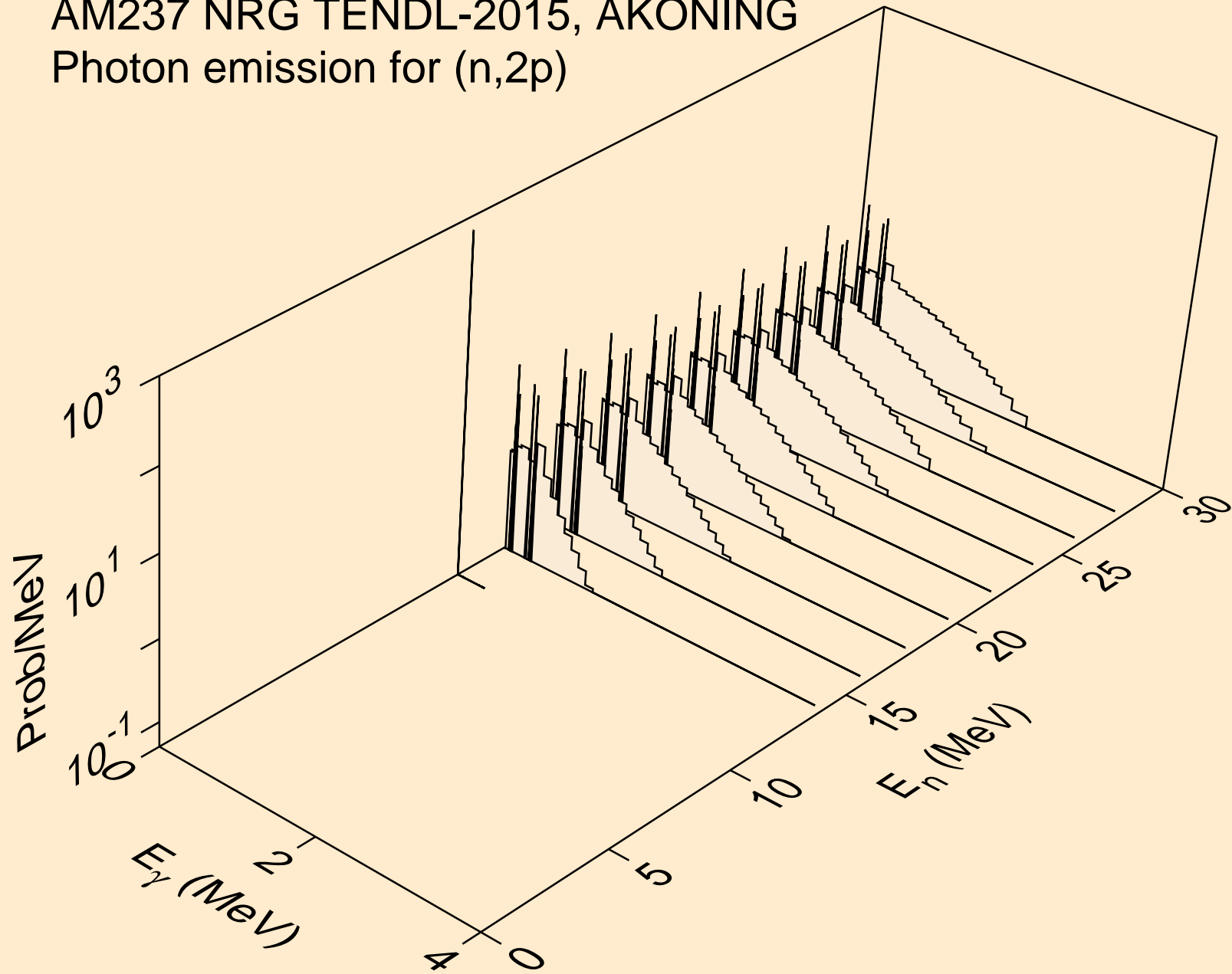

AM237 NRG TENDL-2015, AKONING
Photon emission for (n,pa)

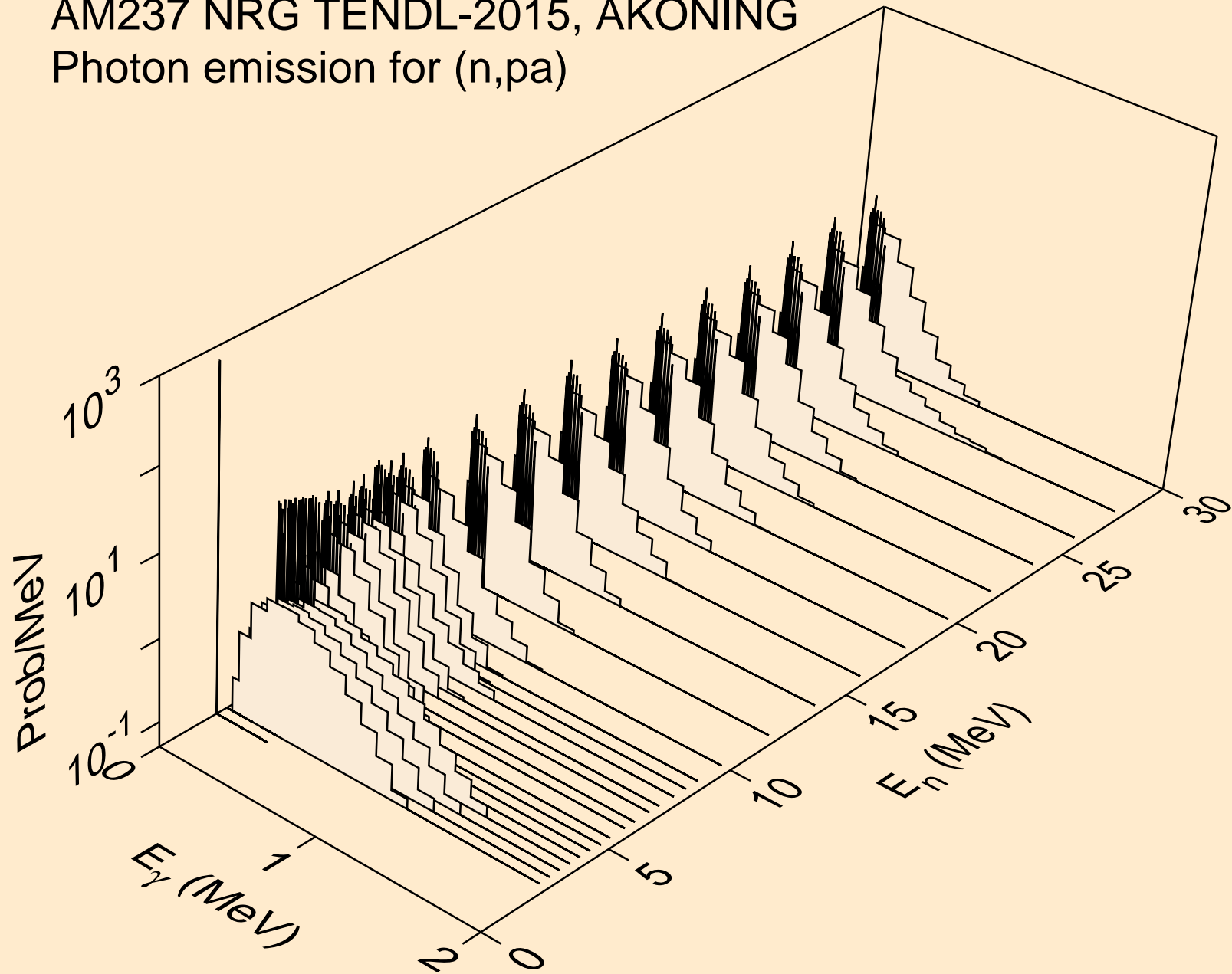

AM237 NRG TENDL-2015, AKONING
Photon emission for (n,pd)

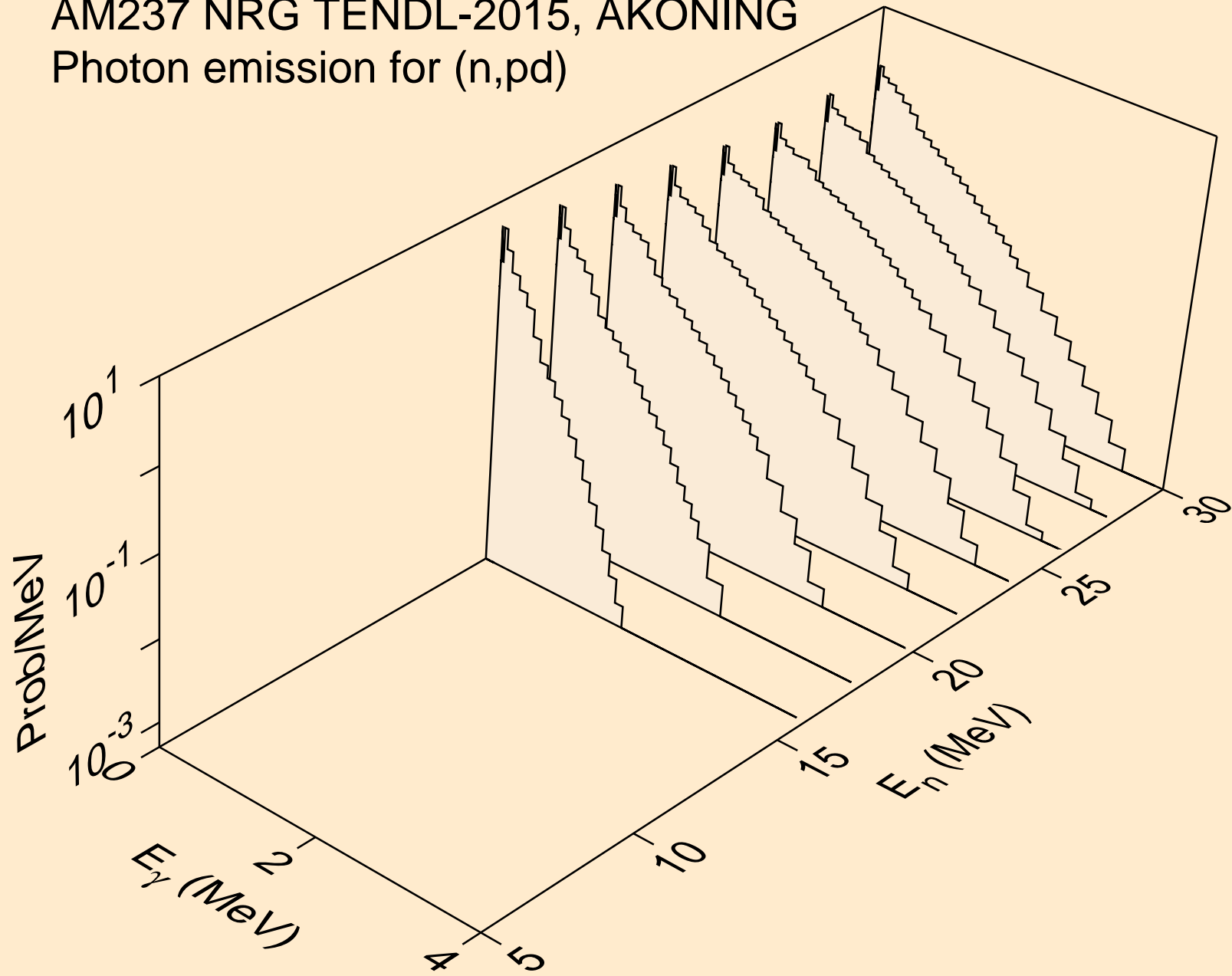

AM237 NRG TENDL-2015, AKONING
Photon emission for (n,pt)

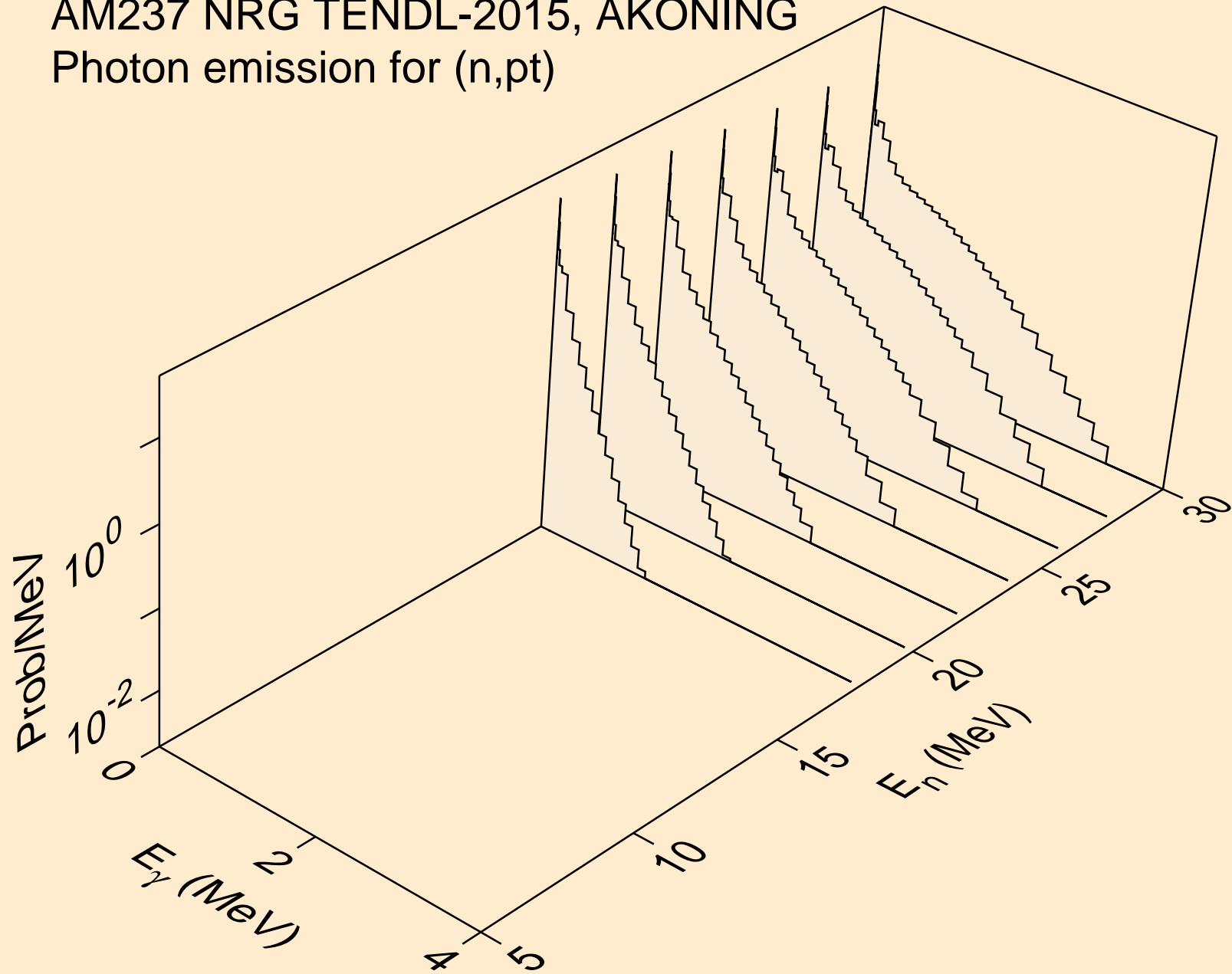

AM237 NRG TENDL-2015, AKONING
Photon emission for (n,da)

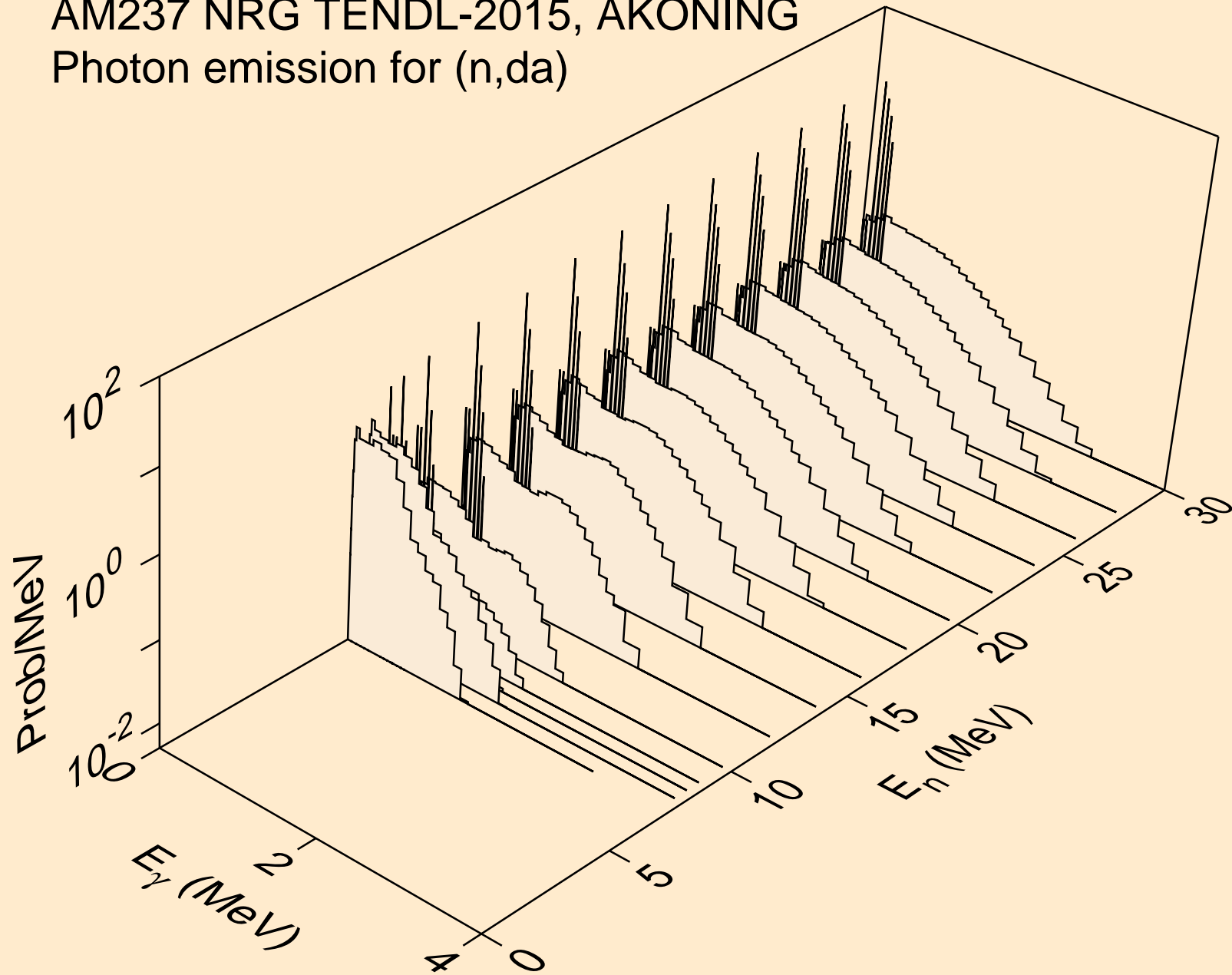

AM237 NRG TENDL-2015, AKONING
thermal capture photon spectrum

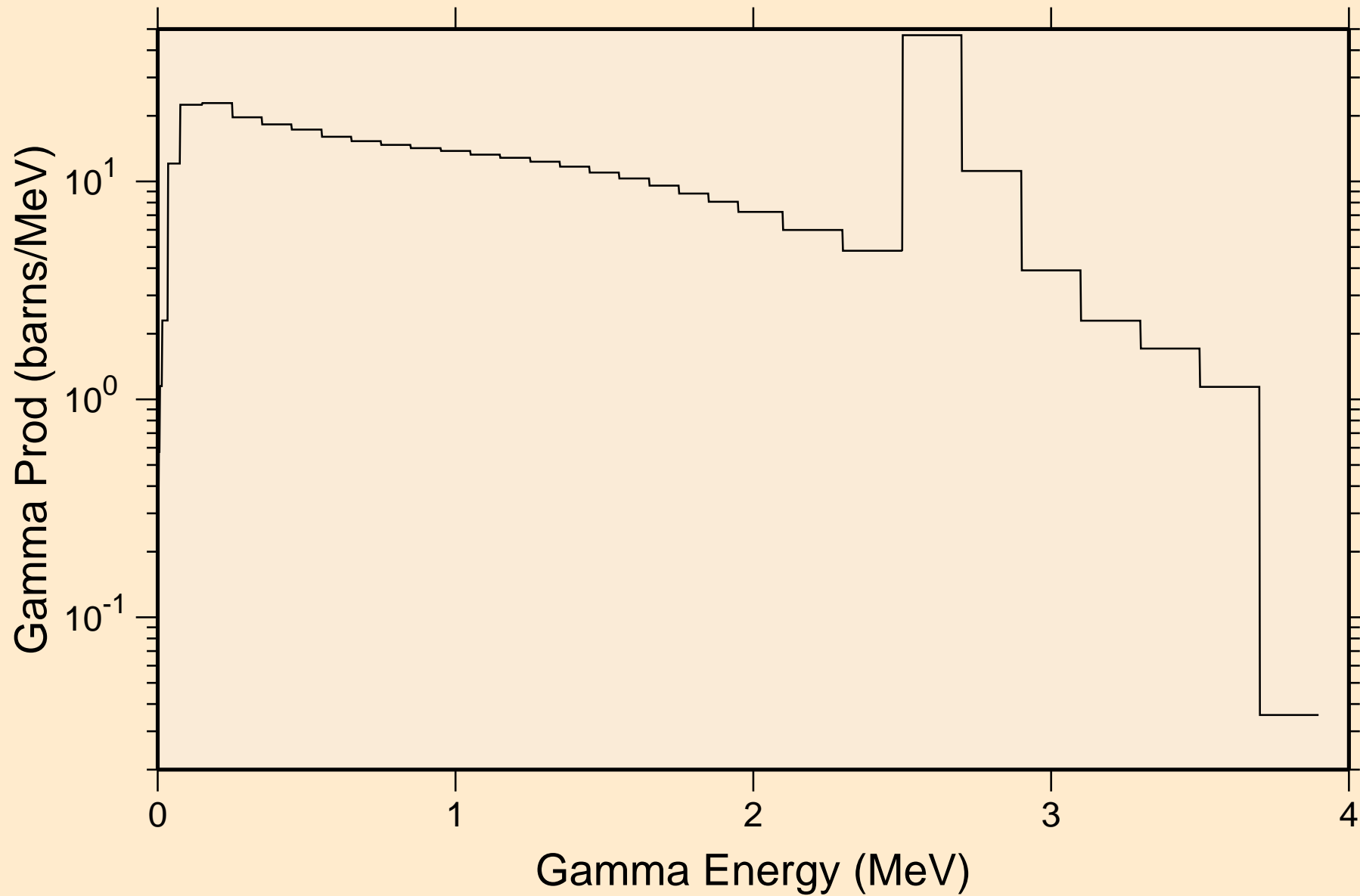

AM237 NRG TENDL-2015, AKONING
14 MeV photon spectrum

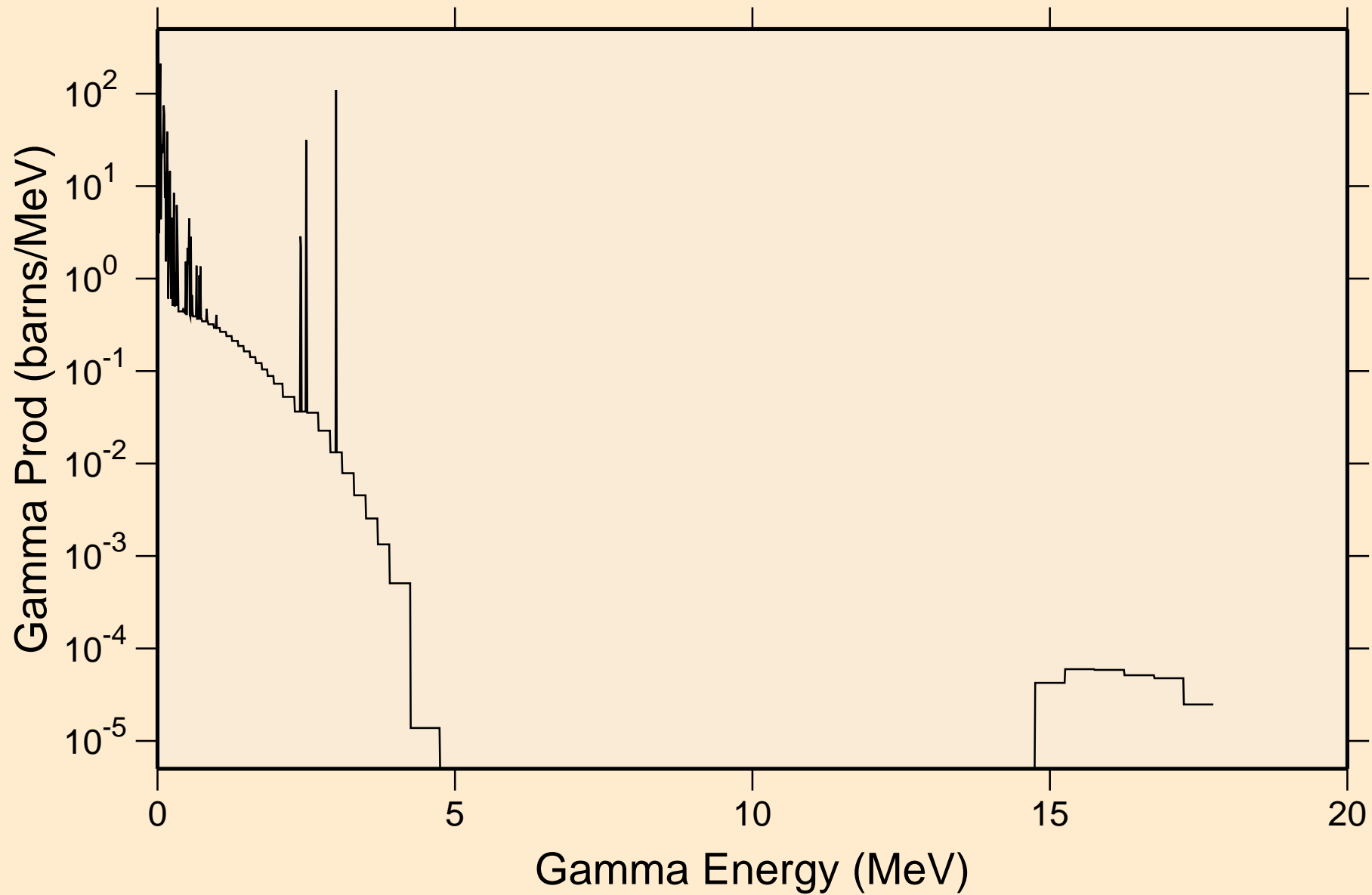

AM237 NRG TENDL-2015, AKONING

Particle heating contributions

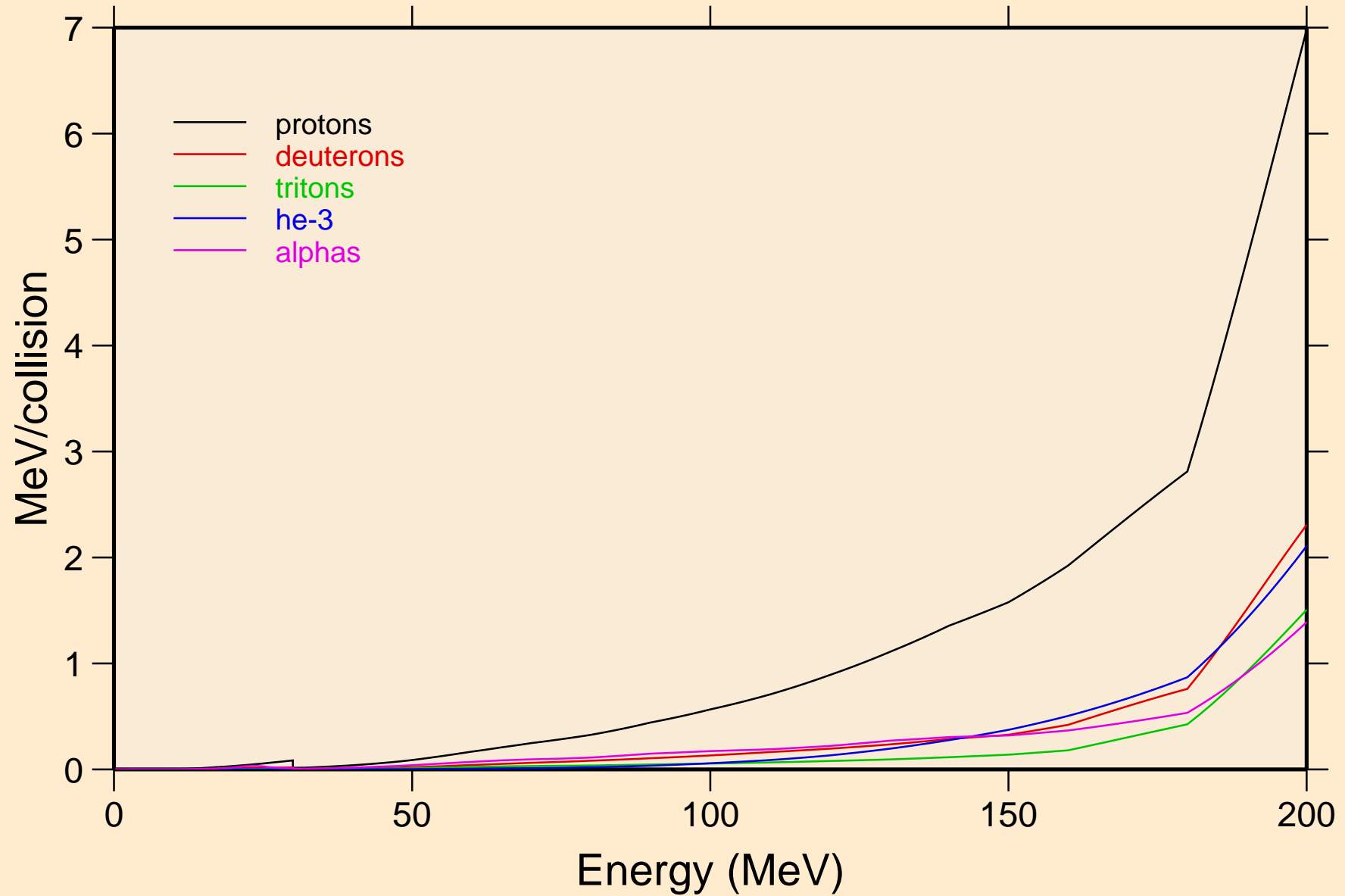

AM237 NRG TENDL-2015, AKONING

Recoil Heating

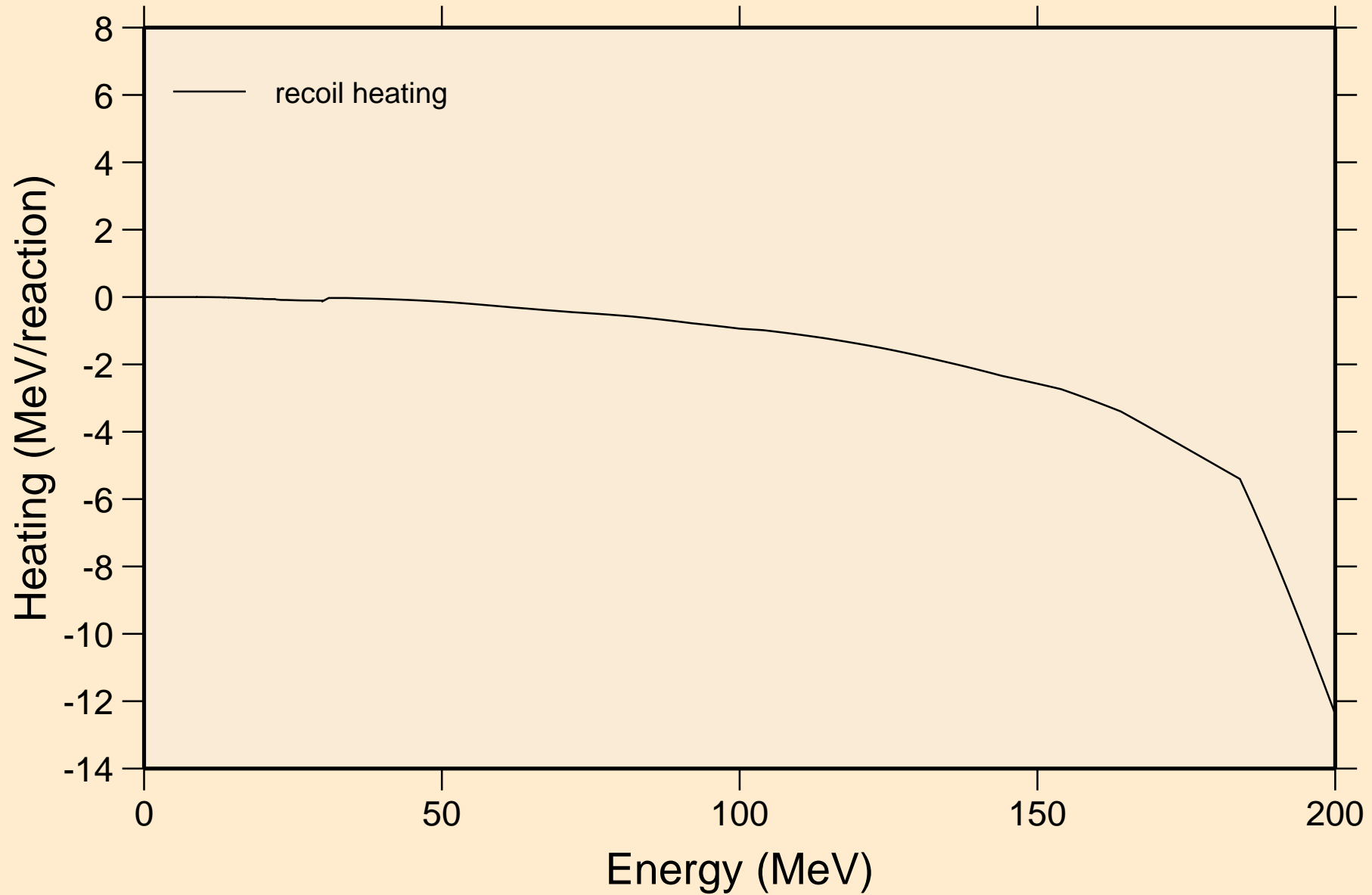

AM237 NRG TENDL-2015, AKONING

Particle production cross sections

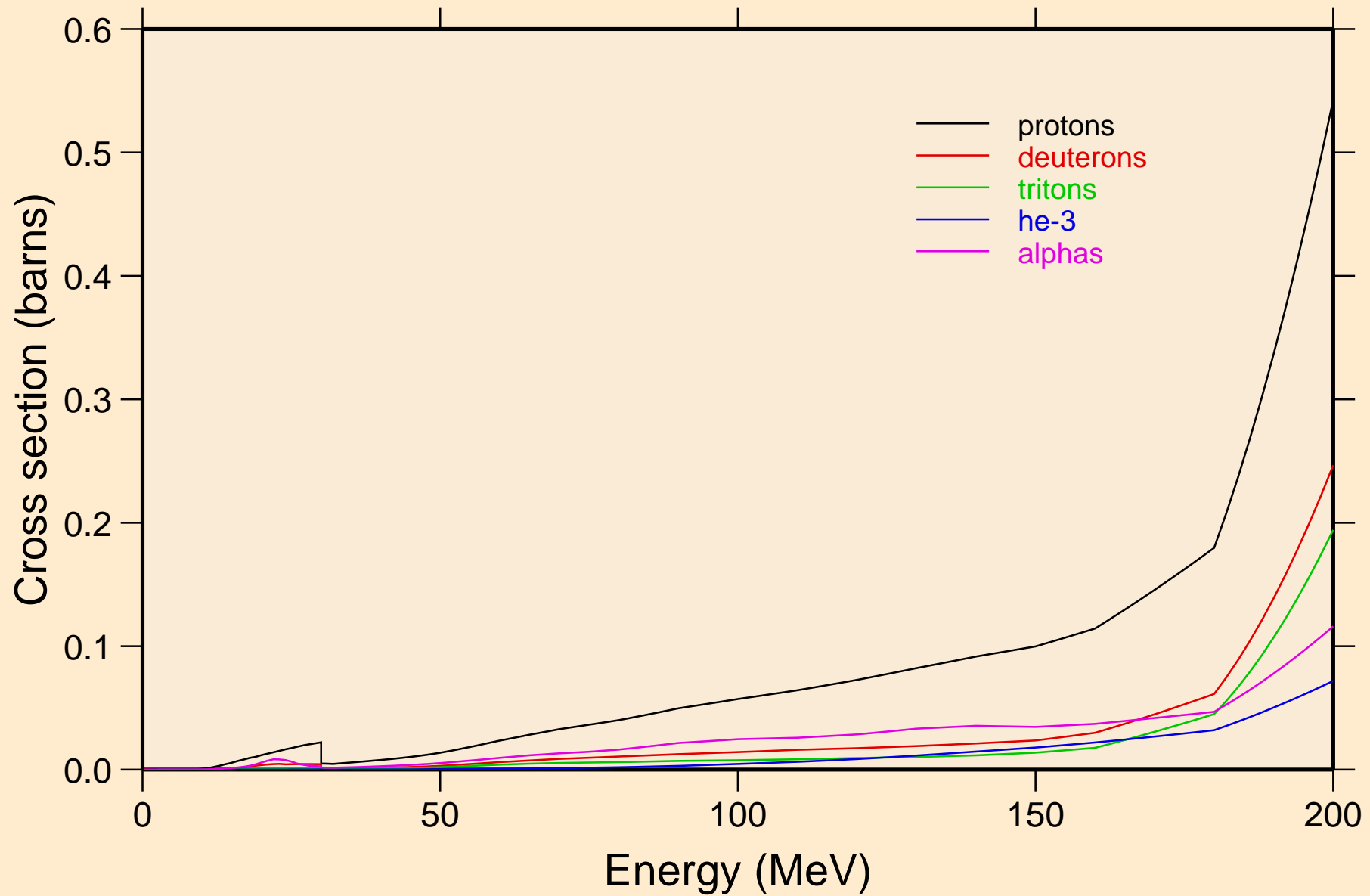

AM237 NRG TENDL-2015, AKONING
protons from (n,x)

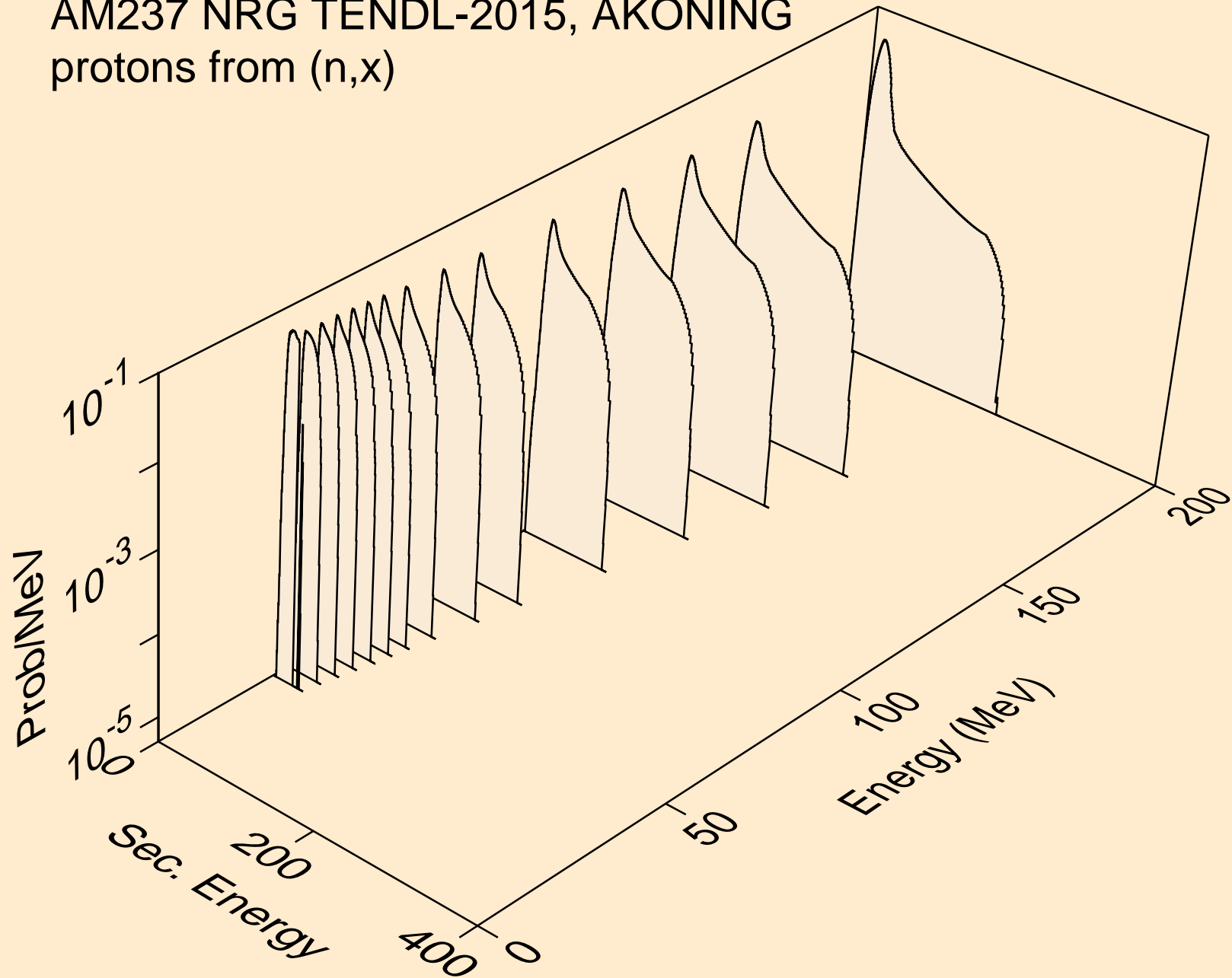

AM237 NRG TENDL-2015, AKONING
protons from (n,n*)p

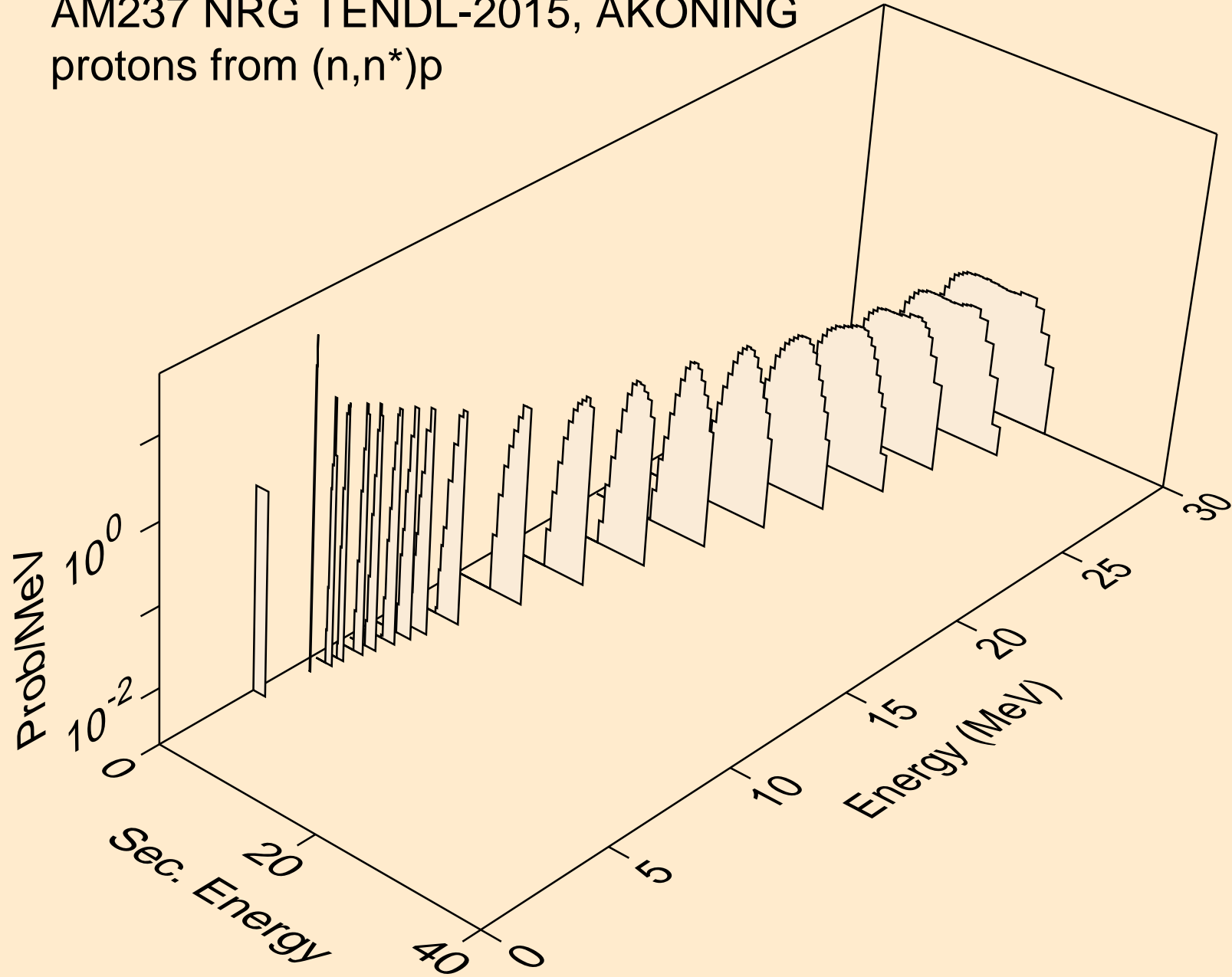

AM237 NRG TENDL-2015, AKONING
protons from (n,2np)

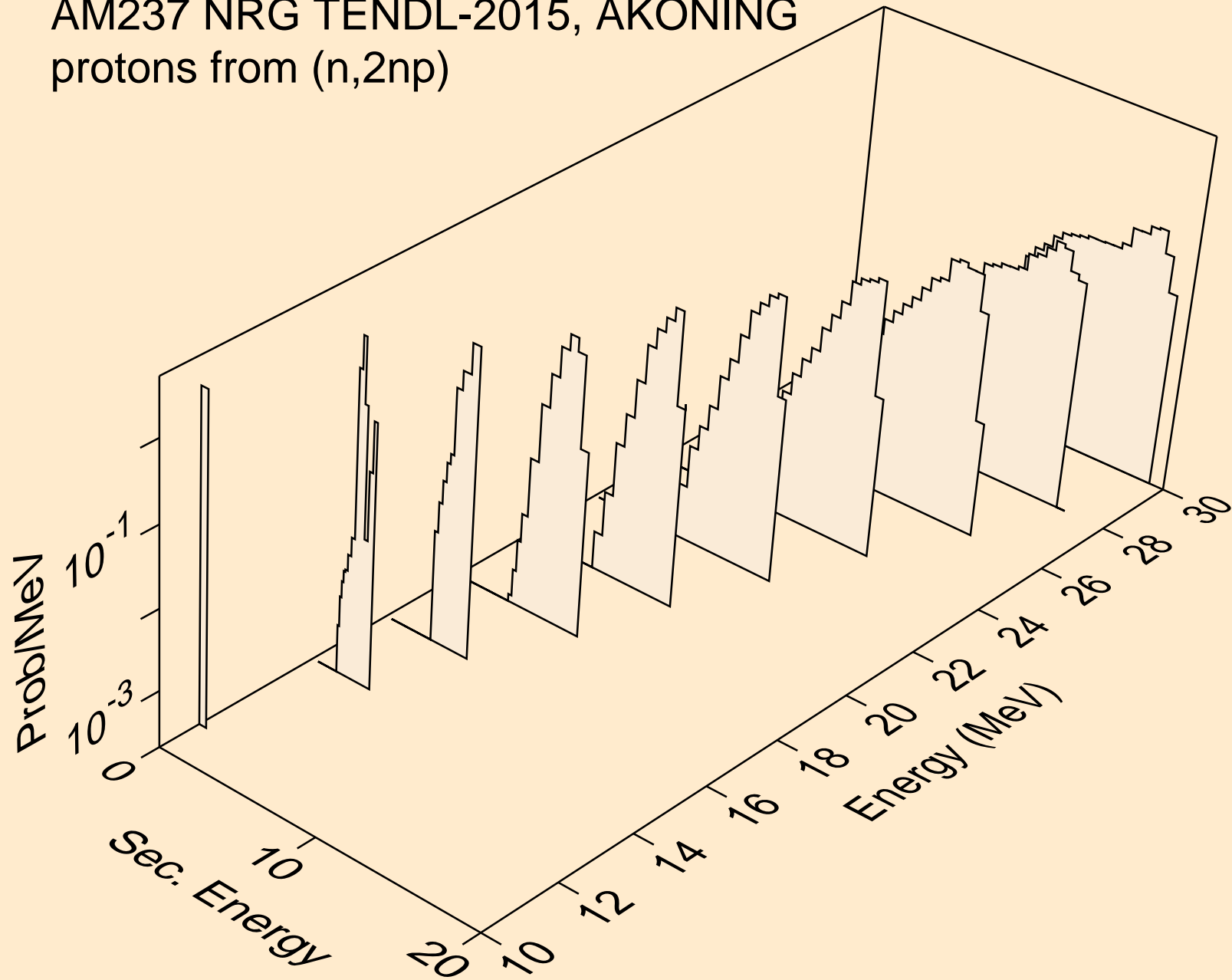

AM237 NRG TENDL-2015, AKONING
protons from (n,3np)

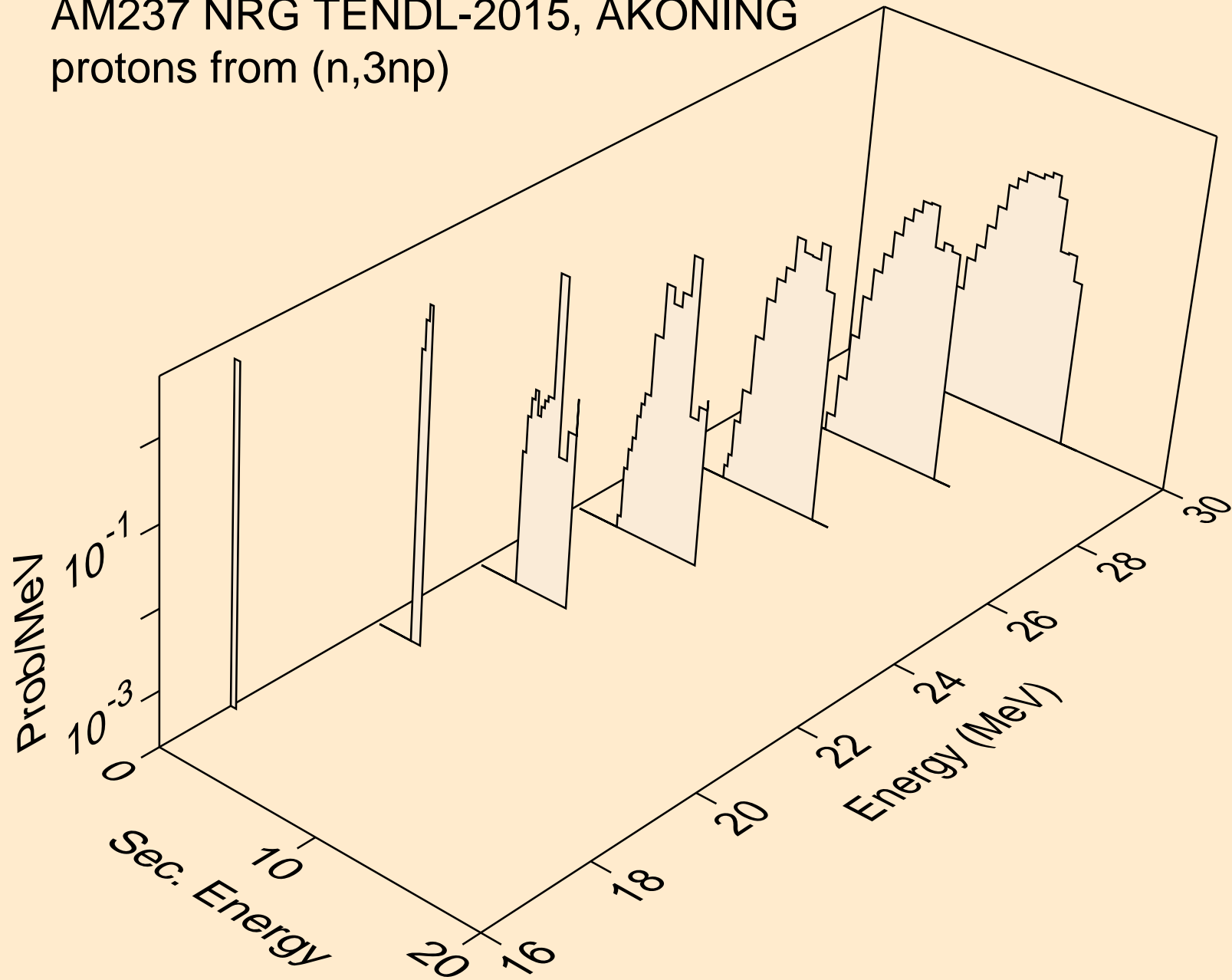

AM237 NRG TENDL-2015, AKONING
protons from (n,2np)

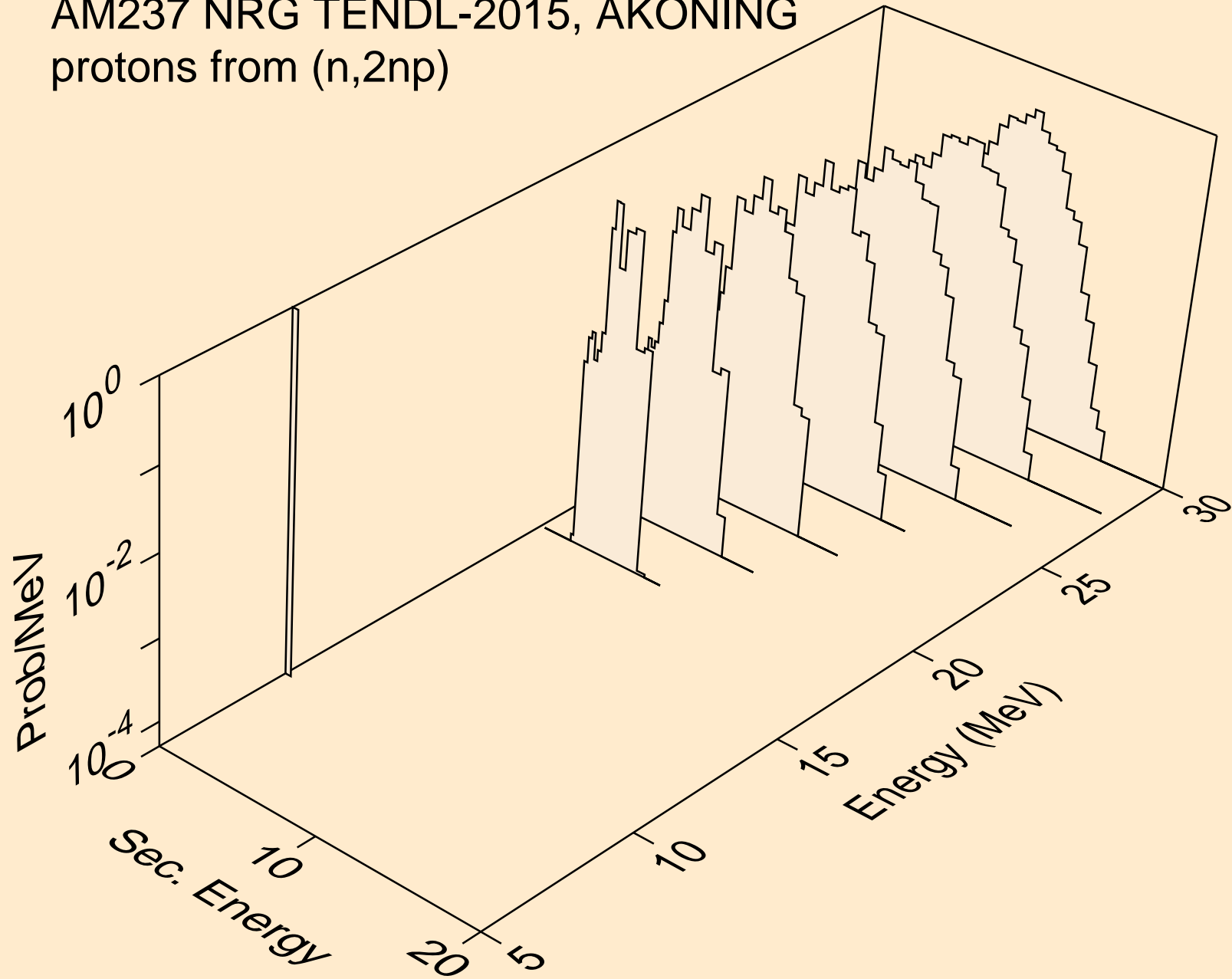

AM237 NRG TENDL-2015, AKONING
protons from (n,npa)

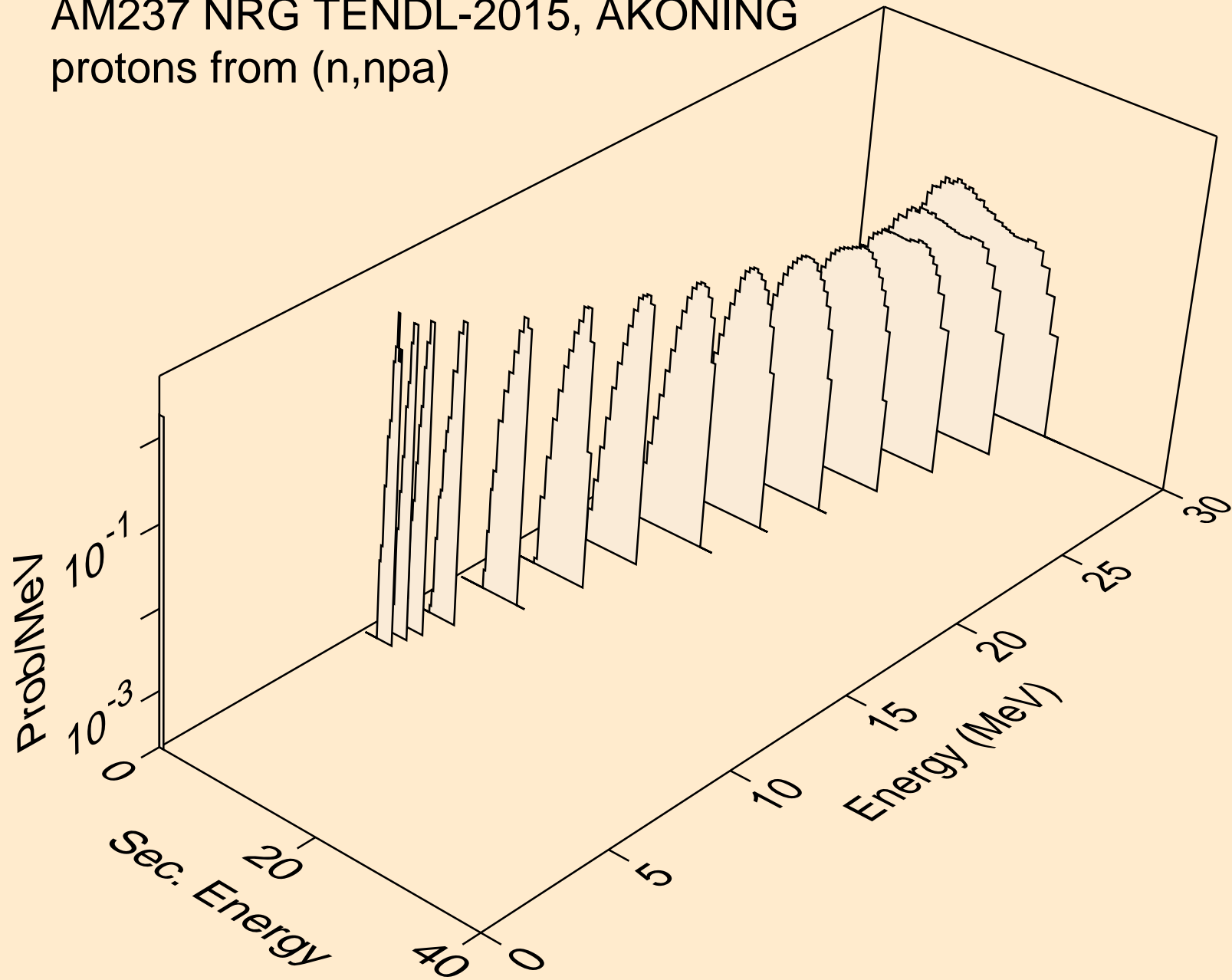

AM237 NRG TENDL-2015, AKONING
protons from (n,p)

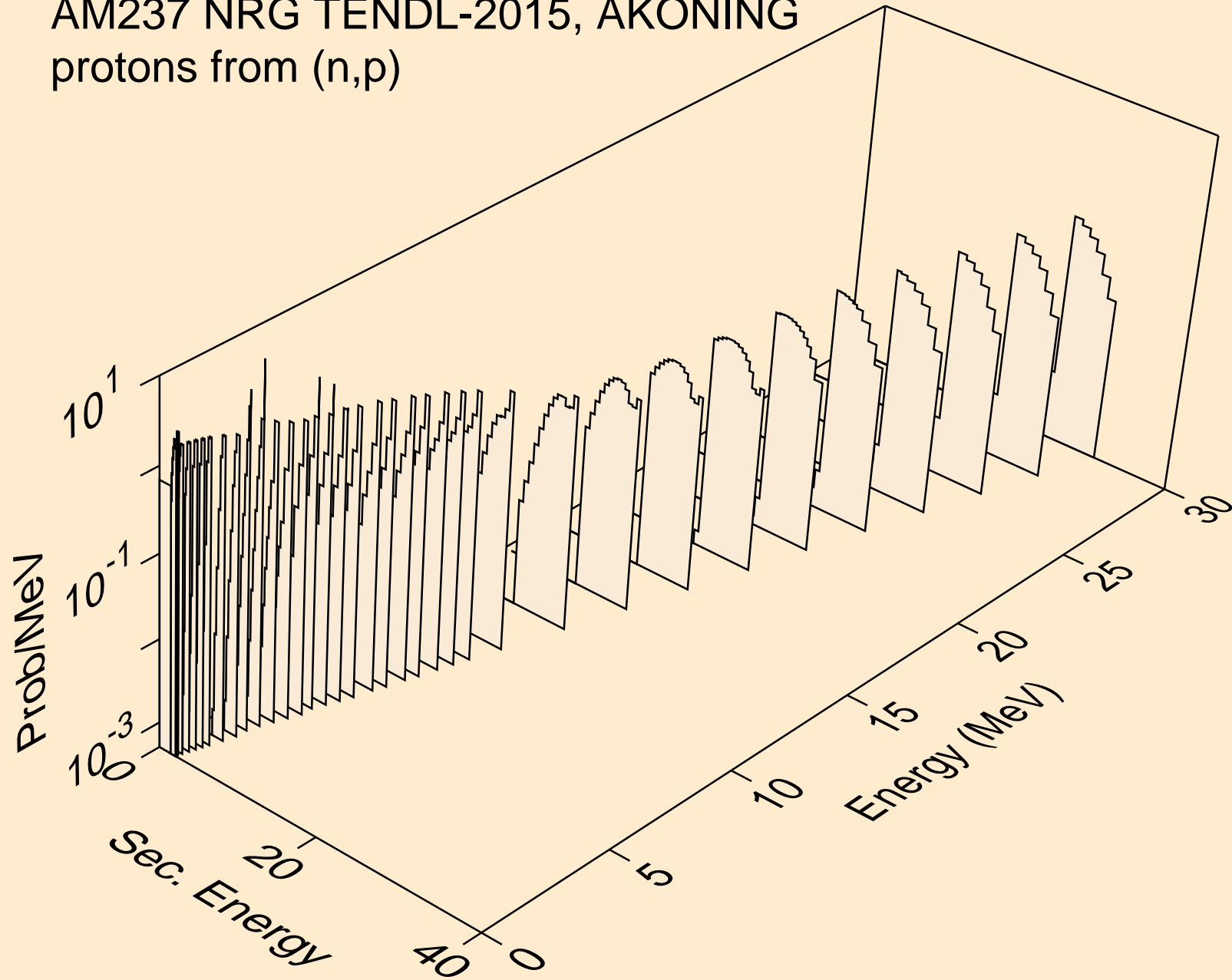

AM237 NRG TENDL-2015, AKONING
protons from (n,2p)

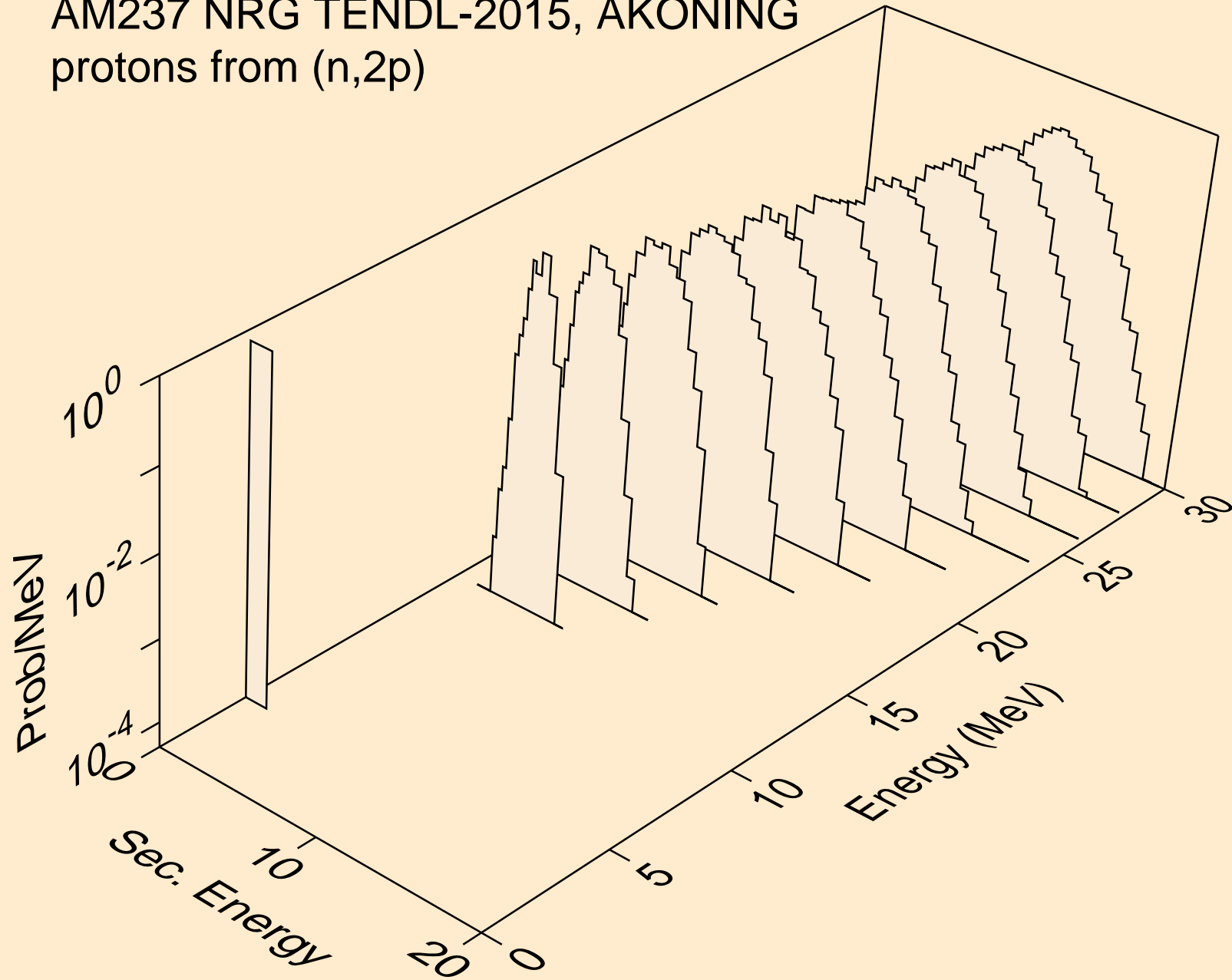

AM237 NRG TENDL-2015, AKONING
protons from (n,pa)

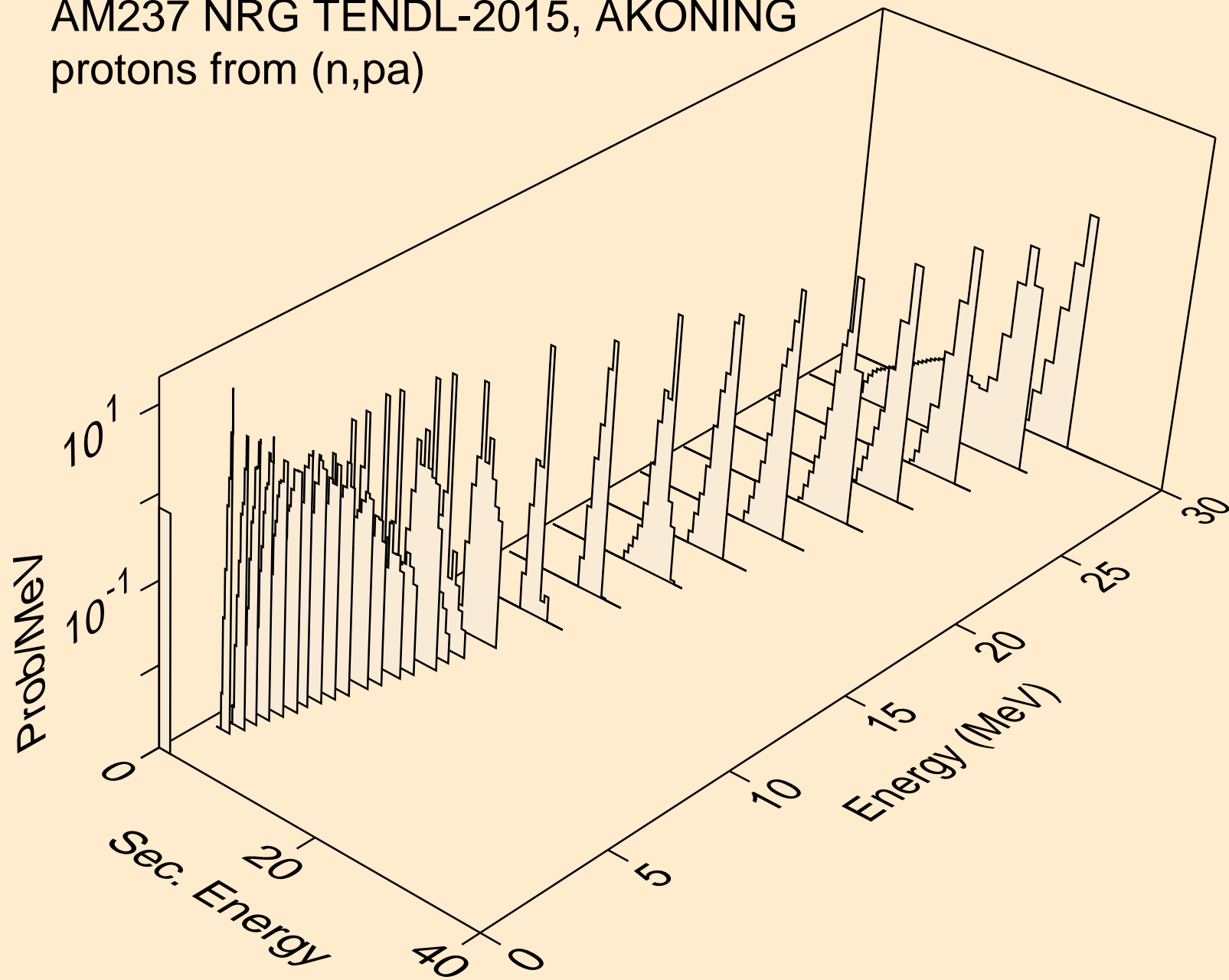

AM237 NRG TENDL-2015, AKONING
protons from (n,pd)

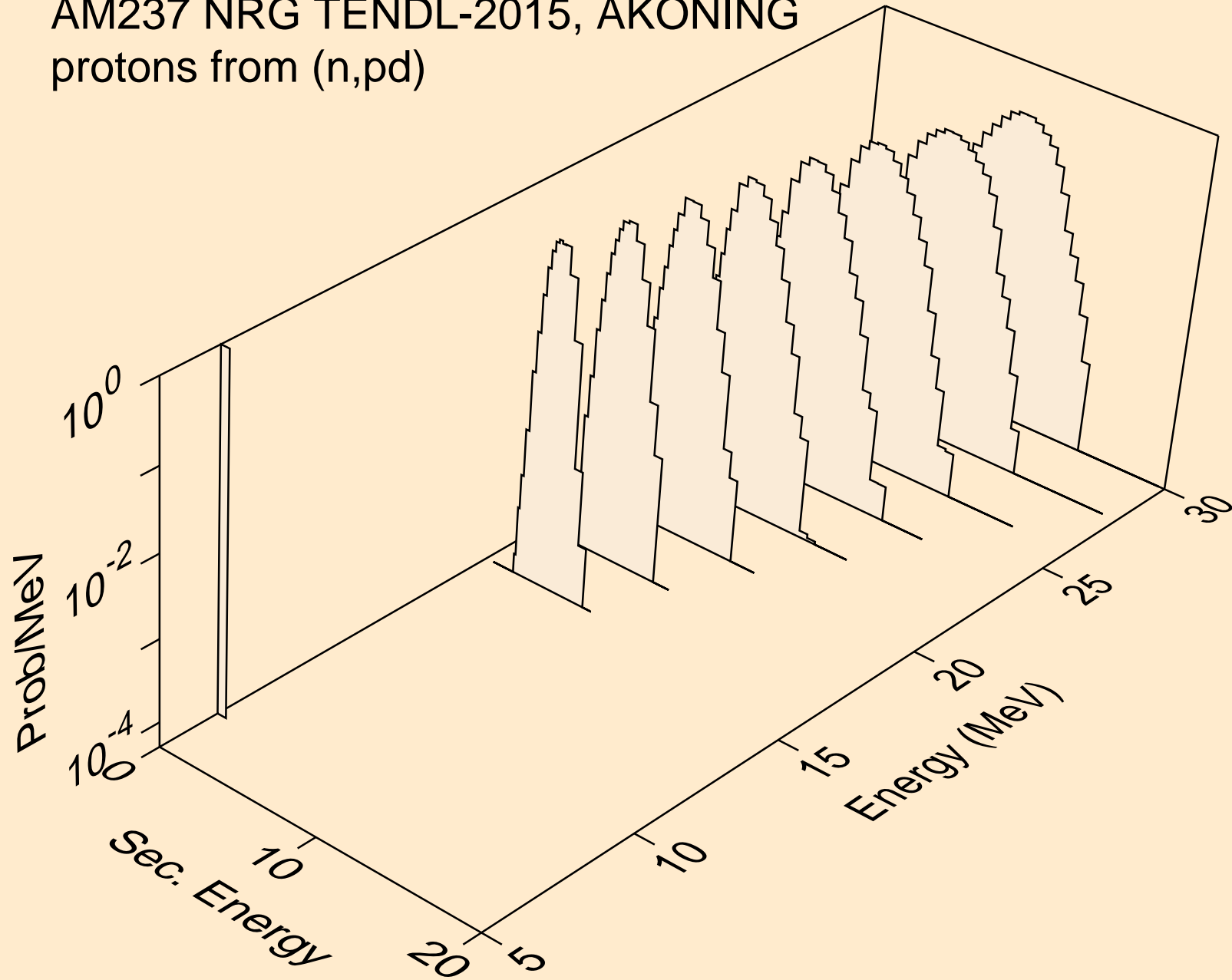

AM237 NRG TENDL-2015, AKONING
protons from (n,pt)

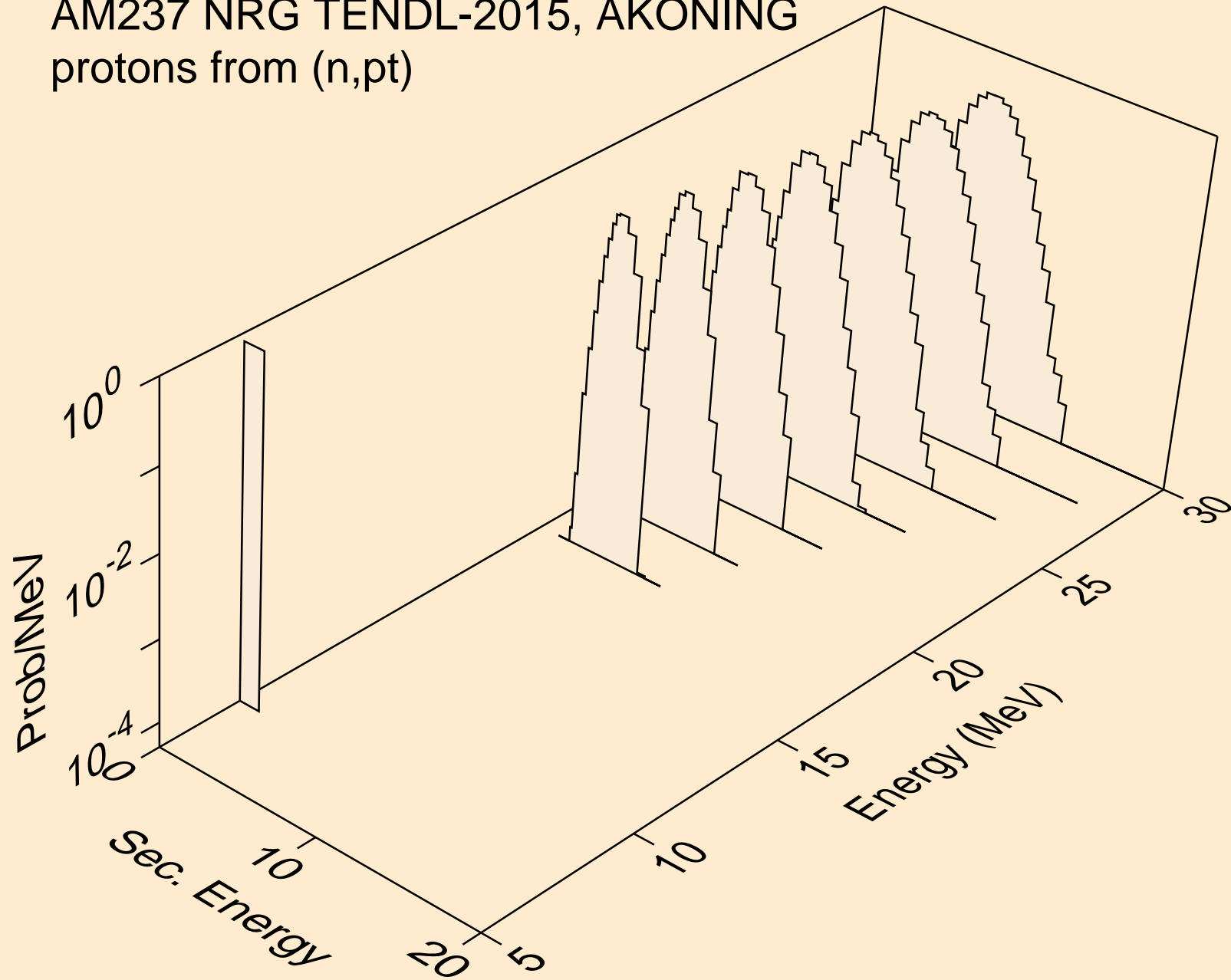

AM237 NRG TENDL-2015, AKONING
deuterons from (n,x)

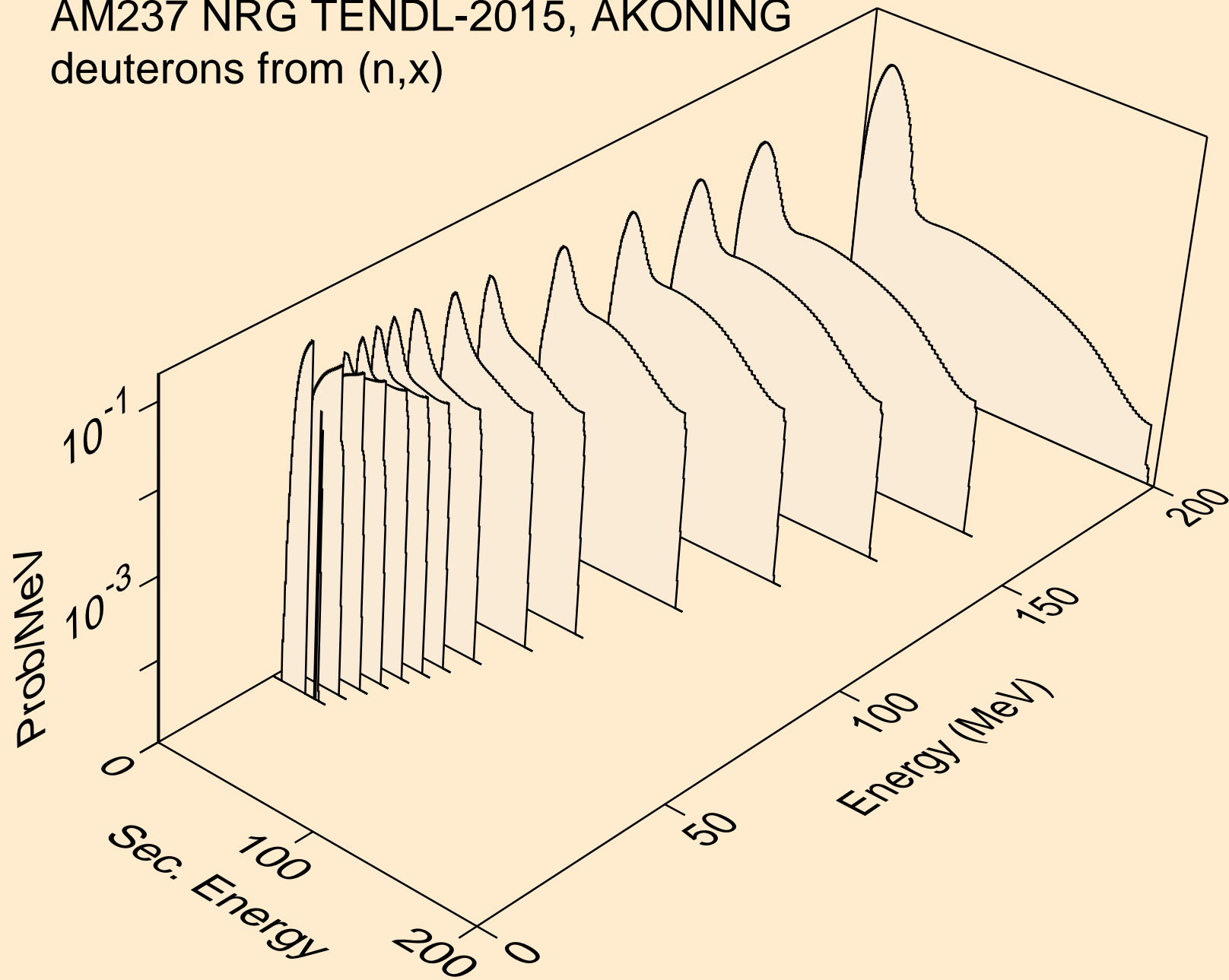

AM237 NRG TENDL-2015, AKONING
deuterons from (n,2nd)

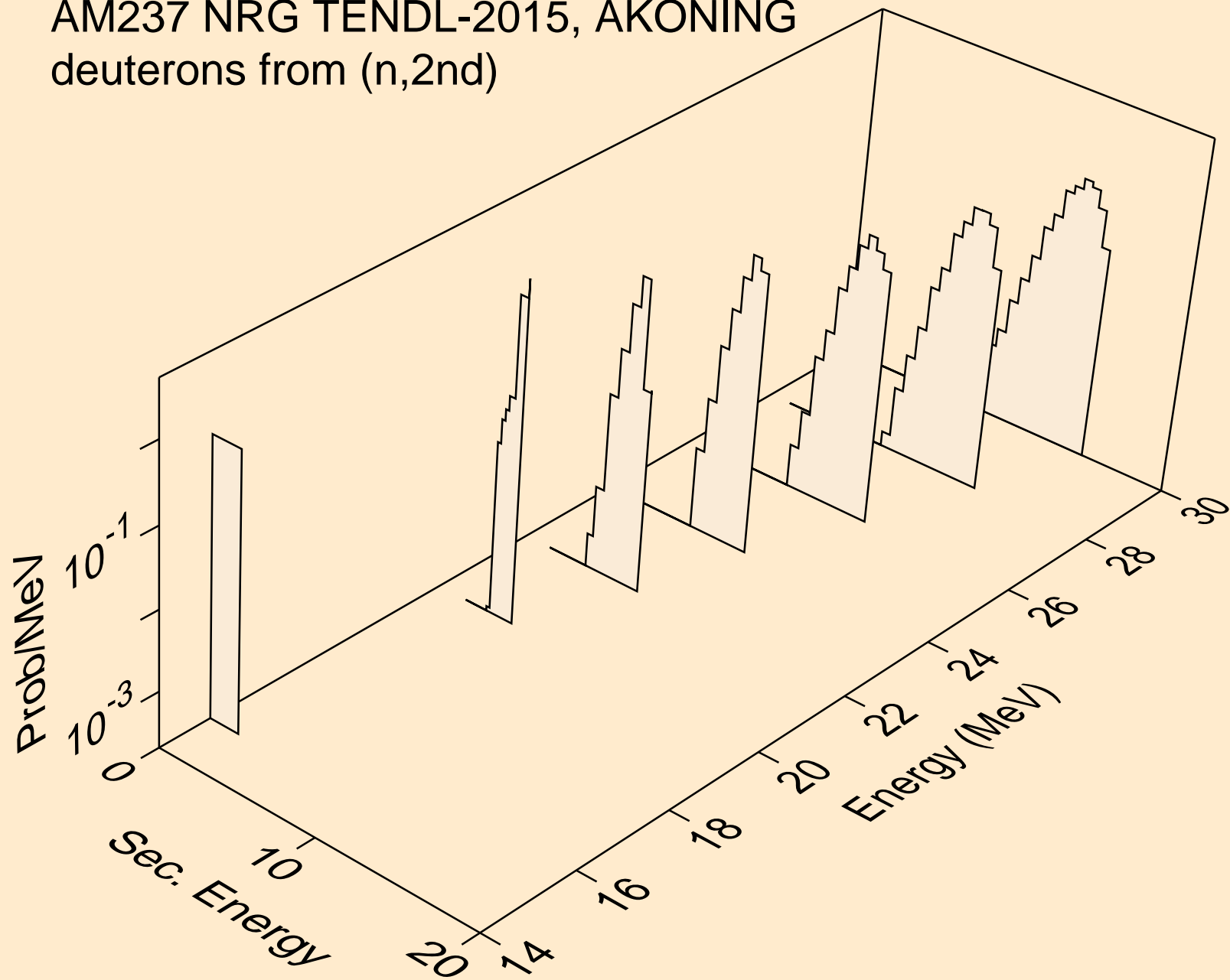

AM237 NRG TENDL-2015, AKONING
deuterons from (n,n*)d

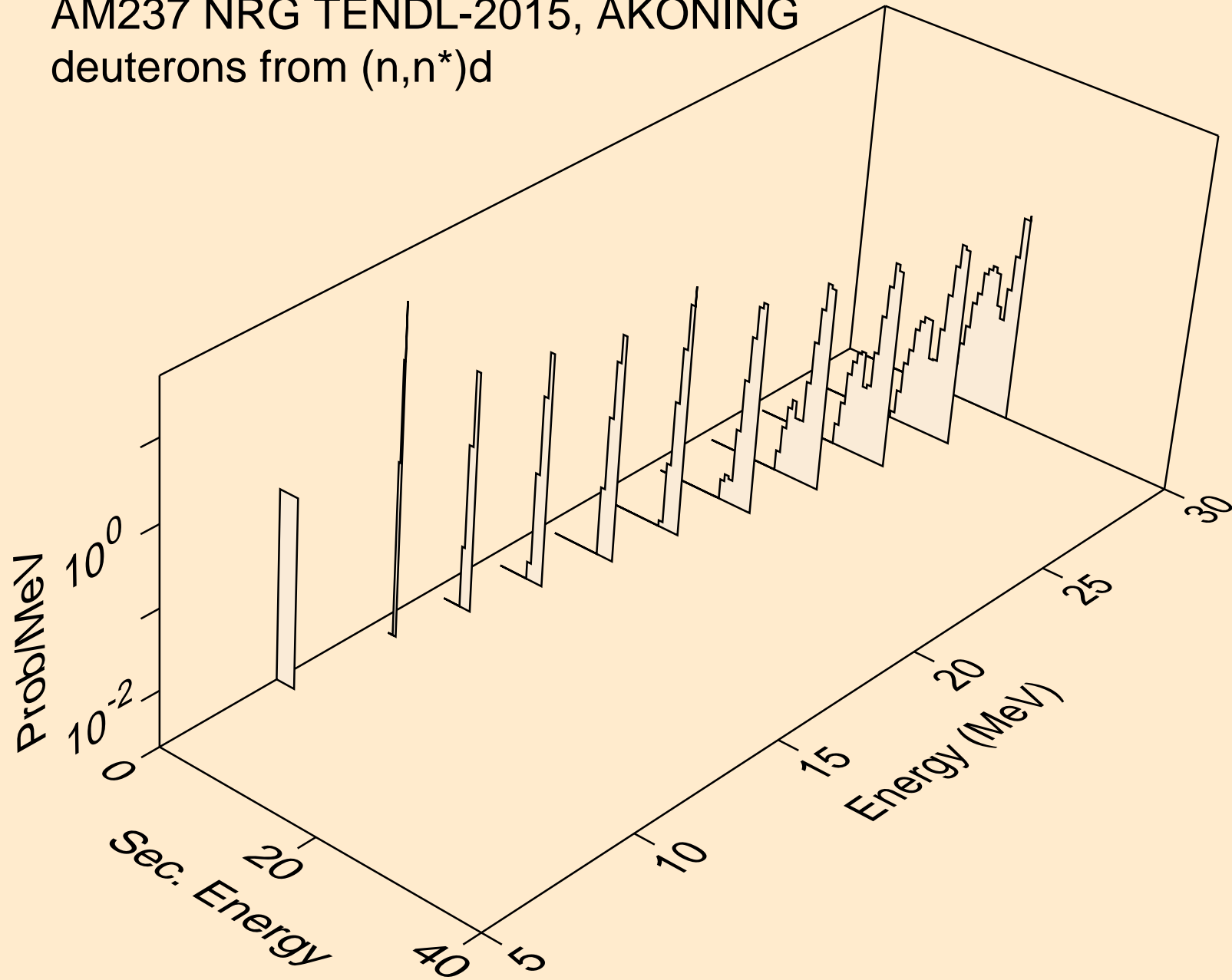

AM237 NRG TENDL-2015, AKONING
deuterons from (n,d)

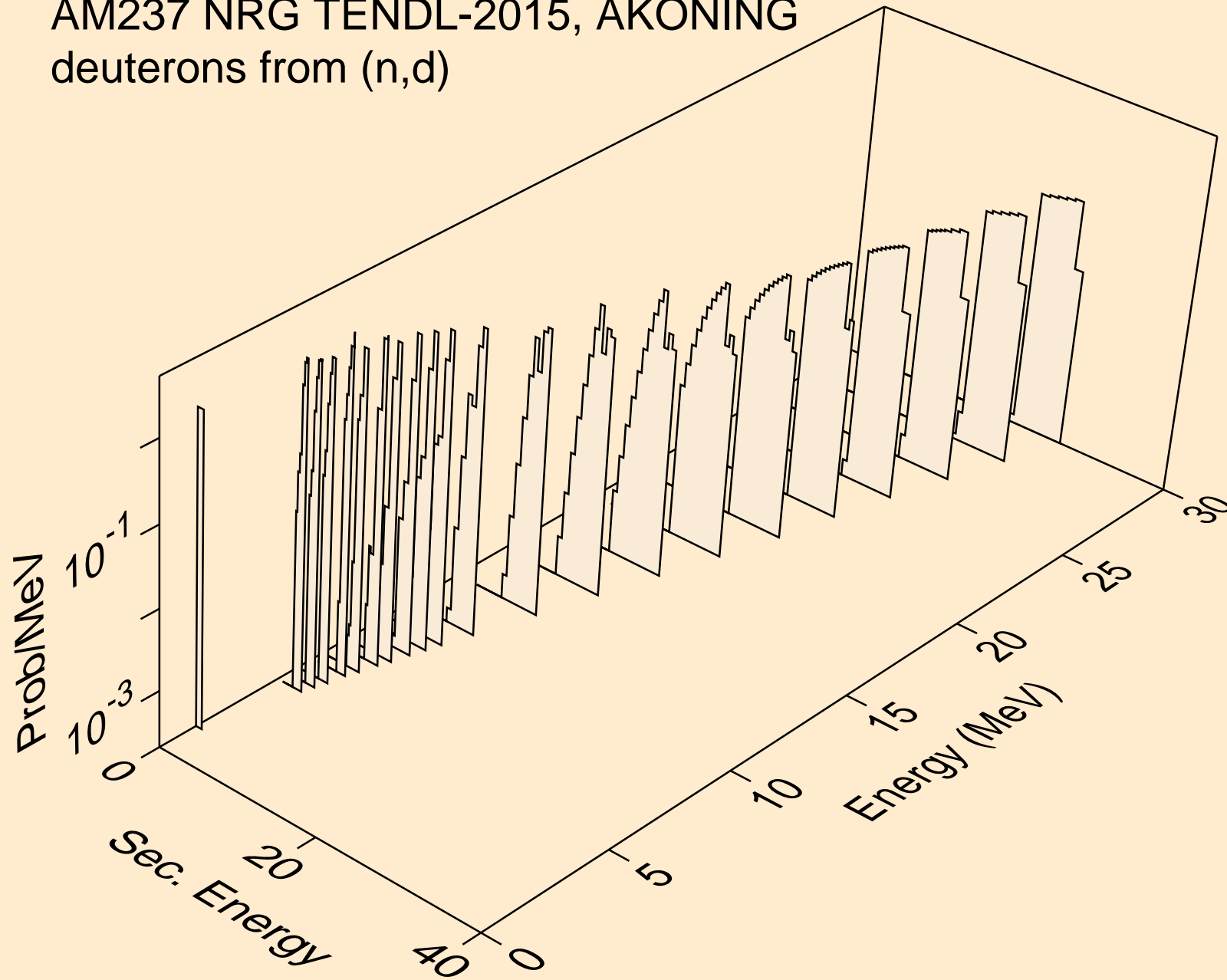

AM237 NRG TENDL-2015, AKONING
deuterons from (n,pd)

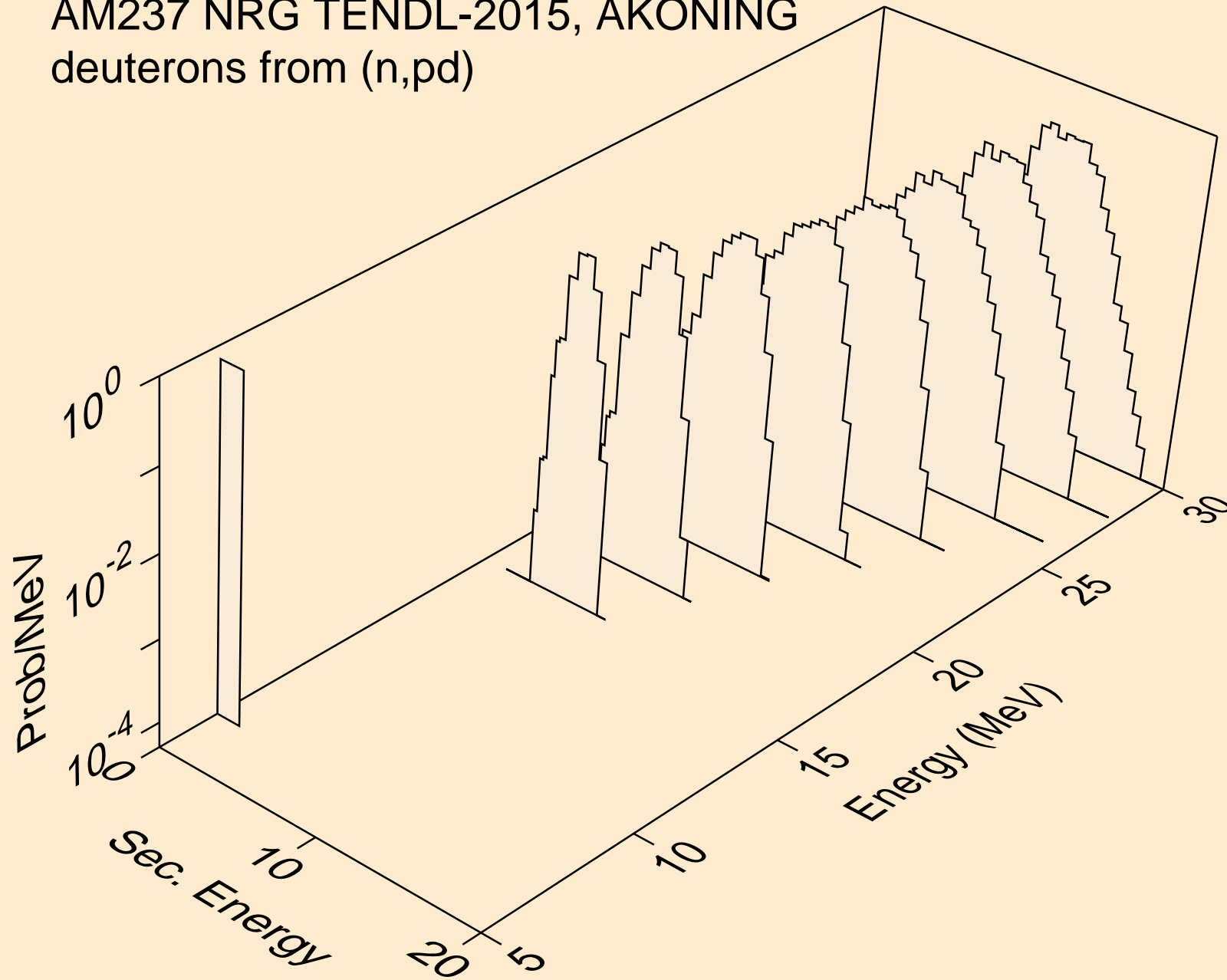

AM237 NRG TENDL-2015, AKONING
deuterons from (n,da)

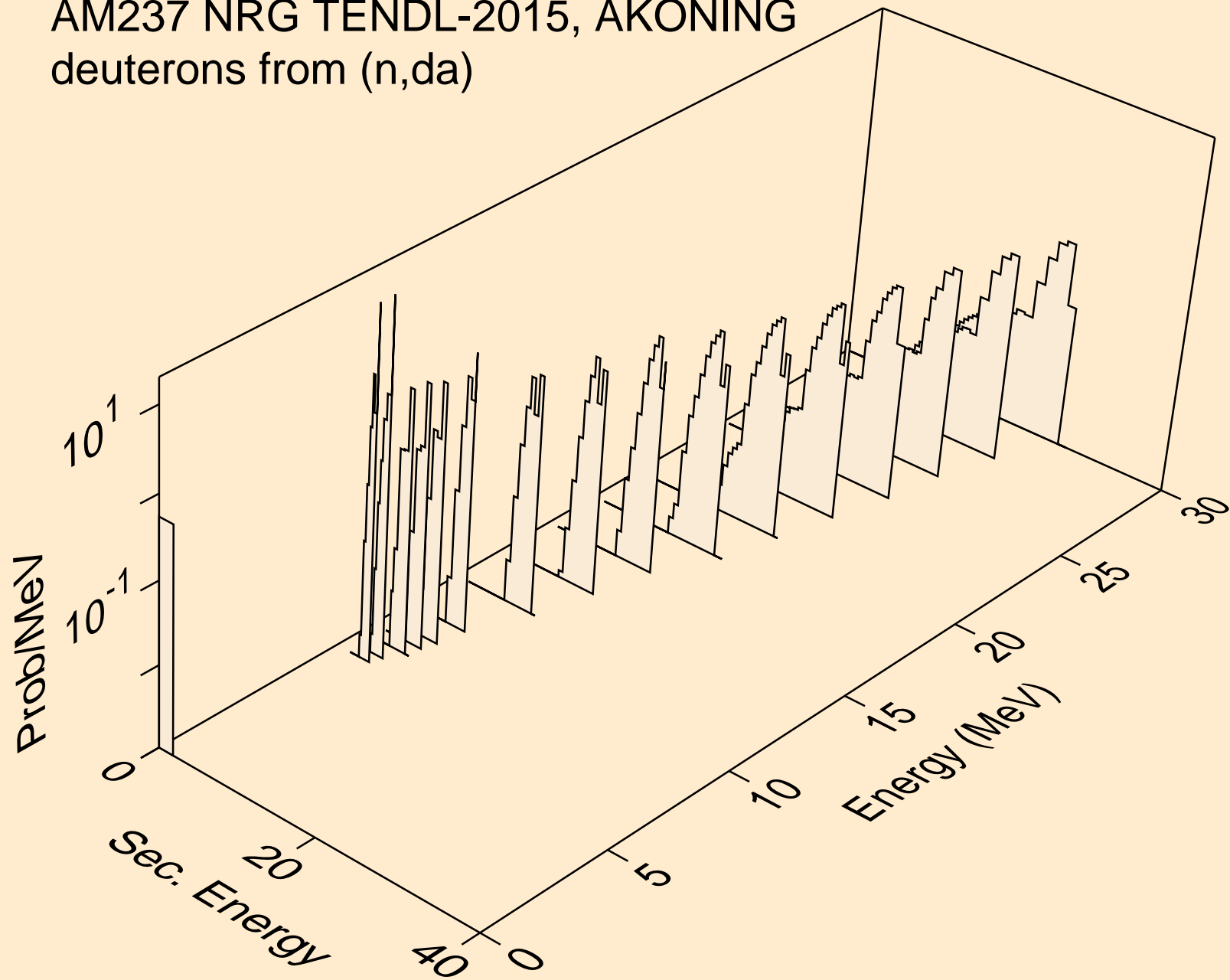

AM237 NRG TENDL-2015, AKONING
tritons from (n,x)

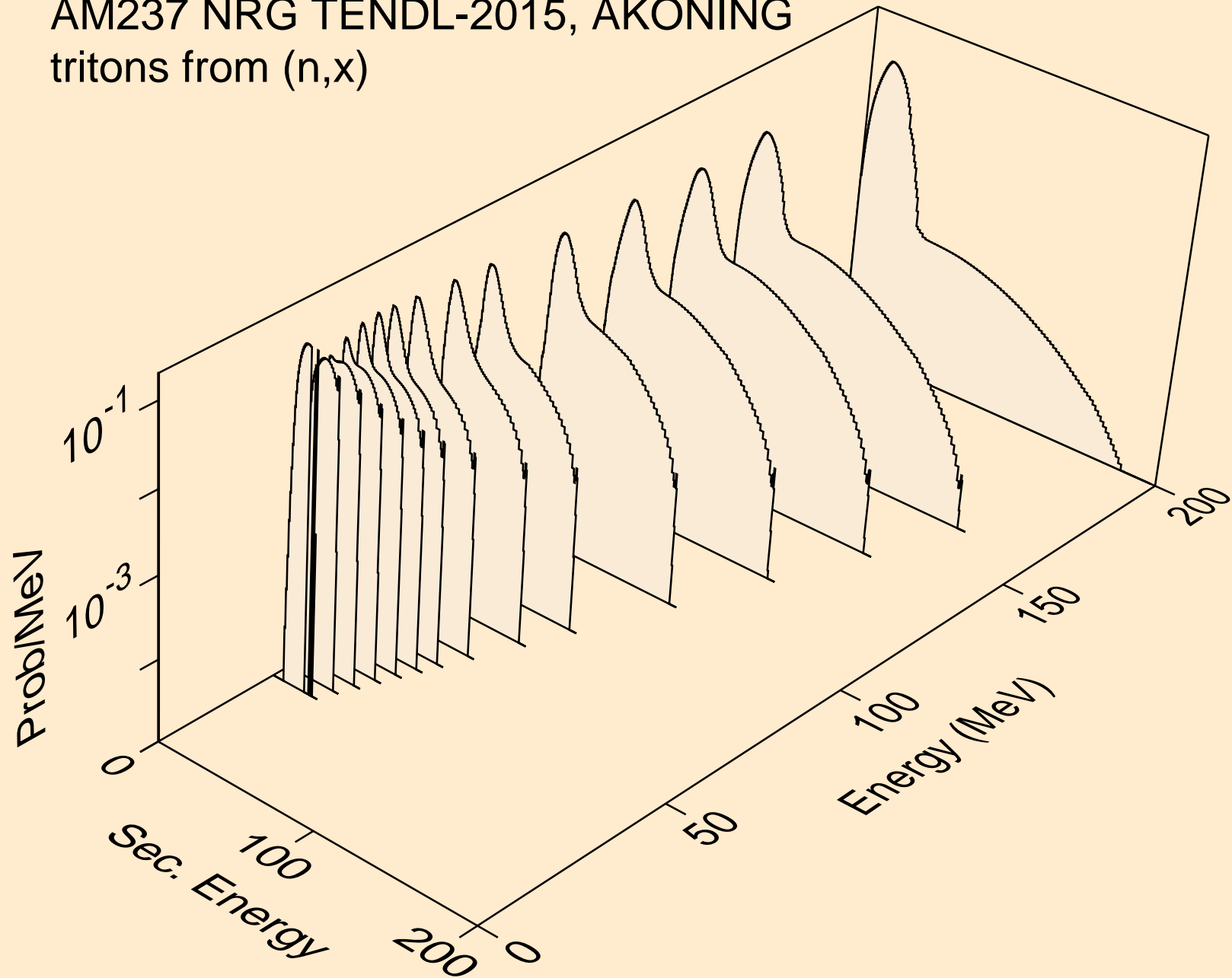

AM237 NRG TENDL-2015, AKONING
tritons from (n,n*)t

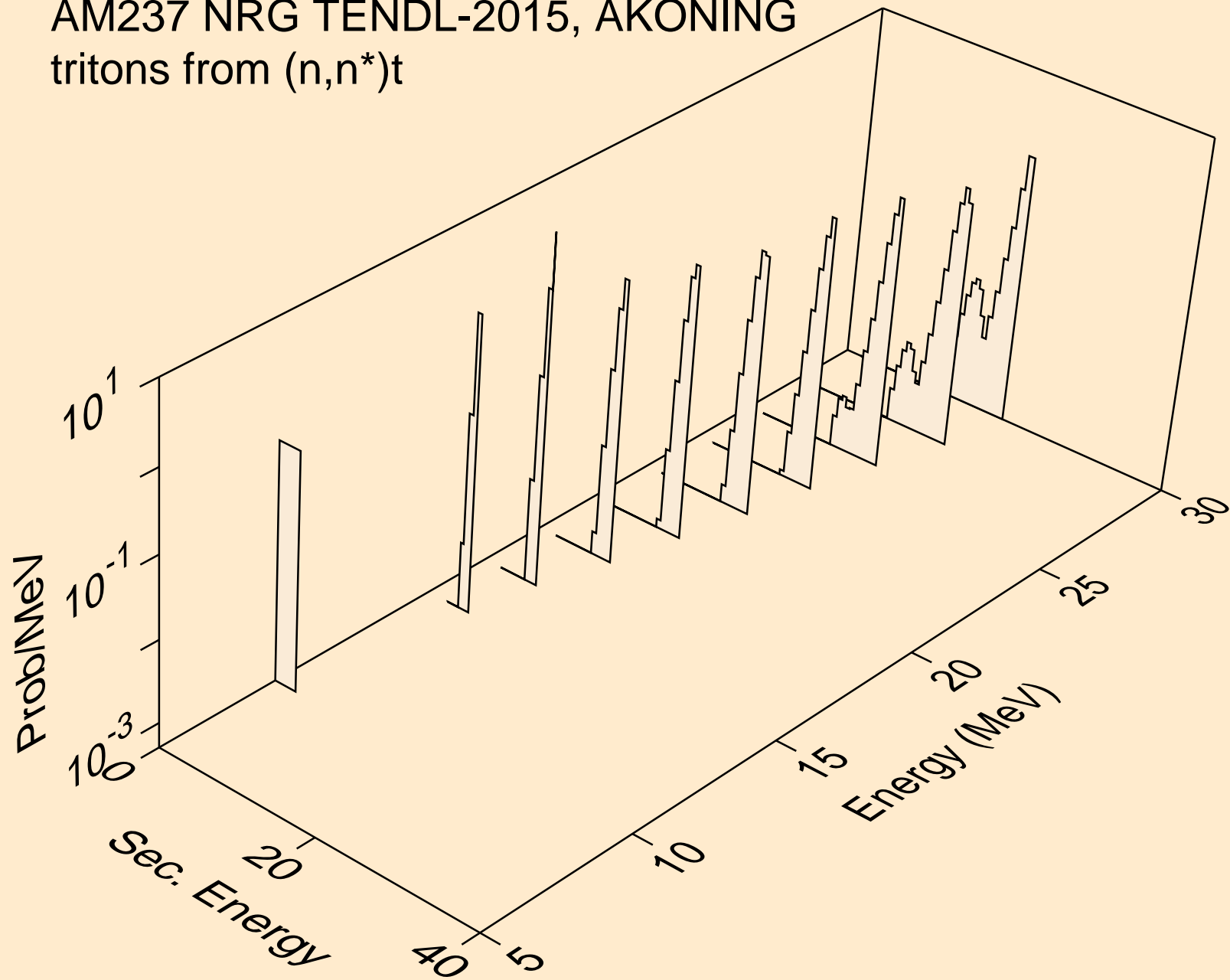

AM237 NRG TENDL-2015, AKONING
tritons from (n,t)

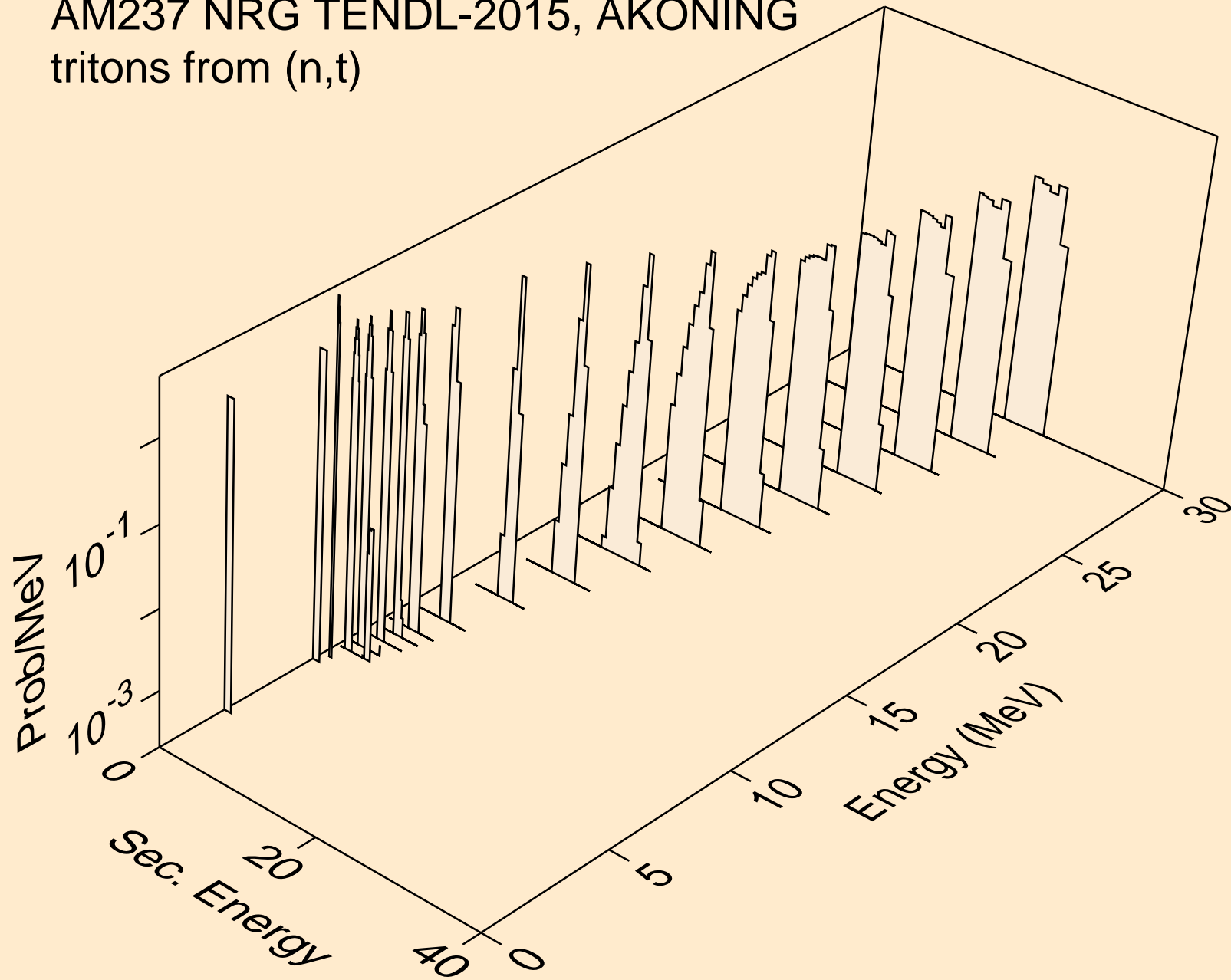

AM237 NRG TENDL-2015, AKONING
tritons from (n,pt)

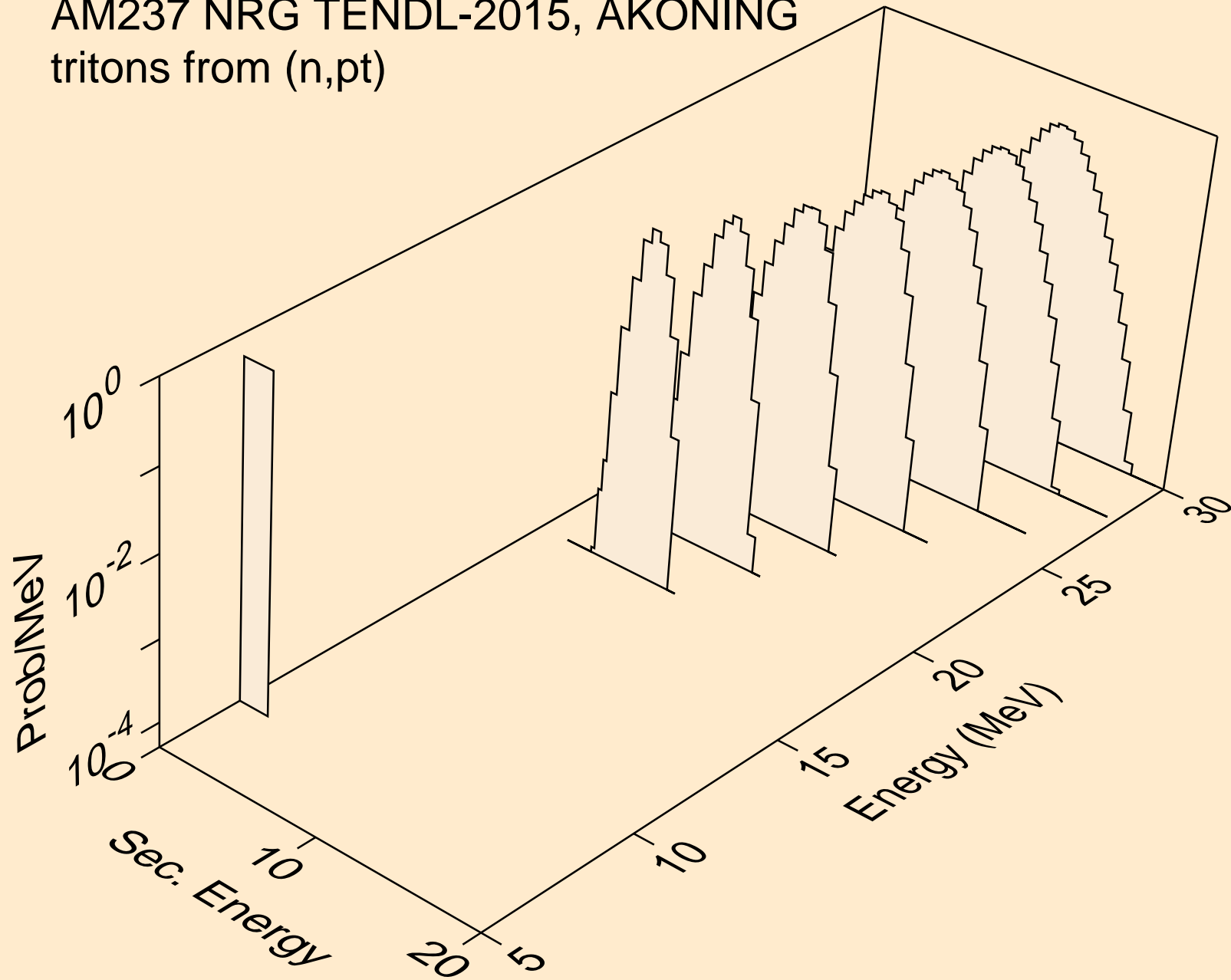

AM237 NRG TENDL-2015, AKONING
he3s from (n,x)

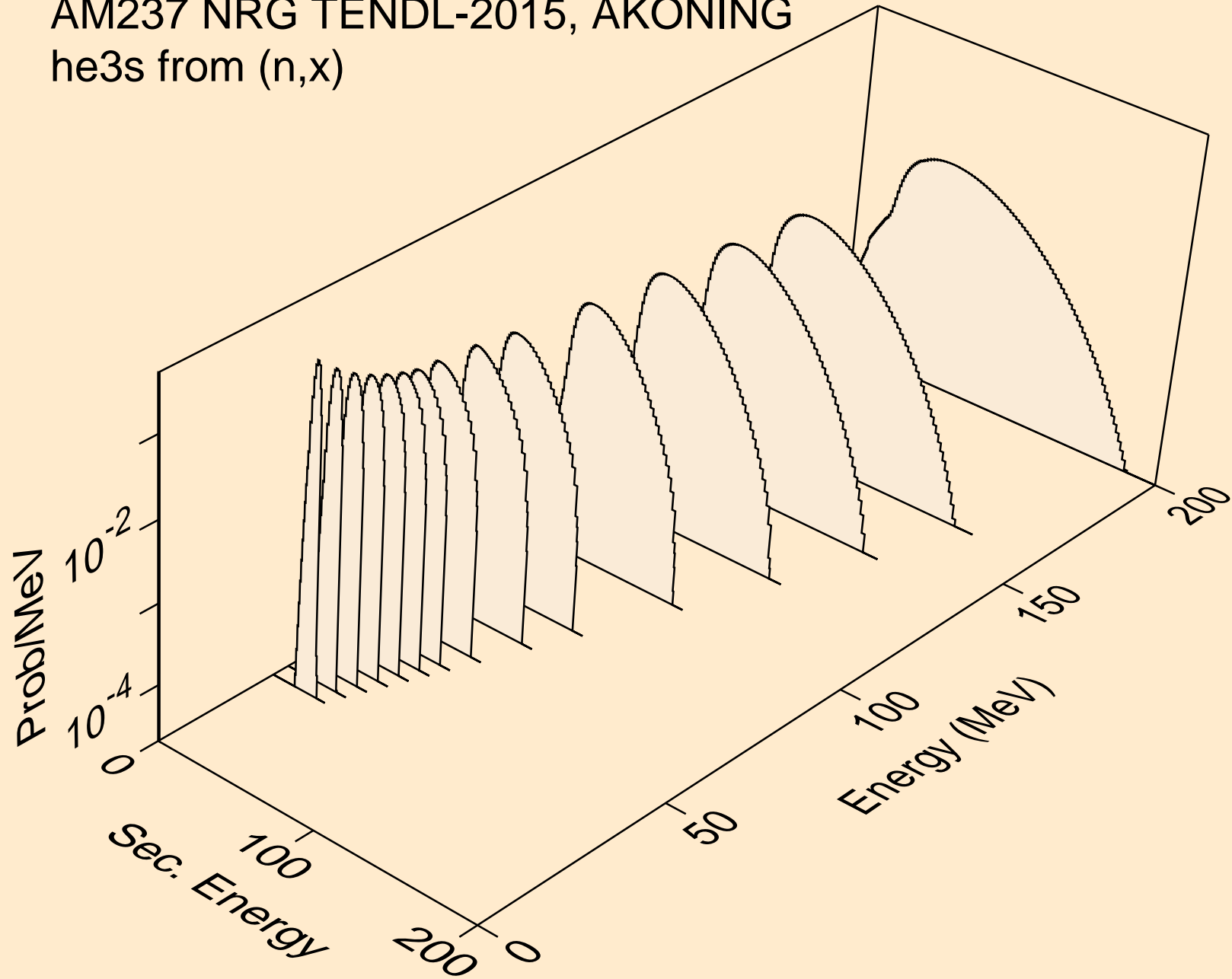

AM237 NRG TENDL-2015, AKONING
he3s from (n,n*)he3

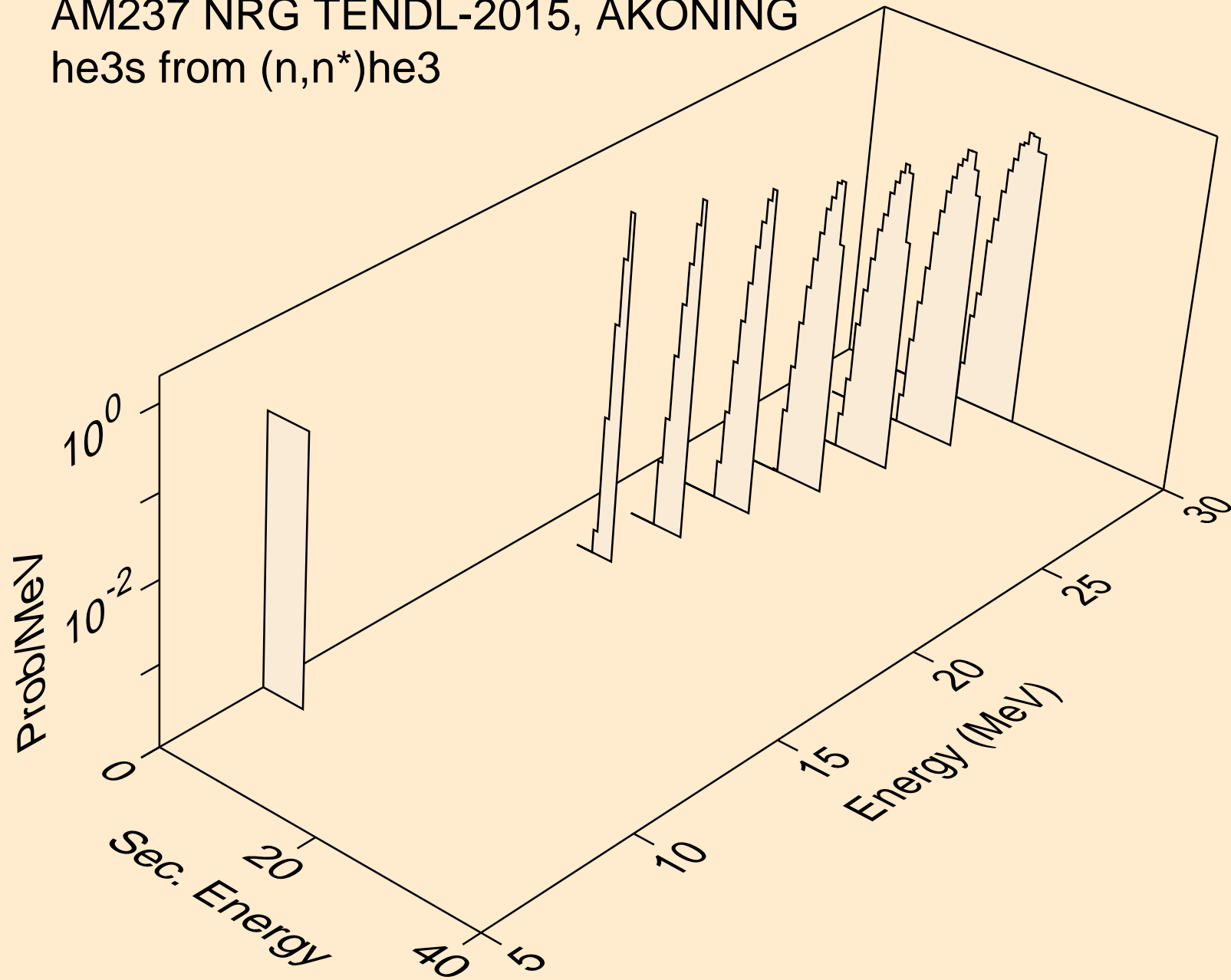

AM237 NRG TENDL-2015, AKONING
he3s from (n,he3)

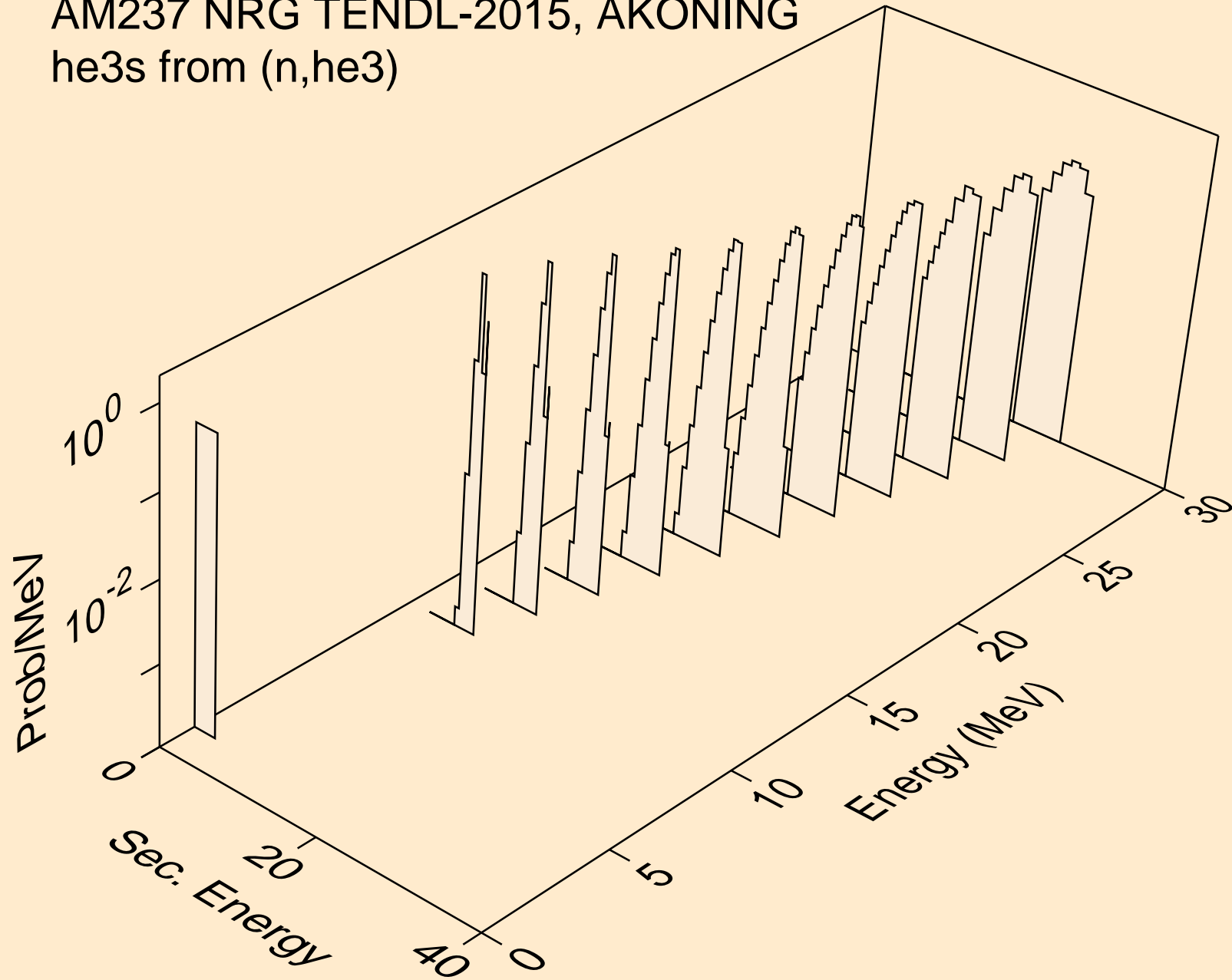

AM237 NRG TENDL-2015, AKONING
alphas from (n,x)

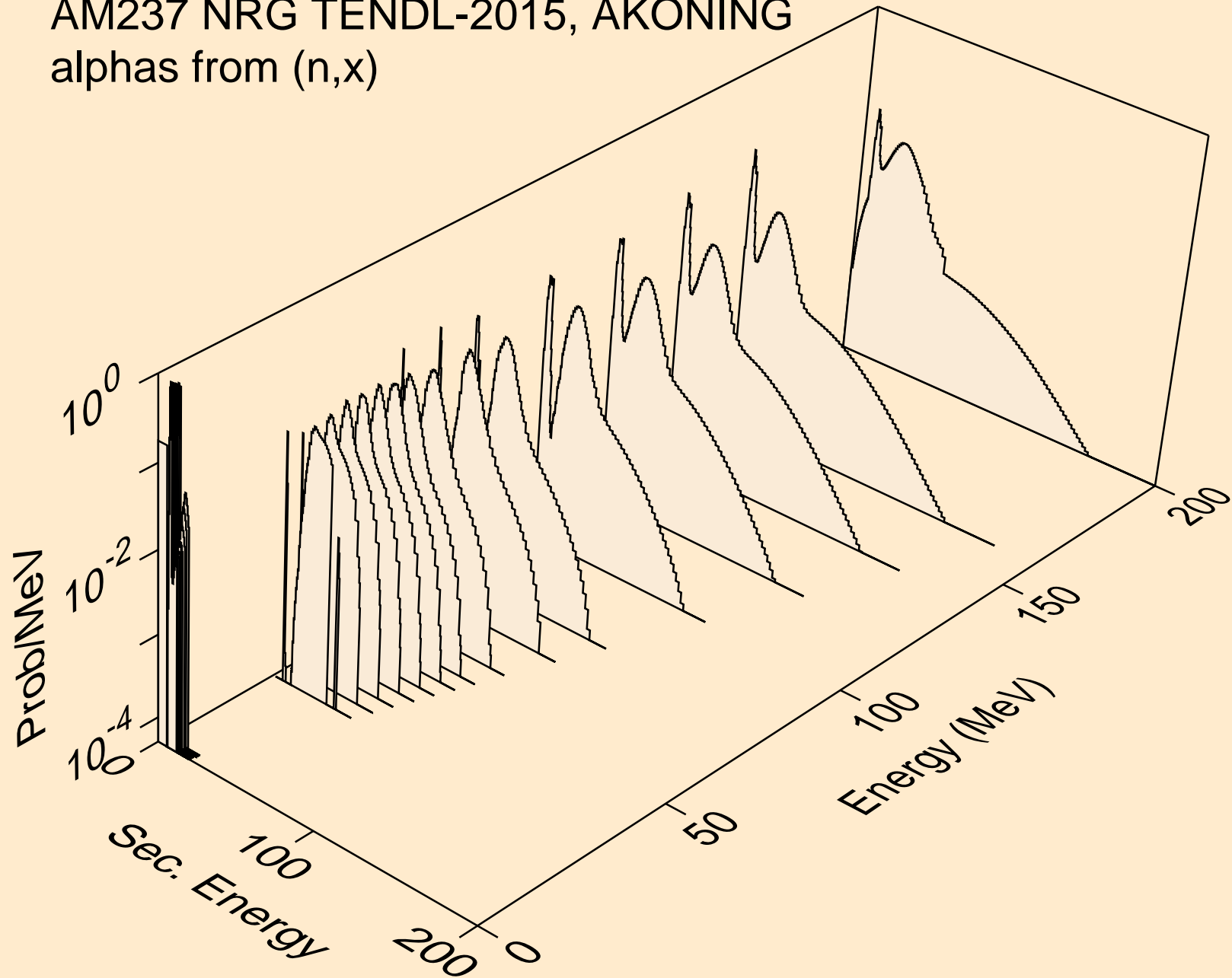

AM237 NRG TENDL-2015, AKONING
alphas from (n,n*)a

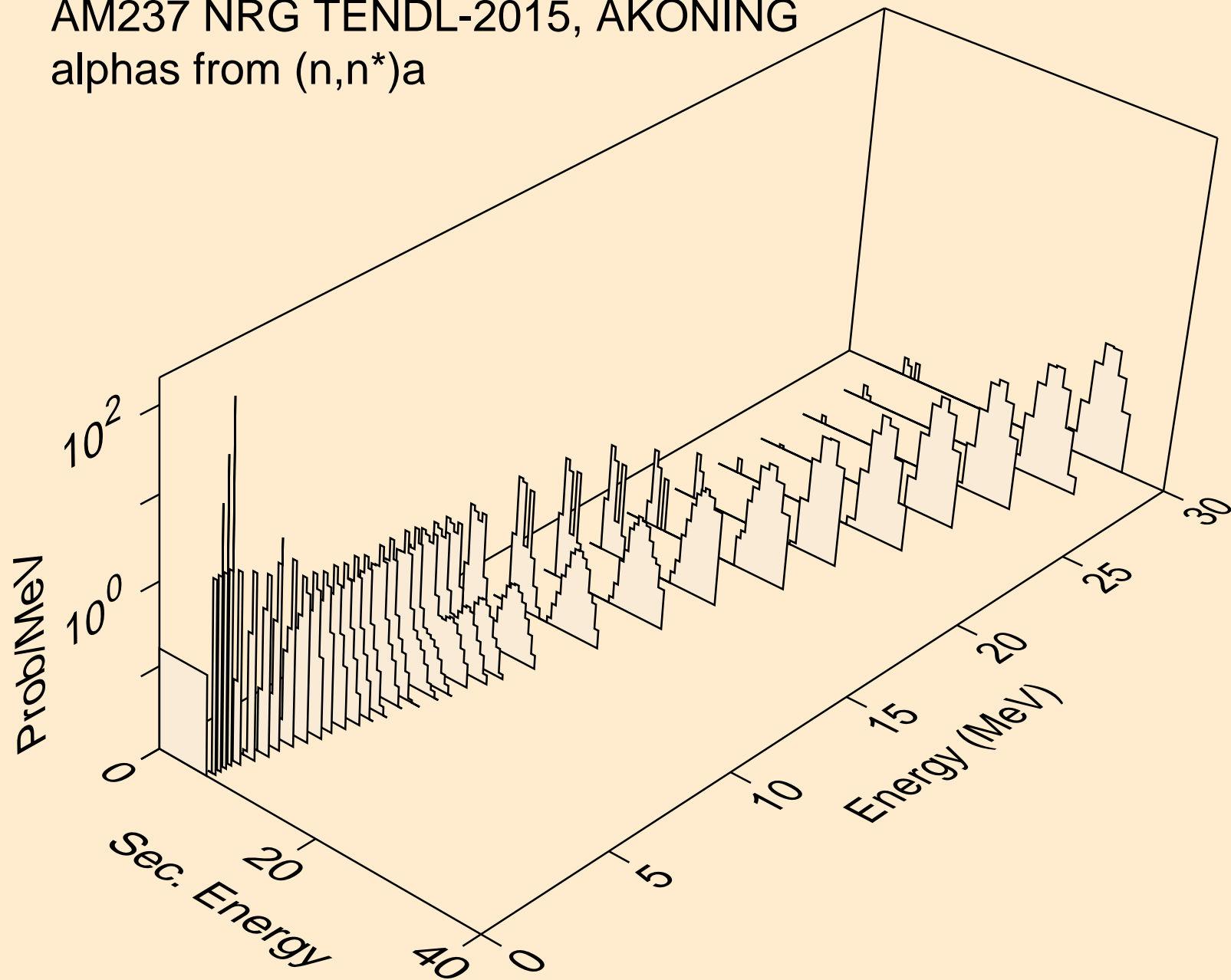

AM237 NRG TENDL-2015, AKONING
alphas from (n,2n)a

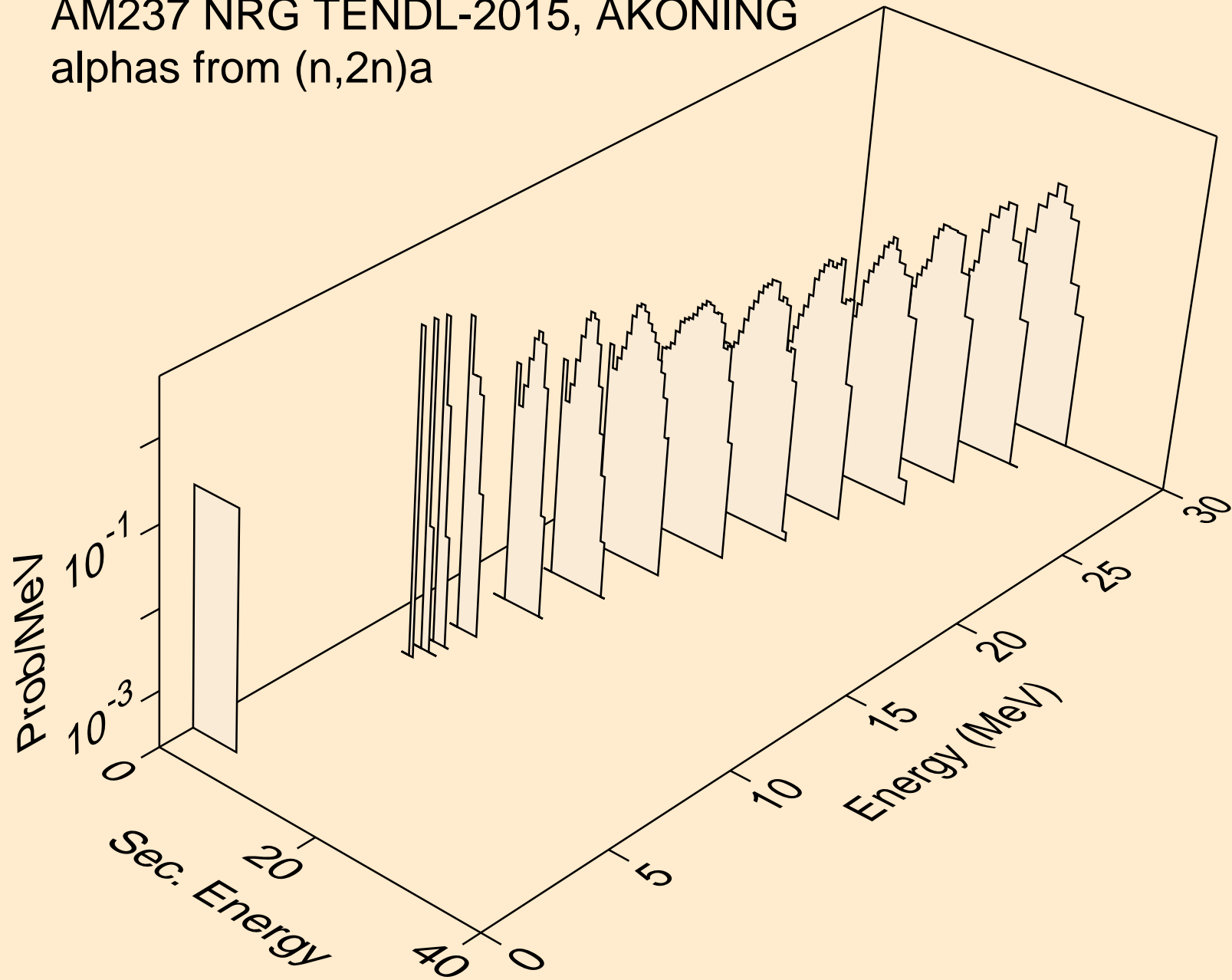

AM237 NRG TENDL-2015, AKONING
alphas from (n,3n)a

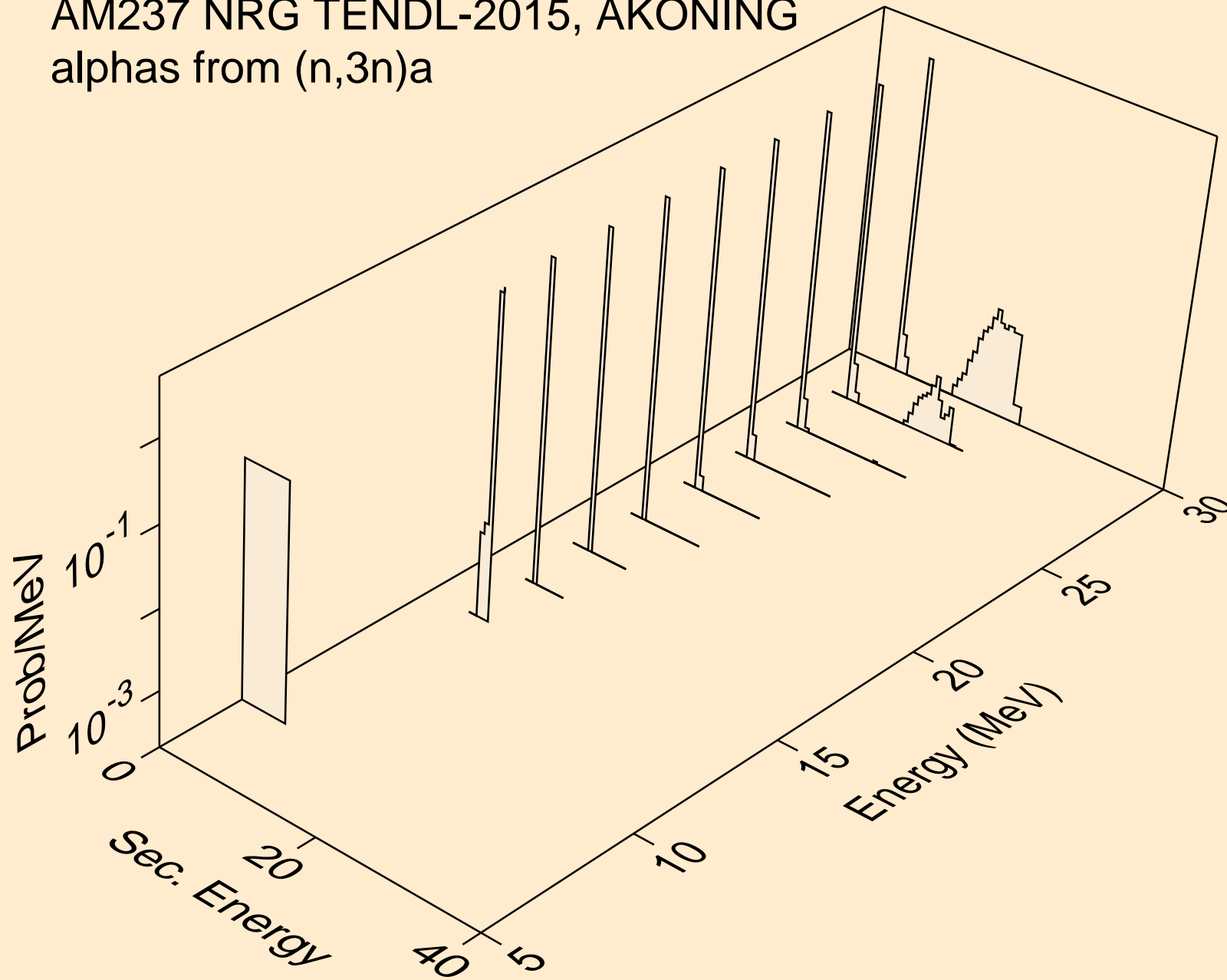

AM237 NRG TENDL-2015, AKONING
alphas from (n,n*)2a

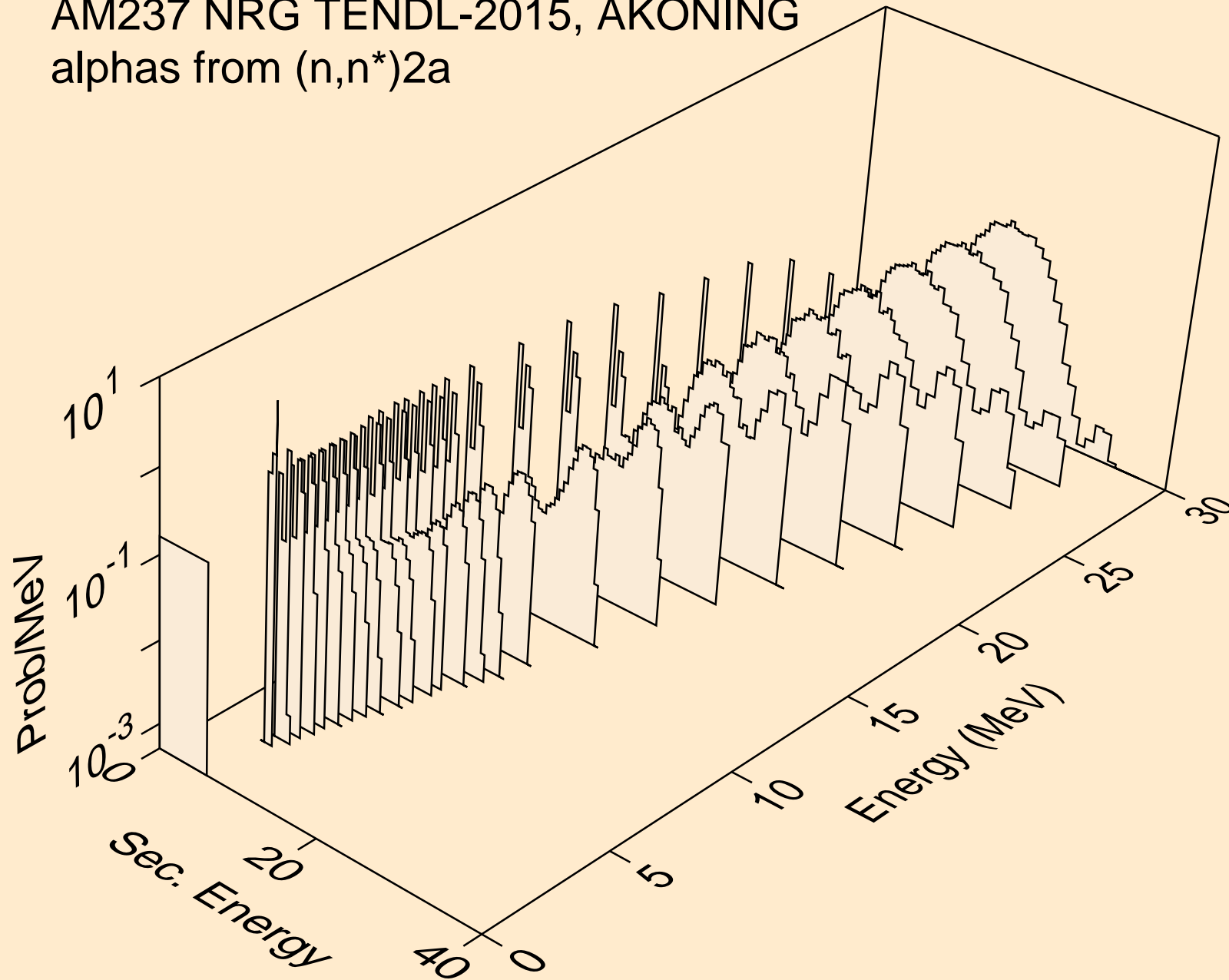

AM237 NRG TENDL-2015, AKONING
alphas from (n,2n)2a

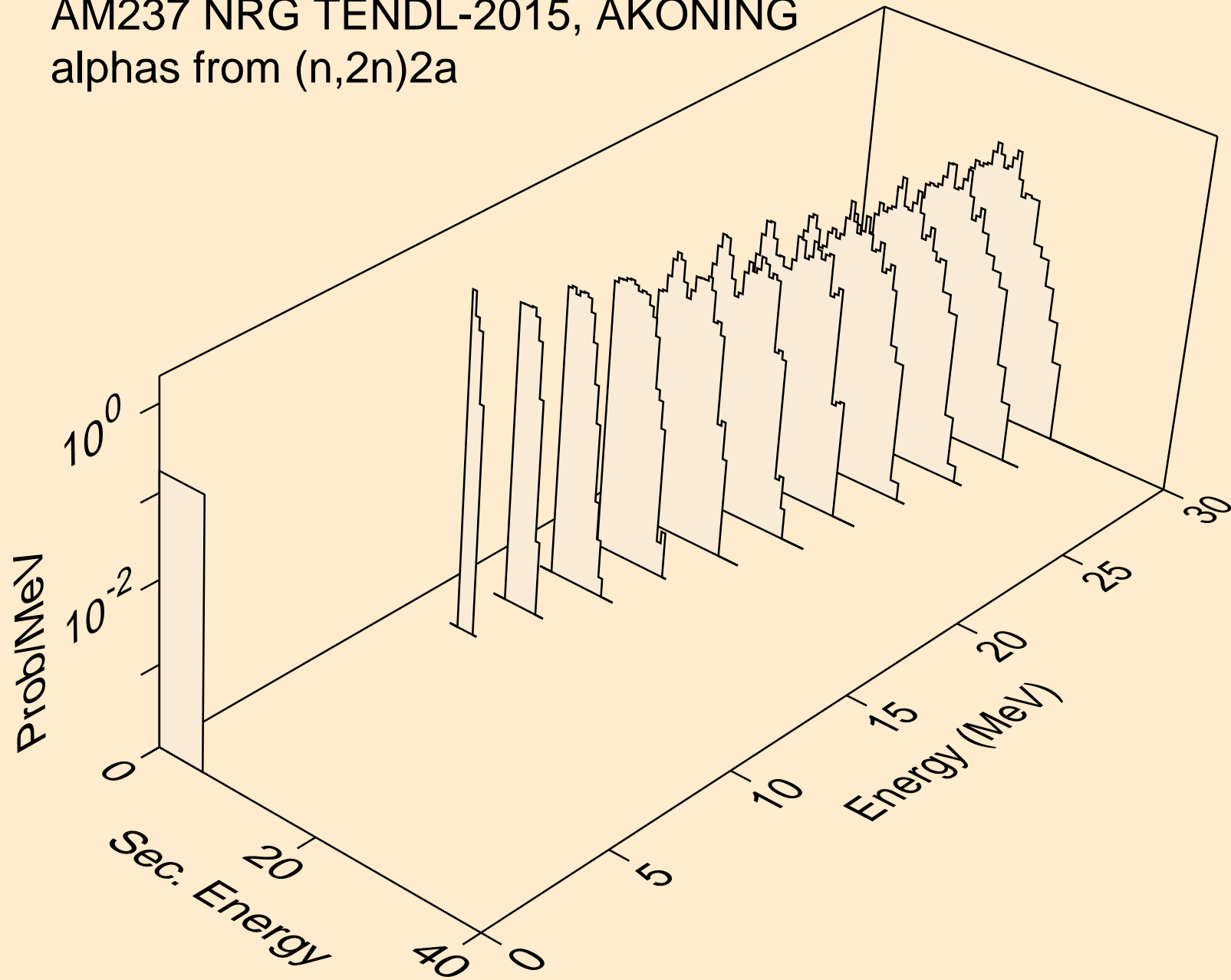

AM237 NRG TENDL-2015, AKONING
alphas from (n,npa)

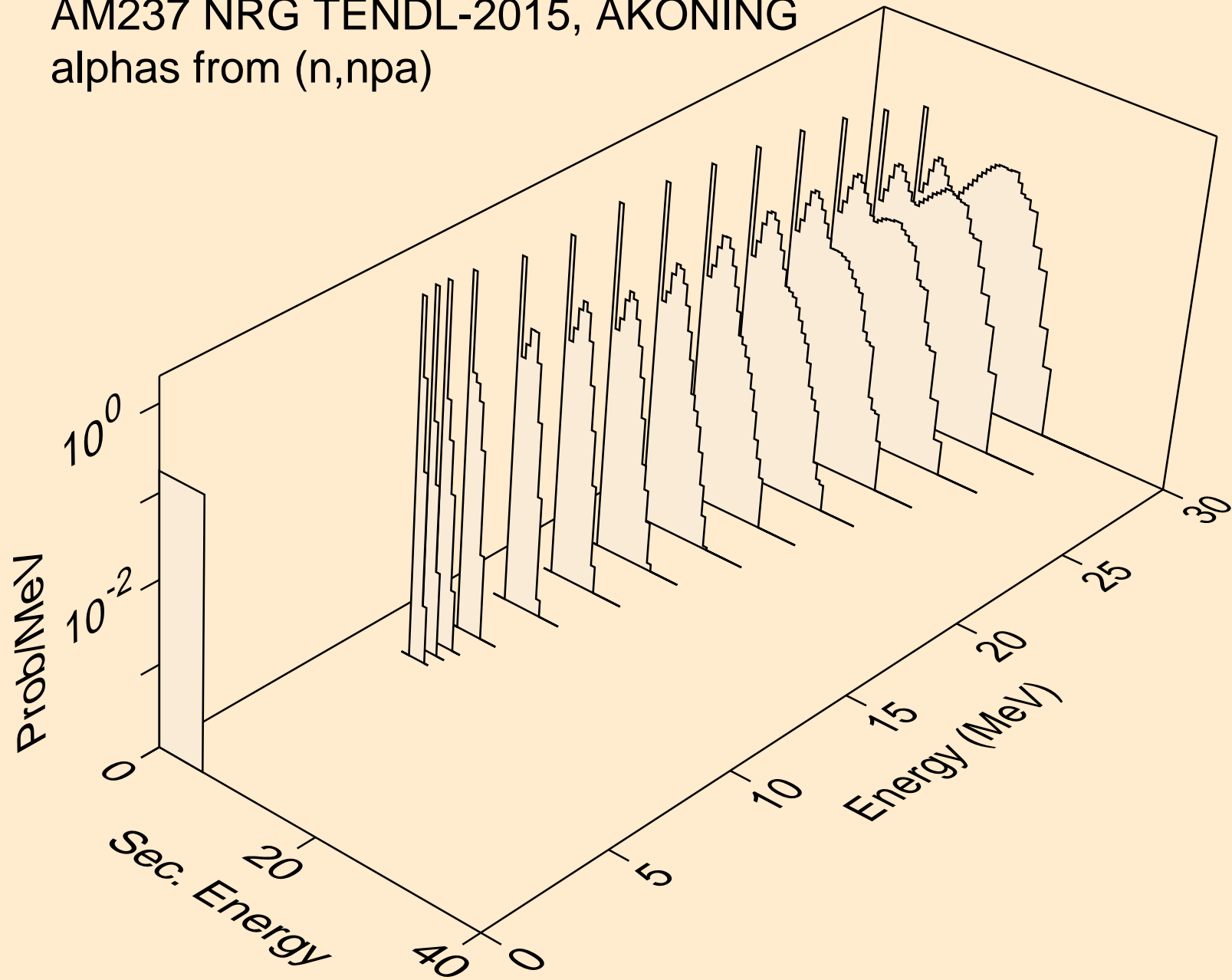

AM237 NRG TENDL-2015, AKONING
alphas from (n,a)

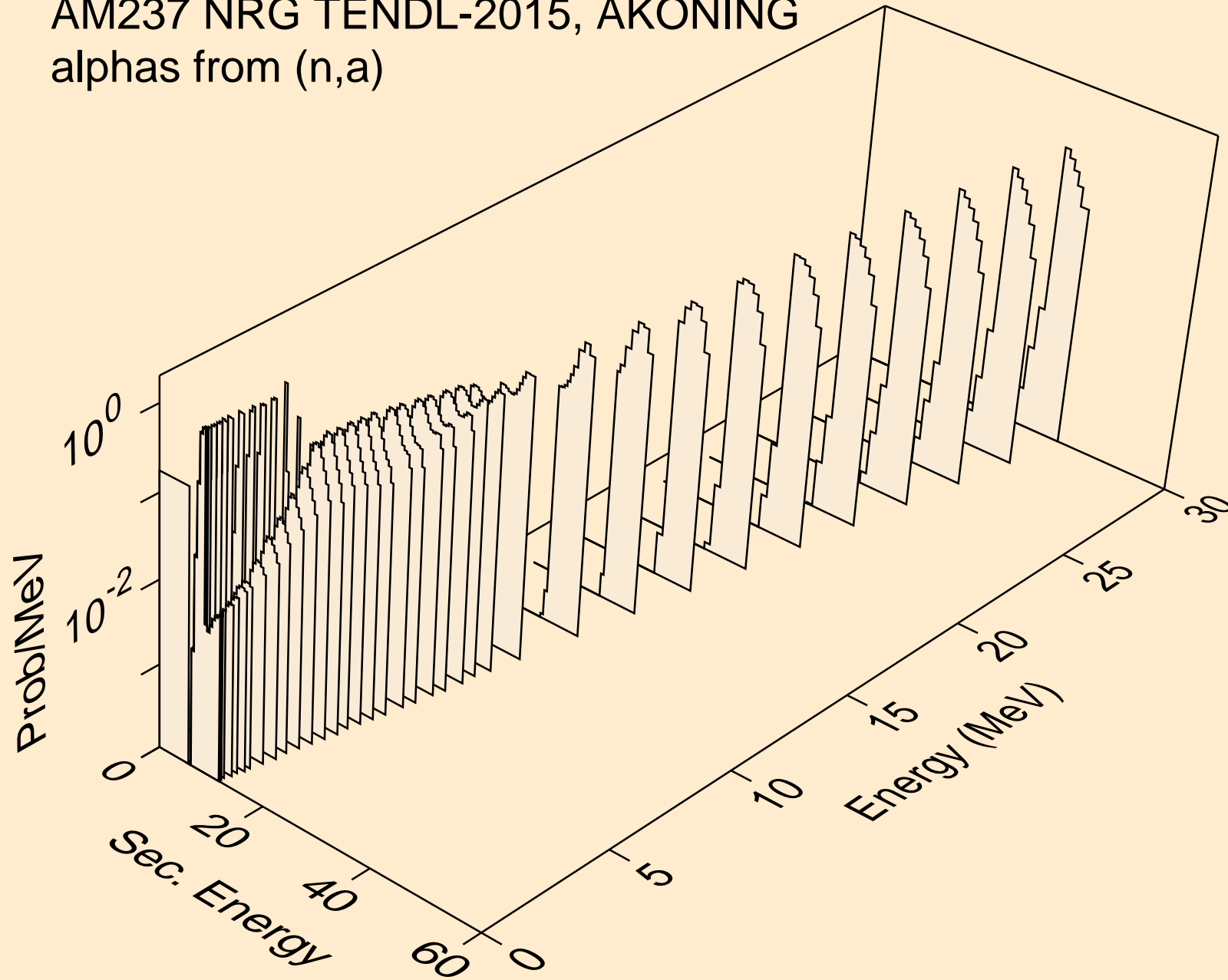

AM237 NRG TENDL-2015, AKONING
alphas from (n,2a)

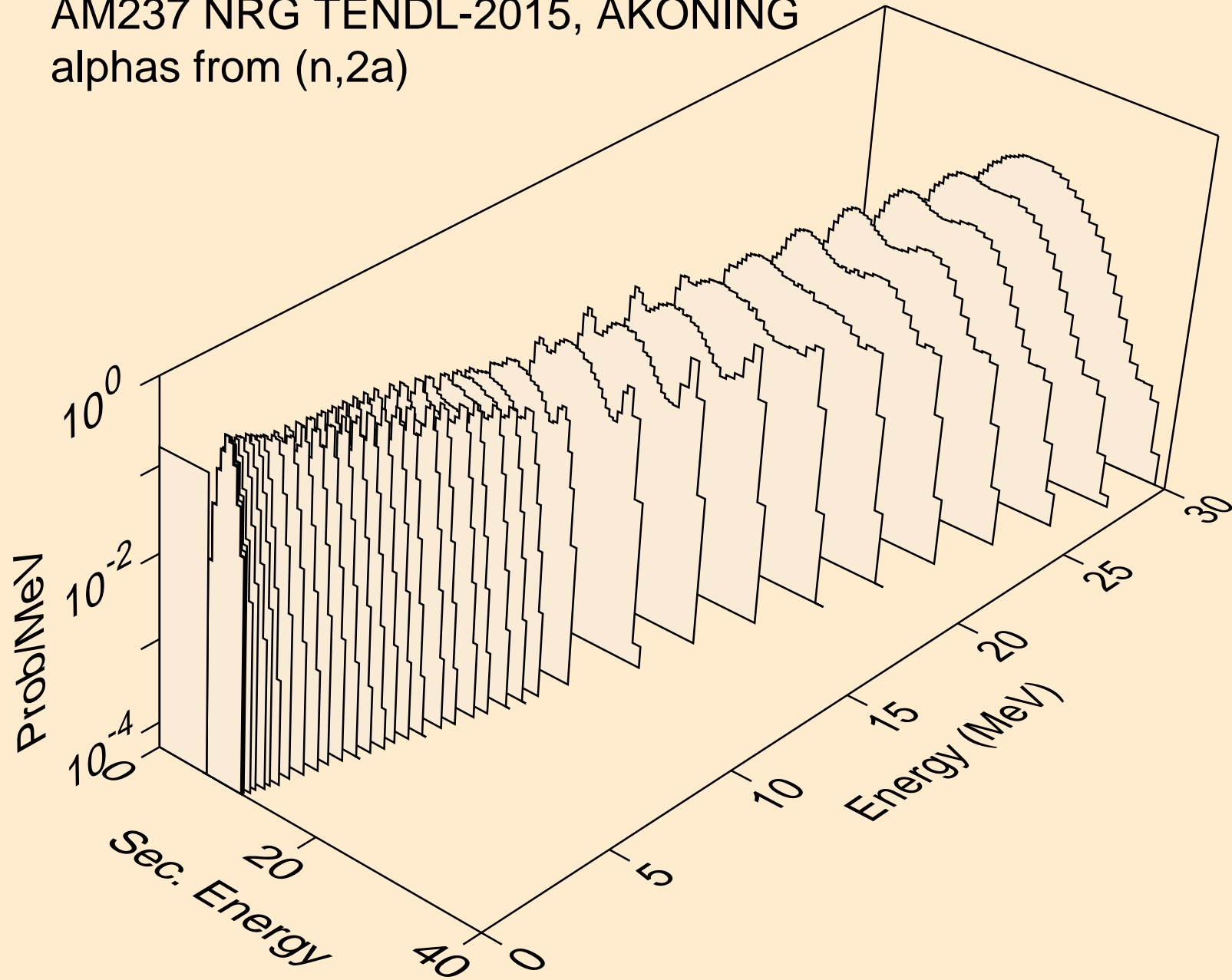

AM237 NRG TENDL-2015, AKONING
alphas from (n,pa)

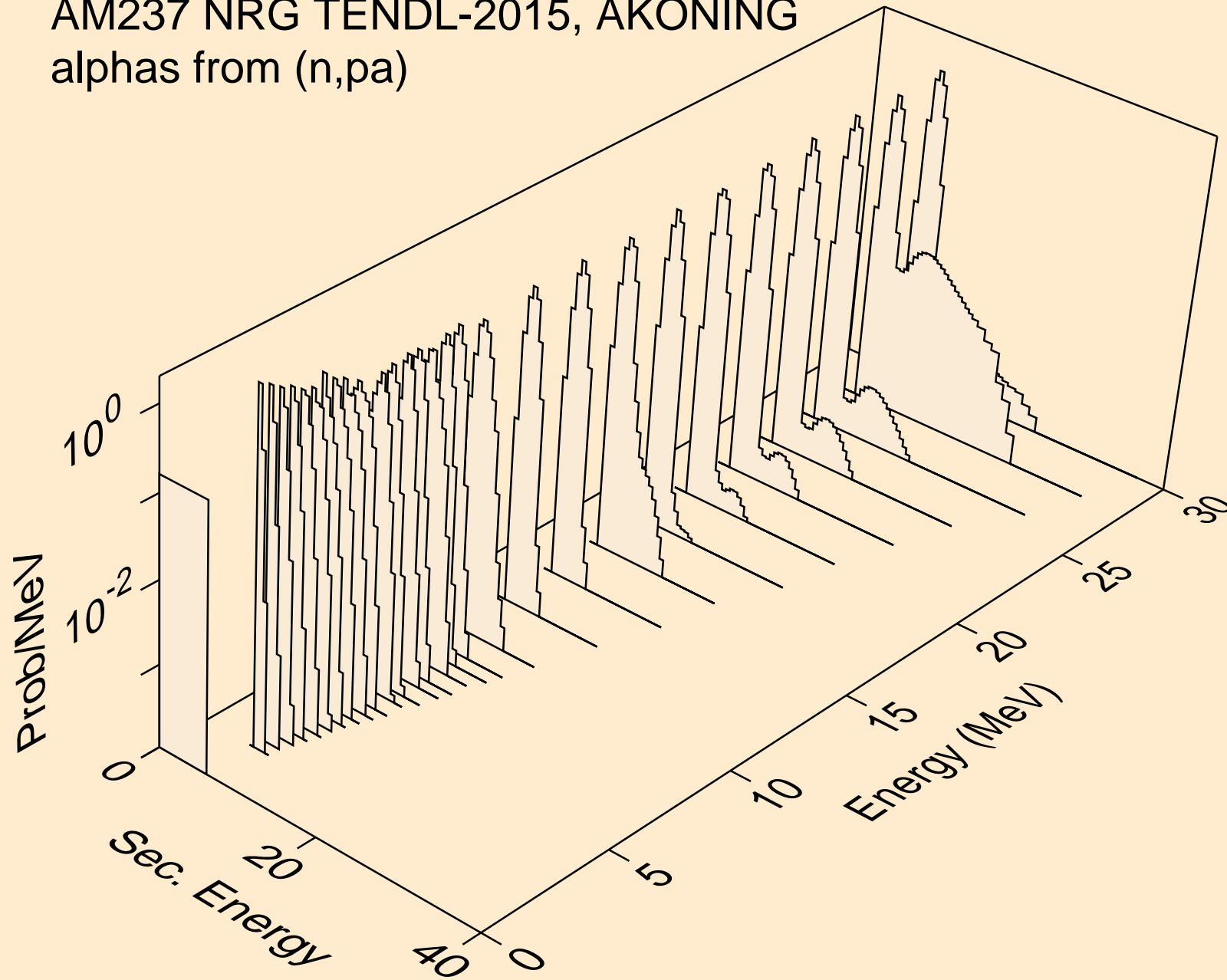

AM237 NRG TENDL-2015, AKONING
alphas from (n,da)

