

# AT202 NRG TENDL-2015, AKONING

## Principal cross sections

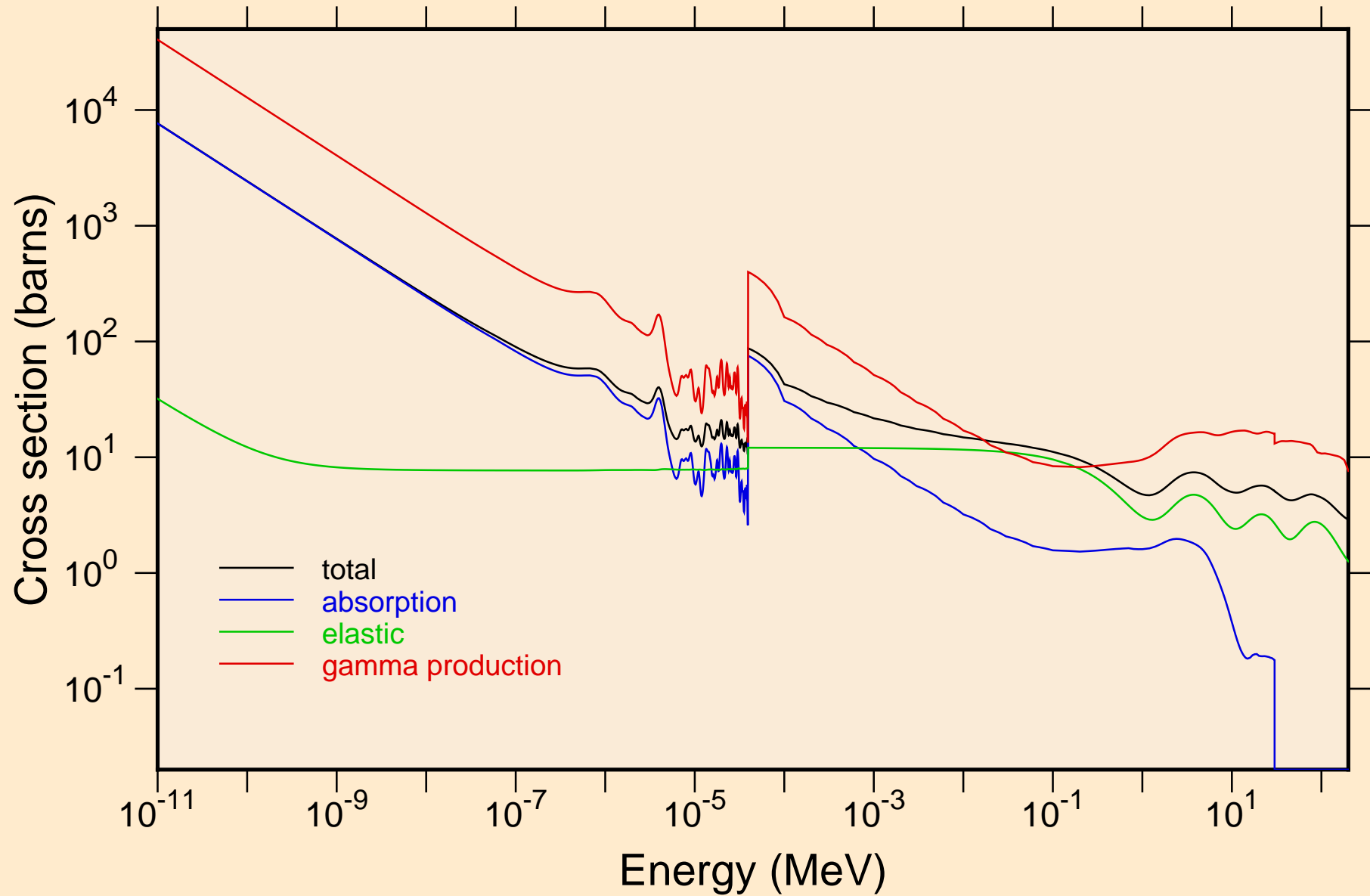

# AT202 NRG TENDL-2015, AKONING

## Non-threshold reactions

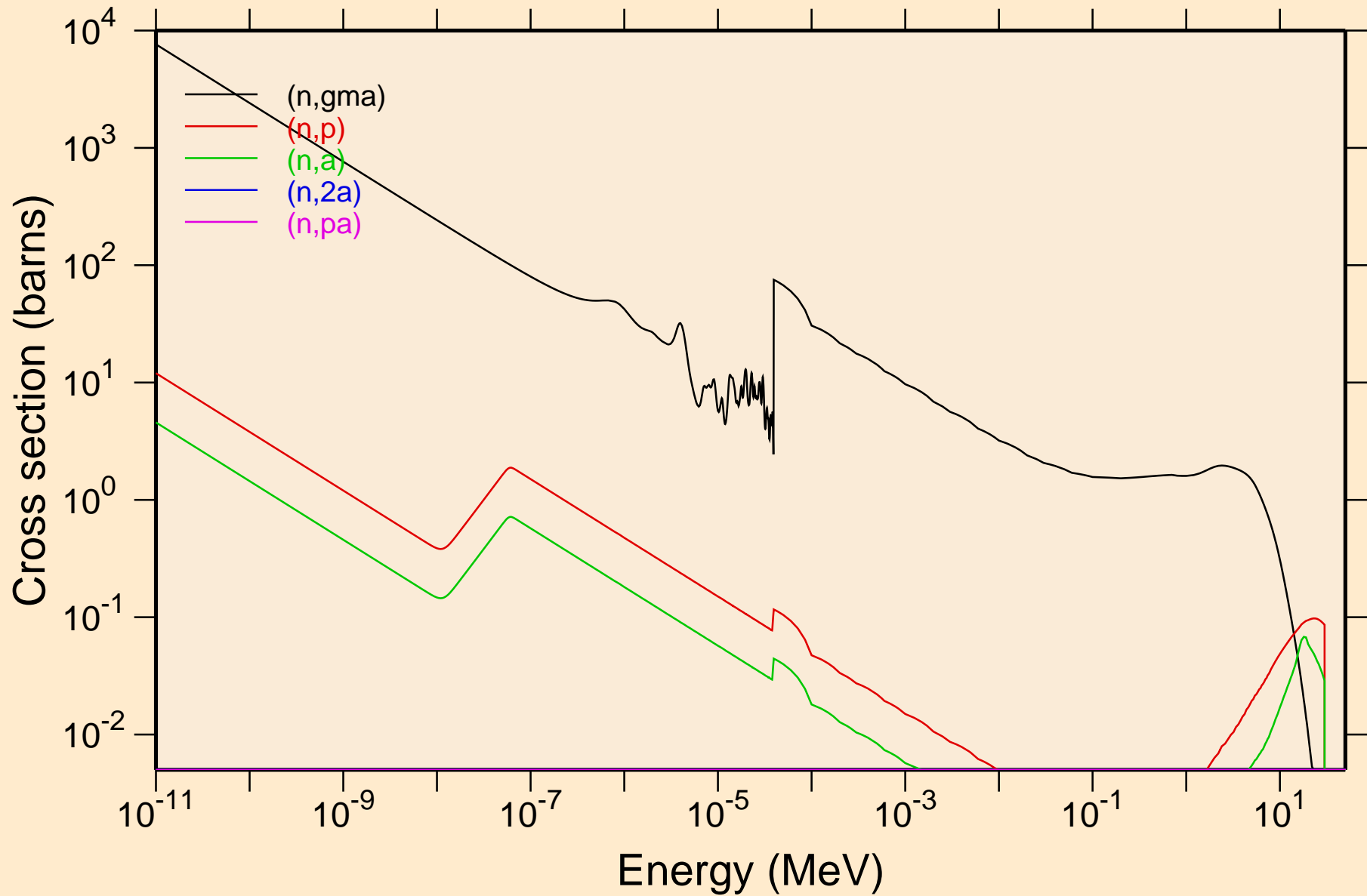

# AT202 NRG TENDL-2015, AKONING

## Principal cross sections

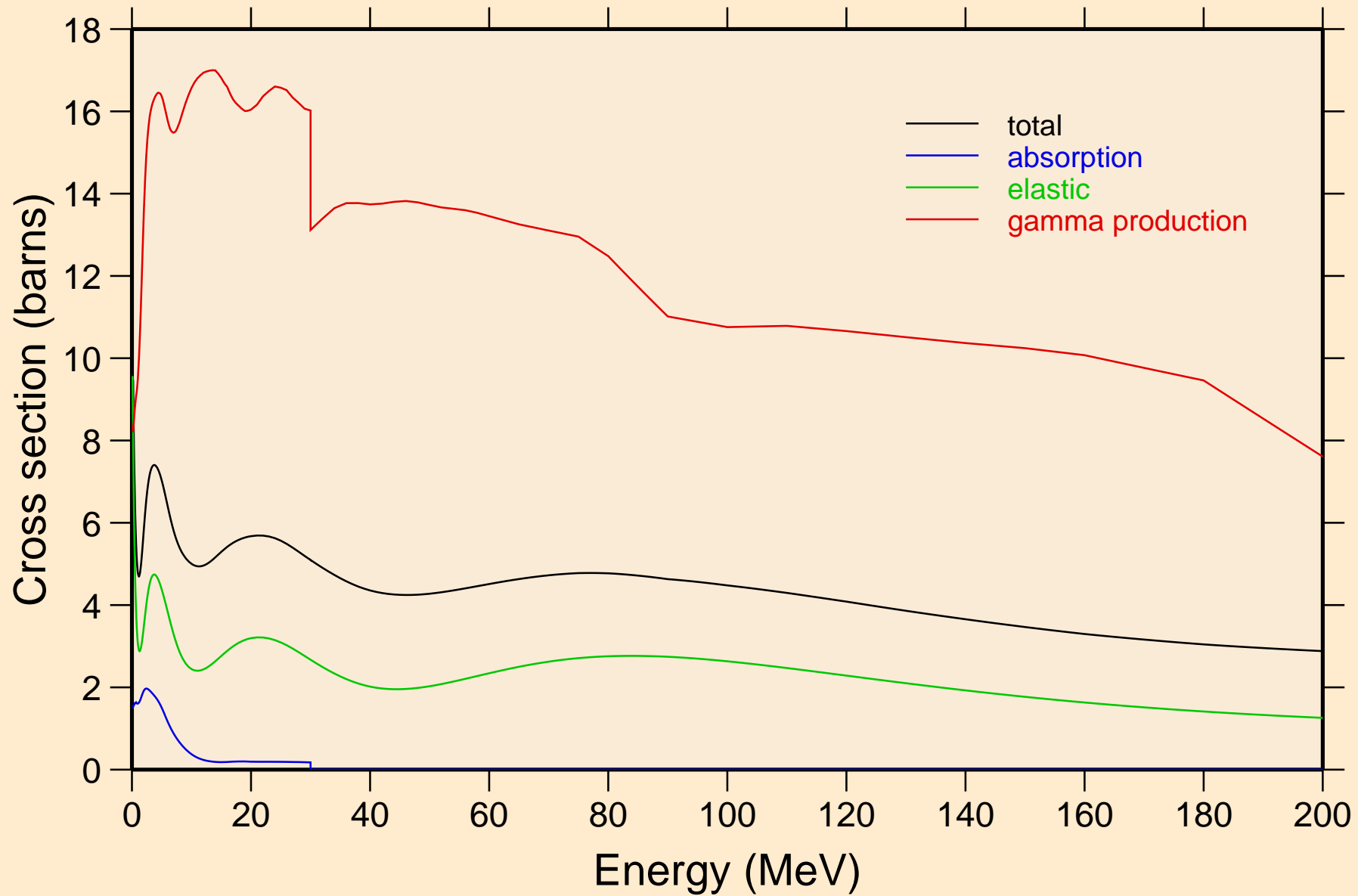

# AT202 NRG TENDL-2015, AKONING

## Non-threshold reactions

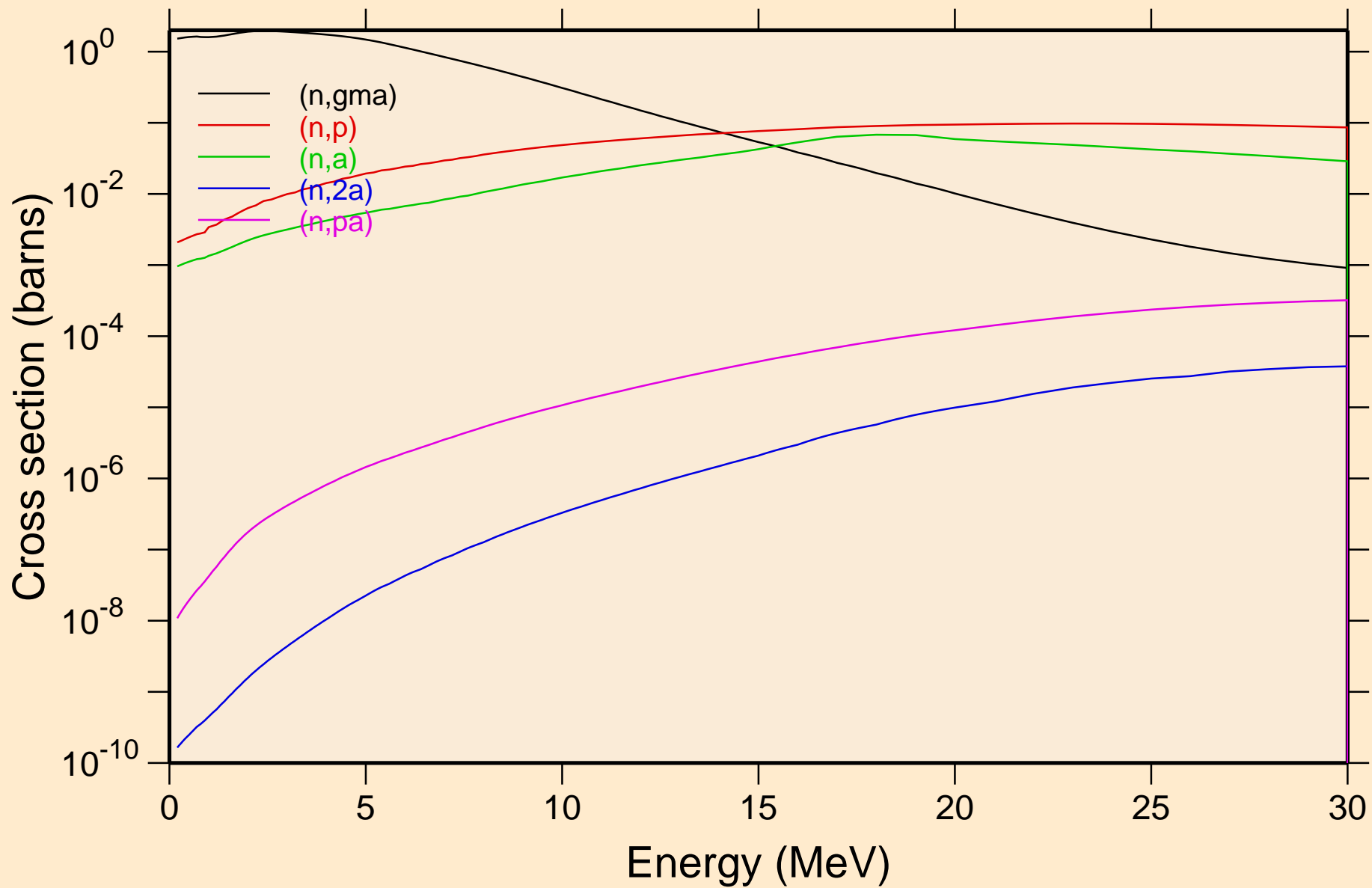

# AT202 NRG TENDL-2015, AKONING

## Inelastic levels

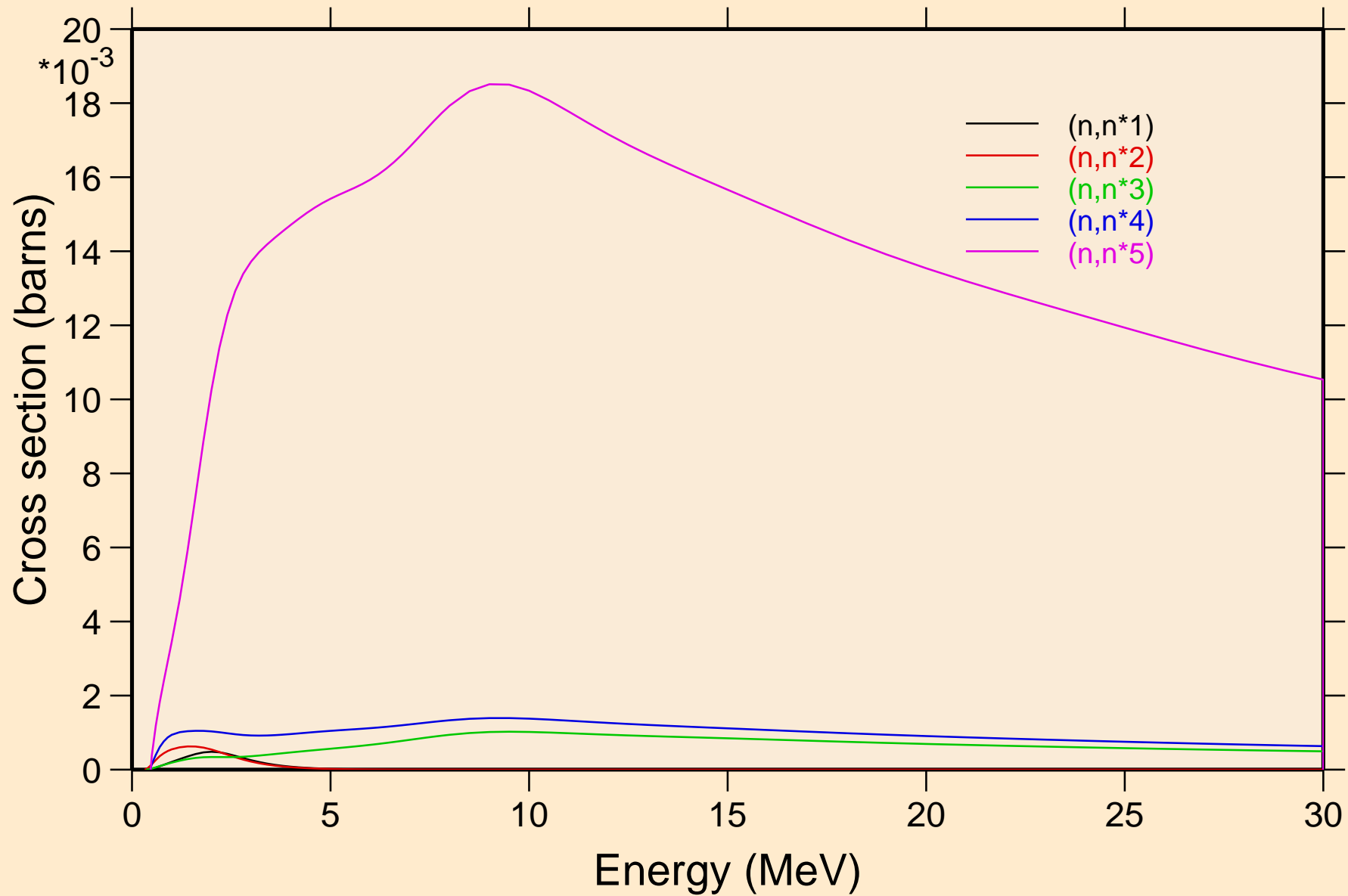

# AT202 NRG TENDL-2015, AKONING

## Inelastic levels

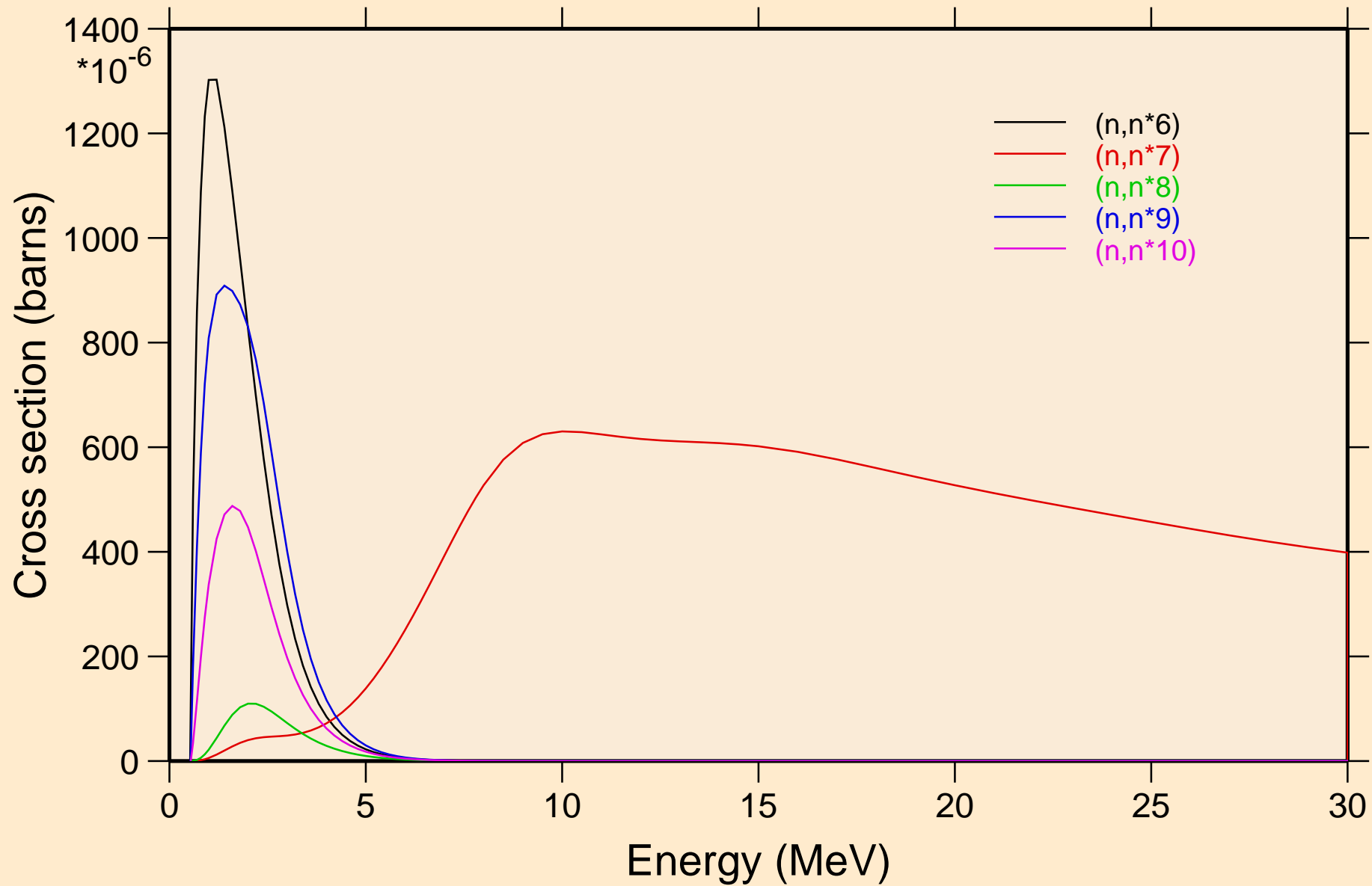

# AT202 NRG TENDL-2015, AKONING

## Inelastic levels

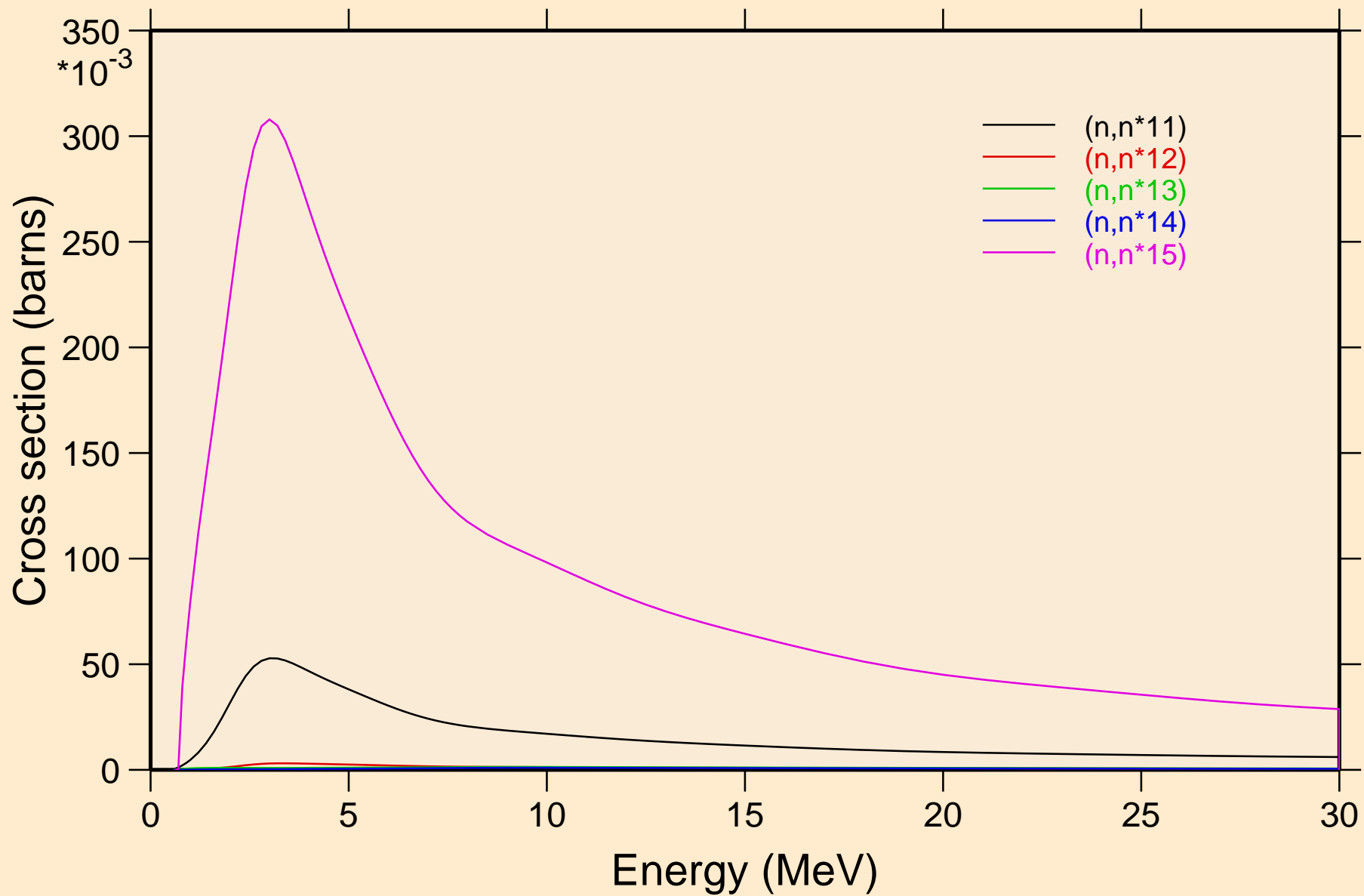

# AT202 NRG TENDL-2015, AKONING

## Threshold reactions

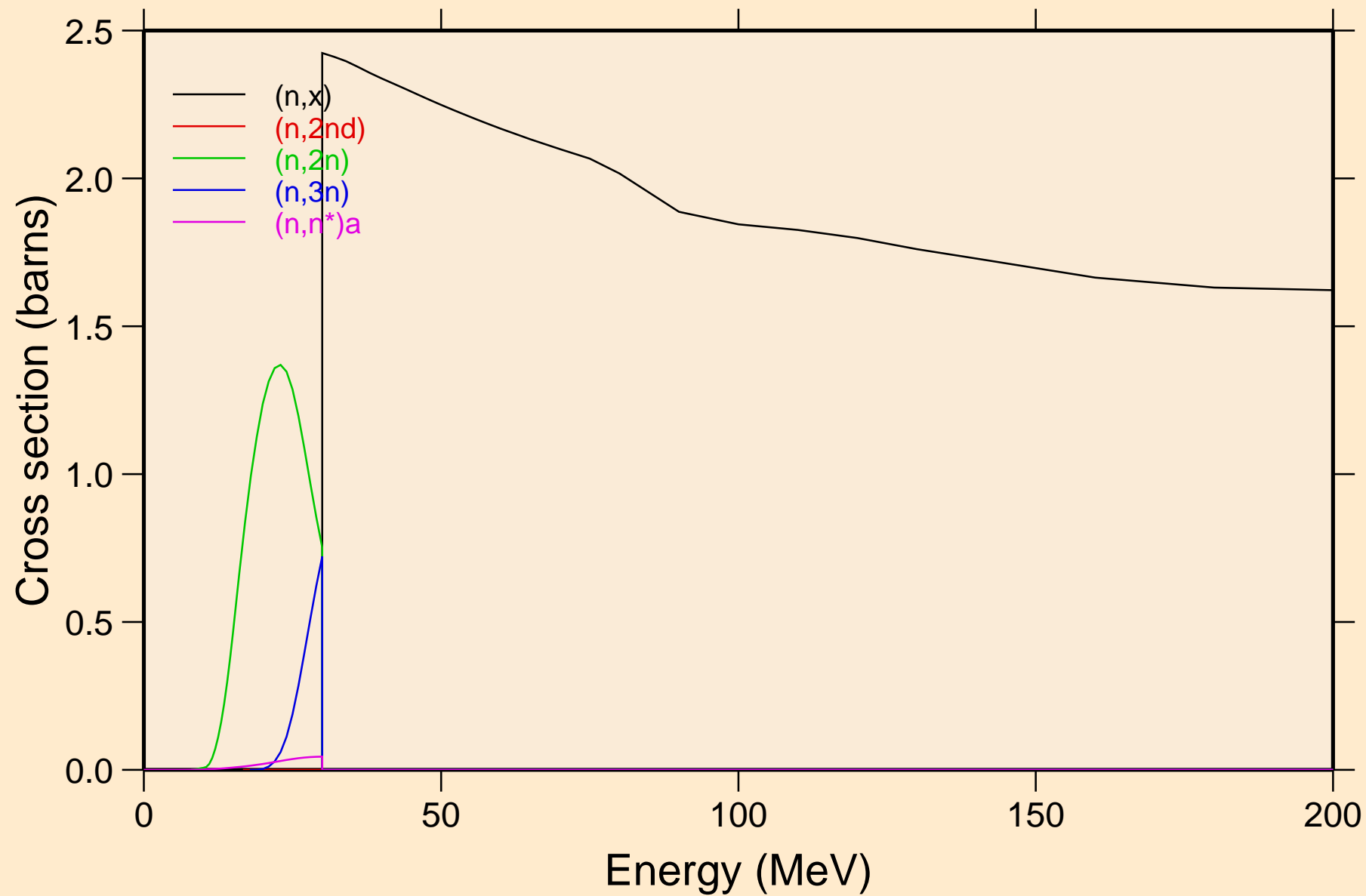



# AT202 NRG TENDL-2015, AKONING

## Threshold reactions

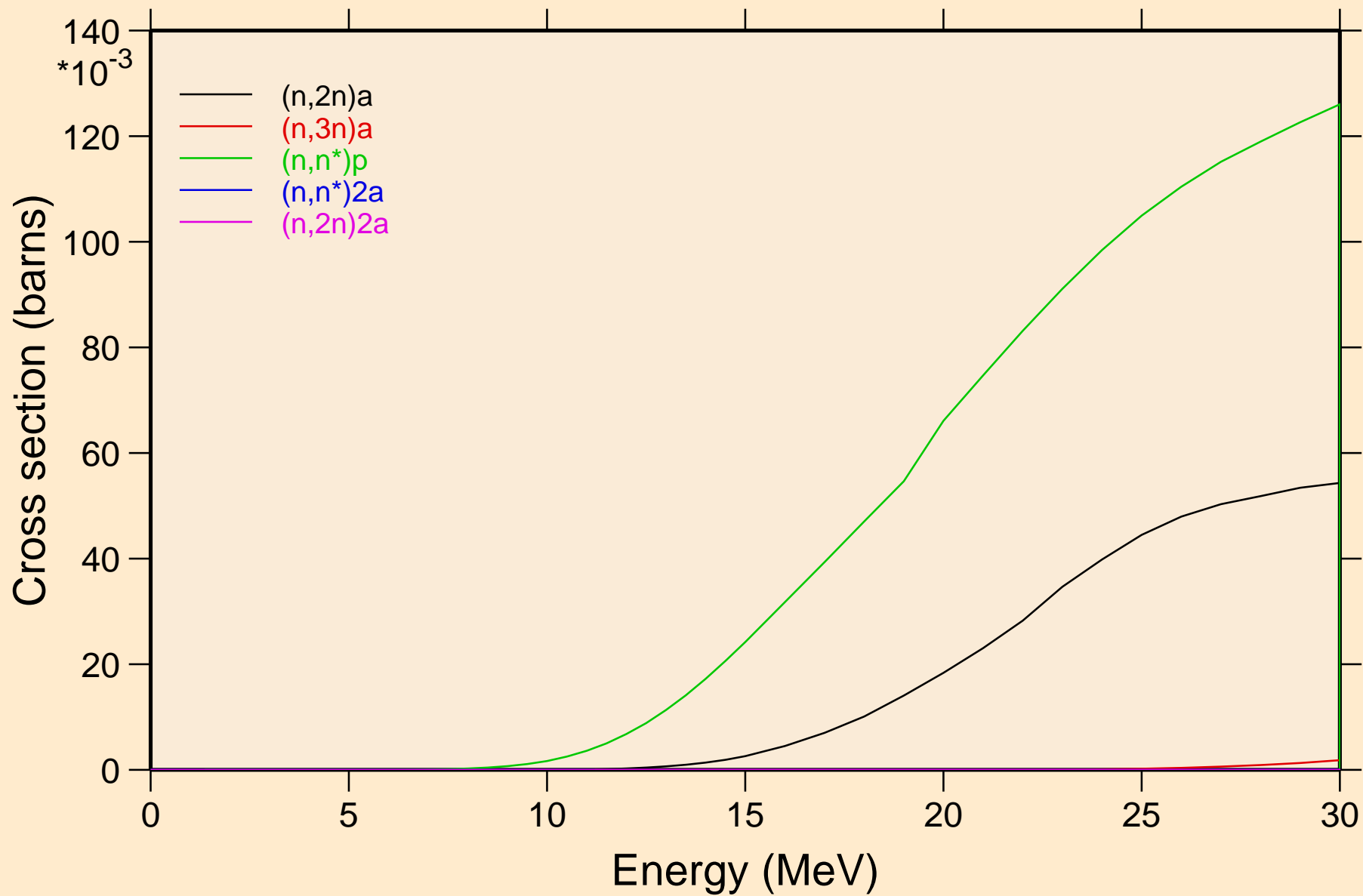

# AT202 NRG TENDL-2015, AKONING

## Threshold reactions

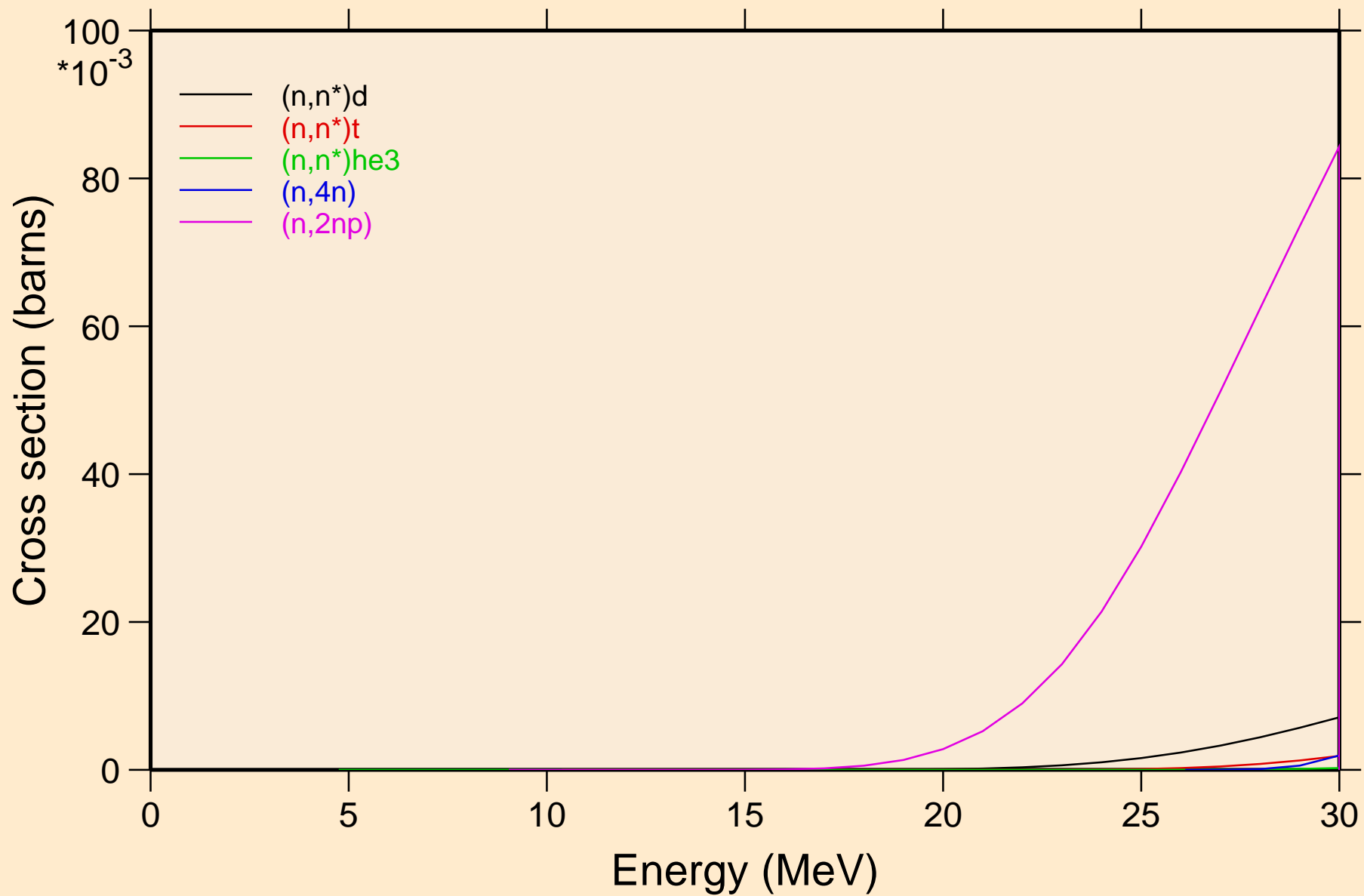

# AT202 NRG TENDL-2015, AKONING

## Threshold reactions

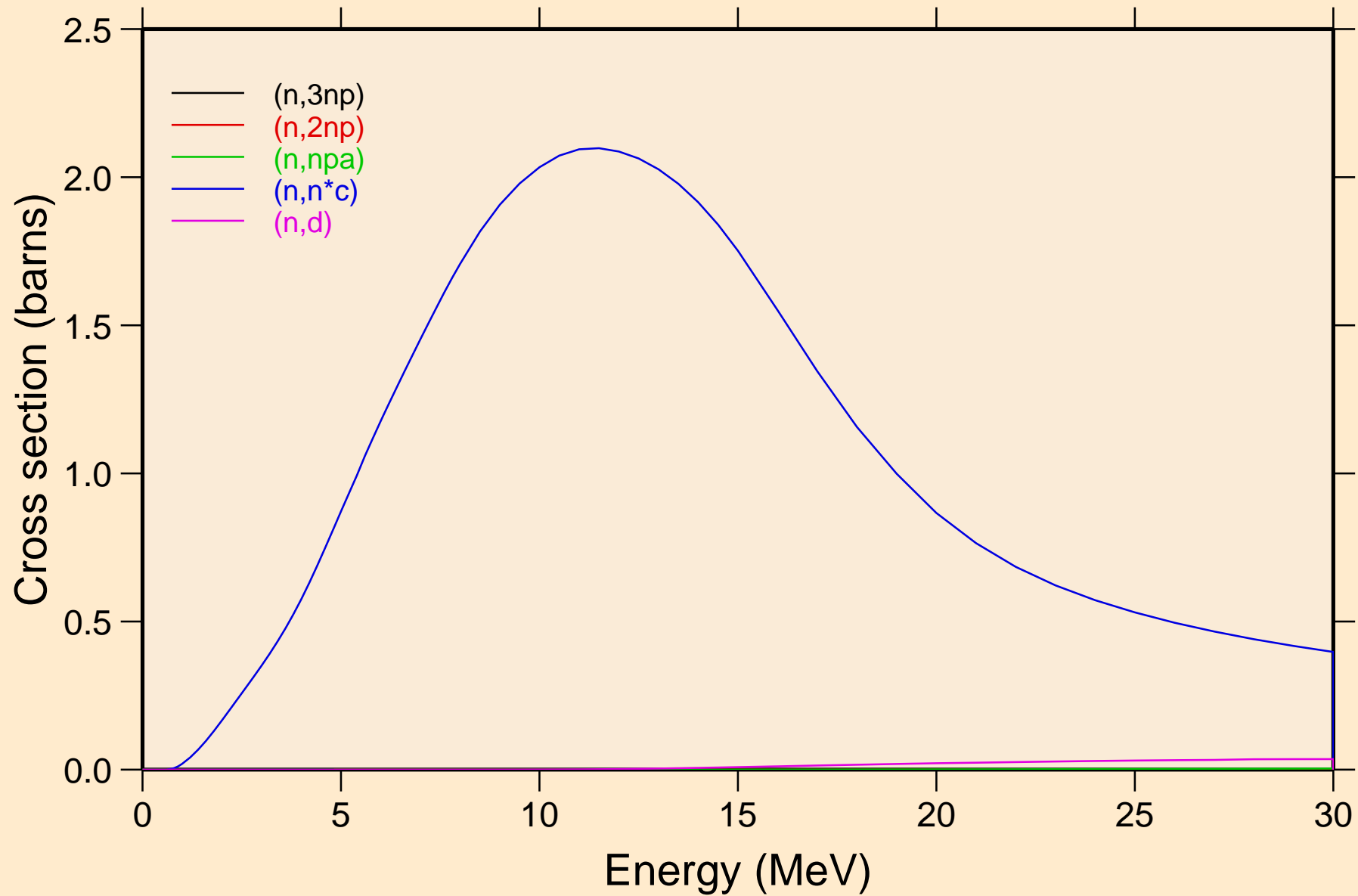

# AT202 NRG TENDL-2015, AKONING

## Threshold reactions

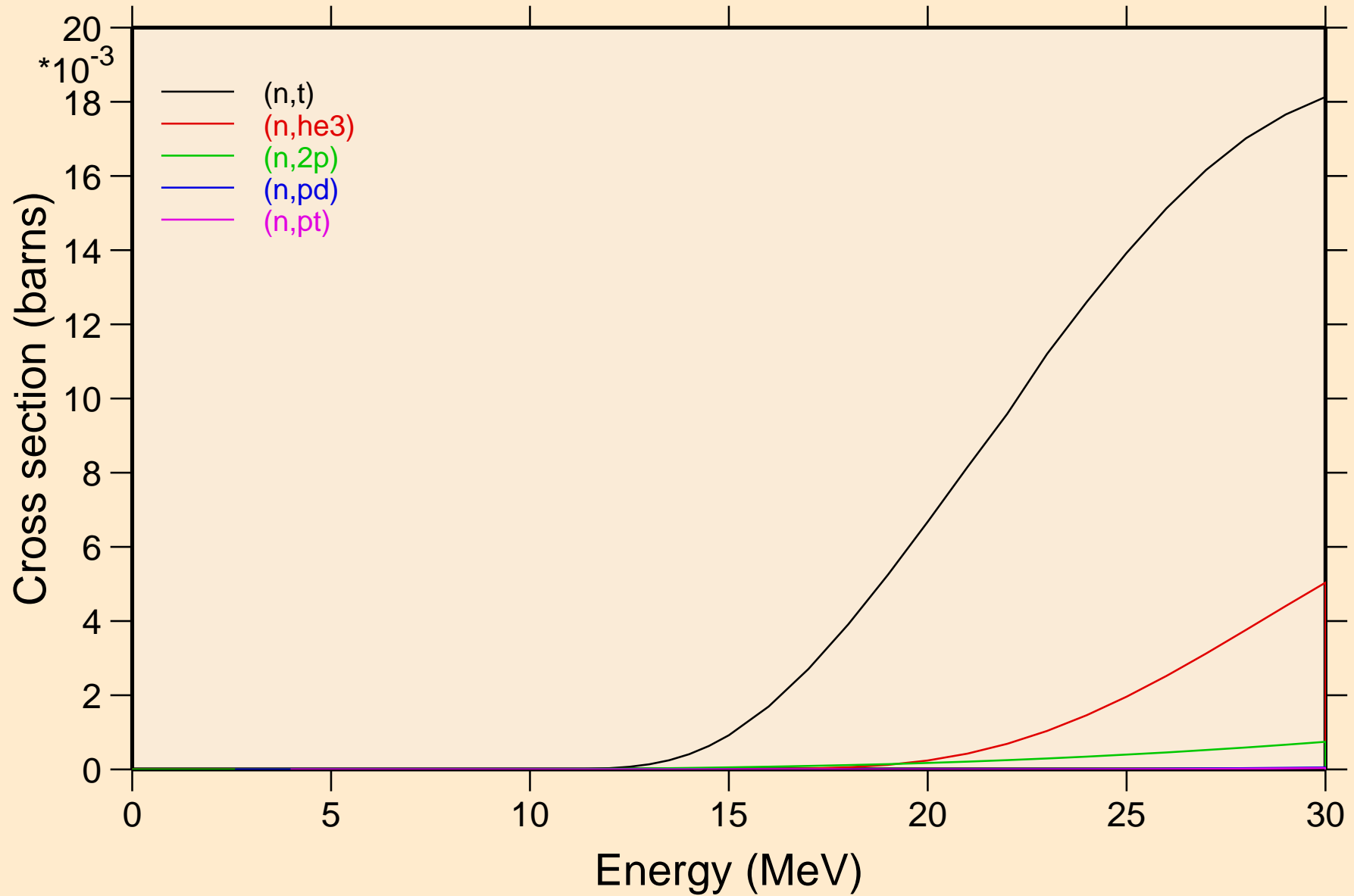

# AT202 NRG TENDL-2015, AKONING

## Threshold reactions

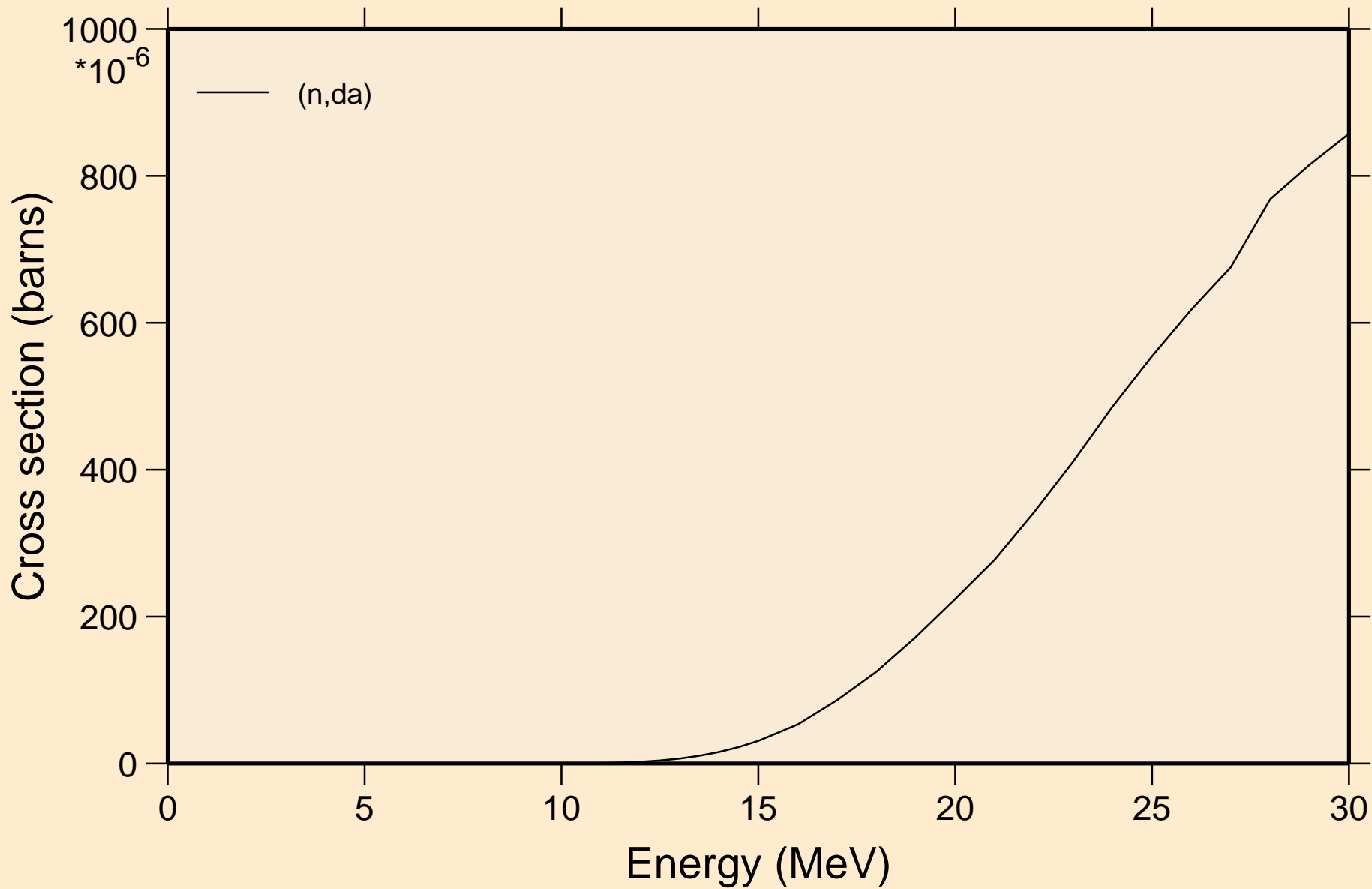

AT202 NRG TENDL-2015, AKONING  
angular distribution for elastic

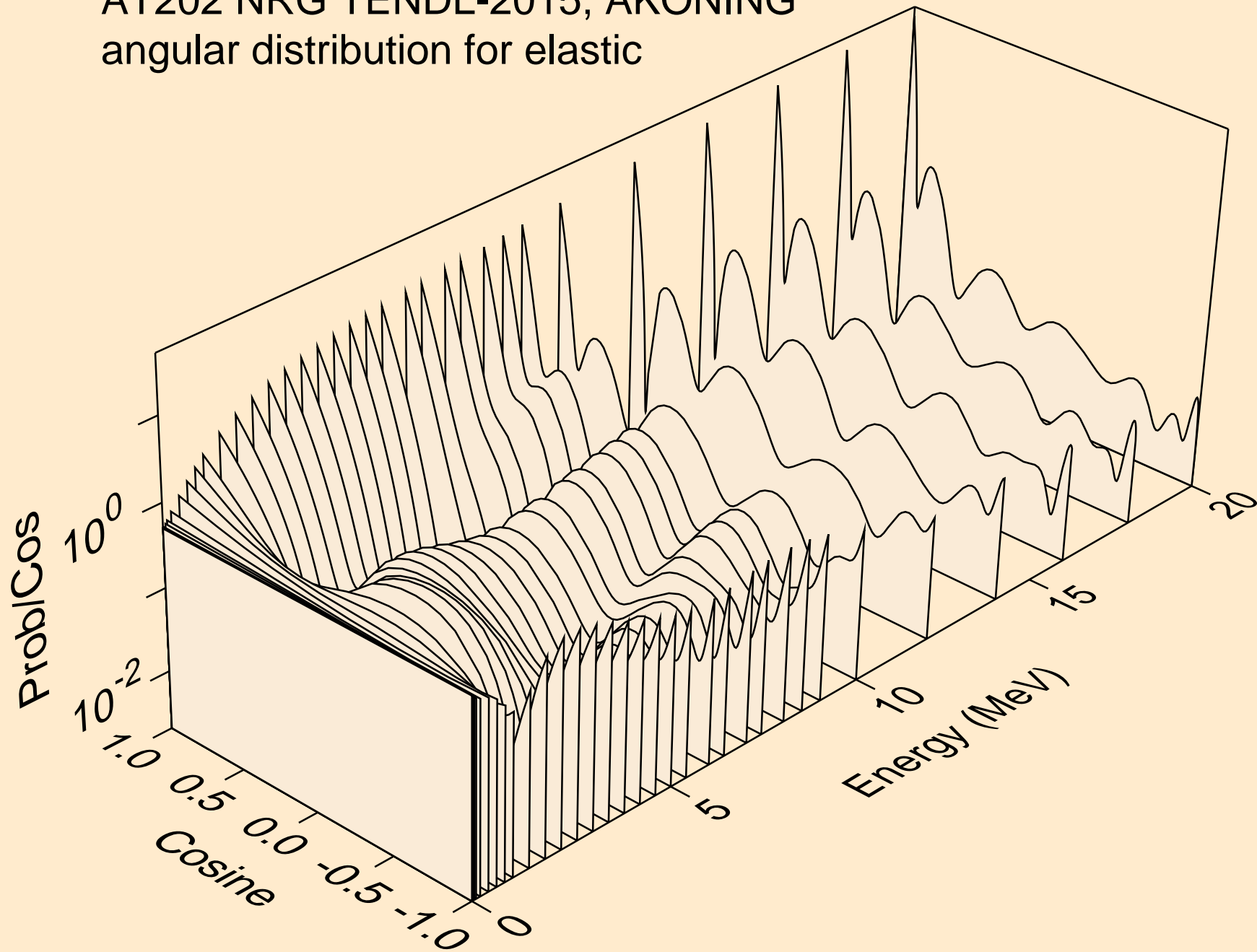

AT202 NRG TENDL-2015, AKONING  
angular distribution for elastic

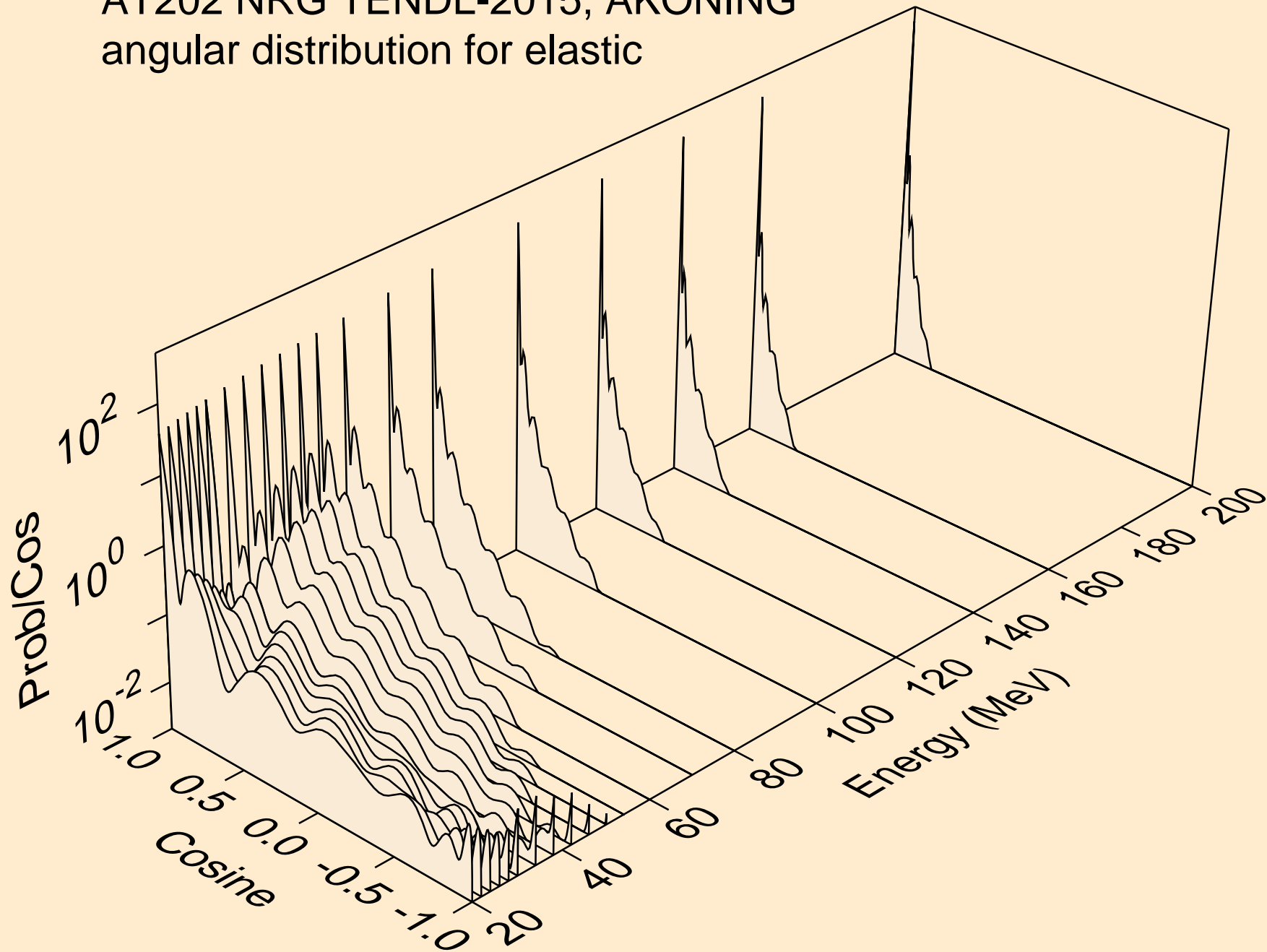

AT202 NRG TENDL-2015, AKONING  
angular distribution for (n,n\*1)

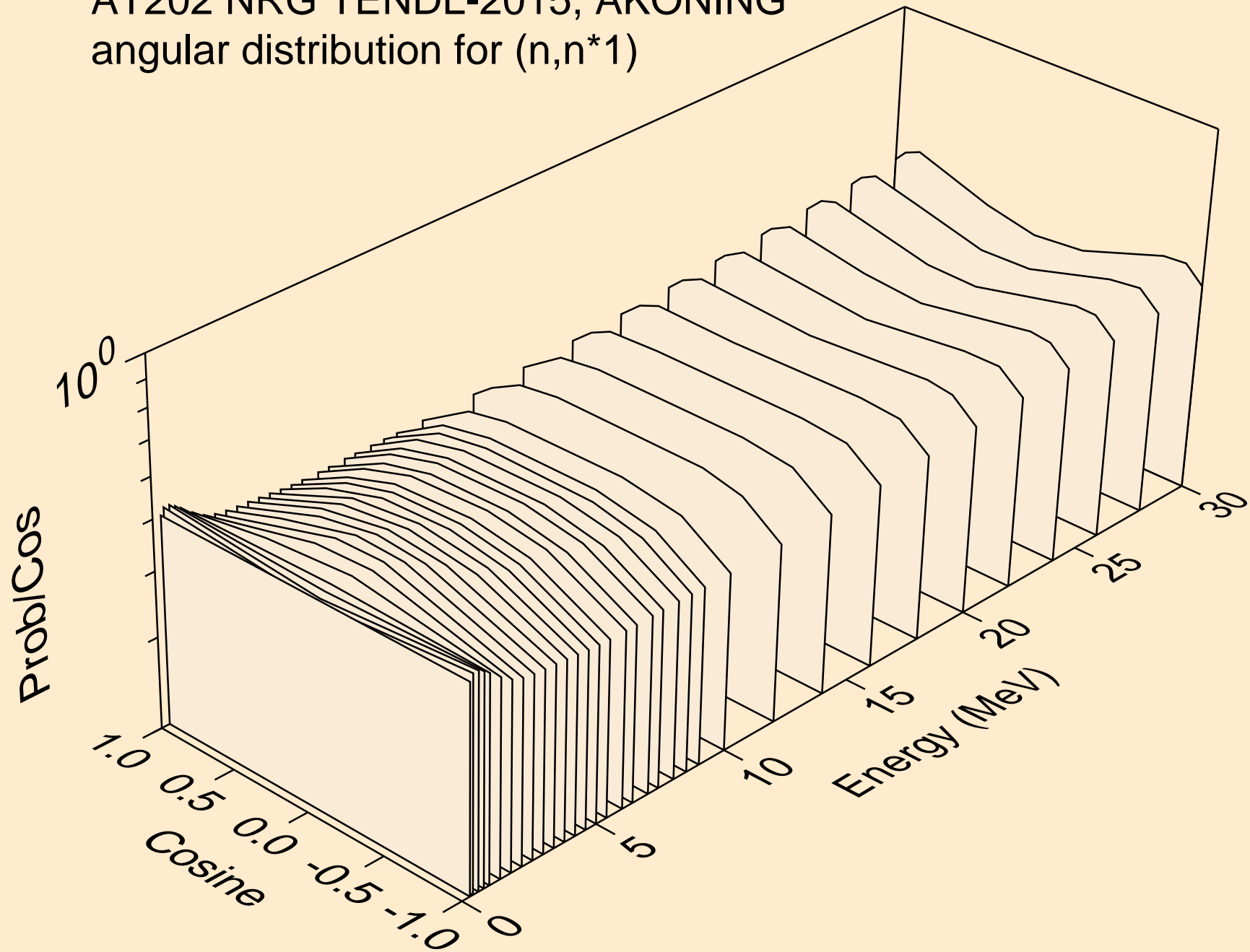



AT202 NRG TENDL-2015, AKONING  
angular distribution for (n,n\*2)

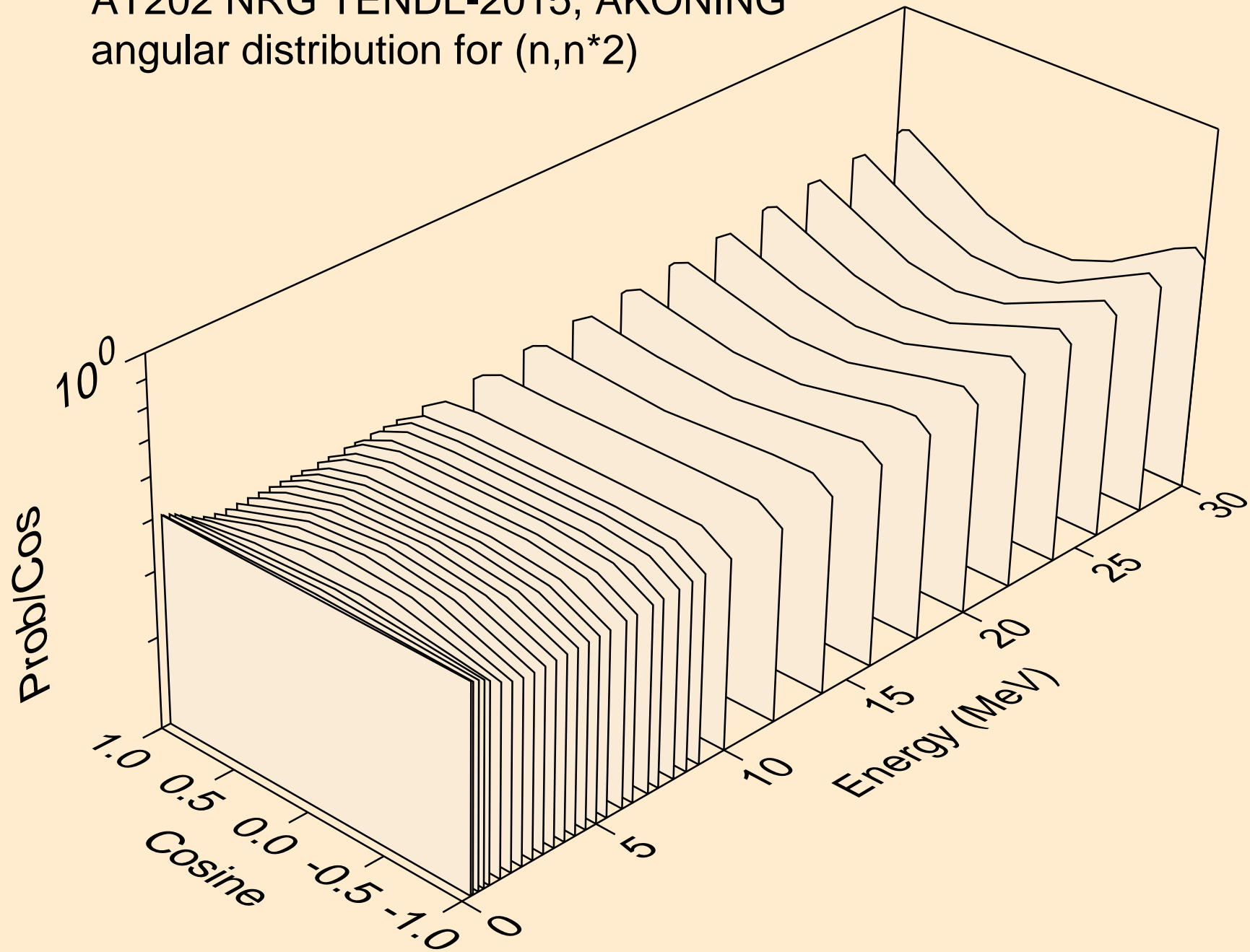

AT202 NRG TENDL-2015, AKONING  
angular distribution for (n,n\*3)

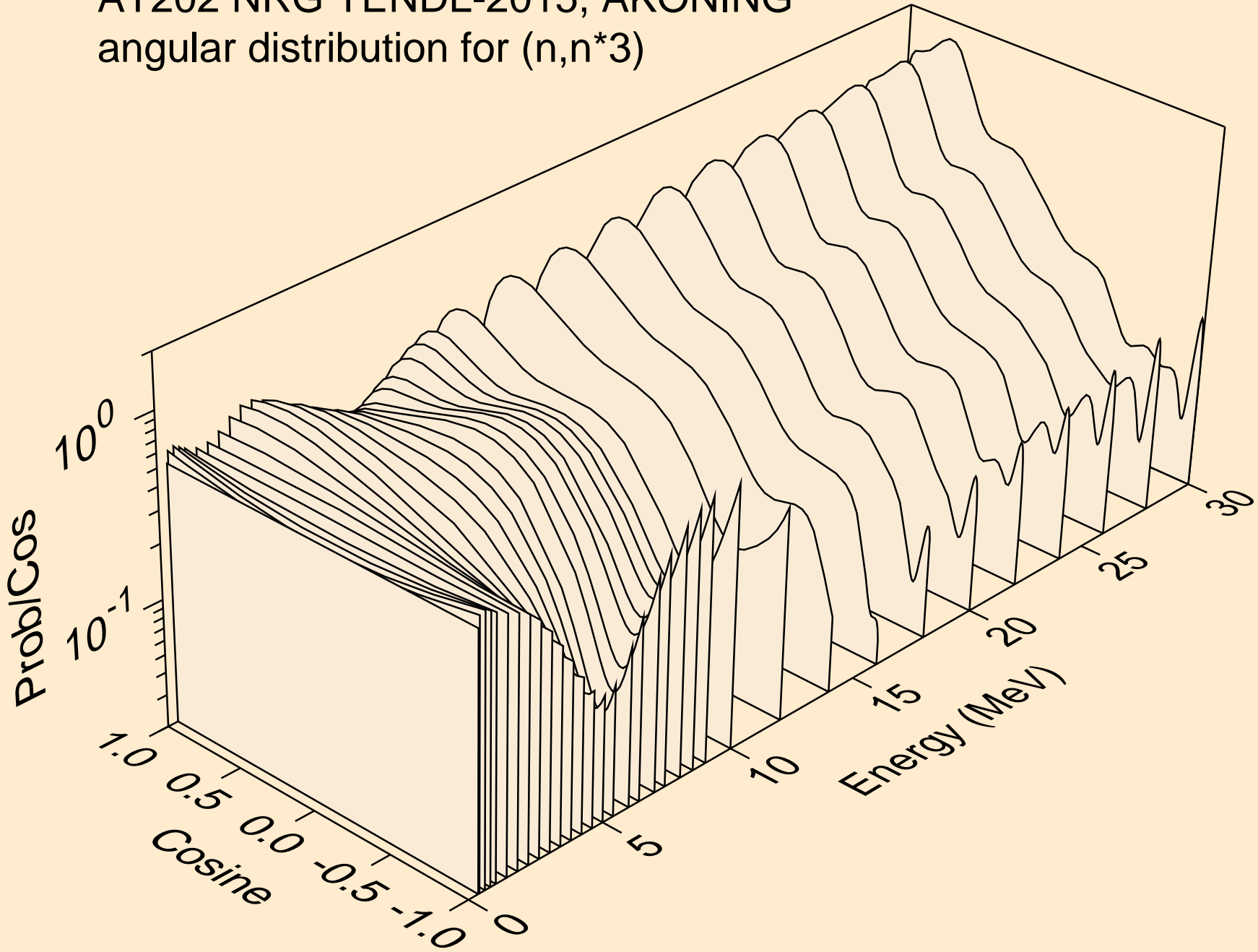

AT202 NRG TENDL-2015, AKONING  
angular distribution for (n,n\*4)

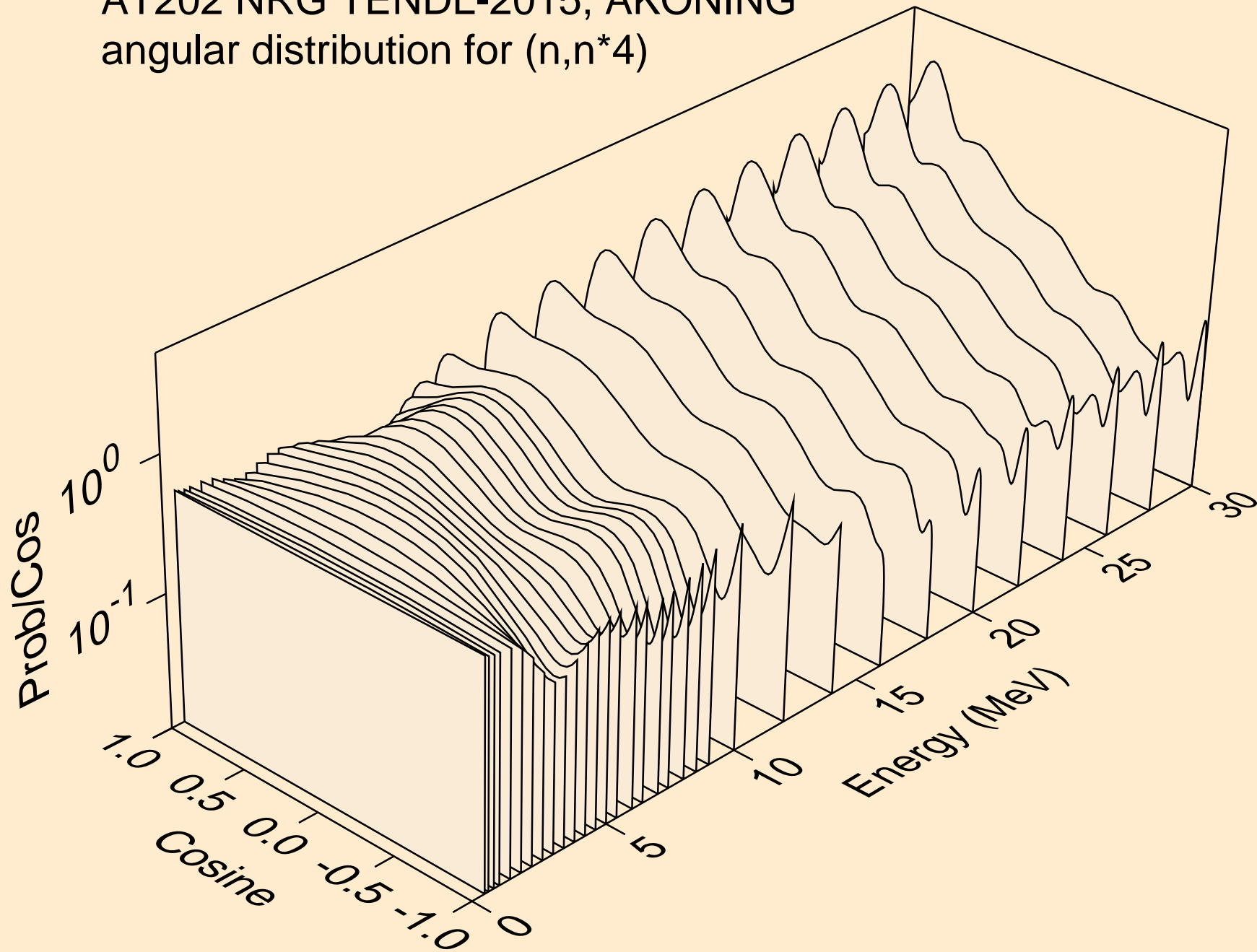

AT202 NRG TENDL-2015, AKONING  
angular distribution for (n,n\*5)

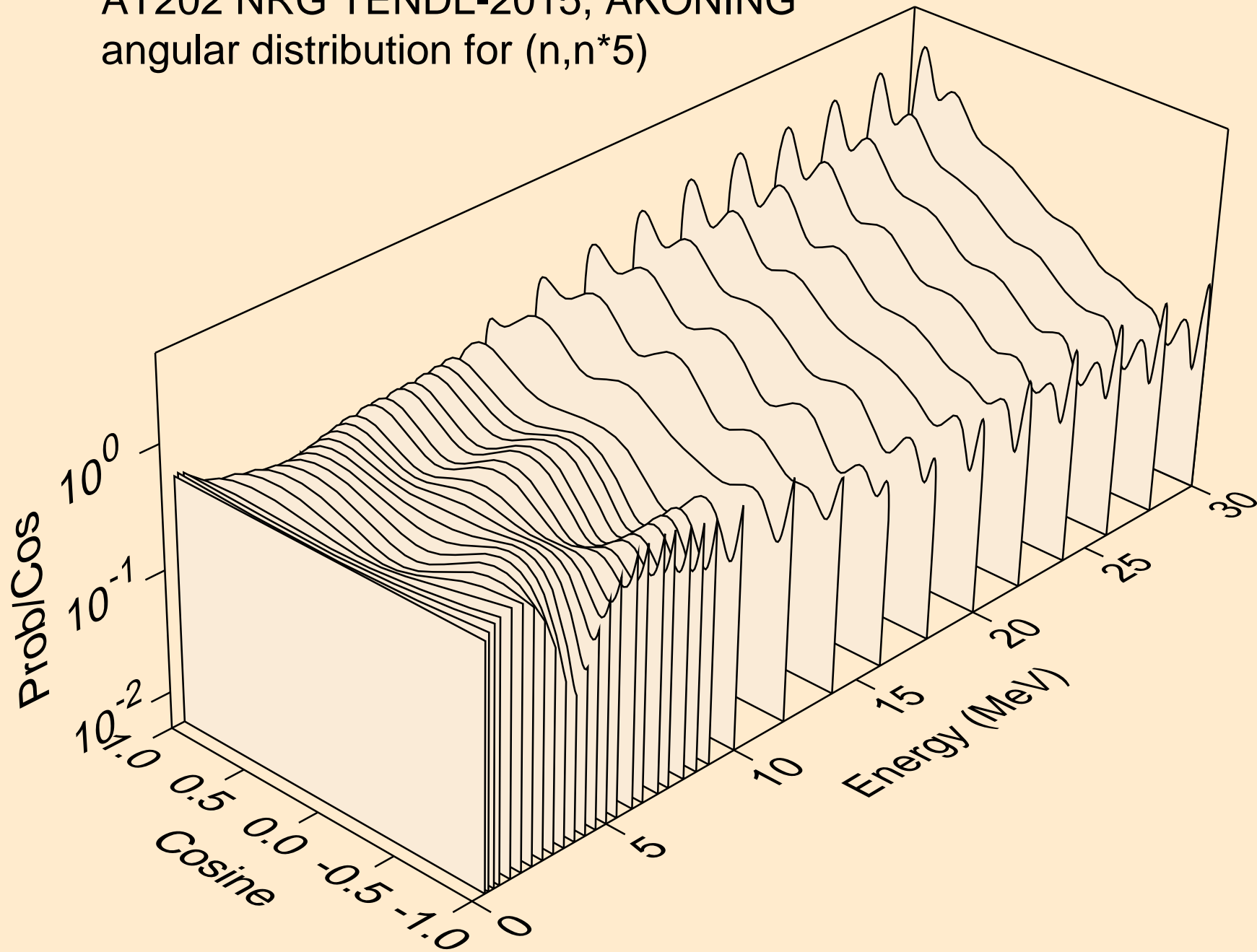

AT202 NRG TENDL-2015, AKONING  
angular distribution for (n,n\*6)

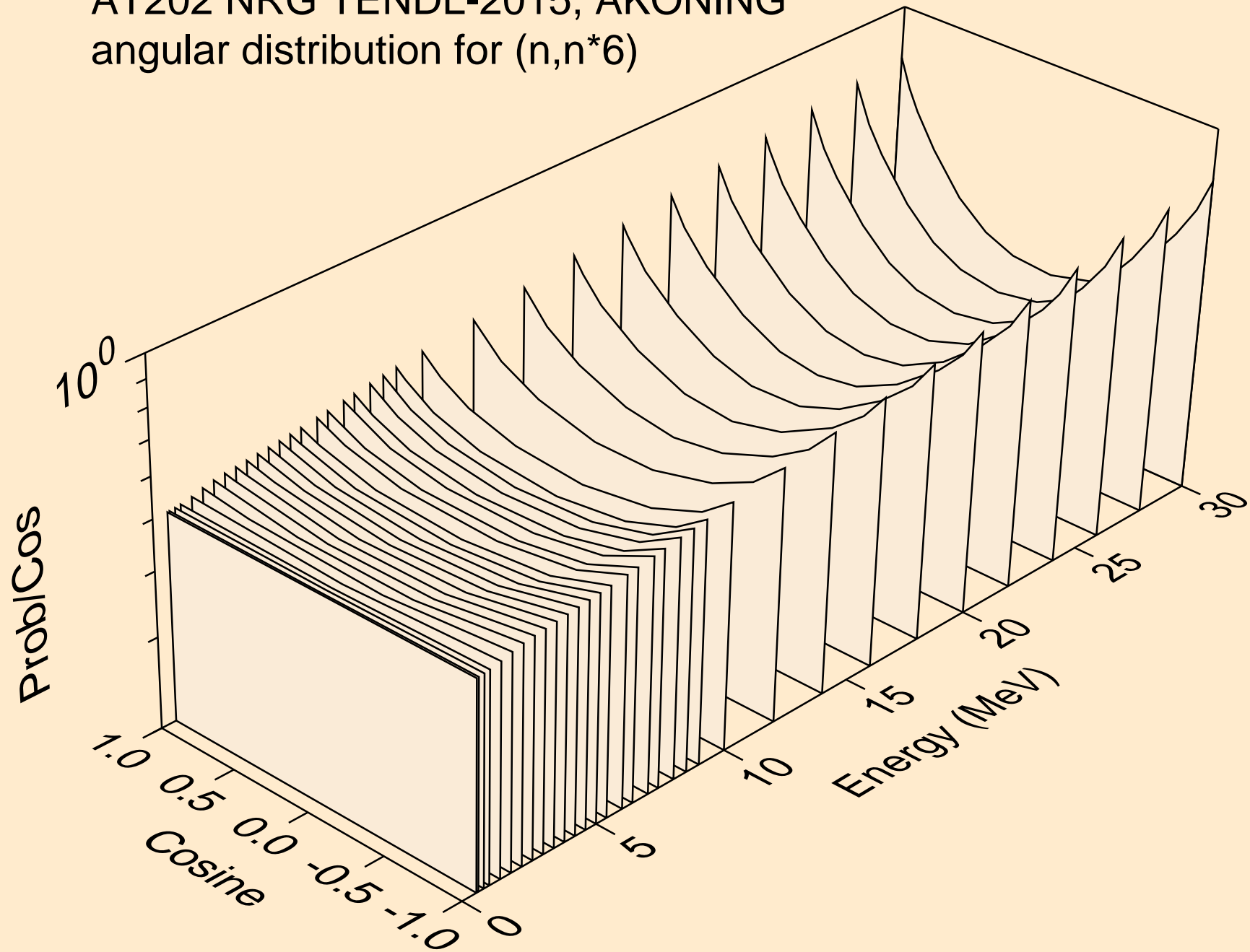

AT202 NRG TENDL-2015, AKONING  
angular distribution for (n,n\*7)

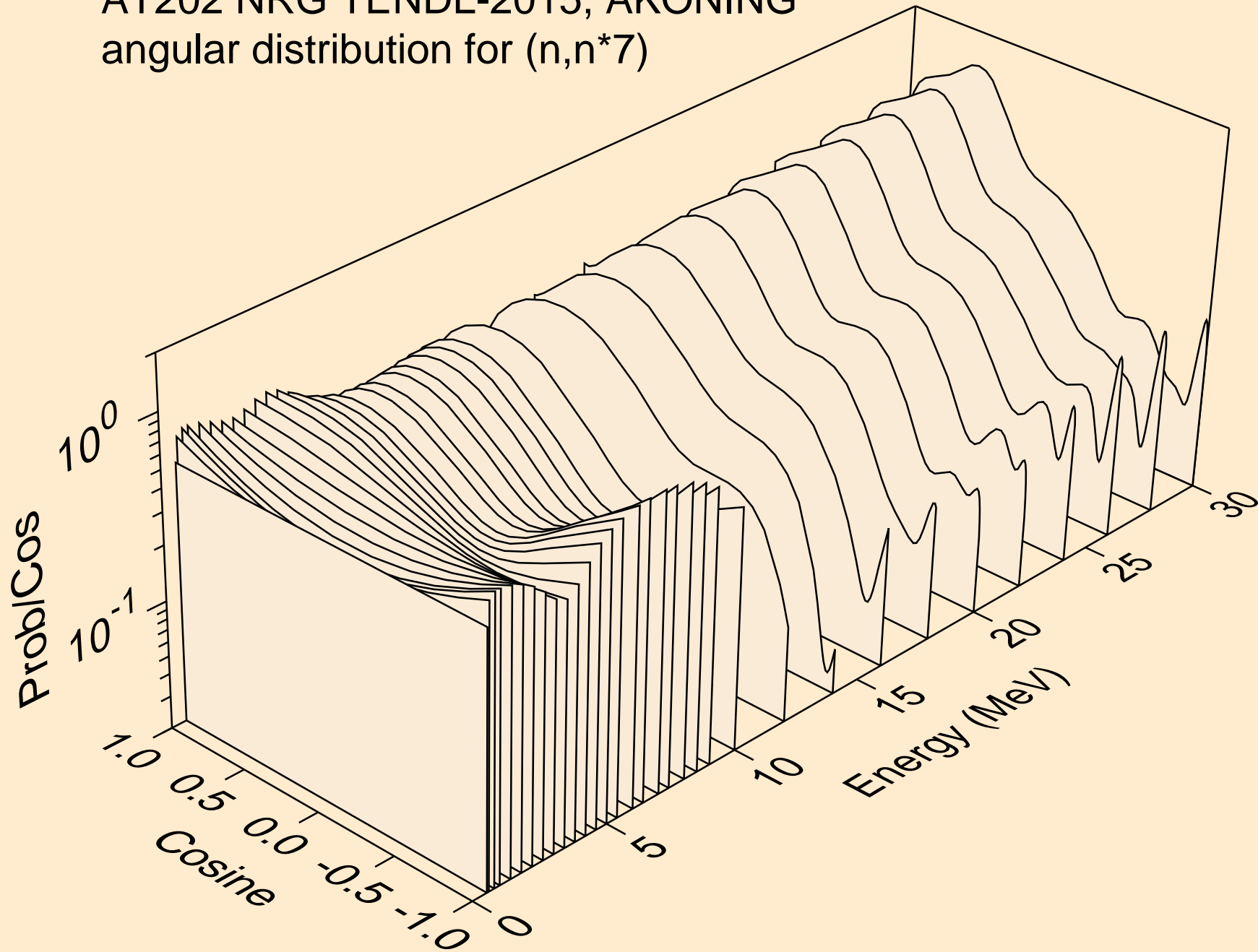

AT202 NRG TENDL-2015, AKONING  
angular distribution for (n,n\*8)

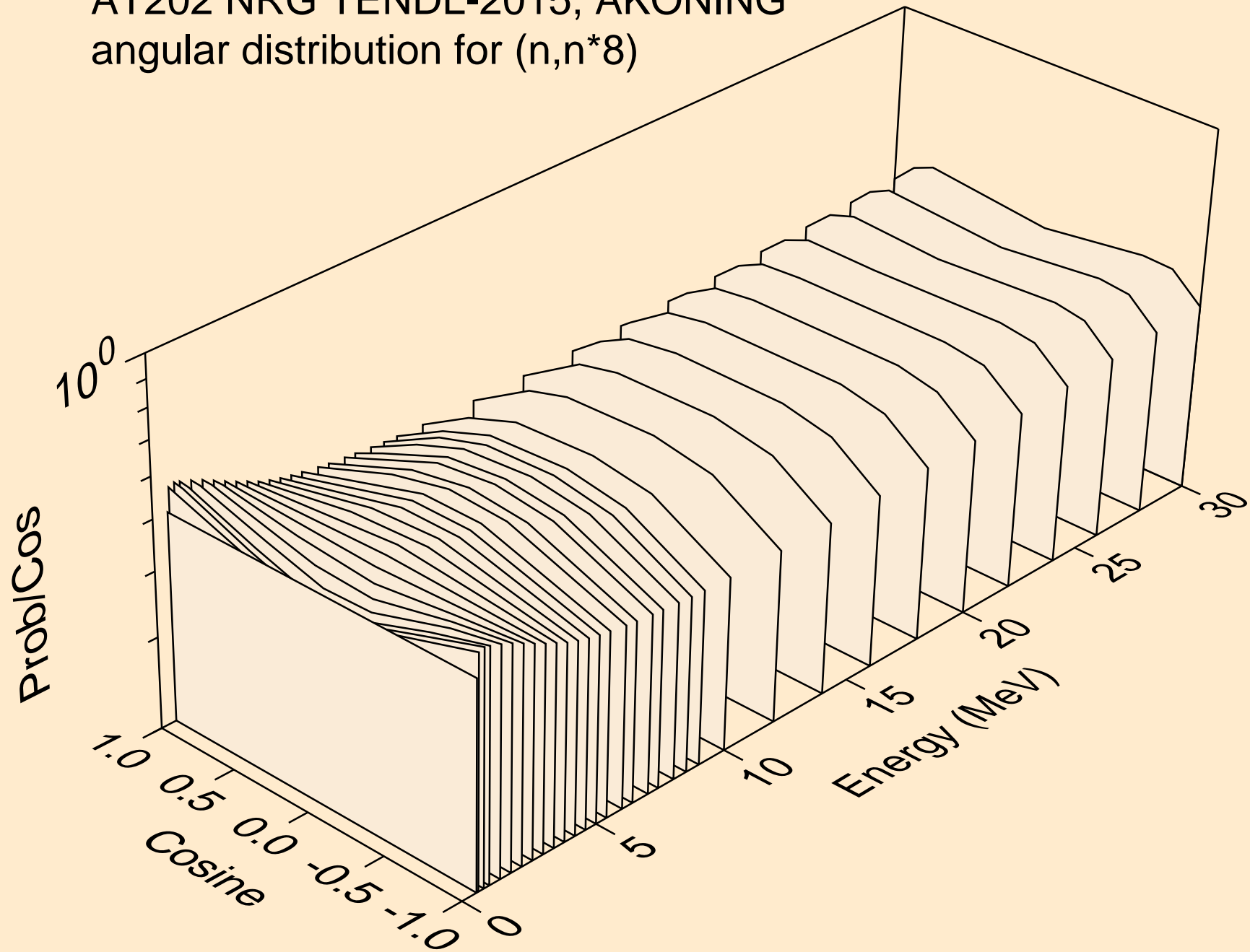

AT202 NRG TENDL-2015, AKONING  
angular distribution for (n,n\*9)

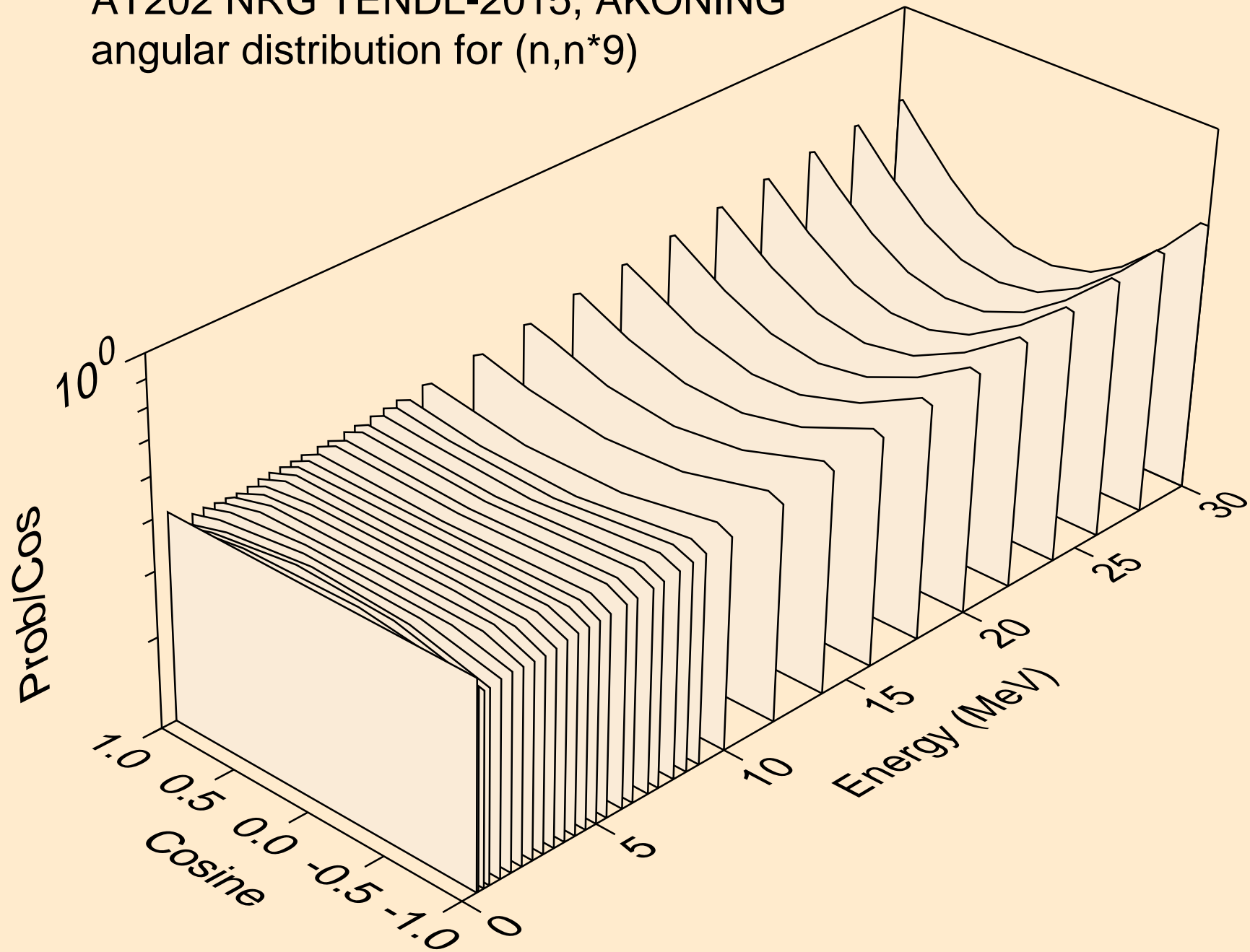



AT202 NRG TENDL-2015, AKONING  
angular distribution for (n,n\*10)

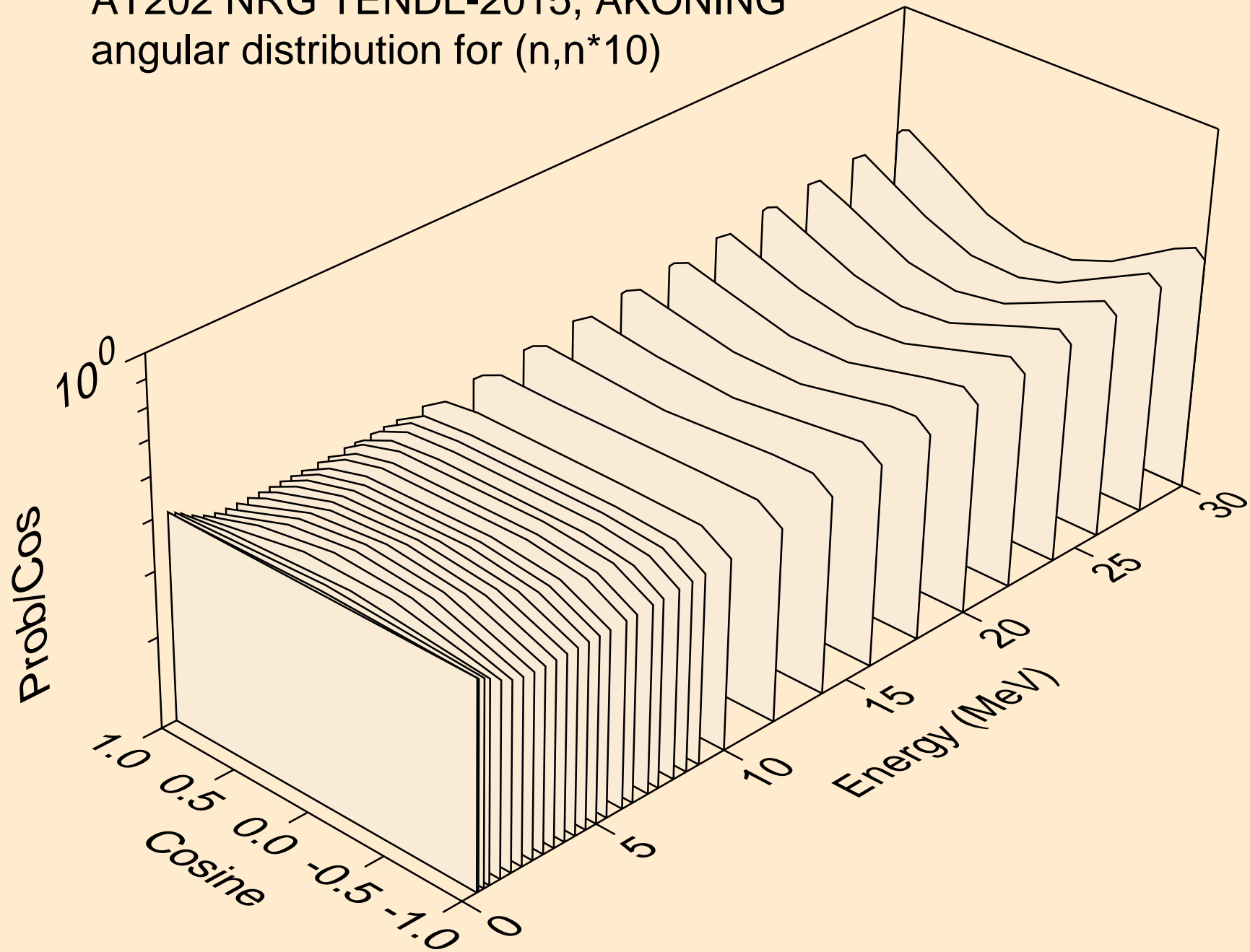

AT202 NRG TENDL-2015, AKONING  
angular distribution for (n,n\*11)

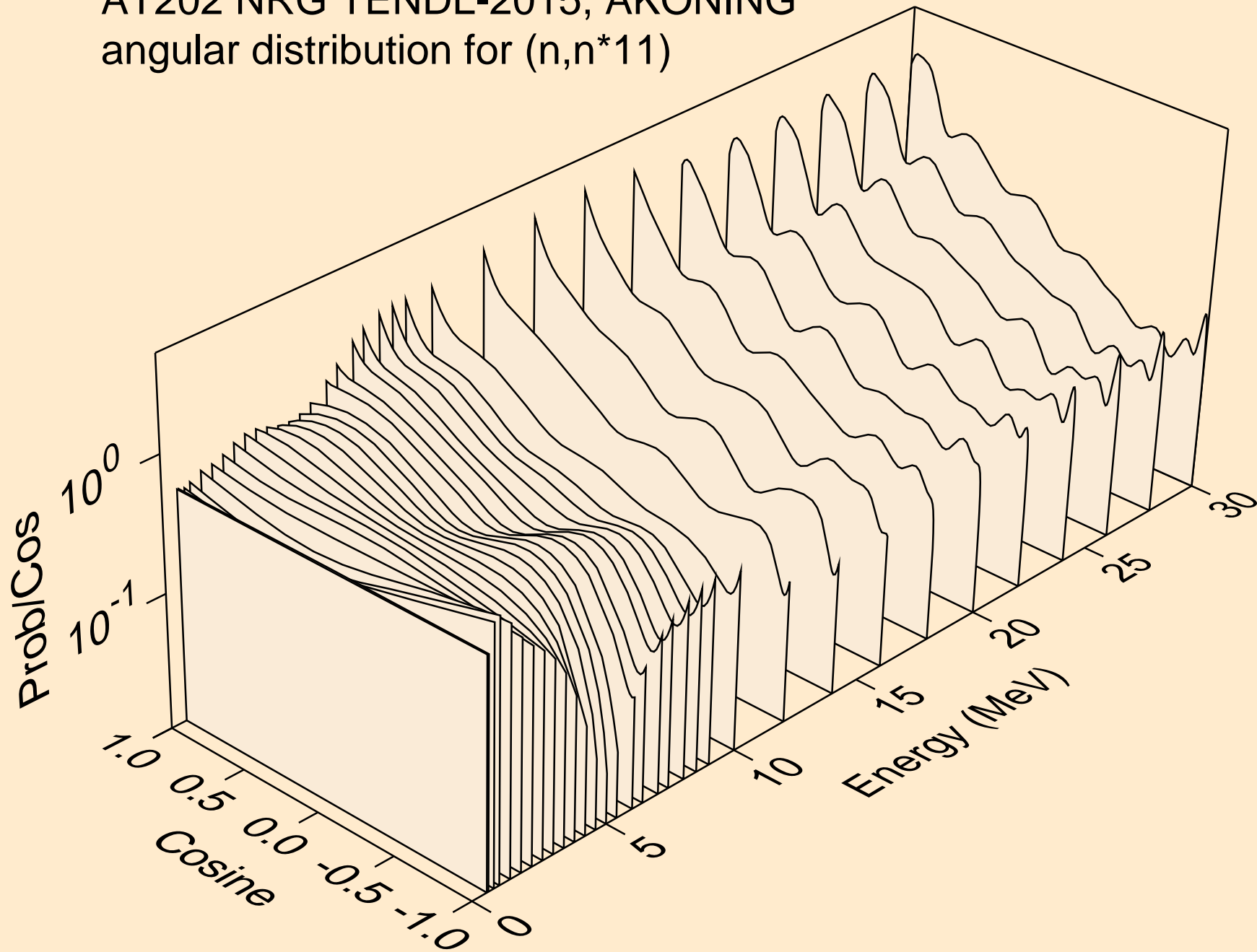

AT202 NRG TENDL-2015, AKONING  
angular distribution for (n,n\*12)

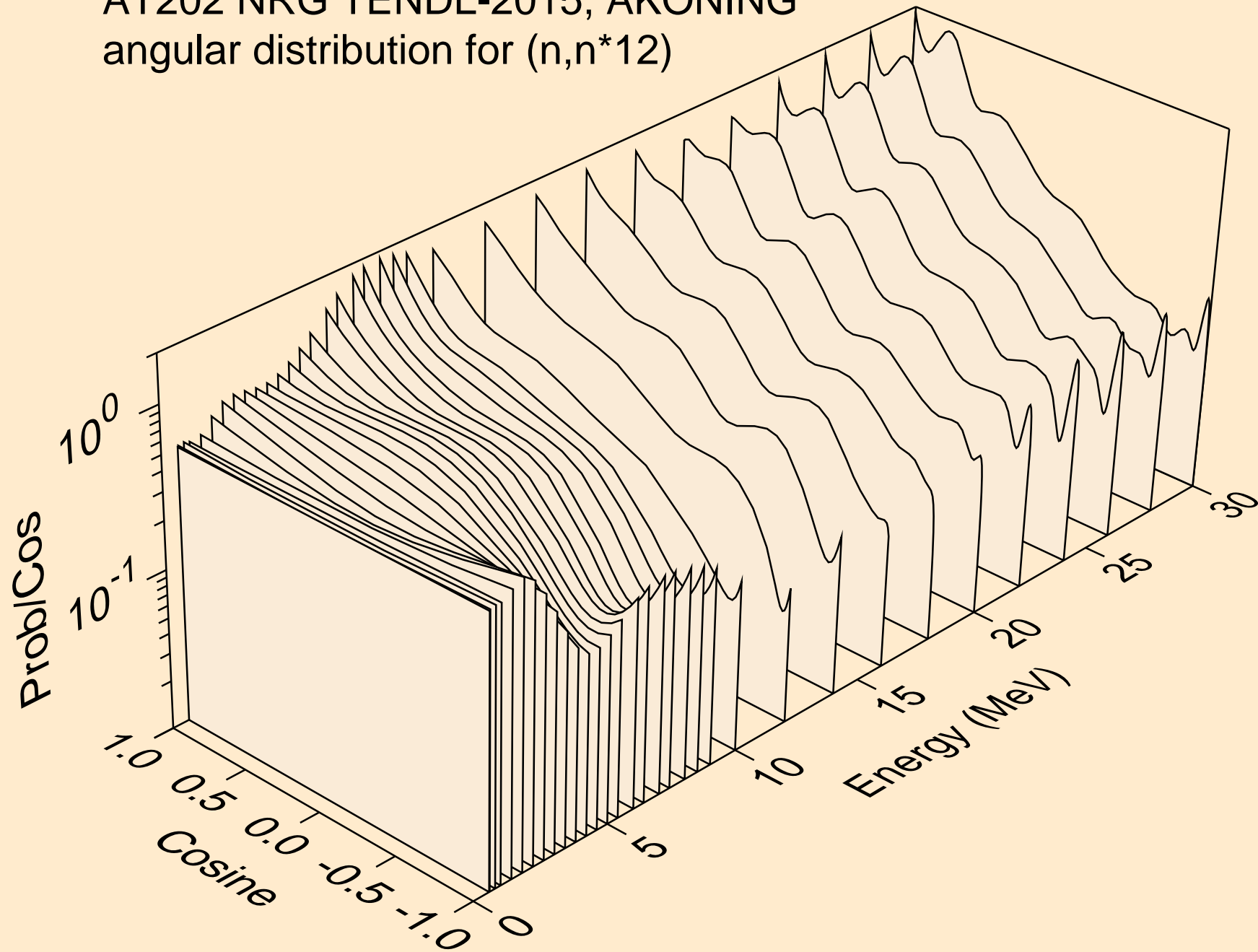

AT202 NRG TENDL-2015, AKONING  
angular distribution for (n,n\*13)

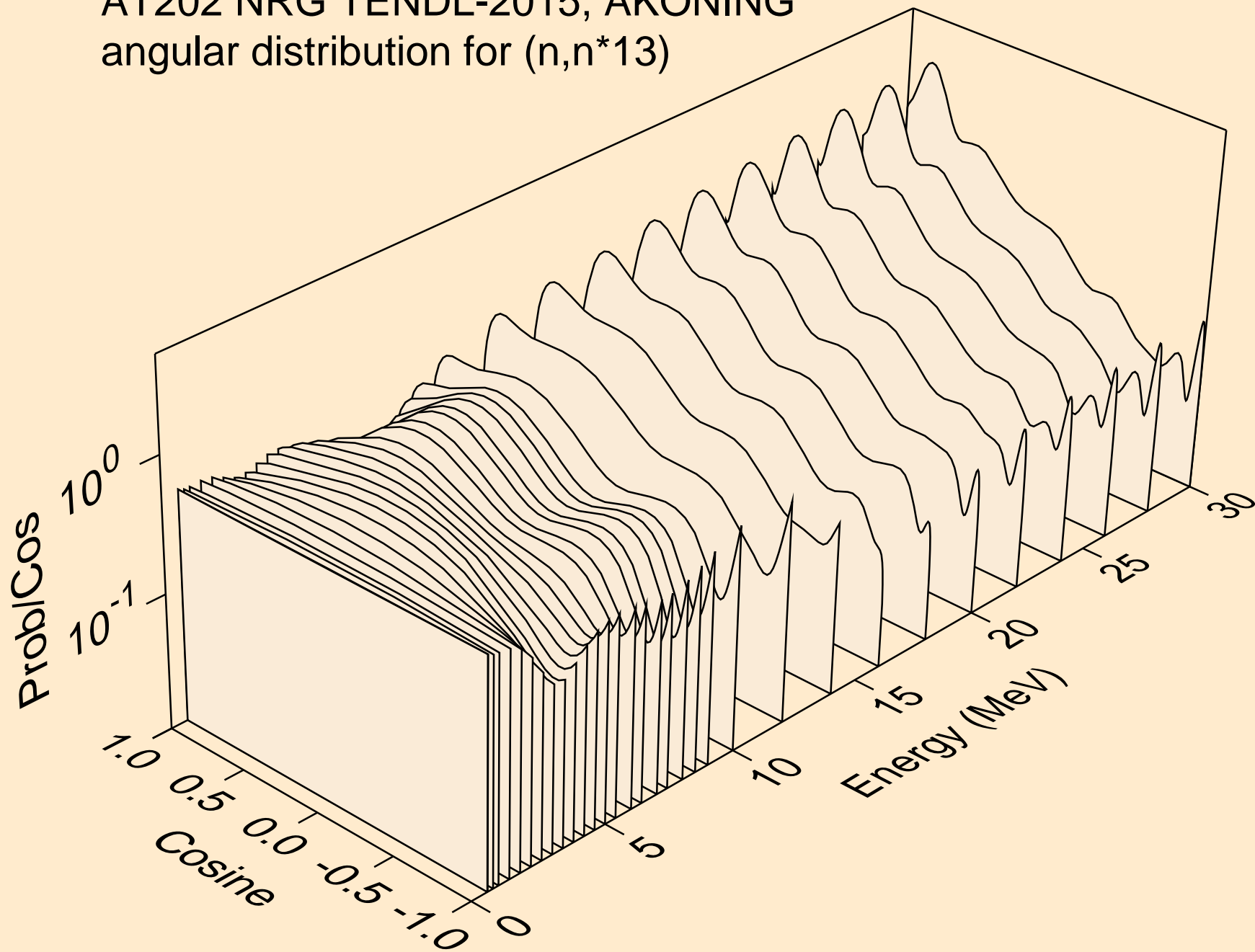

AT202 NRG TENDL-2015, AKONING  
angular distribution for (n,n\*14)

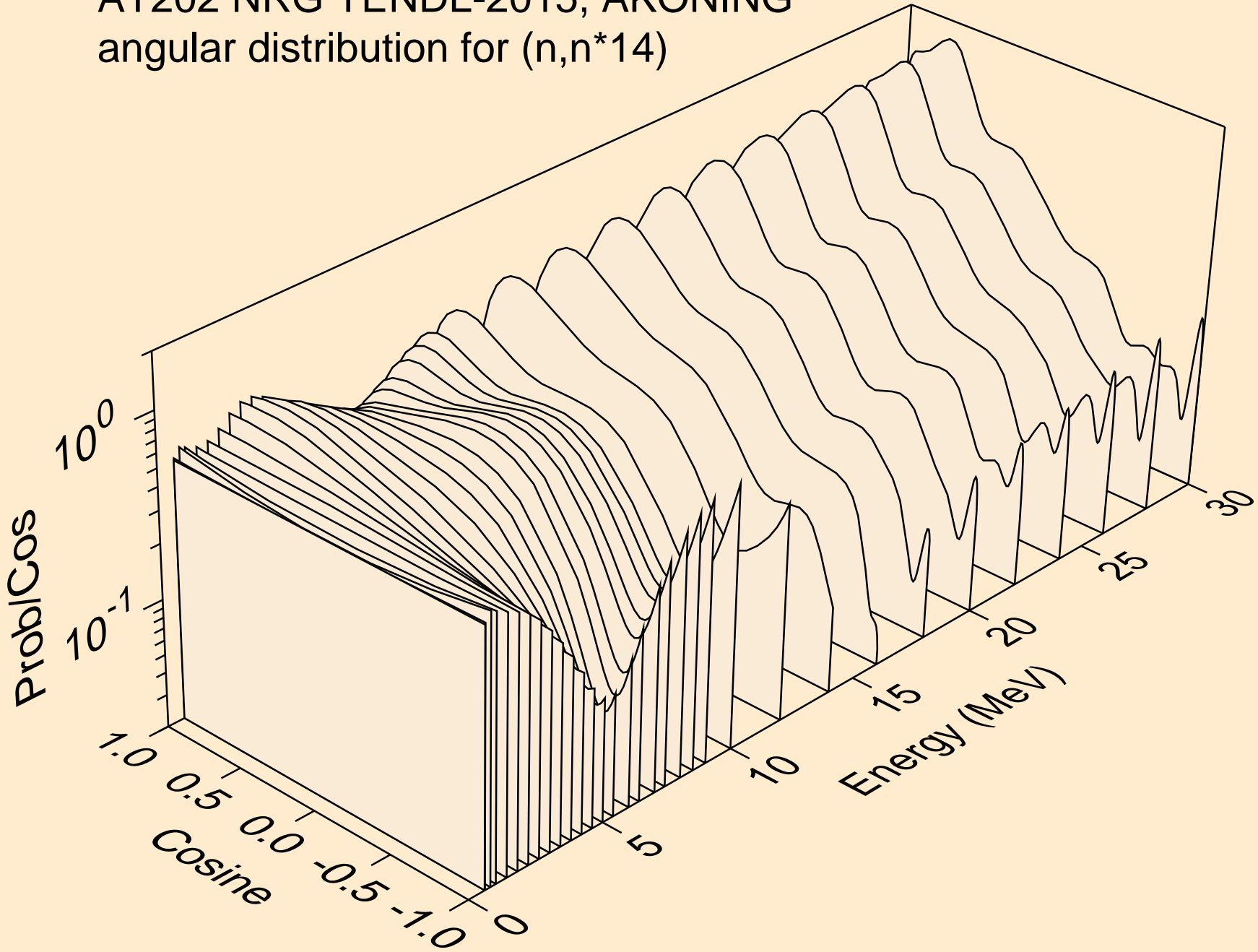

AT202 NRG TENDL-2015, AKONING  
angular distribution for (n,n\*15)

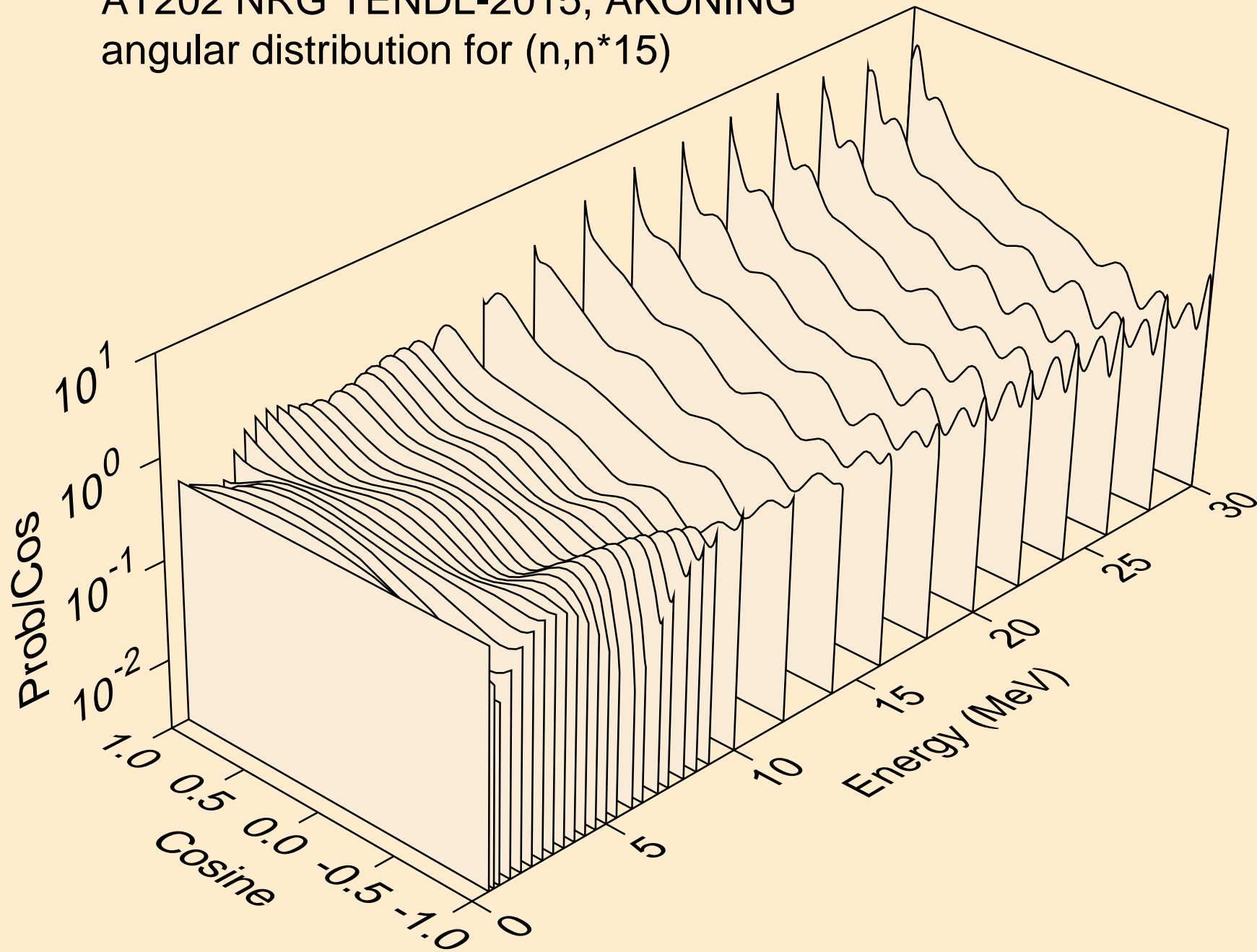

AT202 NRG TENDL-2015, AKONING  
Neutron emission for (n,x)

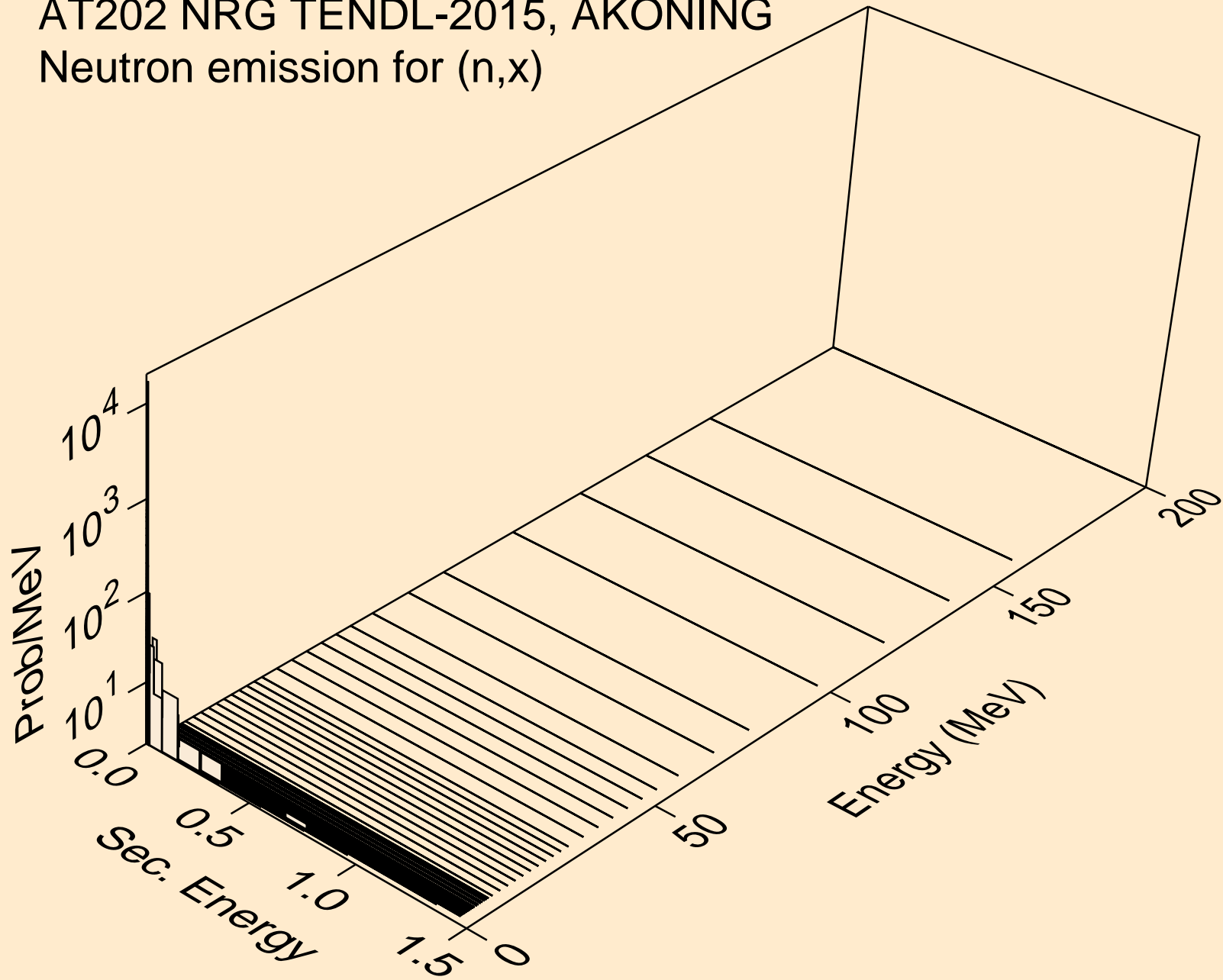

AT202 NRG TENDL-2015, AKONING  
Neutron emission for (n,2nd)

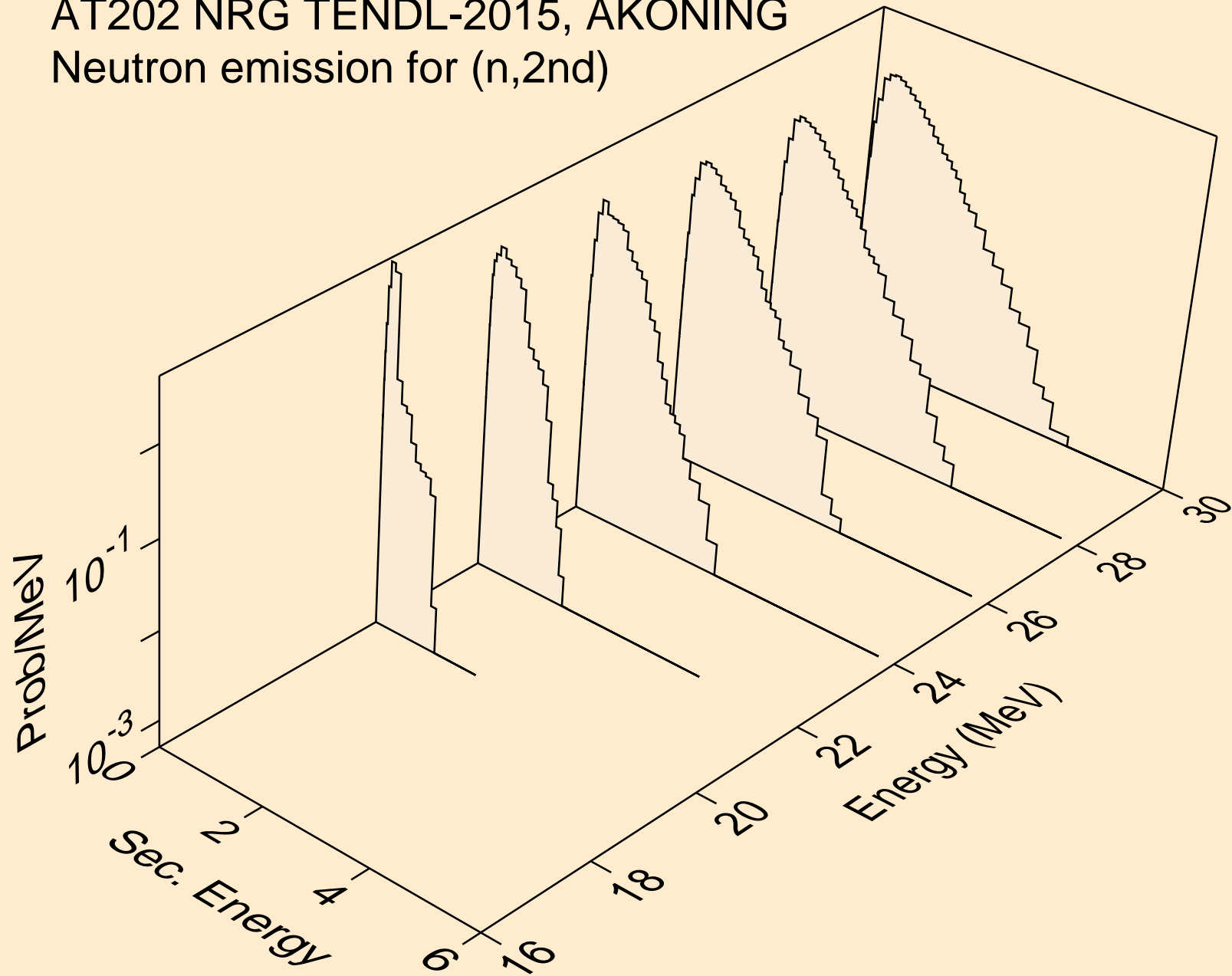



AT202 NRG TENDL-2015, AKONING  
Neutron emission for (n,2n)

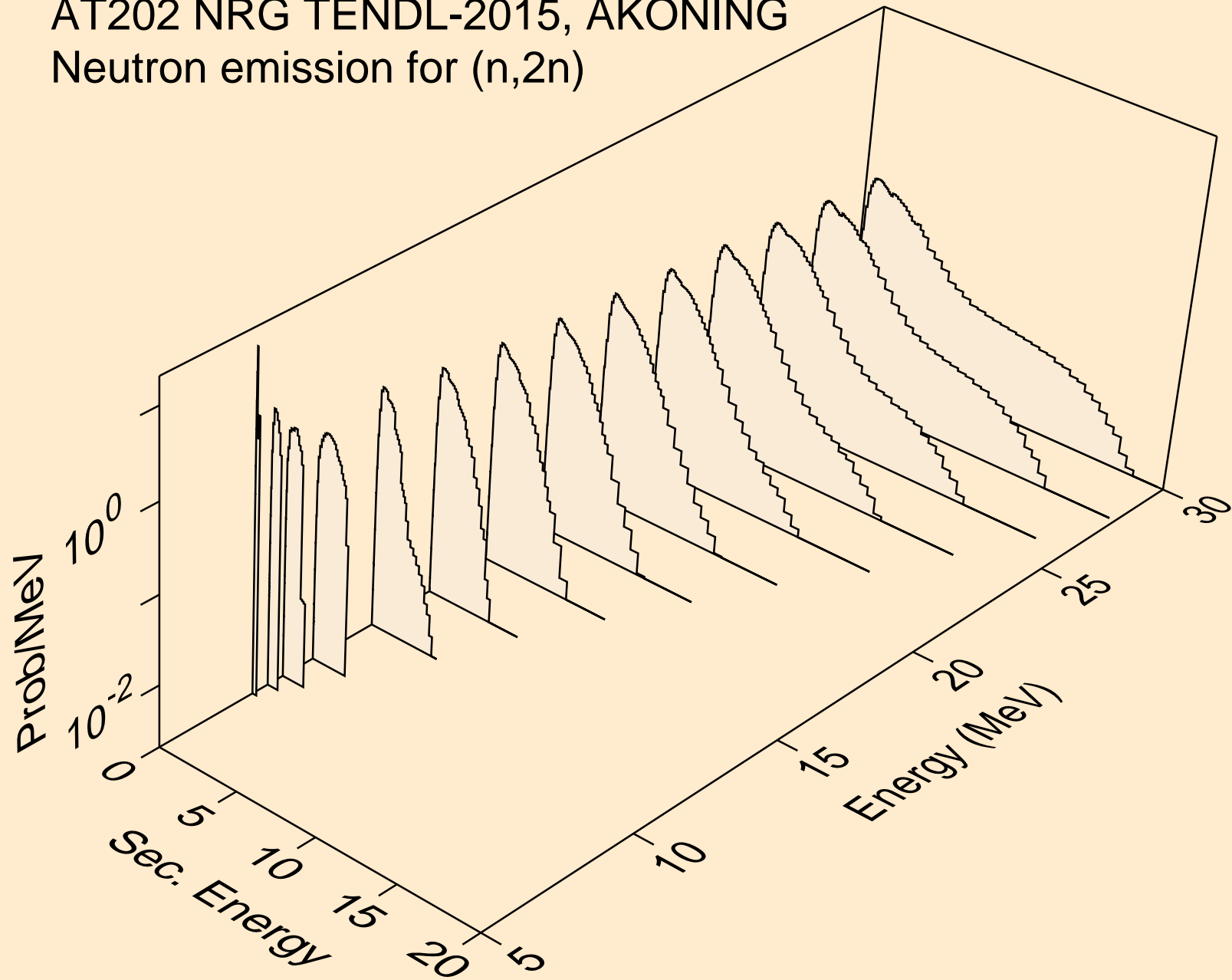

AT202 NRG TENDL-2015, AKONING  
Neutron emission for (n,3n)

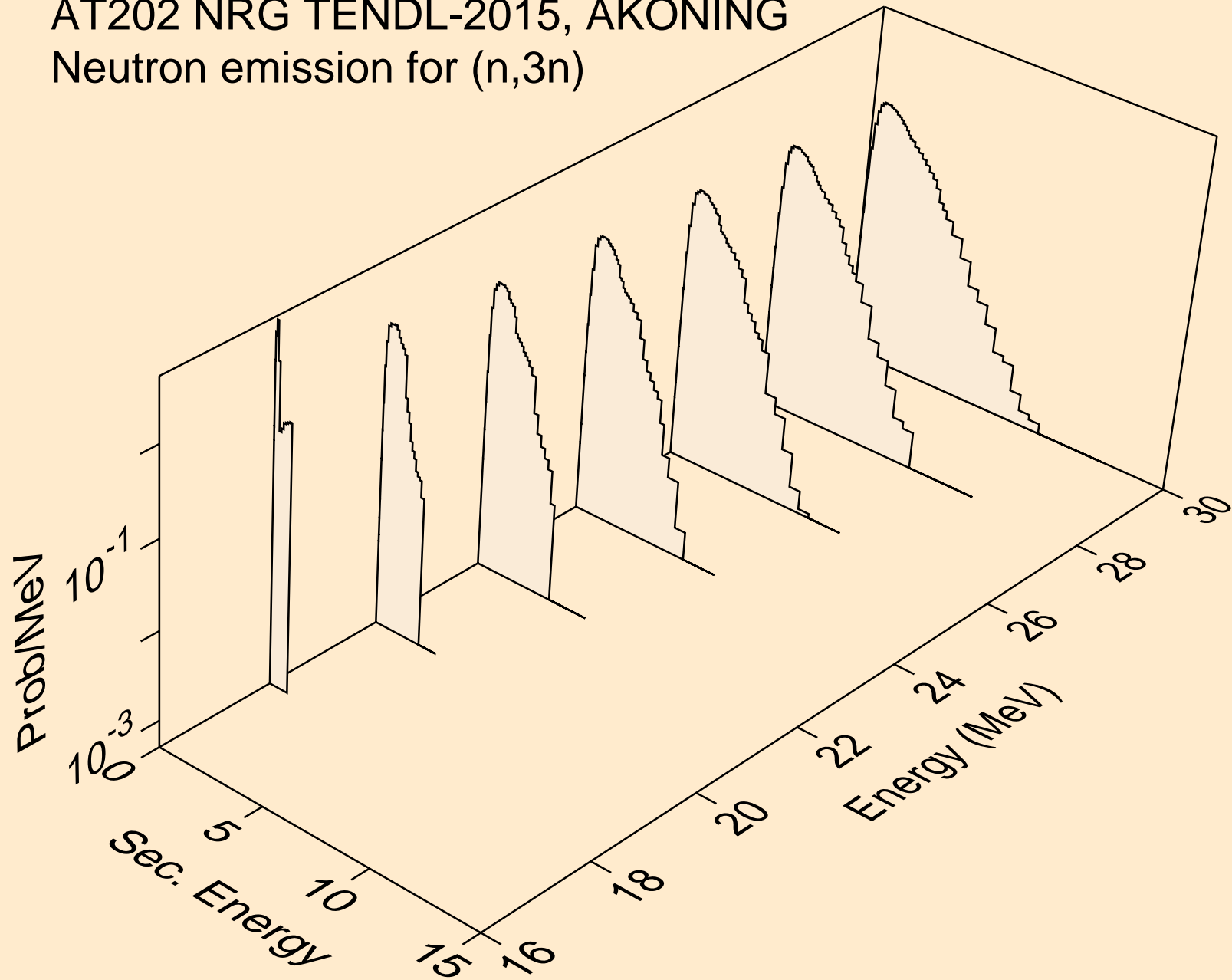

AT202 NRG TENDL-2015, AKONING  
Neutron emission for (n,n\*)a

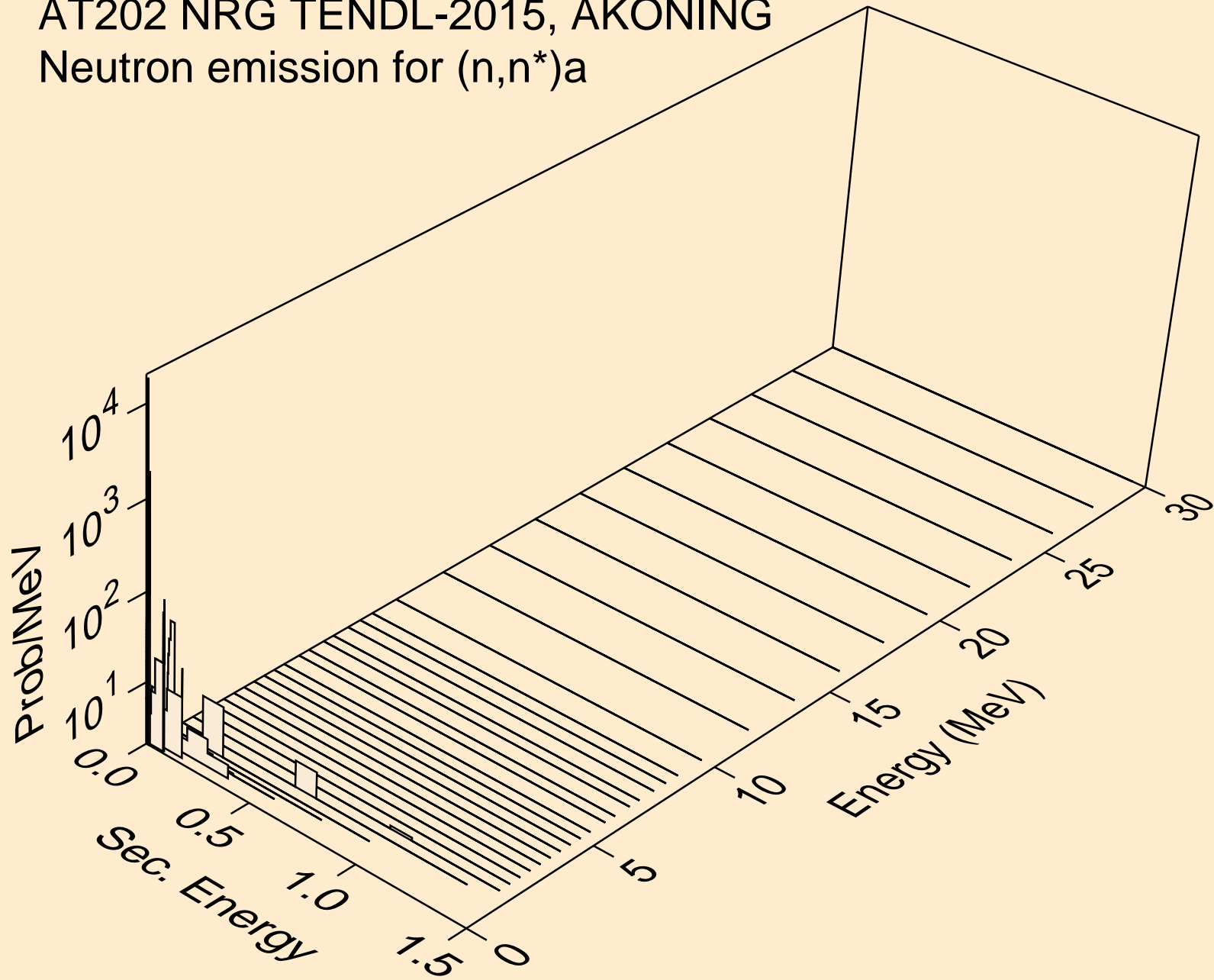

AT202 NRG TENDL-2015, AKONING  
Neutron emission for (n,2n)<sub>a</sub>

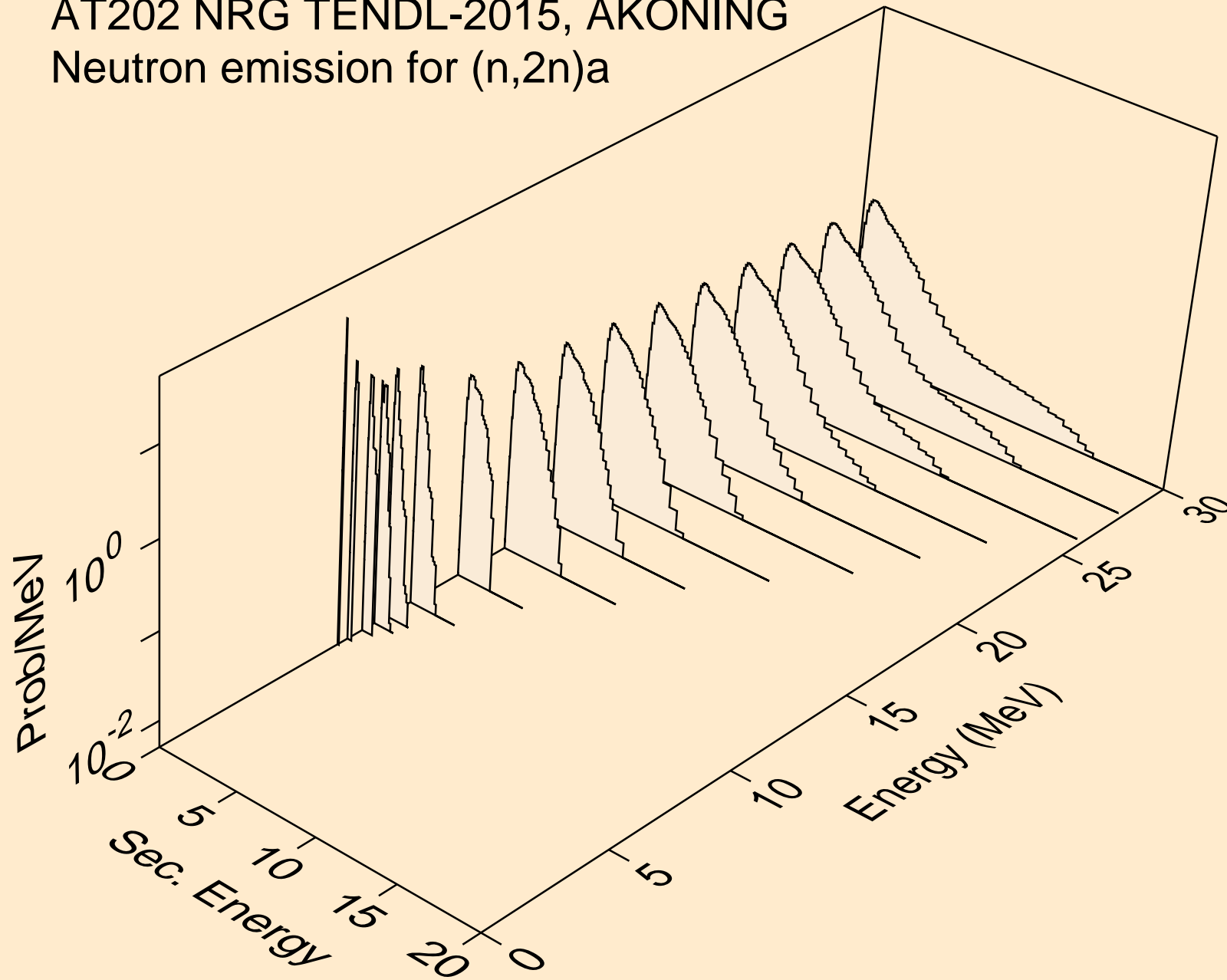

AT202 NRG TENDL-2015, AKONING  
Neutron emission for (n,3n)a

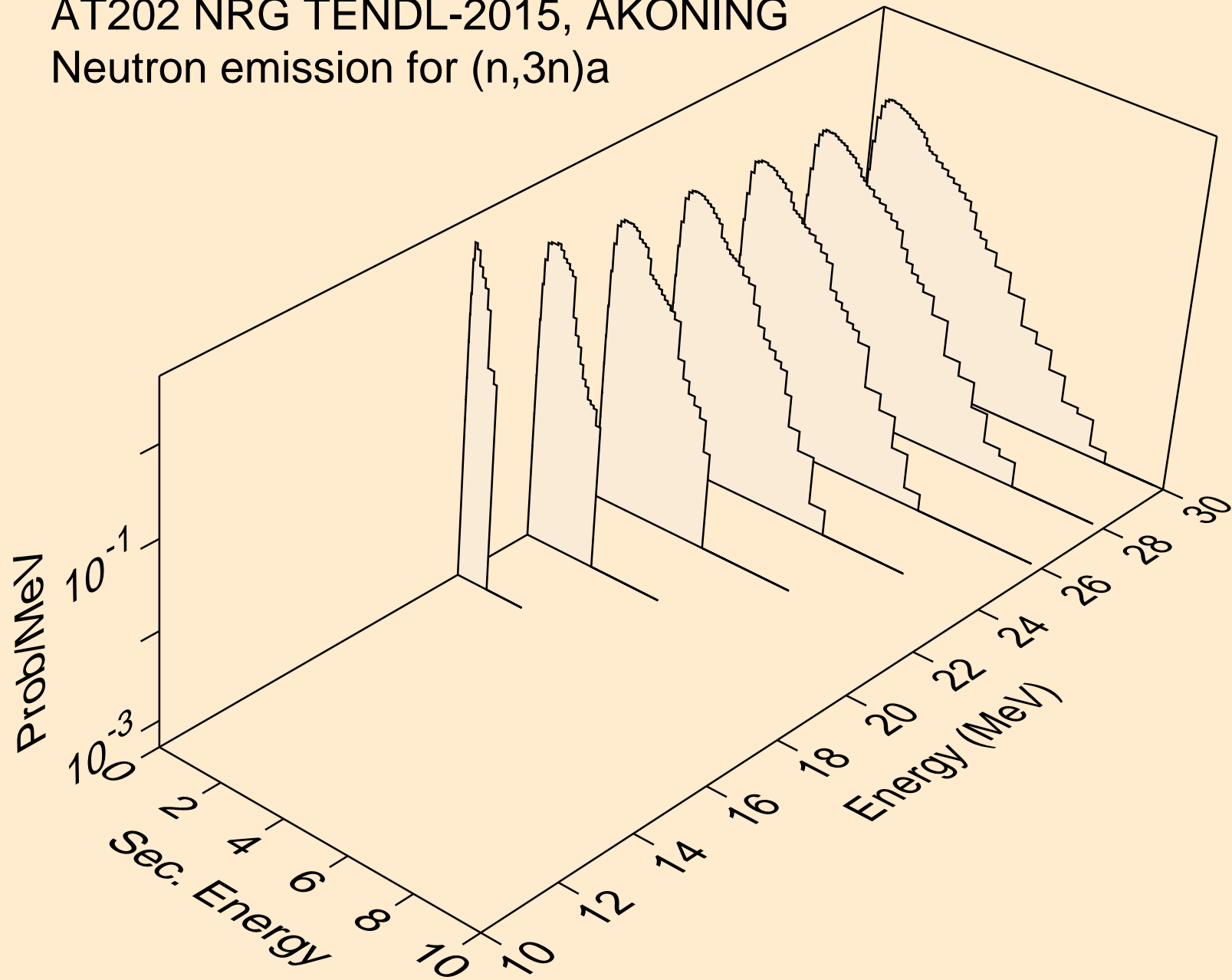

AT202 NRG TENDL-2015, AKONING  
Neutron emission for (n,n\*)p

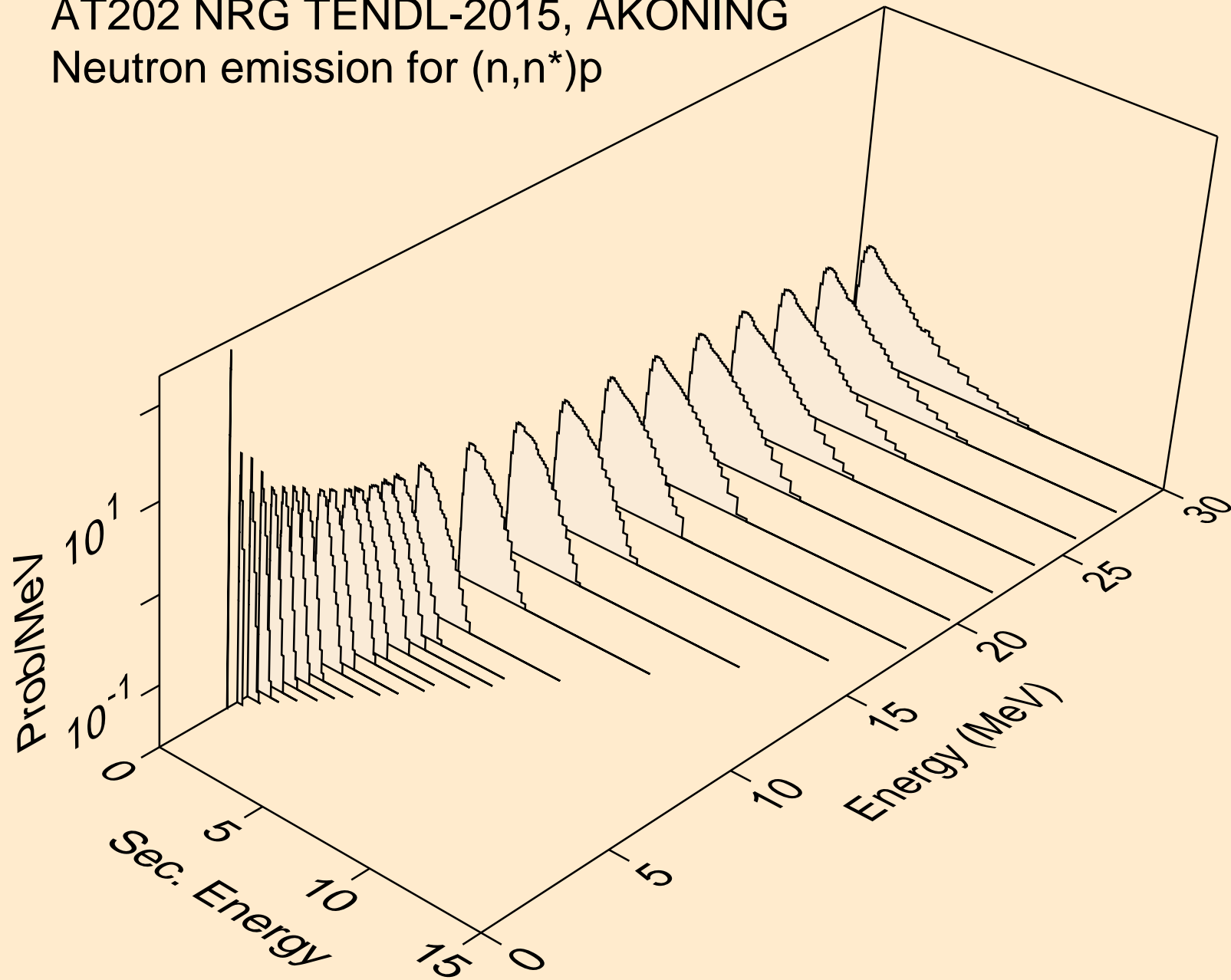

AT202 NRG TENDL-2015, AKONING  
Neutron emission for (n,n\*)2a

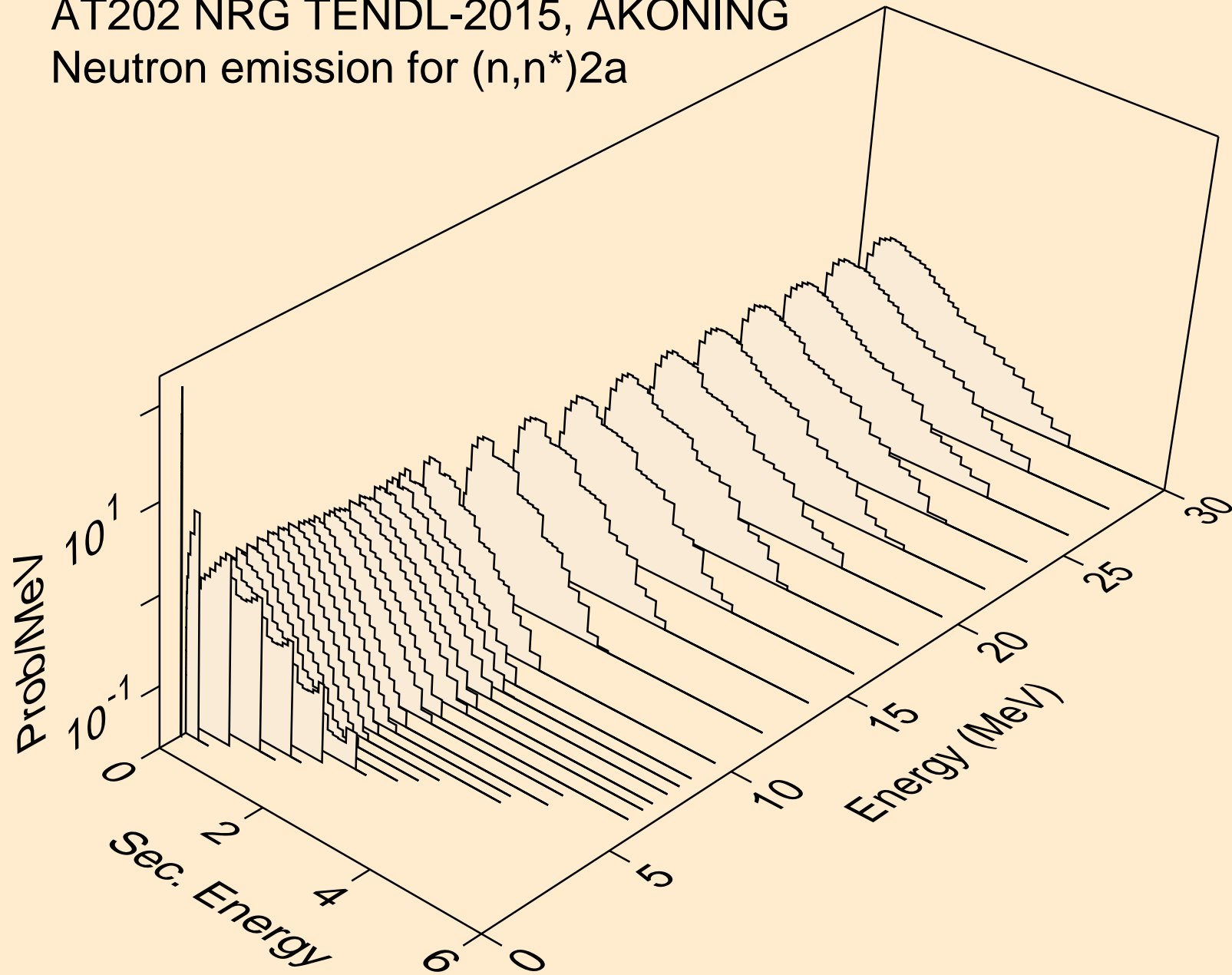

AT202 NRG TENDL-2015, AKONING  
Neutron emission for (n,2n)2a

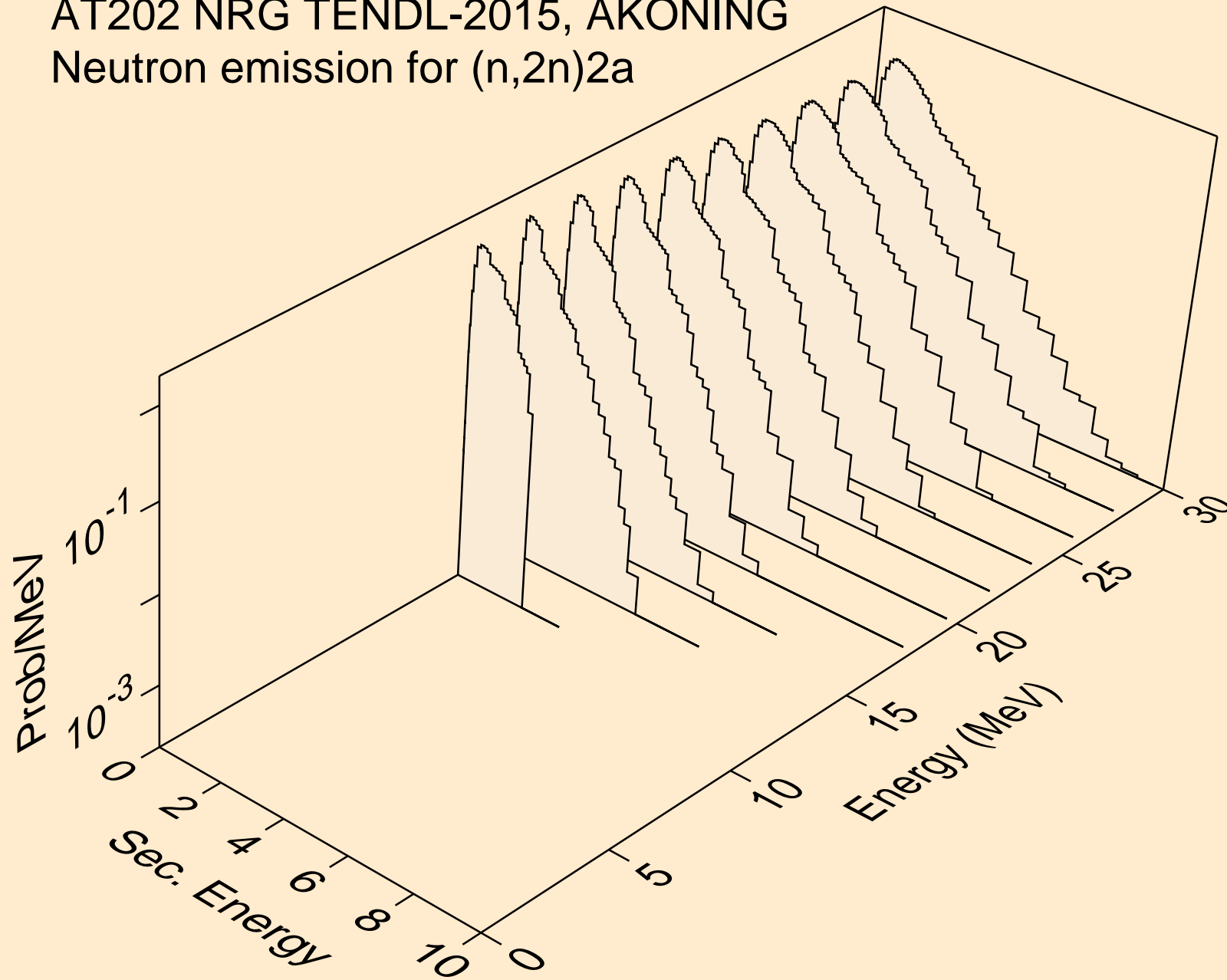



AT202 NRG TENDL-2015, AKONING  
Neutron emission for (n,n\*)d

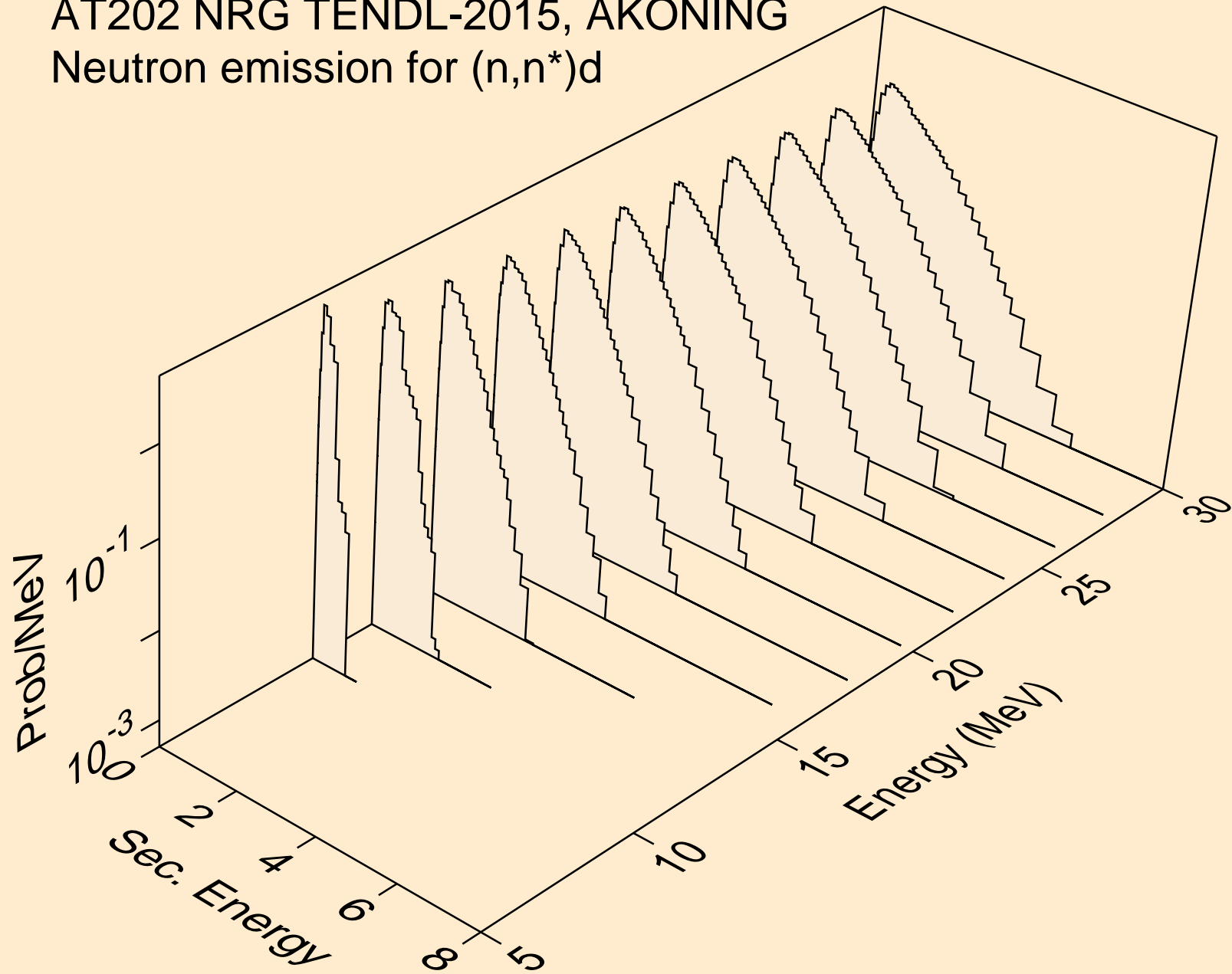

AT202 NRG TENDL-2015, AKONING  
Neutron emission for (n,n\*)t

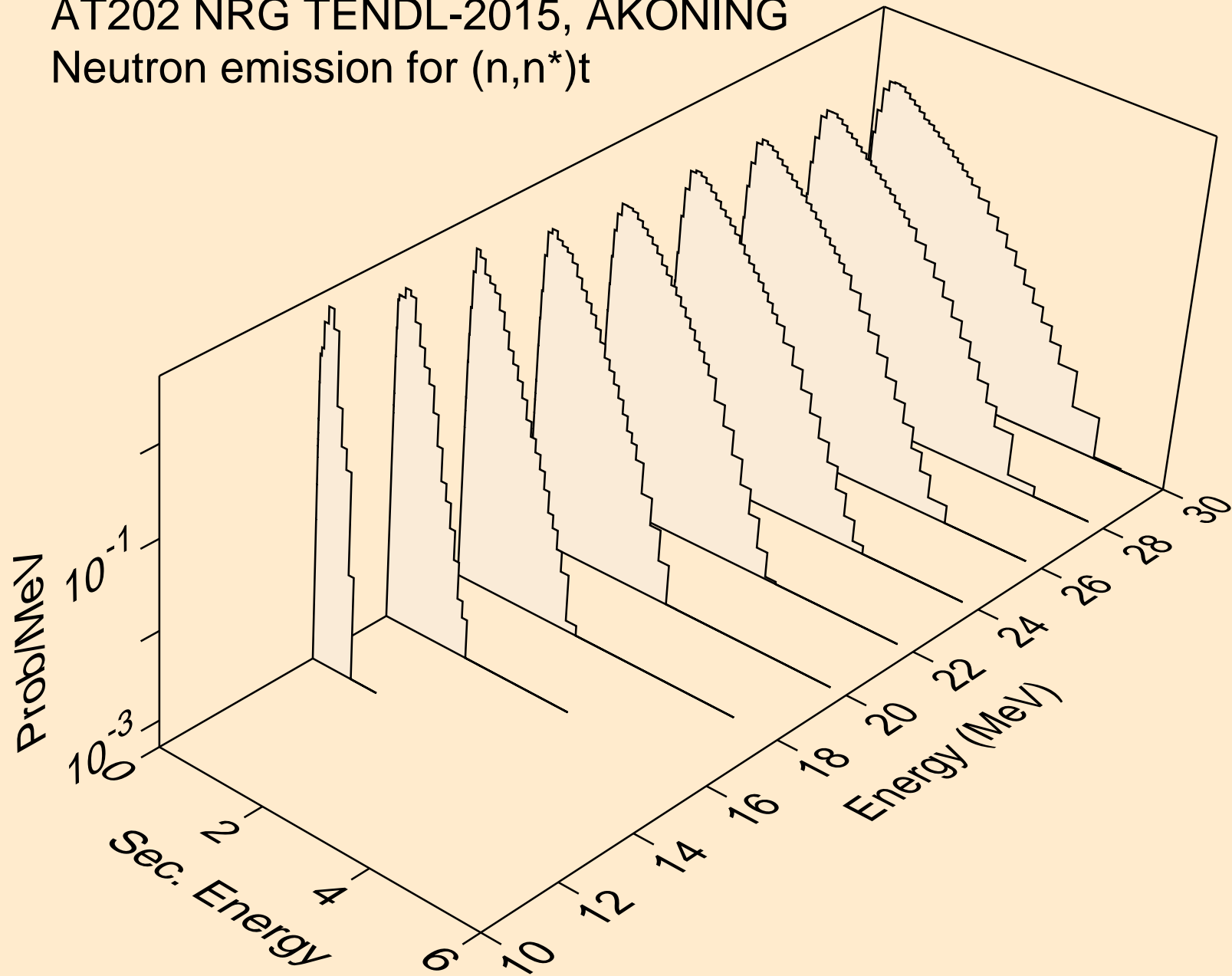

AT202 NRG TENDL-2015, AKONING  
Neutron emission for (n,n\*)he3

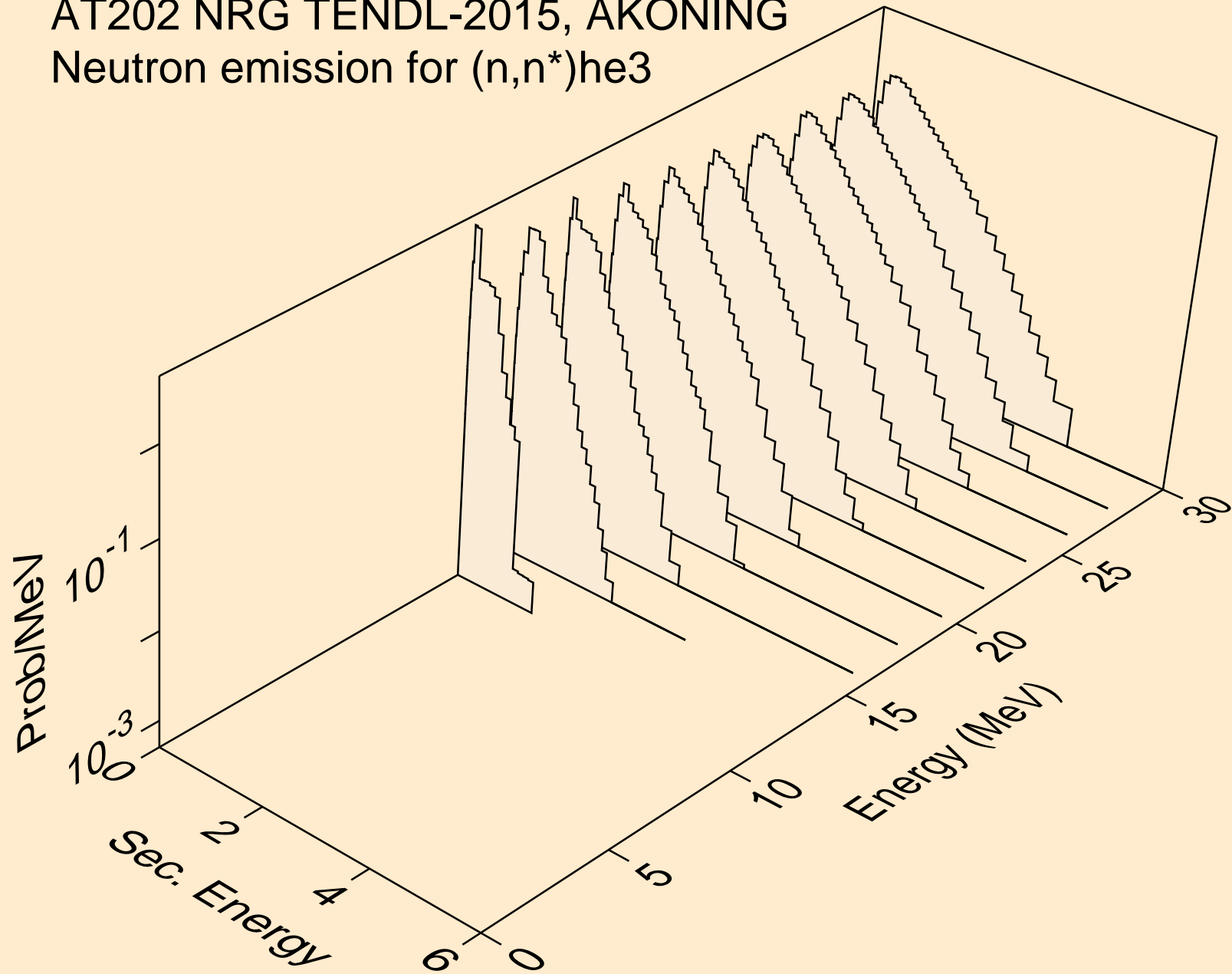

AT202 NRG TENDL-2015, AKONING  
Neutron emission for (n,4n)

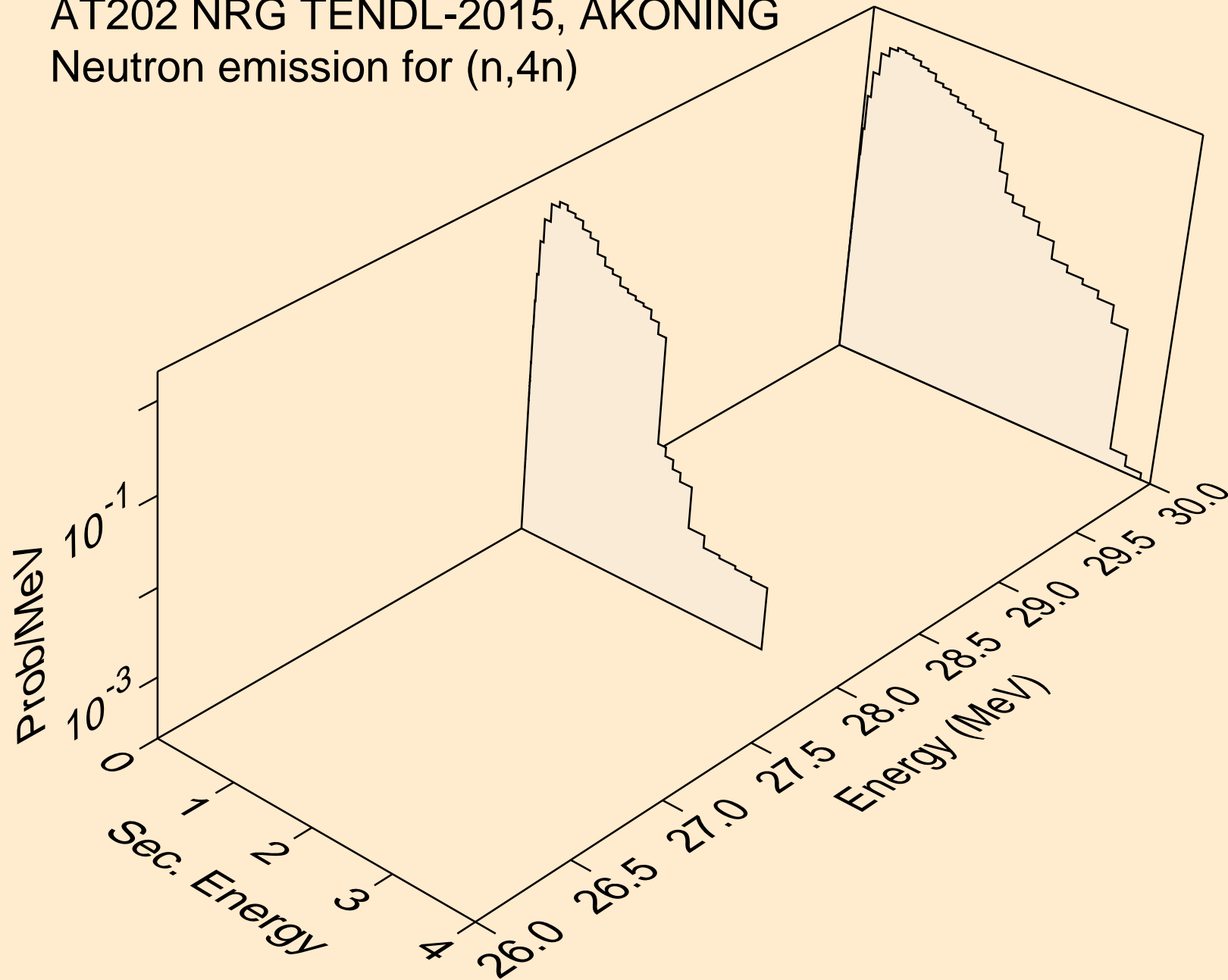

AT202 NRG TENDL-2015, AKONING  
Neutron emission for (n,2np)

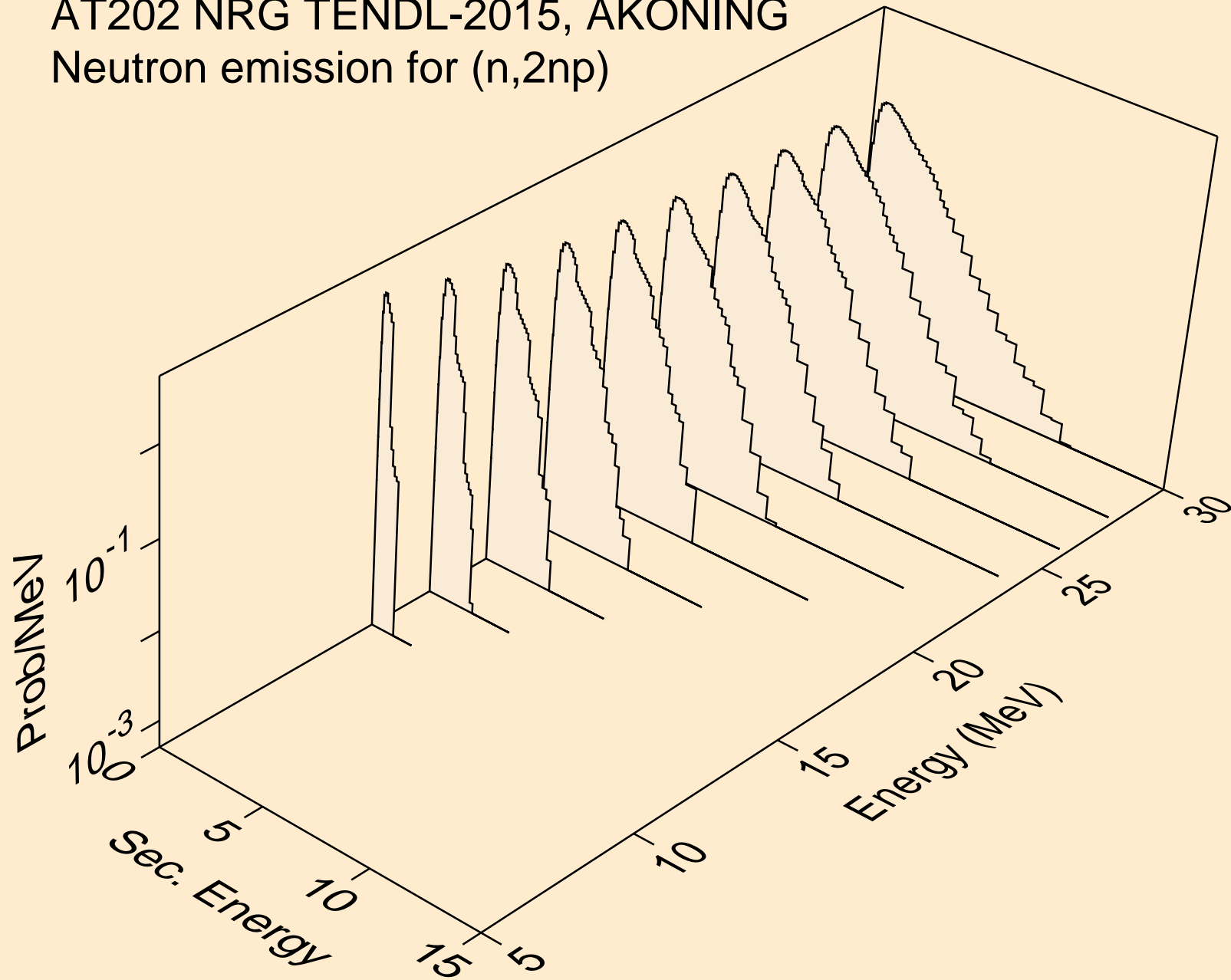

AT202 NRG TENDL-2015, AKONING  
Neutron emission for (n,3np)

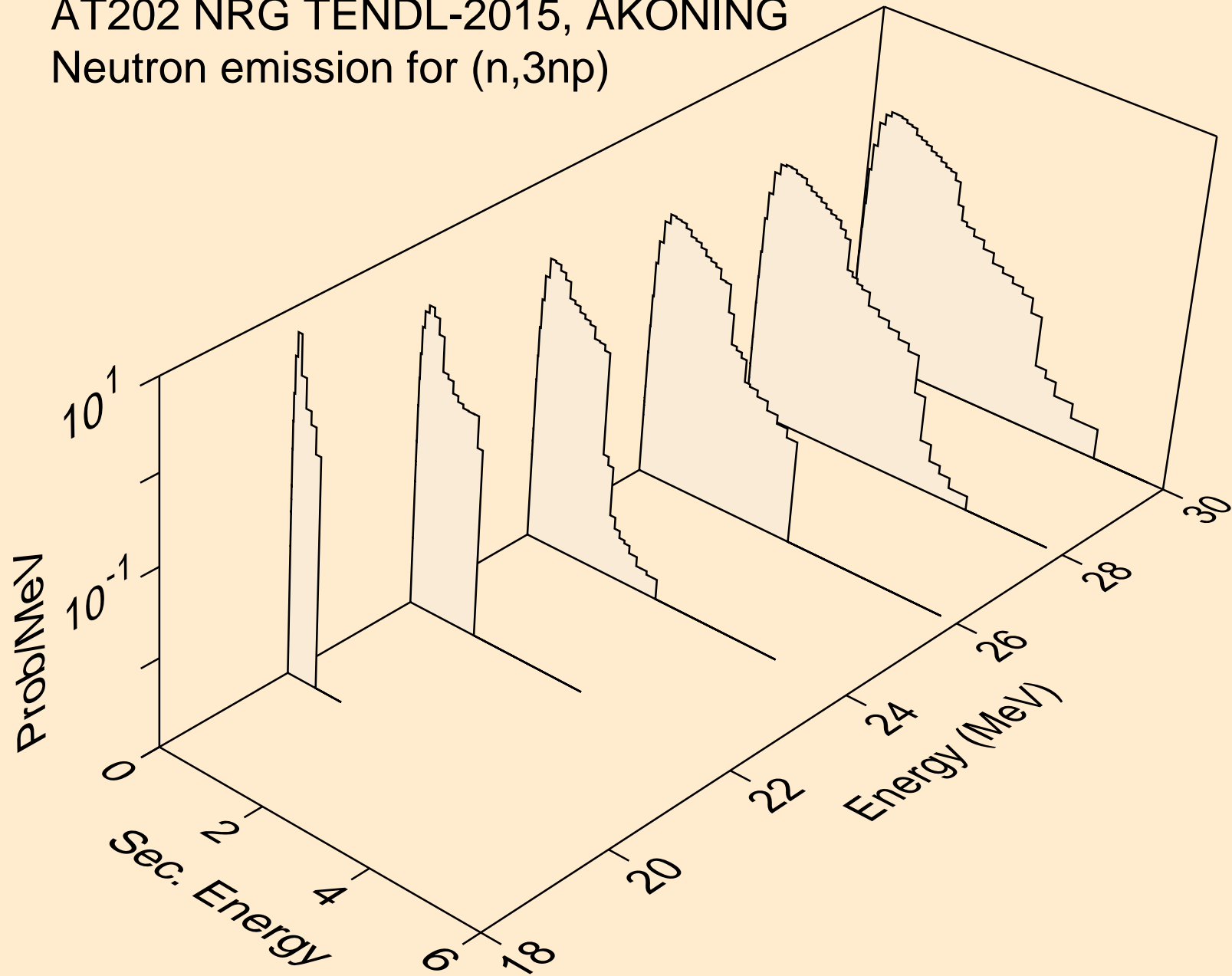

AT202 NRG TENDL-2015, AKONING  
Neutron emission for (n,2np)

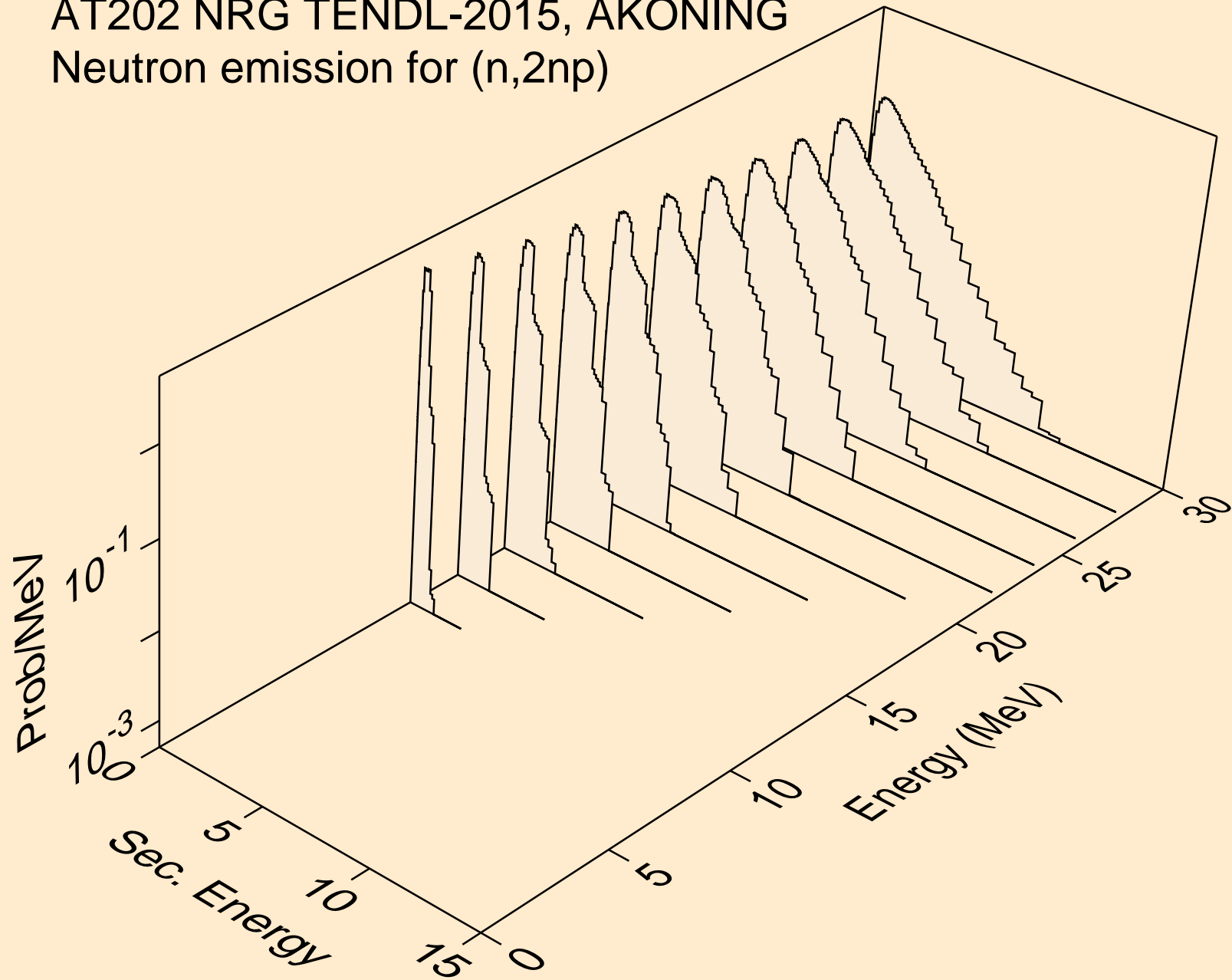

AT202 NRG TENDL-2015, AKONING  
Neutron emission for (n,npa)

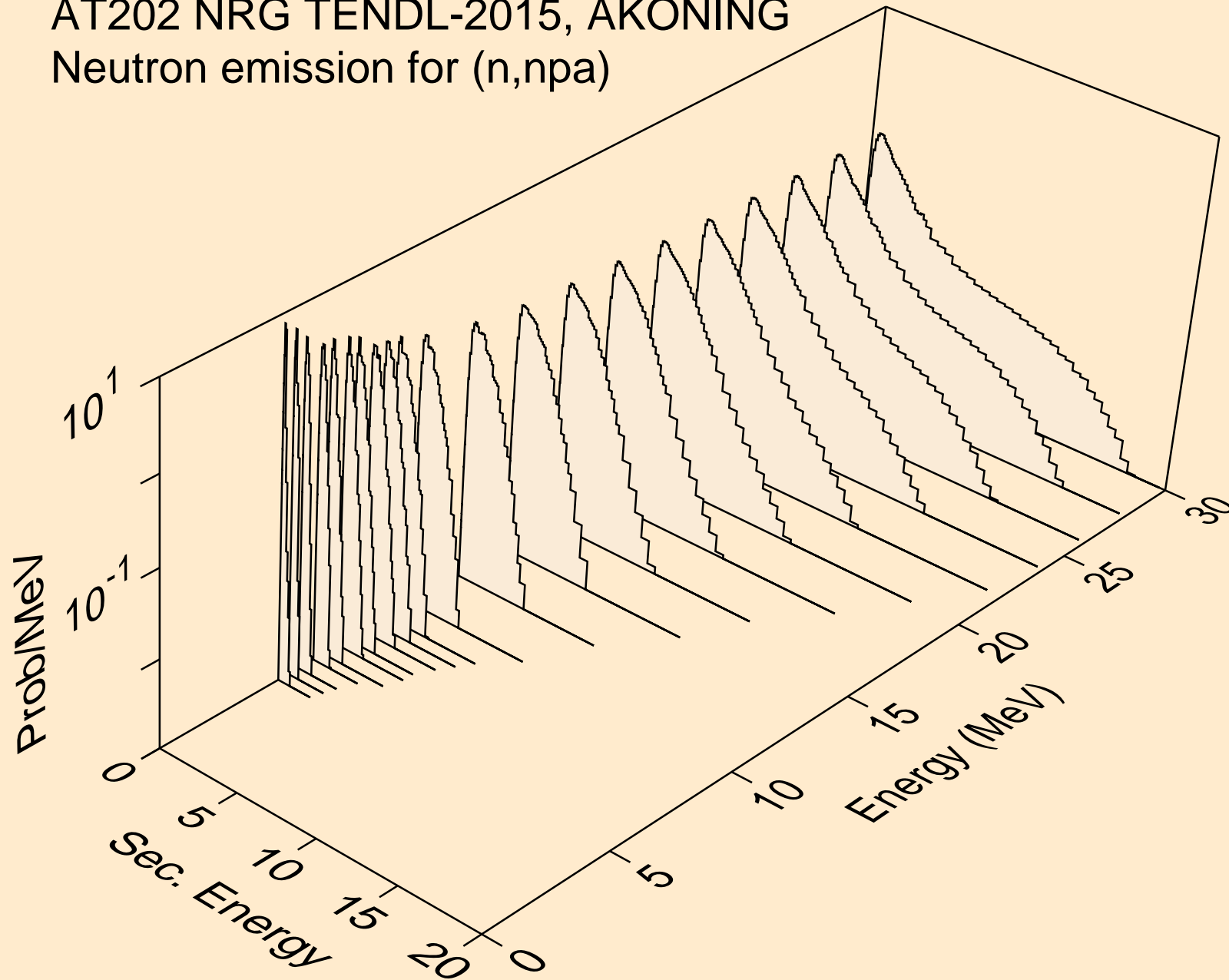



AT202 NRG TENDL-2015, AKONING  
Neutron emission for (n,n\*c)

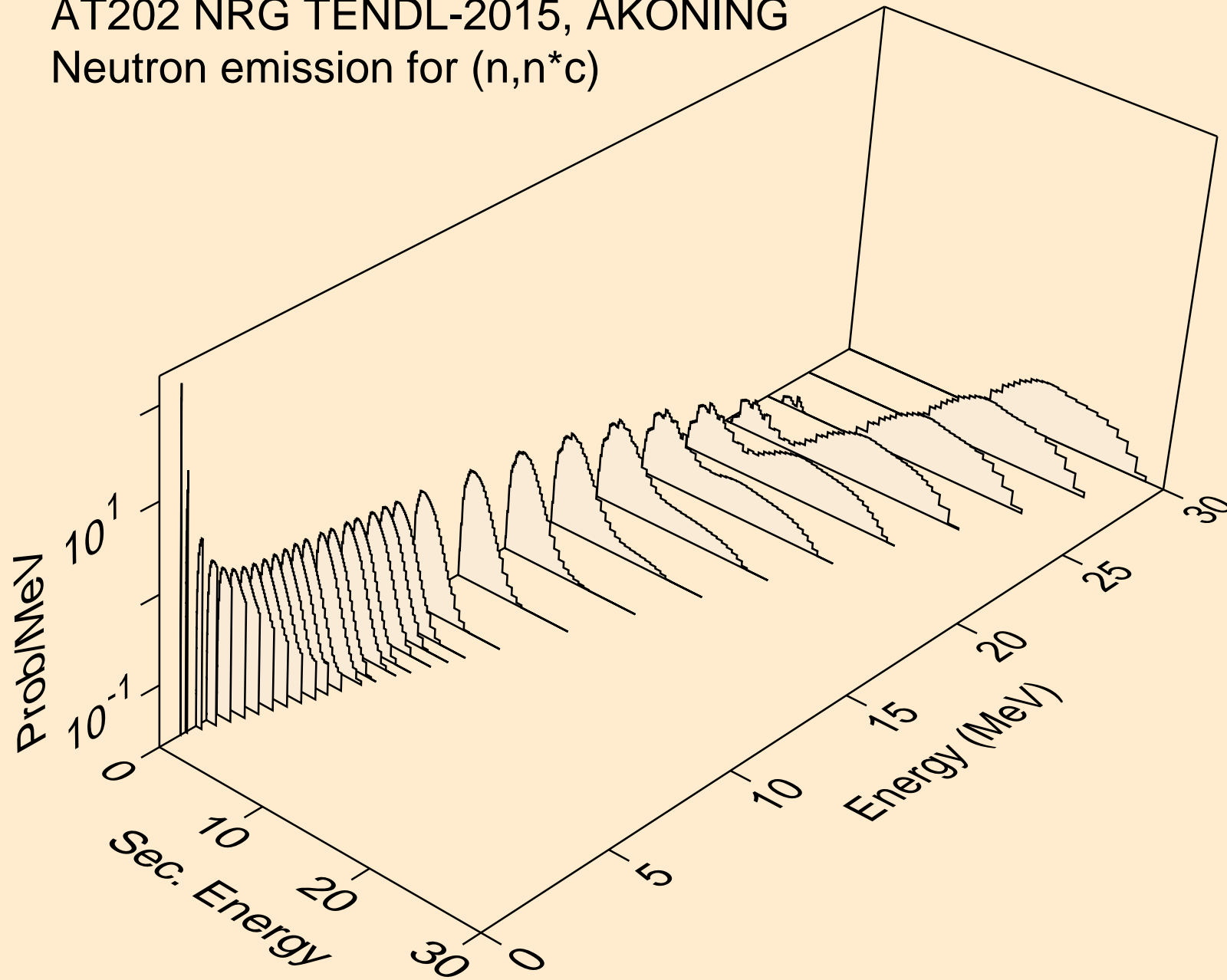

AT202 NRG TENDL-2015, AKONING  
Photon emission for (n,x)

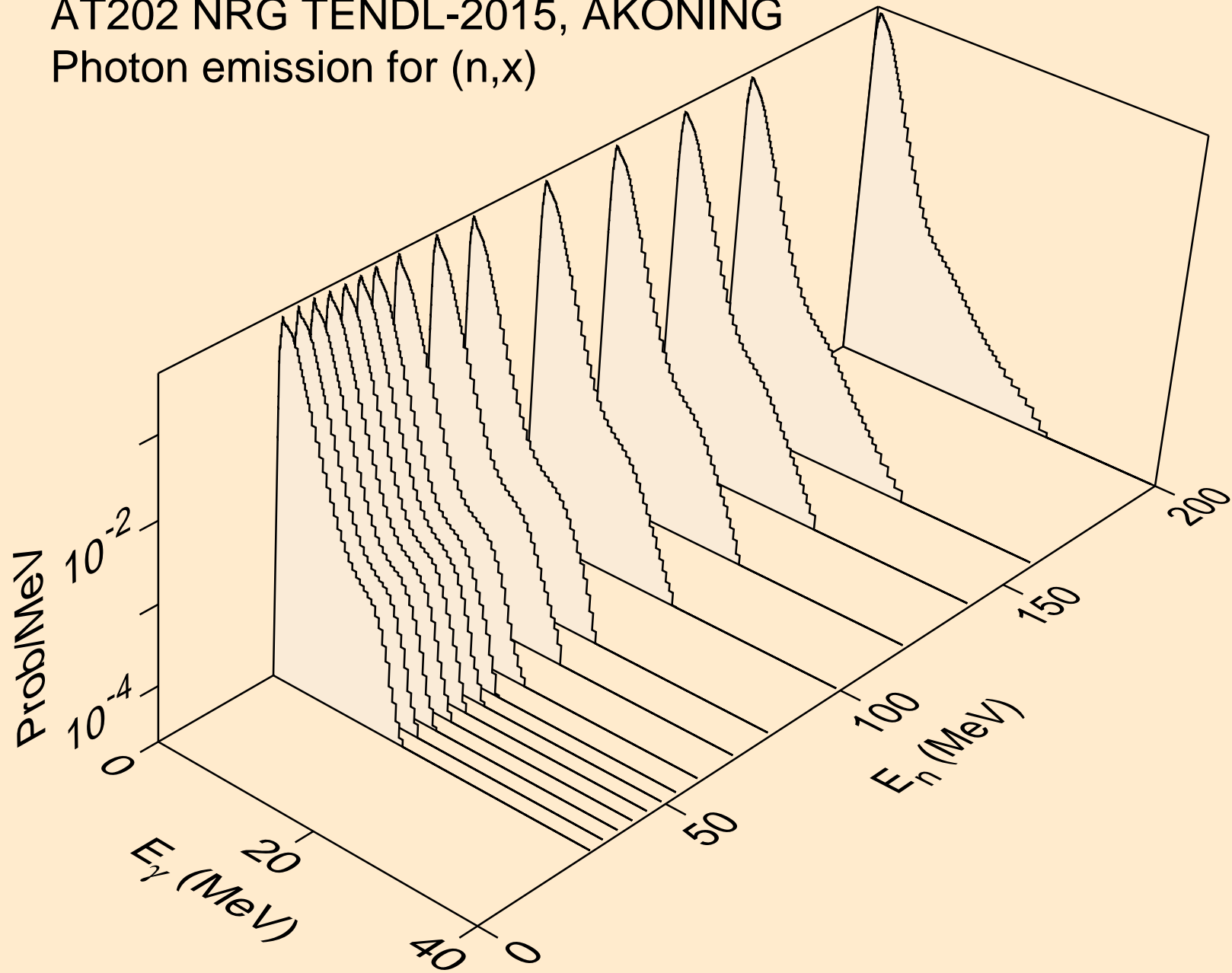

AT202 NRG TENDL-2015, AKONING  
Photon emission for (n,2nd)

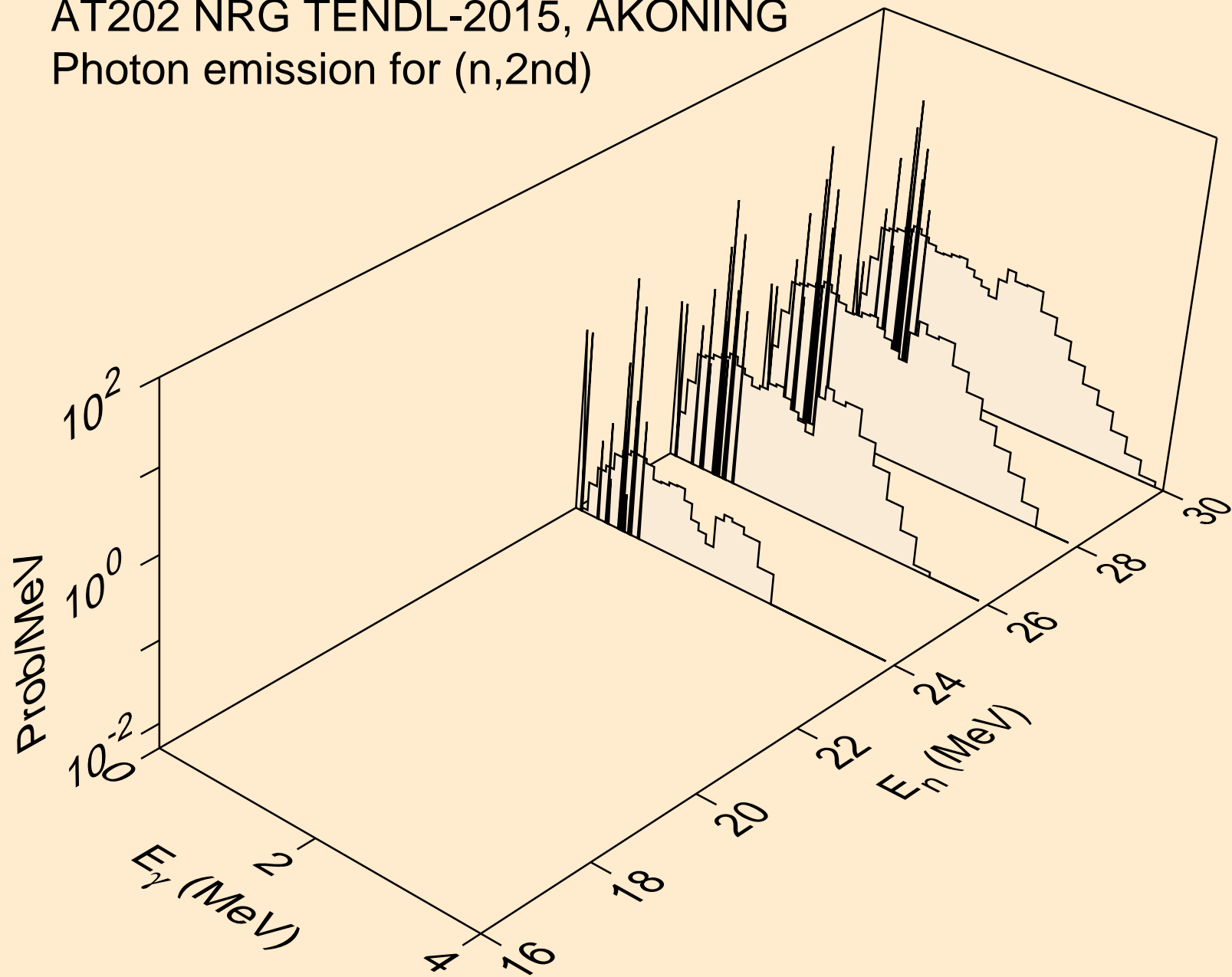

AT202 NRG TENDL-2015, AKONING  
Photon emission for (n,2n)

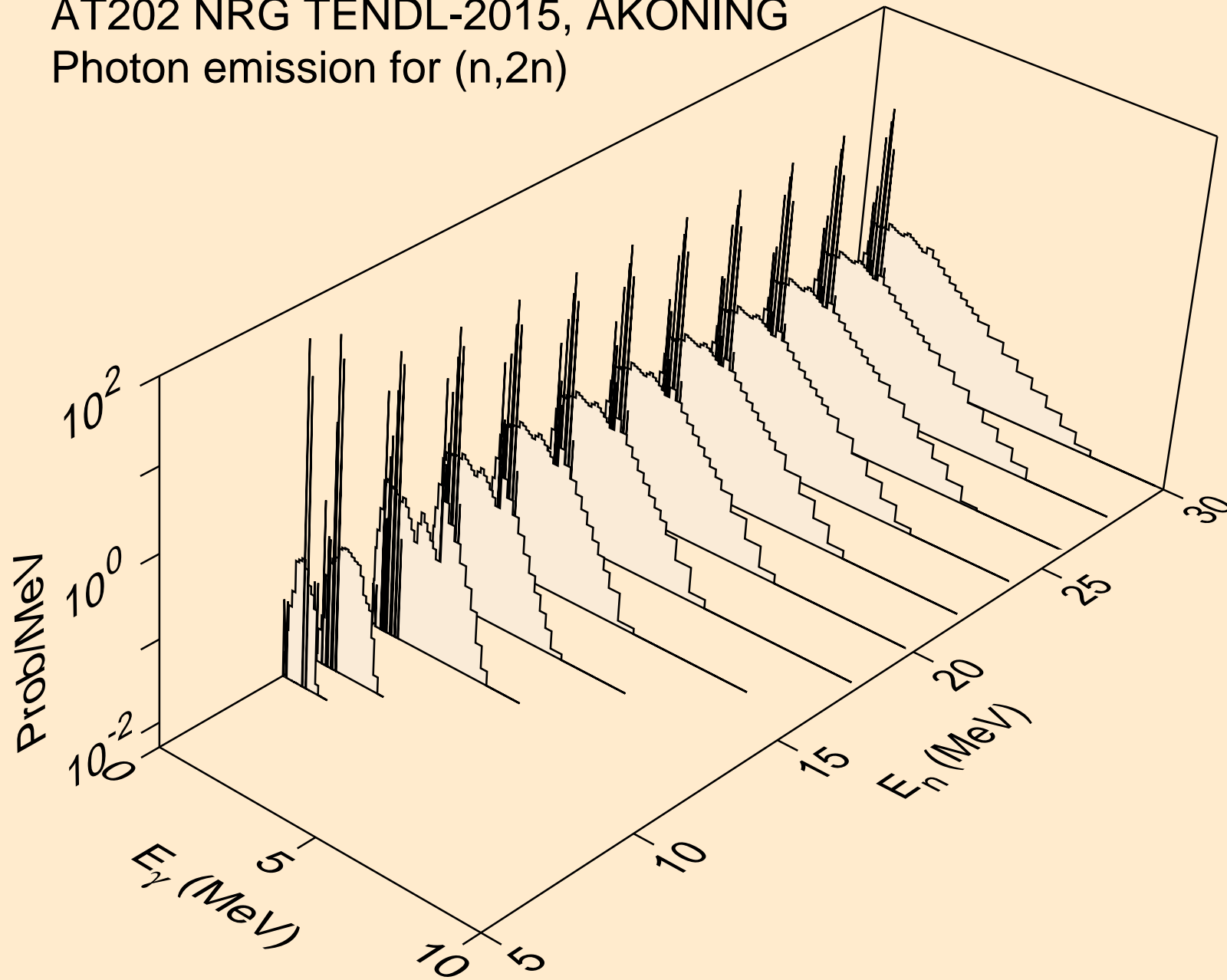

AT202 NRG TENDL-2015, AKONING  
Photon emission for (n,3n)

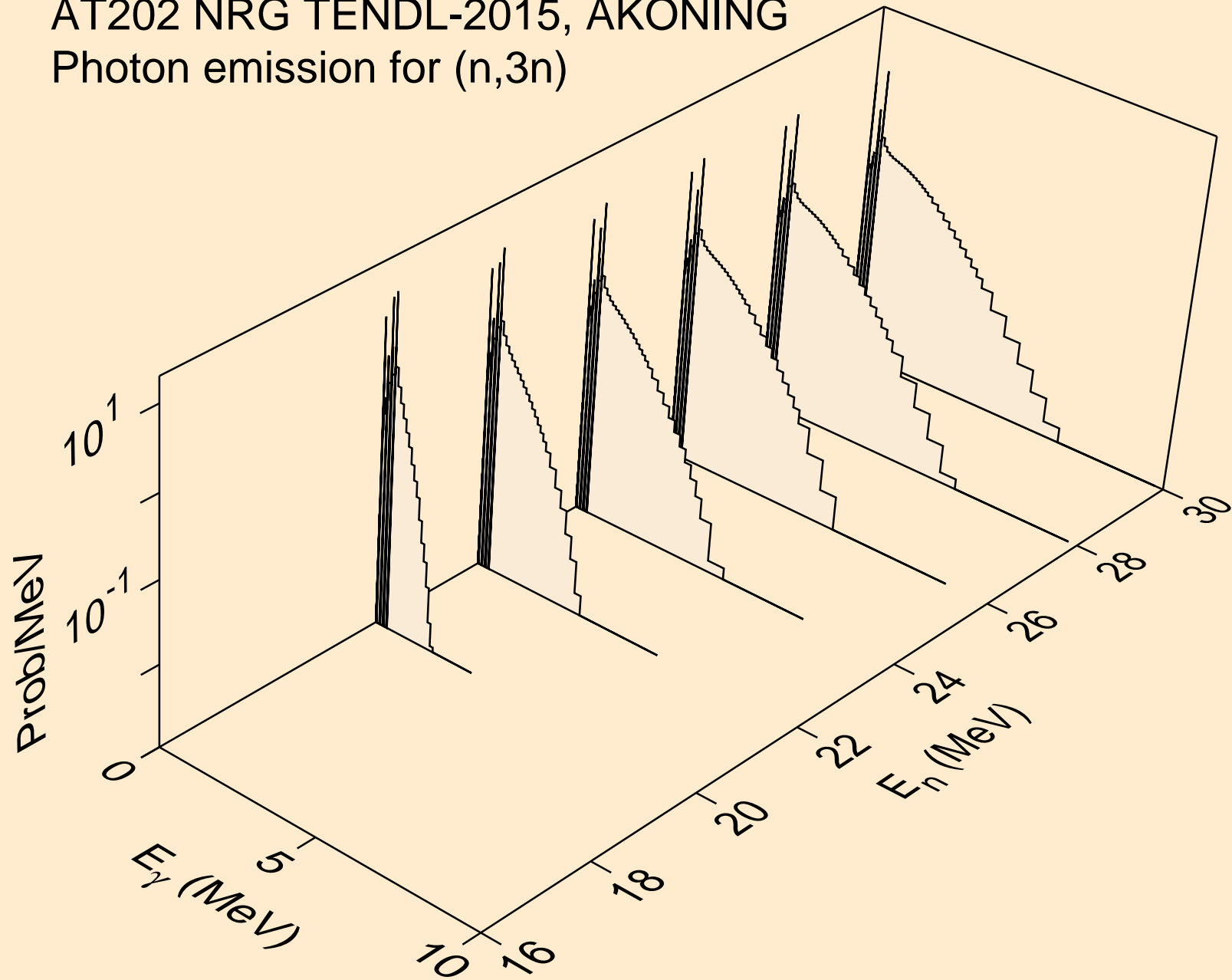

AT202 NRG TENDL-2015, AKONING  
Photon emission for (n,n\*)a

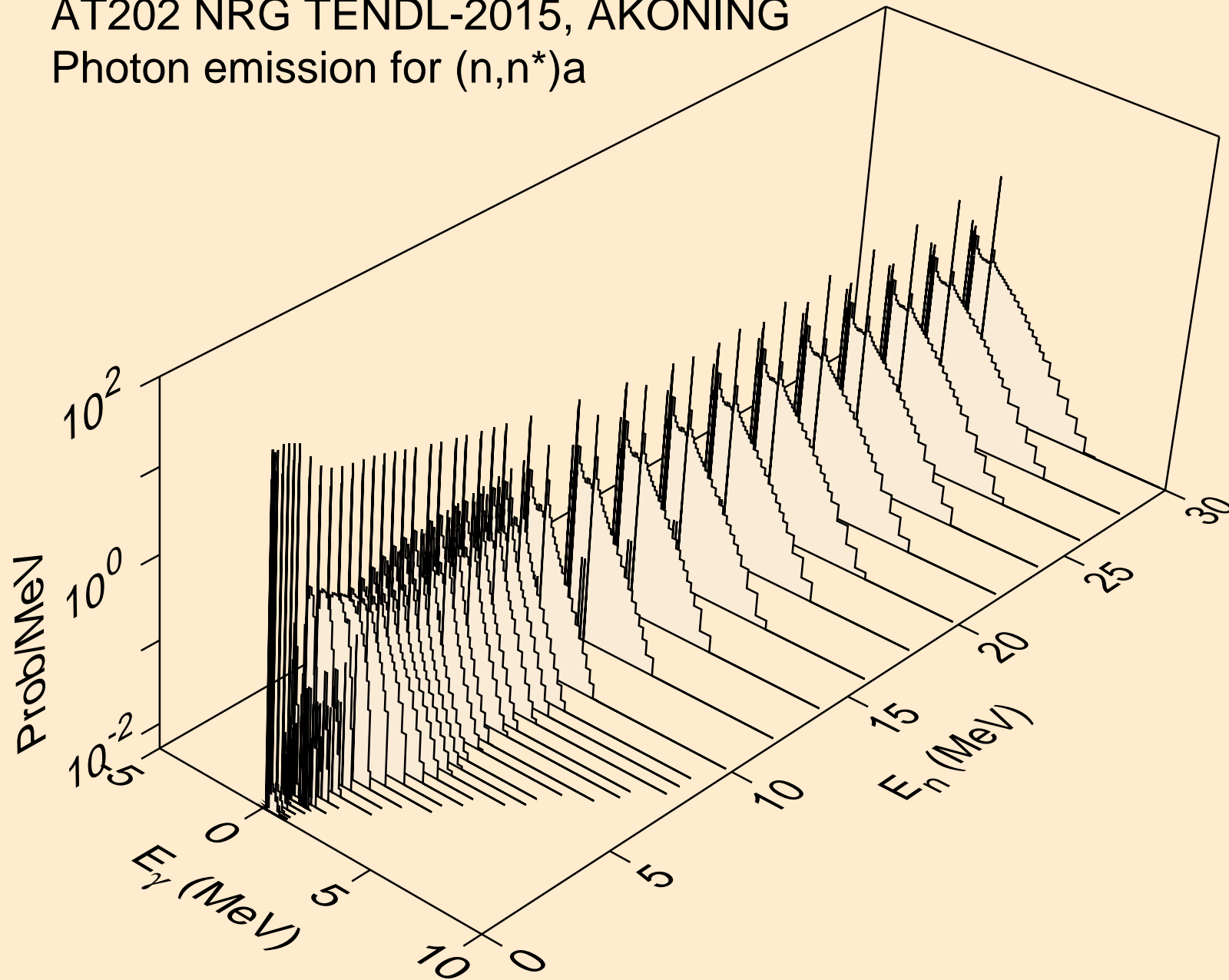

AT202 NRG TENDL-2015, AKONING  
Photon emission for (n,2n)a

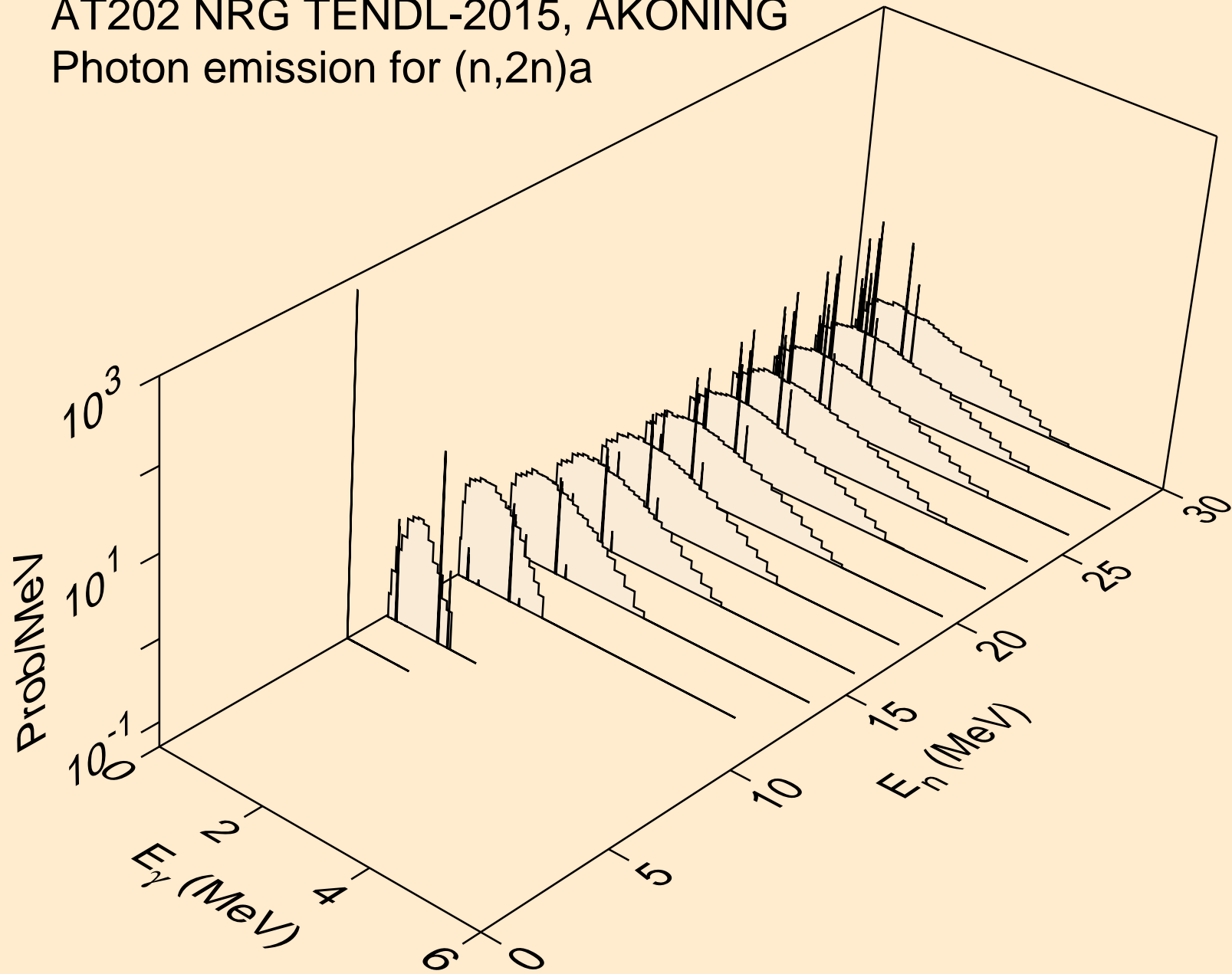

AT202 NRG TENDL-2015, AKONING  
Photon emission for (n,3n)a

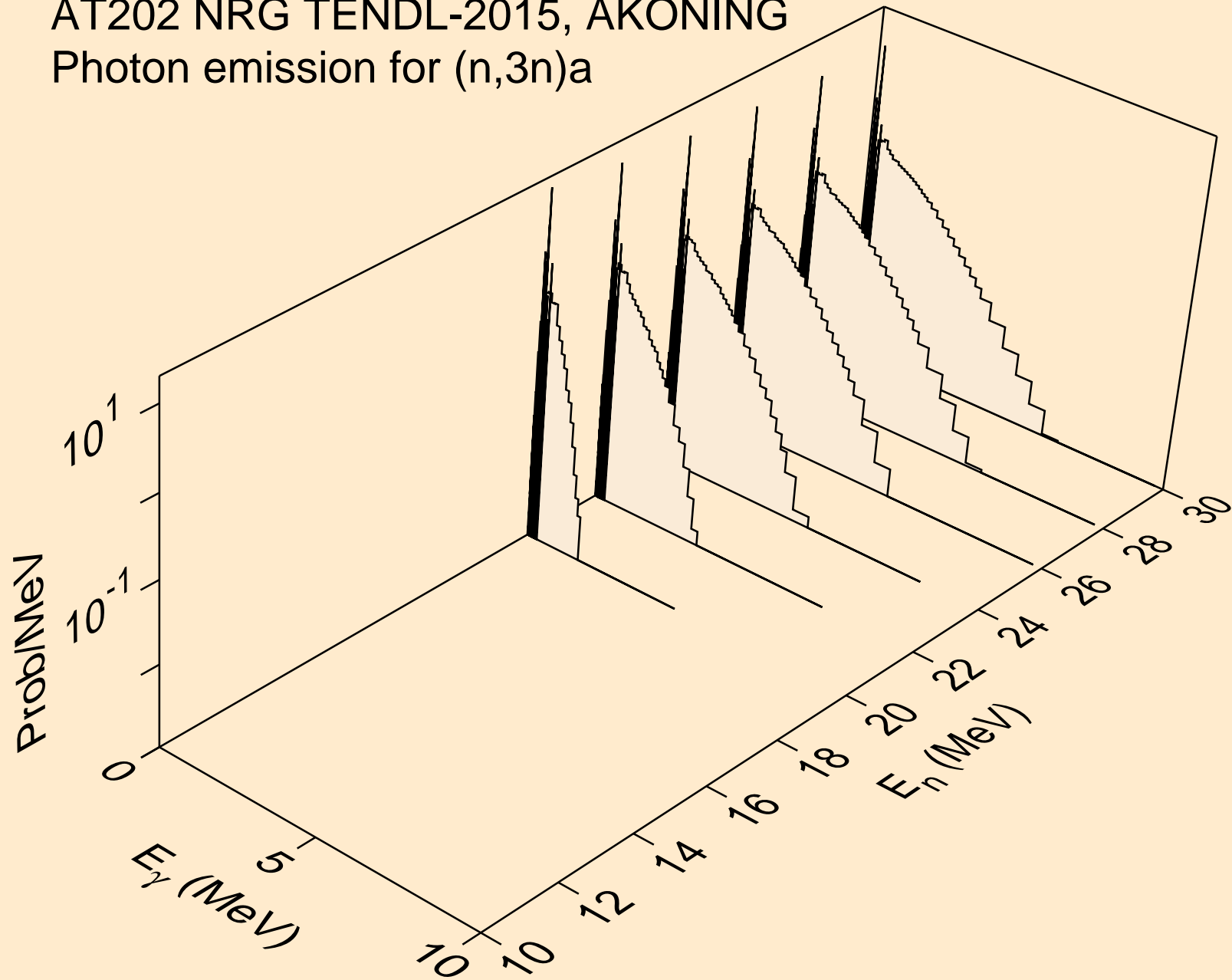



AT202 NRG TENDL-2015, AKONING  
Photon emission for (n,n\*)p

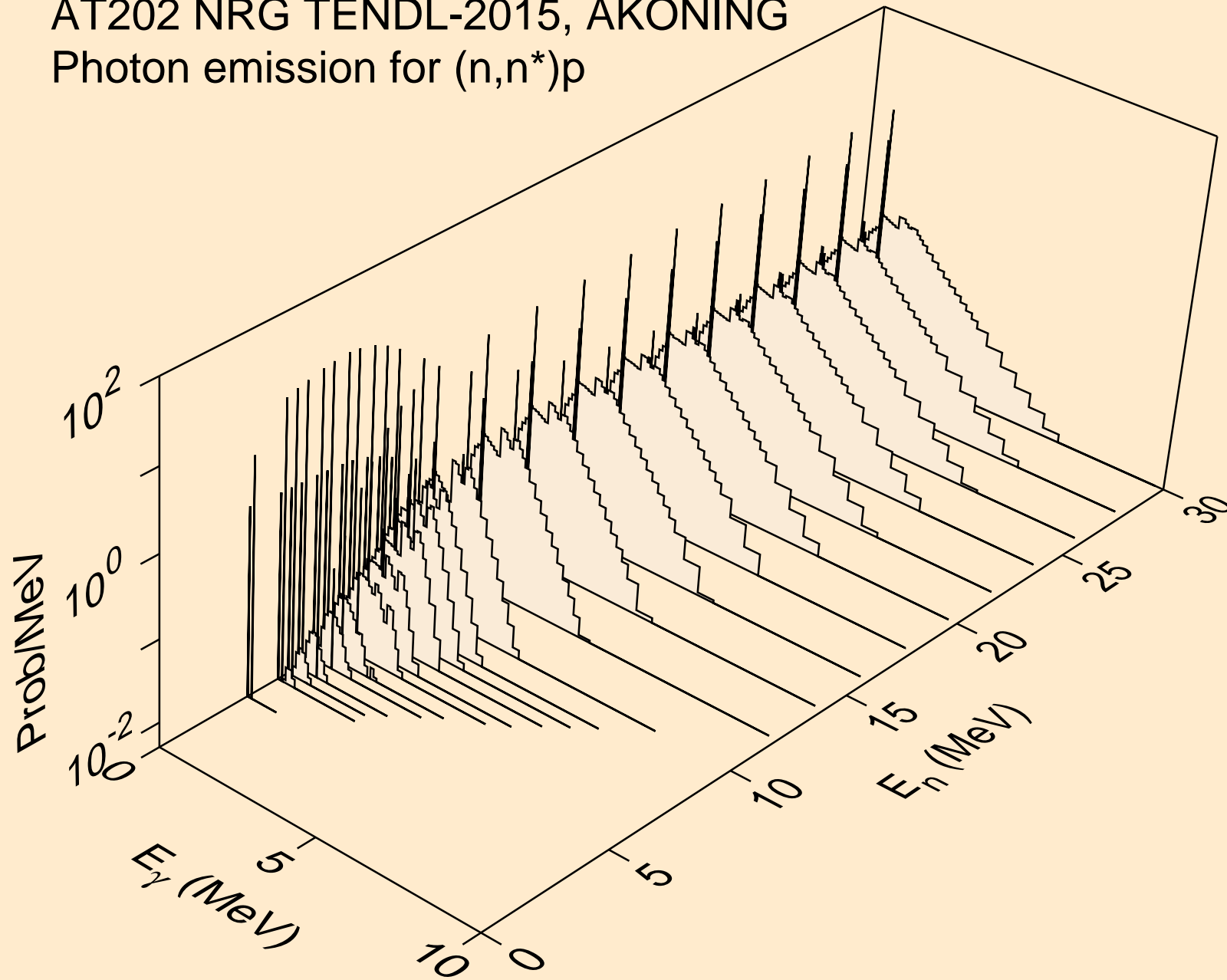

AT202 NRG TENDL-2015, AKONING  
Photon emission for (n,n\*)2a

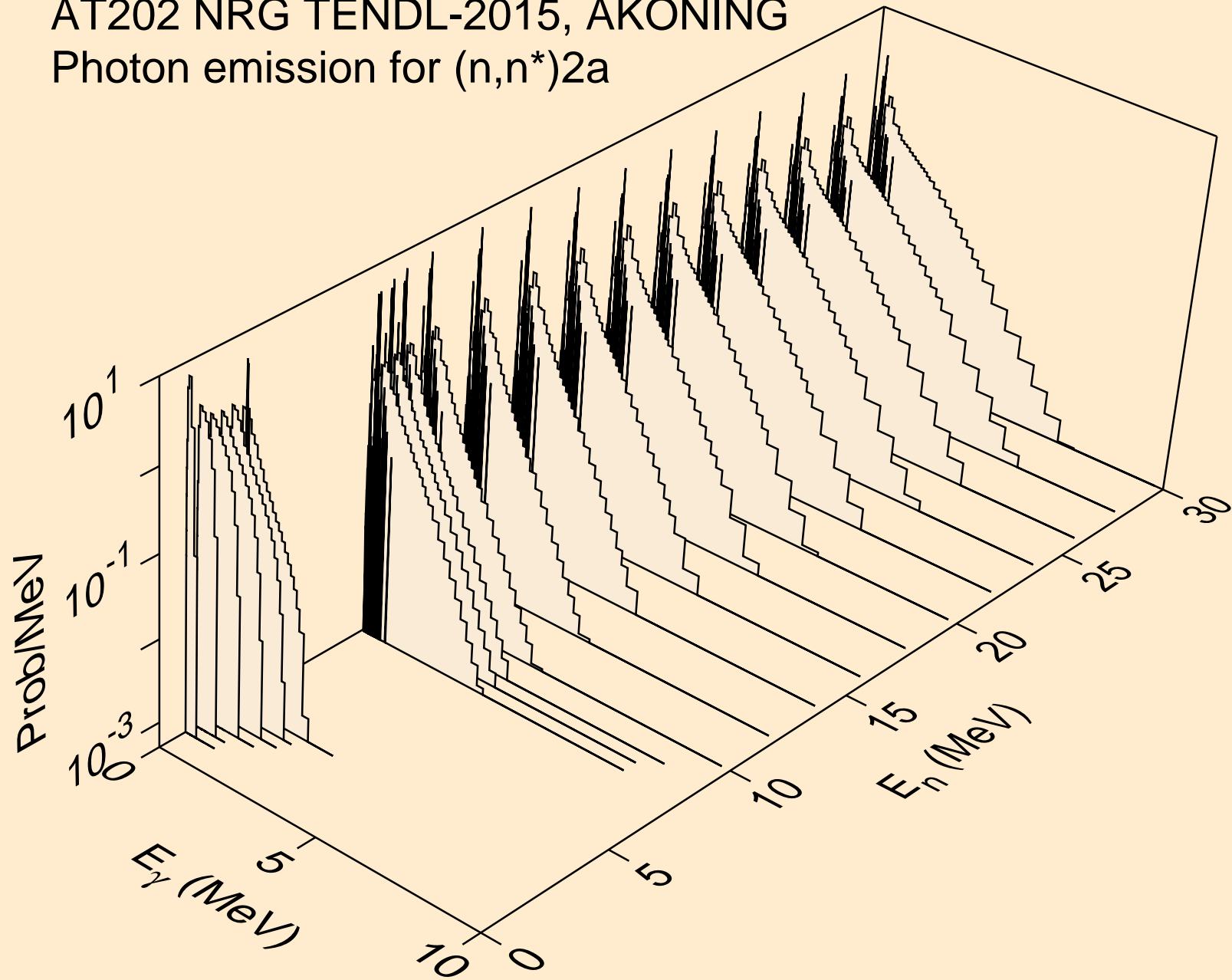

AT202 NRG TENDL-2015, AKONING  
Photon emission for (n,2n)2a

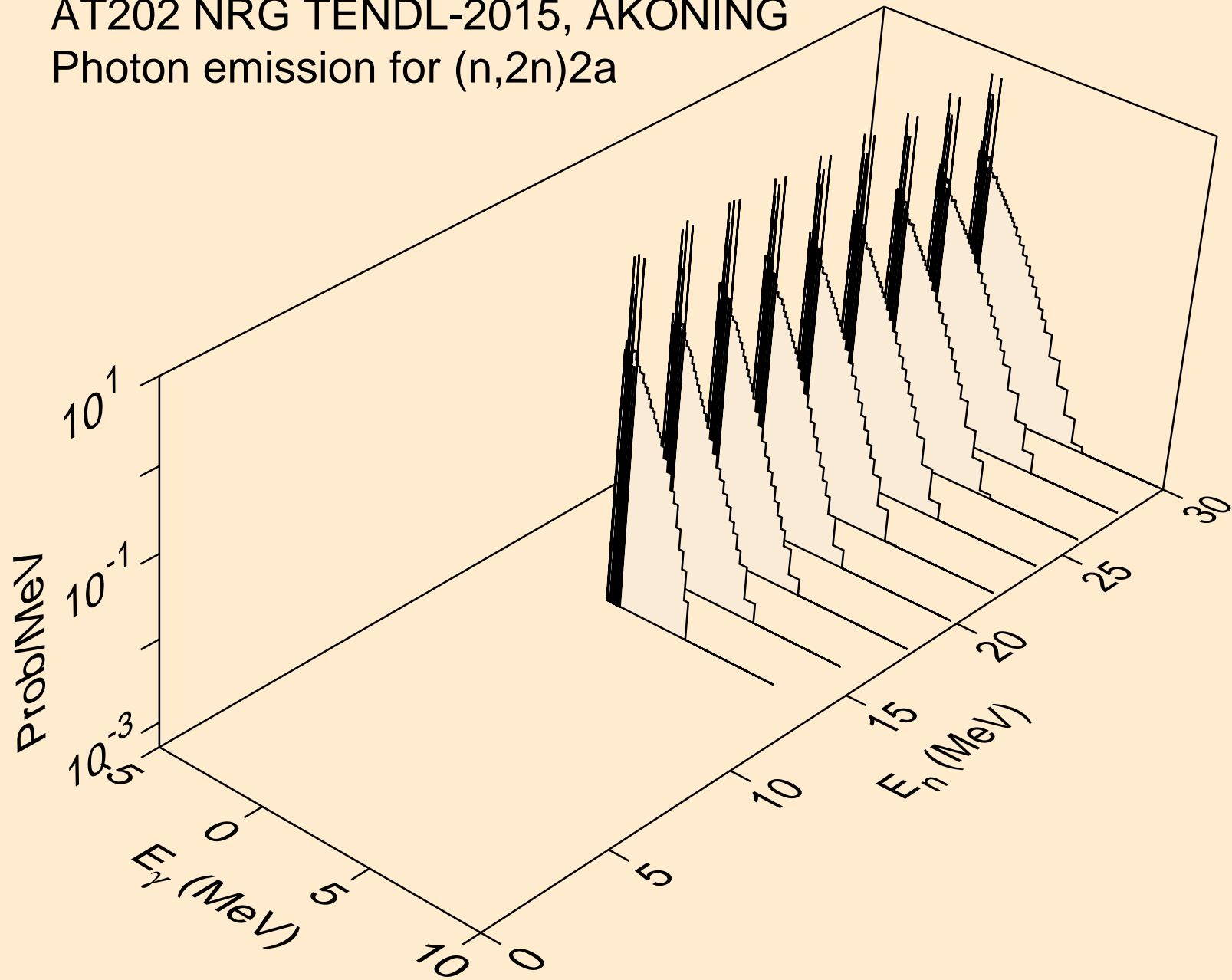

AT202 NRG TENDL-2015, AKONING  
Photon emission for (n,n\*)d

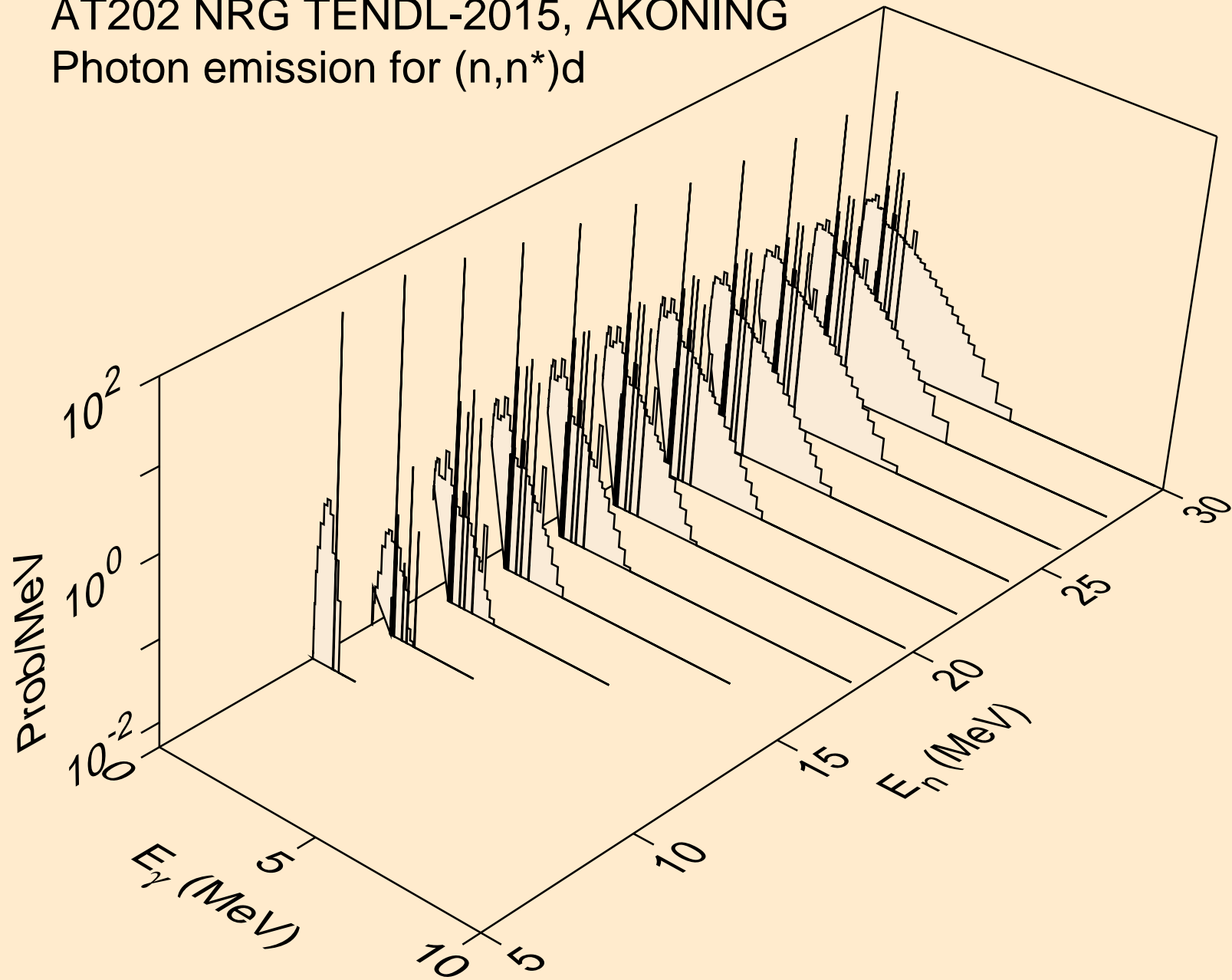

AT202 NRG TENDL-2015, AKONING  
Photon emission for (n,n\*)t

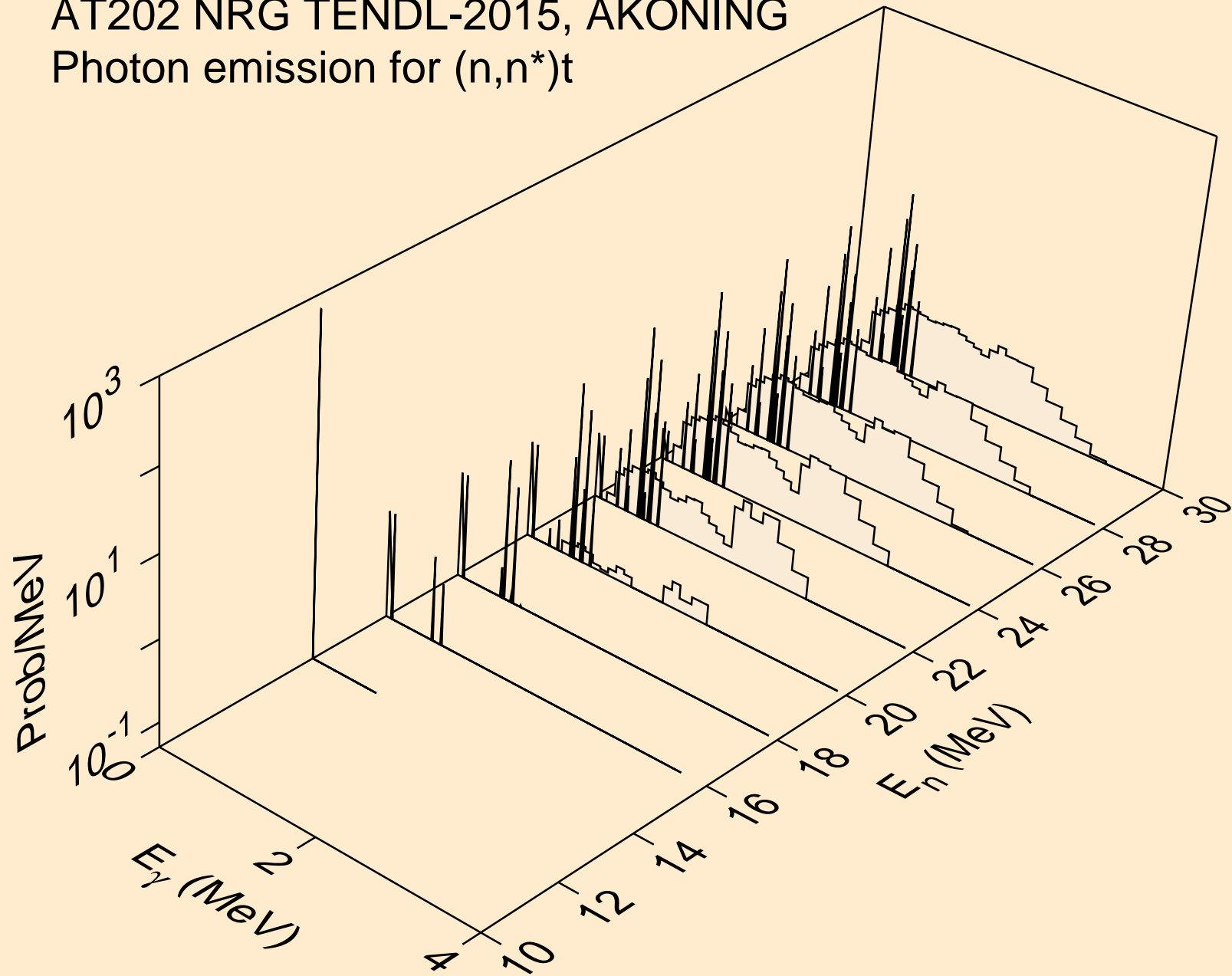

AT202 NRG TENDL-2015, AKONING  
Photon emission for (n,n\*)he3

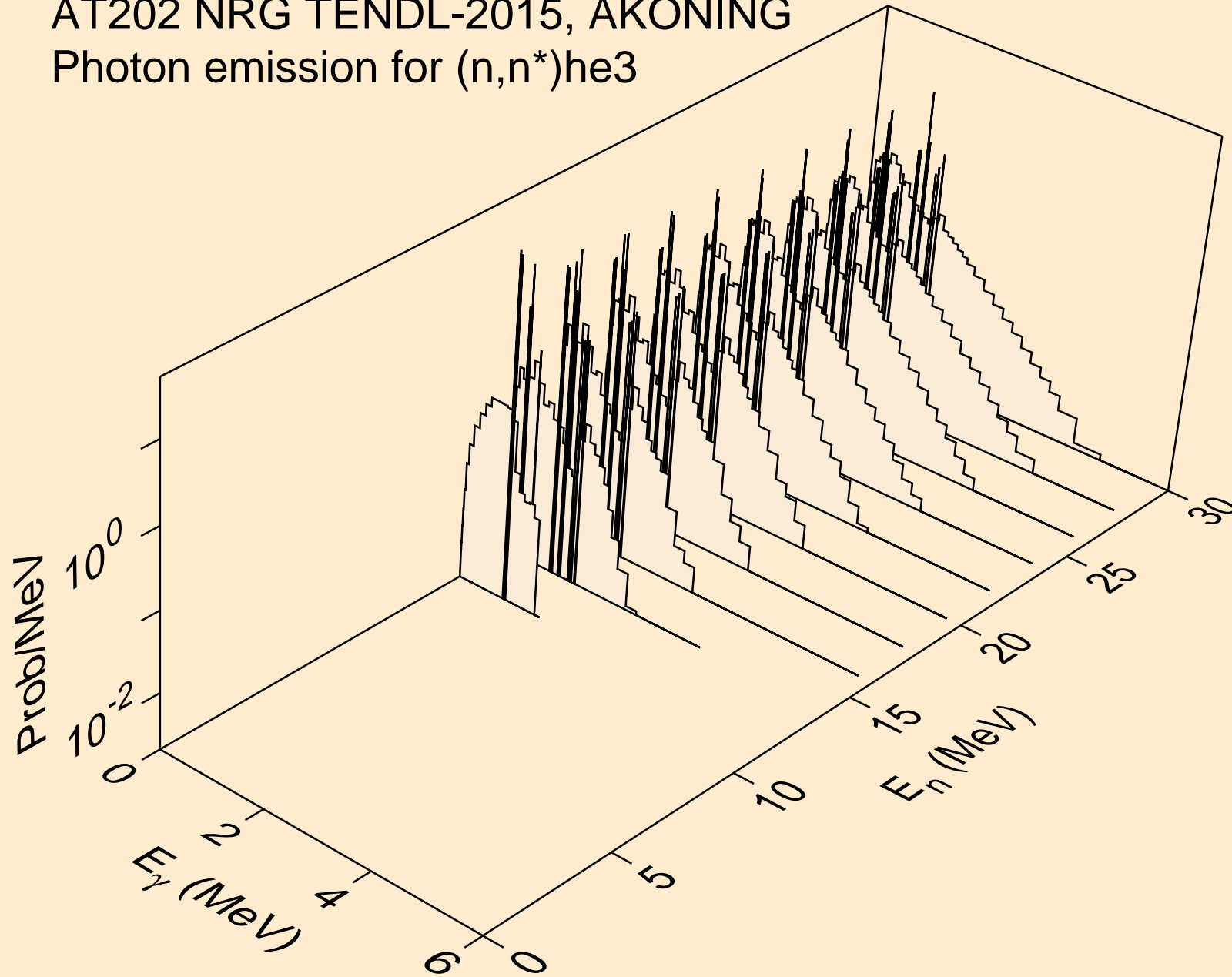

AT202 NRG TENDL-2015, AKONING  
Photon emission for (n,4n)

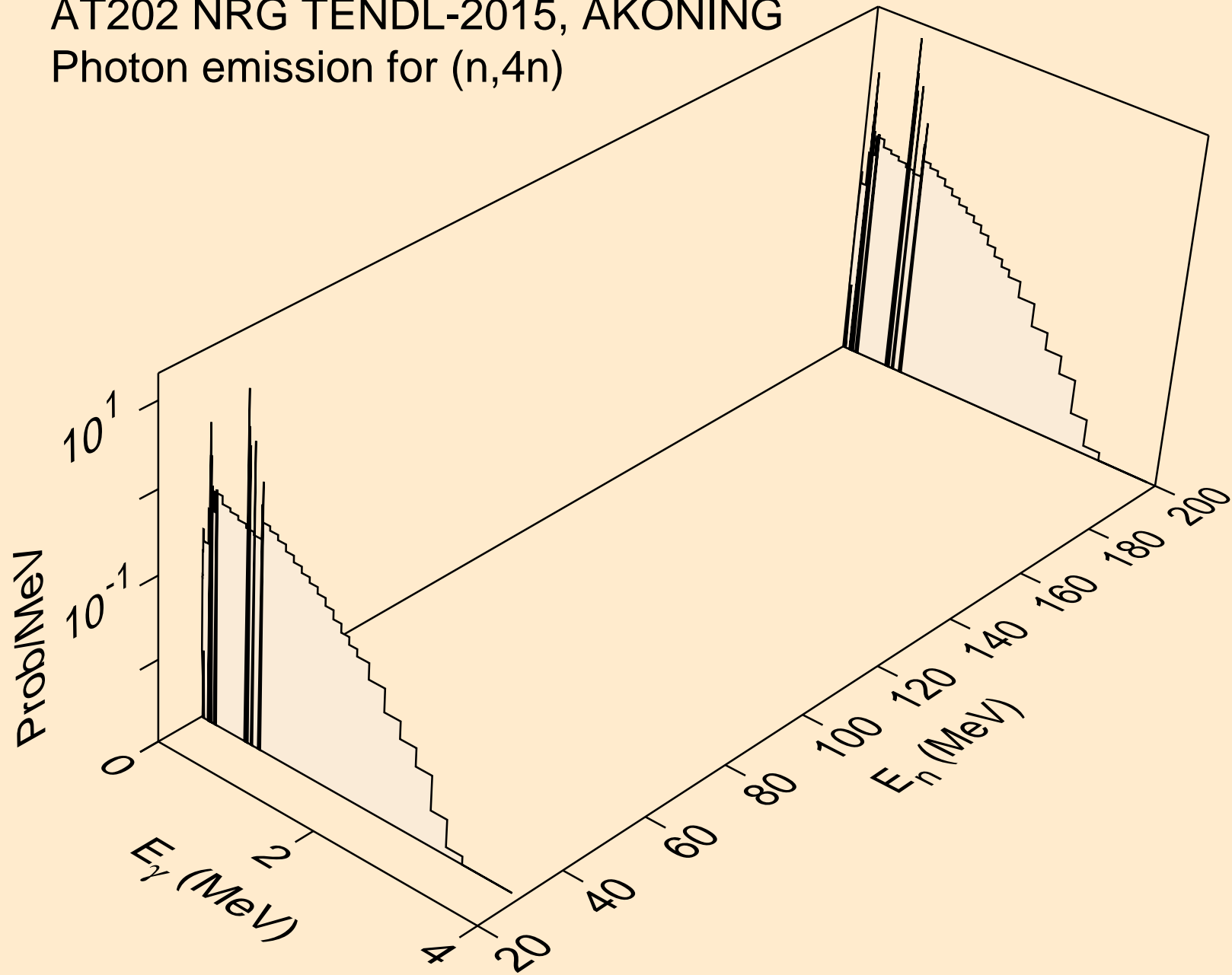

AT202 NRG TENDL-2015, AKONING  
Photon emission for (n,2np)

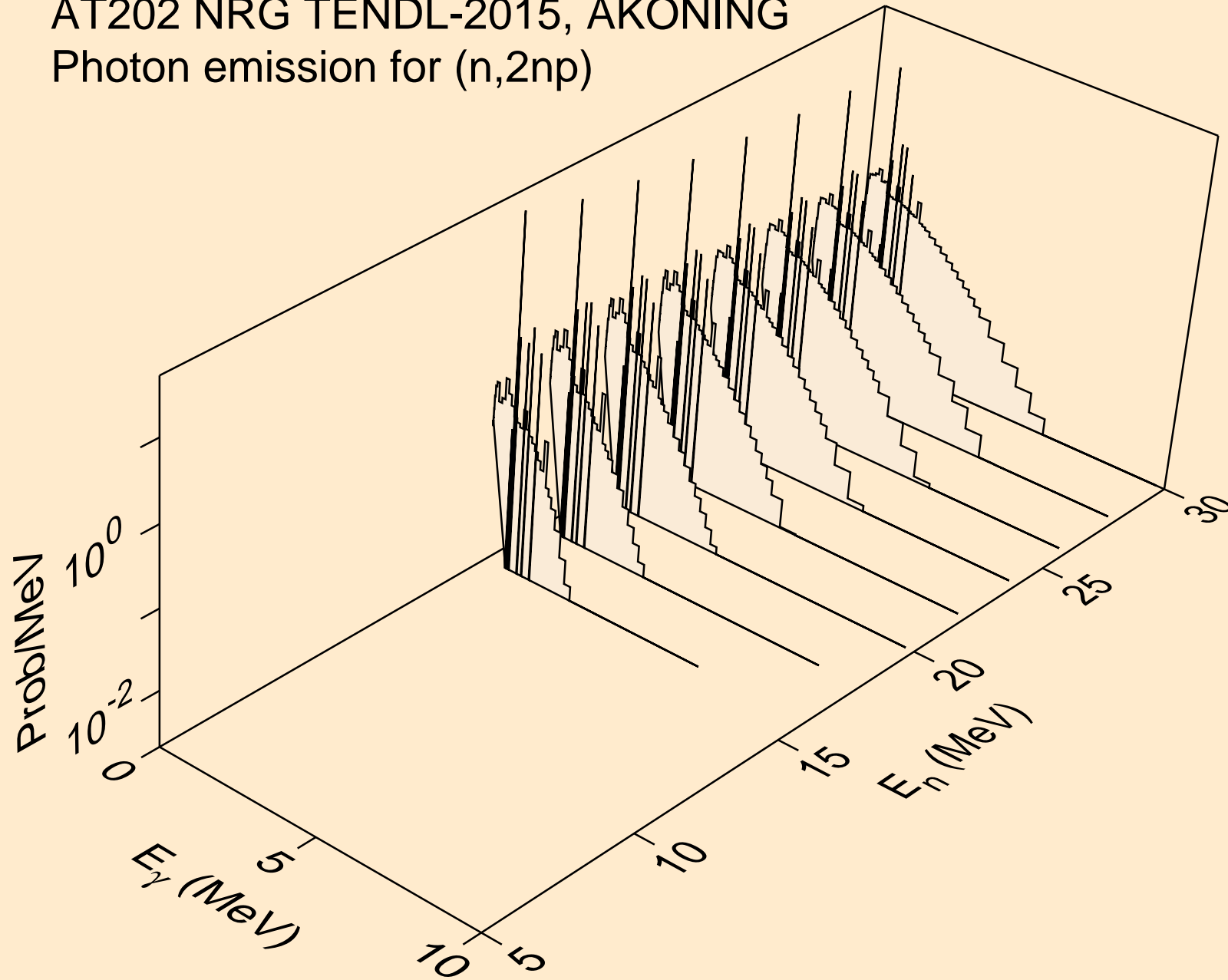



AT202 NRG TENDL-2015, AKONING  
Photon emission for (n,3np)

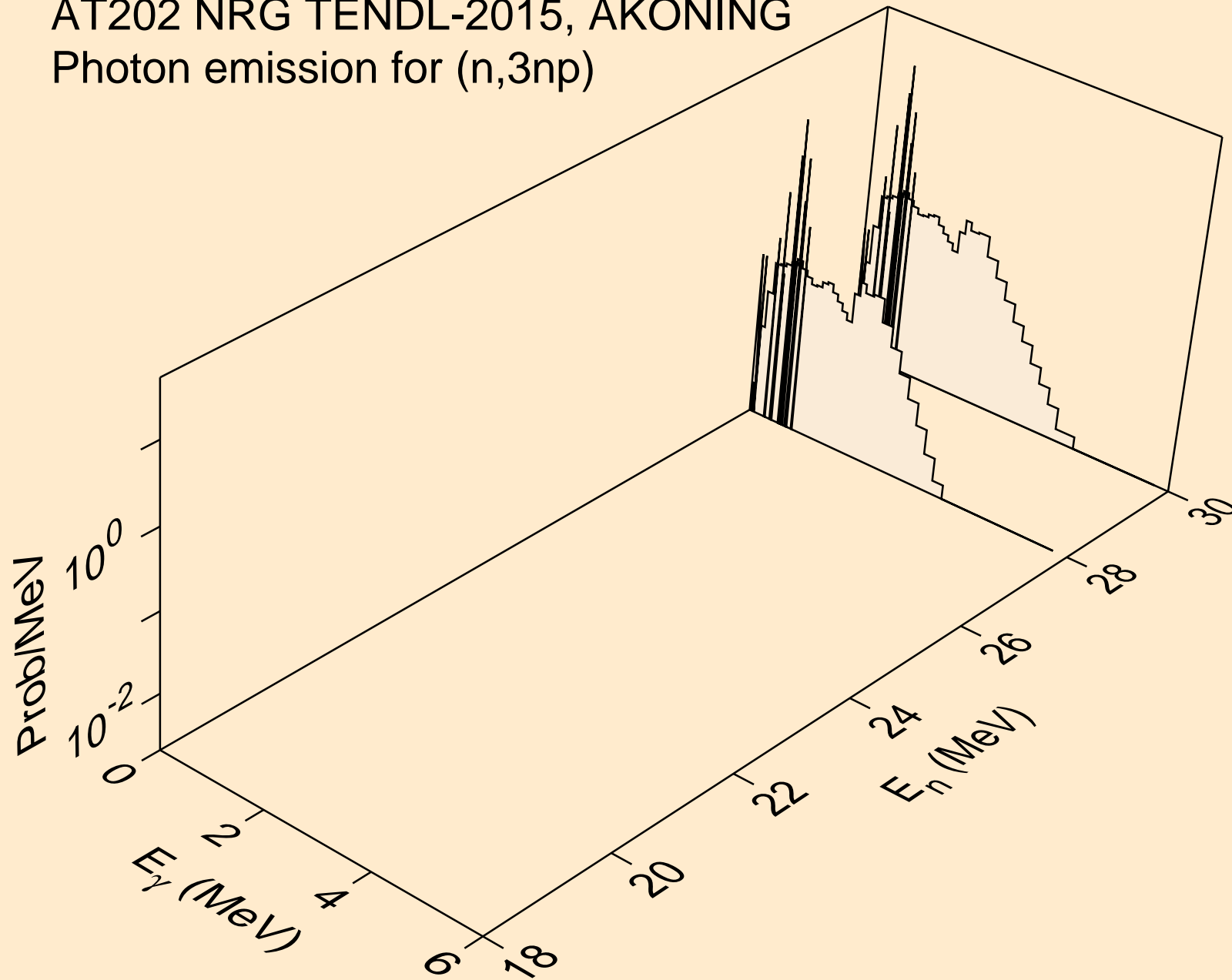

AT202 NRG TENDL-2015, AKONING  
Photon emission for (n,2np)

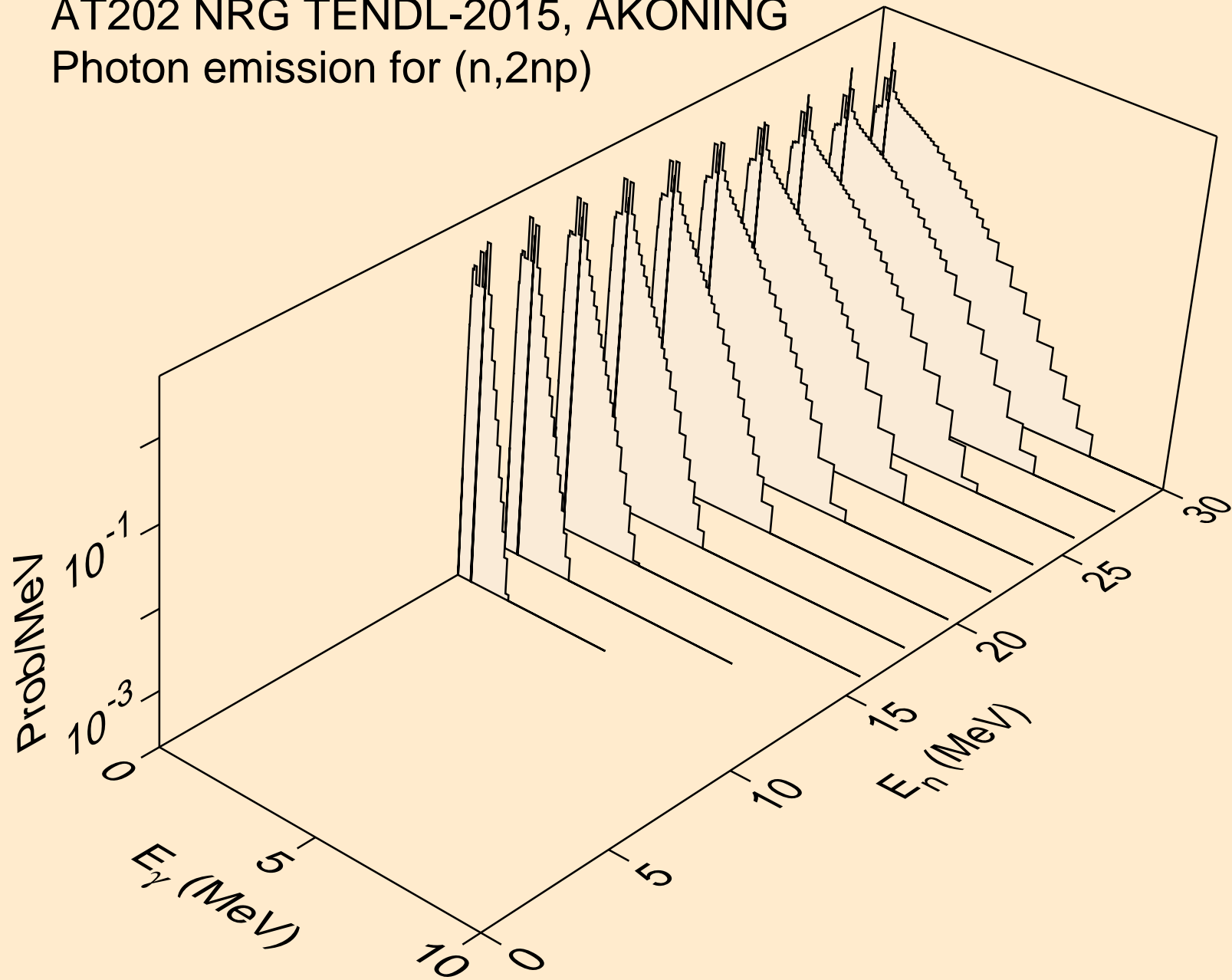

AT202 NRG TENDL-2015, AKONING  
Photon emission for (n,npa)

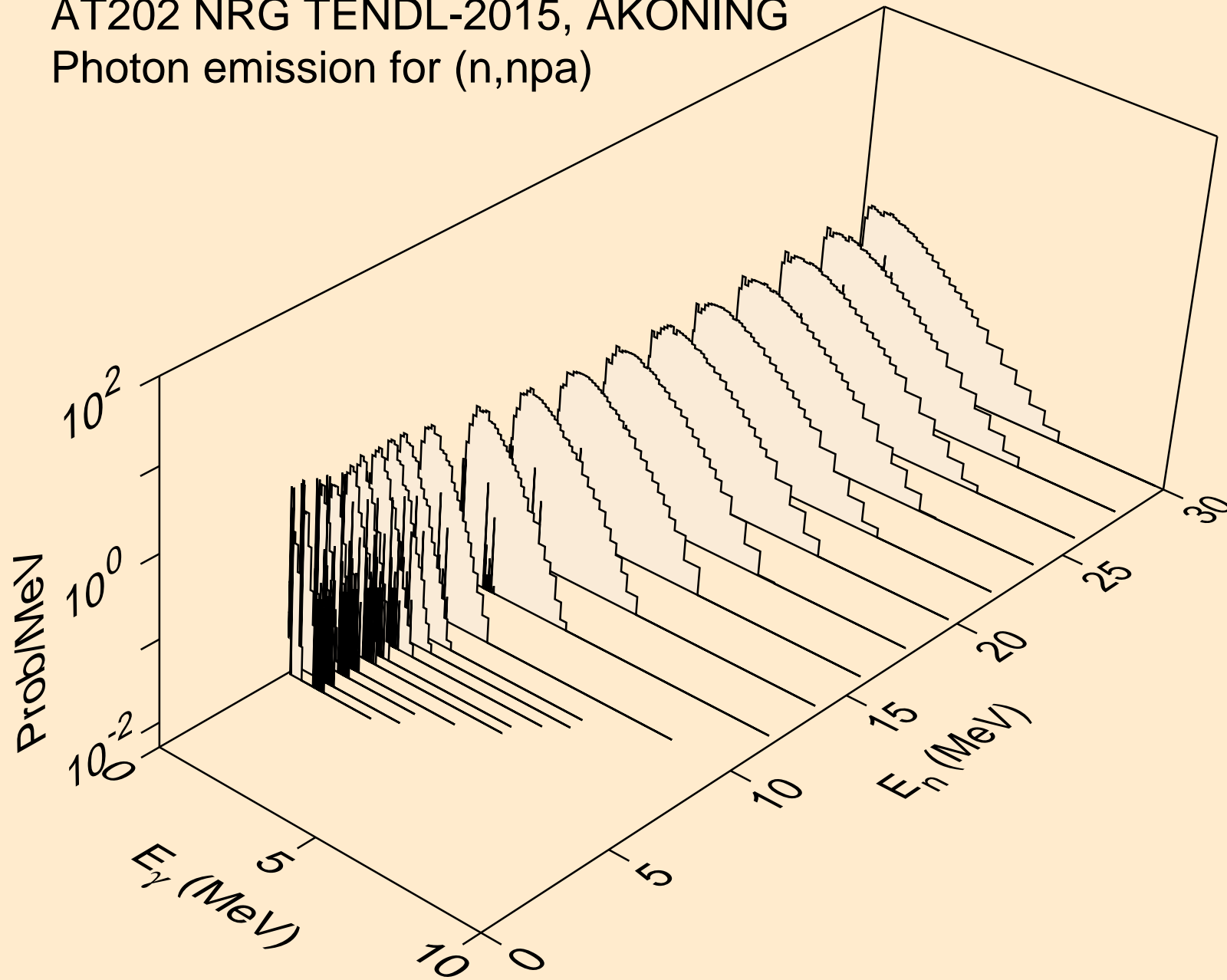

AT202 NRG TENDL-2015, AKONING  
Photon emission for (n,n\*c)

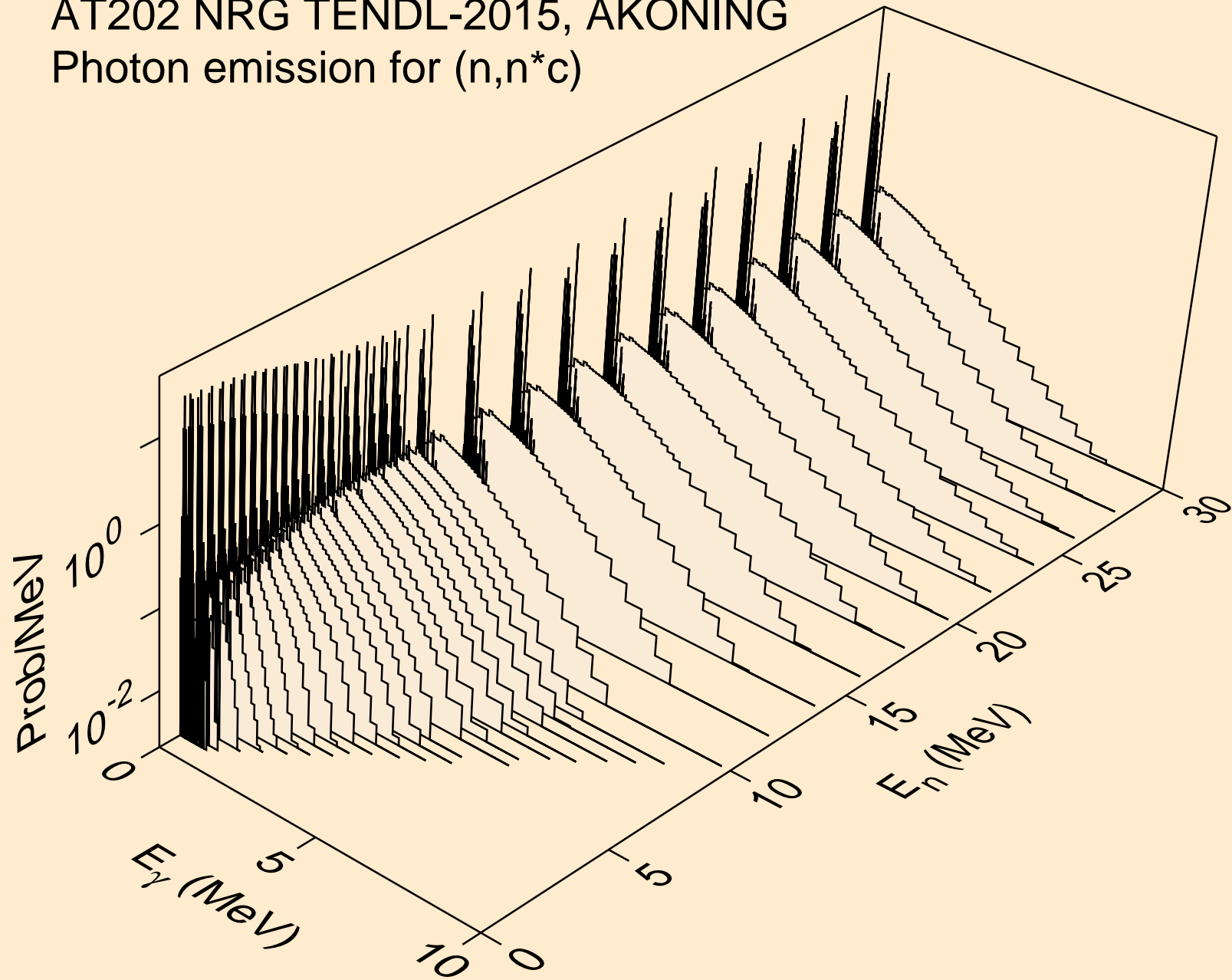

AT202 NRG TENDL-2015, AKONING  
Photon emission for (n,gma)

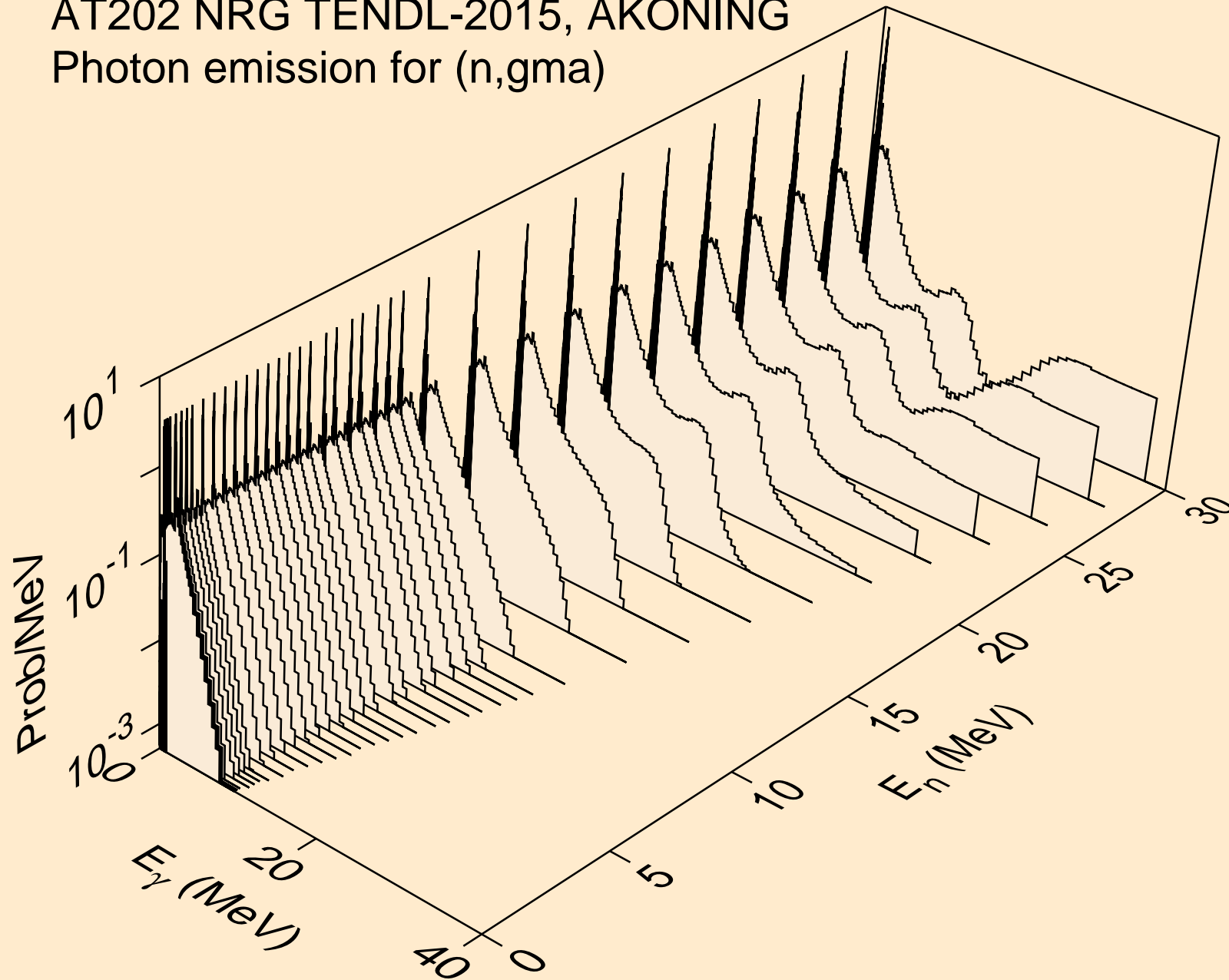

AT202 NRG TENDL-2015, AKONING  
Photon emission for (n,p)

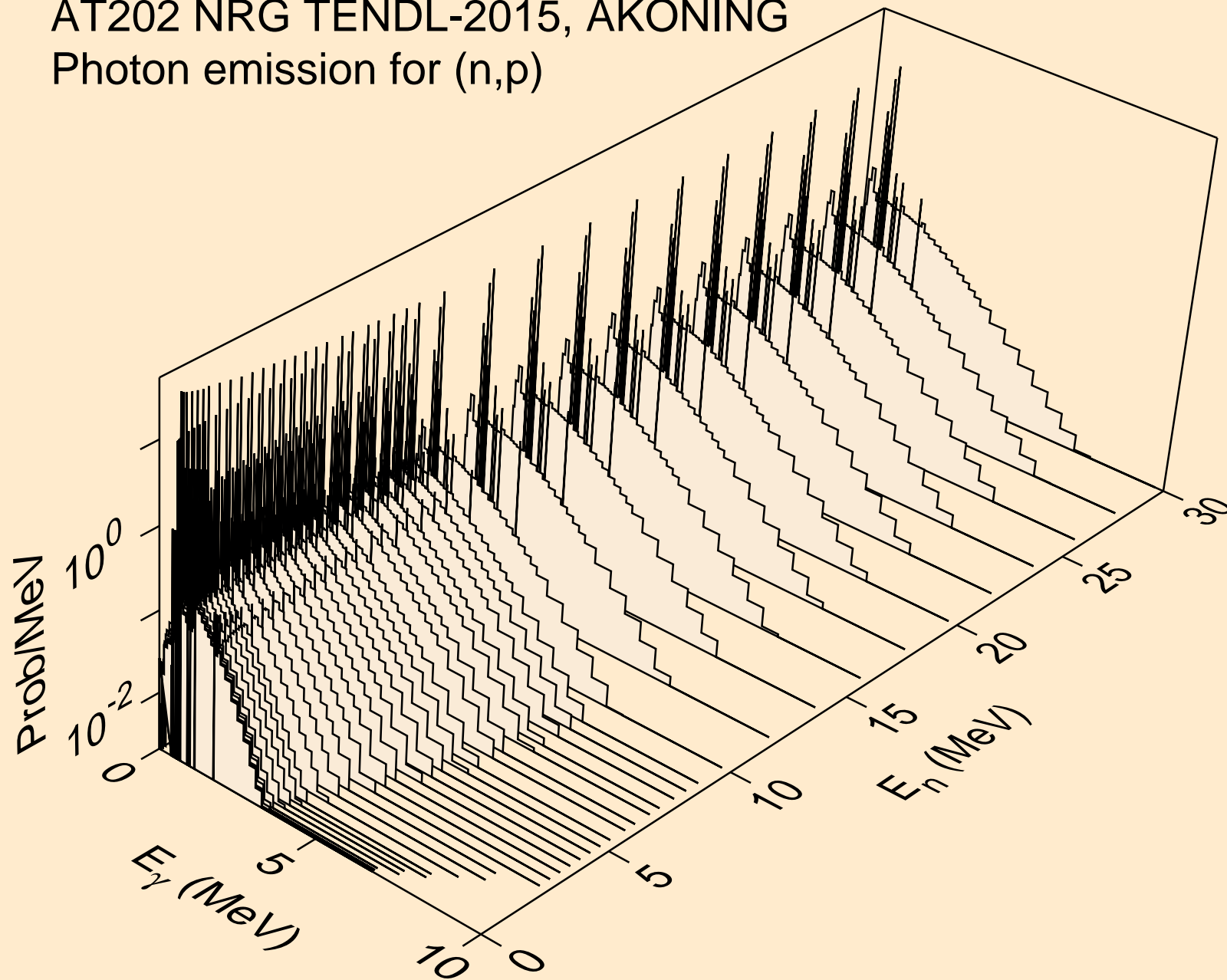

AT202 NRG TENDL-2015, AKONING  
Photon emission for (n,d)

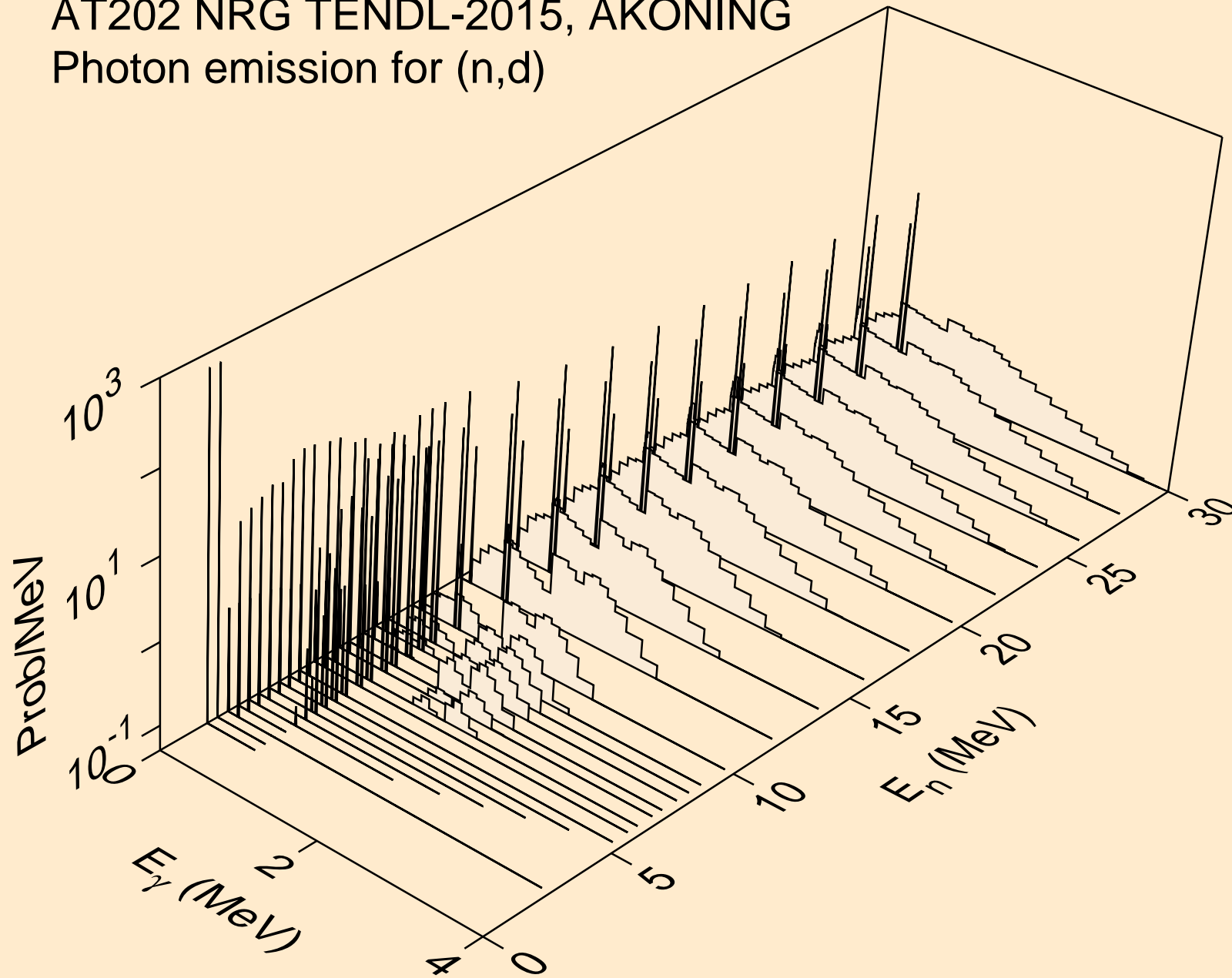

AT202 NRG TENDL-2015, AKONING  
Photon emission for (n,t)

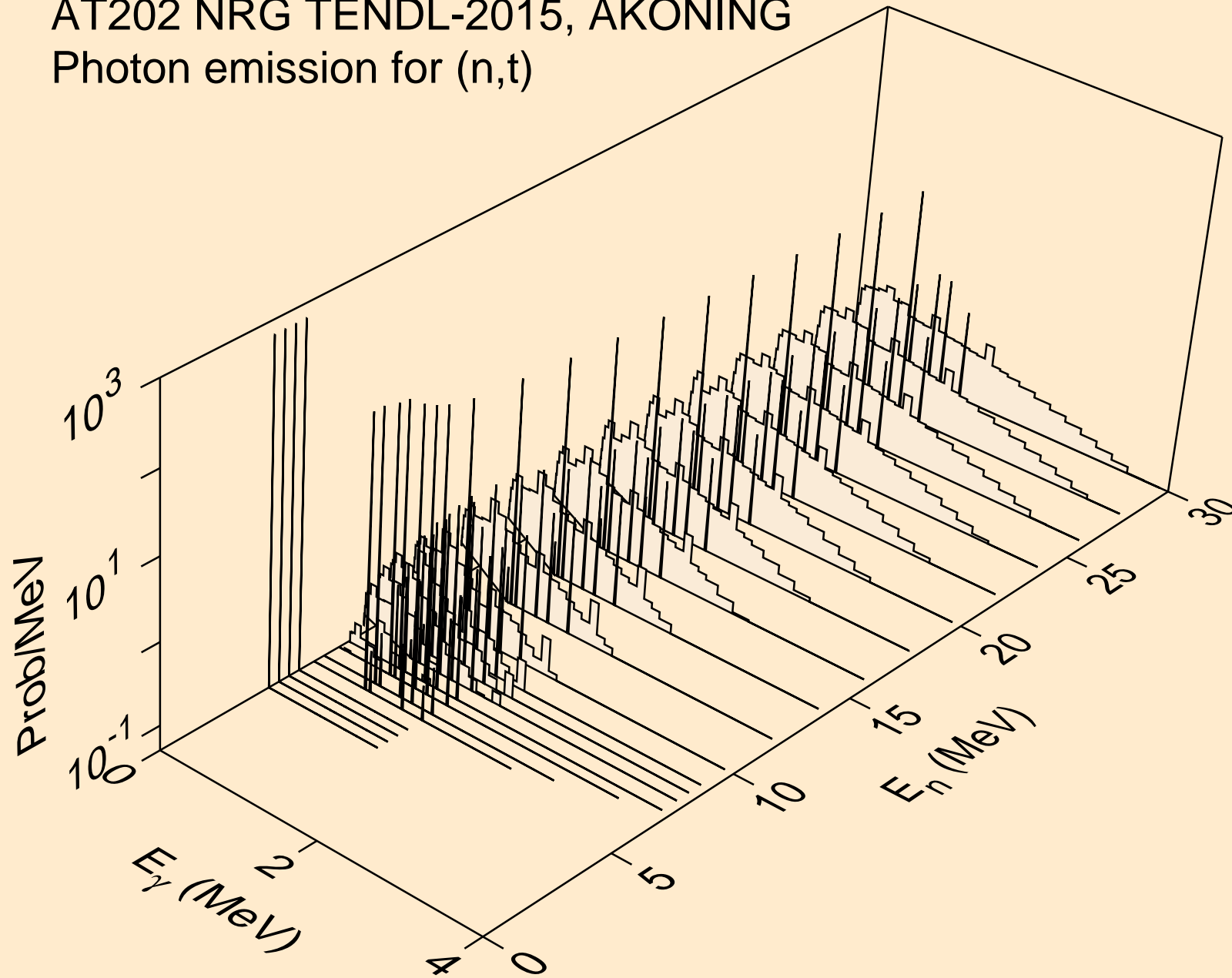



AT202 NRG TENDL-2015, AKONING  
Photon emission for (n,he3)

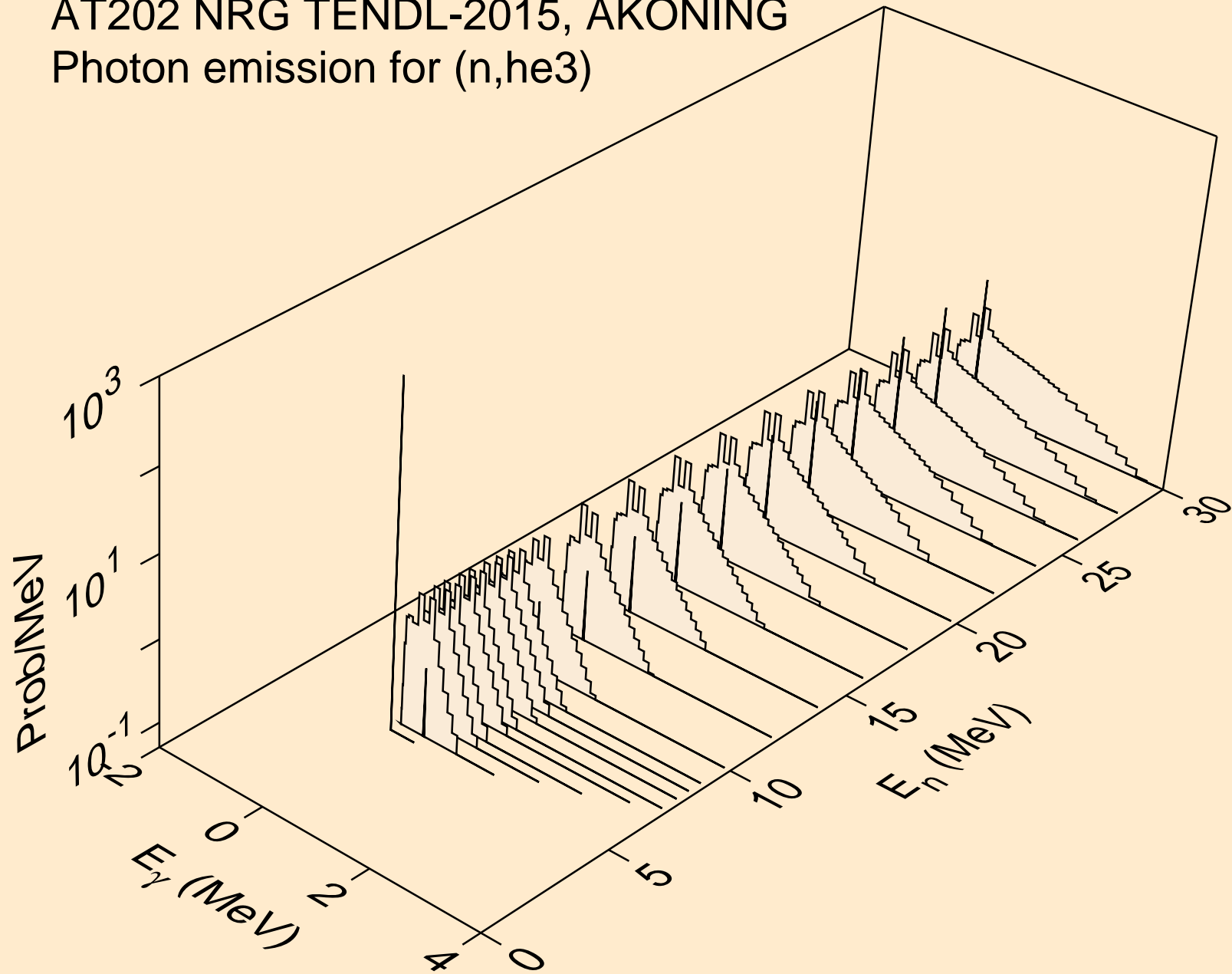

AT202 NRG TENDL-2015, AKONING  
Photon emission for (n,a)

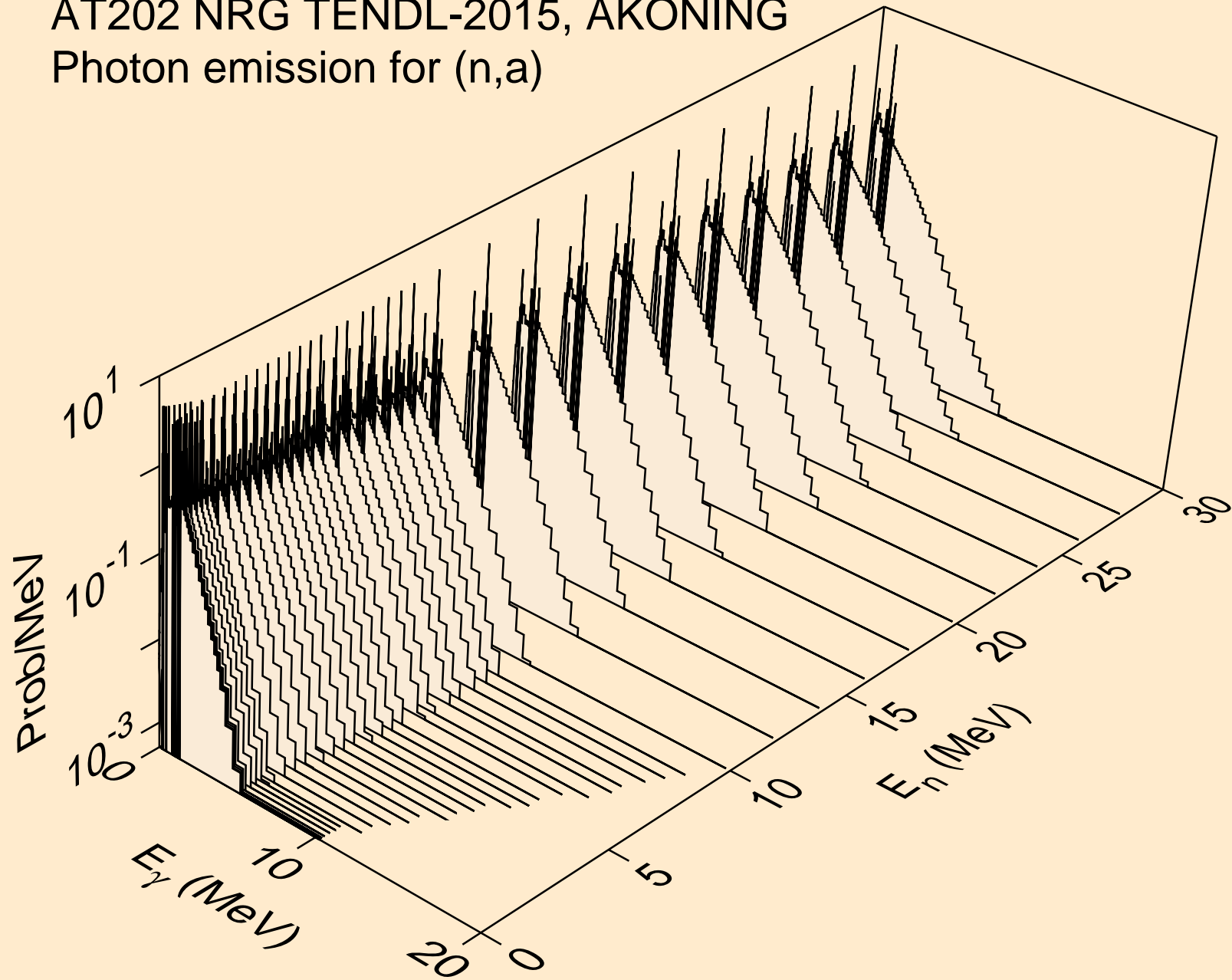

AT202 NRG TENDL-2015, AKONING  
Photon emission for (n,2a)

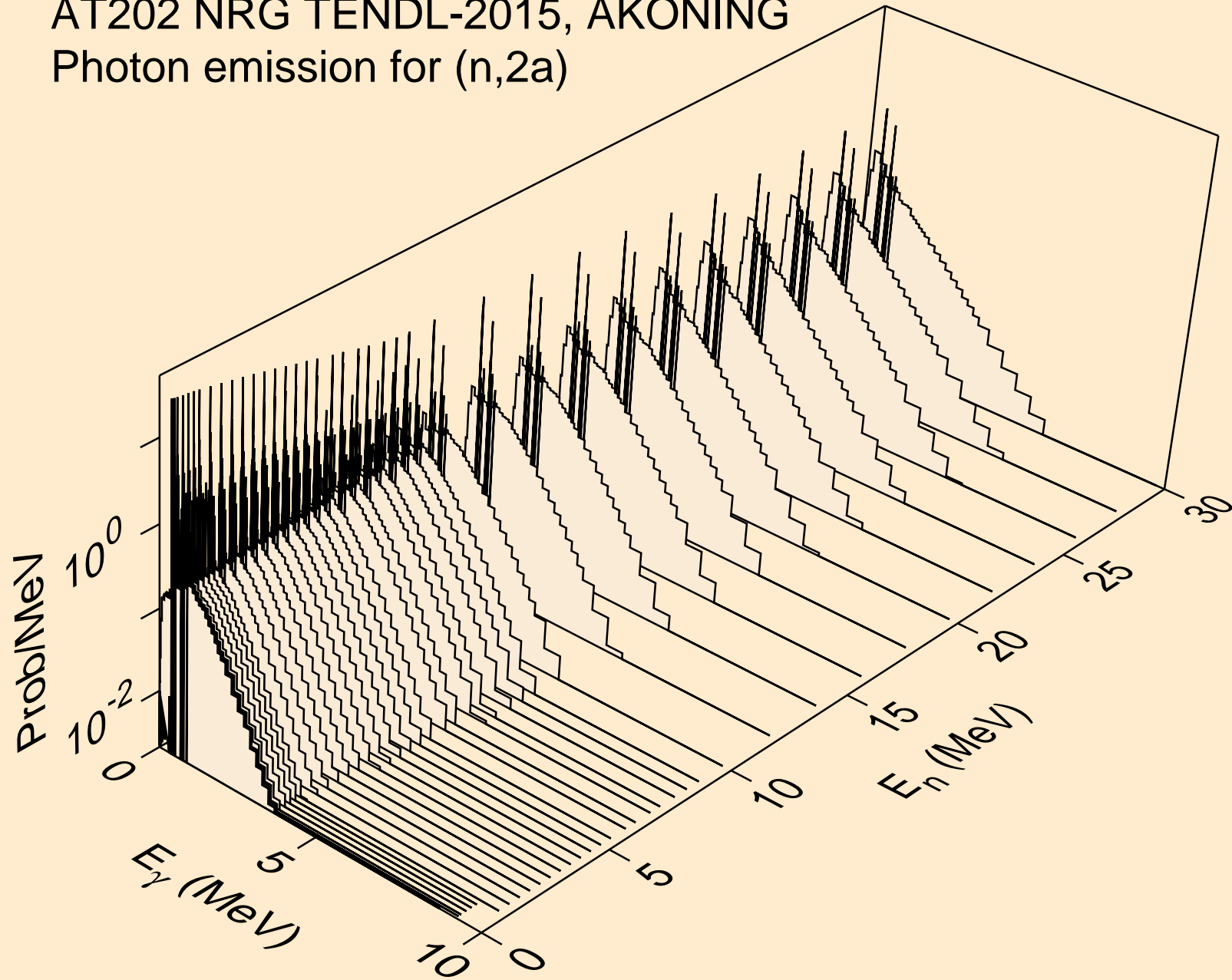

AT202 NRG TENDL-2015, AKONING  
Photon emission for (n,2p)

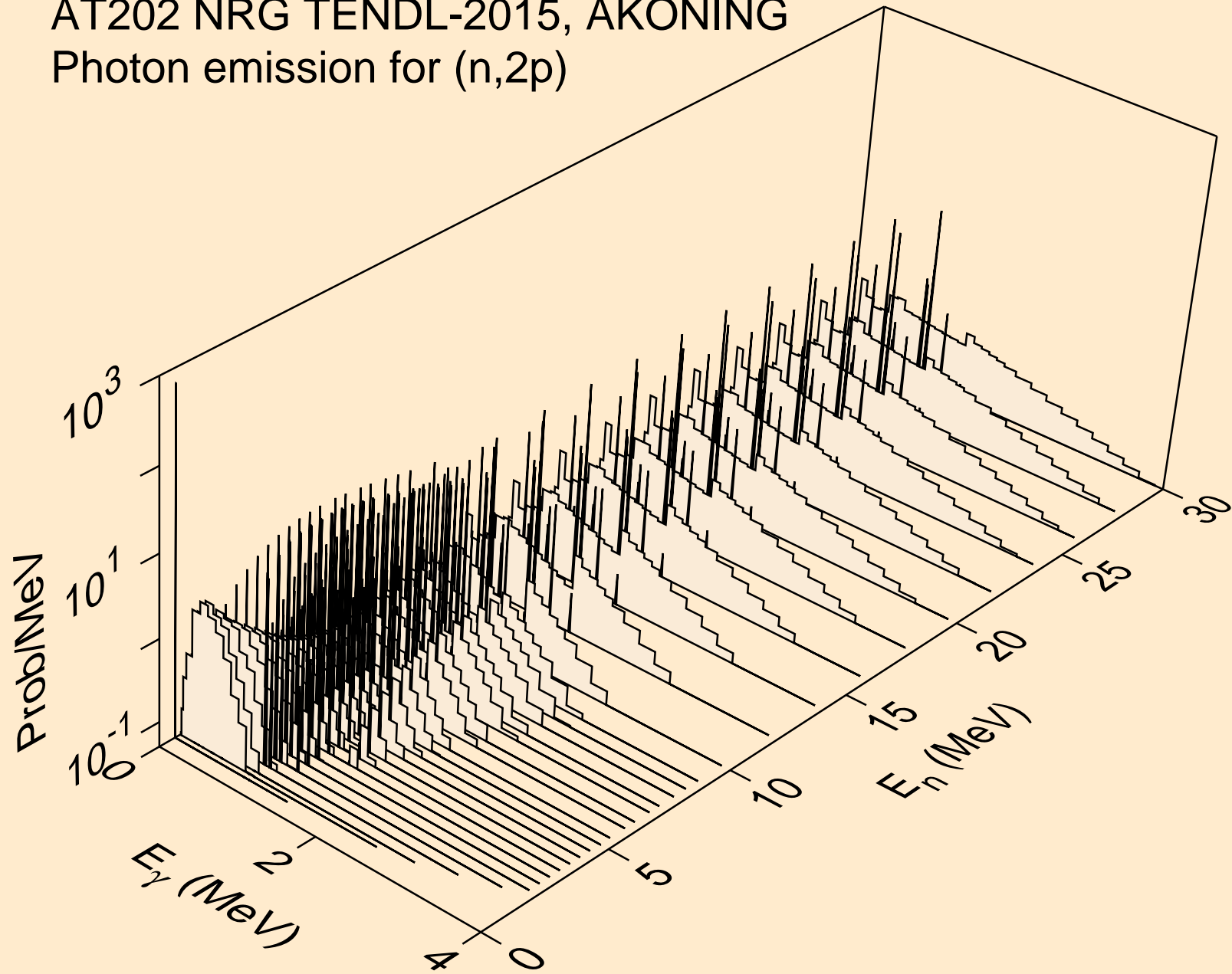

AT202 NRG TENDL-2015, AKONING  
Photon emission for (n,p $\alpha$ )

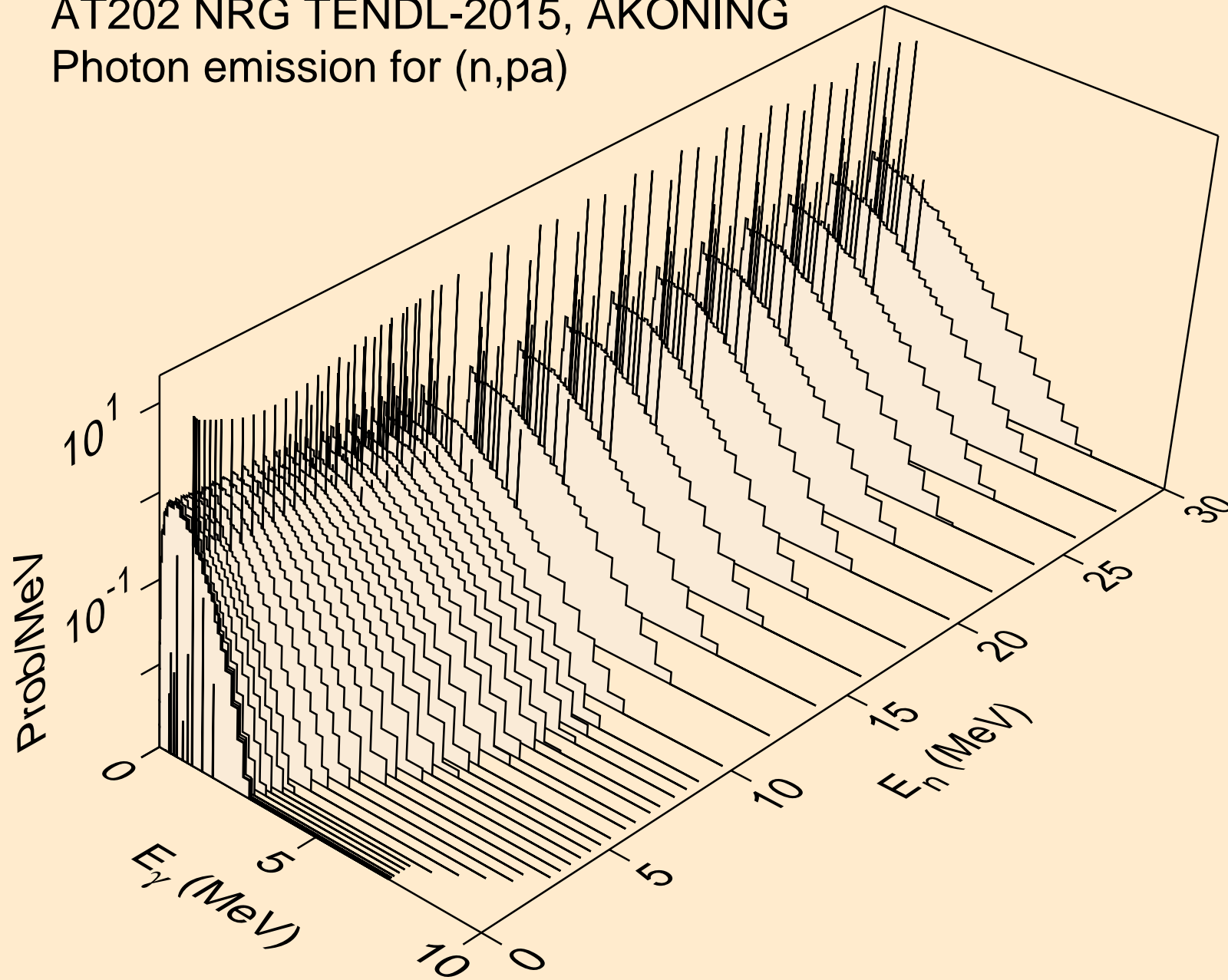

AT202 NRG TENDL-2015, AKONING  
Photon emission for (n,pd)

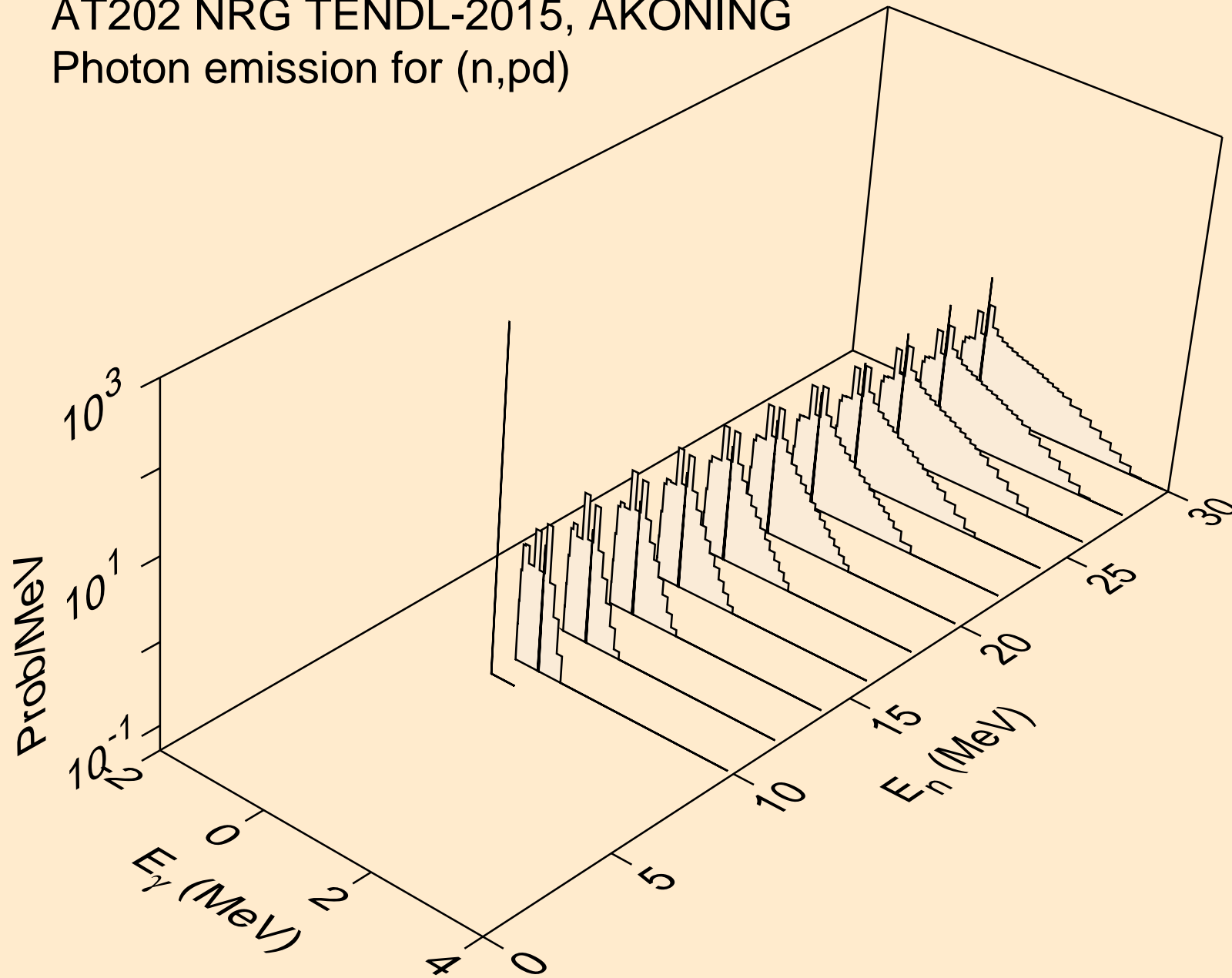

AT202 NRG TENDL-2015, AKONING  
Photon emission for (n,pt)

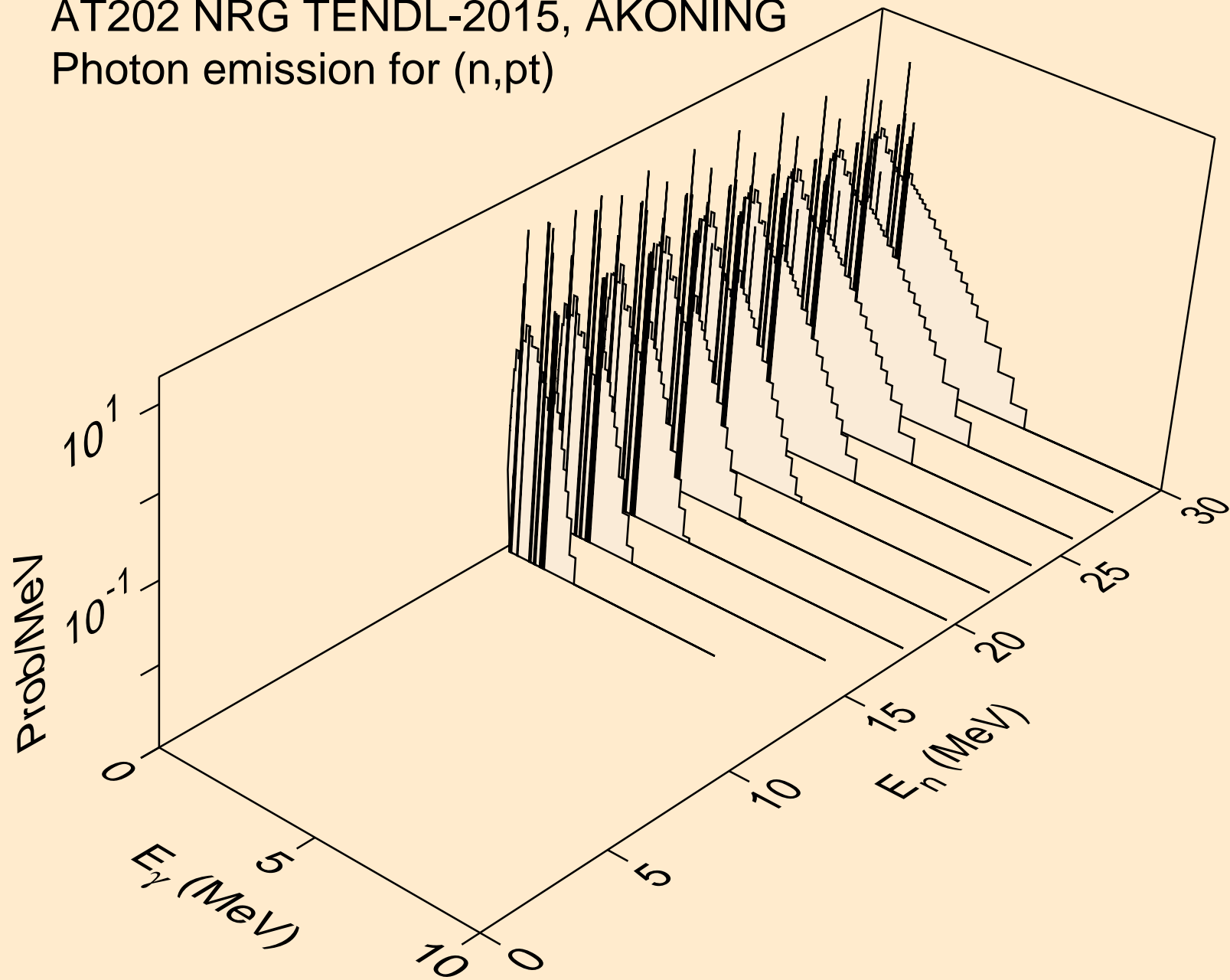

AT202 NRG TENDL-2015, AKONING  
Photon emission for (n,da)

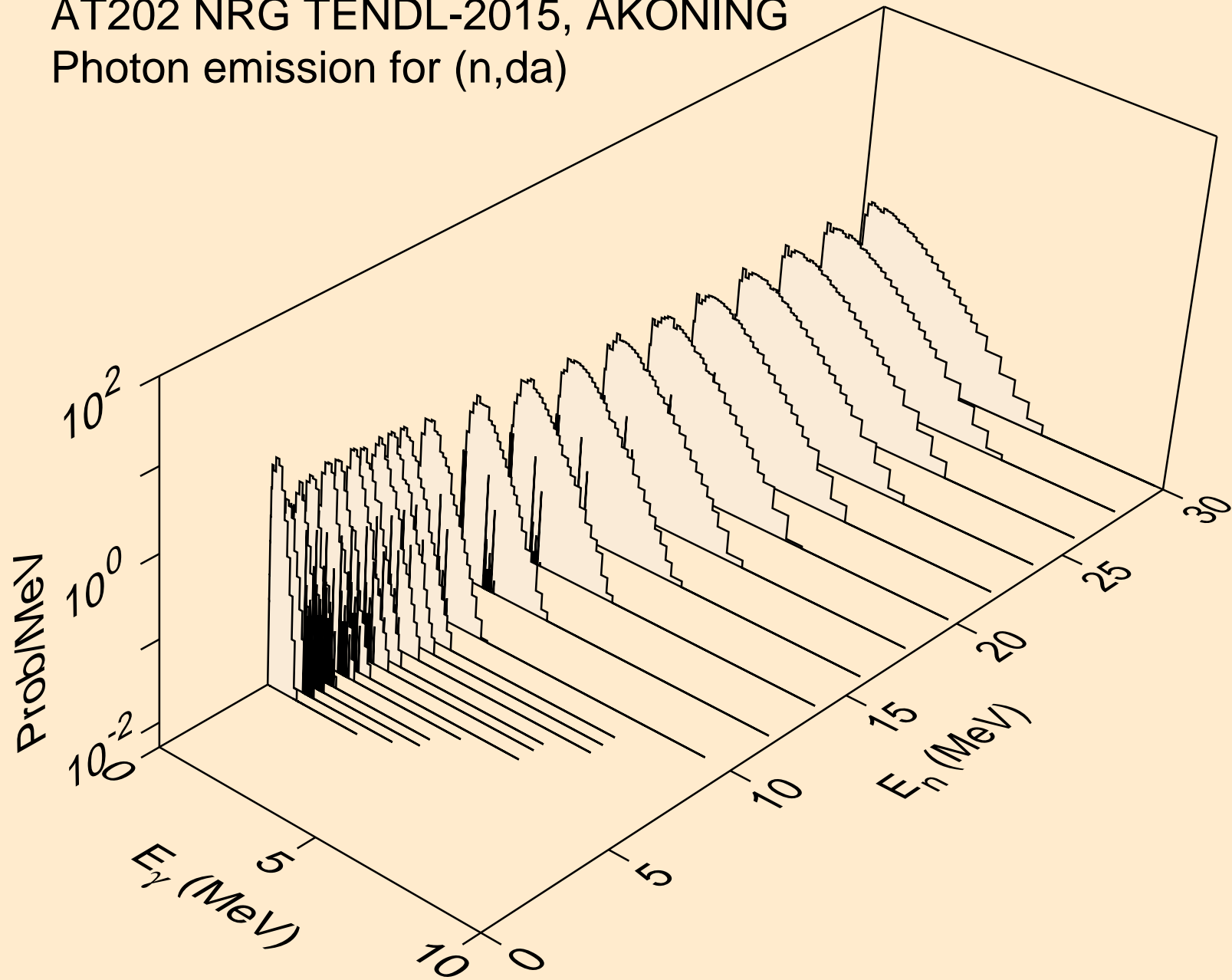



AT202 NRG TENDL-2015, AKONING  
thermal capture photon spectrum

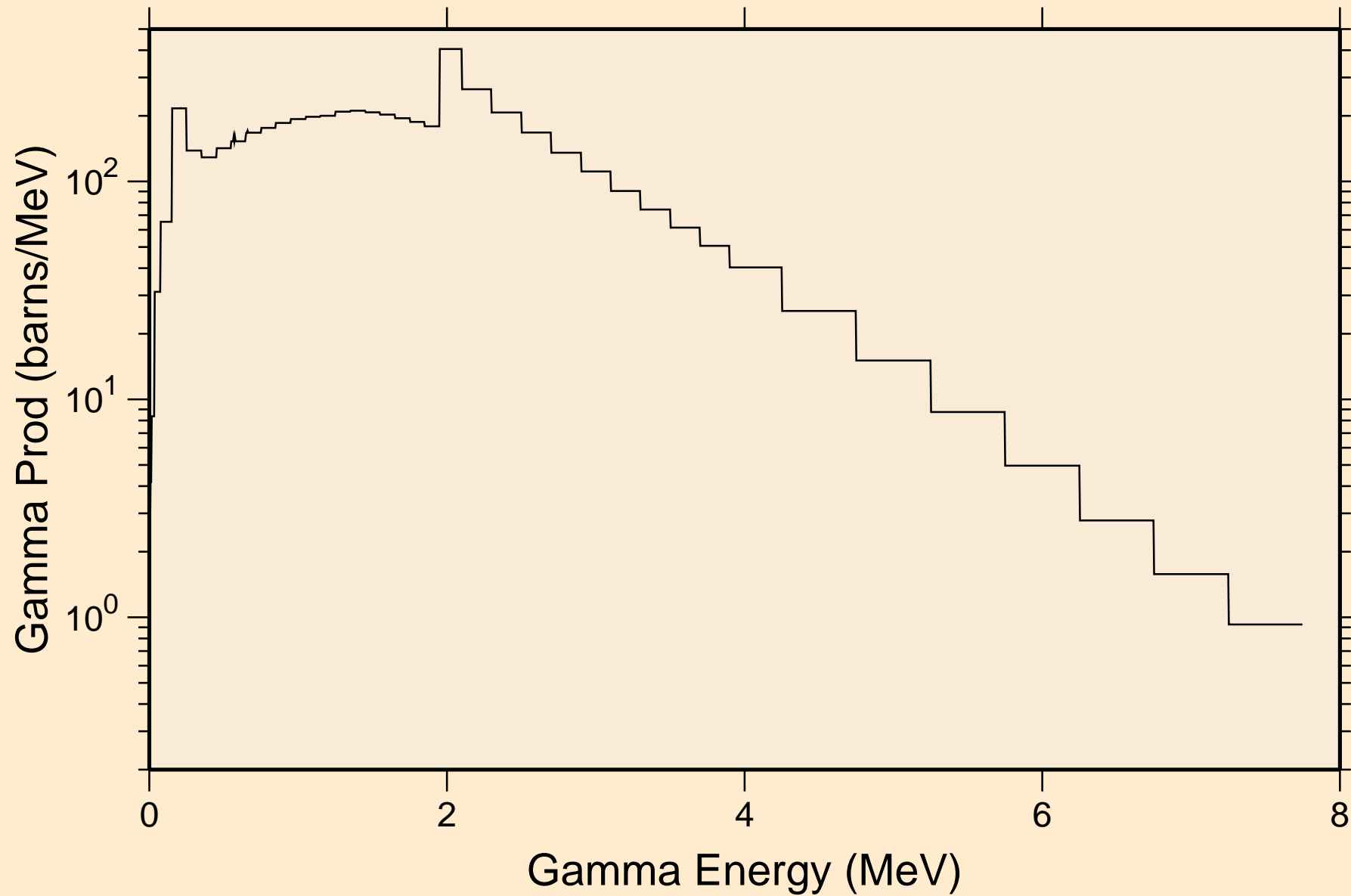

AT202 NRG TENDL-2015, AKONING  
14 MeV photon spectrum

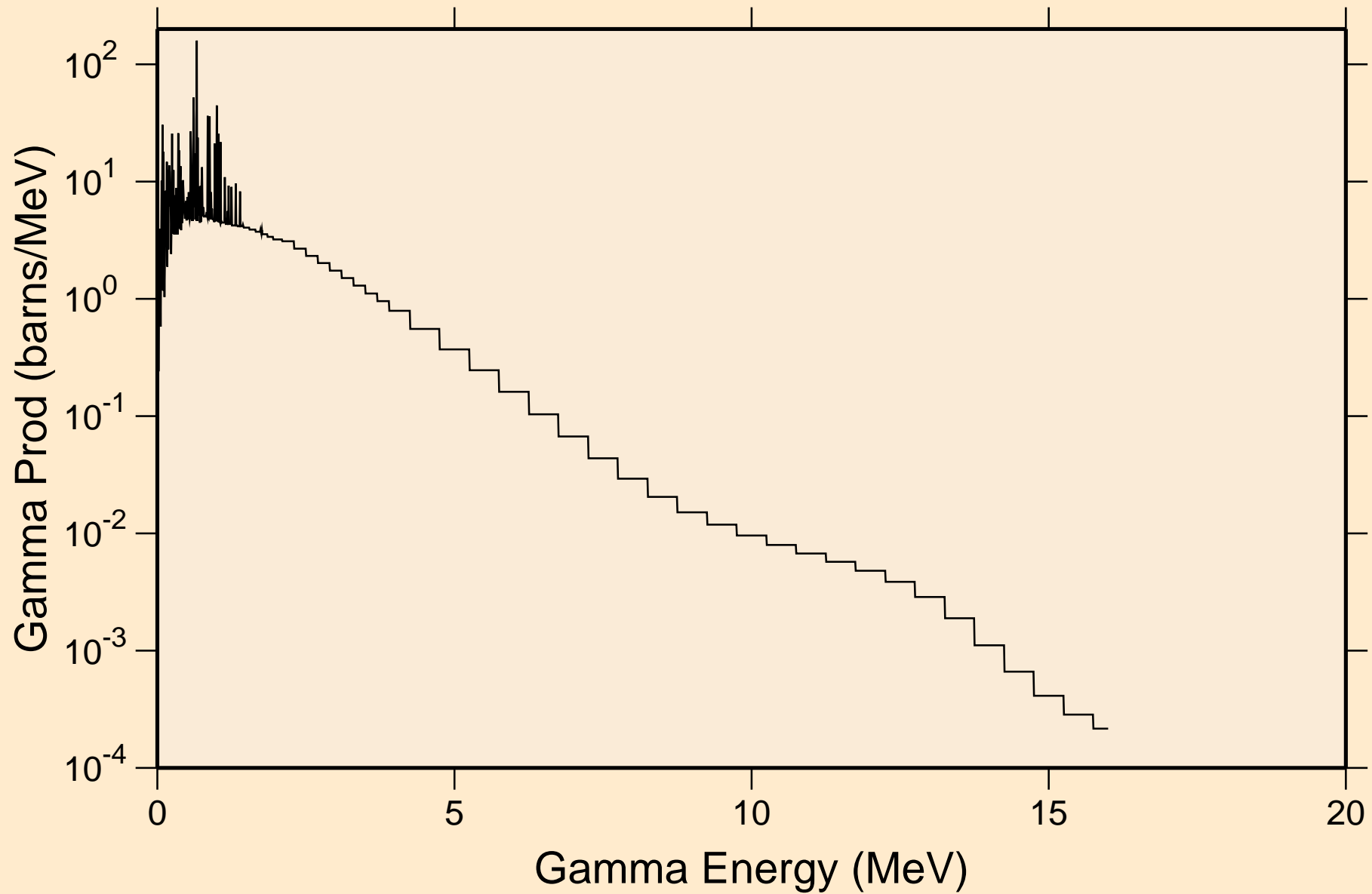

# AT202 NRG TENDL-2015, AKONING

## Particle heating contributions

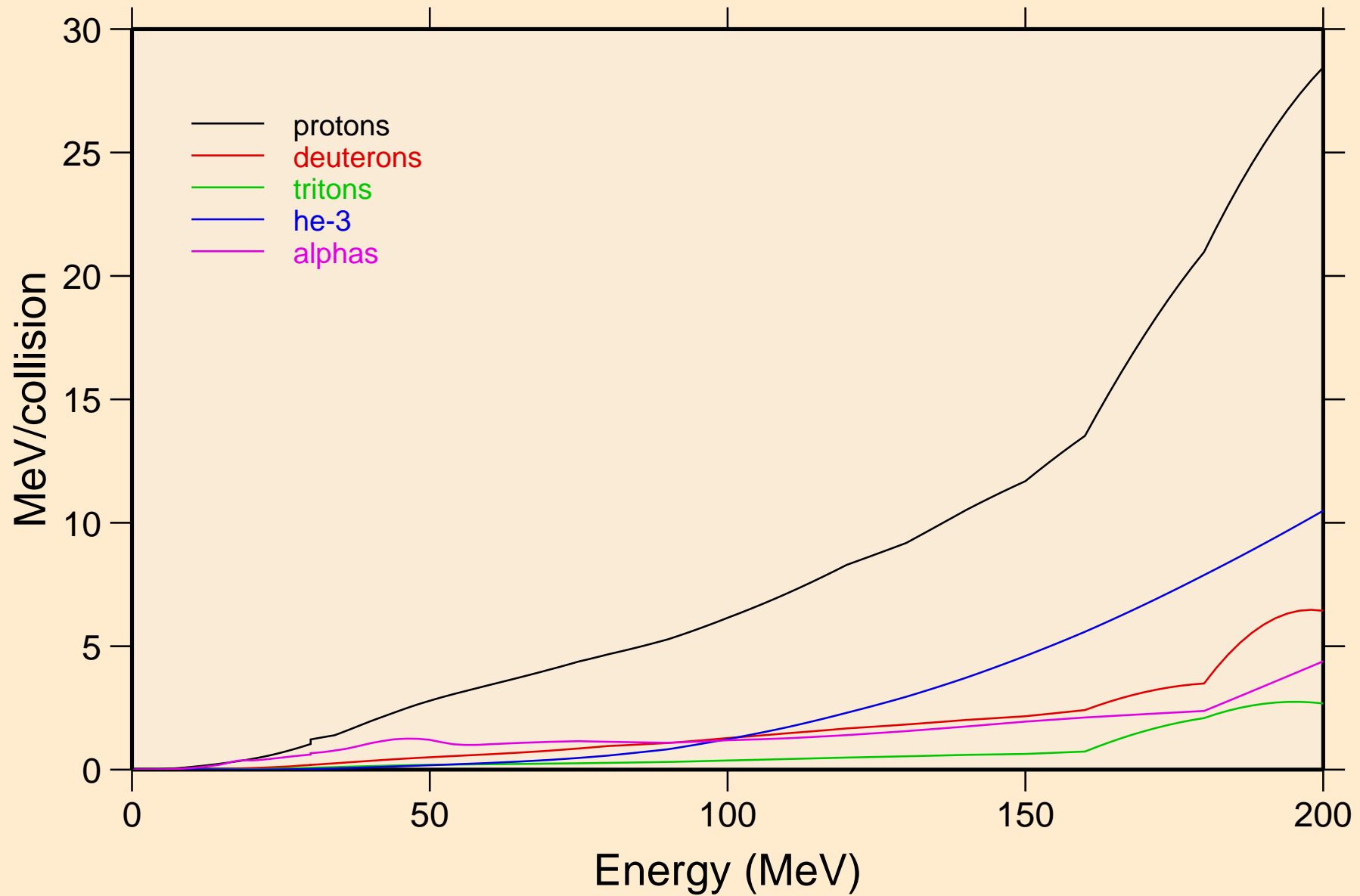

# AT202 NRG TENDL-2015, AKONING

## Recoil Heating

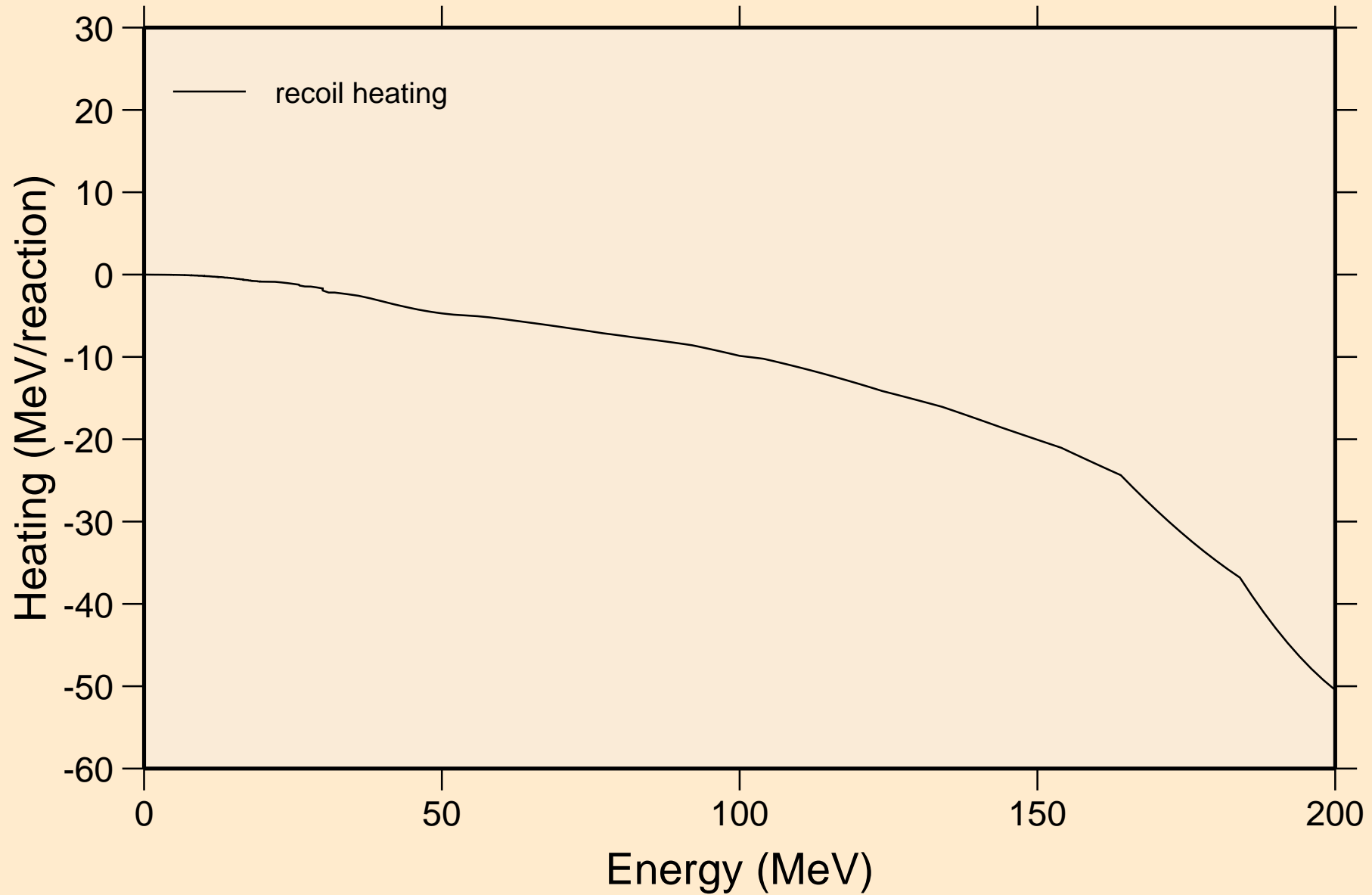

AT202 NRG TENDL-2015, AKONING  
Particle production cross sections

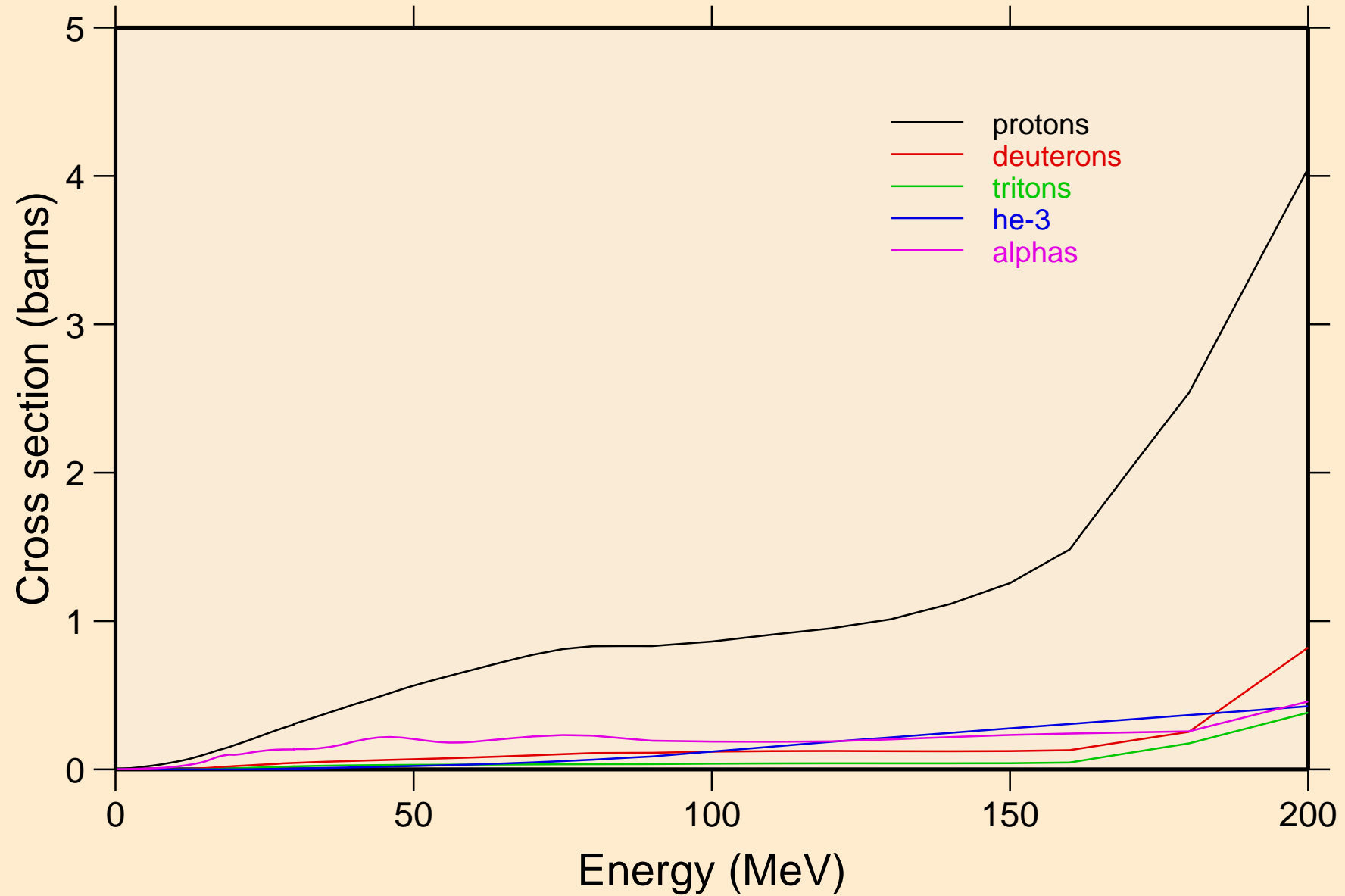

AT202 NRG TENDL-2015, AKONING  
protons from (n,x)

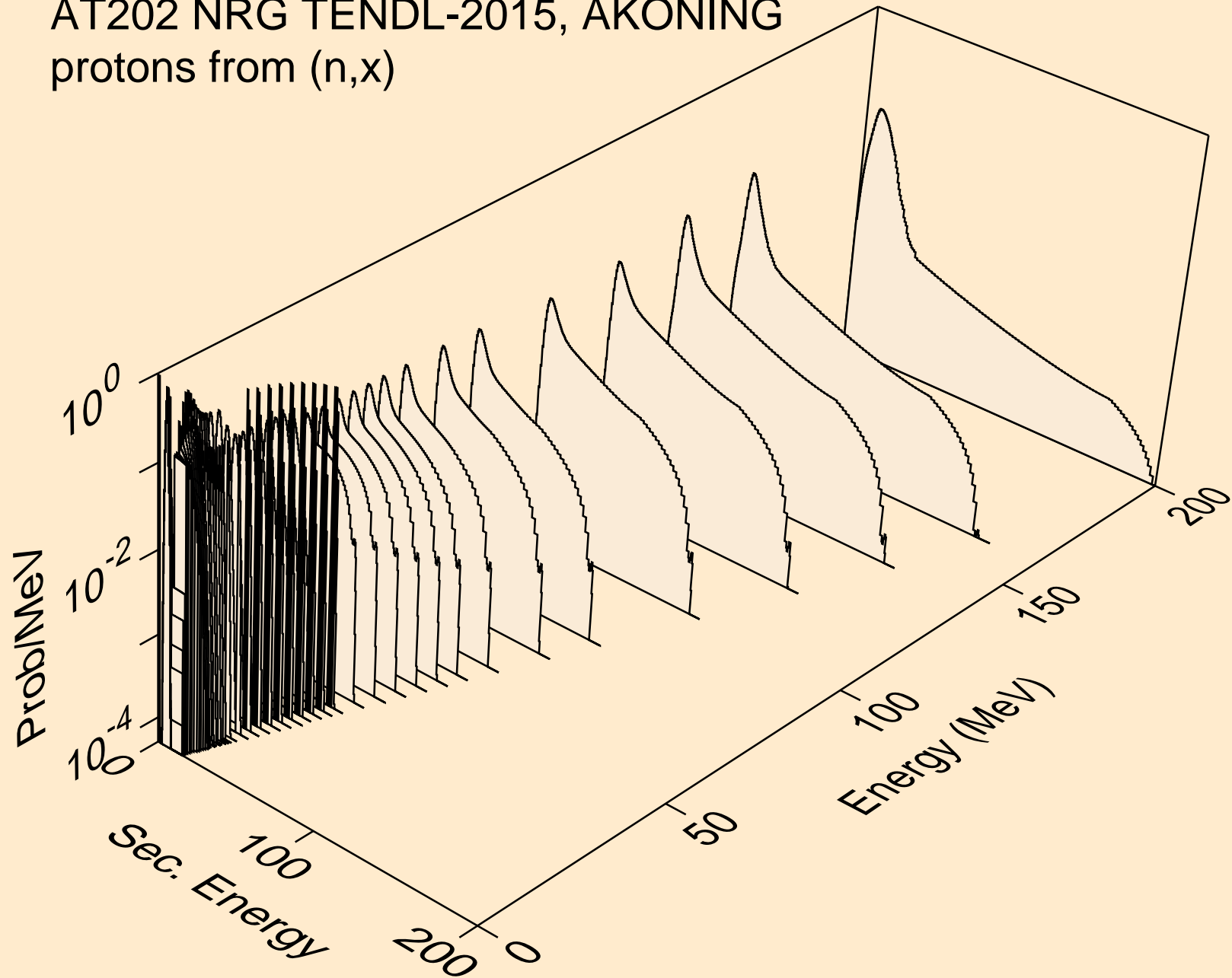

AT202 NRG TENDL-2015, AKONING  
protons from (n,n\*)p

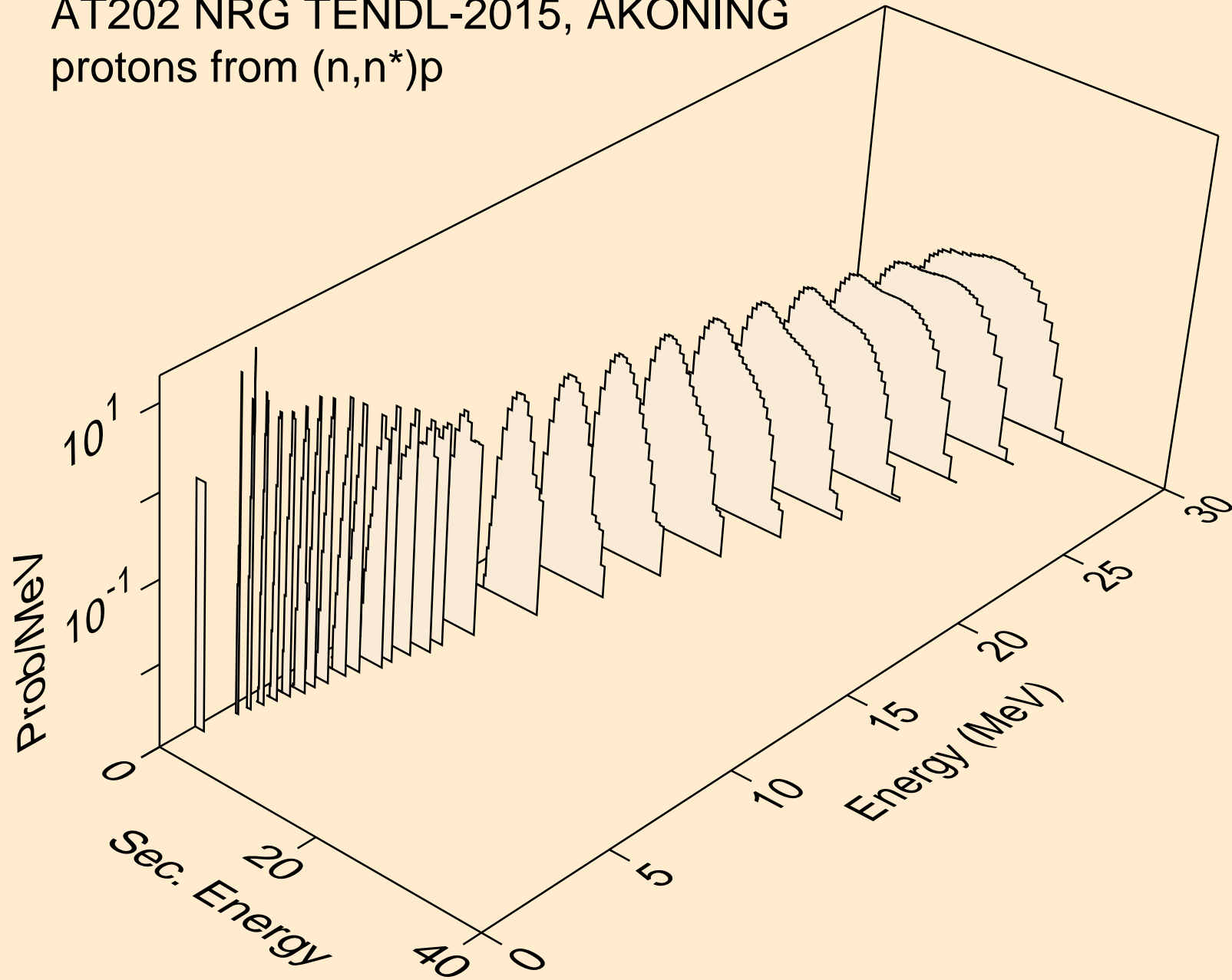

AT202 NRG TENDL-2015, AKONING  
protons from (n,2np)

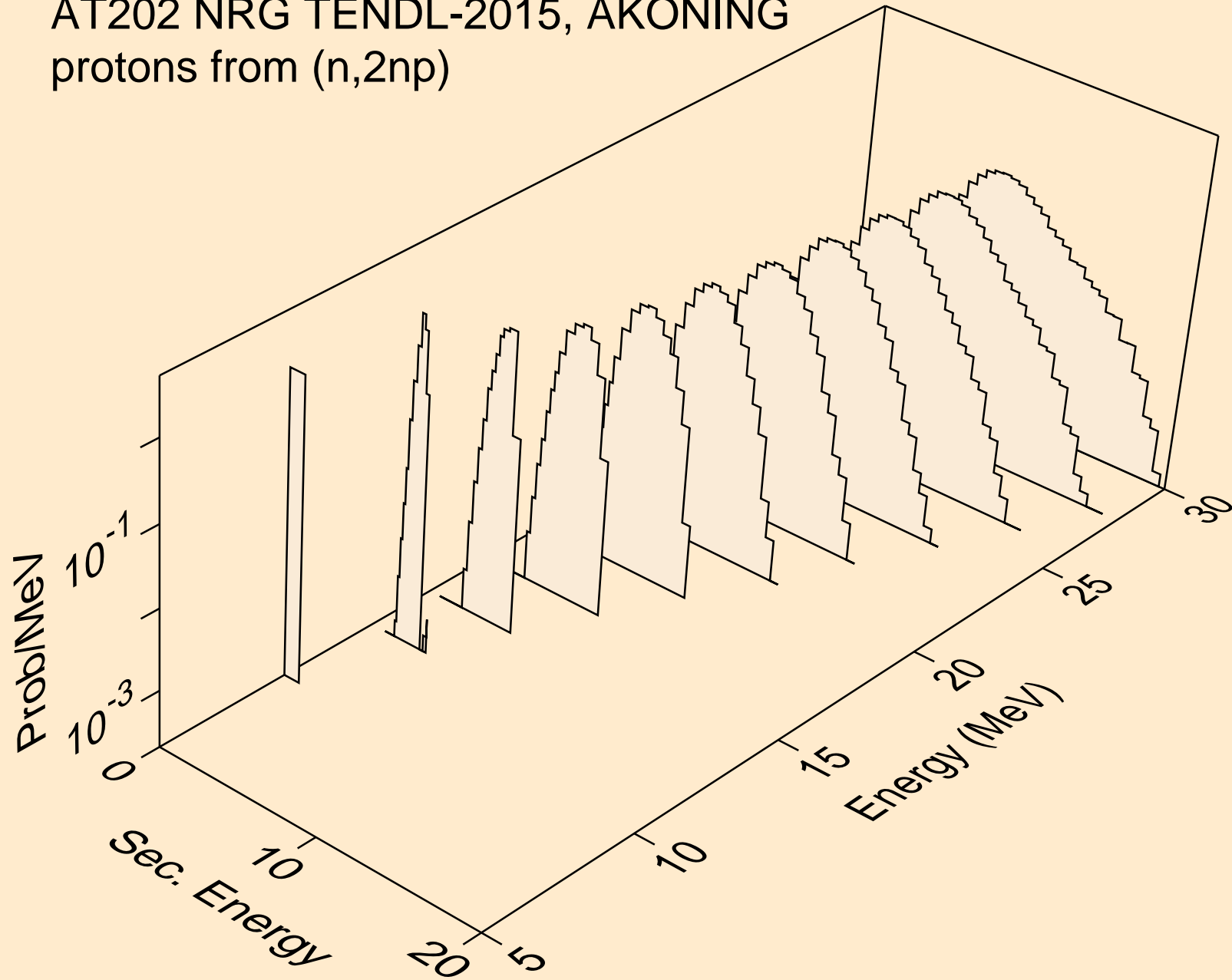



AT202 NRG TENDL-2015, AKONING  
protons from (n,3np)

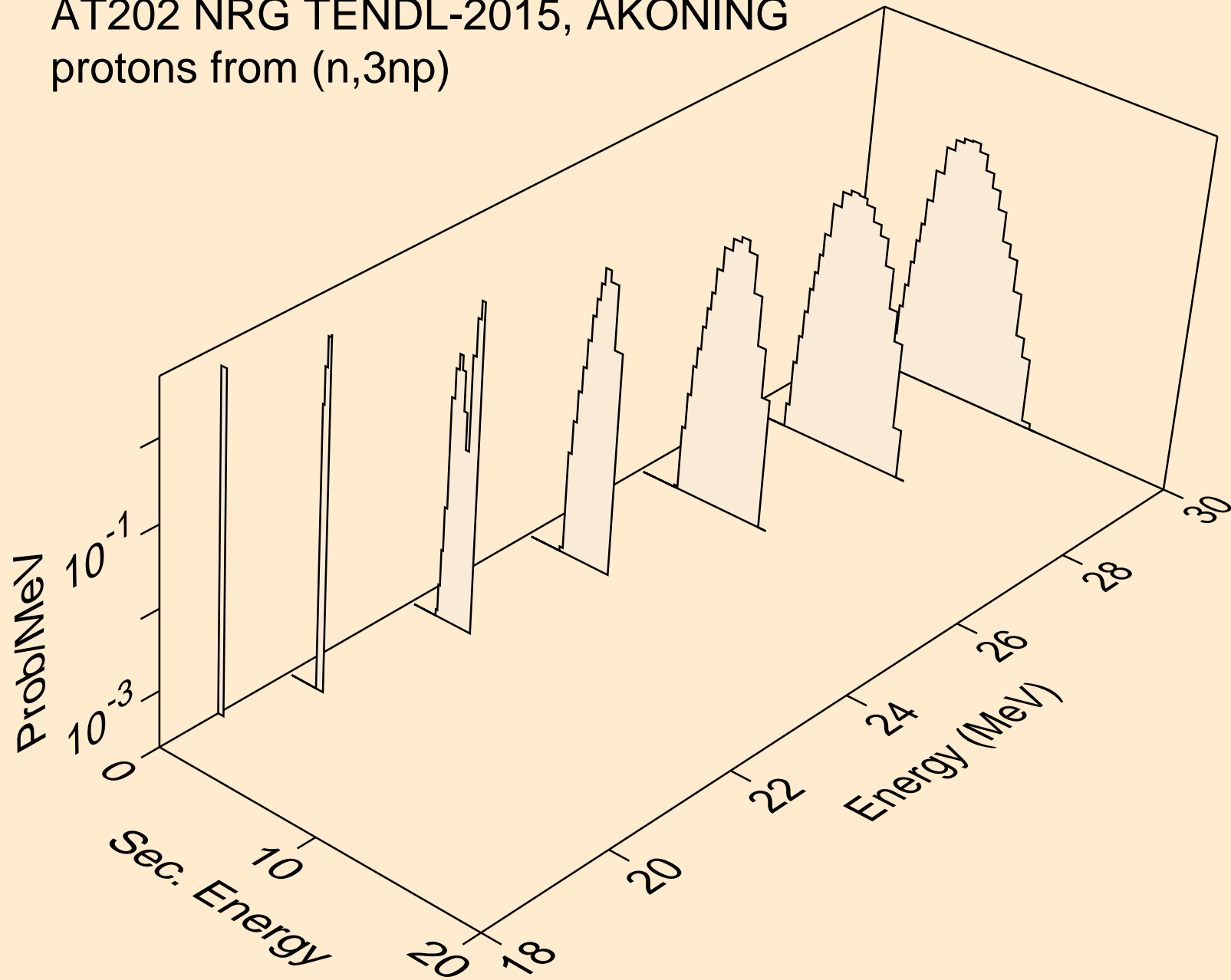

AT202 NRG TENDL-2015, AKONING  
protons from (n,2np)

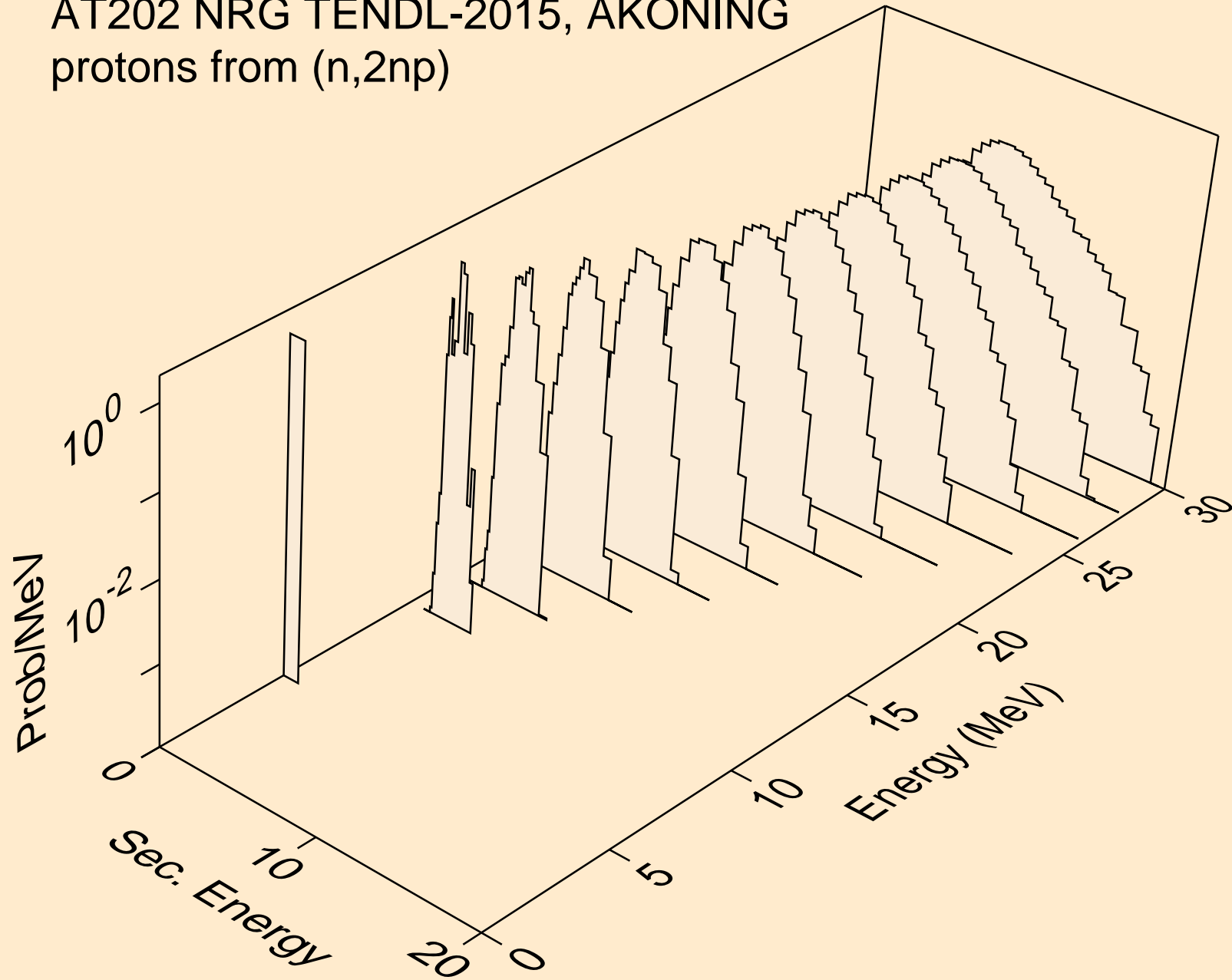

AT202 NRG TENDL-2015, AKONING  
protons from (n,npa)

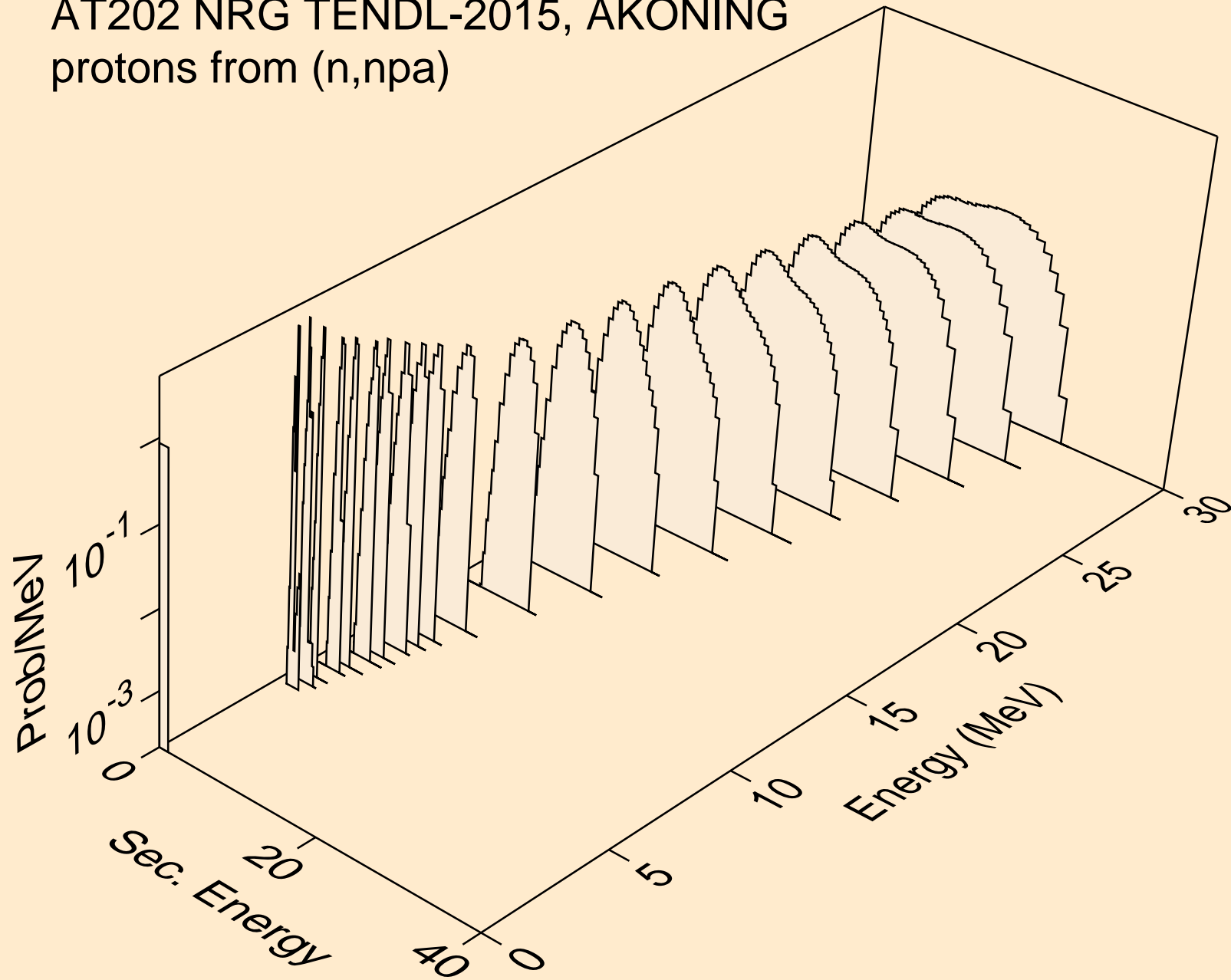

AT202 NRG TENDL-2015, AKONING  
protons from (n,p)

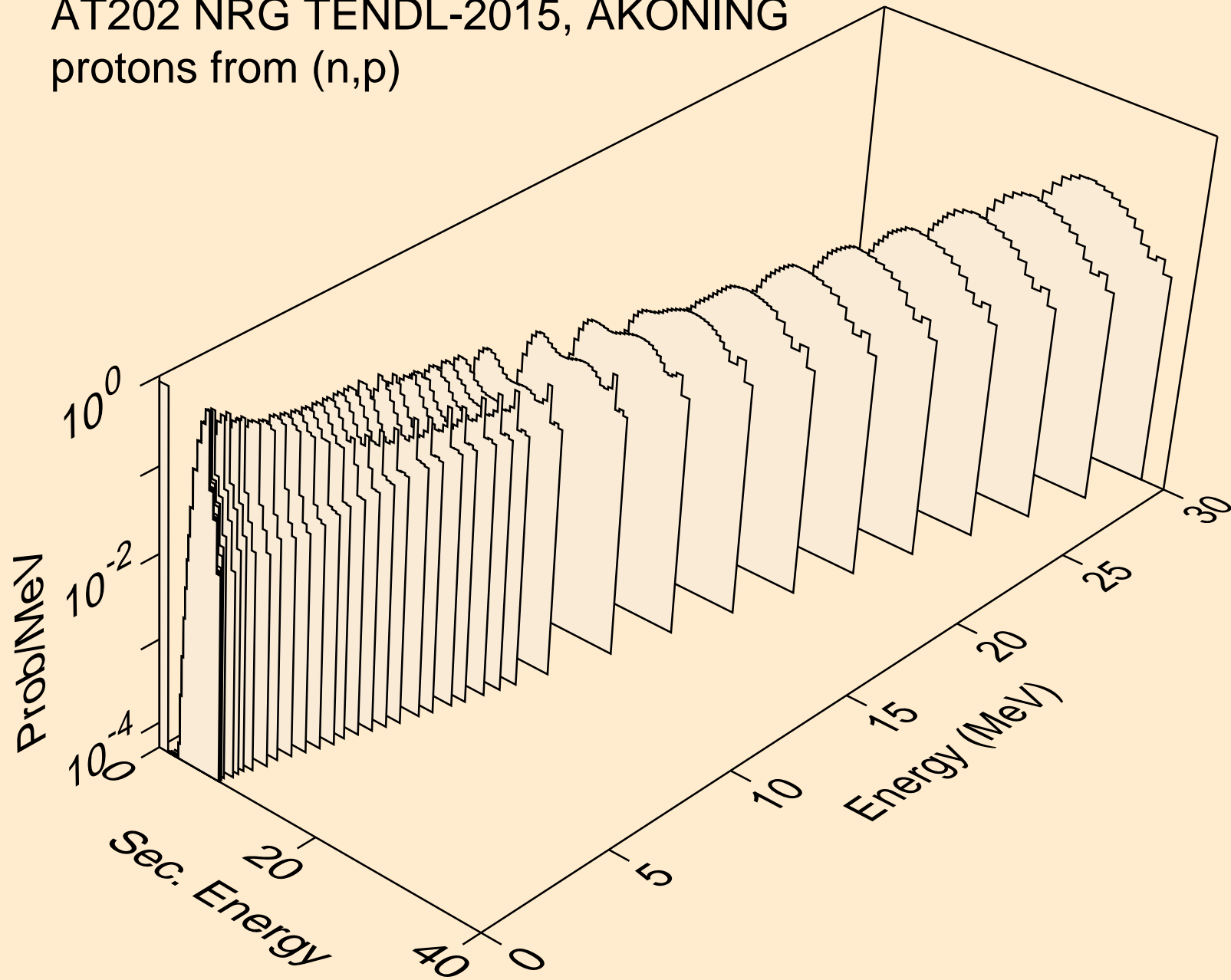

AT202 NRG TENDL-2015, AKONING  
protons from (n,2p)

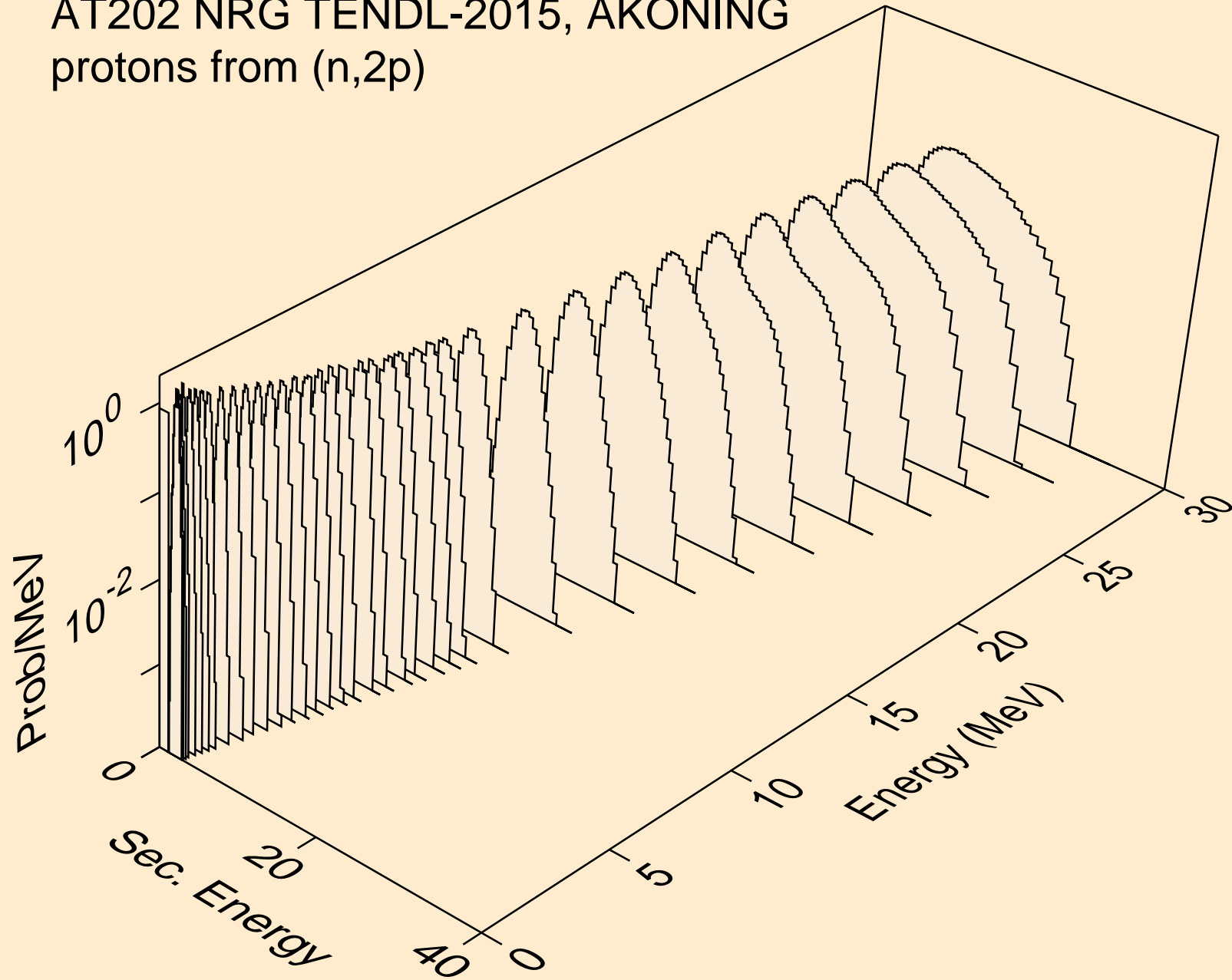

AT202 NRG TENDL-2015, AKONING  
protons from (n,pa)

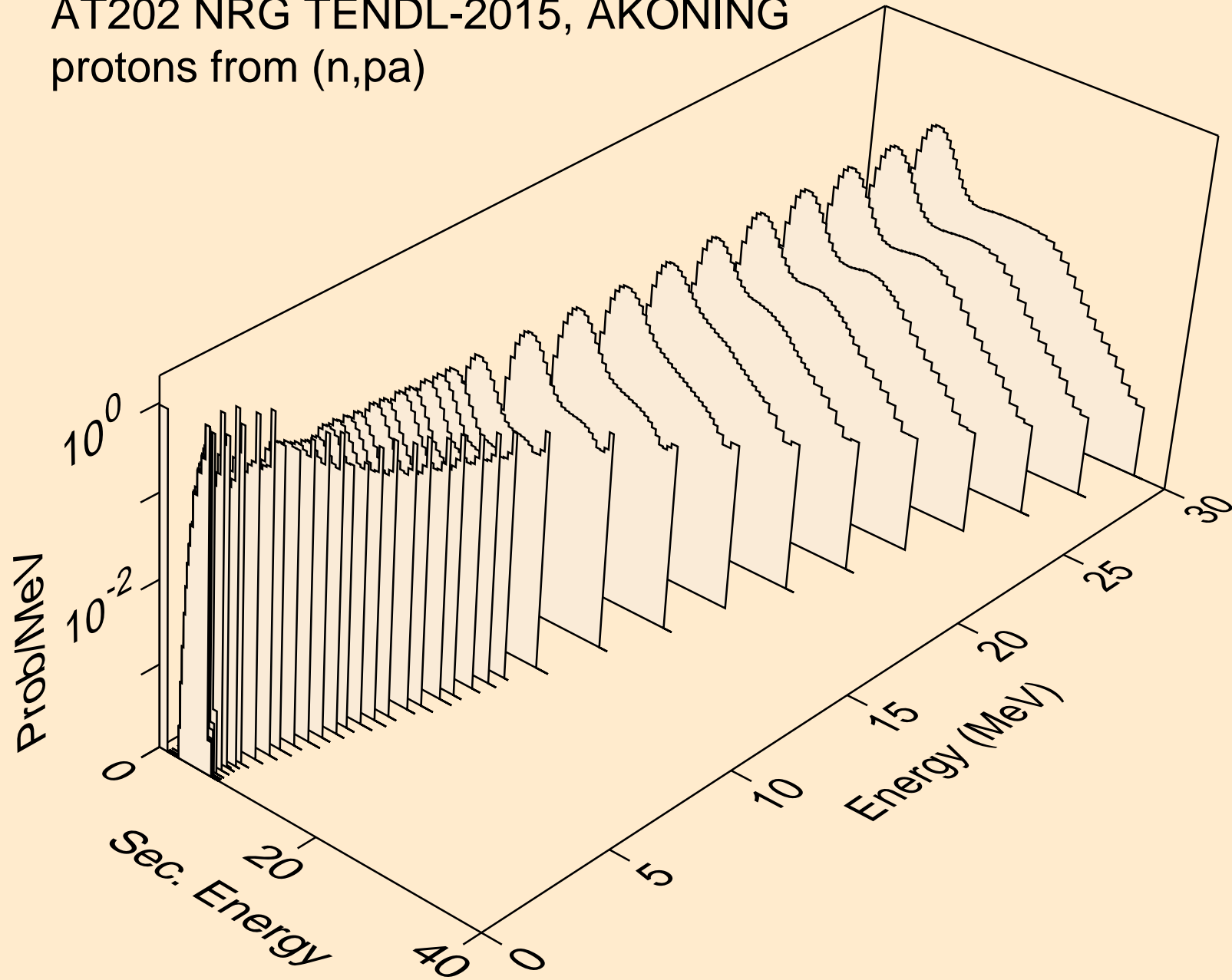

AT202 NRG TENDL-2015, AKONING  
protons from (n,pd)

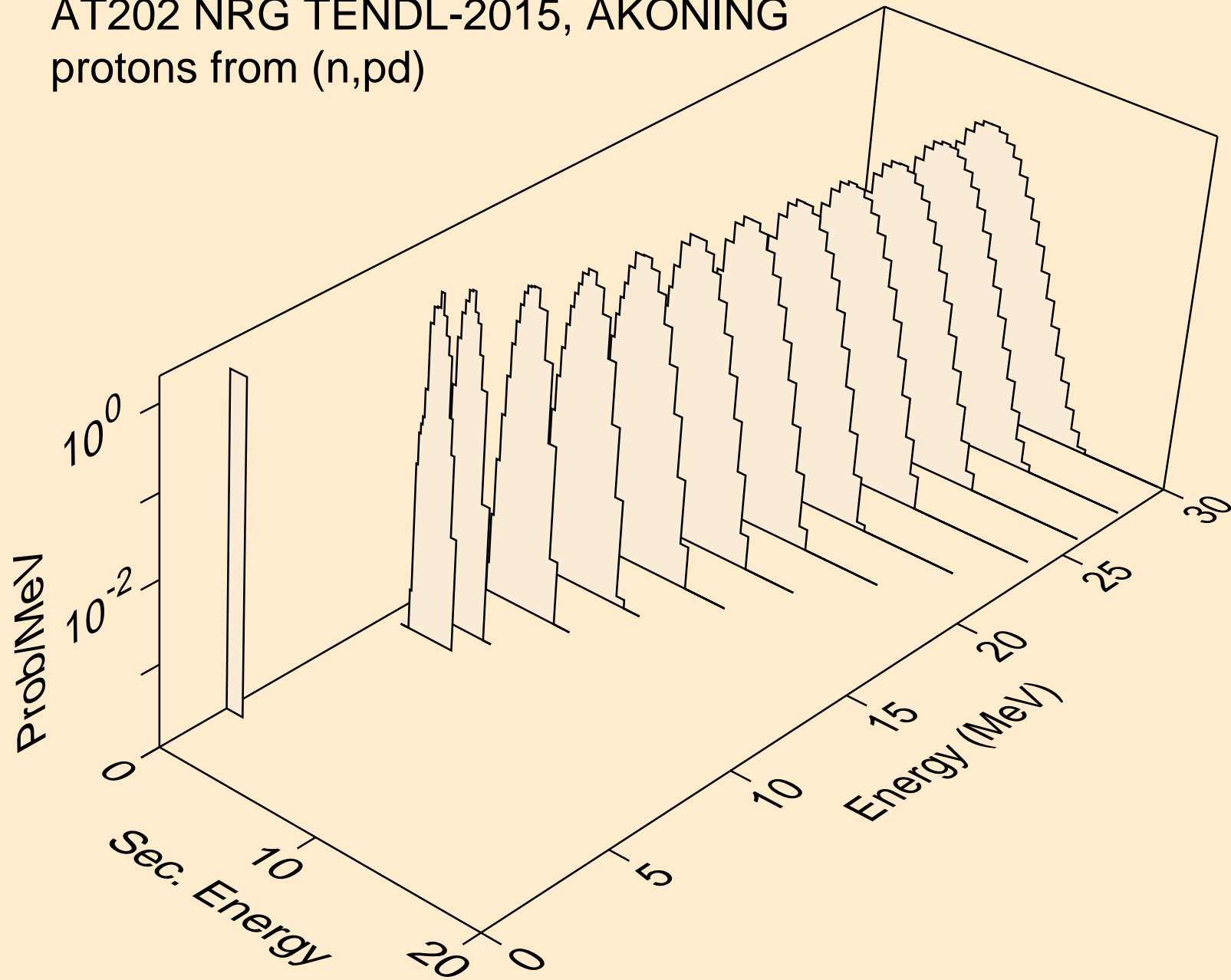

AT202 NRG TENDL-2015, AKONING  
protons from (n,pt)

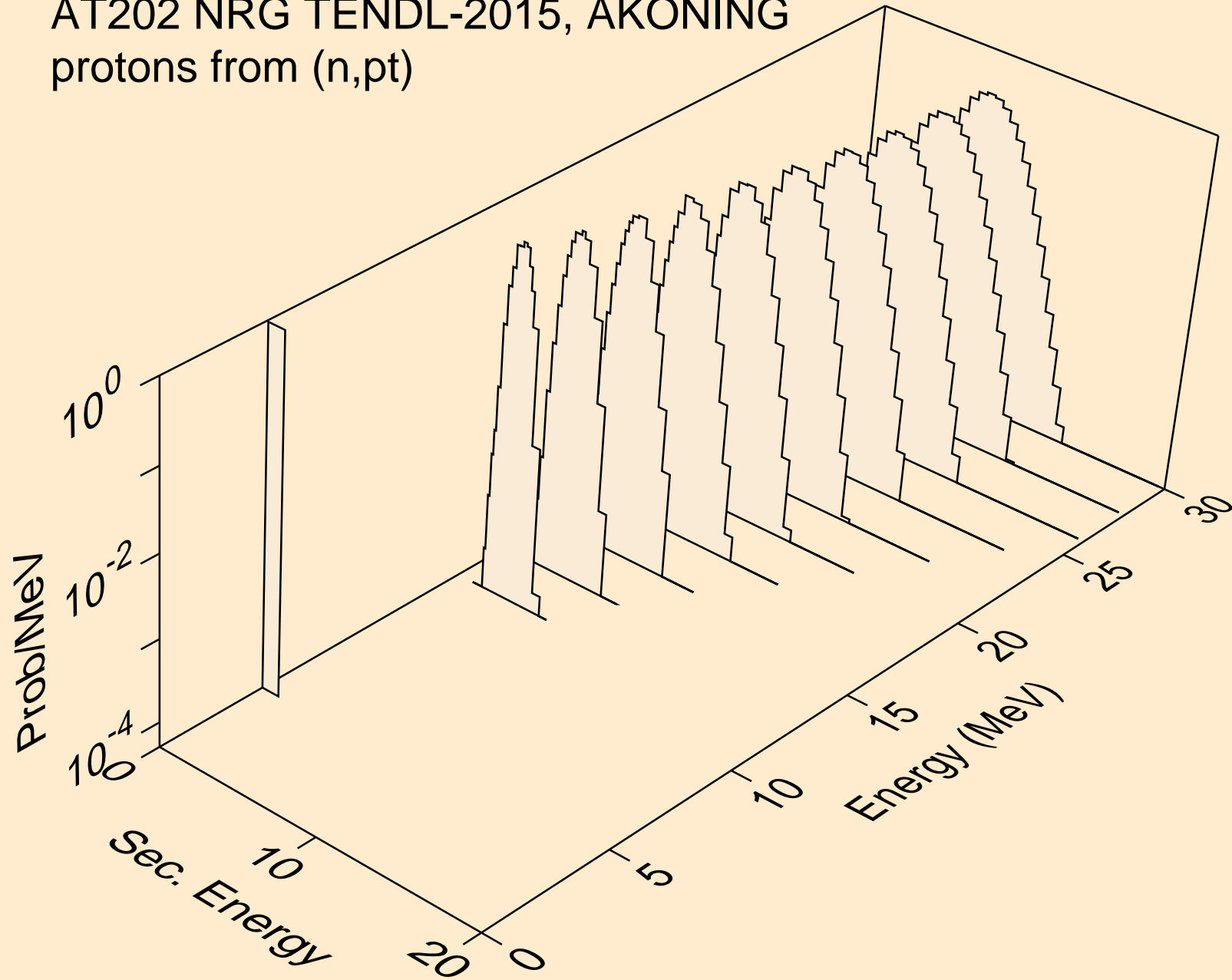



AT202 NRG TENDL-2015, AKONING  
deuterons from (n,x)

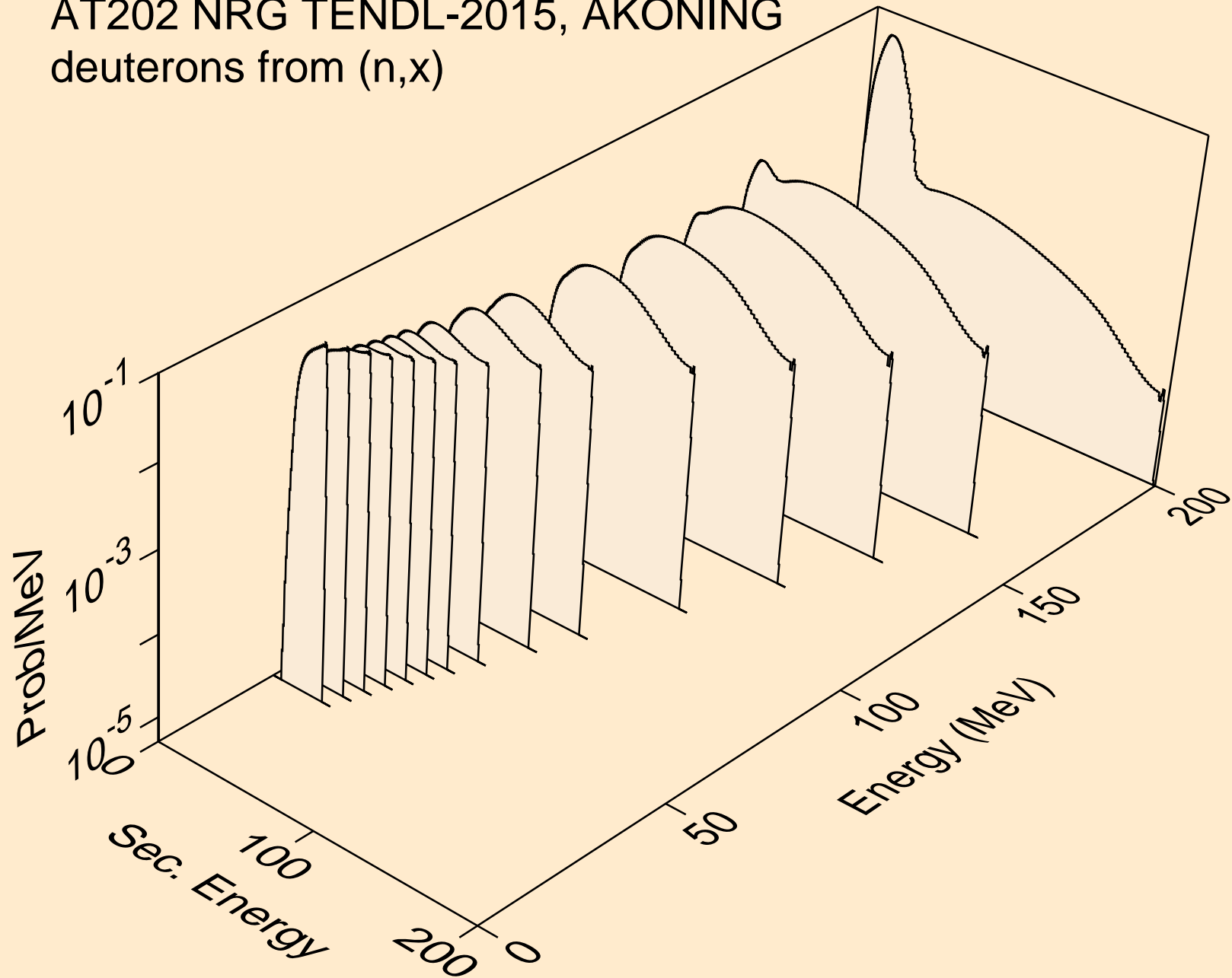

AT202 NRG TENDL-2015, AKONING  
deuterons from (n,2nd)

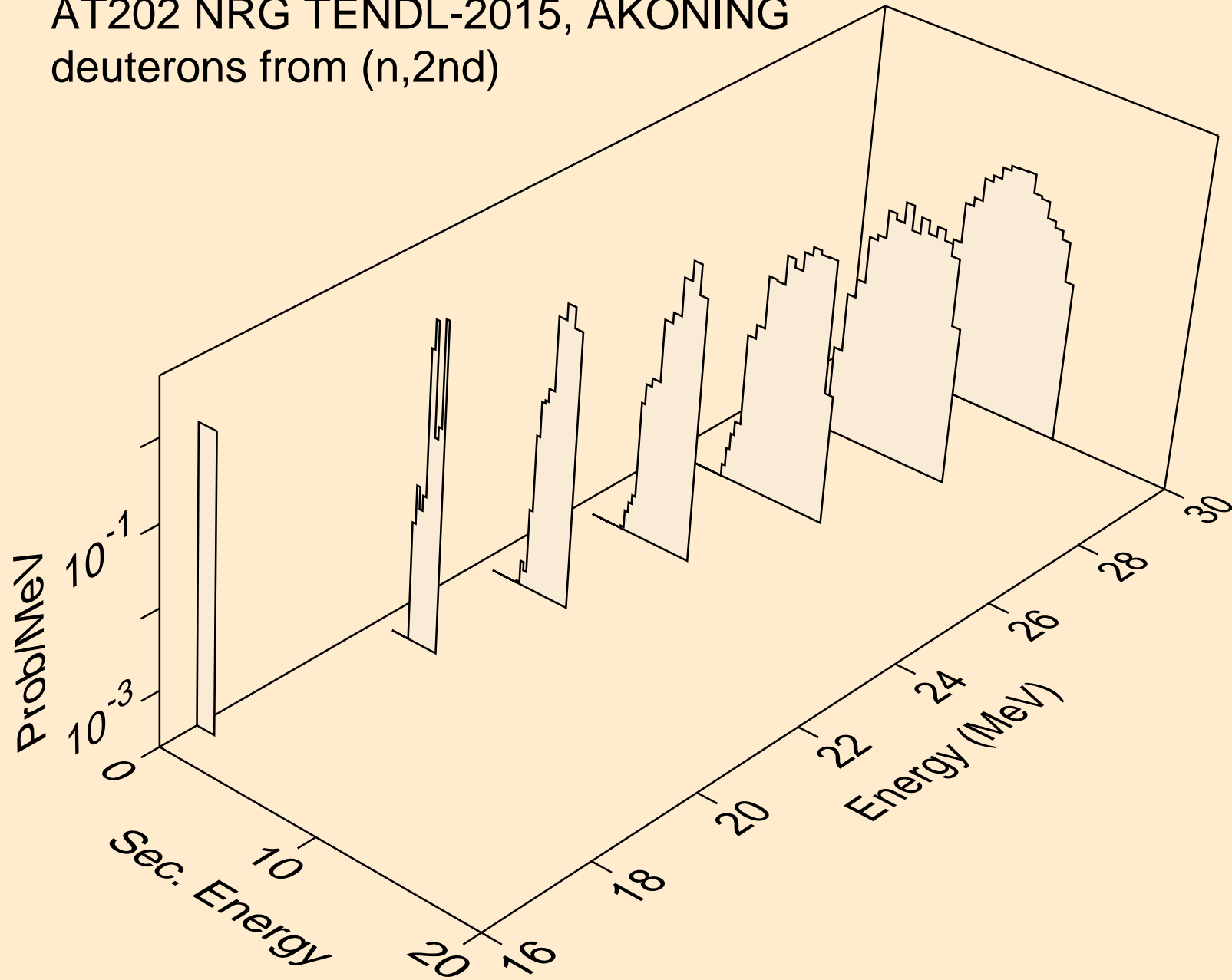

AT202 NRG TENDL-2015, AKONING  
deuterons from (n,n\*)d

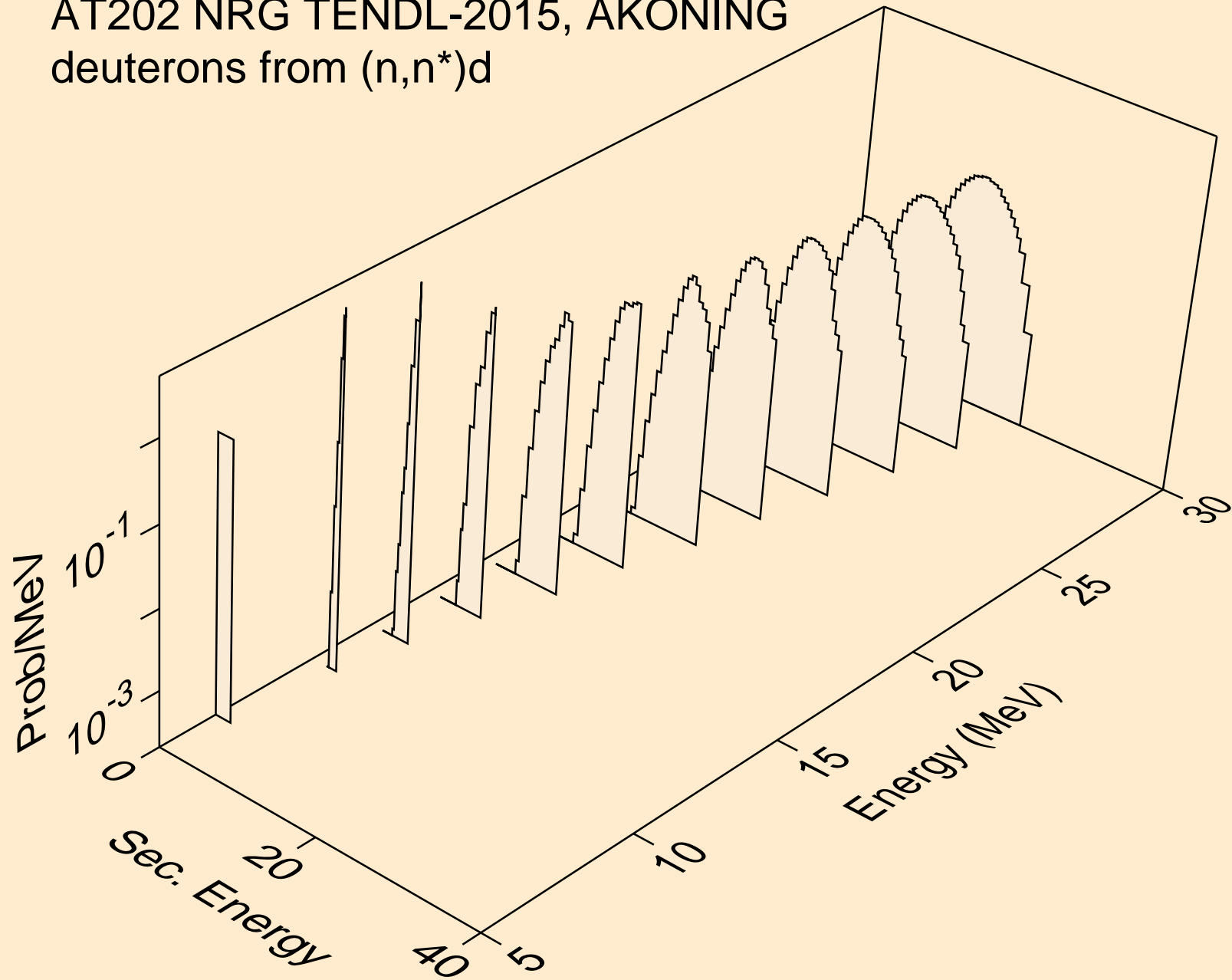

AT202 NRG TENDL-2015, AKONING  
deuterons from (n,d)

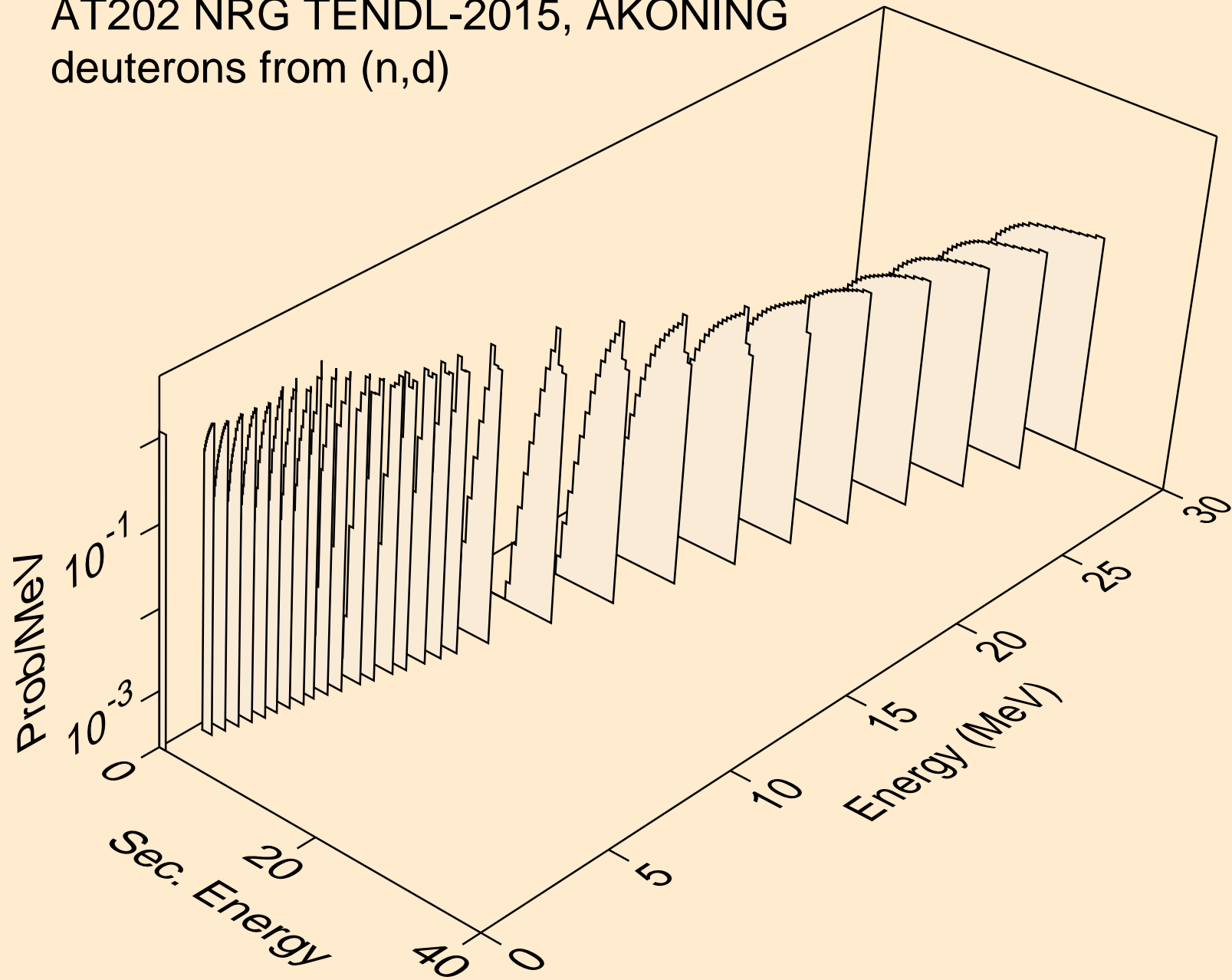

AT202 NRG TENDL-2015, AKONING  
deuterons from (n,pd)

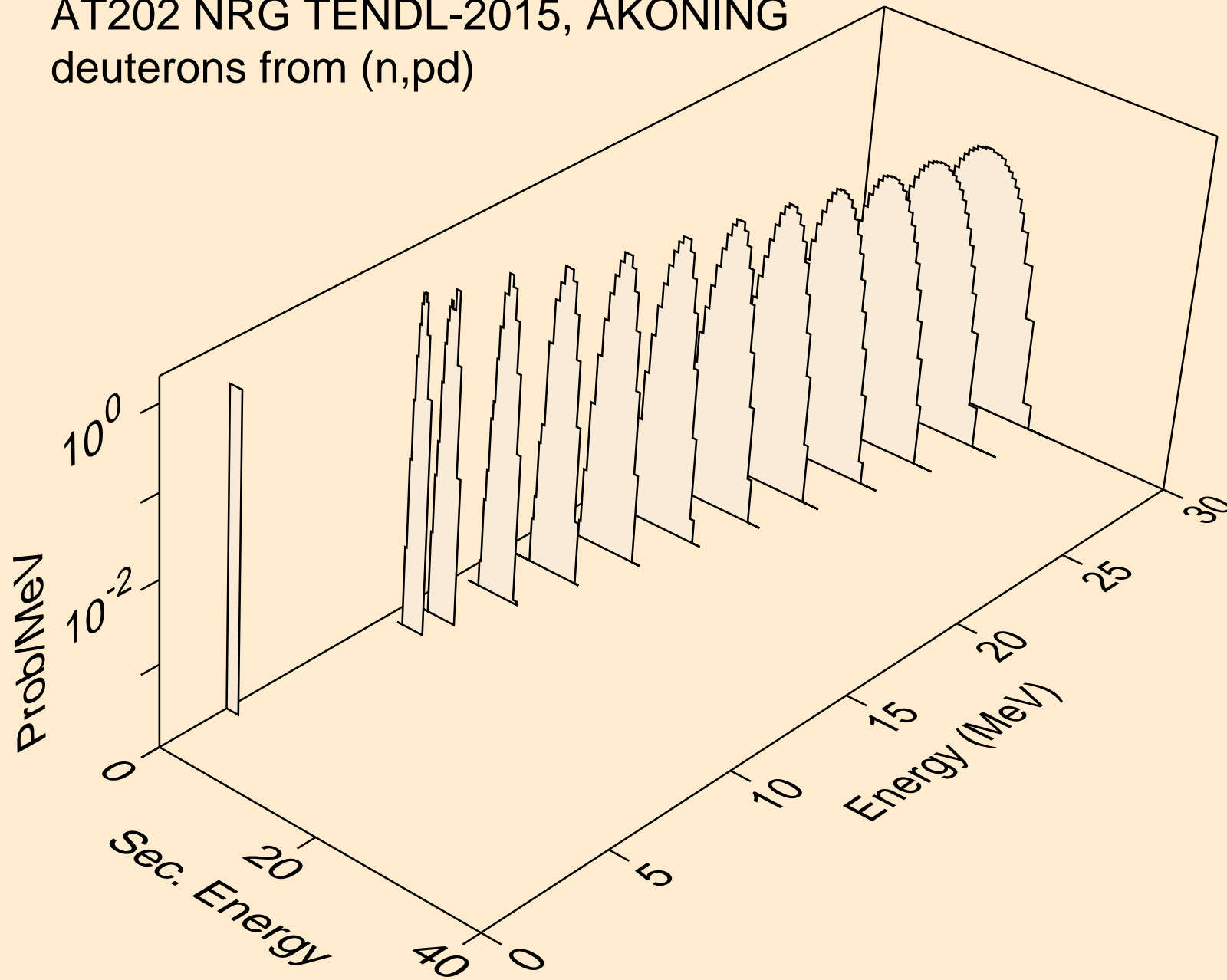

AT202 NRG TENDL-2015, AKONING  
deuterons from (n,da)

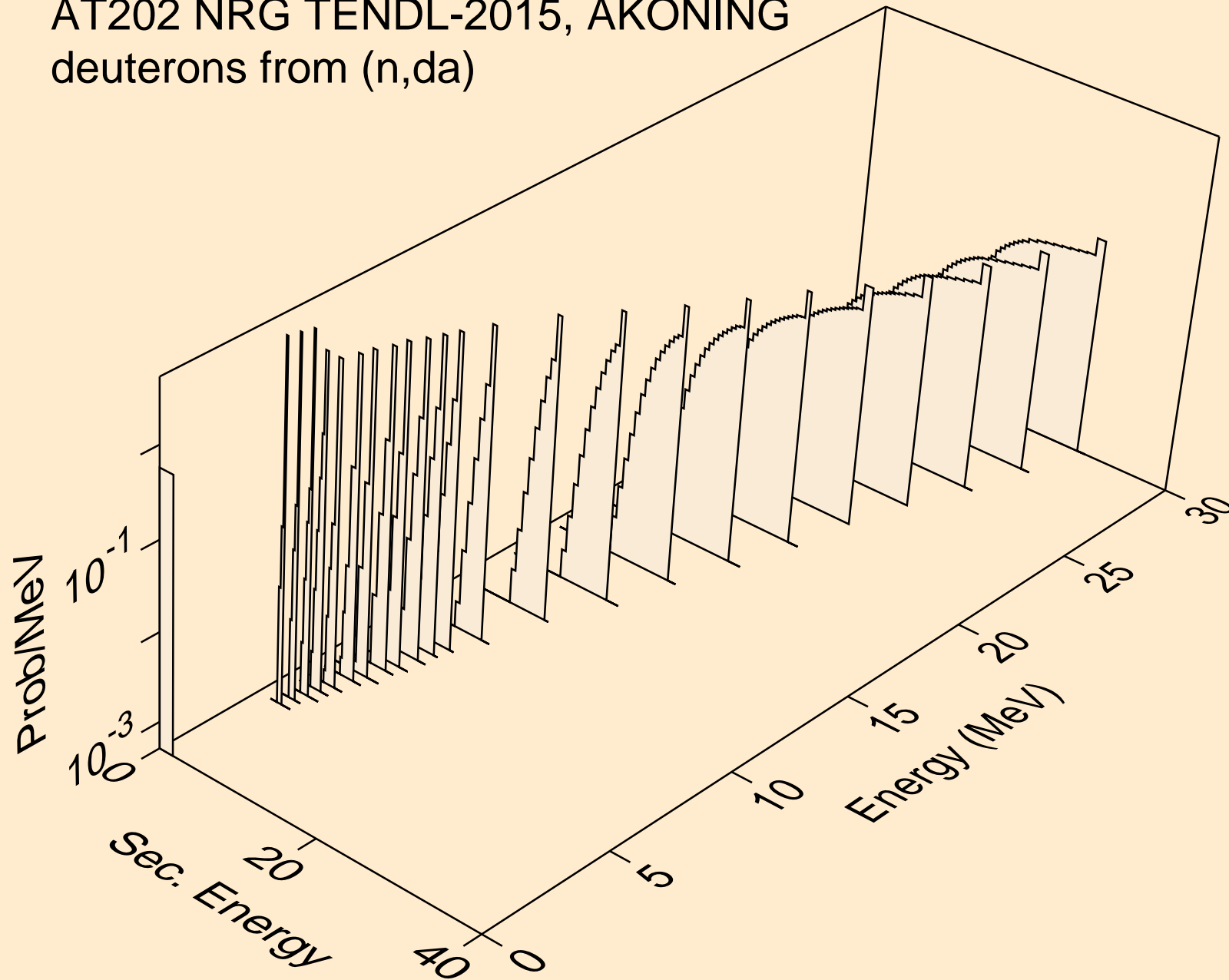

AT202 NRG TENDL-2015, AKONING  
tritons from (n,x)

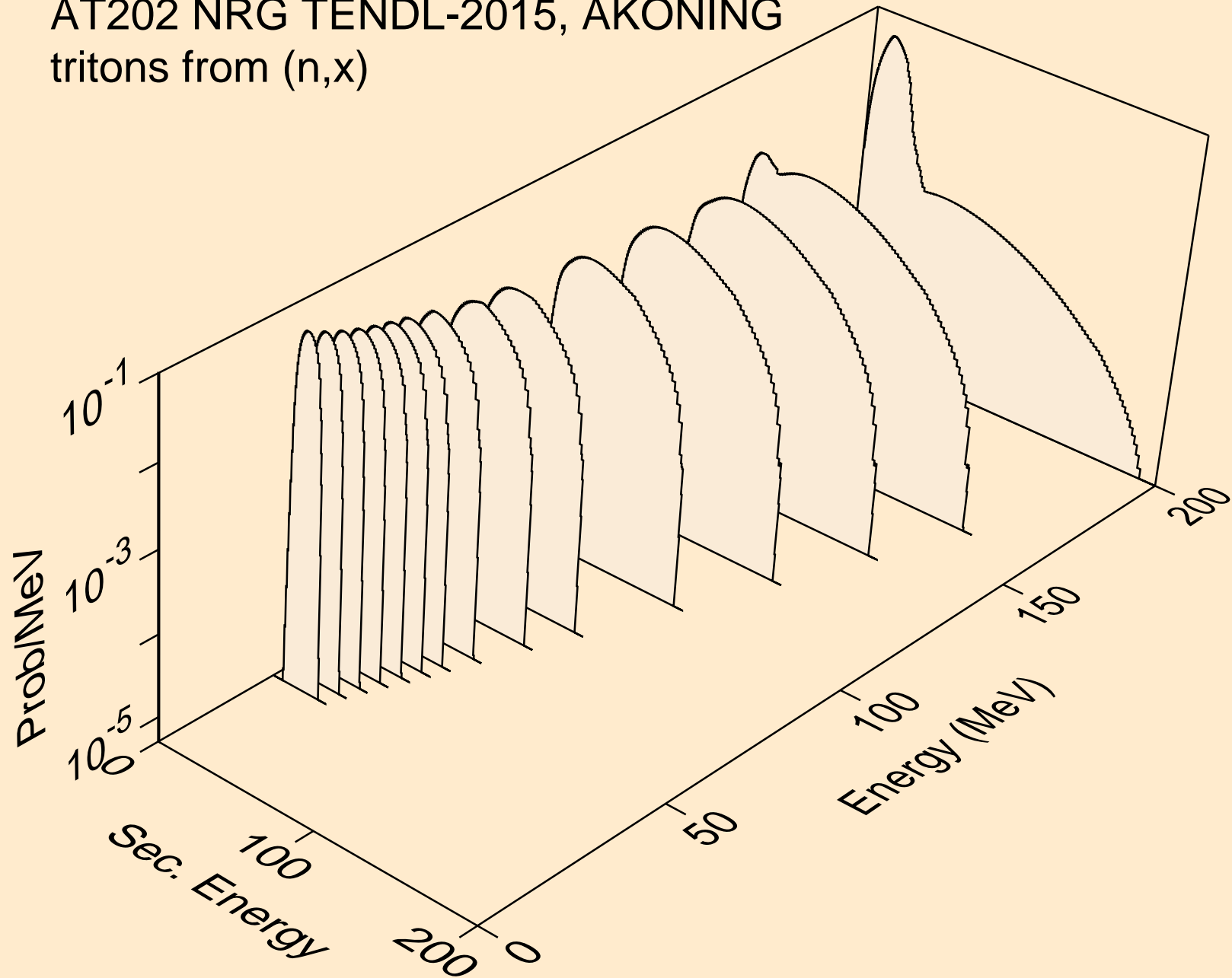

AT202 NRG TENDL-2015, AKONING  
tritons from (n,n\*)t

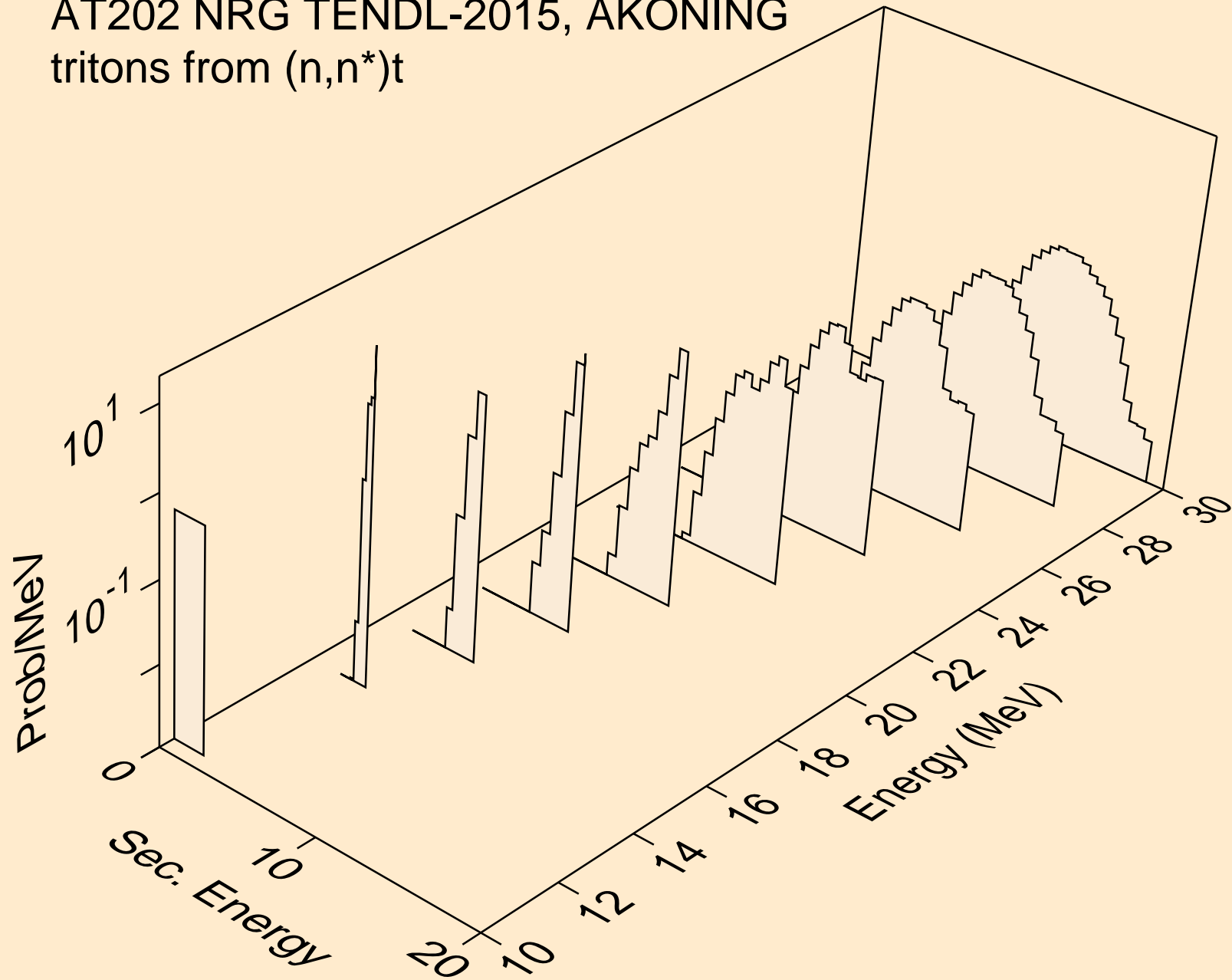



AT202 NRG TENDL-2015, AKONING  
tritons from (n,t)

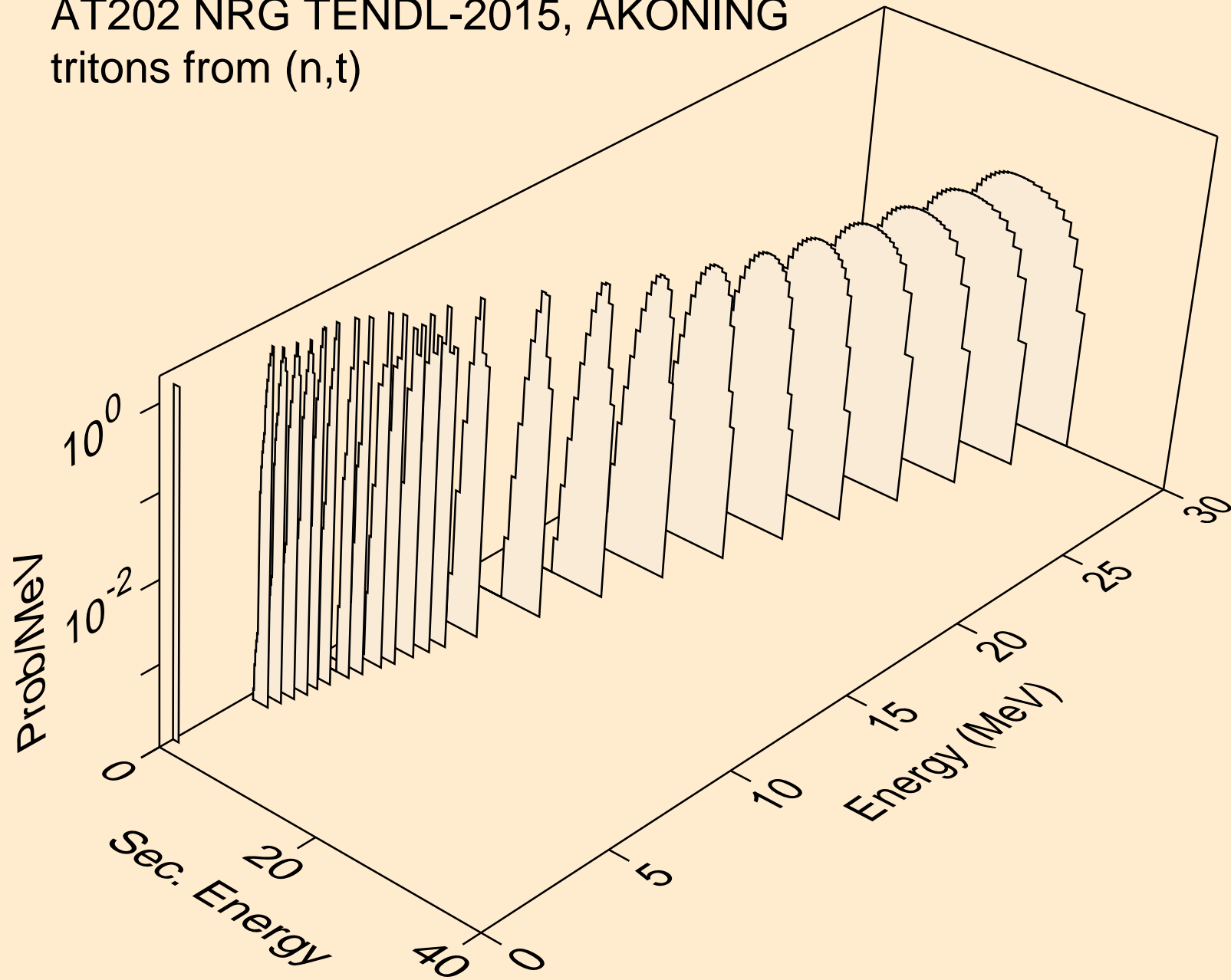

AT202 NRG TENDL-2015, AKONING  
tritons from (n,pt)

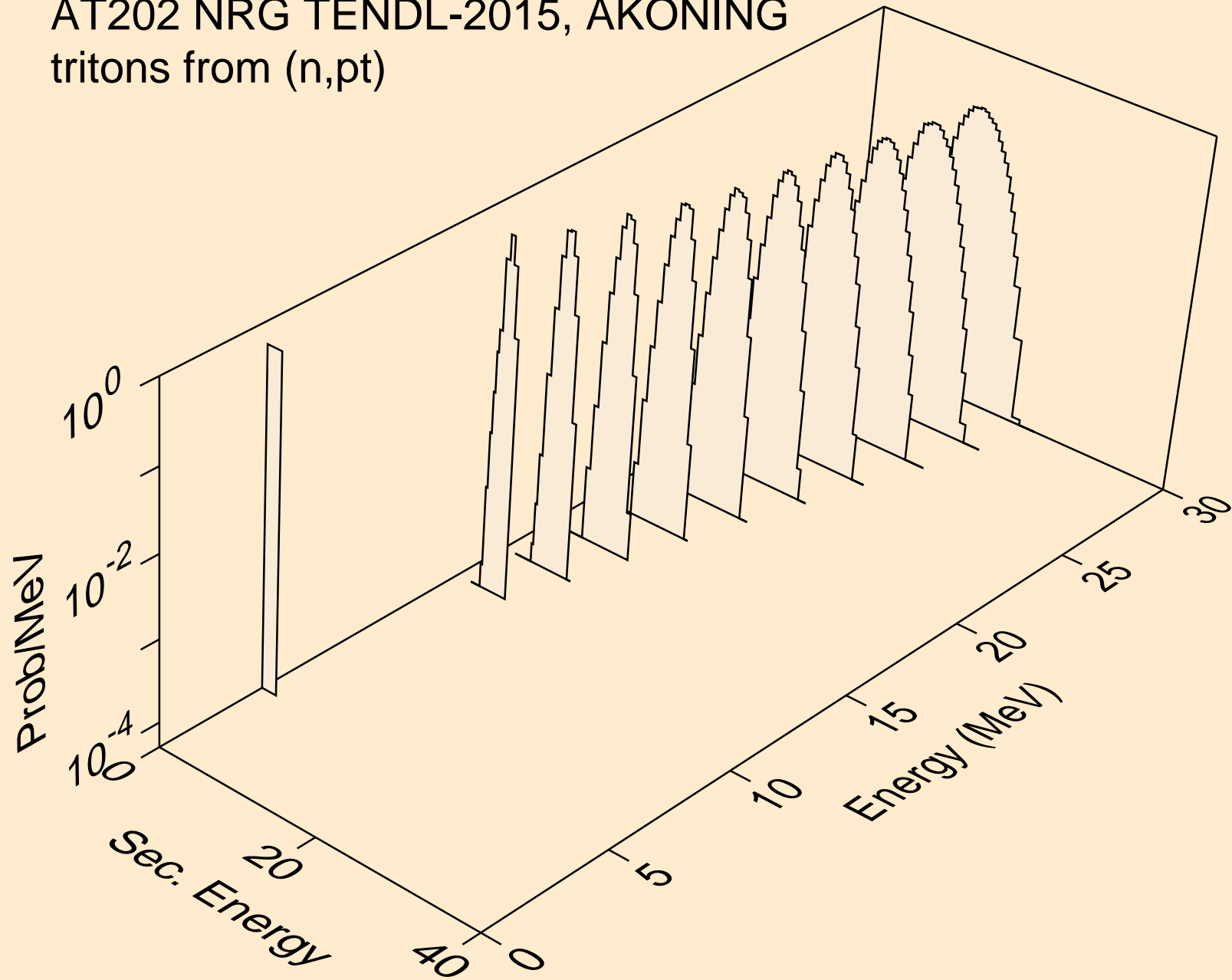

AT202 NRG TENDL-2015, AKONING  
he3s from (n,x)

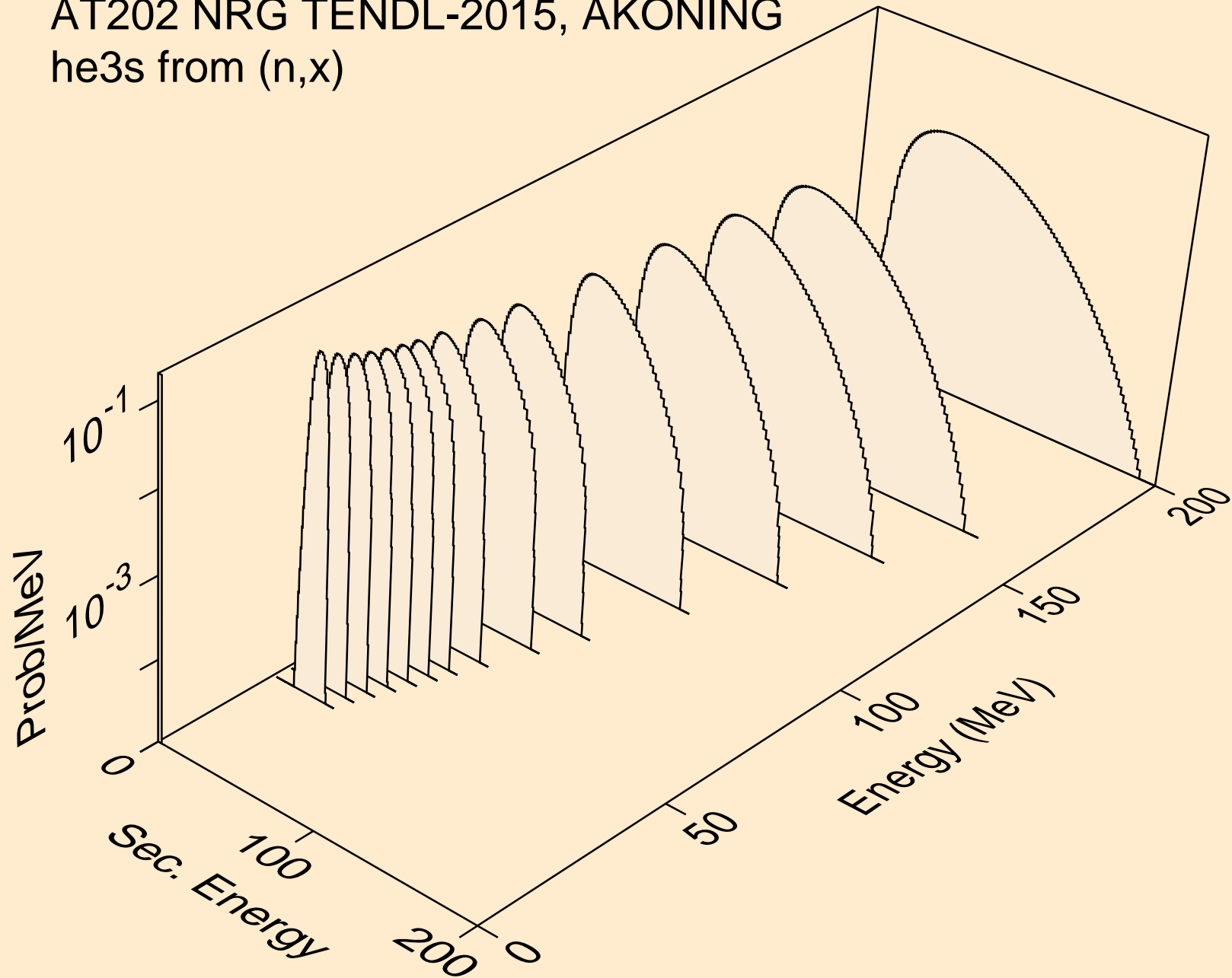

AT202 NRG TENDL-2015, AKONING  
he3s from (n,n\*)he3

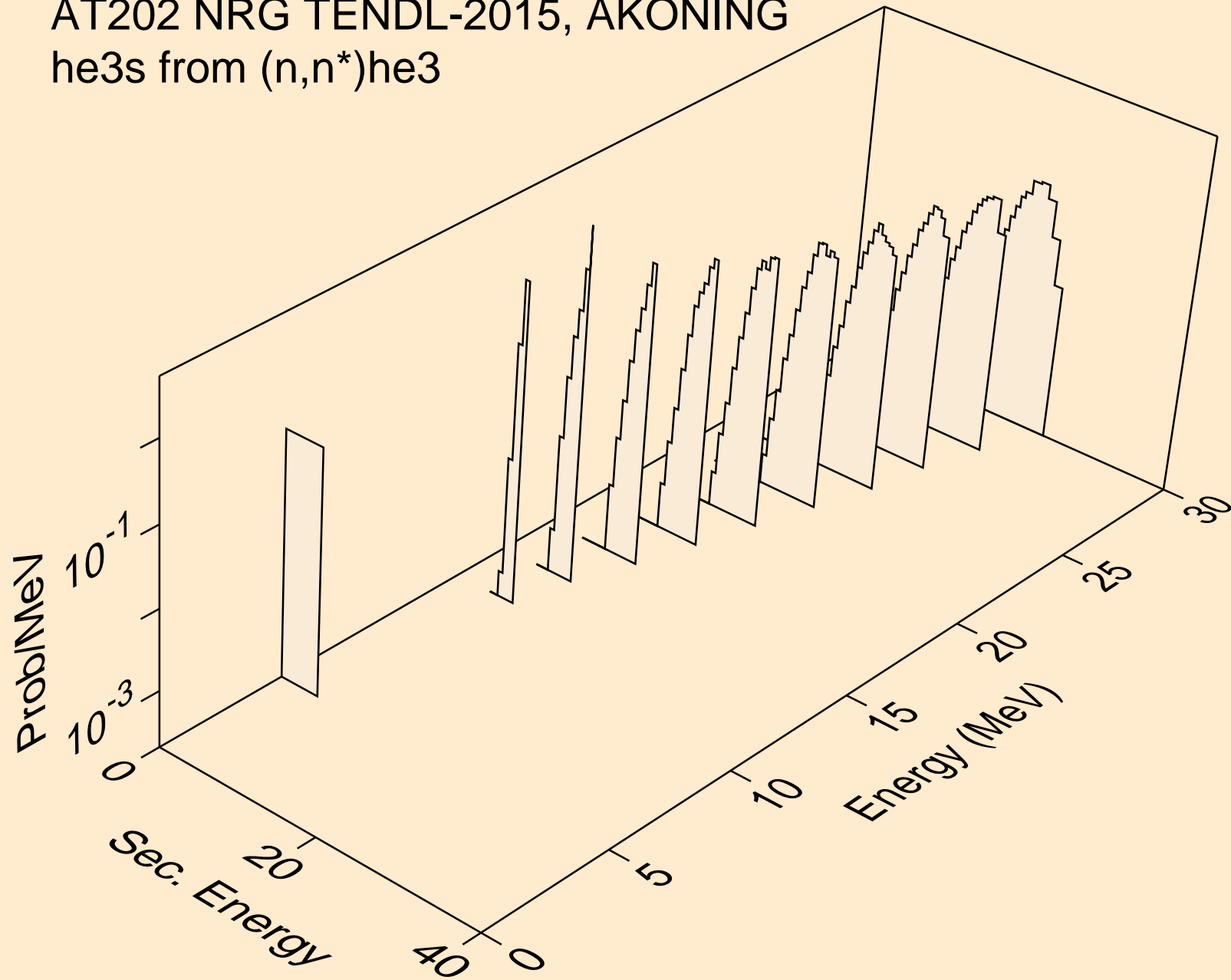

AT202 NRG TENDL-2015, AKONING  
he3s from (n,he3)

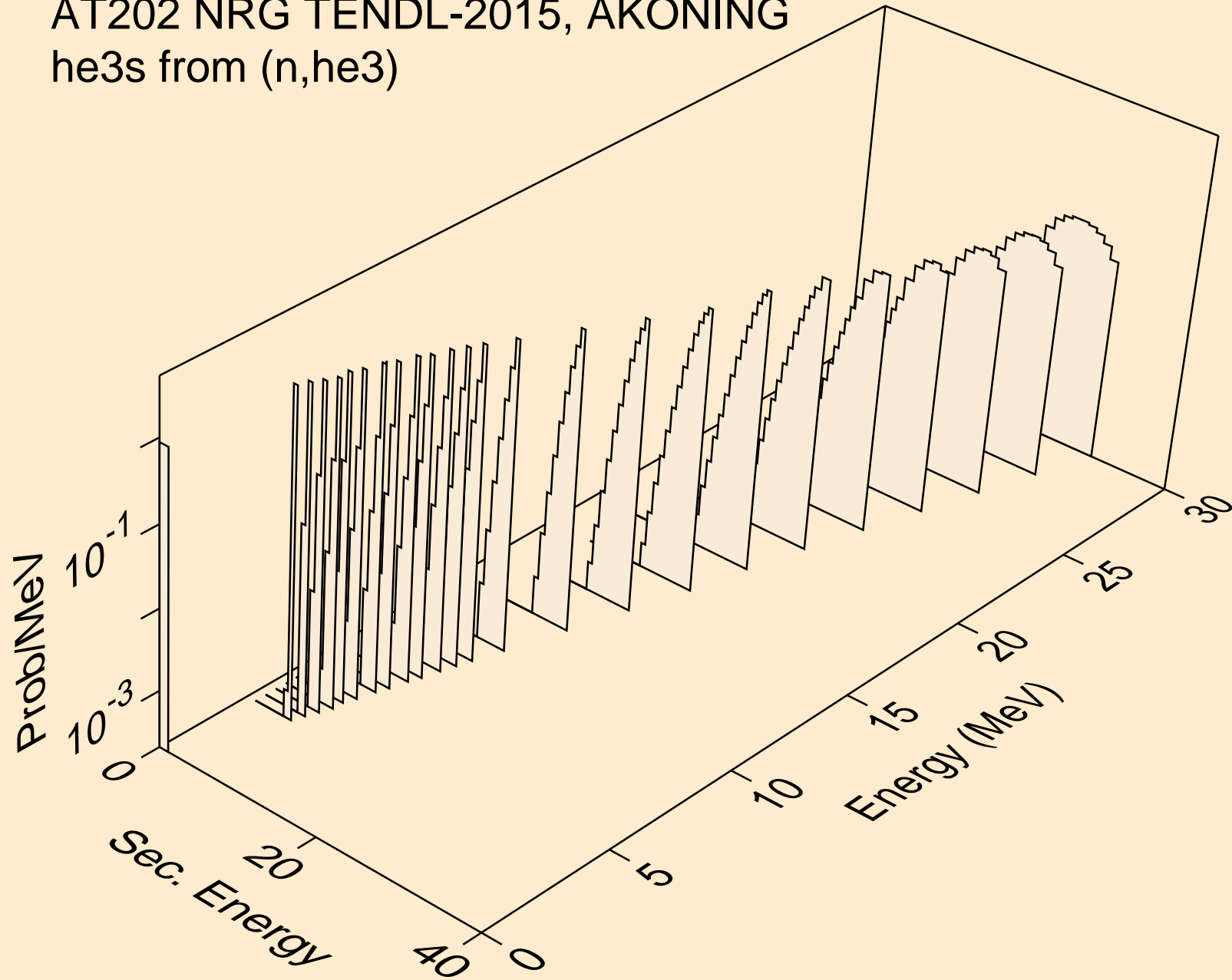

AT202 NRG TENDL-2015, AKONING  
alphas from (n,x)

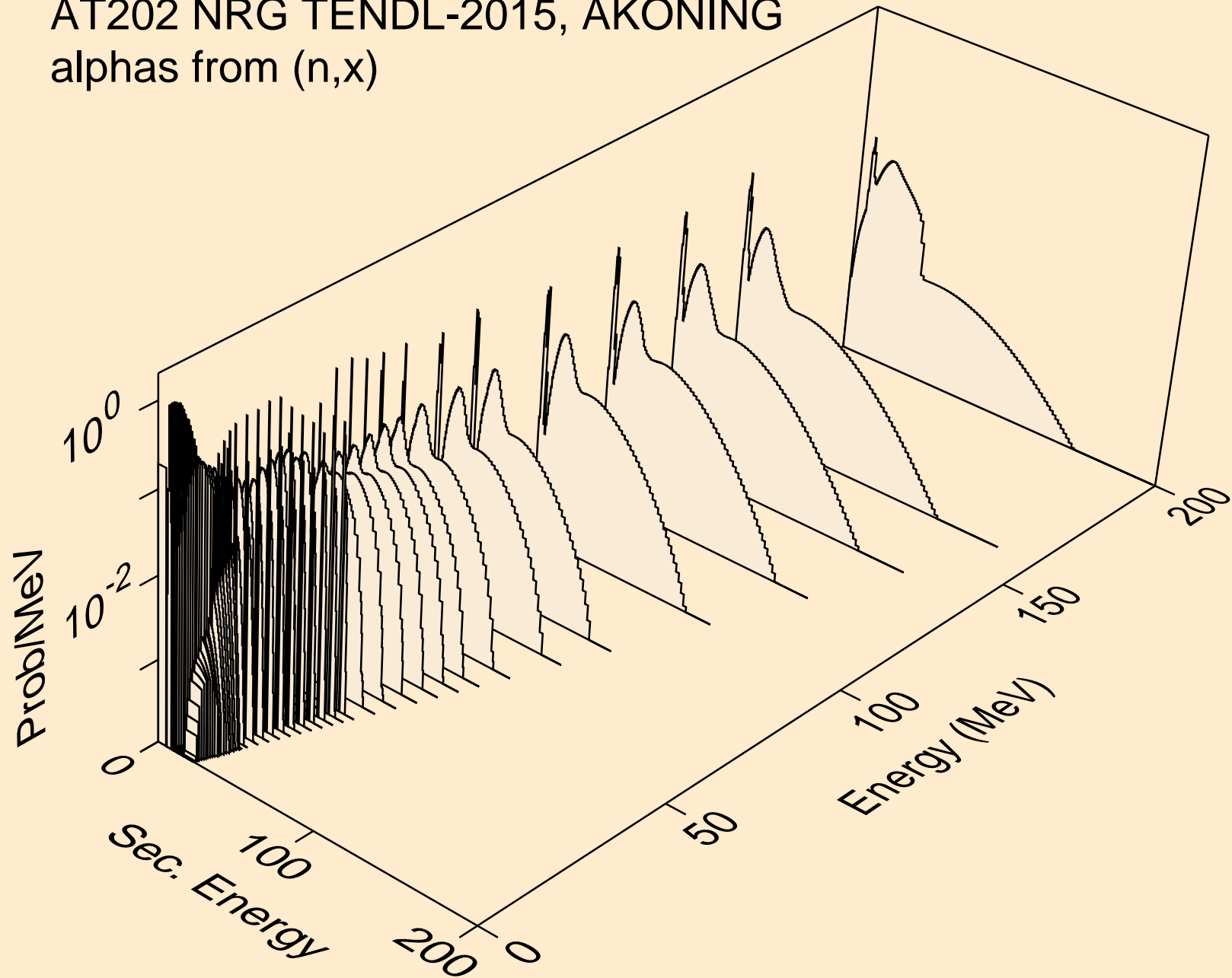

AT202 NRG TENDL-2015, AKONING  
alphas from (n,n\*)a

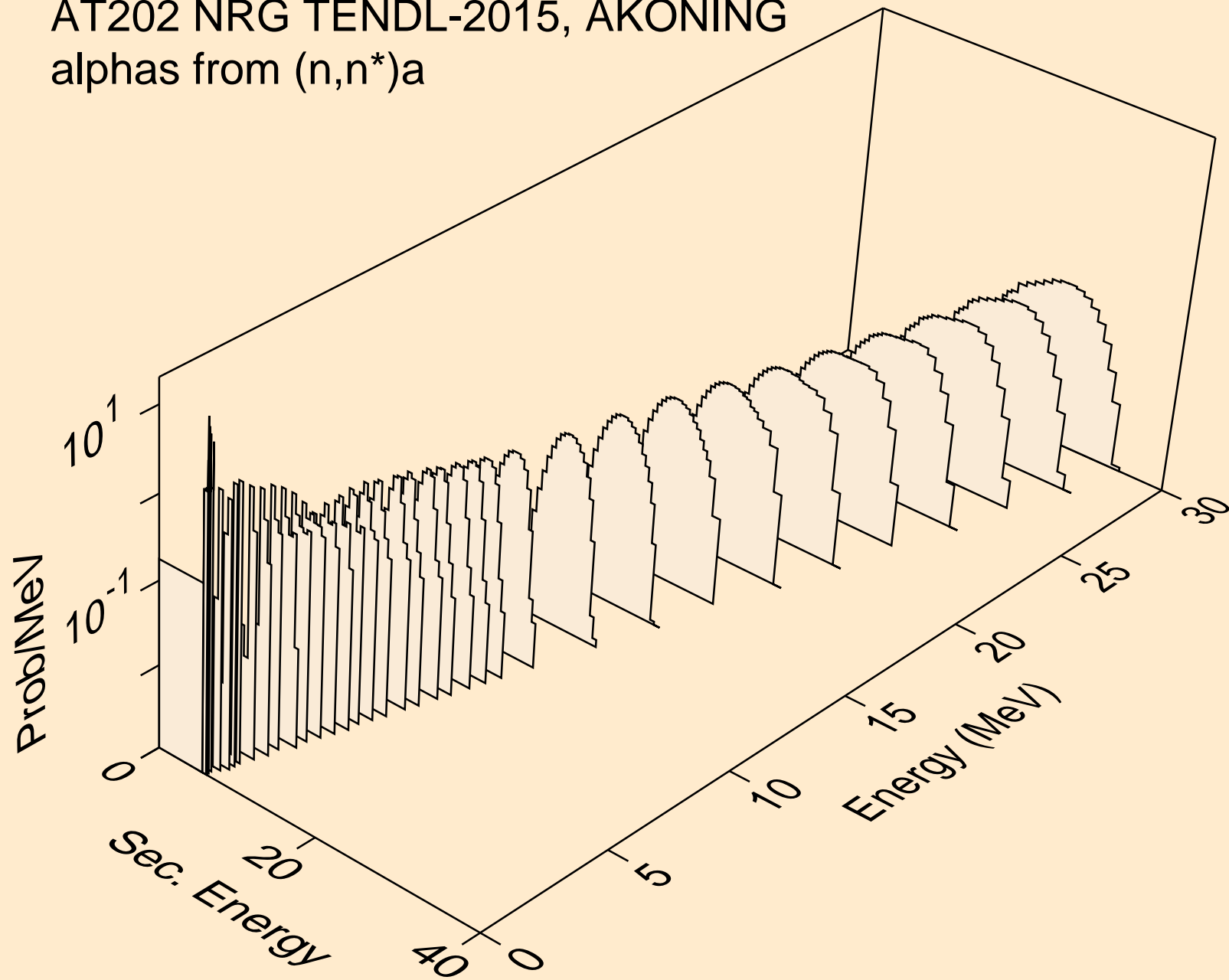

AT202 NRG TENDL-2015, AKONING  
alphas from (n,2n)a

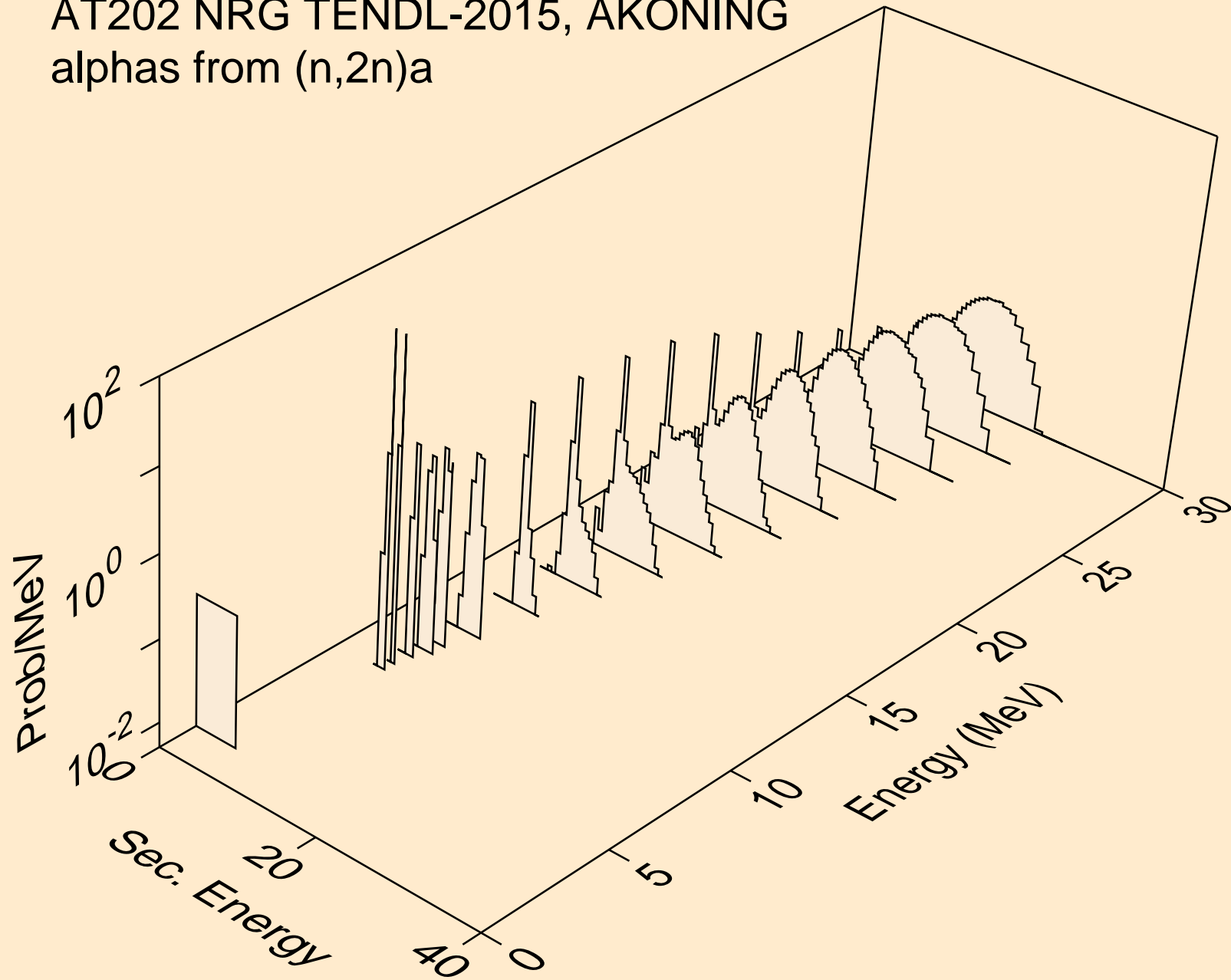



AT202 NRG TENDL-2015, AKONING  
alphas from (n,3n)a

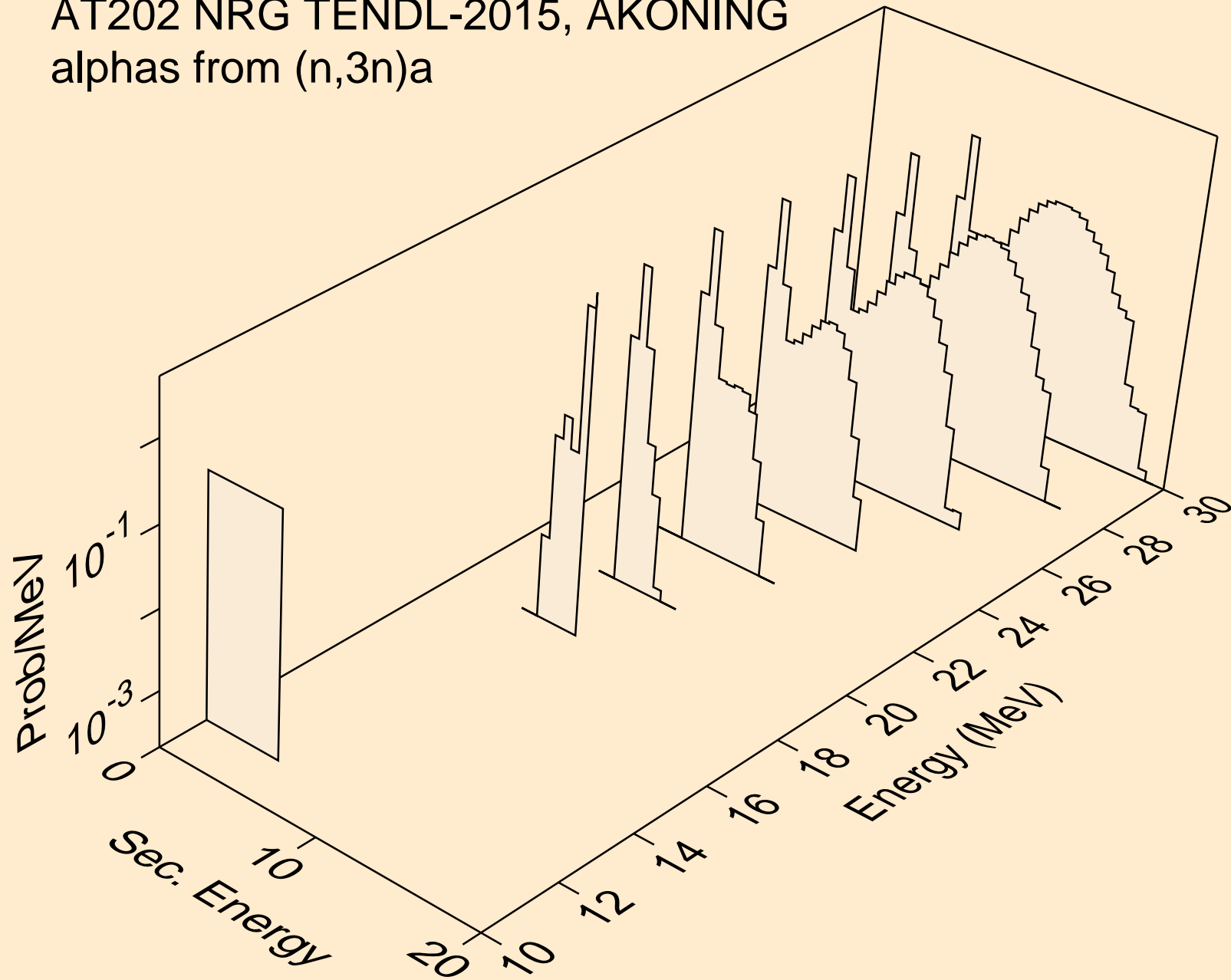

AT202 NRG TENDL-2015, AKONING  
alphas from (n,n\*)2a

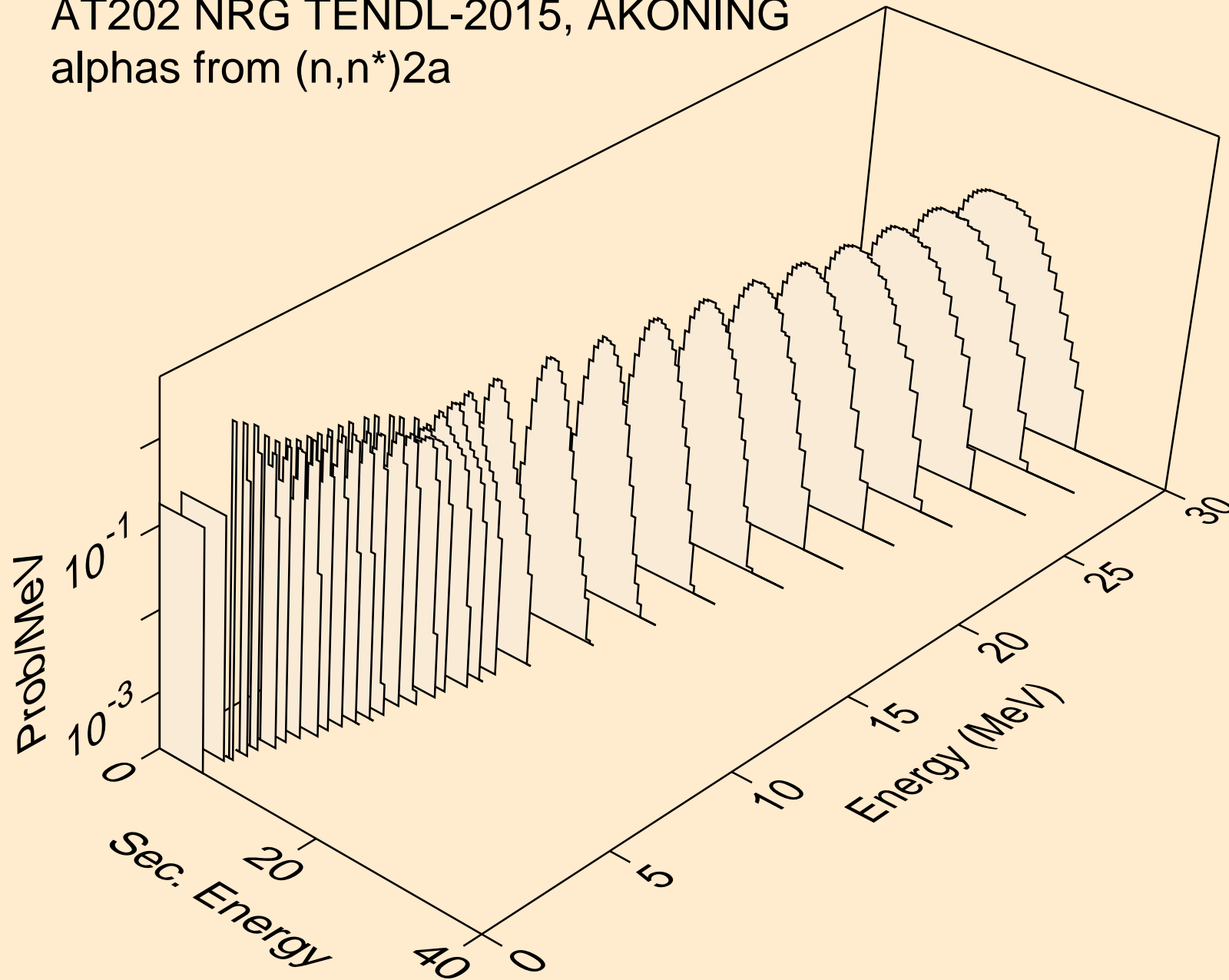

AT202 NRG TENDL-2015, AKONING  
alphas from (n,2n)2a

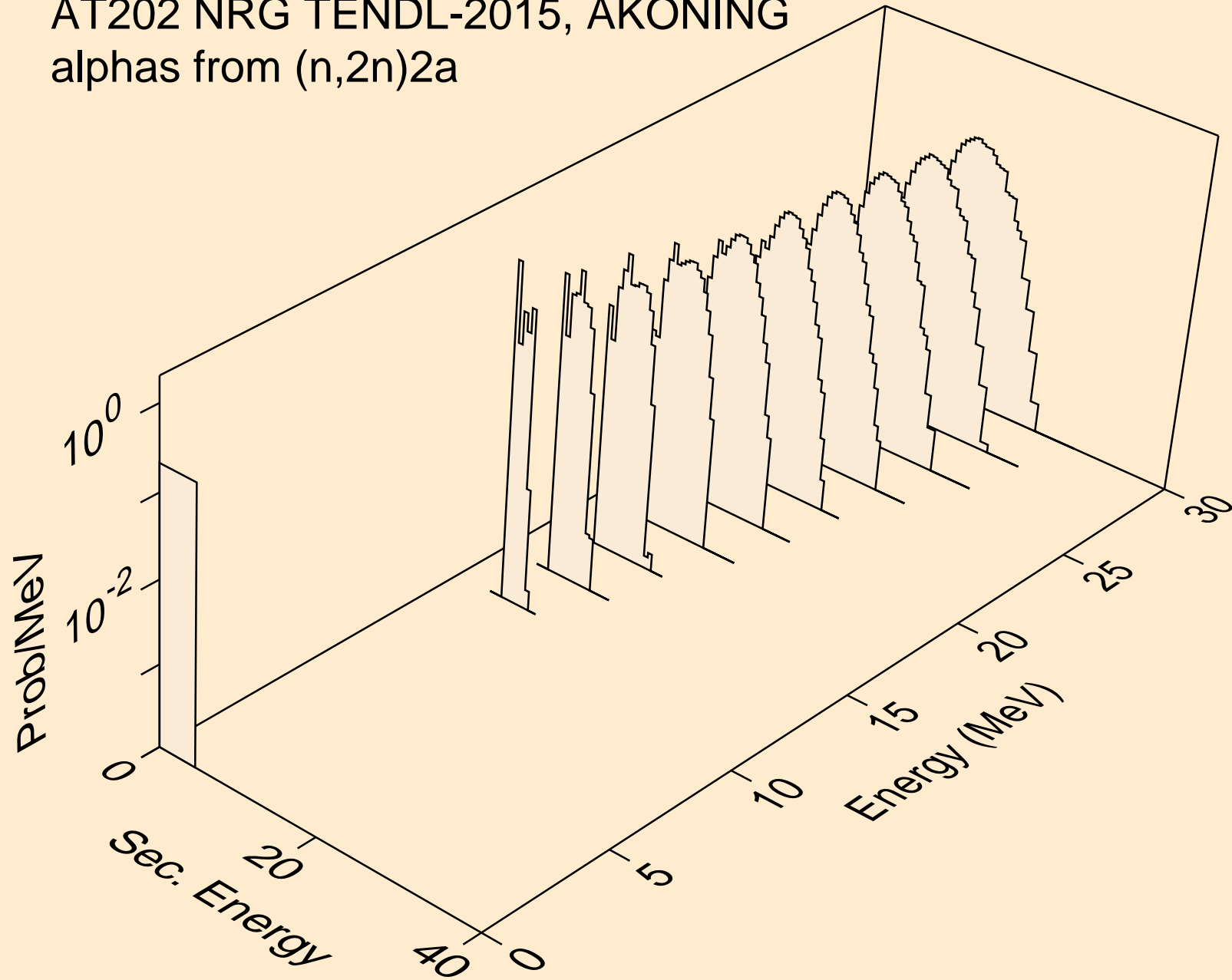

AT202 NRG TENDL-2015, AKONING  
alphas from (n,npa)

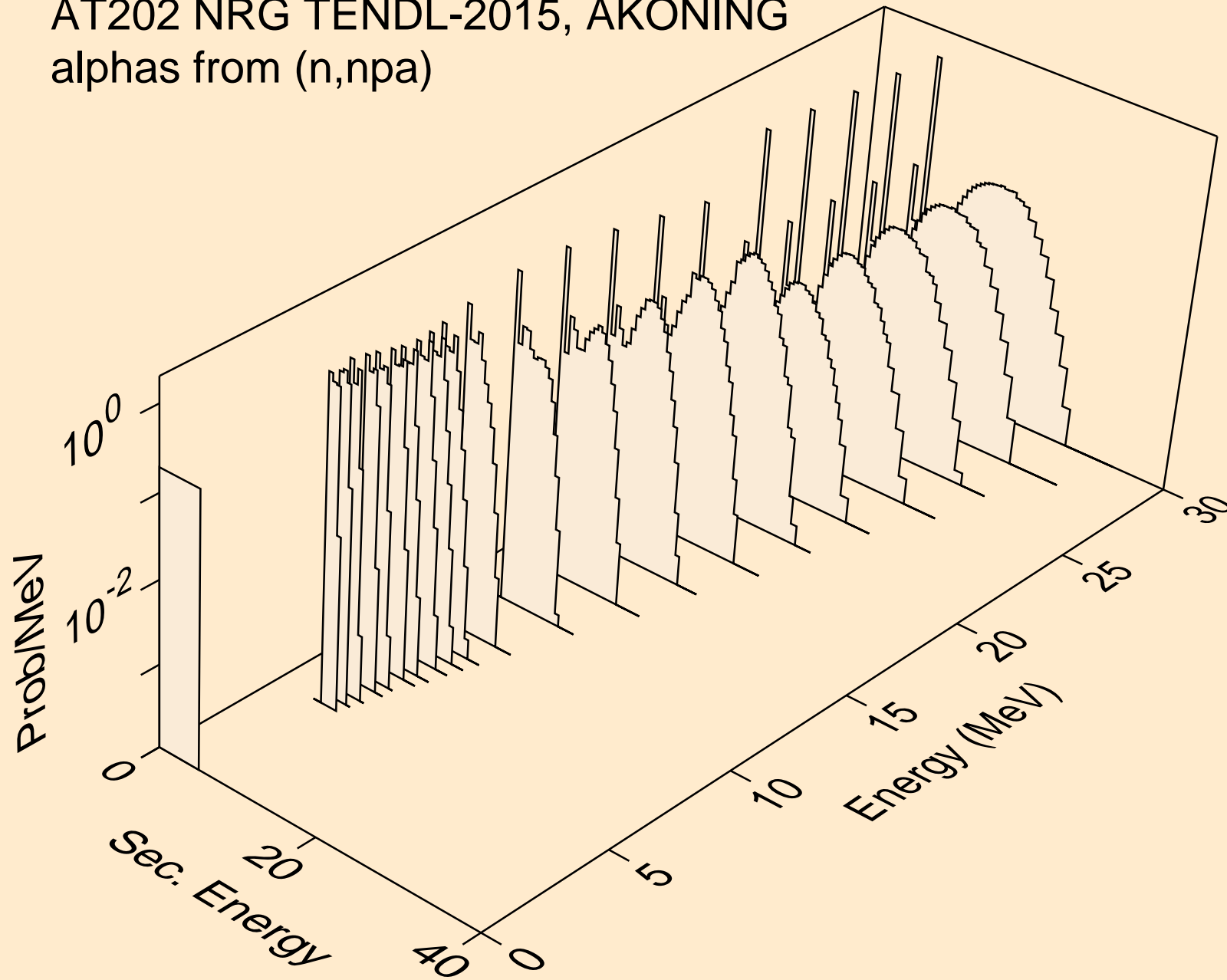

AT202 NRG TENDL-2015, AKONING  
alphas from (n,a)

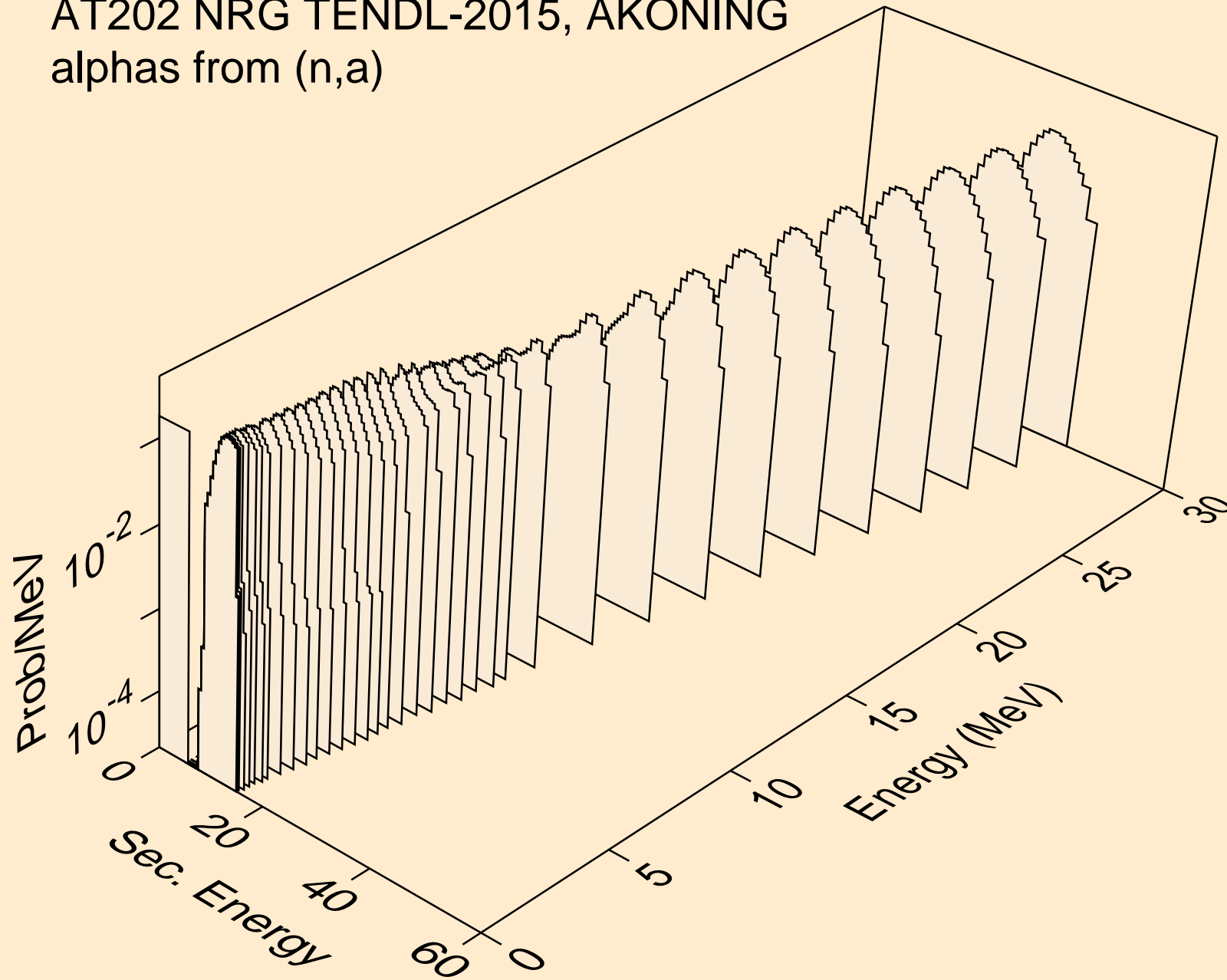

AT202 NRG TENDL-2015, AKONING  
alphas from (n,2a)

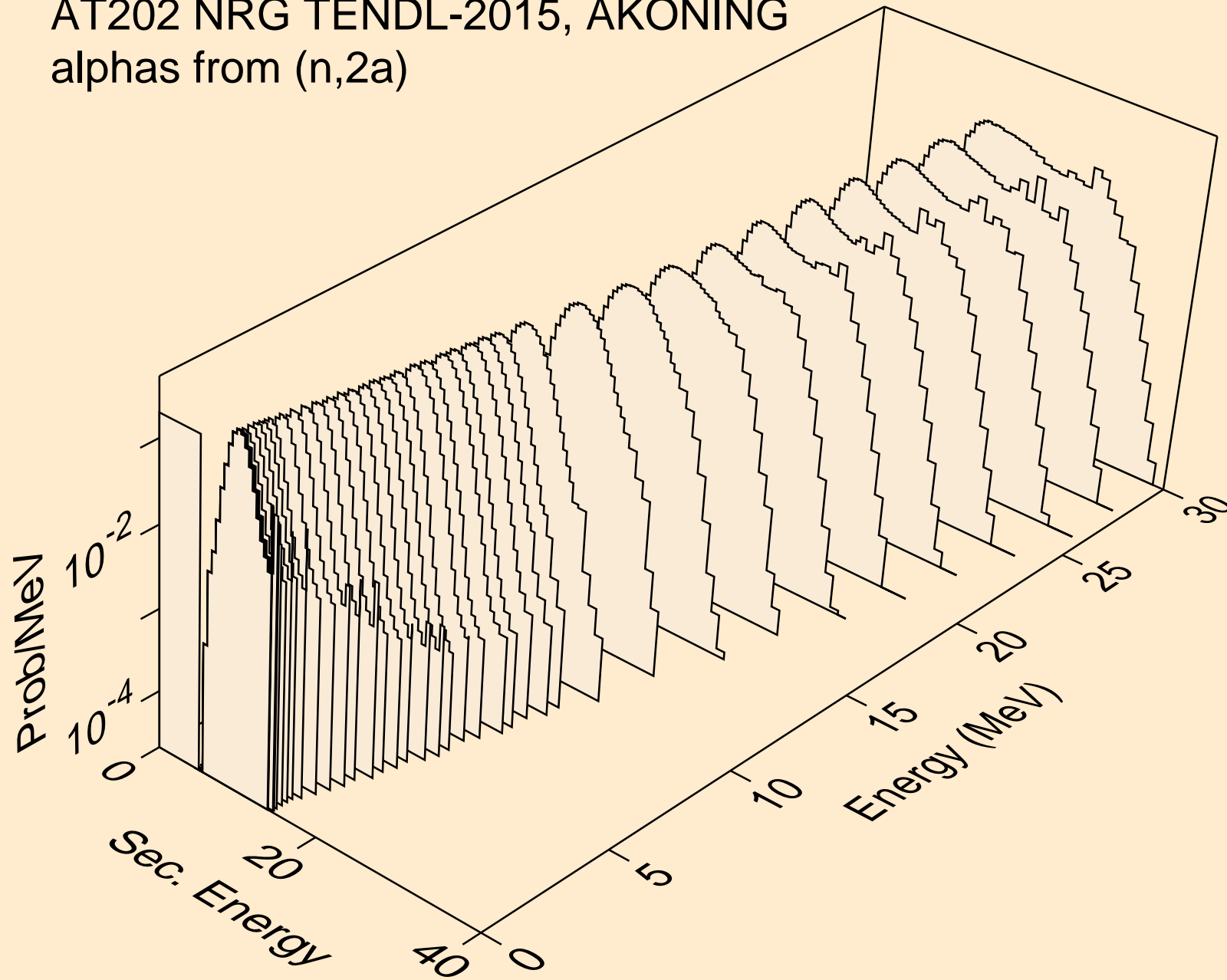

AT202 NRG TENDL-2015, AKONING  
alphas from (n,pa)

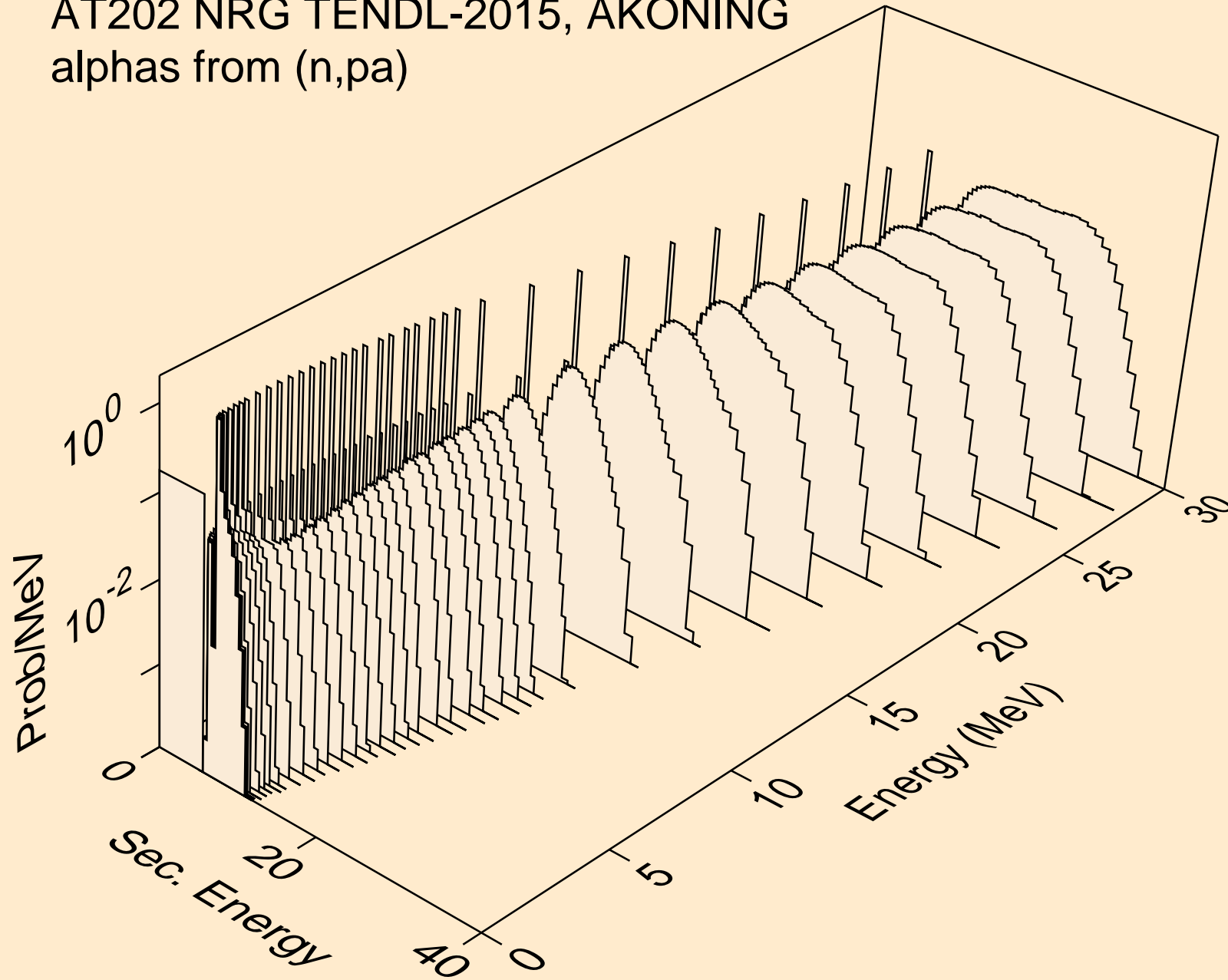

AT202 NRG TENDL-2015, AKONING  
alphas from (n,da)

