

# AT221 NRG TENDL-2015, AKONING

## Principal cross sections

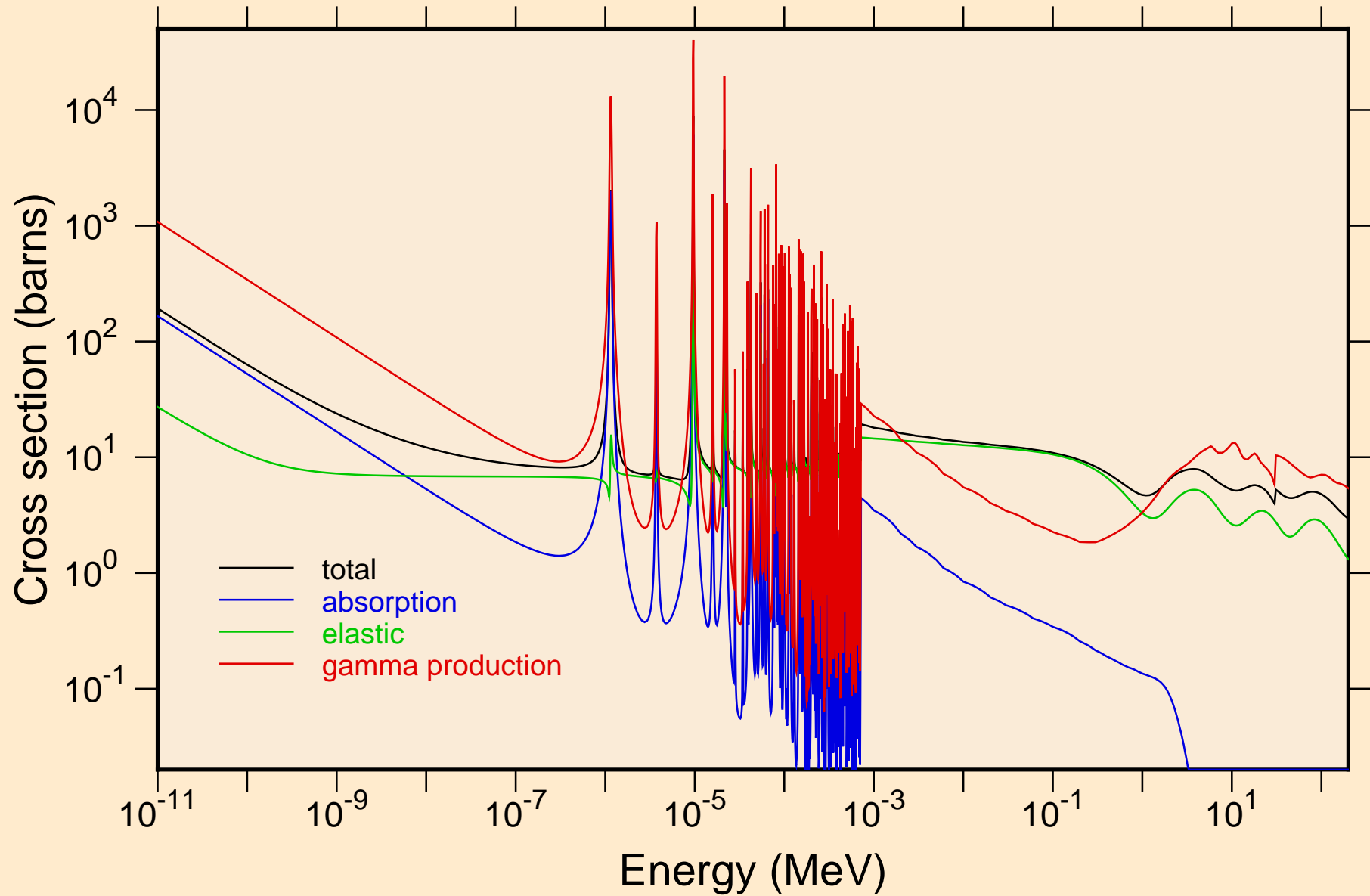

AT221 NRG TENDL-2015, AKONING  
resonance total cross section

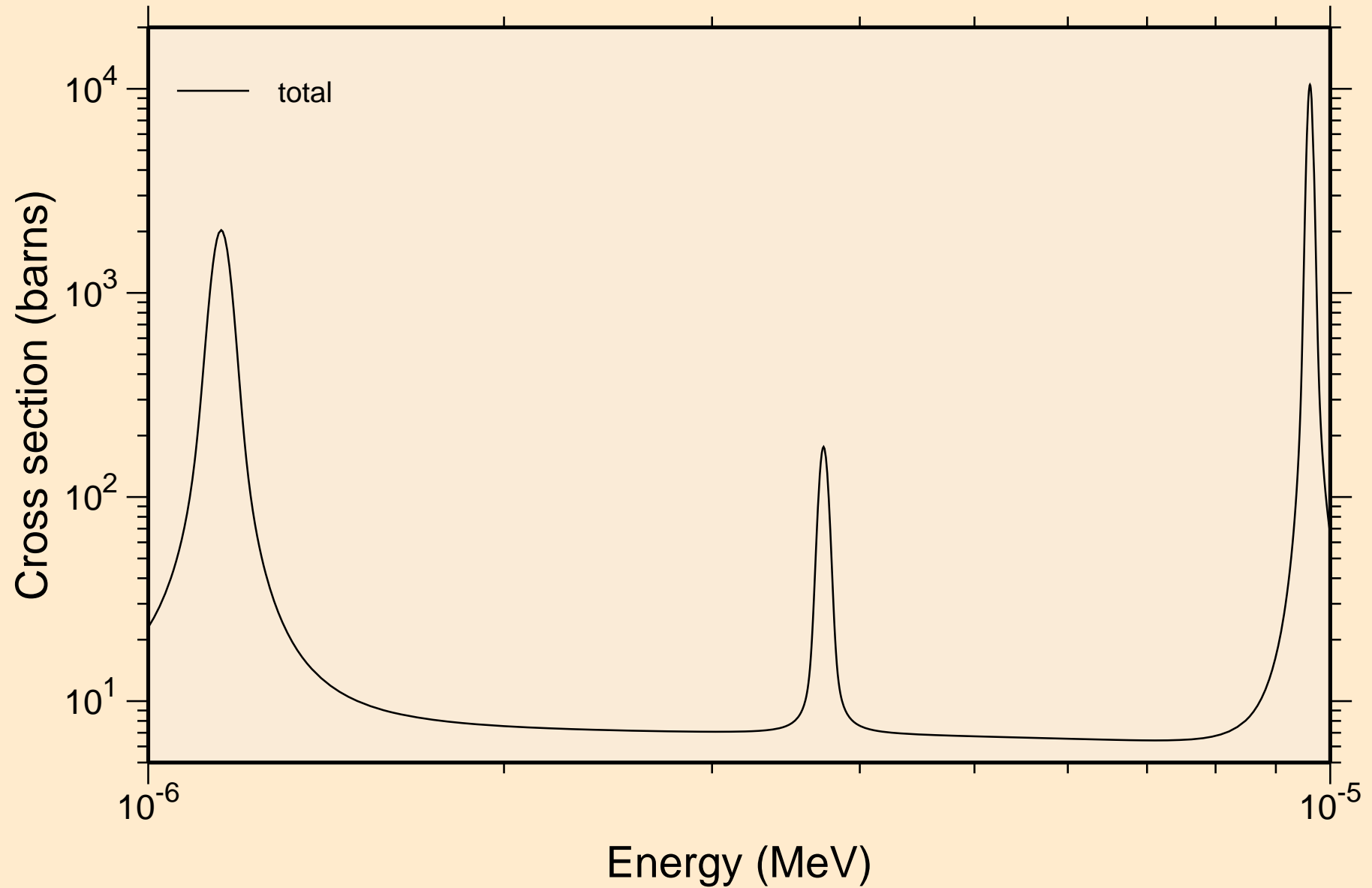

AT221 NRG TENDL-2015, AKONING  
resonance total cross section

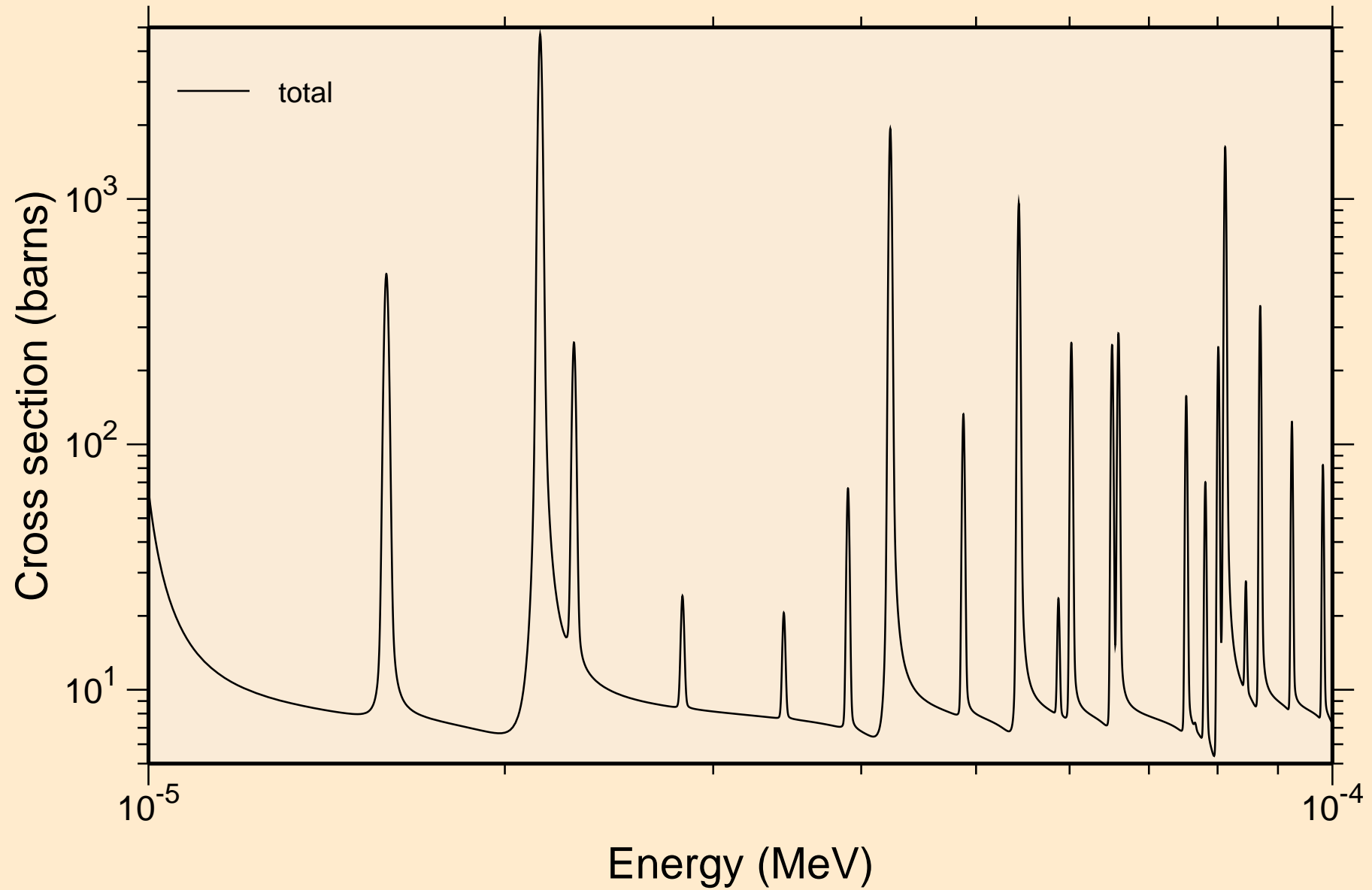

AT221 NRG TENDL-2015, AKONING  
resonance total cross section

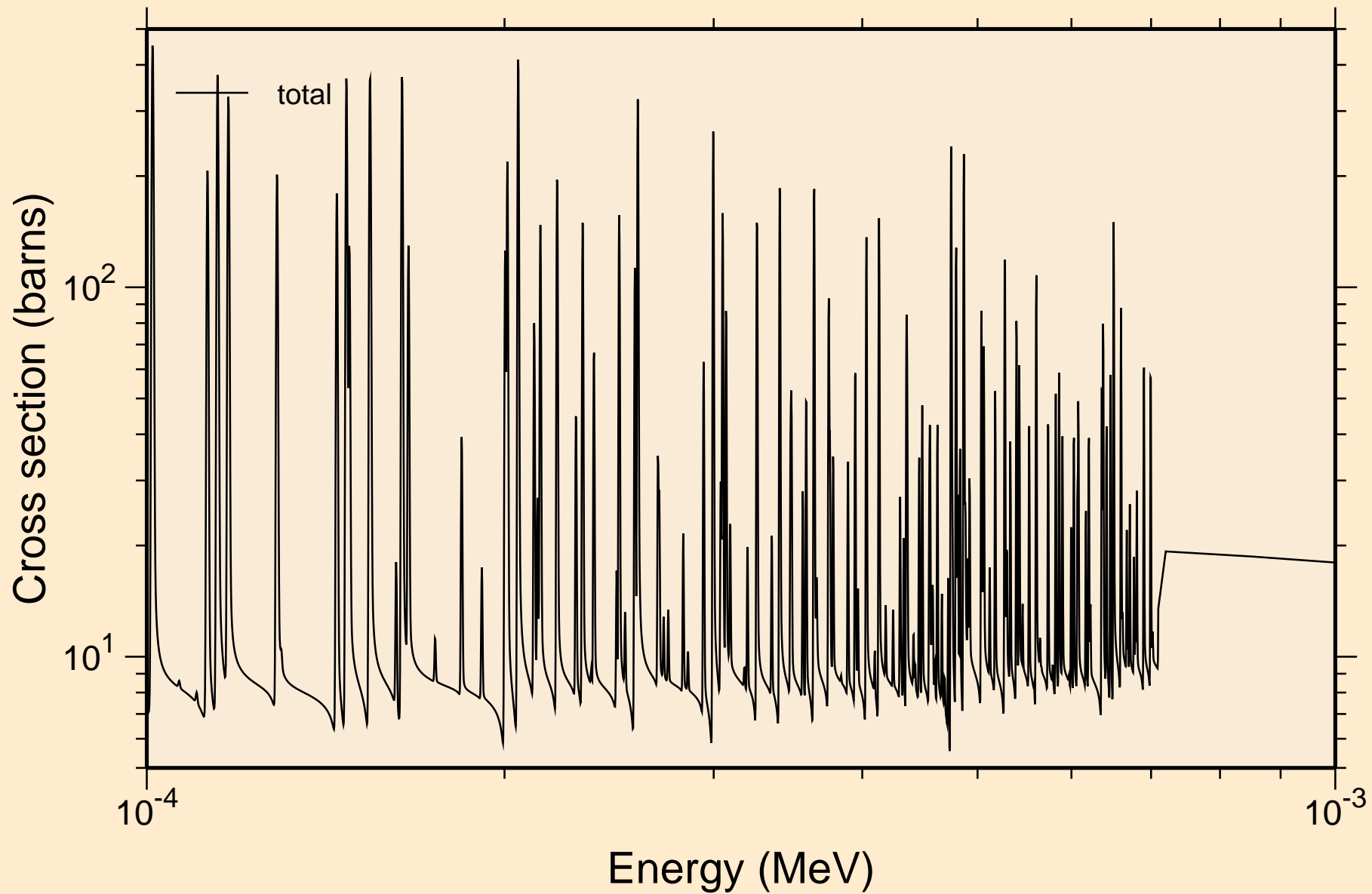

AT221 NRG TENDL-2015, AKONING  
resonance total cross section

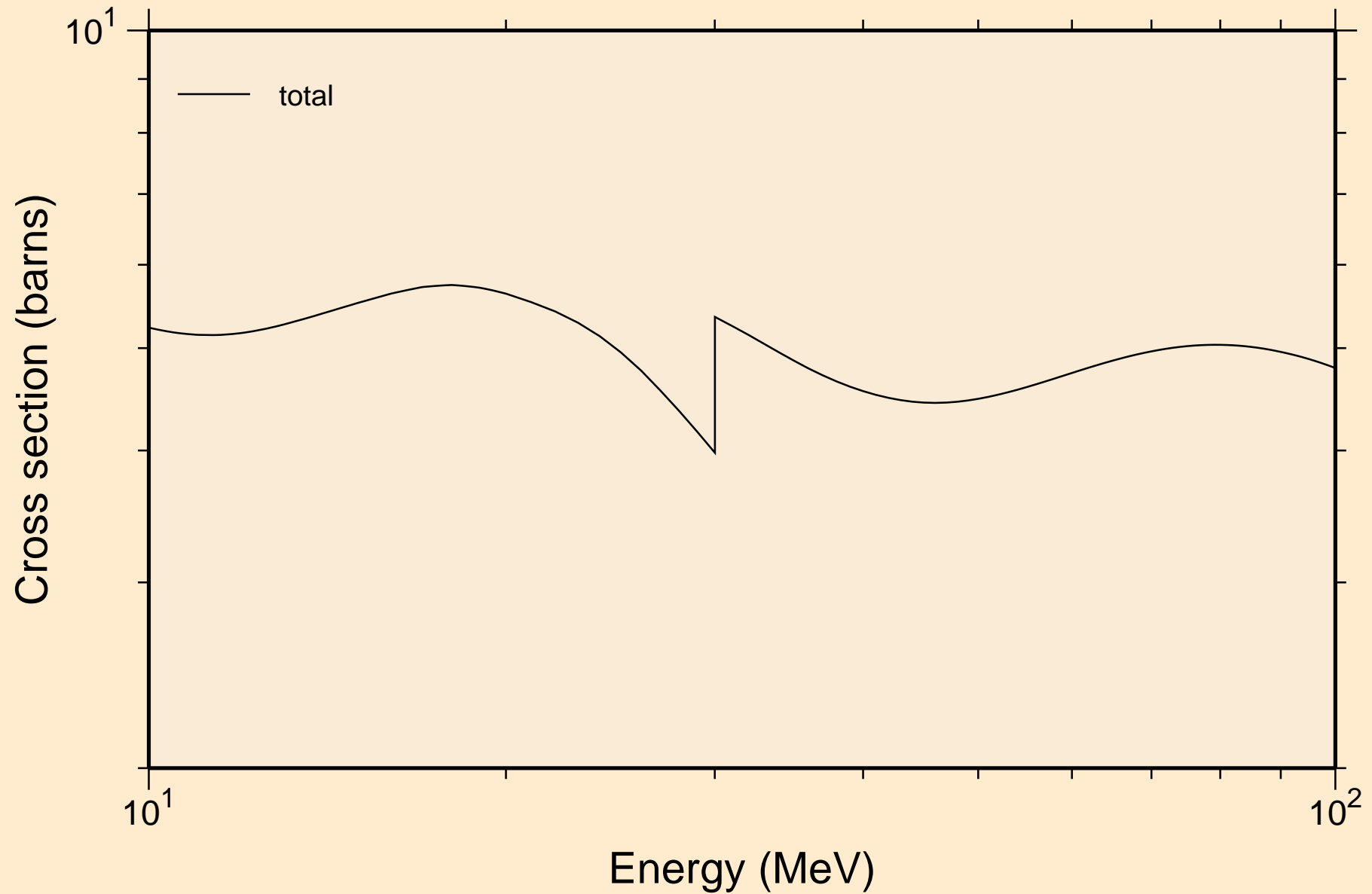

# AT221 NRG TENDL-2015, AKONING resonance absorption cross sections

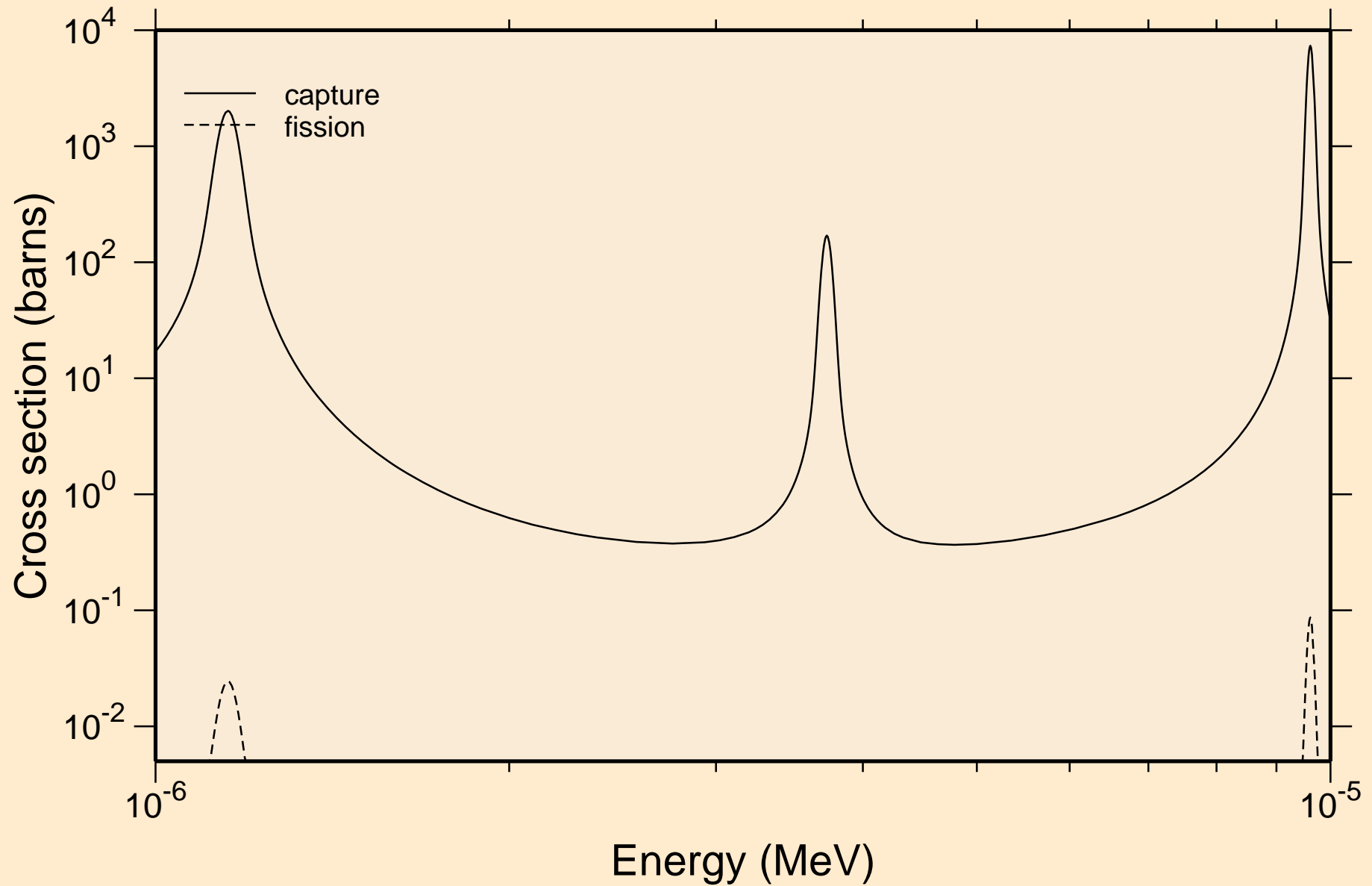

# AT221 NRG TENDL-2015, AKONING resonance absorption cross sections

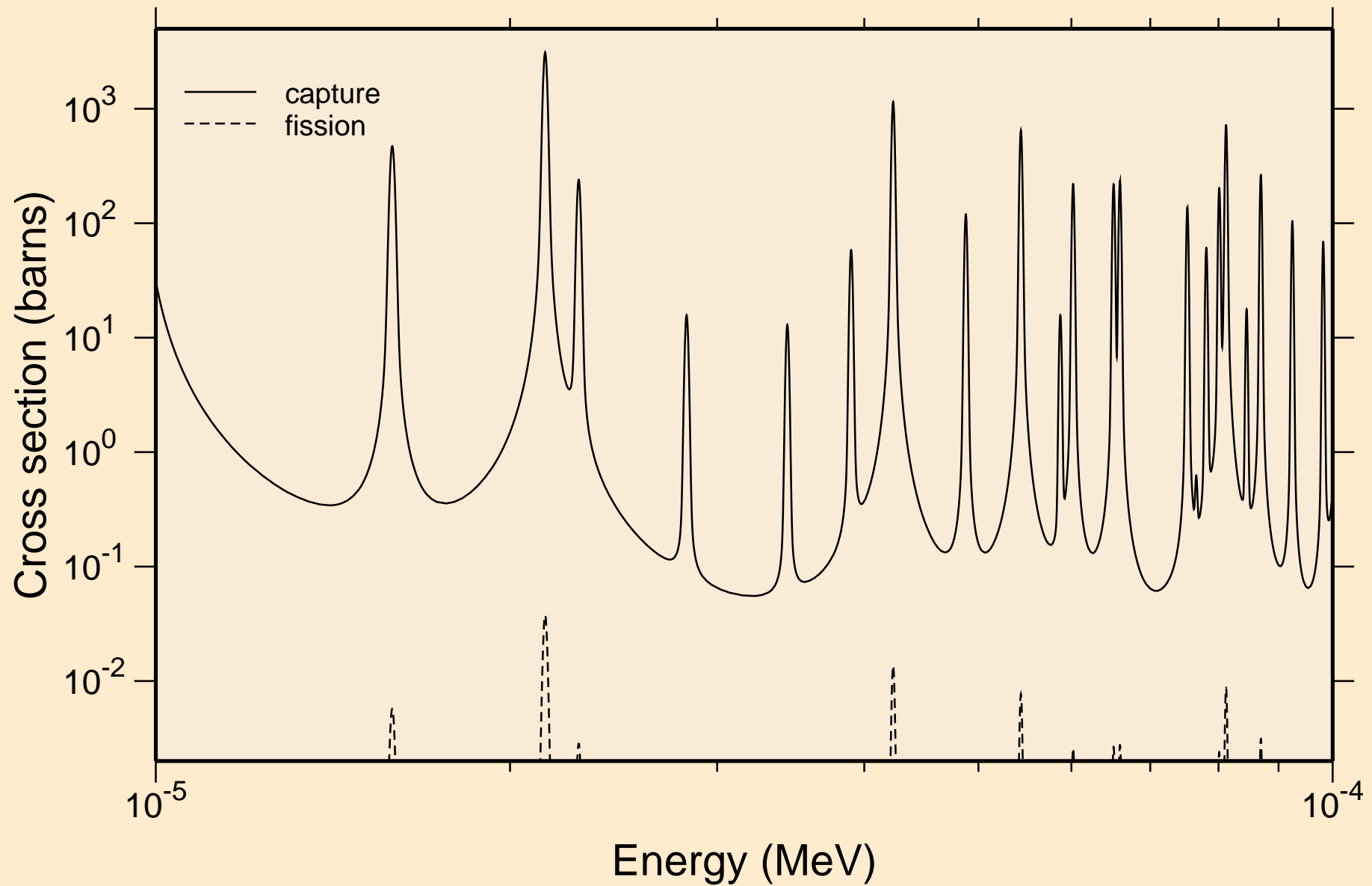

AT221 NRG TENDL-2015, AKONING  
resonance absorption cross sections

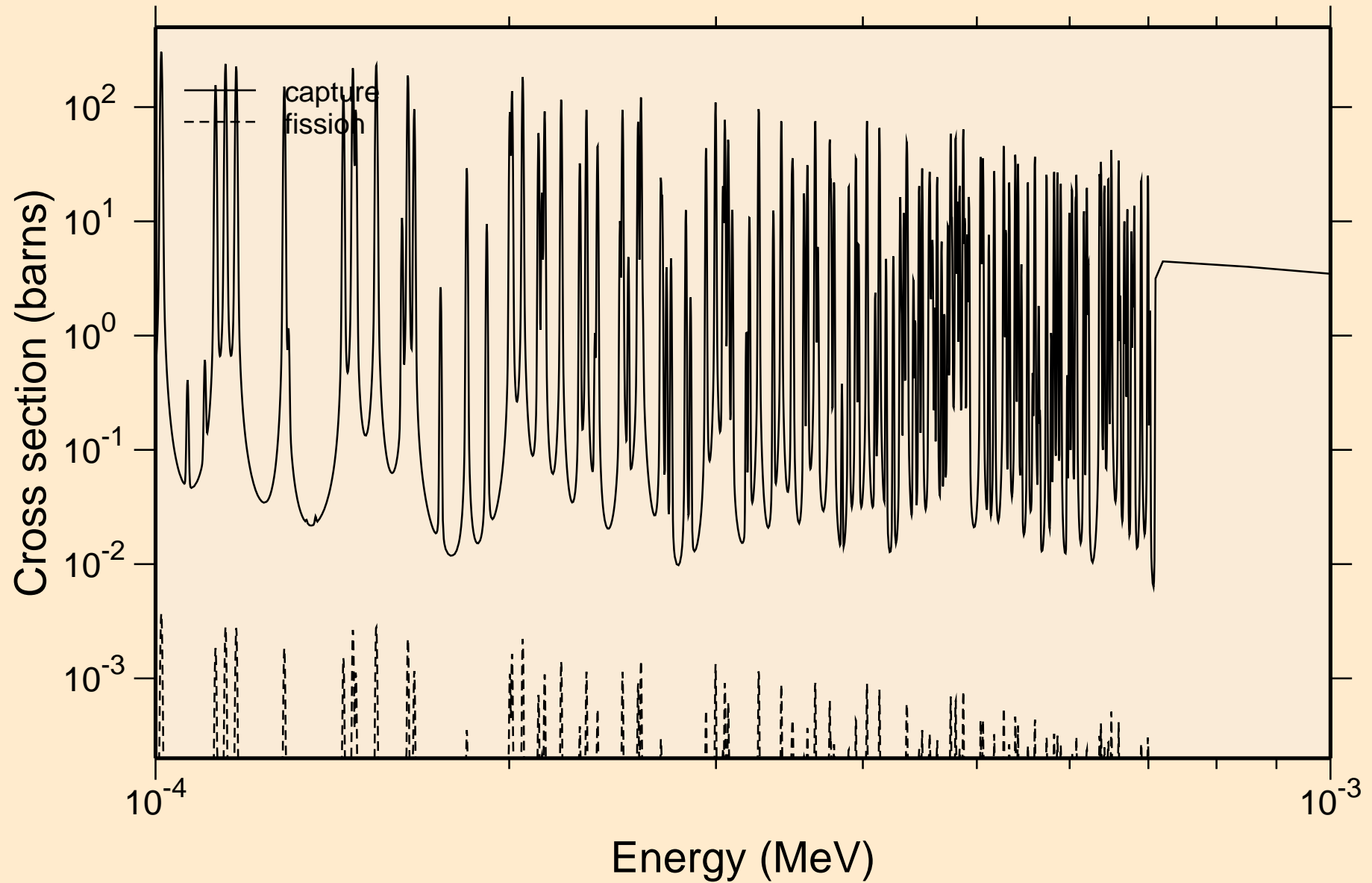



# AT221 NRG TENDL-2015, AKONING

## resonance absorption cross sections

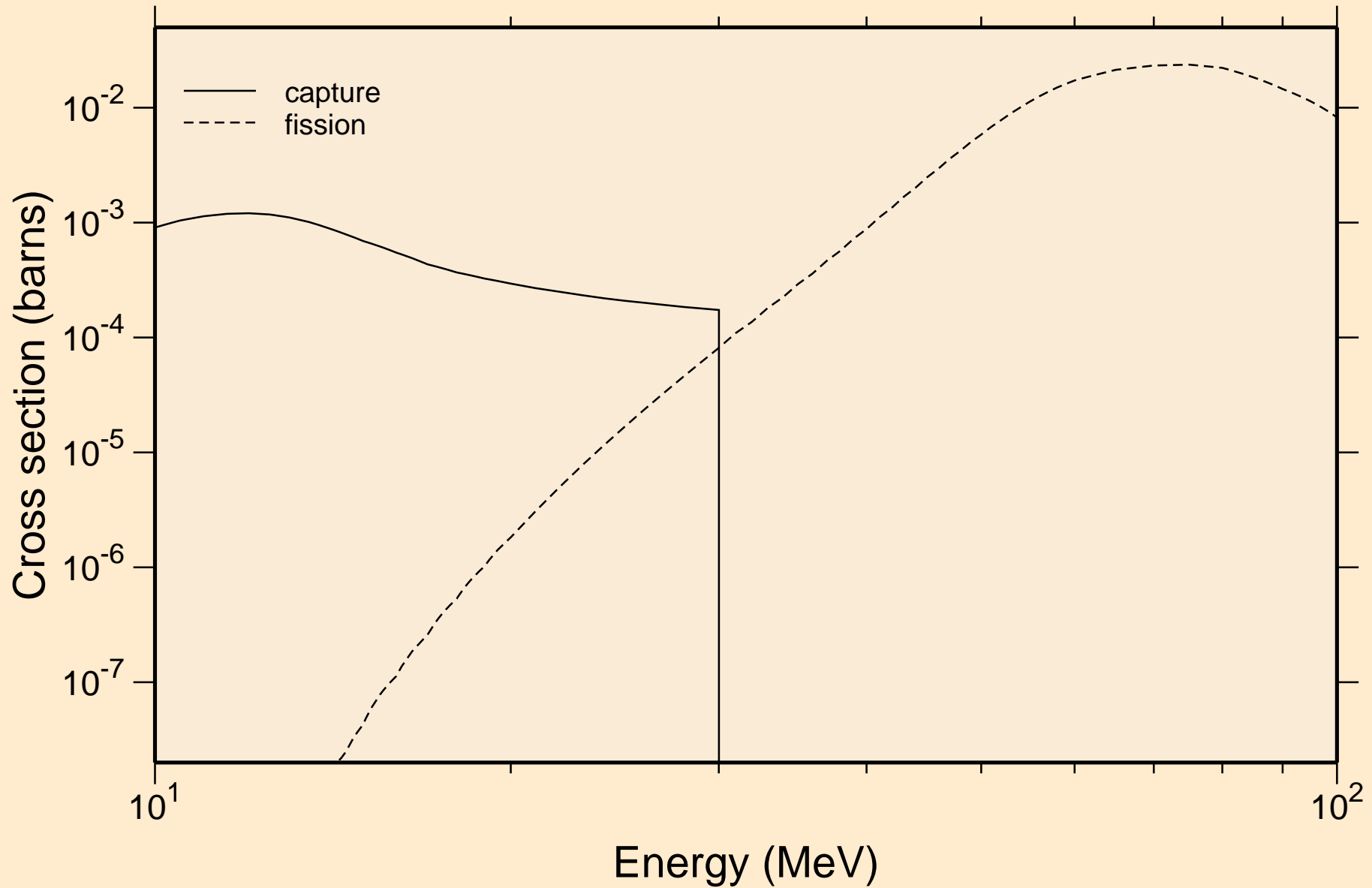

# AT221 NRG TENDL-2015, AKONING

## Non-threshold reactions

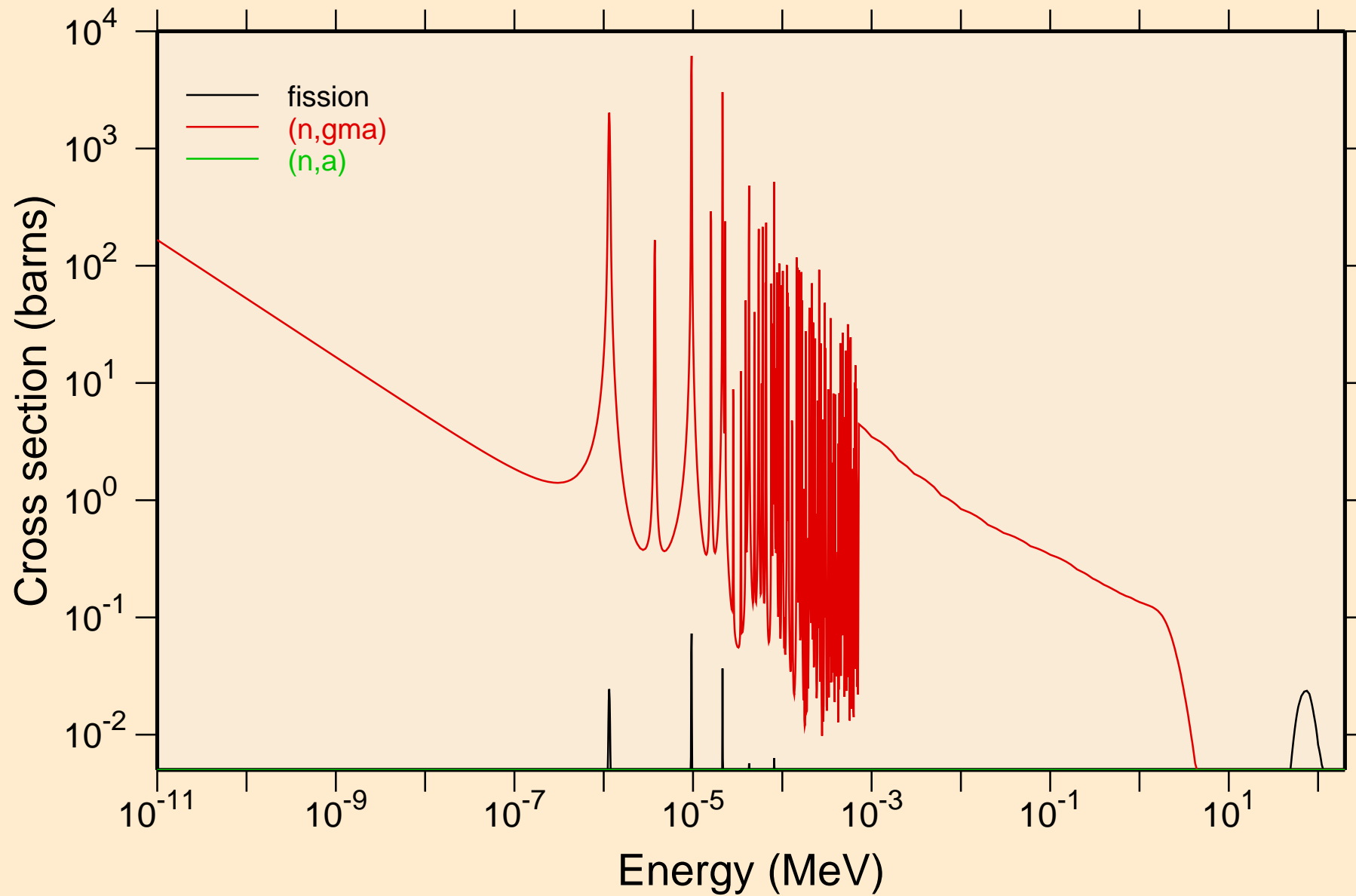

# AT221 NRG TENDL-2015, AKONING

## Principal cross sections

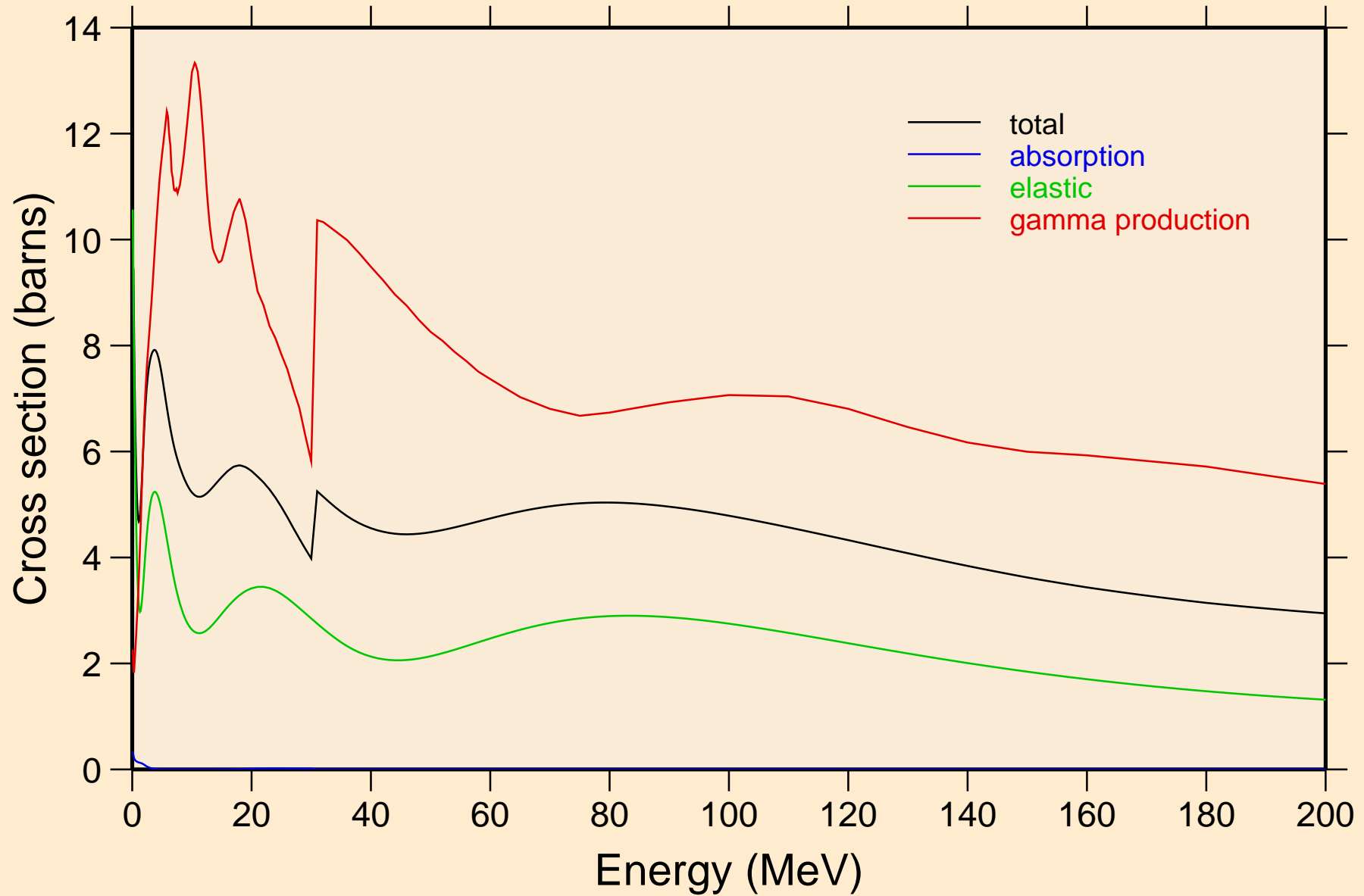

# AT221 NRG TENDL-2015, AKONING

## Non-threshold reactions

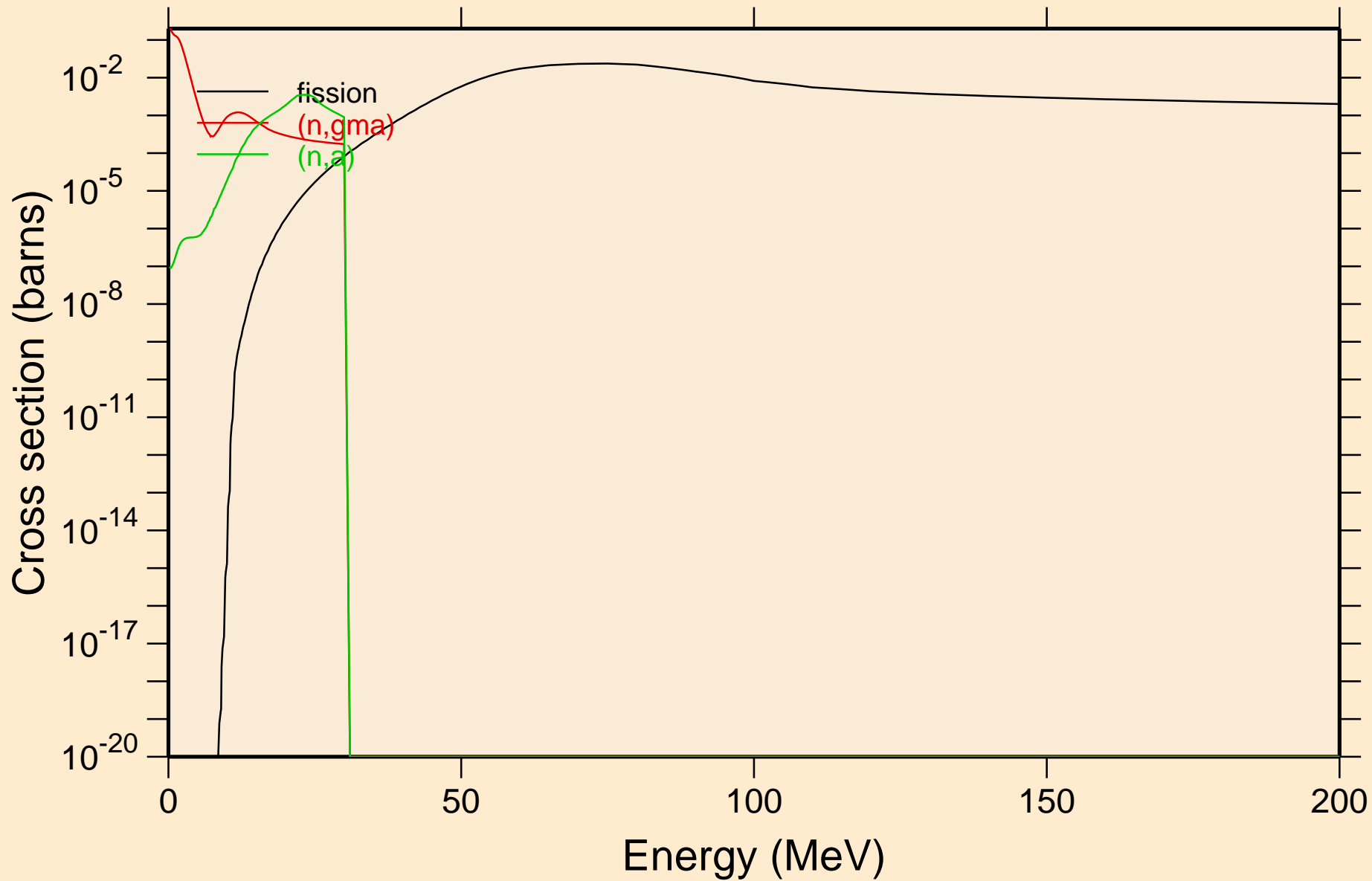

AT221 NRG TENDL-2015, AKONING  
Inelastic levels

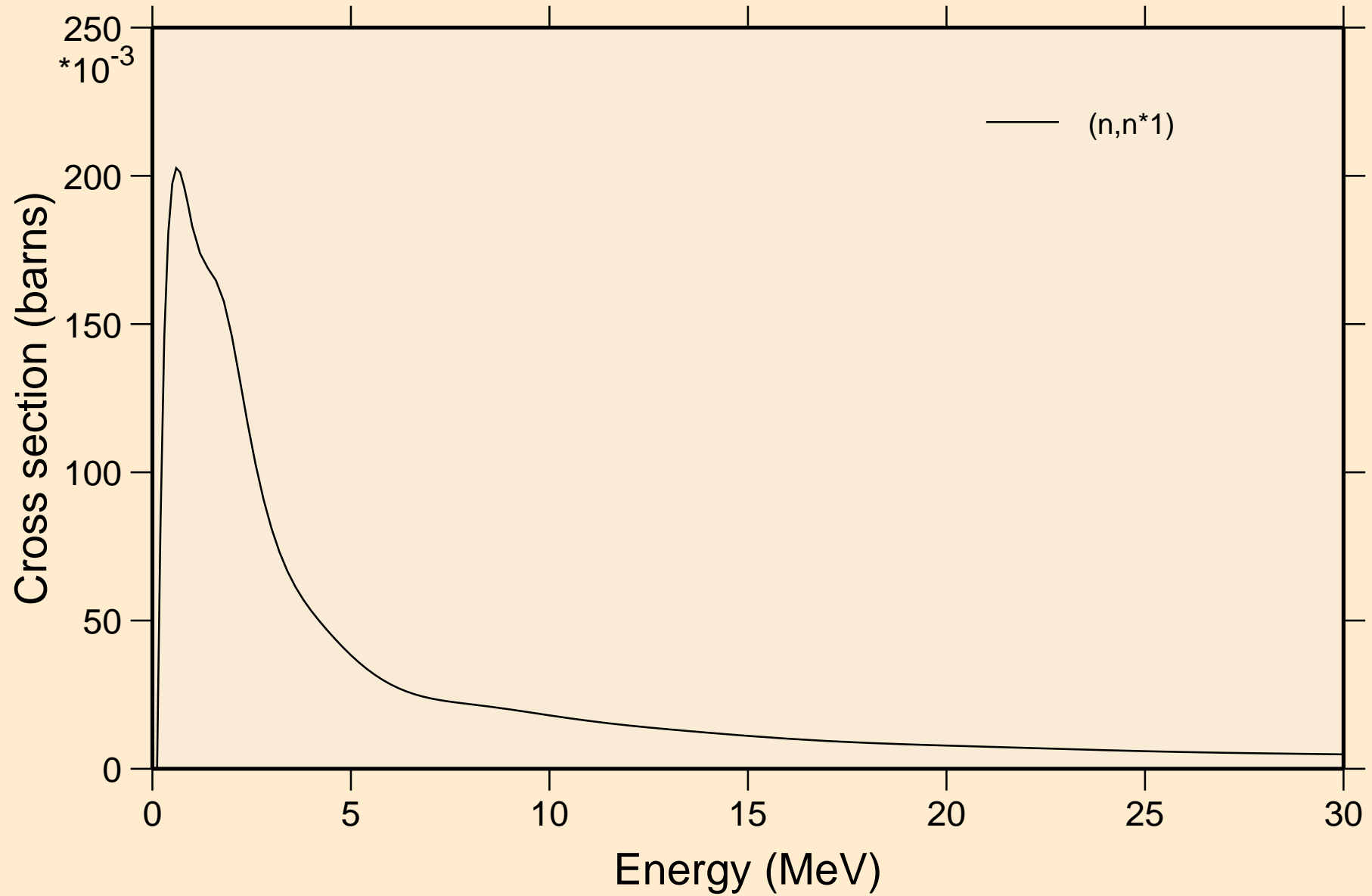

# AT221 NRG TENDL-2015, AKONING

## Threshold reactions

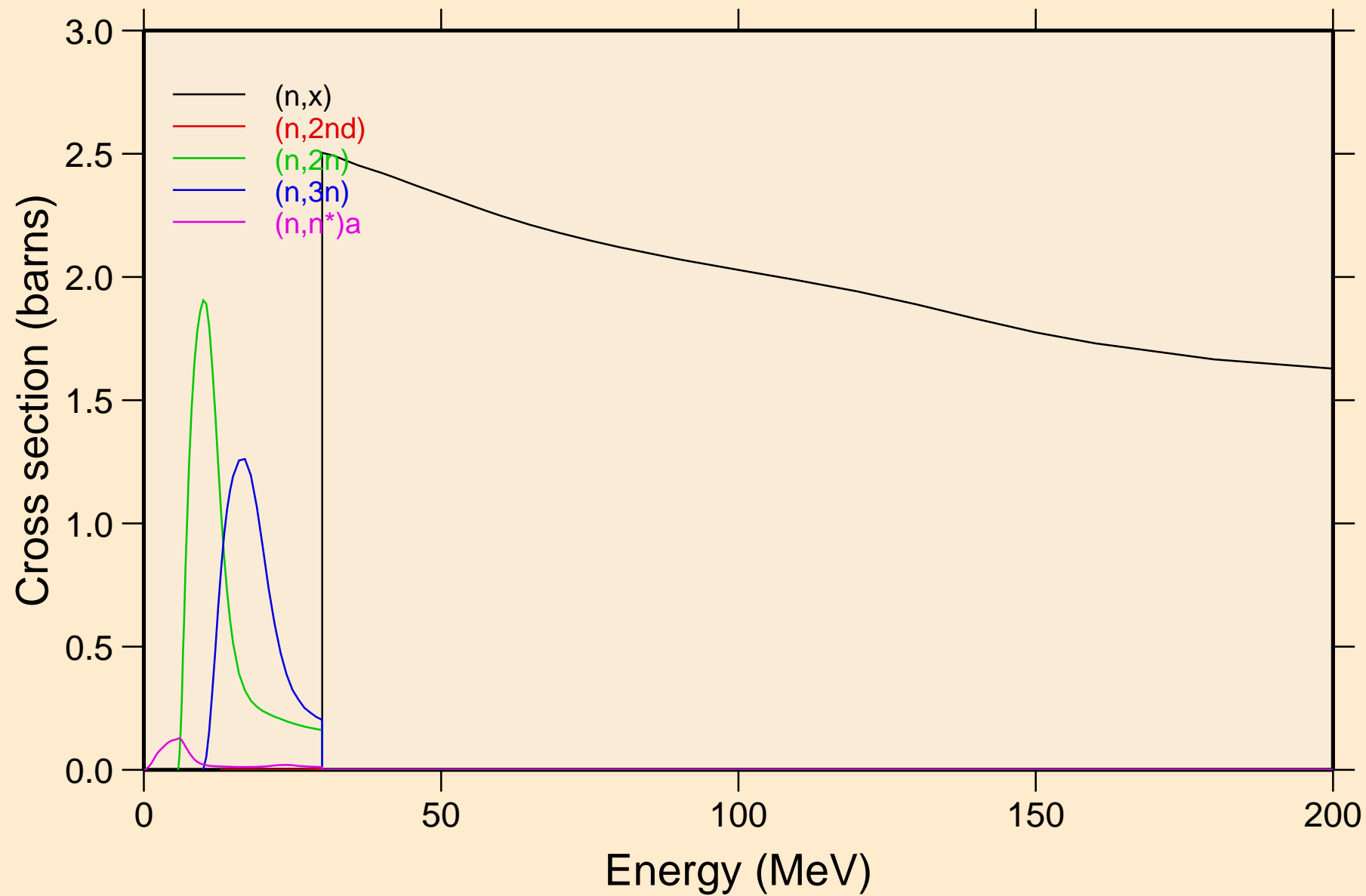

# AT221 NRG TENDL-2015, AKONING

## Threshold reactions

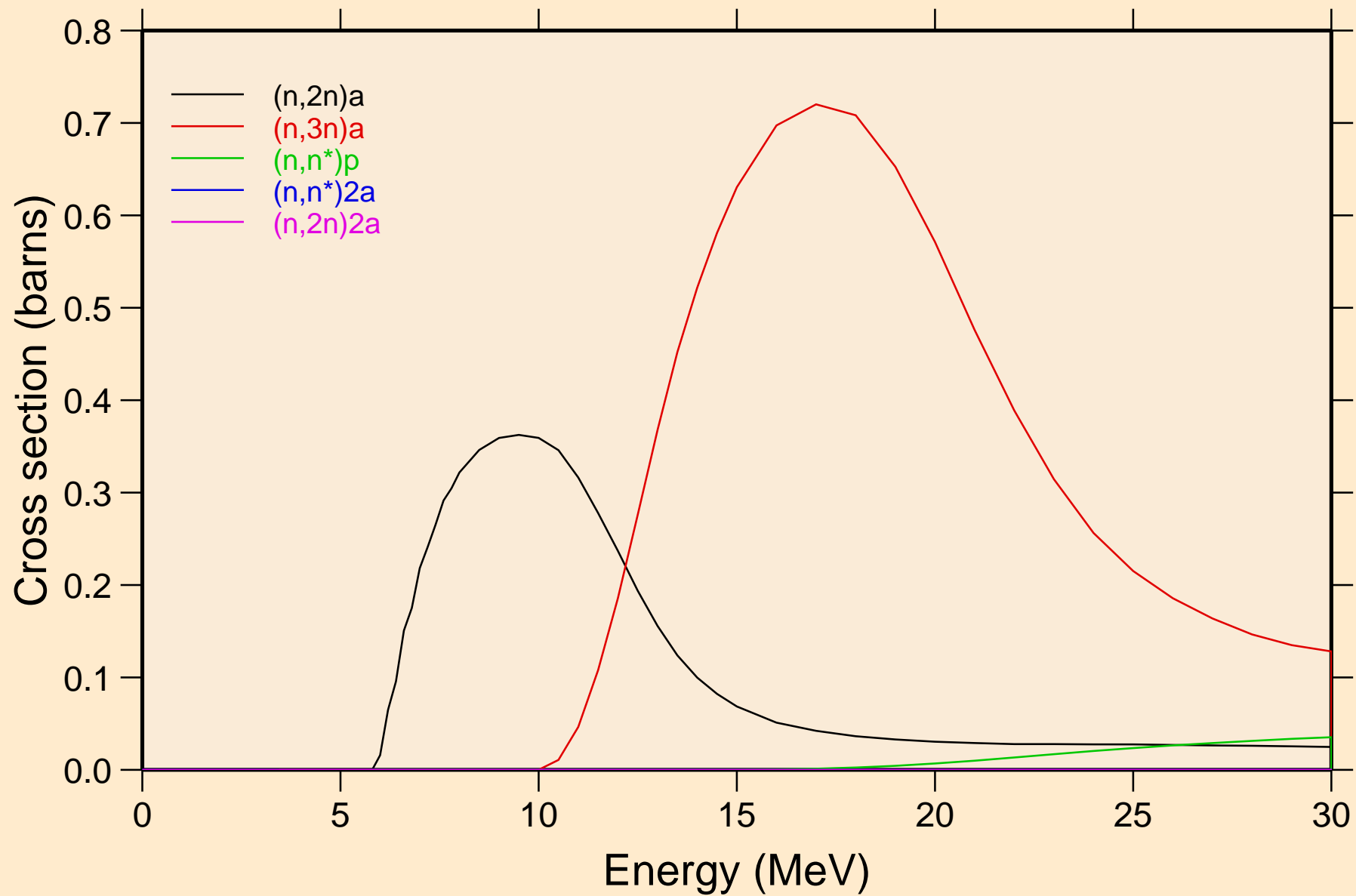

# AT221 NRG TENDL-2015, AKONING

## Threshold reactions

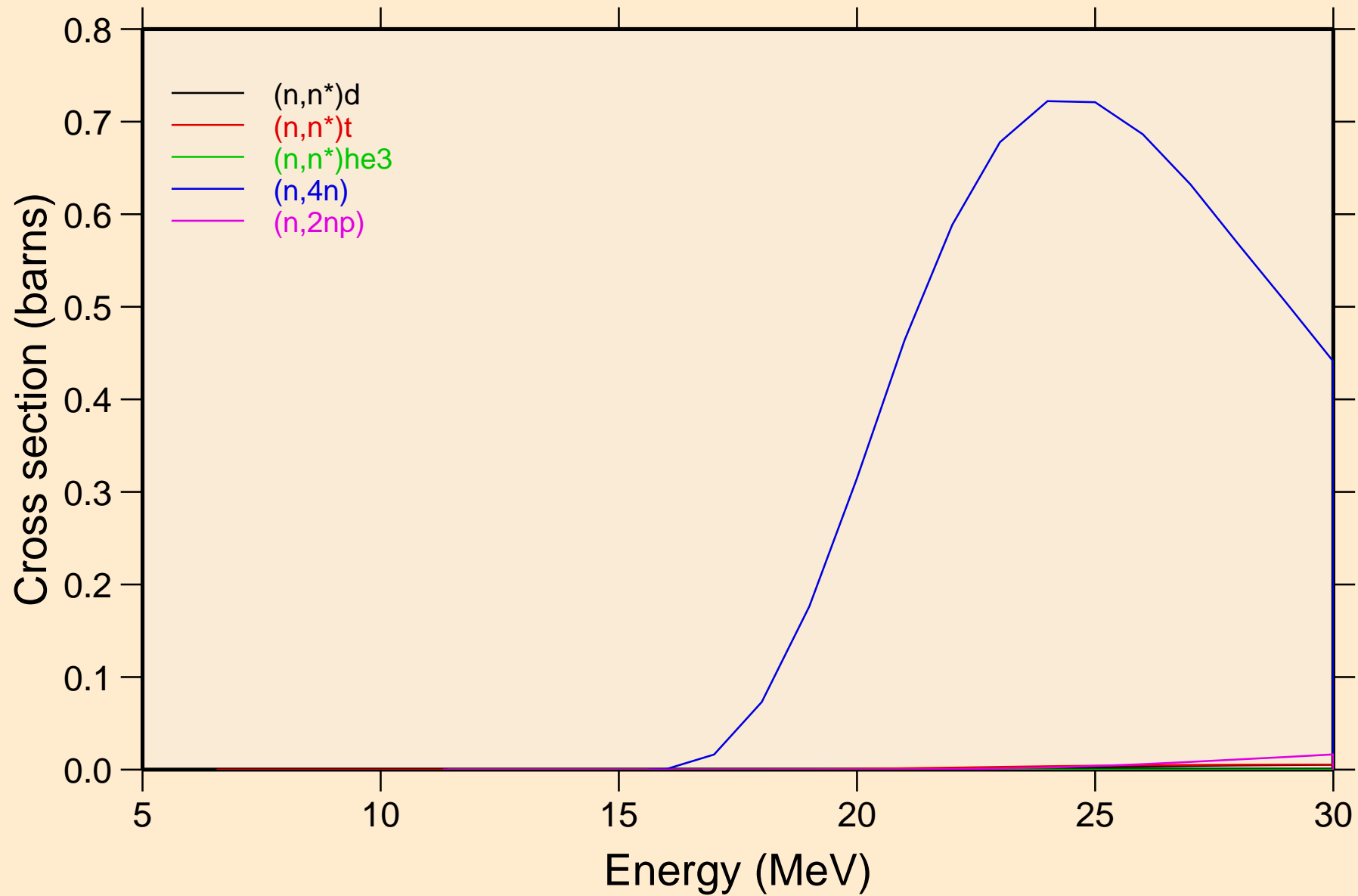



# AT221 NRG TENDL-2015, AKONING

## Threshold reactions

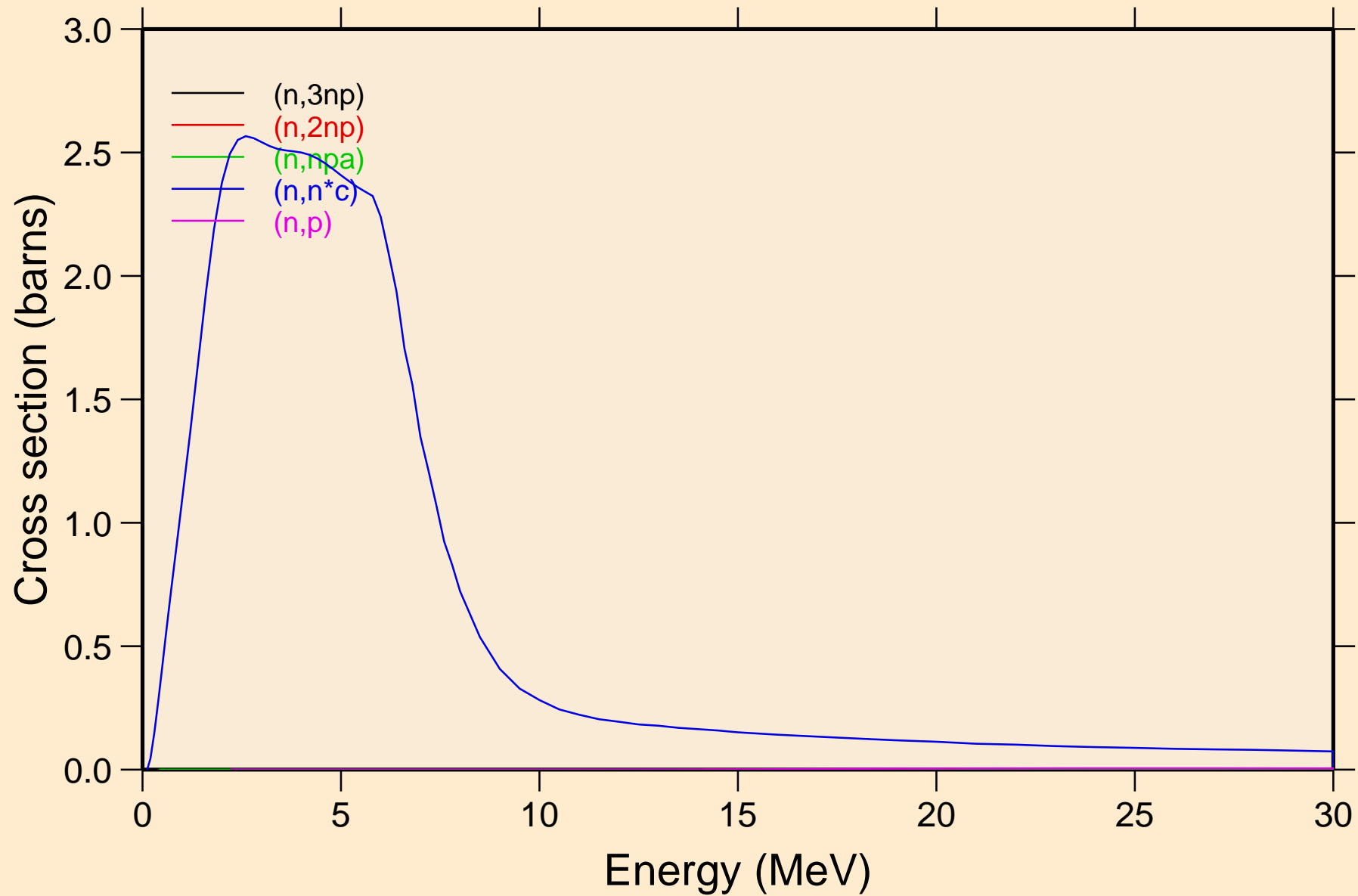

# AT221 NRG TENDL-2015, AKONING

## Threshold reactions

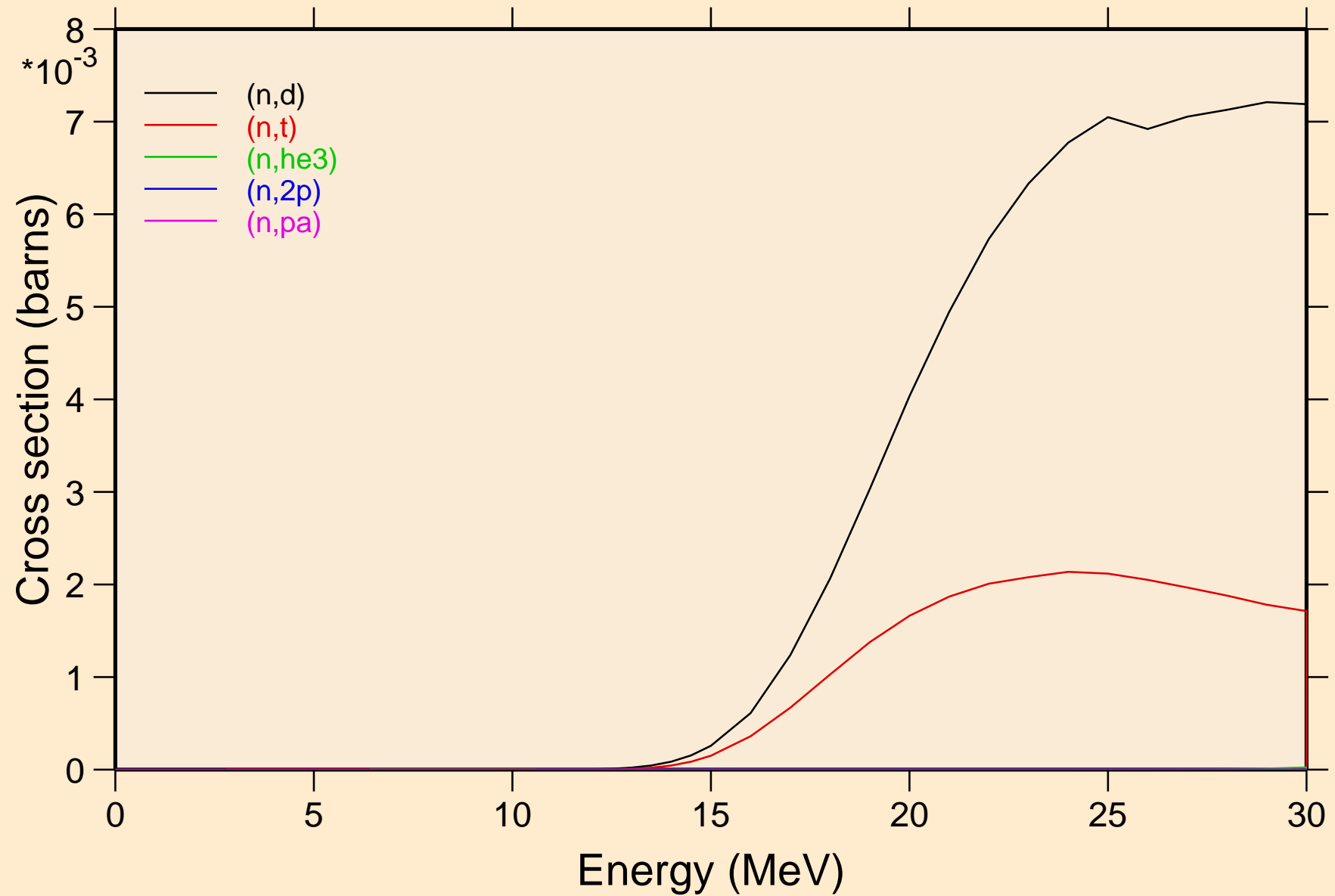

# AT221 NRG TENDL-2015, AKONING

## Threshold reactions

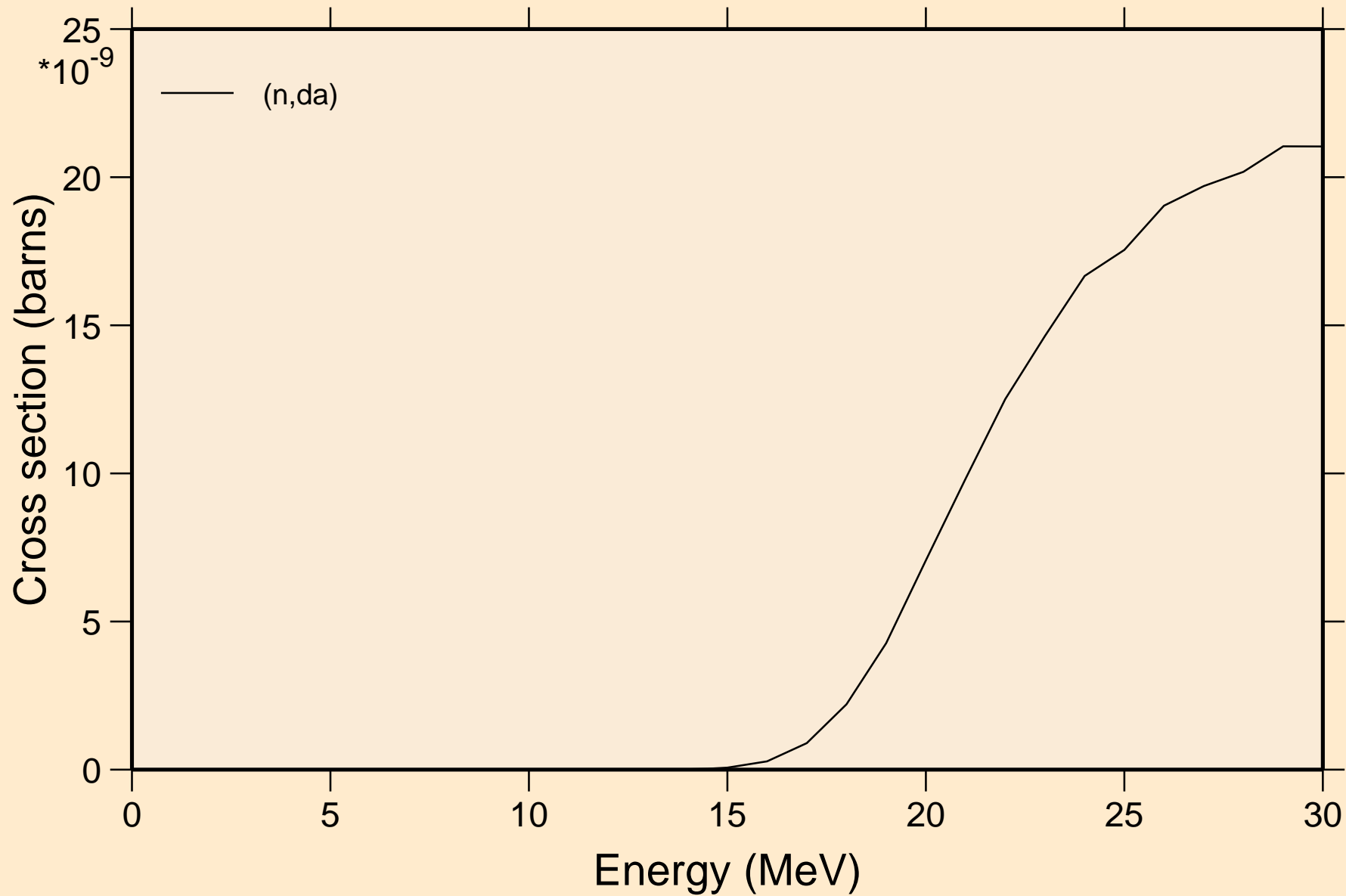

AT221 NRG TENDL-2015, AKONING  
angular distribution for elastic

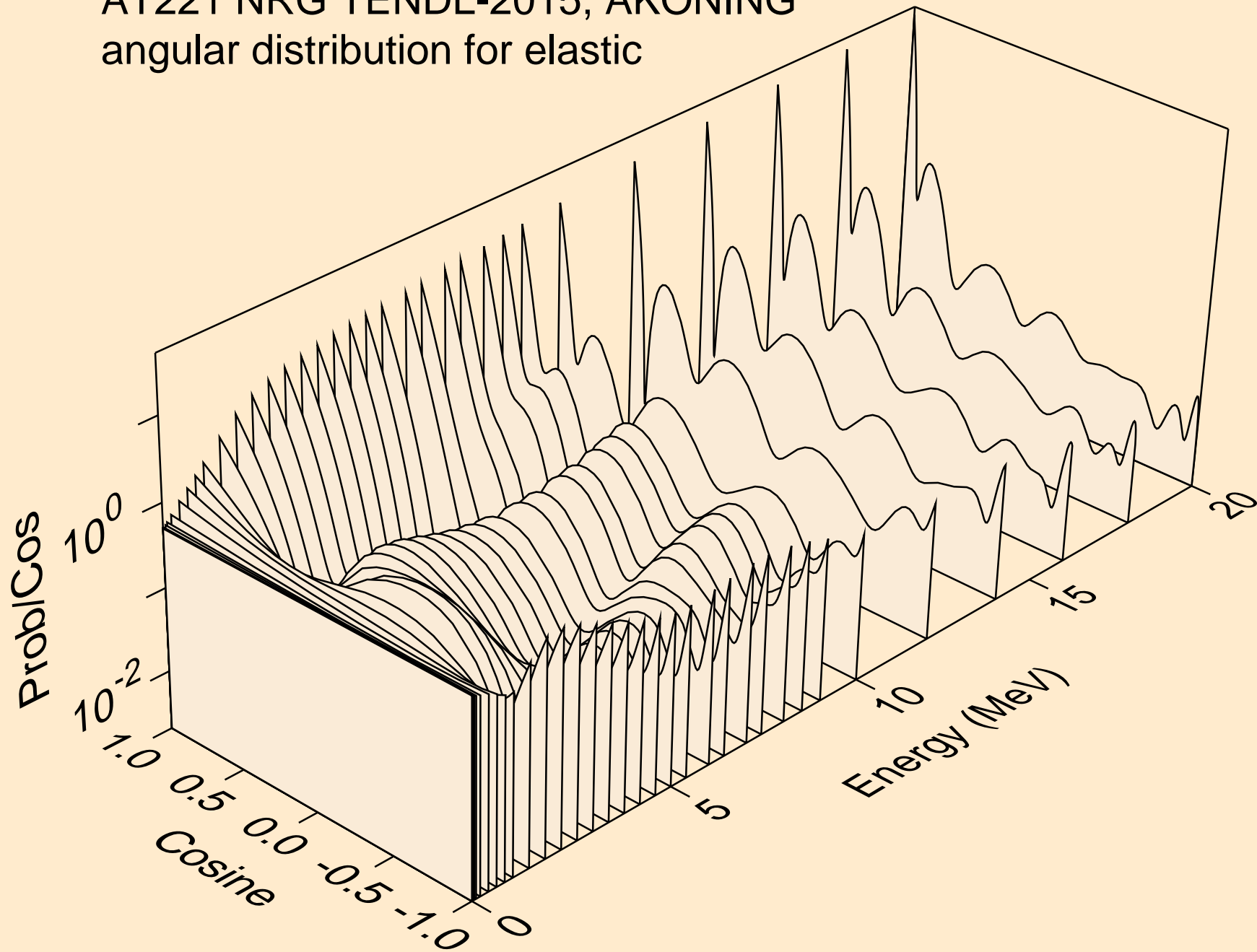

AT221 NRG TENDL-2015, AKONING  
angular distribution for elastic

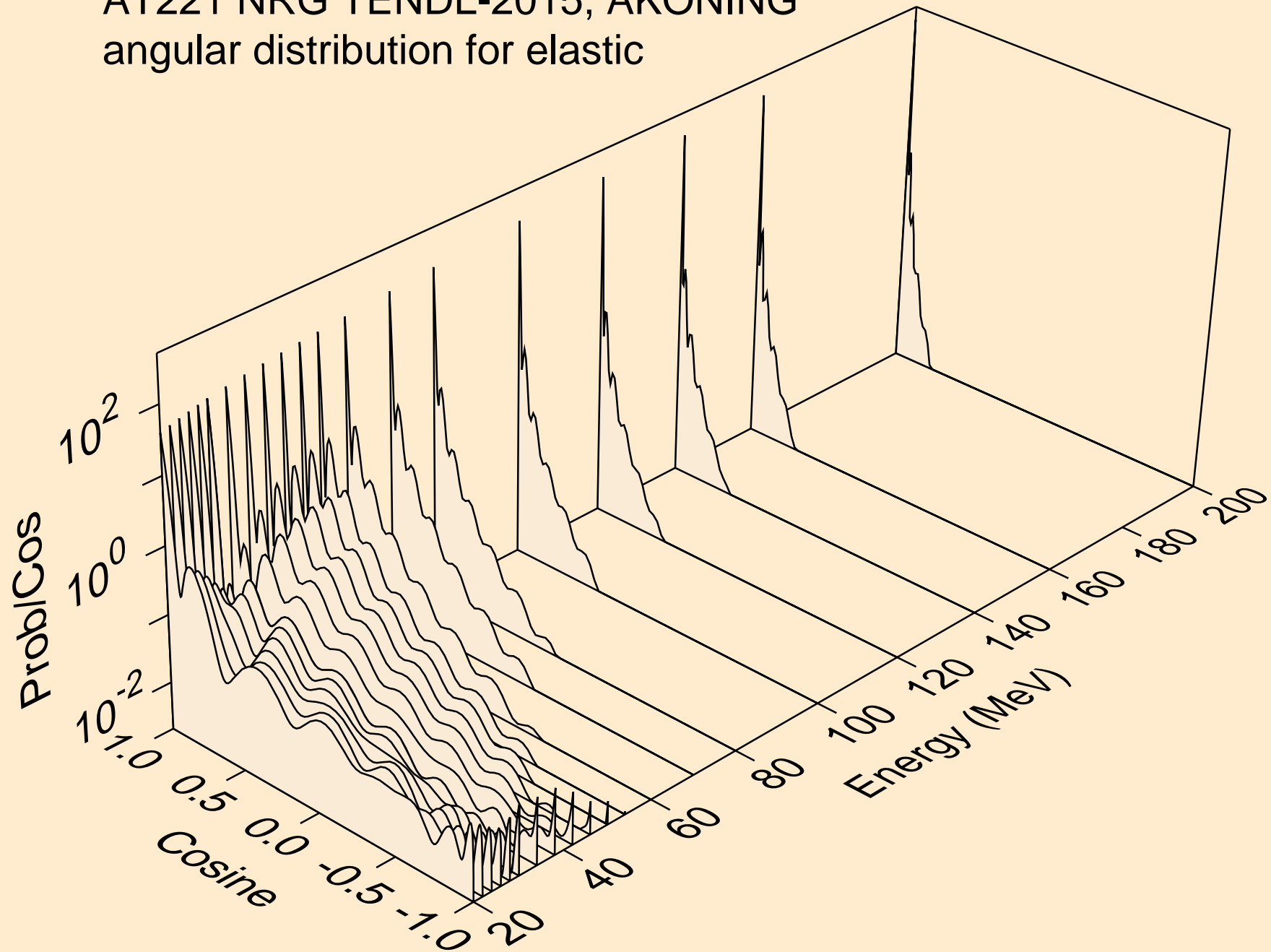

AT221 NRG TENDL-2015, AKONING  
angular distribution for (n,n\*1)

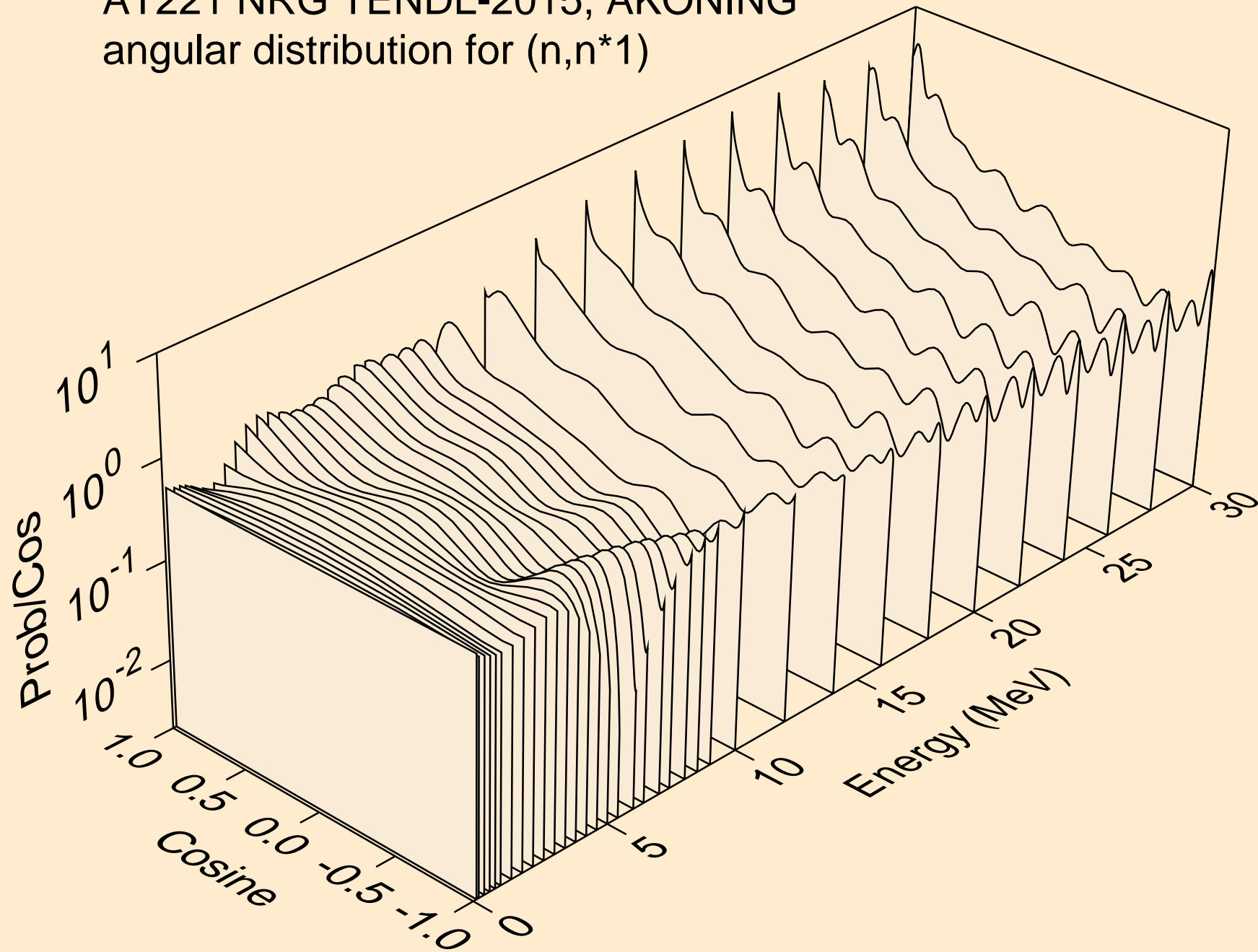

# AT221 NRG TENDL-2015, AKONING

## Total fission nubar

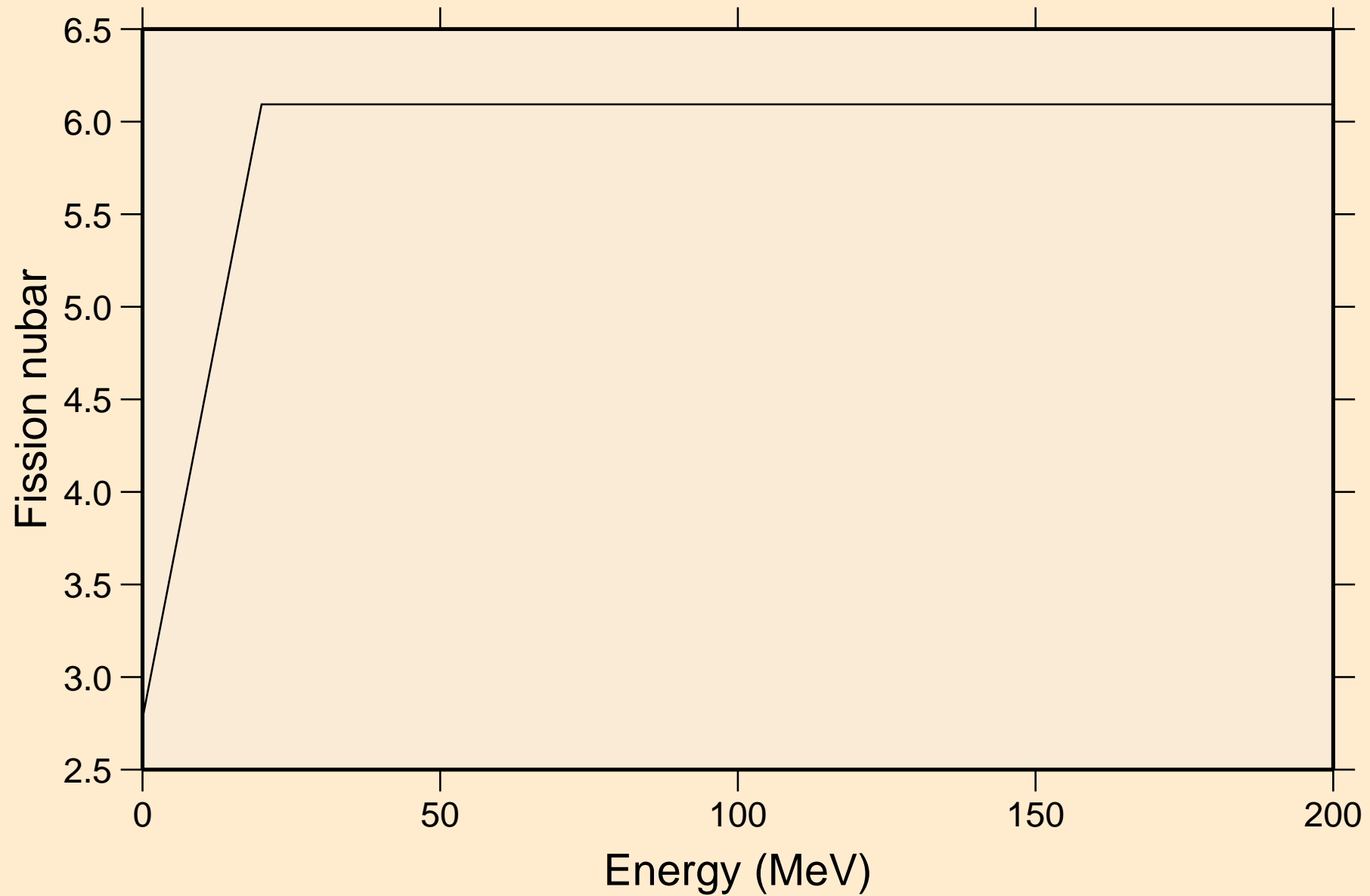

AT221 NRG TENDL-2015, AKONING  
Neutron emission for (n,x)

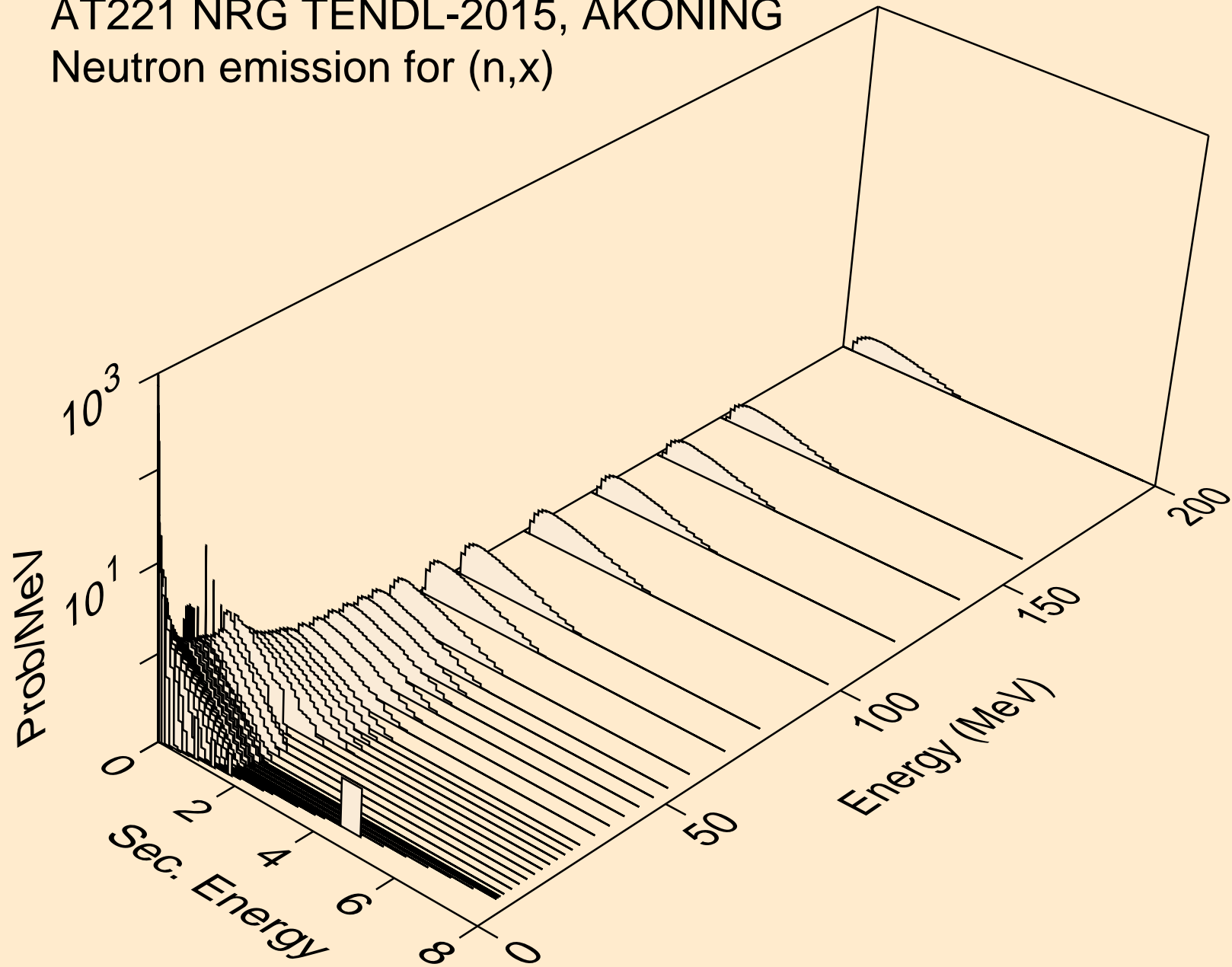



AT221 NRG TENDL-2015, AKONING  
Neutron emission for (n,2nd)

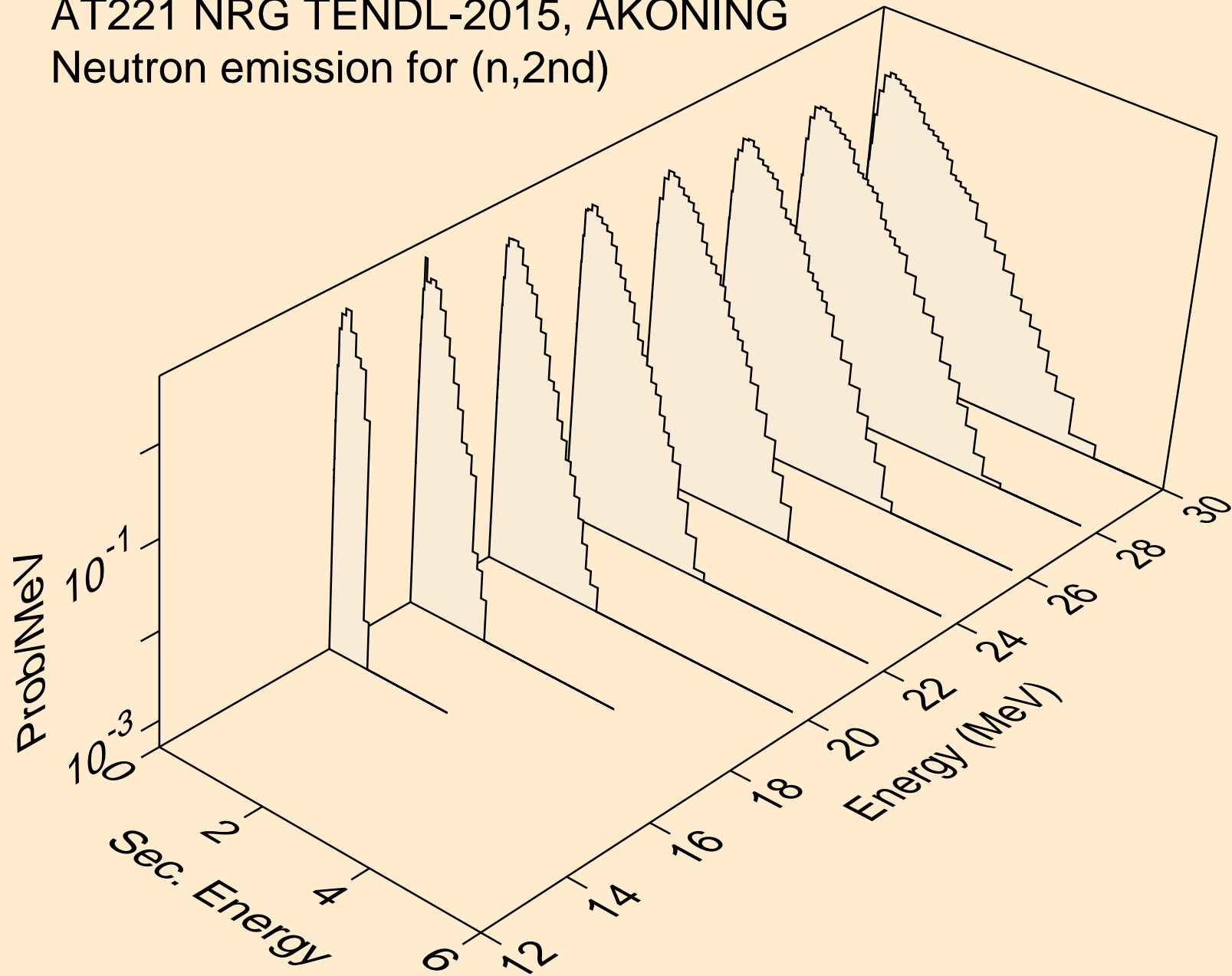

AT221 NRG TENDL-2015, AKONING  
Neutron emission for (n,2n)

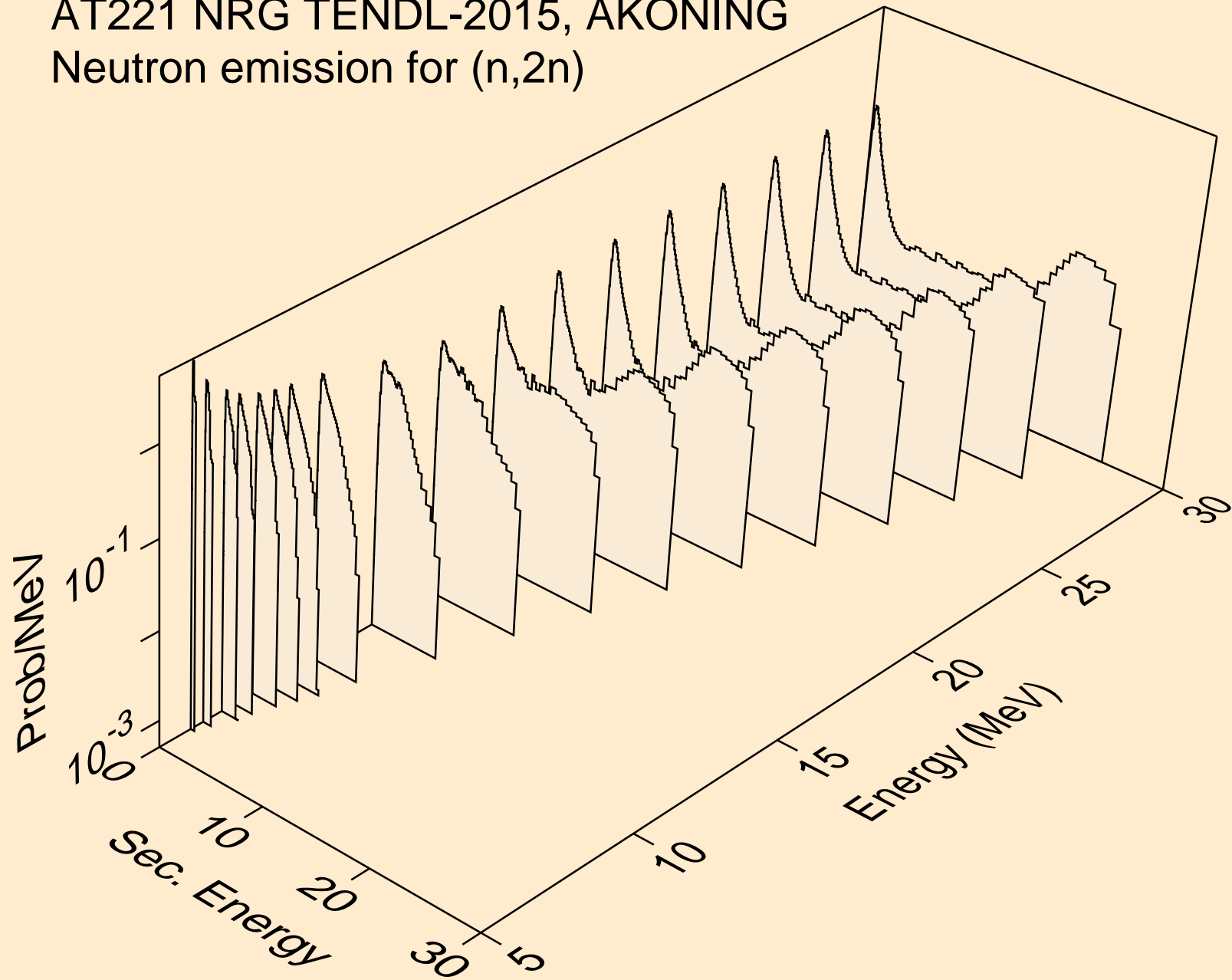

AT221 NRG TENDL-2015, AKONING  
Neutron emission for (n,3n)

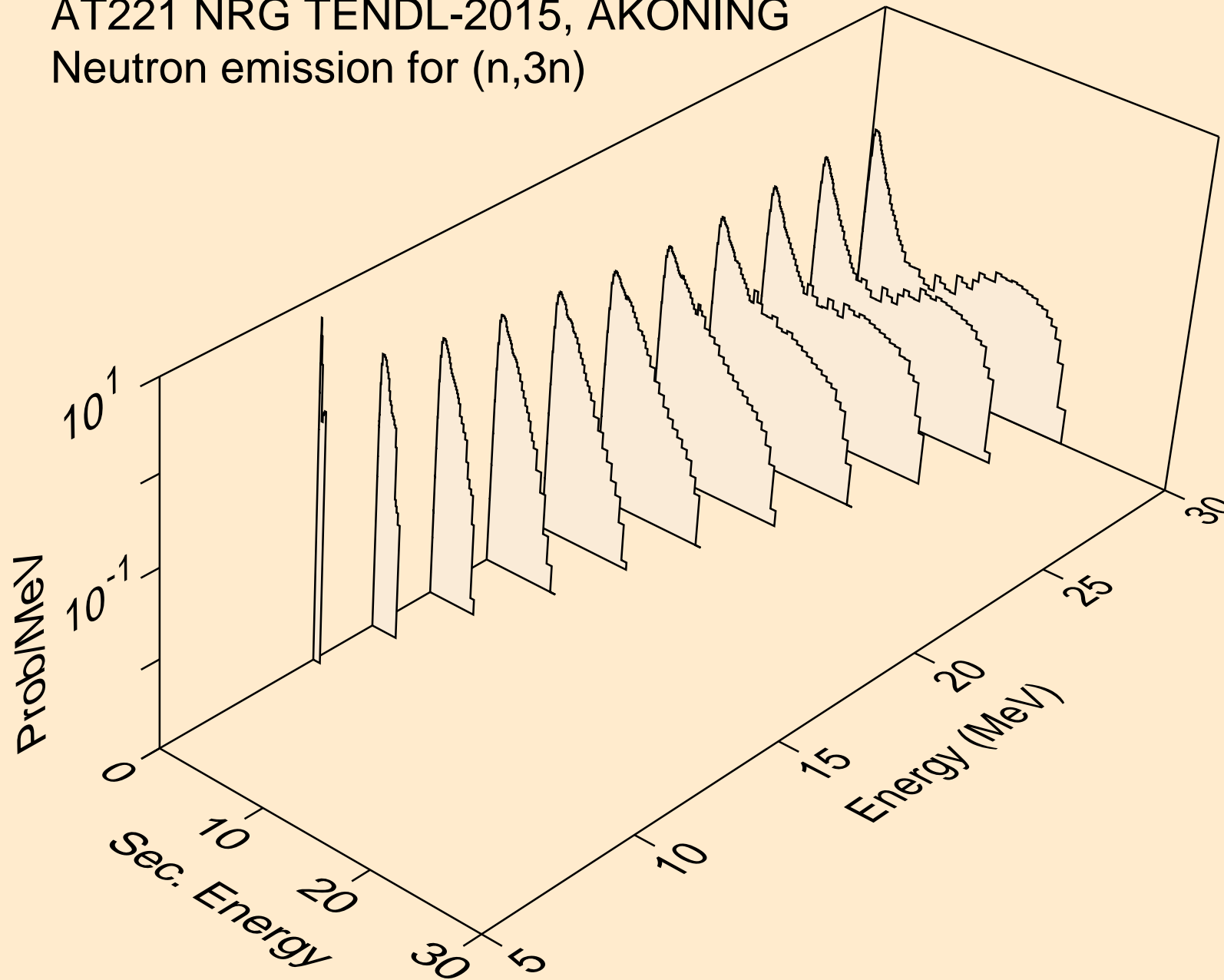

AT221 NRG TENDL-2015, AKONING  
Neutron emission for fission

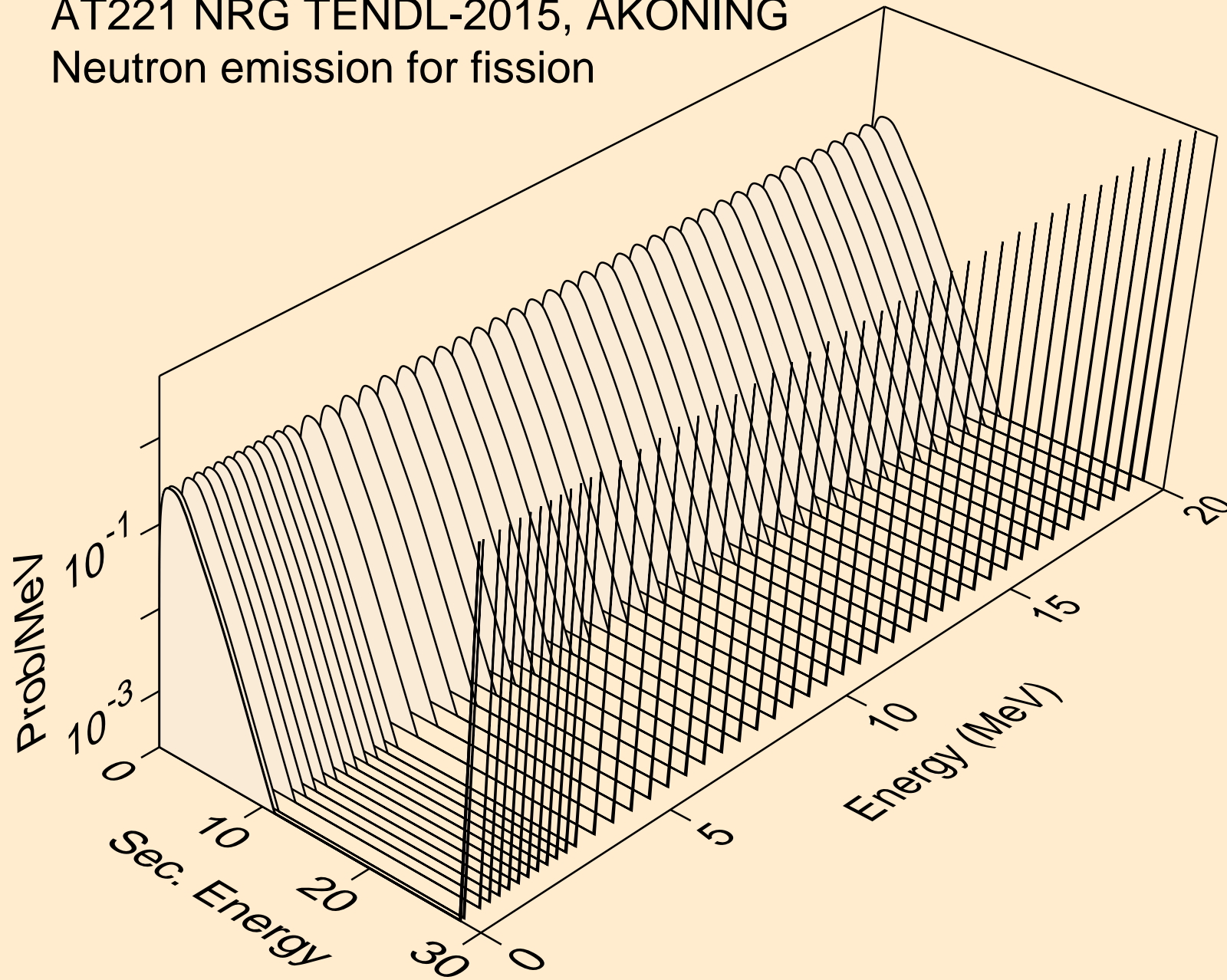

AT221 NRG TENDL-2015, AKONING  
Neutron emission for (n,n\*)a

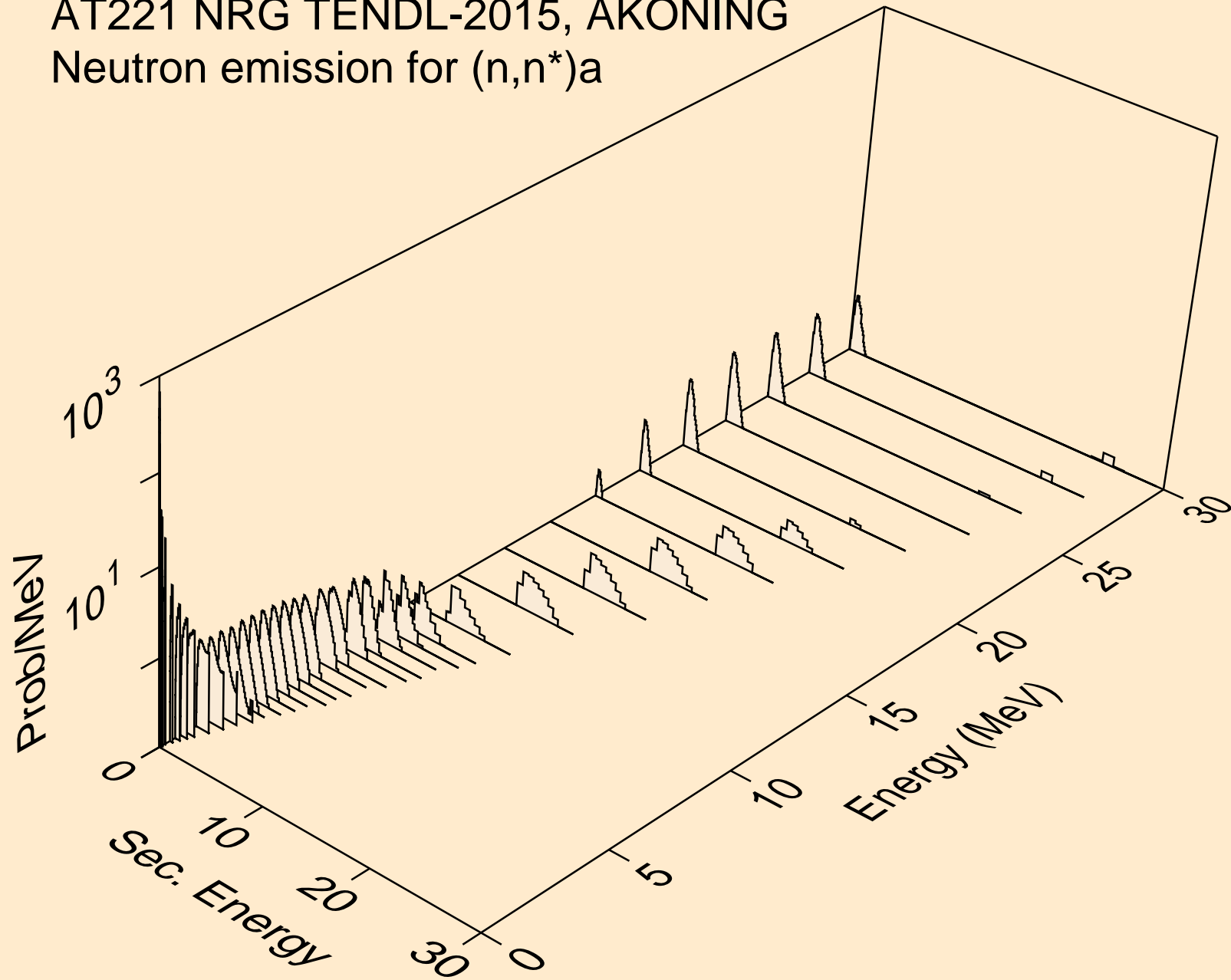

AT221 NRG TENDL-2015, AKONING  
Neutron emission for (n,2n)a

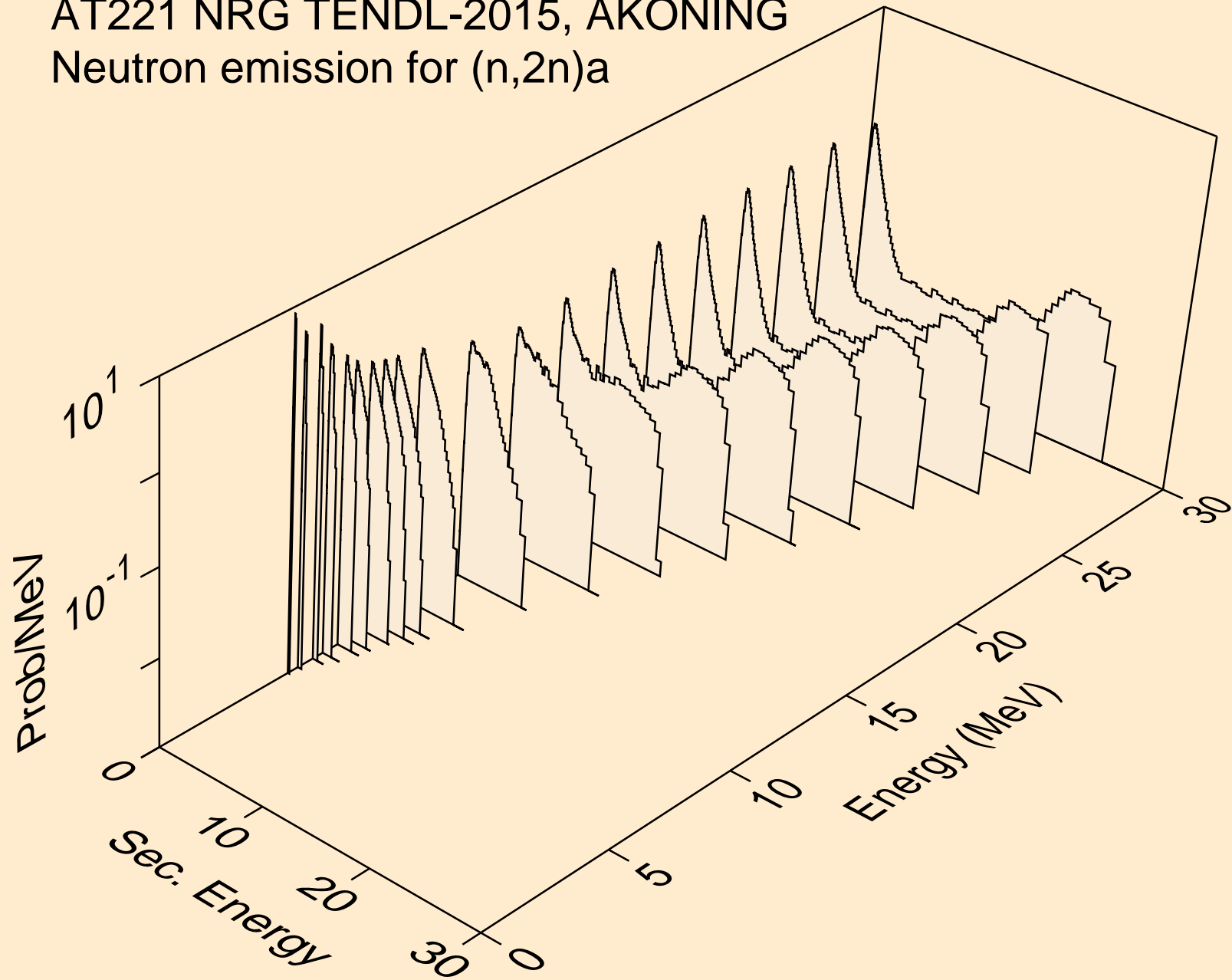

AT221 NRG TENDL-2015, AKONING  
Neutron emission for (n,3n)a

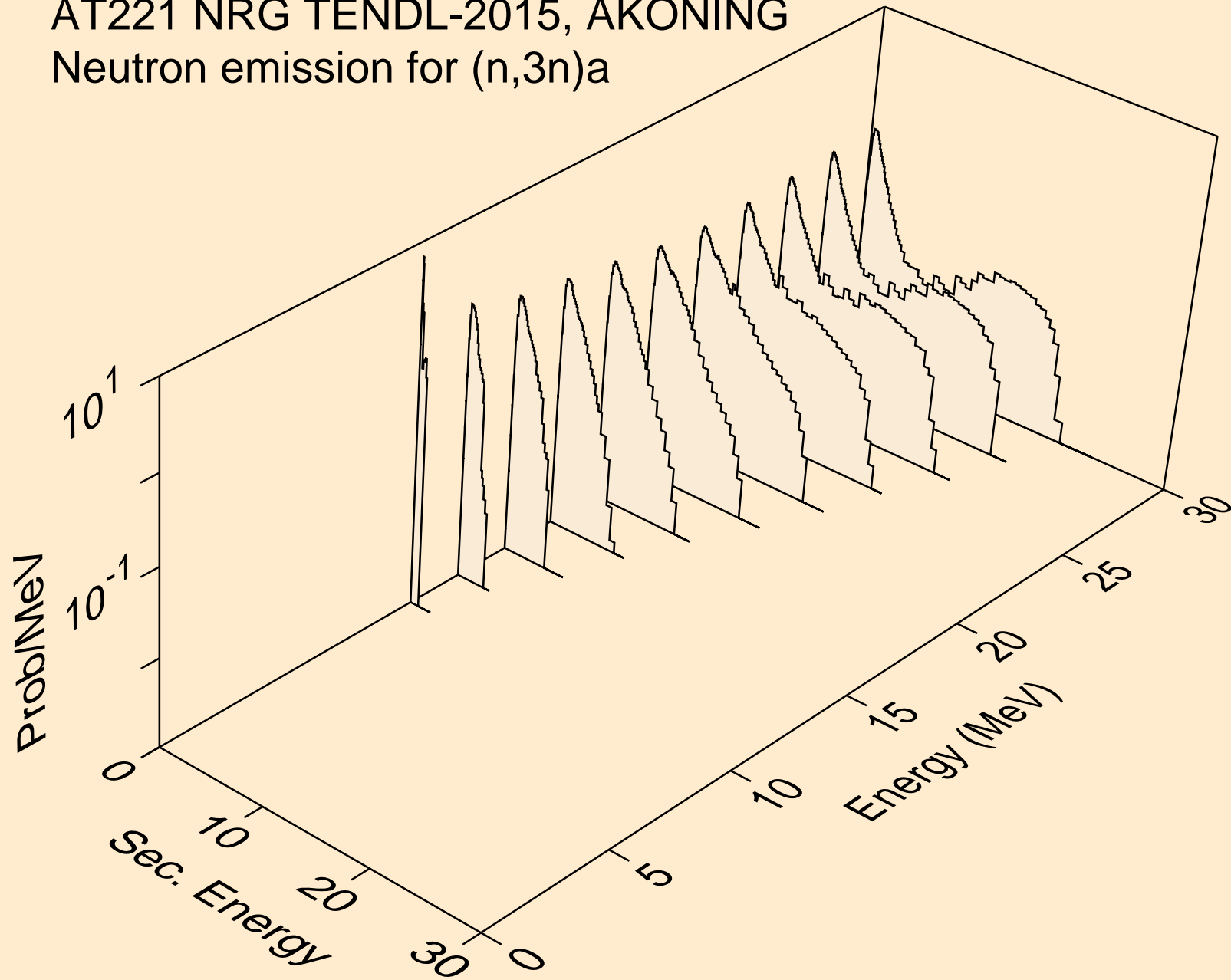

AT221 NRG TENDL-2015, AKONING  
Neutron emission for (n,n\*)p

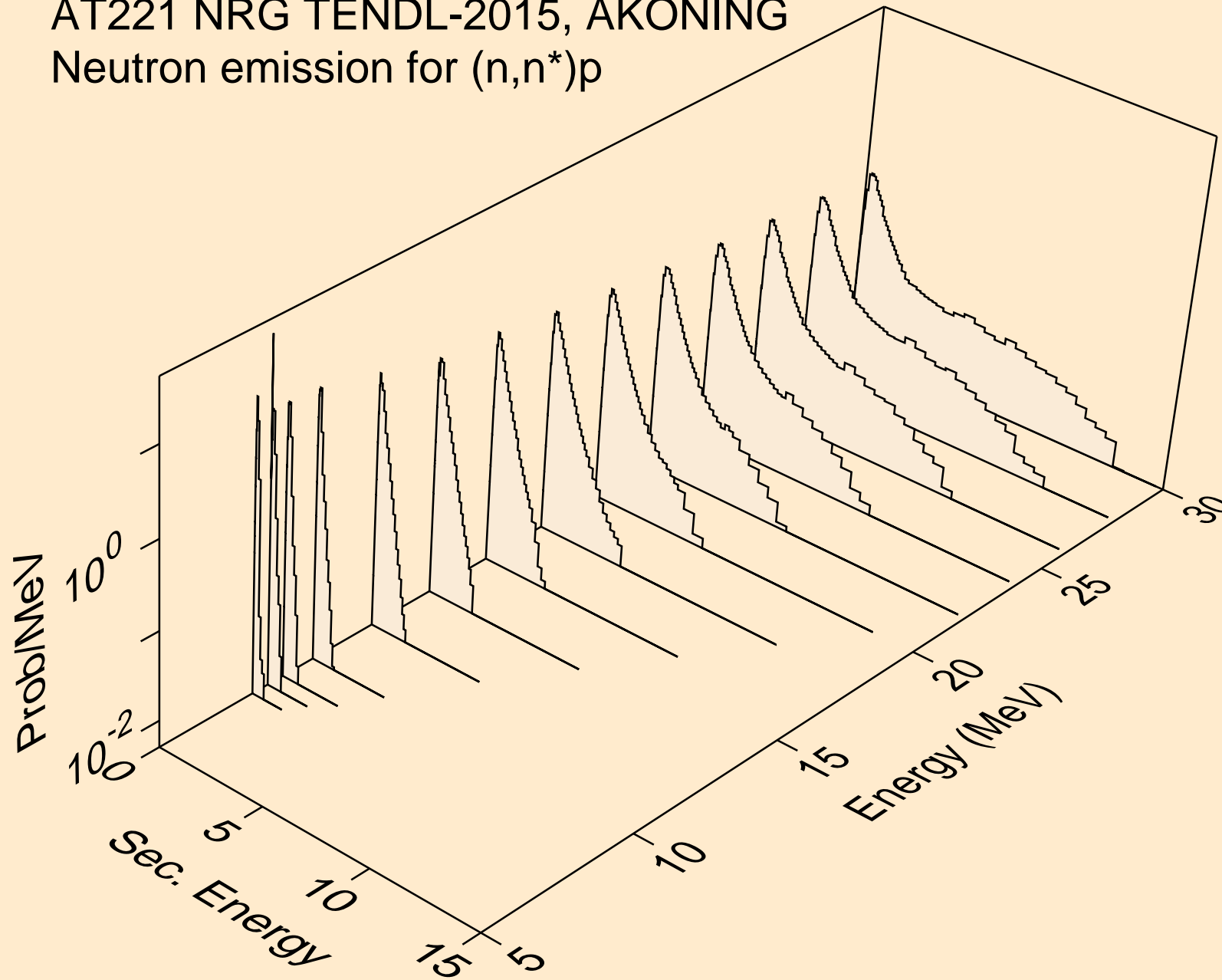



AT221 NRG TENDL-2015, AKONING  
Neutron emission for (n,n\*)2a

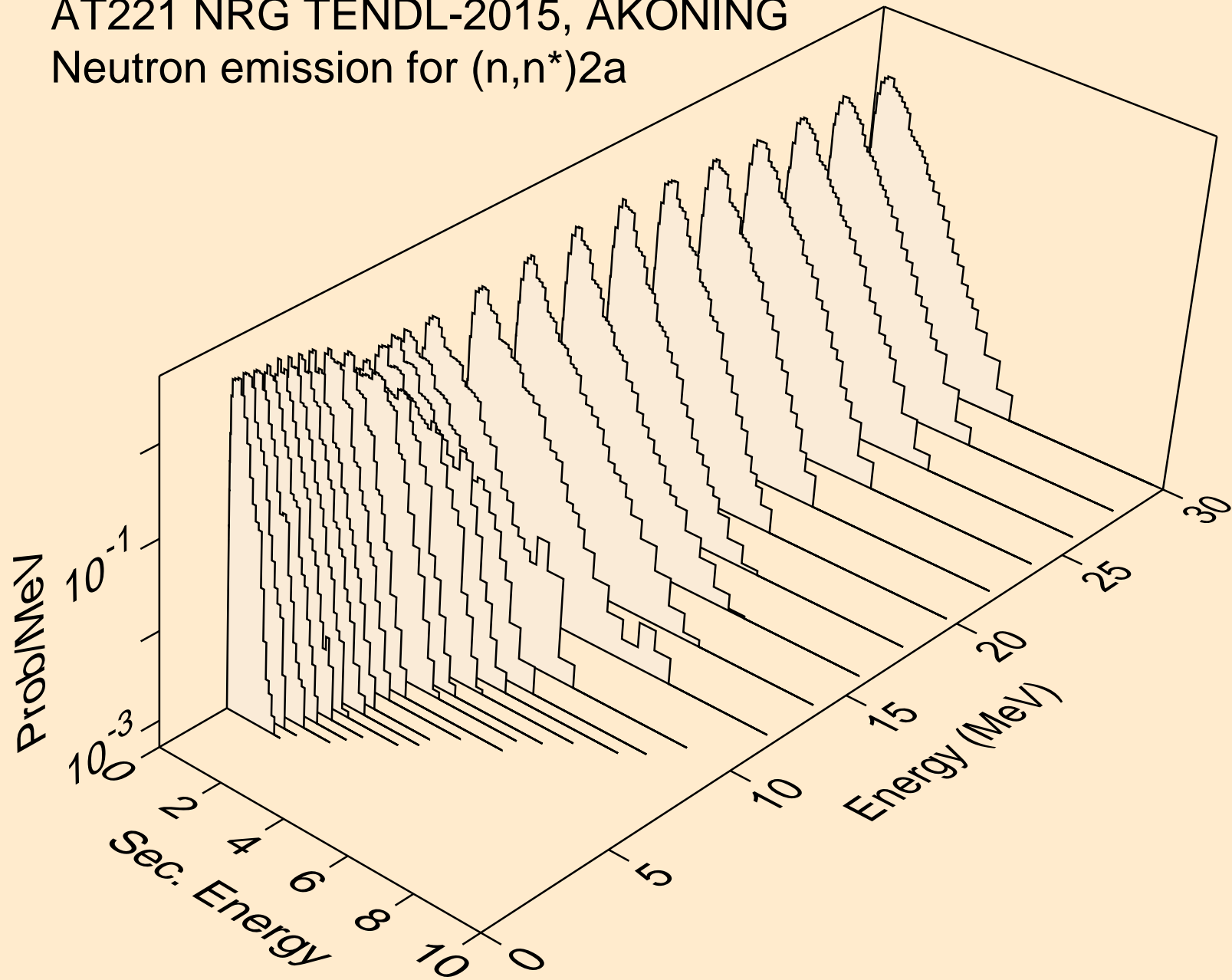

AT221 NRG TENDL-2015, AKONING  
Neutron emission for (n,2n)2a

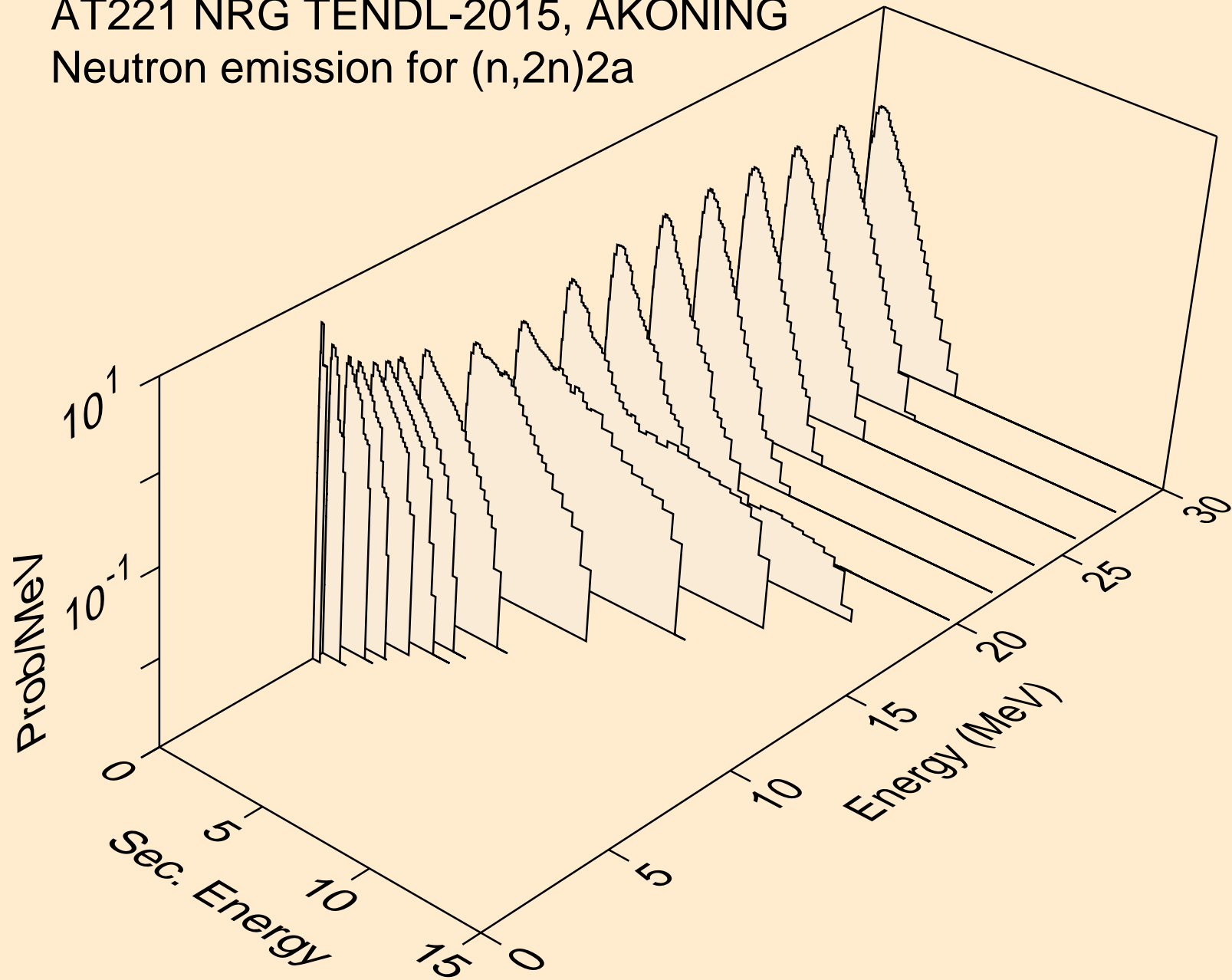

AT221 NRG TENDL-2015, AKONING  
Neutron emission for (n,n\*)d

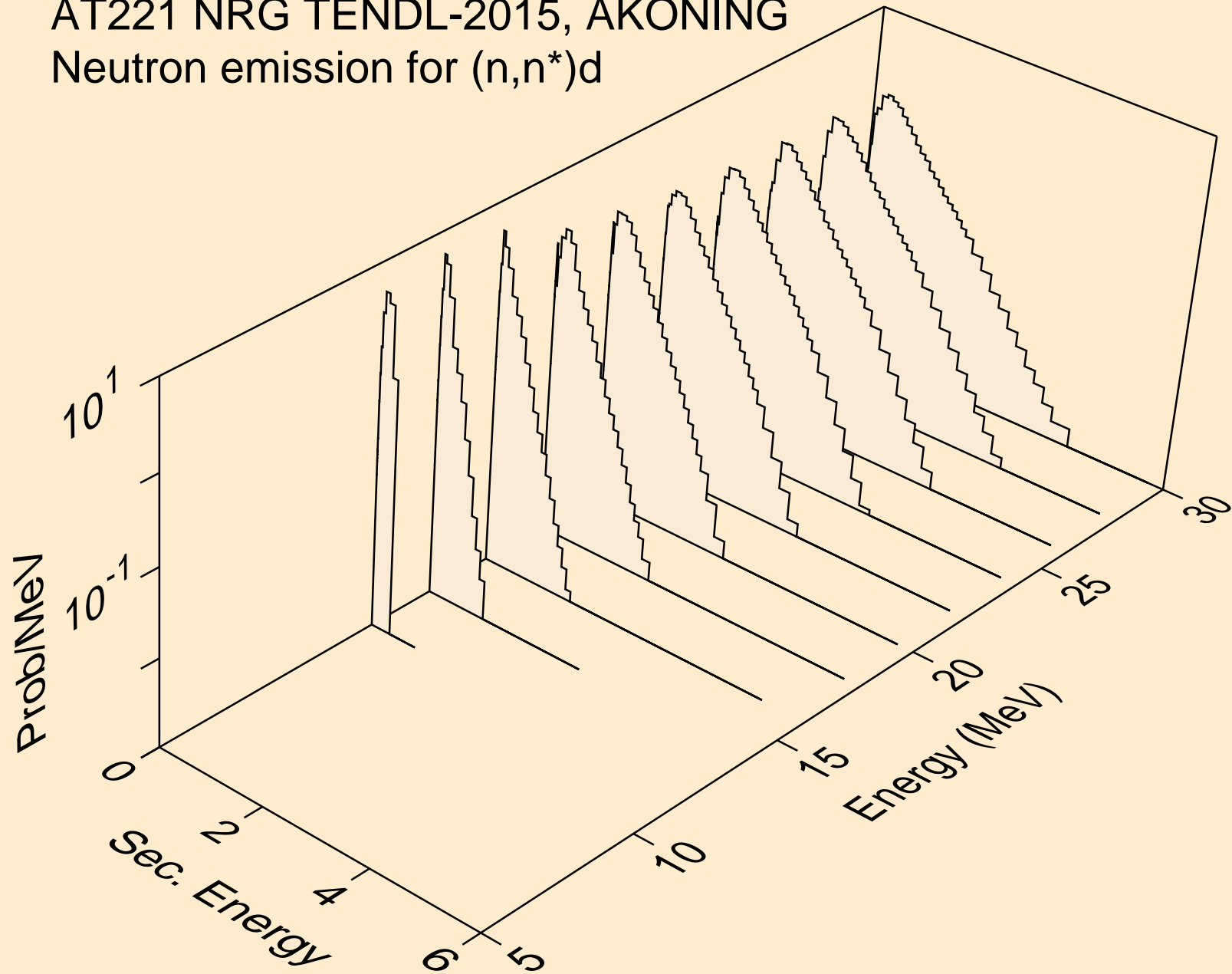

AT221 NRG TENDL-2015, AKONING  
Neutron emission for (n,n\*)t

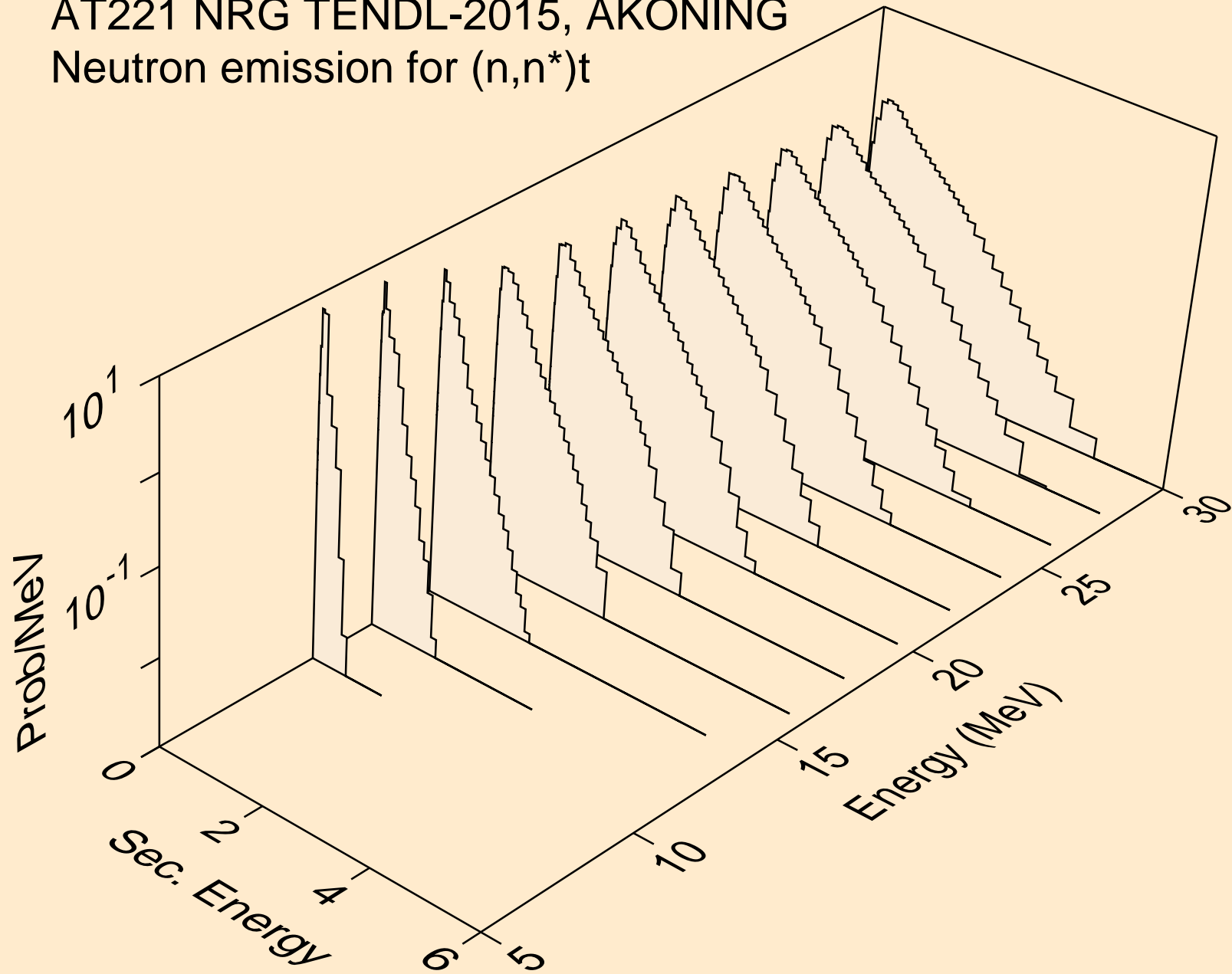

AT221 NRG TENDL-2015, AKONING  
Neutron emission for (n,n\*)he3

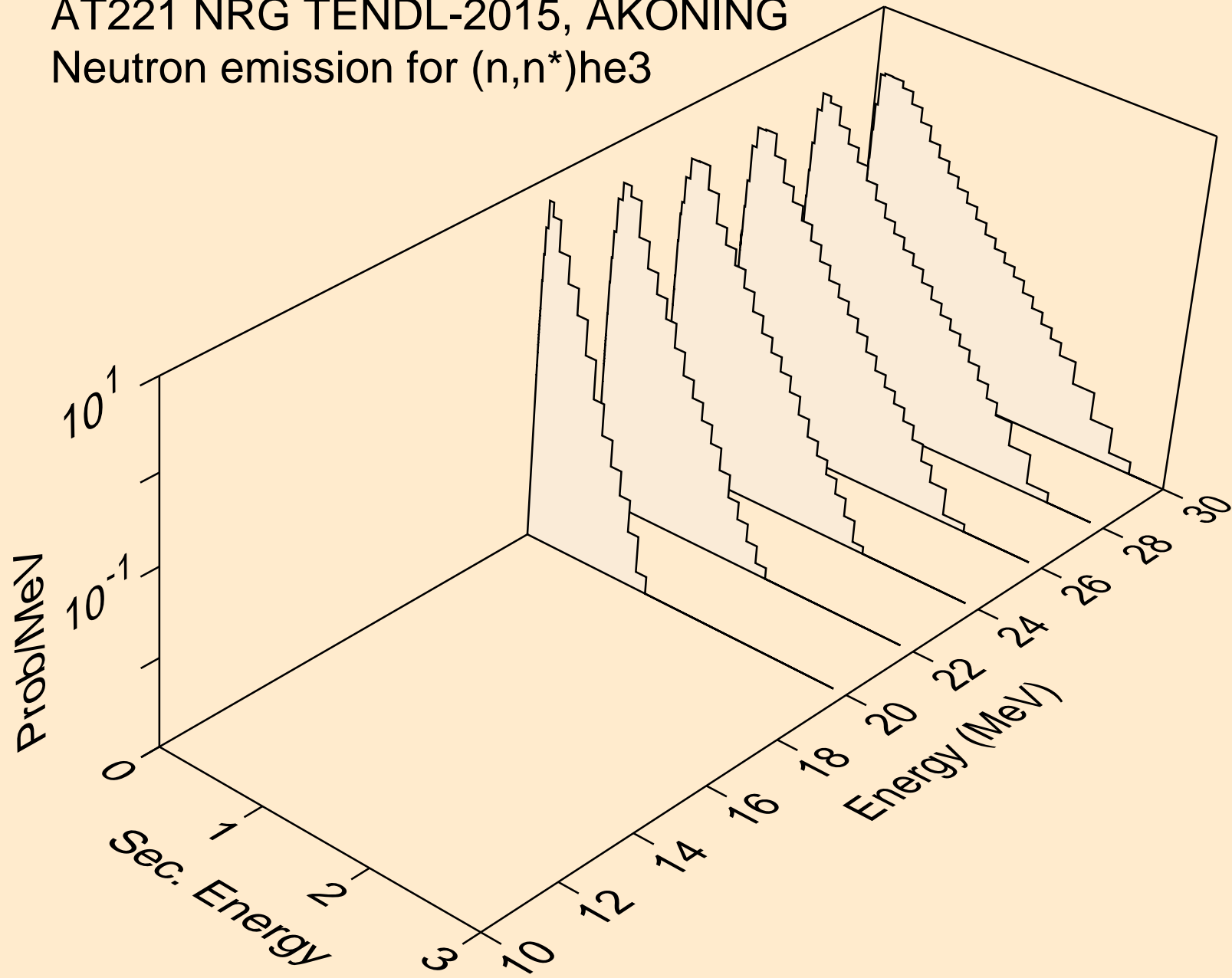

AT221 NRG TENDL-2015, AKONING  
Neutron emission for (n,4n)

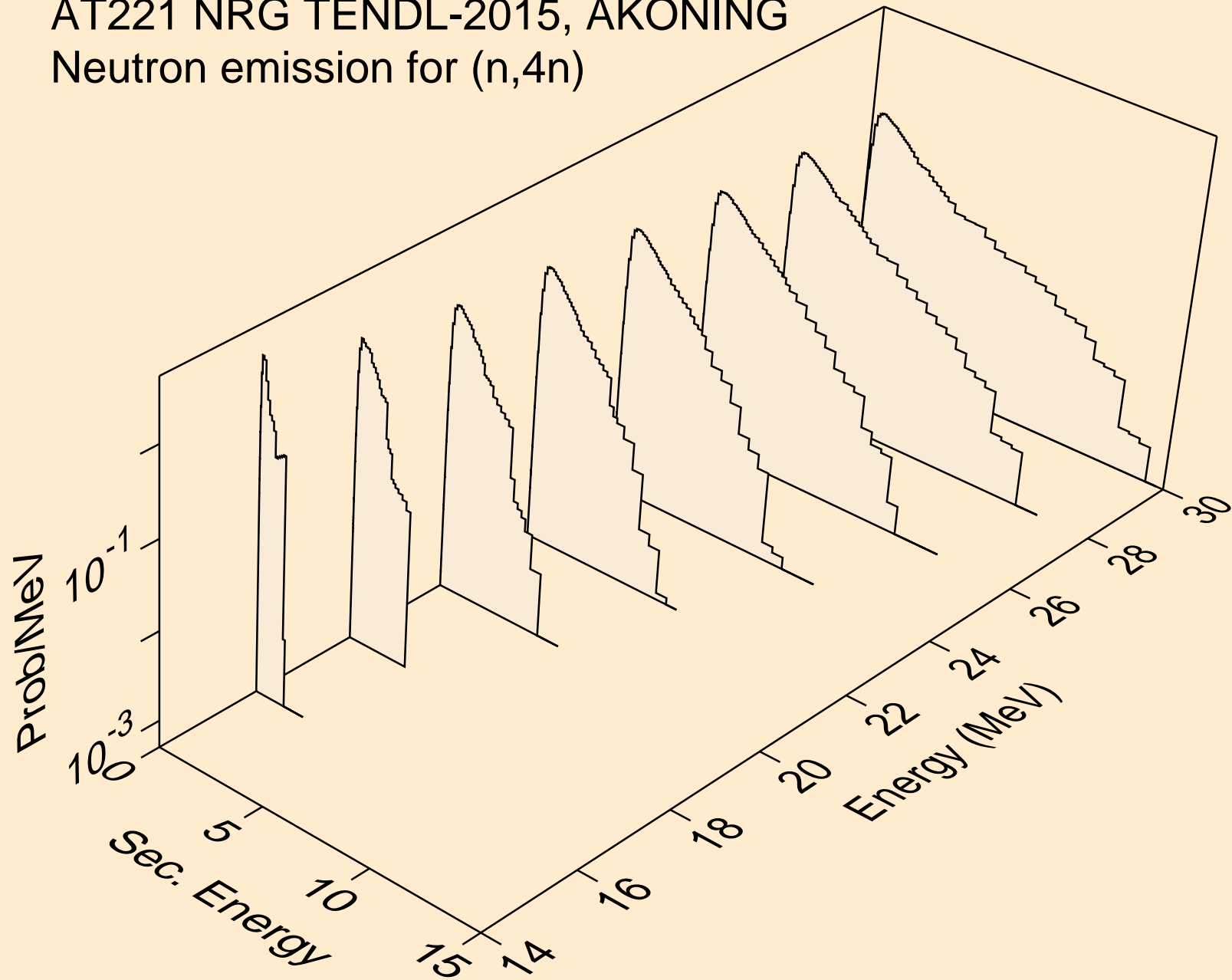

AT221 NRG TENDL-2015, AKONING  
Neutron emission for (n,2np)

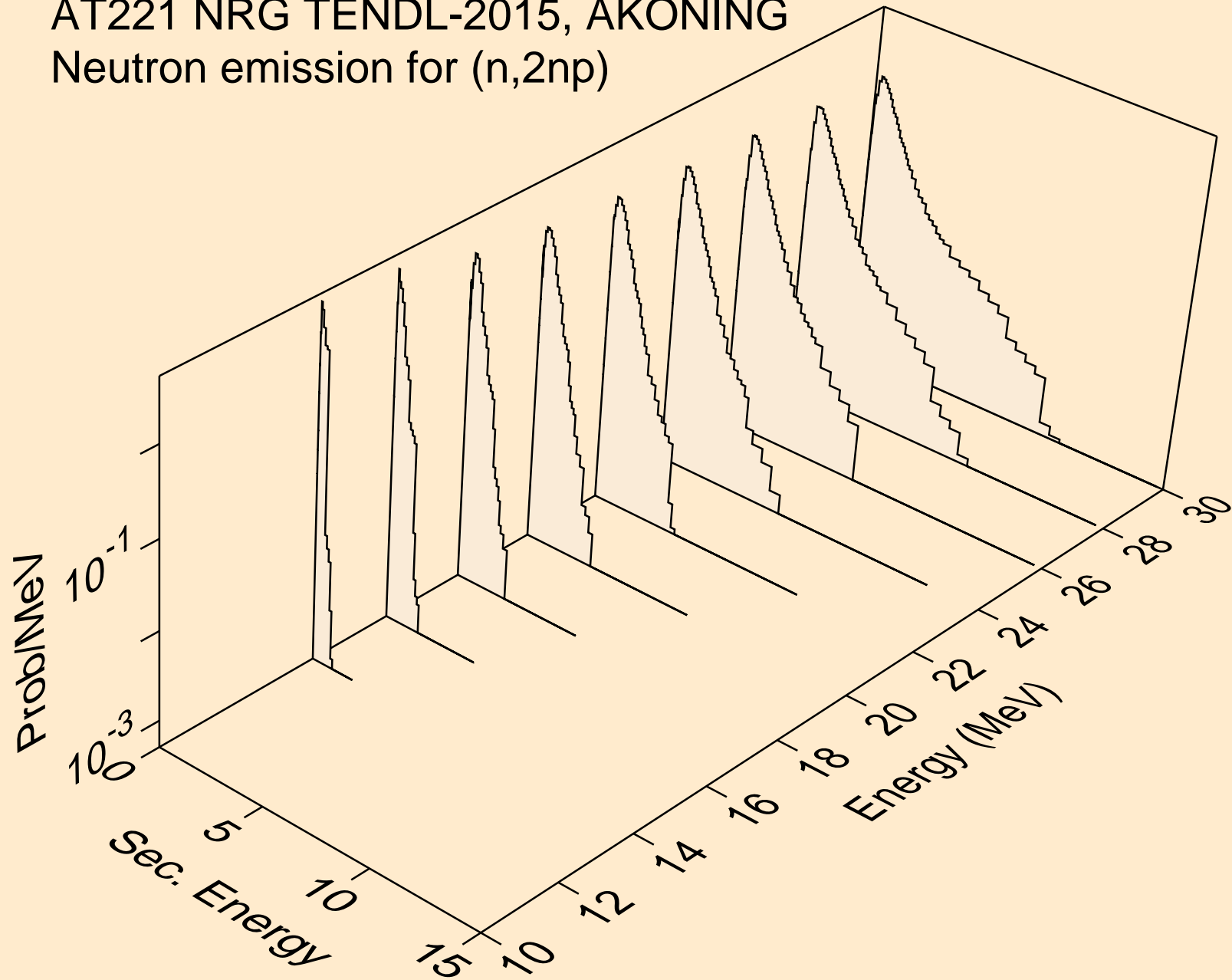

AT221 NRG TENDL-2015, AKONING  
Neutron emission for (n,3np)

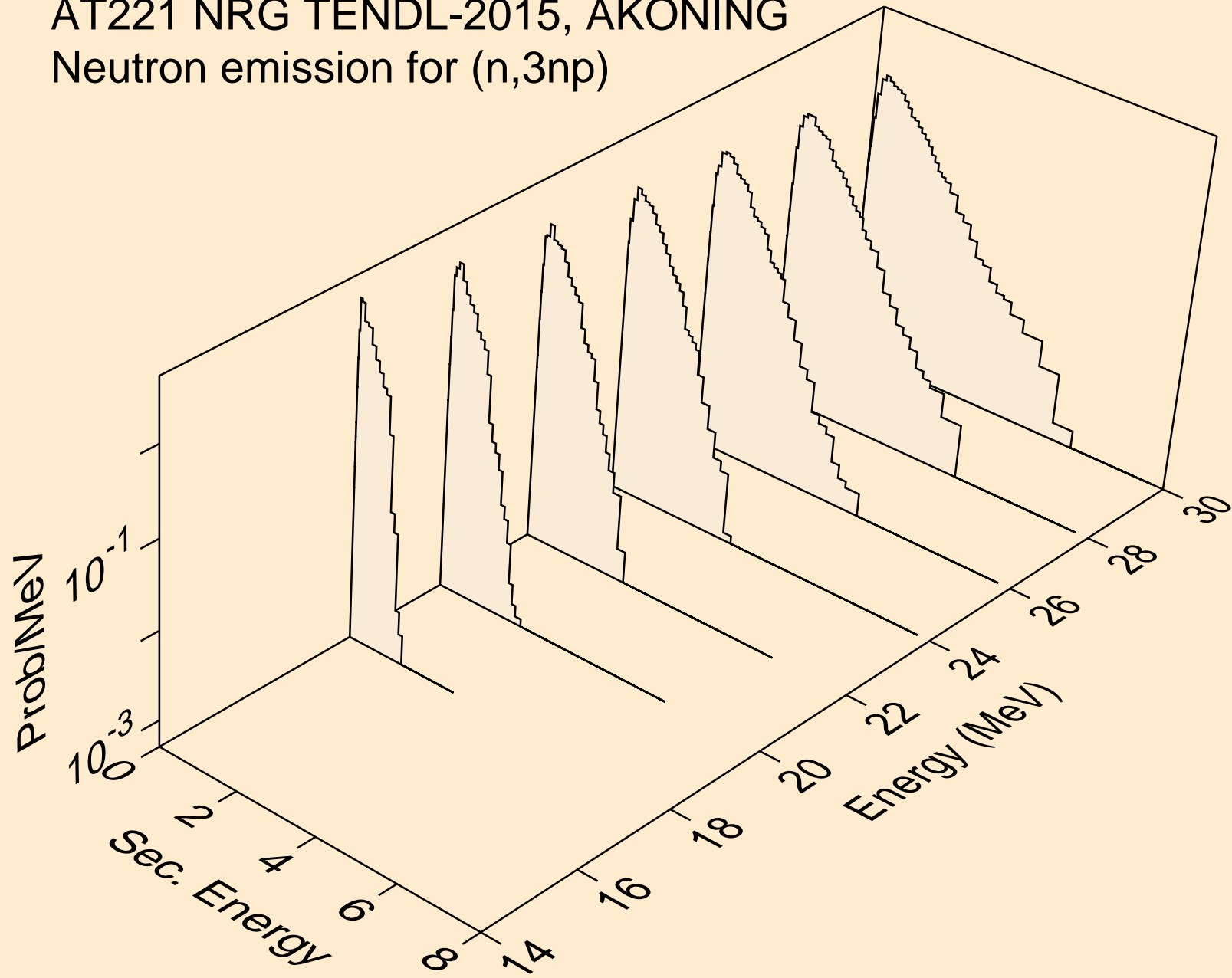



AT221 NRG TENDL-2015, AKONING  
Neutron emission for (n,2np)

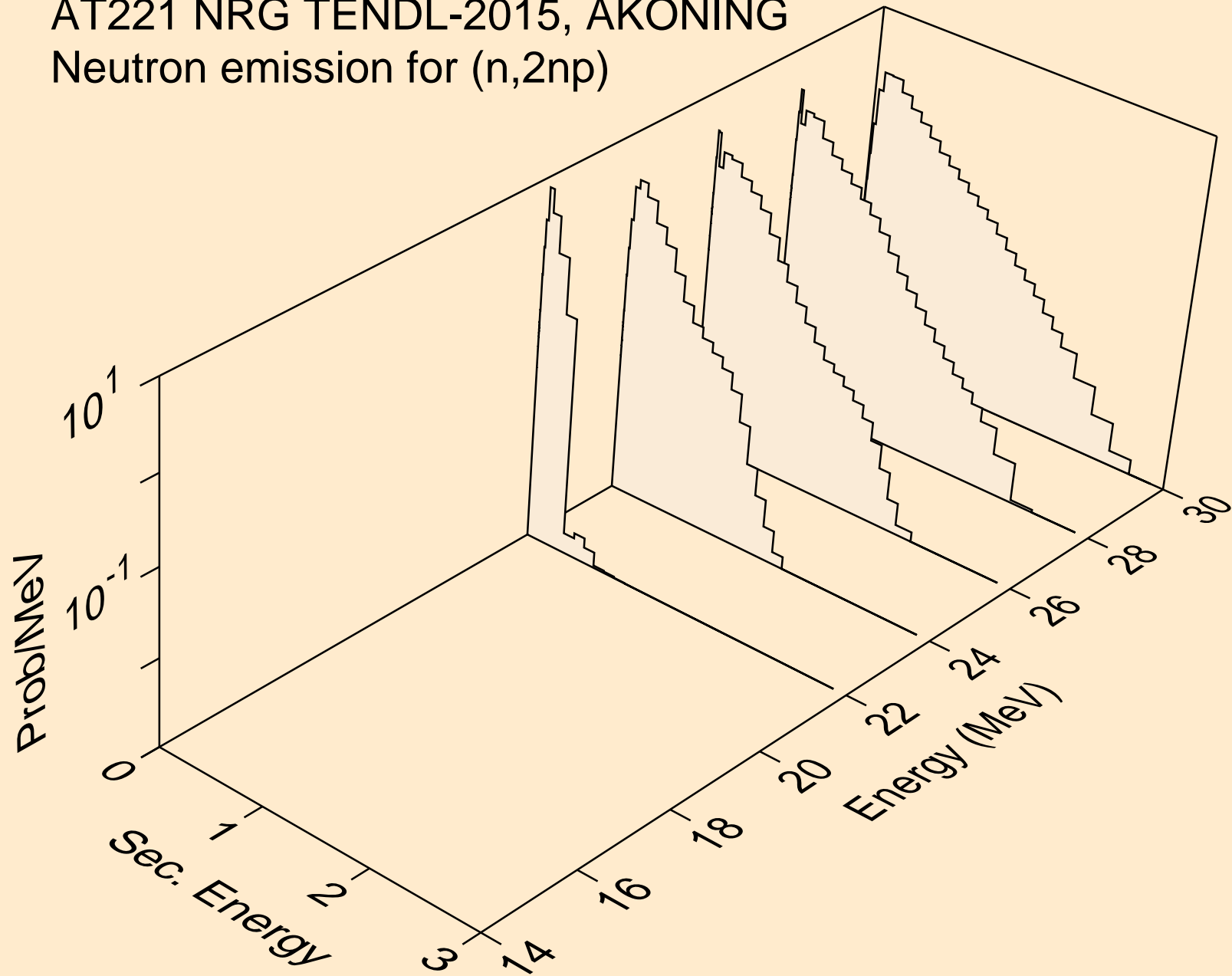

AT221 NRG TENDL-2015, AKONING  
Neutron emission for (n,npa)

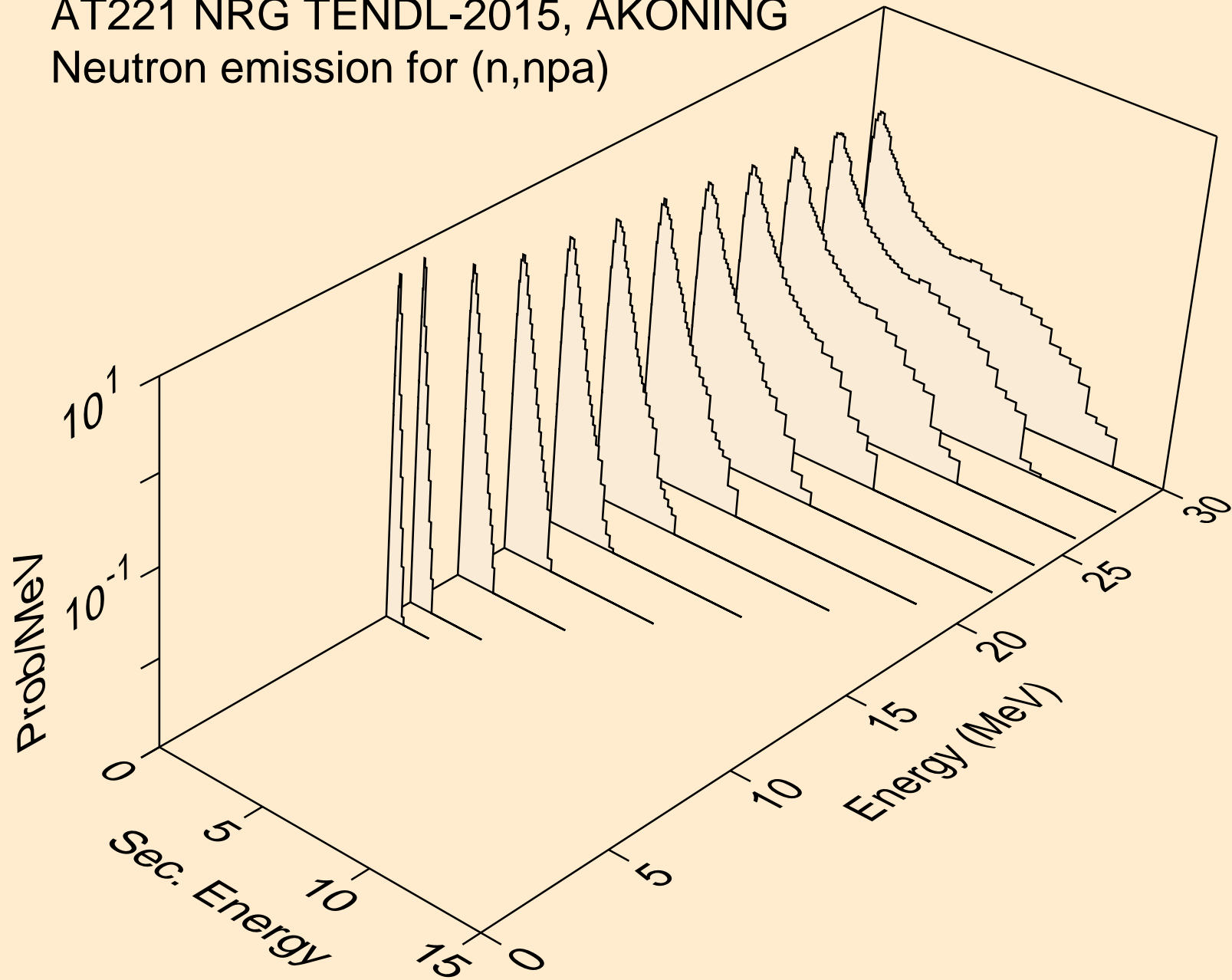

AT221 NRG TENDL-2015, AKONING  
Neutron emission for (n,n\*c)

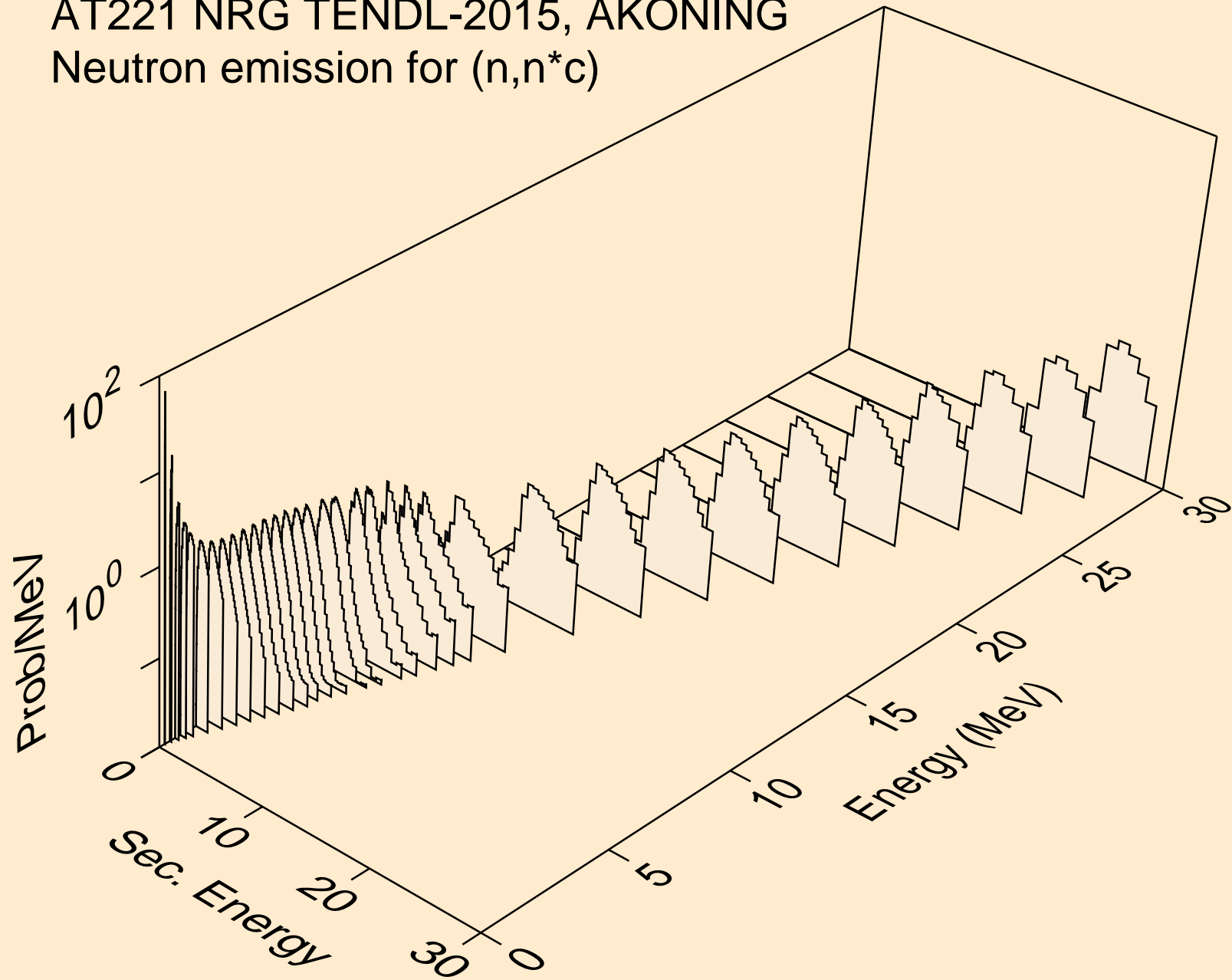

# AT221 NRG TENDL-2015, AKONING

## Delayed nubar

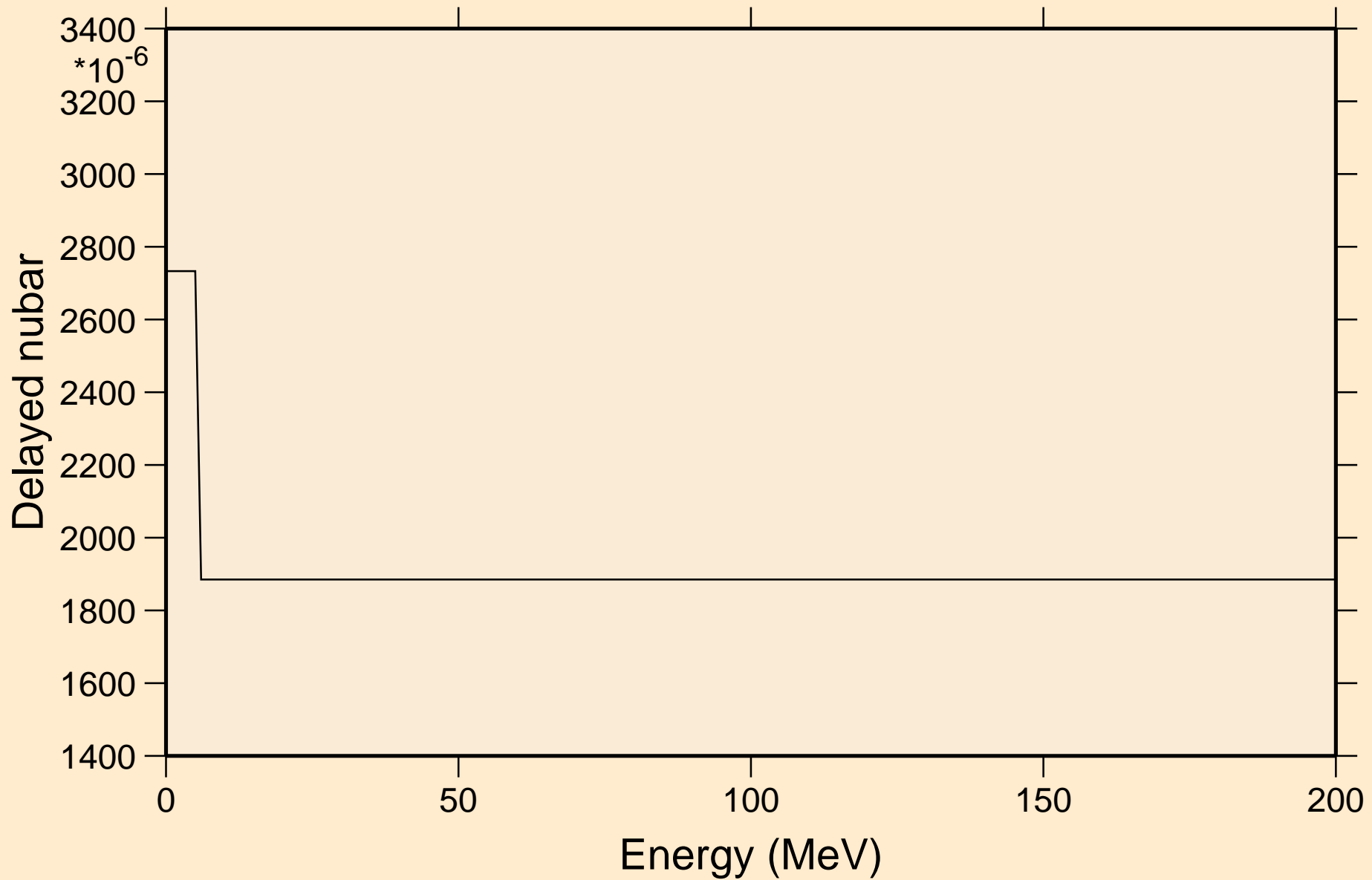

# AT221 NRG TENDL-2015, AKONING

## Delayed neutron spectra

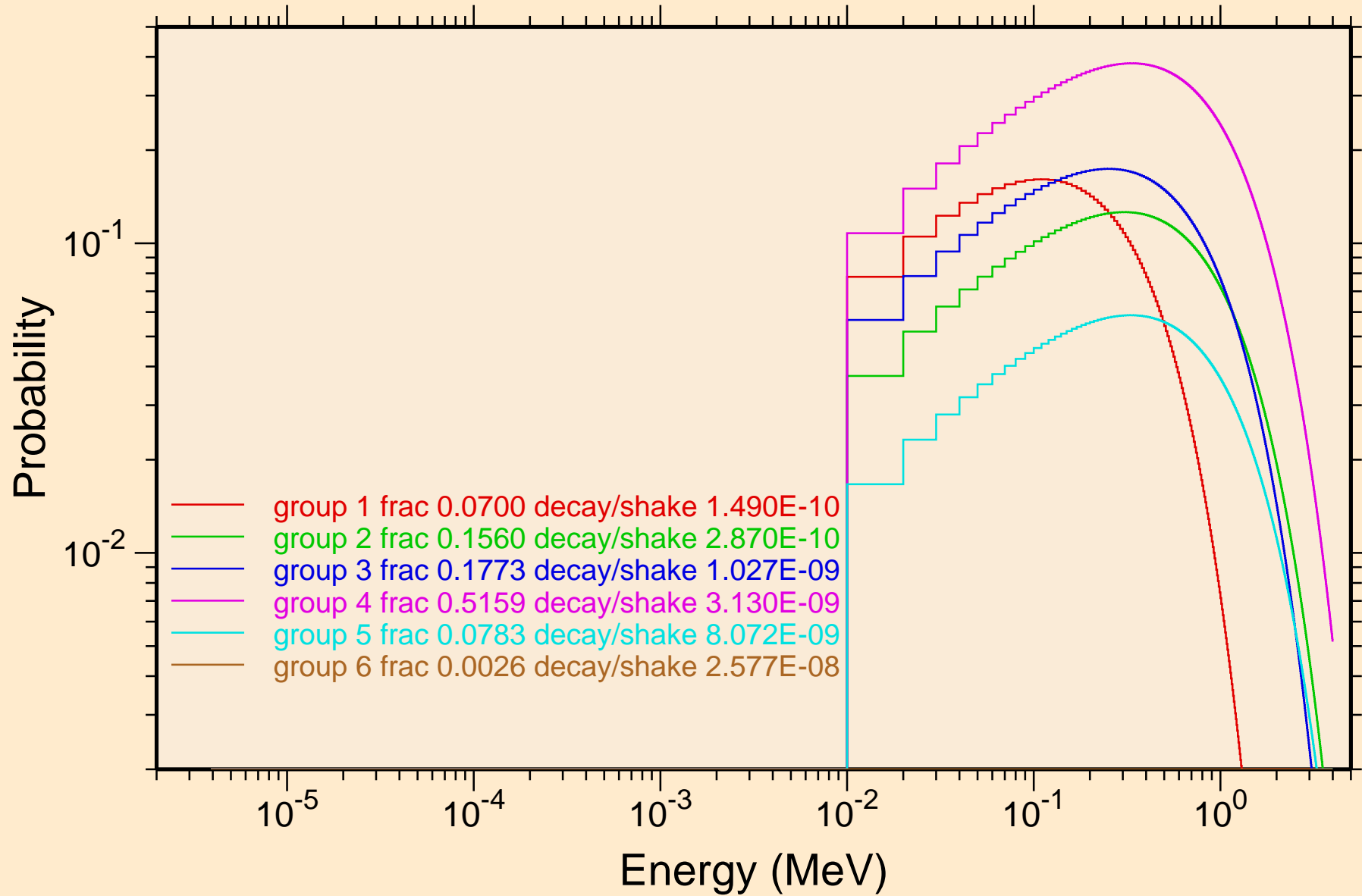

AT221 NRG TENDL-2015, AKONING  
Photon emission for (n,x)

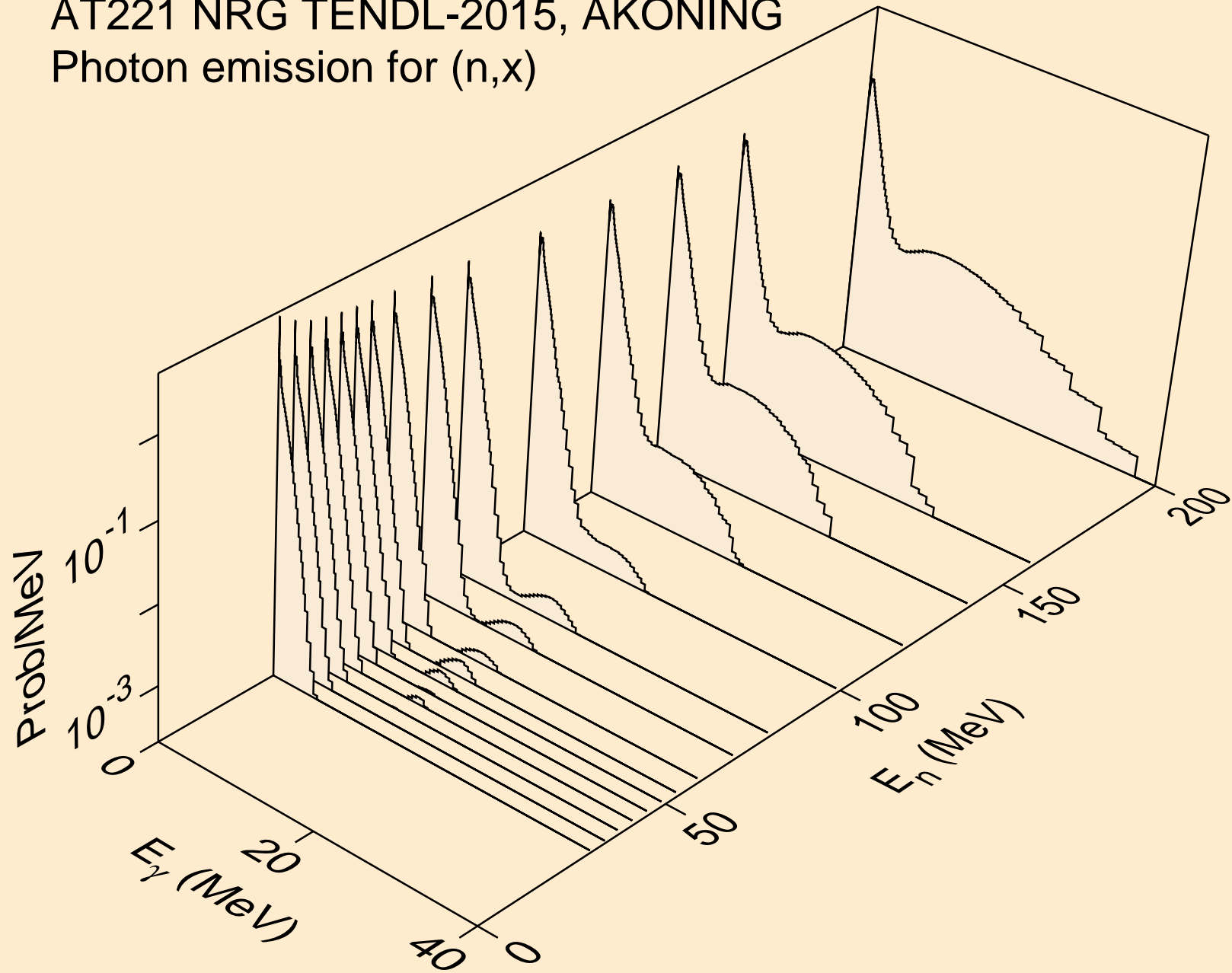

AT221 NRG TENDL-2015, AKONING  
Photon emission for (n,2nd)

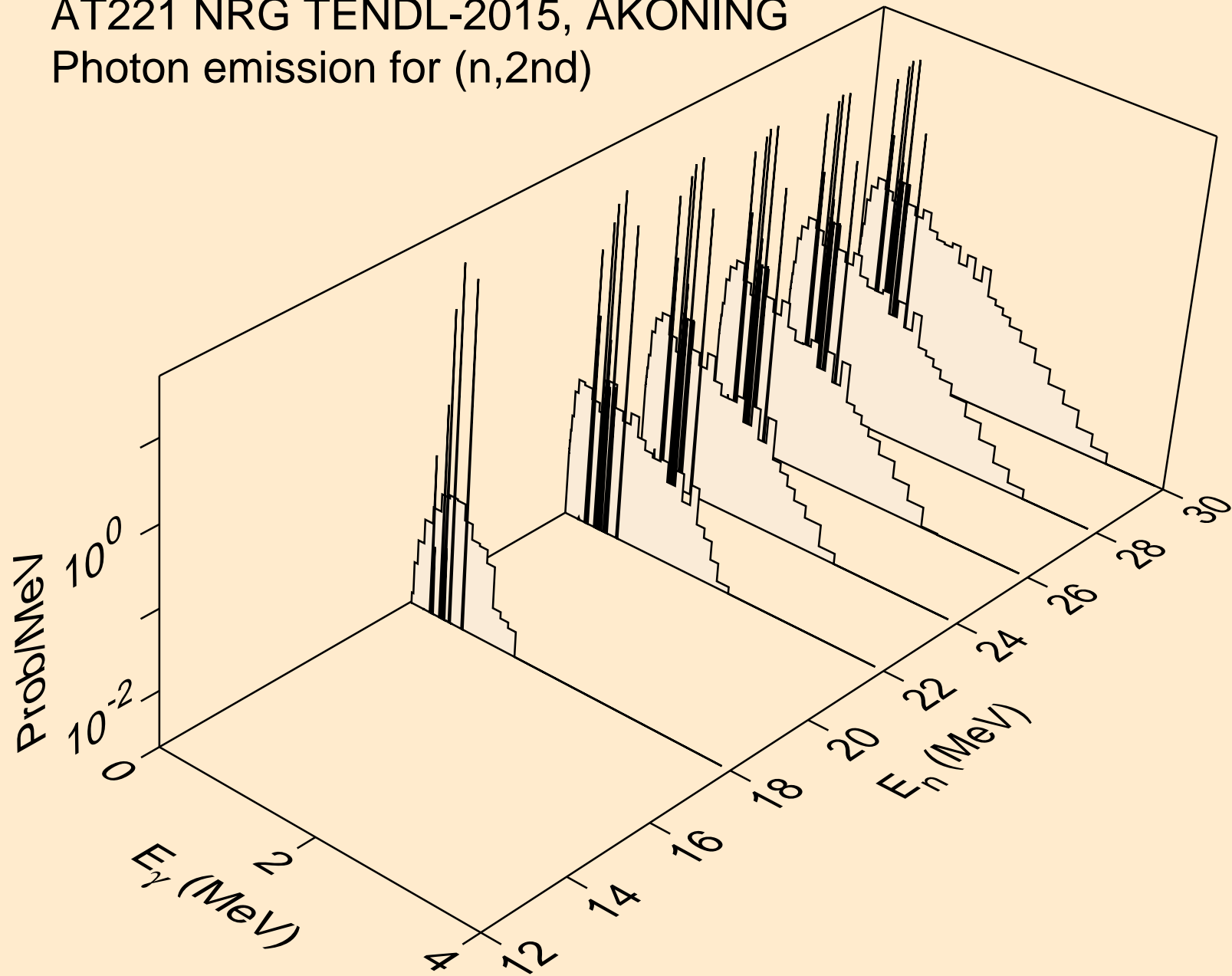

AT221 NRG TENDL-2015, AKONING  
Photon emission for (n,2n)

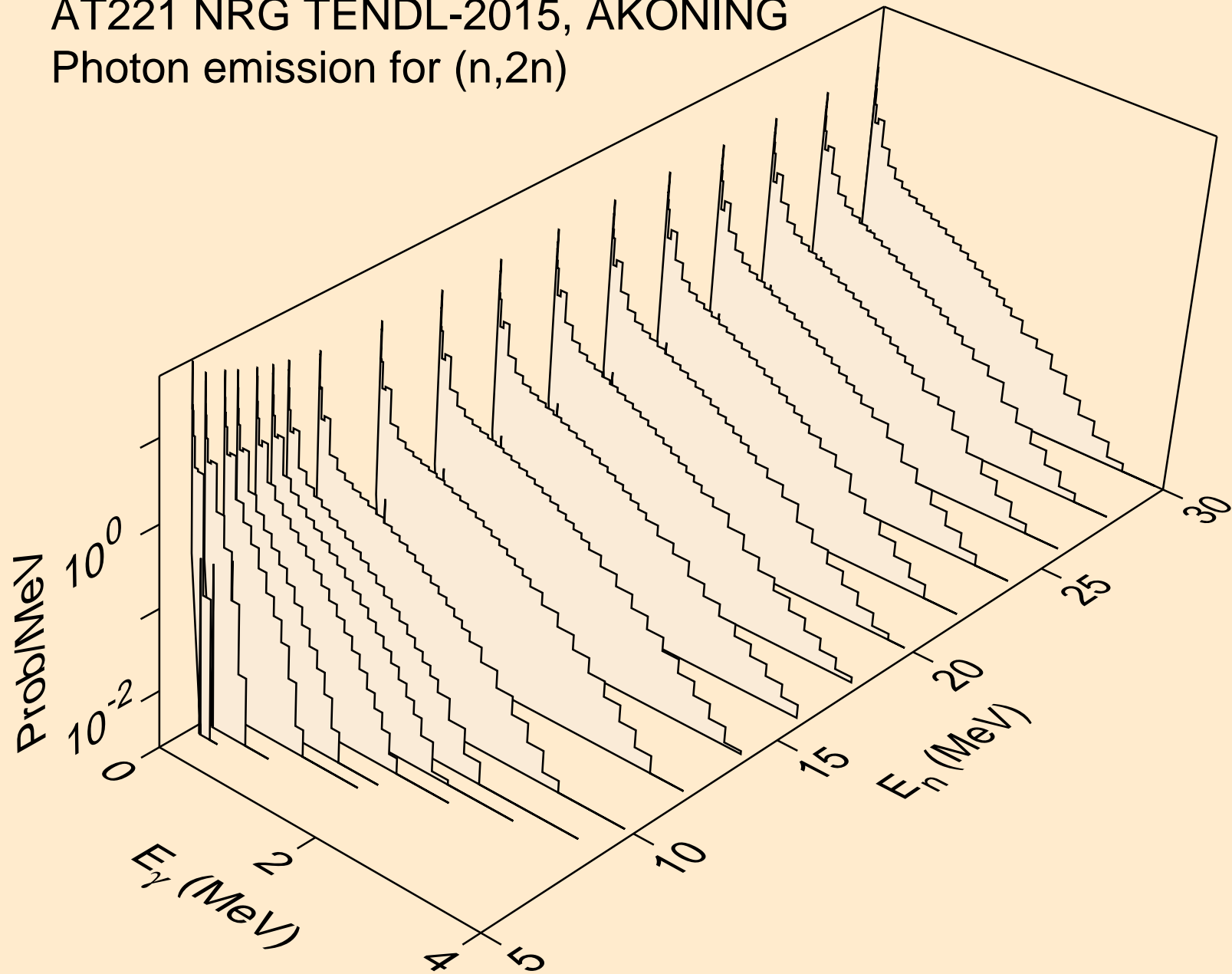



AT221 NRG TENDL-2015, AKONING  
Photon emission for (n,3n)

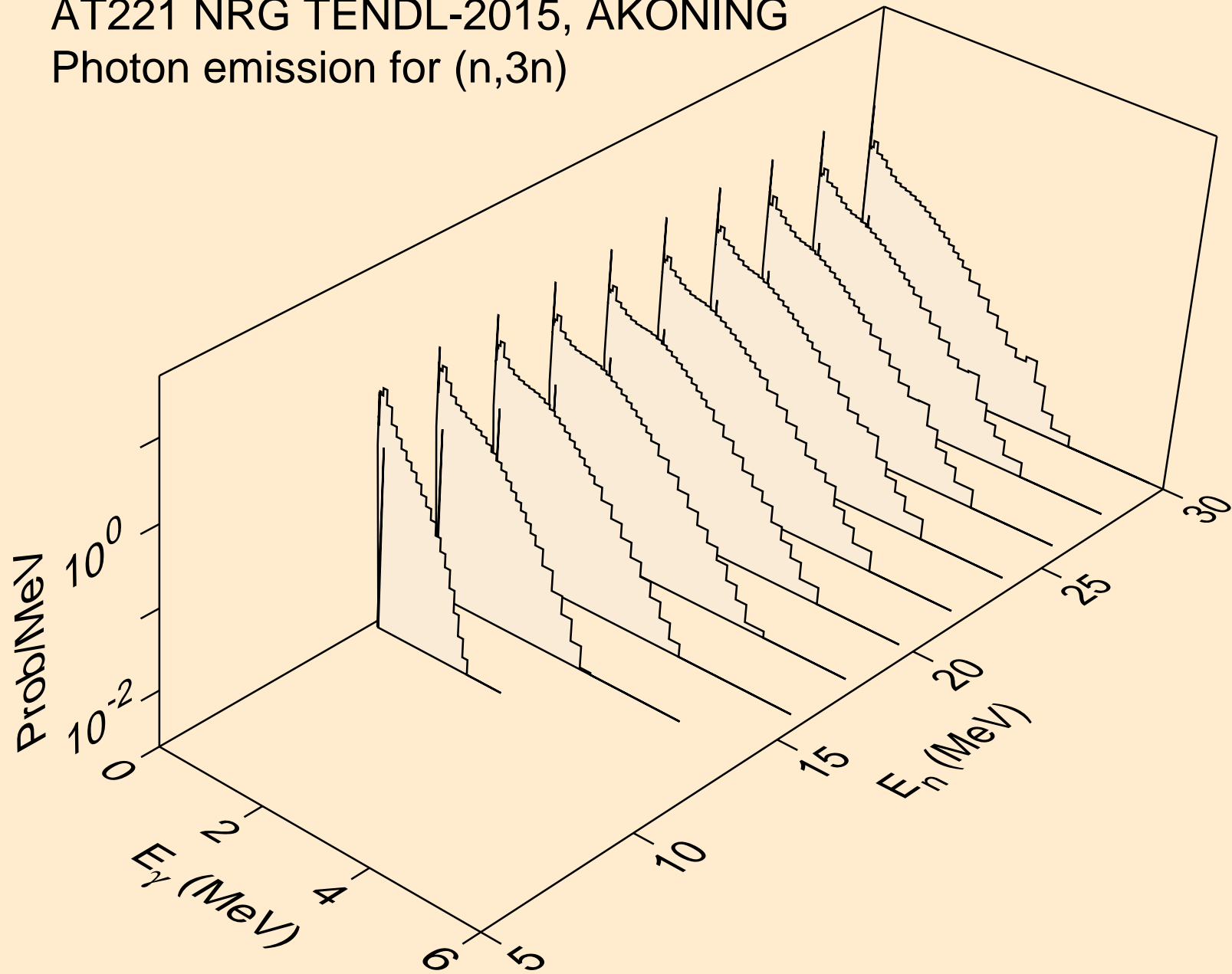

AT221 NRG TENDL-2015, AKONING  
Photon emission for (n,n\*)a

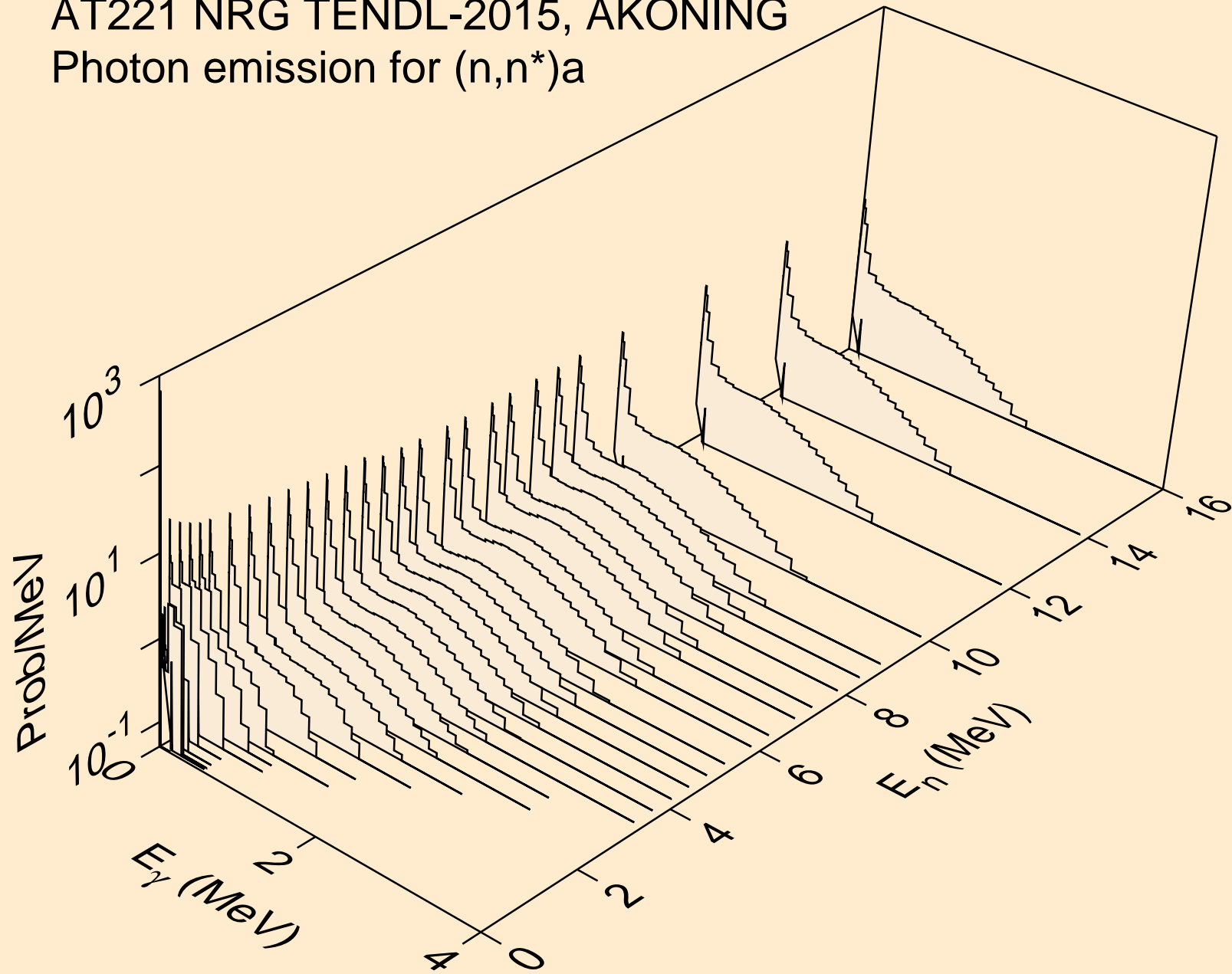

AT221 NRG TENDL-2015, AKONING  
Photon emission for (n,2n)a

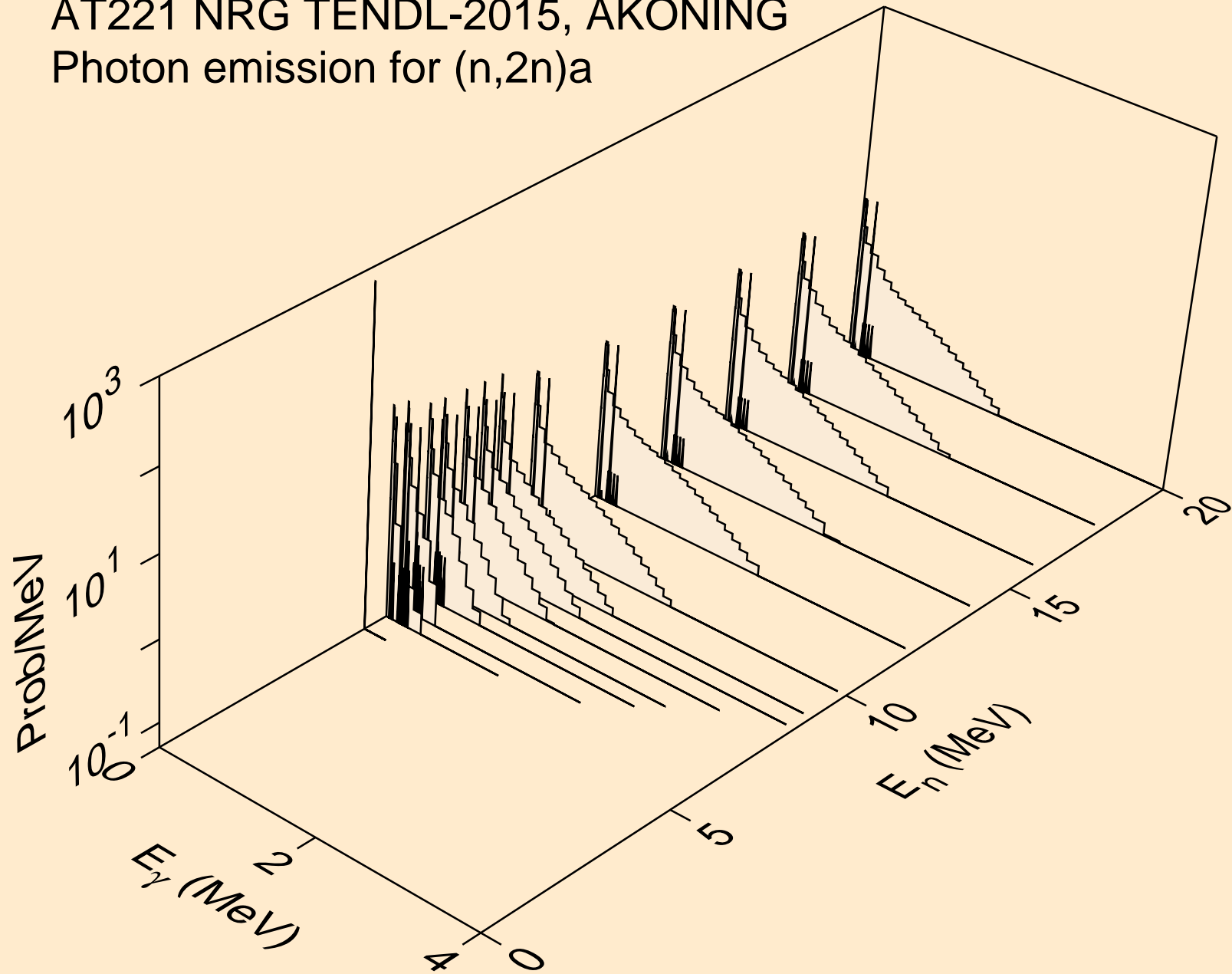

AT221 NRG TENDL-2015, AKONING  
Photon emission for (n,3n)a

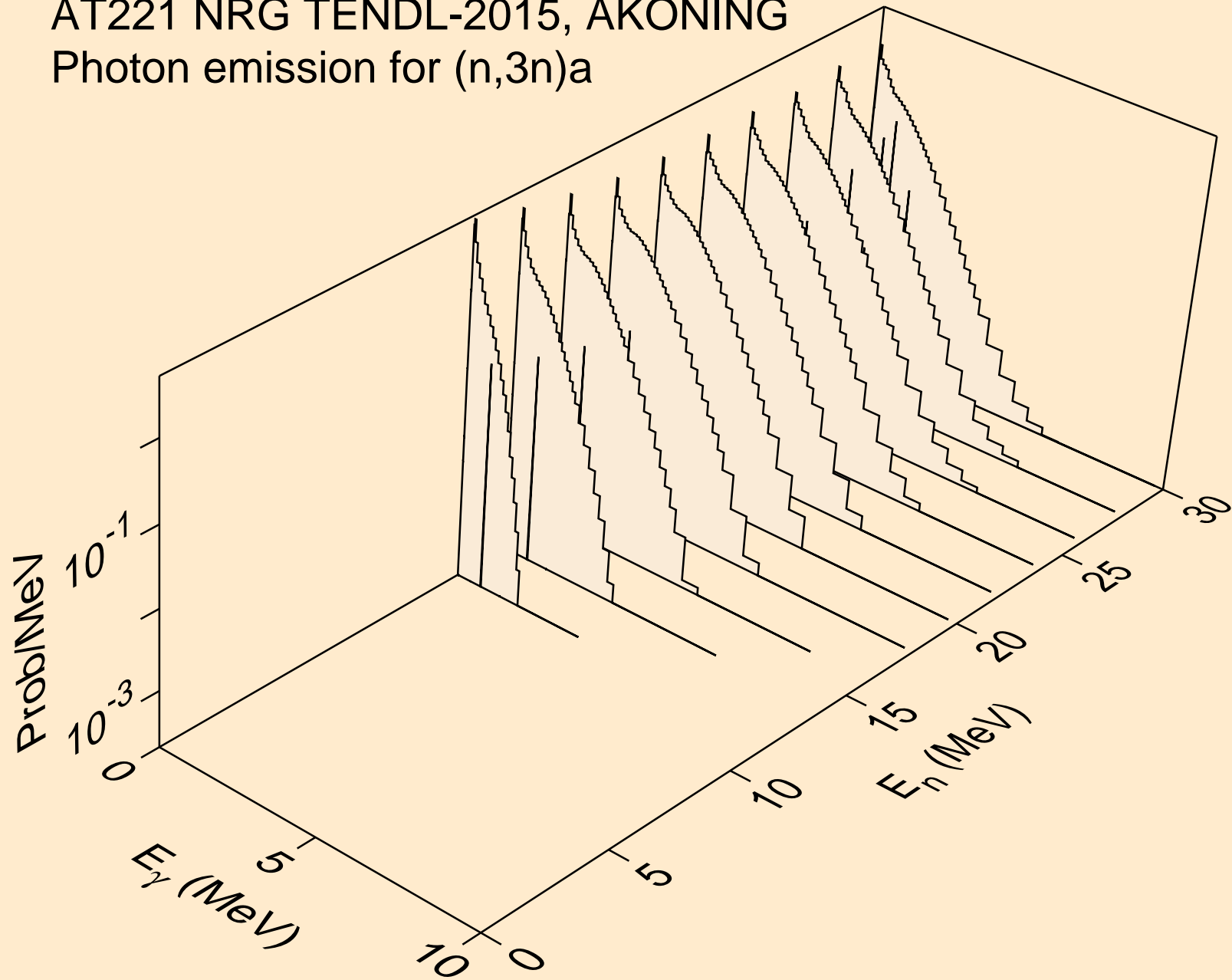

AT221 NRG TENDL-2015, AKONING  
Photon emission for (n,n\*)p

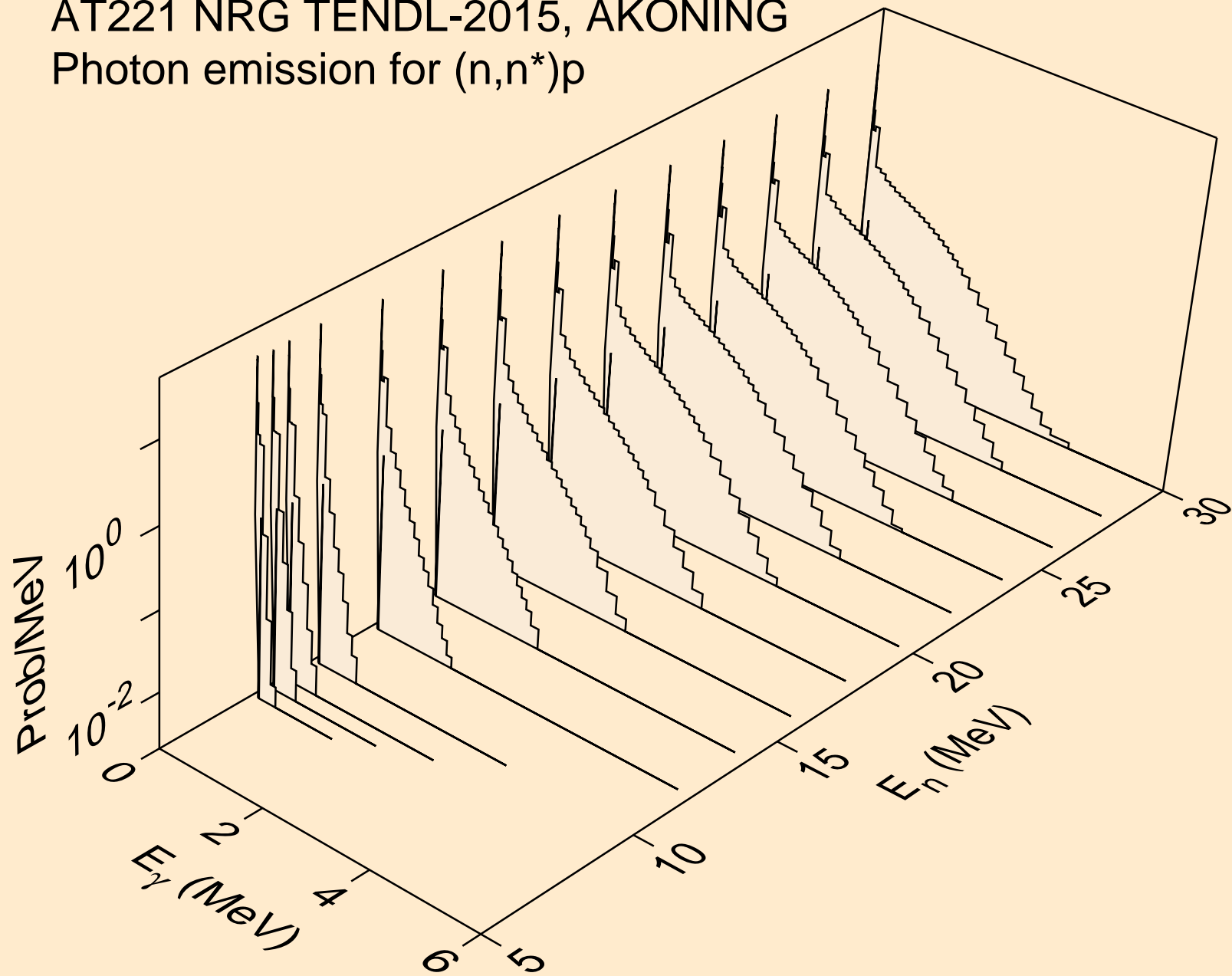

AT221 NRG TENDL-2015, AKONING  
Photon emission for (n,n\*)2a

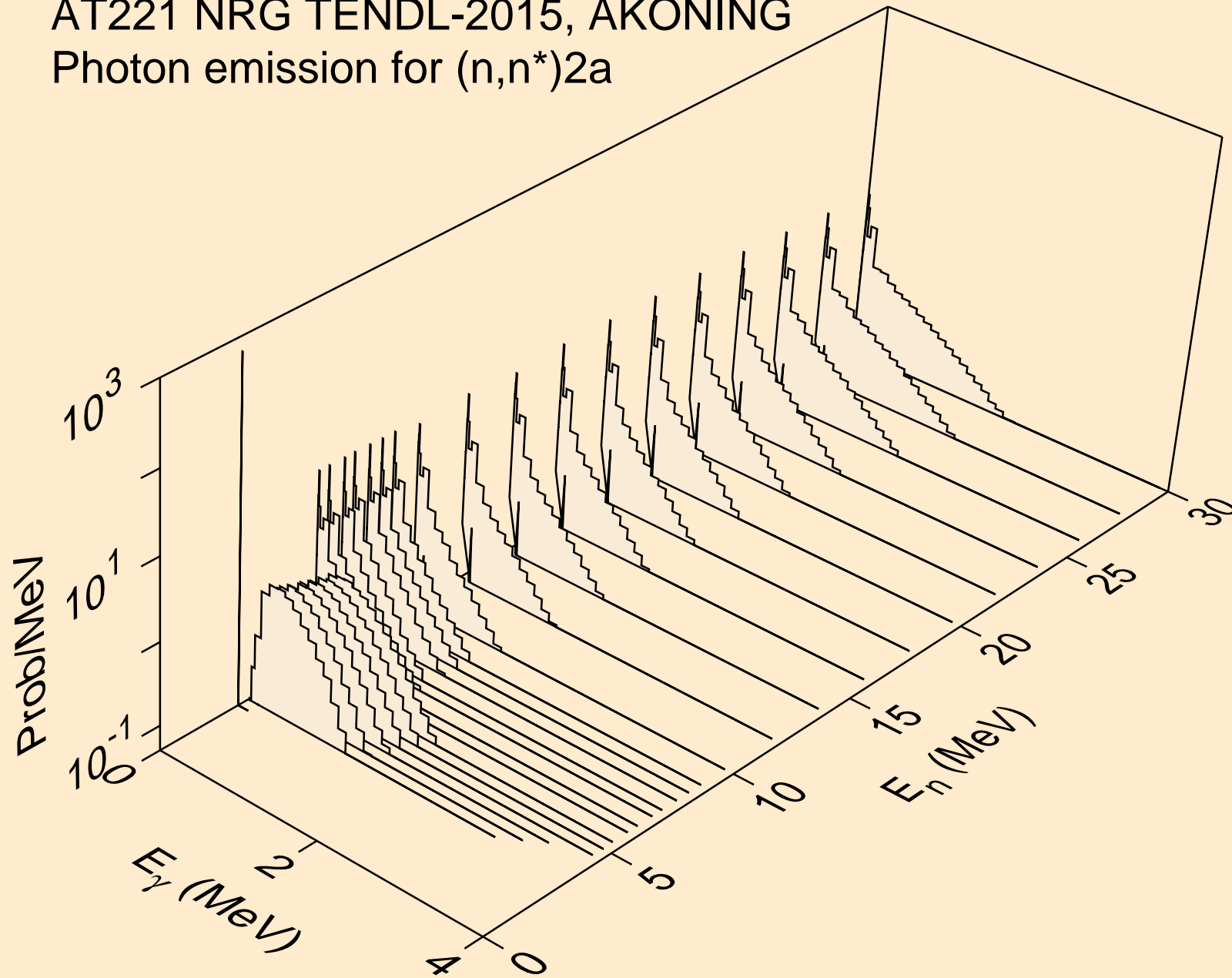

AT221 NRG TENDL-2015, AKONING  
Photon emission for (n,2n)2a

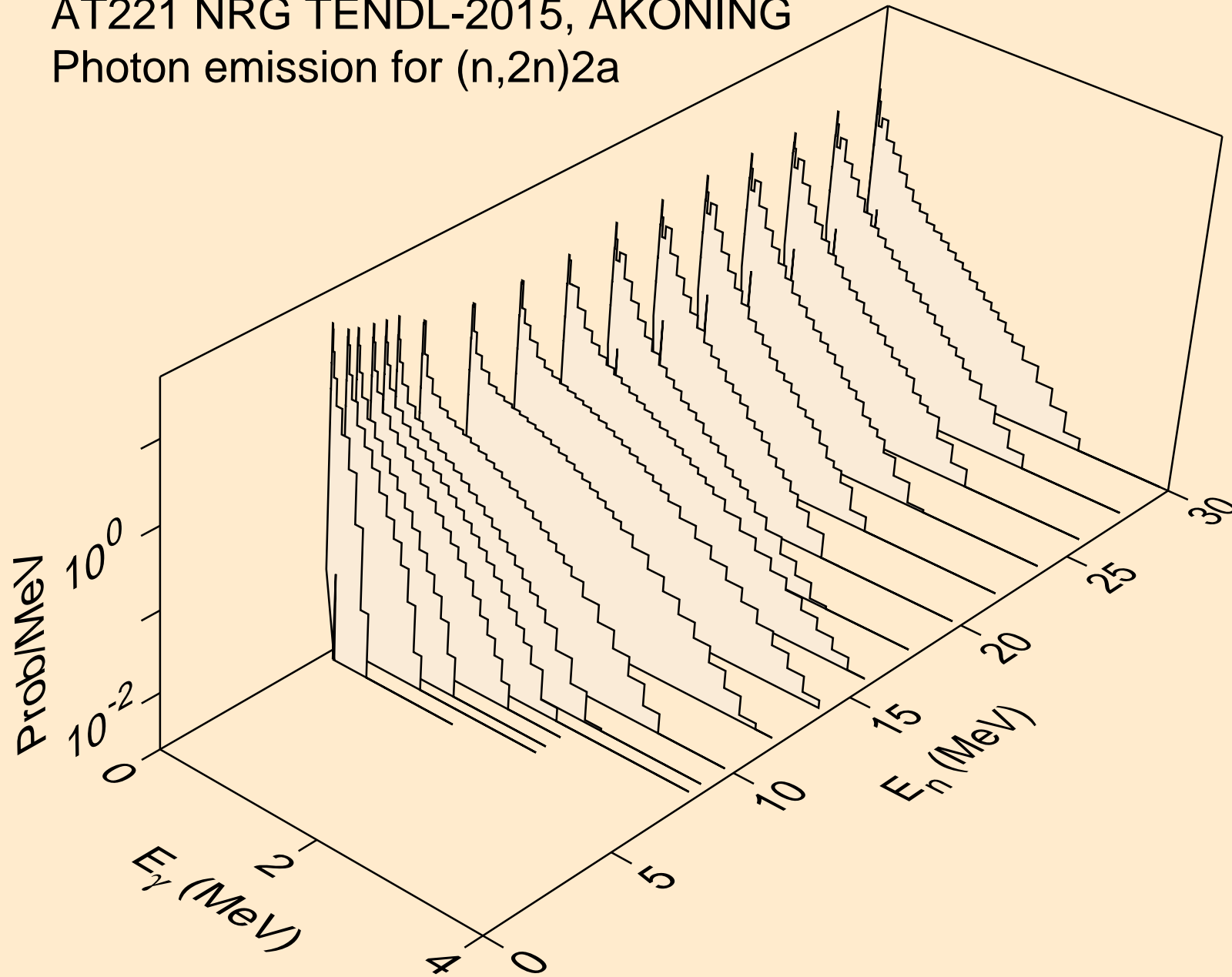

AT221 NRG TENDL-2015, AKONING  
Photon emission for (n,n\*)d

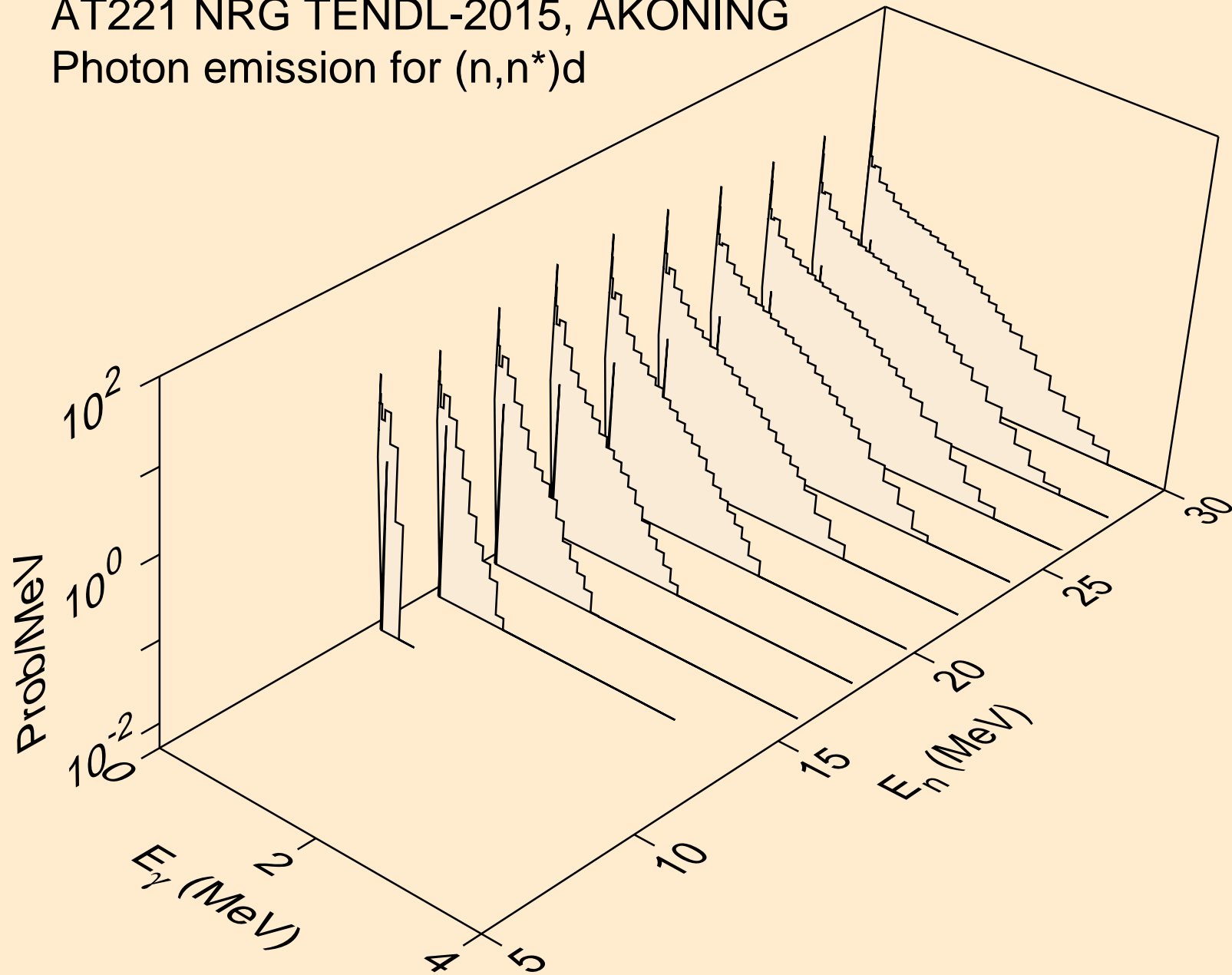



AT221 NRG TENDL-2015, AKONING  
Photon emission for (n,n\*)t

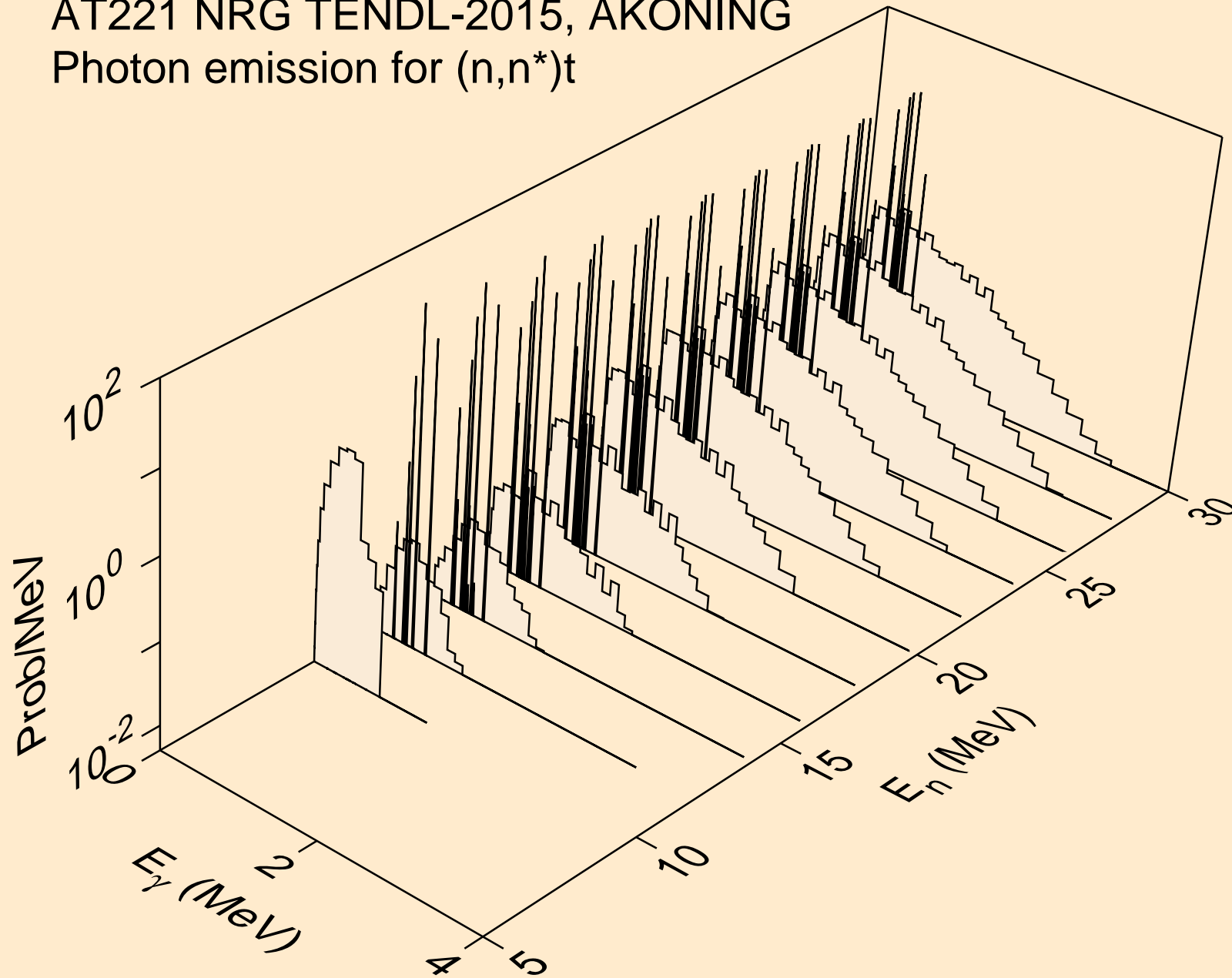

AT221 NRG TENDL-2015, AKONING  
Photon emission for (n,n\*)he3

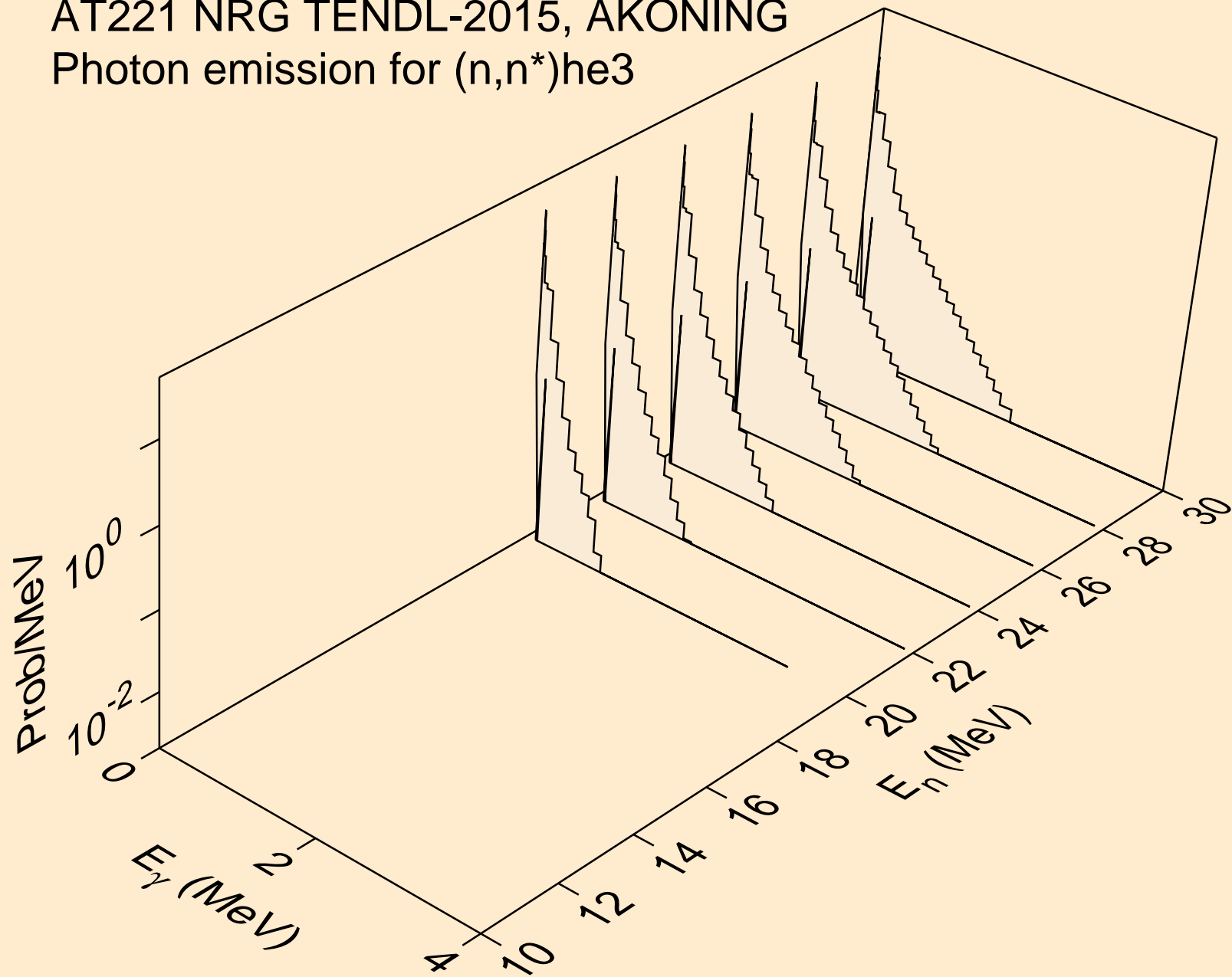

AT221 NRG TENDL-2015, AKONING  
Photon emission for (n,4n)

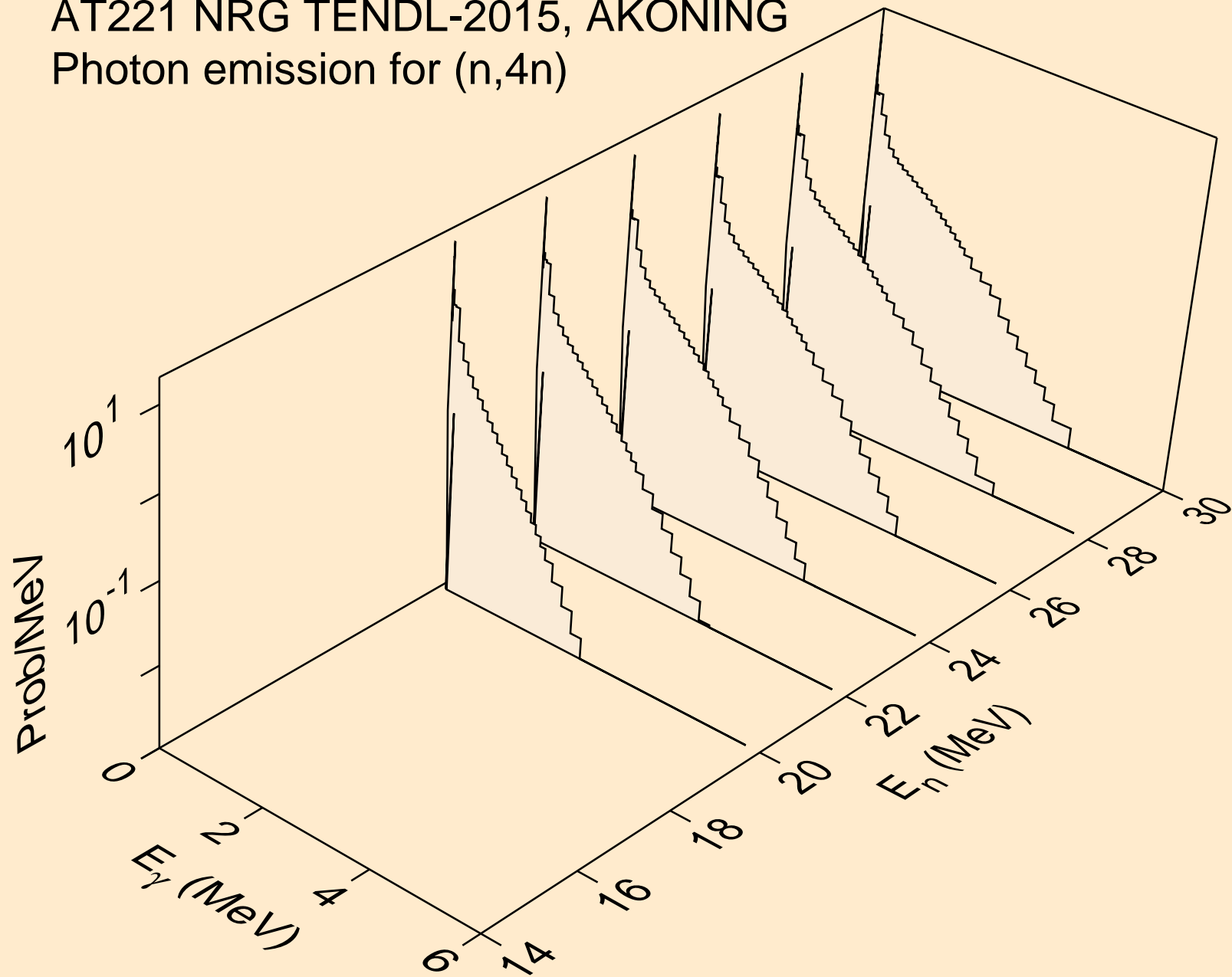

AT221 NRG TENDL-2015, AKONING  
Photon emission for (n,2np)

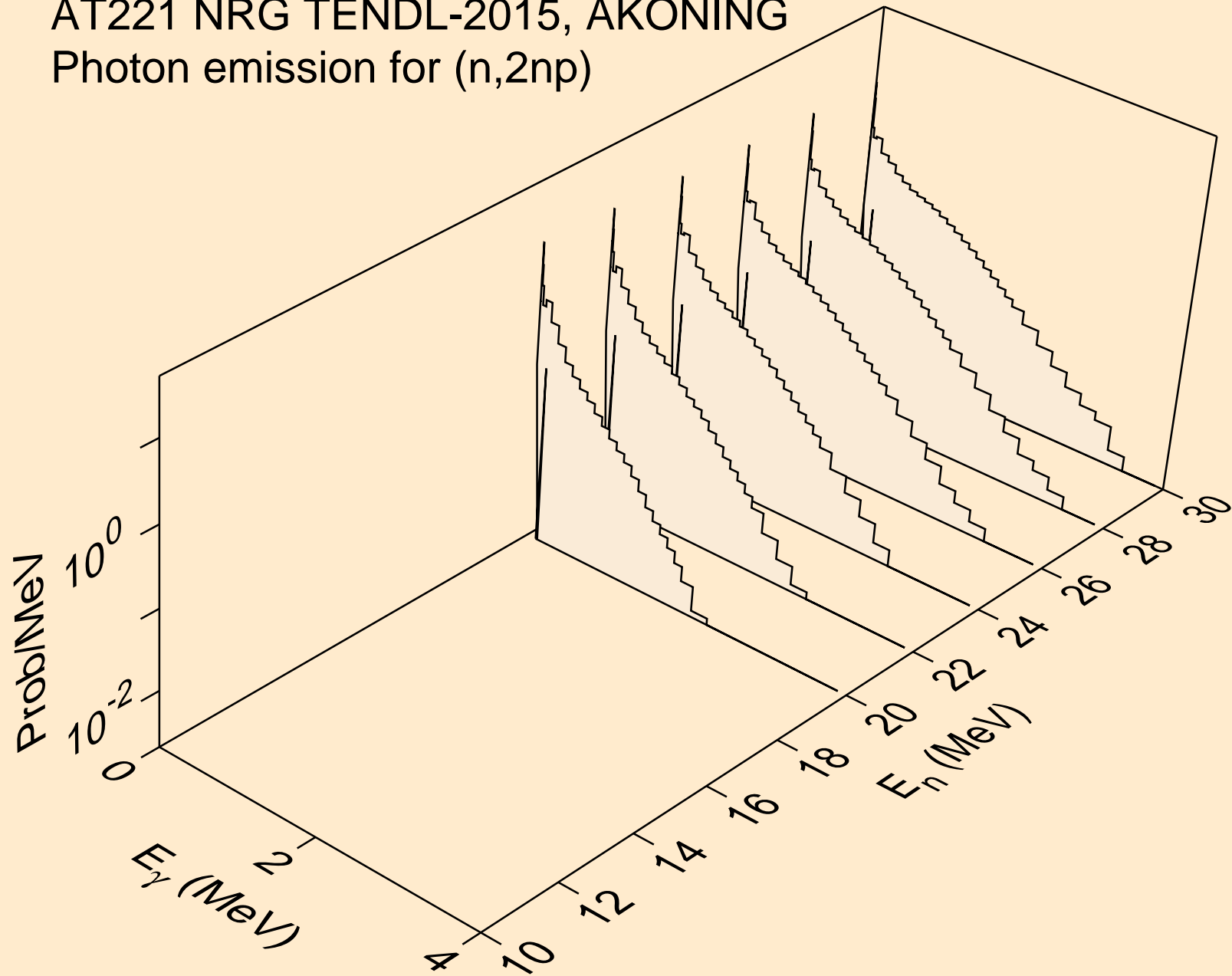

AT221 NRG TENDL-2015, AKONING  
Photon emission for (n,3np)

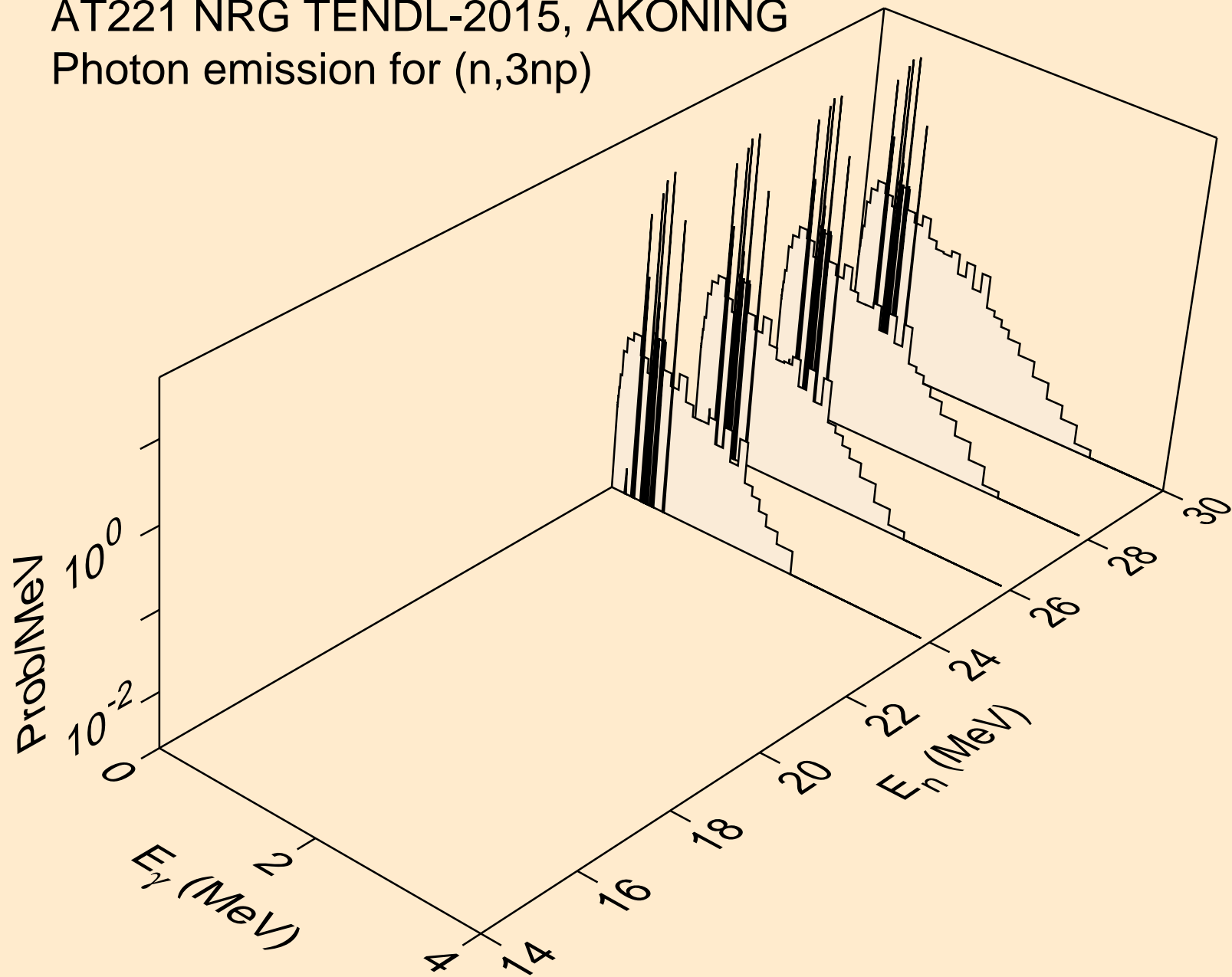

AT221 NRG TENDL-2015, AKONING  
Photon emission for (n,2np)

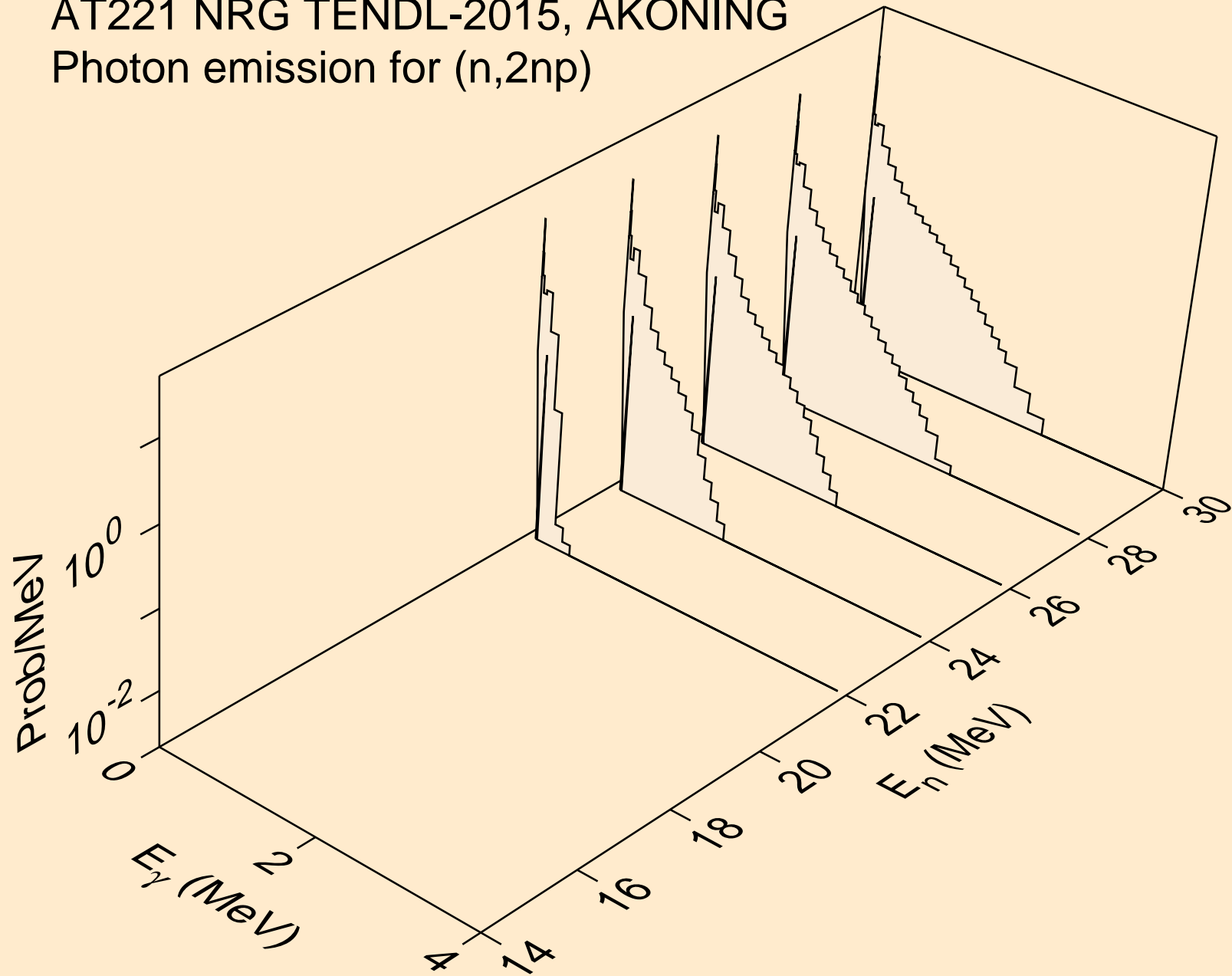

AT221 NRG TENDL-2015, AKONING  
Photon emission for (n,npa)

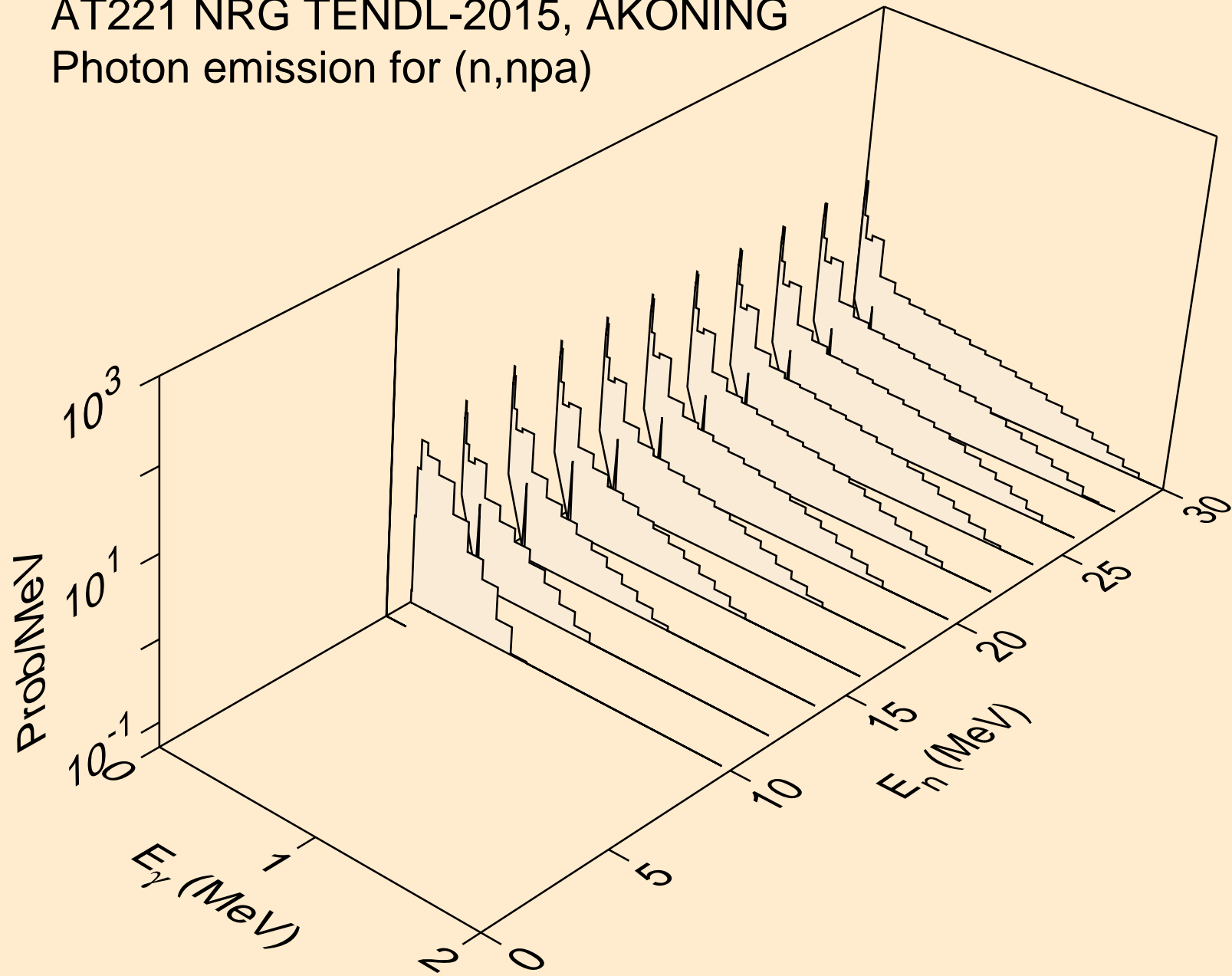

AT221 NRG TENDL-2015, AKONING  
Photon emission for (n,n\*c)

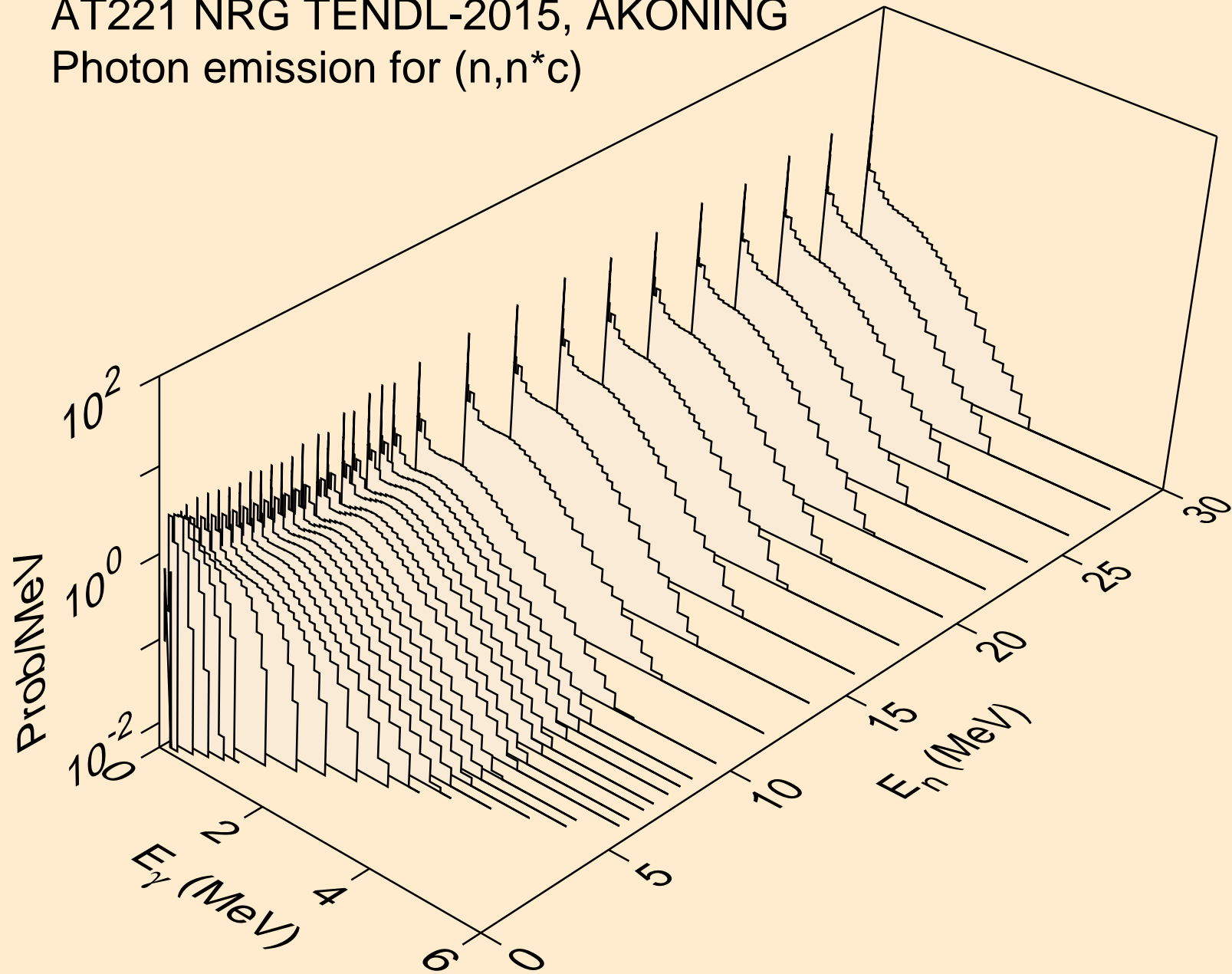



AT221 NRG TENDL-2015, AKONING  
Photon emission for (n,gma)

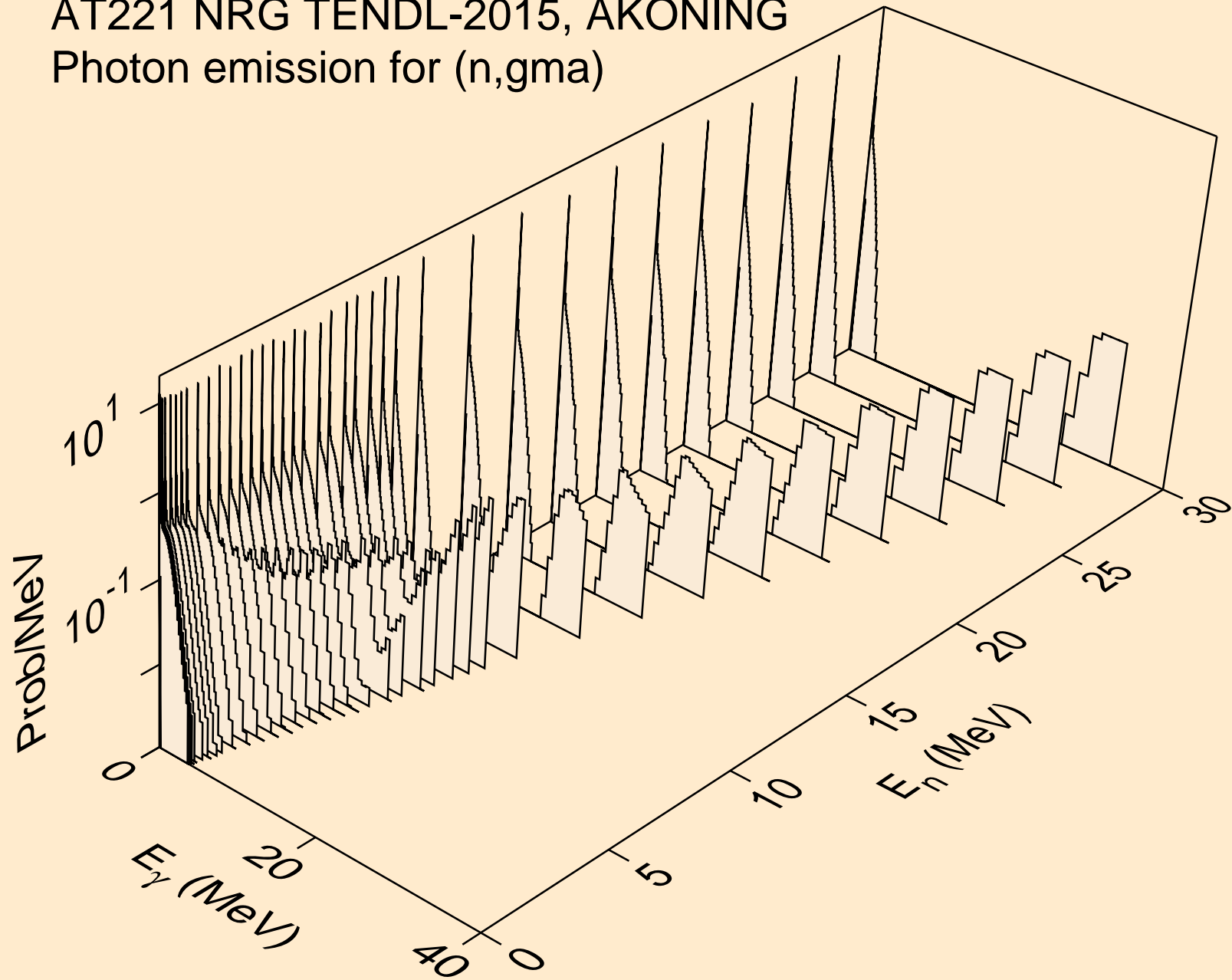

AT221 NRG TENDL-2015, AKONING  
Photon emission for (n,p)

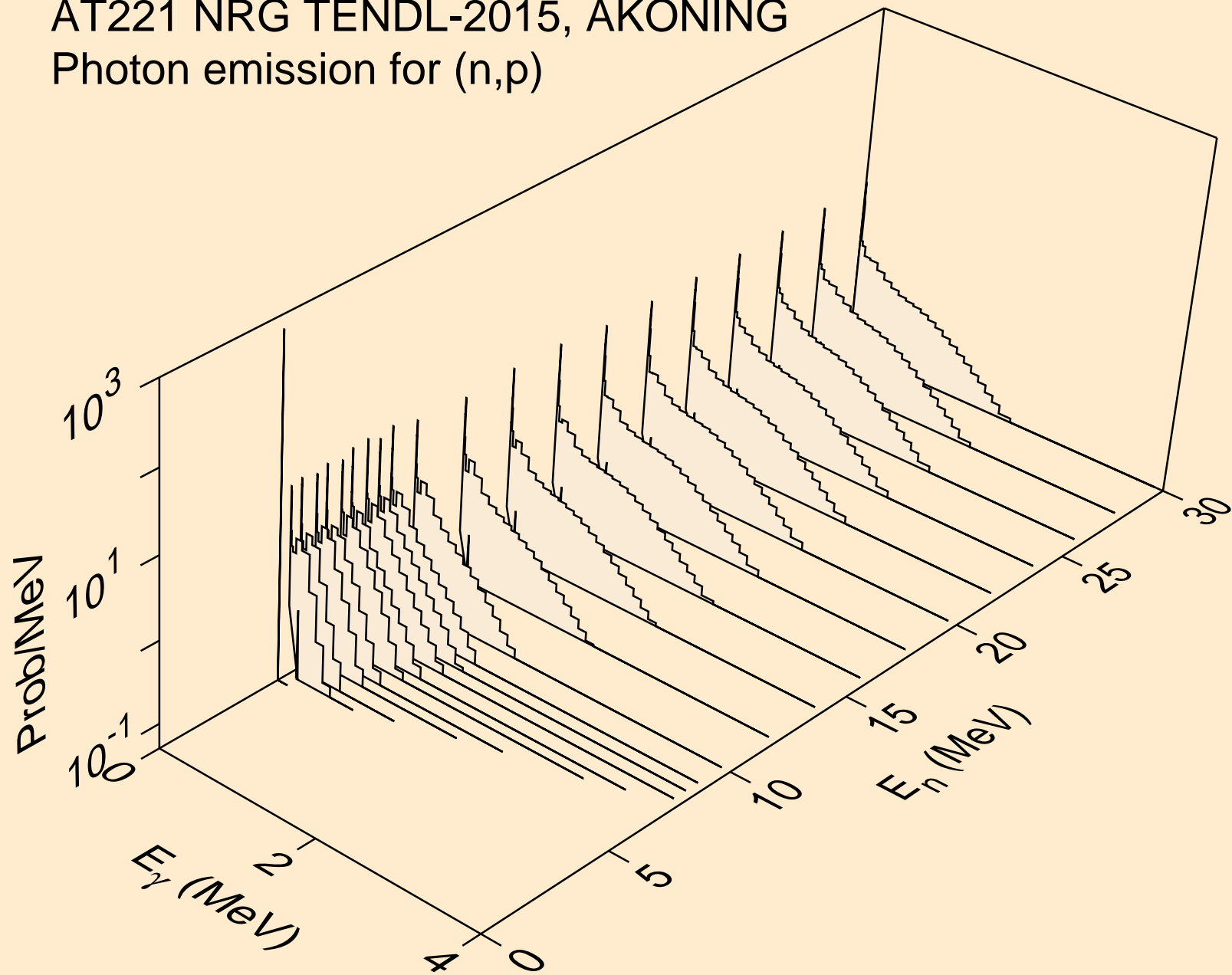

AT221 NRG TENDL-2015, AKONING  
Photon emission for (n,d)

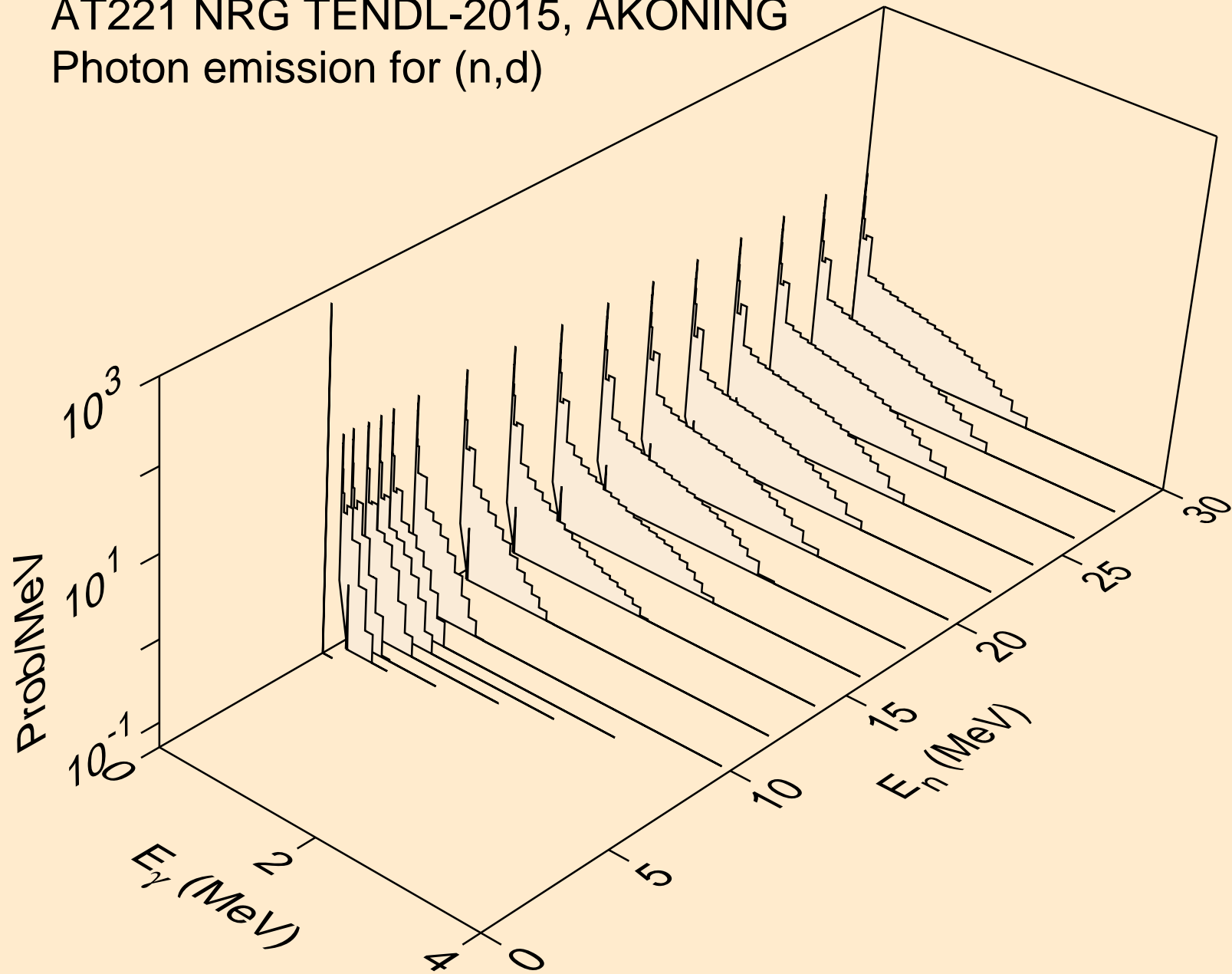

AT221 NRG TENDL-2015, AKONING  
Photon emission for (n,t)

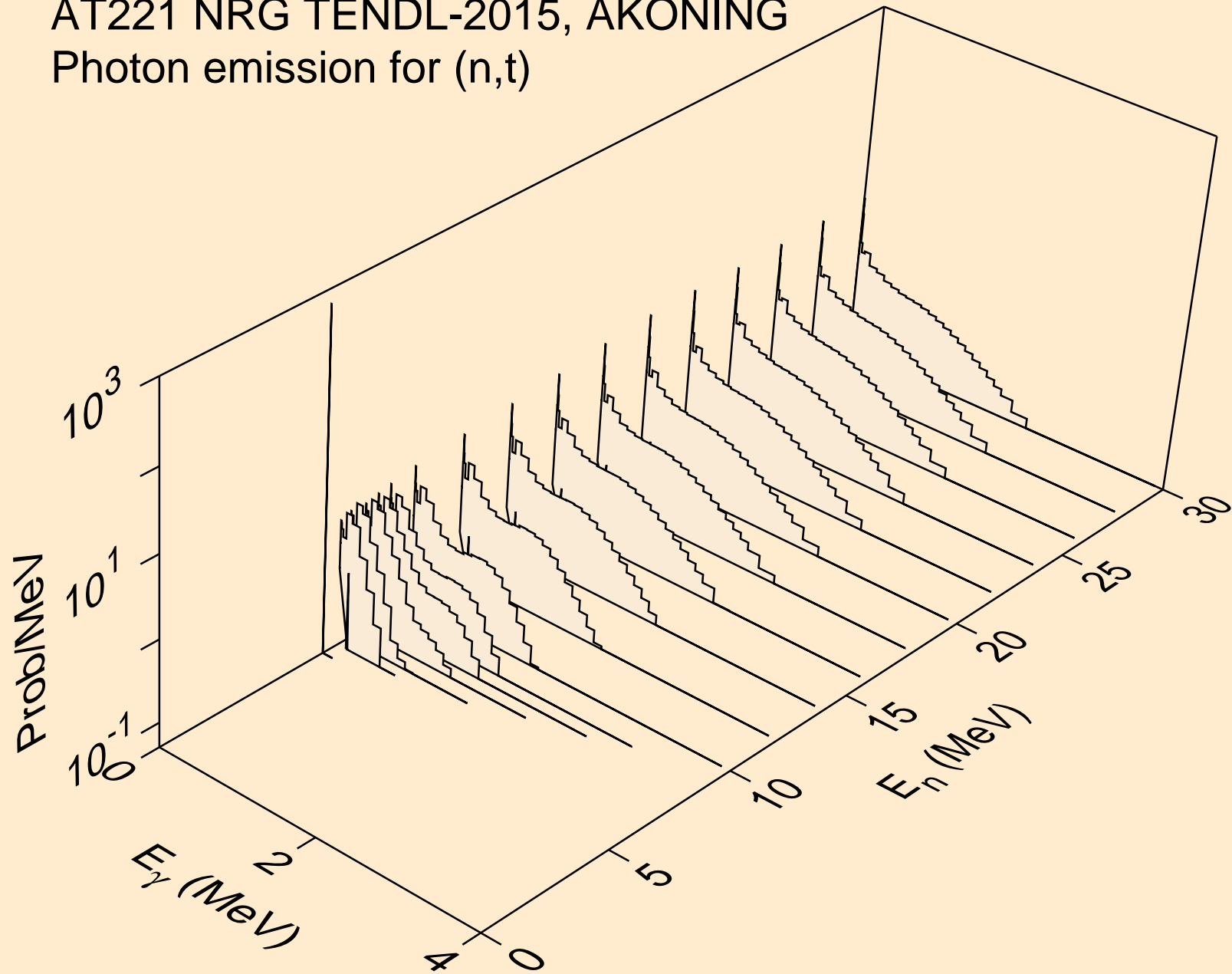

AT221 NRG TENDL-2015, AKONING  
Photon emission for (n,he3)

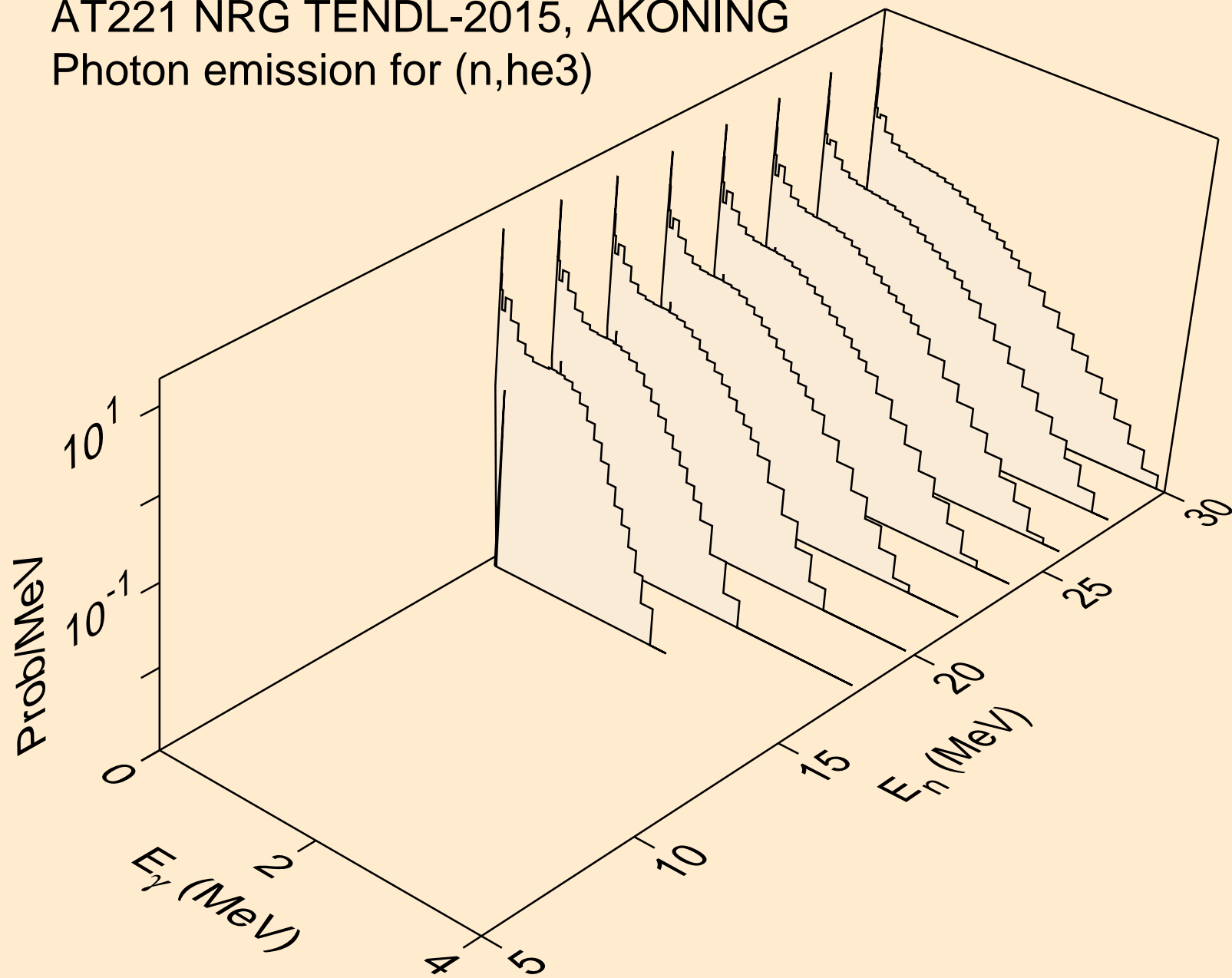

AT221 NRG TENDL-2015, AKONING  
Photon emission for (n,a)

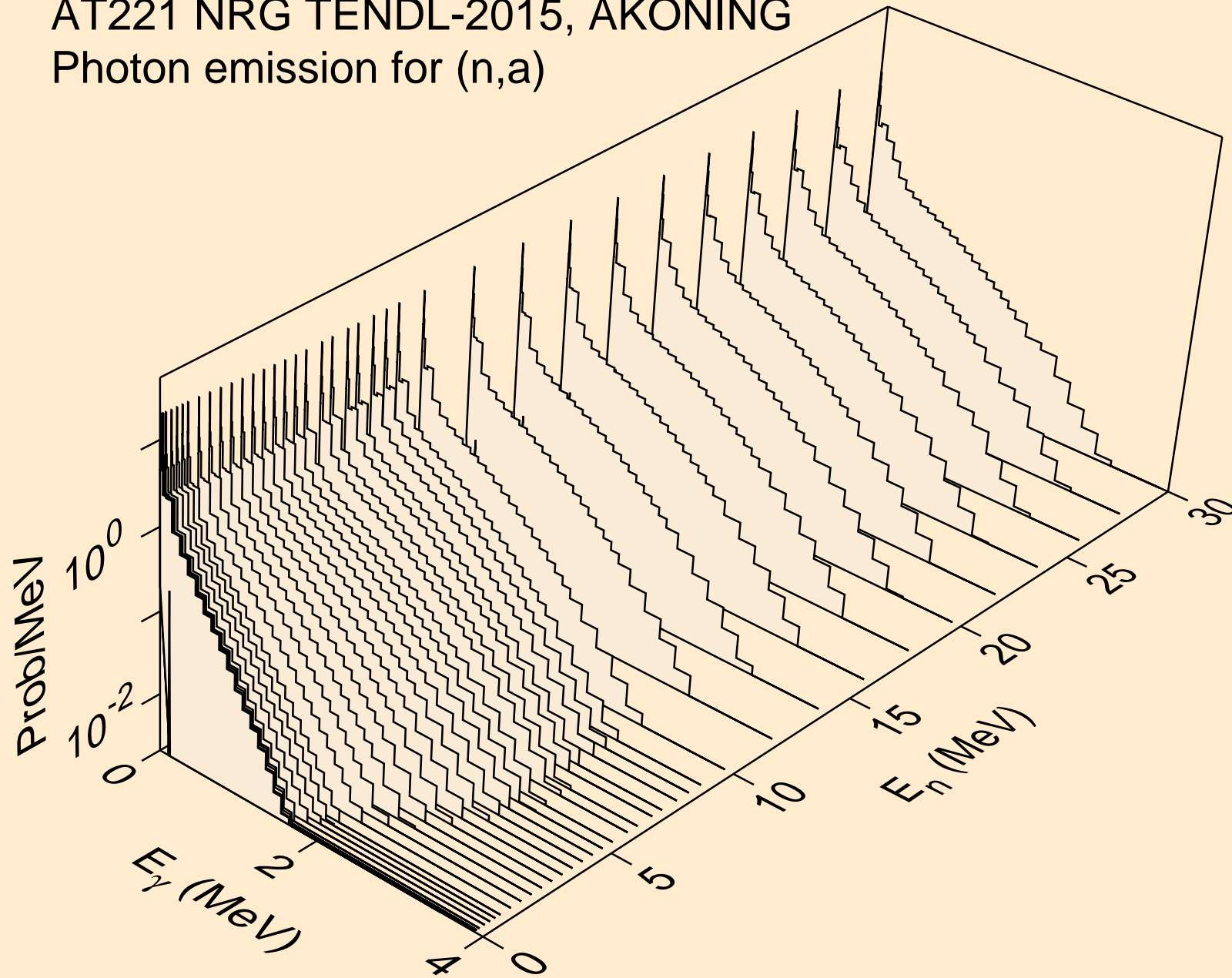

AT221 NRG TENDL-2015, AKONING  
Photon emission for (n,2p)

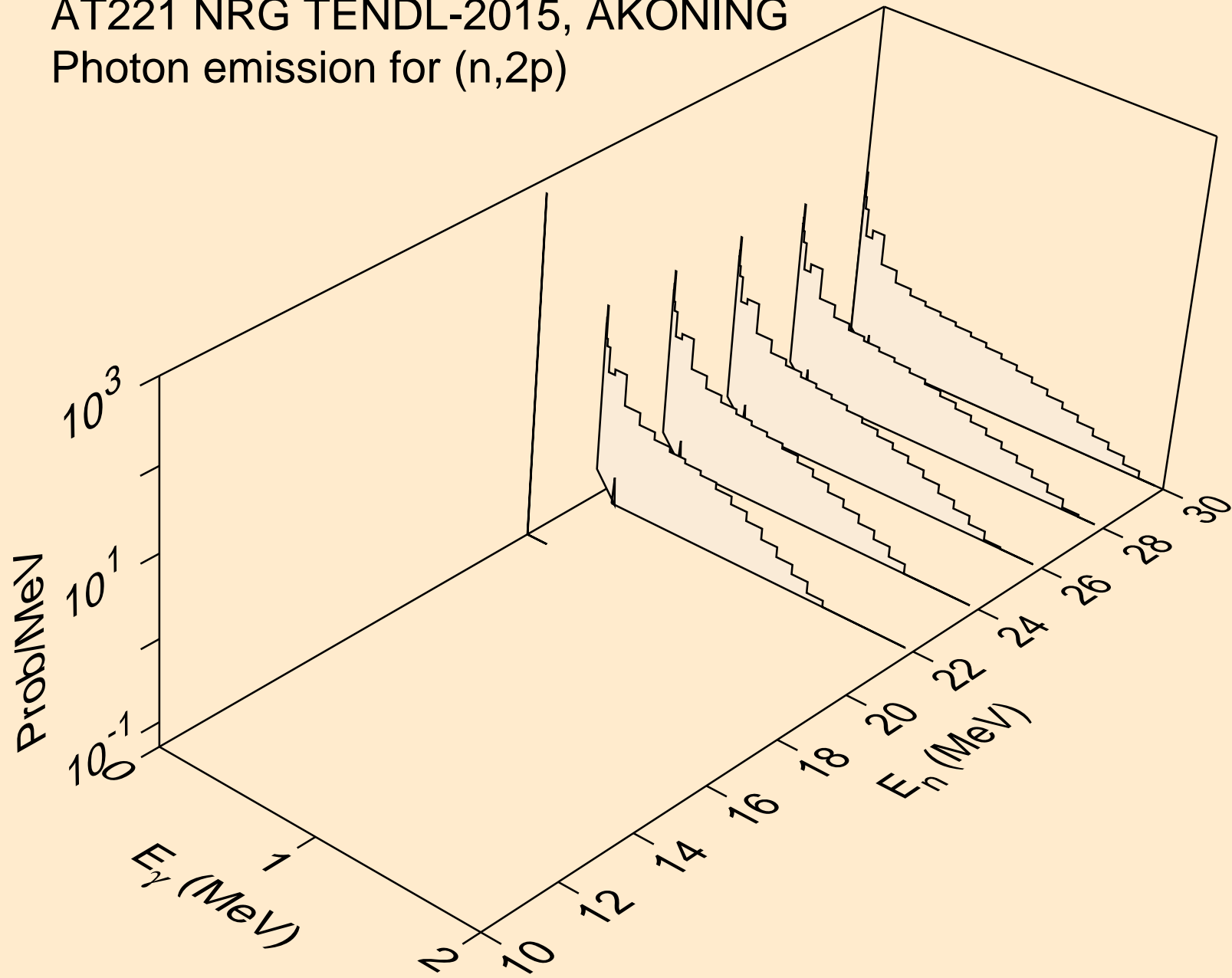

AT221 NRG TENDL-2015, AKONING  
Photon emission for (n,p $\alpha$ )

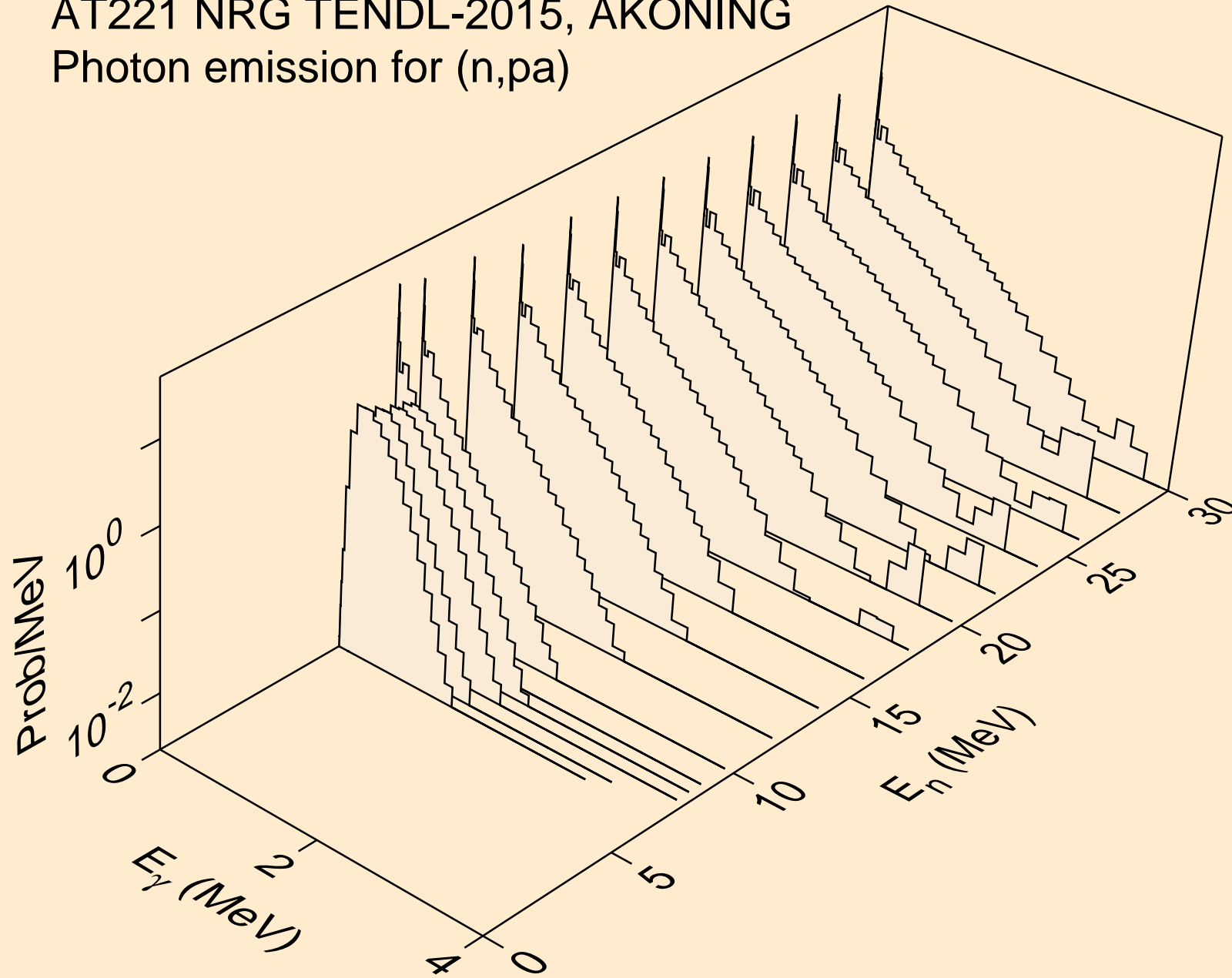



AT221 NRG TENDL-2015, AKONING  
Photon emission for (n,da)

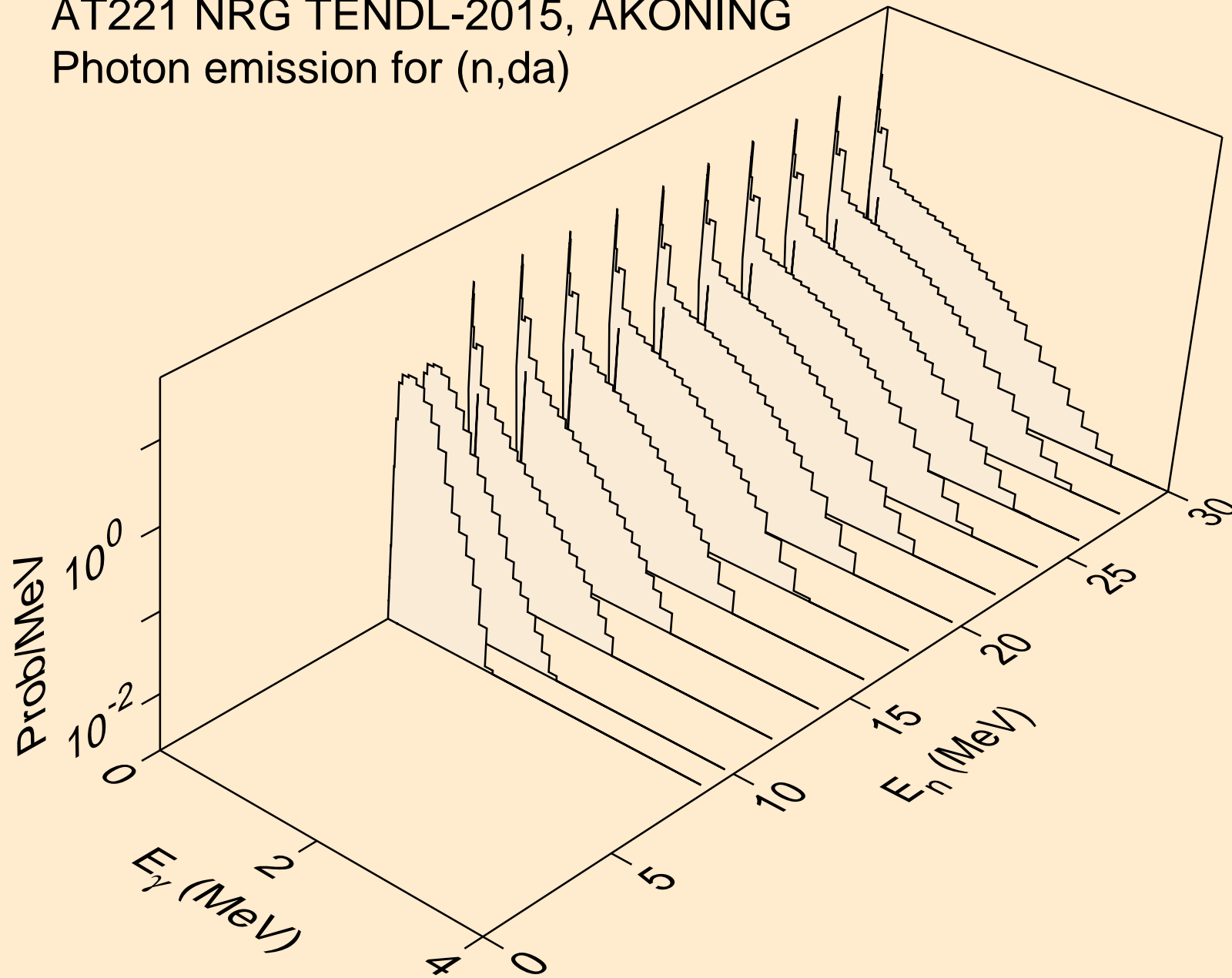

AT221 NRG TENDL-2015, AKONING  
thermal capture photon spectrum

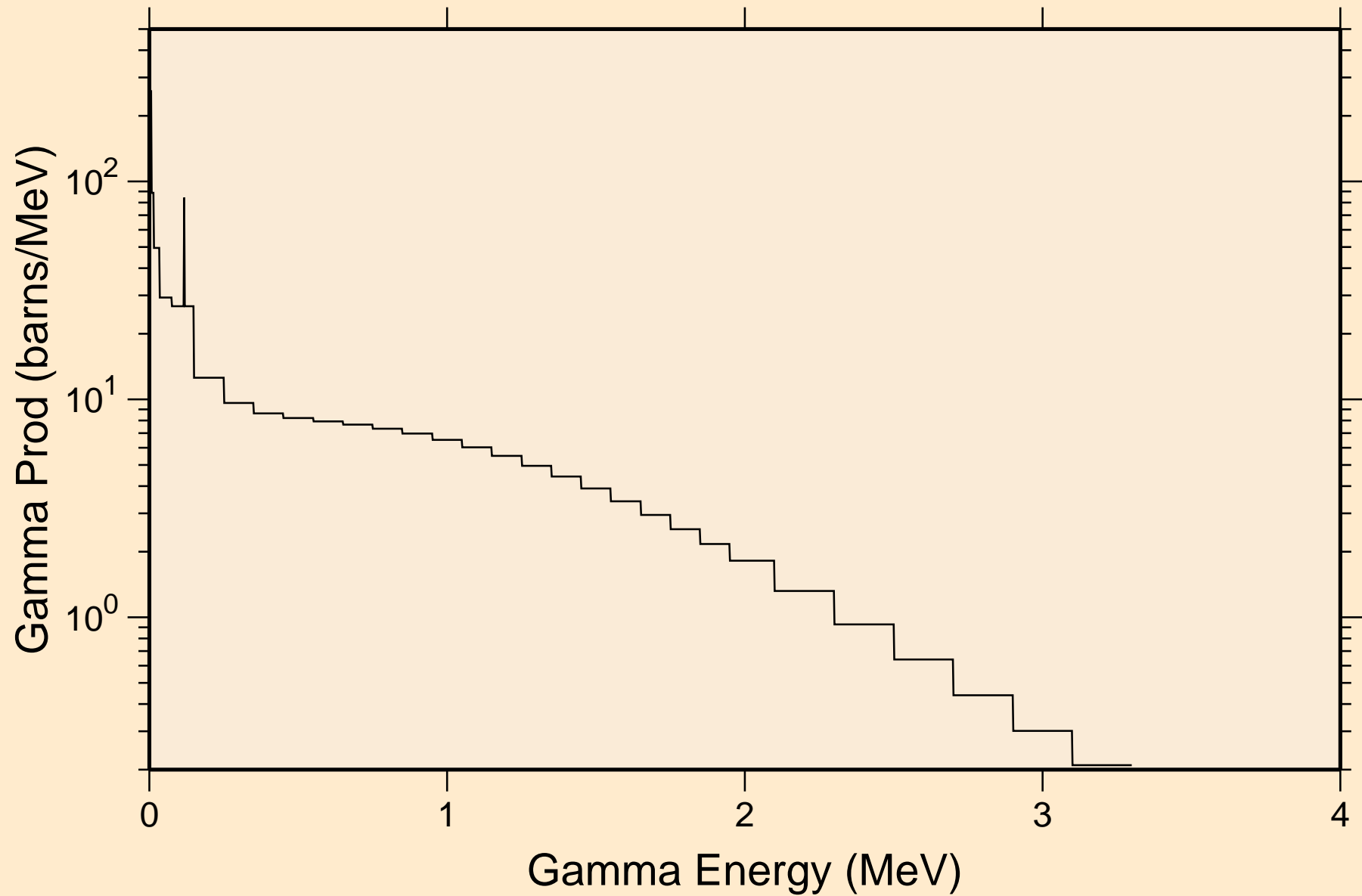

AT221 NRG TENDL-2015, AKONING  
14 MeV photon spectrum

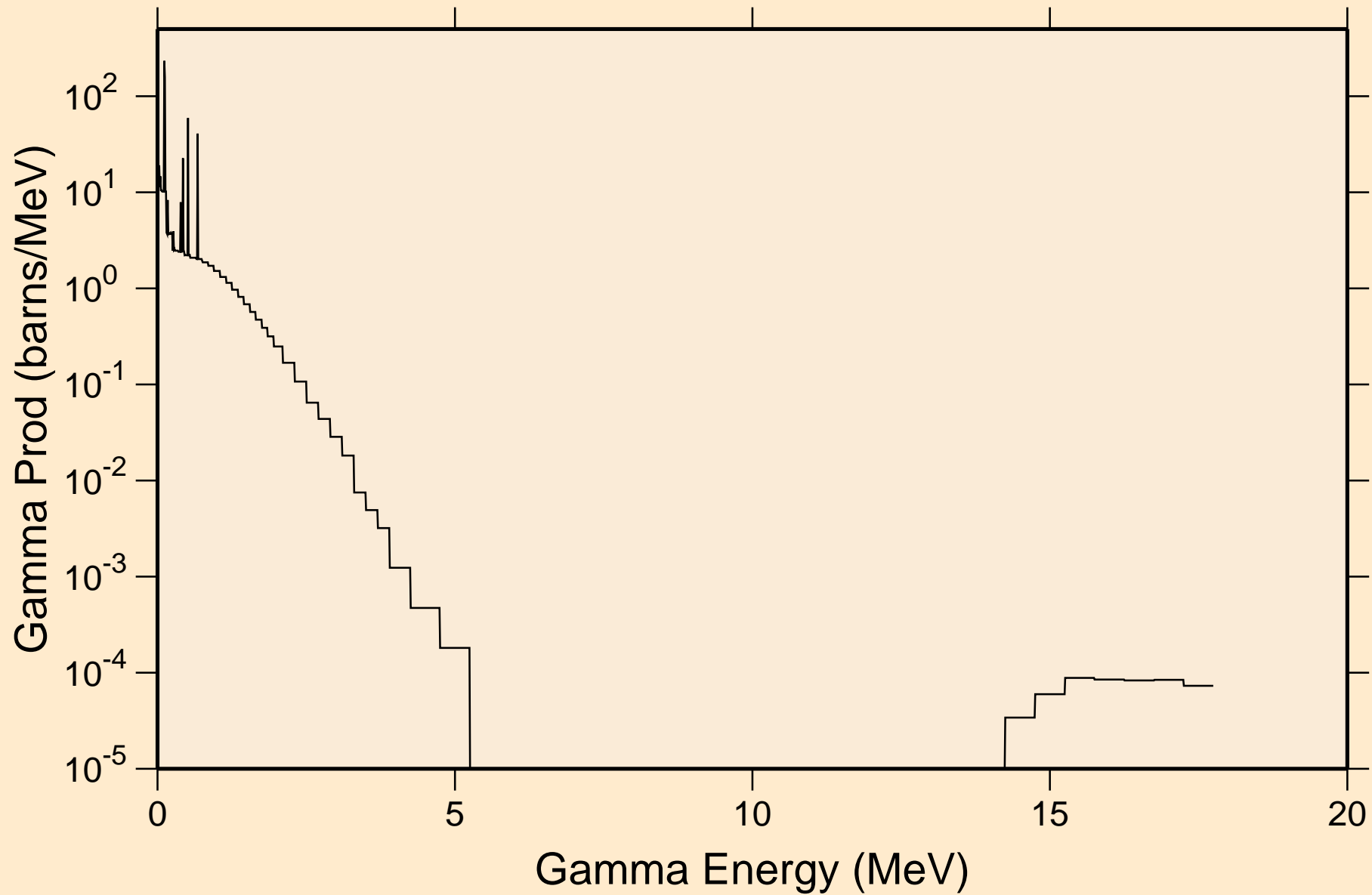

# AT221 NRG TENDL-2015, AKONING

## Particle heating contributions

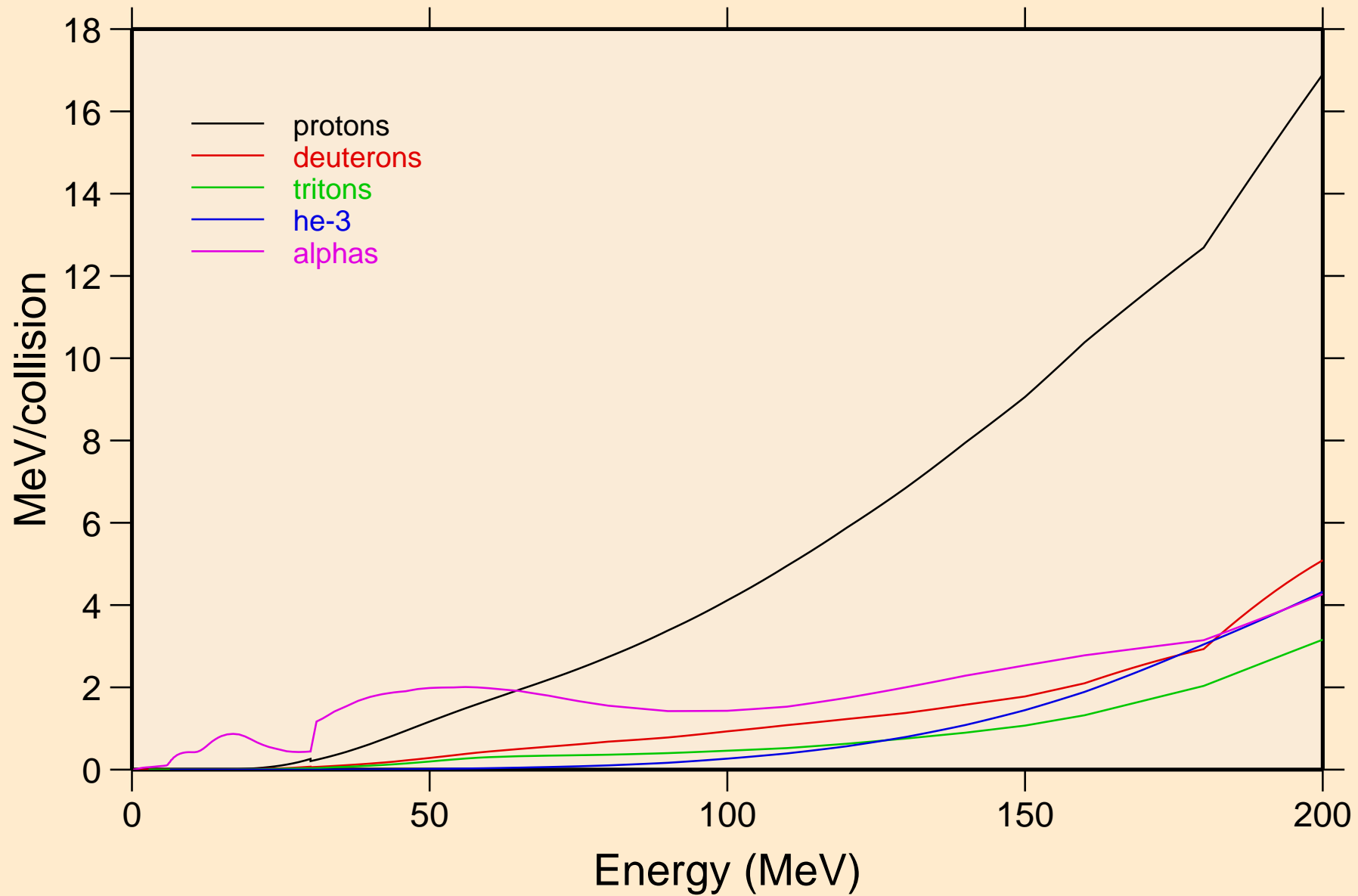

# AT221 NRG TENDL-2015, AKONING

## Recoil Heating

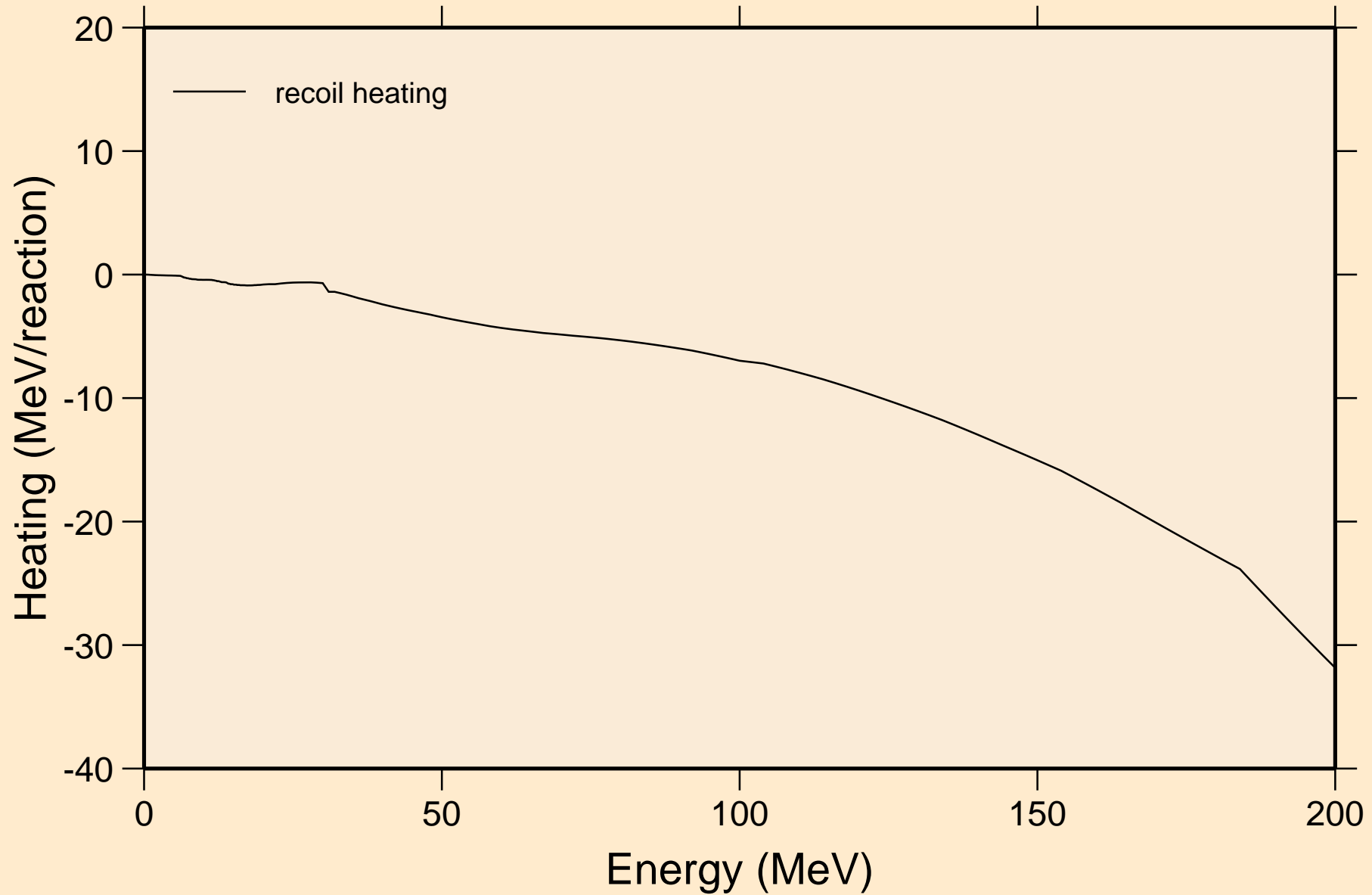

# AT221 NRG TENDL-2015, AKONING

## Particle production cross sections

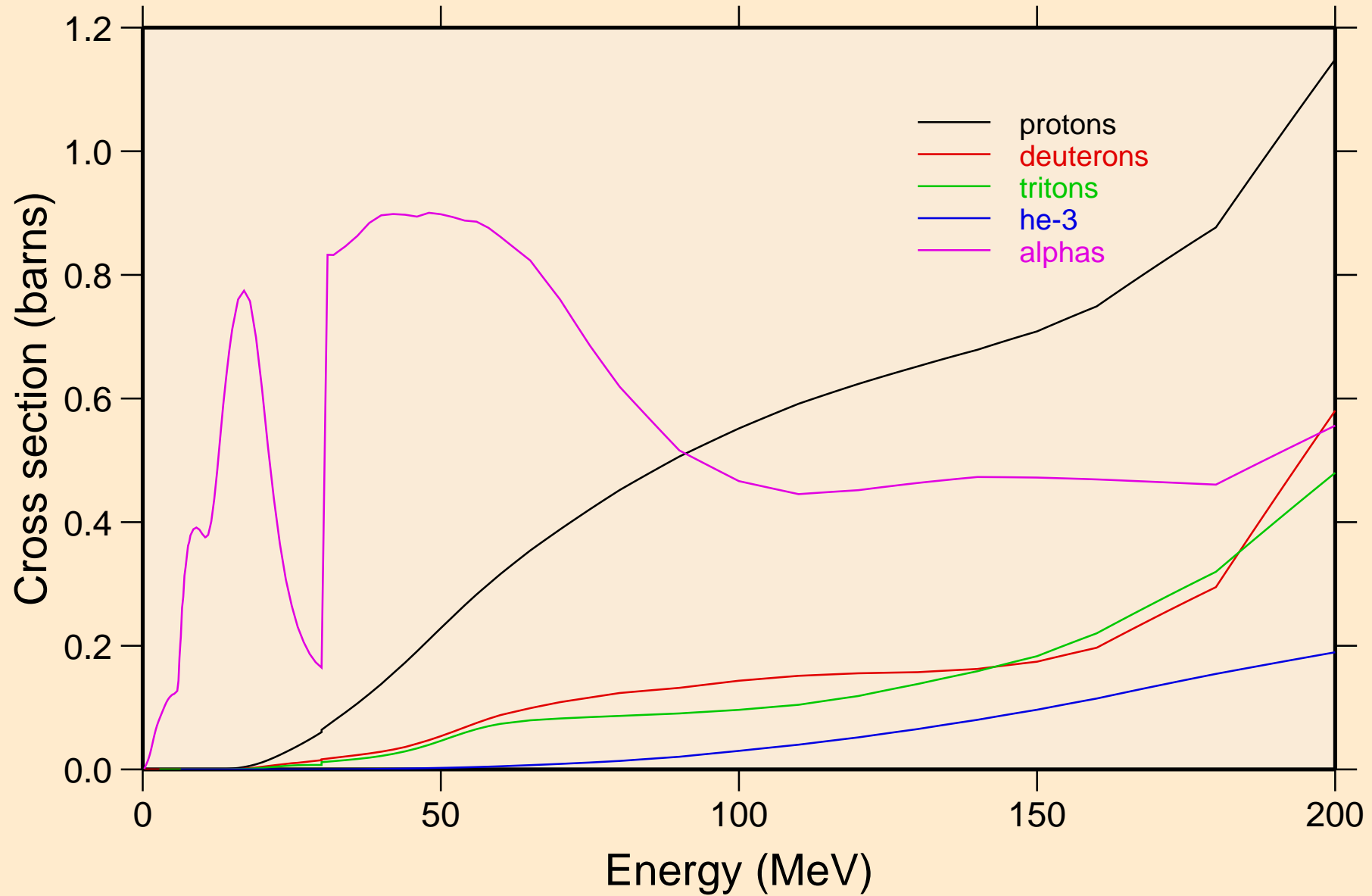

AT221 NRG TENDL-2015, AKONING  
protons from (n,x)

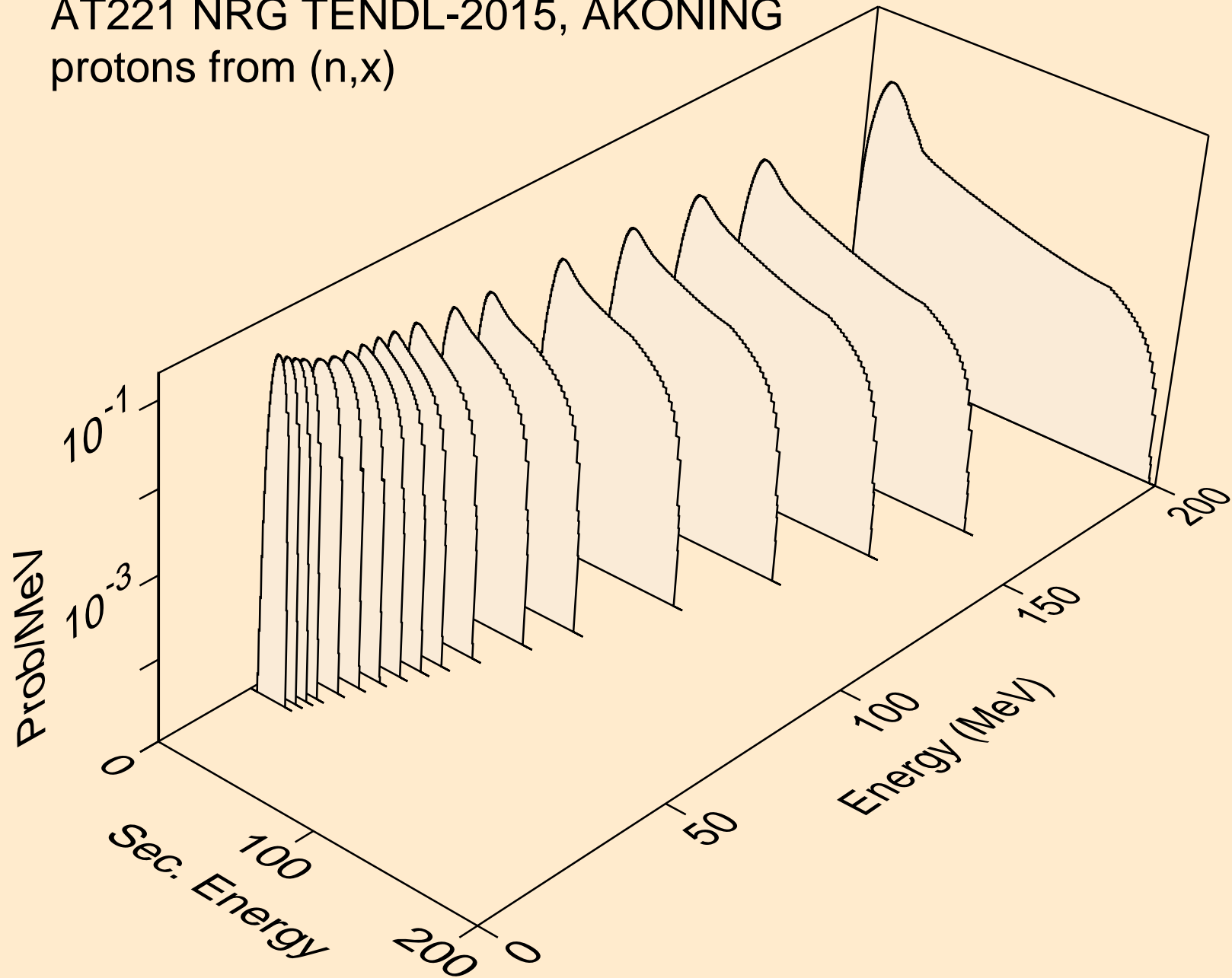

AT221 NRG TENDL-2015, AKONING  
protons from (n,n\*)p

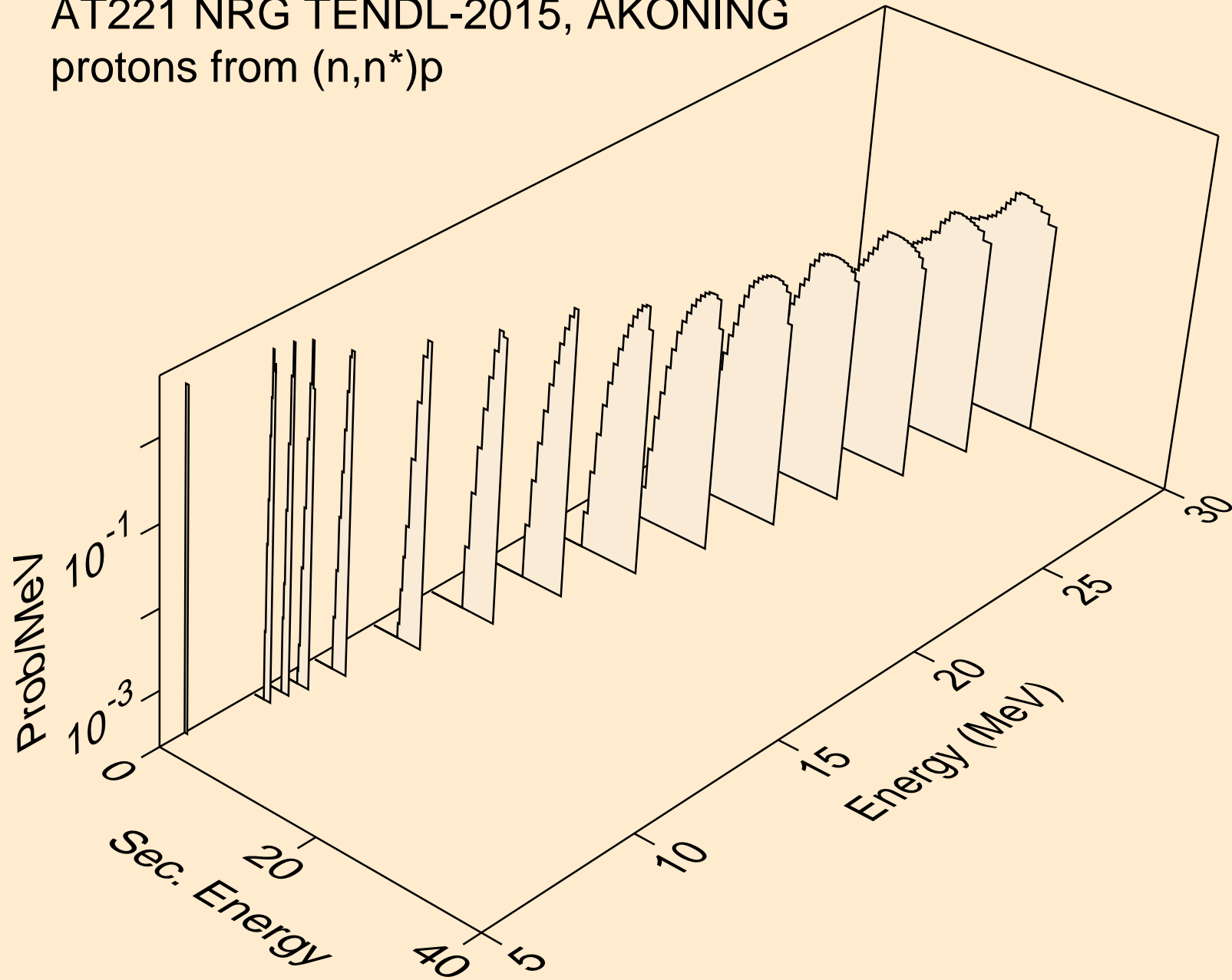



AT221 NRG TENDL-2015, AKONING  
protons from (n,2np)

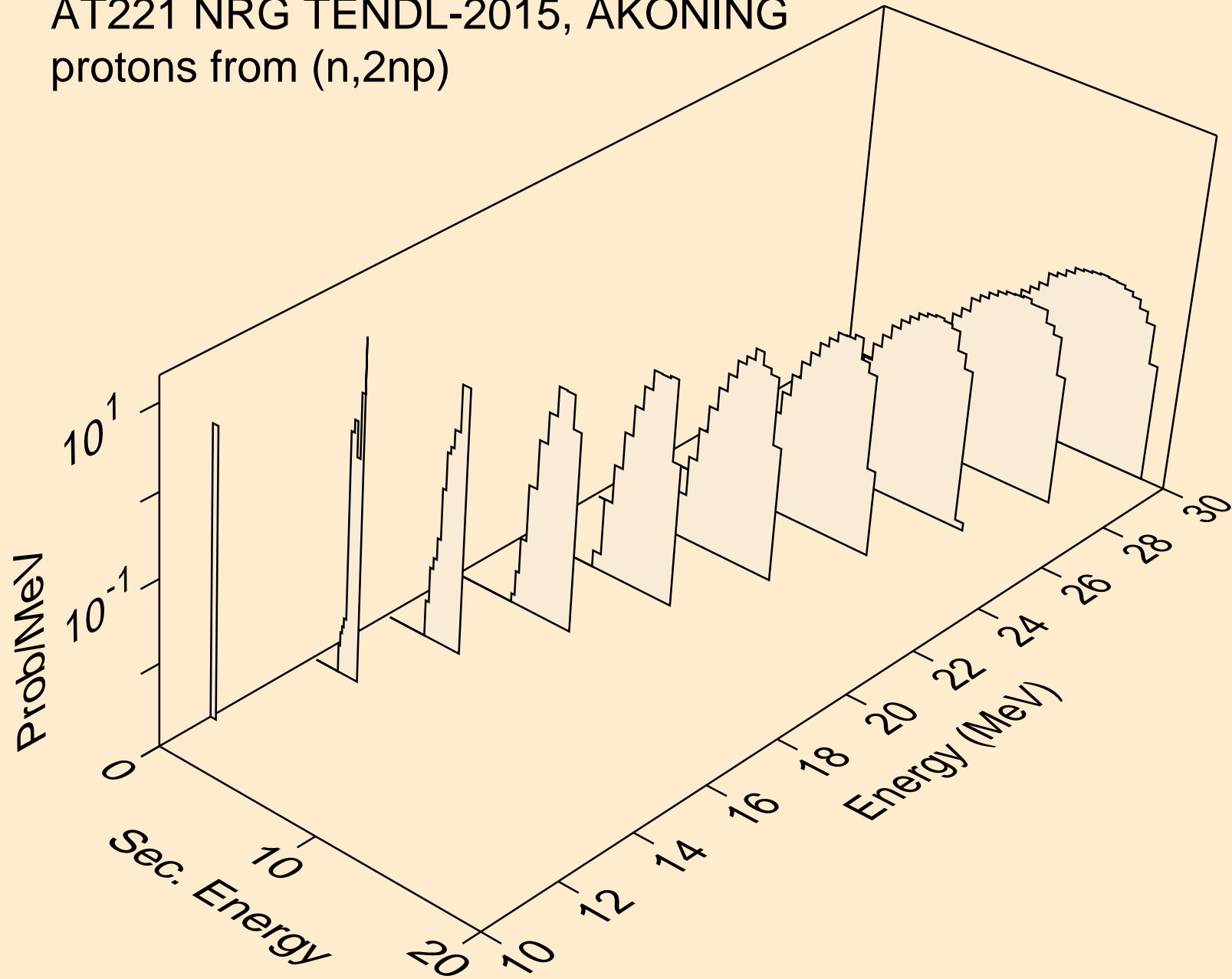

AT221 NRG TENDL-2015, AKONING  
protons from (n,3np)

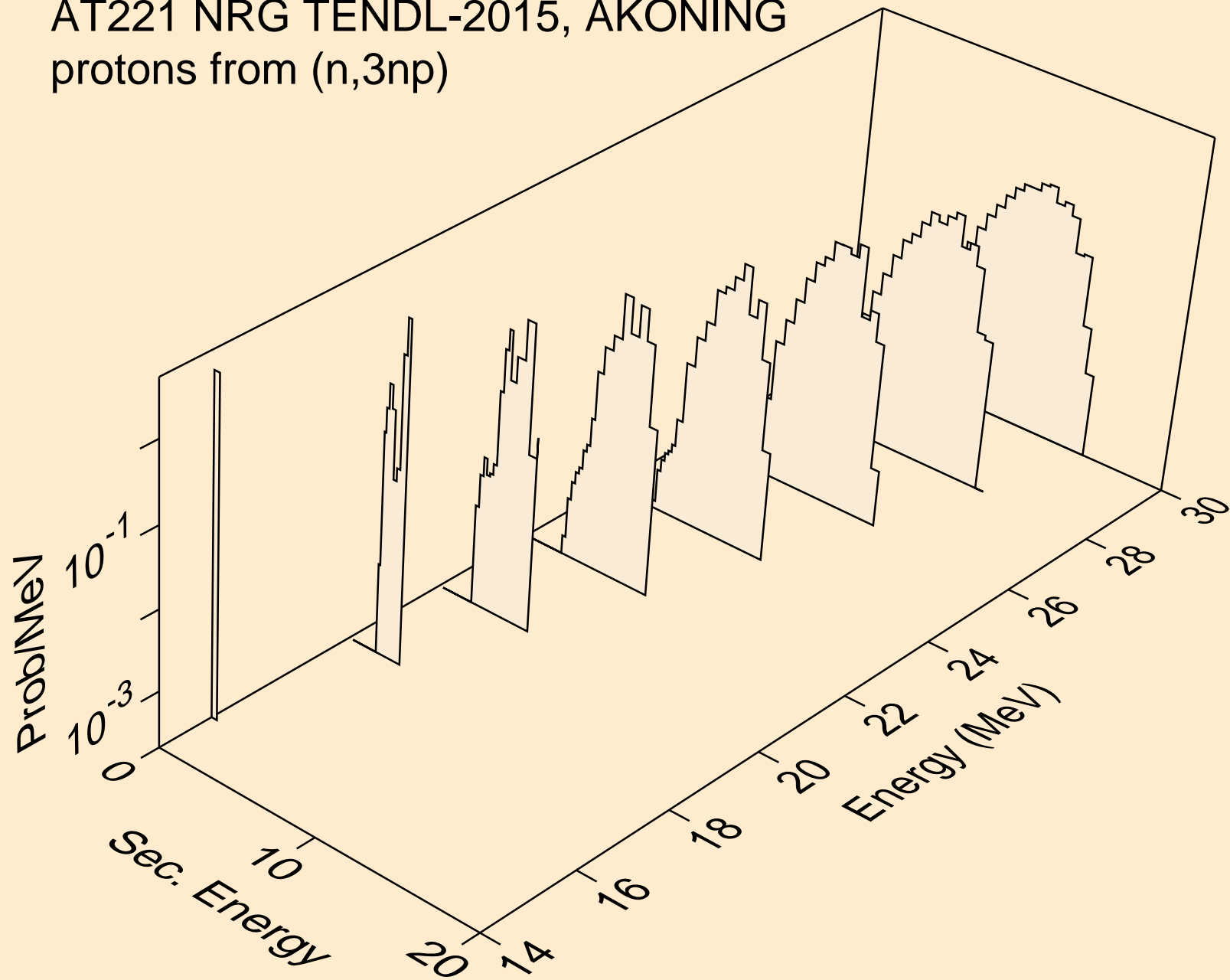

AT221 NRG TENDL-2015, AKONING  
protons from (n,2np)

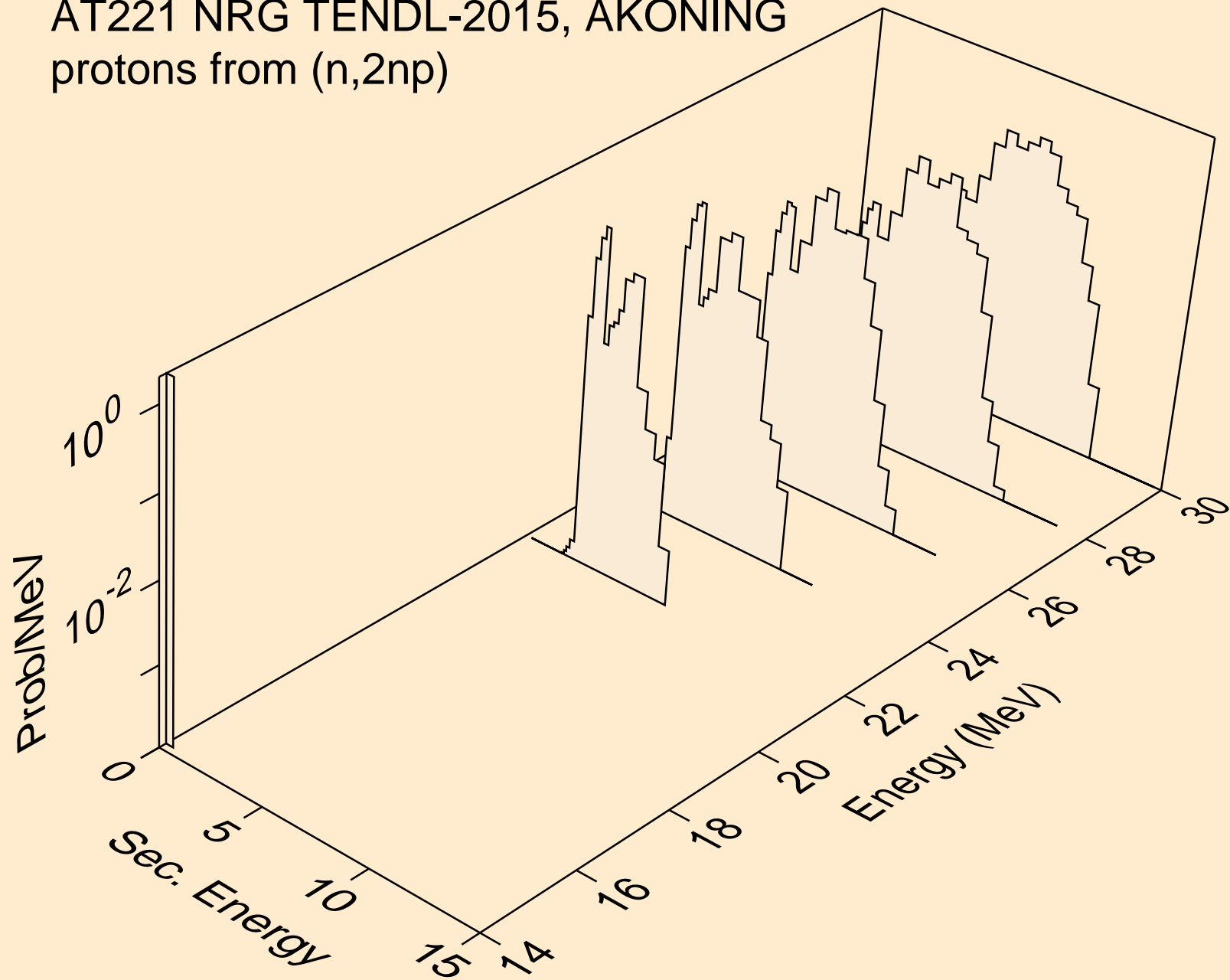

AT221 NRG TENDL-2015, AKONING  
protons from (n,npa)

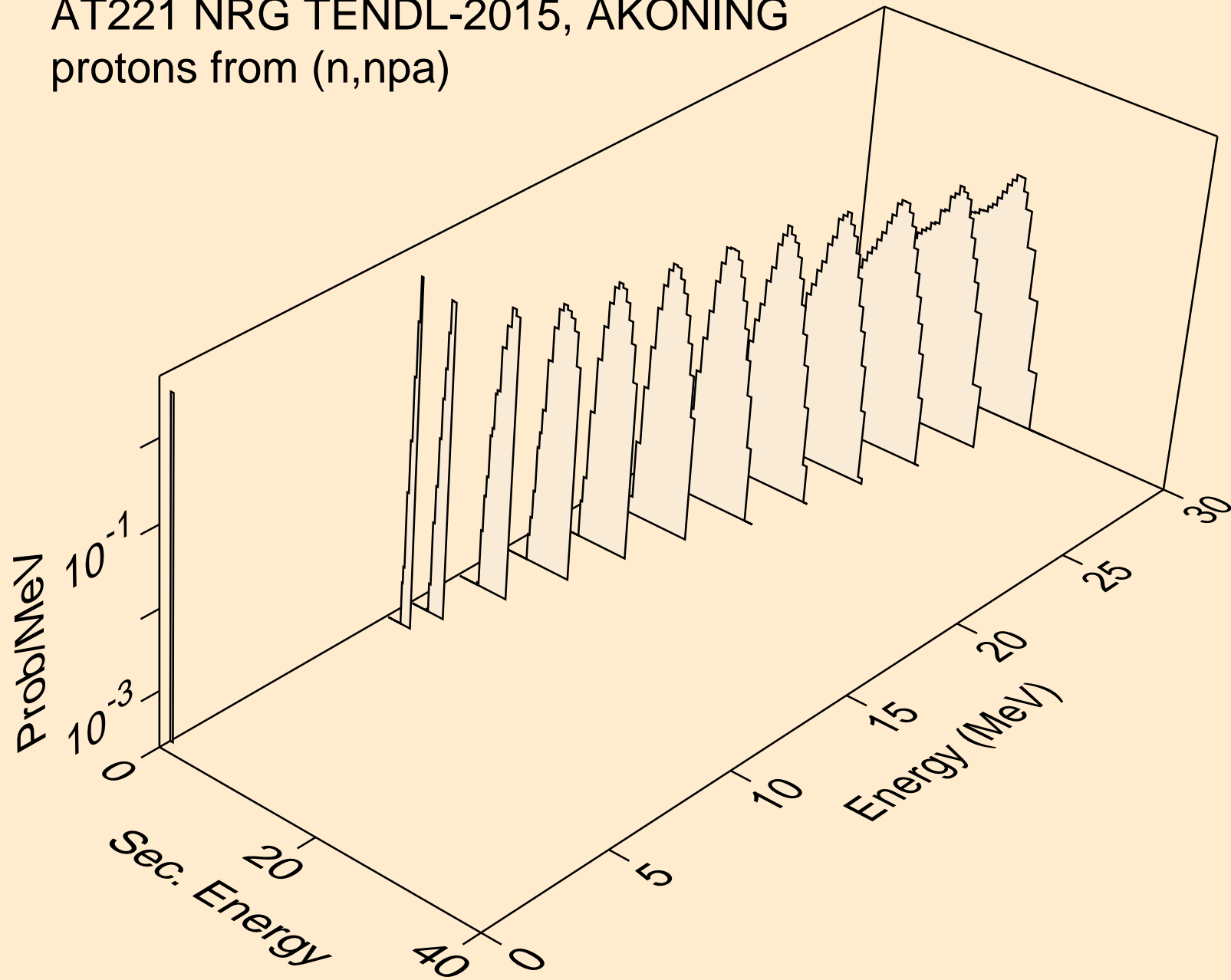

AT221 NRG TENDL-2015, AKONING  
protons from (n,p)

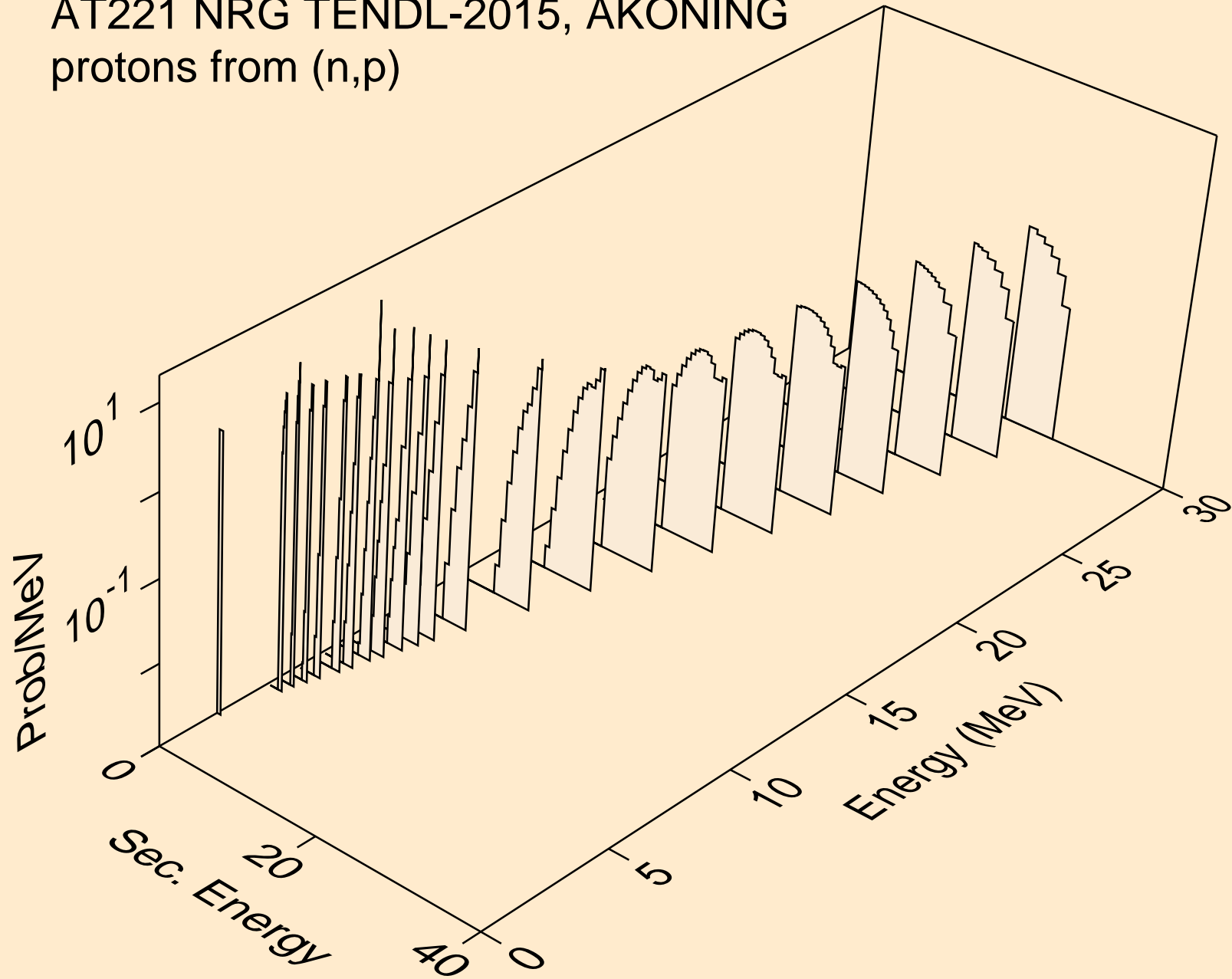

AT221 NRG TENDL-2015, AKONING  
protons from (n,2p)

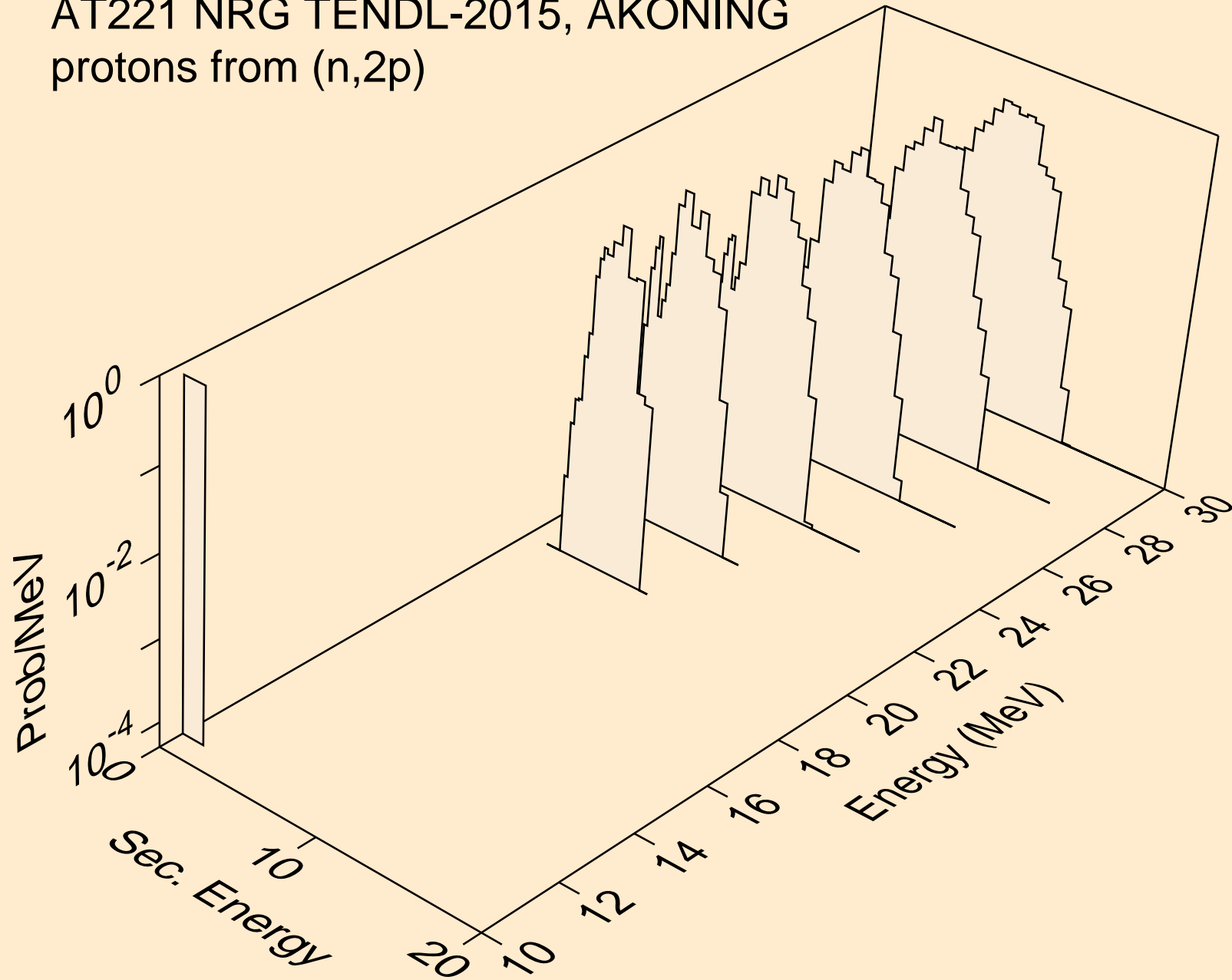

AT221 NRG TENDL-2015, AKONING  
protons from (n,pa)

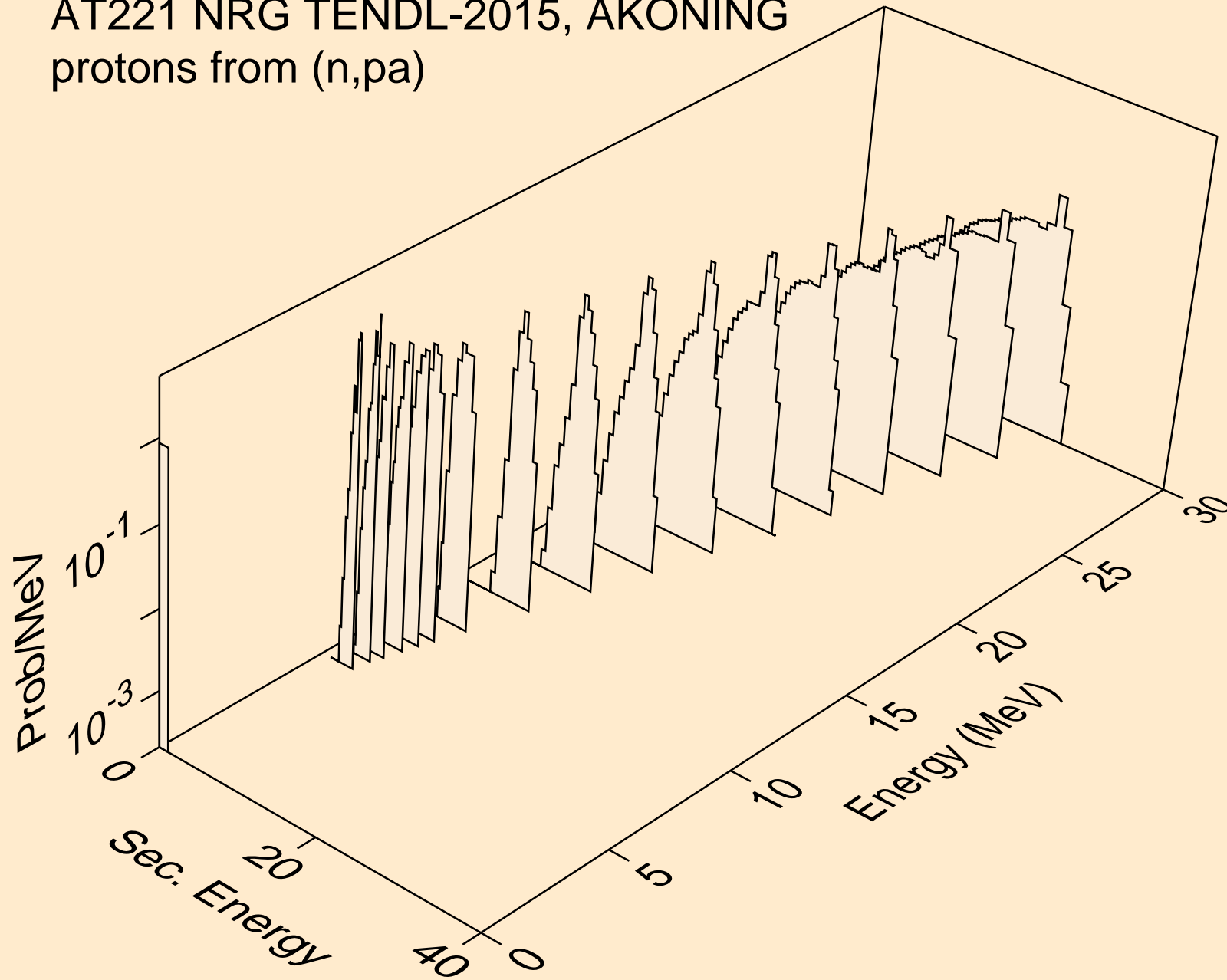

AT221 NRG TENDL-2015, AKONING  
deuterons from (n,x)

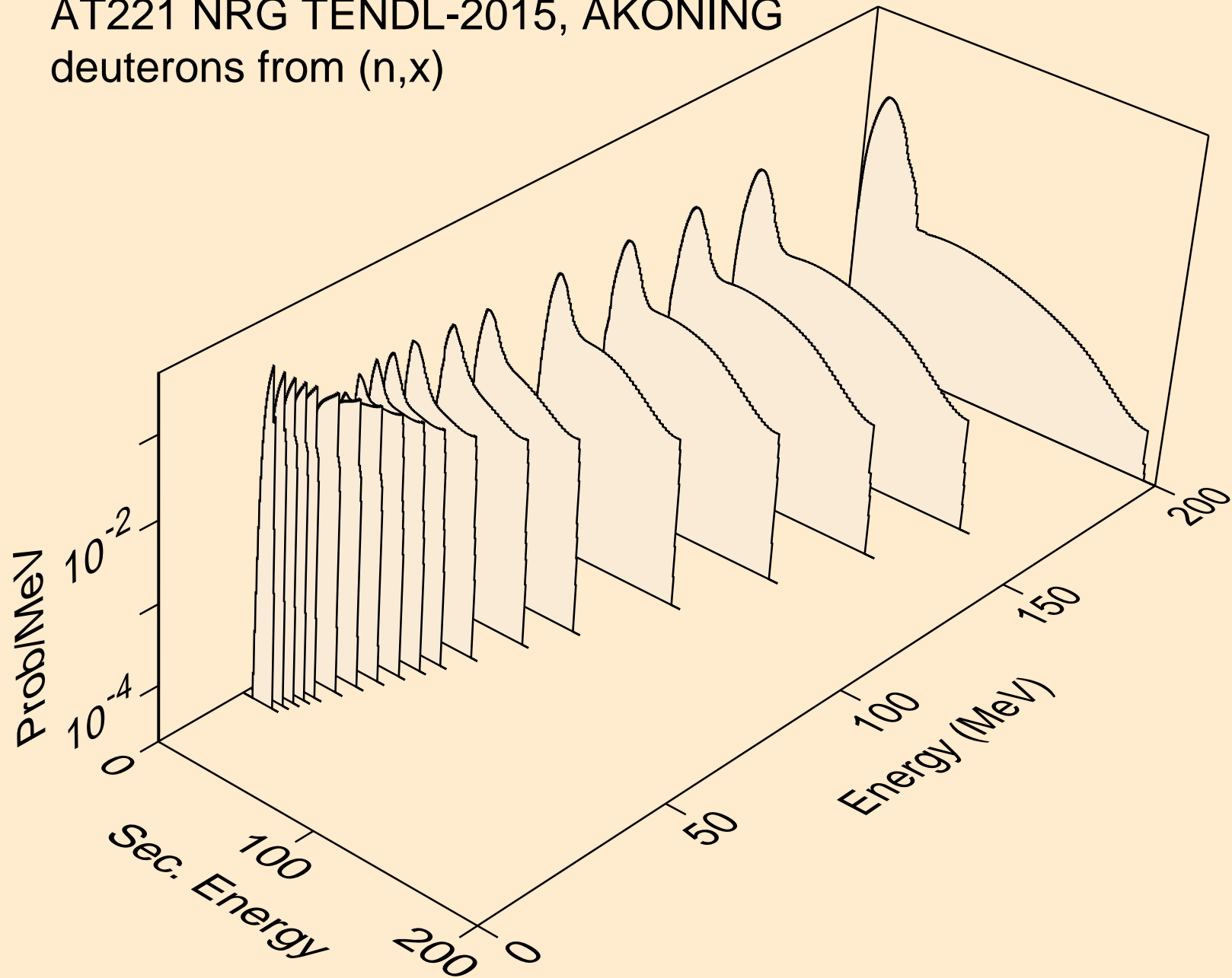



AT221 NRG TENDL-2015, AKONING  
deuterons from (n,2nd)

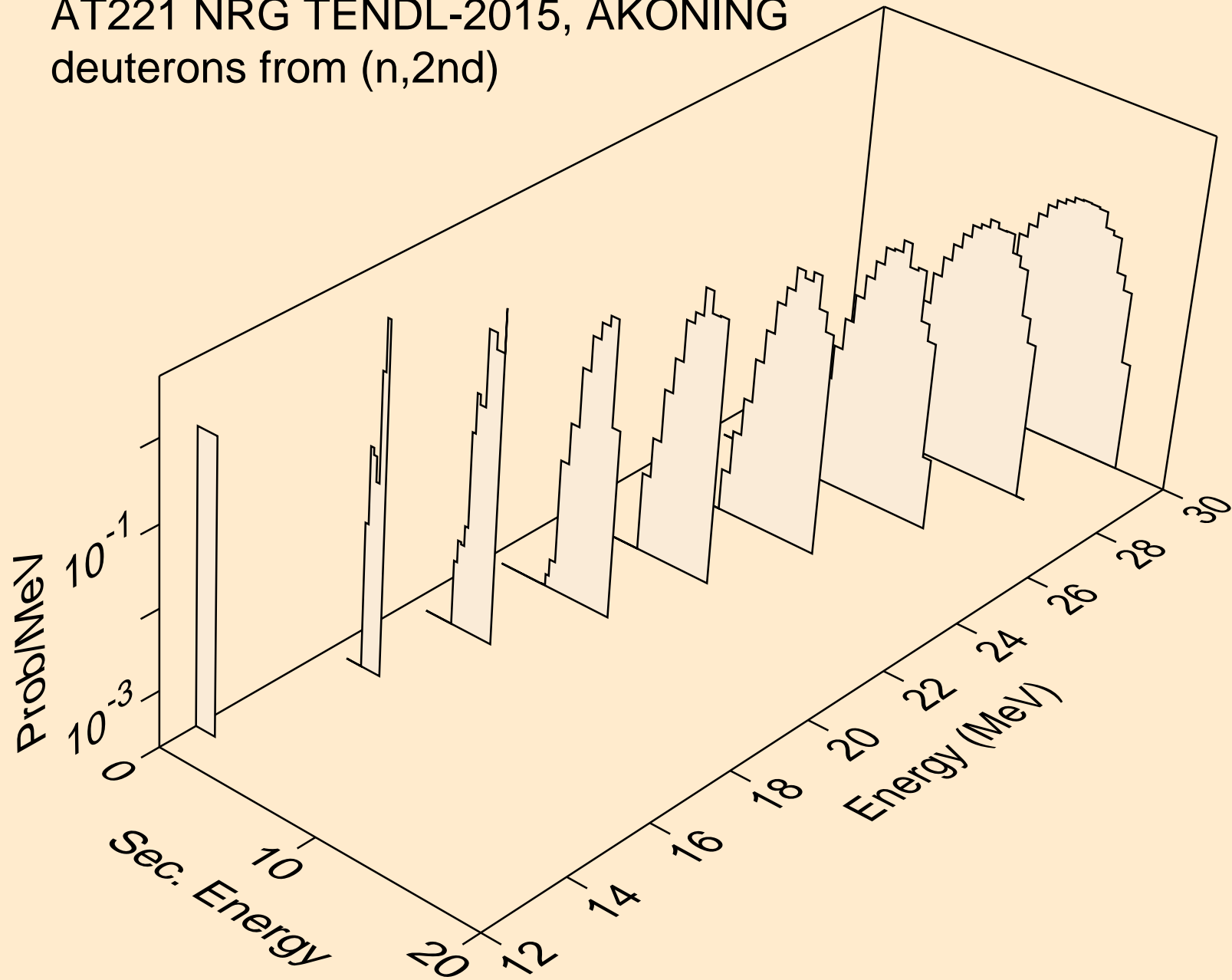

AT221 NRG TENDL-2015, AKONING  
deuterons from (n,n\*)d

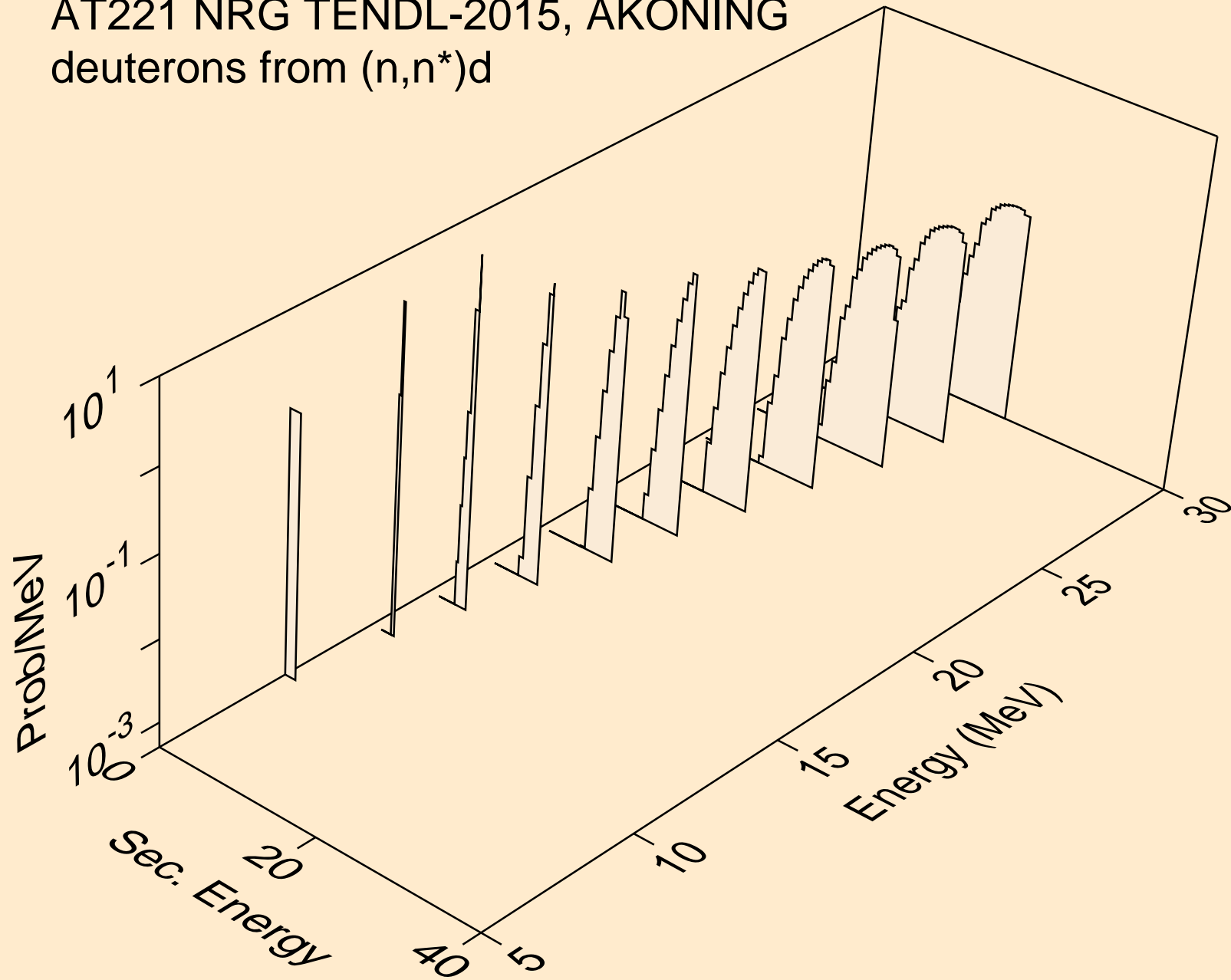

AT221 NRG TENDL-2015, AKONING  
deuterons from (n,d)

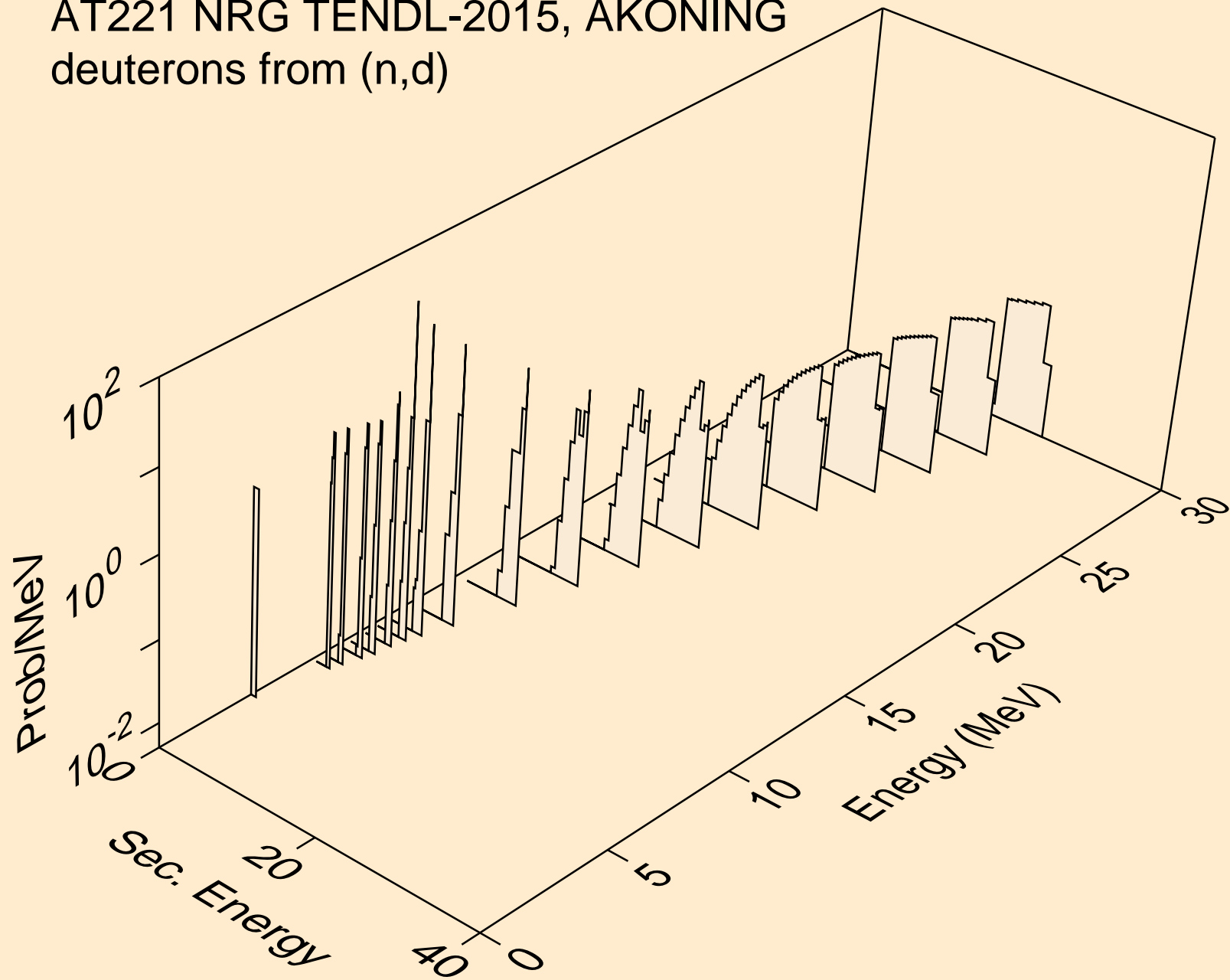

AT221 NRG TENDL-2015, AKONING  
deuterons from (n,da)

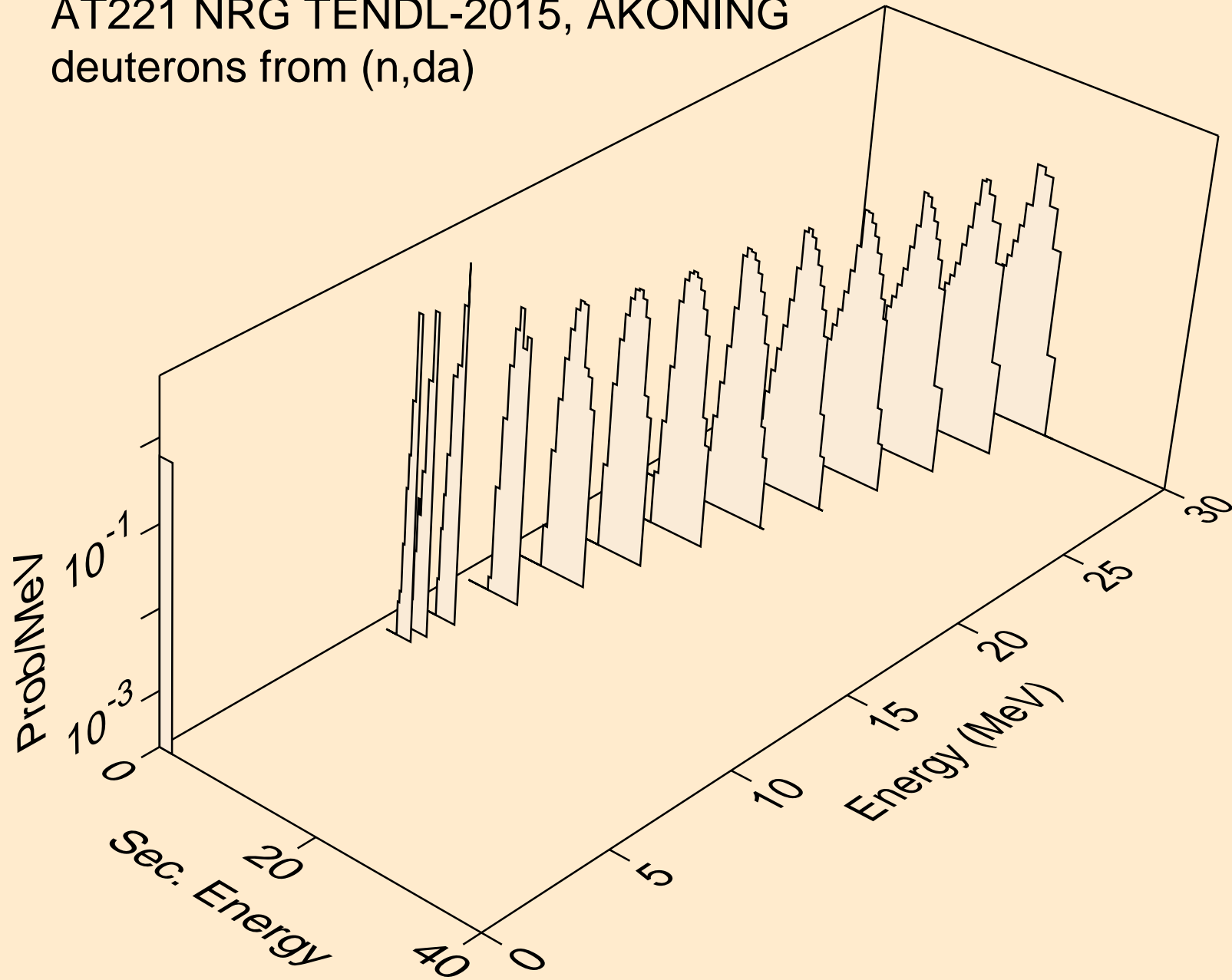

AT221 NRG TENDL-2015, AKONING  
tritons from (n,x)

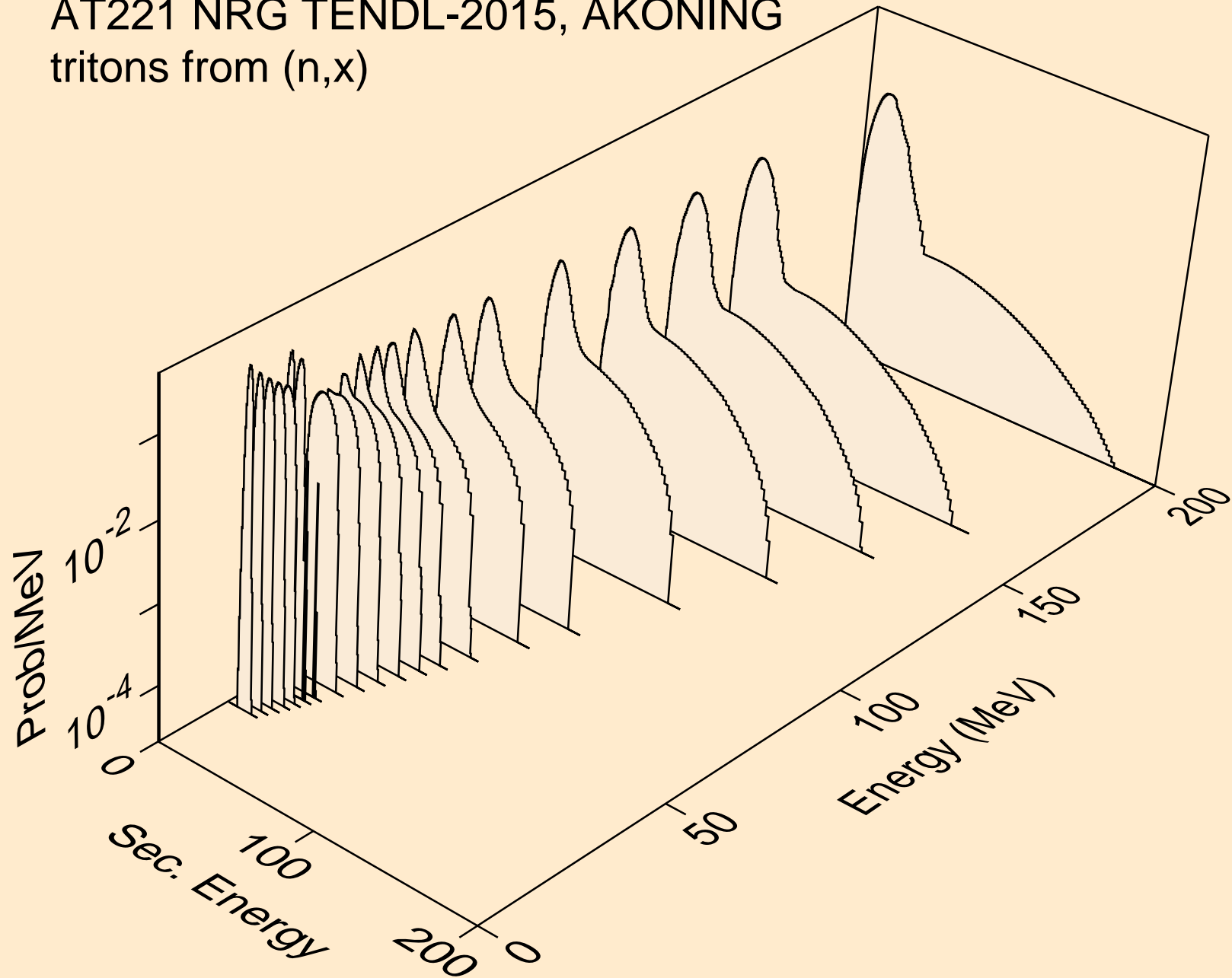

AT221 NRG TENDL-2015, AKONING  
tritons from (n,n\*)t

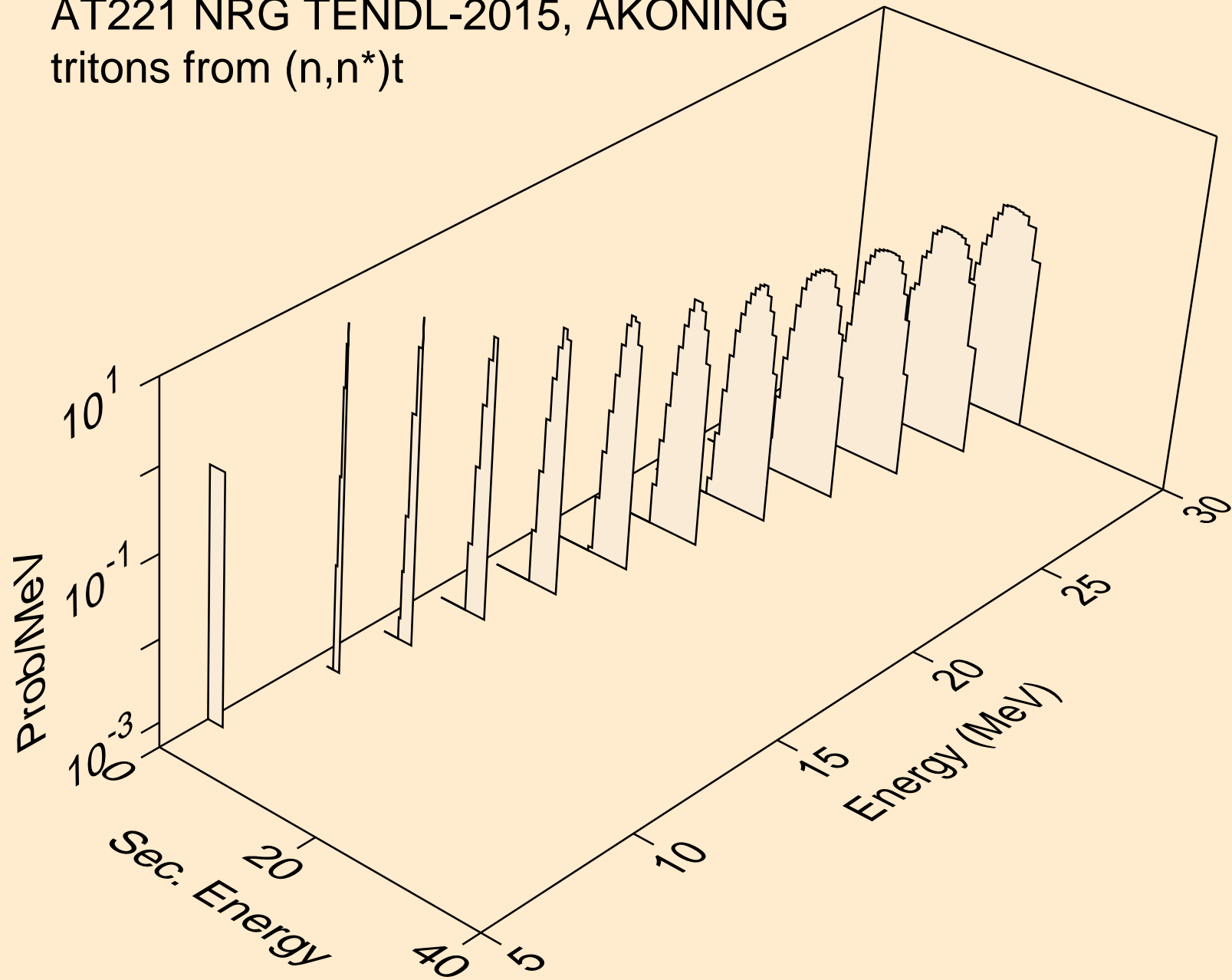

AT221 NRG TENDL-2015, AKONING  
tritons from (n,t)

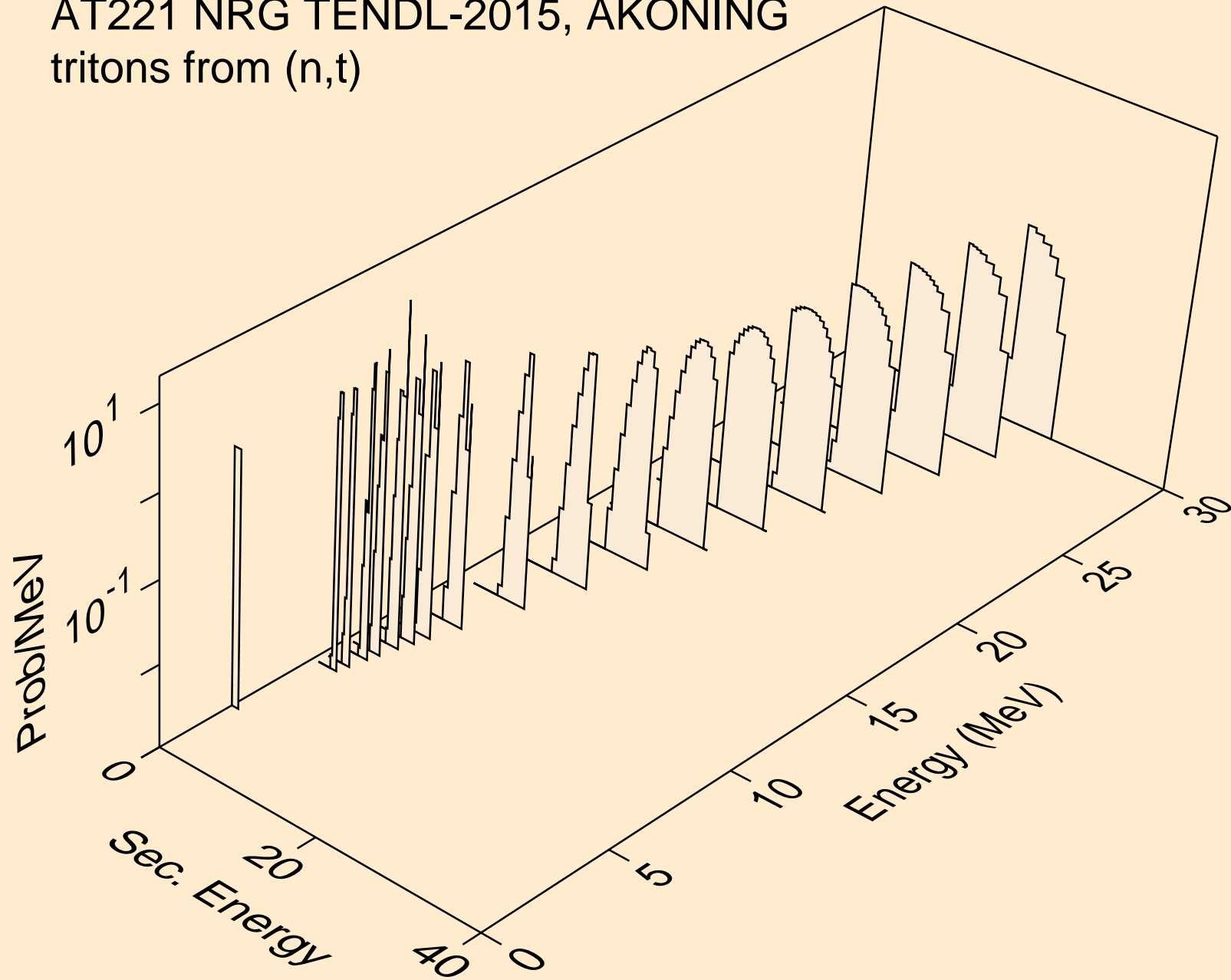

AT221 NRG TENDL-2015, AKONING  
he3s from (n,x)

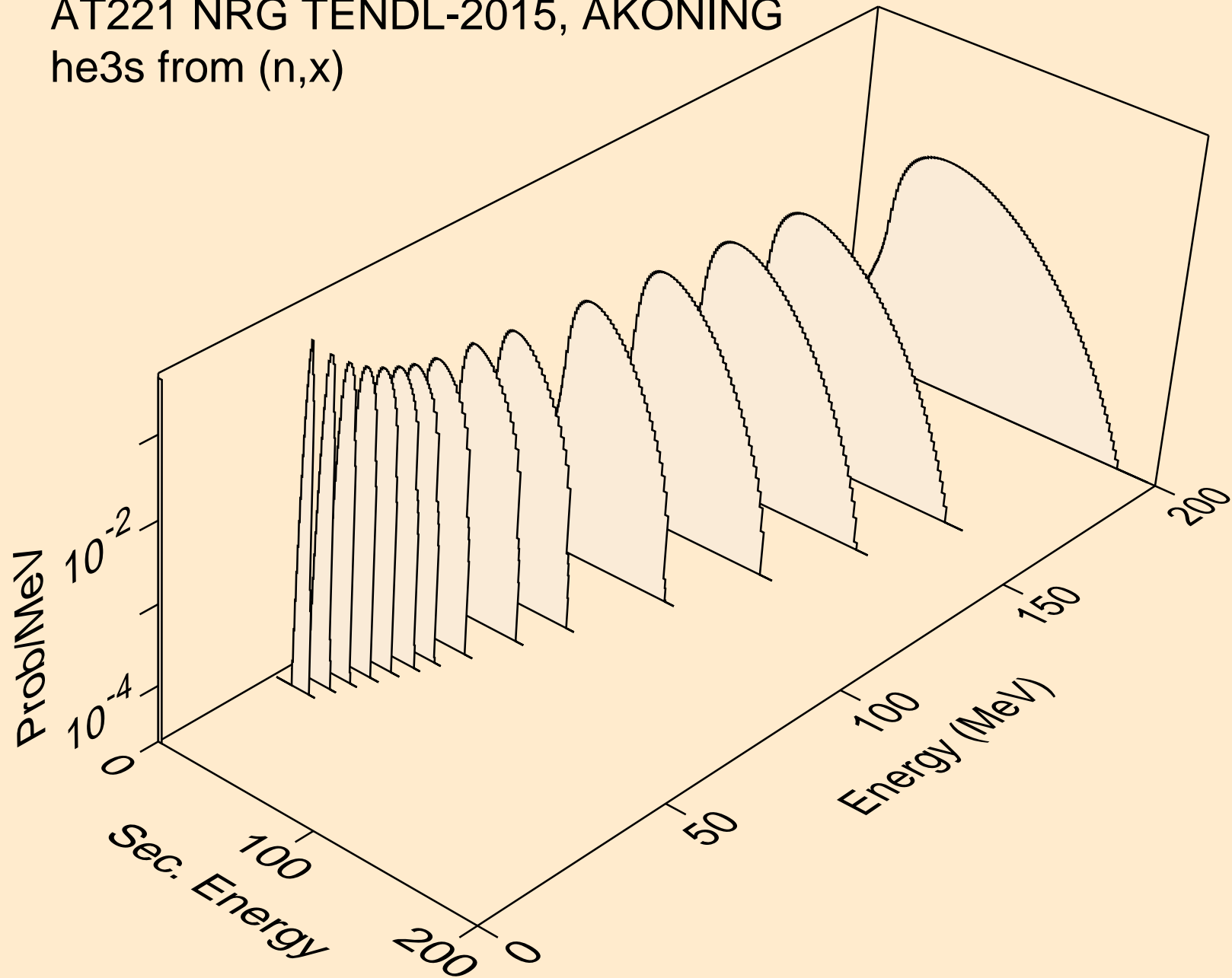



AT221 NRG TENDL-2015, AKONING  
he3s from (n,n\*)he3

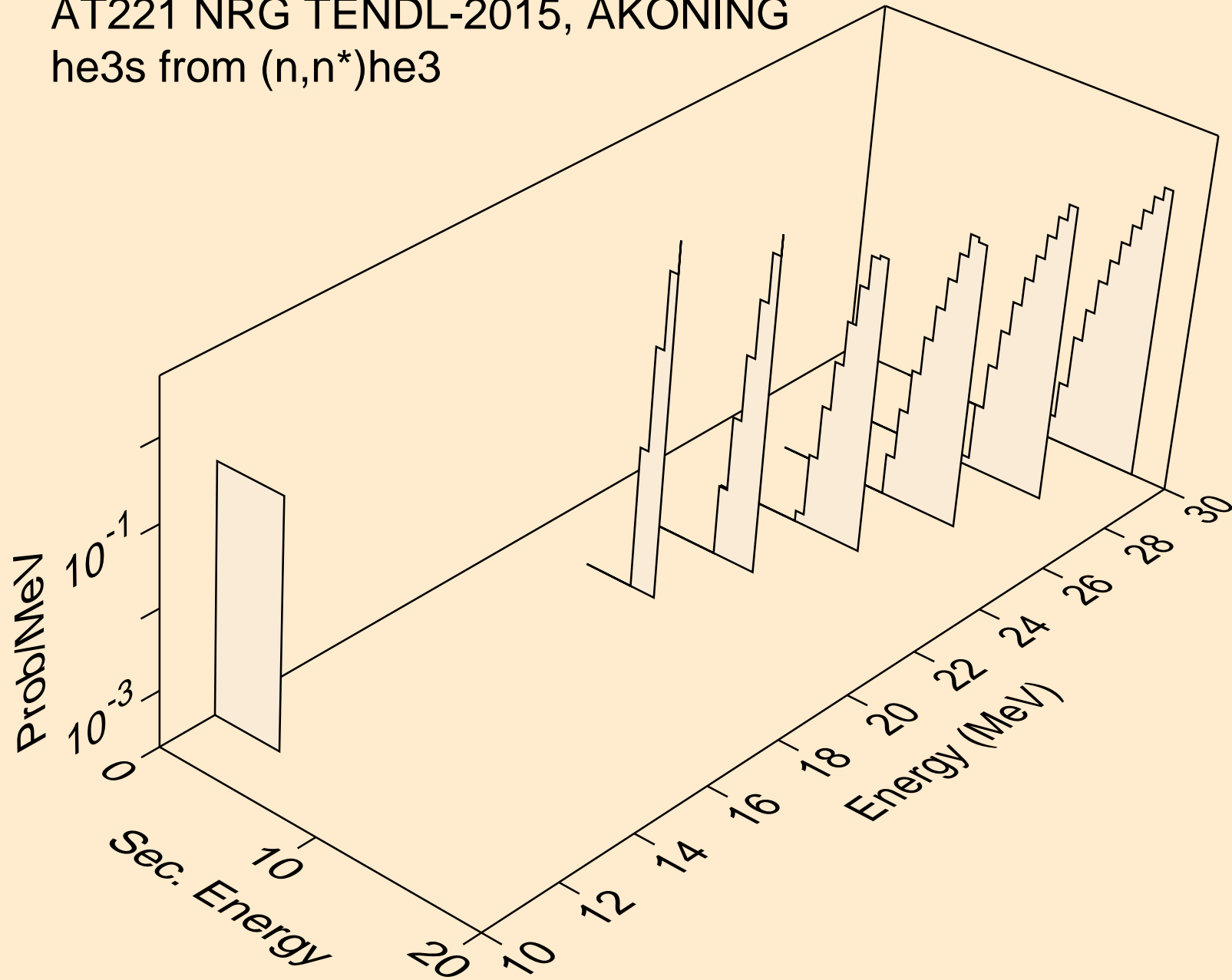

AT221 NRG TENDL-2015, AKONING  
he3s from (n,he3)

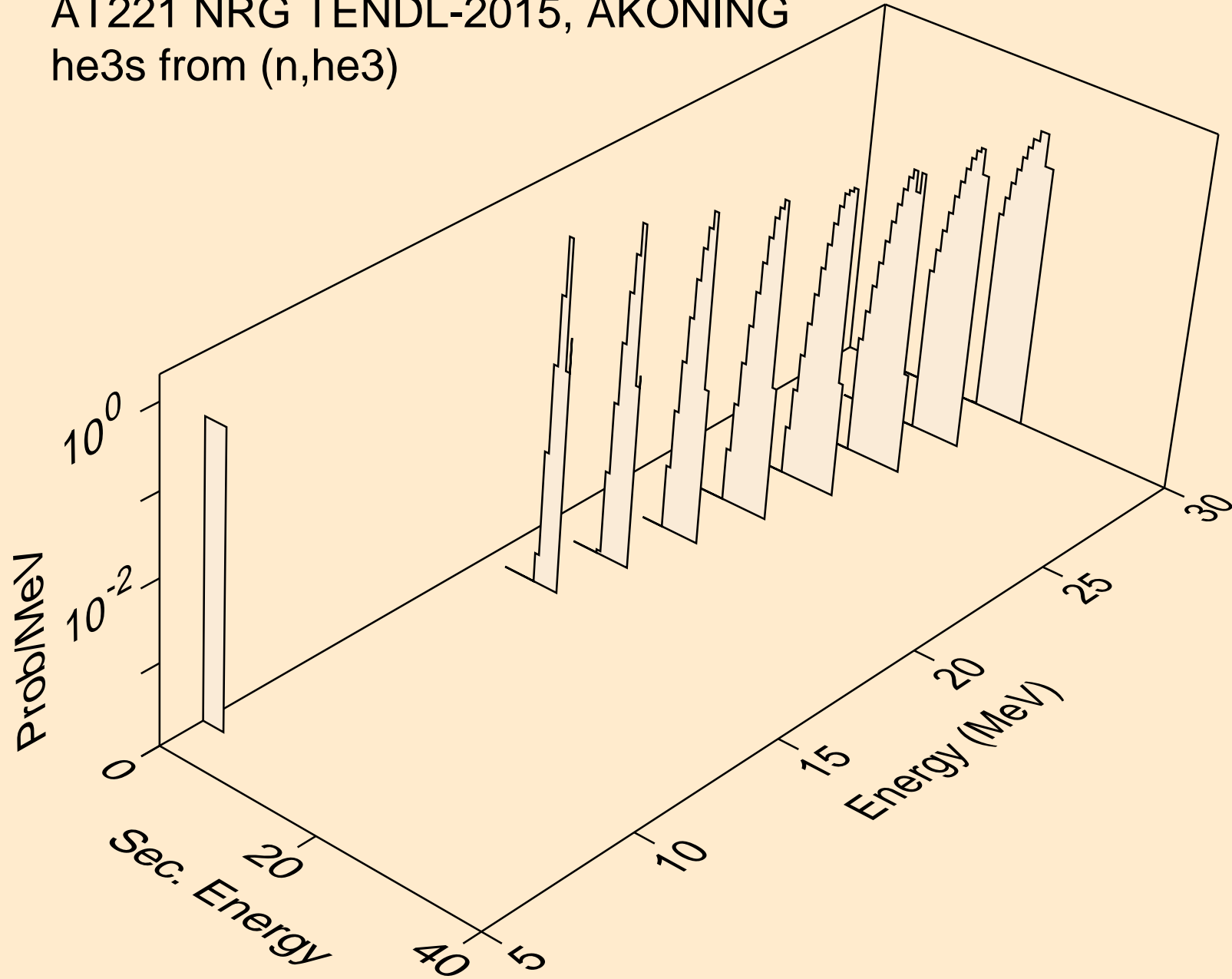

AT221 NRG TENDL-2015, AKONING  
alphas from (n,x)

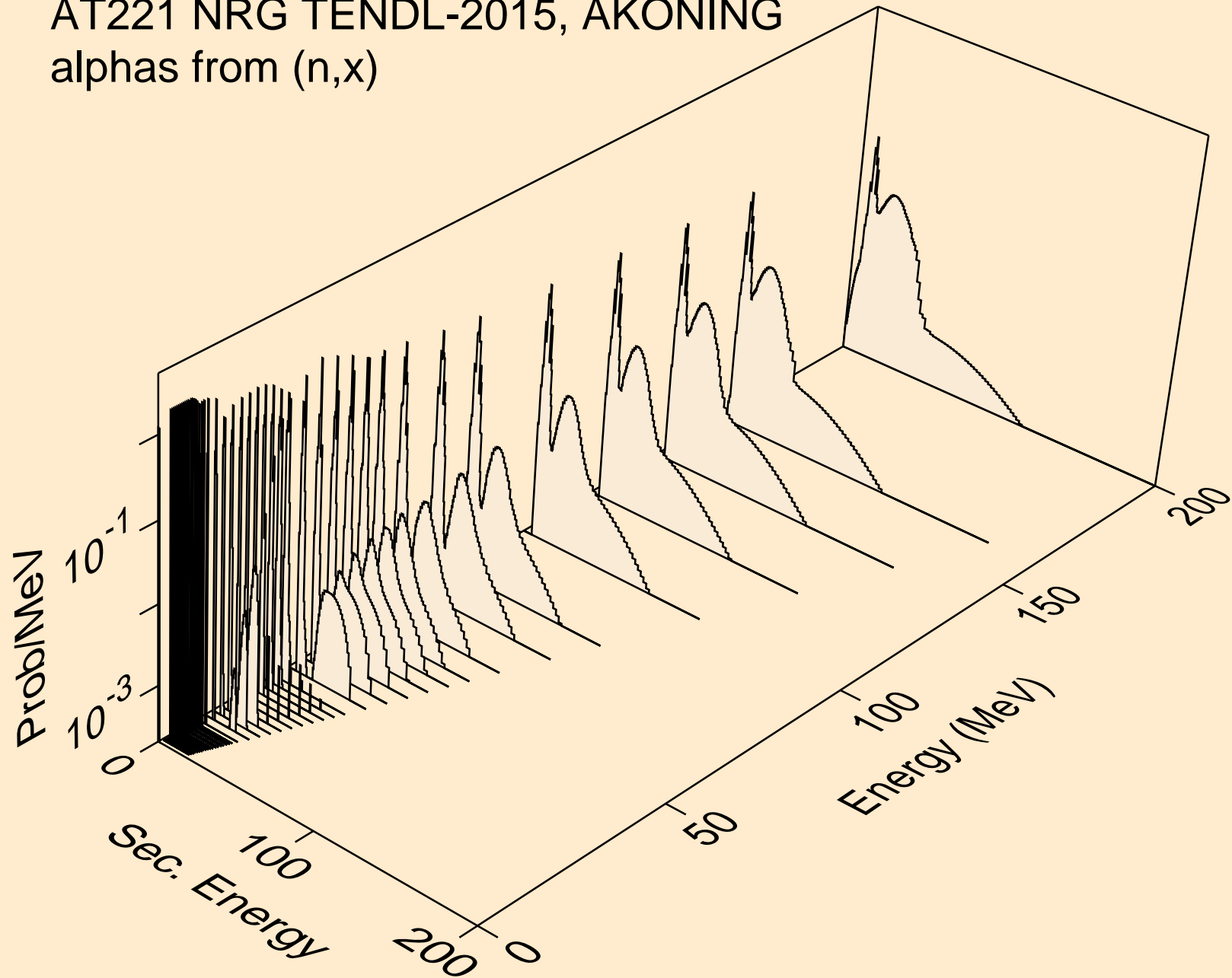

AT221 NRG TENDL-2015, AKONING  
alphas from (n,n\*)a

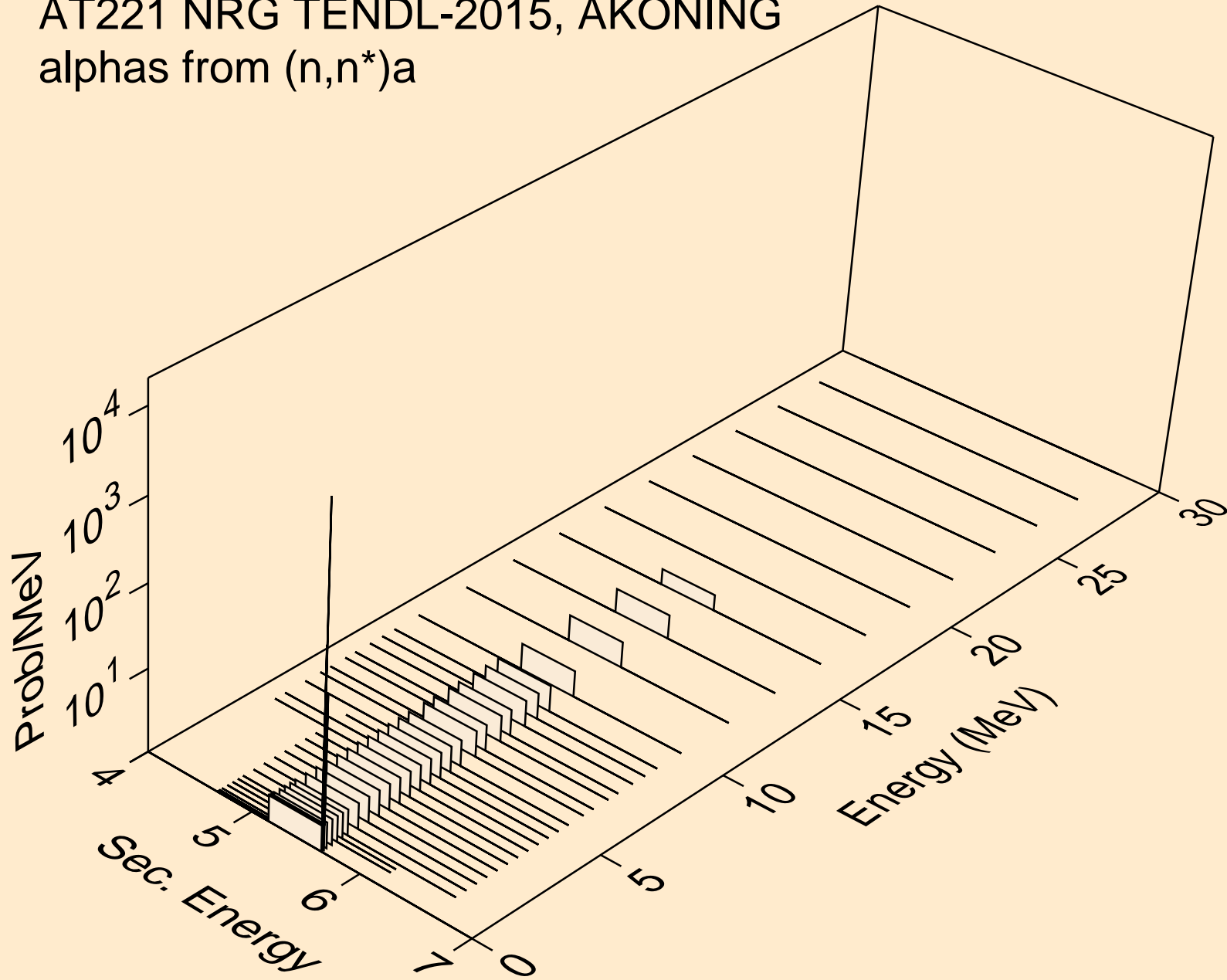

AT221 NRG TENDL-2015, AKONING  
alphas from (n,2n)a

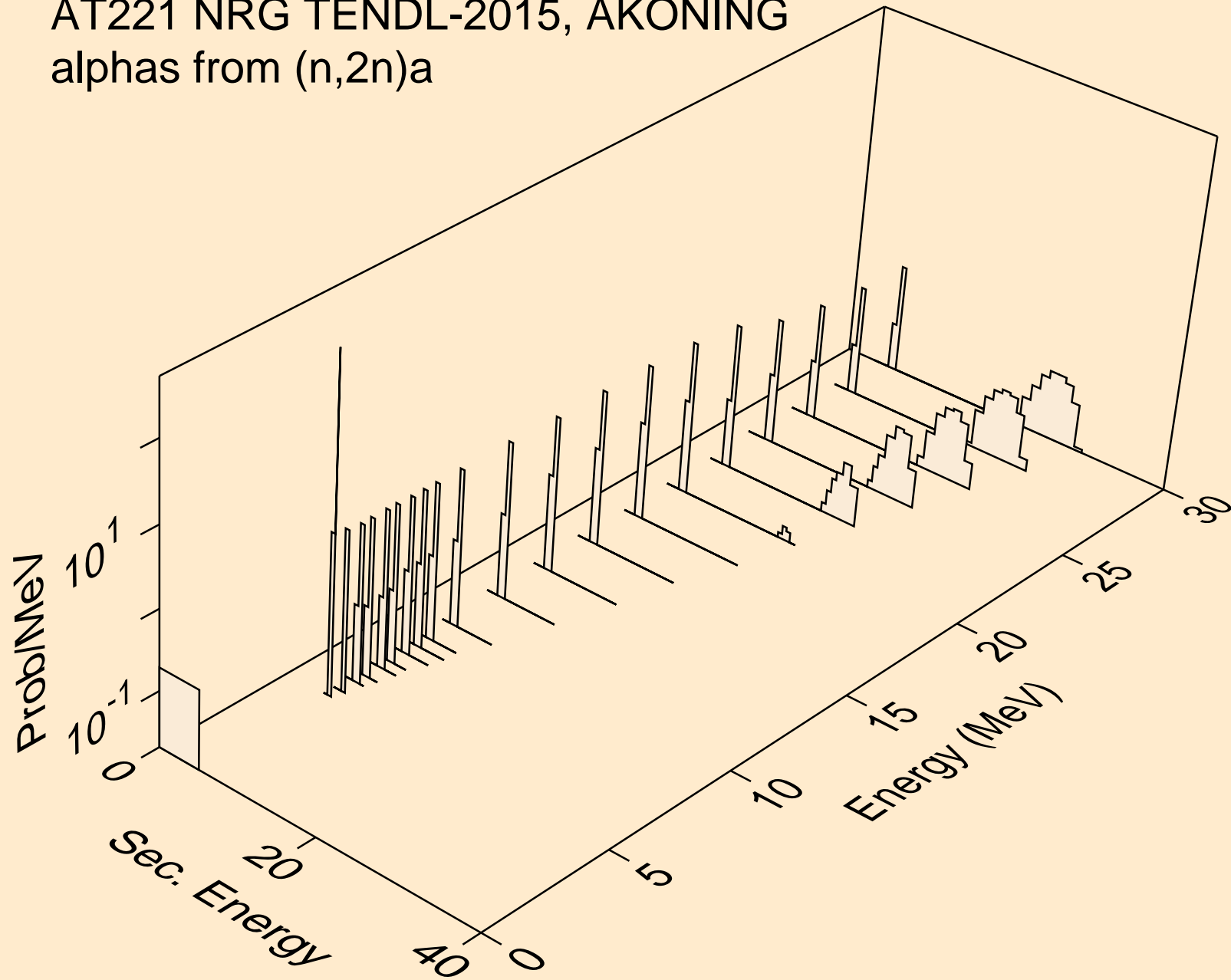

AT221 NRG TENDL-2015, AKONING  
alphas from (n,3n)a

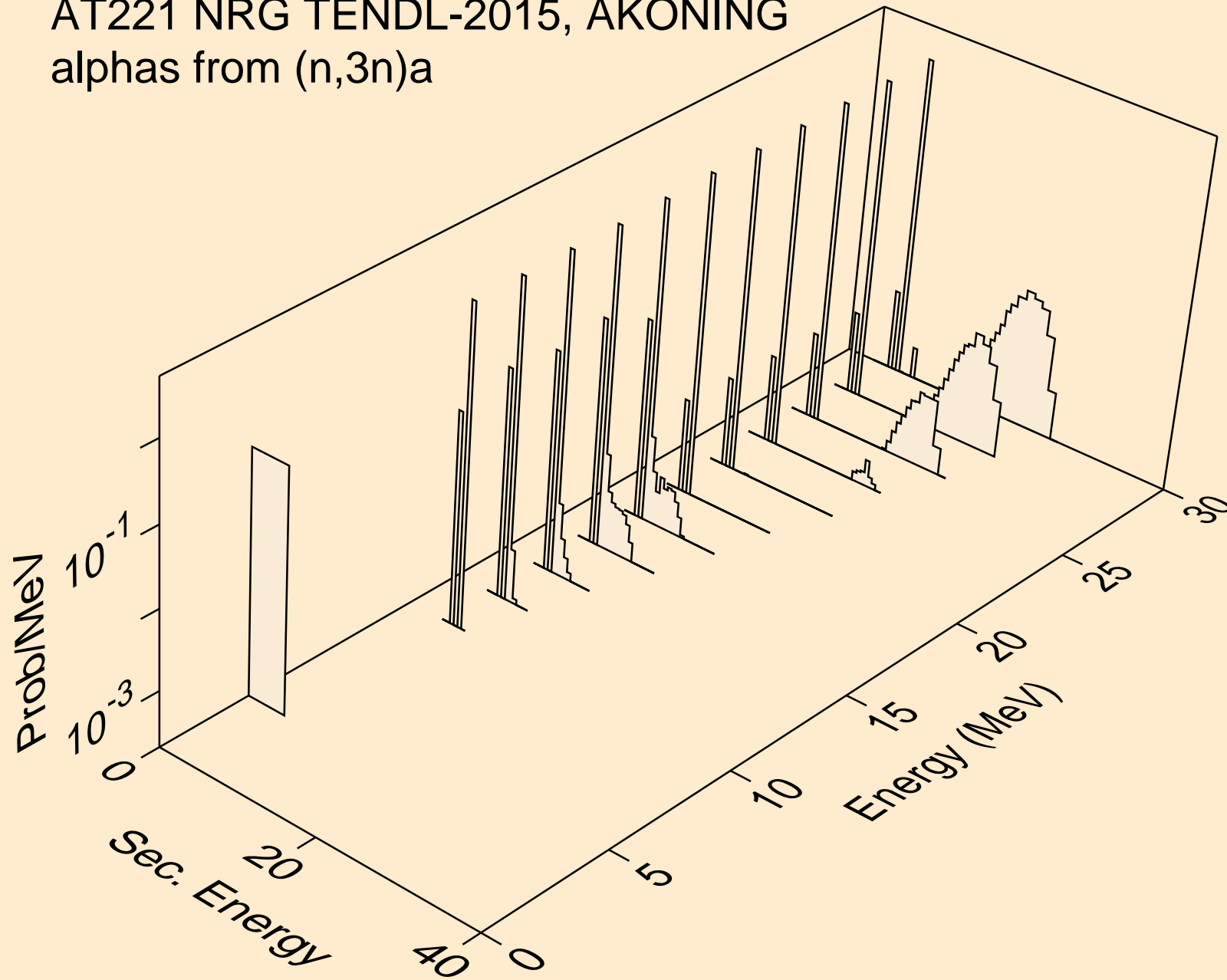

AT221 NRG TENDL-2015, AKONING  
alphas from (n,n\*)2a

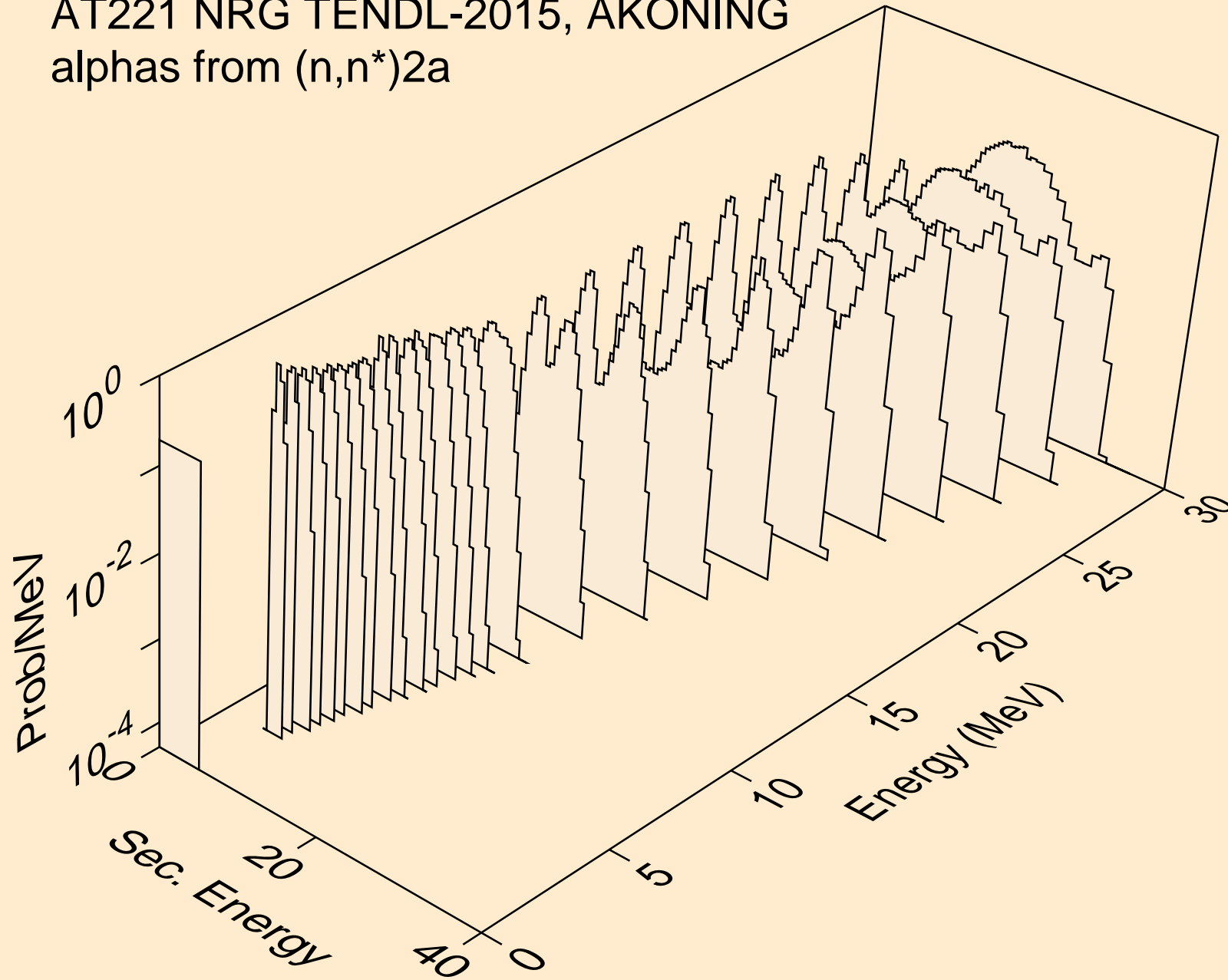

AT221 NRG TENDL-2015, AKONING  
alphas from (n,2n)2a

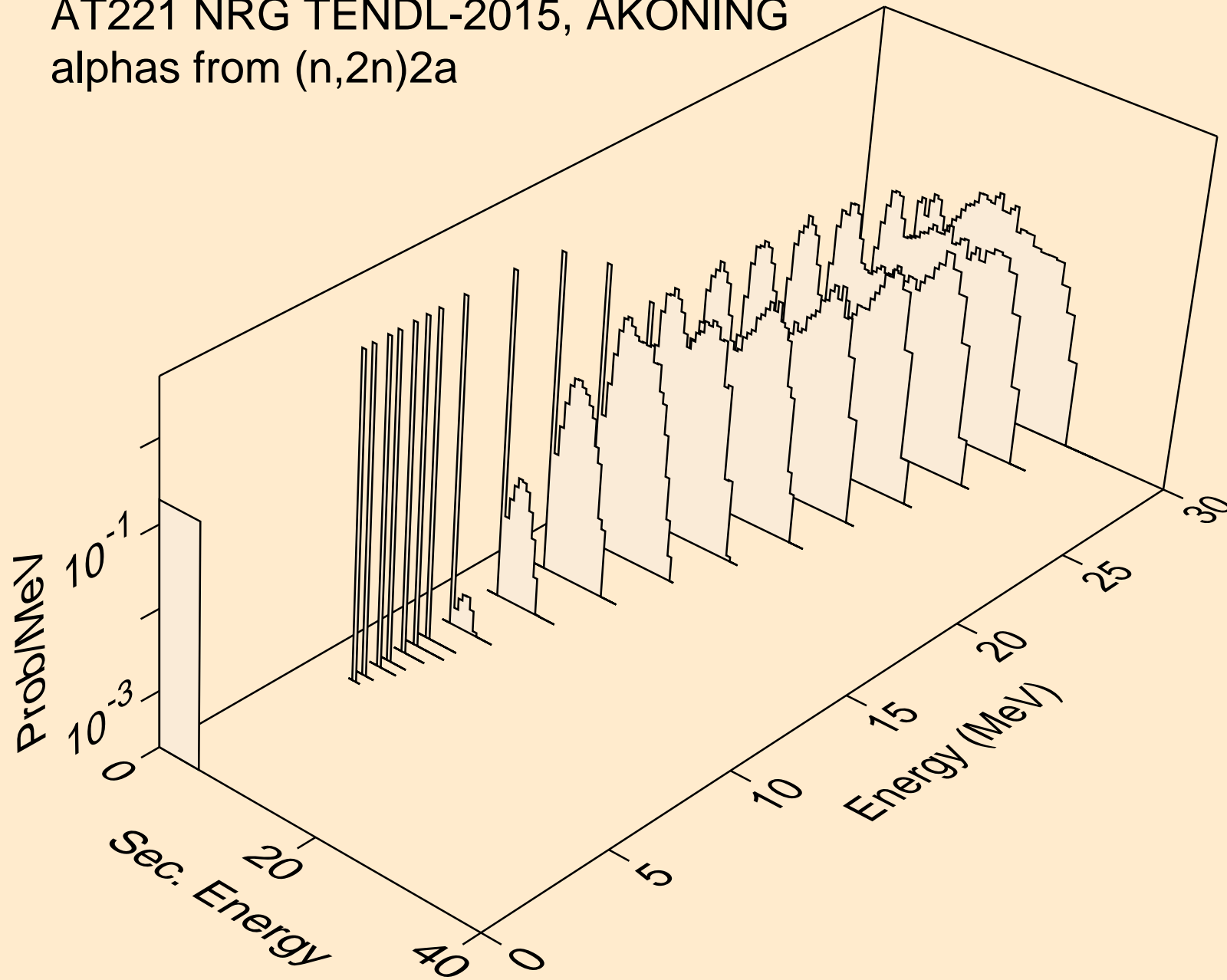



AT221 NRG TENDL-2015, AKONING  
alphas from (n,npa)

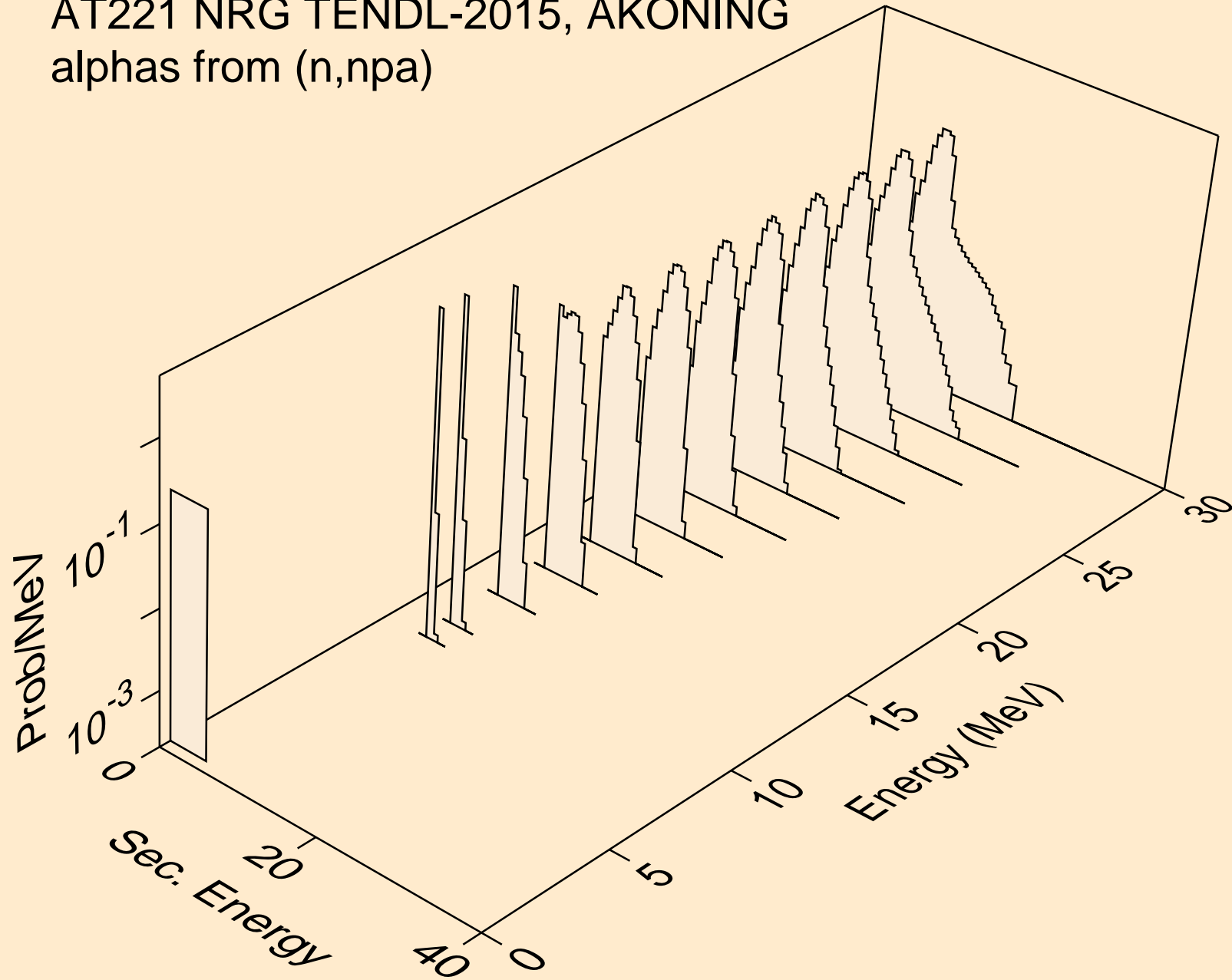

AT221 NRG TENDL-2015, AKONING  
alphas from (n,a)

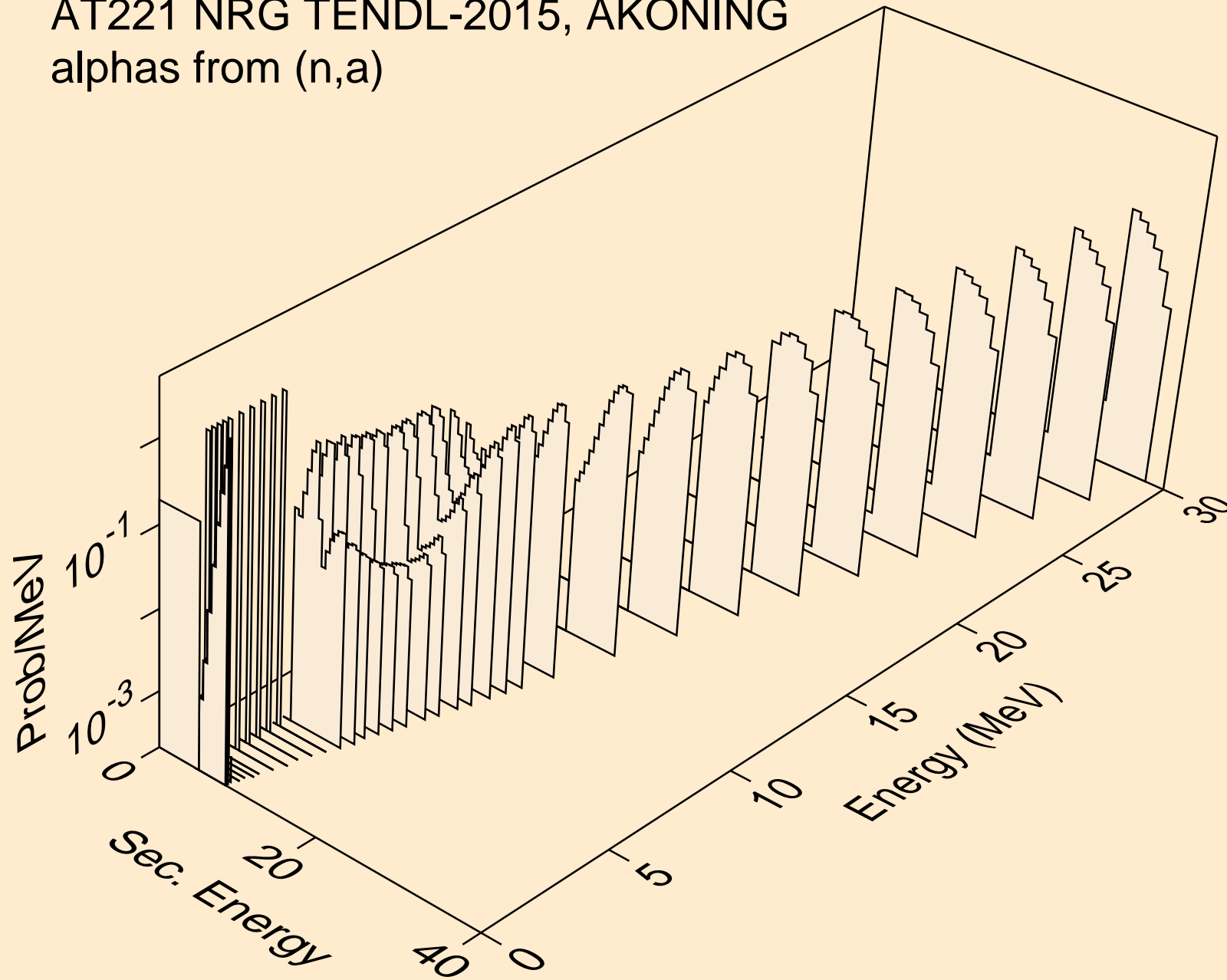

AT221 NRG TENDL-2015, AKONING  
alphas from (n,pa)

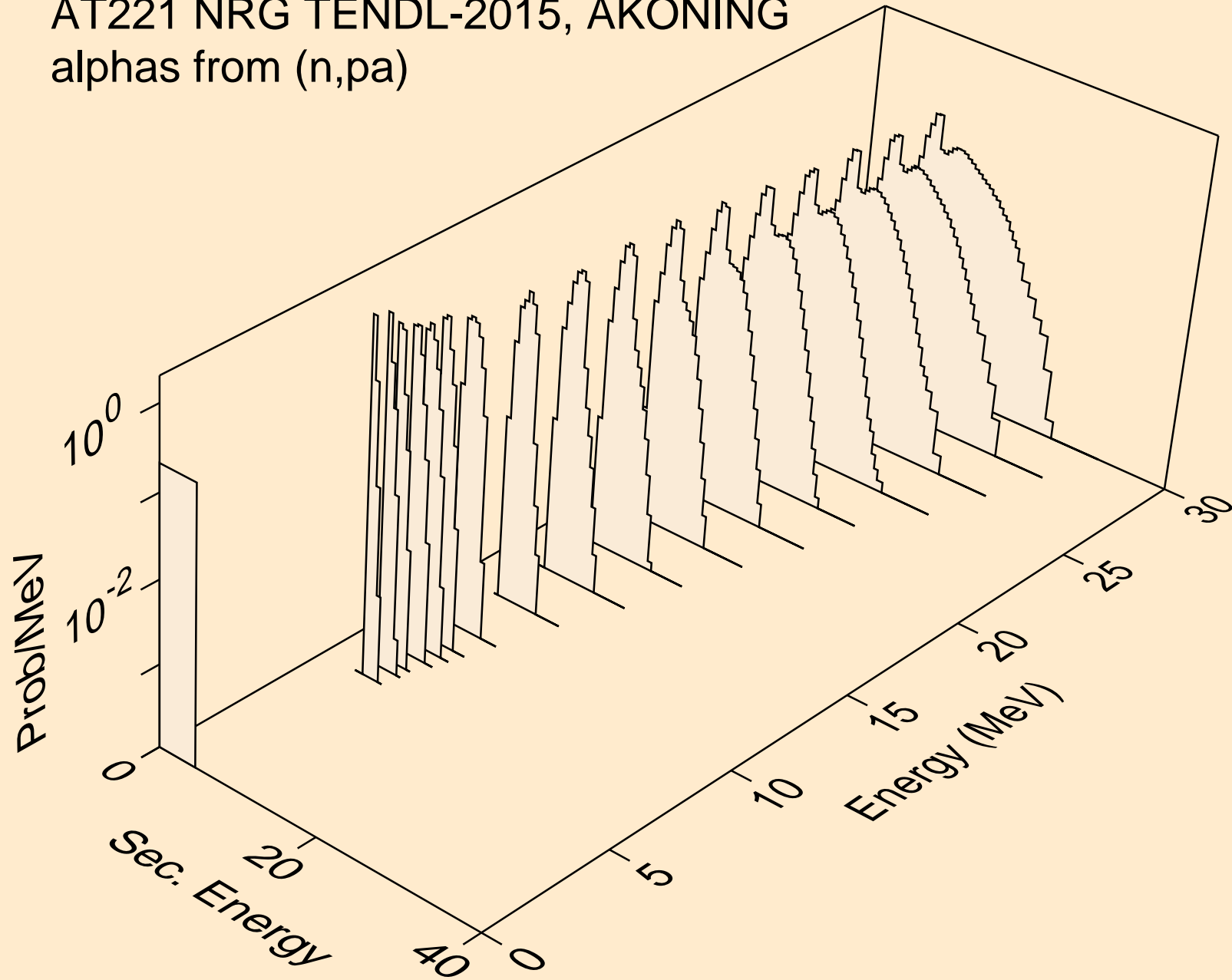

AT221 NRG TENDL-2015, AKONING  
alphas from (n,da)

