

AT222 NRG TENDL-2015, AKONING

Principal cross sections

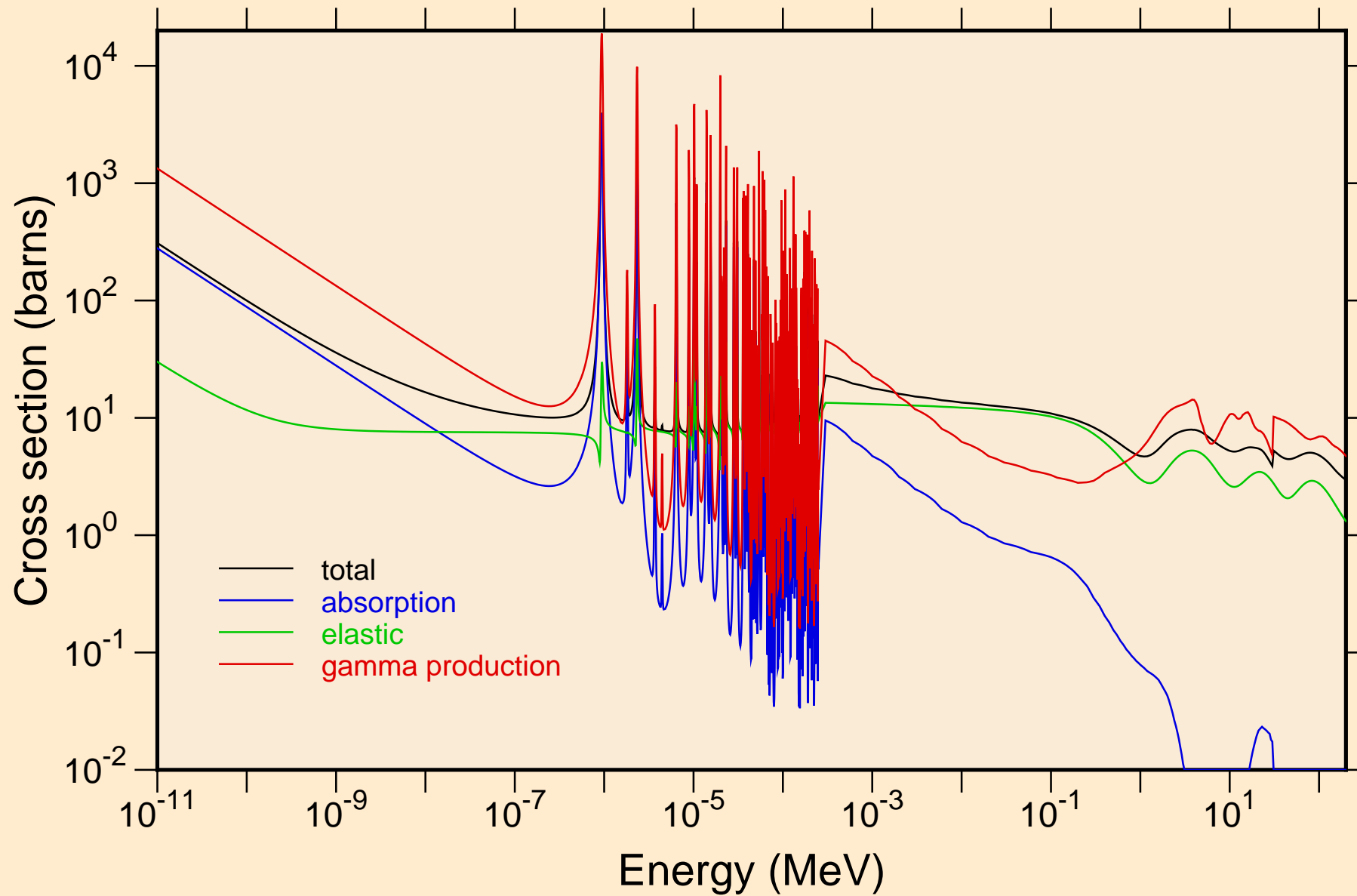

AT222 NRG TENDL-2015, AKONING
resonance total cross section

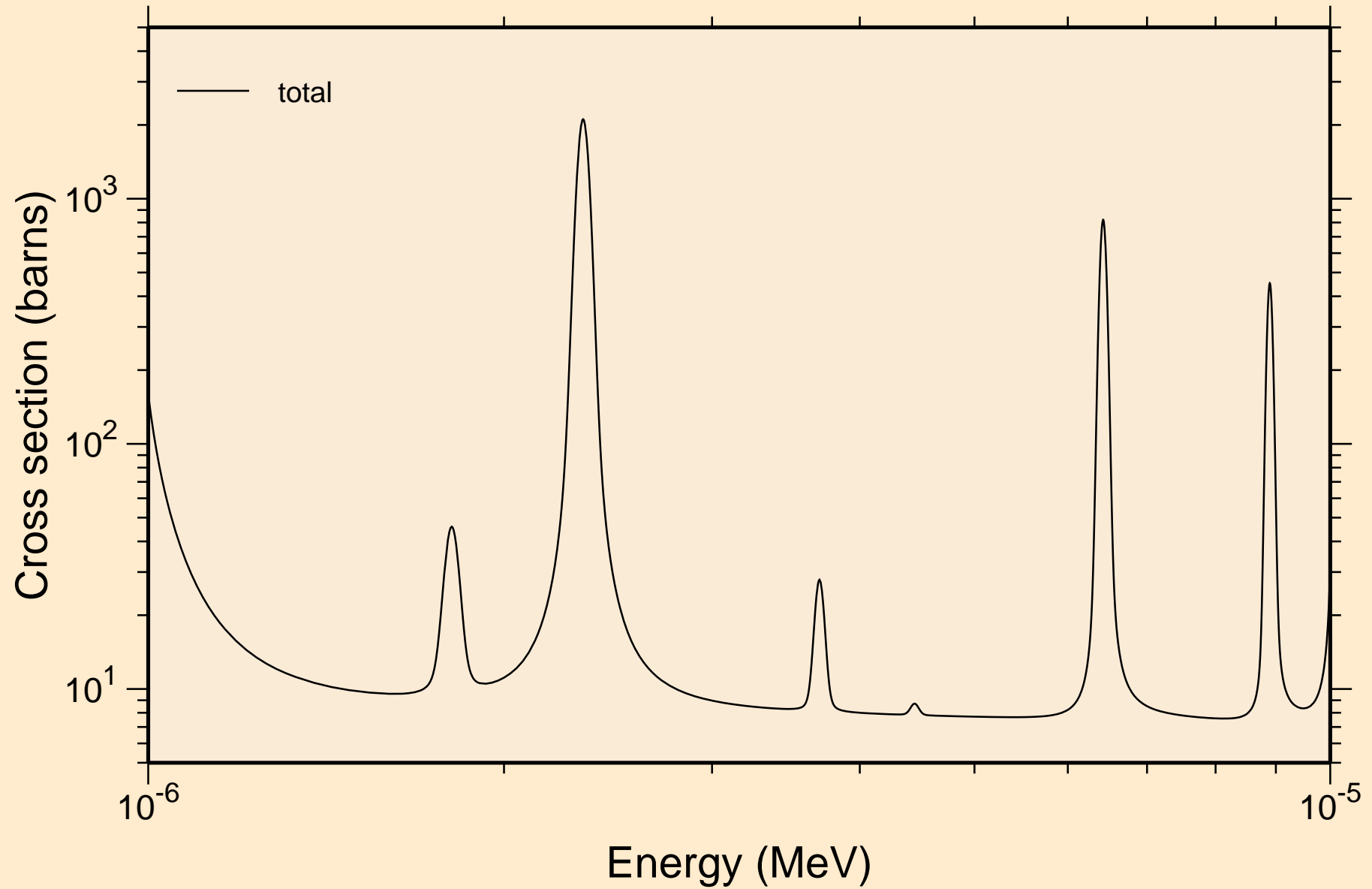

AT222 NRG TENDL-2015, AKONING
resonance total cross section

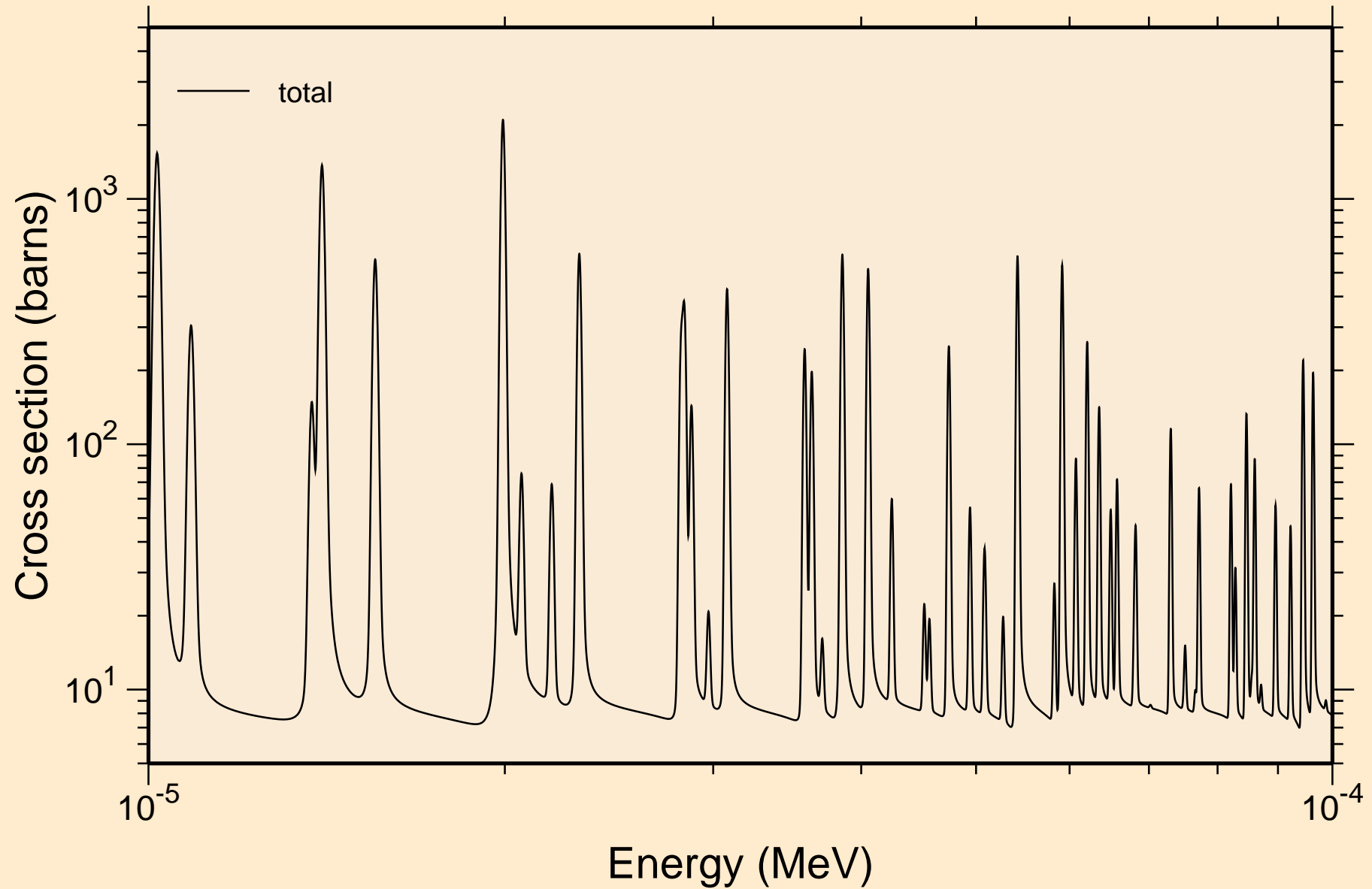

AT222 NRG TENDL-2015, AKONING
resonance total cross section

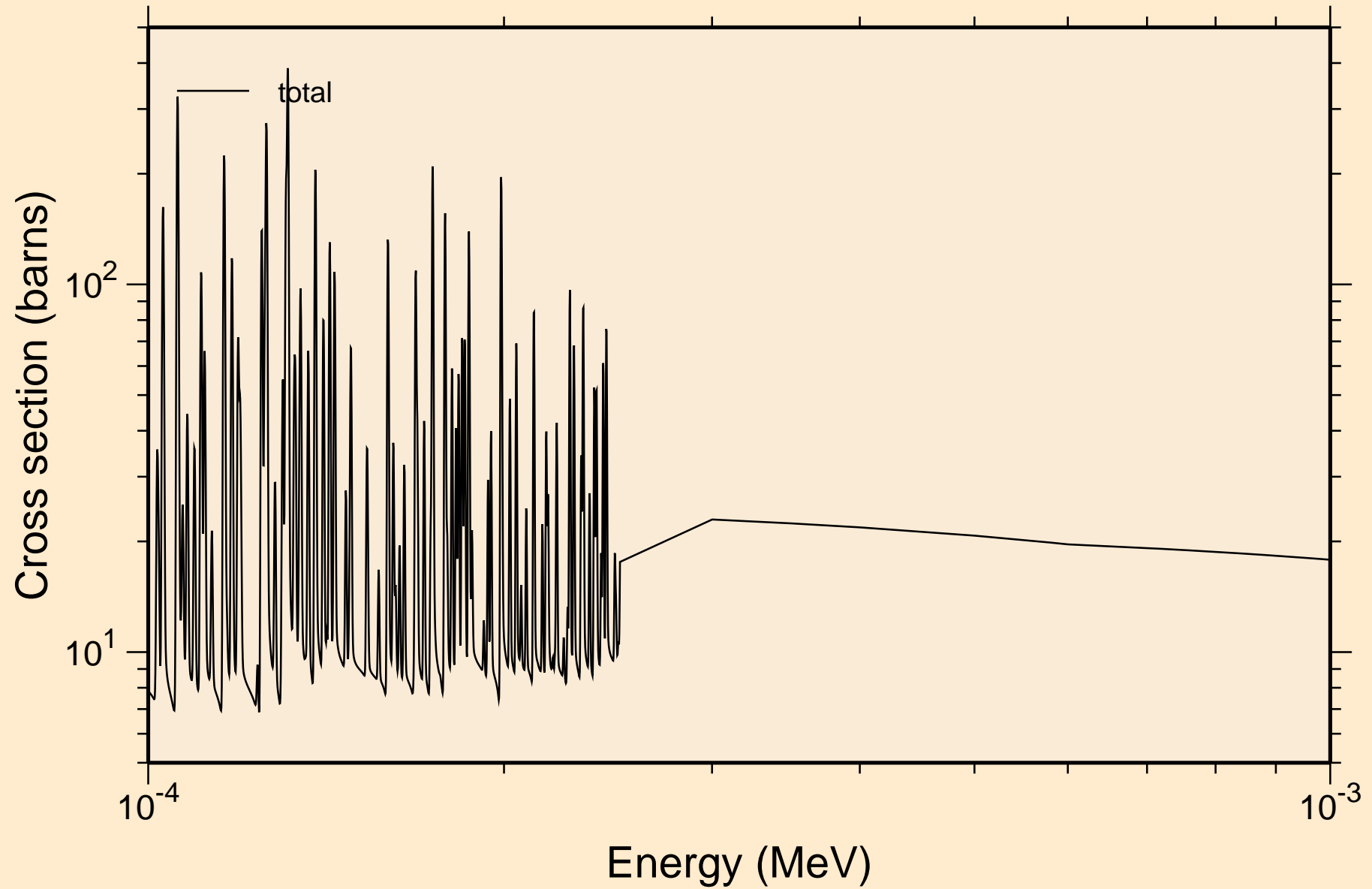

AT222 NRG TENDL-2015, AKONING
resonance total cross section

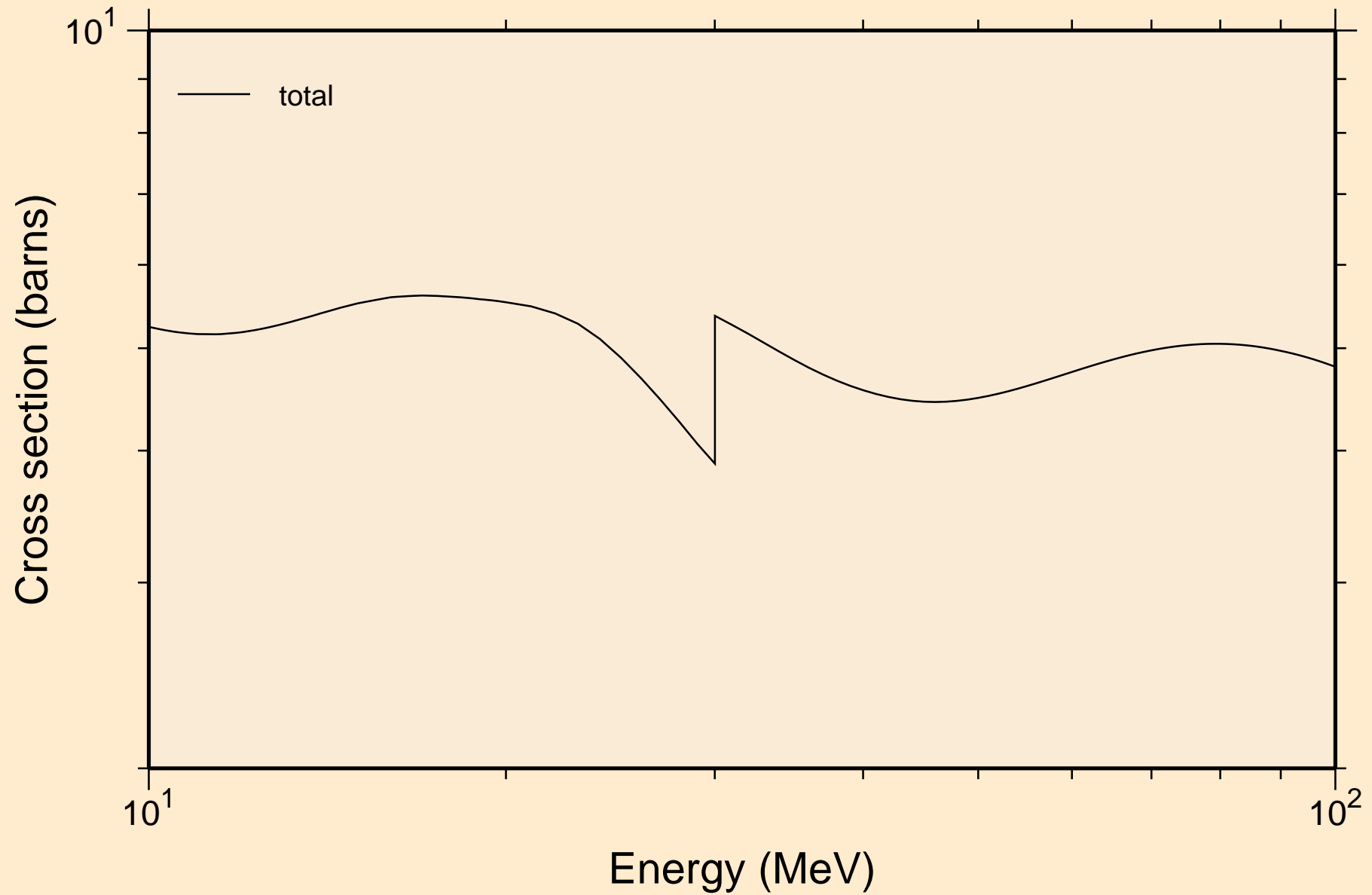

AT222 NRG TENDL-2015, AKONING resonance absorption cross sections

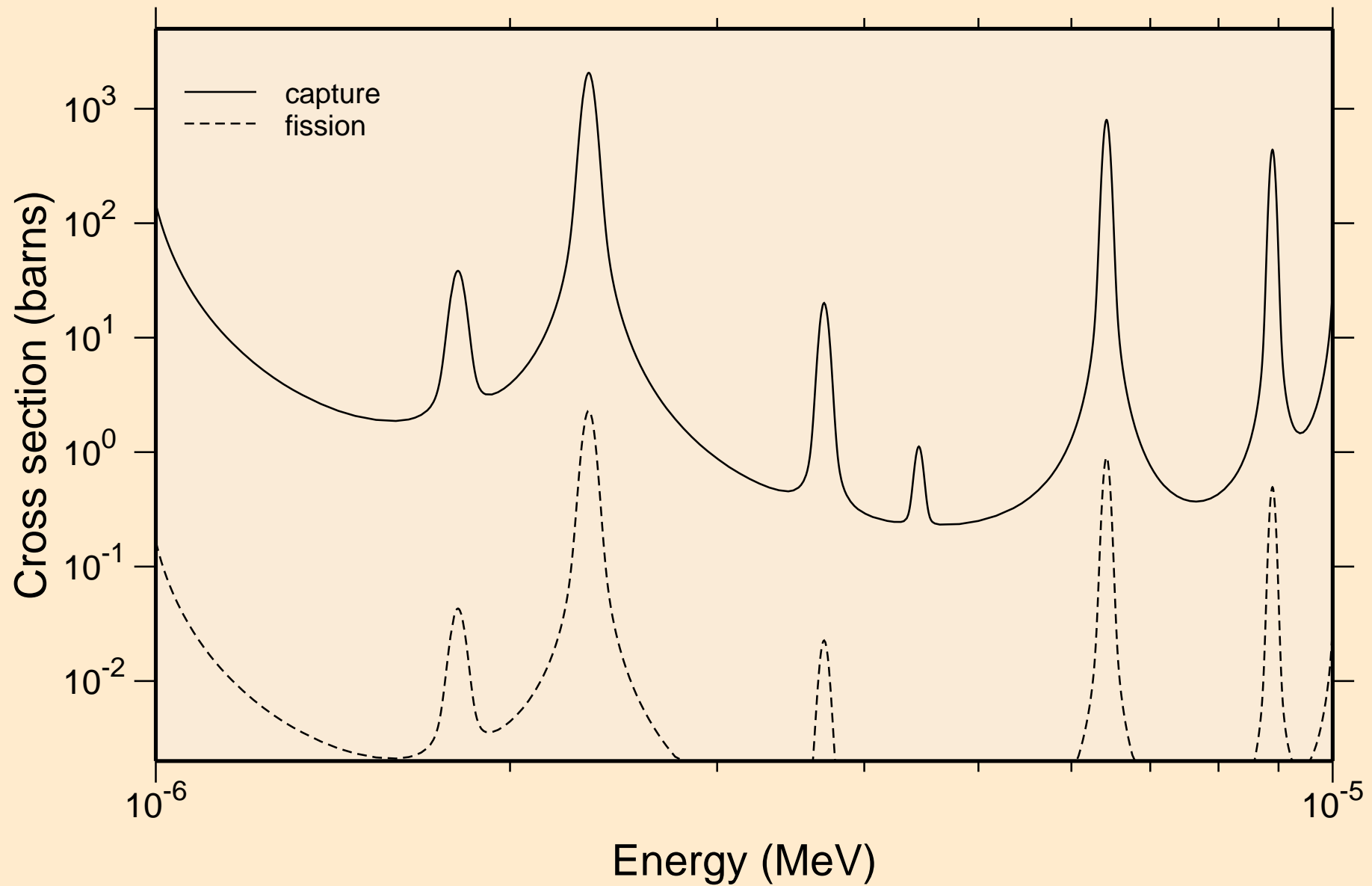

AT222 NRG TENDL-2015, AKONING
resonance absorption cross sections

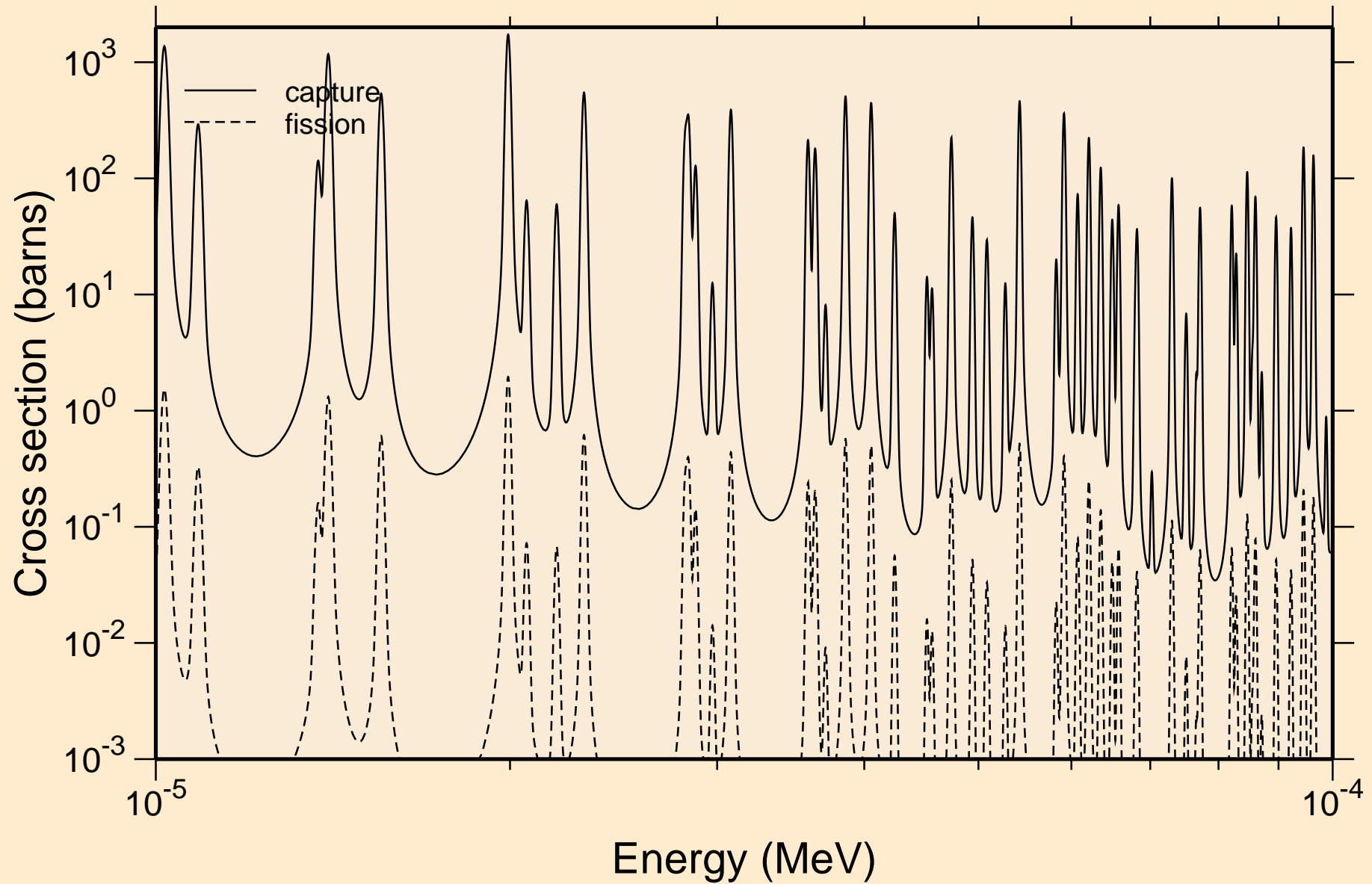

AT222 NRG TENDL-2015, AKONING
resonance absorption cross sections

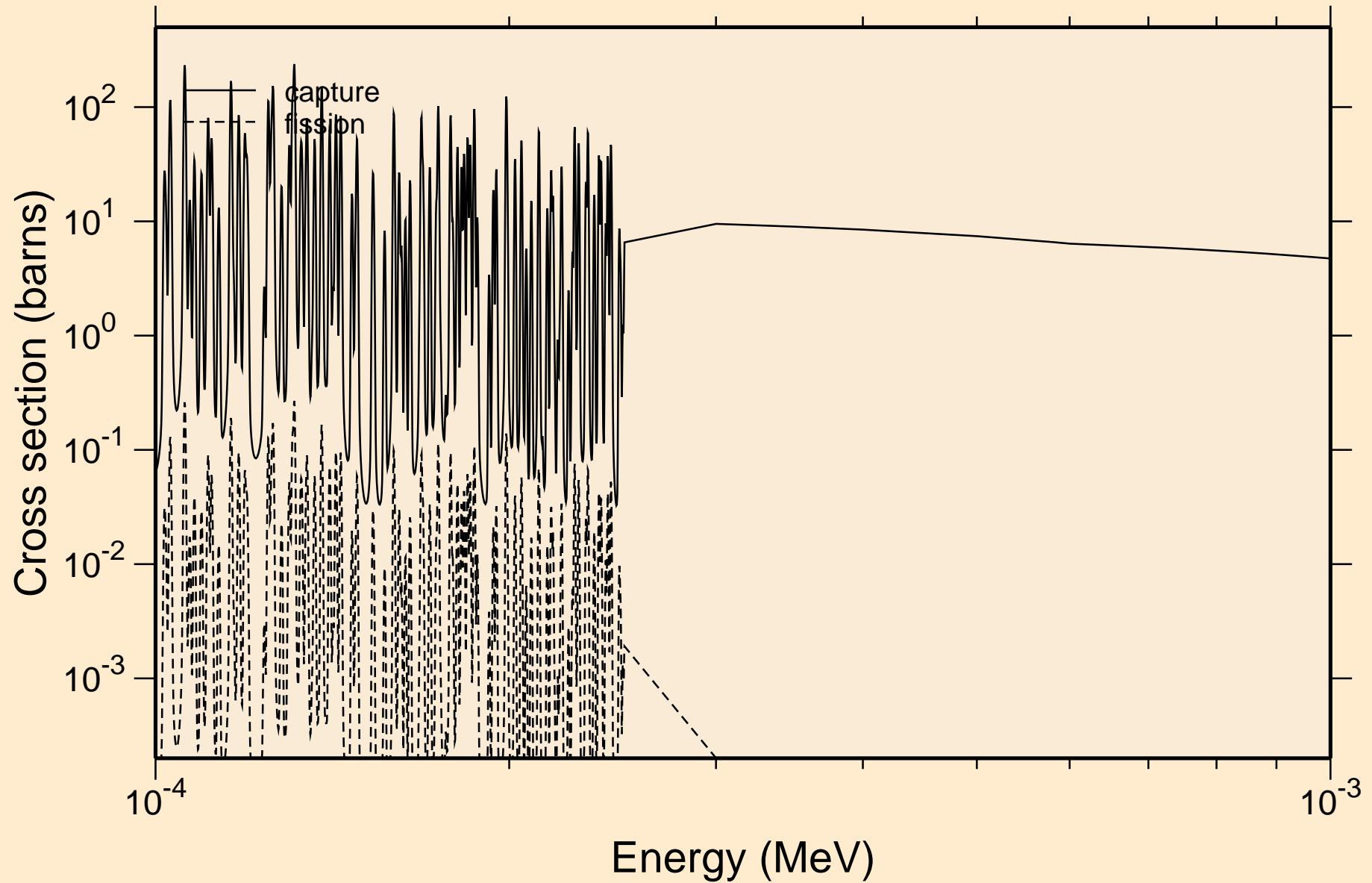

AT222 NRG TENDL-2015, AKONING
resonance absorption cross sections

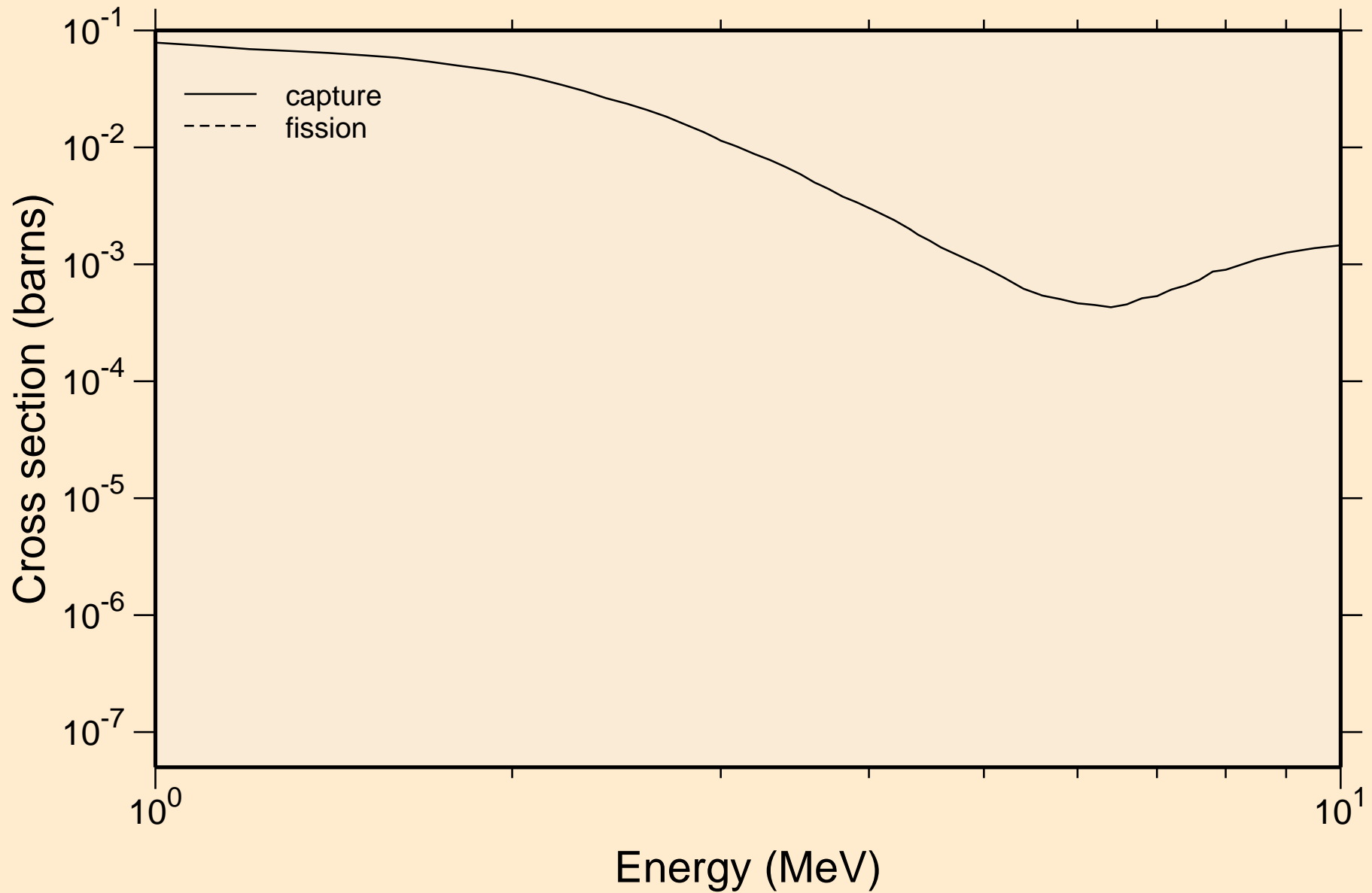

AT222 NRG TENDL-2015, AKONING

Non-threshold reactions

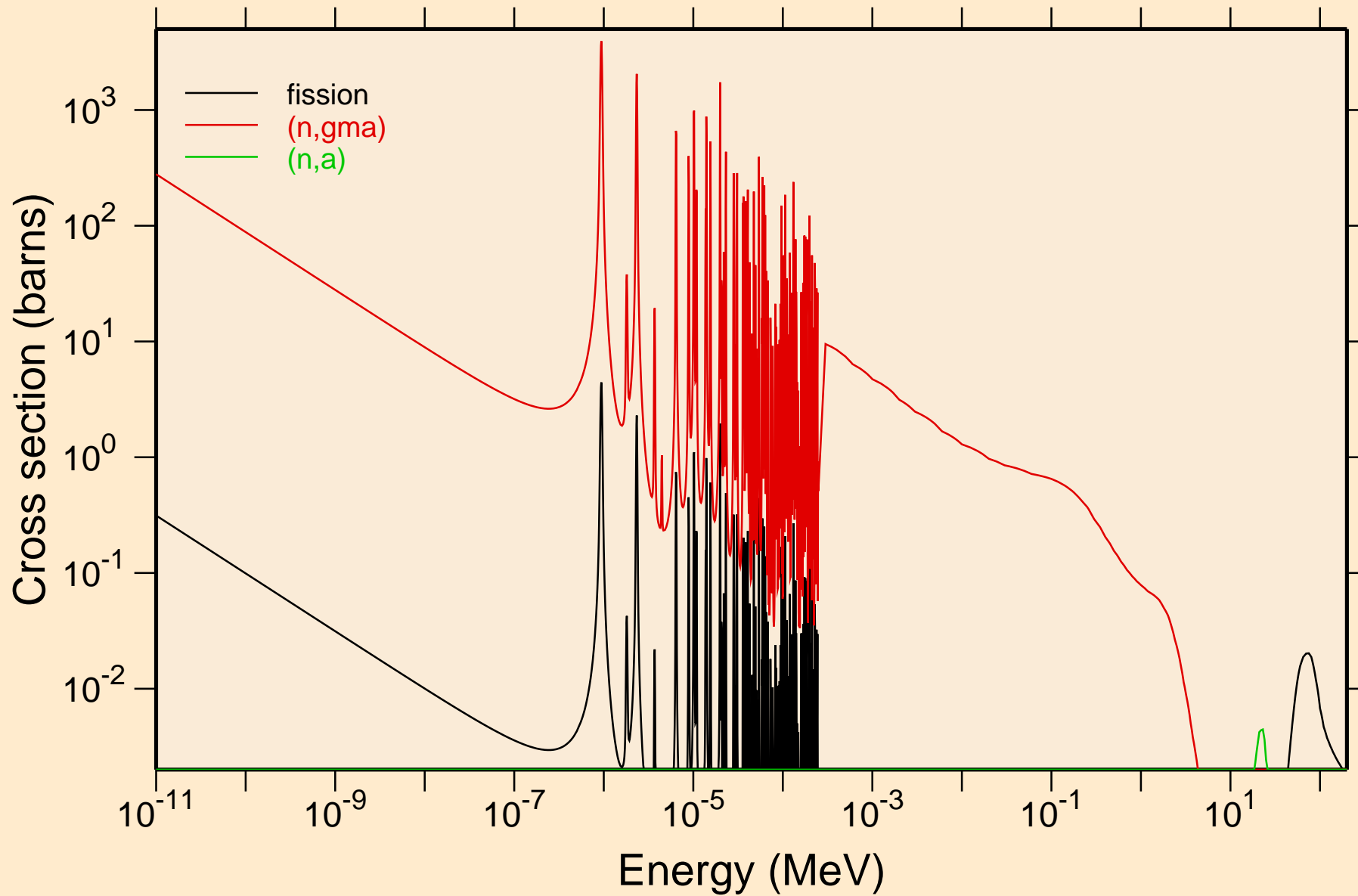

AT222 NRG TENDL-2015, AKONING

Principal cross sections

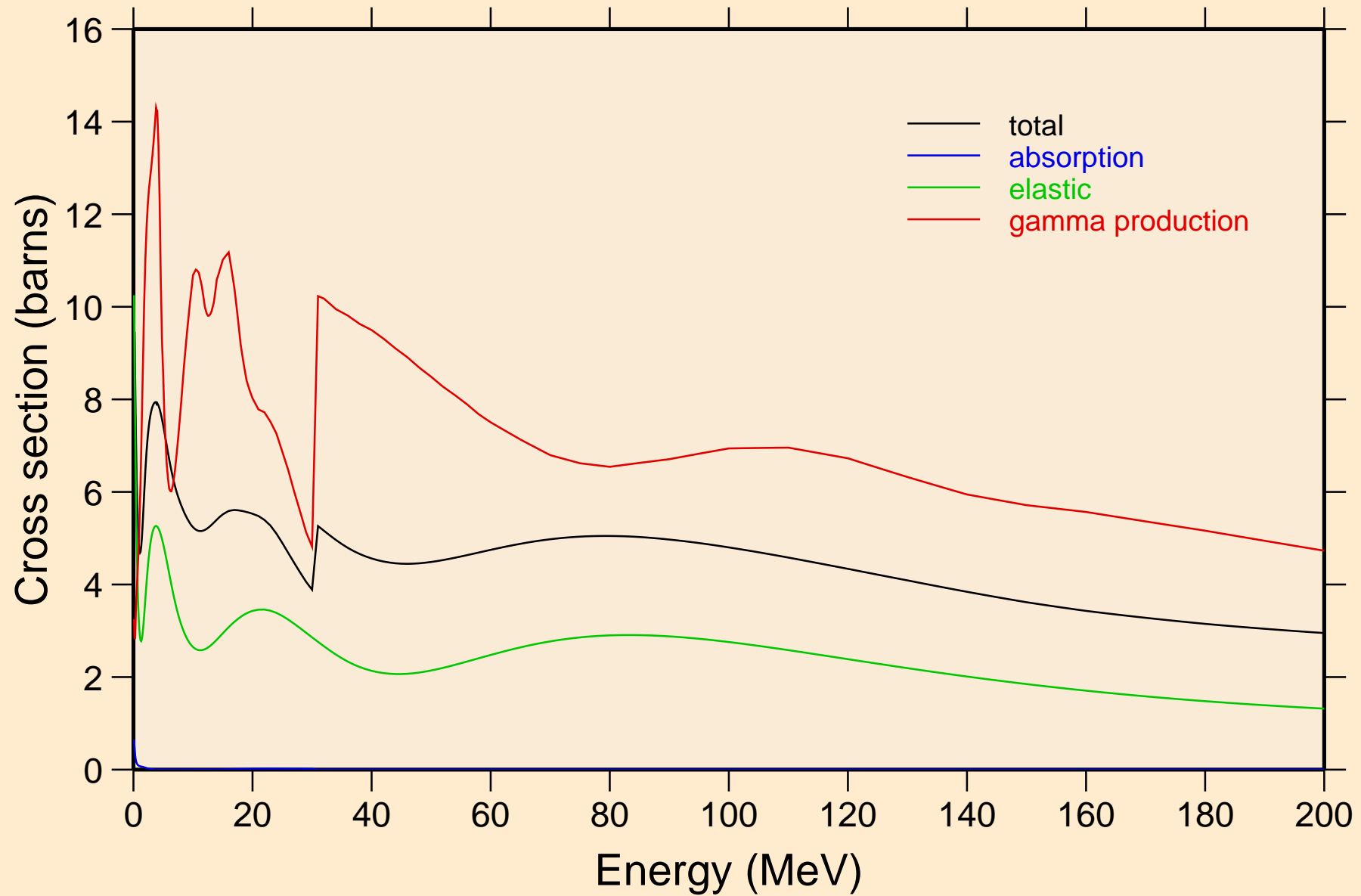

AT222 NRG TENDL-2015, AKONING

Non-threshold reactions

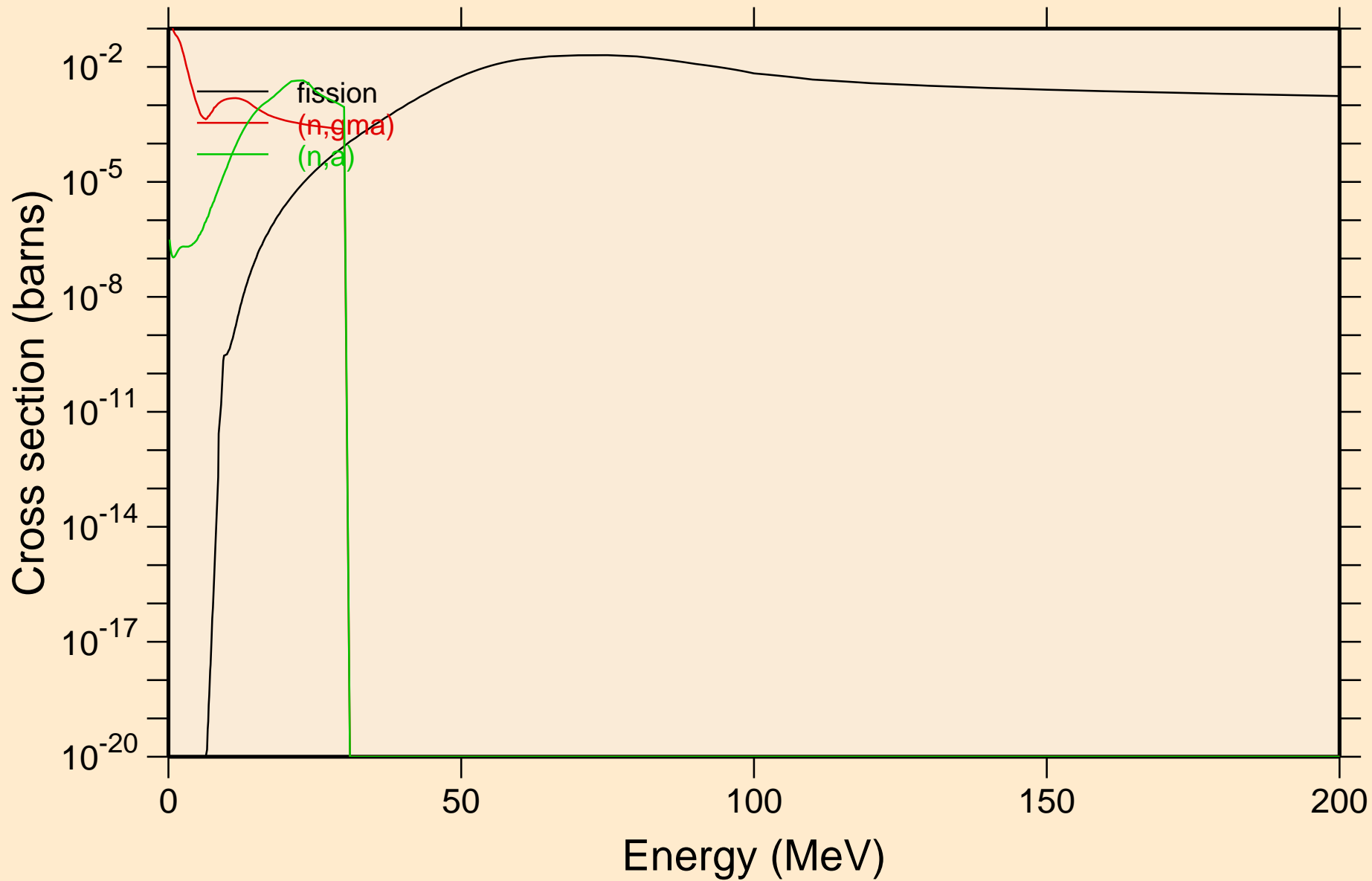

AT222 NRG TENDL-2015, AKONING

Inelastic levels

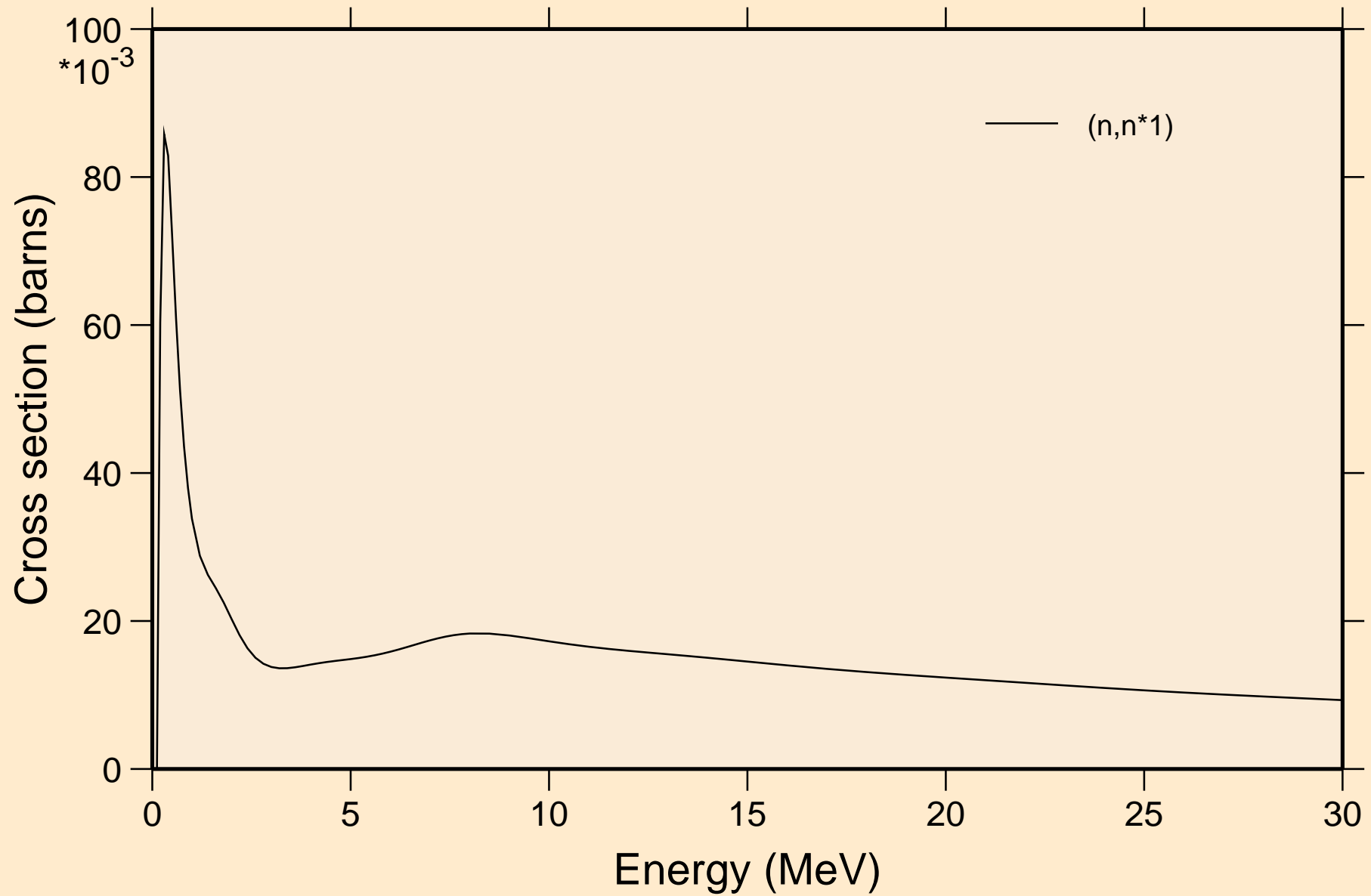

AT222 NRG TENDL-2015, AKONING

Threshold reactions

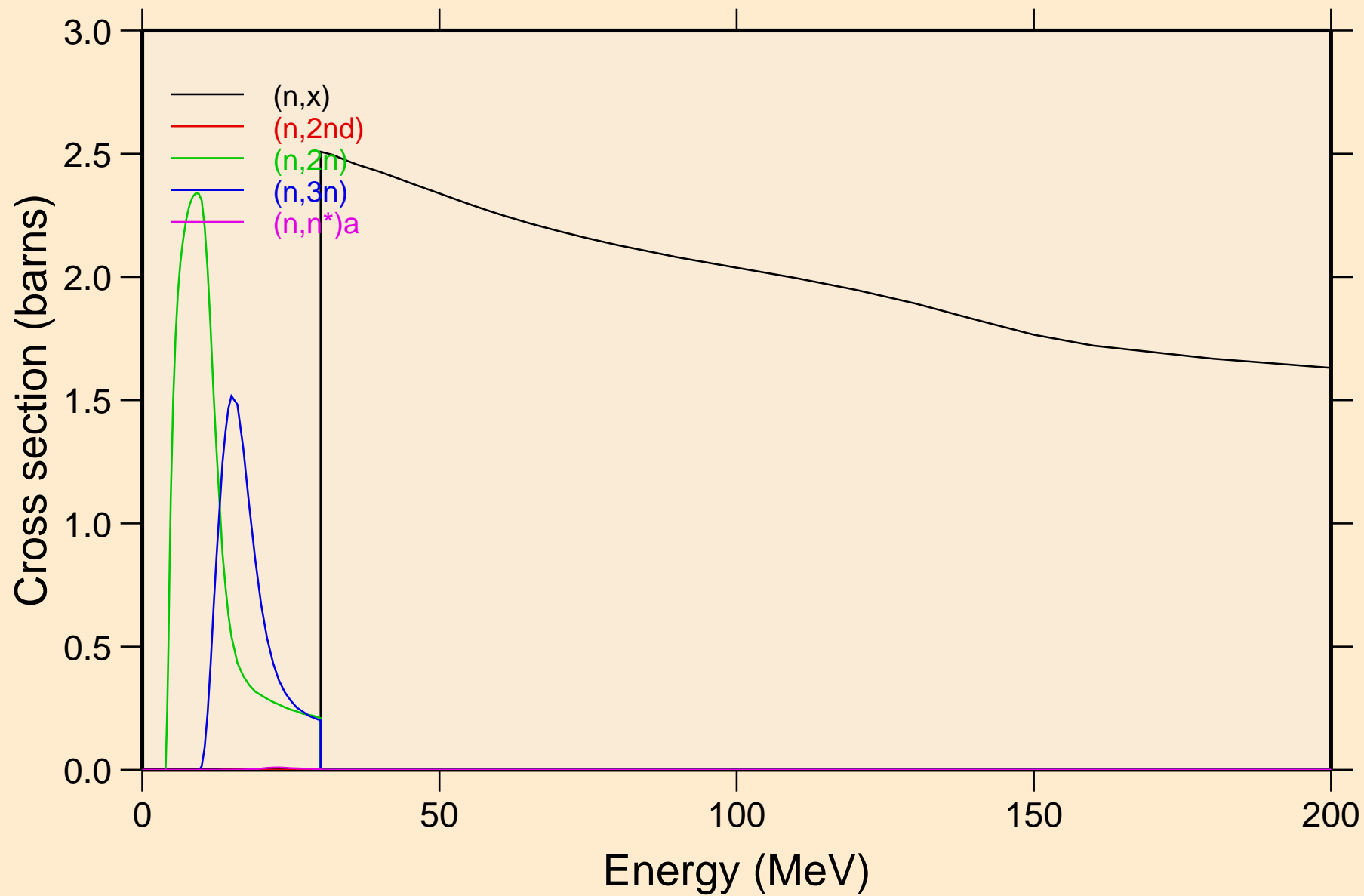

AT222 NRG TENDL-2015, AKONING

Threshold reactions

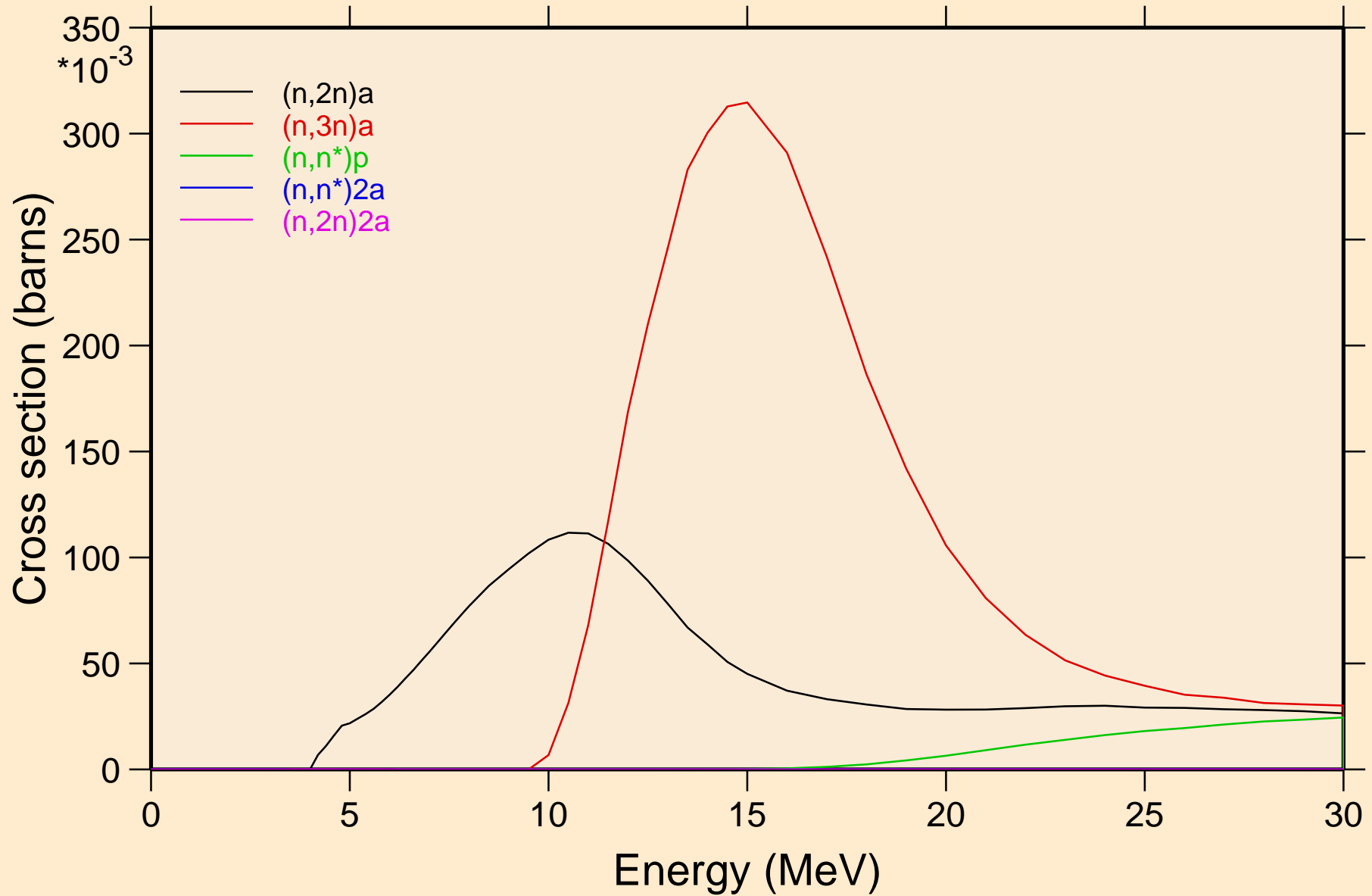

AT222 NRG TENDL-2015, AKONING

Threshold reactions

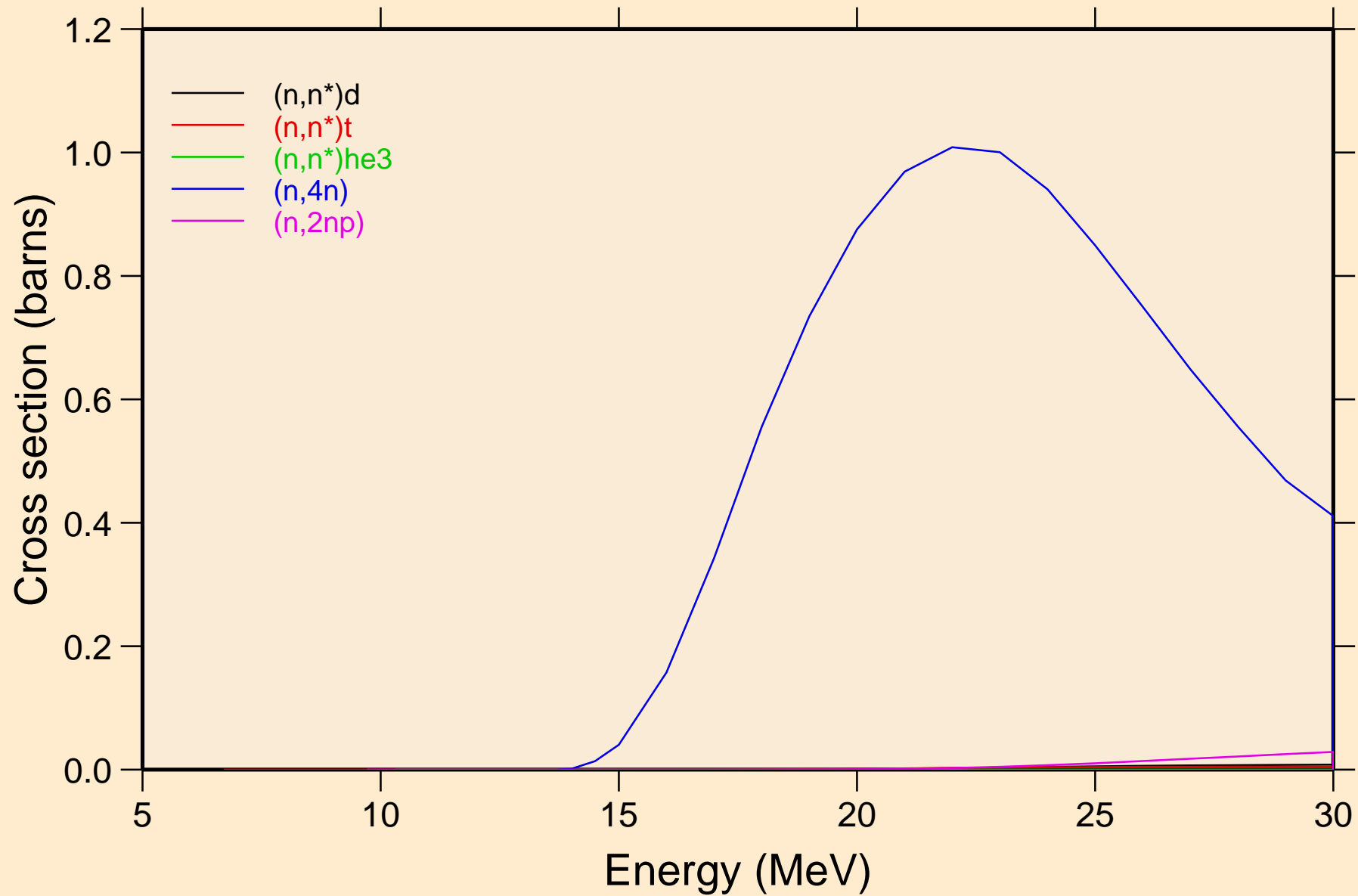

AT222 NRG TENDL-2015, AKONING

Threshold reactions

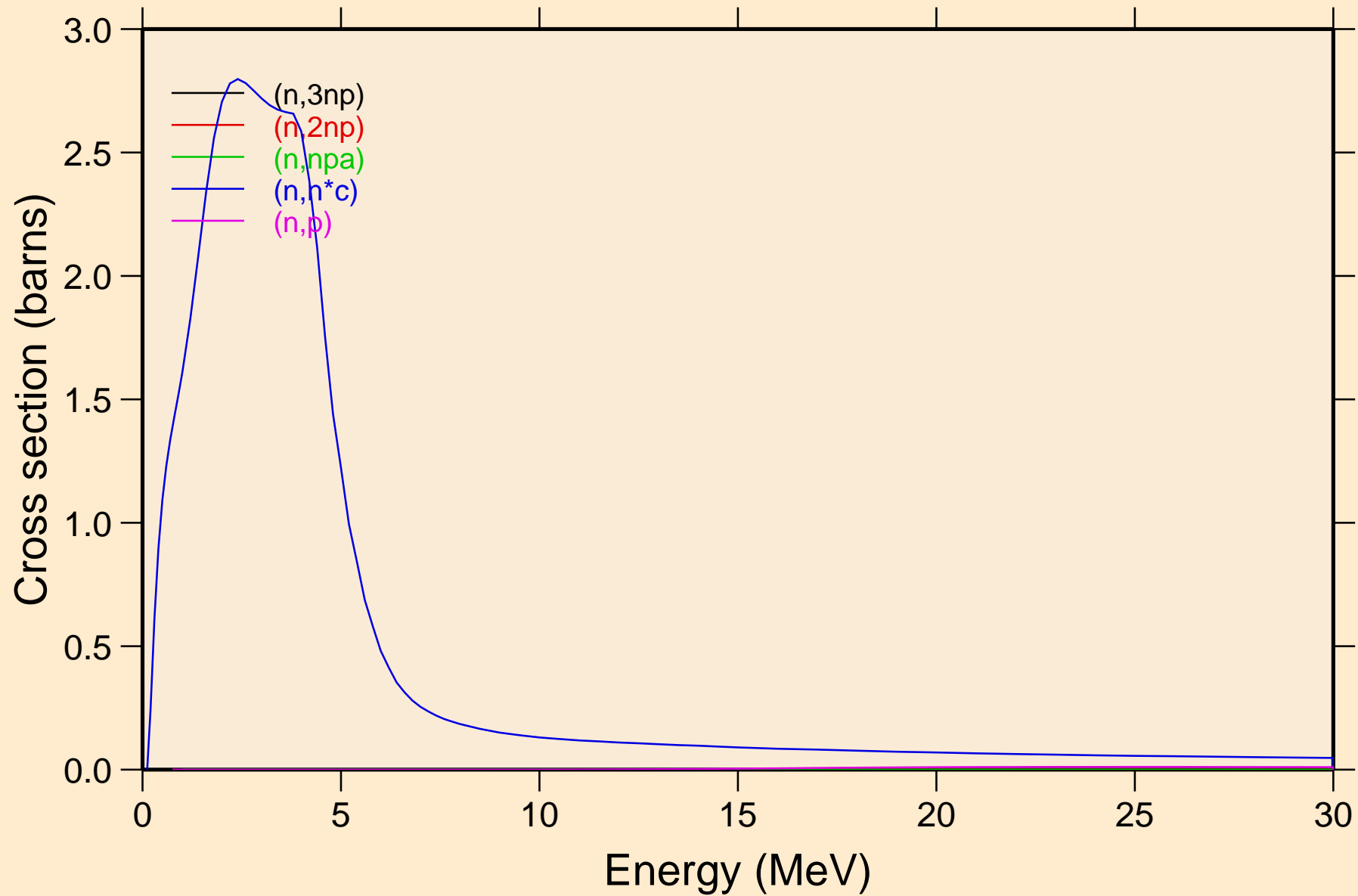

AT222 NRG TENDL-2015, AKONING

Threshold reactions

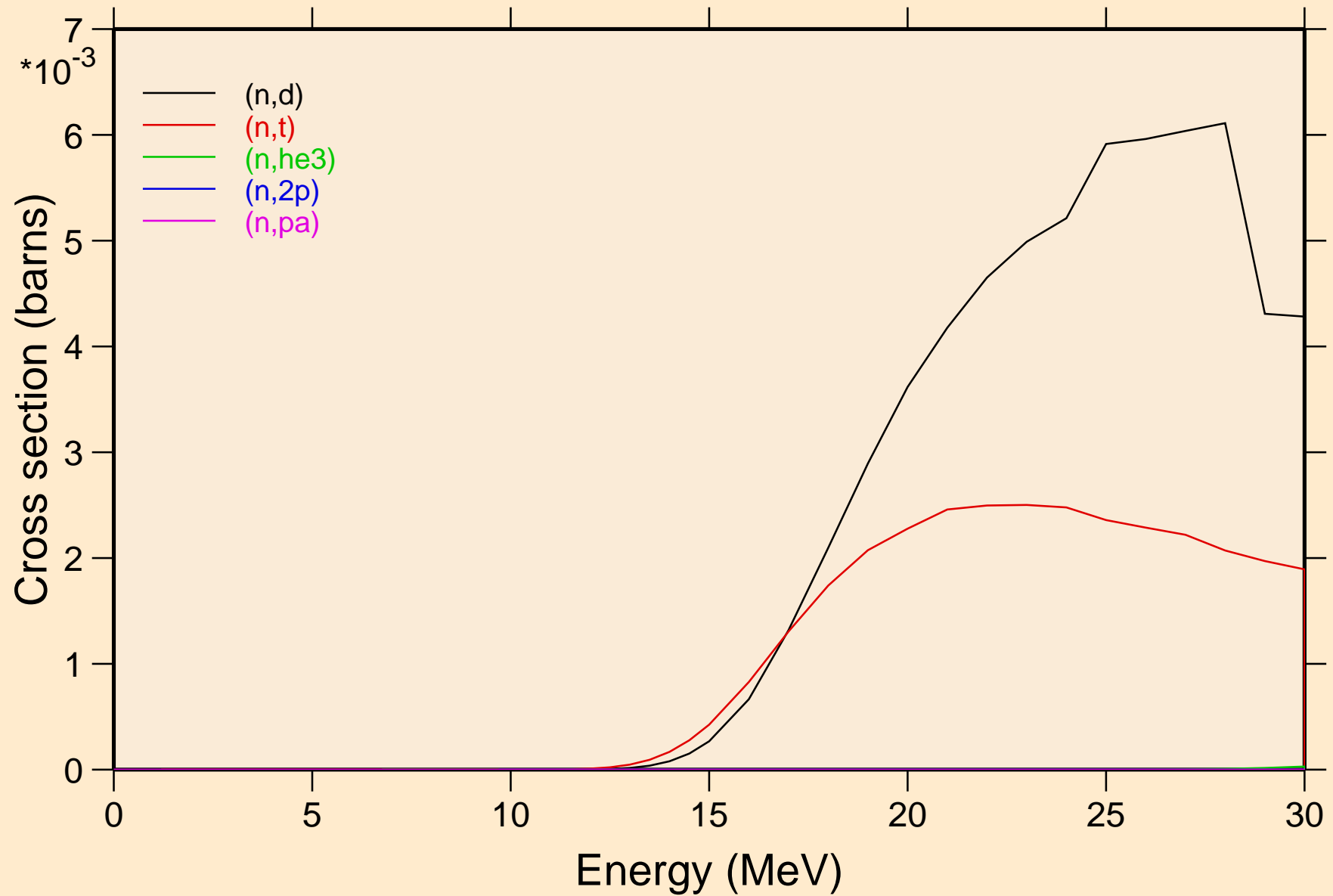

AT222 NRG TENDL-2015, AKONING
angular distribution for elastic

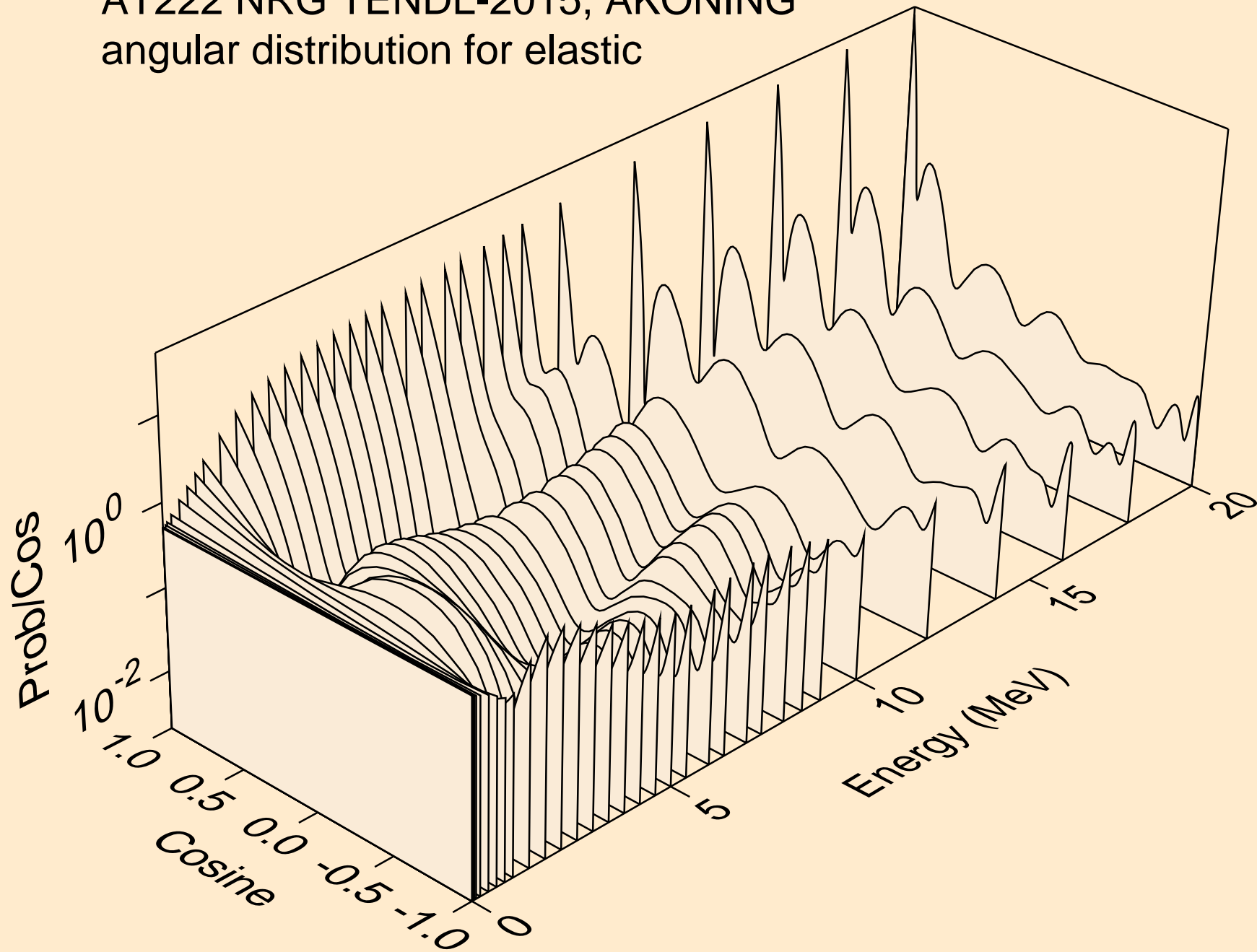

AT222 NRG TENDL-2015, AKONING
angular distribution for elastic

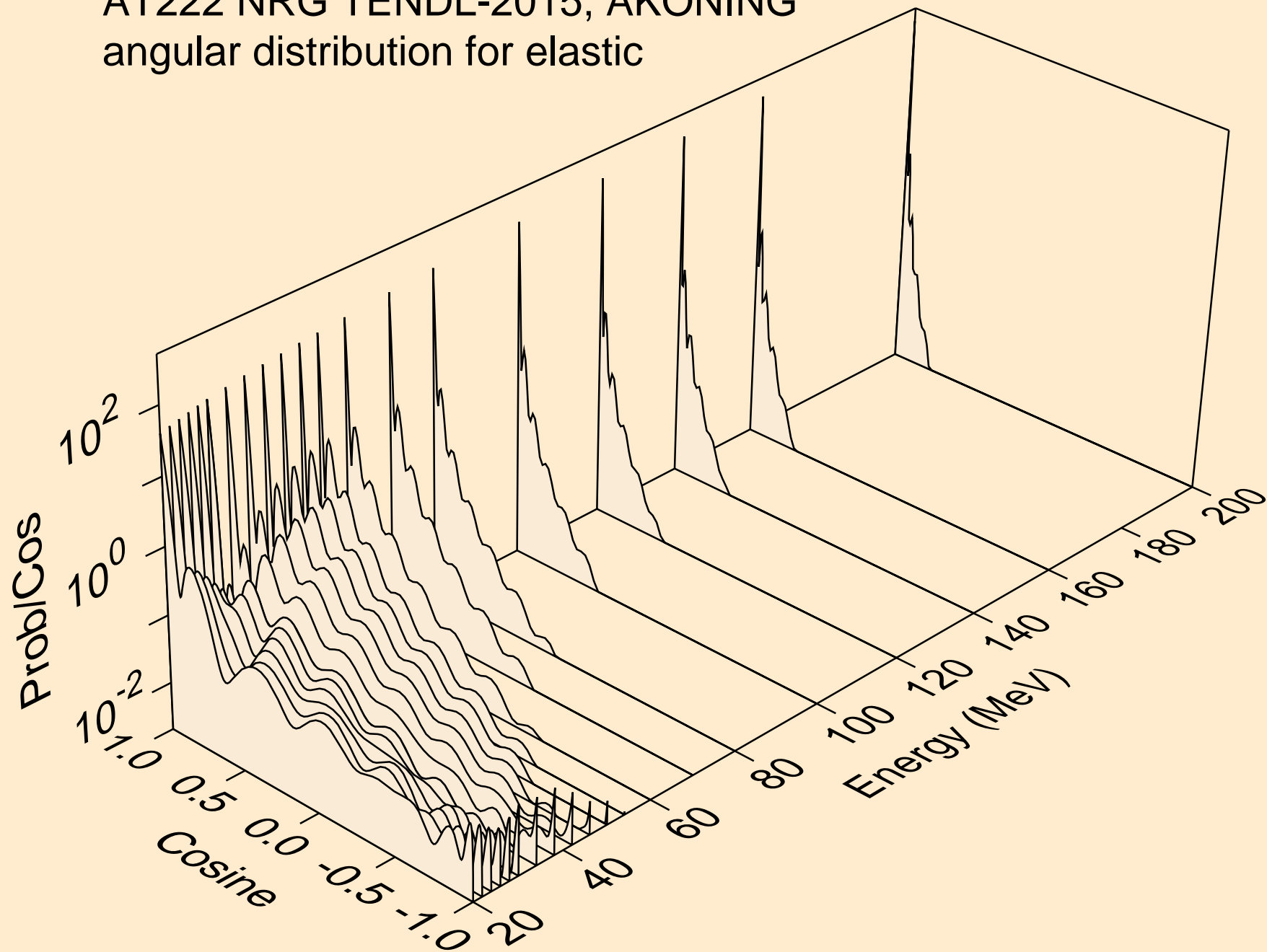

AT222 NRG TENDL-2015, AKONING
angular distribution for (n,n*1)

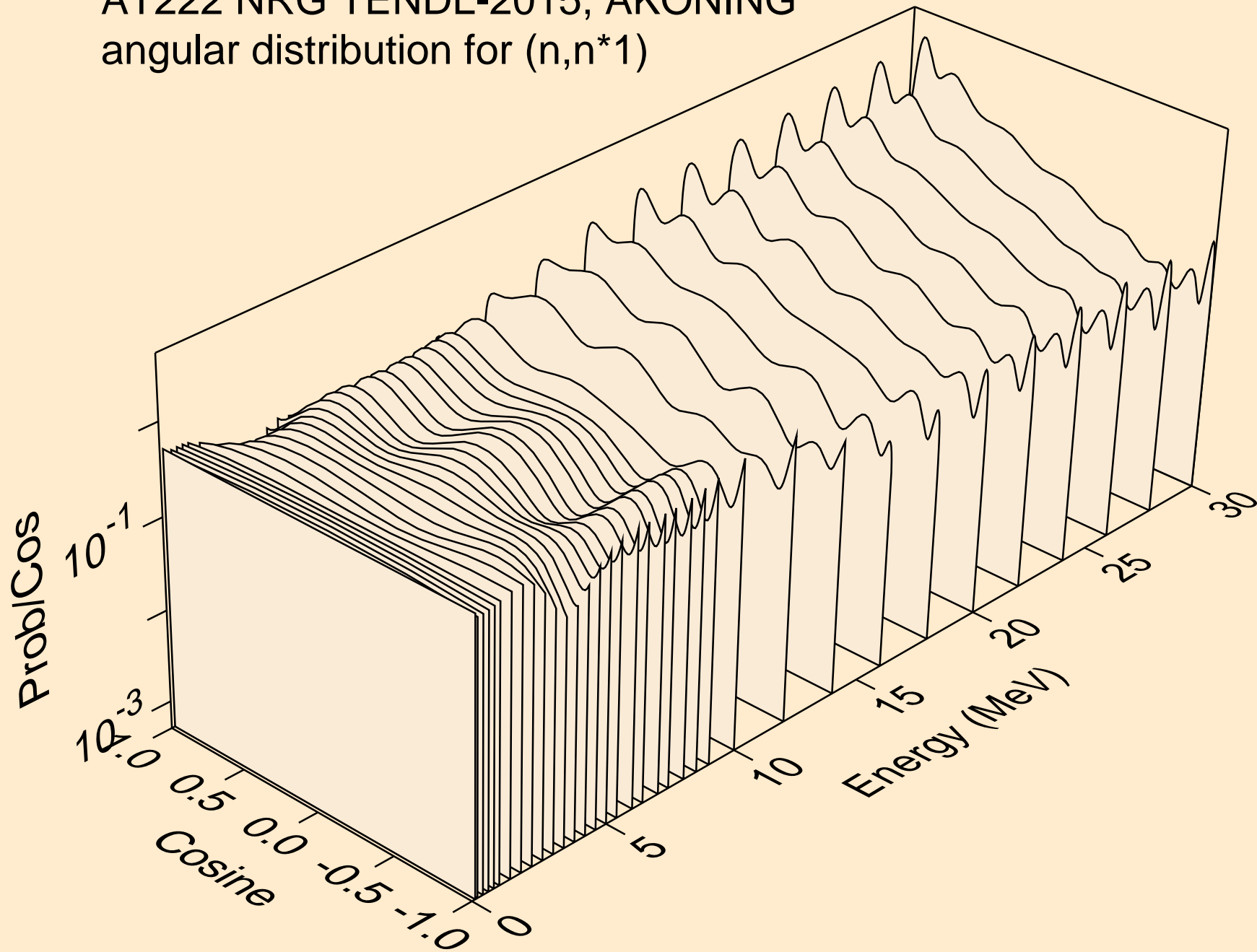

AT222 NRG TENDL-2015, AKONING

Total fission nubar

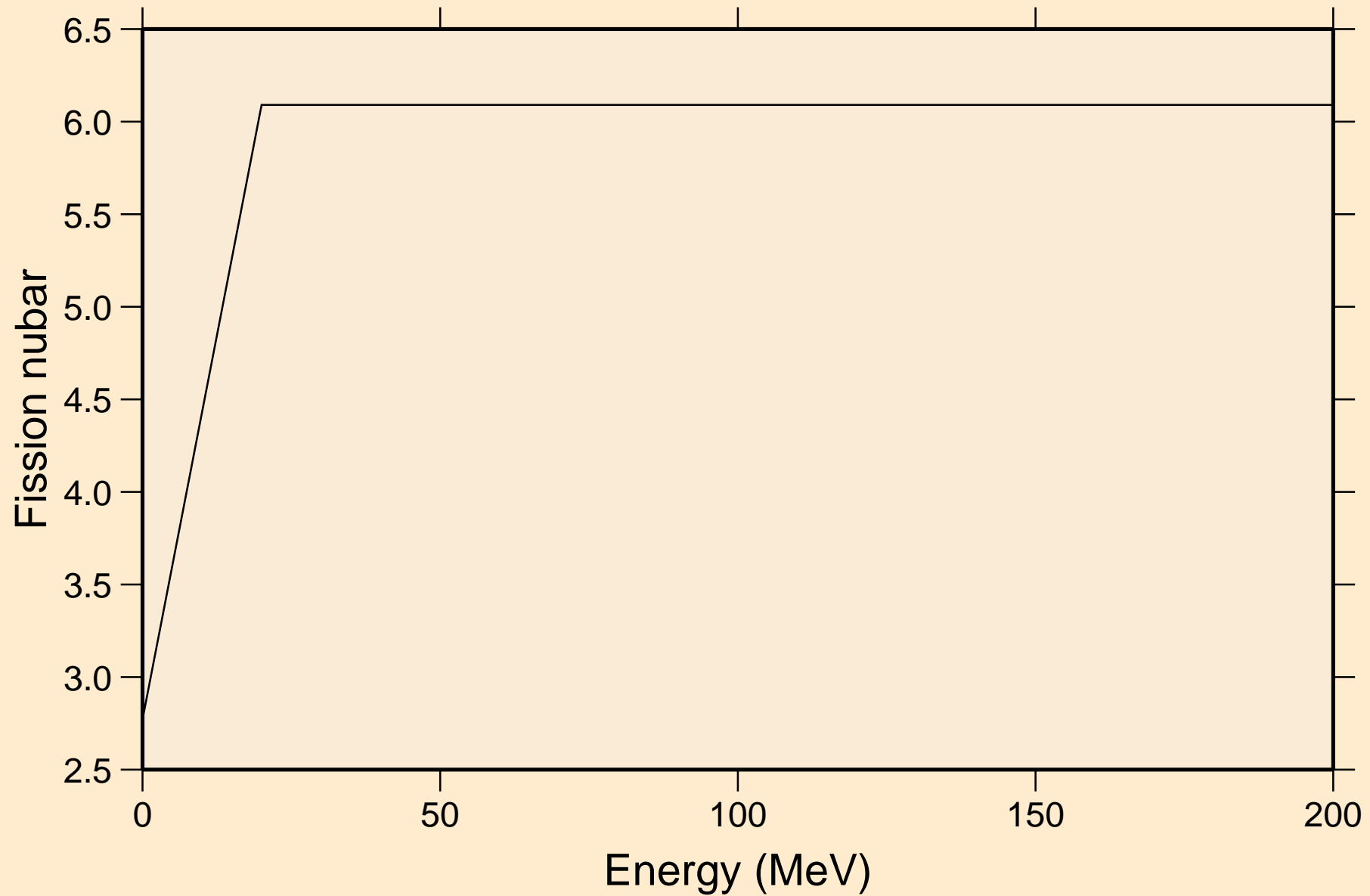

AT222 NRG TENDL-2015, AKONING
Neutron emission for (n,x)

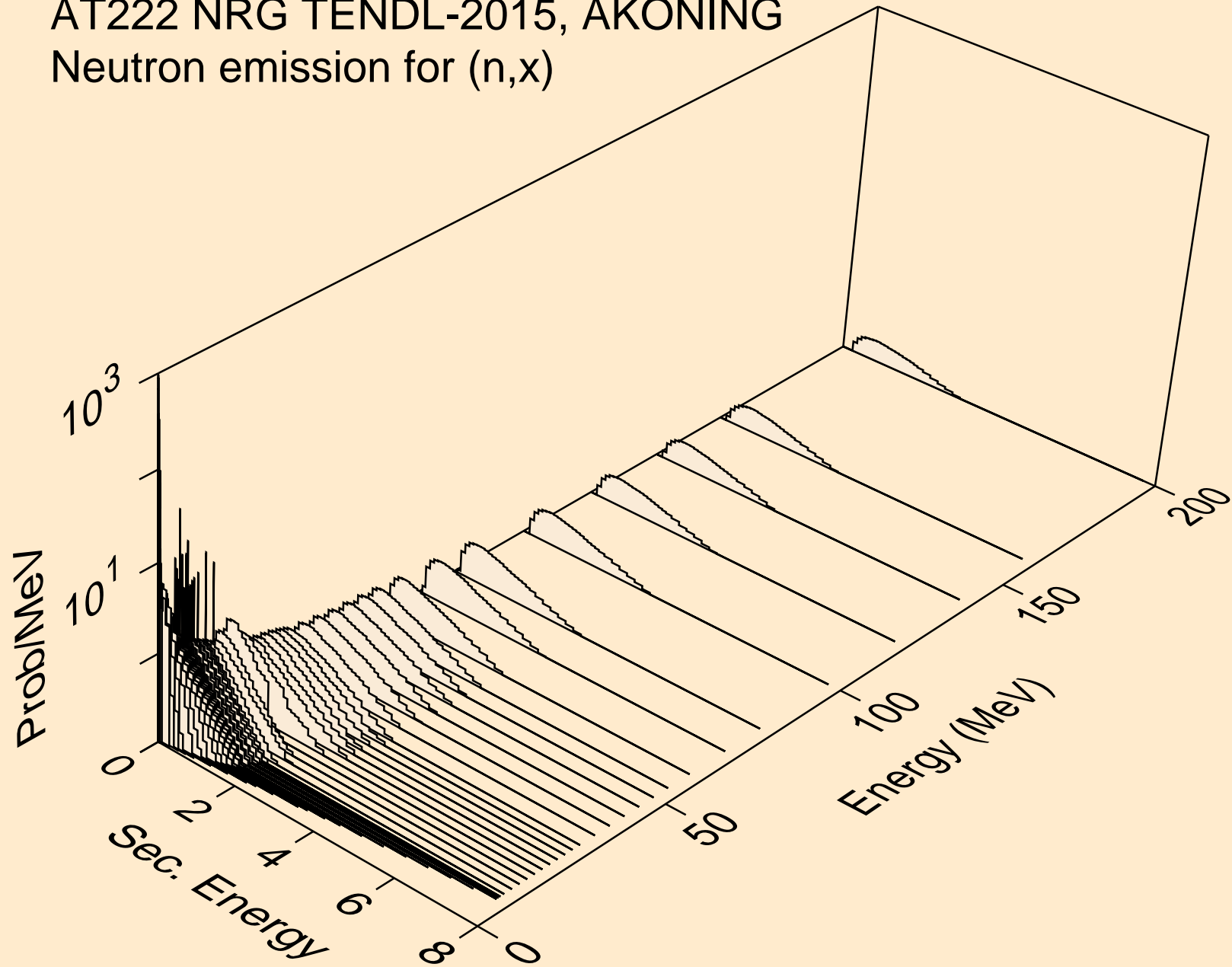

AT222 NRG TENDL-2015, AKONING
Neutron emission for (n,2nd)

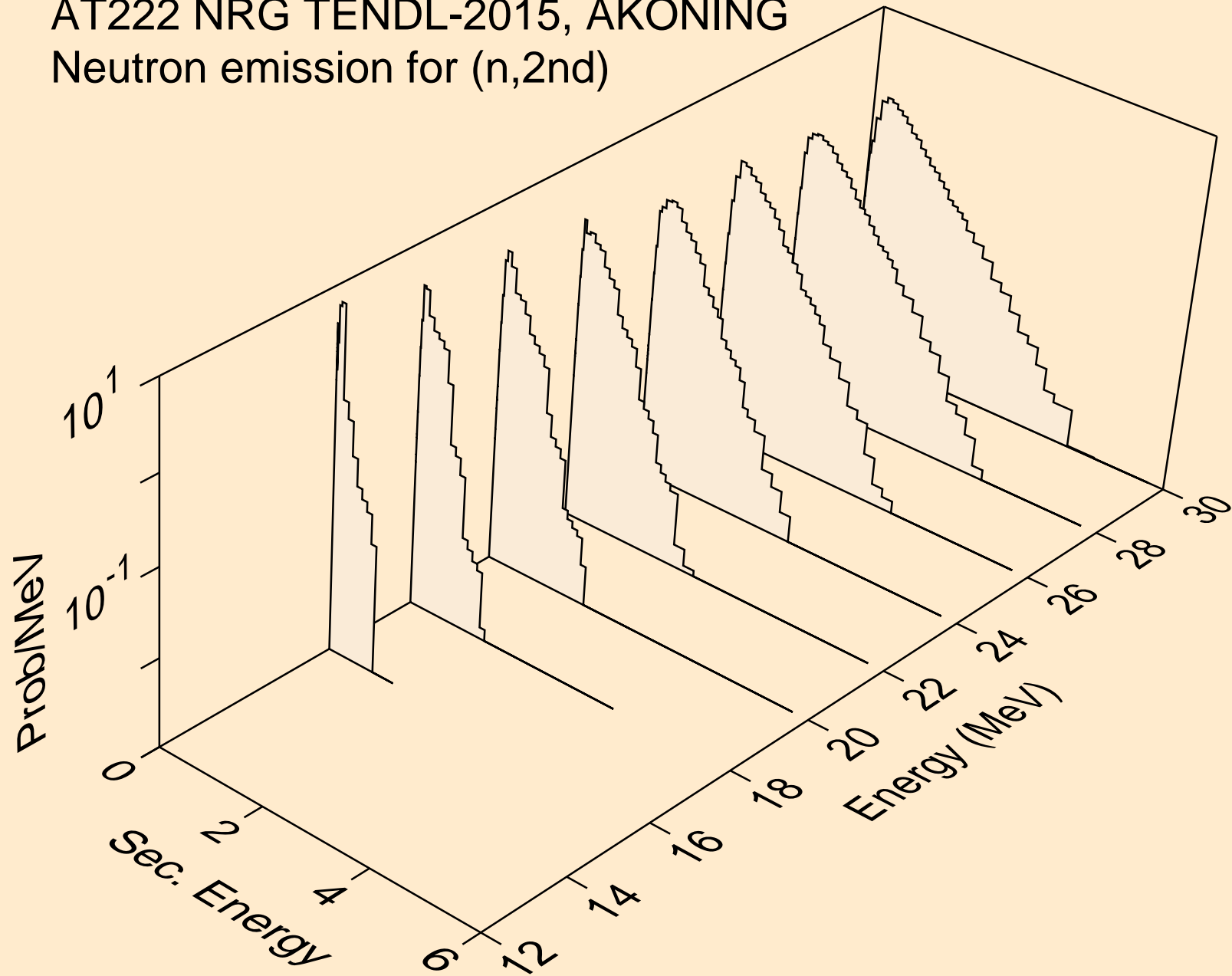

AT222 NRG TENDL-2015, AKONING
Neutron emission for (n,2n)

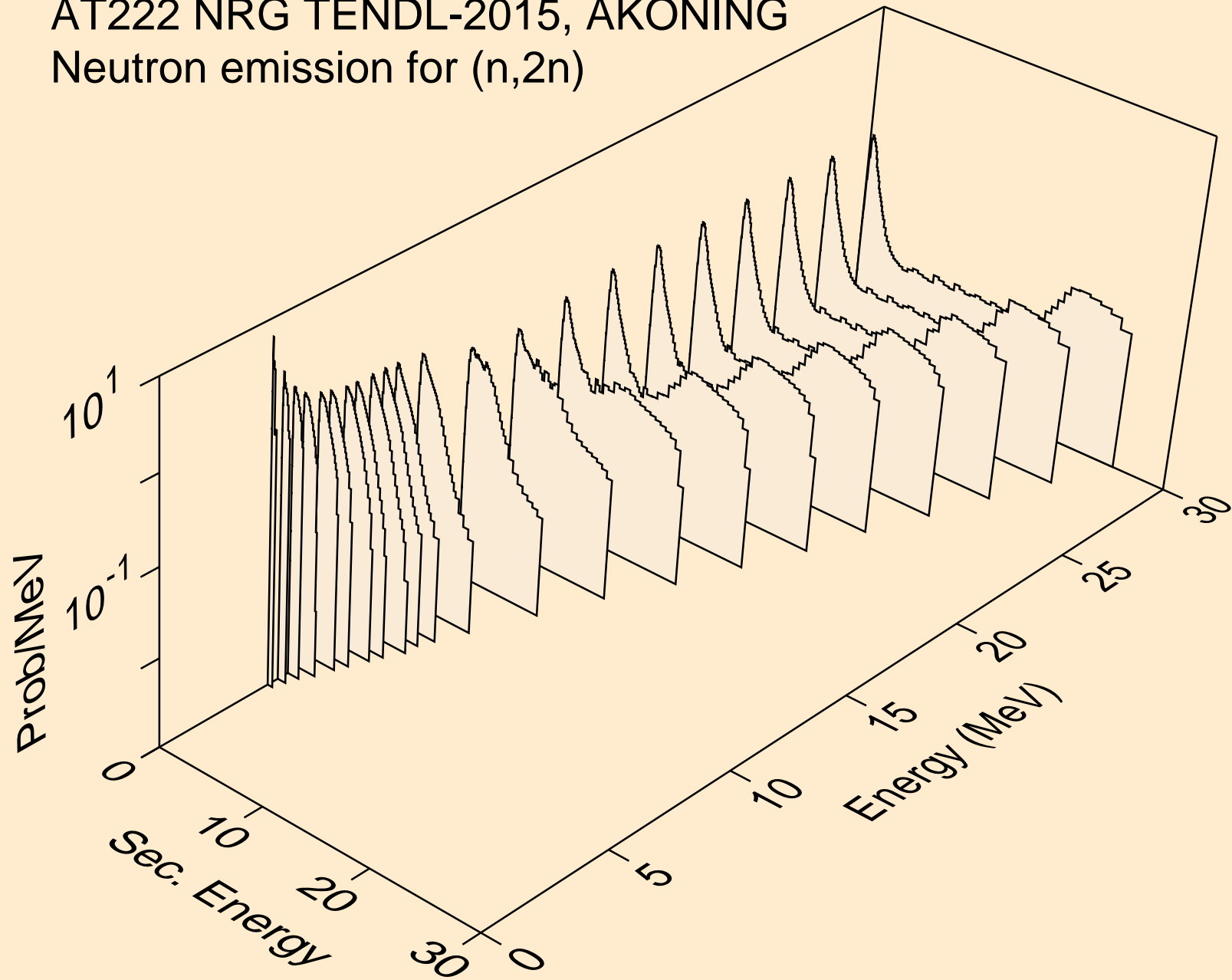

AT222 NRG TENDL-2015, AKONING
Neutron emission for (n,3n)

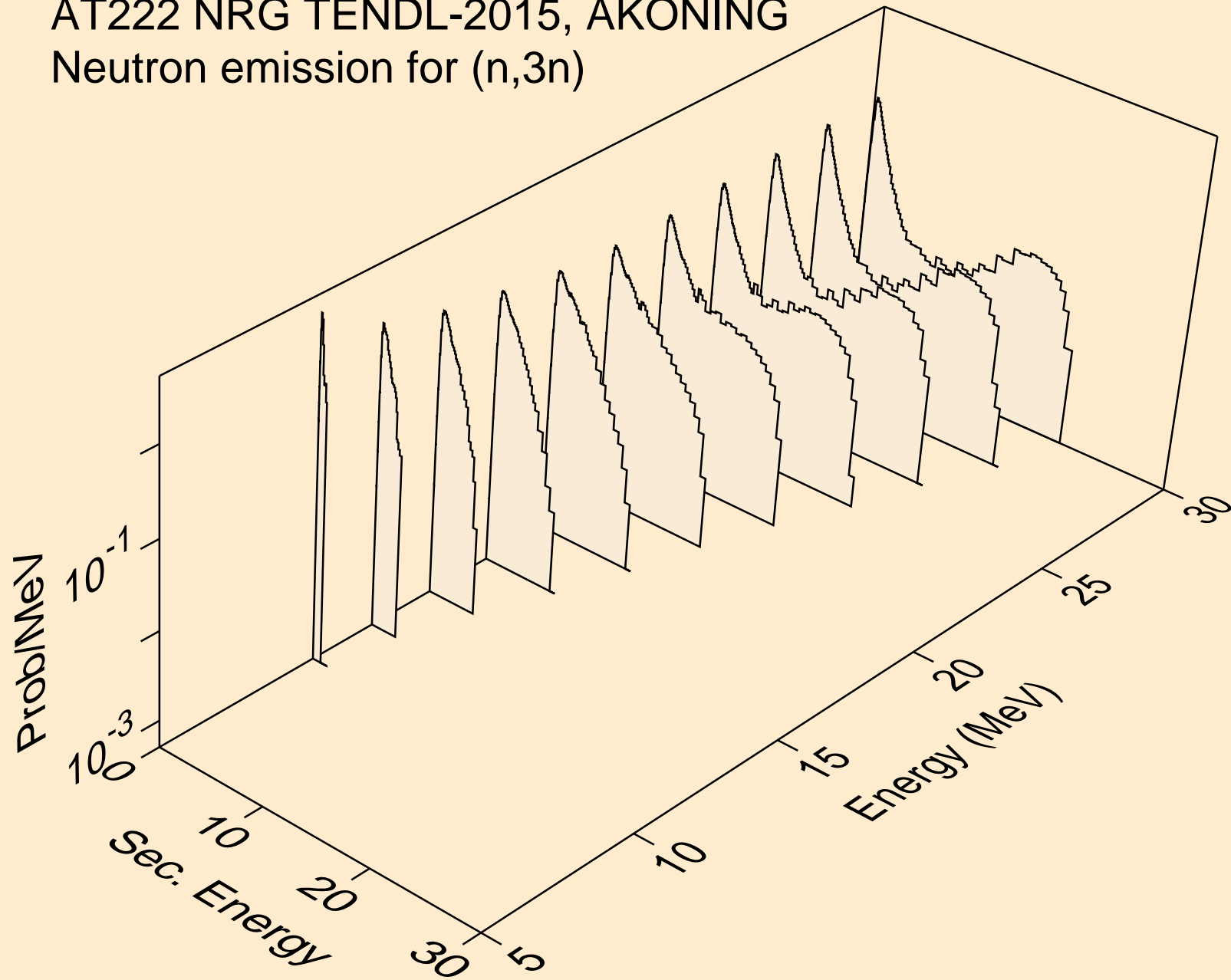

AT222 NRG TENDL-2015, AKONING
Neutron emission for fission

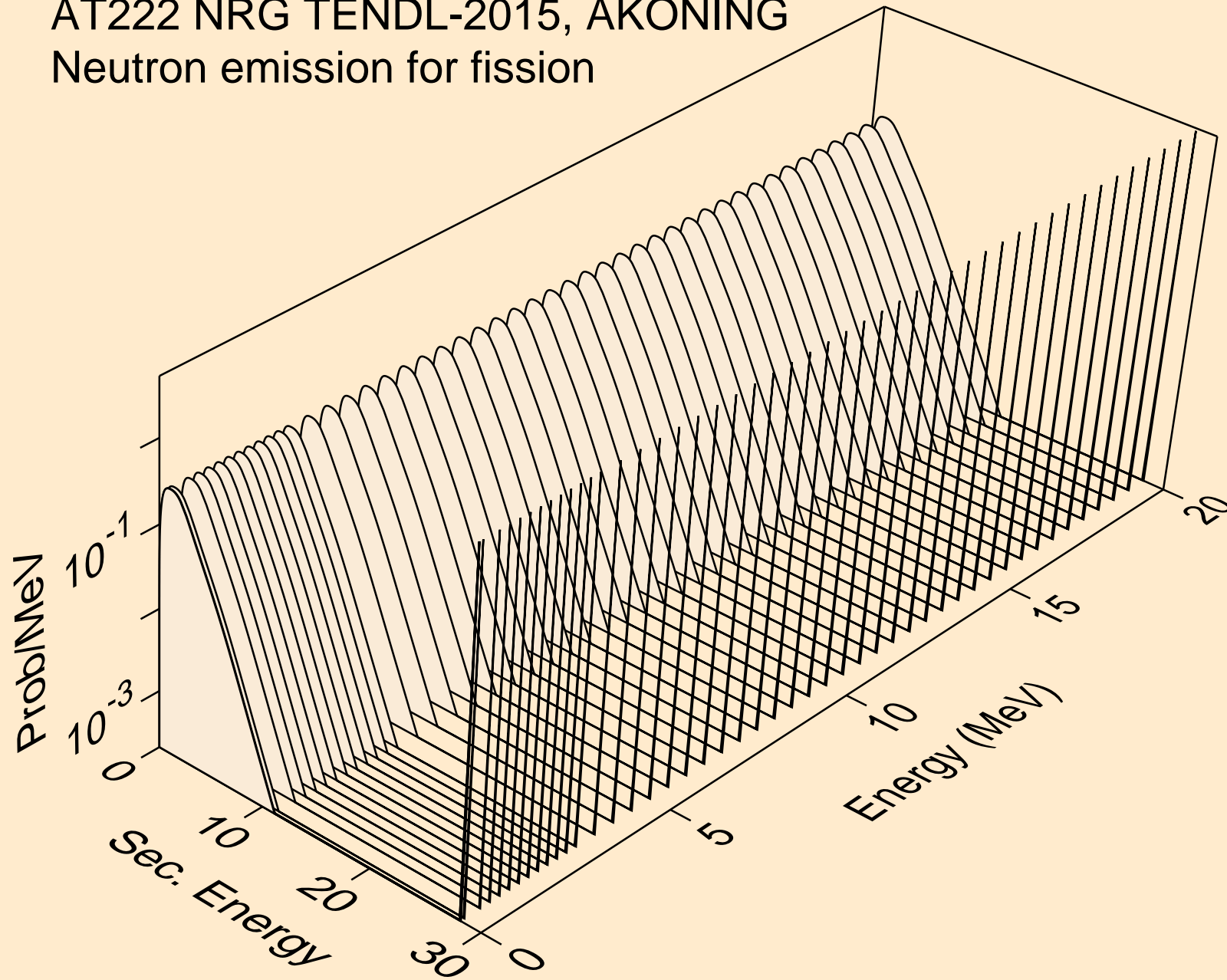

AT222 NRG TENDL-2015, AKONING
Neutron emission for (n,n*)a

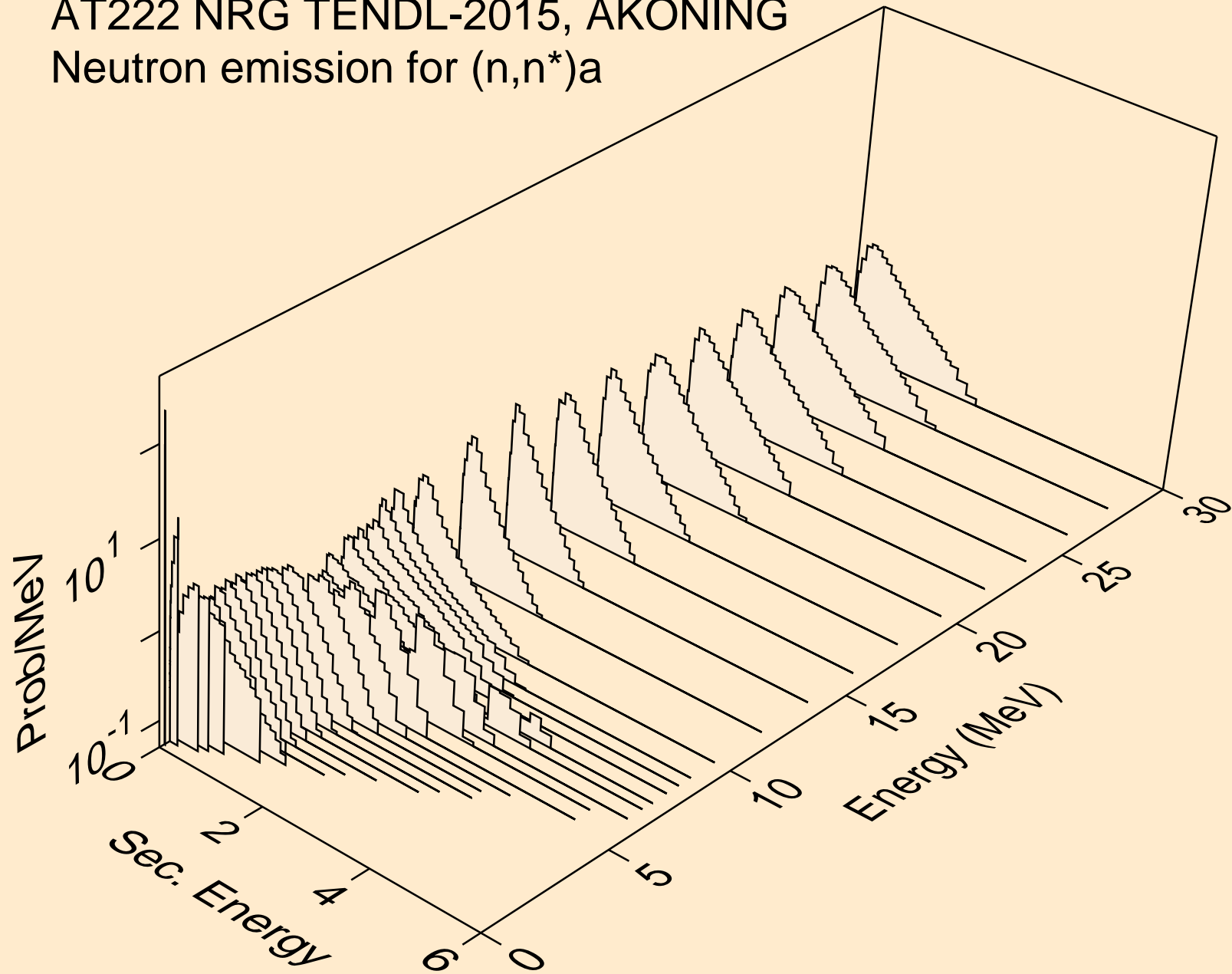

AT222 NRG TENDL-2015, AKONING
Neutron emission for (n,2n)a

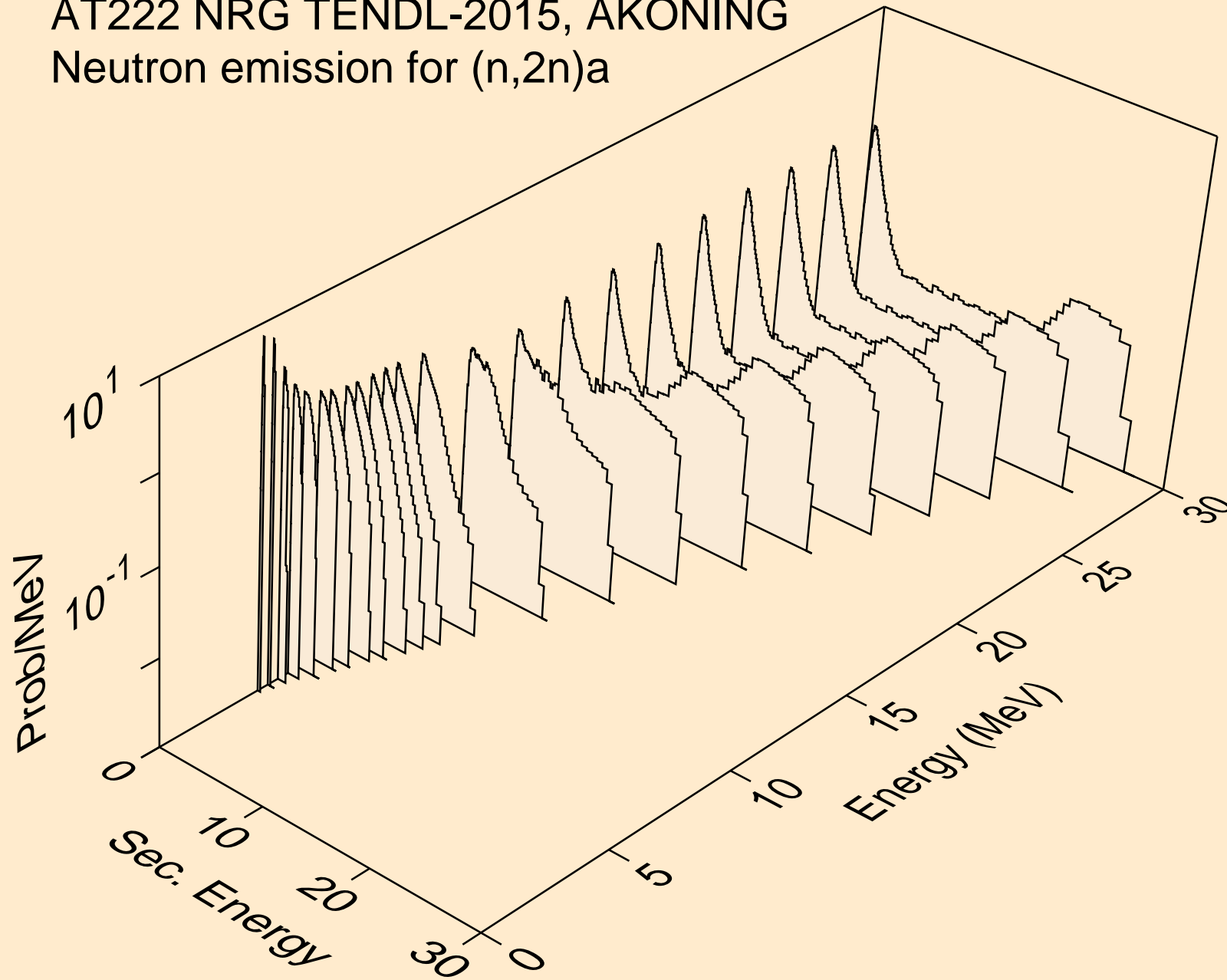

AT222 NRG TENDL-2015, AKONING
Neutron emission for (n,3n)a

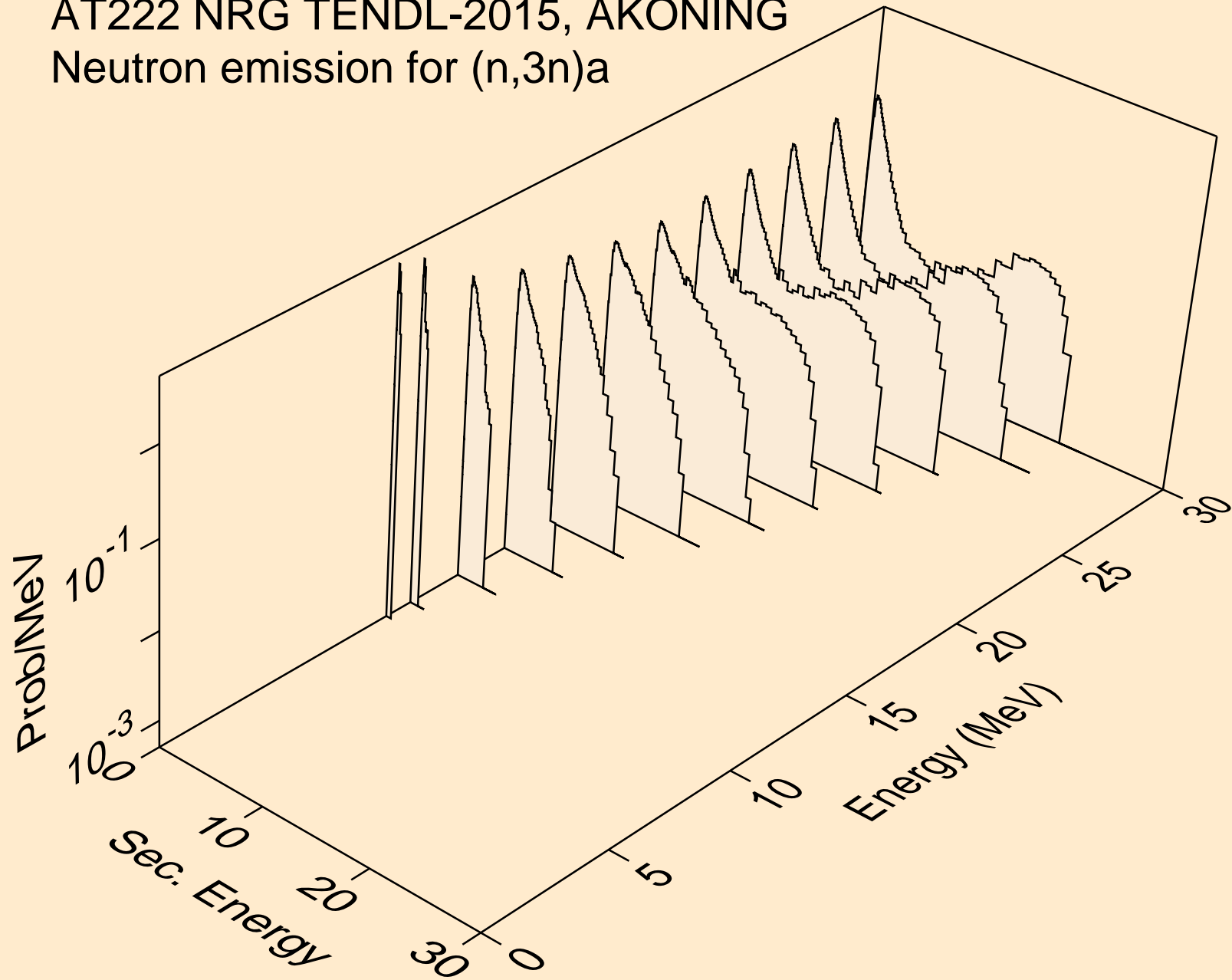

AT222 NRG TENDL-2015, AKONING
Neutron emission for (n,n*)p

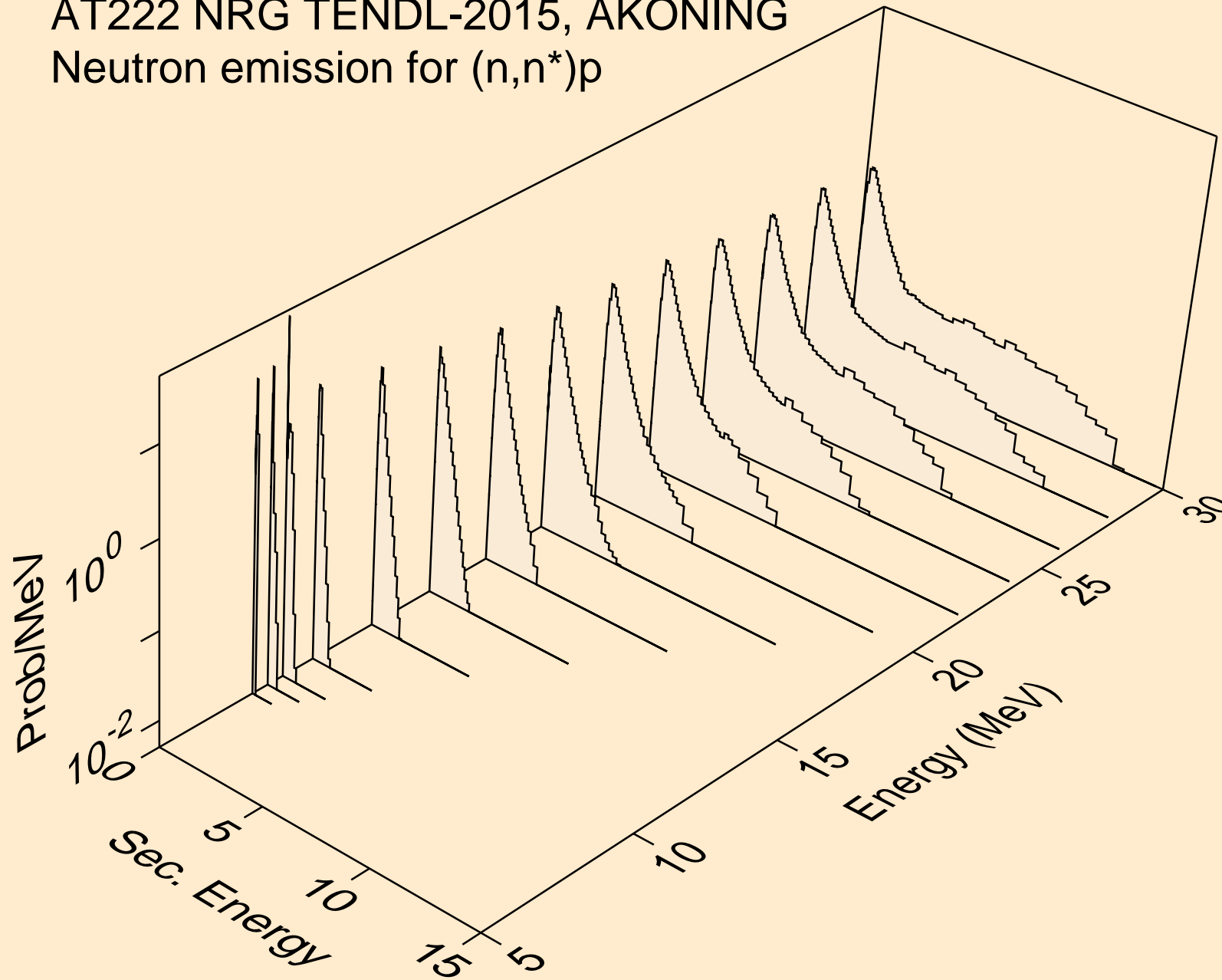

AT222 NRG TENDL-2015, AKONING
Neutron emission for (n,n*)2a

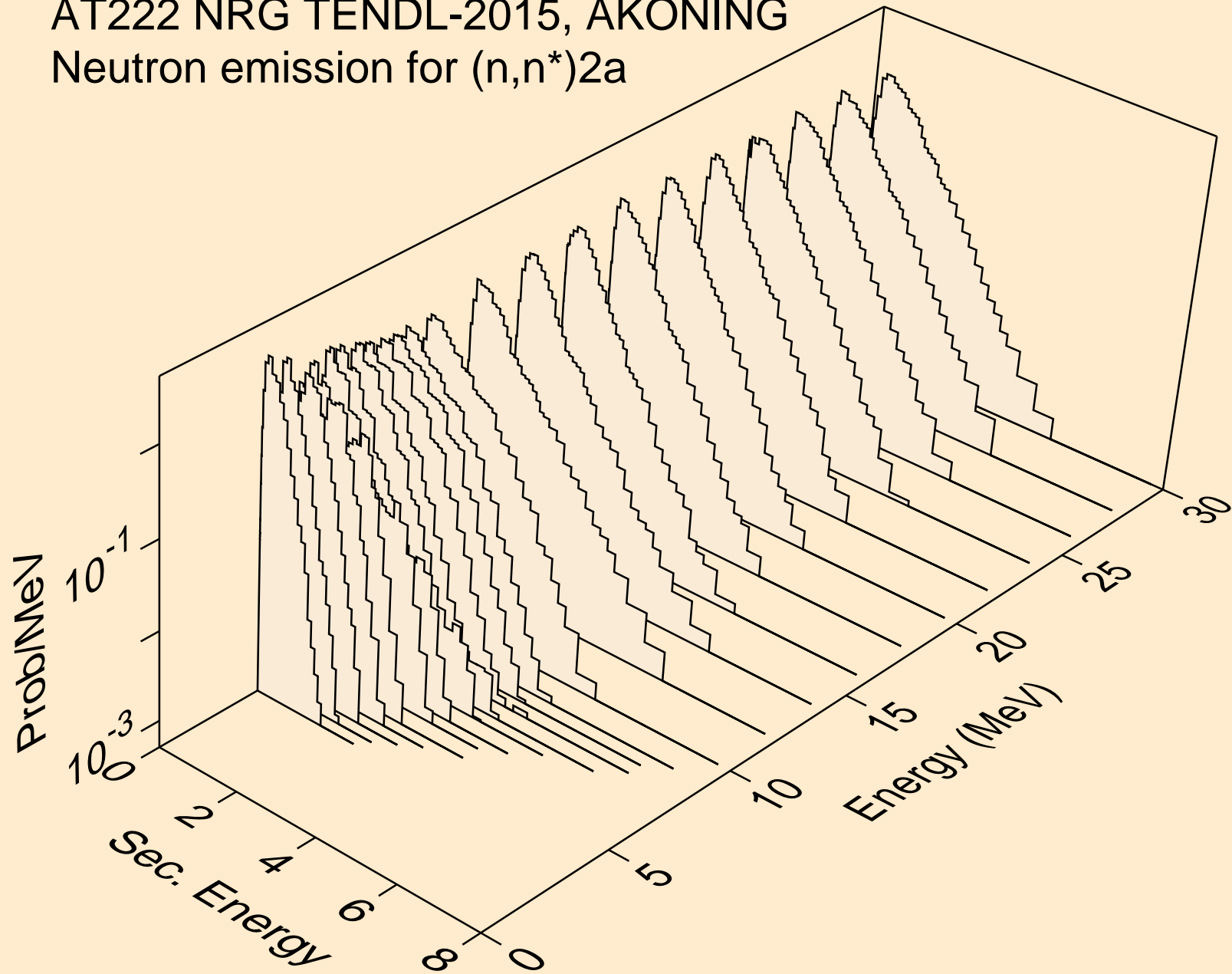

AT222 NRG TENDL-2015, AKONING
Neutron emission for (n,2n)2a

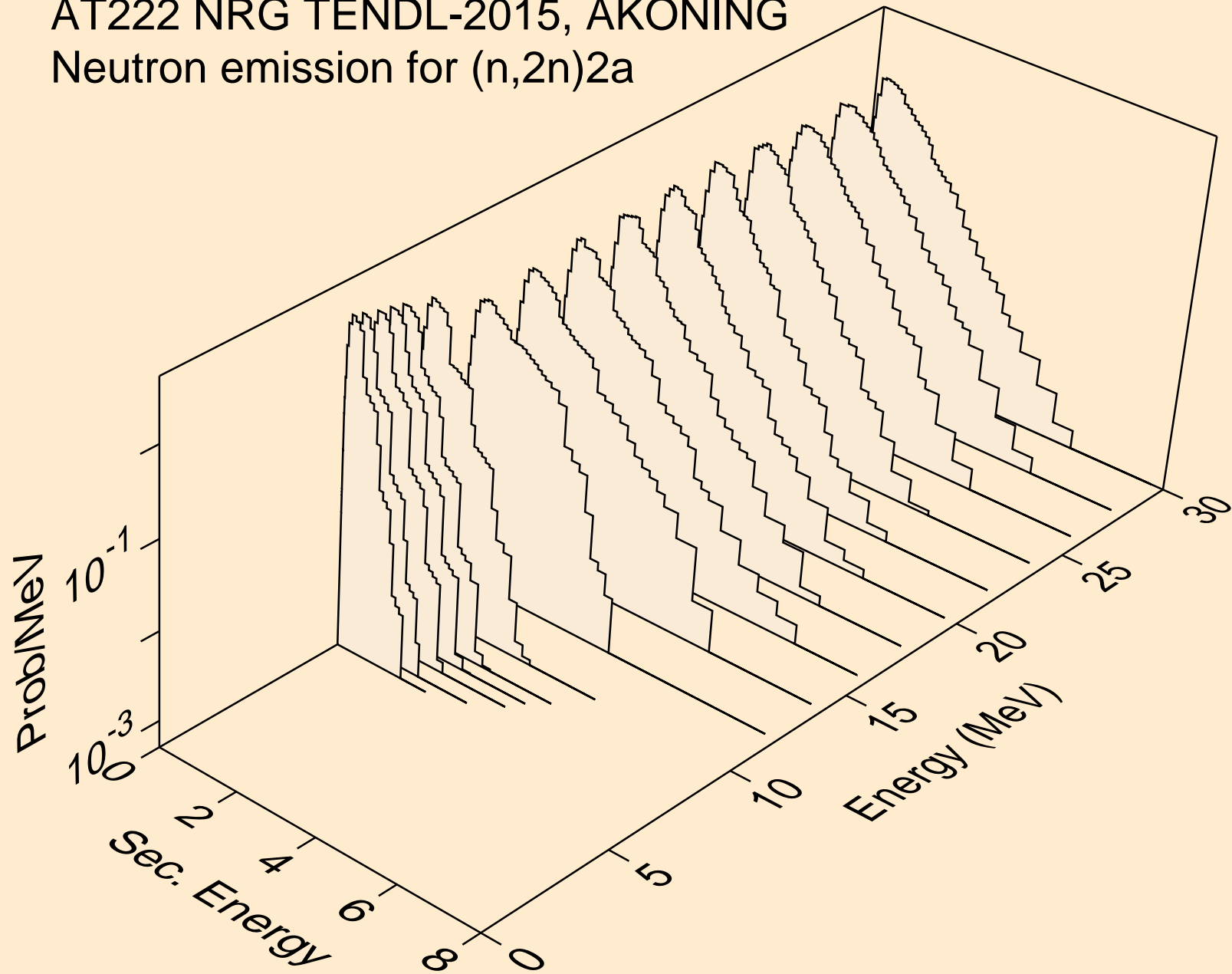

AT222 NRG TENDL-2015, AKONING
Neutron emission for (n,n*)d

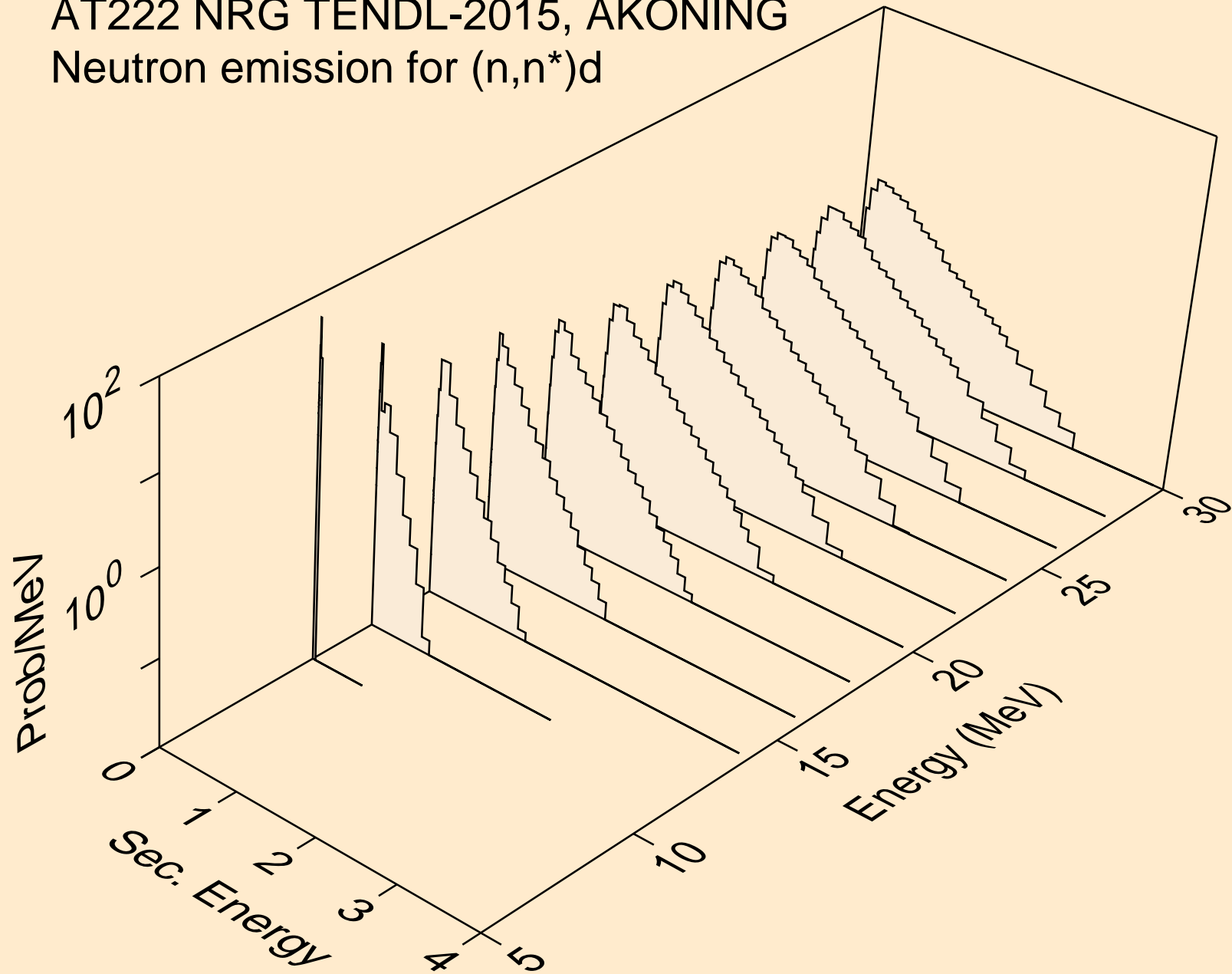

AT222 NRG TENDL-2015, AKONING
Neutron emission for (n,n*)t

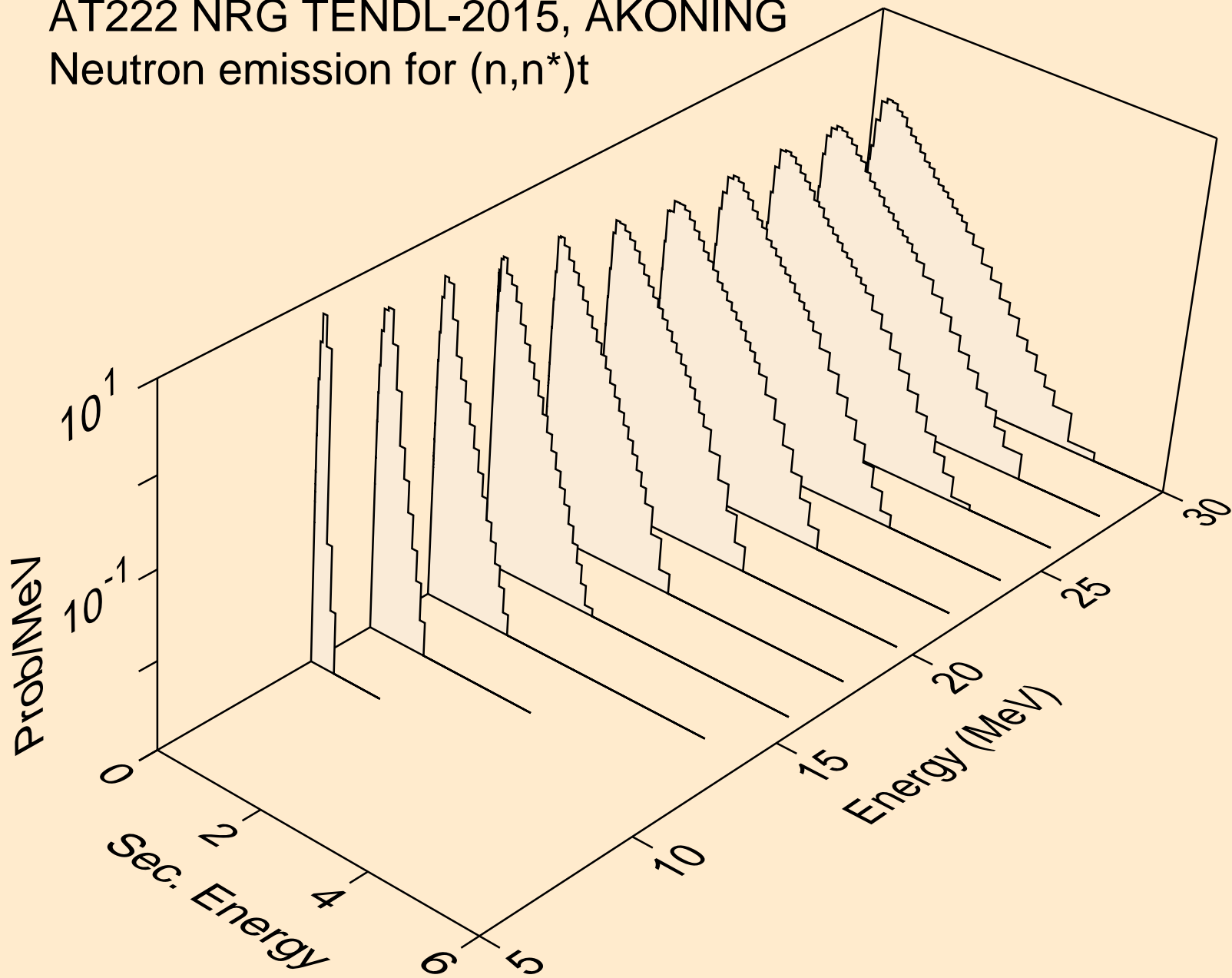

AT222 NRG TENDL-2015, AKONING
Neutron emission for (n,n*)he3

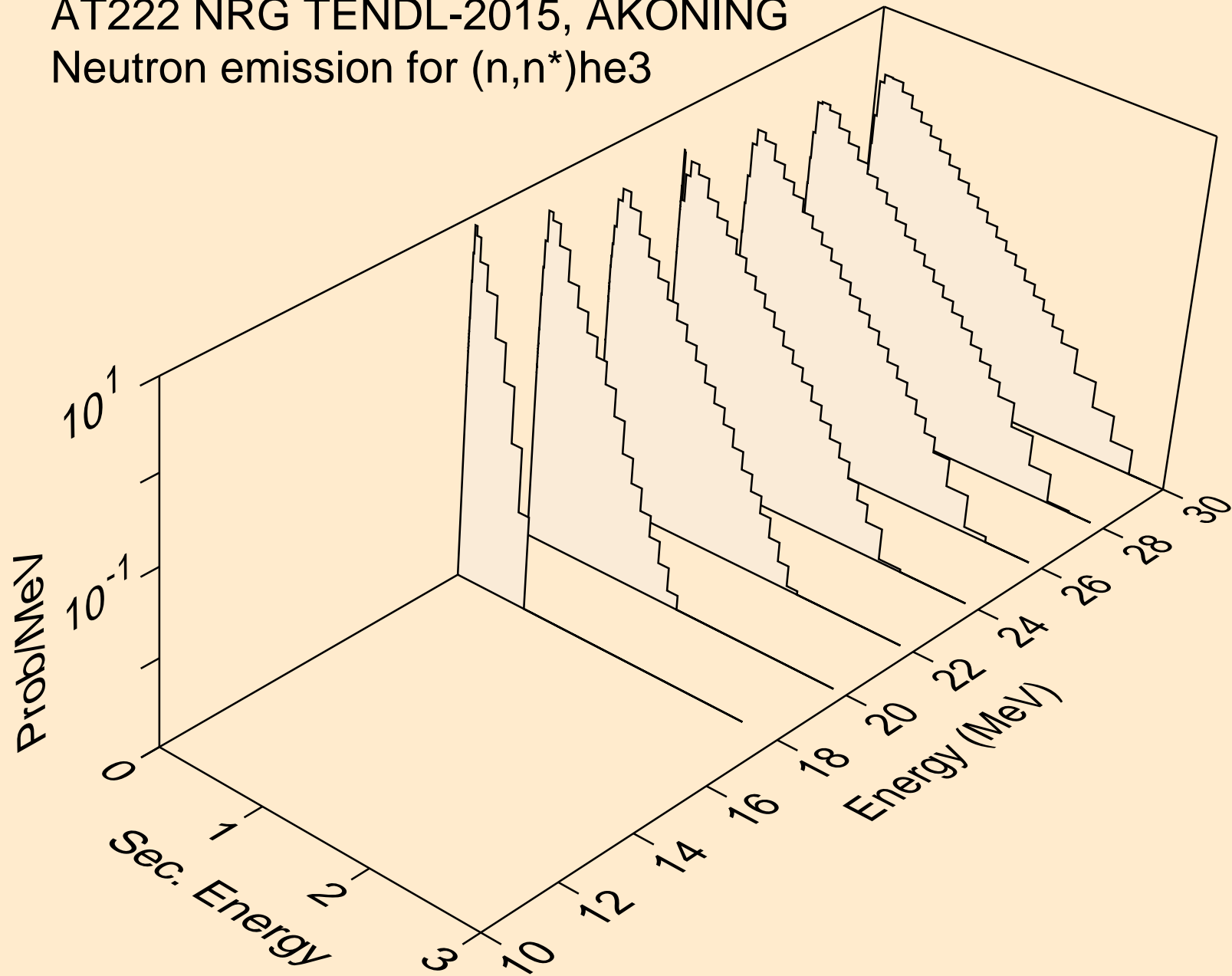

AT222 NRG TENDL-2015, AKONING
Neutron emission for (n,4n)

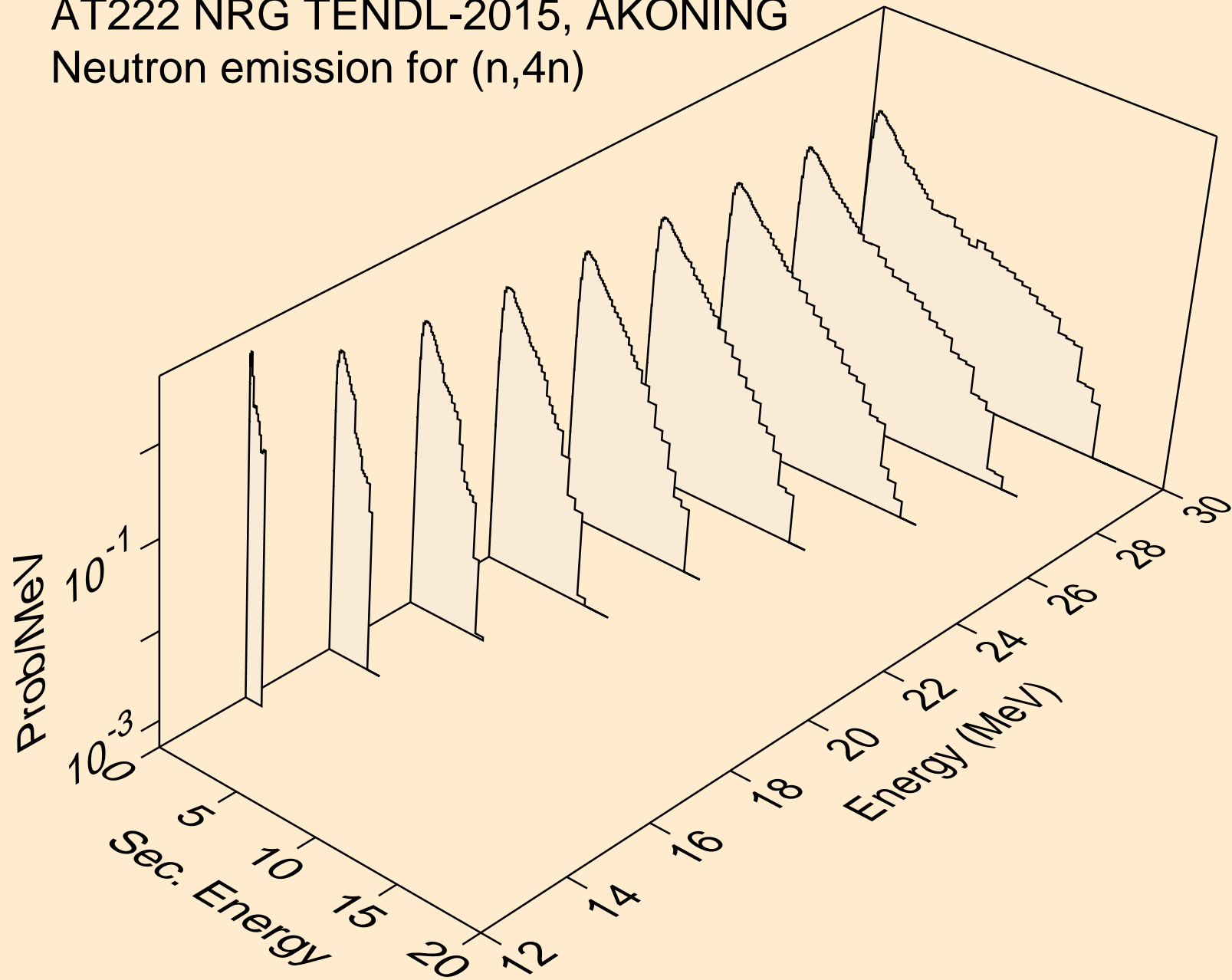

AT222 NRG TENDL-2015, AKONING
Neutron emission for (n,2np)

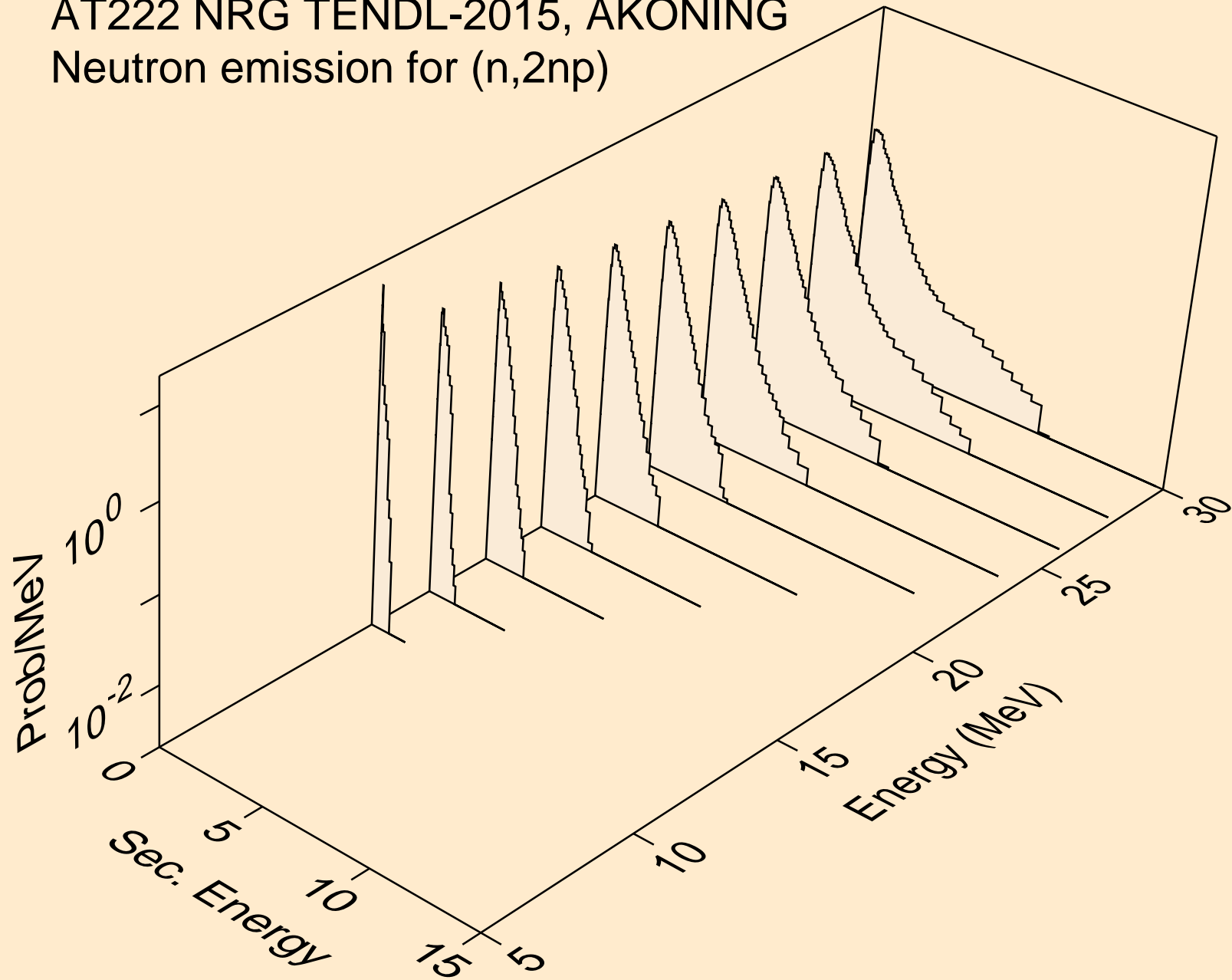

AT222 NRG TENDL-2015, AKONING
Neutron emission for (n,3np)

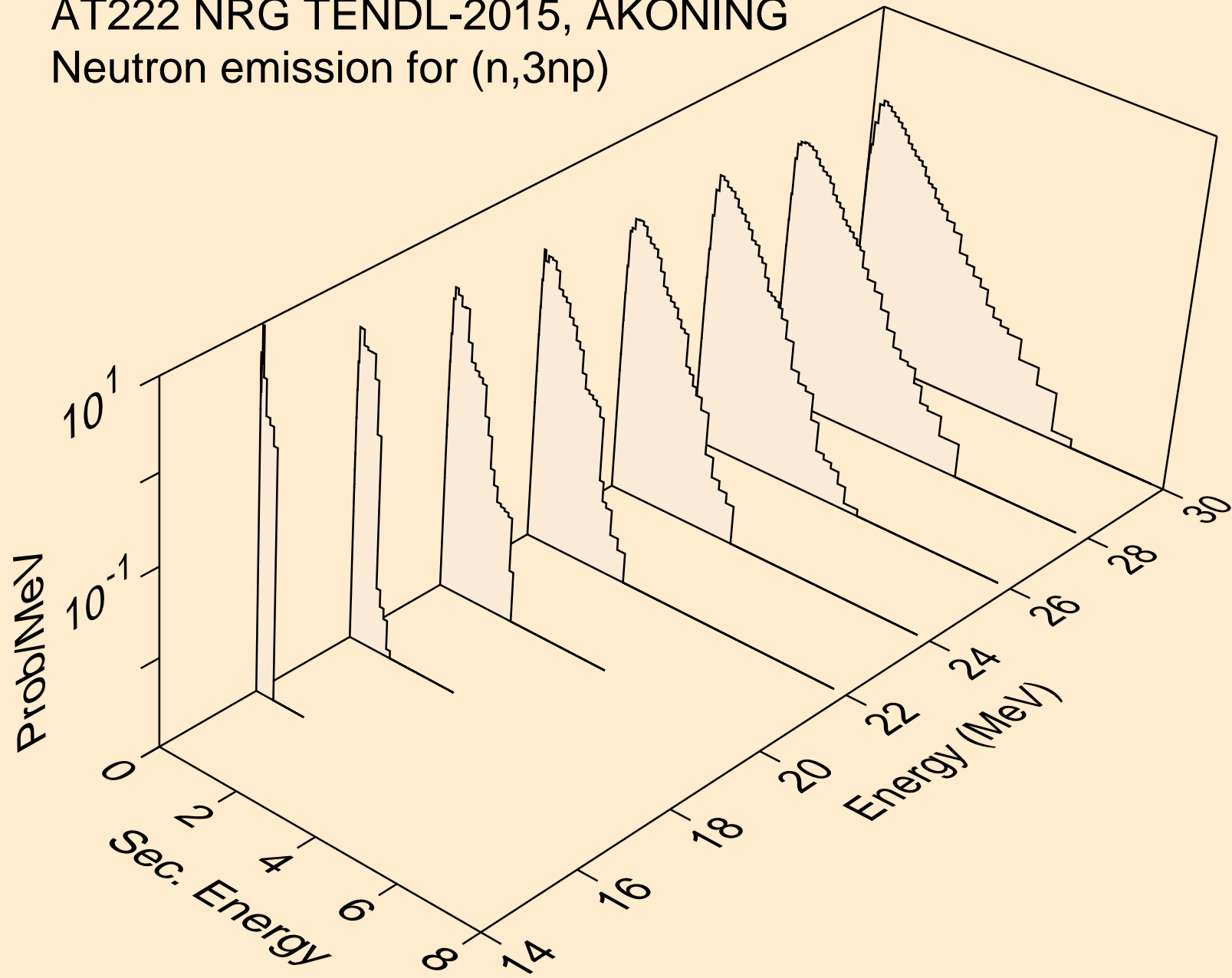

AT222 NRG TENDL-2015, AKONING
Neutron emission for (n,2np)

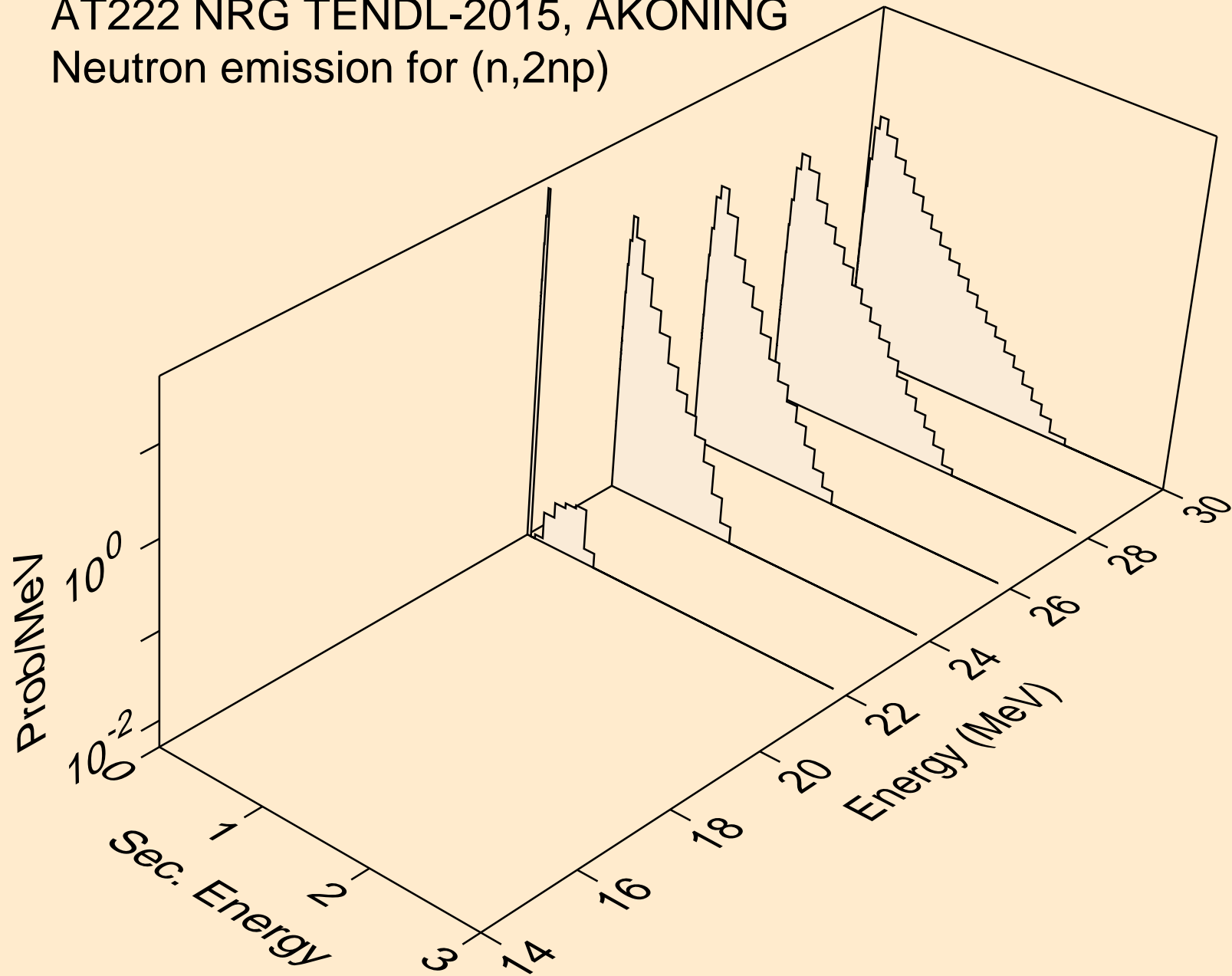

AT222 NRG TENDL-2015, AKONING
Neutron emission for (n,npa)

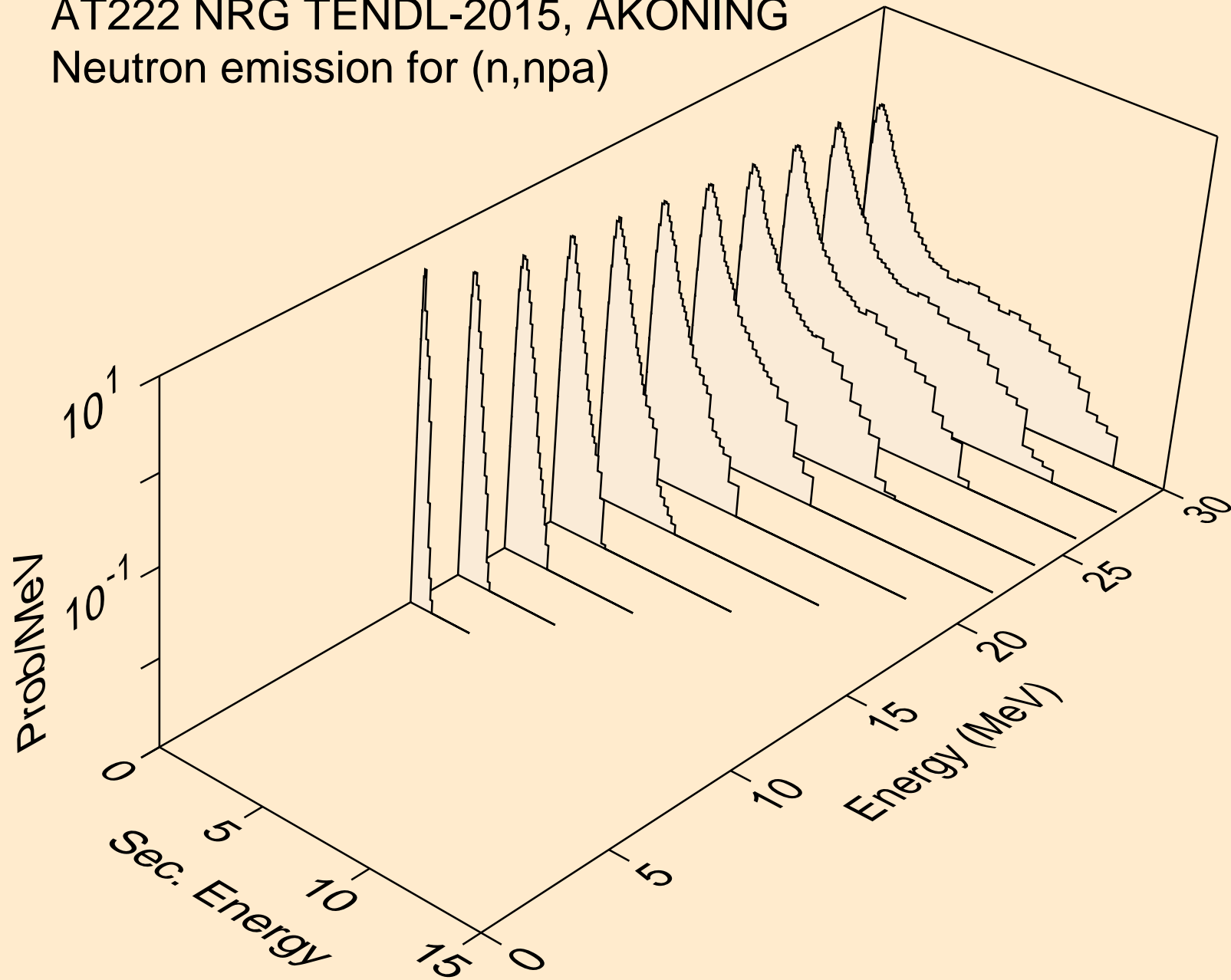

AT222 NRG TENDL-2015, AKONING
Neutron emission for (n,n*c)

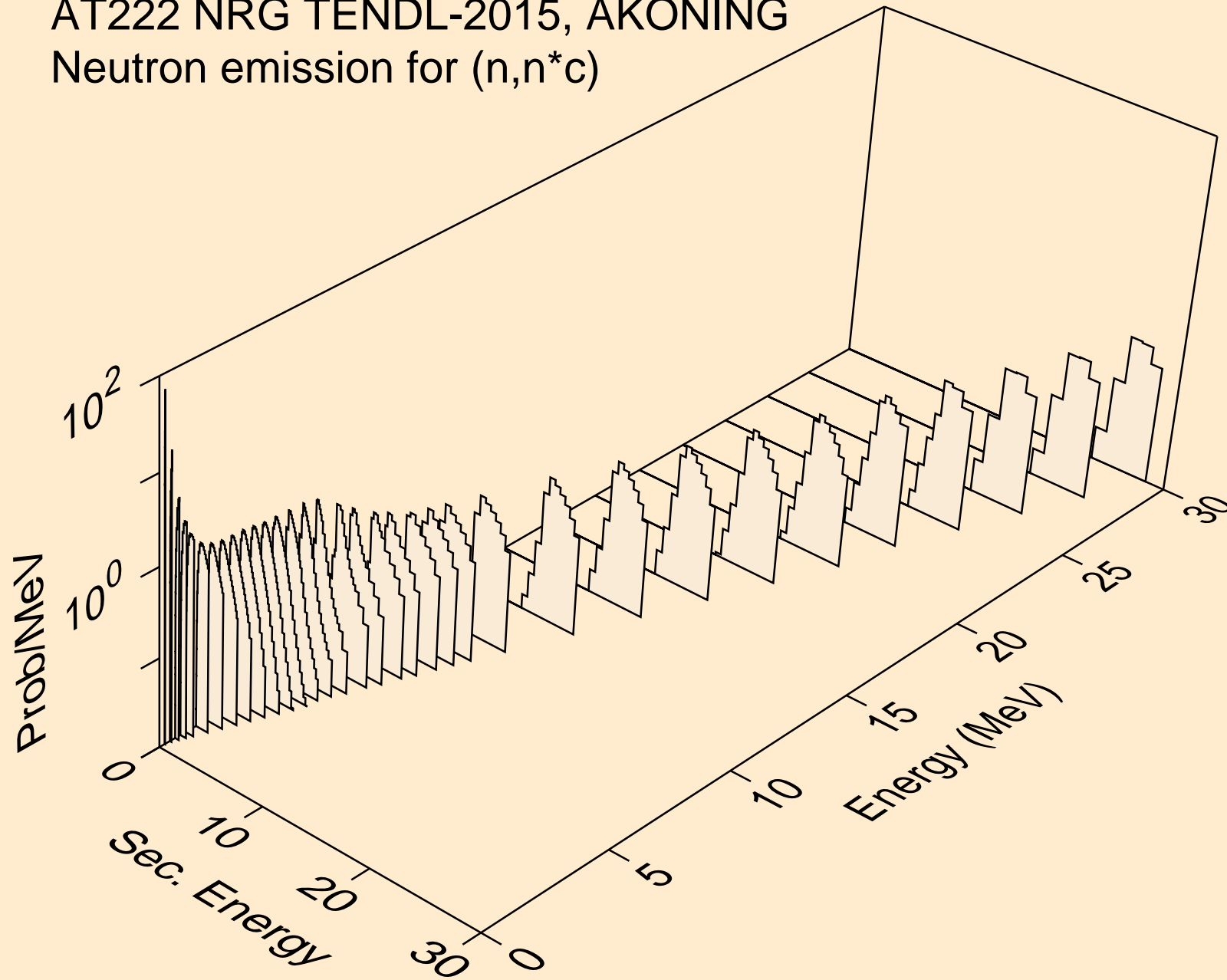

AT222 NRG TENDL-2015, AKONING

Delayed nubar

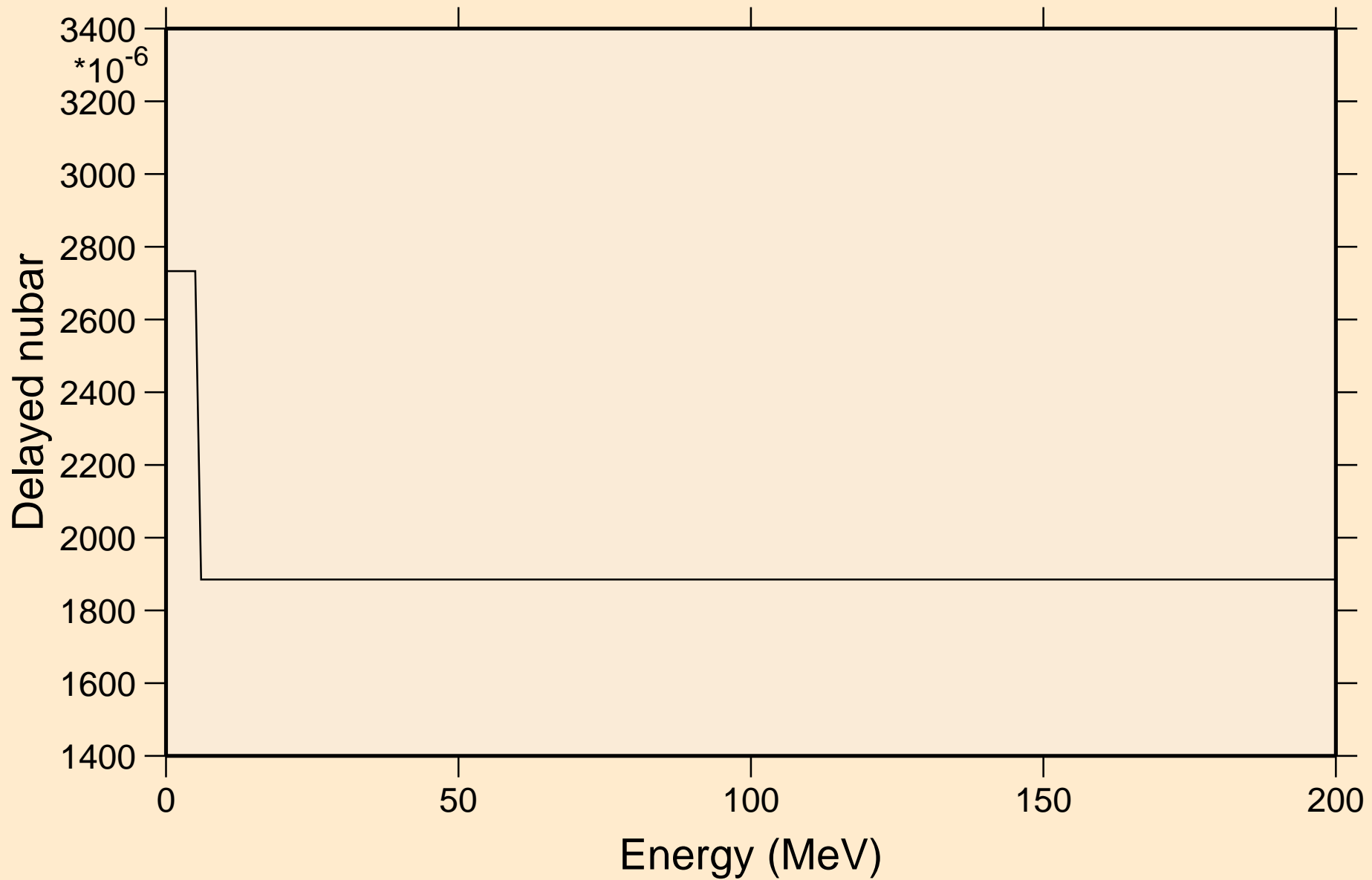

AT222 NRG TENDL-2015, AKONING

Delayed neutron spectra

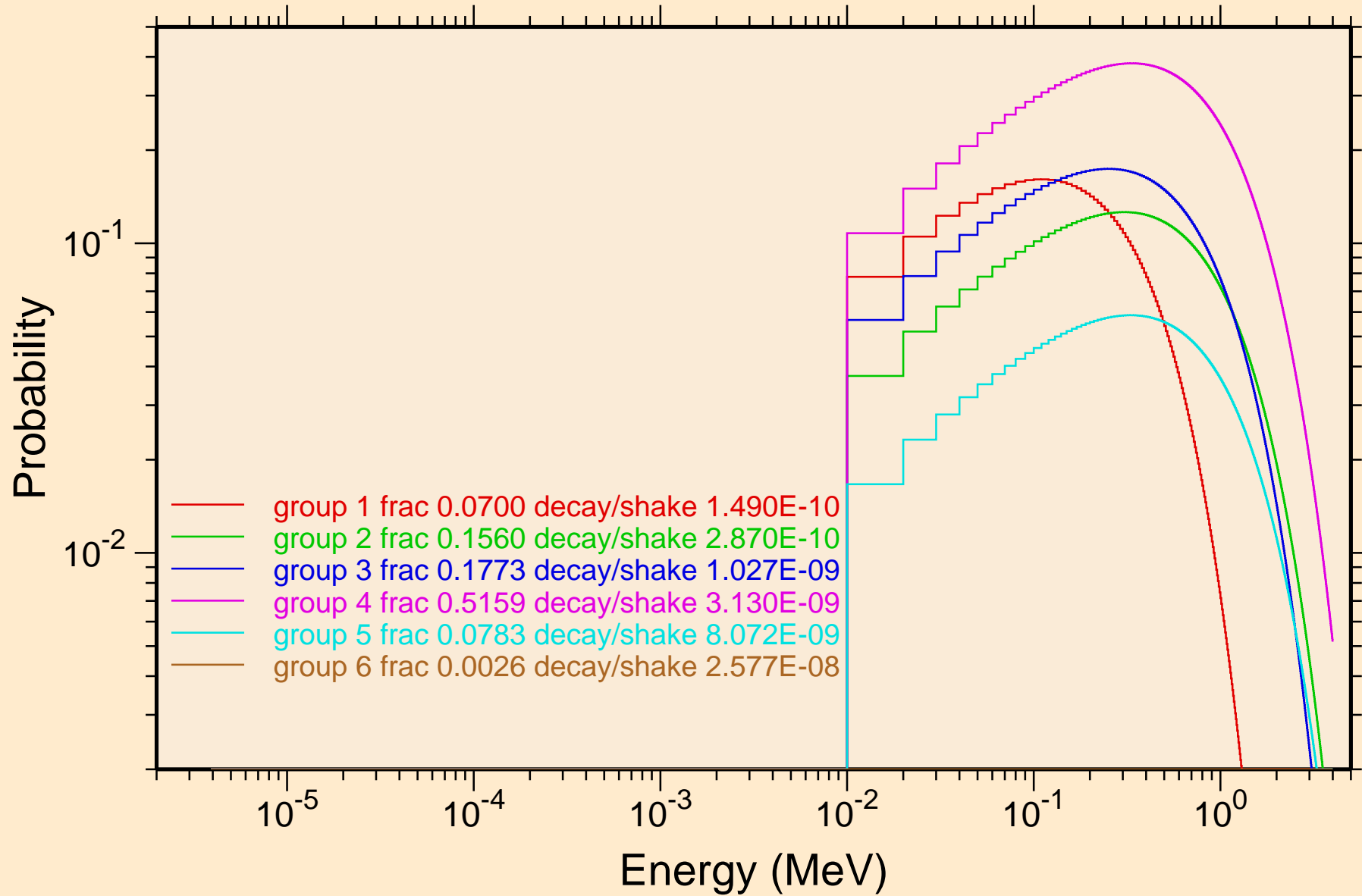

AT222 NRG TENDL-2015, AKONING
Photon emission for (n,x)

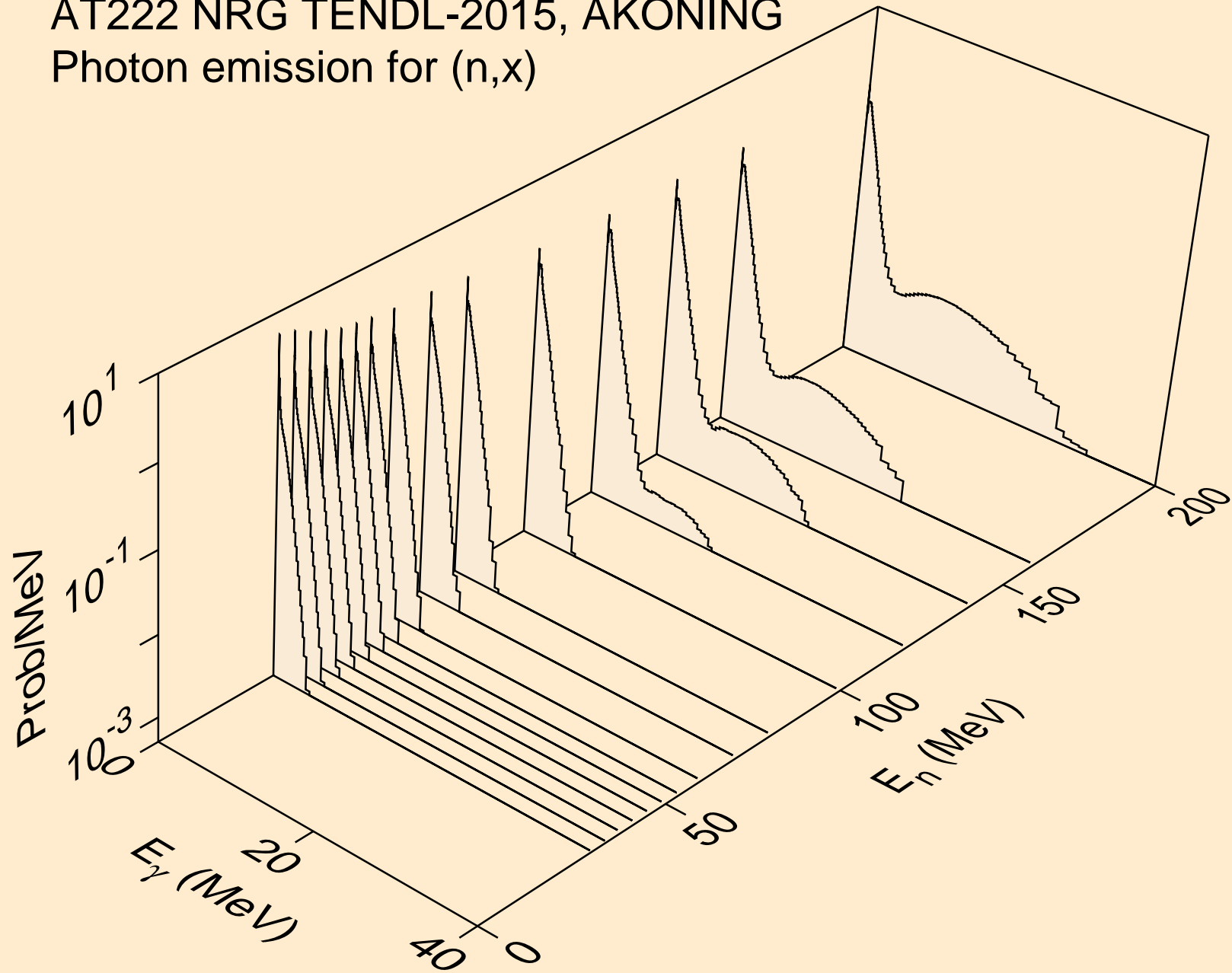

AT222 NRG TENDL-2015, AKONING
Photon emission for (n,2nd)

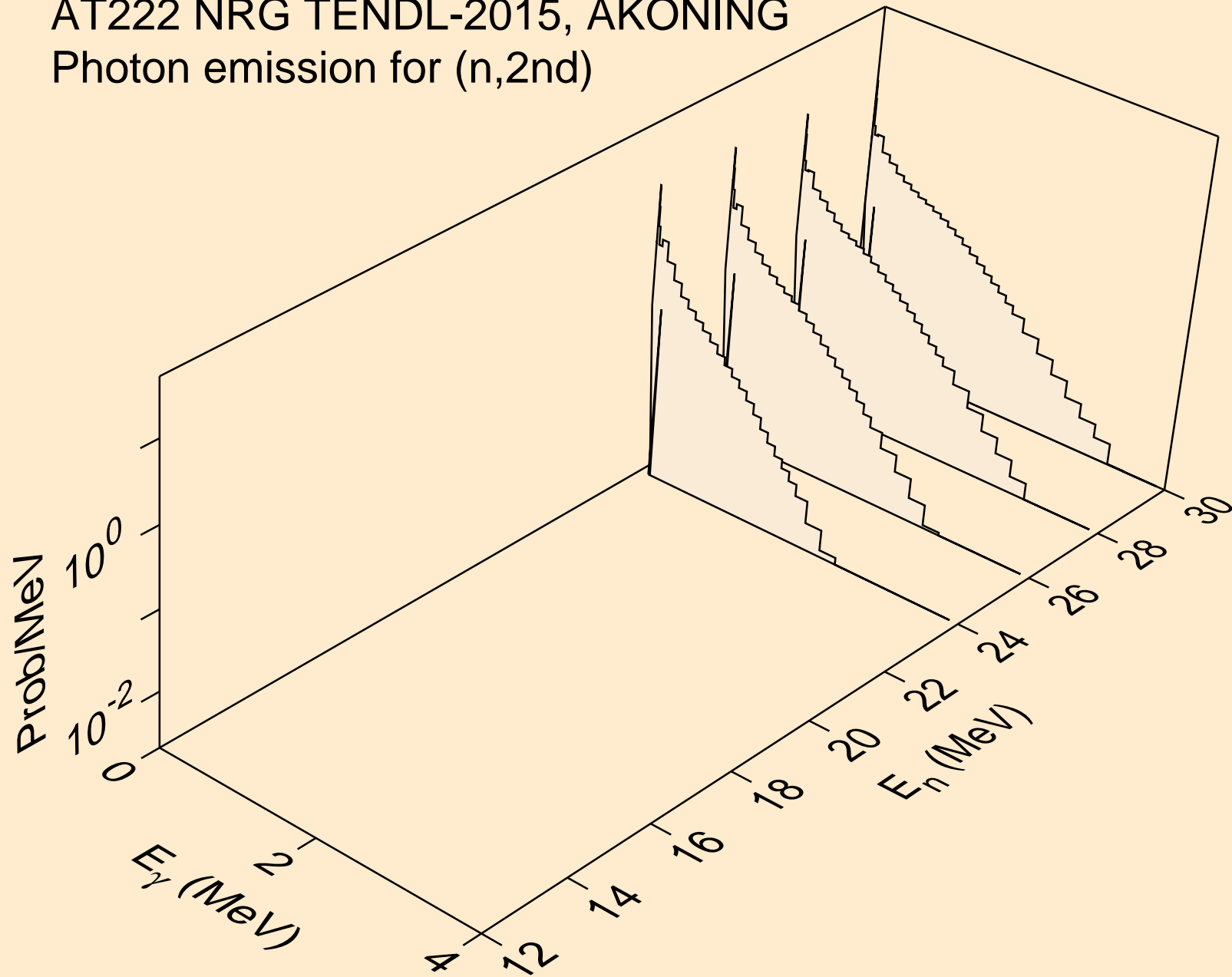

AT222 NRG TENDL-2015, AKONING
Photon emission for (n,2n)

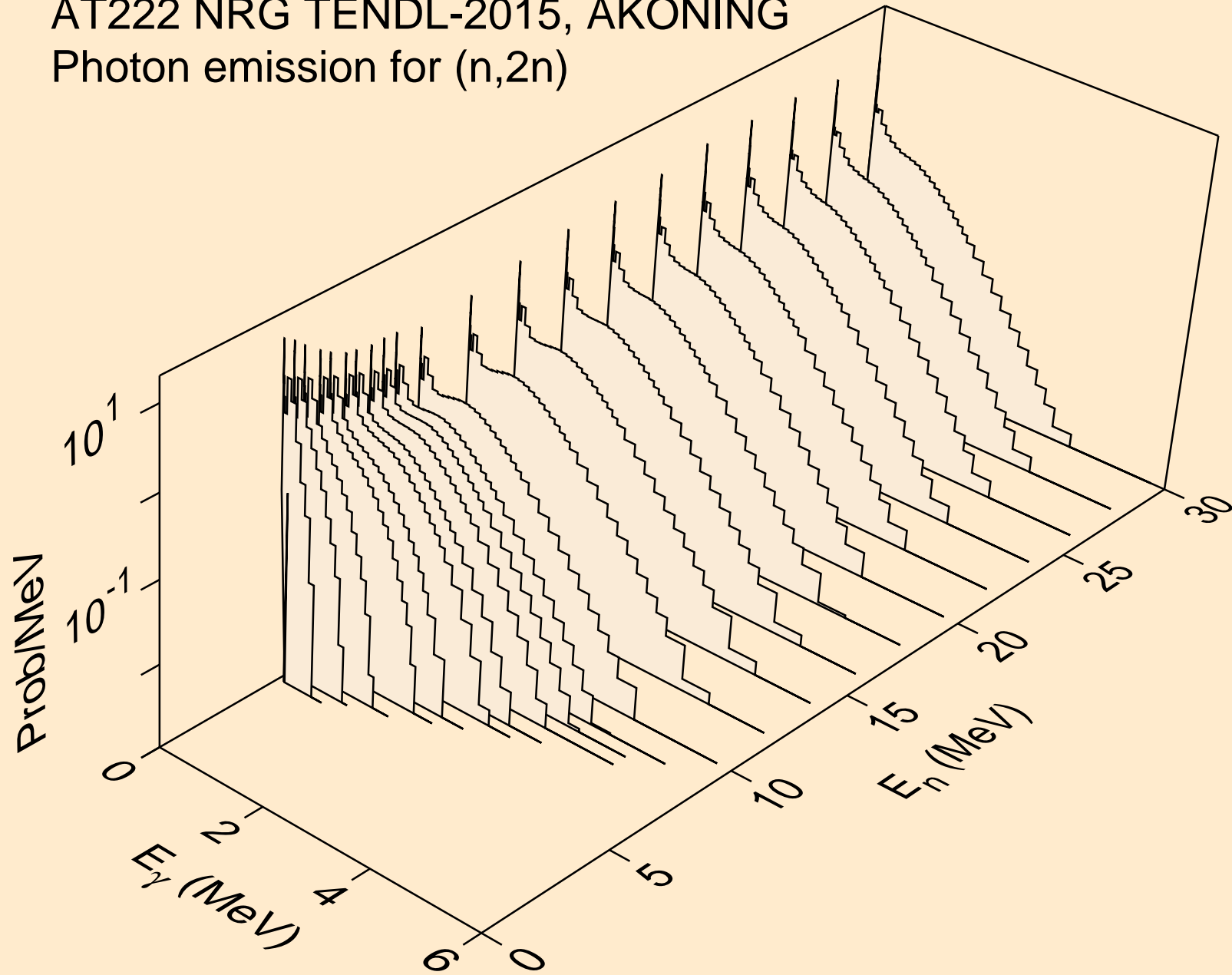

AT222 NRG TENDL-2015, AKONING
Photon emission for (n,3n)

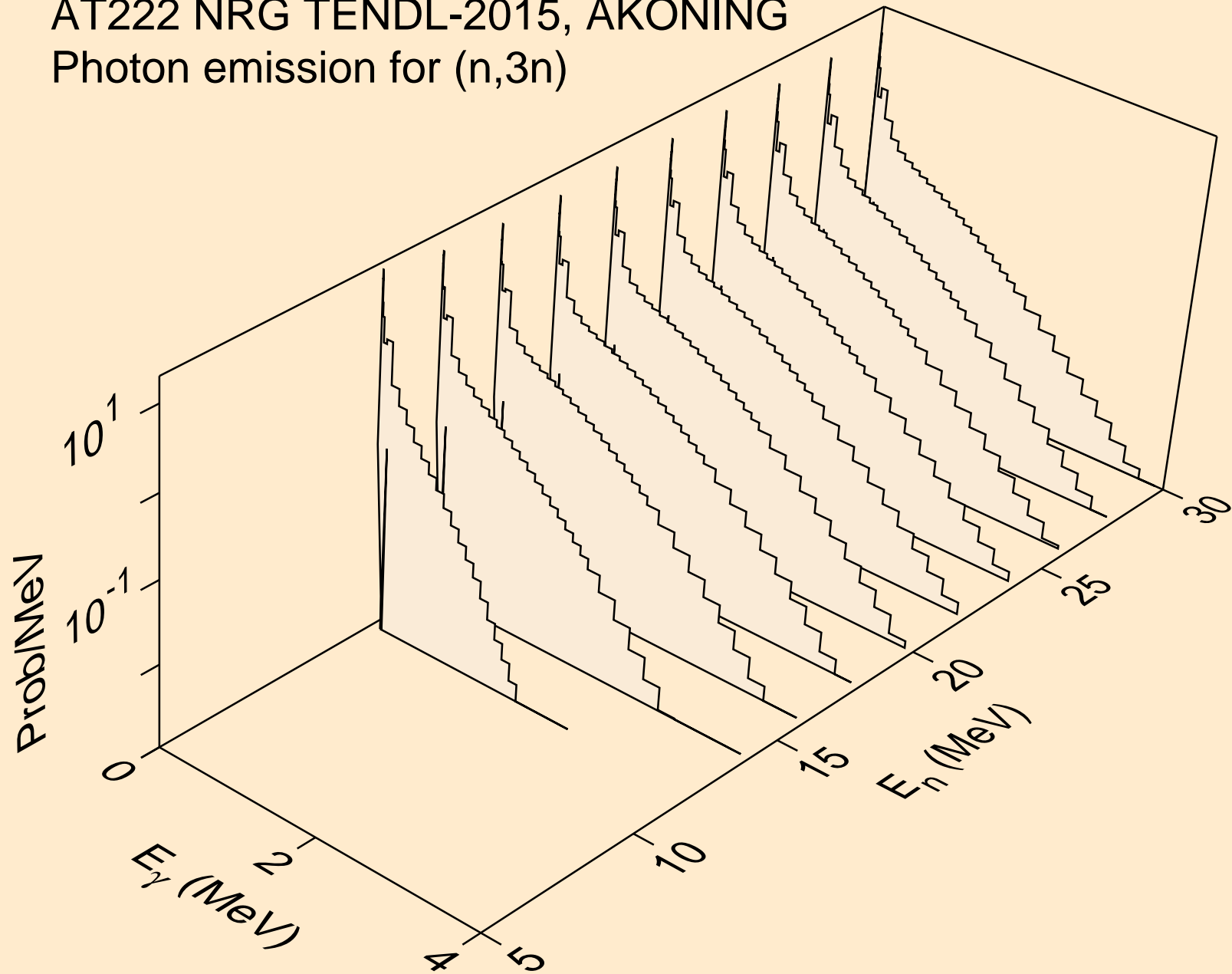

AT222 NRG TENDL-2015, AKONING
Photon emission for (n,n*)a

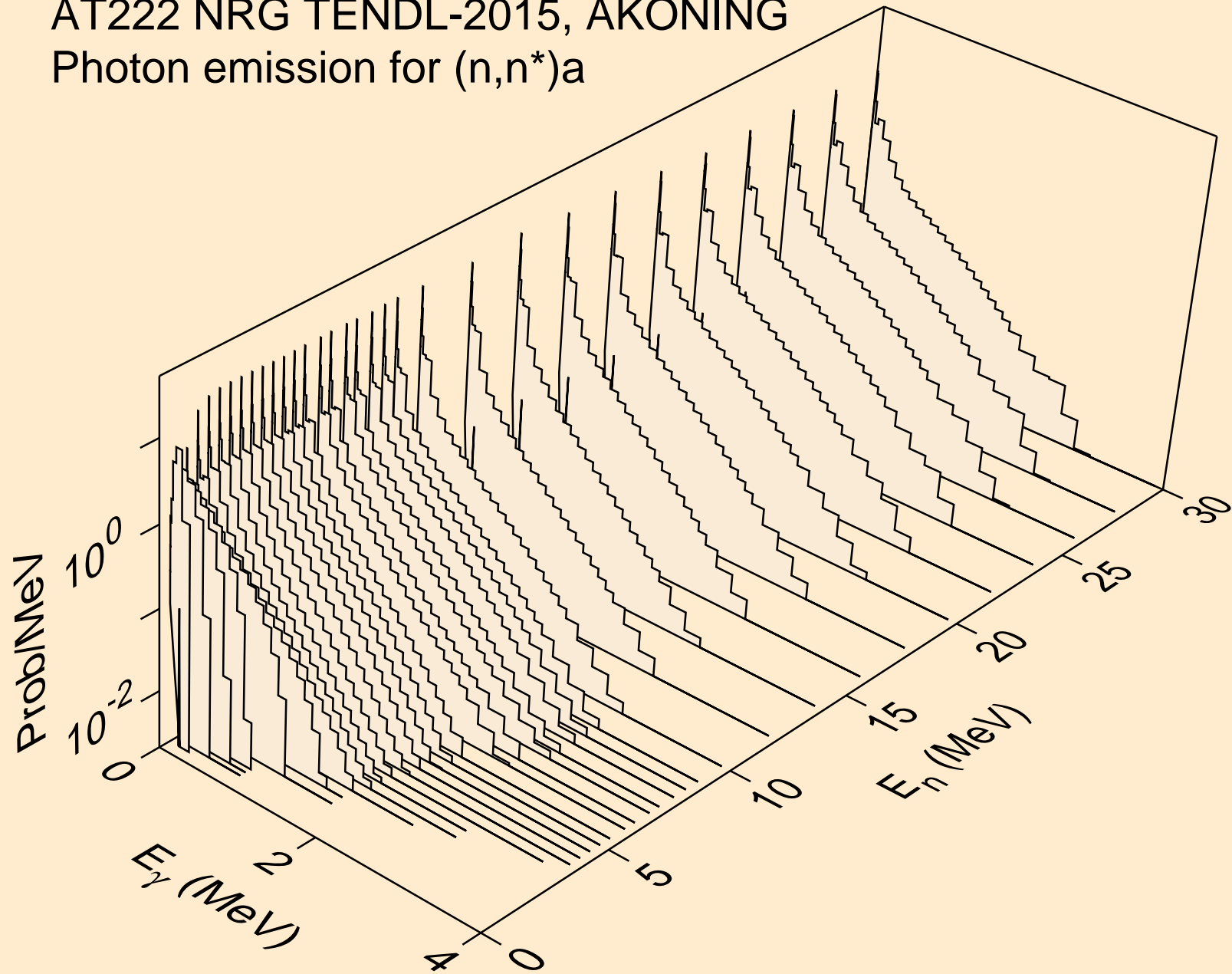

AT222 NRG TENDL-2015, AKONING
Photon emission for (n,2n) α

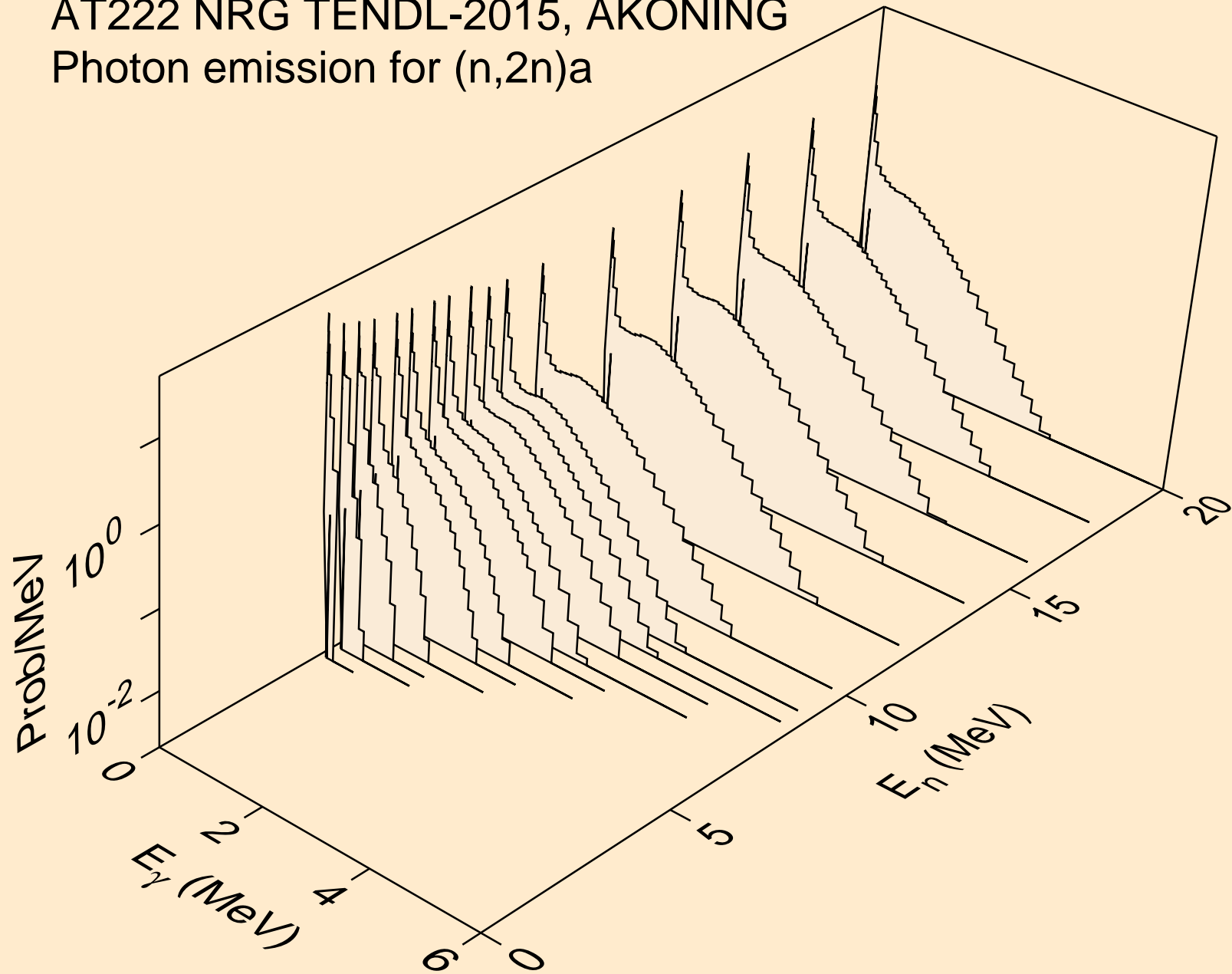

AT222 NRG TENDL-2015, AKONING
Photon emission for (n,3n)a

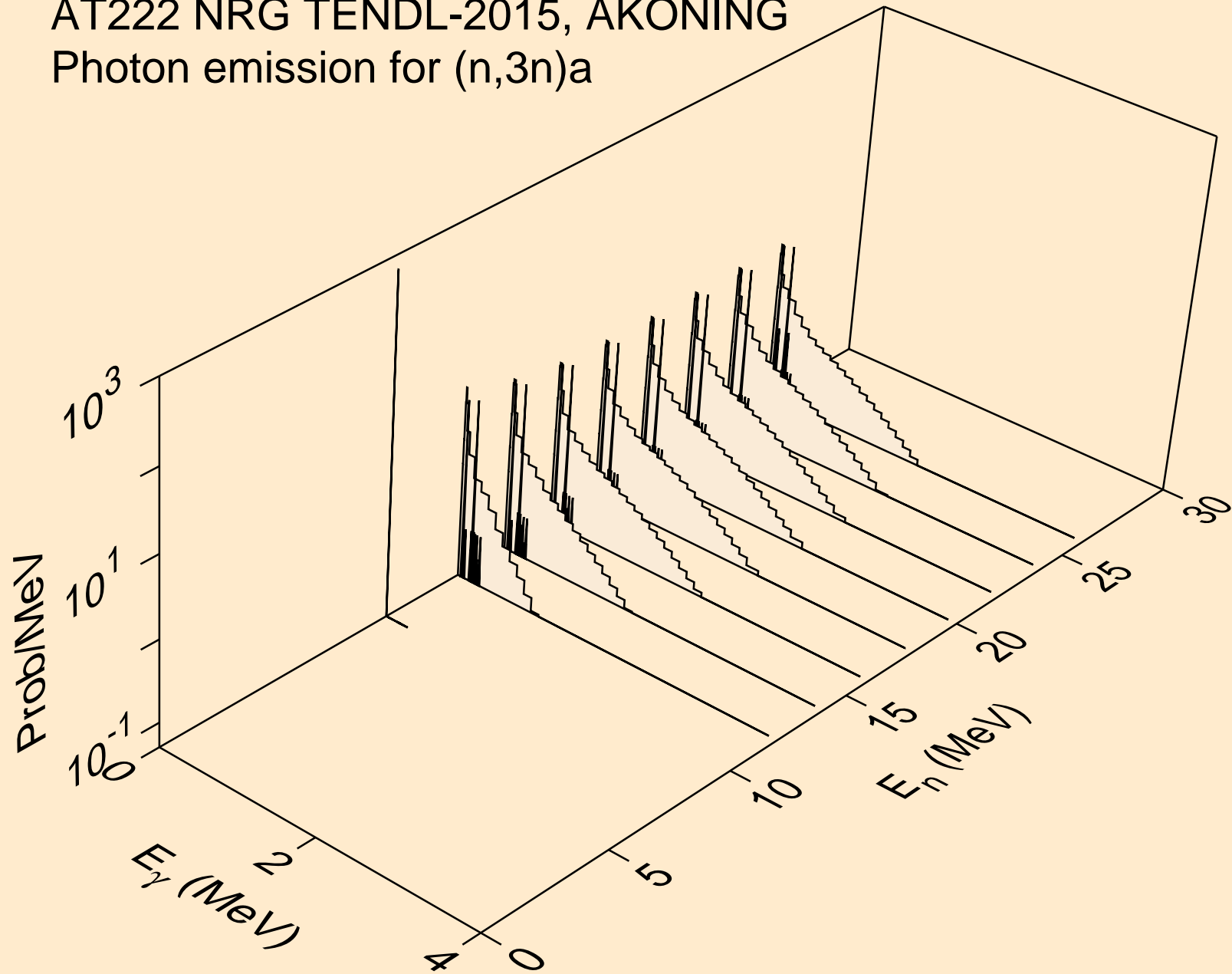

AT222 NRG TENDL-2015, AKONING
Photon emission for (n,n*)p

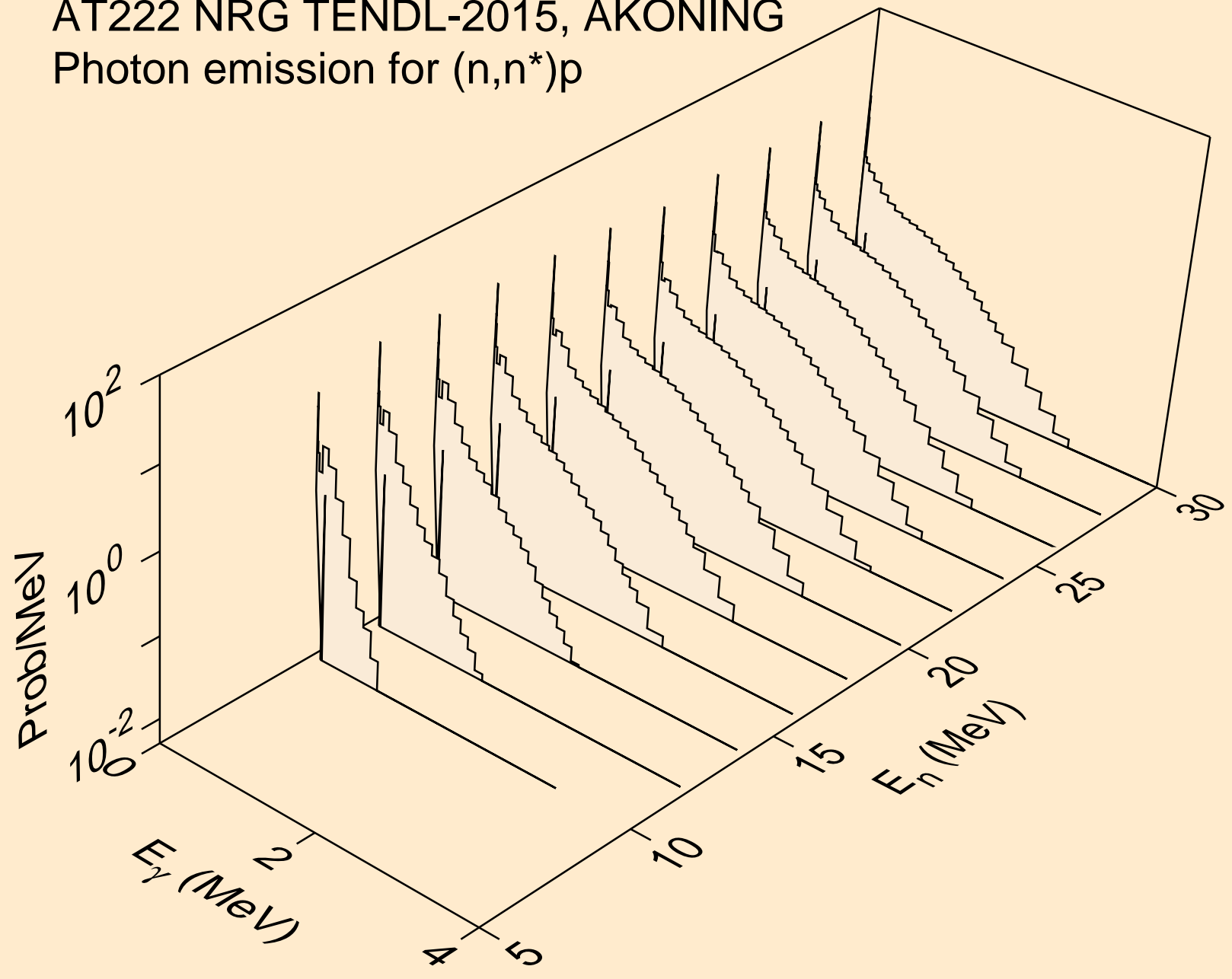

AT222 NRG TENDL-2015, AKONING
Photon emission for (n,n*)2a

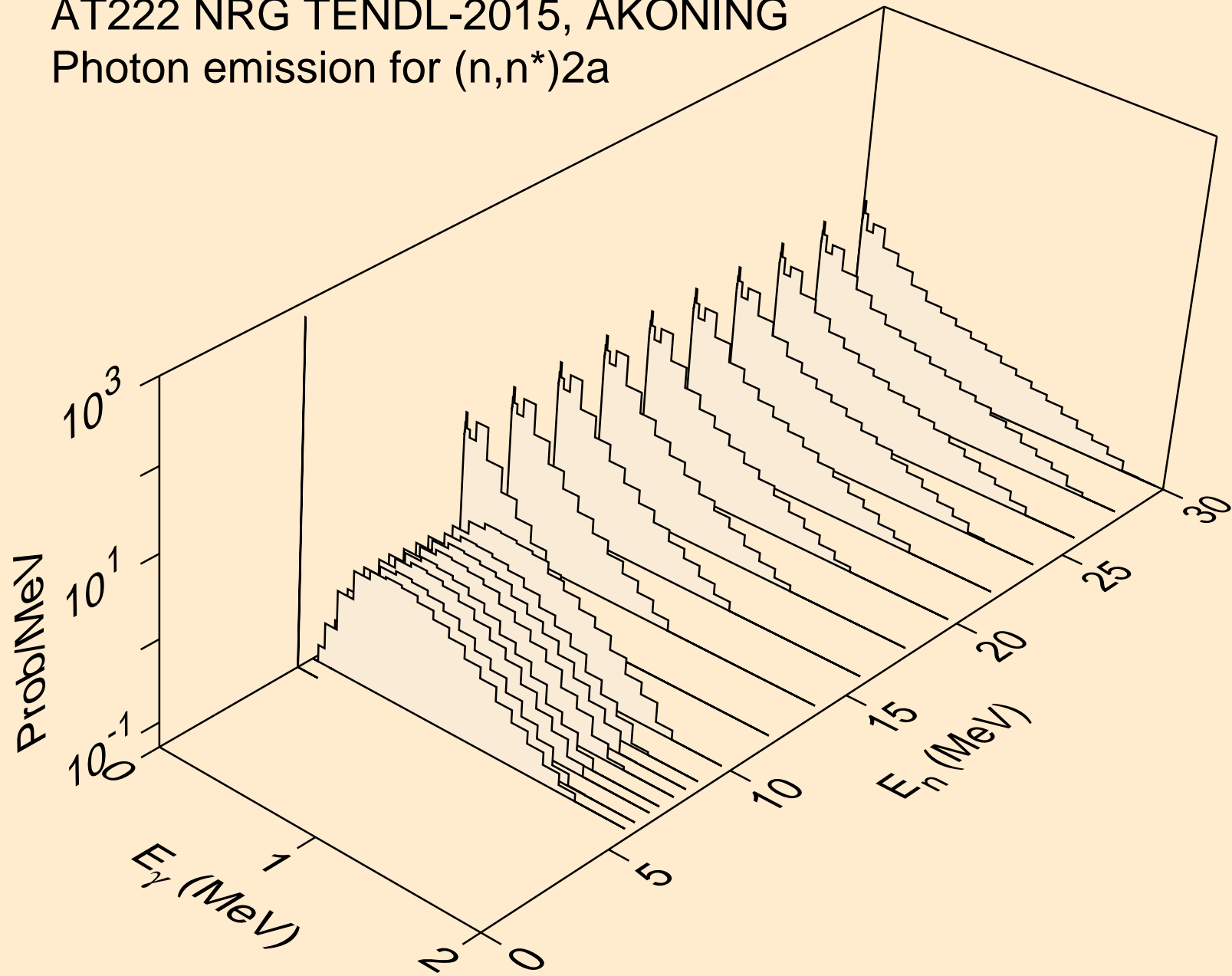

AT222 NRG TENDL-2015, AKONING
Photon emission for (n,2n)2a

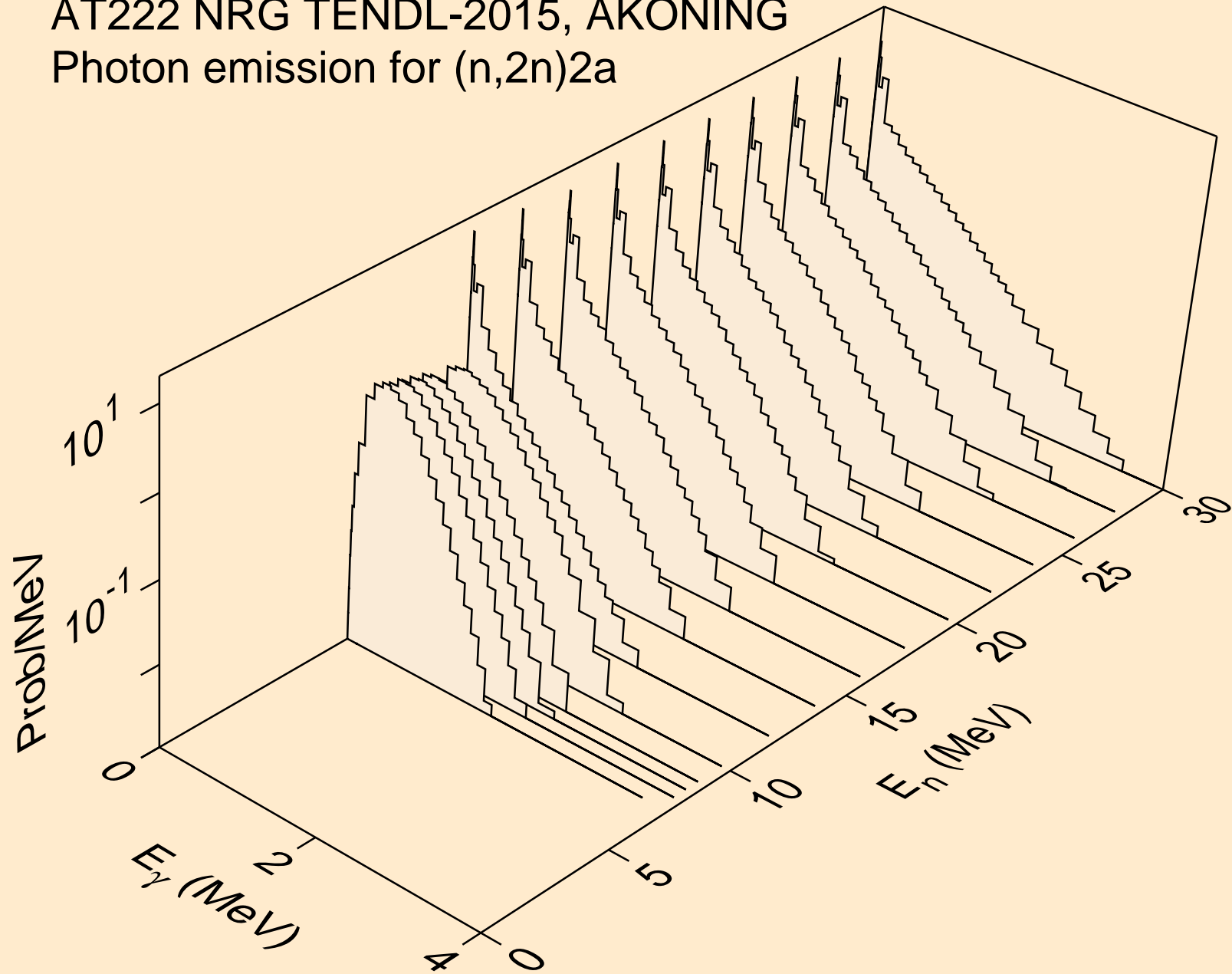

AT222 NRG TENDL-2015, AKONING
Photon emission for (n,n*)d

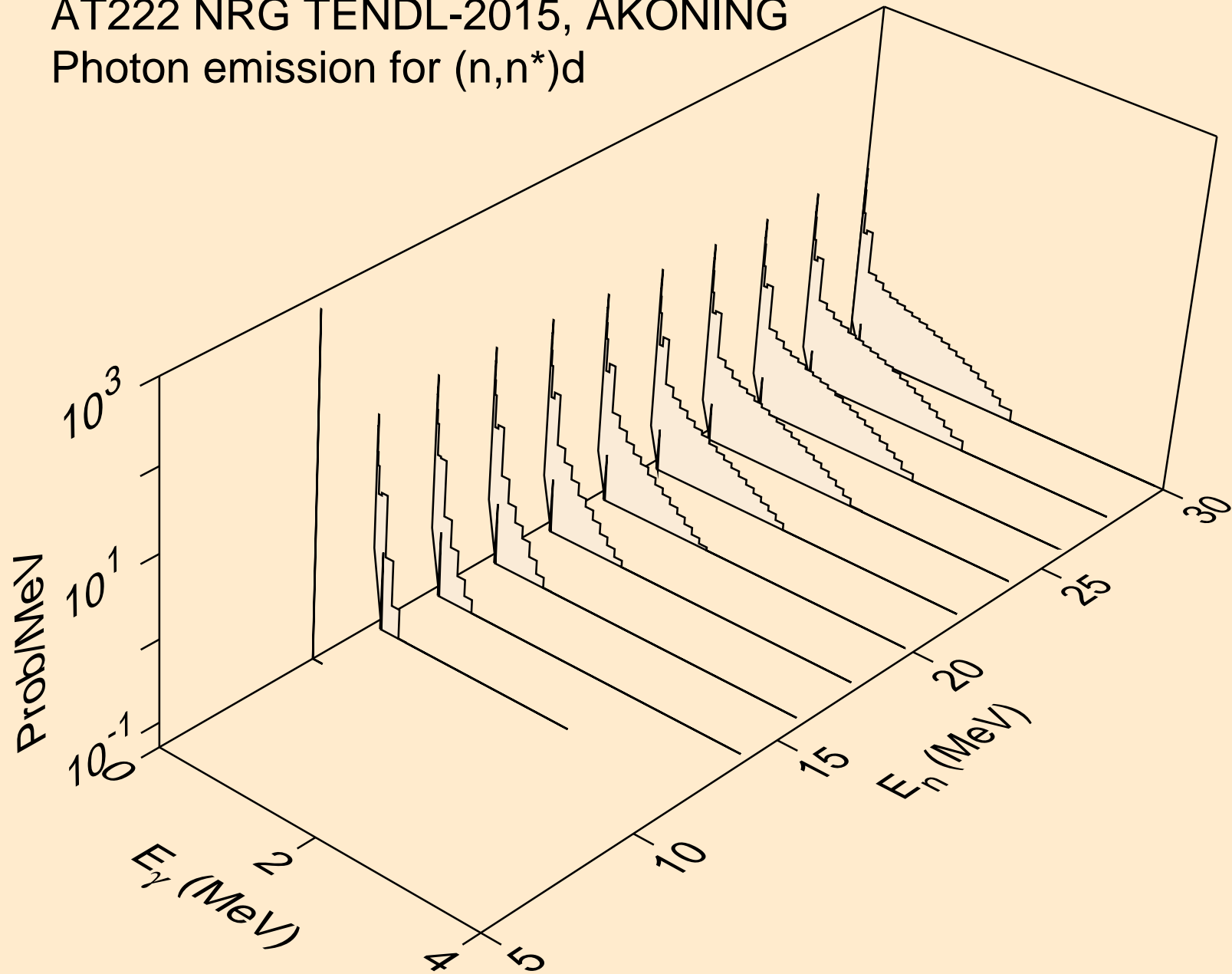

AT222 NRG TENDL-2015, AKONING
Photon emission for (n,n*)t

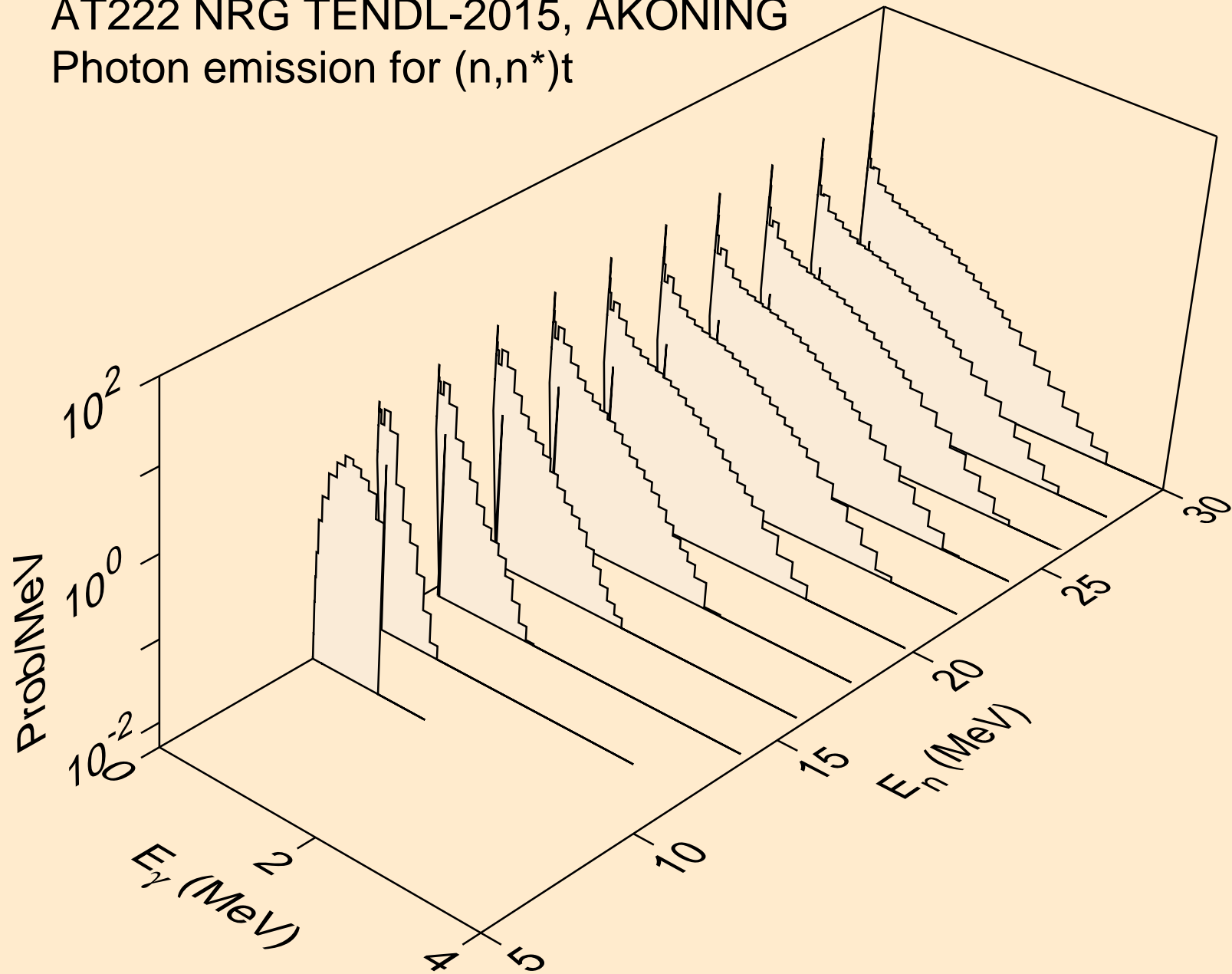

AT222 NRG TENDL-2015, AKONING
Photon emission for (n,n*)he3

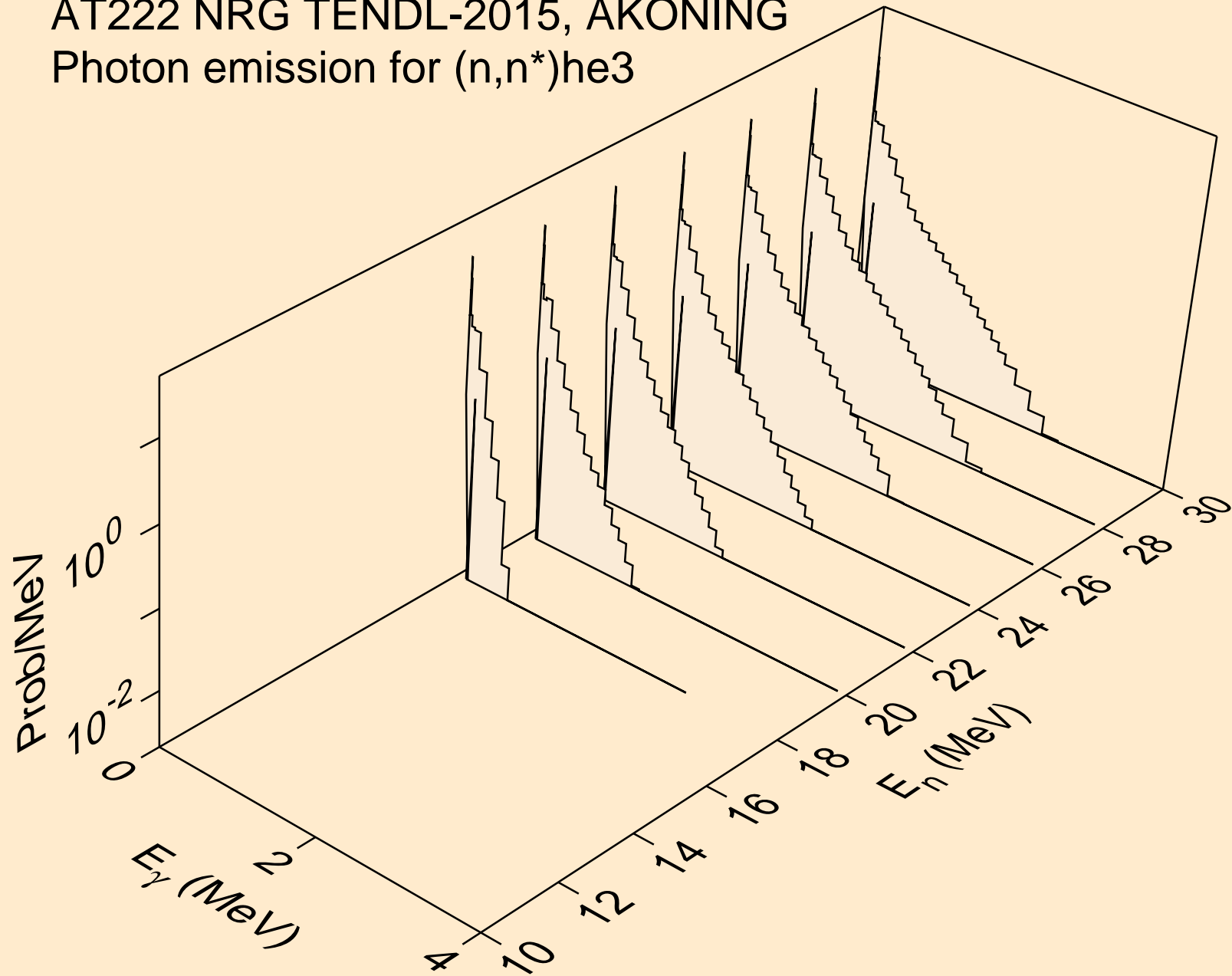

AT222 NRG TENDL-2015, AKONING
Photon emission for (n,4n)

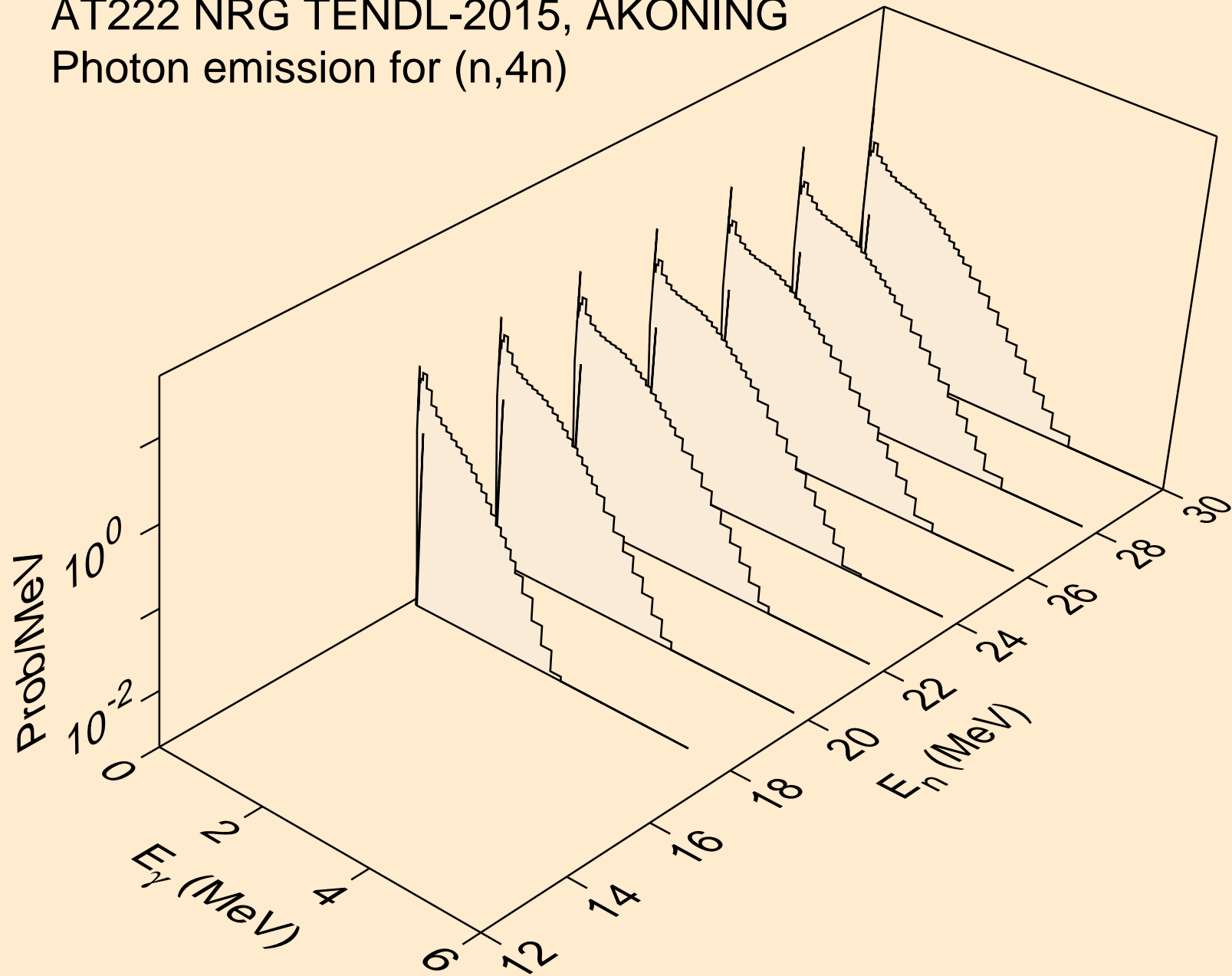

AT222 NRG TENDL-2015, AKONING
Photon emission for (n,2np)

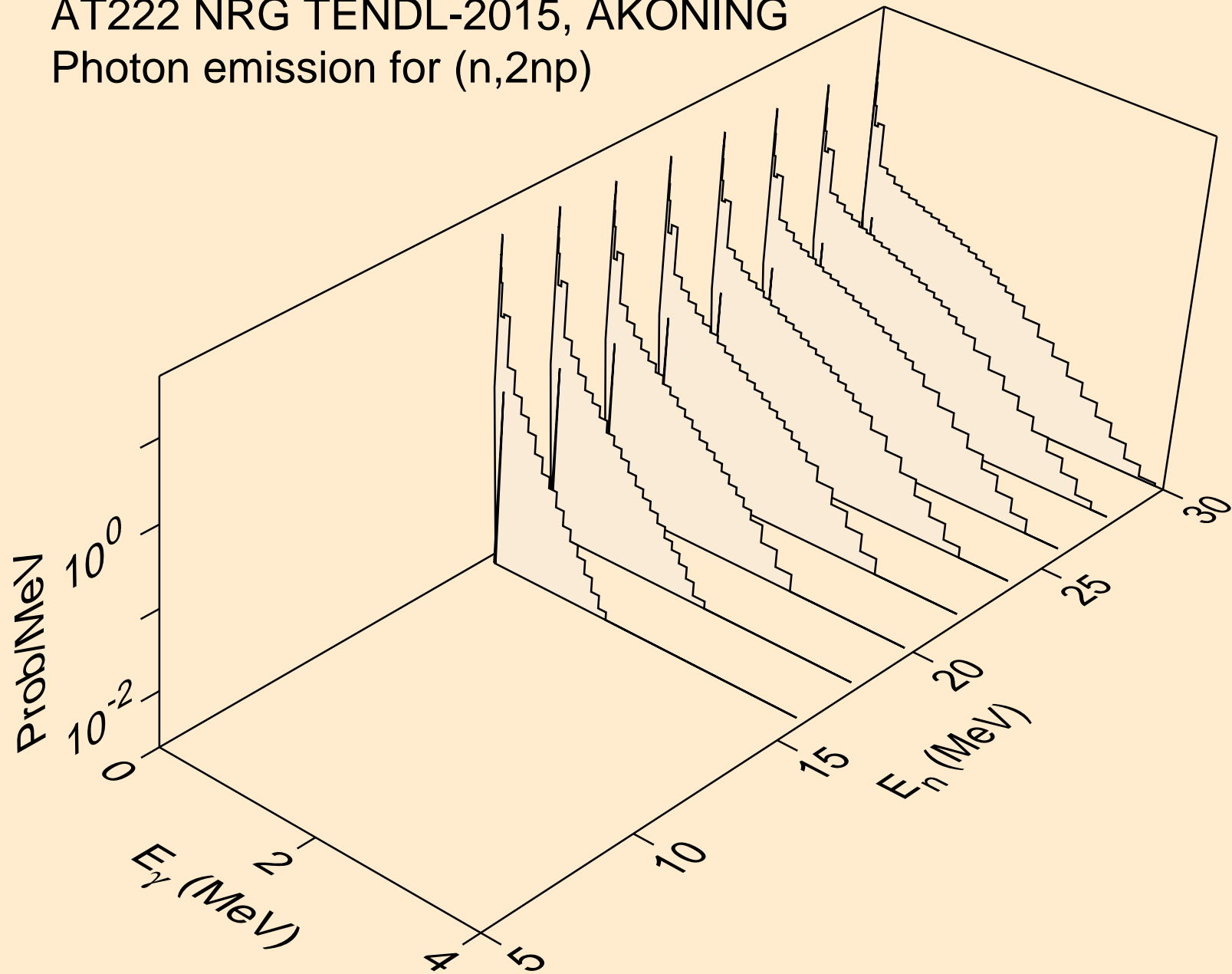

AT222 NRG TENDL-2015, AKONING
Photon emission for (n,3np)

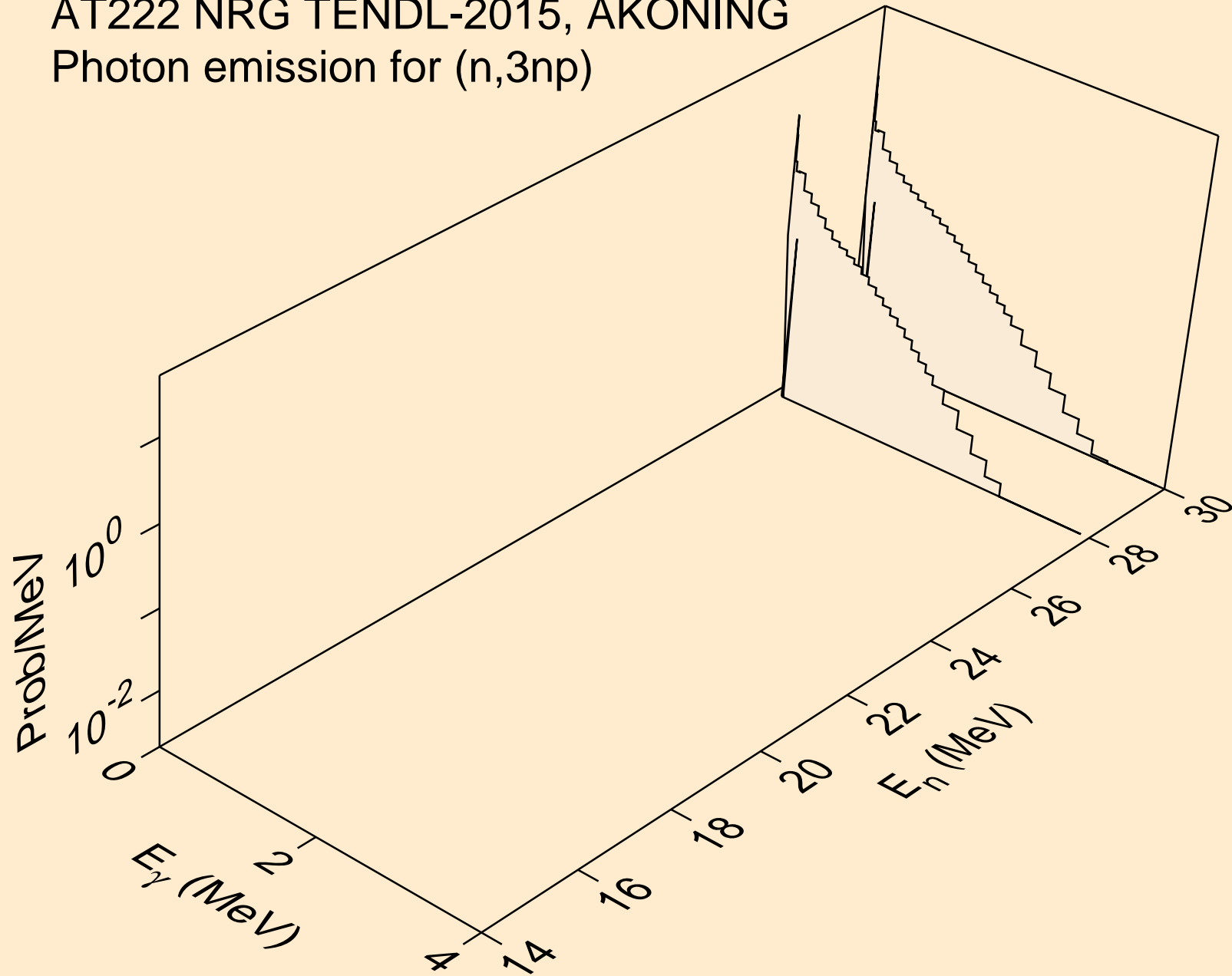

AT222 NRG TENDL-2015, AKONING
Photon emission for (n,2np)

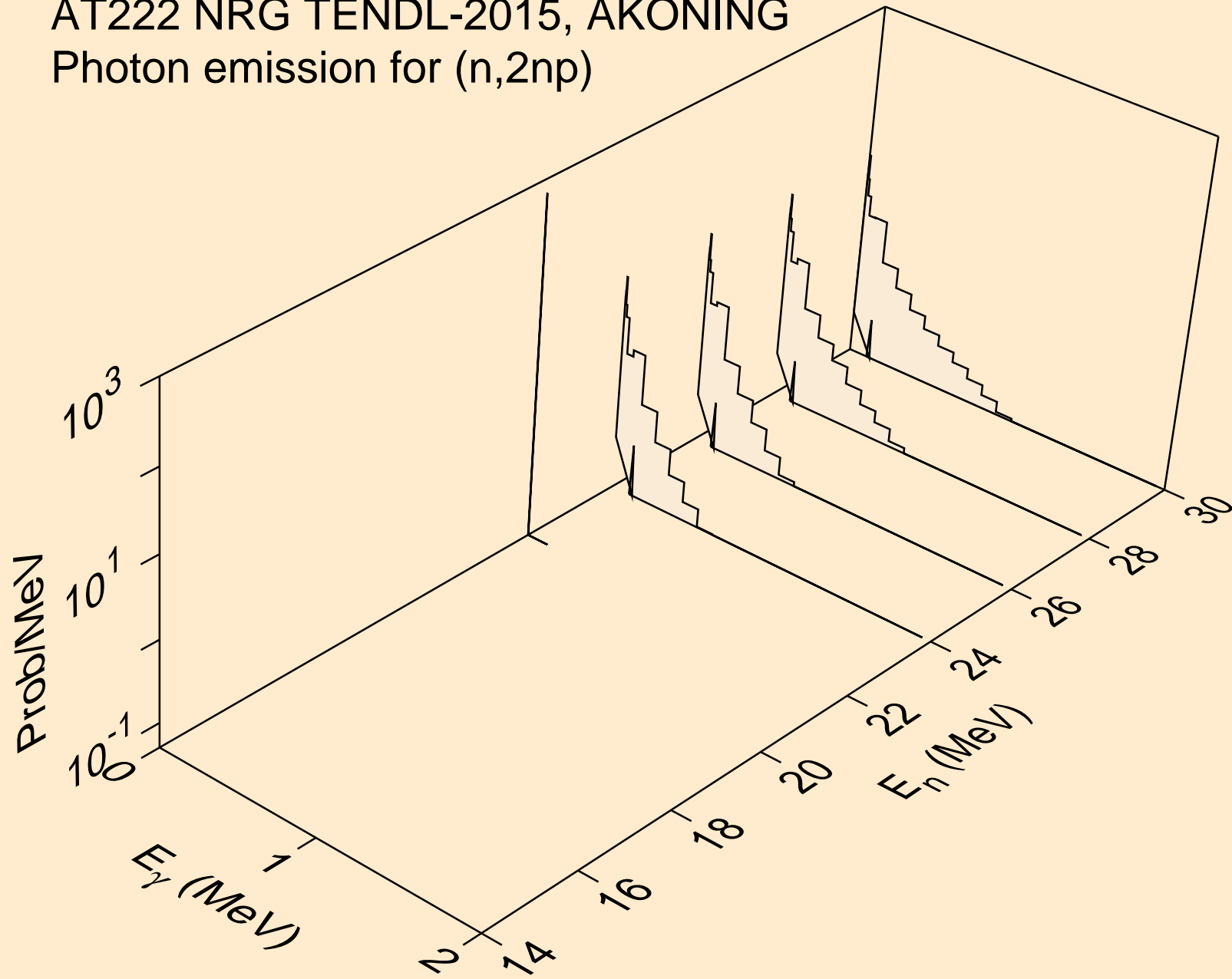

AT222 NRG TENDL-2015, AKONING
Photon emission for (n,npa)

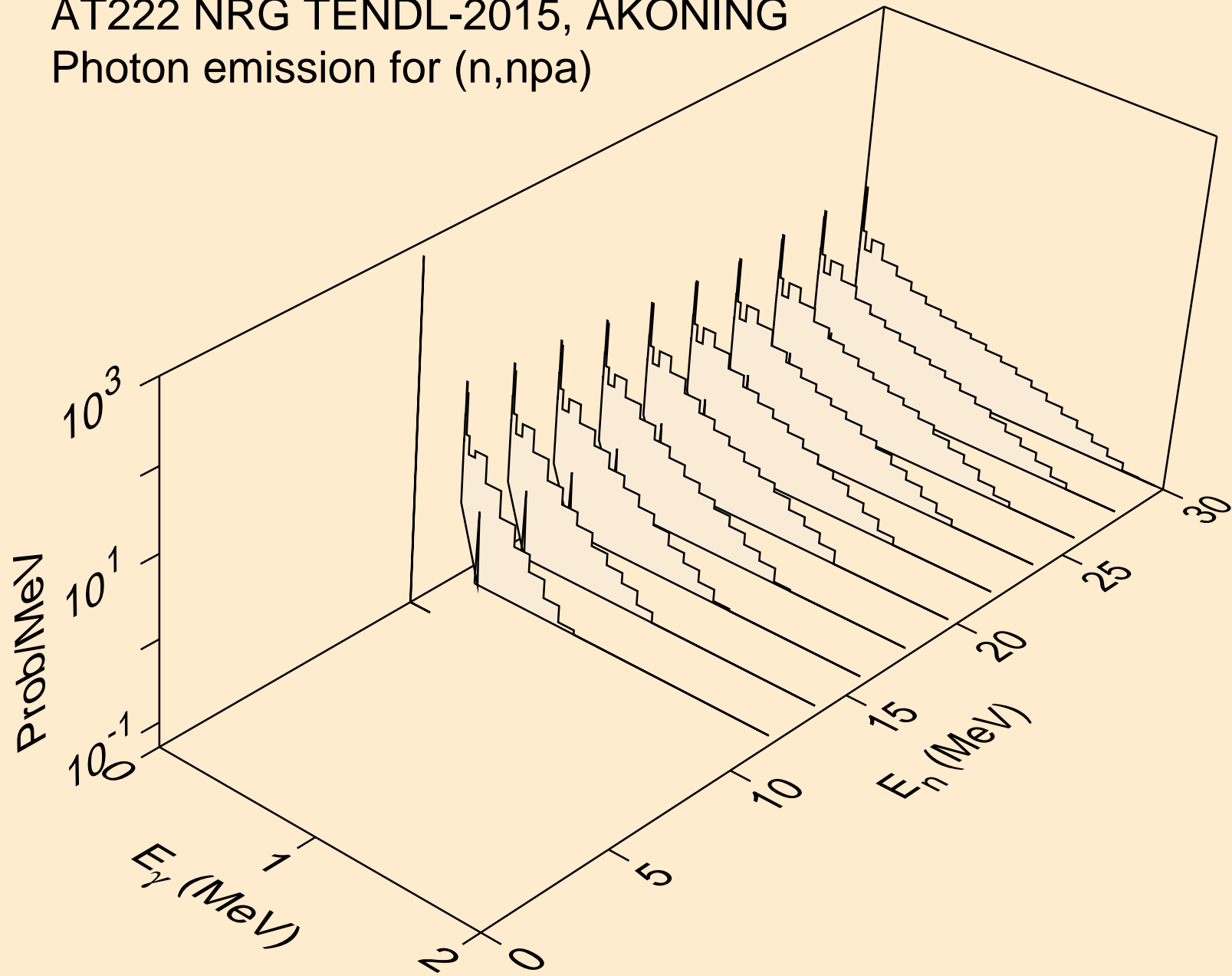

AT222 NRG TENDL-2015, AKONING
Photon emission for (n,n*c)

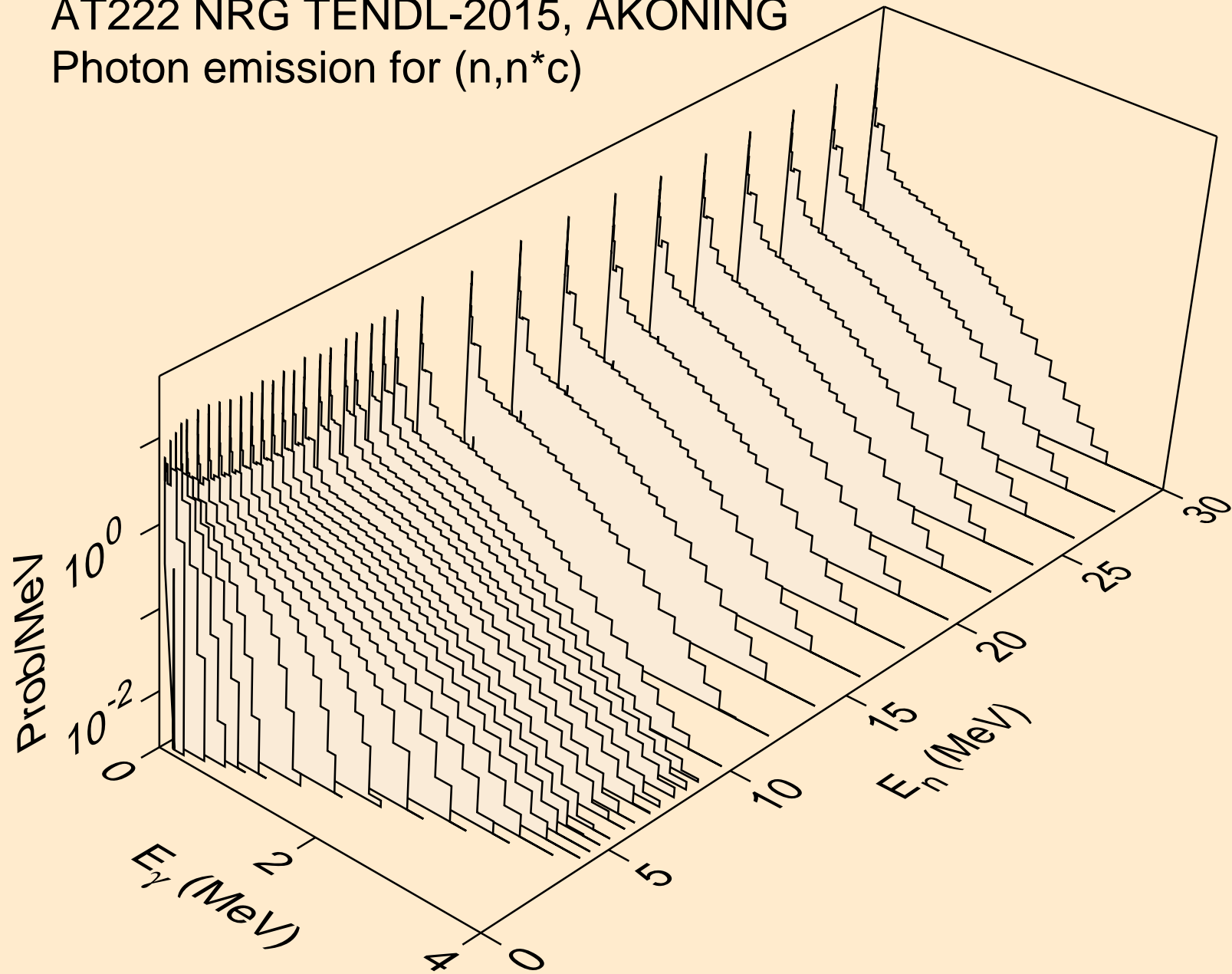

AT222 NRG TENDL-2015, AKONING
Photon emission for (n,gma)

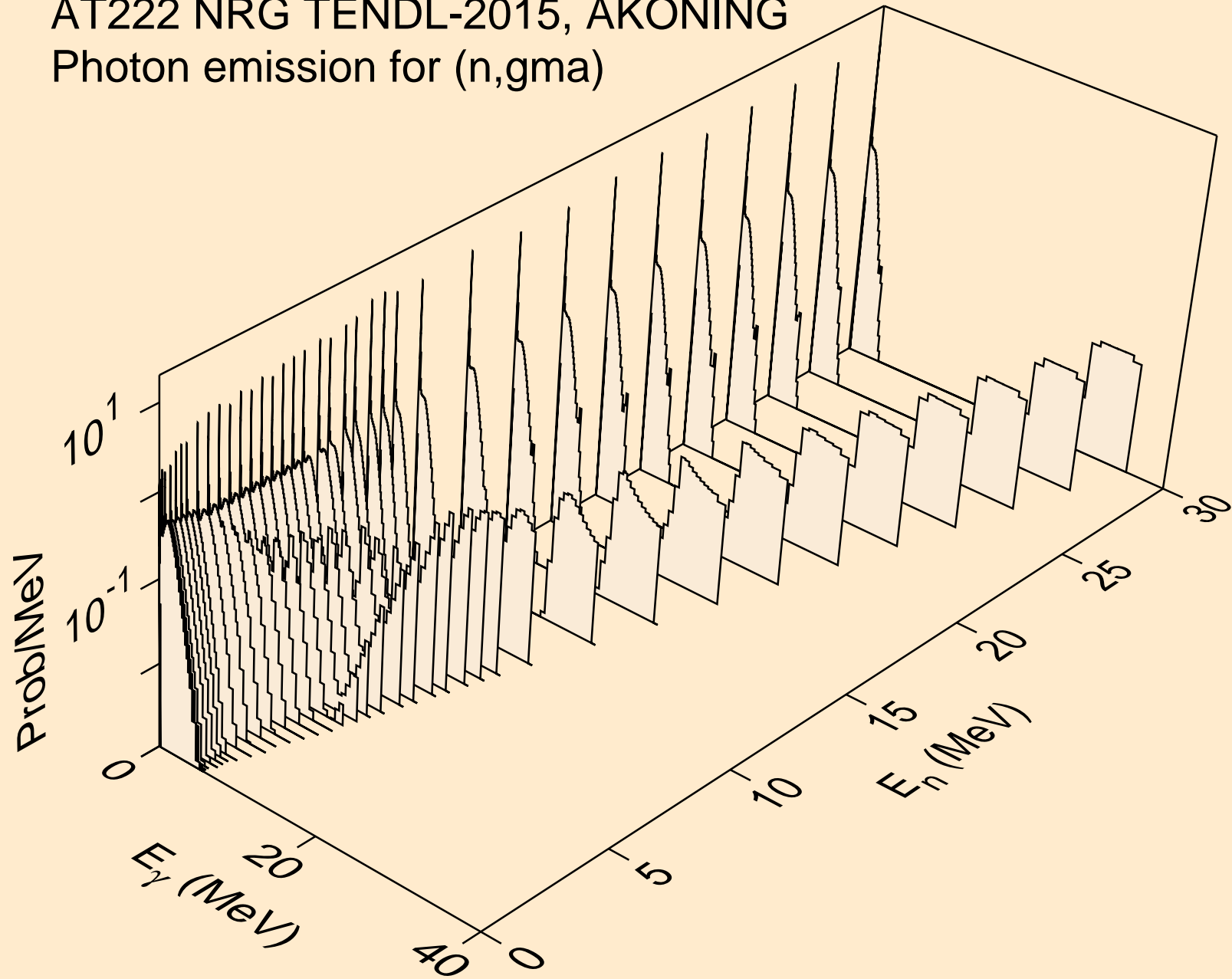

AT222 NRG TENDL-2015, AKONING
Photon emission for (n,p)

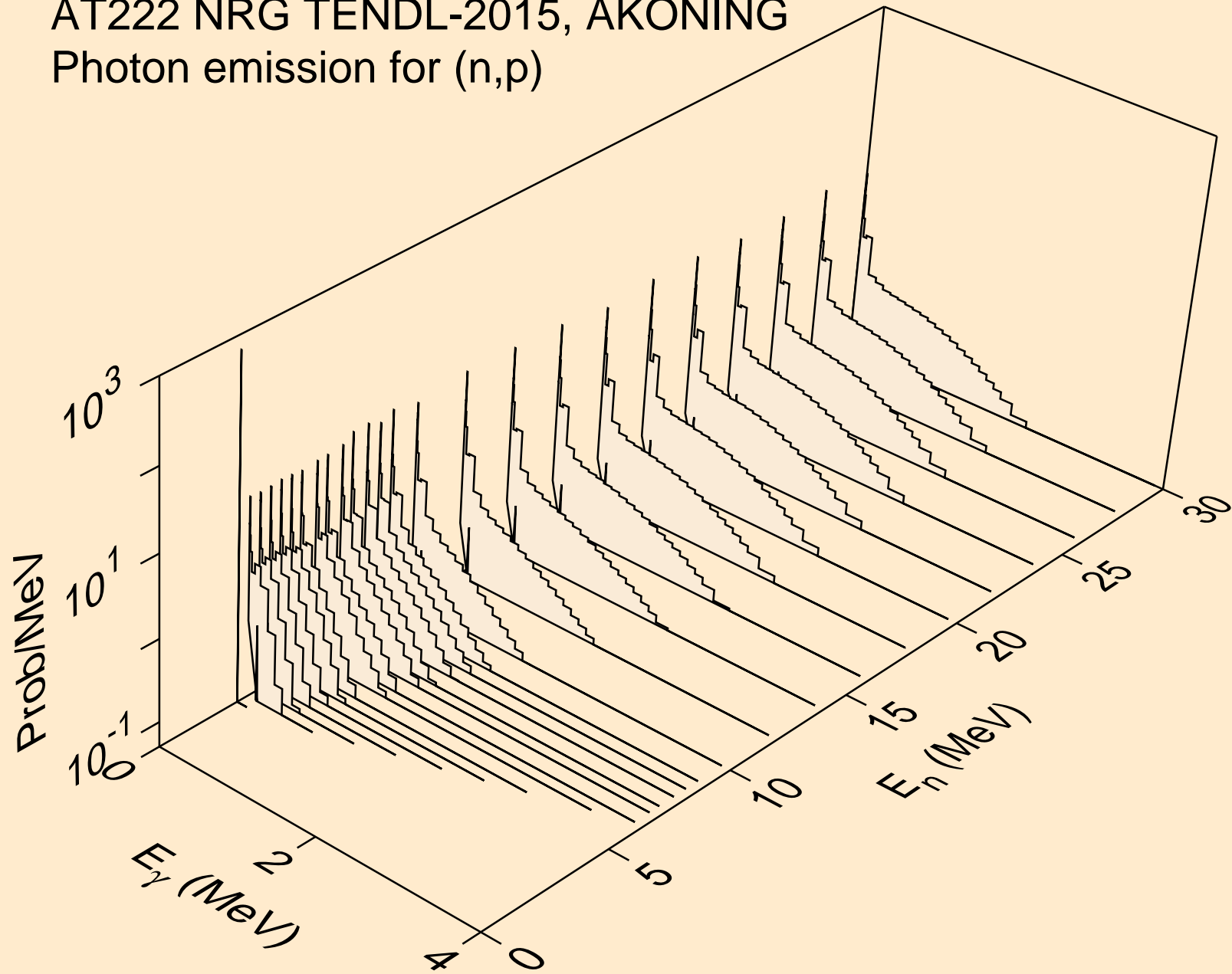

AT222 NRG TENDL-2015, AKONING
Photon emission for (n,d)

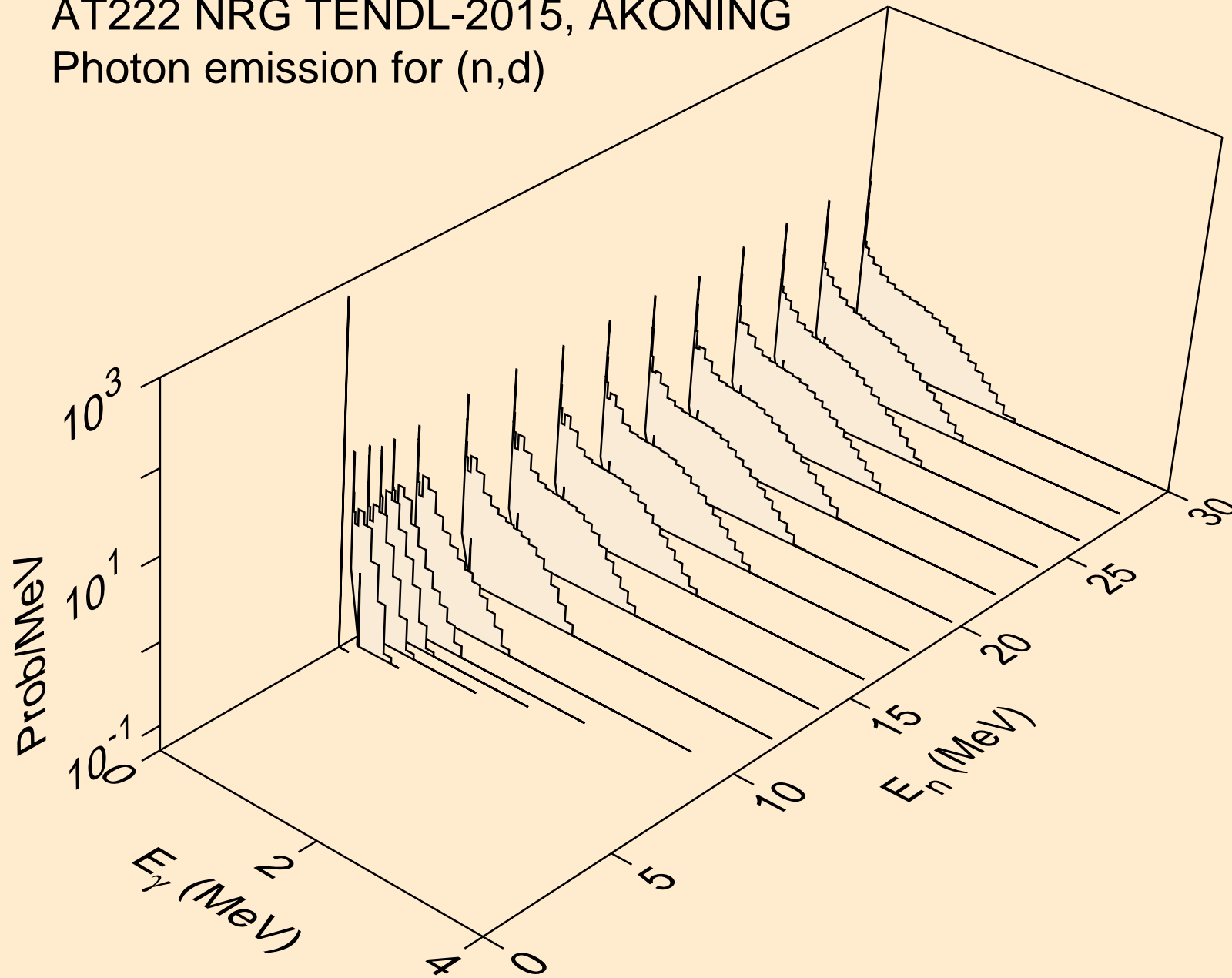

AT222 NRG TENDL-2015, AKONING
Photon emission for (n,t)

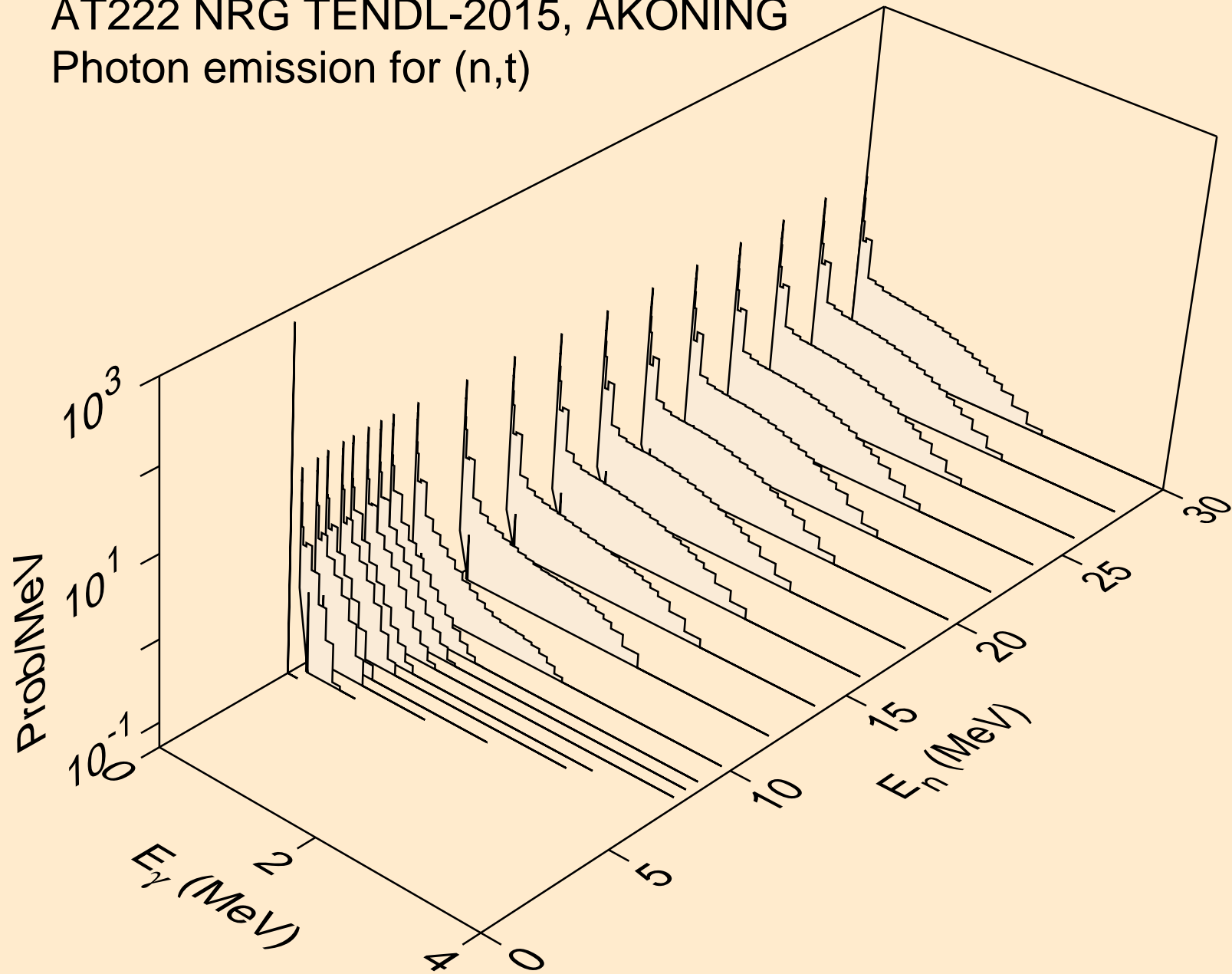

AT222 NRG TENDL-2015, AKONING
Photon emission for (n,he3)

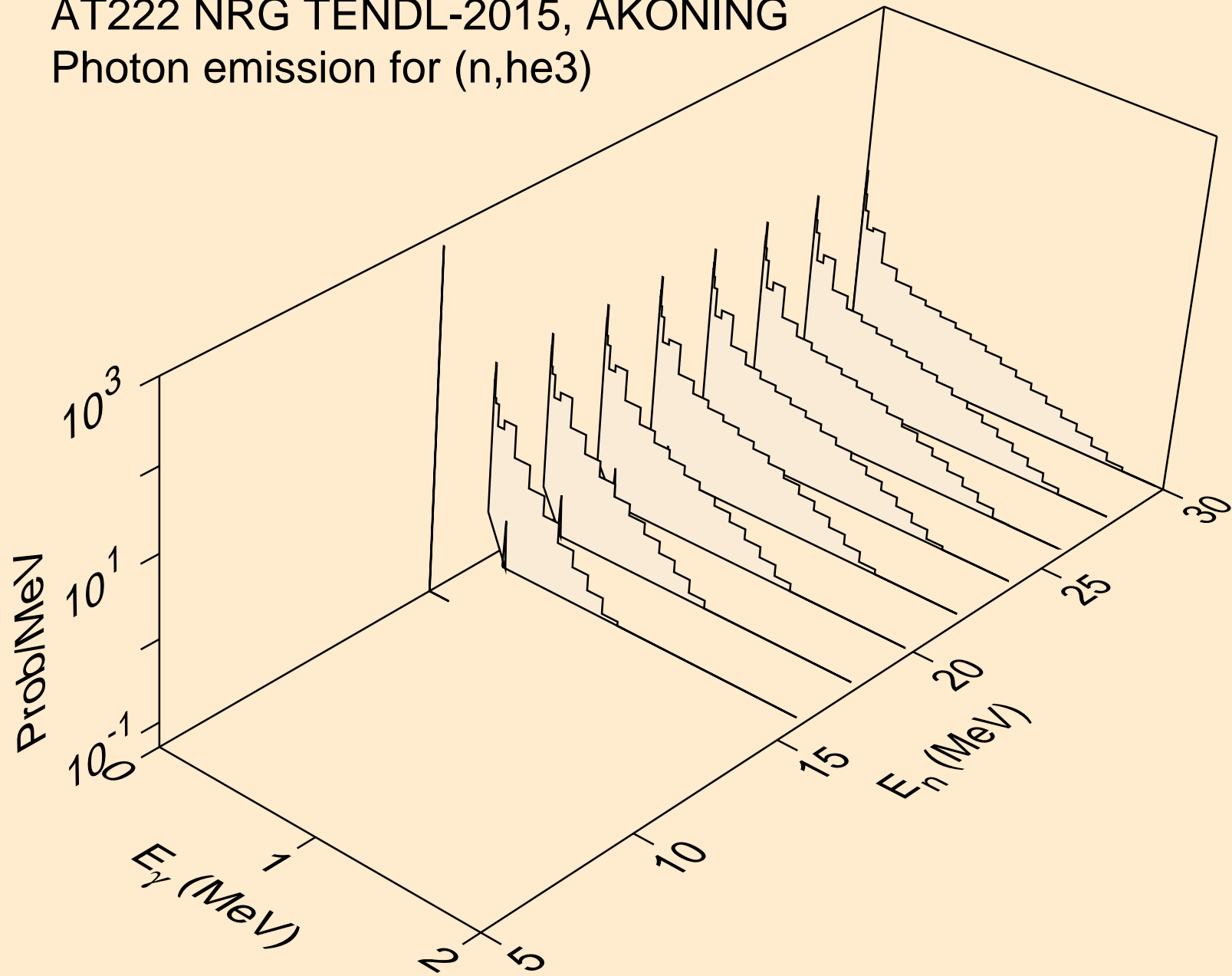

AT222 NRG TENDL-2015, AKONING
Photon emission for (n,a)

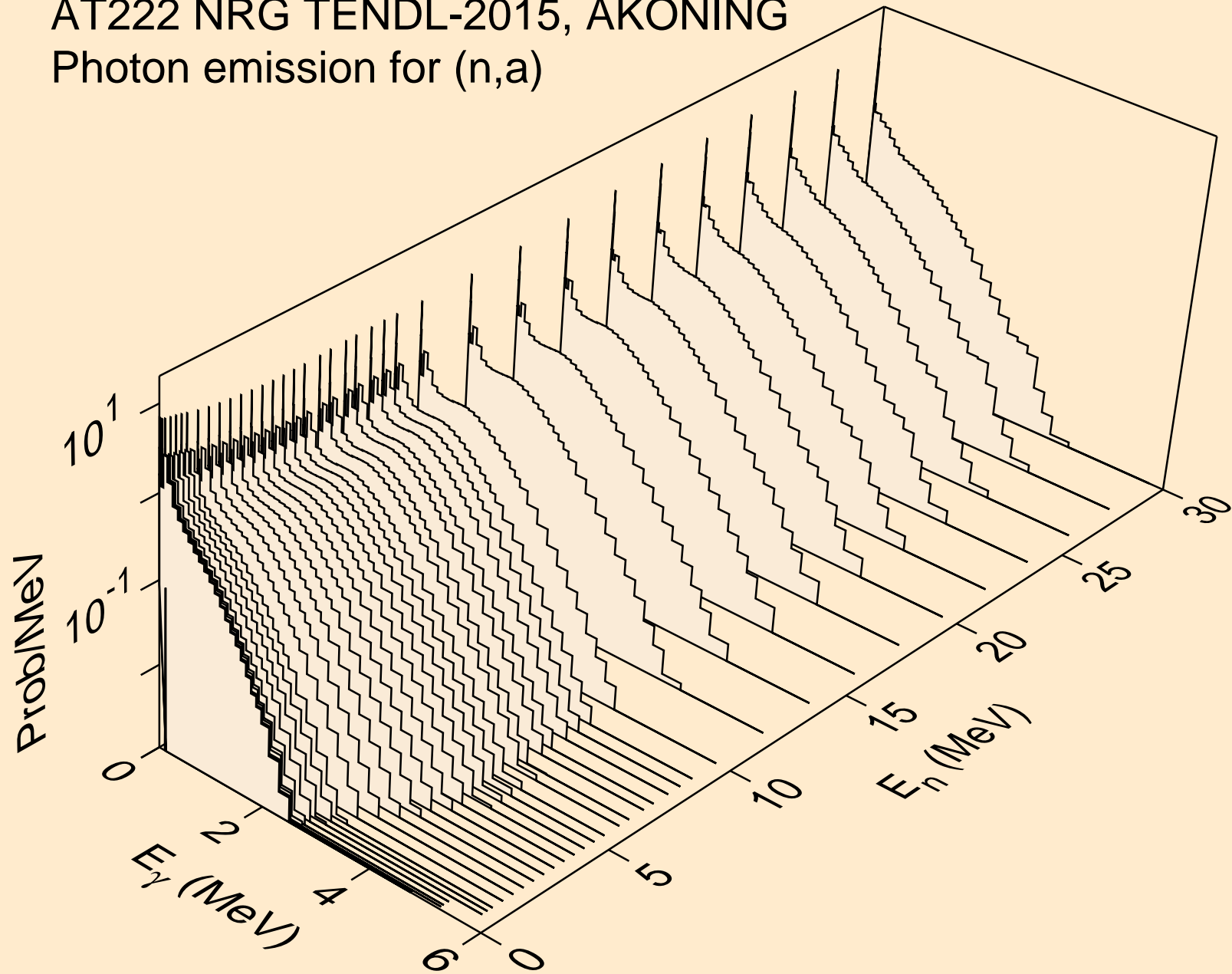

AT222 NRG TENDL-2015, AKONING
Photon emission for (n,2p)

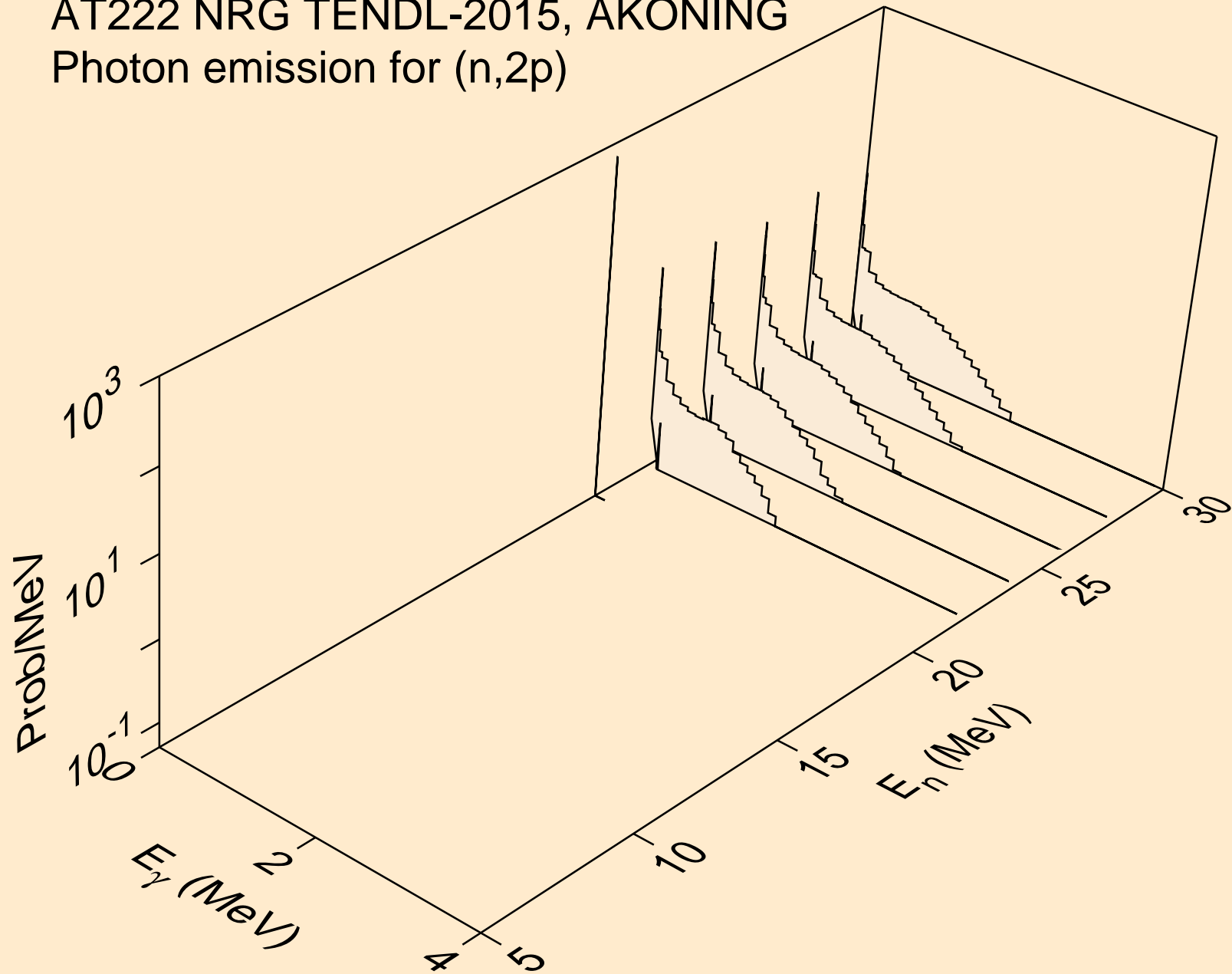

AT222 NRG TENDL-2015, AKONING
Photon emission for (n,p α)

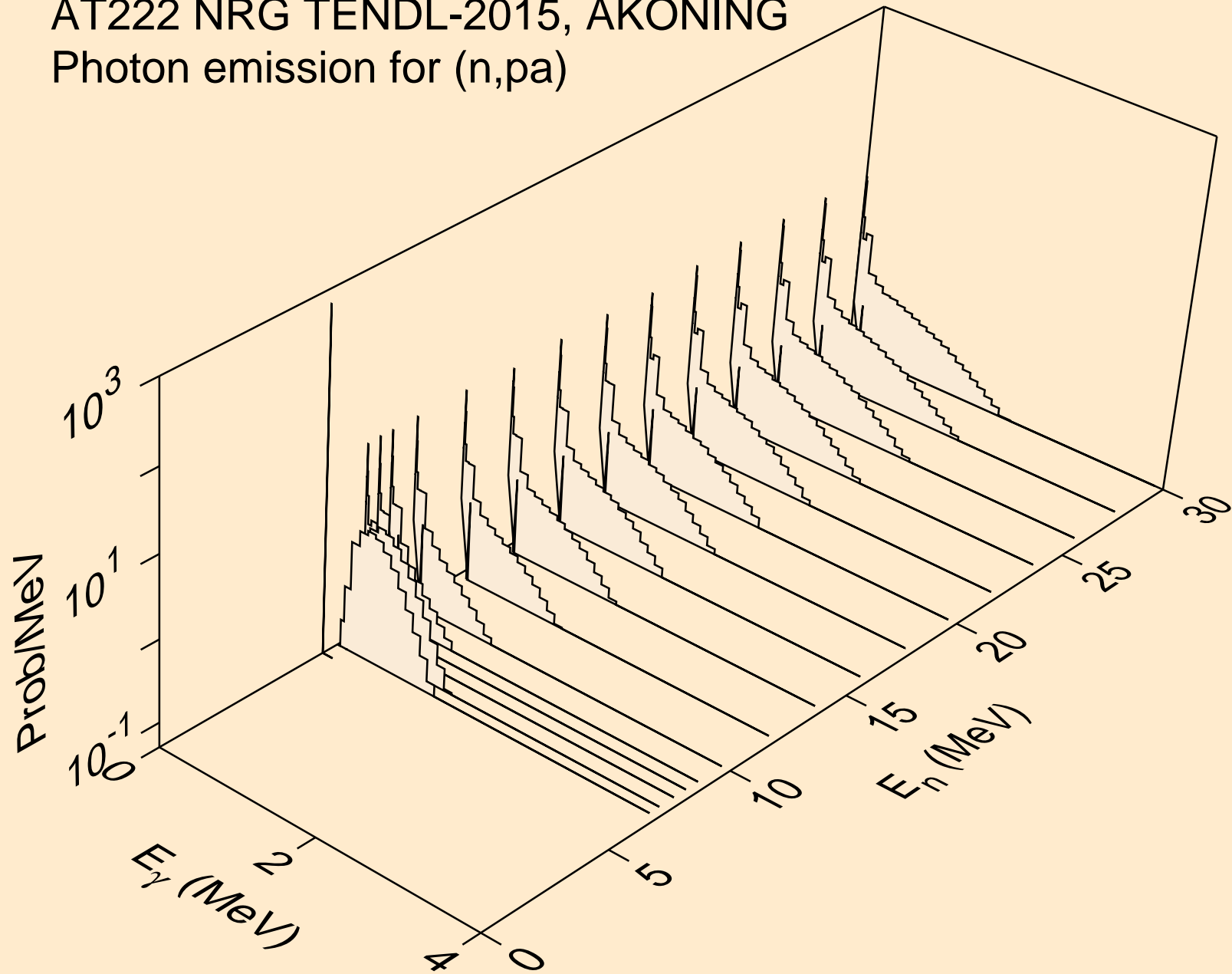

AT222 NRG TENDL-2015, AKONING
thermal capture photon spectrum

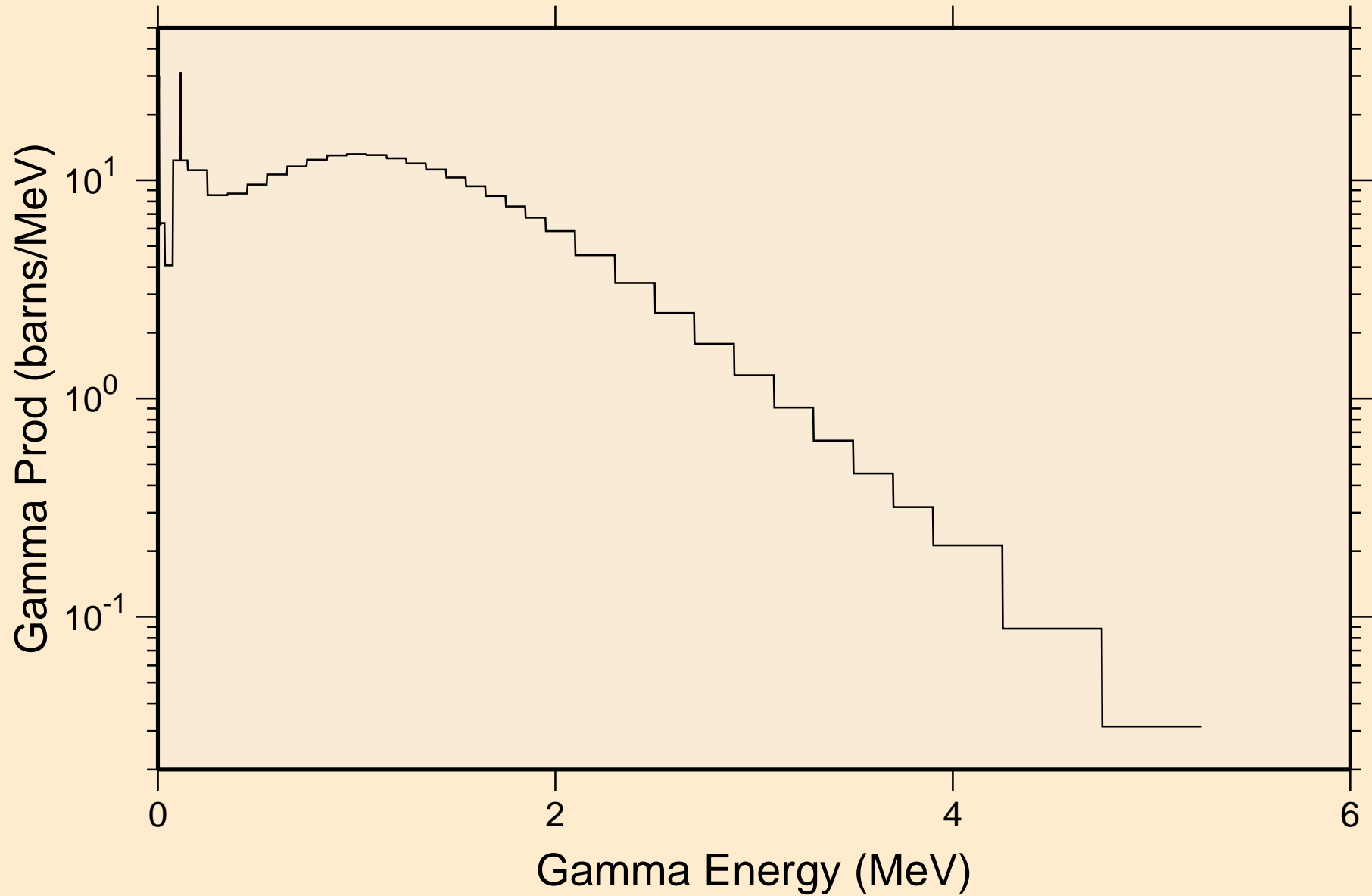

AT222 NRG TENDL-2015, AKONING
14 MeV photon spectrum

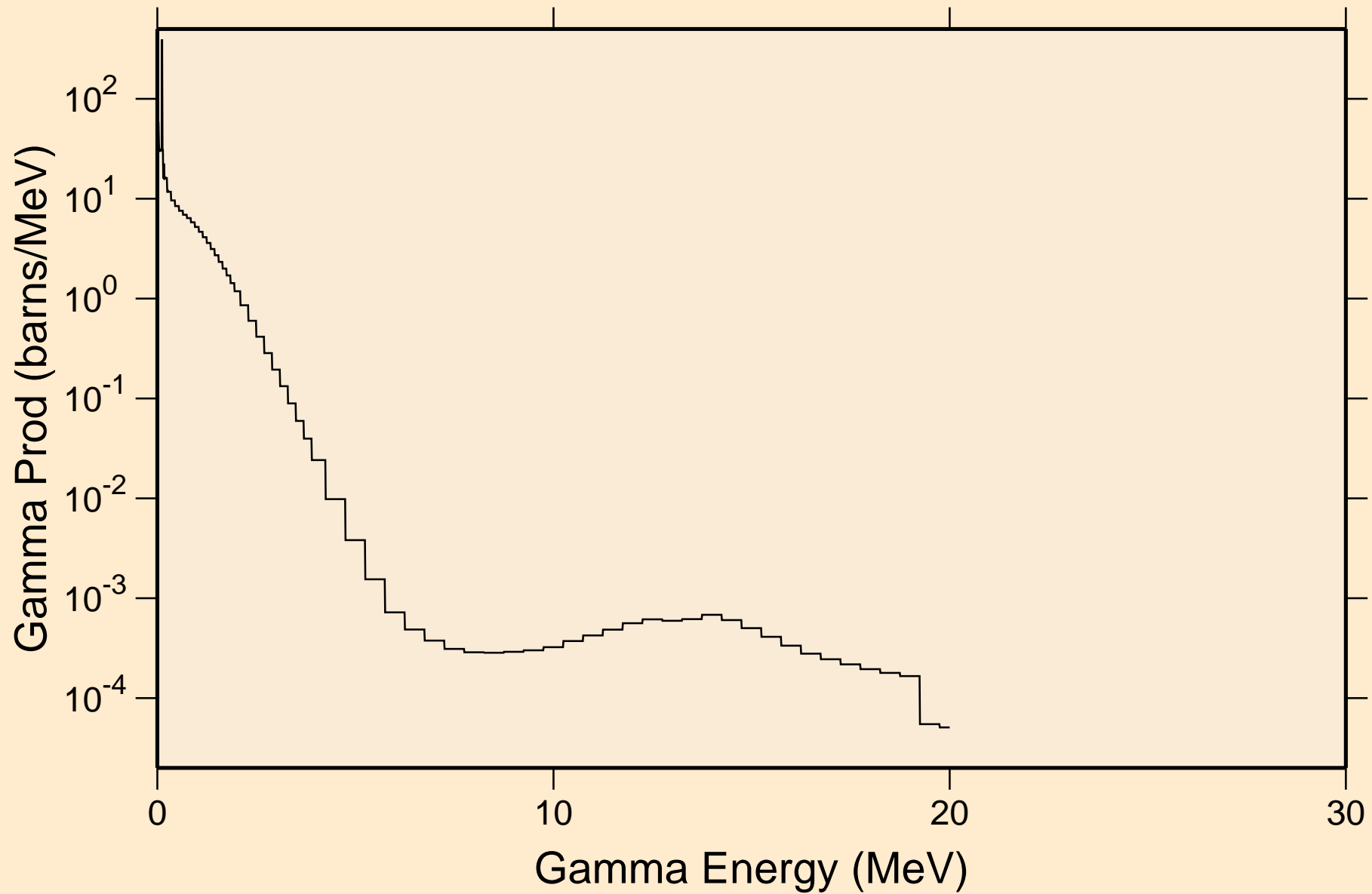

AT222 NRG TENDL-2015, AKONING

Particle heating contributions

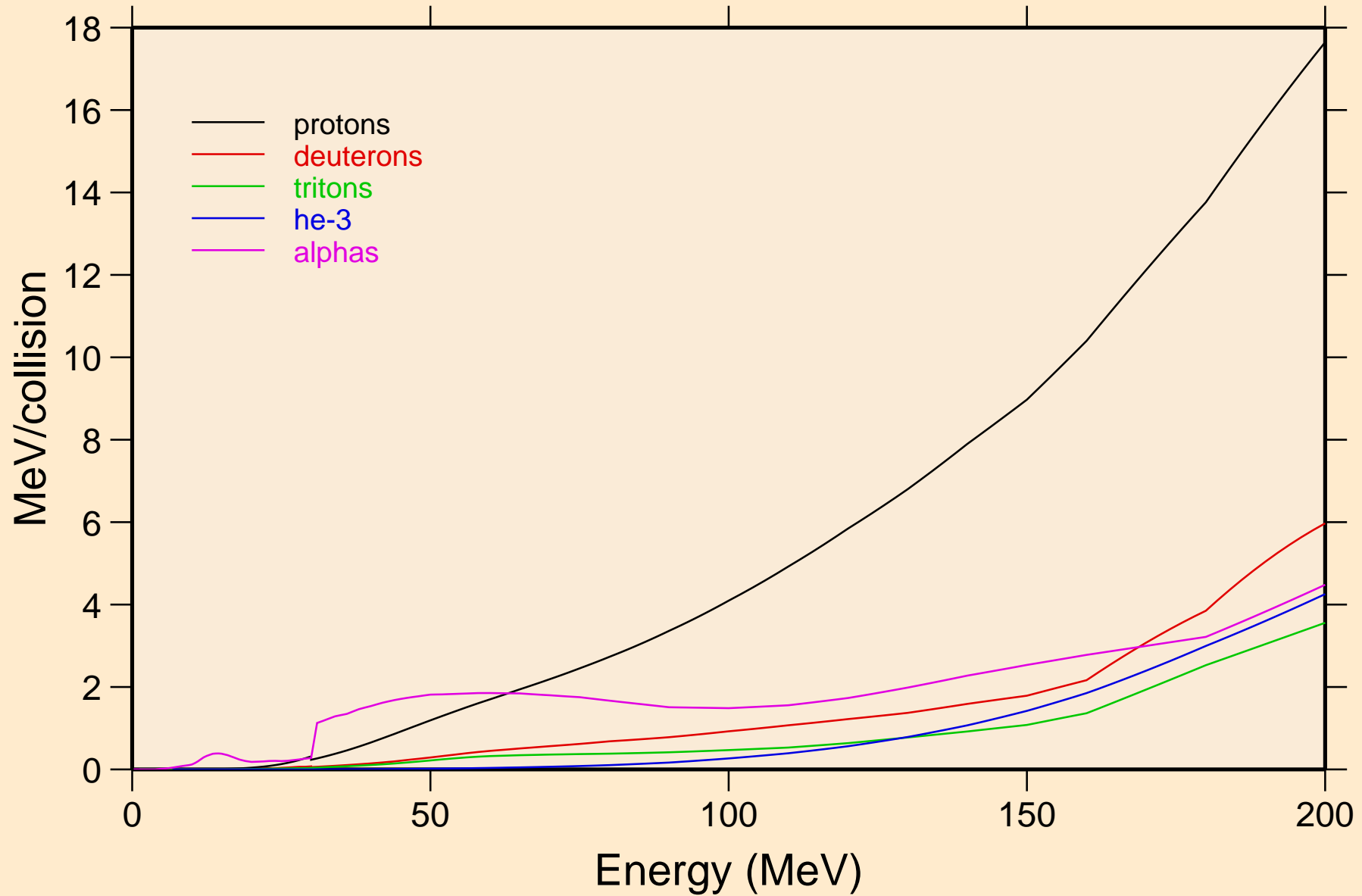

AT222 NRG TENDL-2015, AKONING

Recoil Heating

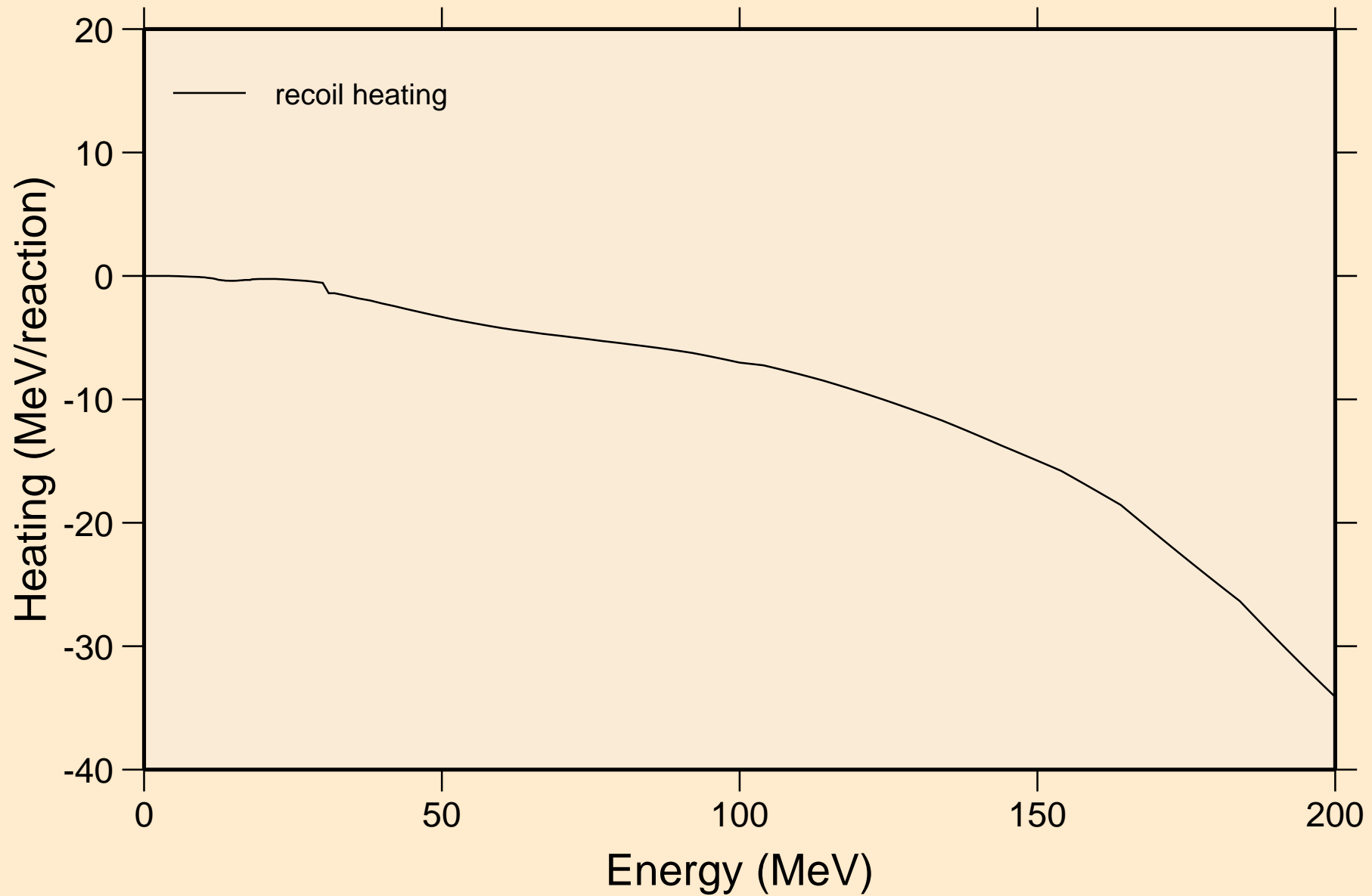

AT222 NRG TENDL-2015, AKONING

Particle production cross sections

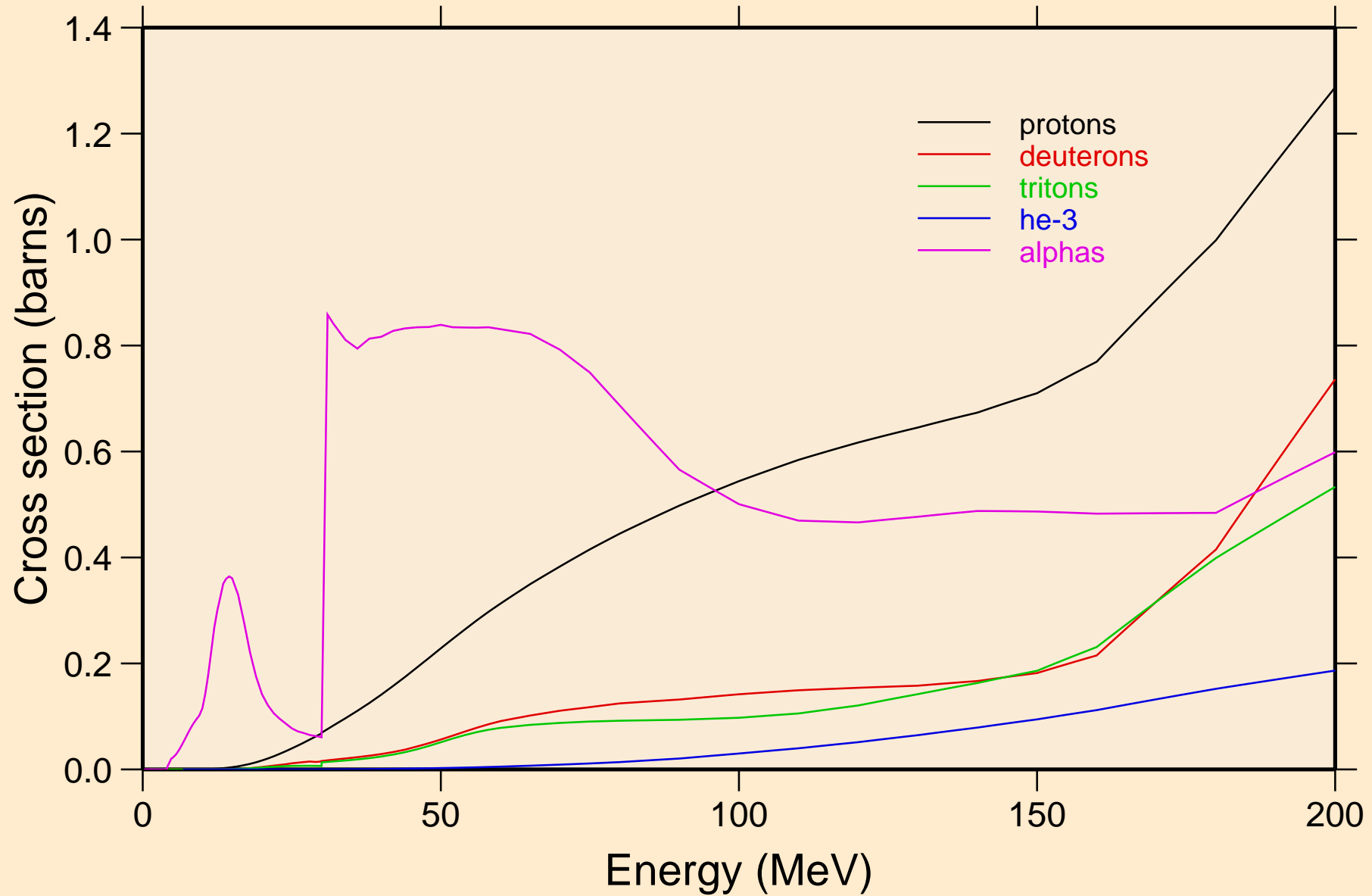

AT222 NRG TENDL-2015, AKONING
protons from (n,x)

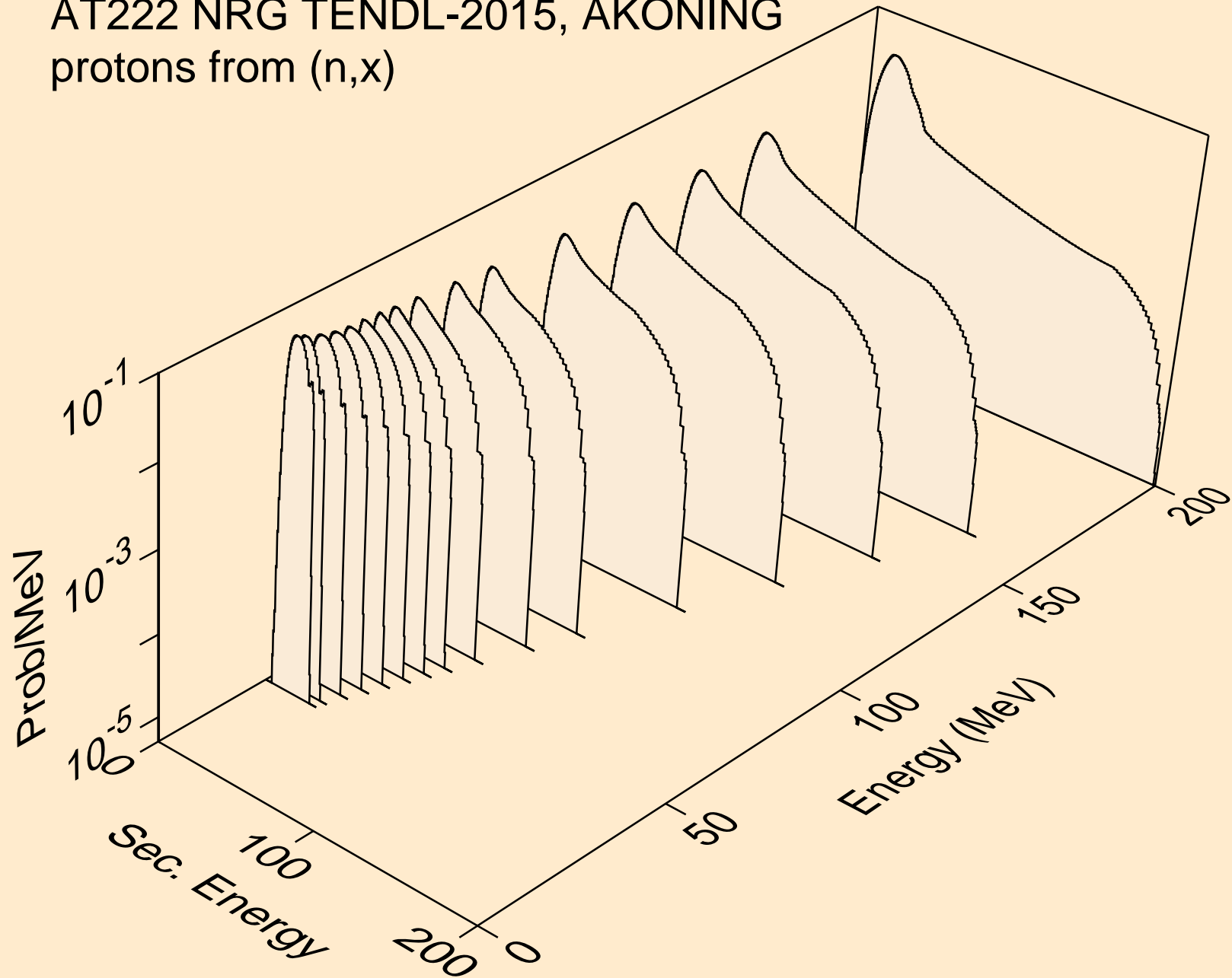

AT222 NRG TENDL-2015, AKONING
protons from (n,n*)p

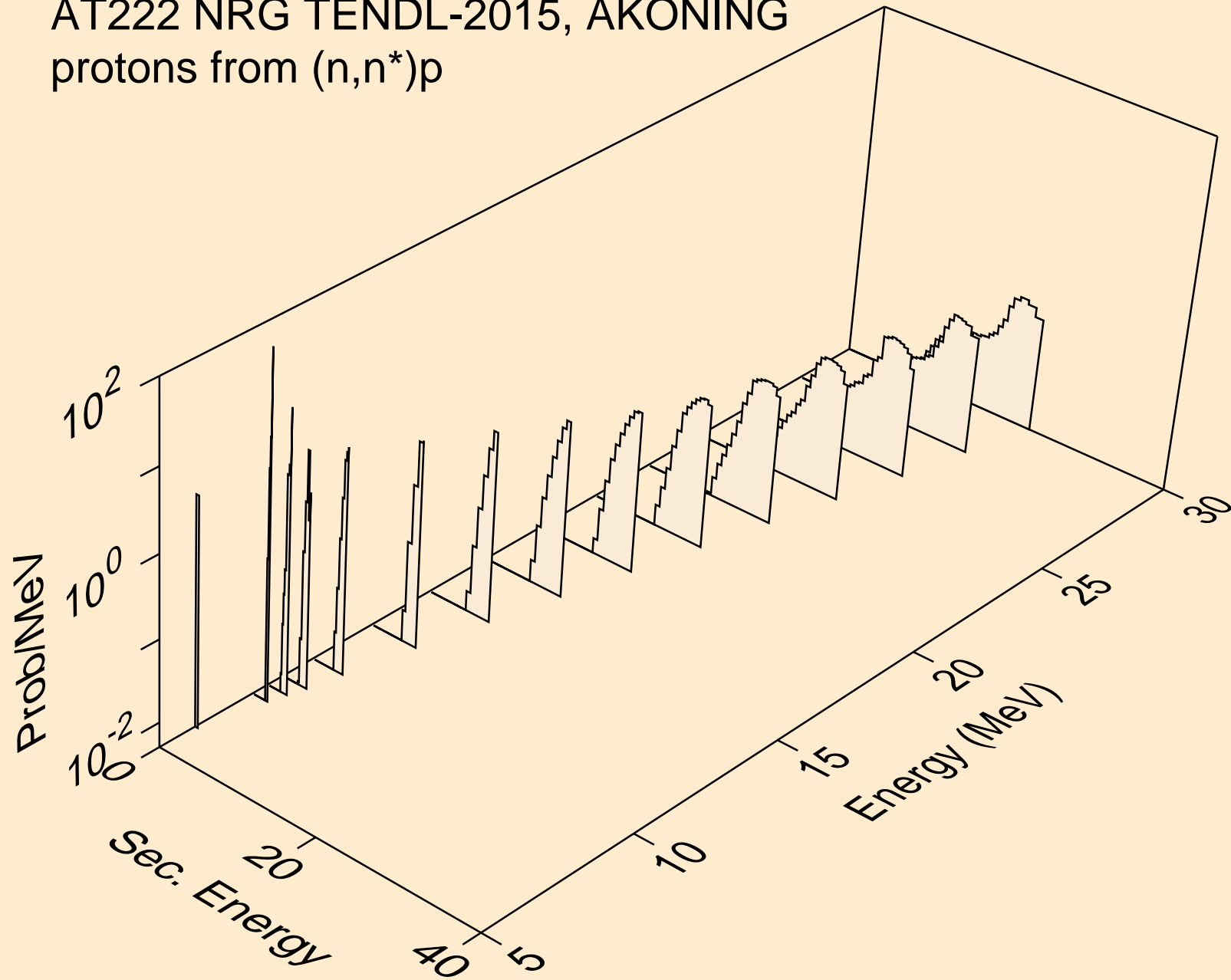

AT222 NRG TENDL-2015, AKONING
protons from (n,2np)

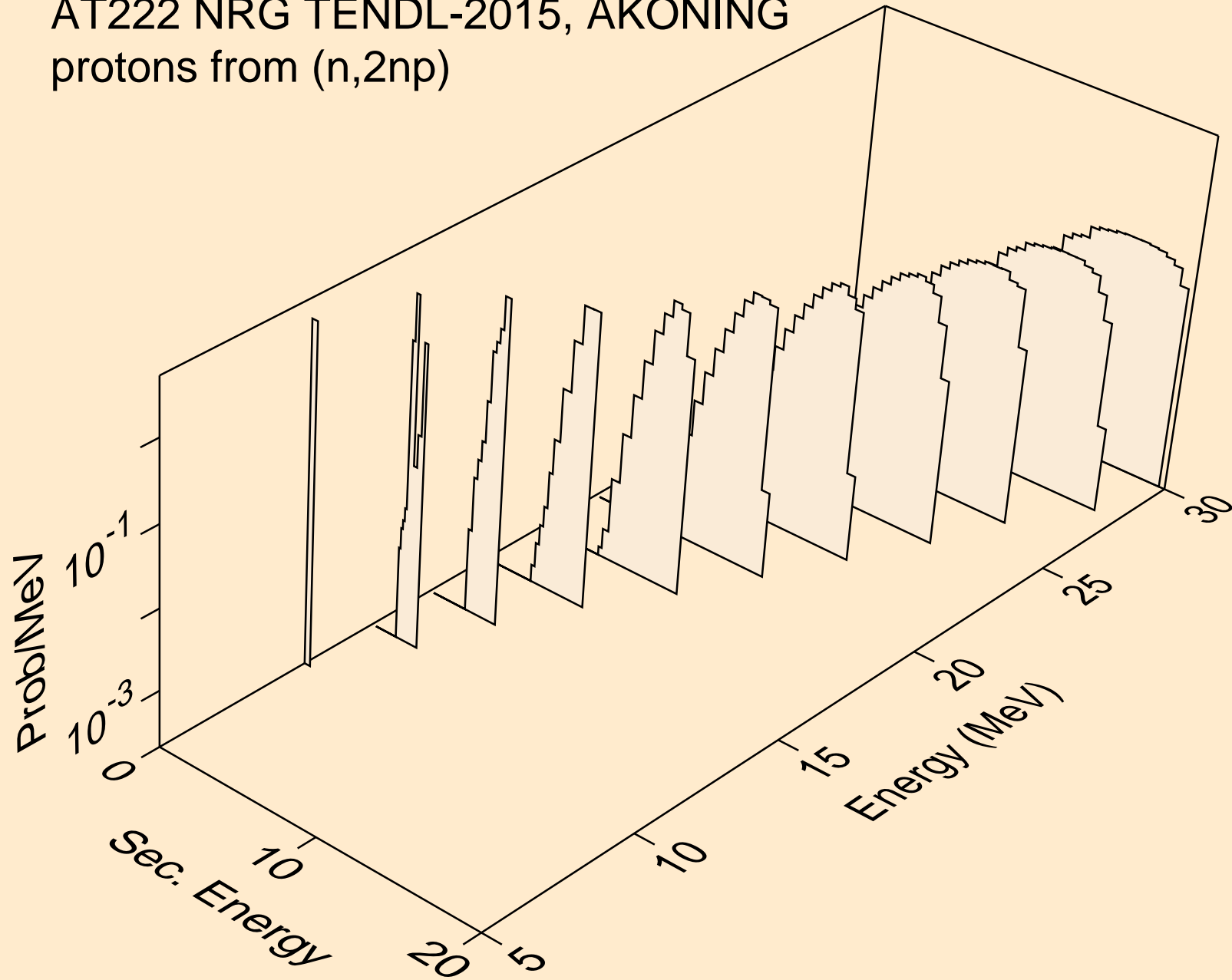

AT222 NRG TENDL-2015, AKONING
protons from (n,3np)

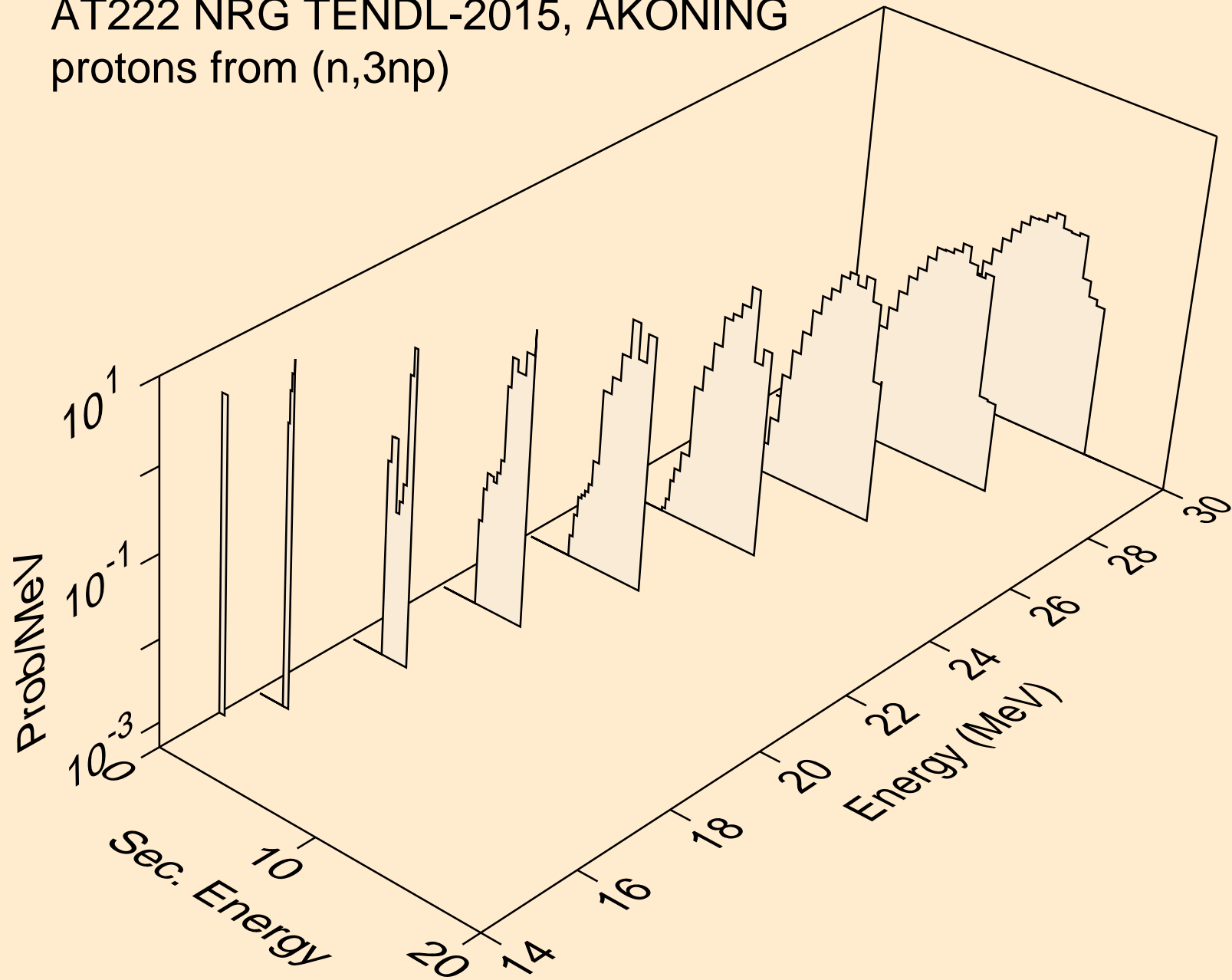

AT222 NRG TENDL-2015, AKONING
protons from (n,2np)

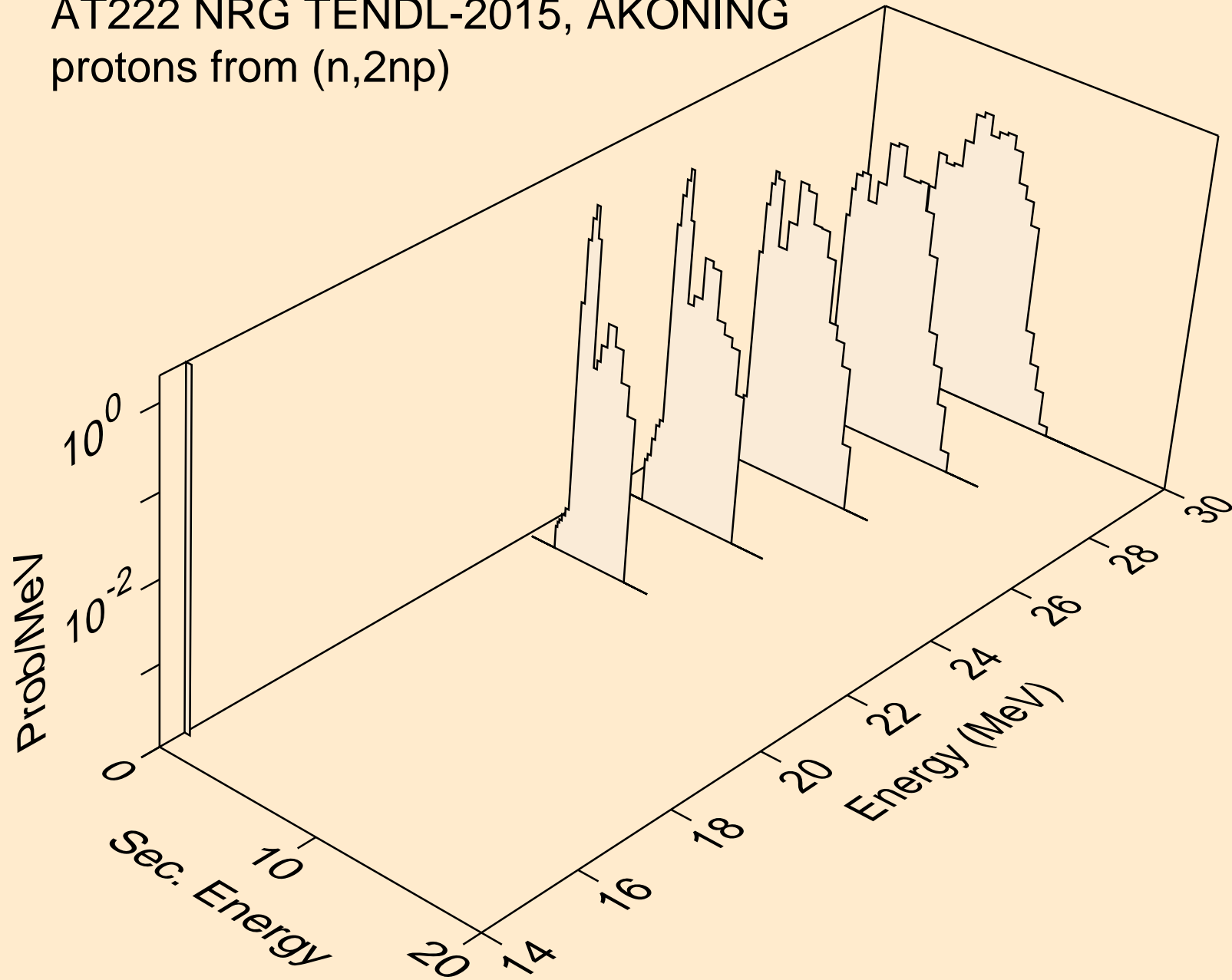

AT222 NRG TENDL-2015, AKONING
protons from (n,npa)

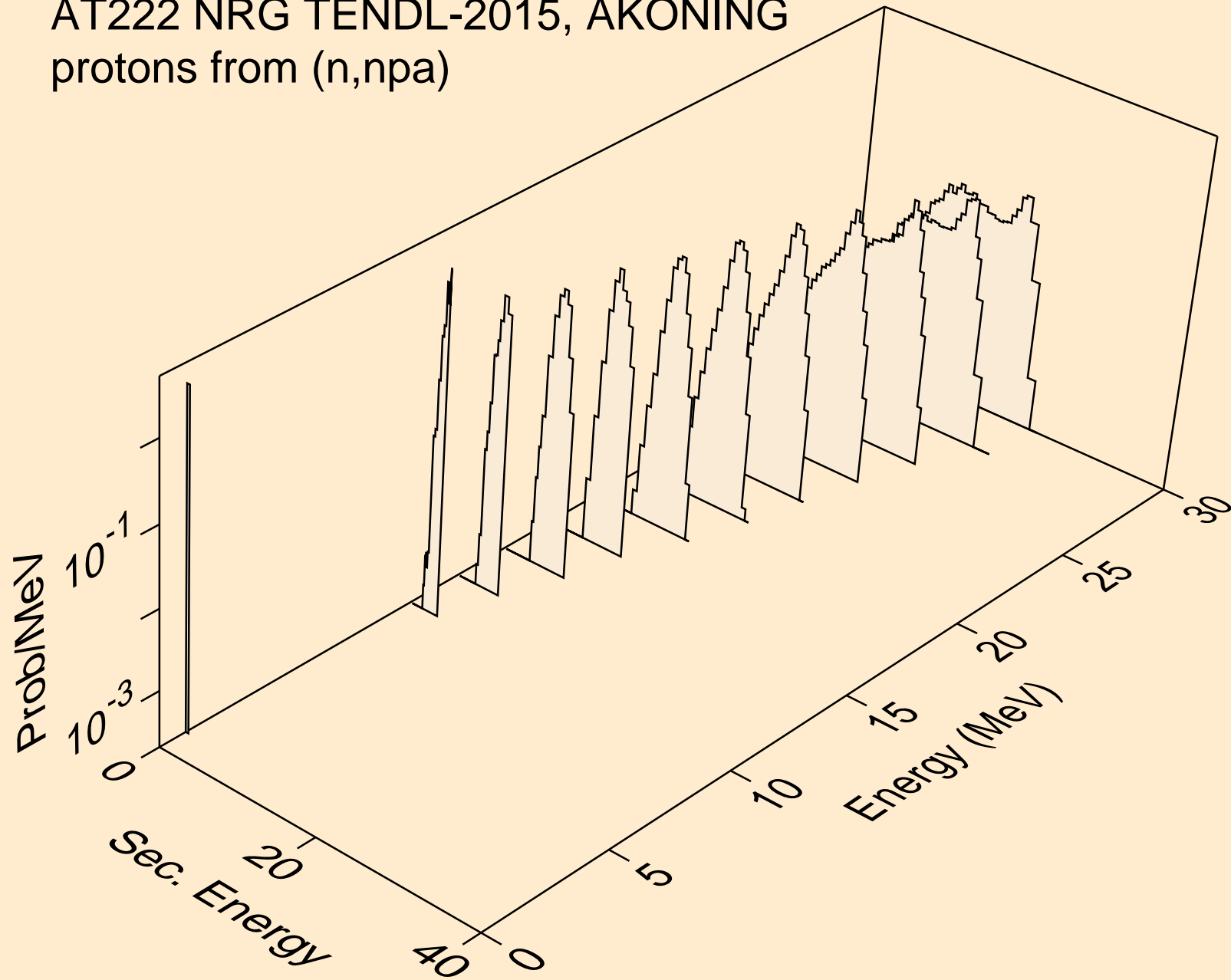

AT222 NRG TENDL-2015, AKONING
protons from (n,p)

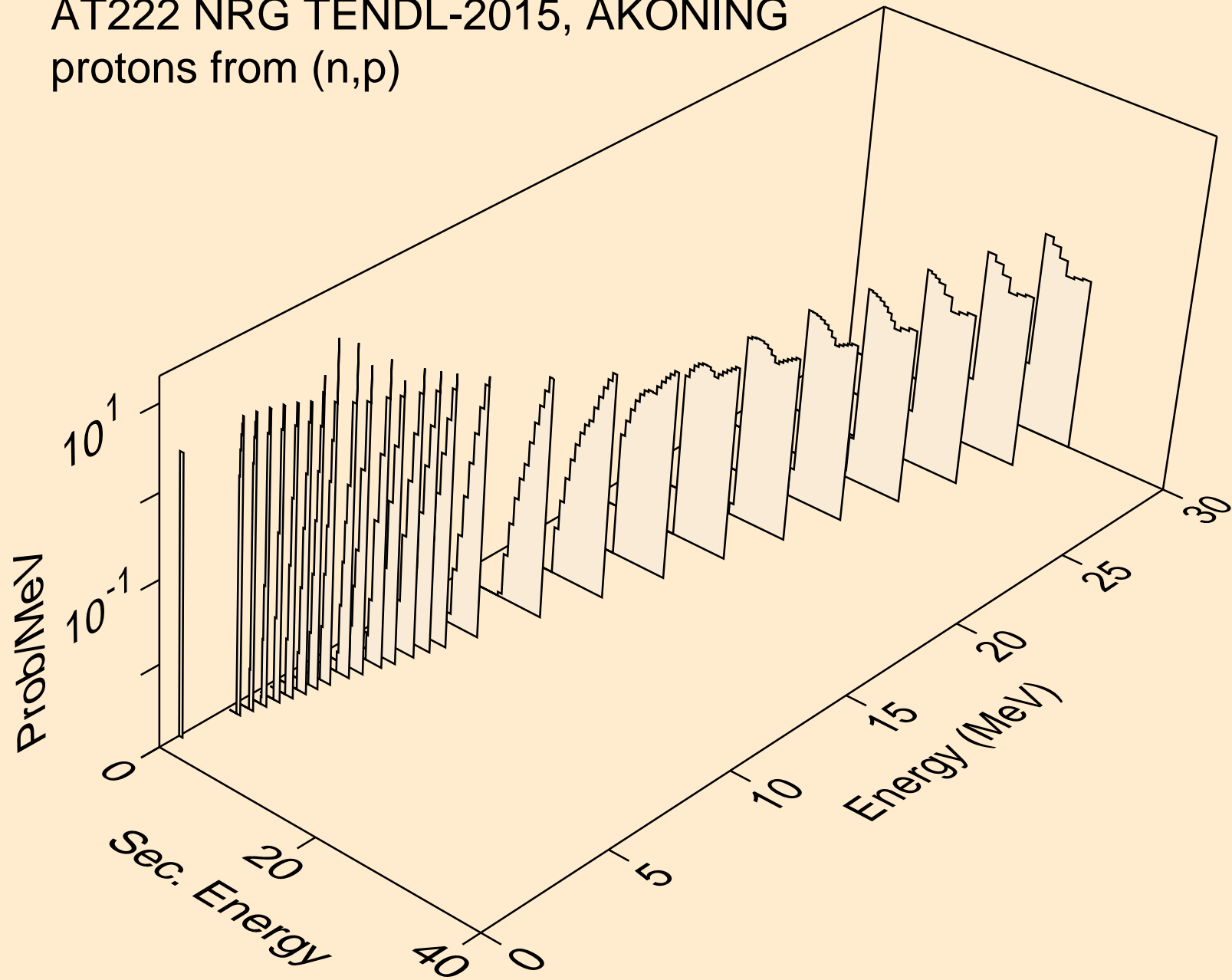

AT222 NRG TENDL-2015, AKONING
protons from (n,2p)

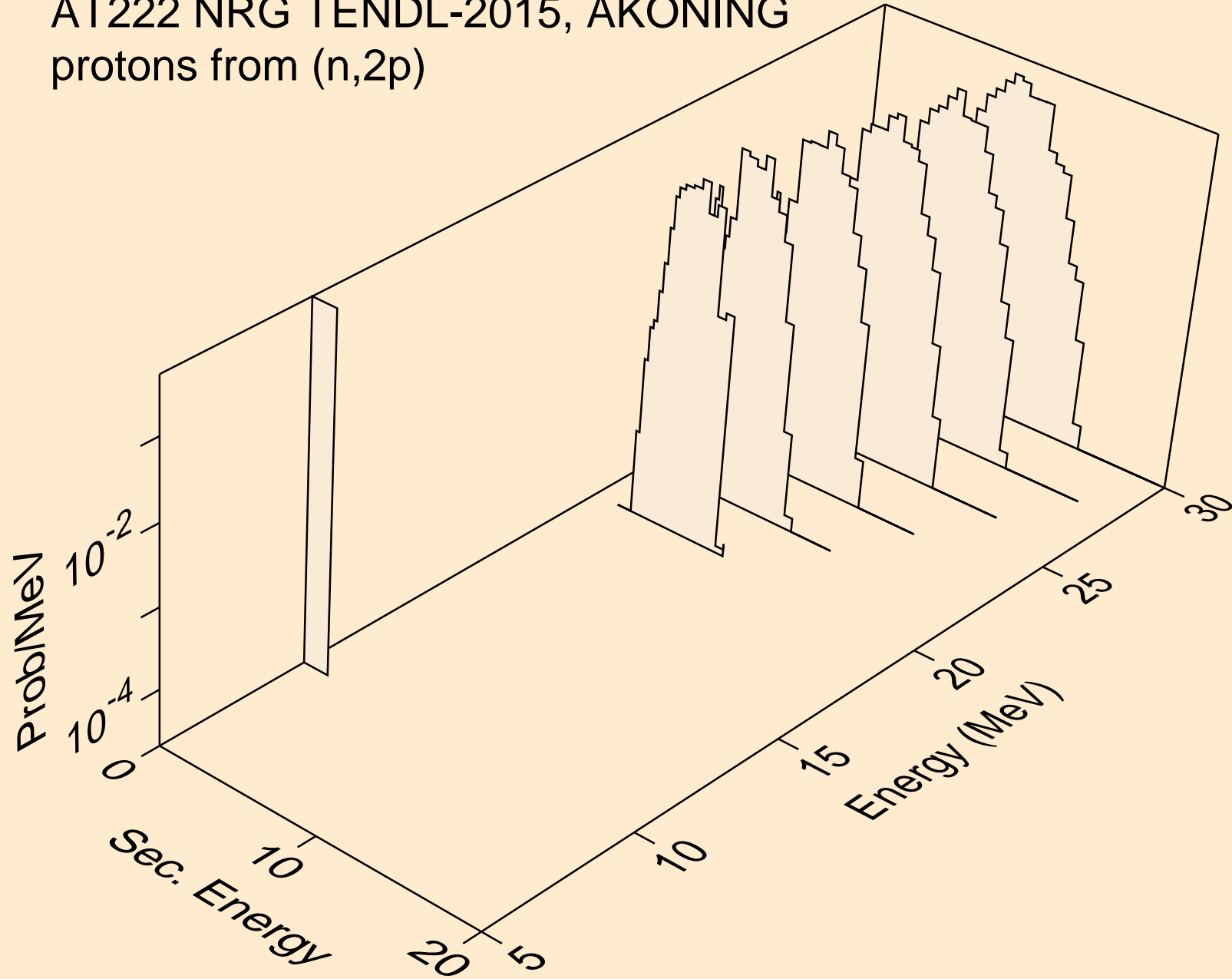

AT222 NRG TENDL-2015, AKONING
protons from (n,pa)

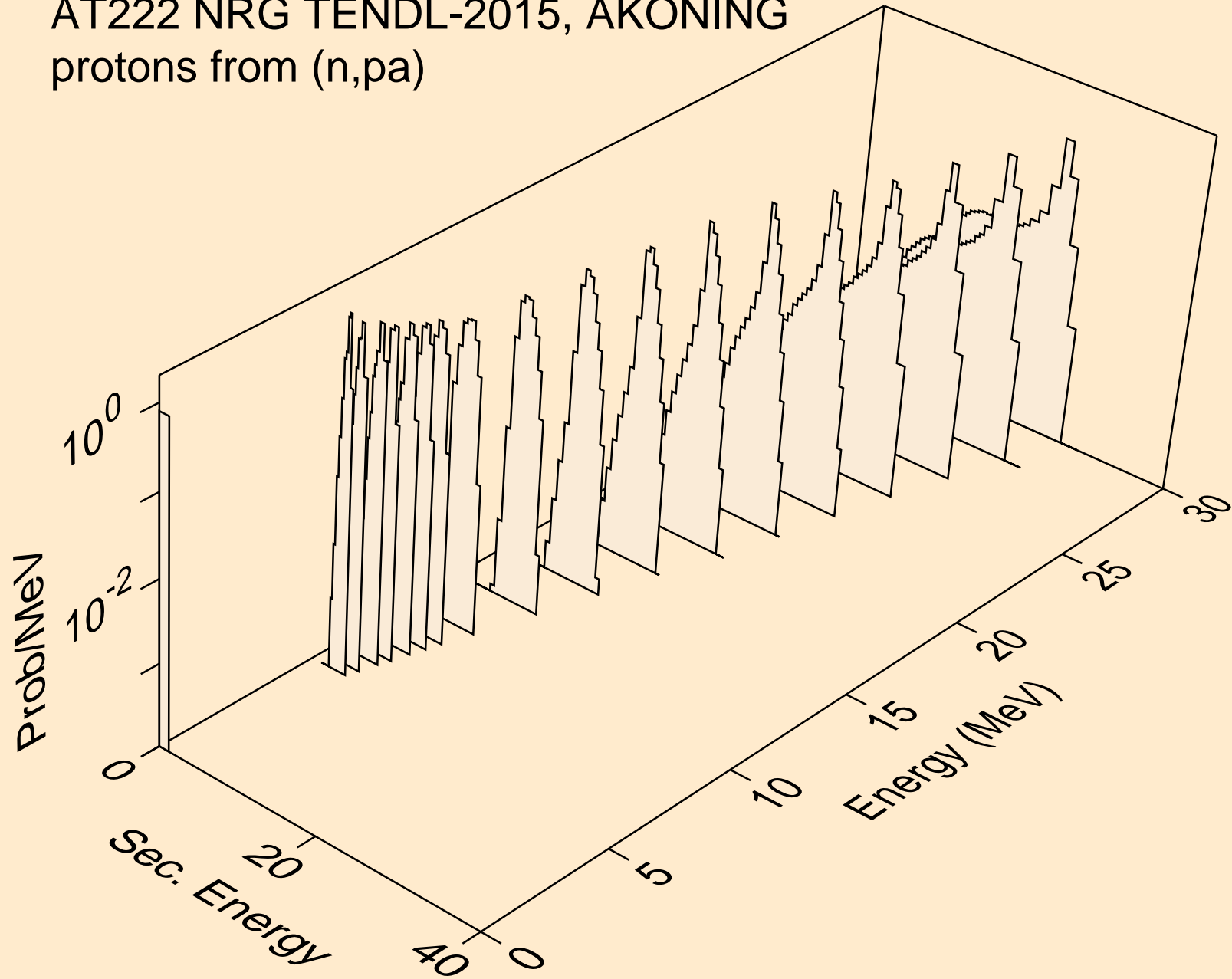

AT222 NRG TENDL-2015, AKONING
deuterons from (n,x)

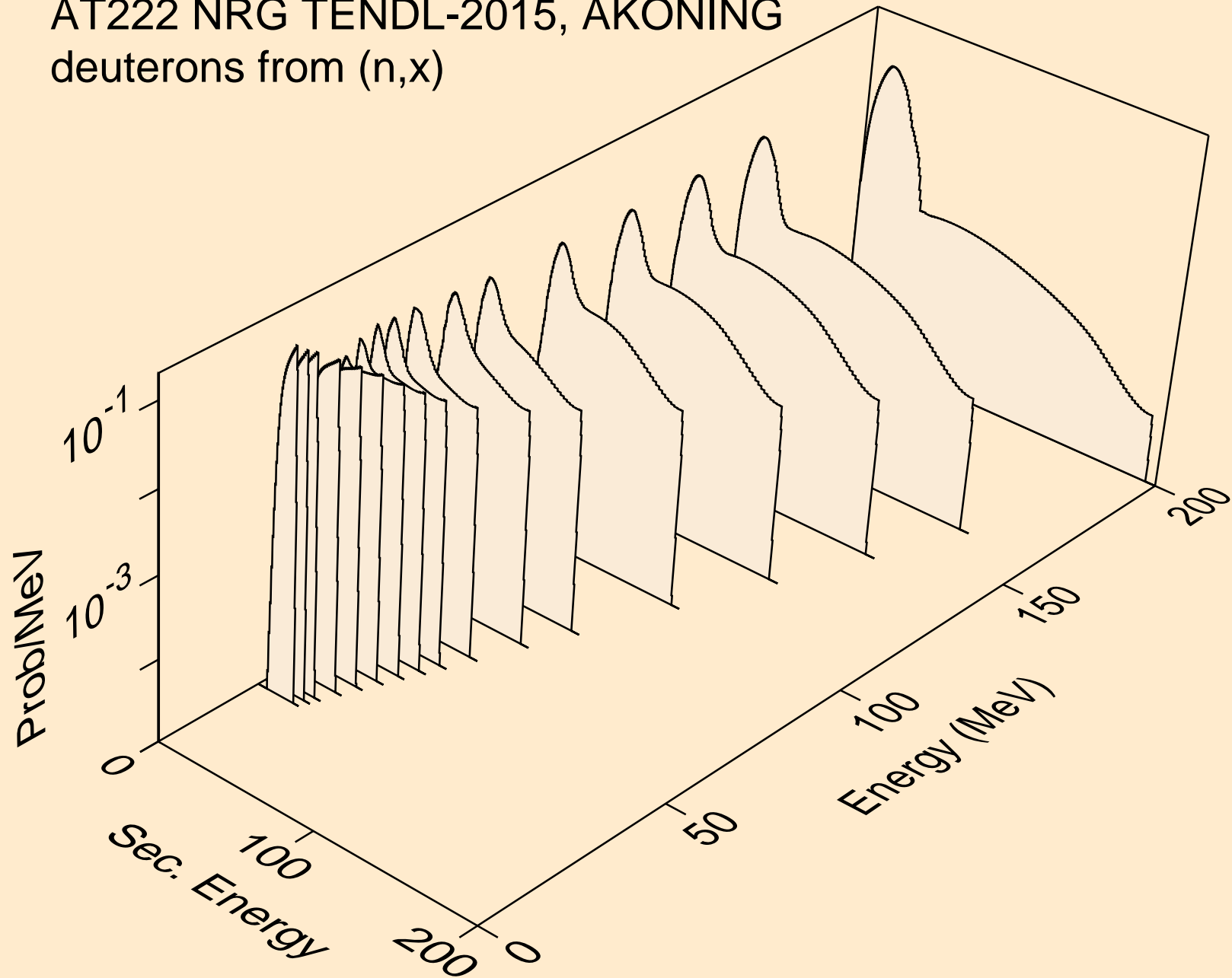

AT222 NRG TENDL-2015, AKONING
deuterons from (n,2nd)

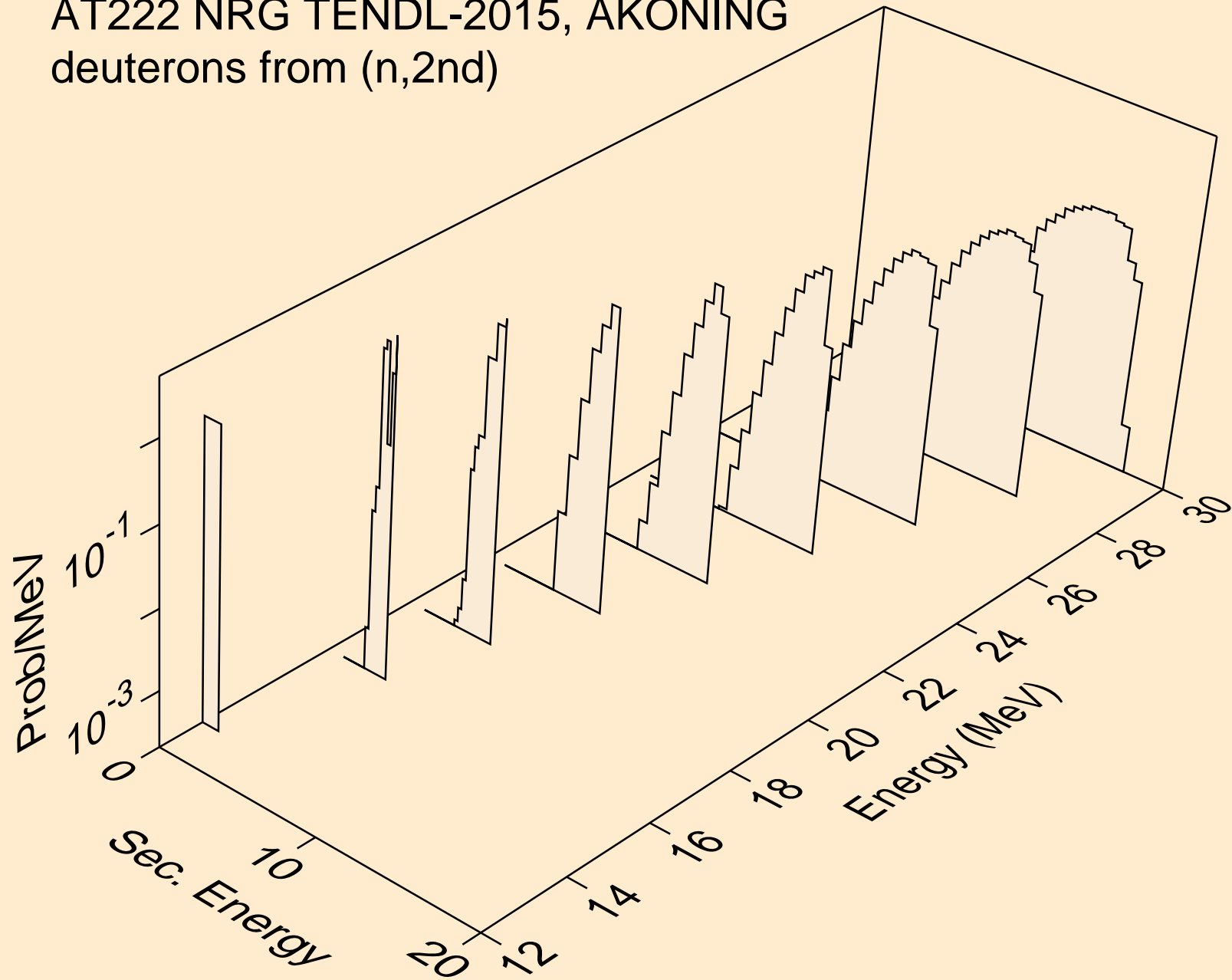

AT222 NRG TENDL-2015, AKONING
deuterons from (n,n*)d

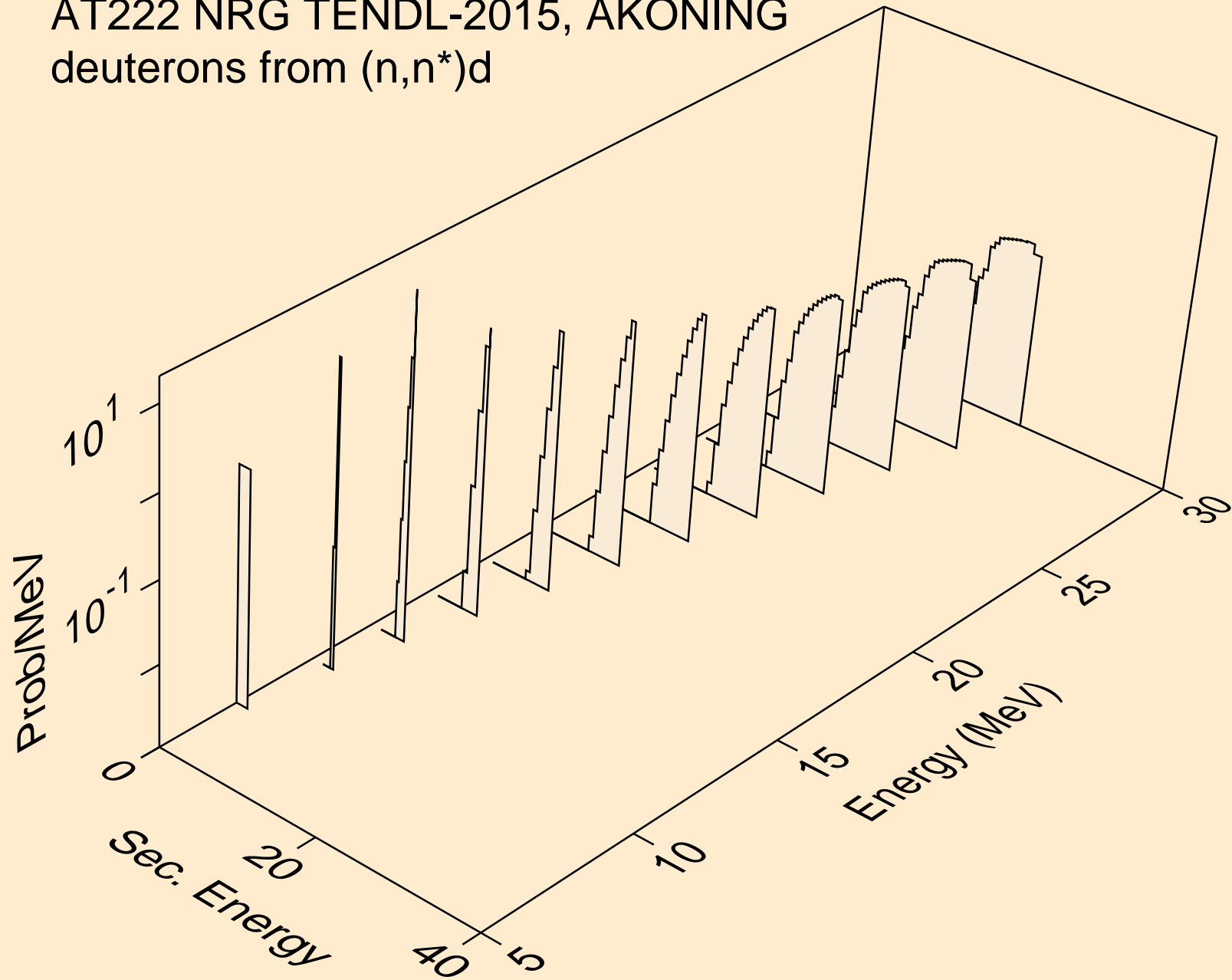

AT222 NRG TENDL-2015, AKONING
deuterons from (n,d)

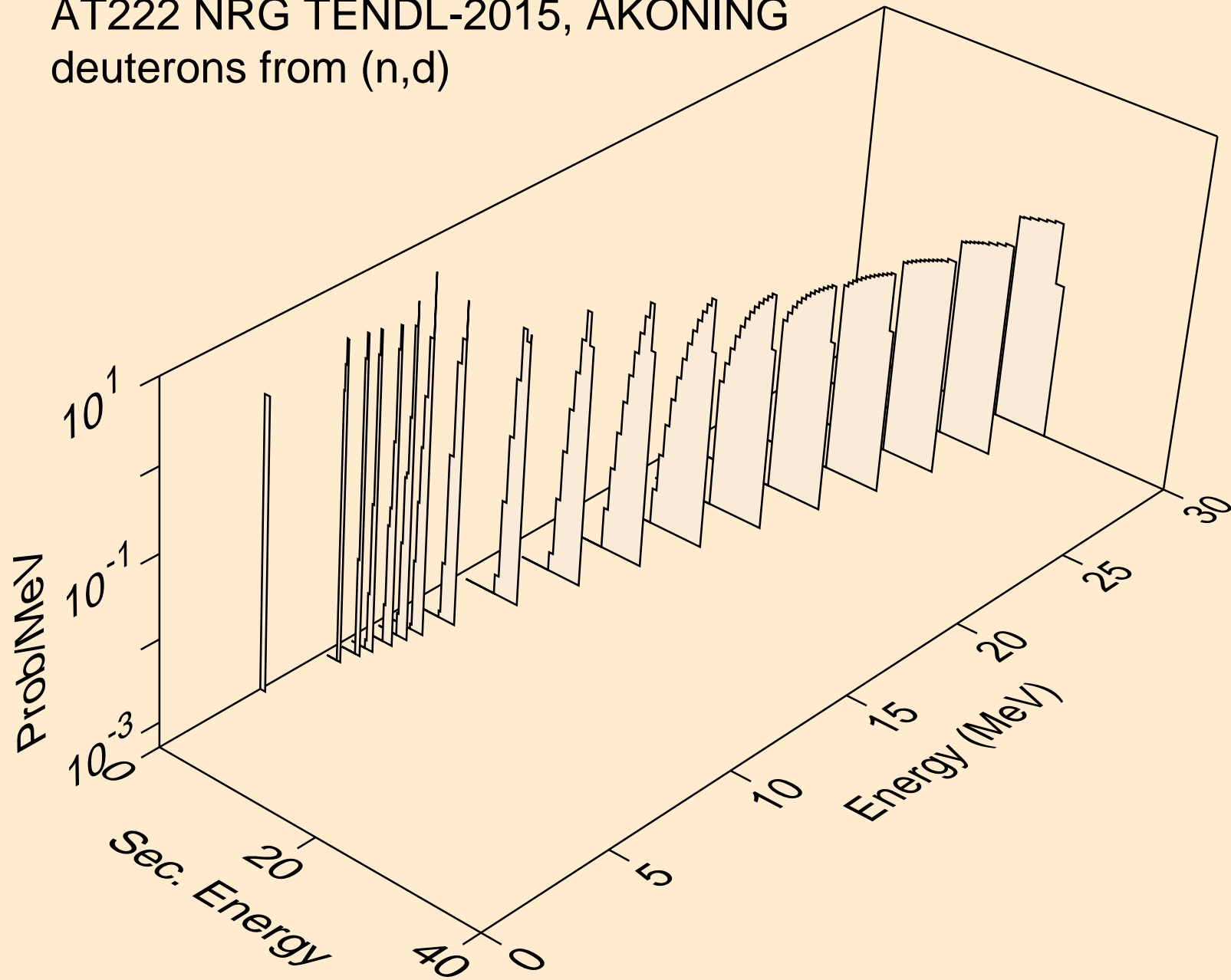

AT222 NRG TENDL-2015, AKONING
tritons from (n,x)

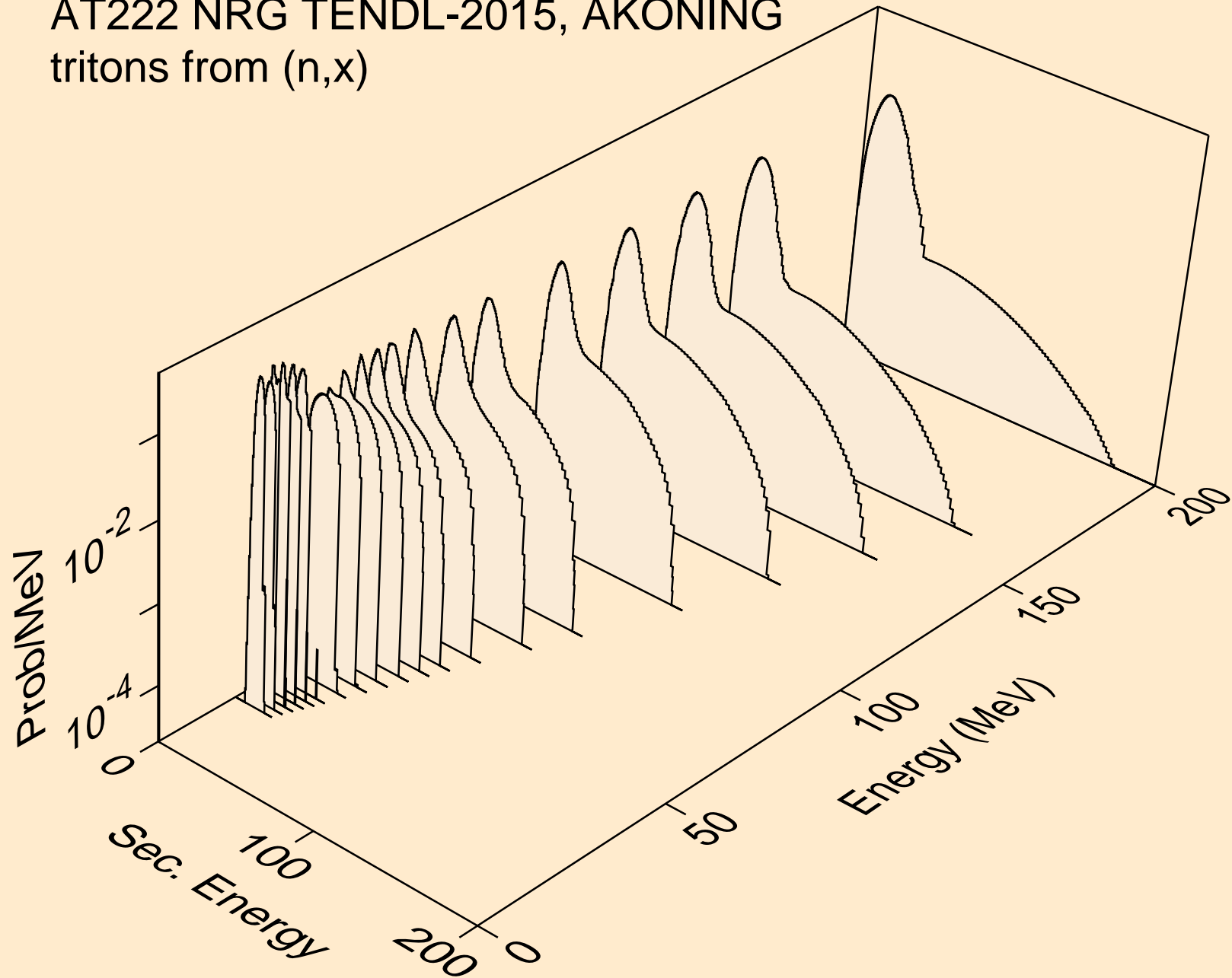

AT222 NRG TENDL-2015, AKONING
tritons from (n,n*)t

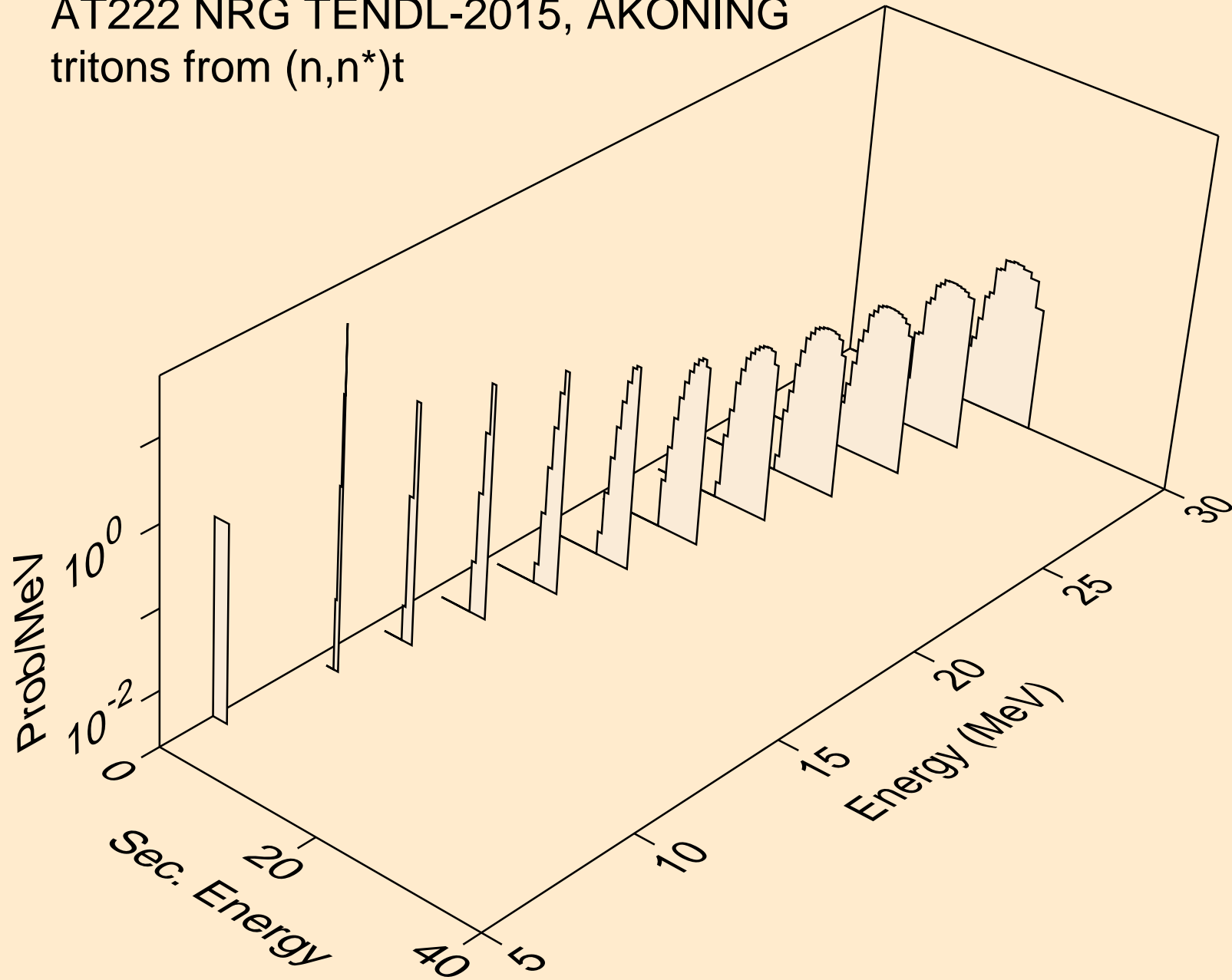

AT222 NRG TENDL-2015, AKONING
tritons from (n,t)

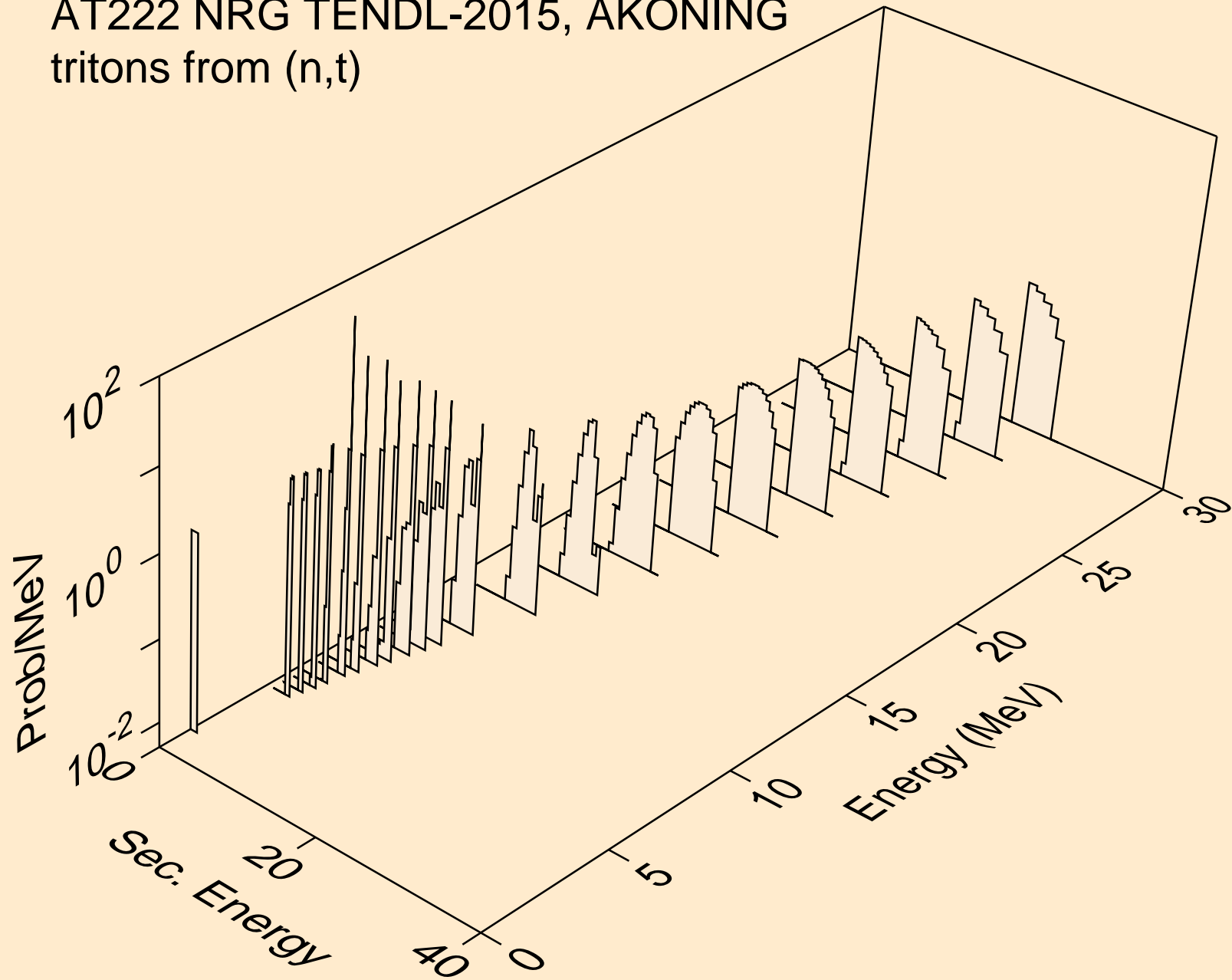

AT222 NRG TENDL-2015, AKONING
he3s from (n,x)

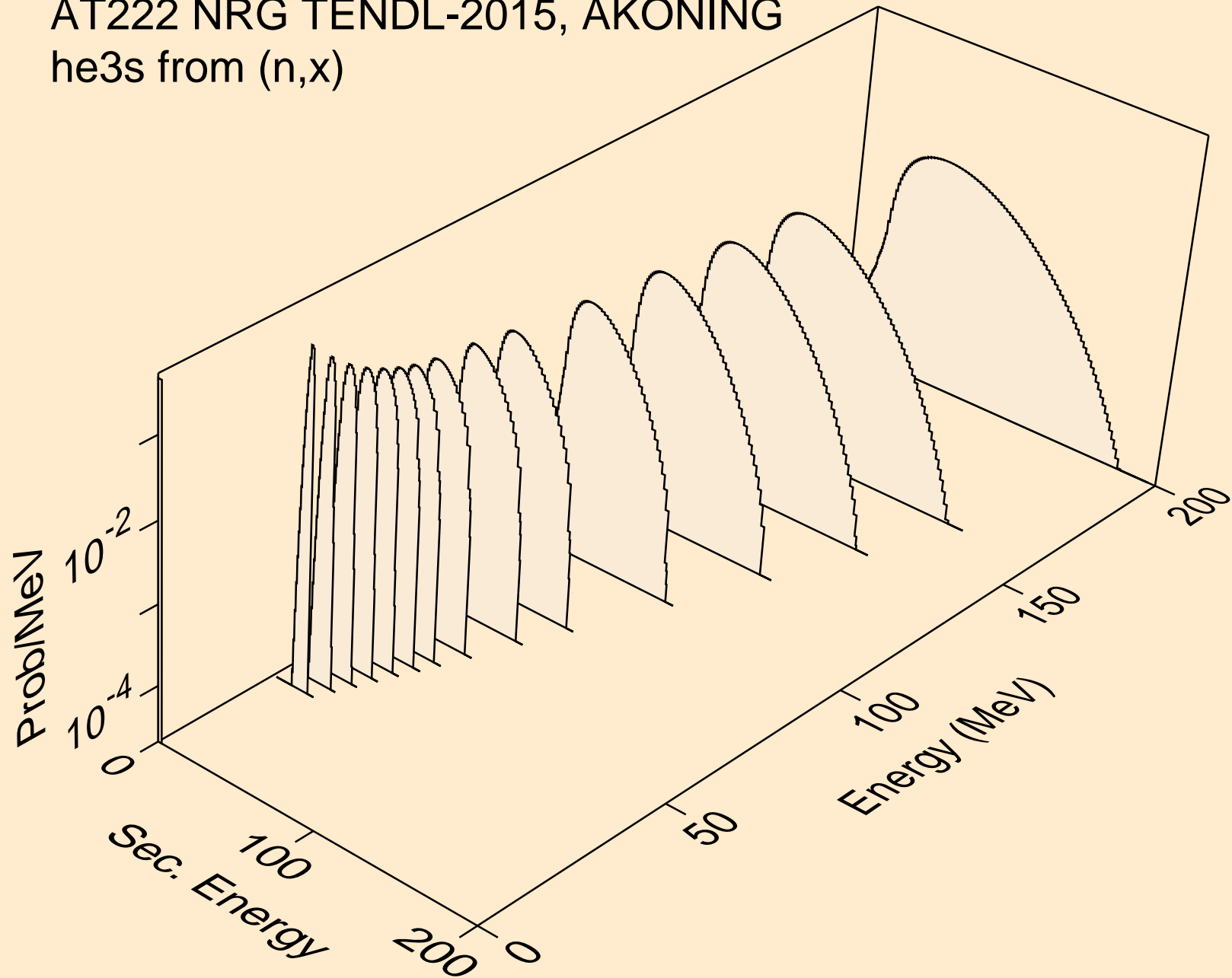

AT222 NRG TENDL-2015, AKONING
he3s from (n,n*)he3

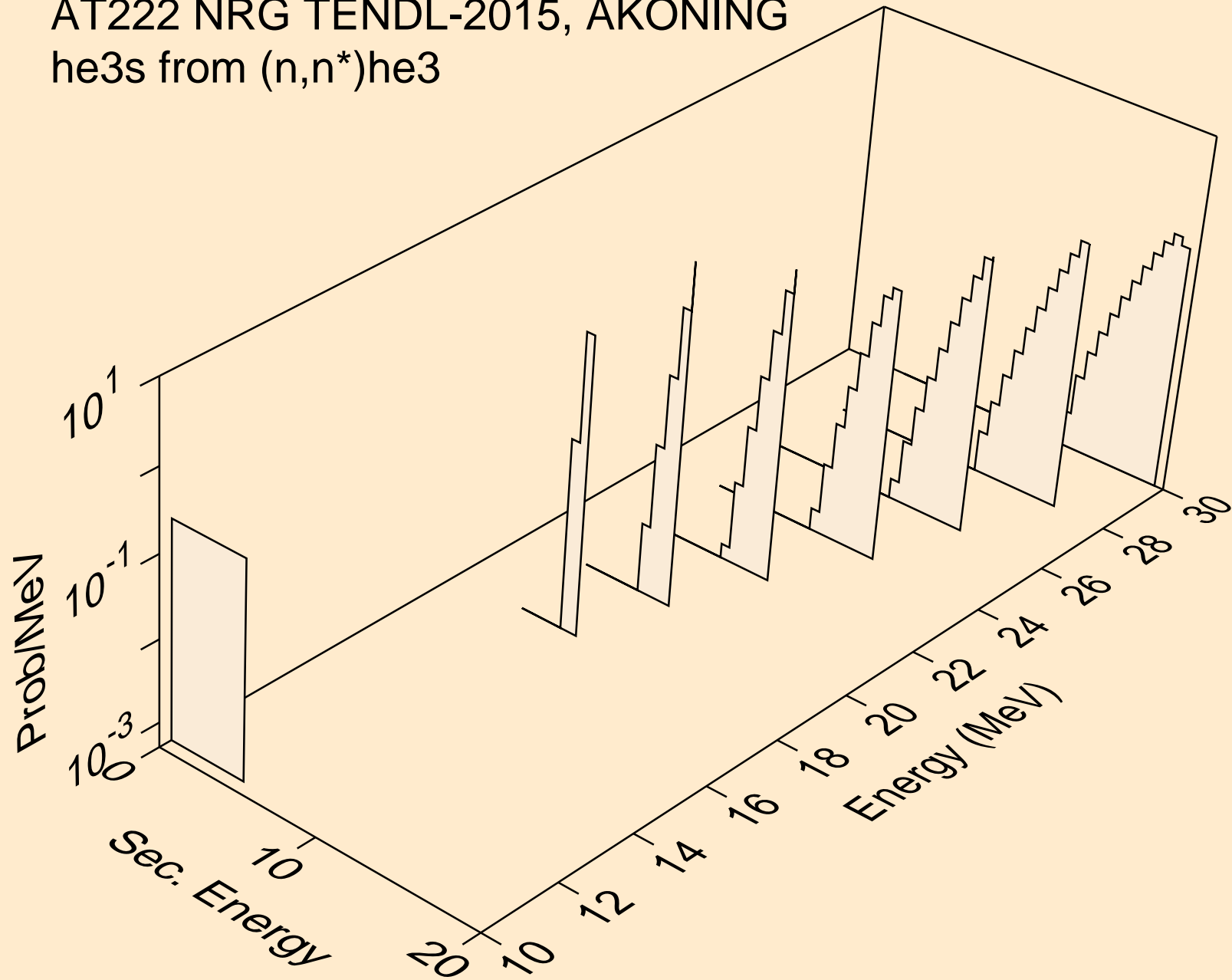

AT222 NRG TENDL-2015, AKONING
he3s from (n,he3)

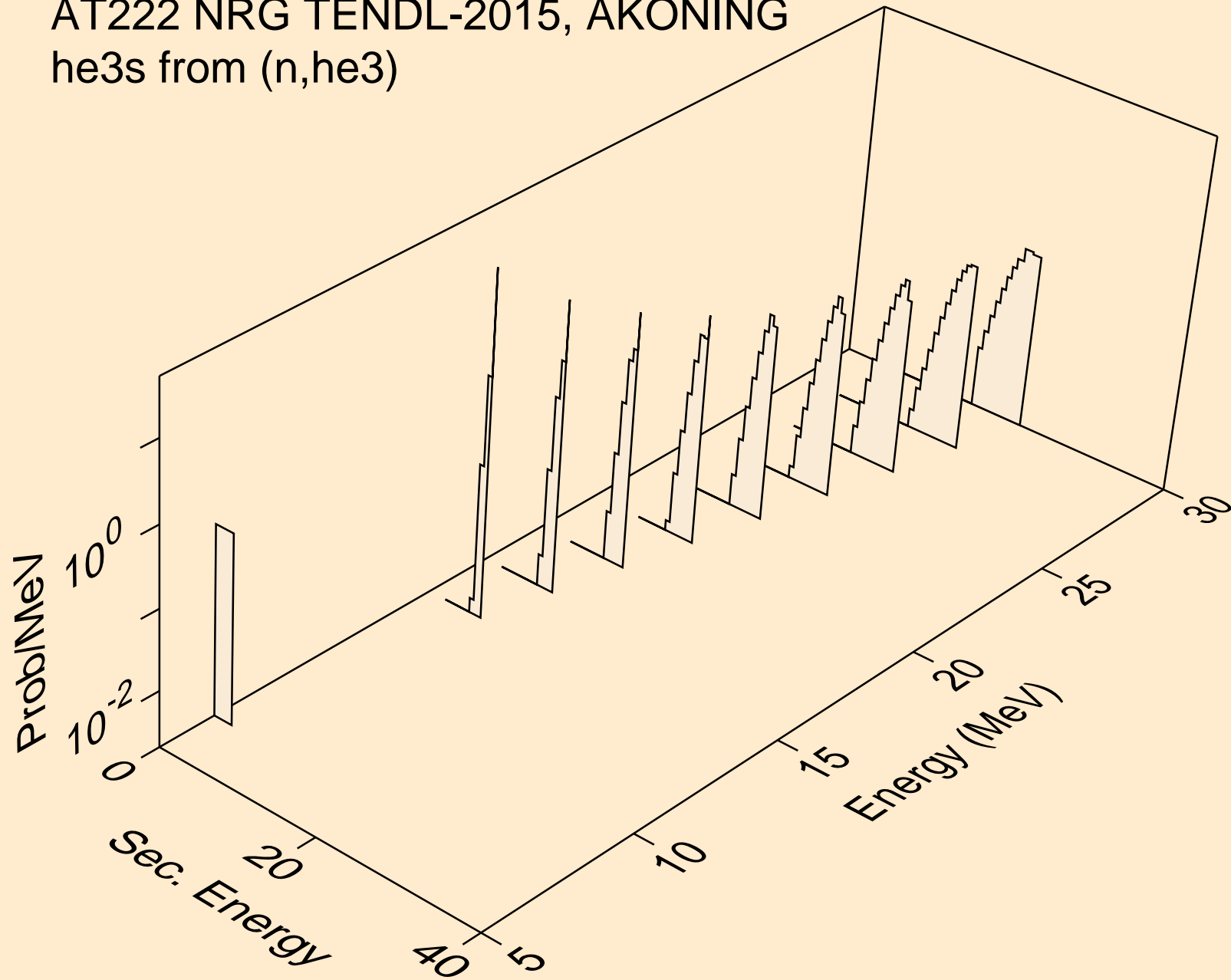

AT222 NRG TENDL-2015, AKONING
alphas from (n,x)

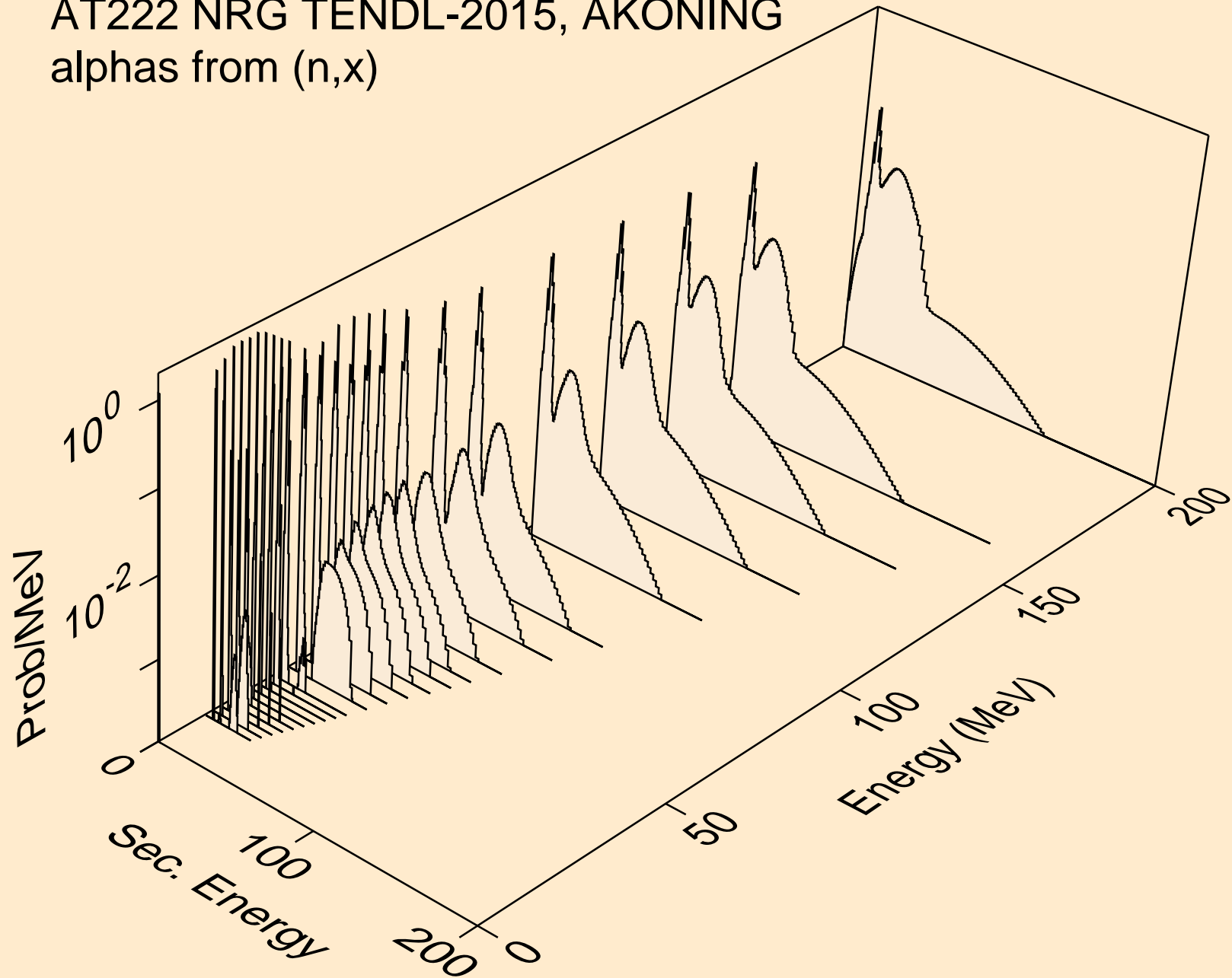

AT222 NRG TENDL-2015, AKONING
alphas from (n,n*)a

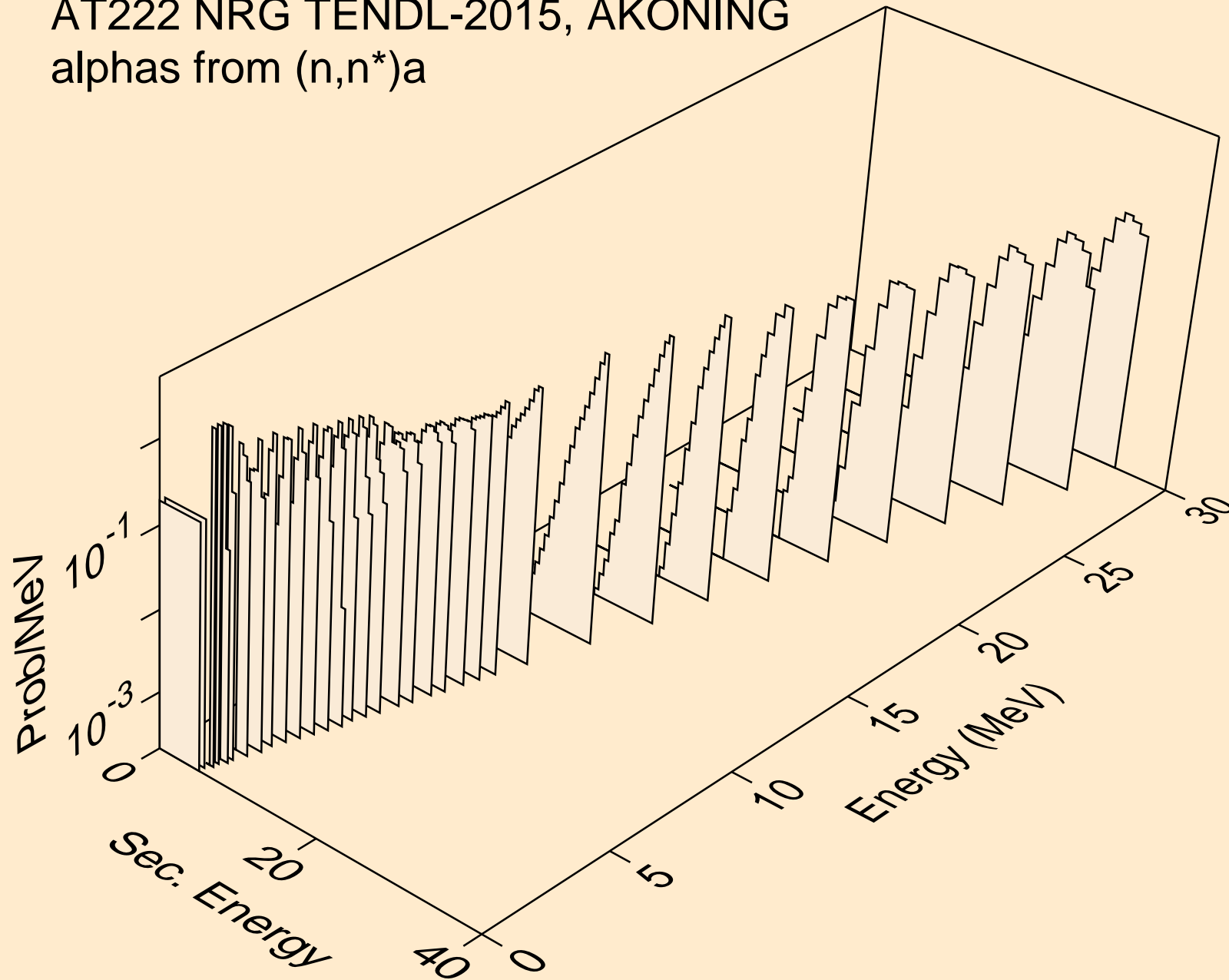

AT222 NRG TENDL-2015, AKONING
alphas from (n,2n)a

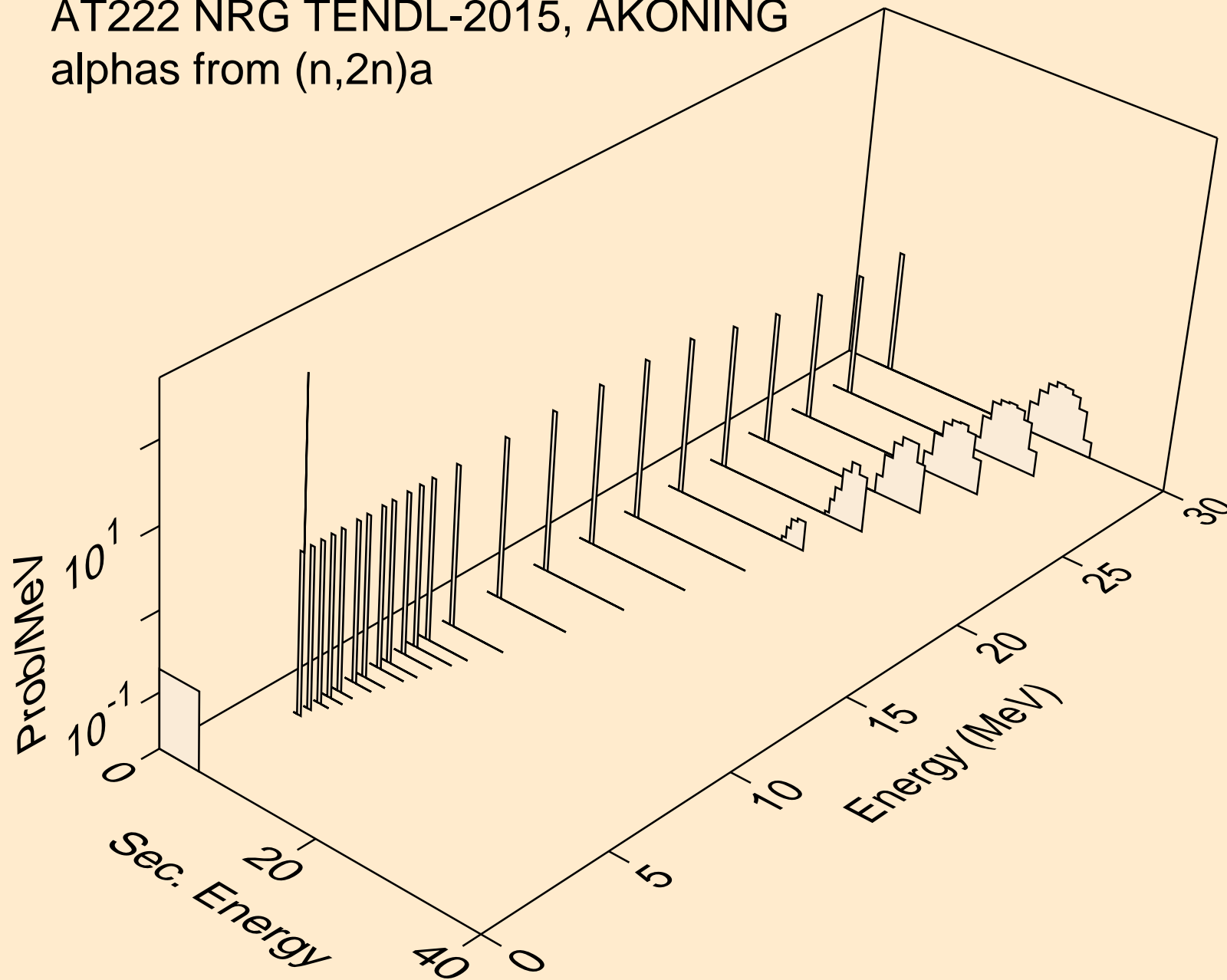

AT222 NRG TENDL-2015, AKONING
alphas from (n,3n)a

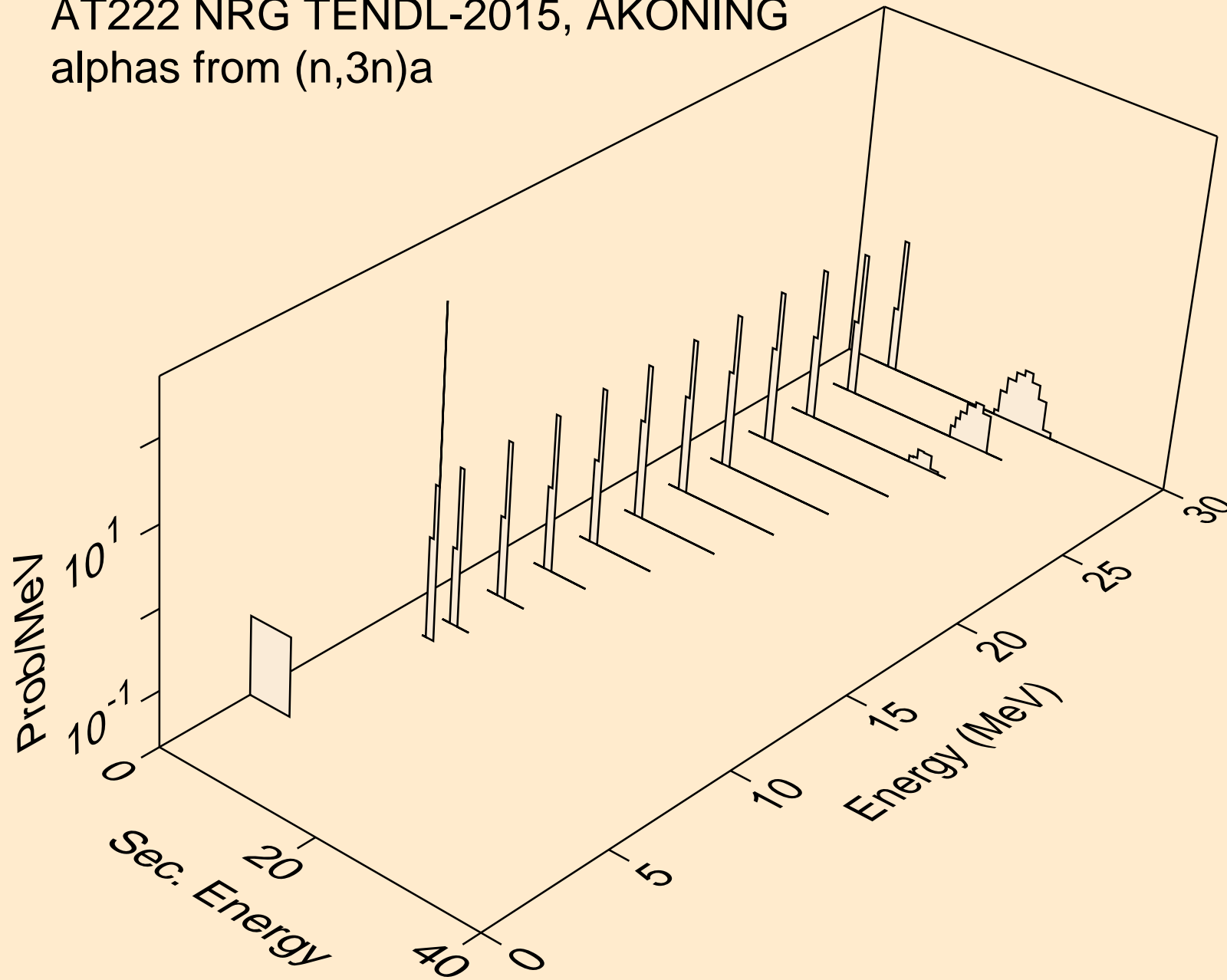

AT222 NRG TENDL-2015, AKONING
alphas from (n,n*)2a

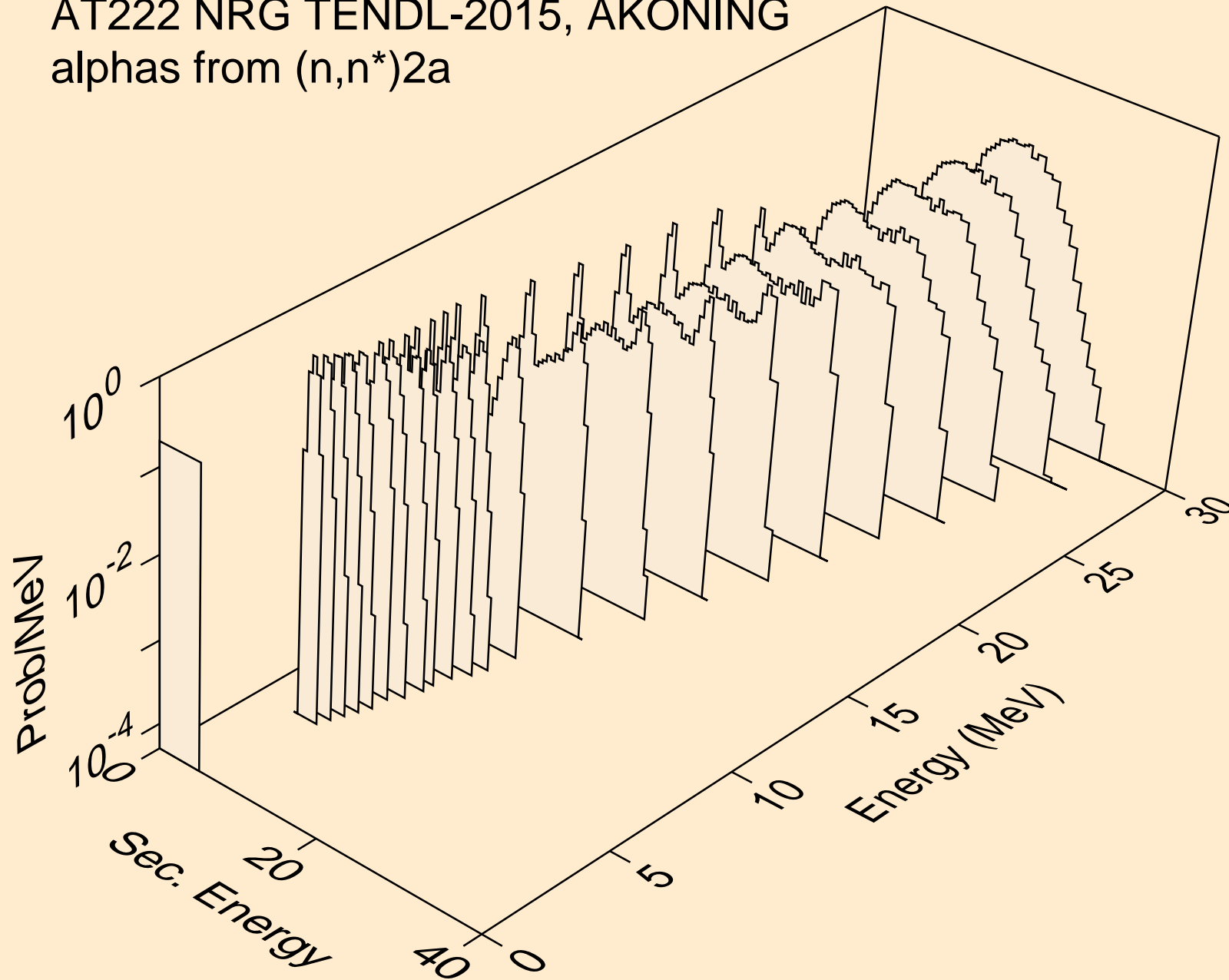

AT222 NRG TENDL-2015, AKONING
alphas from (n,2n)2a

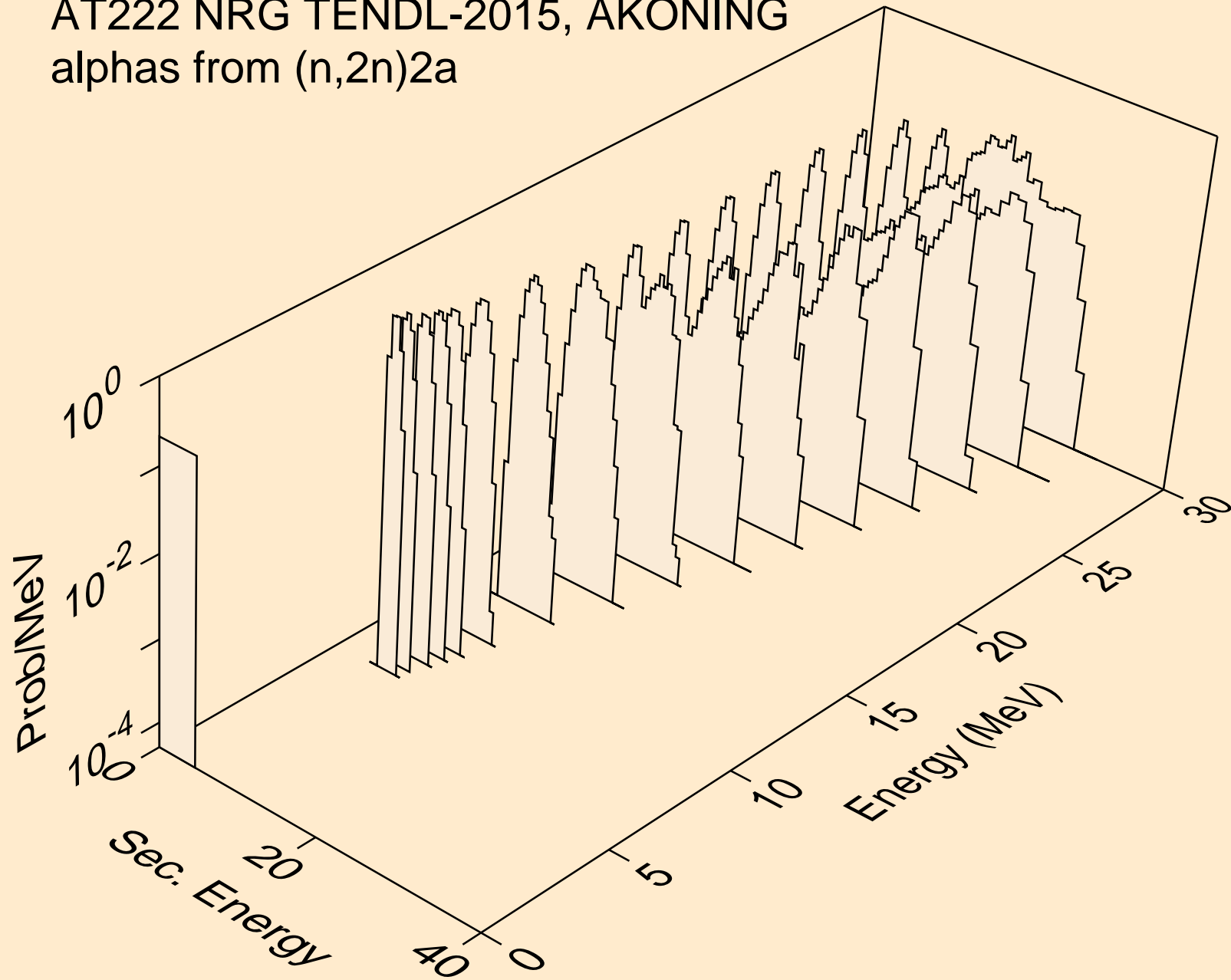

AT222 NRG TENDL-2015, AKONING
alphas from (n,npa)

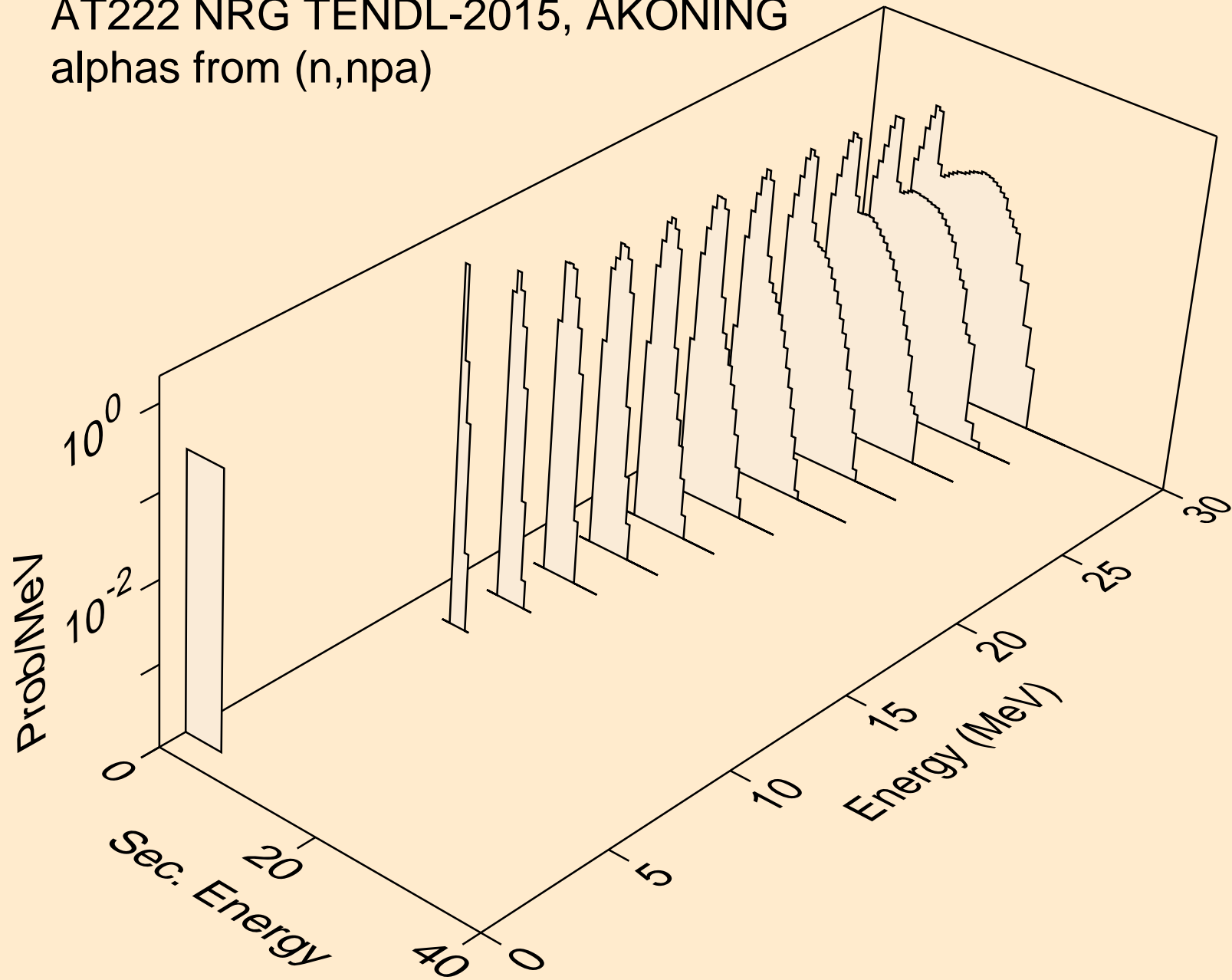

AT222 NRG TENDL-2015, AKONING
alphas from (n,a)

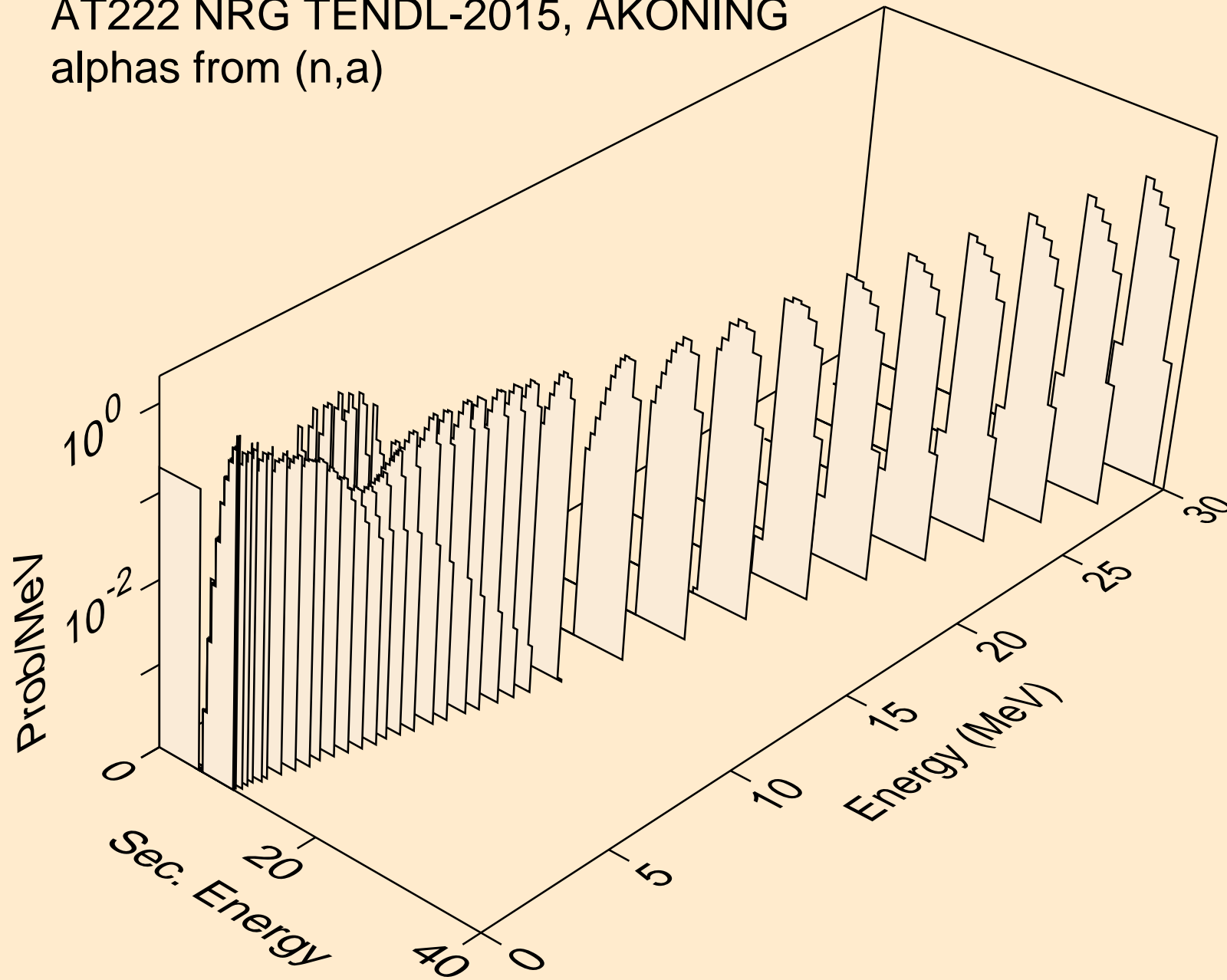

AT222 NRG TENDL-2015, AKONING
alphas from (n,pa)

