

AU189 NRG TENDL-2015, AKONING

Principal cross sections

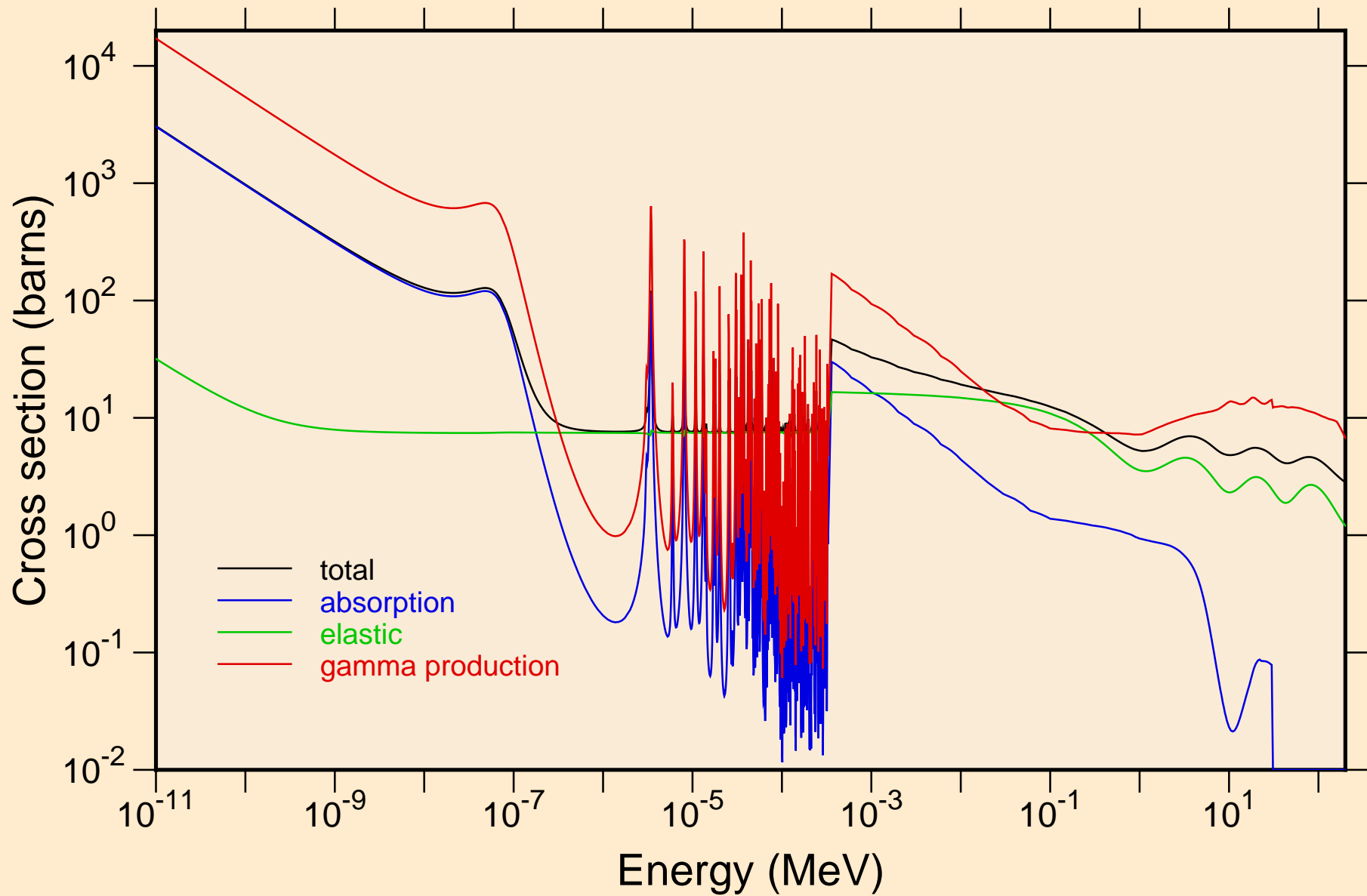

AU189 NRG TENDL-2015, AKONING
resonance total cross section

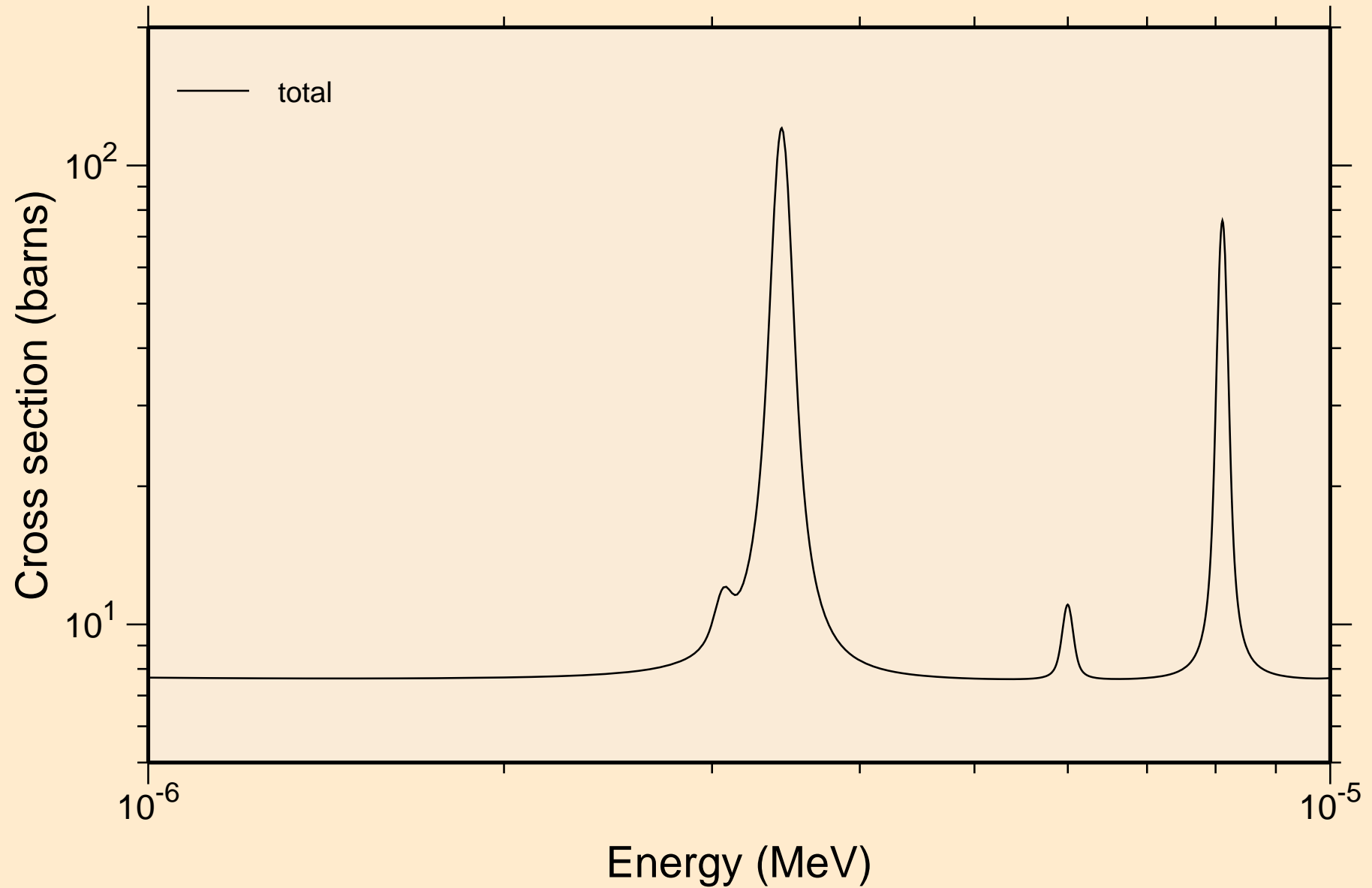

AU189 NRG TENDL-2015, AKONING
resonance total cross section

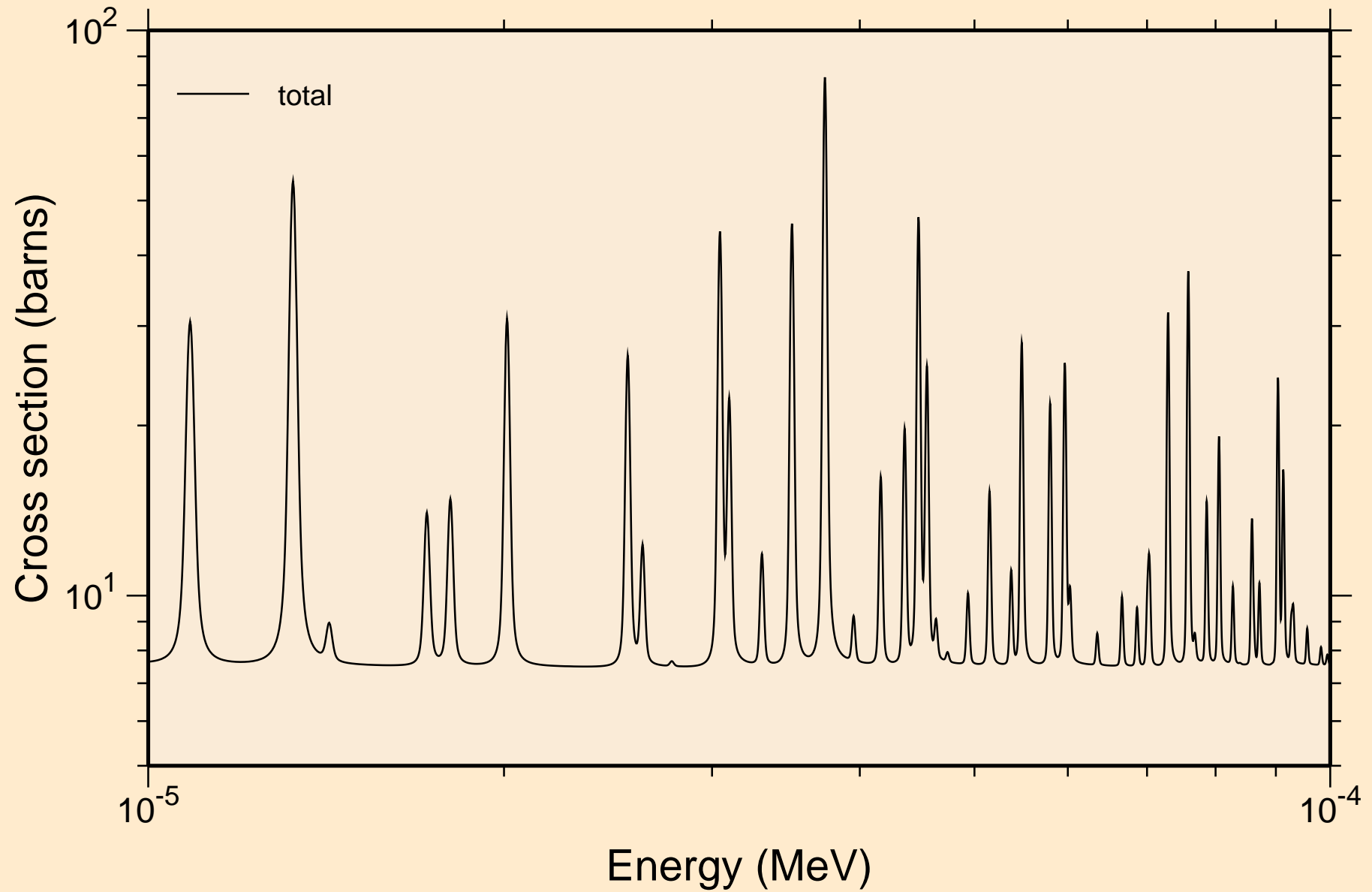

AU189 NRG TENDL-2015, AKONING
resonance total cross section

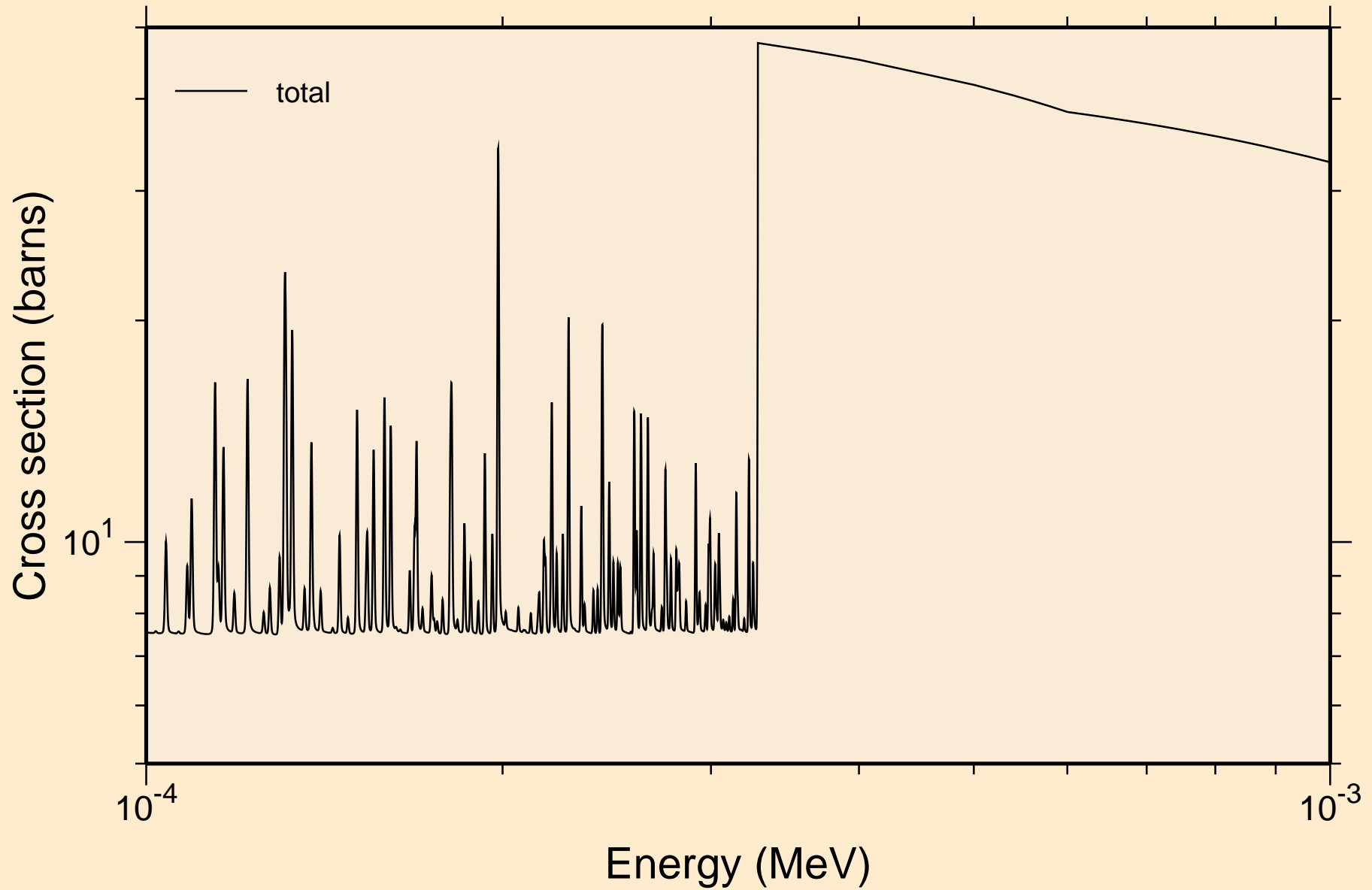

AU189 NRG TENDL-2015, AKONING
resonance total cross section

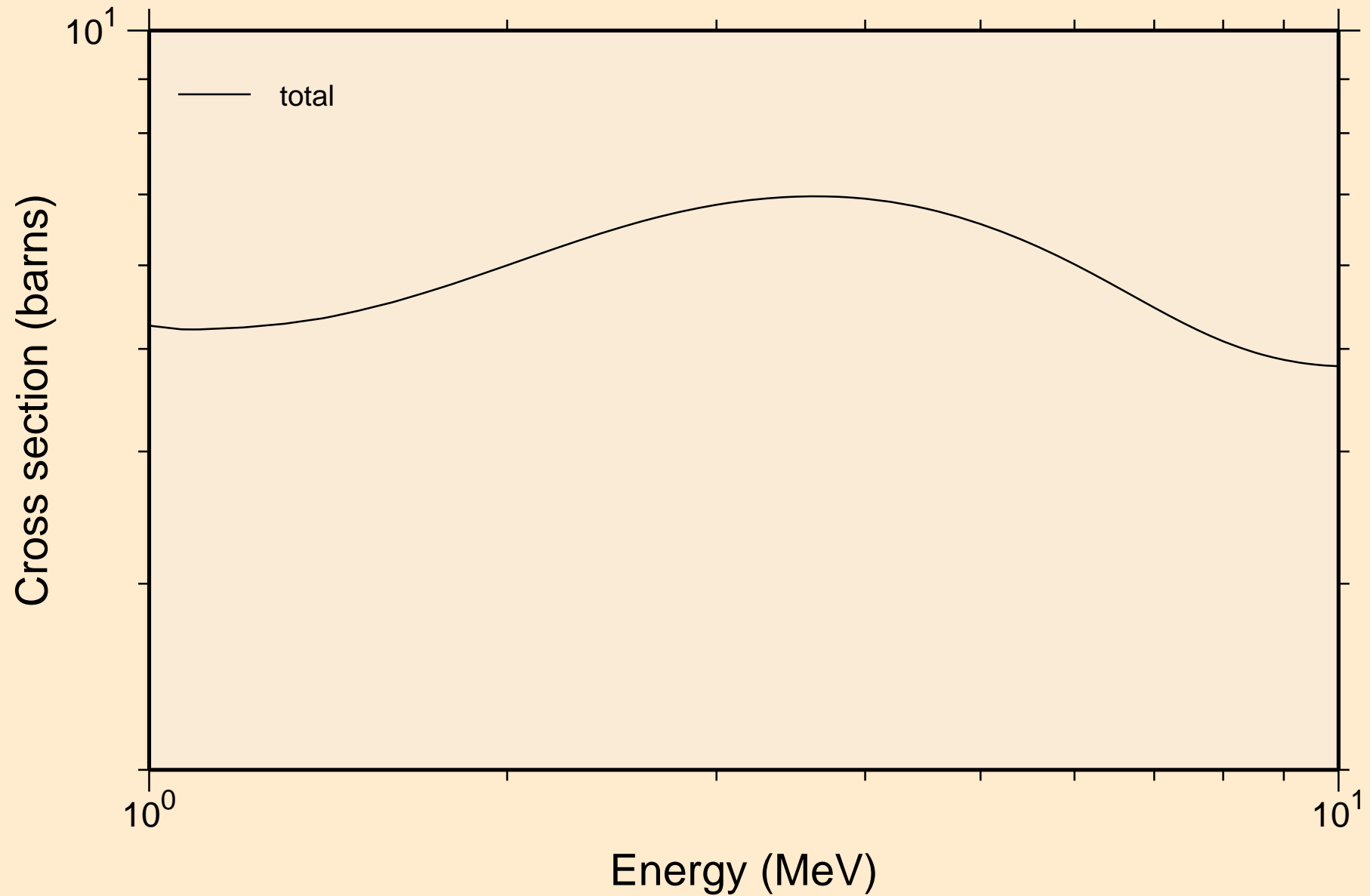

AU189 NRG TENDL-2015, AKONING
resonance absorption cross sections

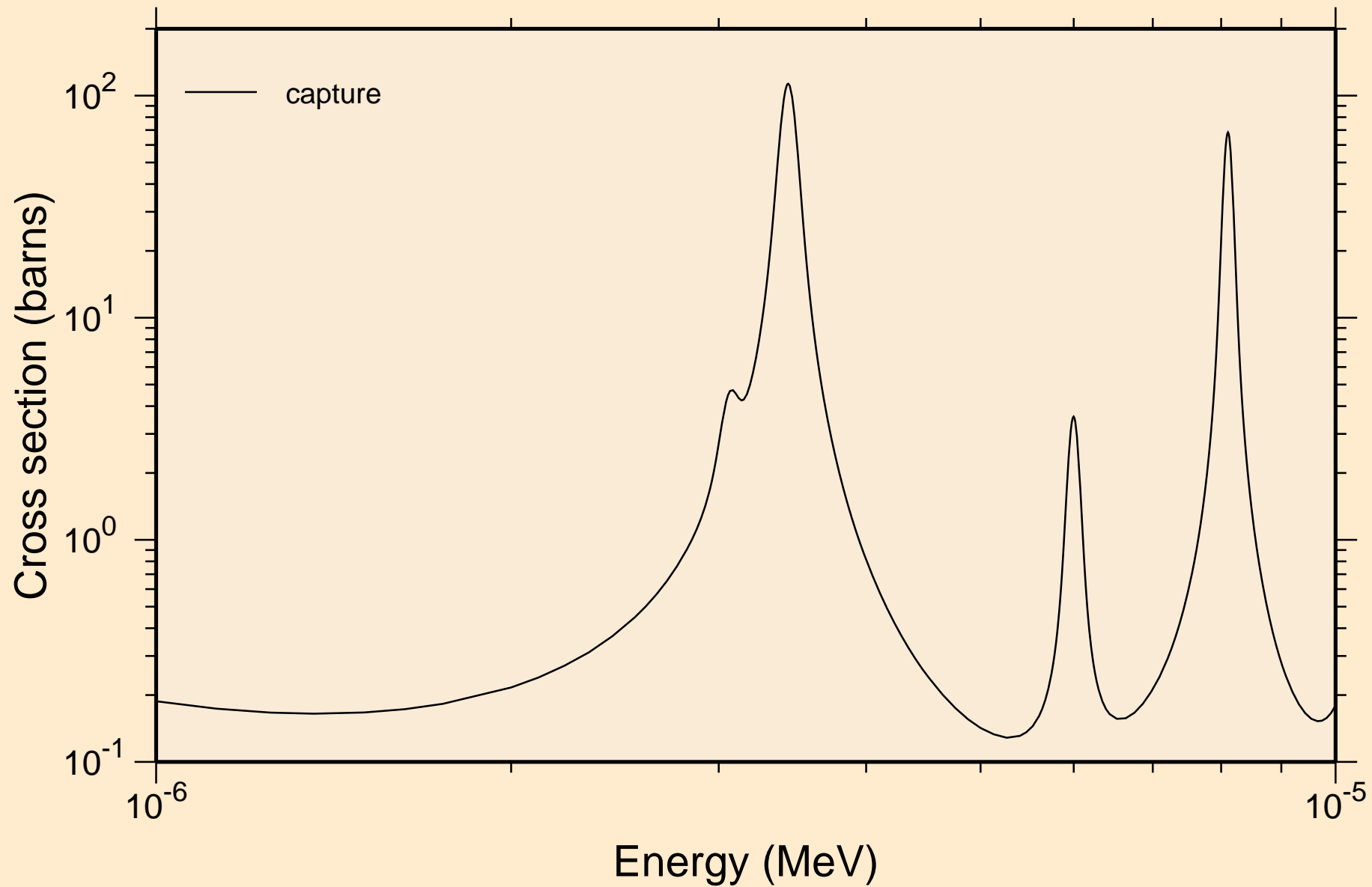

AU189 NRG TENDL-2015, AKONING
resonance absorption cross sections

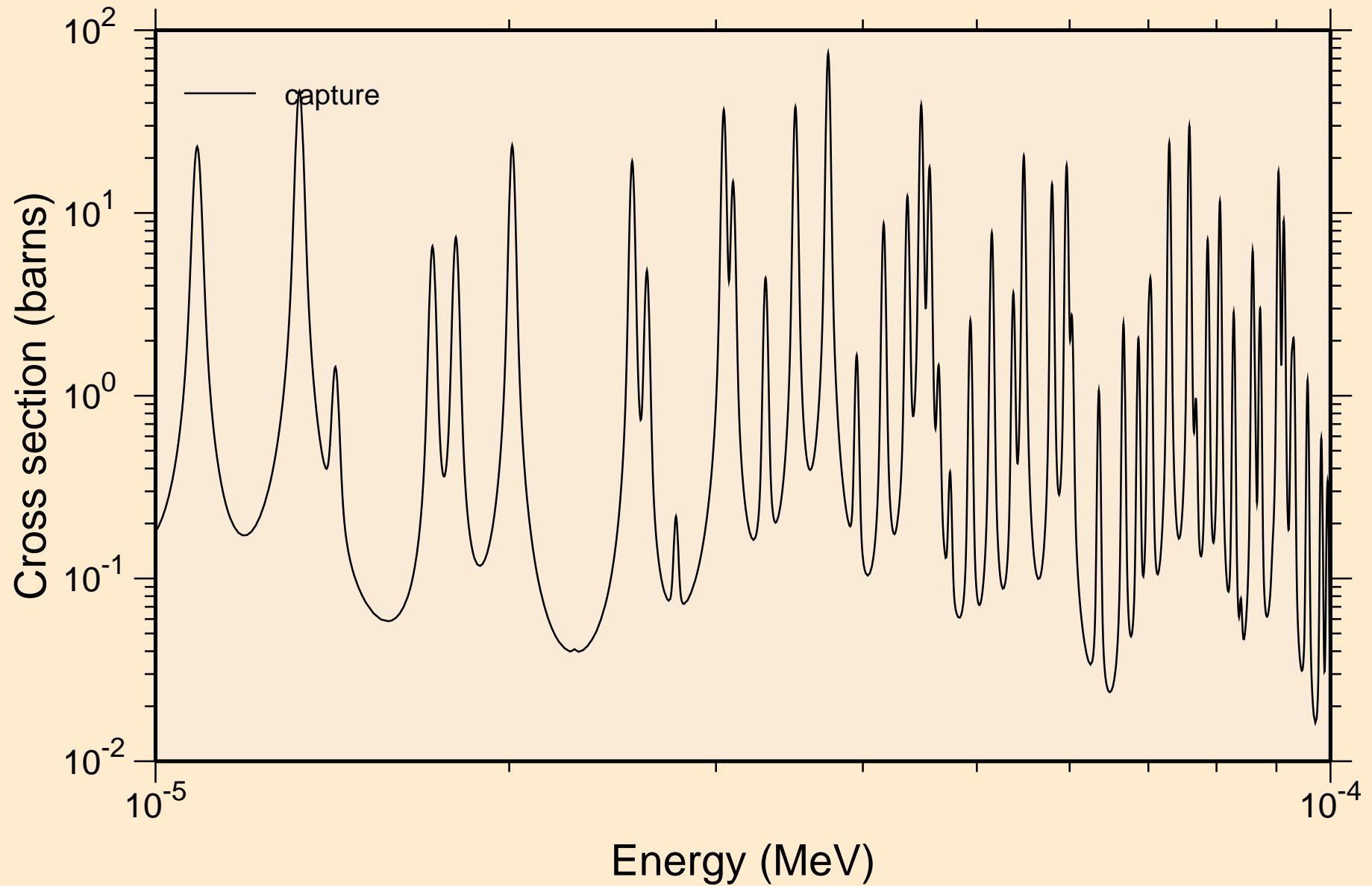

AU189 NRG TENDL-2015, AKONING
resonance absorption cross sections

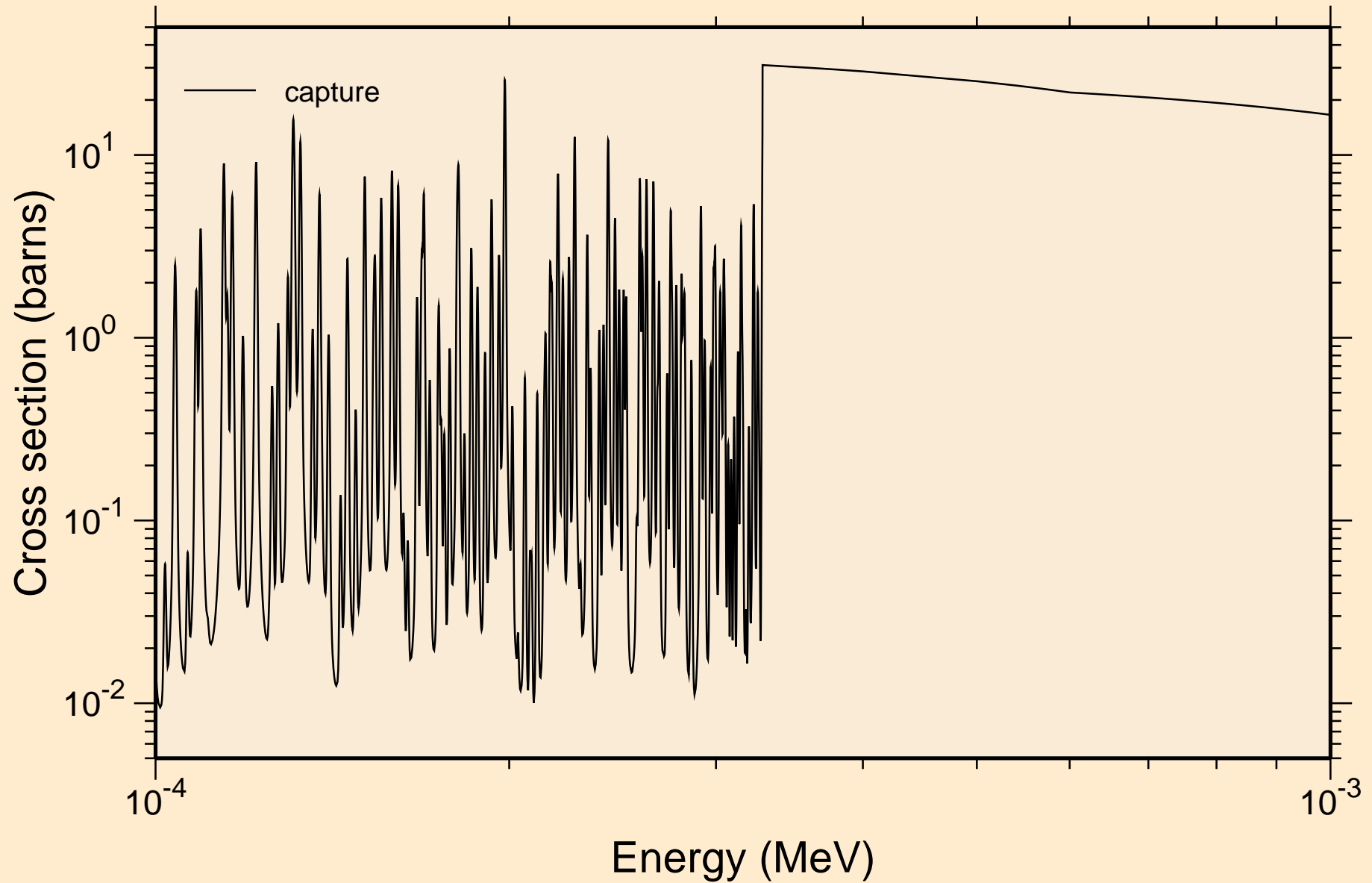

AU189 NRG TENDL-2015, AKONING
resonance absorption cross sections

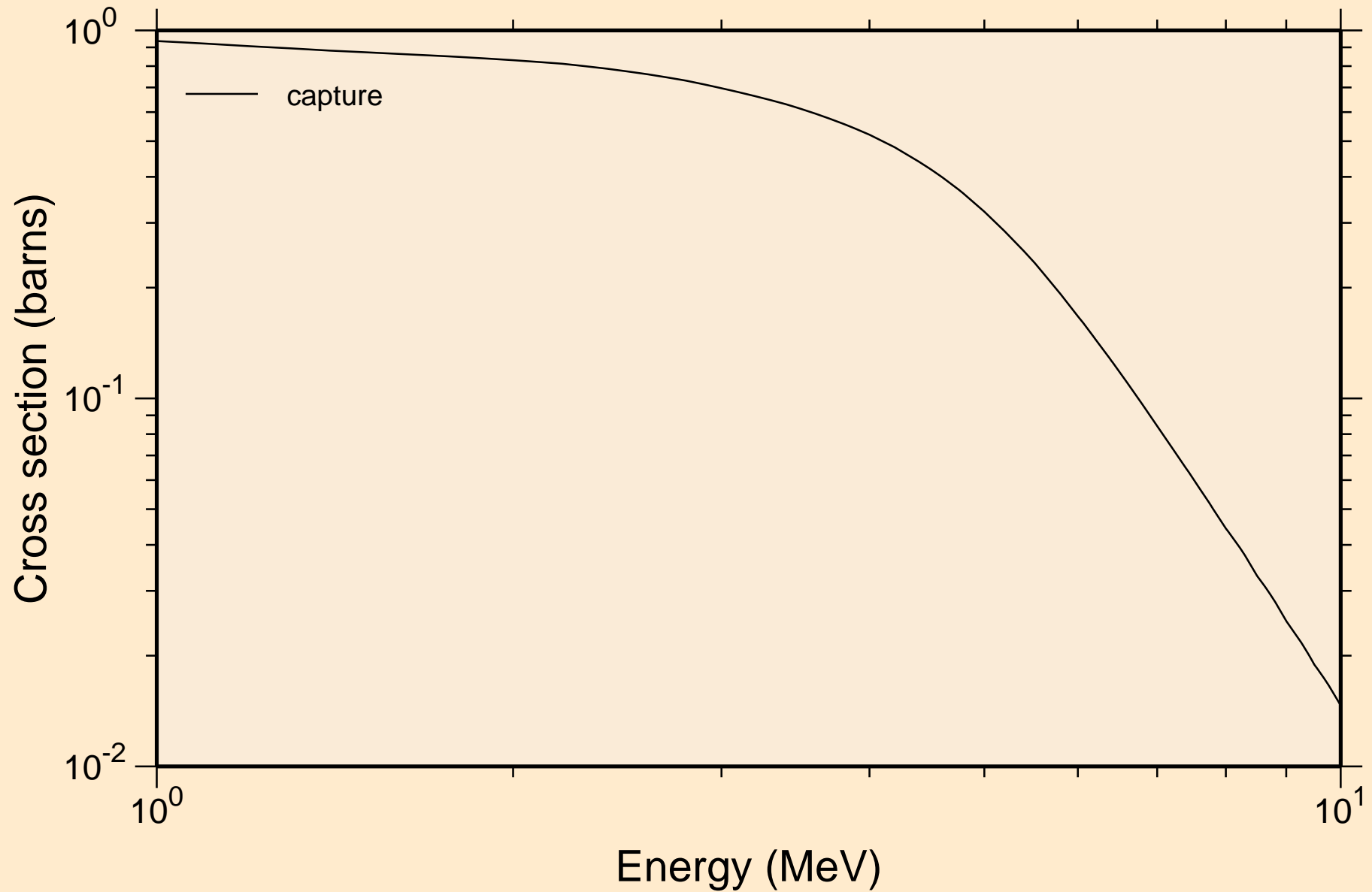

AU189 NRG TENDL-2015, AKONING

Non-threshold reactions

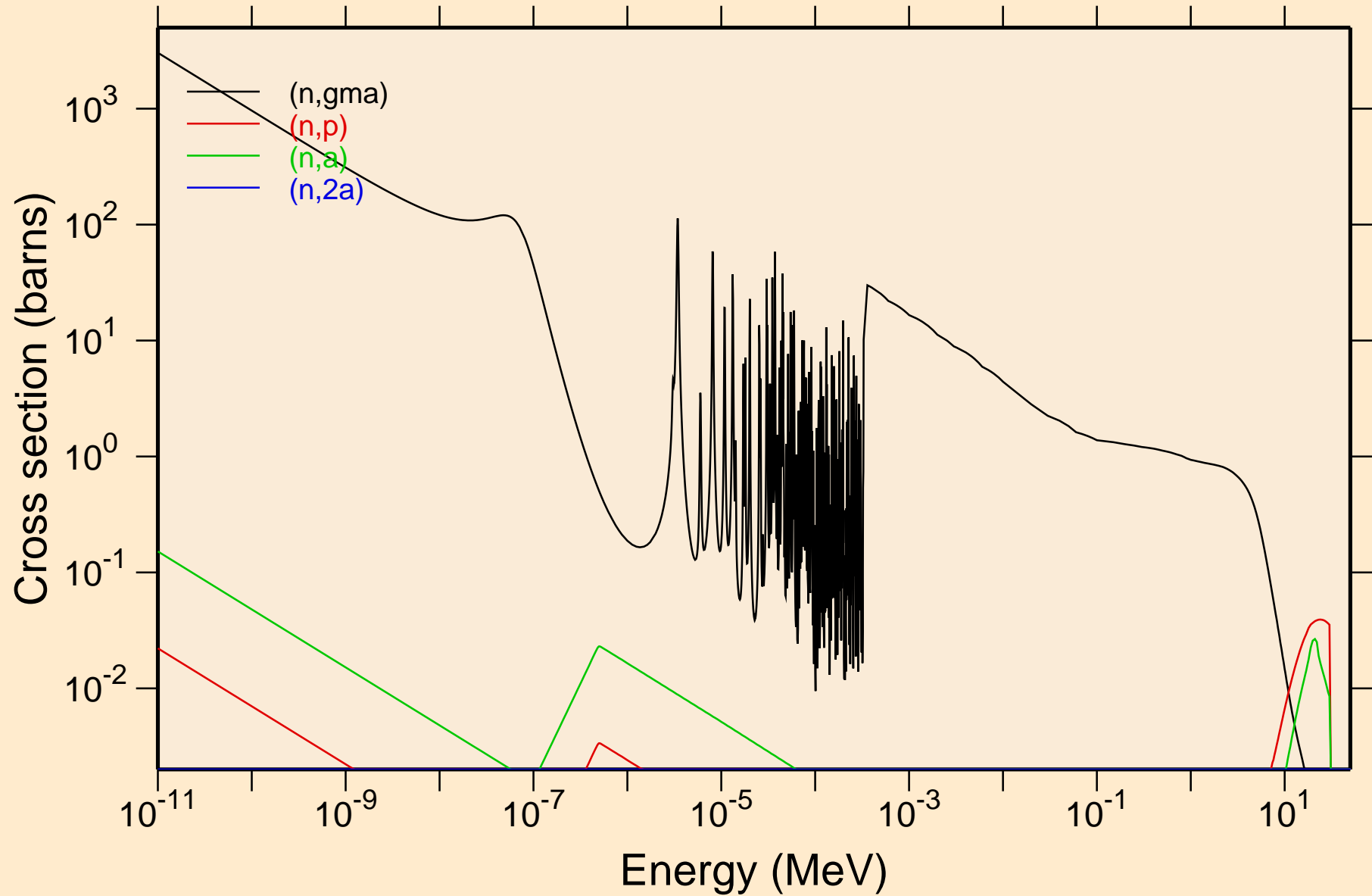

AU189 NRG TENDL-2015, AKONING

Principal cross sections

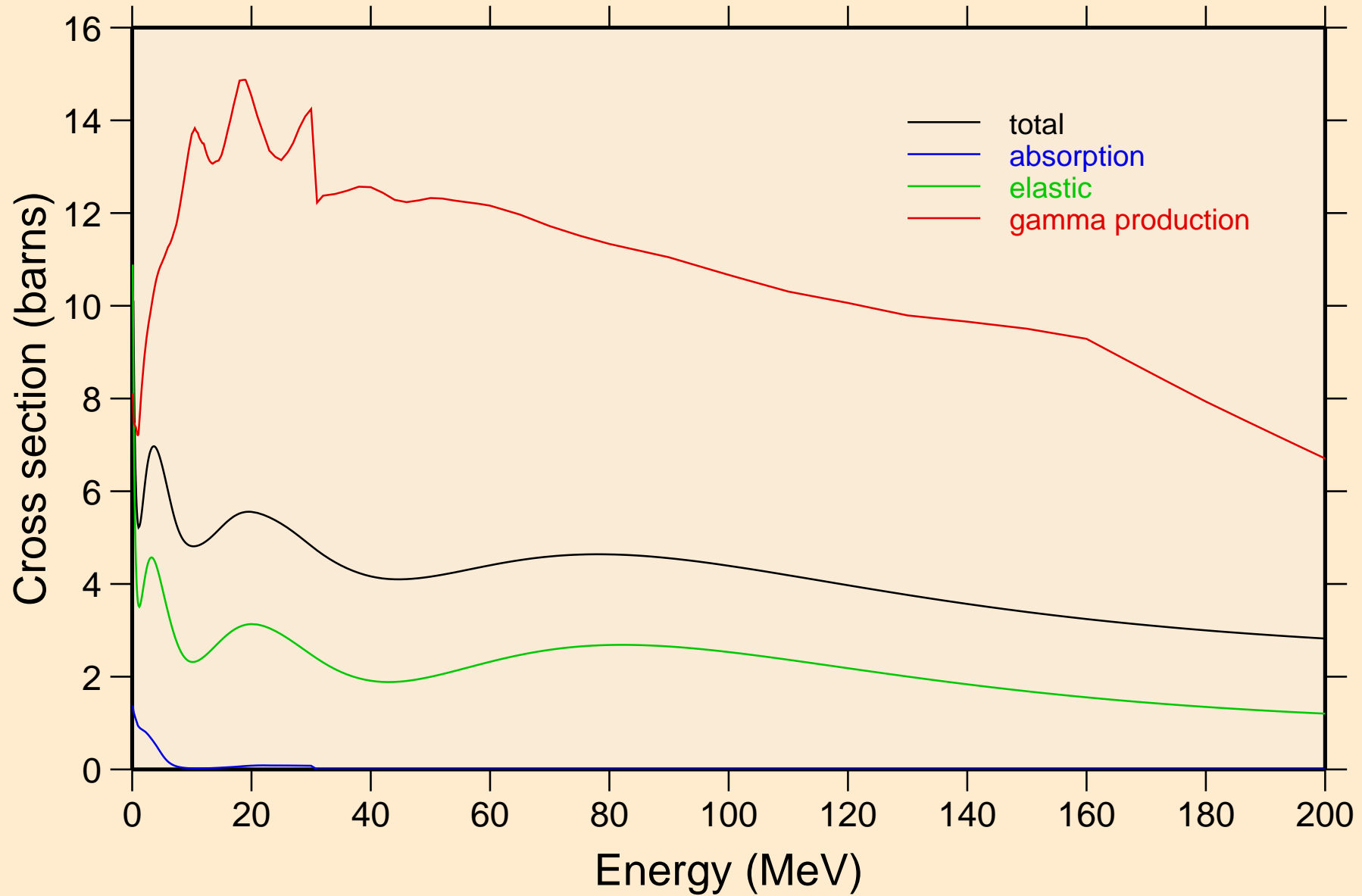

AU189 NRG TENDL-2015, AKONING

Non-threshold reactions

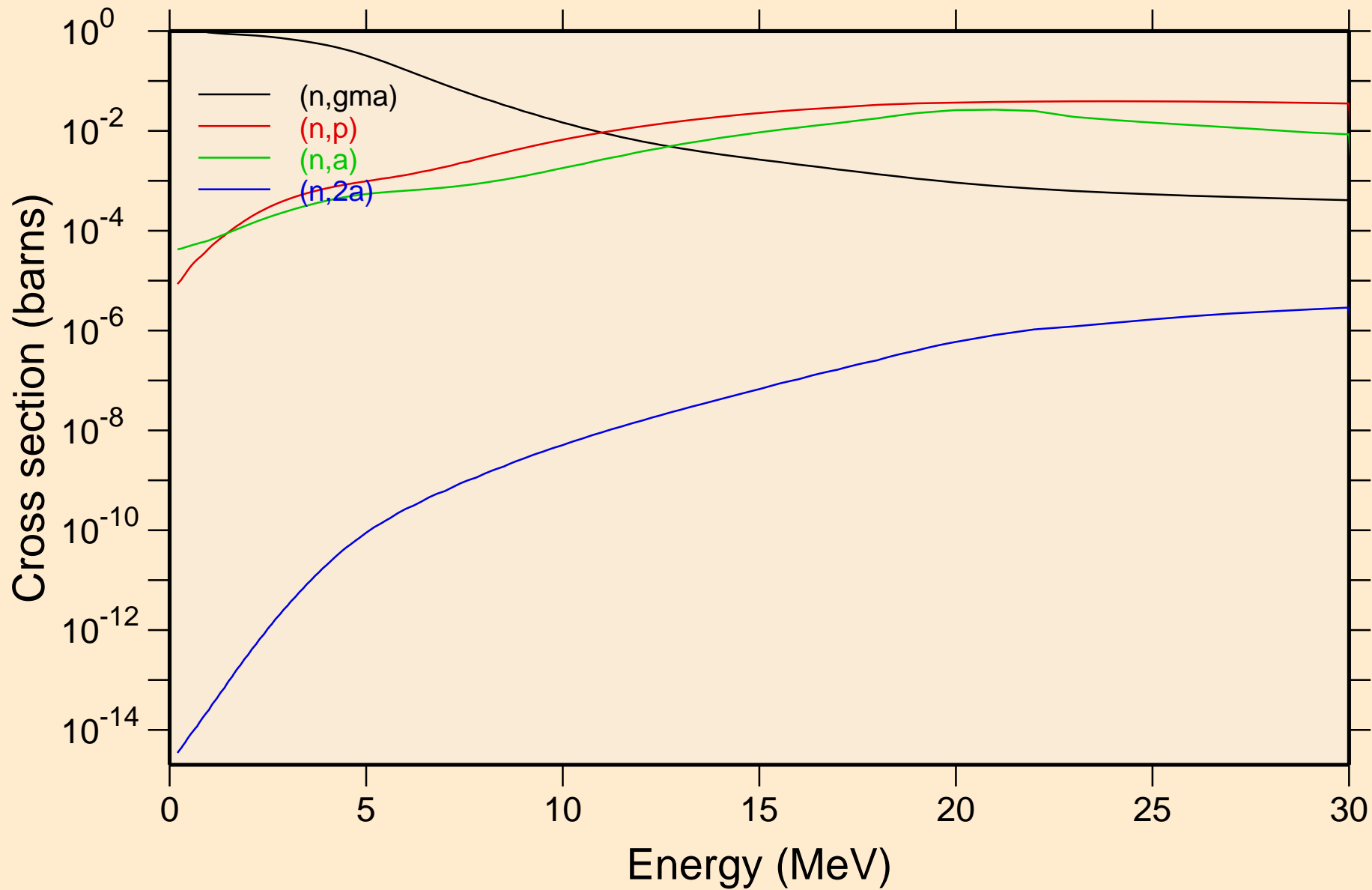

AU189 NRG TENDL-2015, AKONING

Inelastic levels

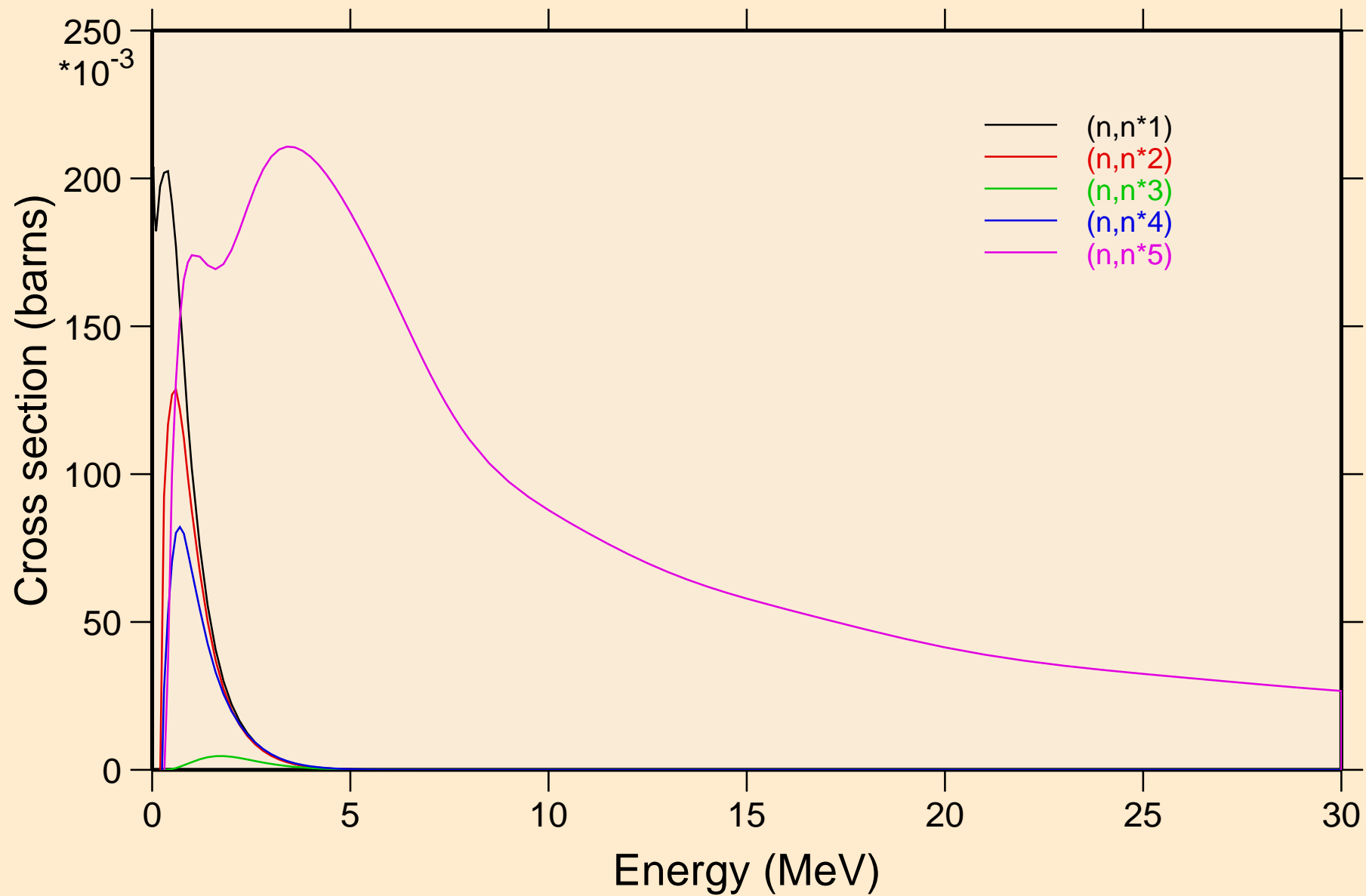

AU189 NRG TENDL-2015, AKONING

Inelastic levels

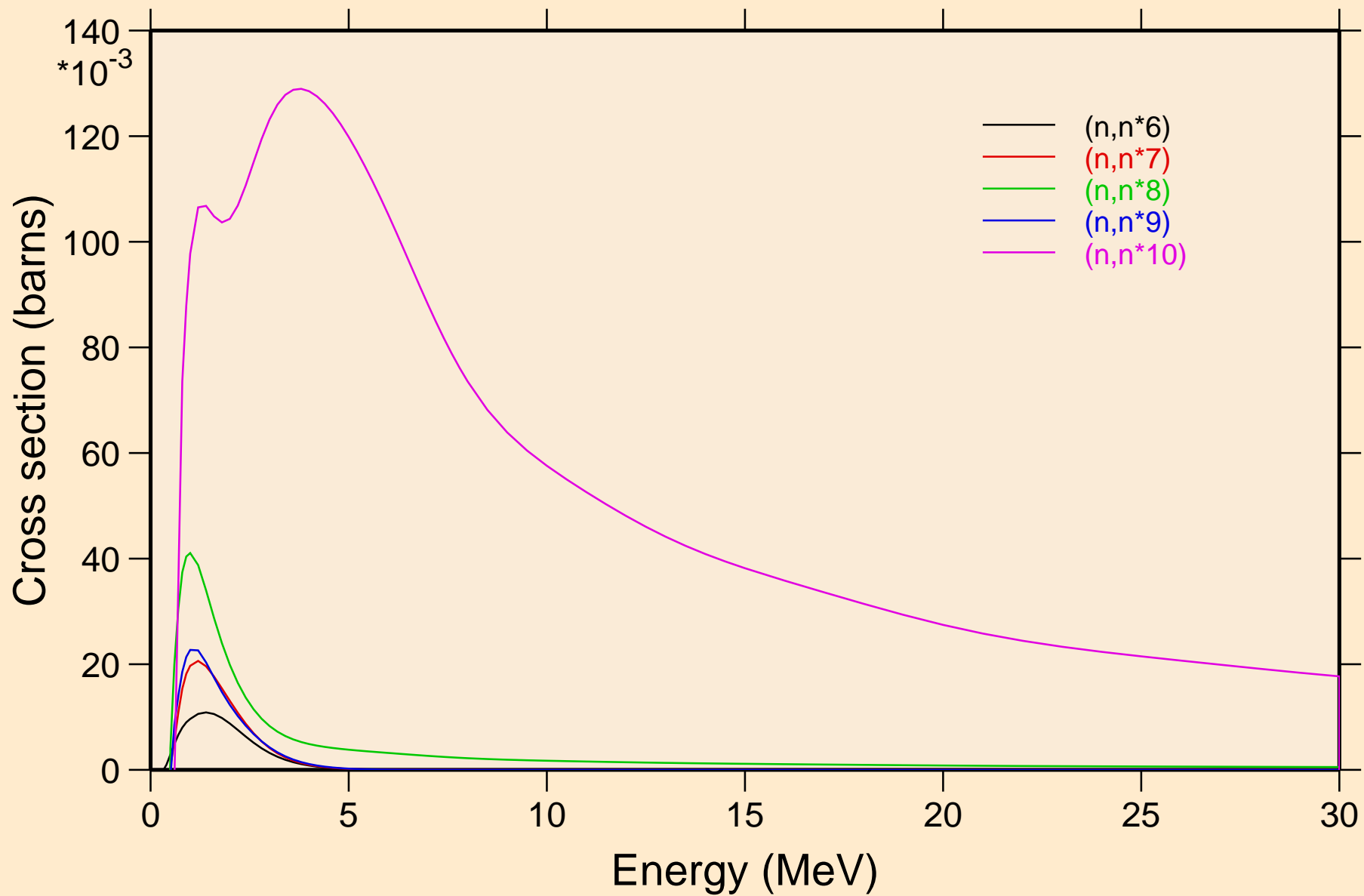

AU189 NRG TENDL-2015, AKONING

Inelastic levels

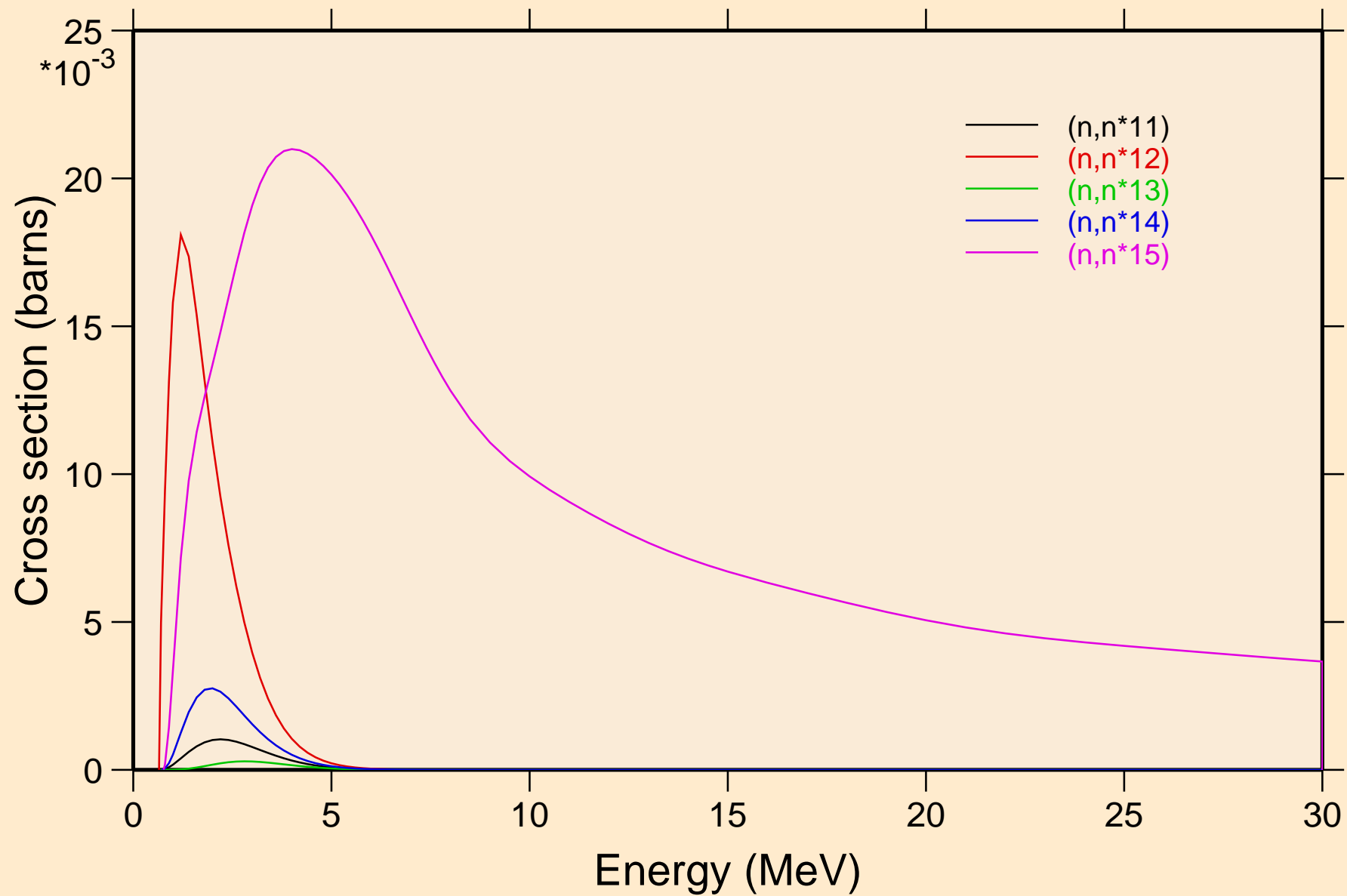

AU189 NRG TENDL-2015, AKONING

Inelastic levels

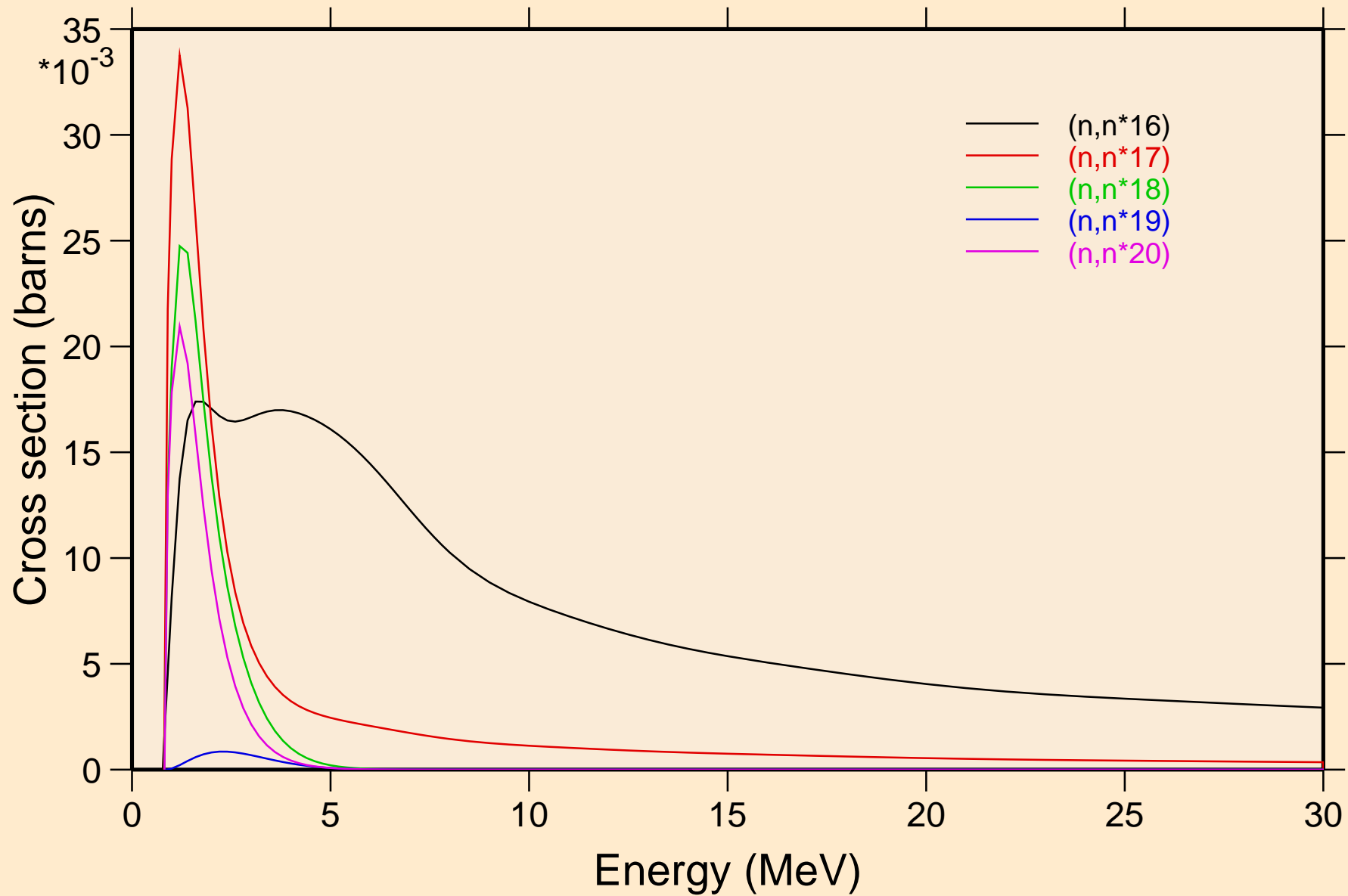

AU189 NRG TENDL-2015, AKONING

Inelastic levels

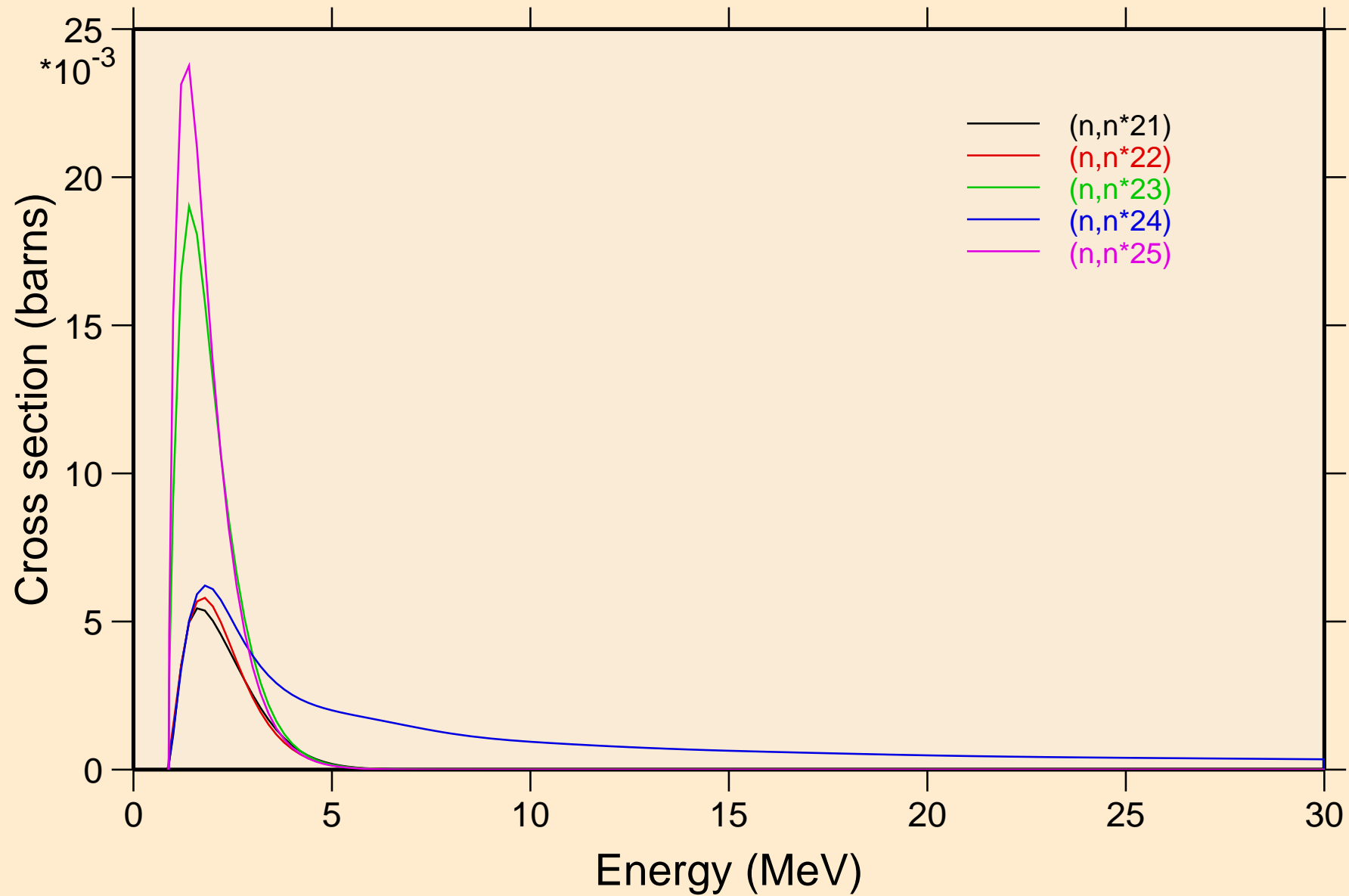

AU189 NRG TENDL-2015, AKONING

Inelastic levels

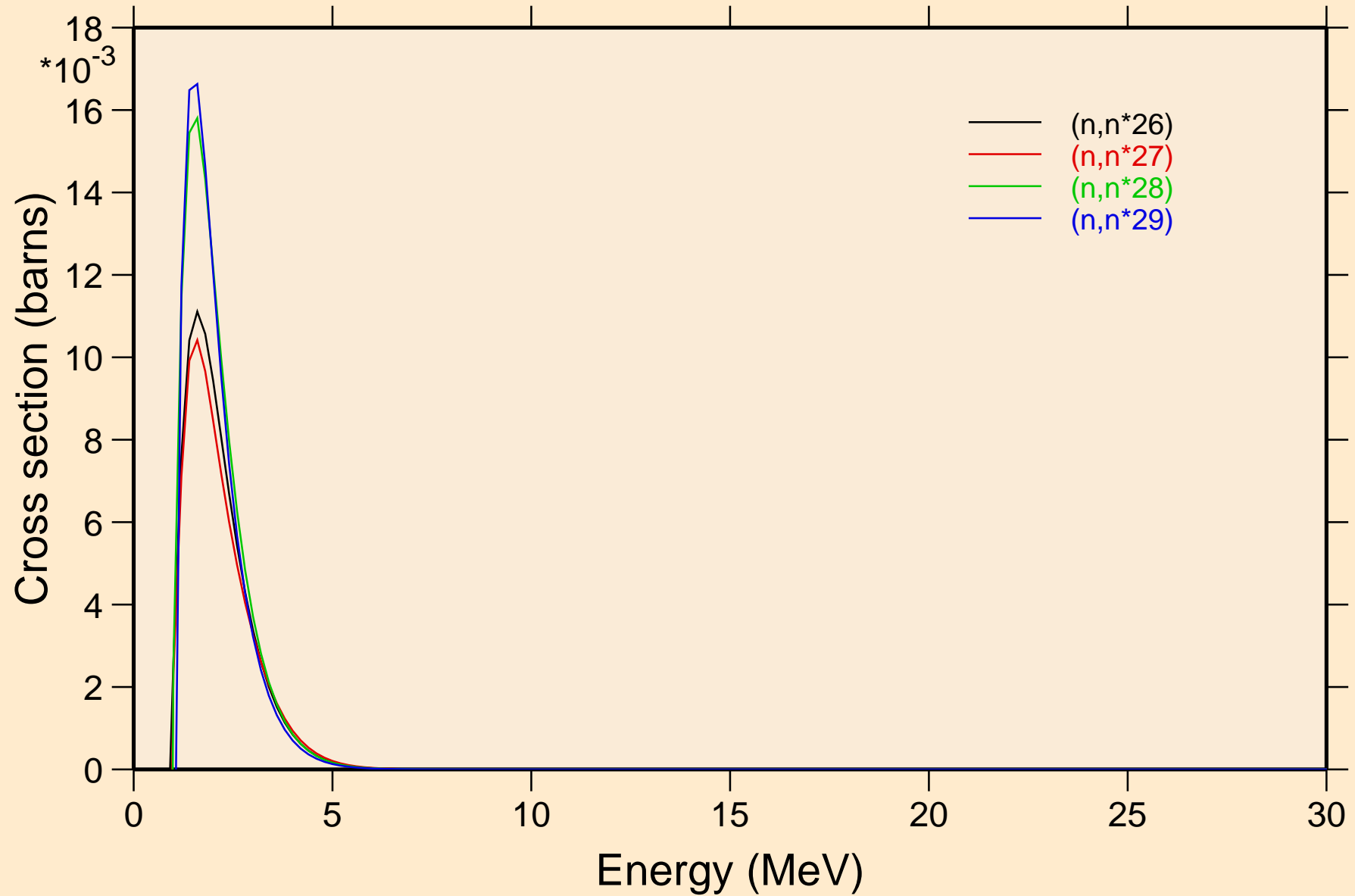

AU189 NRG TENDL-2015, AKONING

Threshold reactions

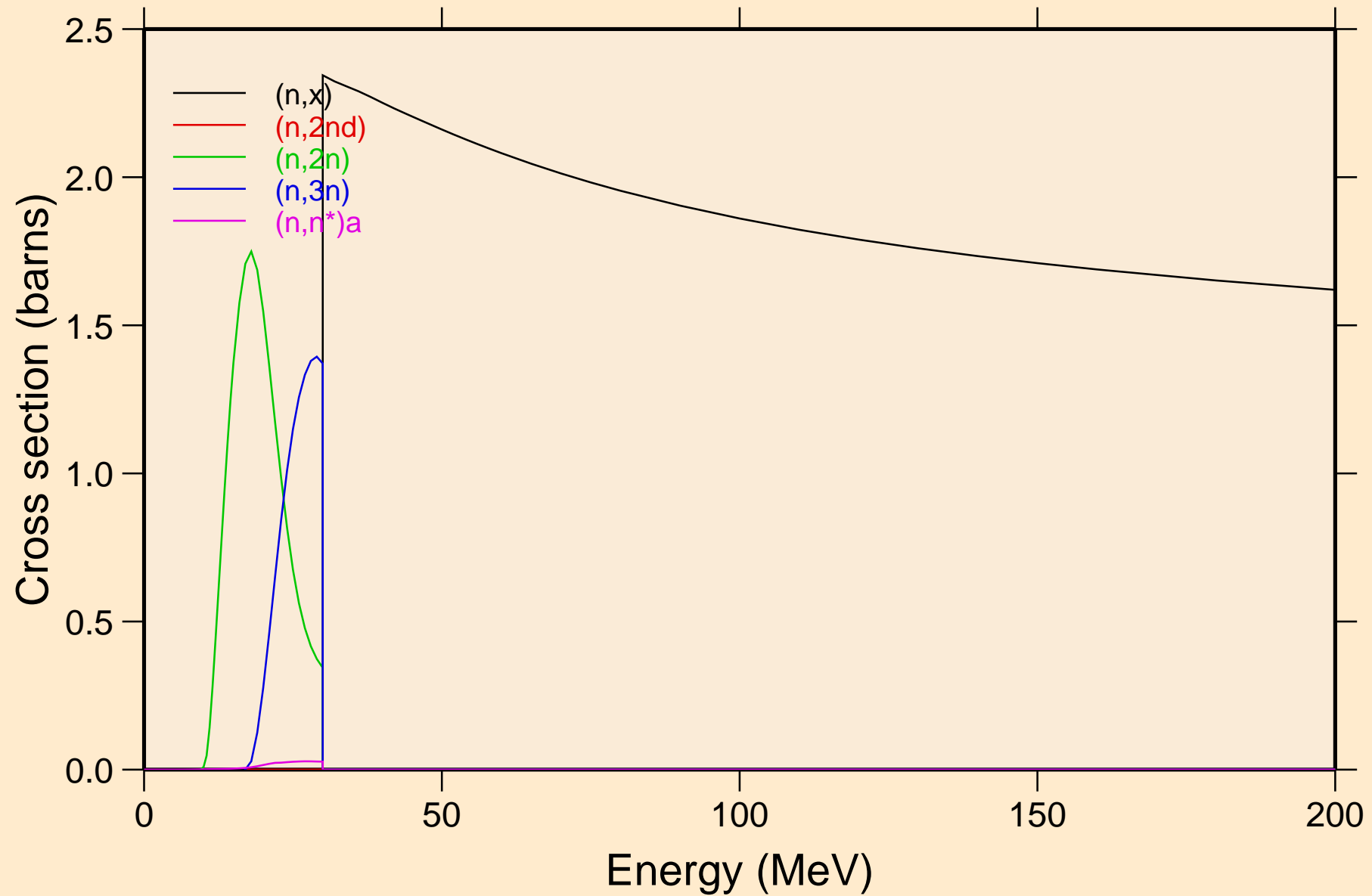

AU189 NRG TENDL-2015, AKONING

Threshold reactions

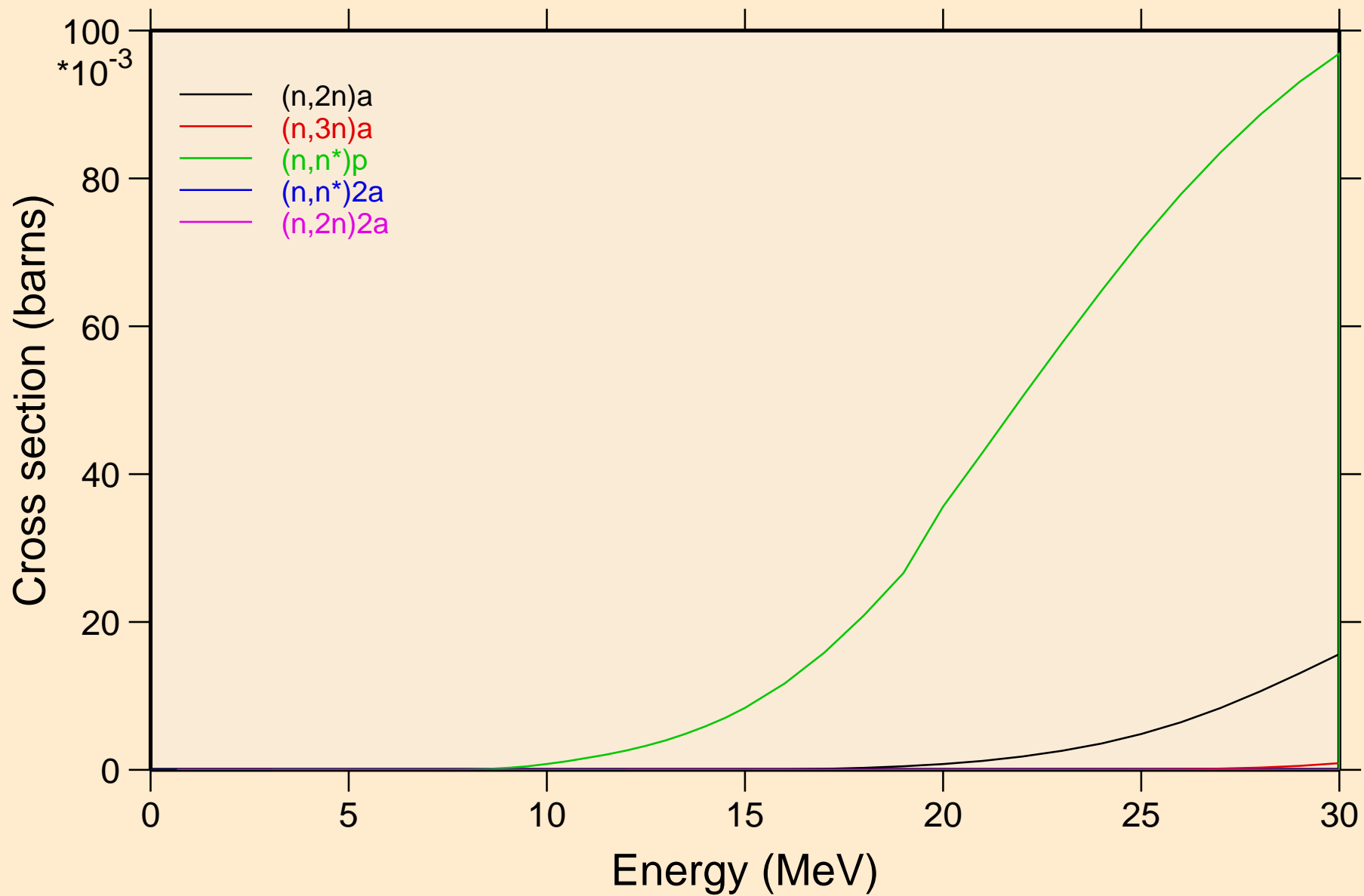

AU189 NRG TENDL-2015, AKONING

Threshold reactions

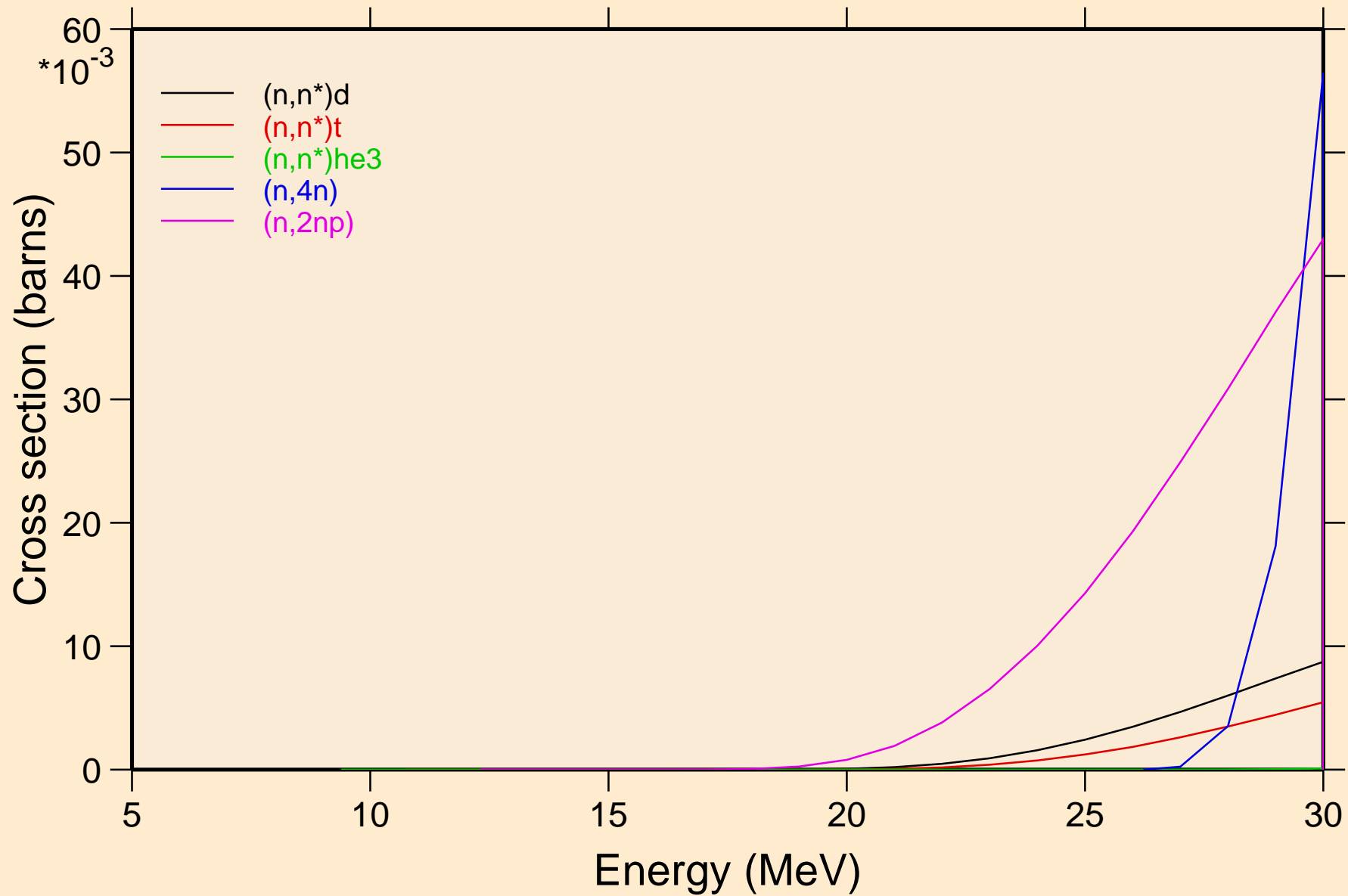

AU189 NRG TENDL-2015, AKONING

Threshold reactions

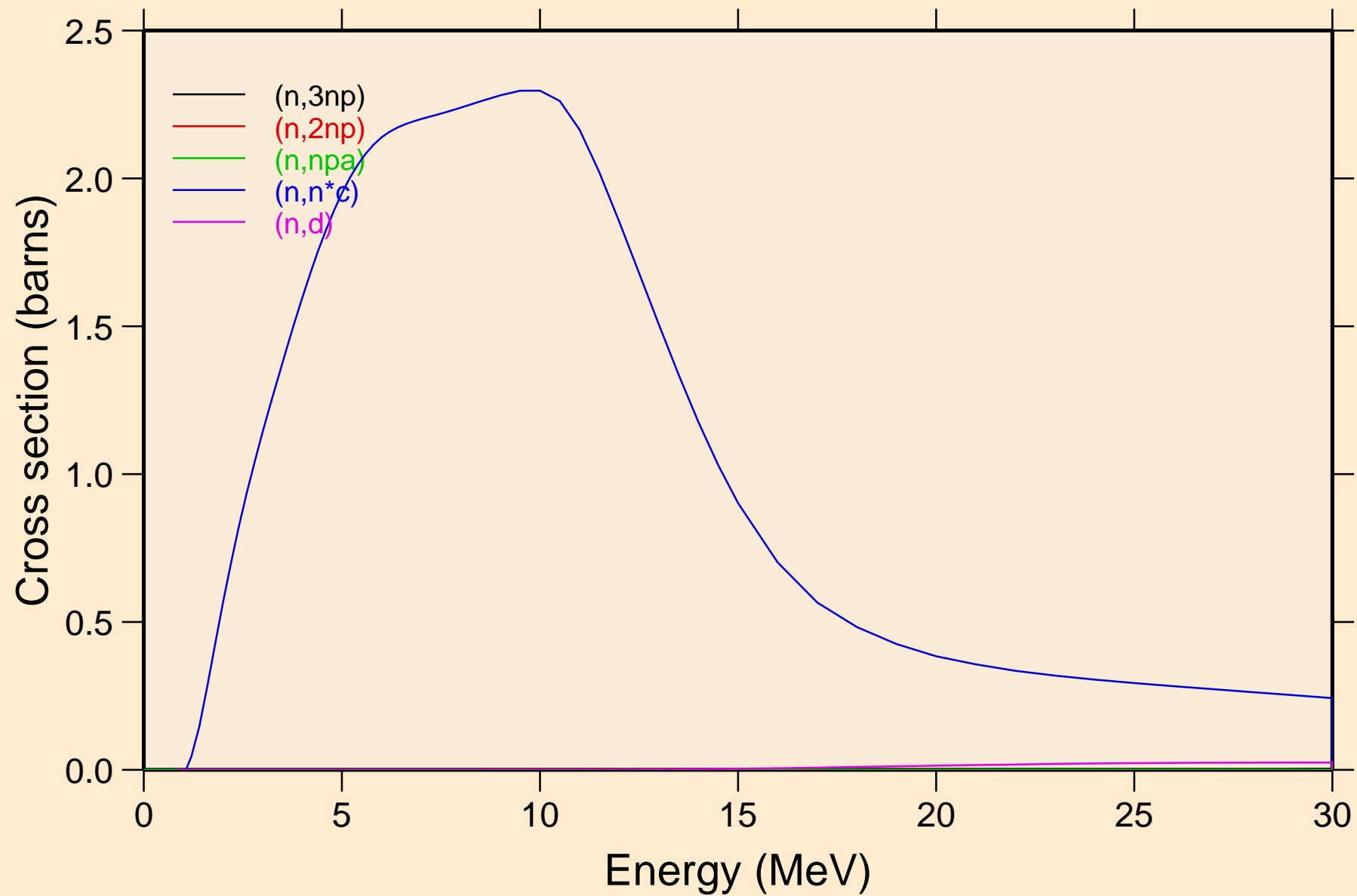

AU189 NRG TENDL-2015, AKONING

Threshold reactions

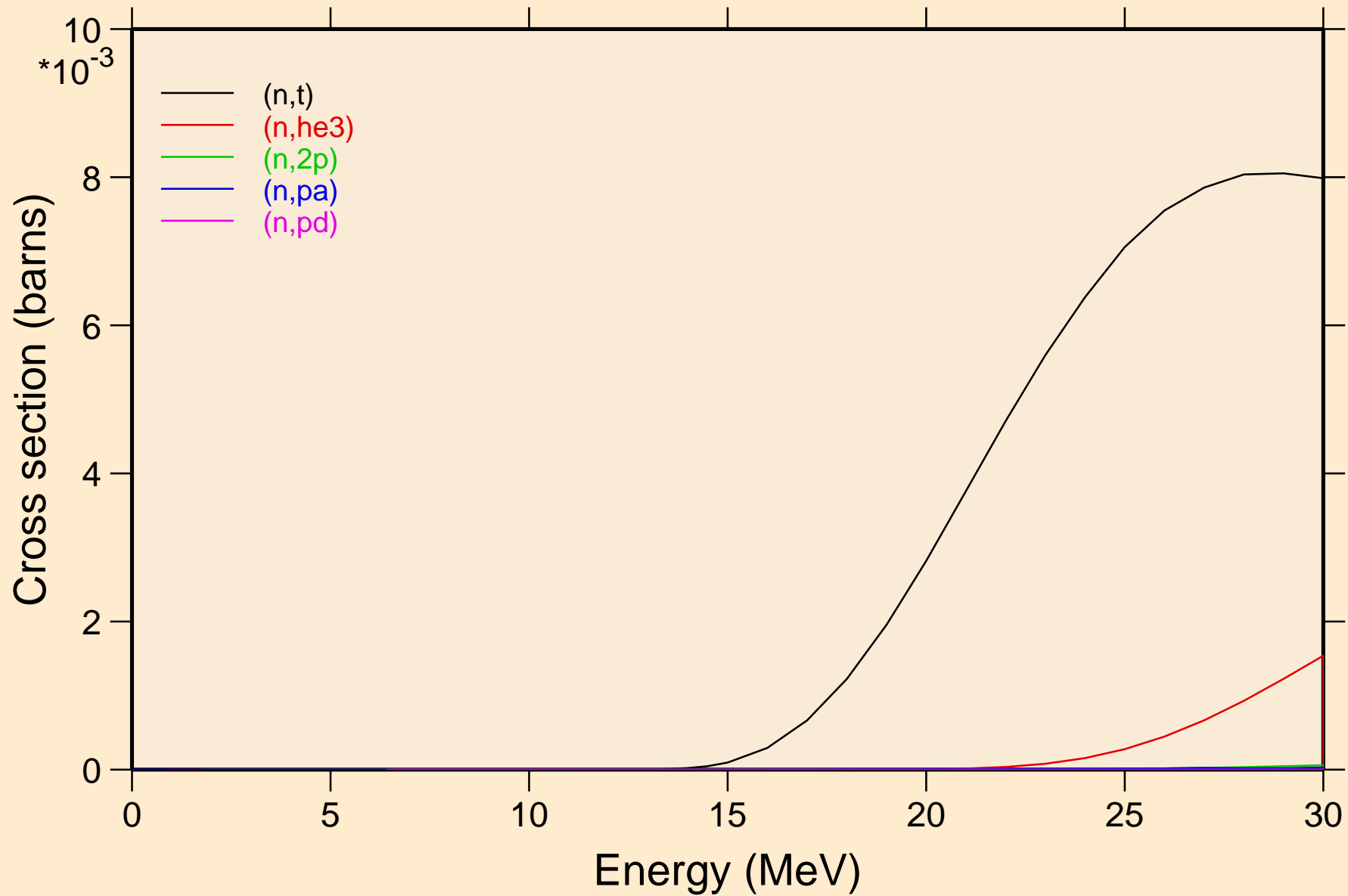

AU189 NRG TENDL-2015, AKONING

Threshold reactions

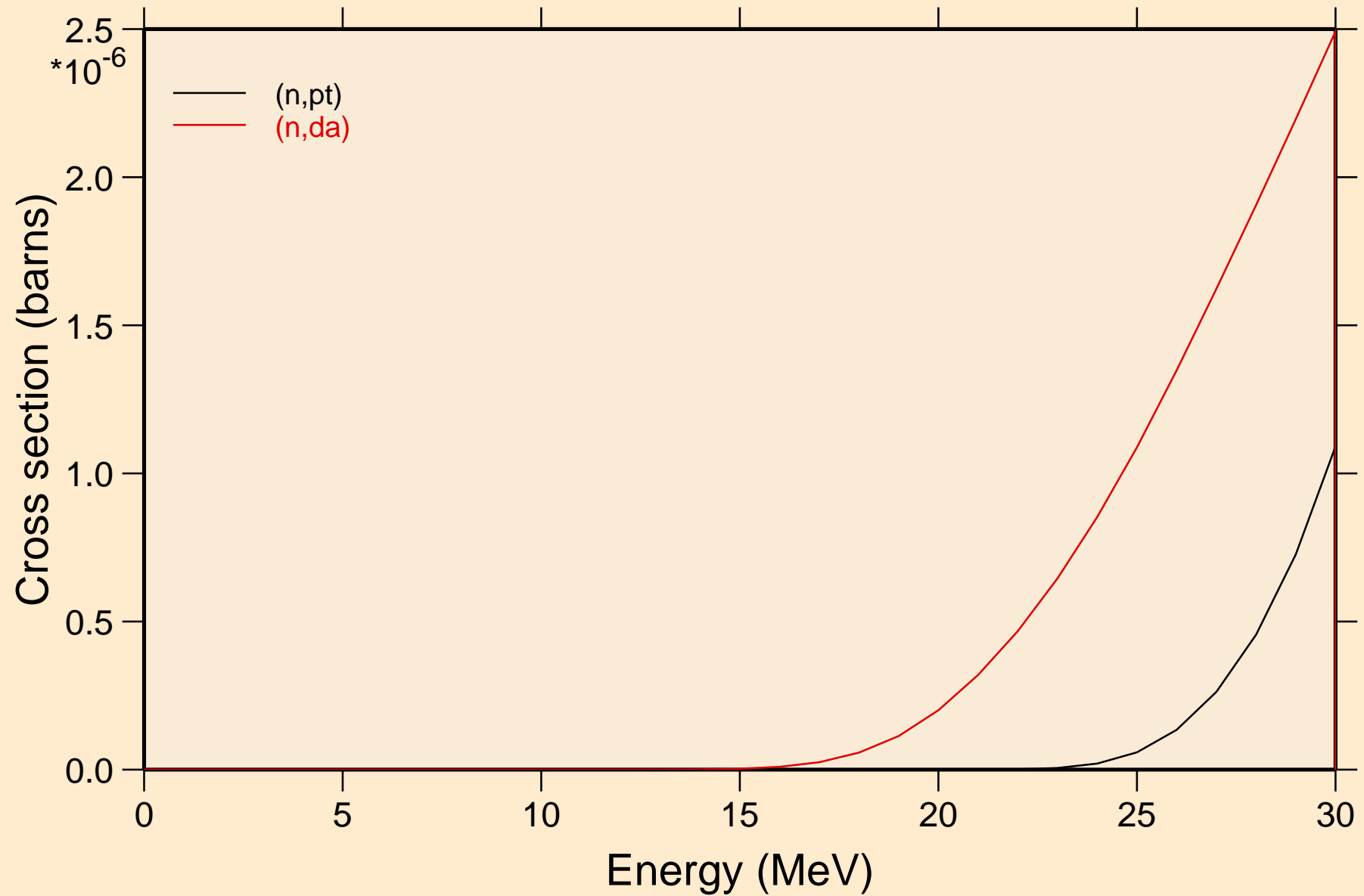

AU189 NRG TENDL-2015, AKONING
angular distribution for elastic

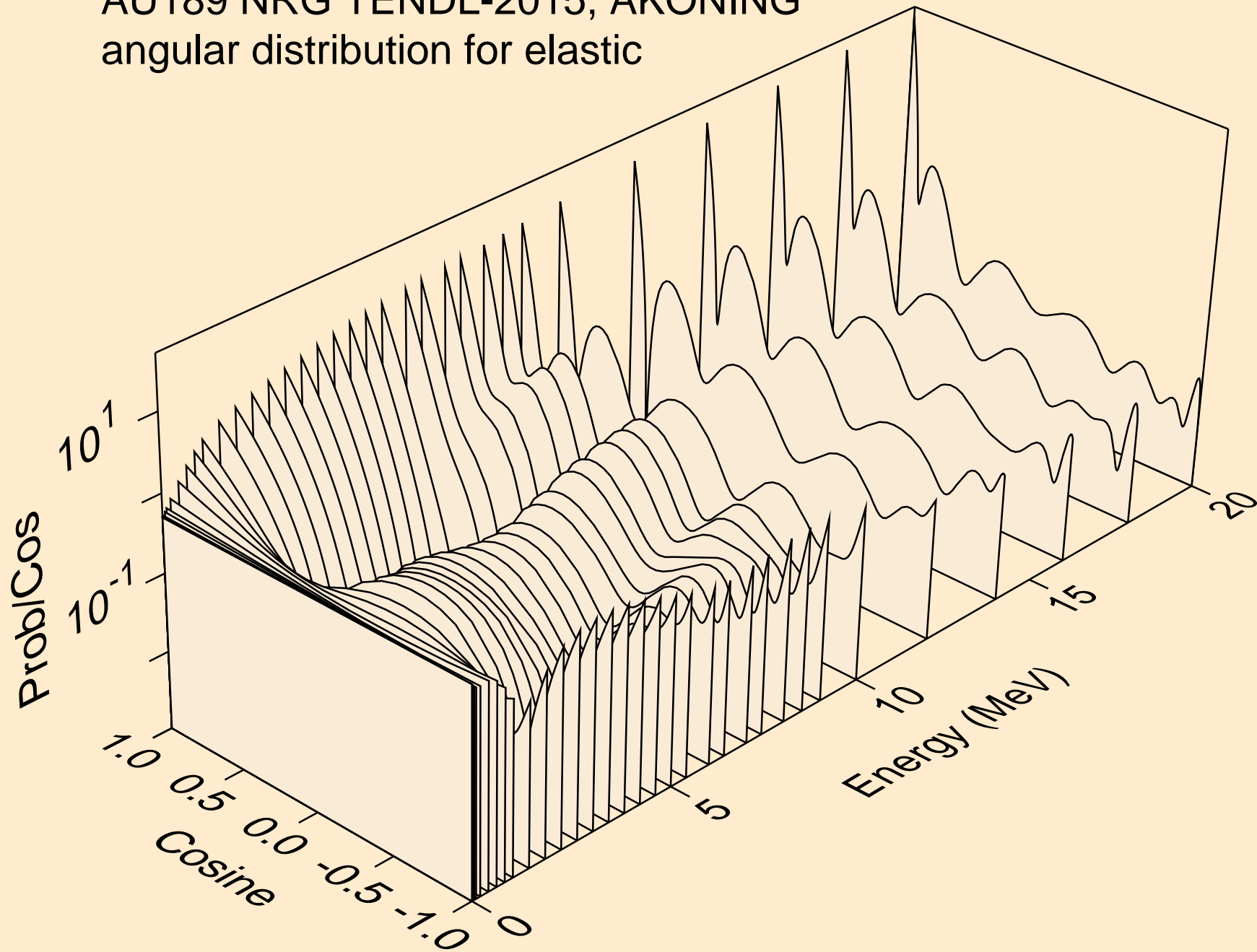

AU189 NRG TENDL-2015, AKONING
angular distribution for elastic

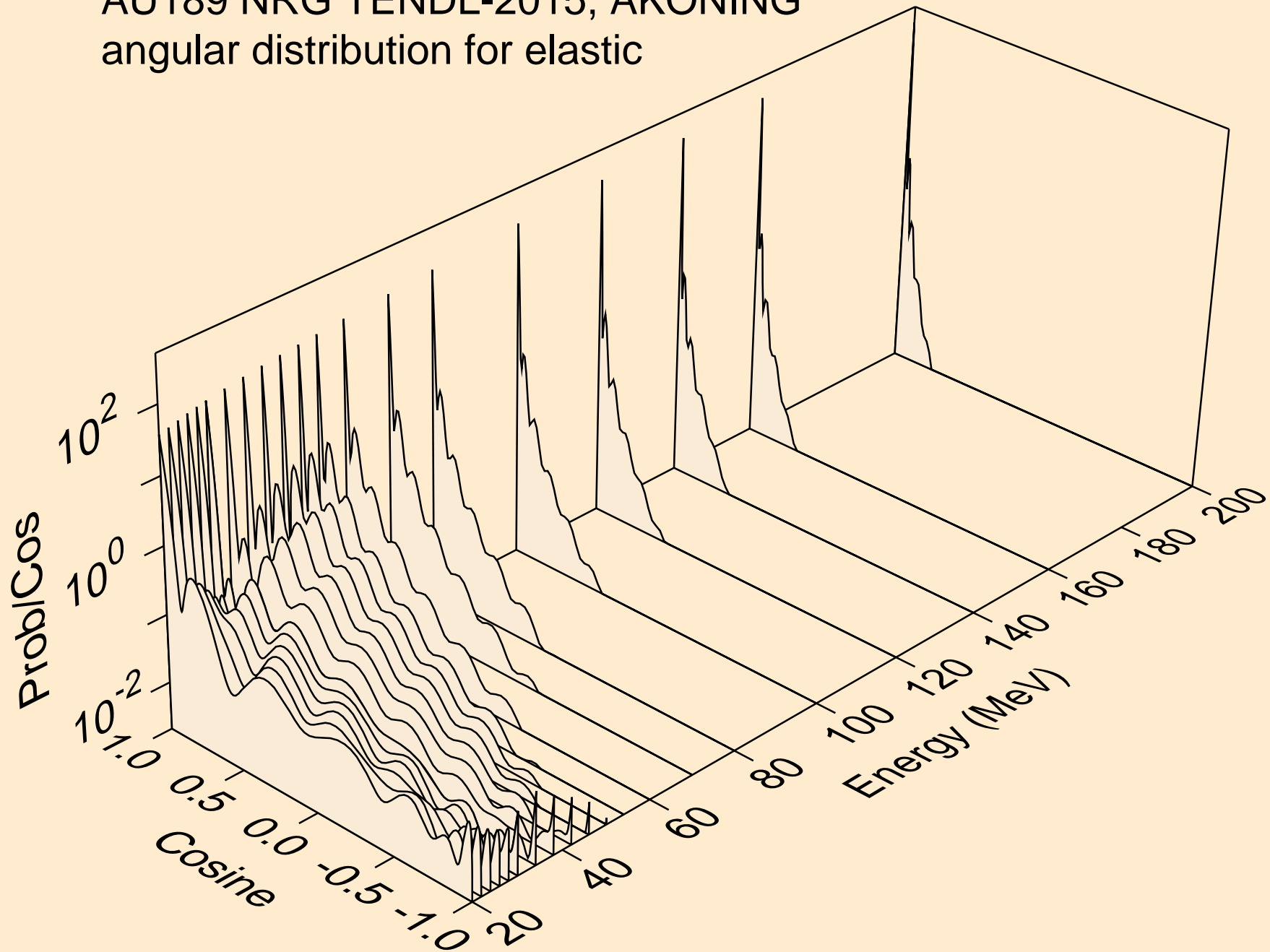

AU189 NRG TENDL-2015, AKONING
angular distribution for (n,n*1)

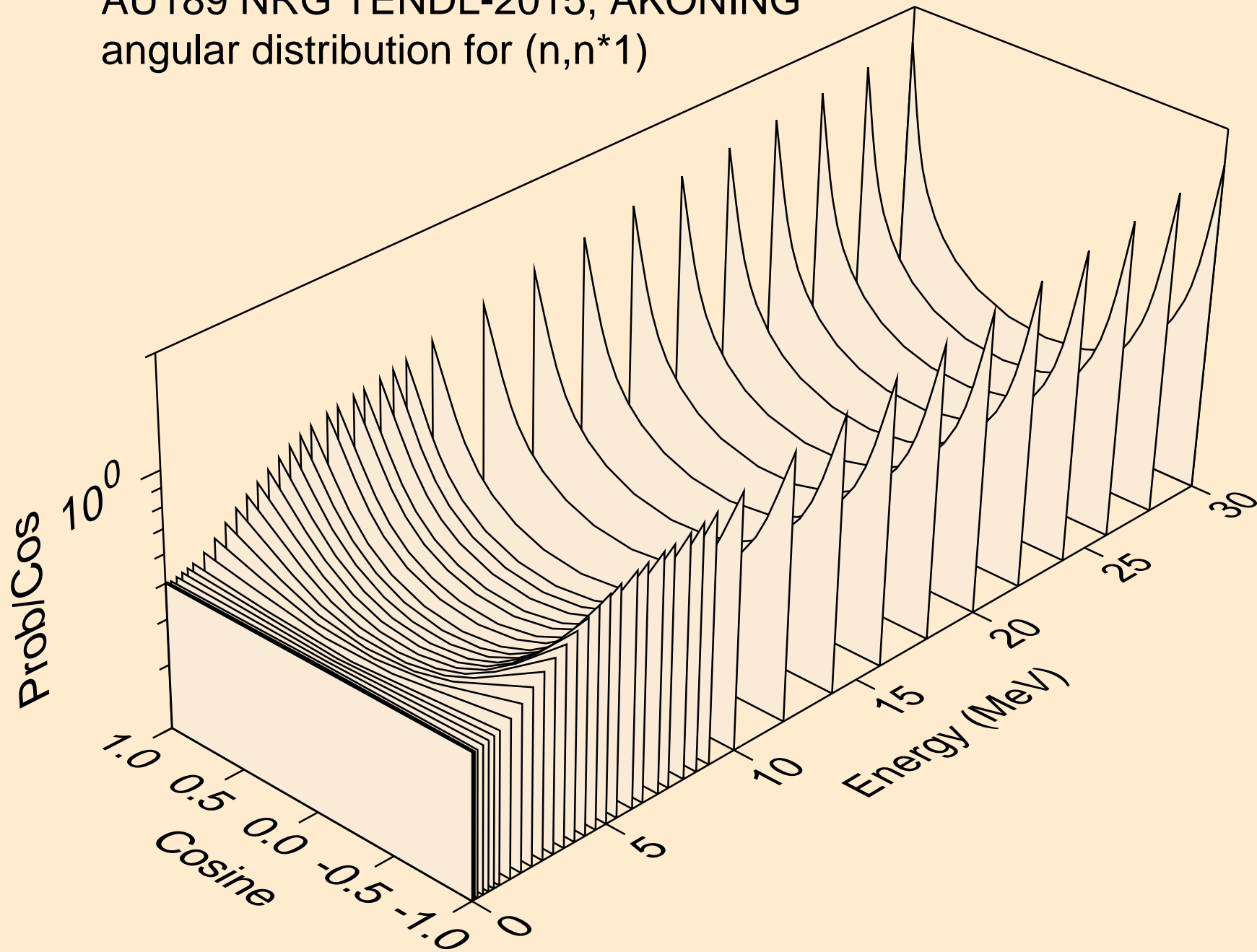

AU189 NRG TENDL-2015, AKONING
angular distribution for (n,n*2)

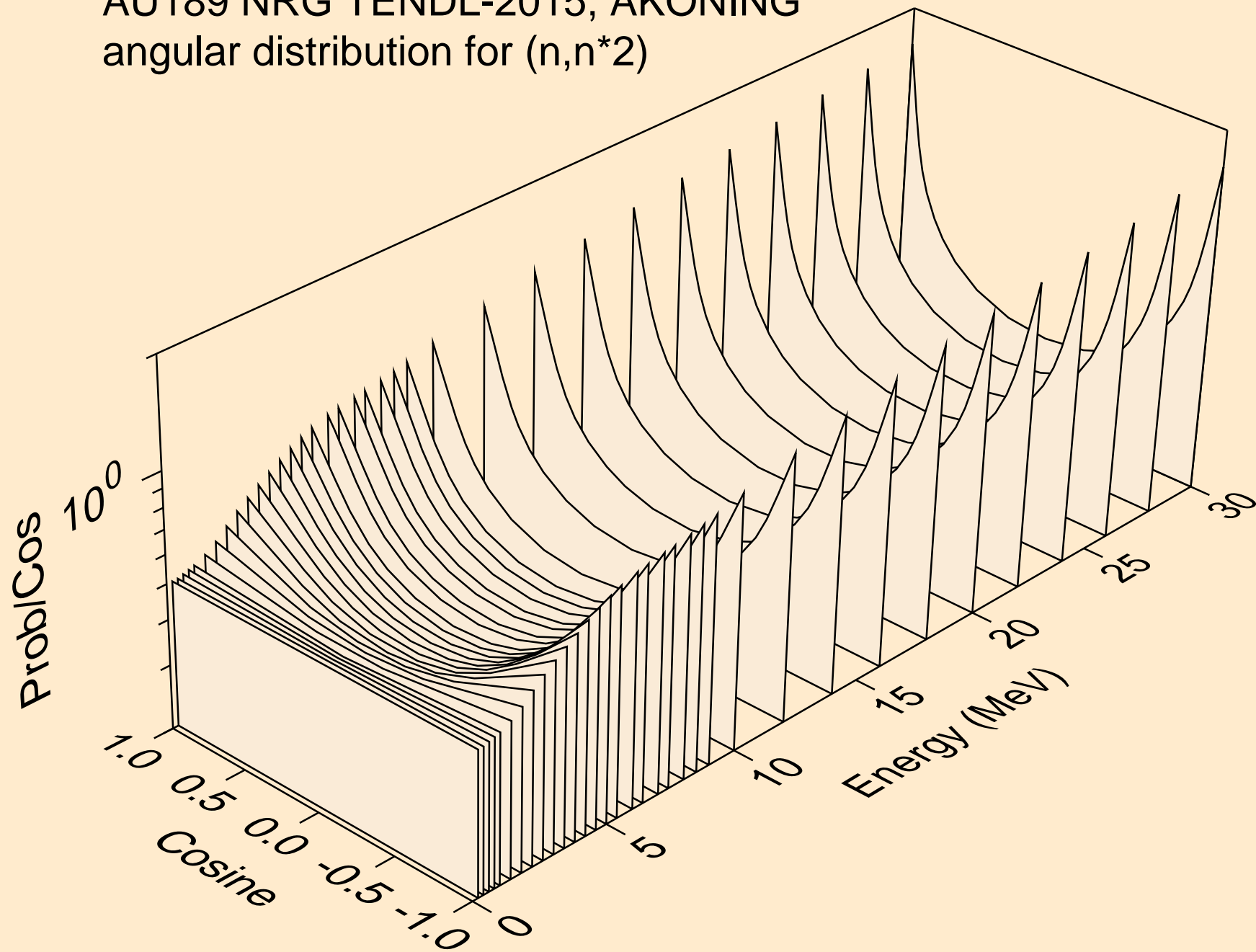

AU189 NRG TENDL-2015, AKONING
angular distribution for (n,n*3)

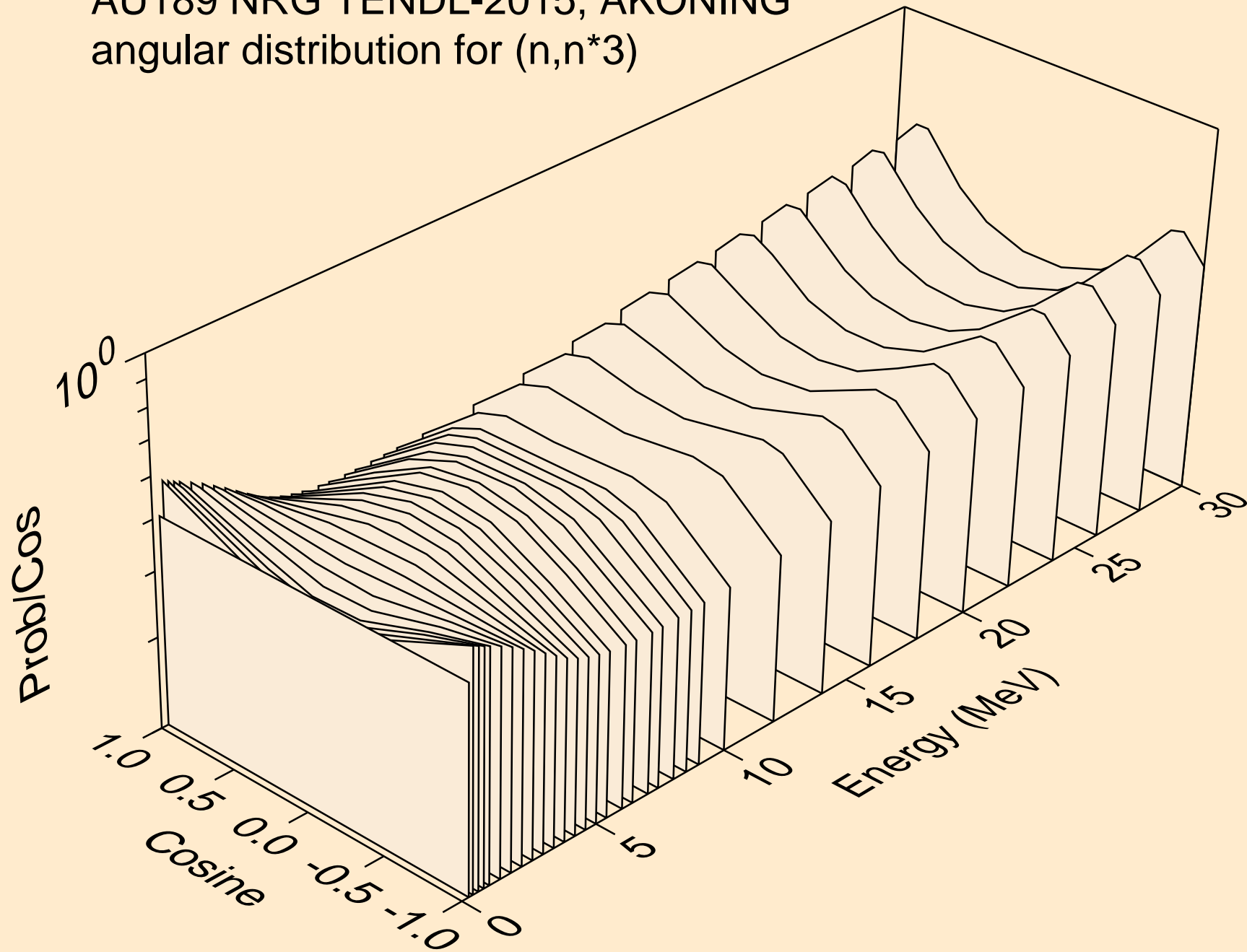

AU189 NRG TENDL-2015, AKONING
angular distribution for (n,n*4)

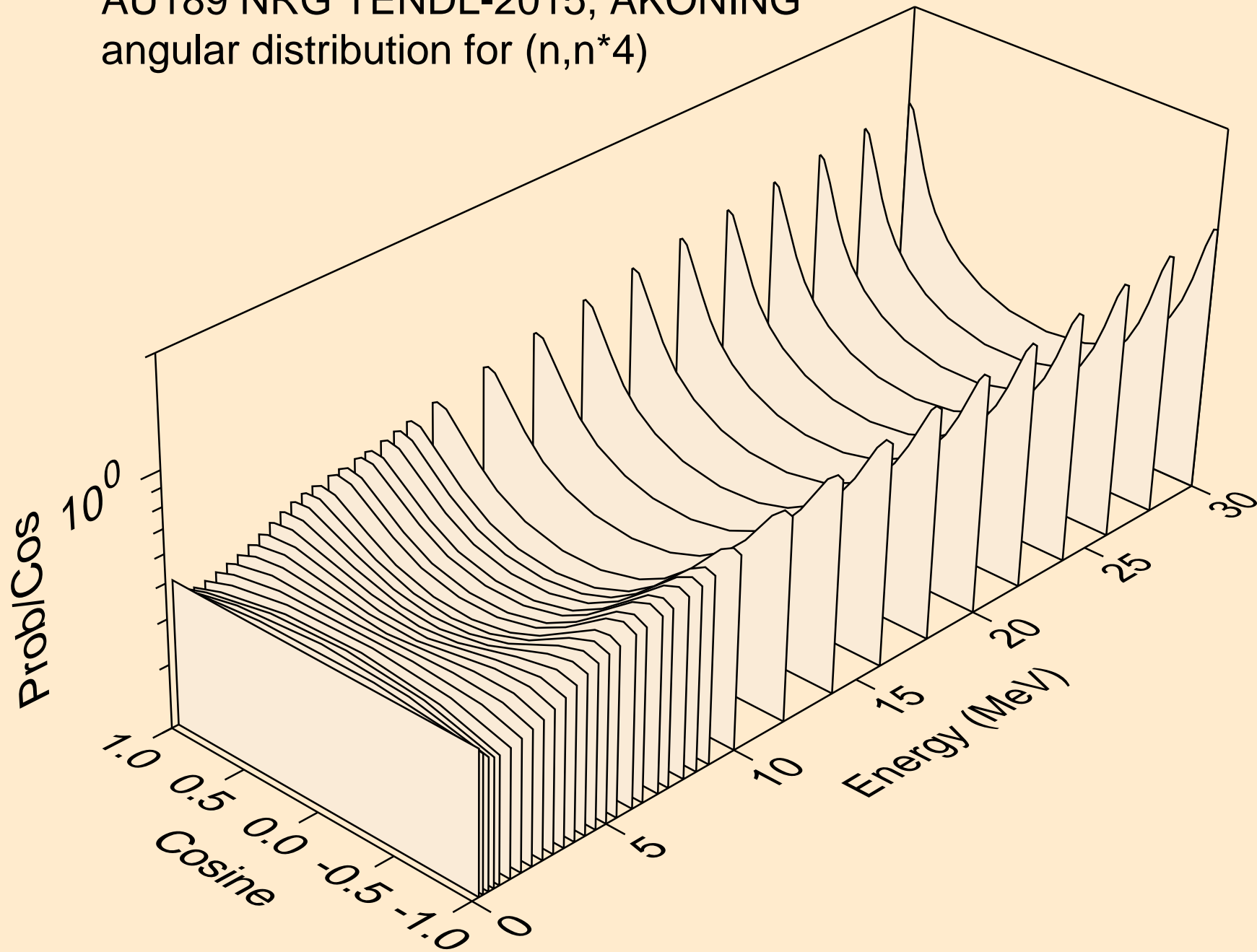

AU189 NRG TENDL-2015, AKONING
angular distribution for (n,n*5)

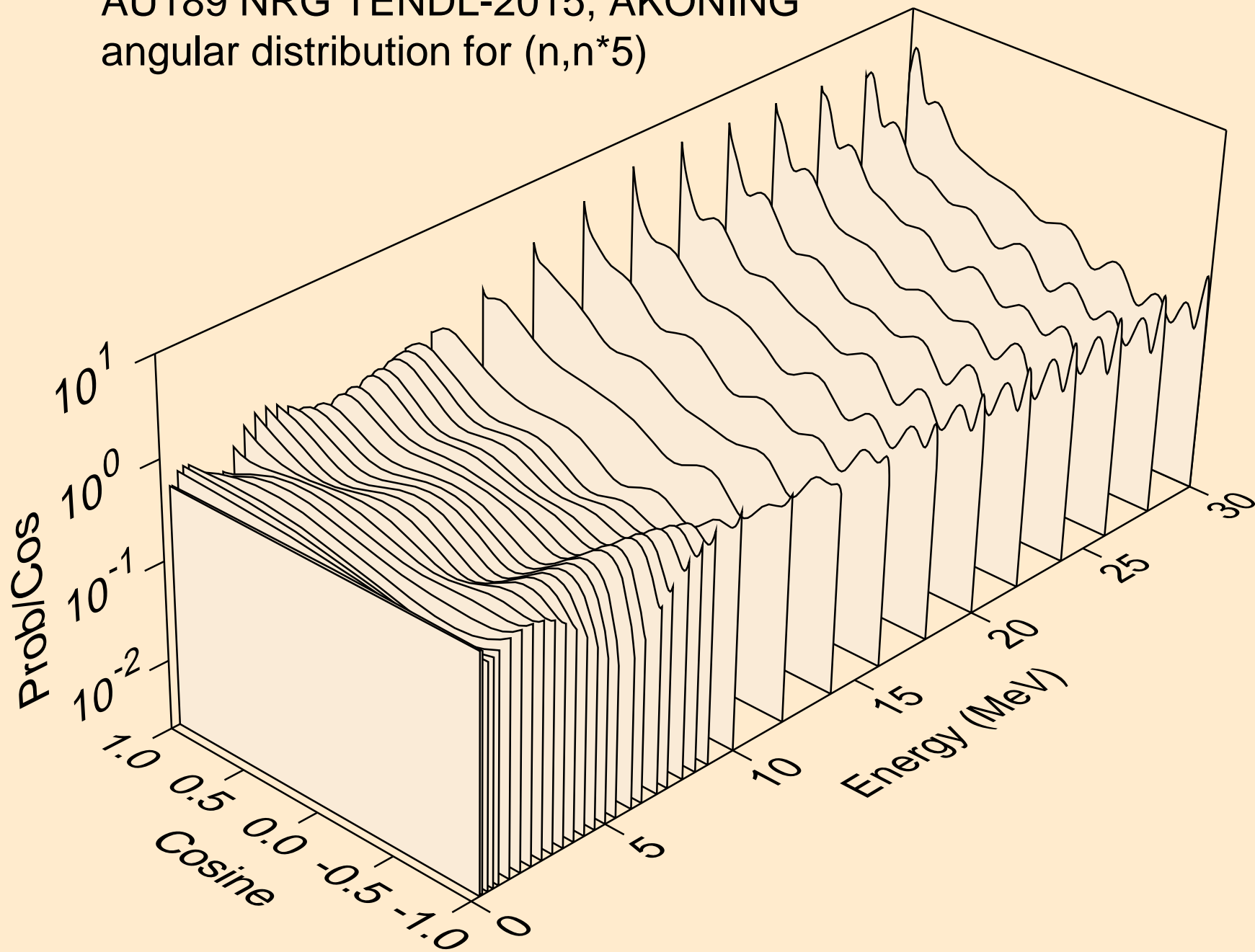

AU189 NRG TENDL-2015, AKONING
angular distribution for (n,n*6)

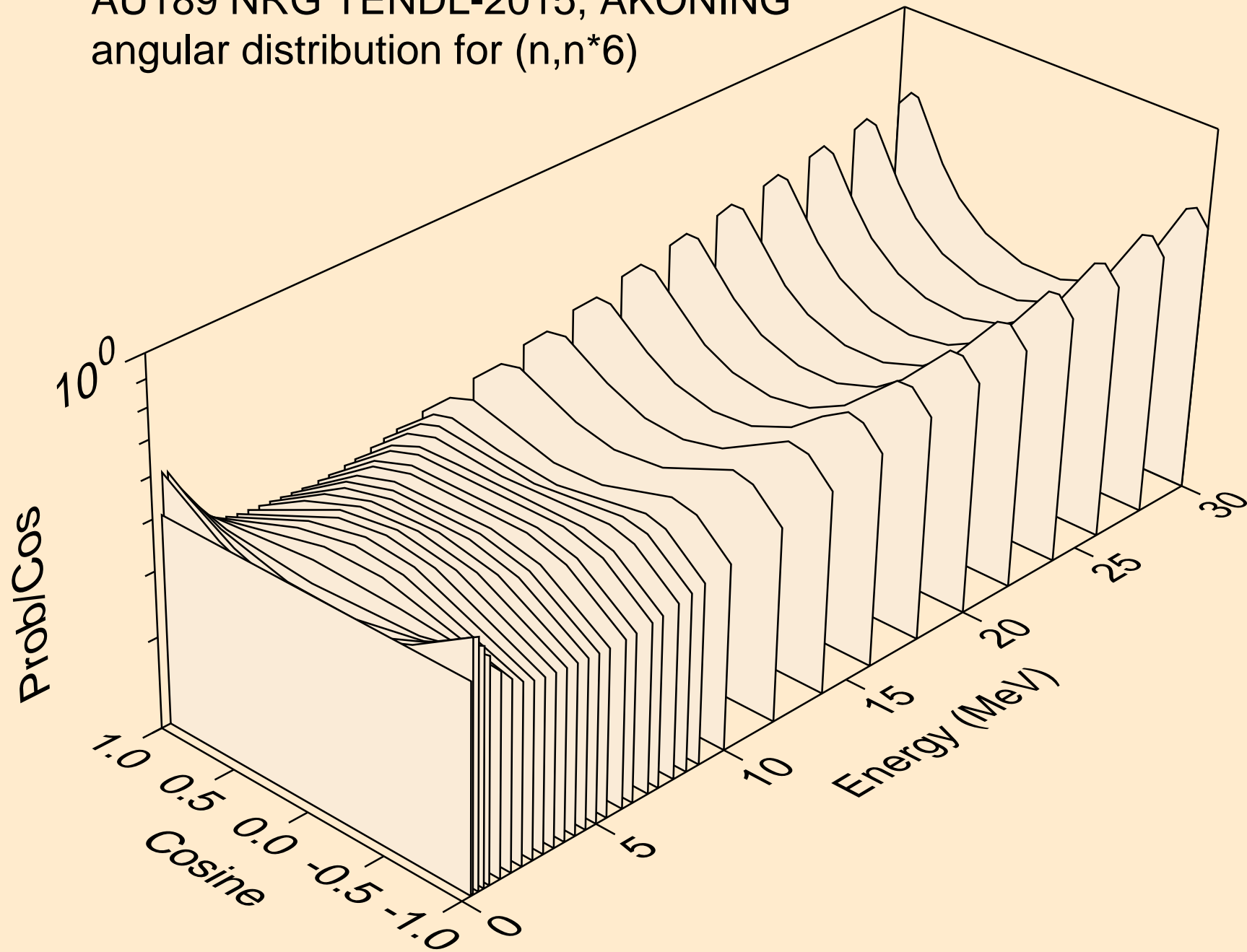

AU189 NRG TENDL-2015, AKONING
angular distribution for (n,n*7)

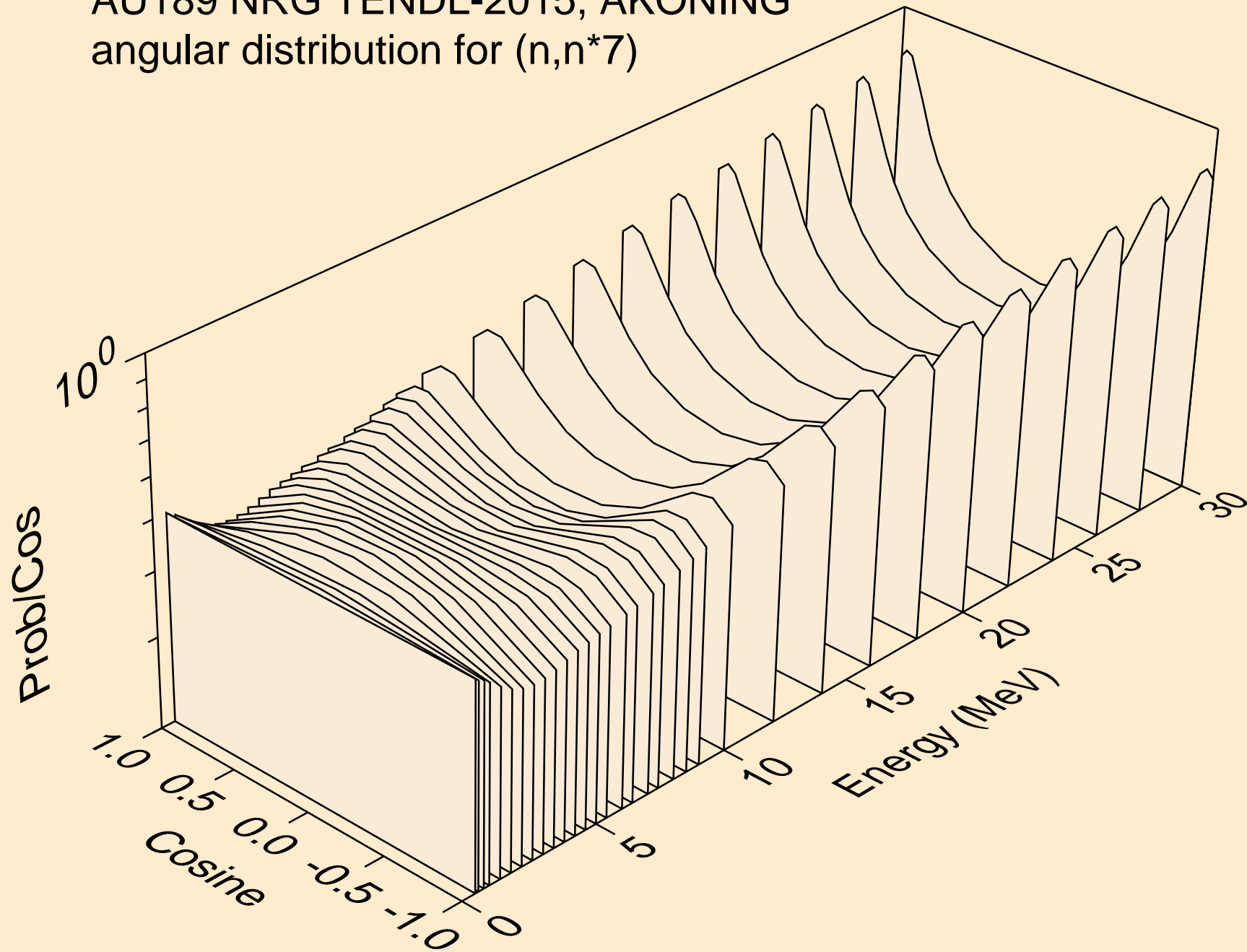

AU189 NRG TENDL-2015, AKONING
angular distribution for (n,n*8)

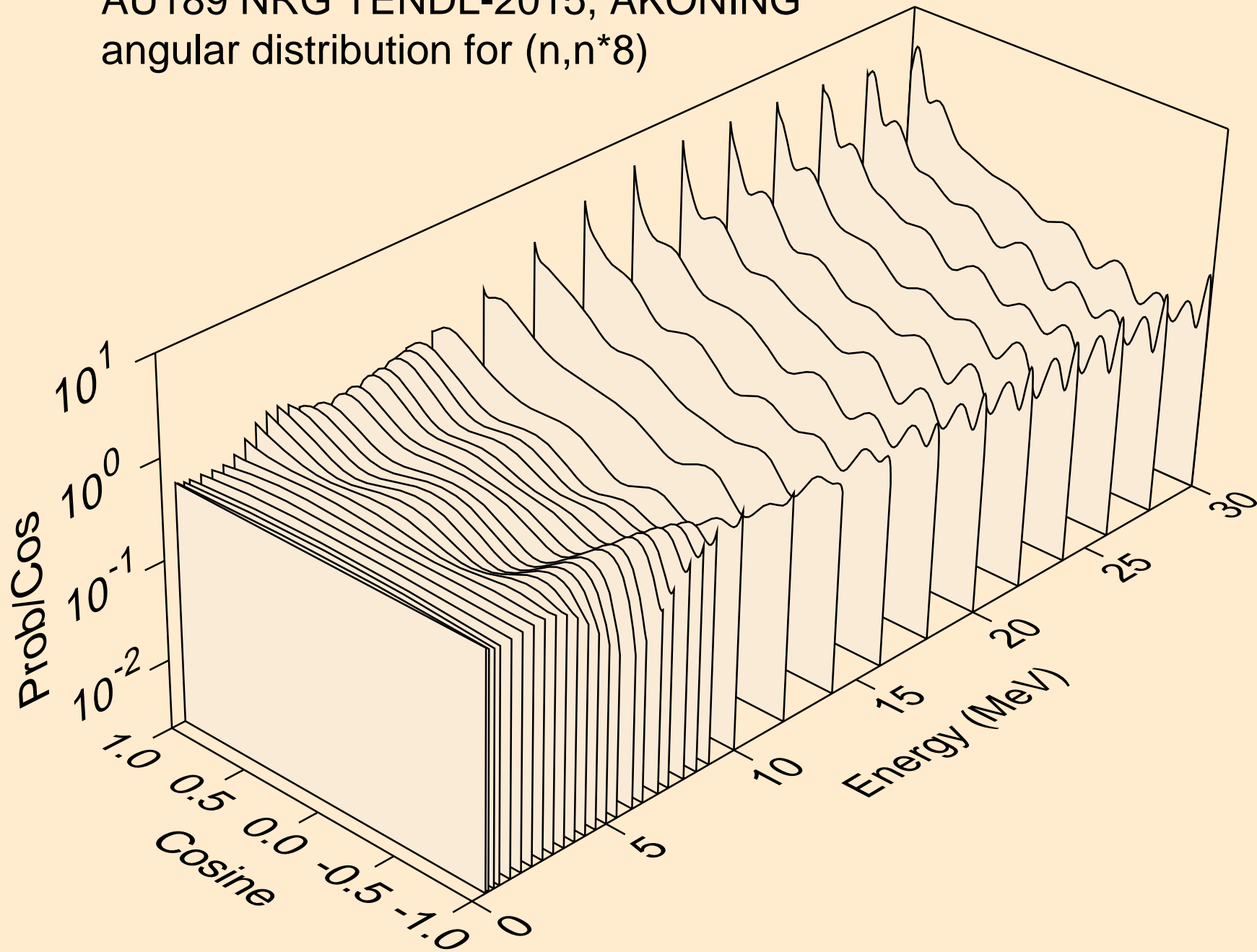

AU189 NRG TENDL-2015, AKONING
angular distribution for (n,n*9)

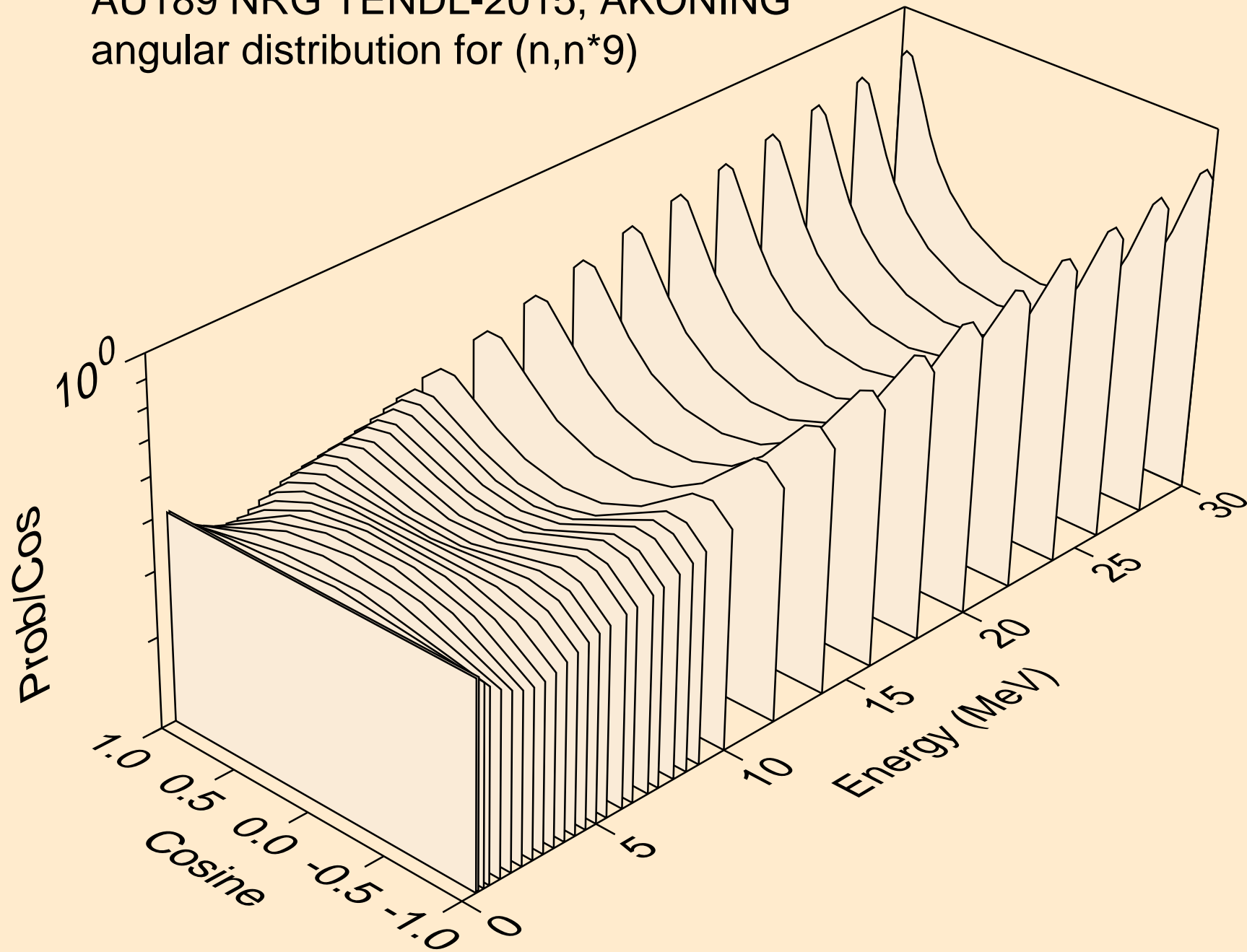

AU189 NRG TENDL-2015, AKONING
angular distribution for (n,n*10)

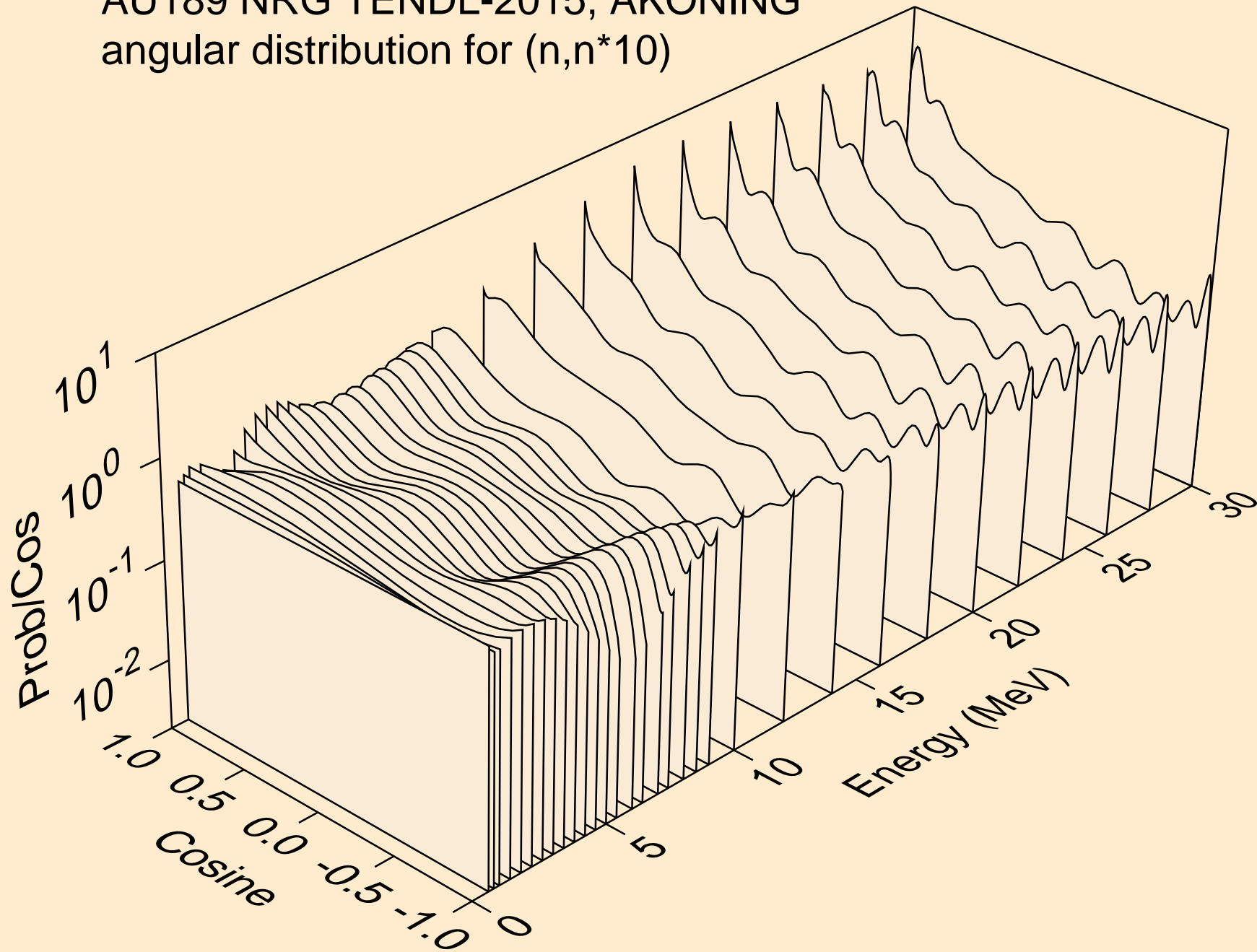

AU189 NRG TENDL-2015, AKONING
angular distribution for (n,n*11)

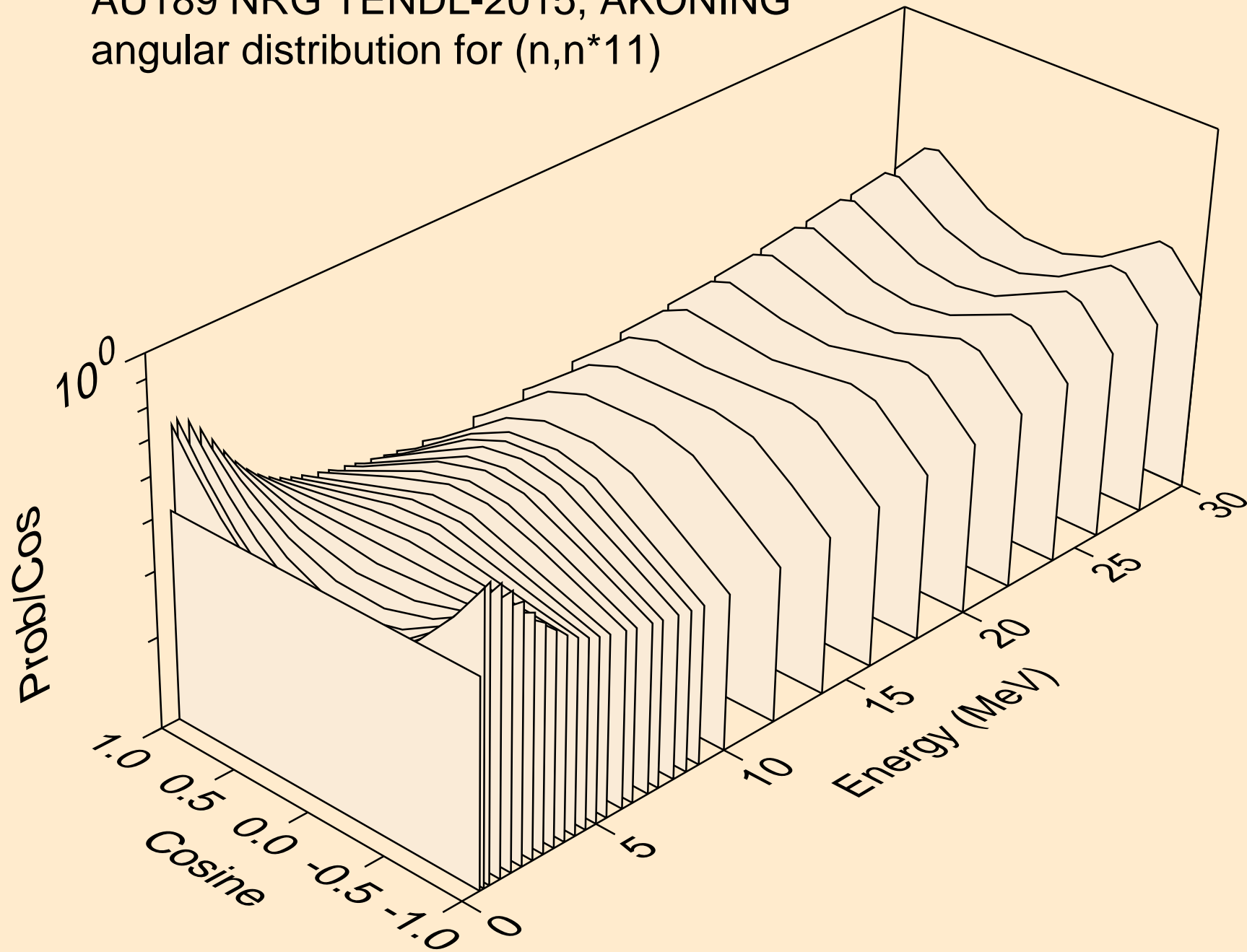

AU189 NRG TENDL-2015, AKONING
angular distribution for (n,n*12)

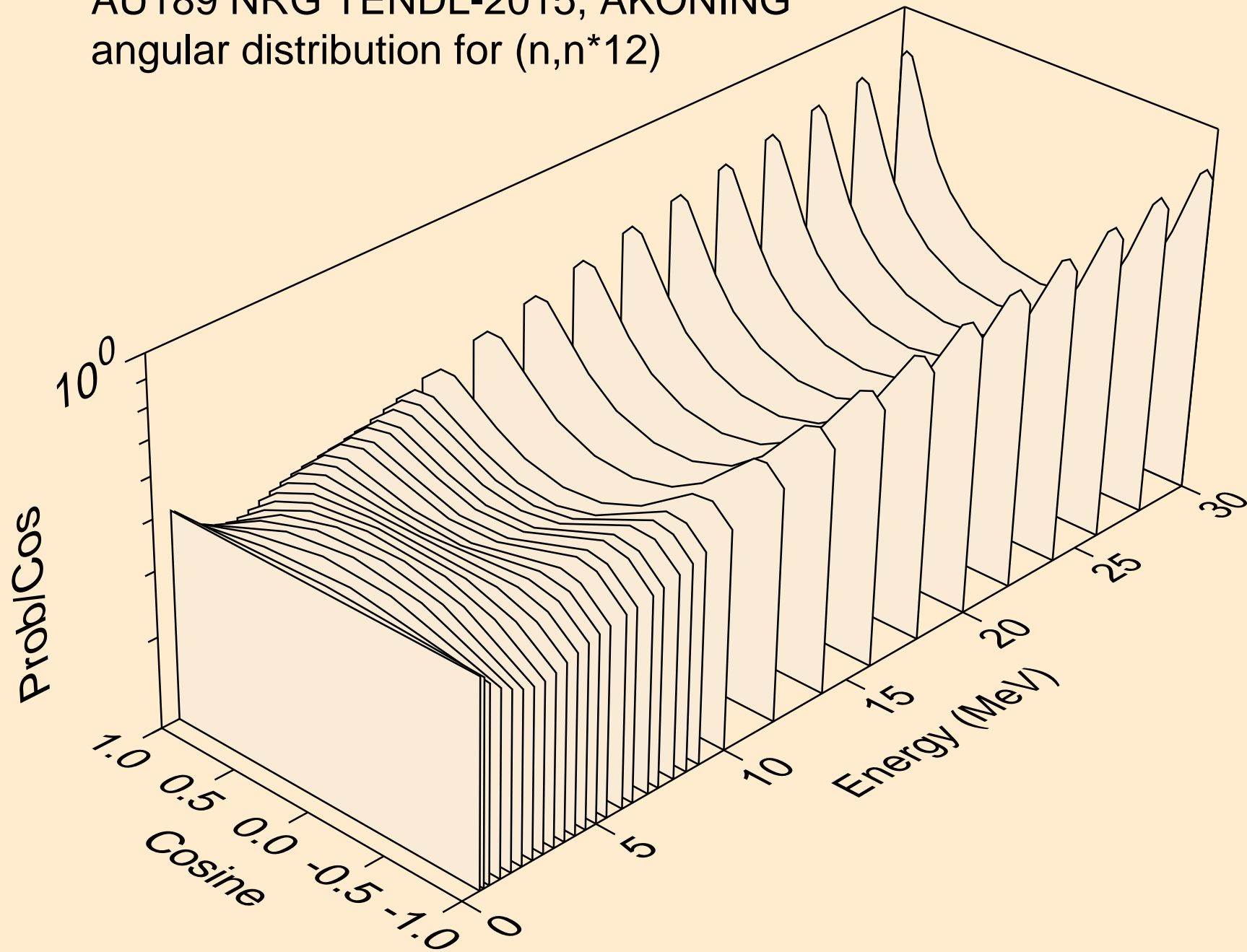

AU189 NRG TENDL-2015, AKONING
angular distribution for (n,n*13)

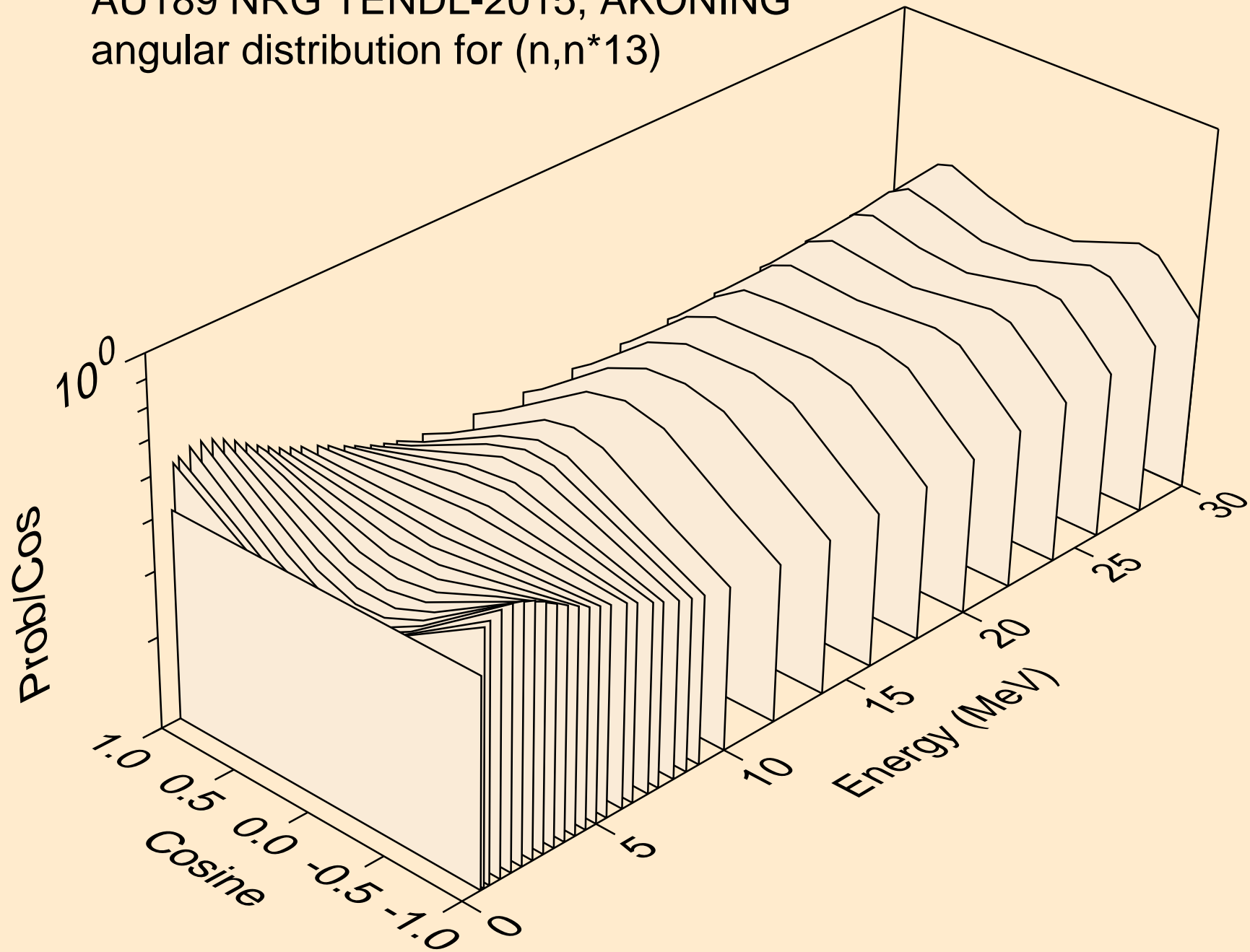

AU189 NRG TENDL-2015, AKONING
angular distribution for (n,n*14)

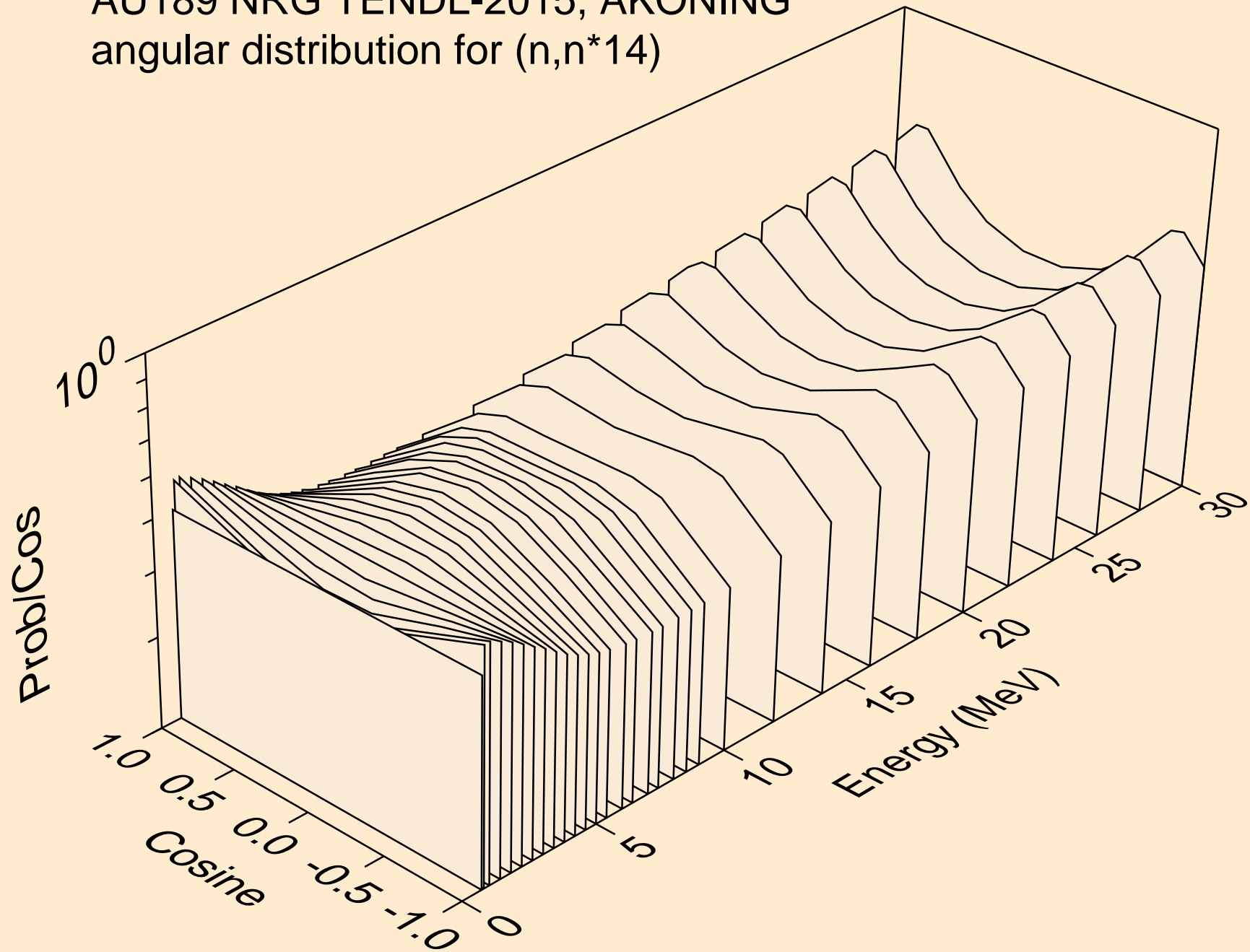

AU189 NRG TENDL-2015, AKONING
angular distribution for (n,n*15)

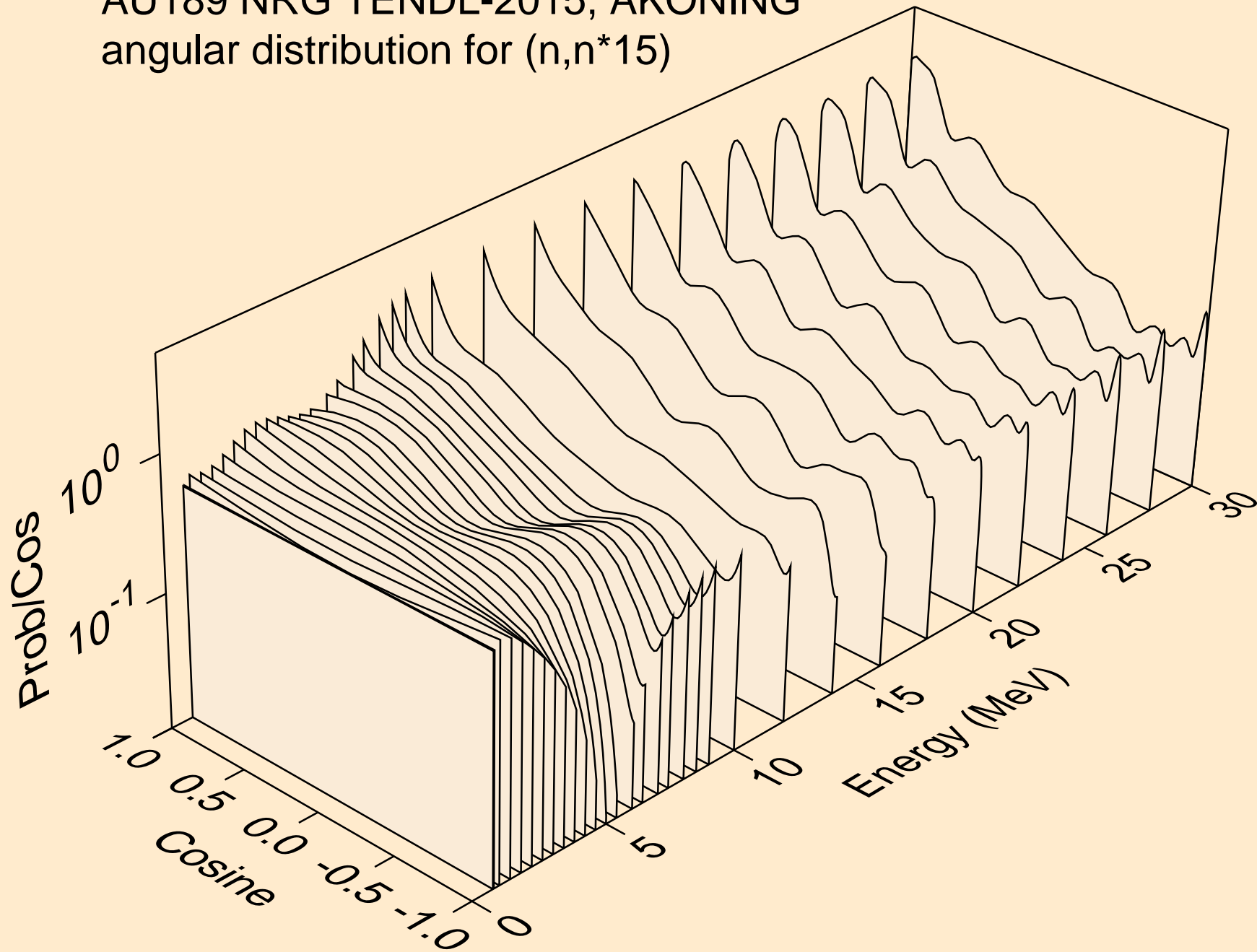

AU189 NRG TENDL-2015, AKONING
angular distribution for (n,n*16)

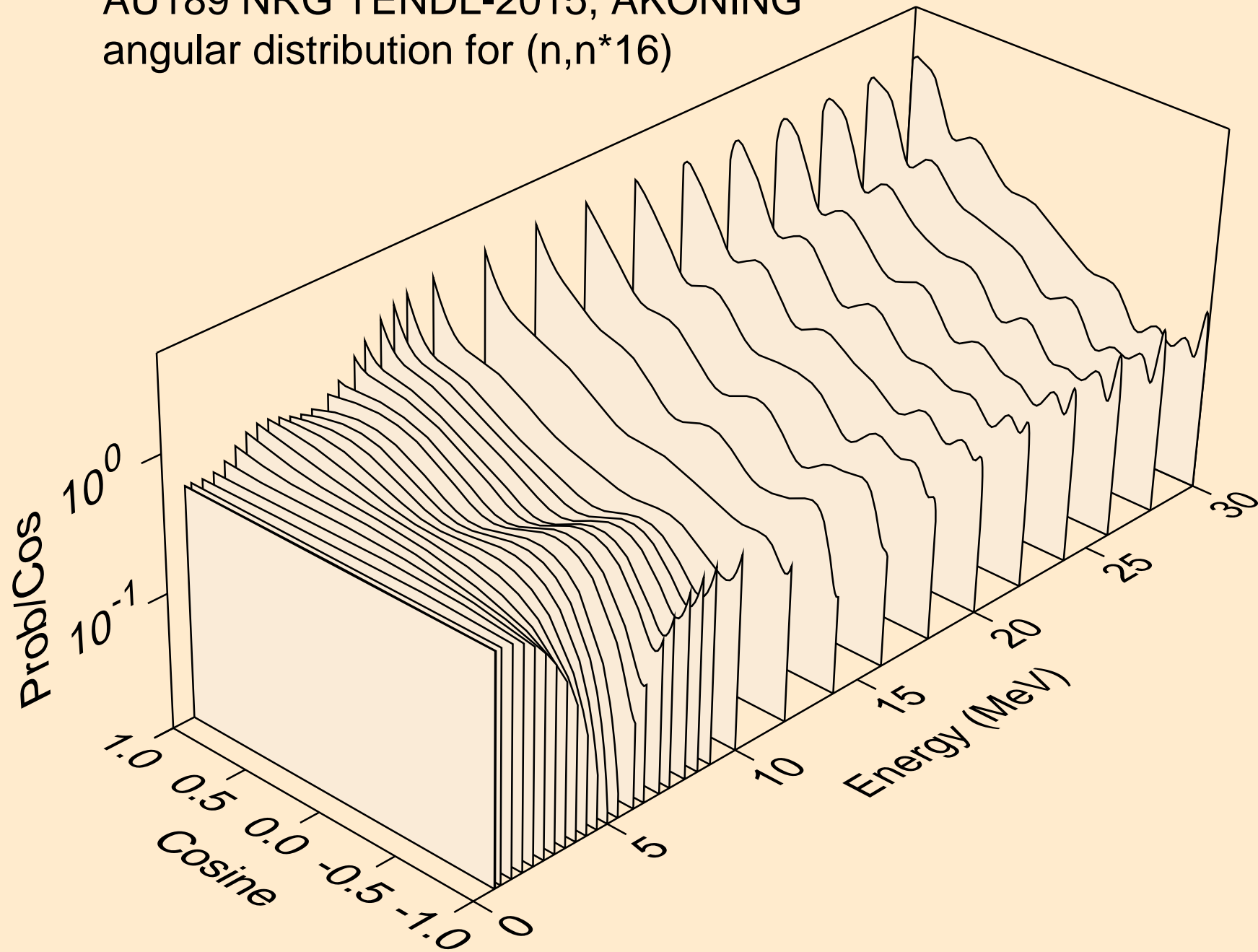

AU189 NRG TENDL-2015, AKONING
angular distribution for (n,n*17)

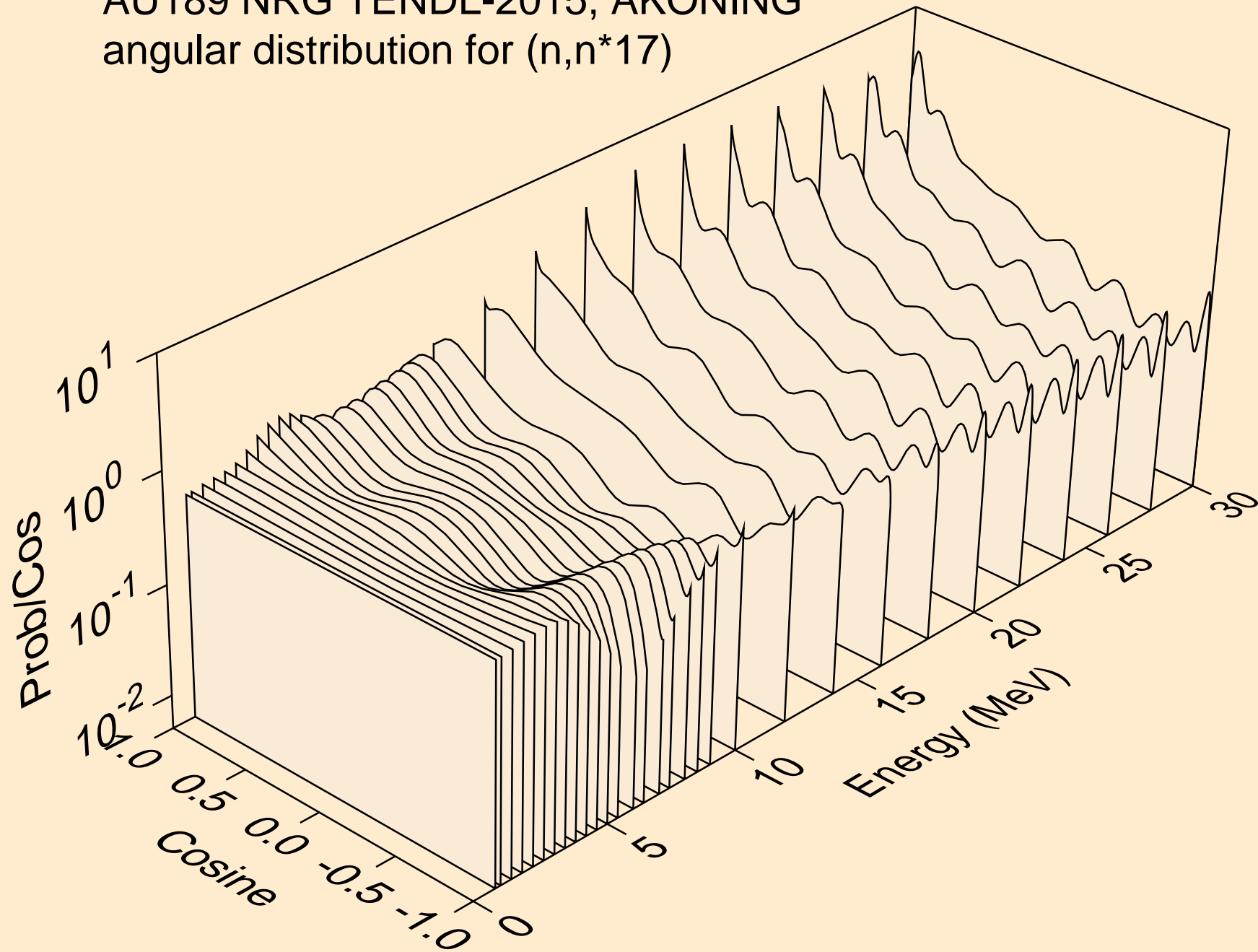

AU189 NRG TENDL-2015, AKONING
angular distribution for (n,n*18)

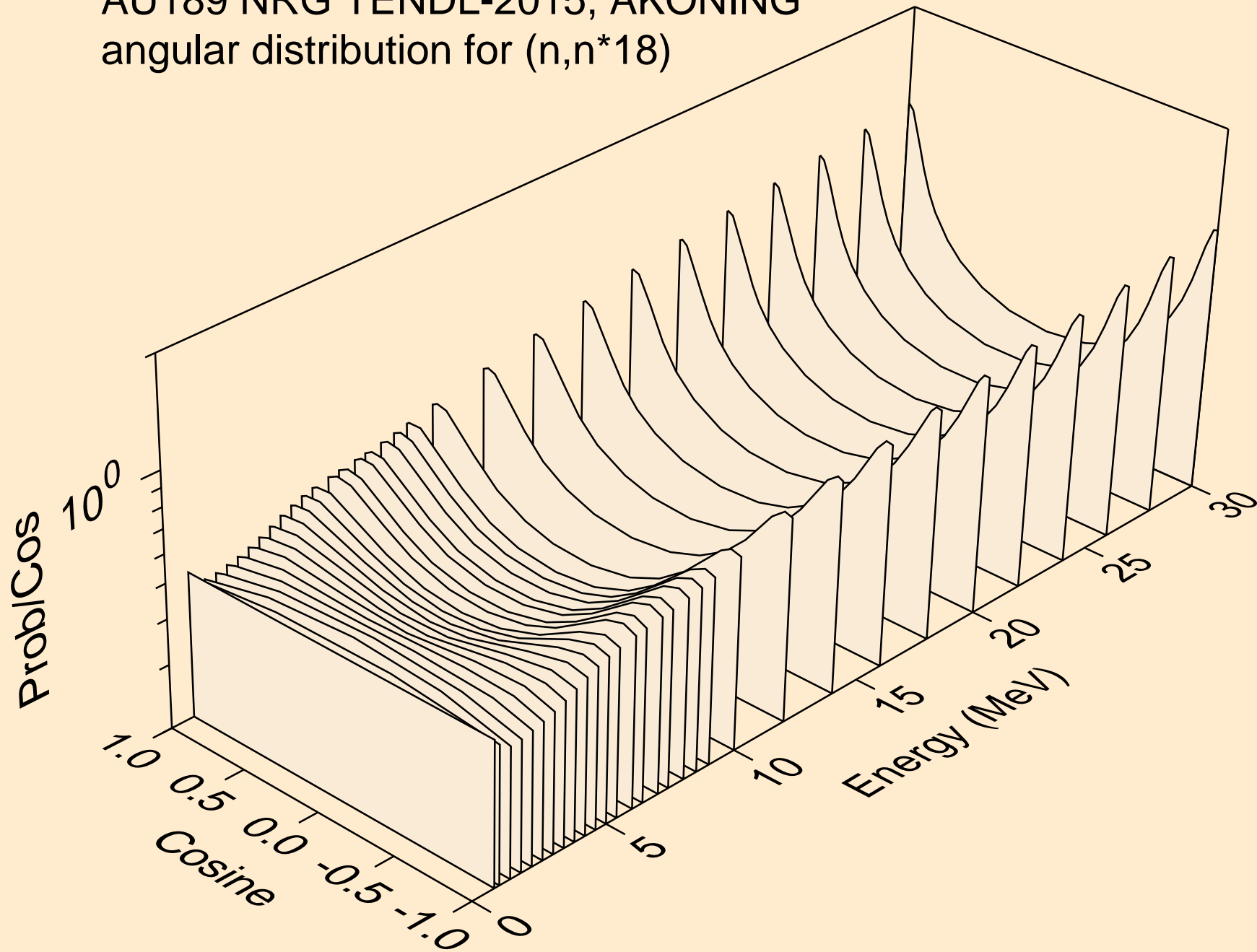

AU189 NRG TENDL-2015, AKONING
angular distribution for (n,n*19)

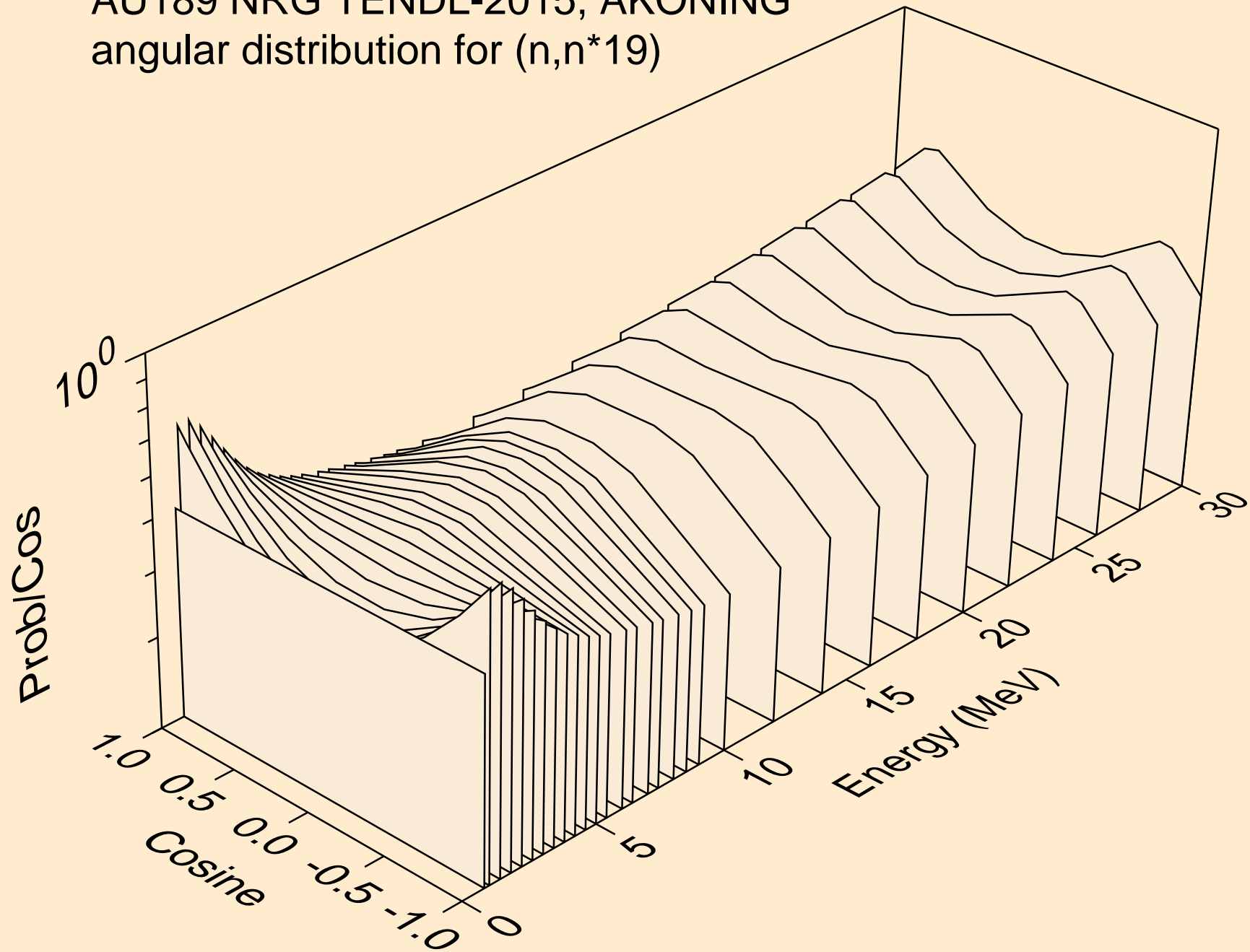

AU189 NRG TENDL-2015, AKONING
angular distribution for (n,n*20)

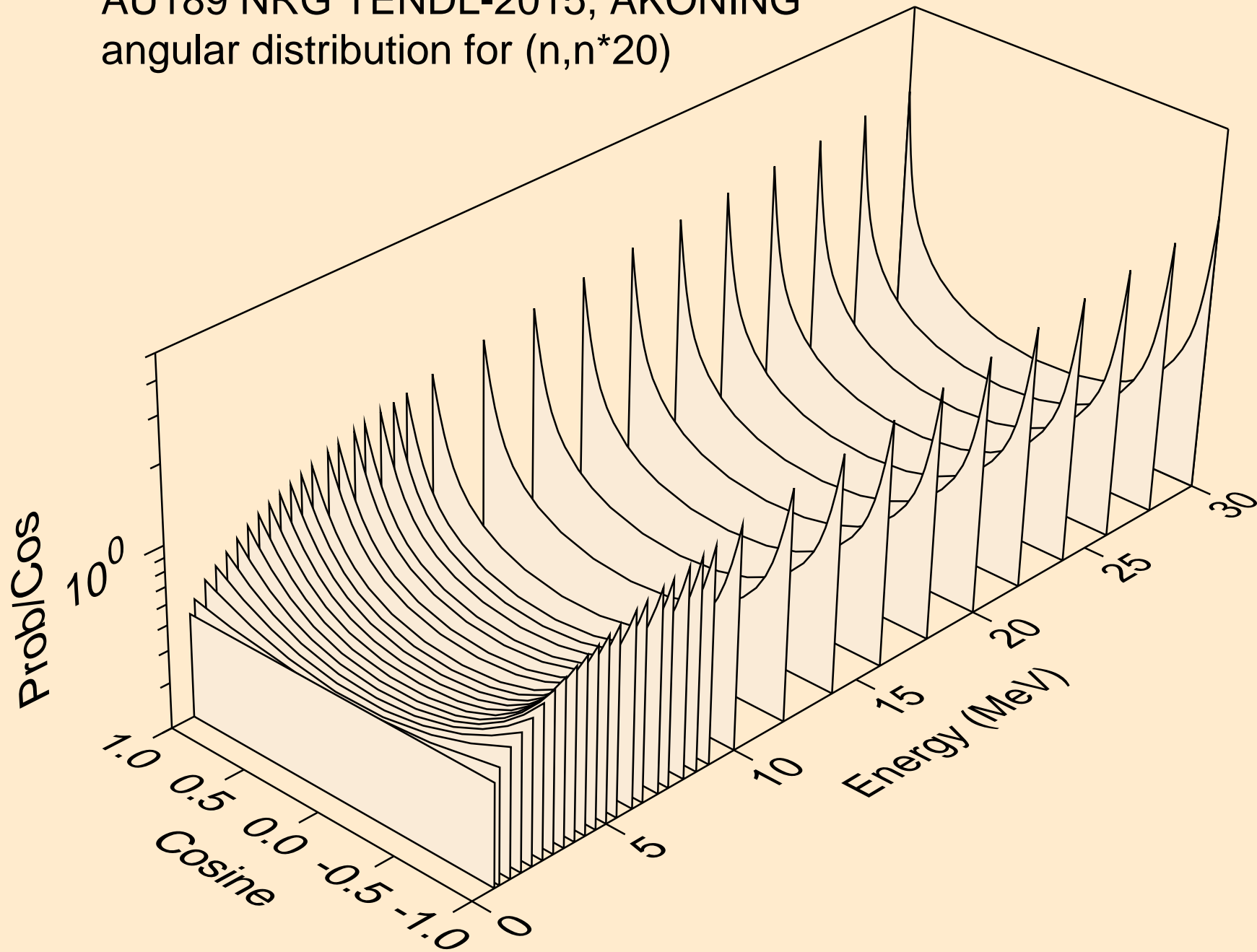

AU189 NRG TENDL-2015, AKONING
angular distribution for (n,n*21)

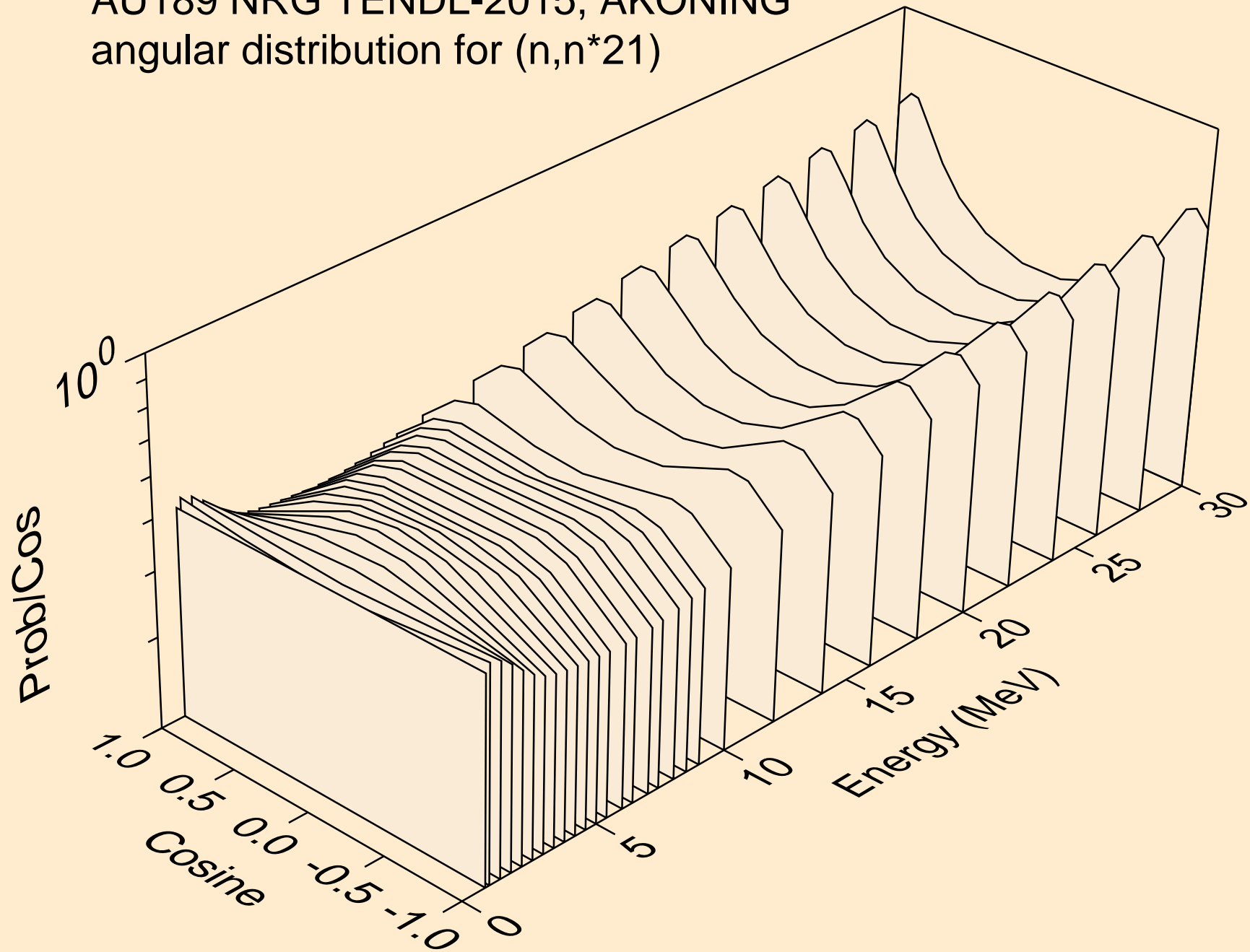

AU189 NRG TENDL-2015, AKONING
angular distribution for (n,n*22)

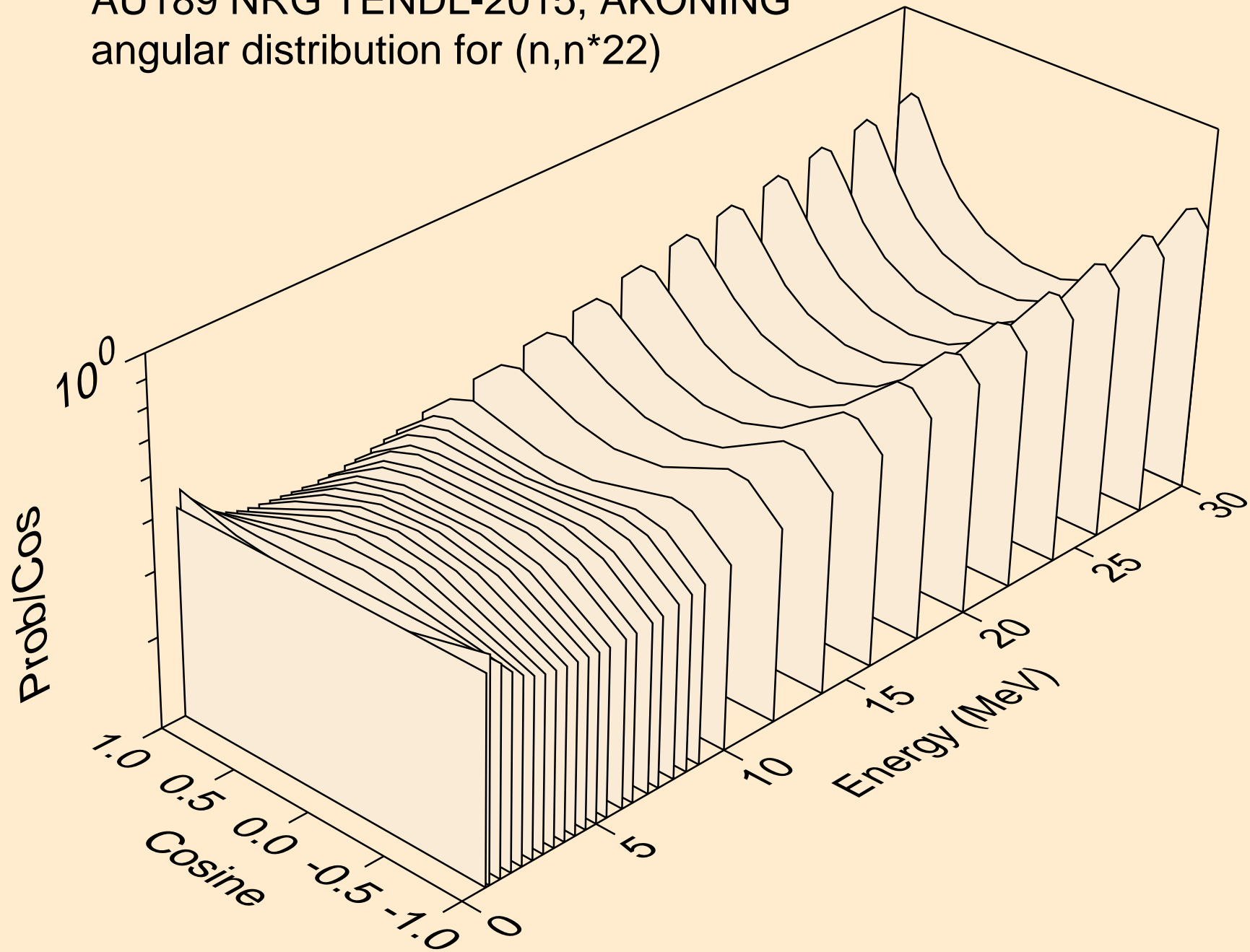

AU189 NRG TENDL-2015, AKONING
angular distribution for (n,n*23)

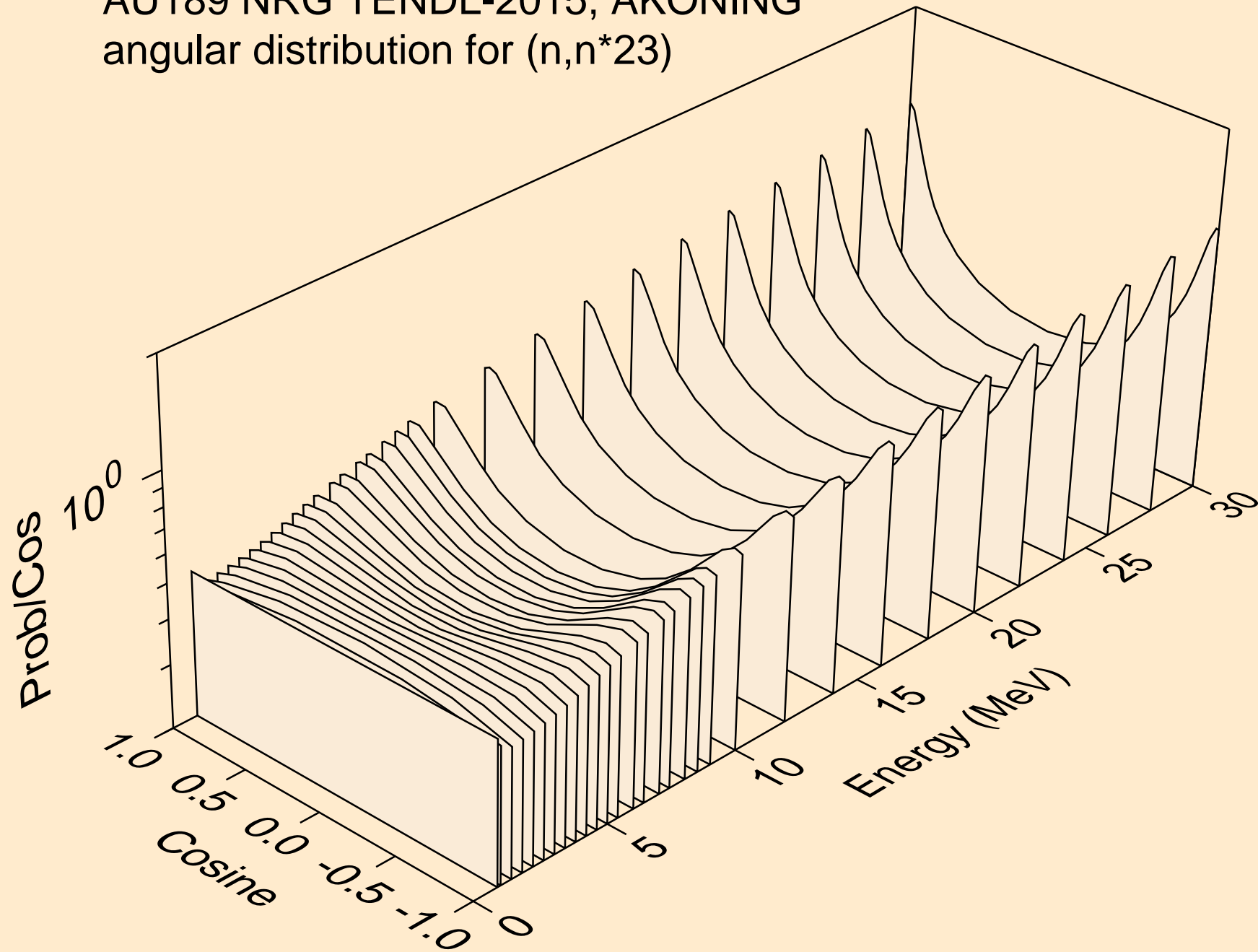

AU189 NRG TENDL-2015, AKONING
angular distribution for (n,n*24)

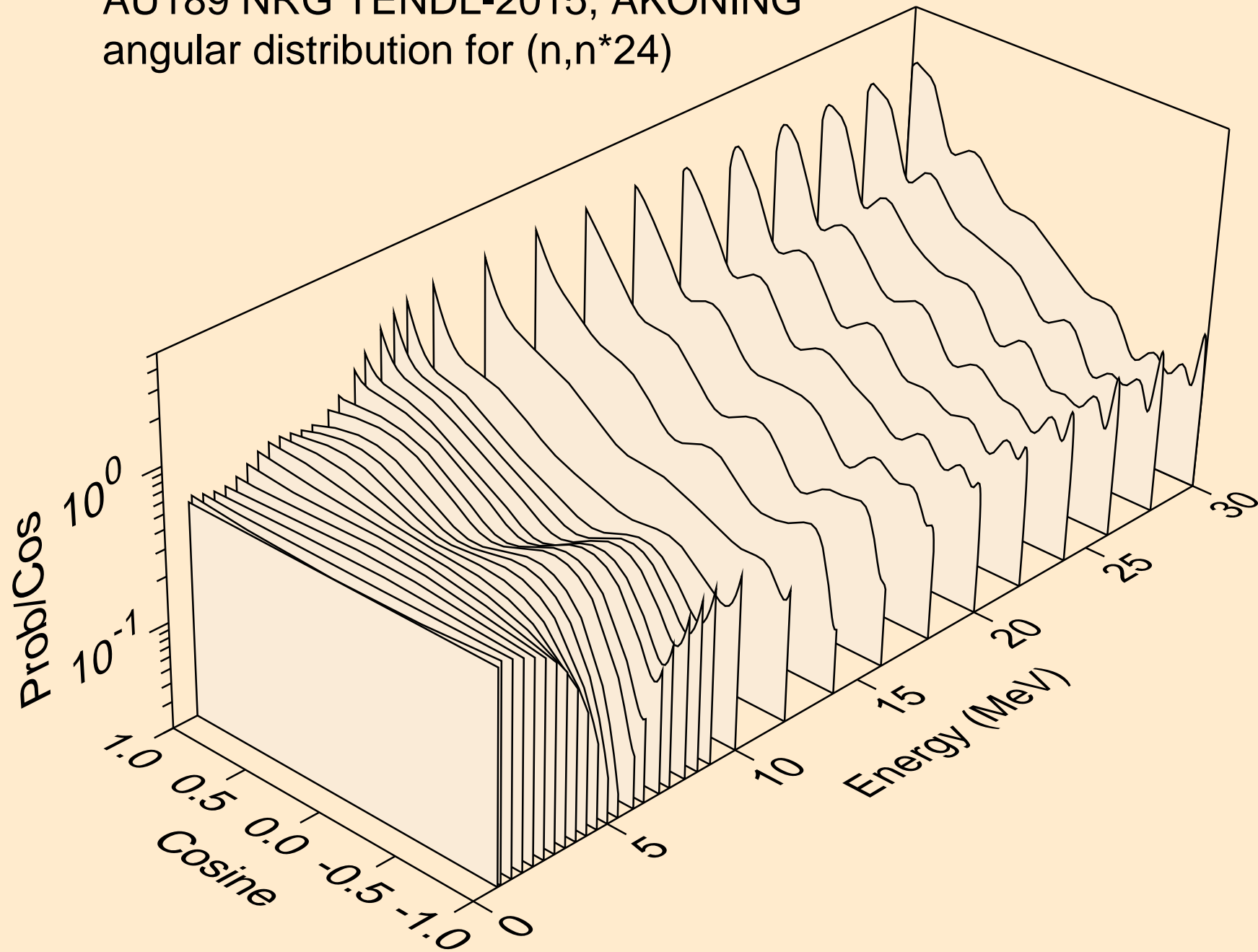

AU189 NRG TENDL-2015, AKONING
angular distribution for (n,n*25)

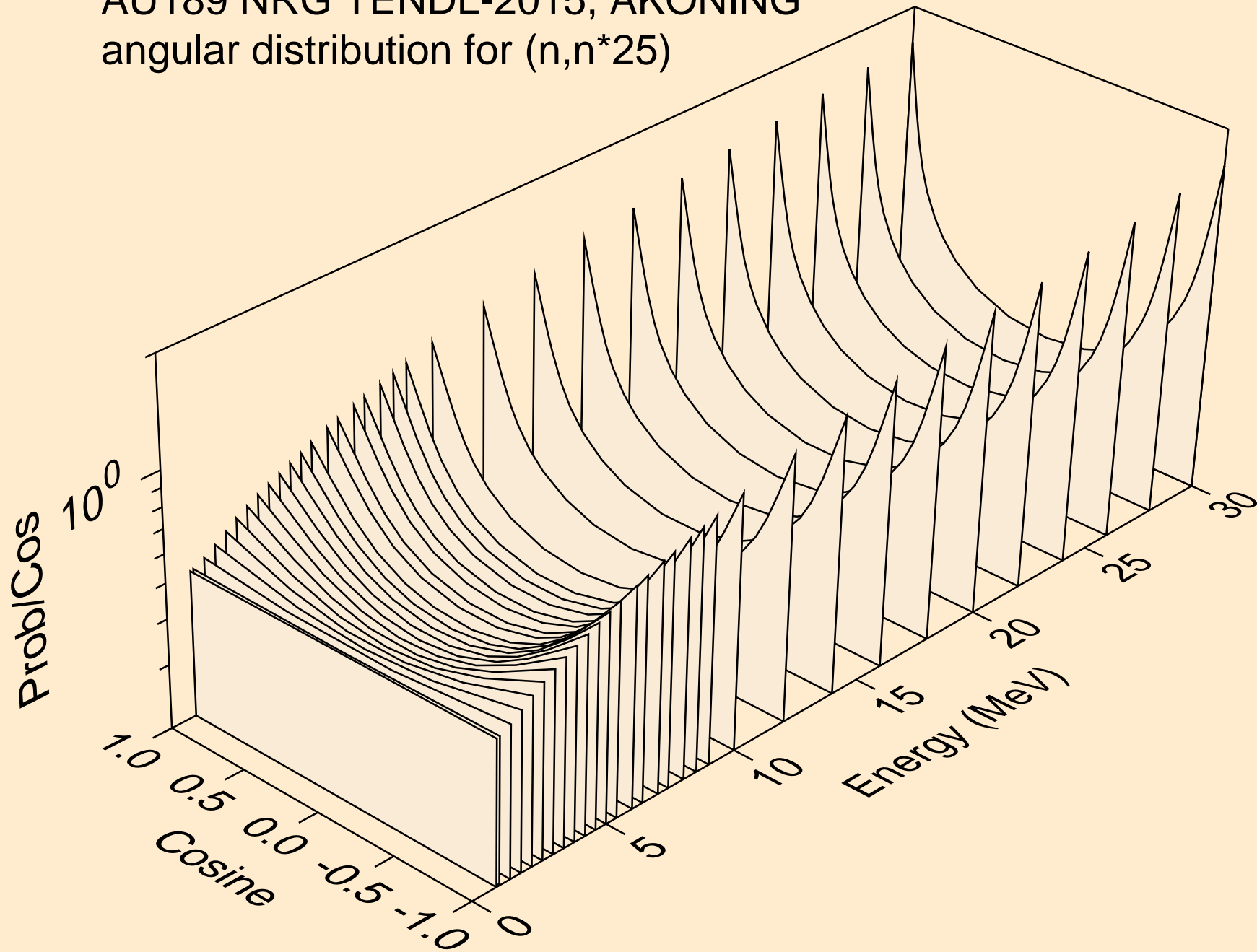

AU189 NRG TENDL-2015, AKONING
angular distribution for (n,n*26)

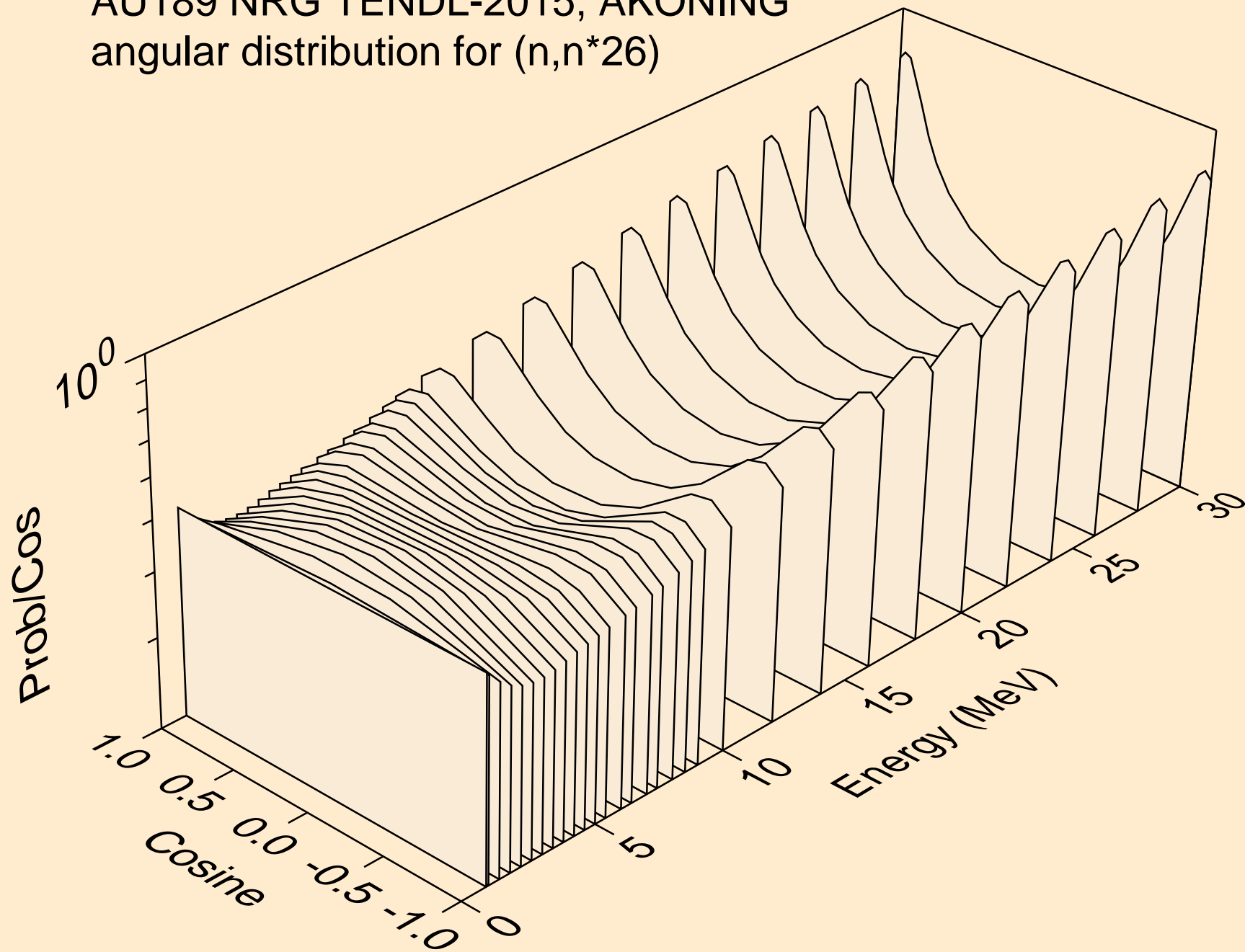

AU189 NRG TENDL-2015, AKONING
angular distribution for (n,n*27)

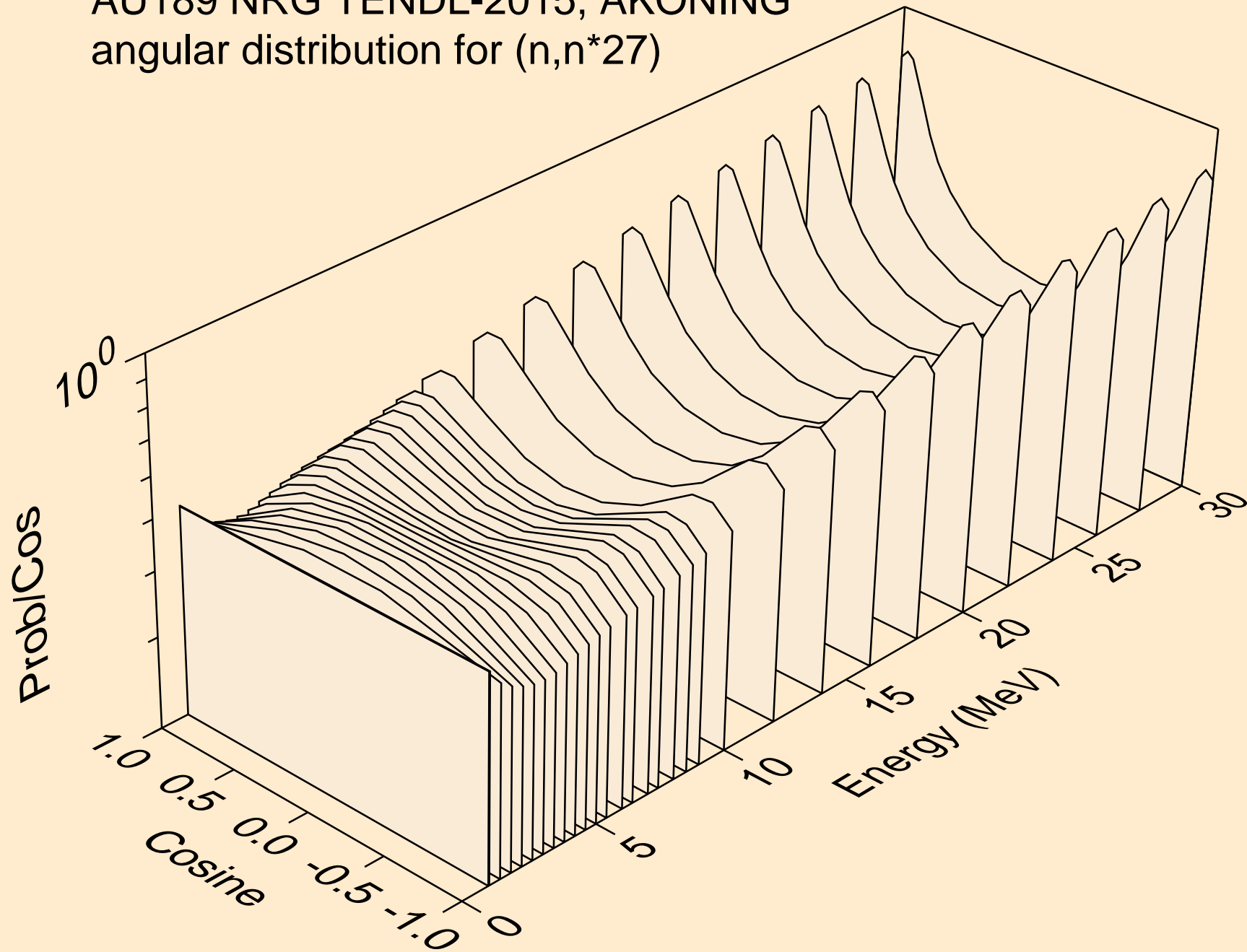

AU189 NRG TENDL-2015, AKONING
angular distribution for (n,n*28)

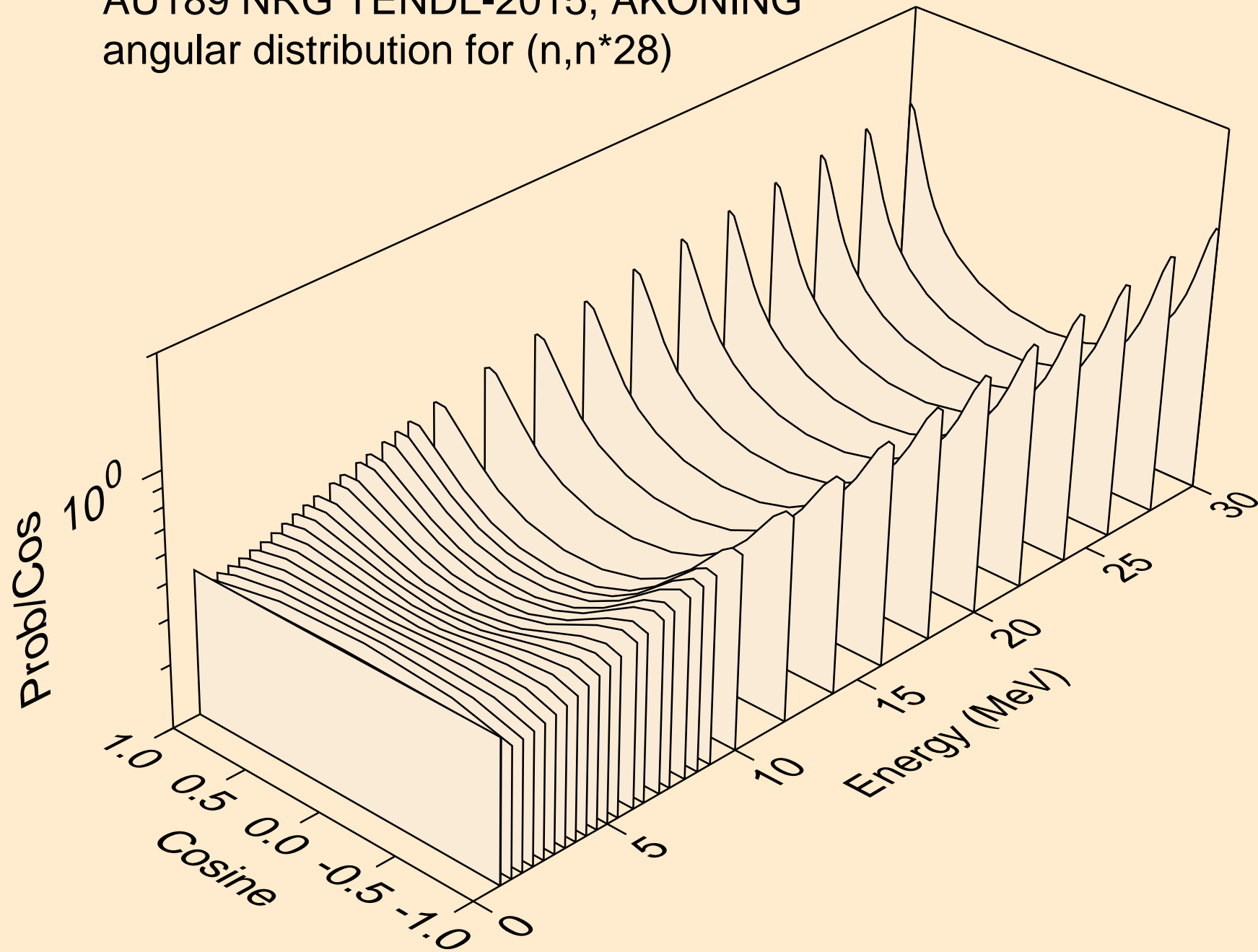

AU189 NRG TENDL-2015, AKONING
angular distribution for (n,n*29)

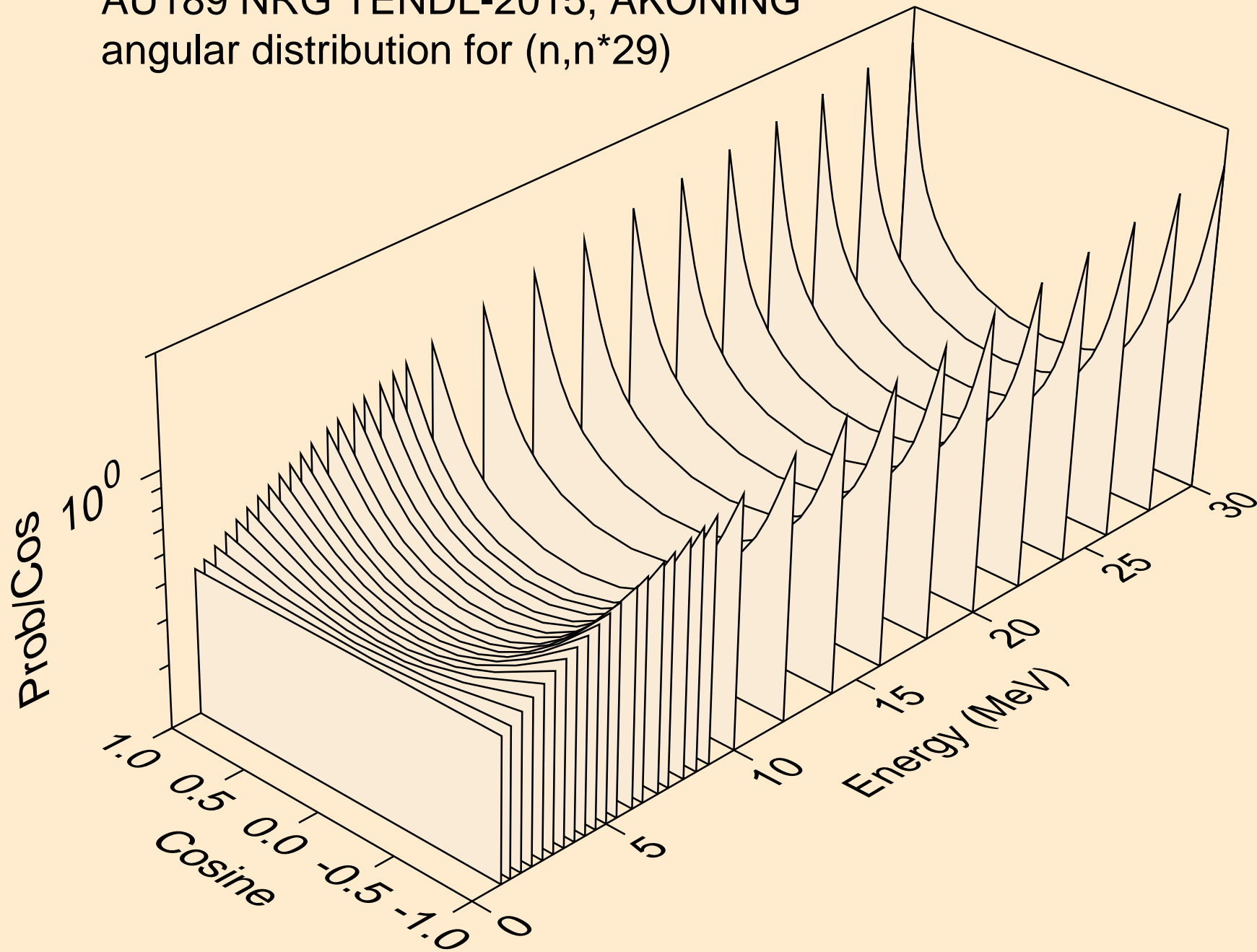

AU189 NRG TENDL-2015, AKONING
Neutron emission for (n,x)

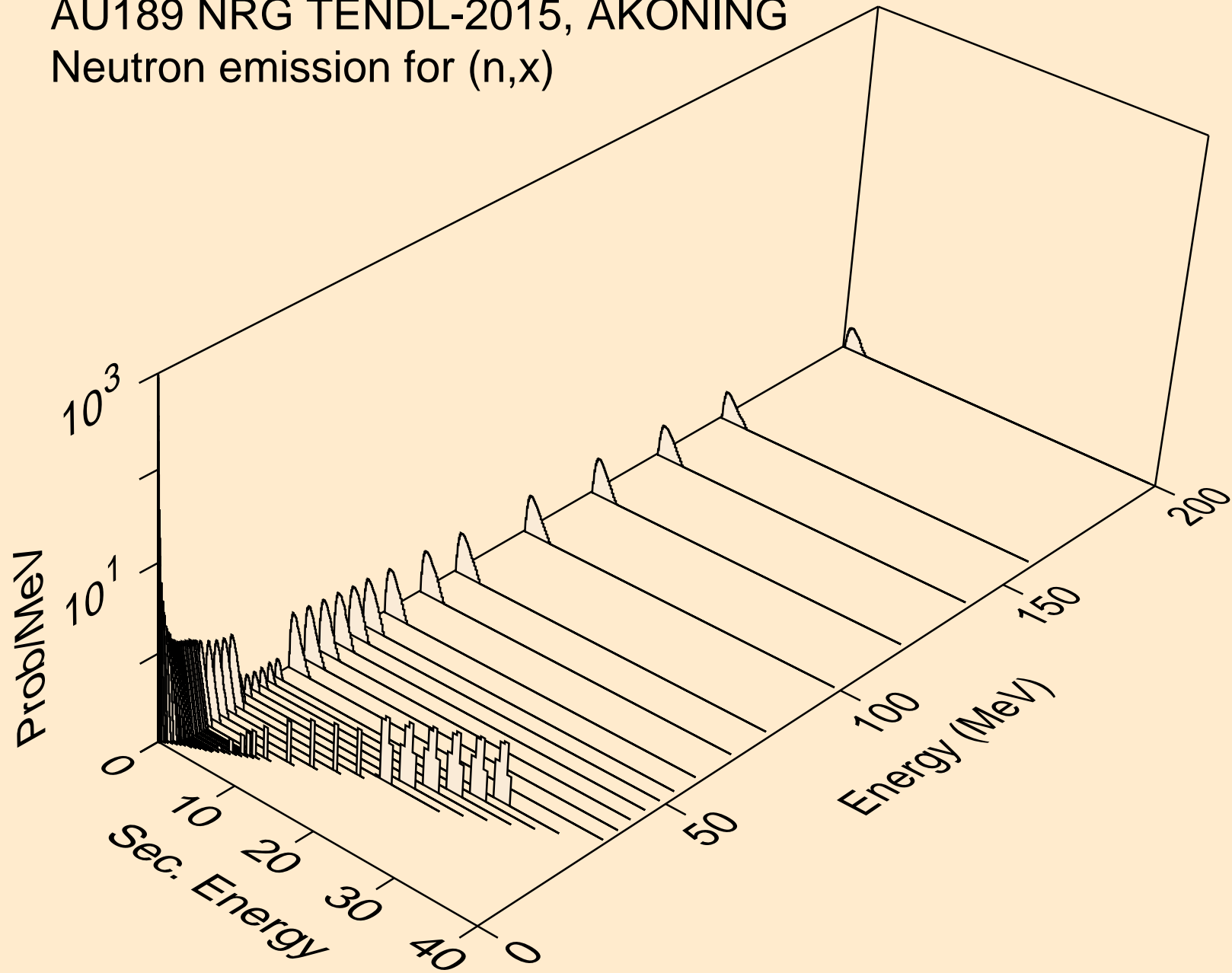

AU189 NRG TENDL-2015, AKONING
Neutron emission for (n,2nd)

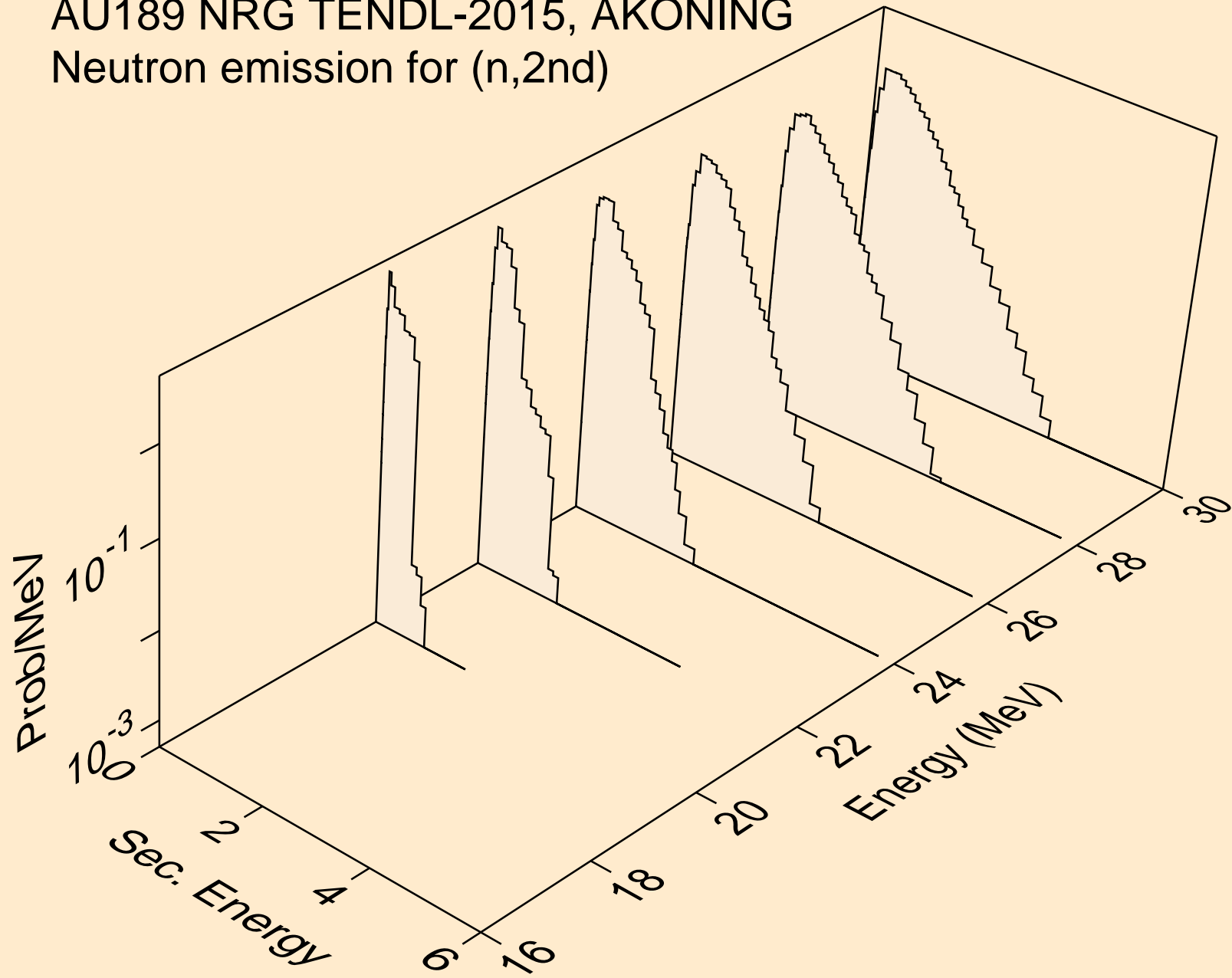

AU189 NRG TENDL-2015, AKONING
Neutron emission for (n,2n)

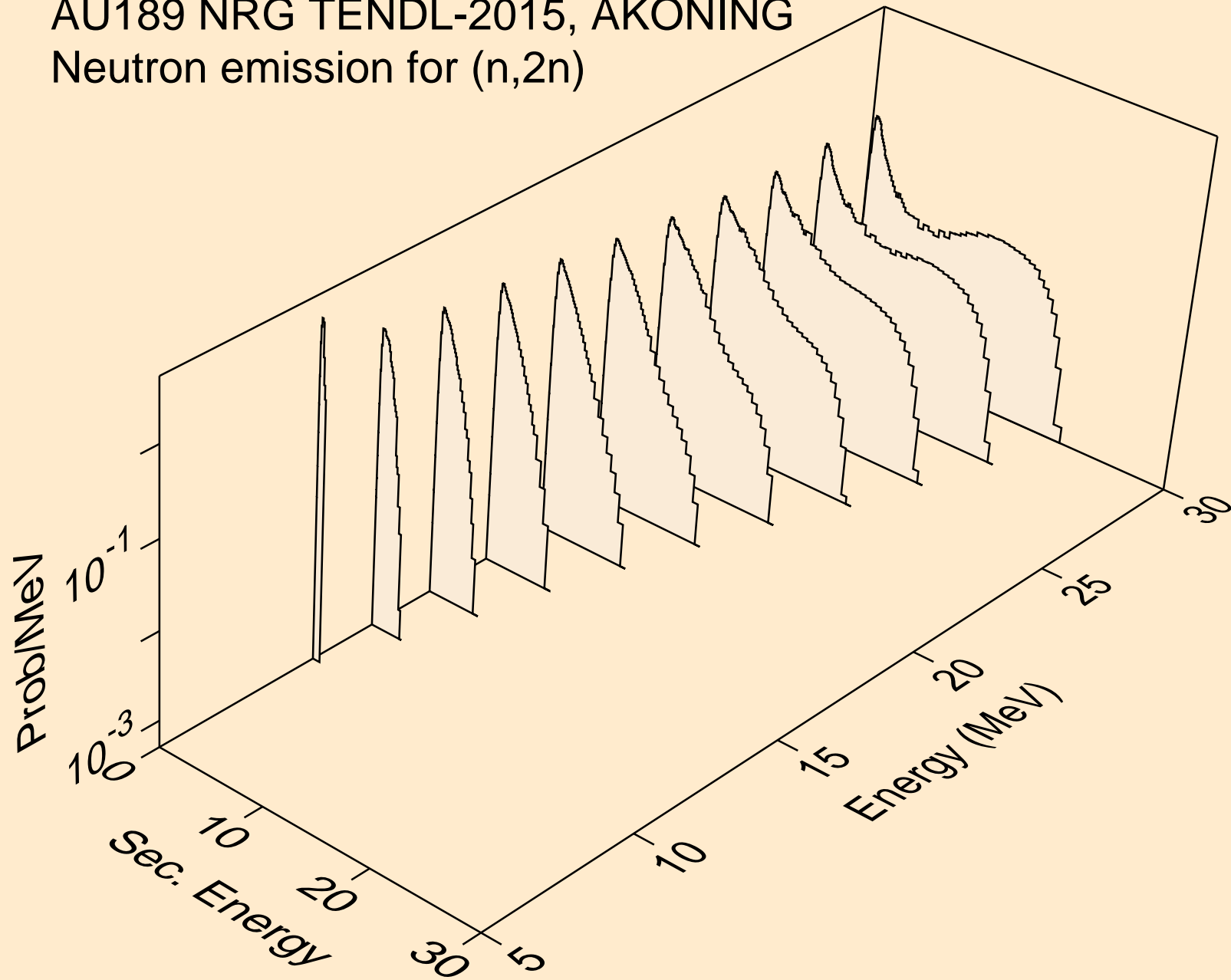

AU189 NRG TENDL-2015, AKONING
Neutron emission for (n,3n)

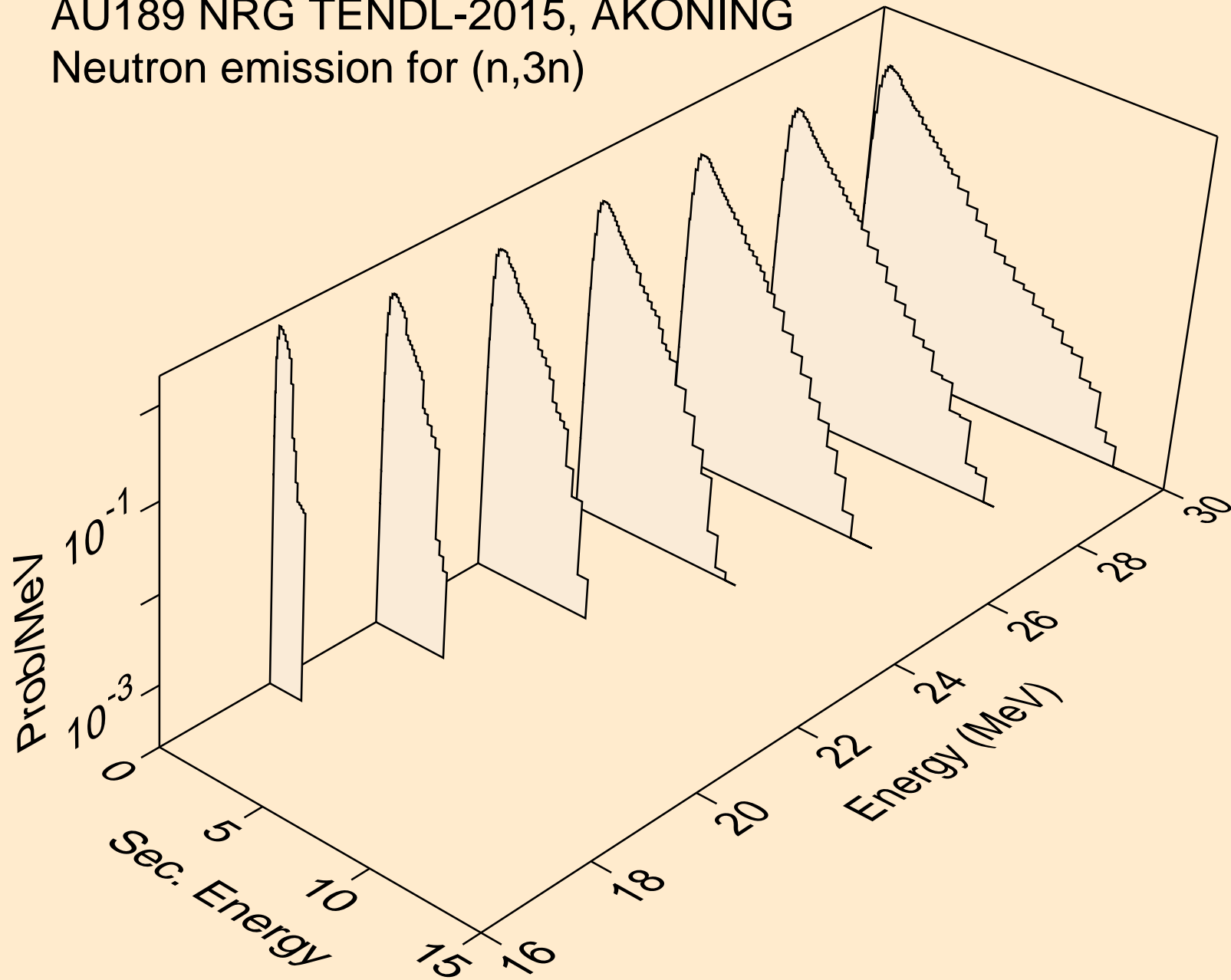

AU189 NRG TENDL-2015, AKONING
Neutron emission for (n,n*)a

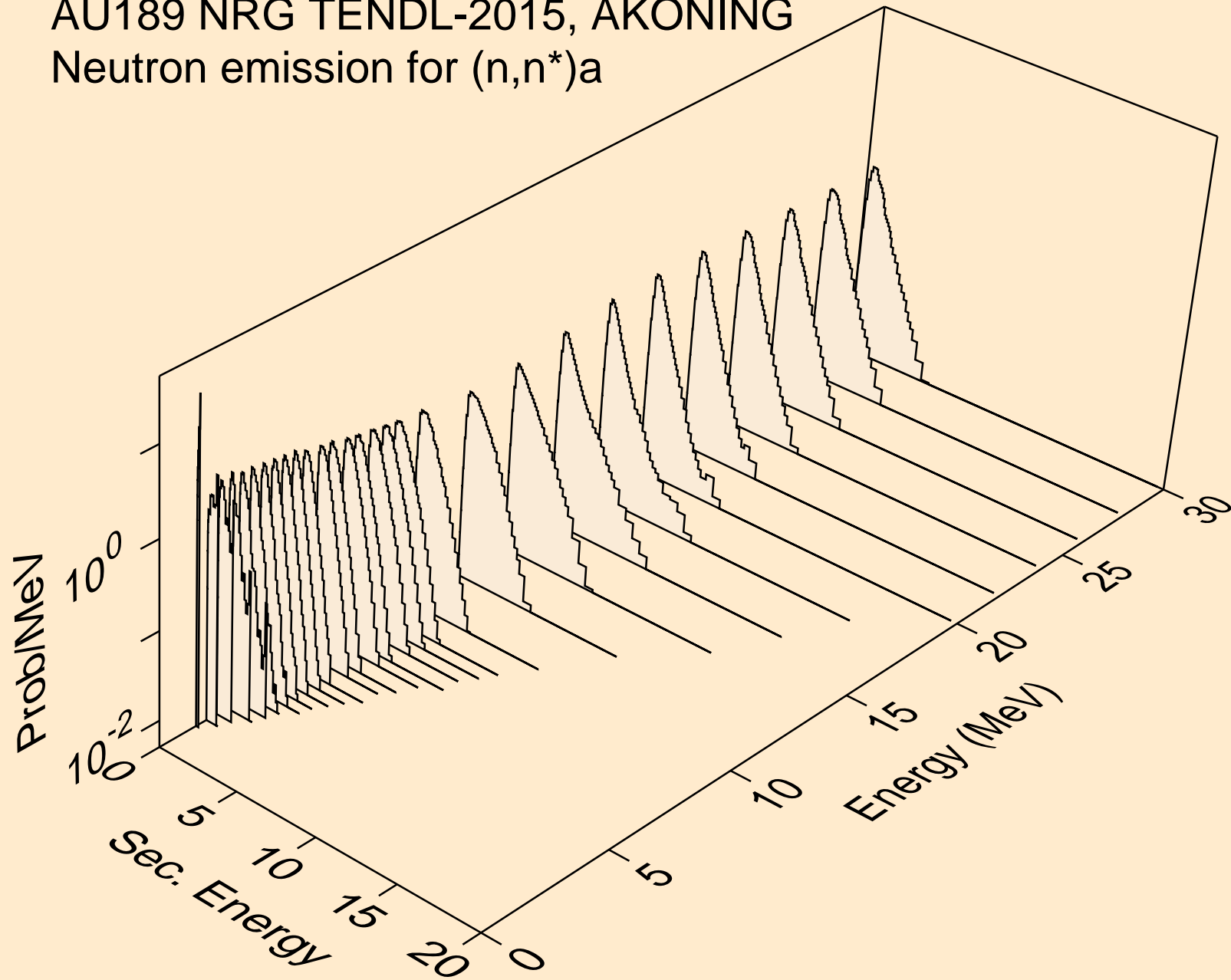

AU189 NRG TENDL-2015, AKONING
Neutron emission for (n,2n)_a

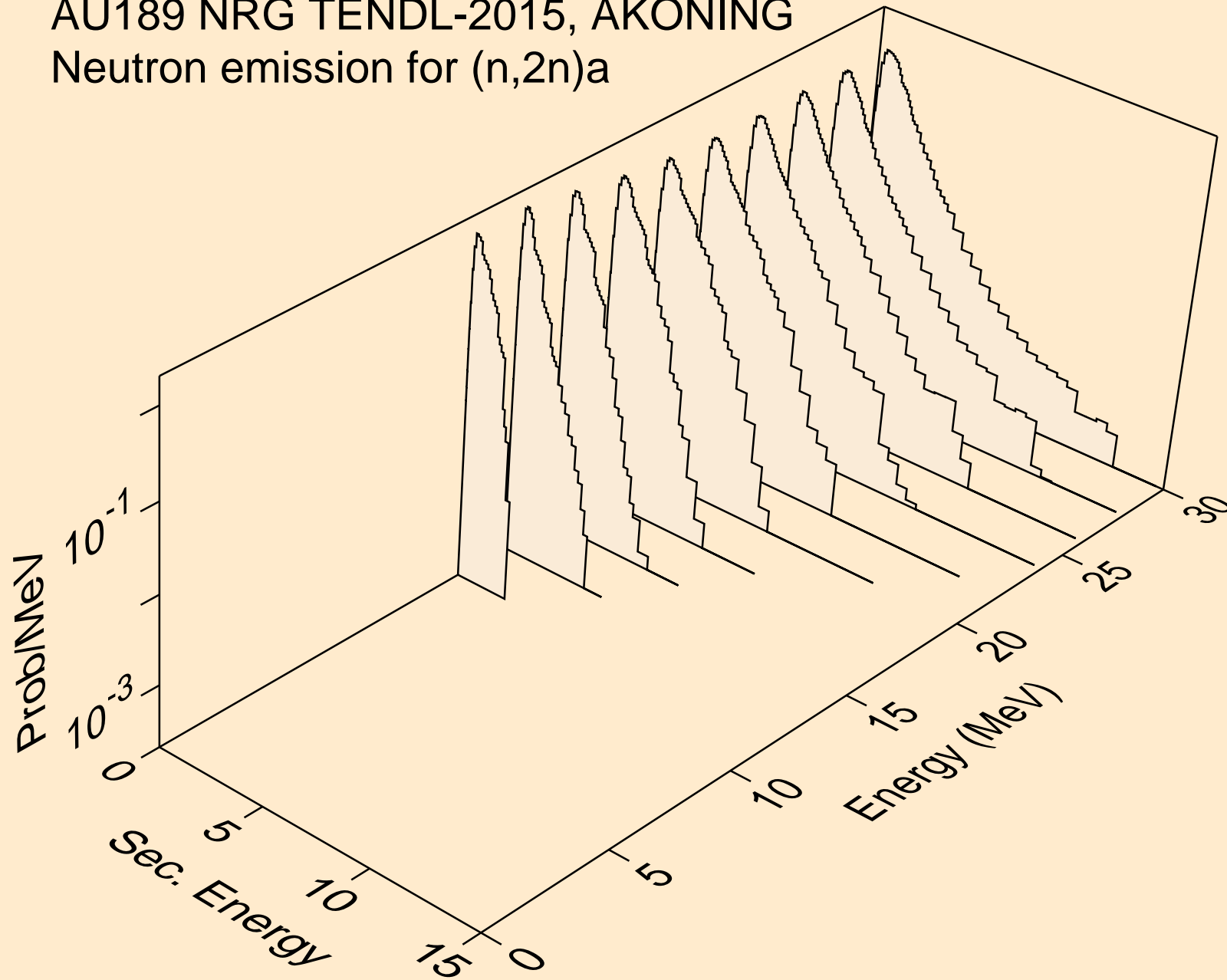

AU189 NRG TENDL-2015, AKONING
Neutron emission for (n,3n)a

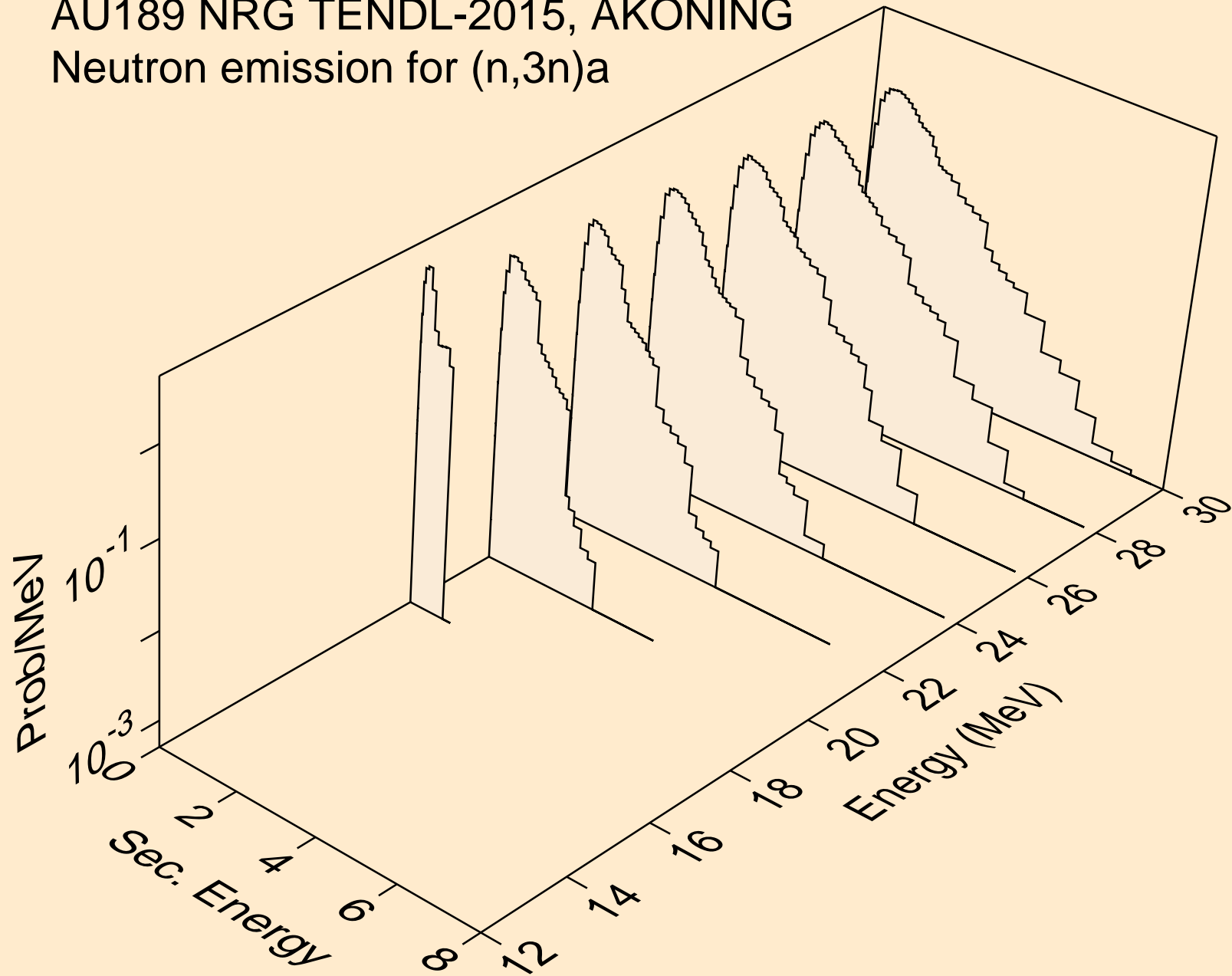

AU189 NRG TENDL-2015, AKONING
Neutron emission for (n,n*)p

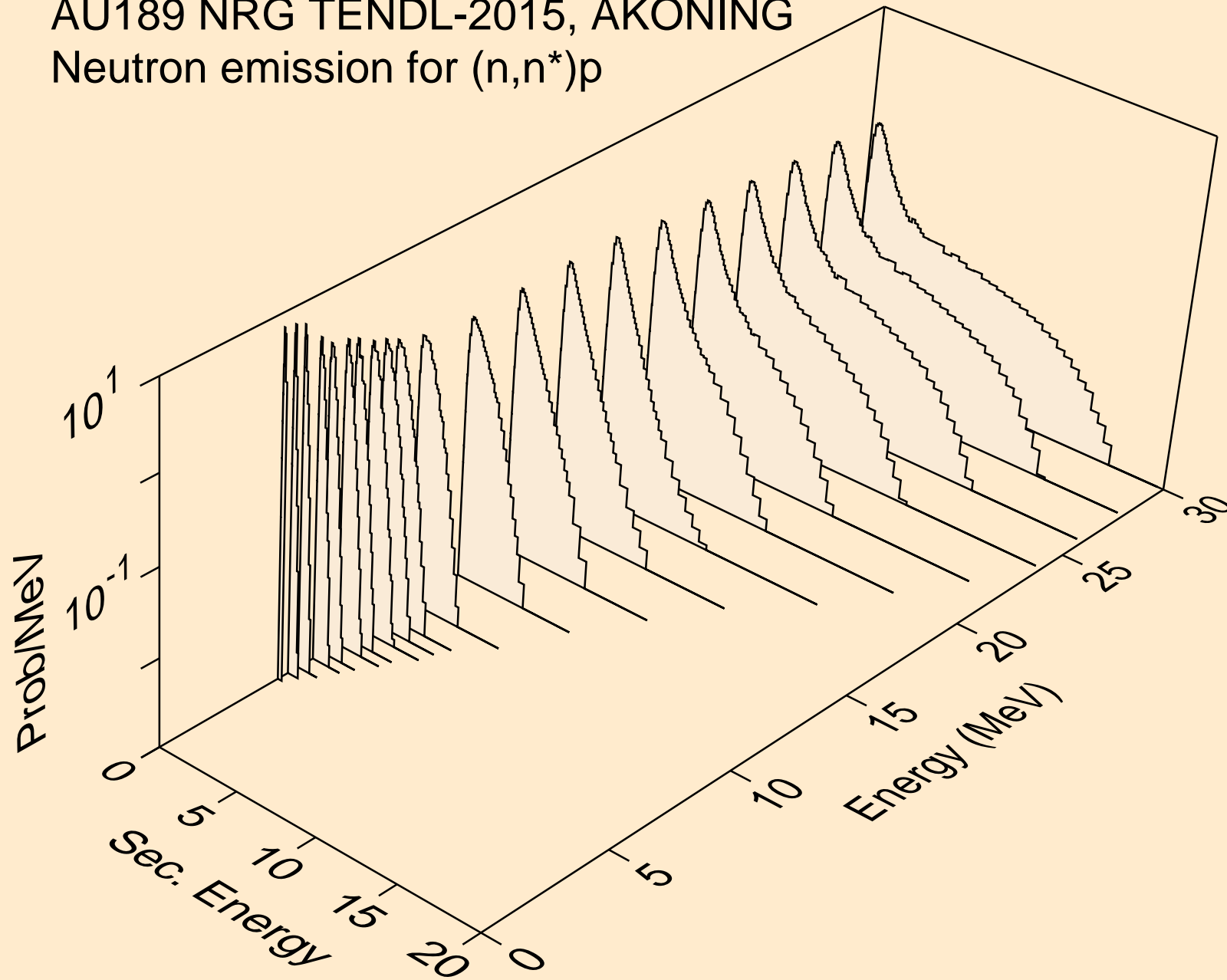

AU189 NRG TENDL-2015, AKONING
Neutron emission for (n,n*)2a

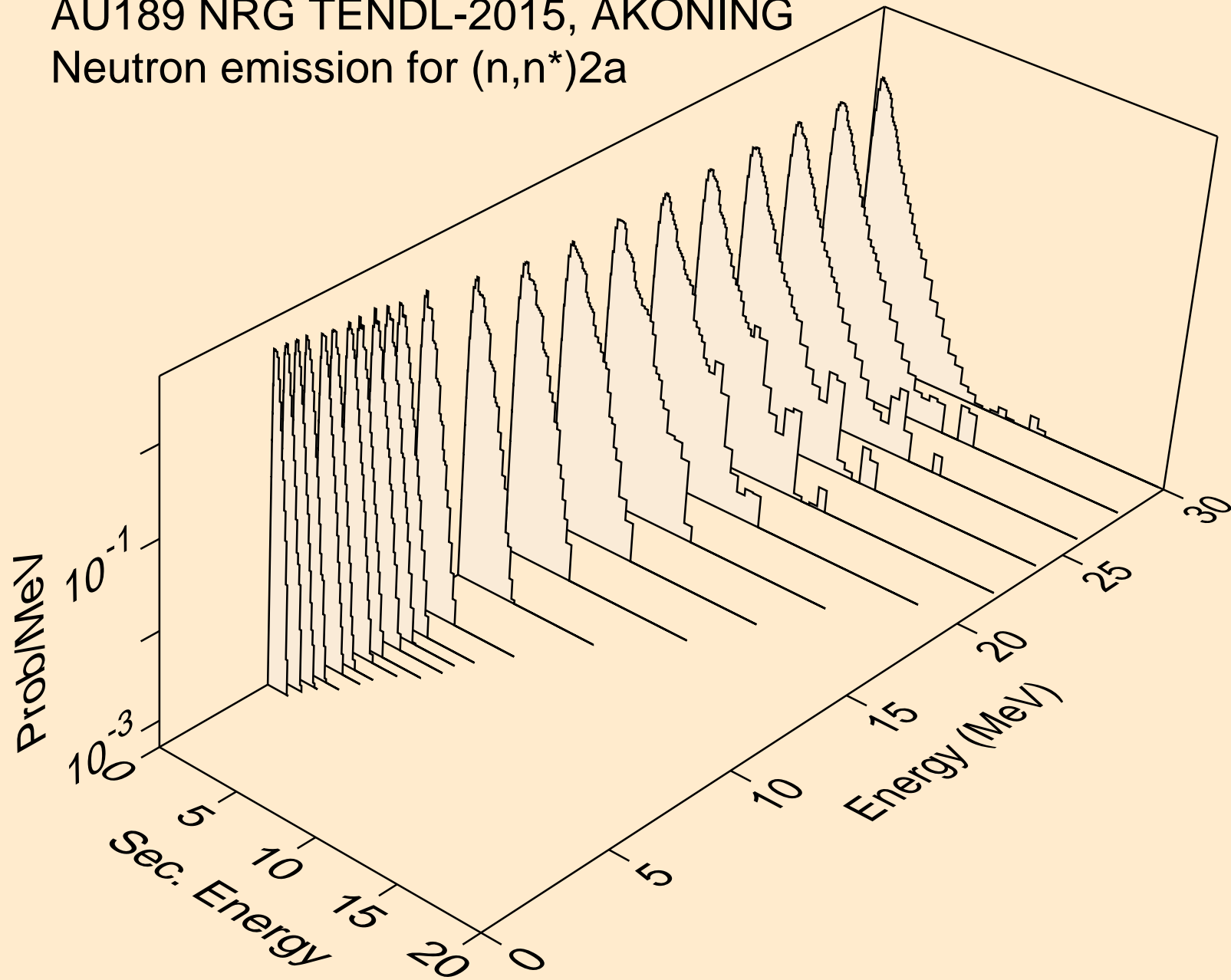

AU189 NRG TENDL-2015, AKONING
Neutron emission for (n,2n)2a

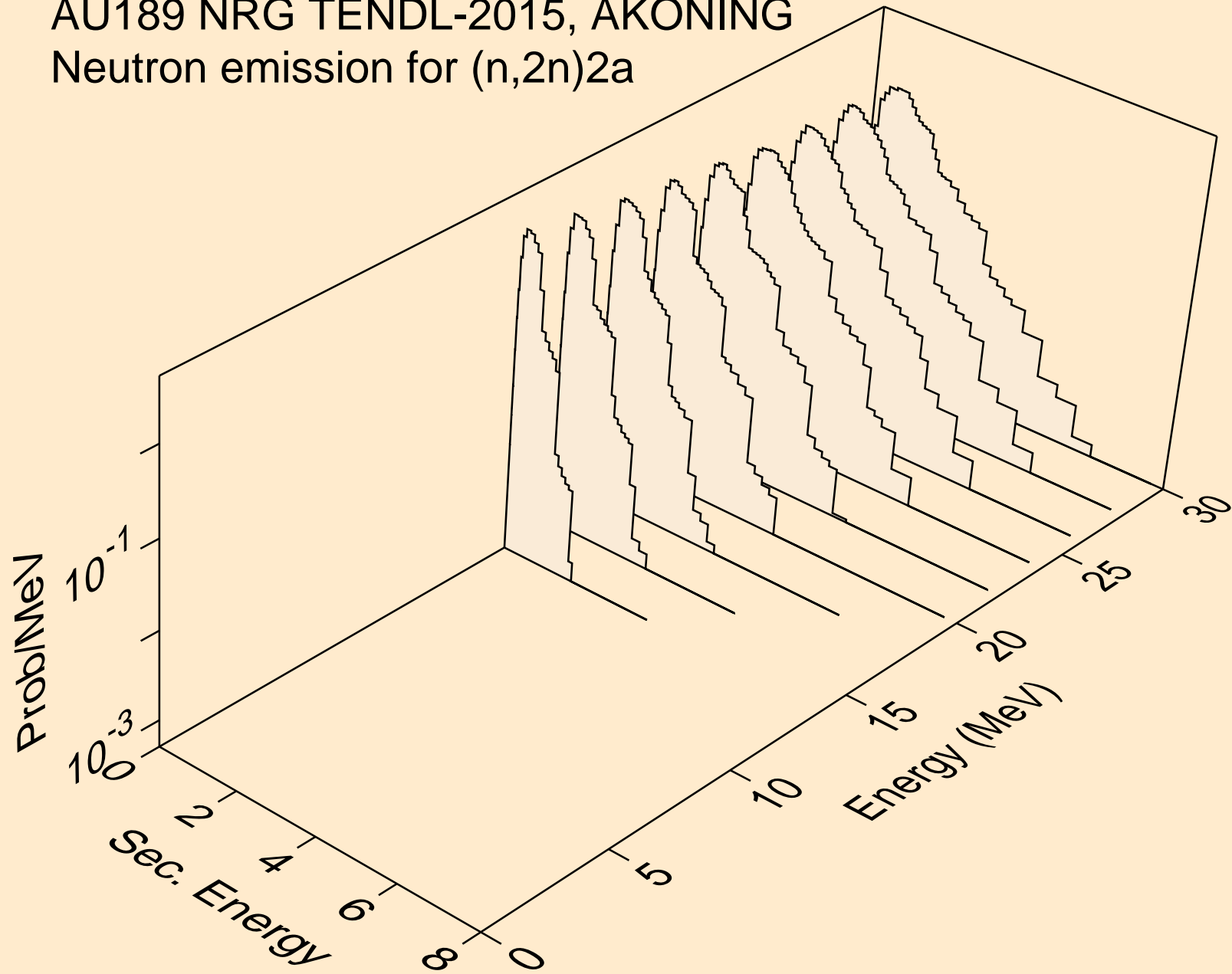

AU189 NRG TENDL-2015, AKONING
Neutron emission for (n,n*)d

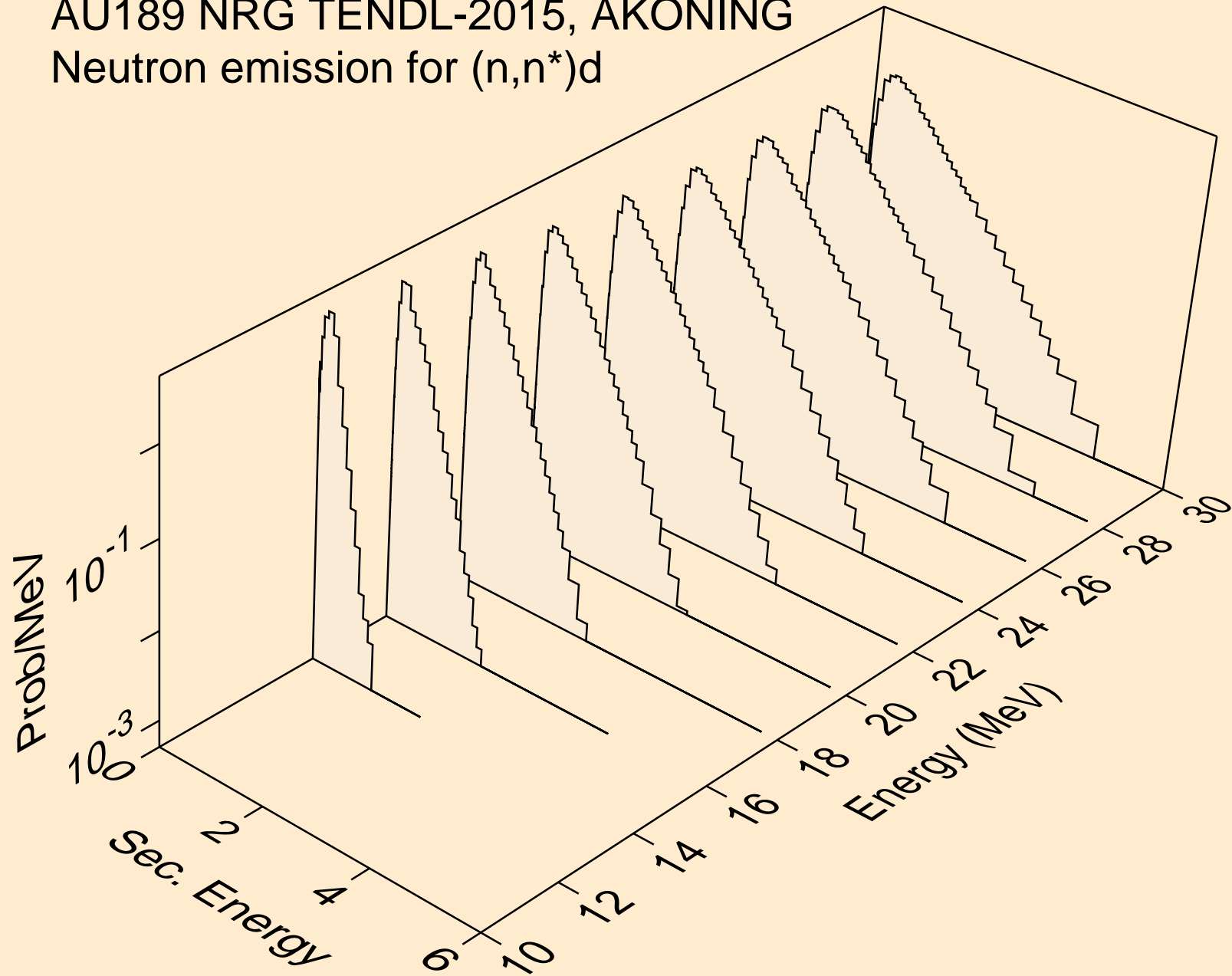

AU189 NRG TENDL-2015, AKONING
Neutron emission for (n,n*)t

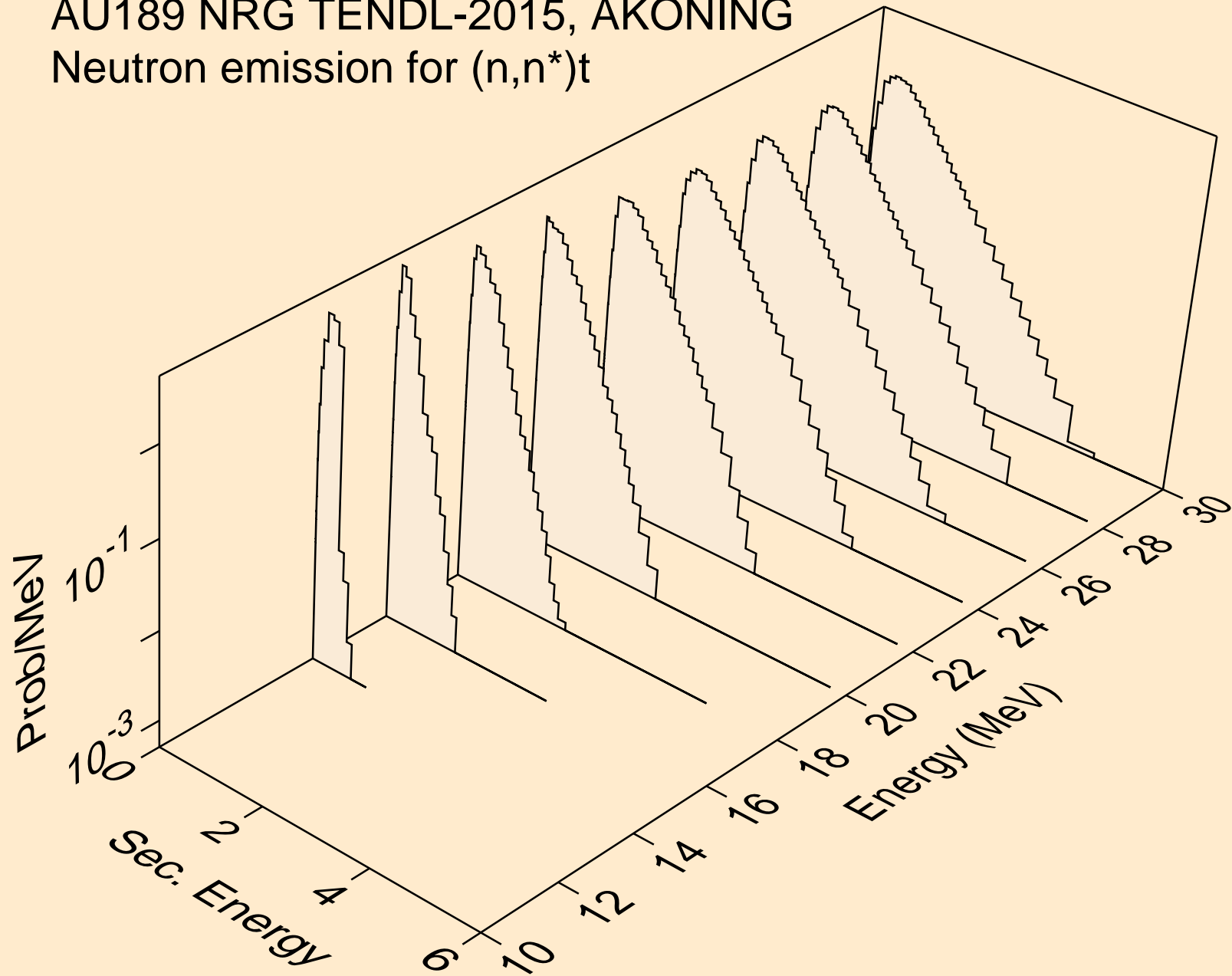

AU189 NRG TENDL-2015, AKONING
Neutron emission for (n,n*)he3

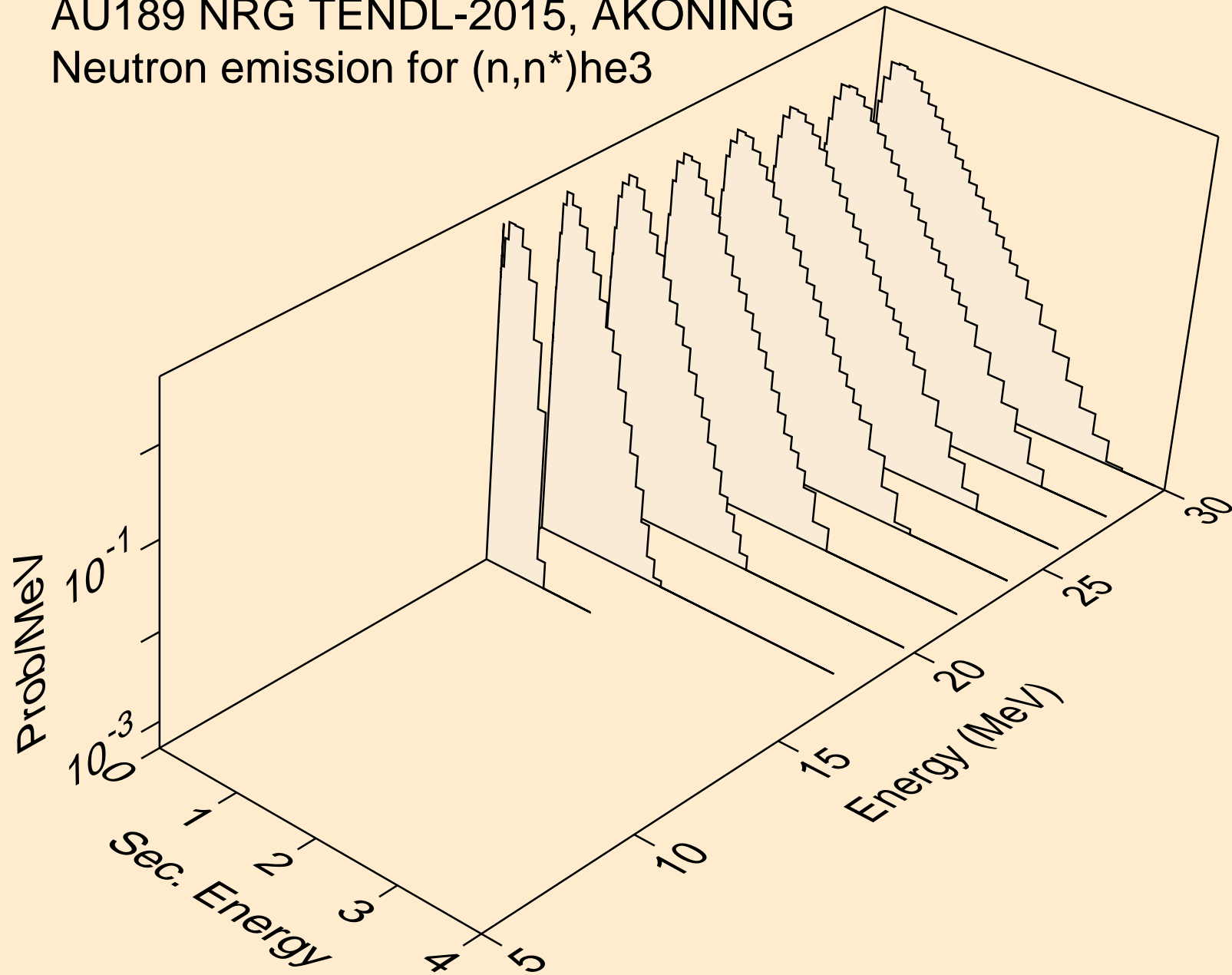

AU189 NRG TENDL-2015, AKONING
Neutron emission for (n,4n)

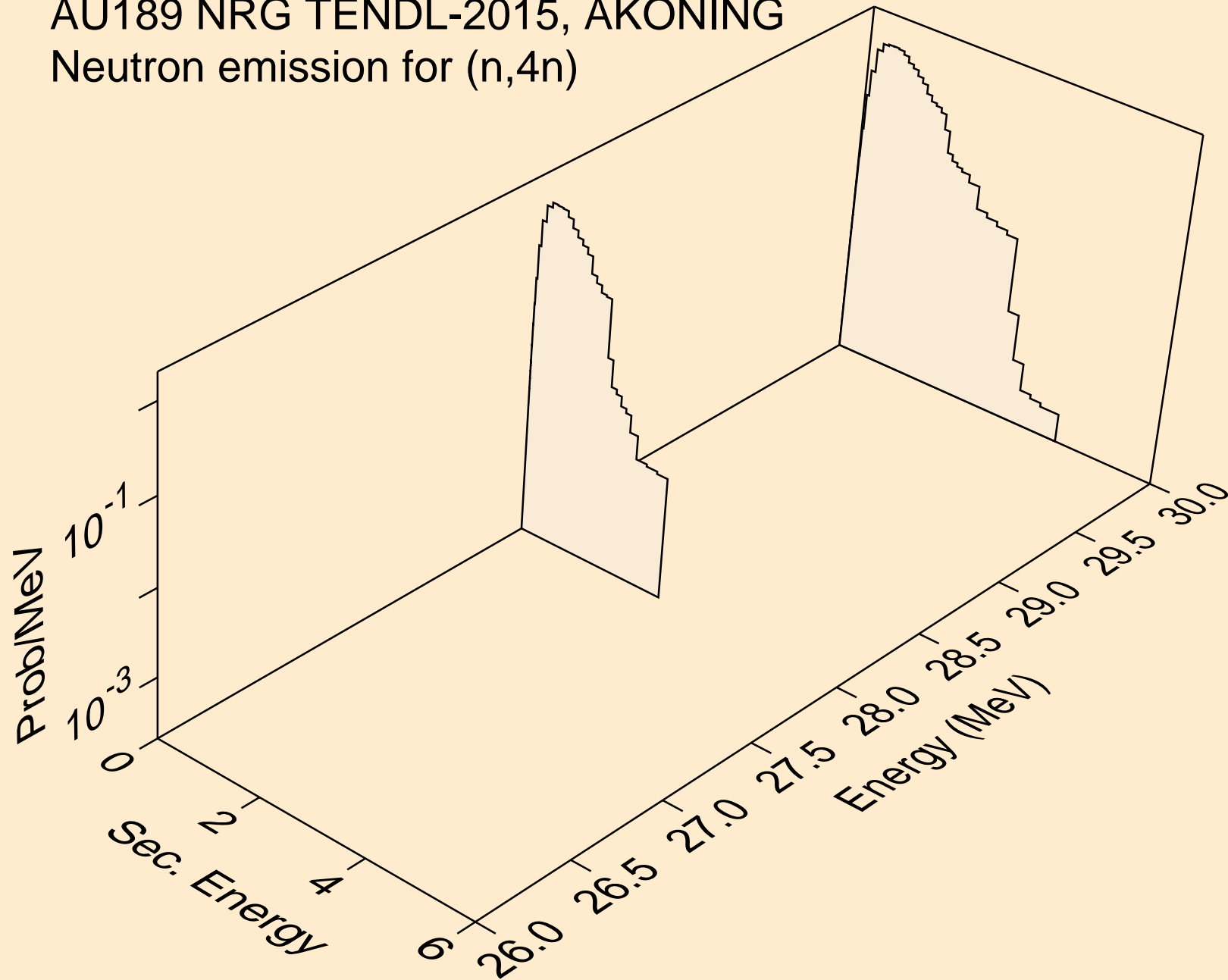

AU189 NRG TENDL-2015, AKONING
Neutron emission for (n,2np)

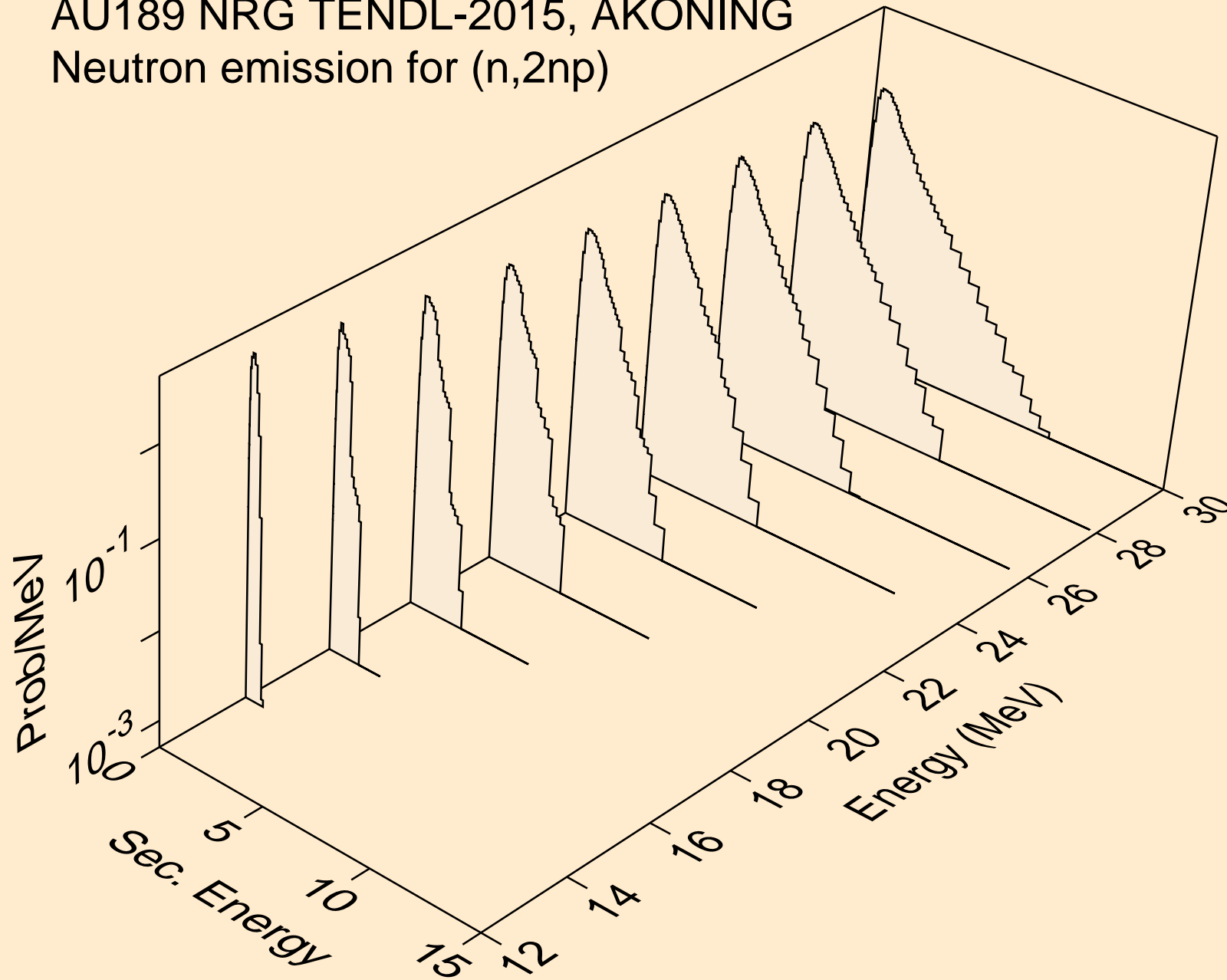

AU189 NRG TENDL-2015, AKONING
Neutron emission for (n,3np)

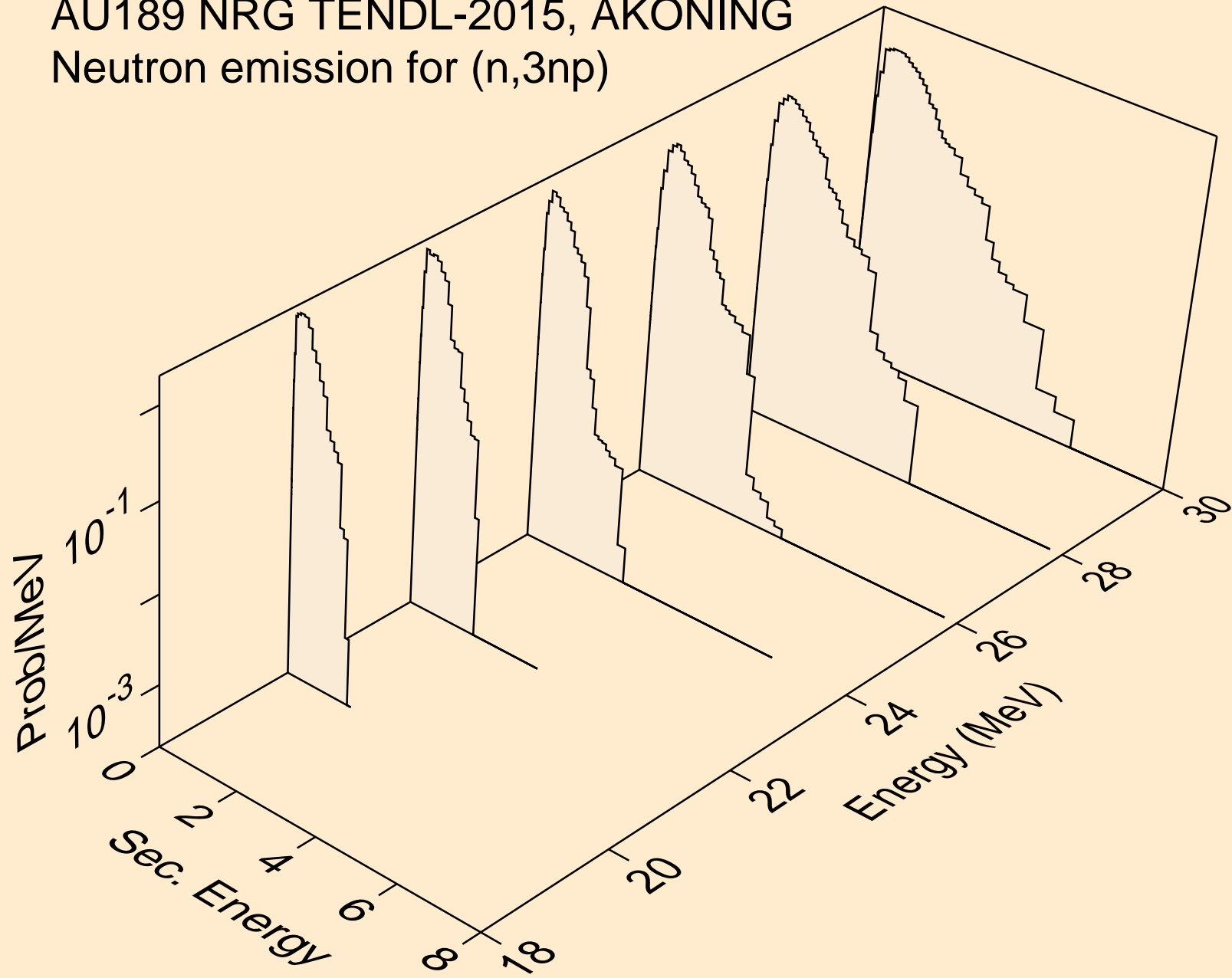

AU189 NRG TENDL-2015, AKONING
Neutron emission for (n,2np)

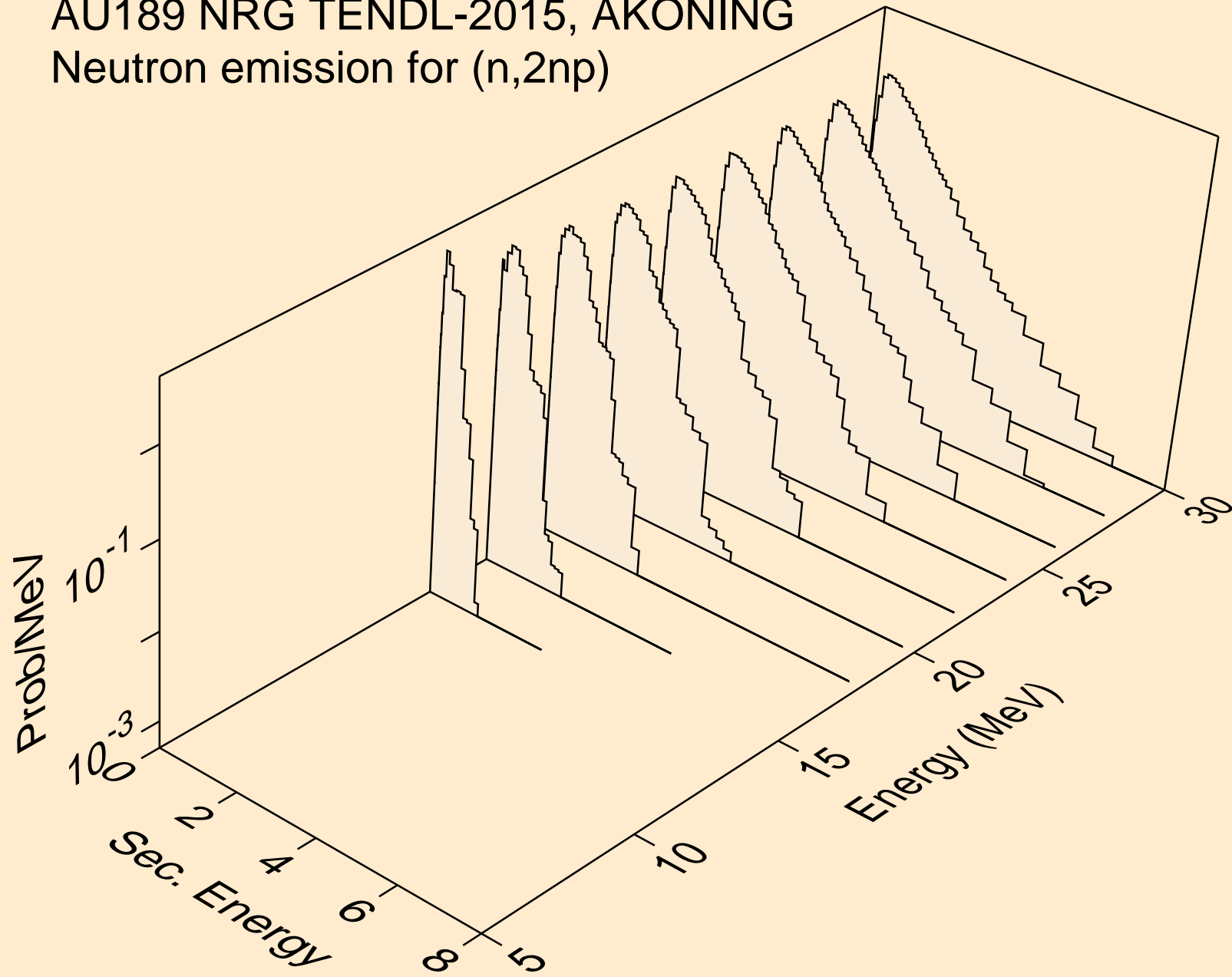

AU189 NRG TENDL-2015, AKONING
Neutron emission for (n,npa)

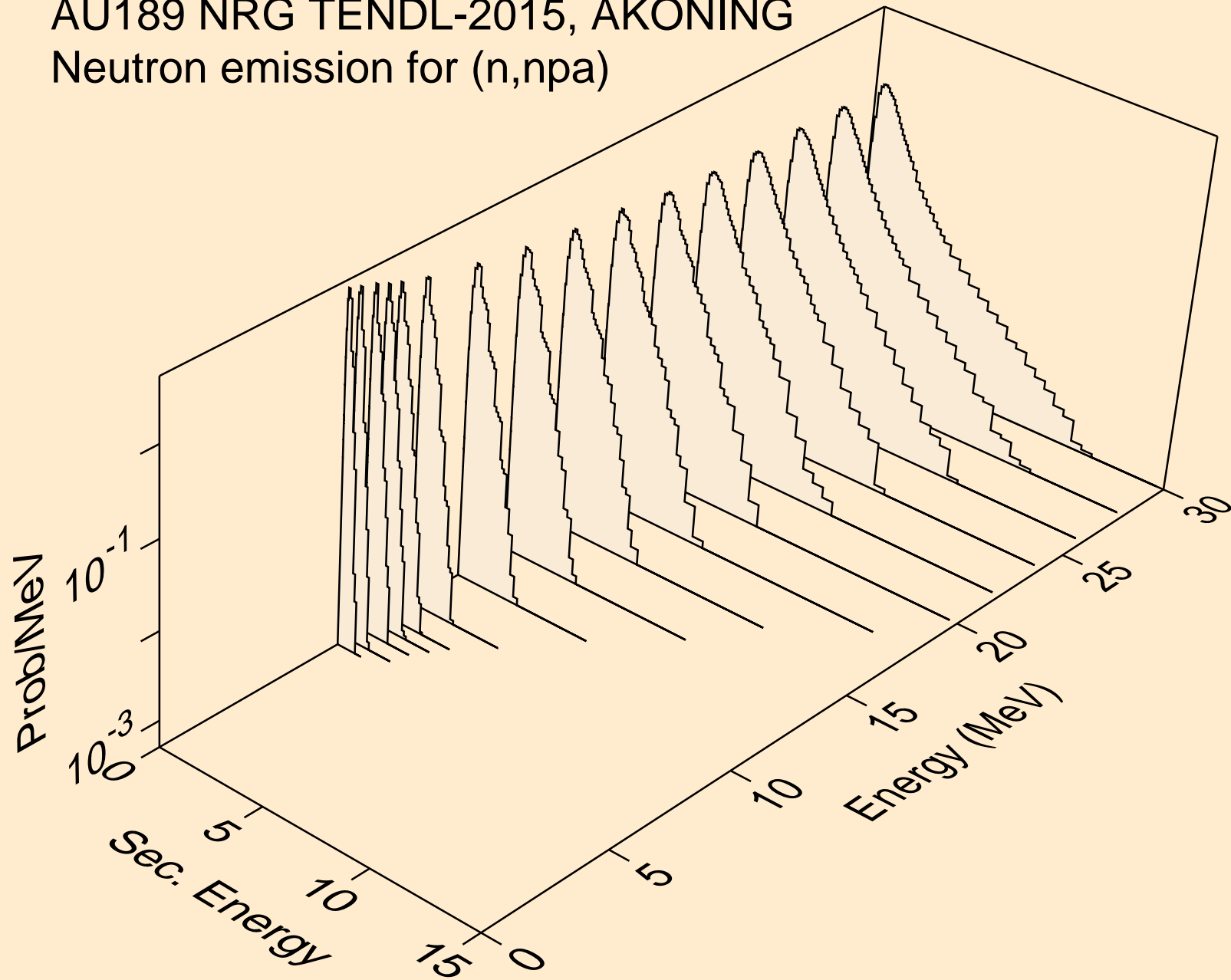

AU189 NRG TENDL-2015, AKONING
Neutron emission for (n,n*c)

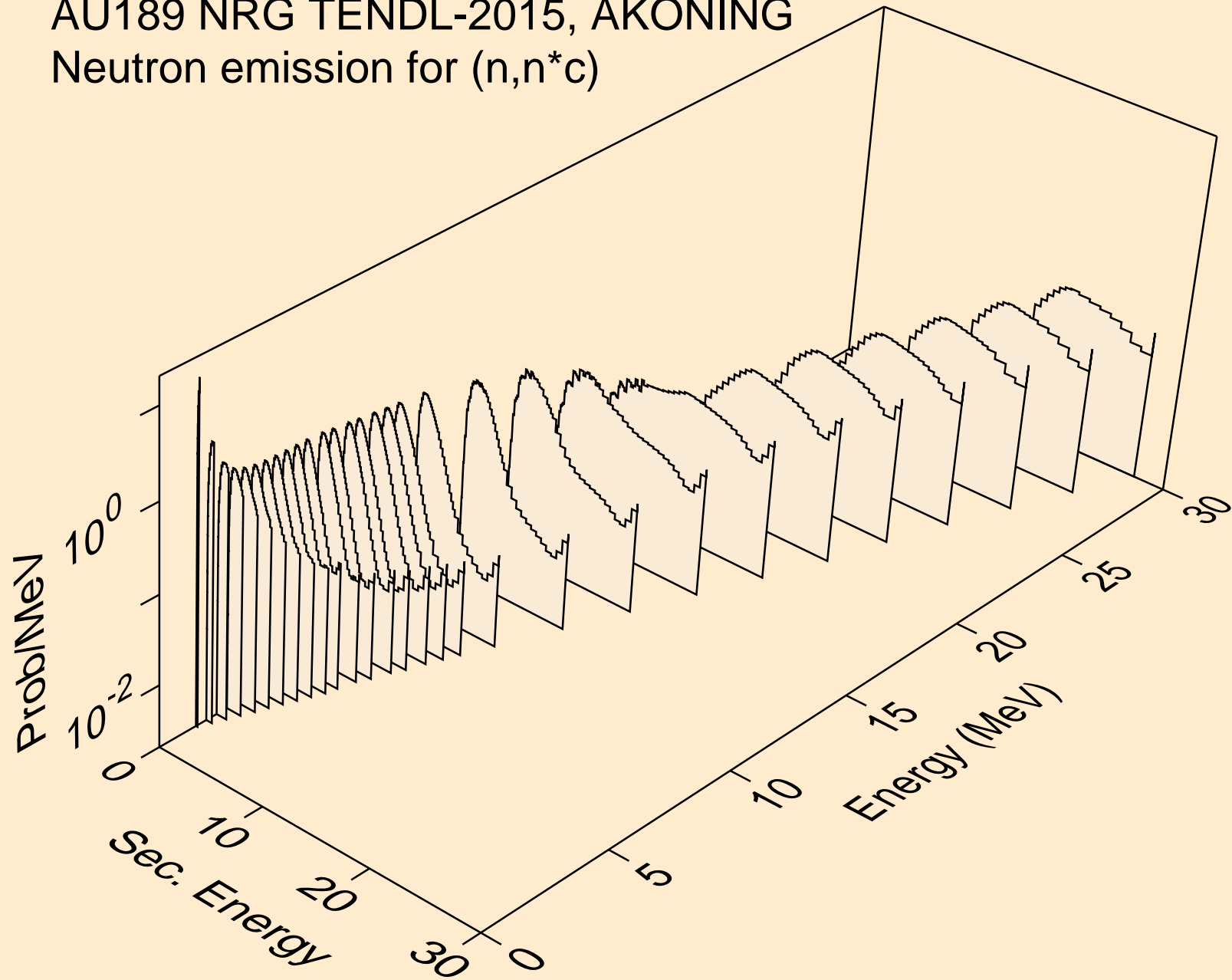

AU189 NRG TENDL-2015, AKONING
Photon emission for (n,x)

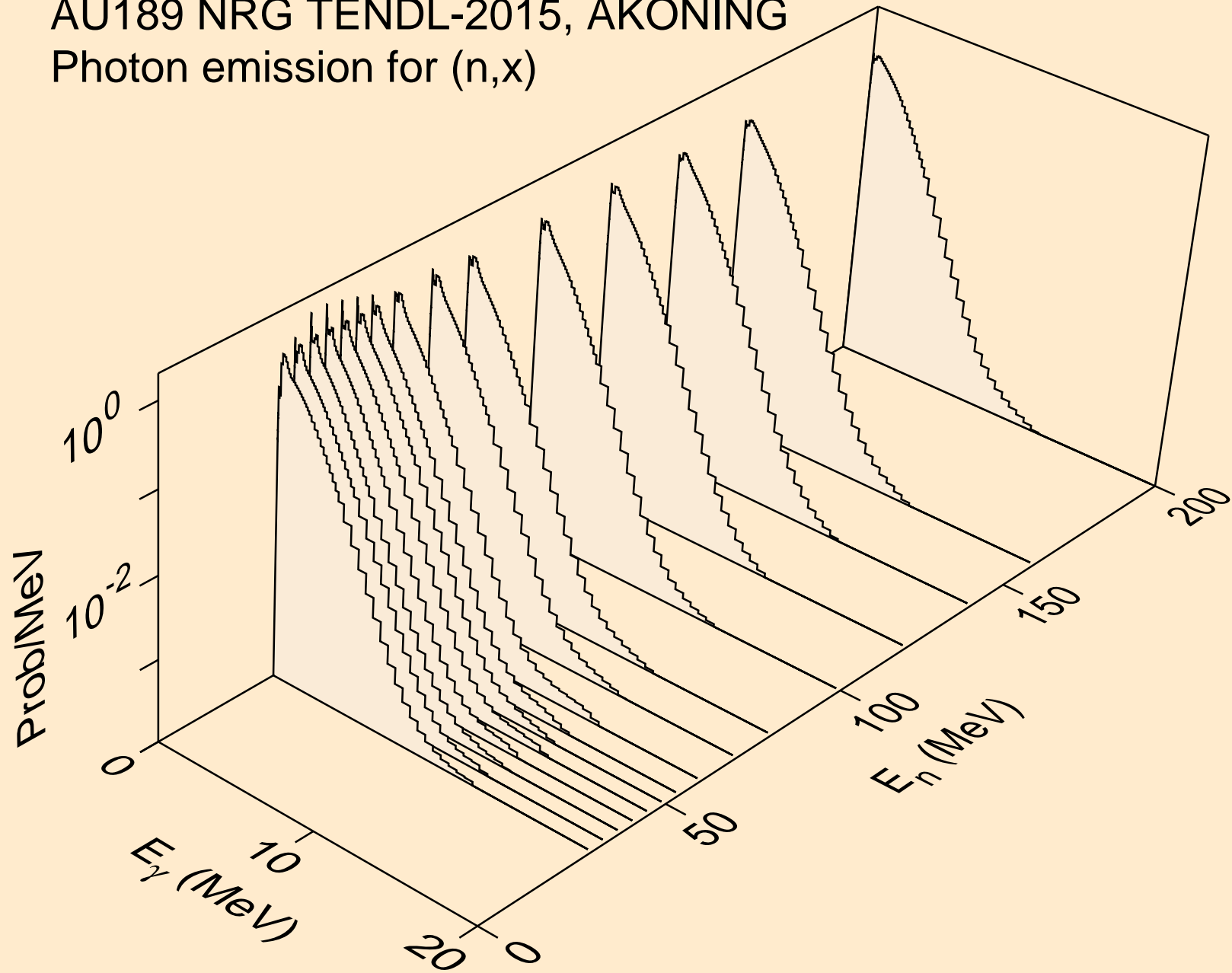

AU189 NRG TENDL-2015, AKONING
Photon emission for (n,2nd)

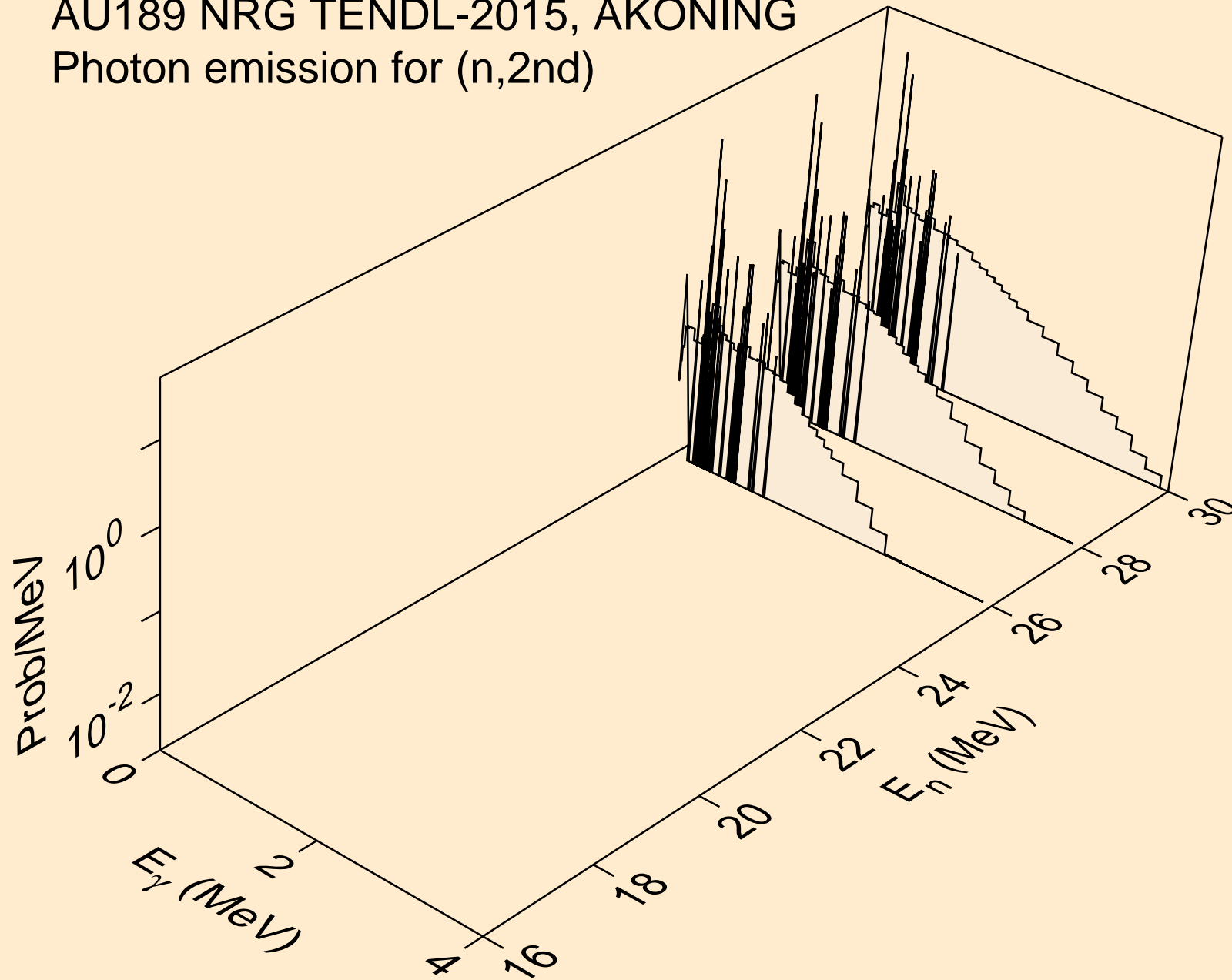

AU189 NRG TENDL-2015, AKONING
Photon emission for (n,2n)

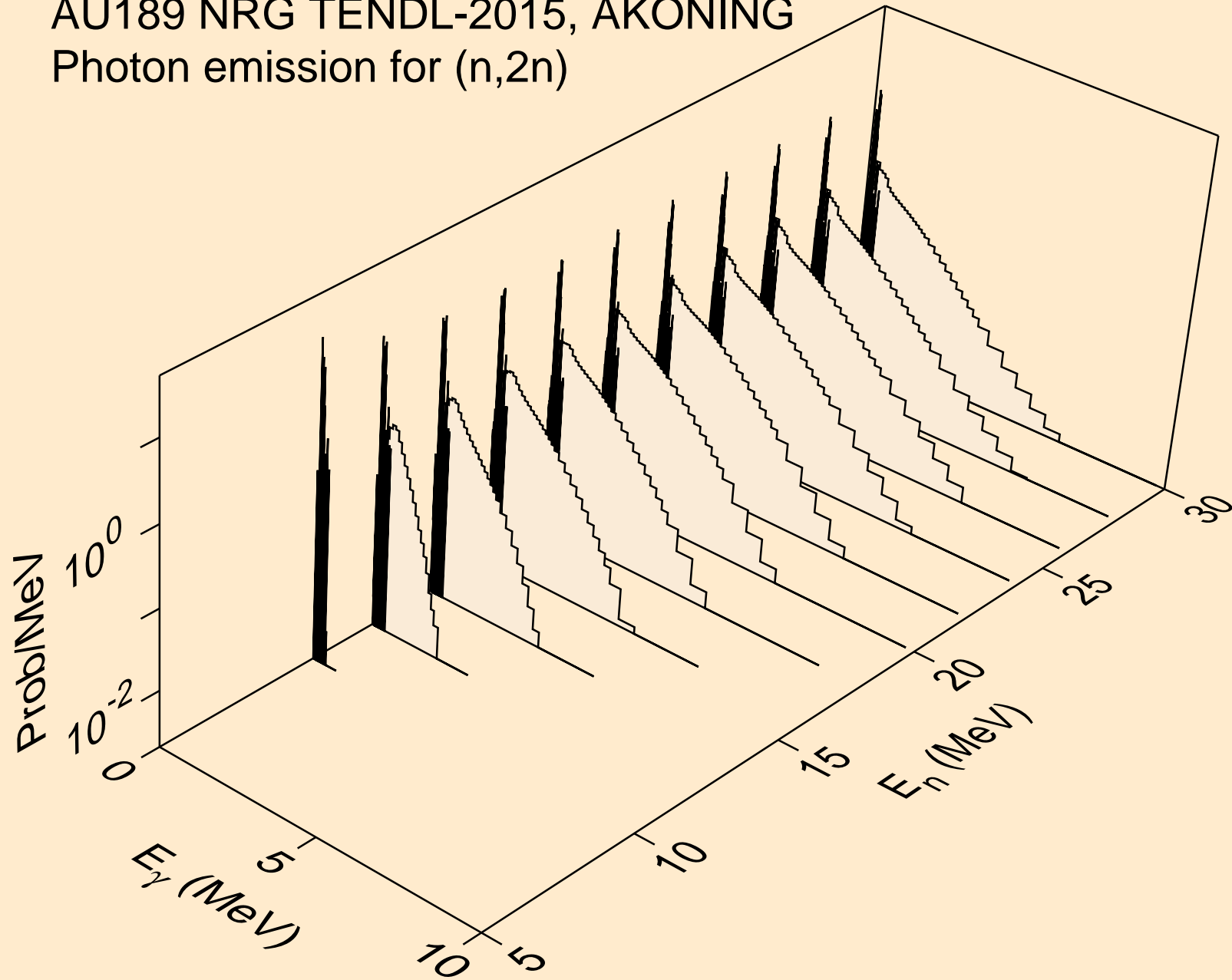

AU189 NRG TENDL-2015, AKONING
Photon emission for (n,3n)

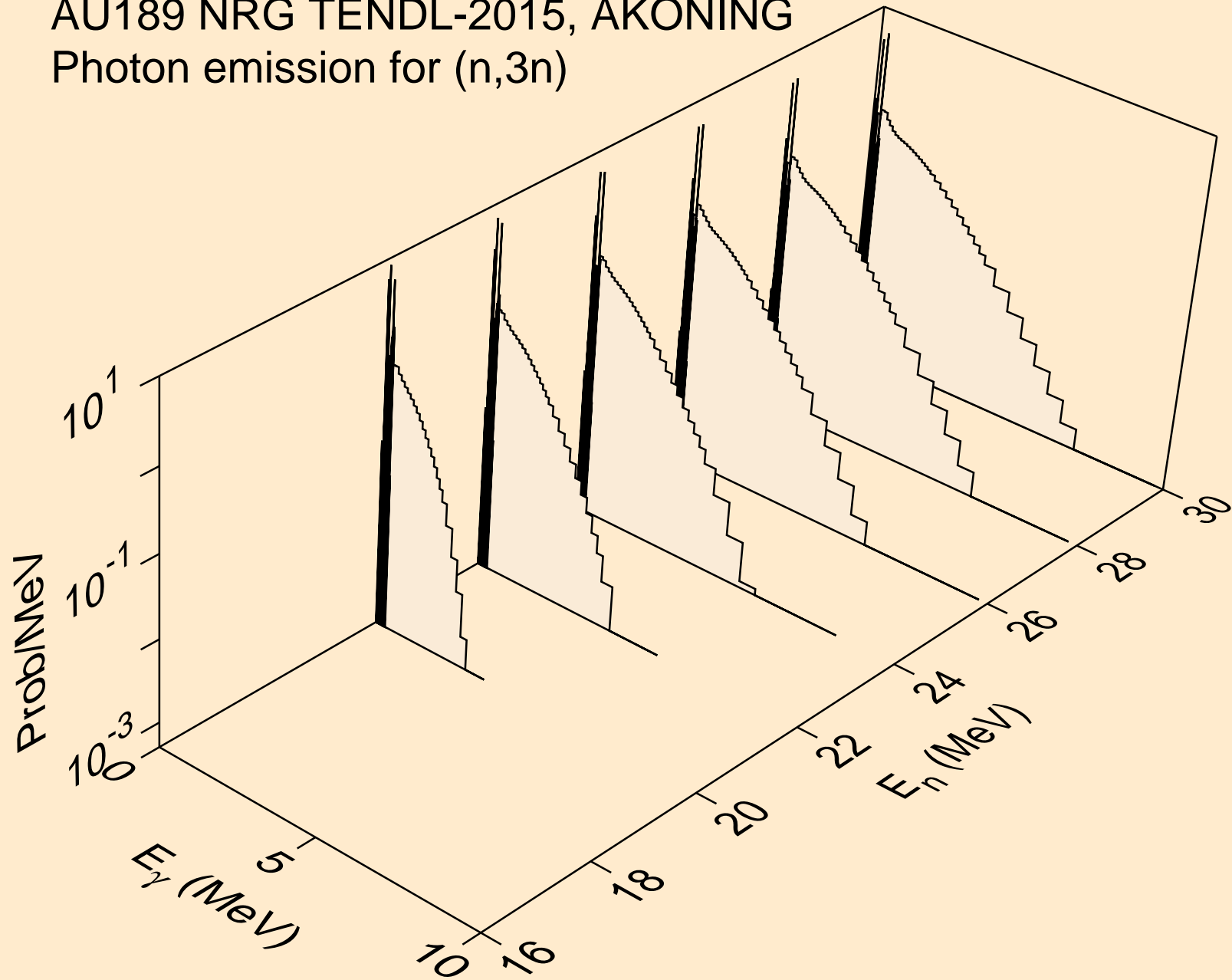

AU189 NRG TENDL-2015, AKONING
Photon emission for (n,n*)a

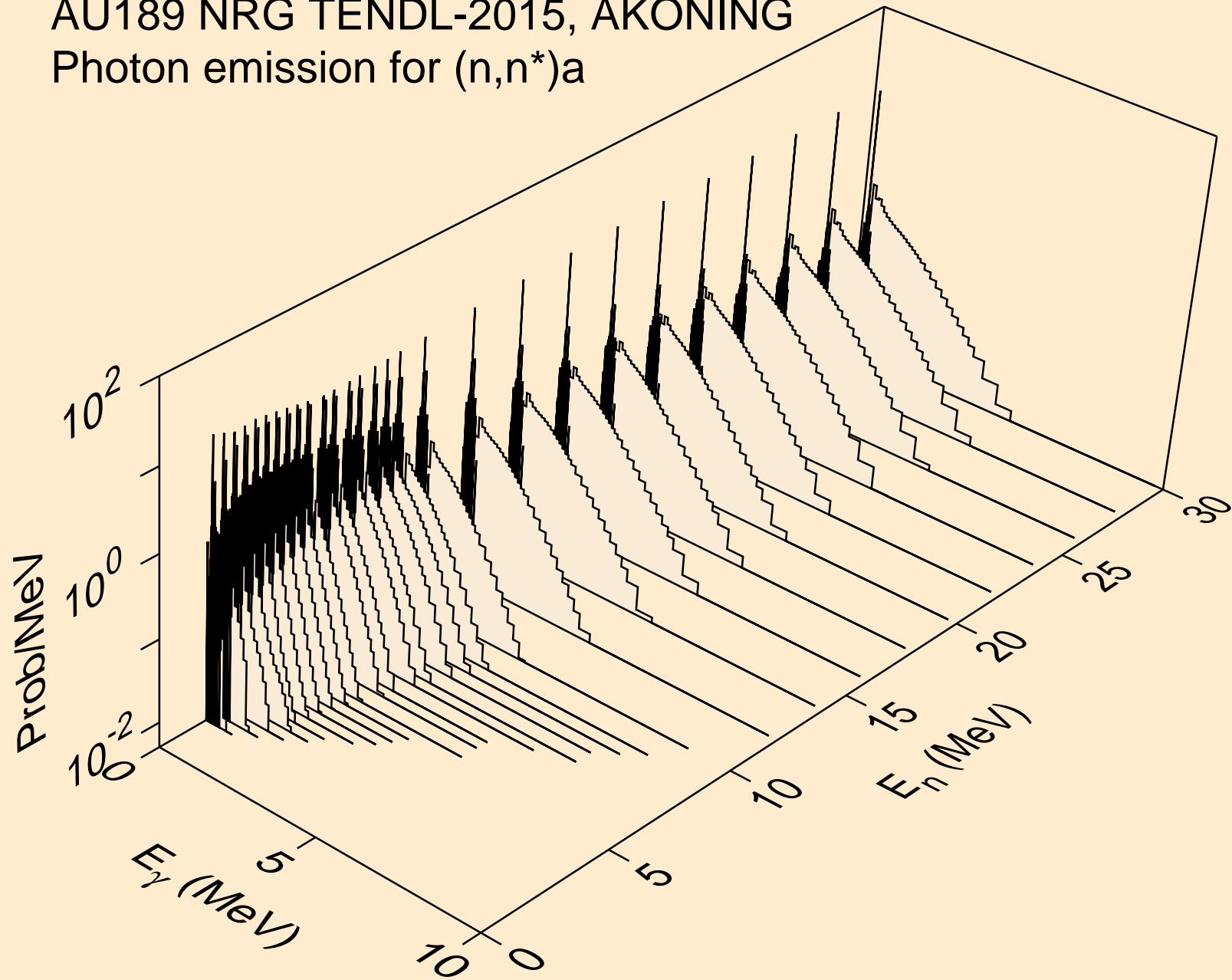

AU189 NRG TENDL-2015, AKONING
Photon emission for (n,2n) α

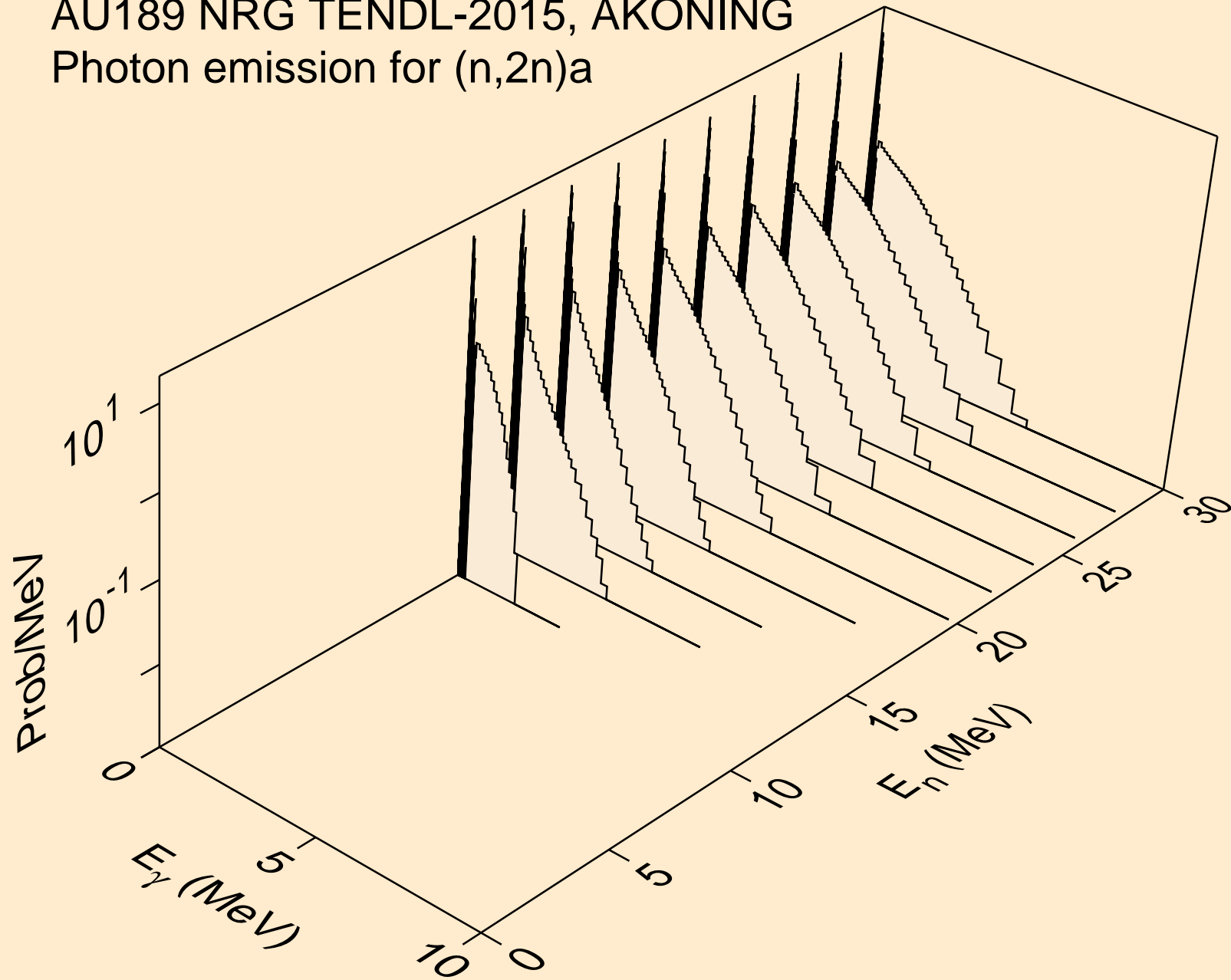

AU189 NRG TENDL-2015, AKONING
Photon emission for (n,3n)a

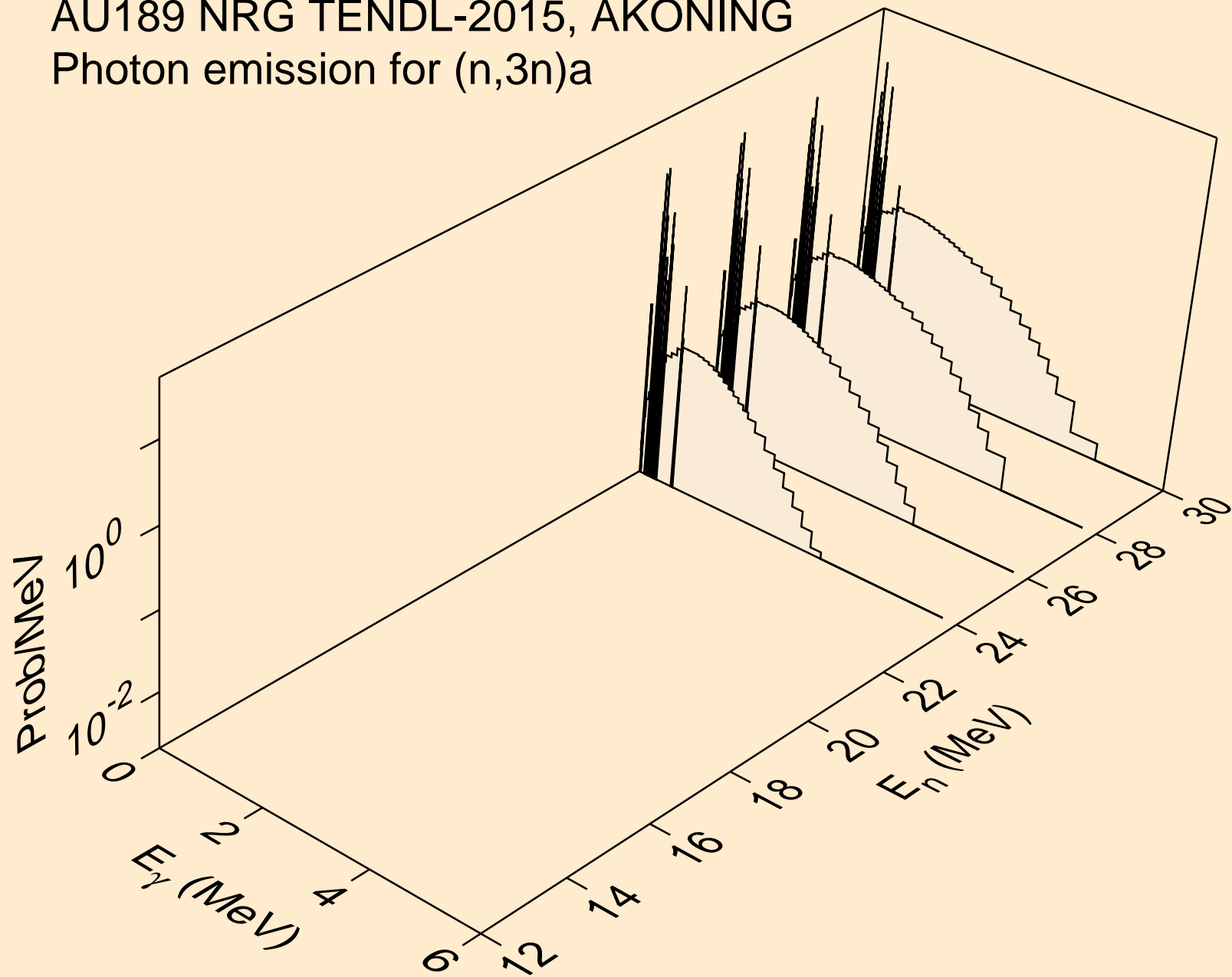

AU189 NRG TENDL-2015, AKONING
Photon emission for (n,n*)p

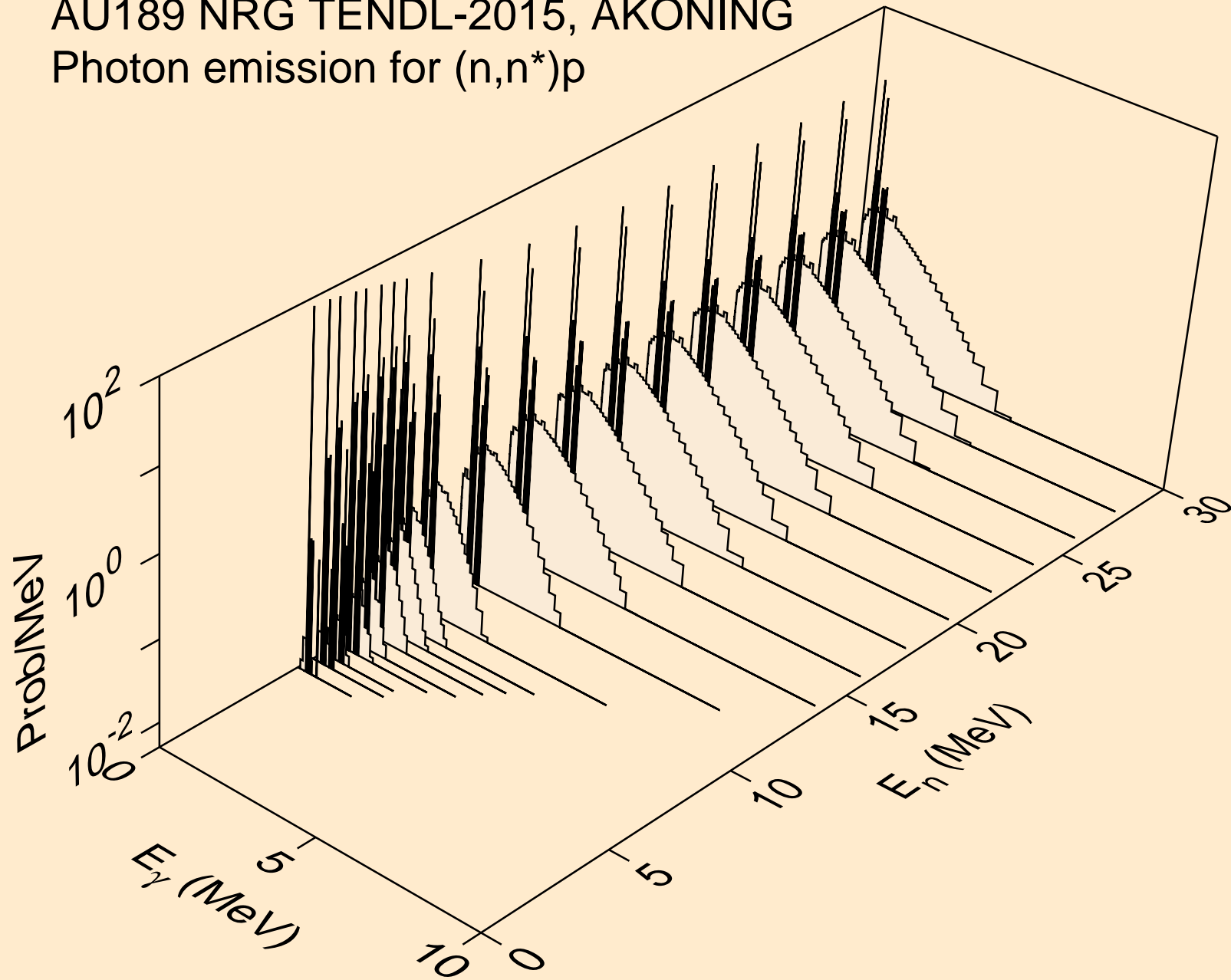

AU189 NRG TENDL-2015, AKONING
Photon emission for (n,n*)2a

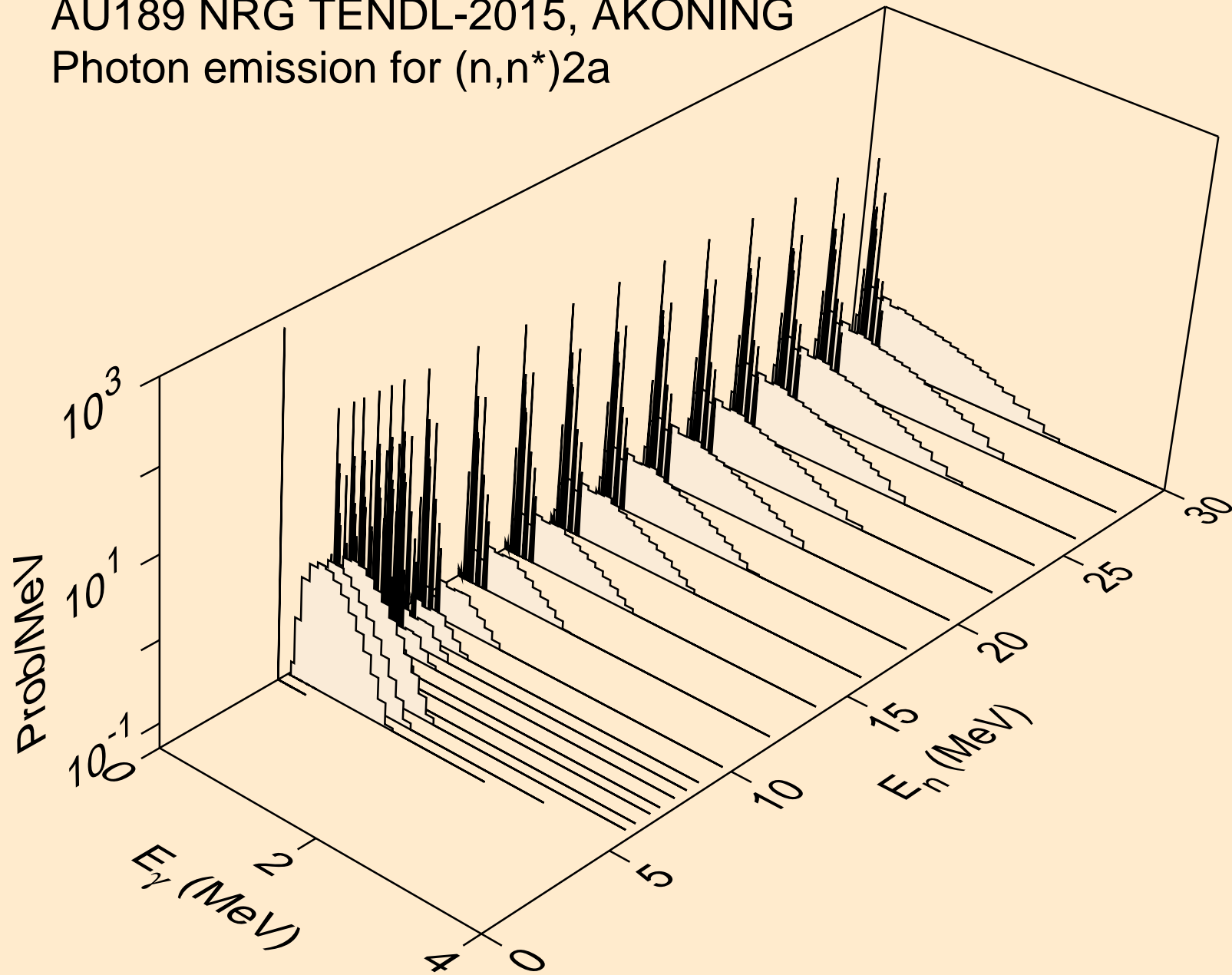

AU189 NRG TENDL-2015, AKONING
Photon emission for (n,2n)2a

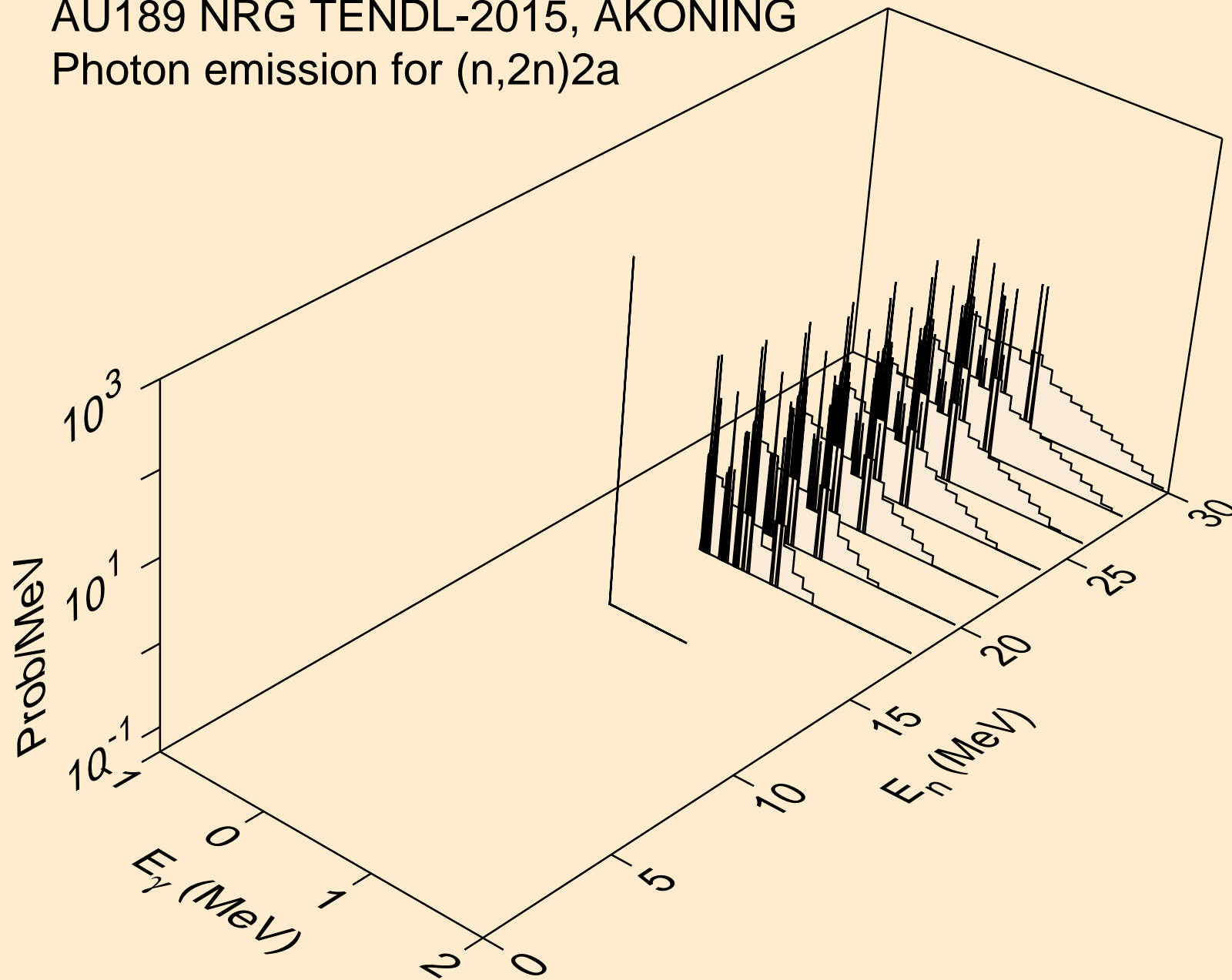

AU189 NRG TENDL-2015, AKONING
Photon emission for (n,n*)d

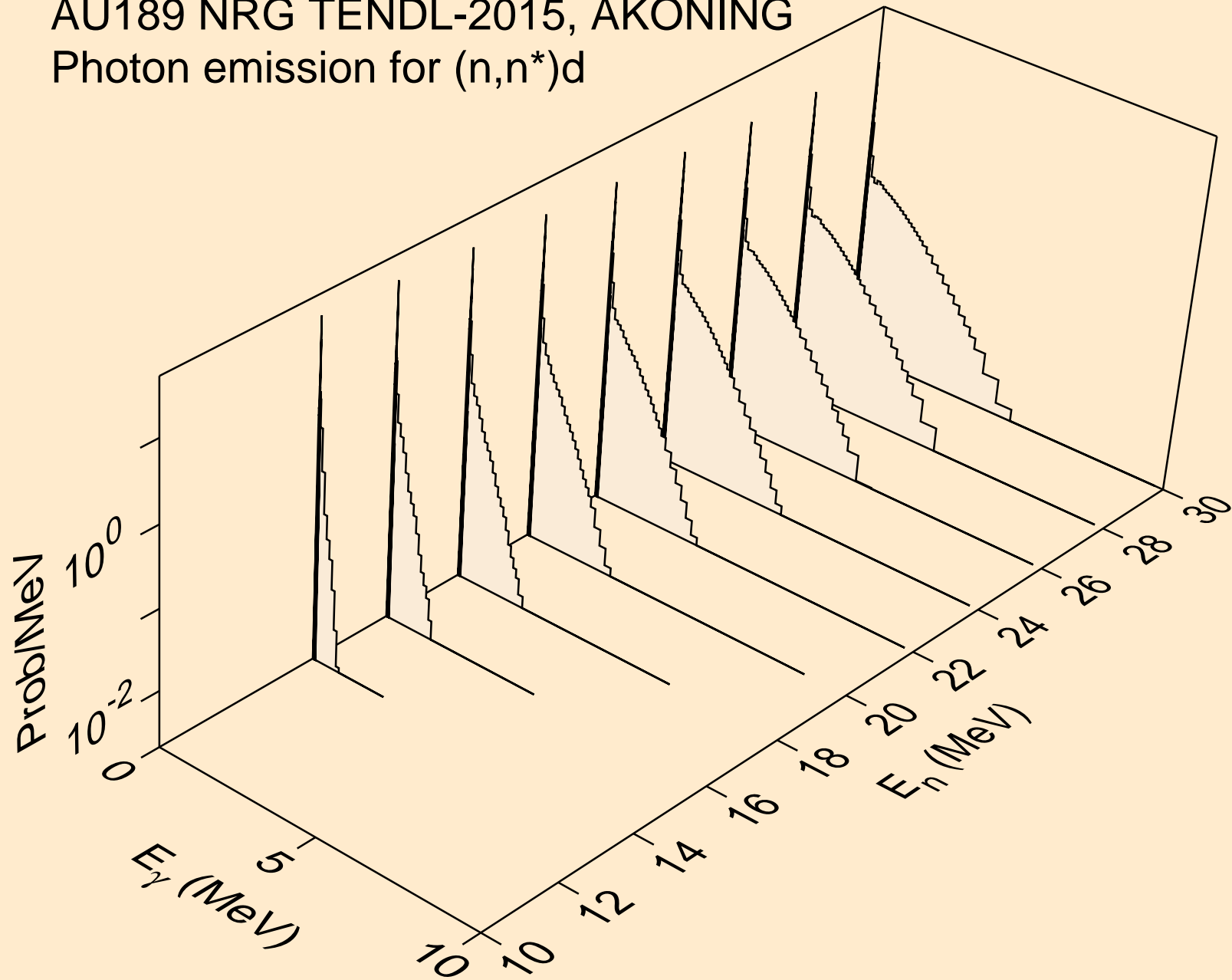

AU189 NRG TENDL-2015, AKONING
Photon emission for (n,n*)t

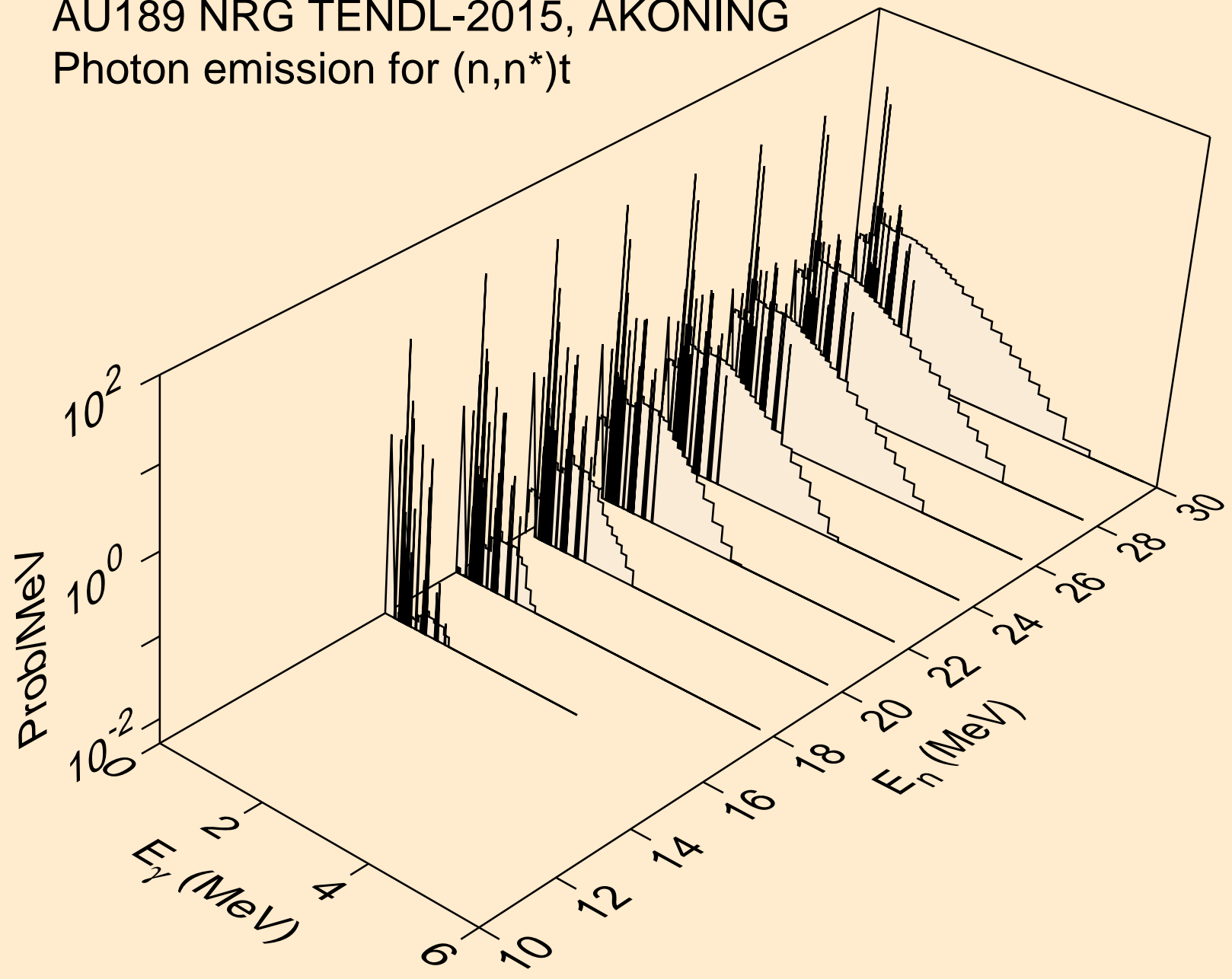

AU189 NRG TENDL-2015, AKONING

Photon emission for (n,n*)he3

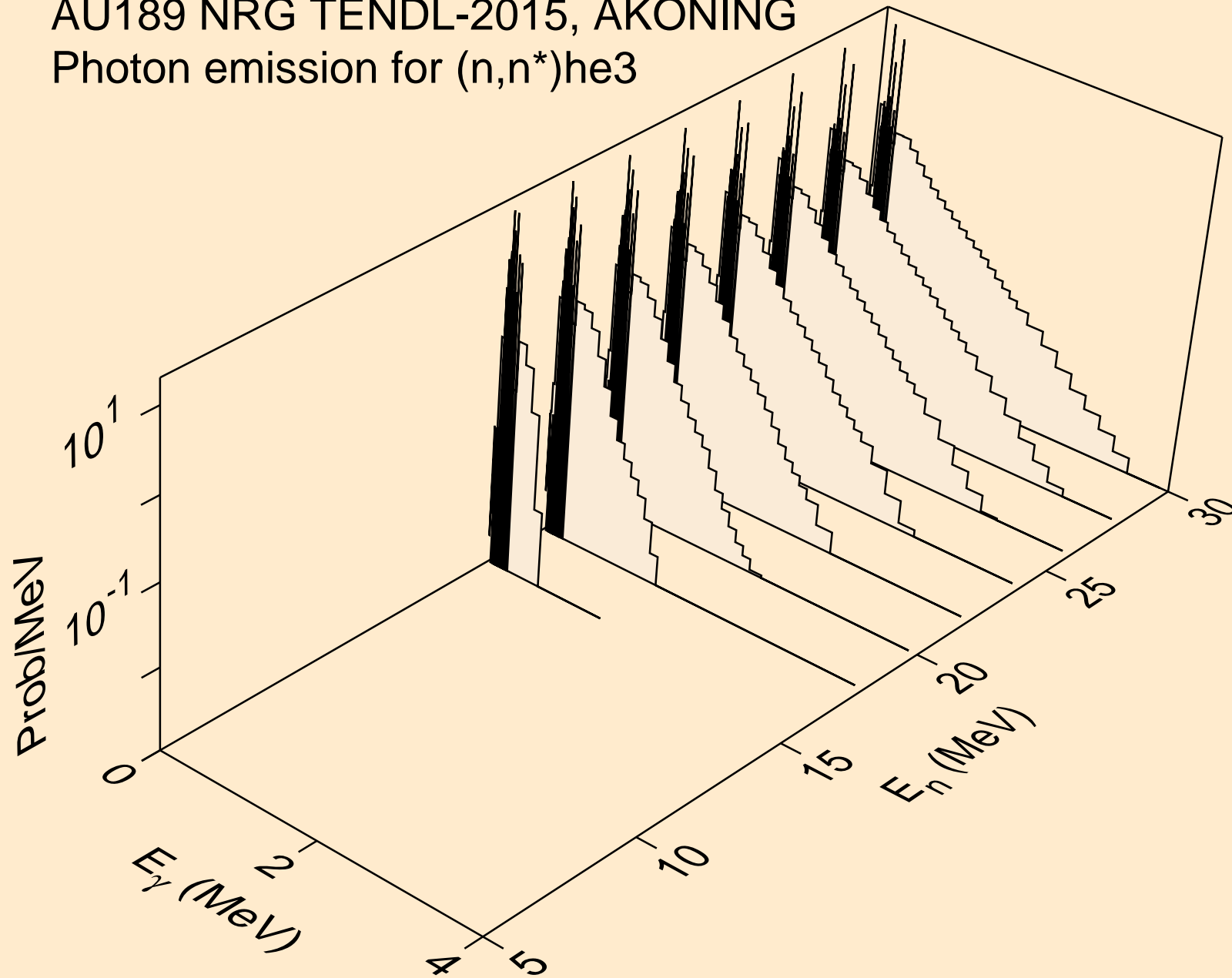

AU189 NRG TENDL-2015, AKONING
Photon emission for (n,4n)

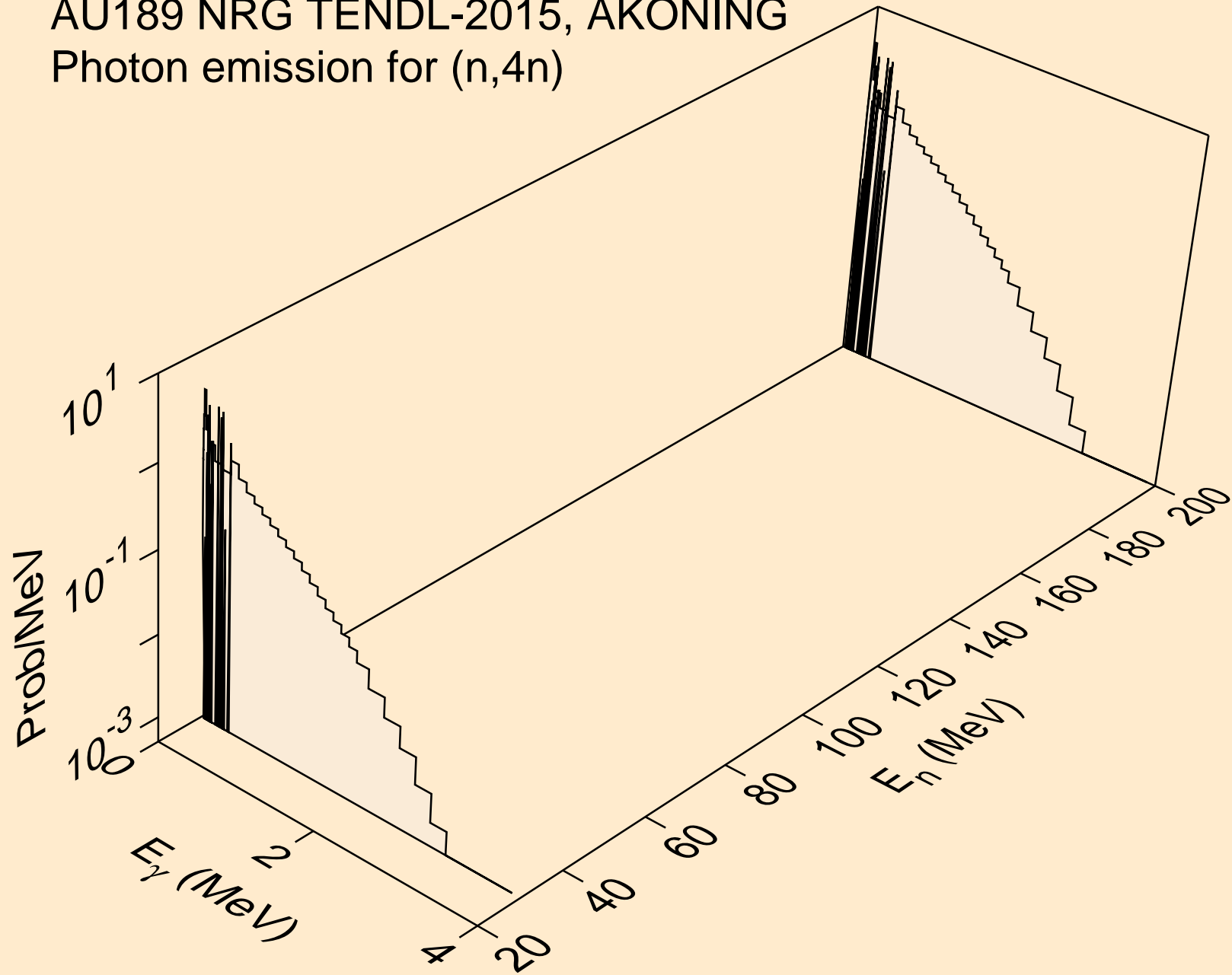

AU189 NRG TENDL-2015, AKONING
Photon emission for (n,2np)

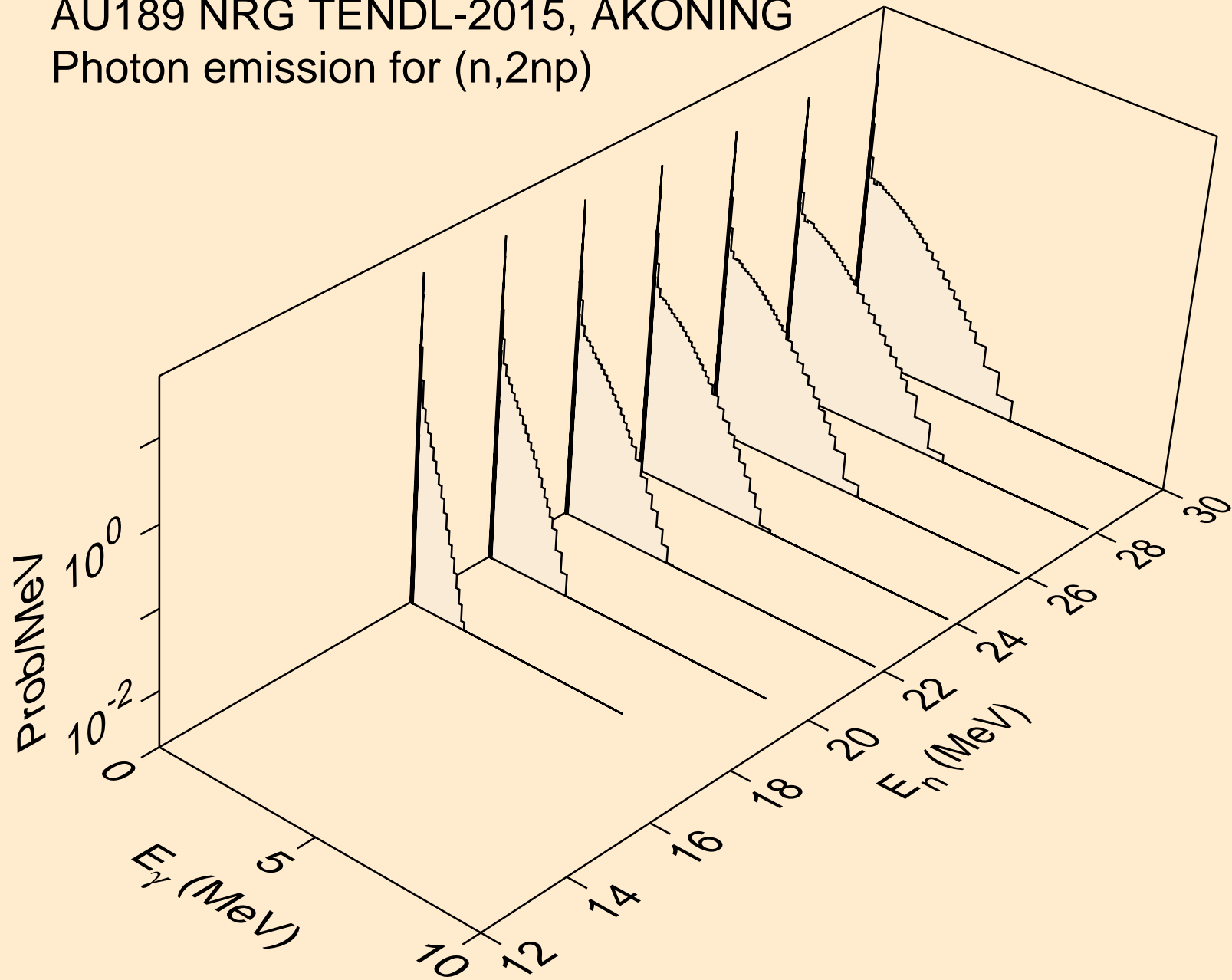

AU189 NRG TENDL-2015, AKONING
Photon emission for (n,3np)

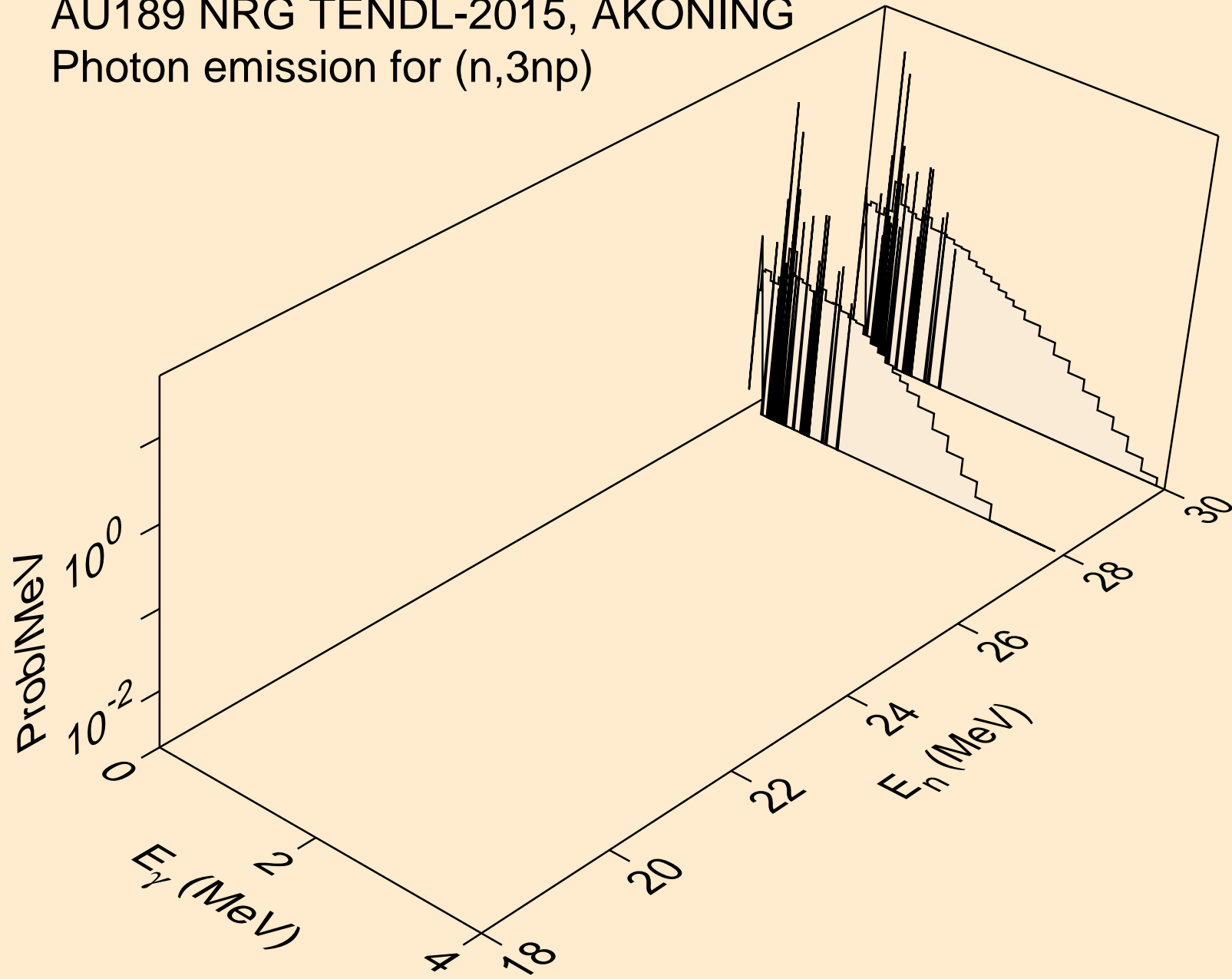

AU189 NRG TENDL-2015, AKONING
Photon emission for (n,2np)

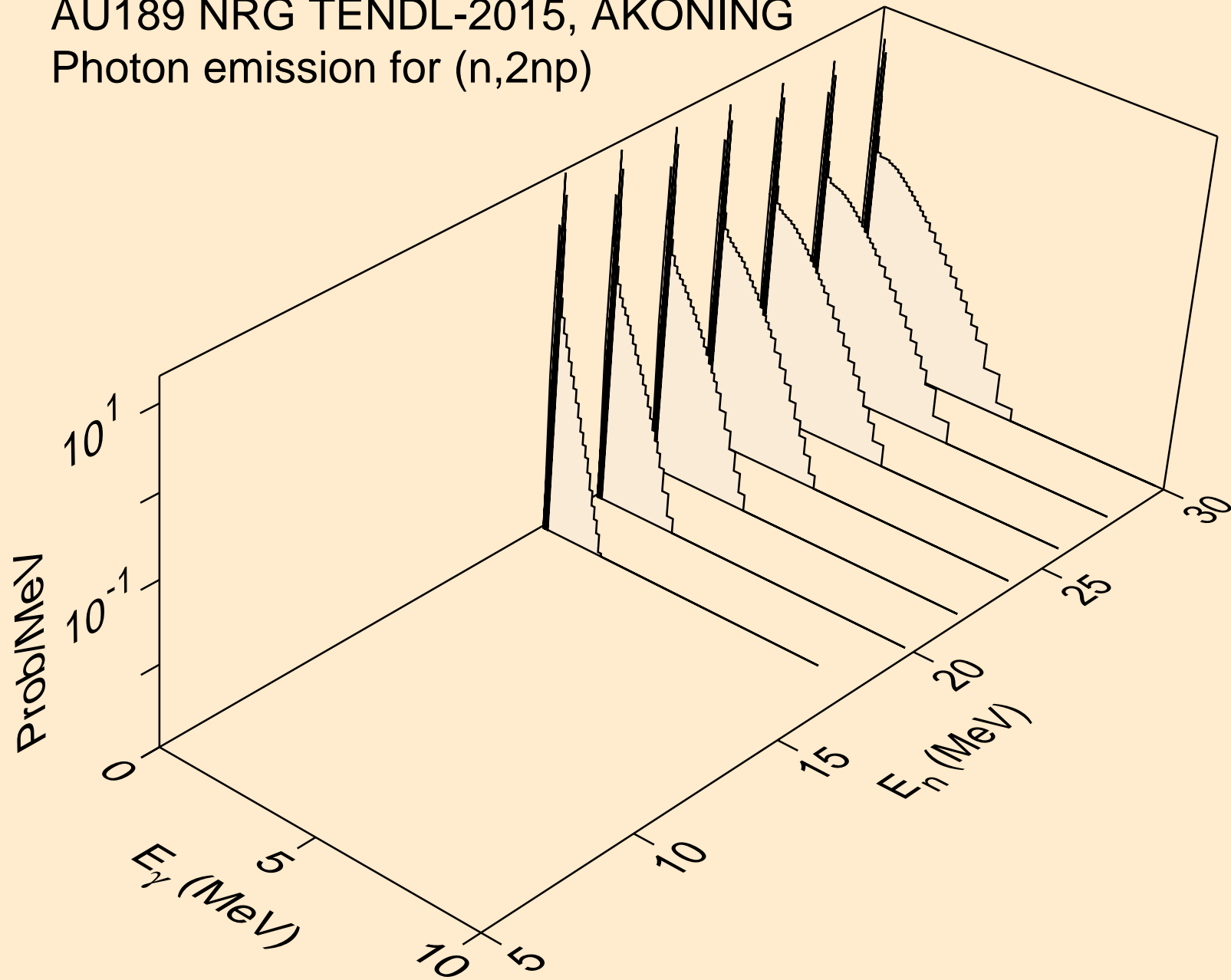

AU189 NRG TENDL-2015, AKONING
Photon emission for (n,npa)

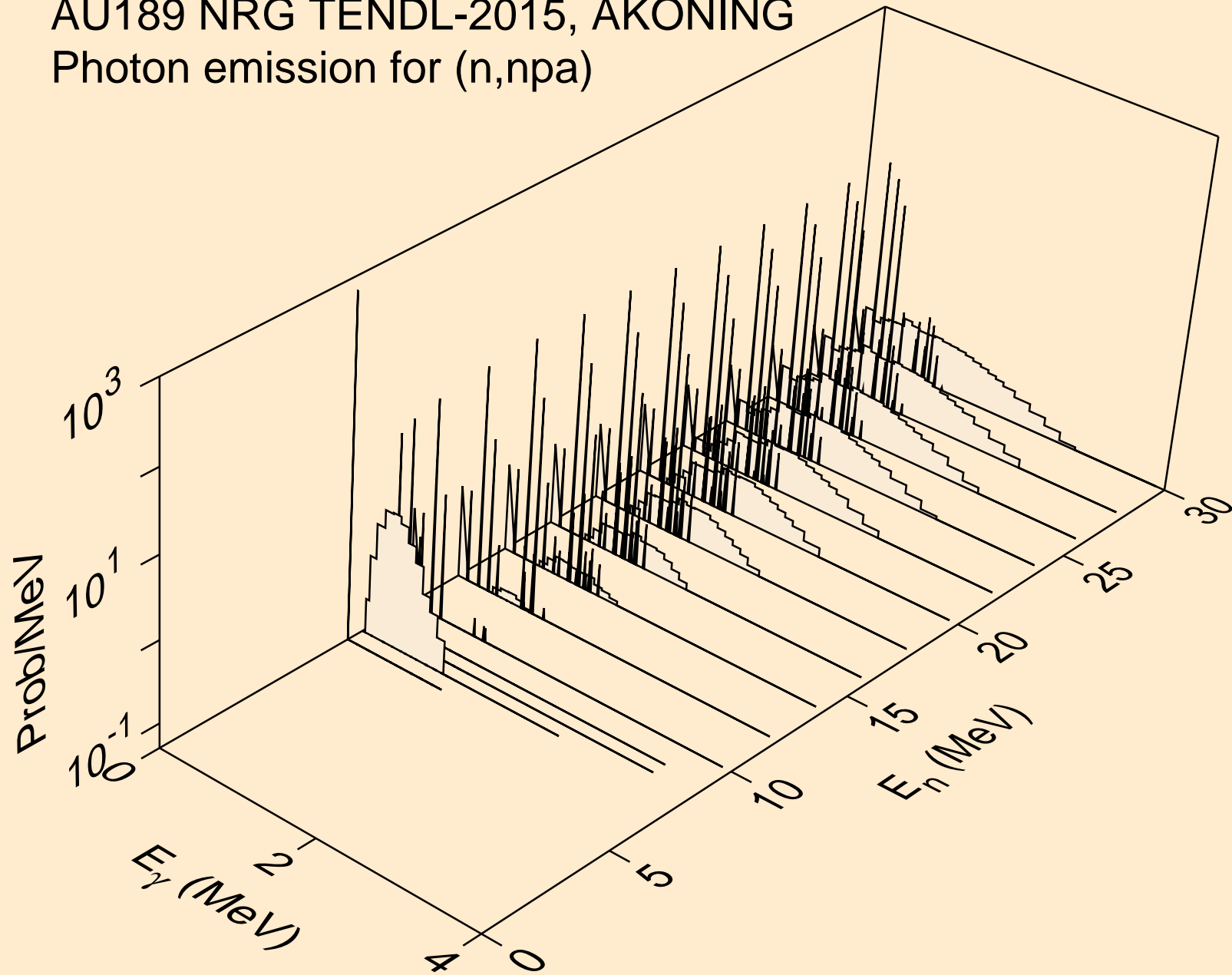

AU189 NRG TENDL-2015, AKONING
Photon emission for (n,n*c)

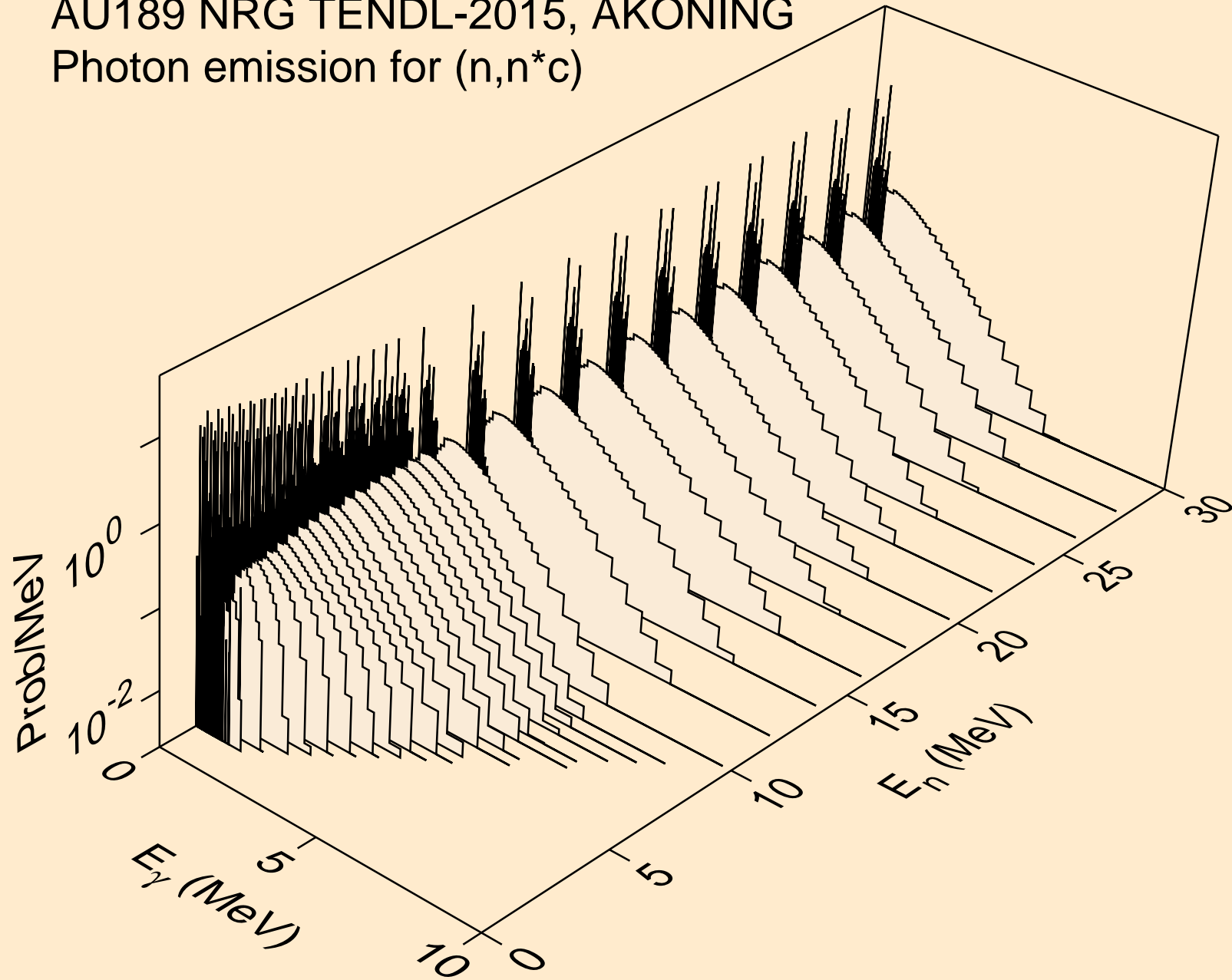

AU189 NRG TENDL-2015, AKONING
Photon emission for (n,gma)

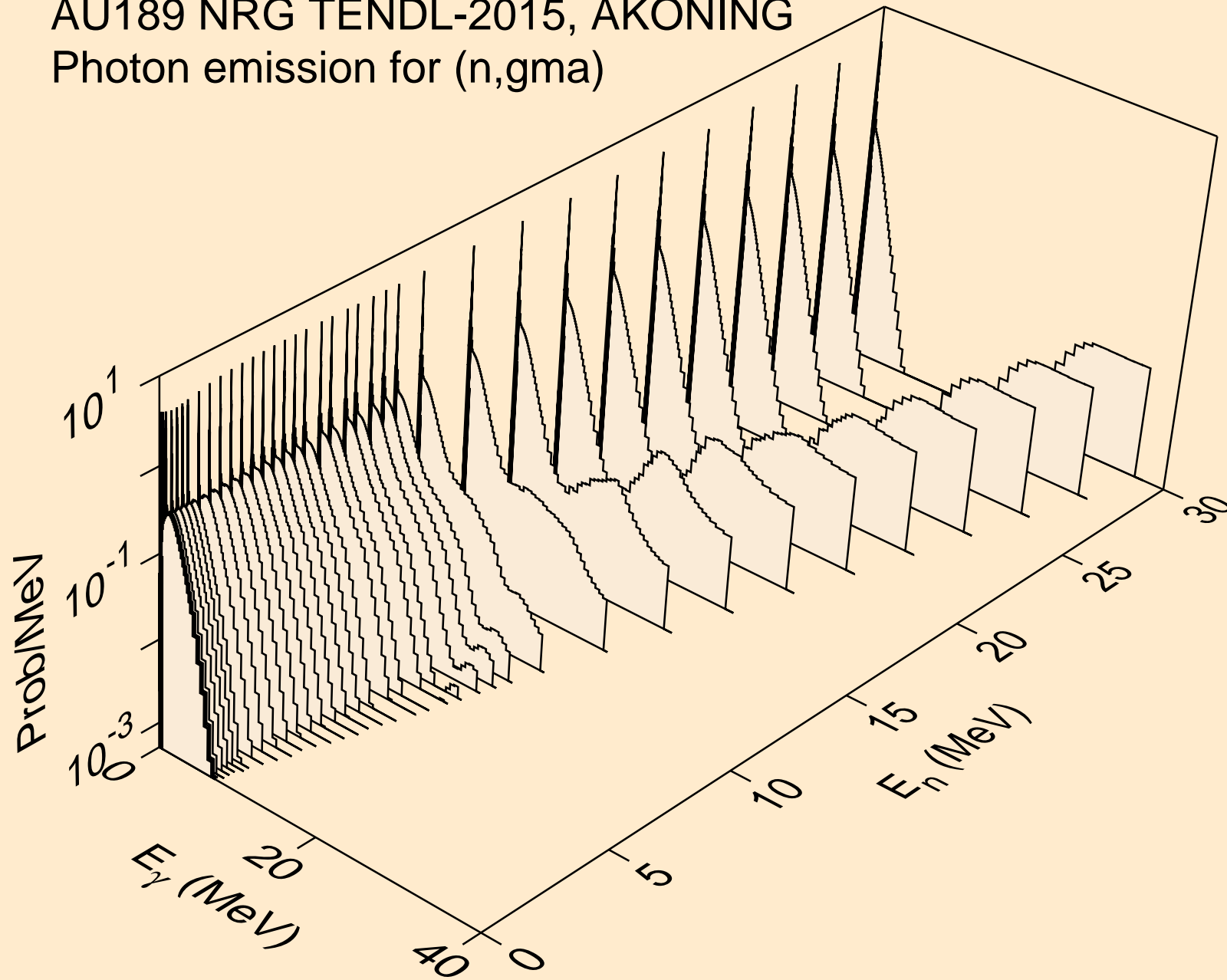

AU189 NRG TENDL-2015, AKONING
Photon emission for (n,p)

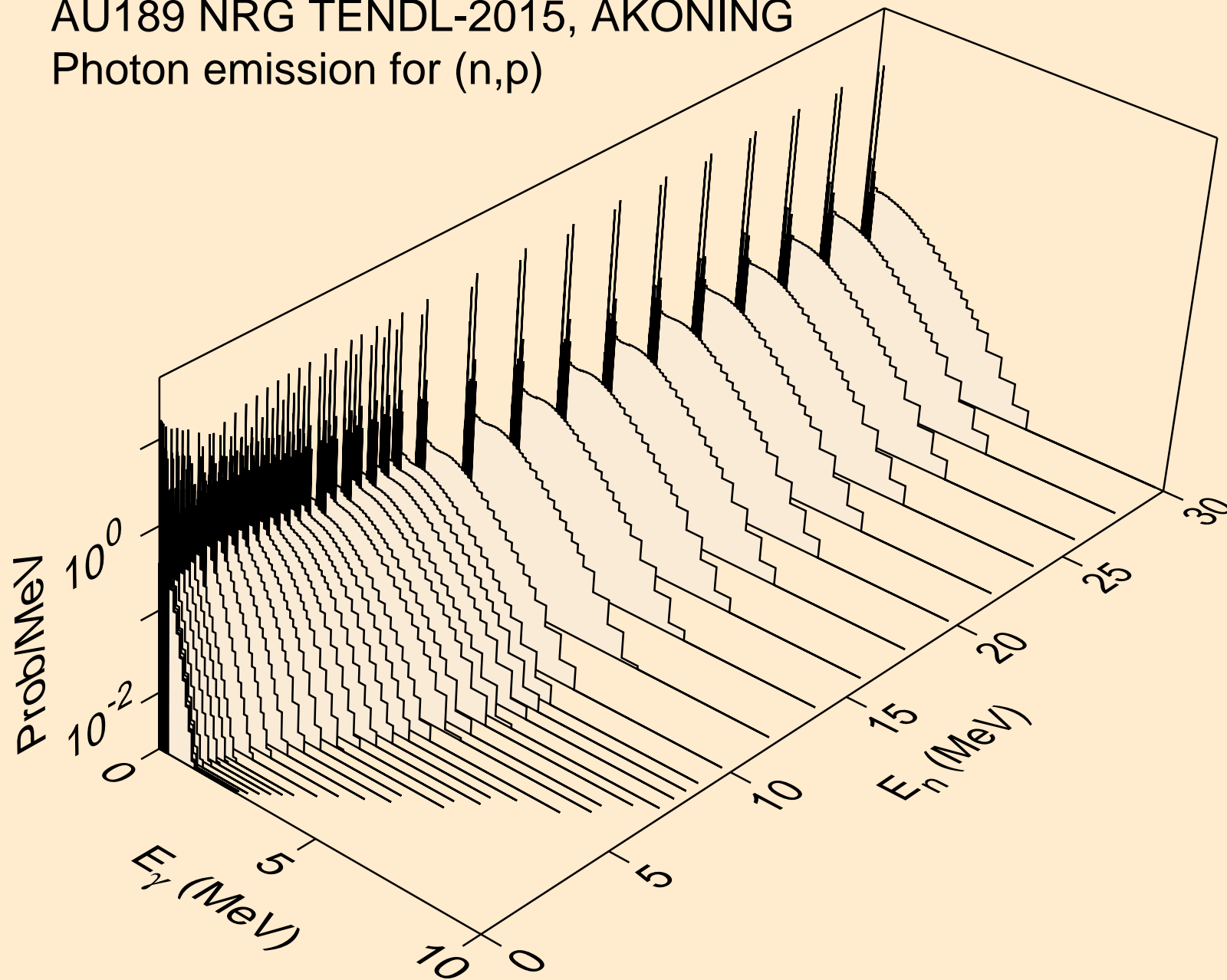

AU189 NRG TENDL-2015, AKONING
Photon emission for (n,d)

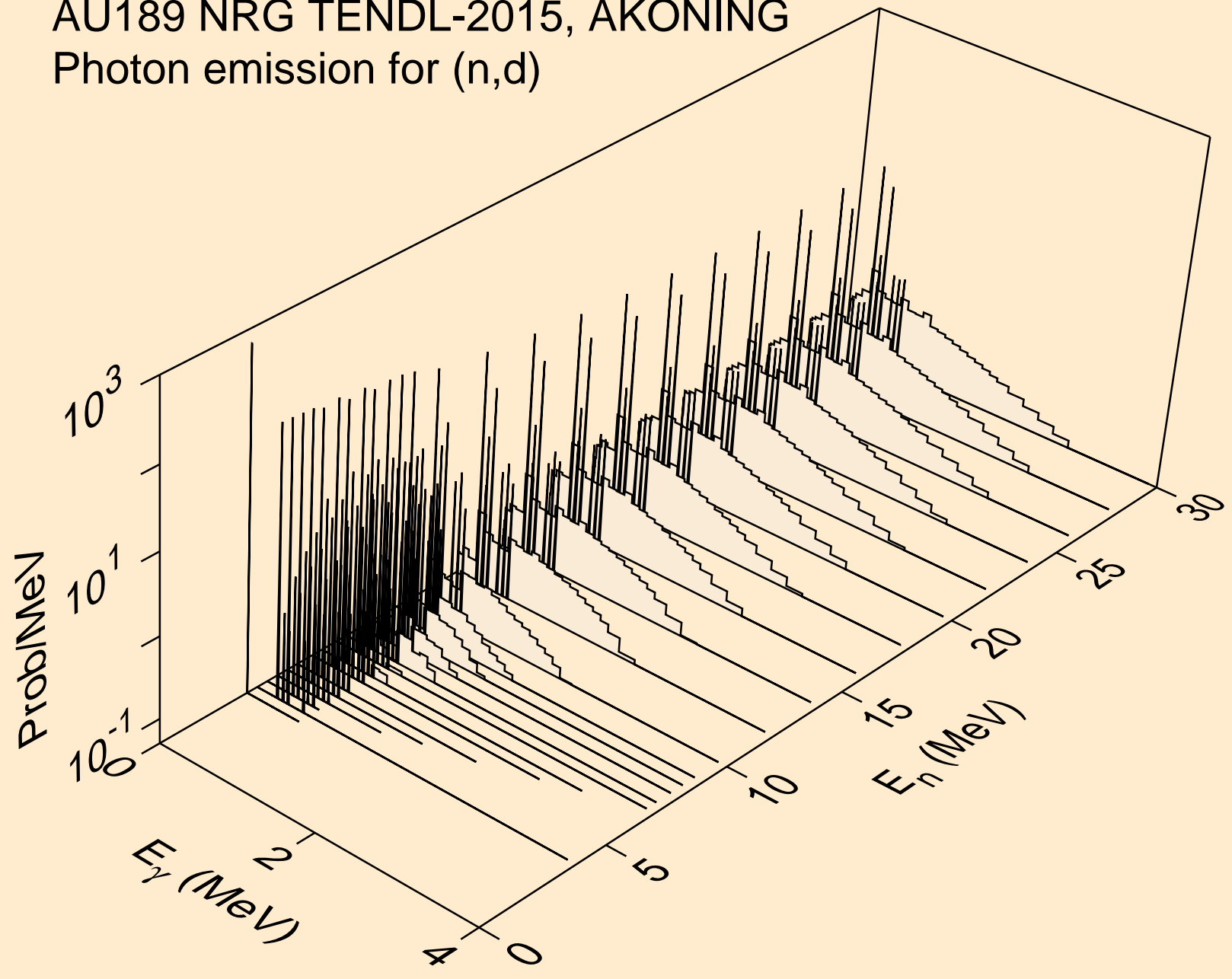

AU189 NRG TENDL-2015, AKONING
Photon emission for (n,t)

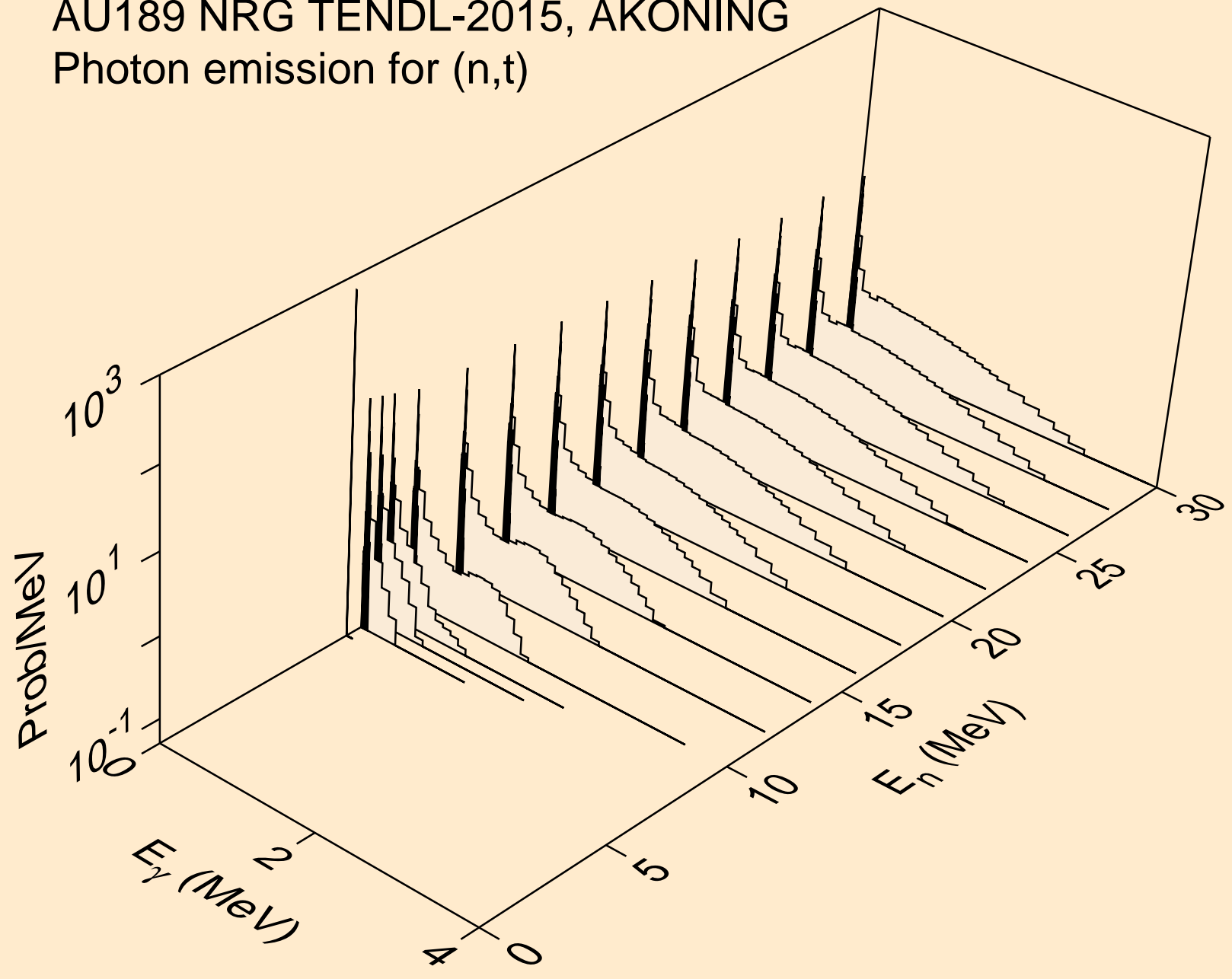

AU189 NRG TENDL-2015, AKONING
Photon emission for (n,he3)

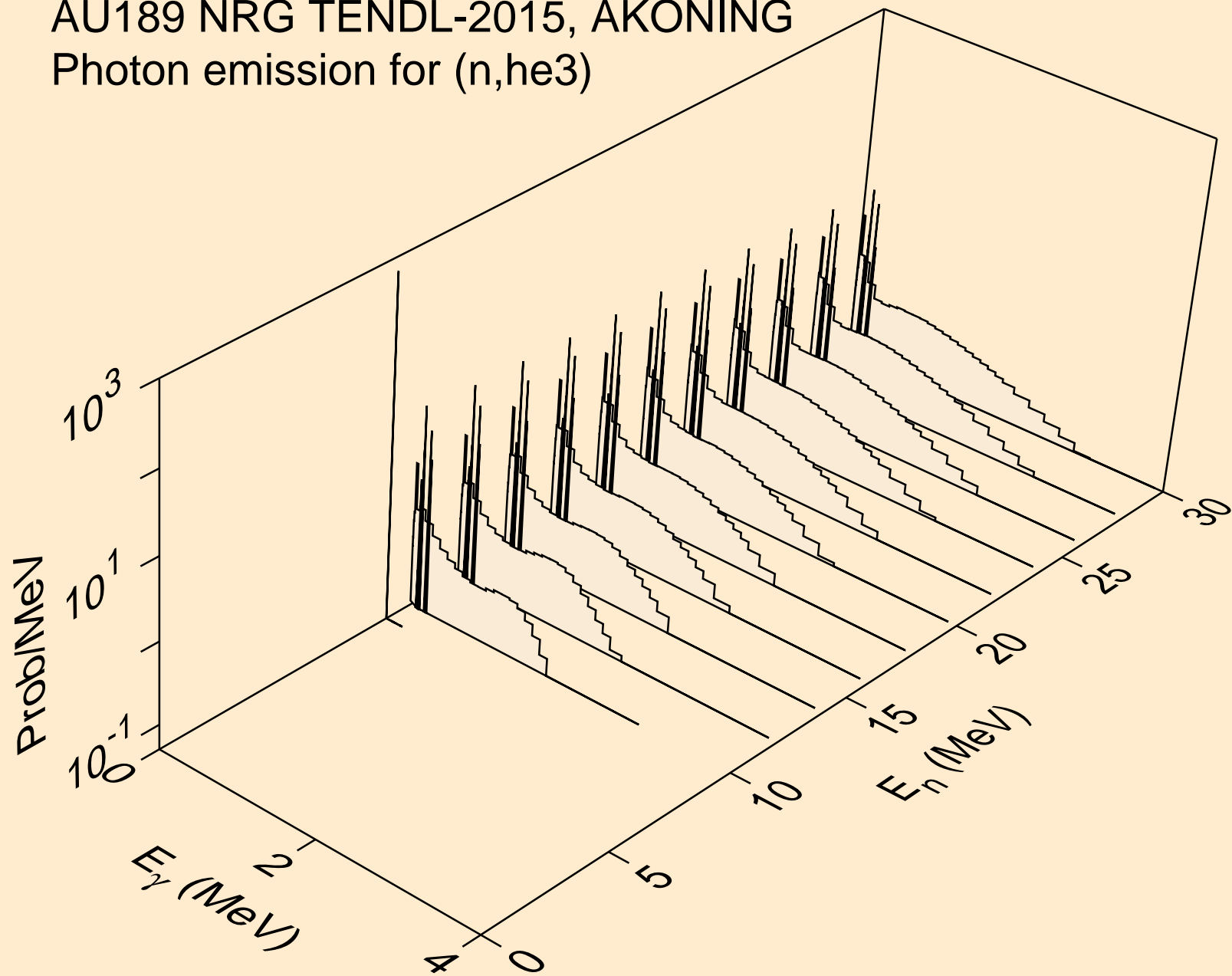

AU189 NRG TENDL-2015, AKONING
Photon emission for (n,a)

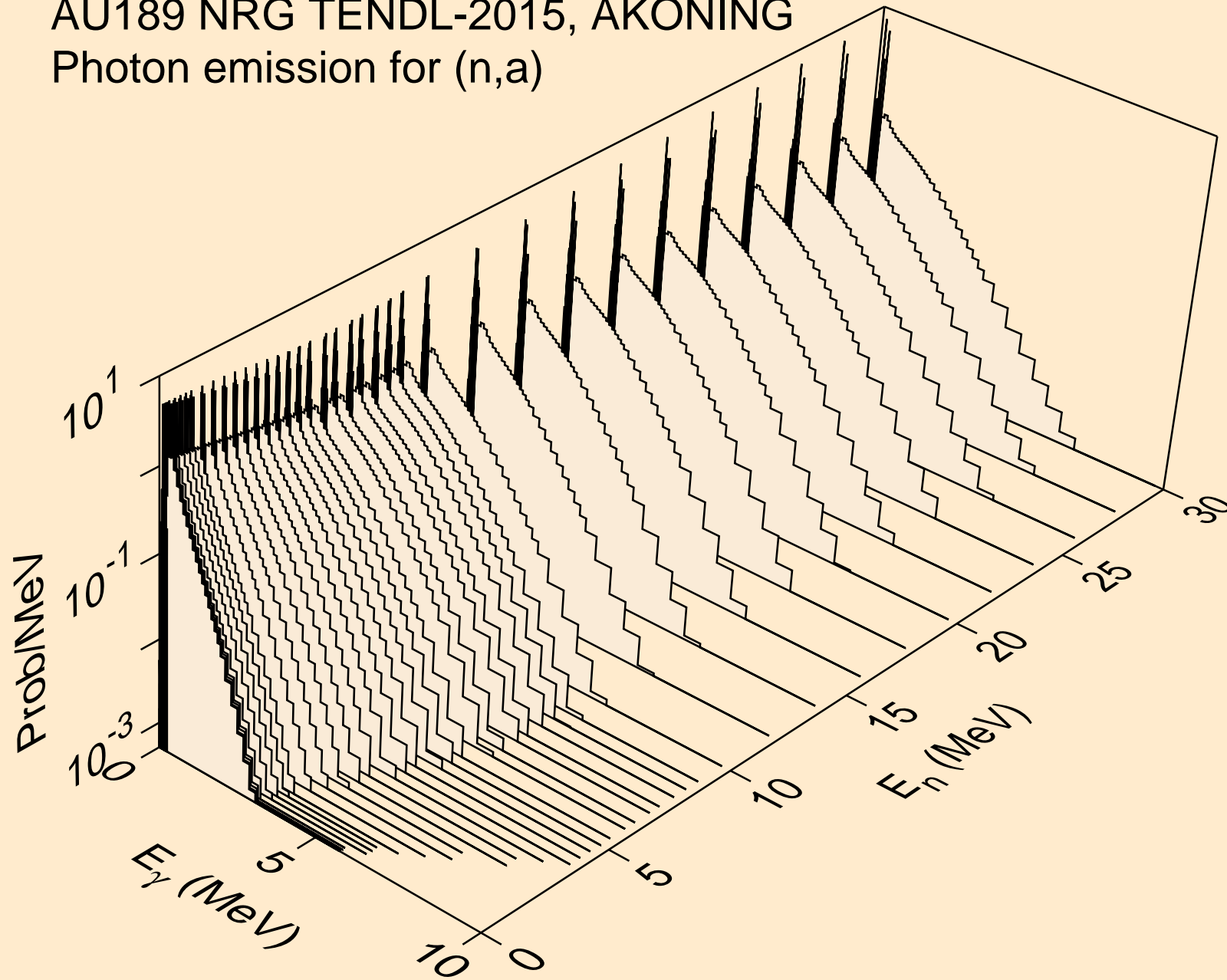

AU189 NRG TENDL-2015, AKONING
Photon emission for (n,2a)

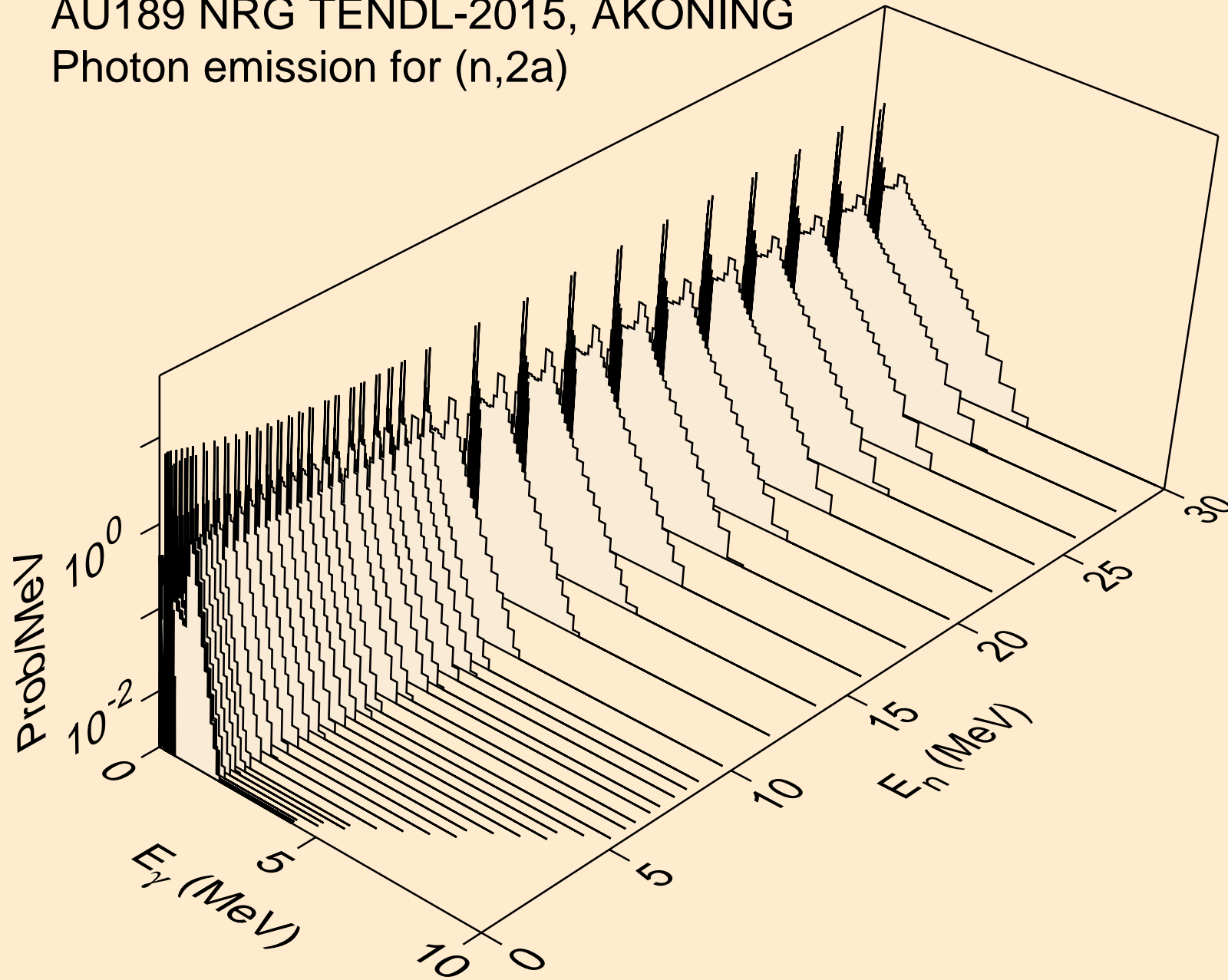

AU189 NRG TENDL-2015, AKONING
Photon emission for (n,2p)

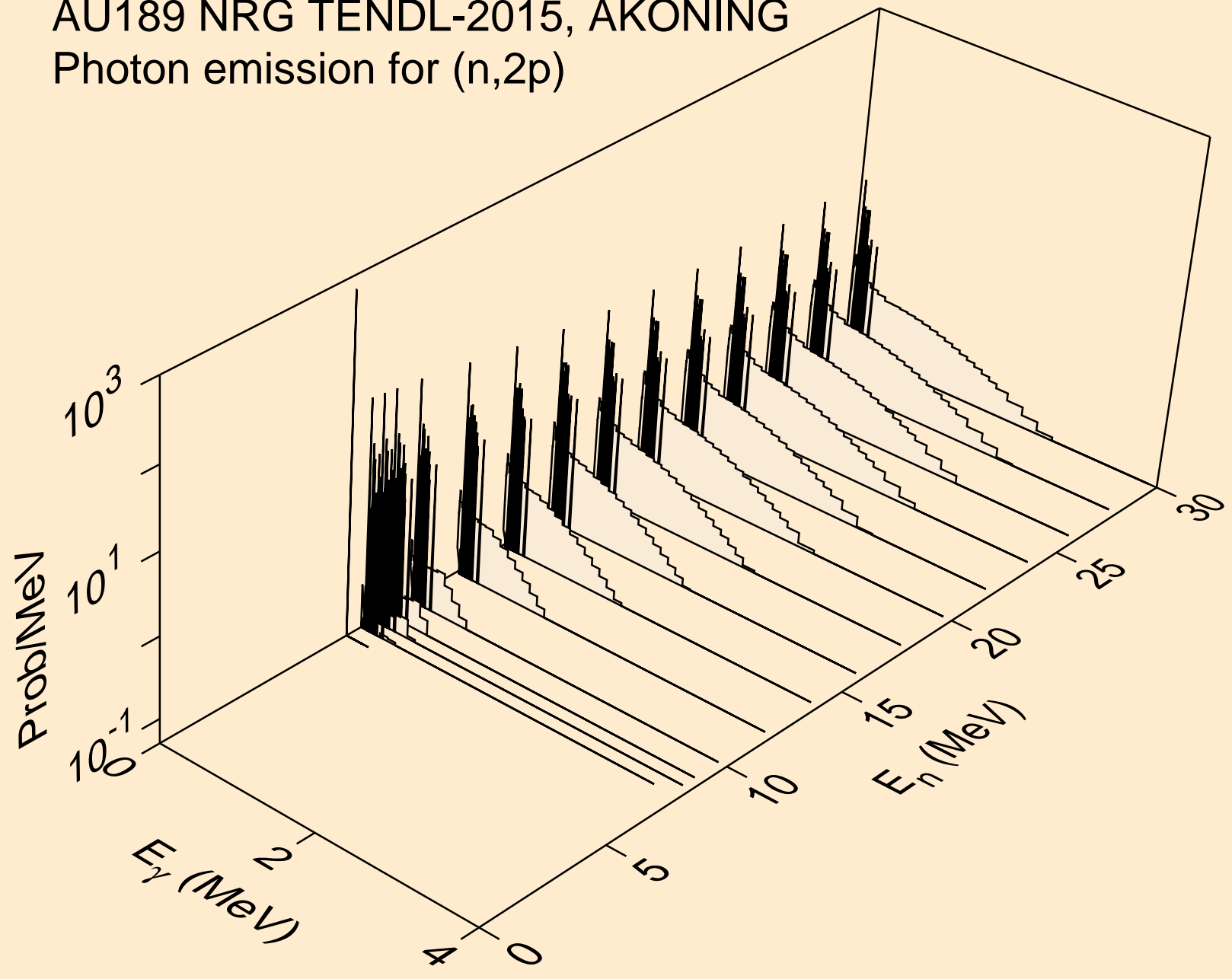

AU189 NRG TENDL-2015, AKONING
Photon emission for (n,pa)

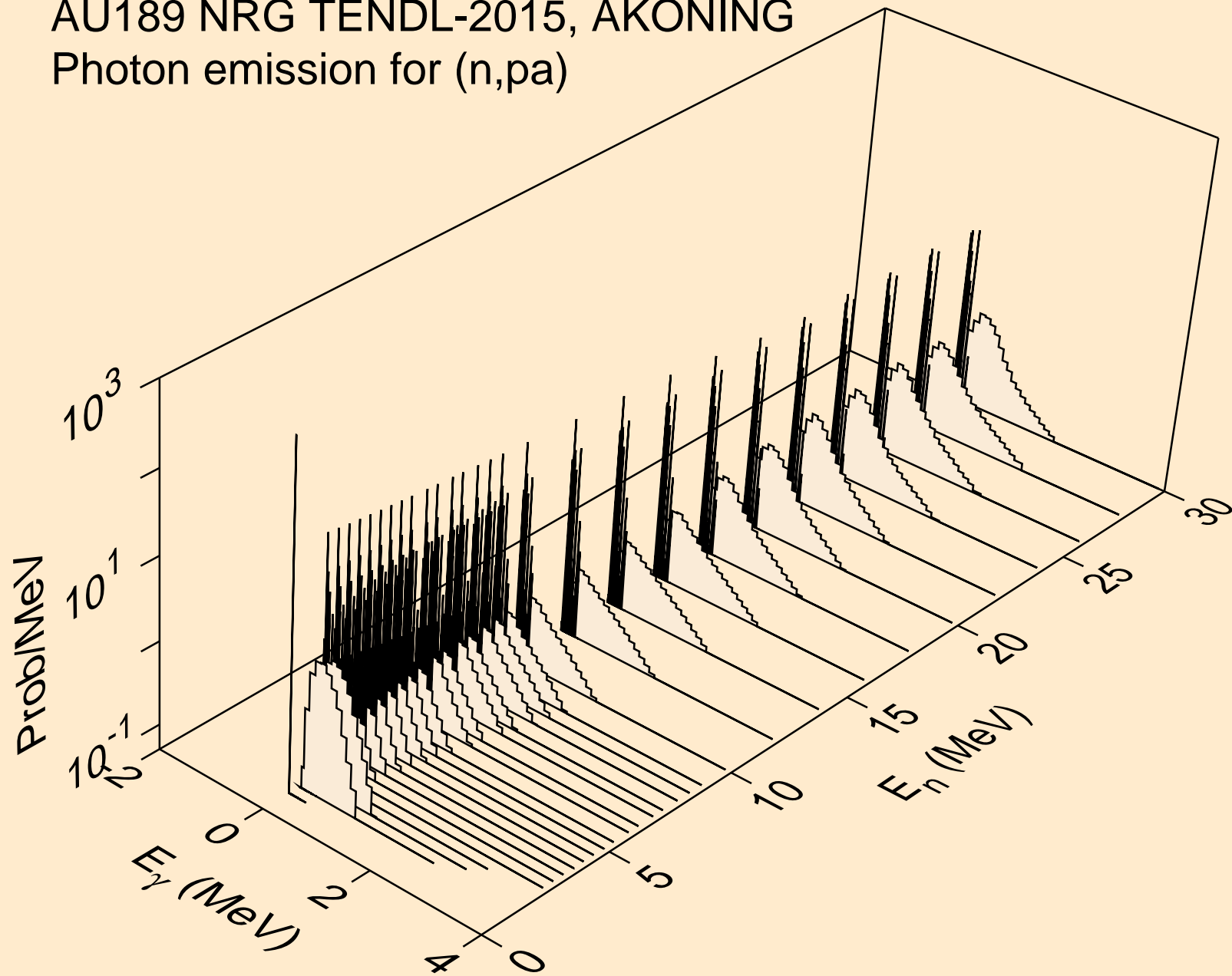

AU189 NRG TENDL-2015, AKONING
Photon emission for (n,pd)

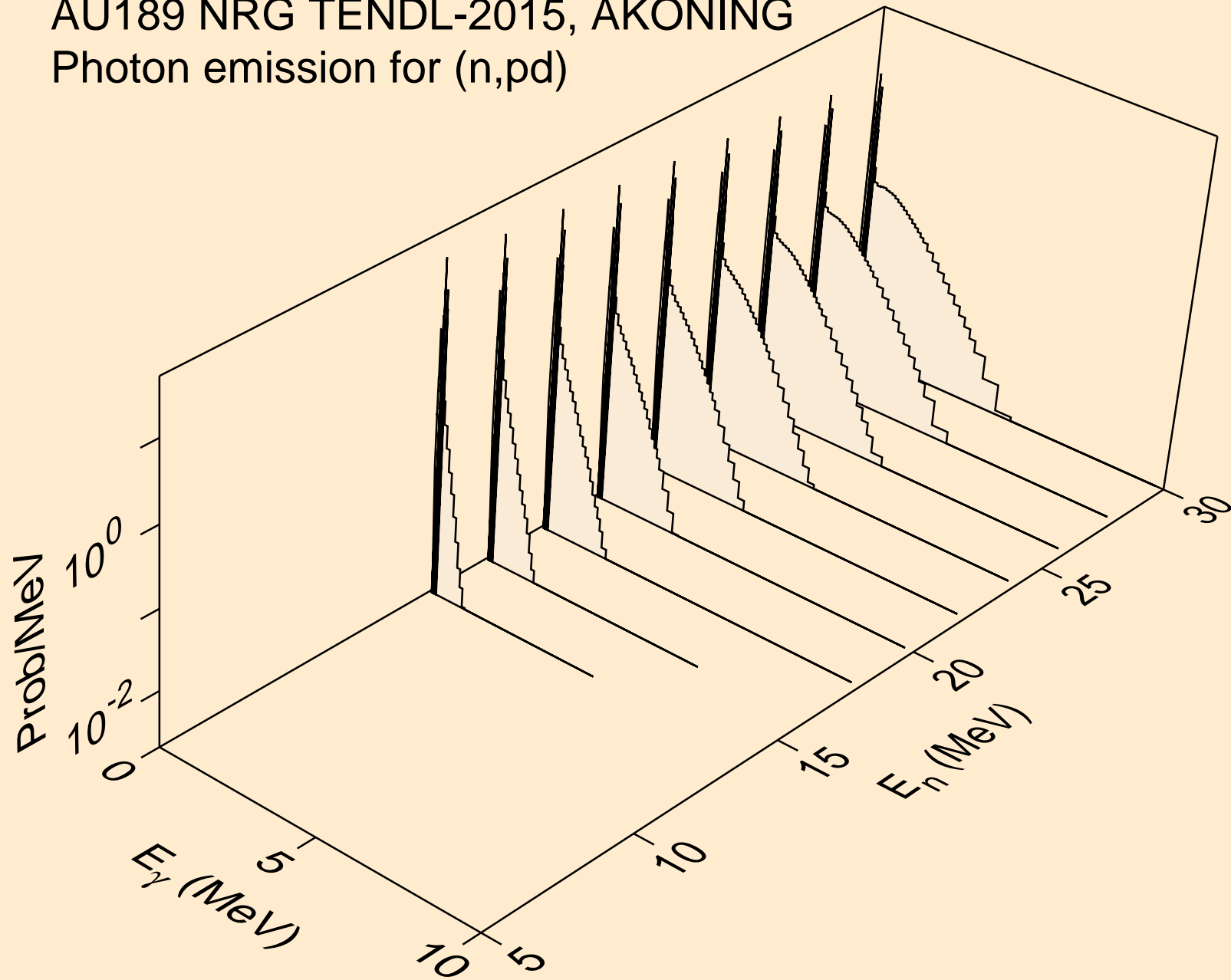

AU189 NRG TENDL-2015, AKONING
Photon emission for (n,pt)

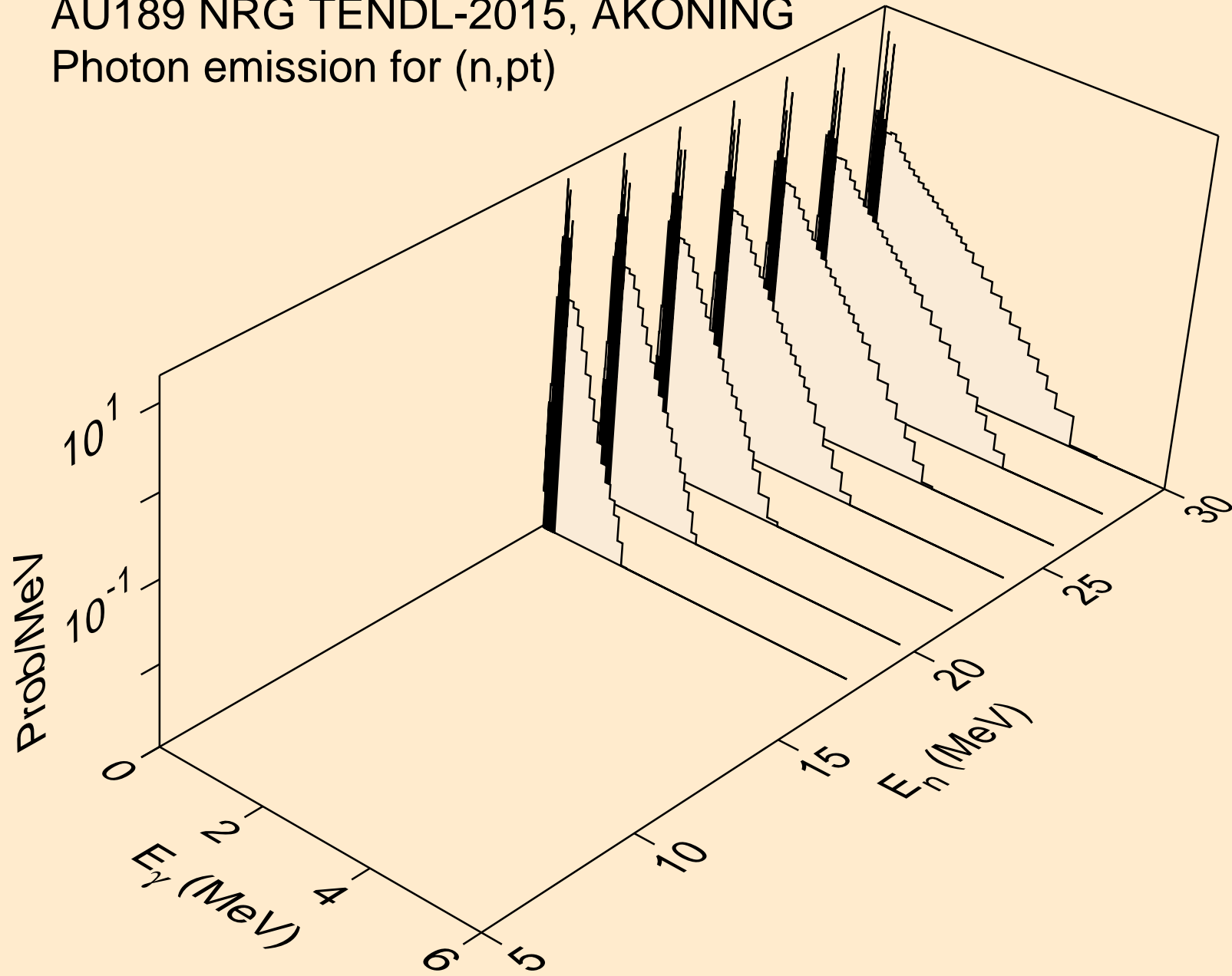

AU189 NRG TENDL-2015, AKONING
Photon emission for (n,da)

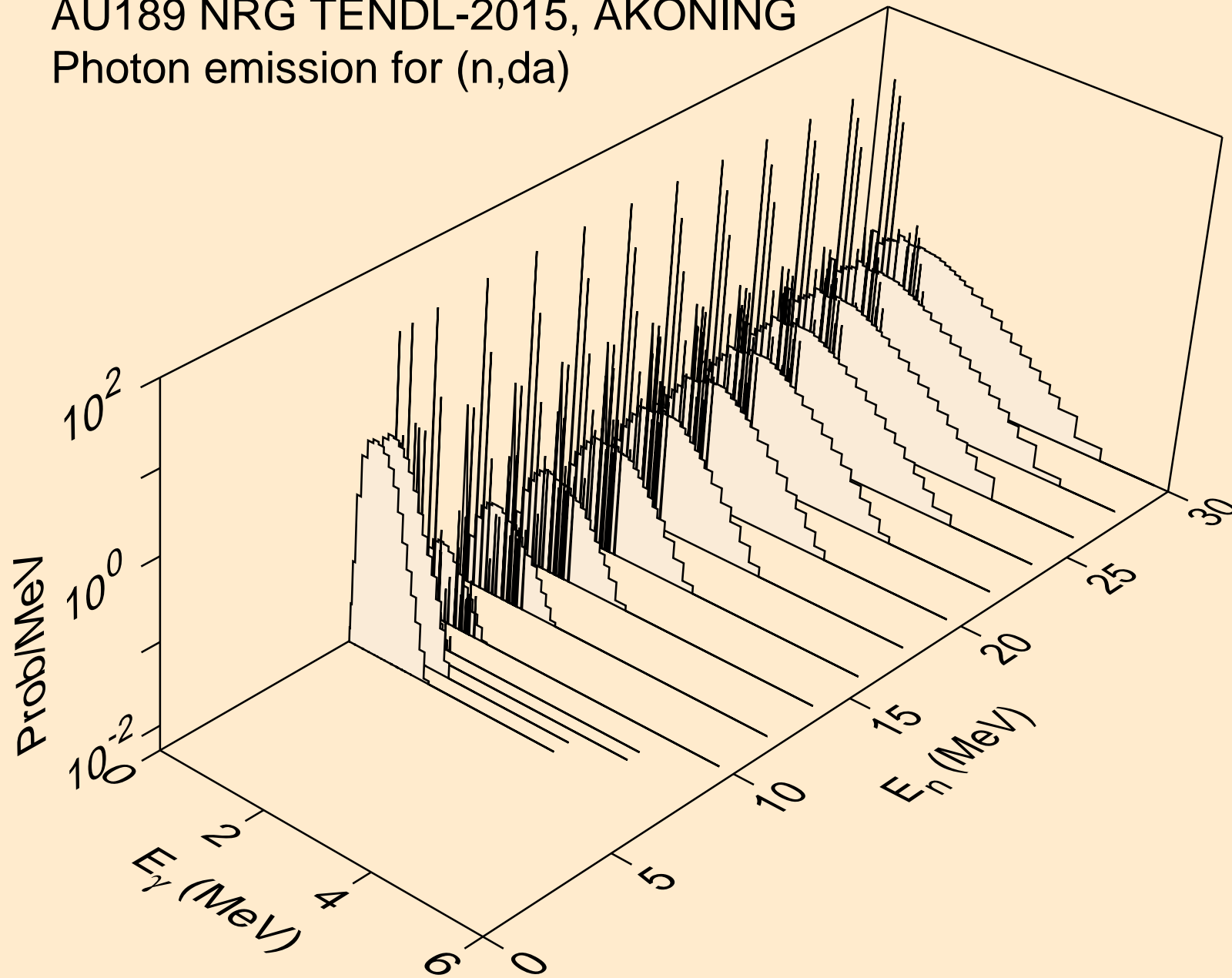

AU189 NRG TENDL-2015, AKONING
thermal capture photon spectrum

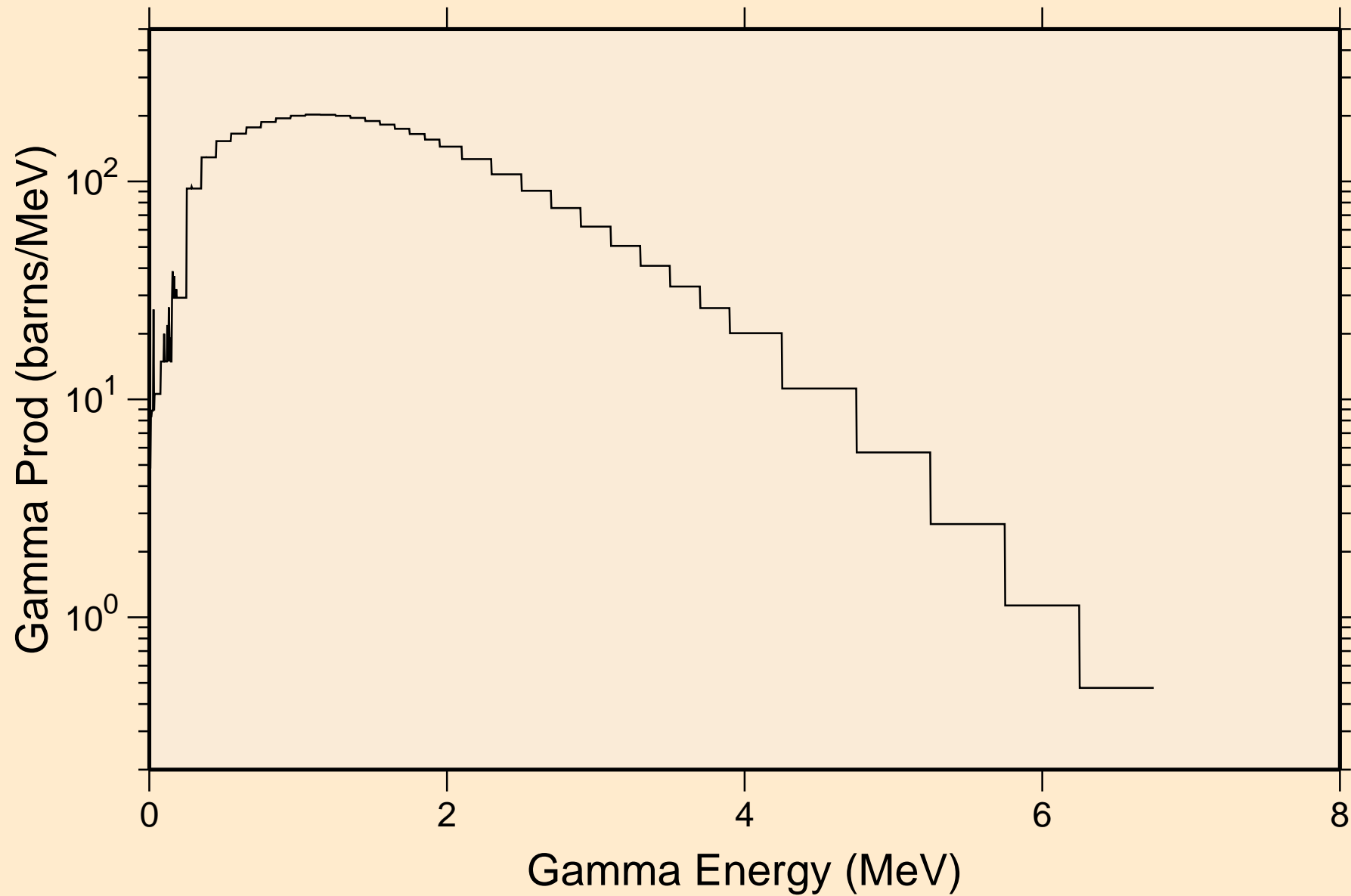

AU189 NRG TENDL-2015, AKONING
14 MeV photon spectrum

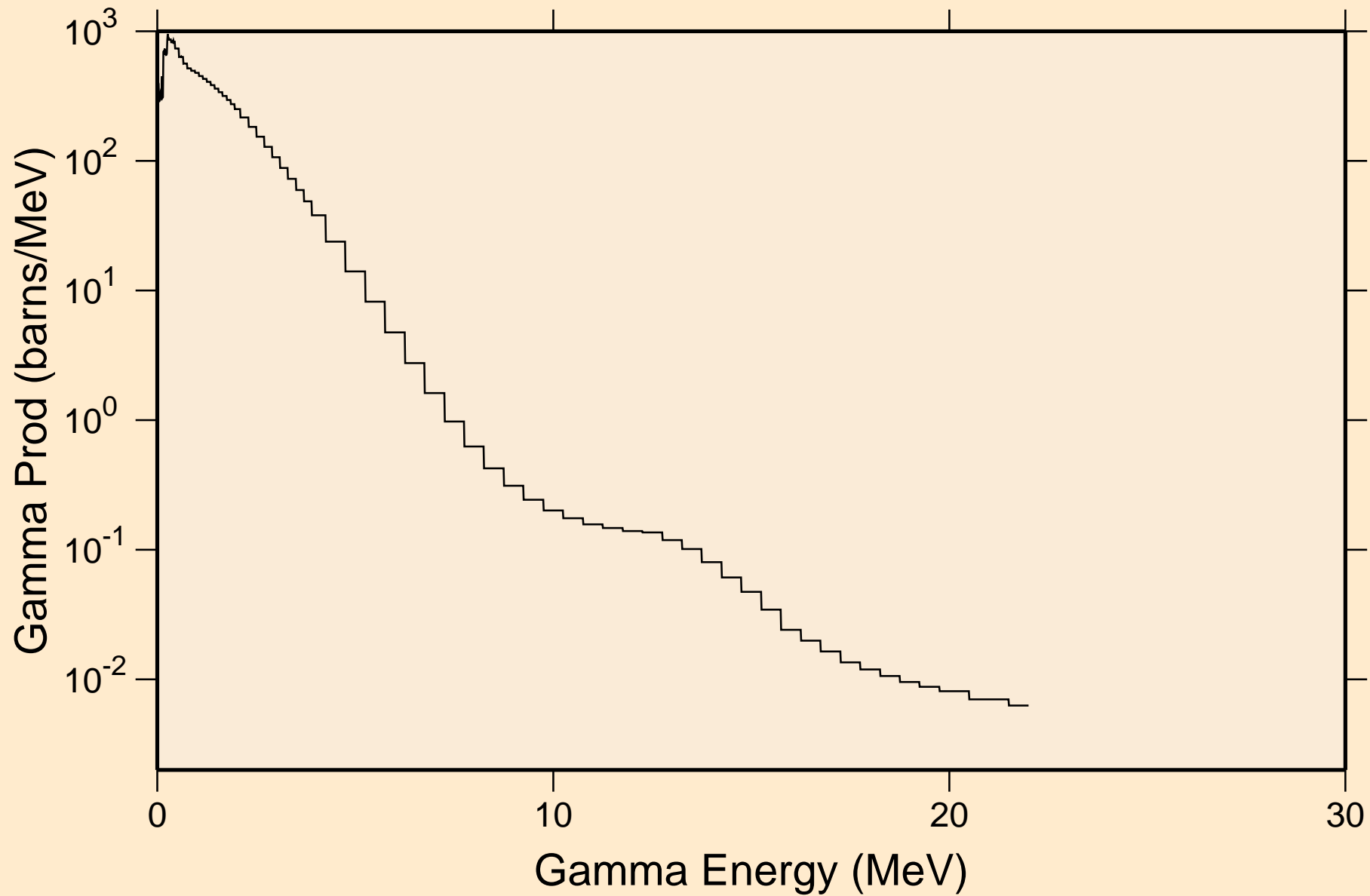

AU189 NRG TENDL-2015, AKONING

Particle heating contributions

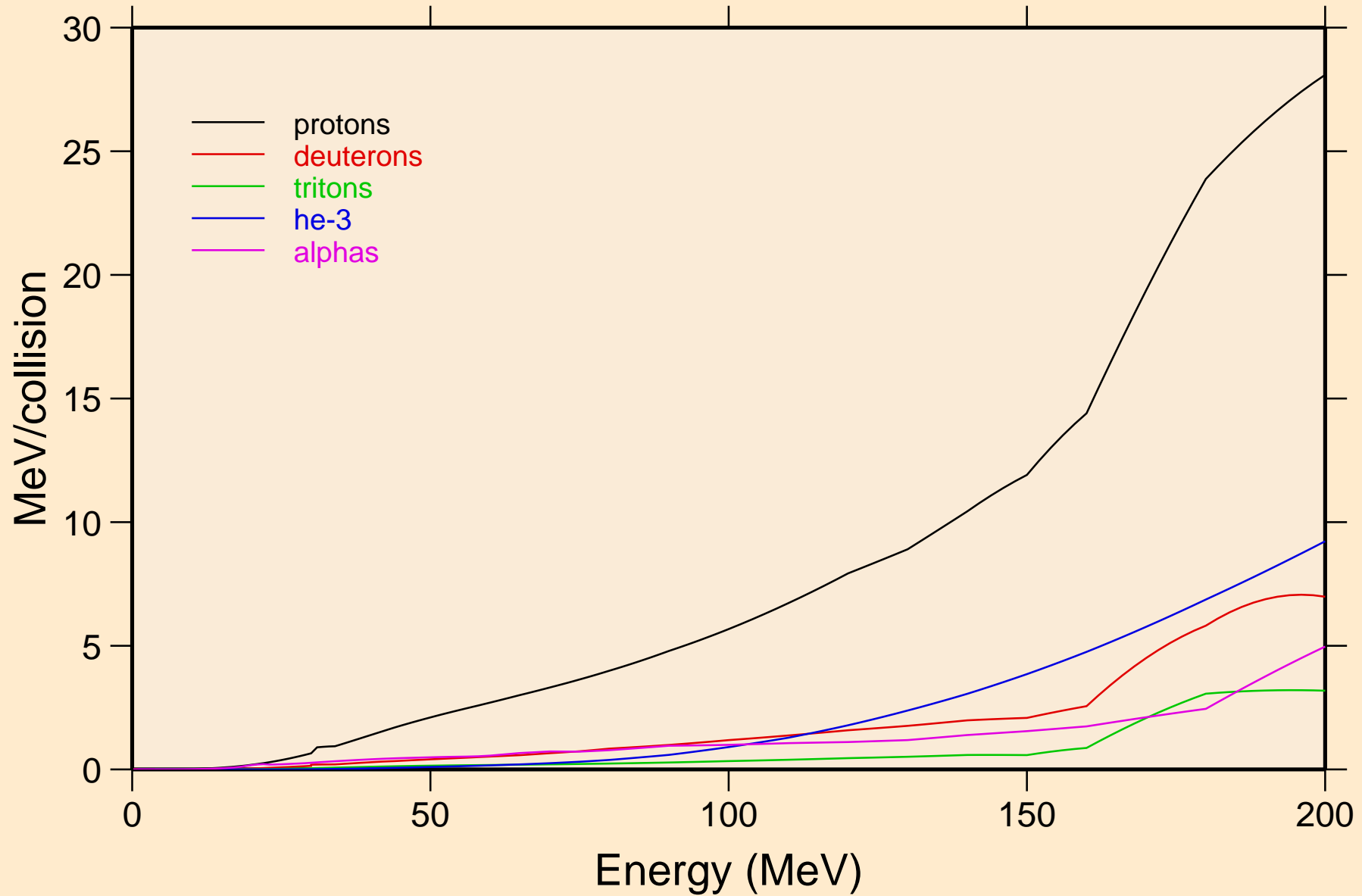

AU189 NRG TENDL-2015, AKONING

Recoil Heating

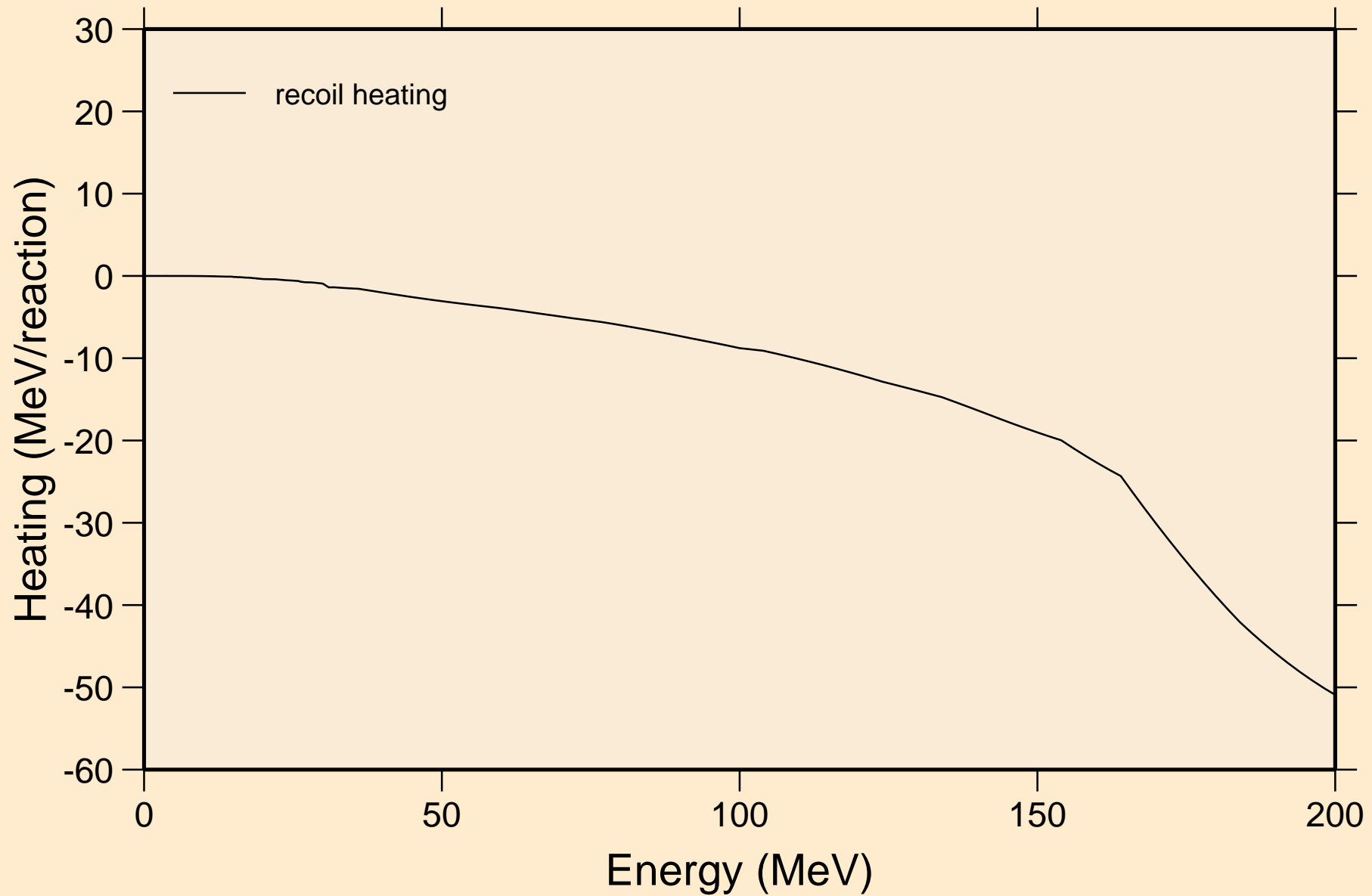

AU189 NRG TENDL-2015, AKONING

Particle production cross sections

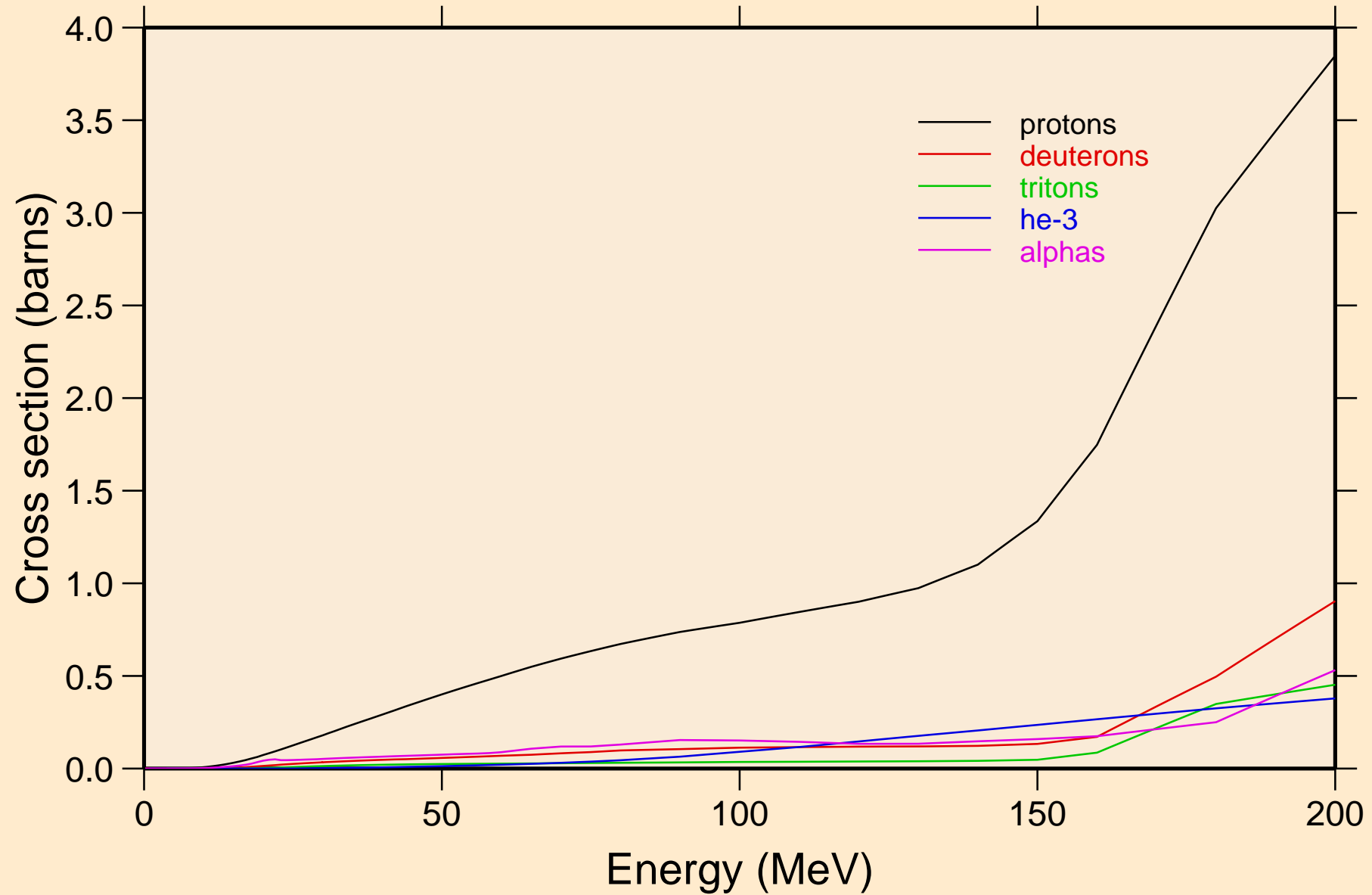

AU189 NRG TENDL-2015, AKONING
protons from (n,x)

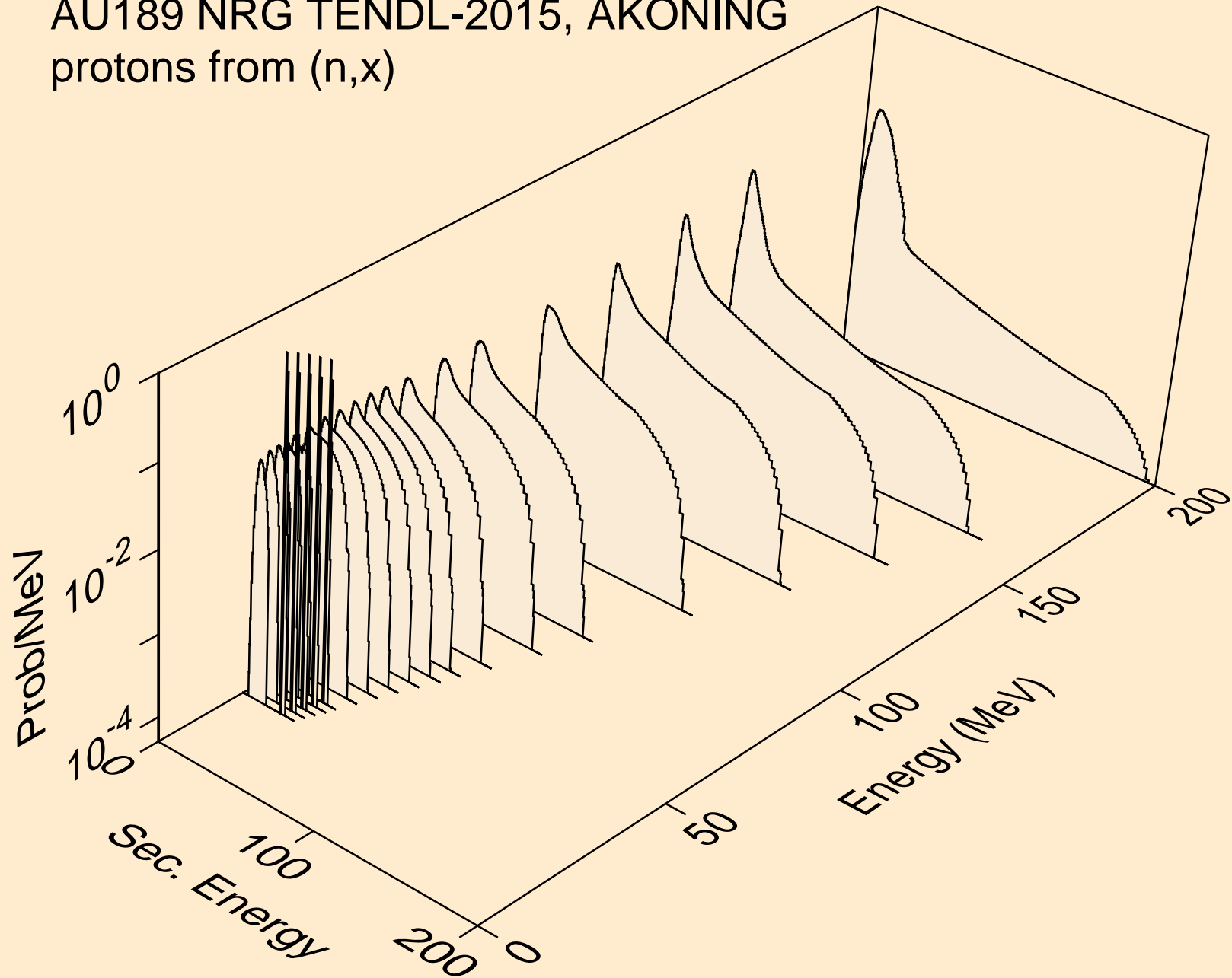

AU189 NRG TENDL-2015, AKONING
protons from (n,n*)p

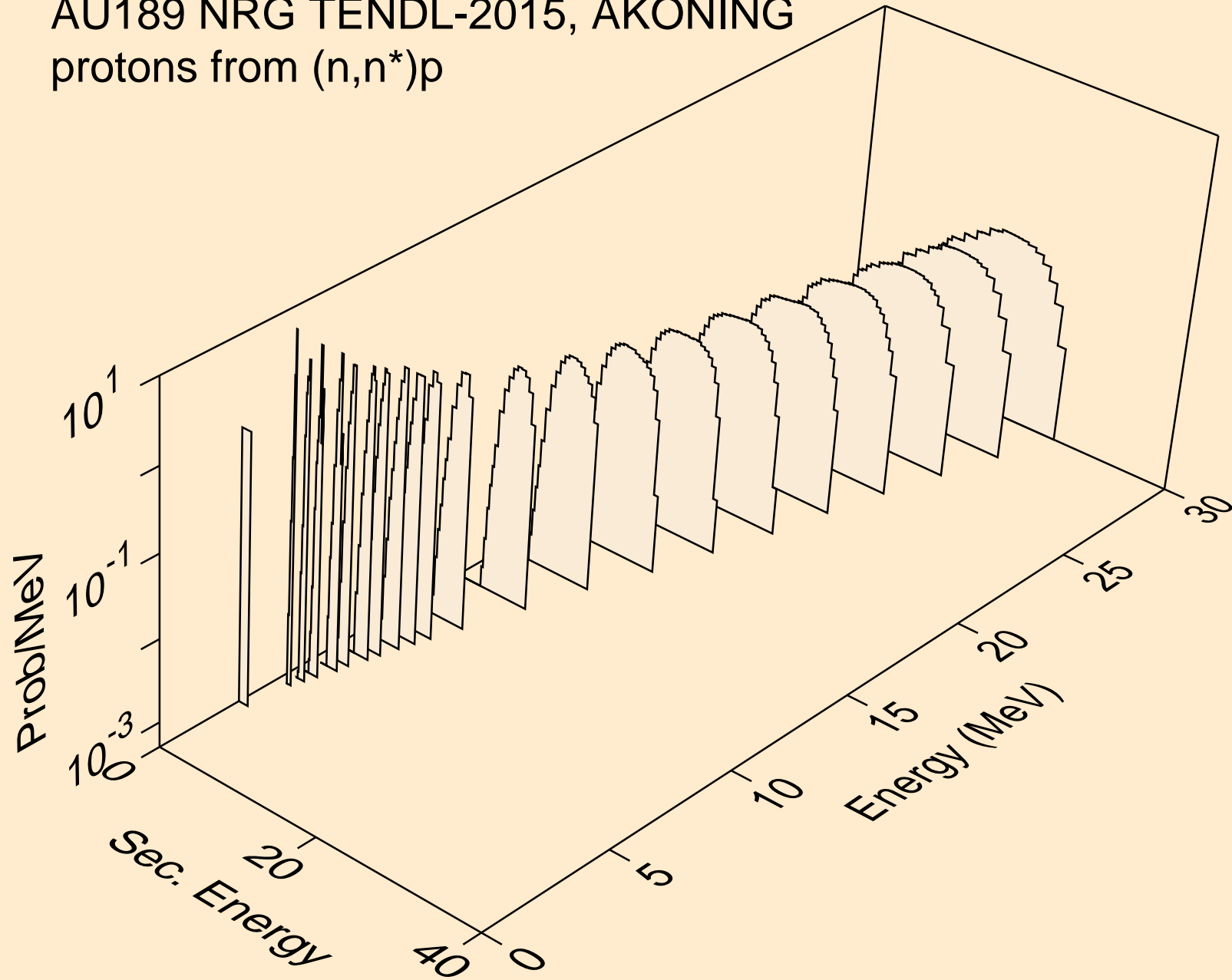

AU189 NRG TENDL-2015, AKONING
protons from (n,2np)

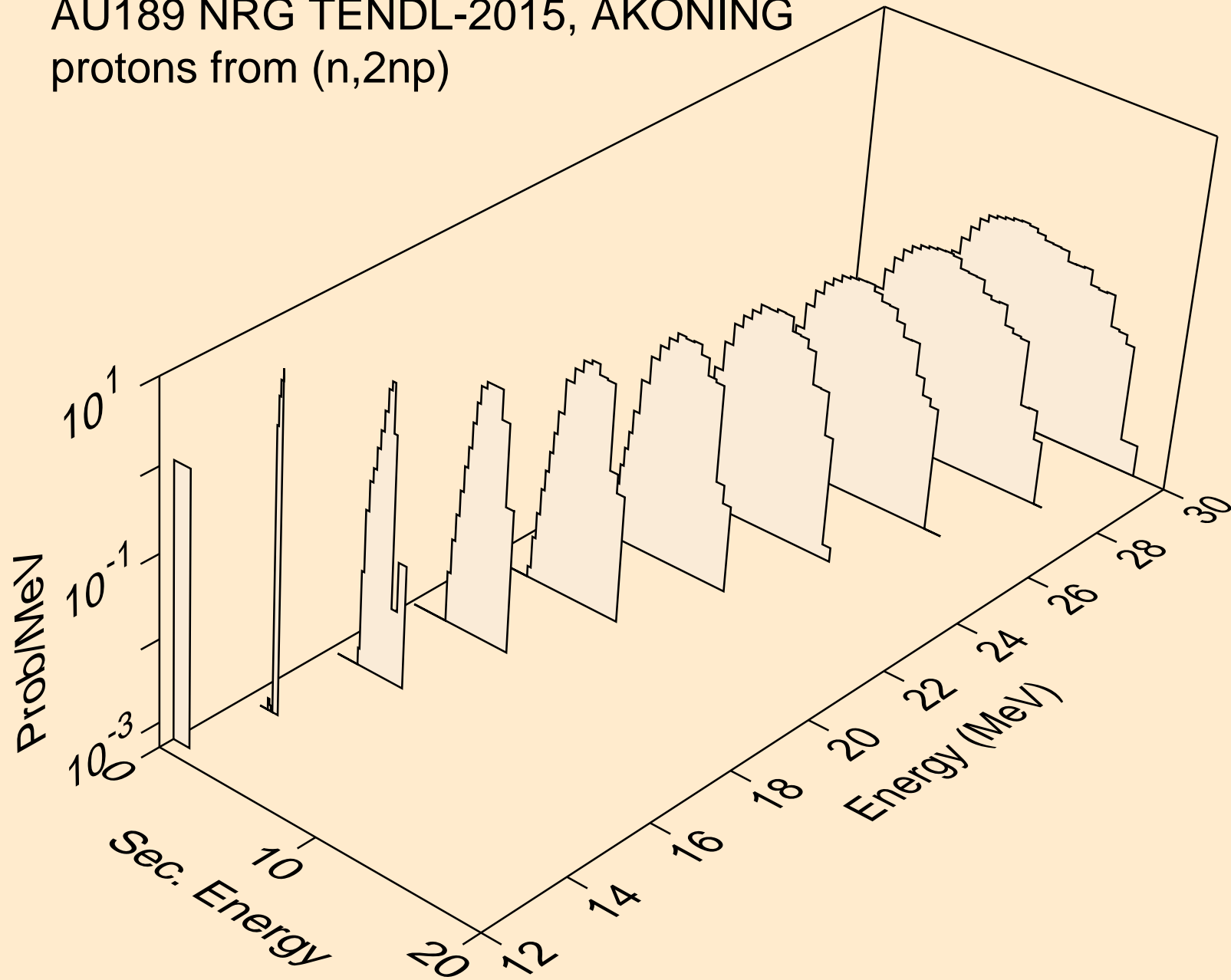

AU189 NRG TENDL-2015, AKONING
protons from (n,3np)

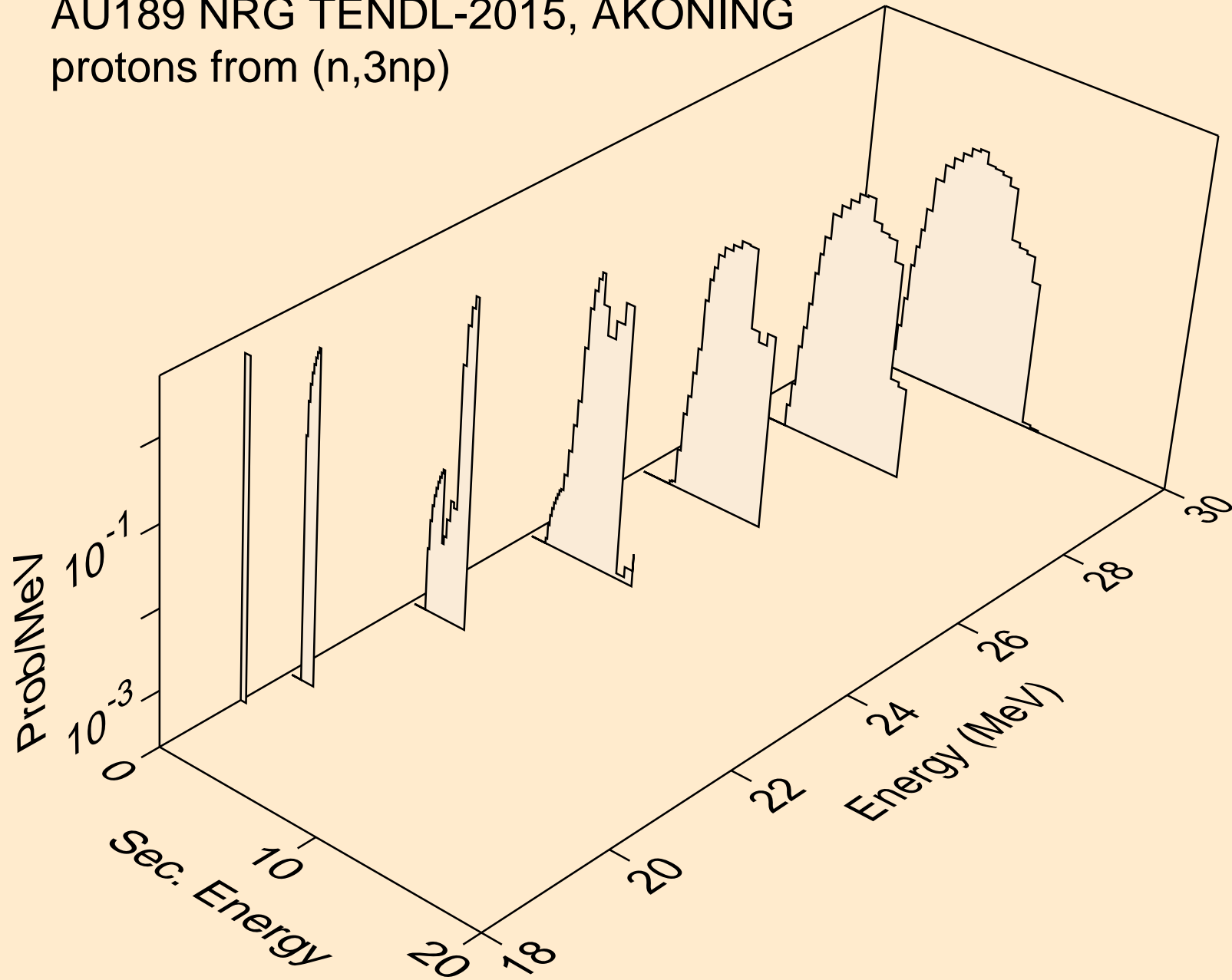

AU189 NRG TENDL-2015, AKONING
protons from (n,2np)

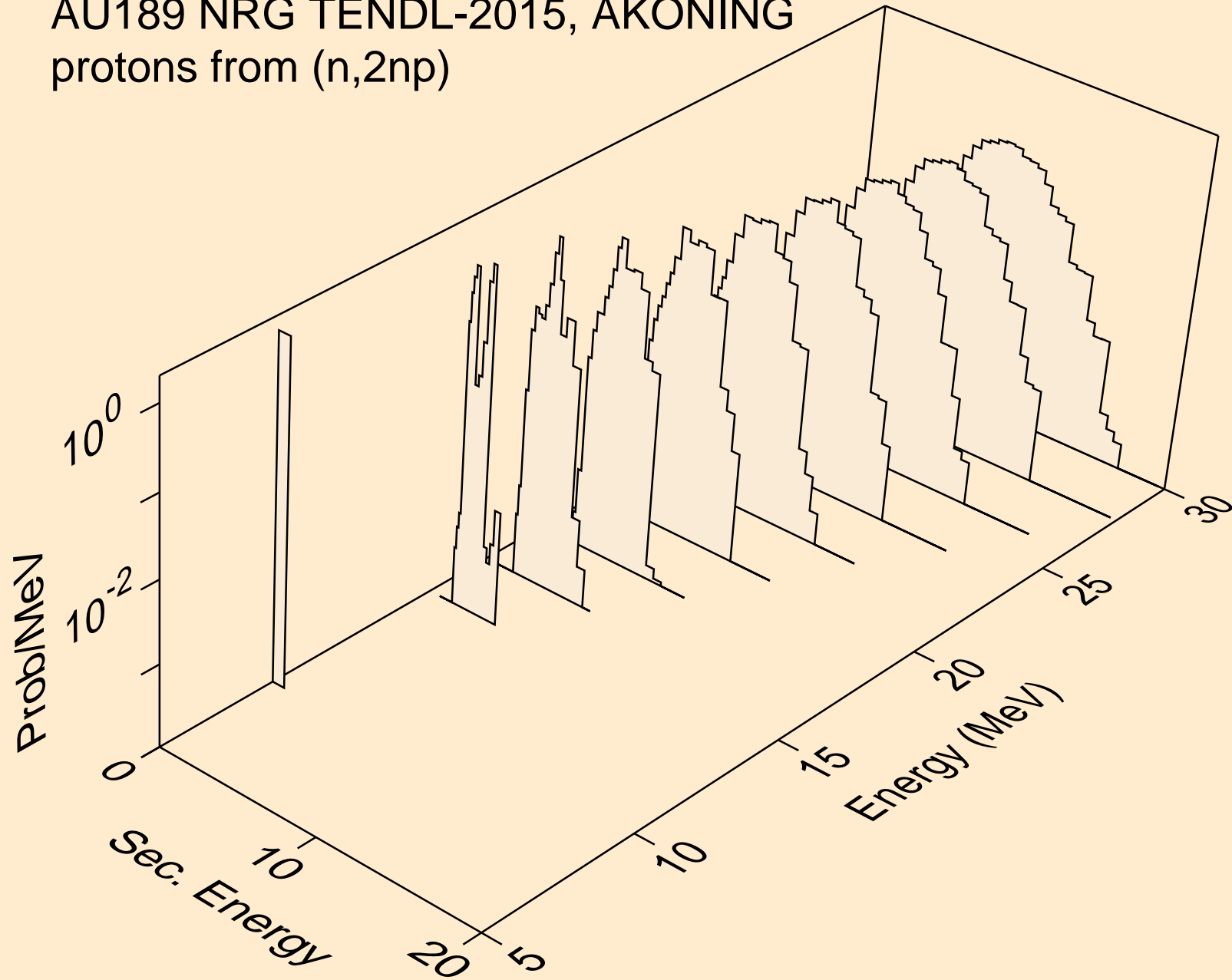

AU189 NRG TENDL-2015, AKONING
protons from (n,npa)

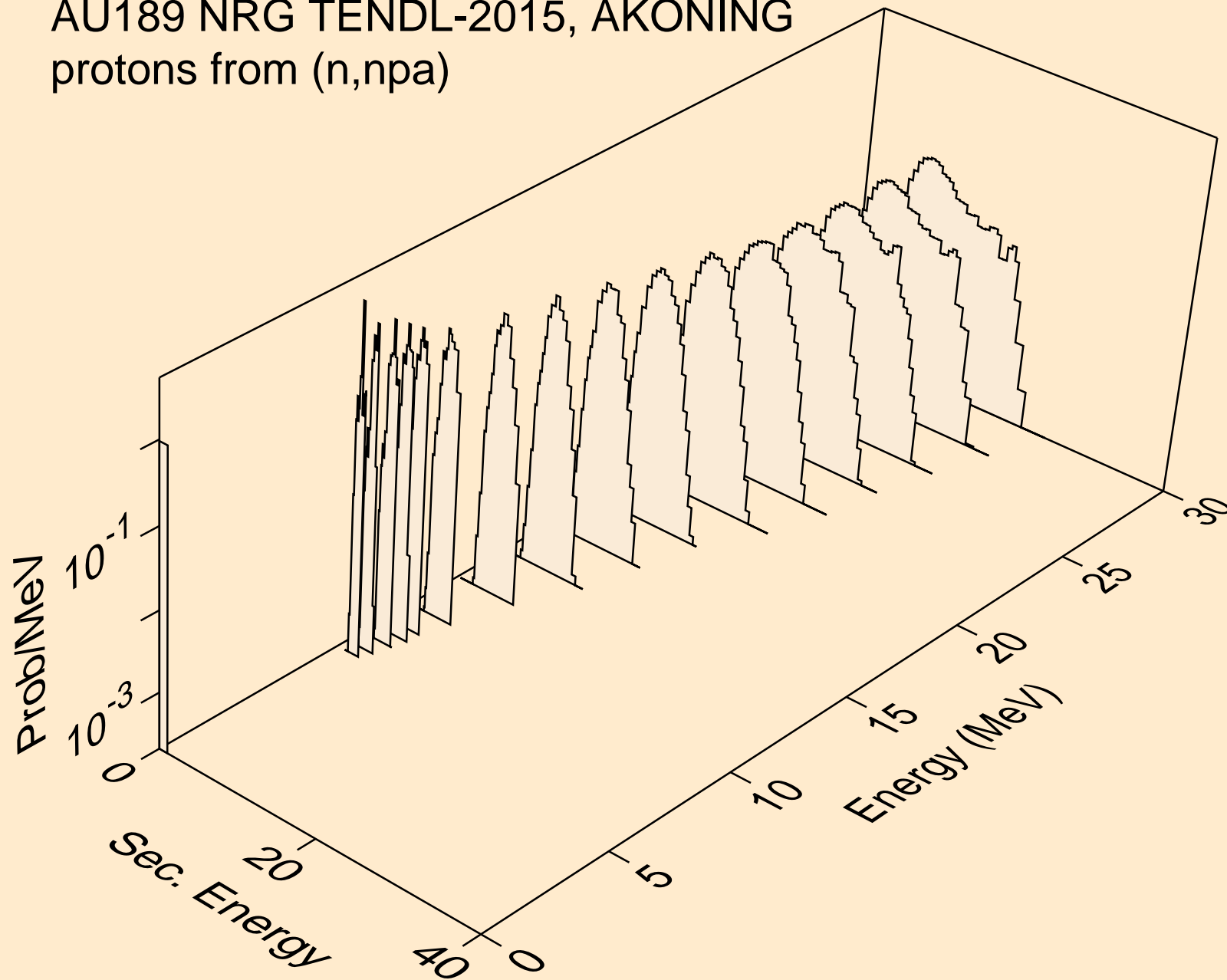

AU189 NRG TENDL-2015, AKONING
protons from (n,p)

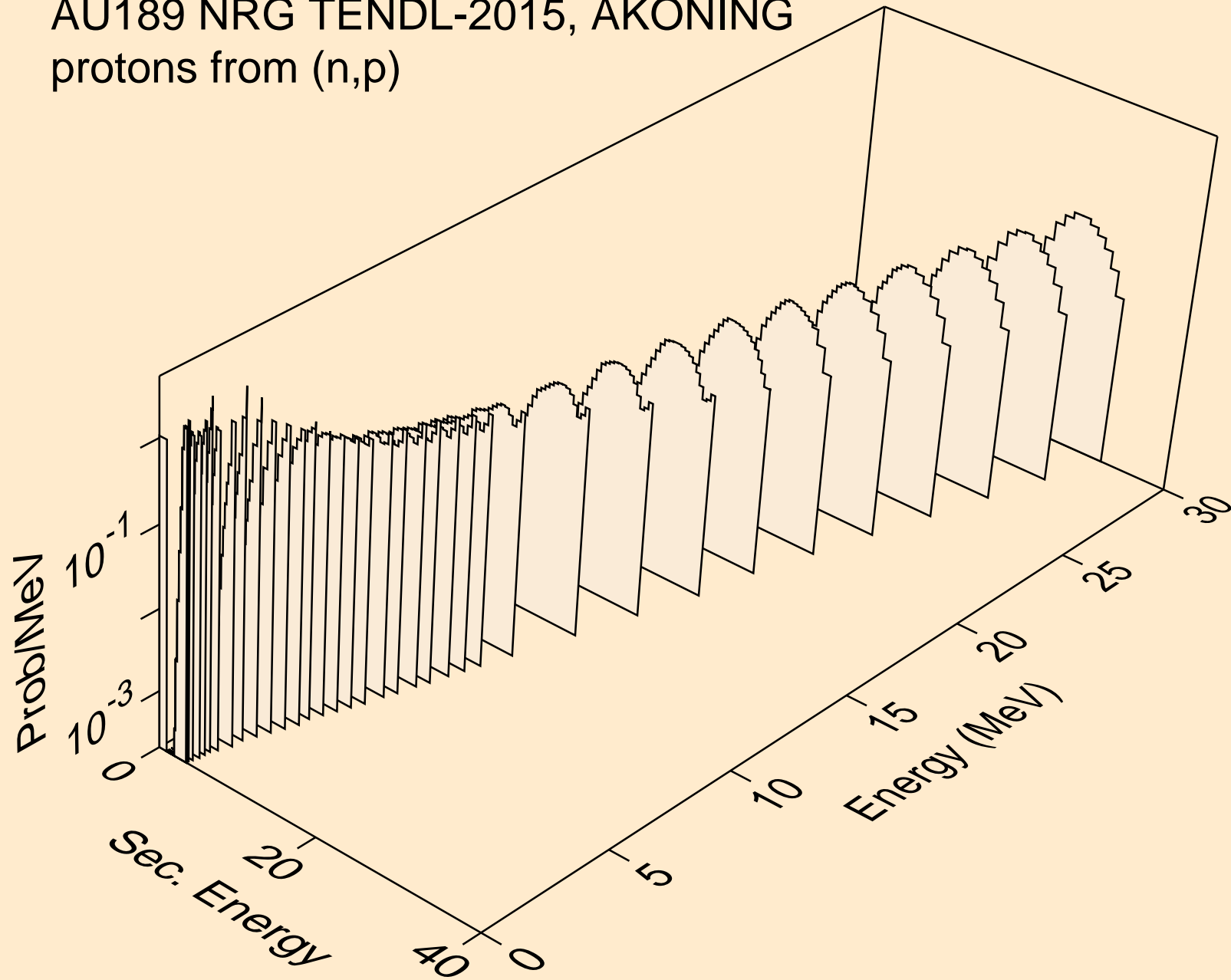

AU189 NRG TENDL-2015, AKONING
protons from (n,2p)

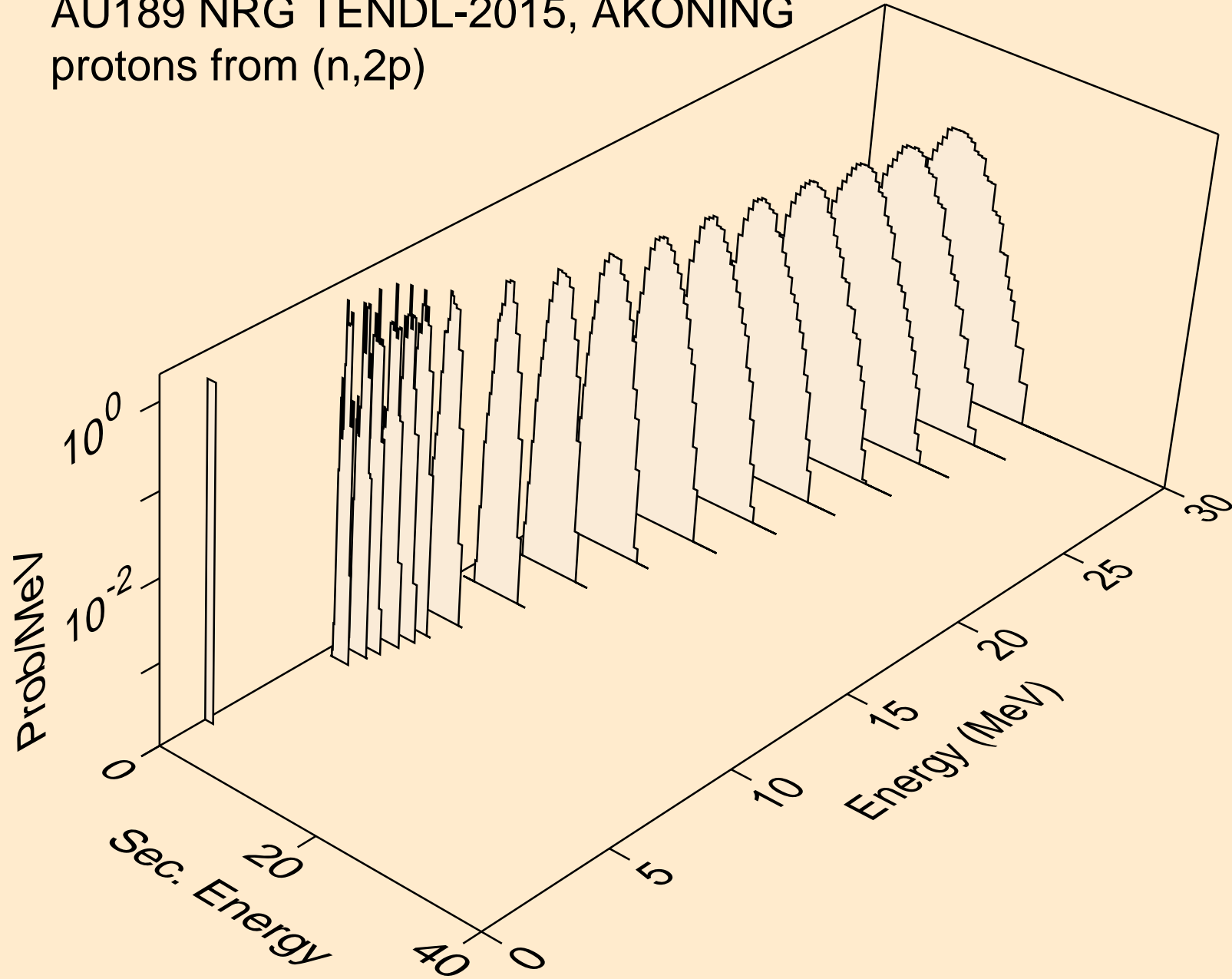

AU189 NRG TENDL-2015, AKONING
protons from (n,pa)

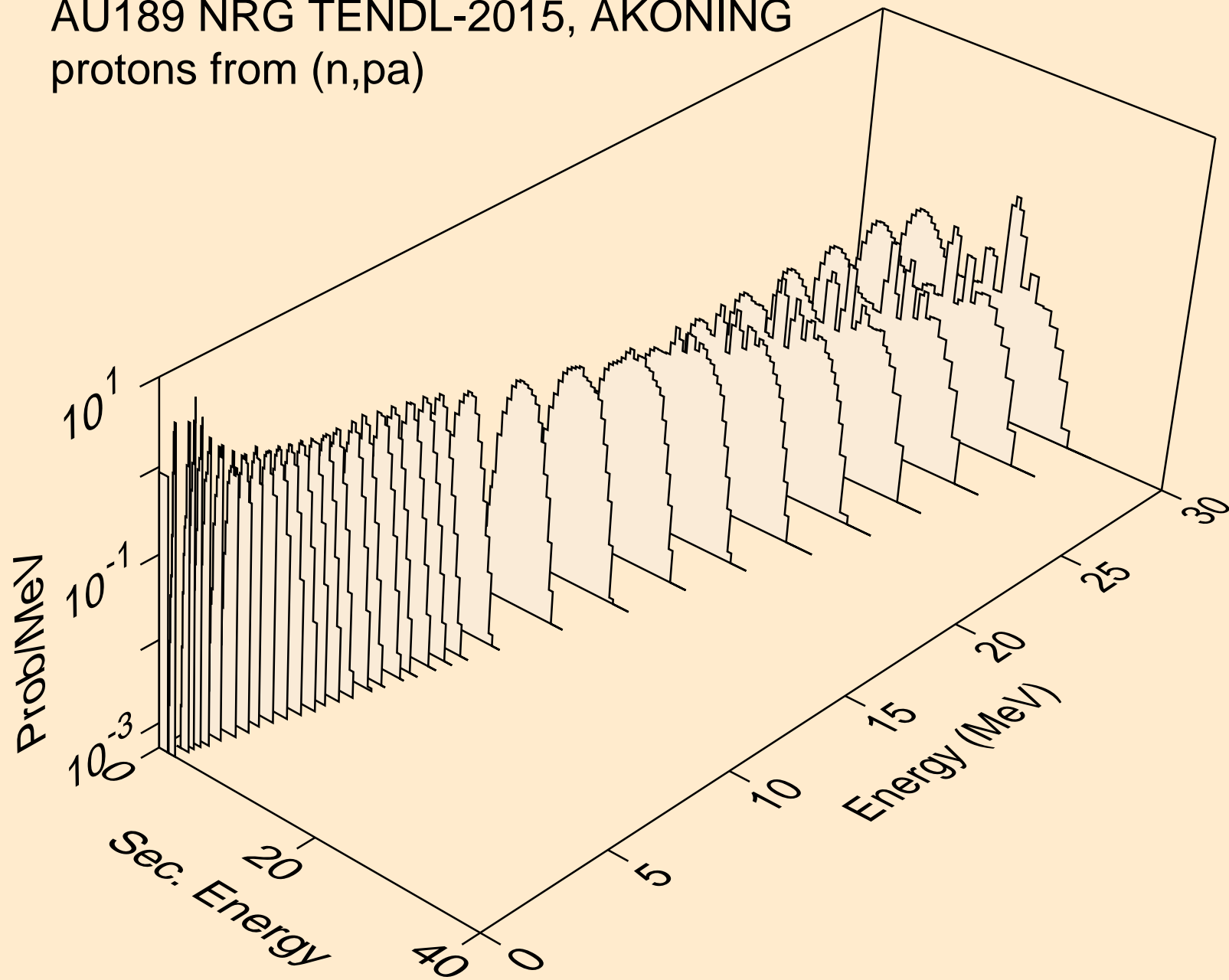

AU189 NRG TENDL-2015, AKONING
protons from (n,pd)

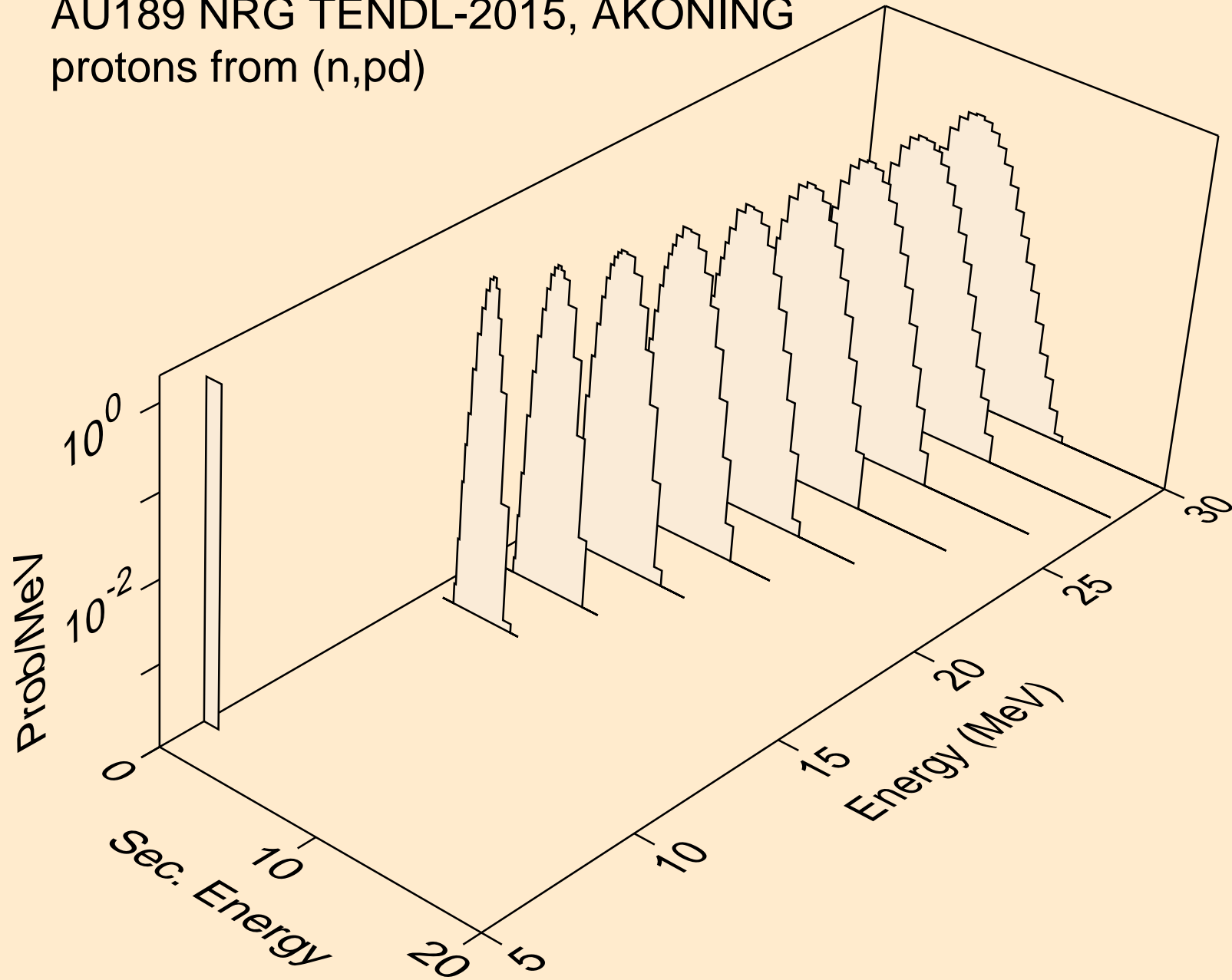

AU189 NRG TENDL-2015, AKONING
protons from (n,pt)

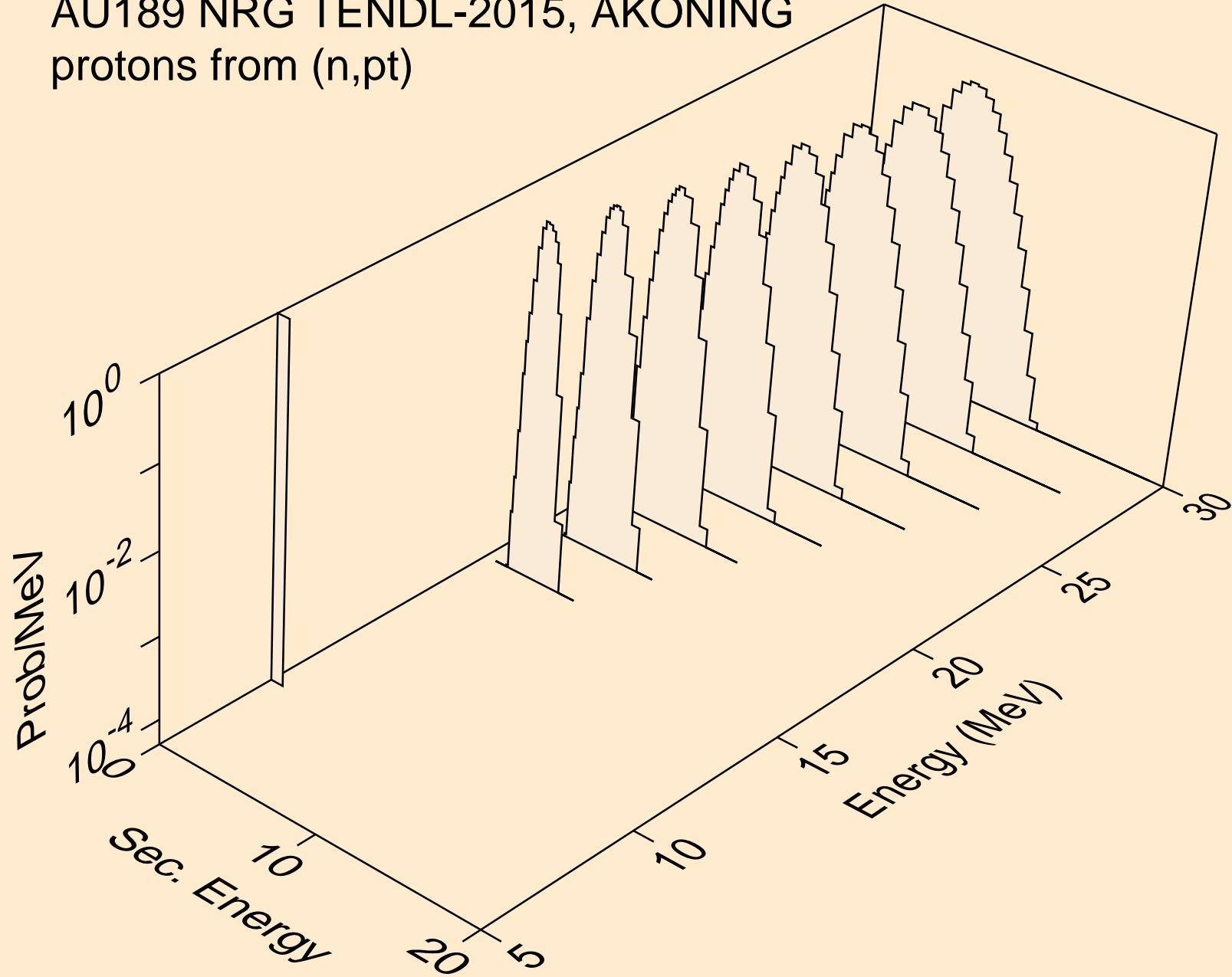

AU189 NRG TENDL-2015, AKONING
deuterons from (n,x)

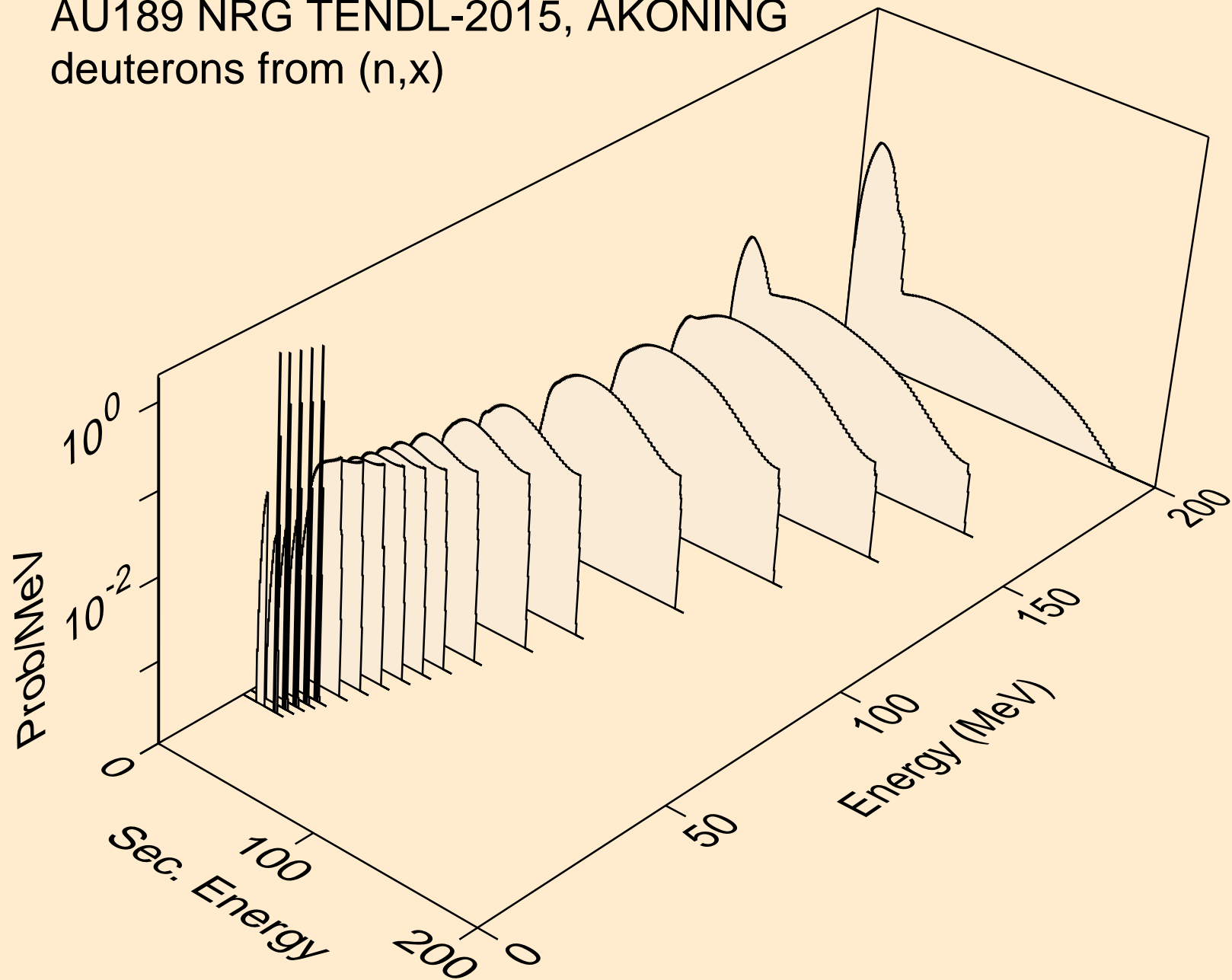

AU189 NRG TENDL-2015, AKONING
deuterons from (n,2nd)

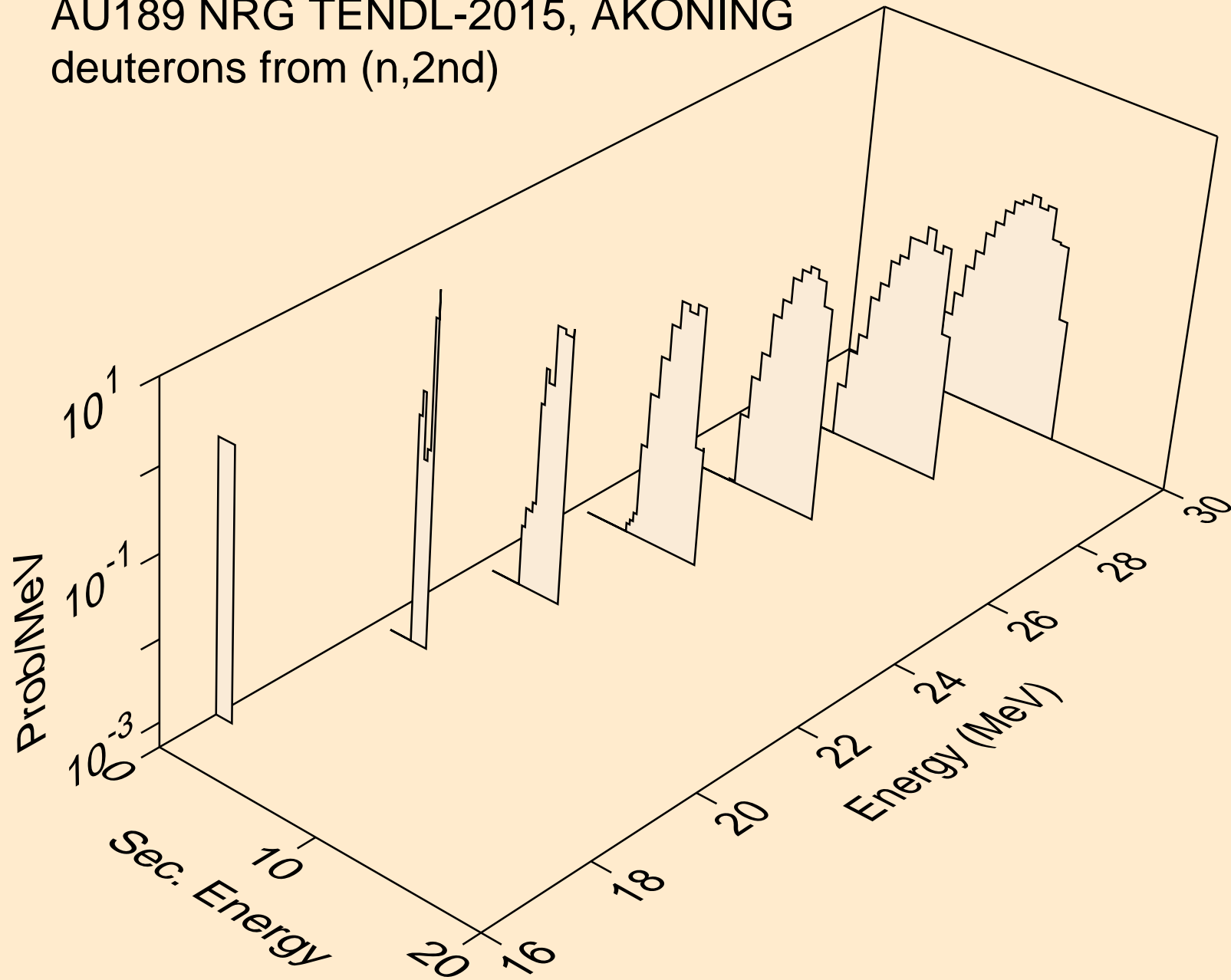

AU189 NRG TENDL-2015, AKONING
deuterons from (n,n*)d

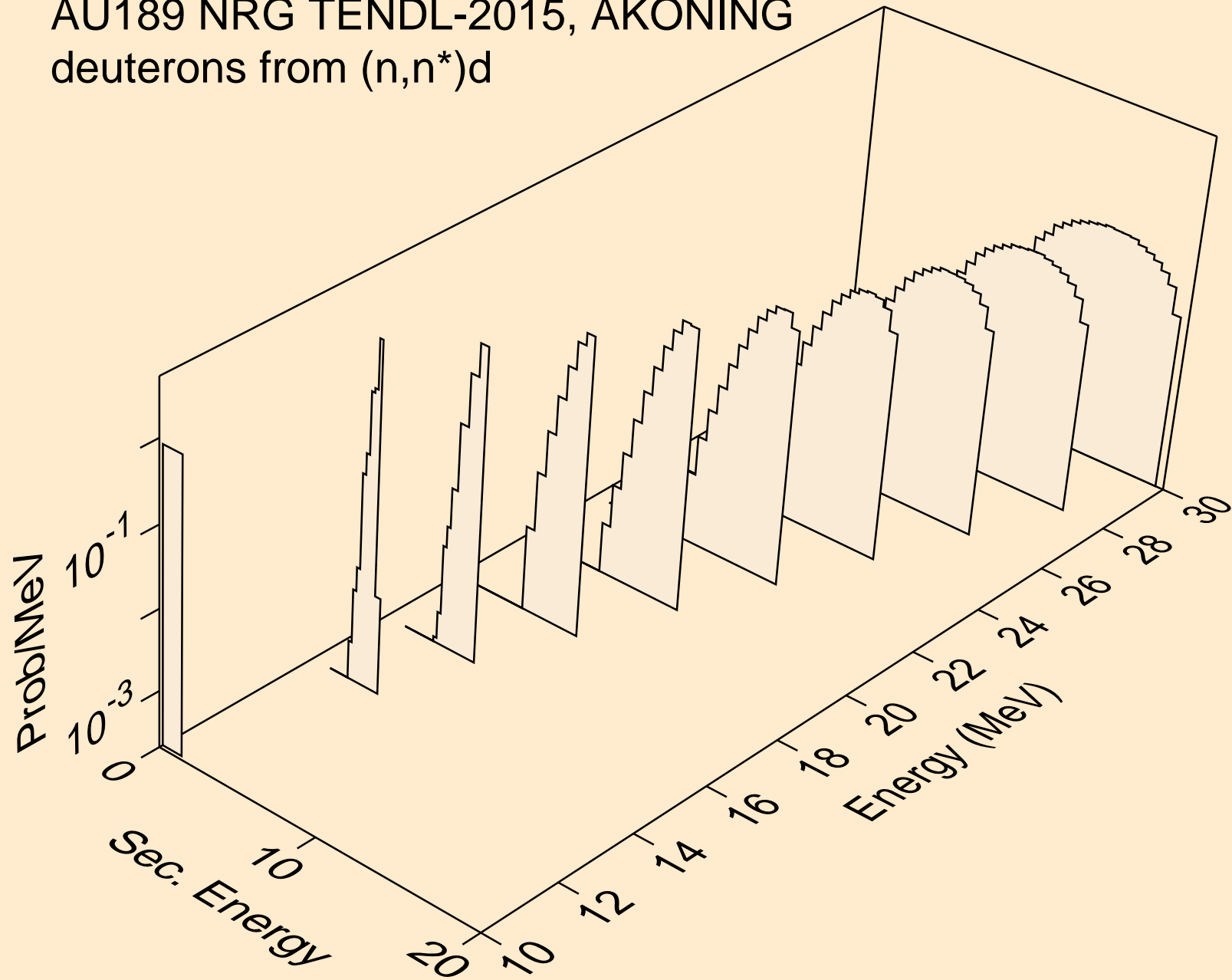

AU189 NRG TENDL-2015, AKONING
deuterons from (n,d)

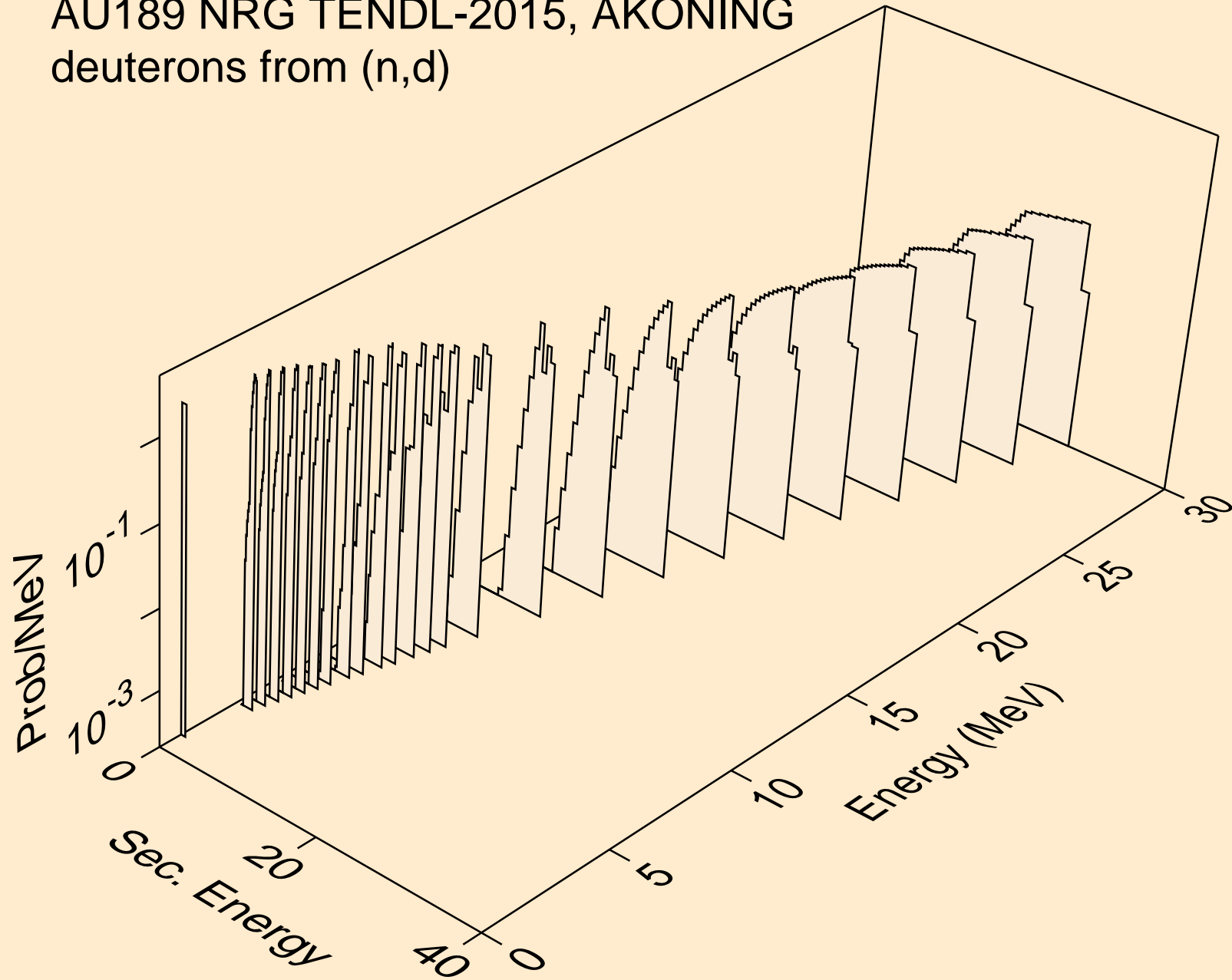

AU189 NRG TENDL-2015, AKONING
deuterons from (n,pd)

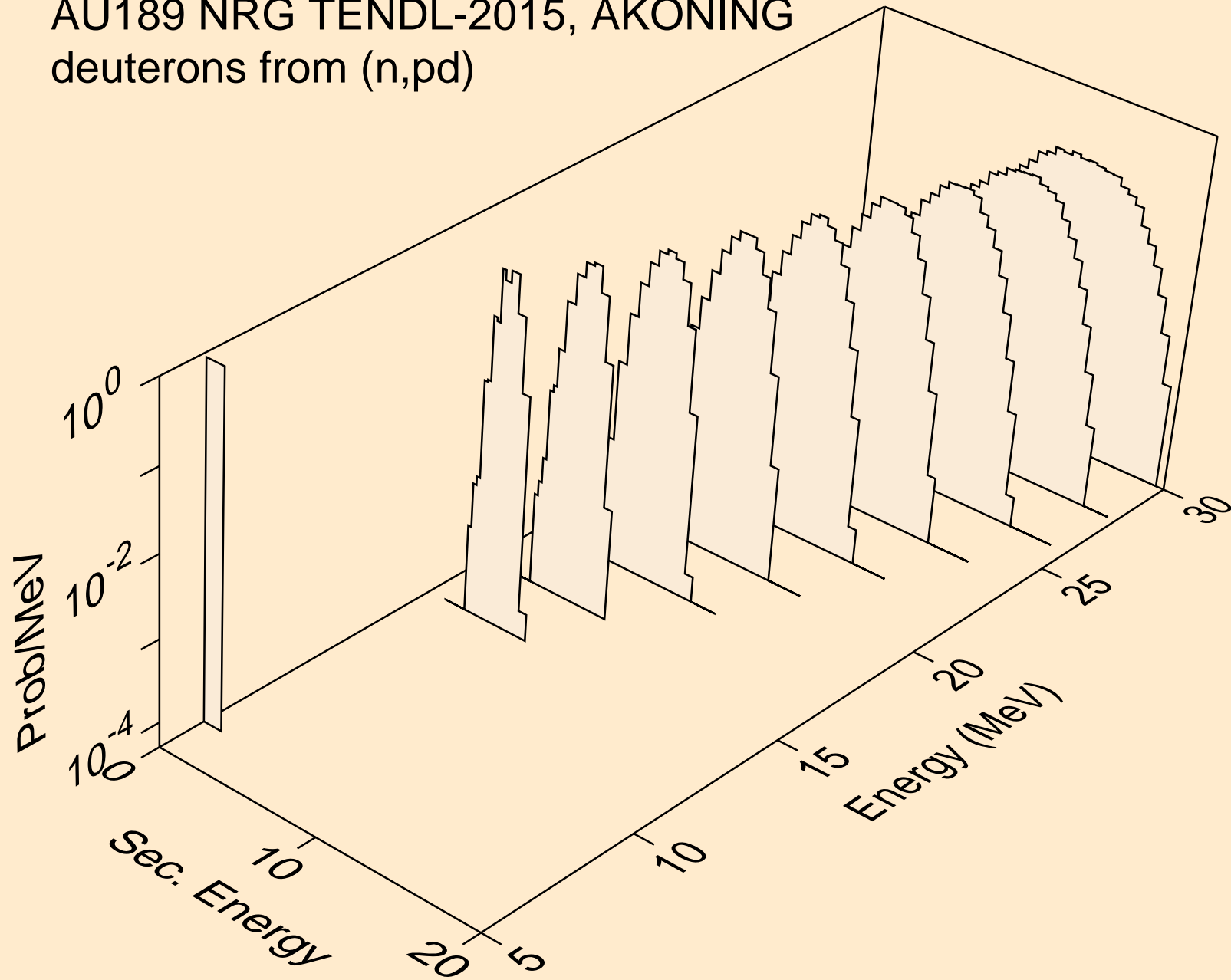

AU189 NRG TENDL-2015, AKONING
deuterons from (n,da)

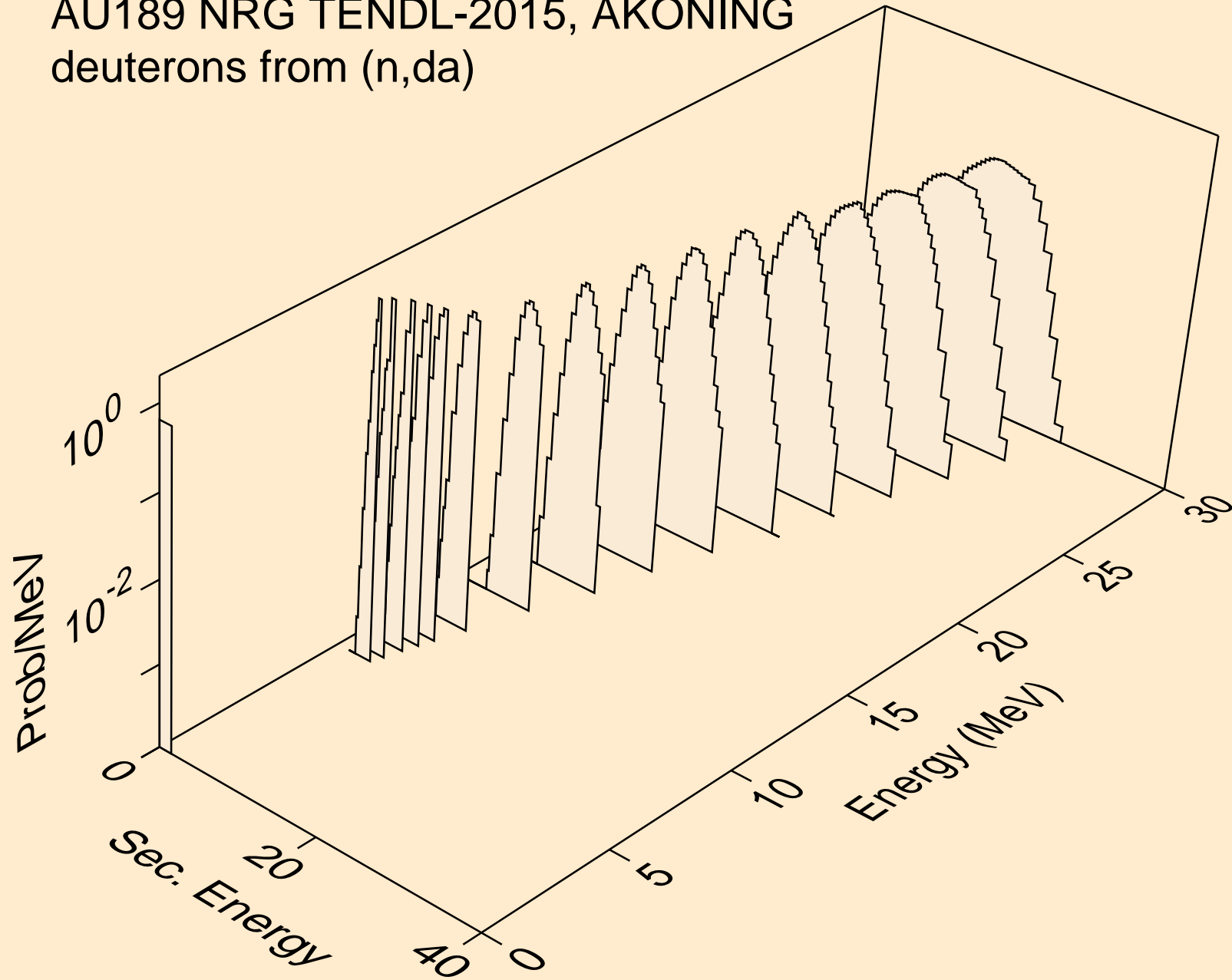

AU189 NRG TENDL-2015, AKONING
tritons from (n,x)

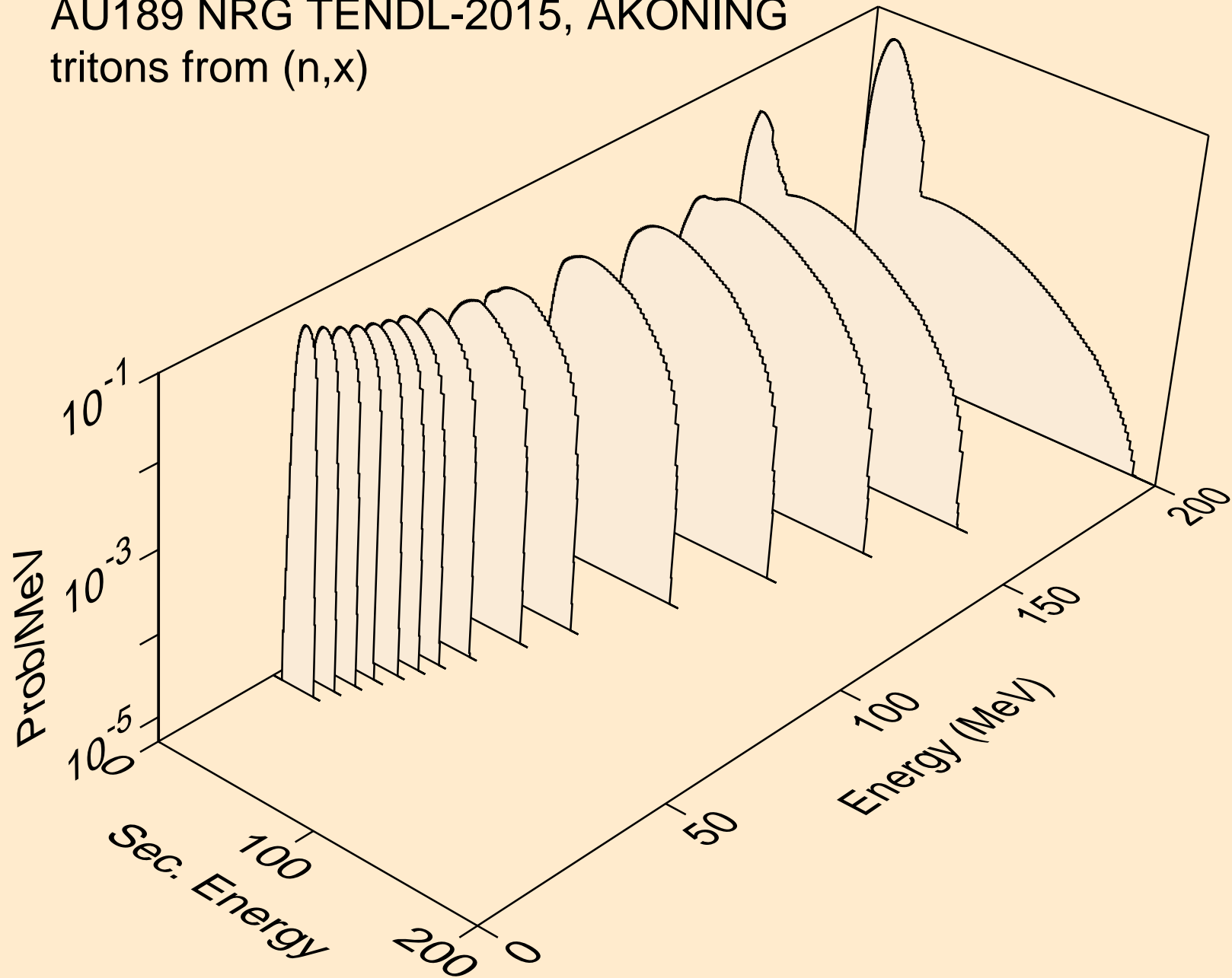

AU189 NRG TENDL-2015, AKONING
tritons from (n,n*)t

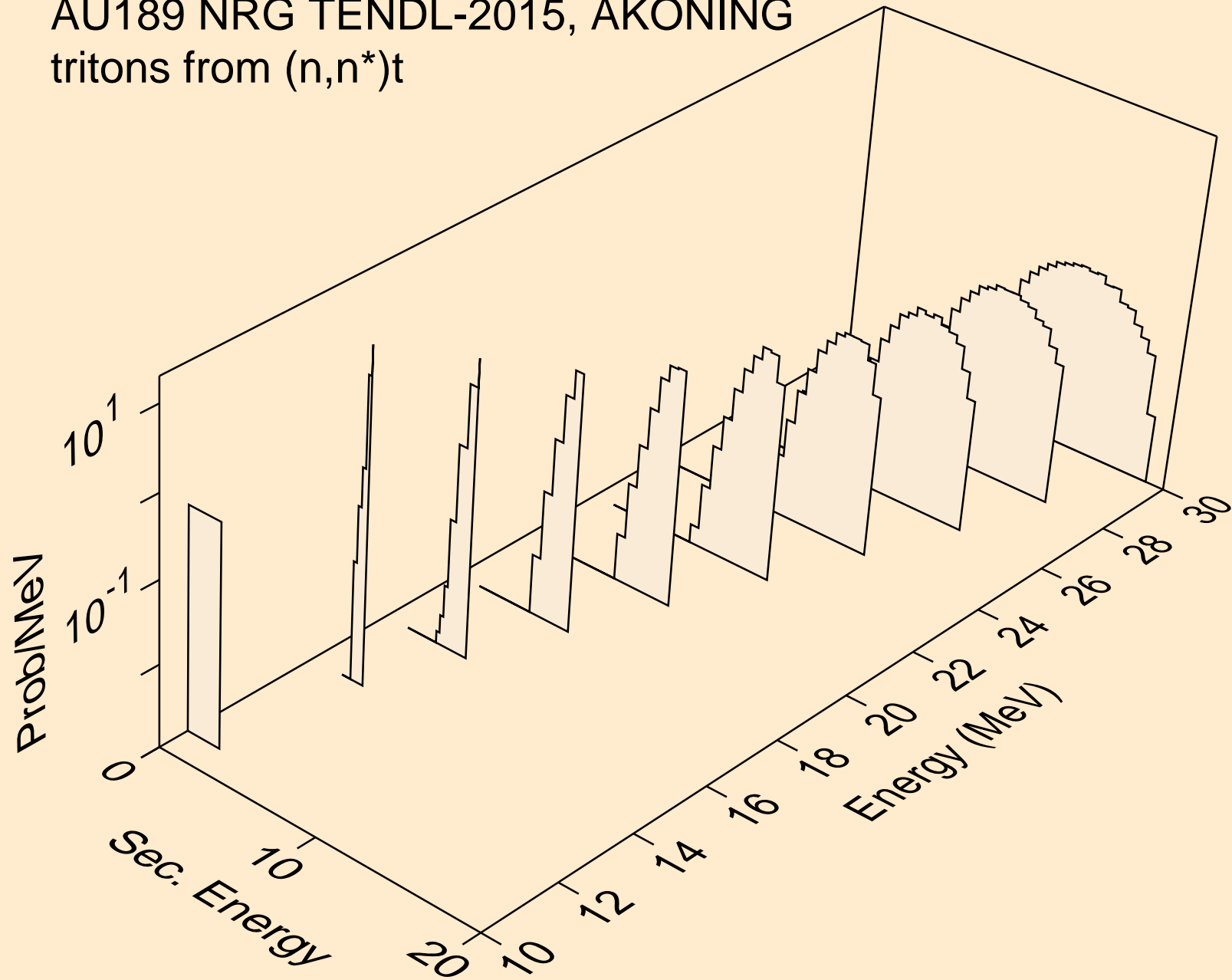

AU189 NRG TENDL-2015, AKONING
tritons from (n,t)

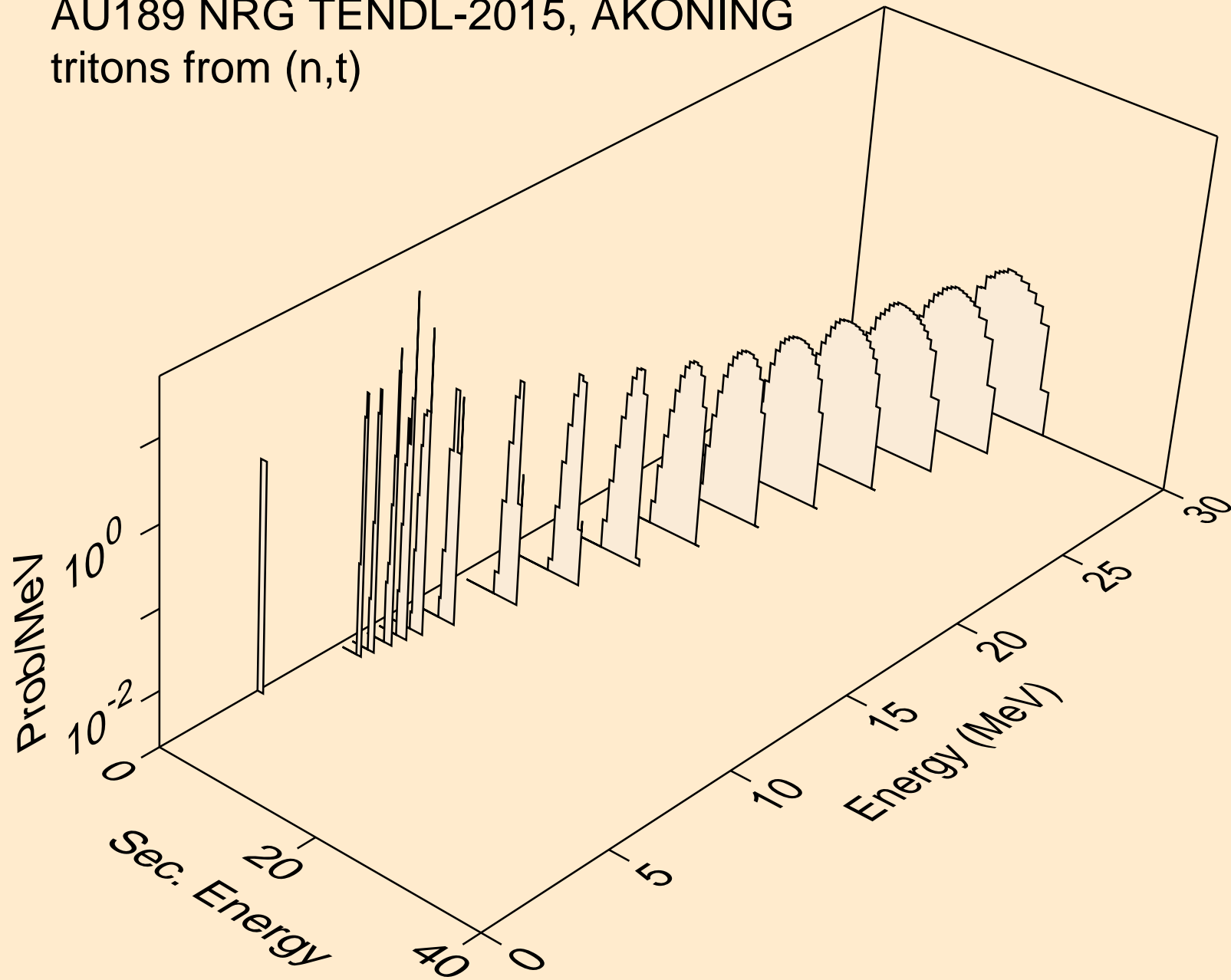

AU189 NRG TENDL-2015, AKONING
tritons from (n,pt)

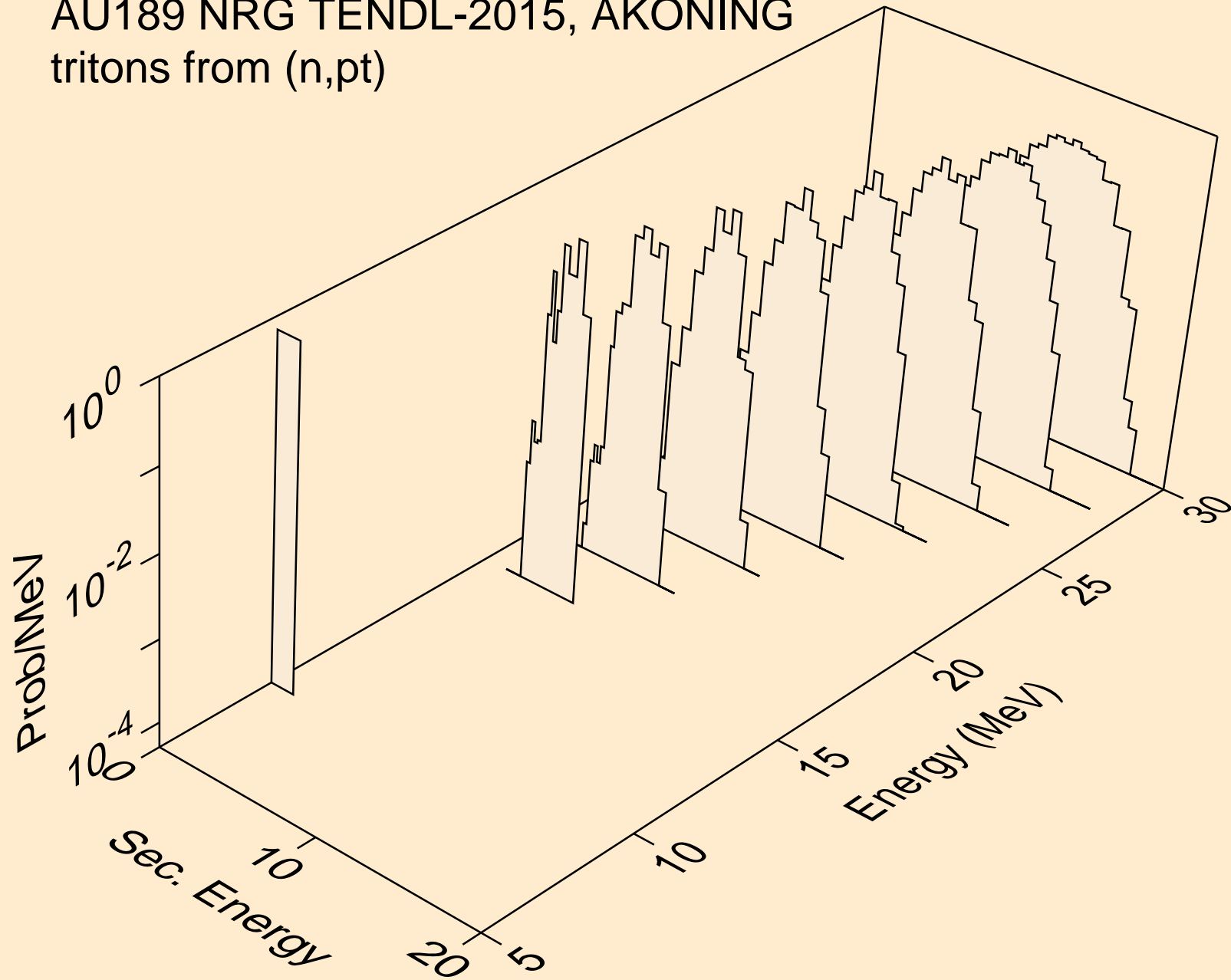

AU189 NRG TENDL-2015, AKONING
he3s from (n,x)

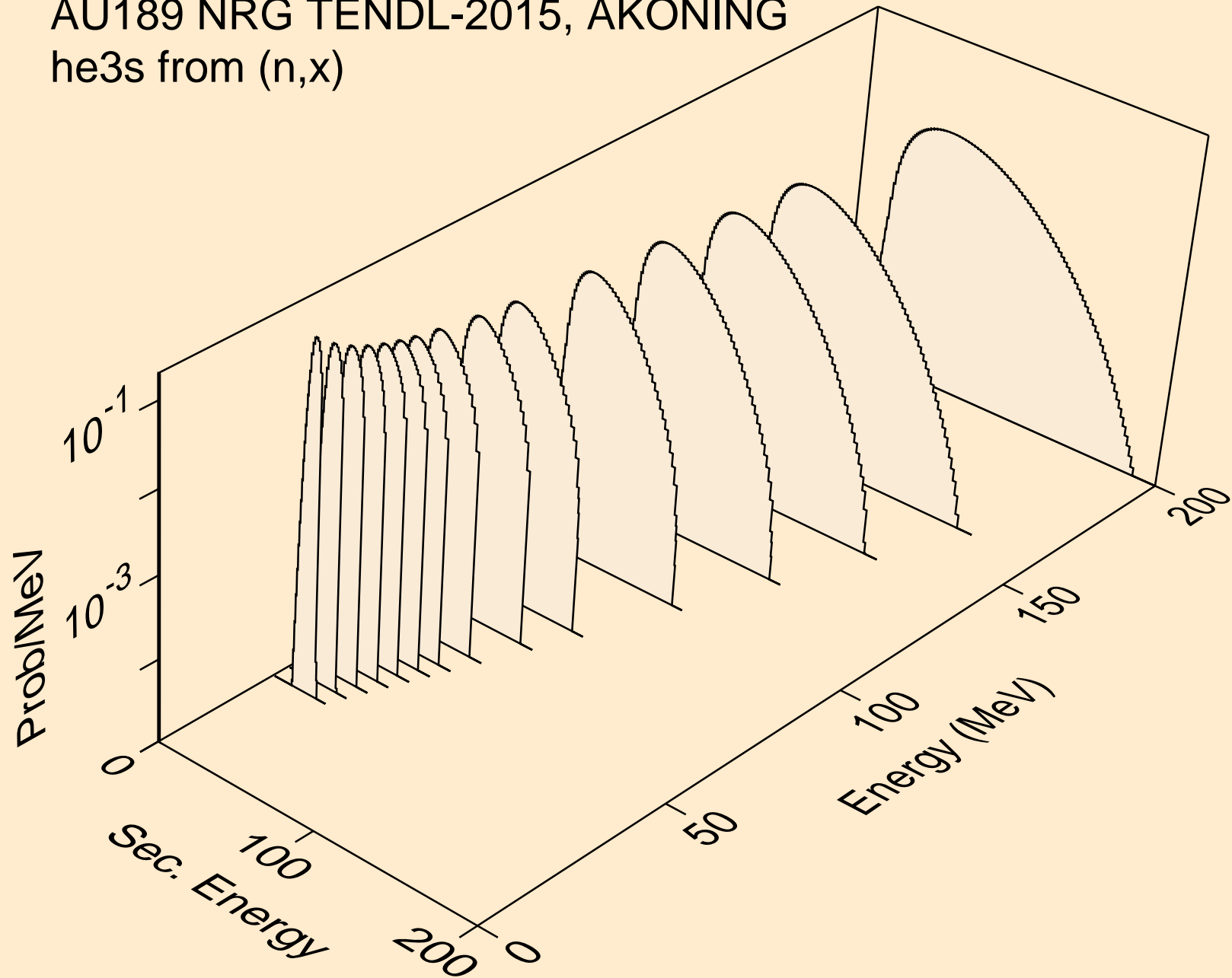

AU189 NRG TENDL-2015, AKONING
he3s from (n,n*)he3

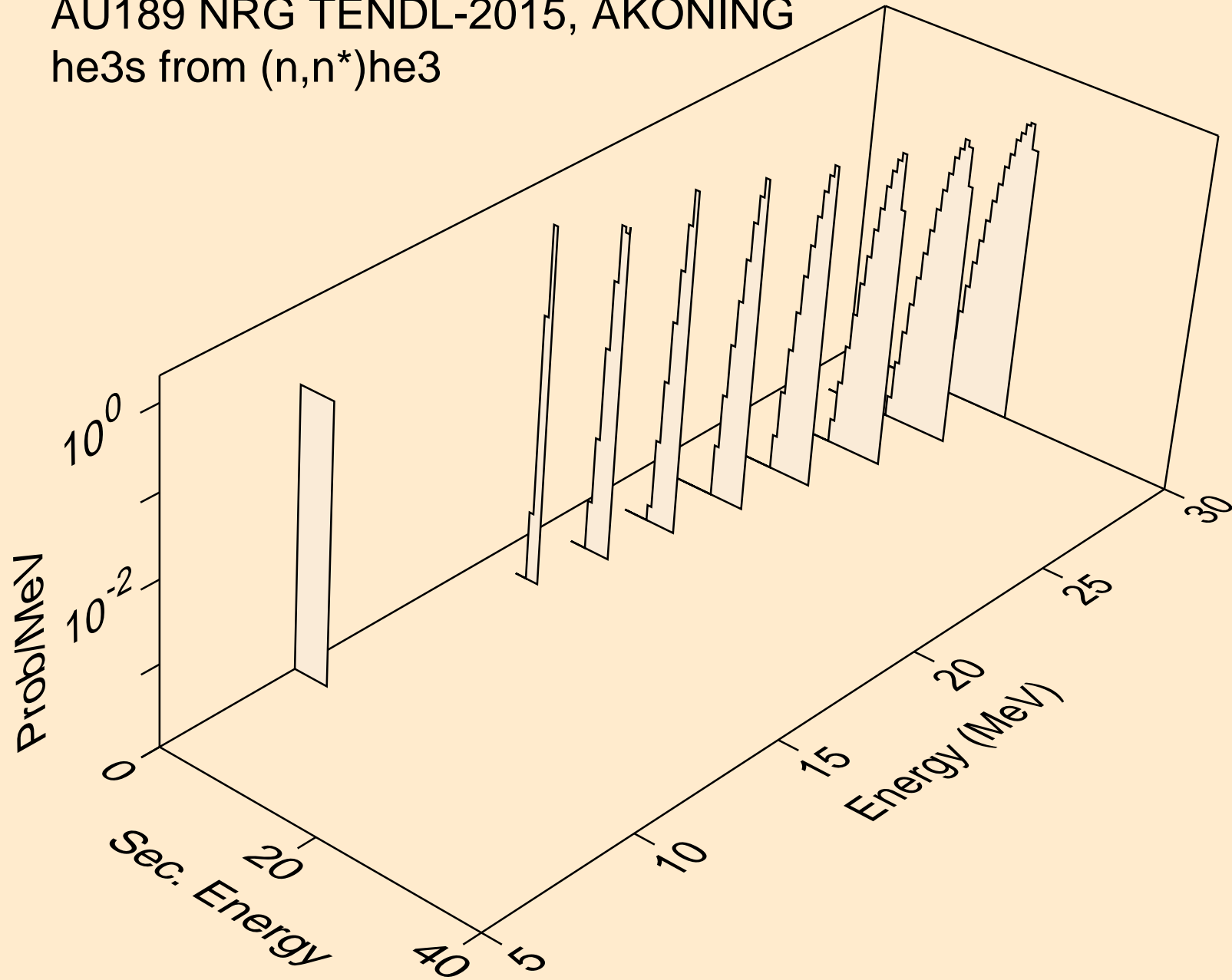

AU189 NRG TENDL-2015, AKONING
he3s from (n,he3)

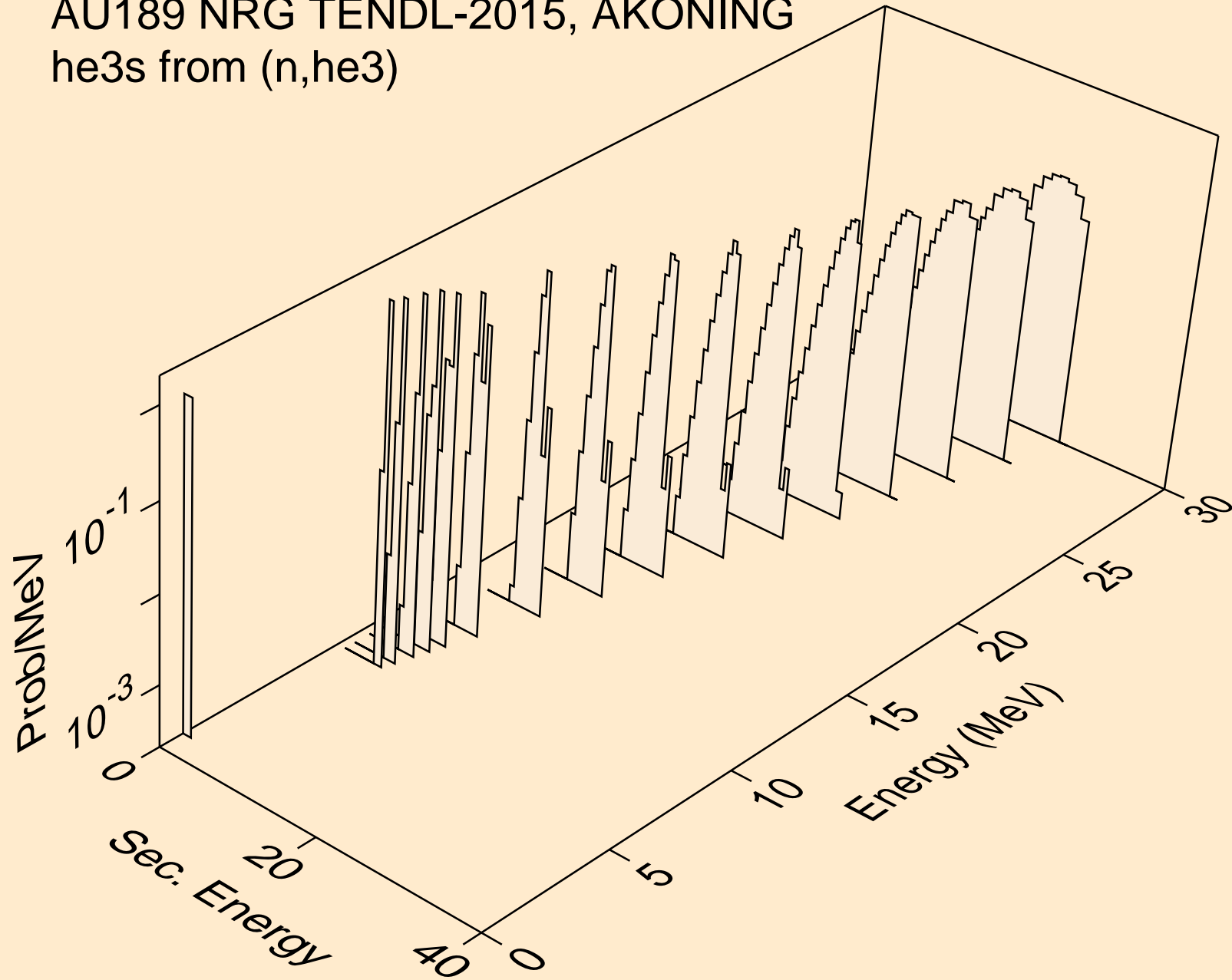

AU189 NRG TENDL-2015, AKONING
alphas from (n,x)

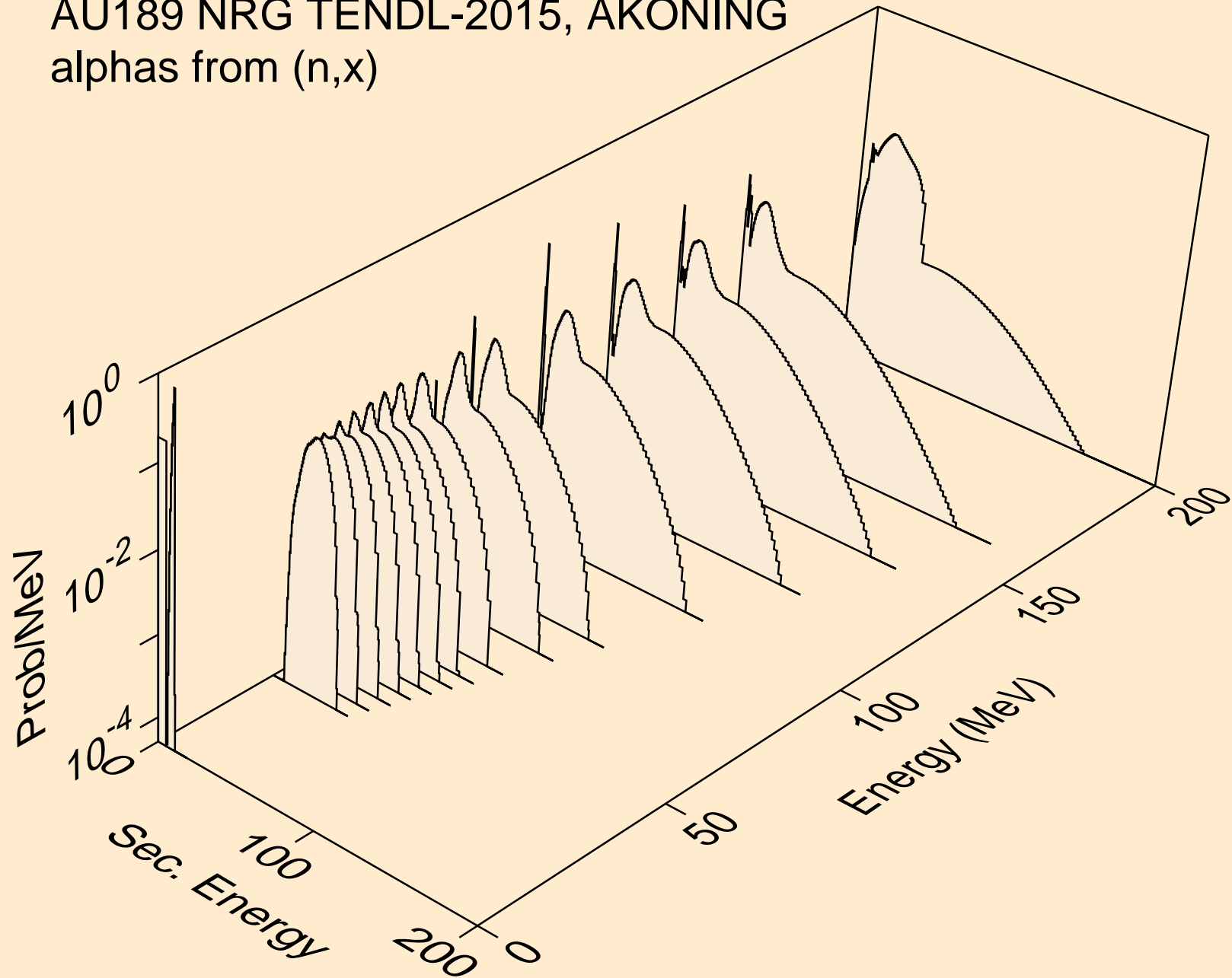

AU189 NRG TENDL-2015, AKONING
alphas from (n,n*)a

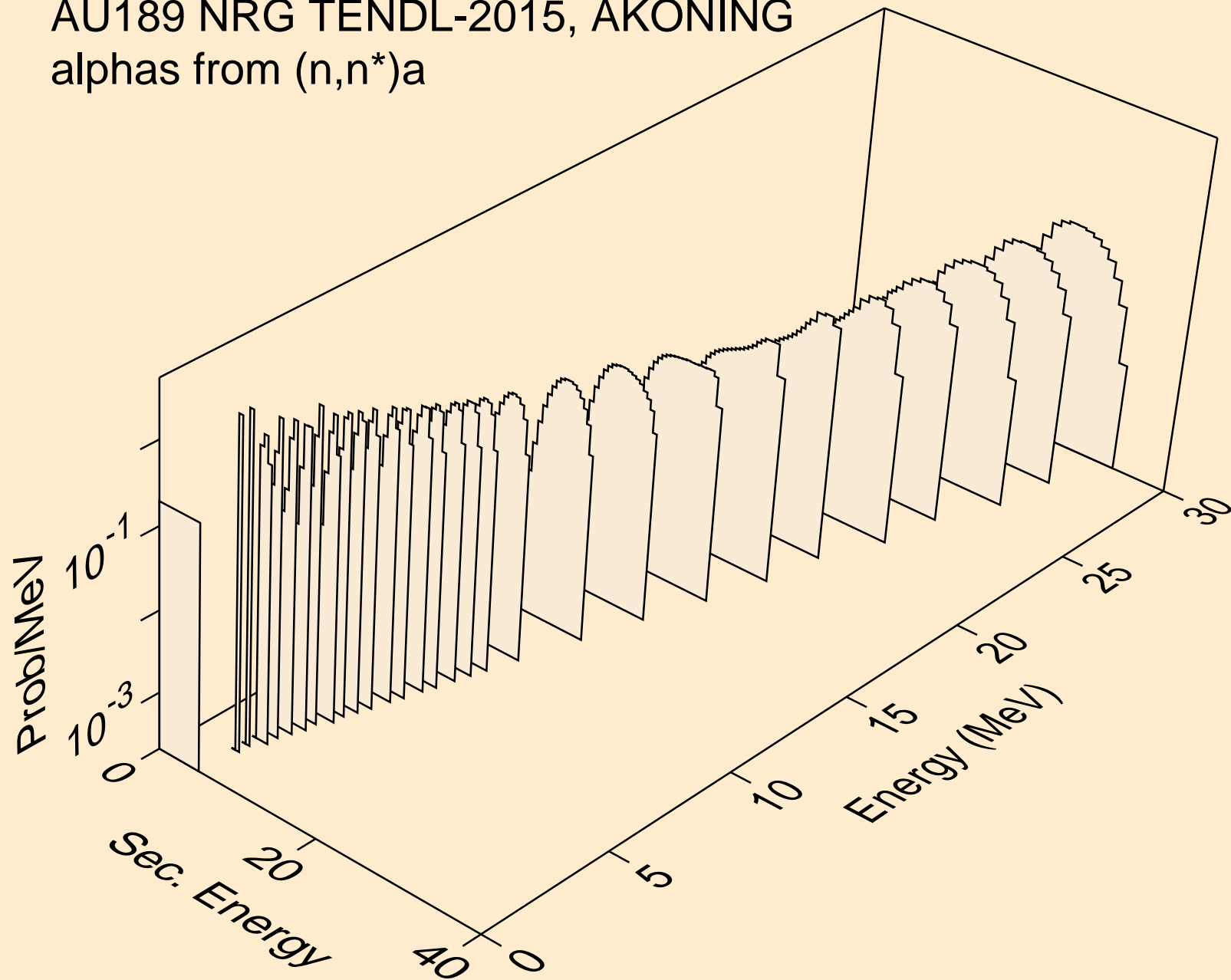

AU189 NRG TENDL-2015, AKONING
alphas from (n,2n)a

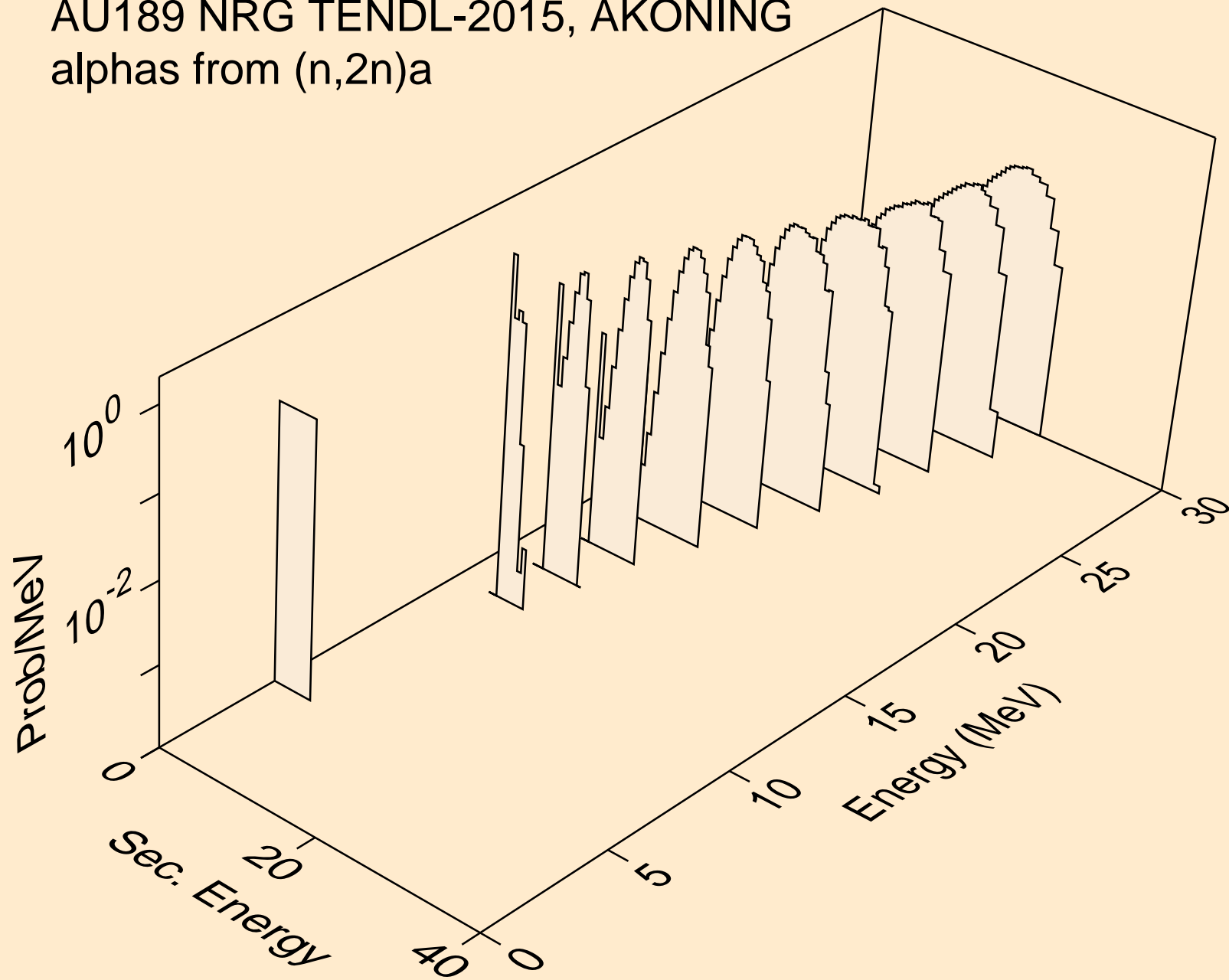

AU189 NRG TENDL-2015, AKONING
alphas from (n,3n)a

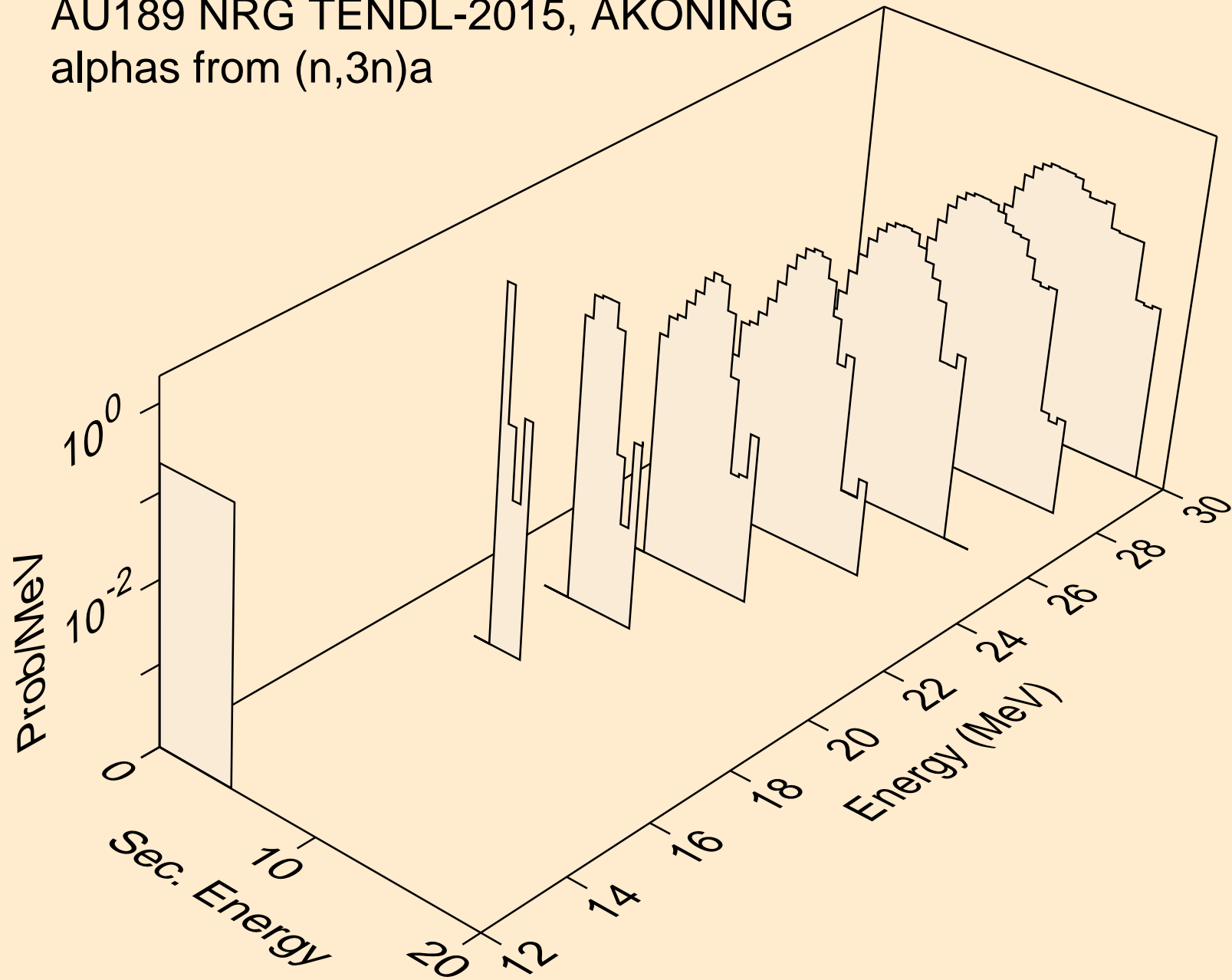

AU189 NRG TENDL-2015, AKONING
alphas from (n,n*)2a

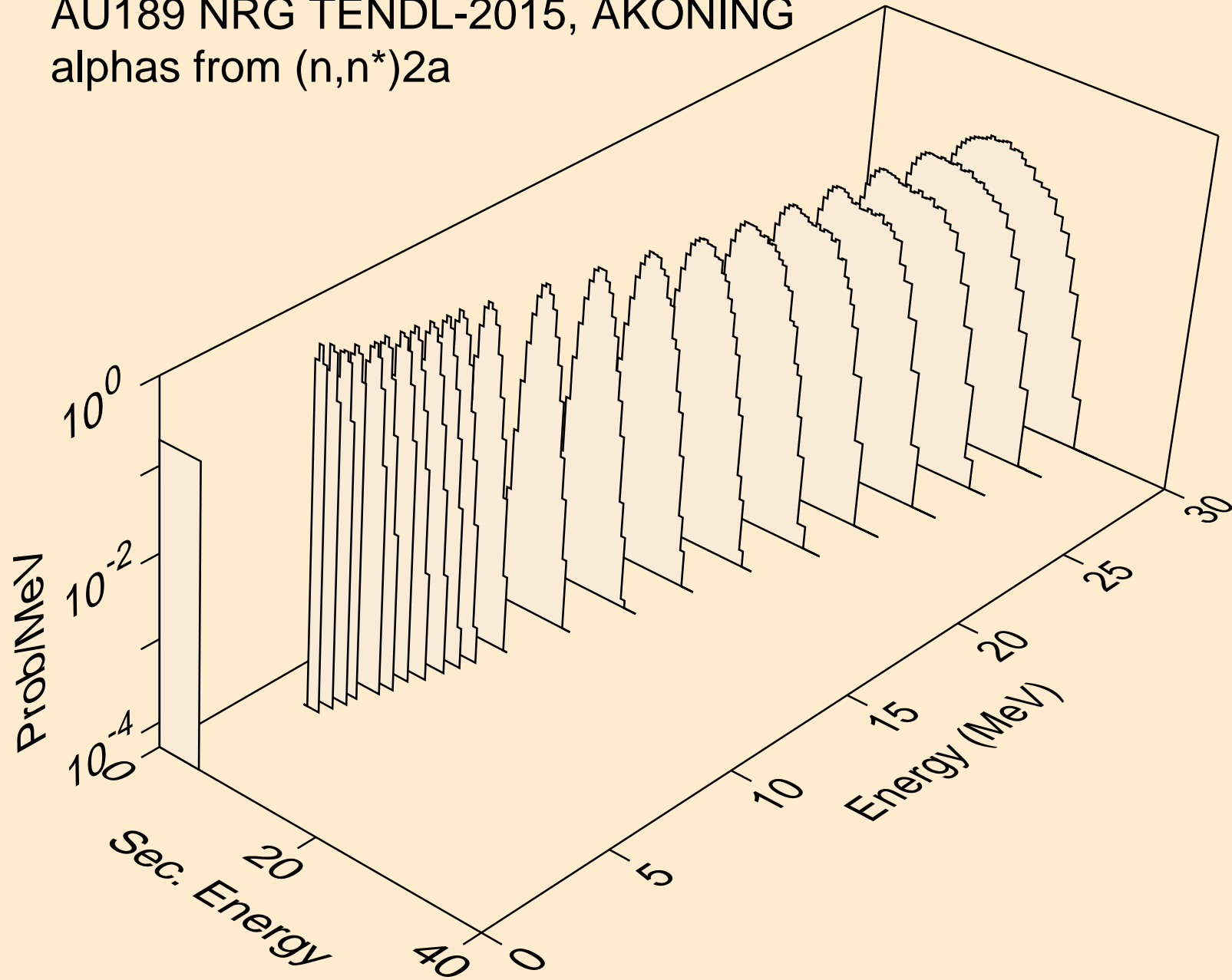

AU189 NRG TENDL-2015, AKONING
alphas from (n,2n)2a

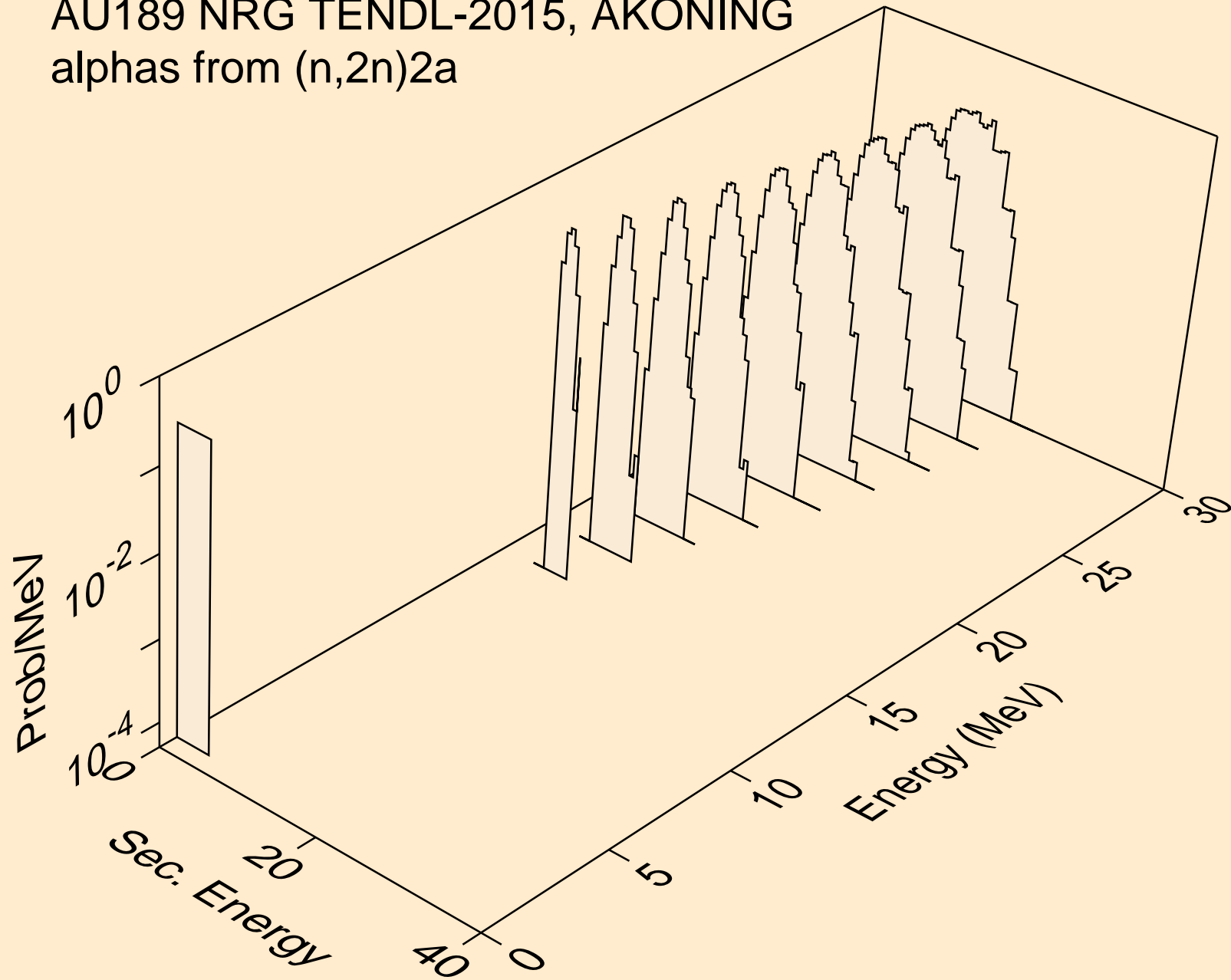

AU189 NRG TENDL-2015, AKONING
alphas from (n,npa)

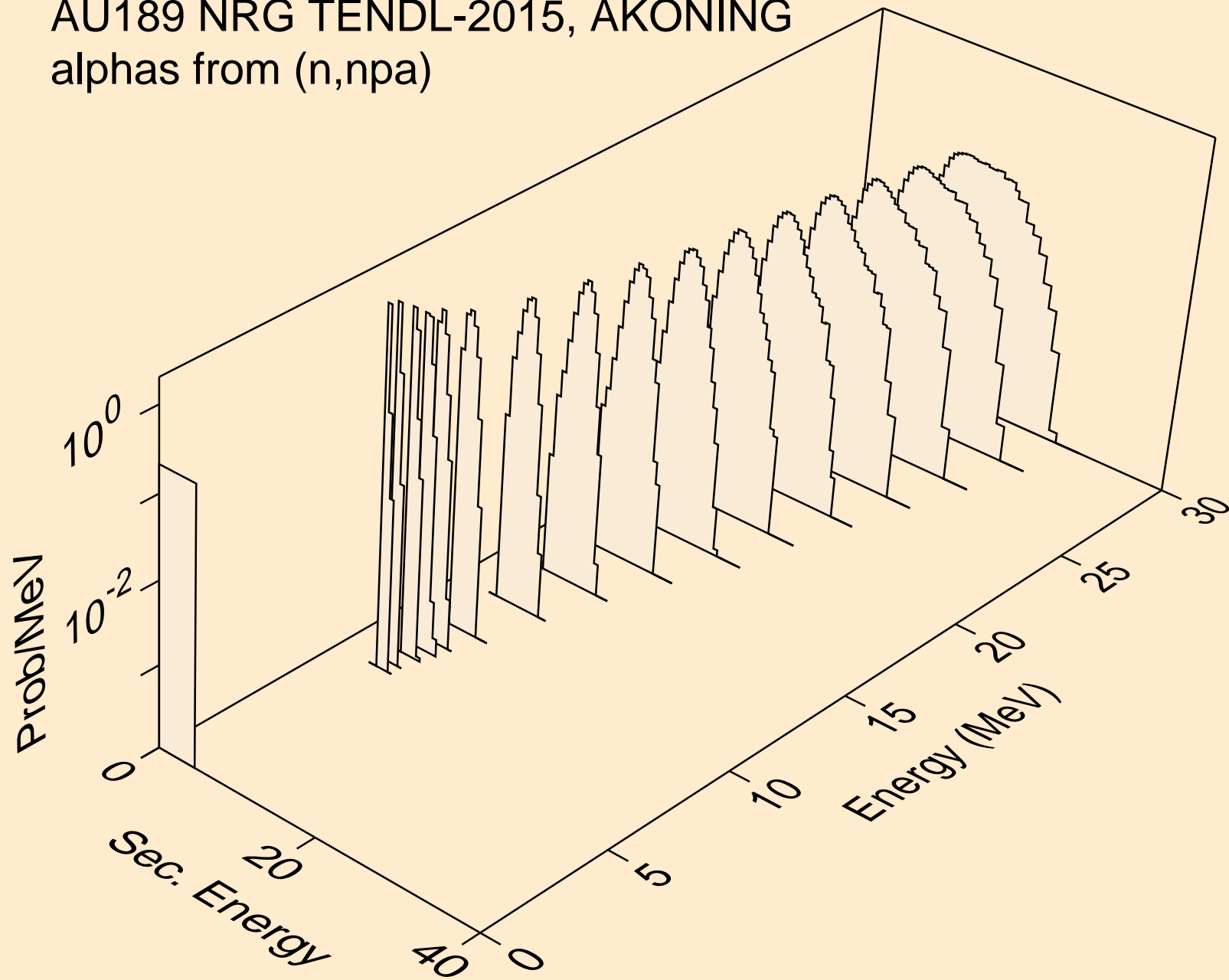

AU189 NRG TENDL-2015, AKONING
alphas from (n,a)

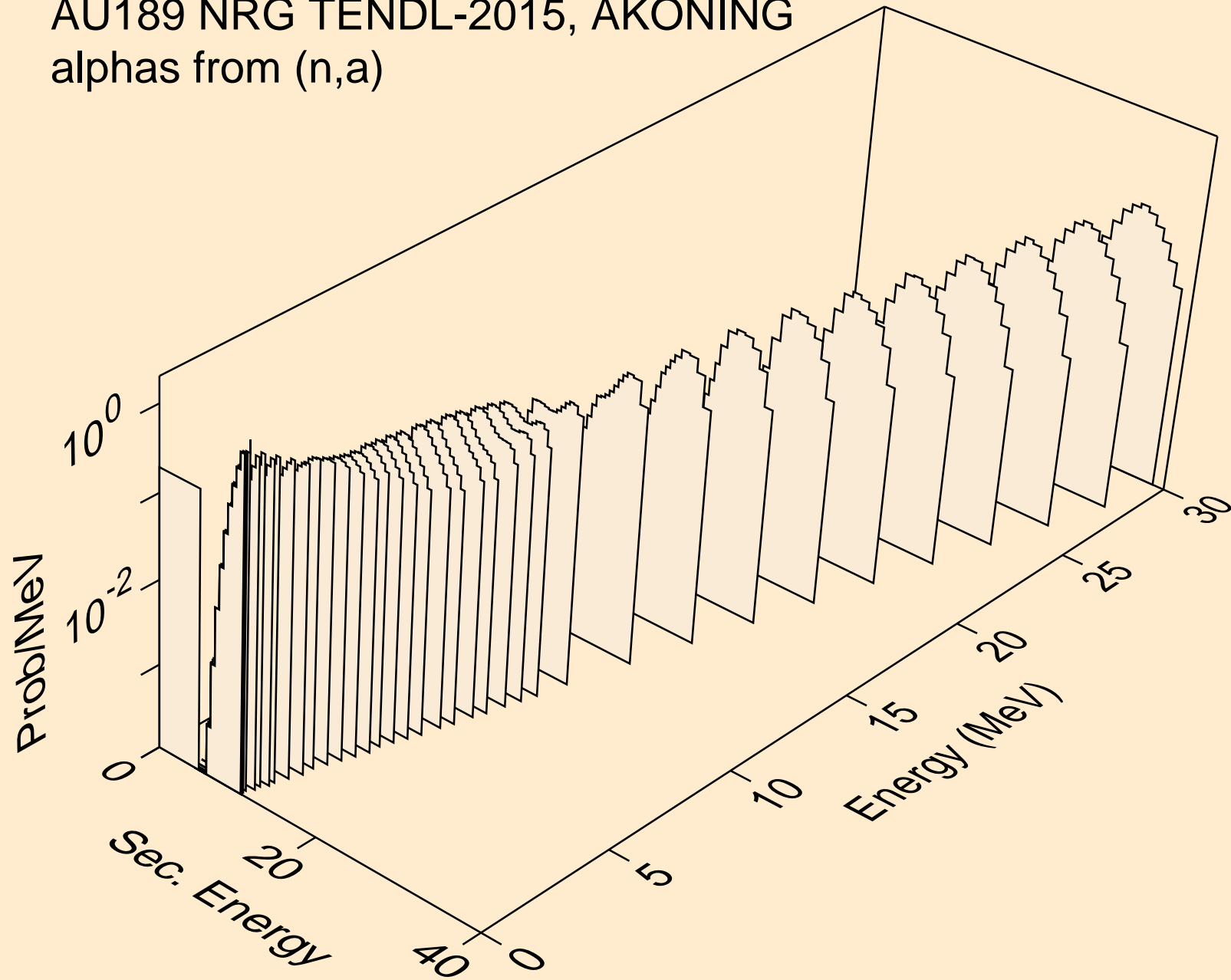

AU189 NRG TENDL-2015, AKONING
alphas from (n,2a)

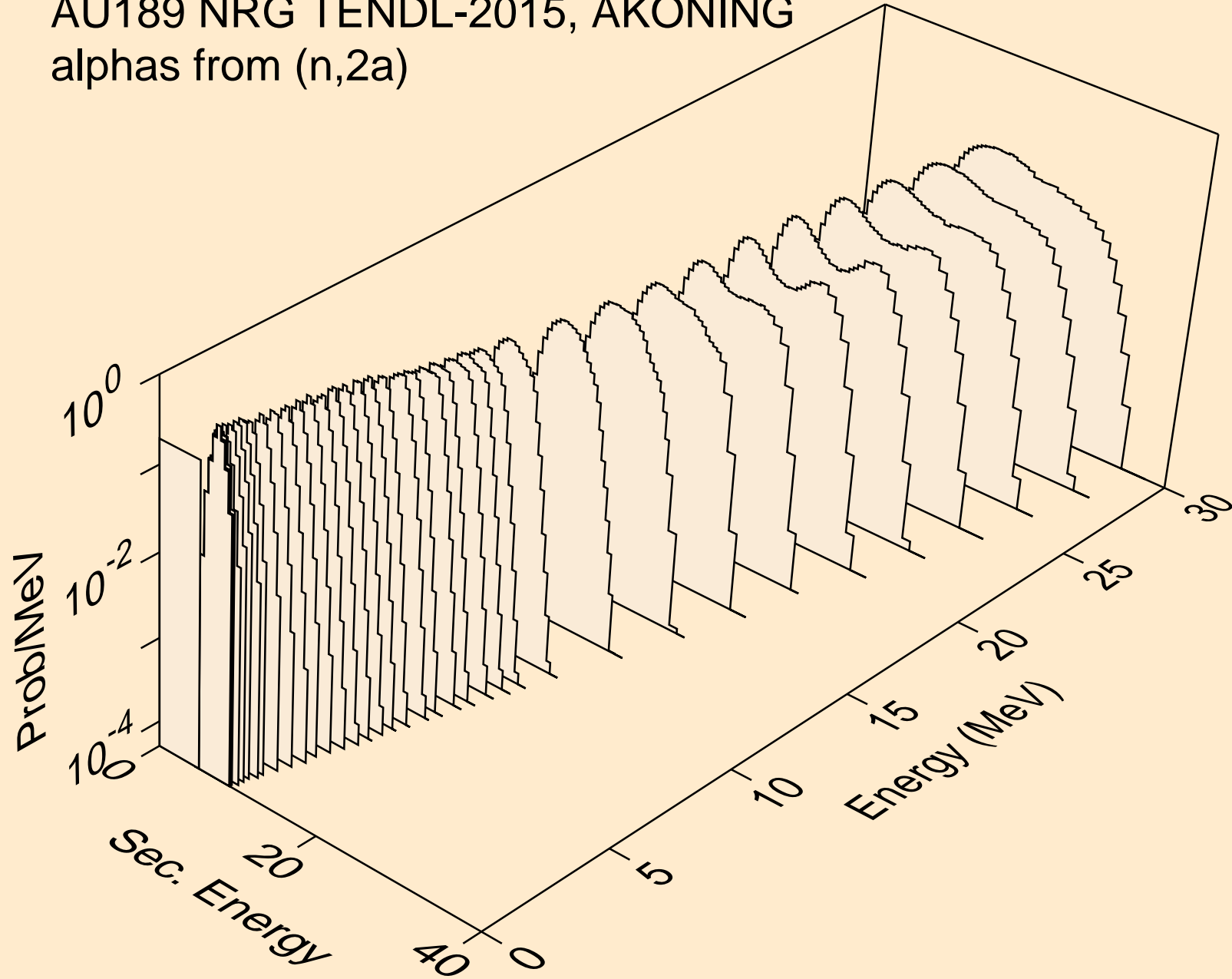

AU189 NRG TENDL-2015, AKONING
alphas from (n,pa)

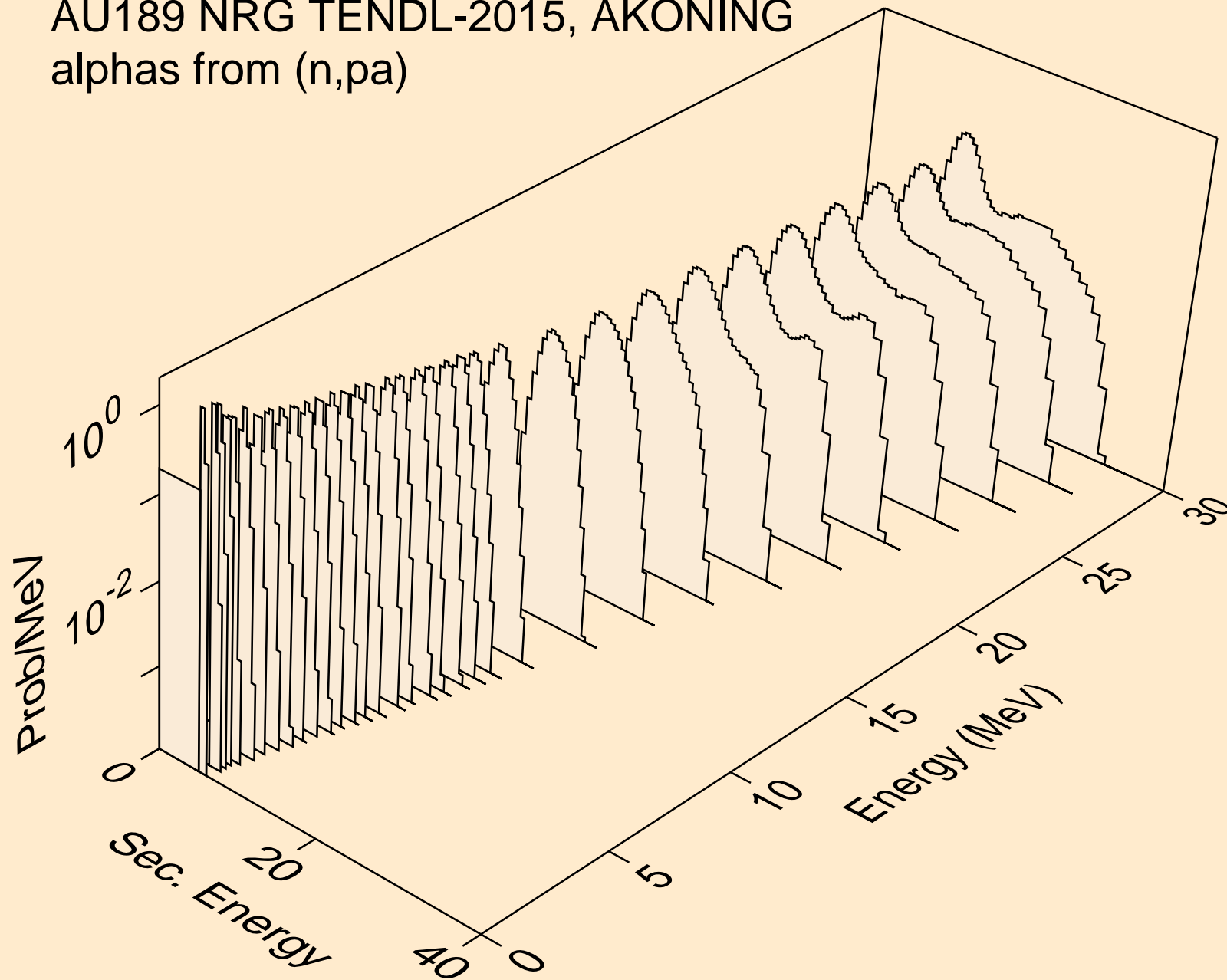

AU189 NRG TENDL-2015, AKONING
alphas from (n,da)

