

BA116 NRG TENDL-2015, AKONING

Principal cross sections

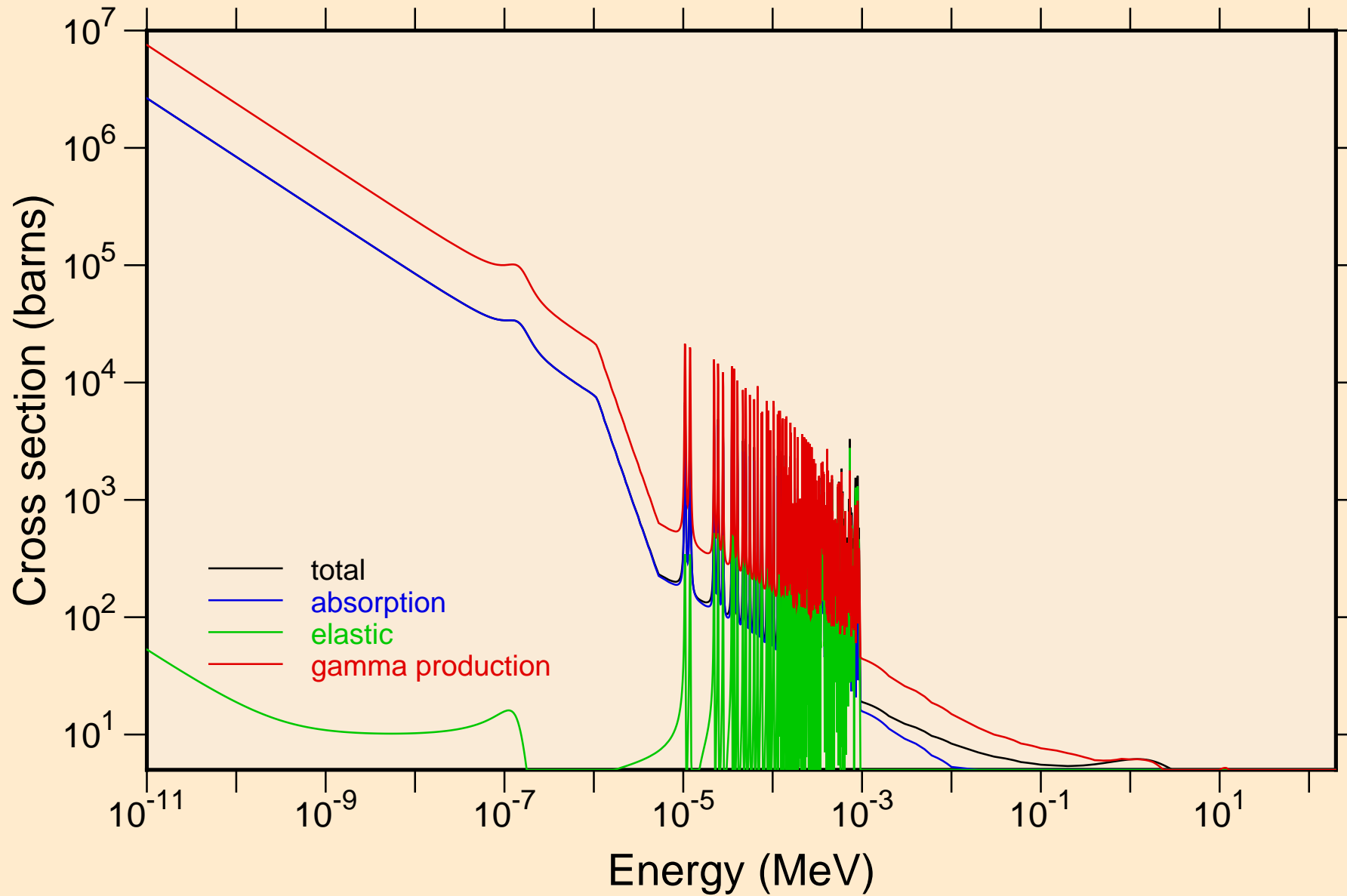

BA116 NRG TENDL-2015, AKONING
resonance total cross section

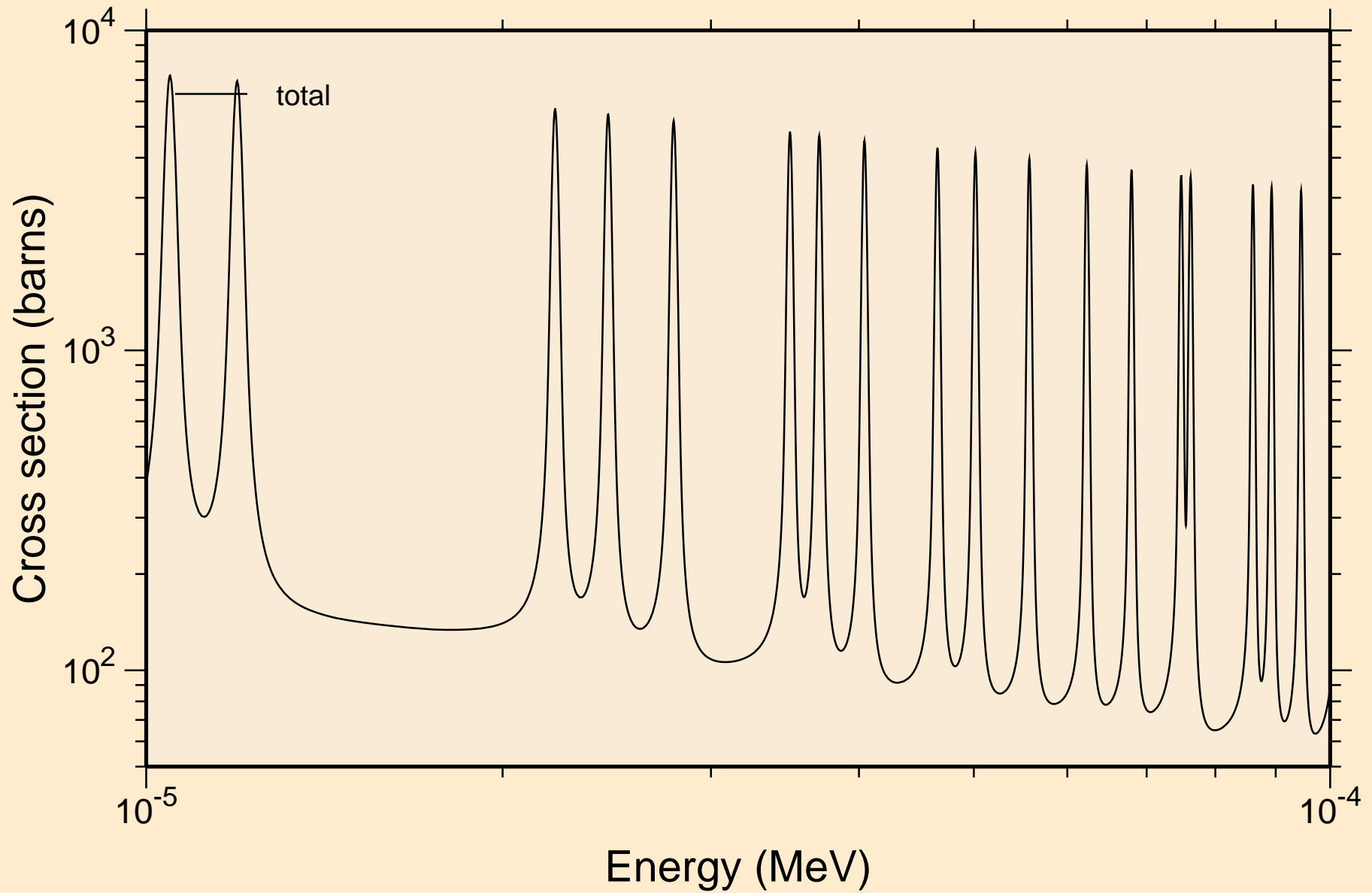

BA116 NRG TENDL-2015, AKONING
resonance total cross section

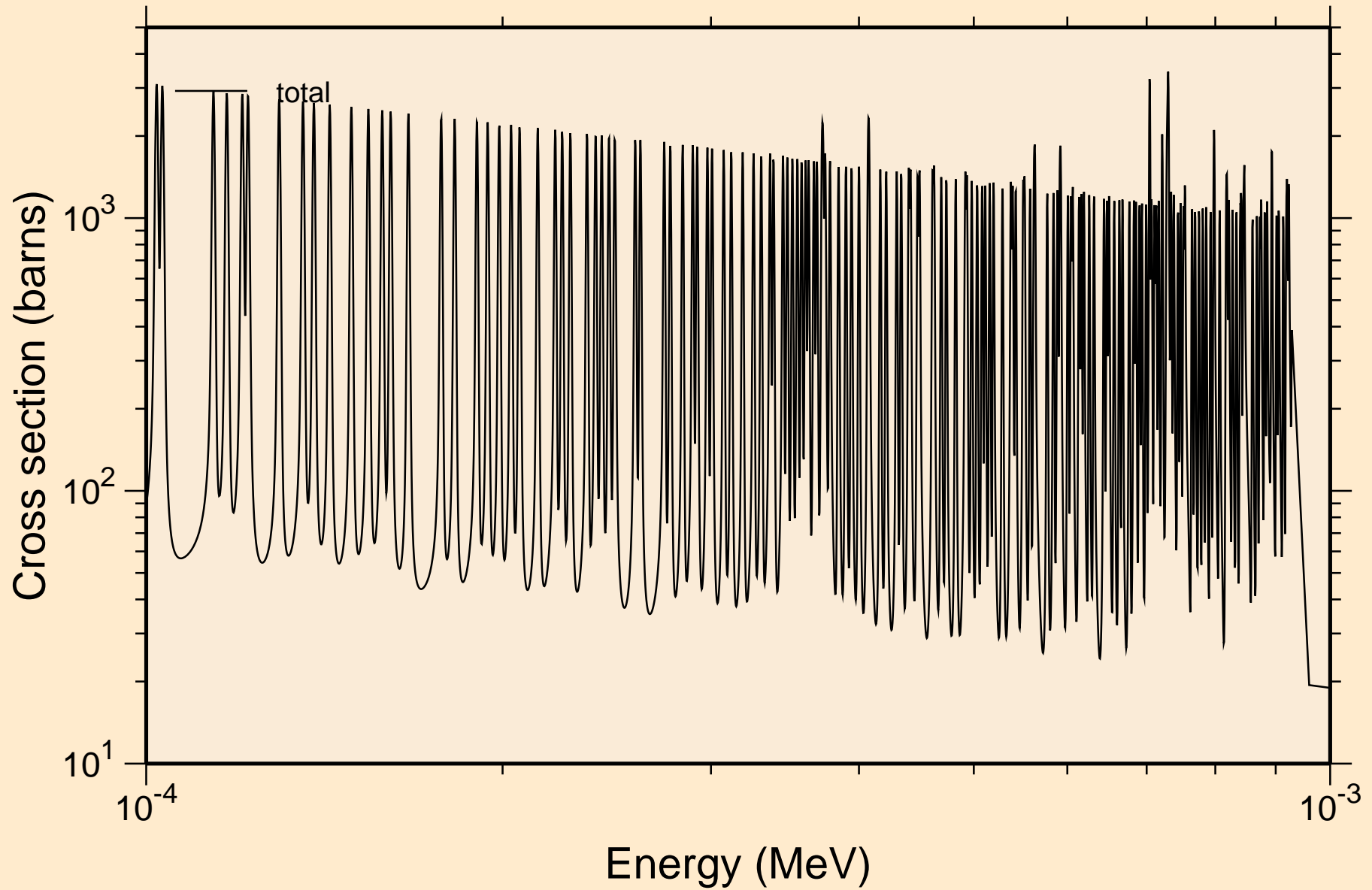

B̄A116 NRG TENDL-2015, AKONING
resonance total cross section

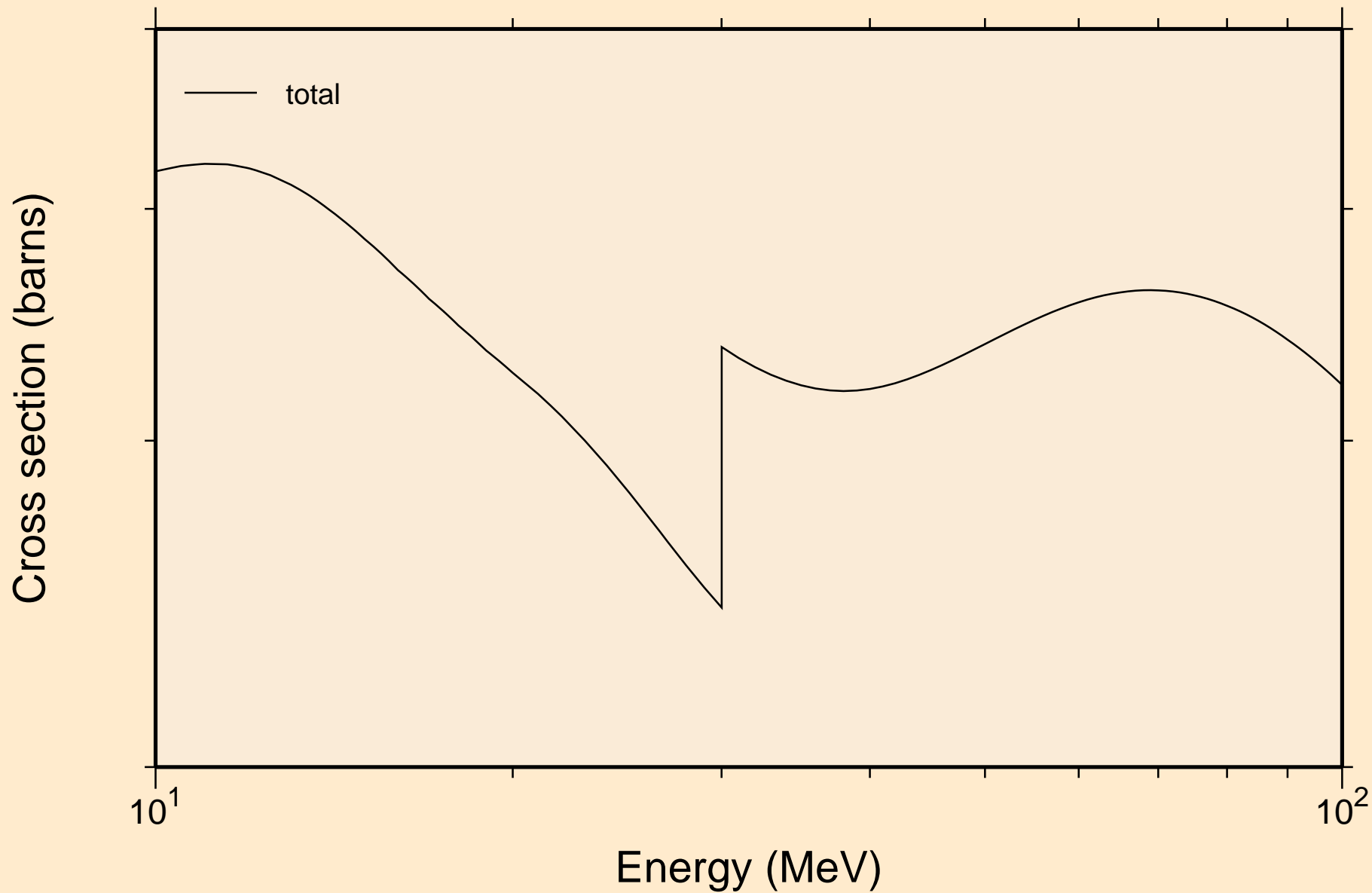

BA116 NRG TENDL-2015, AKONING
resonance absorption cross sections

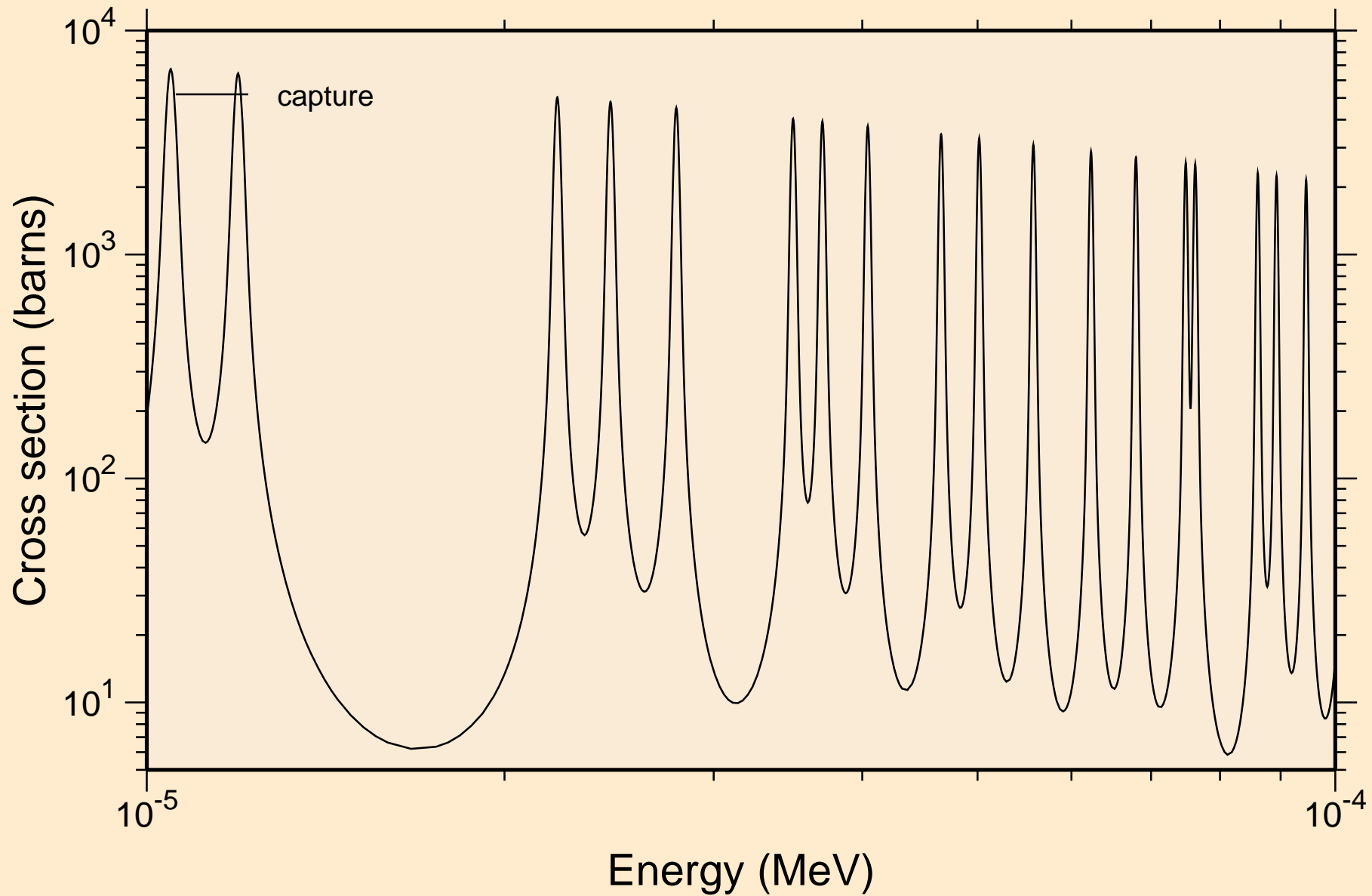

BA116 NRG TENDL-2015, AKONING
resonance absorption cross sections

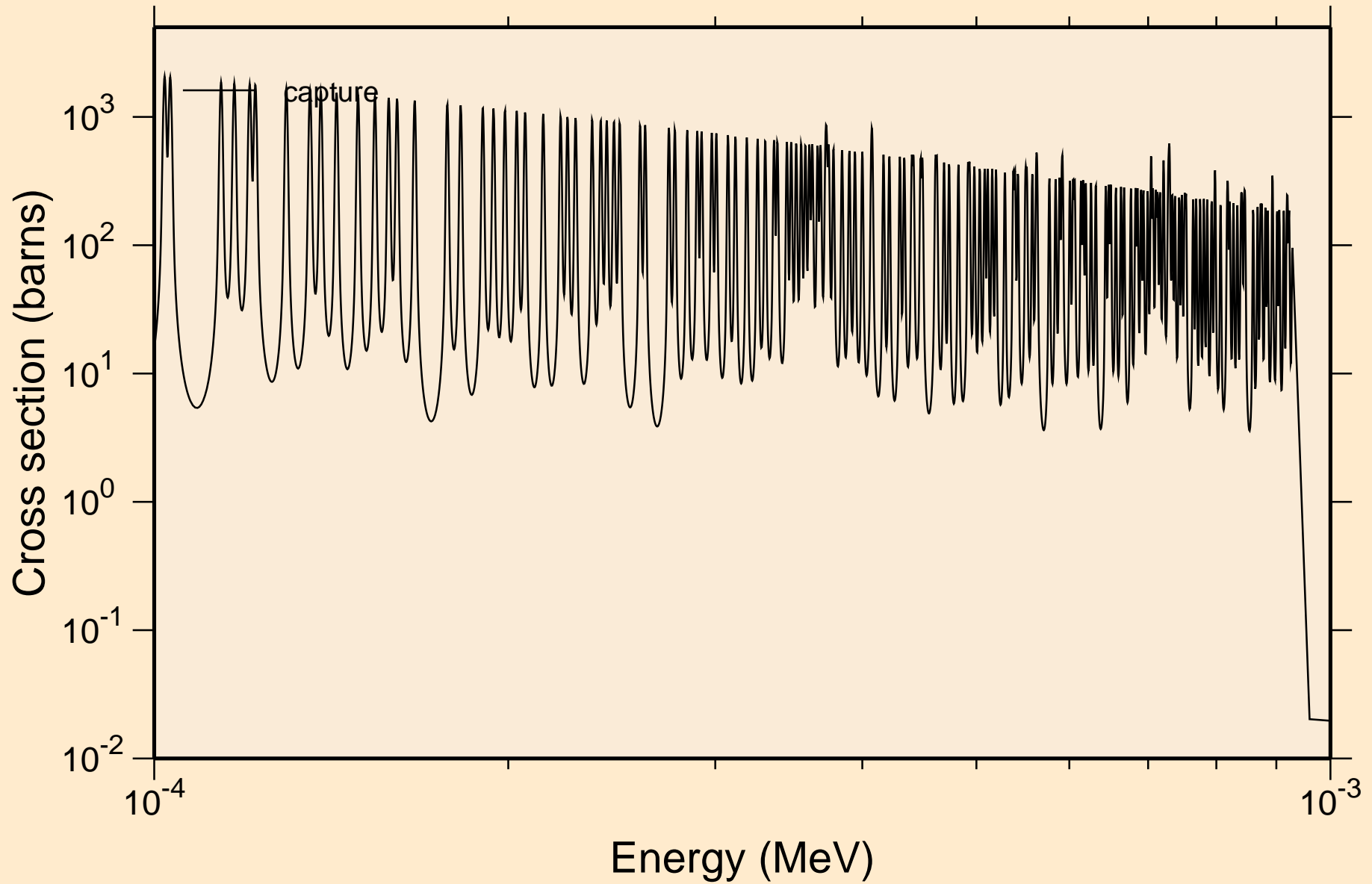

BA116 NRG TENDL-2015, AKONING
resonance absorption cross sections

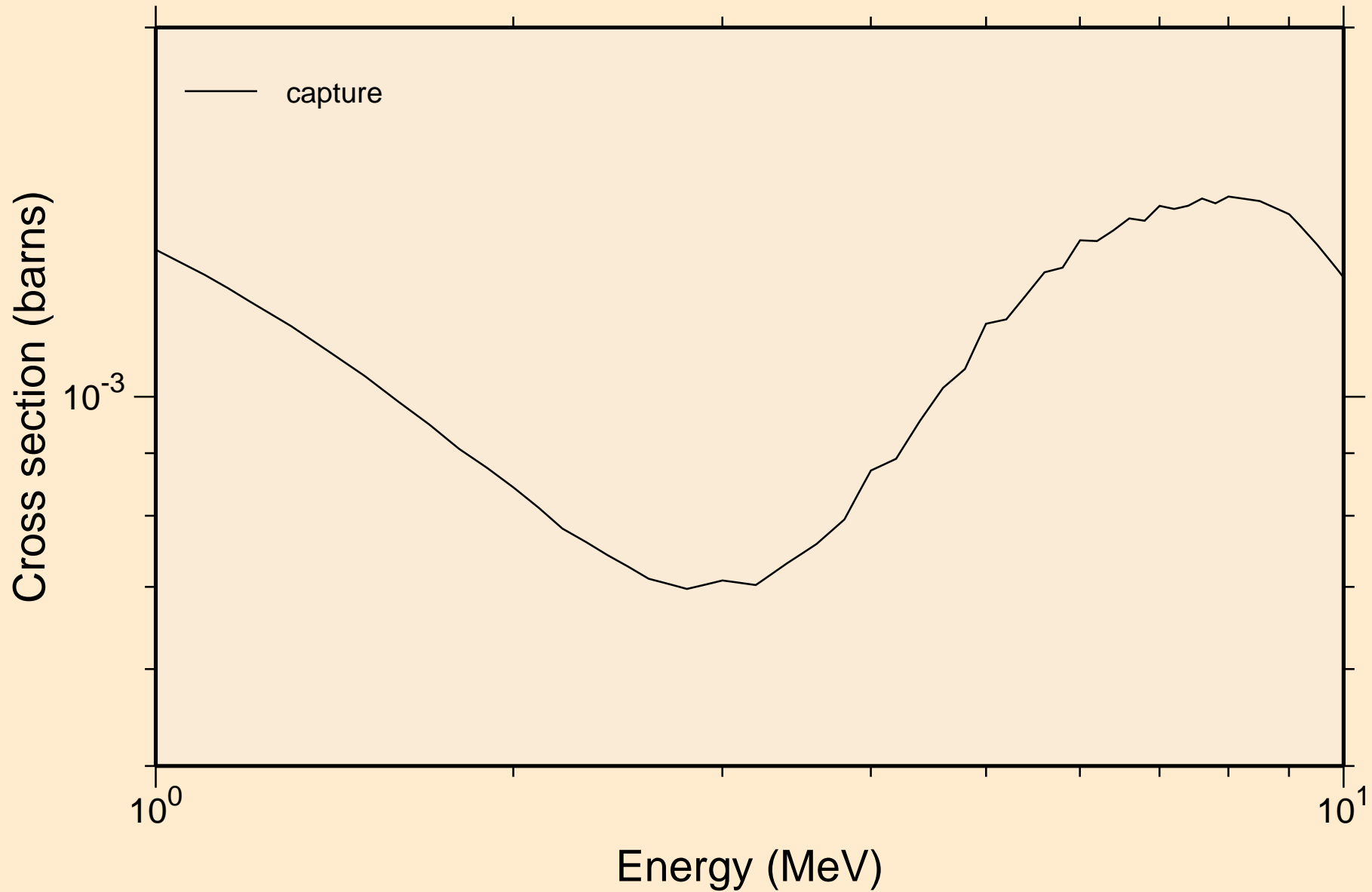

BA116 NRG TENDL-2015, AKONING
Non-threshold reactions

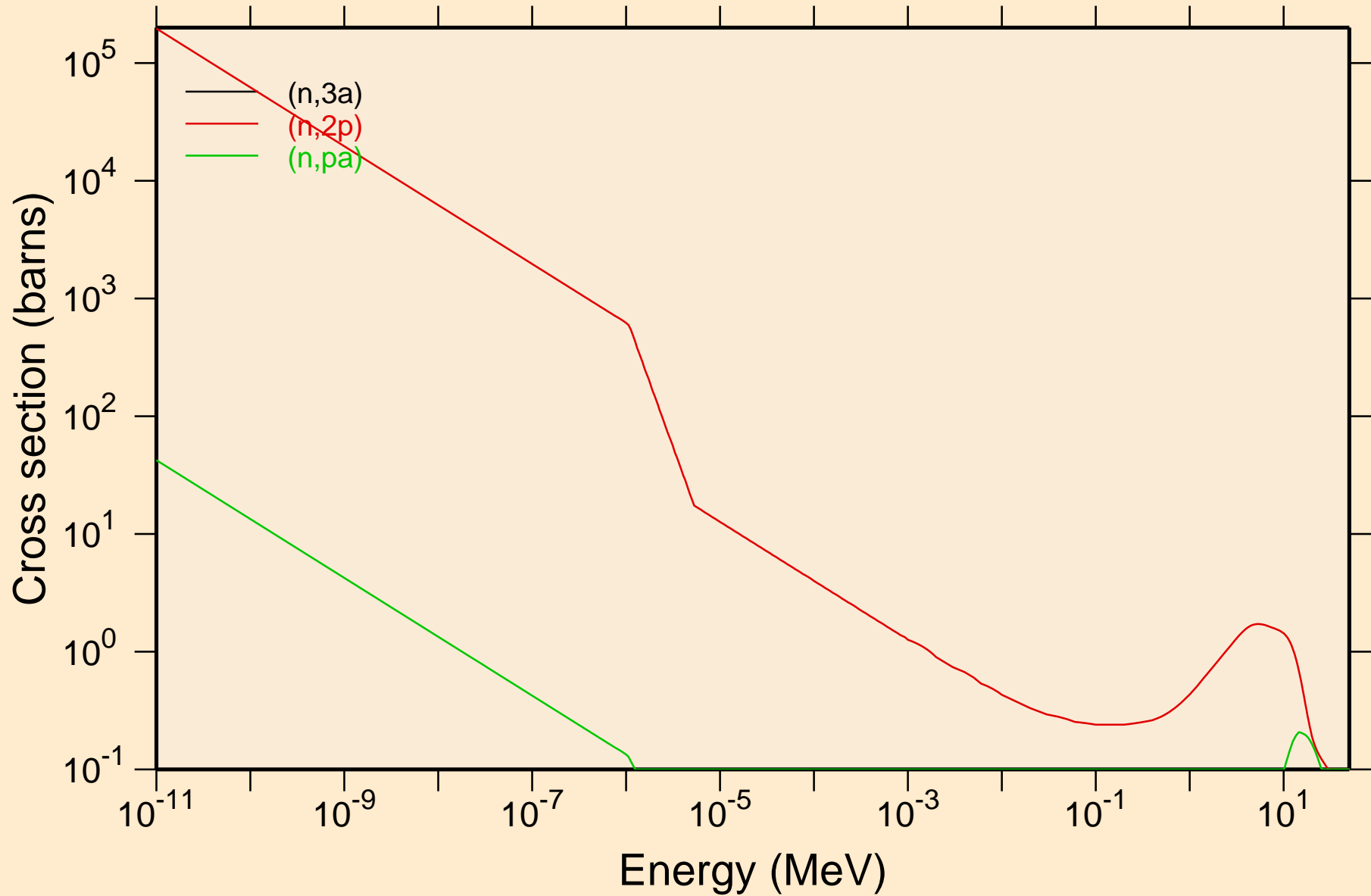

BA116 NRG TENDL-2015, AKONING

Principal cross sections

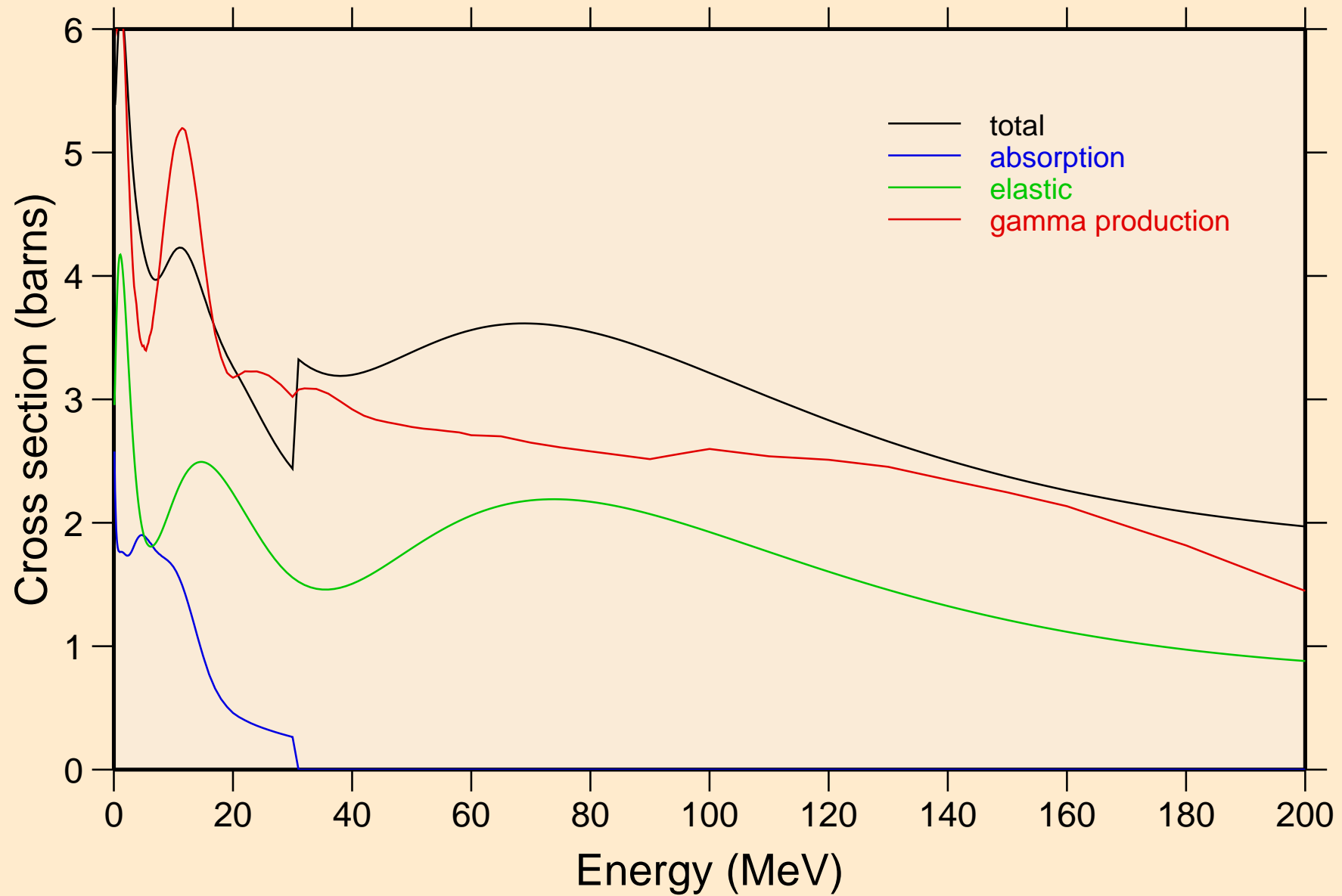

BA116 NRG TENDL-2015, AKONING

Non-threshold reactions

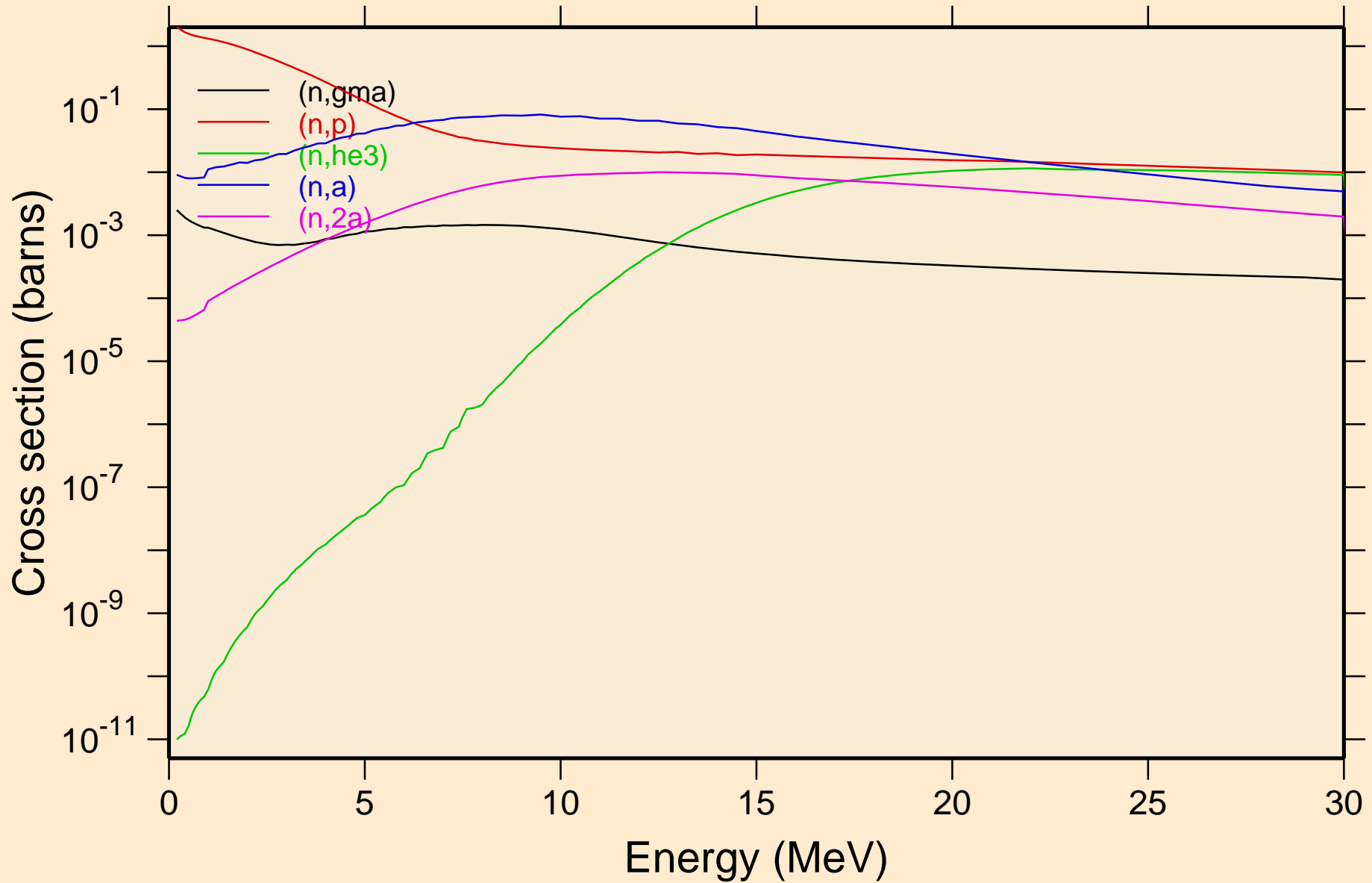

BA116 NRG TENDL-2015, AKONING
Non-threshold reactions

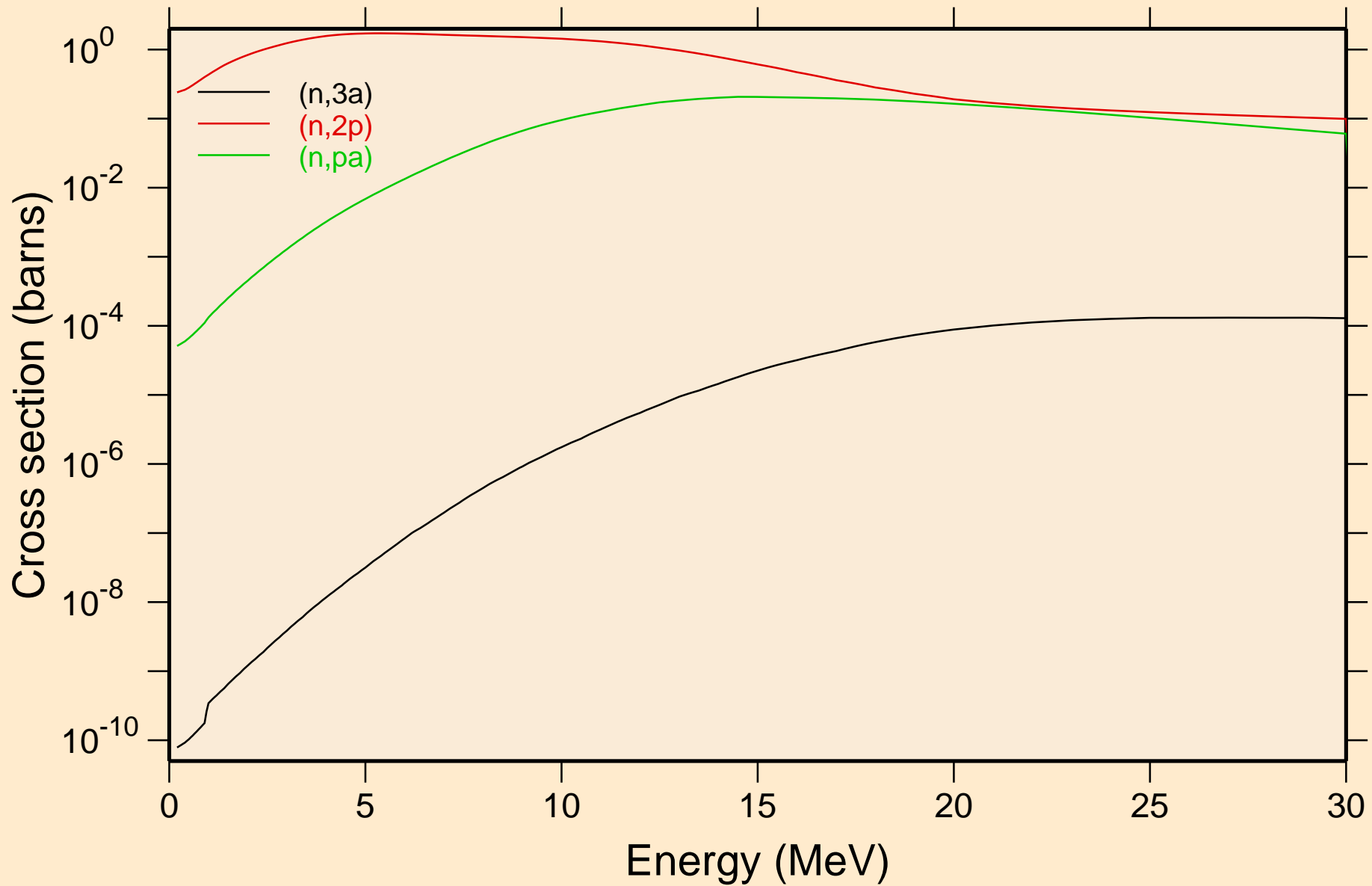

BA116 NRG TENDL-2015, AKONING
Inelastic levels

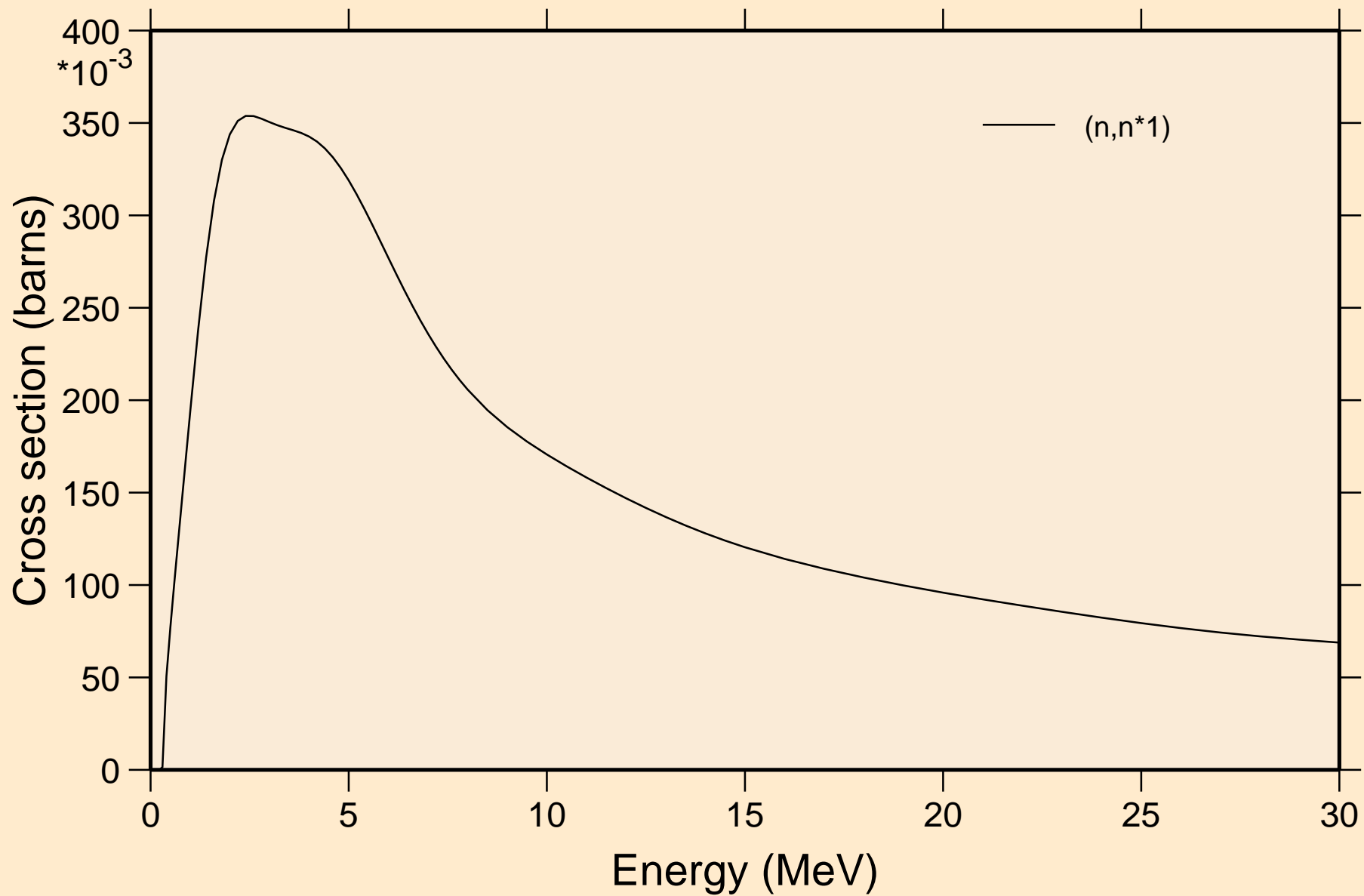

BA116 NRG TENDL-2015, AKONING

Threshold reactions

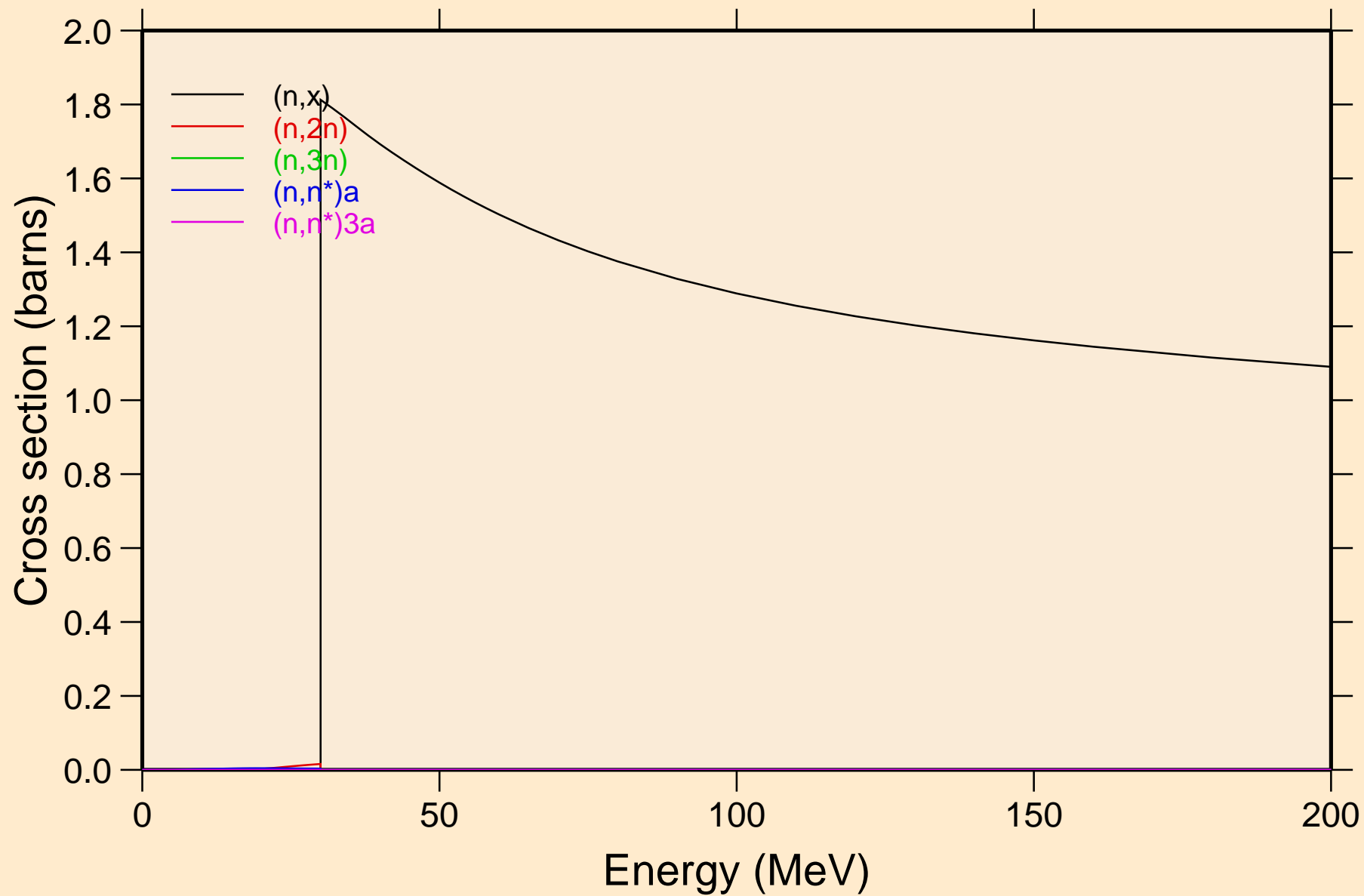

BA116 NRG TENDL-2015, AKONING

Threshold reactions

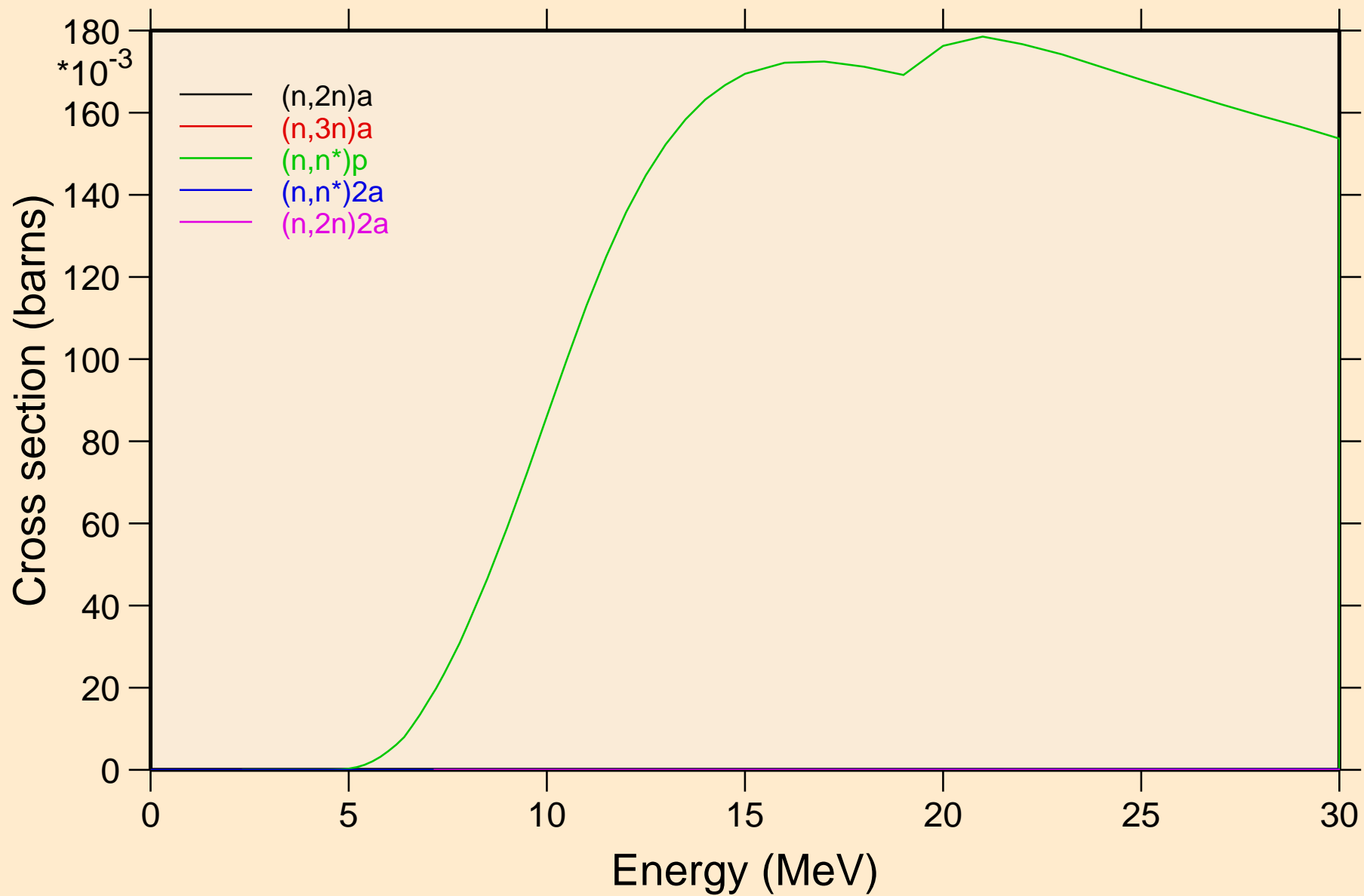

BA116 NRG TENDL-2015, AKONING

Threshold reactions

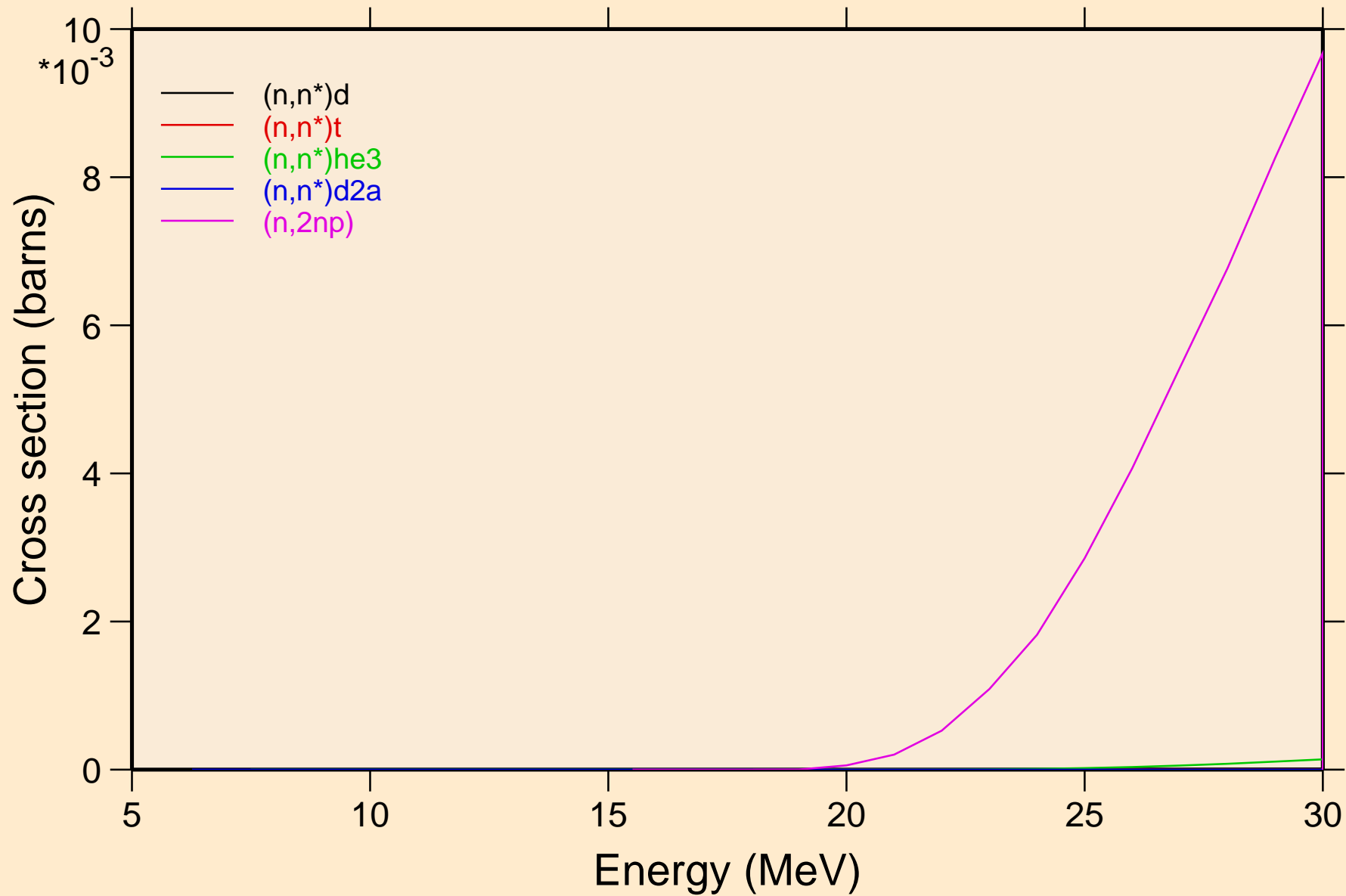

BA116 NRG TENDL-2015, AKONING

Threshold reactions

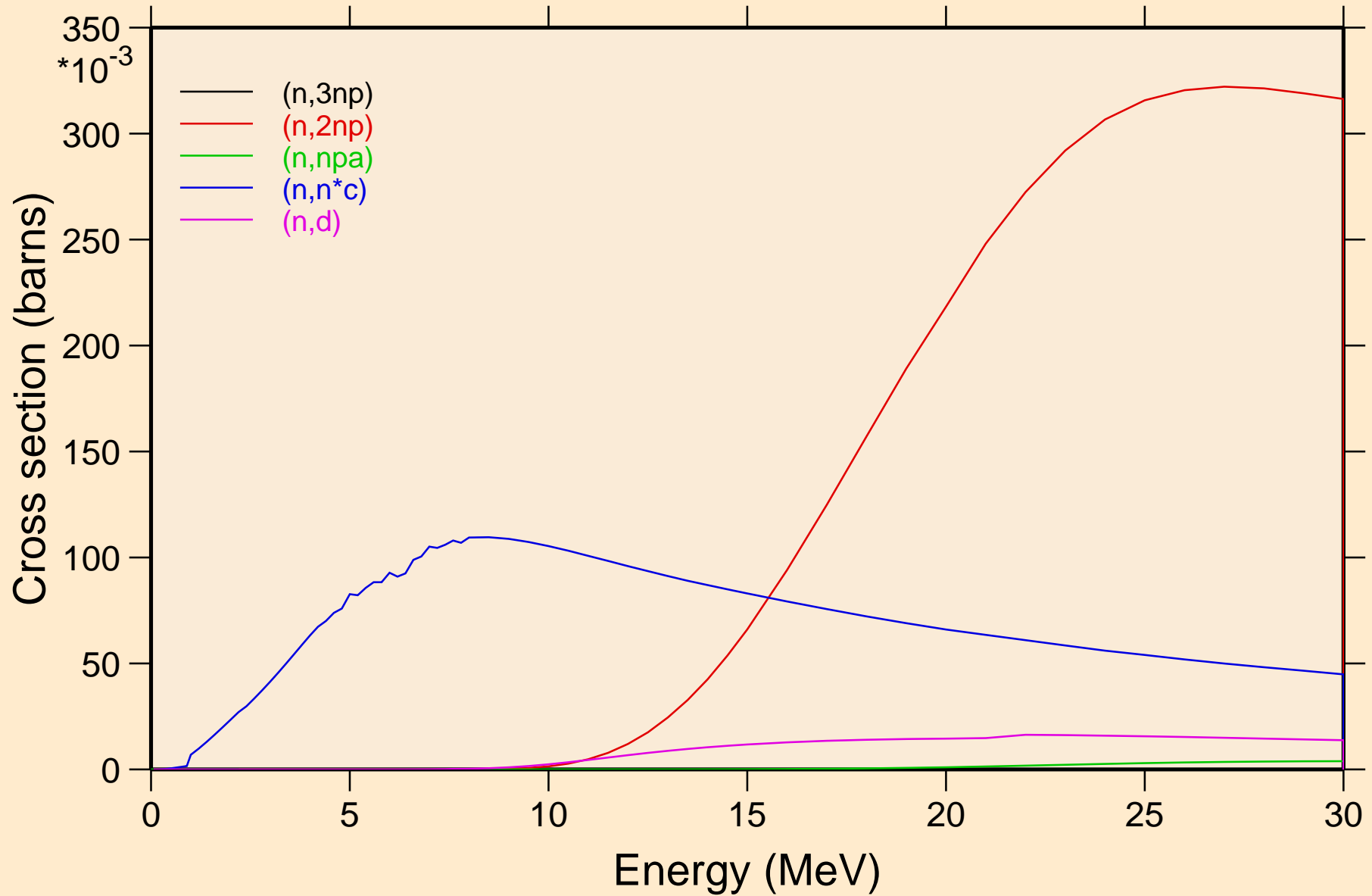

BA116 NRG TENDL-2015, AKONING

Threshold reactions

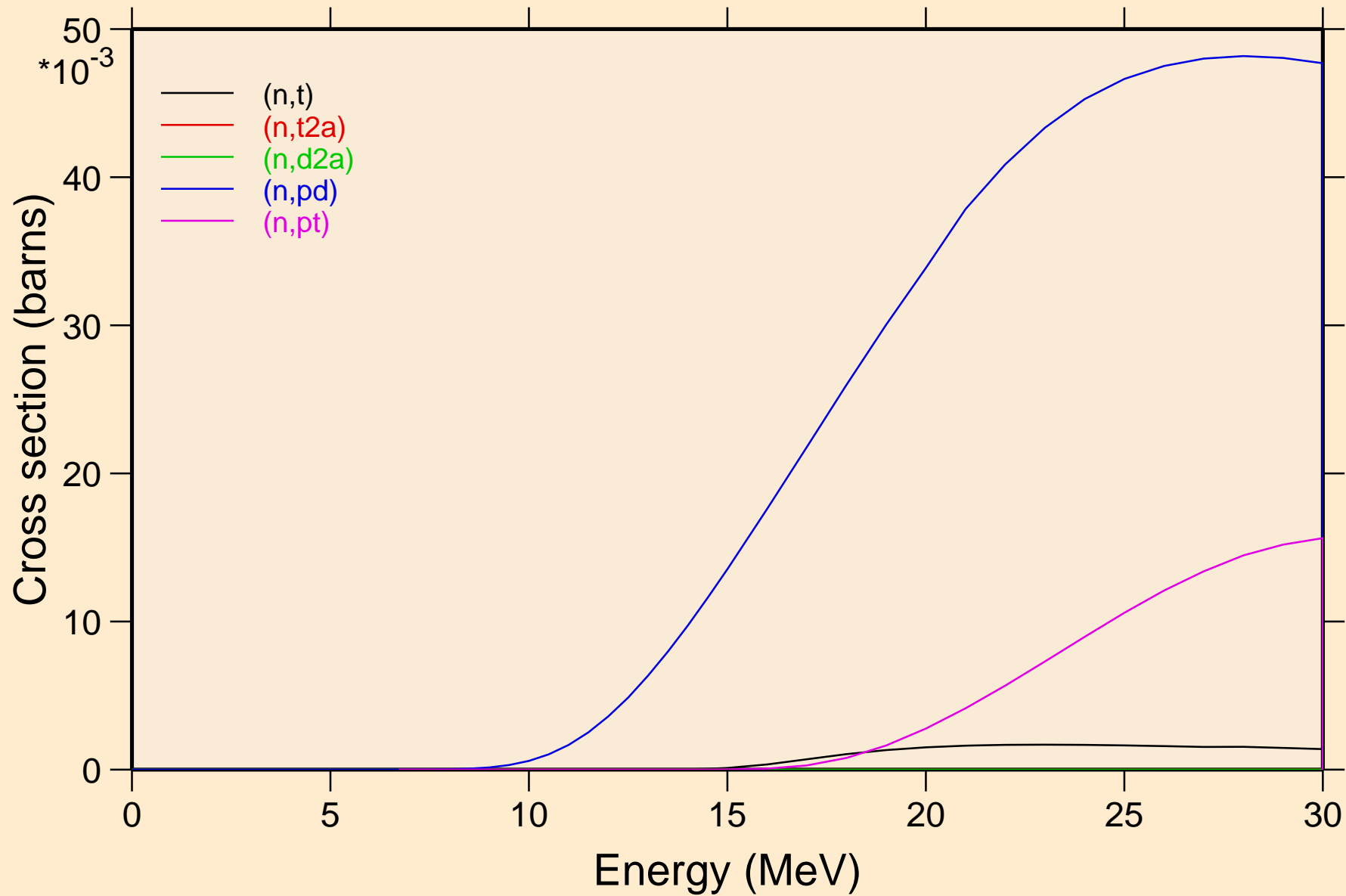

BA116 NRG TENDL-2015, AKONING

Threshold reactions

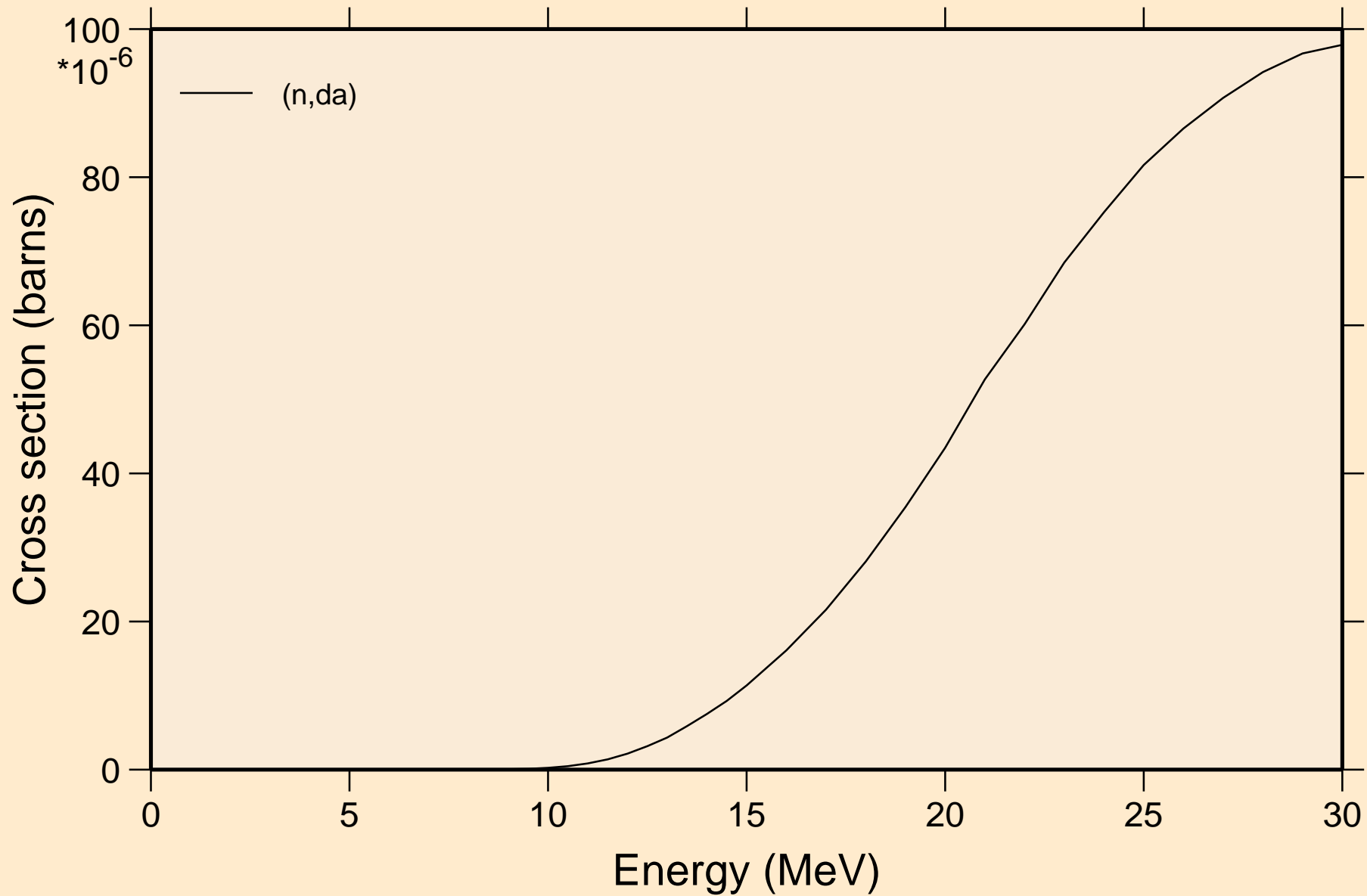

BA116 NRG TENDL-2015, AKONING
angular distribution for elastic

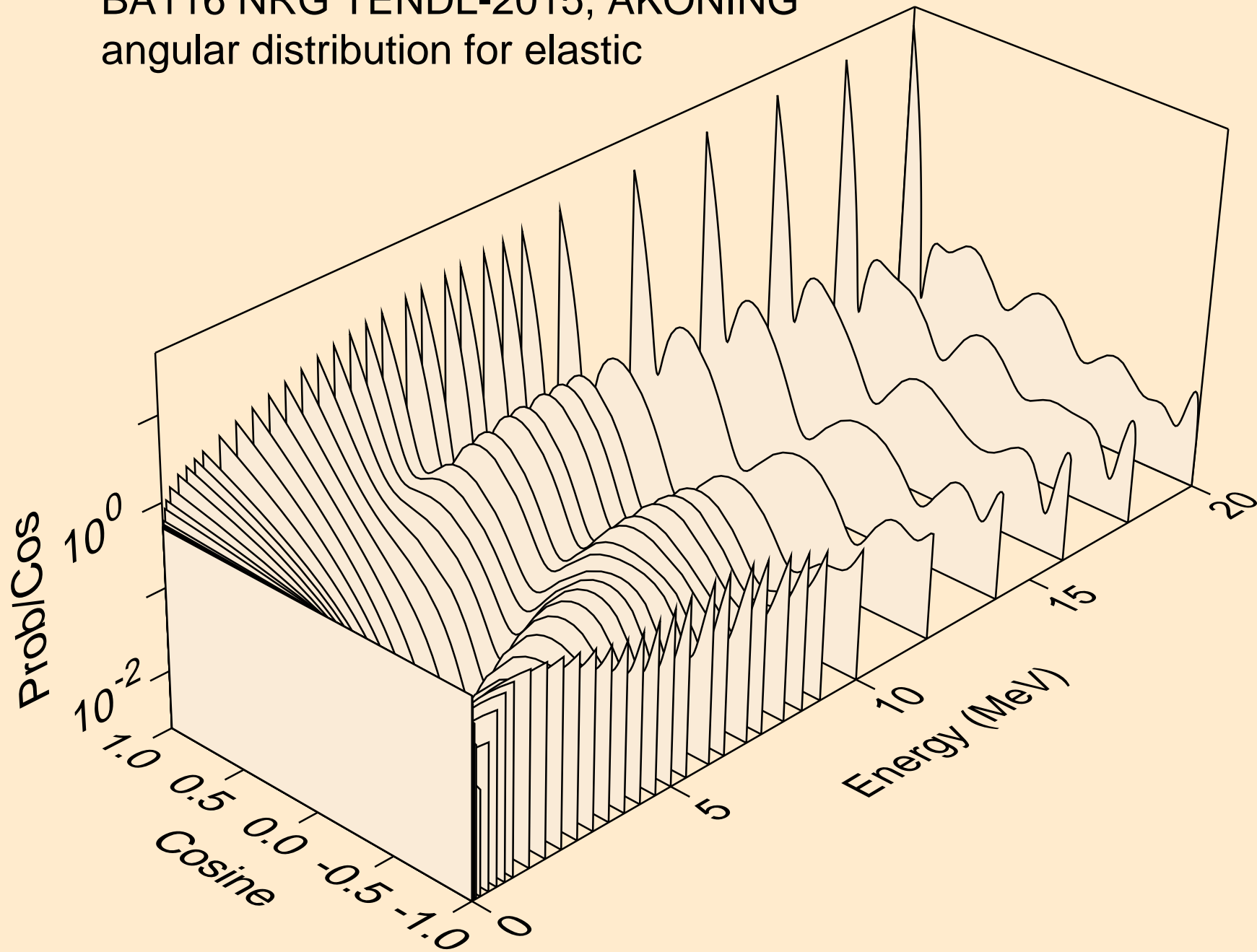

BA116 NRG TENDL-2015, AKONING
angular distribution for elastic

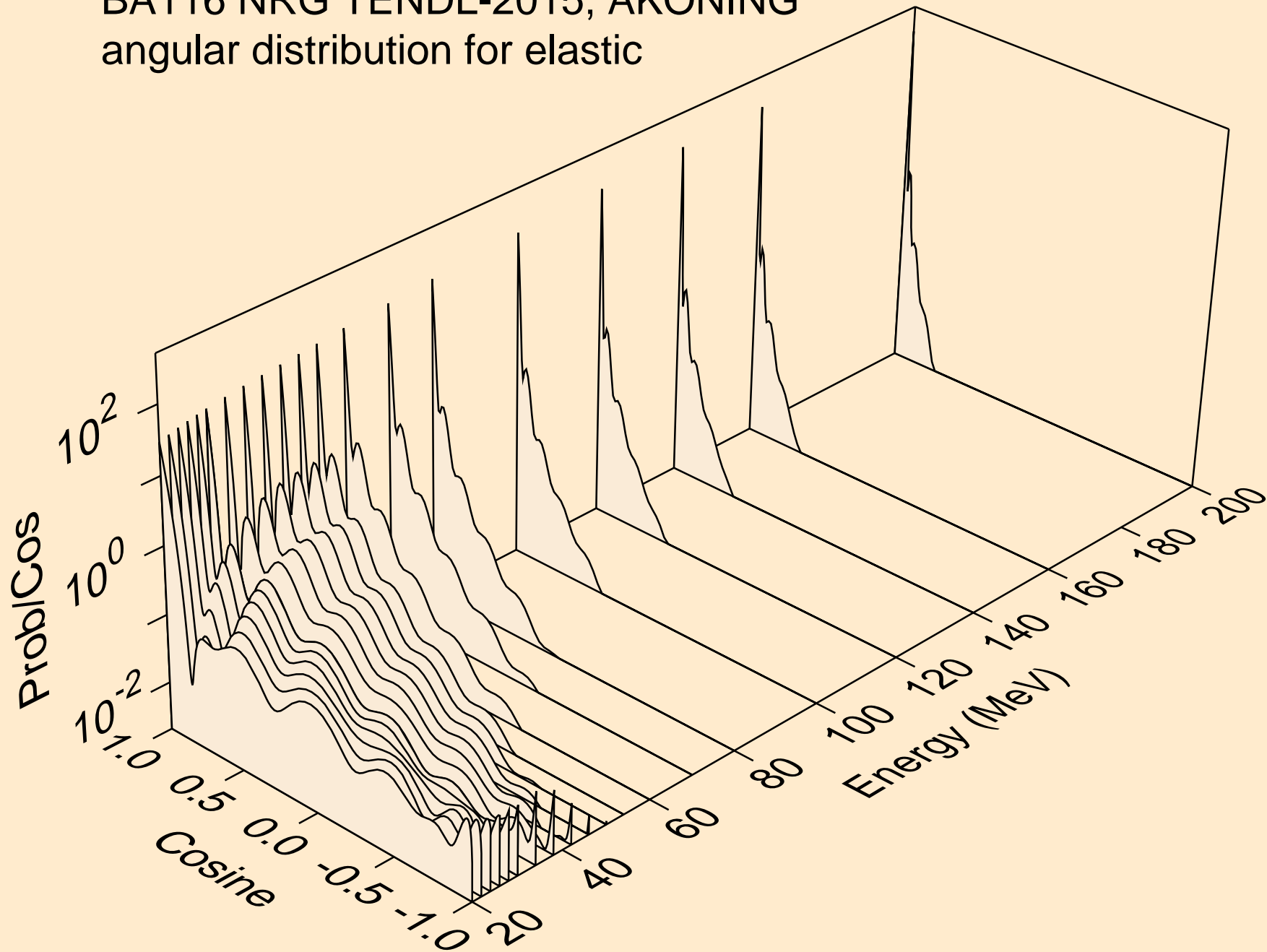

BA116 NRG TENDL-2015, AKONING
angular distribution for (n,n*1)

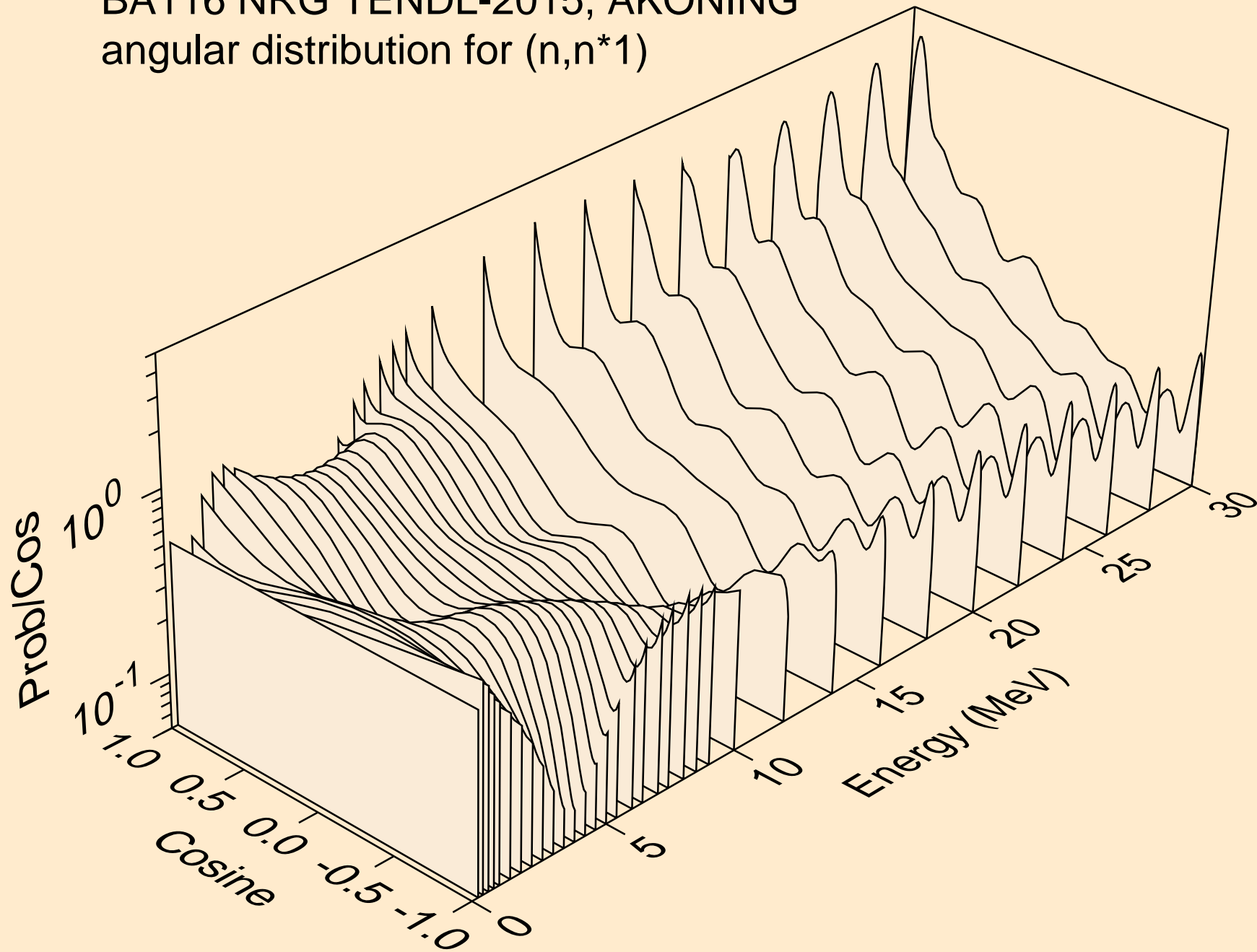

BA116 NRG TENDL-2015, AKONING
Neutron emission for (n,x)

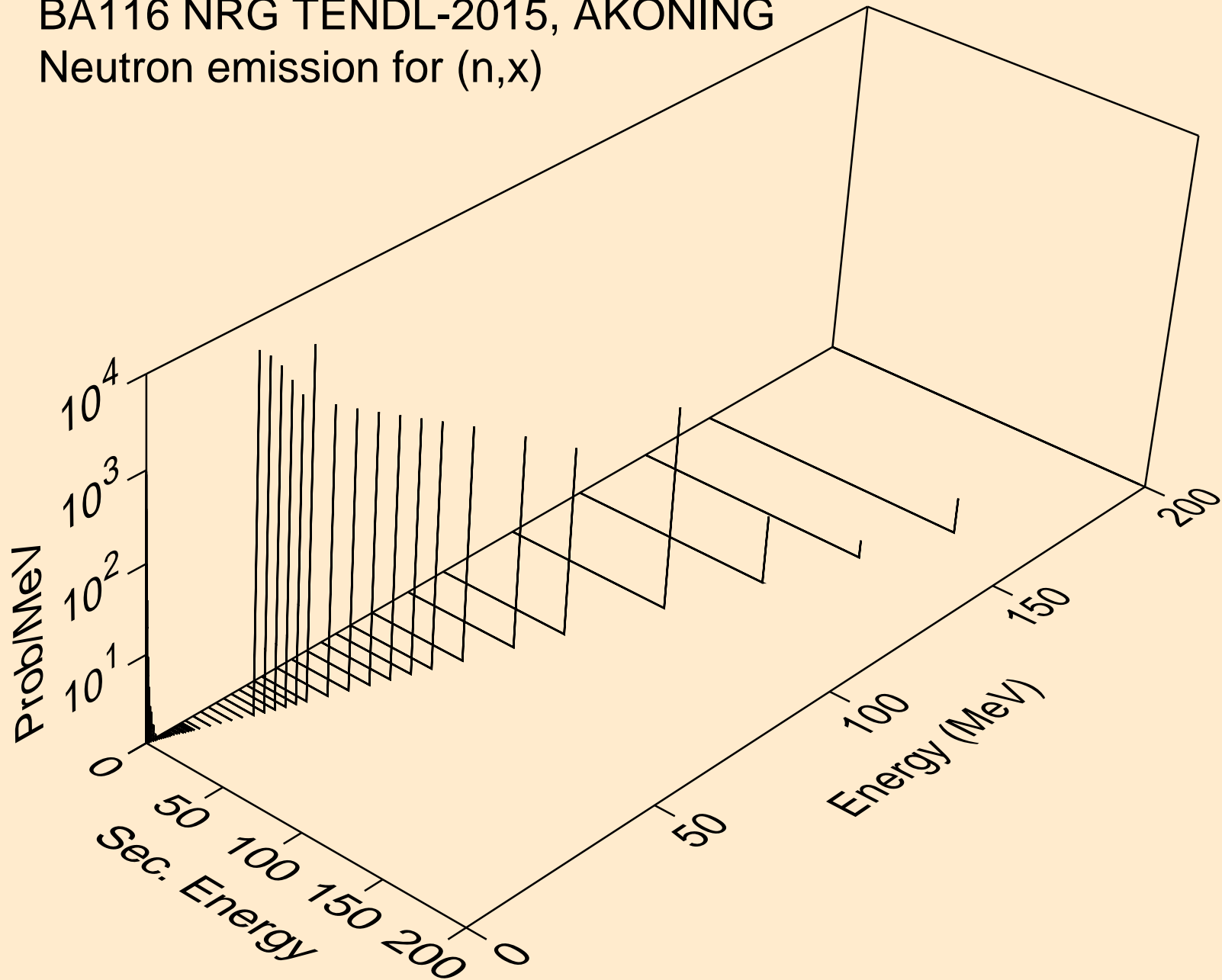

BA116 NRG TENDL-2015, AKONING
Neutron emission for (n,2n)

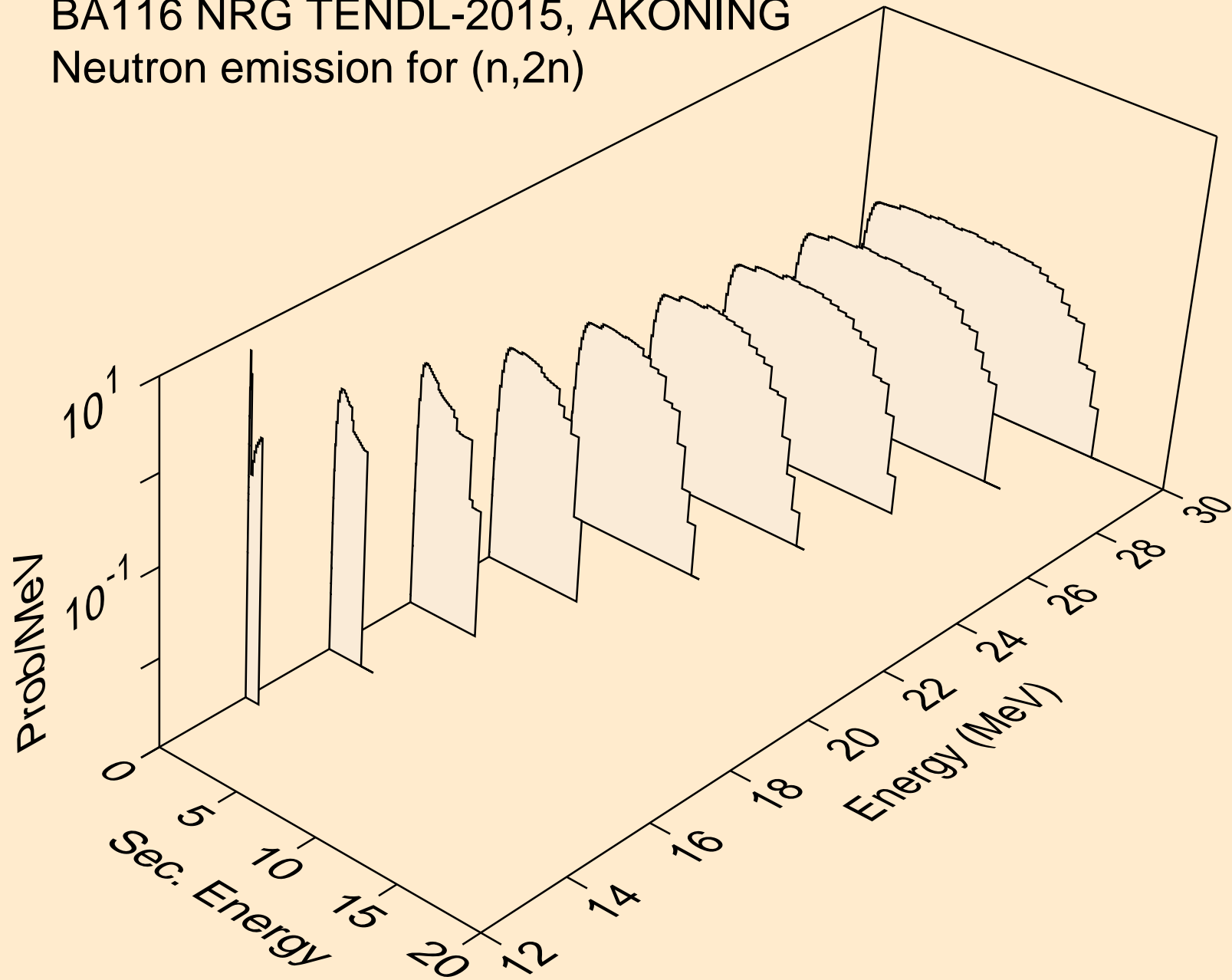

BA116 NRG TENDL-2015, AKONING
Neutron emission for (n,3n)

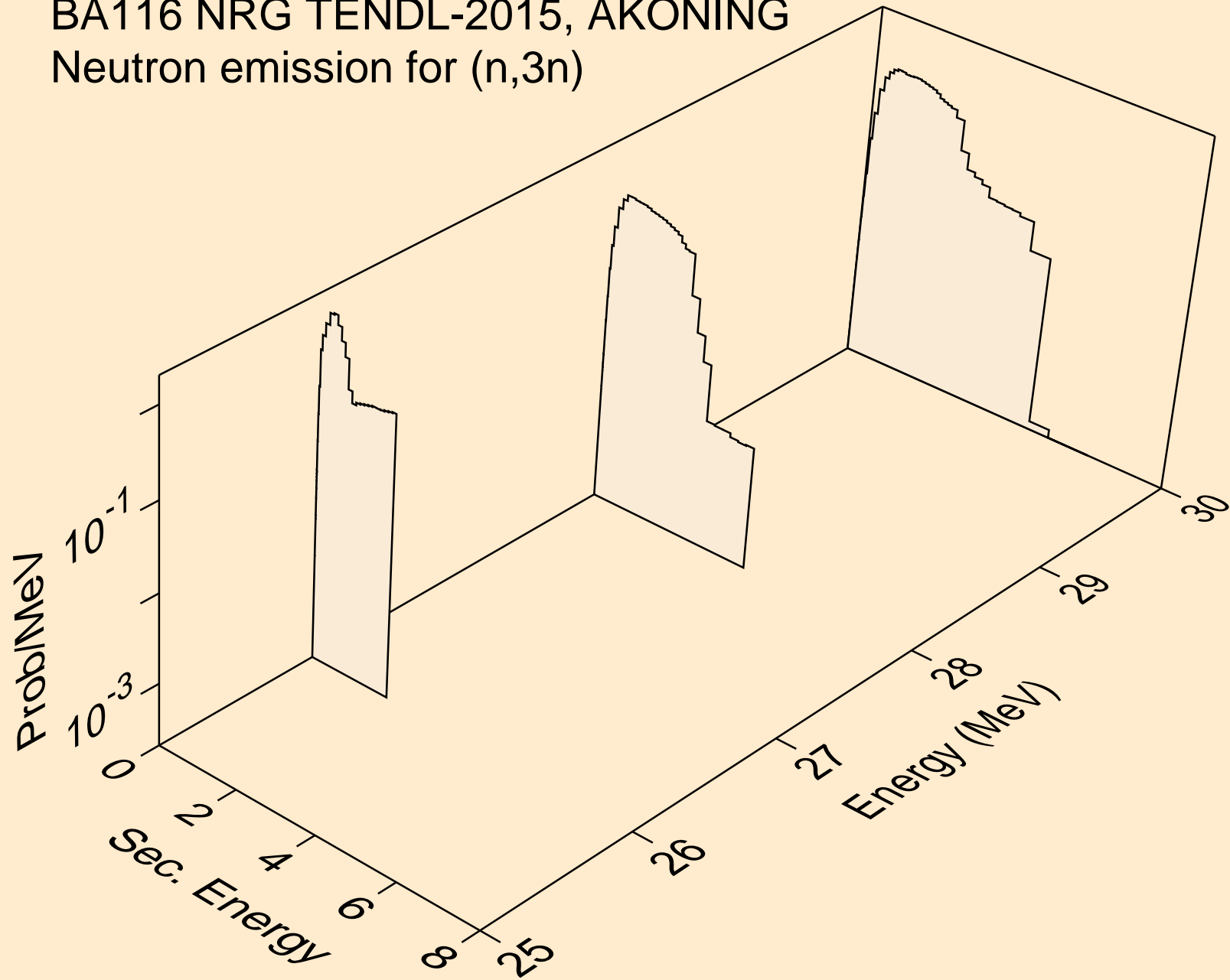

BA116 NRG TENDL-2015, AKONING
Neutron emission for (n,n*)a

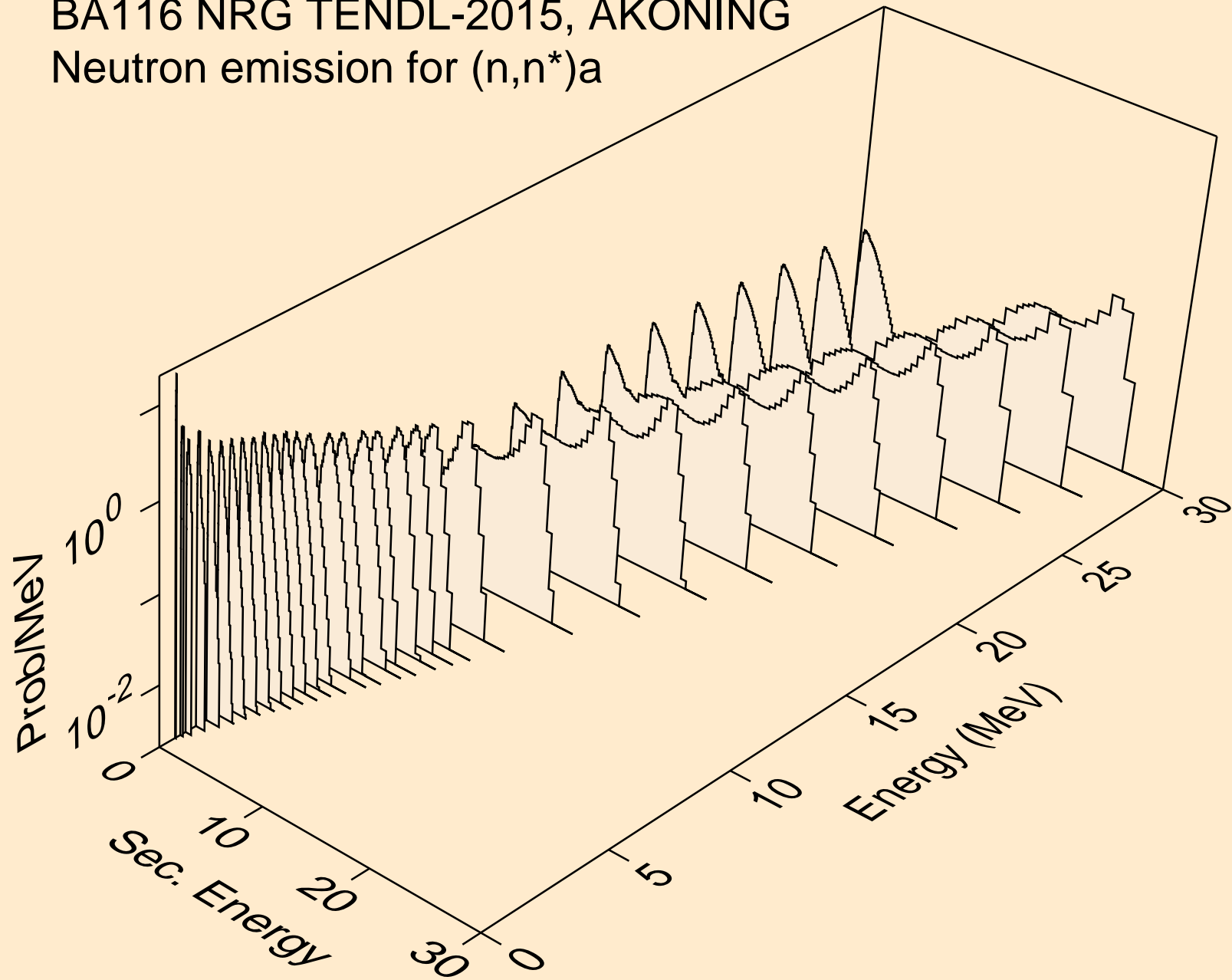

BA116 NRG TENDL-2015, AKONING
Neutron emission for (n,n*)3a

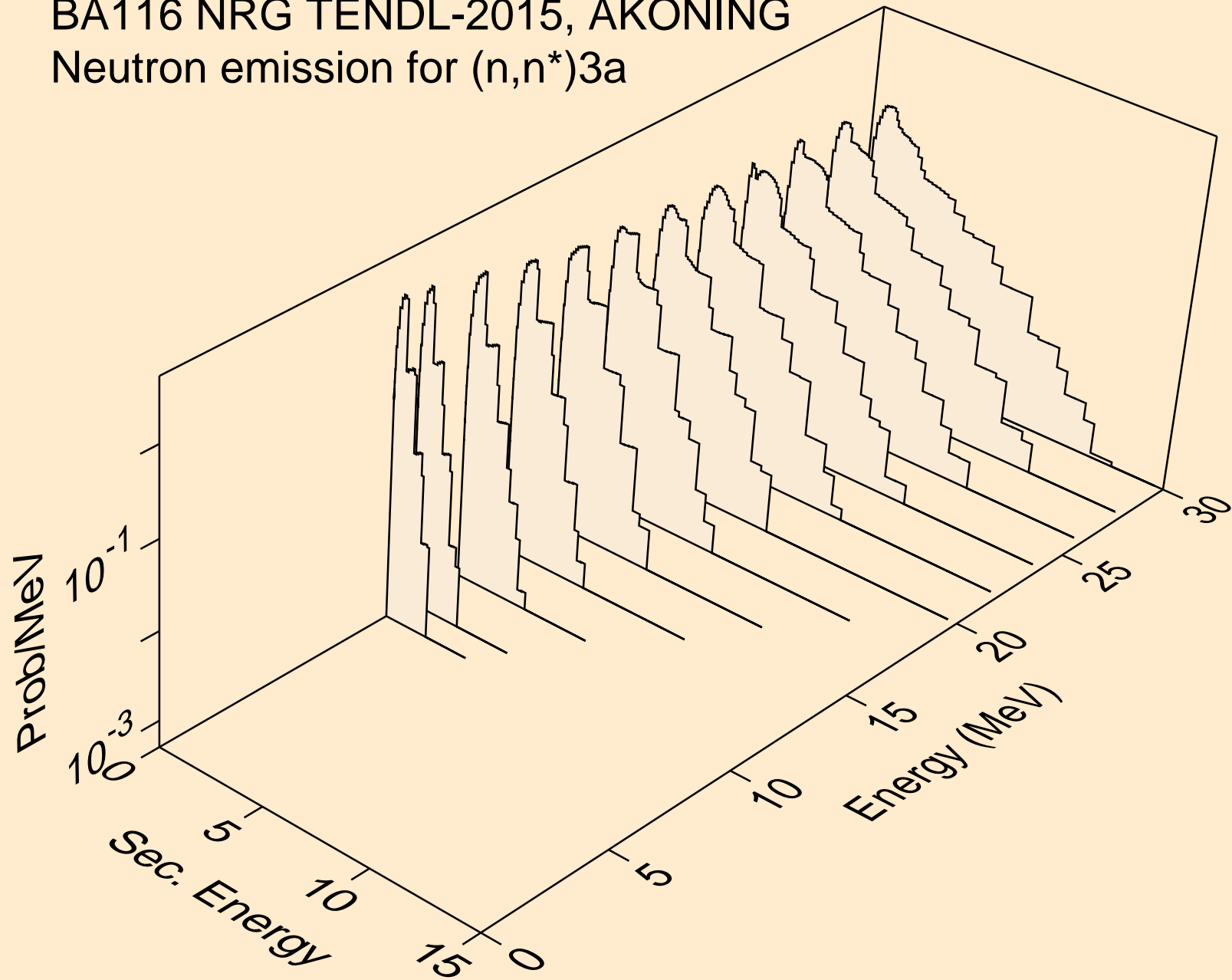

BA116 NRG TENDL-2015, AKONING
Neutron emission for (n,2n)a

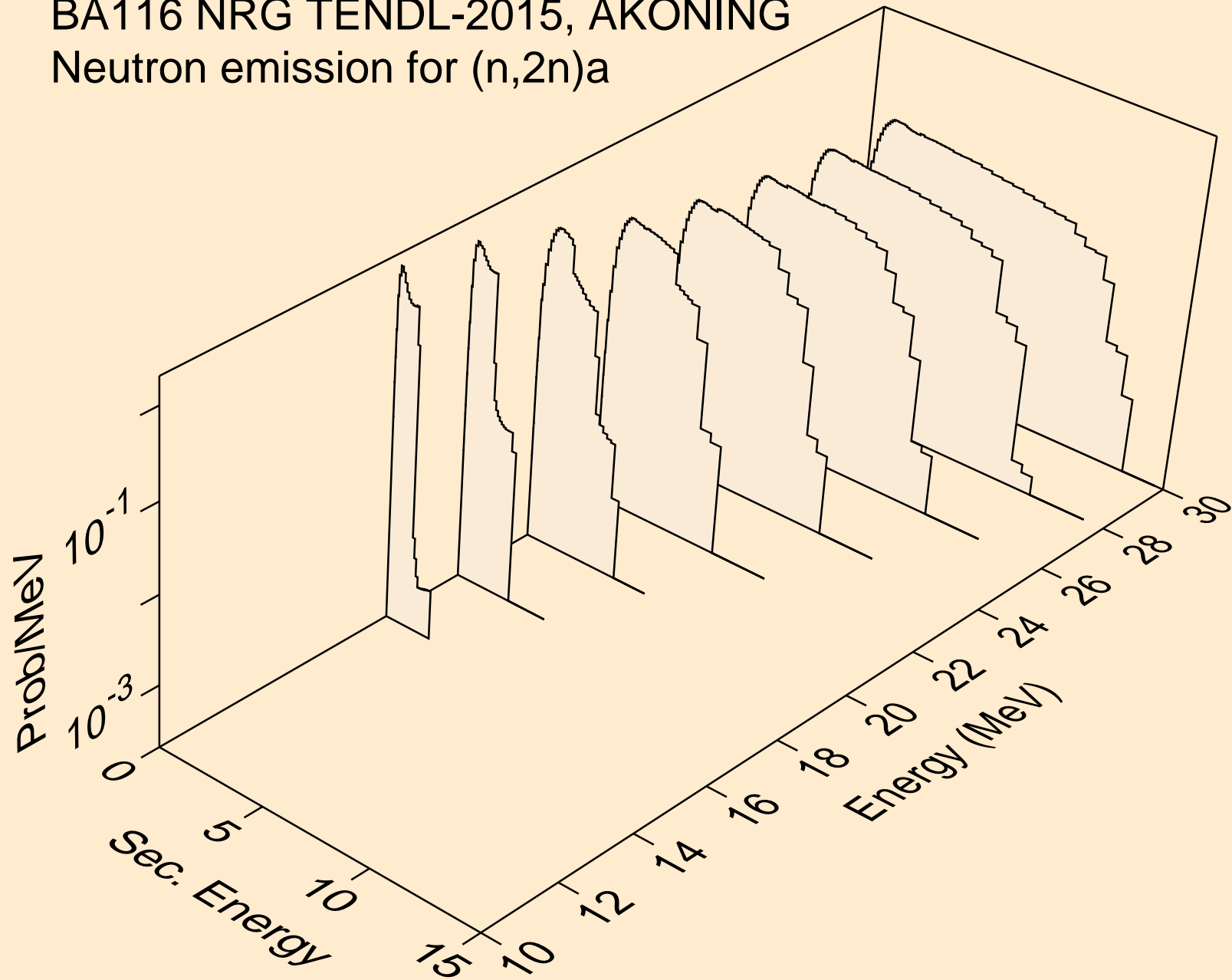

BA116 NRG TENDL-2015, AKONING
Neutron emission for (n,3n)a

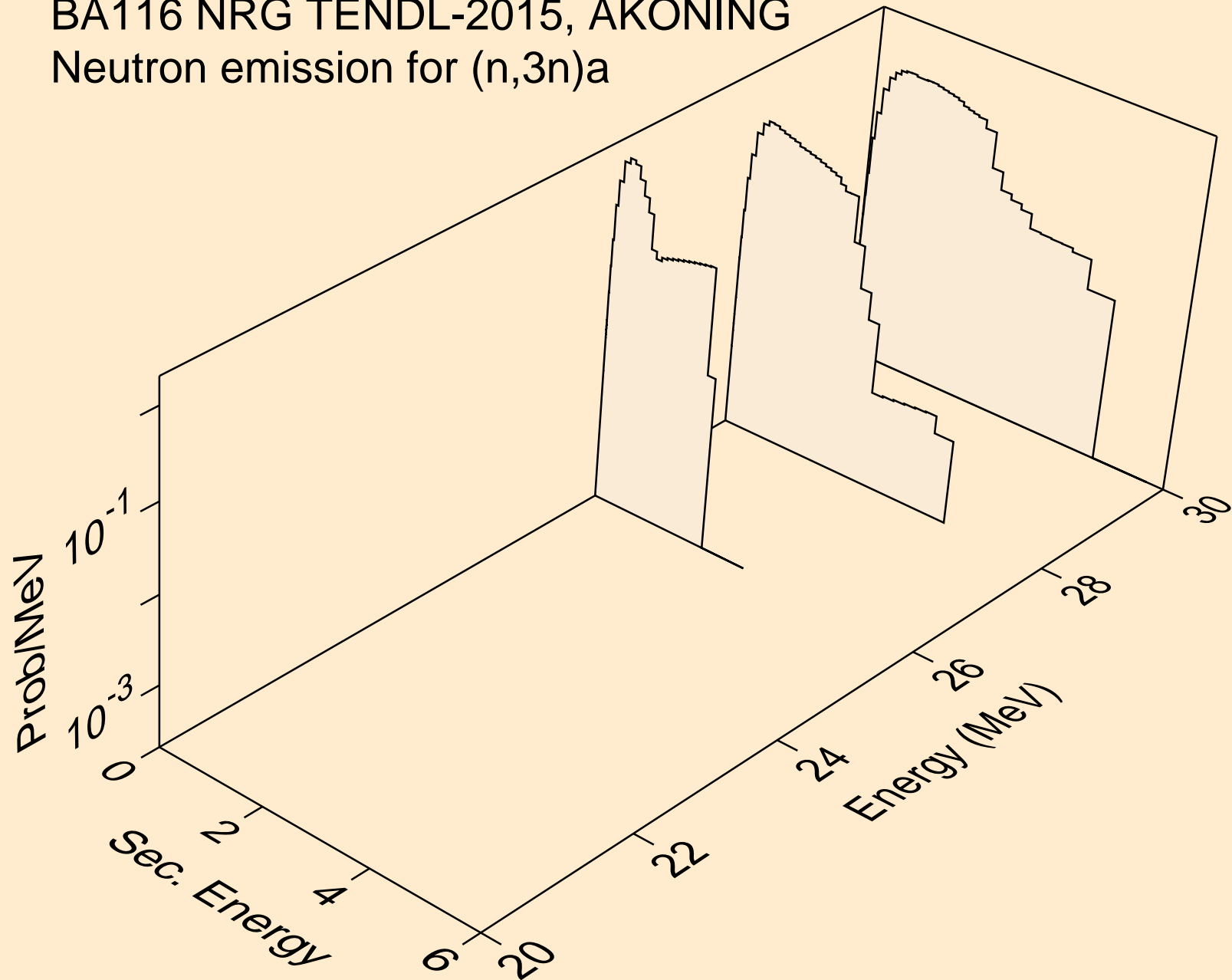

BA116 NRG TENDL-2015, AKONING
Neutron emission for (n,n*)p

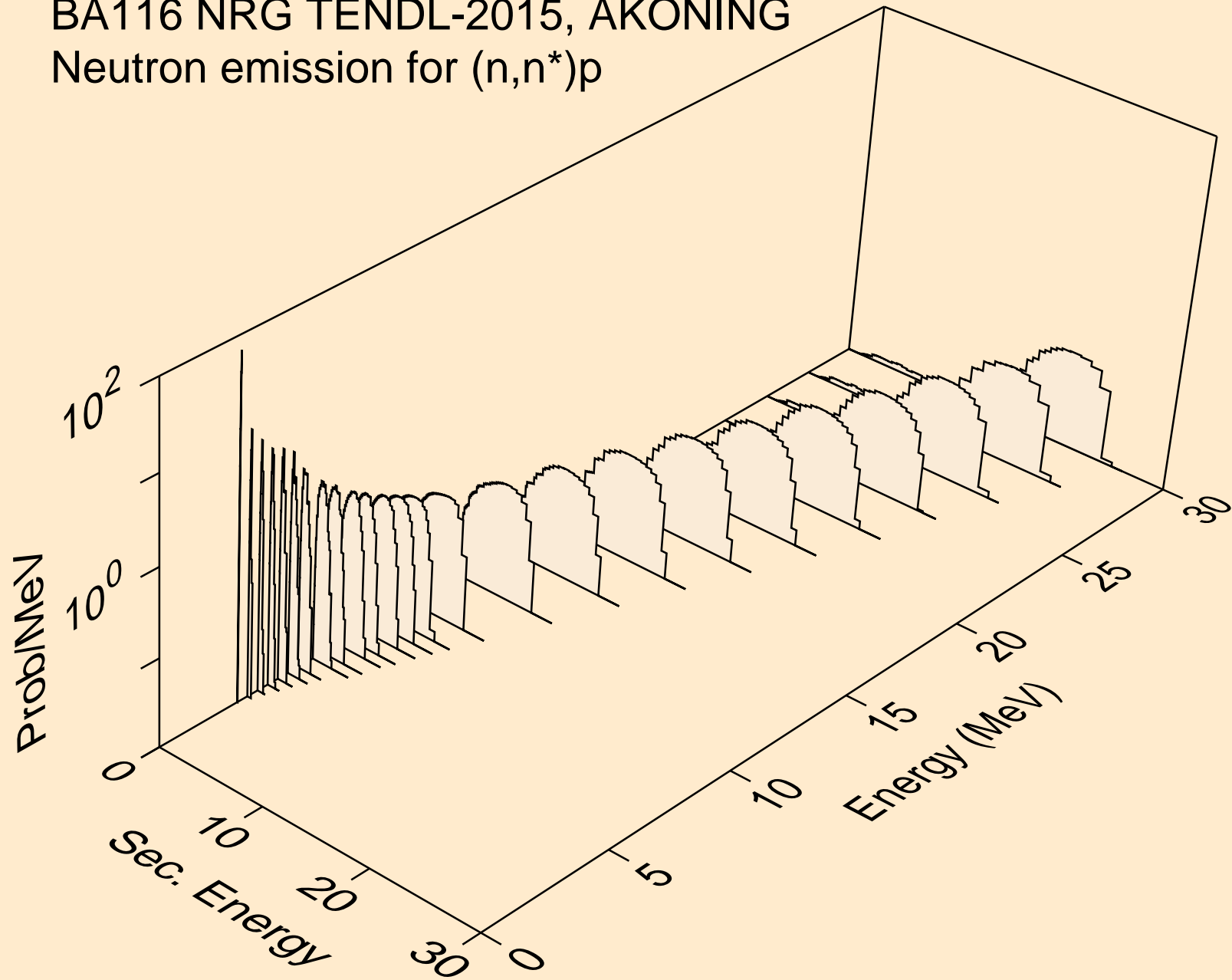

BA116 NRG TENDL-2015, AKONING
Neutron emission for (n,n*)2a

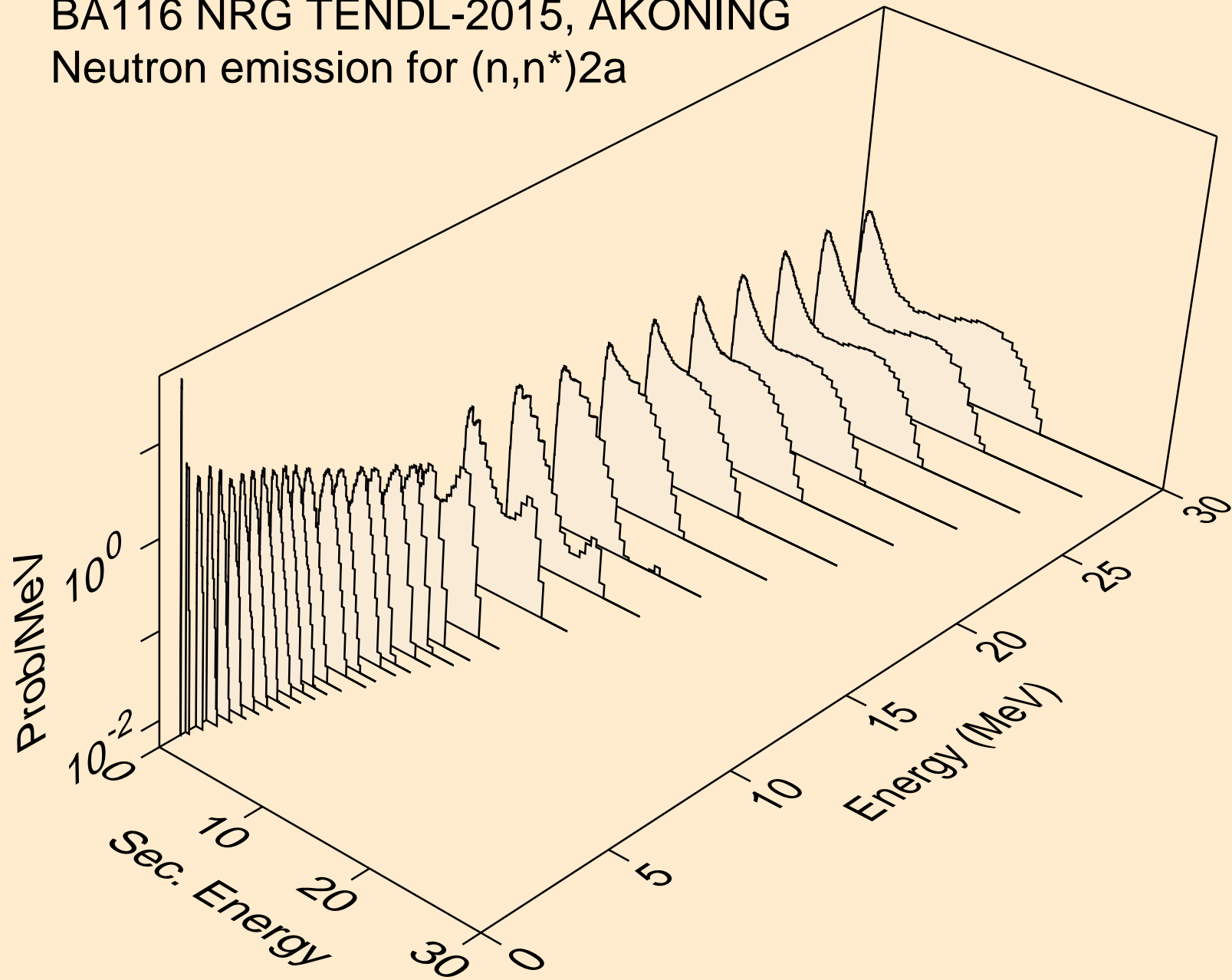

BA116 NRG TENDL-2015, AKONING
Neutron emission for (n,2n)2a

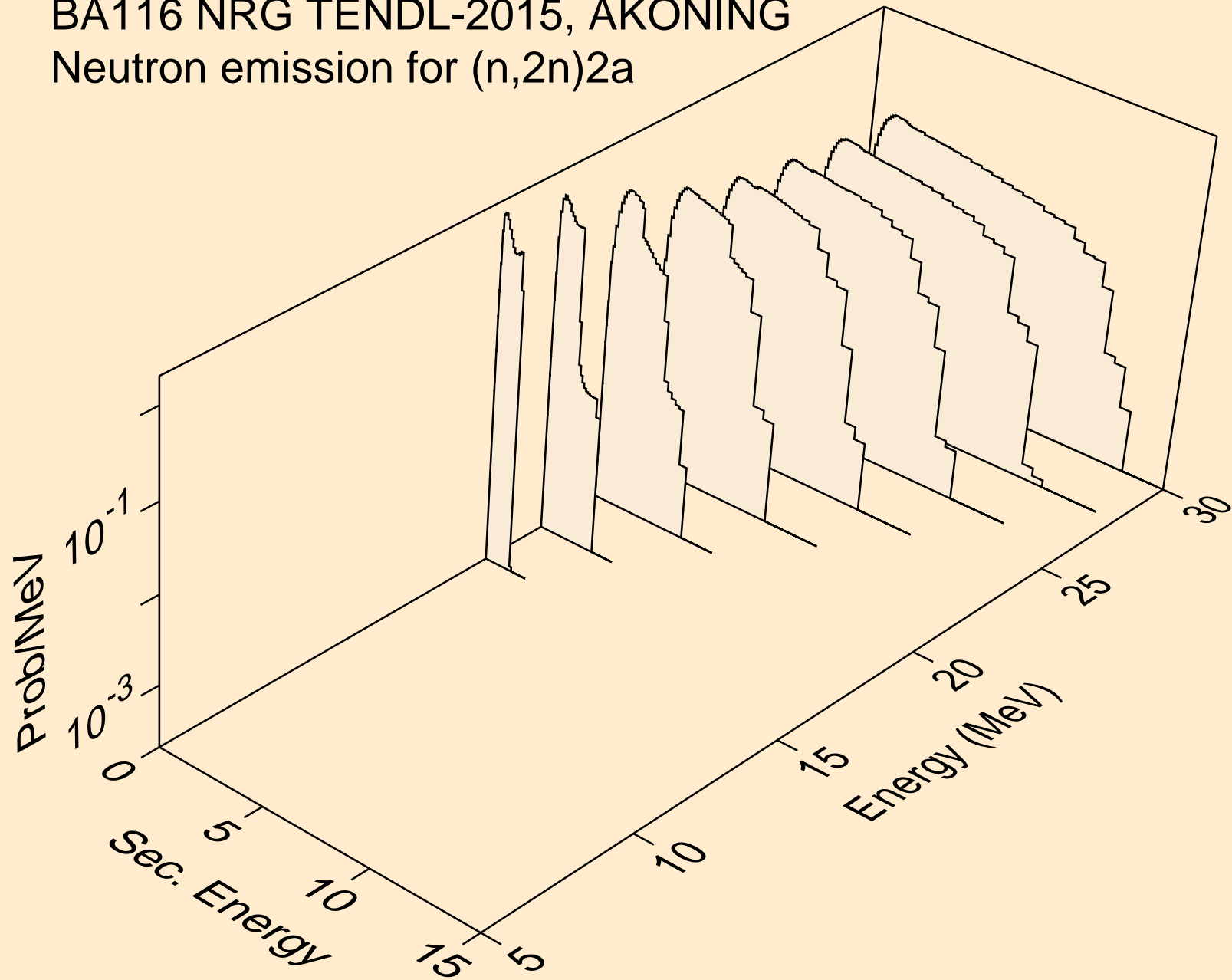

BA116 NRG TENDL-2015, AKONING
Neutron emission for (n,n*)d

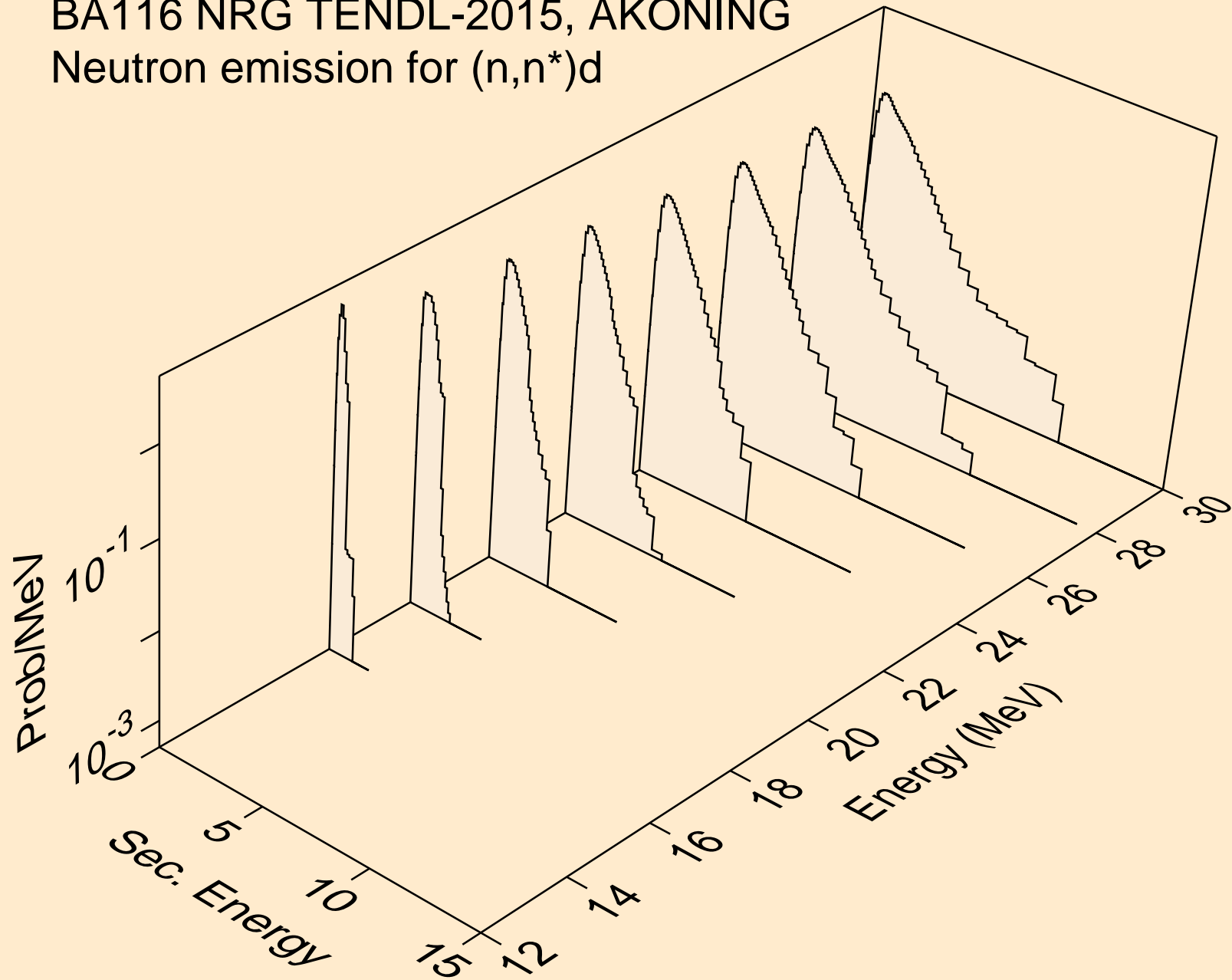

BA116 NRG TENDL-2015, AKONING
Neutron emission for (n,n*)t

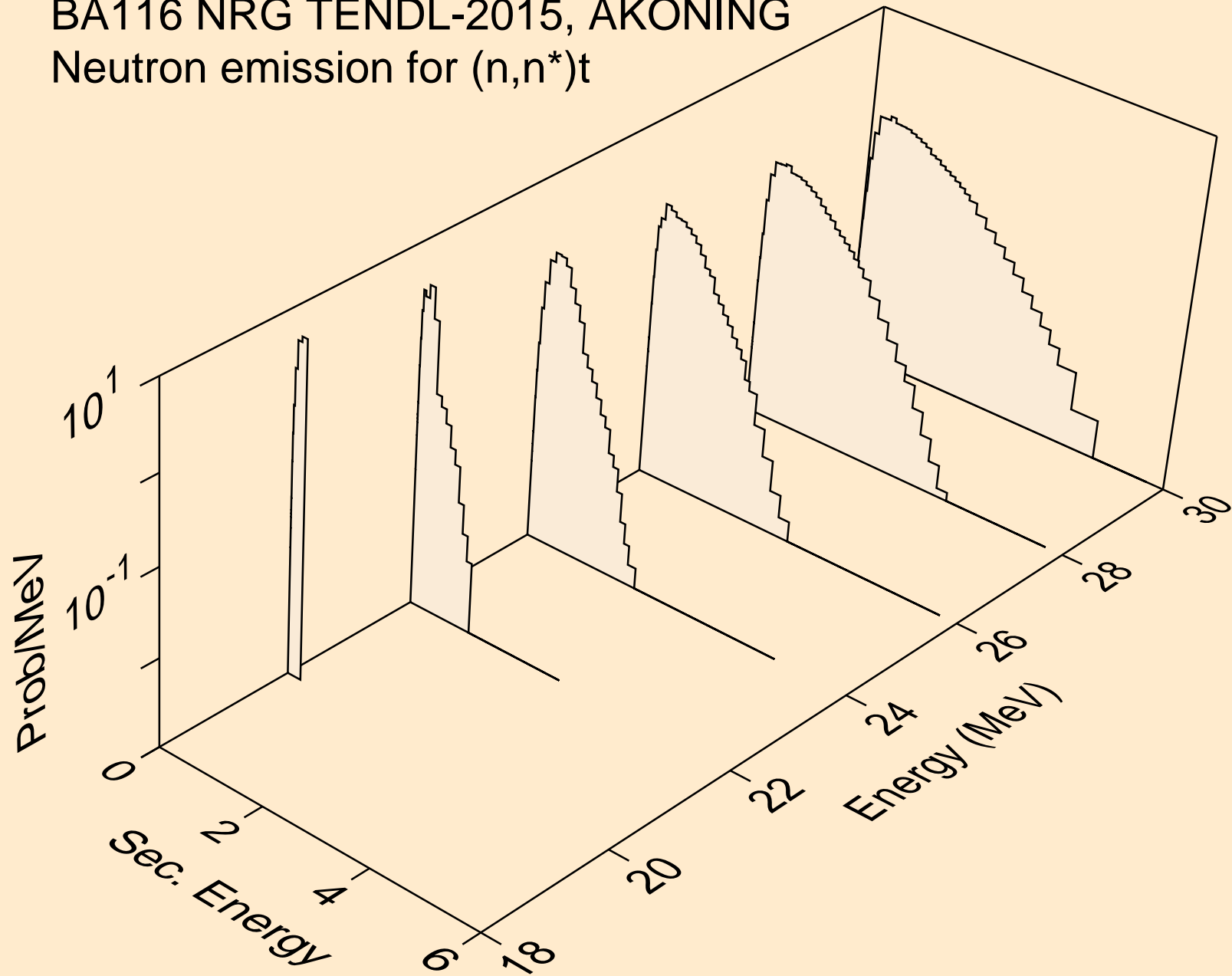

BA116 NRG TENDL-2015, AKONING
Neutron emission for (n,n*)he3

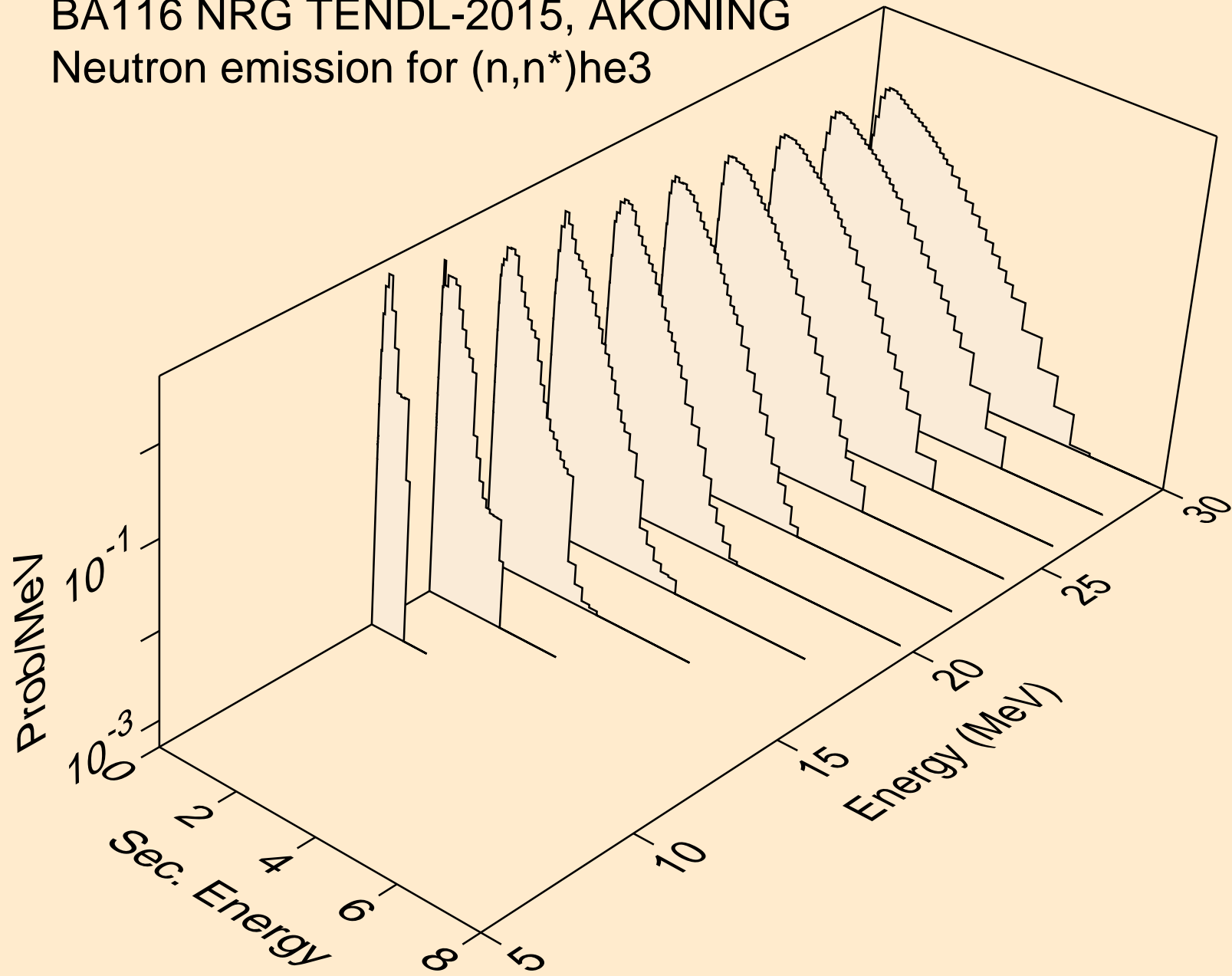

BA116 NRG TENDL-2015, AKONING
Neutron emission for (n,n*)d2a

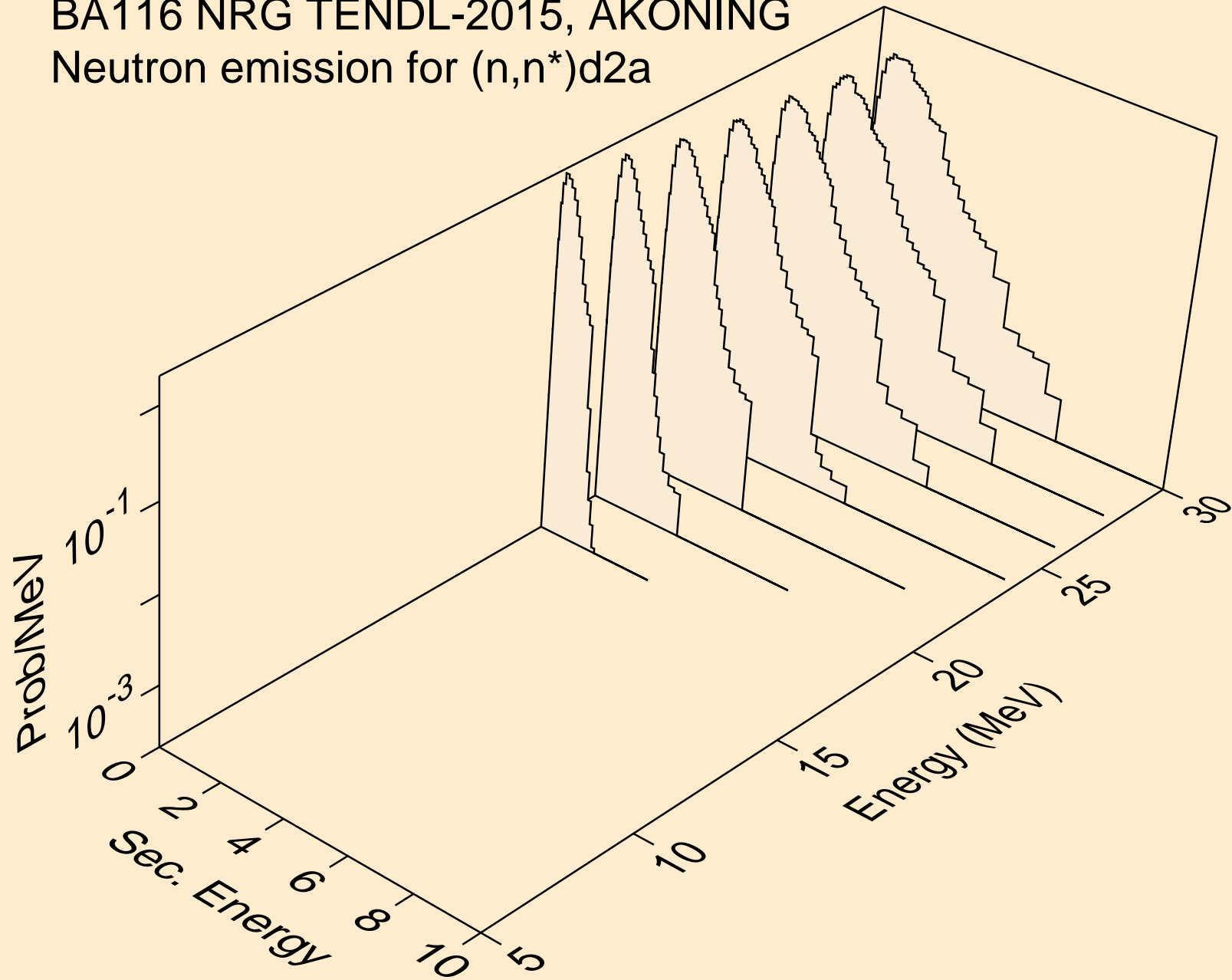

BA116 NRG TENDL-2015, AKONING
Neutron emission for (n,2np)

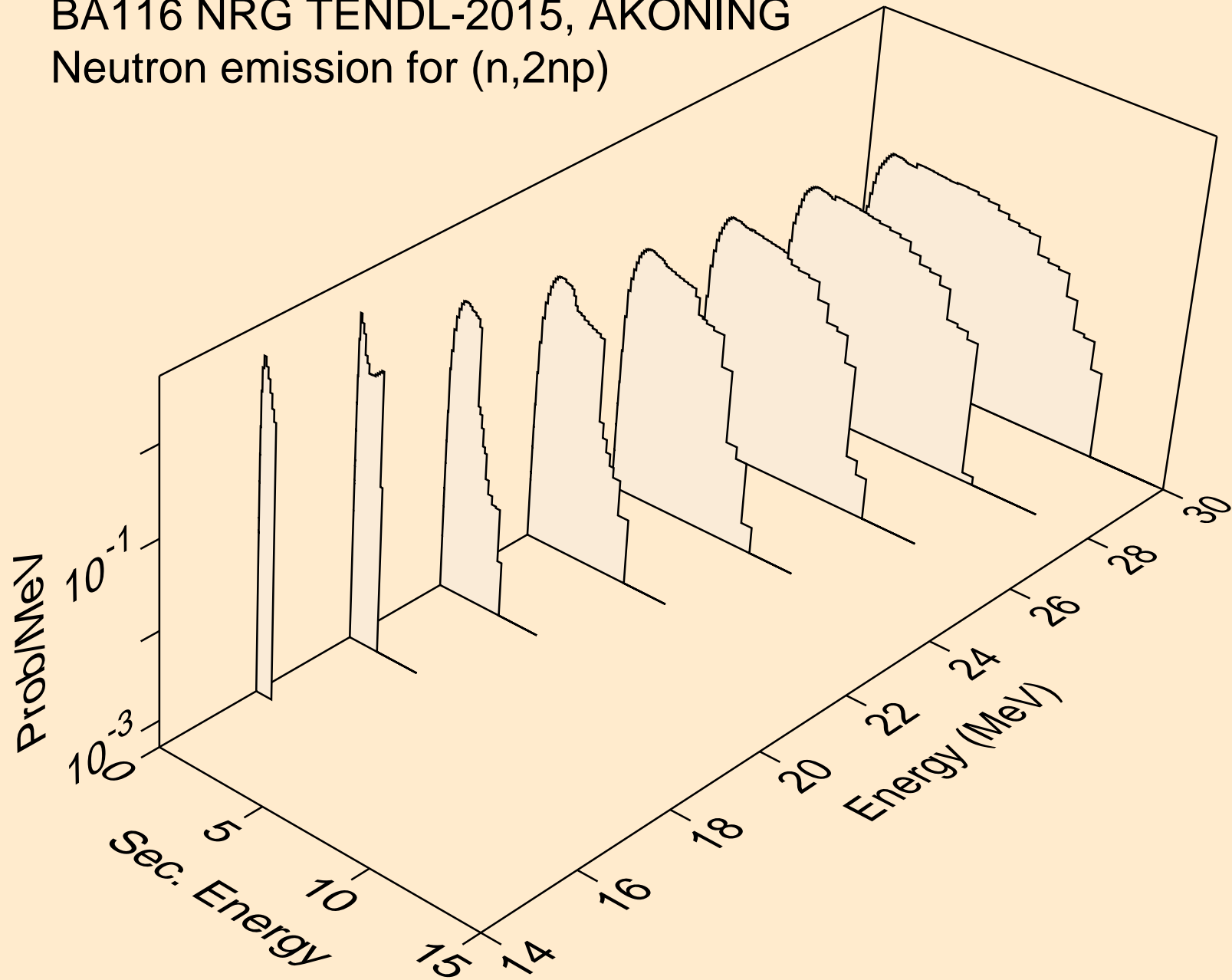

BA116 NRG TENDL-2015, AKONING
Neutron emission for (n,3np)

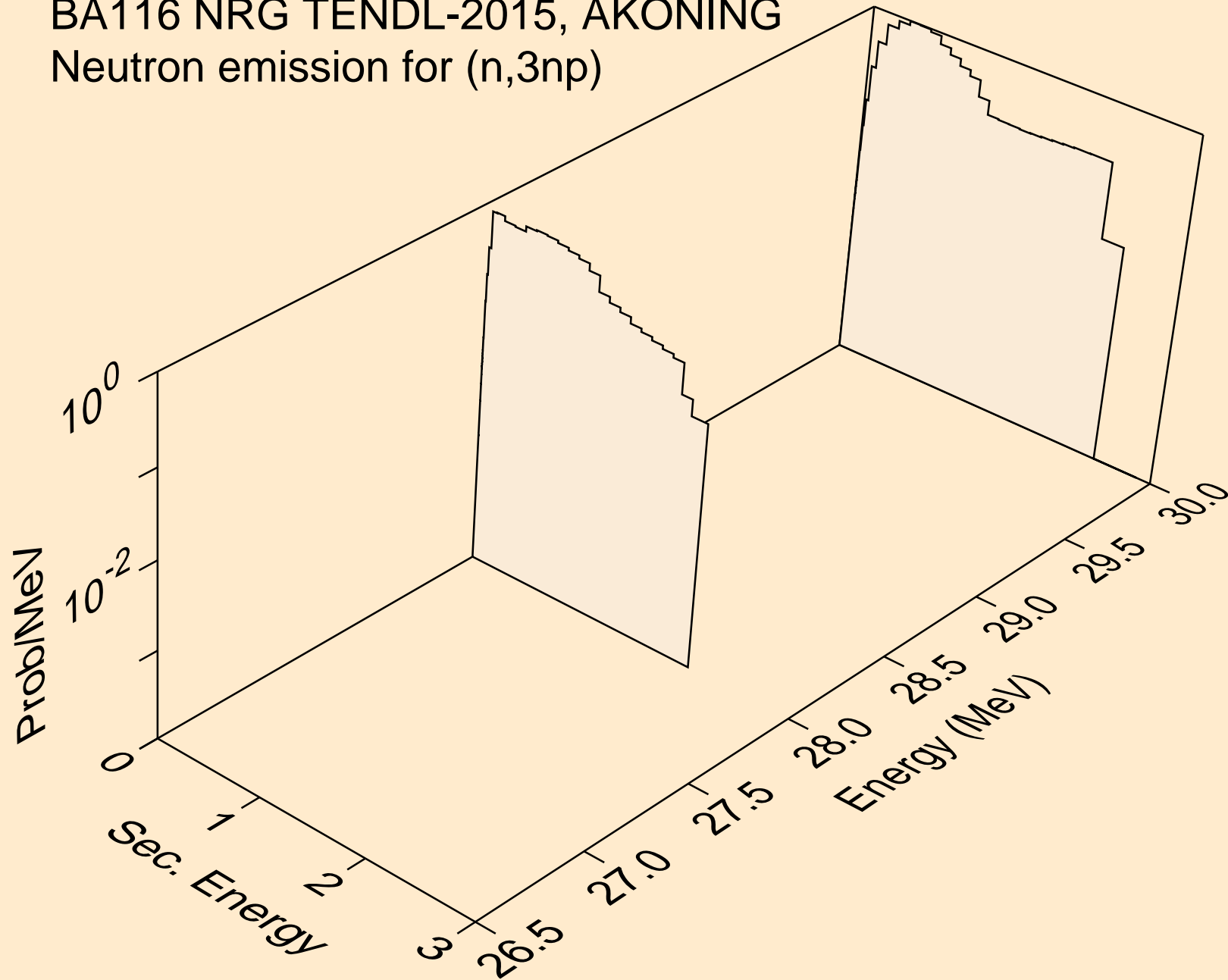

BA116 NRG TENDL-2015, AKONING
Neutron emission for (n,2np)

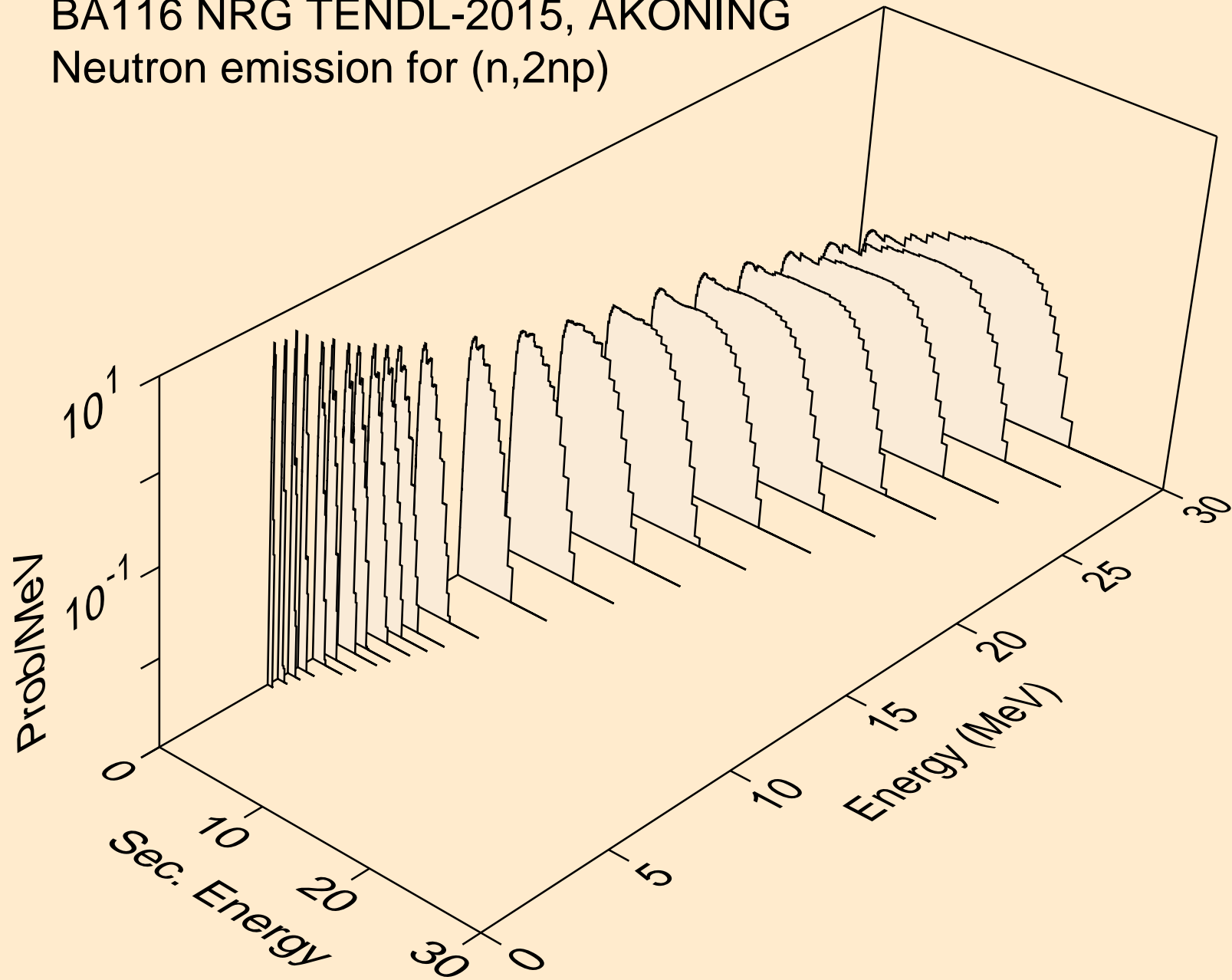

BA116 NRG TENDL-2015, AKONING
Neutron emission for (n,npa)

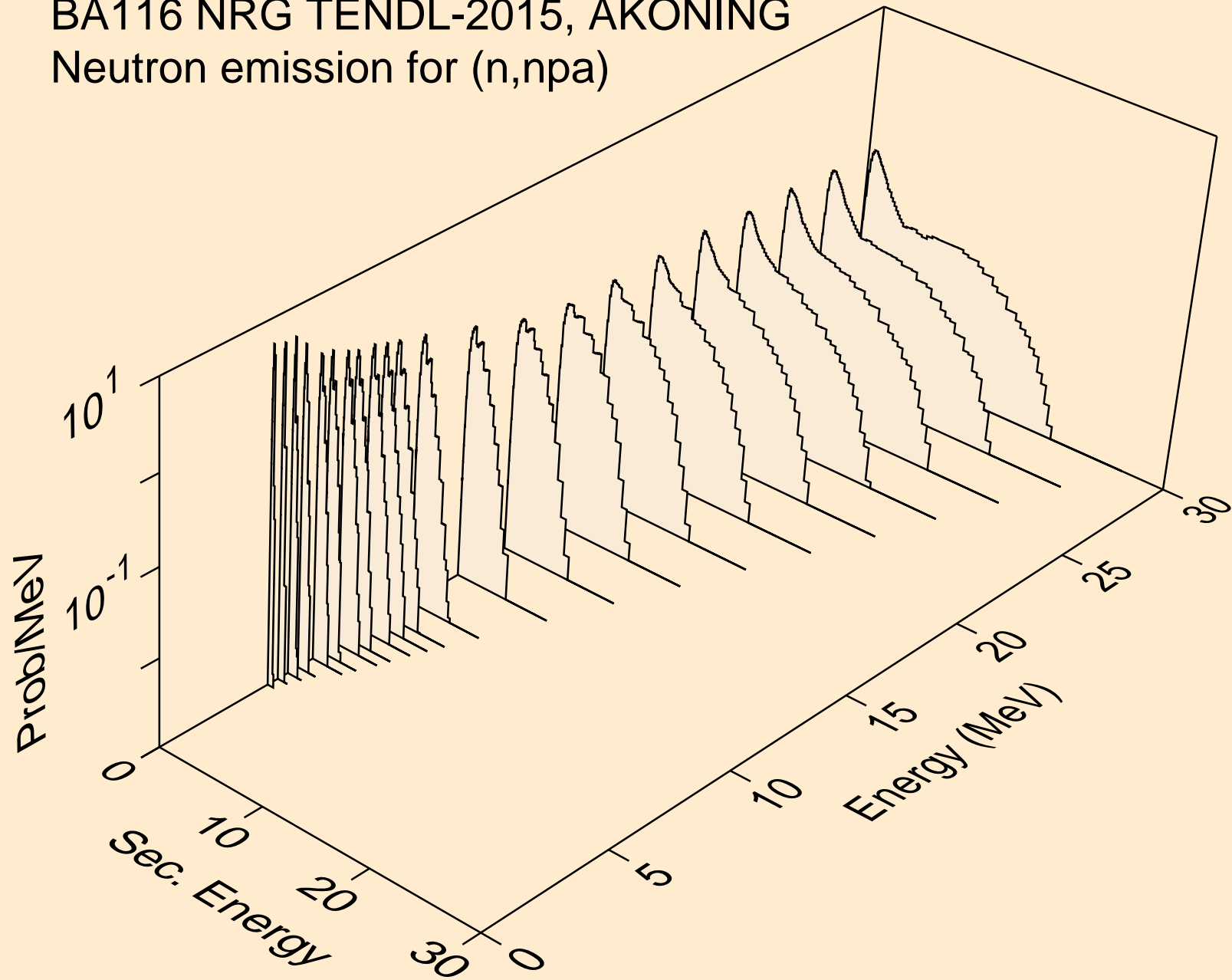

BA116 NRG TENDL-2015, AKONING
Neutron emission for (n,n*c)

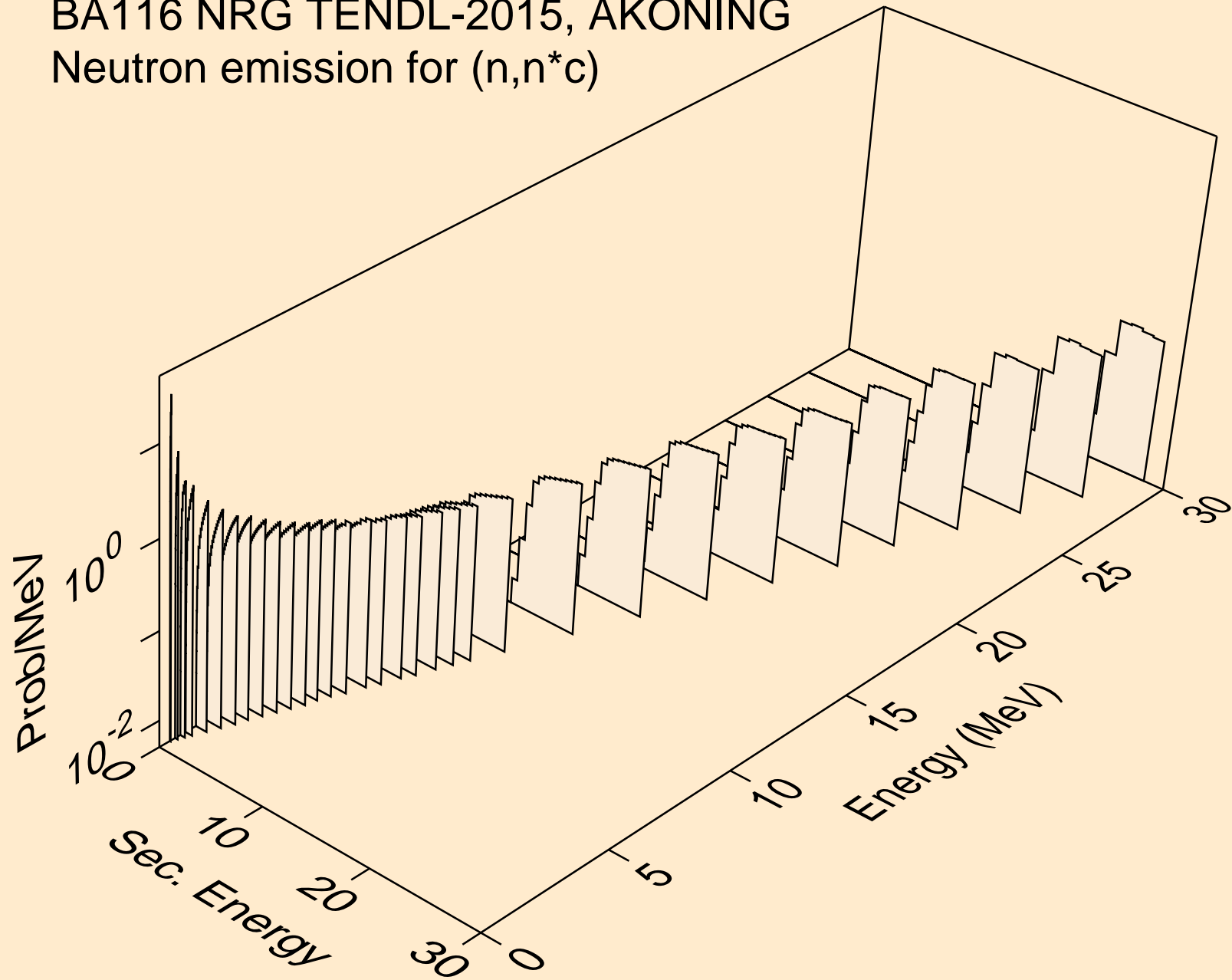

BA116 NRG TENDL-2015, AKONING
Photon emission for (n,x)

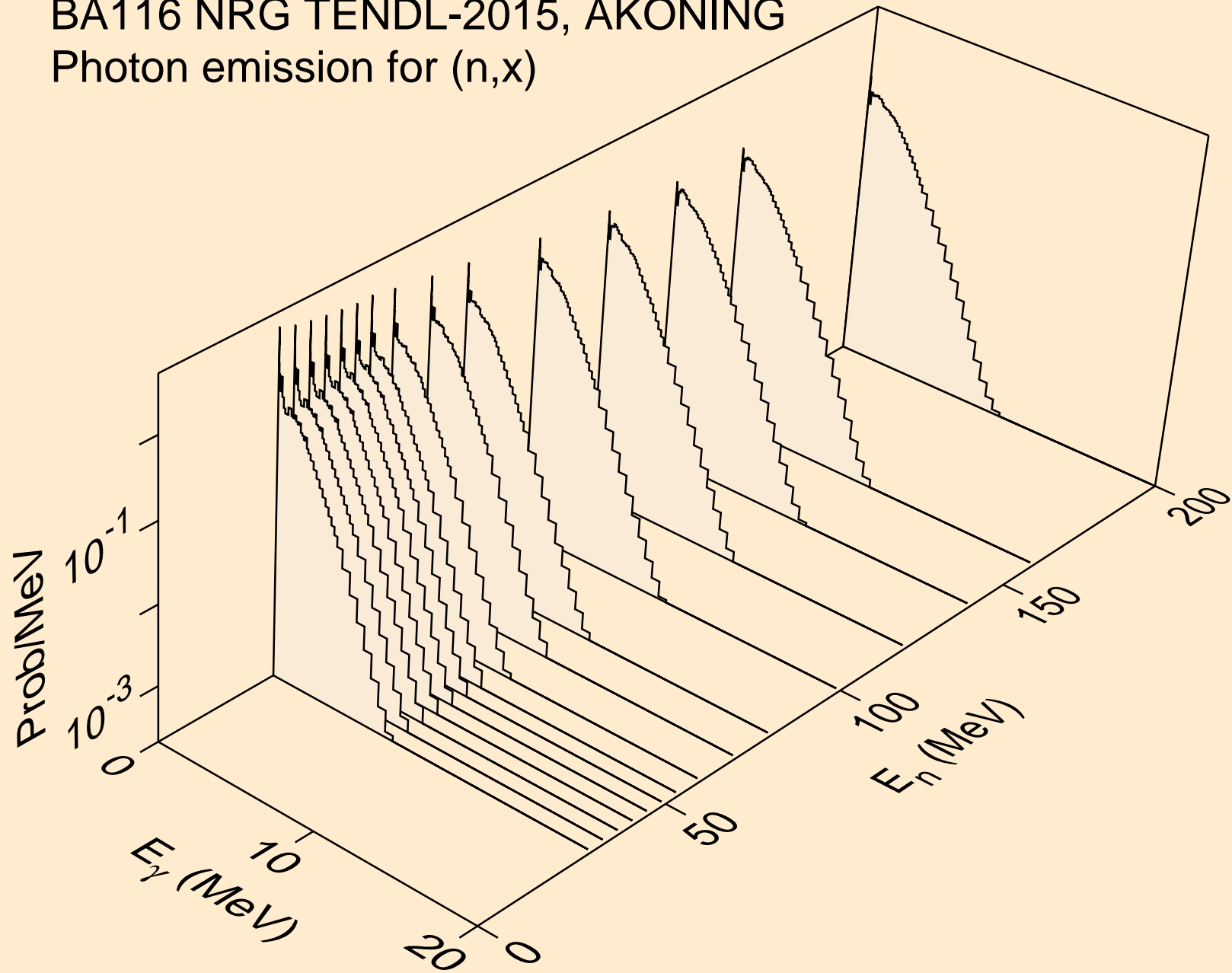

BA116 NRG TENDL-2015, AKONING
Photon emission for (n,2n)

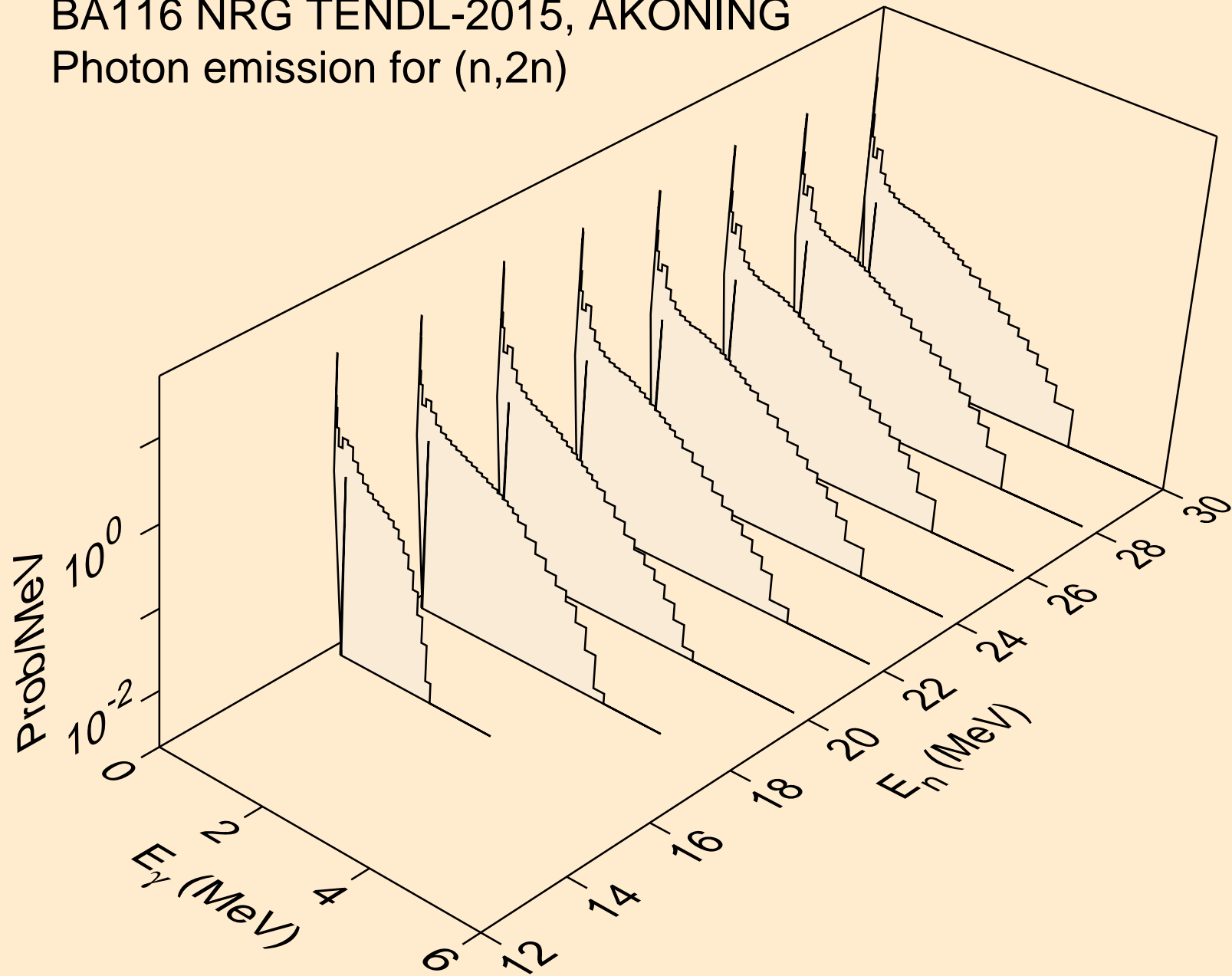

BA116 NRG TENDL-2015, AKONING
Photon emission for (n,3n)

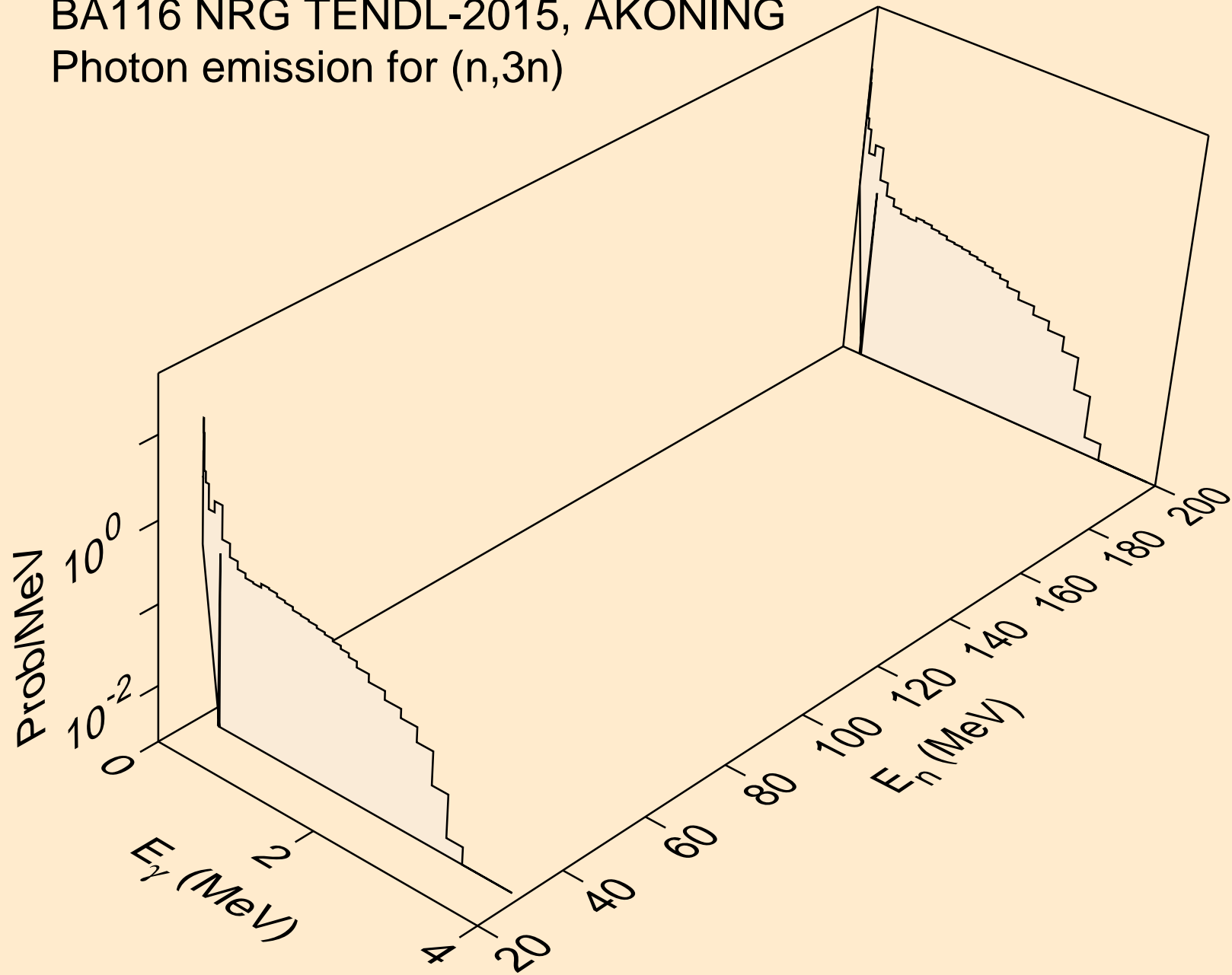

BA116 NRG TENDL-2015, AKONING
Photon emission for (n,n*)a

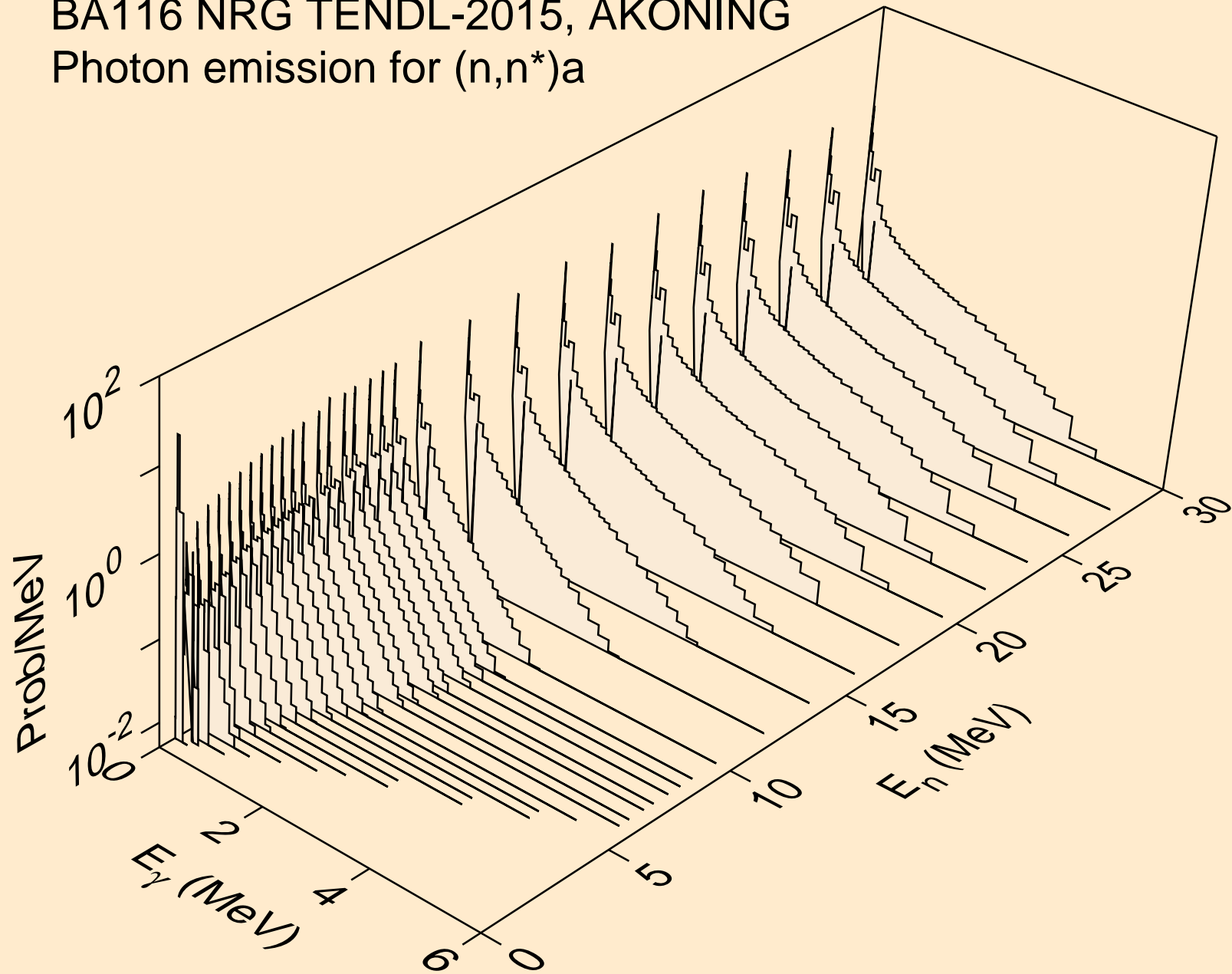

BA116 NRG TENDL-2015, AKONING
Photon emission for (n,n*)3a

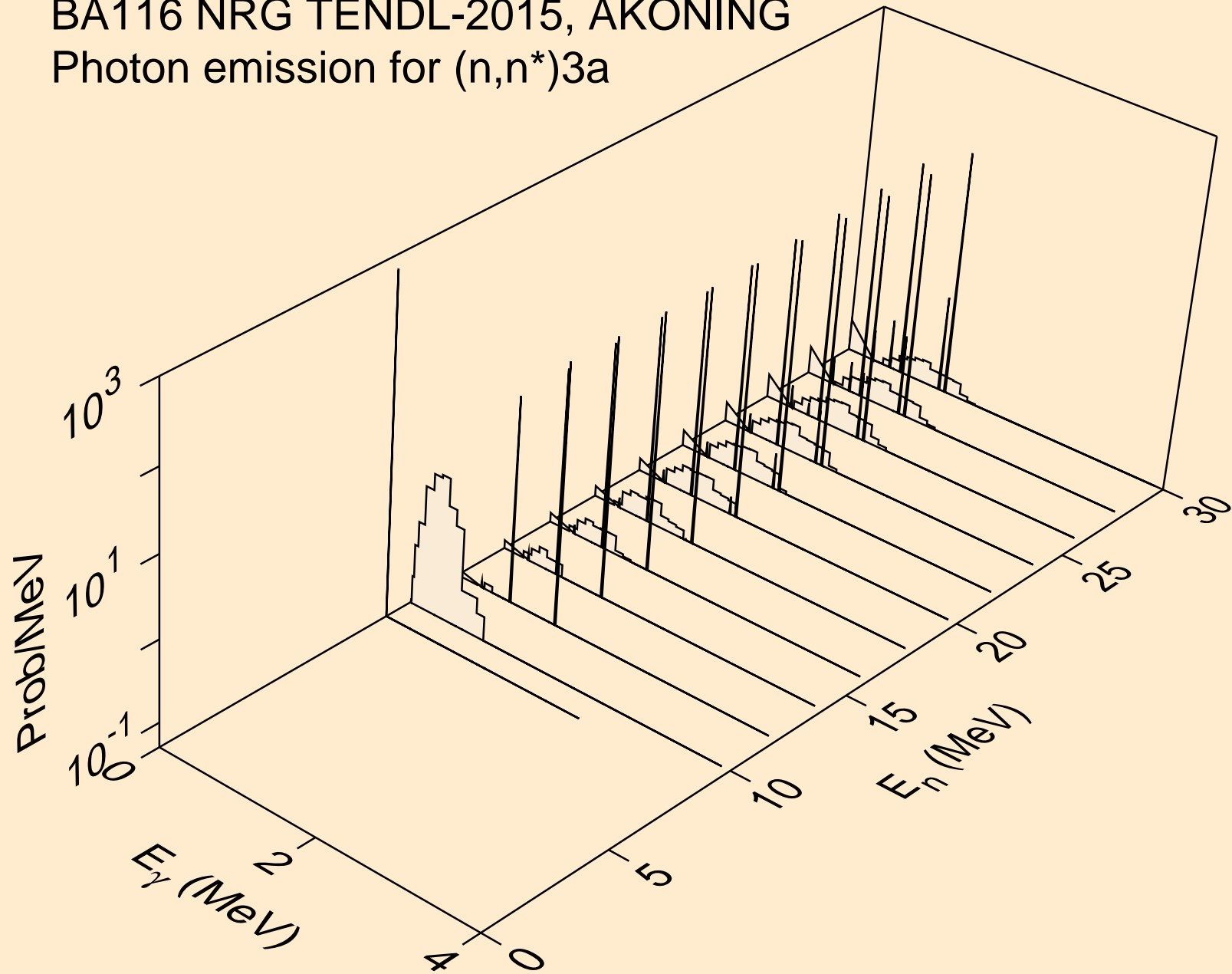

BA116 NRG TENDL-2015, AKONING
Photon emission for (n,2n)a

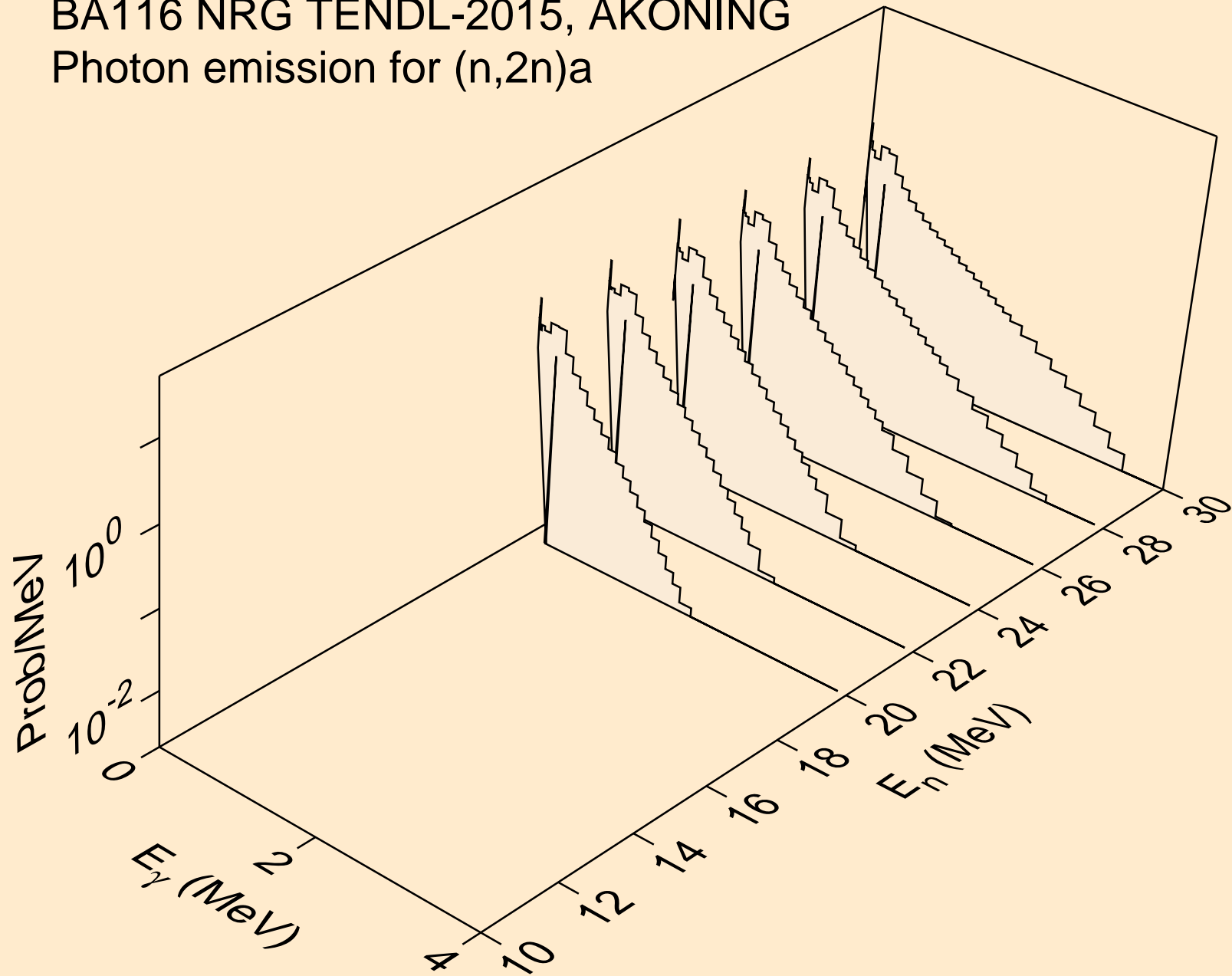

BA116 NRG TENDL-2015, AKONING
Photon emission for (n,3n)a

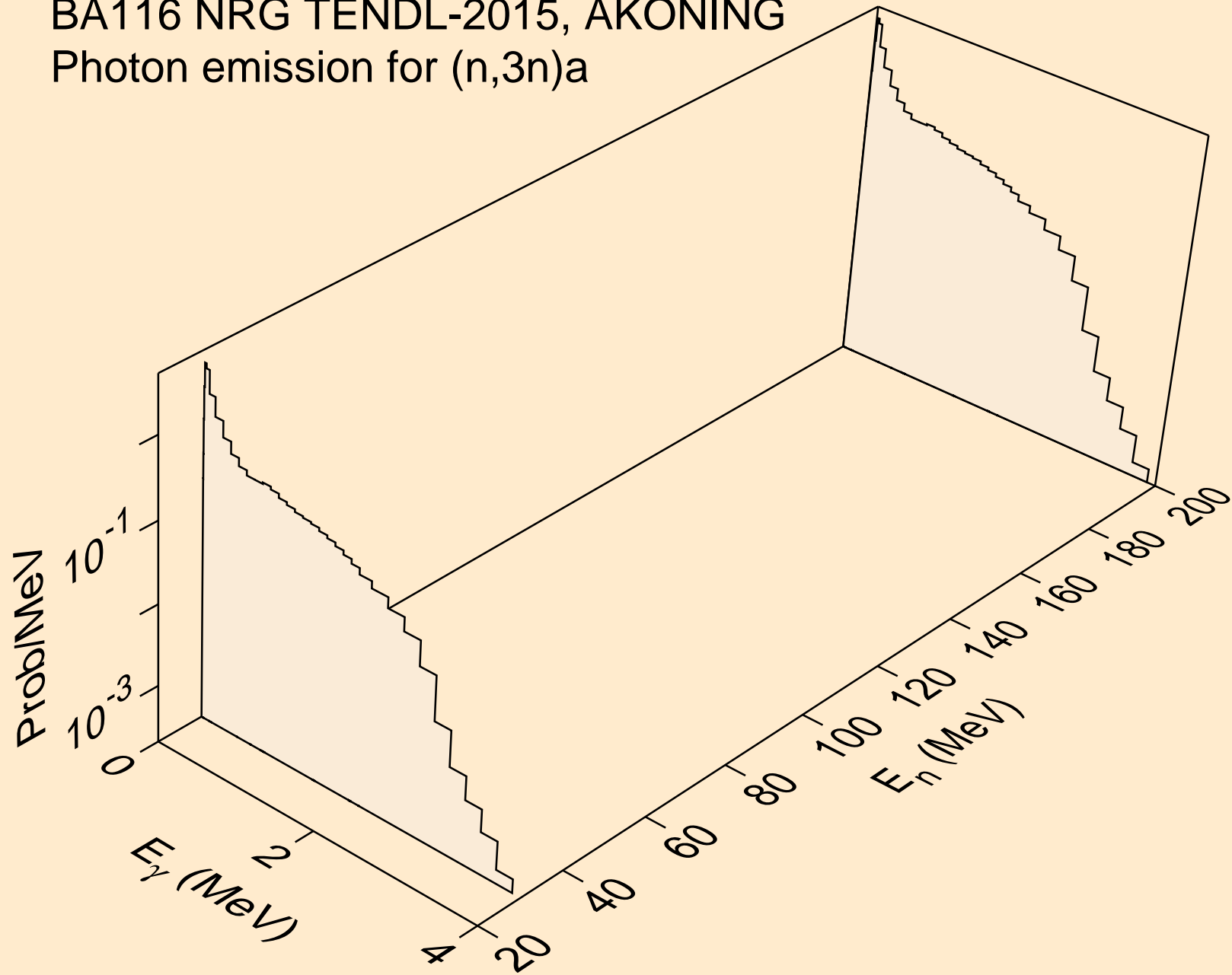

BA116 NRG TENDL-2015, AKONING
Photon emission for (n,n*)p

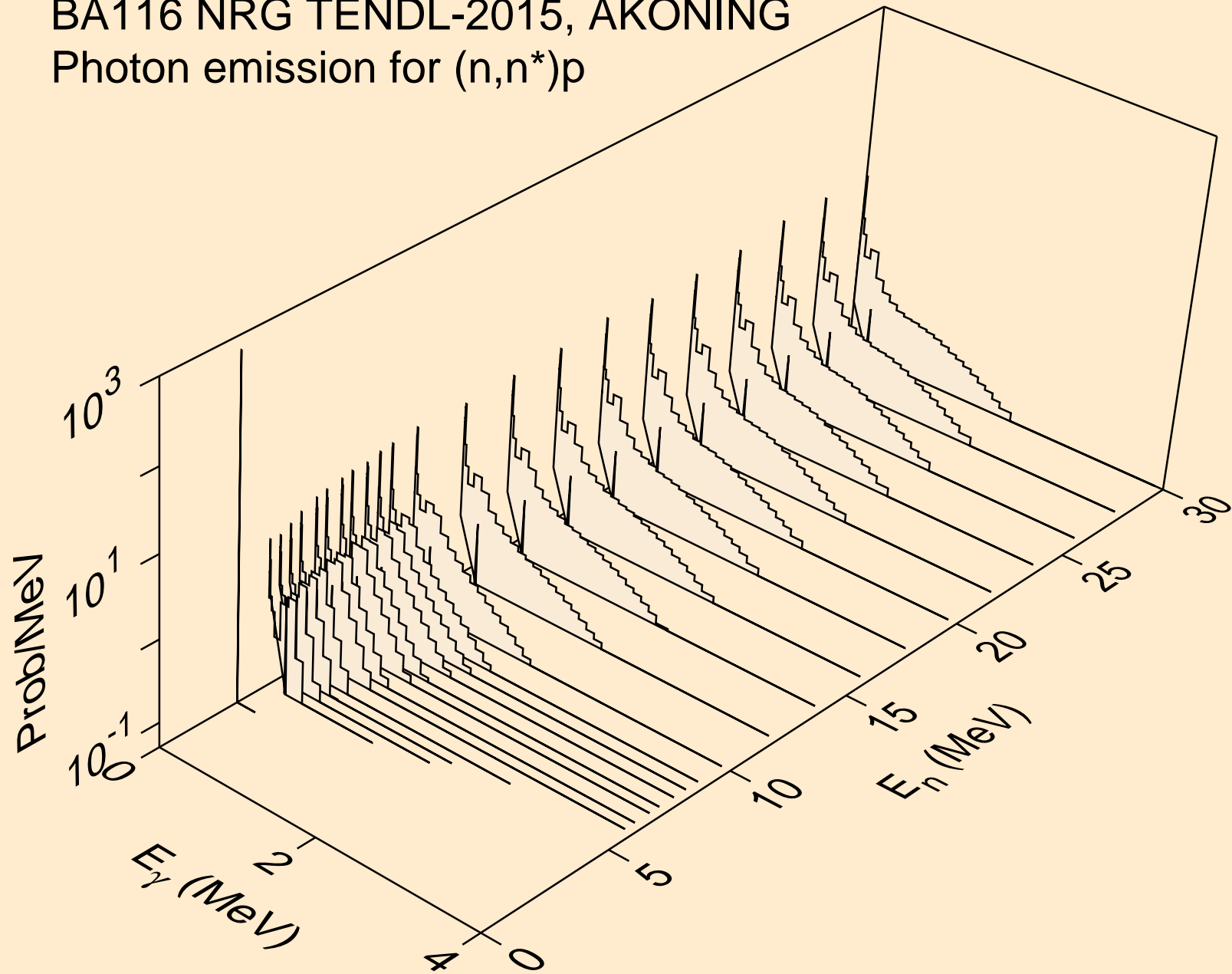

BA116 NRG TENDL-2015, AKONING
Photon emission for (n,n*)2a

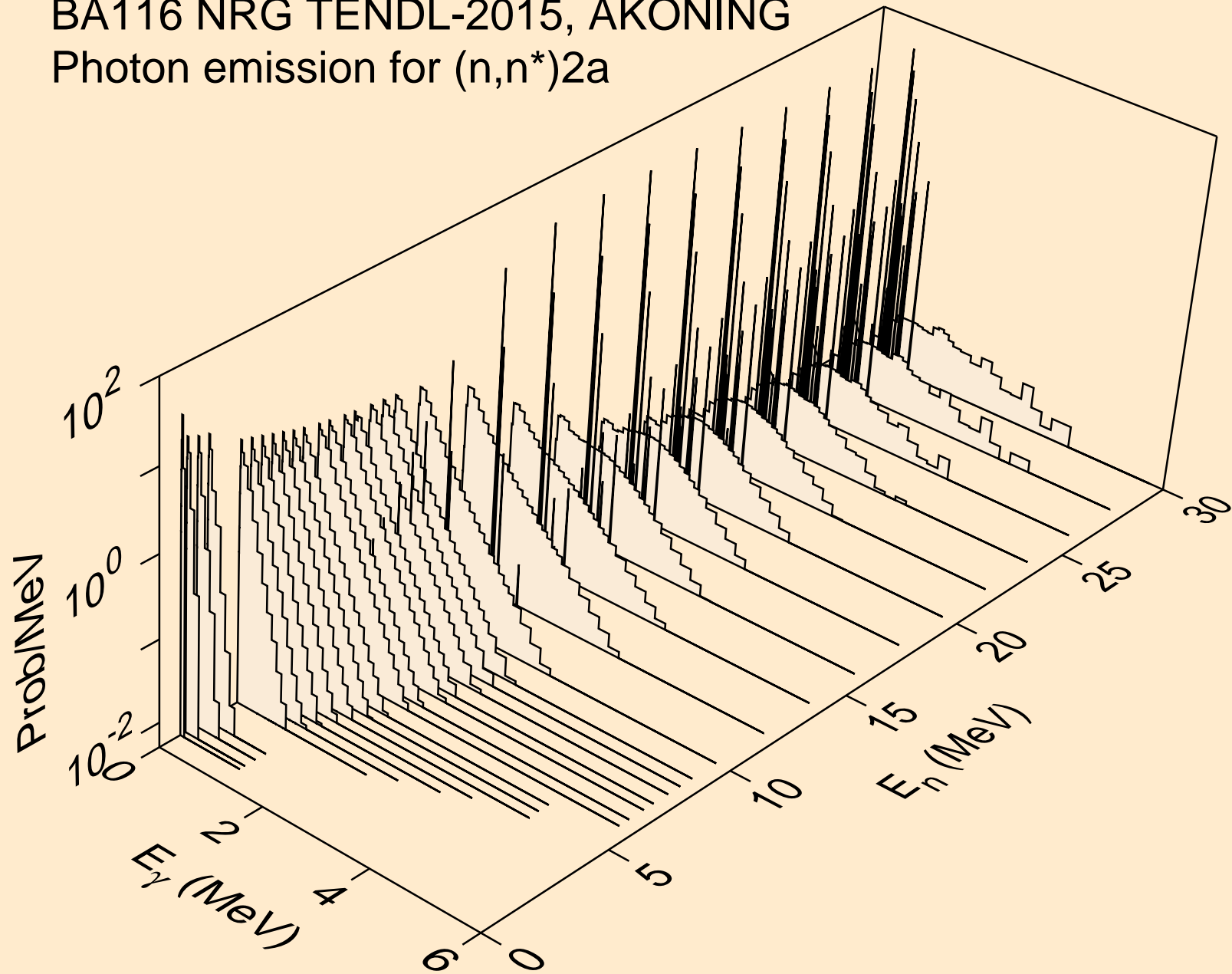

BA116 NRG TENDL-2015, AKONING
Photon emission for (n,2n)2a

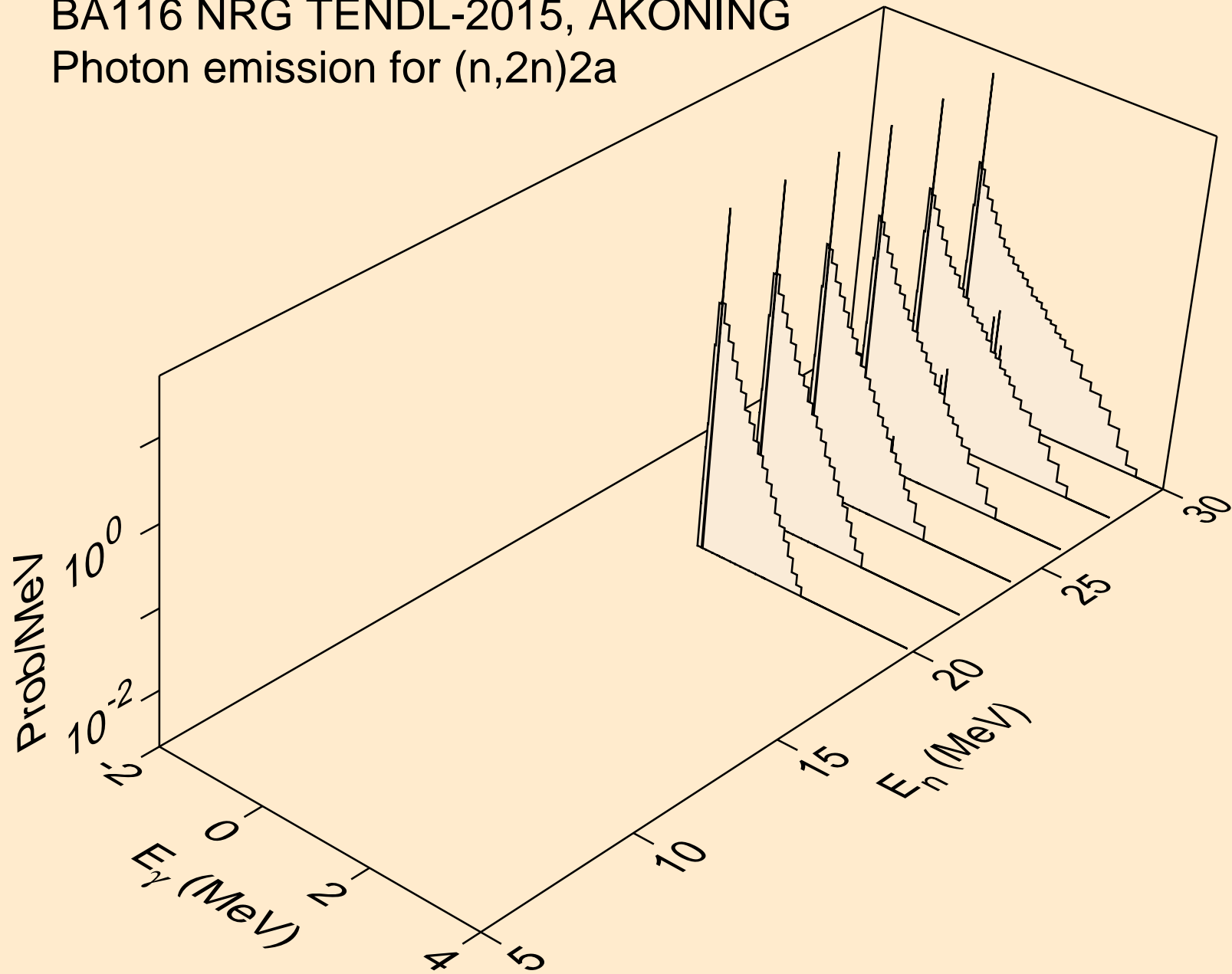

BA116 NRG TENDL-2015, AKONING
Photon emission for (n,n*)d

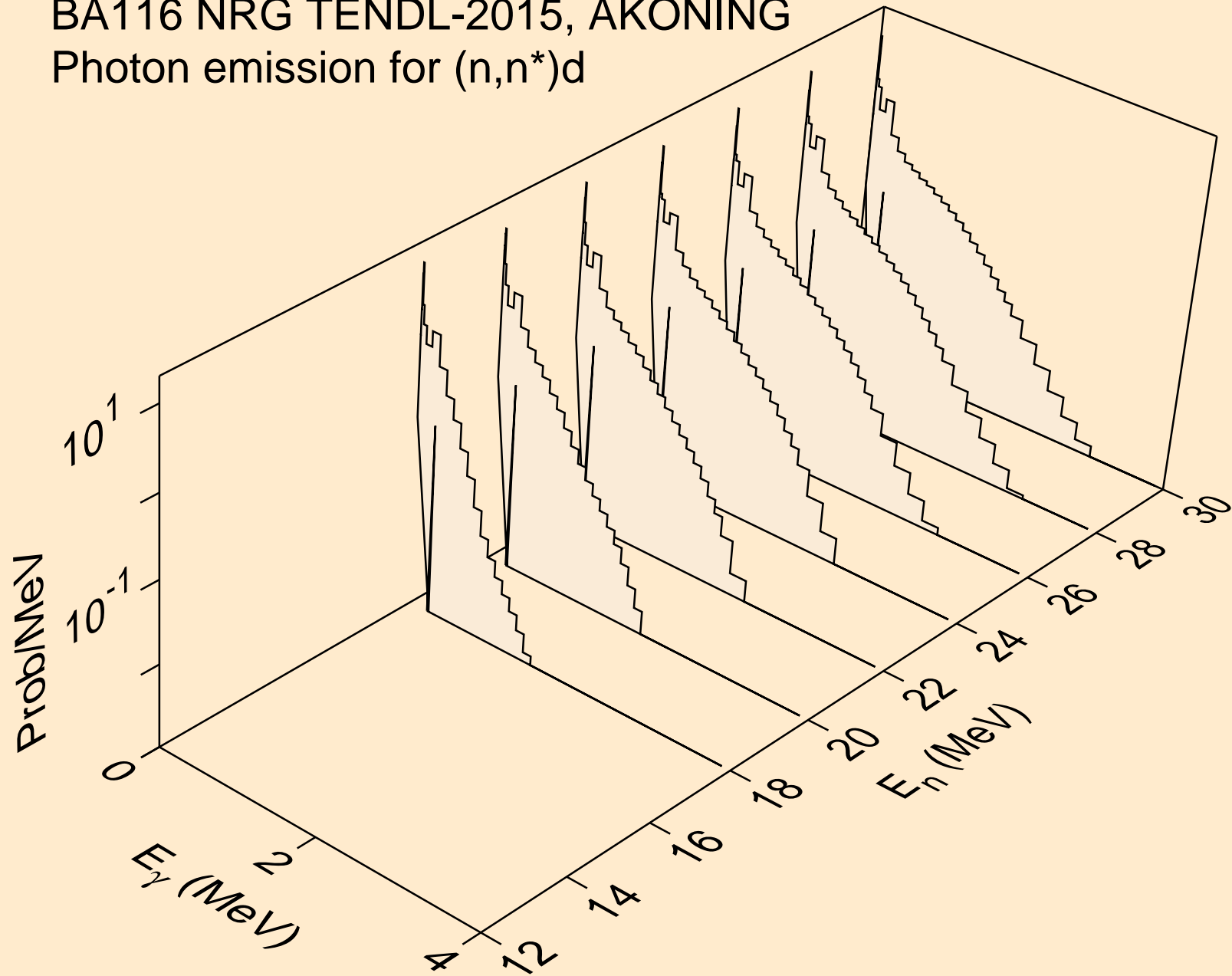

BA116 NRG TENDL-2015, AKONING
Photon emission for (n,n*)t

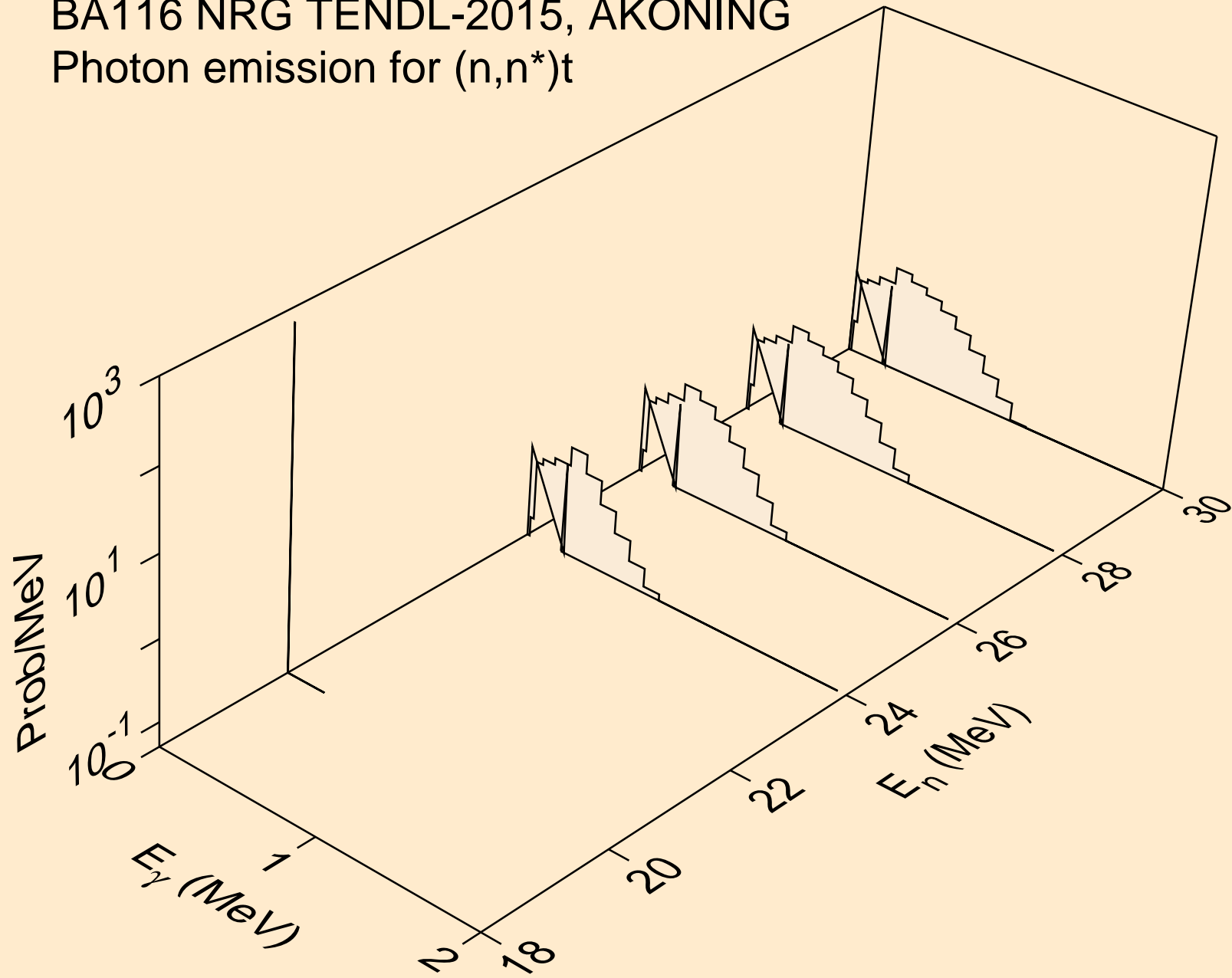

BA116 NRG TENDL-2015, AKONING
Photon emission for (n,n*)he3

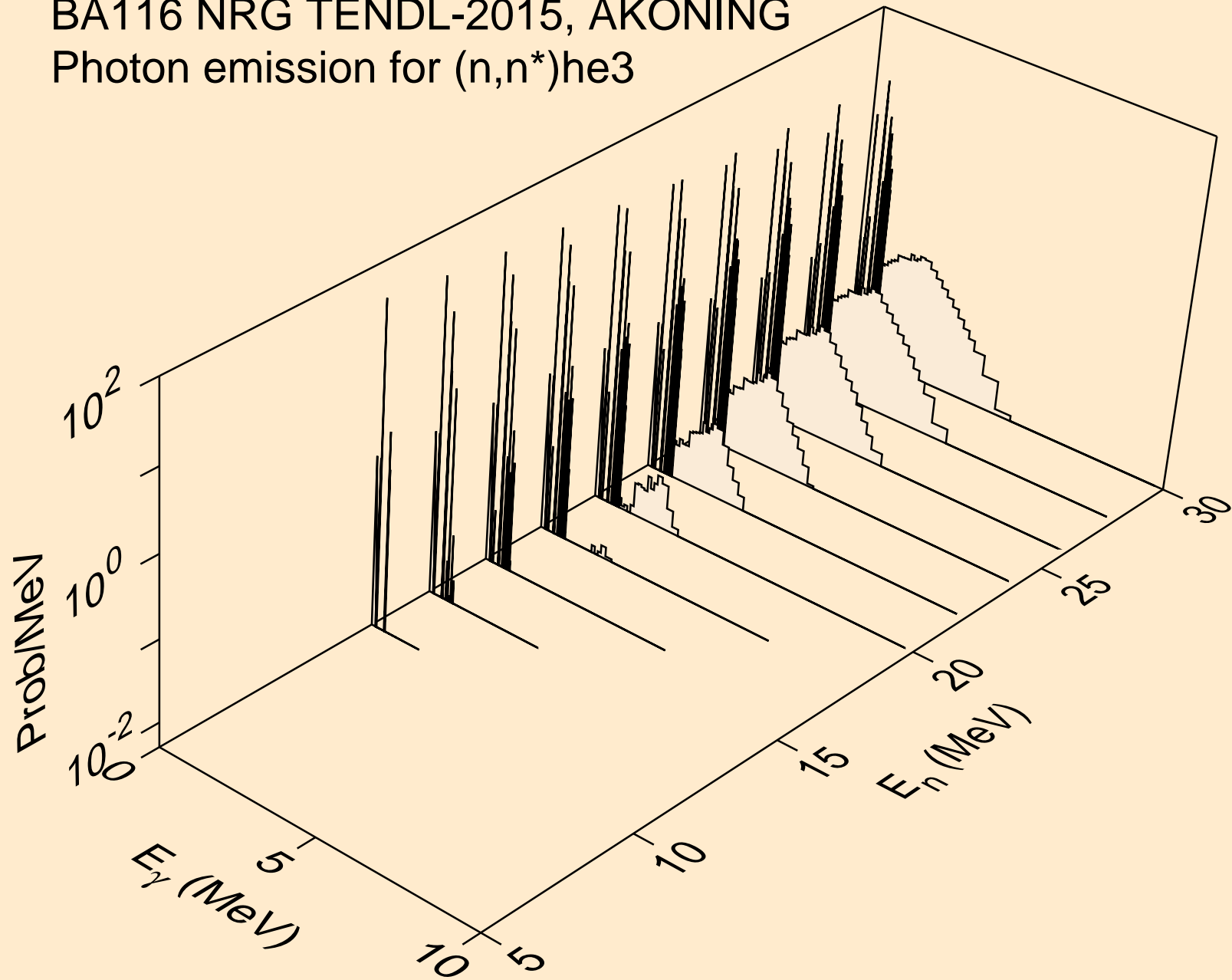

BA116 NRG TENDL-2015, AKONING
Photon emission for (n,n*)d2a

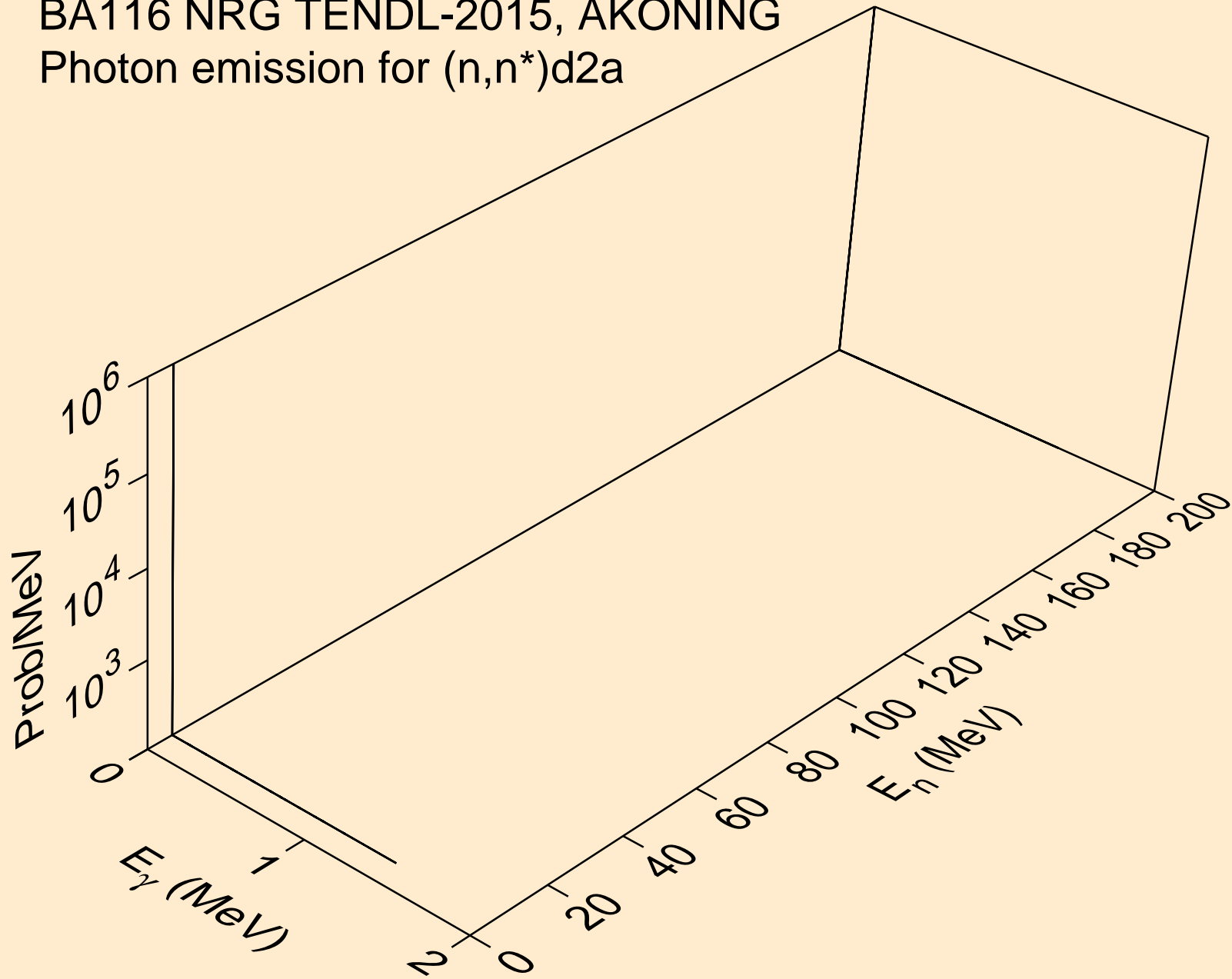

BA116 NRG TENDL-2015, AKONING
Photon emission for (n,2np)

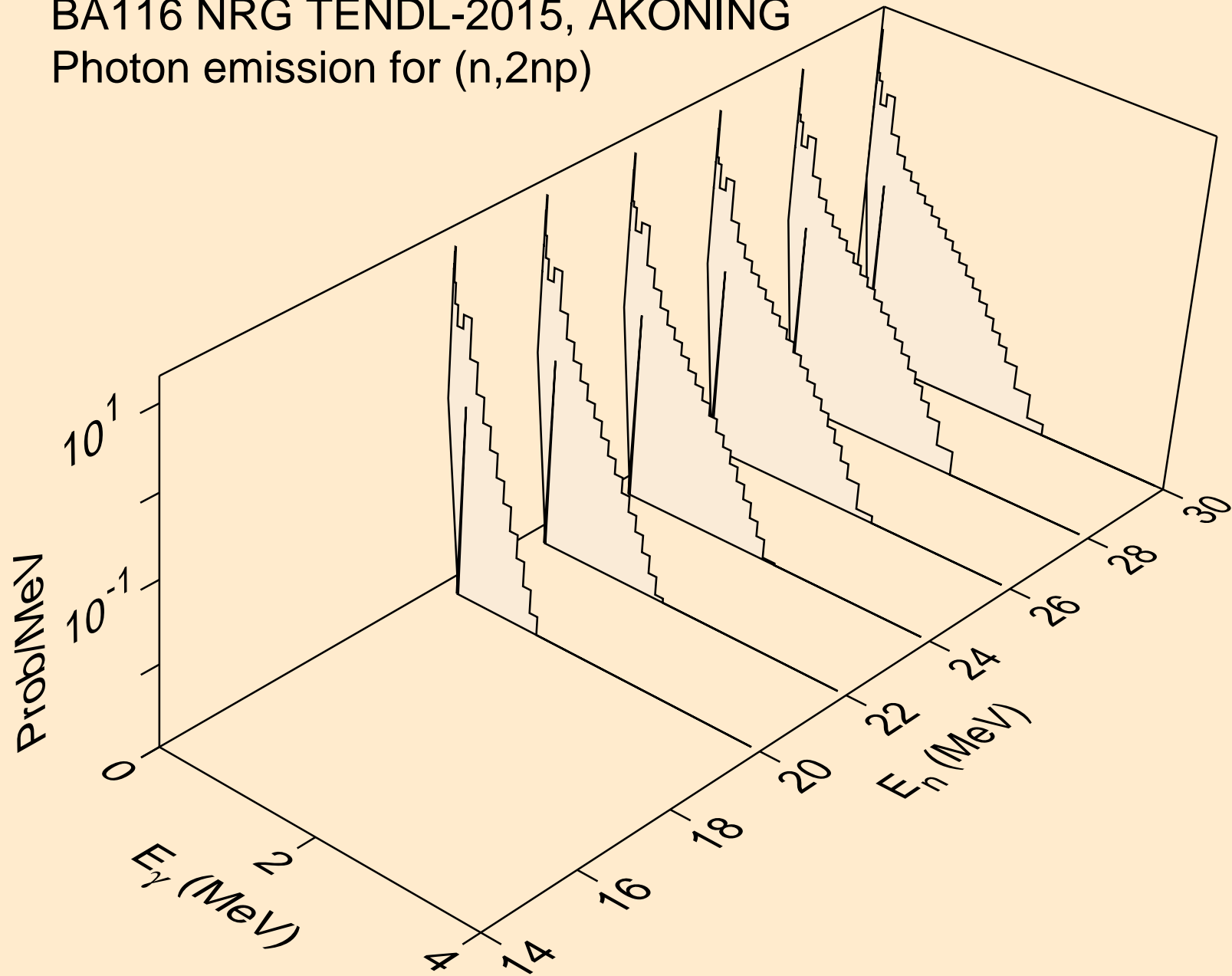

BA116 NRG TENDL-2015, AKONING
Photon emission for (n,3np)

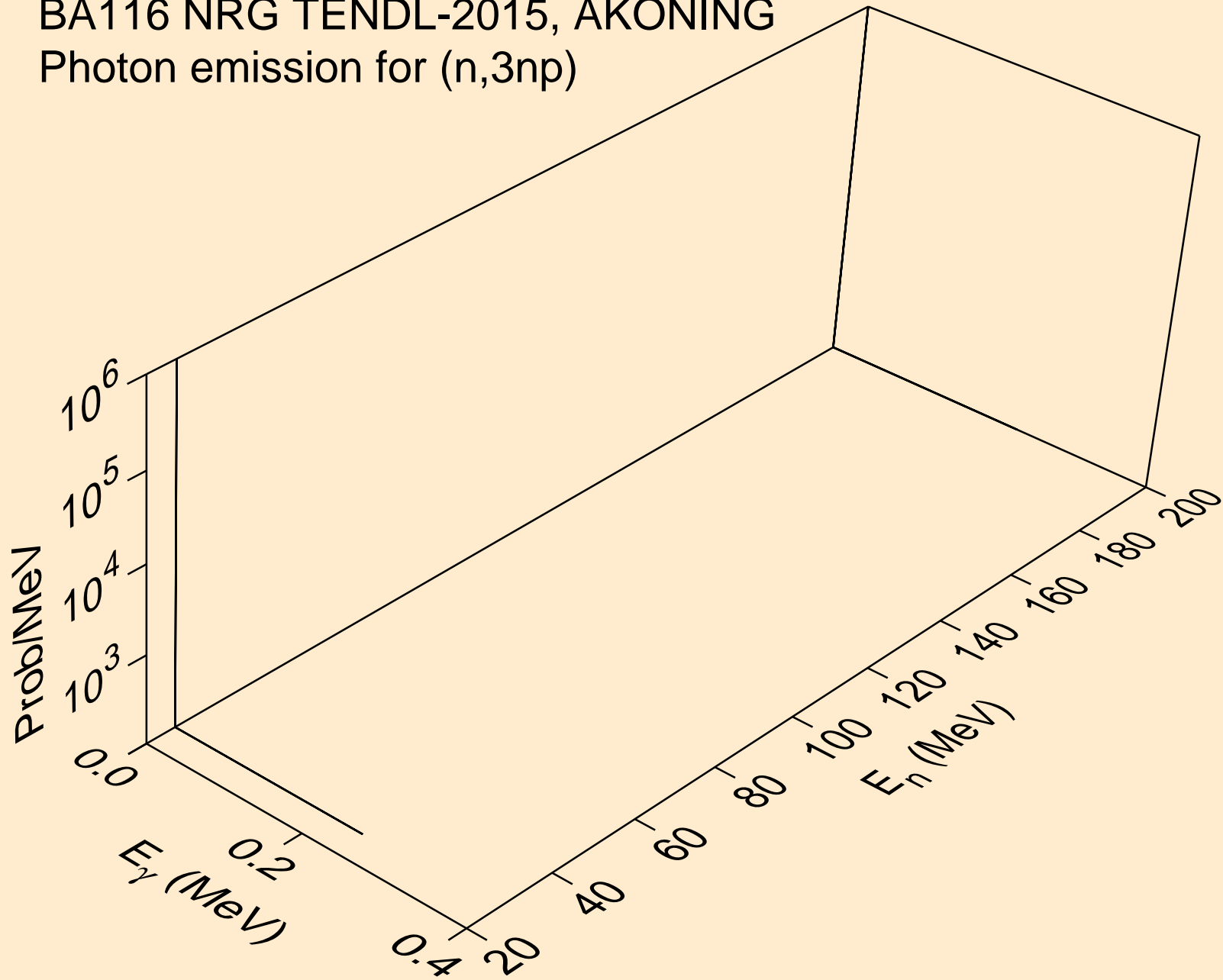

BA116 NRG TENDL-2015, AKONING
Photon emission for (n,2np)

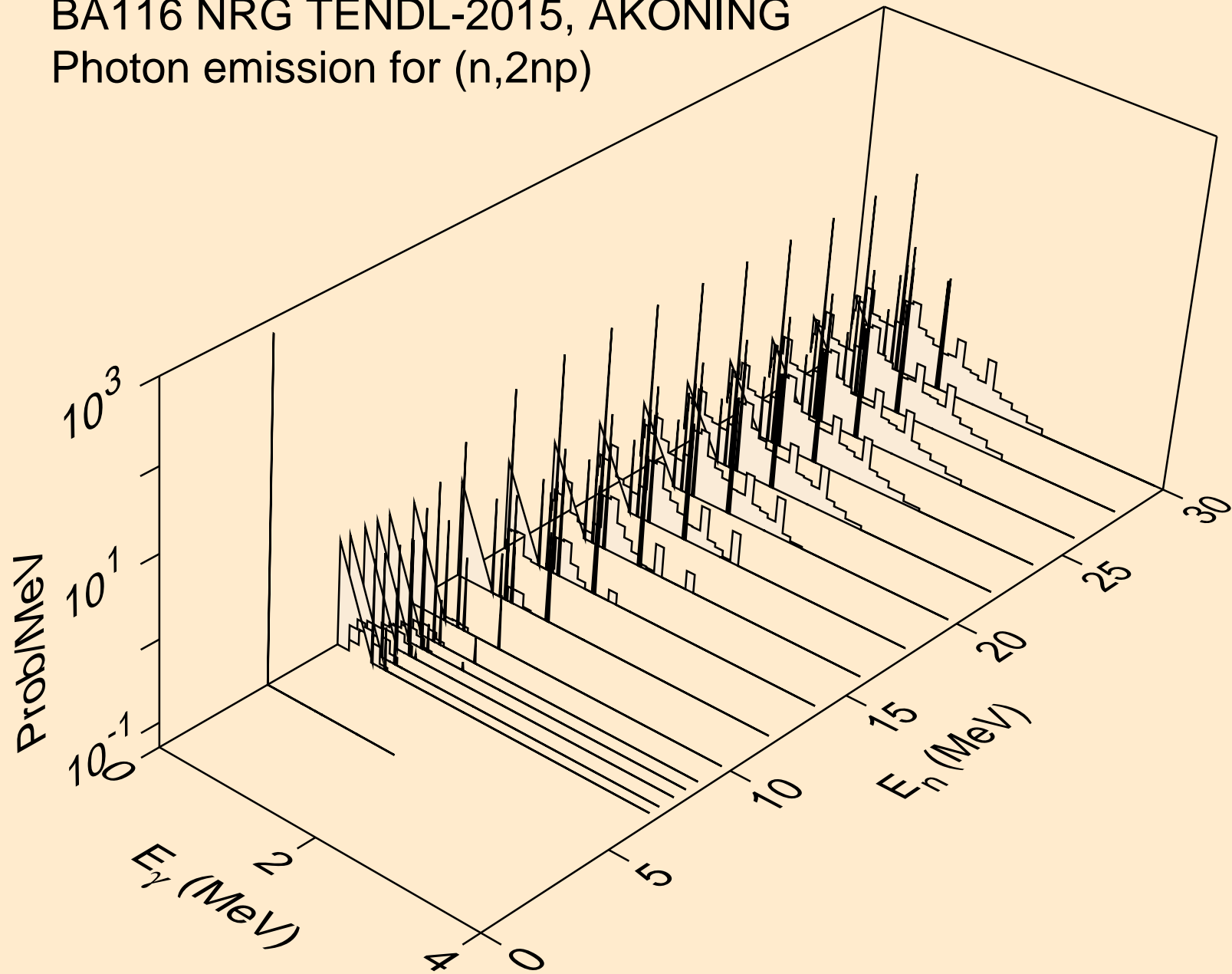

BA116 NRG TENDL-2015, AKONING
Photon emission for (n,npa)

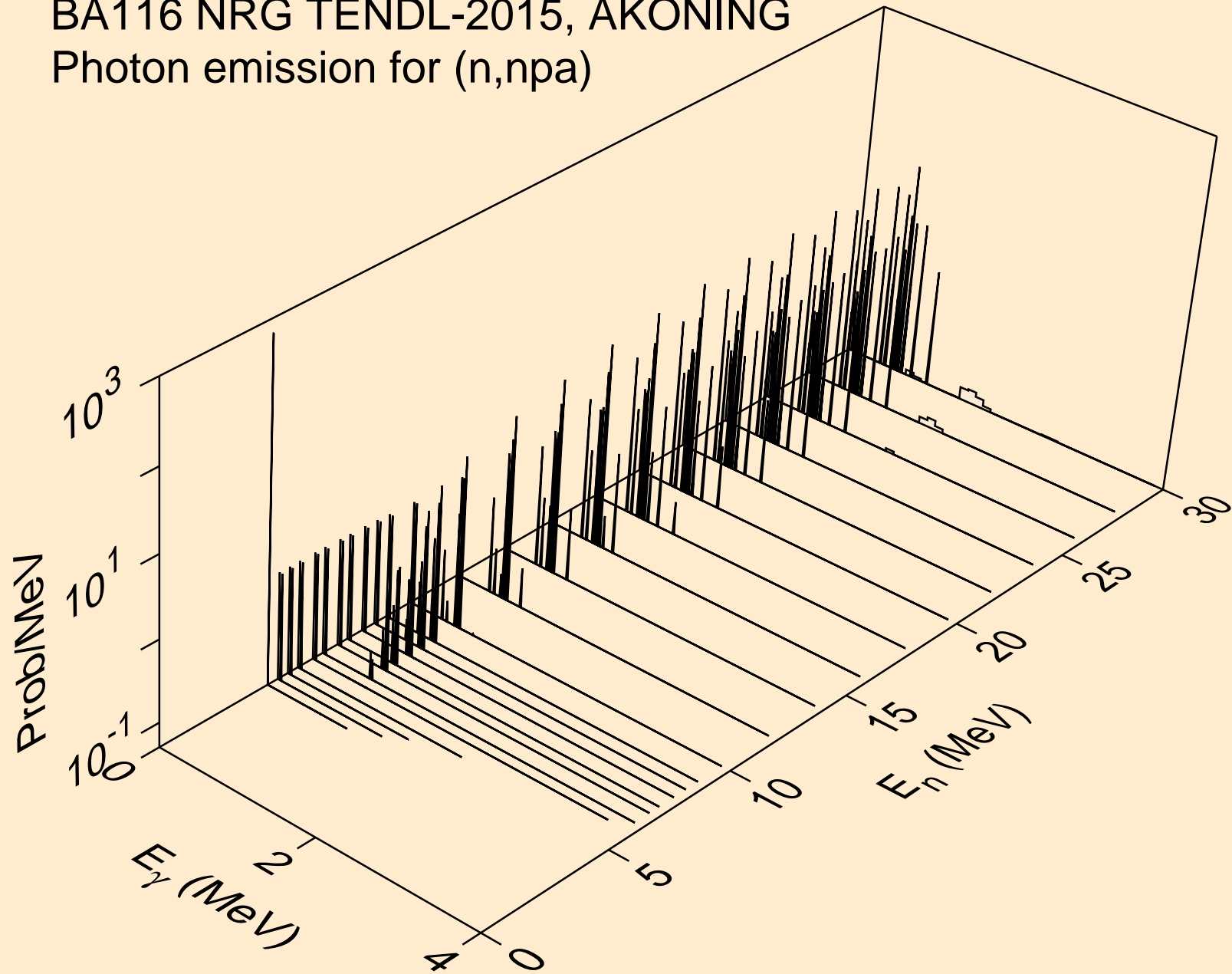

BA116 NRG TENDL-2015, AKONING
Photon emission for (n,n*c)

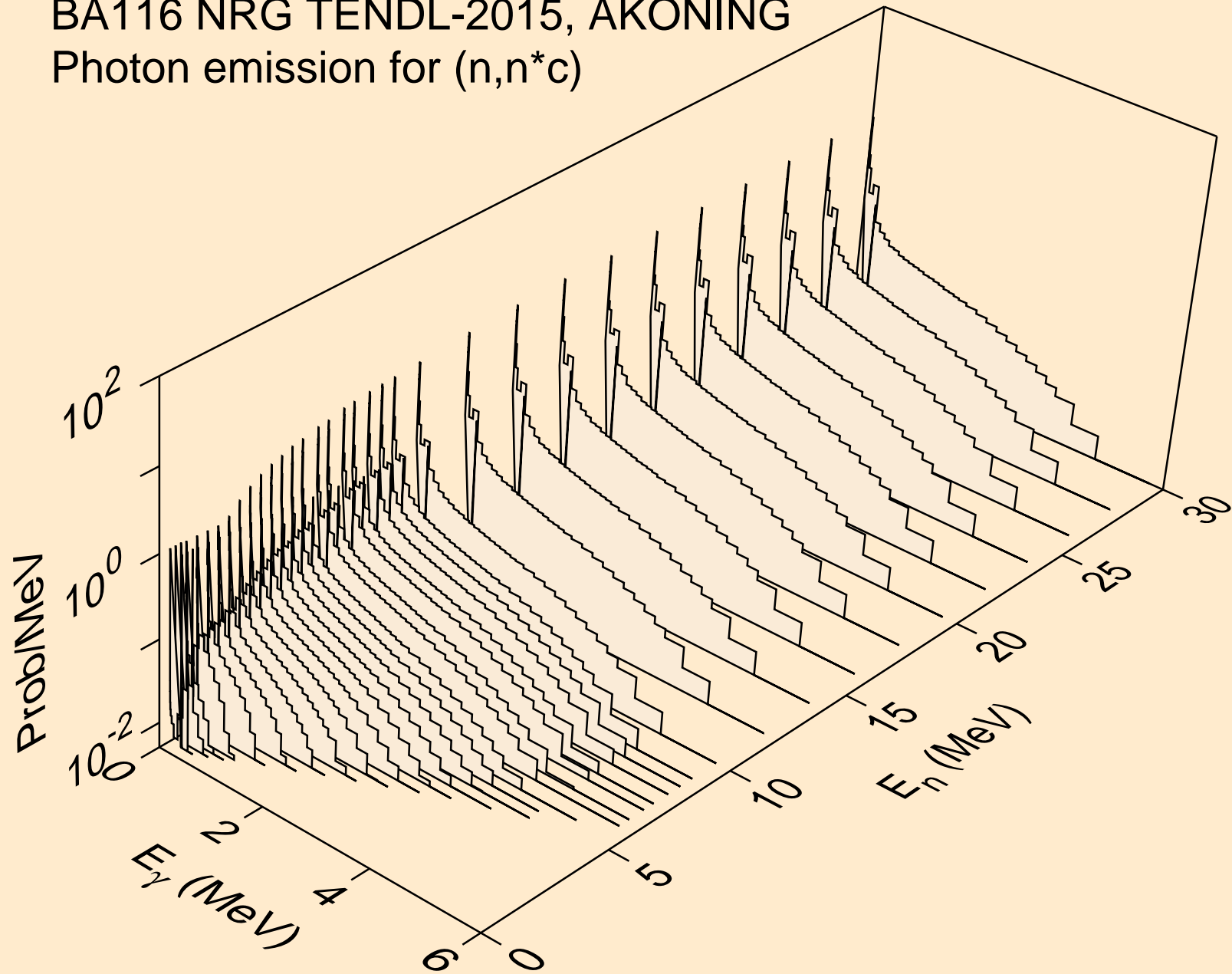

BA116 NRG TENDL-2015, AKONING
Photon emission for (n,gma)

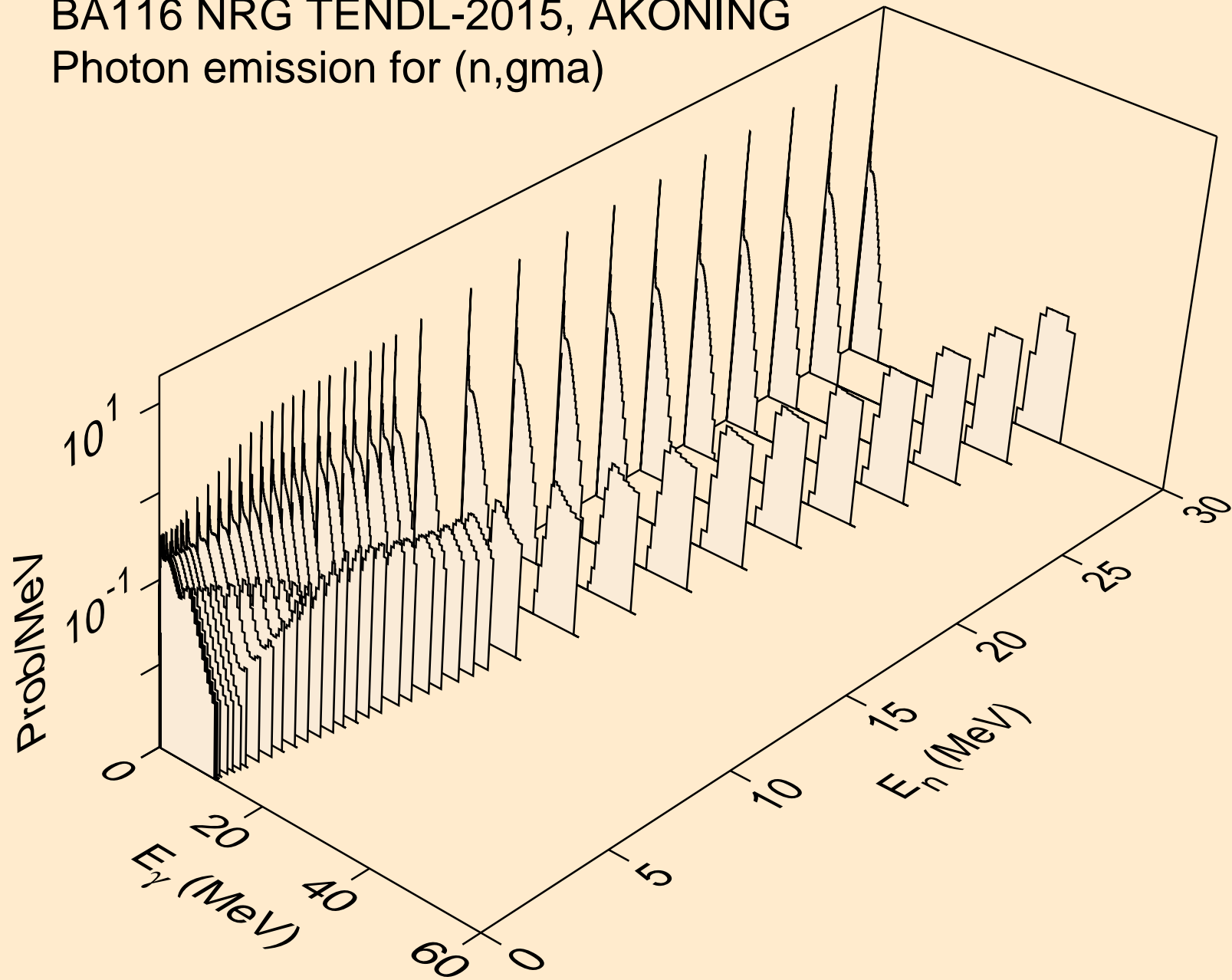

BA116 NRG TENDL-2015, AKONING
Photon emission for (n,p)

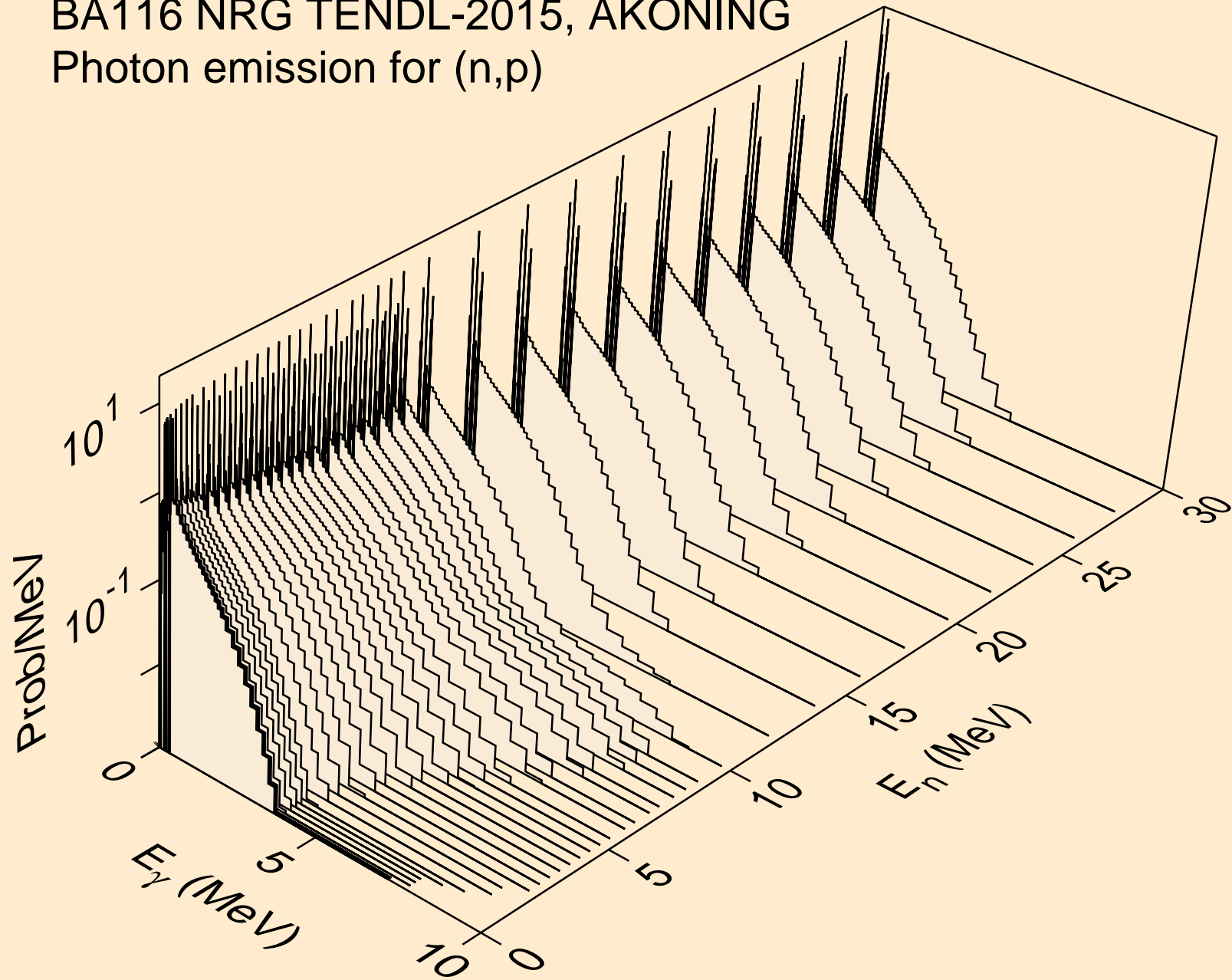

BA116 NRG TENDL-2015, AKONING
Photon emission for (n,d)

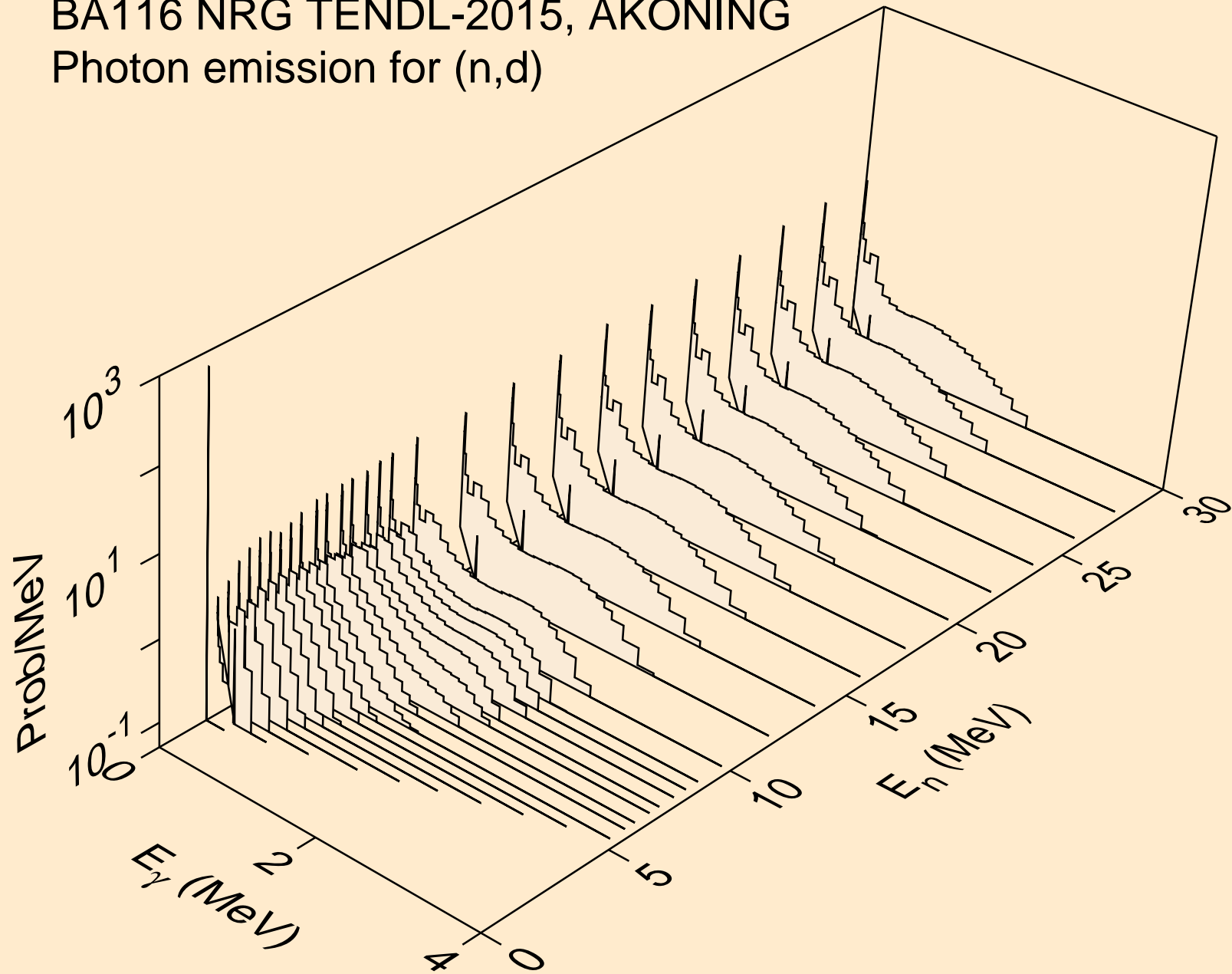

BA116 NRG TENDL-2015, AKONING
Photon emission for (n,t)

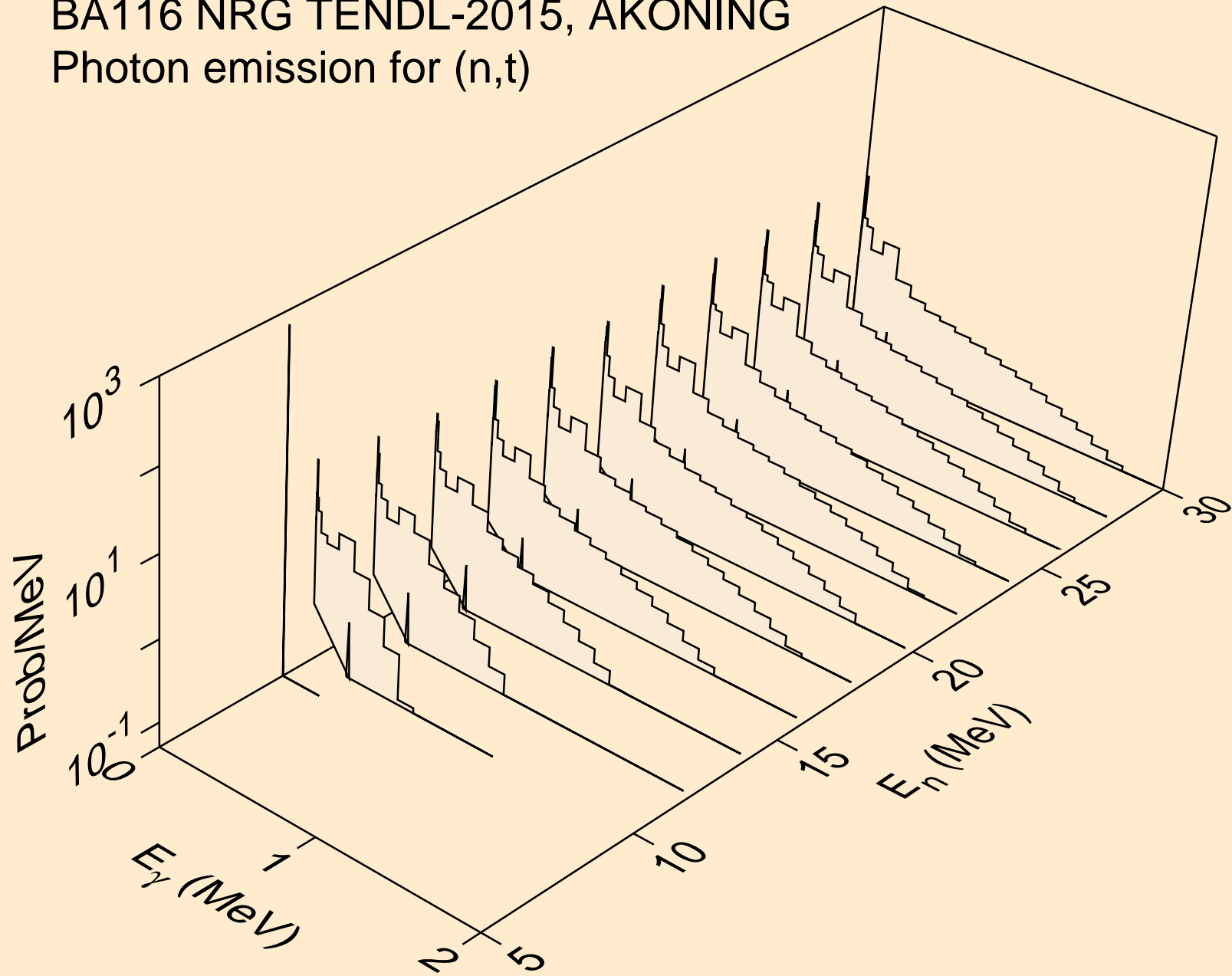

BA116 NRG TENDL-2015, AKONING
Photon emission for (n,he3)

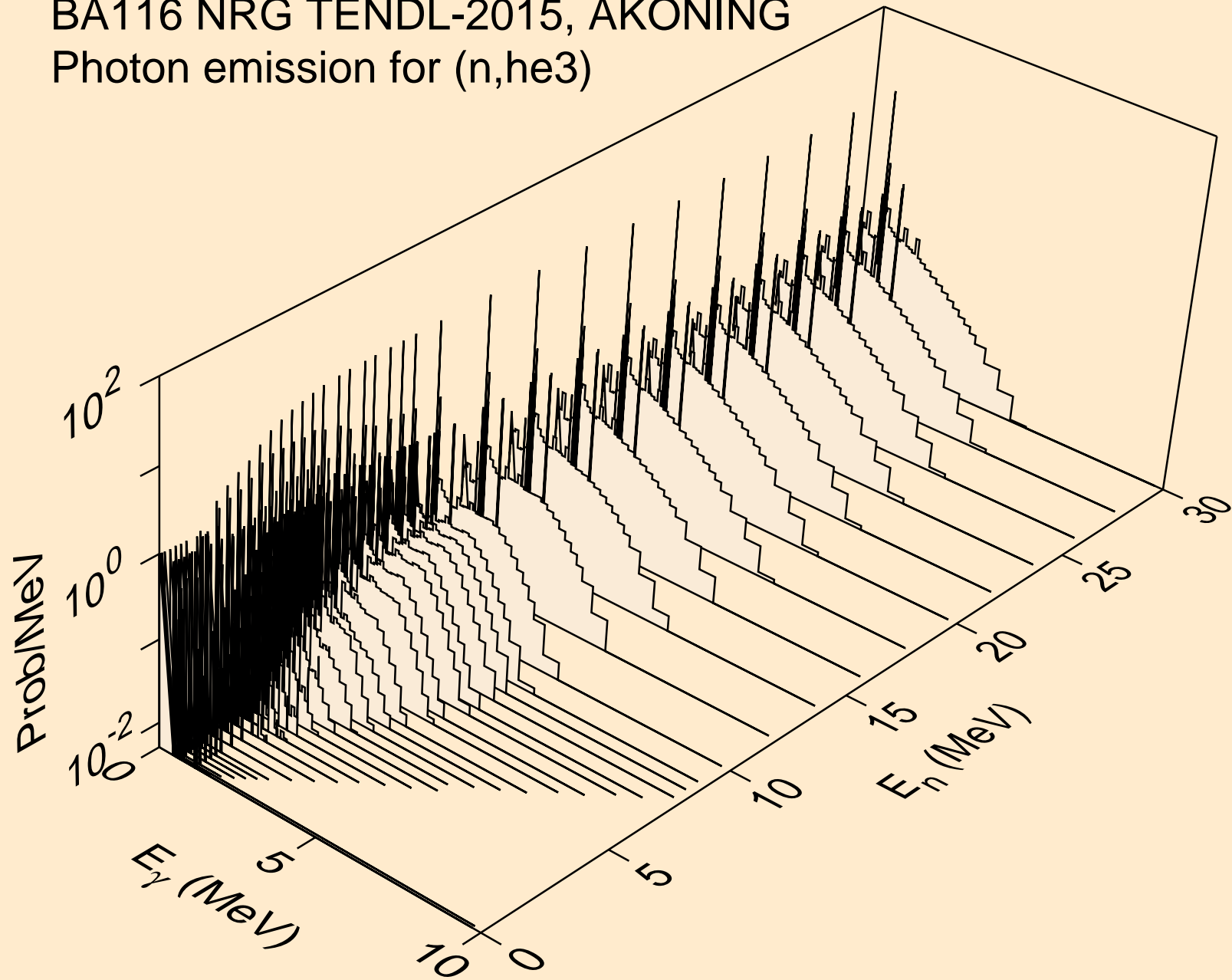

BA116 NRG TENDL-2015, AKONING
Photon emission for (n,a)

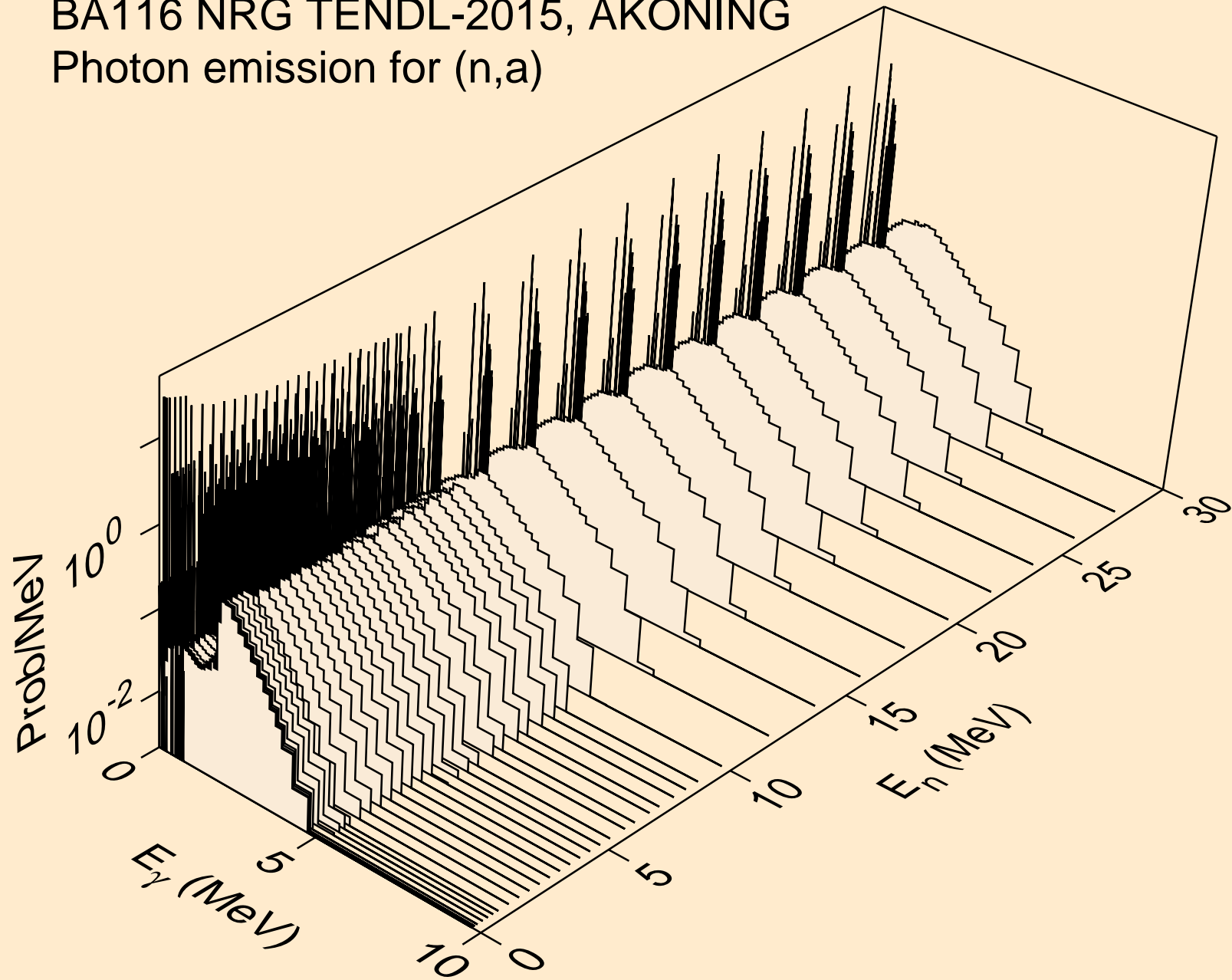

BA116 NRG TENDL-2015, AKONING
Photon emission for (n,2a)

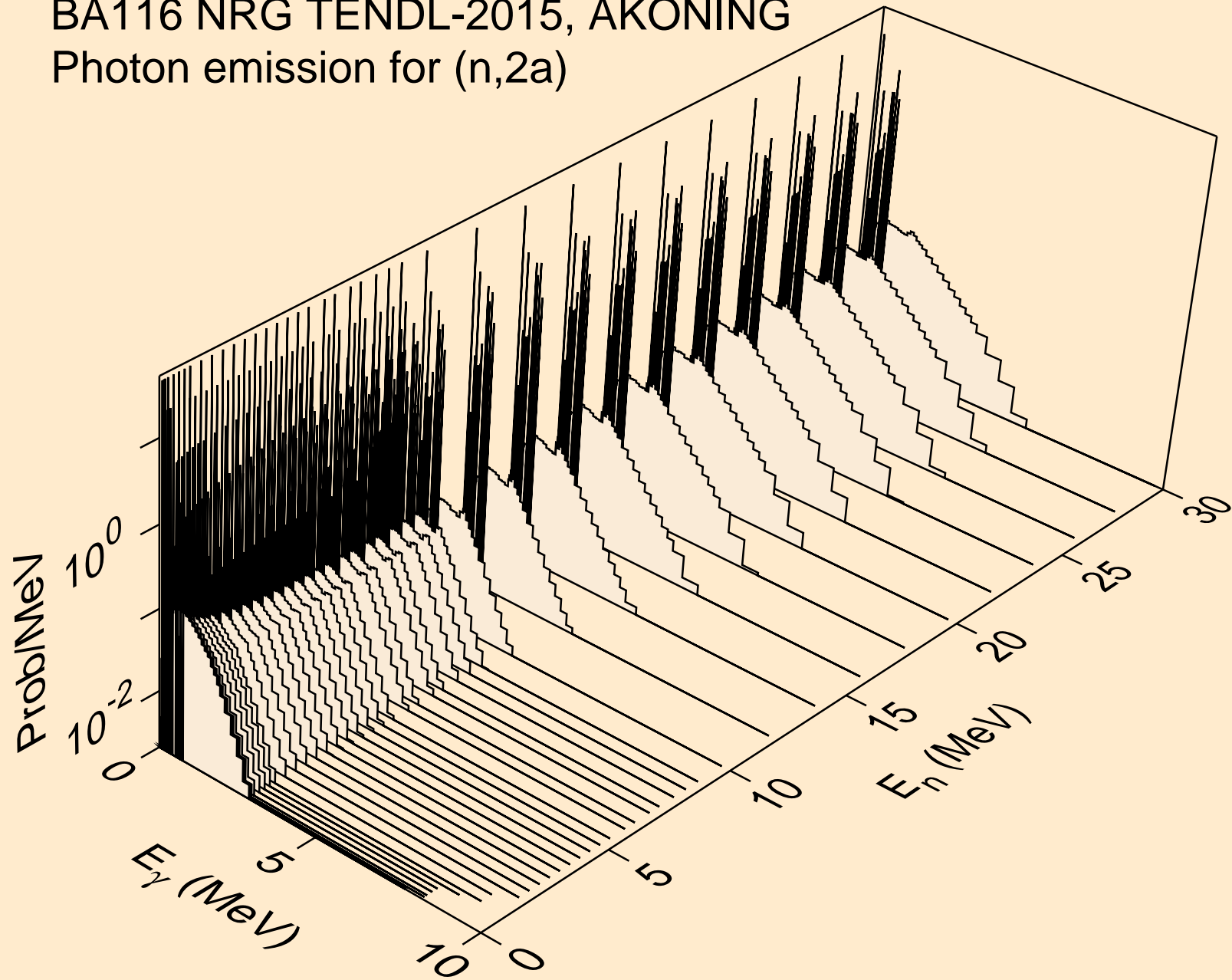

BA116 NRG TENDL-2015, AKONING
Photon emission for (n,3a)

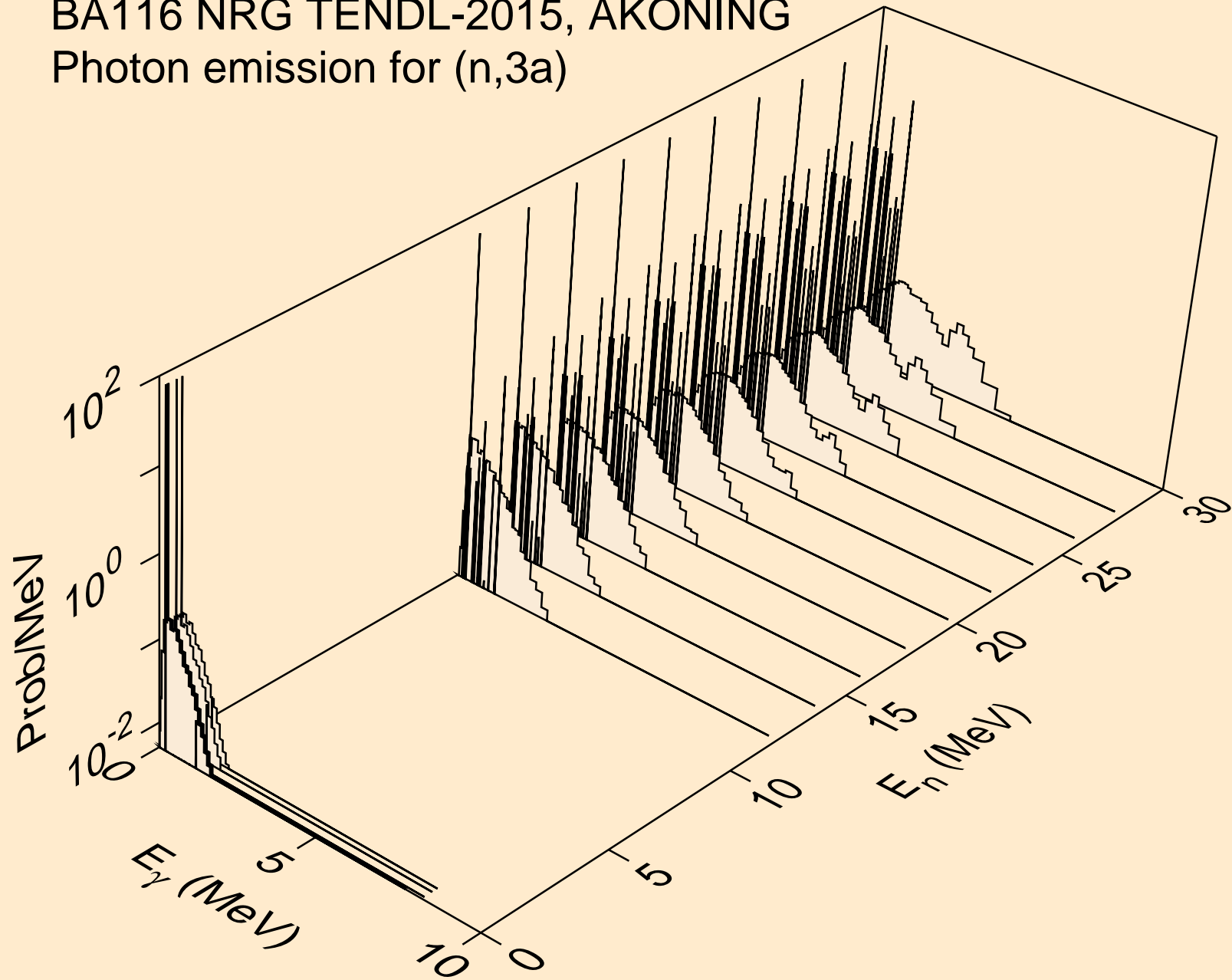

BA116 NRG TENDL-2015, AKONING
Photon emission for (n,2p)

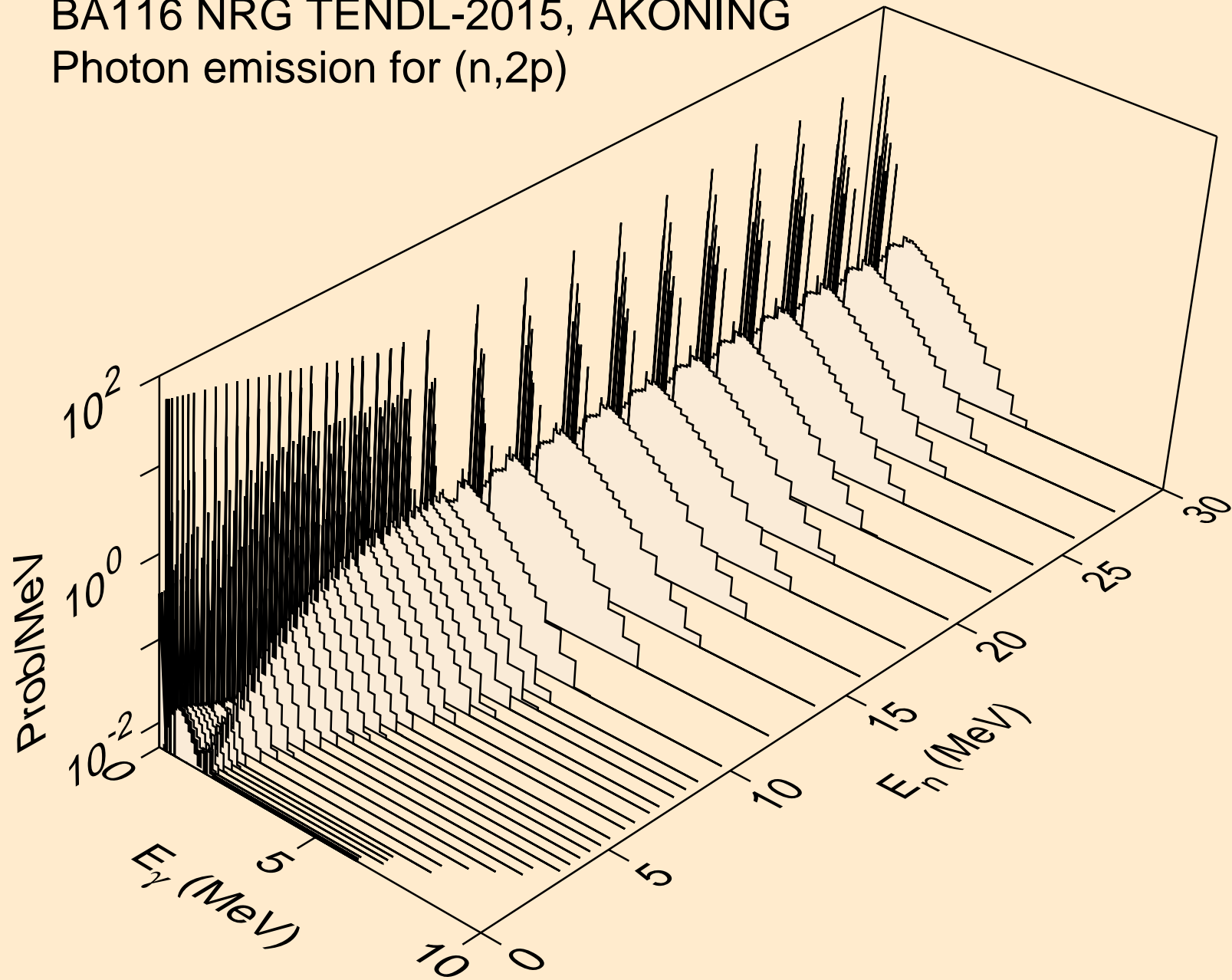

BA116 NRG TENDL-2015, AKONING
Photon emission for (n,p α)

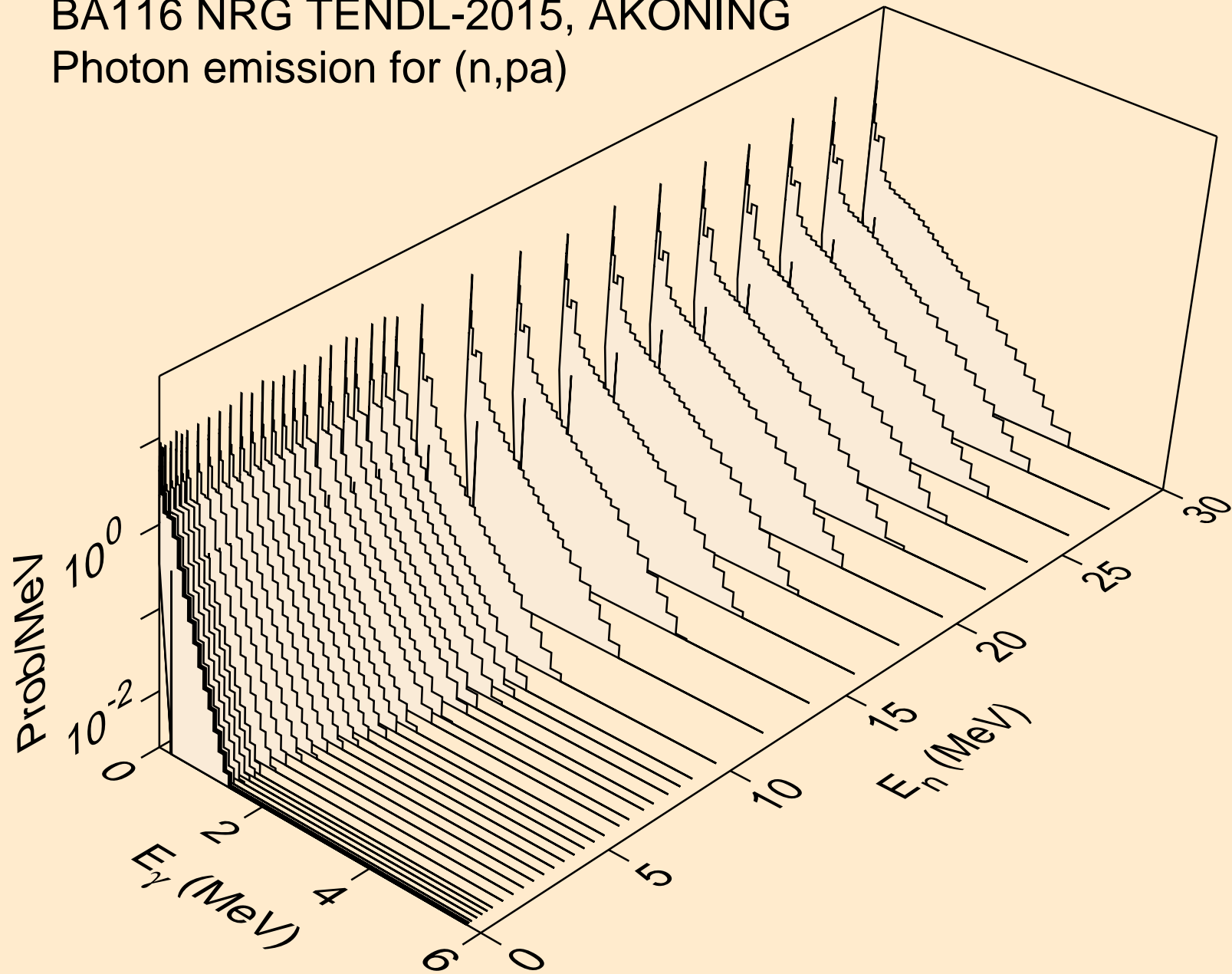

BA116 NRG TENDL-2015, AKONING
Photon emission for (n,t2a)

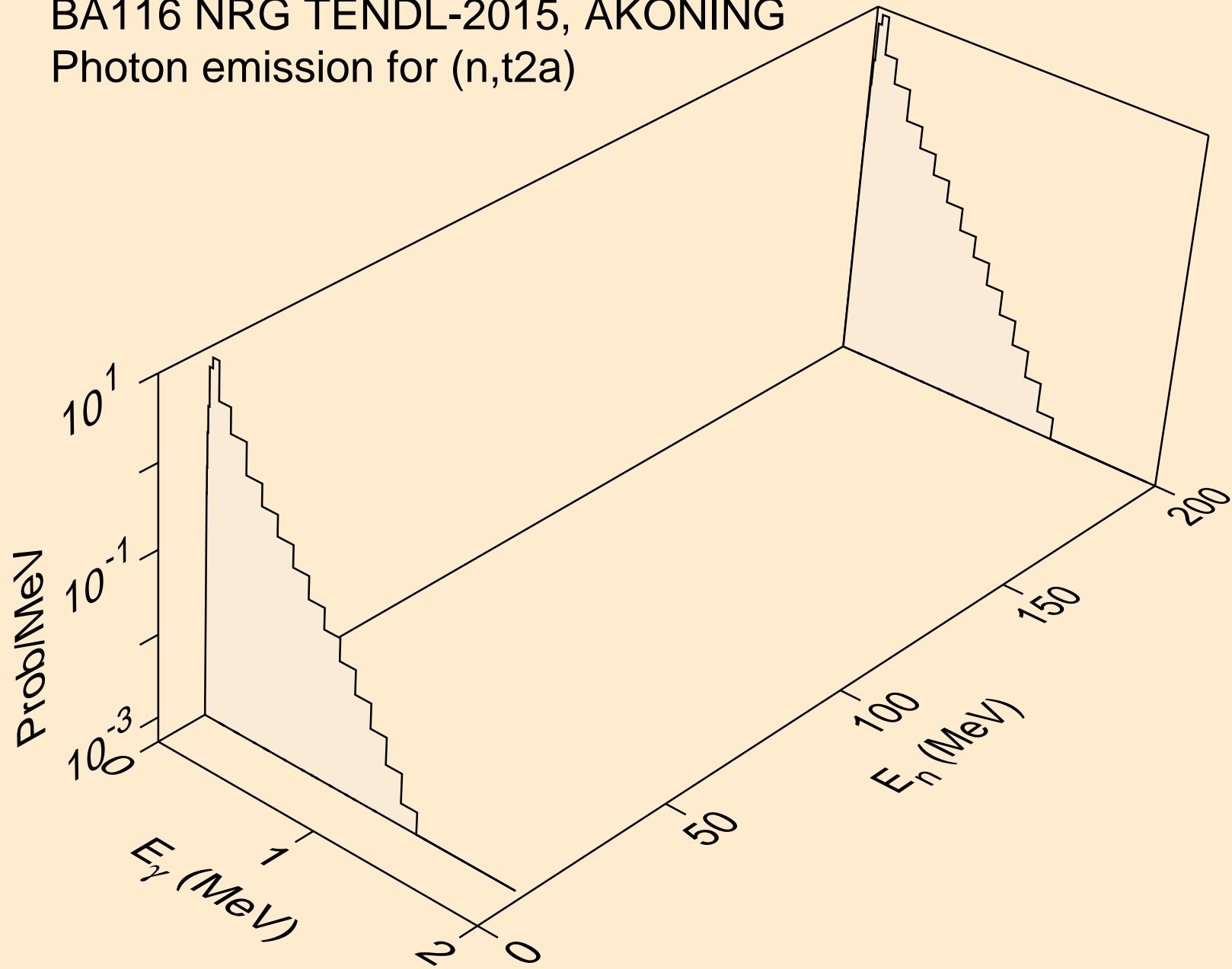

BA116 NRG TENDL-2015, AKONING
Photon emission for (n,d2a)

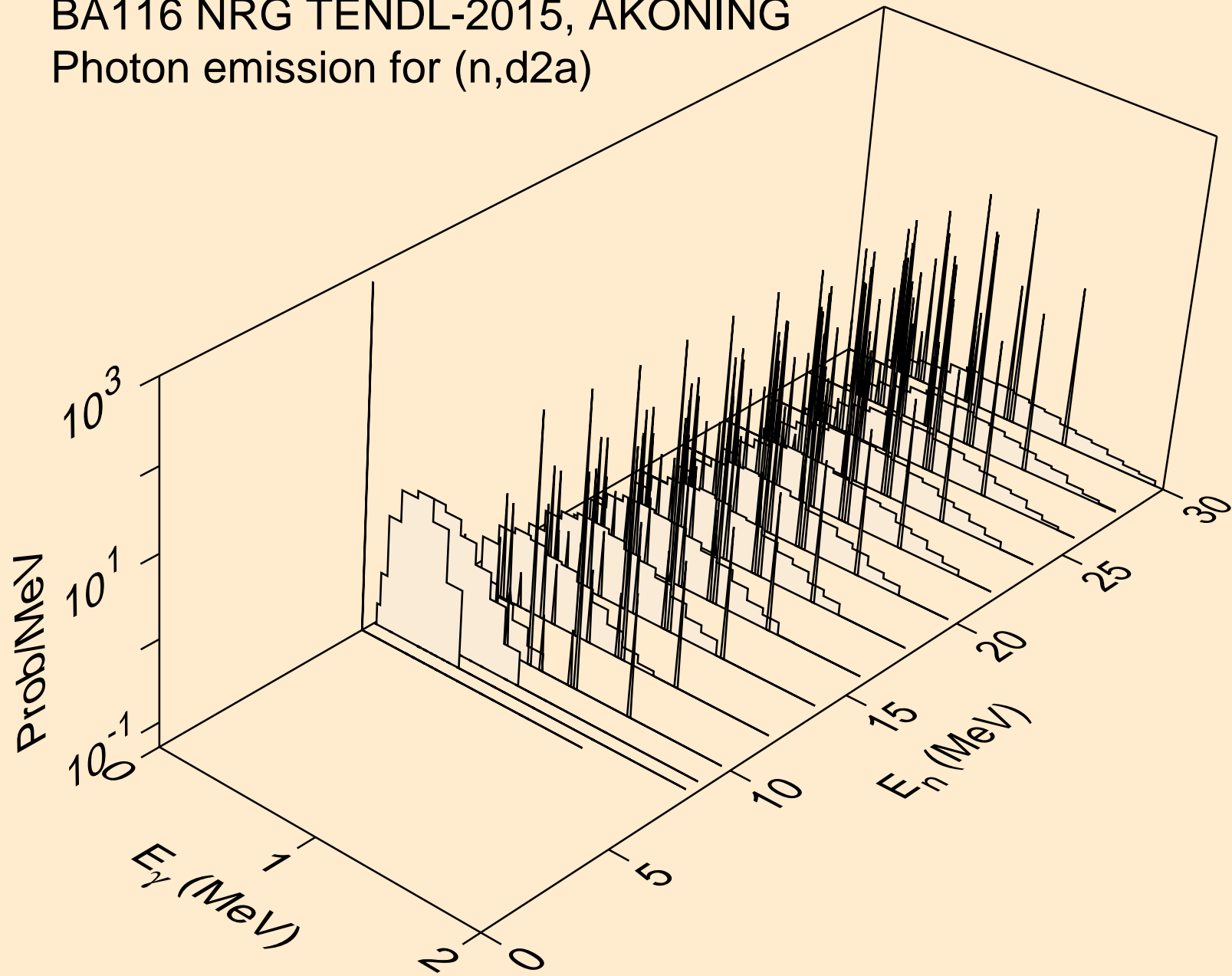

BA116 NRG TENDL-2015, AKONING
Photon emission for (n,pd)

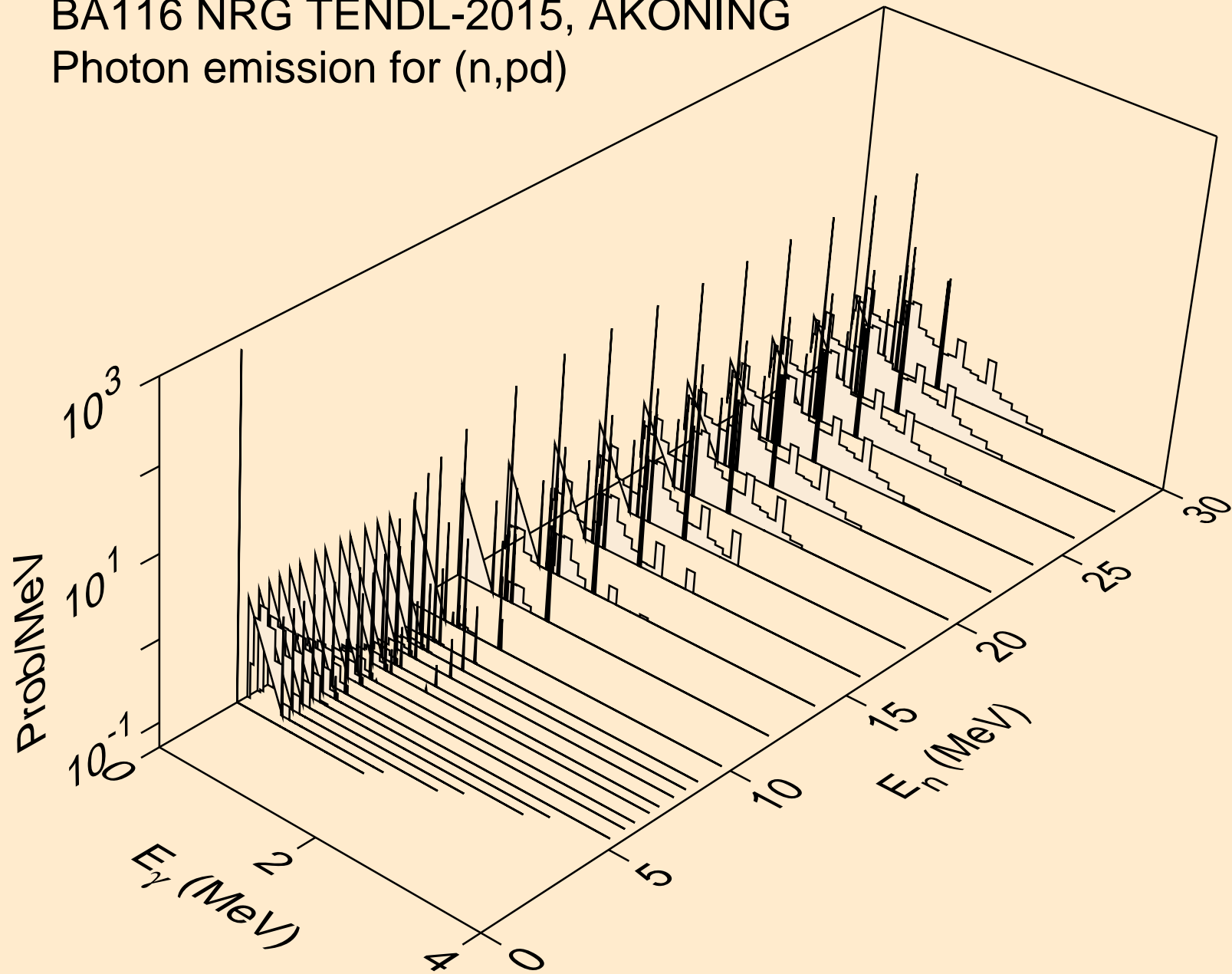

BA116 NRG TENDL-2015, AKONING
Photon emission for (n,pt)

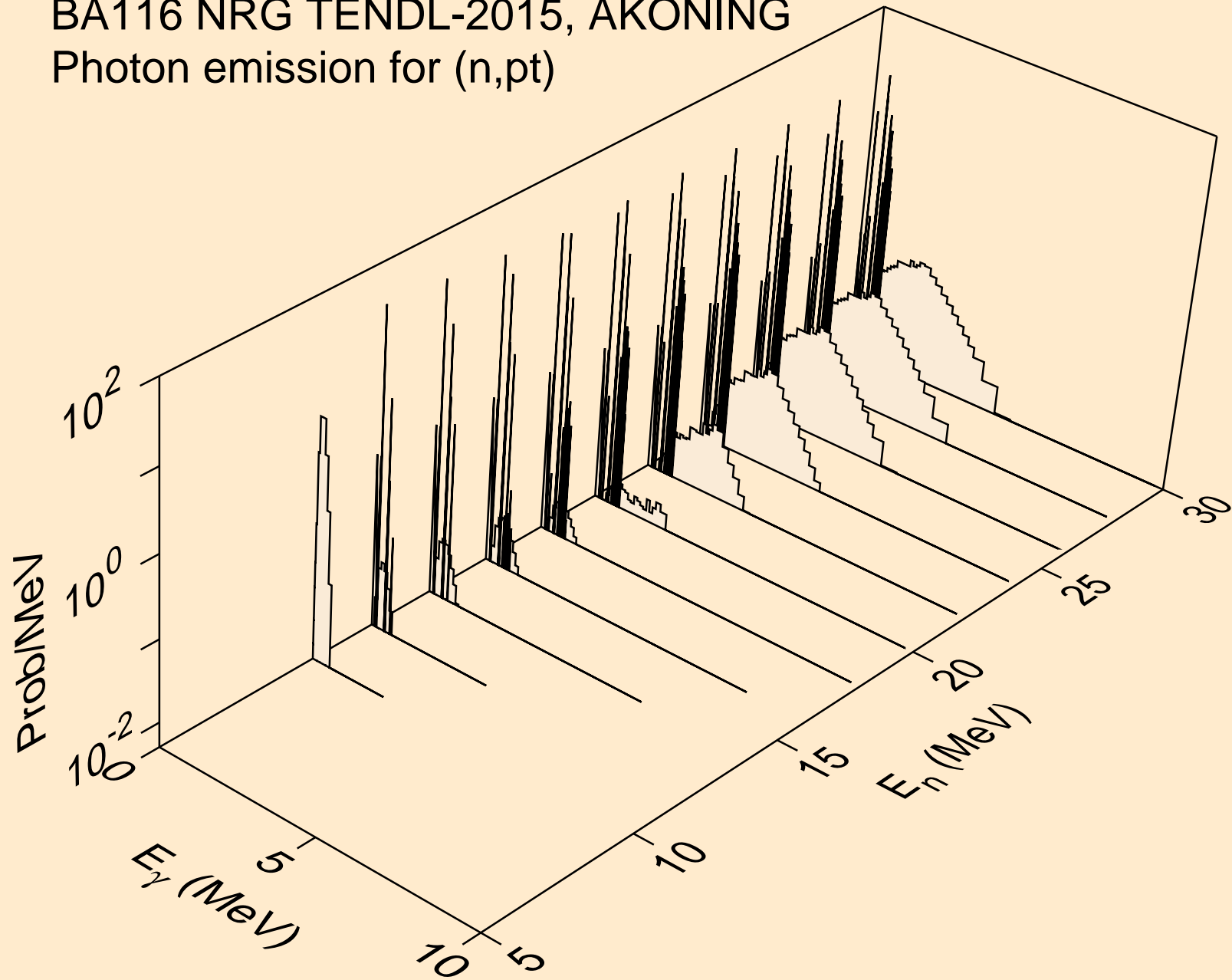

BA116 NRG TENDL-2015, AKONING
Photon emission for (n,da)

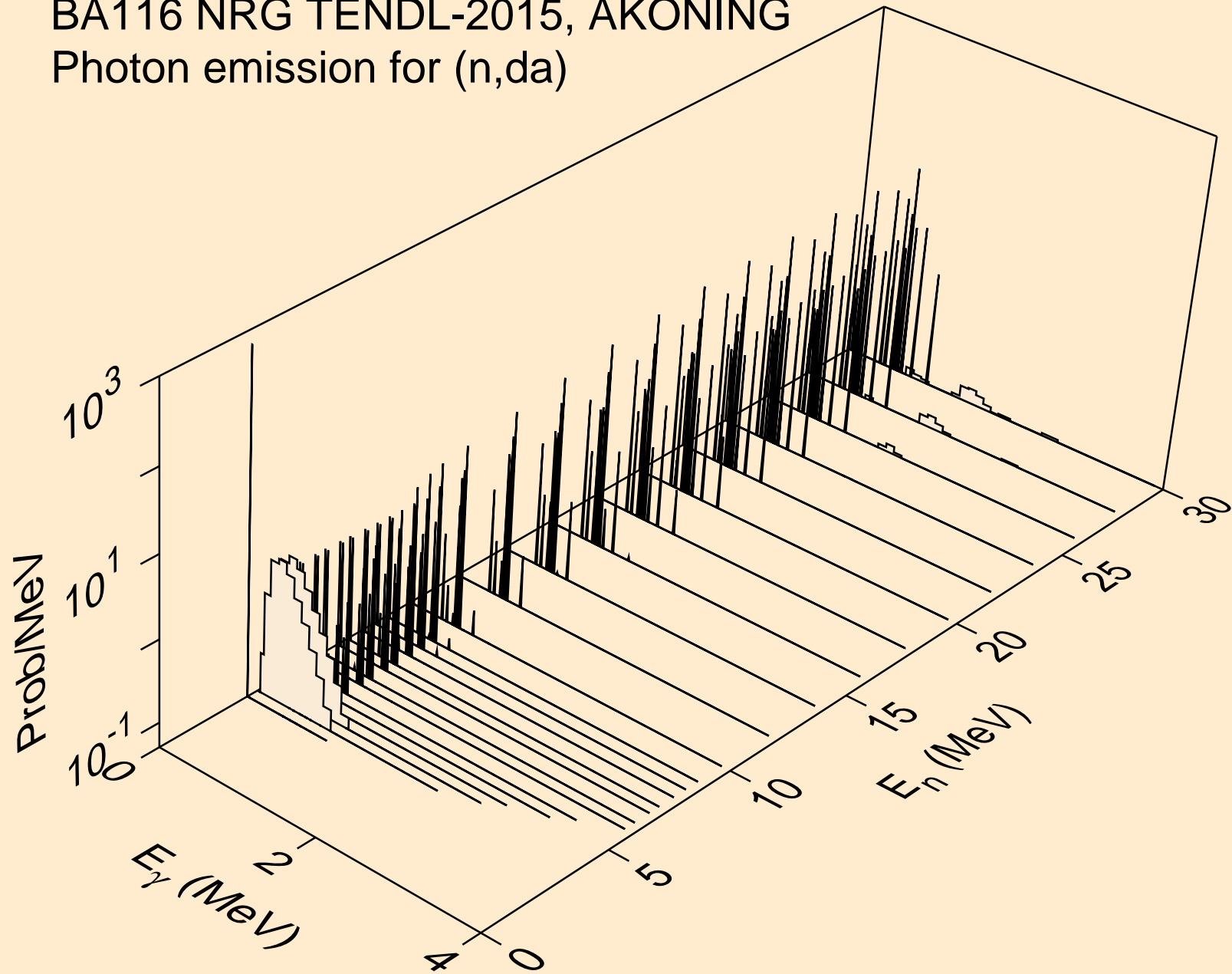

BA116 NRG TENDL-2015, AKONING
thermal capture photon spectrum

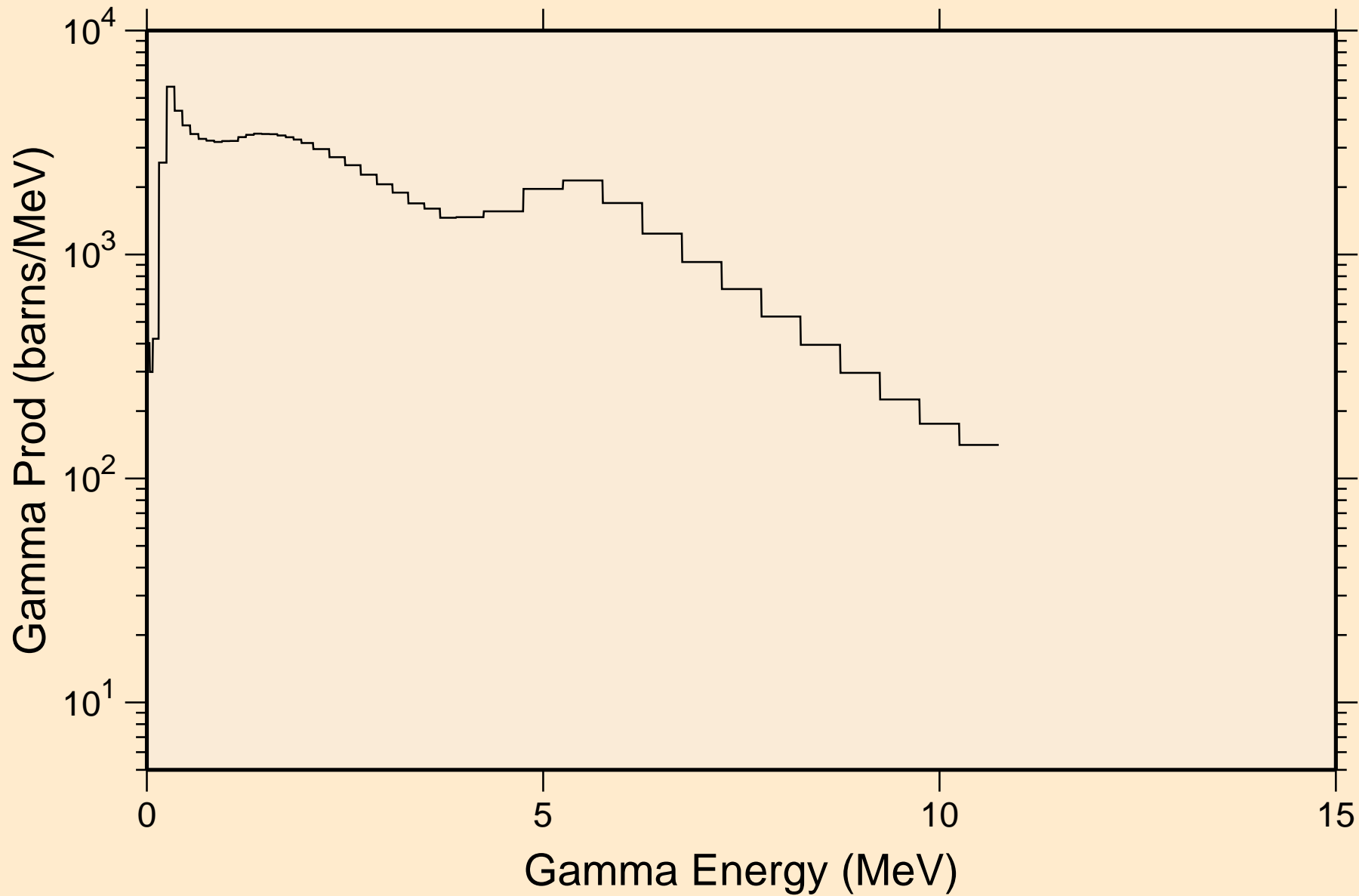

BA116 NRG TENDL-2015, AKONING
14 MeV photon spectrum

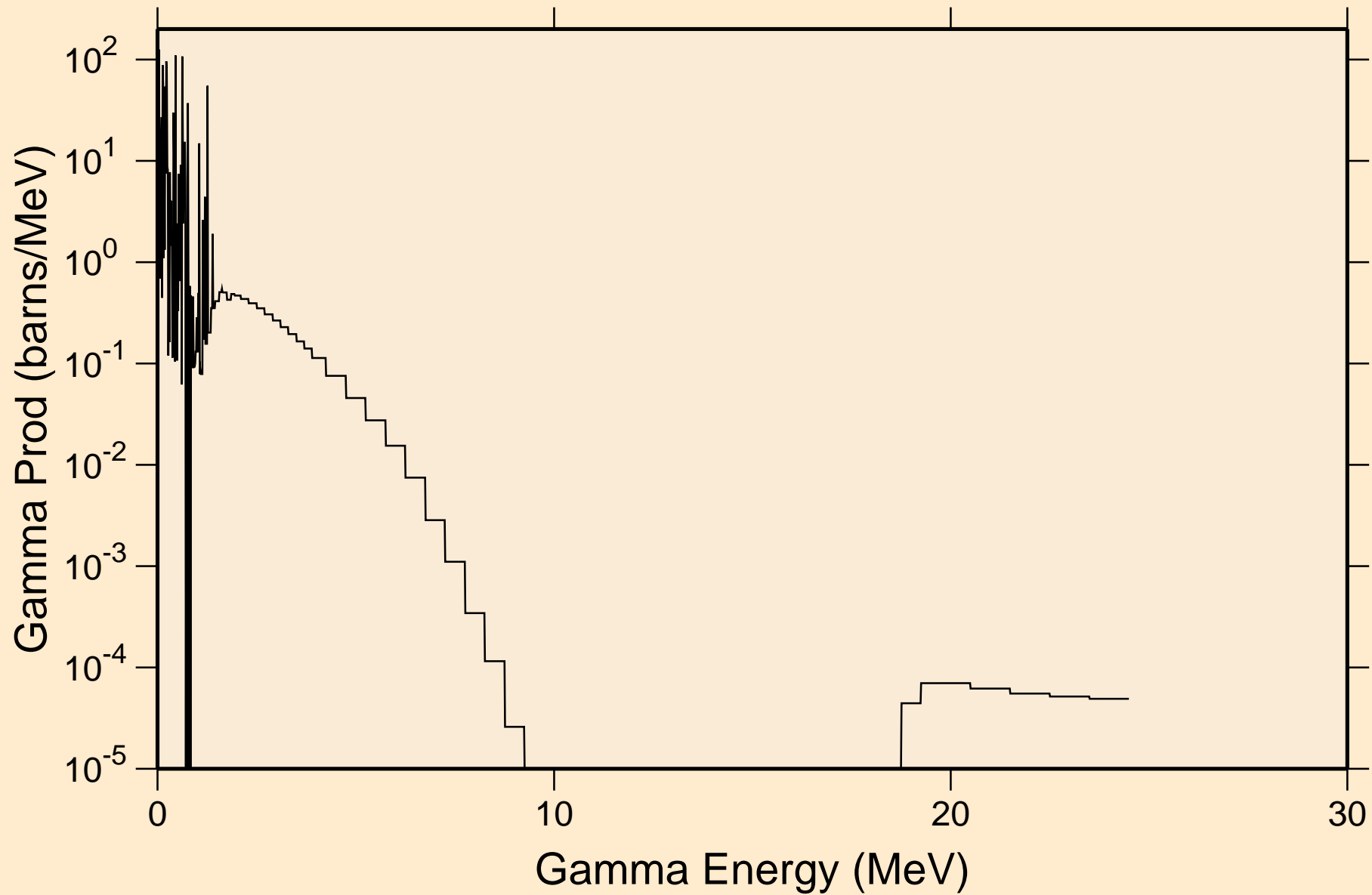

BA116 NRG TENDL-2015, AKONING

Particle heating contributions

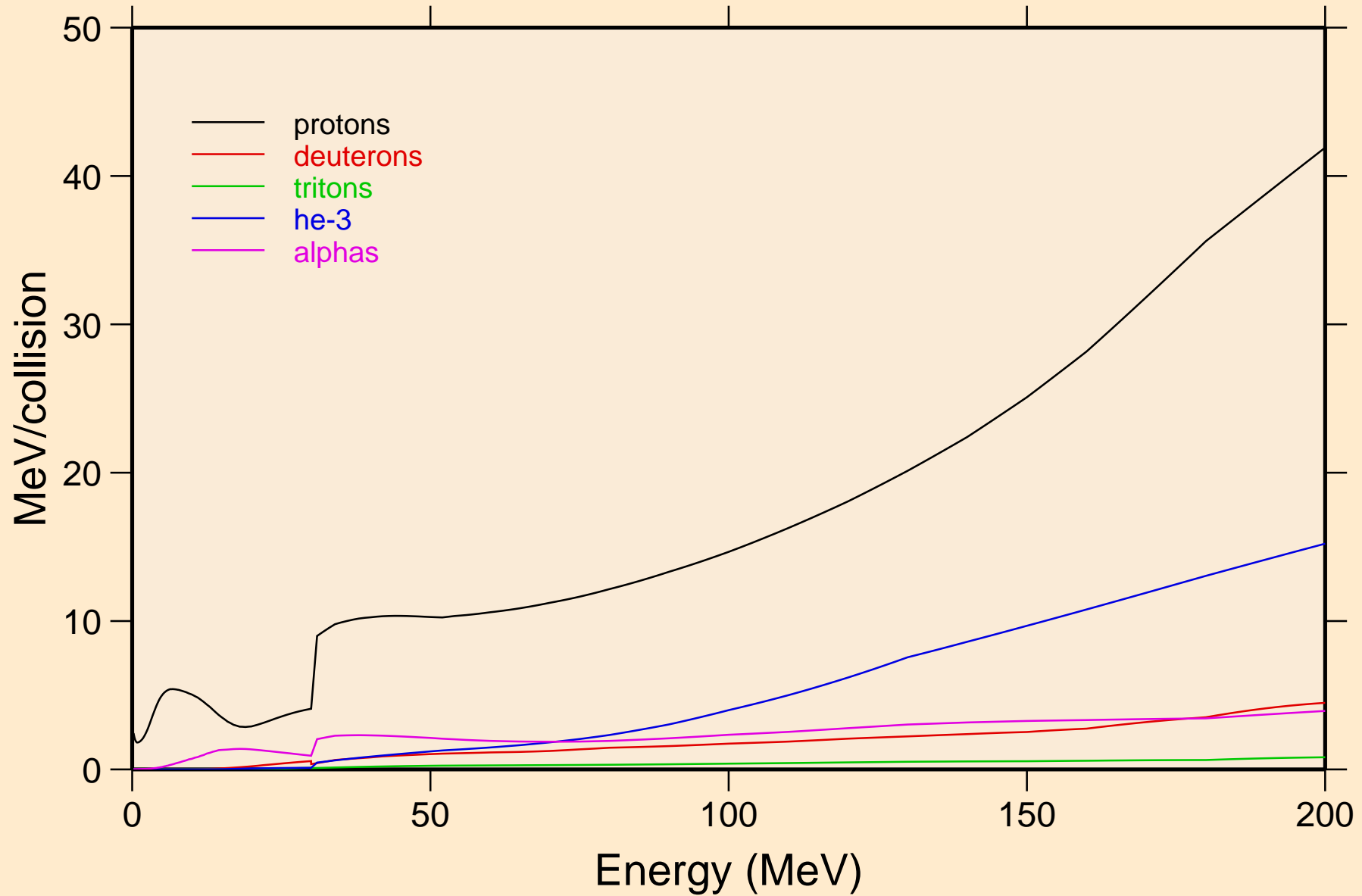

BA116 NRG TENDL-2015, AKONING

Recoil Heating

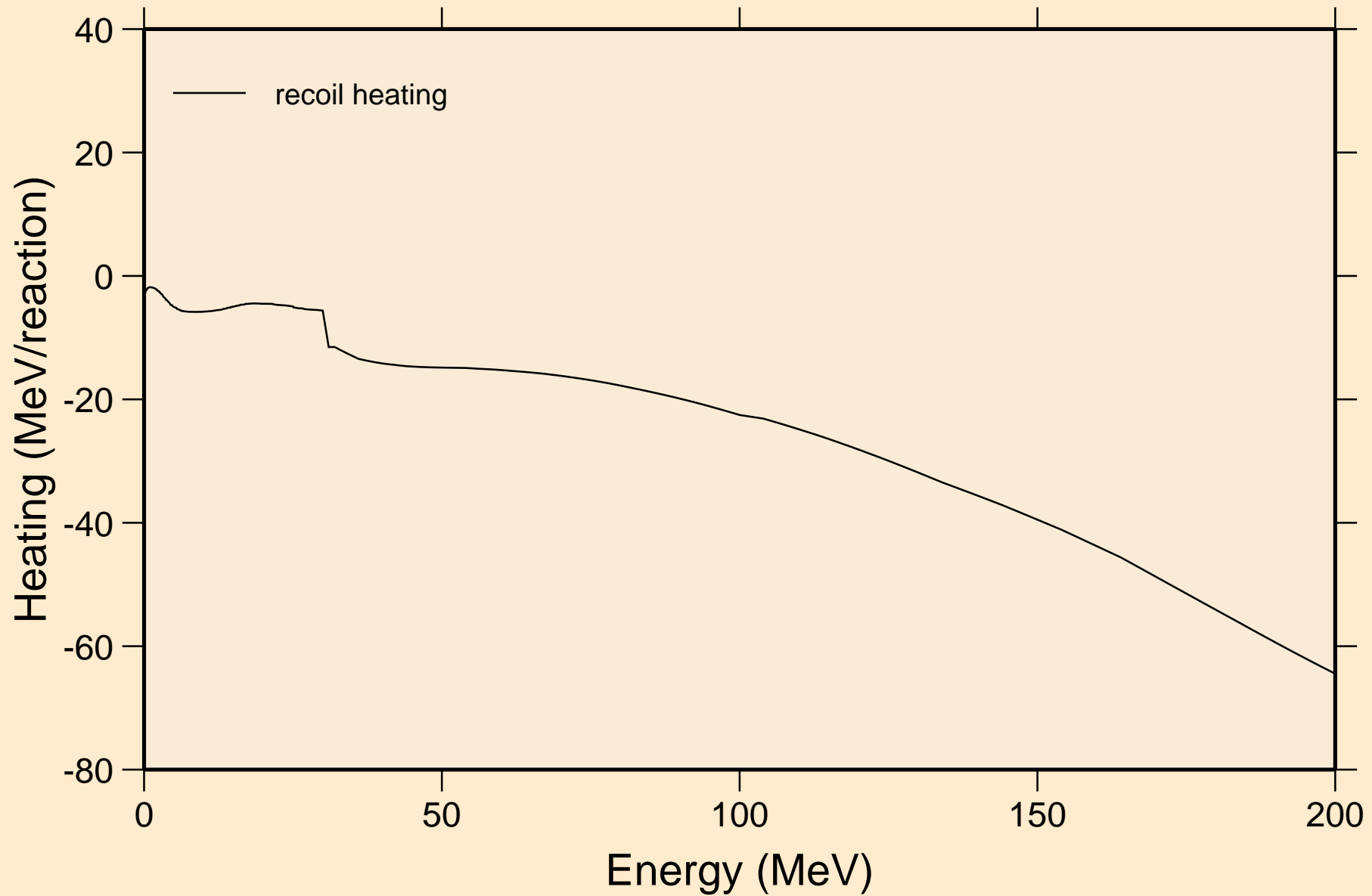

BA116 NRG TENDL-2015, AKONING

Particle production cross sections

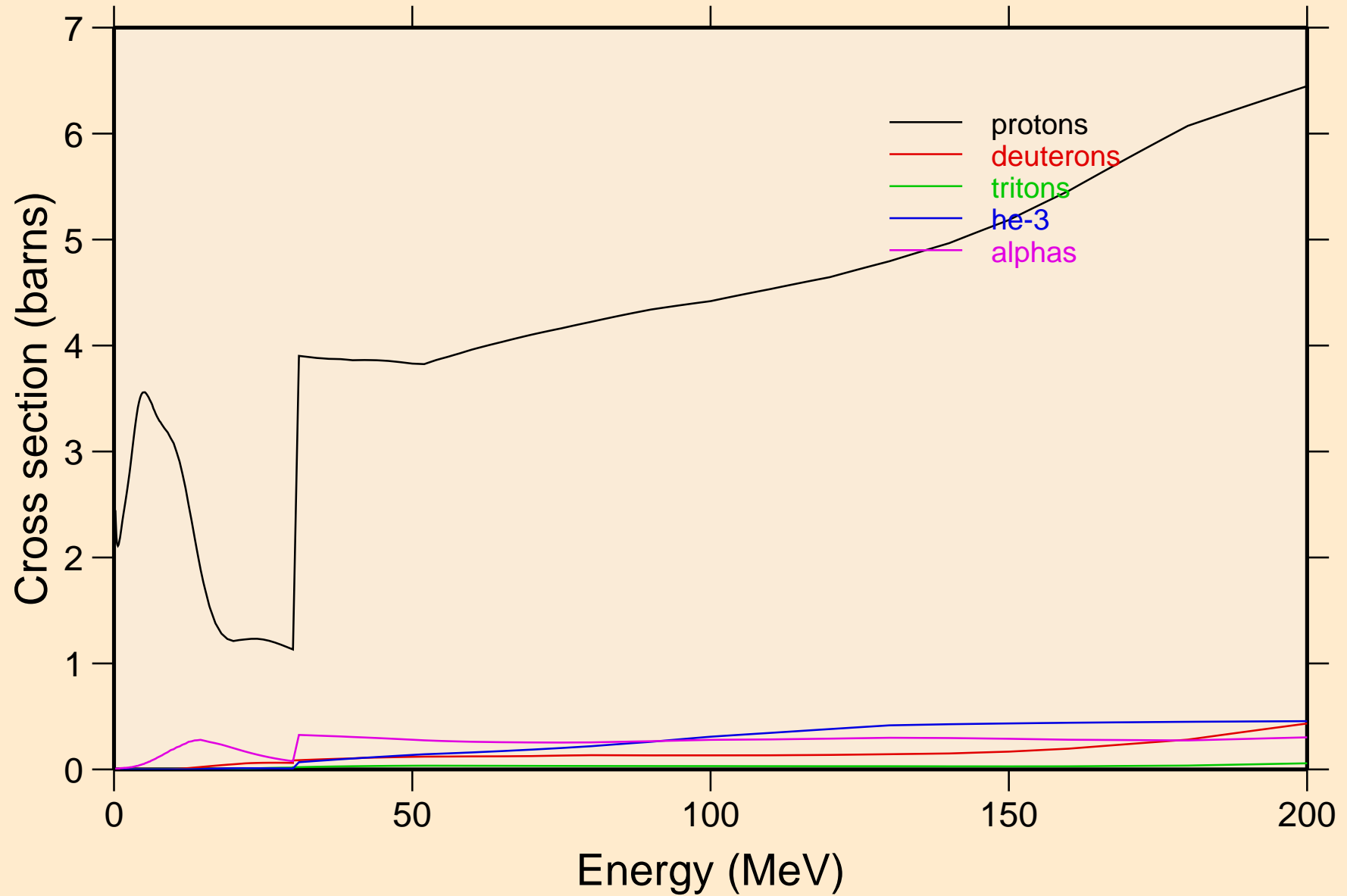

BA116 NRG TENDL-2015, AKONING
protons from (n,x)

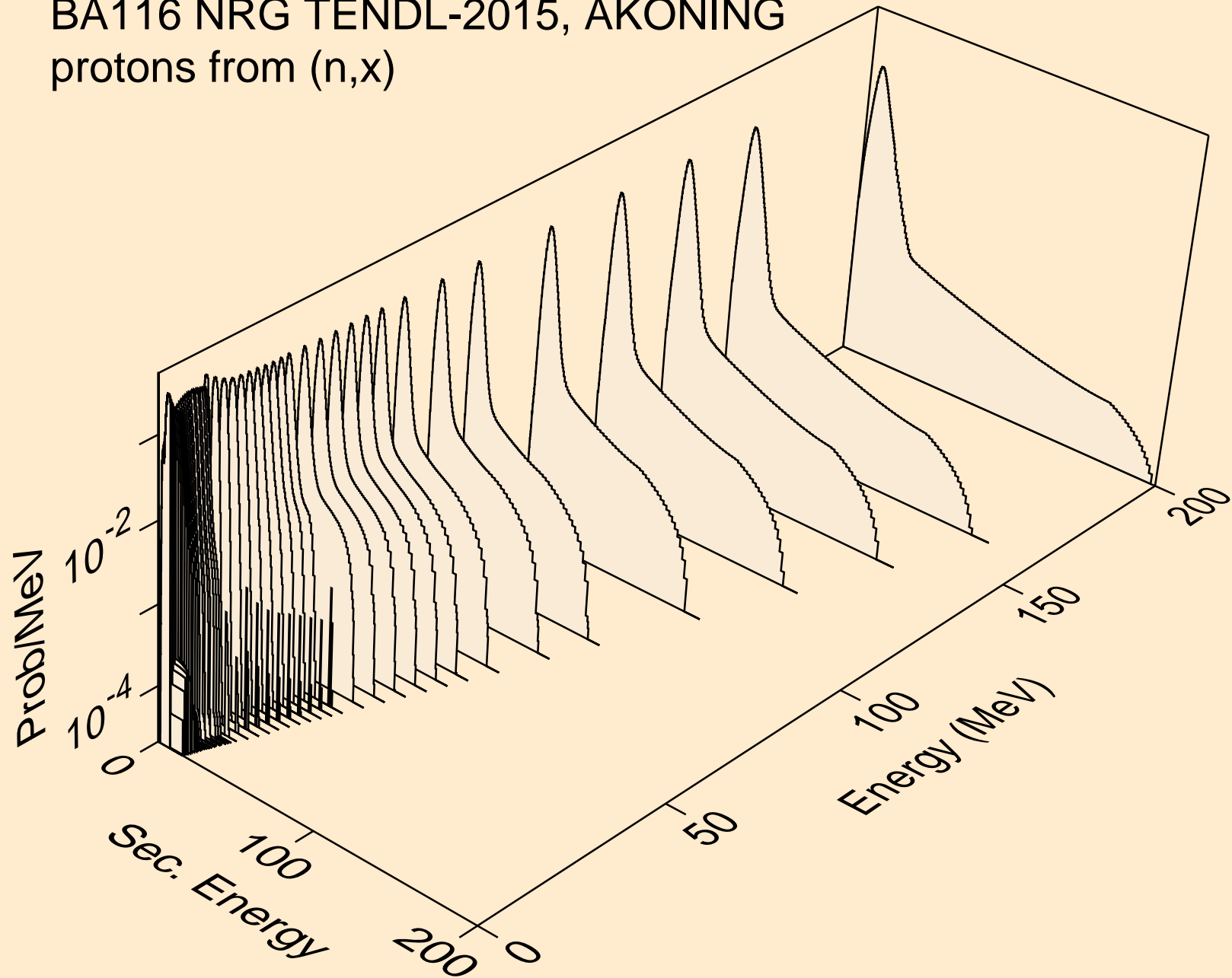

BA116 NRG TENDL-2015, AKONING
protons from (n,n*)p

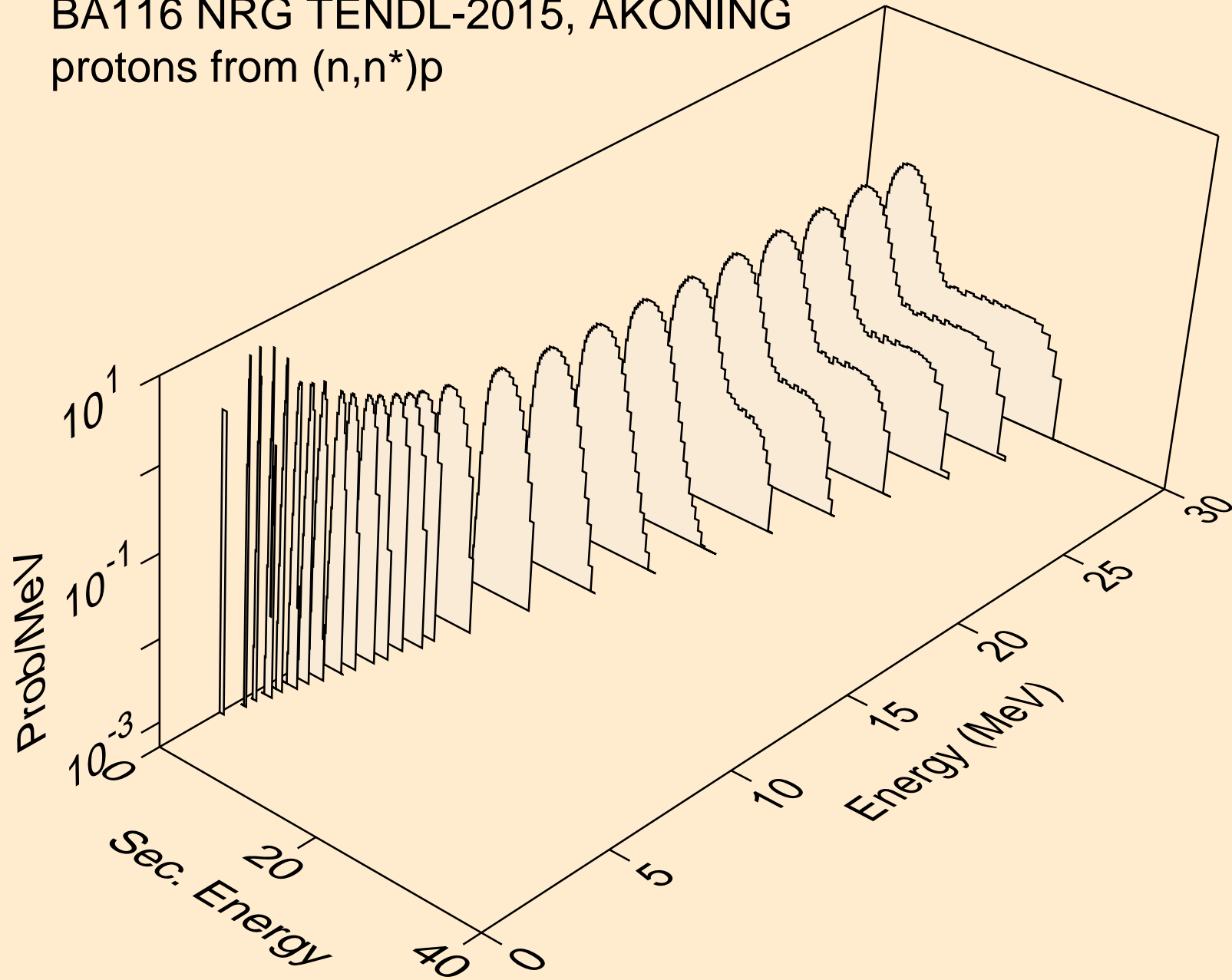

BA116 NRG TENDL-2015, AKONING
protons from (n,2np)

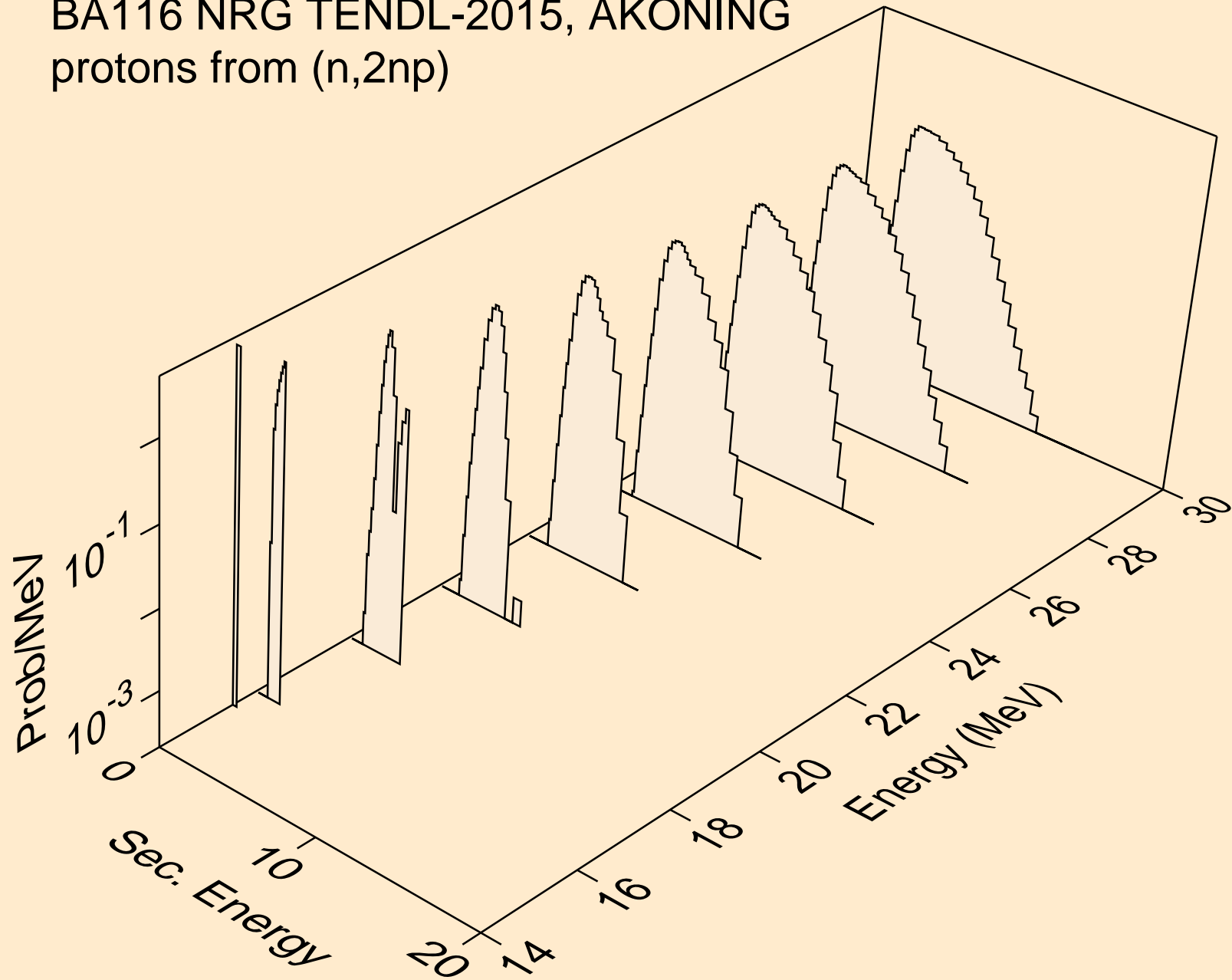

BA116 NRG TENDL-2015, AKONING
protons from (n,3np)

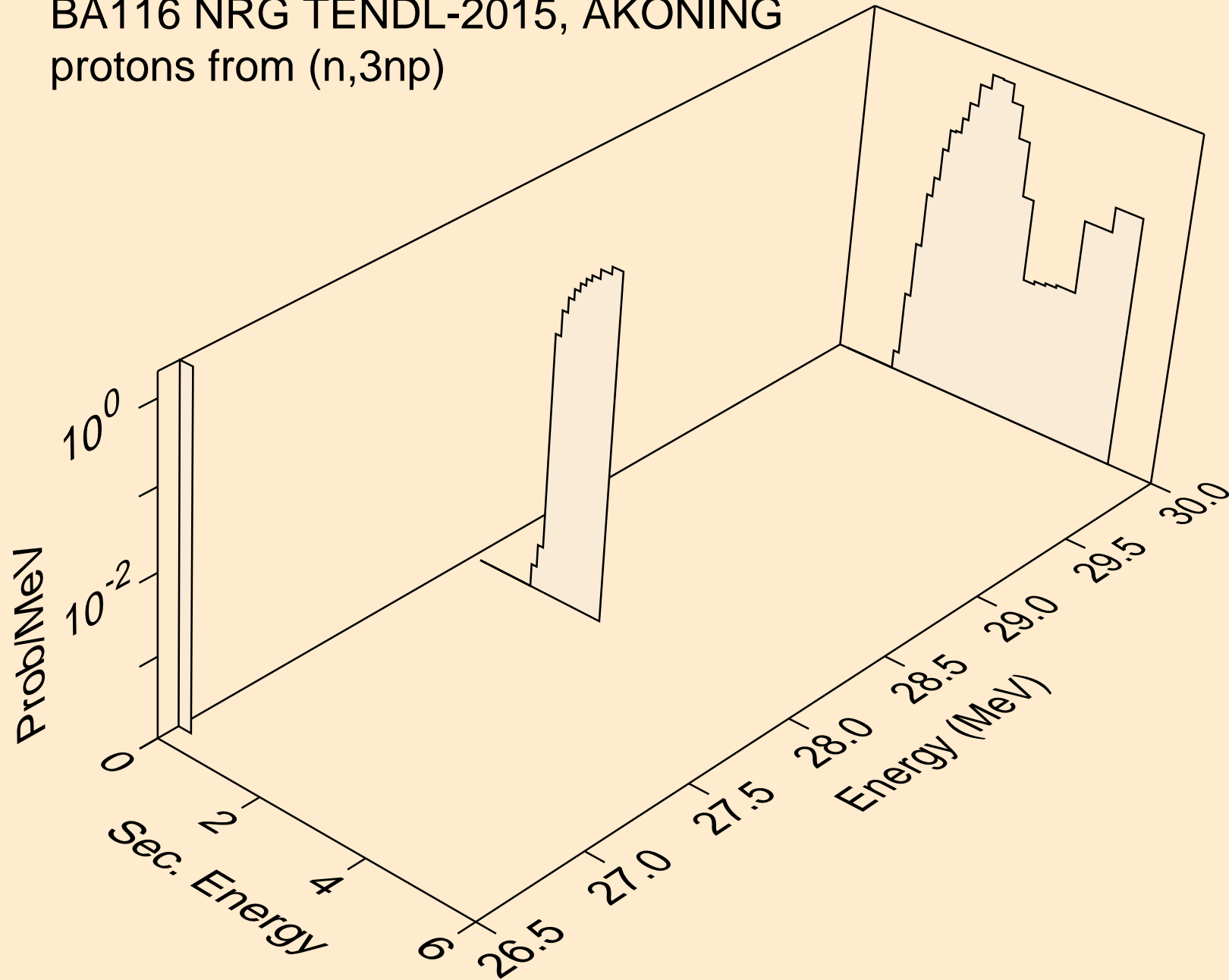

BA116 NRG TENDL-2015, AKONING
protons from (n,2np)

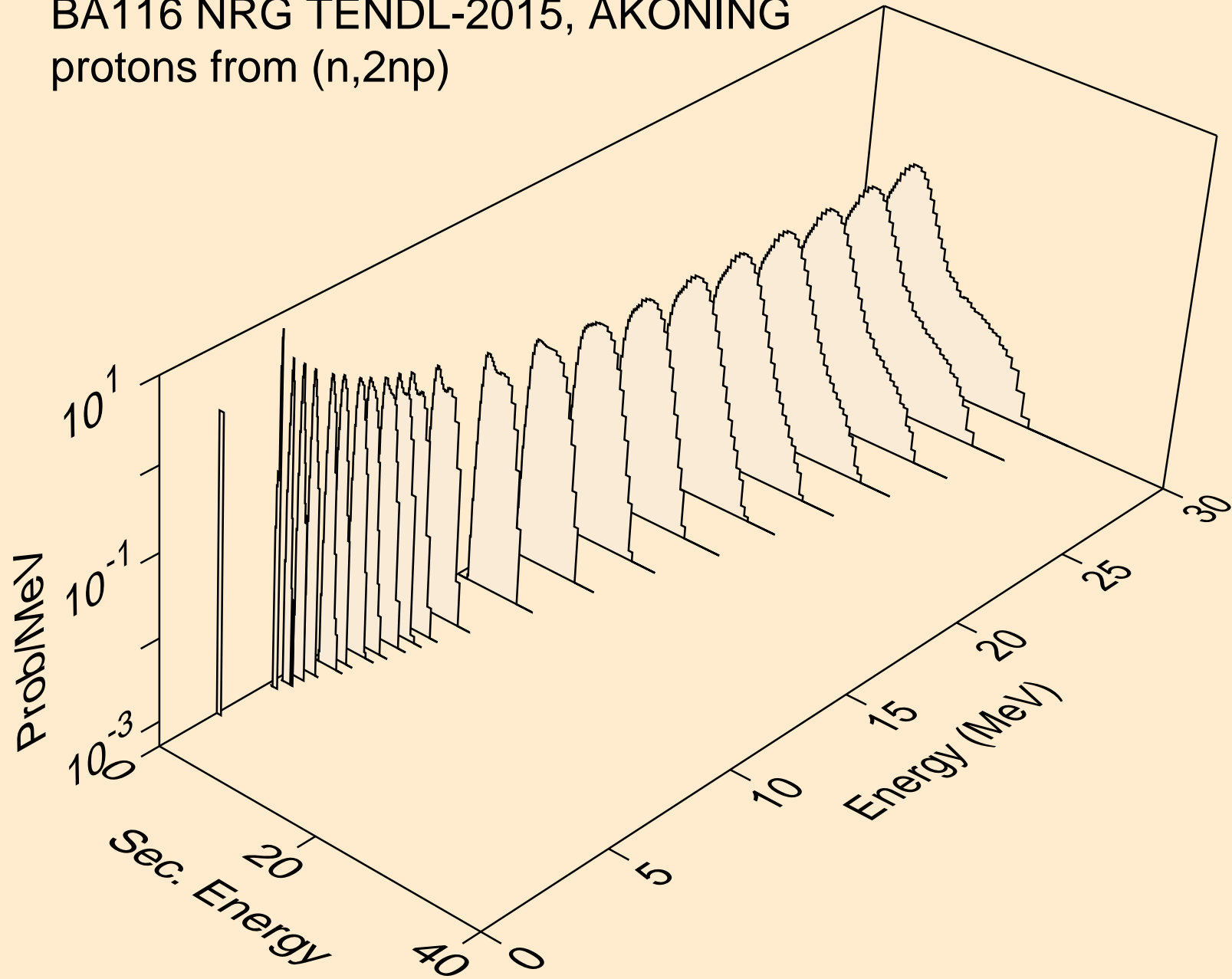

BA116 NRG TENDL-2015, AKONING
protons from (n,npa)

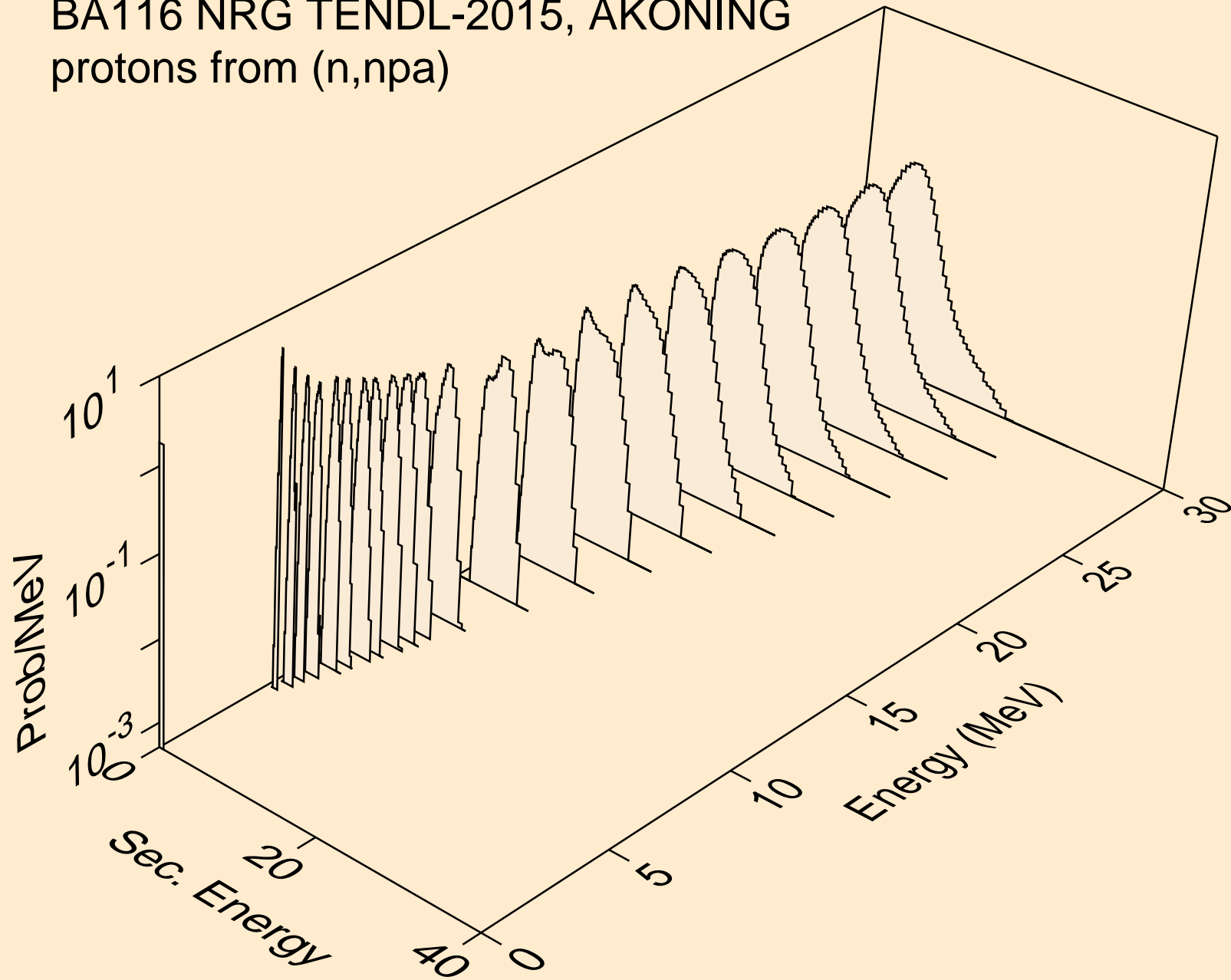

BA116 NRG TENDL-2015, AKONING
protons from (n,p)

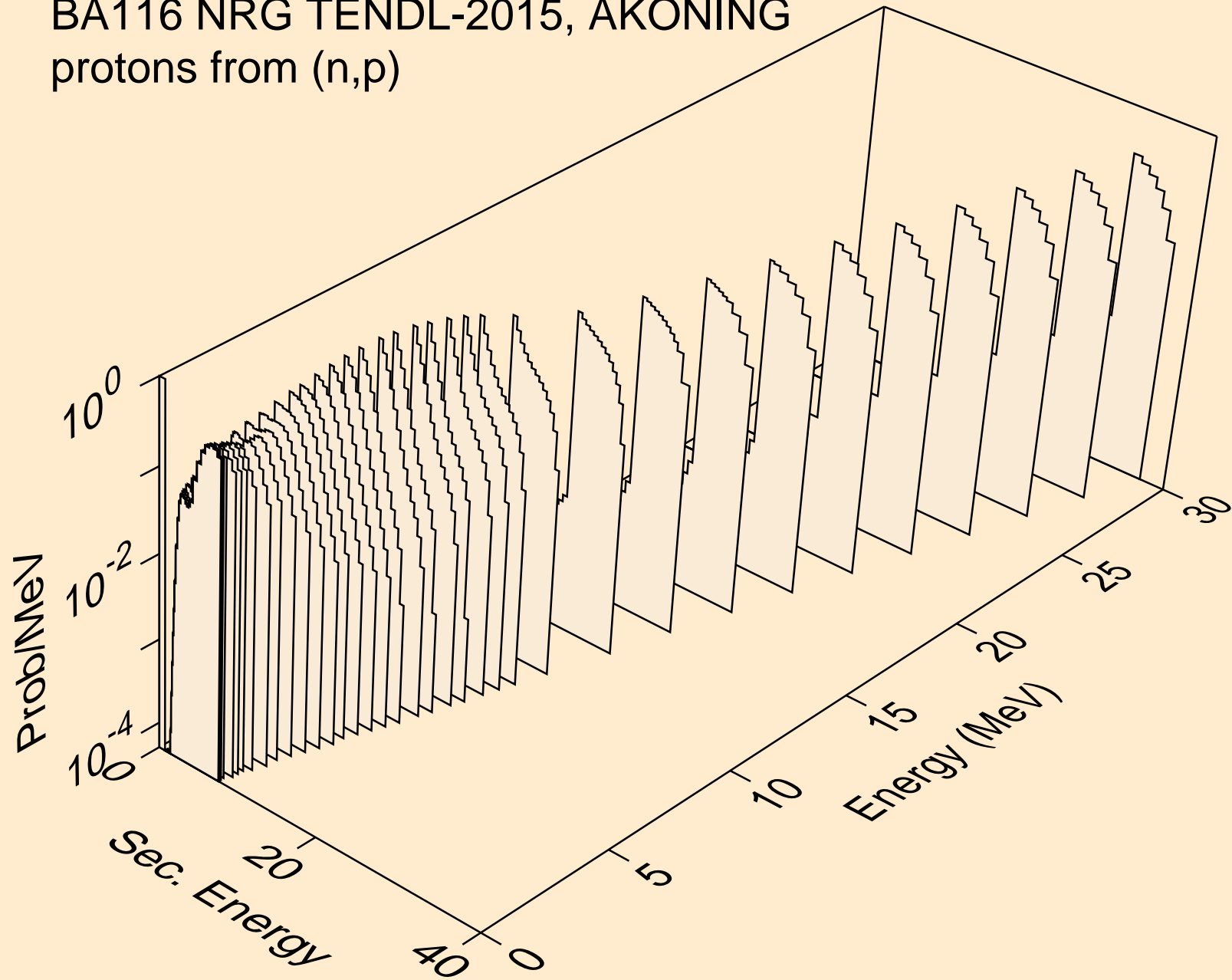

BA116 NRG TENDL-2015, AKONING
protons from (n,2p)

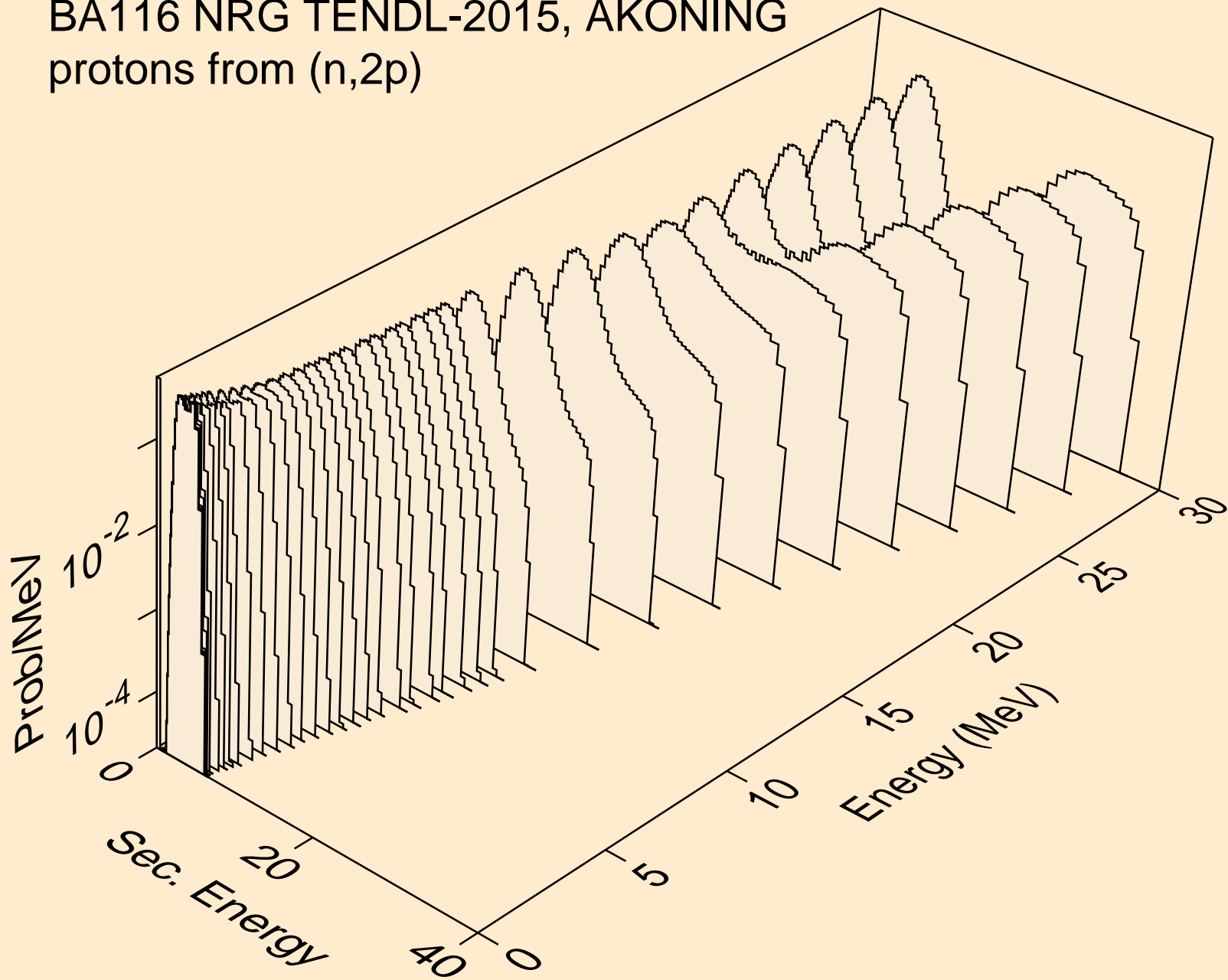

BA116 NRG TENDL-2015, AKONING
protons from (n,pa)

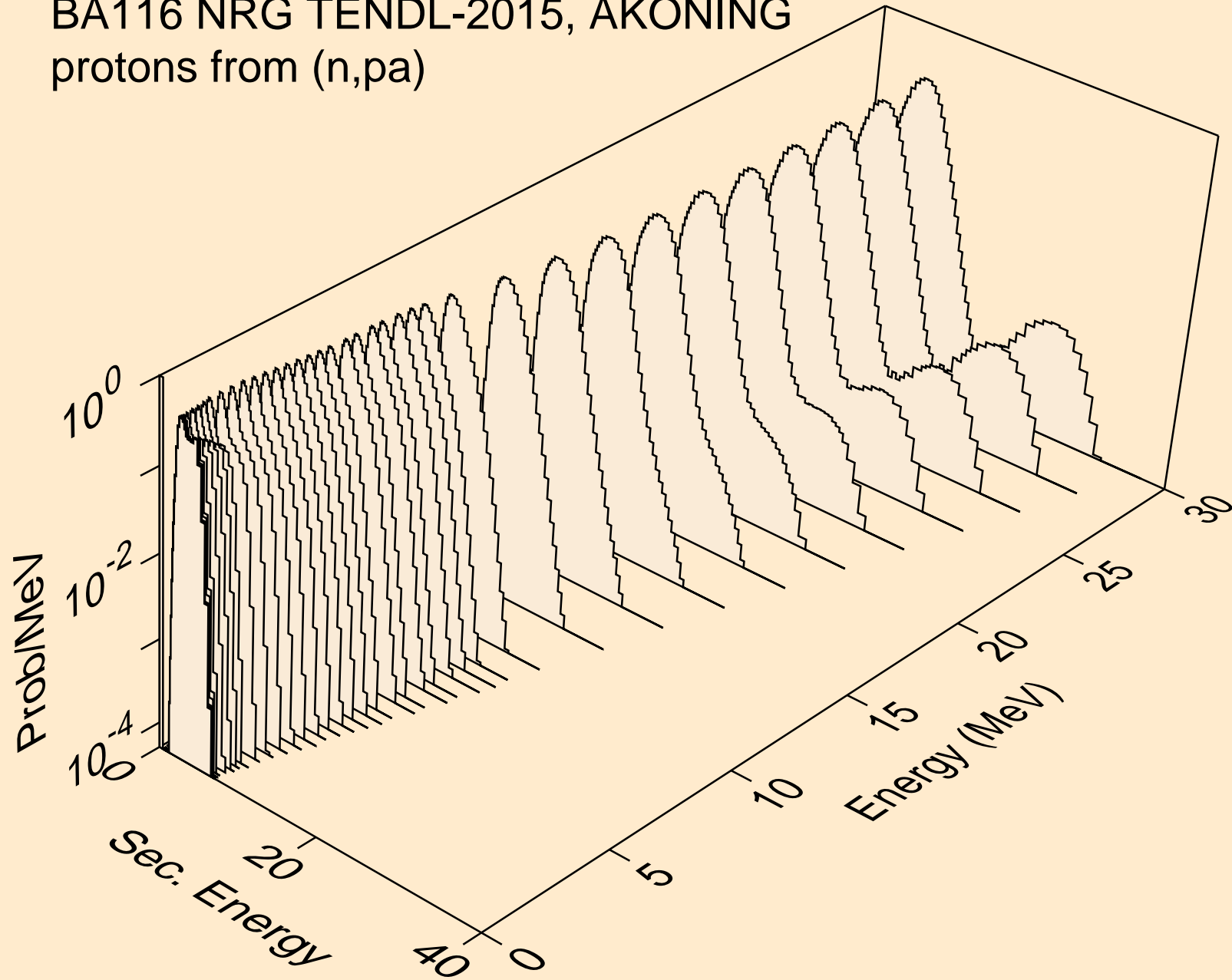

BA116 NRG TENDL-2015, AKONING
protons from (n,pd)

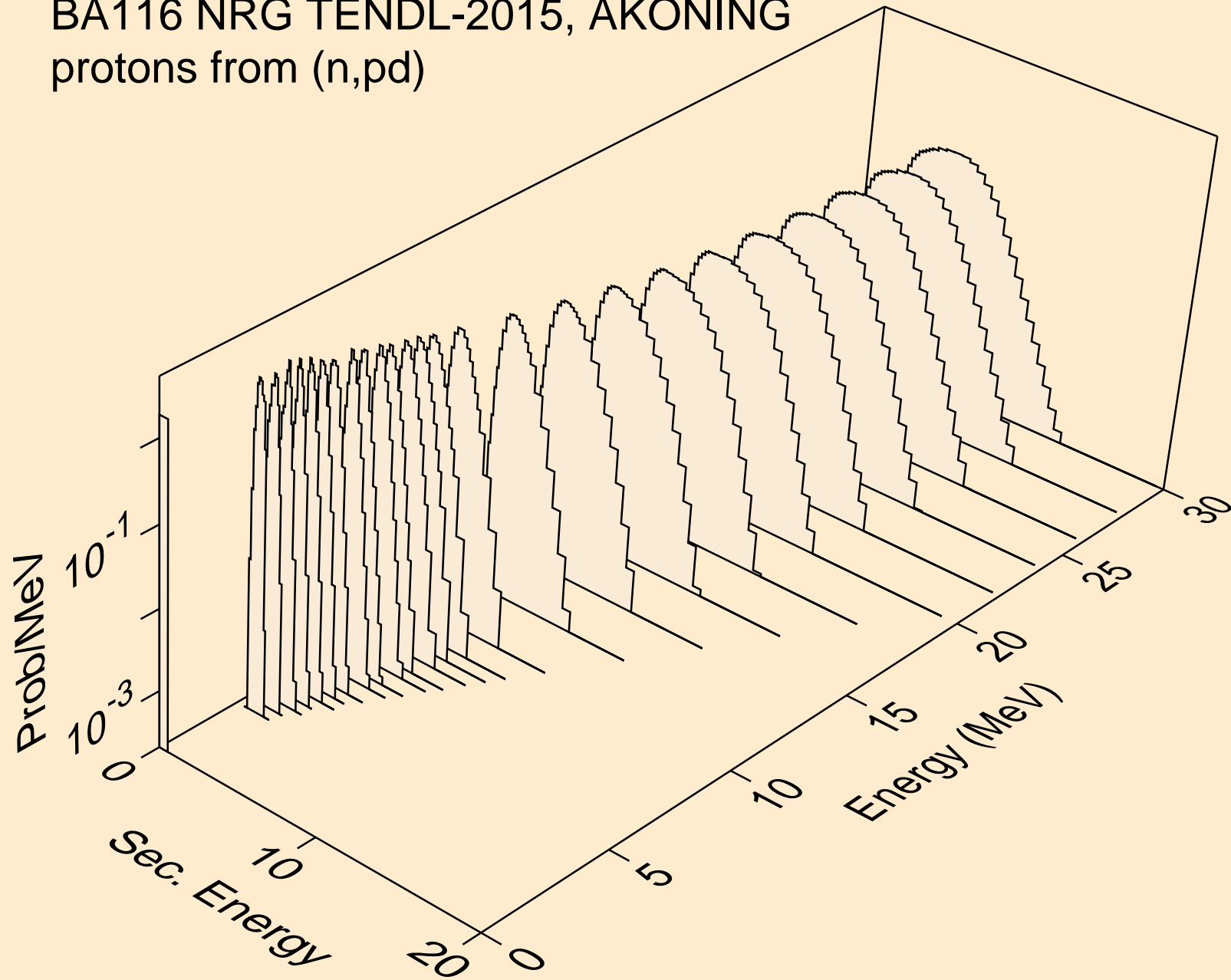

BA116 NRG TENDL-2015, AKONING
protons from (n,pt)

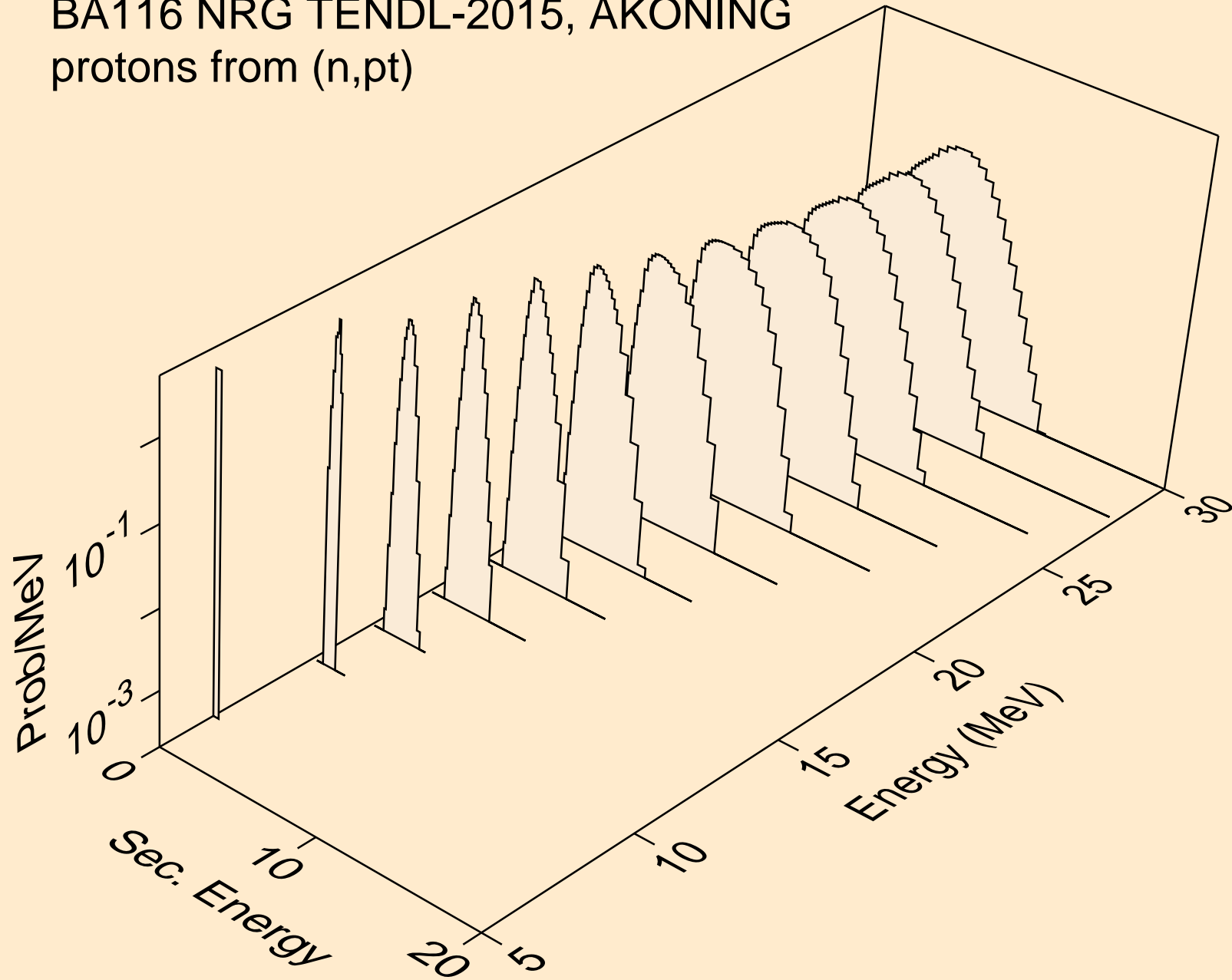

BA116 NRG TENDL-2015, AKONING
deuterons from (n,x)

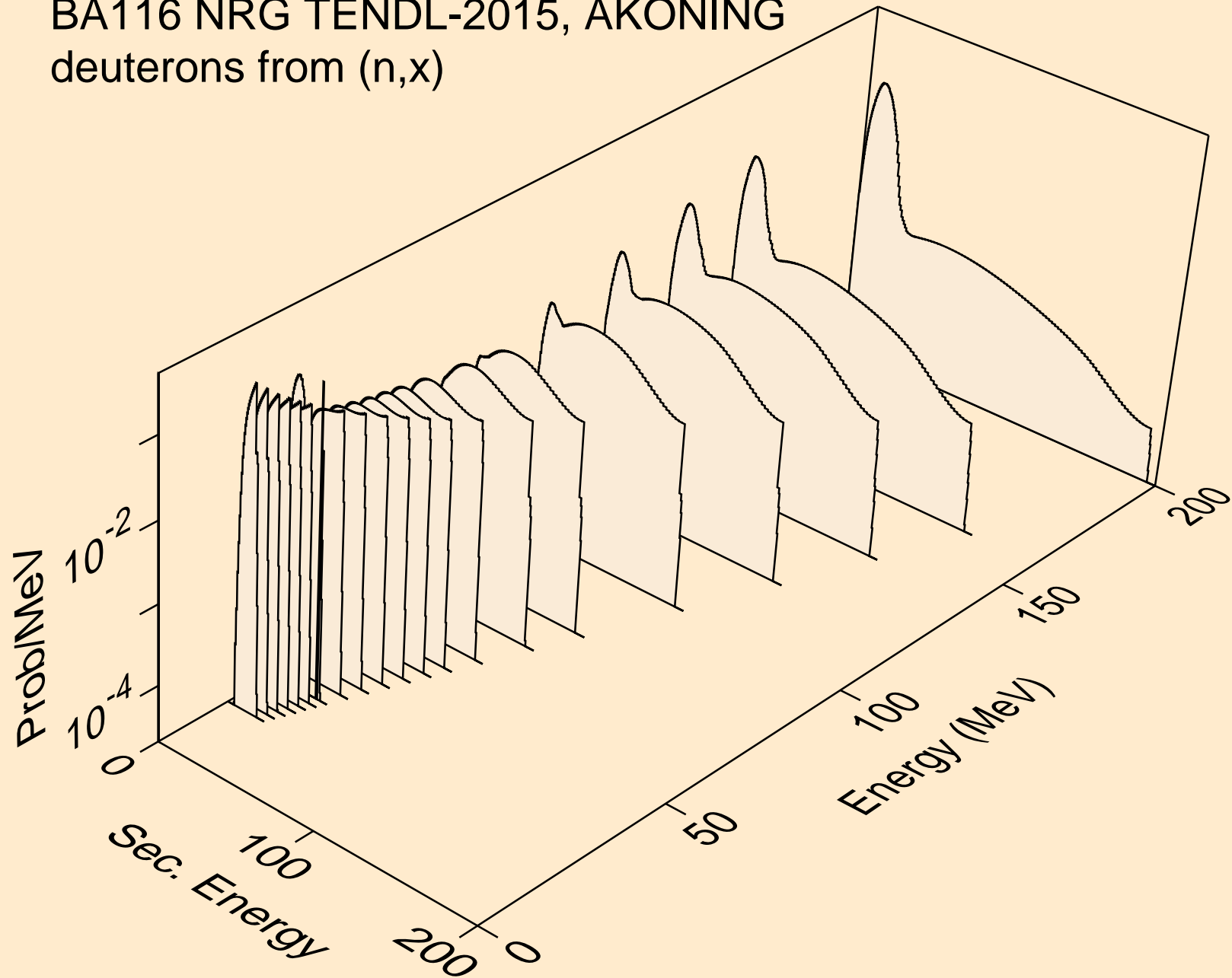

BA116 NRG TENDL-2015, AKONING
deuterons from (n,n*)d

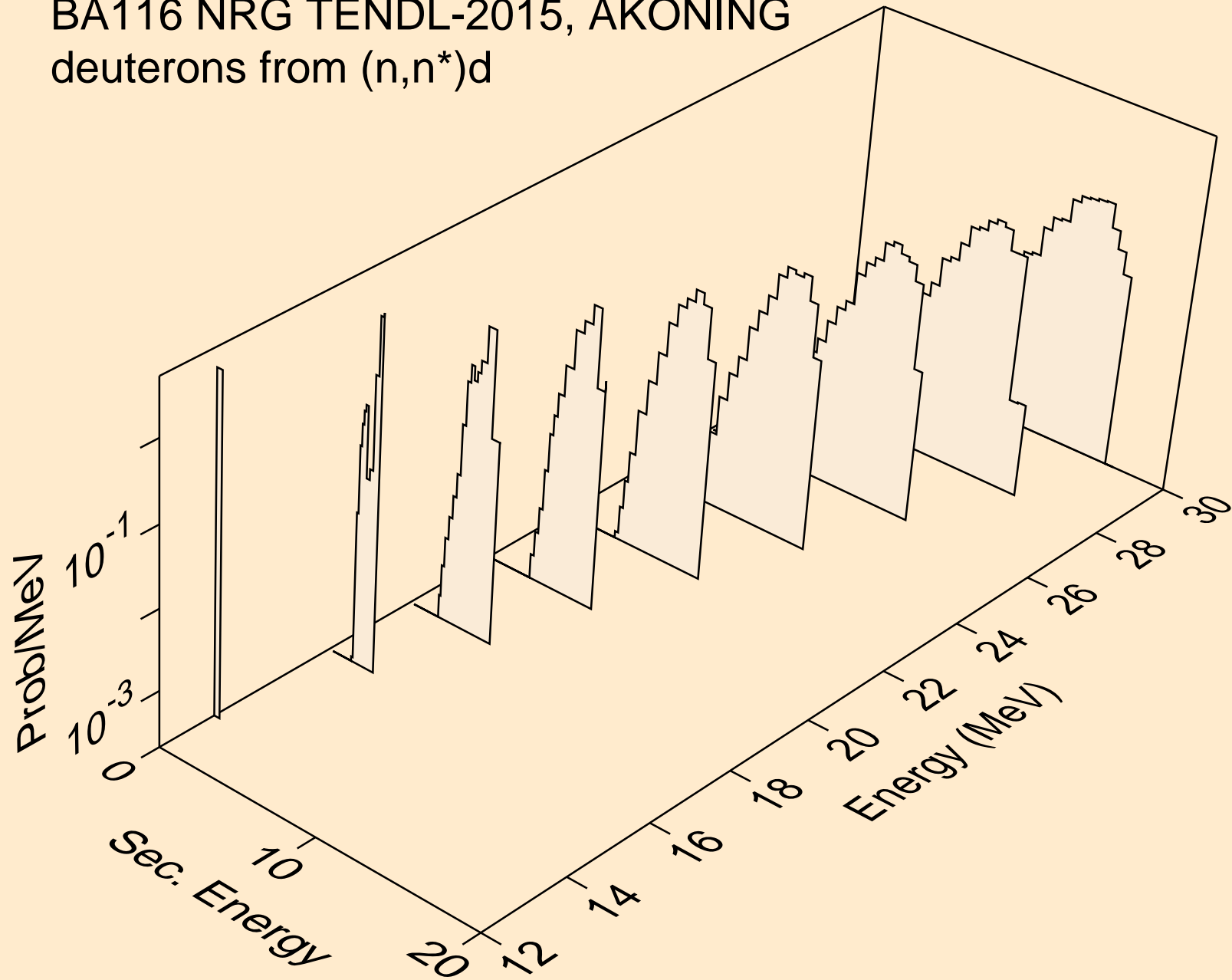

BA116 NRG TENDL-2015, AKONING
deuterons from (n,n*)d2a

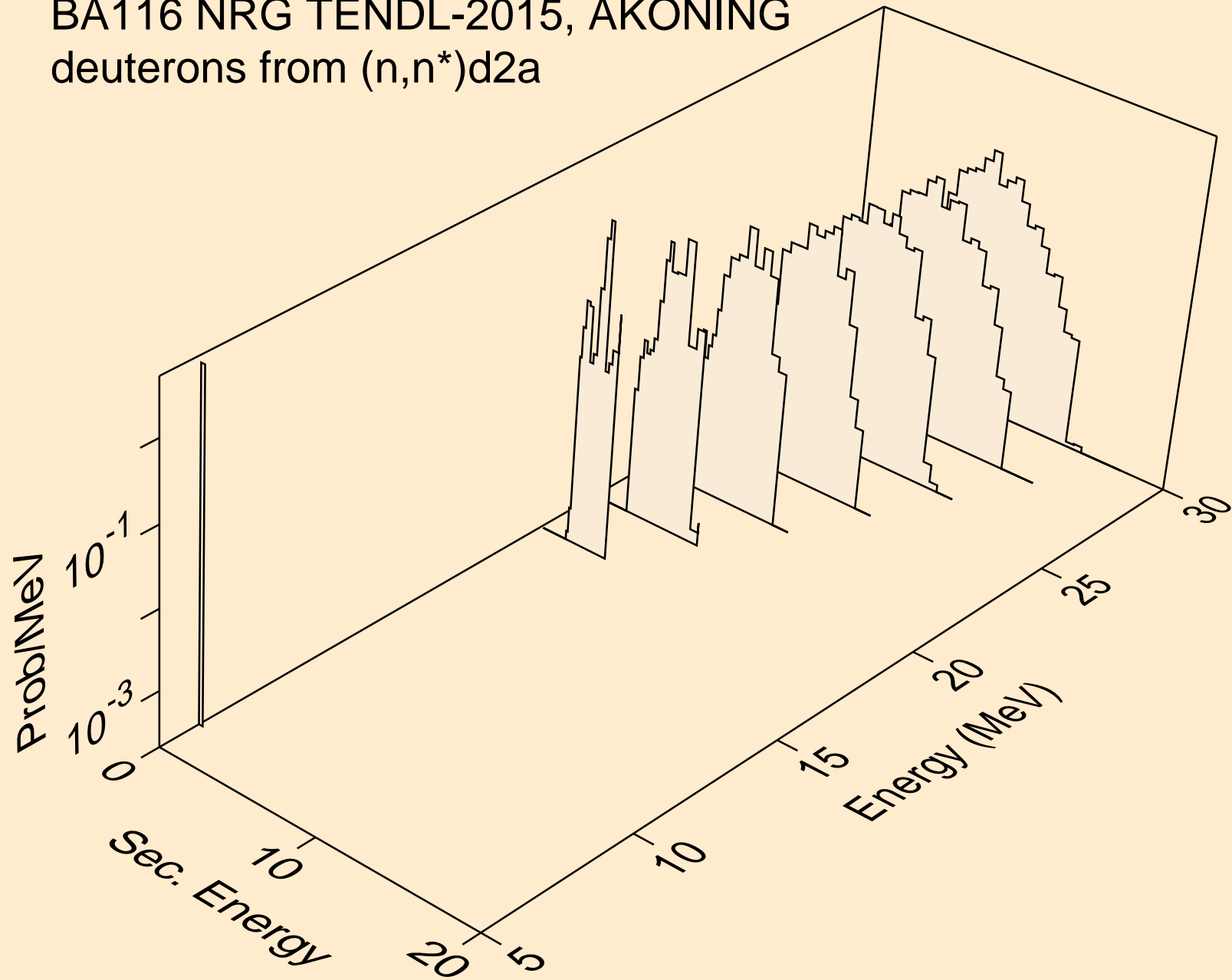

BA116 NRG TENDL-2015, AKONING
deuterons from (n,d)

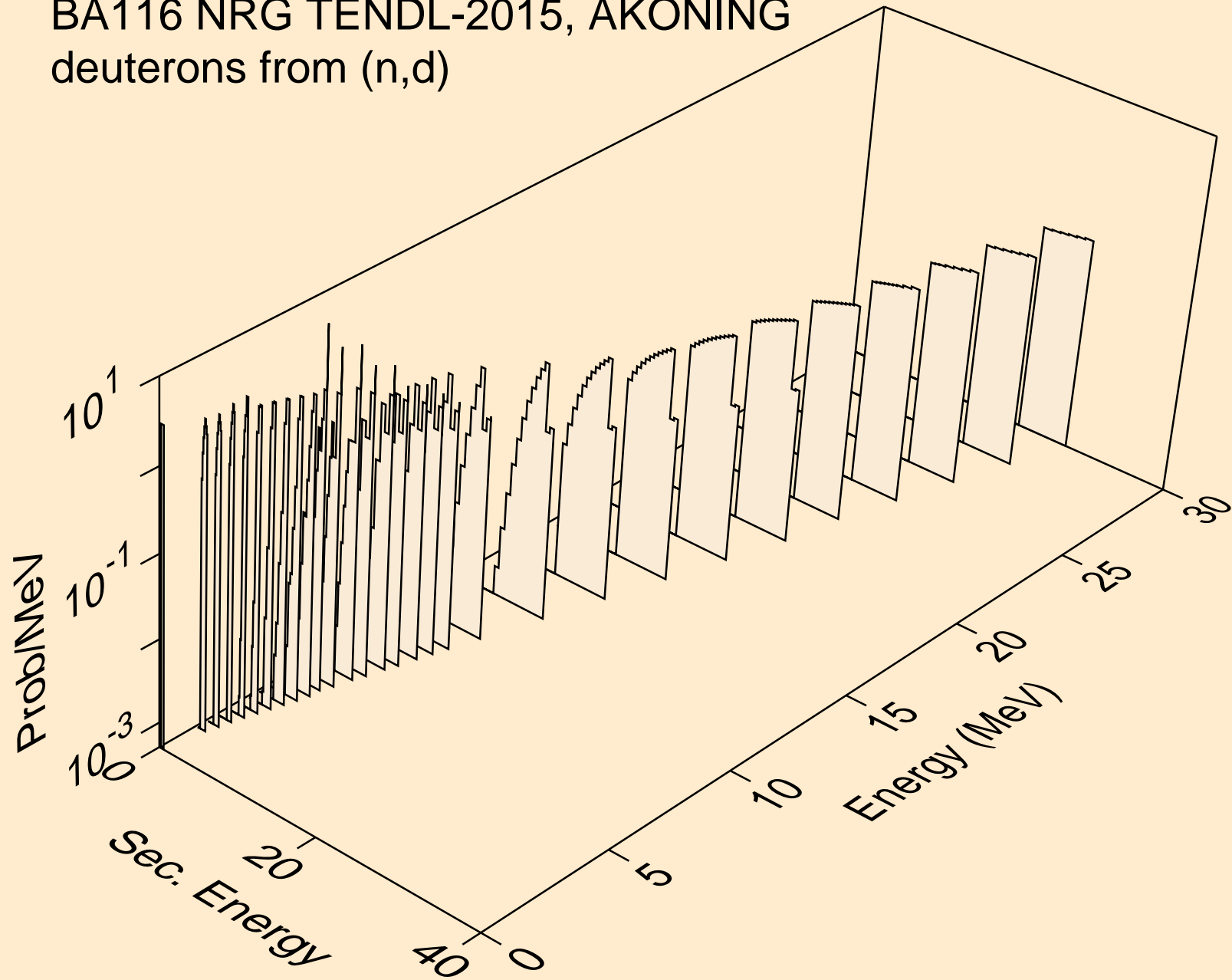

BA116 NRG TENDL-2015, AKONING
deuterons from (n,d2a)

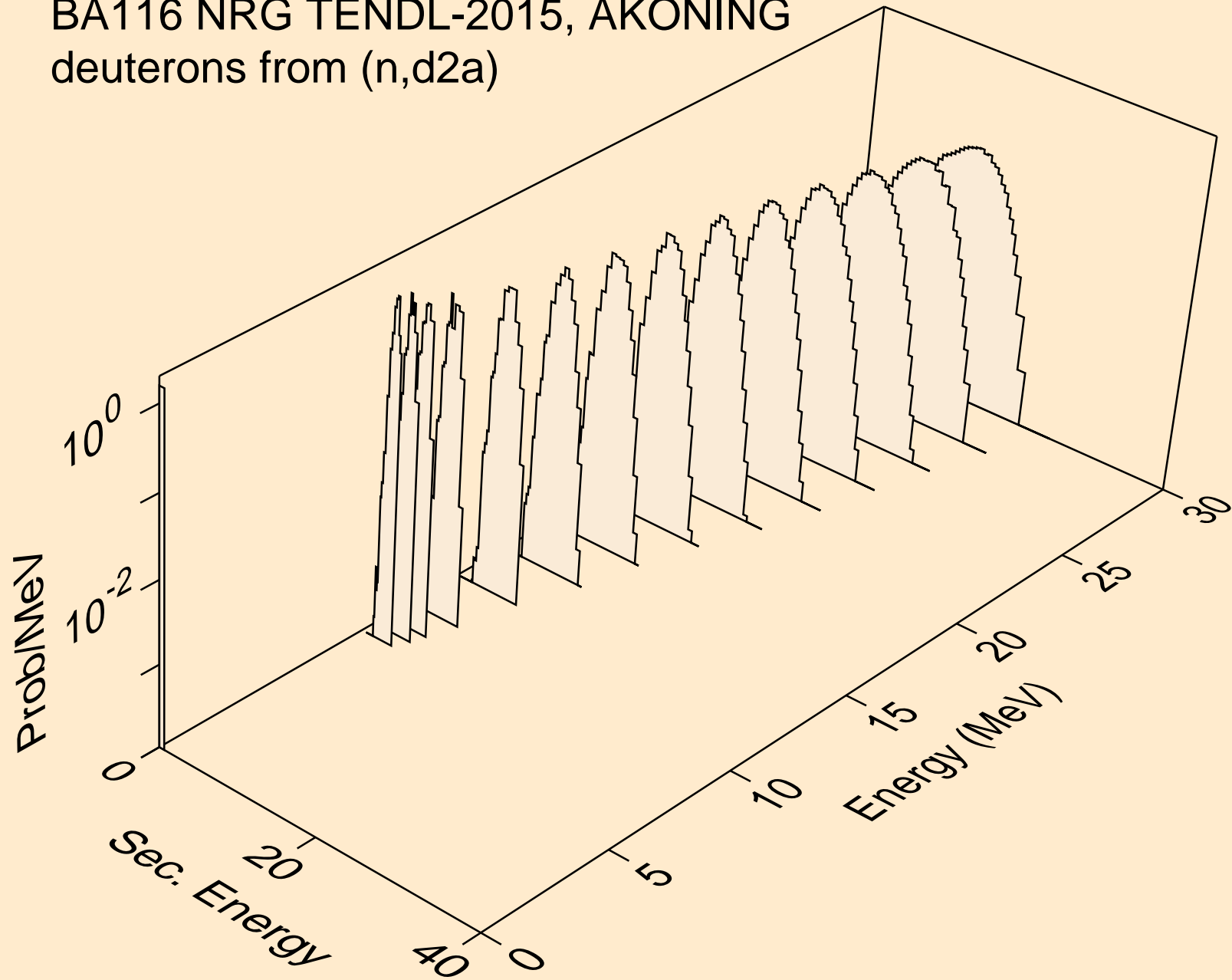

BA116 NRG TENDL-2015, AKONING
deuterons from (n,pd)

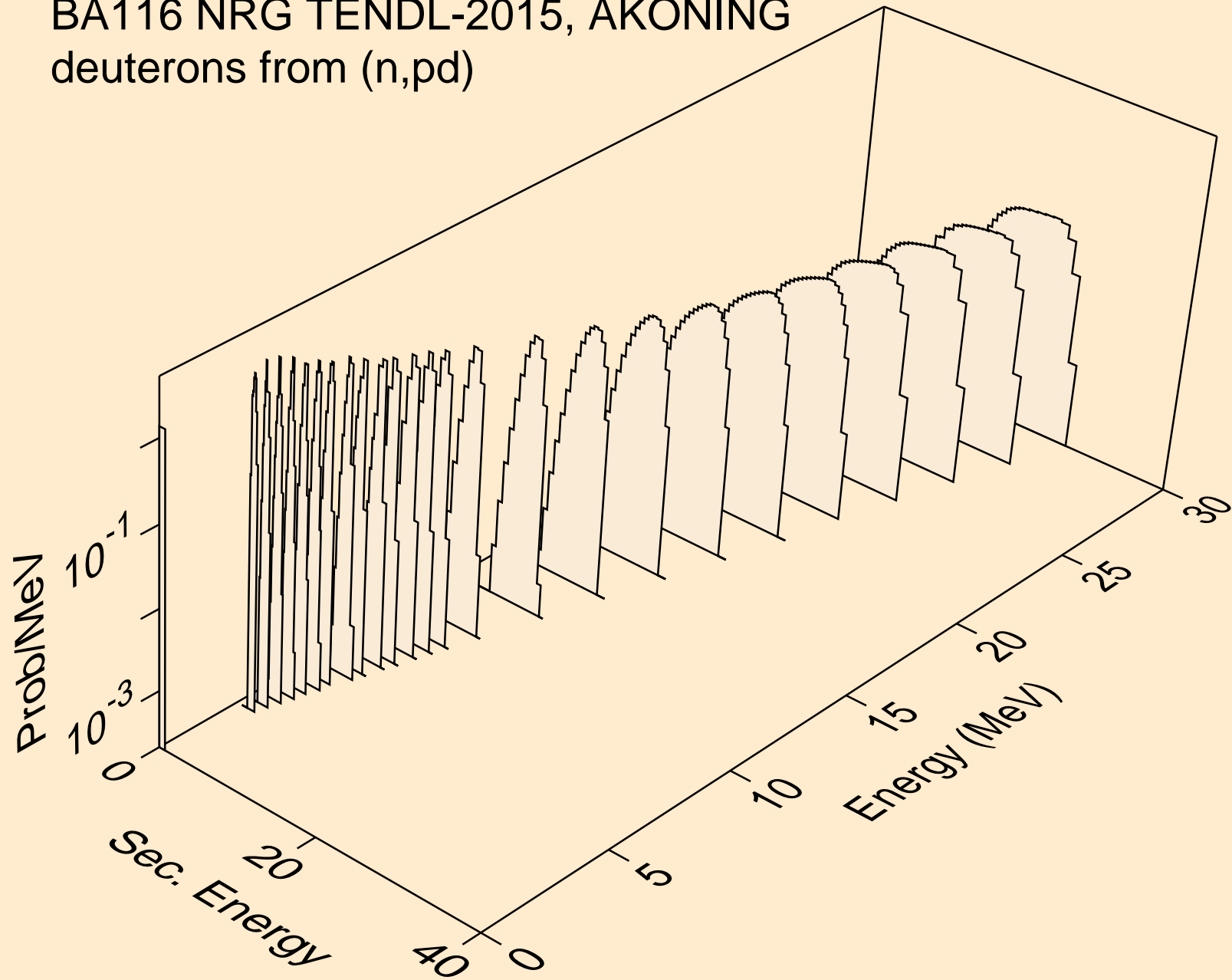

BA116 NRG TENDL-2015, AKONING
deuterons from (n,da)

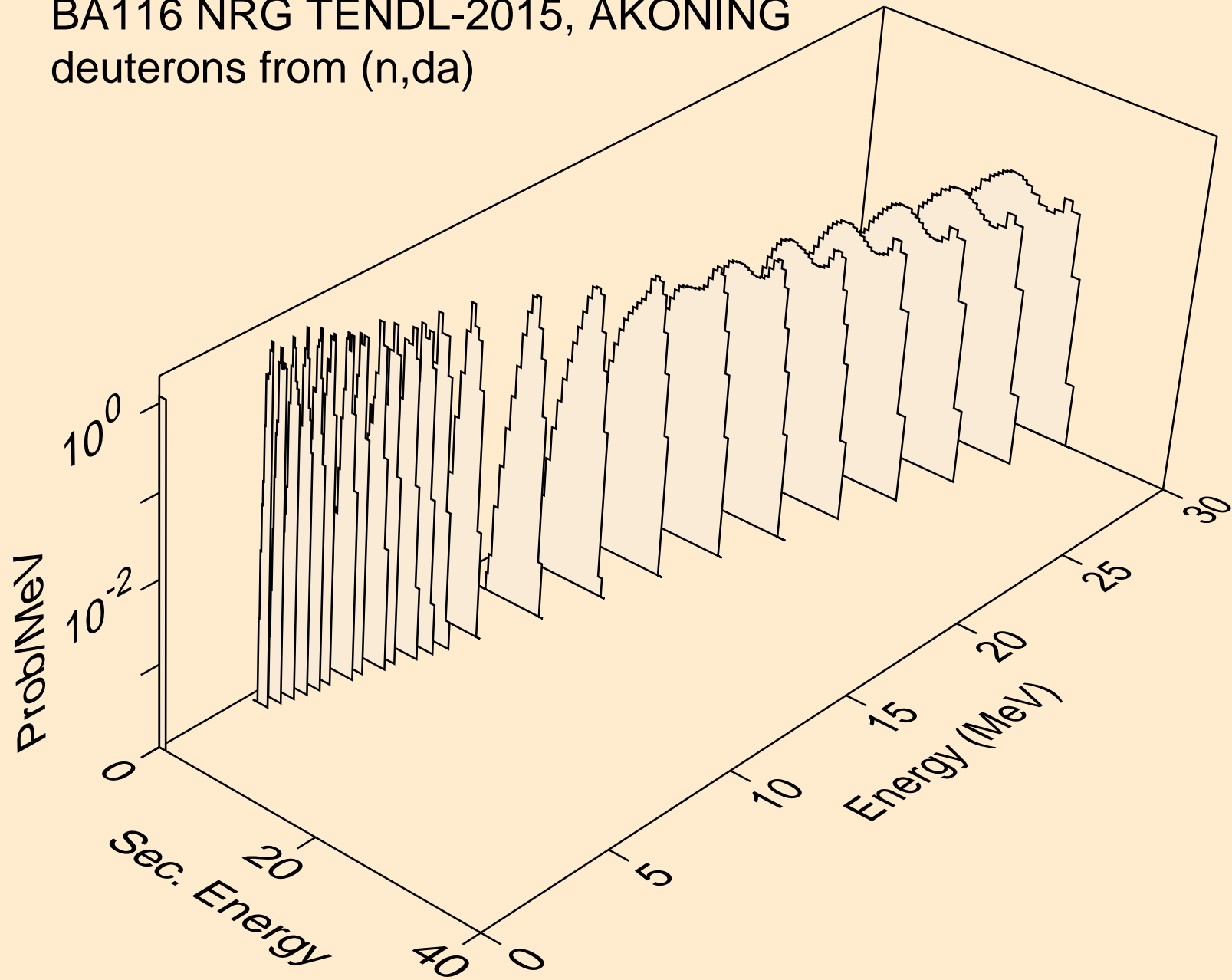

BA116 NRG TENDL-2015, AKONING
tritons from (n,x)

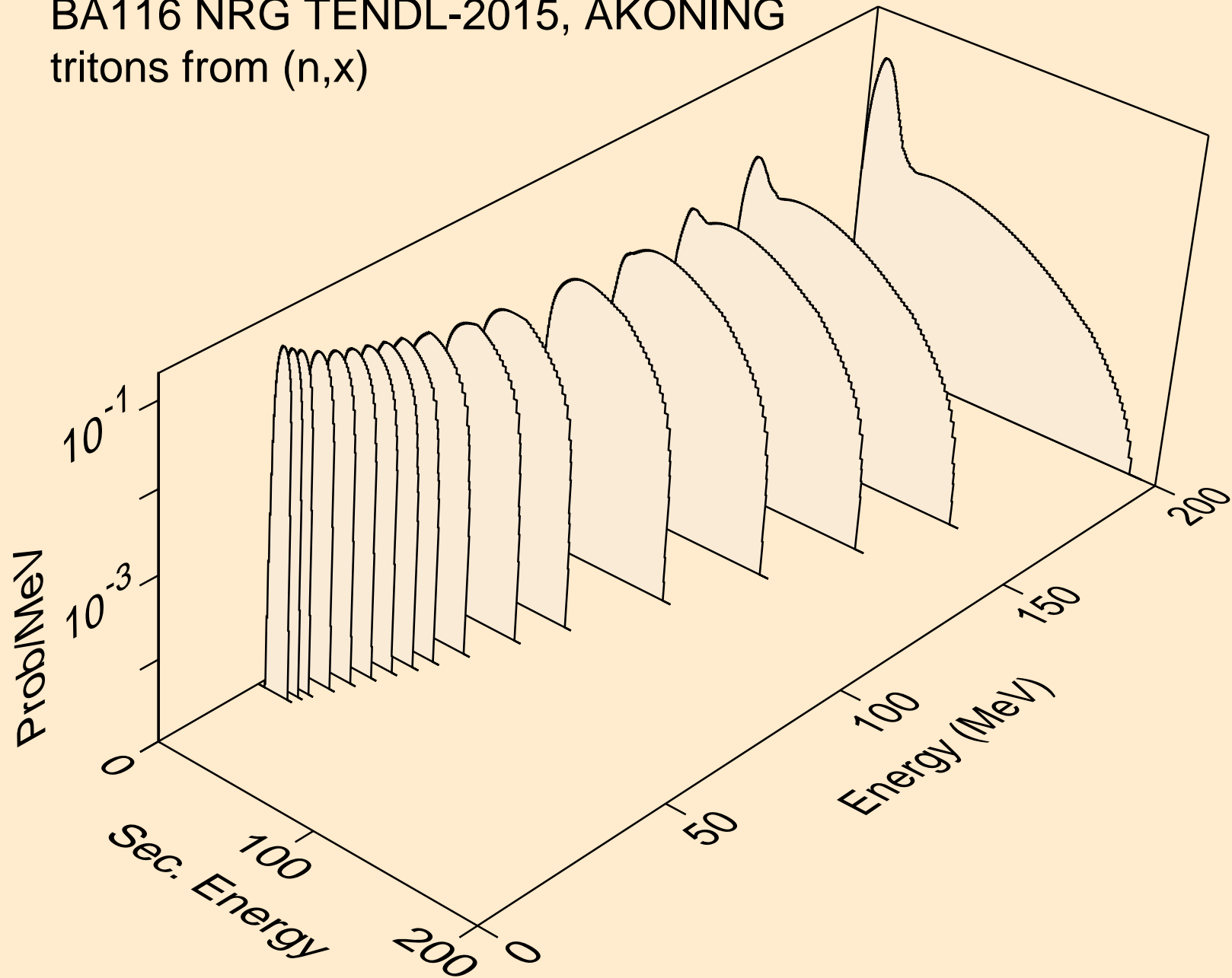

BA116 NRG TENDL-2015, AKONING
tritons from (n,n*)t

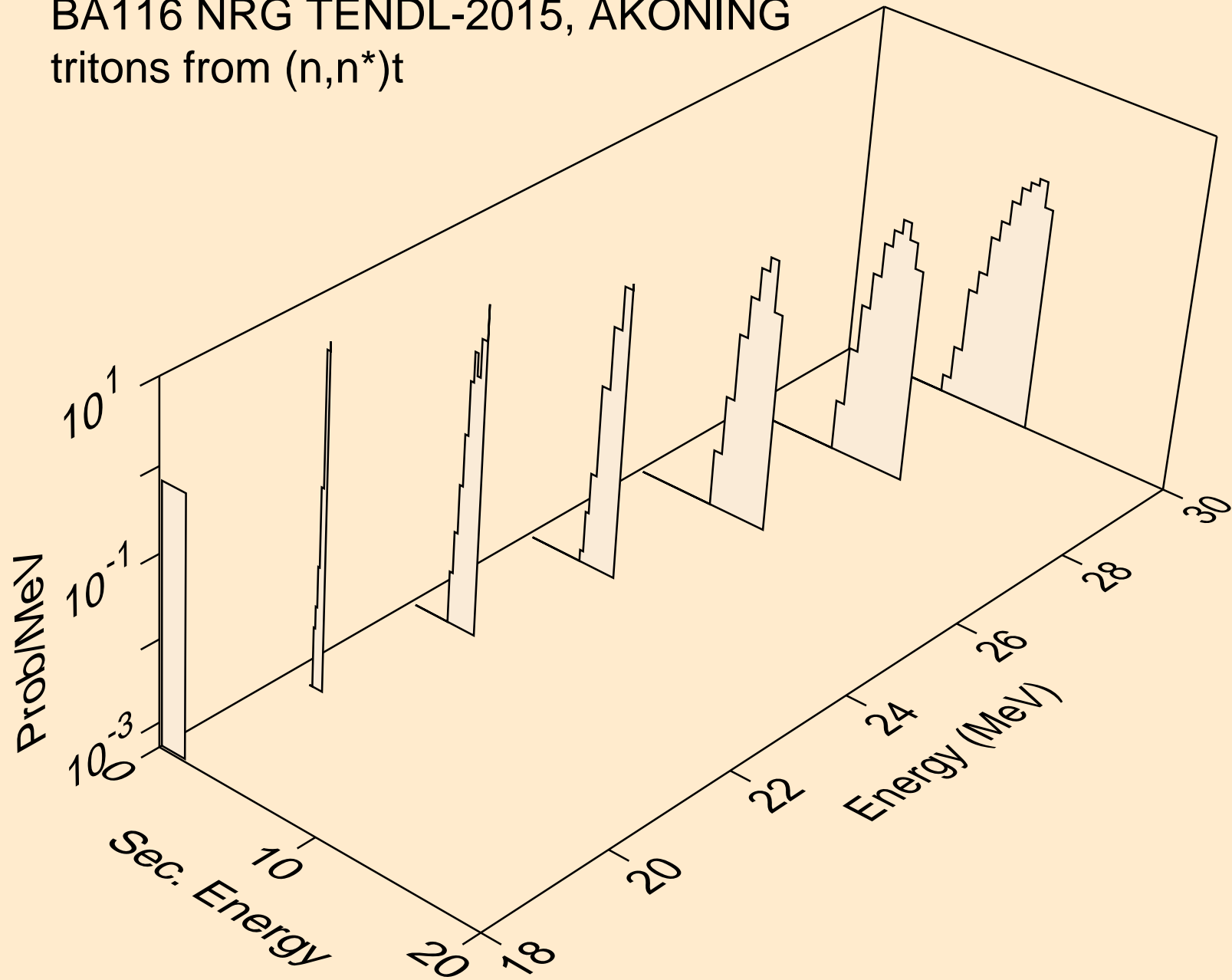

BA116 NRG TENDL-2015, AKONING
tritons from (n,t)

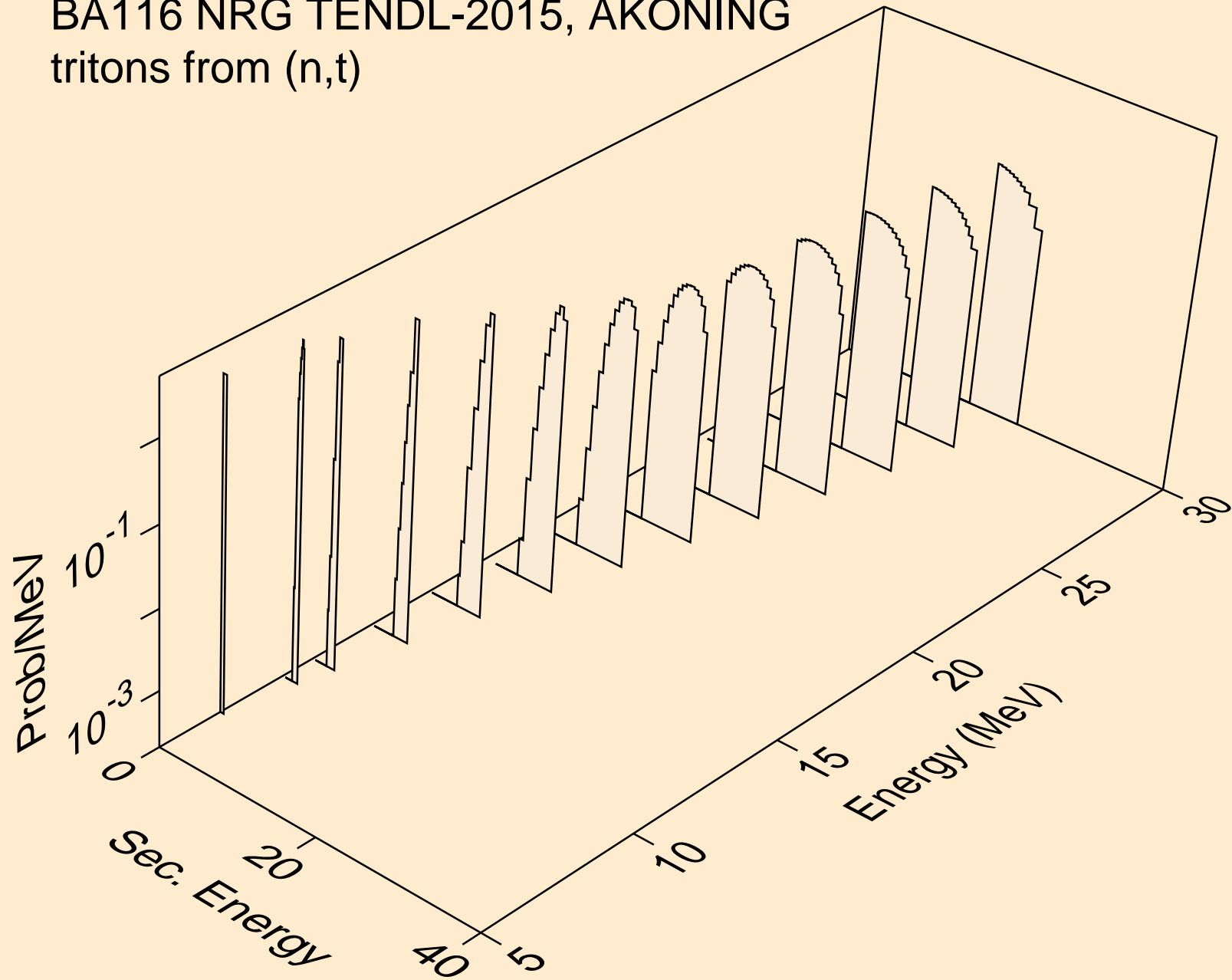

BA116 NRG TENDL-2015, AKONING
tritons from (n,t2a)

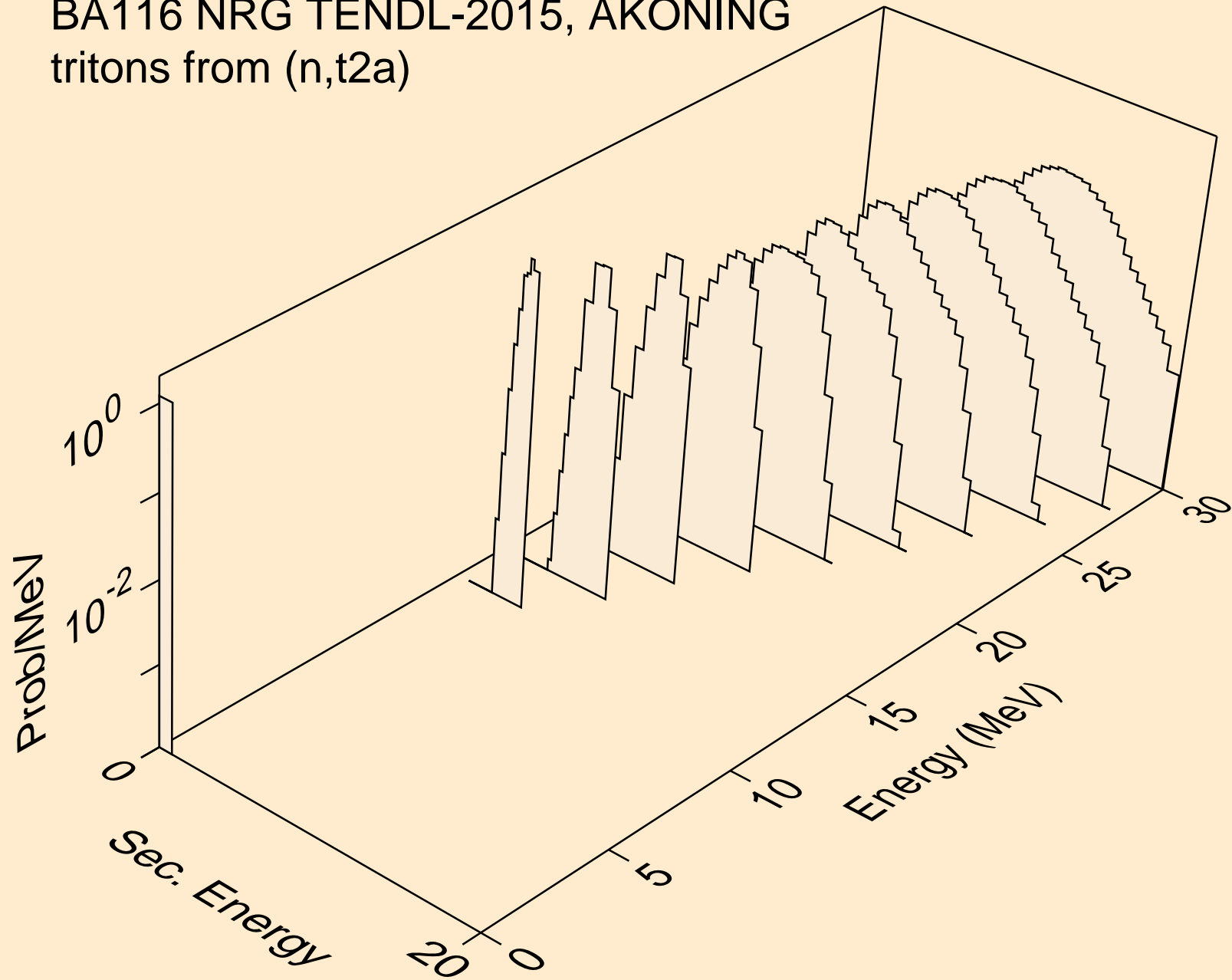

BA116 NRG TENDL-2015, AKONING
tritons from (n,pt)

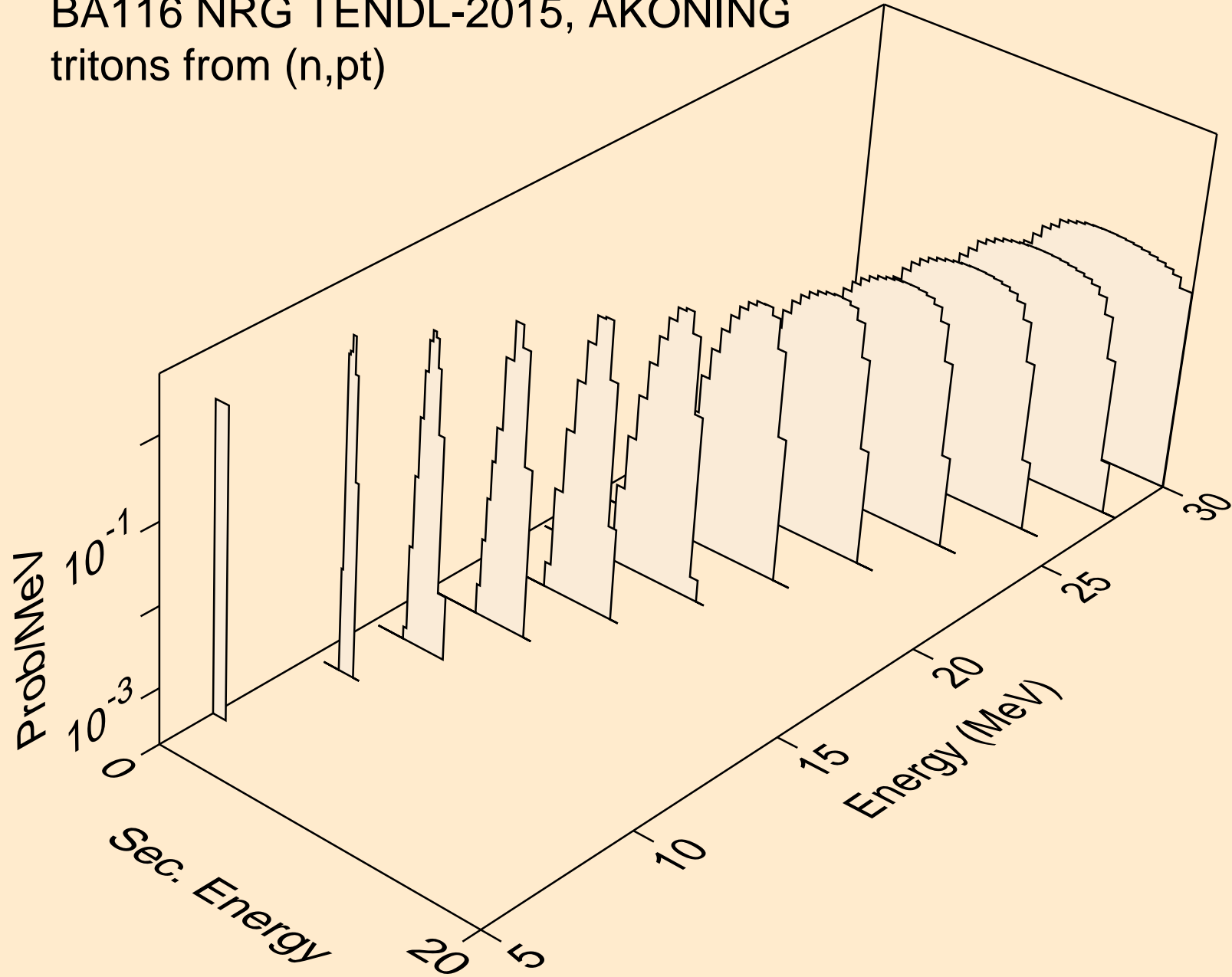

BA116 NRG TENDL-2015, AKONING
he3s from (n,x)

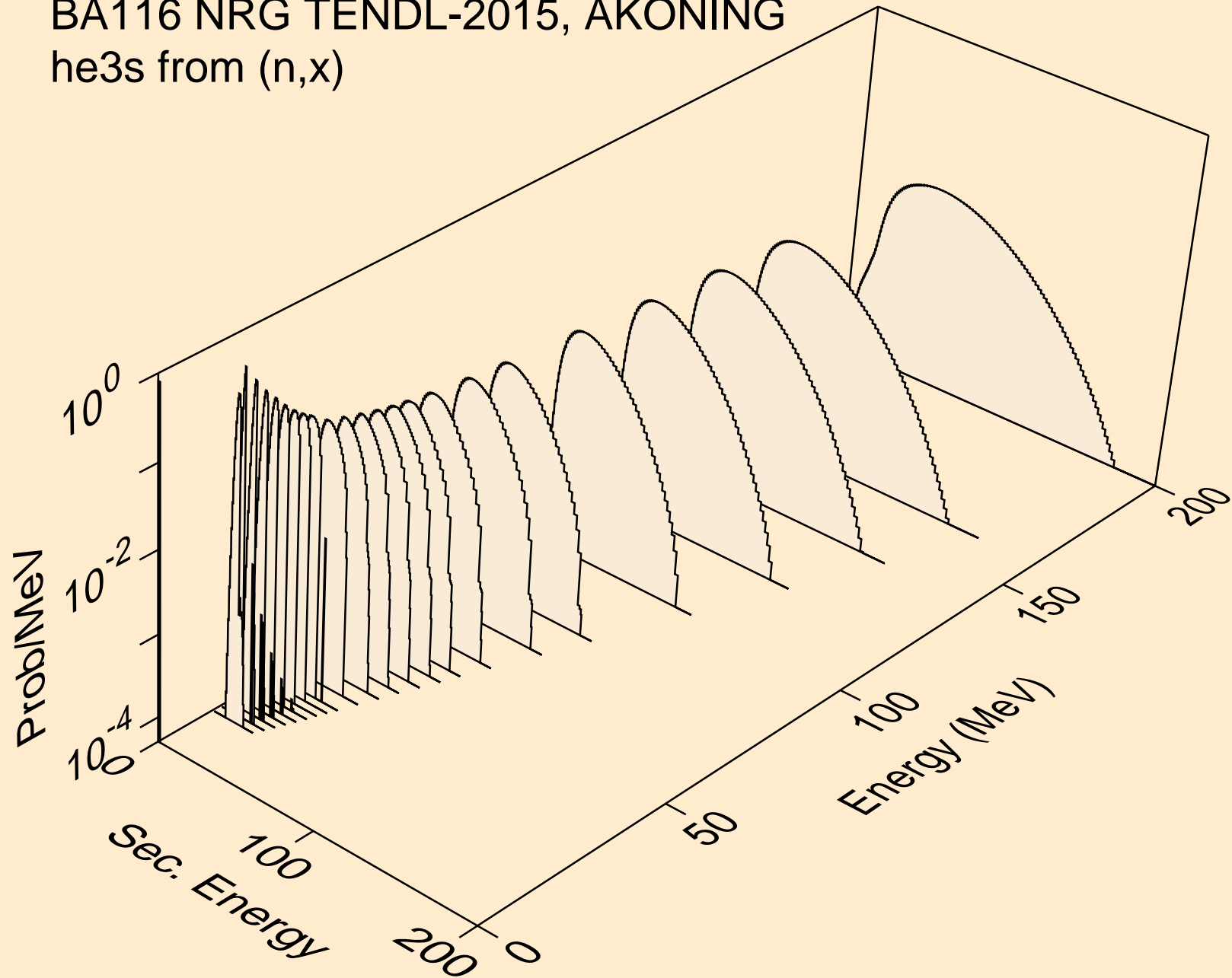

BA116 NRG TENDL-2015, AKONING
he3s from (n,n*)he3

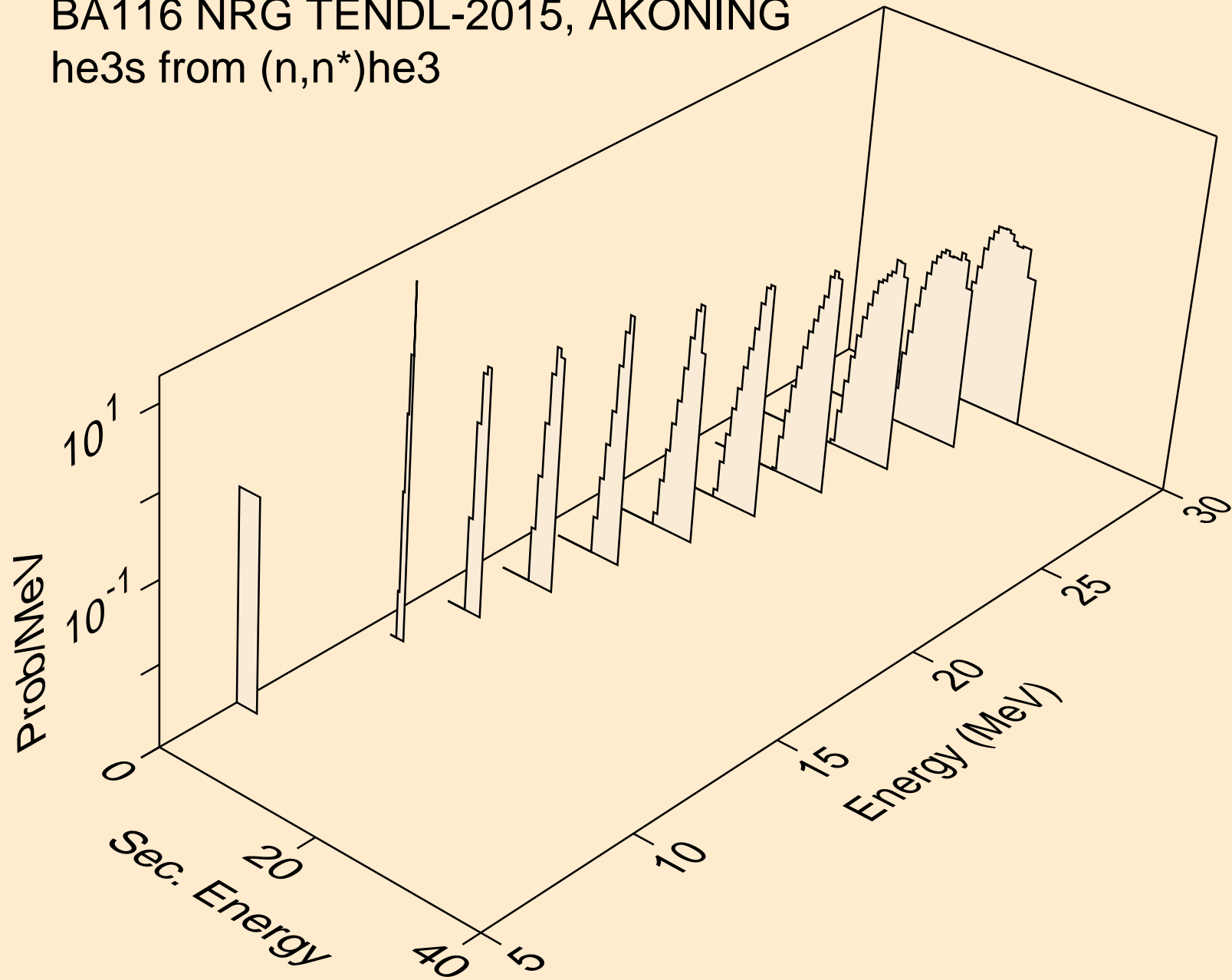

BA116 NRG TENDL-2015, AKONING
he3s from (n,he3)

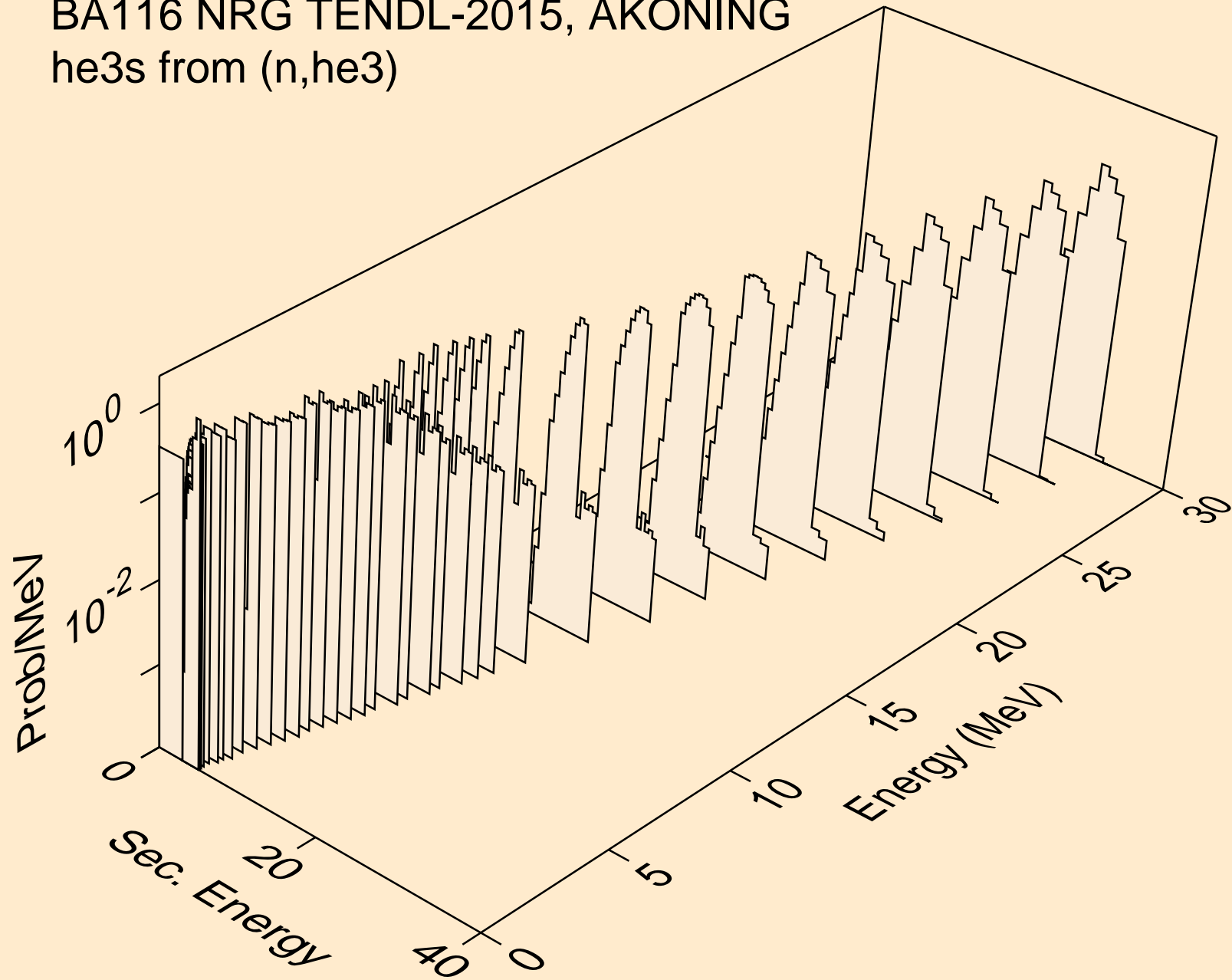

BA116 NRG TENDL-2015, AKONING
alphas from (n,x)

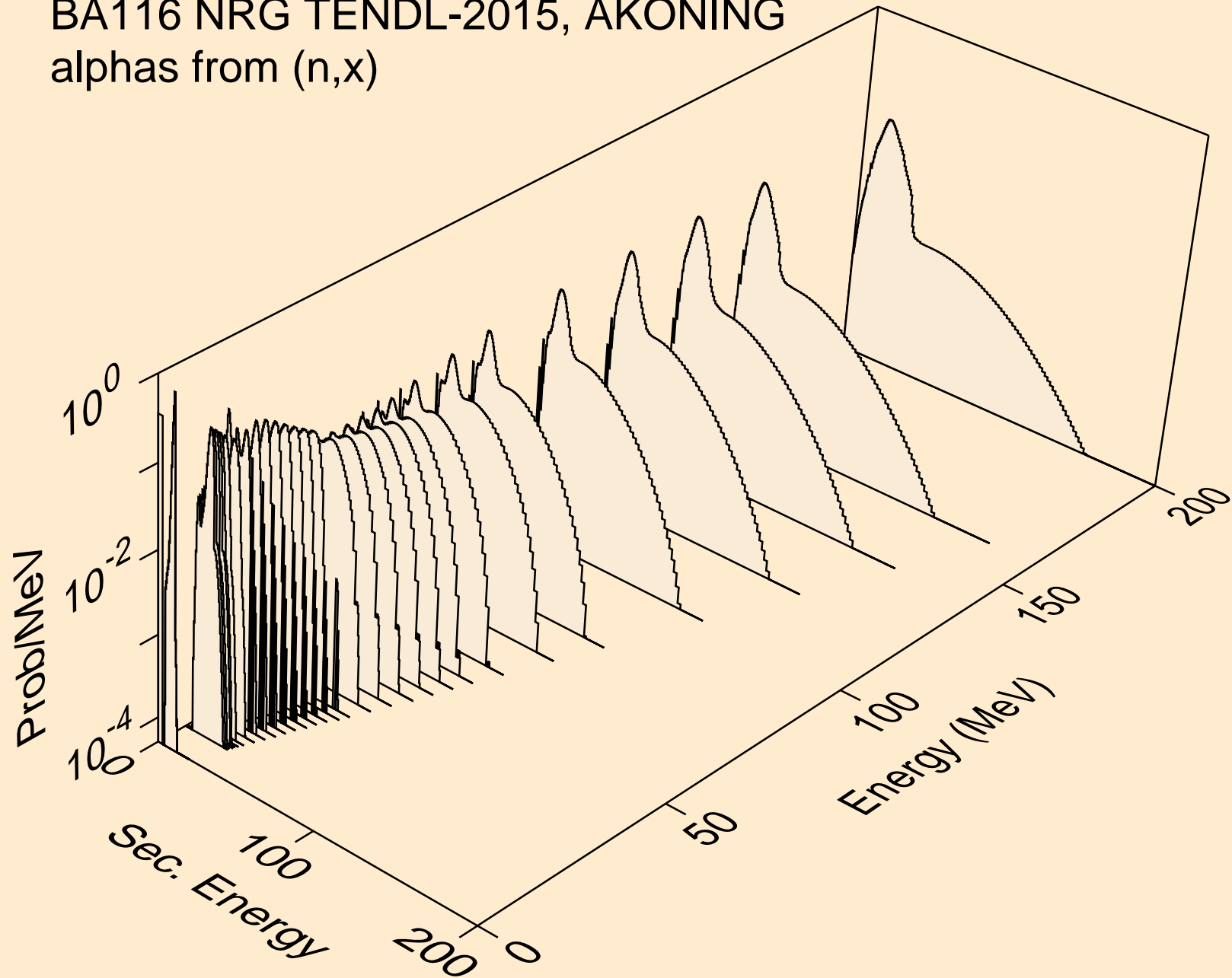

BA116 NRG TENDL-2015, AKONING
alphas from (n,n*)a

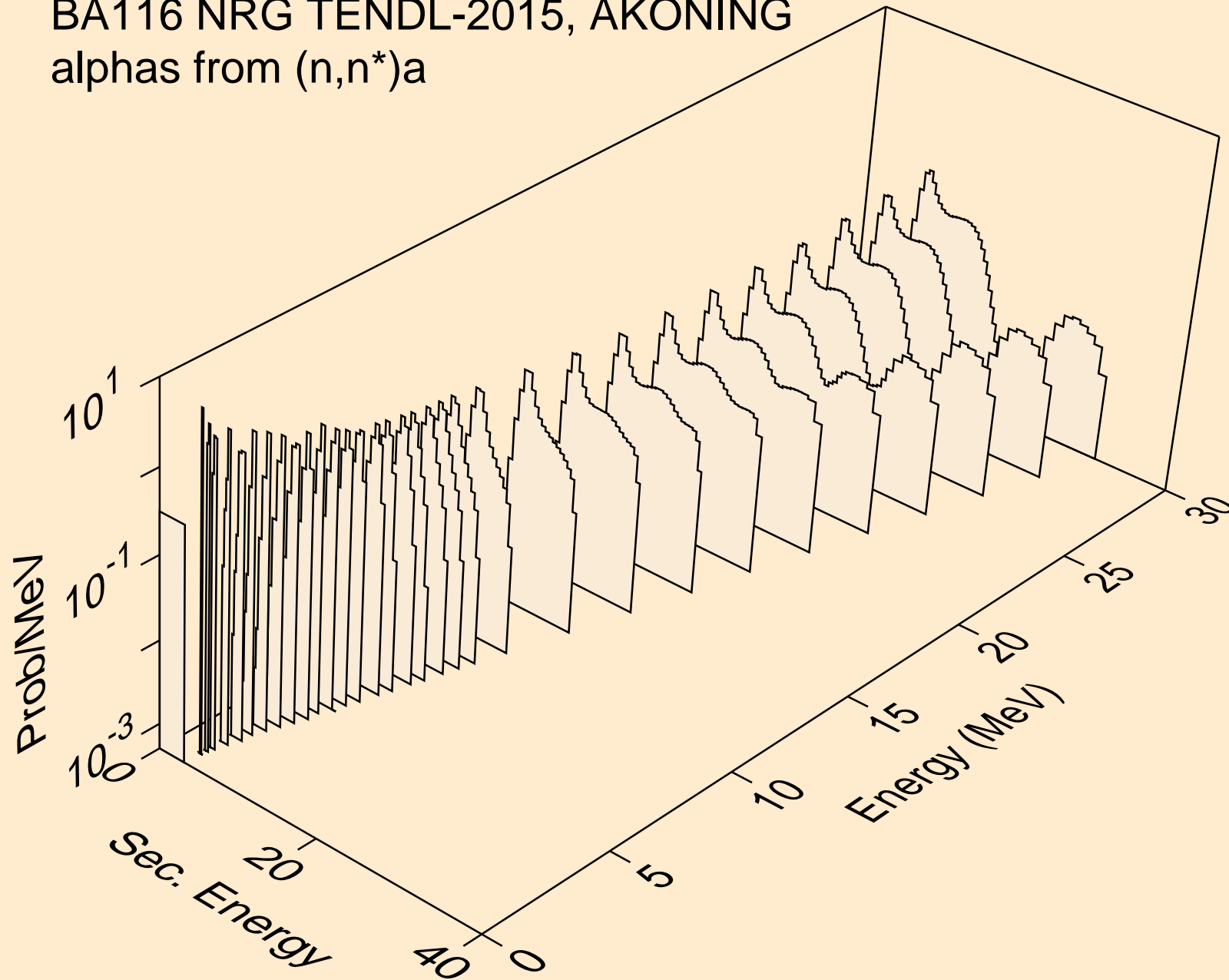

BA116 NRG TENDL-2015, AKONING
alphas from (n,n*)3a

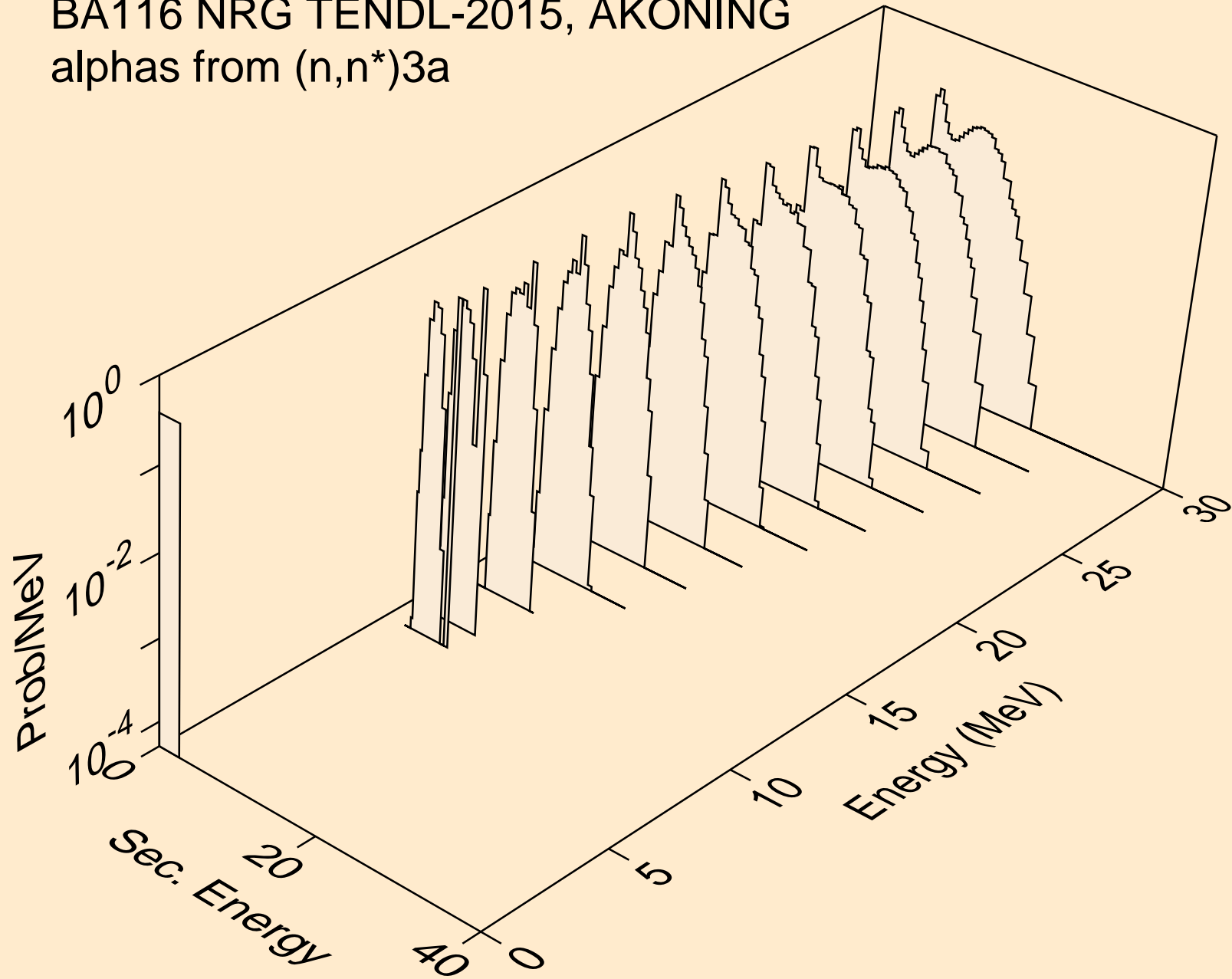

BA116 NRG TENDL-2015, AKONING
alphas from (n,2n)a

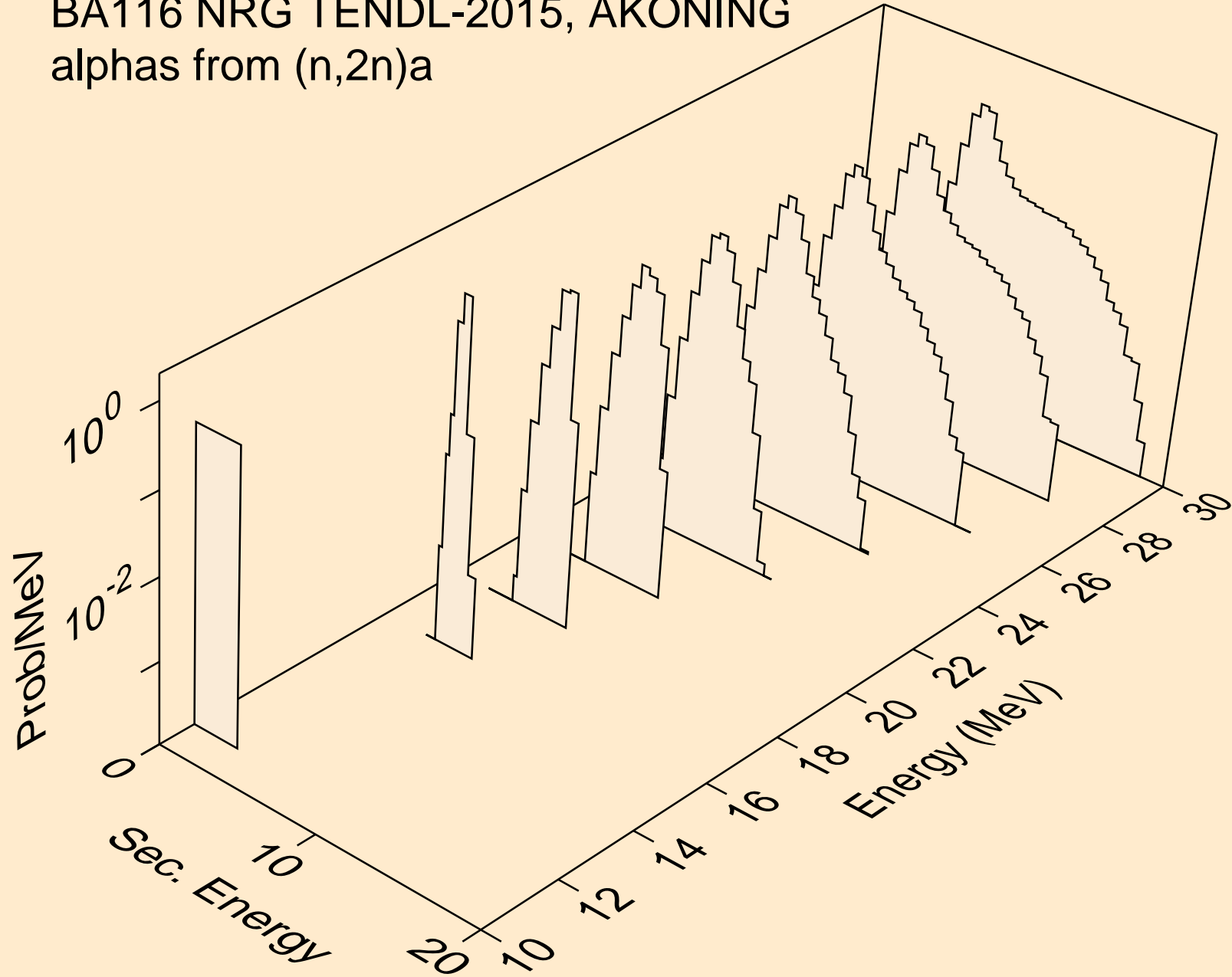

BA116 NRG TENDL-2015, AKONING
alphas from (n,3n)a

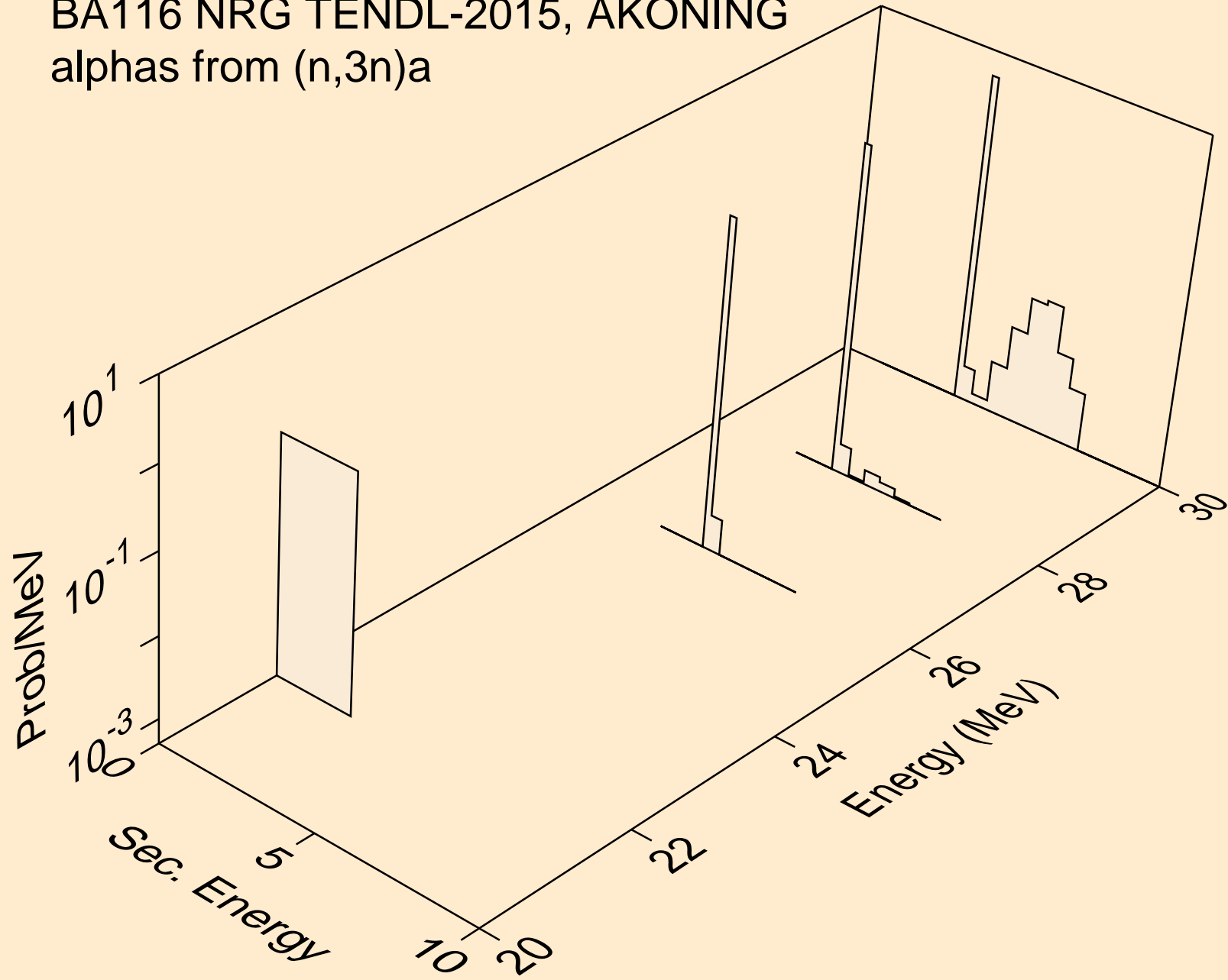

BA116 NRG TENDL-2015, AKONING
alphas from (n,n*)2a

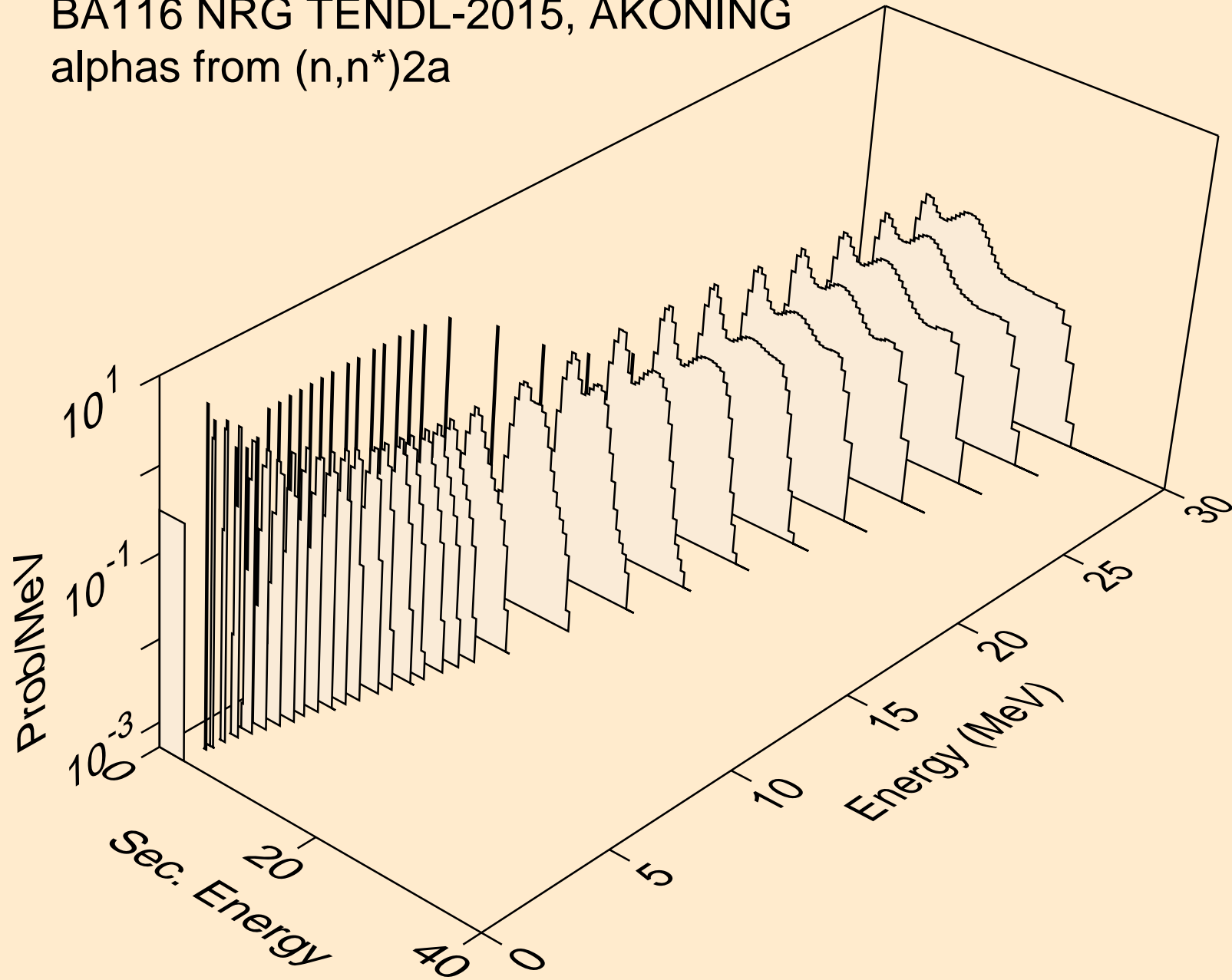

BA116 NRG TENDL-2015, AKONING
alphas from (n,2n)2a

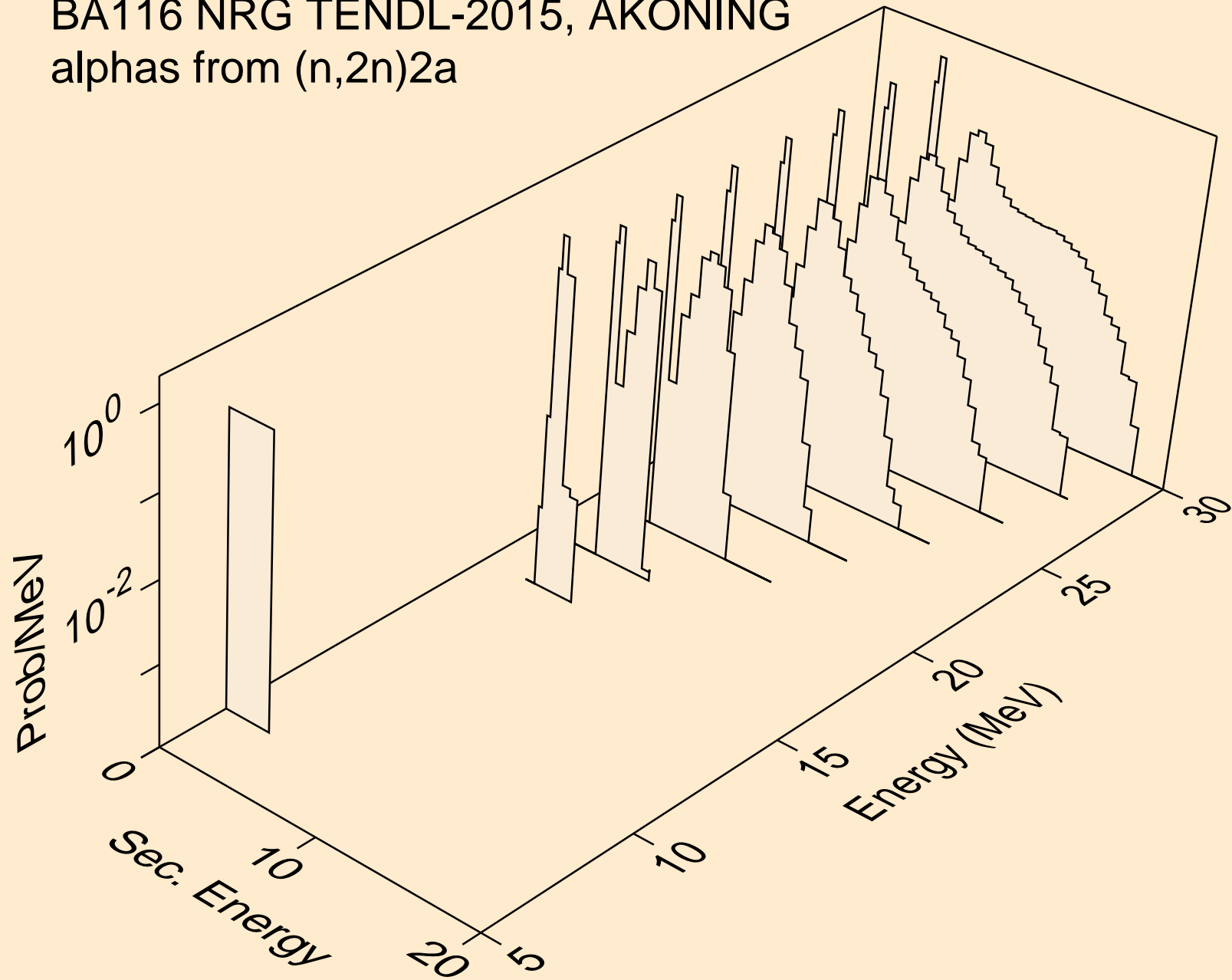

BA116 NRG TENDL-2015, AKONING
alphas from (n,n*)d2a

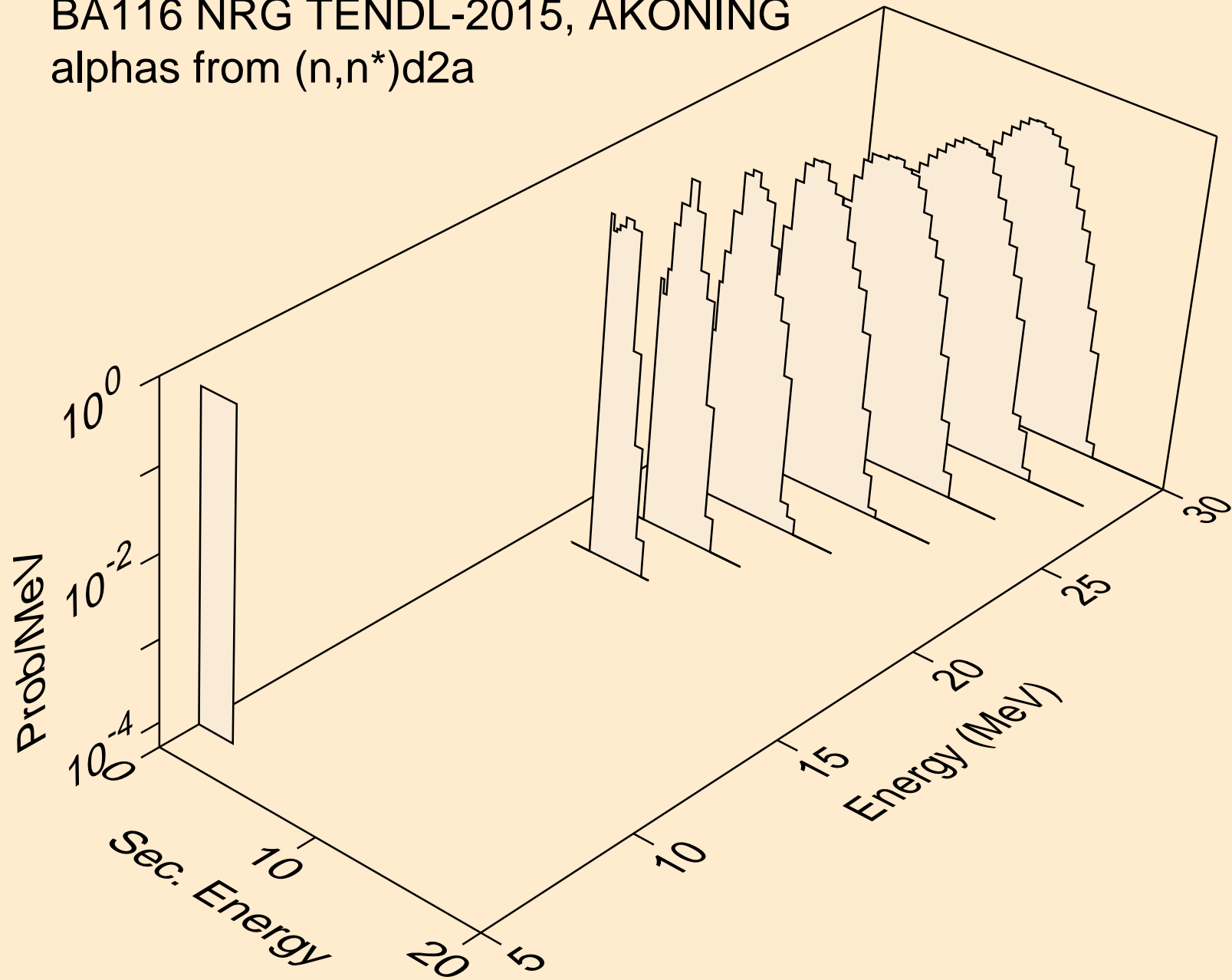

BA116 NRG TENDL-2015, AKONING
alphas from (n,npa)

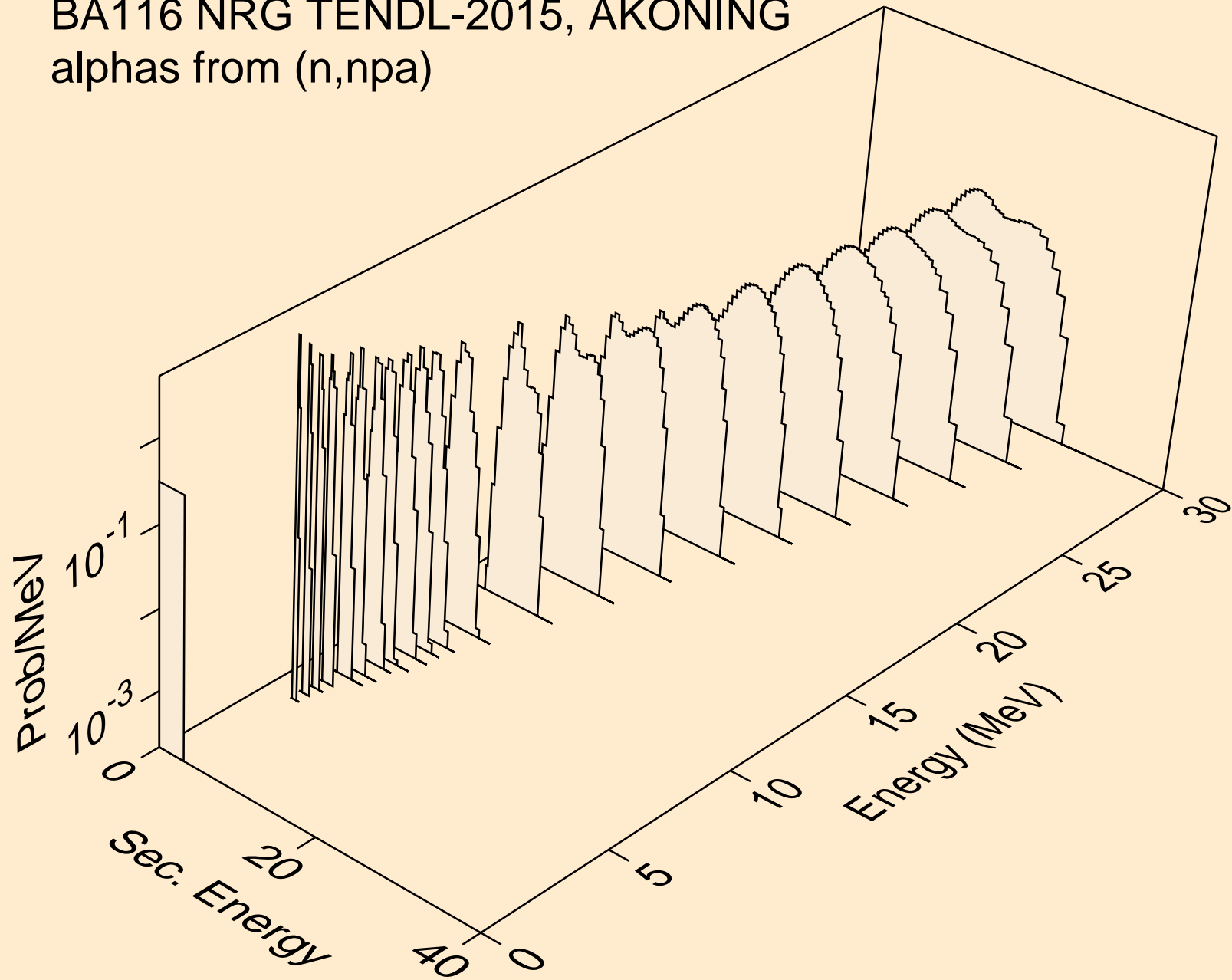

BA116 NRG TENDL-2015, AKONING
alphas from (n,a)

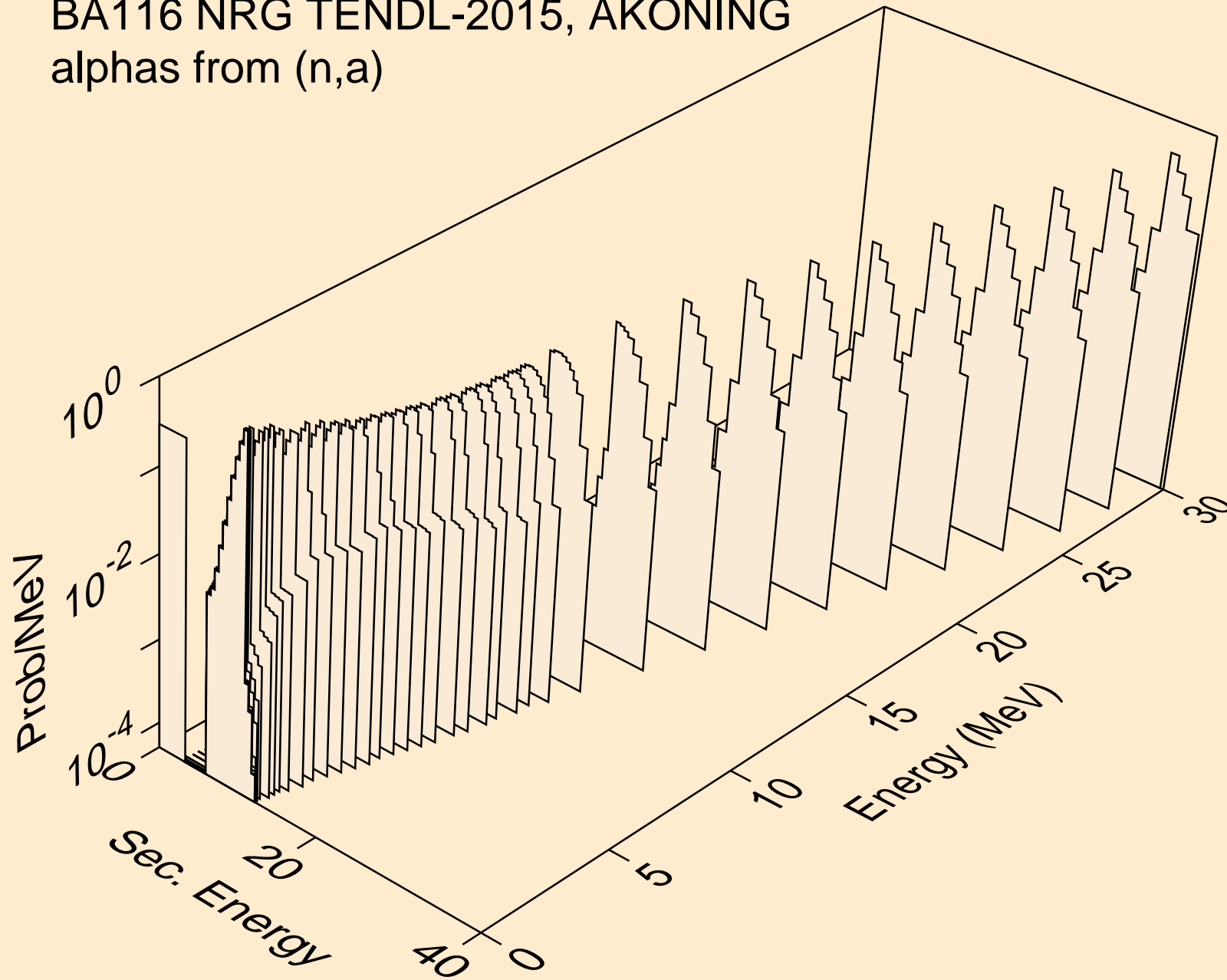

BA116 NRG TENDL-2015, AKONING
alphas from (n,2a)

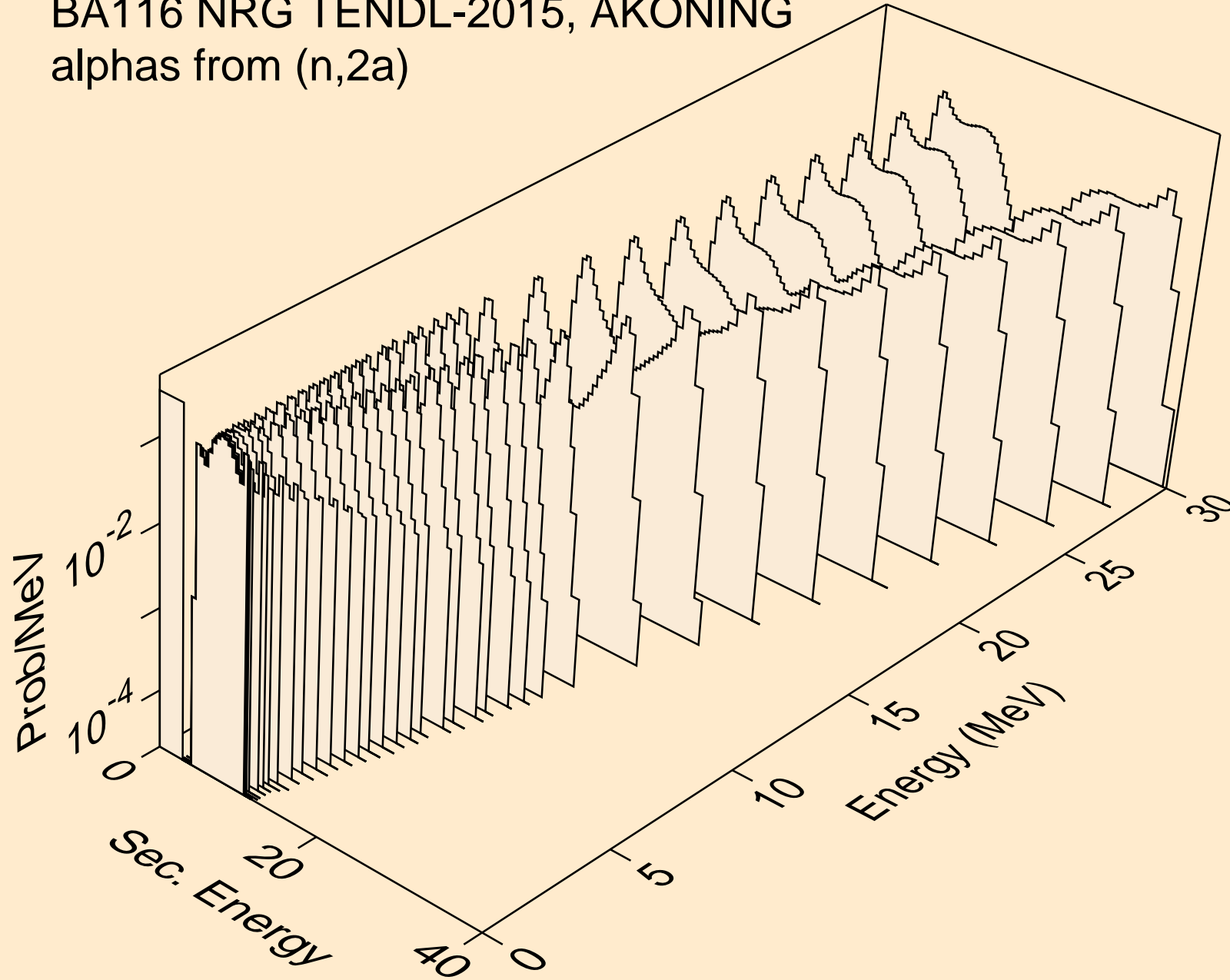

BA116 NRG TENDL-2015, AKONING
alphas from (n,3a)

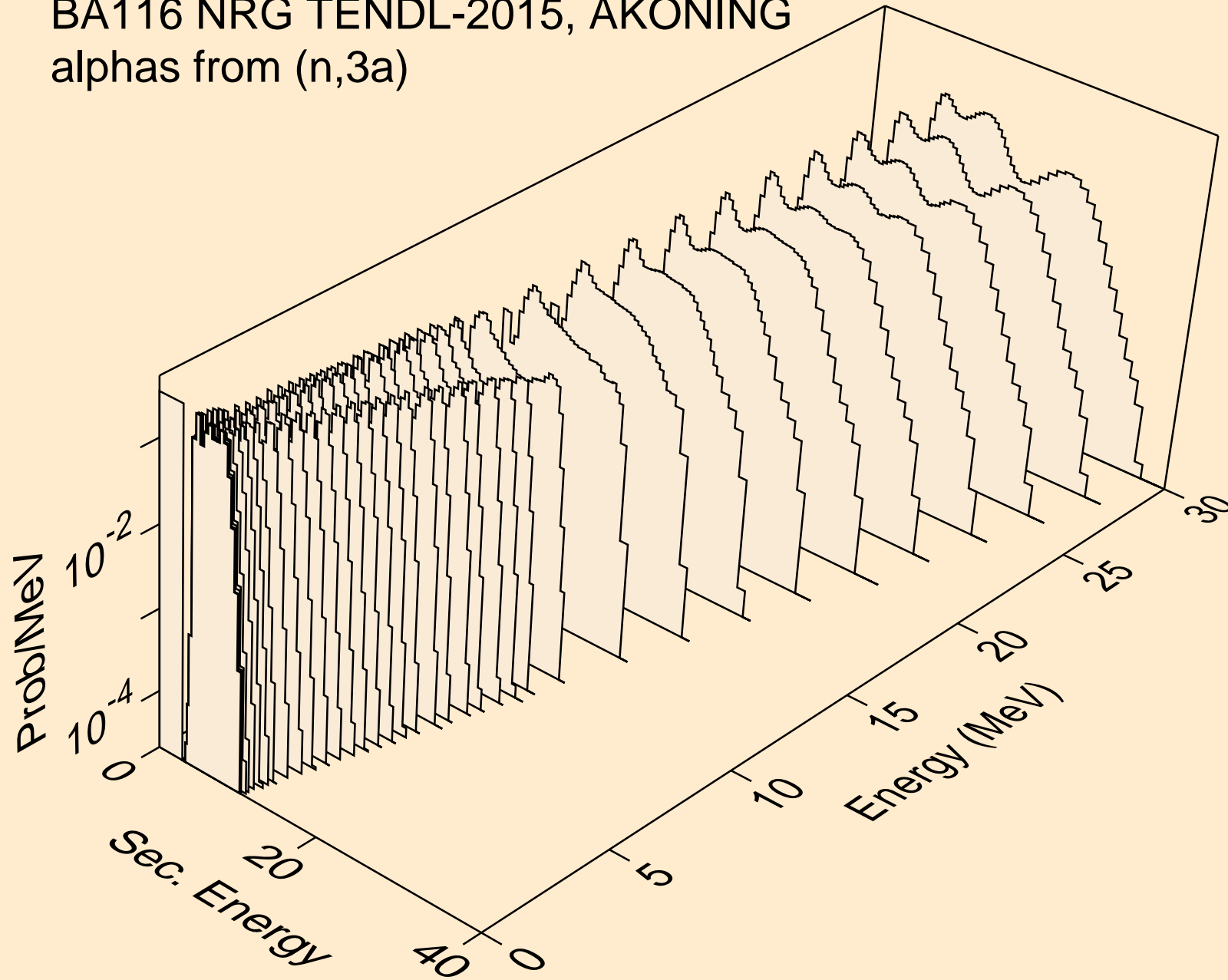

BA116 NRG TENDL-2015, AKONING
alphas from (n,pa)

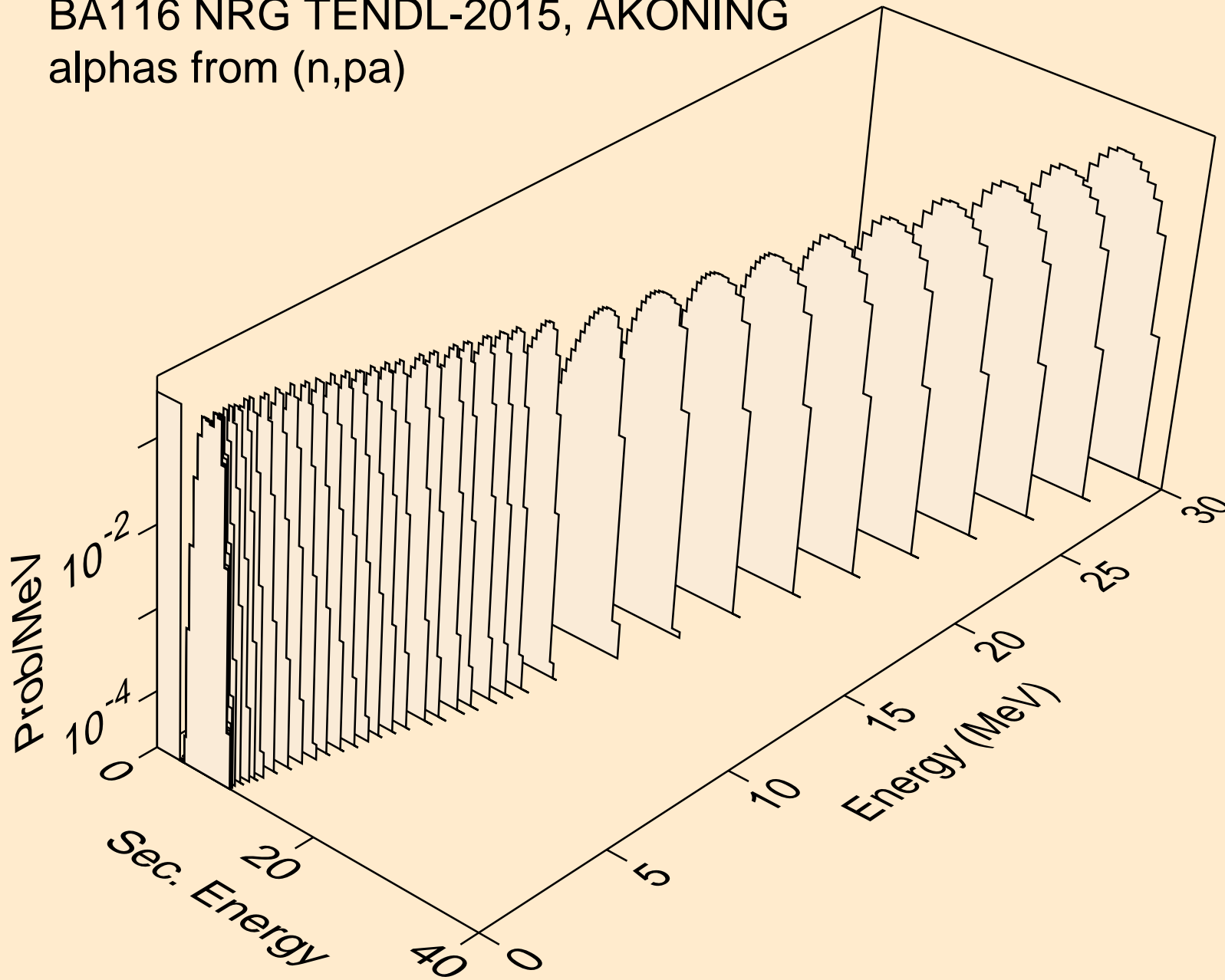

BA116 NRG TENDL-2015, AKONING
alphas from (n,t2a)

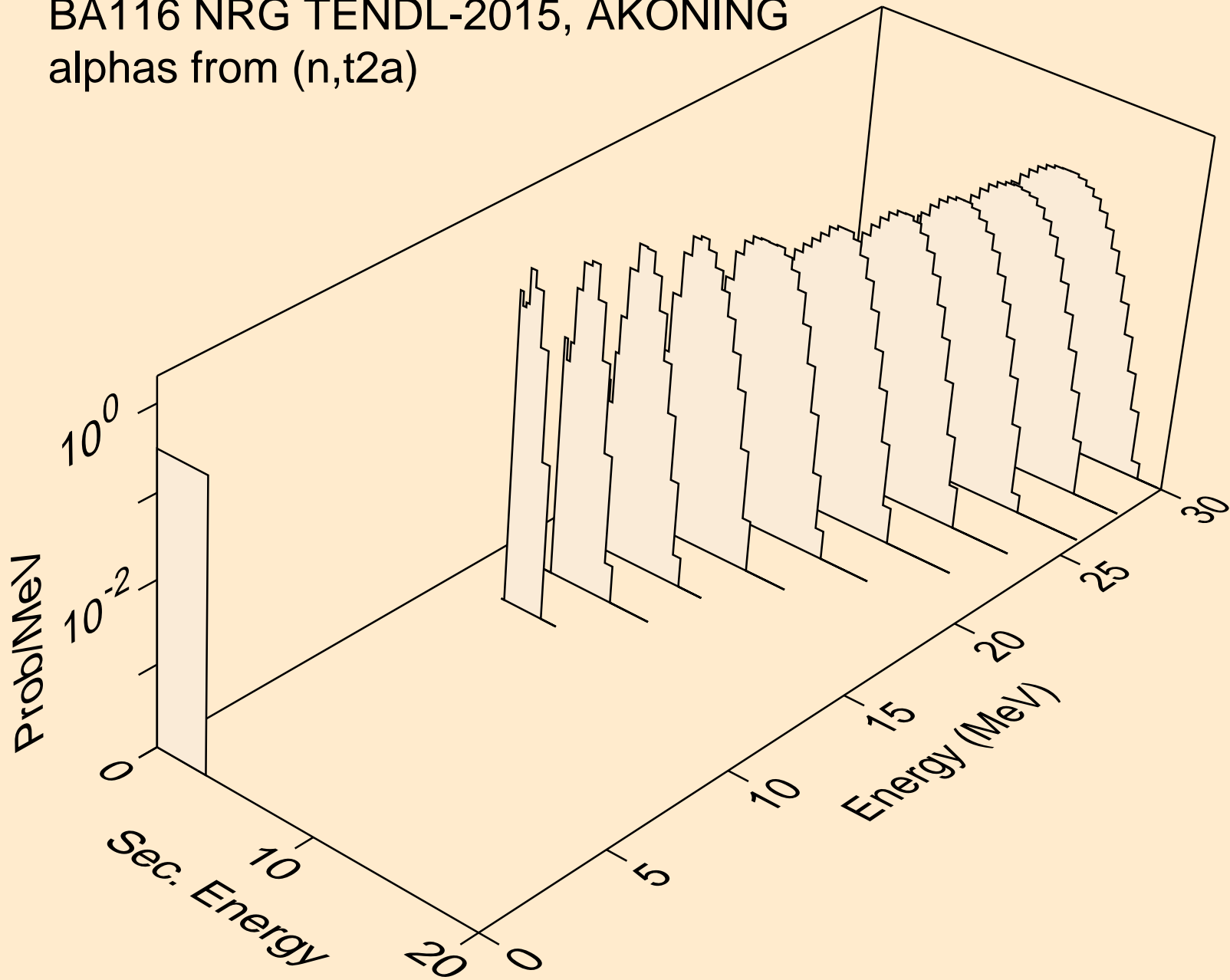

BA116 NRG TENDL-2015, AKONING
alphas from (n,d2a)

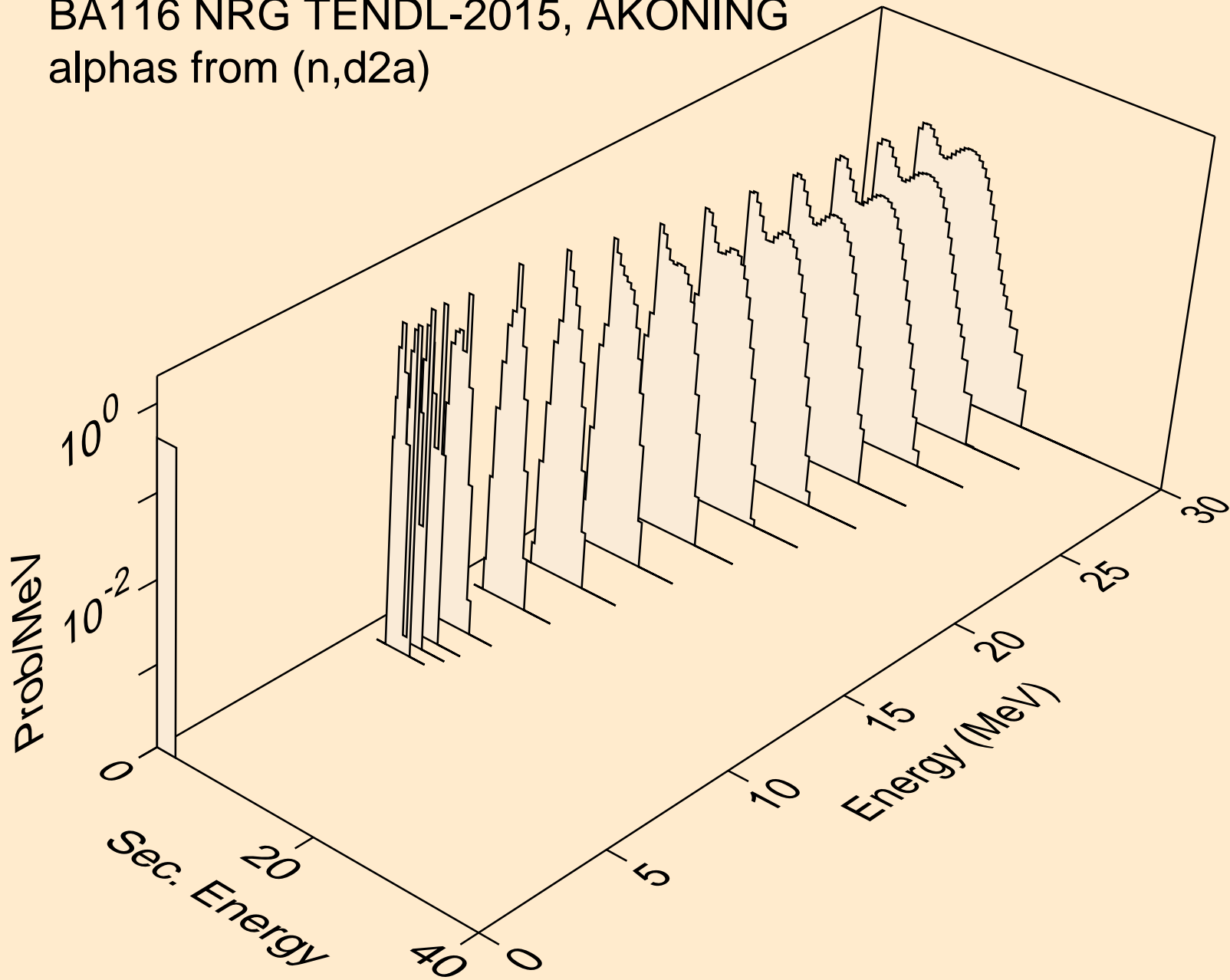

BA116 NRG TENDL-2015, AKONING
alphas from (n,da)

