

BE011 NRG TENDL-2015, AKONING

Principal cross sections

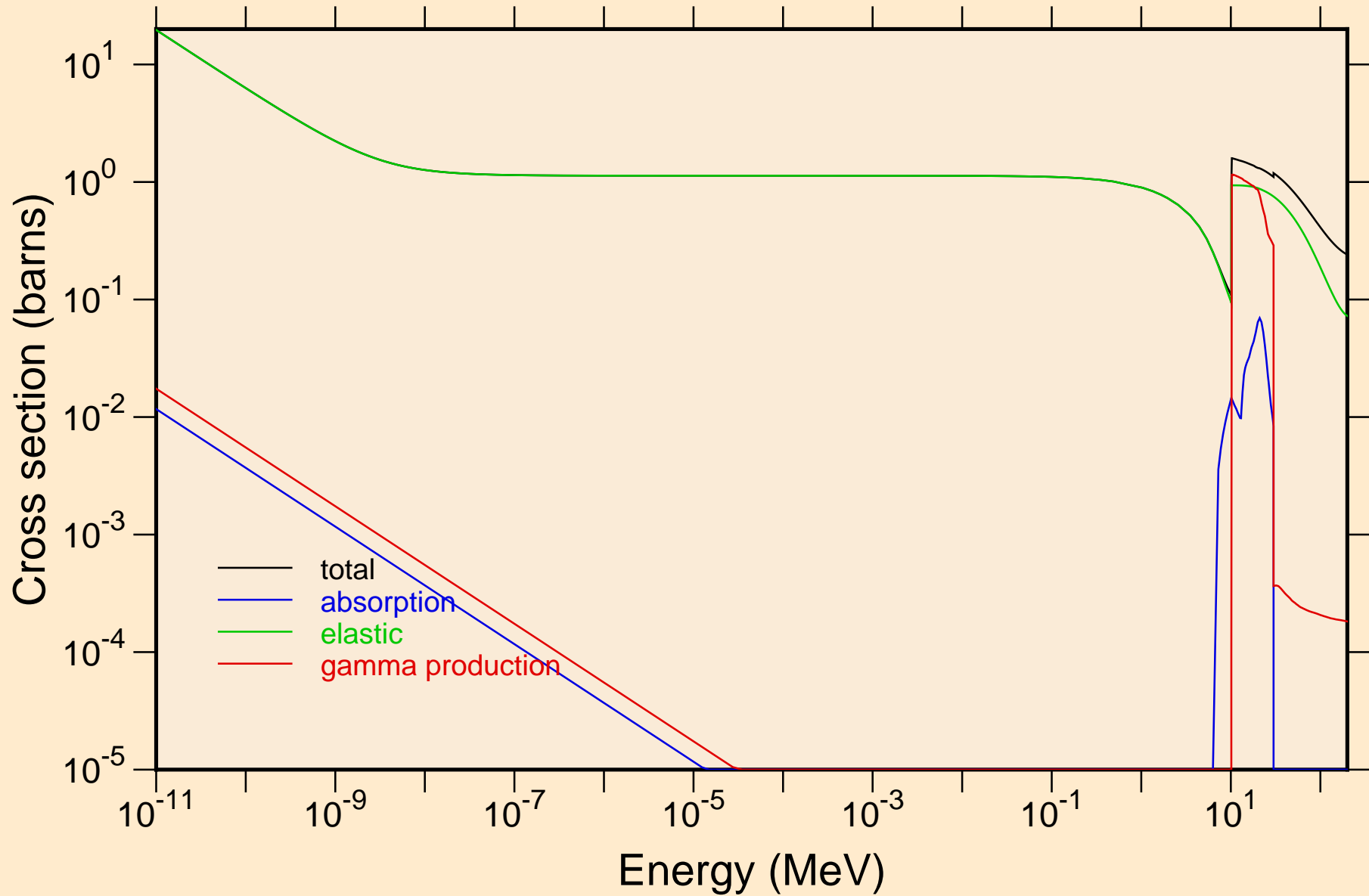

BE011 NRG TENDL-2015, AKONING
Non-threshold reactions

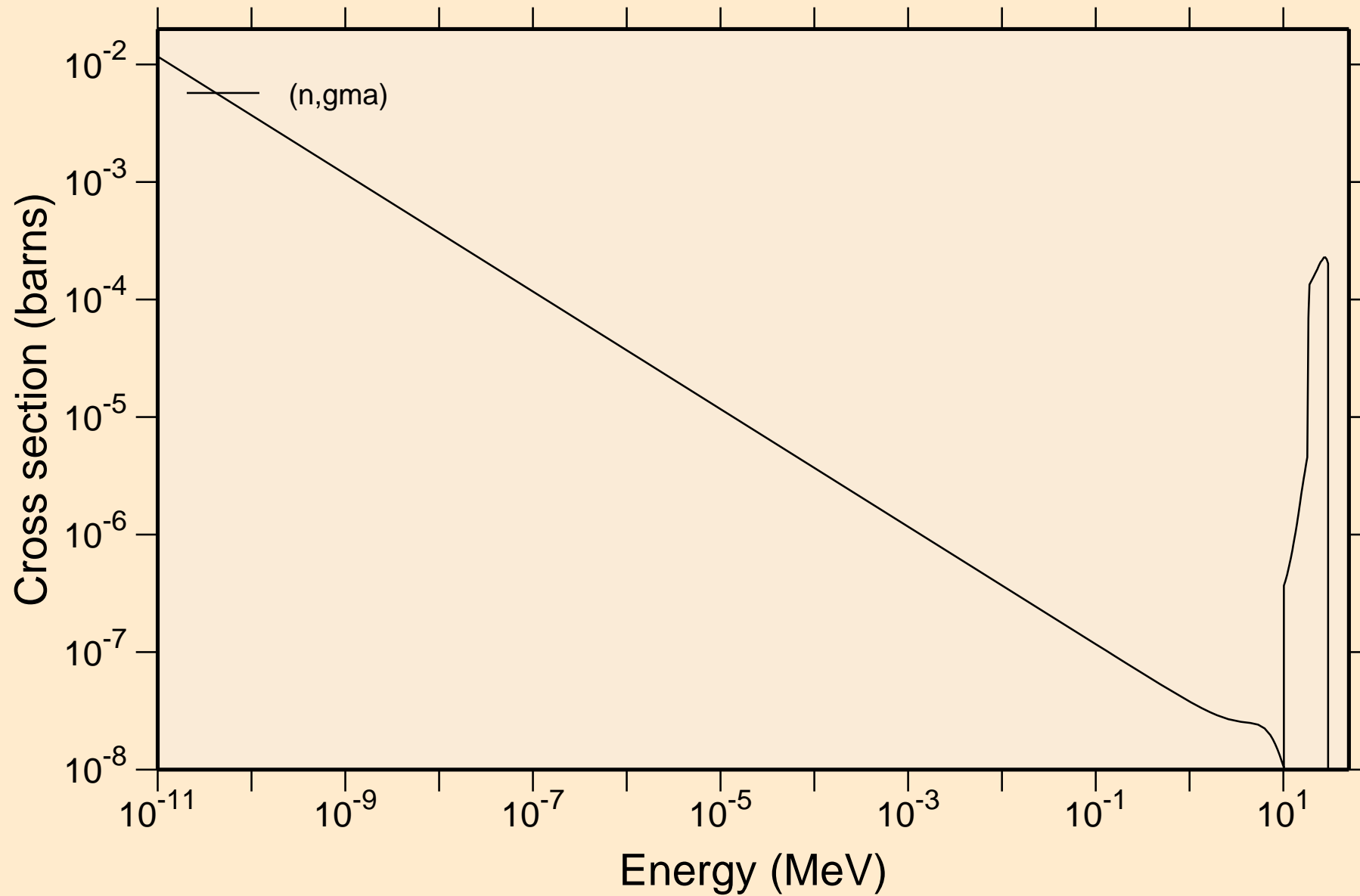

BE011 NRG TENDL-2015, AKONING

Principal cross sections

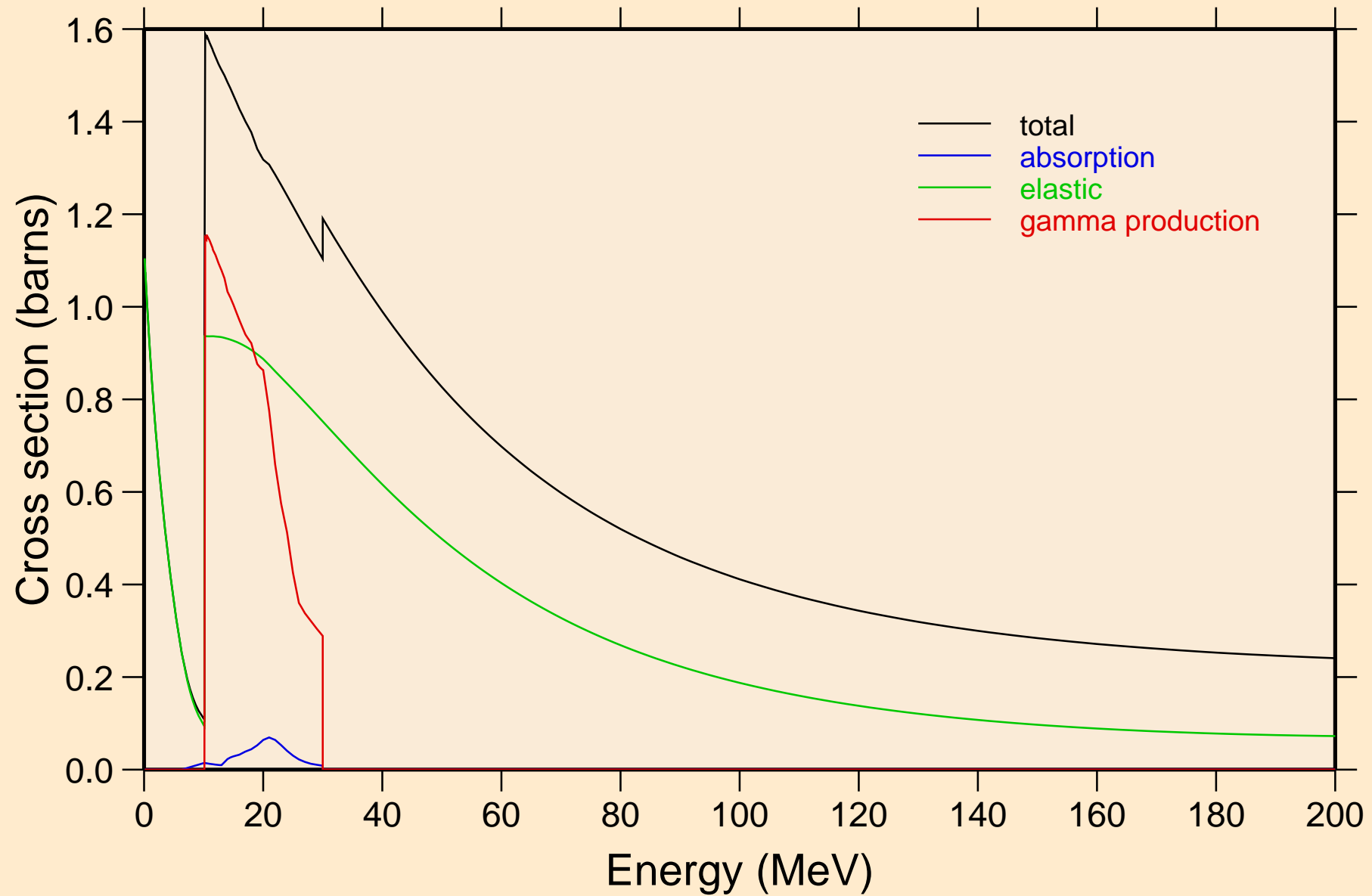

BE011 NRG TENDL-2015, AKONING
Non-threshold reactions

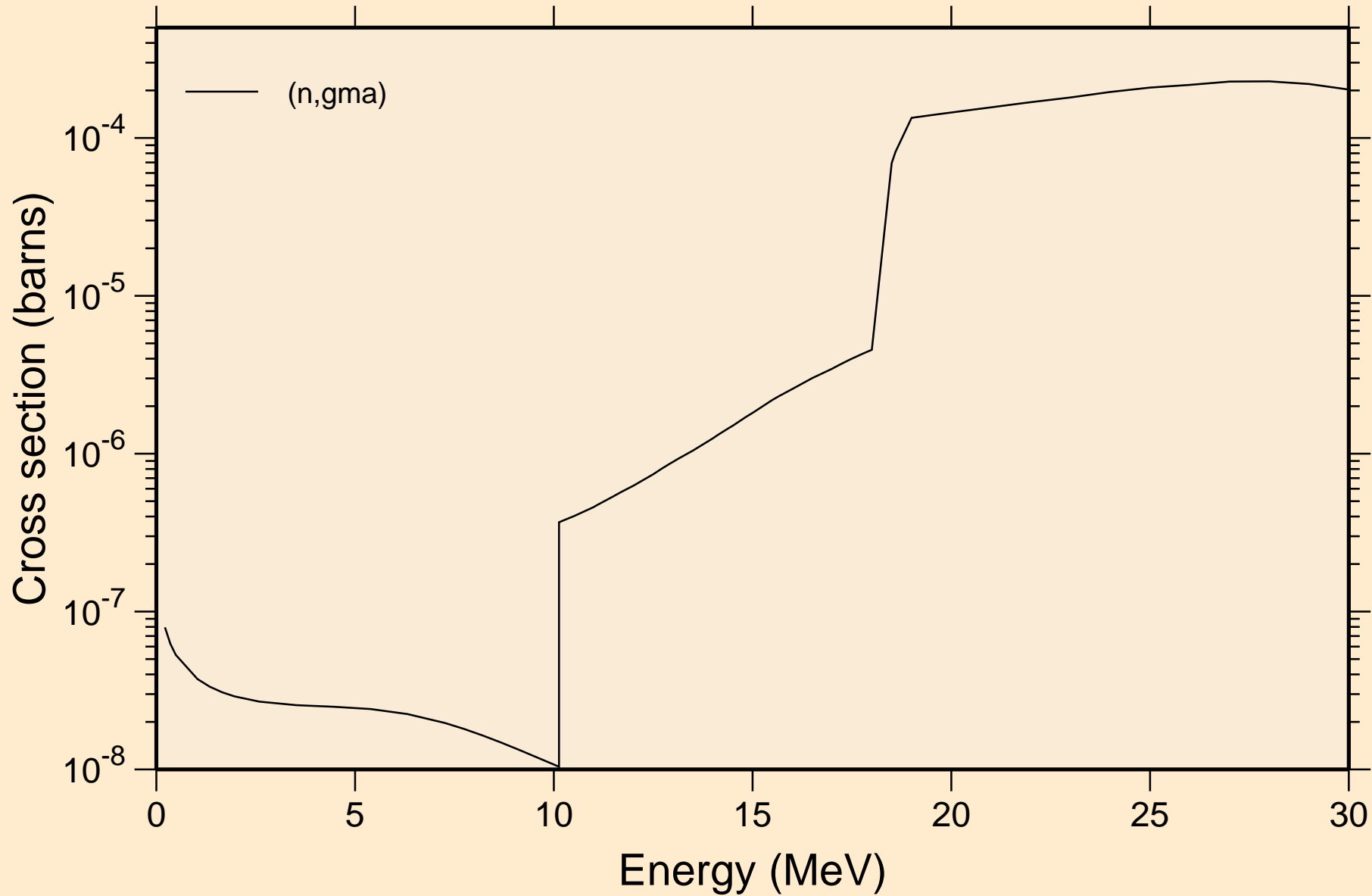

BE011 NRG TENDL-2015, AKONING

Inelastic levels

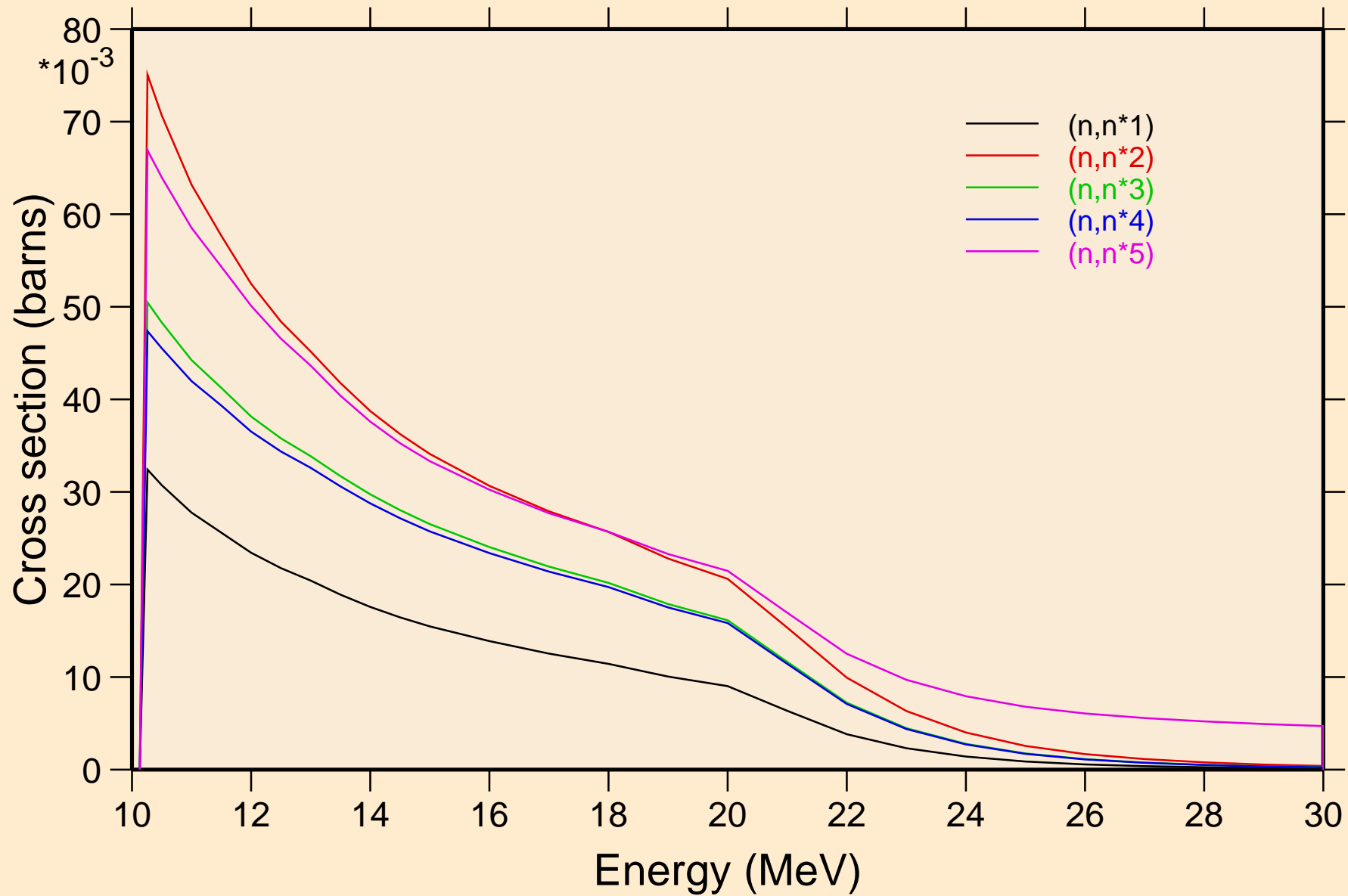

BE011 NRG TENDL-2015, AKONING

Inelastic levels

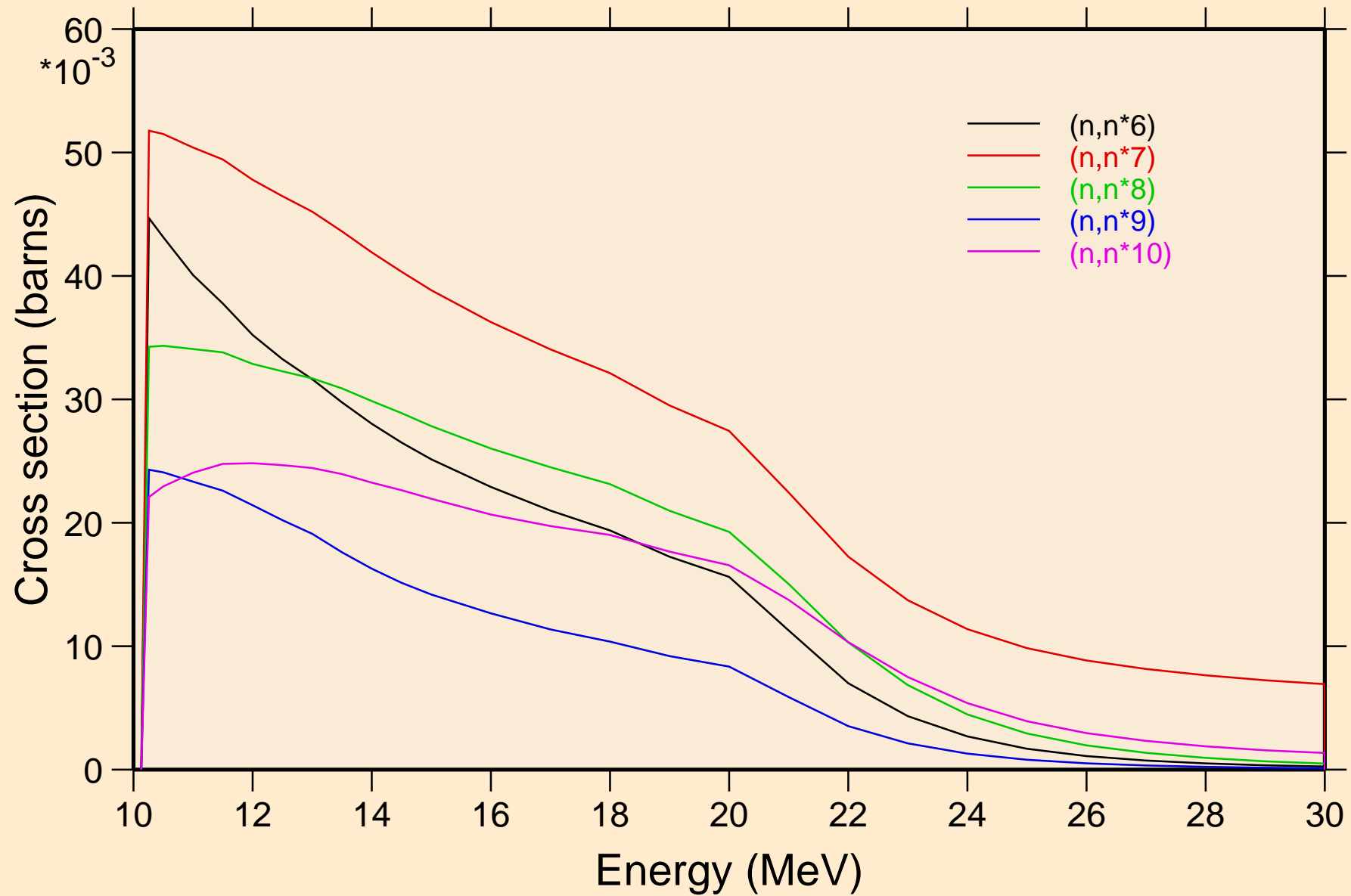

BE011 NRG TENDL-2015, AKONING

Inelastic levels

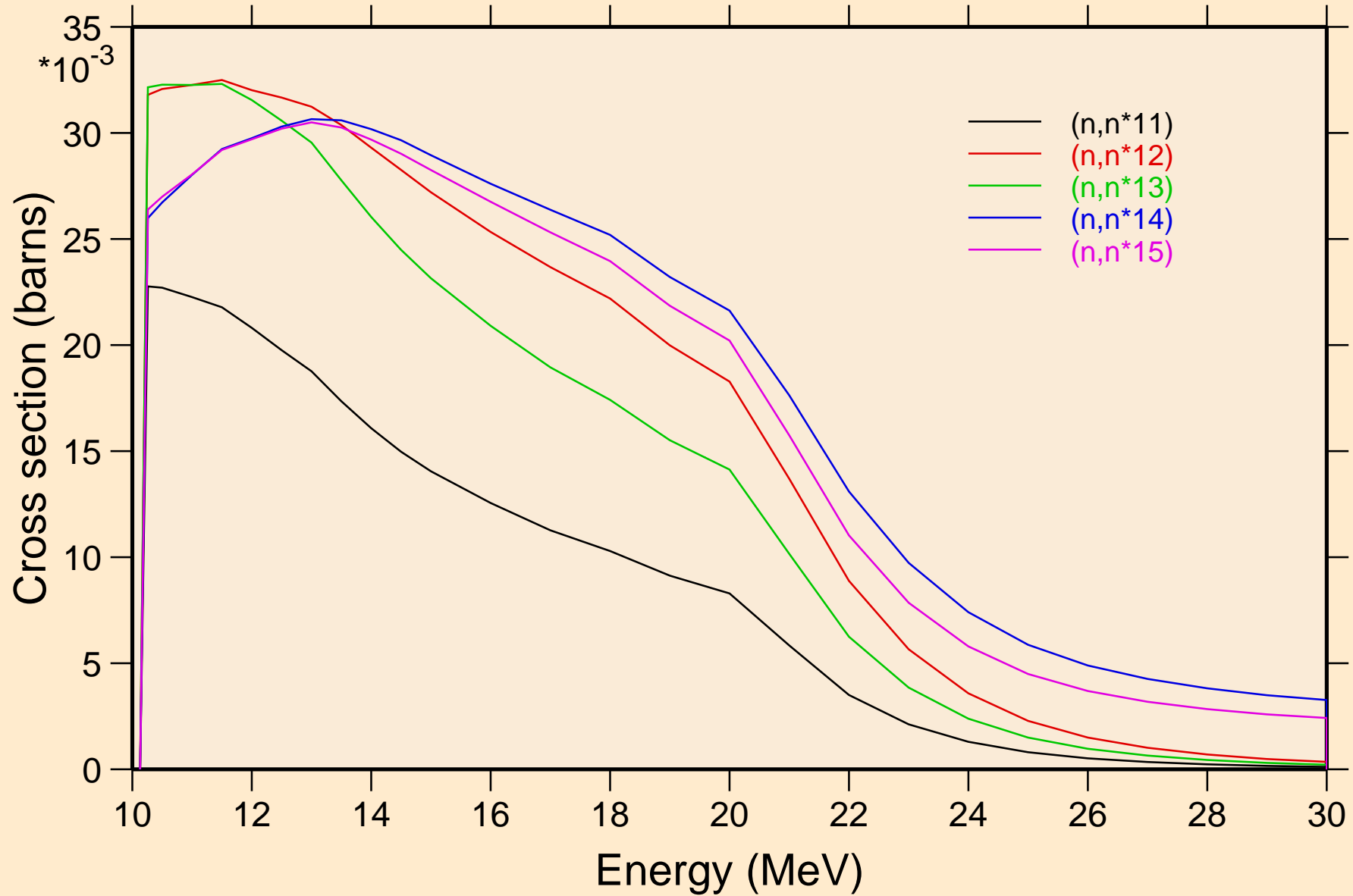

BE011 NRG TENDL-2015, AKONING

Inelastic levels

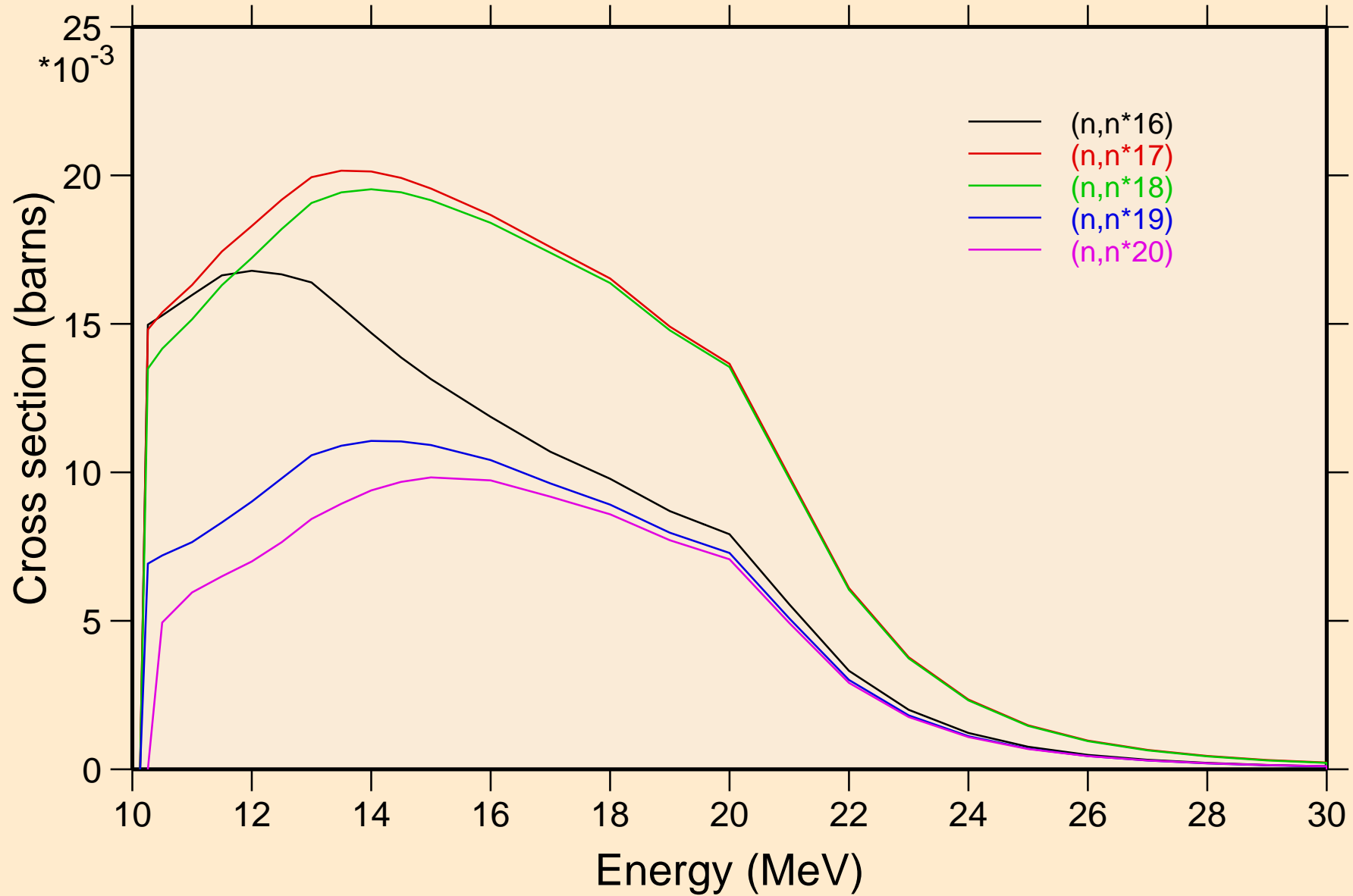

BE011 NRG TENDL-2015, AKONING
Inelastic levels

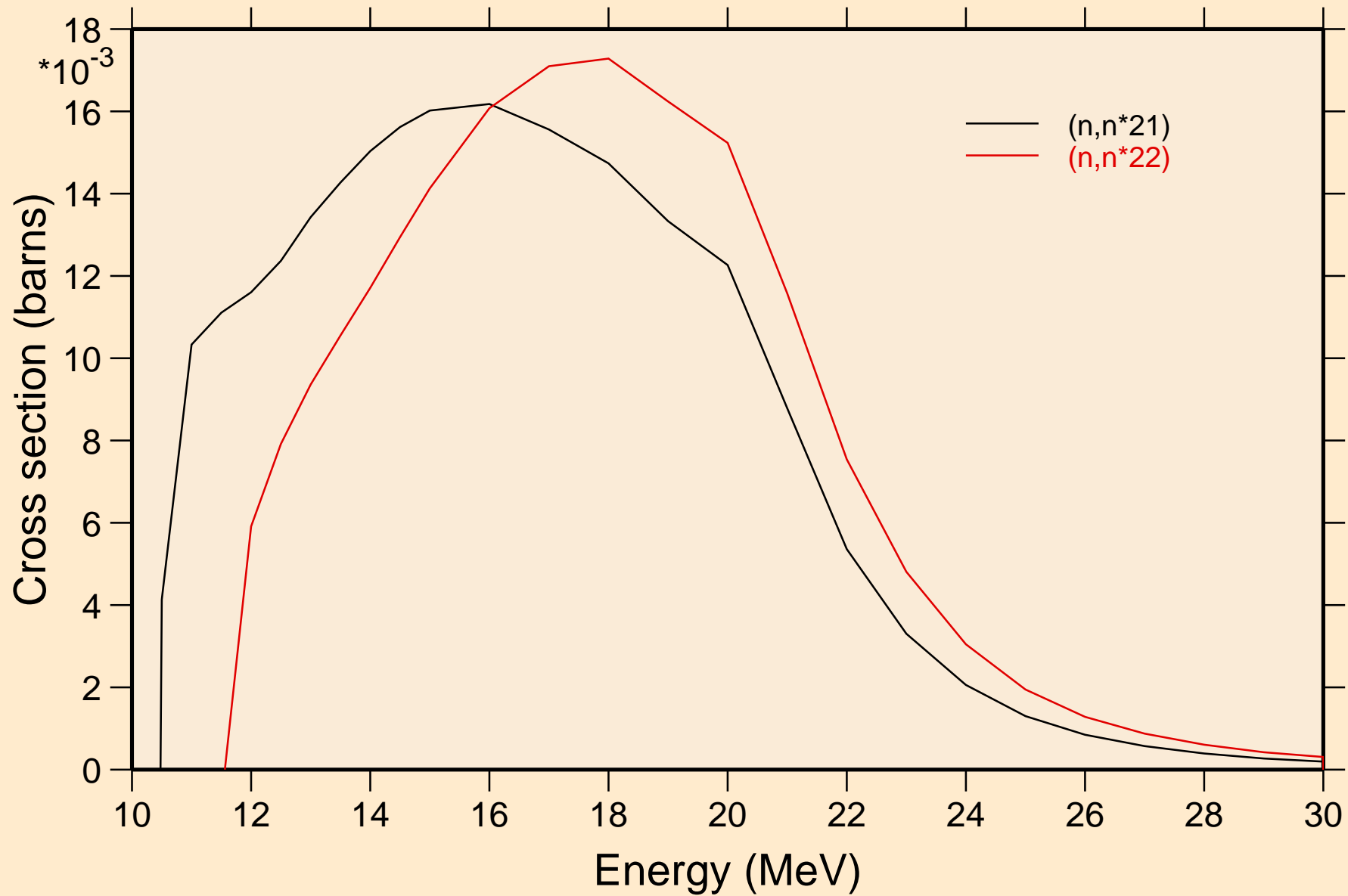

BE011 NRG TENDL-2015, AKONING

Threshold reactions

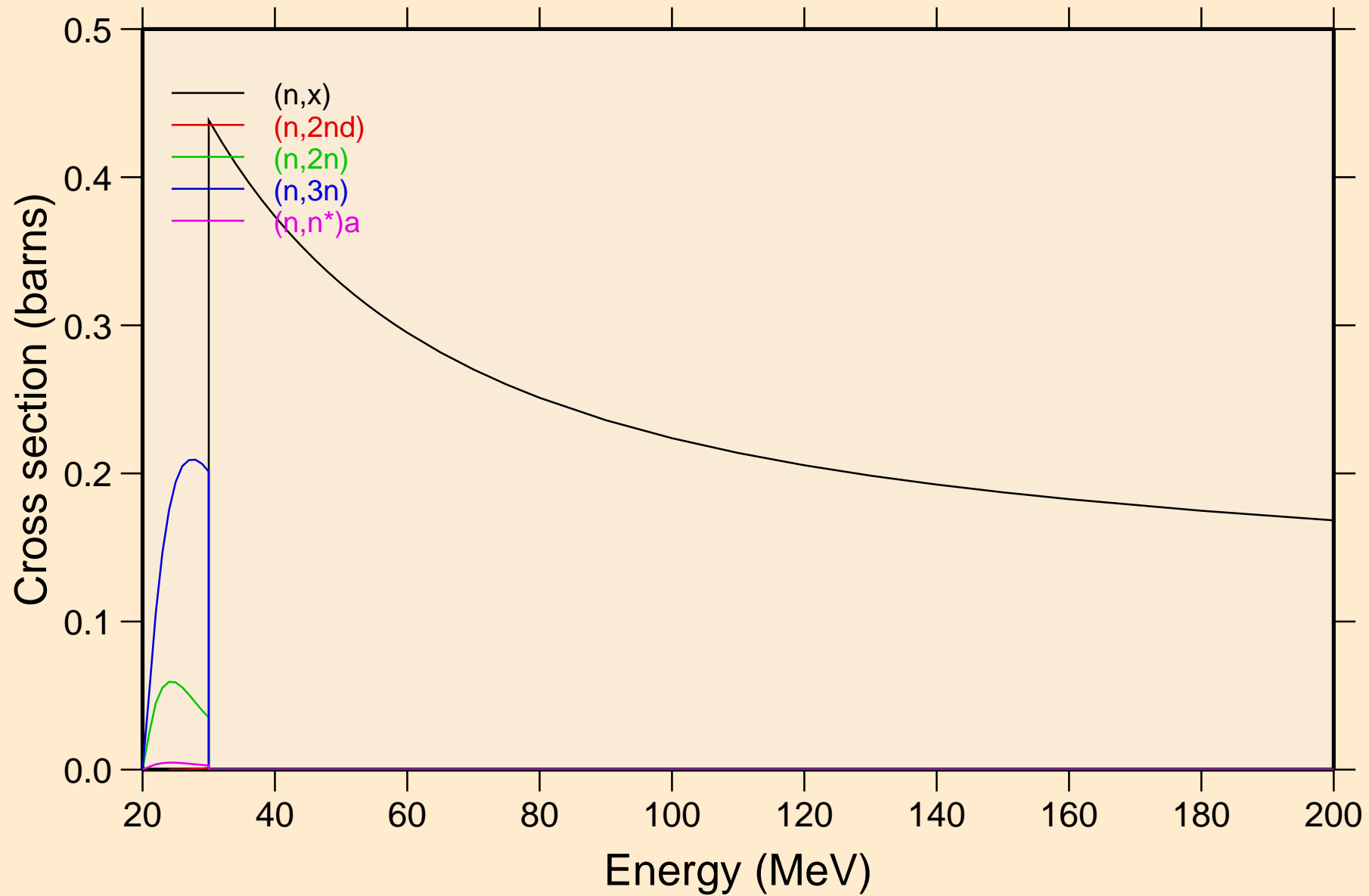

BE011 NRG TENDL-2015, AKONING

Threshold reactions

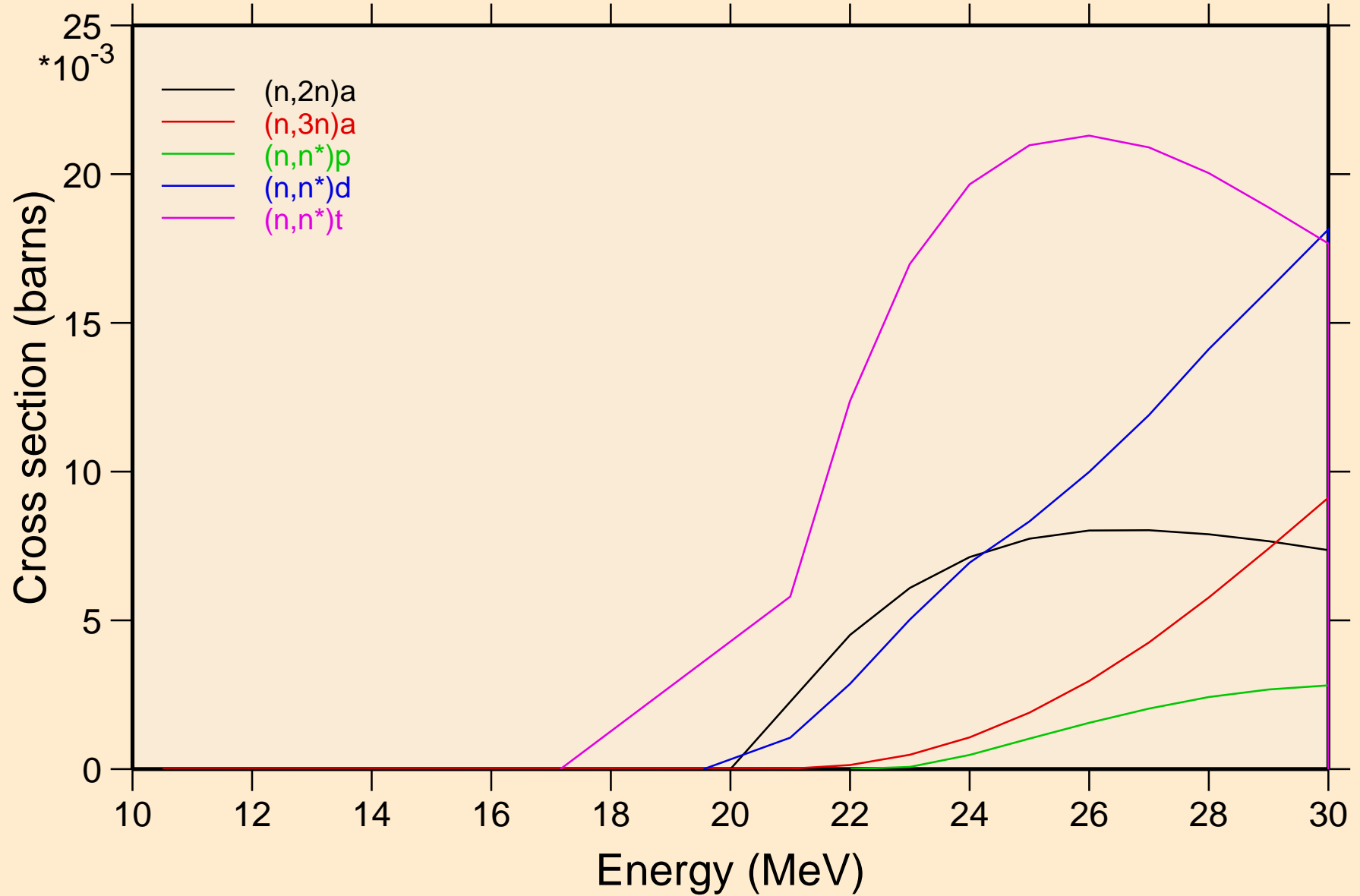

BE011 NRG TENDL-2015, AKONING

Threshold reactions

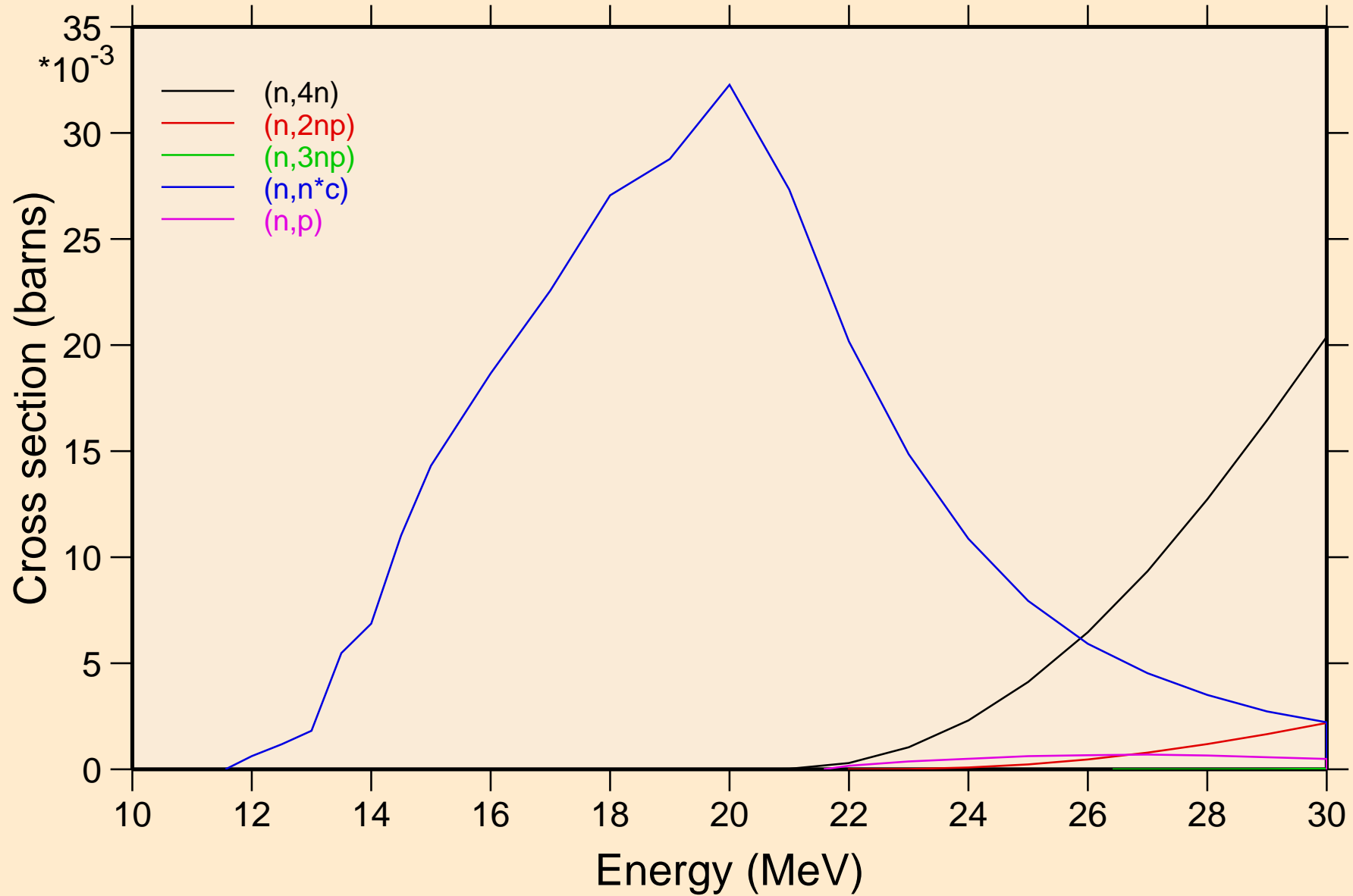

BE011 NRG TENDL-2015, AKONING

Threshold reactions

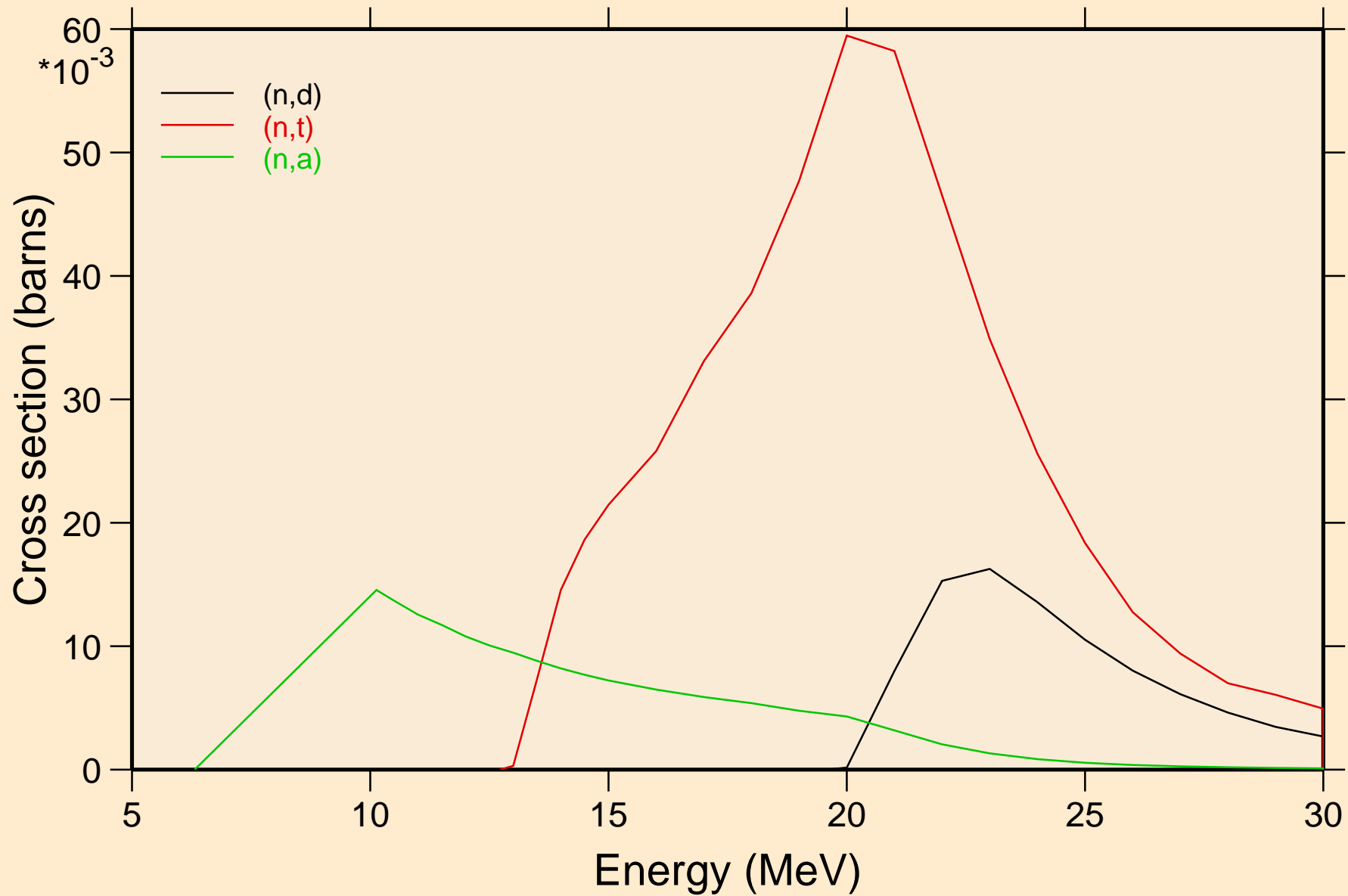

BE011 NRG TENDL-2015, AKONING
angular distribution for elastic

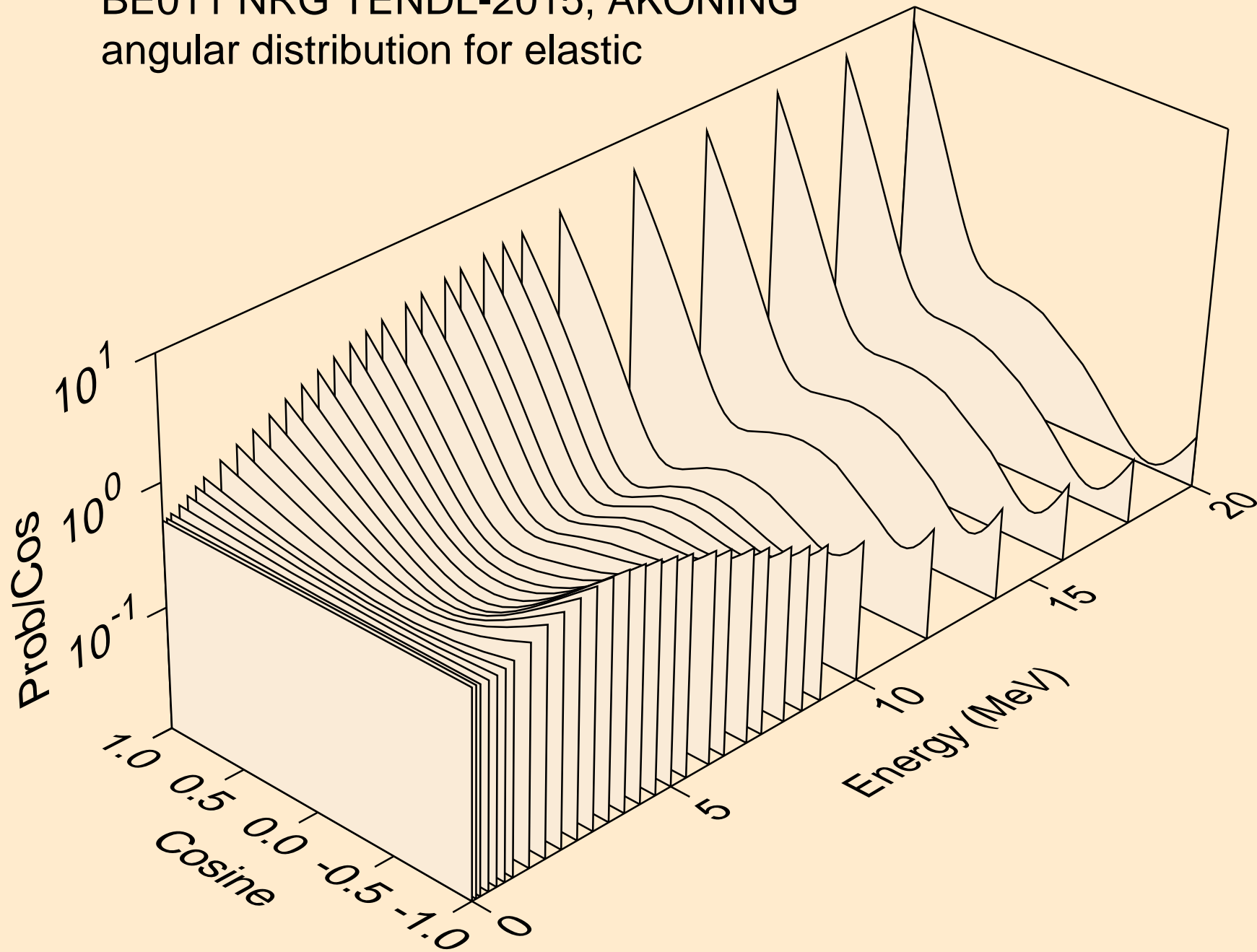

BE011 NRG TENDL-2015, AKONING
angular distribution for elastic

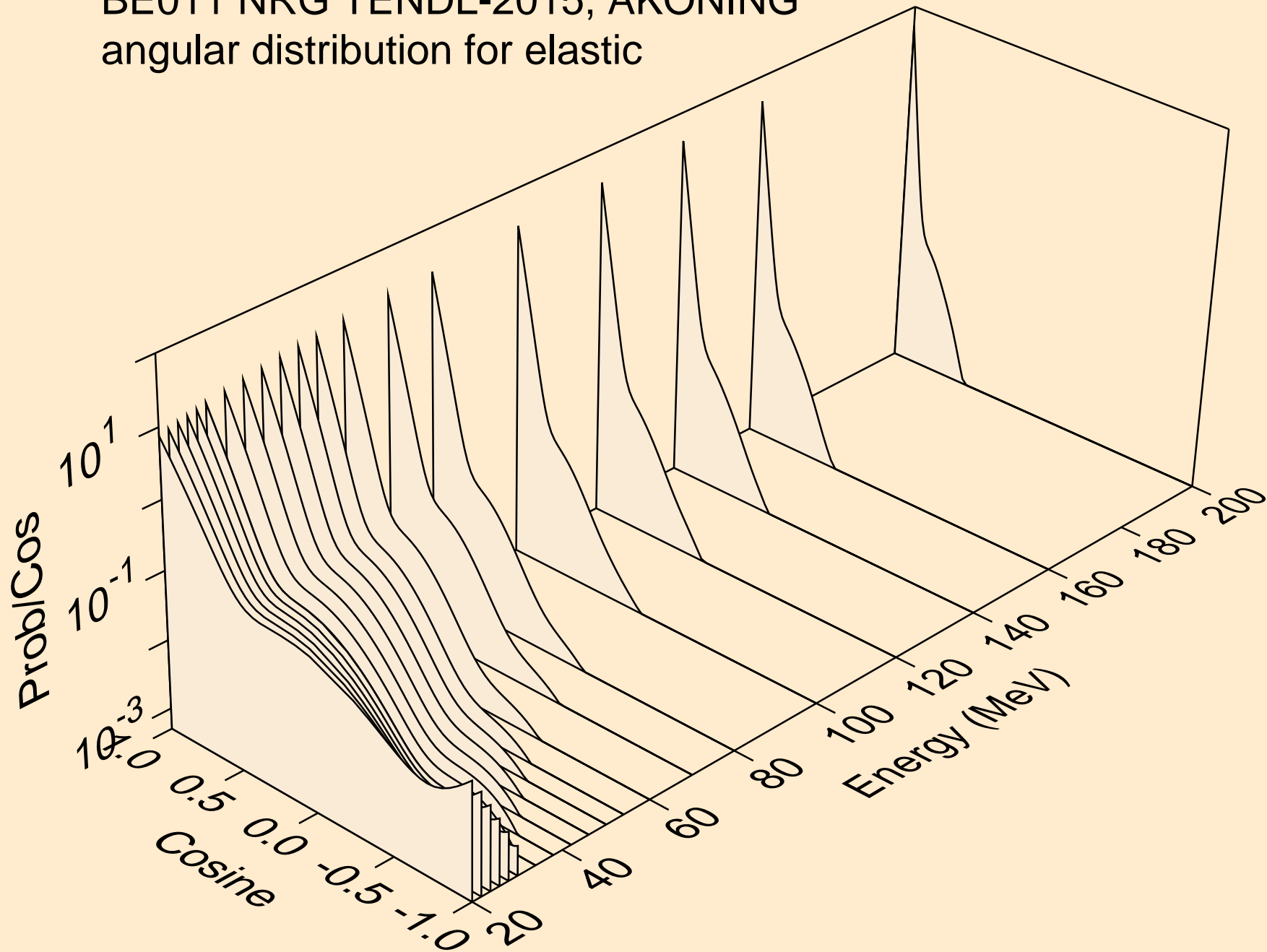

BE011 NRG TENDL-2015, AKONING
angular distribution for (n,n*1)

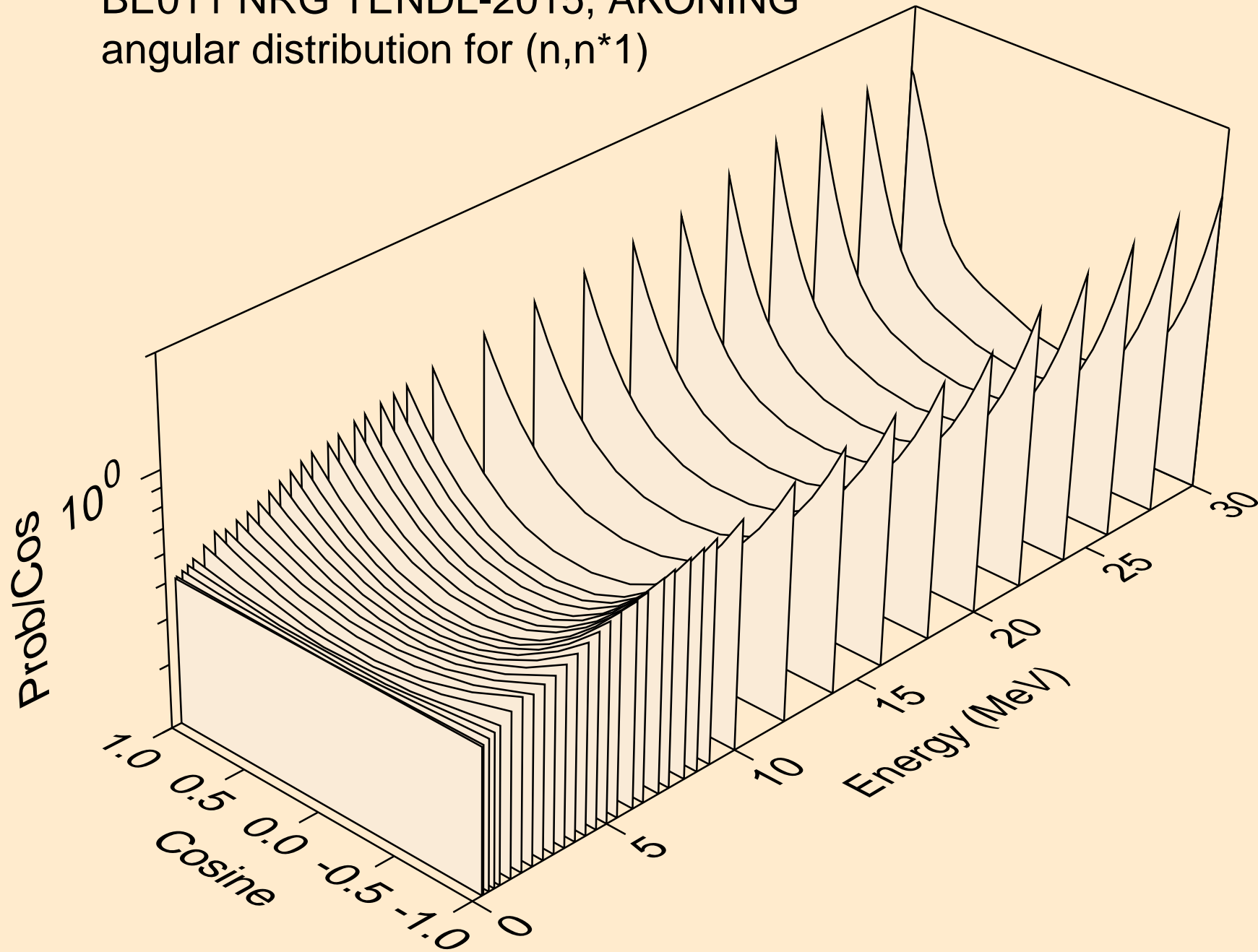

BE011 NRG TENDL-2015, AKONING
angular distribution for (n,n*2)

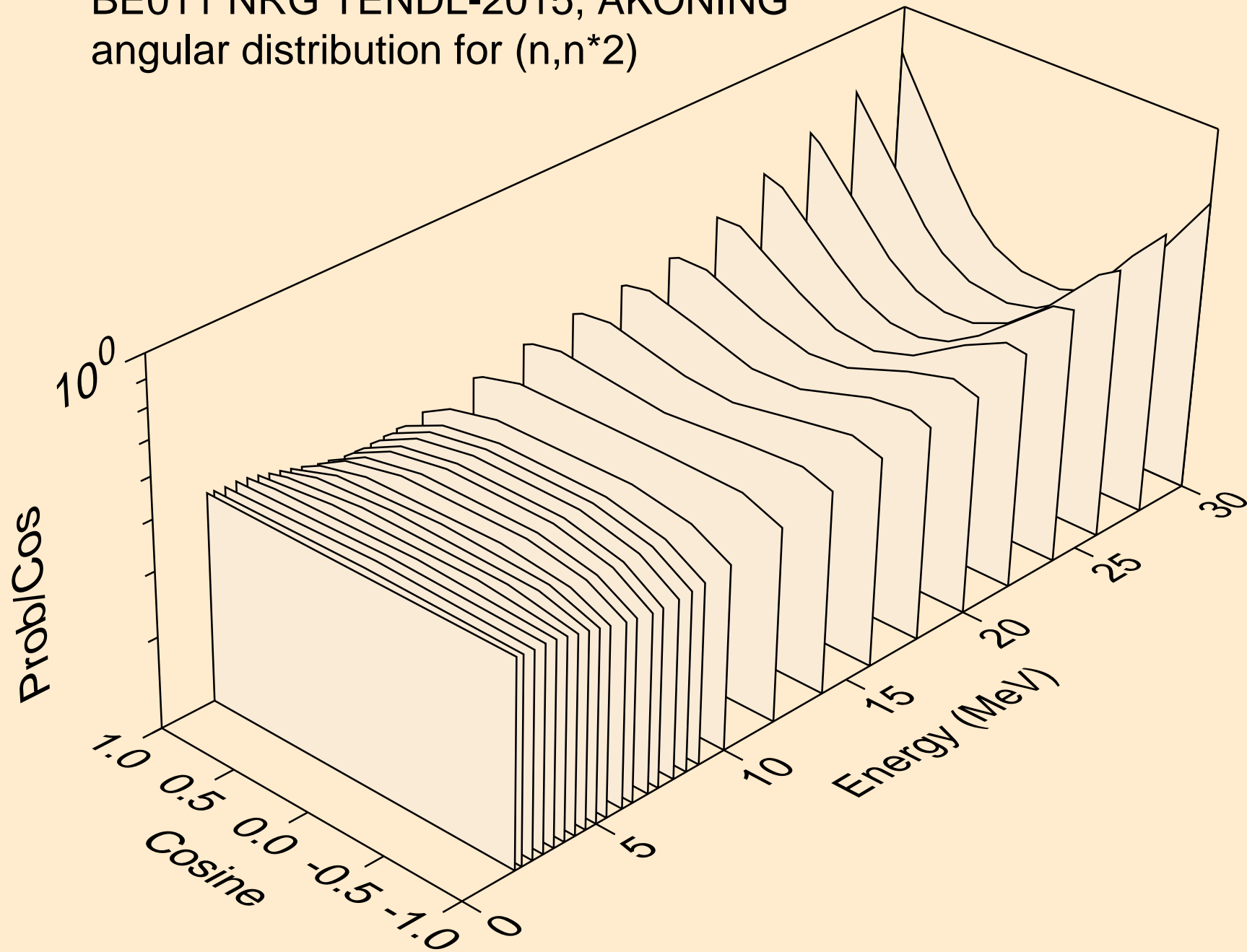

BE011 NRG TENDL-2015, AKONING
angular distribution for (n,n*3)

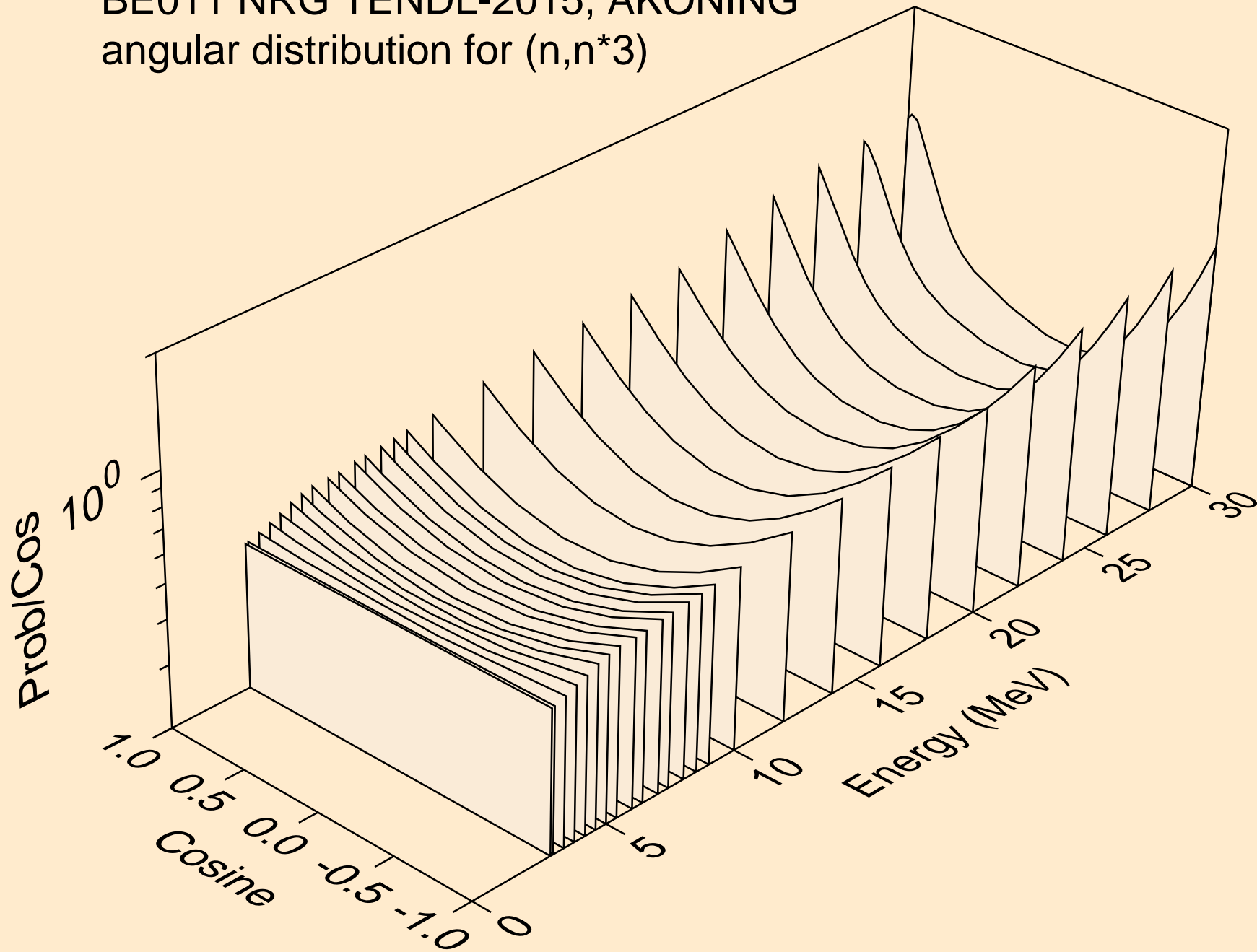

BE011 NRG TENDL-2015, AKONING
angular distribution for (n,n*4)

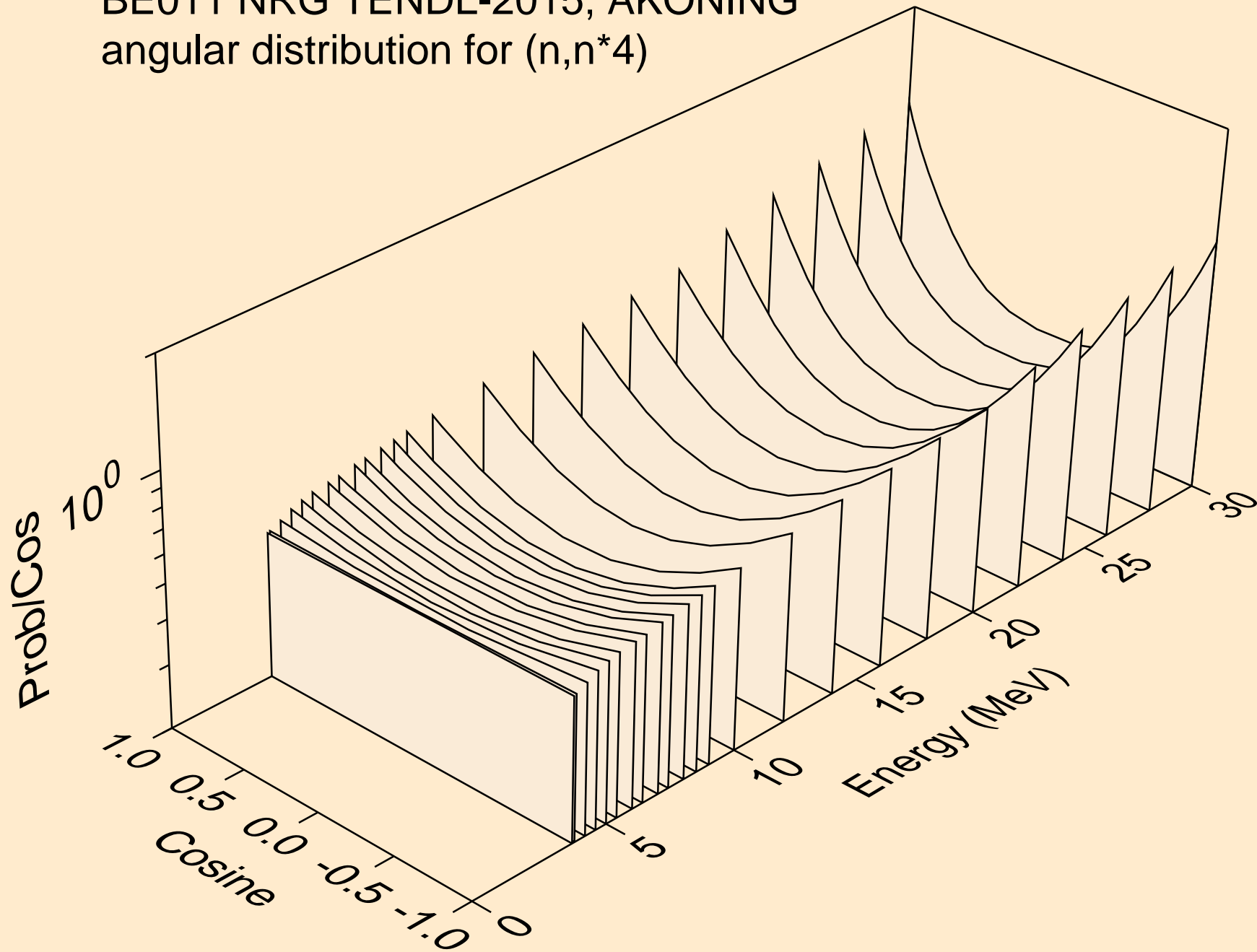

BE011 NRG TENDL-2015, AKONING
angular distribution for (n,n*5)

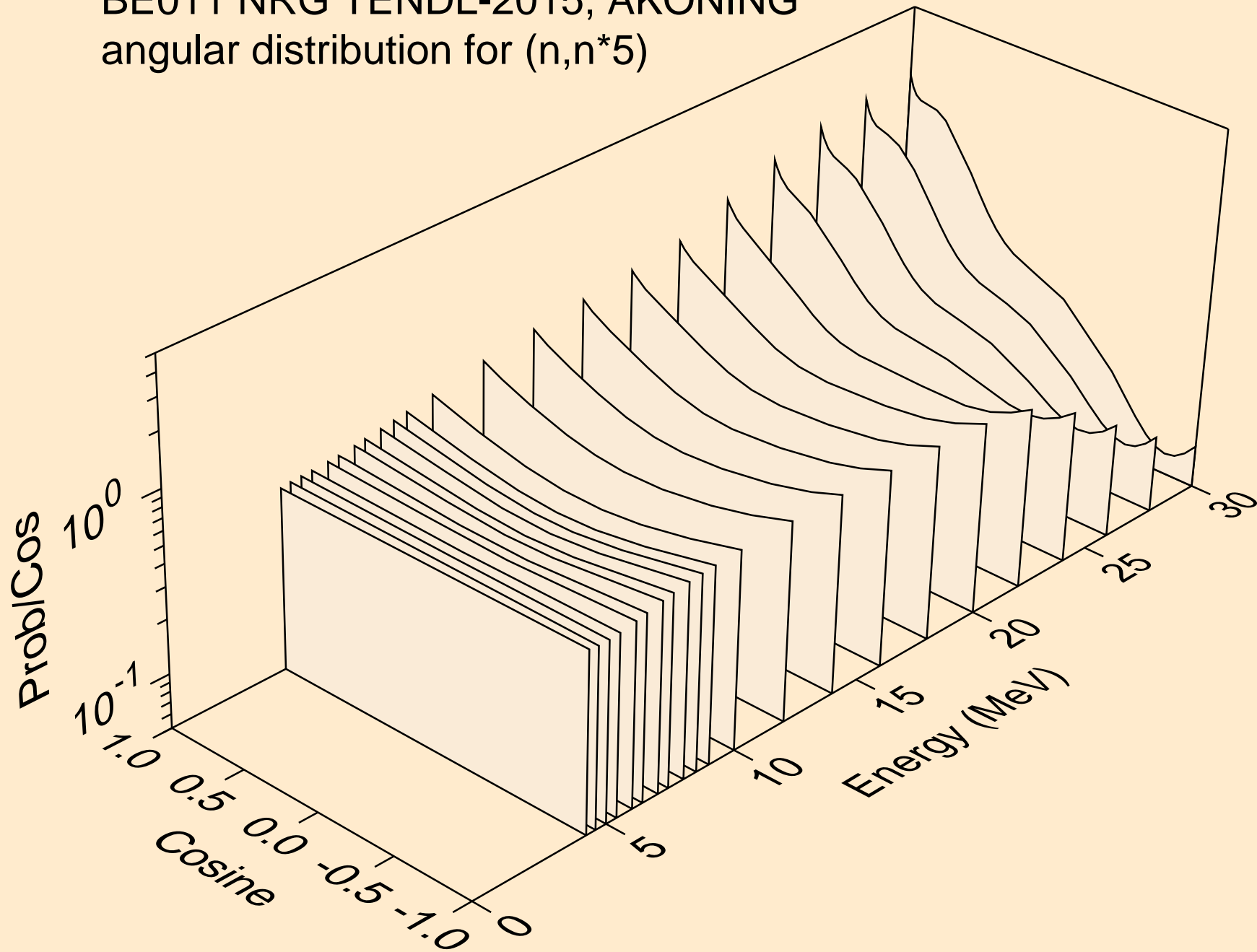

BE011 NRG TENDL-2015, AKONING
angular distribution for (n,n*6)

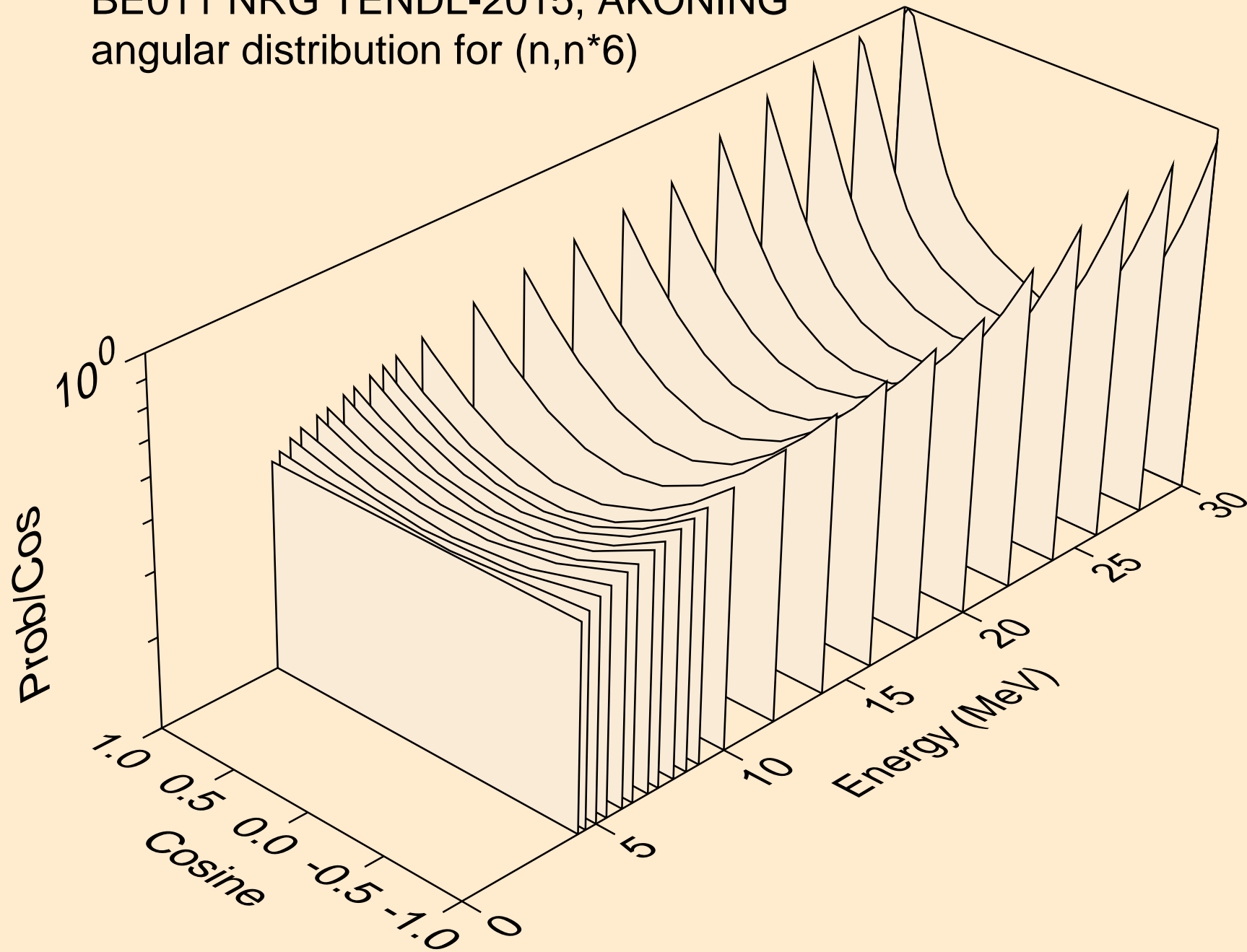

BE011 NRG TENDL-2015, AKONING
angular distribution for (n,n*7)

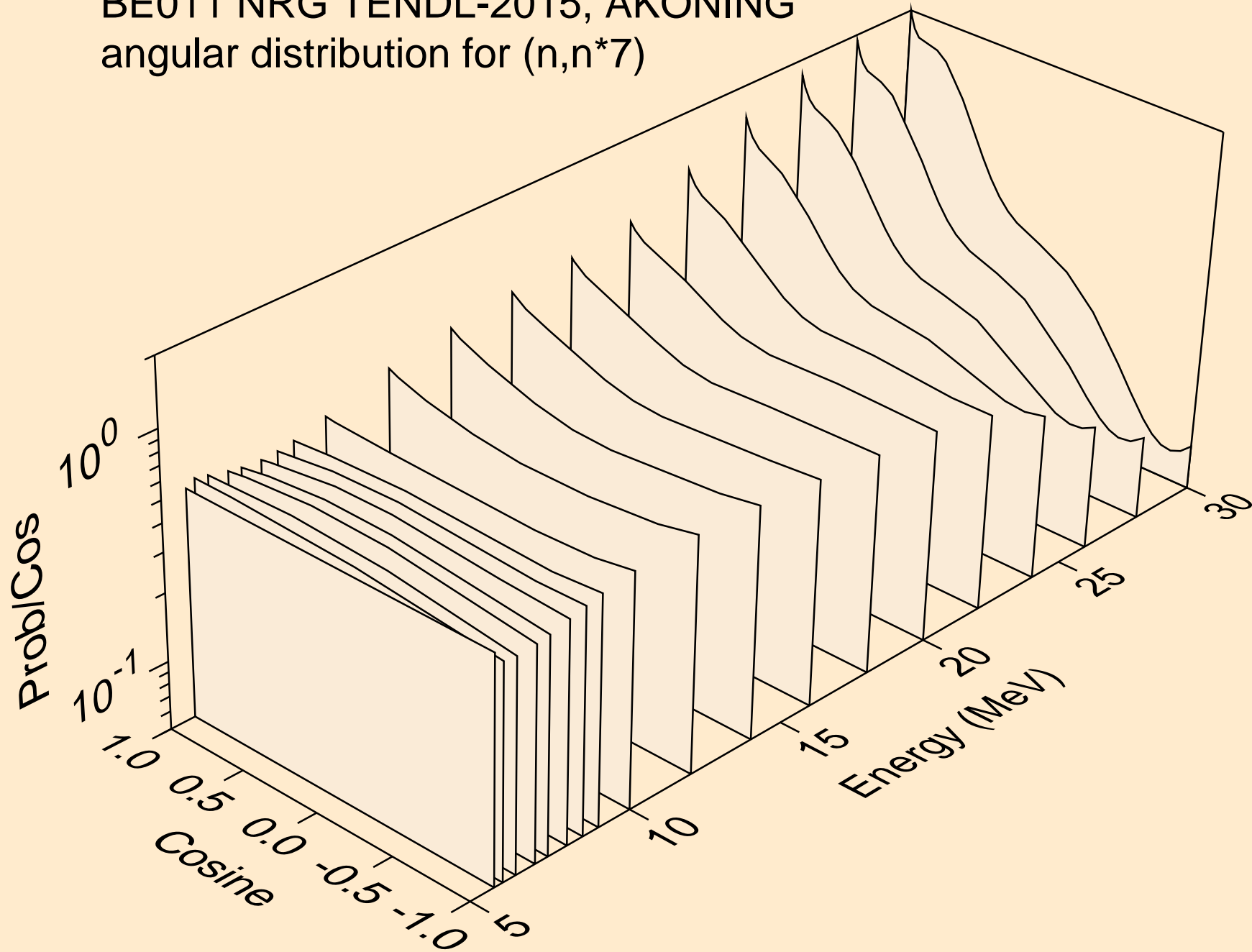

BE011 NRG TENDL-2015, AKONING
angular distribution for (n,n*8)

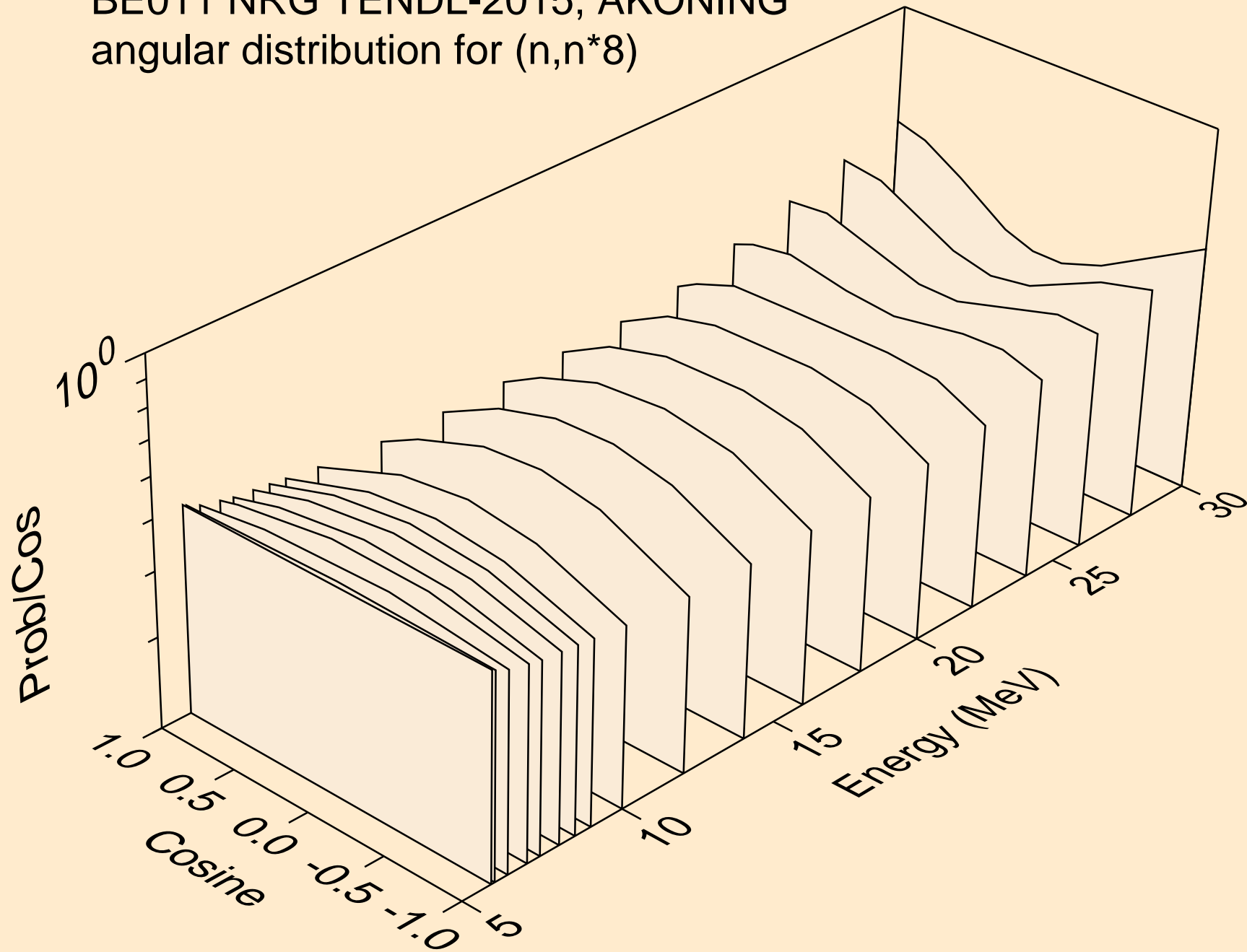

BE011 NRG TENDL-2015, AKONING
angular distribution for (n,n*9)

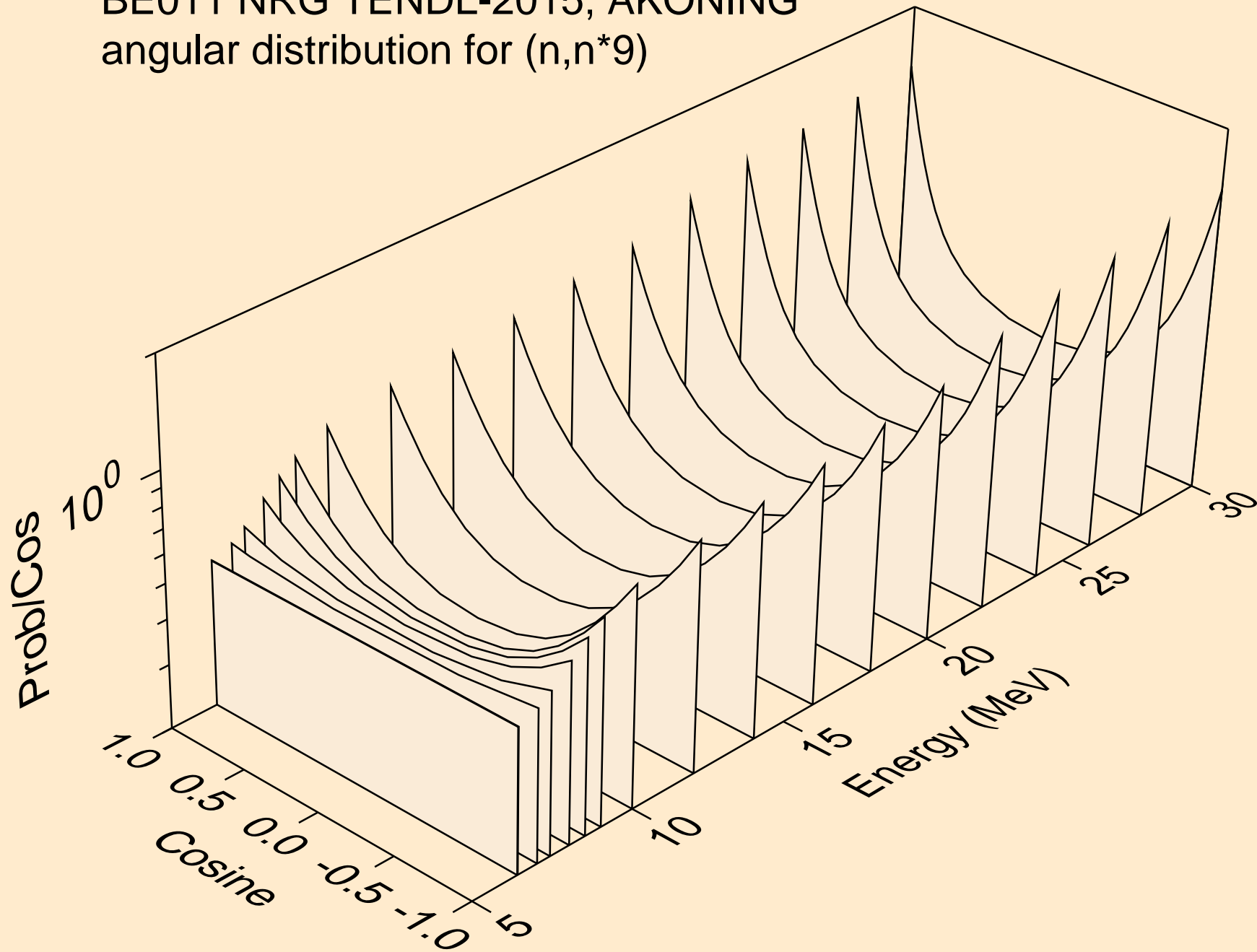

BE011 NRG TENDL-2015, AKONING
angular distribution for (n,n*10)

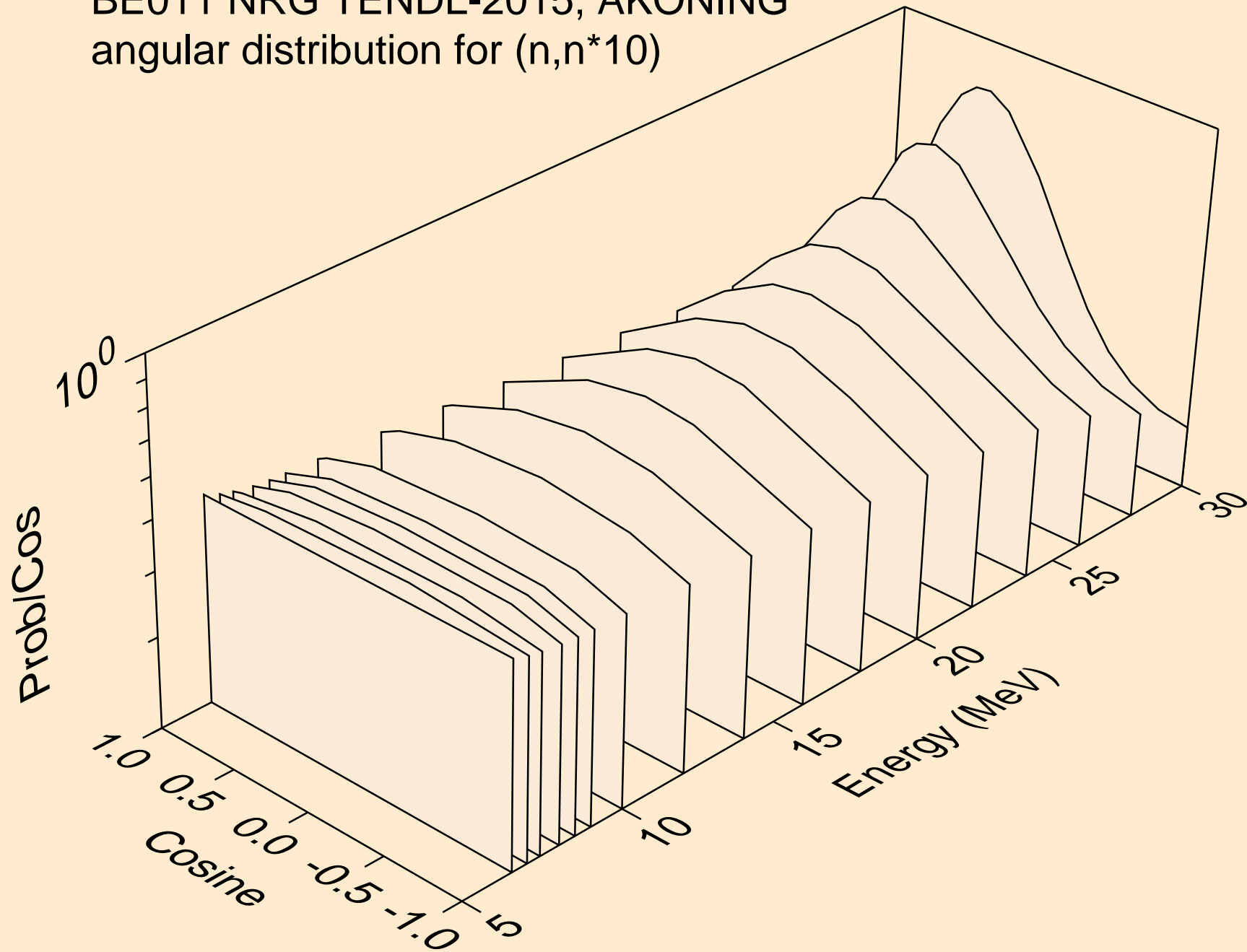

BE011 NRG TENDL-2015, AKONING
angular distribution for (n,n*11)

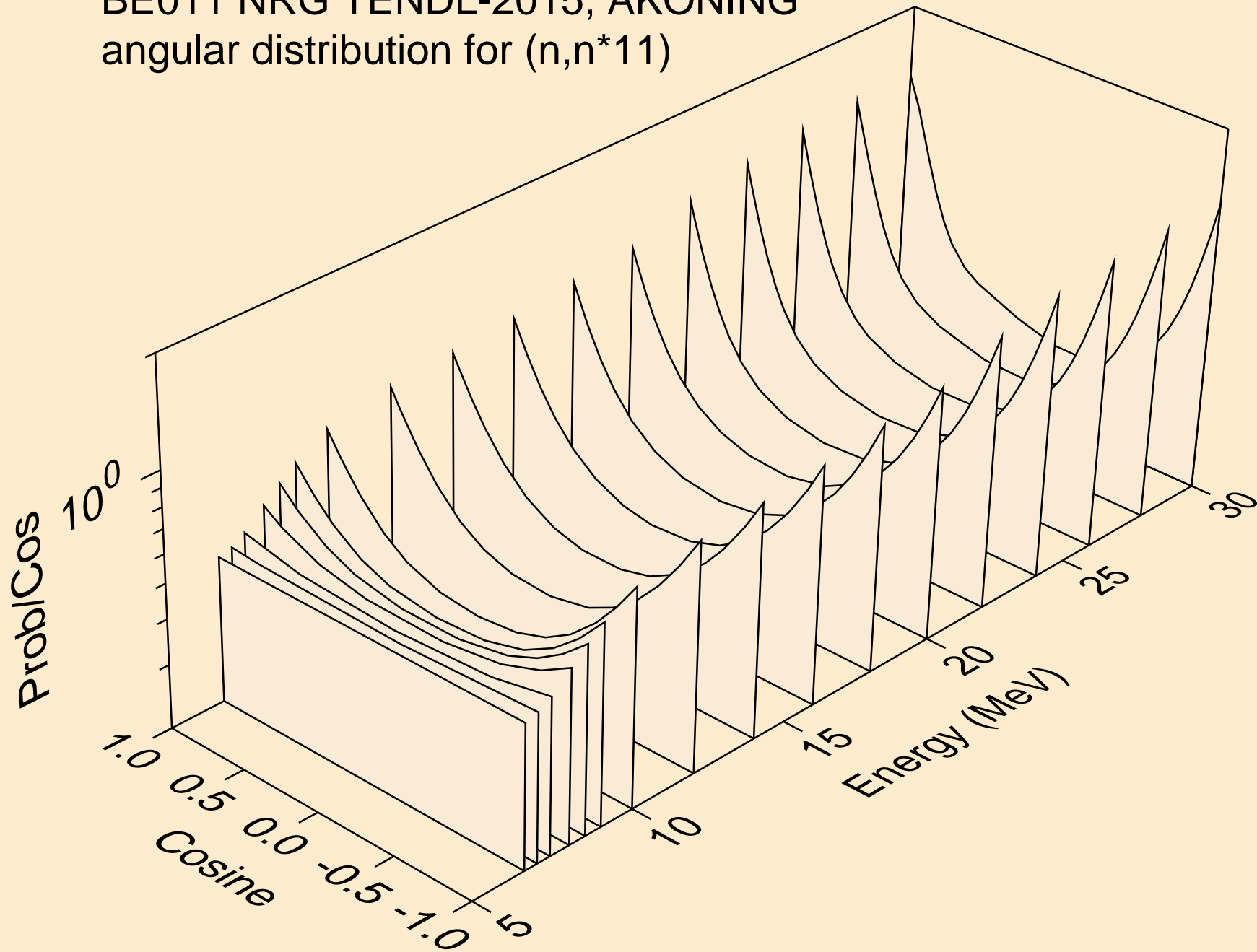

BE011 NRG TENDL-2015, AKONING
angular distribution for (n,n*12)

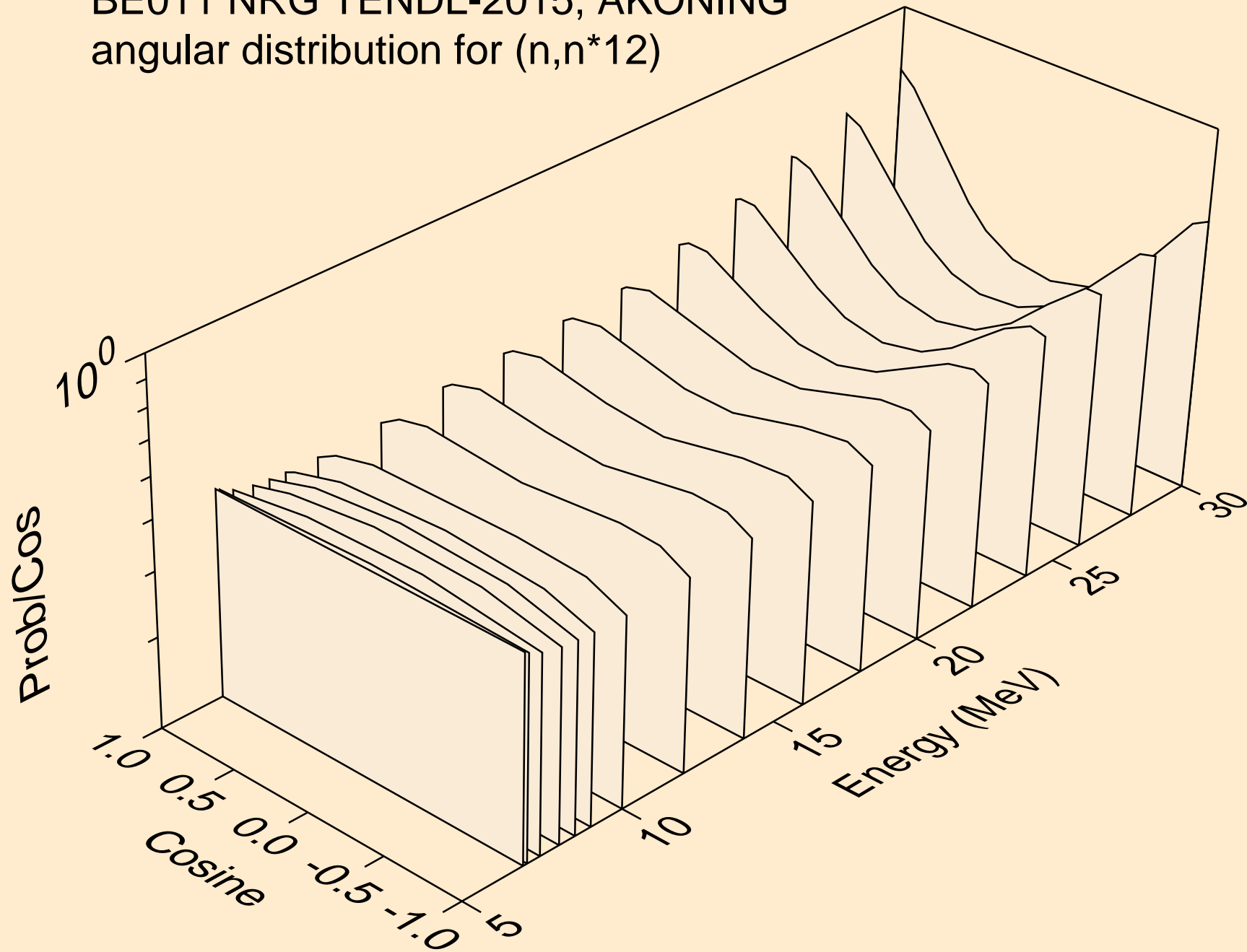

BE011 NRG TENDL-2015, AKONING
angular distribution for (n,n*13)

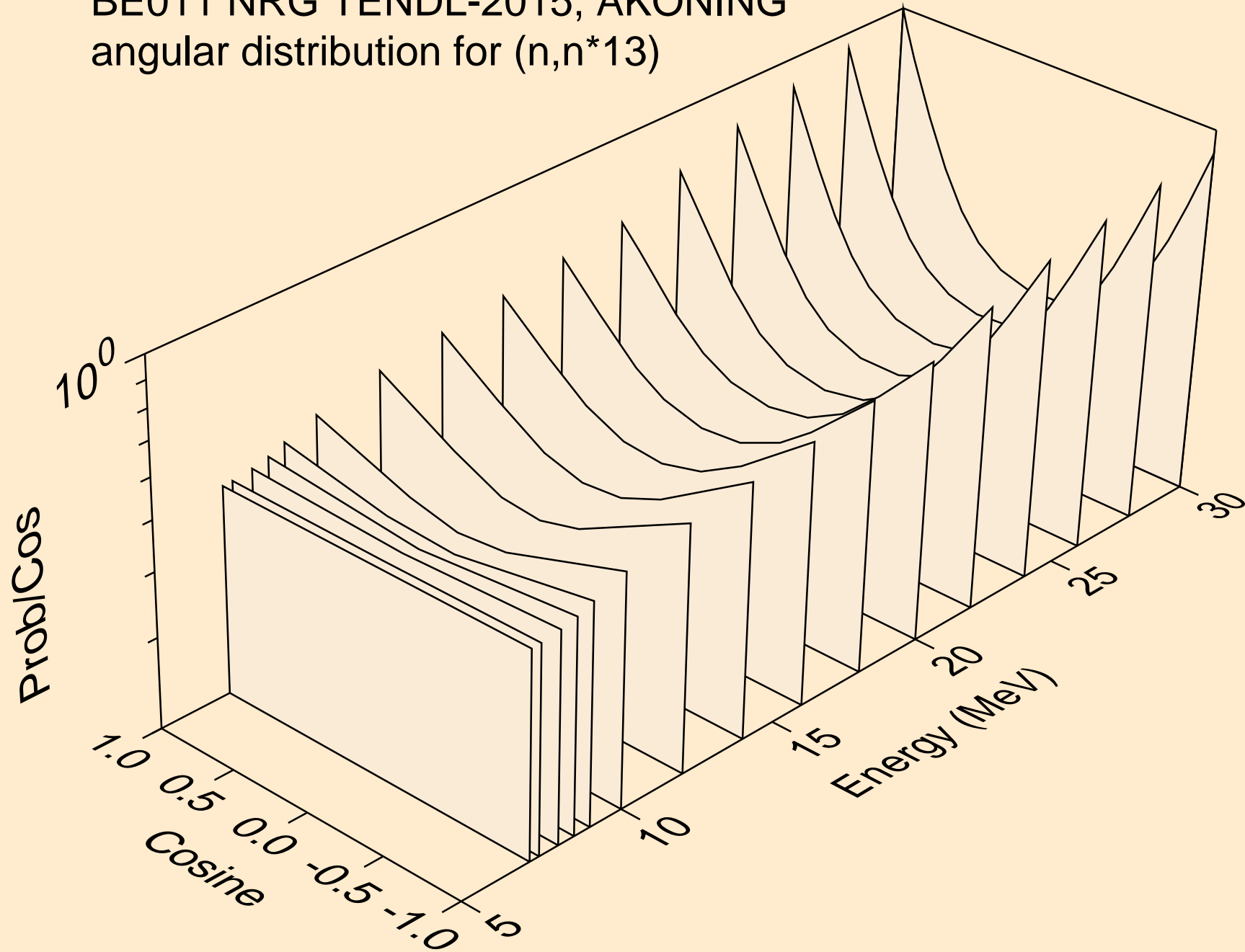

BE011 NRG TENDL-2015, AKONING
angular distribution for (n,n*14)

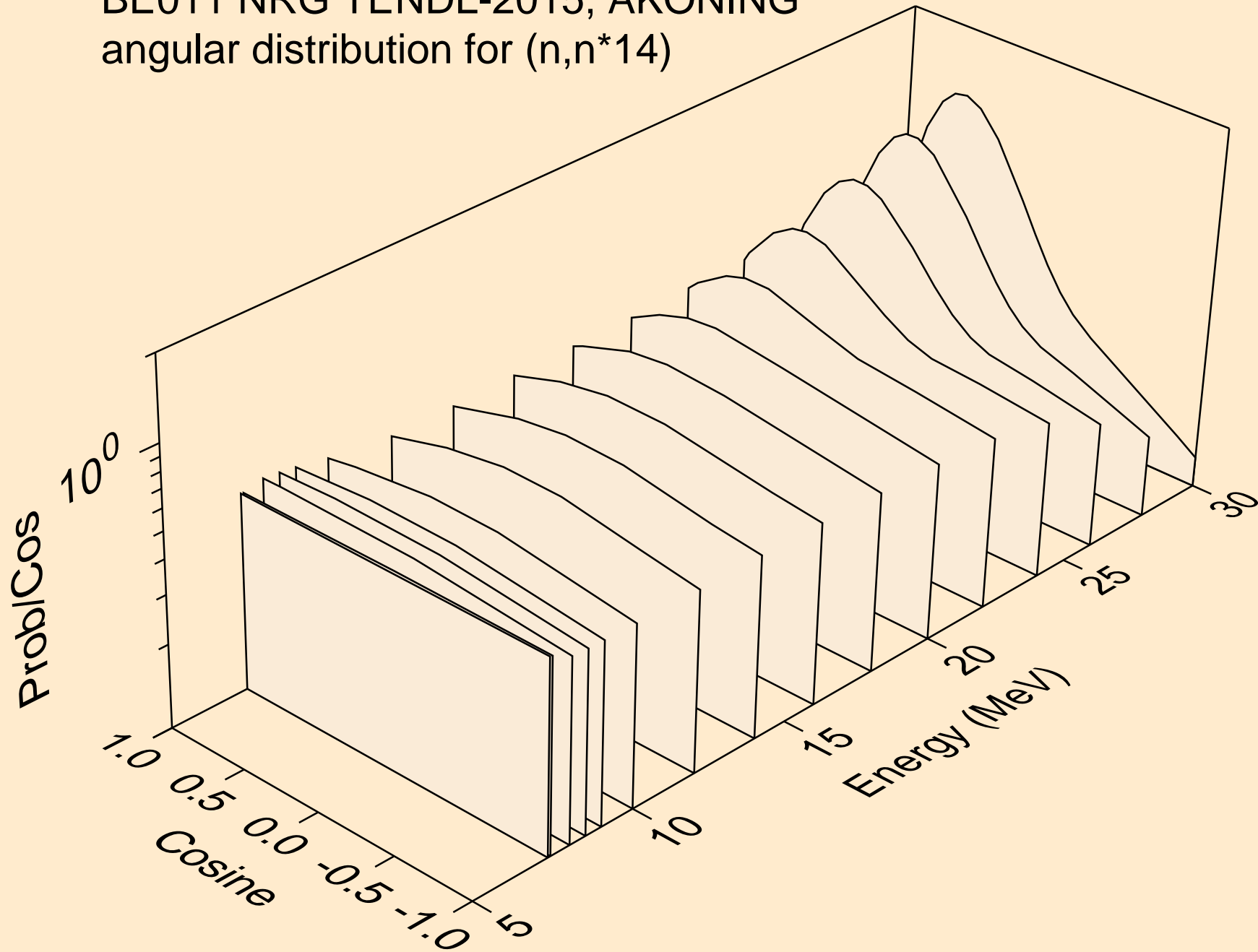

BE011 NRG TENDL-2015, AKONING
angular distribution for (n,n*15)

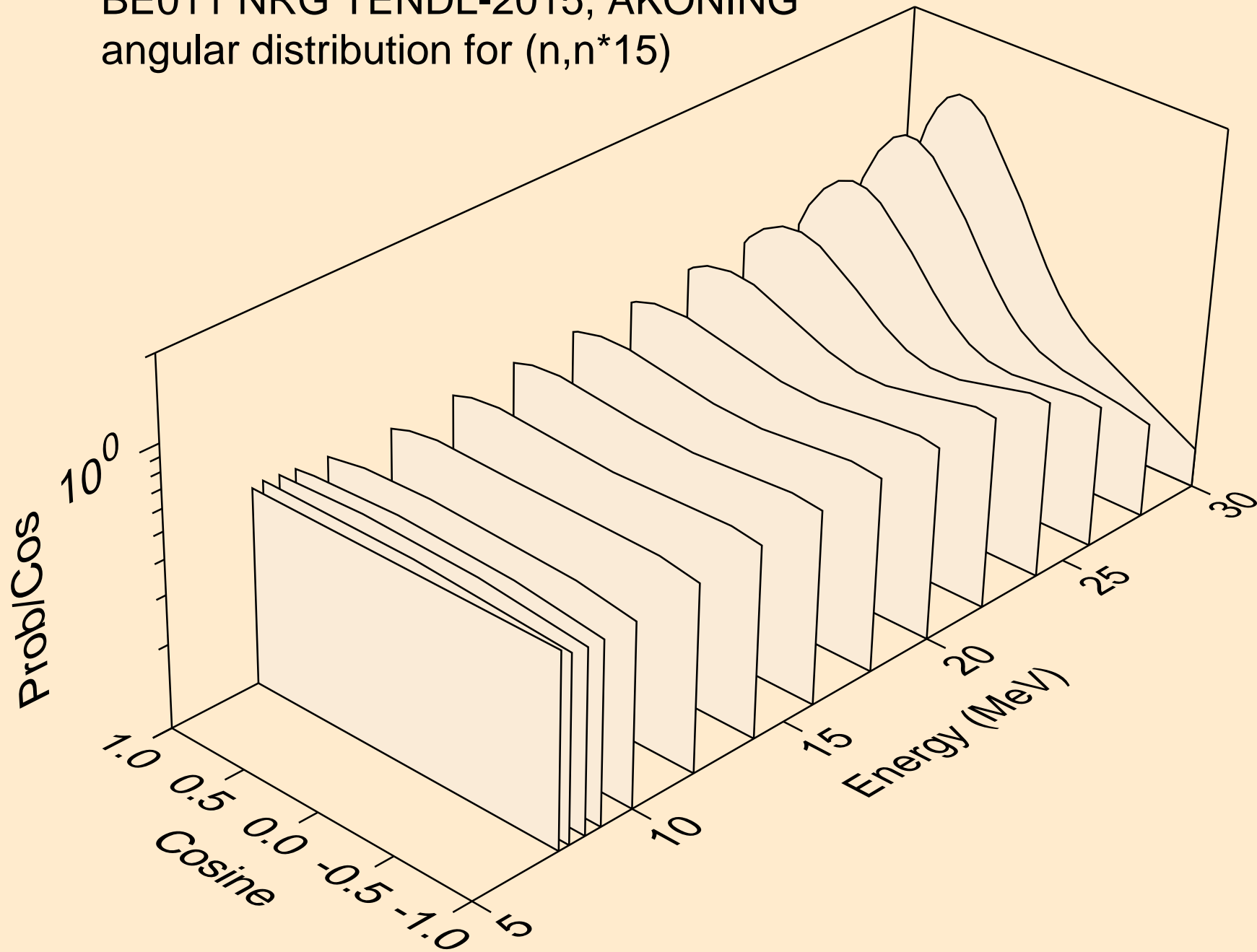

BE011 NRG TENDL-2015, AKONING
angular distribution for (n,n*16)

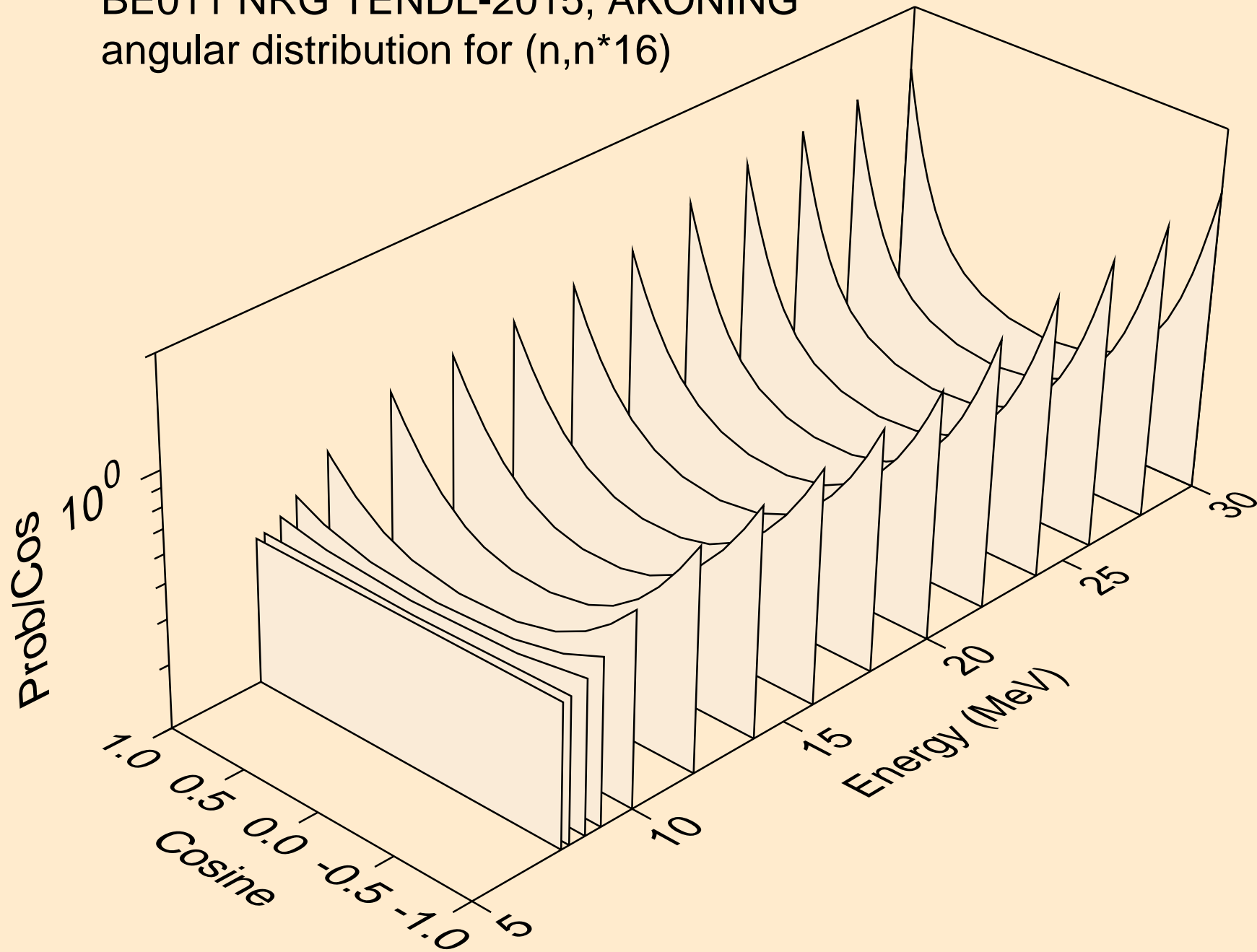

BE011 NRG TENDL-2015, AKONING
angular distribution for (n,n*17)

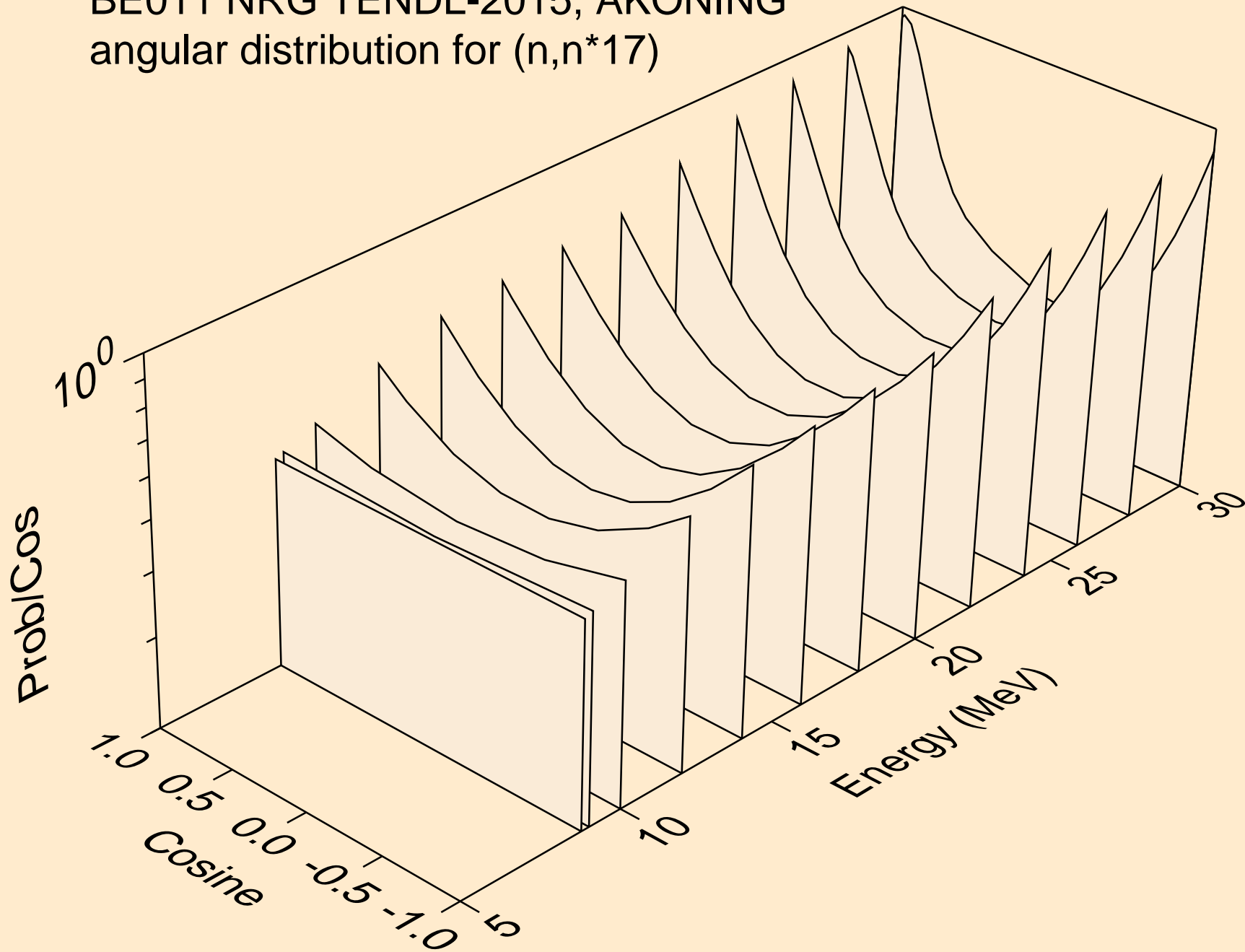

BE011 NRG TENDL-2015, AKONING
angular distribution for (n,n*18)

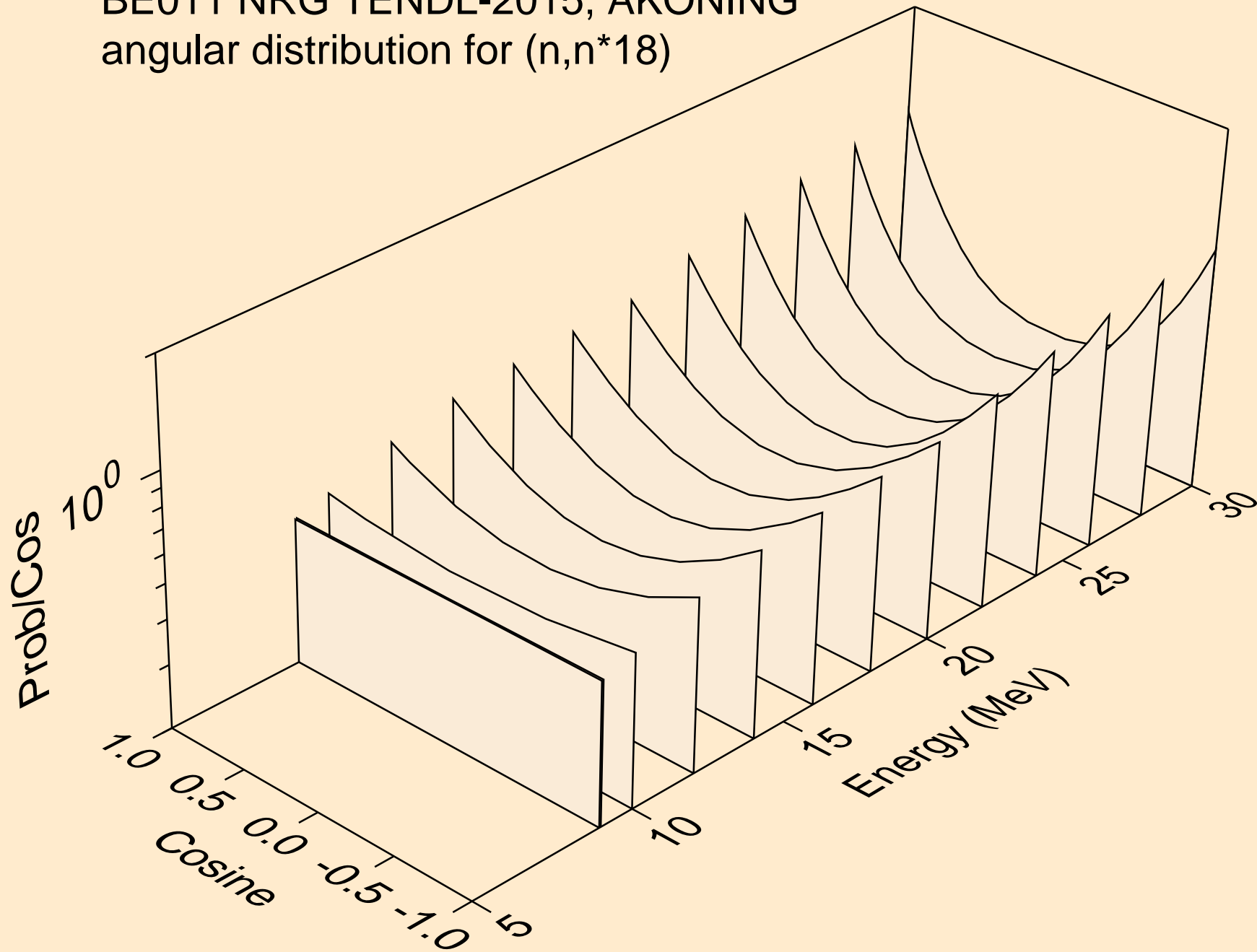

BE011 NRG TENDL-2015, AKONING
angular distribution for (n,n*19)

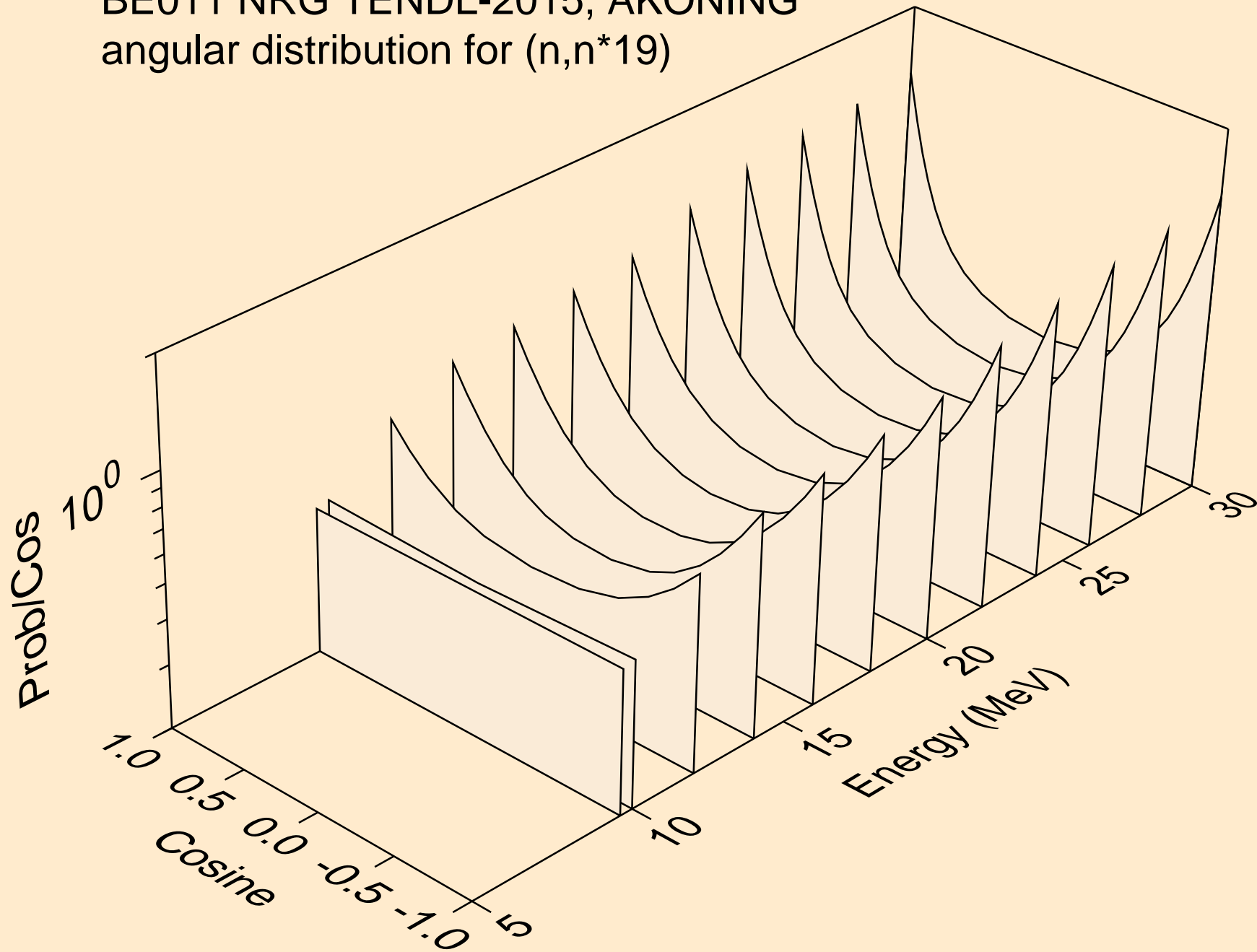

BE011 NRG TENDL-2015, AKONING
angular distribution for (n,n*20)

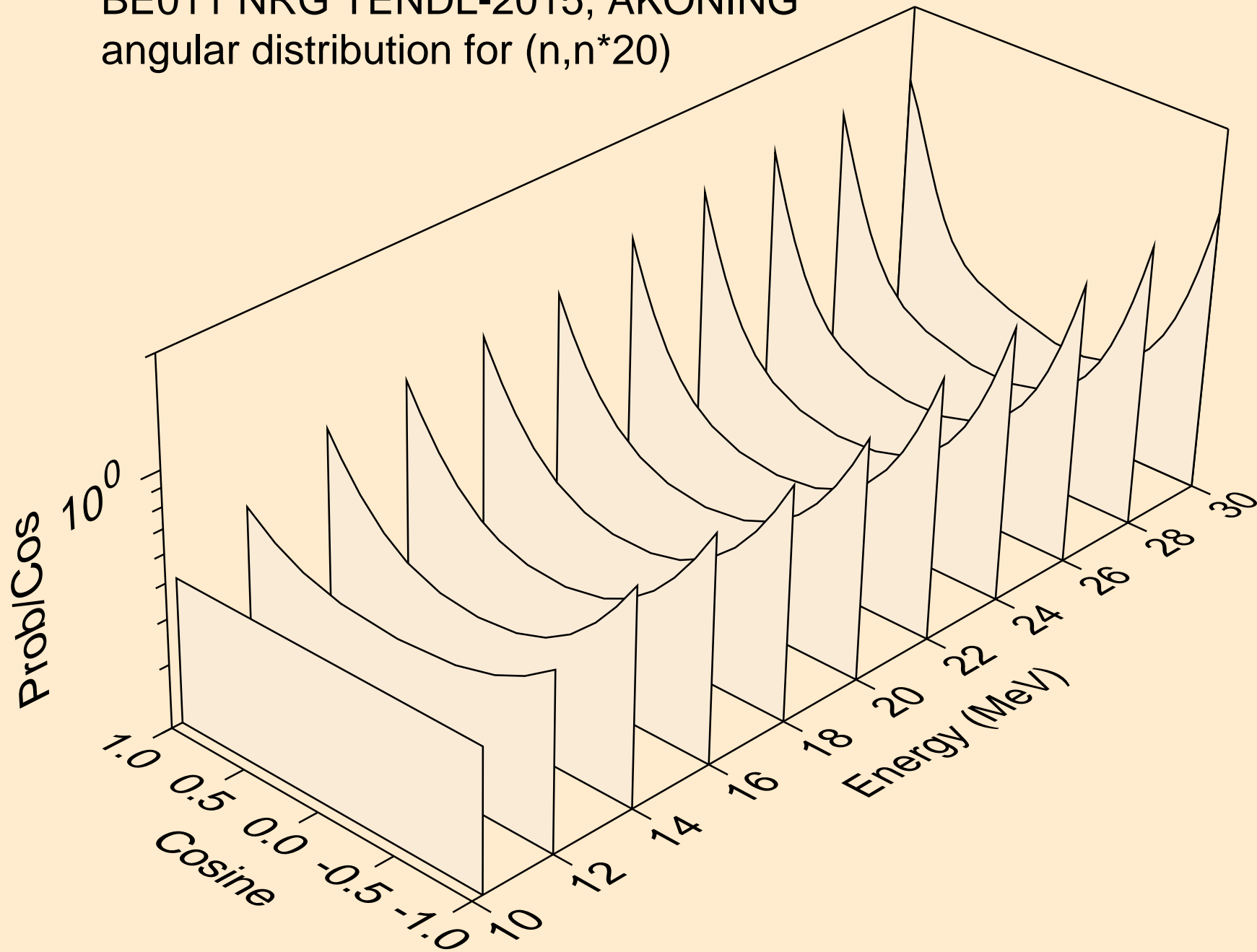

BE011 NRG TENDL-2015, AKONING
angular distribution for (n,n*21)

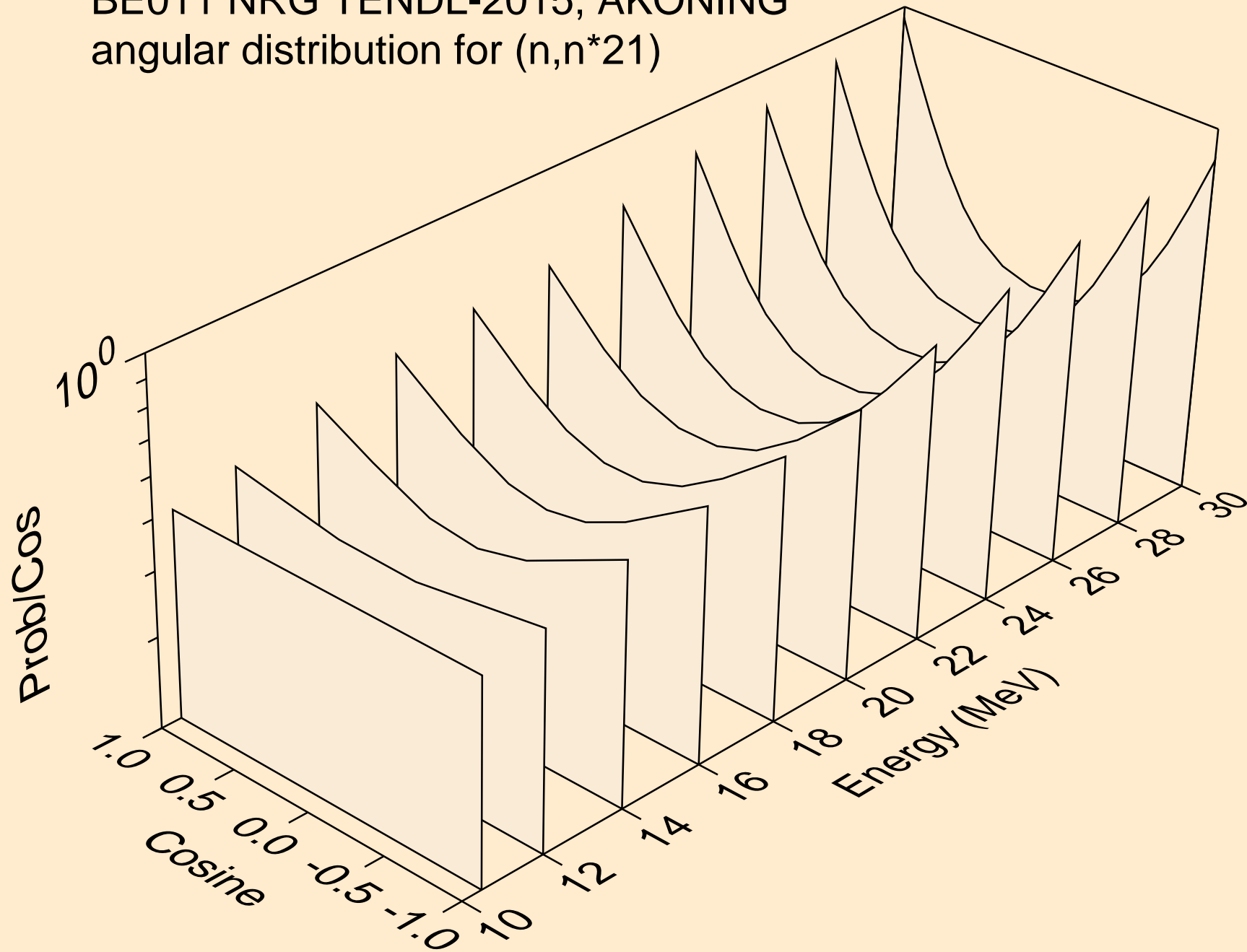

BE011 NRG TENDL-2015, AKONING
angular distribution for (n,n*22)

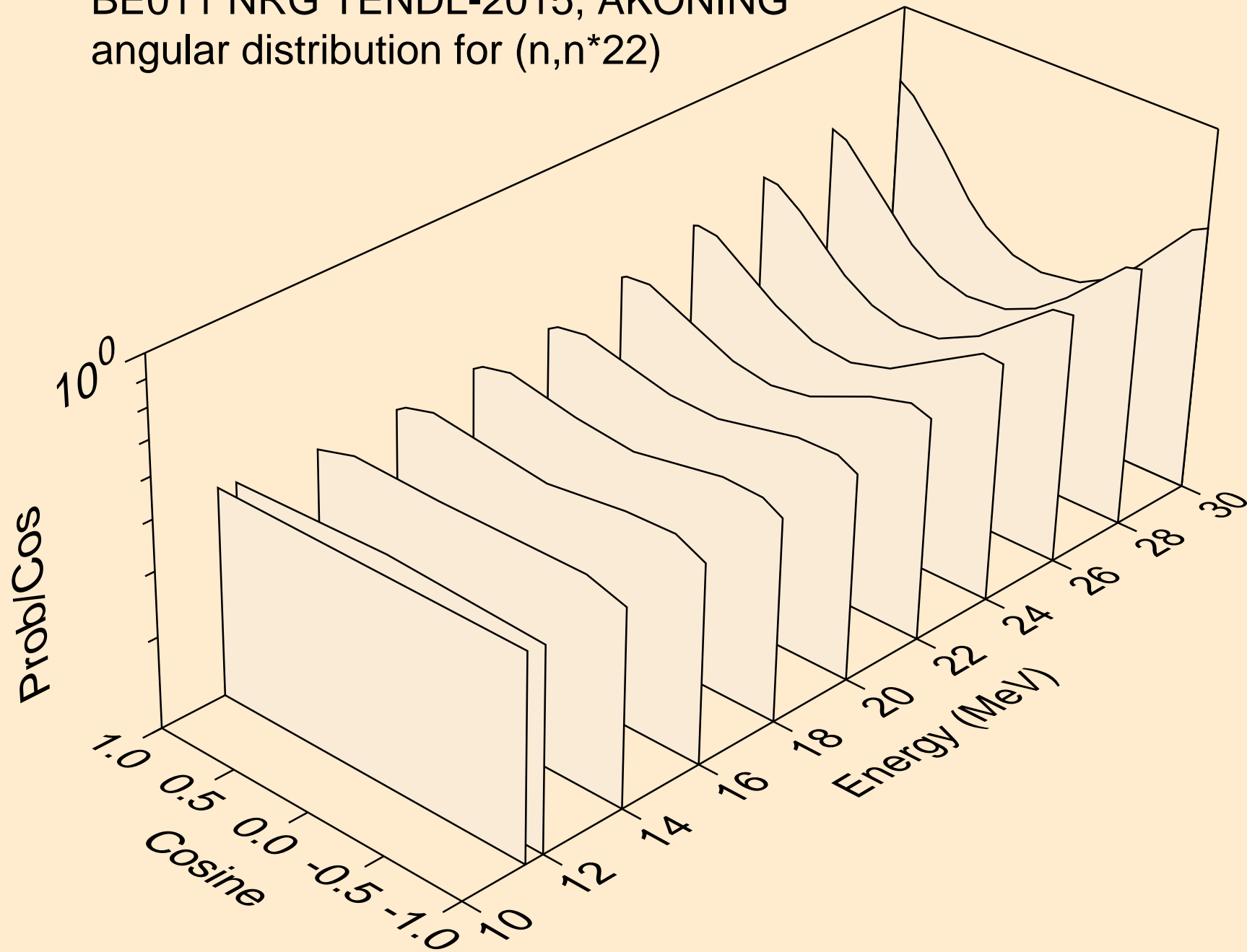

BE011 NRG TENDL-2015, AKONING
Neutron emission for (n,x)

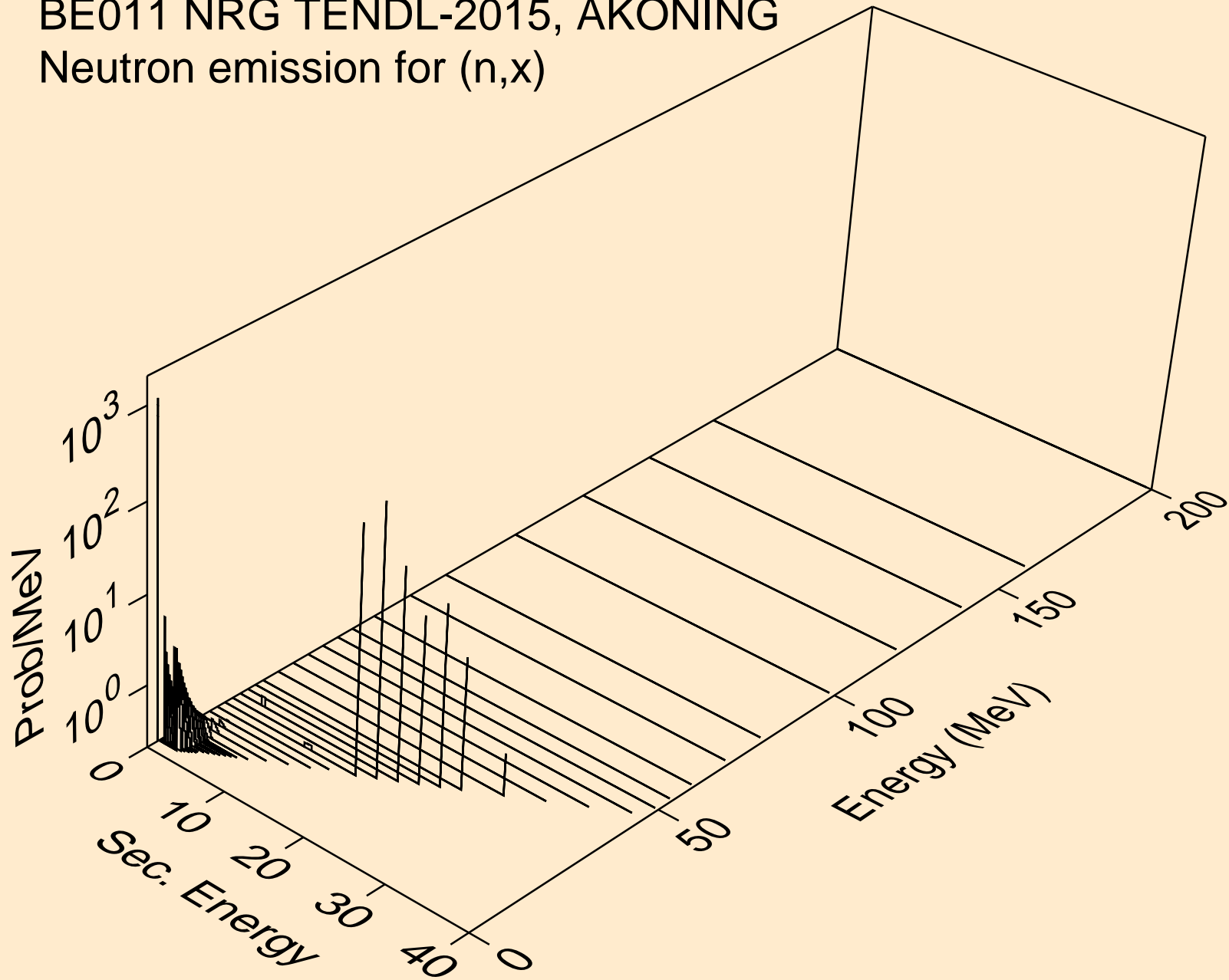

BE011 NRG TENDL-2015, AKONING
Neutron emission for (n,2nd)

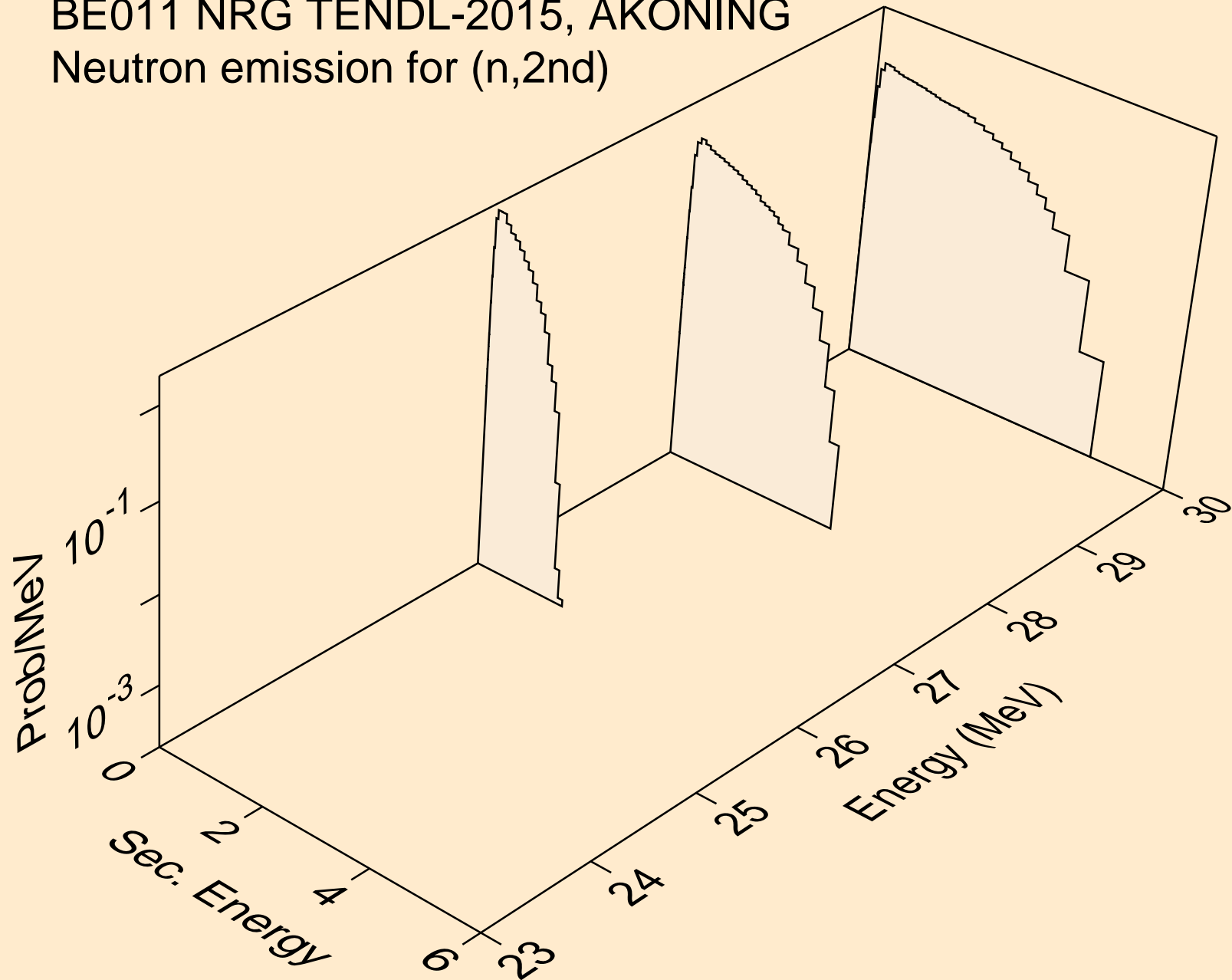

BE011 NRG TENDL-2015, AKONING
Neutron emission for (n,2n)

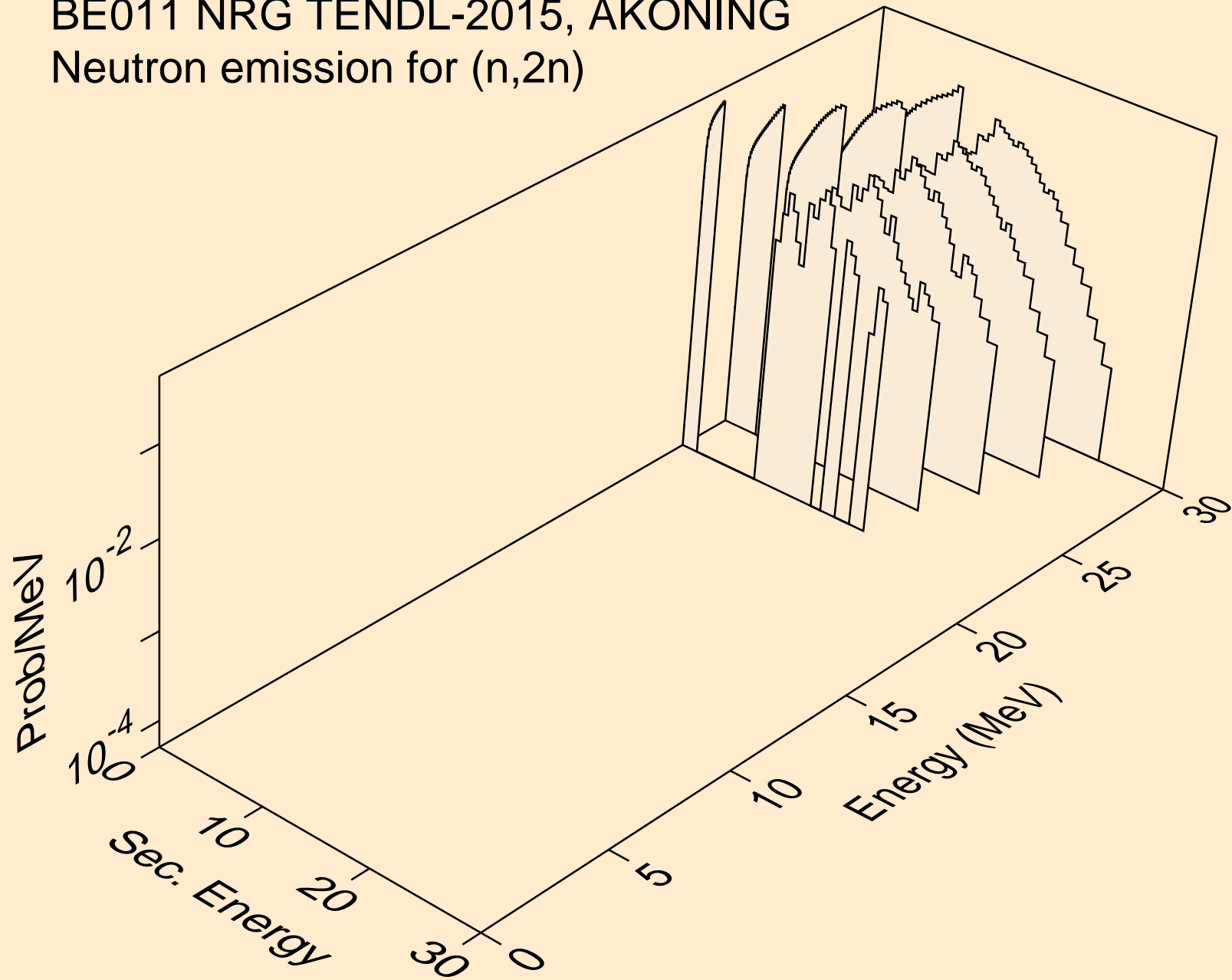

BE011 NRG TENDL-2015, AKONING
Neutron emission for (n,3n)

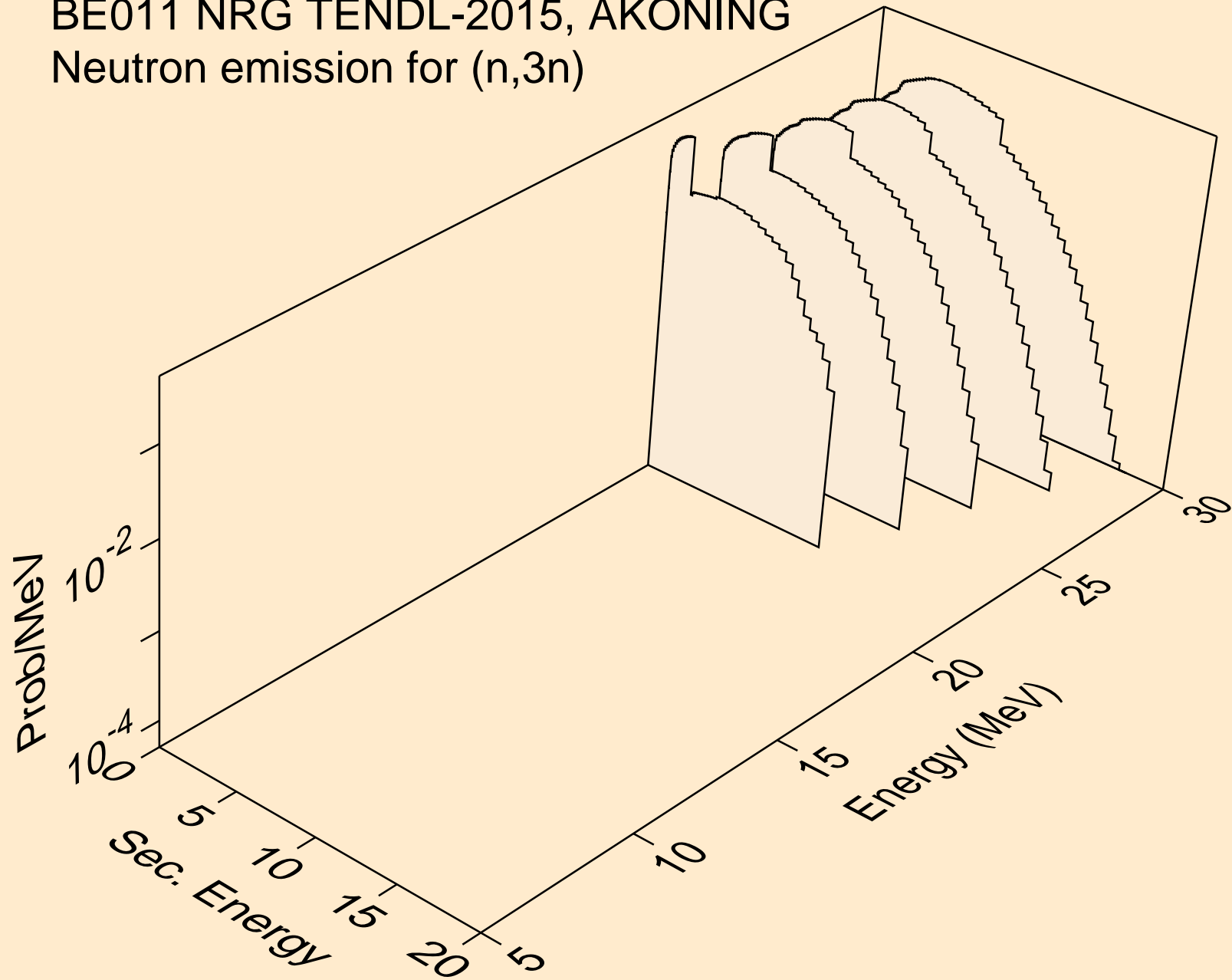

BE011 NRG TENDL-2015, AKONING
Neutron emission for (n,n*)a

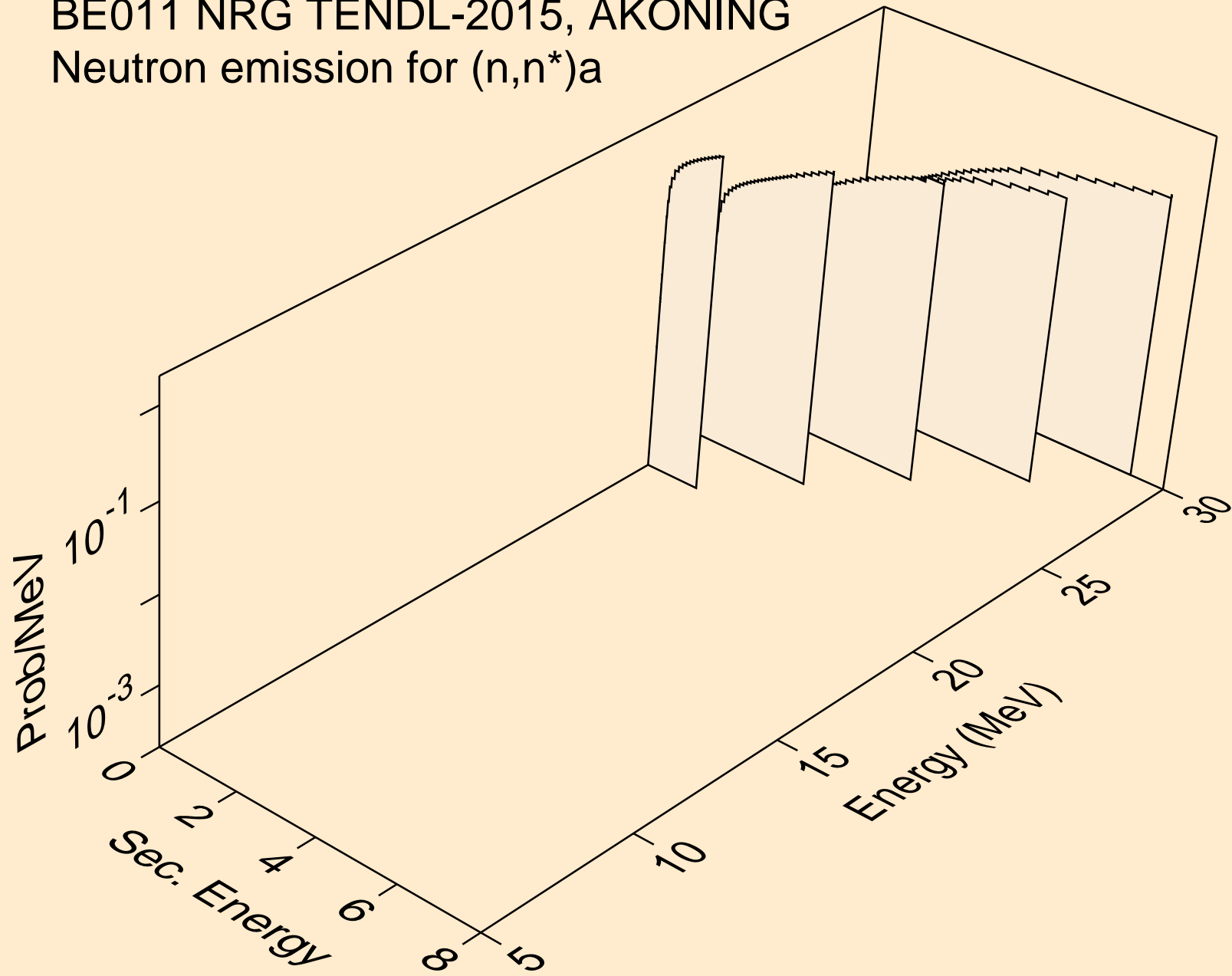

BE011 NRG TENDL-2015, AKONING
Neutron emission for (n,2n)a

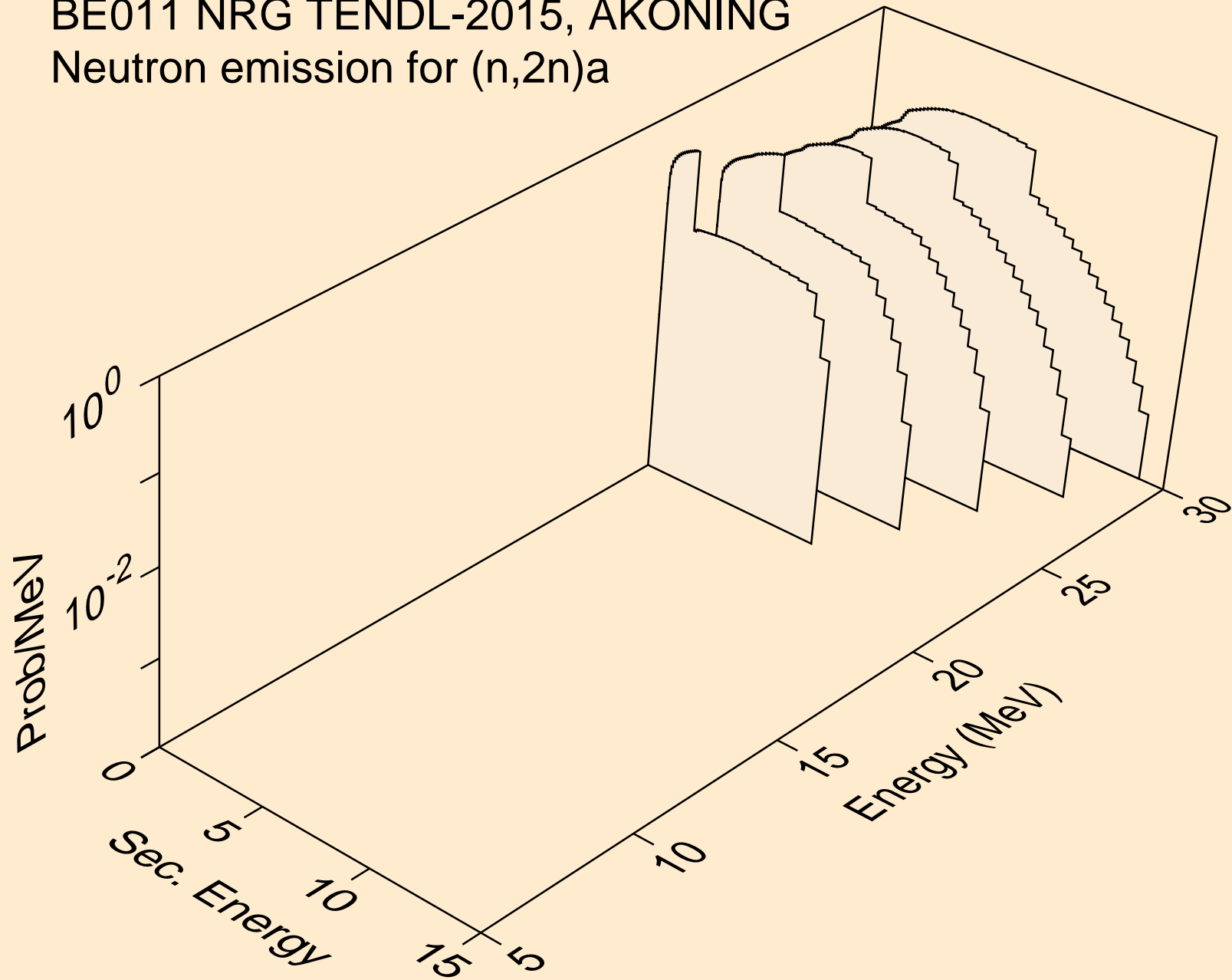

BE011 NRG TENDL-2015, AKONING
Neutron emission for (n,3n)a

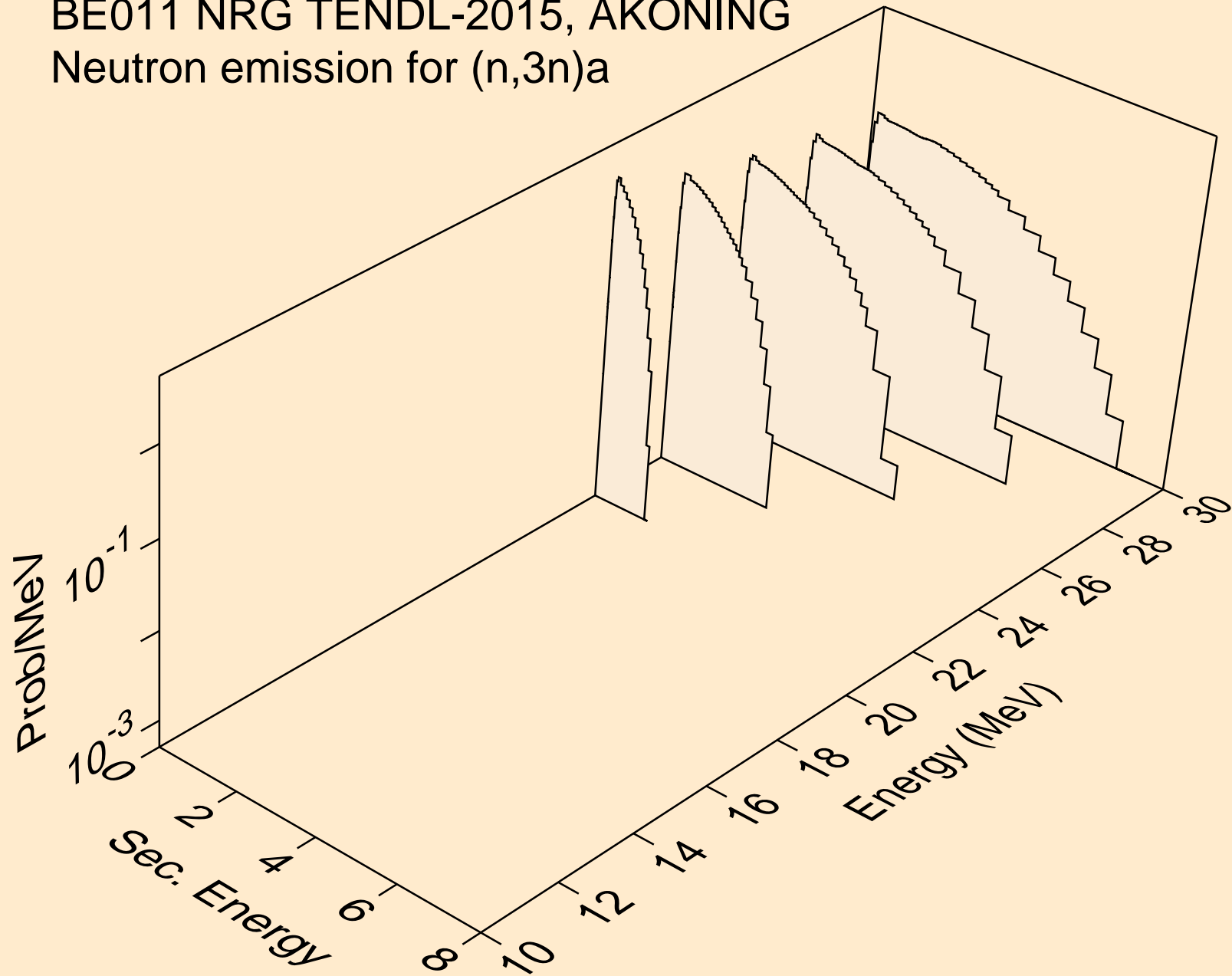

BE011 NRG TENDL-2015, AKONING
Neutron emission for (n,n*)p

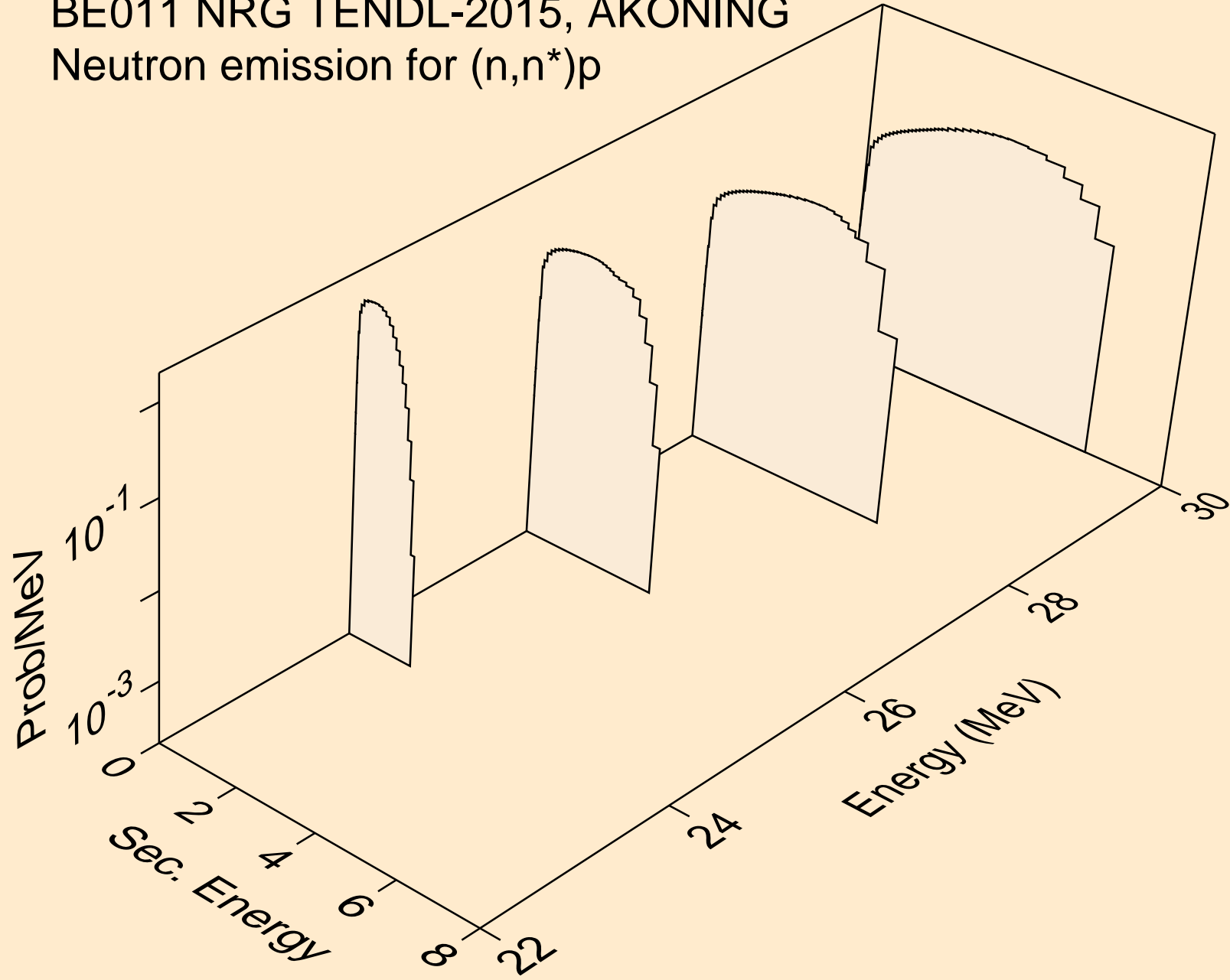

BE011 NRG TENDL-2015, AKONING
Neutron emission for (n,n*)d

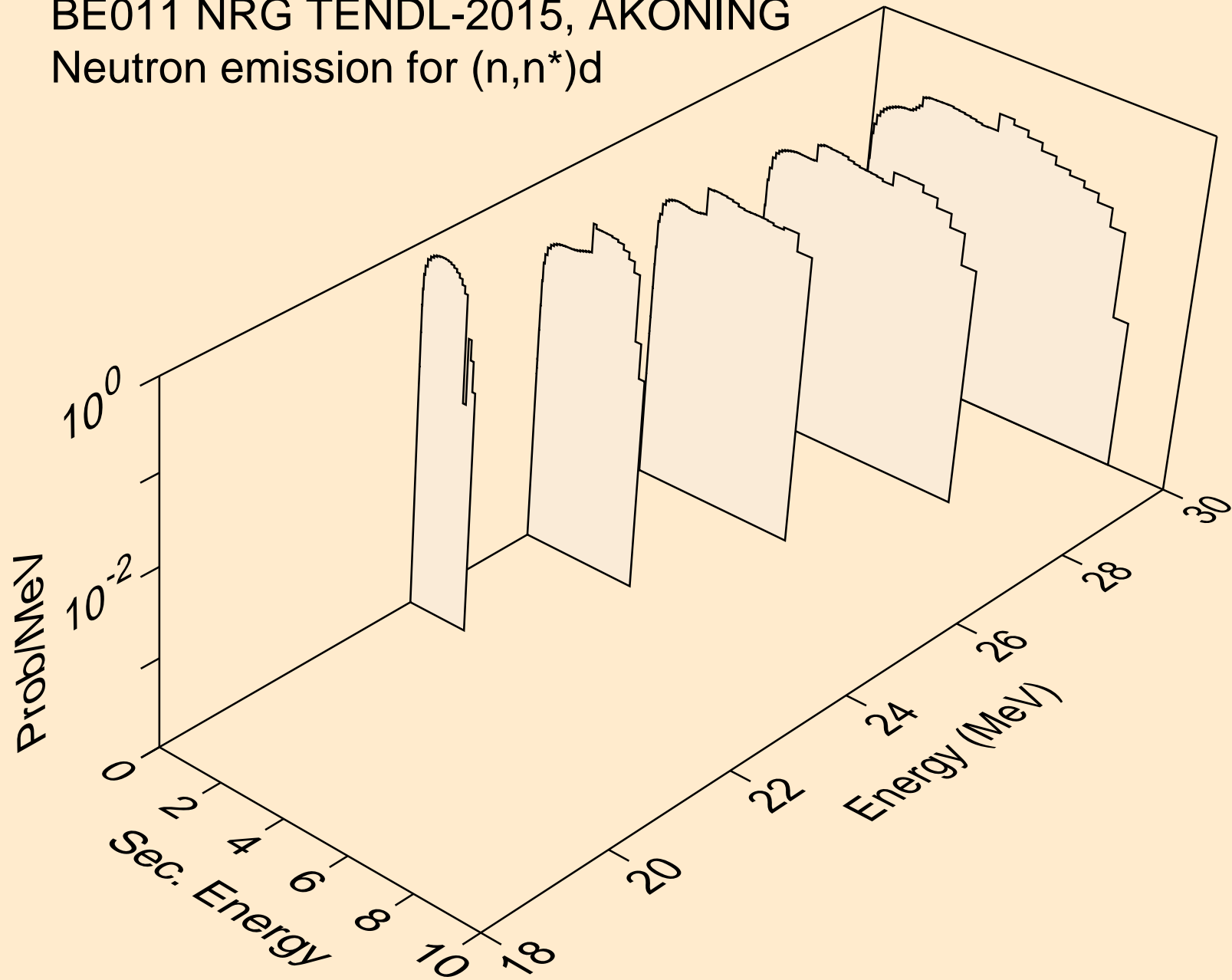

BE011 NRG TENDL-2015, AKONING
Neutron emission for (n,n*)t

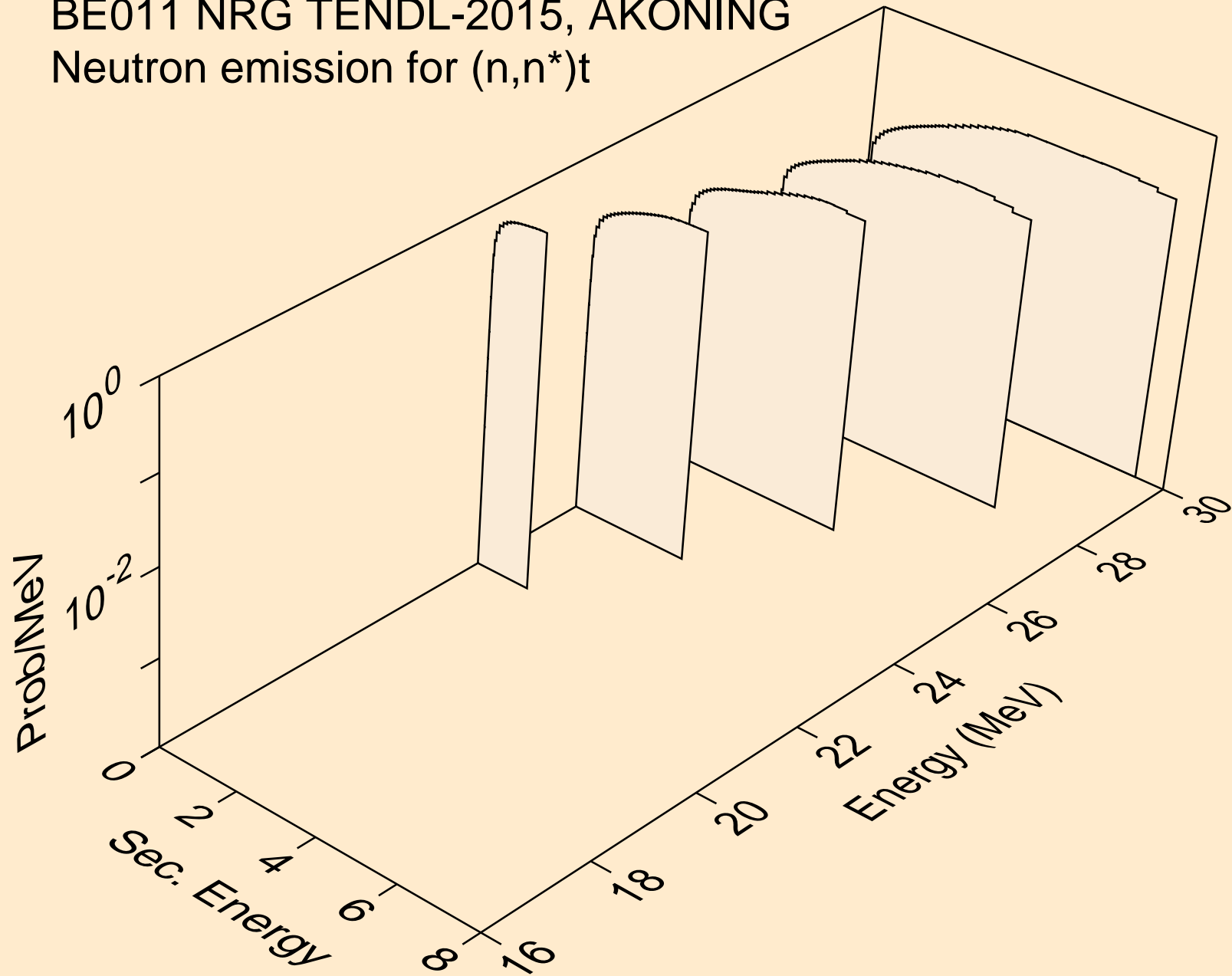

BE011 NRG TENDL-2015, AKONING
Neutron emission for (n,4n)

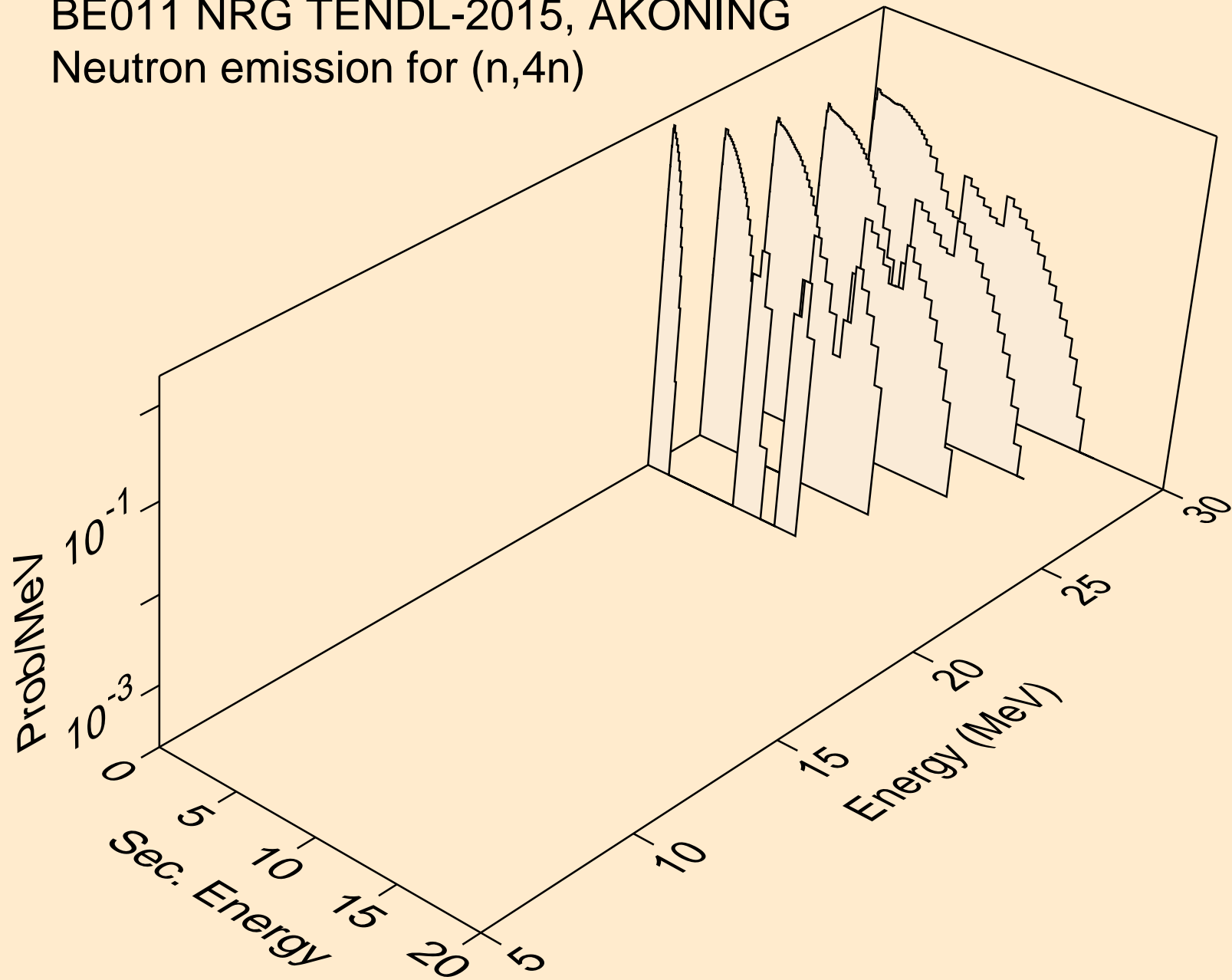

BE011 NRG TENDL-2015, AKONING
Neutron emission for (n,2np)

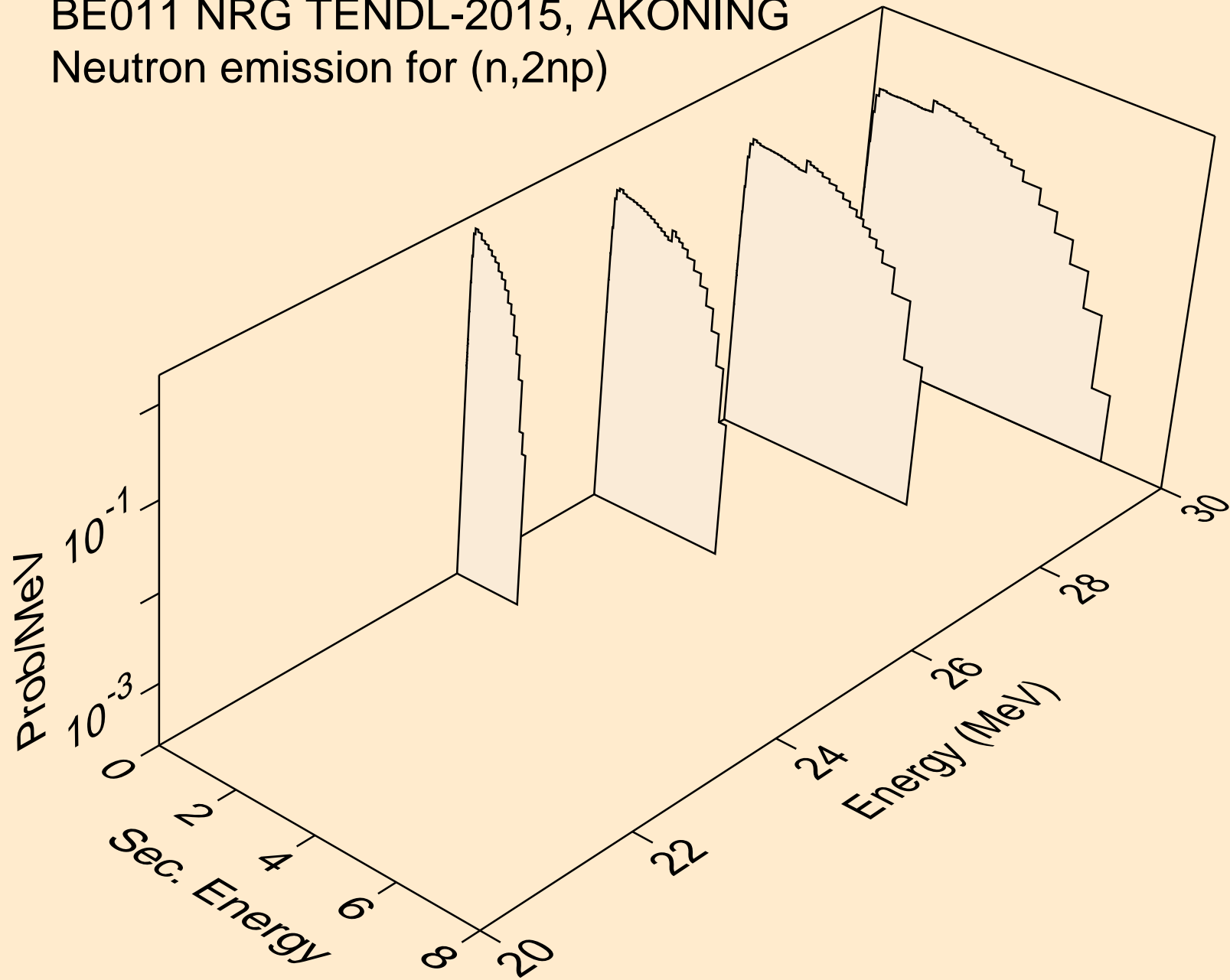

BE011 NRG TENDL-2015, AKONING
Neutron emission for (n,3np)

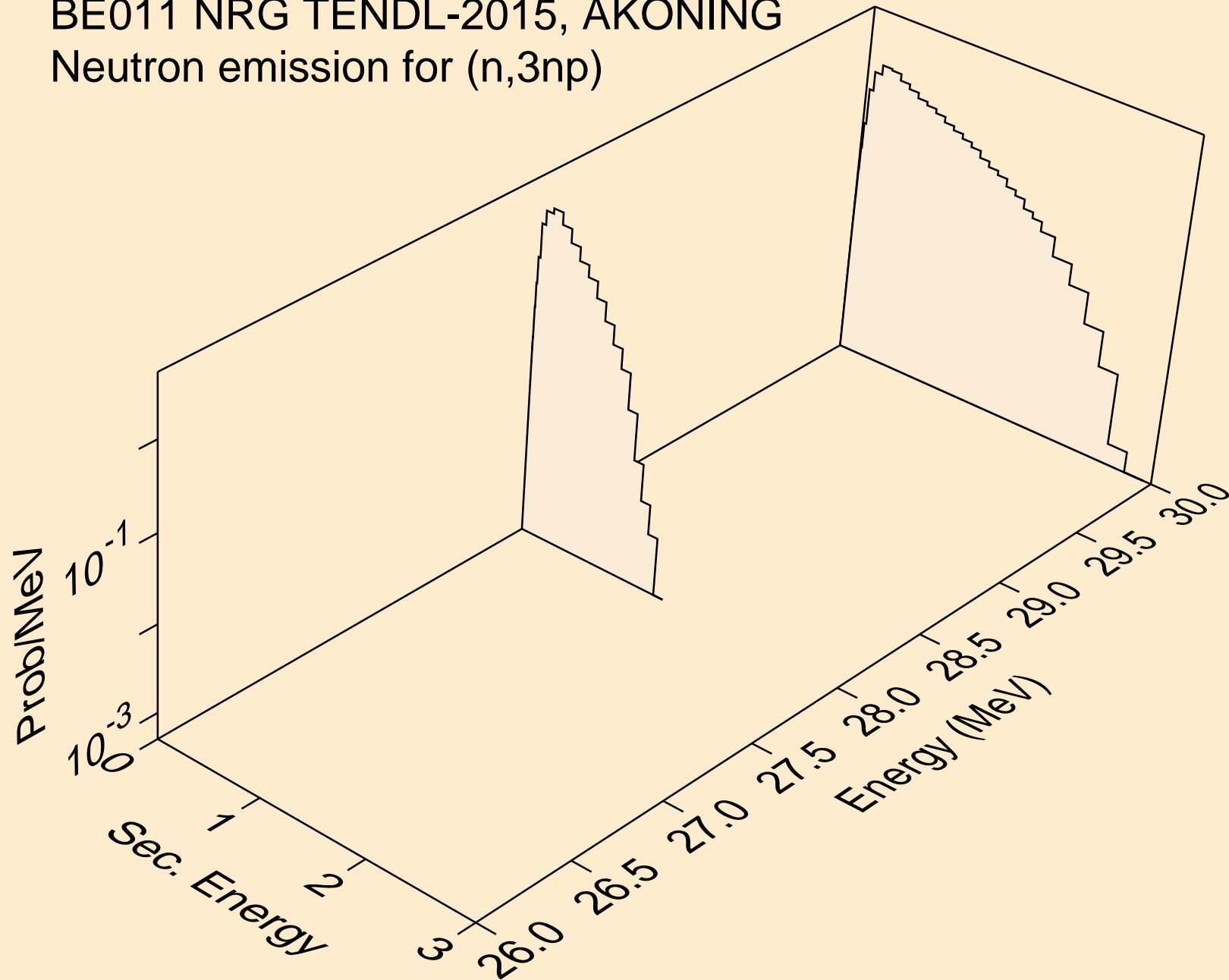

BE011 NRG TENDL-2015, AKONING
Neutron emission for (n,n*c)

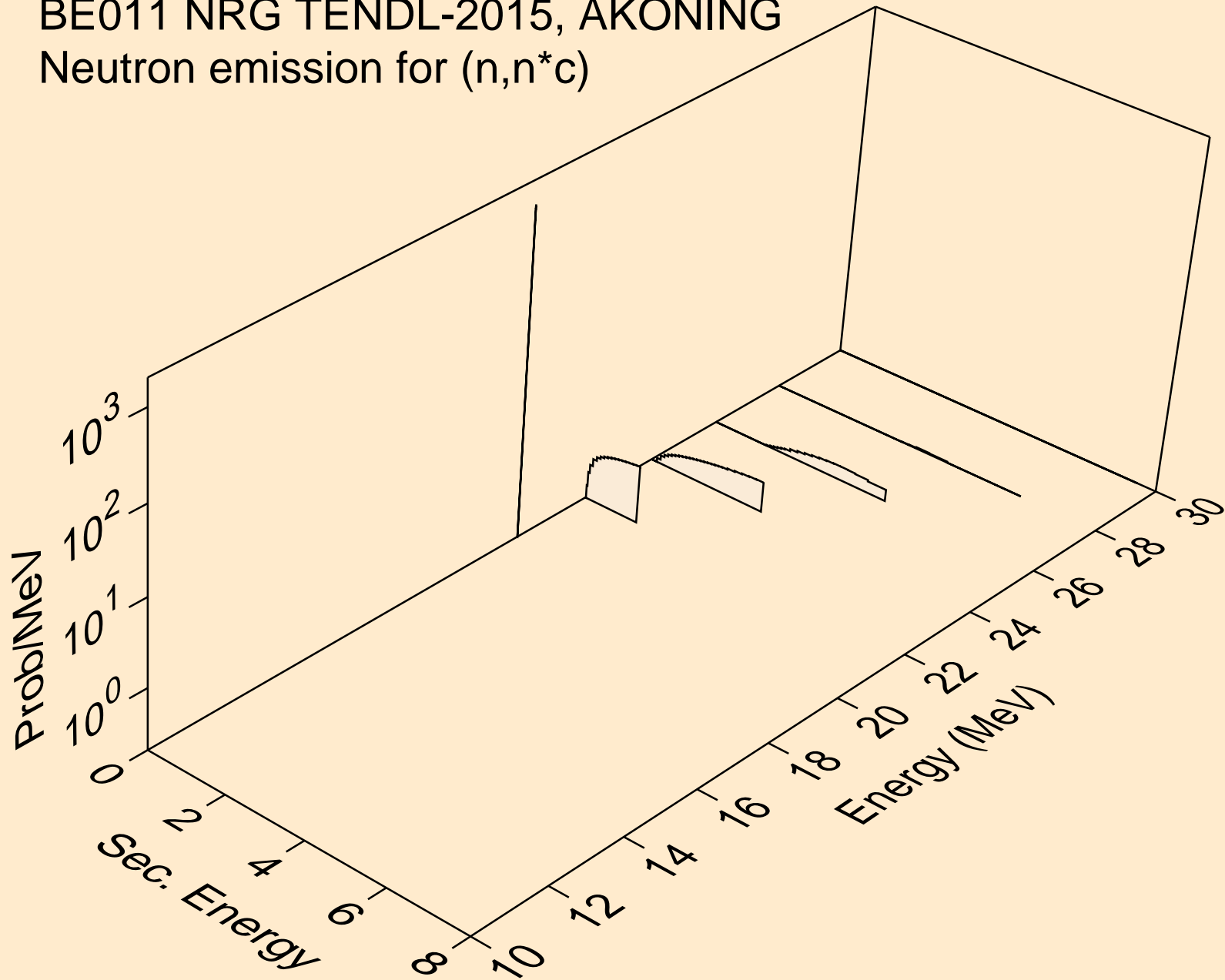

BE011 NRG TENDL-2015, AKONING
Photon emission for (n,x)

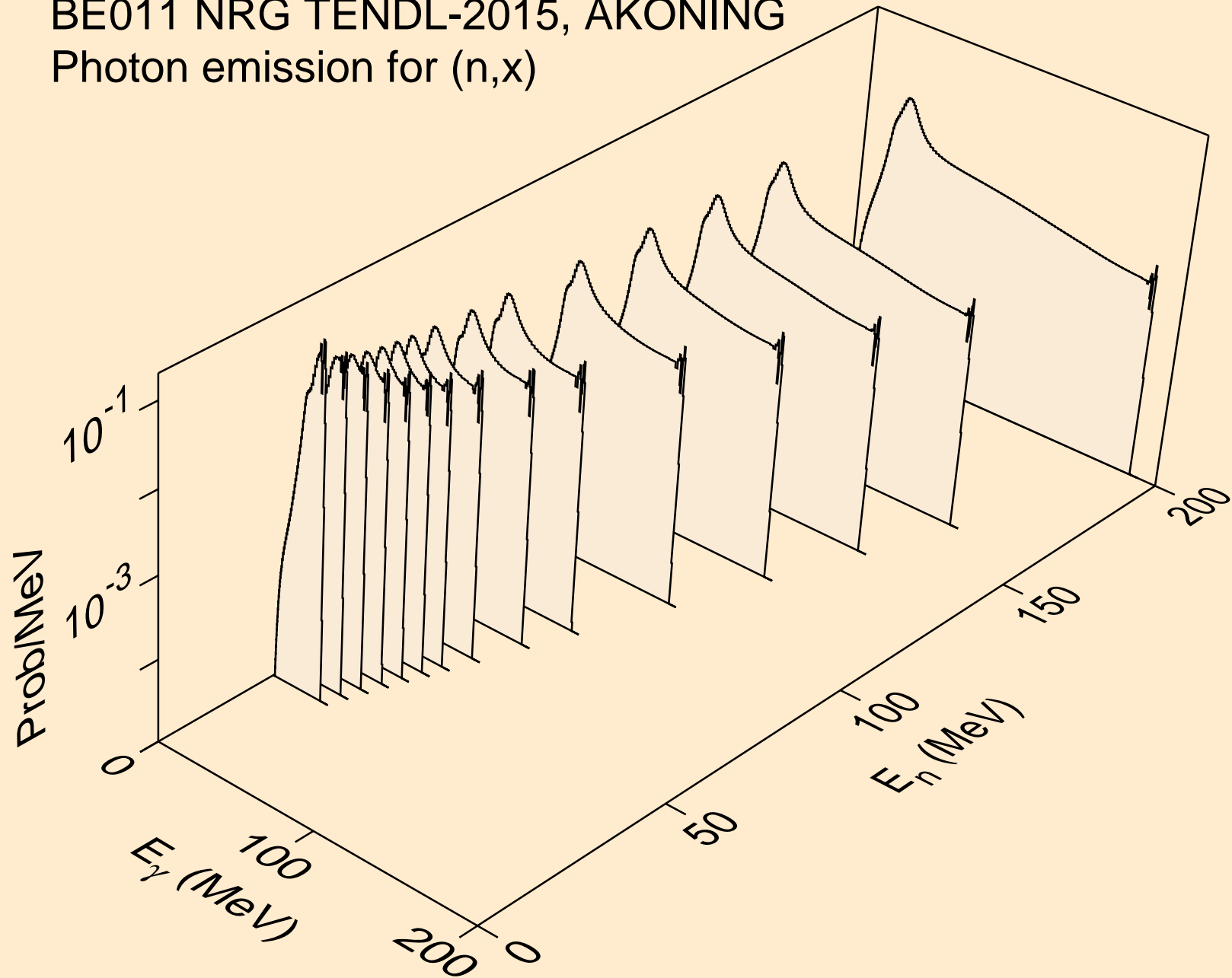

BE011 NRG TENDL-2015, AKONING
Photon emission for (n,2nd)

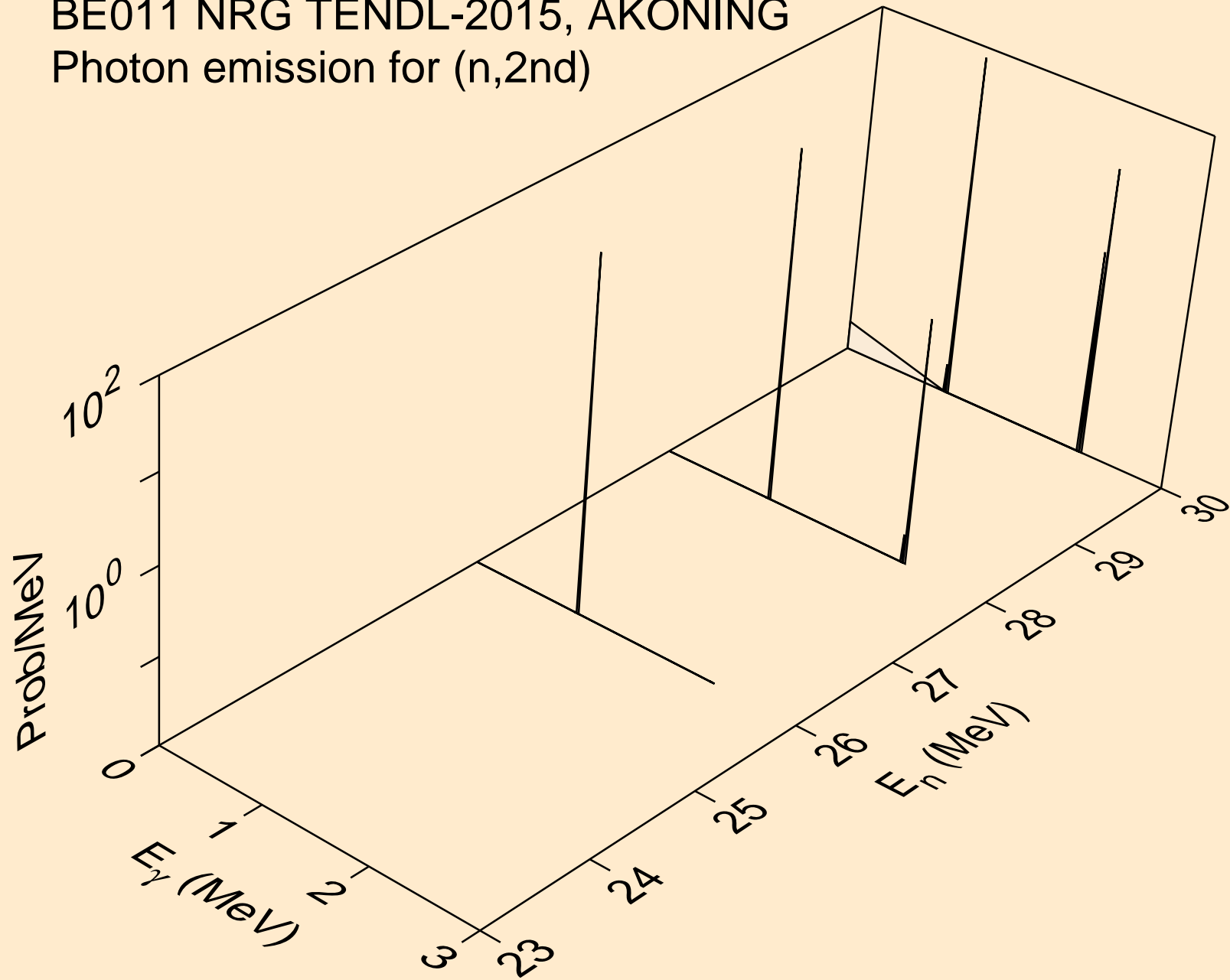

BE011 NRG TENDL-2015, AKONING
Photon emission for (n,2n)

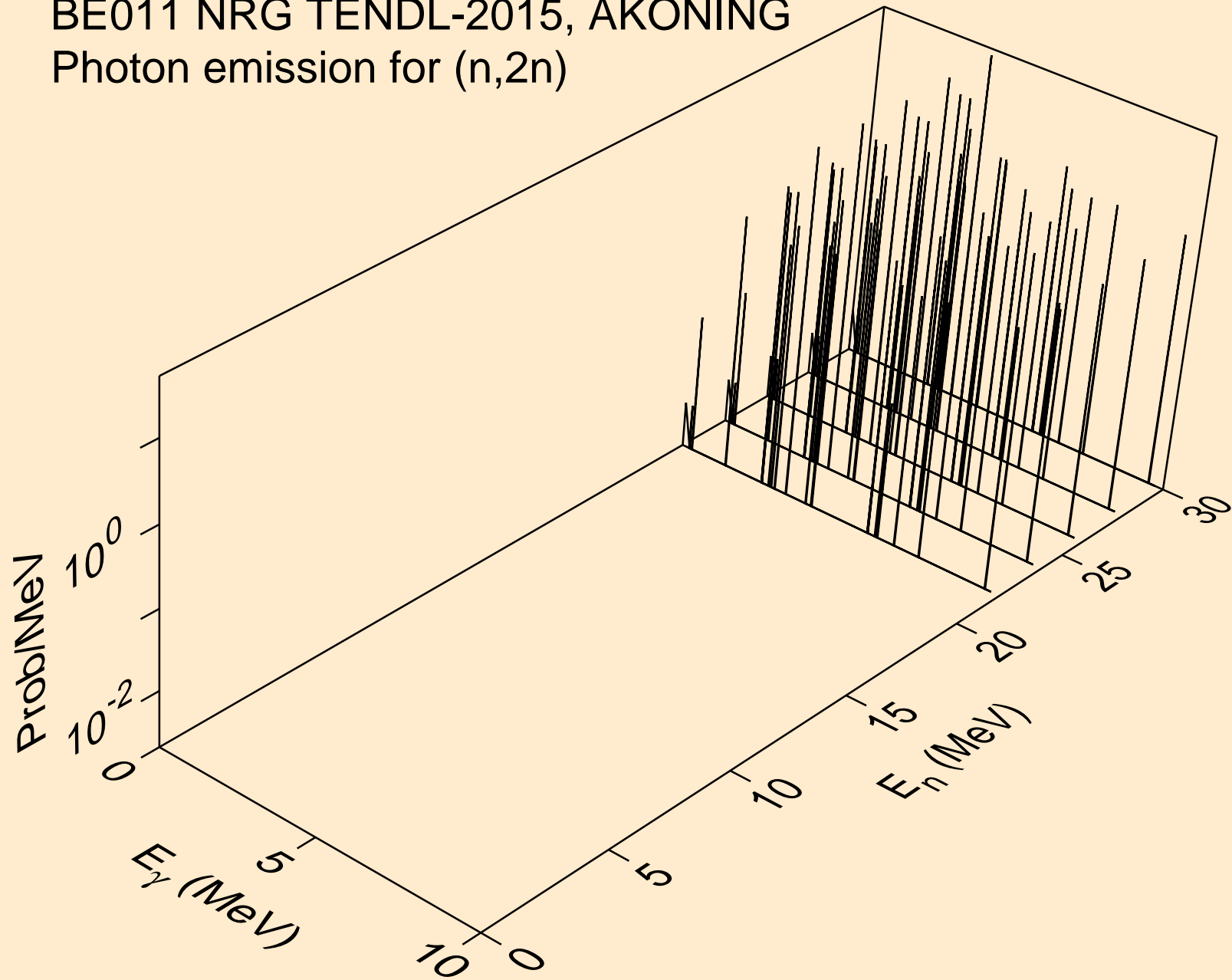

BE011 NRG TENDL-2015, AKONING
Photon emission for (n,3n)

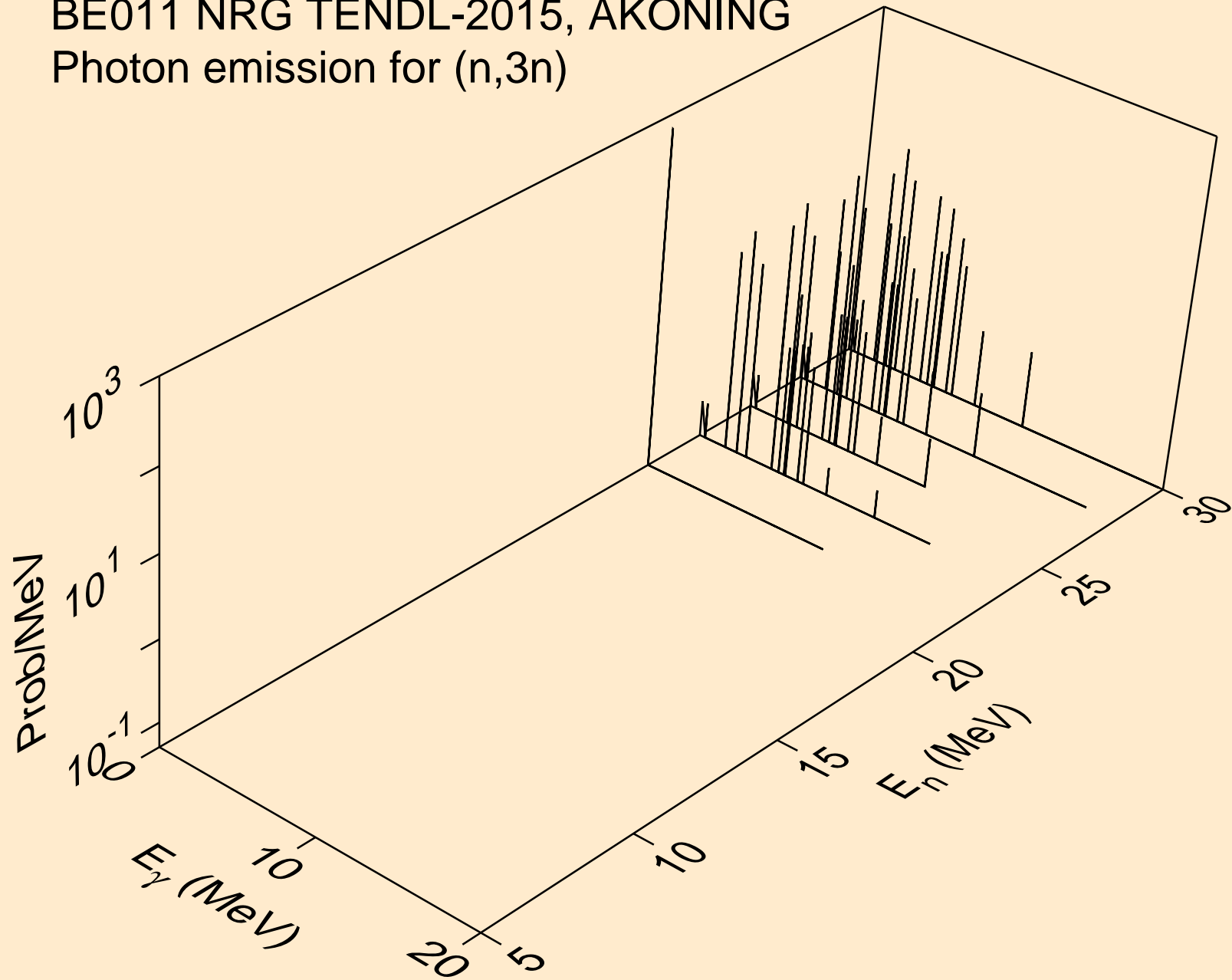

BE011 NRG TENDL-2015, AKONING
Photon emission for (n,2n)a

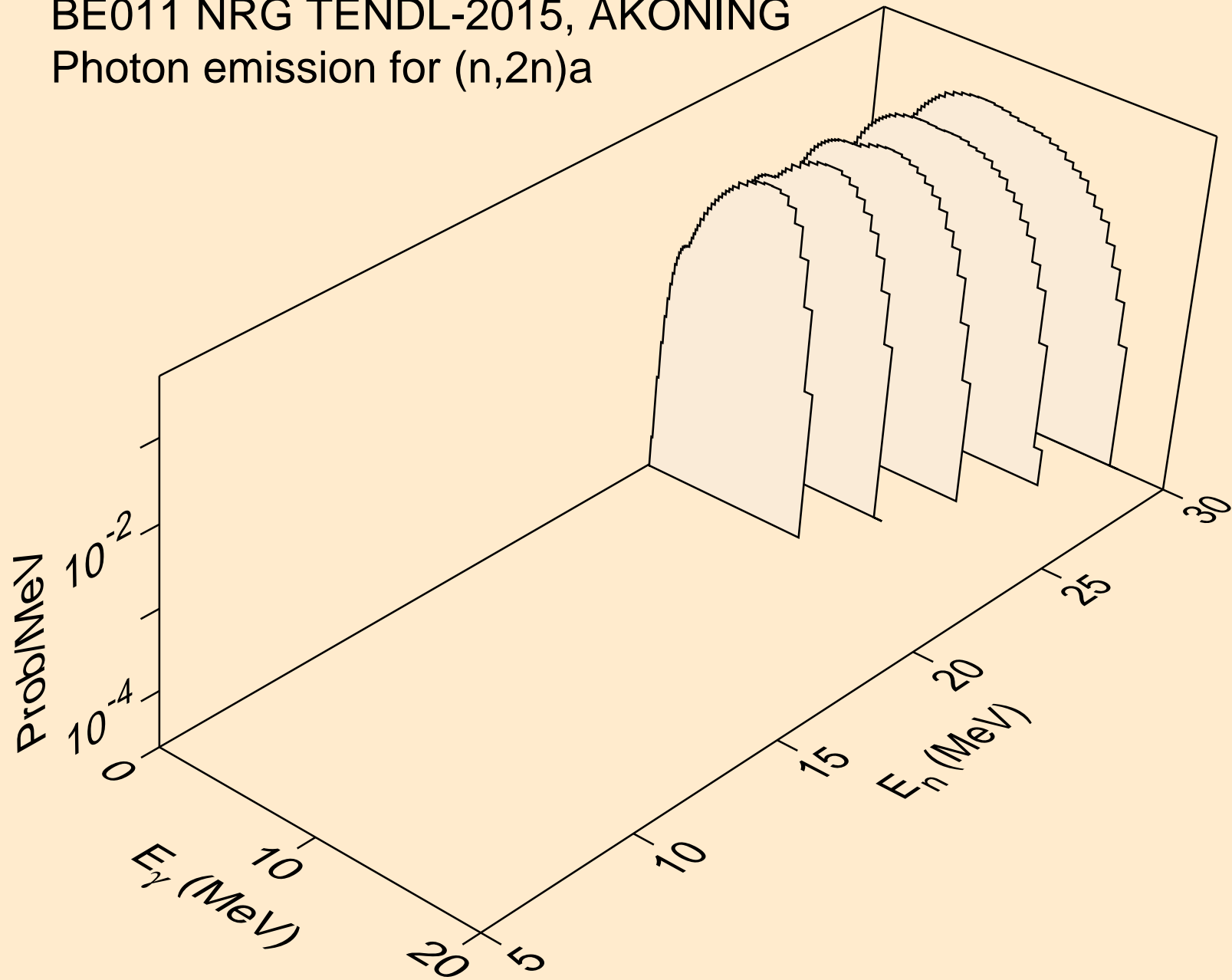

BE011 NRG TENDL-2015, AKONING
Photon emission for (n,3n)a

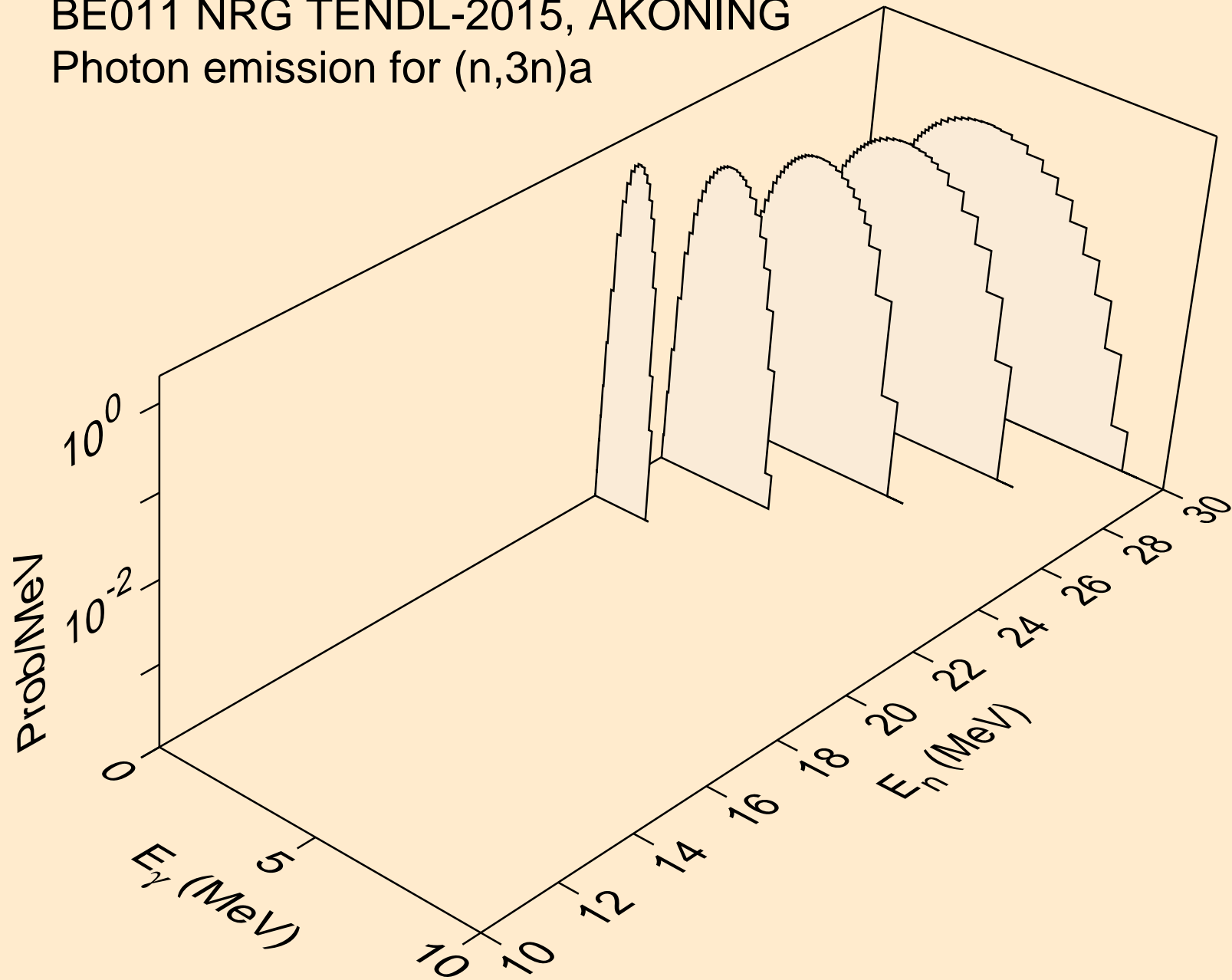

BE011 NRG TENDL-2015, AKONING
Photon emission for (n,n*)p

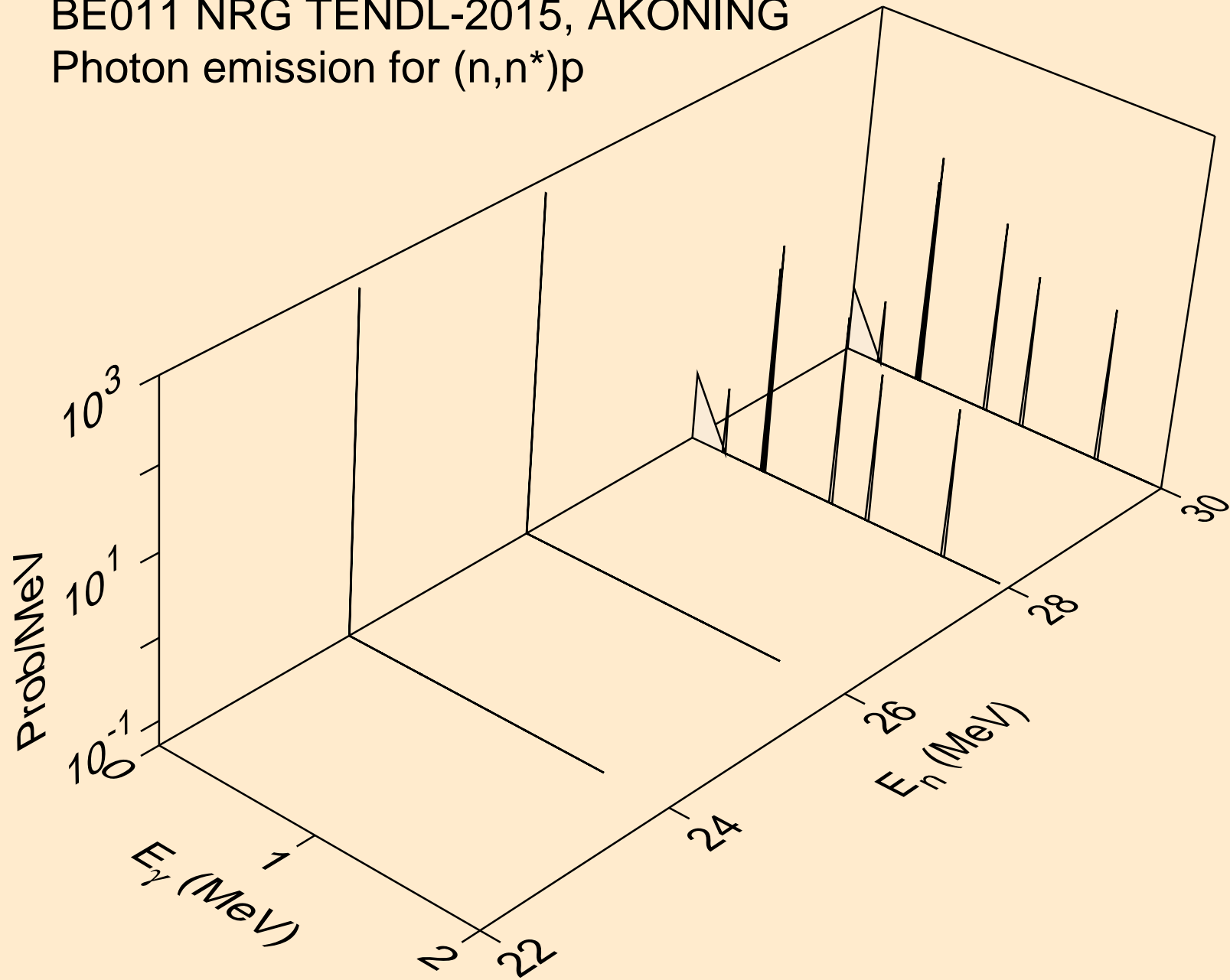

BE011 NRG TENDL-2015, AKONING
Photon emission for (n,n*)d

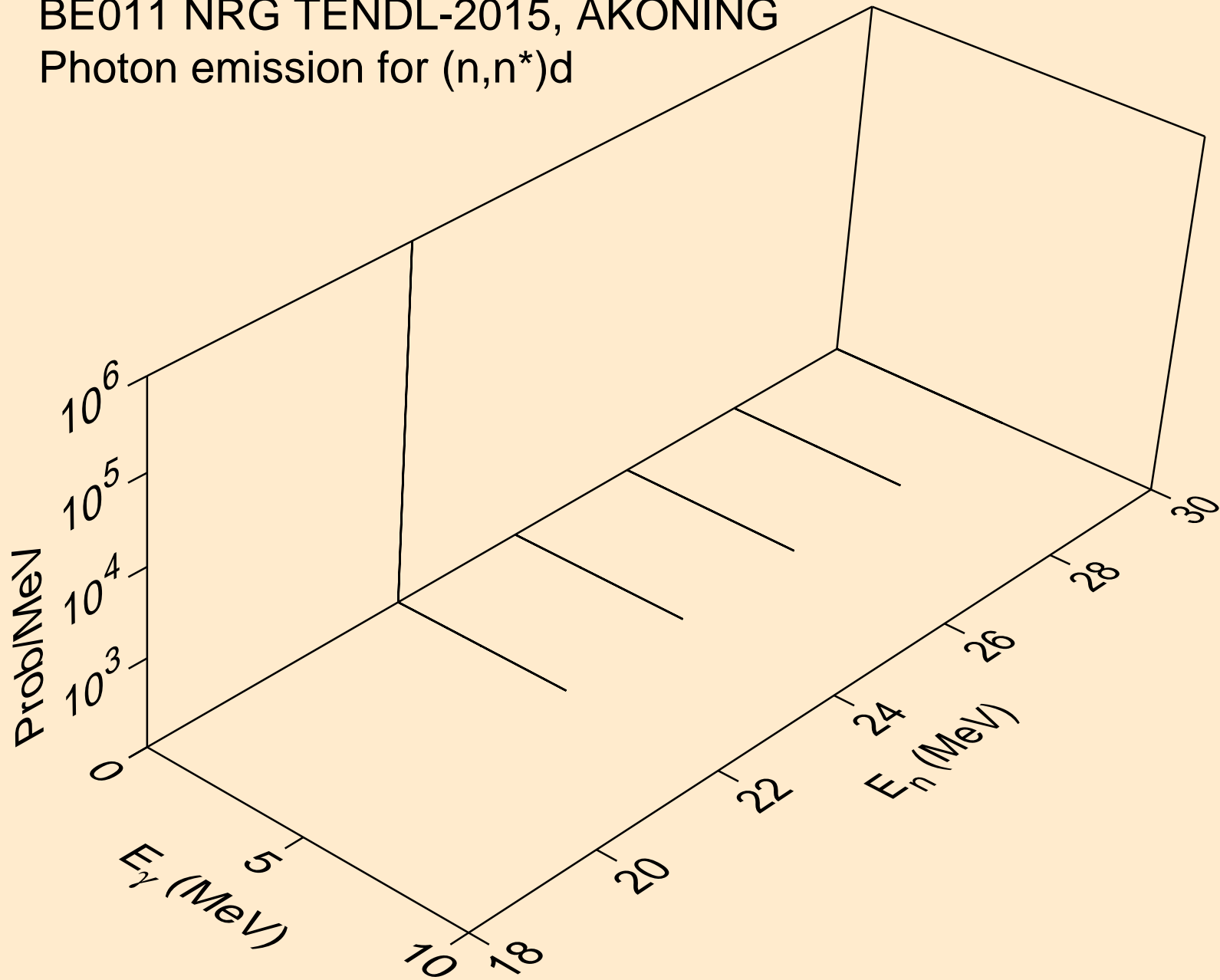

BE011 NRG TENDL-2015, AKONING
Photon emission for (n,n*)t

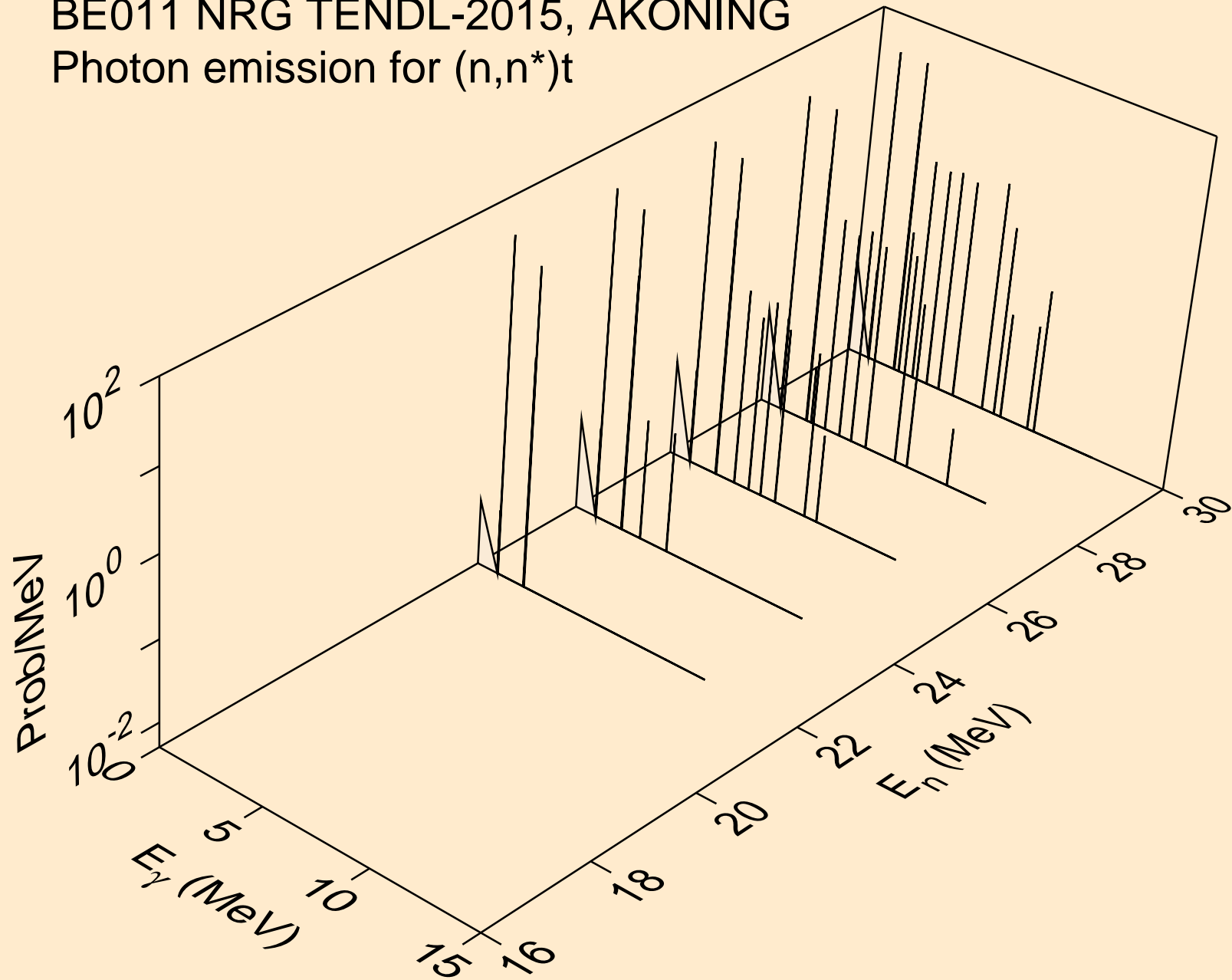

BE011 NRG TENDL-2015, AKONING
Photon emission for (n,4n)

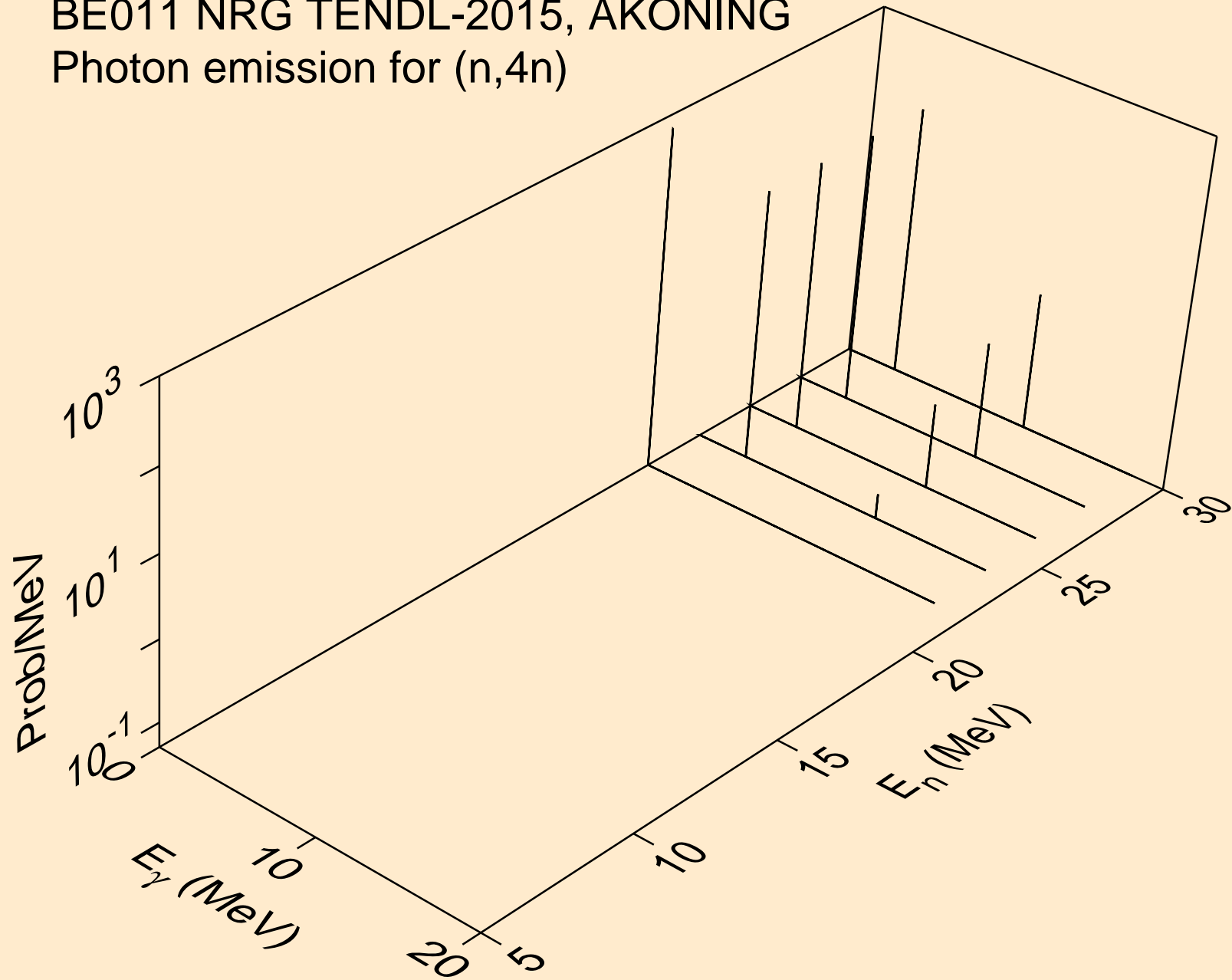

BE011 NRG TENDL-2015, AKONING
Photon emission for (n,2np)

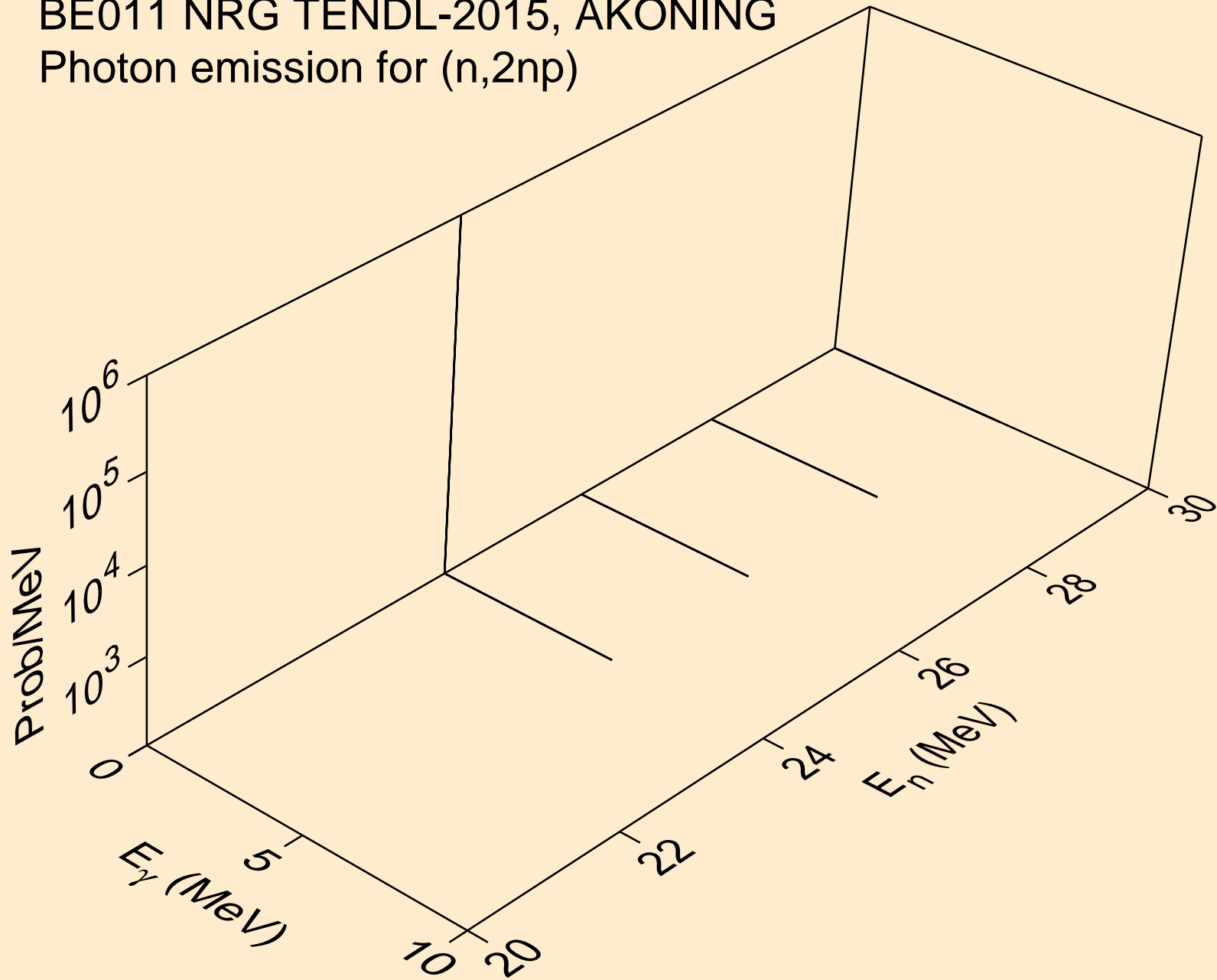

BE011 NRG TENDL-2015, AKONING
Photon emission for (n,3np)

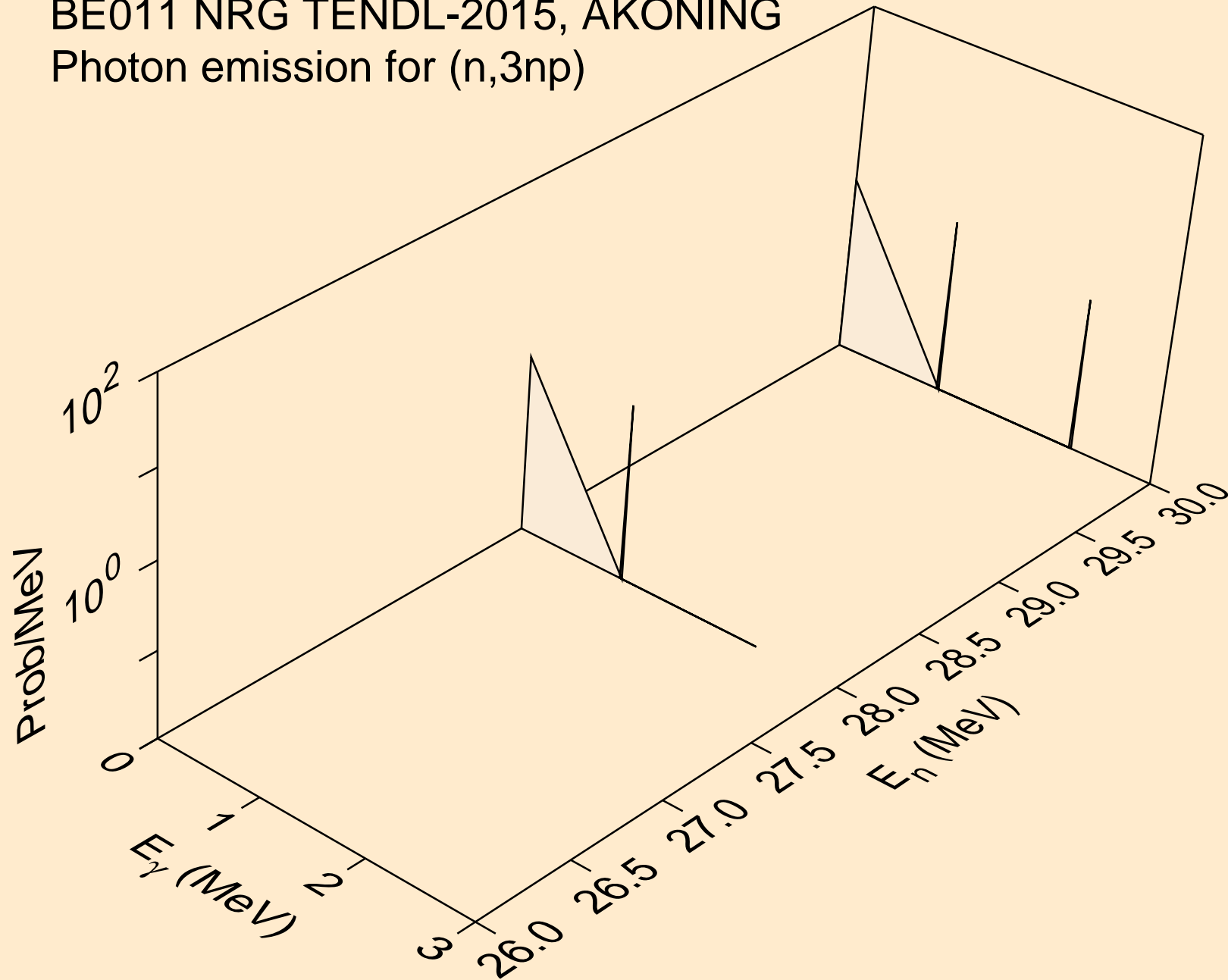

BE011 NRG TENDL-2015, AKONING
Photon emission for (n,n*c)

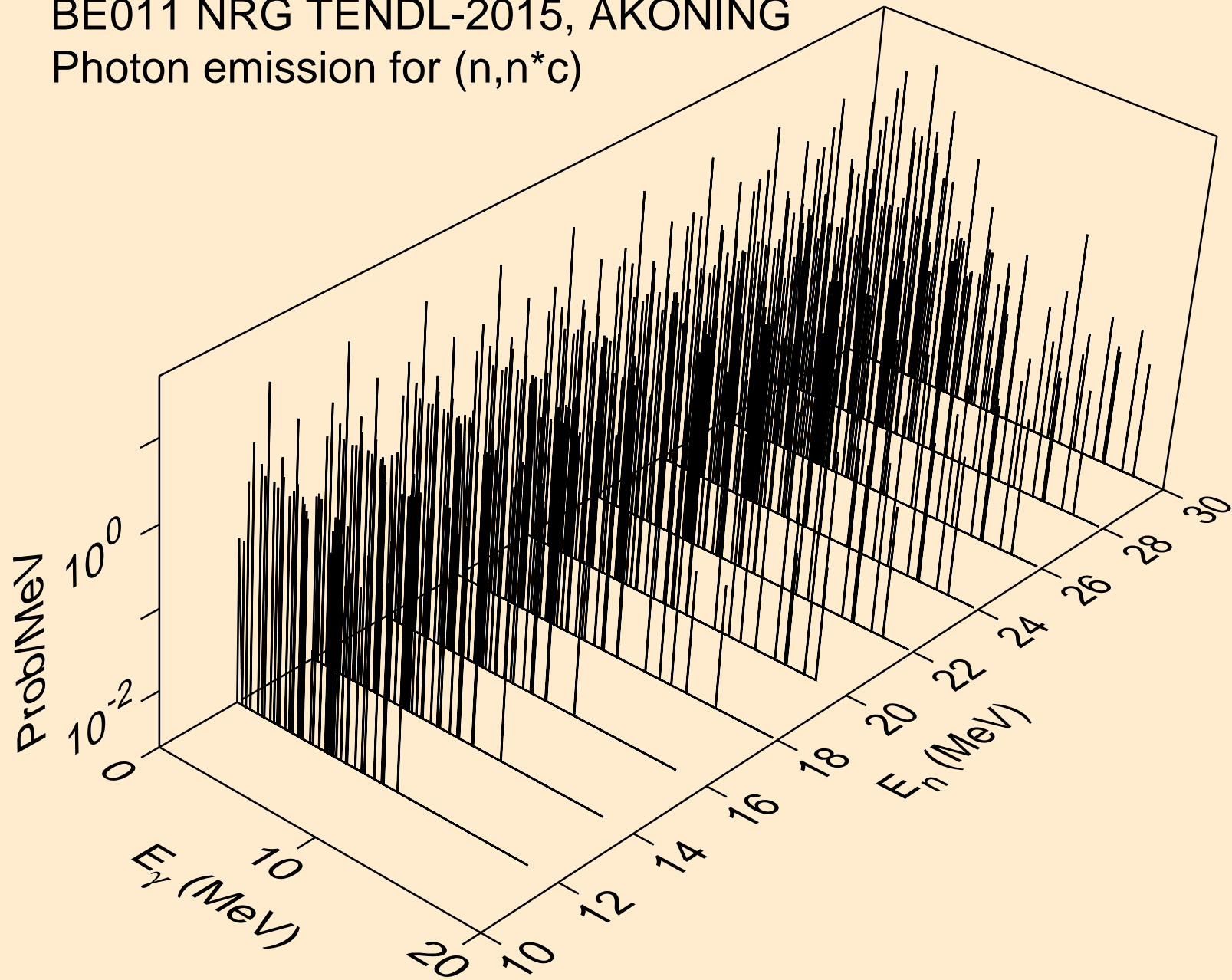

BE011 NRG TENDL-2015, AKONING
Photon emission for (n,gma)

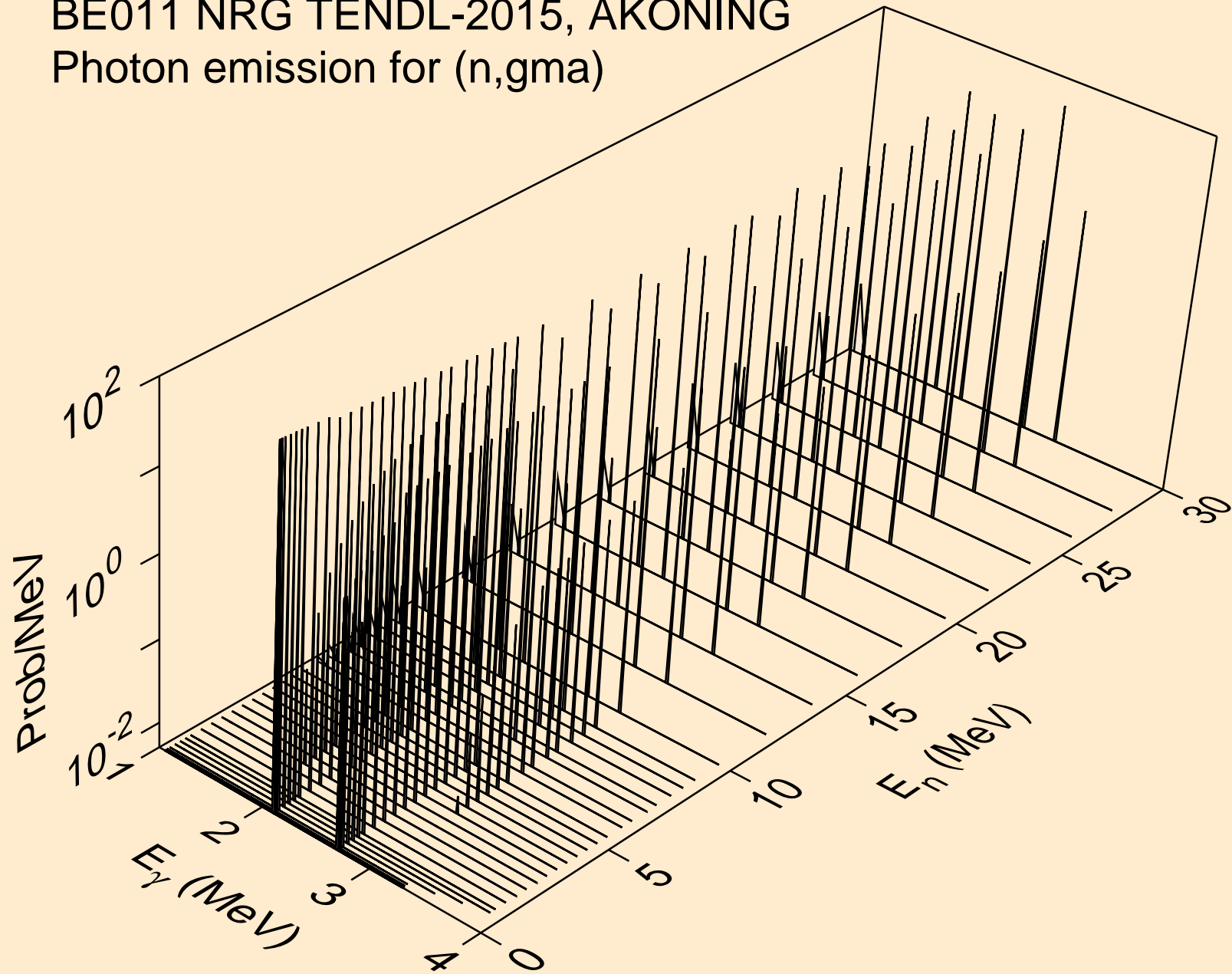

BE011 NRG TENDL-2015, AKONING
Photon emission for (n,p)

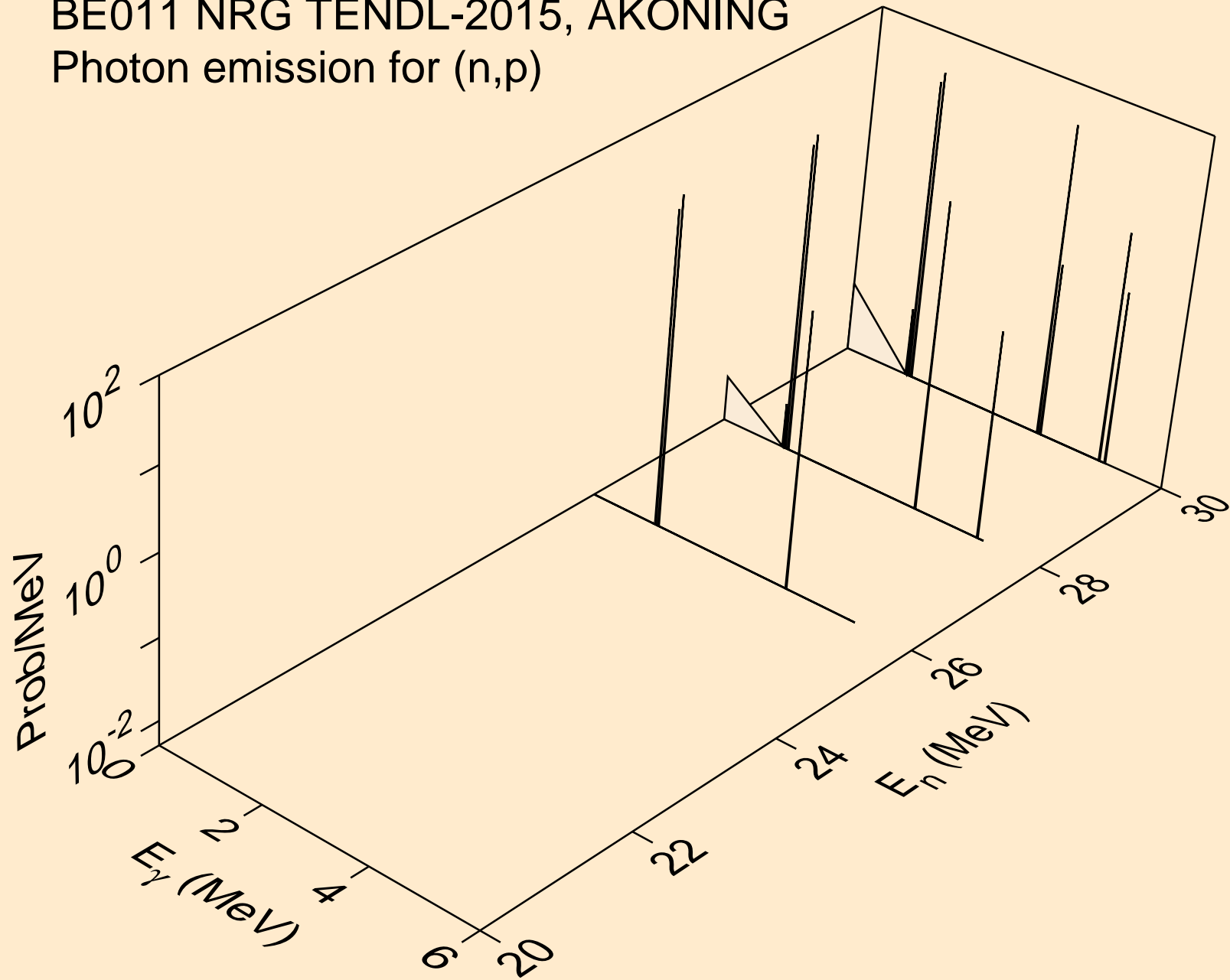

BE011 NRG TENDL-2015, AKONING
Photon emission for (n,d)

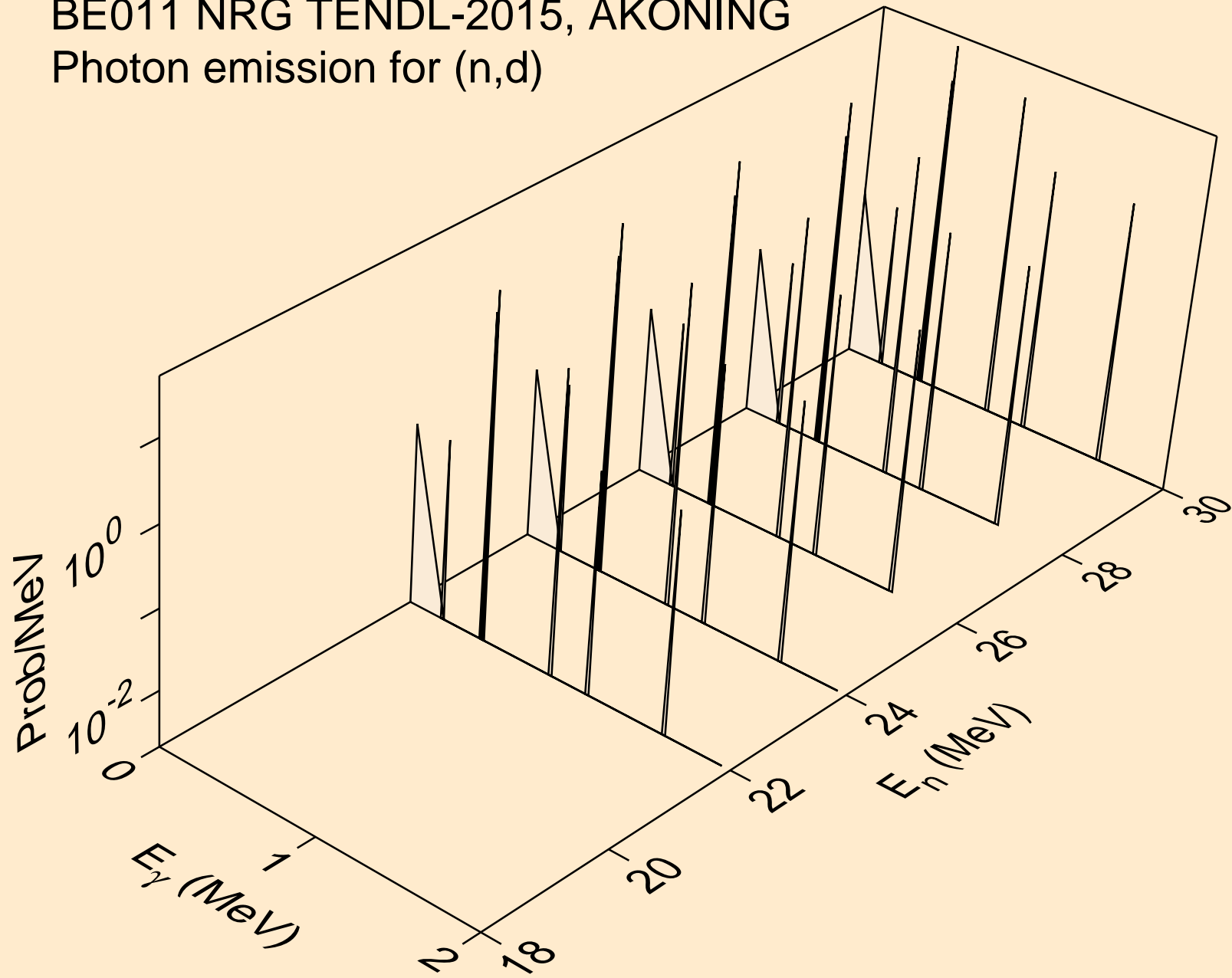

BE011 NRG TENDL-2015, AKONING
Photon emission for (n,t)

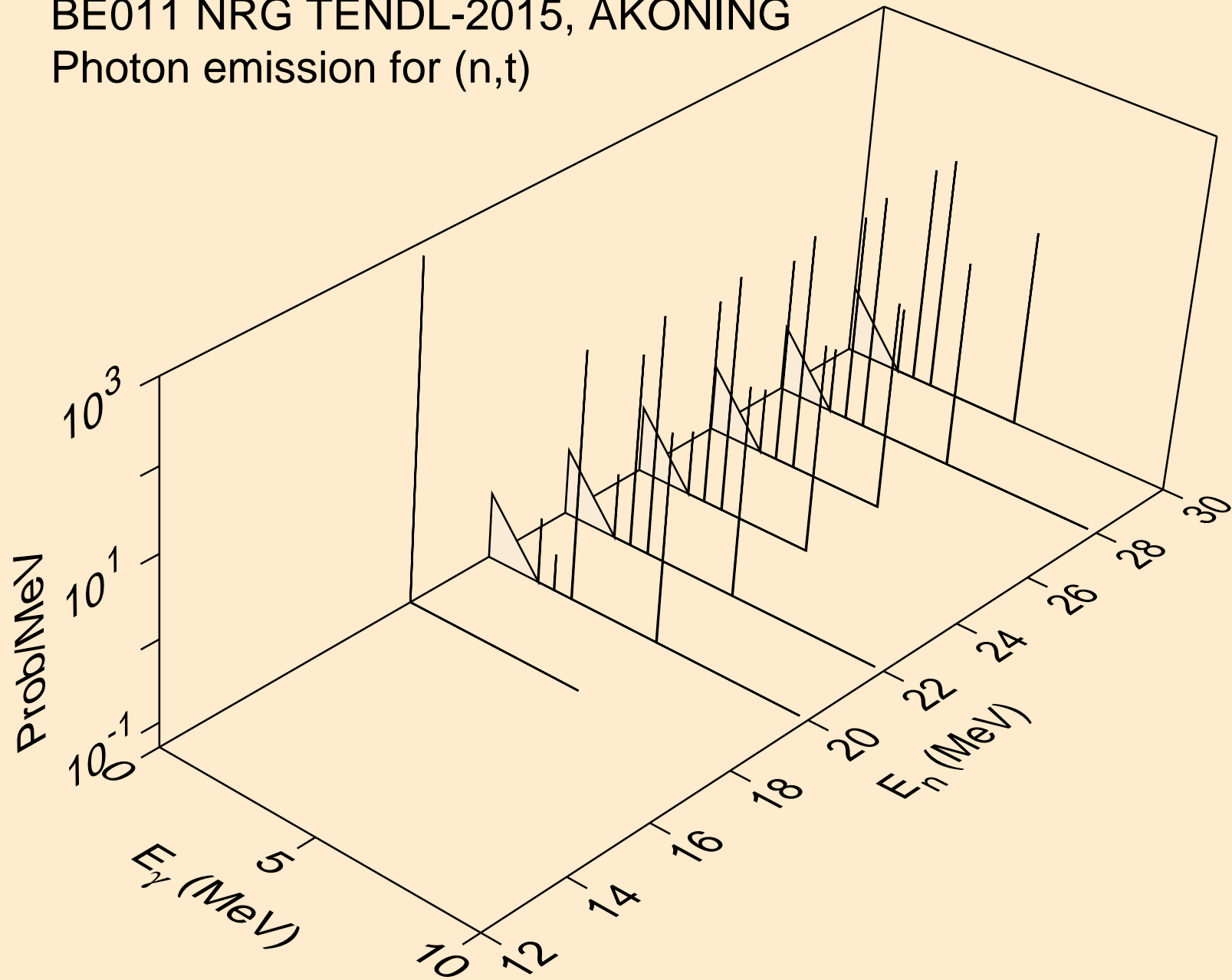

BE011 NRG TENDL-2015, AKONING
thermal capture photon spectrum

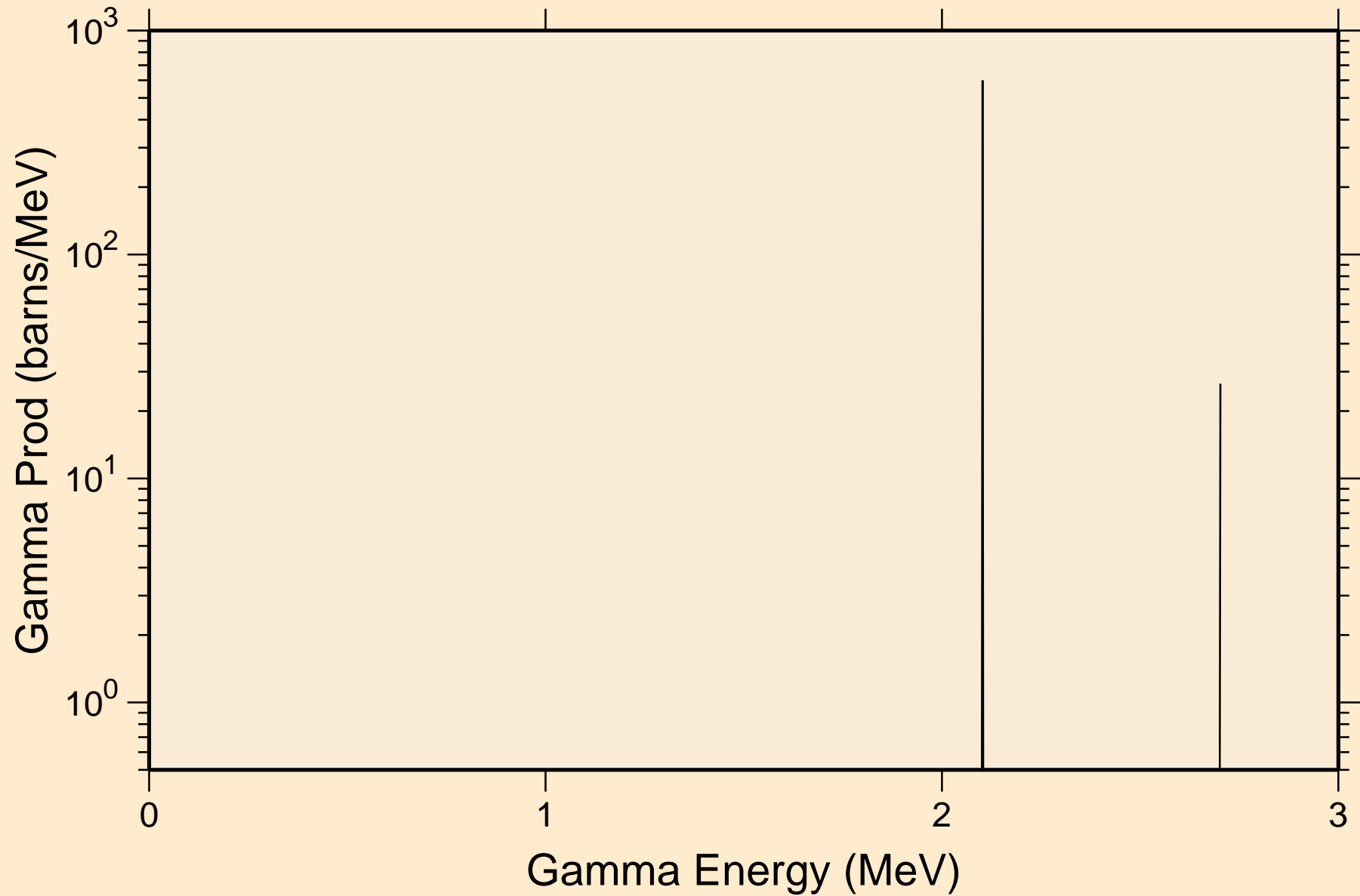

BE011 NRG TENDL-2015, AKONING
14 MeV photon spectrum

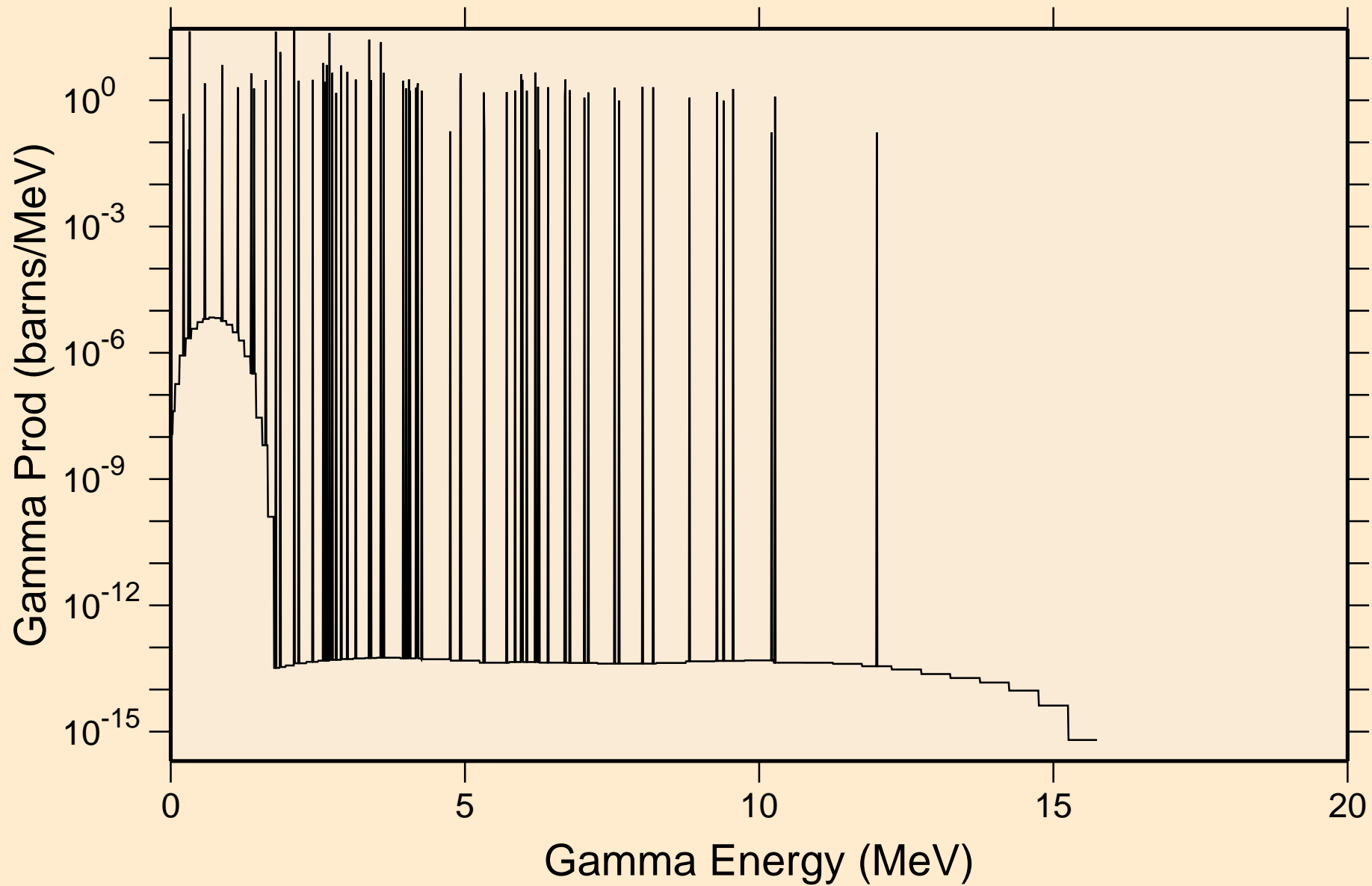

BE011 NRG TENDL-2015, AKONING

Particle heating contributions

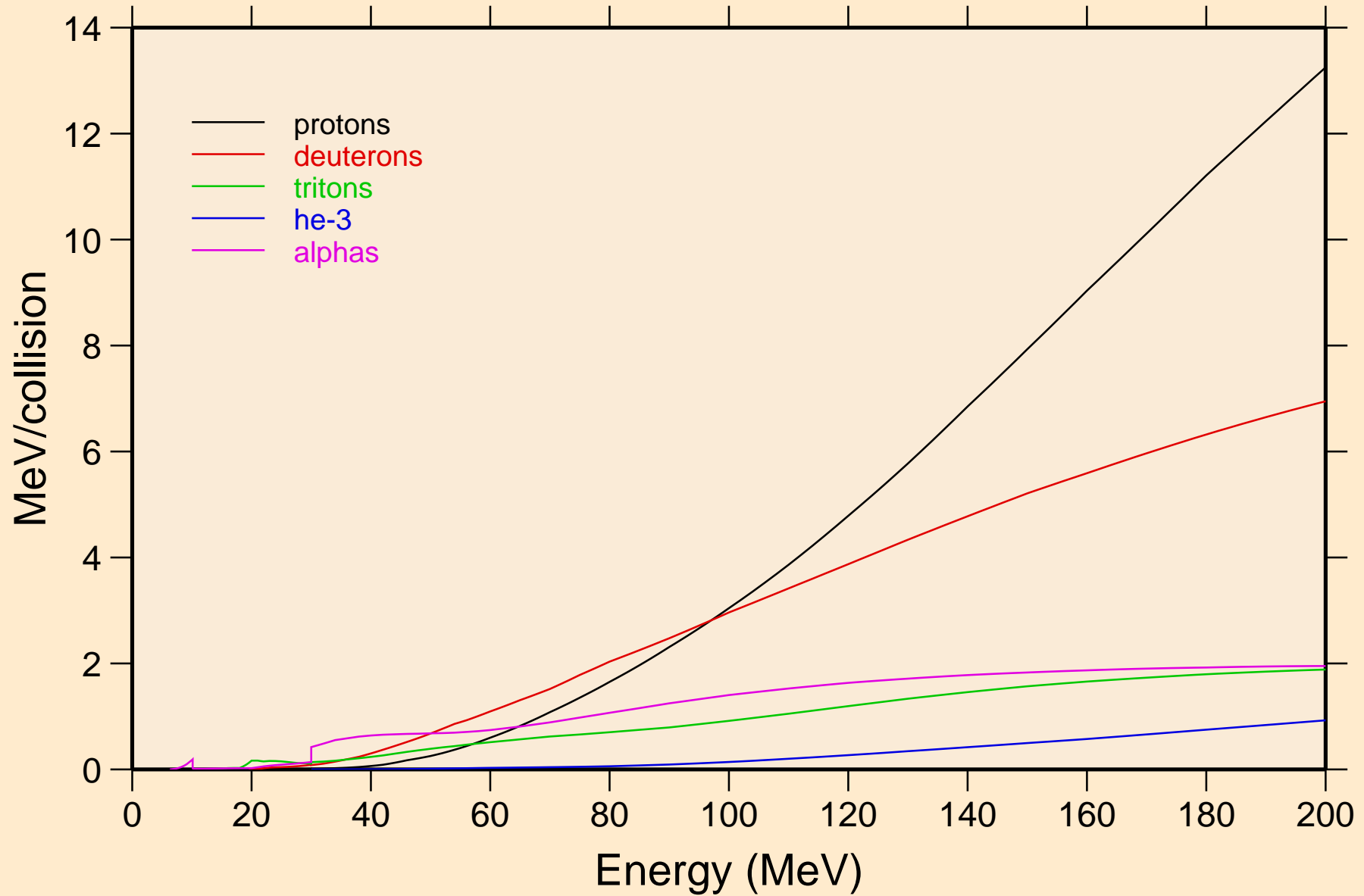

BE011 NRG TENDL-2015, AKONING

Recoil Heating

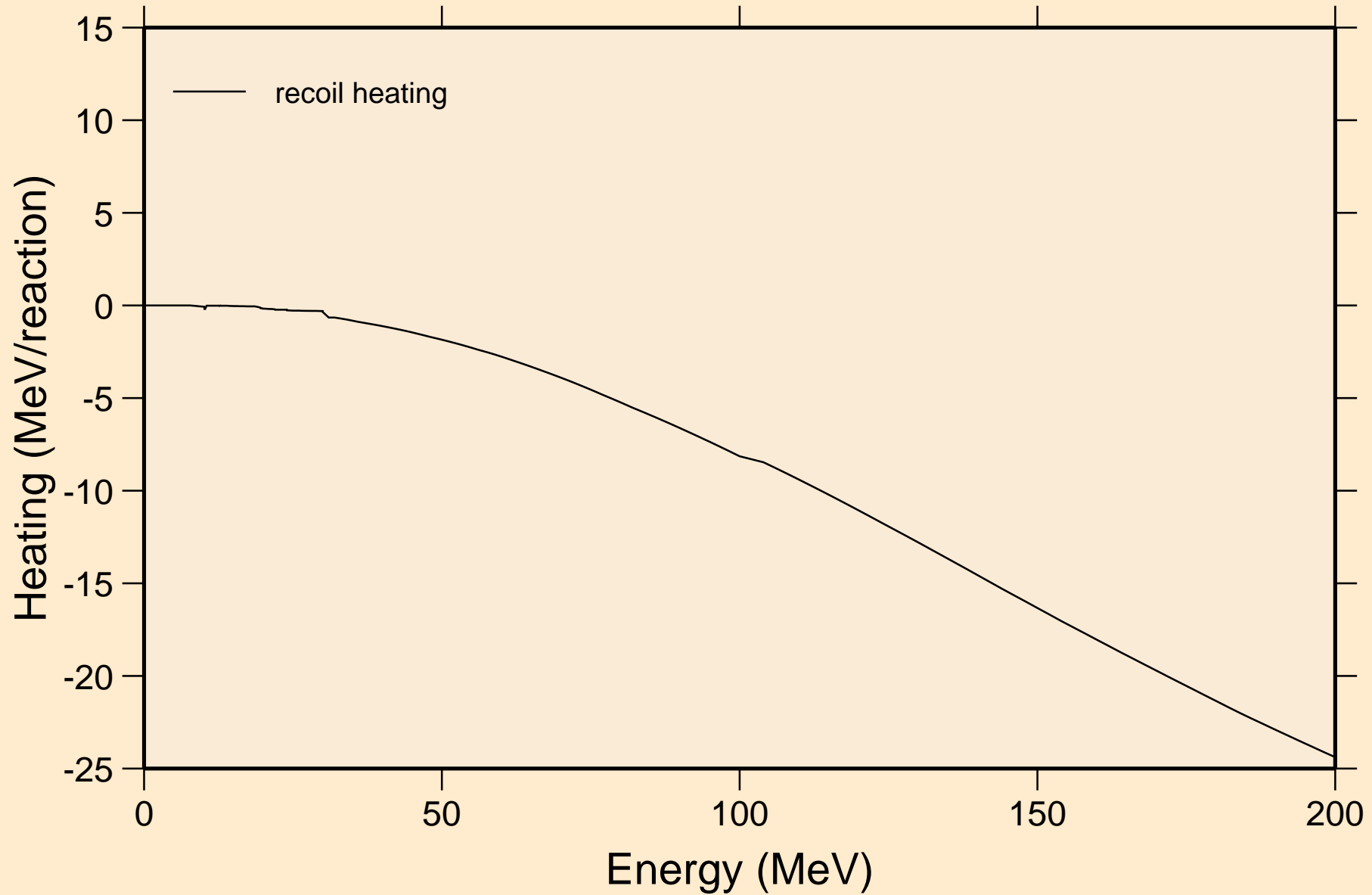

BE011 NRG TENDL-2015, AKONING

Particle production cross sections

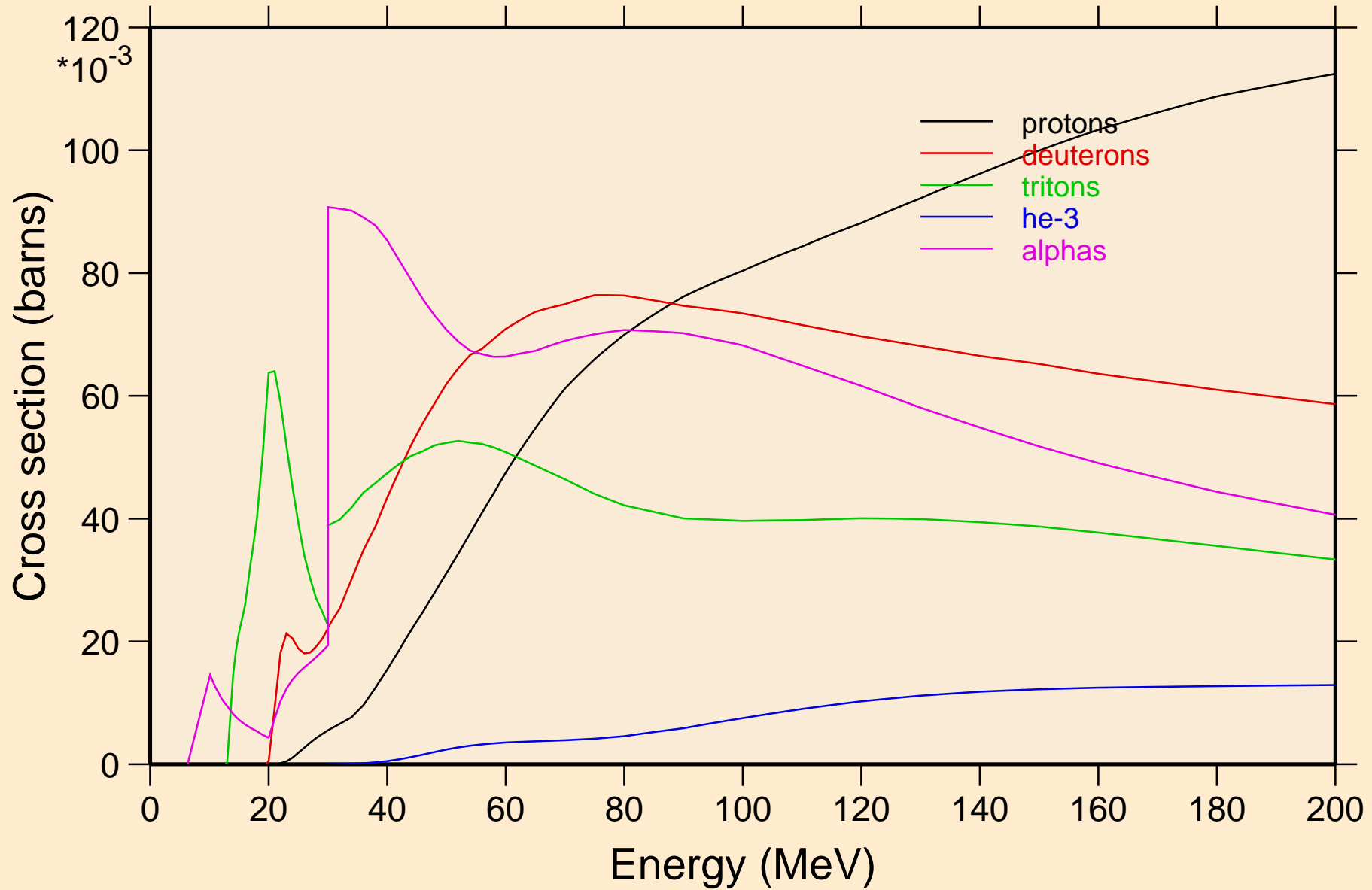

BE011 NRG TENDL-2015, AKONING
protons from (n,x)

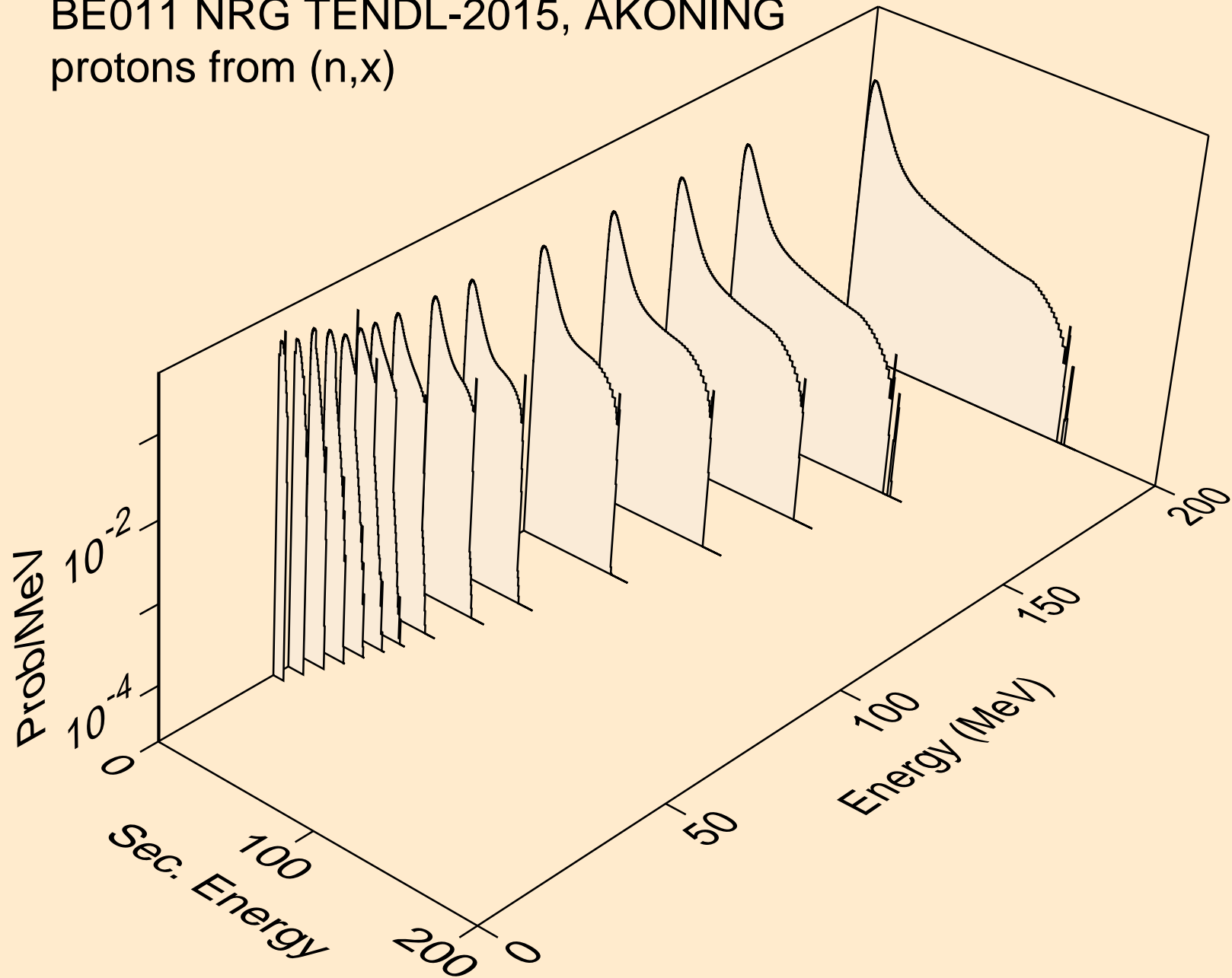

BE011 NRG TENDL-2015, AKONING
protons from (n,n*)p

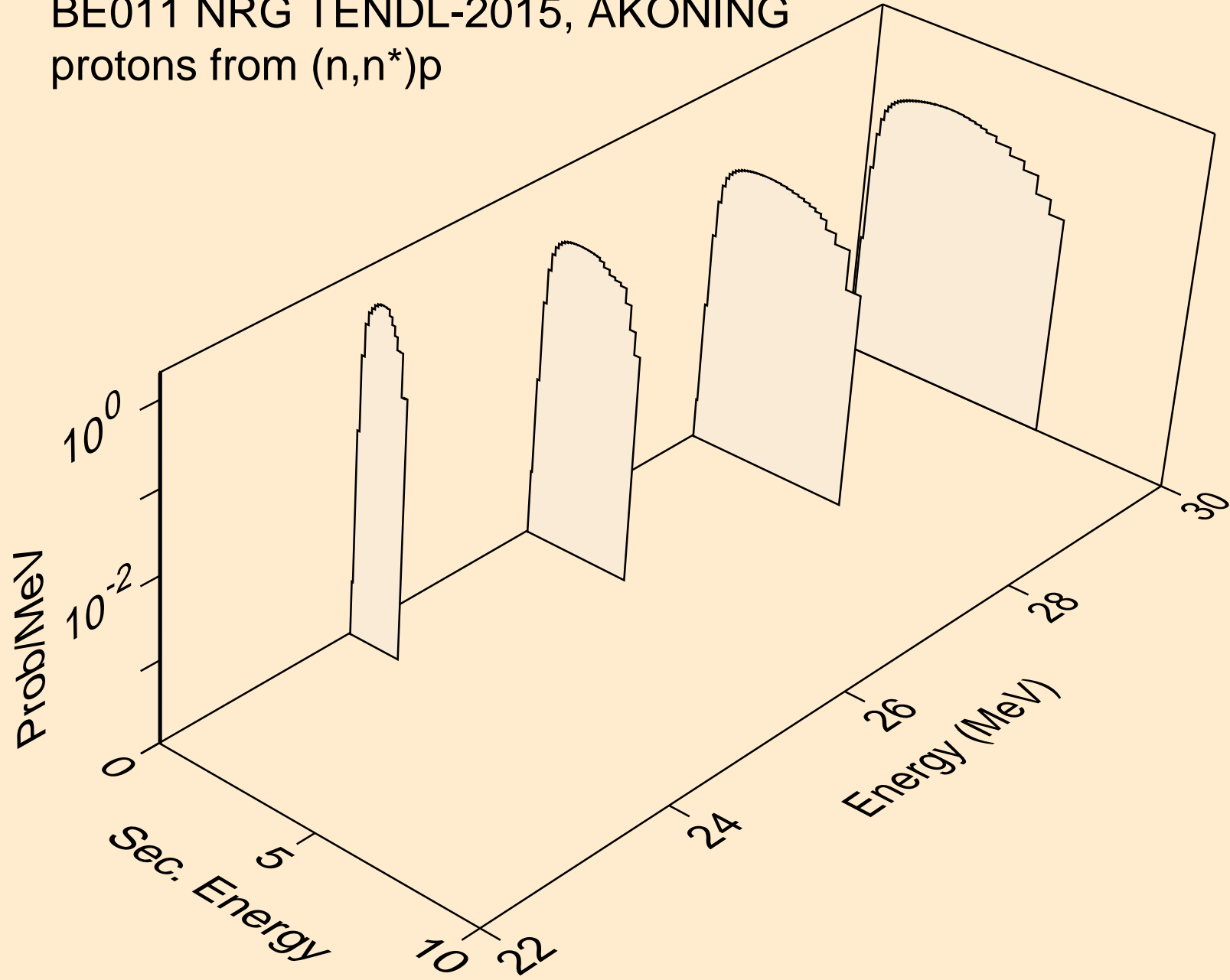

BE011 NRG TENDL-2015, AKONING
protons from (n,2np)

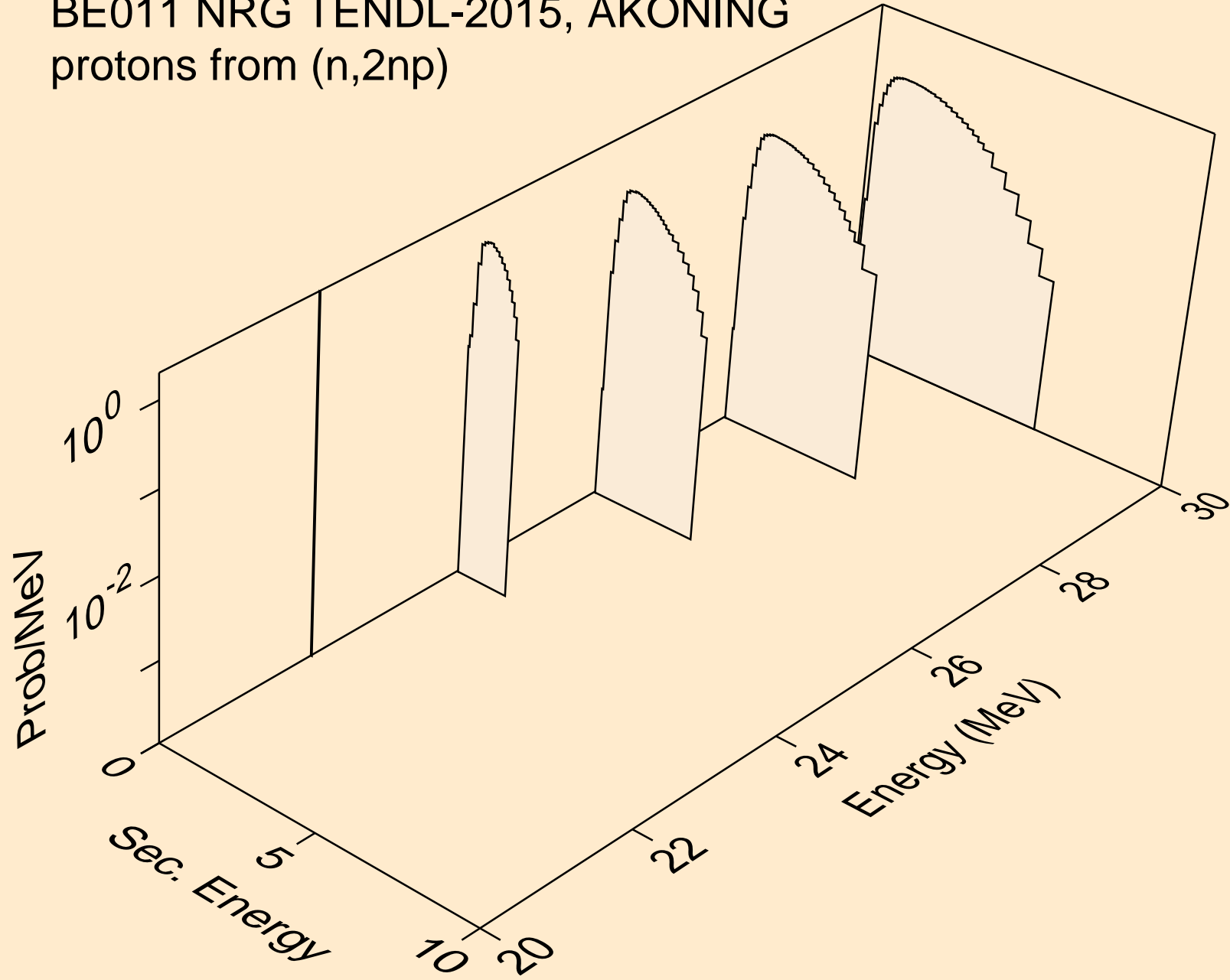

BE011 NRG TENDL-2015, AKONING
protons from (n,3np)

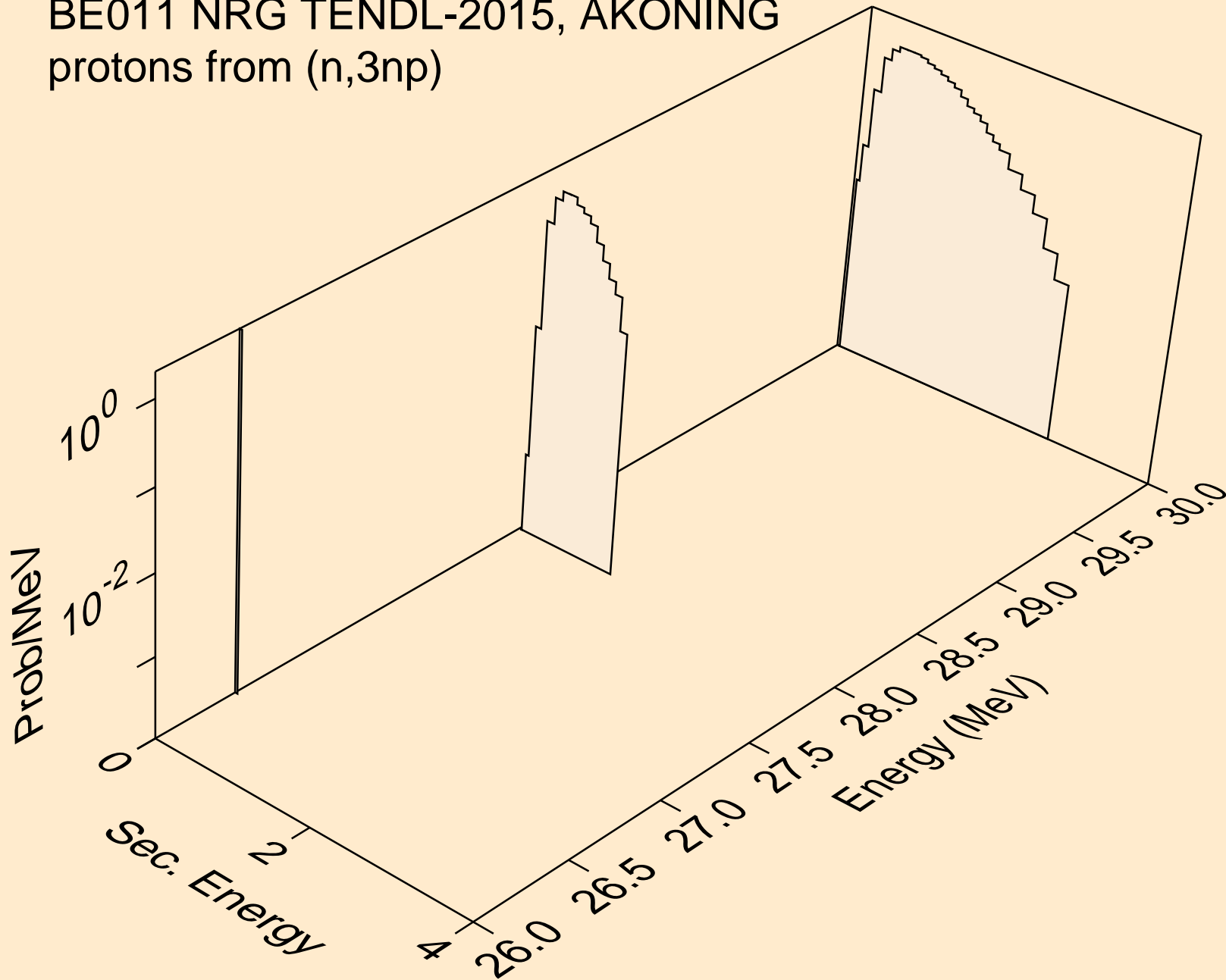

BE011 NRG TENDL-2015, AKONING
protons from (n,p)

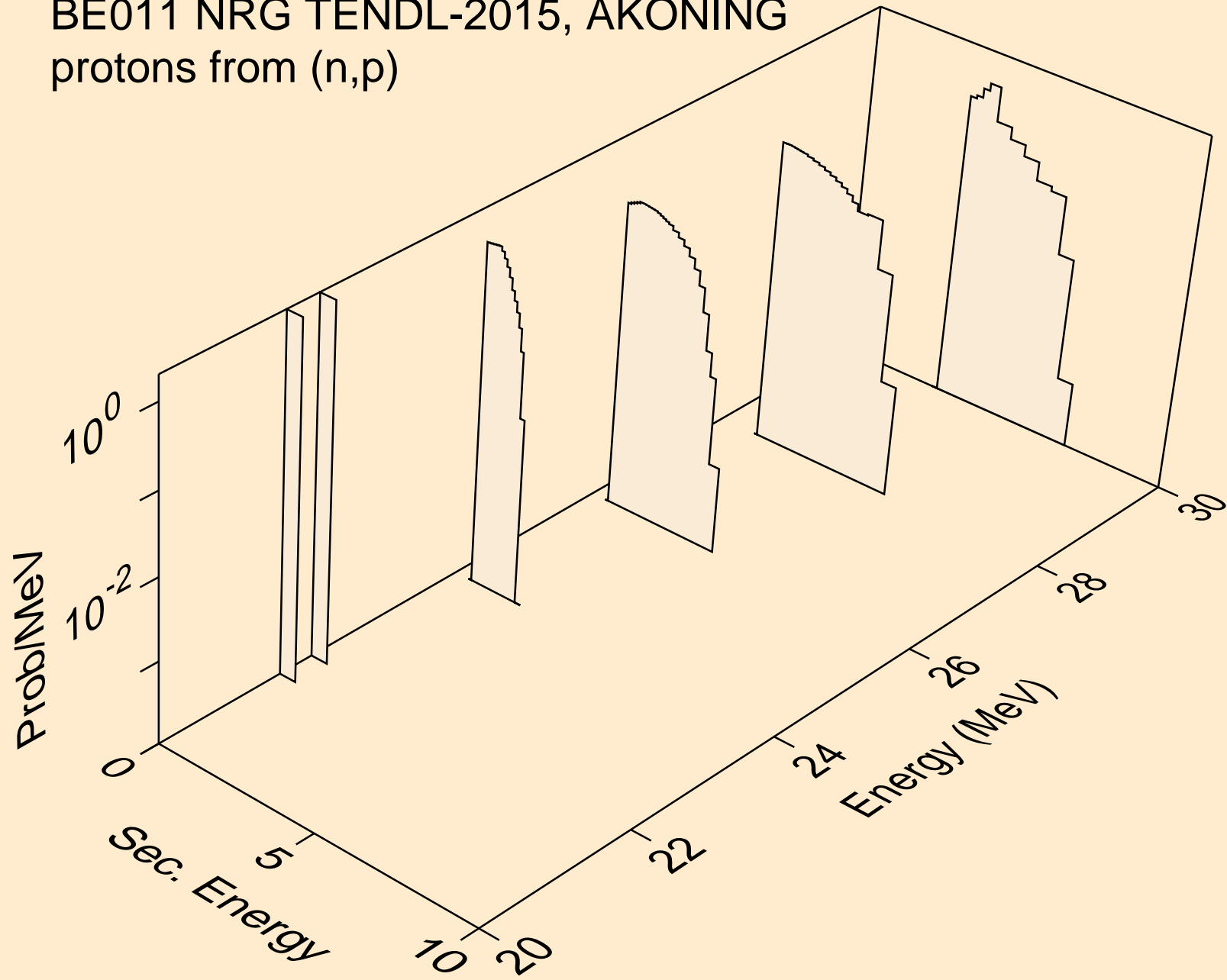

BE011 NRG TENDL-2015, AKONING
deuterons from (n,x)

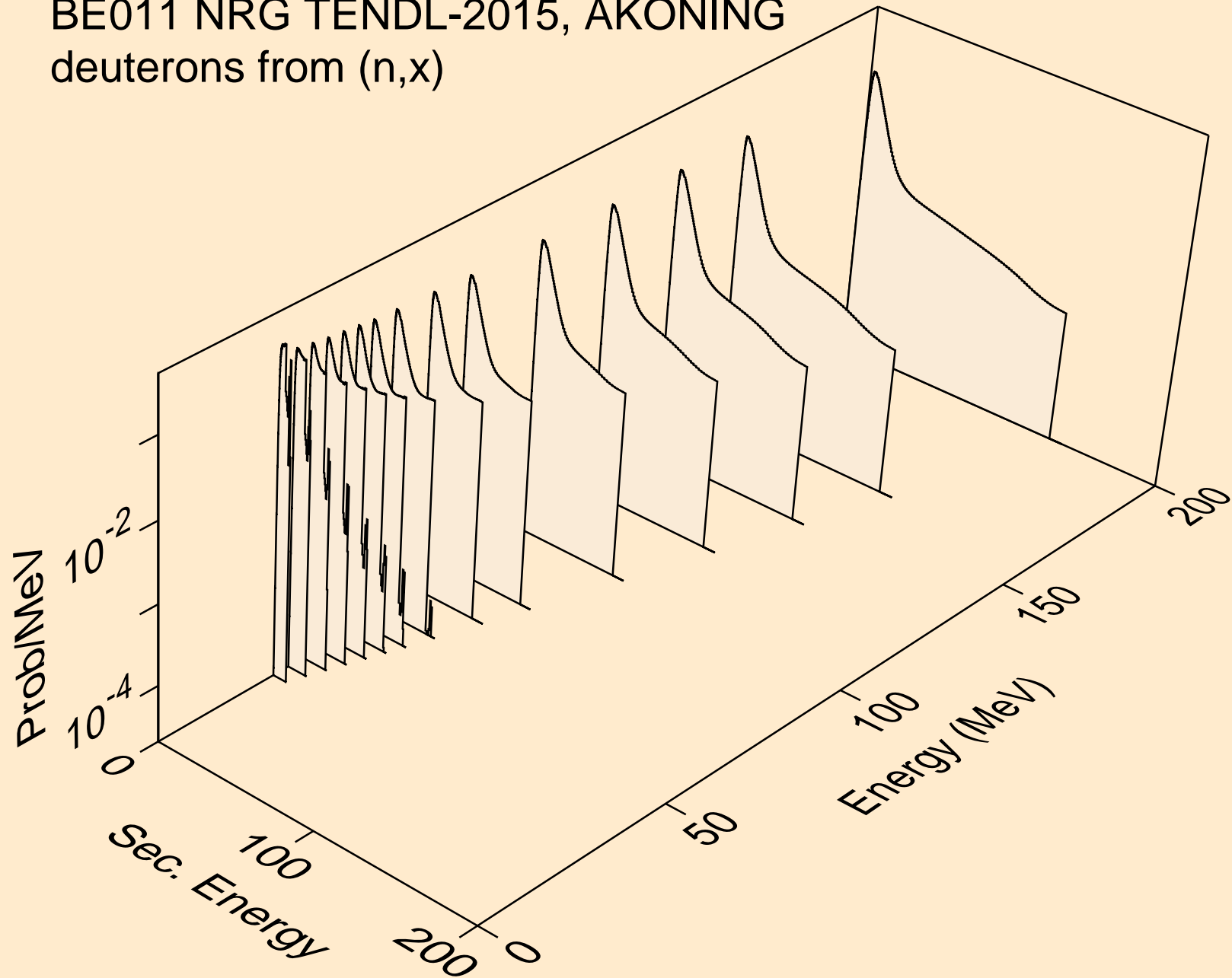

BE011 NRG TENDL-2015, AKONING
deuterons from (n,2nd)

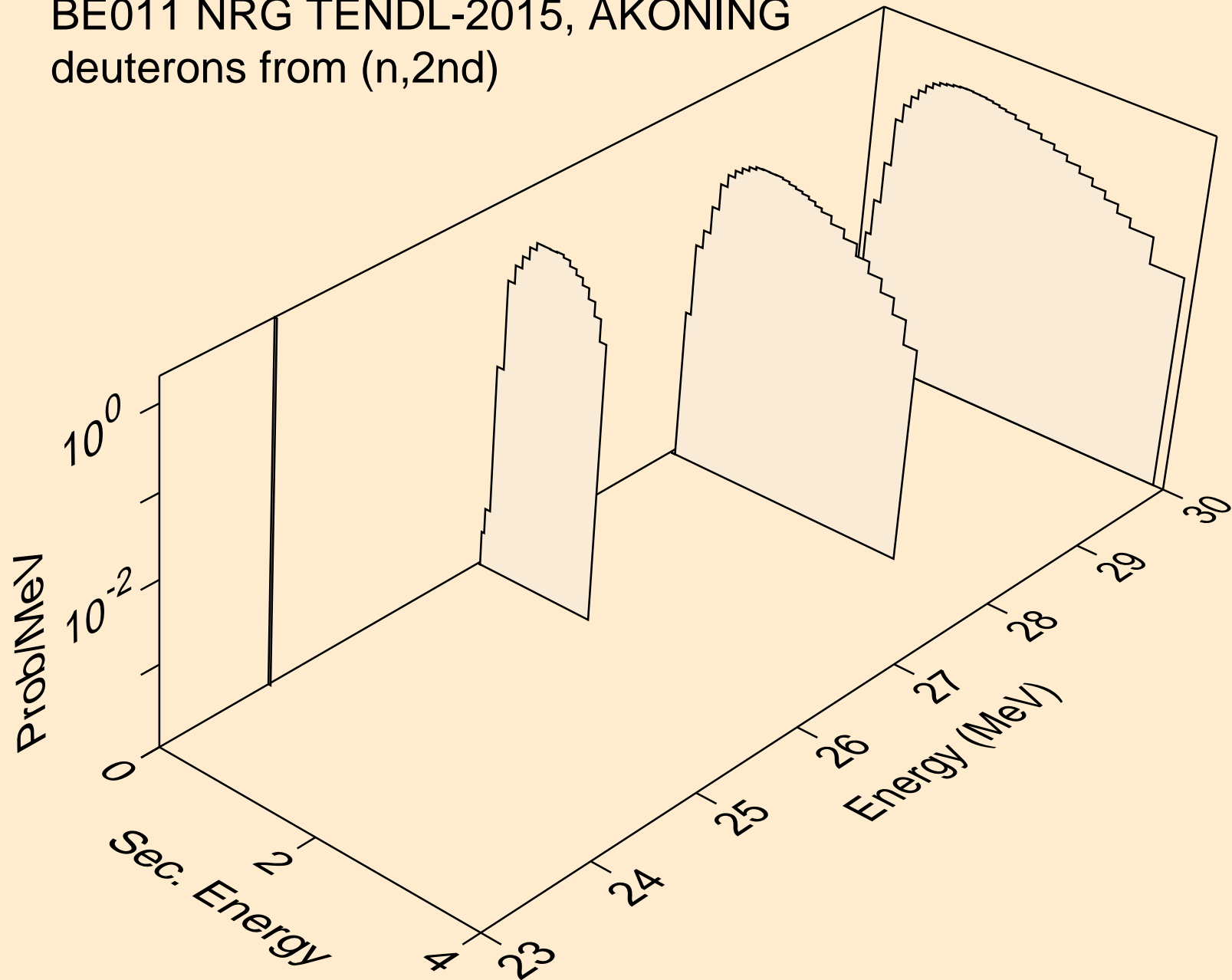

BE011 NRG TENDL-2015, AKONING
deuterons from (n,n*)d

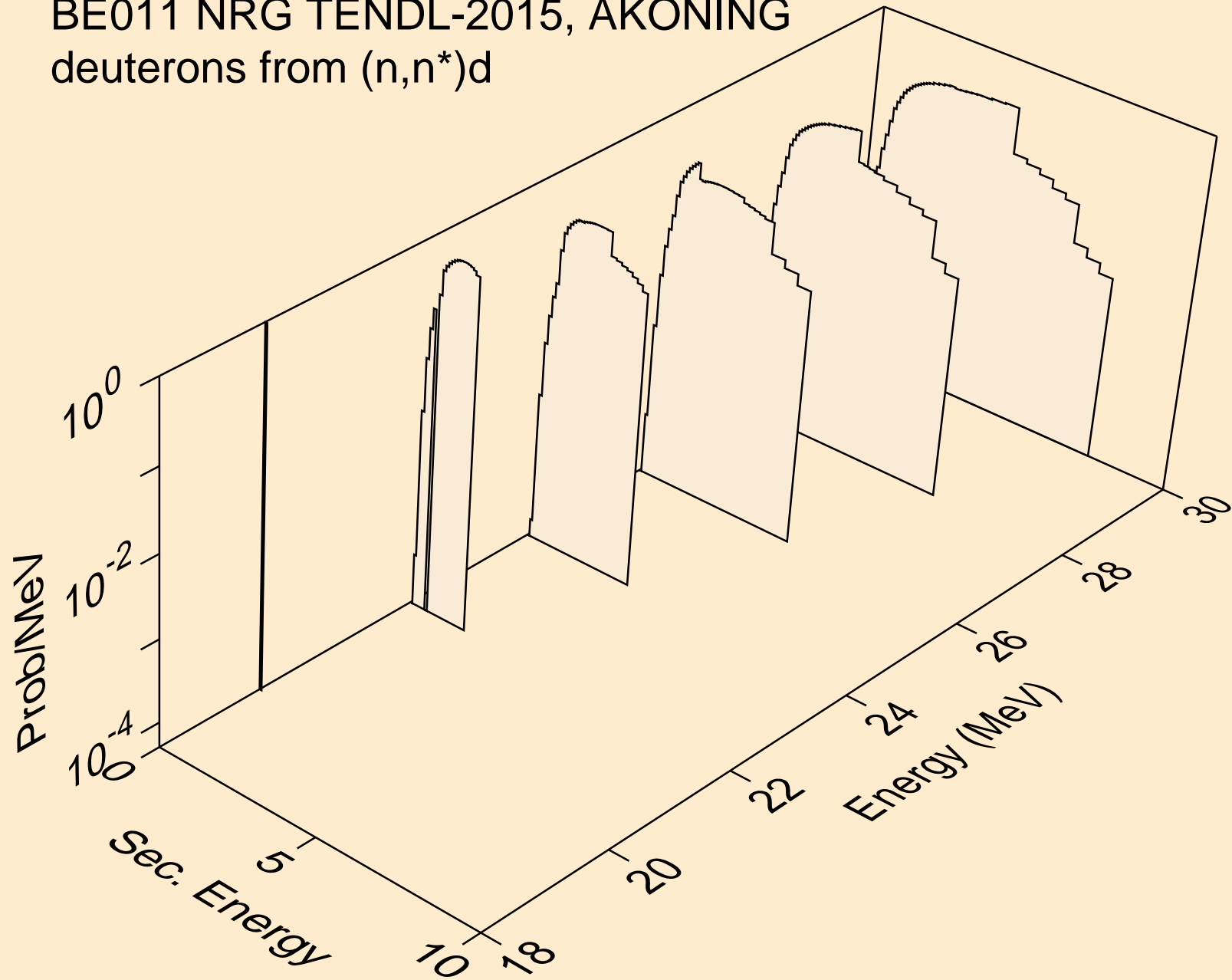

BE011 NRG TENDL-2015, AKONING
deuterons from (n,d)

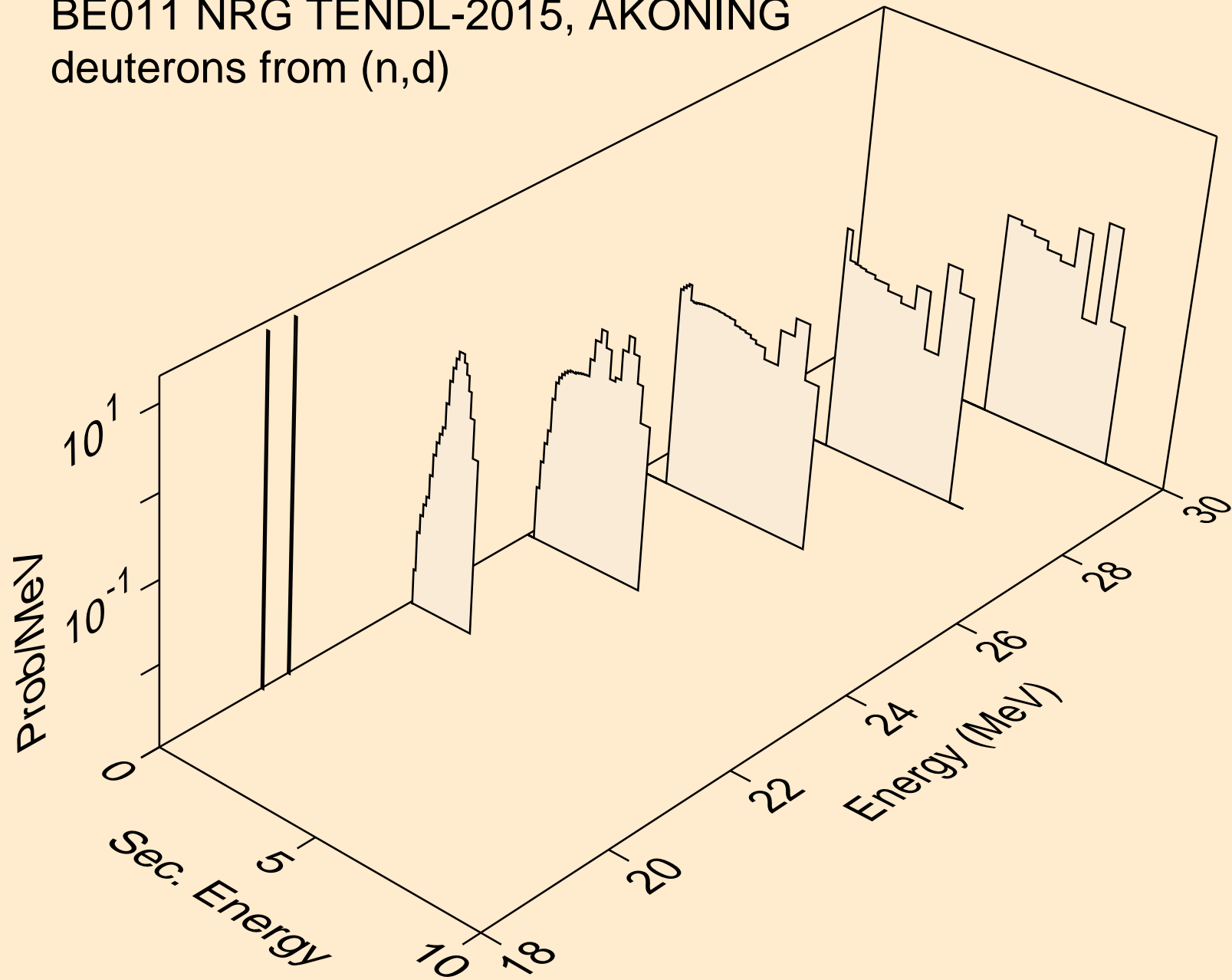

BE011 NRG TENDL-2015, AKONING
tritons from (n,x)

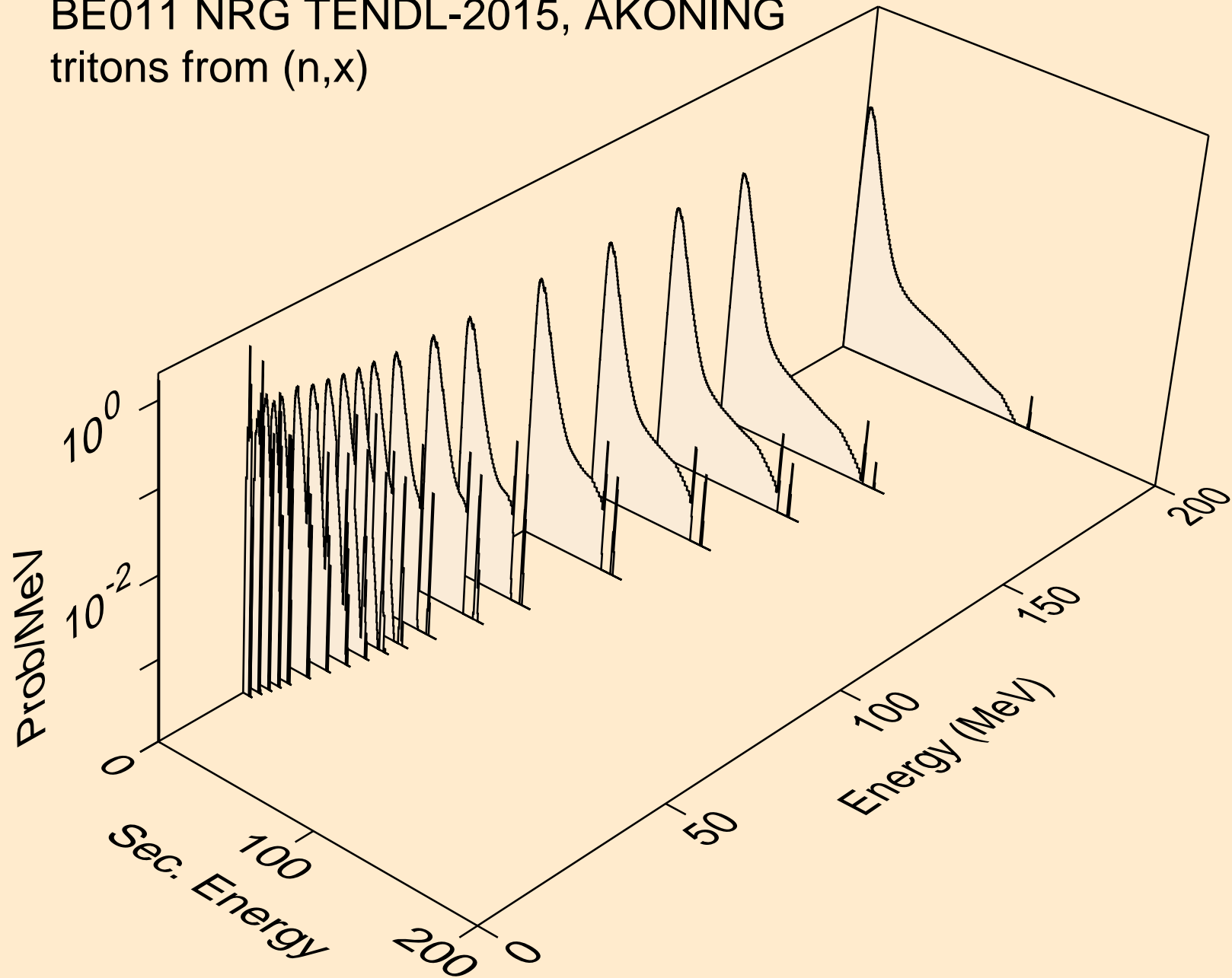

BE011 NRG TENDL-2015, AKONING
tritons from (n,n*)t

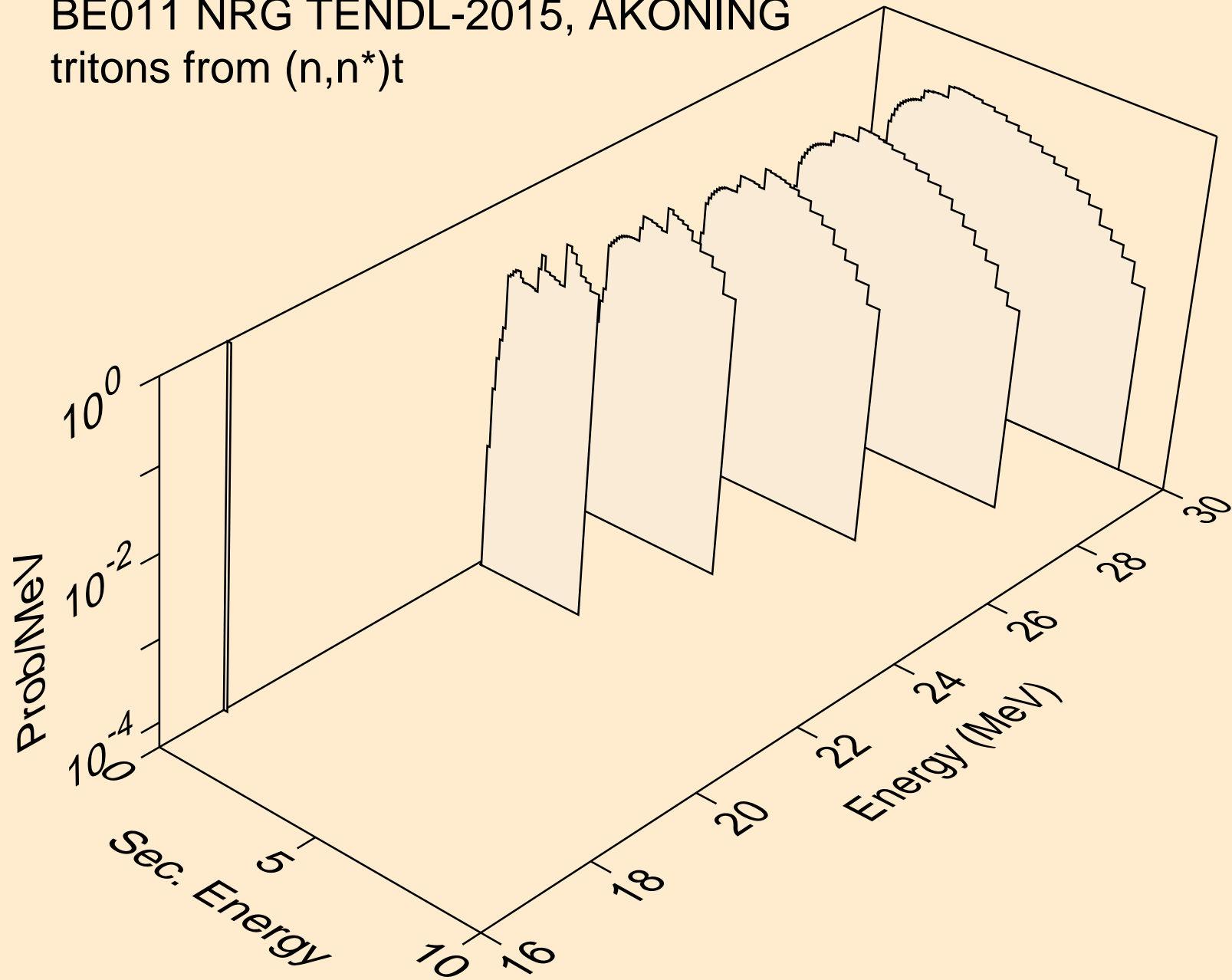

BE011 NRG TENDL-2015, AKONING
tritons from (n,t)

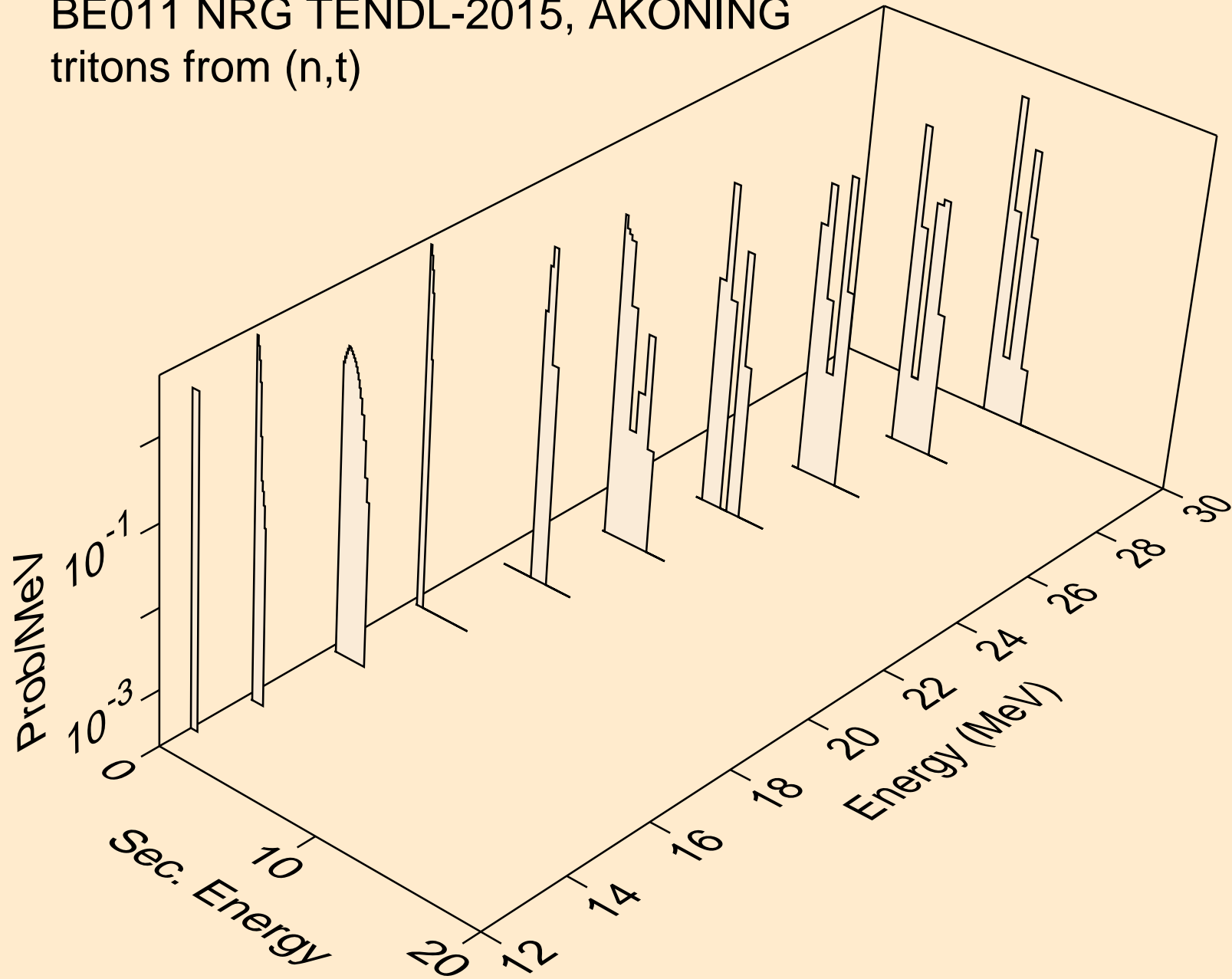

BE011 NRG TENDL-2015, AKONING
he3s from (n,x)

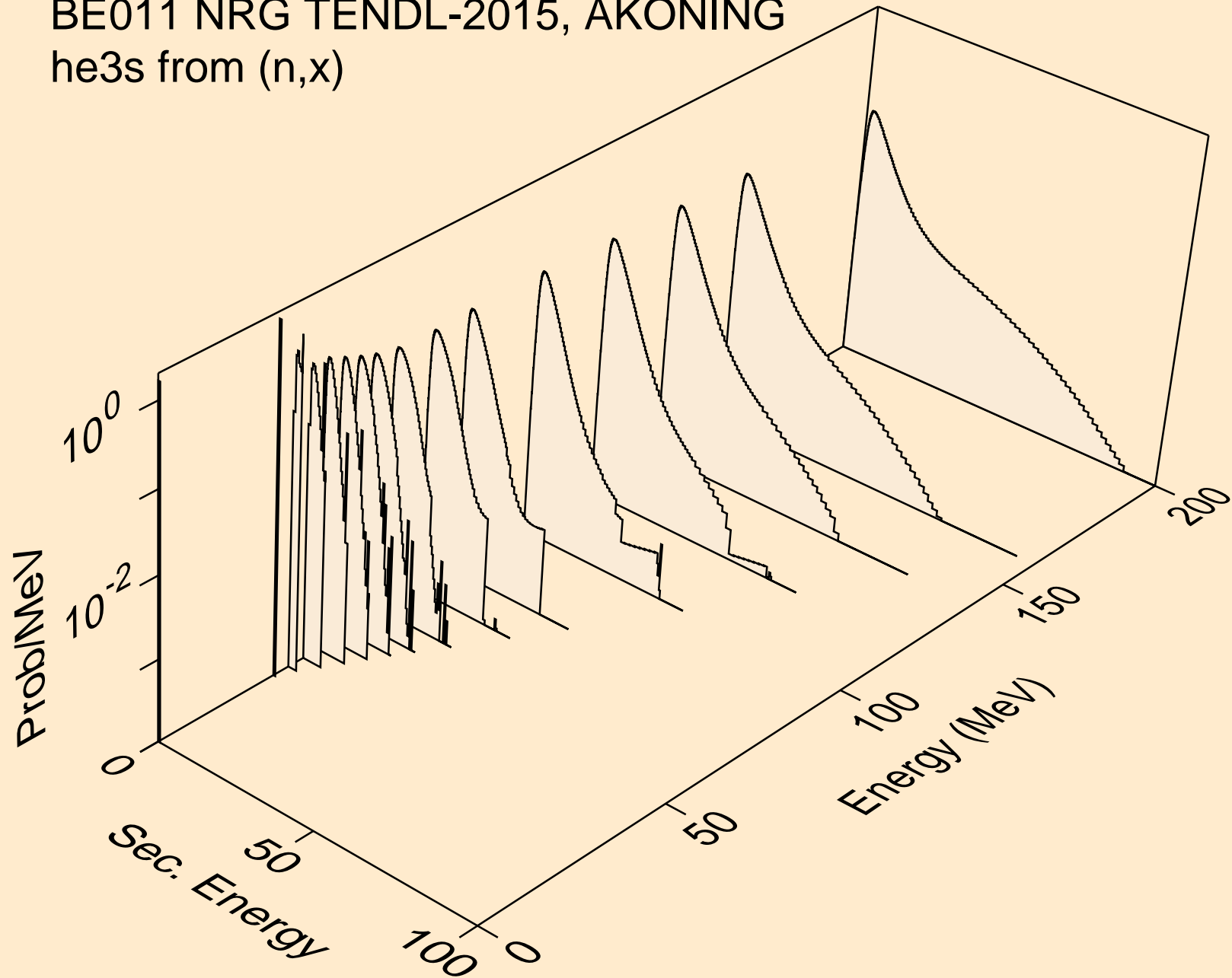

BE011 NRG TENDL-2015, AKONING
alphas from (n,x)

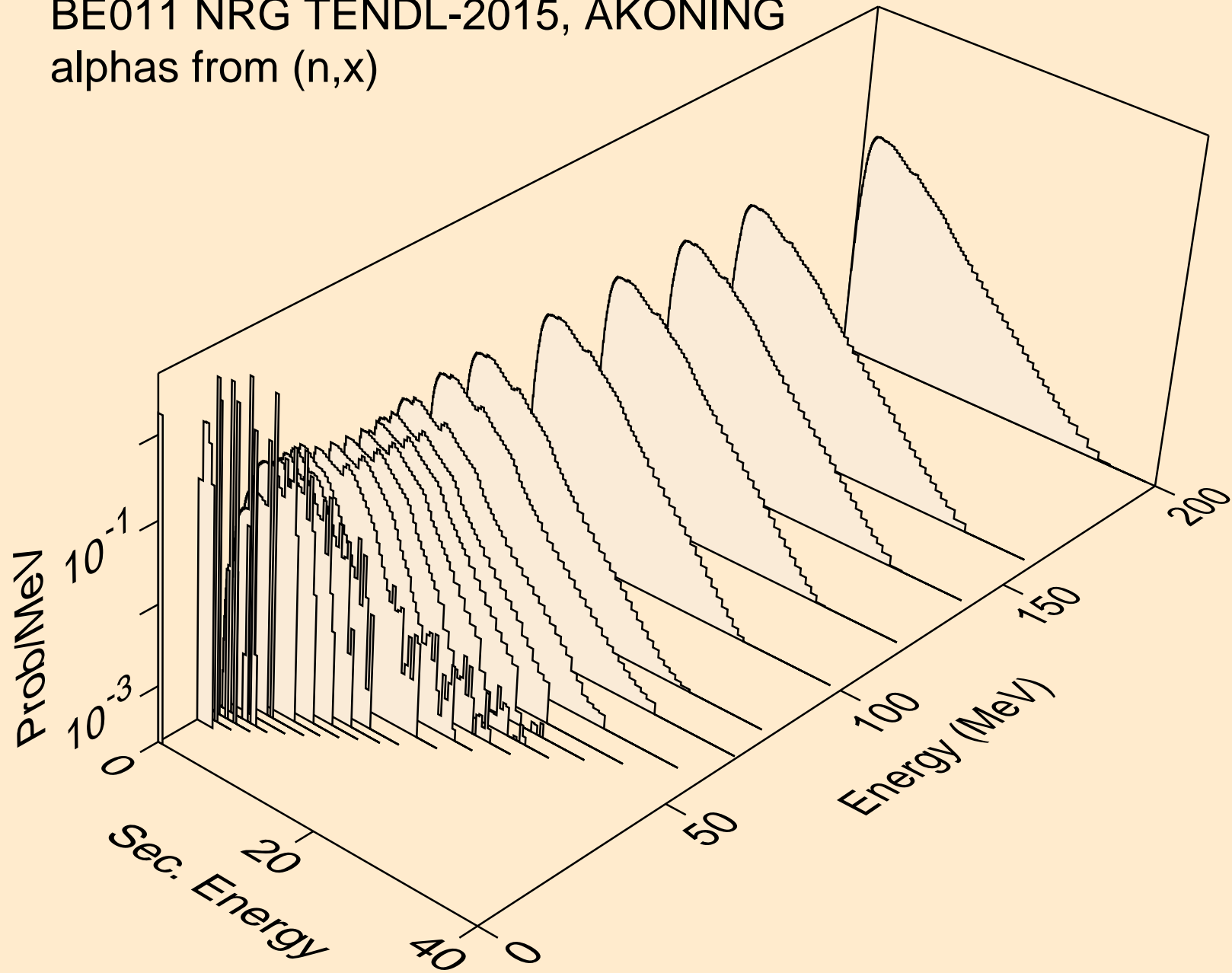

BE011 NRG TENDL-2015, AKONING
alphas from (n,n*)a

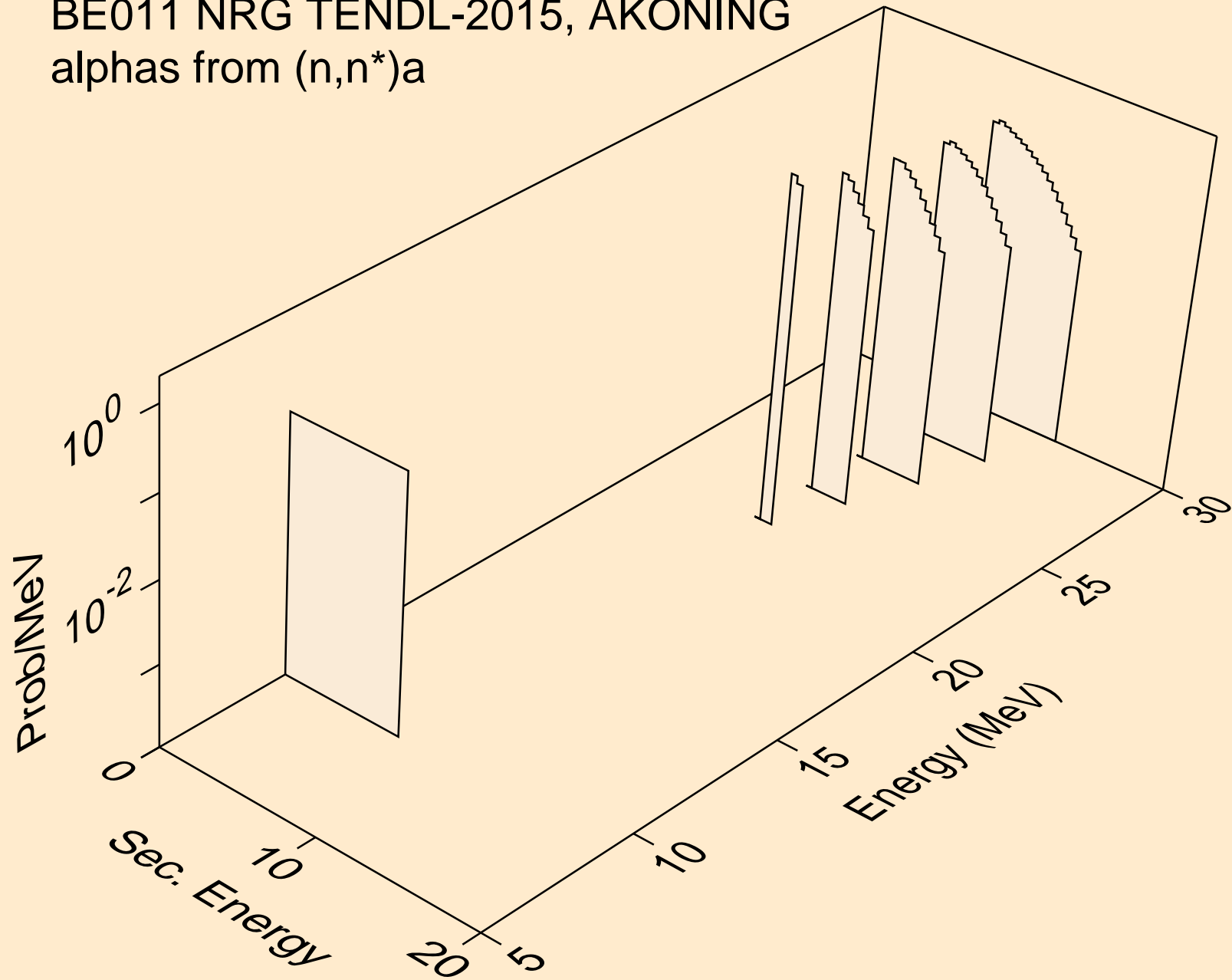

BE011 NRG TENDL-2015, AKONING
alphas from (n,2n)a

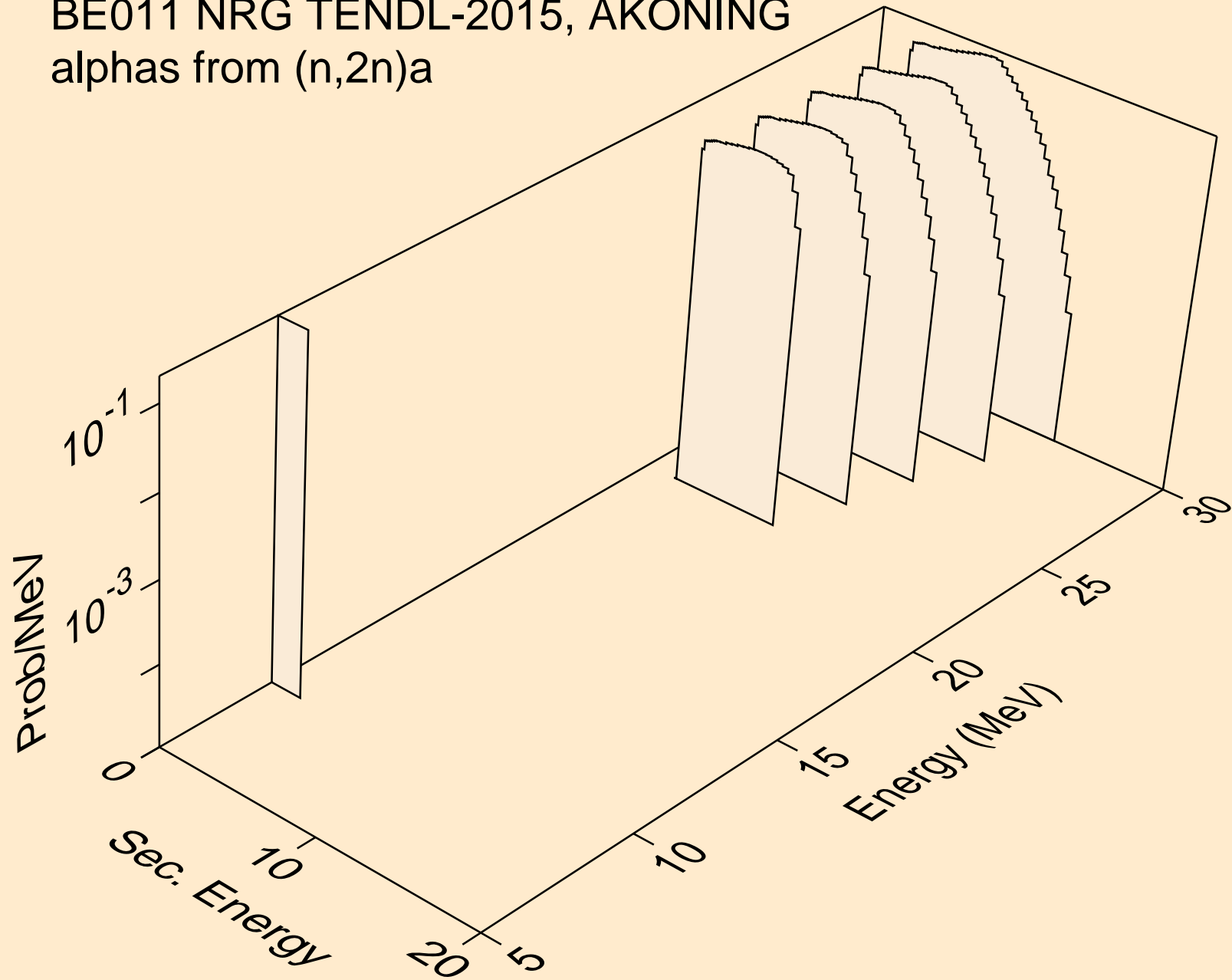

BE011 NRG TENDL-2015, AKONING
alphas from (n,3n)a

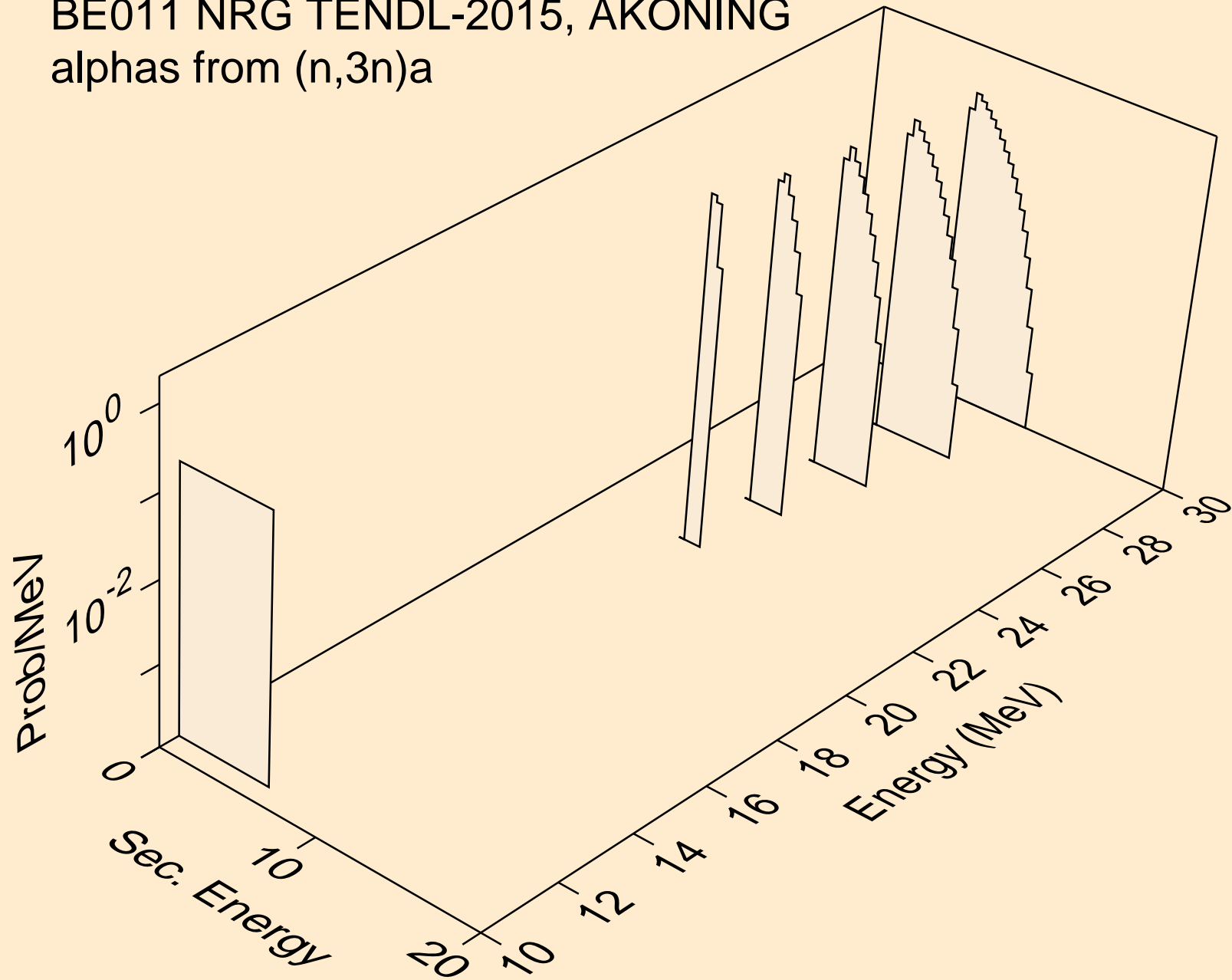

BE011 NRG TENDL-2015, AKONING
alphas from (n,a)

