

# BH270 NRG TENDL-2015, AKONING

## Principal cross sections

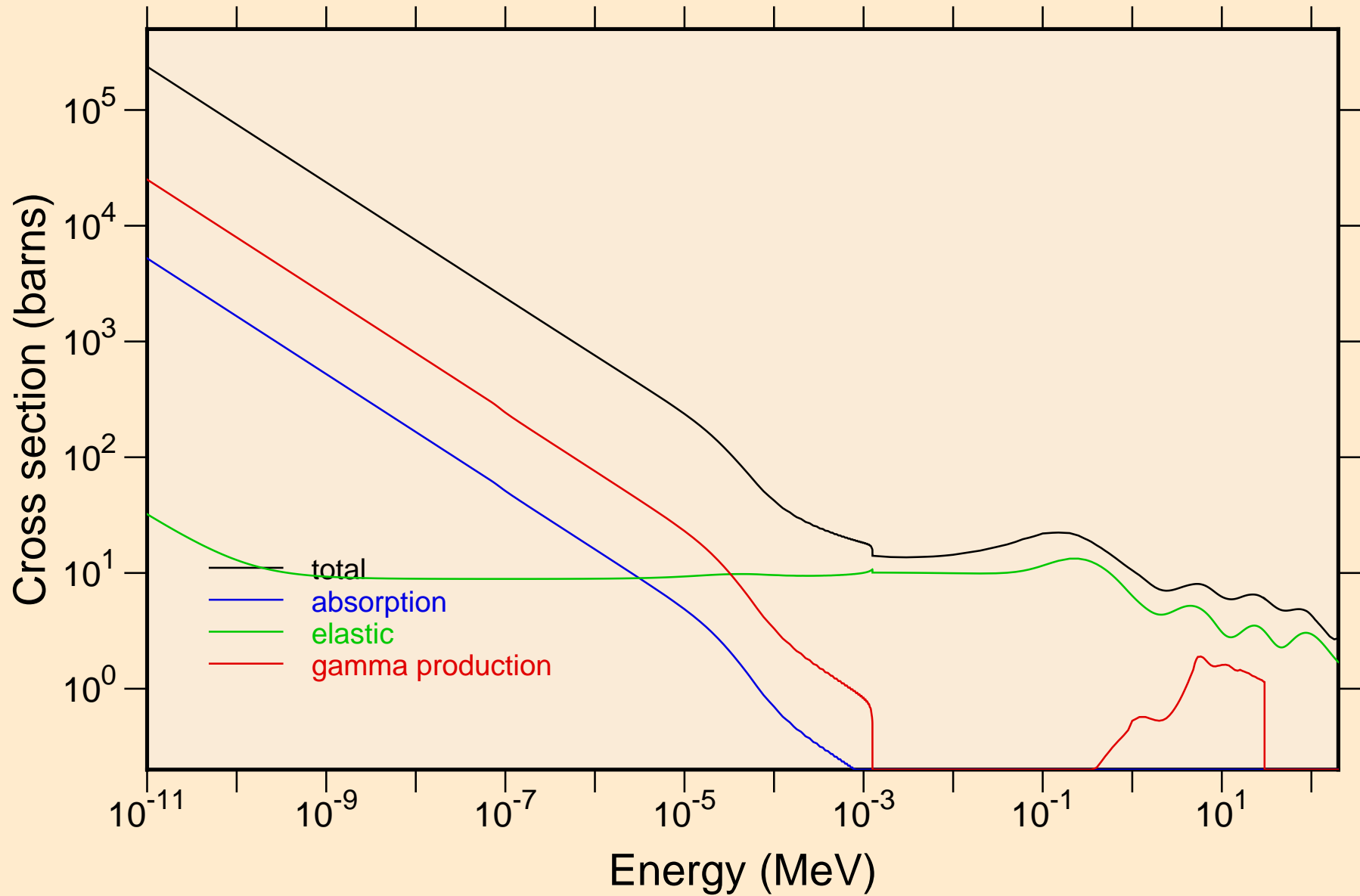

# BH270 NRG TENDL-2015, AKONING

## Non-threshold reactions

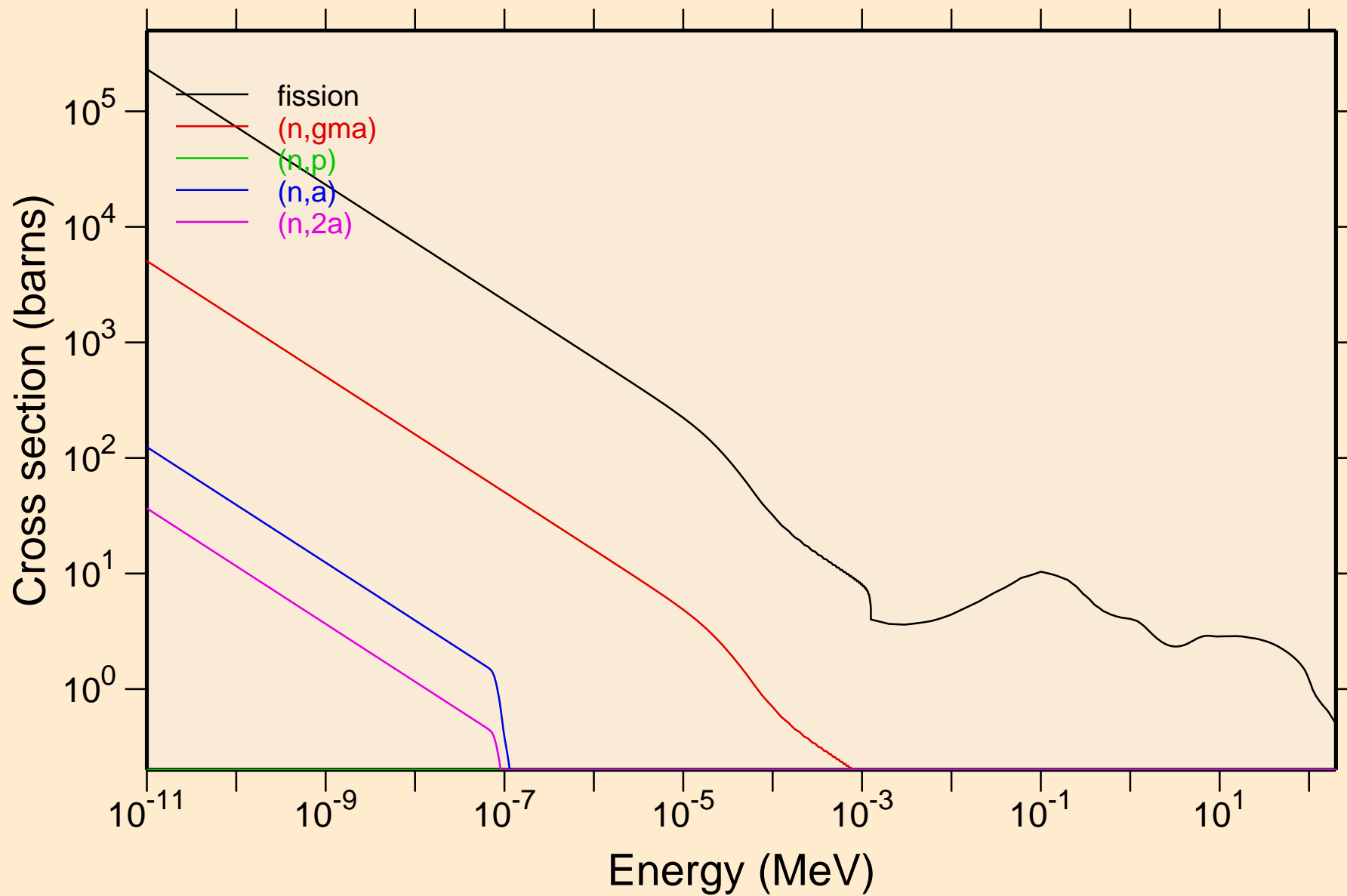

BH270 NRG TENDL-2015, AKONING  
Non-threshold reactions

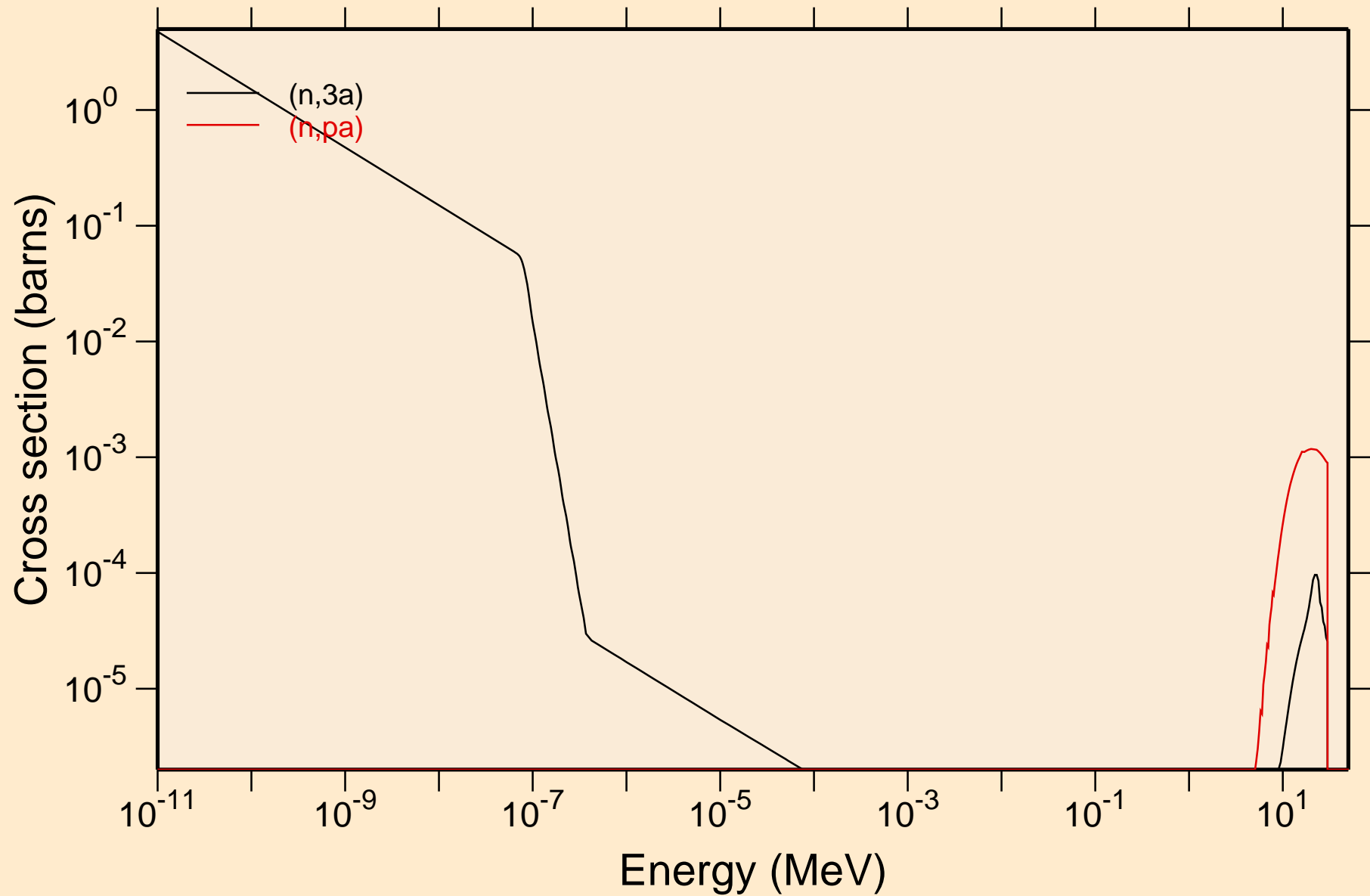

# BH270 NRG TENDL-2015, AKONING

## Principal cross sections

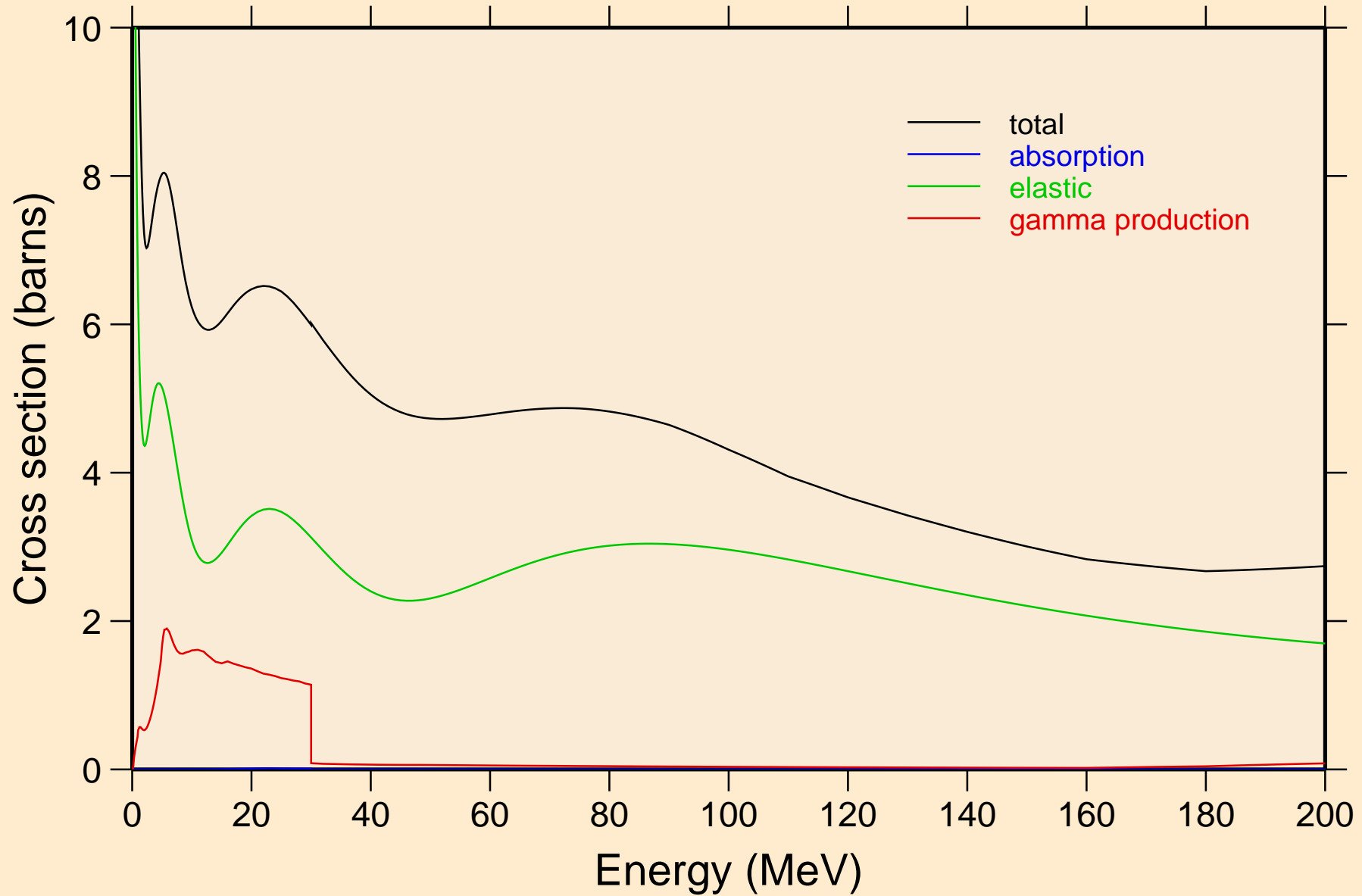

# BH270 NRG TENDL-2015, AKONING

## Non-threshold reactions

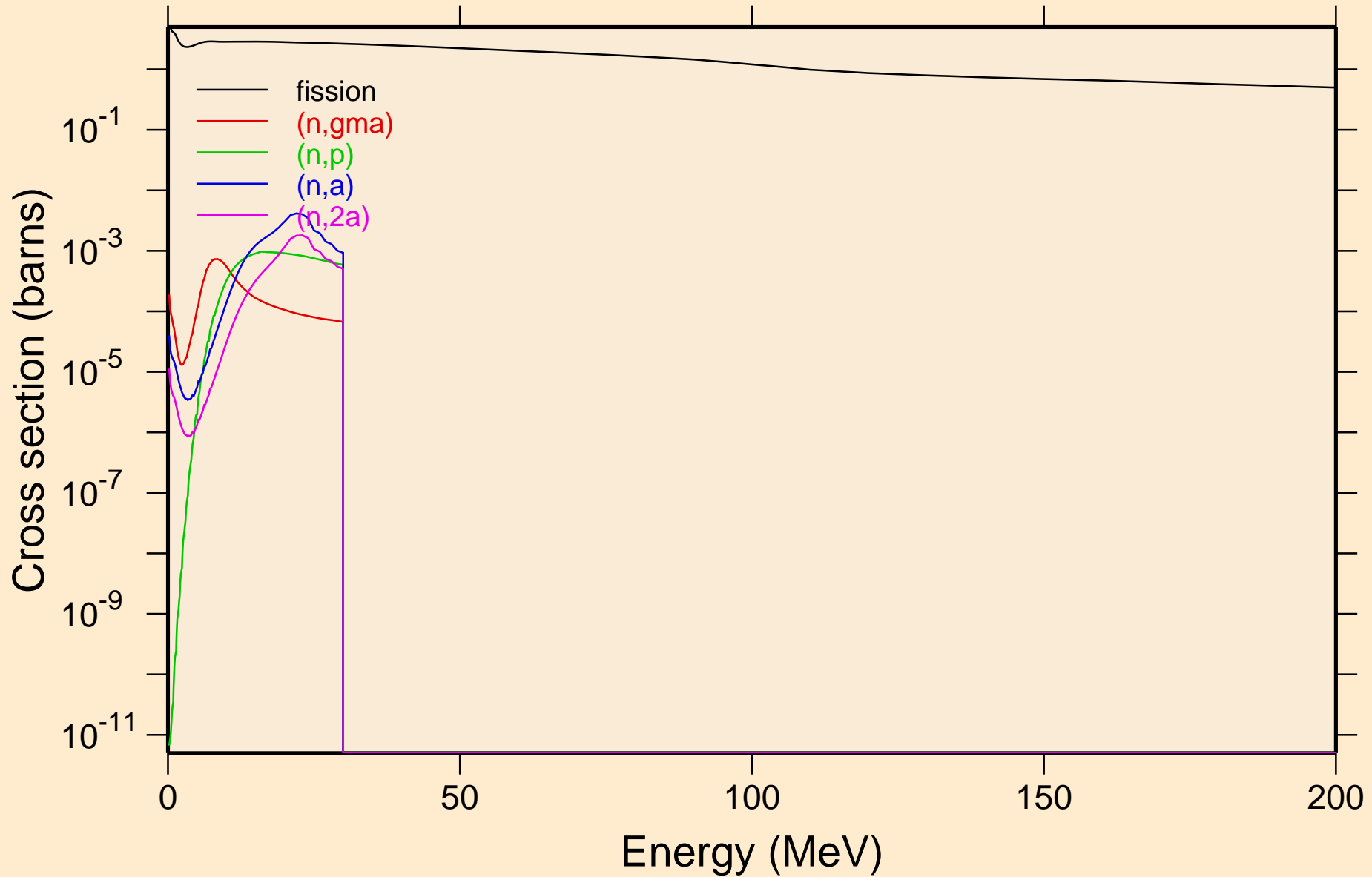

# BH270 NRG TENDL-2015, AKONING

## Non-threshold reactions

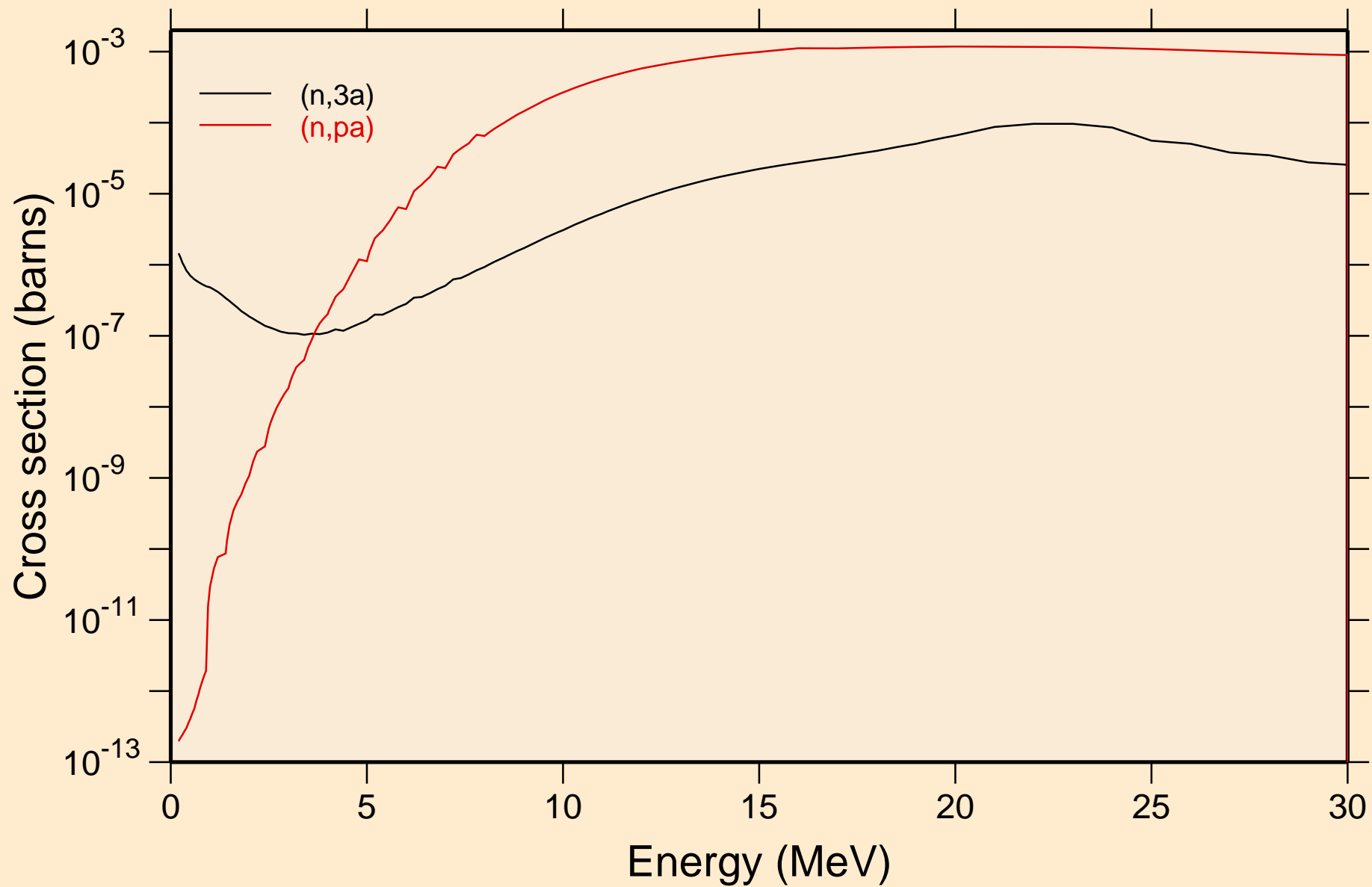

BH270 NRG TENDL-2015, AKONING  
Inelastic levels

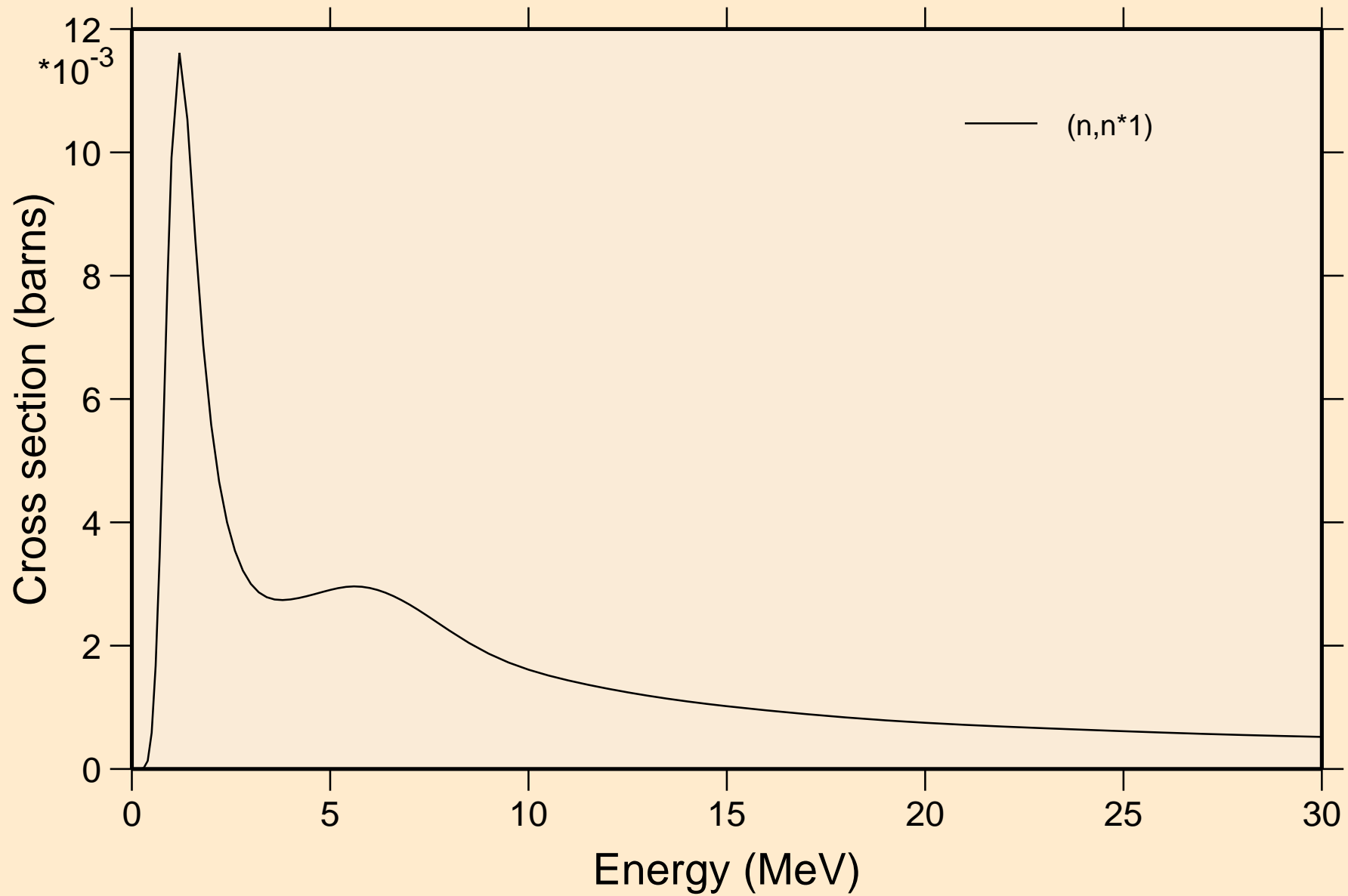

# BH270 NRG TENDL-2015, AKONING

## Threshold reactions

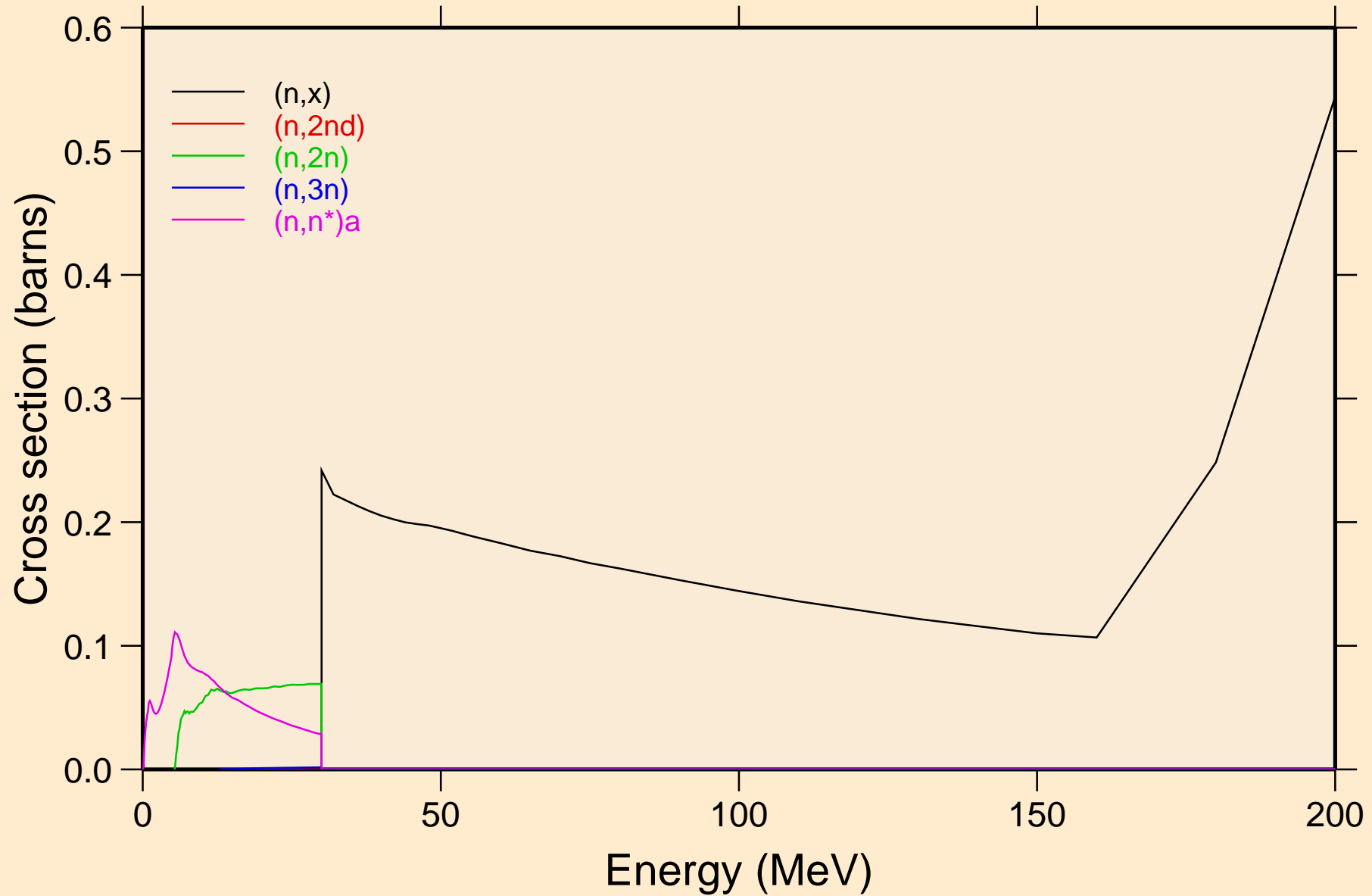



# BH270 NRG TENDL-2015, AKONING

## Threshold reactions

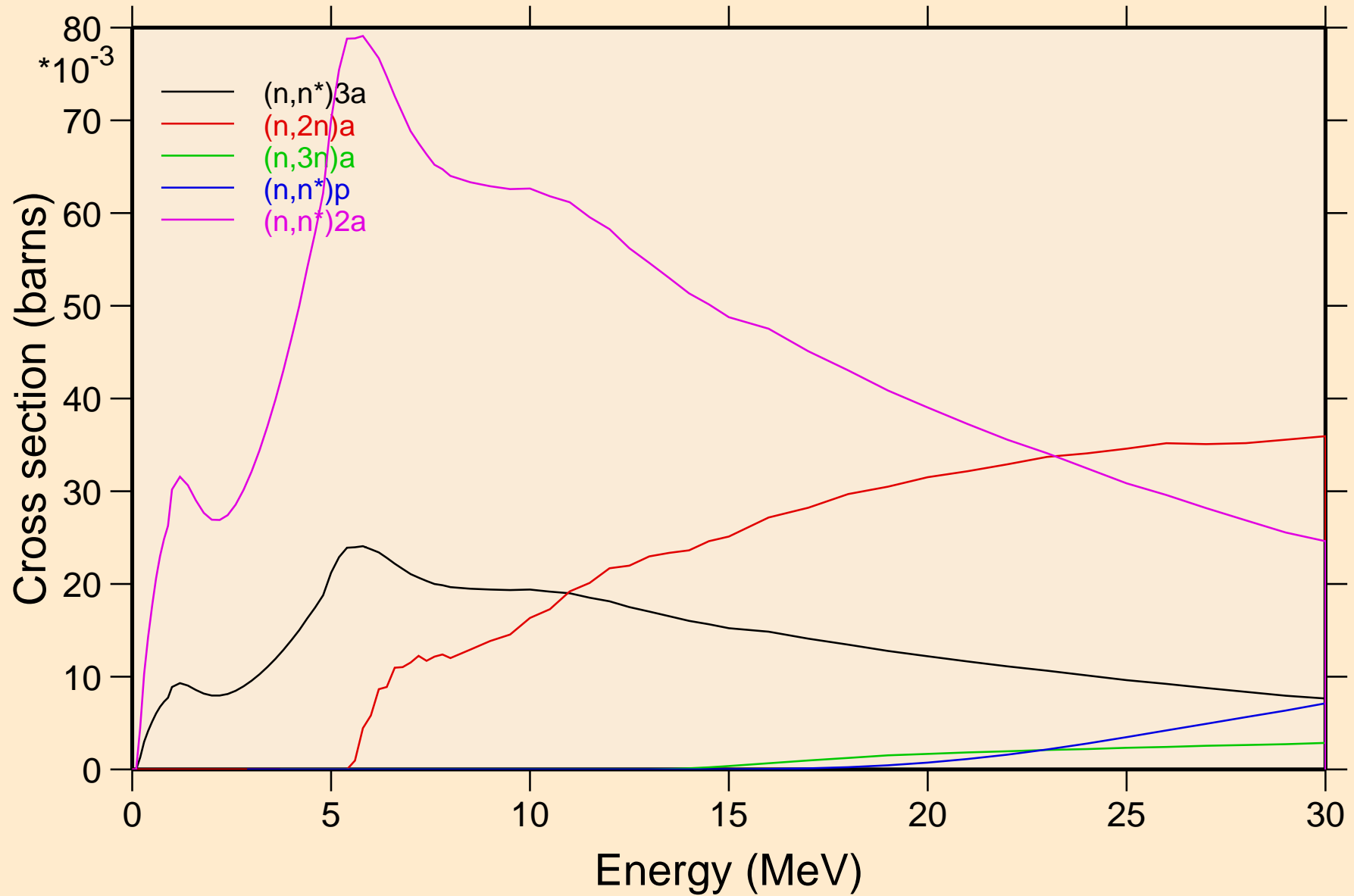

# BH270 NRG TENDL-2015, AKONING

## Threshold reactions

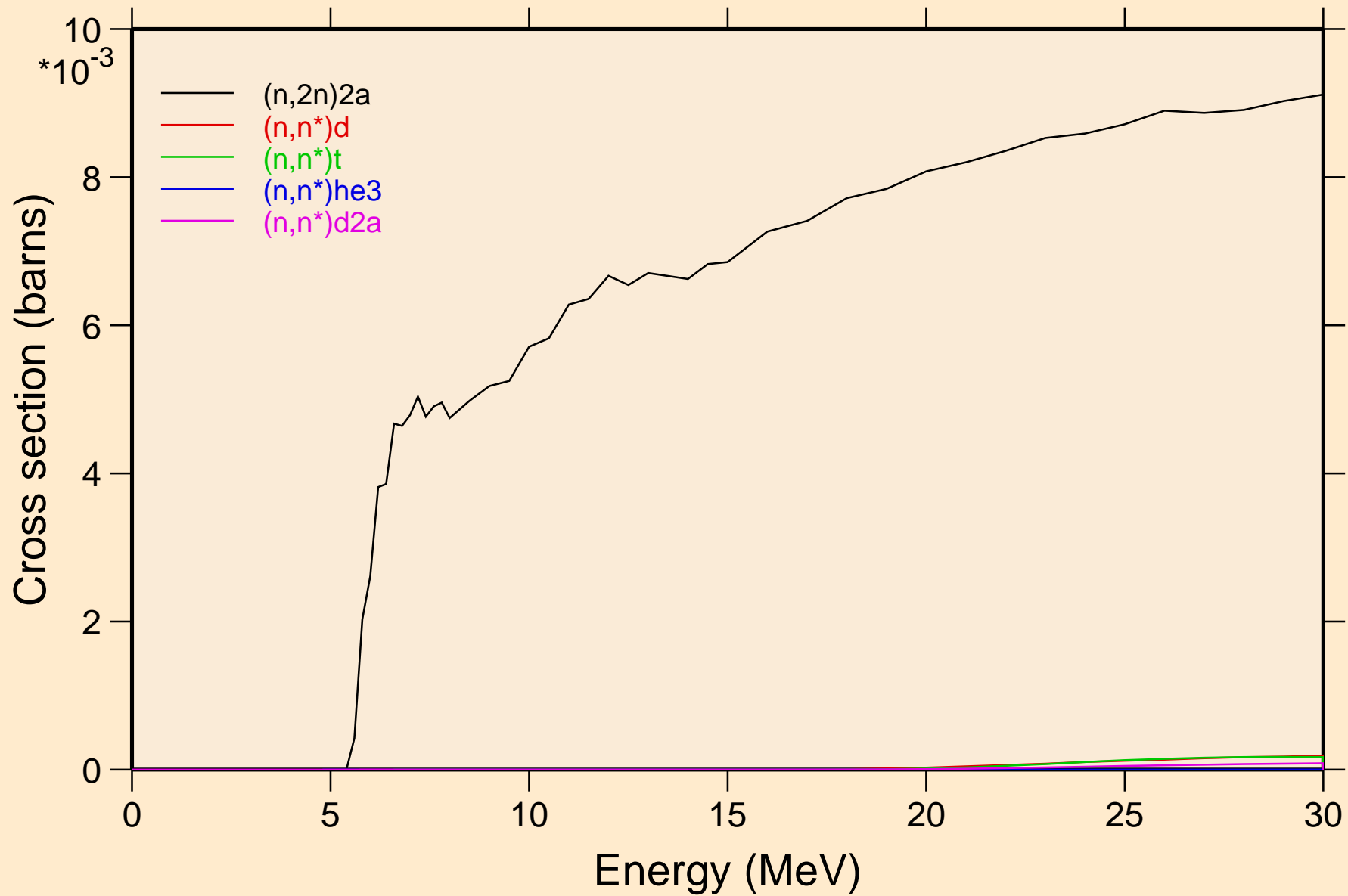

# BH270 NRG TENDL-2015, AKONING

## Threshold reactions

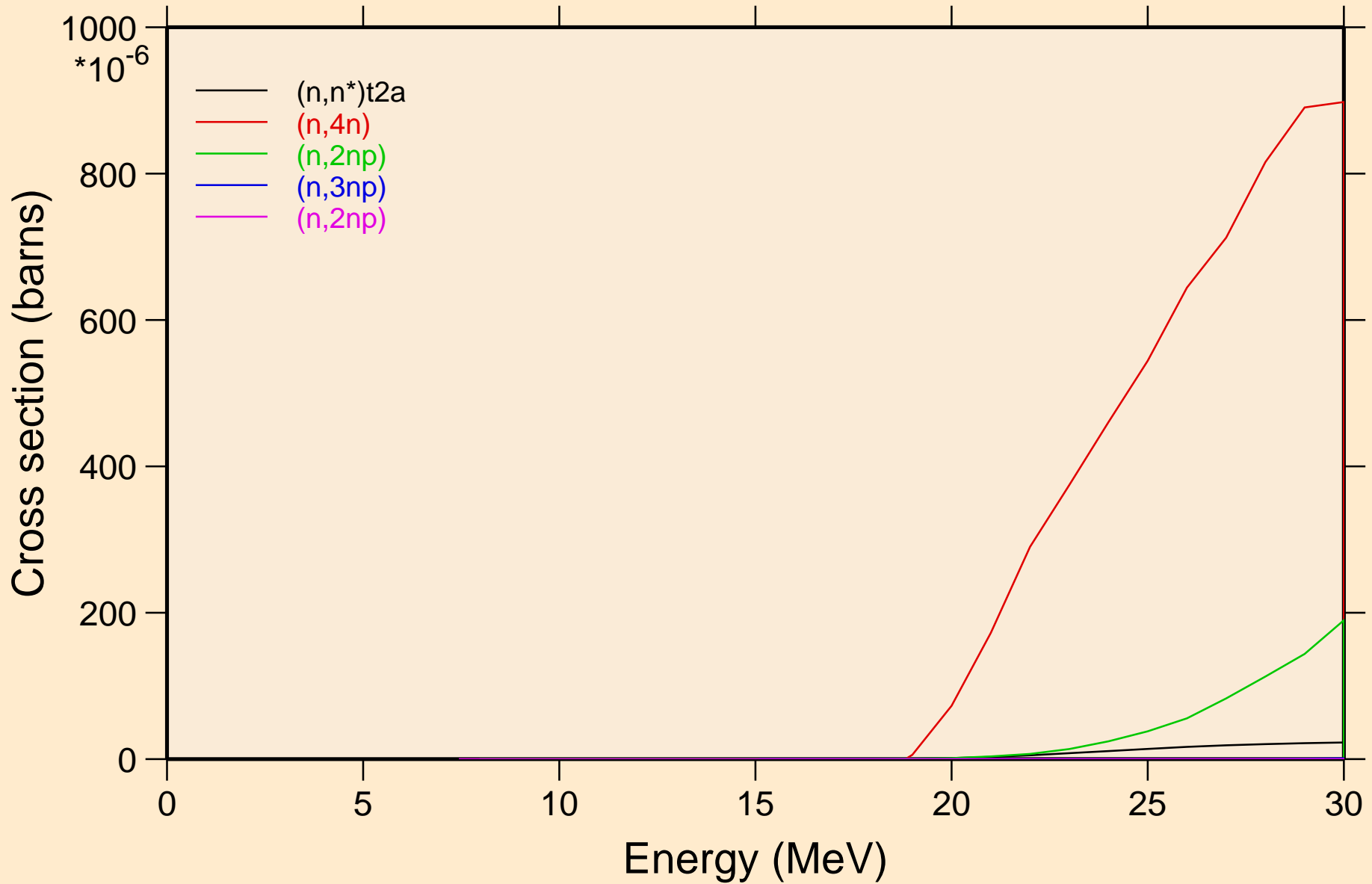

# BH270 NRG TENDL-2015, AKONING

## Threshold reactions

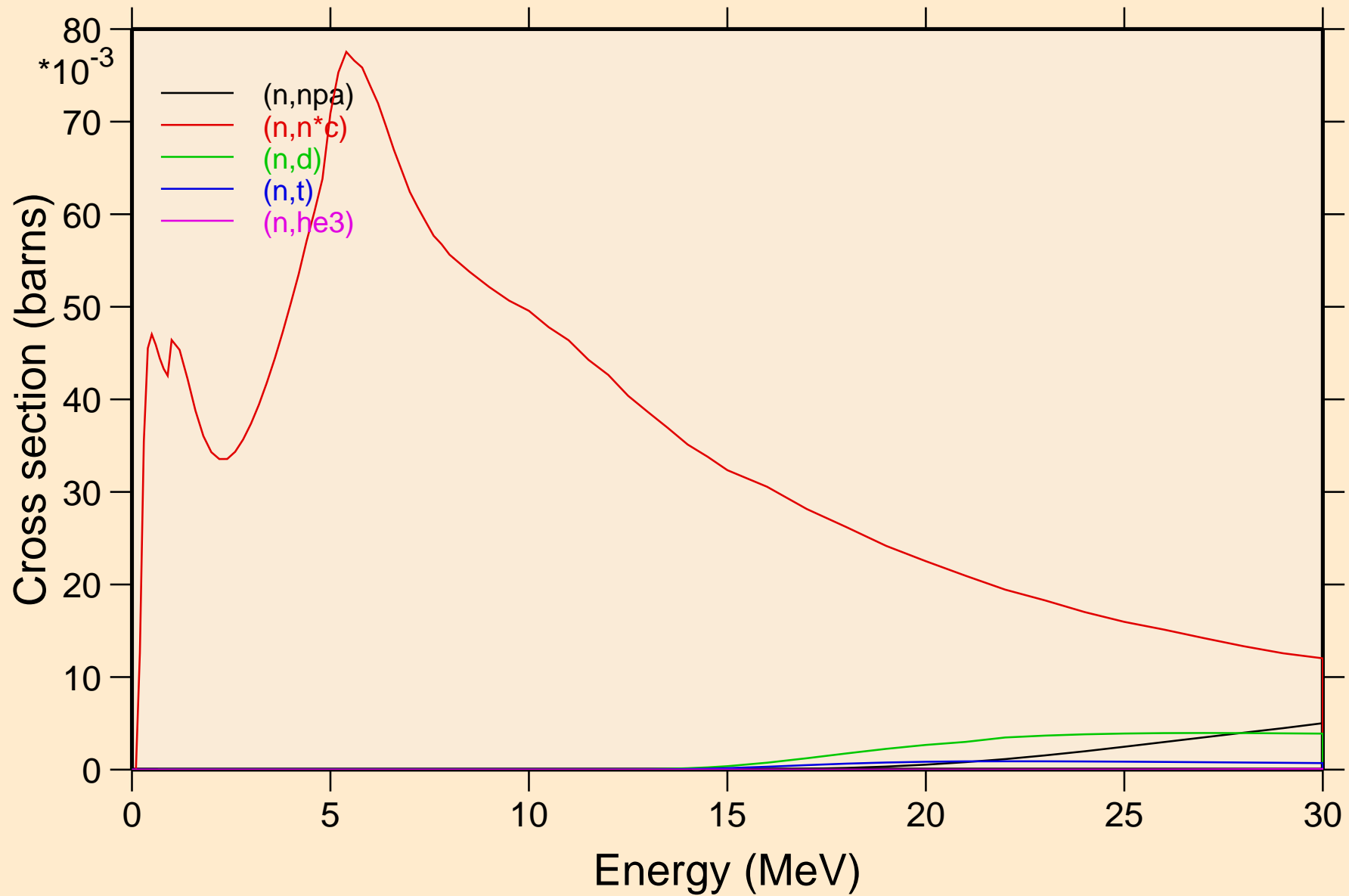

# BH270 NRG TENDL-2015, AKONING

## Threshold reactions

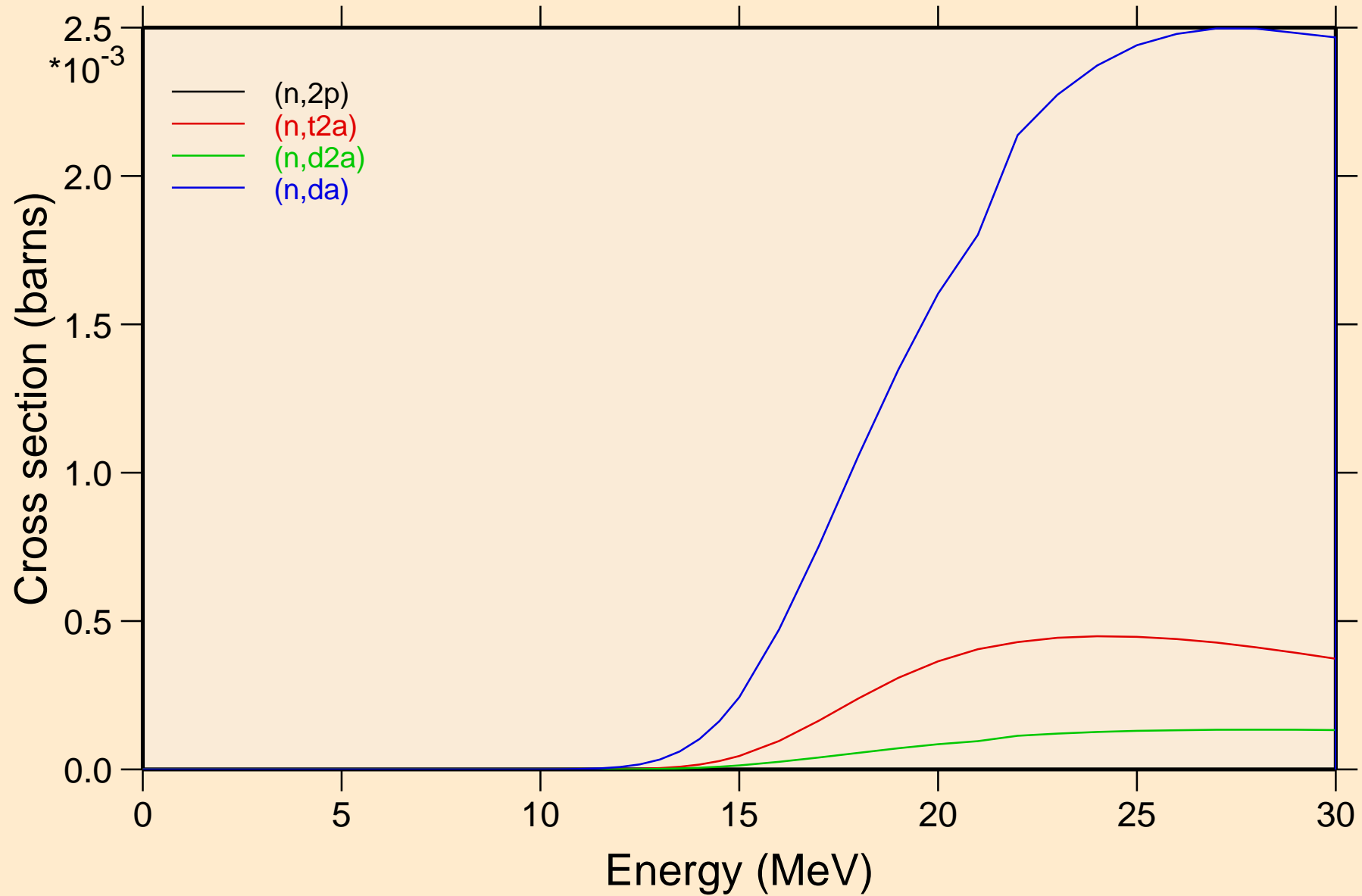

BH270 NRG TENDL-2015, AKONING  
angular distribution for elastic

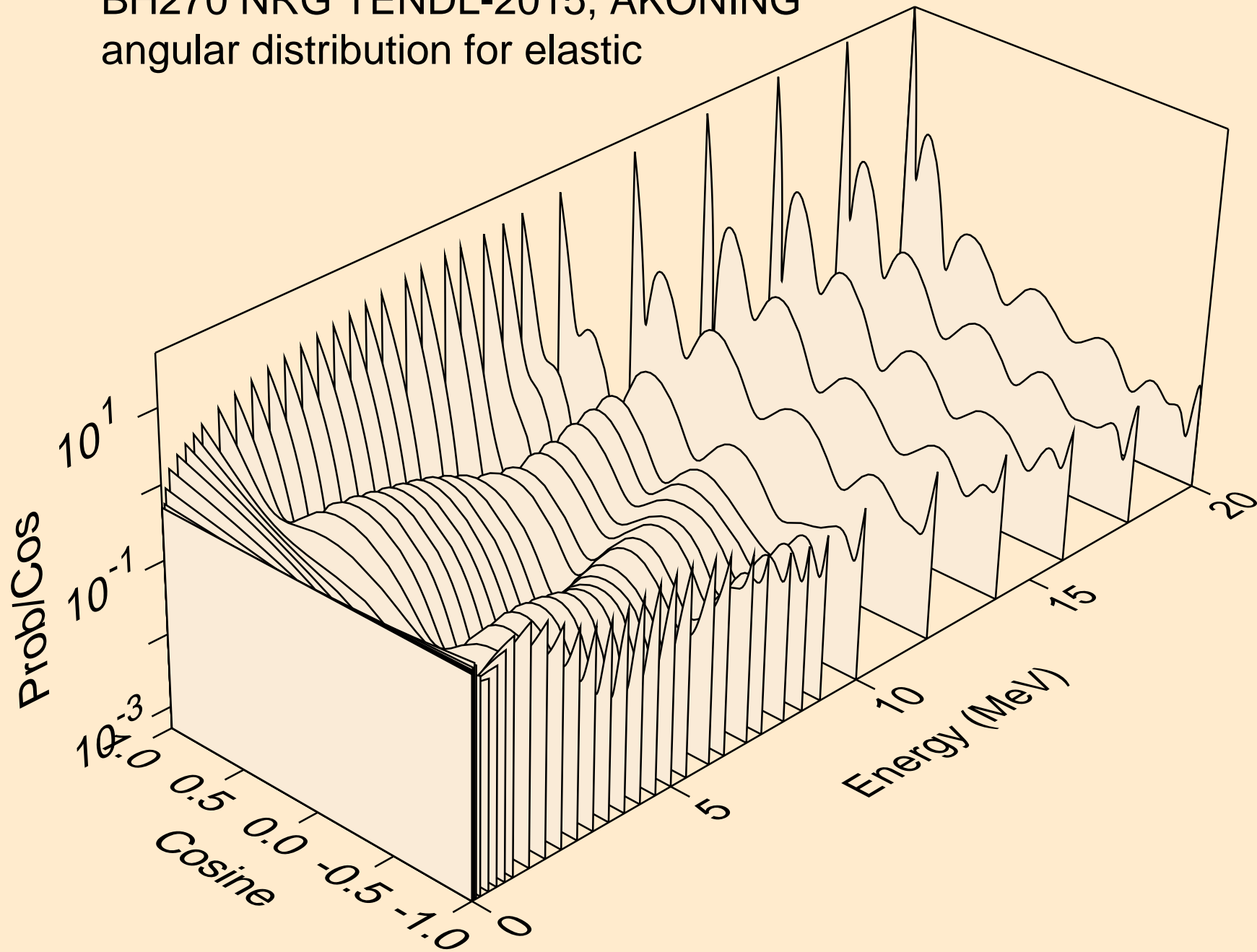

BH270 NRG TENDL-2015, AKONING  
angular distribution for elastic

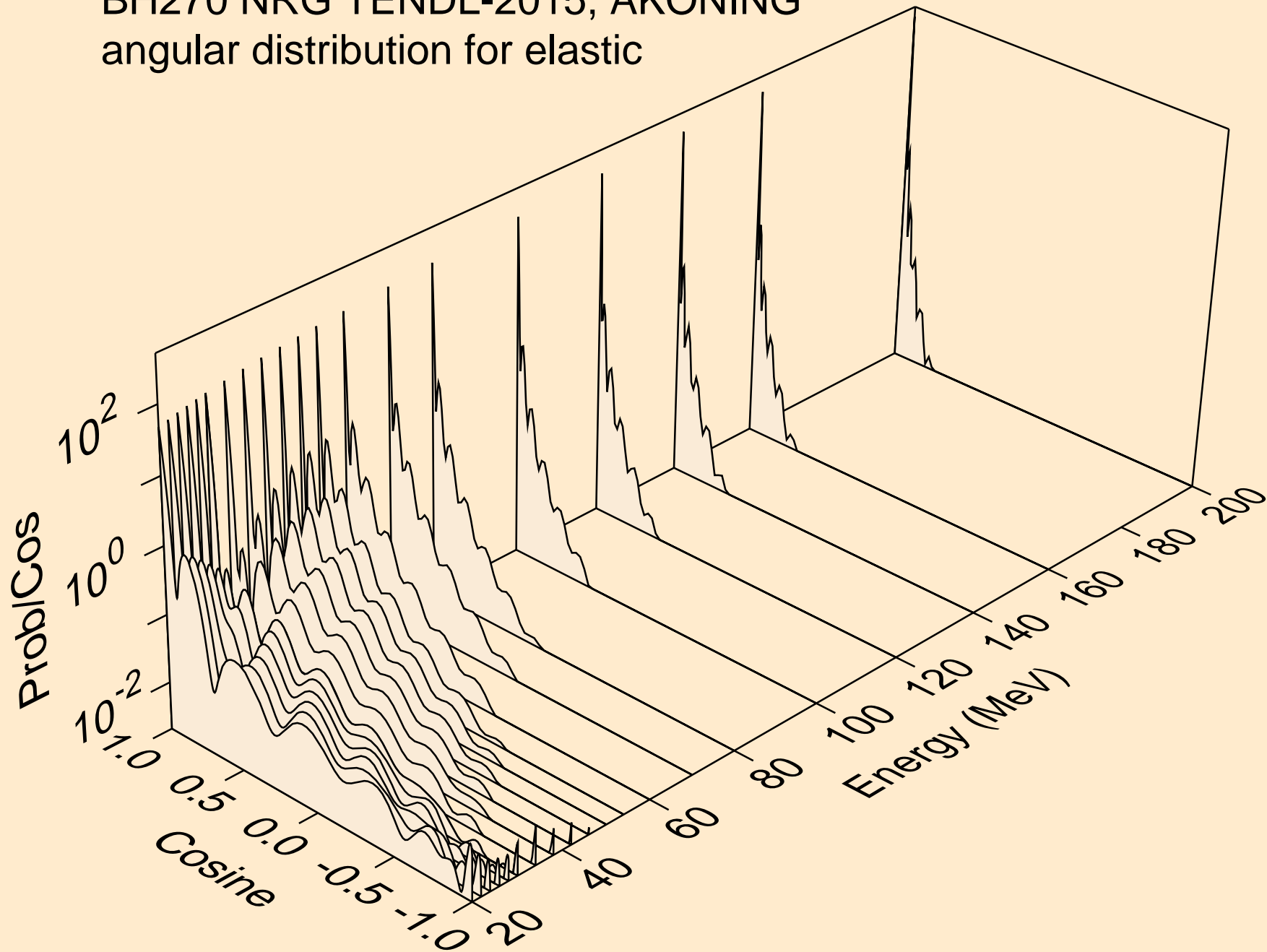

BH270 NRG TENDL-2015, AKONING  
angular distribution for (n,n\*1)

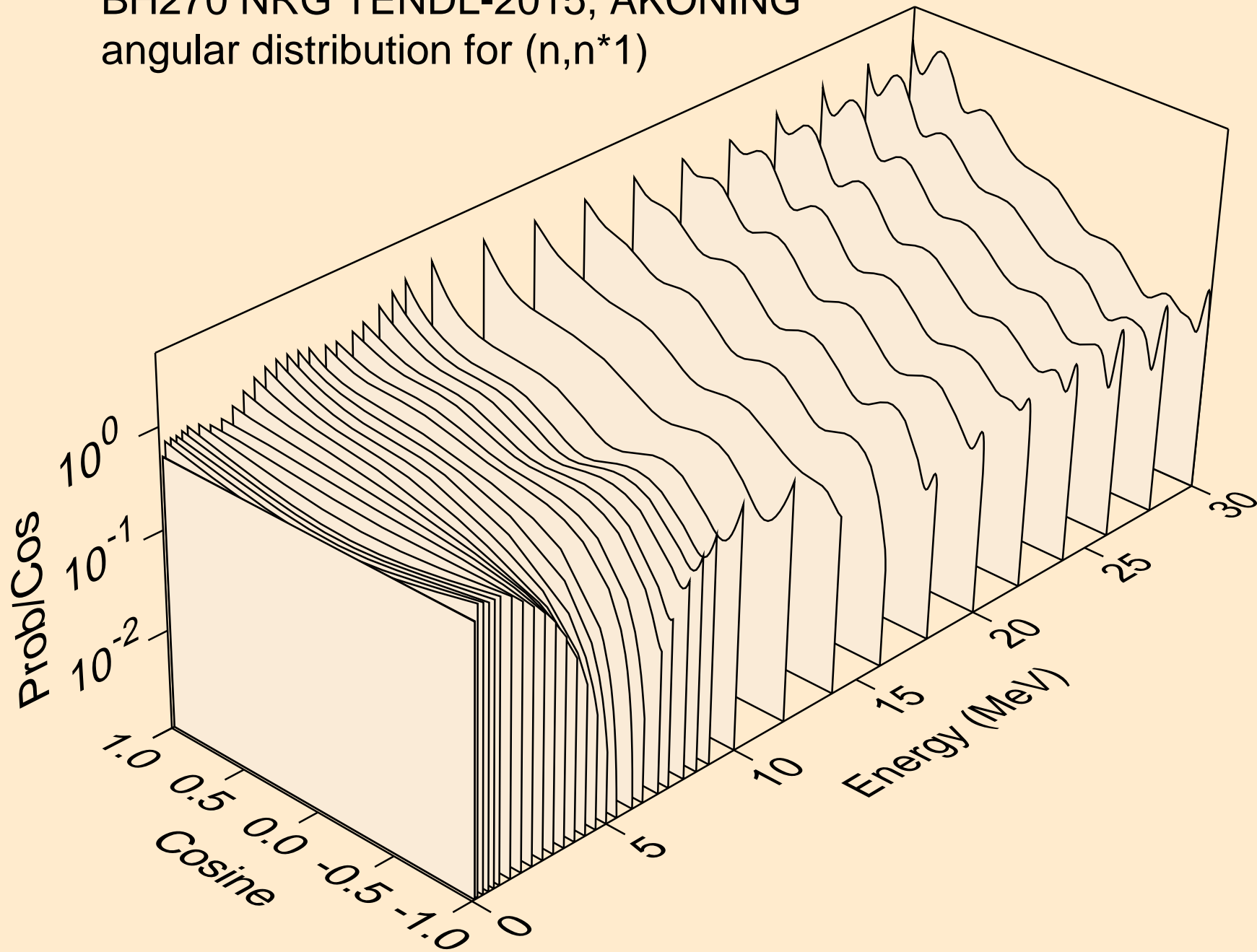



# BH270 NRG TENDL-2015, AKONING

Total fission nubar

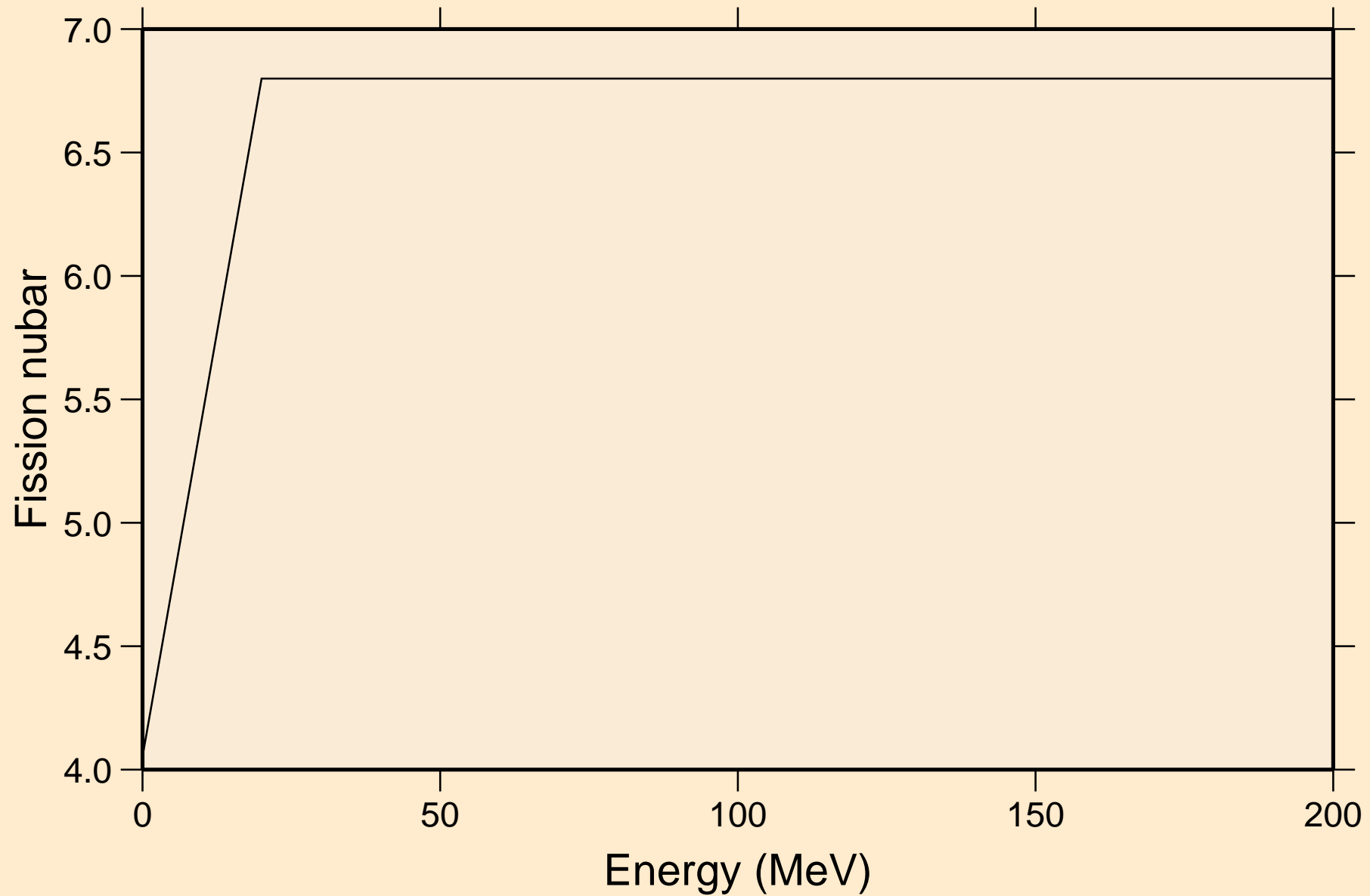

BH270 NRG TENDL-2015, AKONING  
Neutron emission for (n,x)

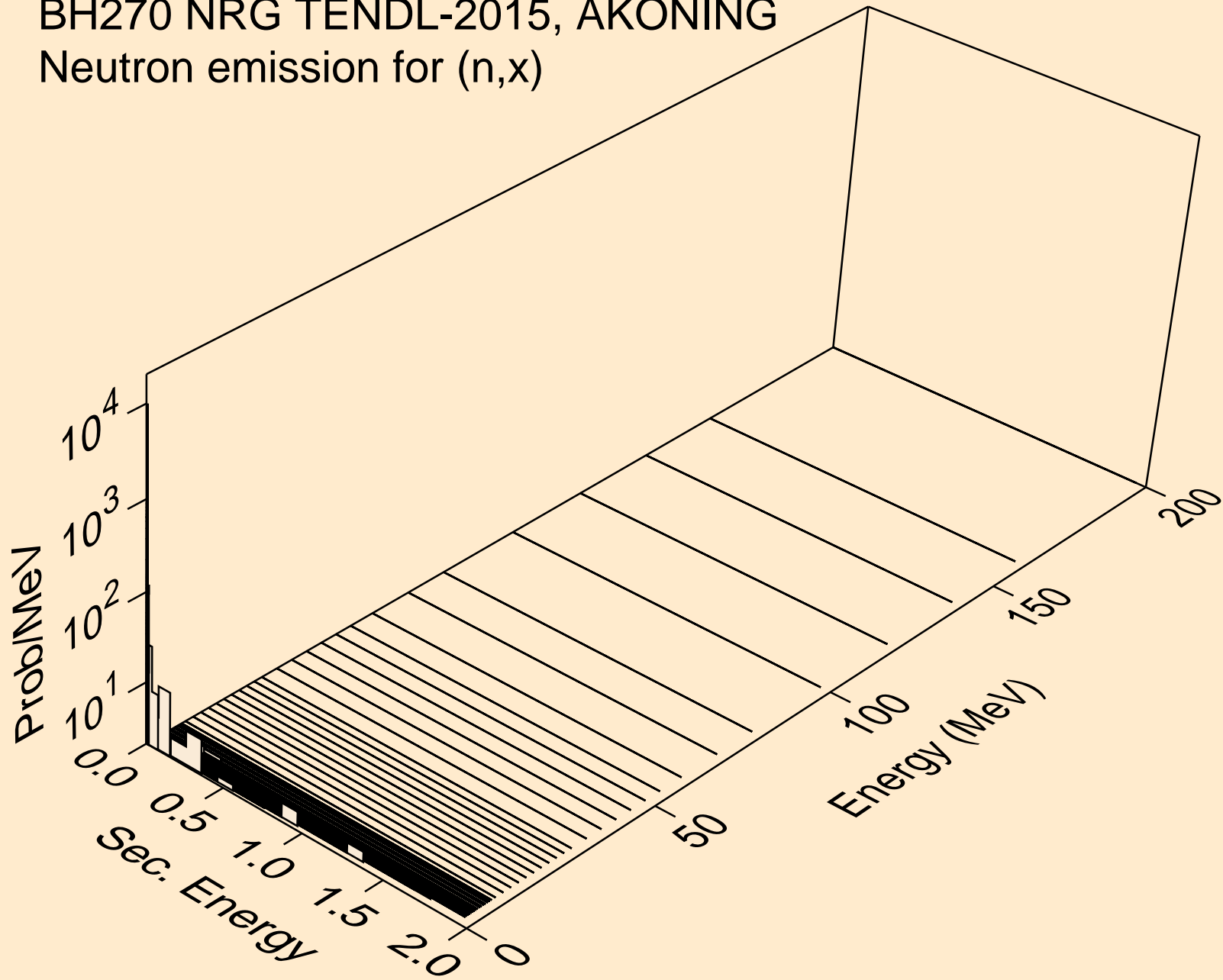

BH270 NRG TENDL-2015, AKONING  
Neutron emission for (n,2nd)

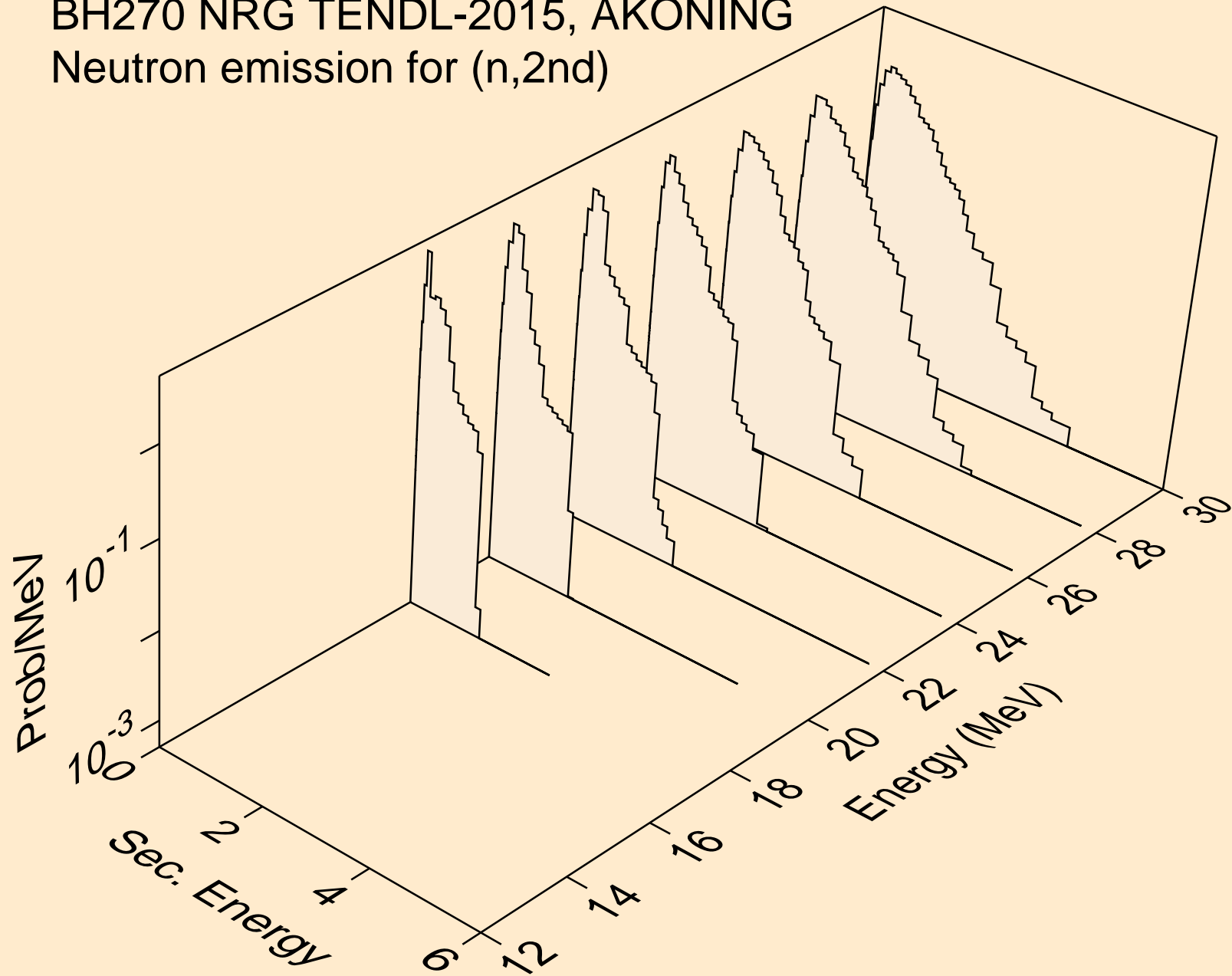

BH270 NRG TENDL-2015, AKONING  
Neutron emission for (n,2n)

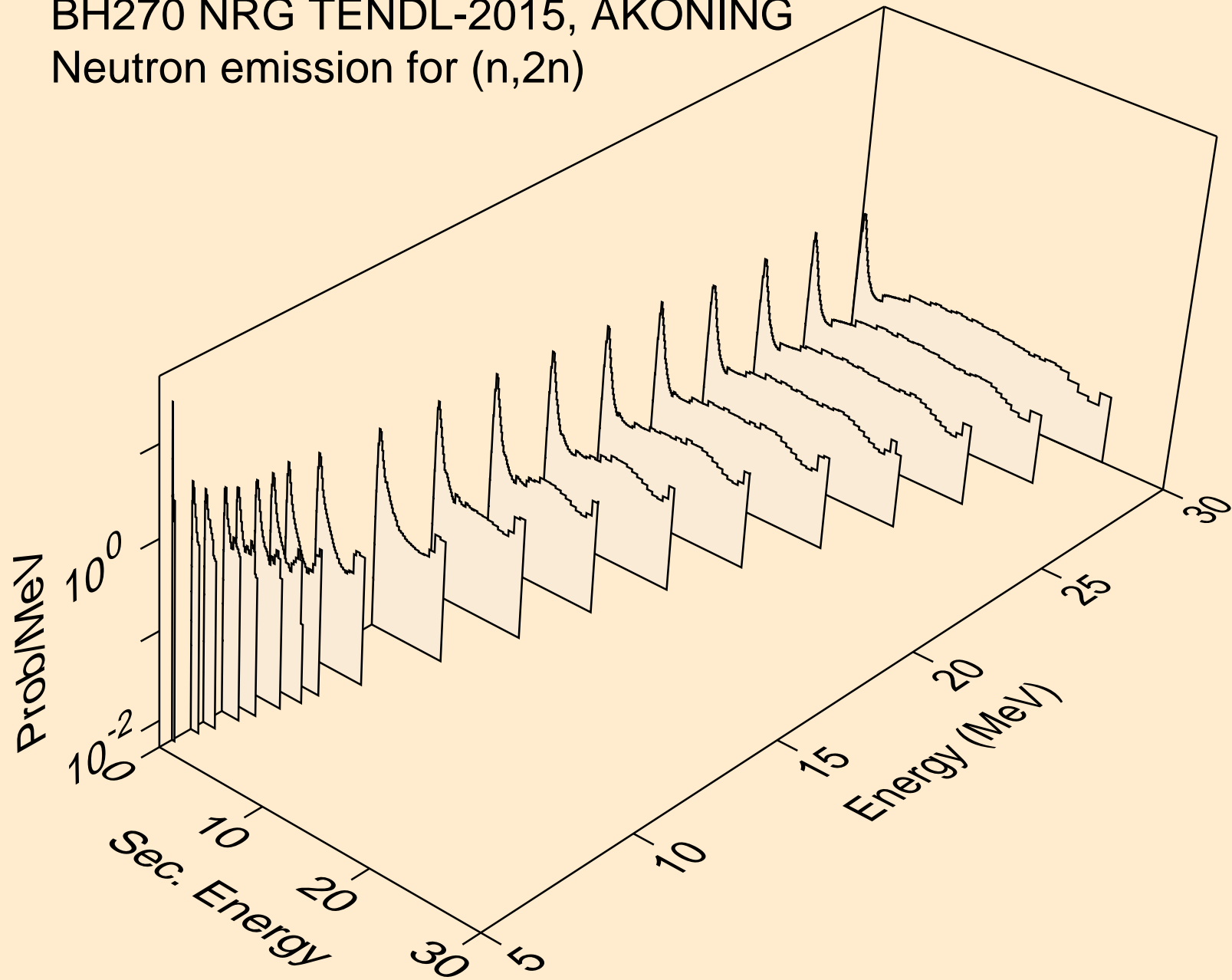

BH270 NRG TENDL-2015, AKONING  
Neutron emission for (n,3n)

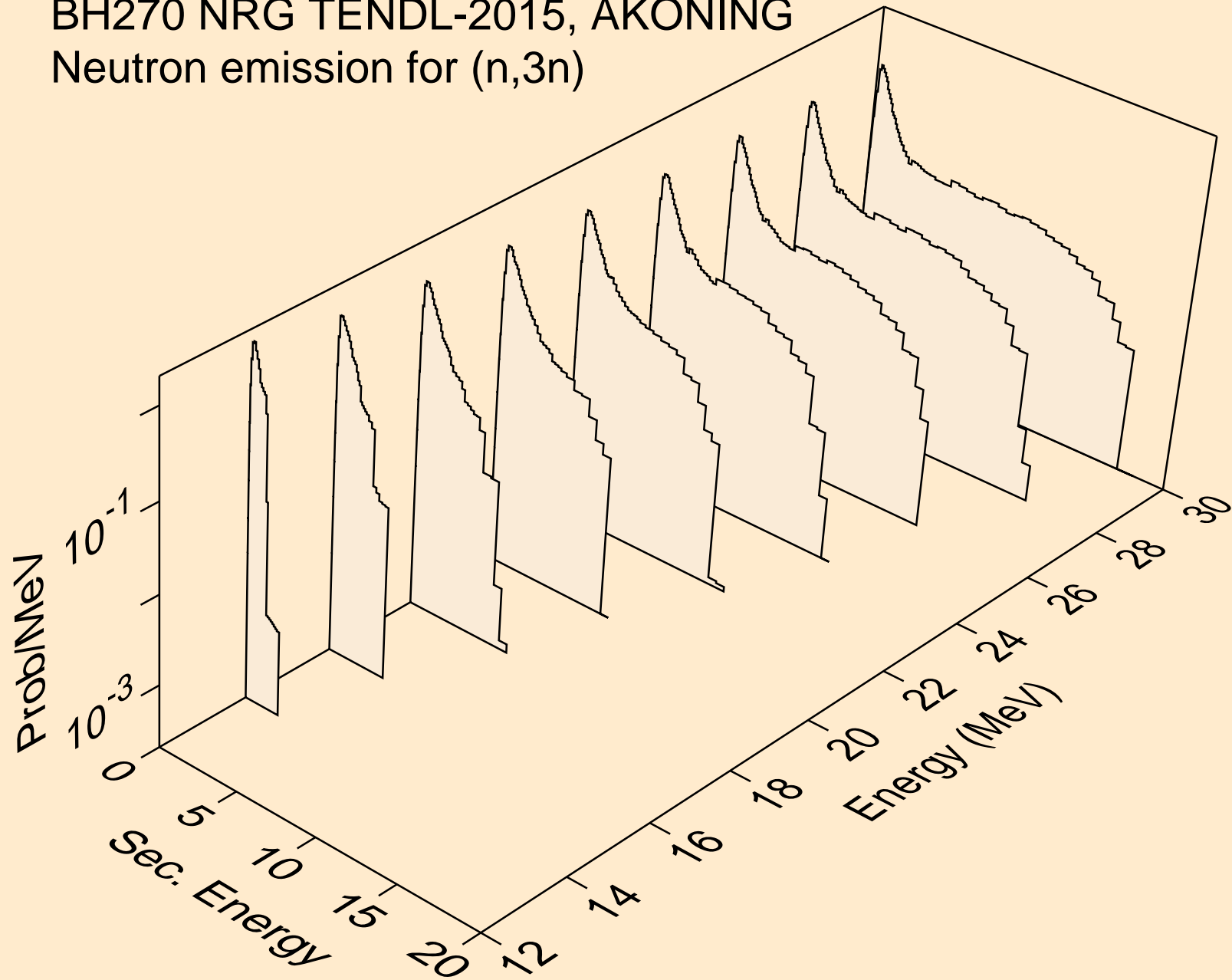

BH270 NRG TENDL-2015, AKONING  
Neutron emission for fission

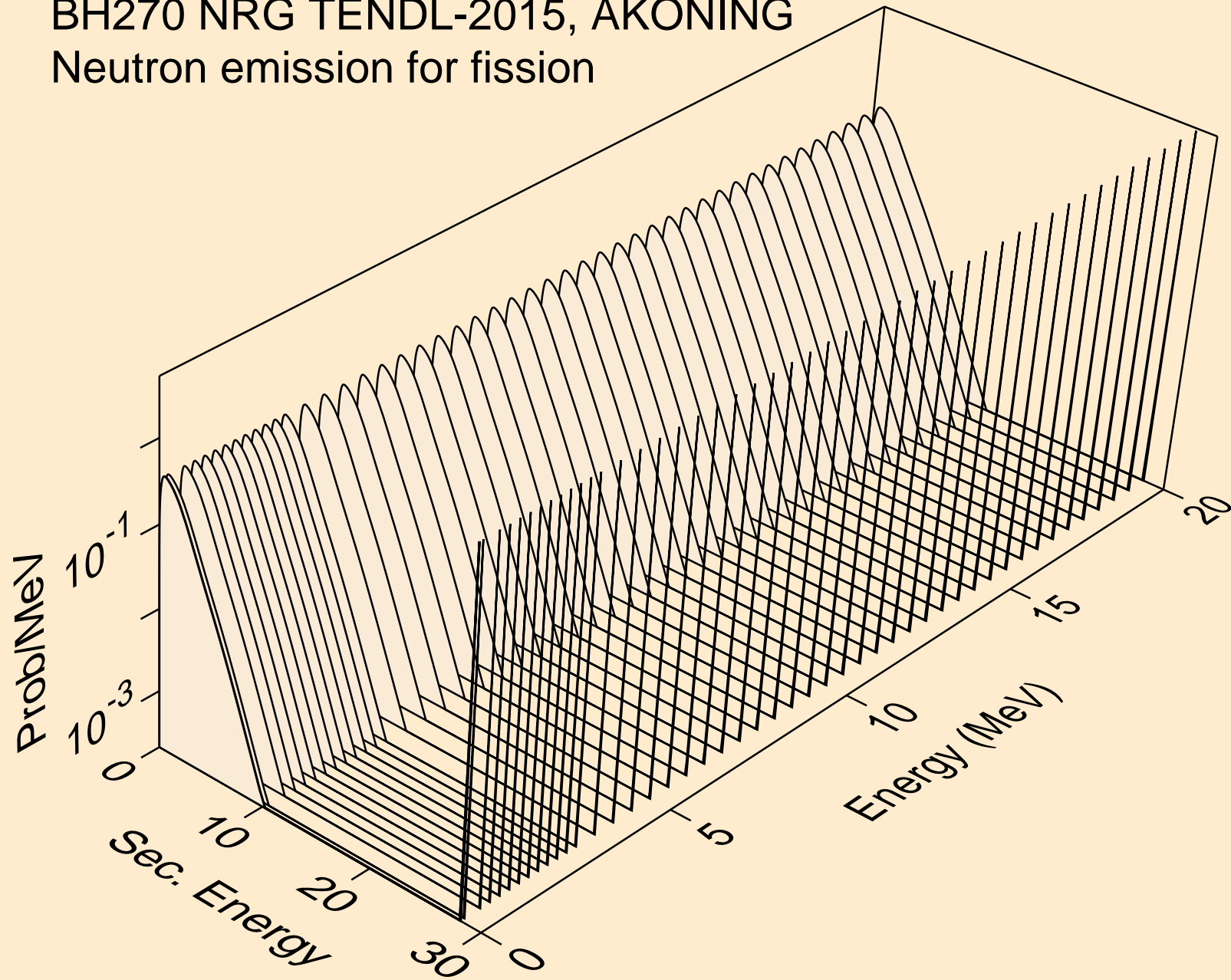

BH270 NRG TENDL-2015, AKONING  
Neutron emission for (n,n\*)a

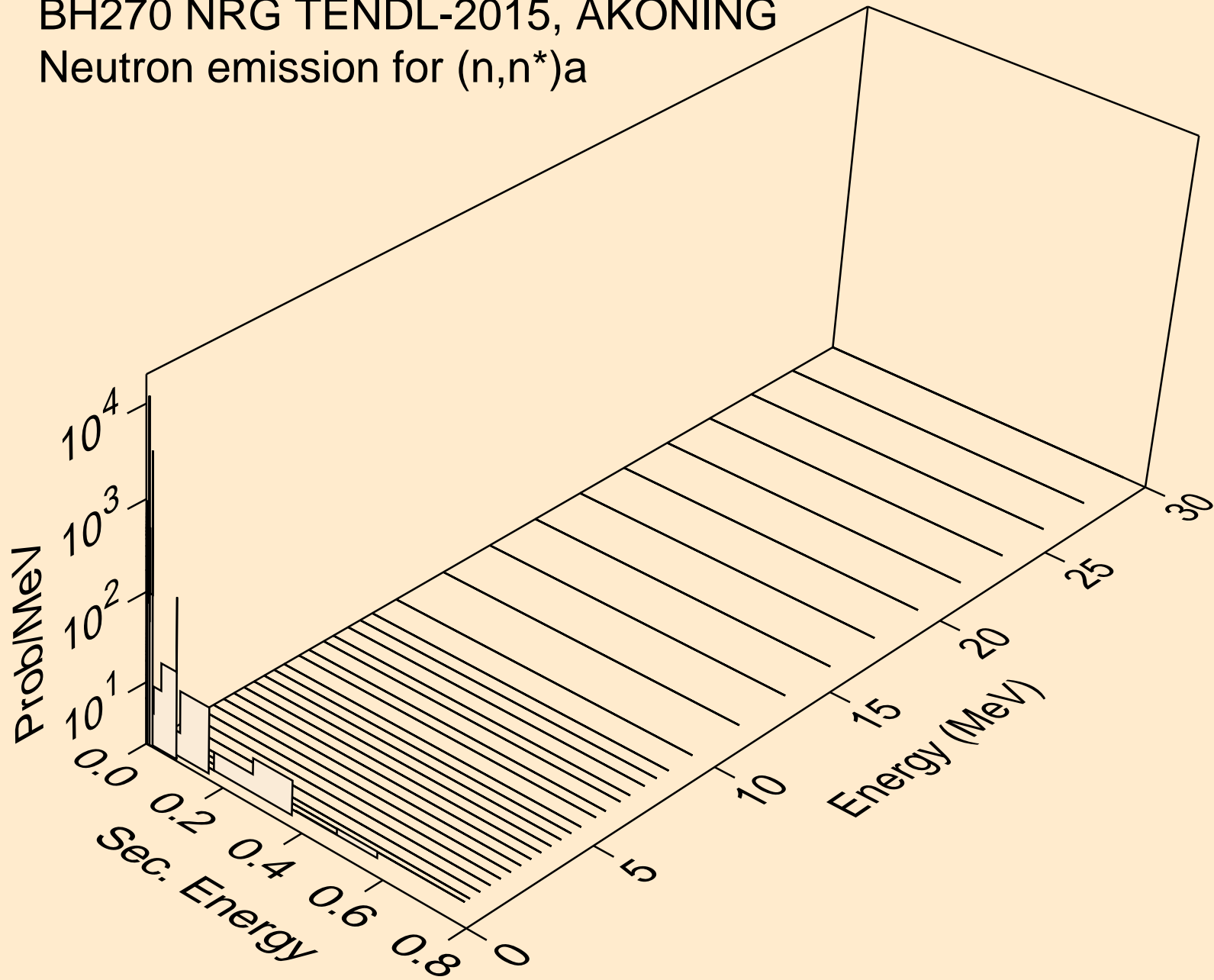

BH270 NRG TENDL-2015, AKONING  
Neutron emission for (n,n\*)3a

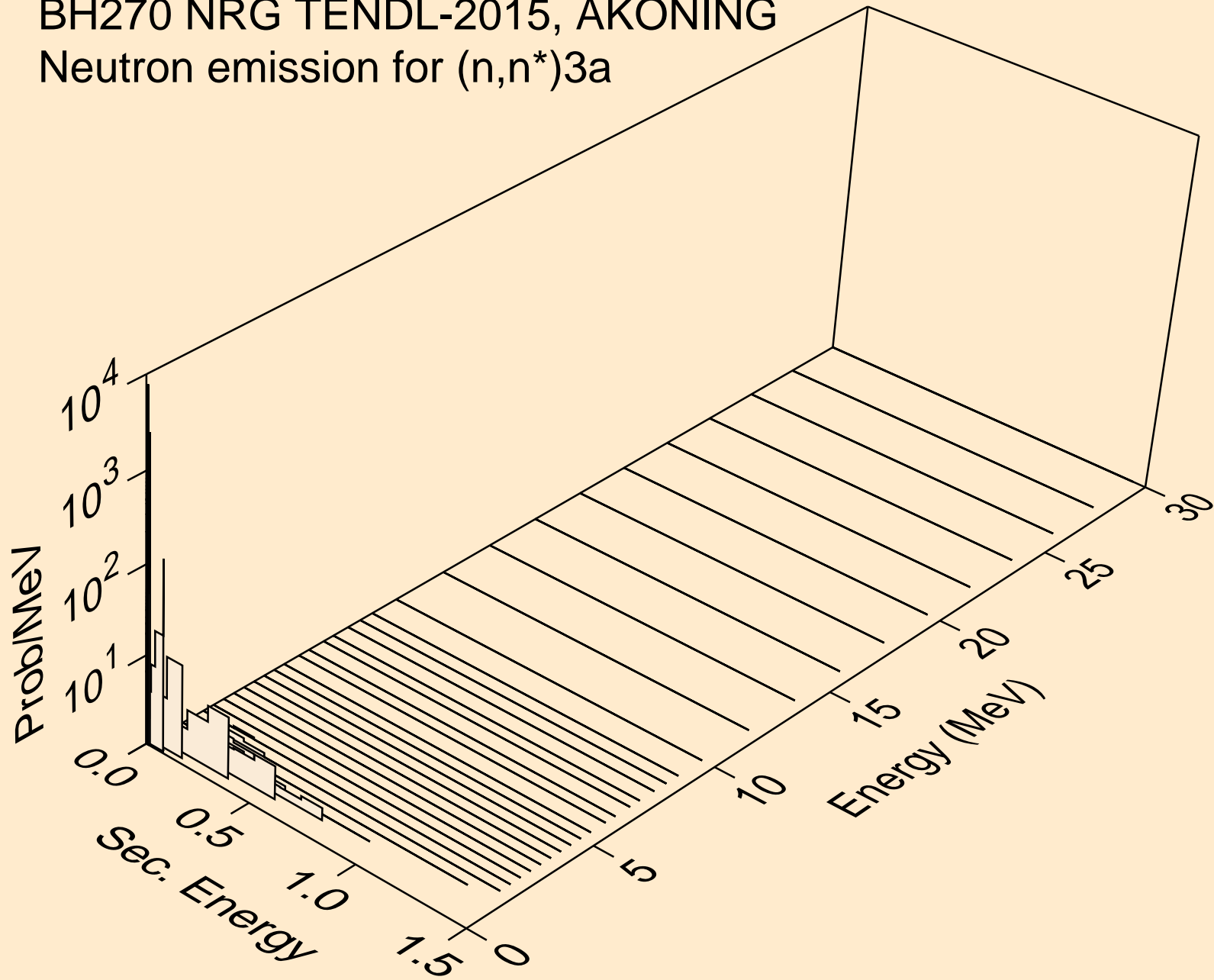



BH270 NRG TENDL-2015, AKONING  
Neutron emission for (n,2n)a

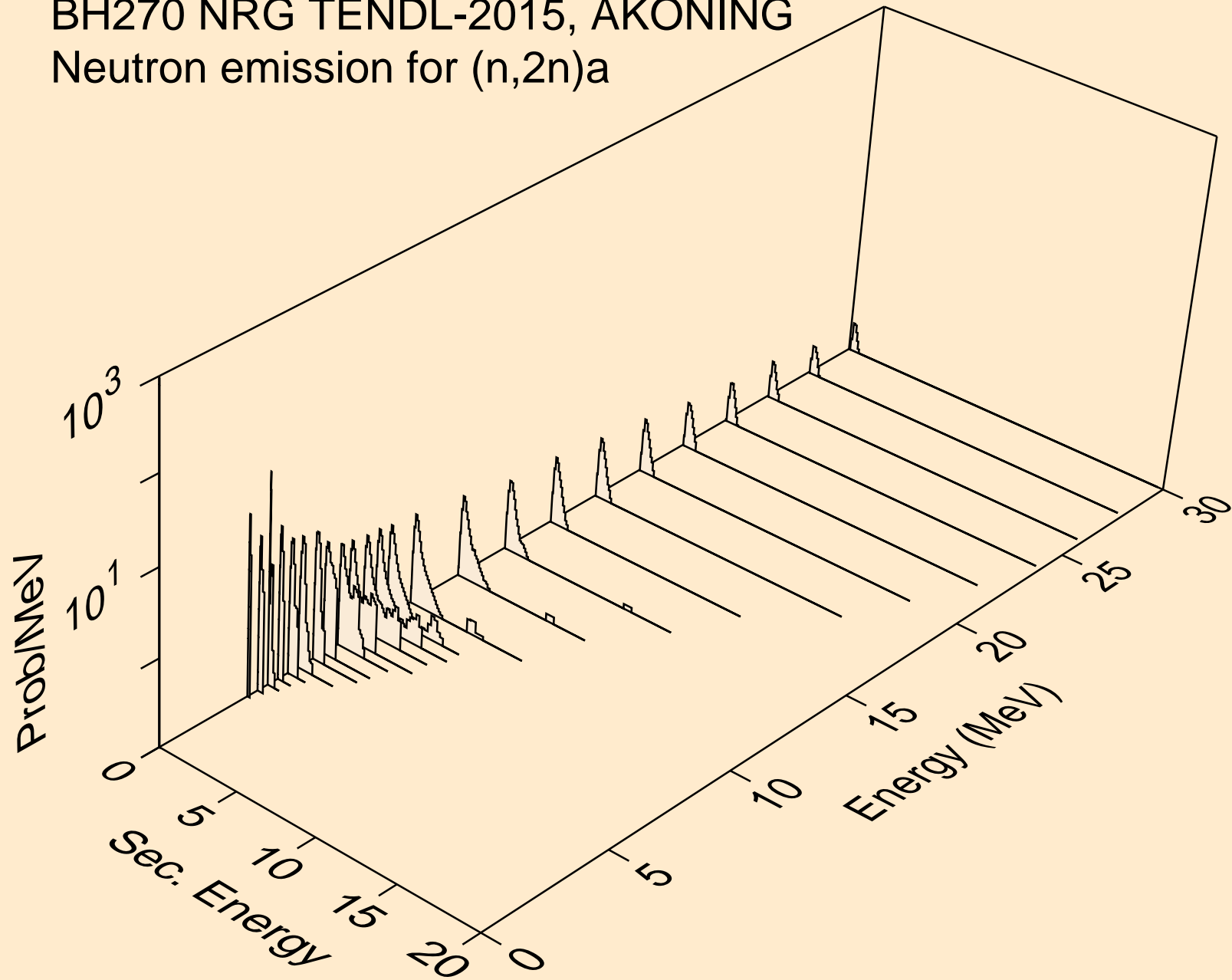

BH270 NRG TENDL-2015, AKONING  
Neutron emission for (n,3n)a

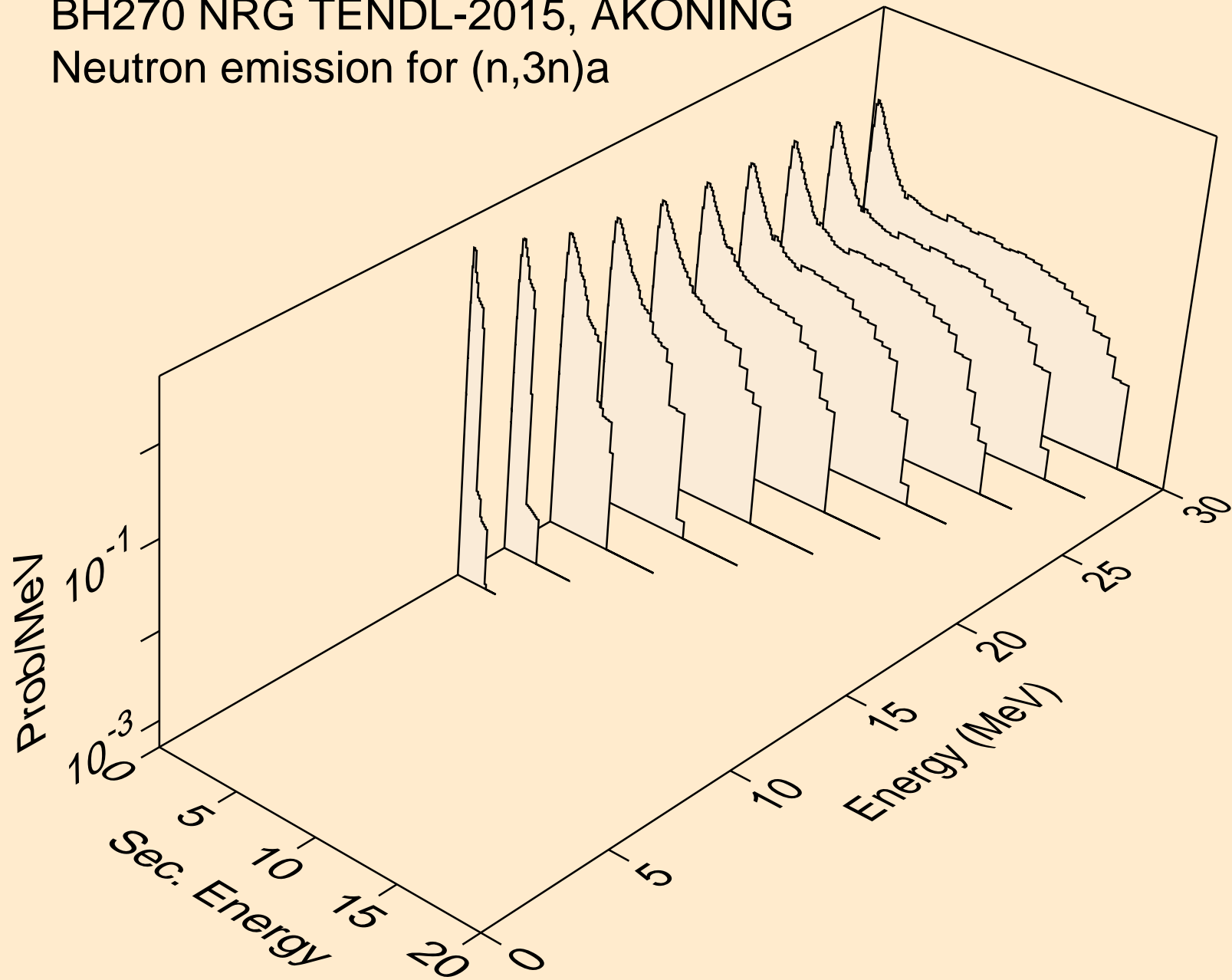

BH270 NRG TENDL-2015, AKONING  
Neutron emission for (n,n\*)p

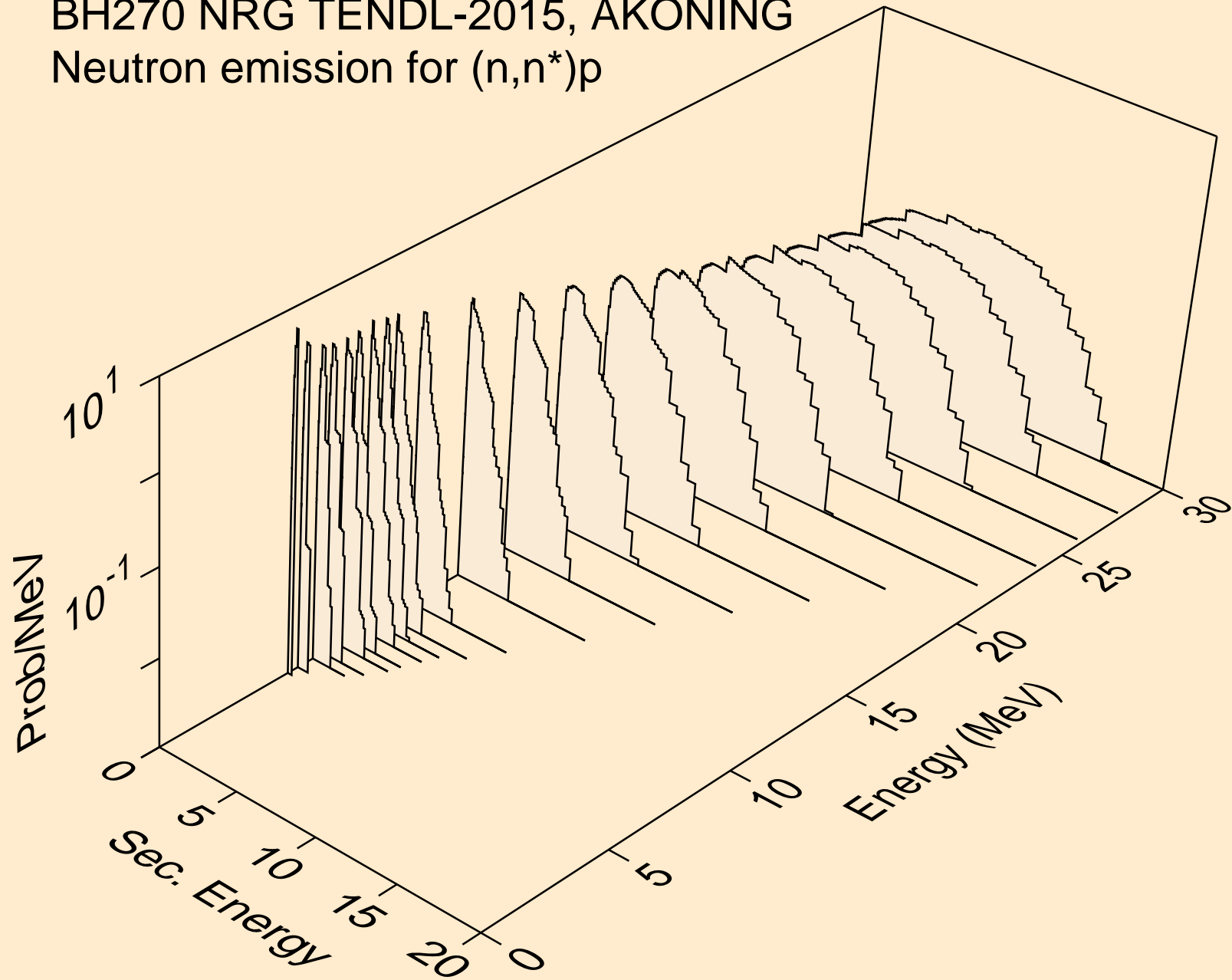

BH270 NRG TENDL-2015, AKONING  
Neutron emission for (n,n\*)2a

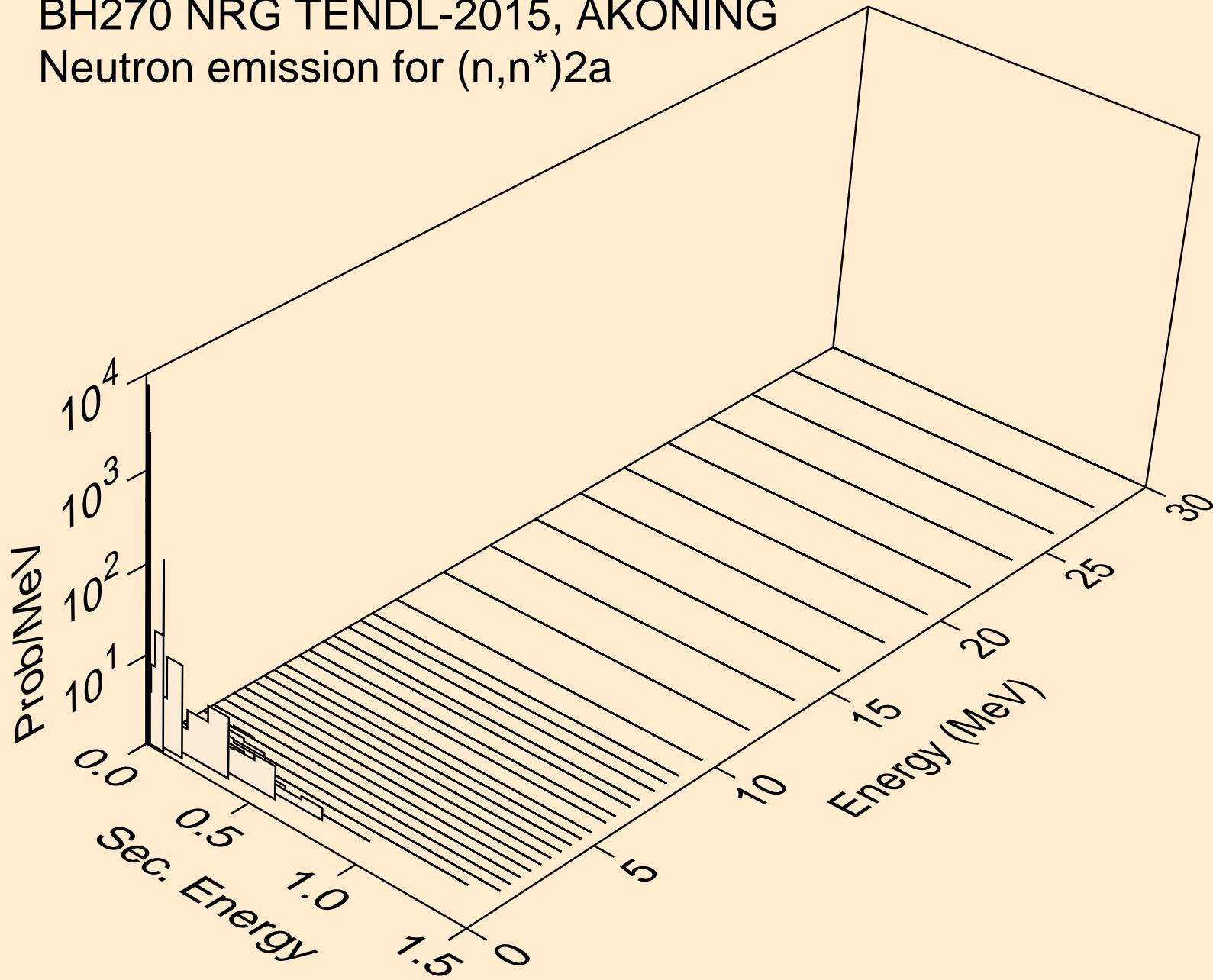

BH270 NRG TENDL-2015, AKONING  
Neutron emission for (n,2n)2a

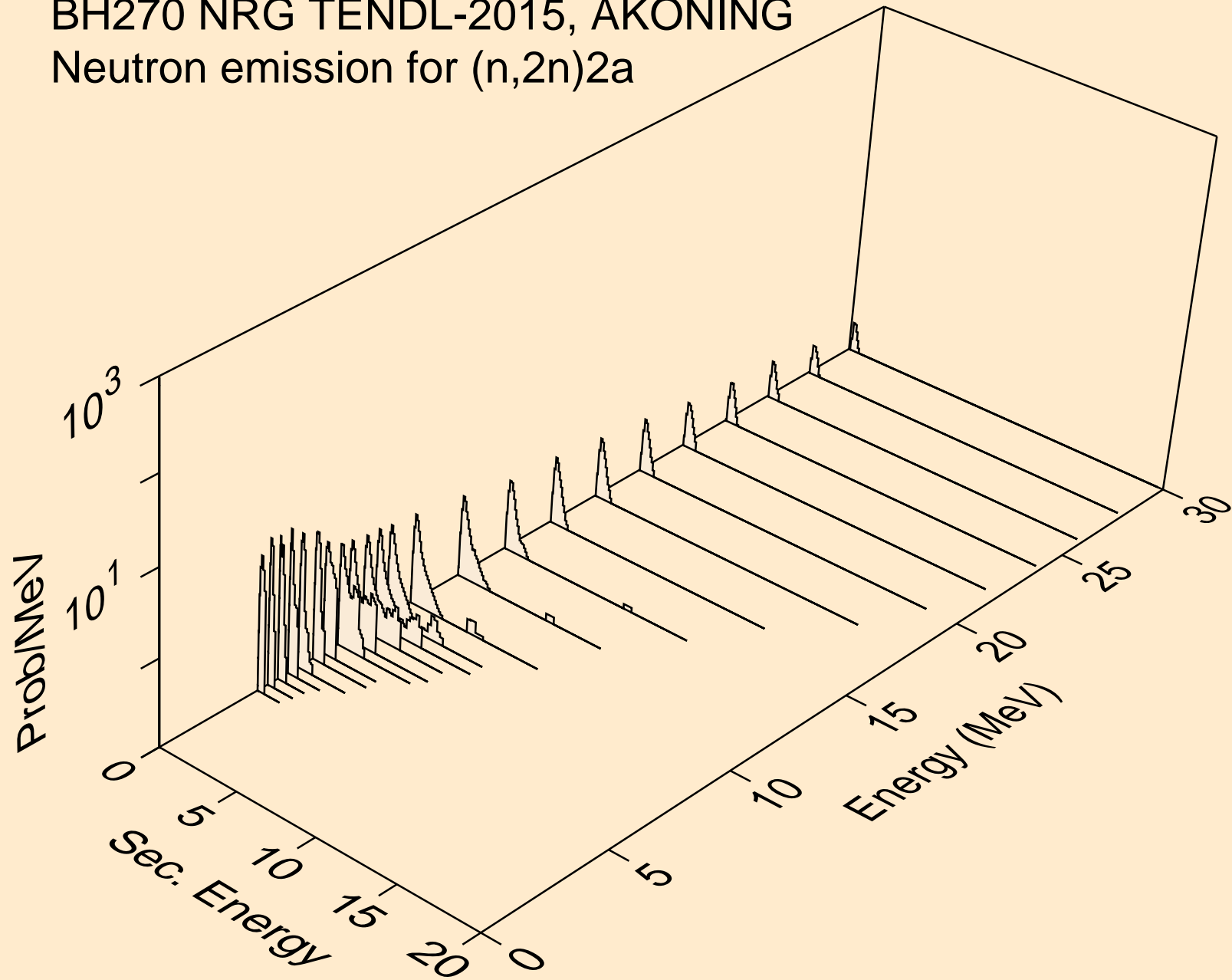

BH270 NRG TENDL-2015, AKONING  
Neutron emission for (n,n\*)d

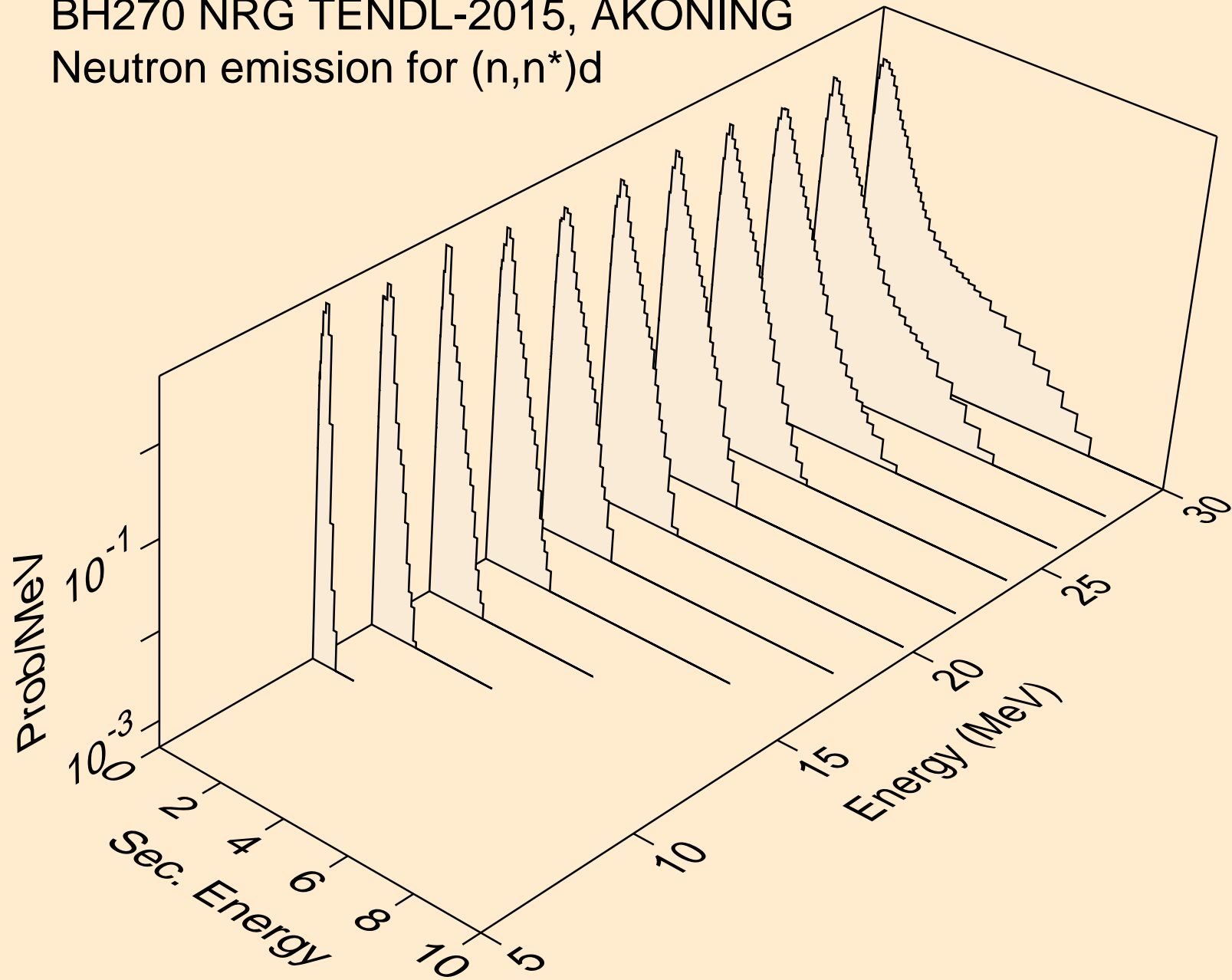

BH270 NRG TENDL-2015, AKONING  
Neutron emission for (n,n\*)t

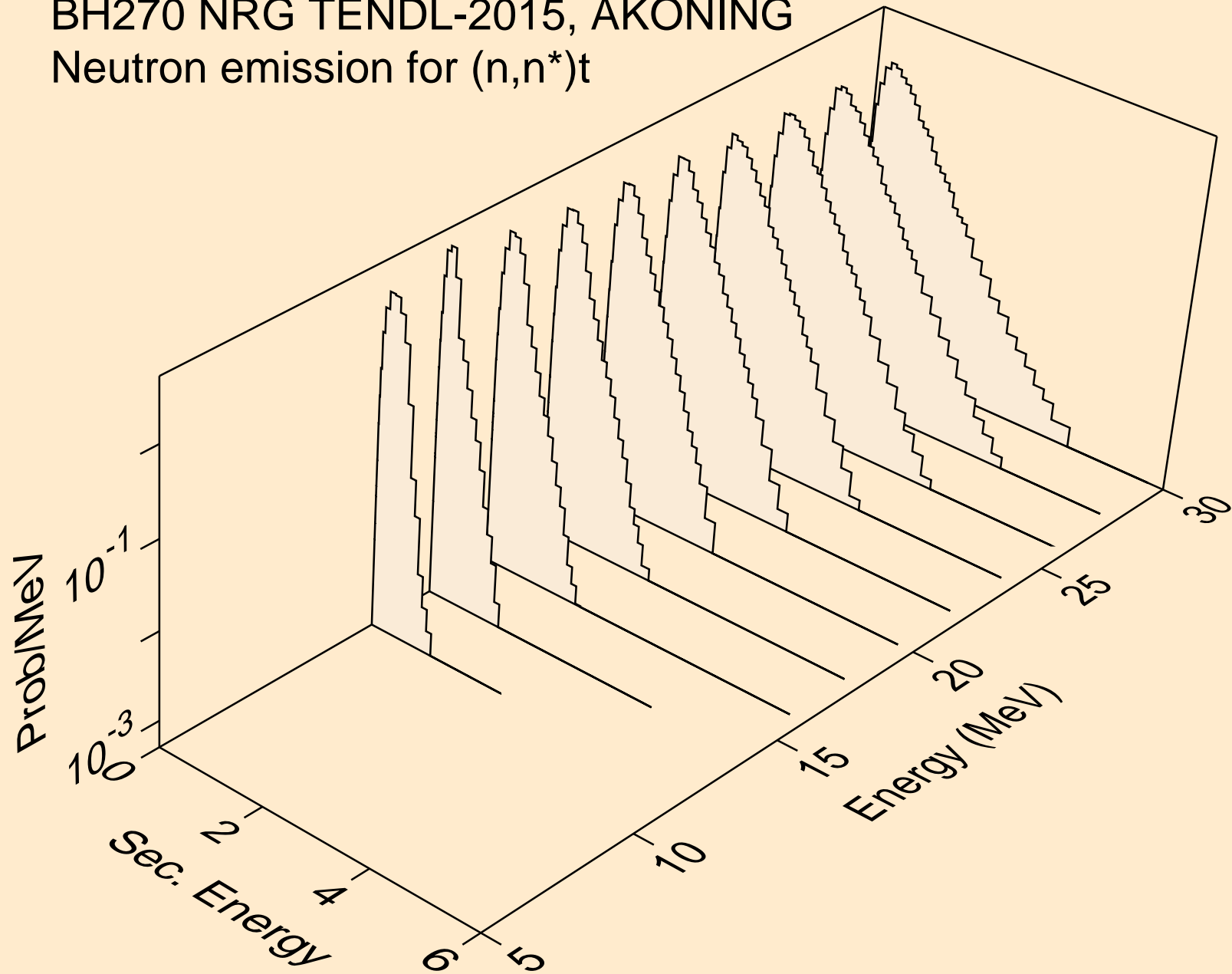

BH270 NRG TENDL-2015, AKONING  
Neutron emission for (n,n\*)he3

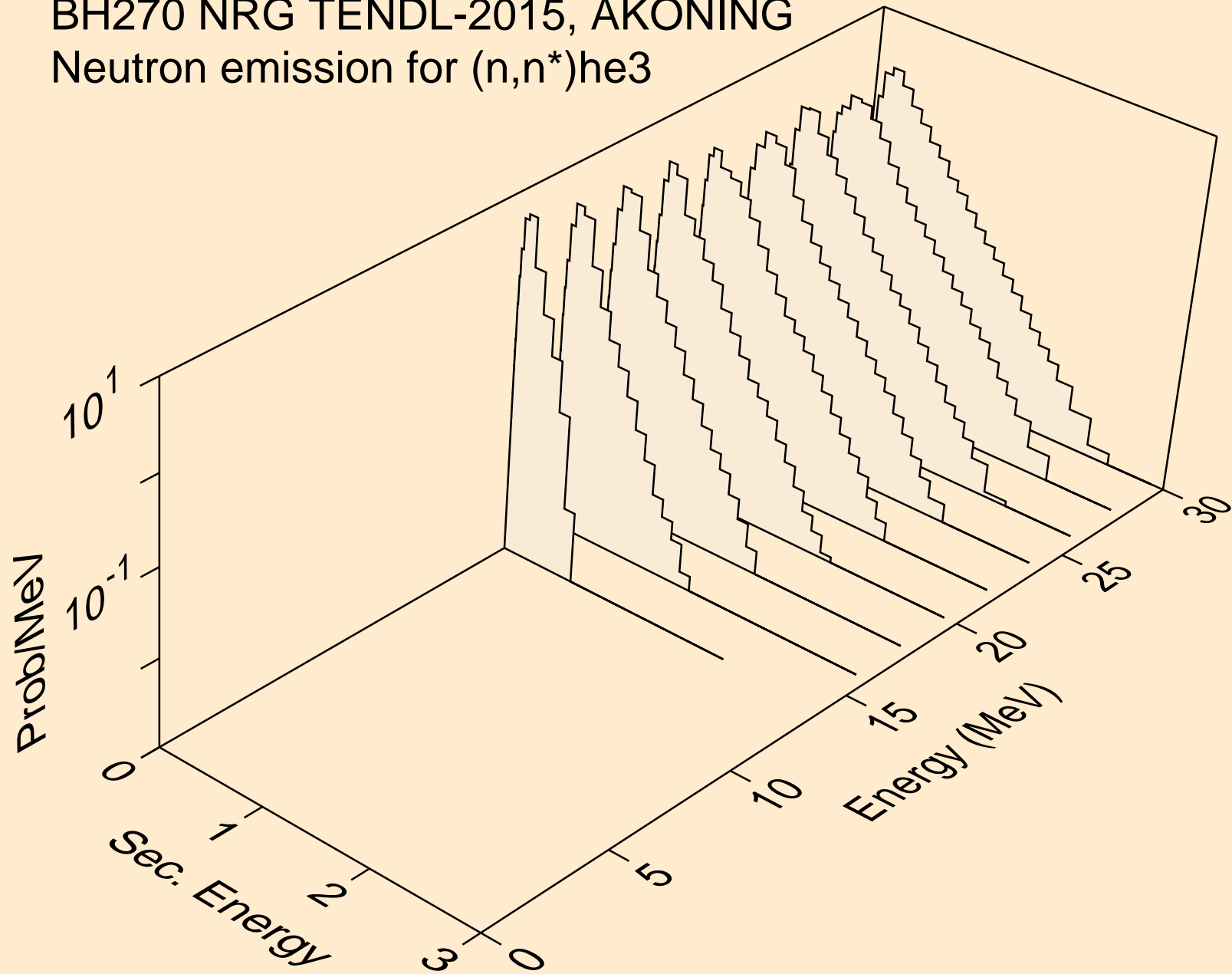



BH270 NRG TENDL-2015, AKONING  
Neutron emission for (n,n\*)d2a

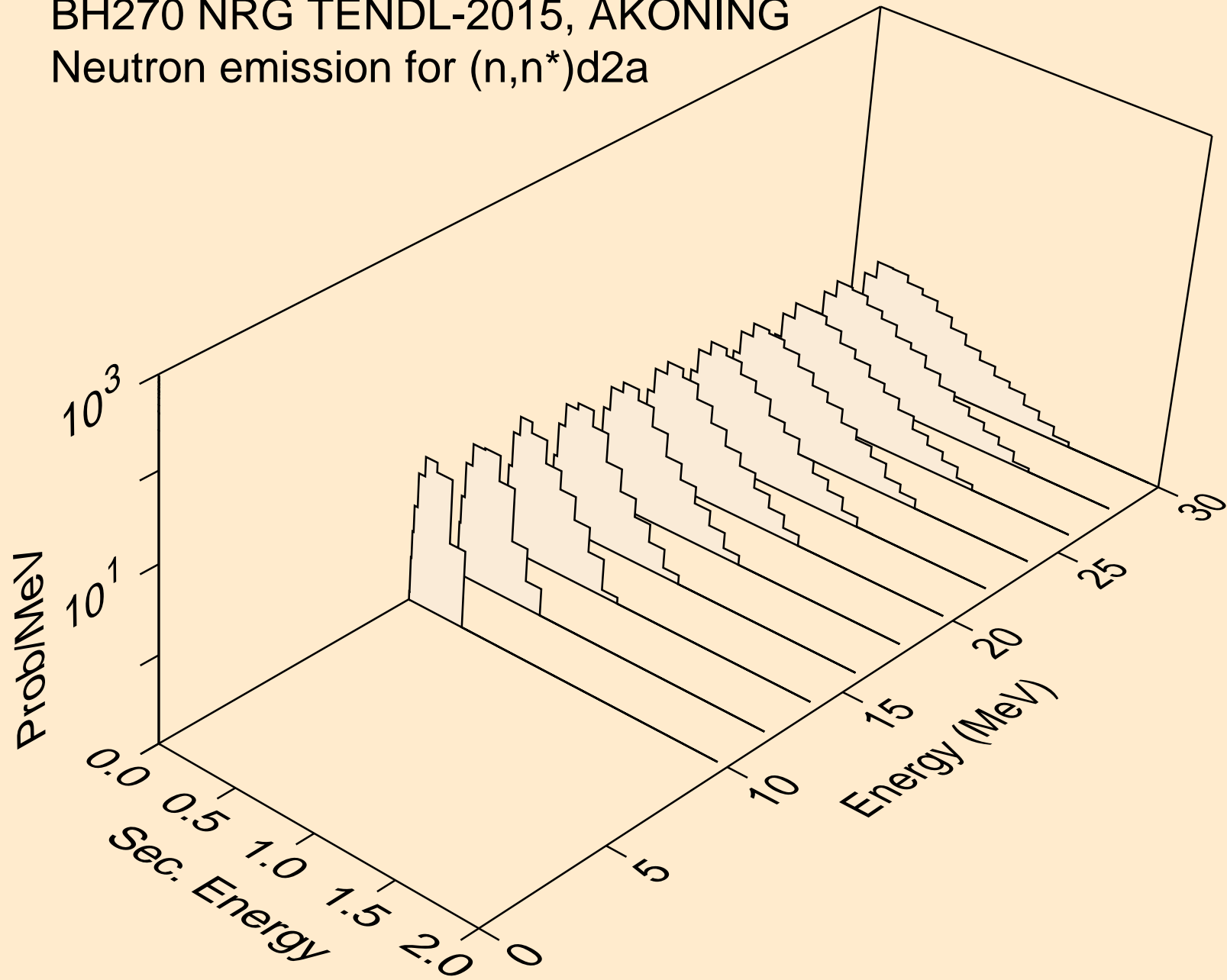

BH270 NRG TENDL-2015, AKONING  
Neutron emission for (n,n\*)t2a

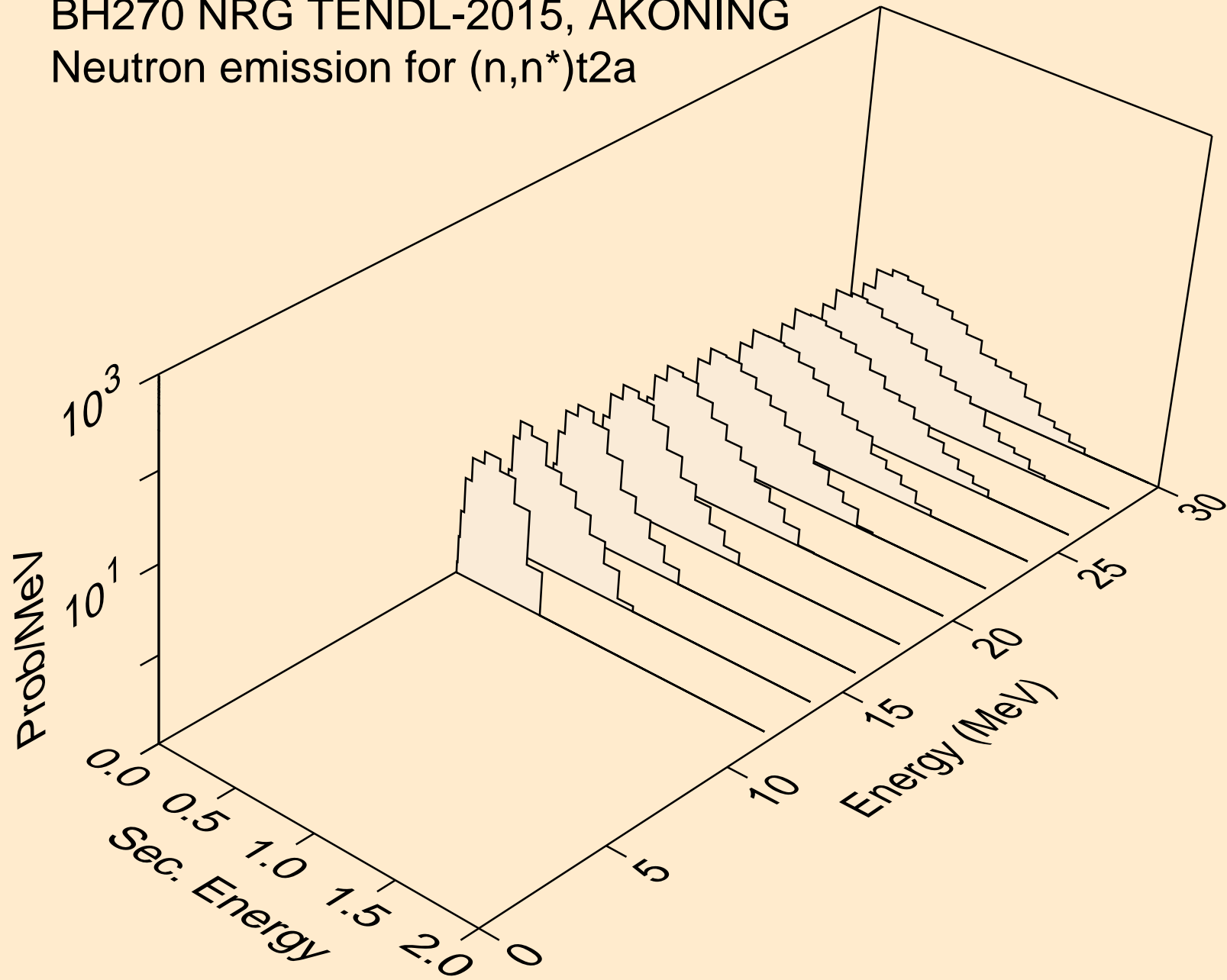

BH270 NRG TENDL-2015, AKONING  
Neutron emission for (n,4n)

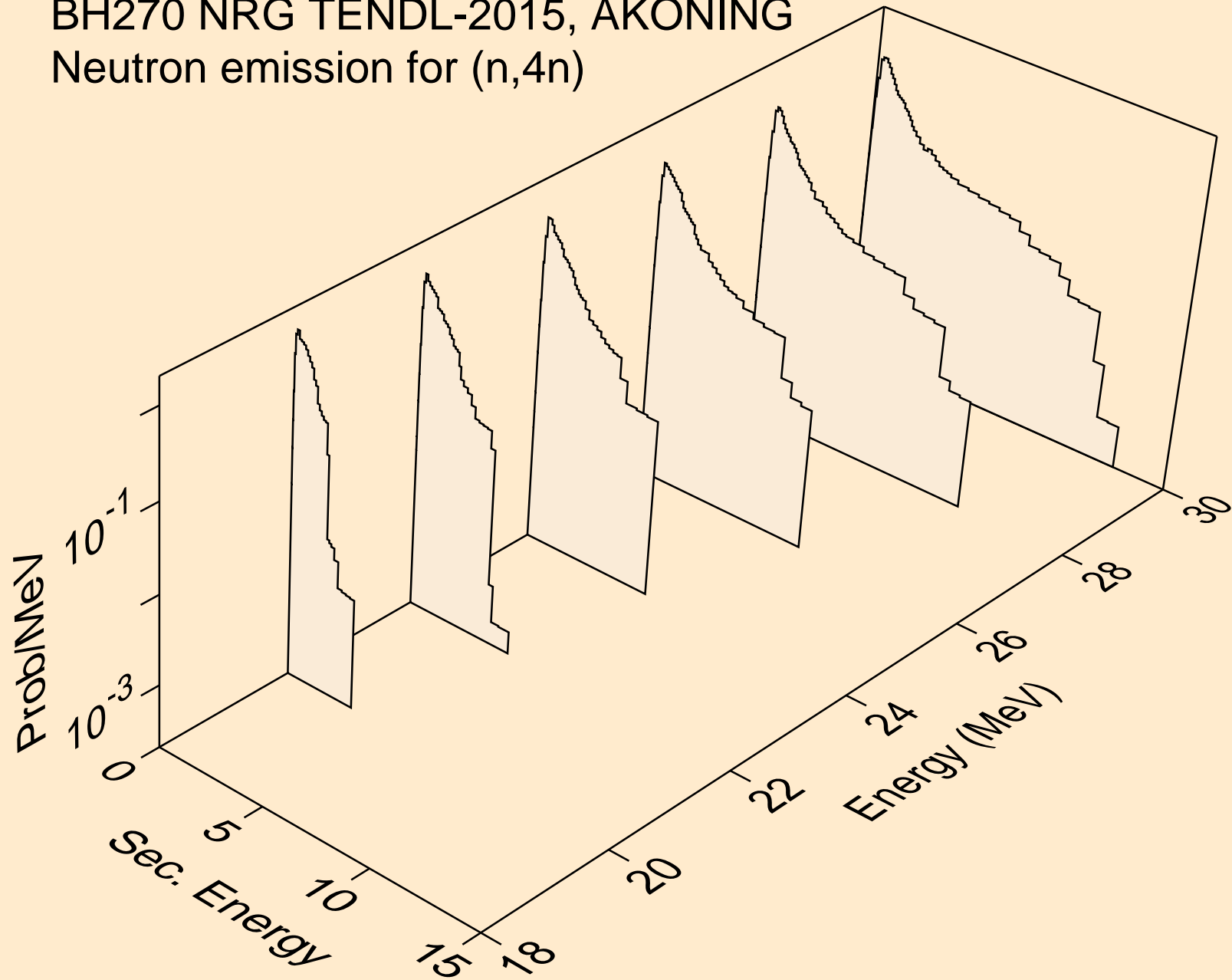

BH270 NRG TENDL-2015, AKONING  
Neutron emission for (n,2np)

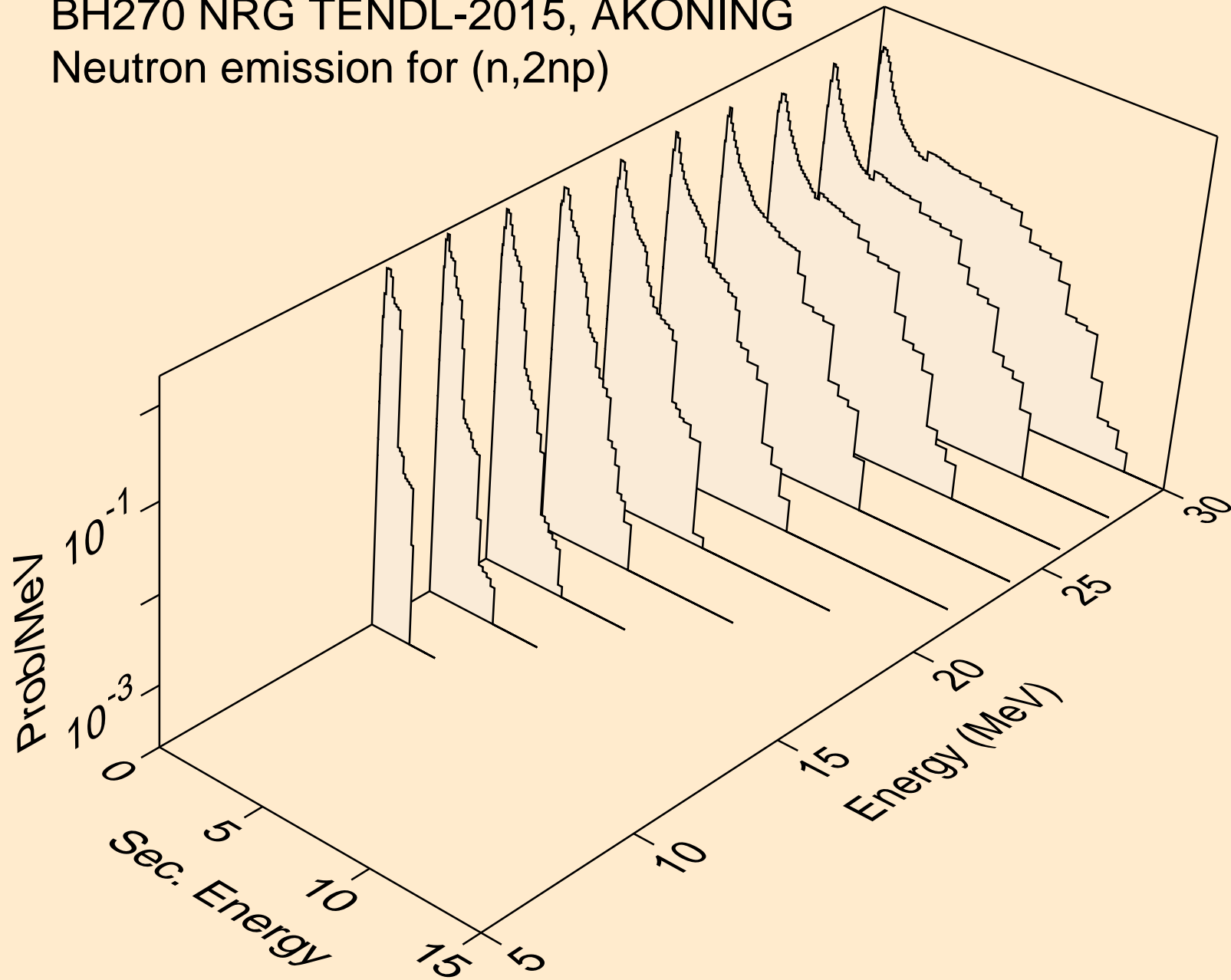

BH270 NRG TENDL-2015, AKONING  
Neutron emission for (n,3np)

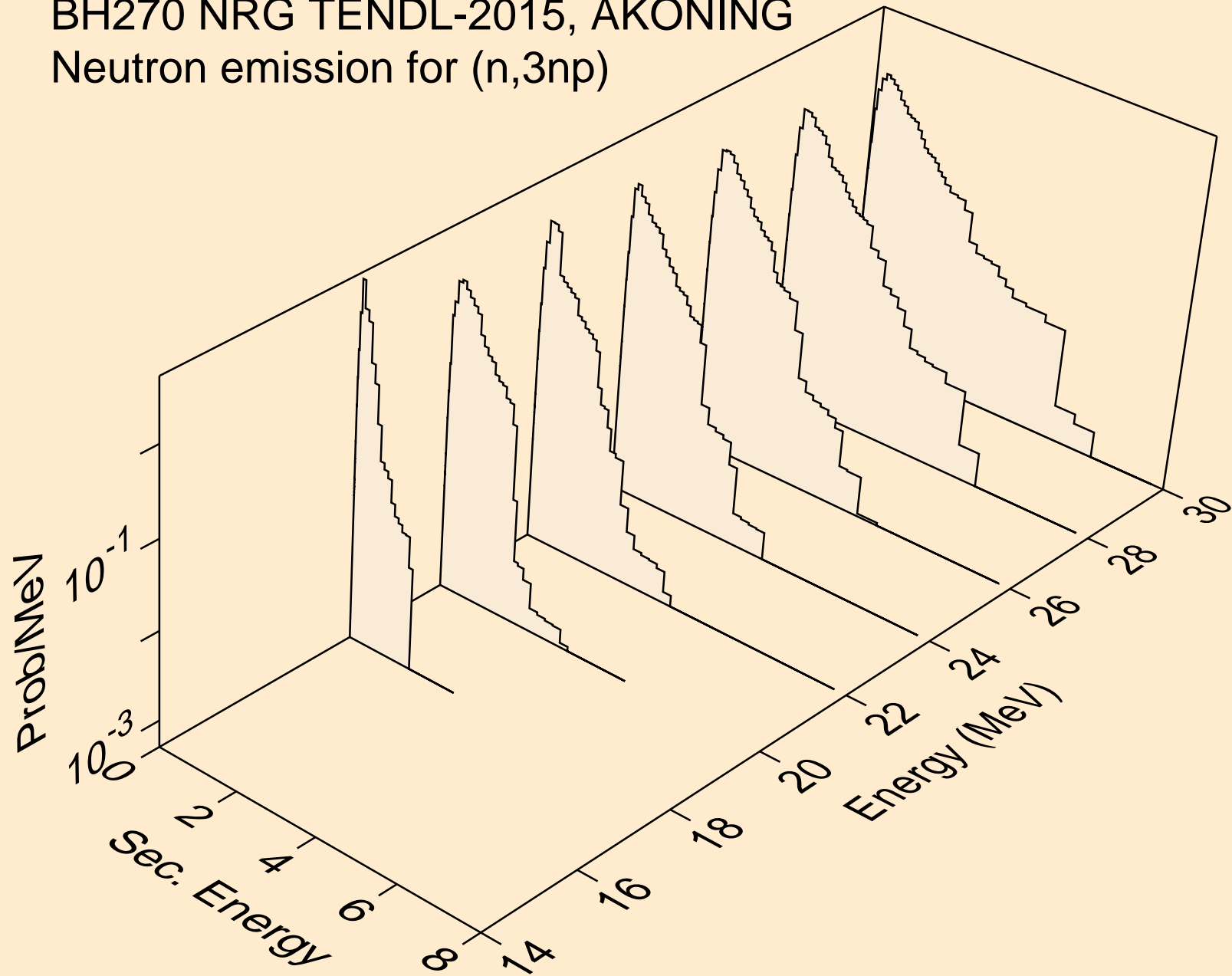

BH270 NRG TENDL-2015, AKONING  
Neutron emission for (n,2np)

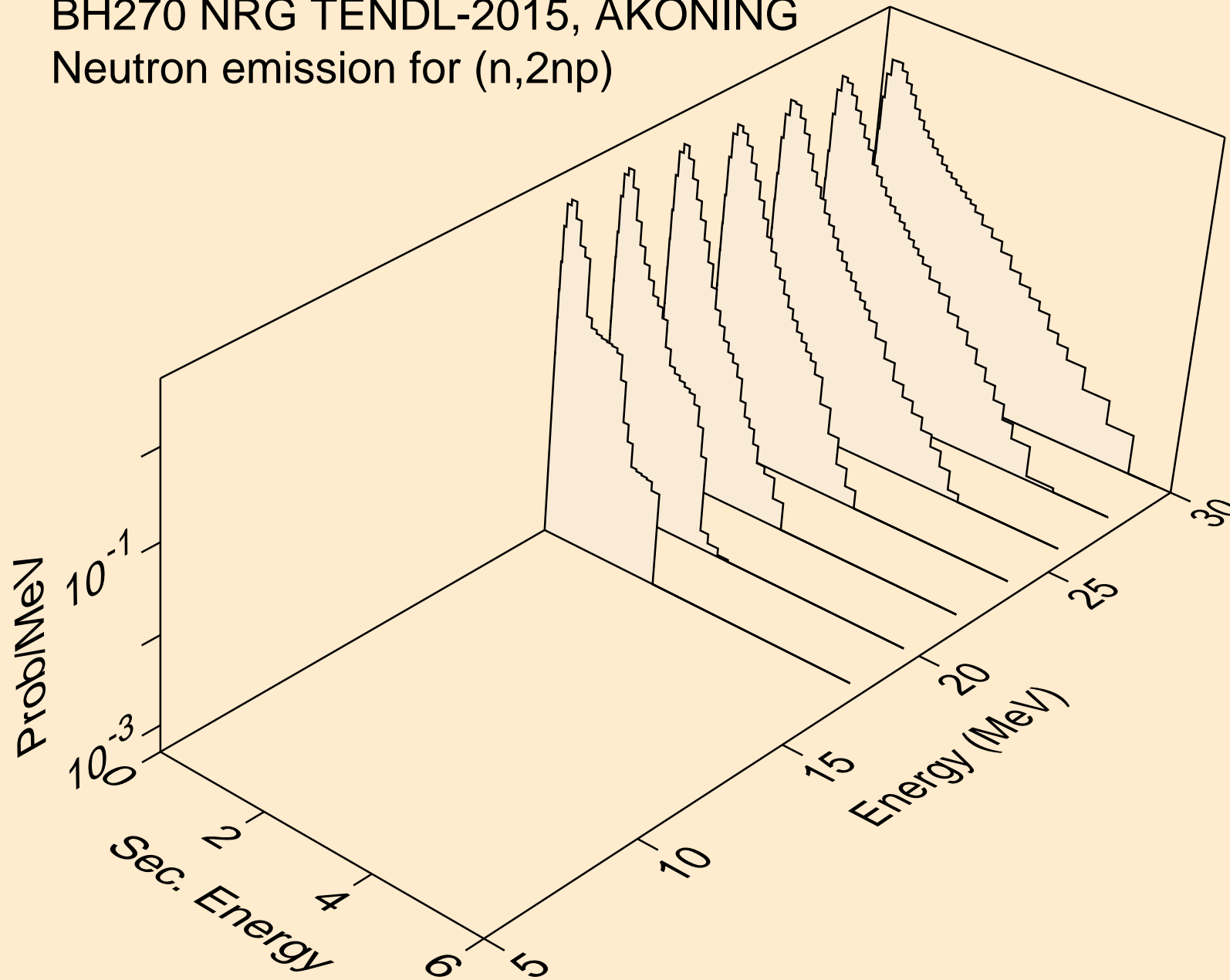

BH270 NRG TENDL-2015, AKONING  
Neutron emission for (n,npa)

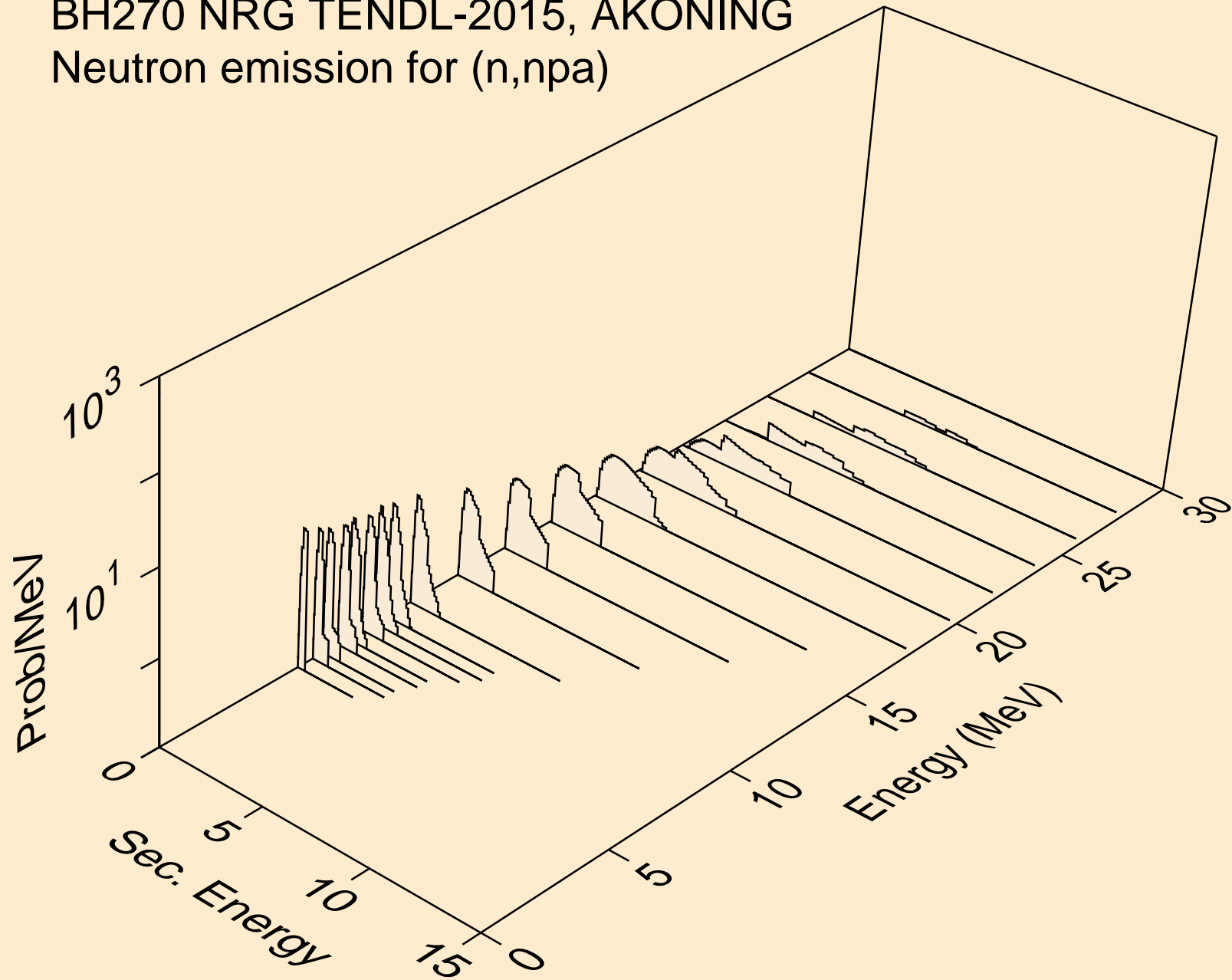

BH270 NRG TENDL-2015, AKONING  
Neutron emission for (n,n\*c)

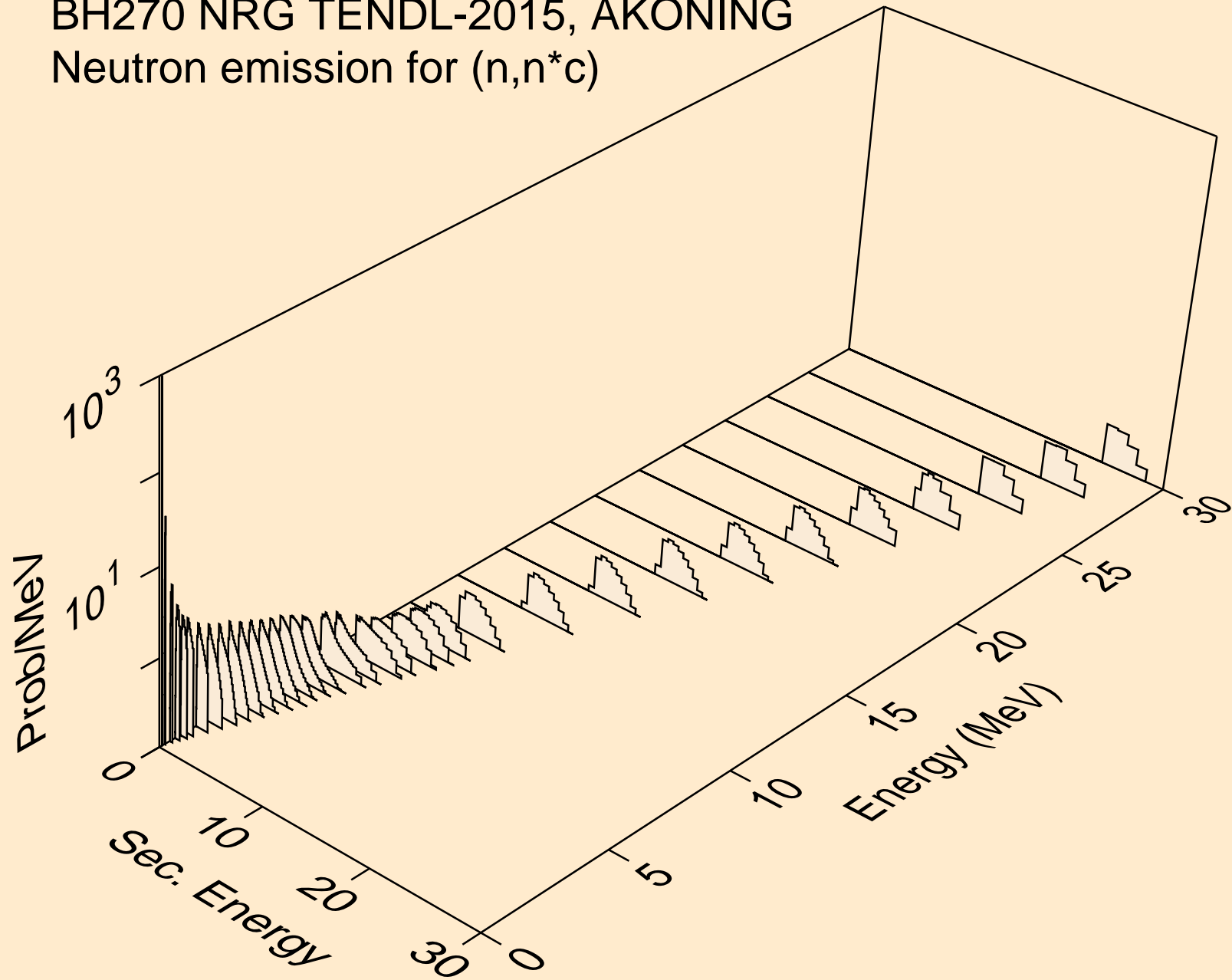



# BH270 NRG TENDL-2015, AKONING

## Delayed nubar

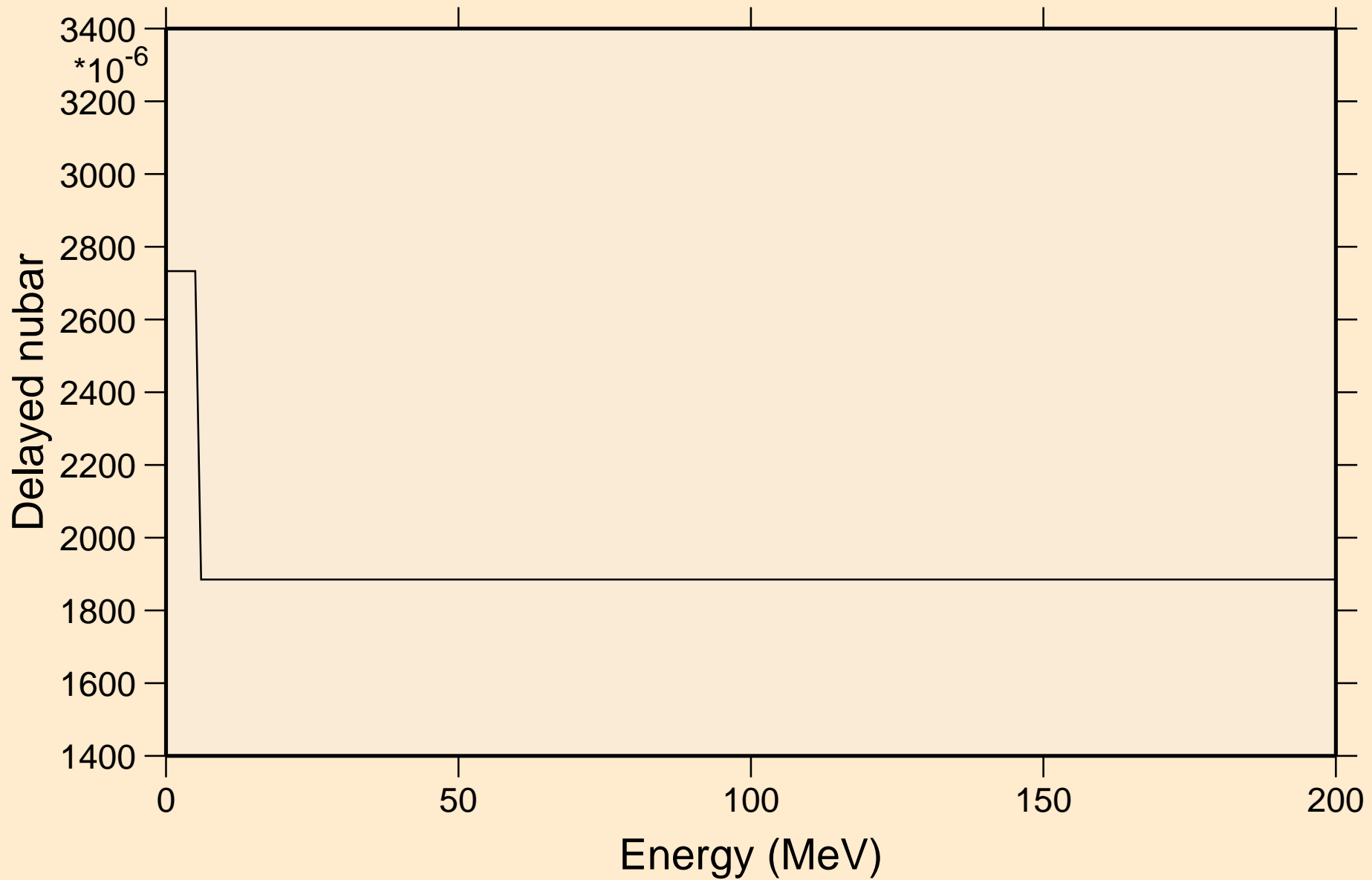

# BH270 NRG TENDL-2015, AKONING

## Delayed neutron spectra

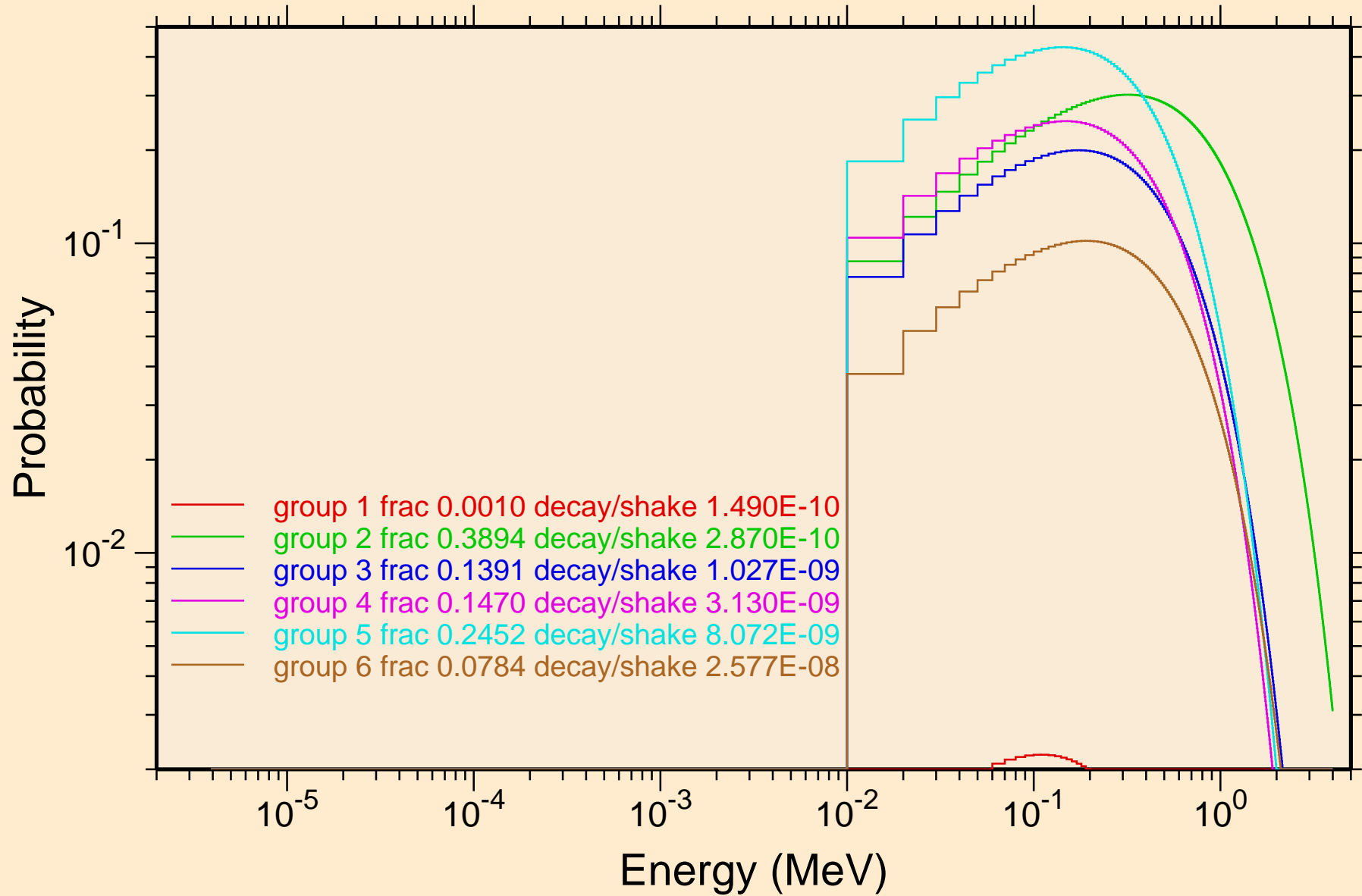

BH270 NRG TENDL-2015, AKONING  
Photon emission for (n,x)

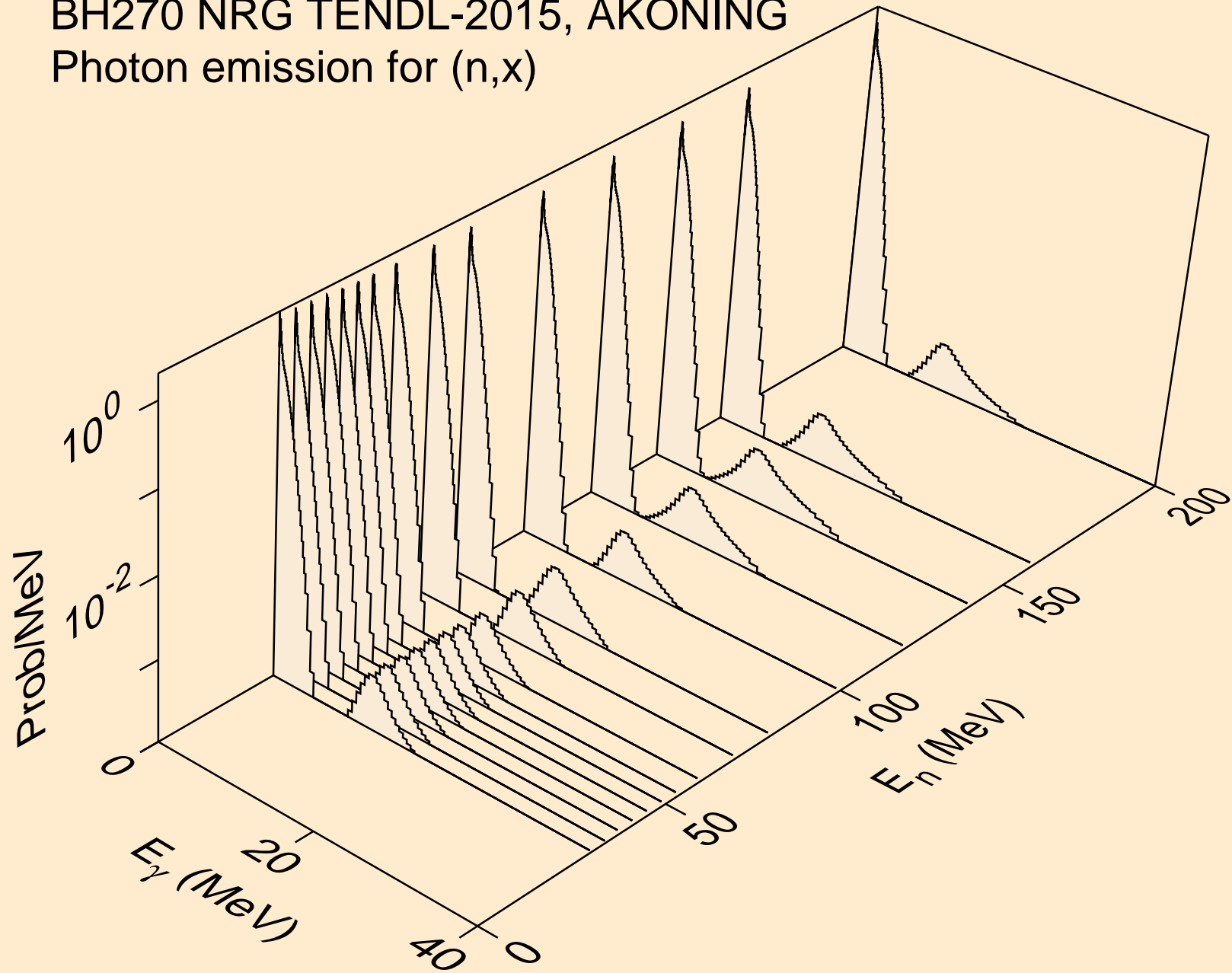

BH270 NRG TENDL-2015, AKONING  
Photon emission for (n,2nd)

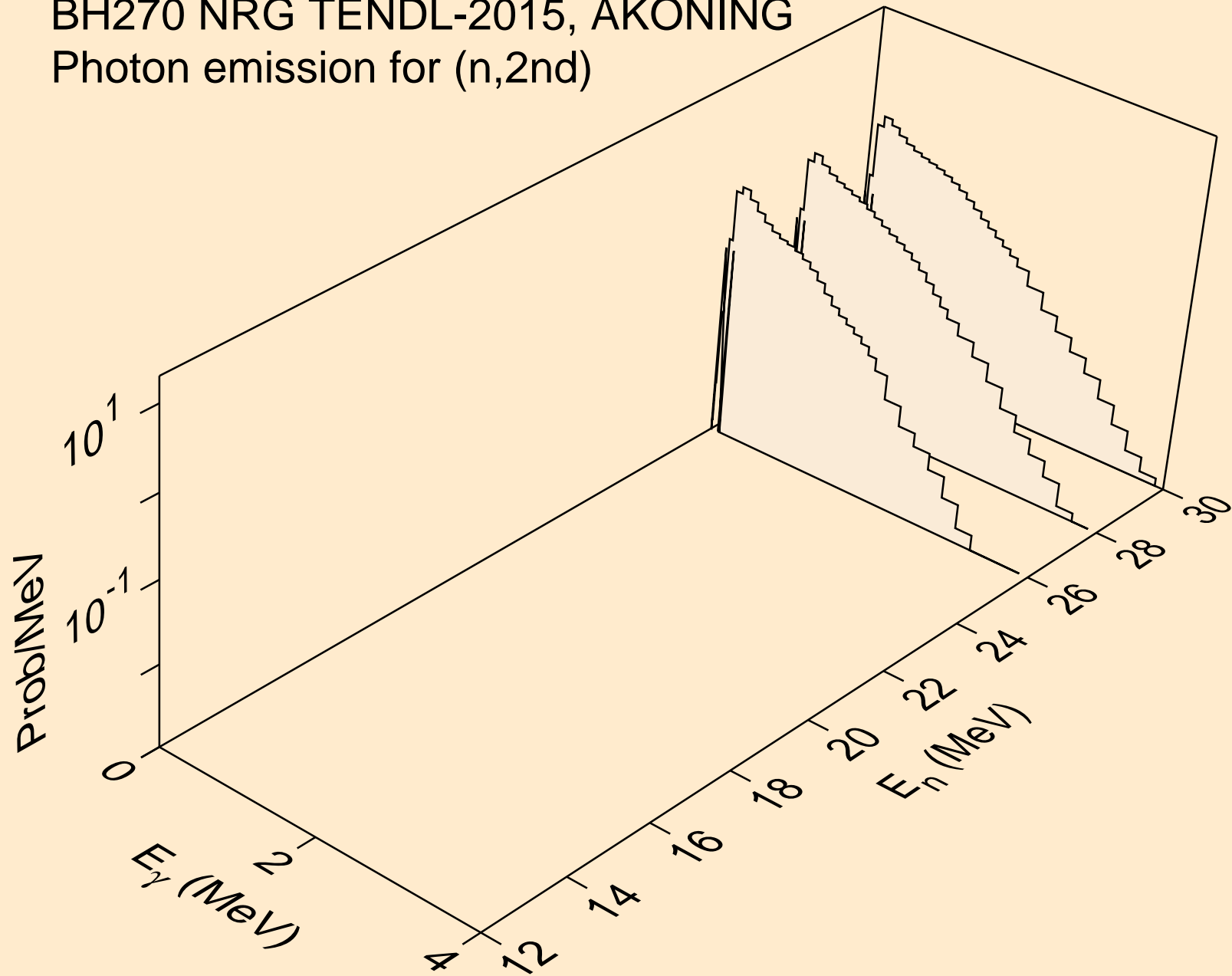

BH270 NRG TENDL-2015, AKONING  
Photon emission for (n,2n)

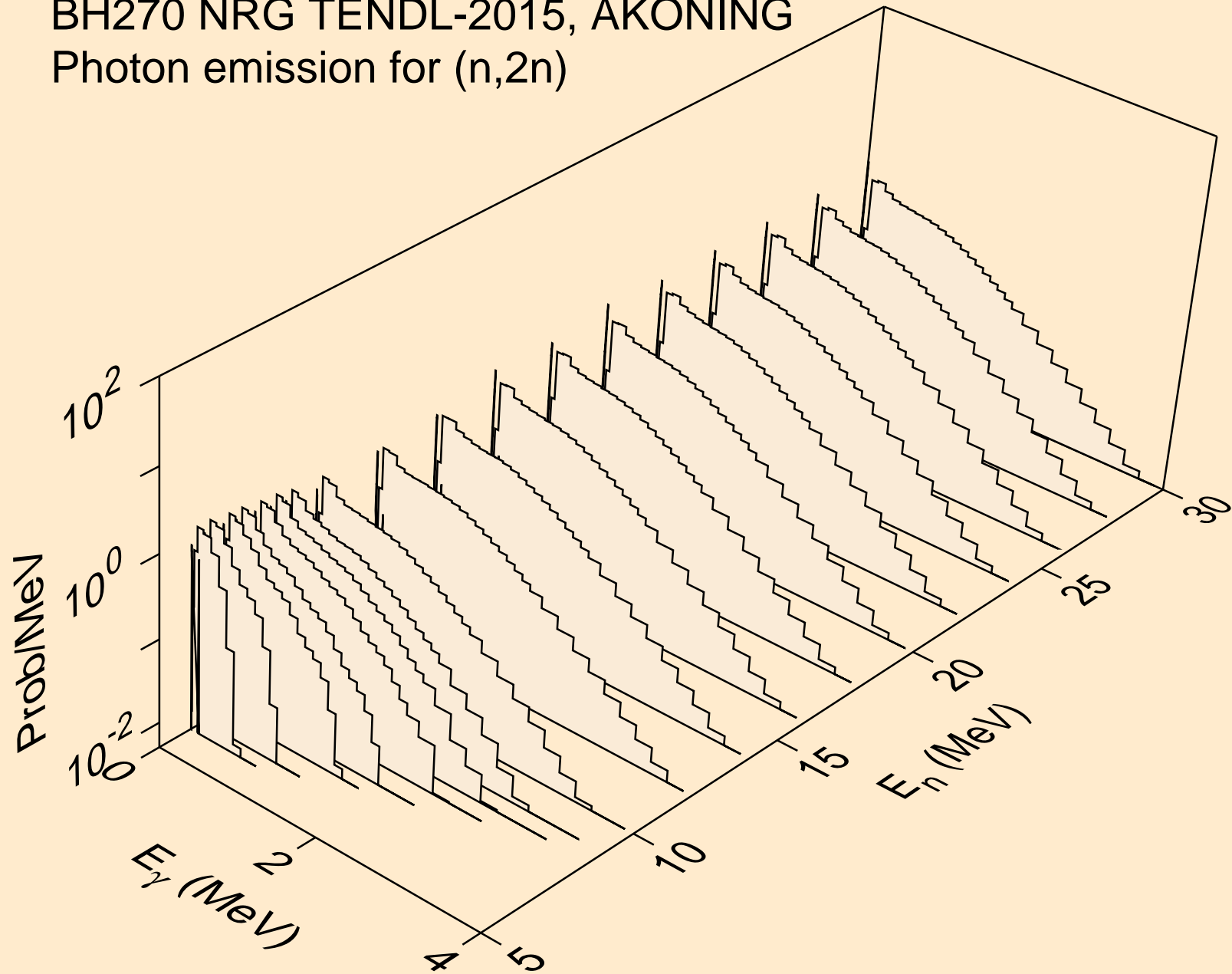

BH270 NRG TENDL-2015, AKONING  
Photon emission for (n,3n)

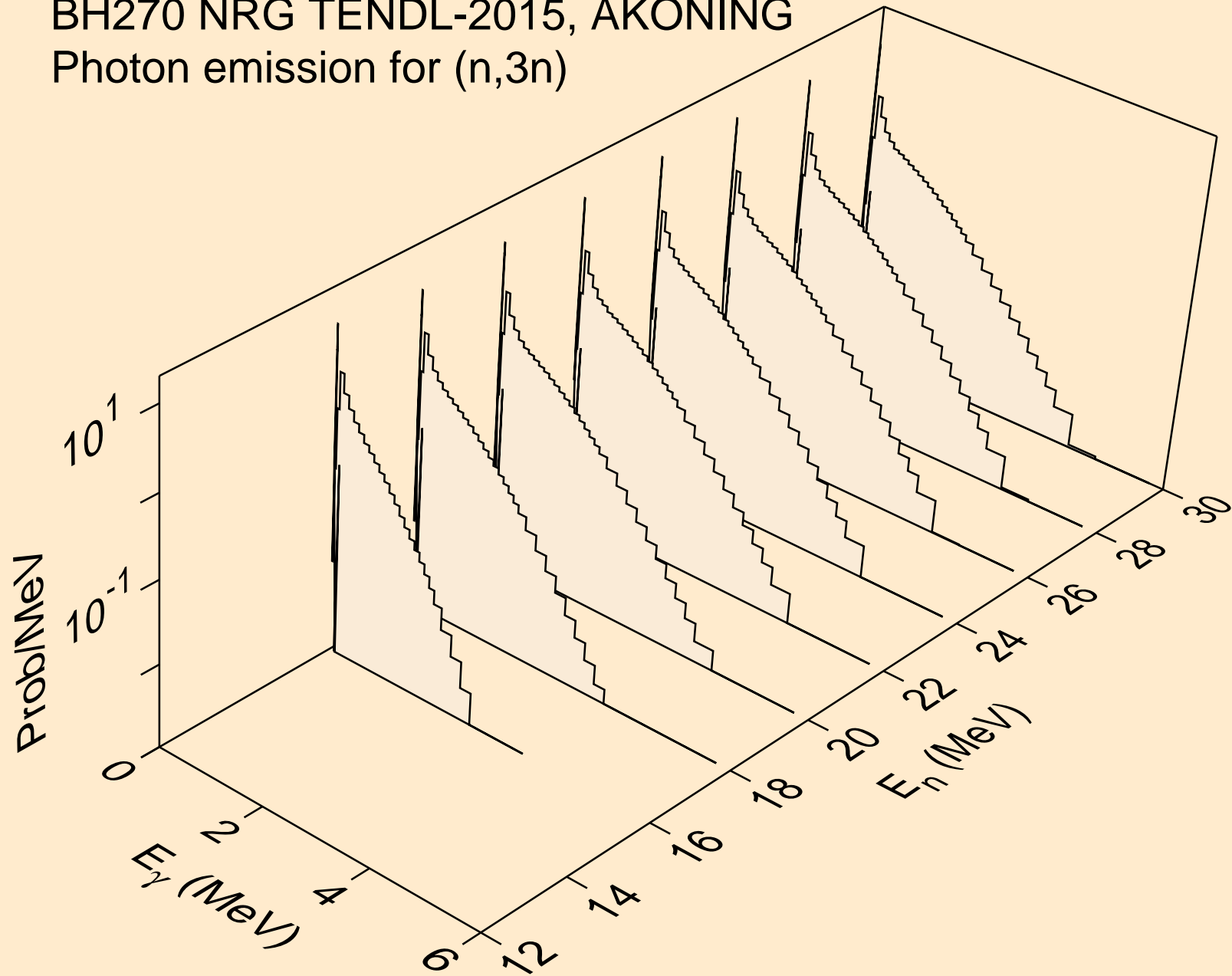

BH270 NRG TENDL-2015, AKONING  
Photon emission for (n,n\*)a

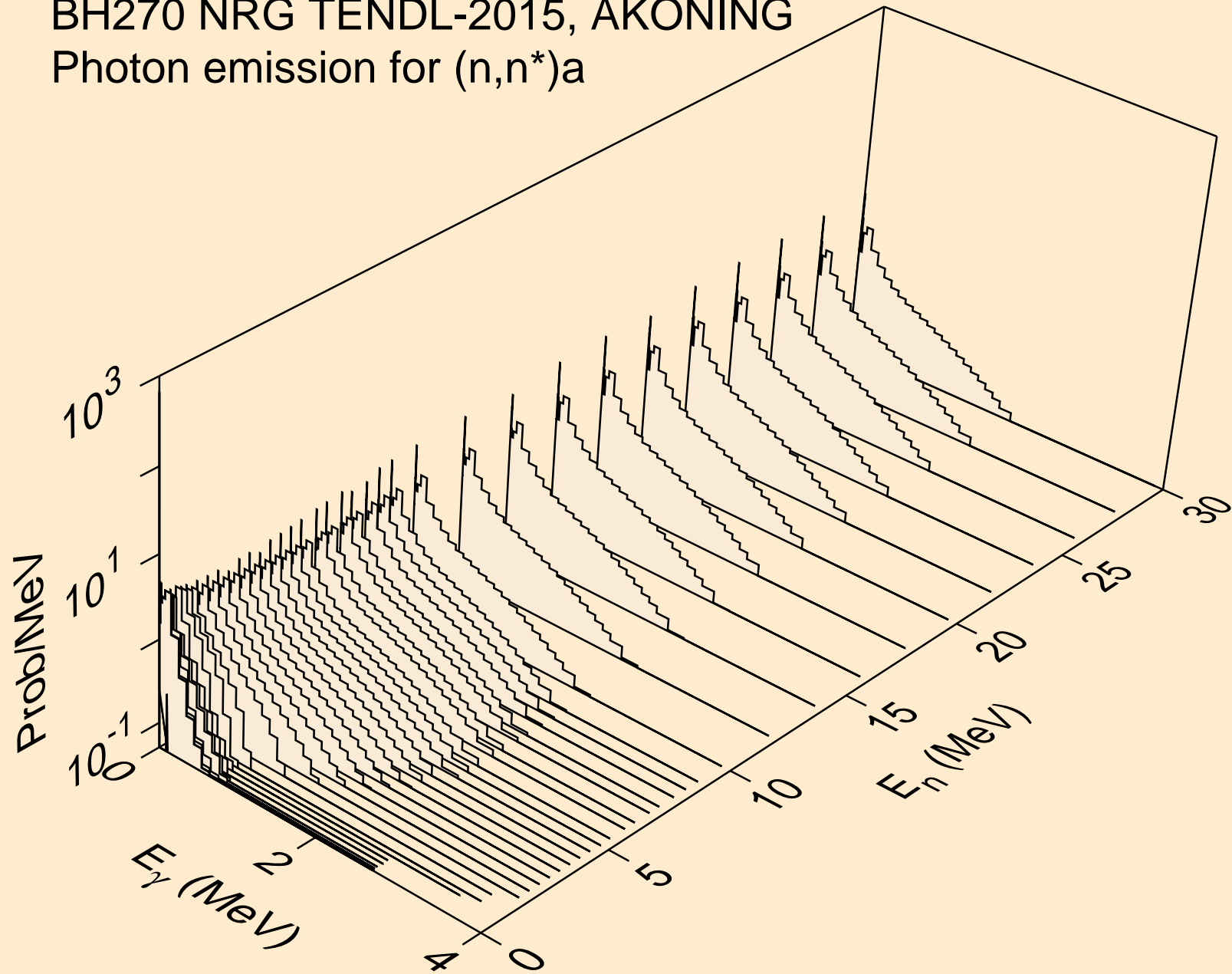

BH270 NRG TENDL-2015, AKONING  
Photon emission for (n,n\*)3a

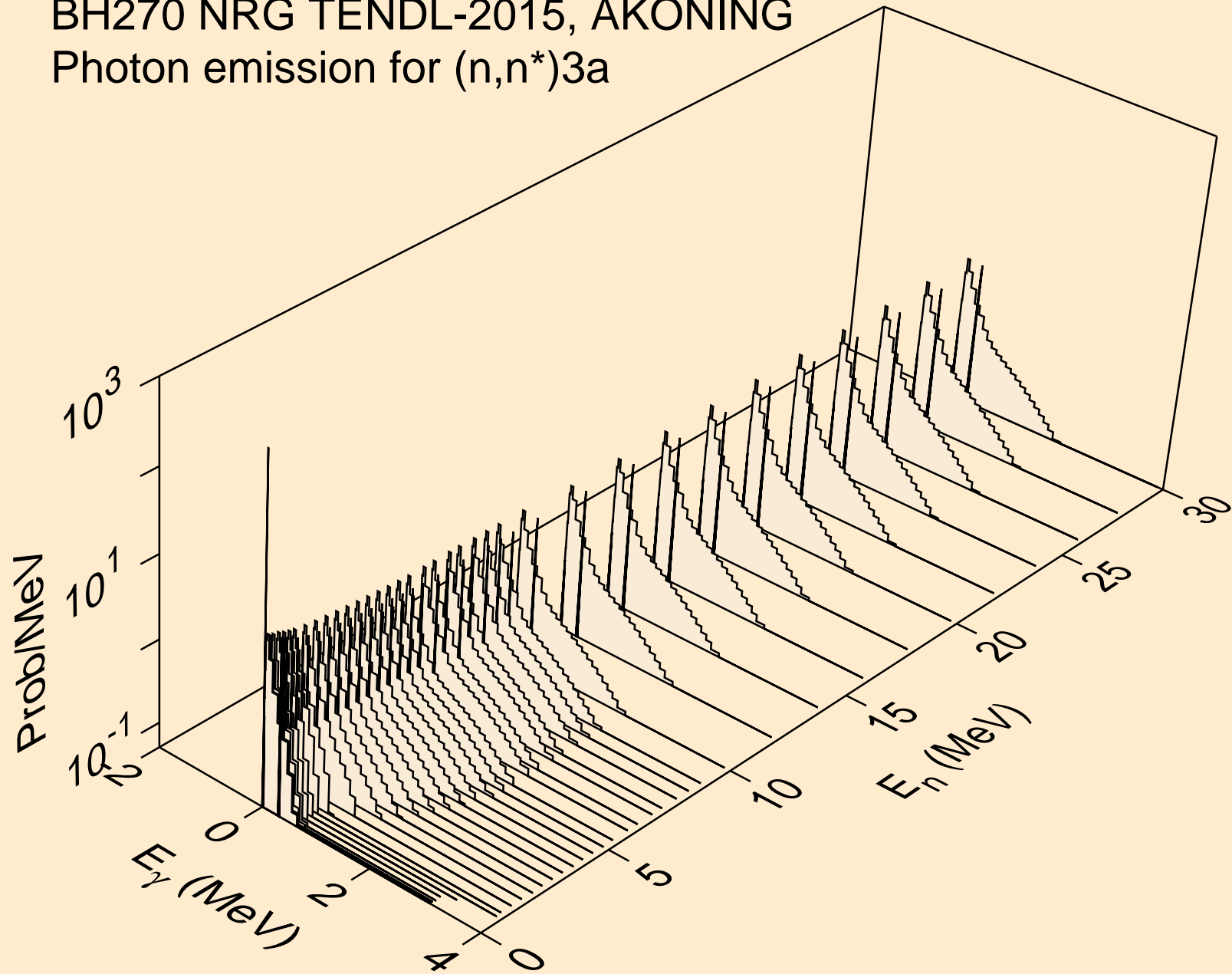



BH270 NRG TENDL-2015, AKONING  
Photon emission for (n,2n)a

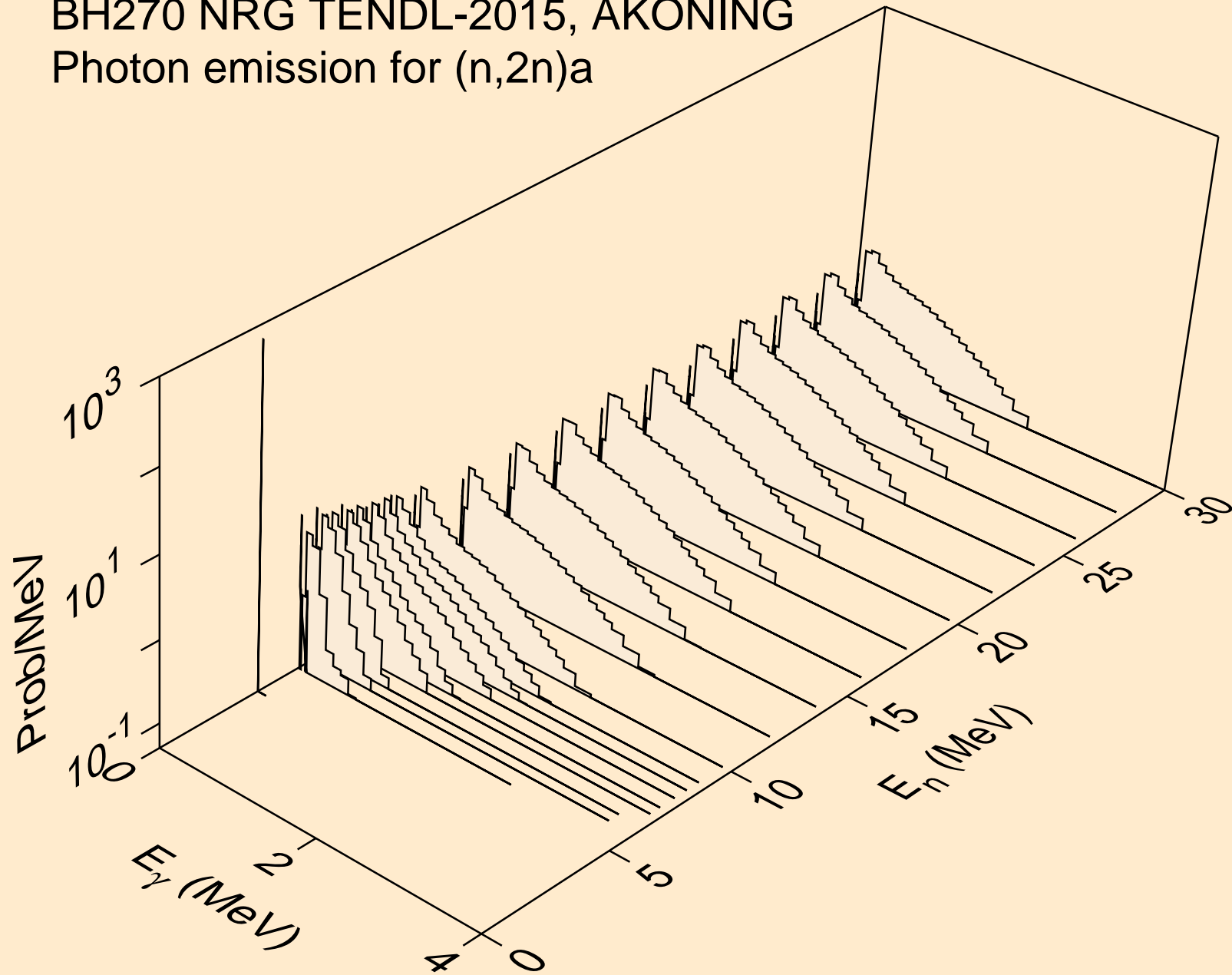

BH270 NRG TENDL-2015, AKONING  
Photon emission for (n,3n)a

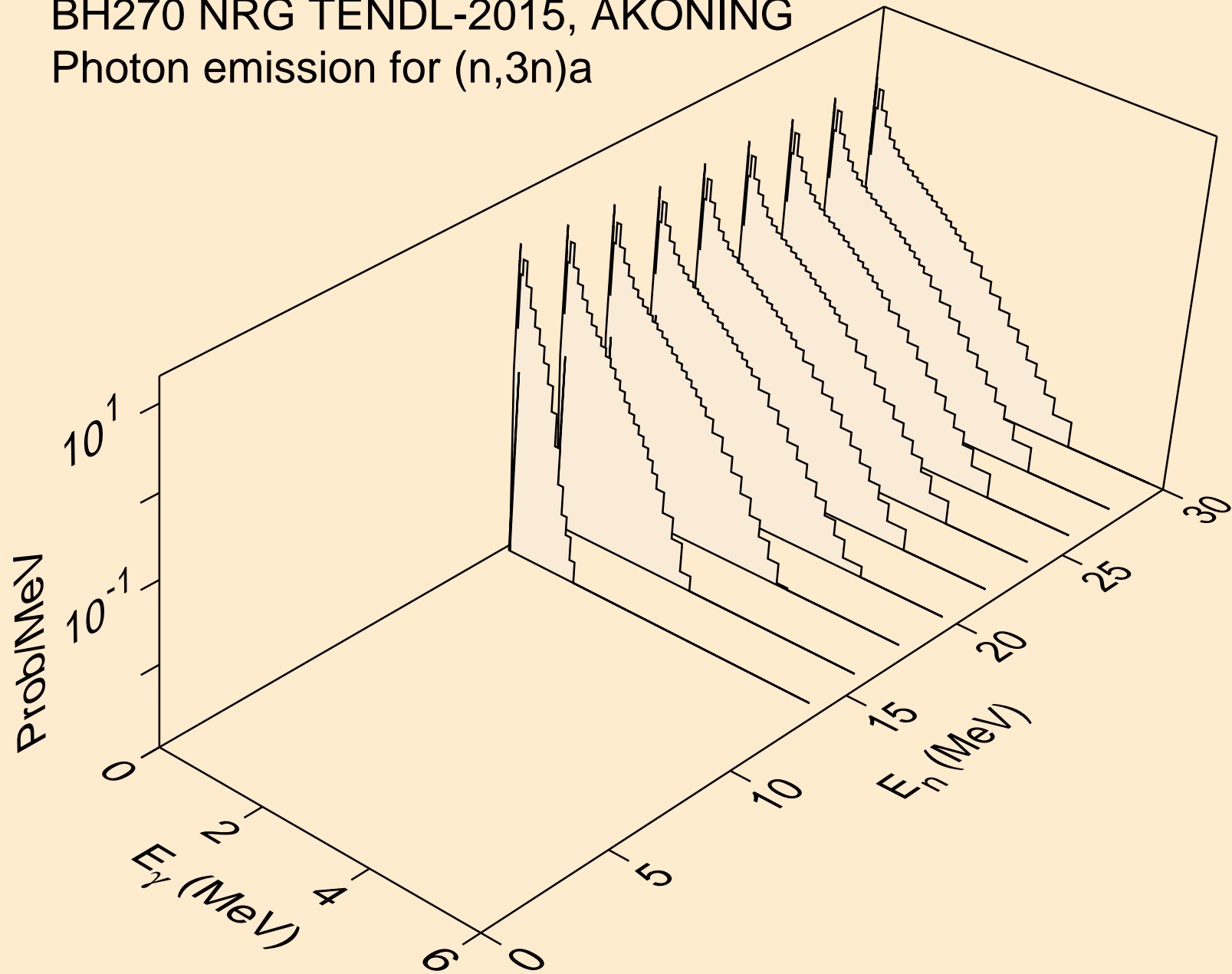

BH270 NRG TENDL-2015, AKONING  
Photon emission for (n,n\*)p

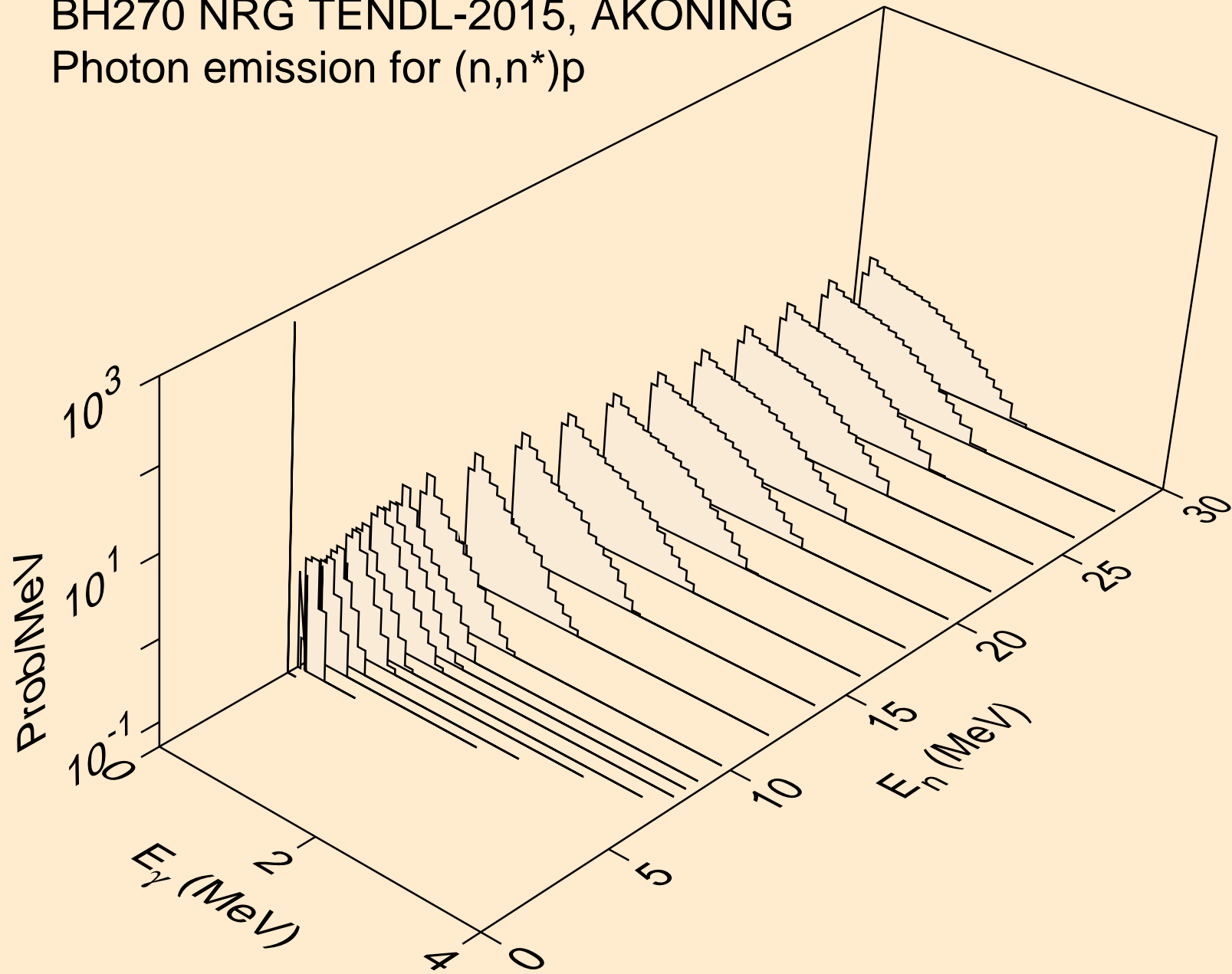

BH270 NRG TENDL-2015, AKONING  
Photon emission for (n,n\*)2a

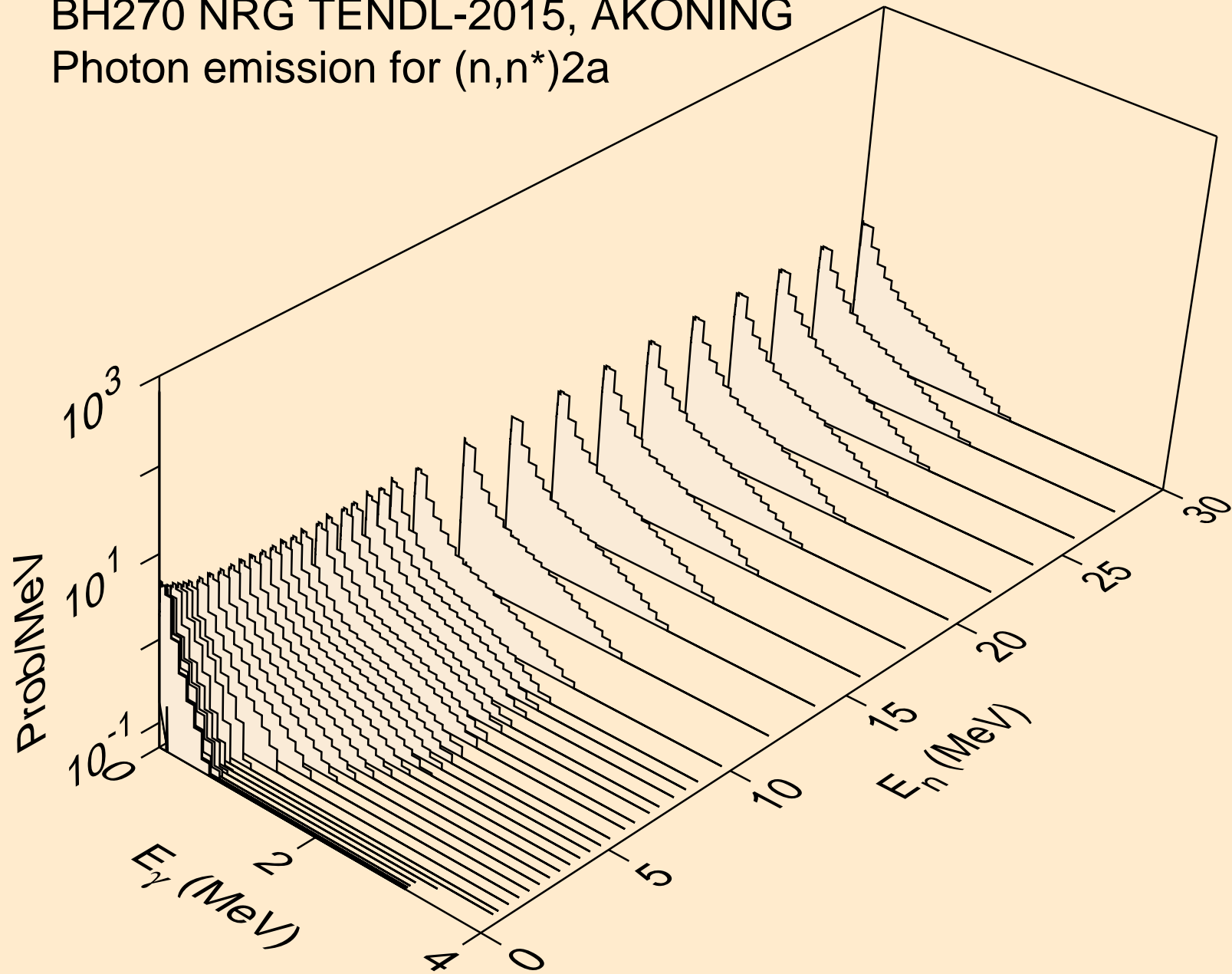

BH270 NRG TENDL-2015, AKONING  
Photon emission for (n,2n)2a

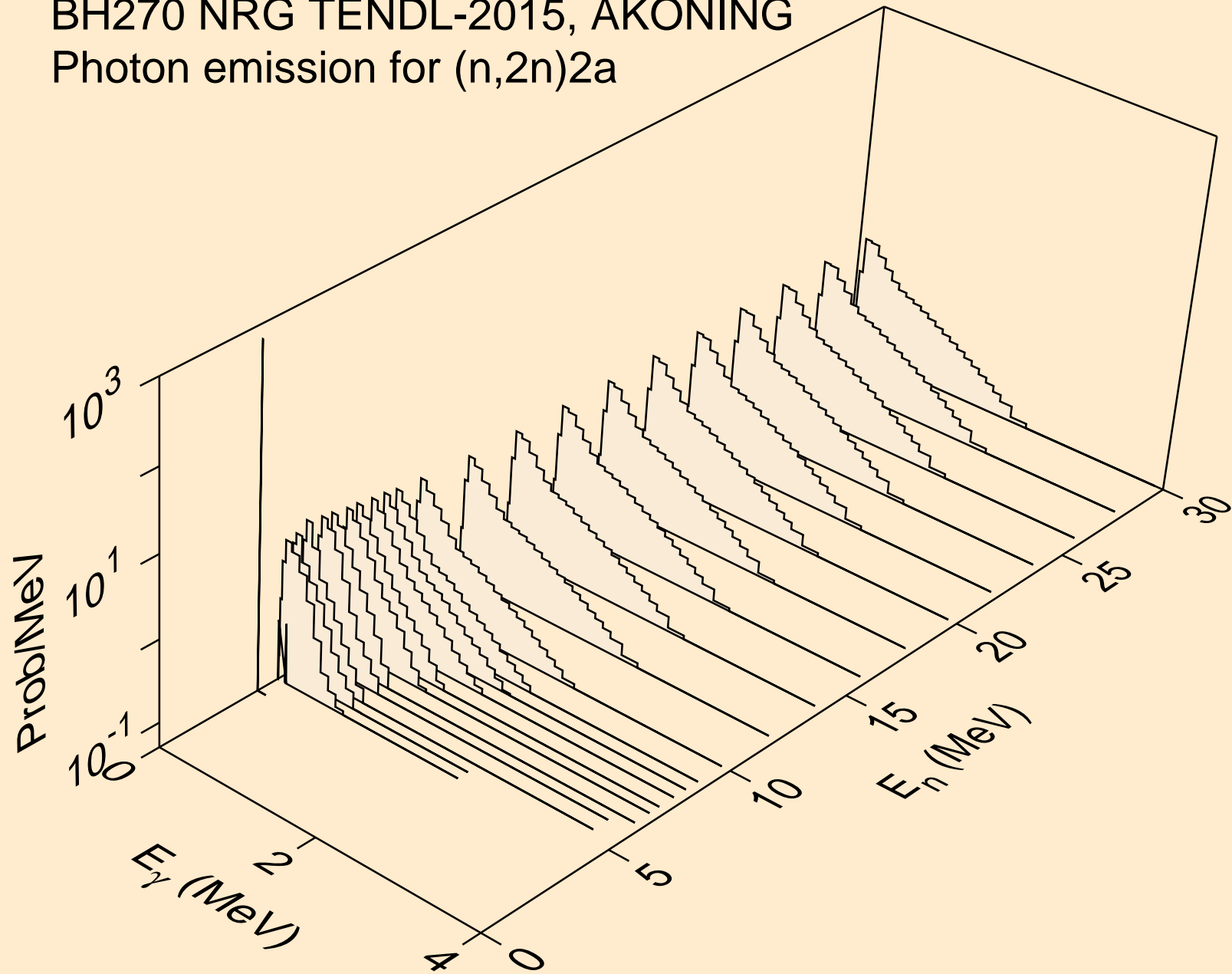

BH270 NRG TENDL-2015, AKONING  
Photon emission for (n,n\*)d

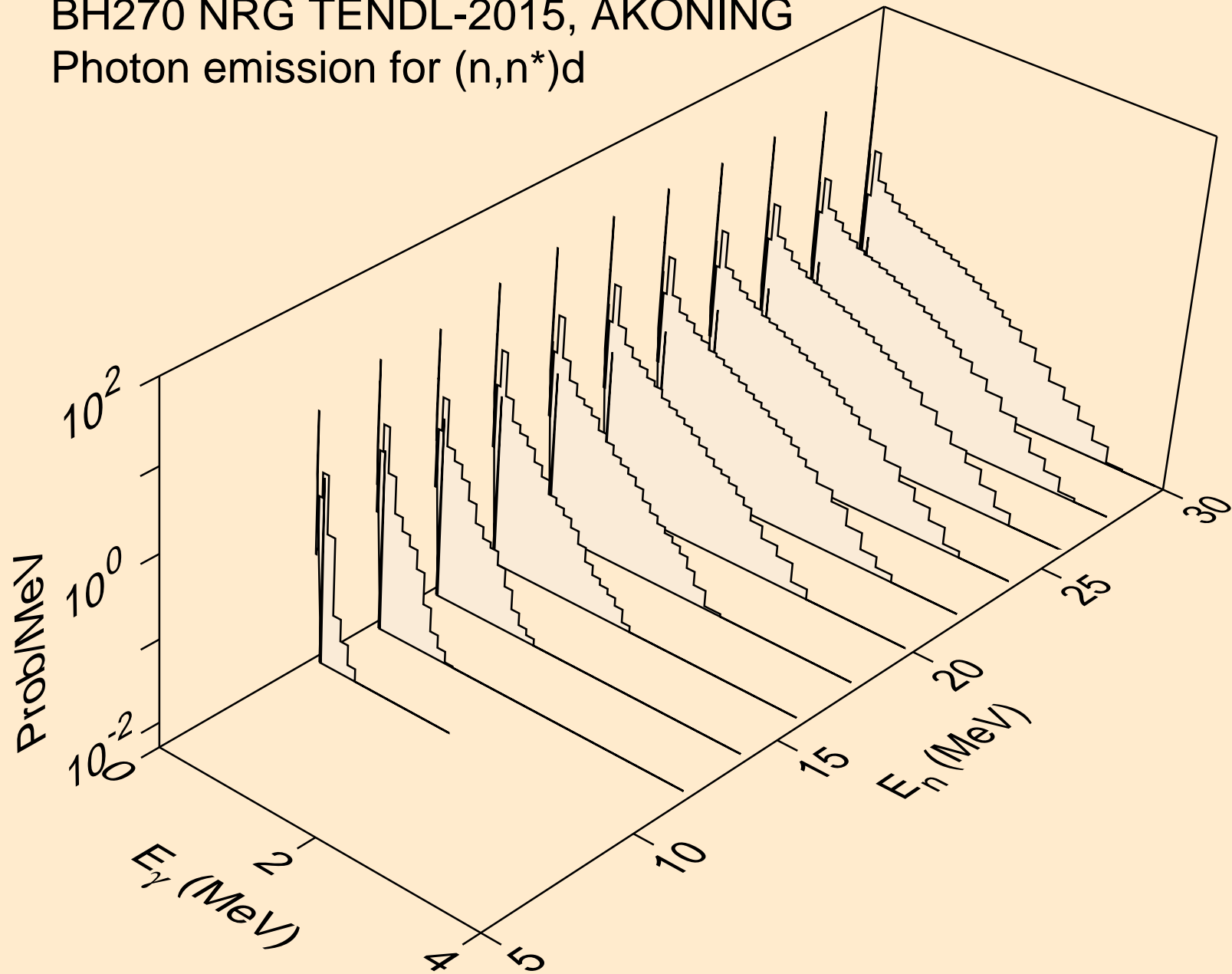

BH270 NRG TENDL-2015, AKONING  
Photon emission for (n,n\*)t

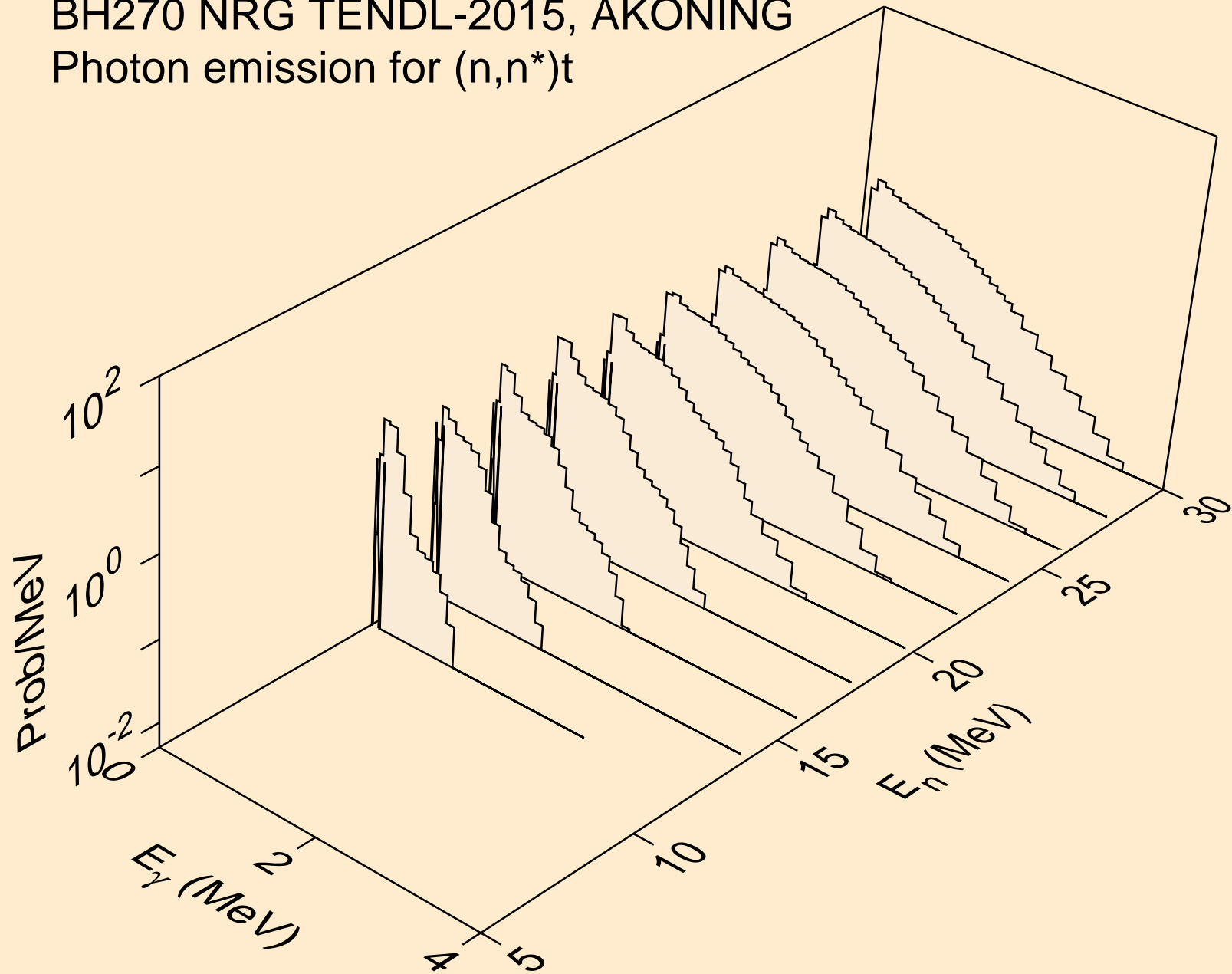

BH270 NRG TENDL-2015, AKONING  
Photon emission for (n,n\*)he3

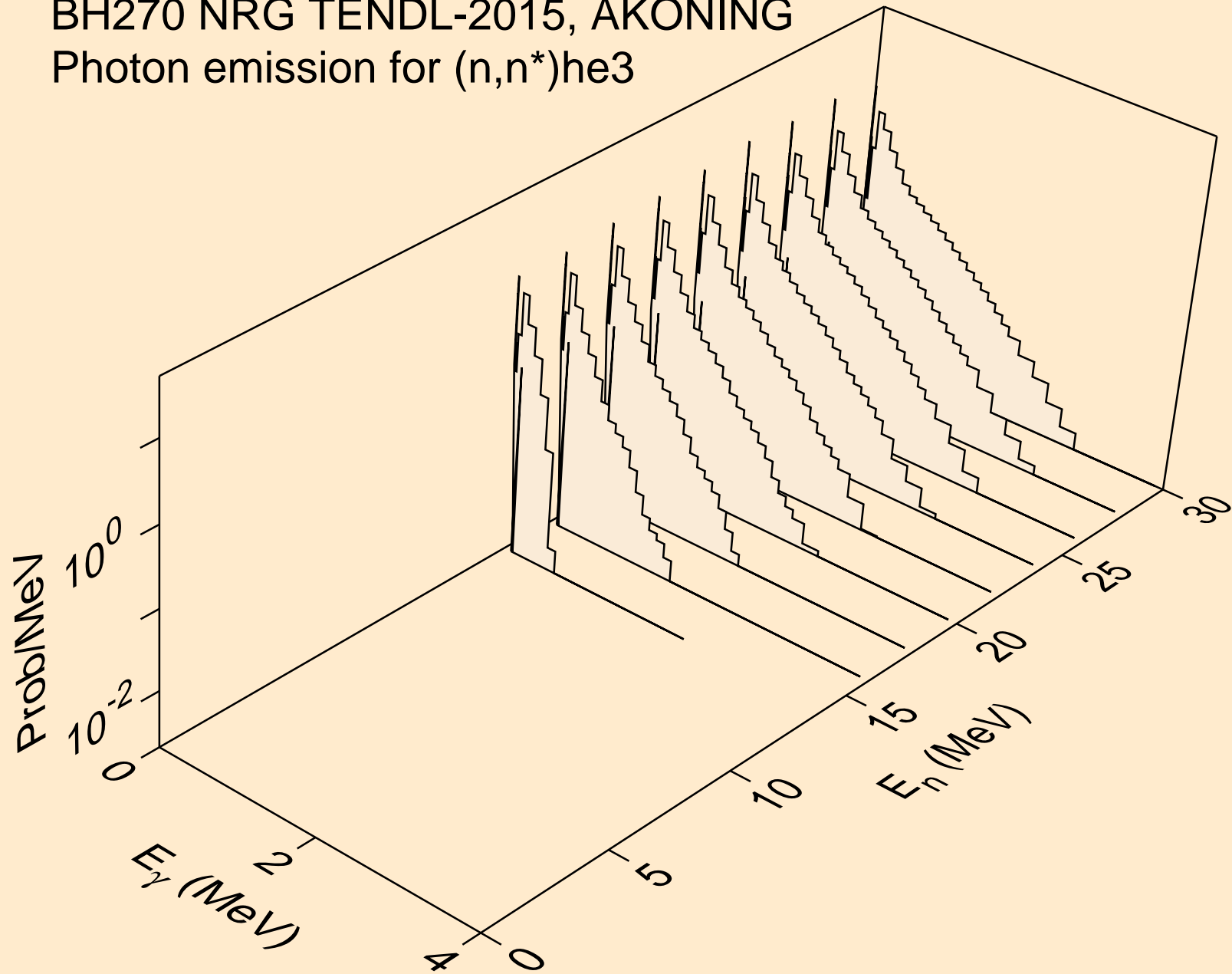



BH270 NRG TENDL-2015, AKONING  
Photon emission for (n,n\*)d2a

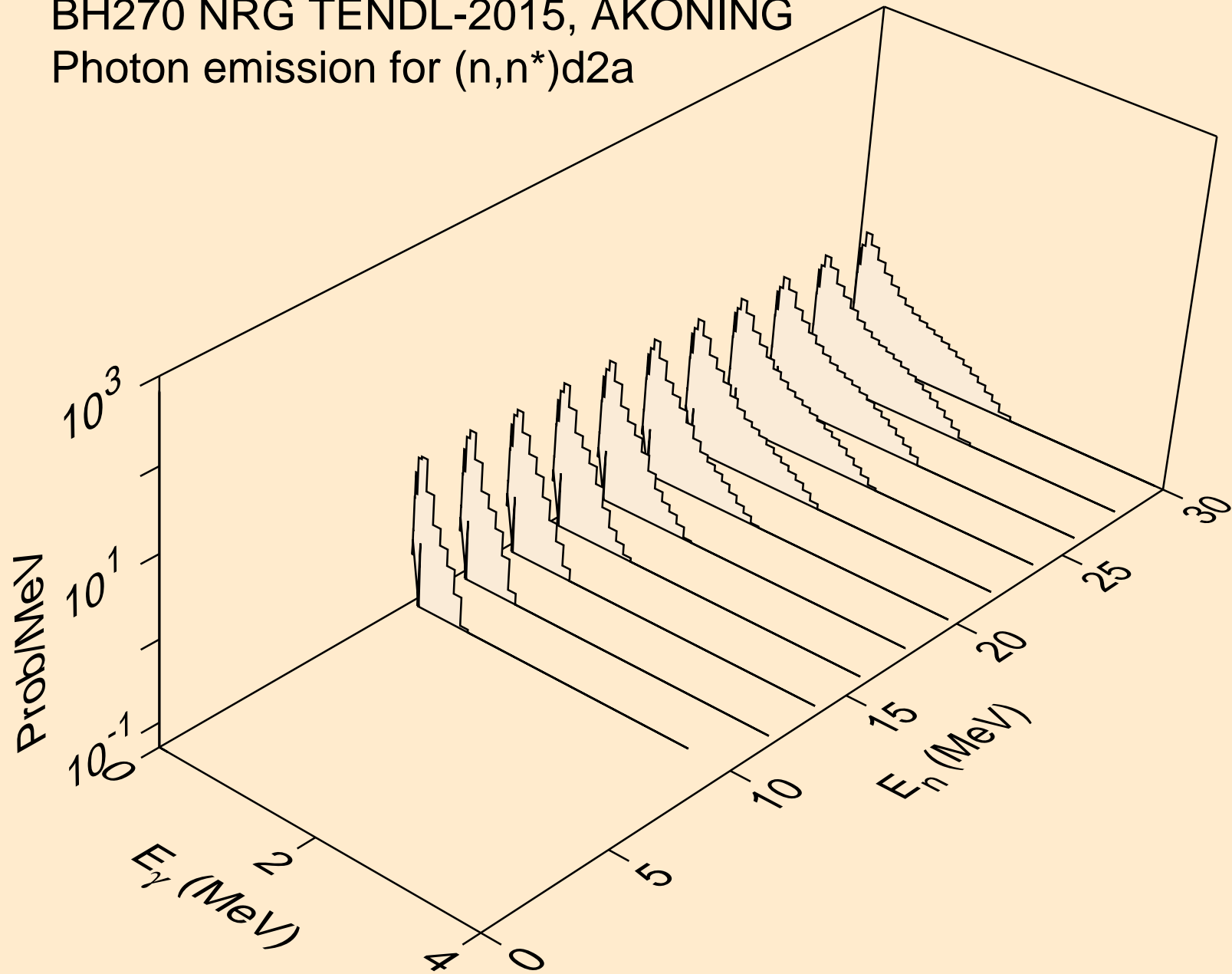

BH270 NRG TENDL-2015, AKONING  
Photon emission for (n,n\*)t2a

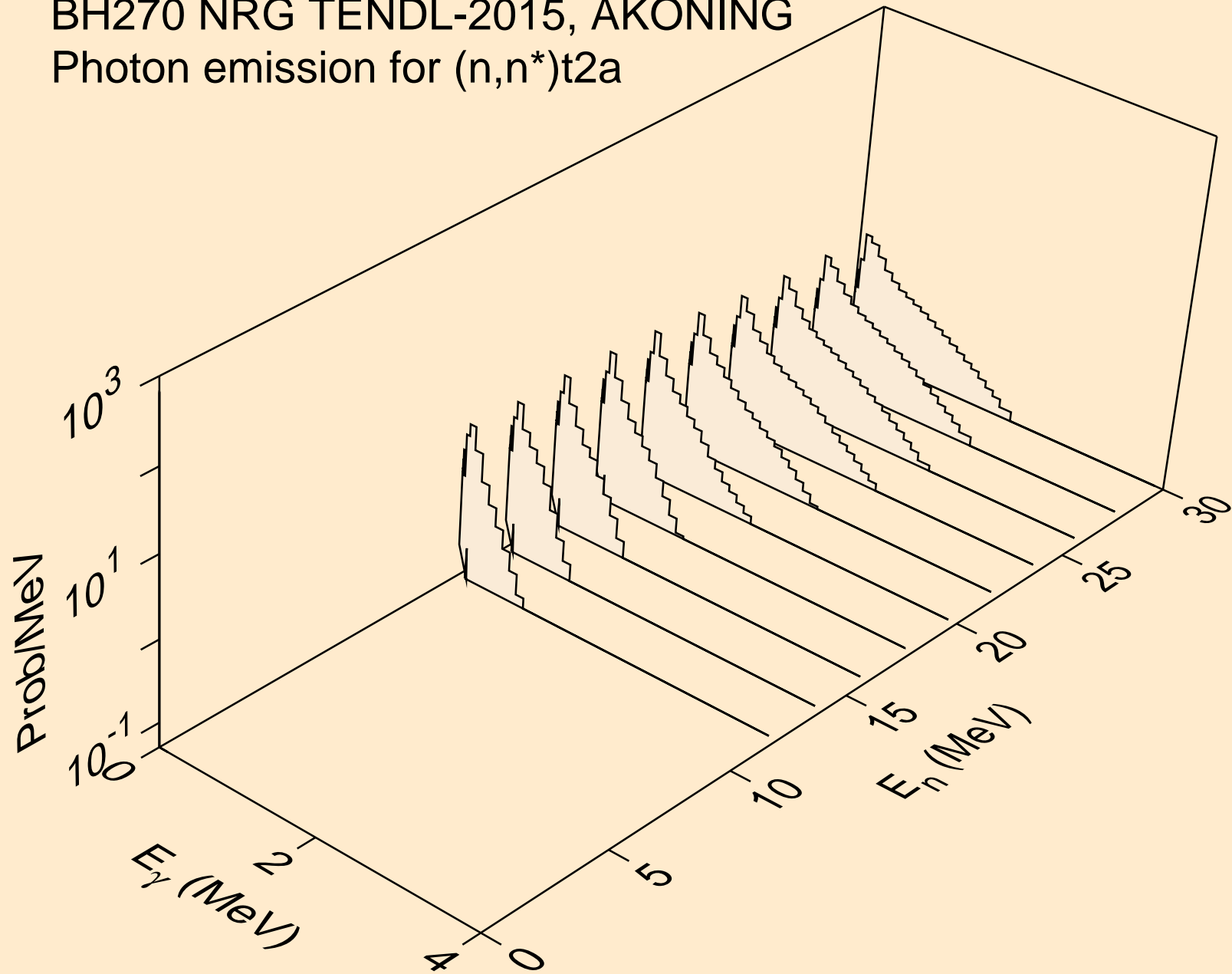

BH270 NRG TENDL-2015, AKONING  
Photon emission for (n,4n)

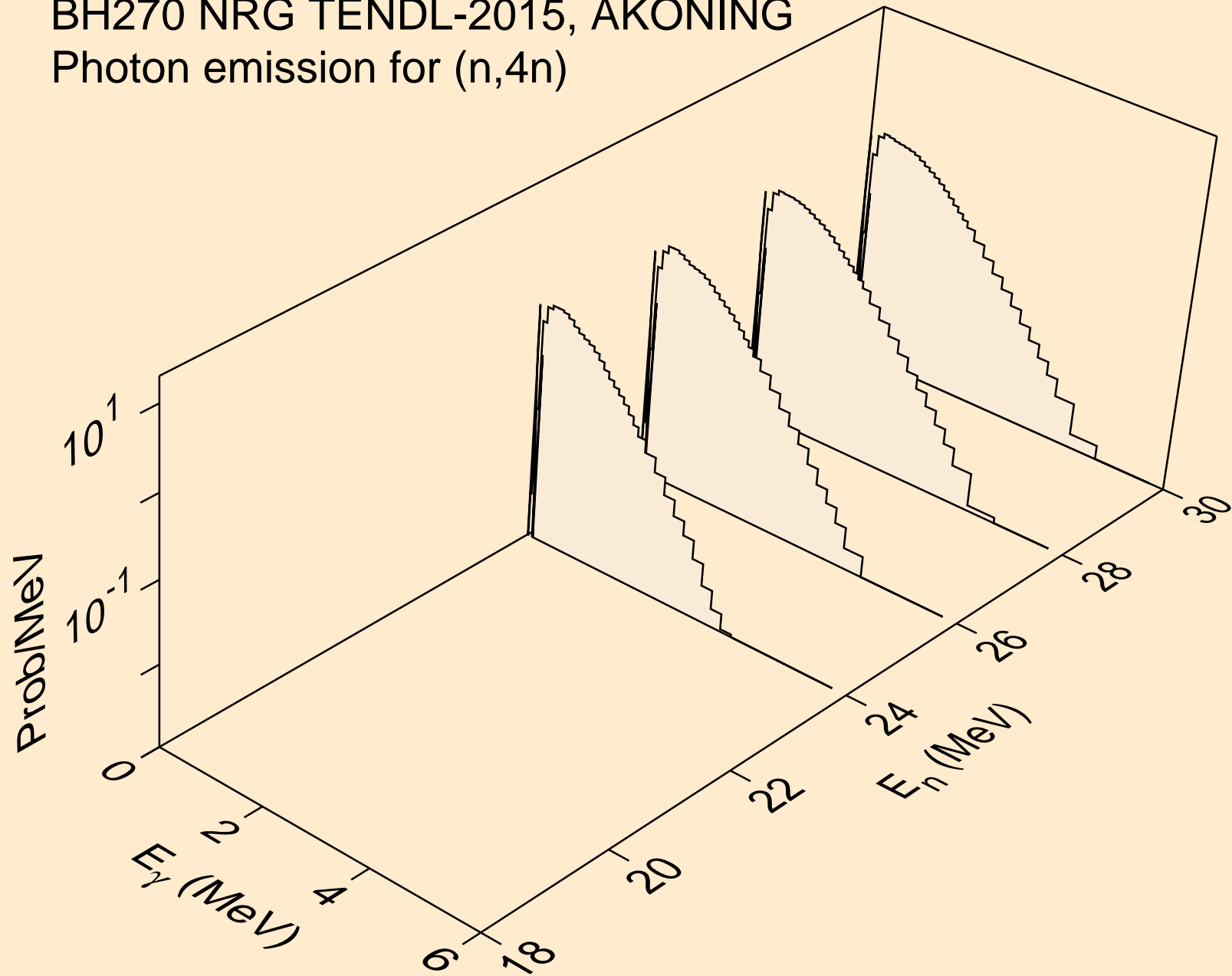

BH270 NRG TENDL-2015, AKONING  
Photon emission for (n,2np)

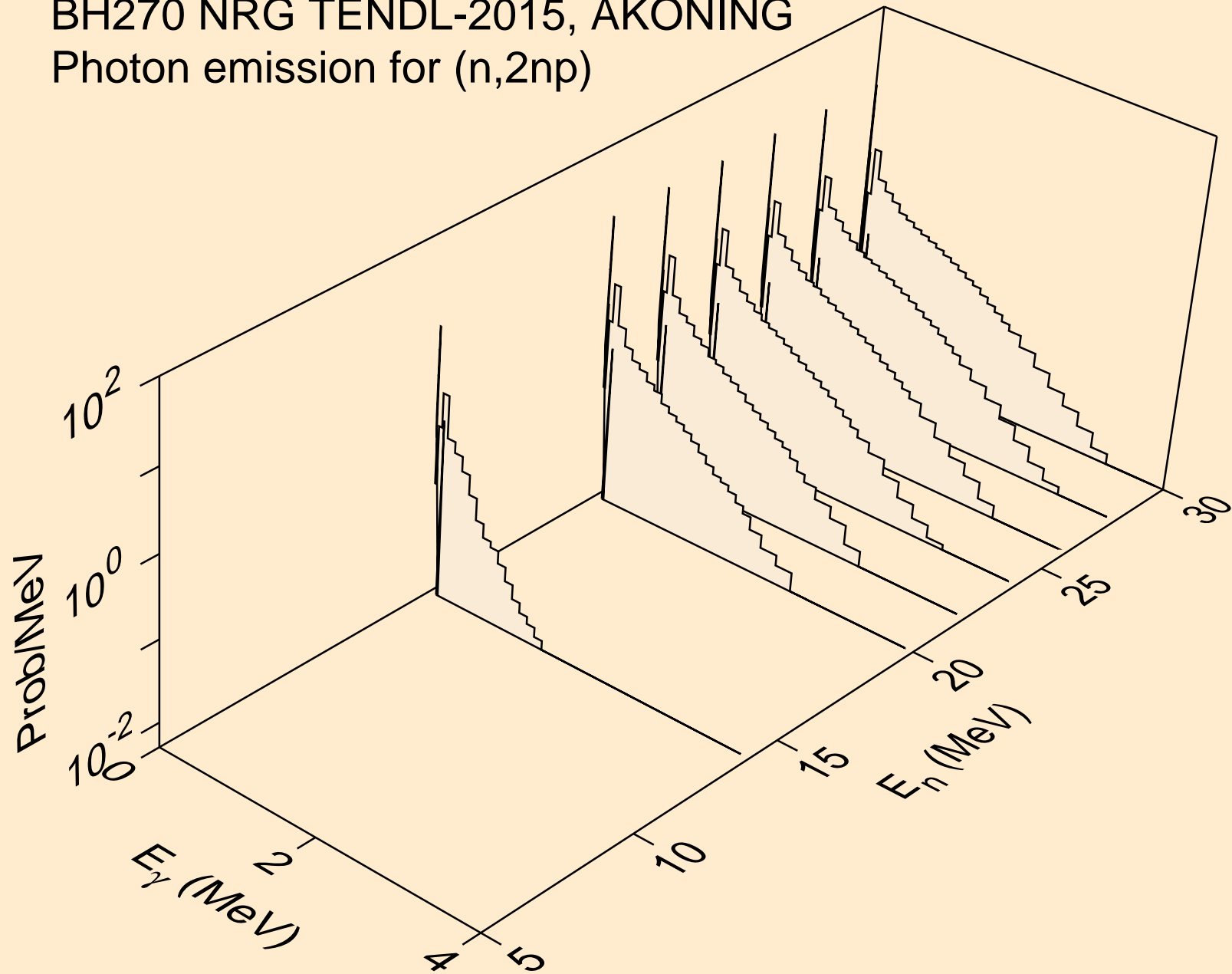

BH270 NRG TENDL-2015, AKONING  
Photon emission for (n,3np)

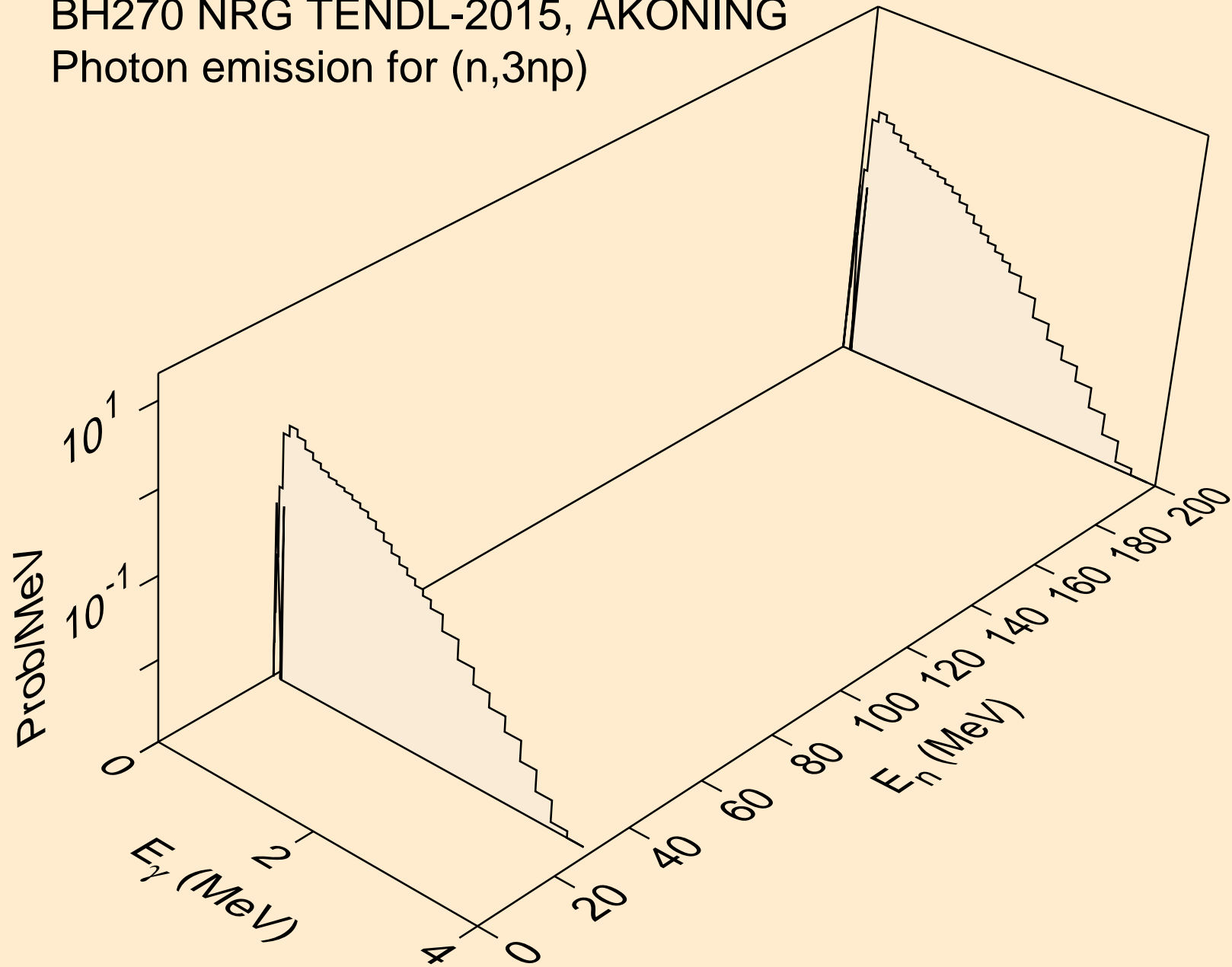

BH270 NRG TENDL-2015, AKONING  
Photon emission for (n,2np)

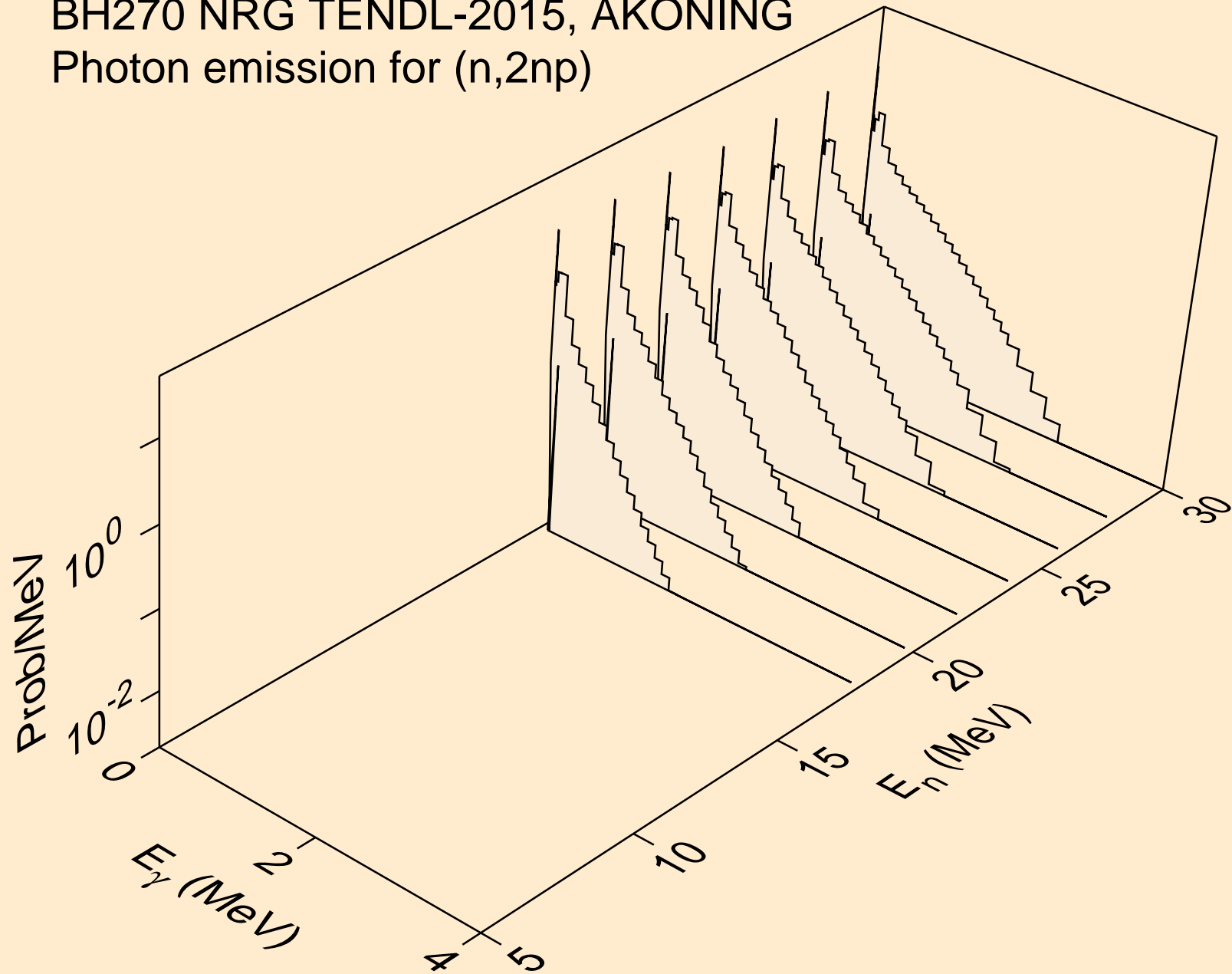

BH270 NRG TENDL-2015, AKONING  
Photon emission for (n,npa)

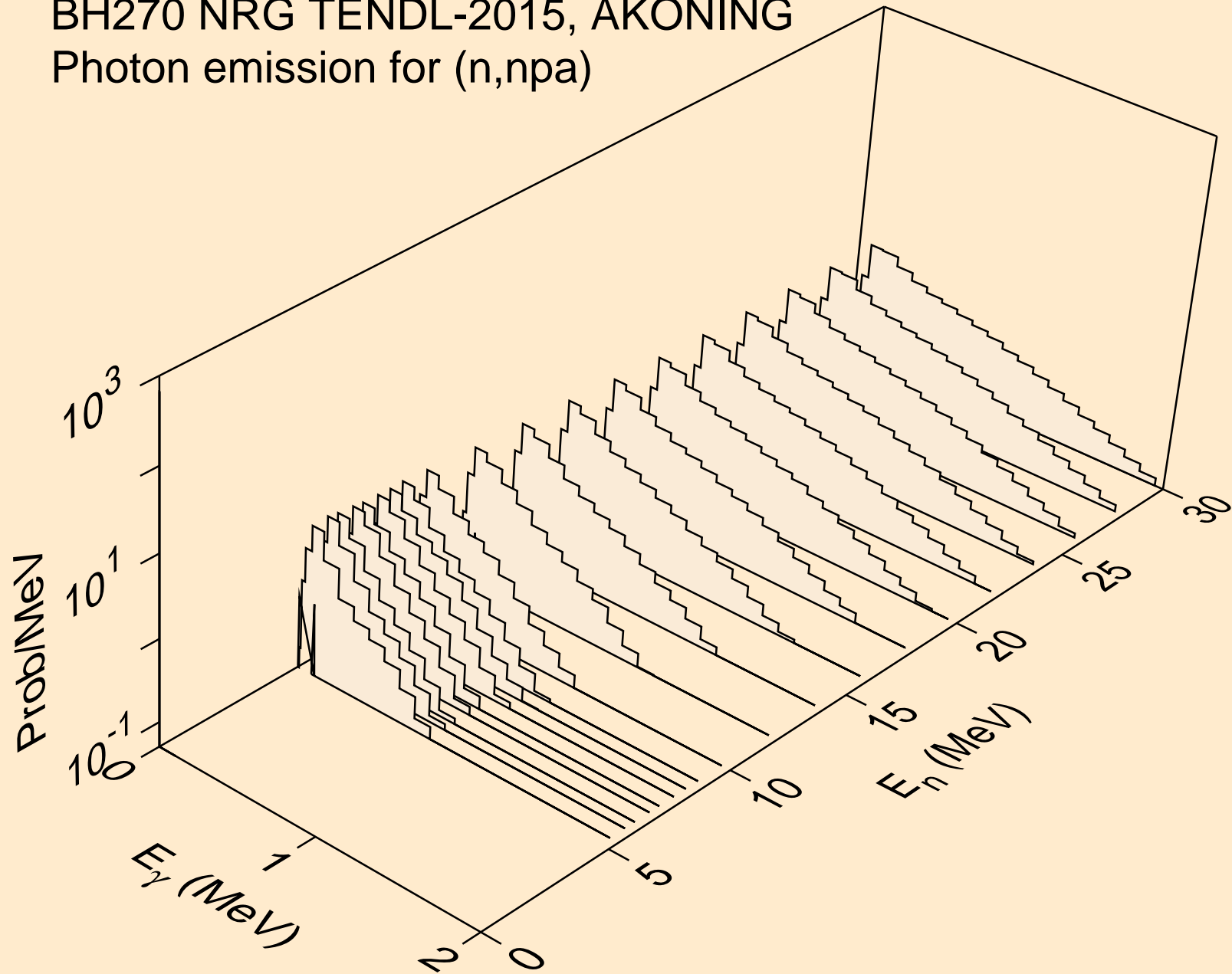

BH270 NRG TENDL-2015, AKONING  
Photon emission for (n,n\*c)

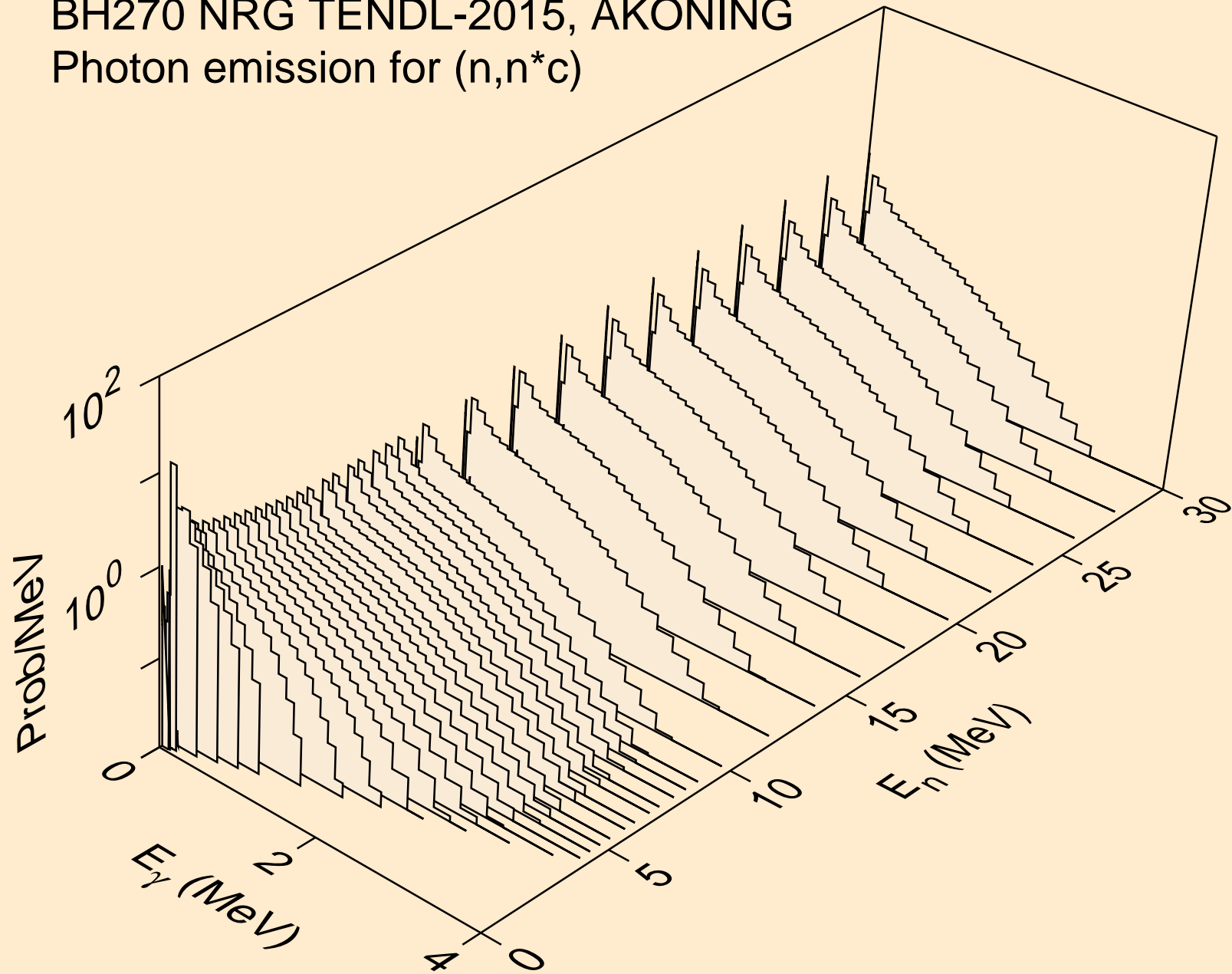



BH270 NRG TENDL-2015, AKONING  
Photon emission for (n,gma)

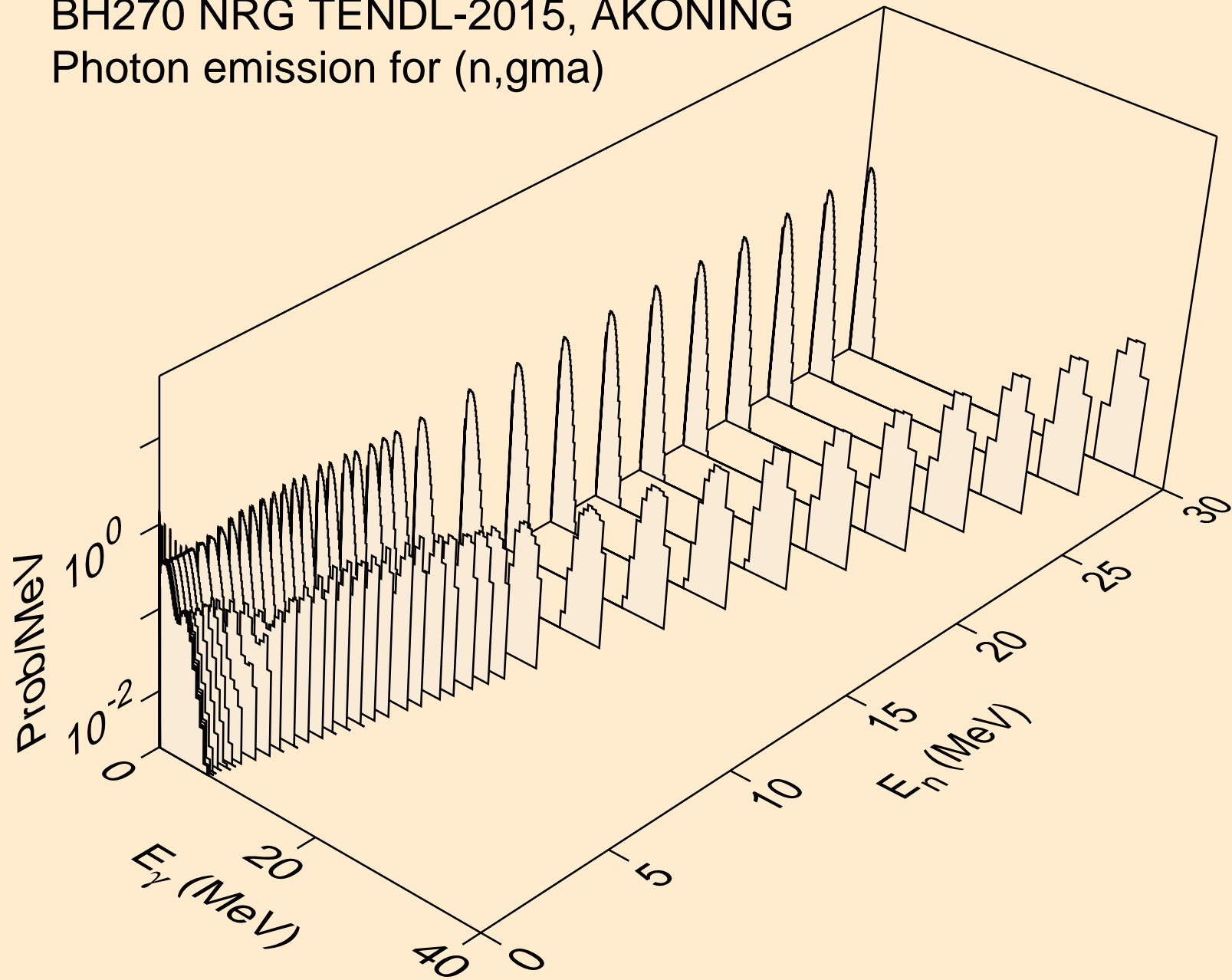

BH270 NRG TENDL-2015, AKONING  
Photon emission for (n,p)

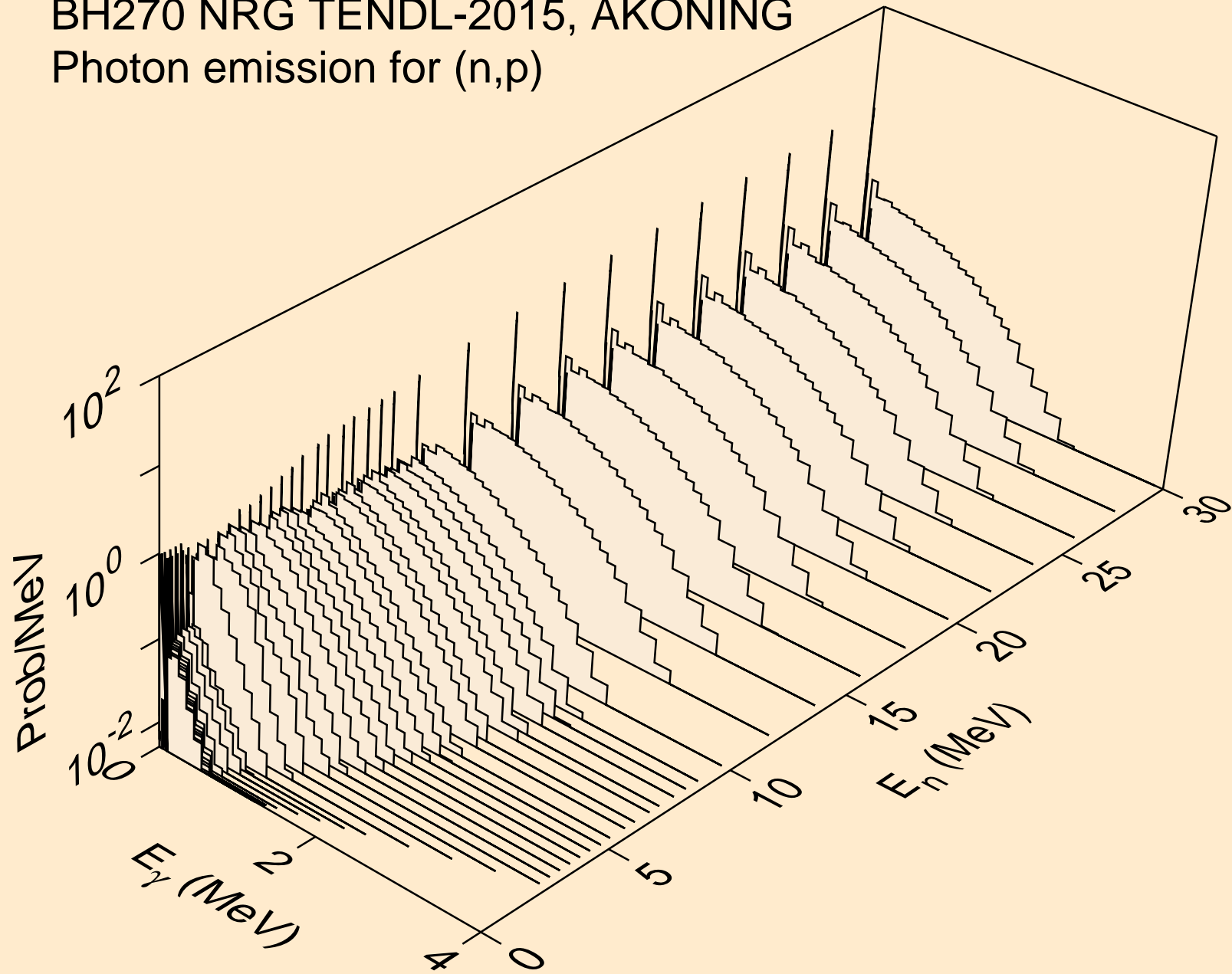

BH270 NRG TENDL-2015, AKONING  
Photon emission for (n,d)

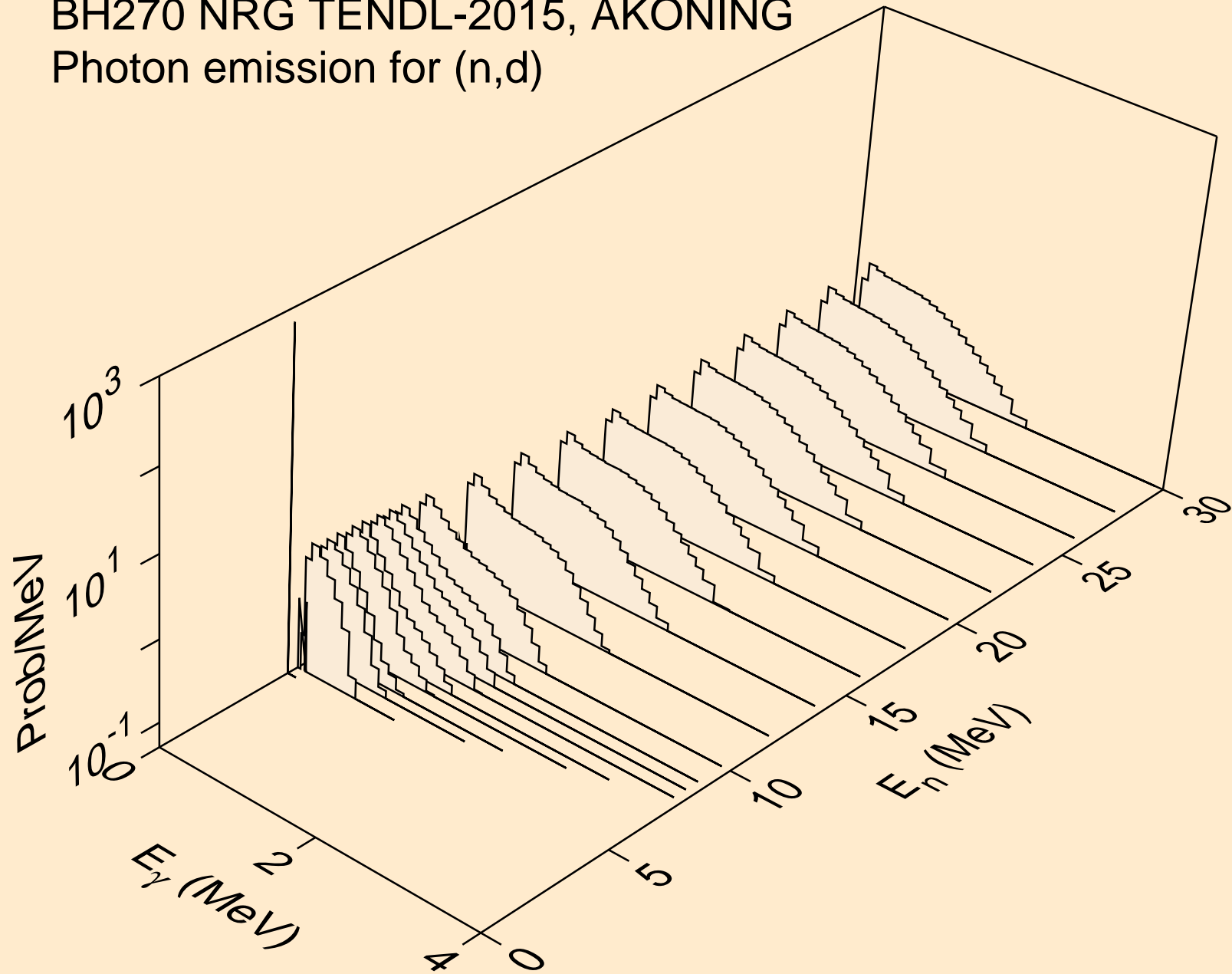

BH270 NRG TENDL-2015, AKONING  
Photon emission for (n,t)

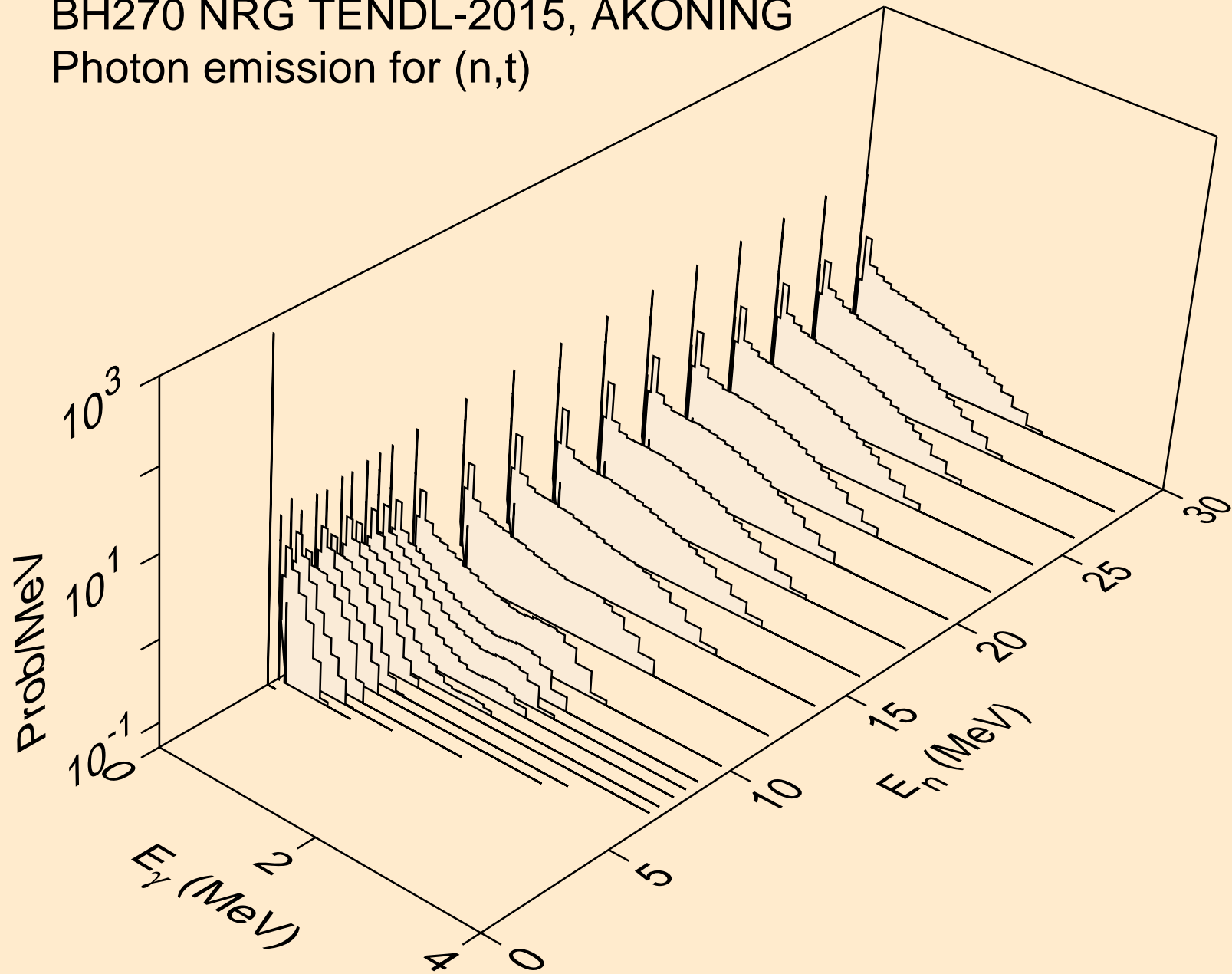

BH270 NRG TENDL-2015, AKONING  
Photon emission for (n,he3)

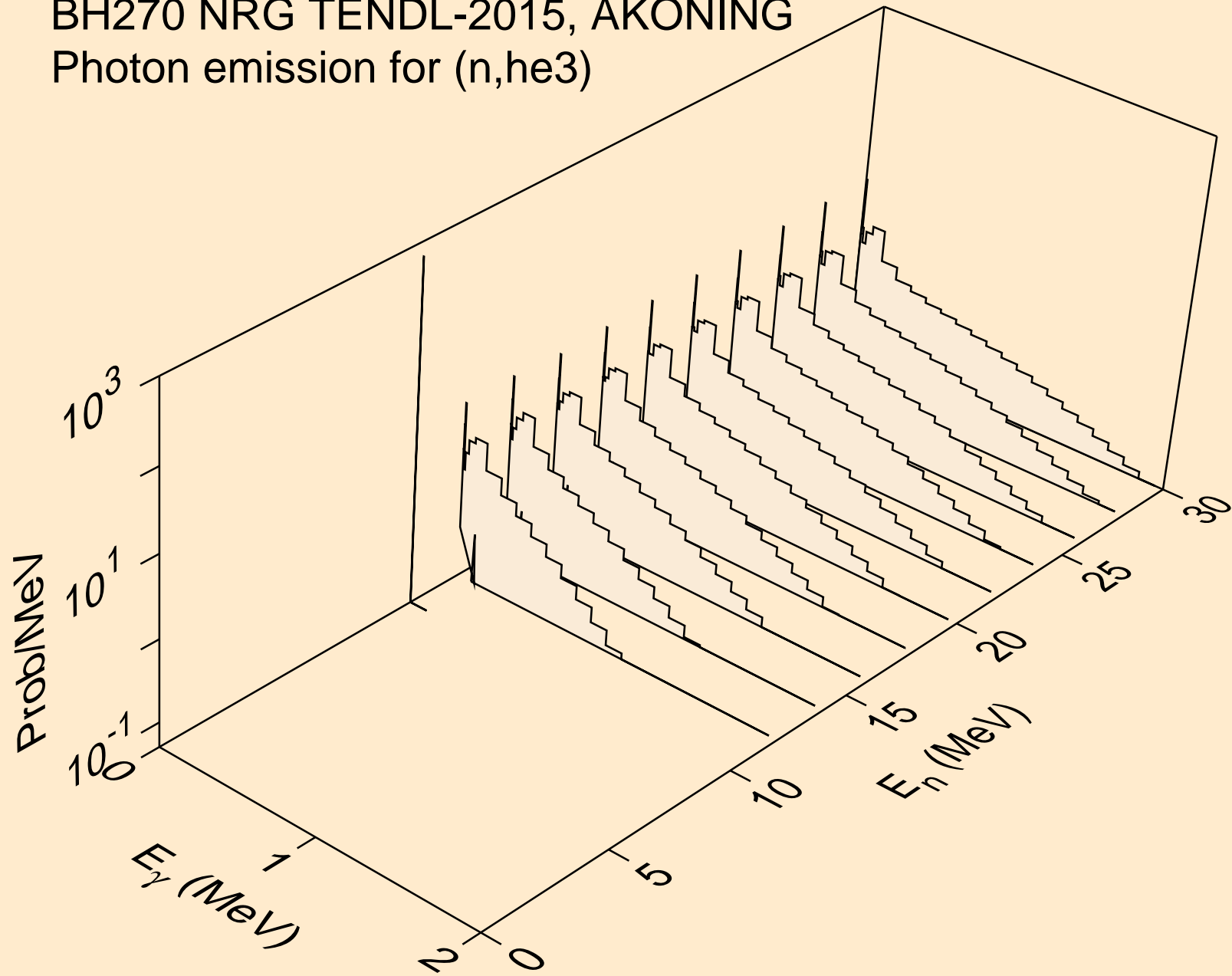

BH270 NRG TENDL-2015, AKONING  
Photon emission for (n,a)

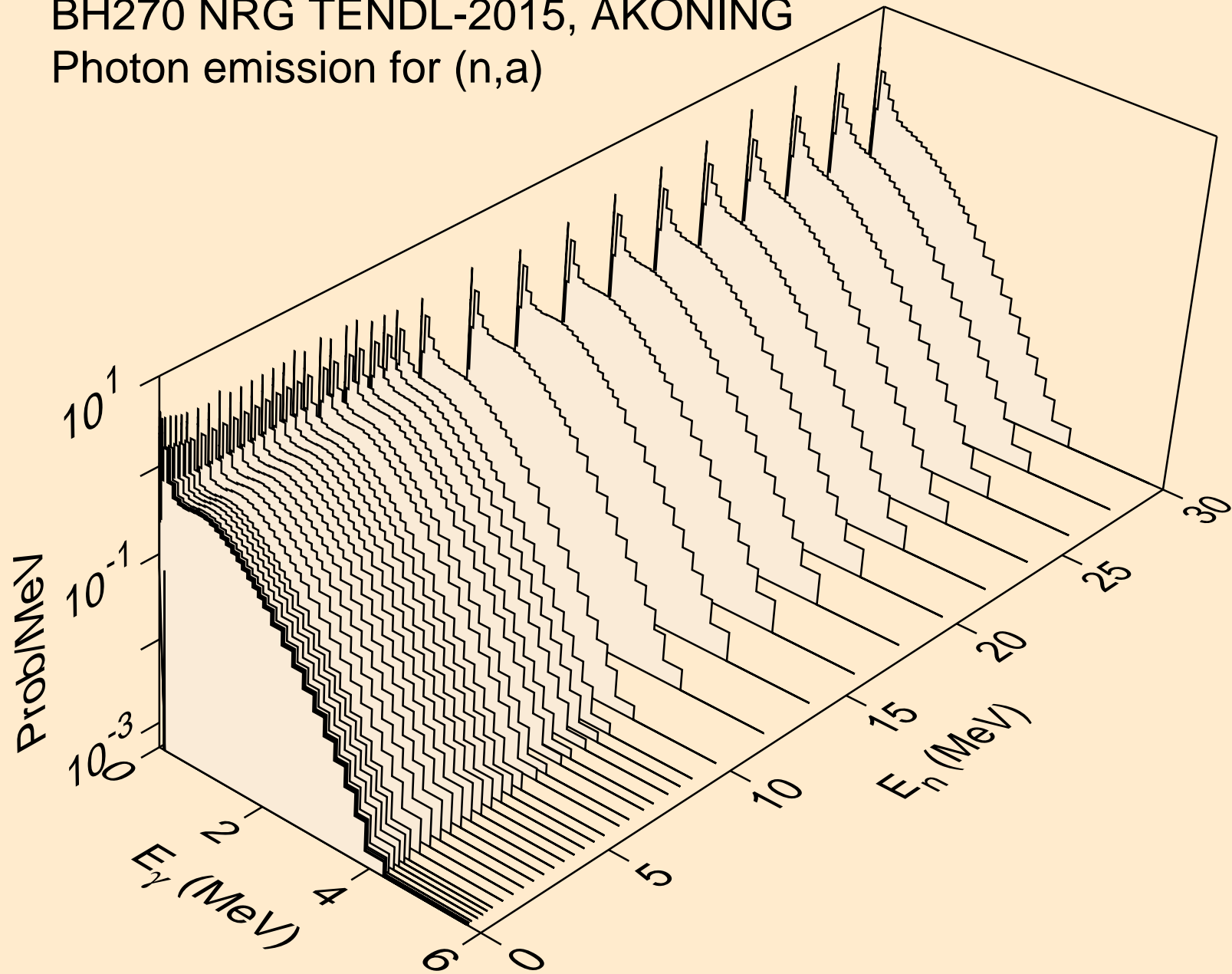

BH270 NRG TENDL-2015, AKONING  
Photon emission for (n,2a)

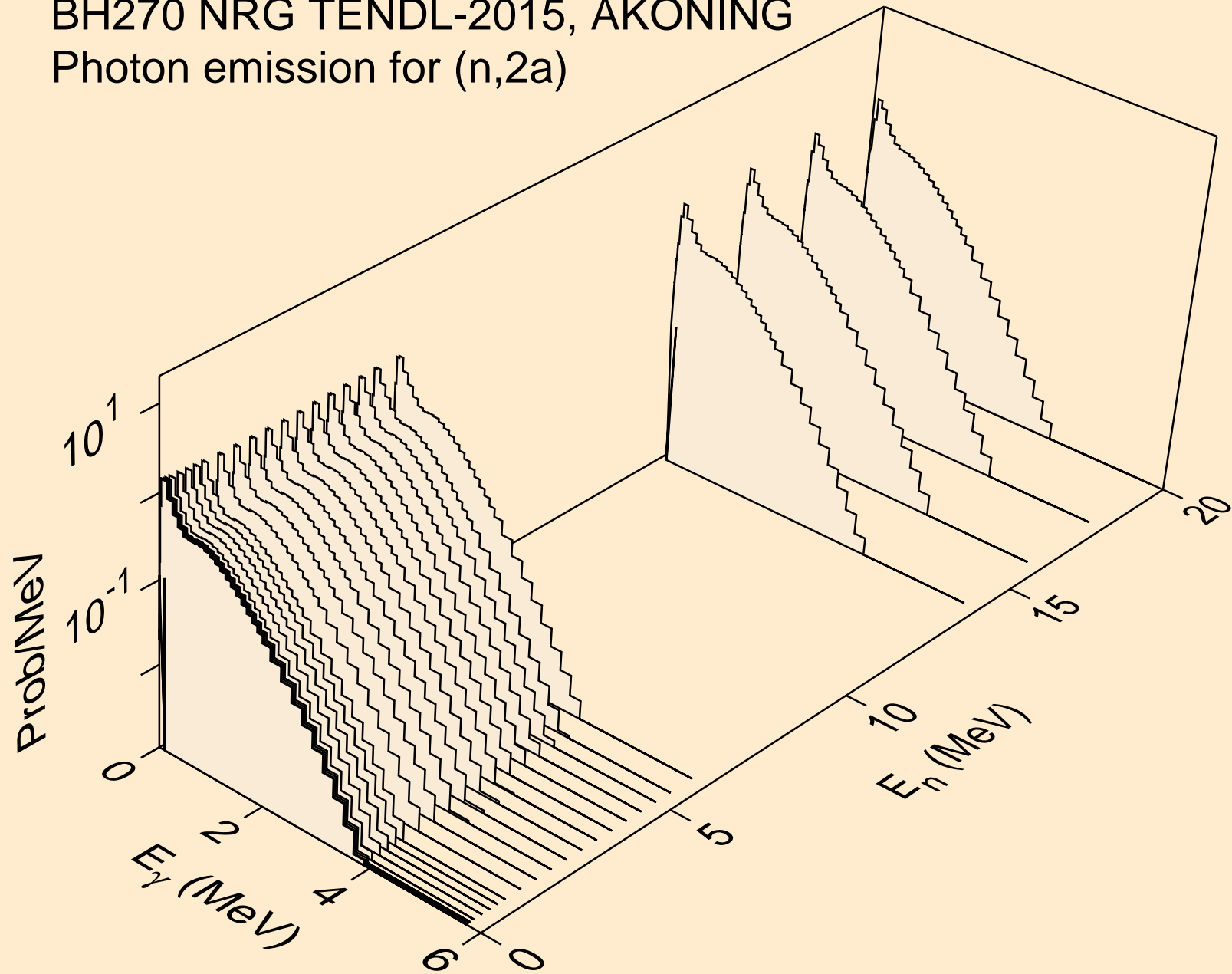

BH270 NRG TENDL-2015, AKONING  
Photon emission for (n,3a)

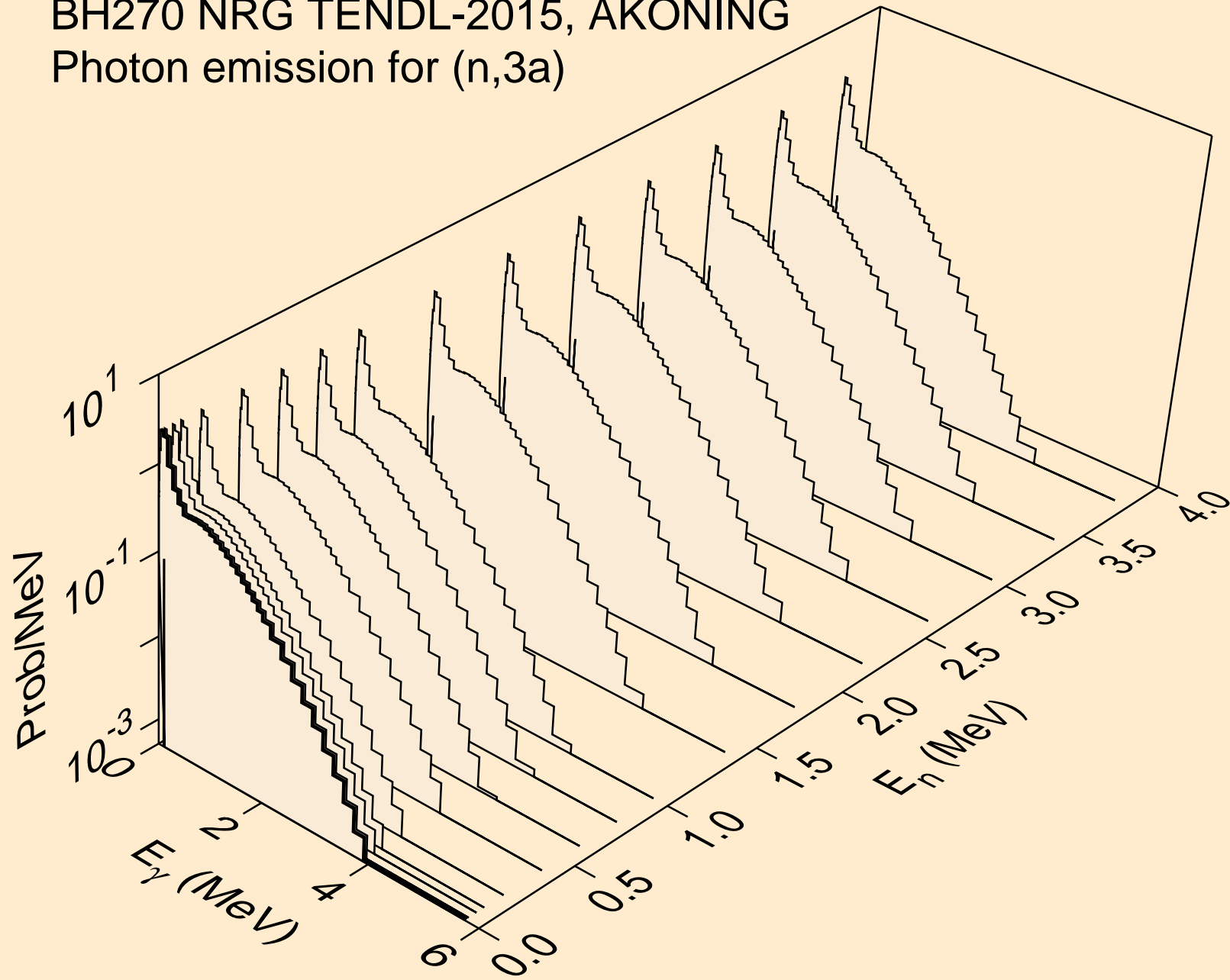



BH270 NRG TENDL-2015, AKONING  
Photon emission for (n,2p)

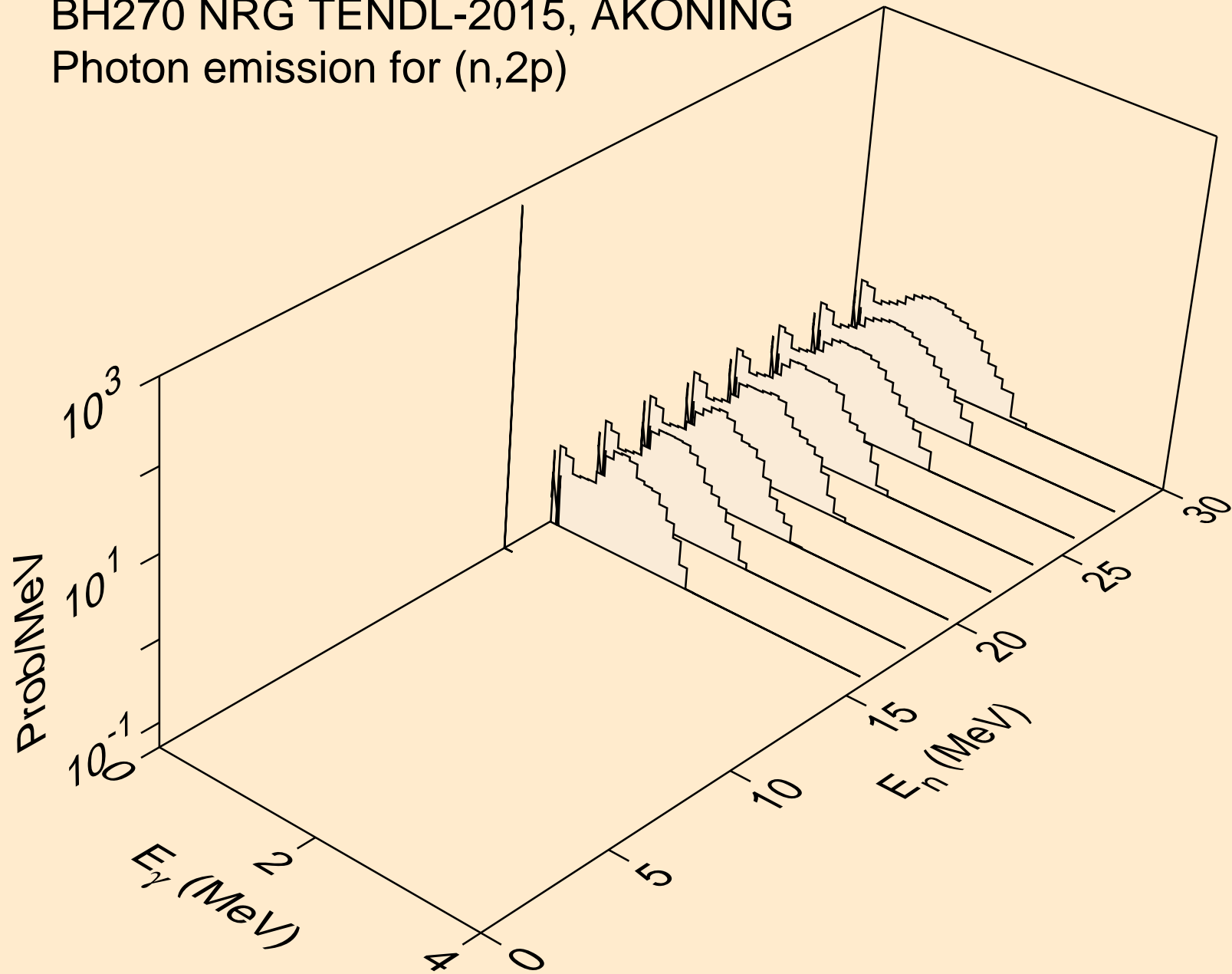

BH270 NRG TENDL-2015, AKONING  
Photon emission for (n,p)

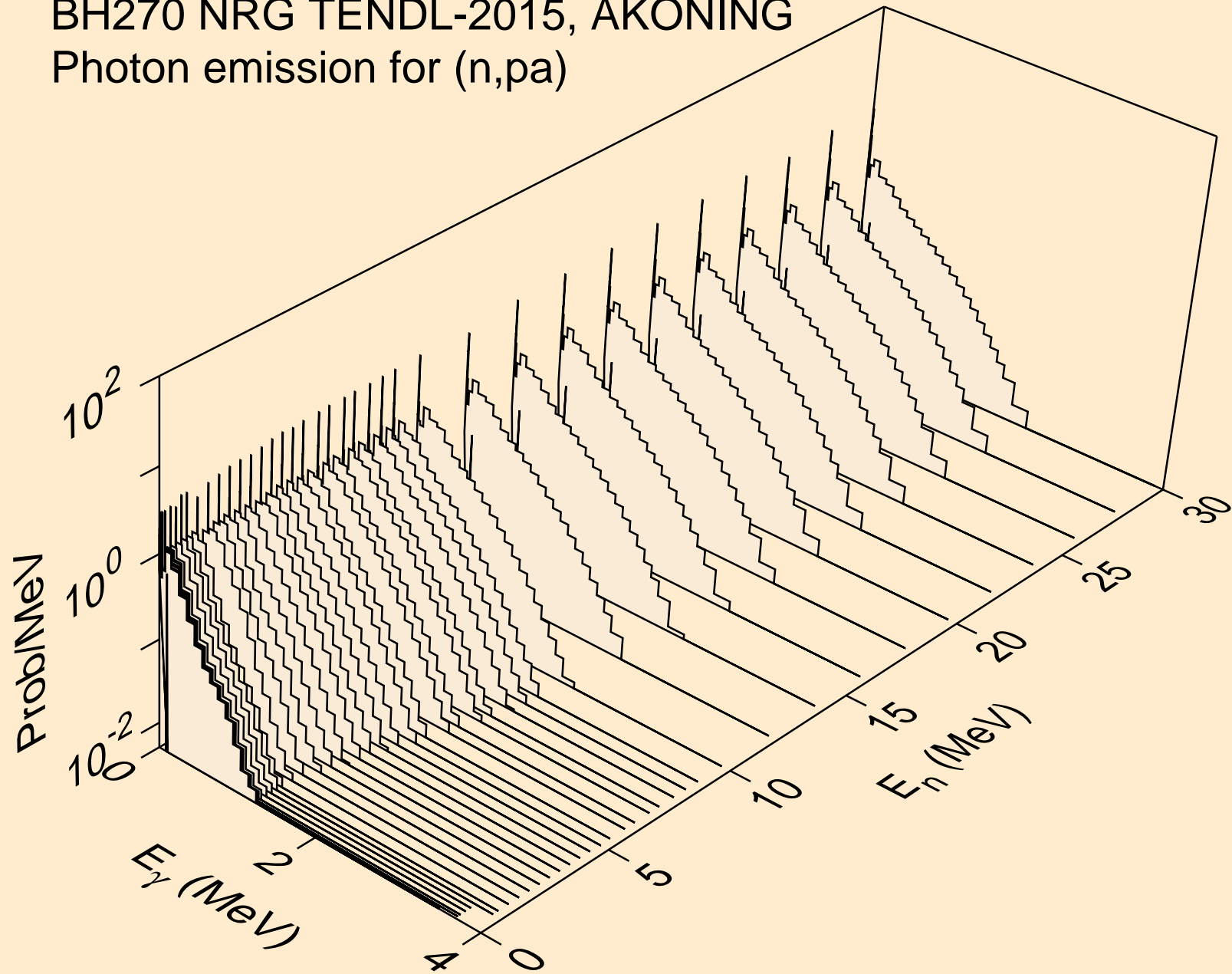

BH270 NRG TENDL-2015, AKONING  
Photon emission for (n,t2a)

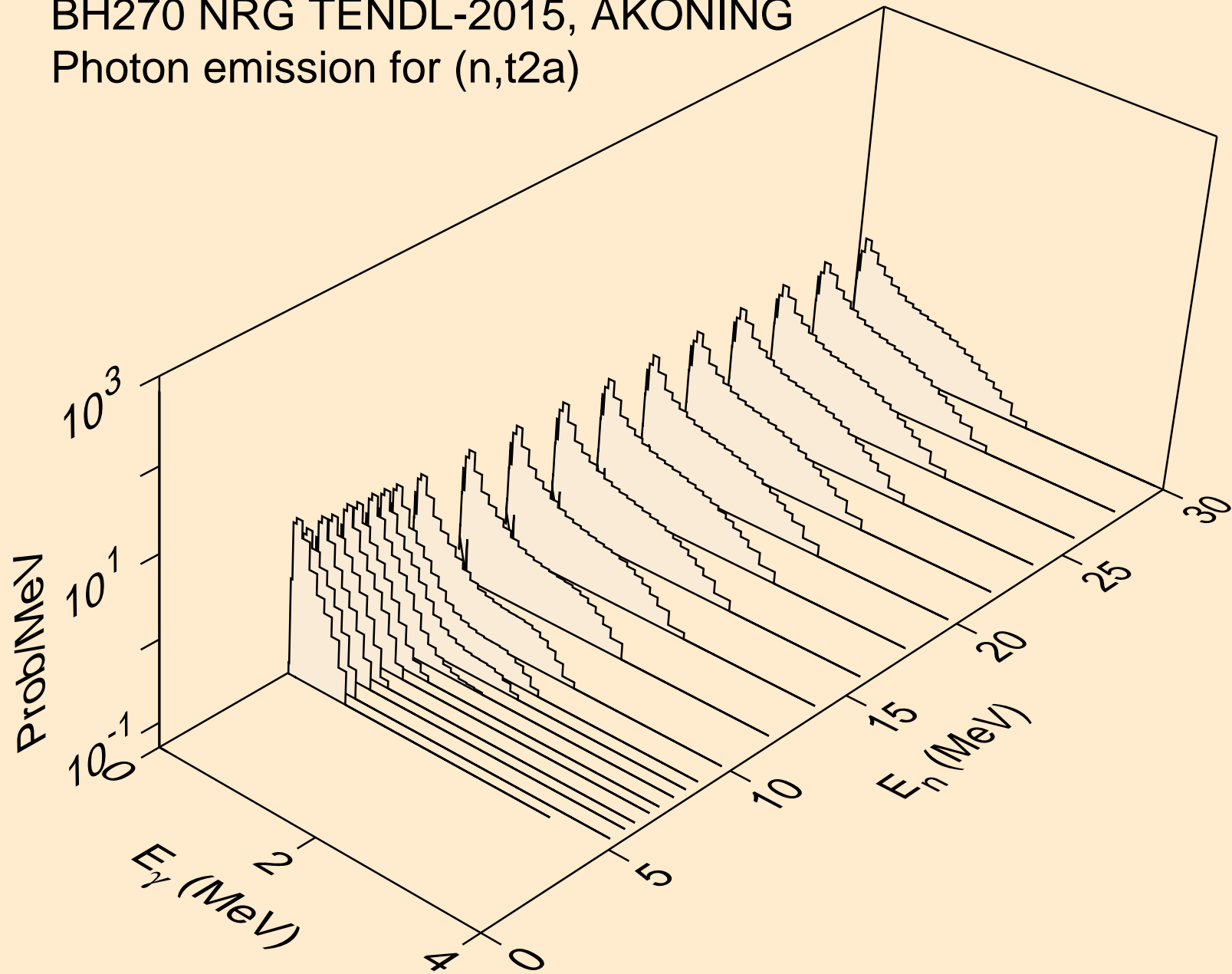

BH270 NRG TENDL-2015, AKONING  
Photon emission for (n,d2a)

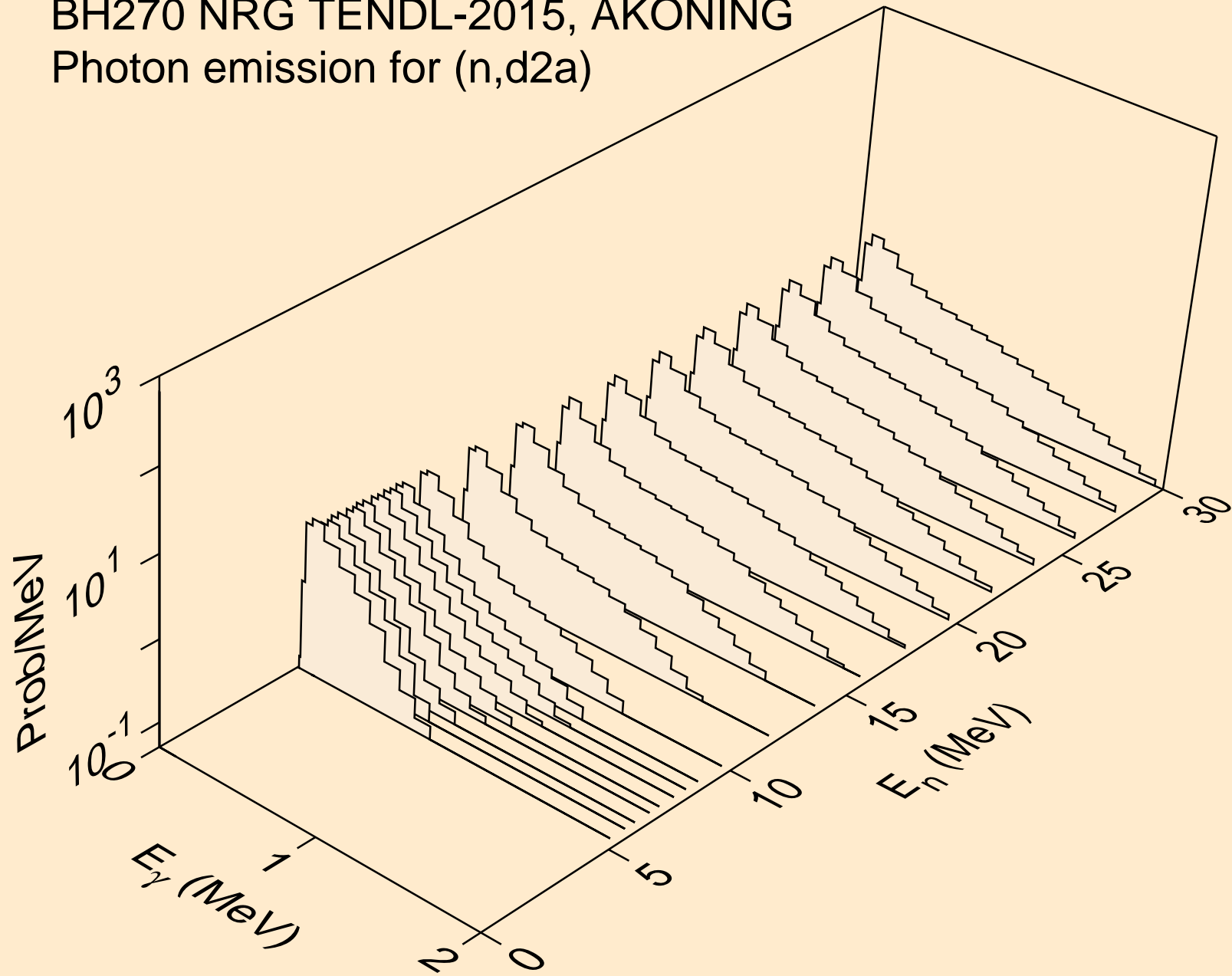

BH270 NRG TENDL-2015, AKONING  
Photon emission for (n,da)

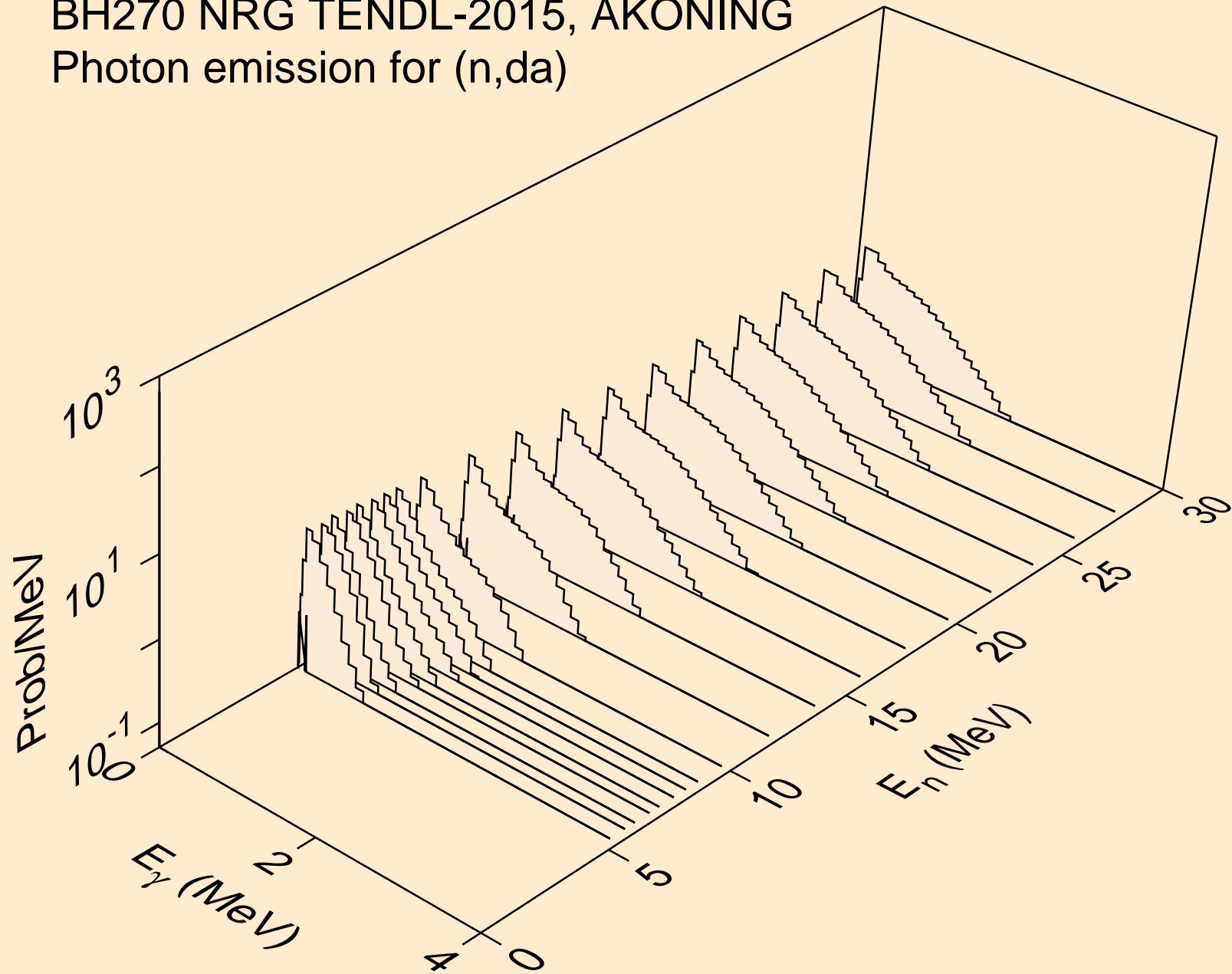

BH270 NRG TENDL-2015, AKONING  
thermal capture photon spectrum

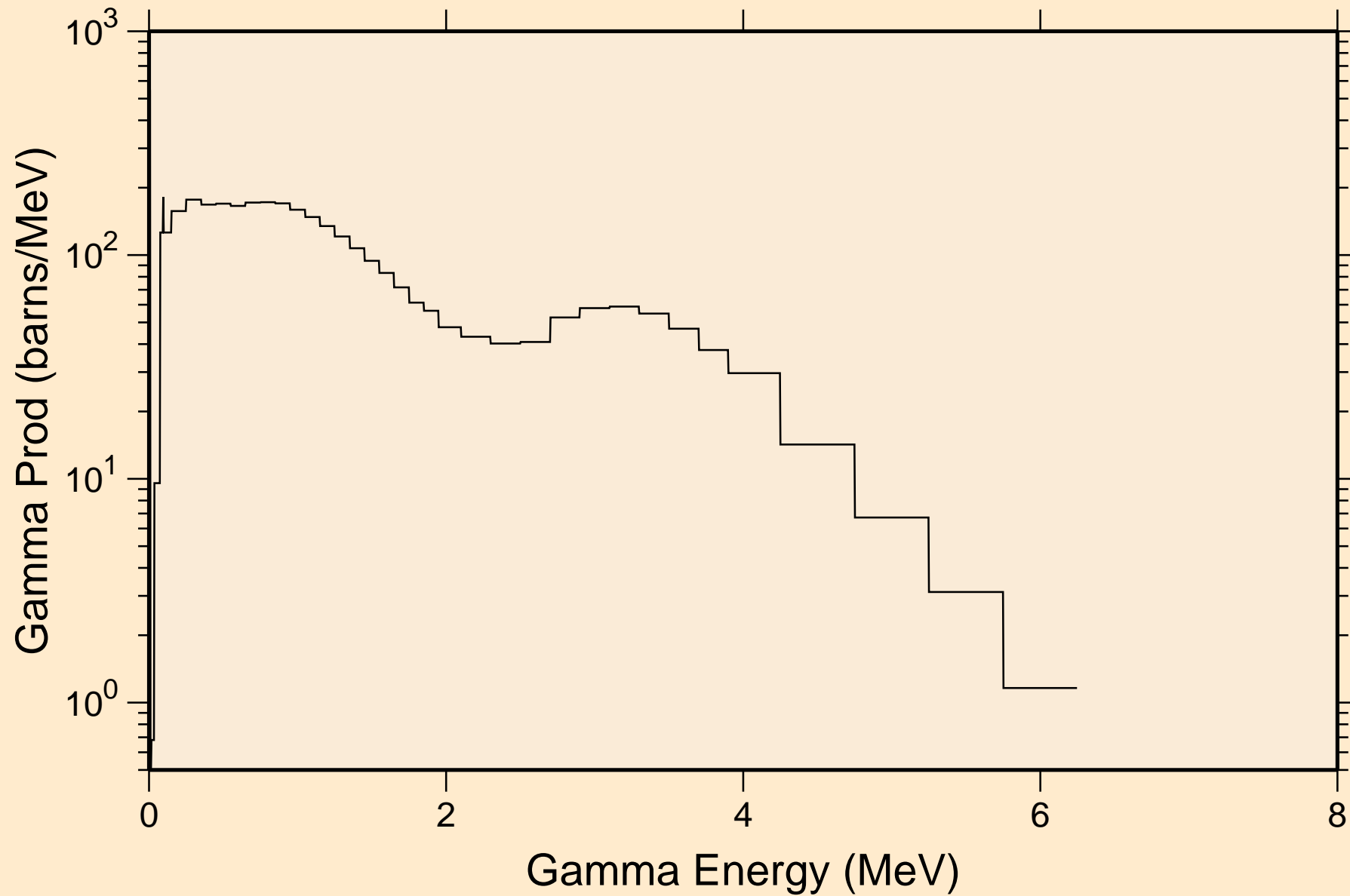

BH270 NRG TENDL-2015, AKONING  
14 MeV photon spectrum

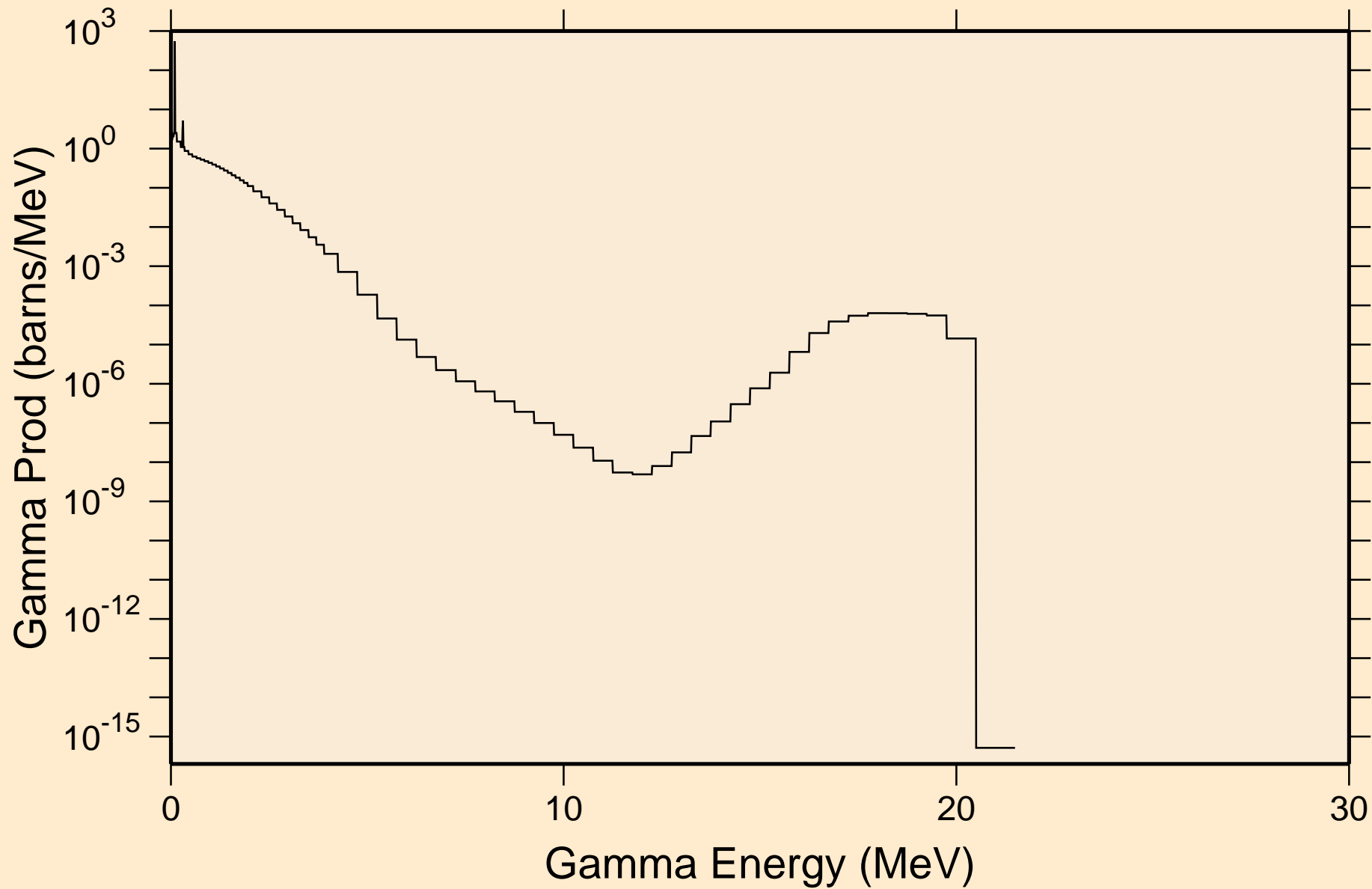

# BH270 NRG TENDL-2015, AKONING

## Particle heating contributions

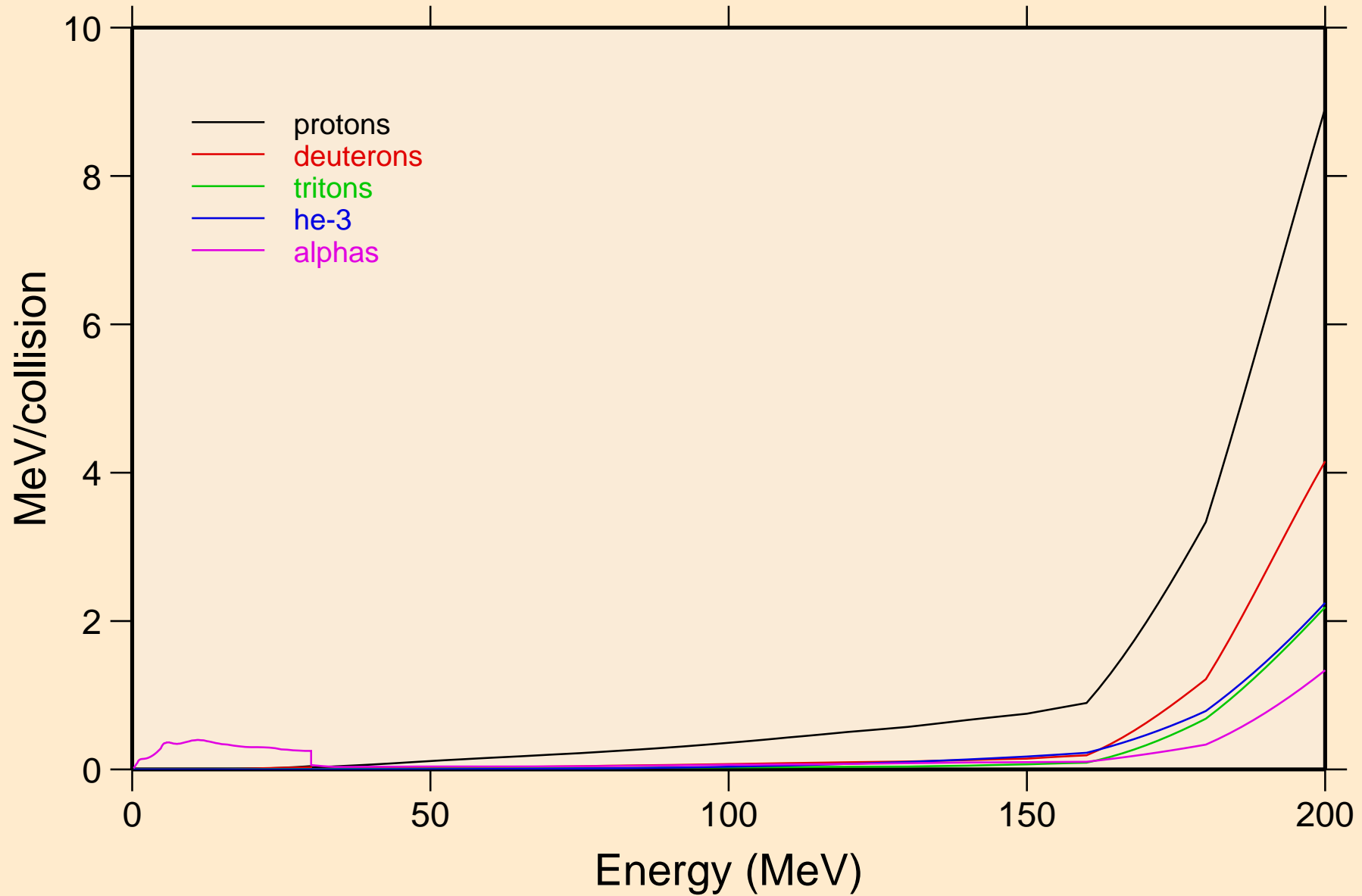



# BH270 NRG TENDL-2015, AKONING

## Recoil Heating

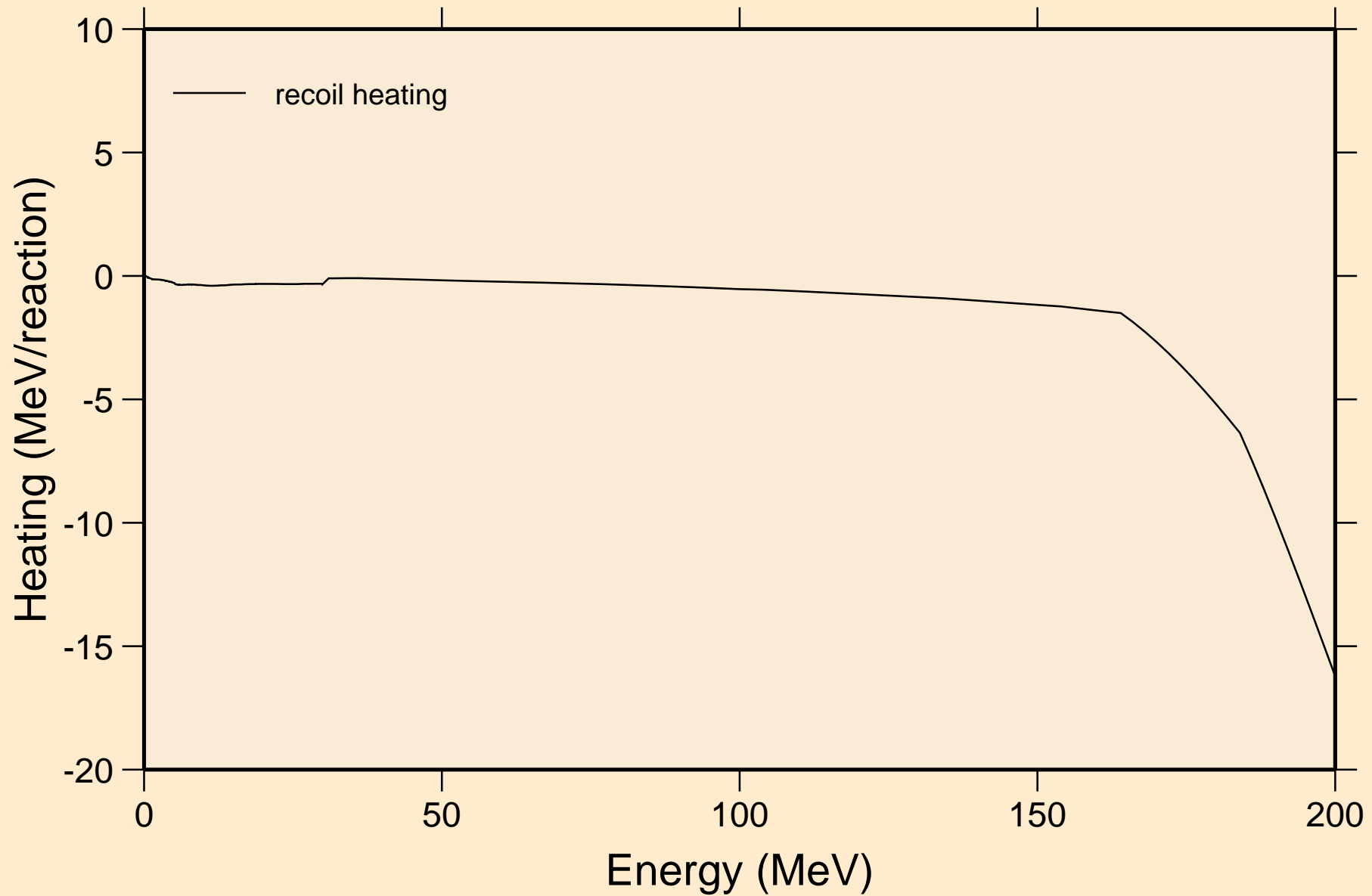

# BH270 NRG TENDL-2015, AKONING

## Particle production cross sections

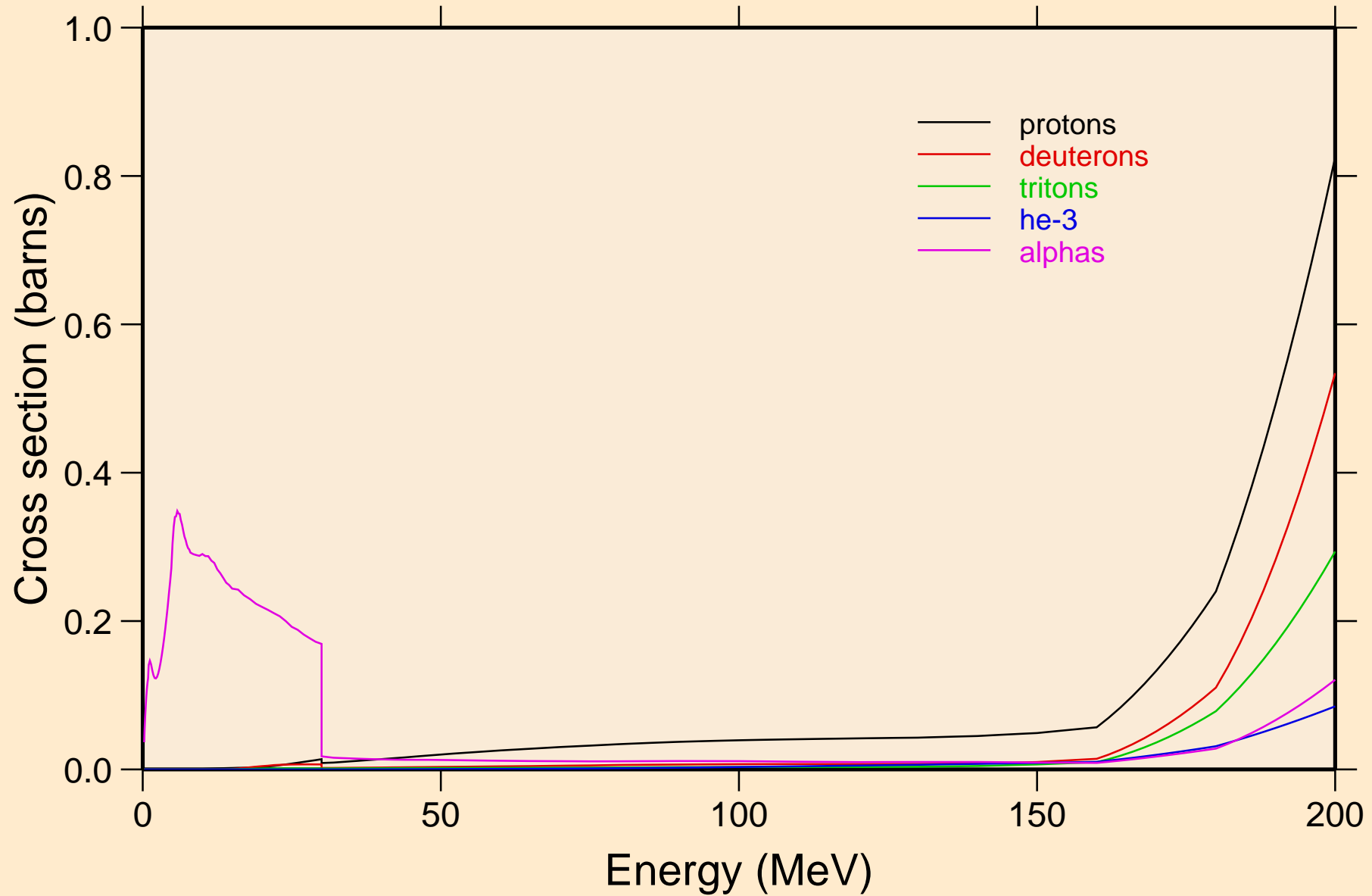

BH270 NRG TENDL-2015, AKONING  
protons from (n,x)

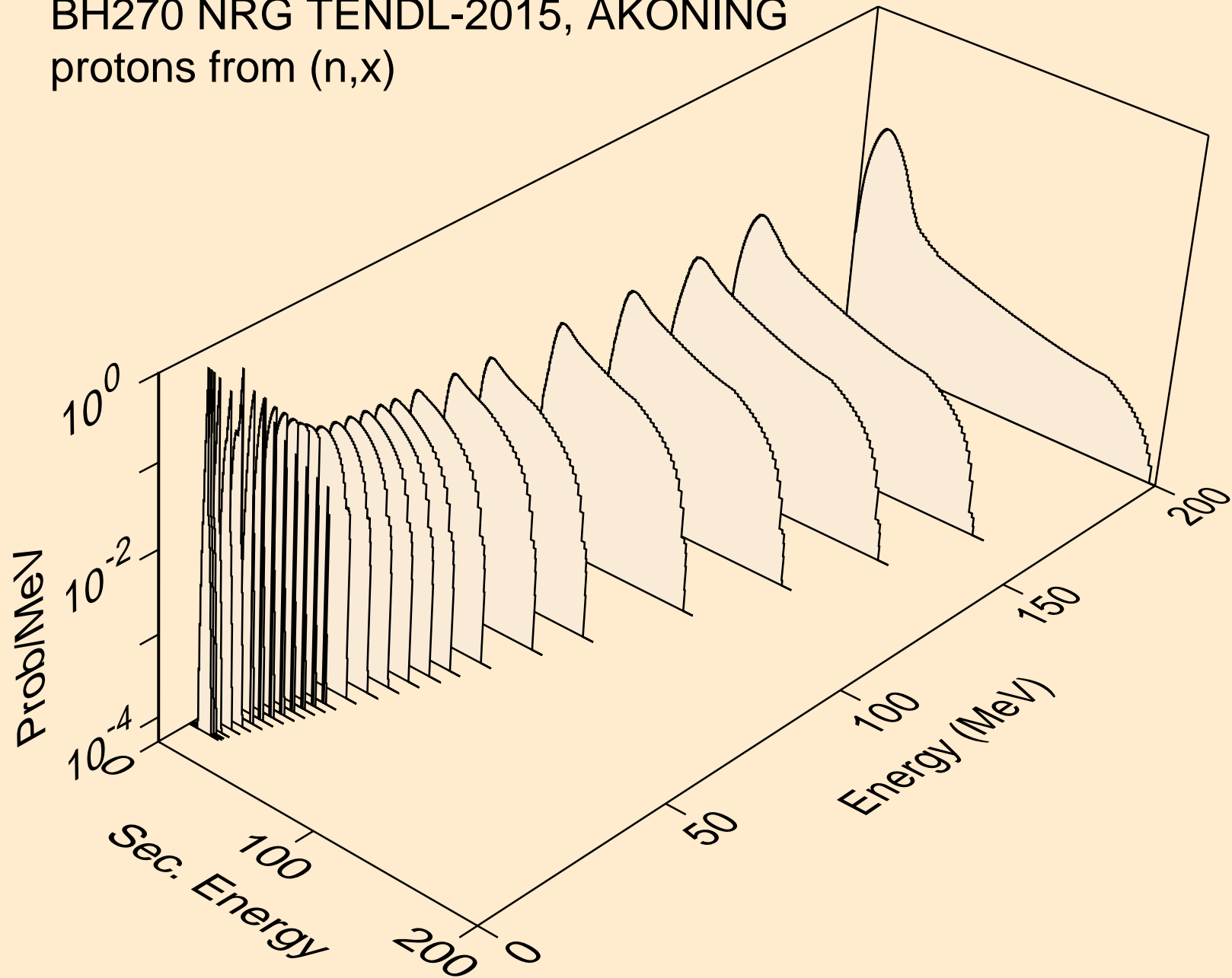

BH270 NRG TENDL-2015, AKONING  
protons from (n,n\*)p

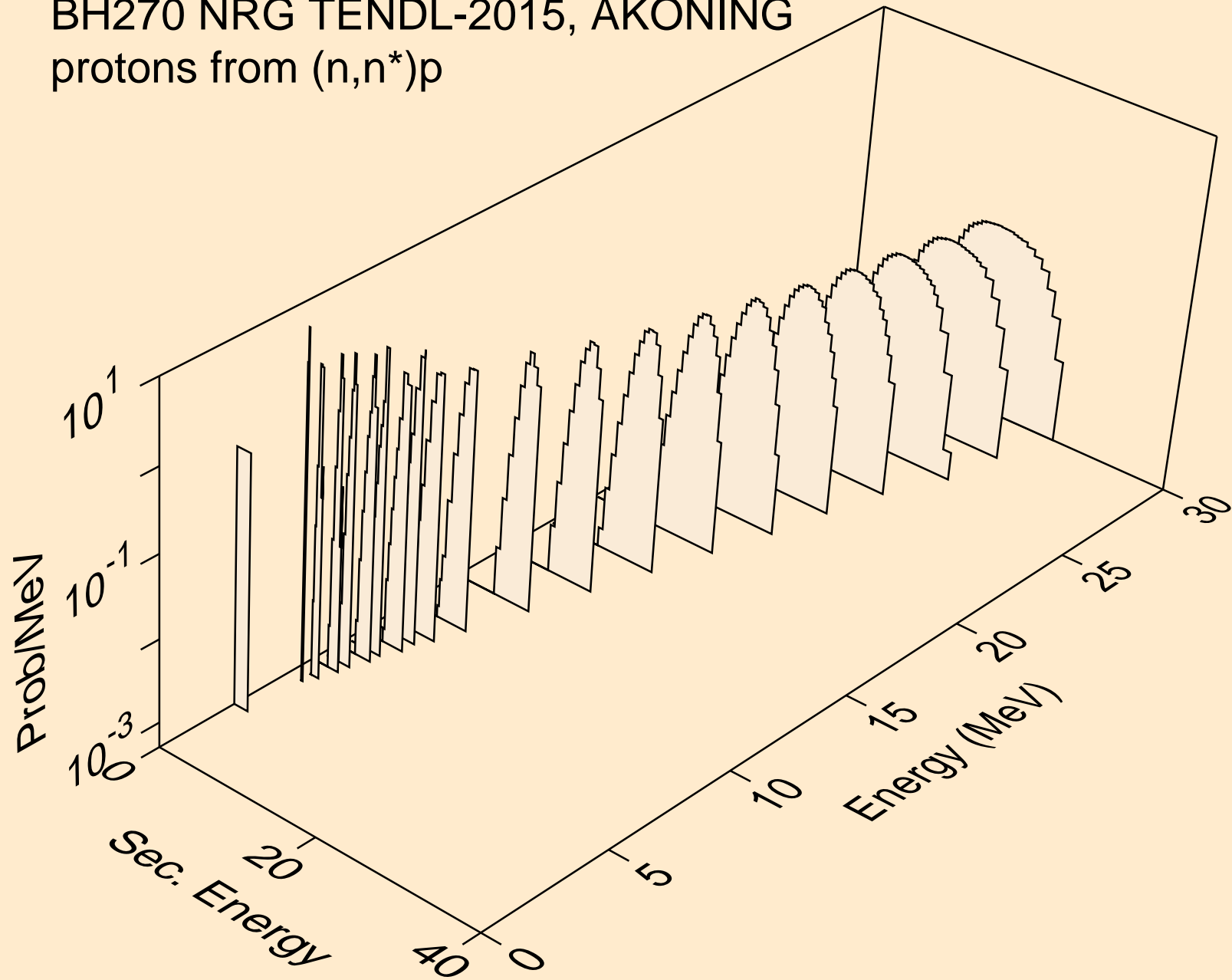

BH270 NRG TENDL-2015, AKONING  
protons from (n,2np)

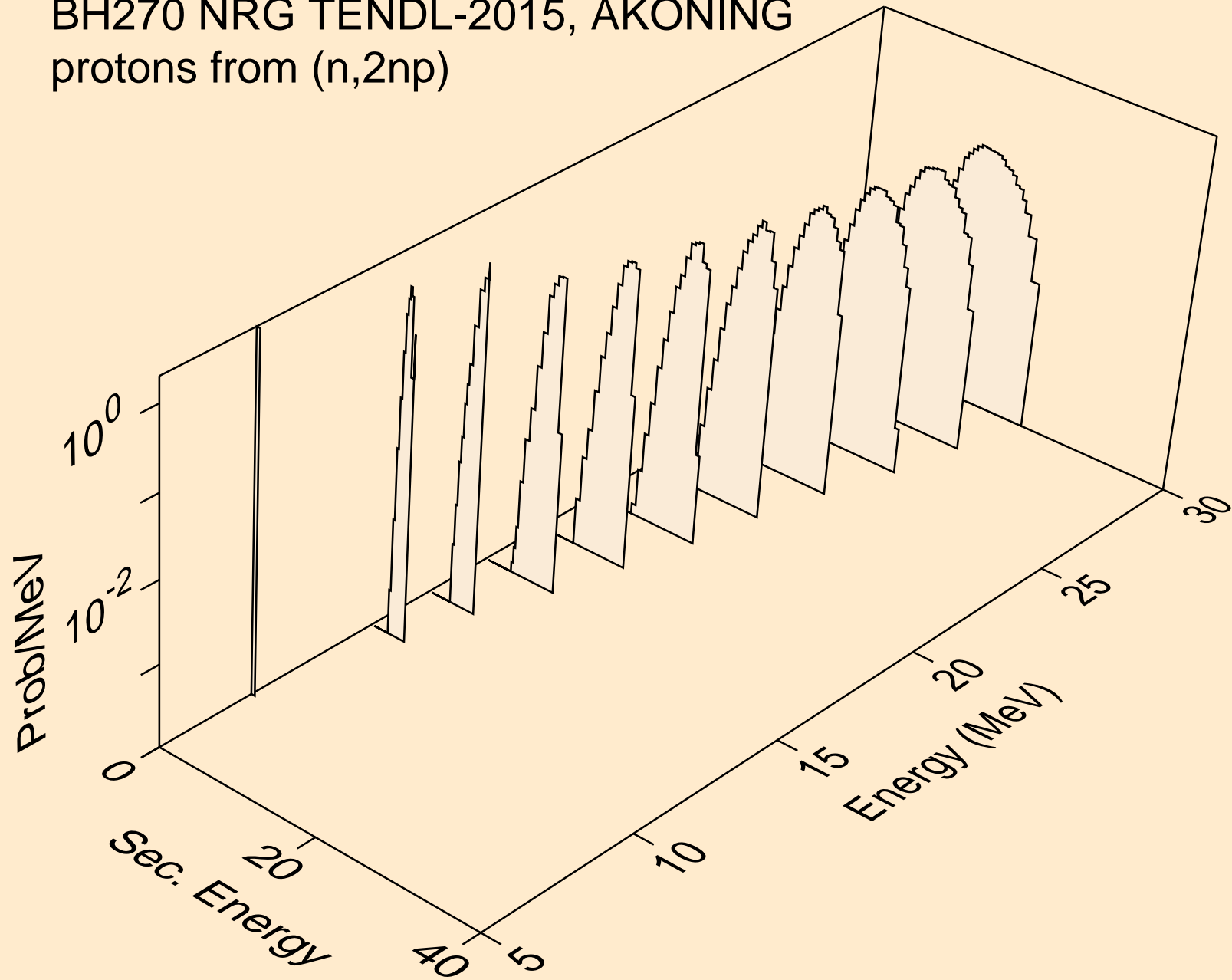

BH270 NRG TENDL-2015, AKONING  
protons from (n,3np)

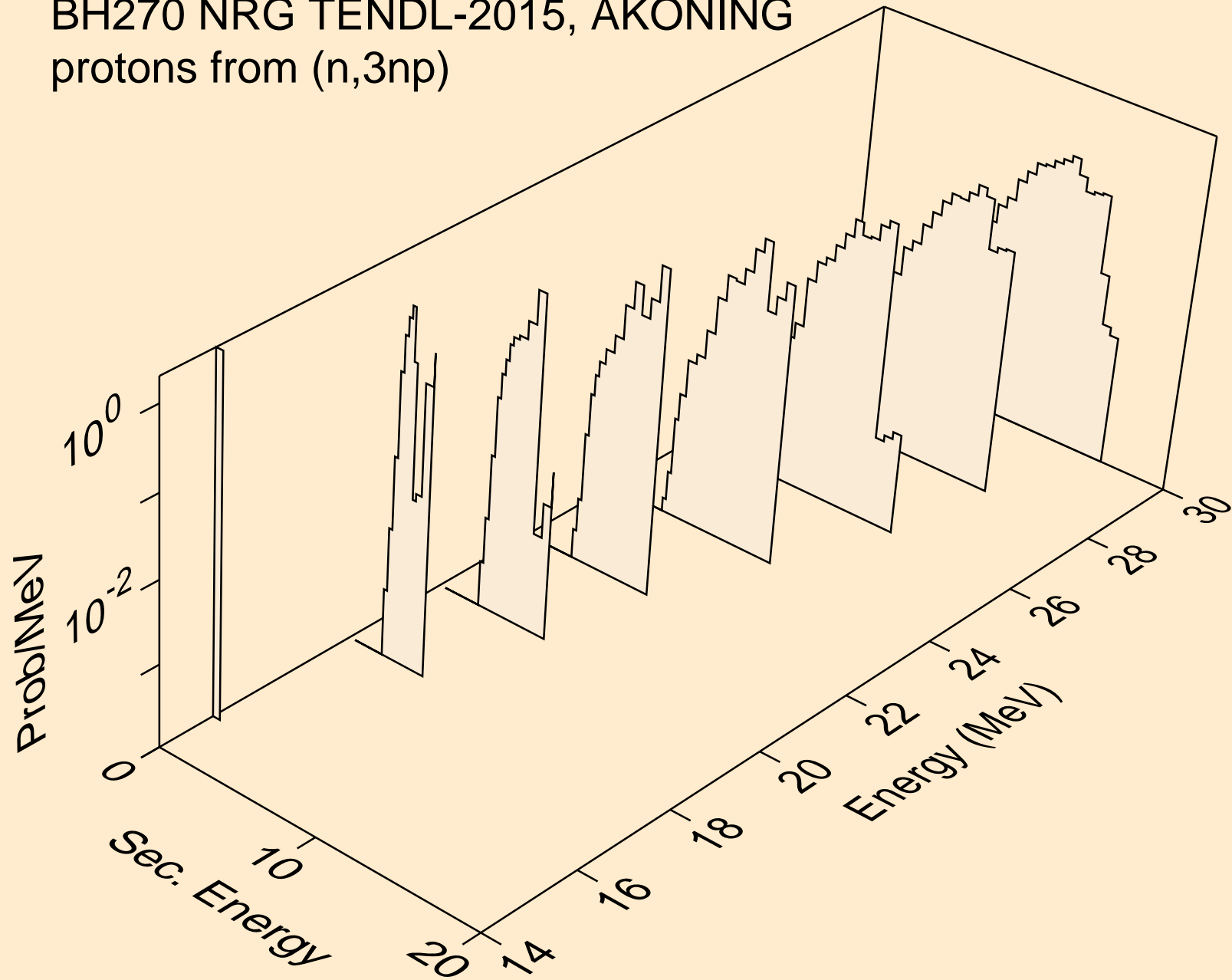

BH270 NRG TENDL-2015, AKONING  
protons from (n,2np)

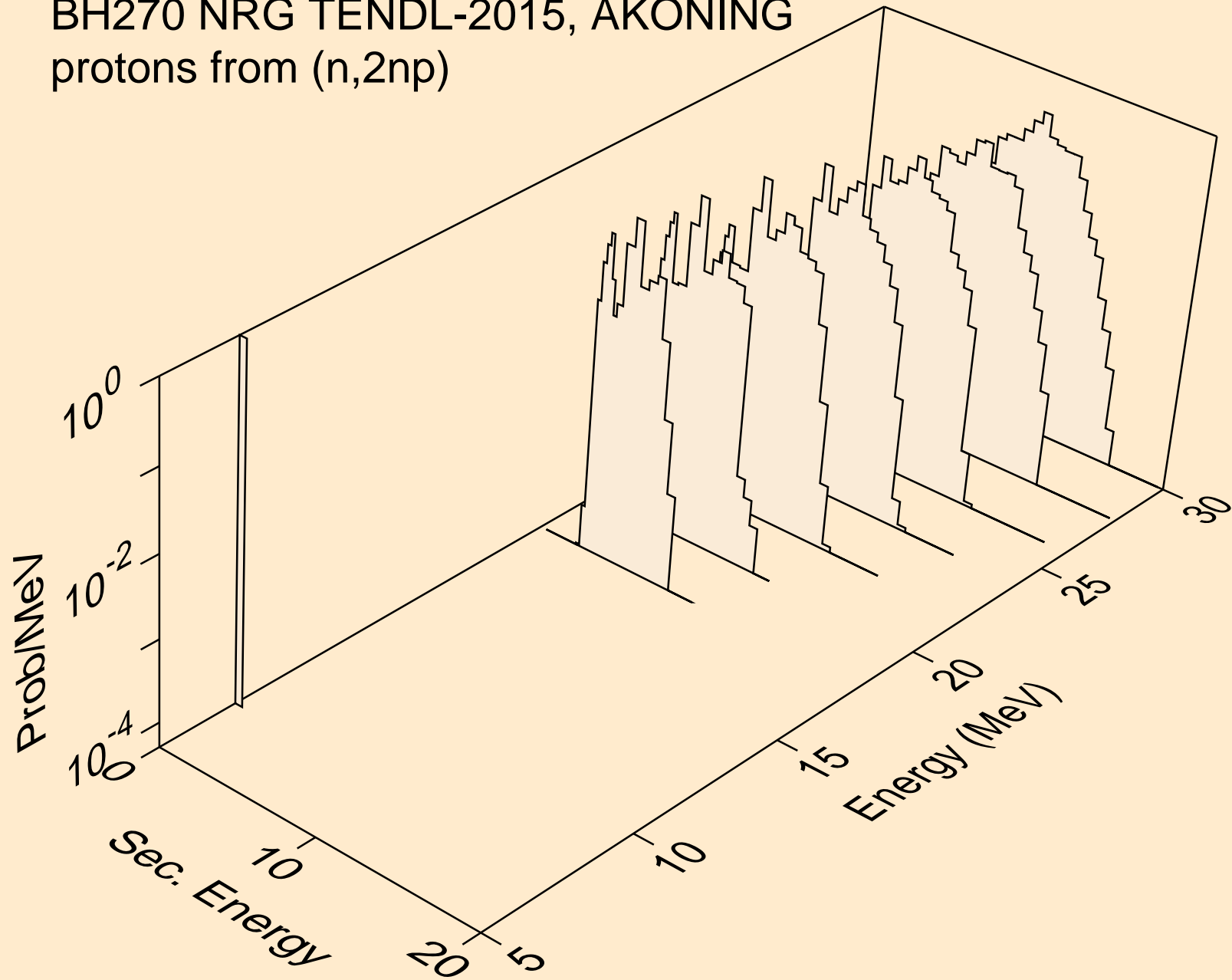

BH270 NRG TENDL-2015, AKONING  
protons from (n,npa)

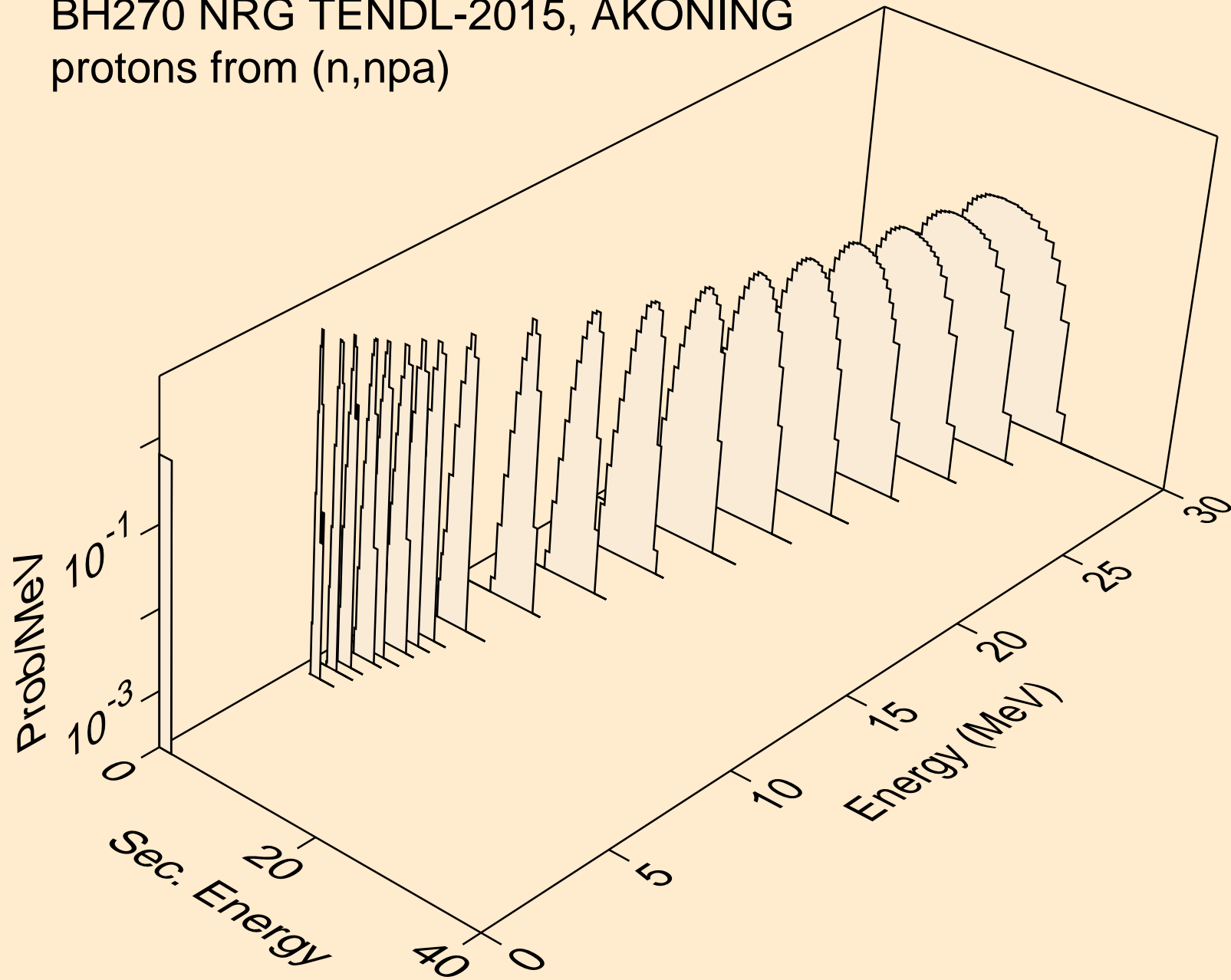



BH270 NRG TENDL-2015, AKONING  
protons from (n,p)

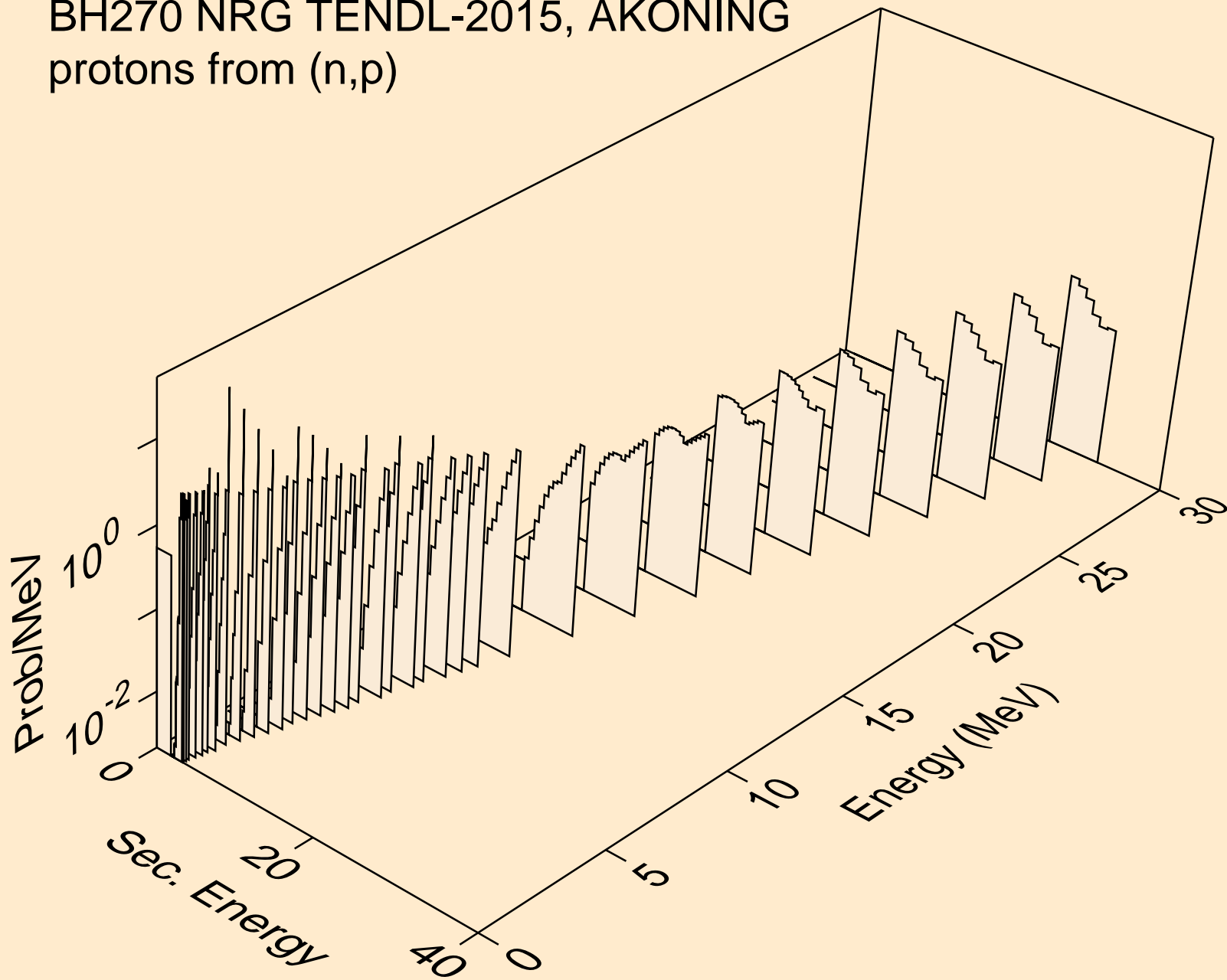

BH270 NRG TENDL-2015, AKONING  
protons from (n,2p)

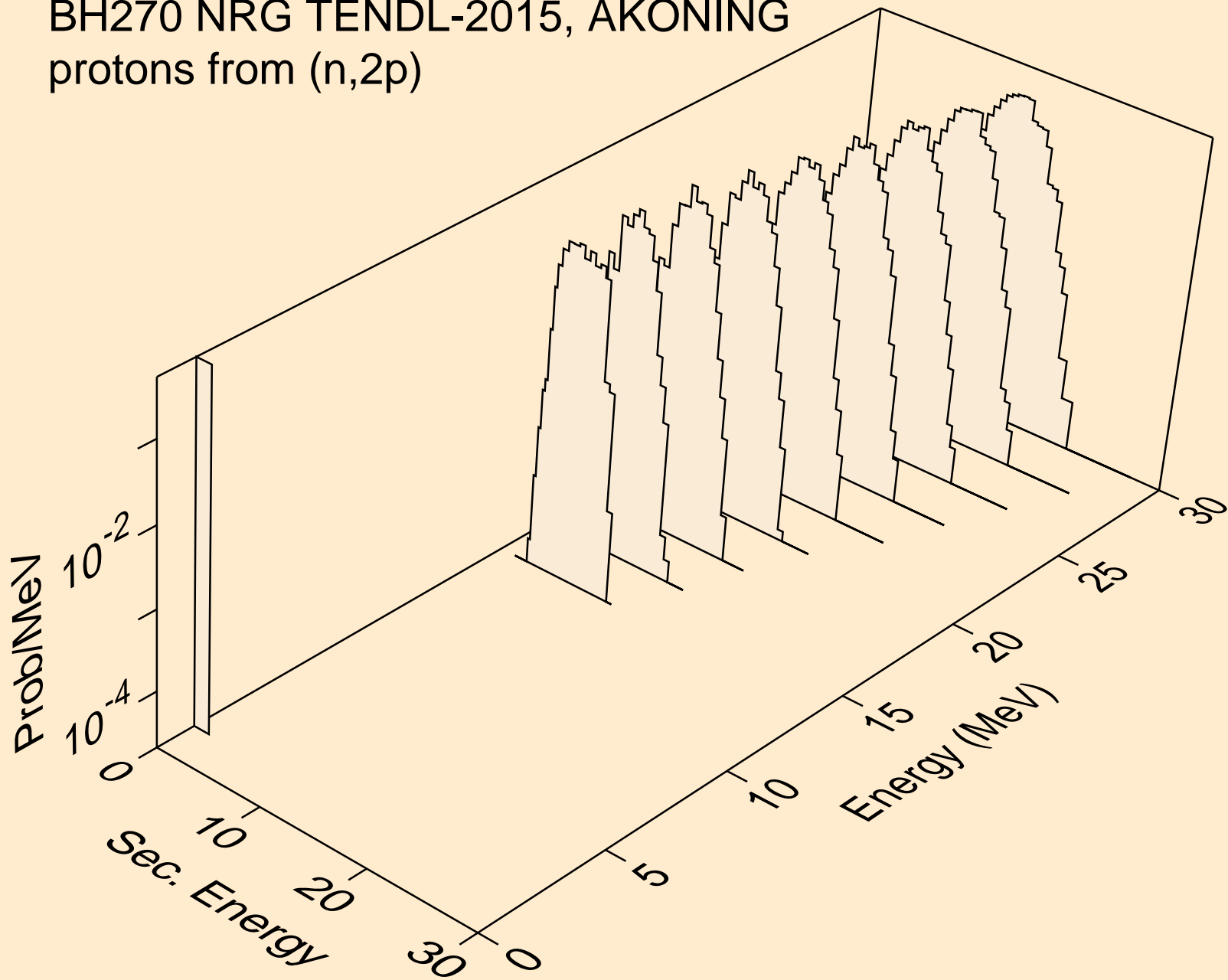

BH270 NRG TENDL-2015, AKONING  
protons from (n,pa)

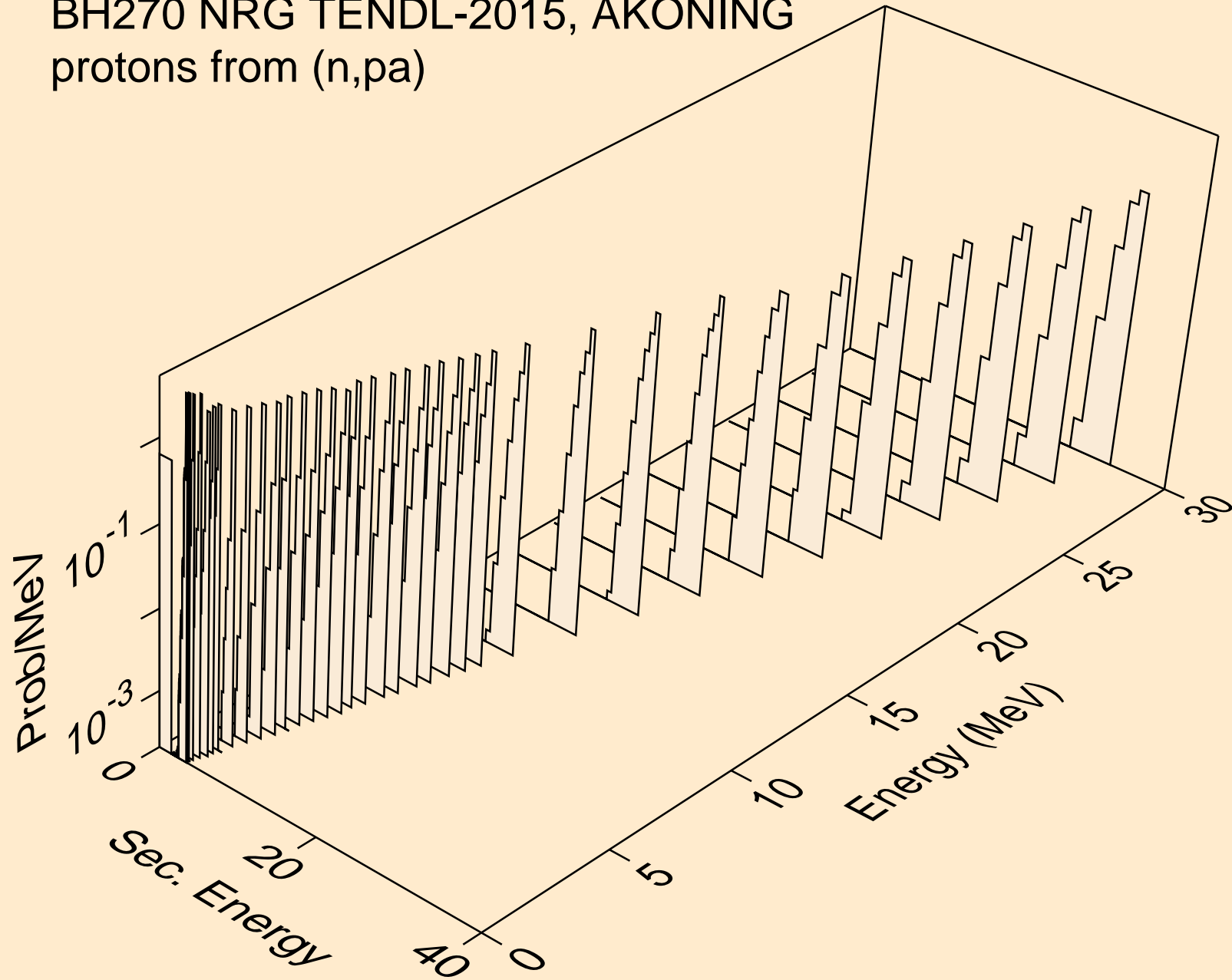

BH270 NRG TENDL-2015, AKONING  
deuterons from (n,x)

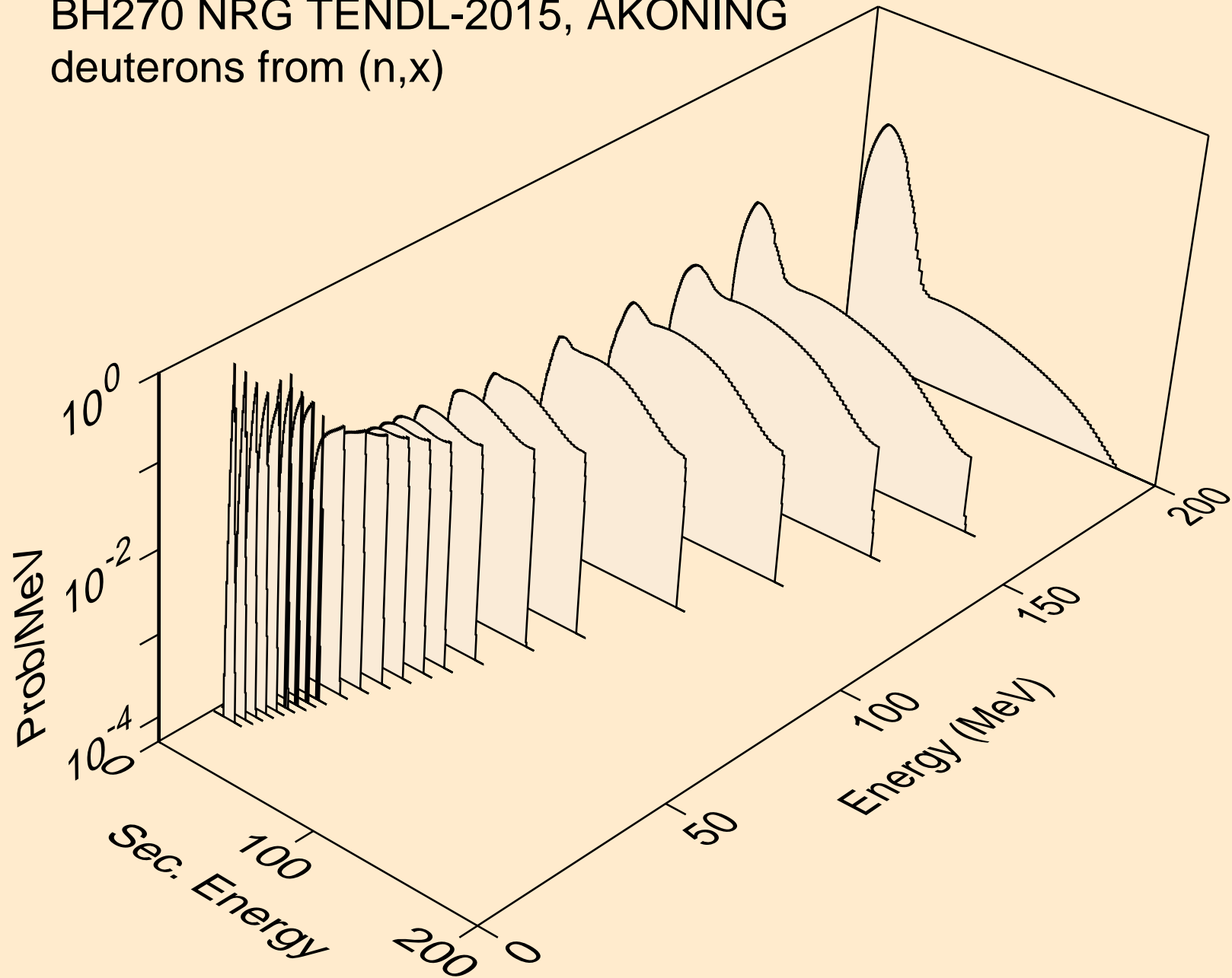

BH270 NRG TENDL-2015, AKONING  
deuterons from (n,2nd)

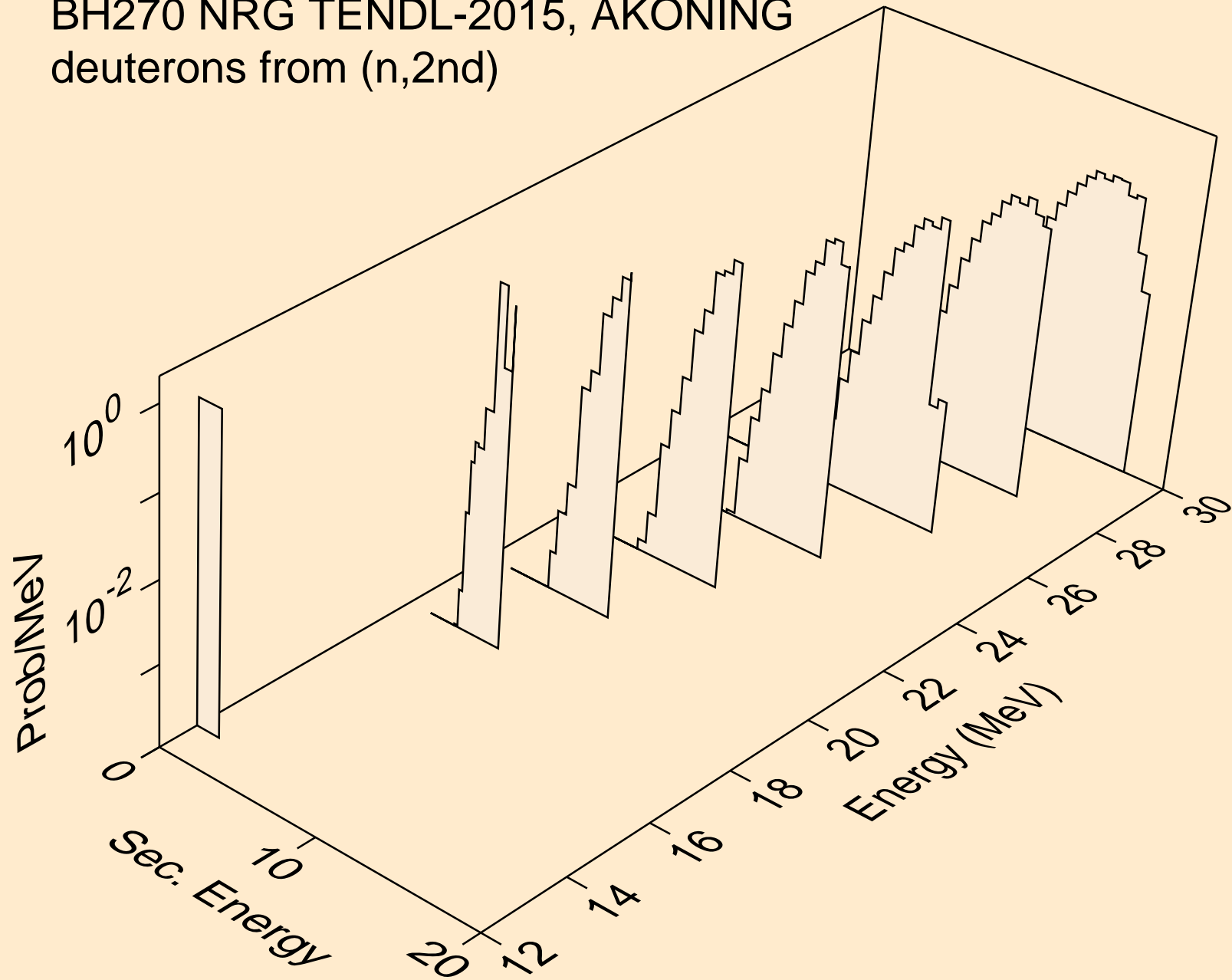

BH270 NRG TENDL-2015, AKONING  
deuterons from (n,n\*)d

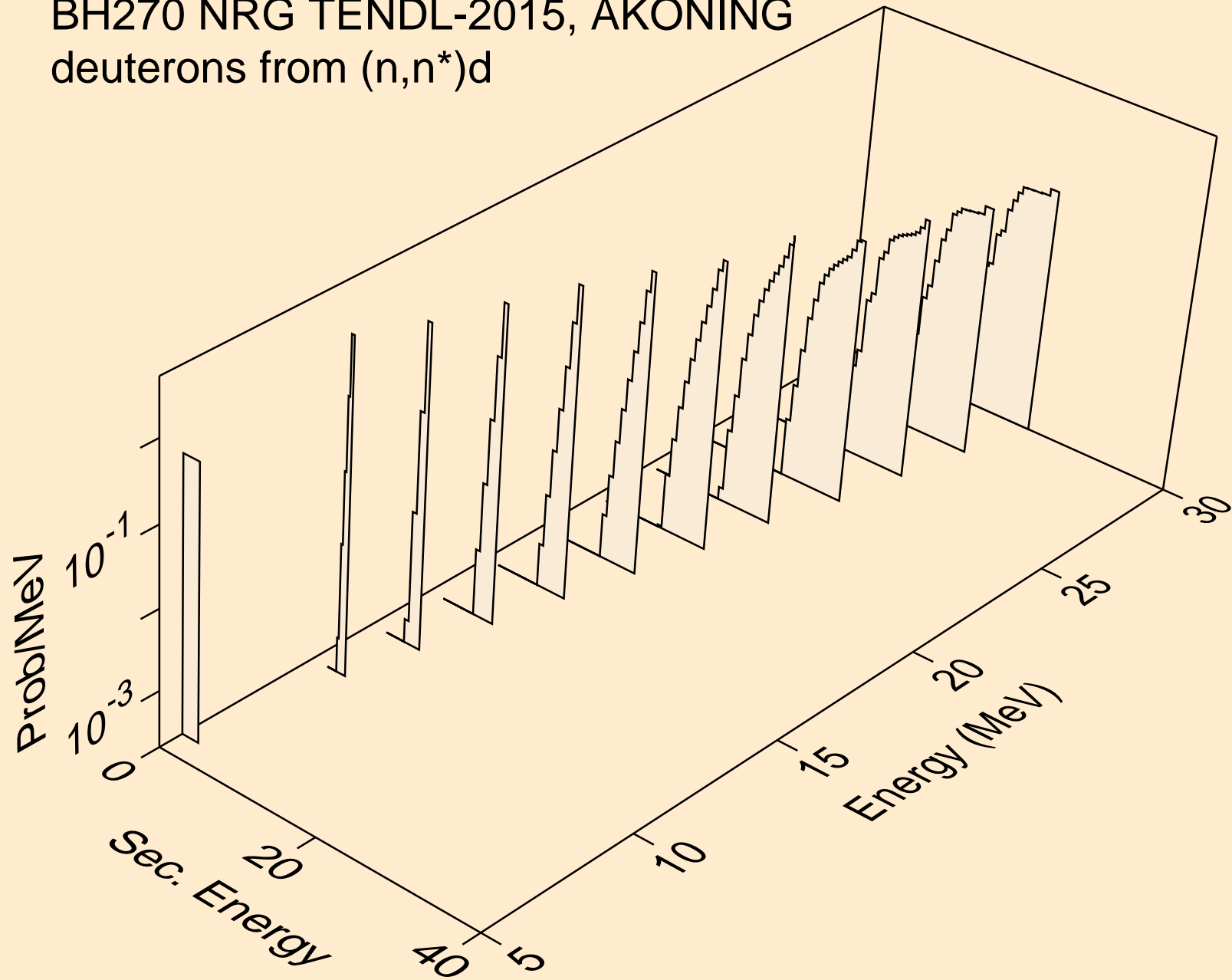

BH270 NRG TENDL-2015, AKONING  
deuterons from (n,n\*)d2a

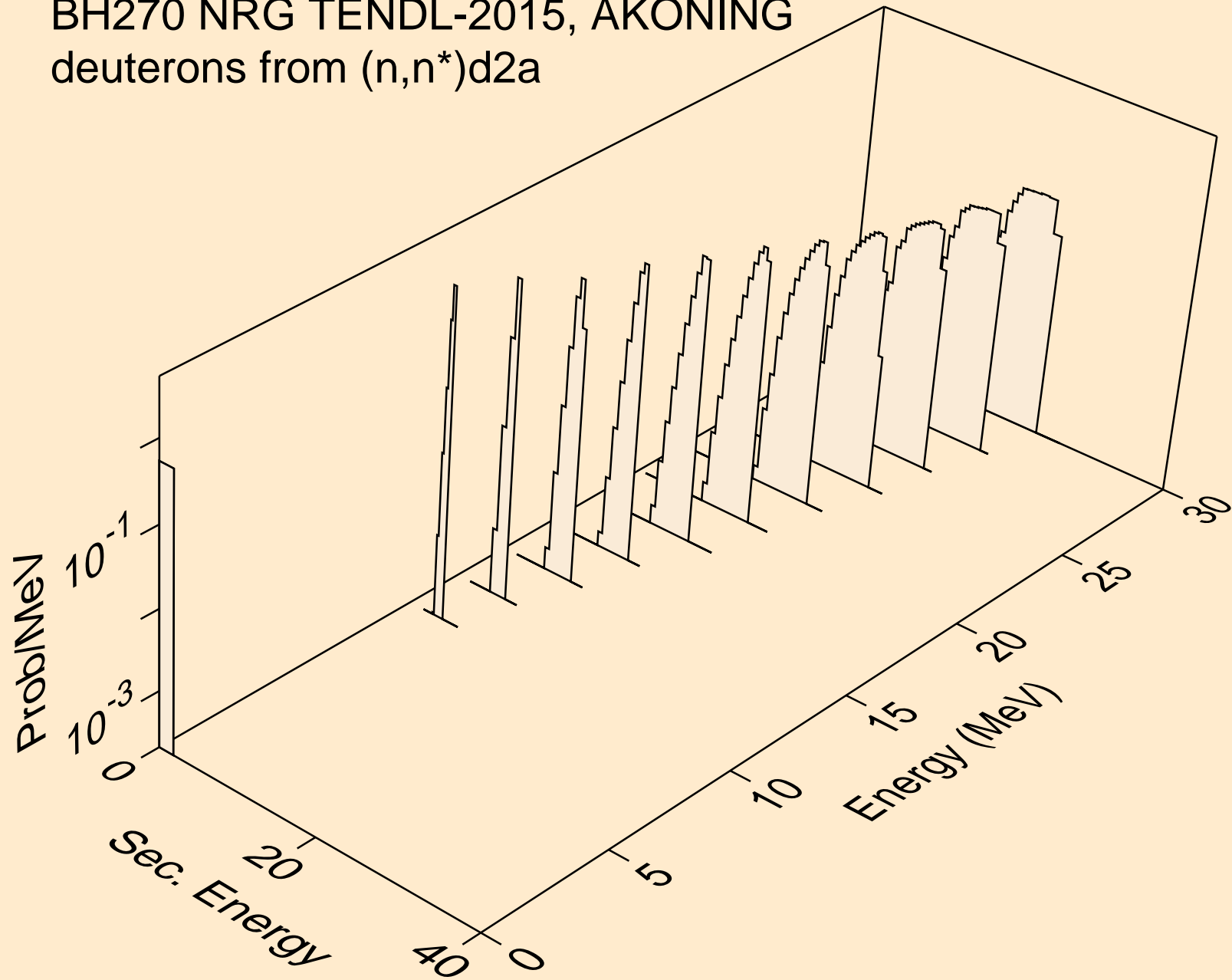

BH270 NRG TENDL-2015, AKONING  
deuterons from (n,d)

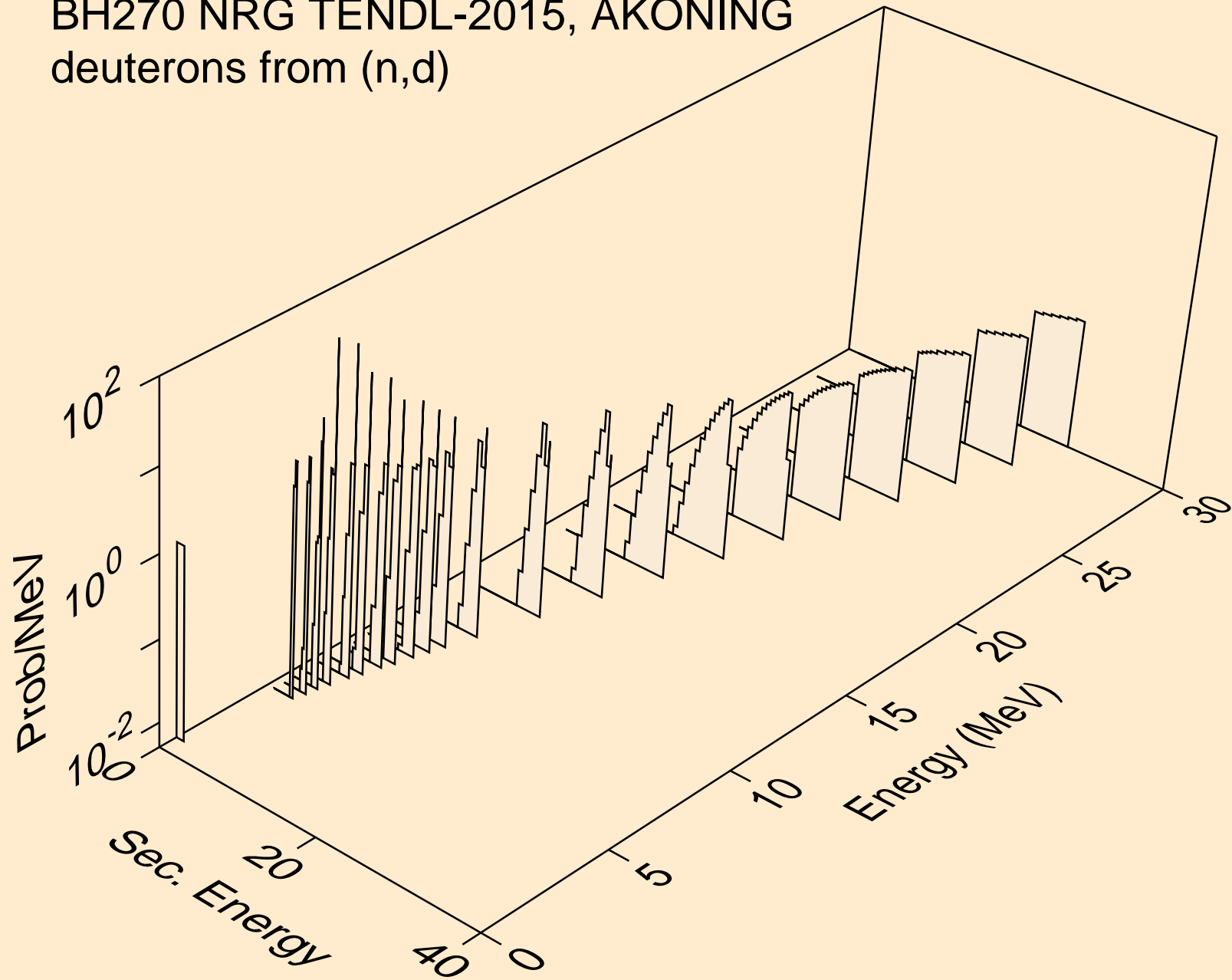



BH270 NRG TENDL-2015, AKONING  
deuterons from (n,d2a)

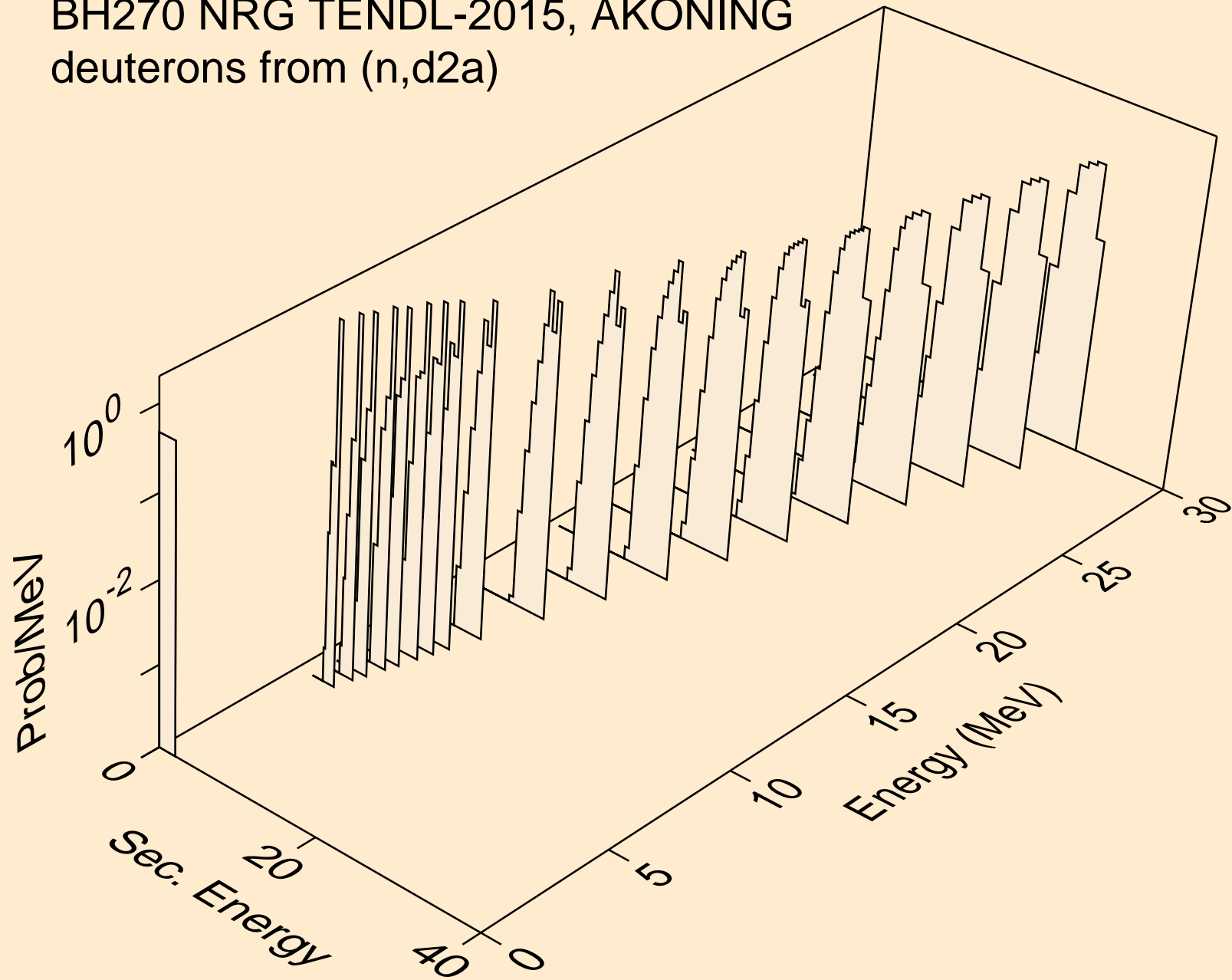

BH270 NRG TENDL-2015, AKONING  
deuterons from (n,da)

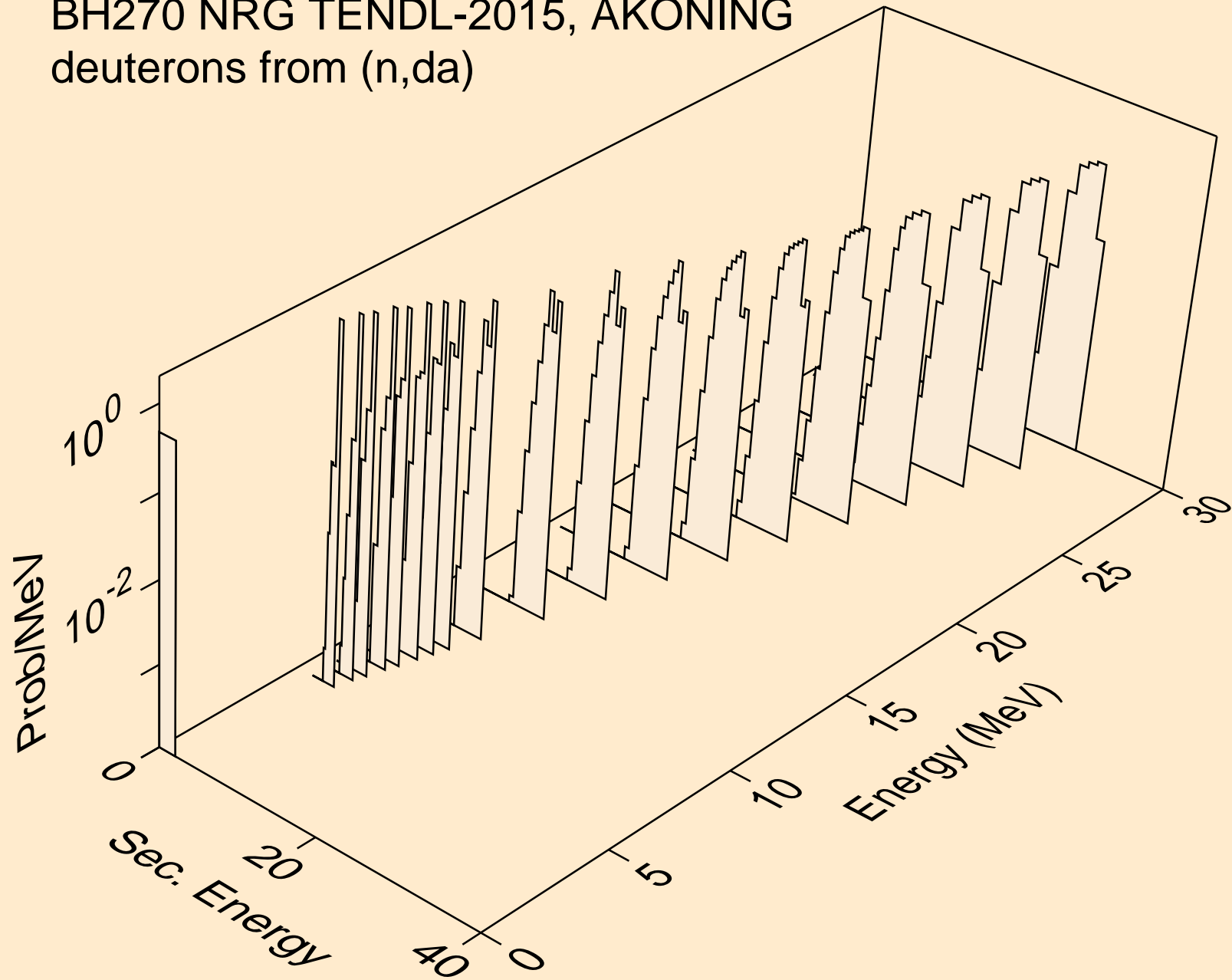

BH270 NRG TENDL-2015, AKONING  
tritons from (n,x)

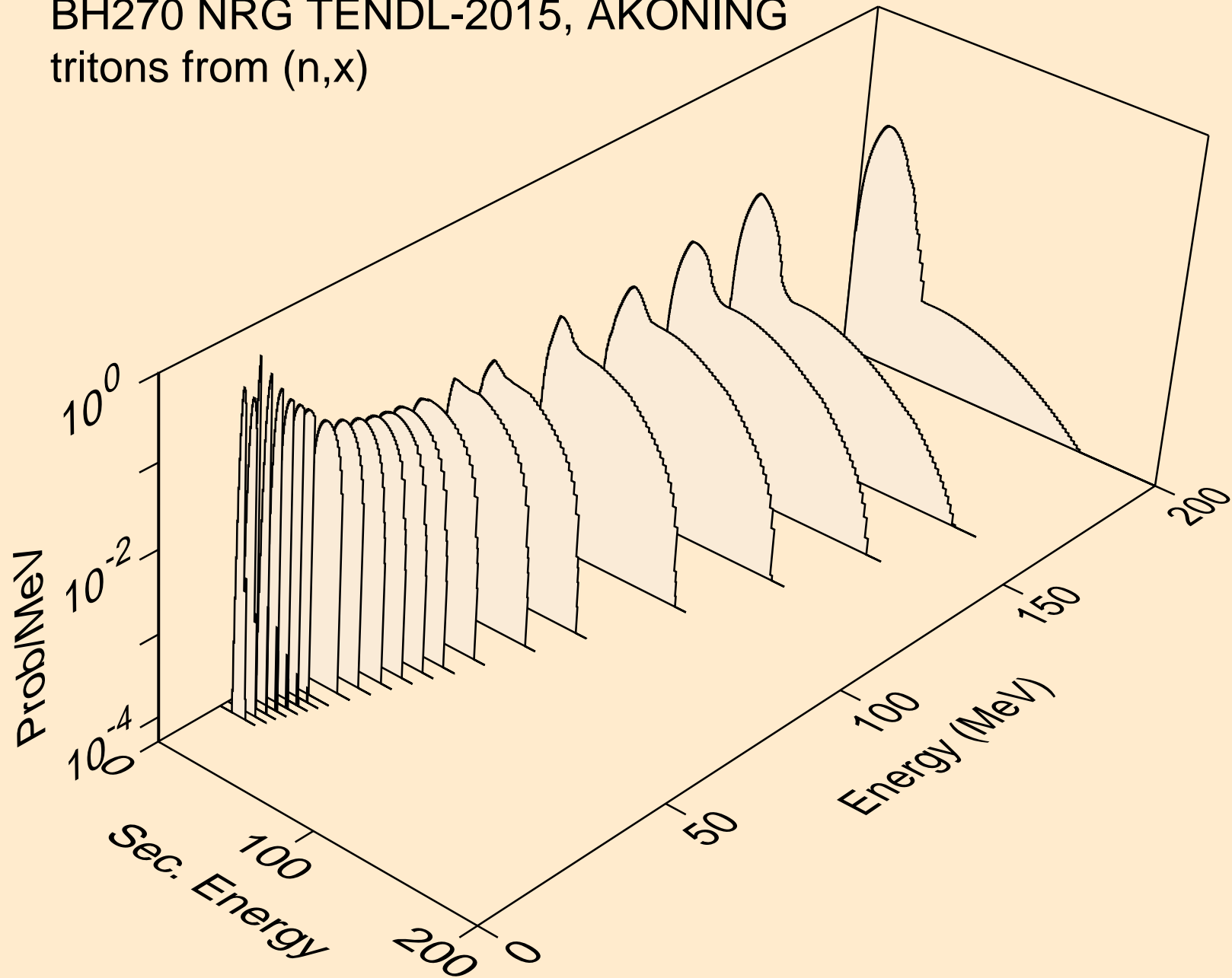

BH270 NRG TENDL-2015, AKONING  
tritons from (n,n\*)t

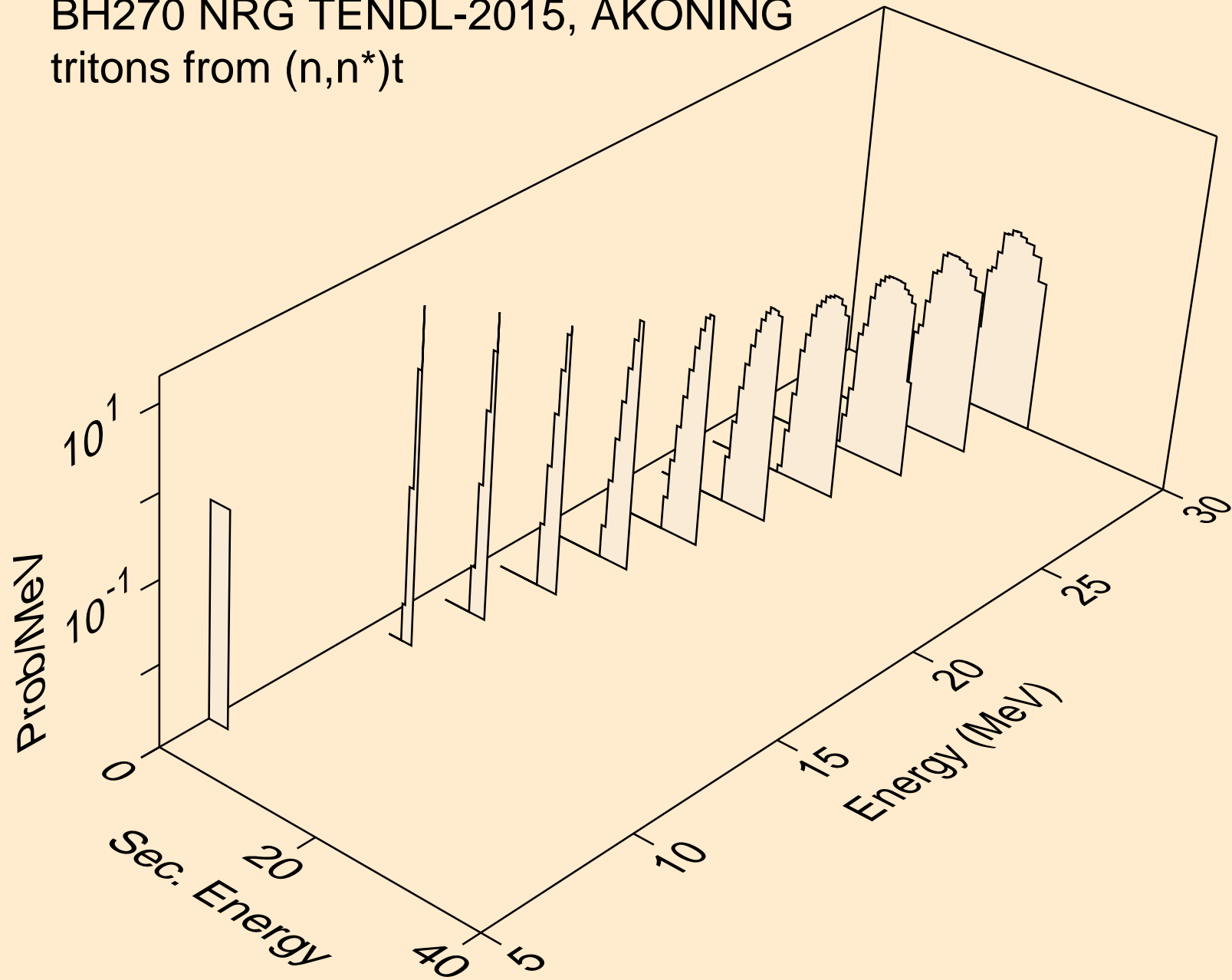

BH270 NRG TENDL-2015, AKONING  
tritons from (n,n\*)t2a

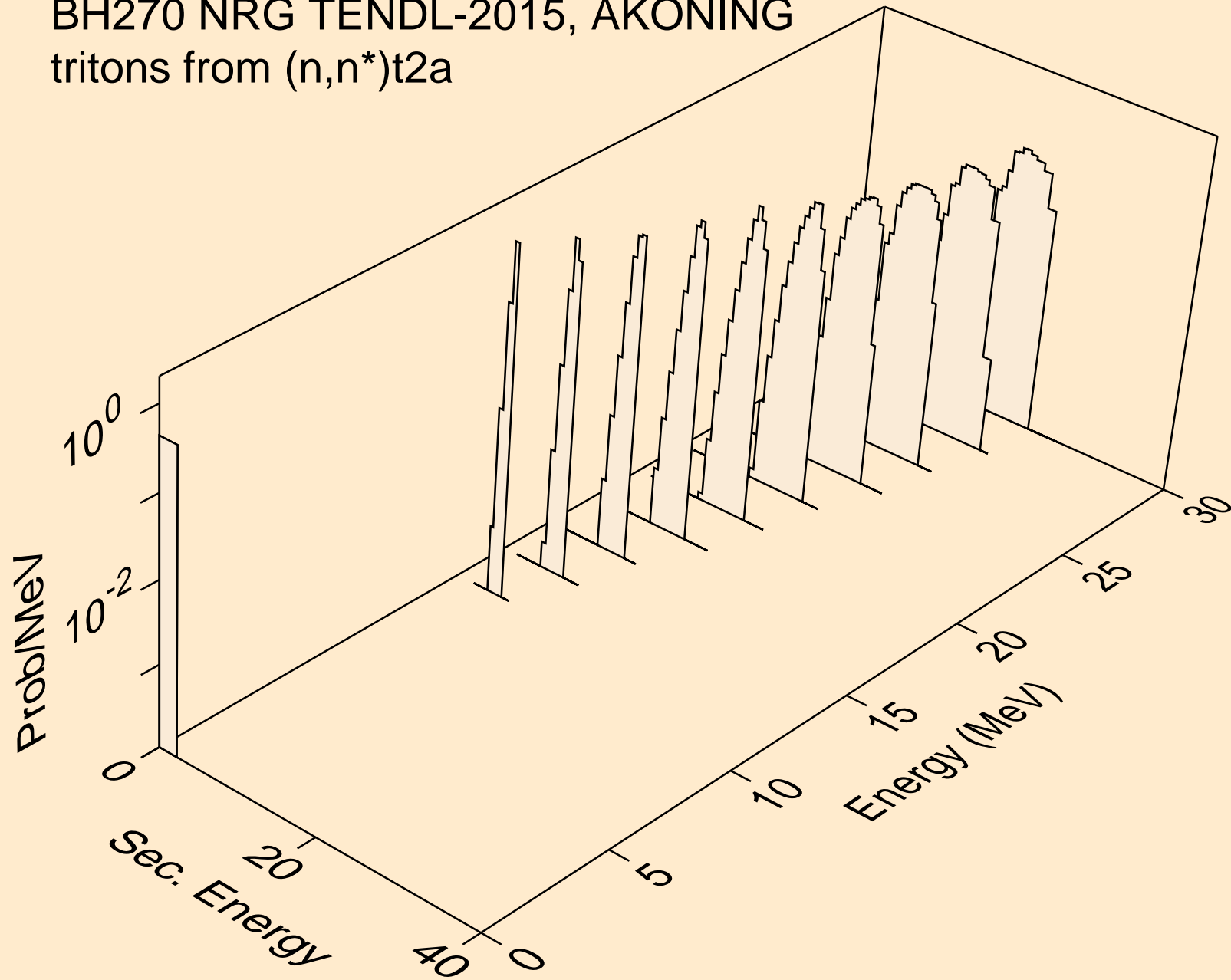

BH270 NRG TENDL-2015, AKONING  
tritons from (n,t)

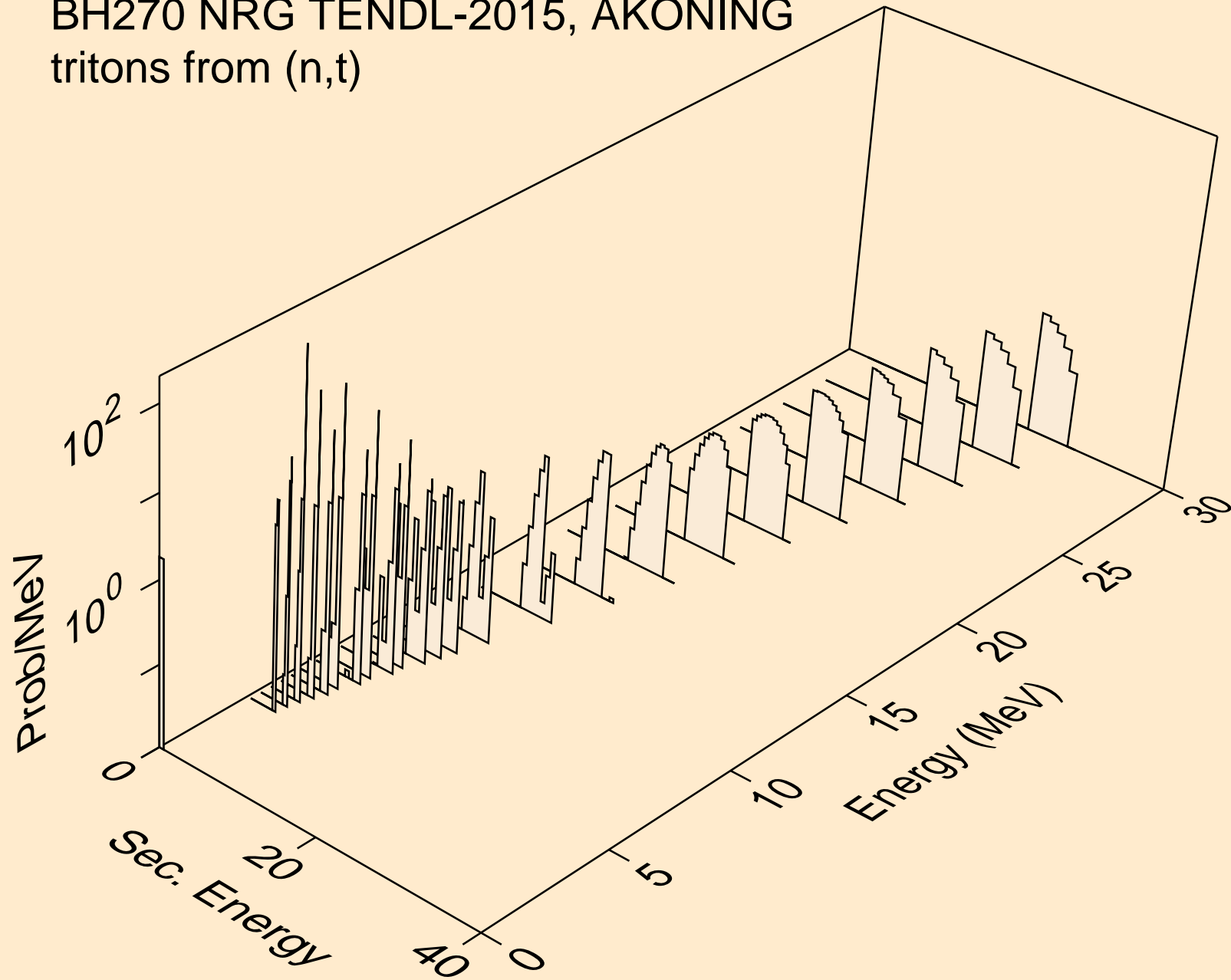

BH270 NRG TENDL-2015, AKONING  
tritons from (n,t2a)

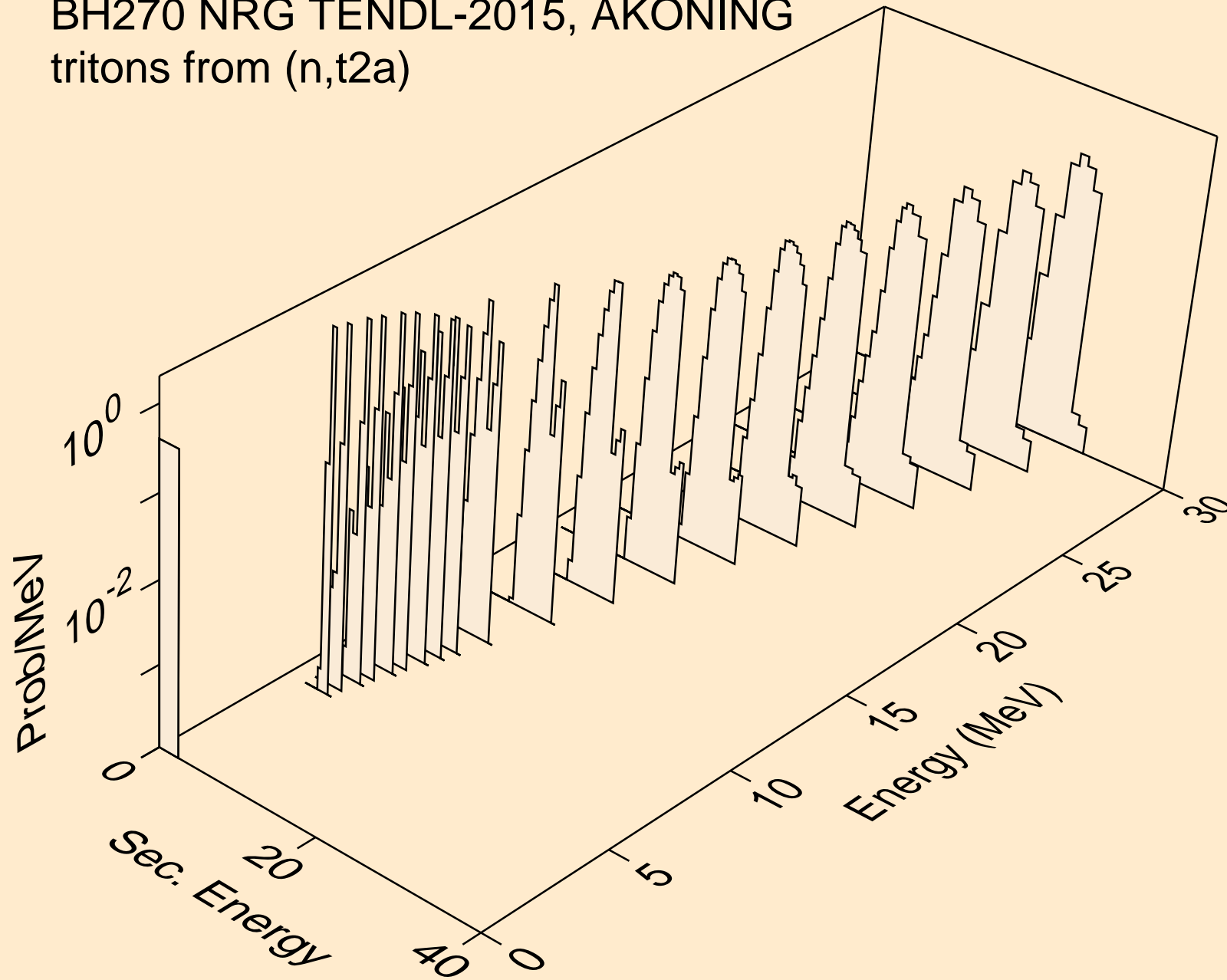

BH270 NRG TENDL-2015, AKONING  
he3s from (n,x)

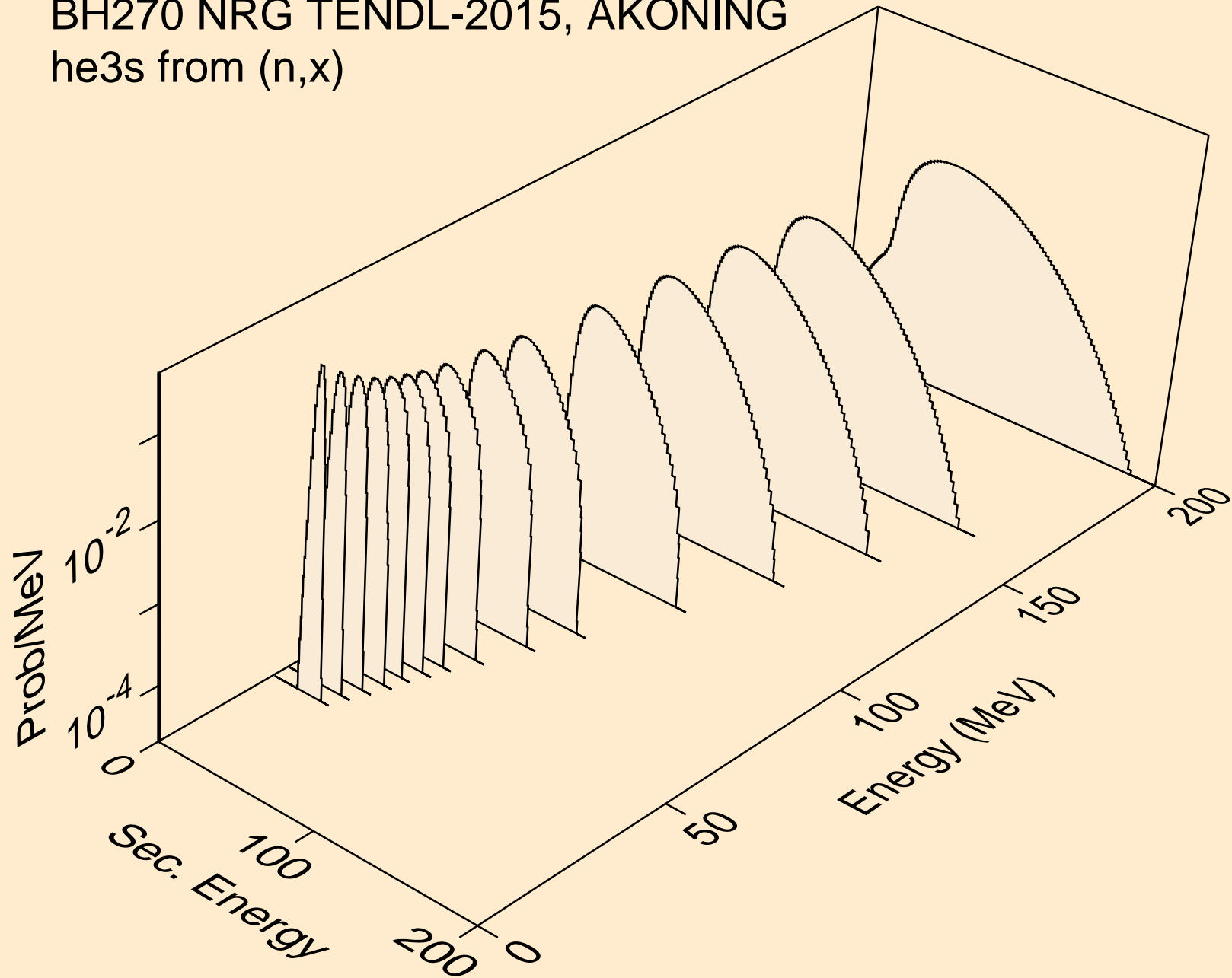



BH270 NRG TENDL-2015, AKONING  
he3s from (n,n\*)he3

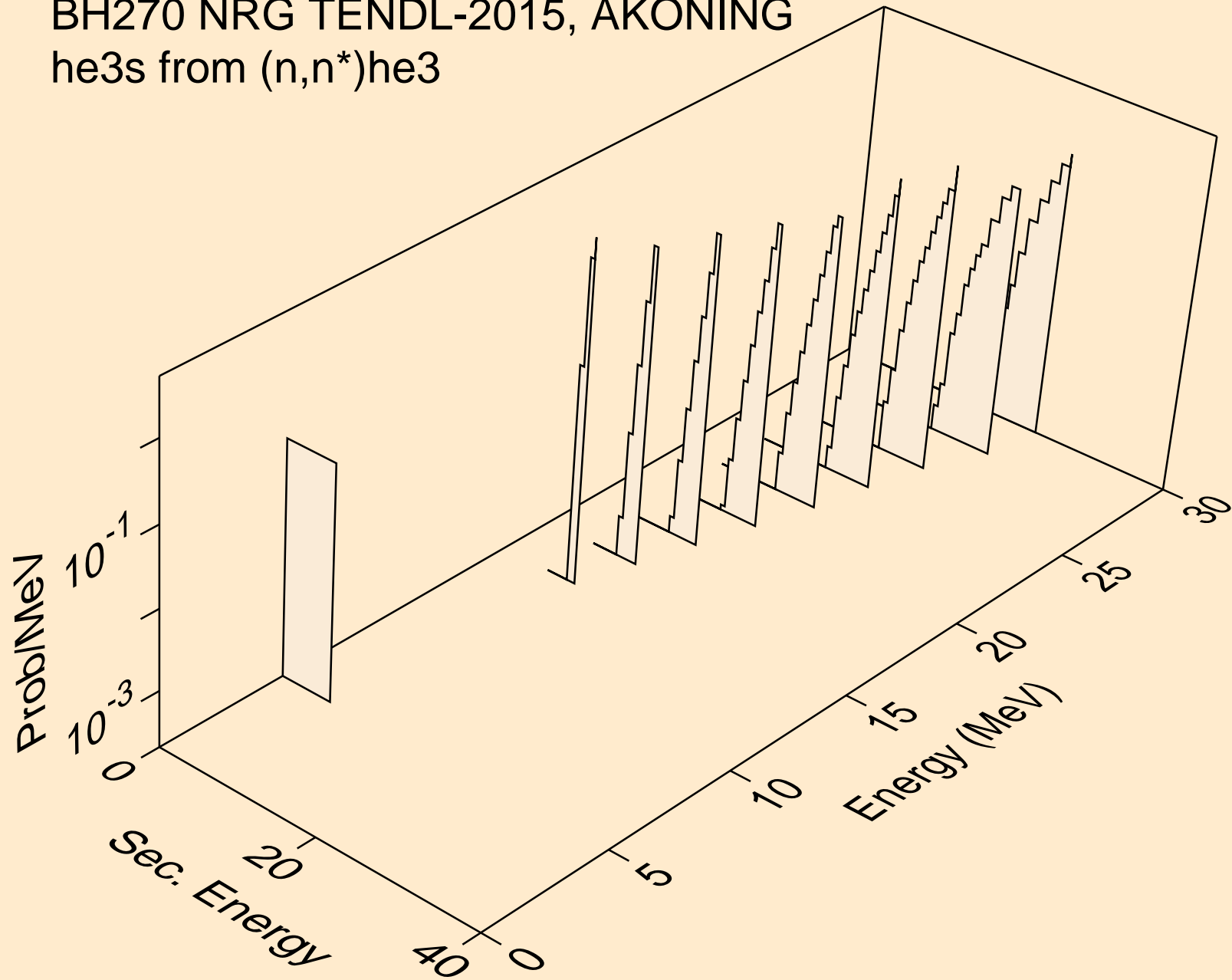

BH270 NRG TENDL-2015, AKONING  
he3s from (n,he3)

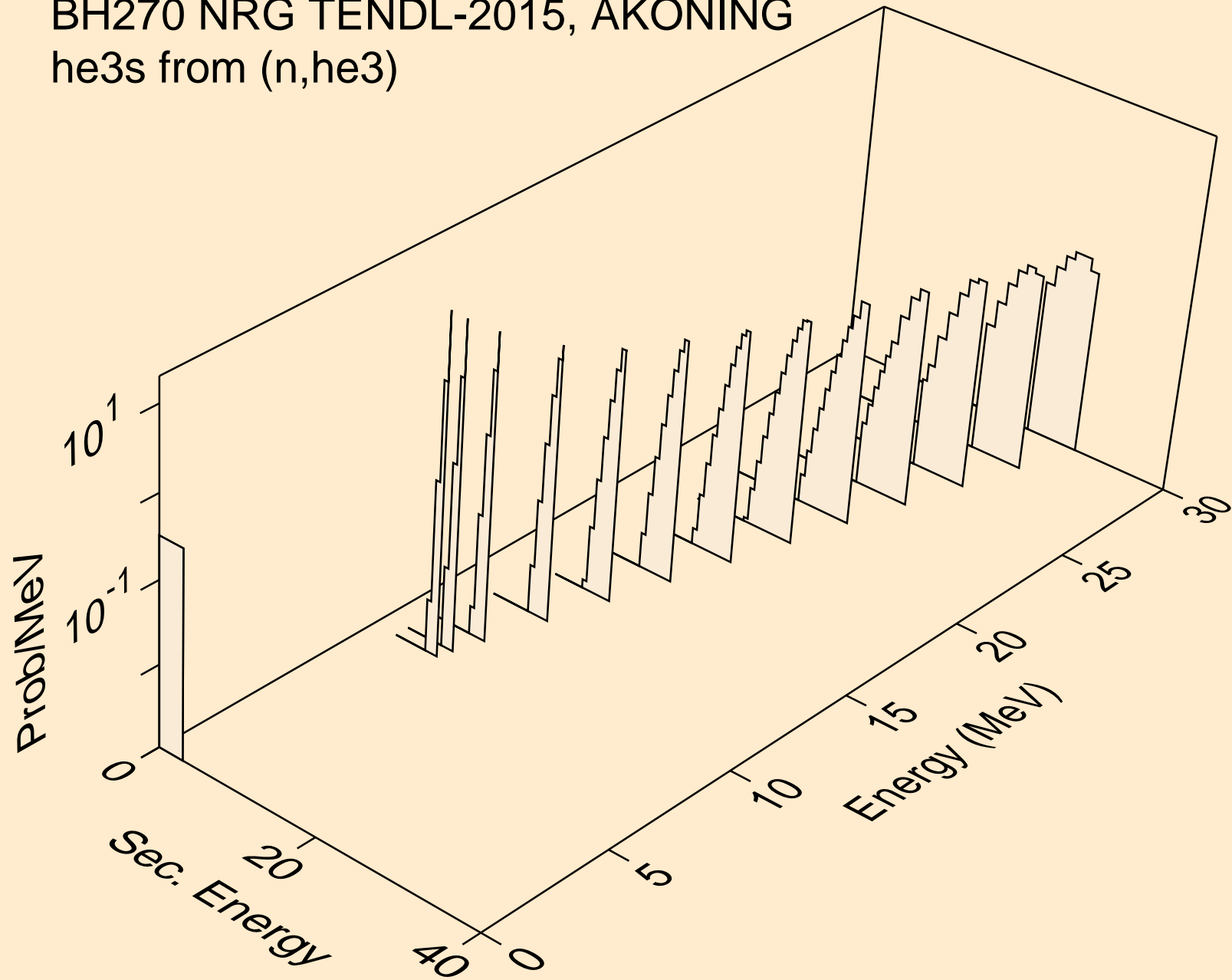

BH270 NRG TENDL-2015, AKONING  
alphas from (n,x)

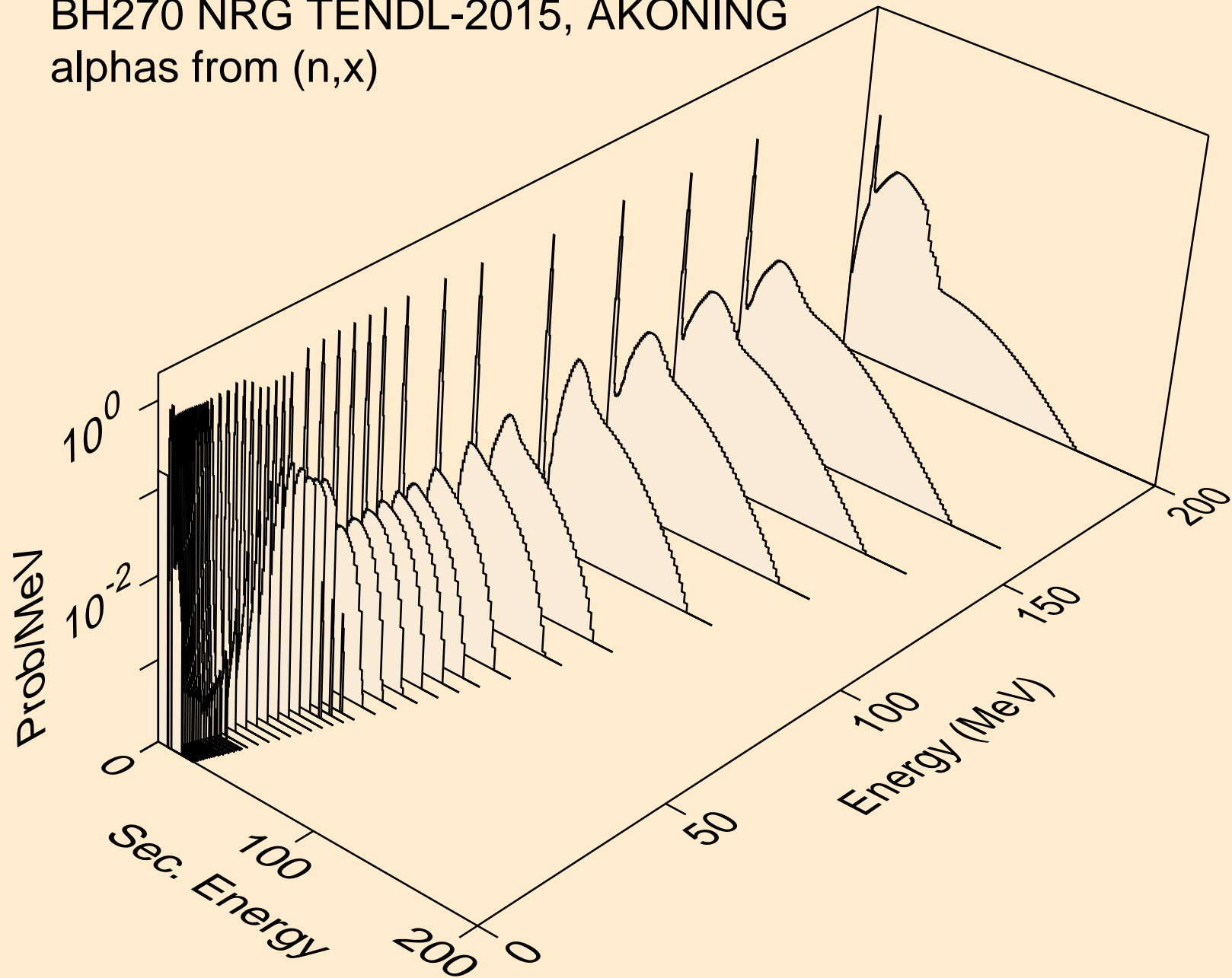

BH270 NRG TENDL-2015, AKONING  
alphas from (n,n\*)a

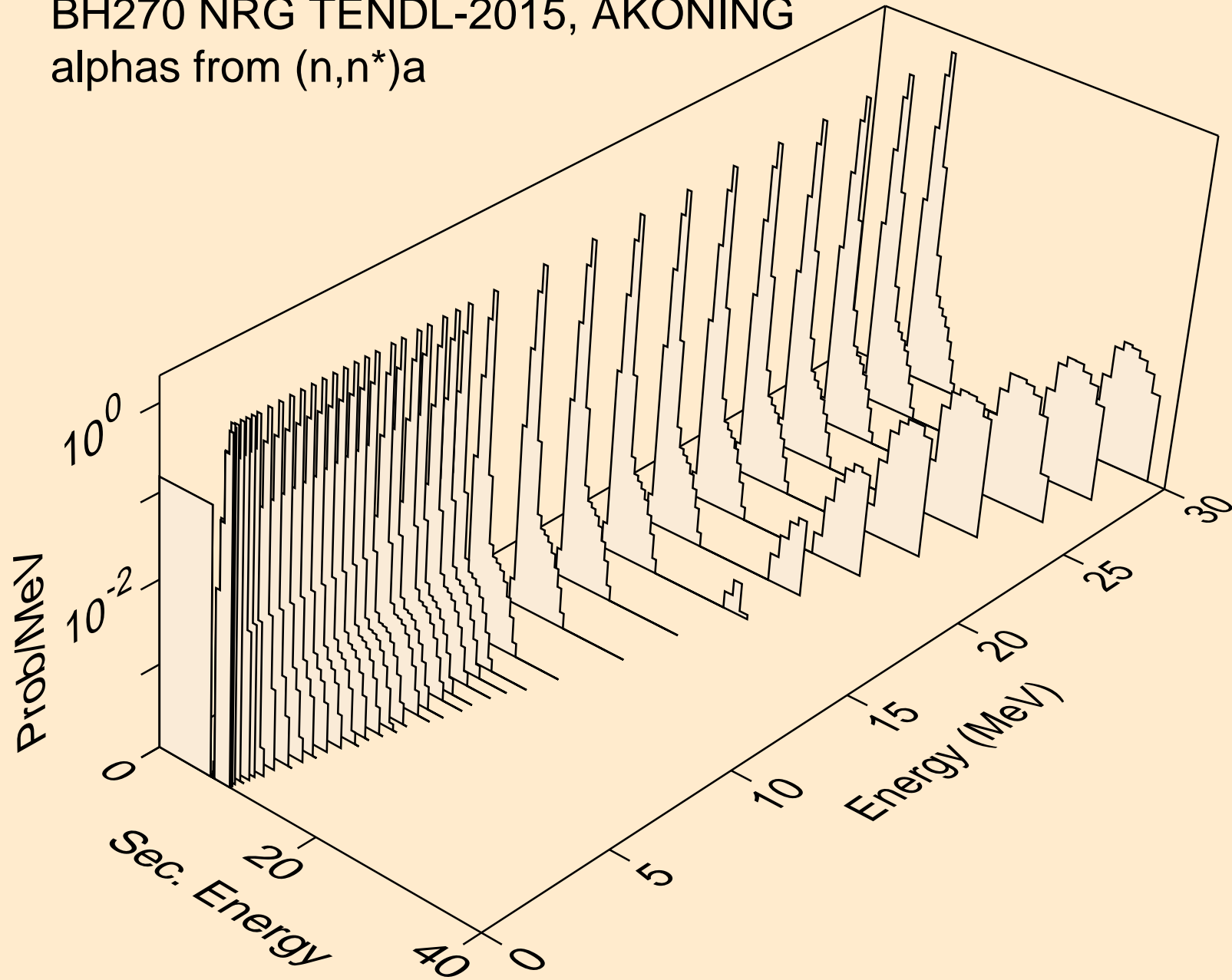

BH270 NRG TENDL-2015, AKONING  
alphas from (n,n\*)3a

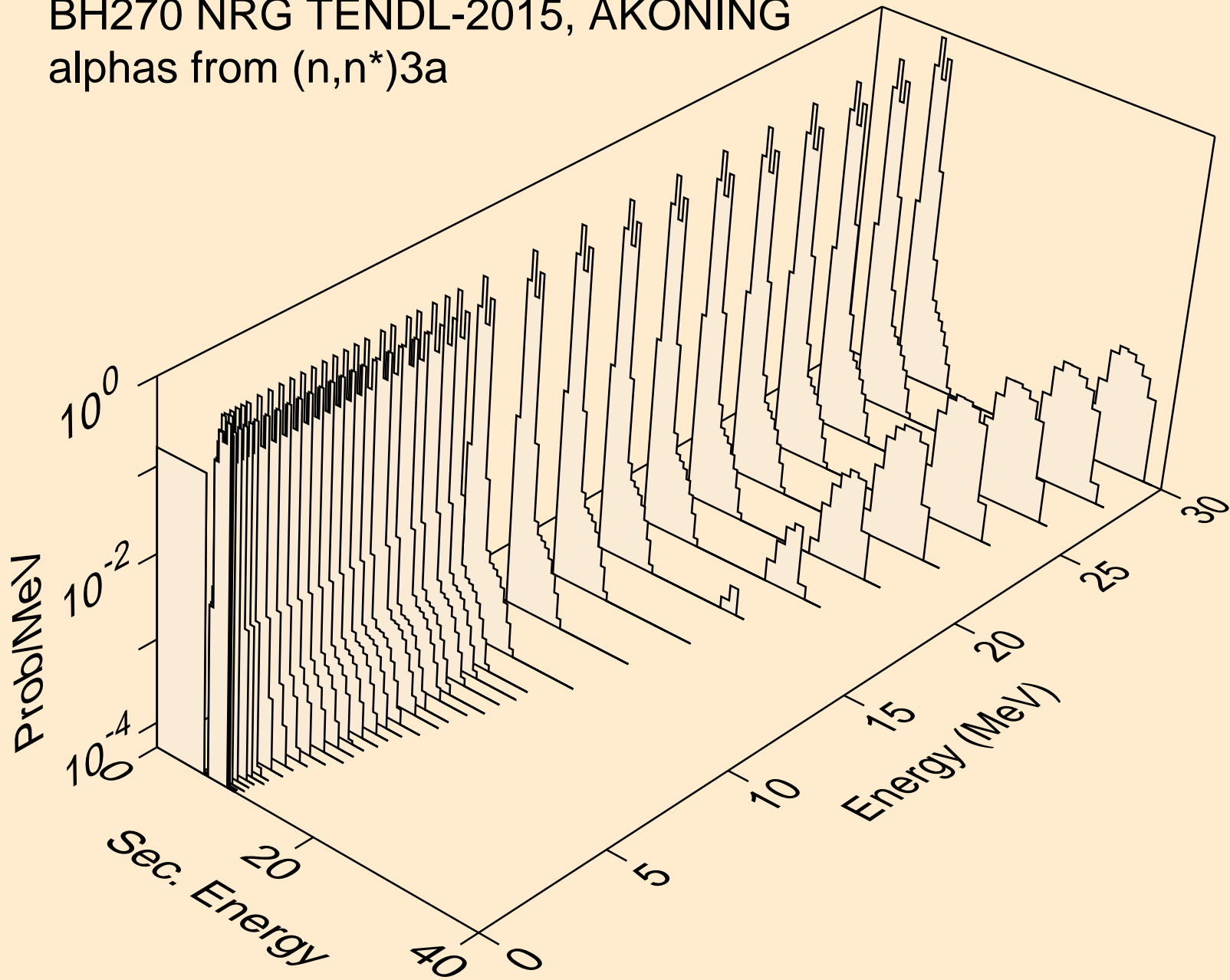

BH270 NRG TENDL-2015, AKONING  
alphas from (n,2n)a

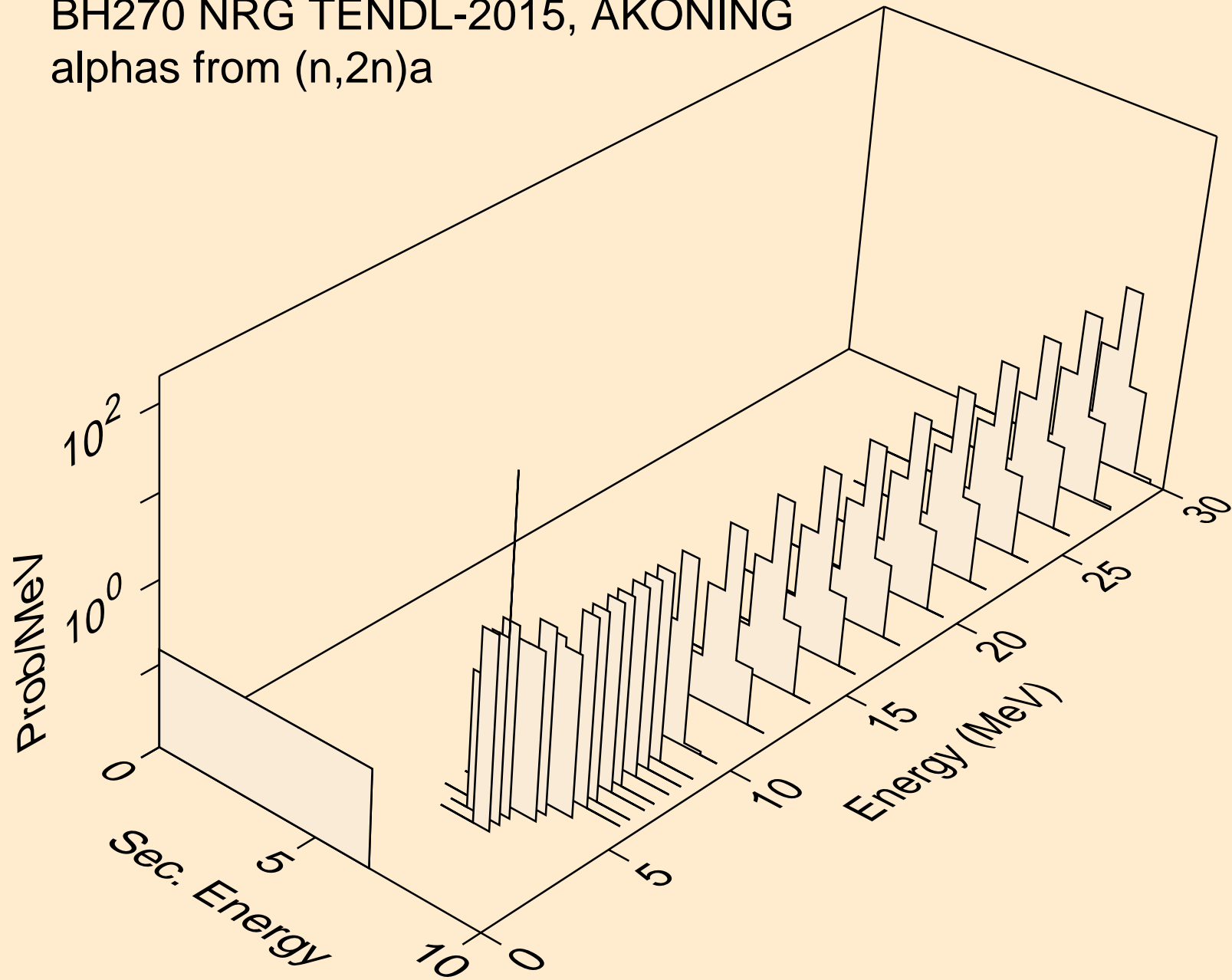

BH270 NRG TENDL-2015, AKONING  
alphas from (n,3n)a

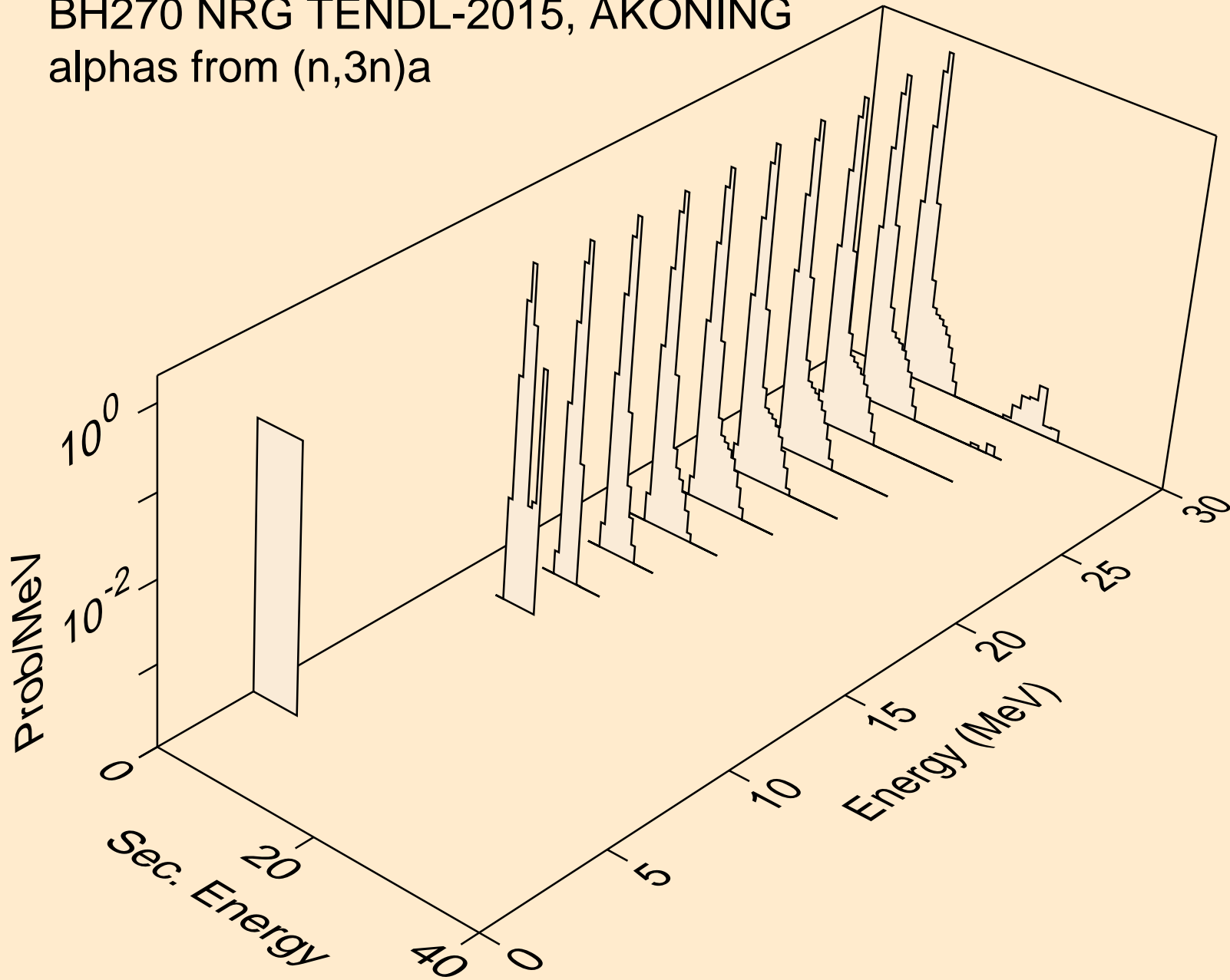

BH270 NRG TENDL-2015, AKONING  
alphas from (n,n\*)2a

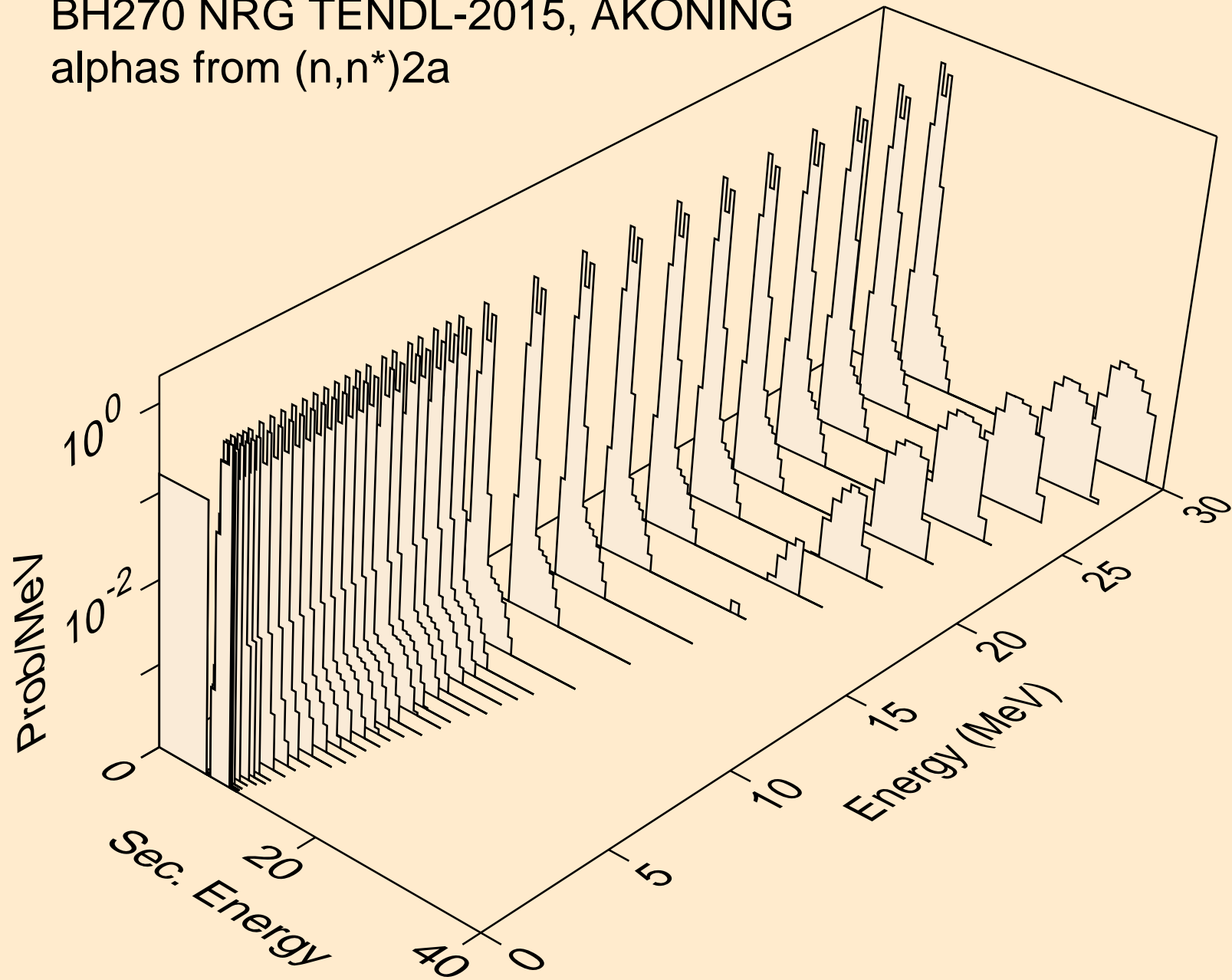



BH270 NRG TENDL-2015, AKONING  
alphas from (n,2n)2a

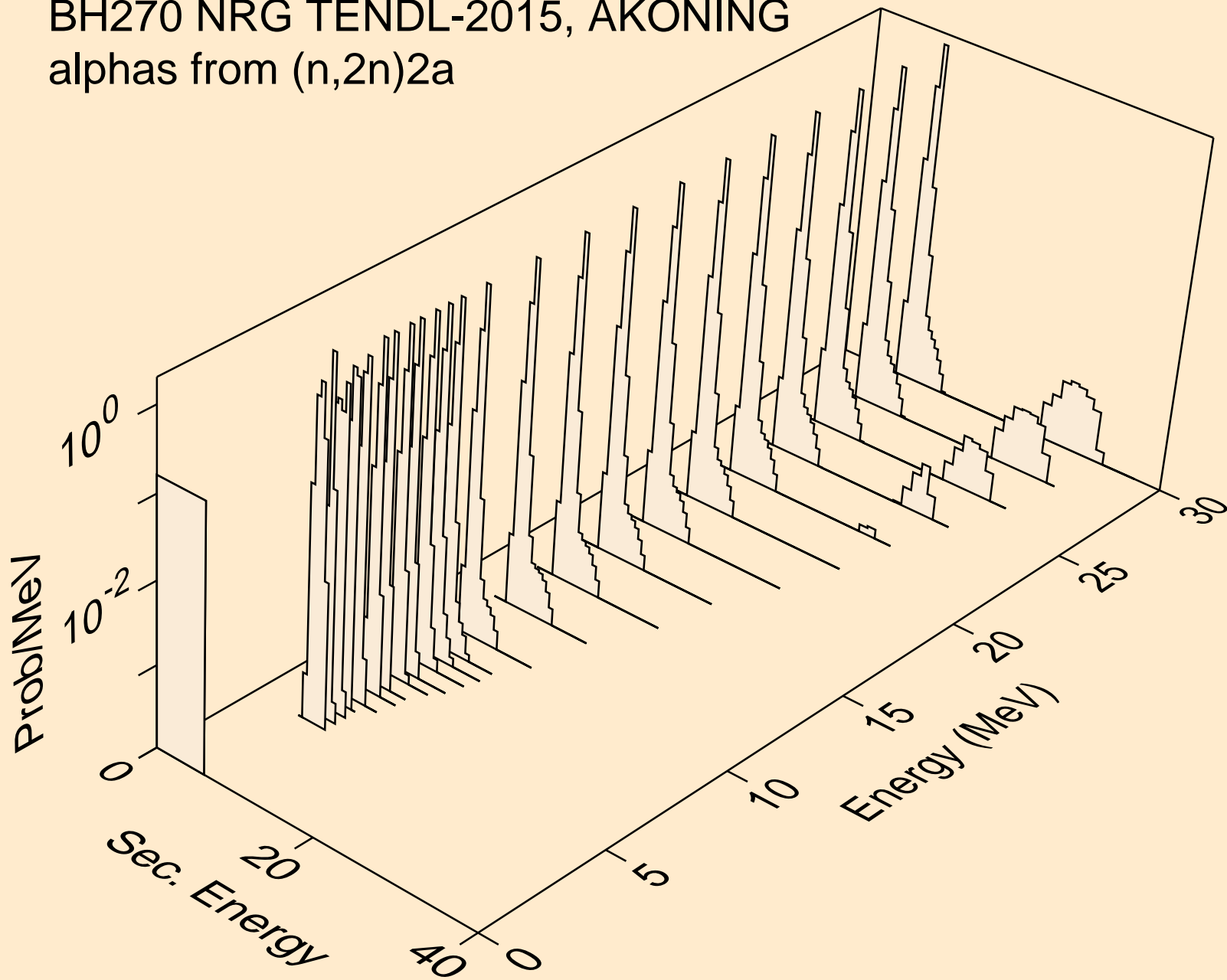

BH270 NRG TENDL-2015, AKONING  
alphas from (n,n\*)d2a

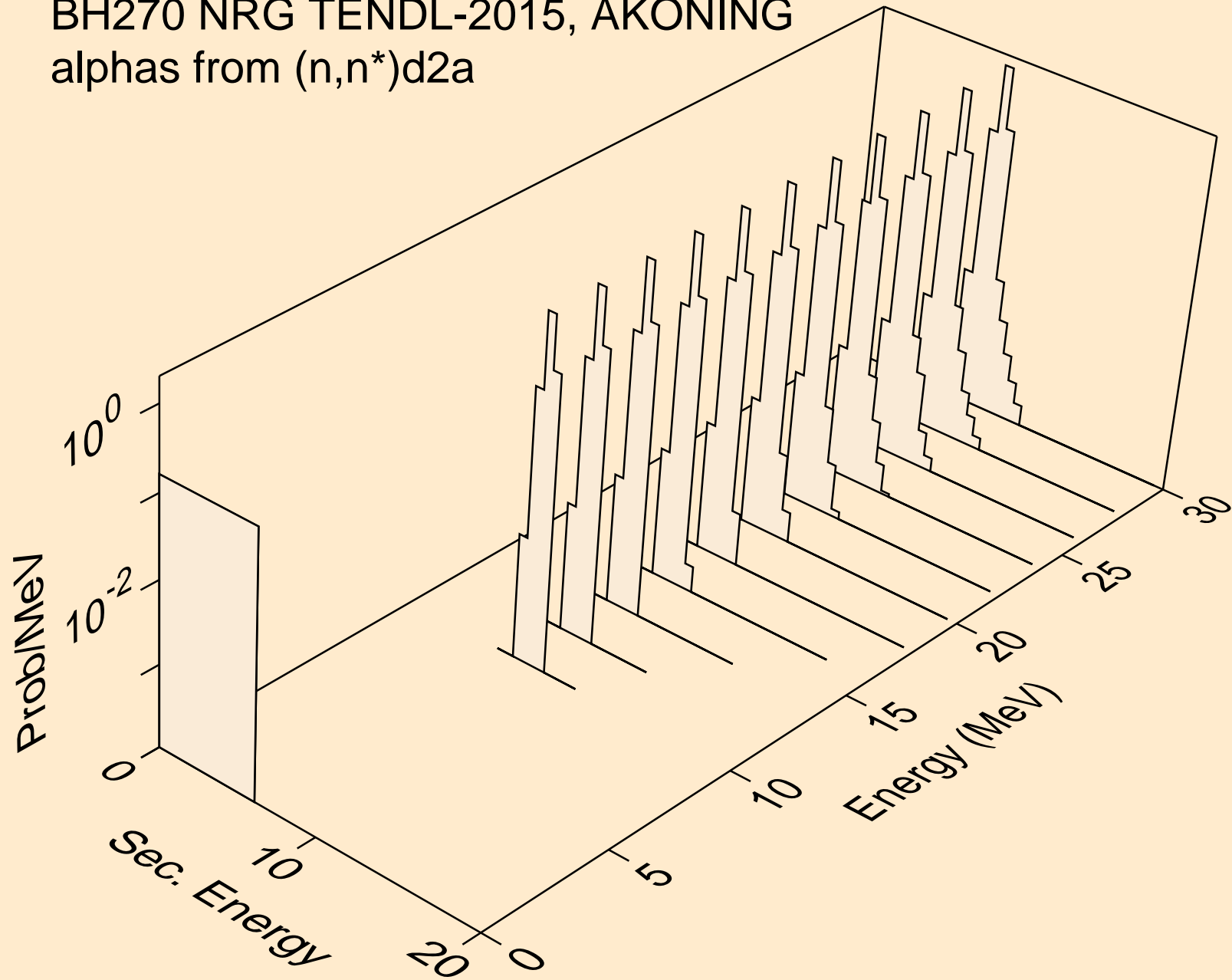

BH270 NRG TENDL-2015, AKONING  
alphas from (n,n\*)t2a

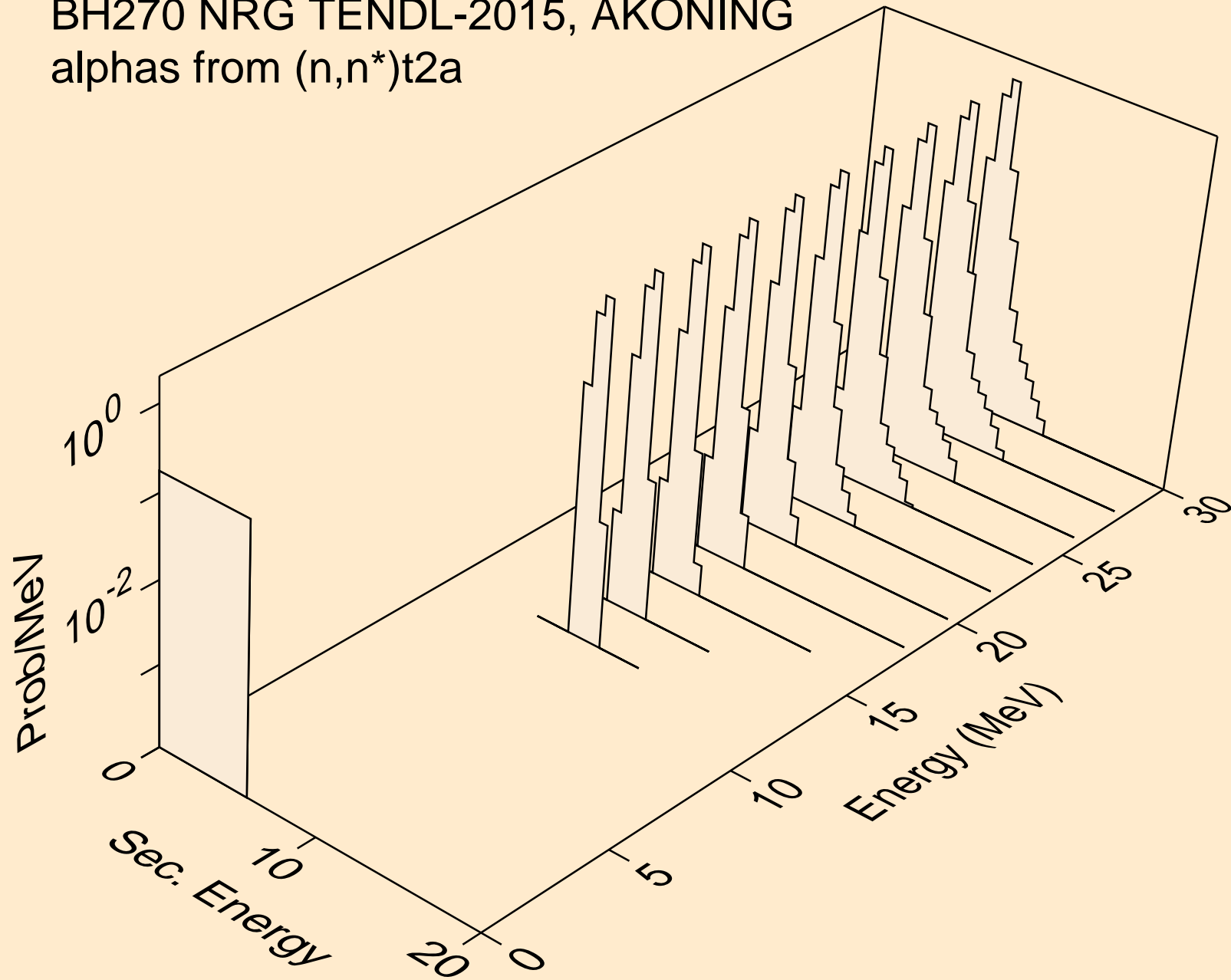

BH270 NRG TENDL-2015, AKONING  
alphas from (n,npa)

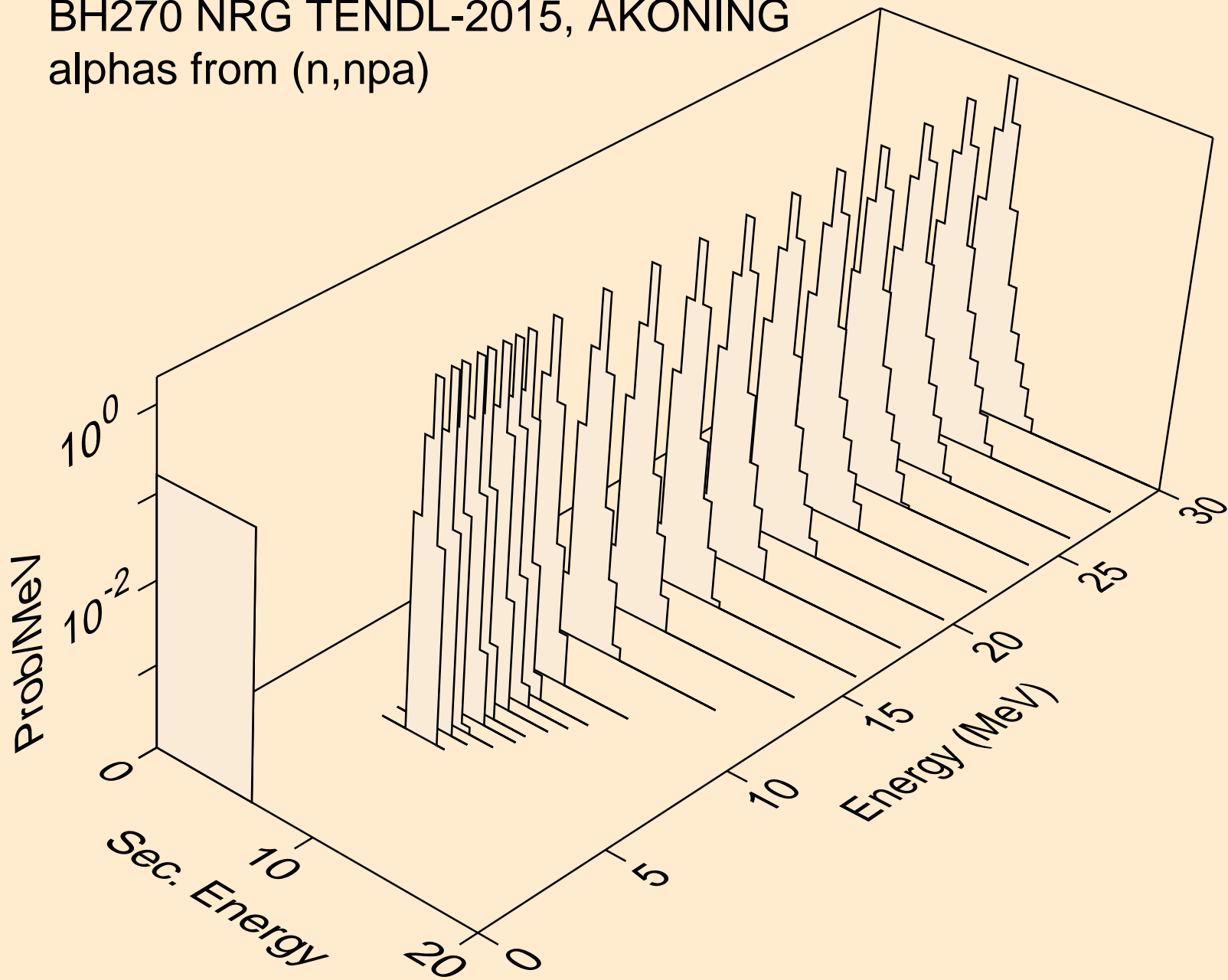

BH270 NRG TENDL-2015, AKONING  
alphas from (n,a)

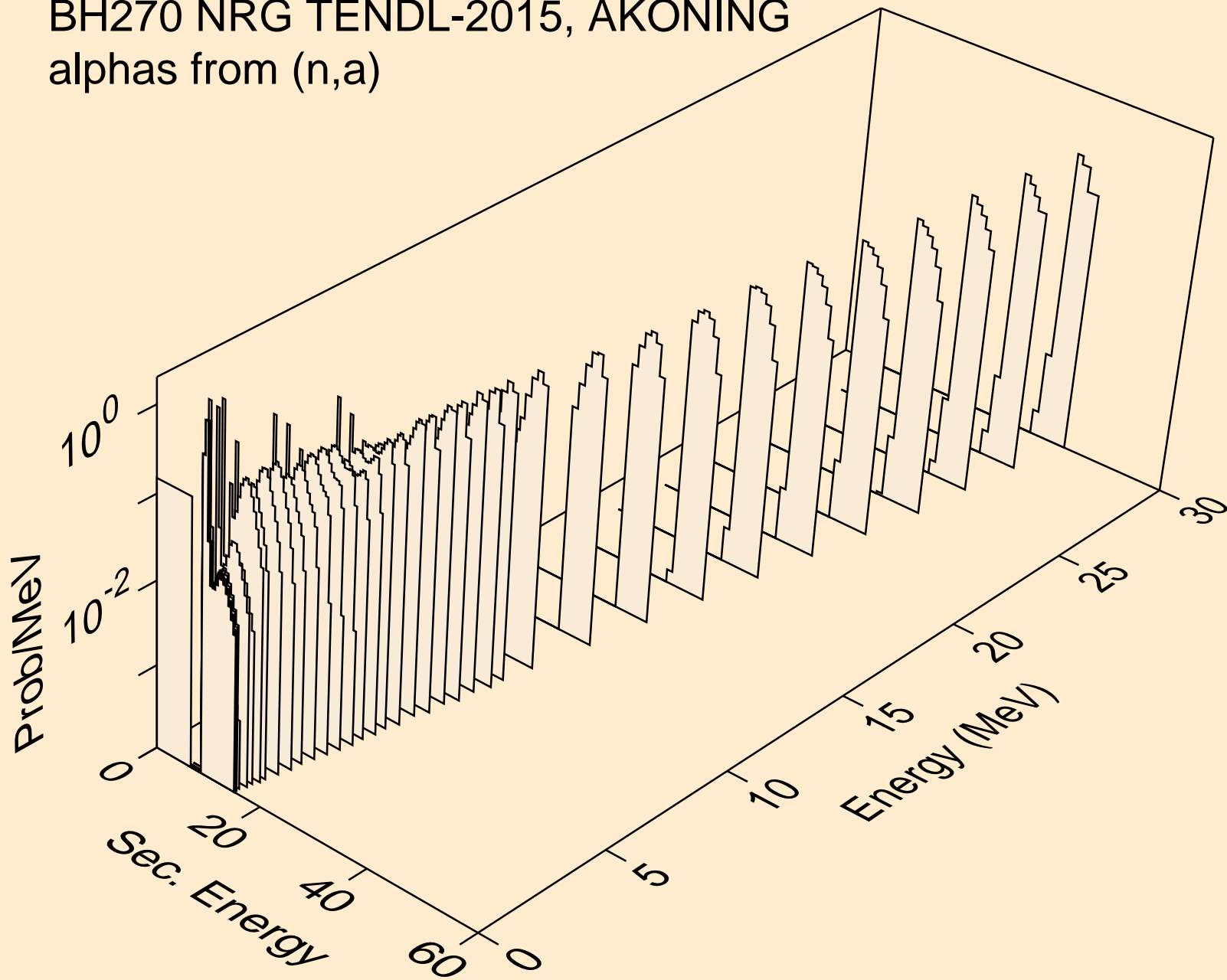

BH270 NRG TENDL-2015, AKONING  
alphas from (n,2a)

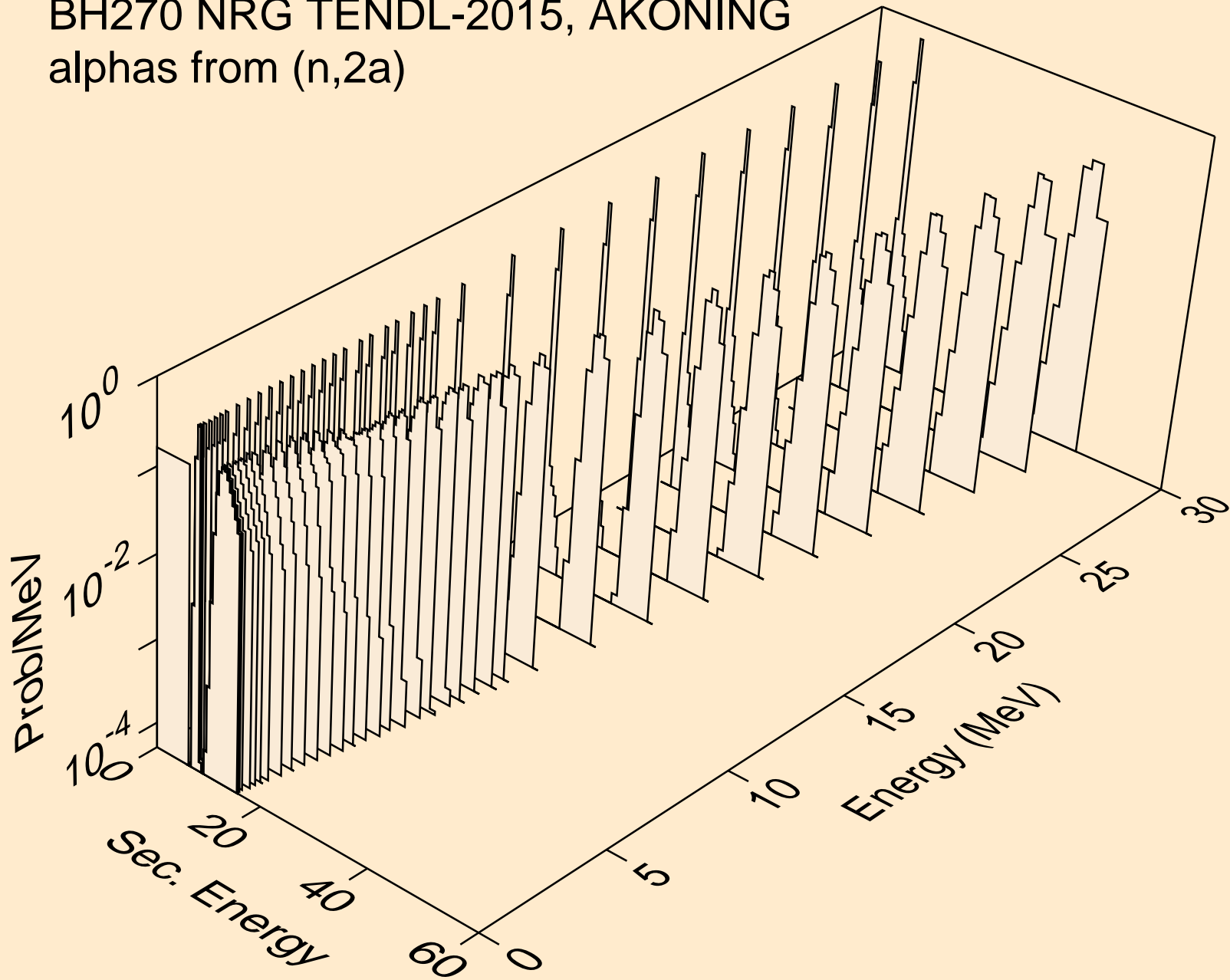

BH270 NRG TENDL-2015, AKONING  
alphas from (n,3a)

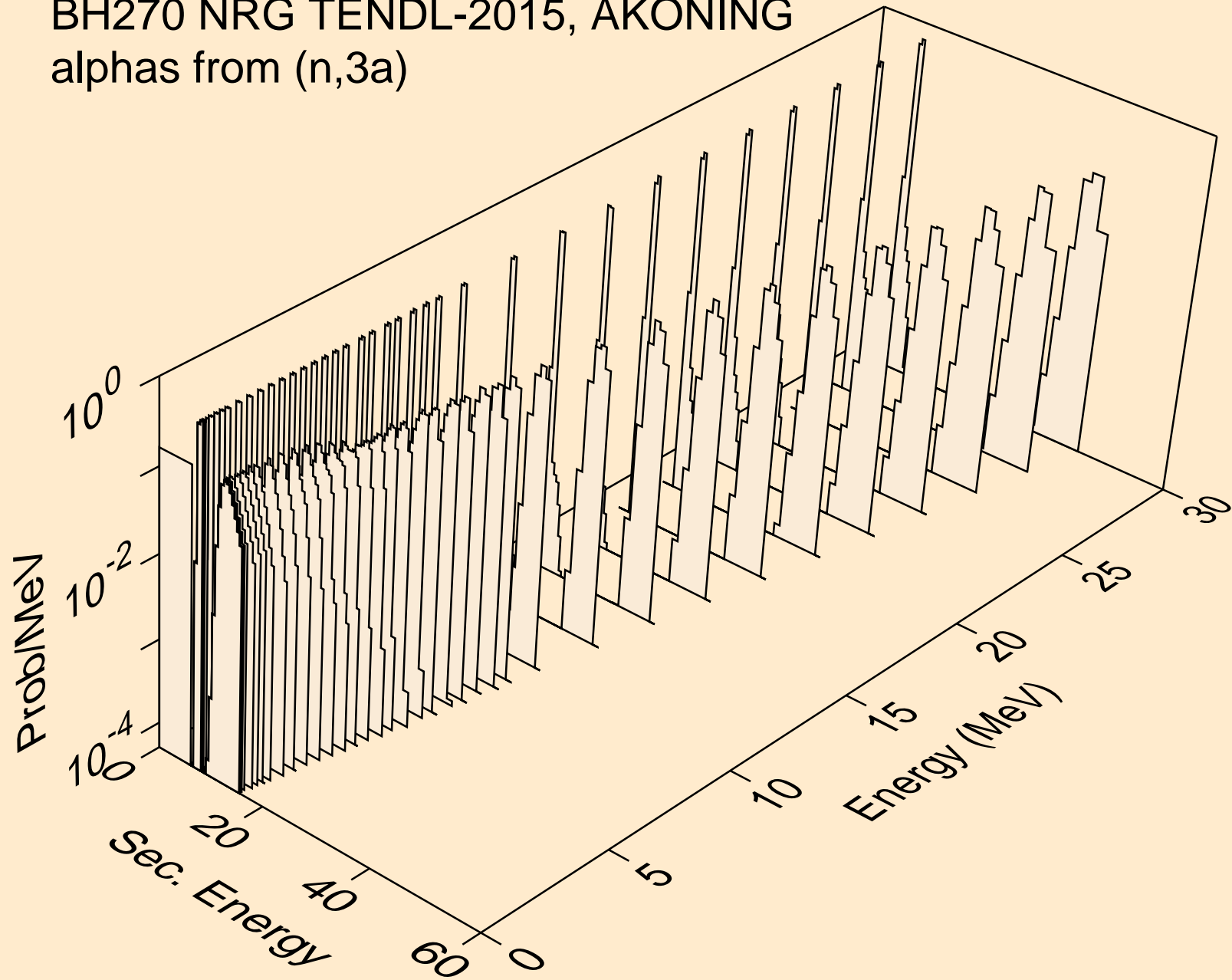

BH270 NRG TENDL-2015, AKONING  
alphas from (n,pa)

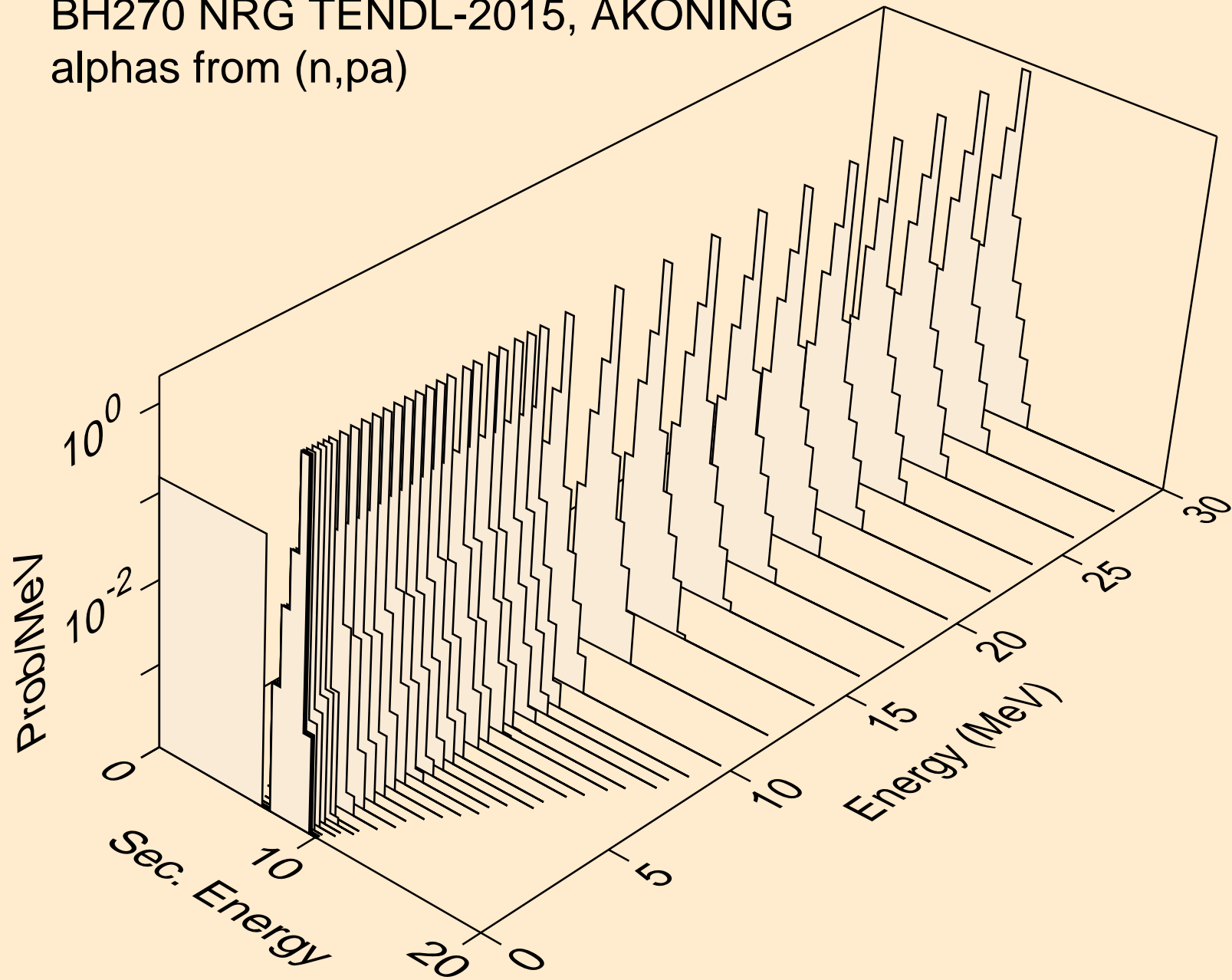



BH270 NRG TENDL-2015, AKONING  
alphas from (n,t2a)

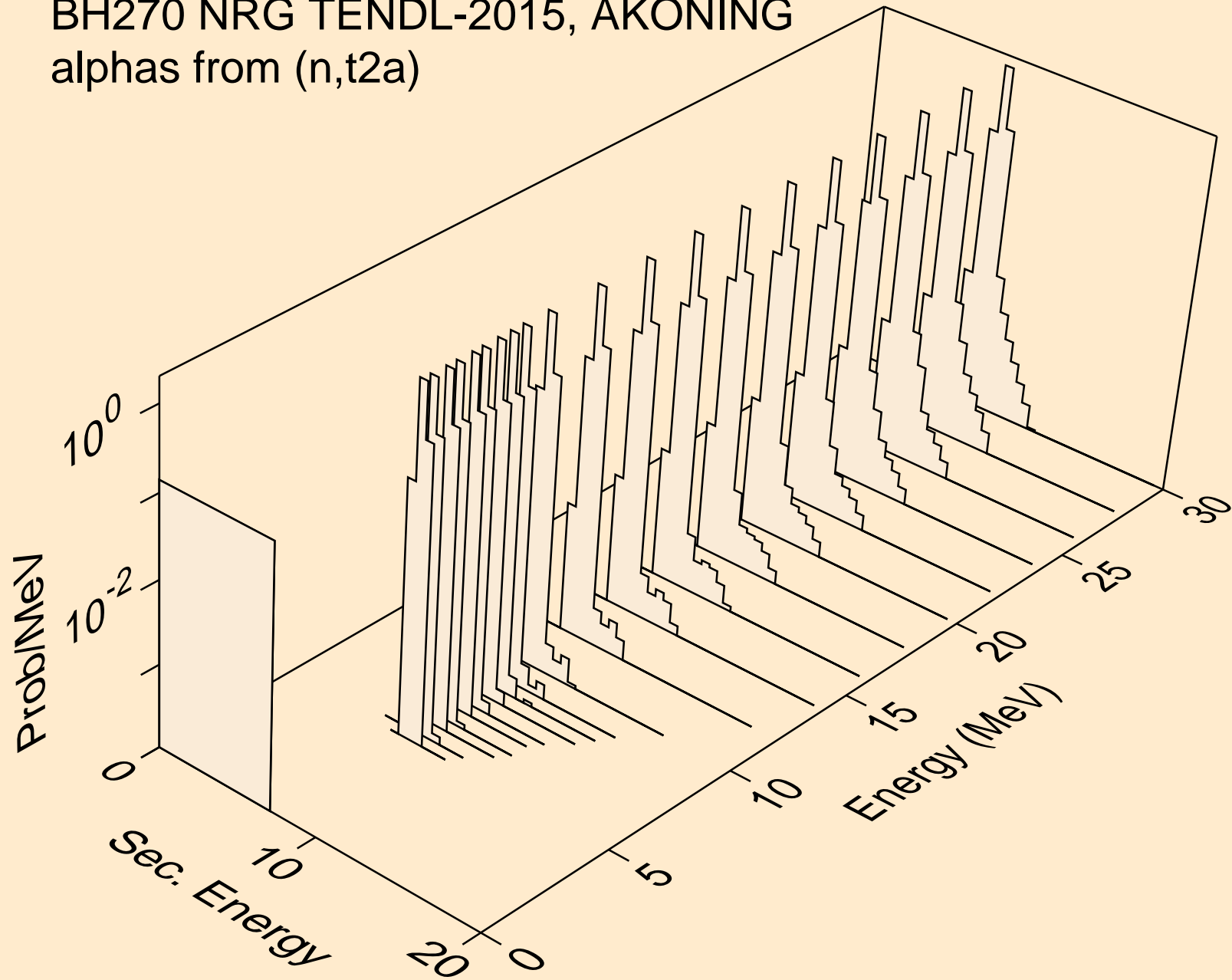

BH270 NRG TENDL-2015, AKONING  
alphas from (n,d2a)

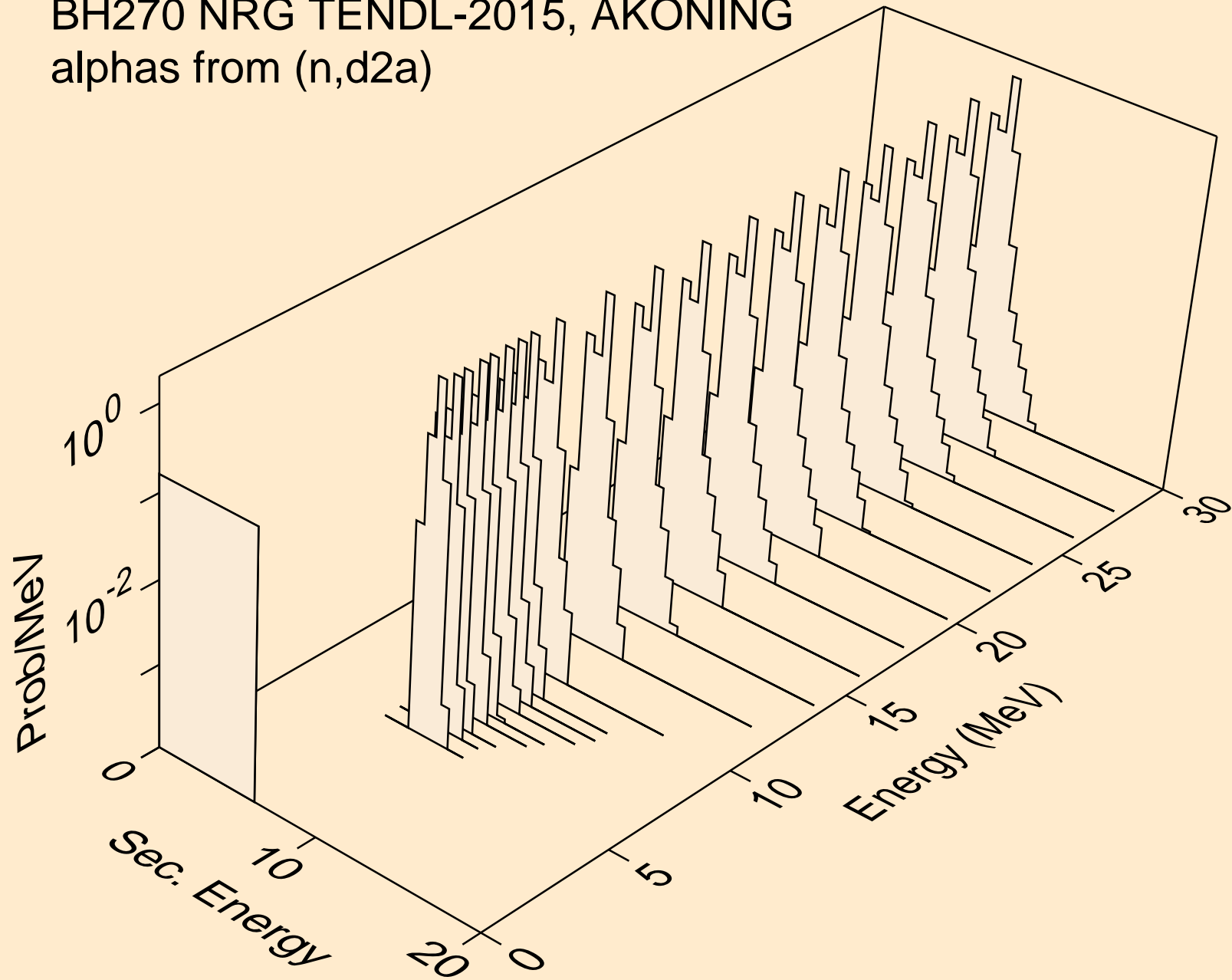

BH270 NRG TENDL-2015, AKONING  
alphas from (n,da)

