

BH271 NRG TENDL-2015, AKONING

Principal cross sections

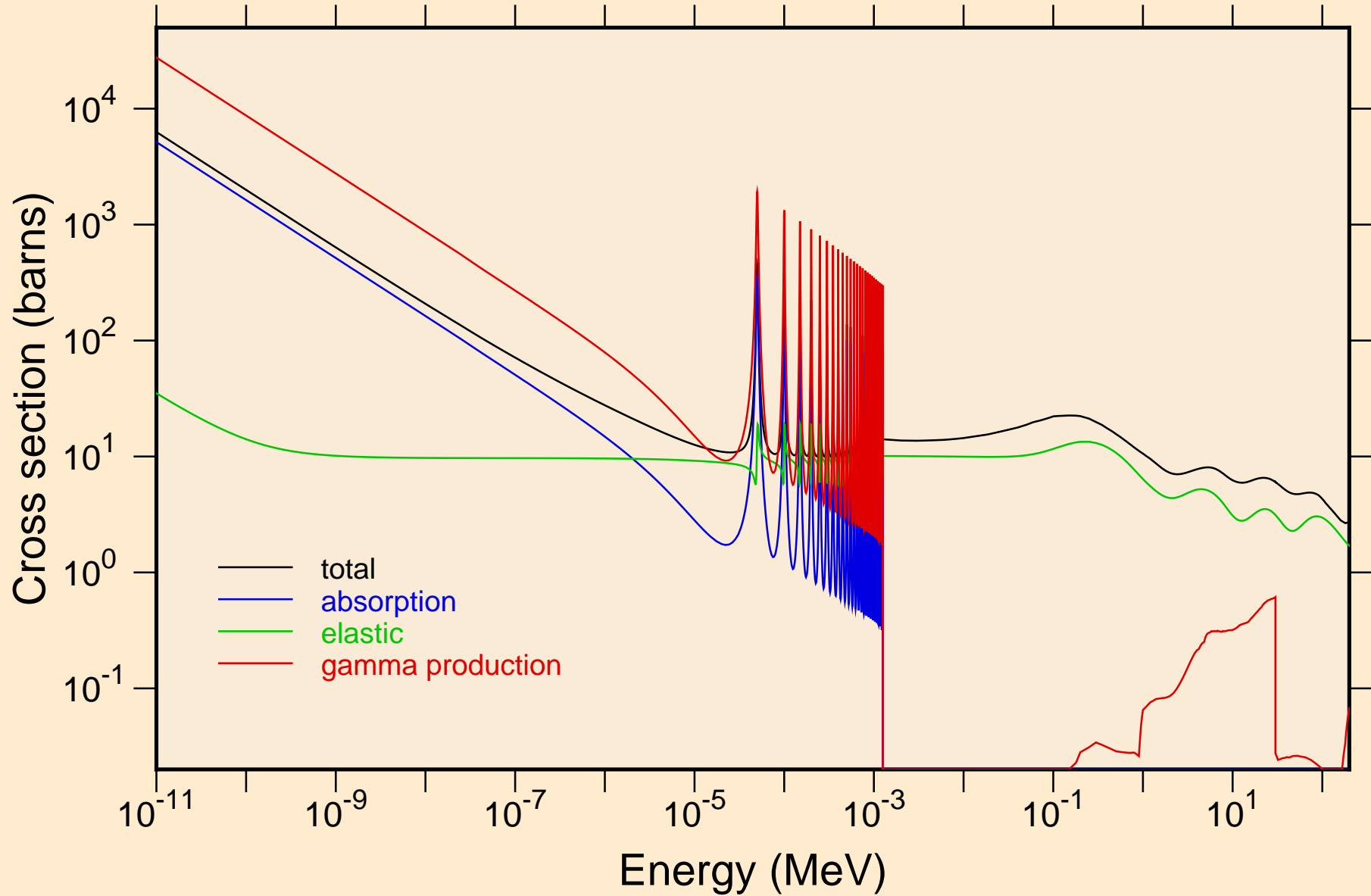

BH271 NRG TENDL-2015, AKONING
resonance total cross section

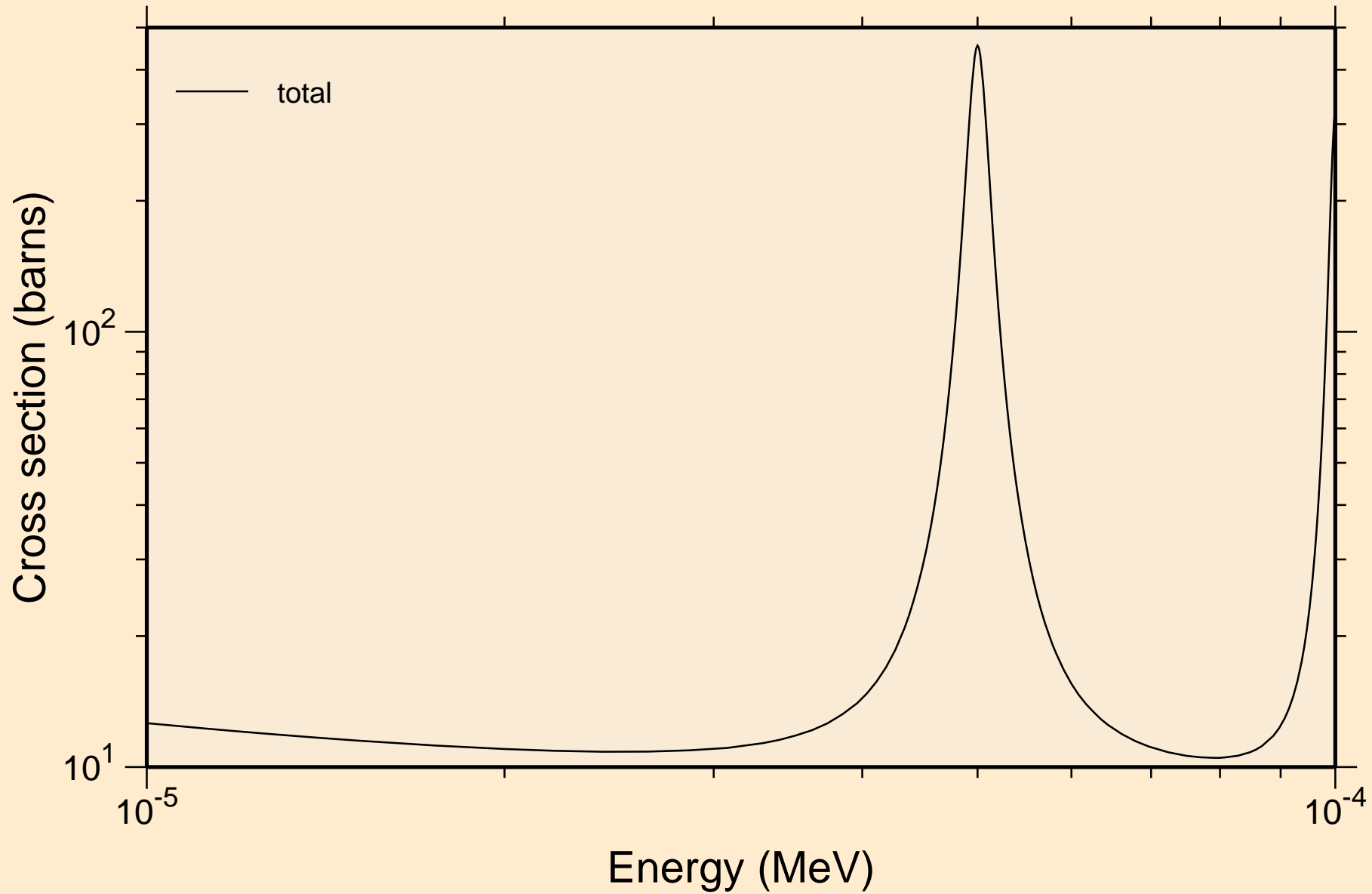

BH271 NRG TENDL-2015, AKONING
resonance total cross section

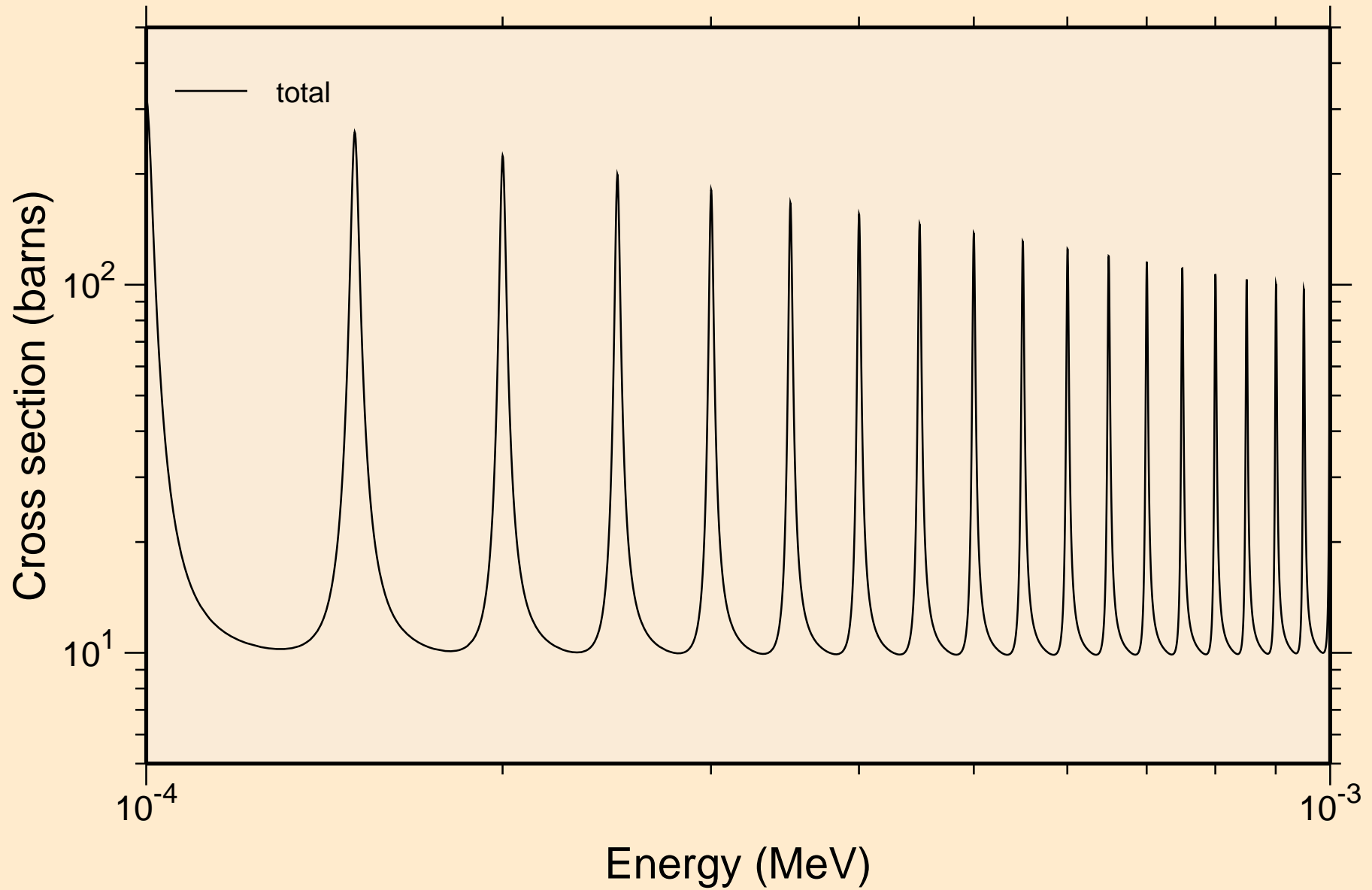

BH271 NRG TENDL-2015, AKONING
resonance total cross section

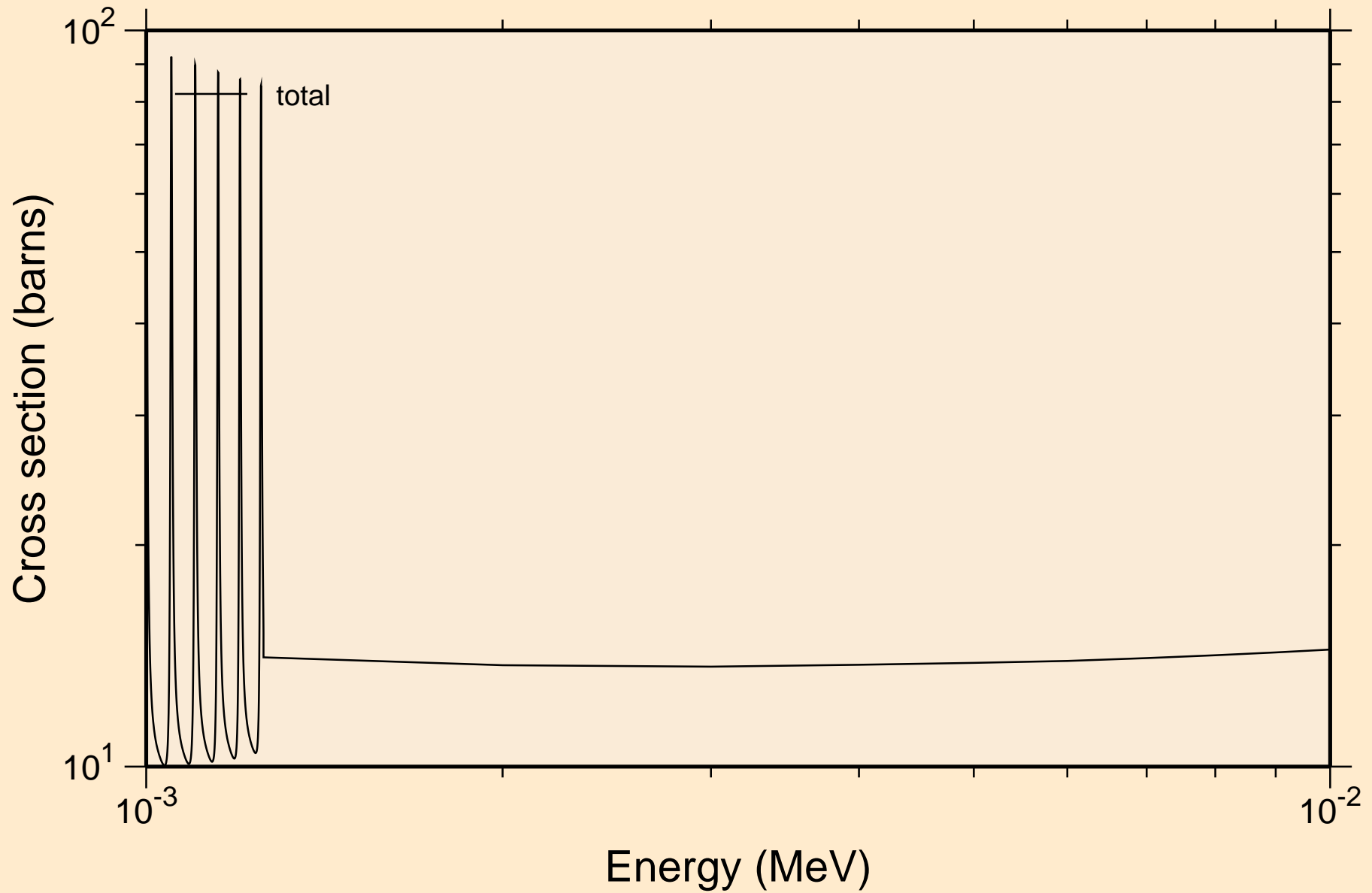

BH271 NRG TENDL-2015, AKONING
resonance total cross section

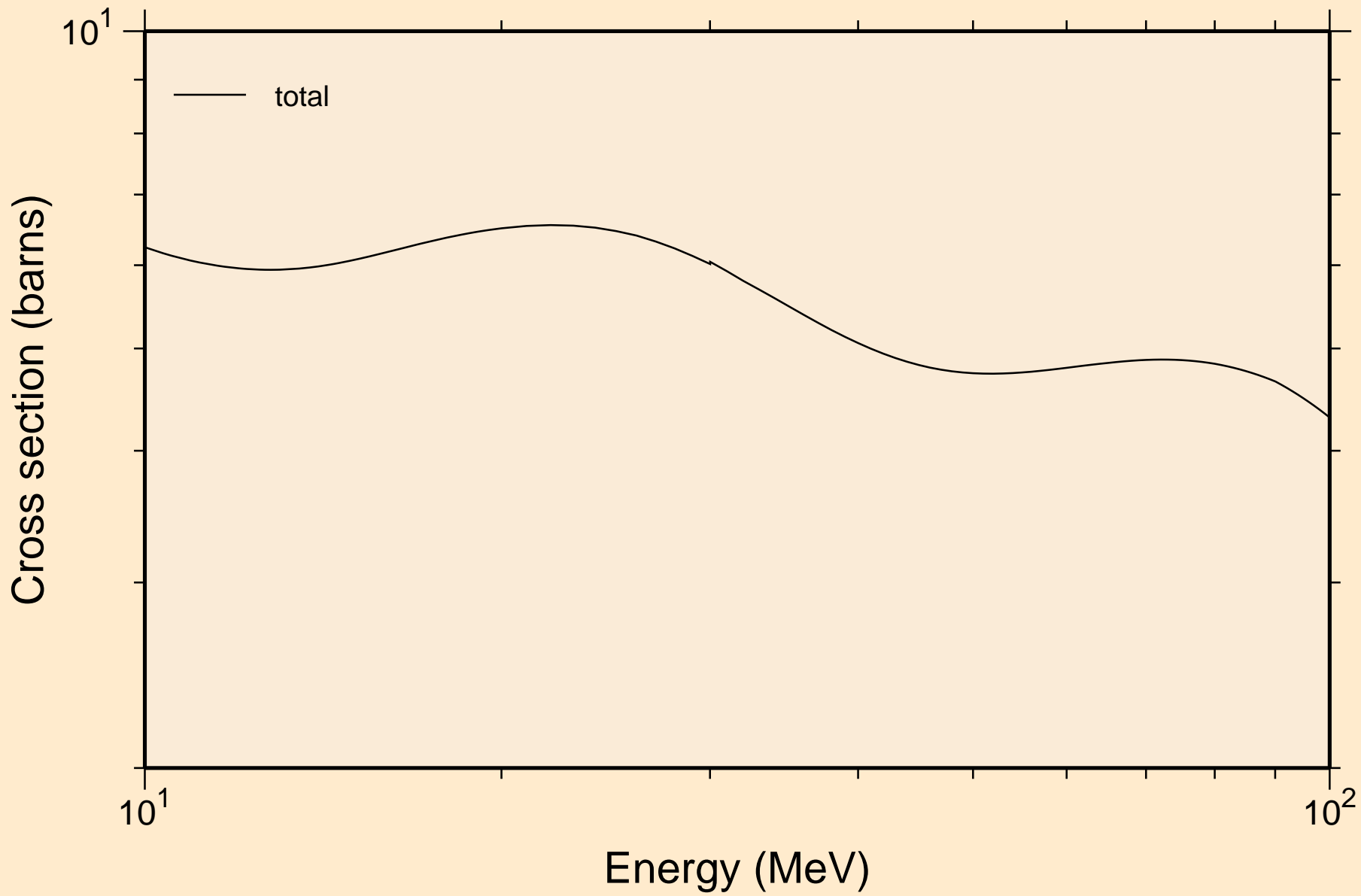

BH271 NRG TENDL-2015, AKONING
resonance absorption cross sections

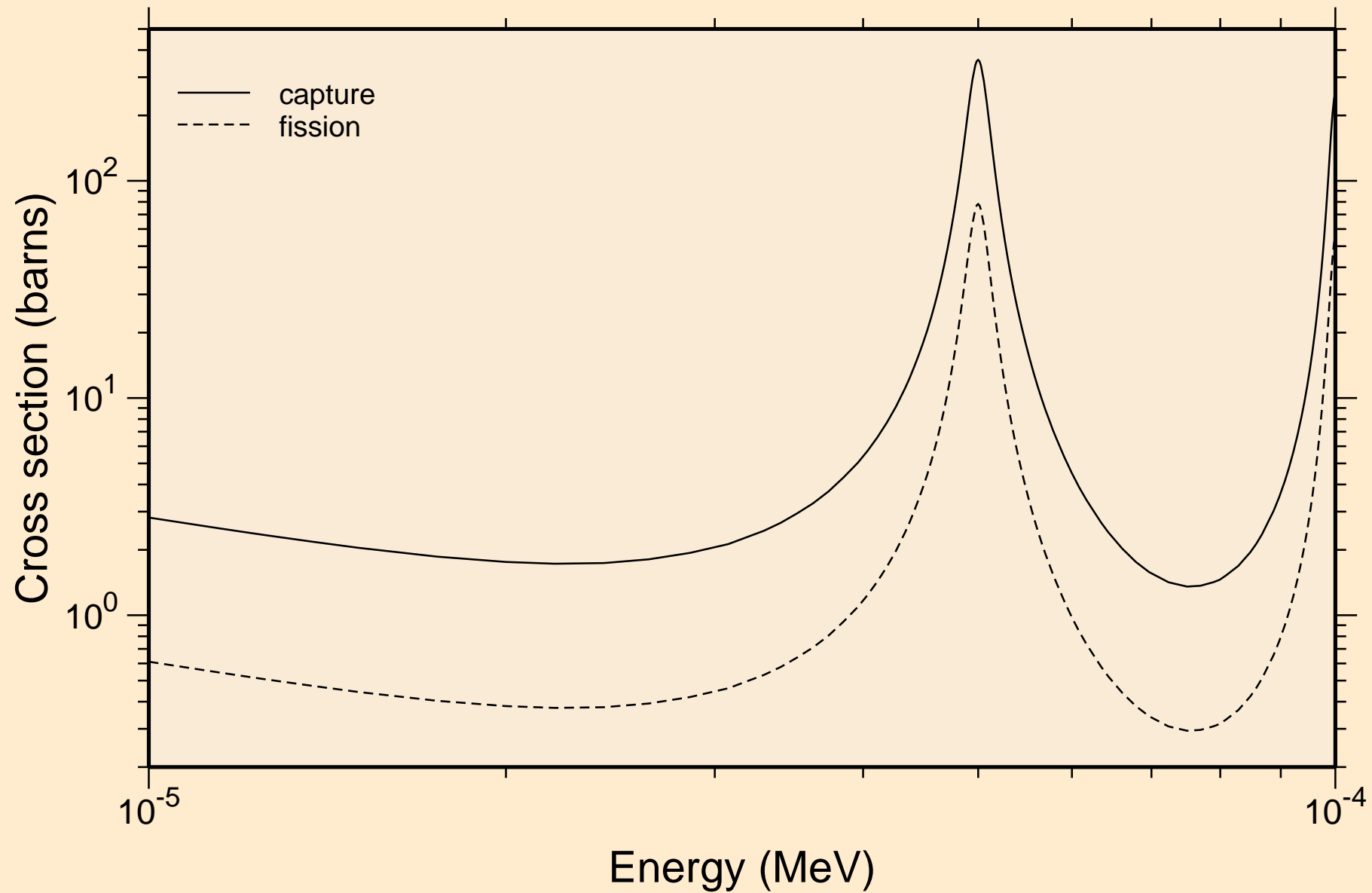

BH271 NRG TENDL-2015, AKONING
resonance absorption cross sections

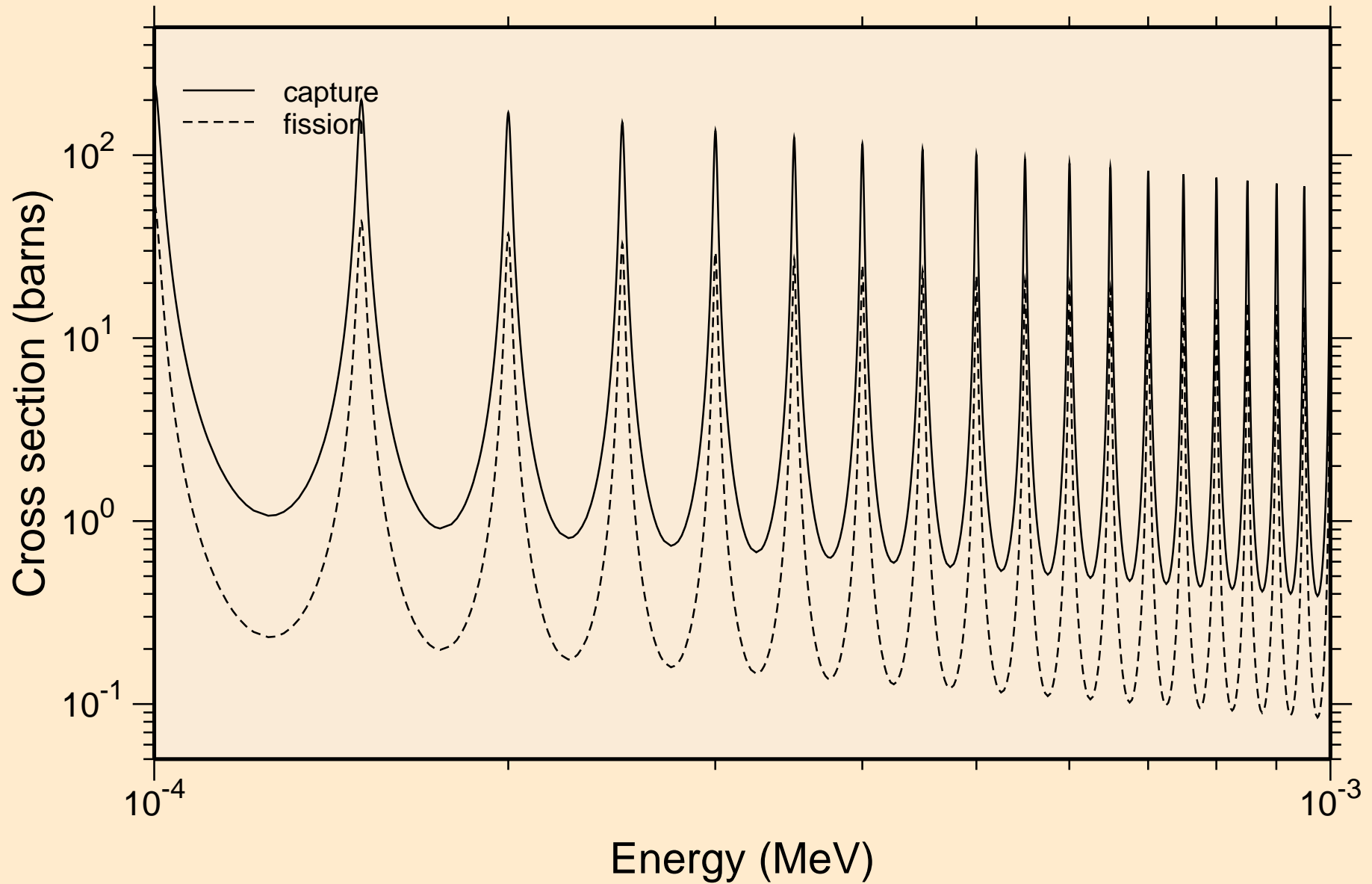

BH271 NRG TENDL-2015, AKONING
resonance absorption cross sections

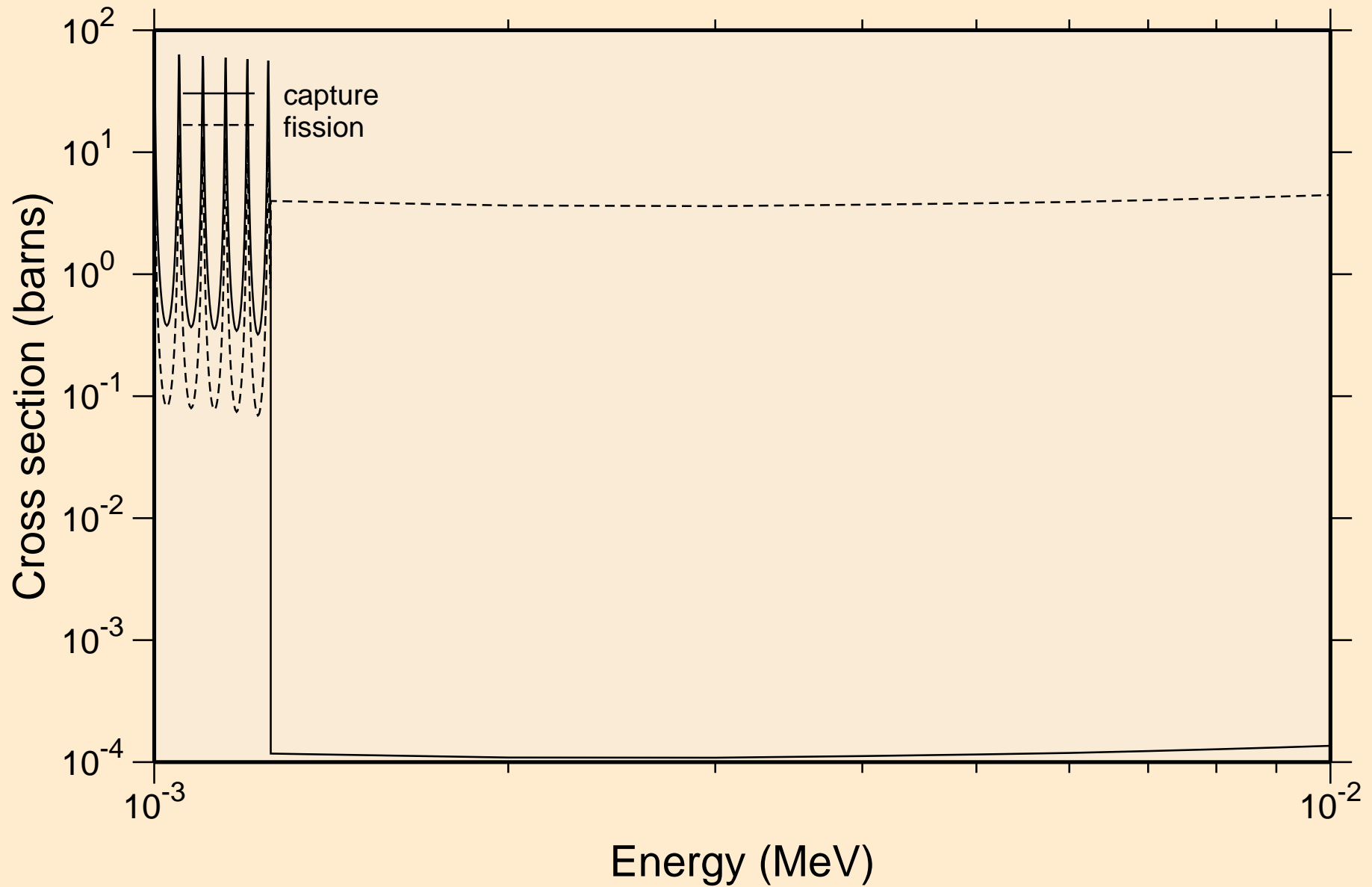

BH271 NRG TENDL-2015, AKONING

resonance absorption cross sections

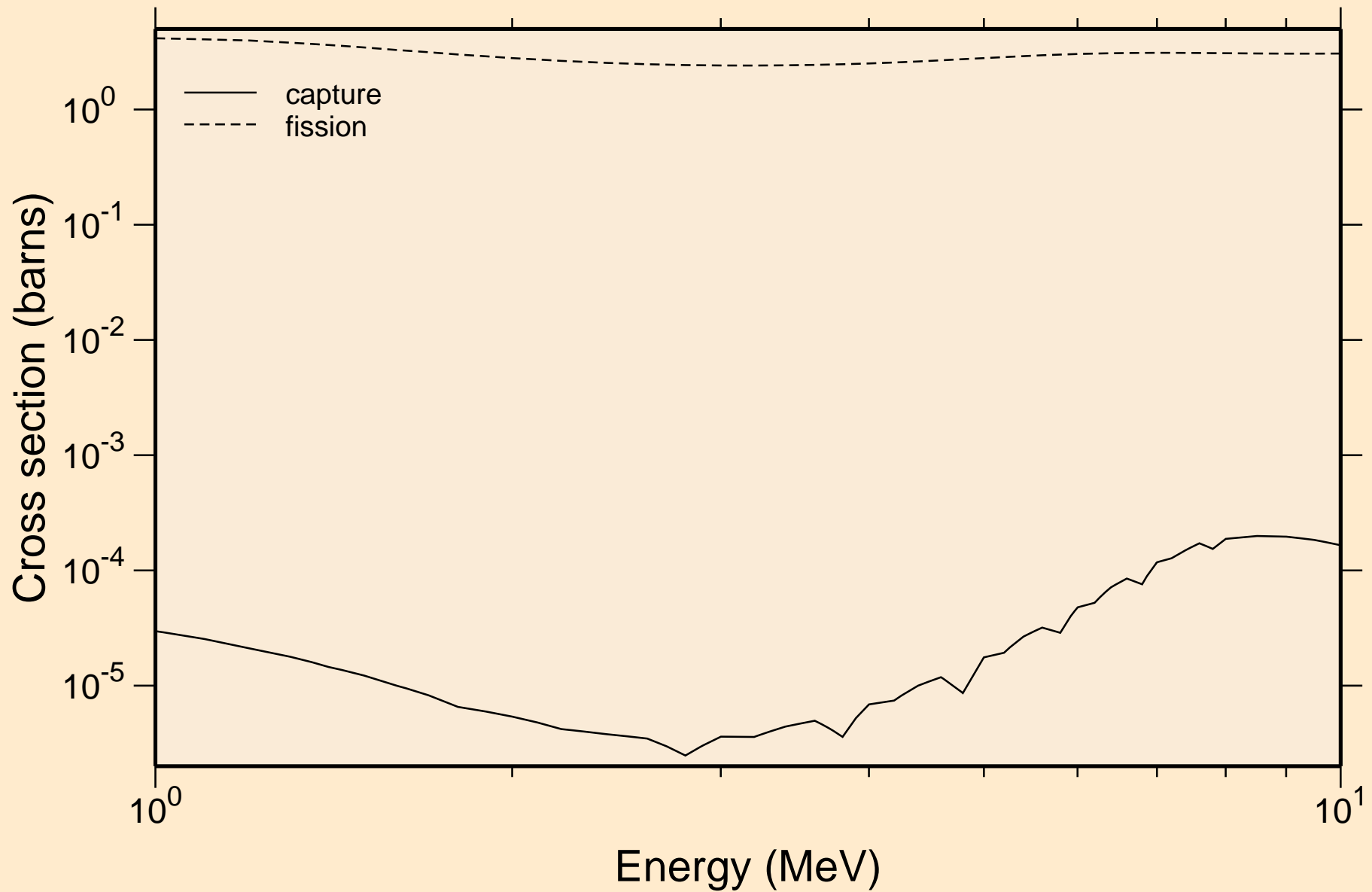

BH271 NRG TENDL-2015, AKONING

Non-threshold reactions

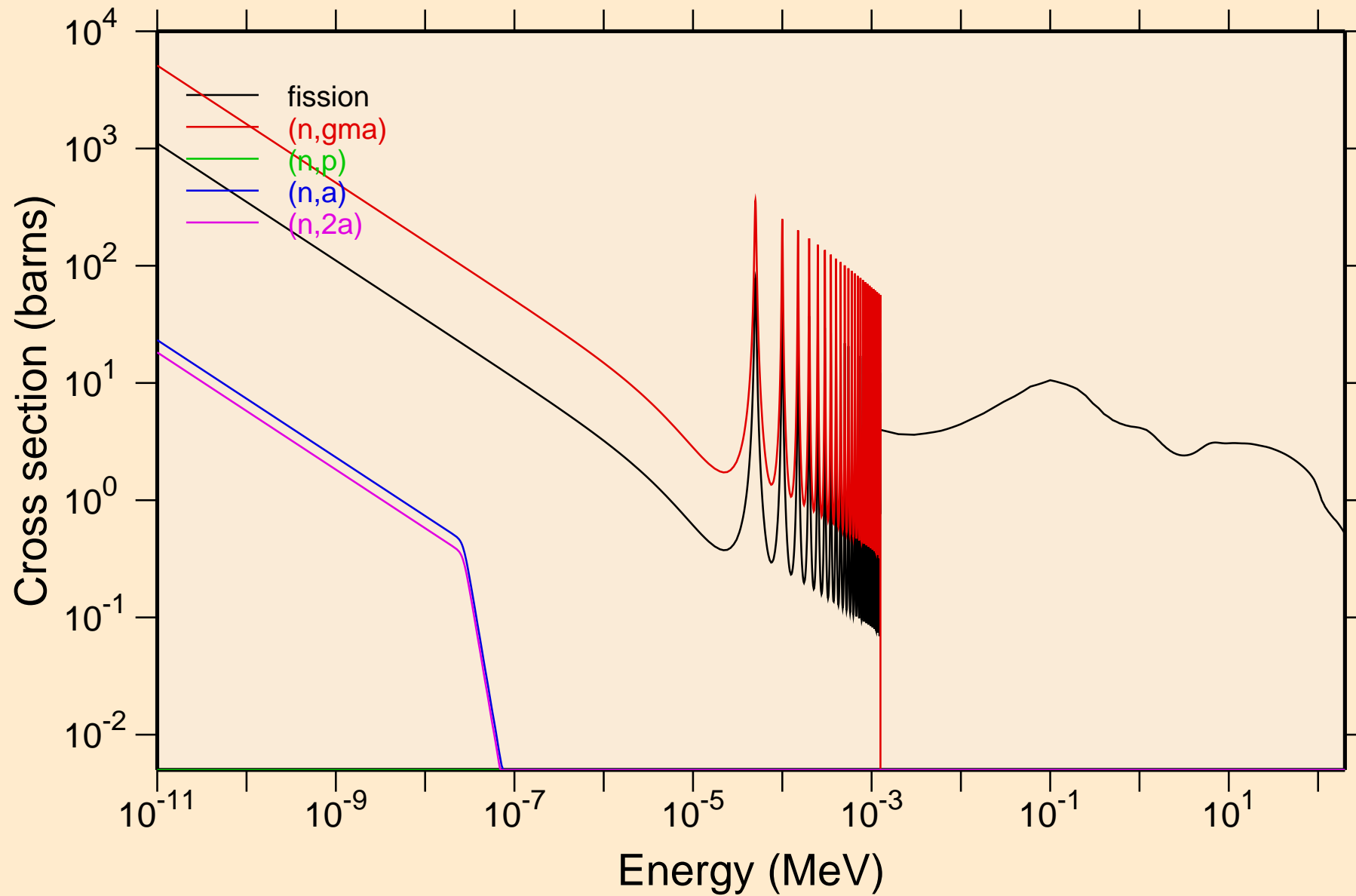

BH271 NRG TENDL-2015, AKONING
Non-threshold reactions

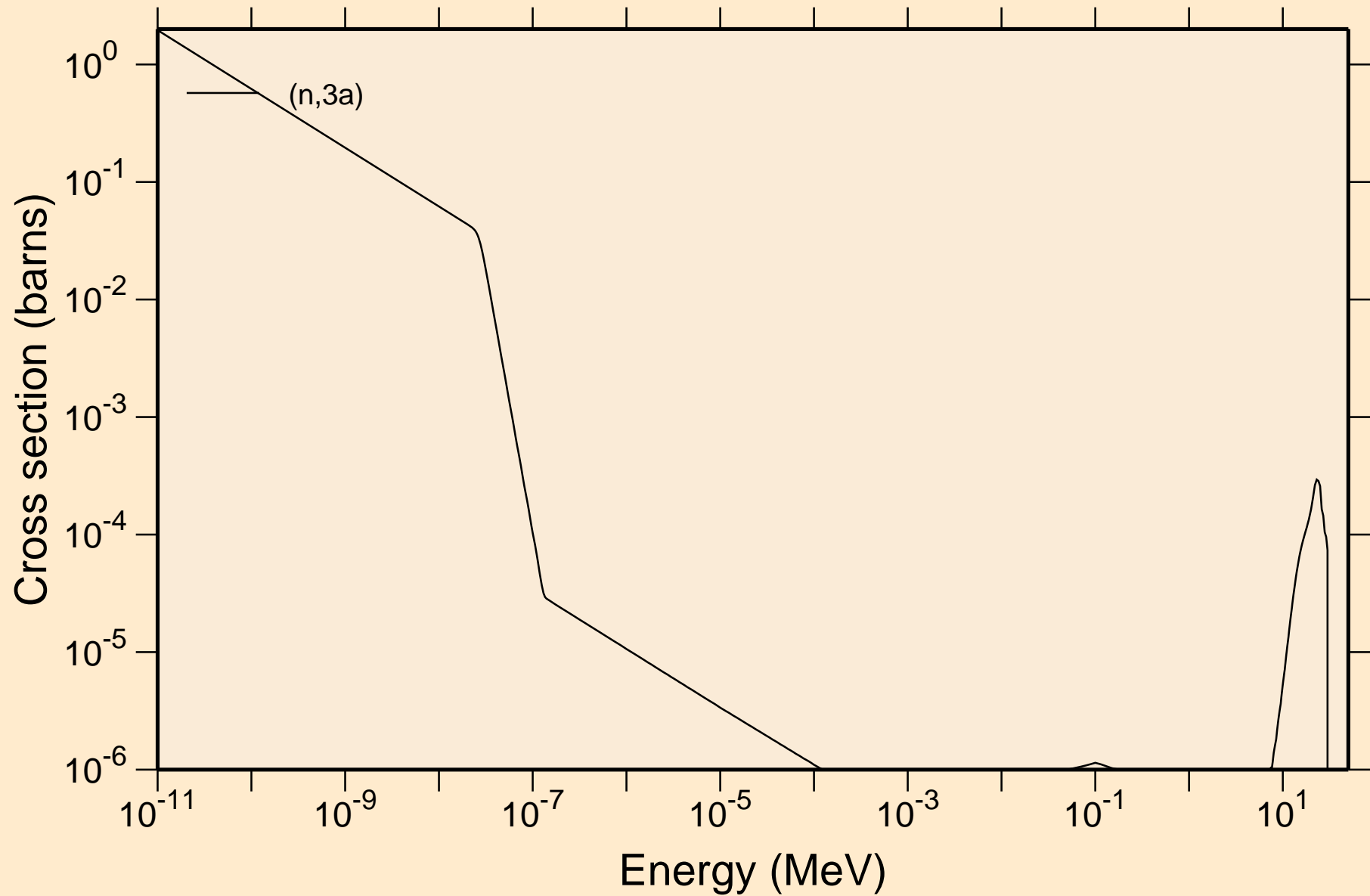

BH271 NRG TENDL-2015, AKONING

Principal cross sections

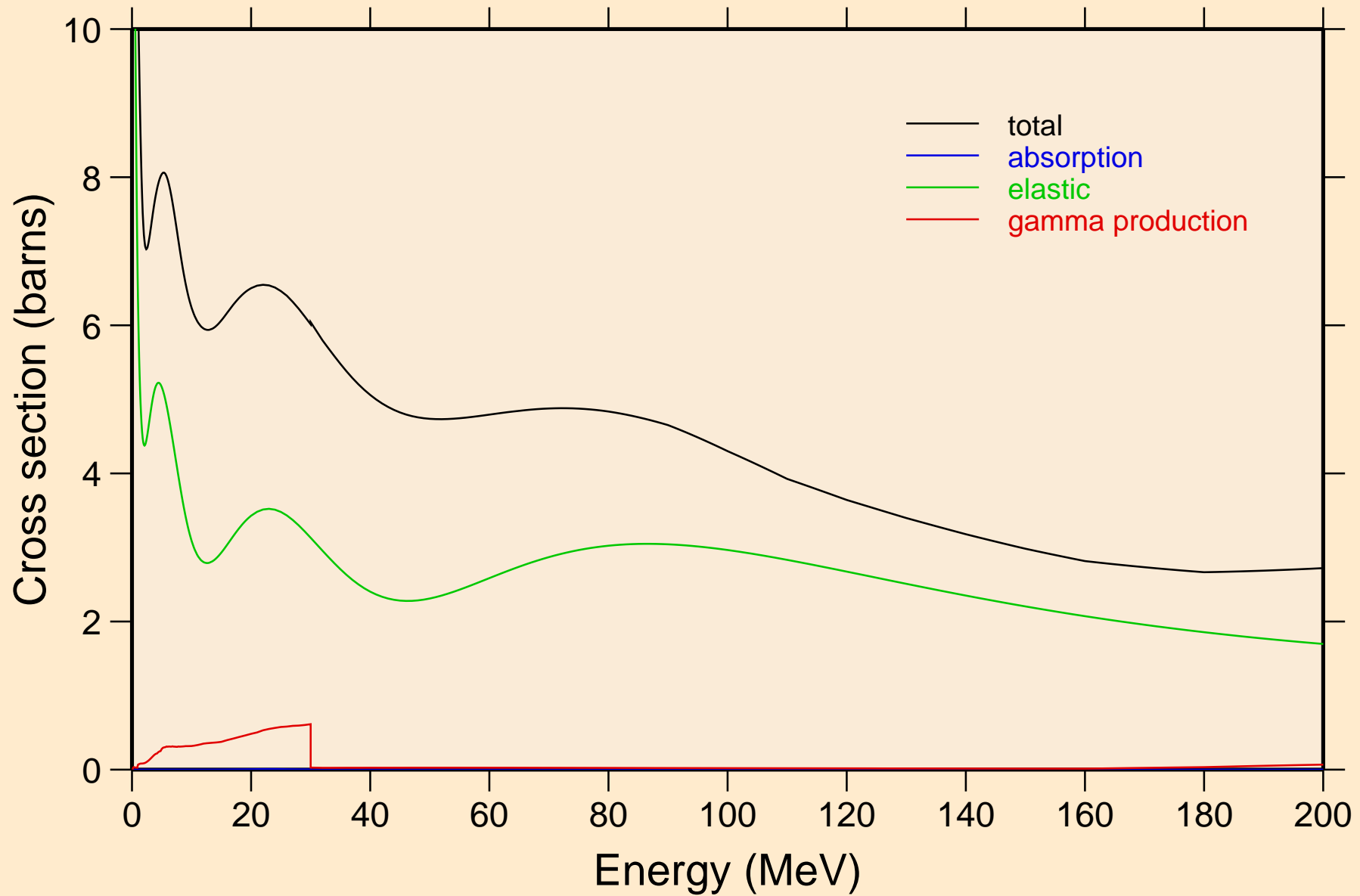

BH271 NRG TENDL-2015, AKONING

Non-threshold reactions

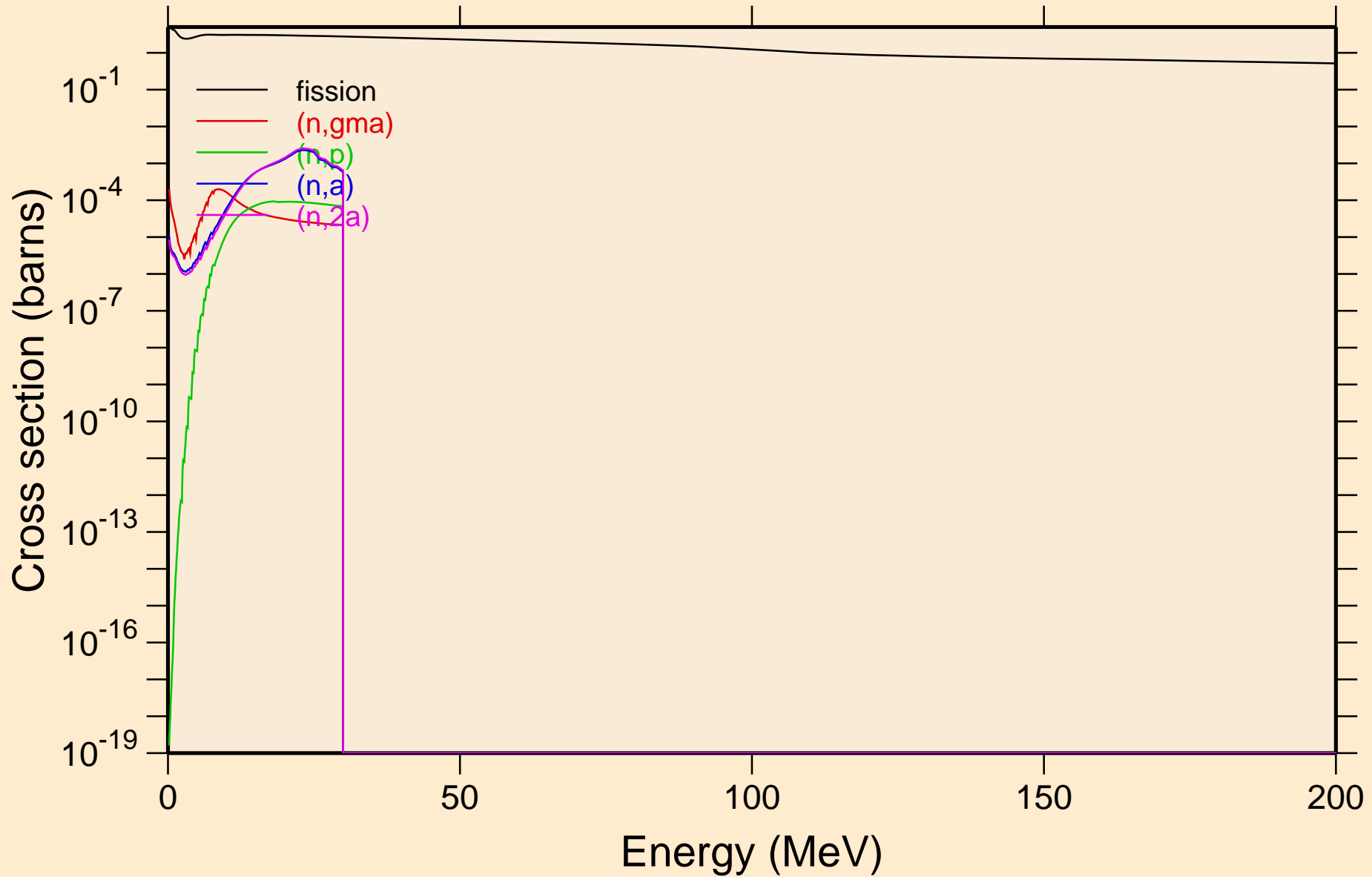

BH271 NRG TENDL-2015, AKONING
Non-threshold reactions

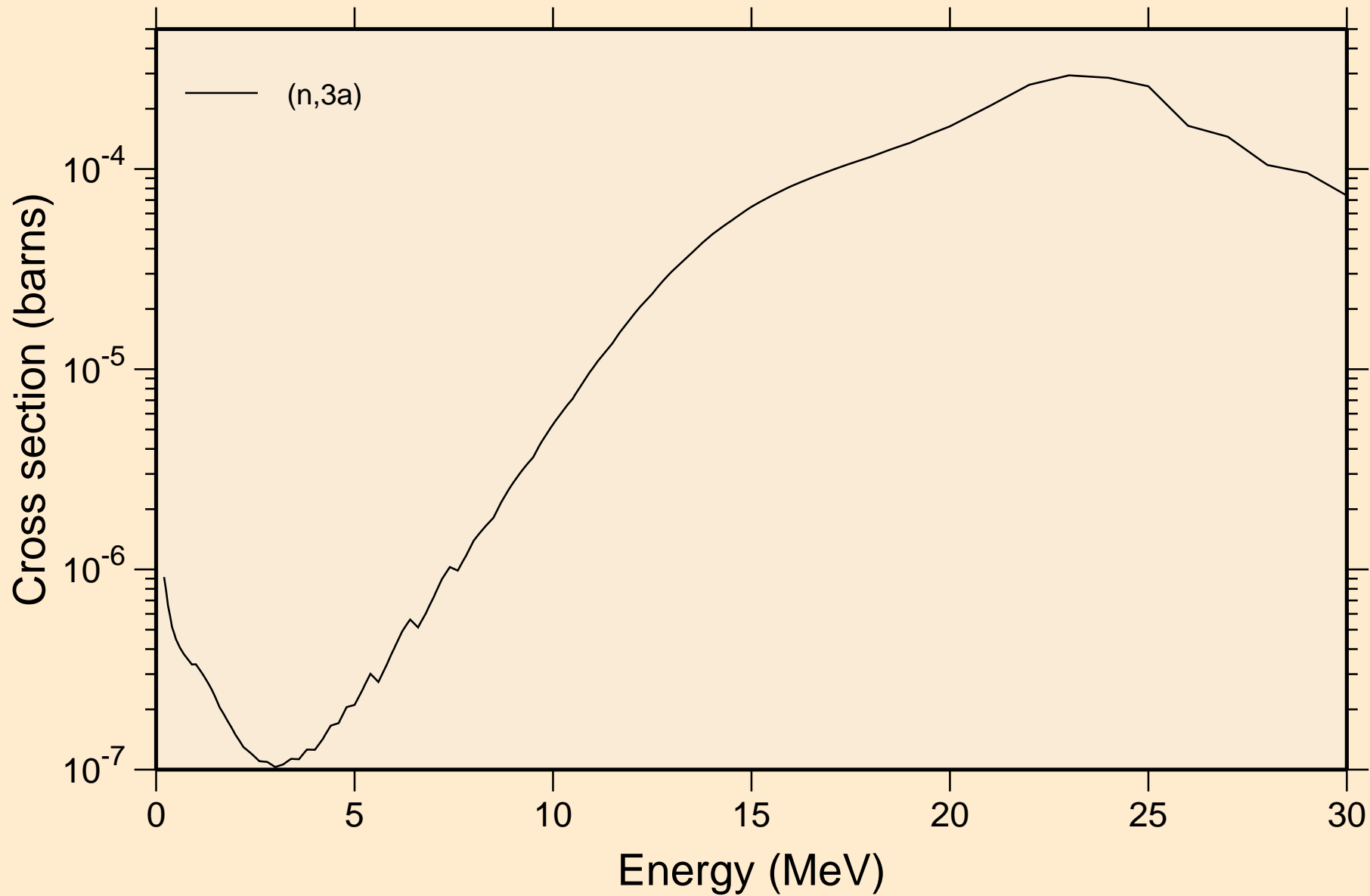

BH271 NRG TENDL-2015, AKONING
Inelastic levels

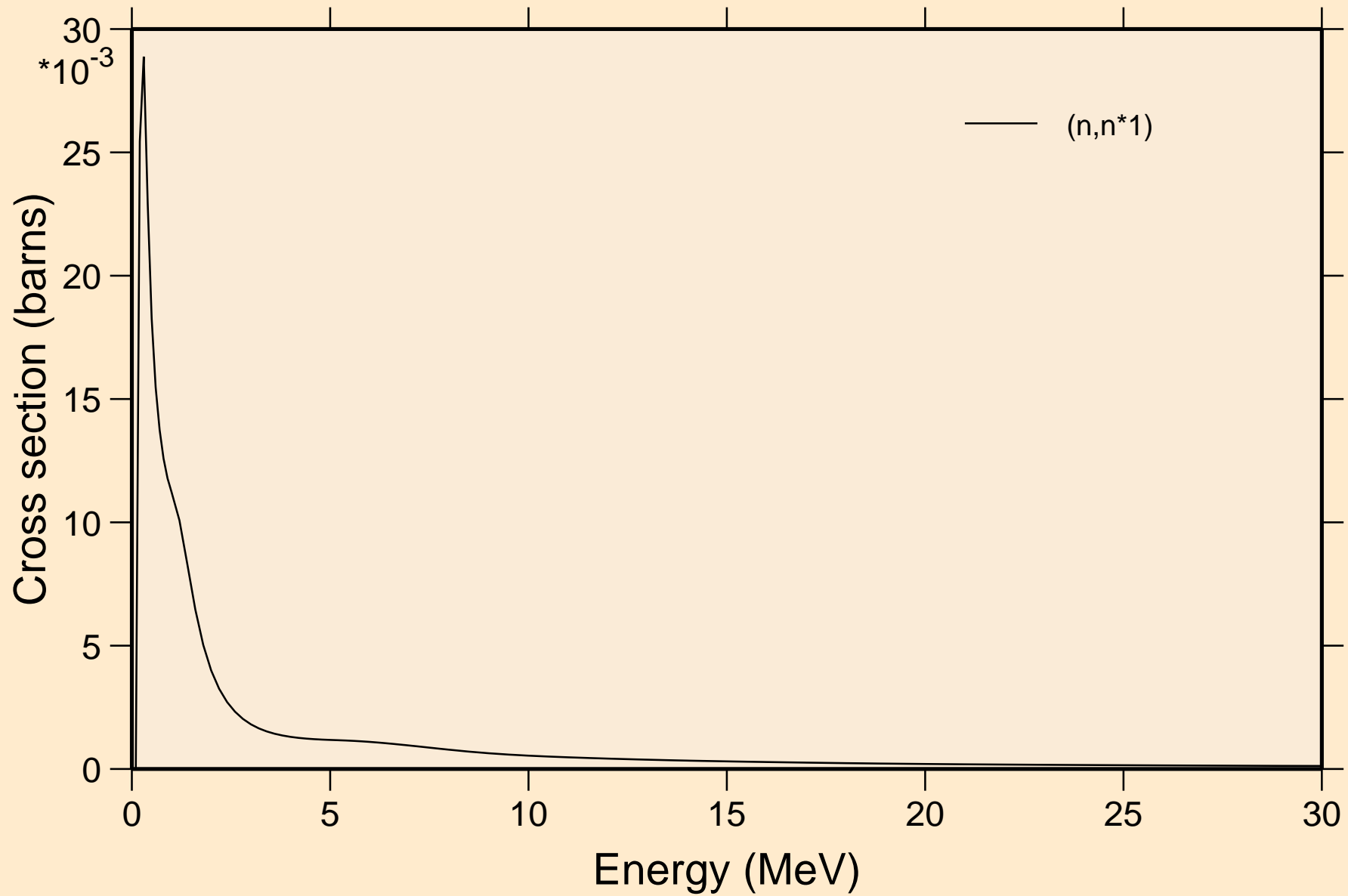

BH271 NRG TENDL-2015, AKONING

Threshold reactions

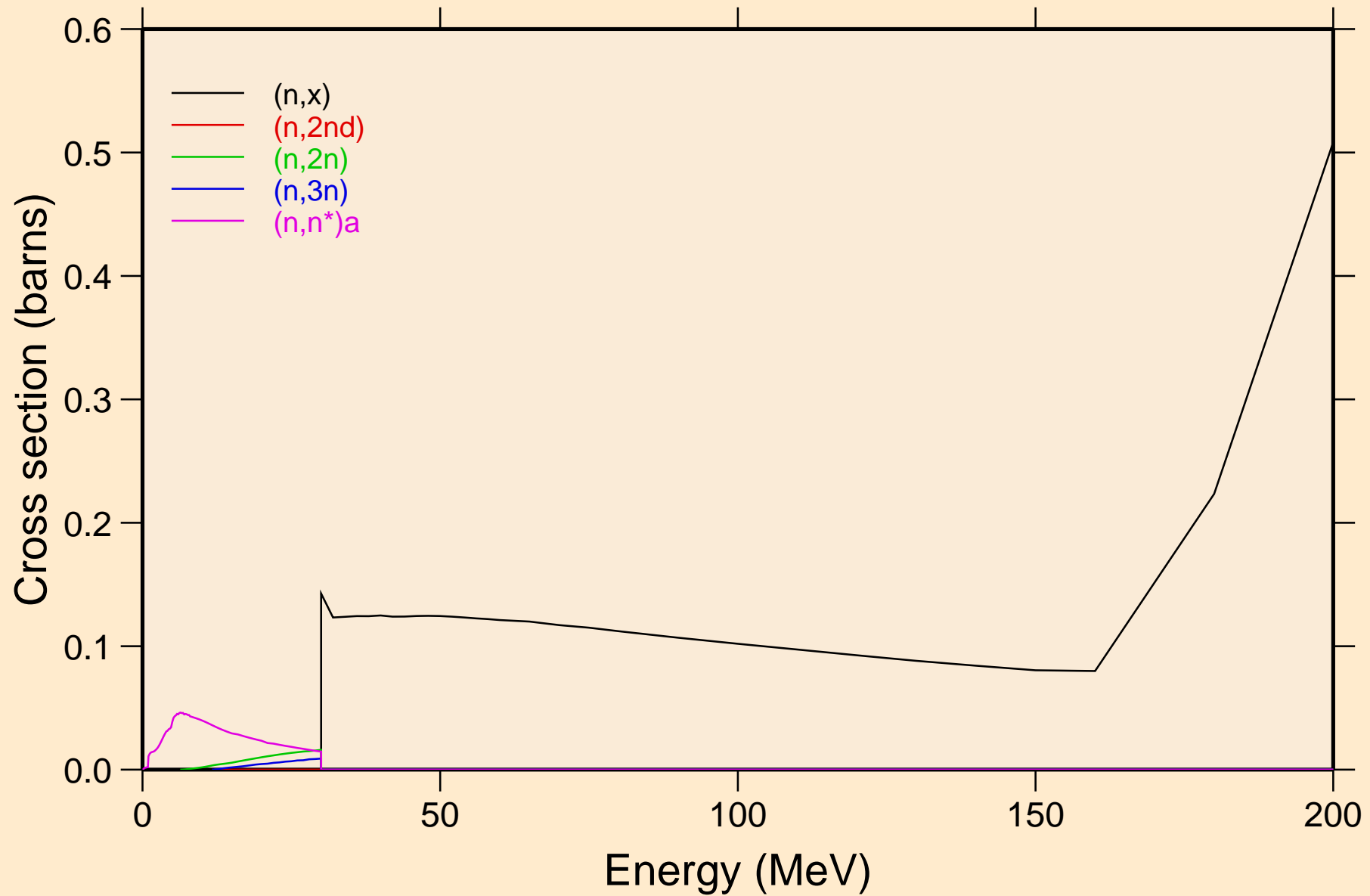

BH271 NRG TENDL-2015, AKONING

Threshold reactions

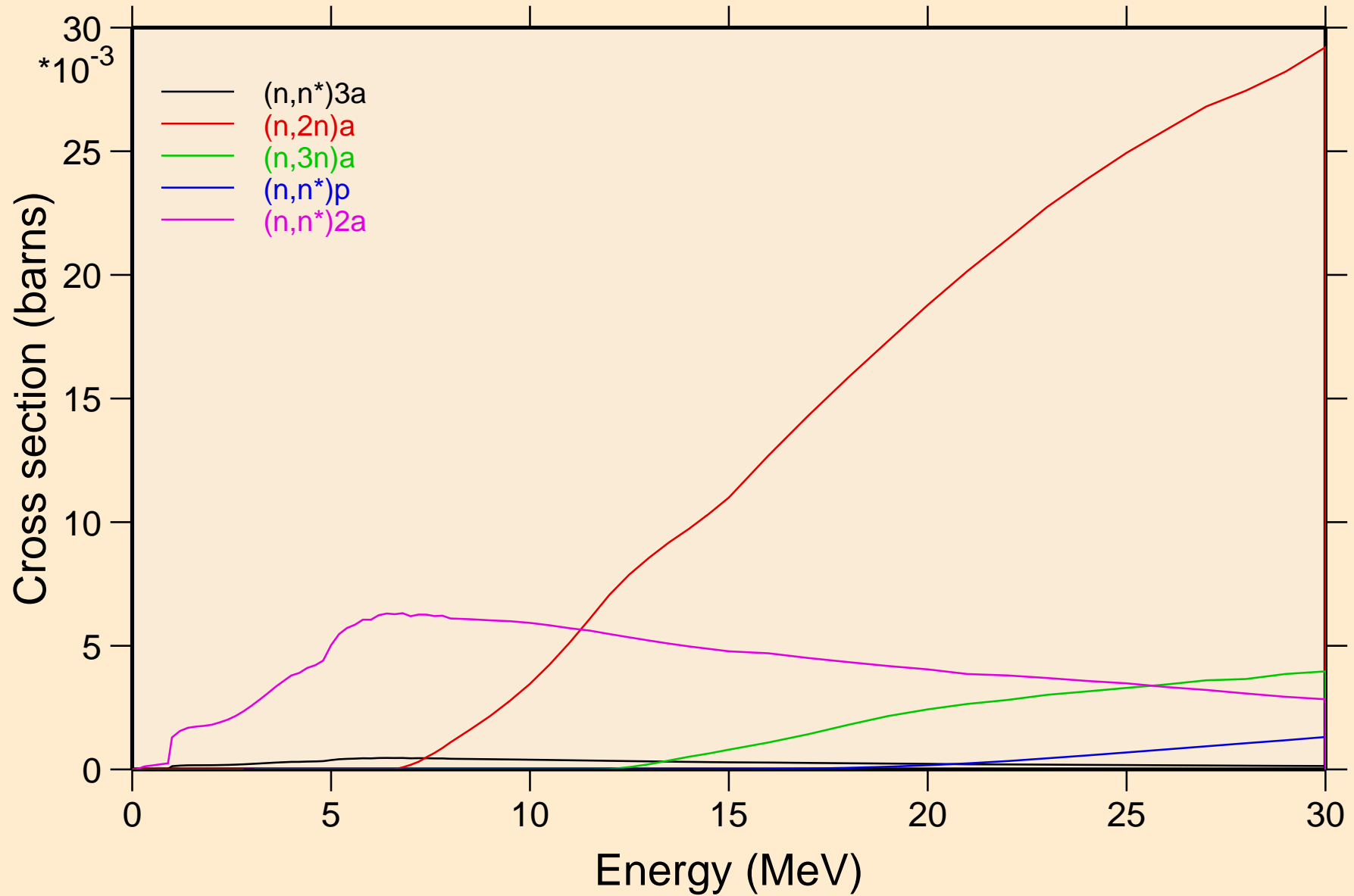

BH271 NRG TENDL-2015, AKONING

Threshold reactions

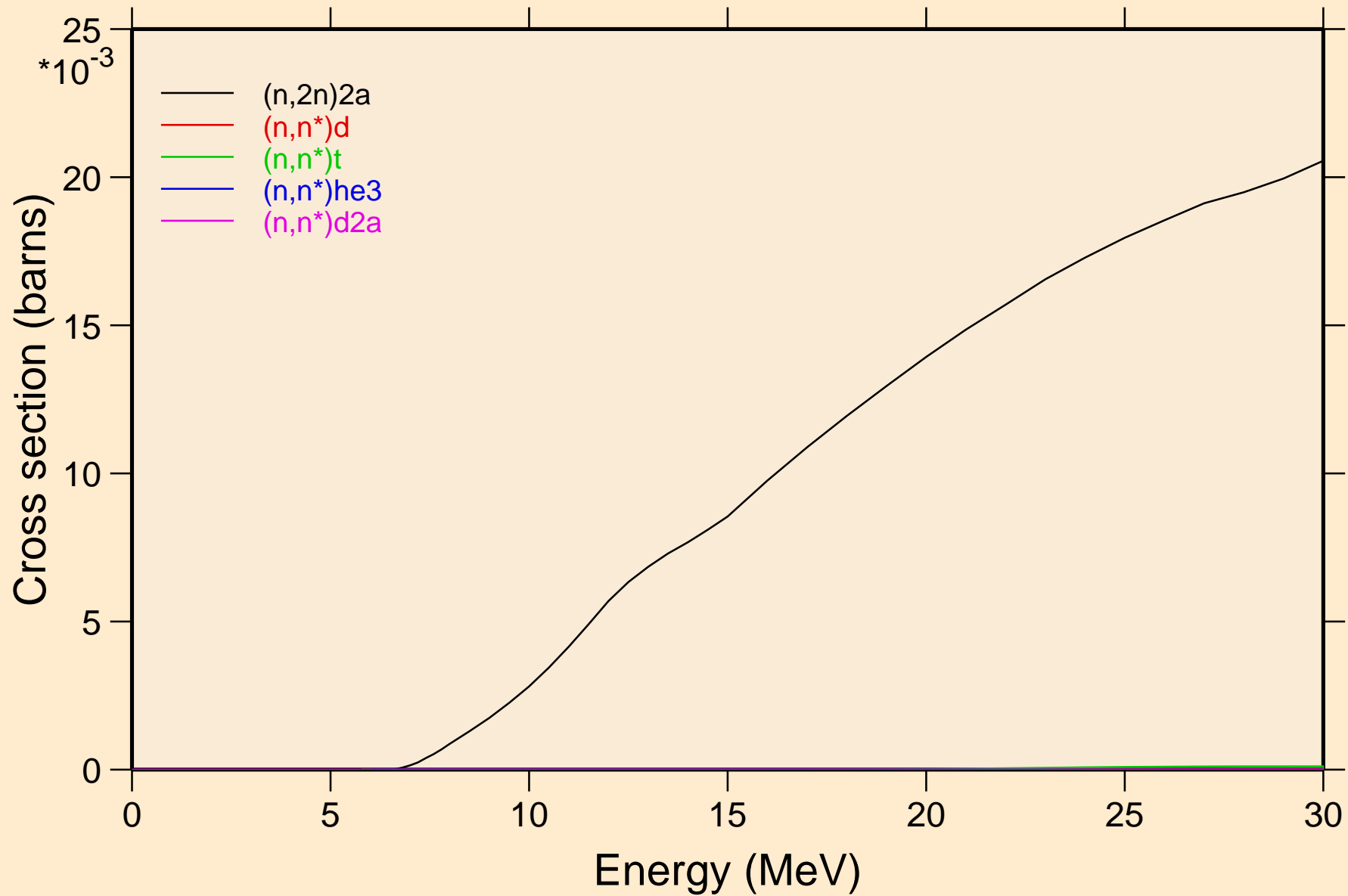

BH271 NRG TENDL-2015, AKONING

Threshold reactions

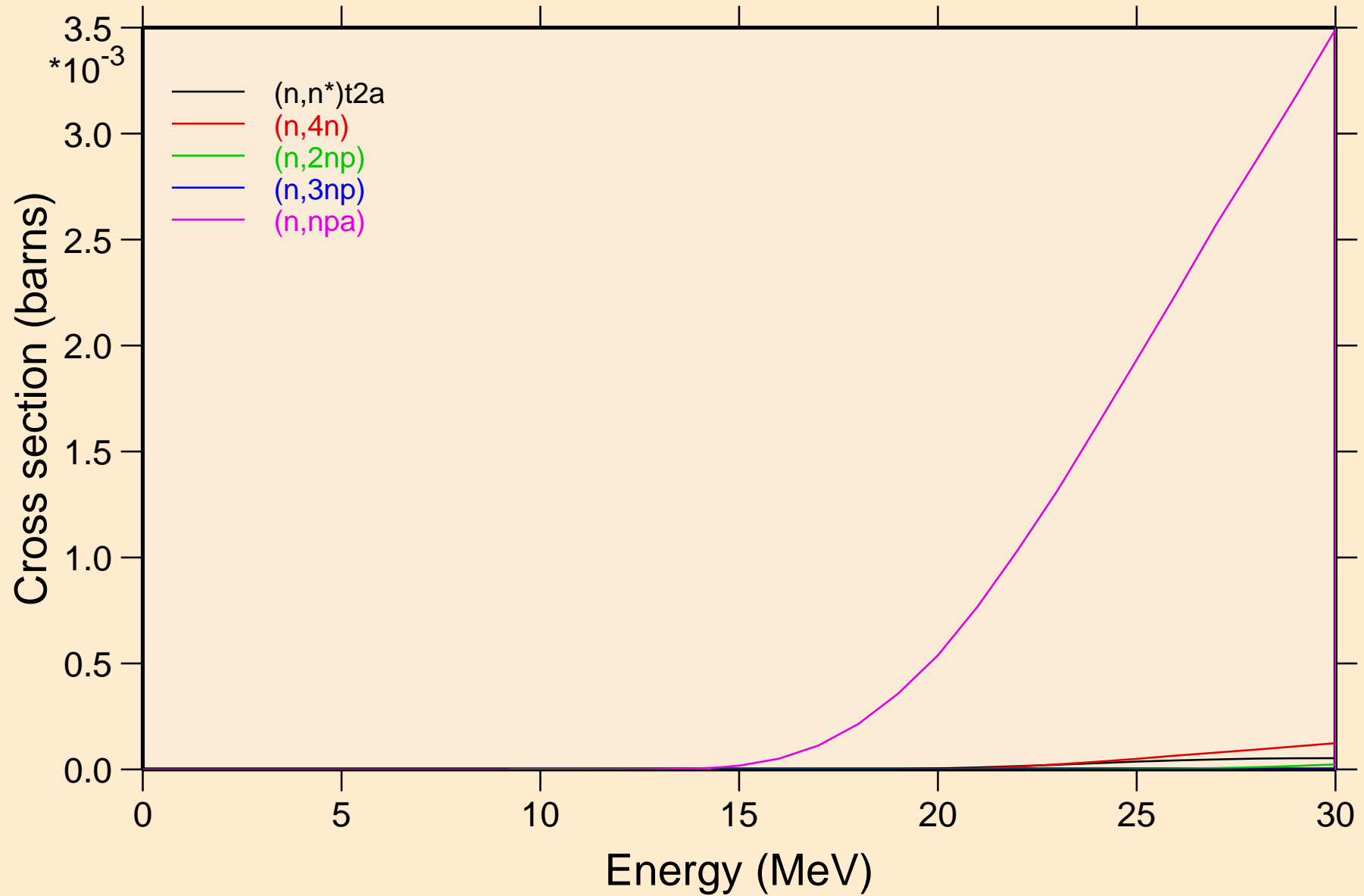

BH271 NRG TENDL-2015, AKONING

Threshold reactions

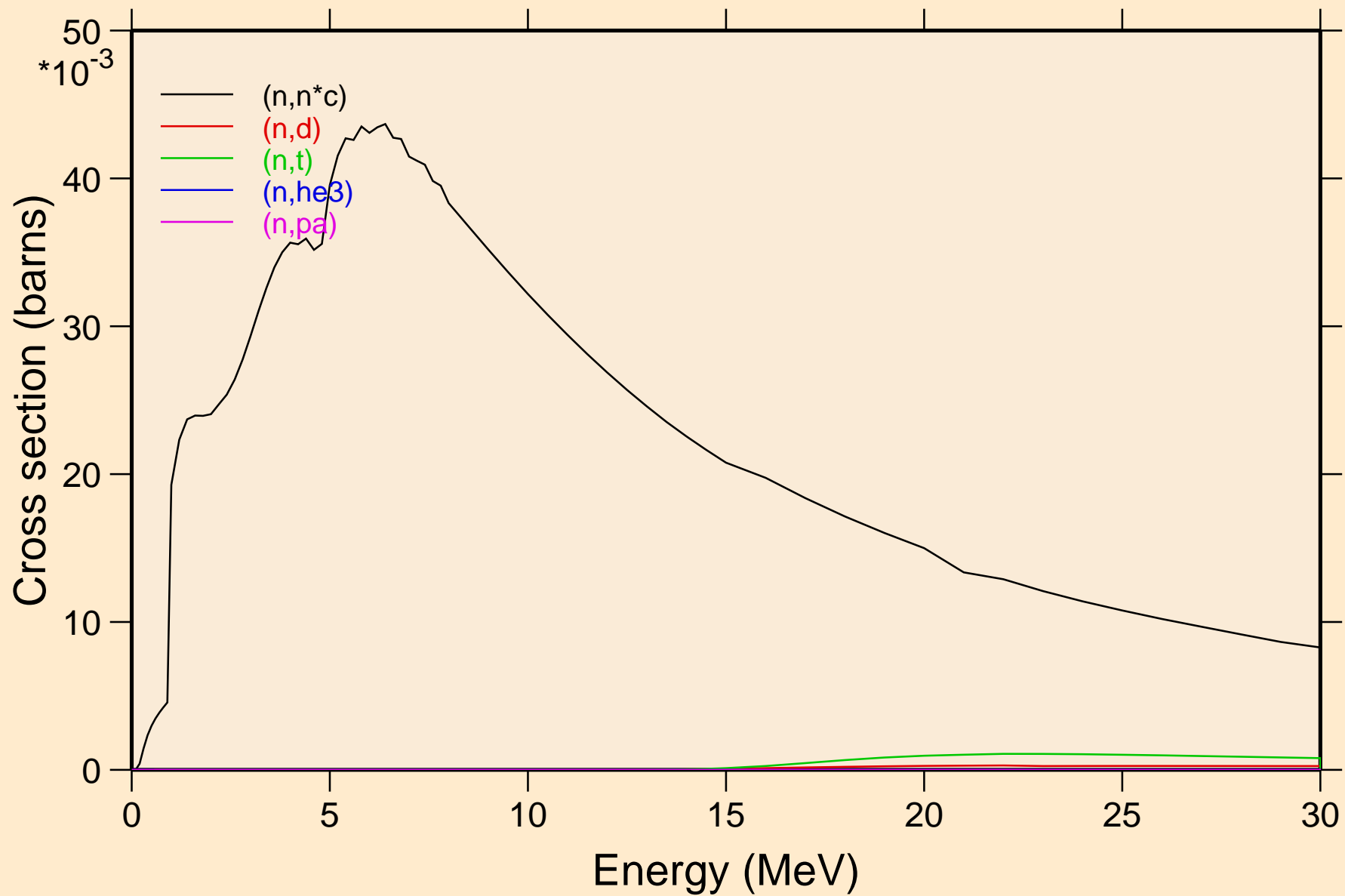

BH271 NRG TENDL-2015, AKONING

Threshold reactions

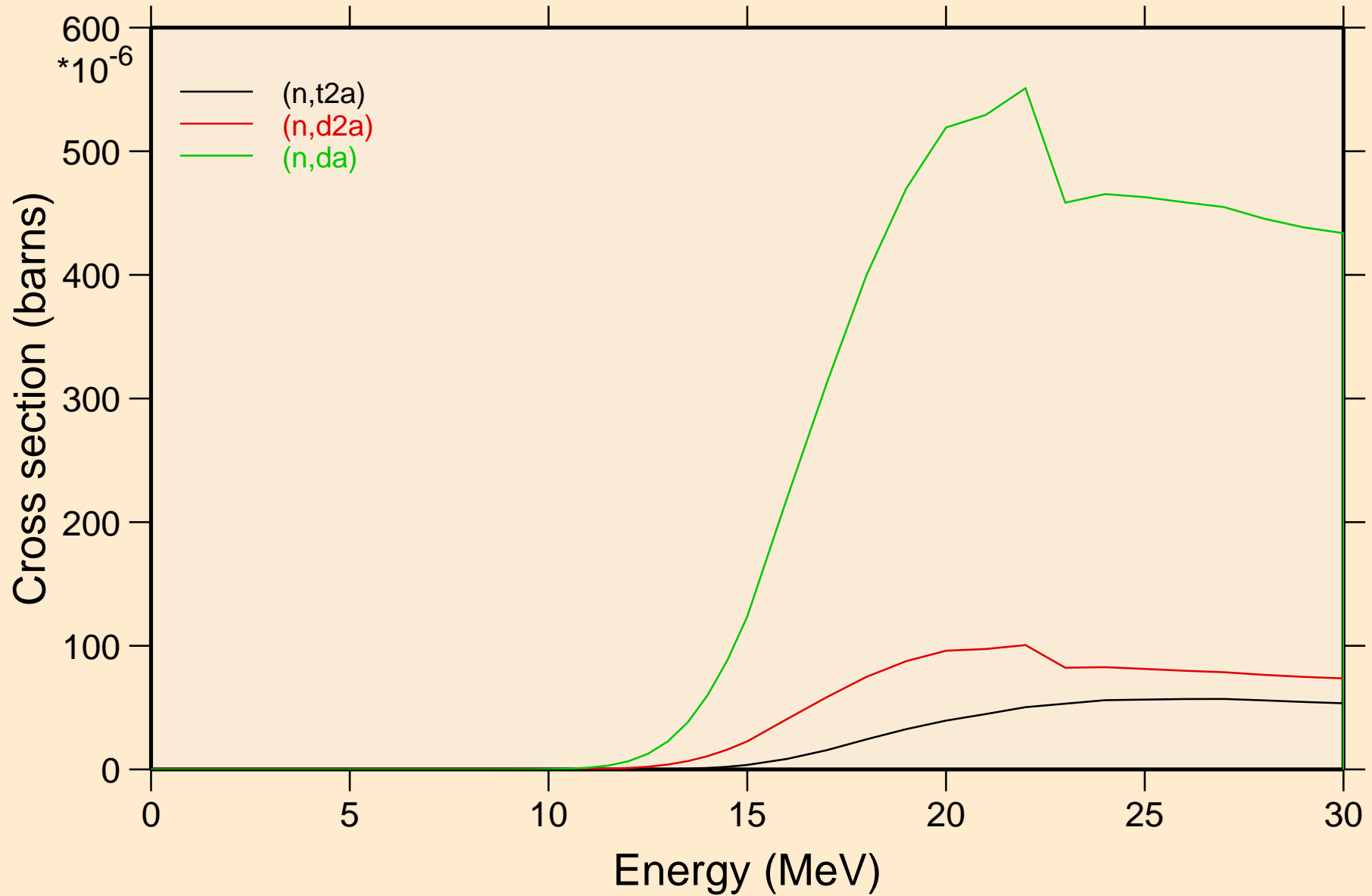

BH271 NRG TENDL-2015, AKONING
angular distribution for elastic

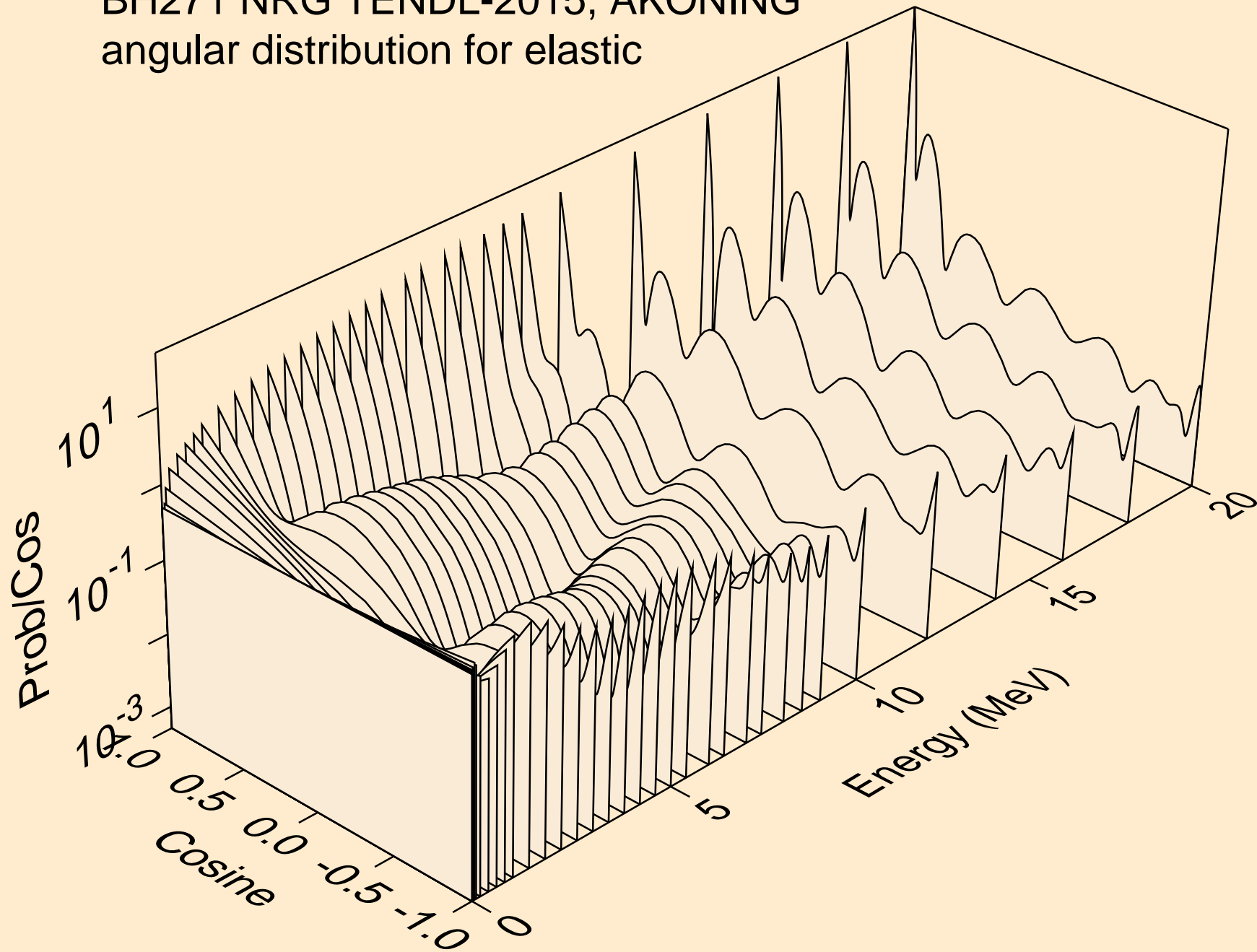

BH271 NRG TENDL-2015, AKONING
angular distribution for elastic

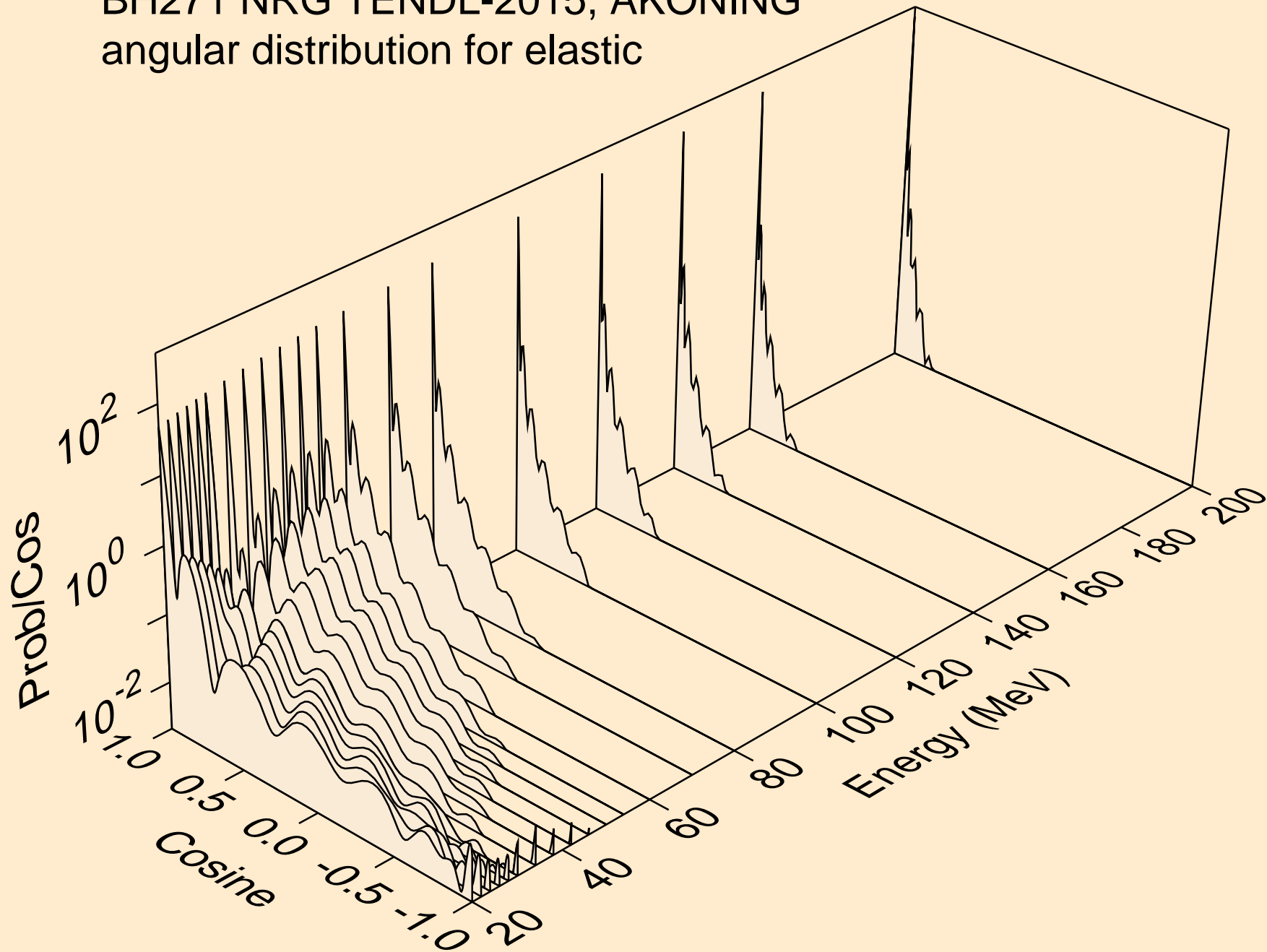

BH271 NRG TENDL-2015, AKONING
angular distribution for (n,n*1)

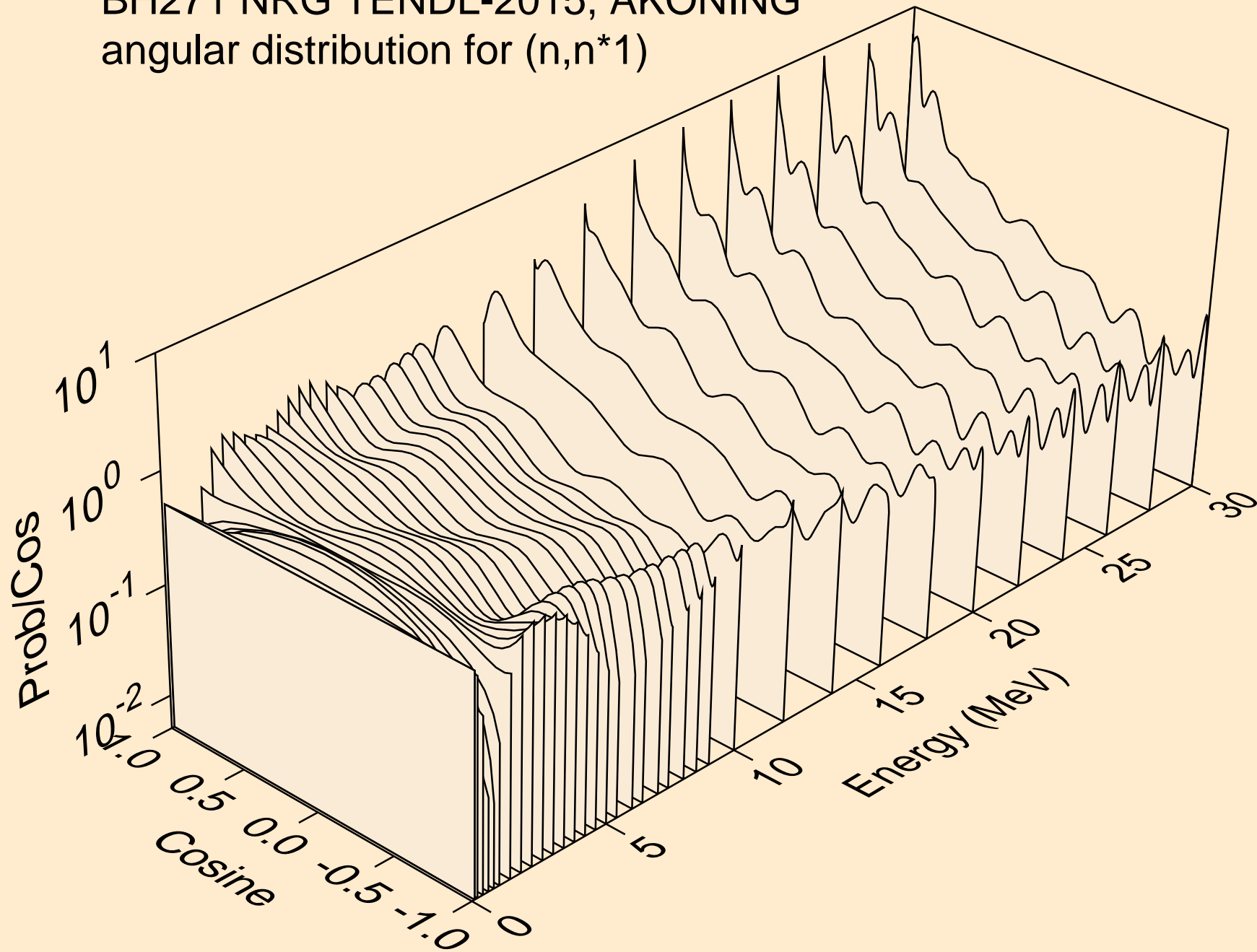

BH271 NRG TENDL-2015, AKONING

Total fission nubar

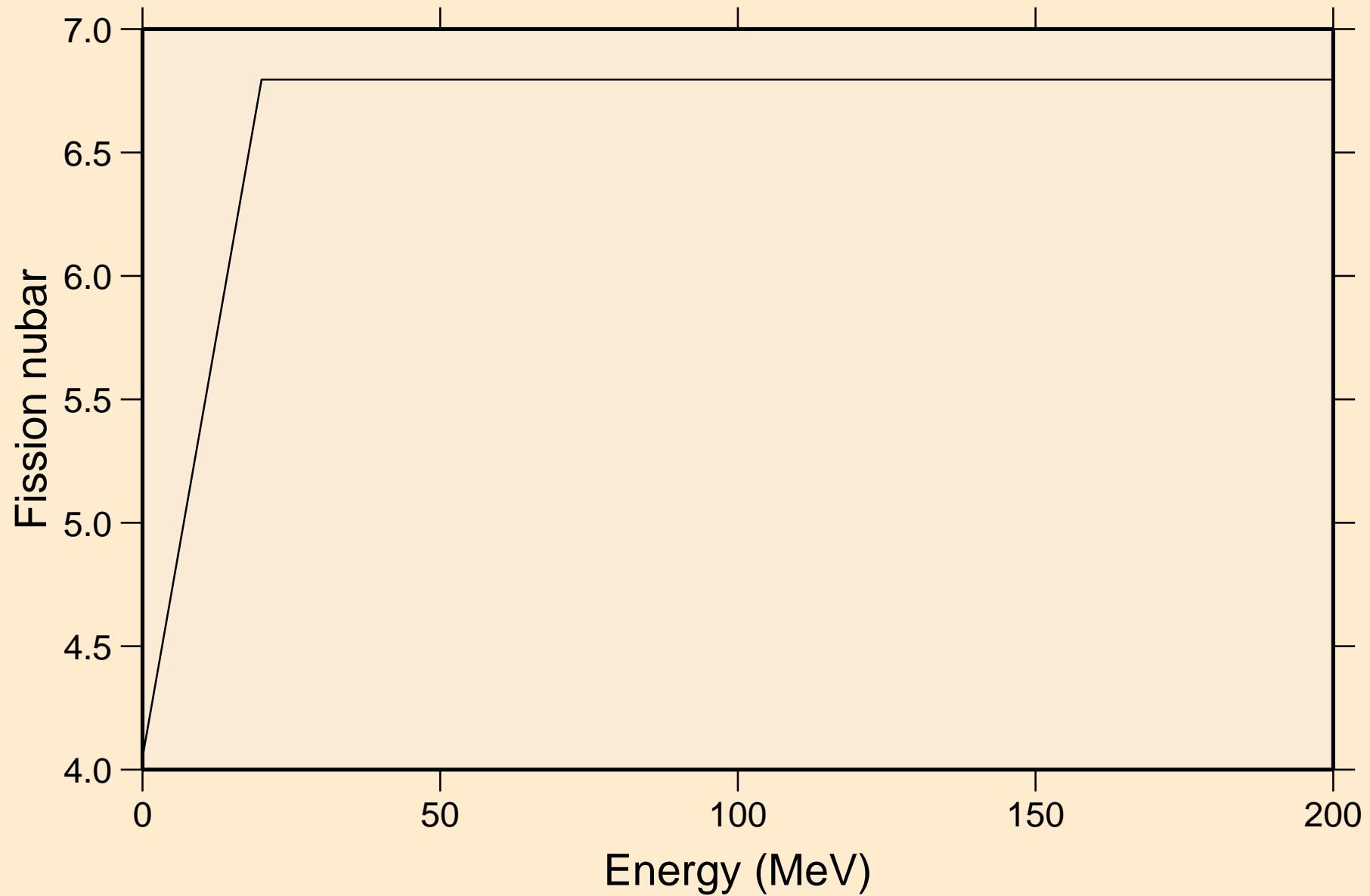

BH271 NRG TENDL-2015, AKONING
Neutron emission for (n,x)

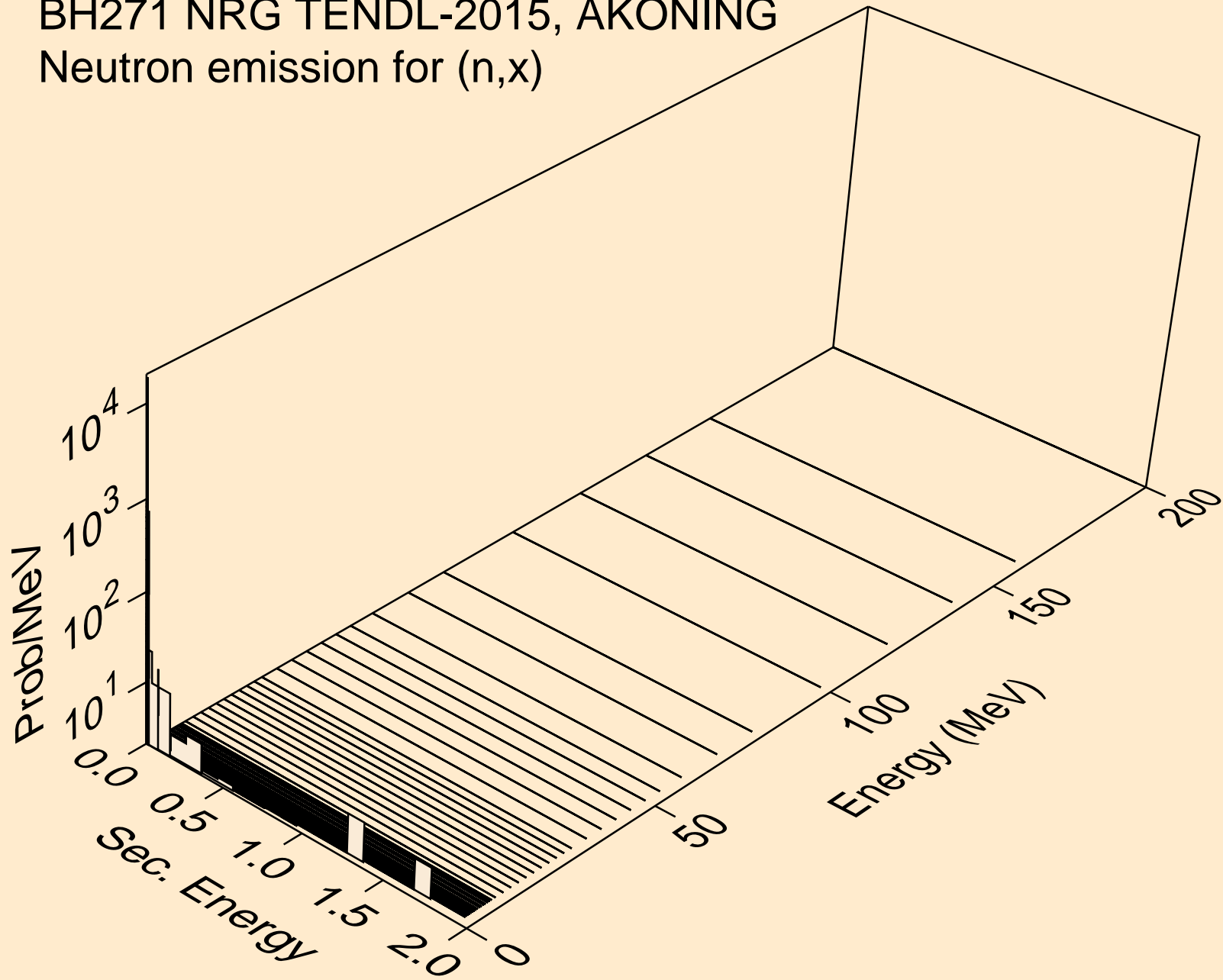

BH271 NRG TENDL-2015, AKONING
Neutron emission for (n,2nd)

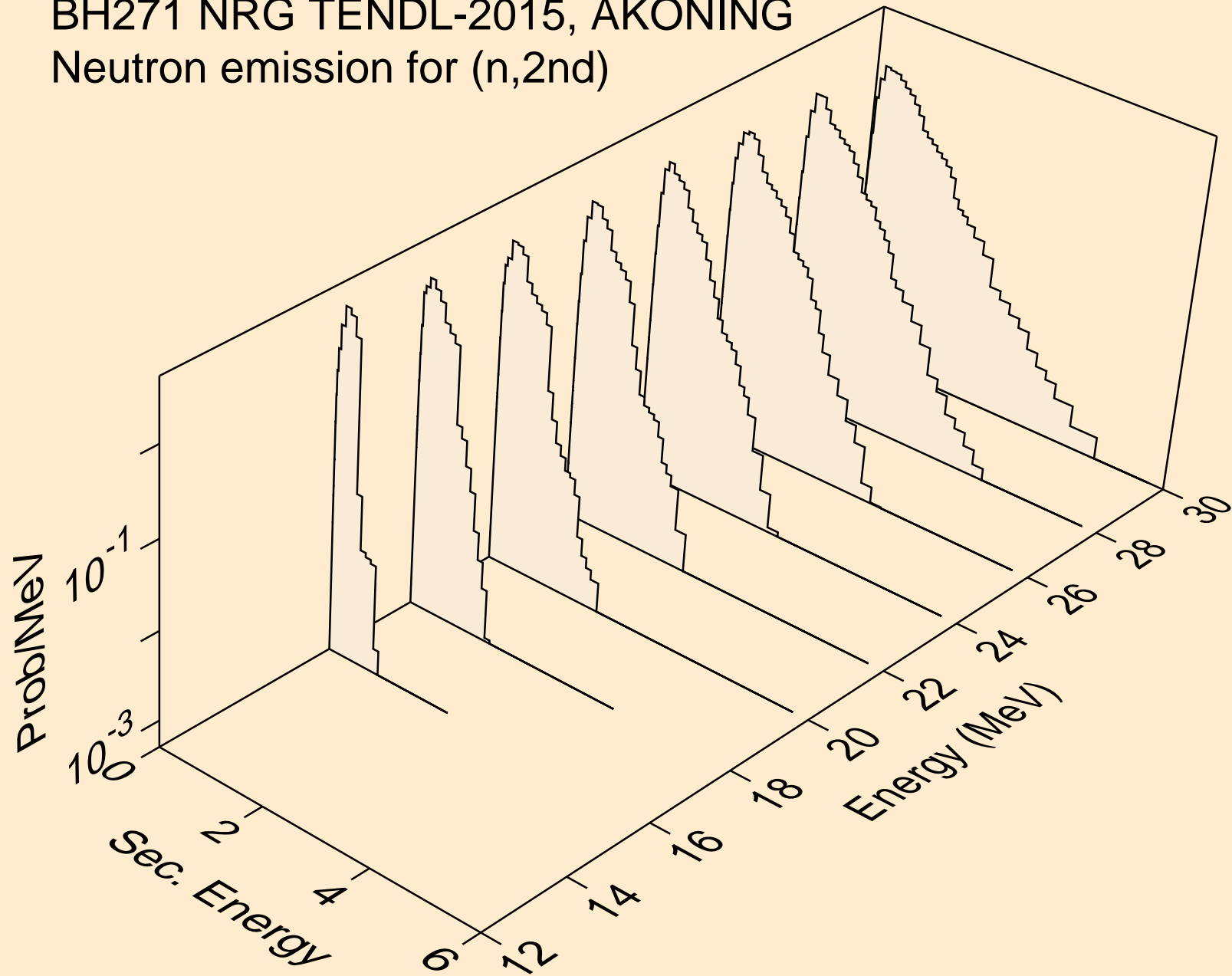

BH271 NRG TENDL-2015, AKONING
Neutron emission for (n,2n)

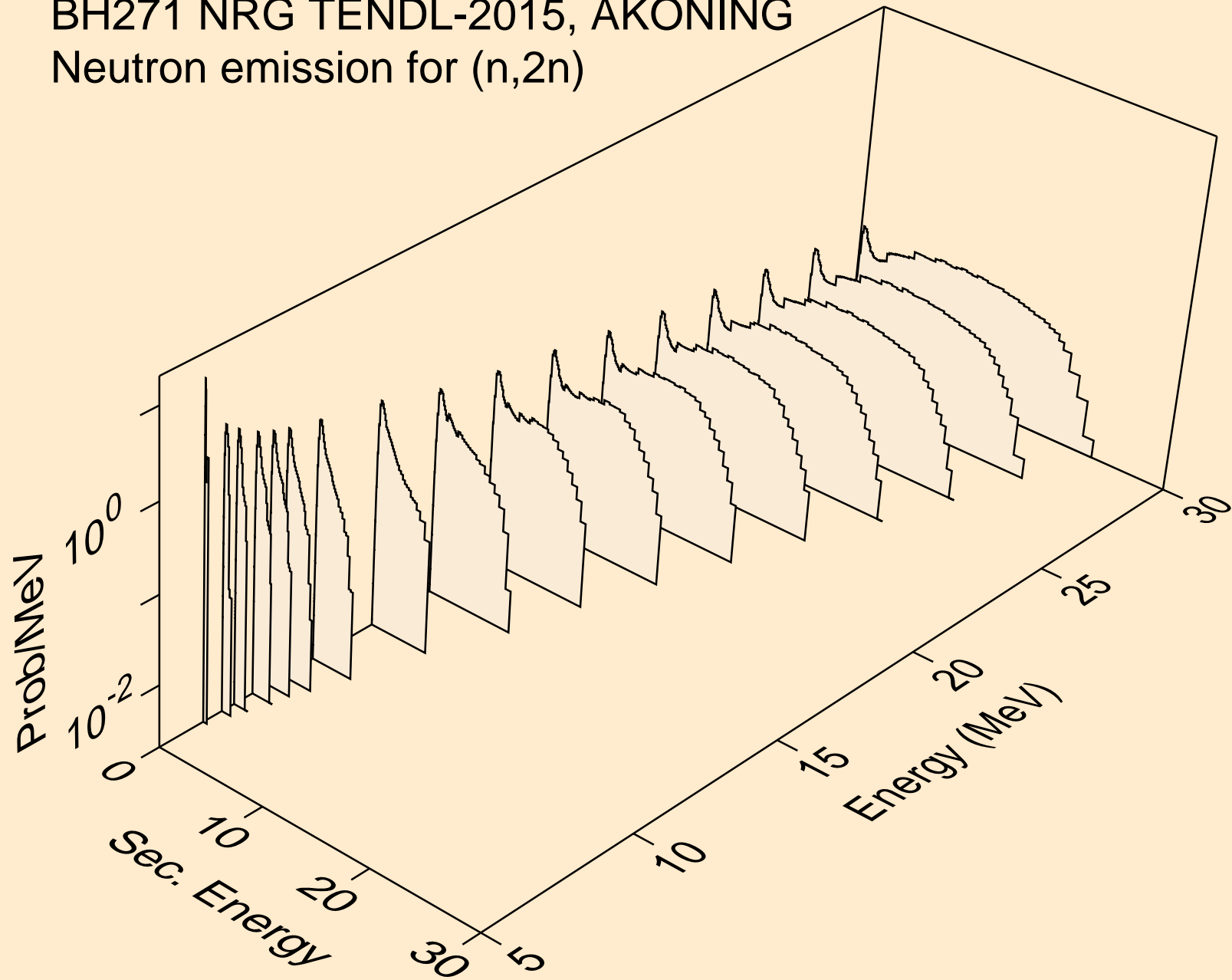

BH271 NRG TENDL-2015, AKONING
Neutron emission for (n,3n)

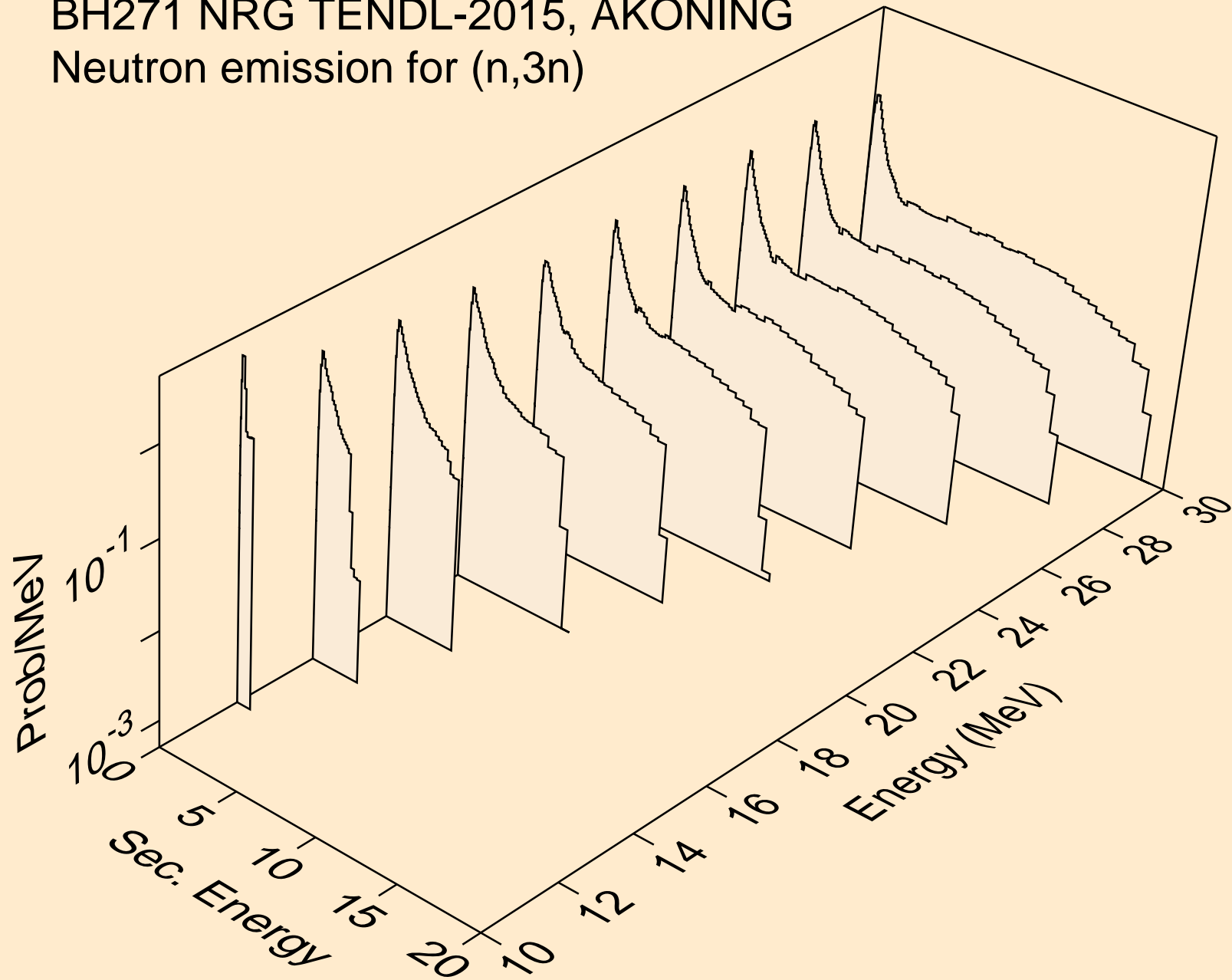

BH271 NRG TENDL-2015, AKONING
Neutron emission for fission

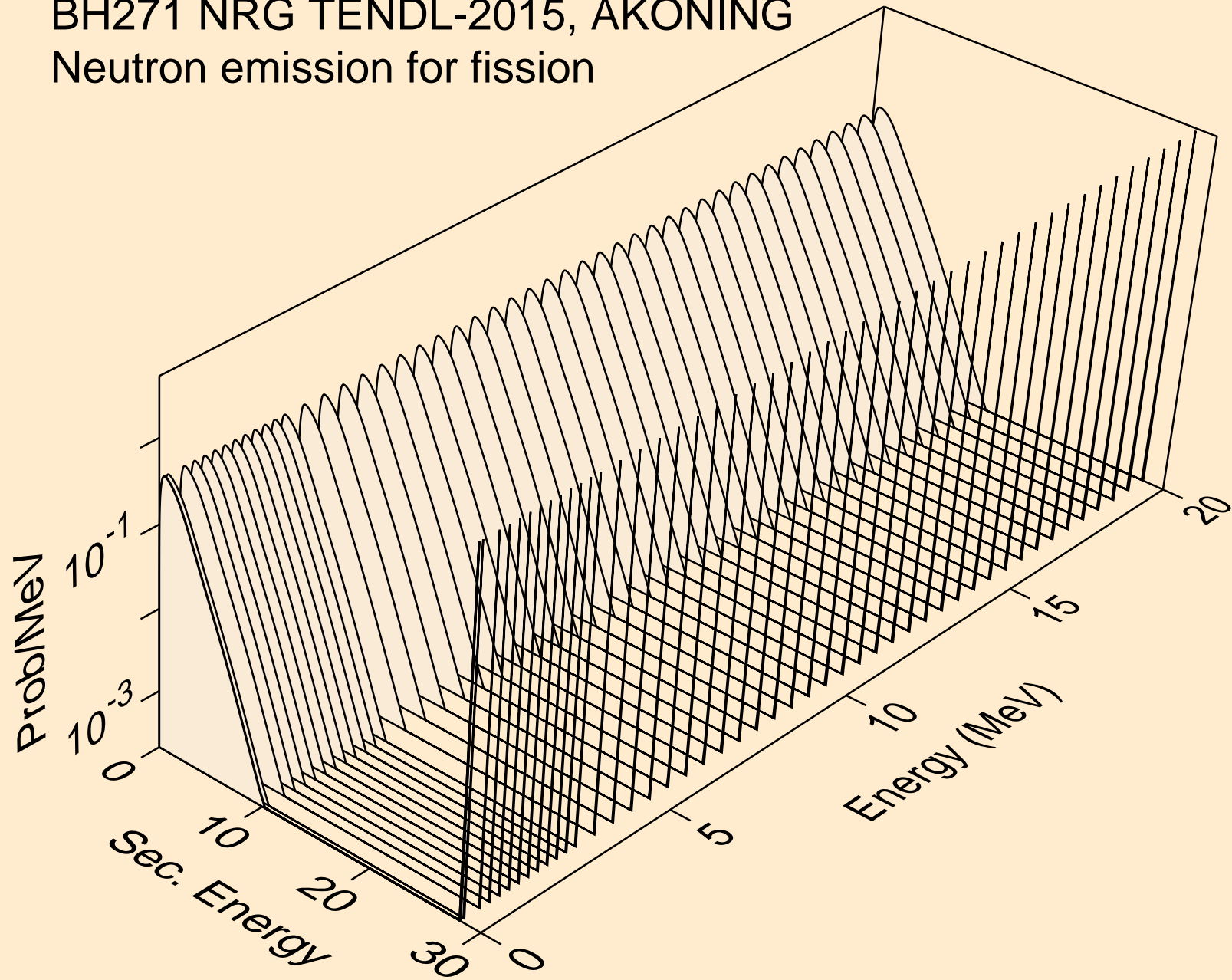

BH271 NRG TENDL-2015, AKONING
Neutron emission for (n,n*)a

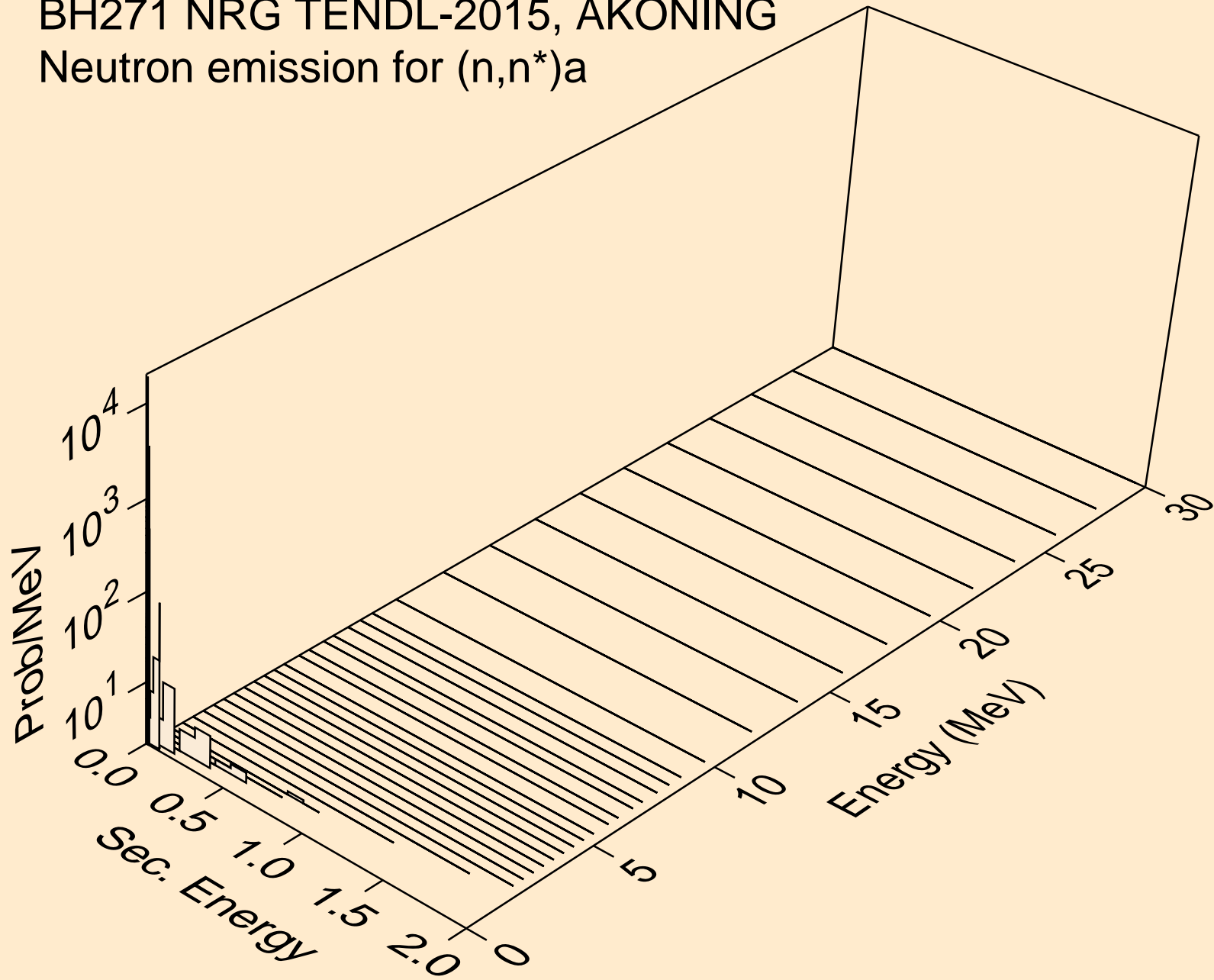

BH271 NRG TENDL-2015, AKONING
Neutron emission for (n,n*)3a

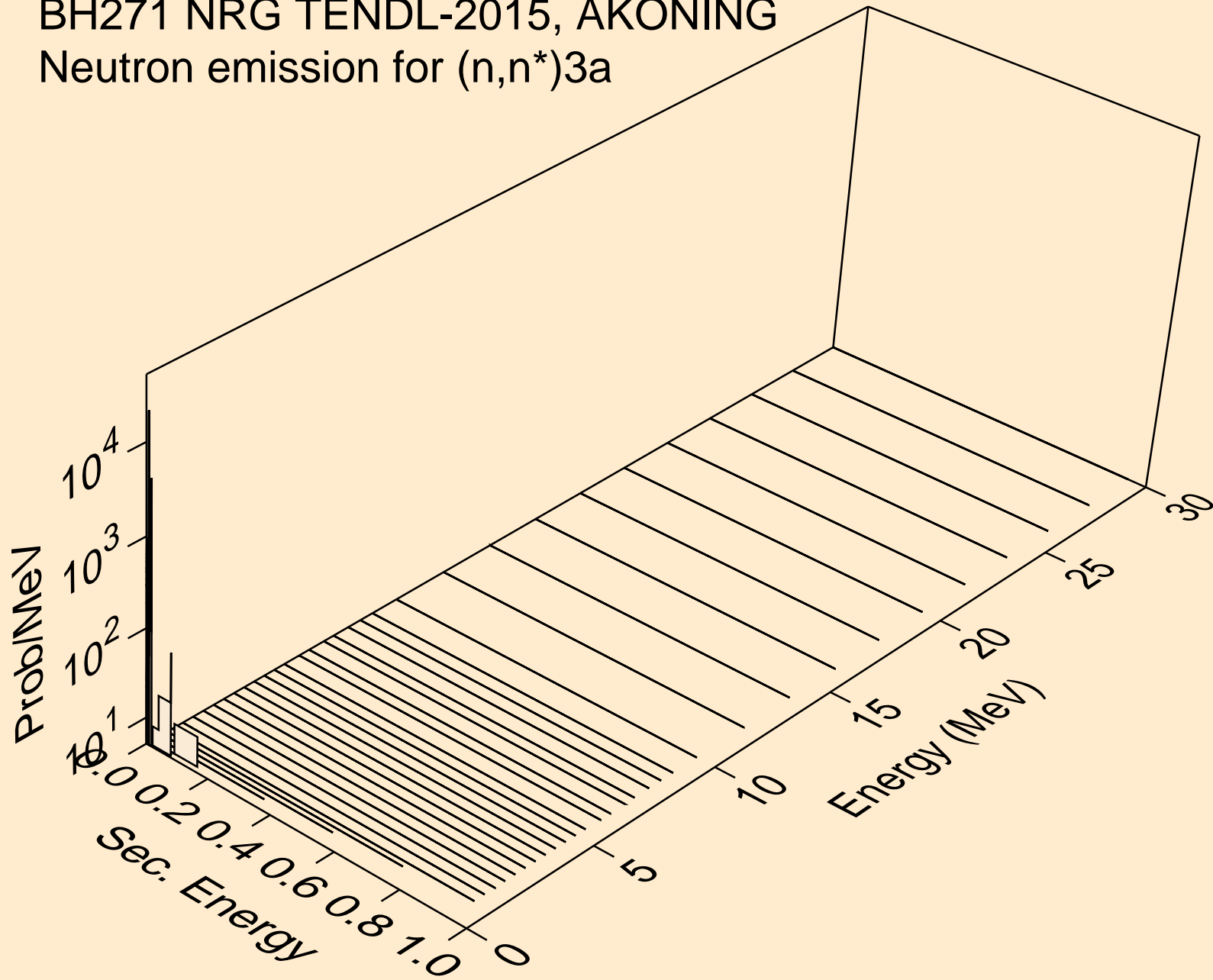

BH271 NRG TENDL-2015, AKONING
Neutron emission for (n,2n)a

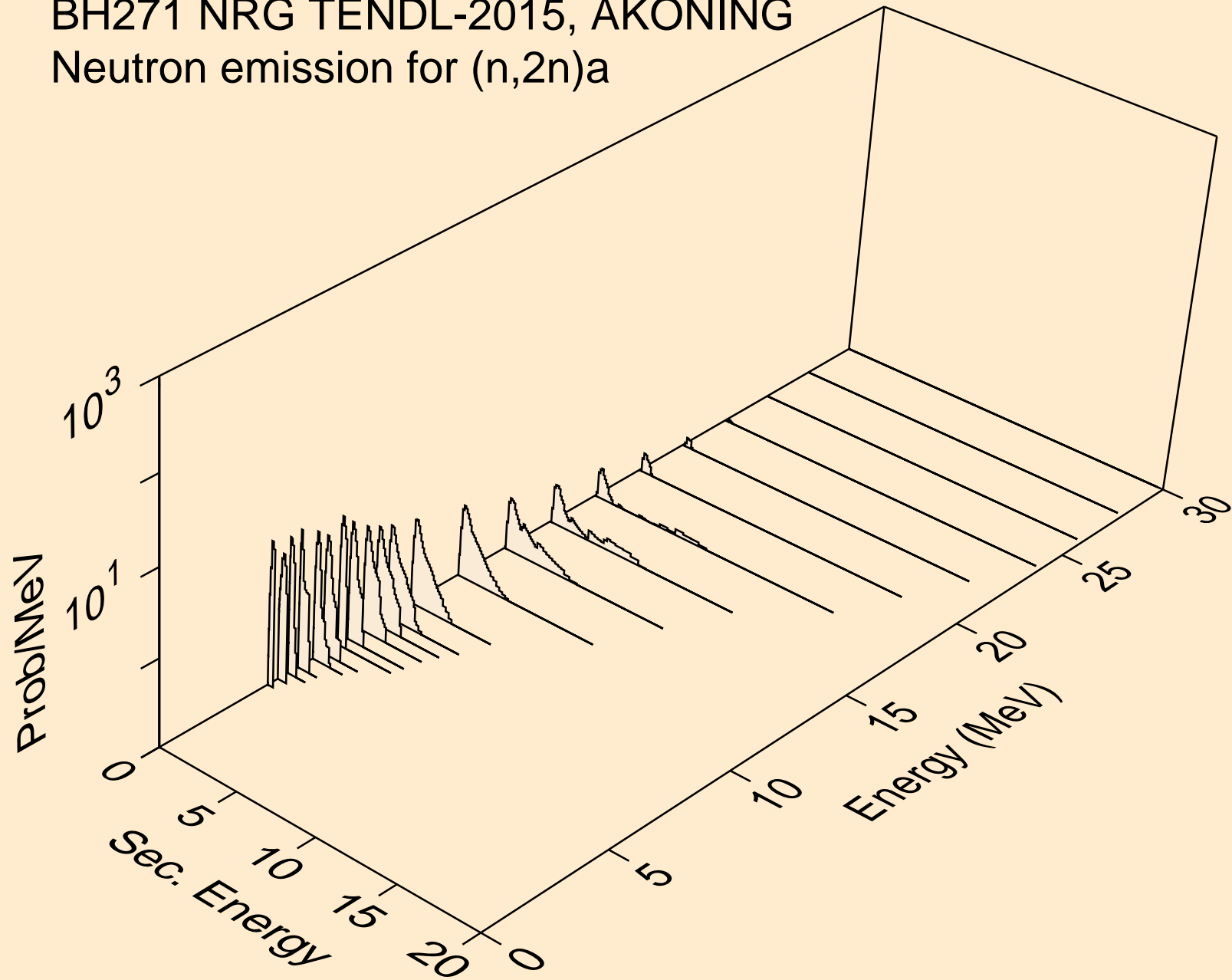

BH271 NRG TENDL-2015, AKONING
Neutron emission for (n,3n)a

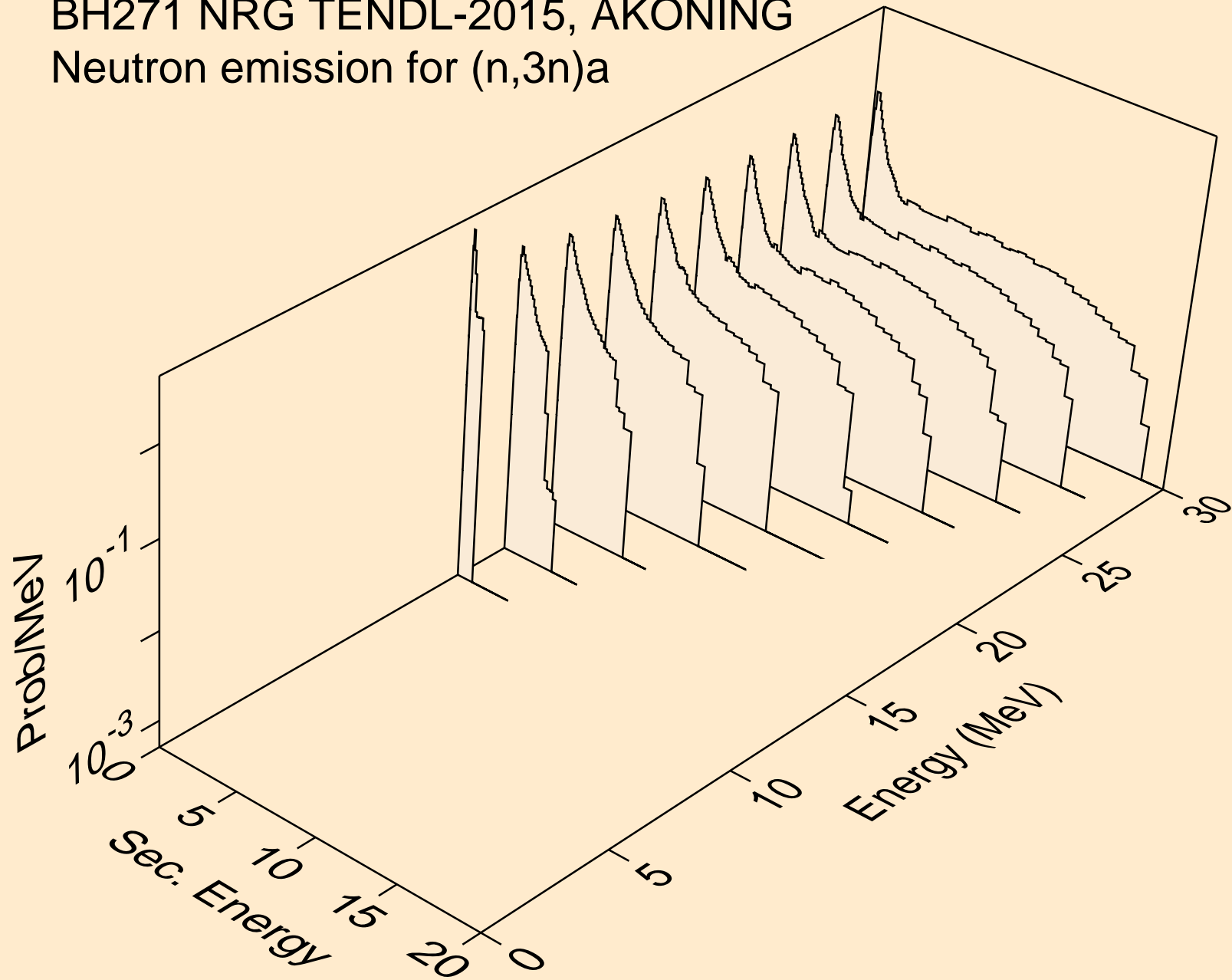

BH271 NRG TENDL-2015, AKONING
Neutron emission for (n,n*)p

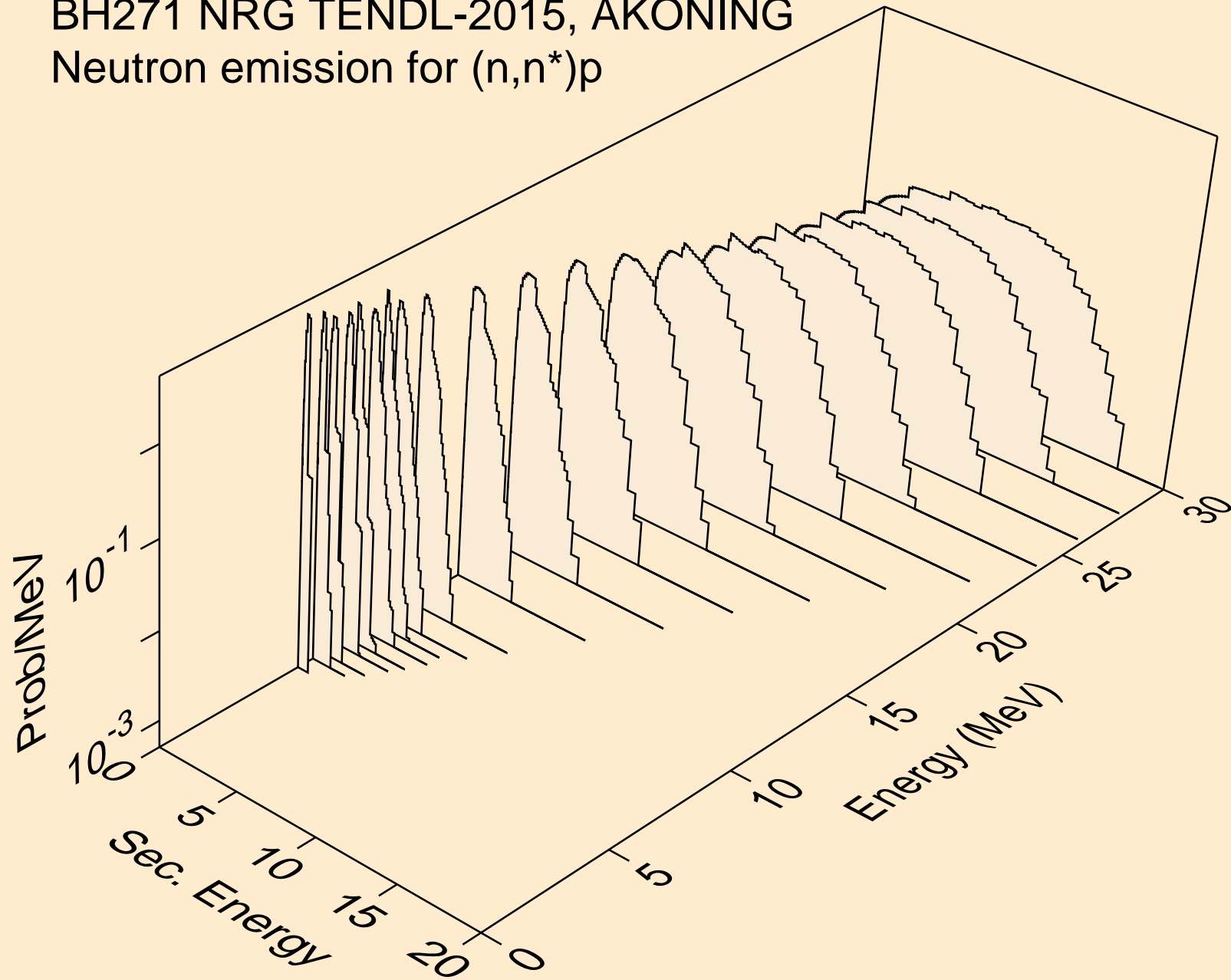

BH271 NRG TENDL-2015, AKONING
Neutron emission for (n,n*)2a

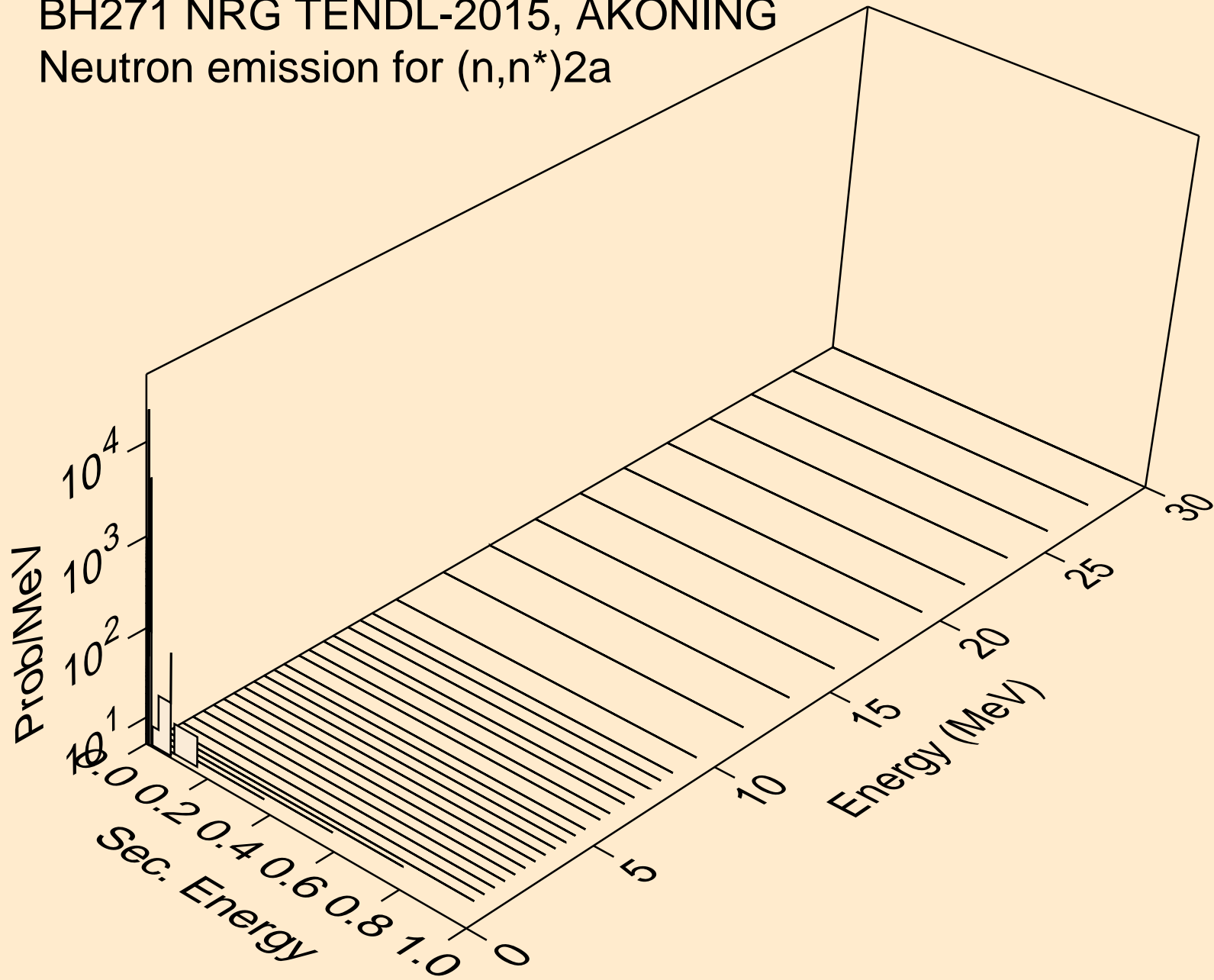

BH271 NRG TENDL-2015, AKONING
Neutron emission for (n,2n)2a

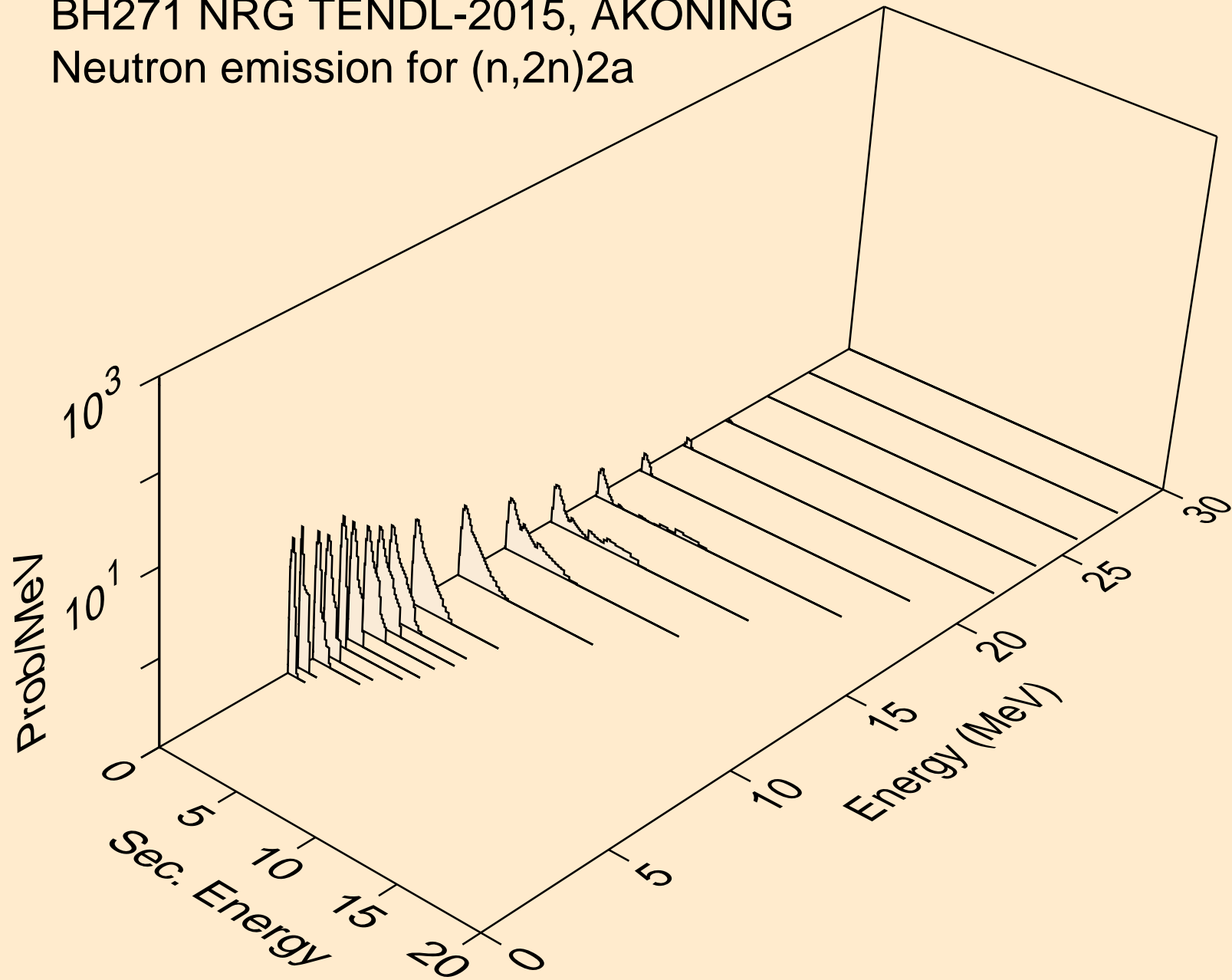

BH271 NRG TENDL-2015, AKONING
Neutron emission for (n,n*)d

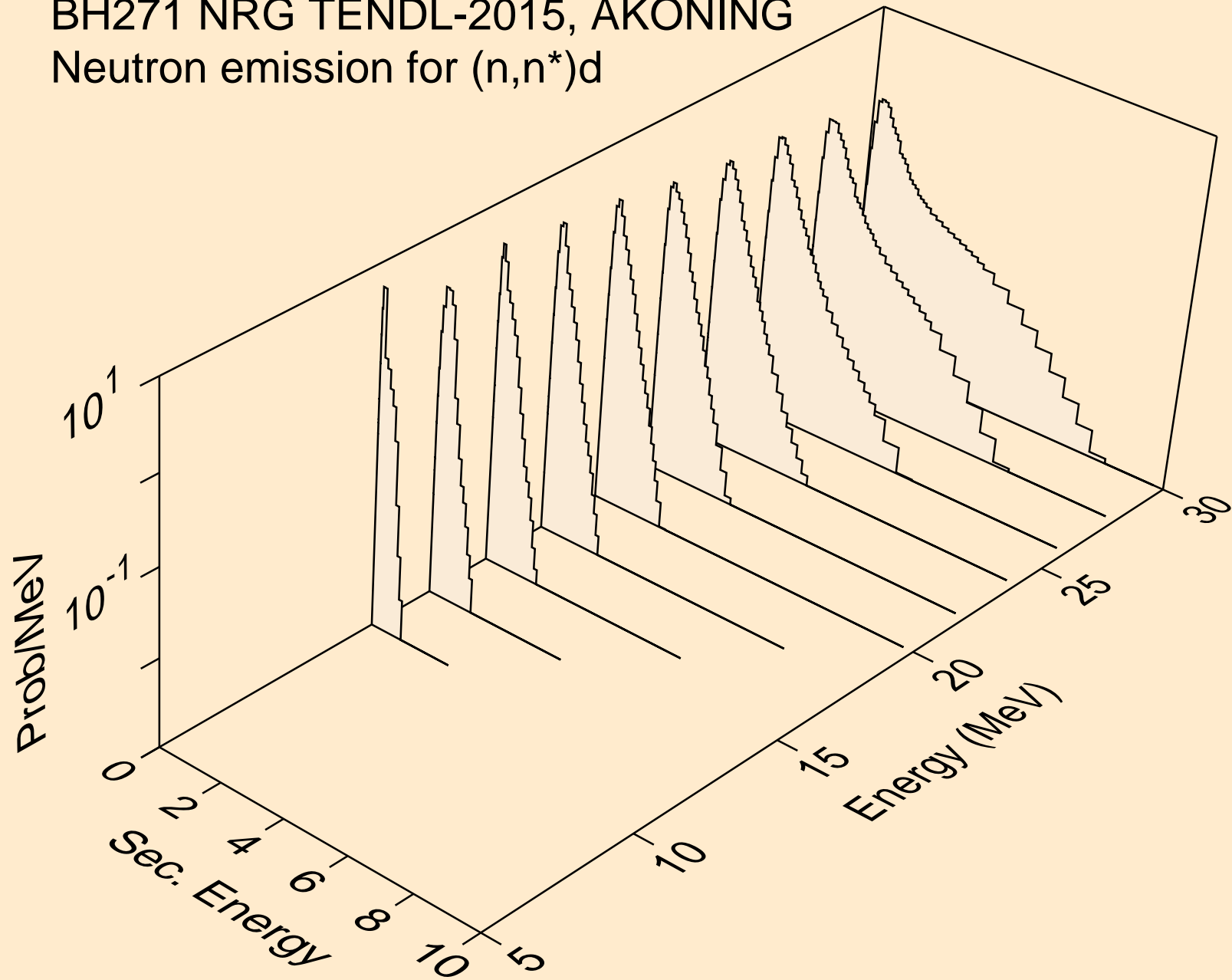

BH271 NRG TENDL-2015, AKONING
Neutron emission for (n,n*)t

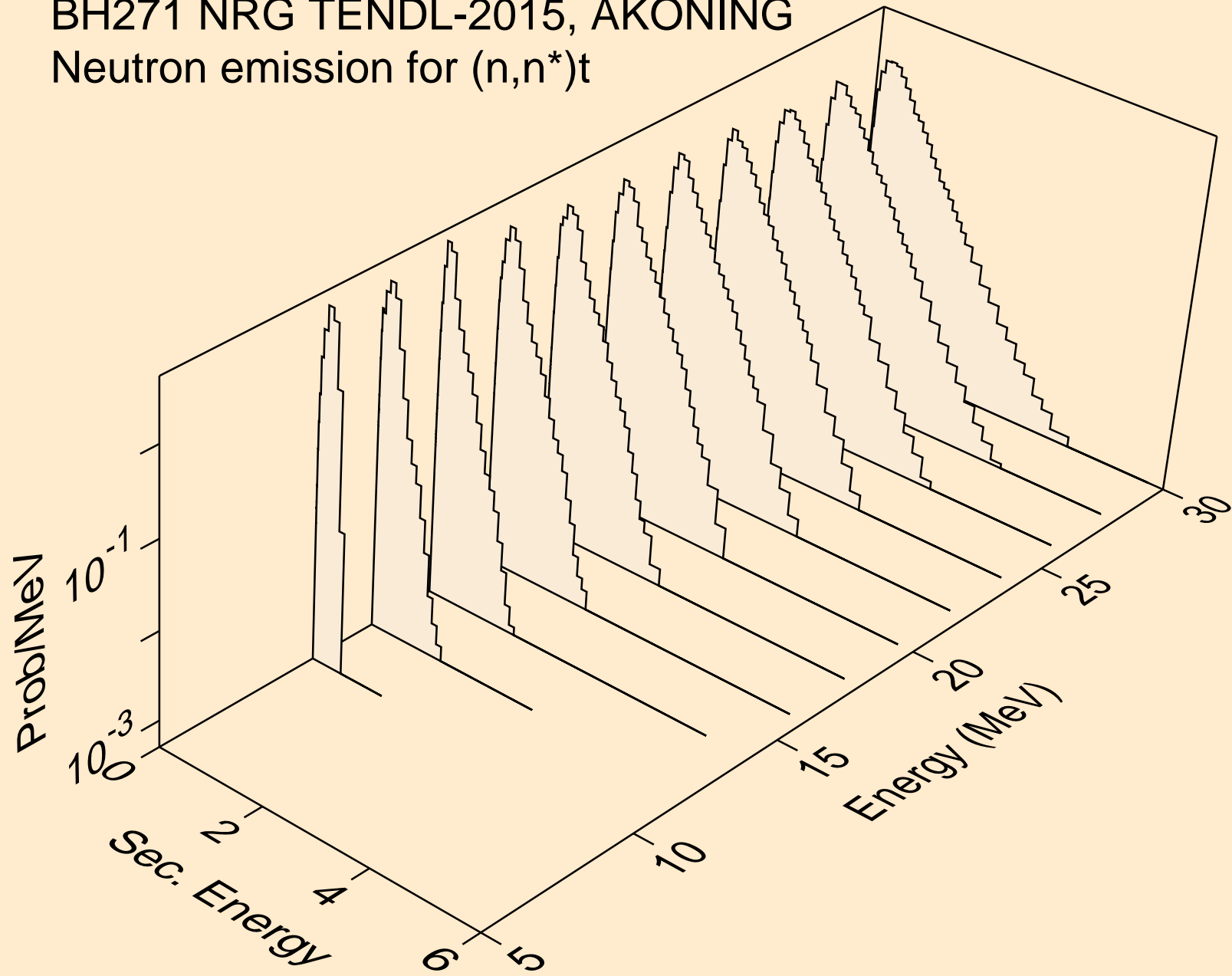

BH271 NRG TENDL-2015, AKONING
Neutron emission for (n,n*)he3

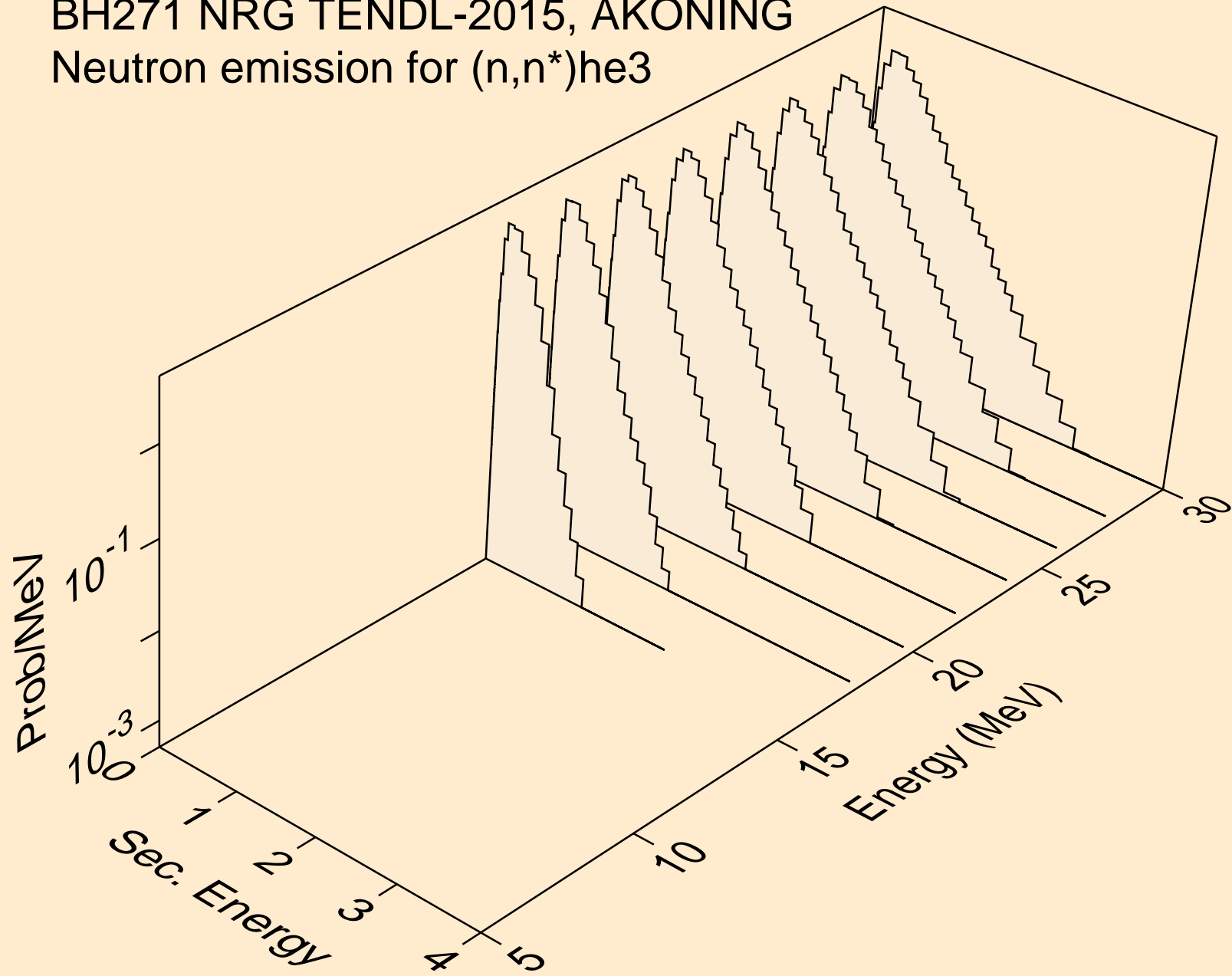

BH271 NRG TENDL-2015, AKONING
Neutron emission for (n,n*)d2a

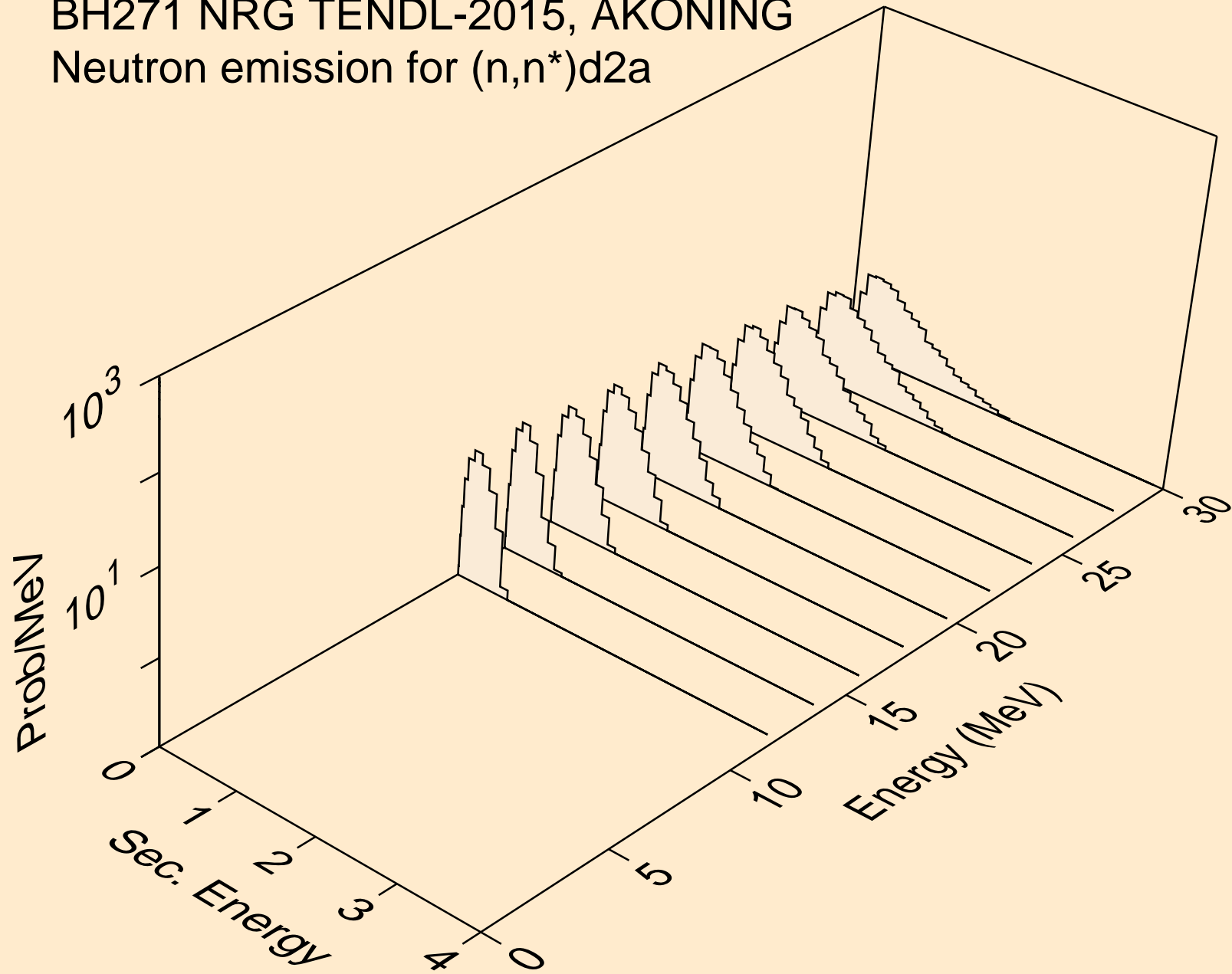

BH271 NRG TENDL-2015, AKONING
Neutron emission for (n,n*)t2a

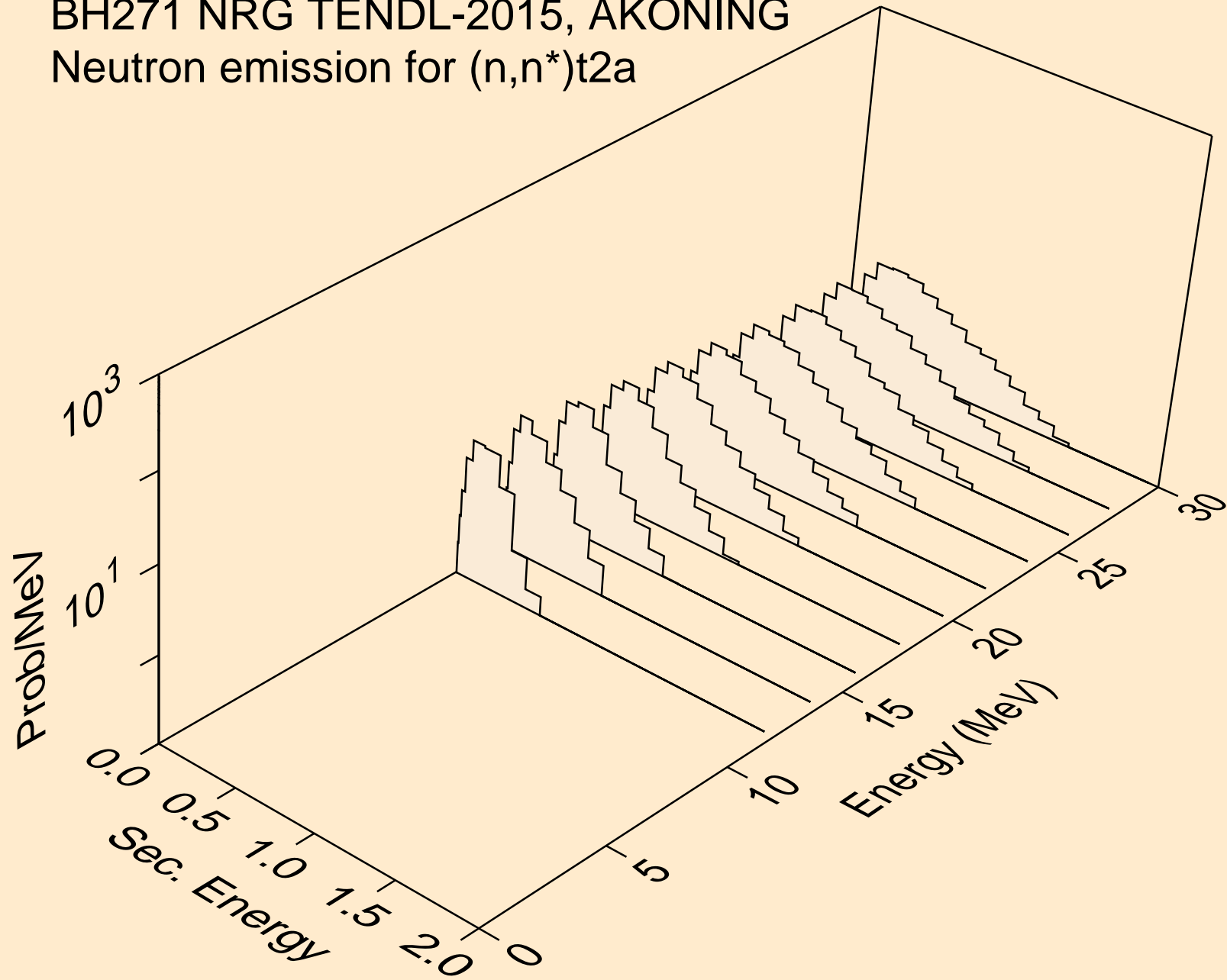

BH271 NRG TENDL-2015, AKONING
Neutron emission for (n,4n)

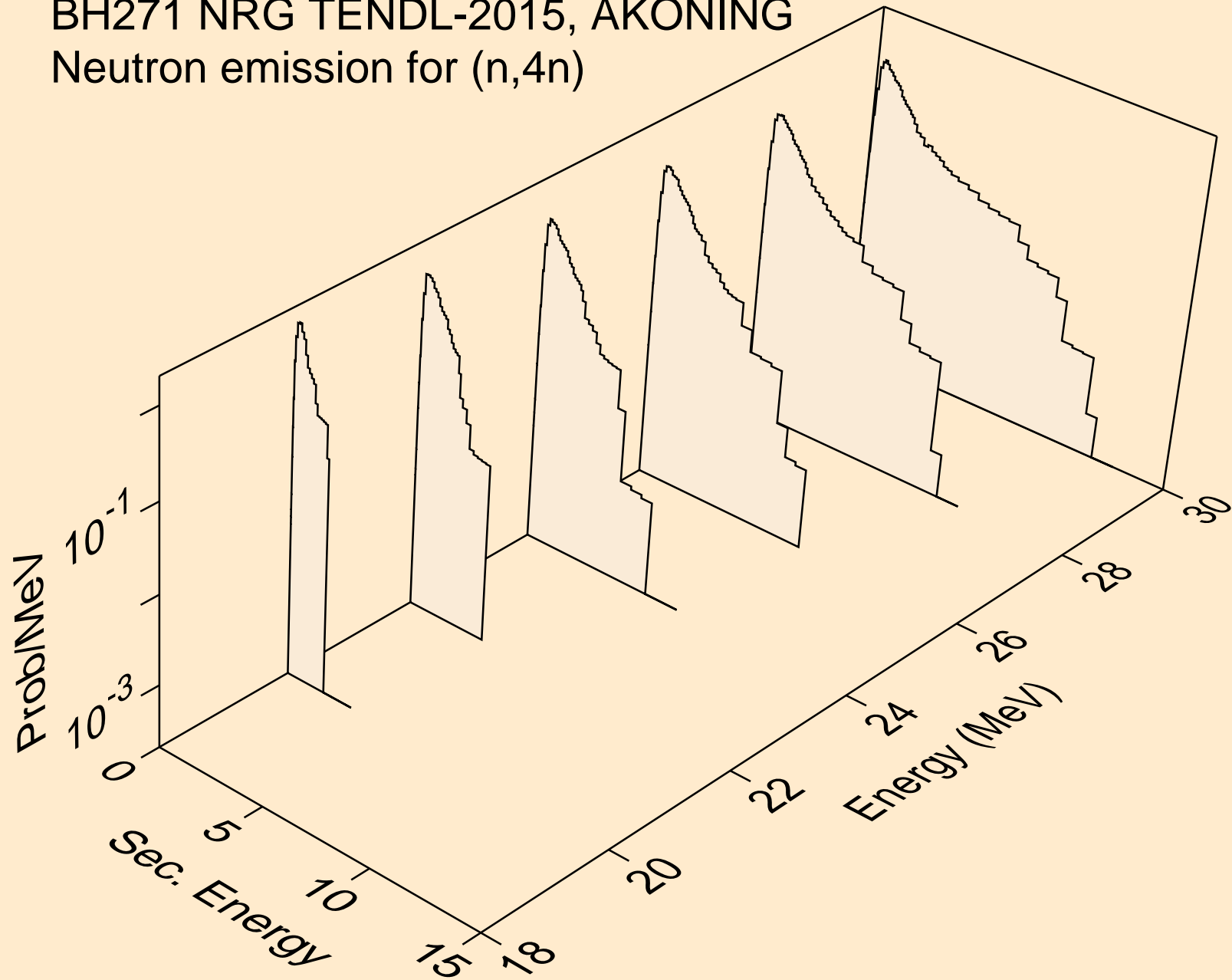

BH271 NRG TENDL-2015, AKONING
Neutron emission for (n,2np)

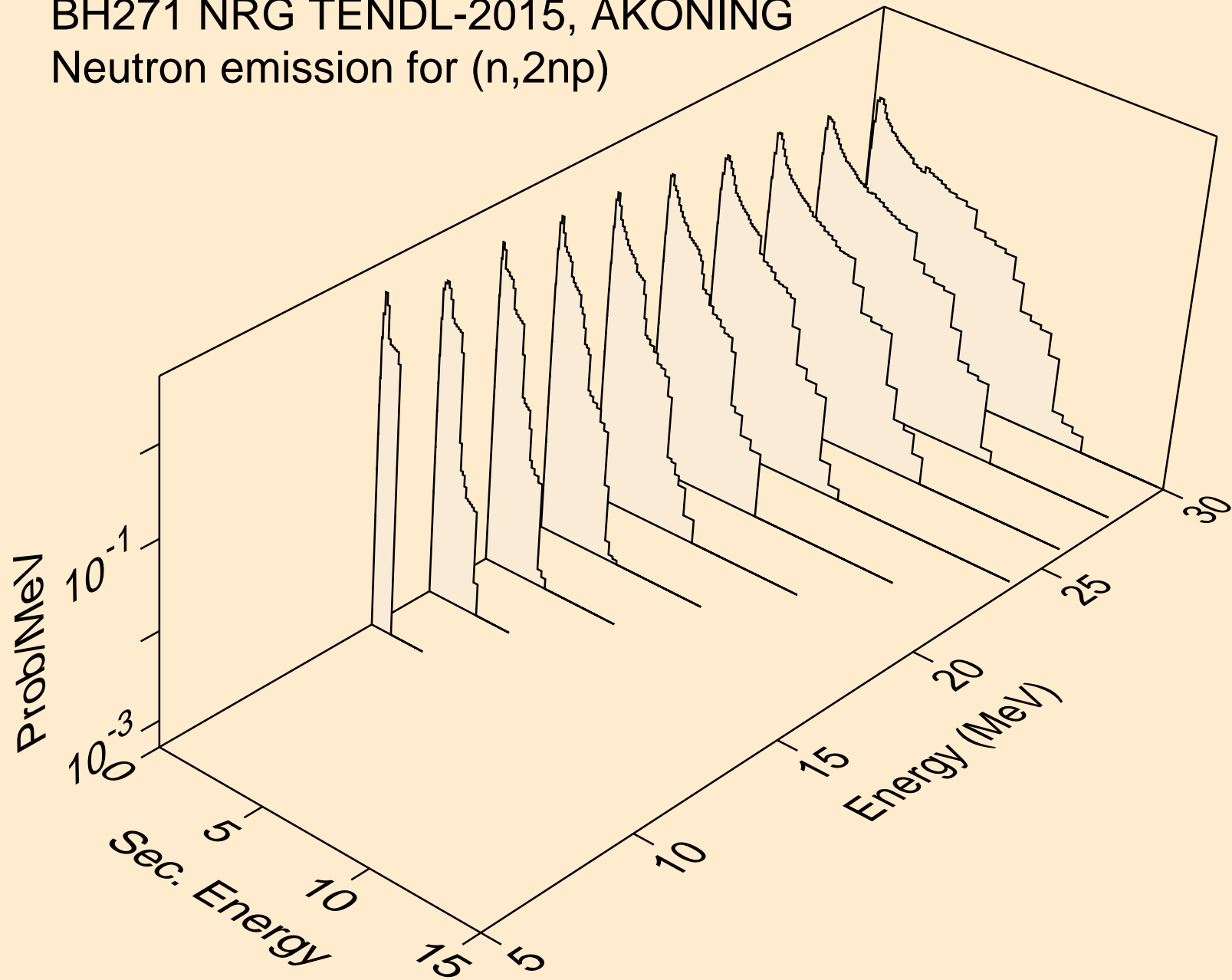

BH271 NRG TENDL-2015, AKONING
Neutron emission for (n,3np)

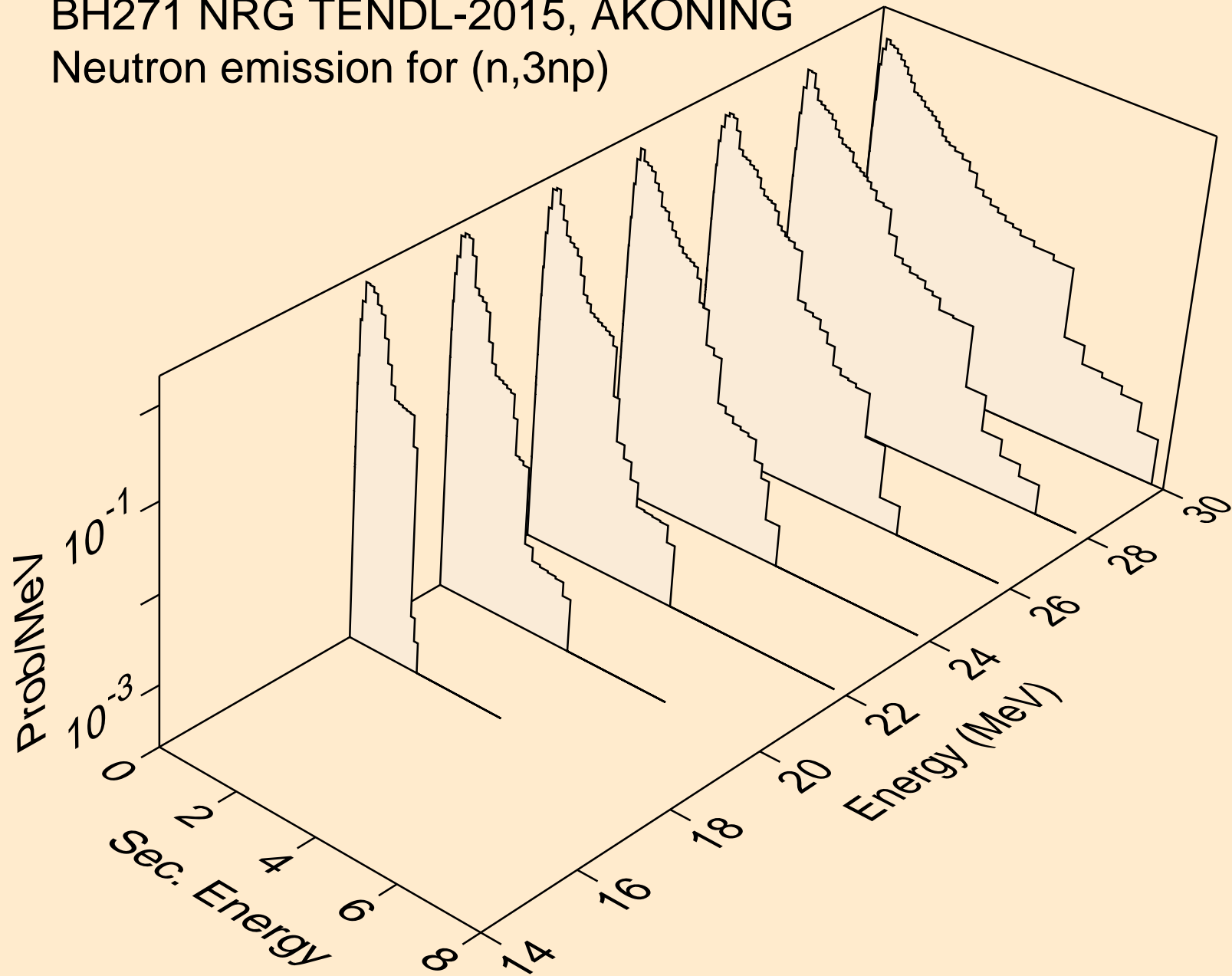

BH271 NRG TENDL-2015, AKONING
Neutron emission for (n,npa)

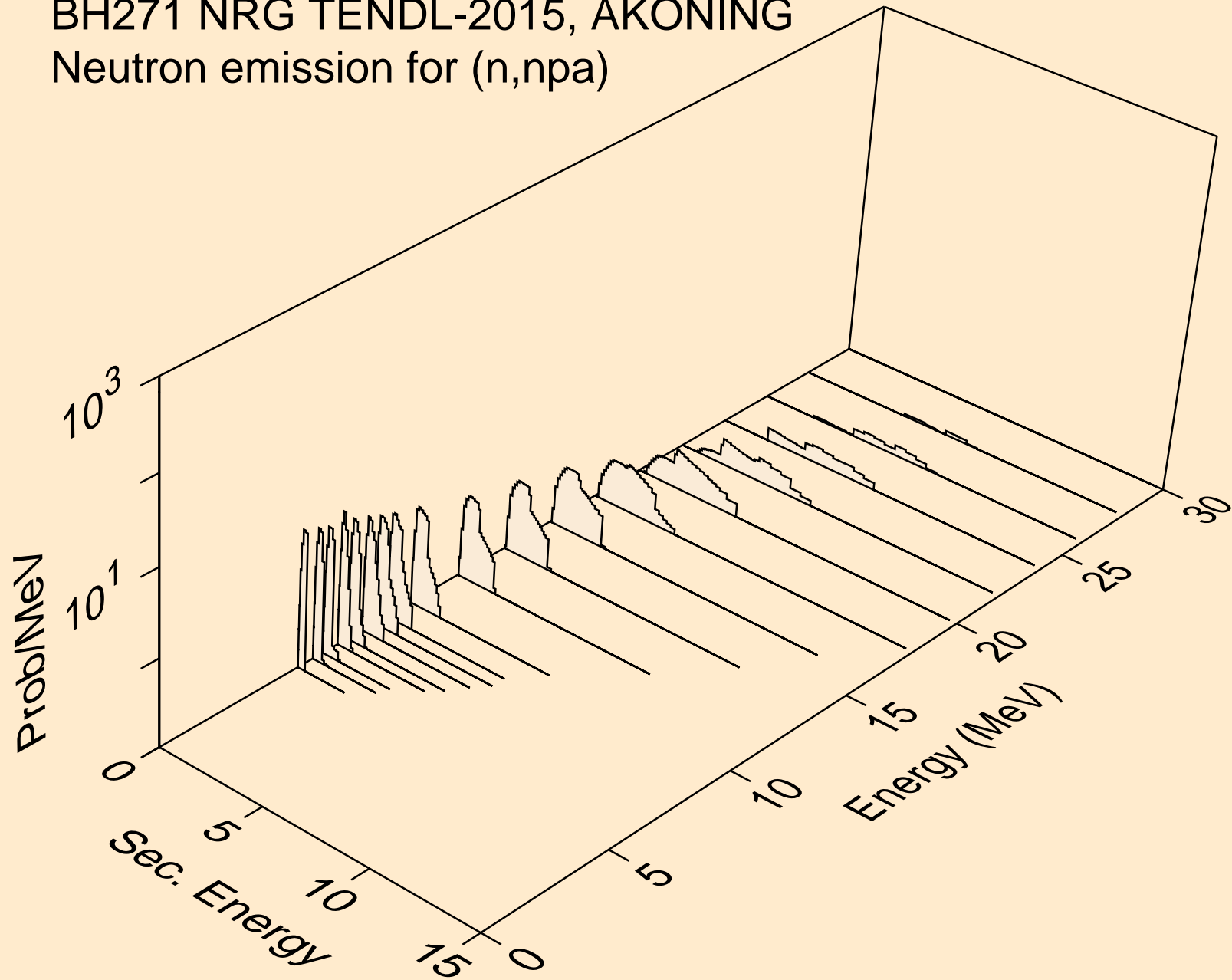

BH271 NRG TENDL-2015, AKONING
Neutron emission for (n,n*c)

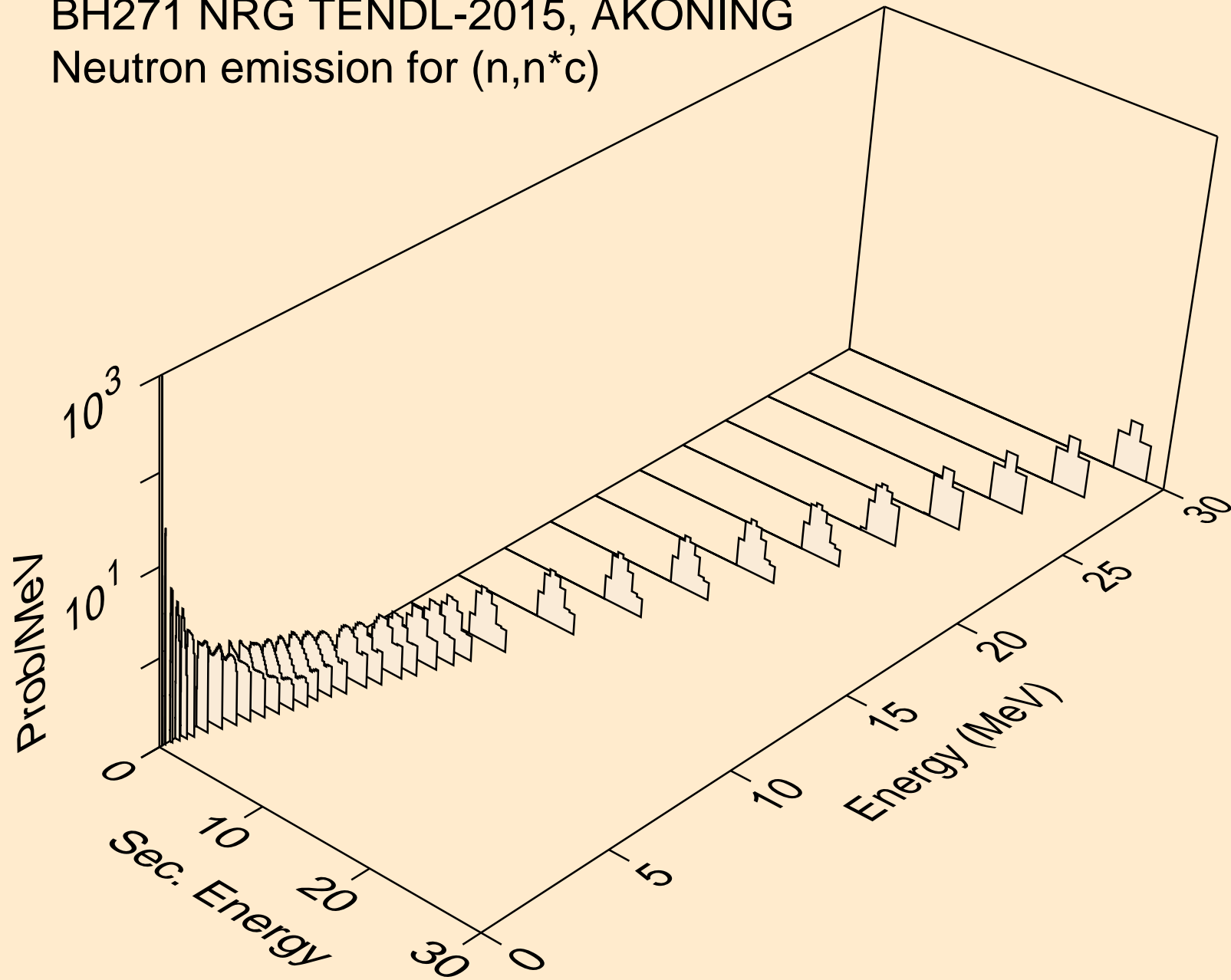

BH271 NRG TENDL-2015, AKONING

Delayed nubar

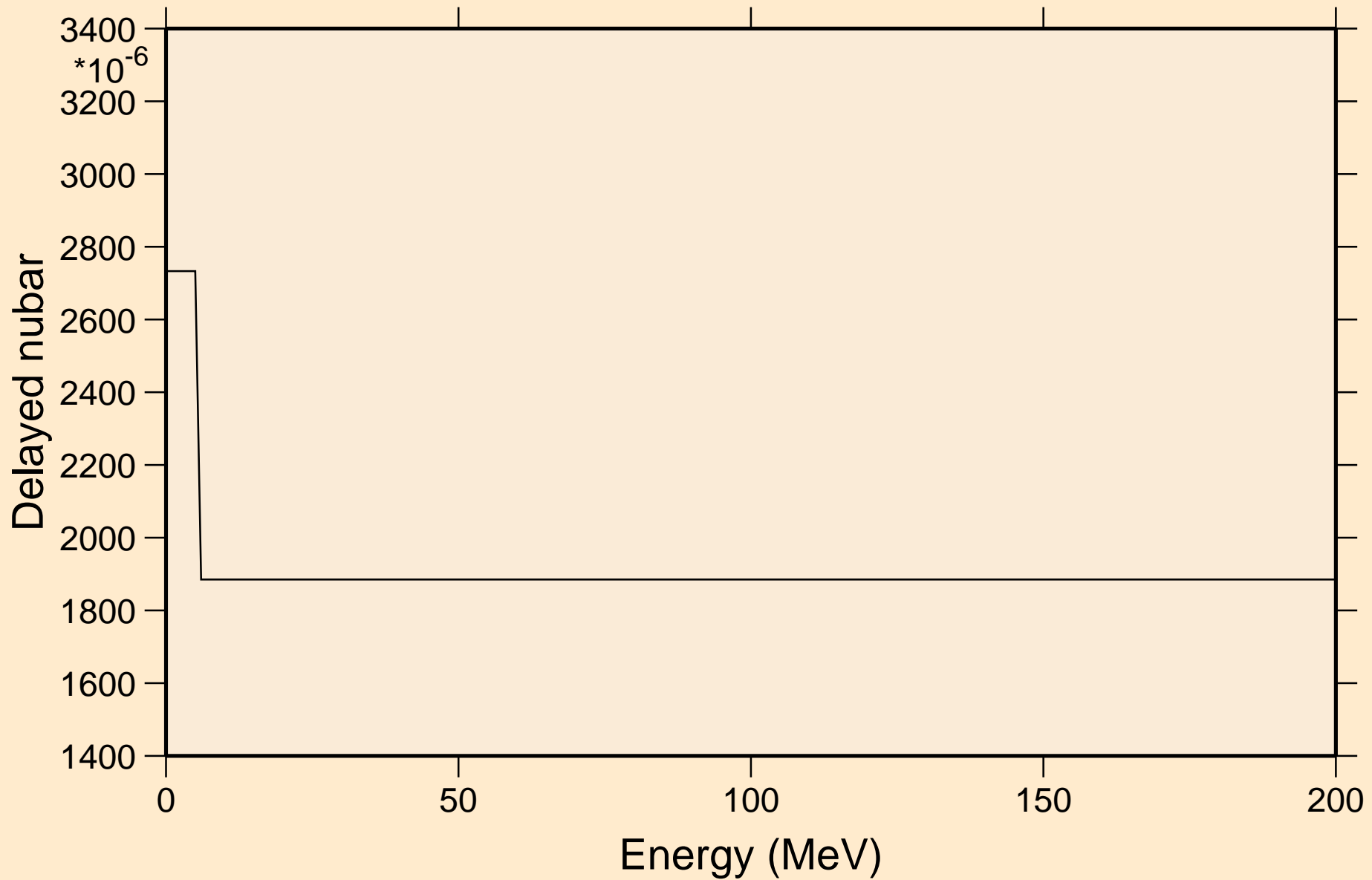

BH271 NRG TENDL-2015, AKONING

Delayed neutron spectra

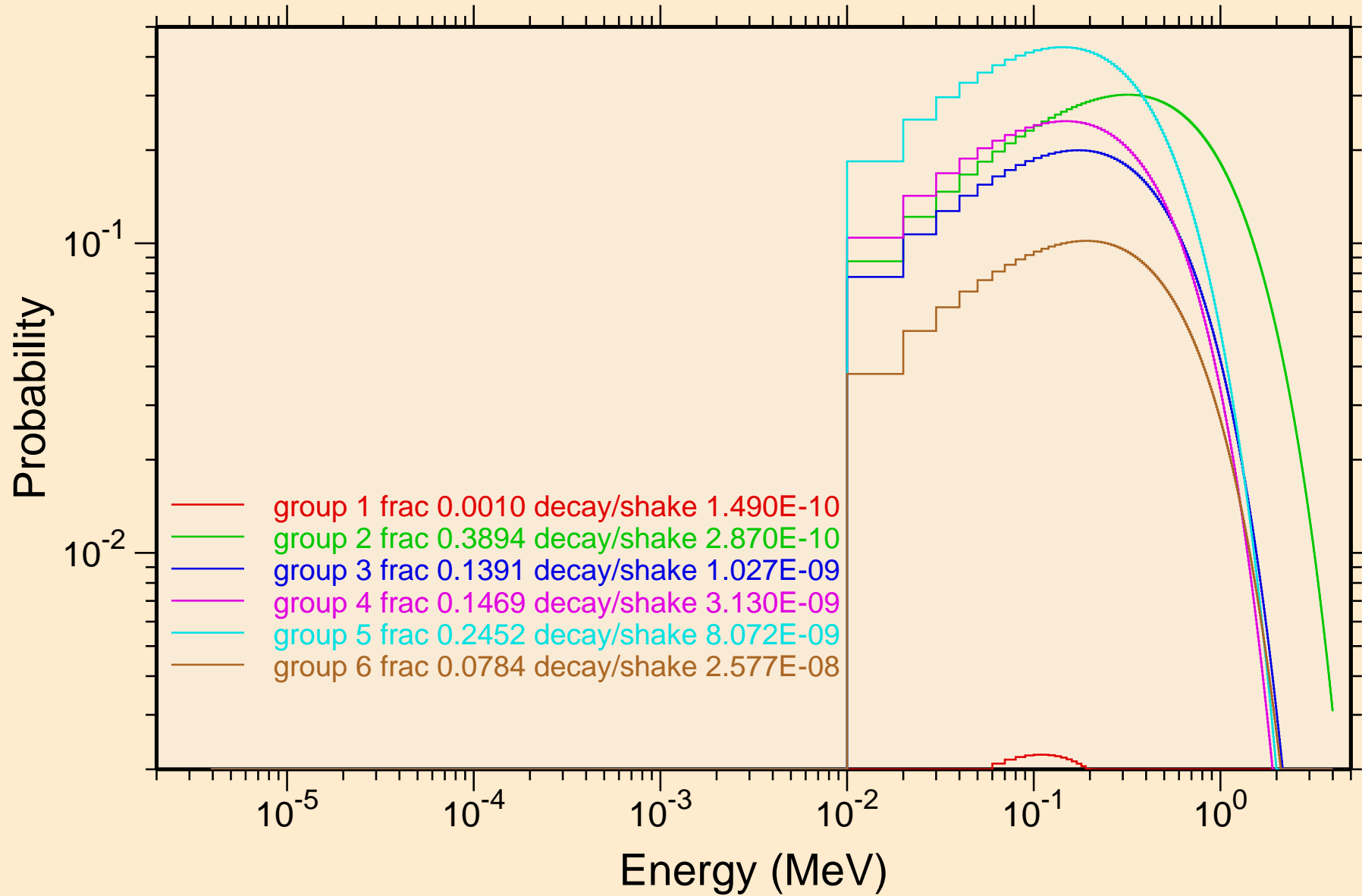

BH271 NRG TENDL-2015, AKONING
Photon emission for (n,x)

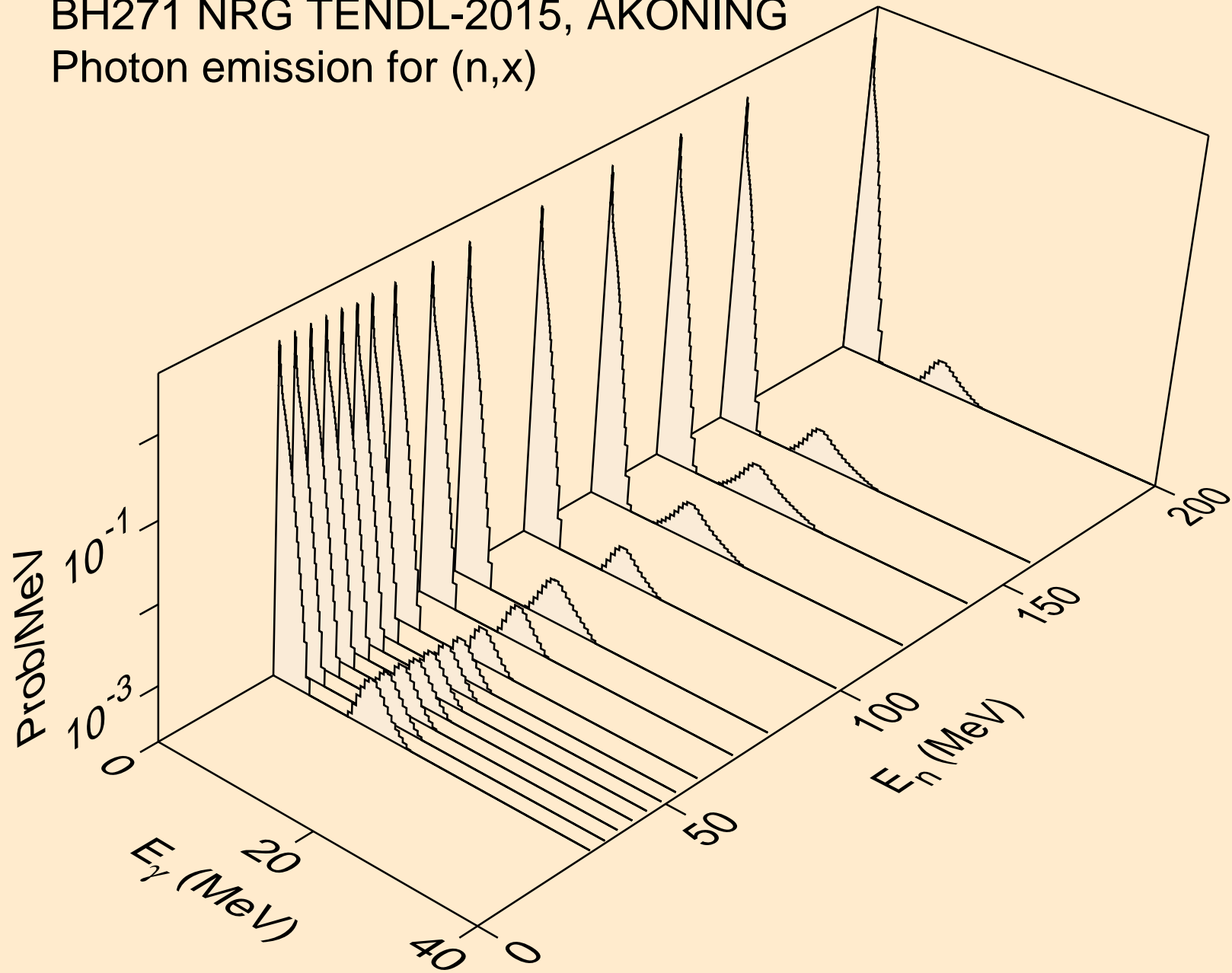

BH271 NRG TENDL-2015, AKONING
Photon emission for (n,2nd)

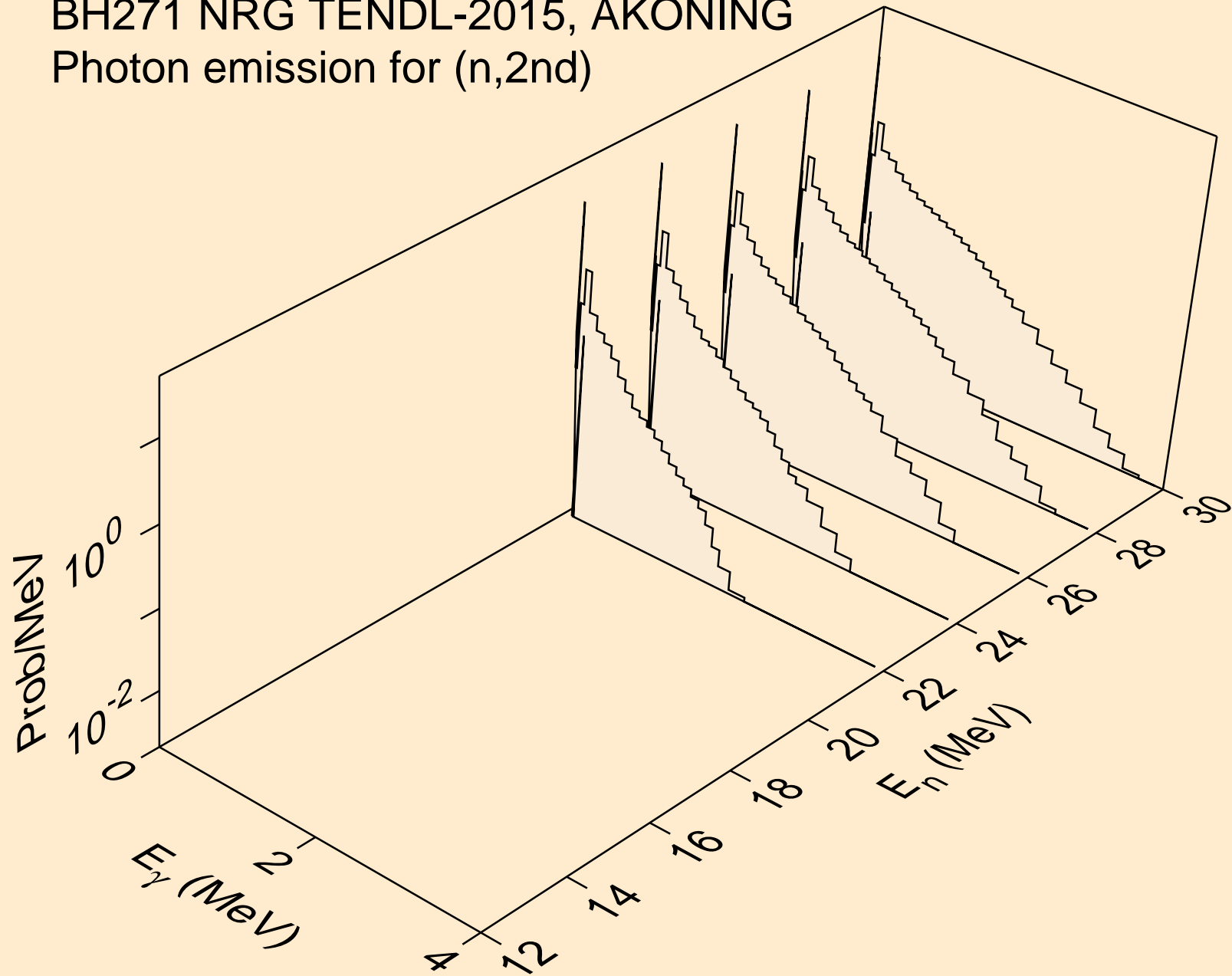

BH271 NRG TENDL-2015, AKONING
Photon emission for (n,2n)

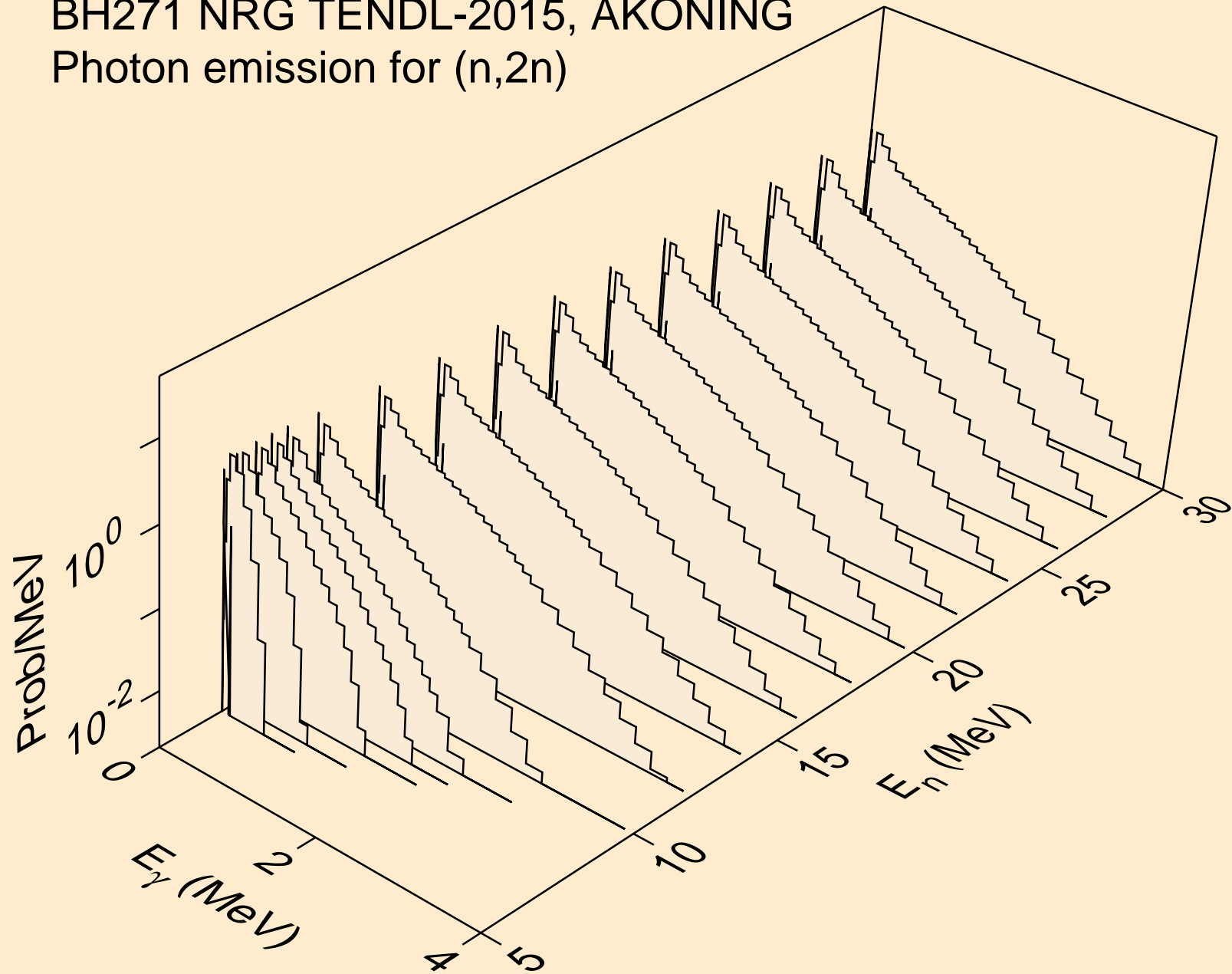

BH271 NRG TENDL-2015, AKONING
Photon emission for (n,3n)

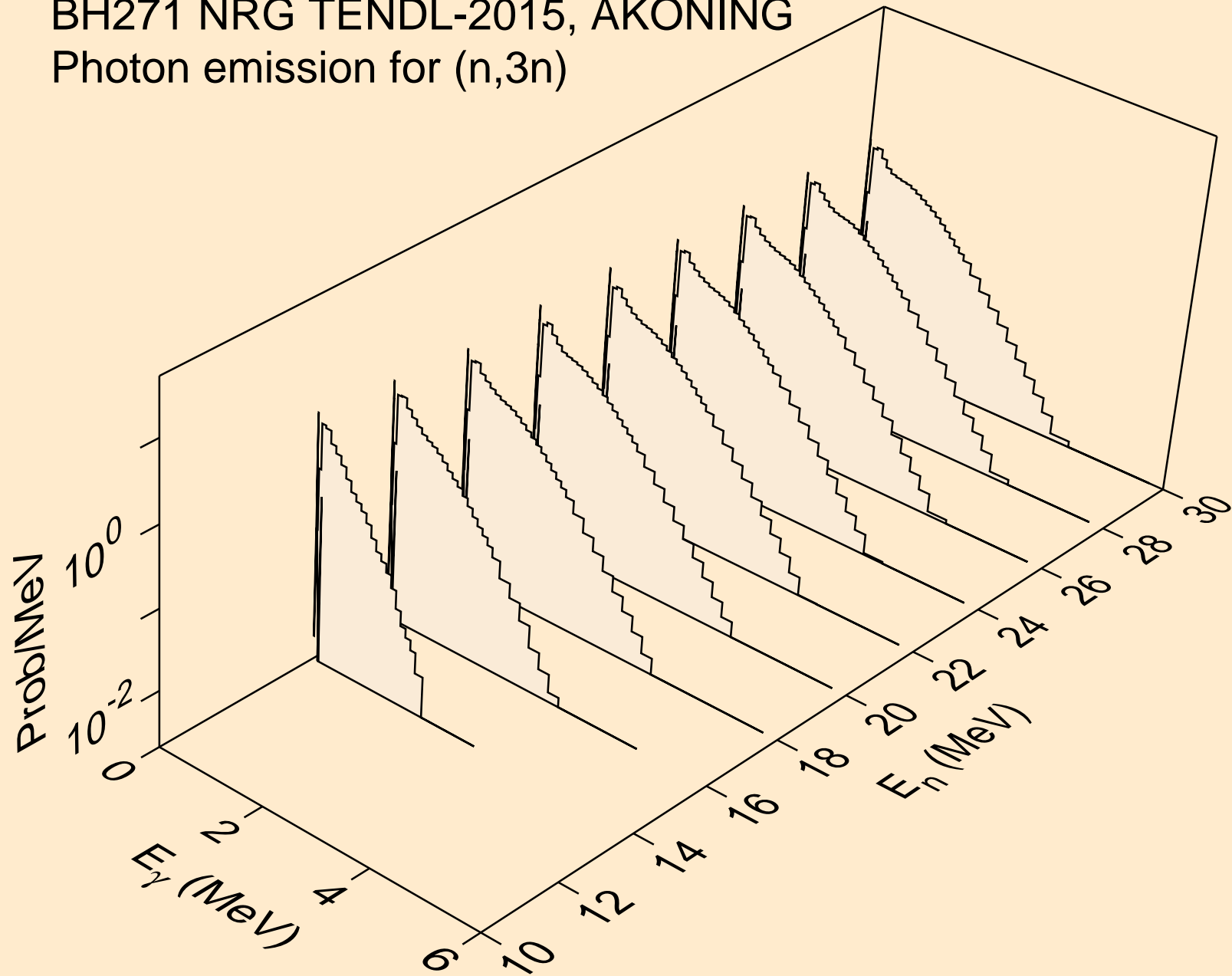

BH271 NRG TENDL-2015, AKONING
Photon emission for (n,n*)a

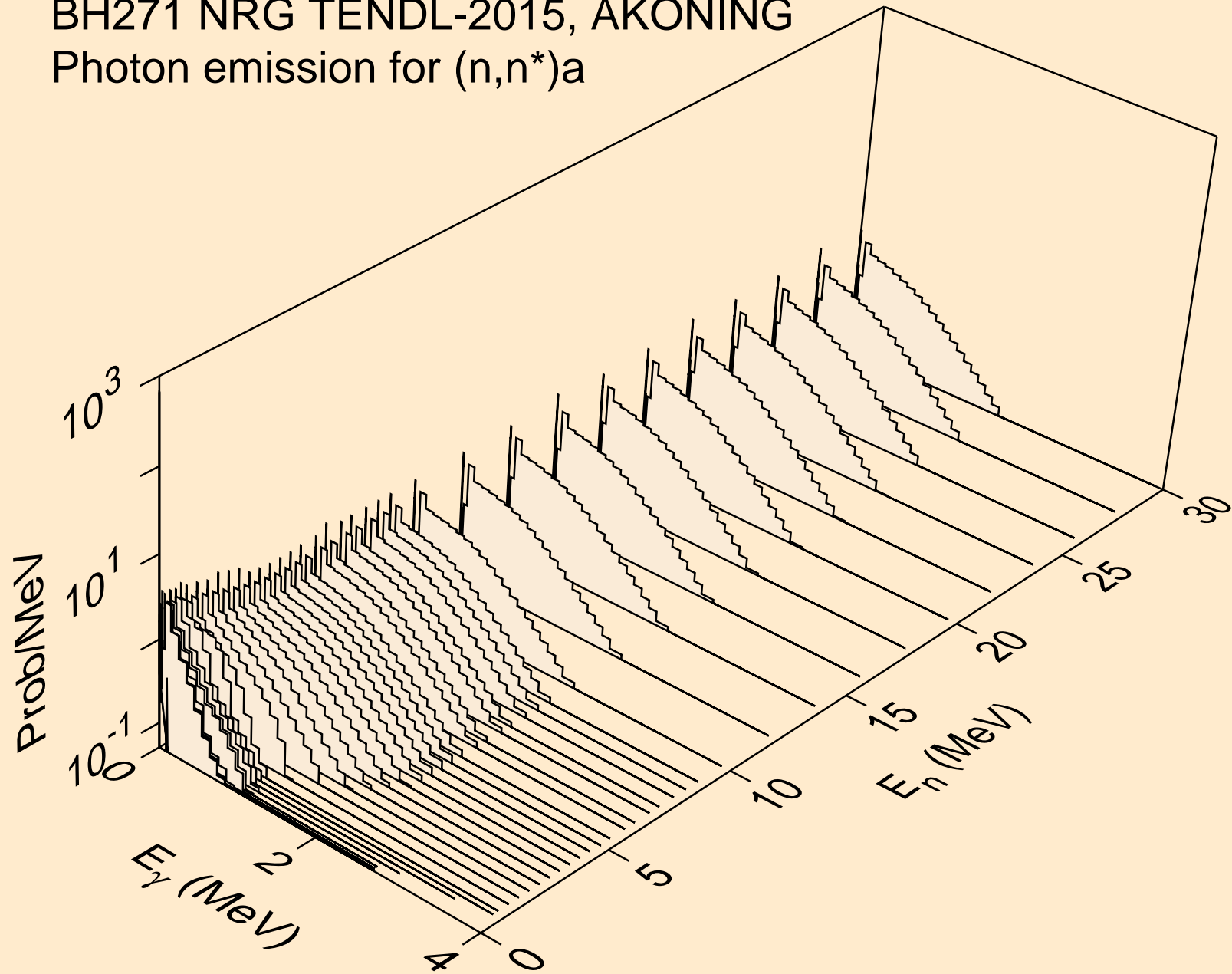

BH271 NRG TENDL-2015, AKONING
Photon emission for (n,n*)3a

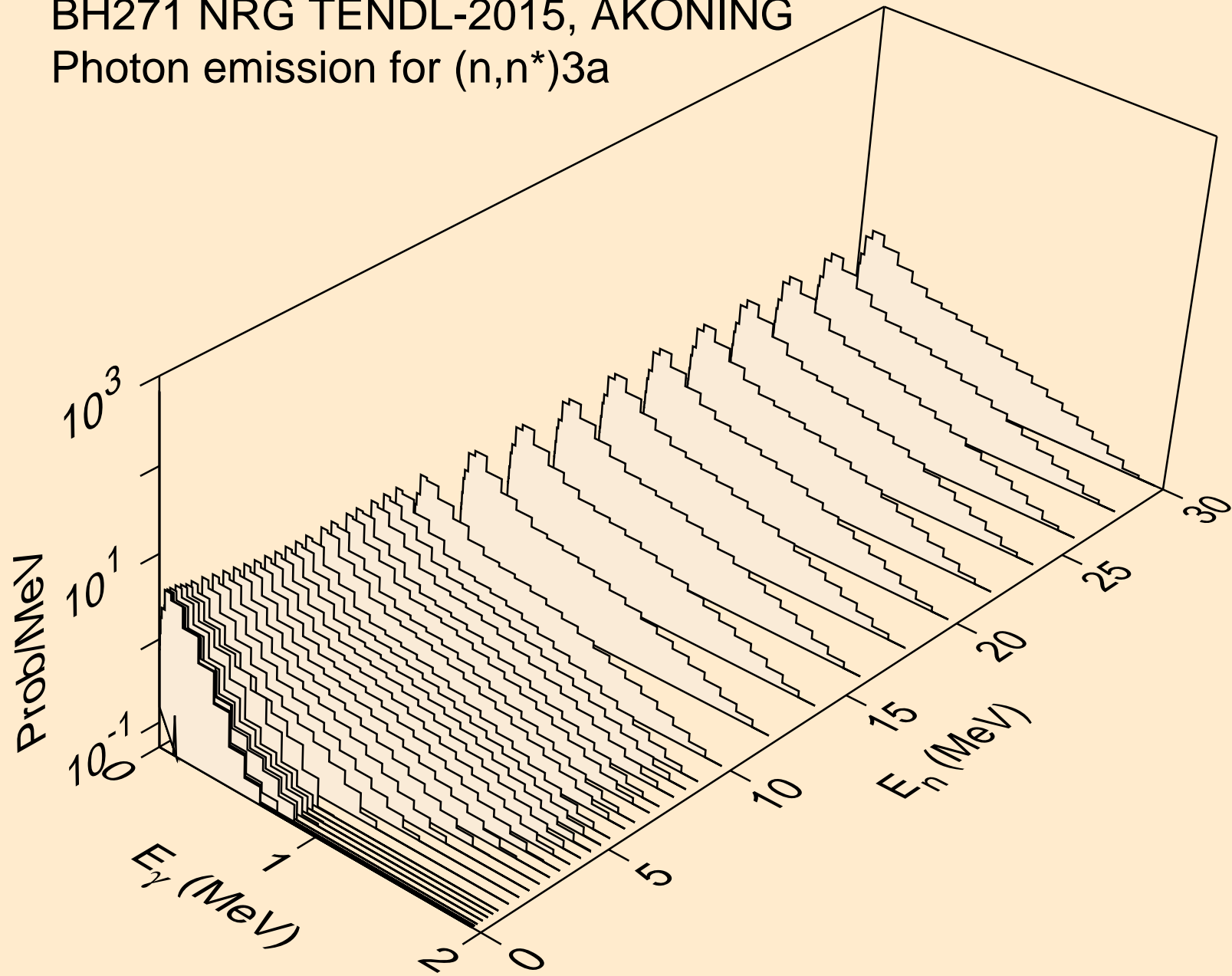

BH271 NRG TENDL-2015, AKONING
Photon emission for (n,2n)_a

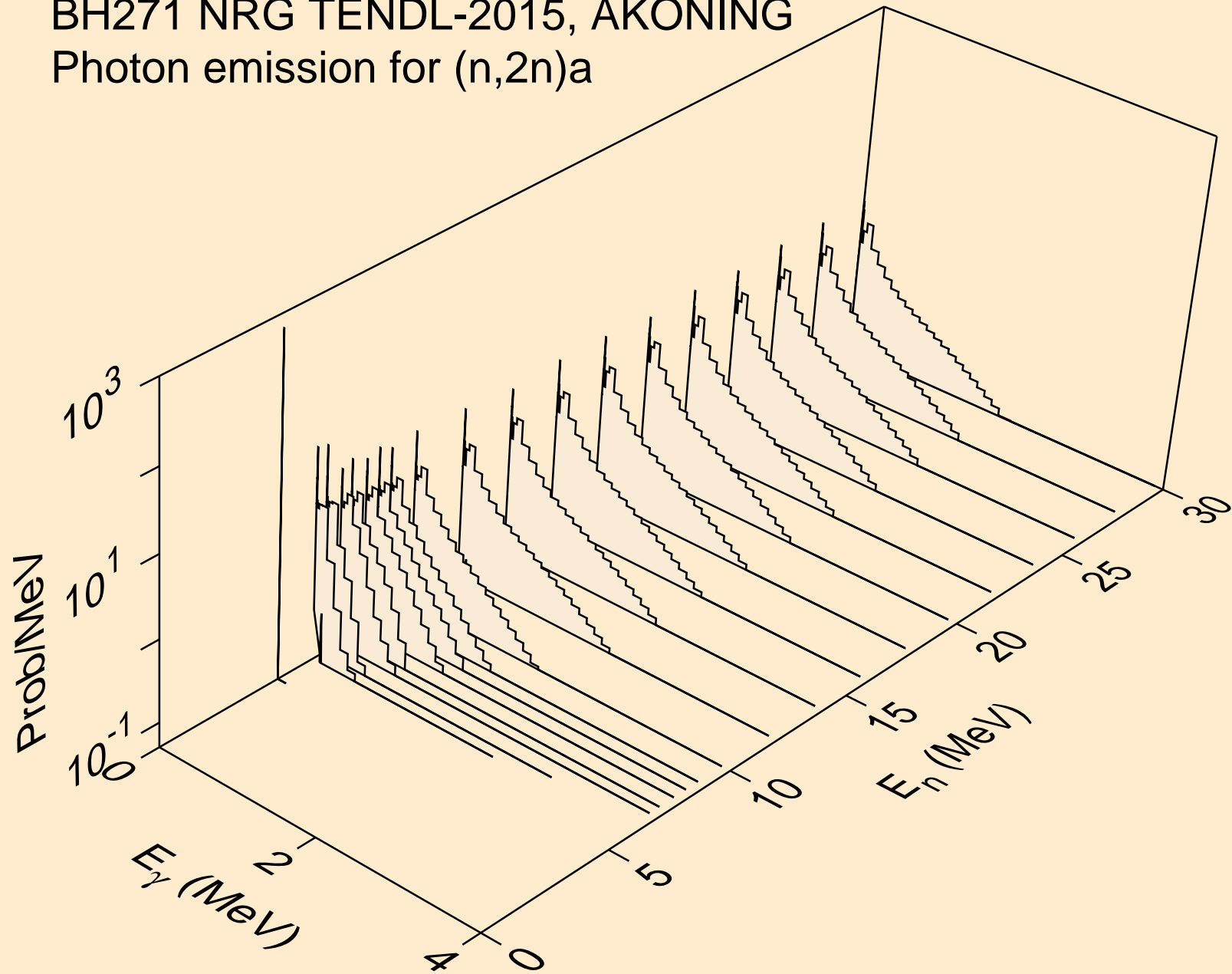

BH271 NRG TENDL-2015, AKONING
Photon emission for (n,3n)a

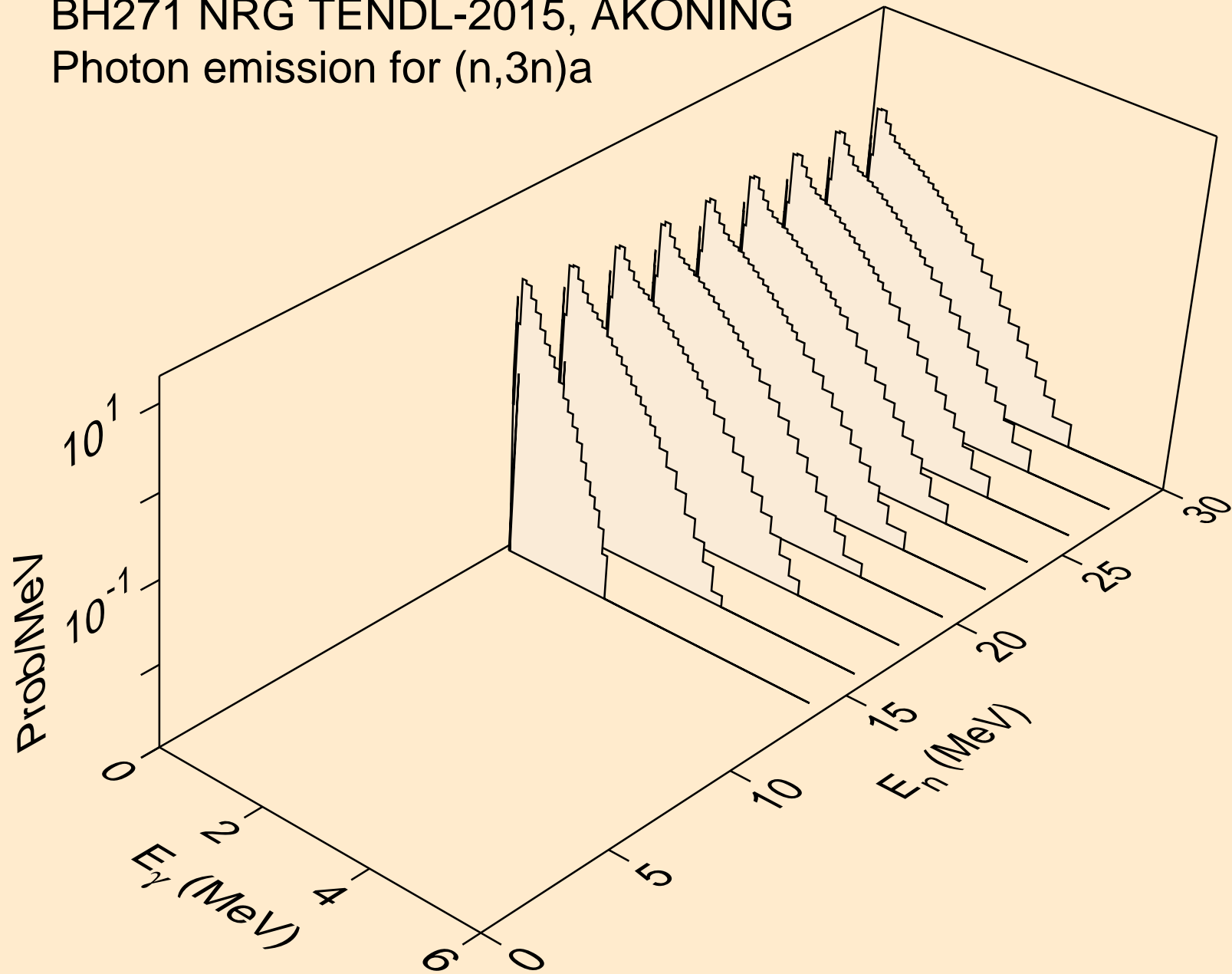

BH271 NRG TENDL-2015, AKONING
Photon emission for (n,n*)p

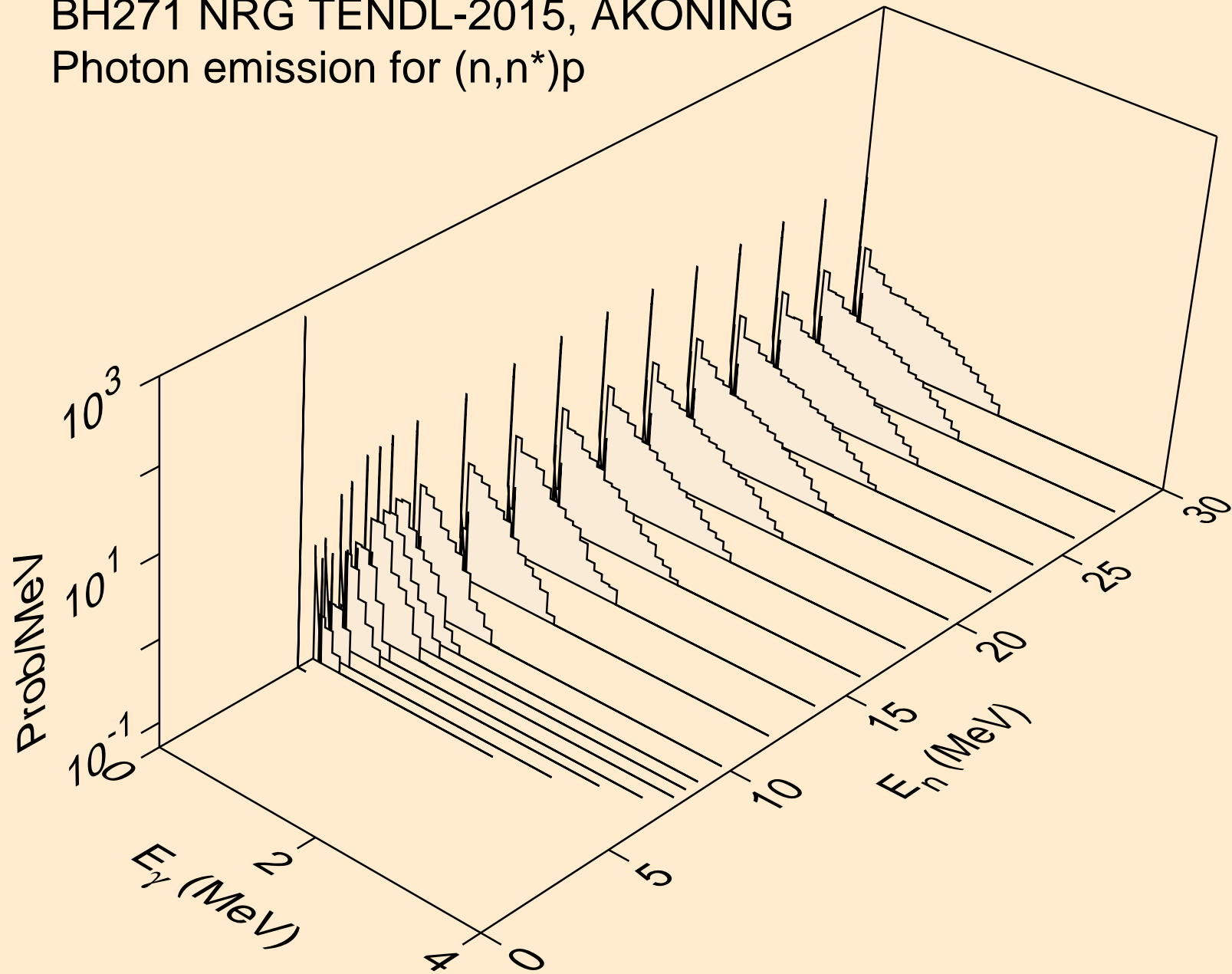

BH271 NRG TENDL-2015, AKONING
Photon emission for (n,n*)2a

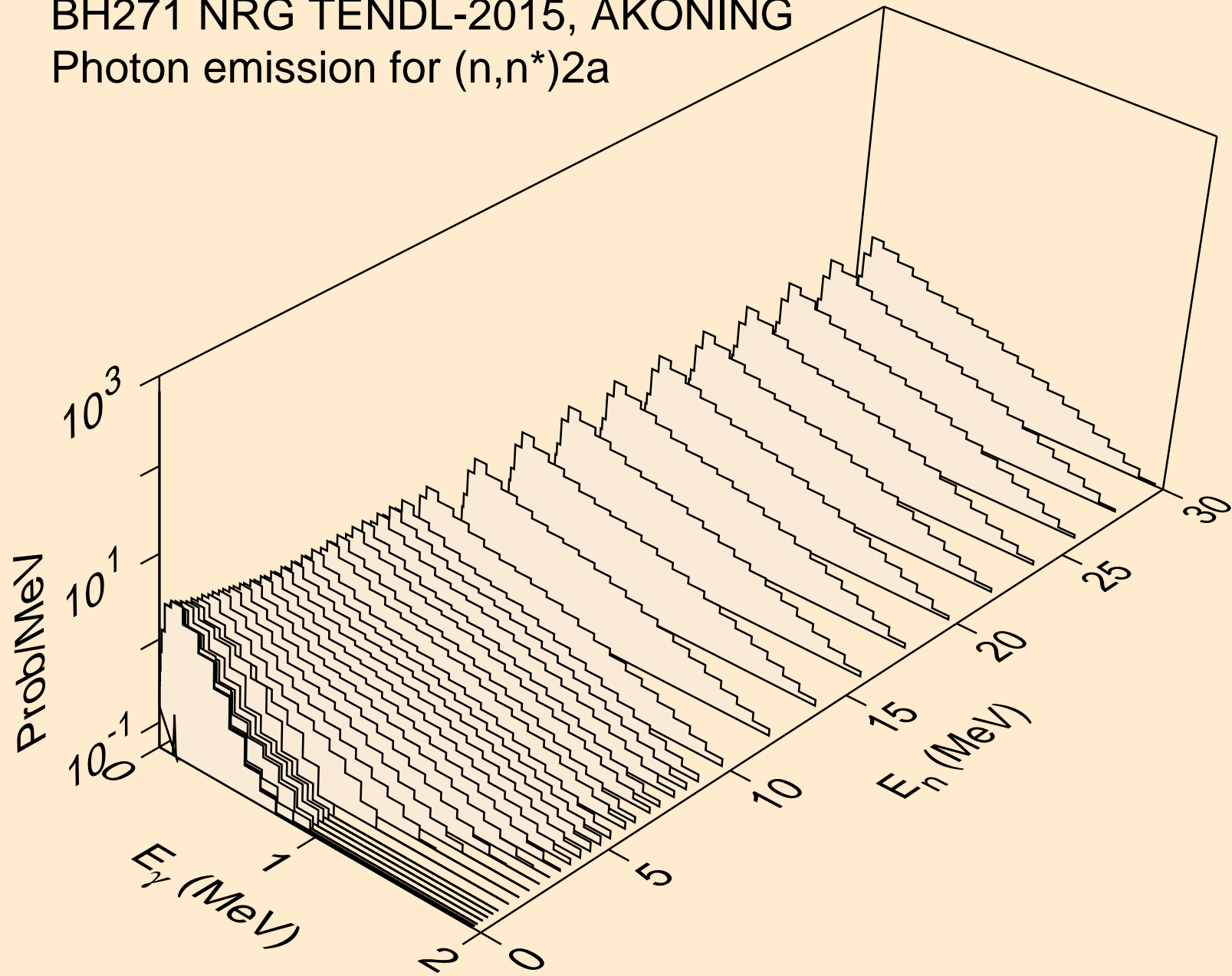

BH271 NRG TENDL-2015, AKONING
Photon emission for (n,2n)2a

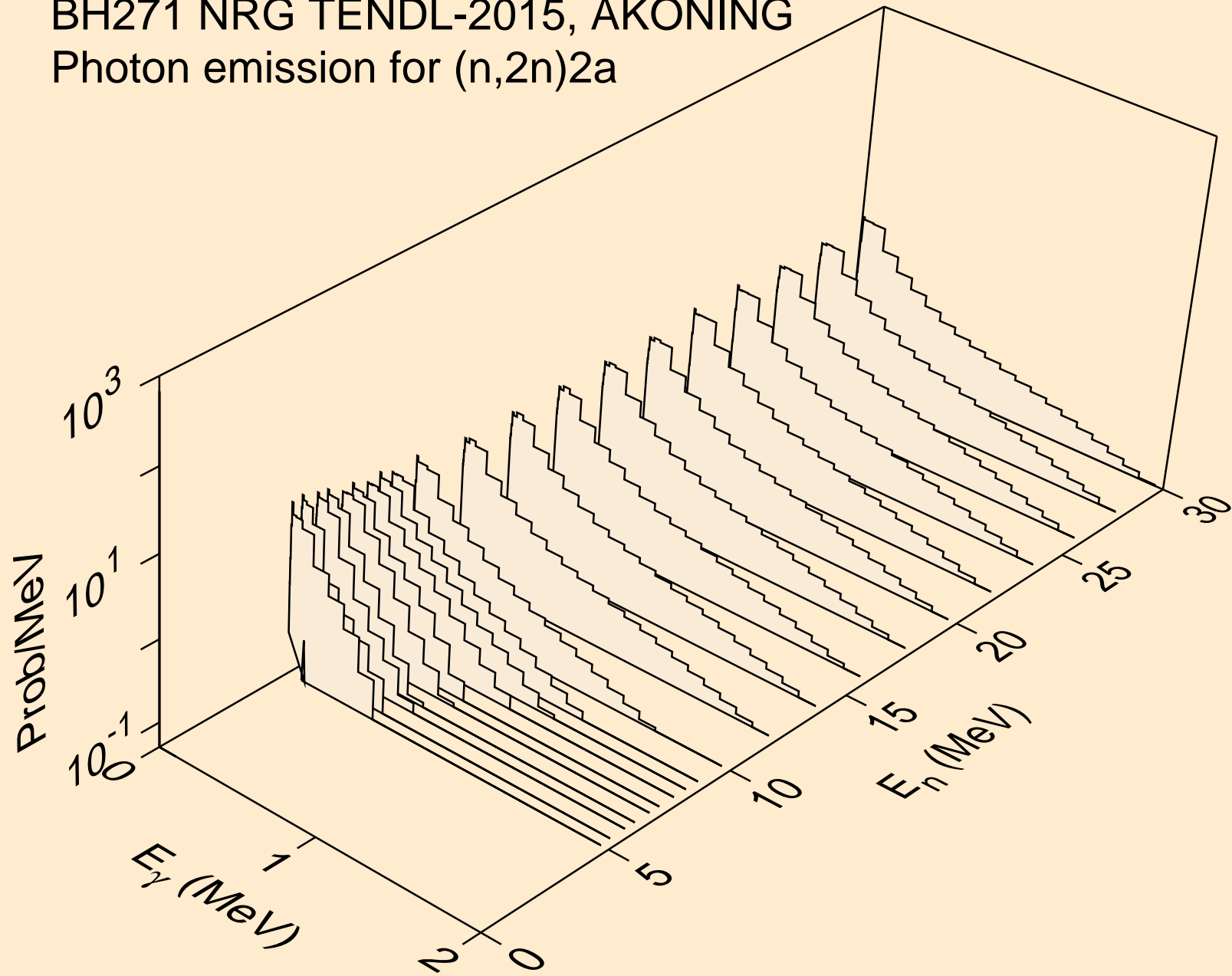

BH271 NRG TENDL-2015, AKONING
Photon emission for (n,n*)d

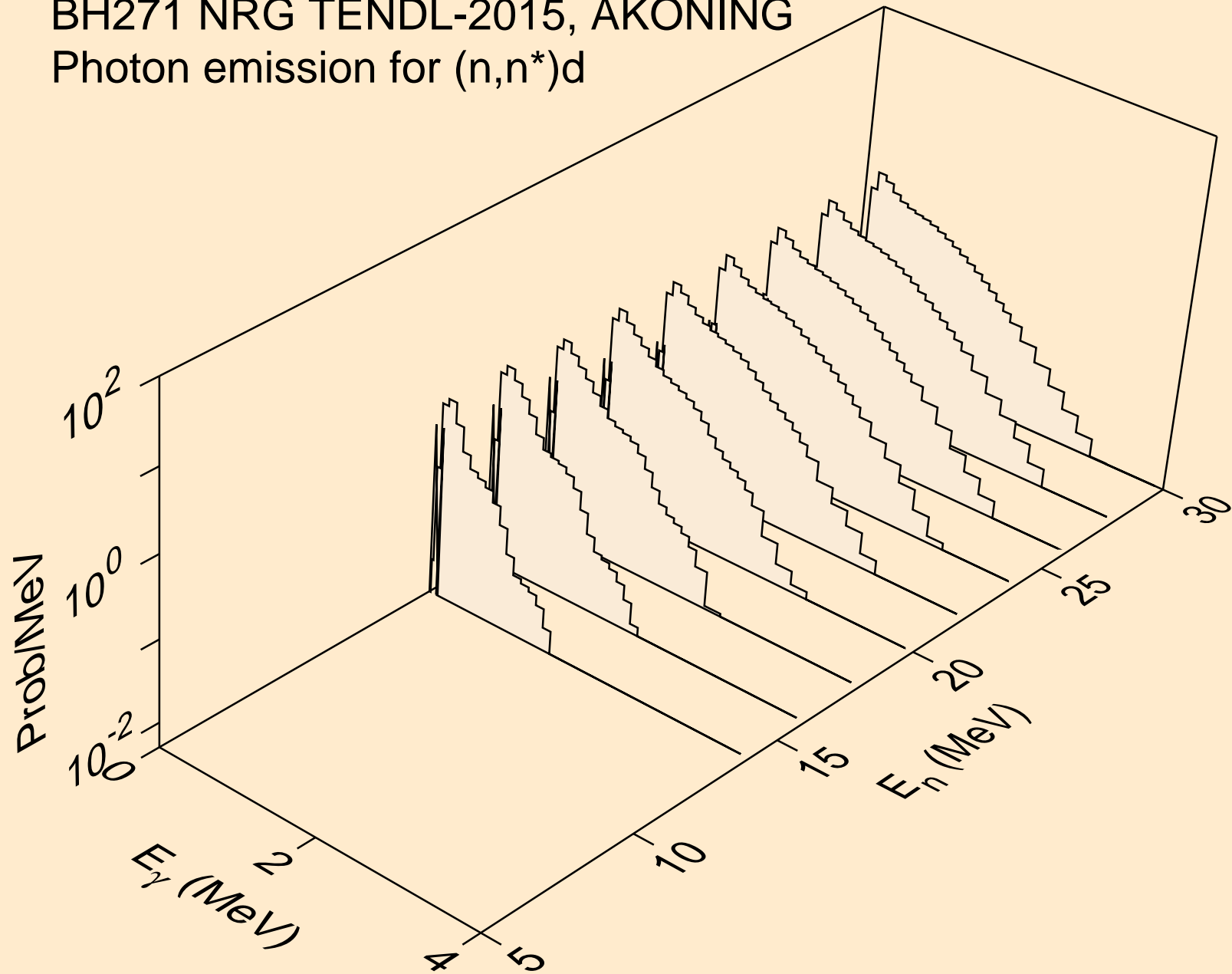

BH271 NRG TENDL-2015, AKONING
Photon emission for (n,n*)t

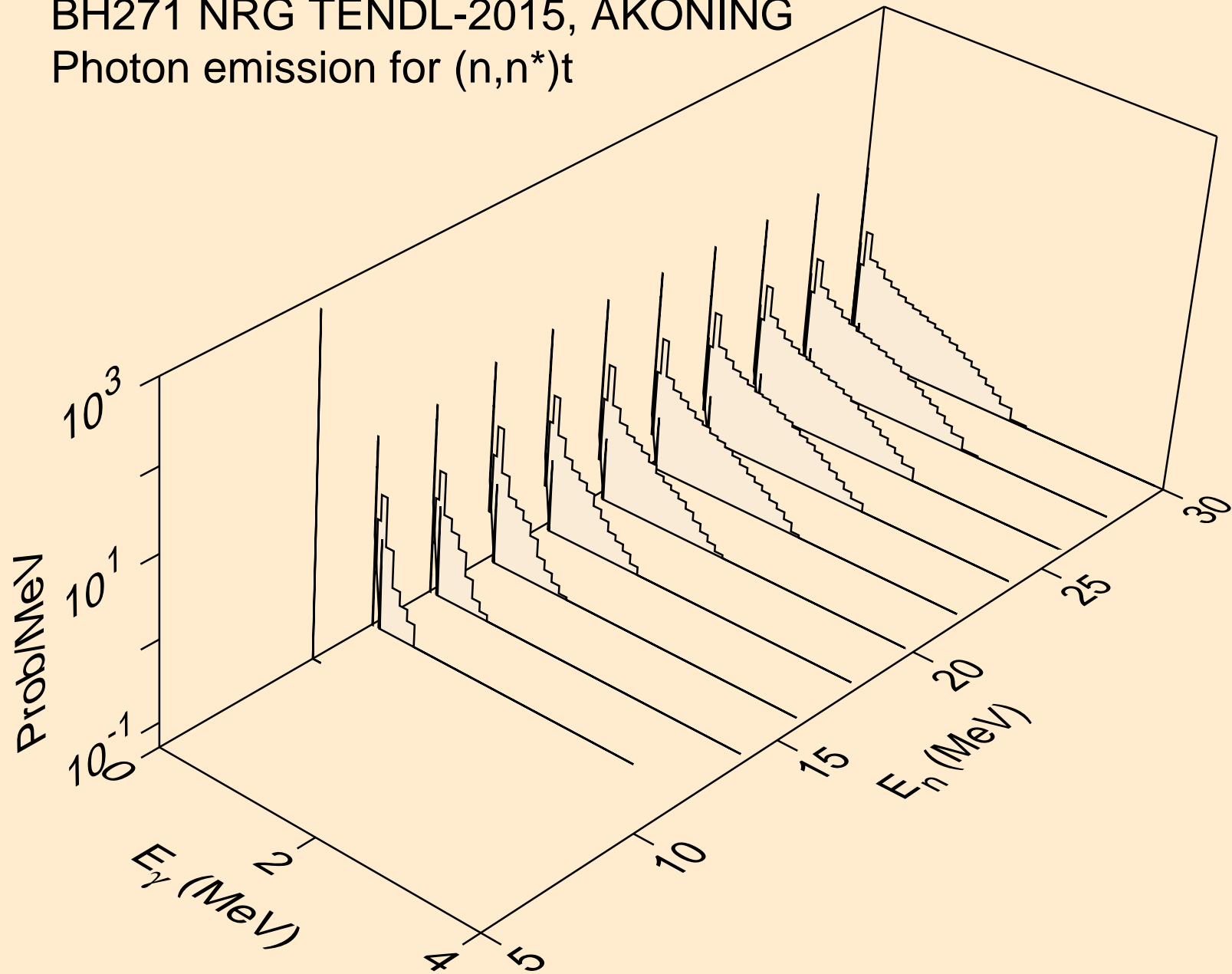

BH271 NRG TENDL-2015, AKONING
Photon emission for (n,n*)he3

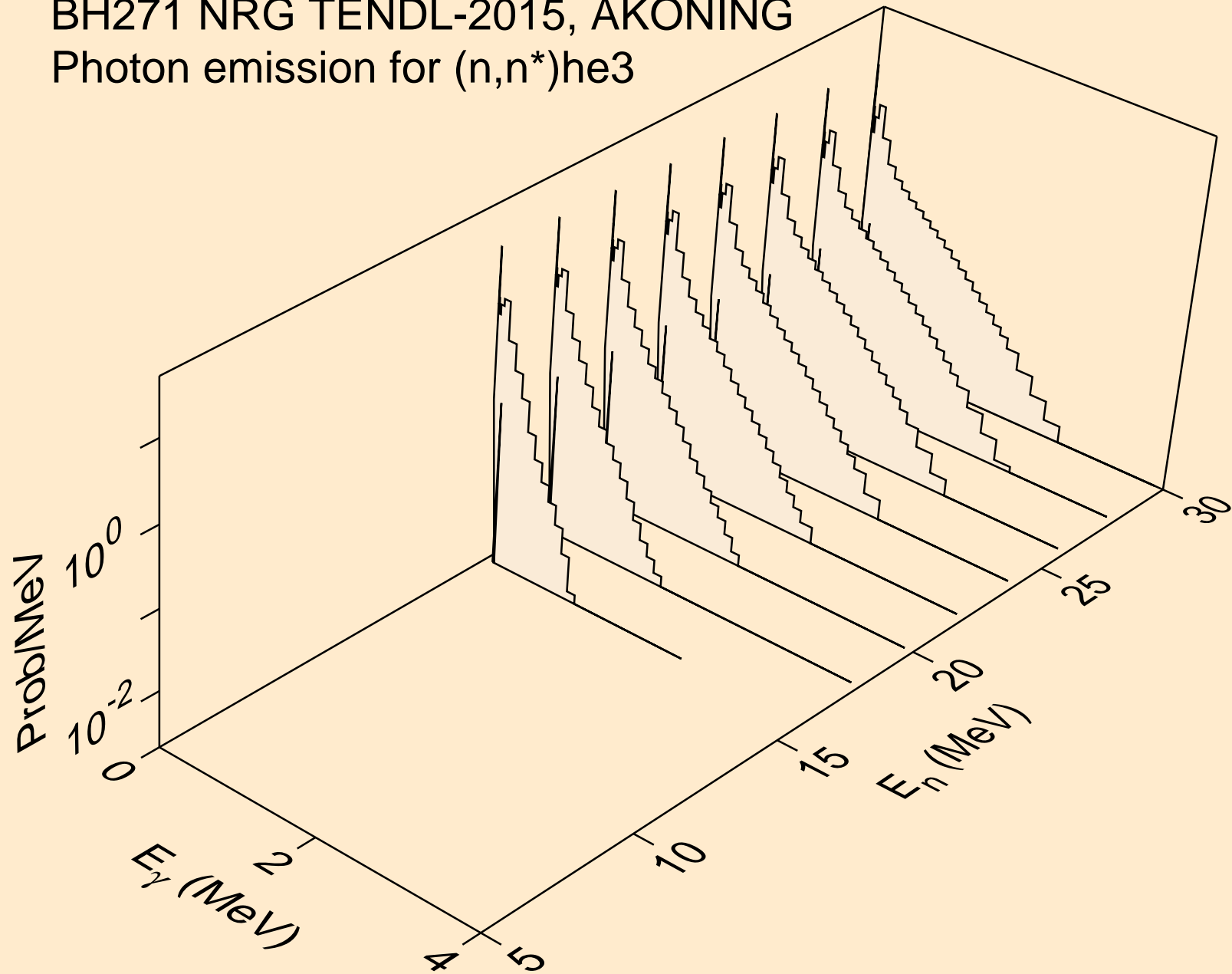

BH271 NRG TENDL-2015, AKONING
Photon emission for (n,n*)d2a

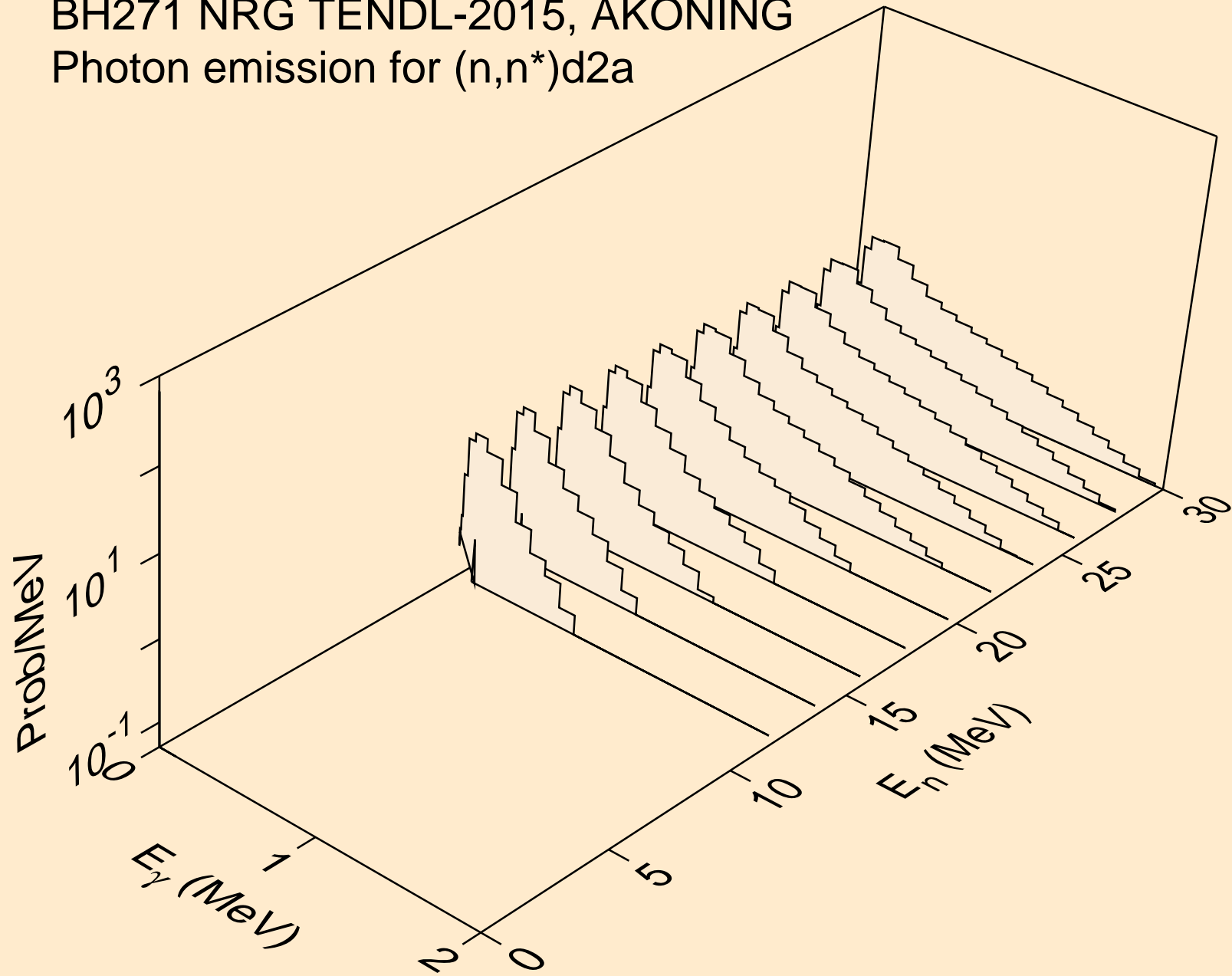

BH271 NRG TENDL-2015, AKONING
Photon emission for (n,n*)t2a

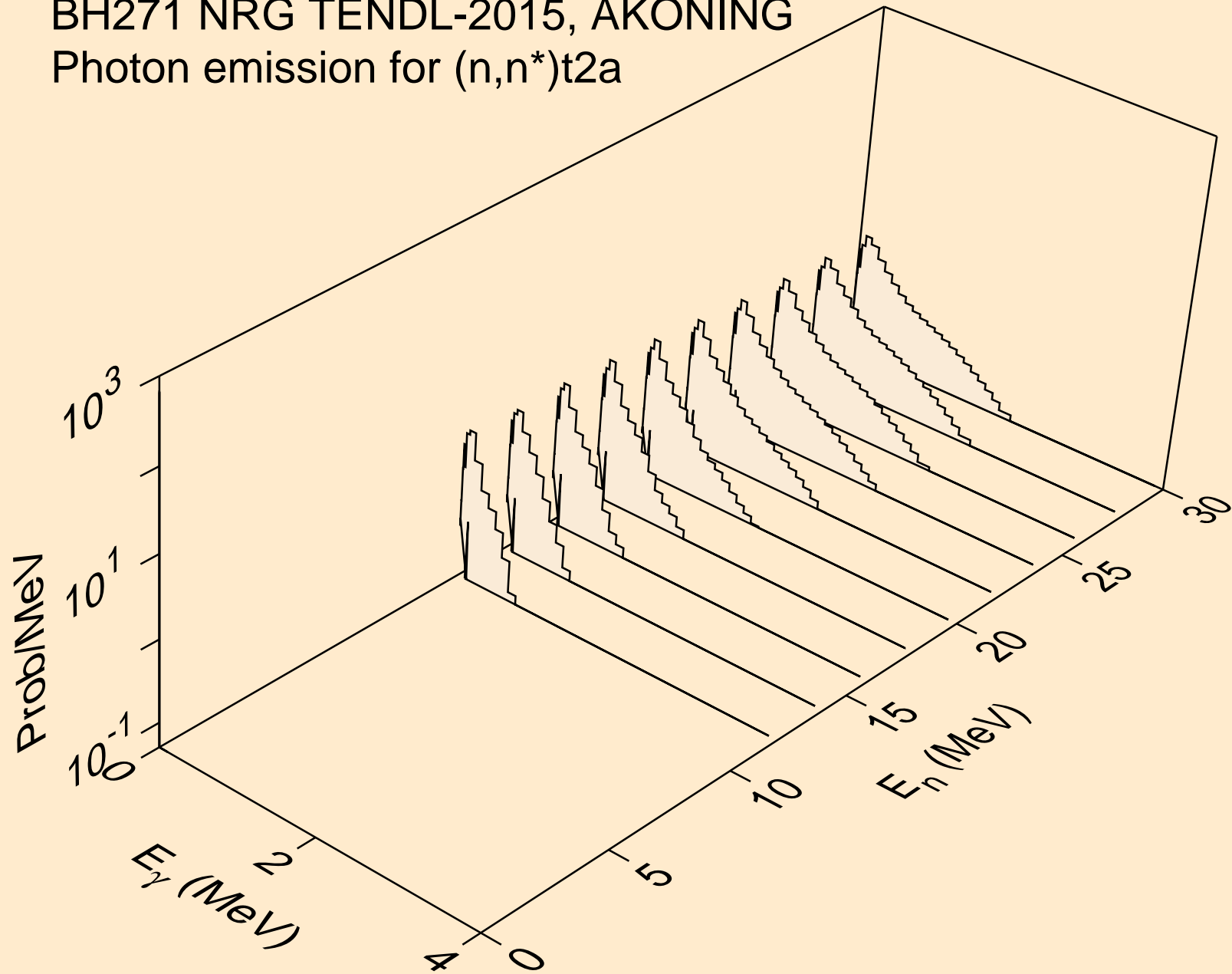

BH271 NRG TENDL-2015, AKONING
Photon emission for (n,4n)

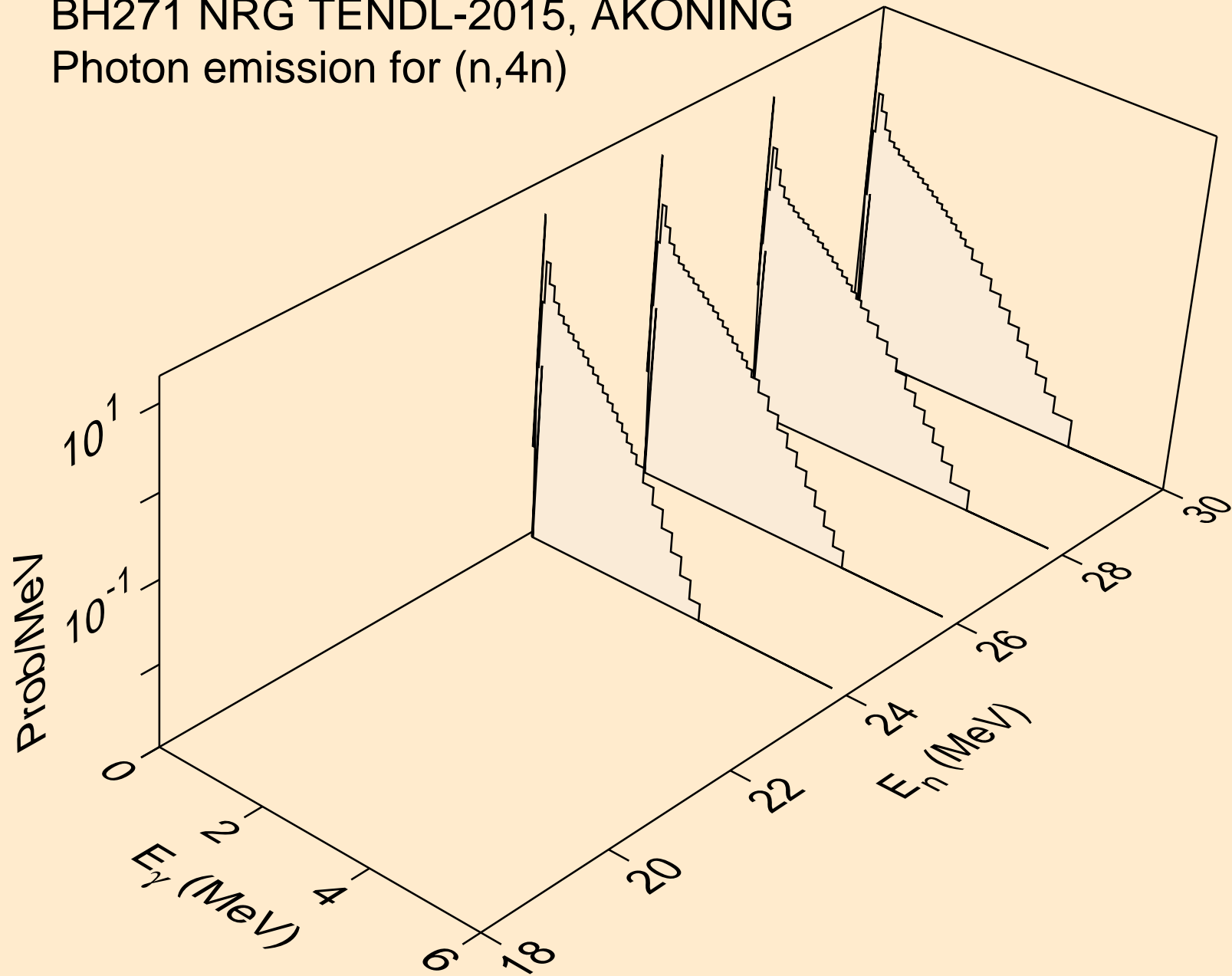

BH271 NRG TENDL-2015, AKONING
Photon emission for (n,2np)

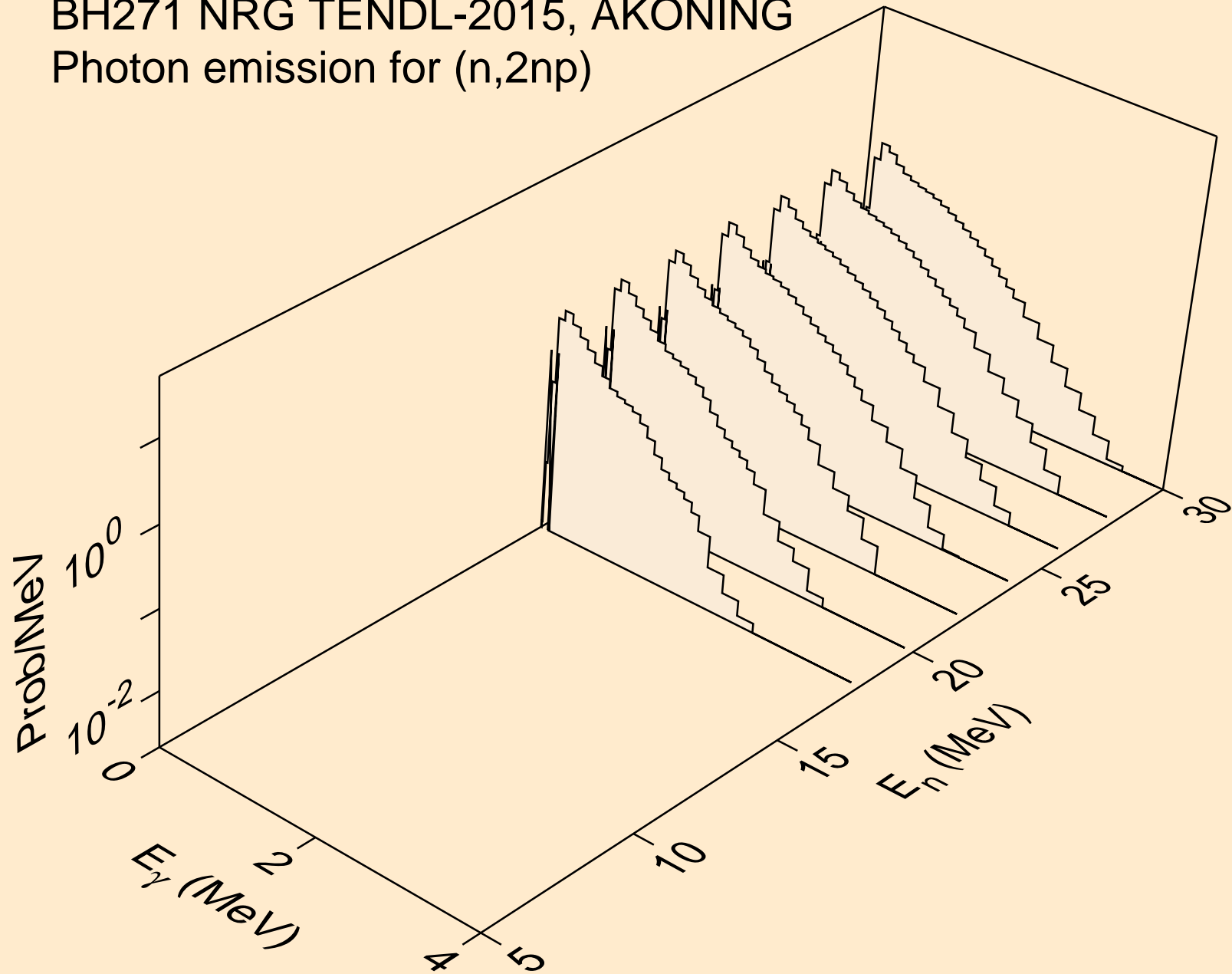

BH271 NRG TENDL-2015, AKONING
Photon emission for (n,3np)

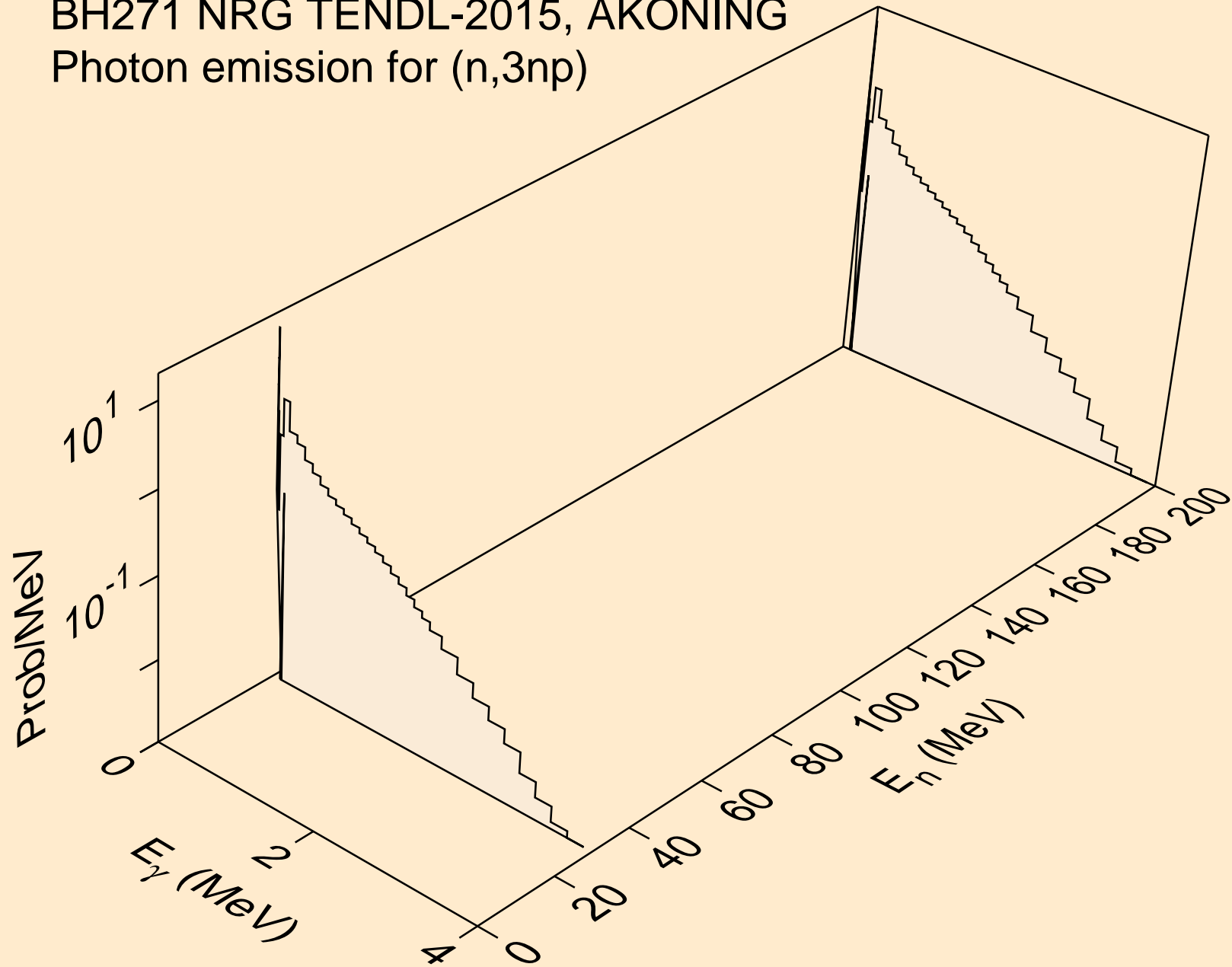

BH271 NRG TENDL-2015, AKONING
Photon emission for (n,npa)

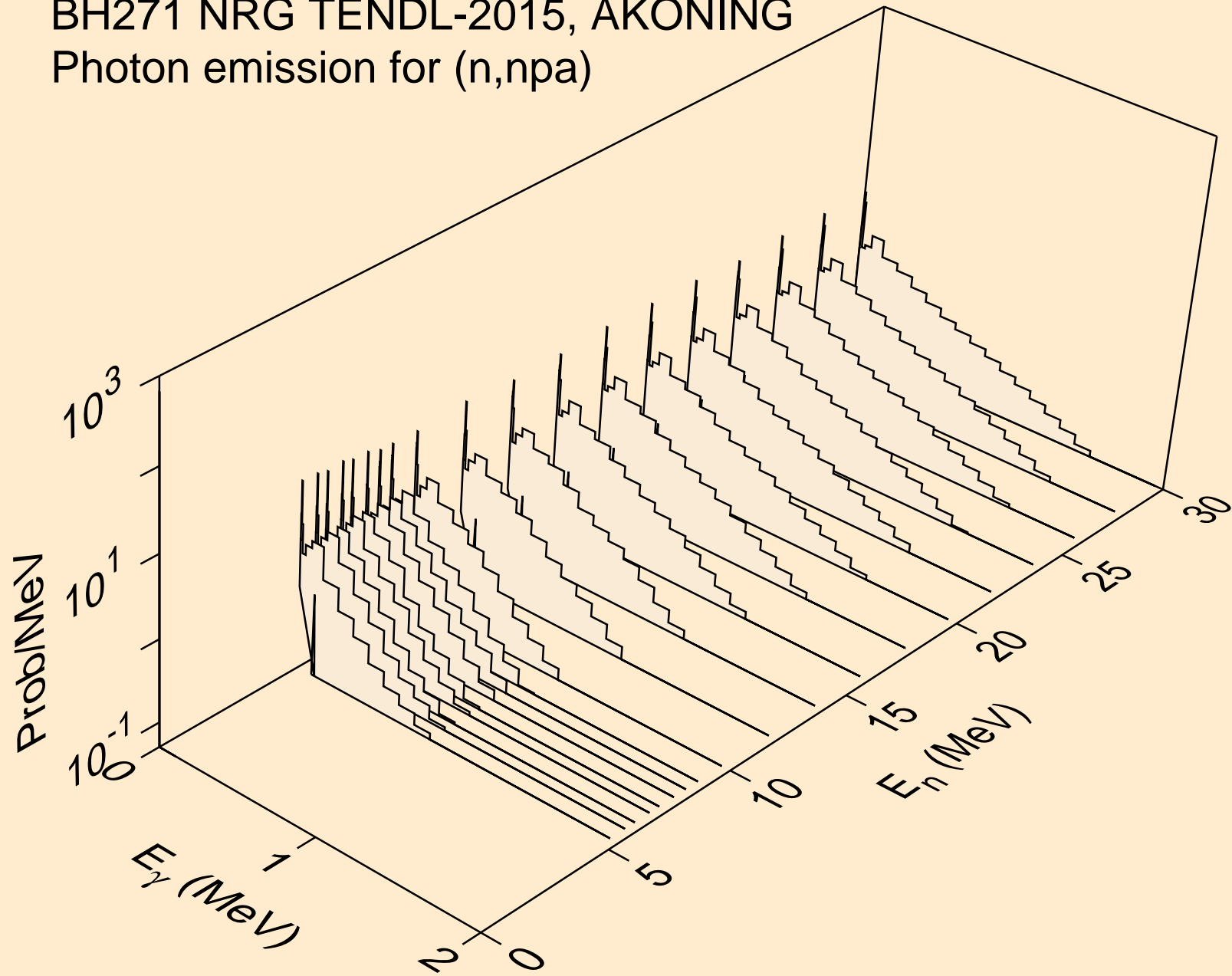

BH271 NRG TENDL-2015, AKONING
Photon emission for (n,n*c)

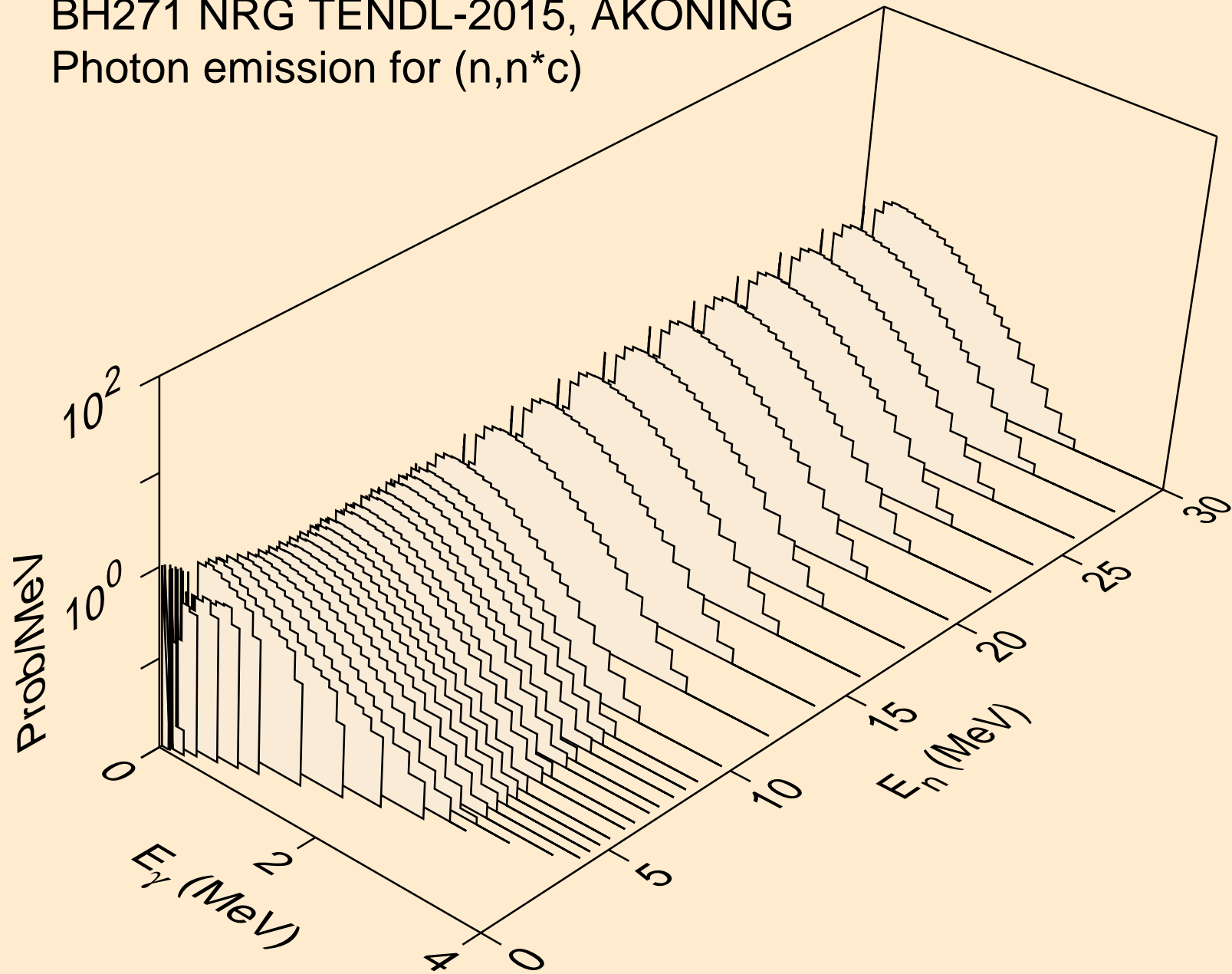

BH271 NRG TENDL-2015, AKONING
Photon emission for (n,gma)

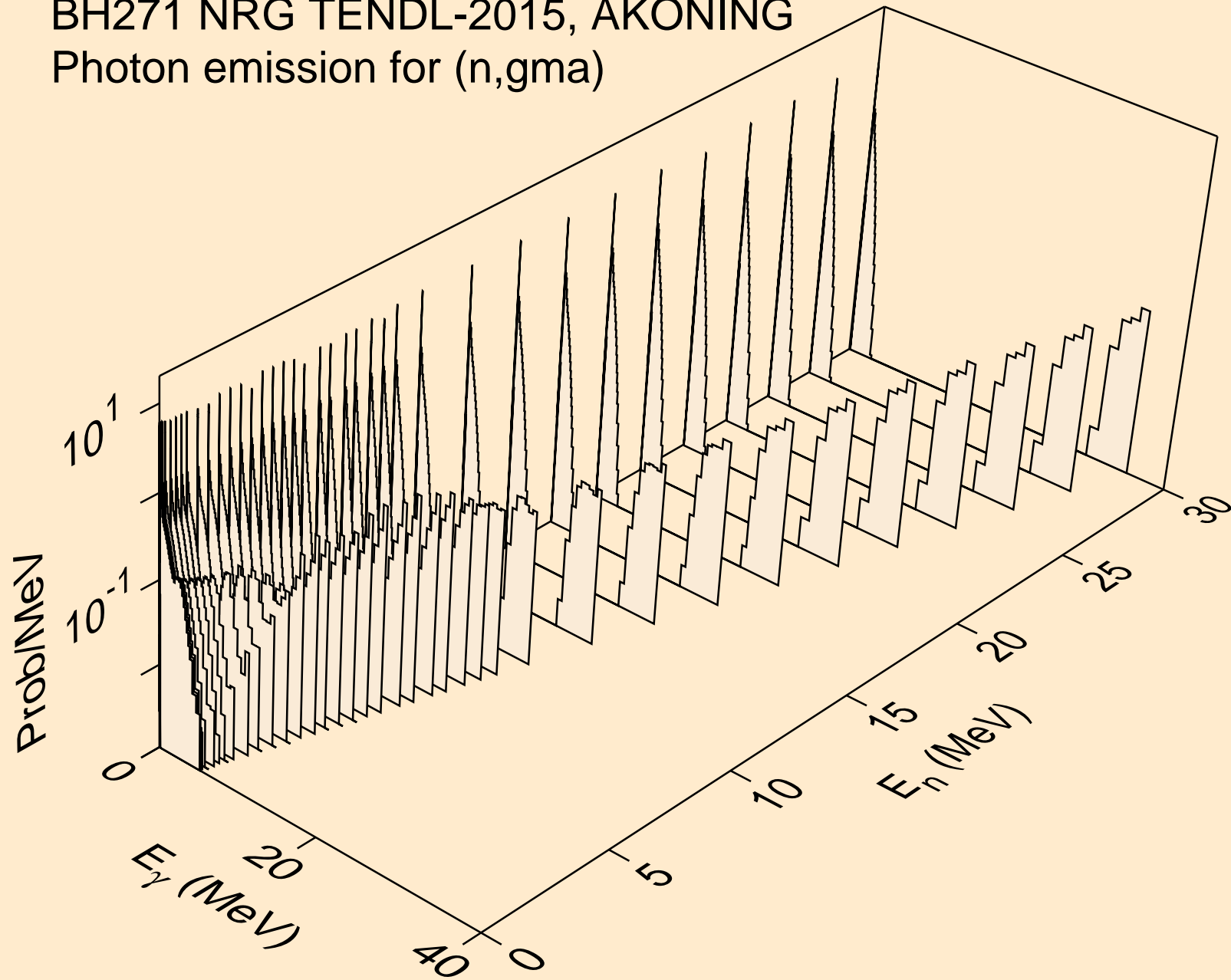

BH271 NRG TENDL-2015, AKONING
Photon emission for (n,p)

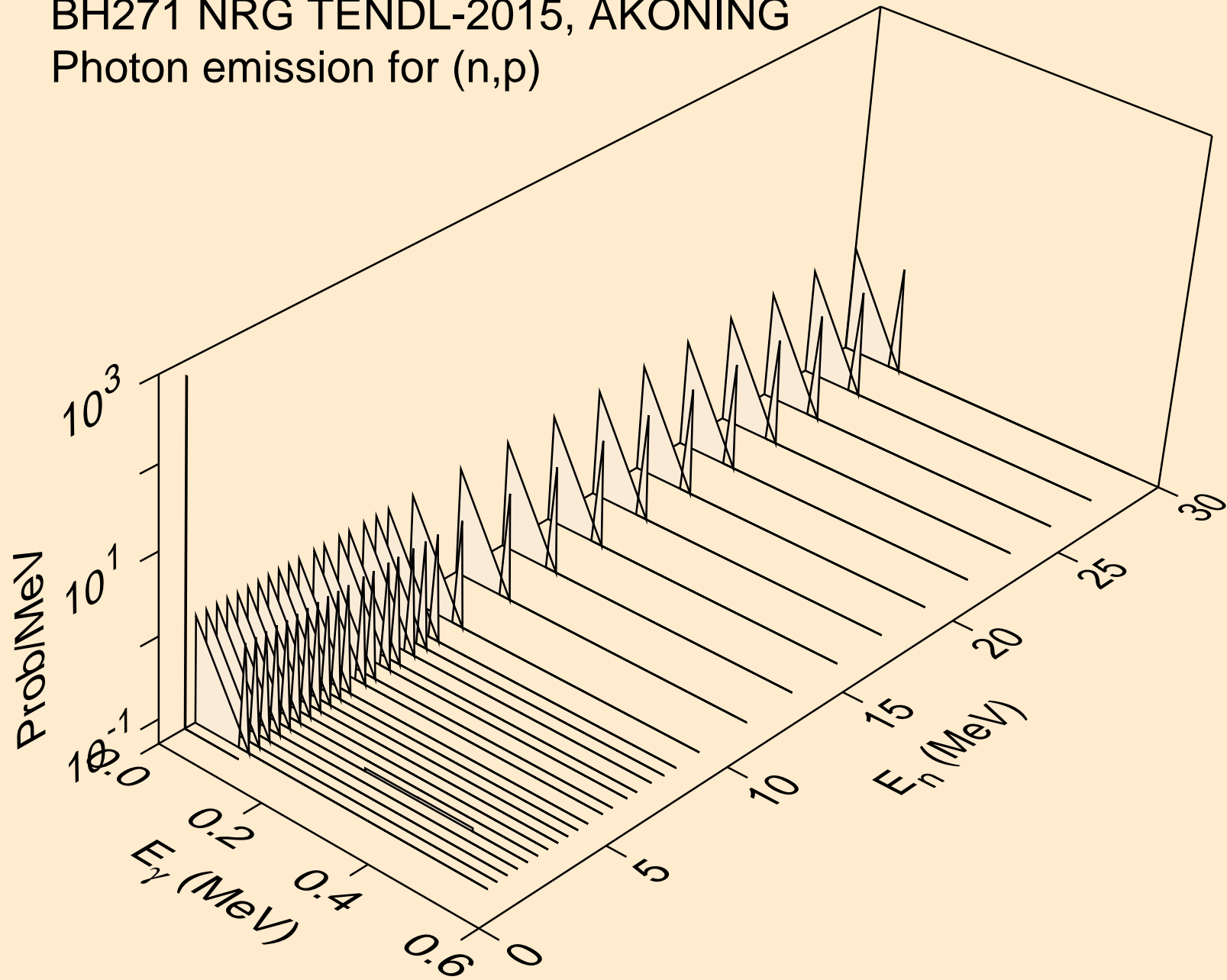

BH271 NRG TENDL-2015, AKONING
Photon emission for (n,d)

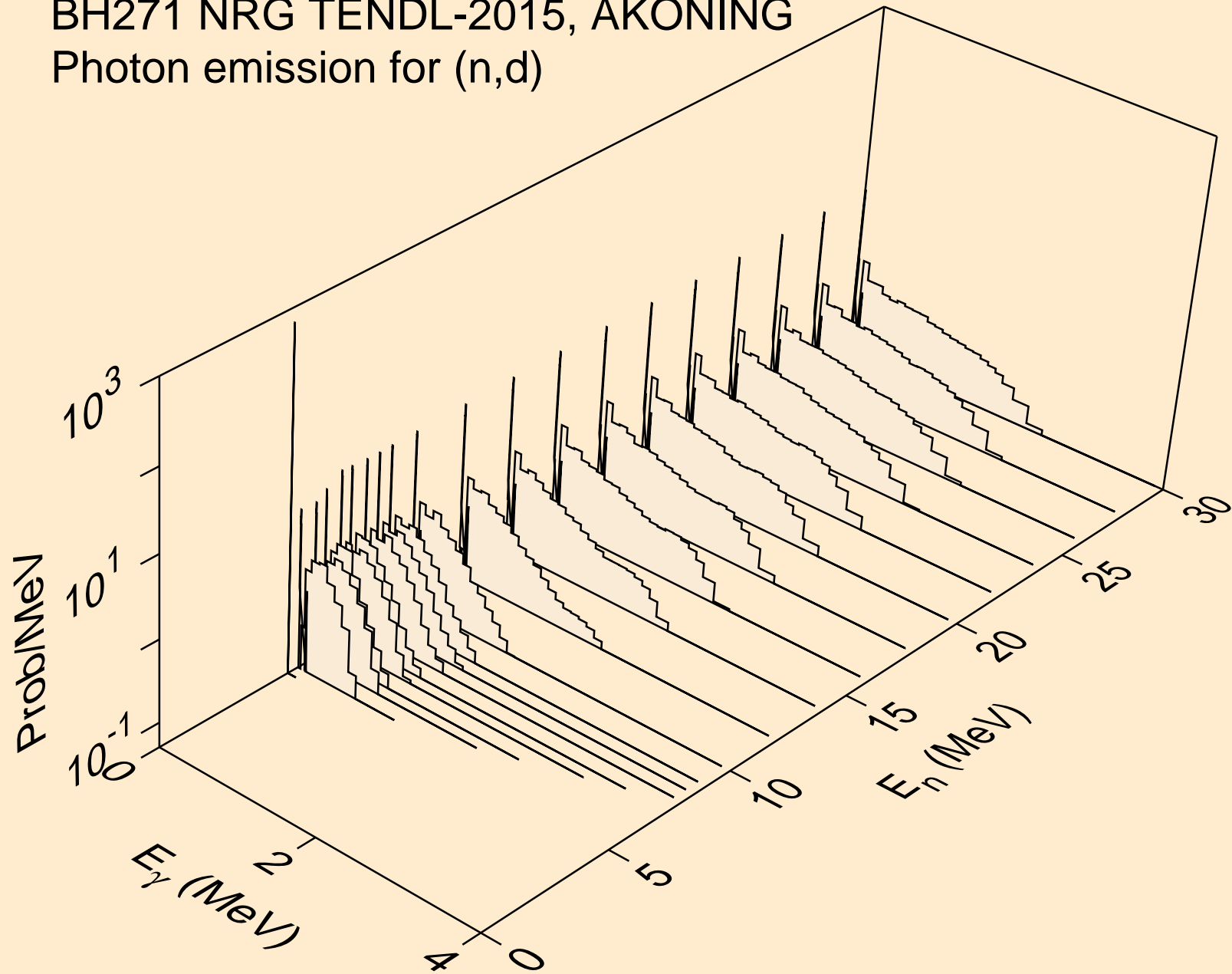

BH271 NRG TENDL-2015, AKONING
Photon emission for (n,t)

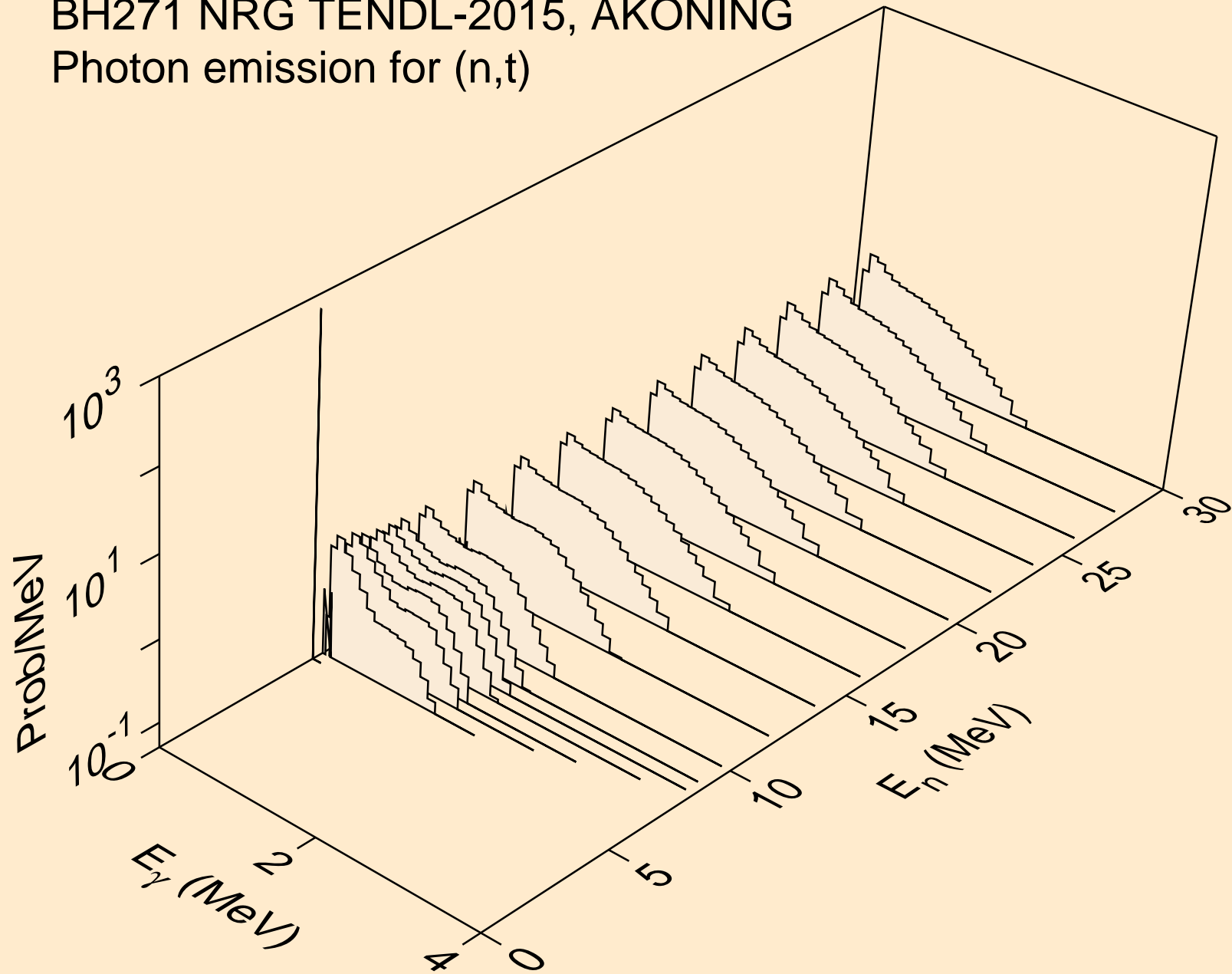

BH271 NRG TENDL-2015, AKONING
Photon emission for (n,he3)

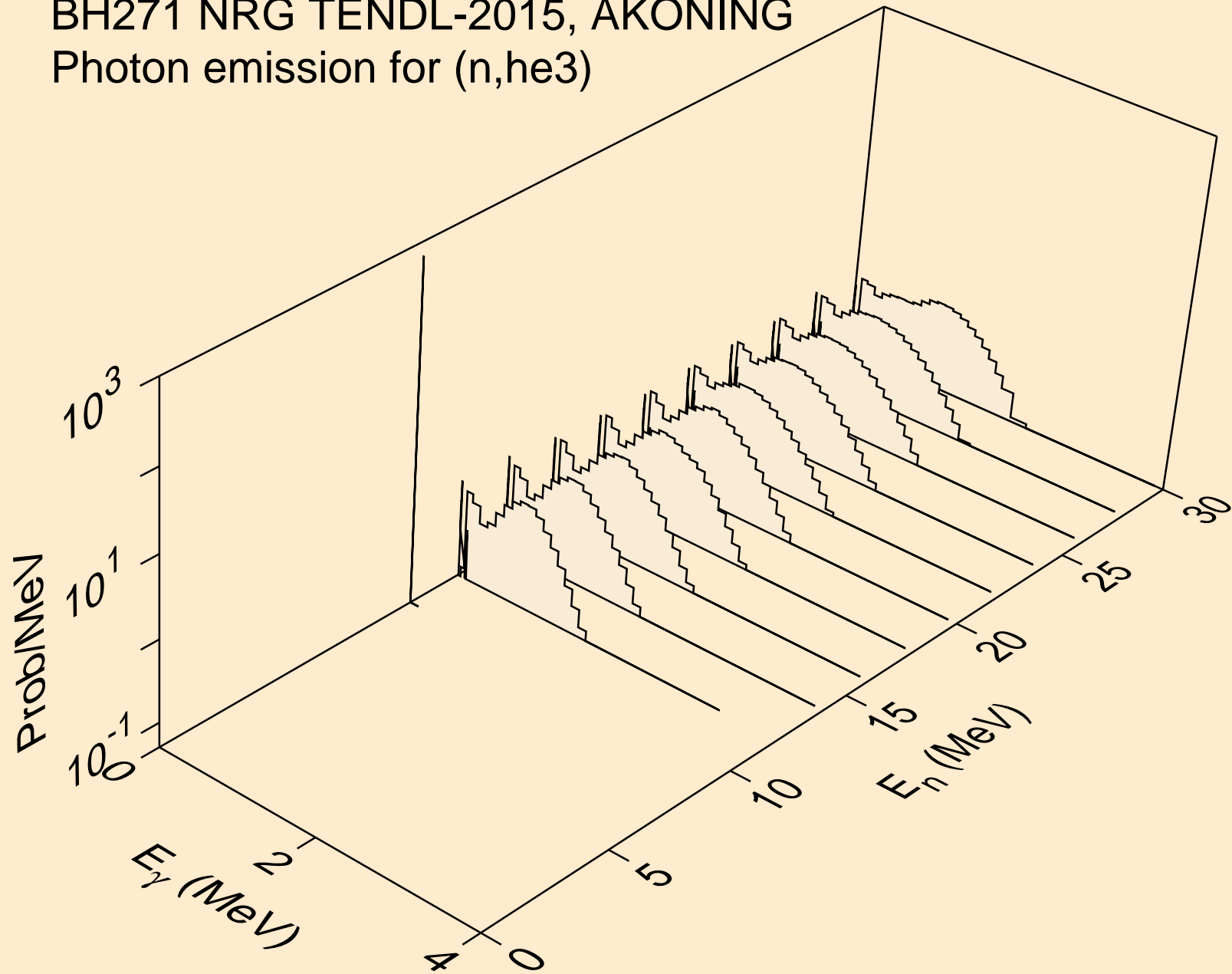

BH271 NRG TENDL-2015, AKONING
Photon emission for (n,a)

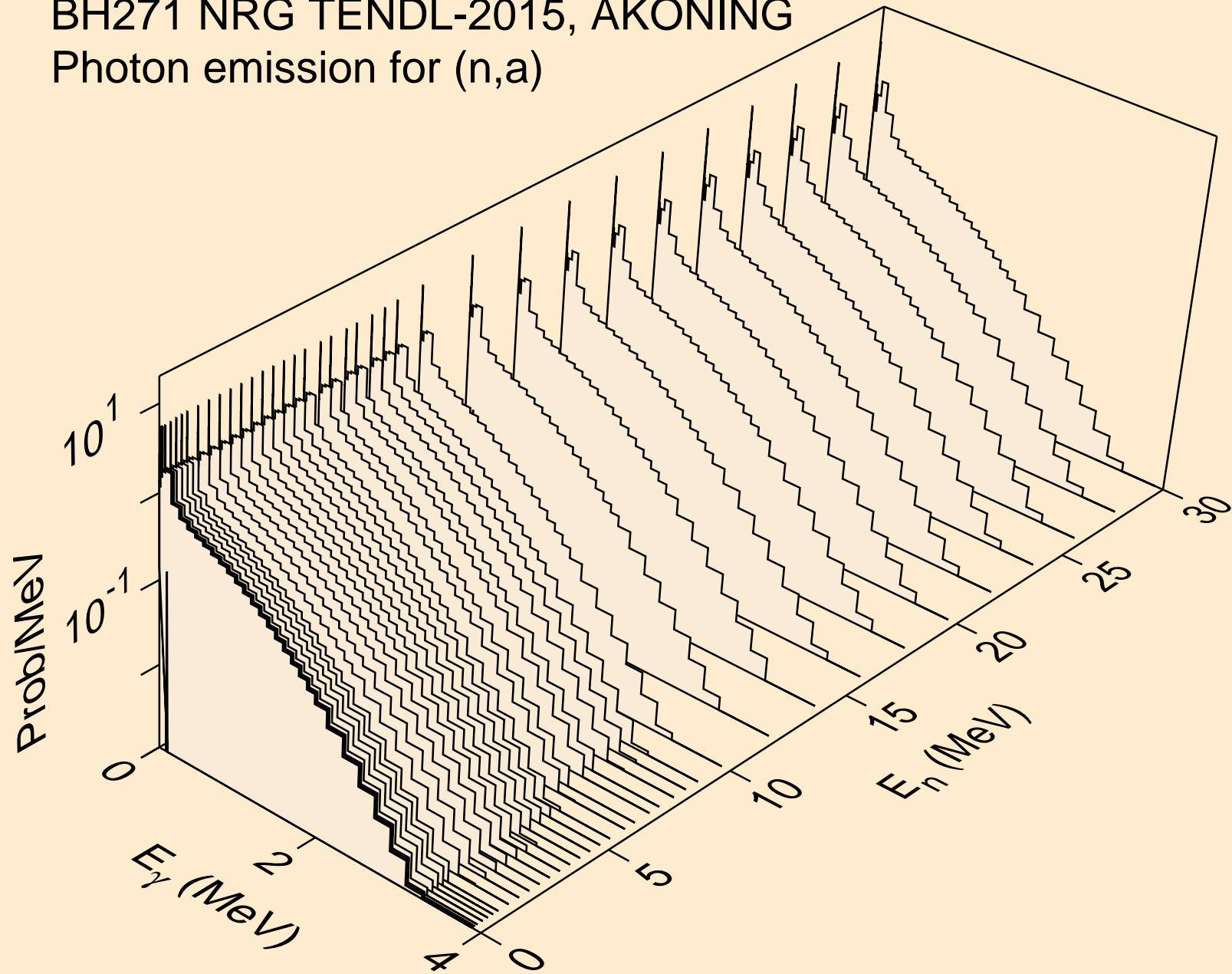

BH271 NRG TENDL-2015, AKONING
Photon emission for (n,2a)

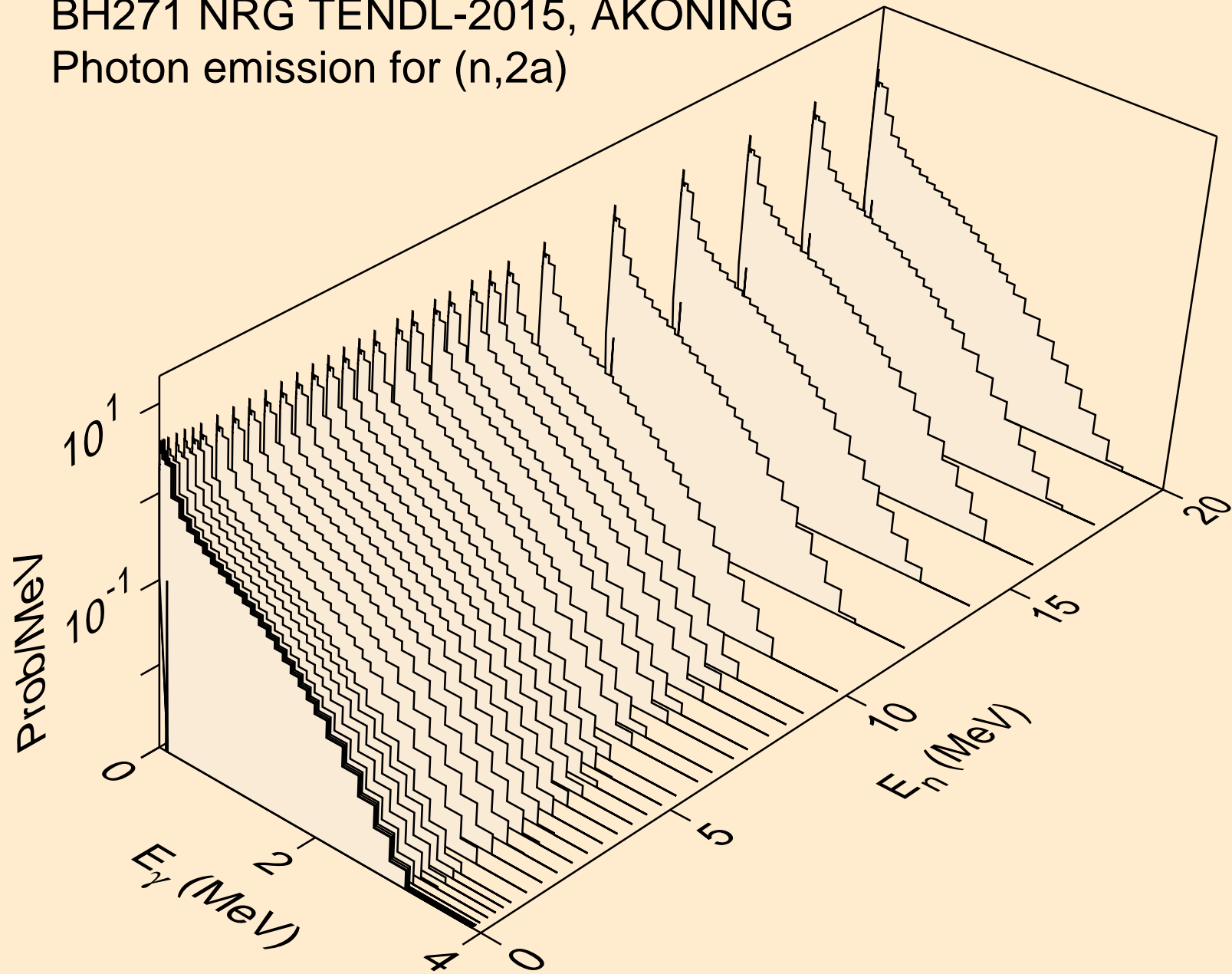

BH271 NRG TENDL-2015, AKONING
Photon emission for (n,3a)

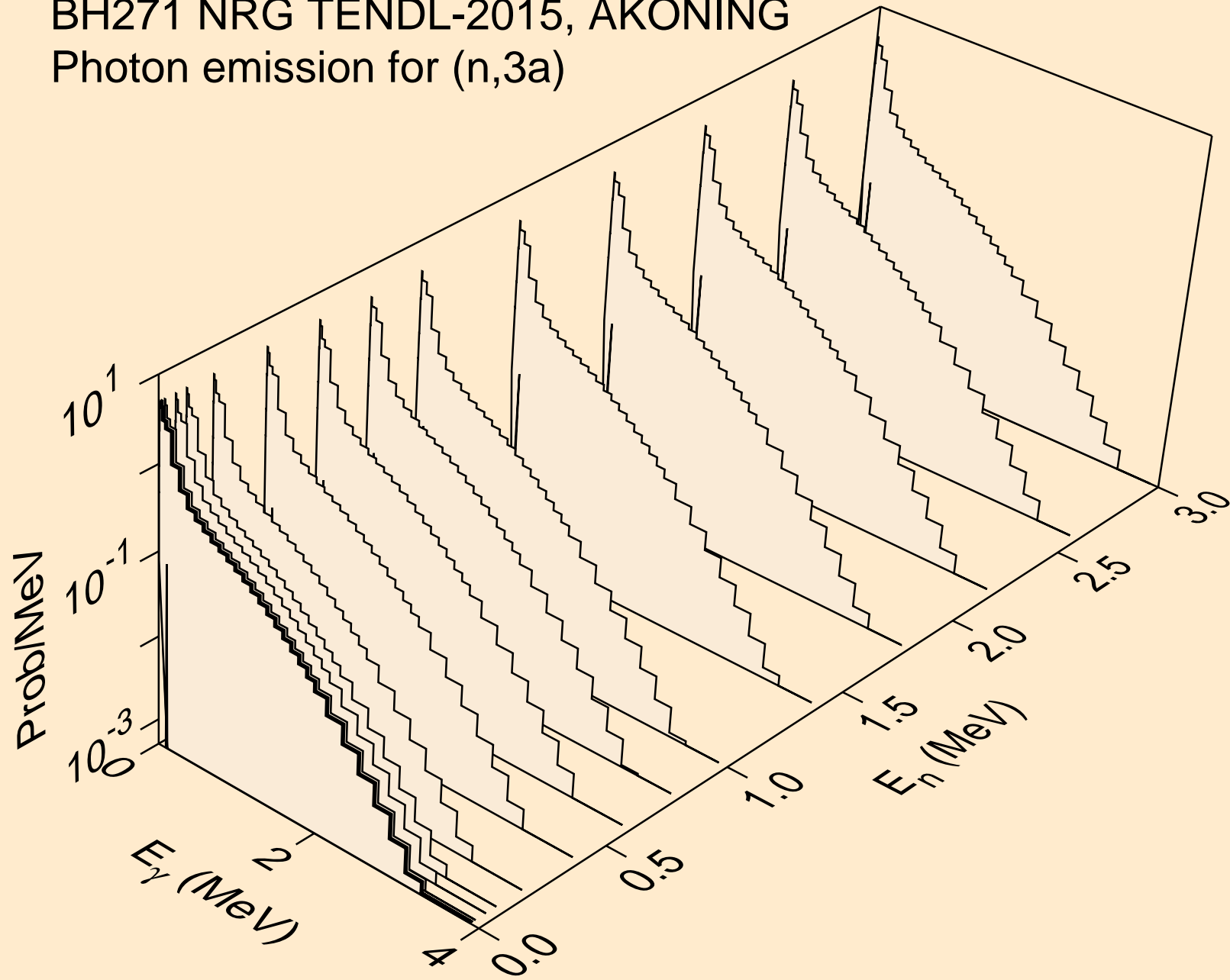

BH271 NRG TENDL-2015, AKONING
Photon emission for (n,p)

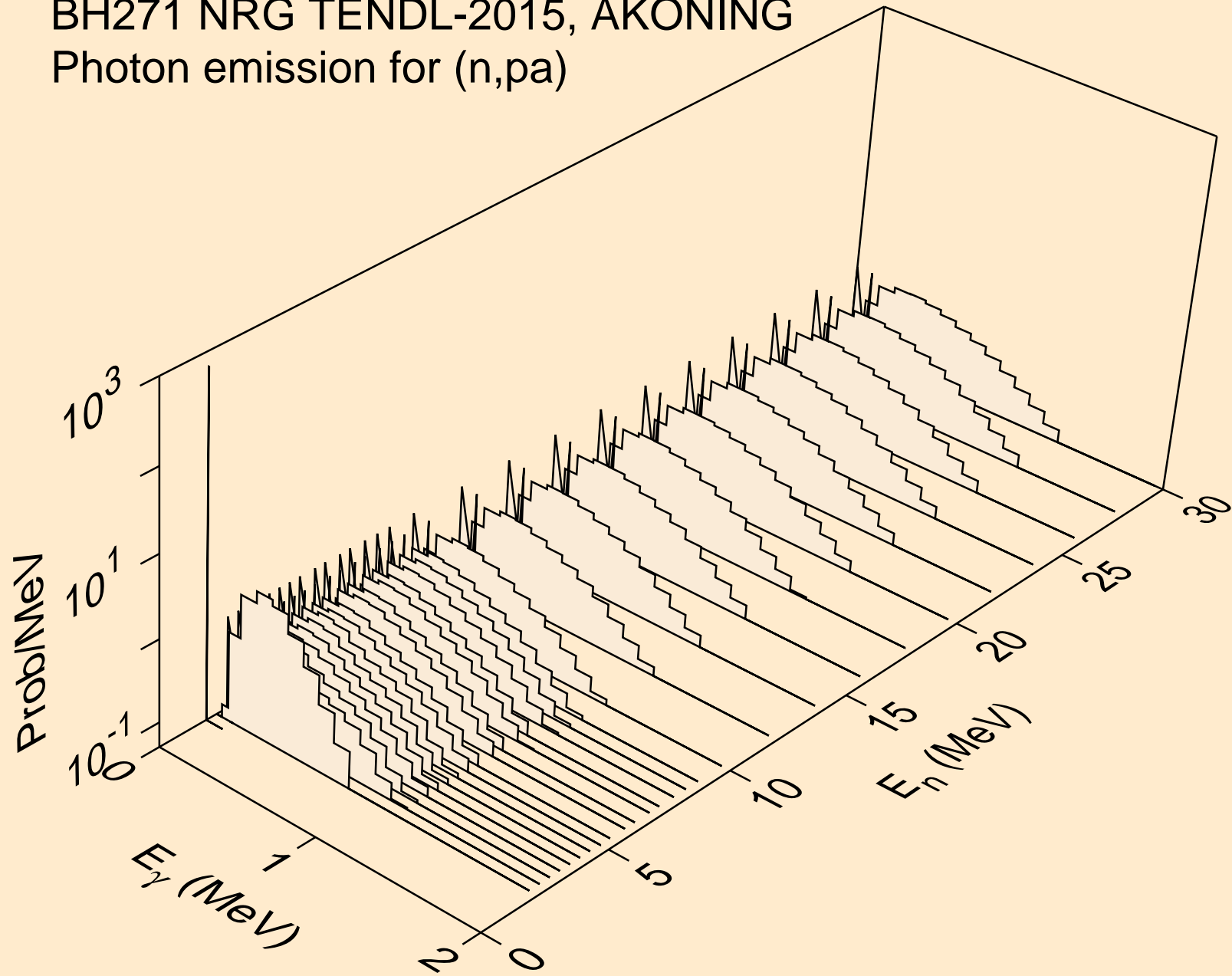

BH271 NRG TENDL-2015, AKONING
Photon emission for (n,t2a)

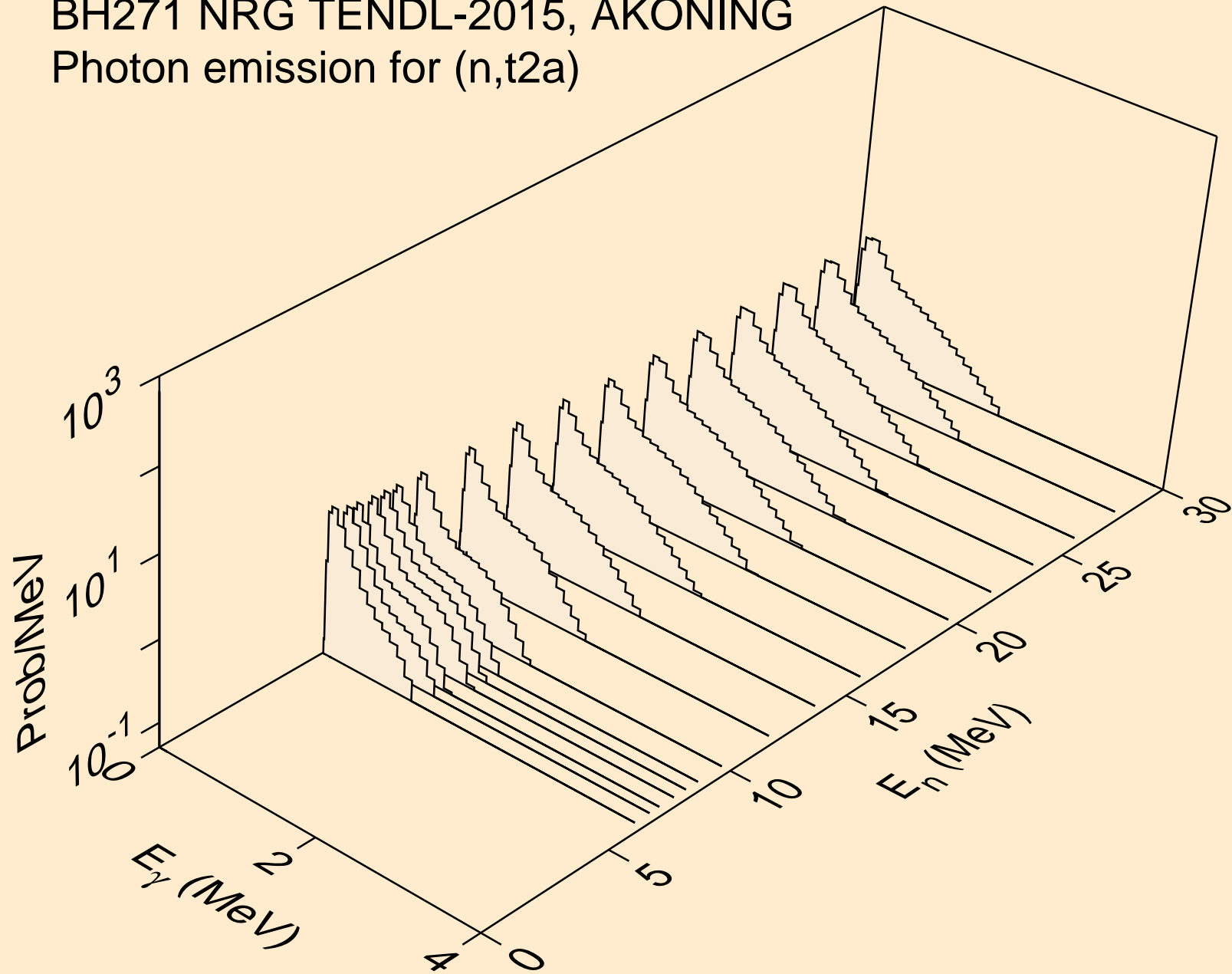

BH271 NRG TENDL-2015, AKONING
Photon emission for (n,d2a)

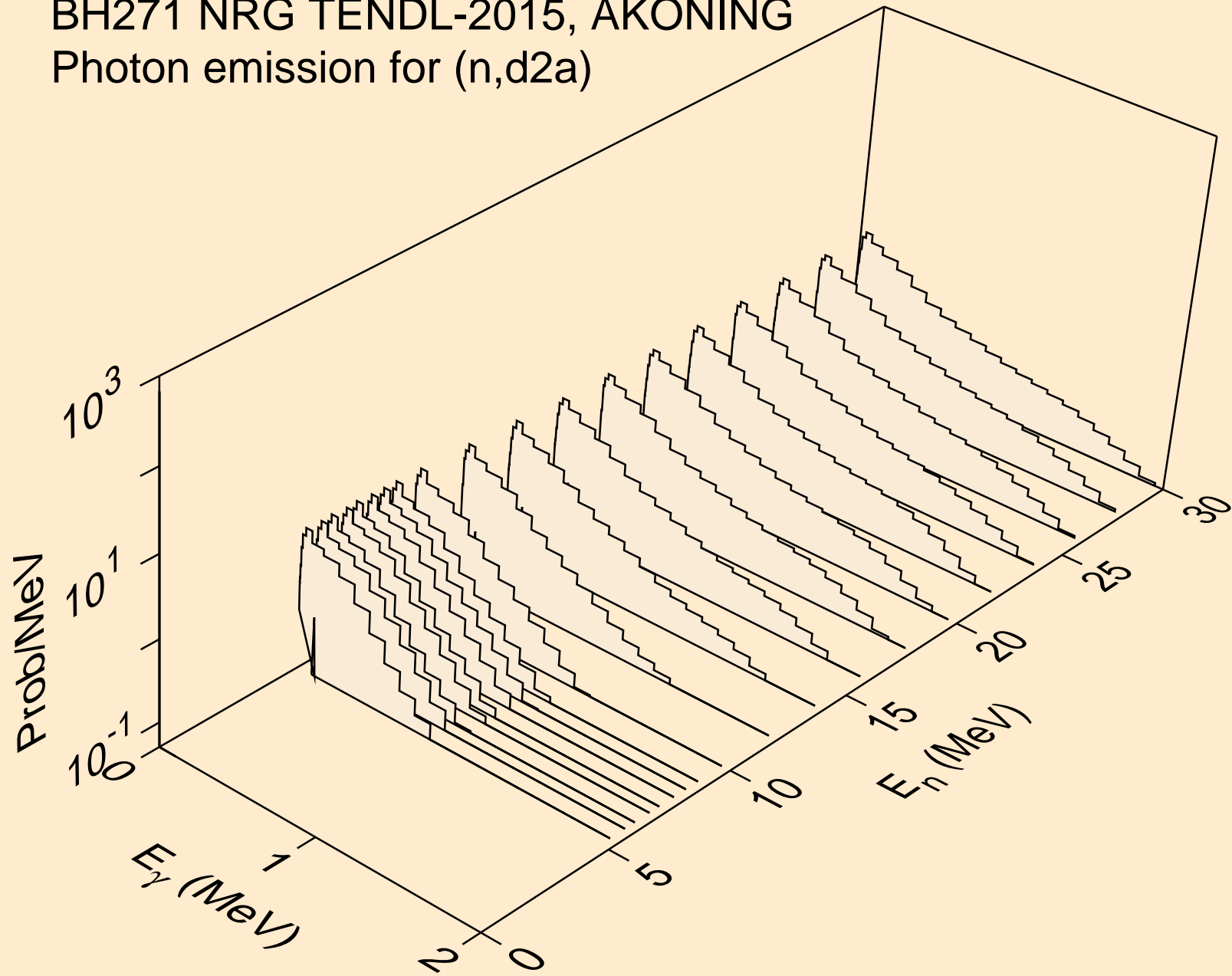

BH271 NRG TENDL-2015, AKONING
Photon emission for (n,da)

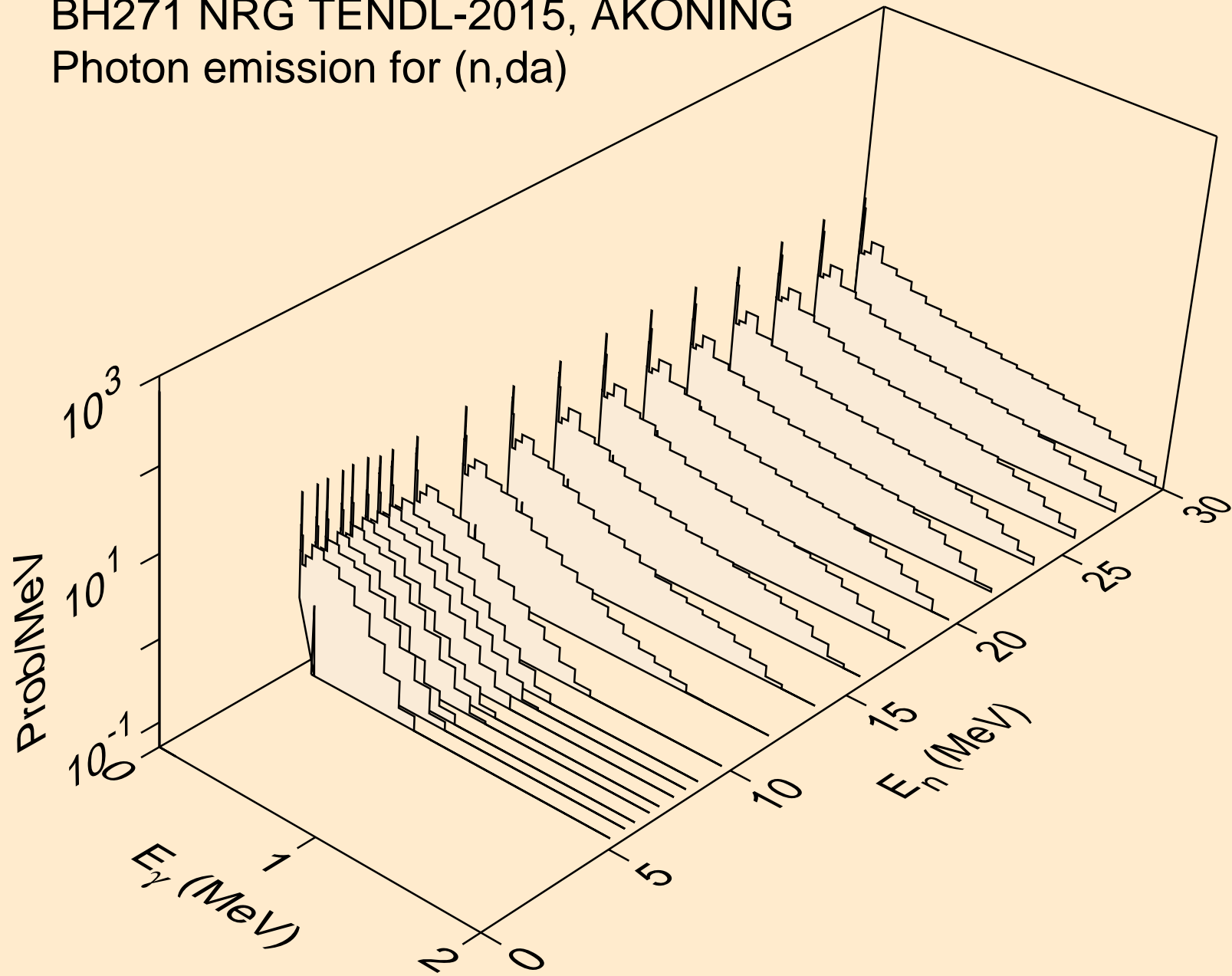

BH271 NRG TENDL-2015, AKONING
thermal capture photon spectrum

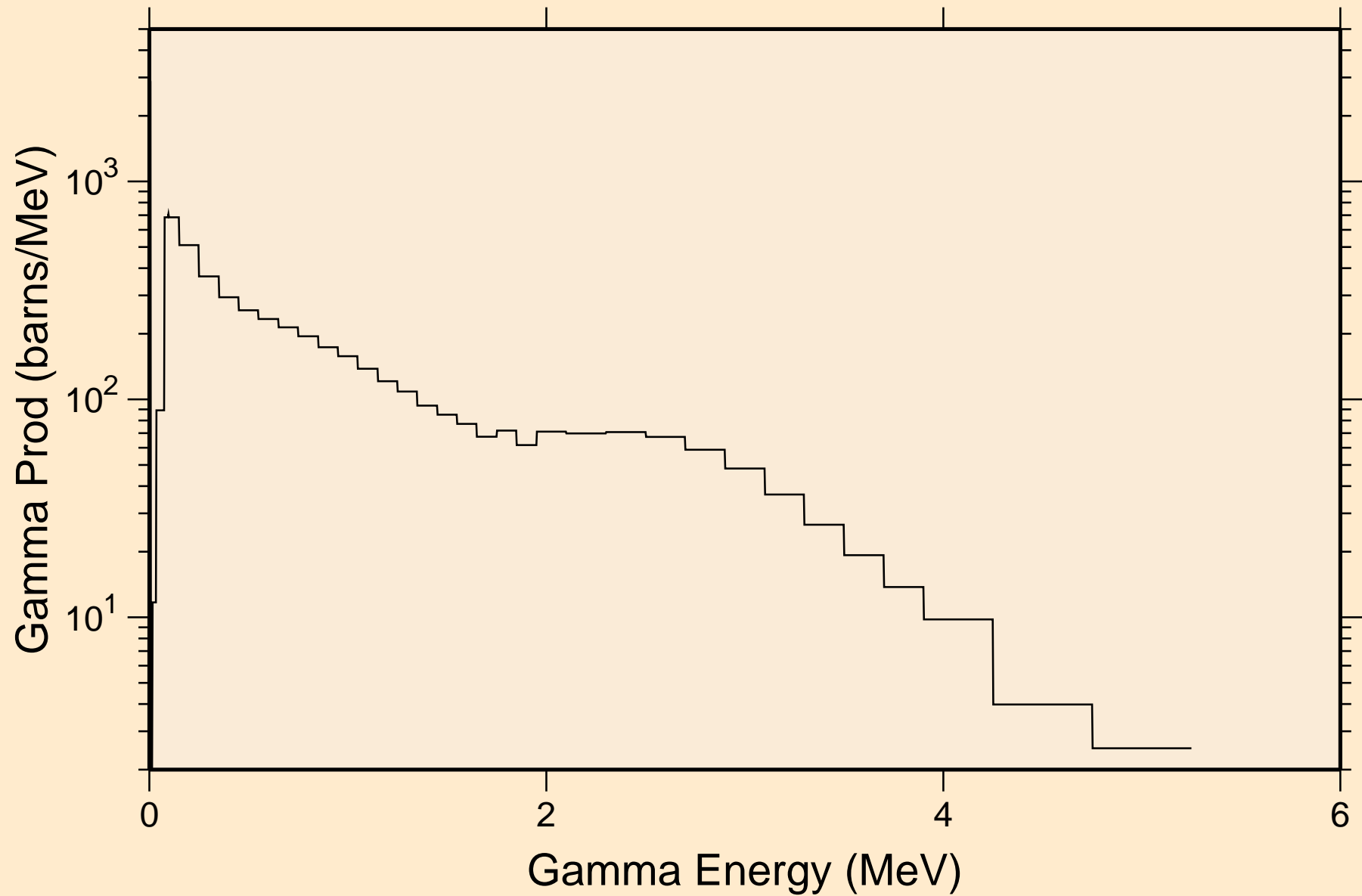

BH271 NRG TENDL-2015, AKONING
14 MeV photon spectrum

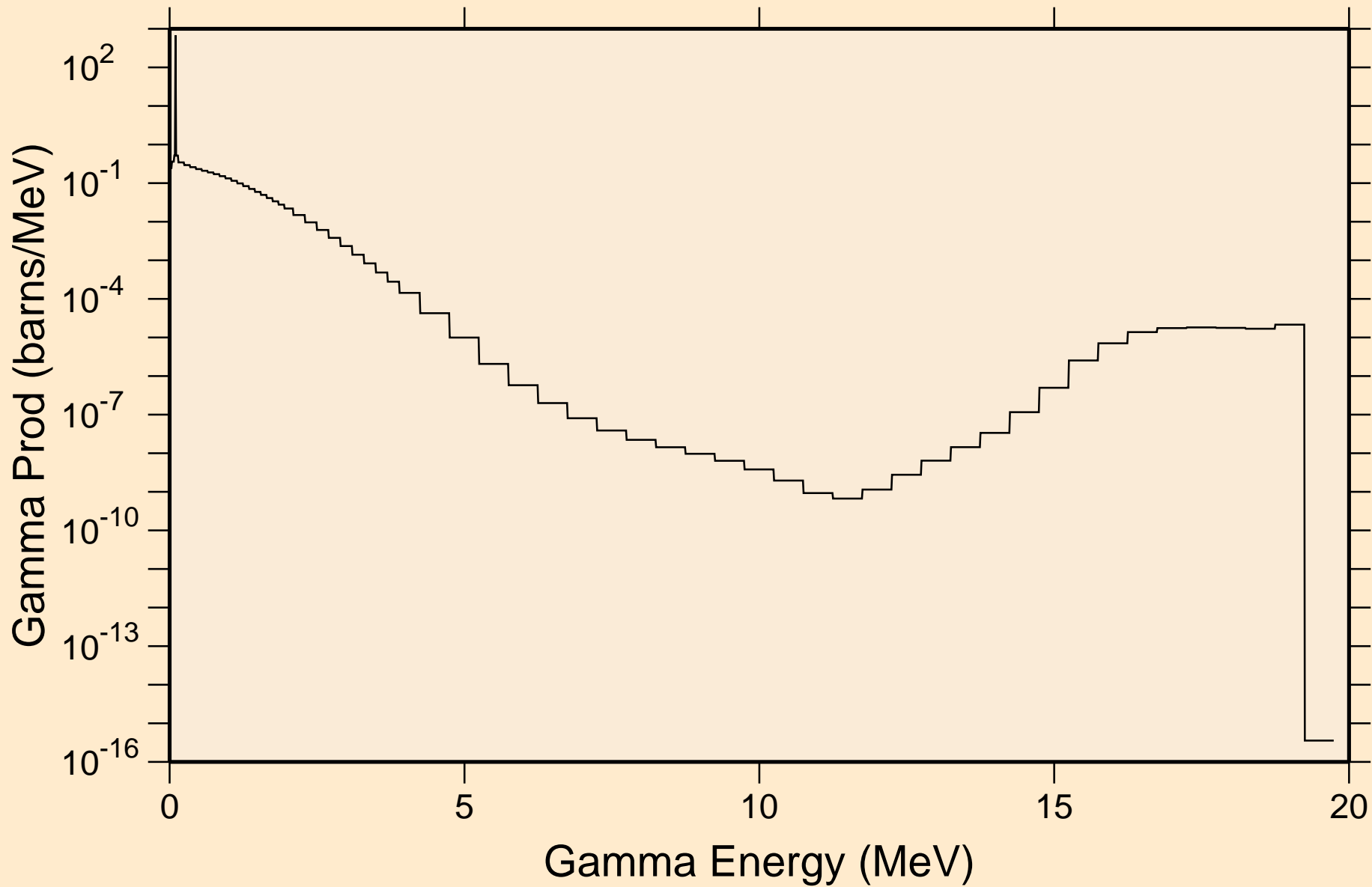

BH271 NRG TENDL-2015, AKONING

Particle heating contributions

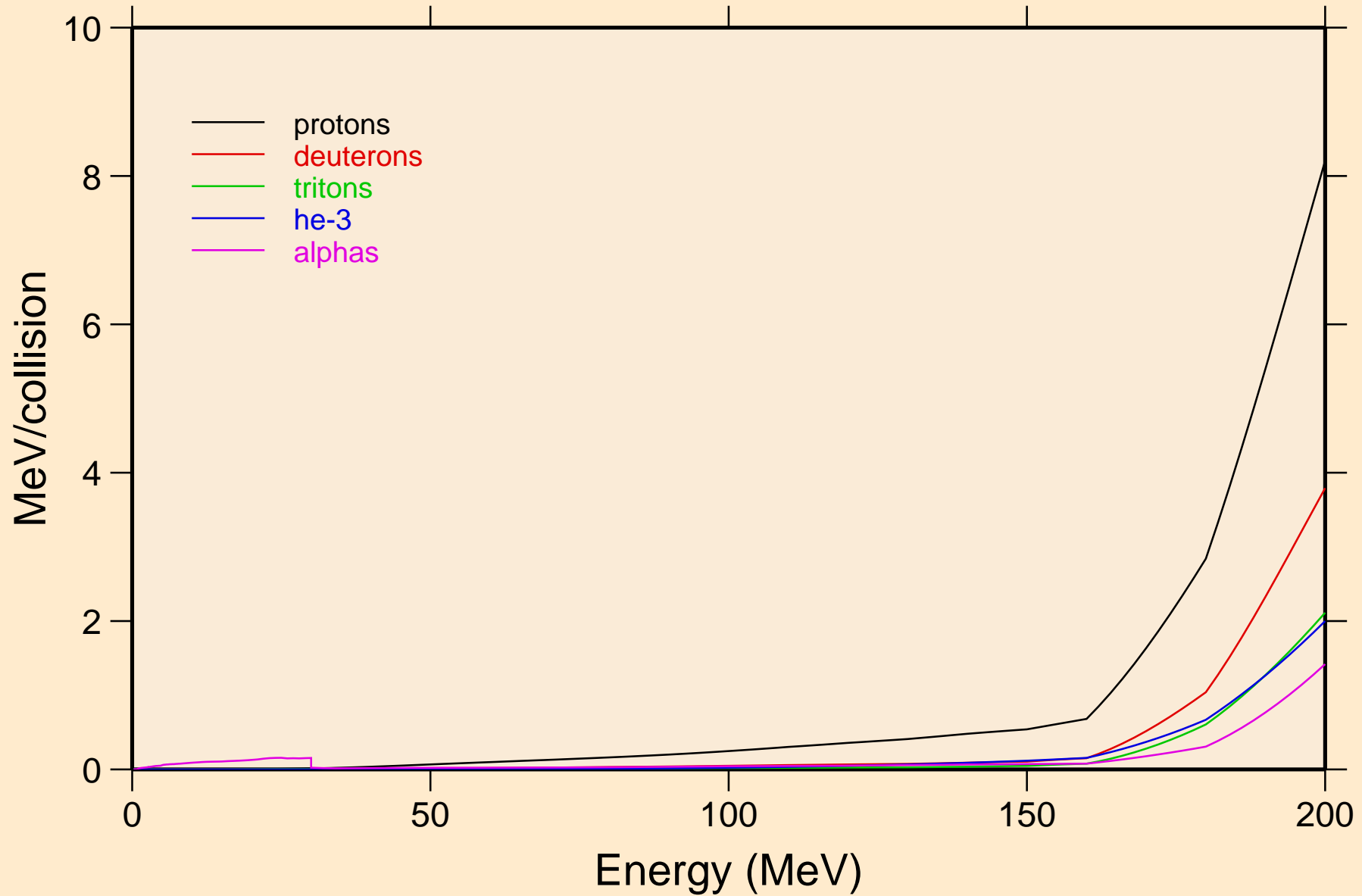

BH271 NRG TENDL-2015, AKONING

Recoil Heating

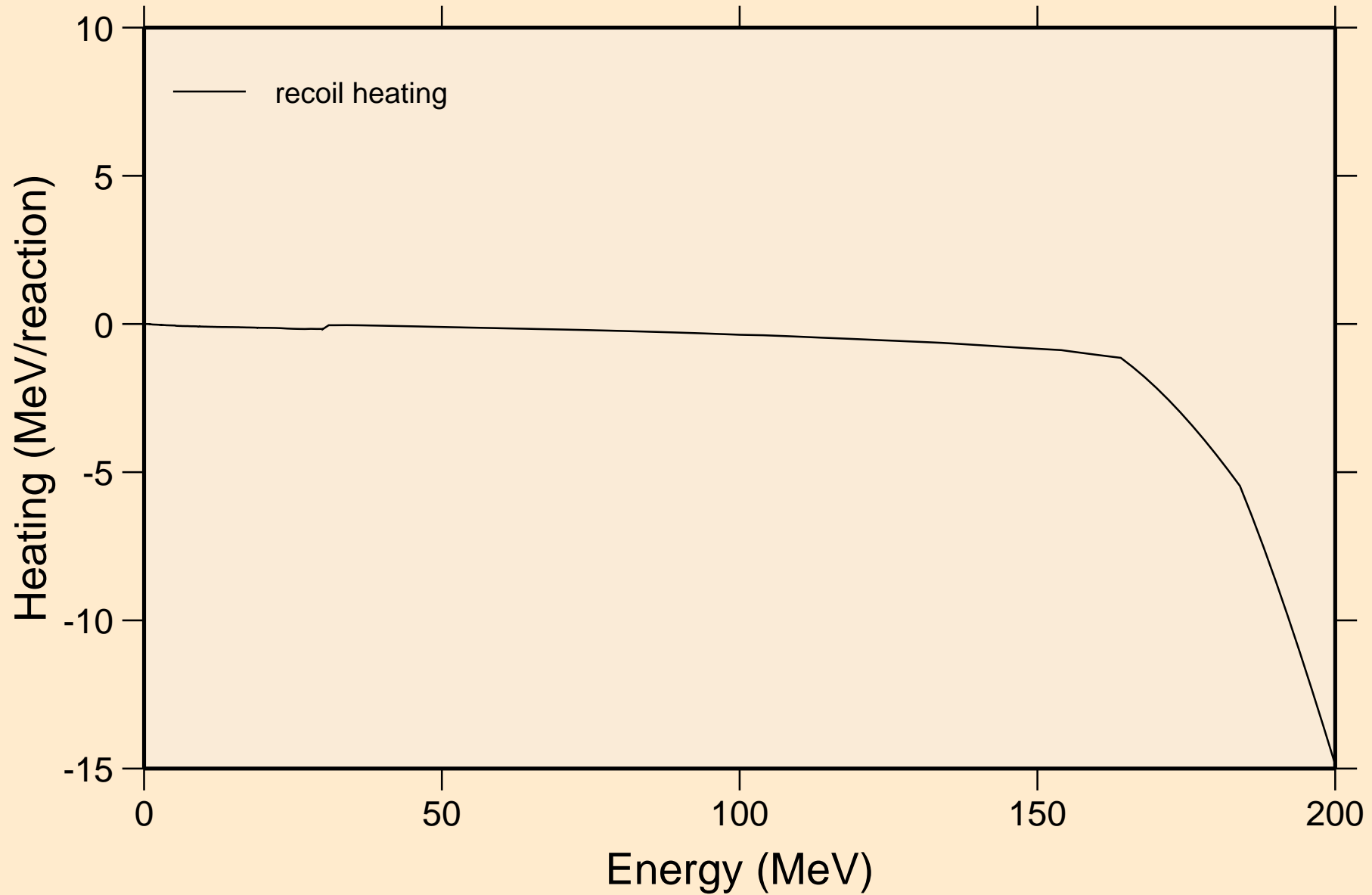

BH271 NRG TENDL-2015, AKONING

Particle production cross sections

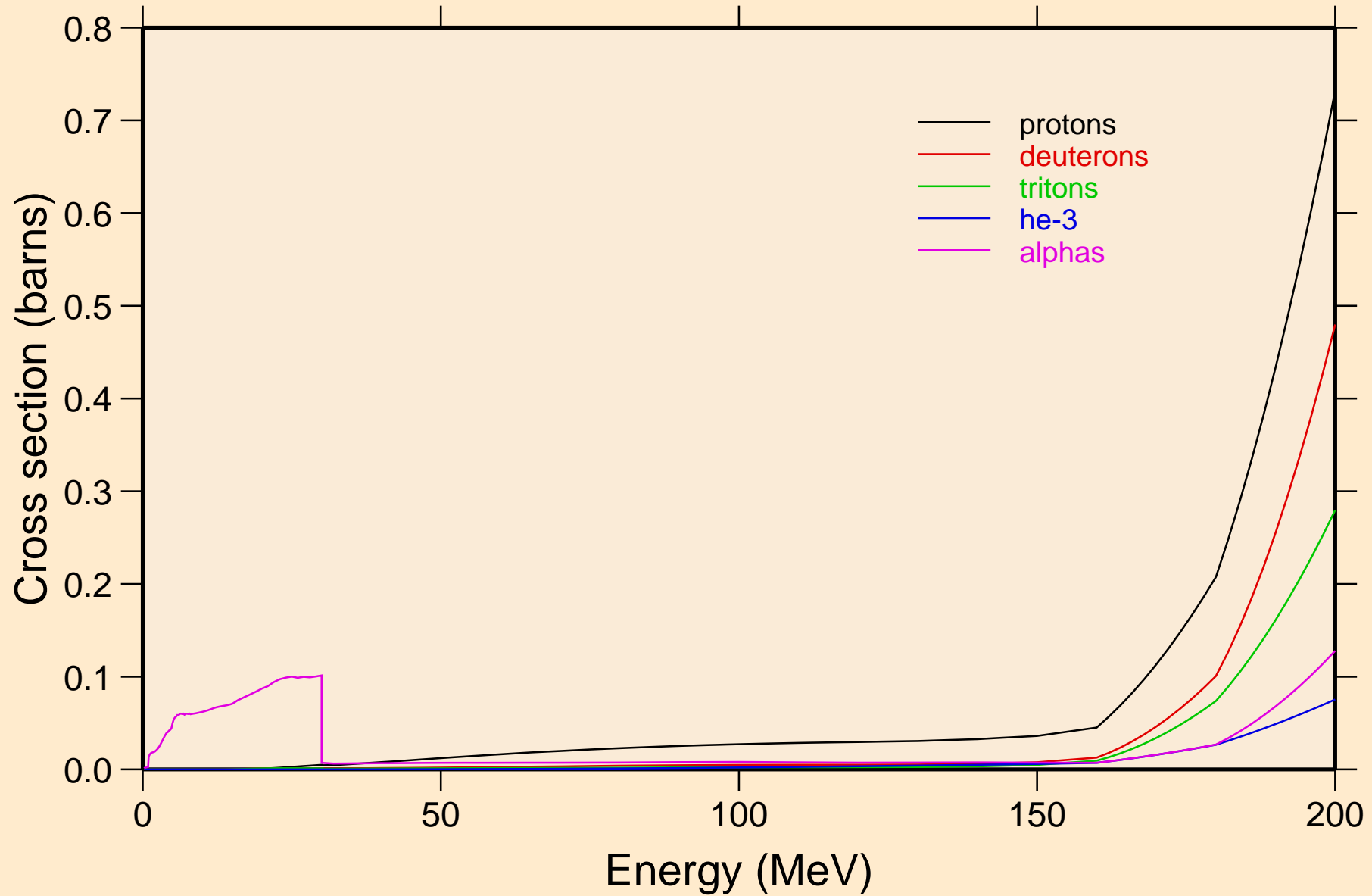

BH271 NRG TENDL-2015, AKONING
protons from (n,x)

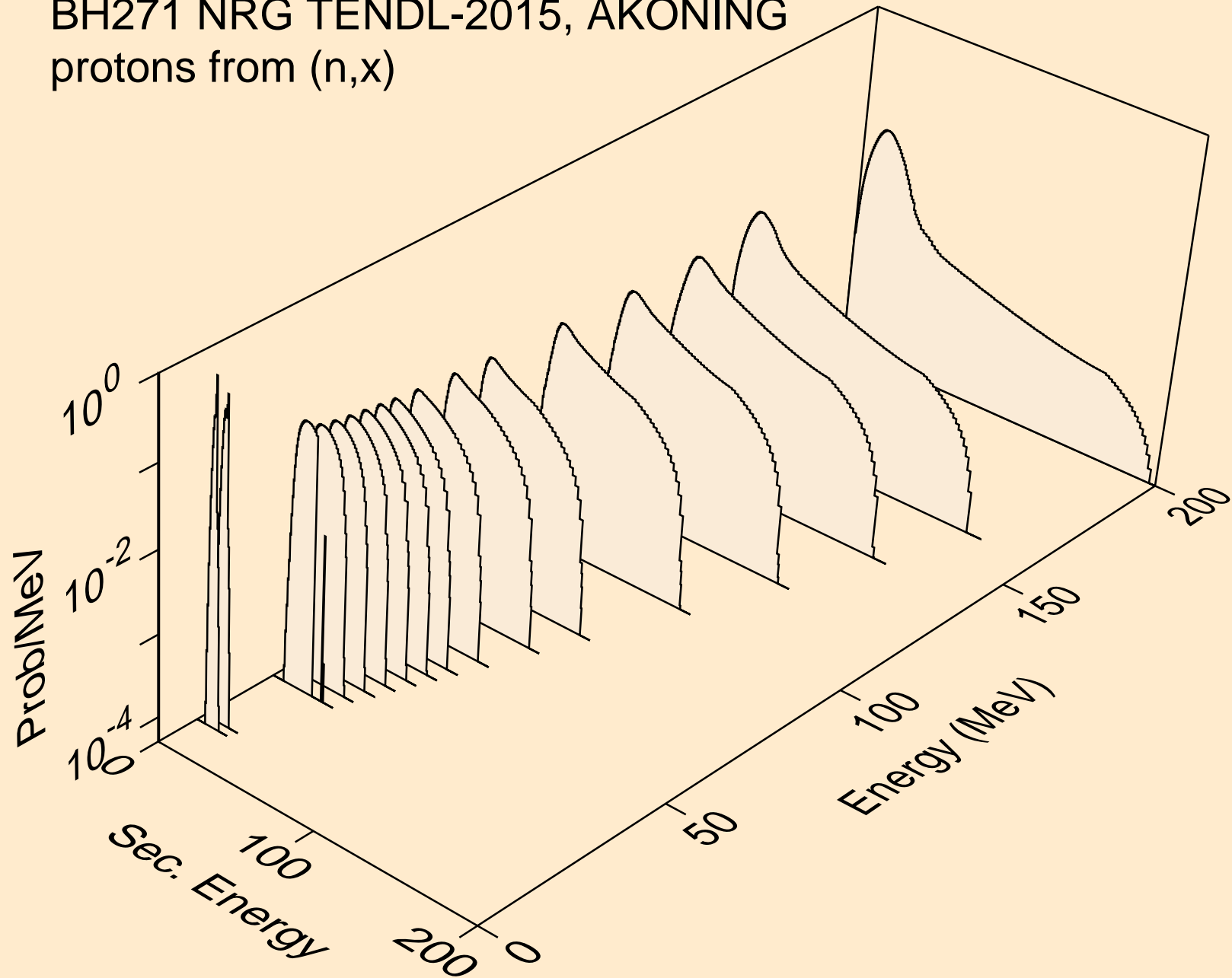

BH271 NRG TENDL-2015, AKONING
protons from (n,n*)p

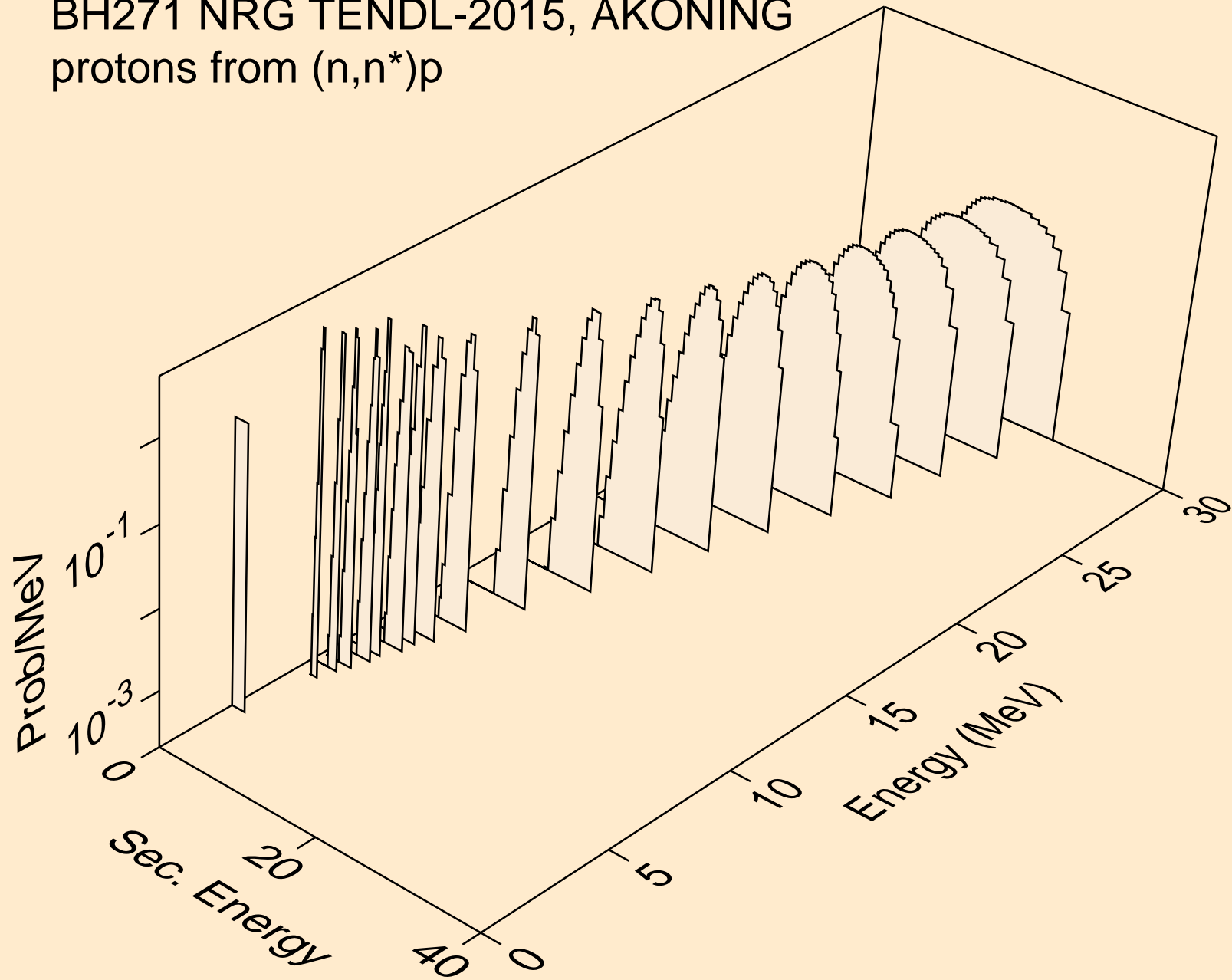

BH271 NRG TENDL-2015, AKONING
protons from (n,2np)

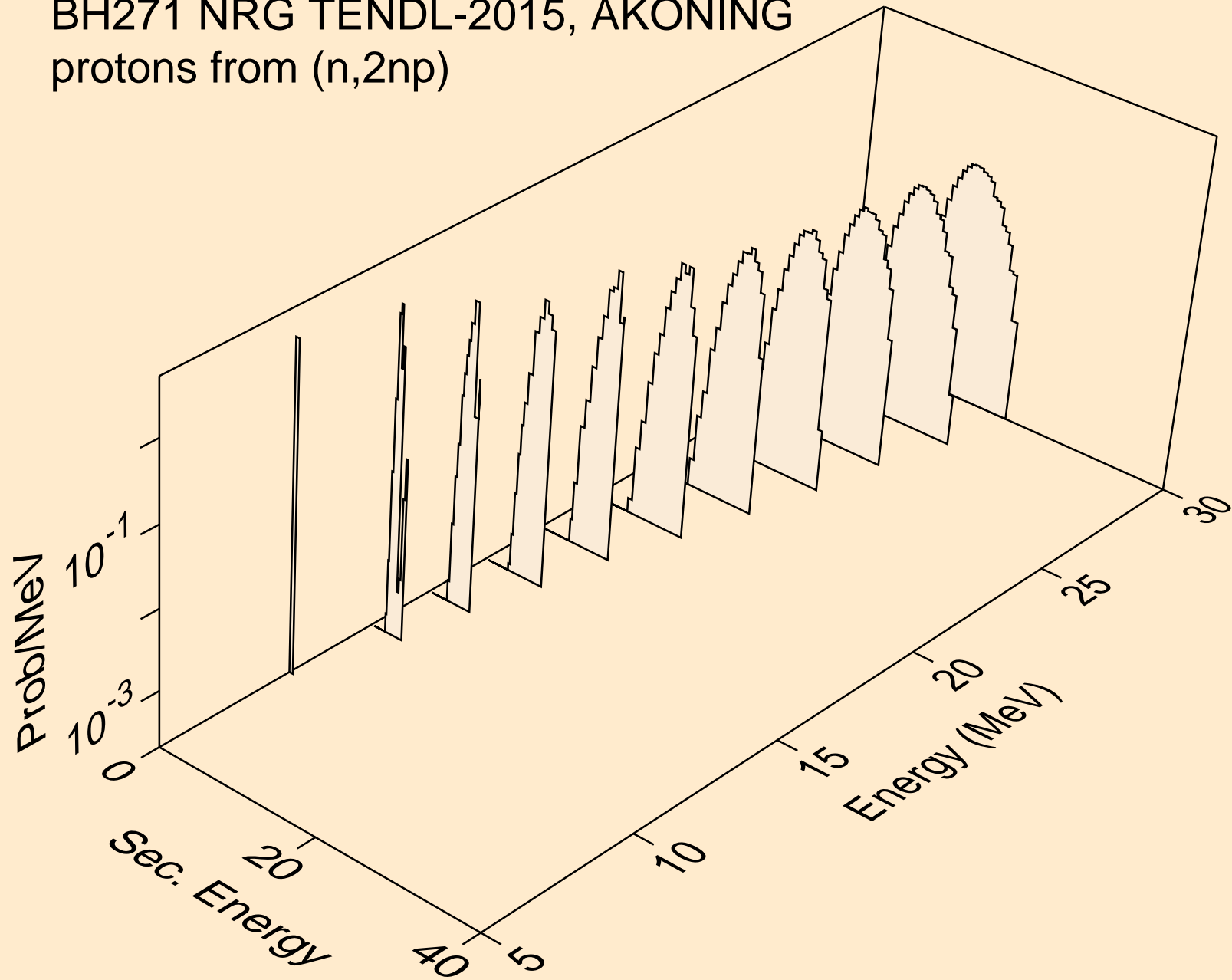

BH271 NRG TENDL-2015, AKONING
protons from (n,3np)

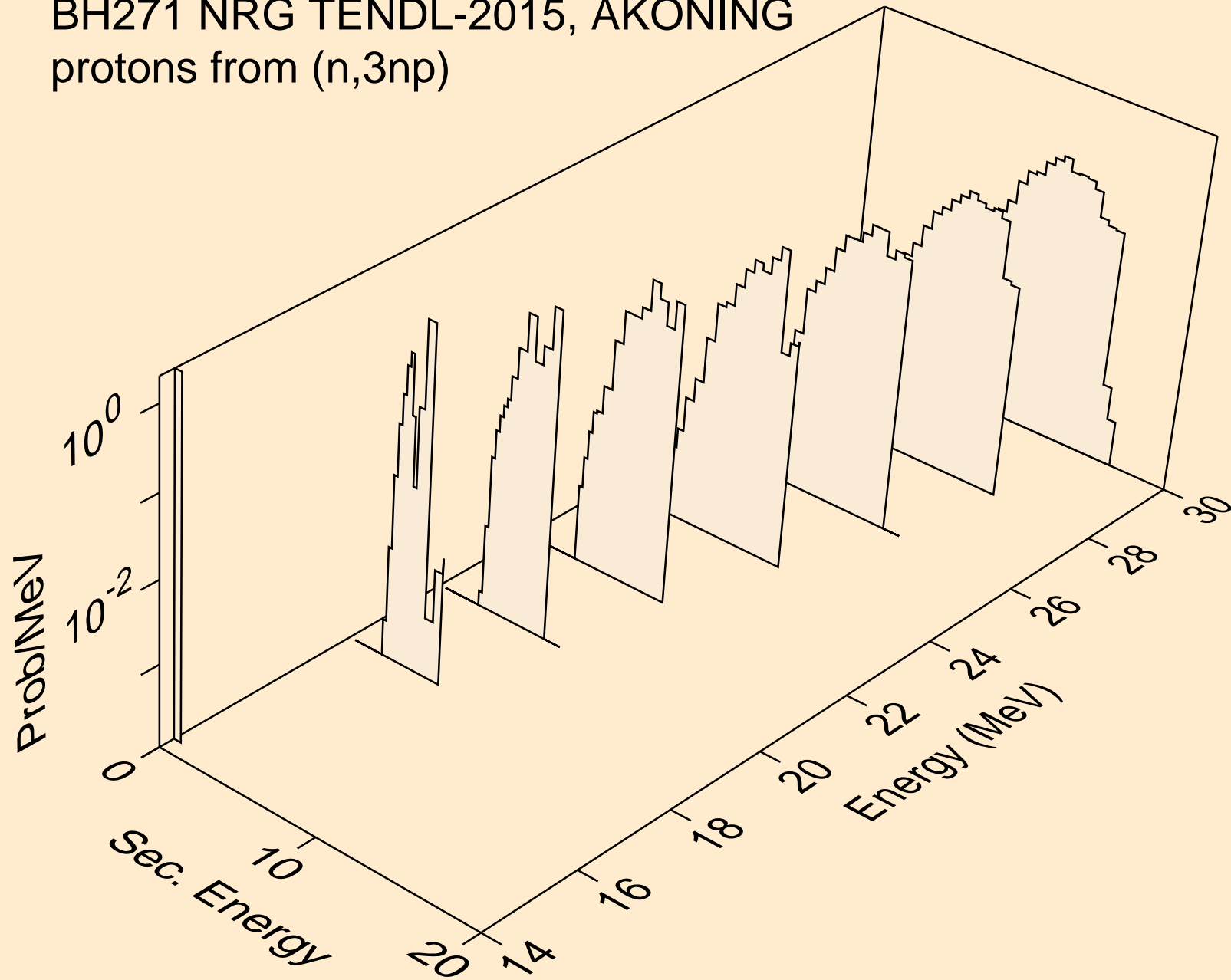

BH271 NRG TENDL-2015, AKONING
protons from (n,npa)

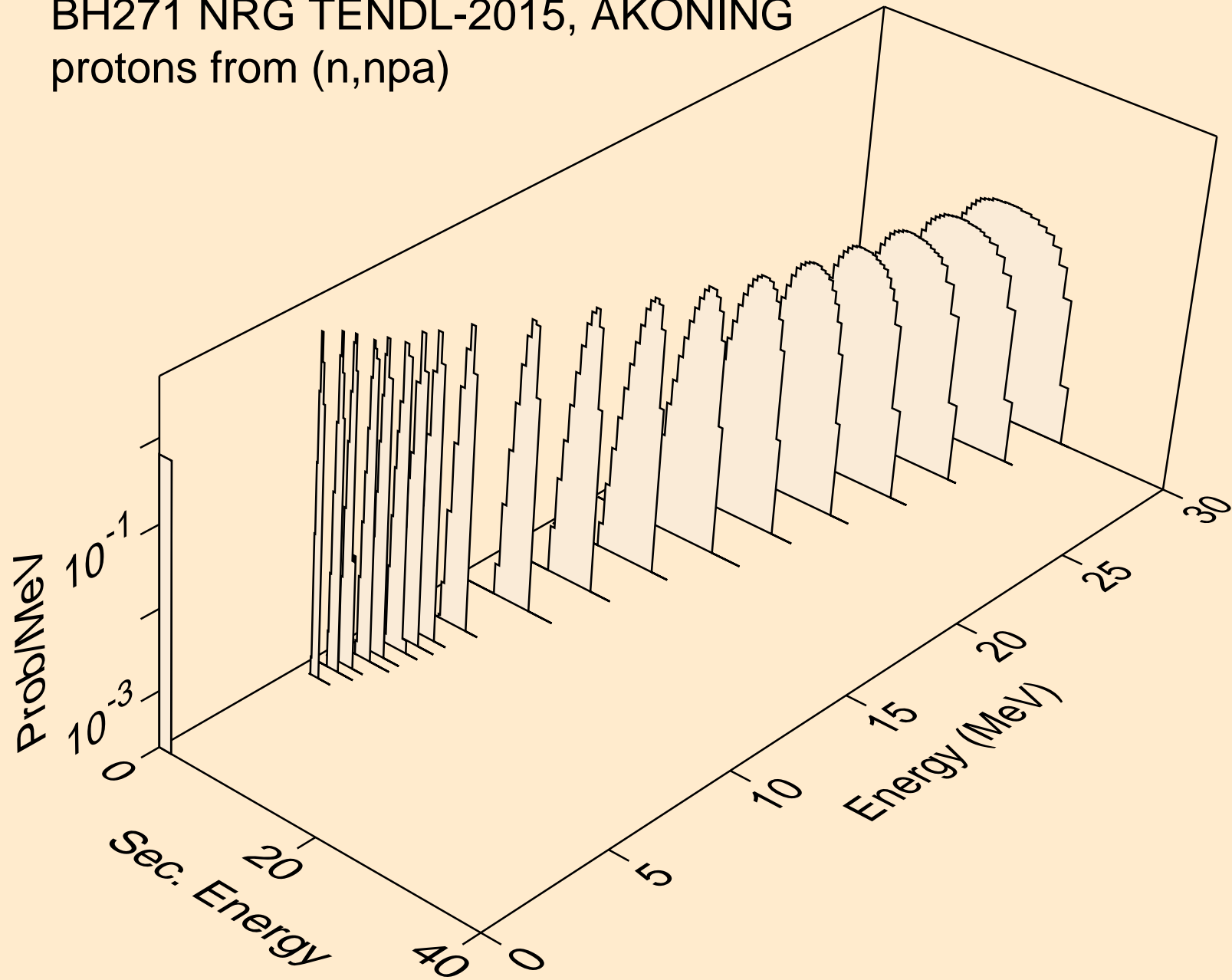

BH271 NRG TENDL-2015, AKONING
protons from (n,p)

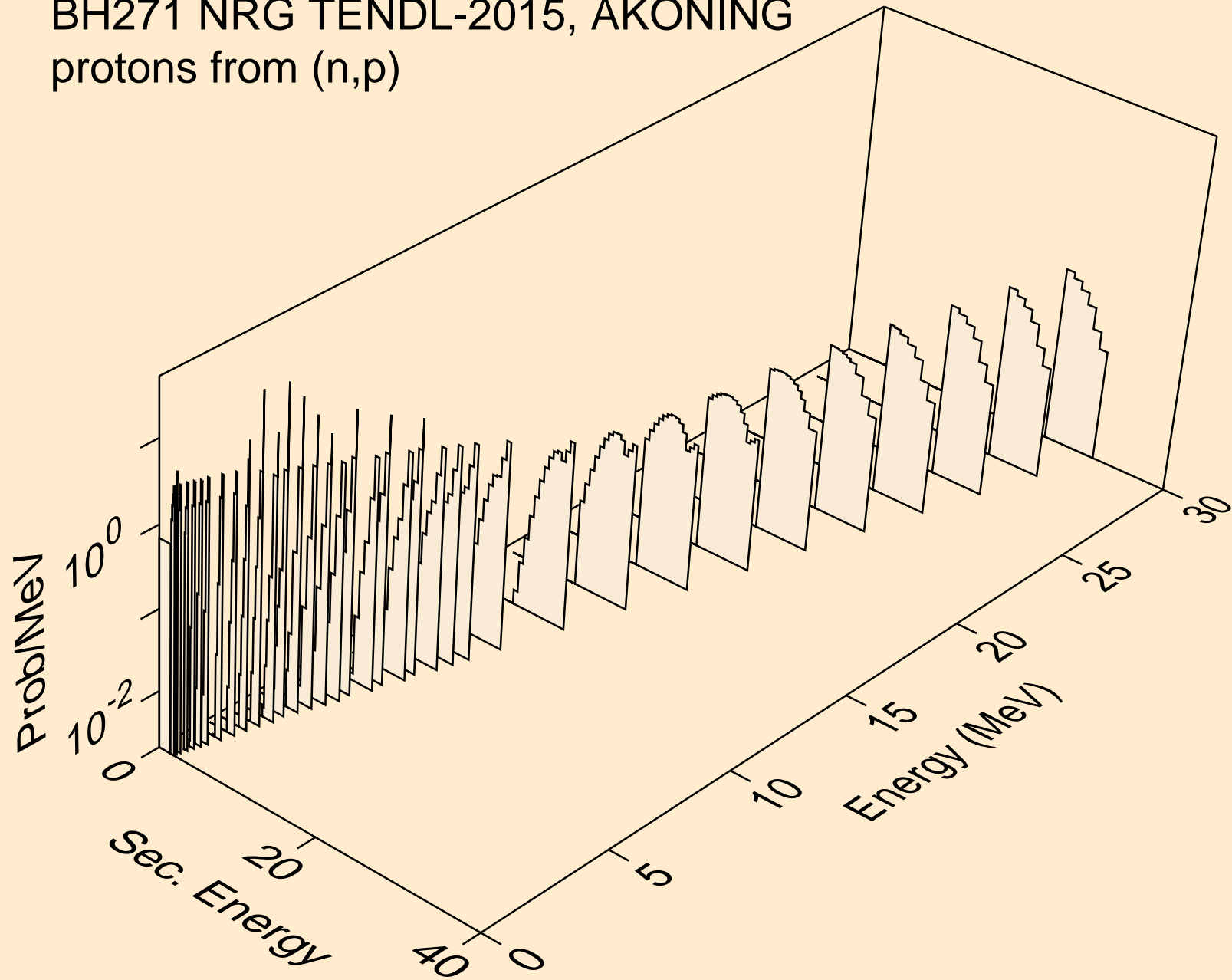

BH271 NRG TENDL-2015, AKONING
protons from (n,pa)

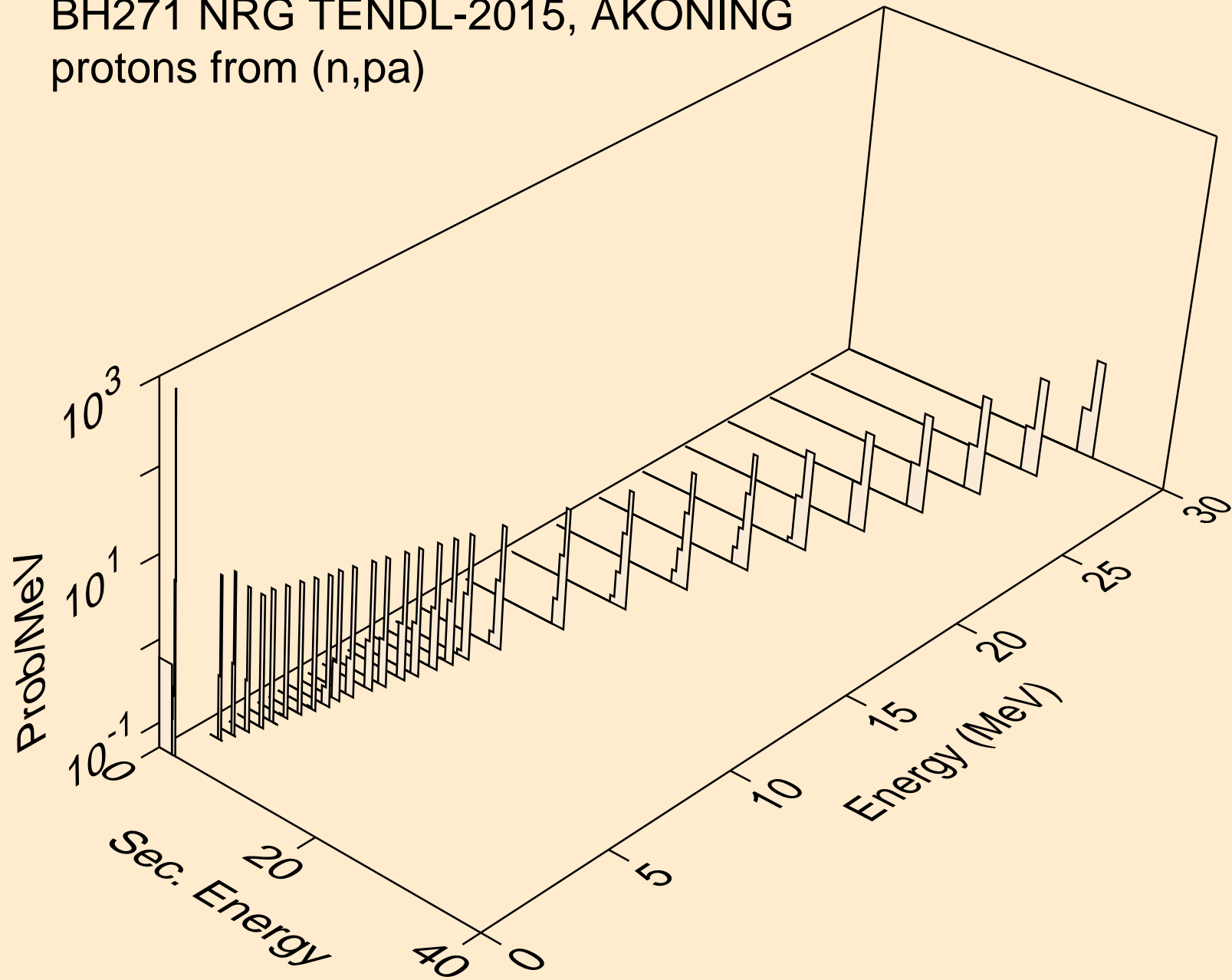

BH271 NRG TENDL-2015, AKONING
deuterons from (n,x)

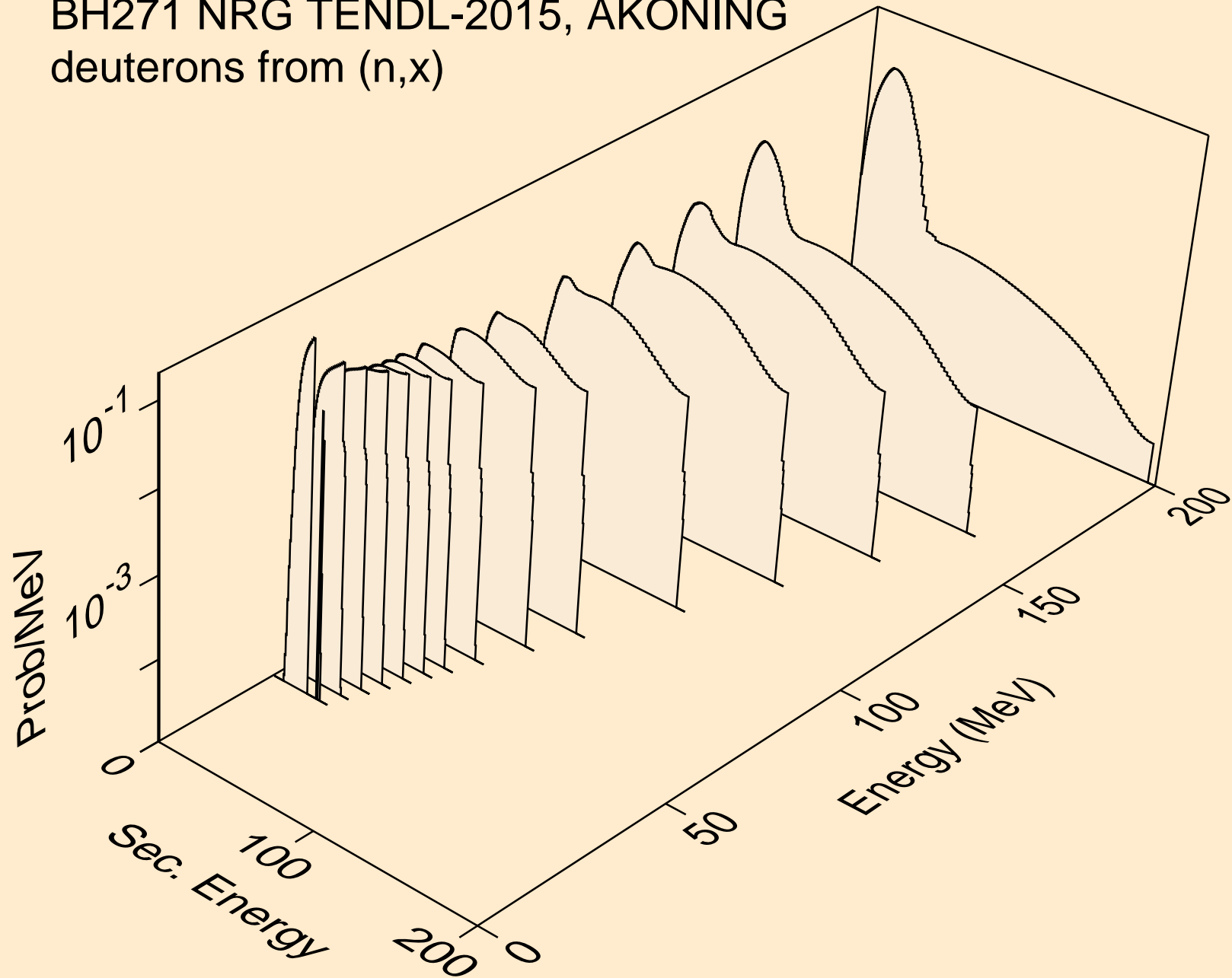

BH271 NRG TENDL-2015, AKONING
deuterons from (n,2nd)

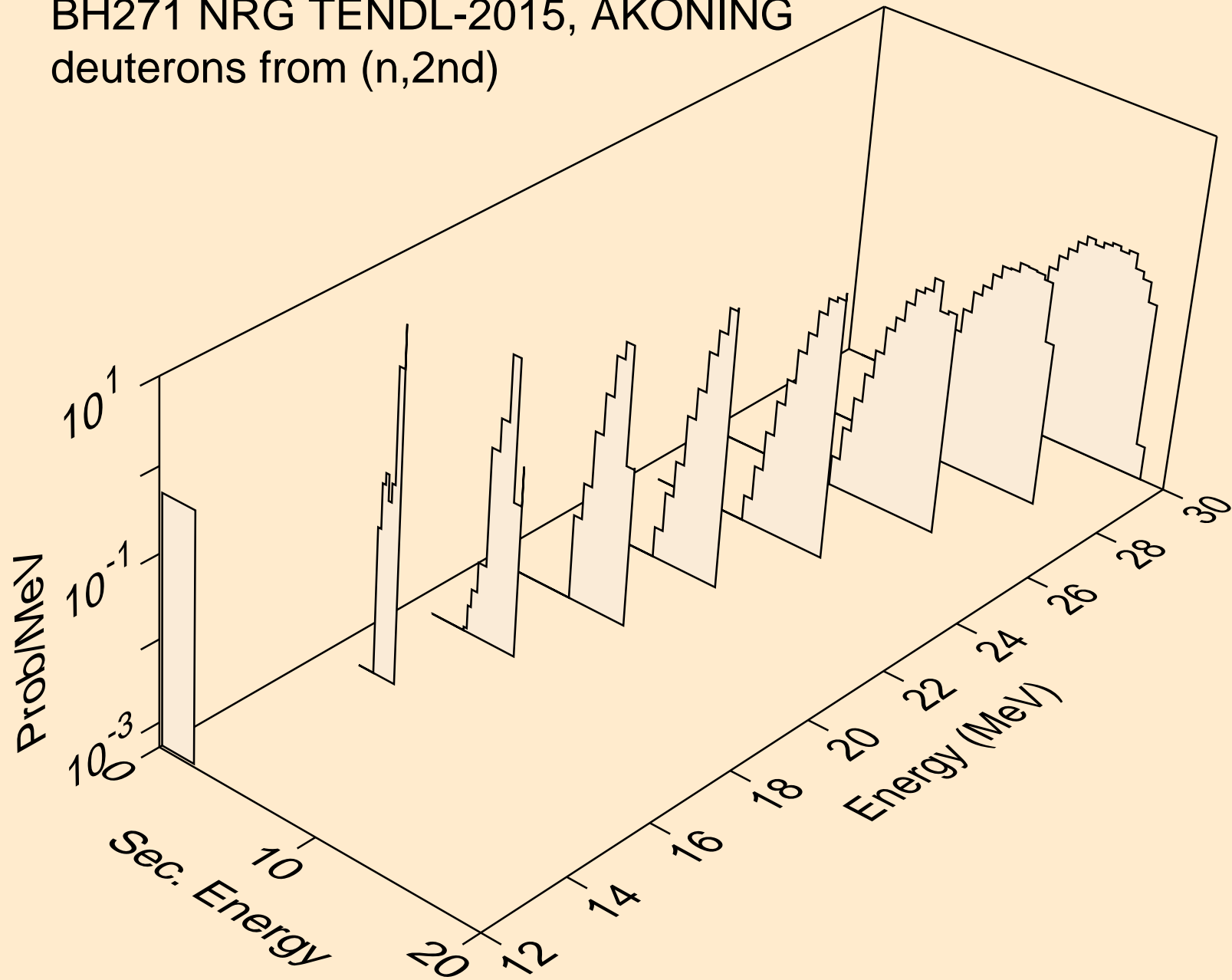

BH271 NRG TENDL-2015, AKONING
deuterons from (n,n*)d

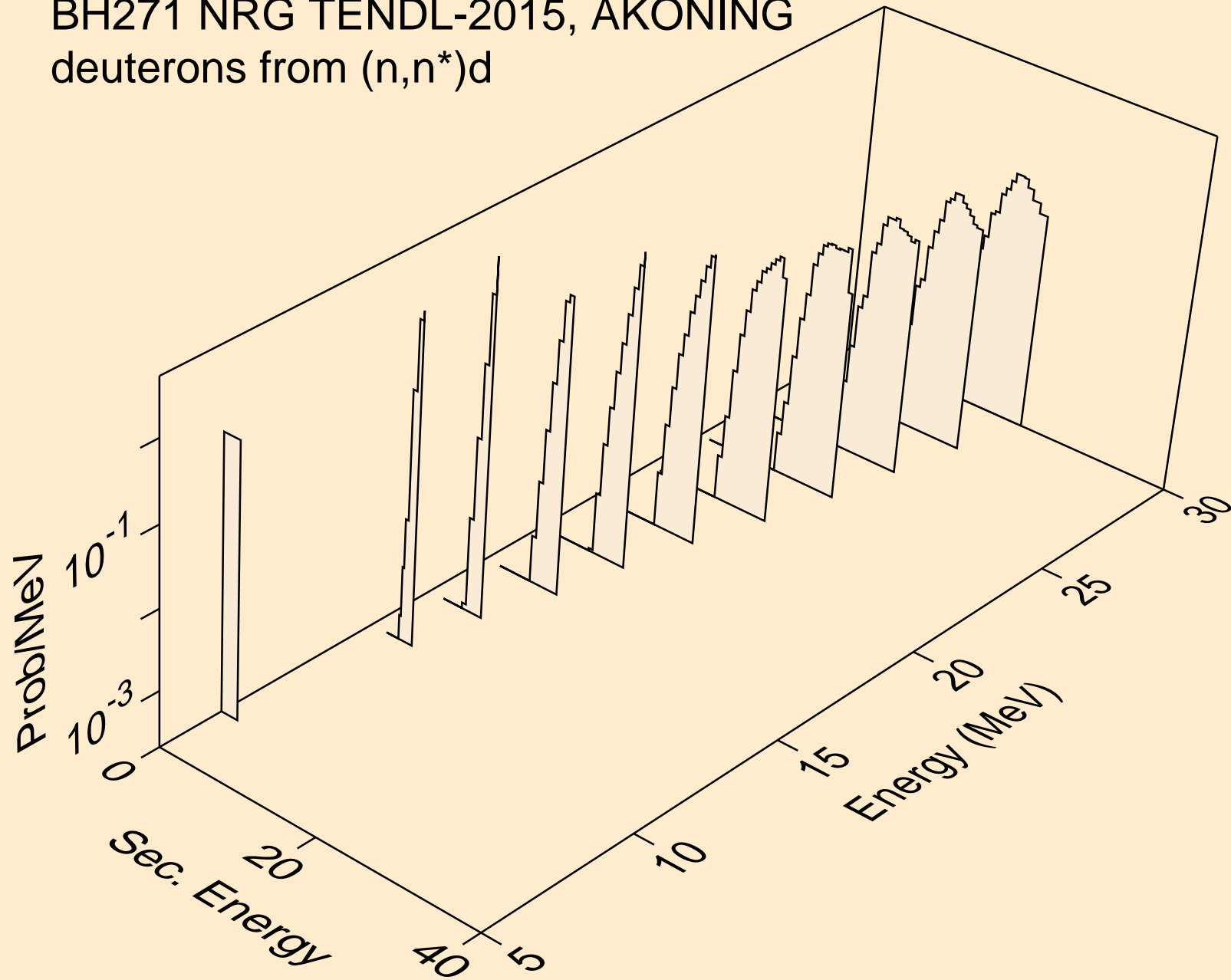

BH271 NRG TENDL-2015, AKONING
deuterons from (n,n*)d2a

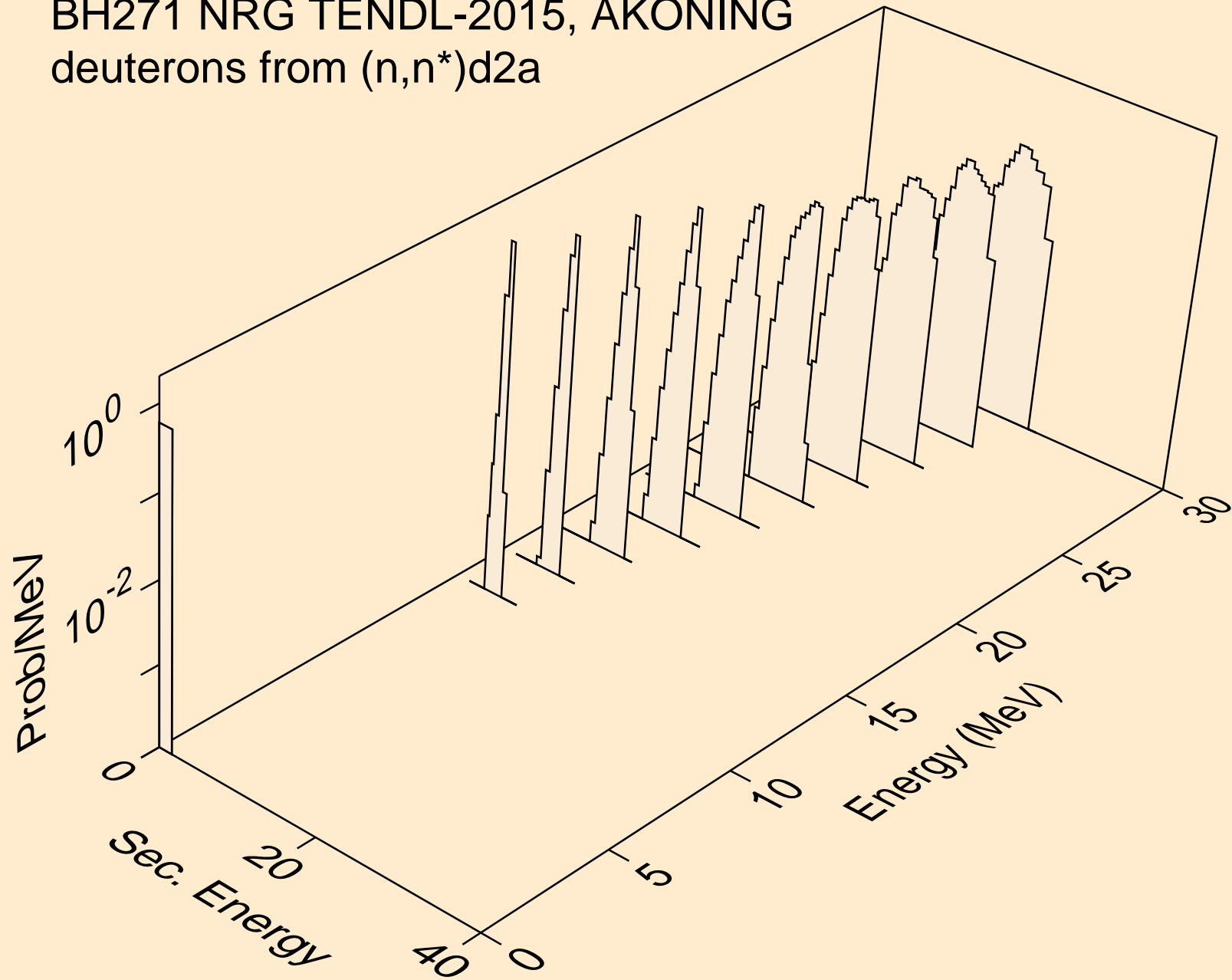

BH271 NRG TENDL-2015, AKONING
deuterons from (n,d)

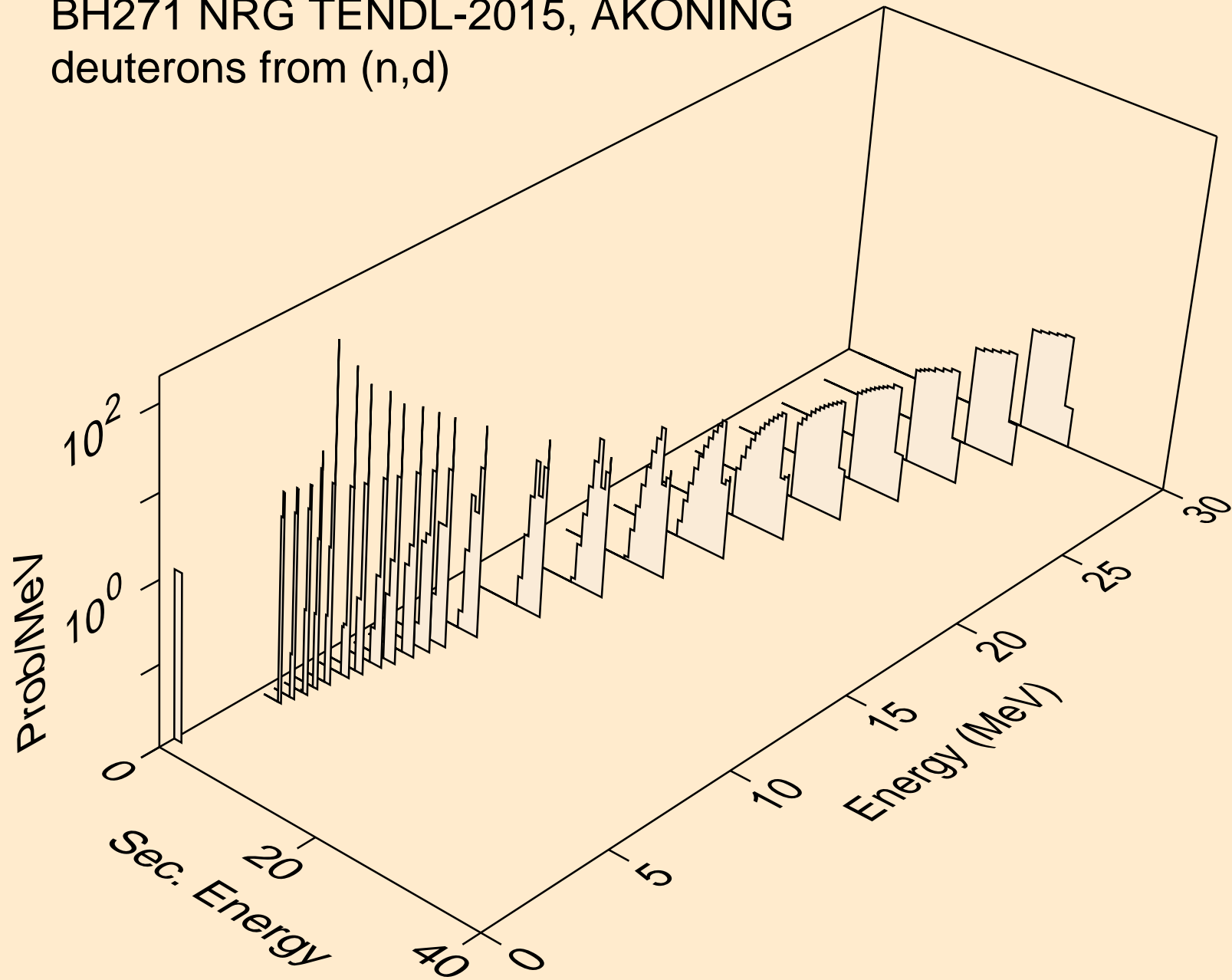

BH271 NRG TENDL-2015, AKONING
deuterons from (n,d2a)

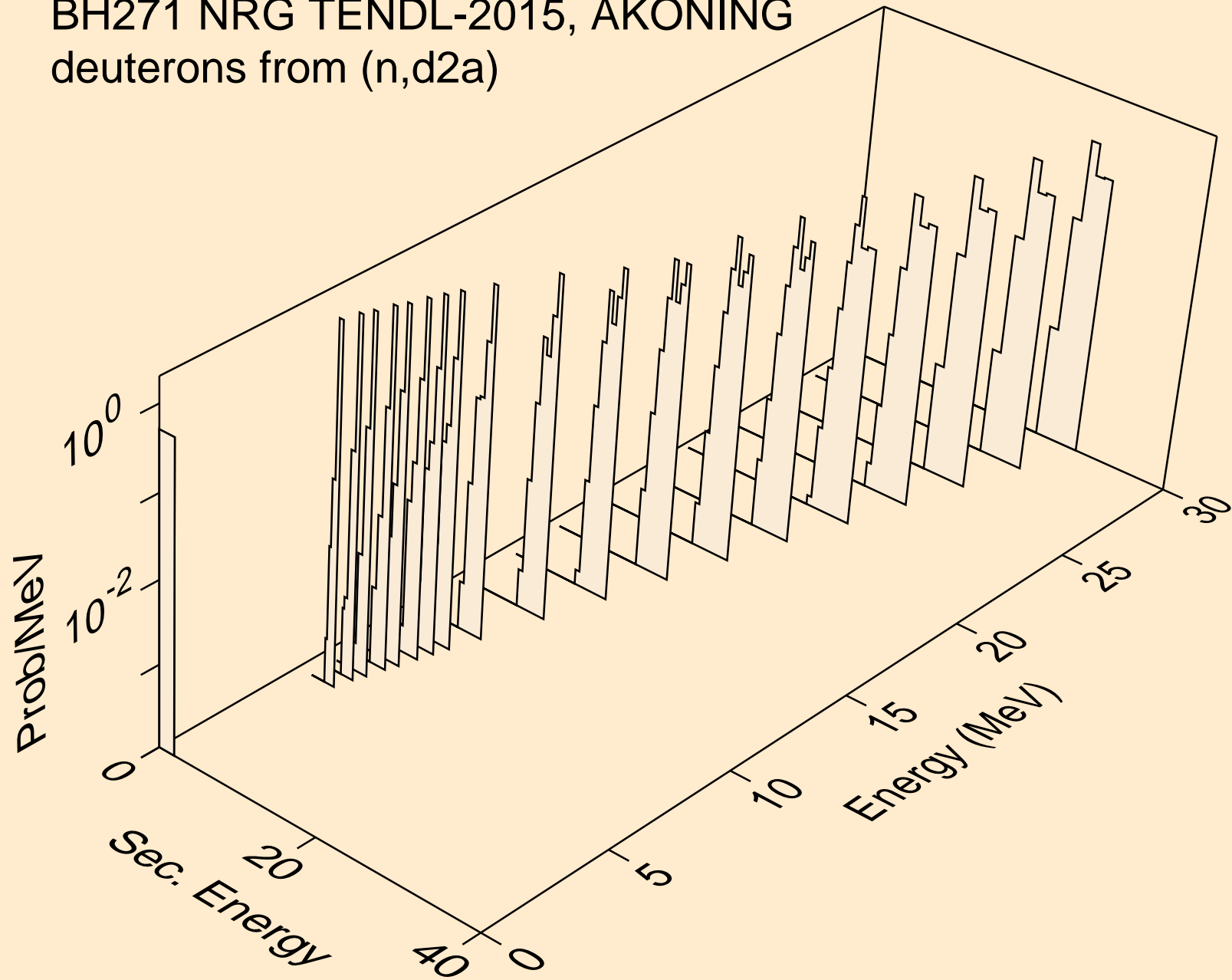

BH271 NRG TENDL-2015, AKONING
deuterons from (n,da)

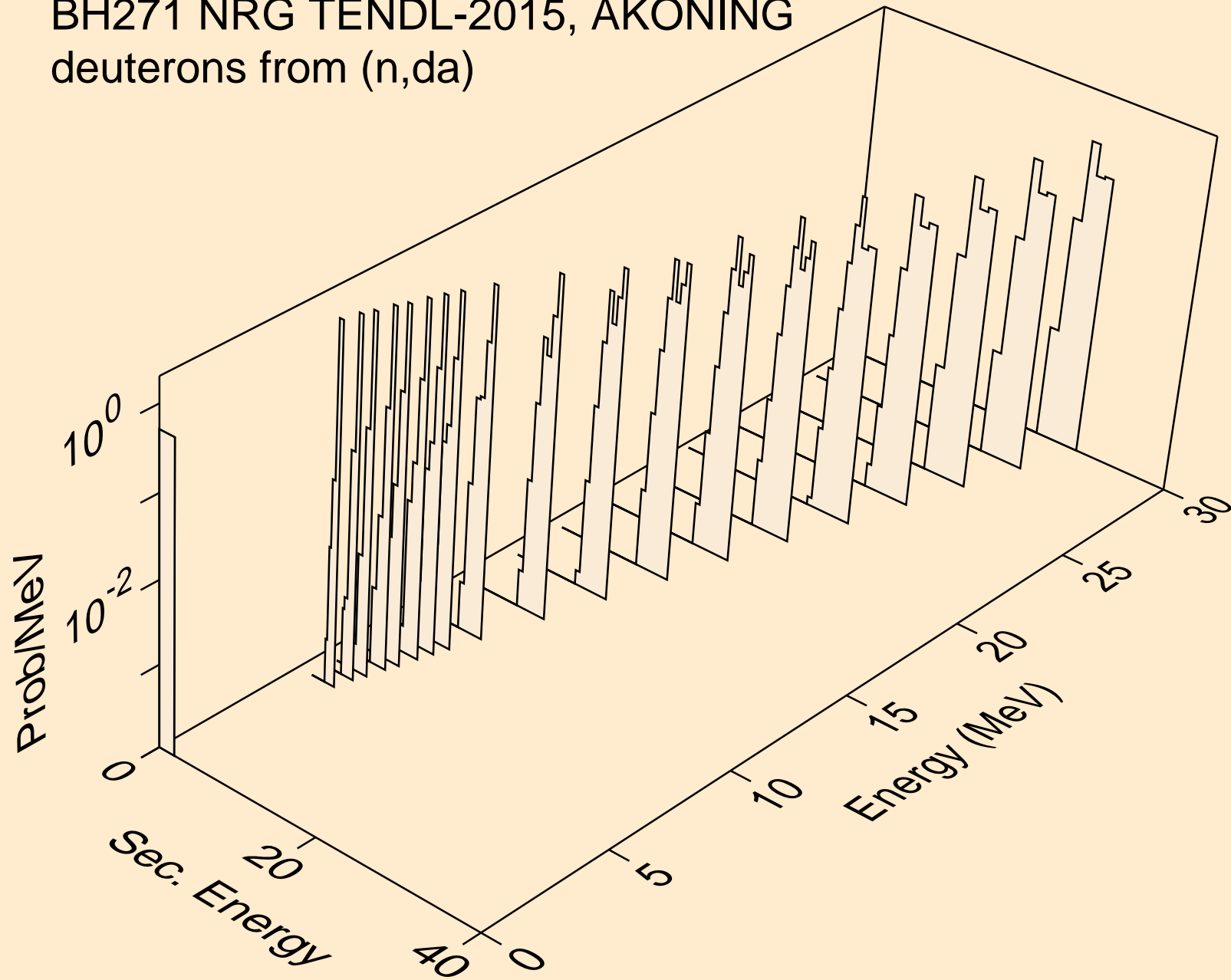

BH271 NRG TENDL-2015, AKONING
tritons from (n,x)

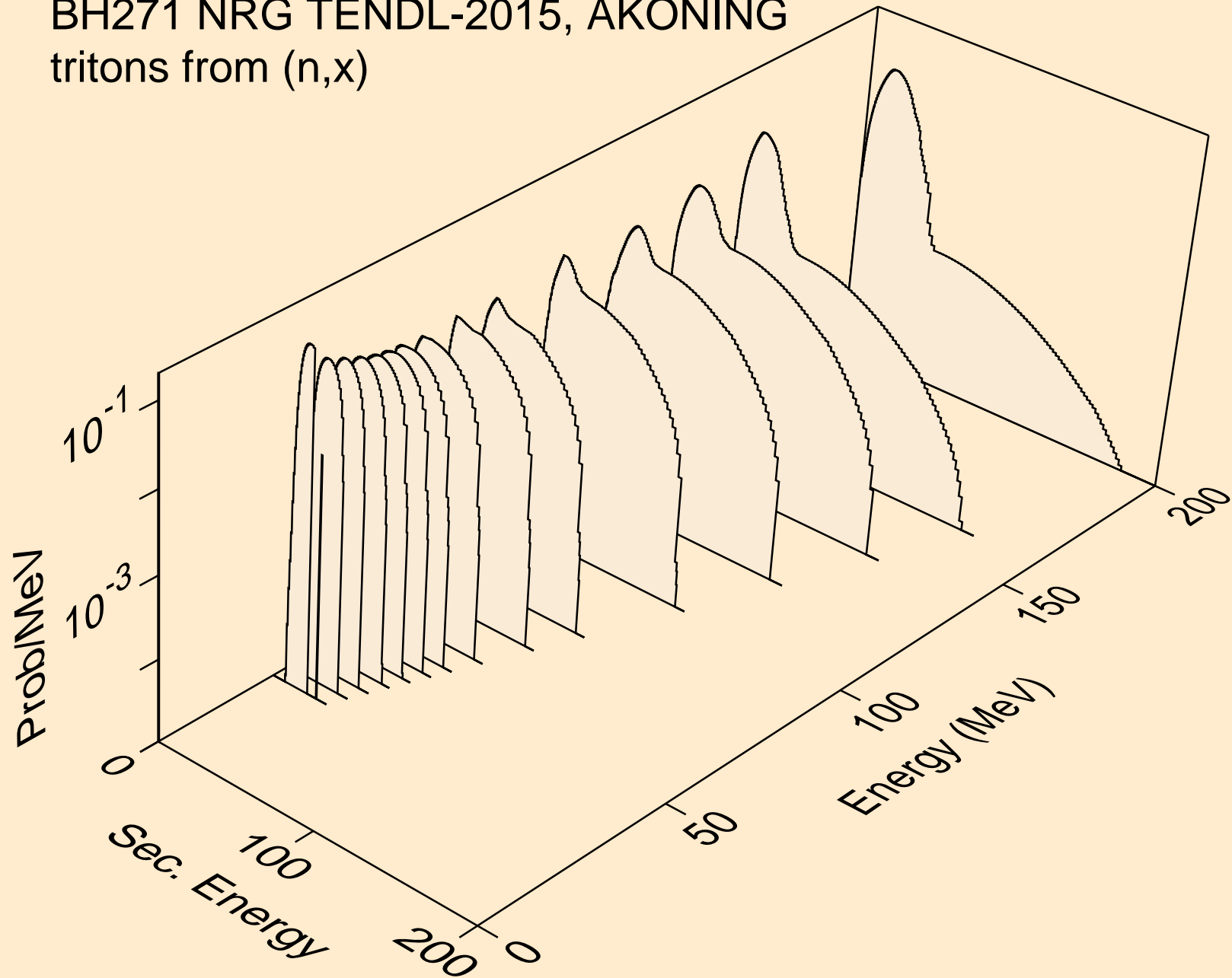

BH271 NRG TENDL-2015, AKONING
tritons from (n,n*)t

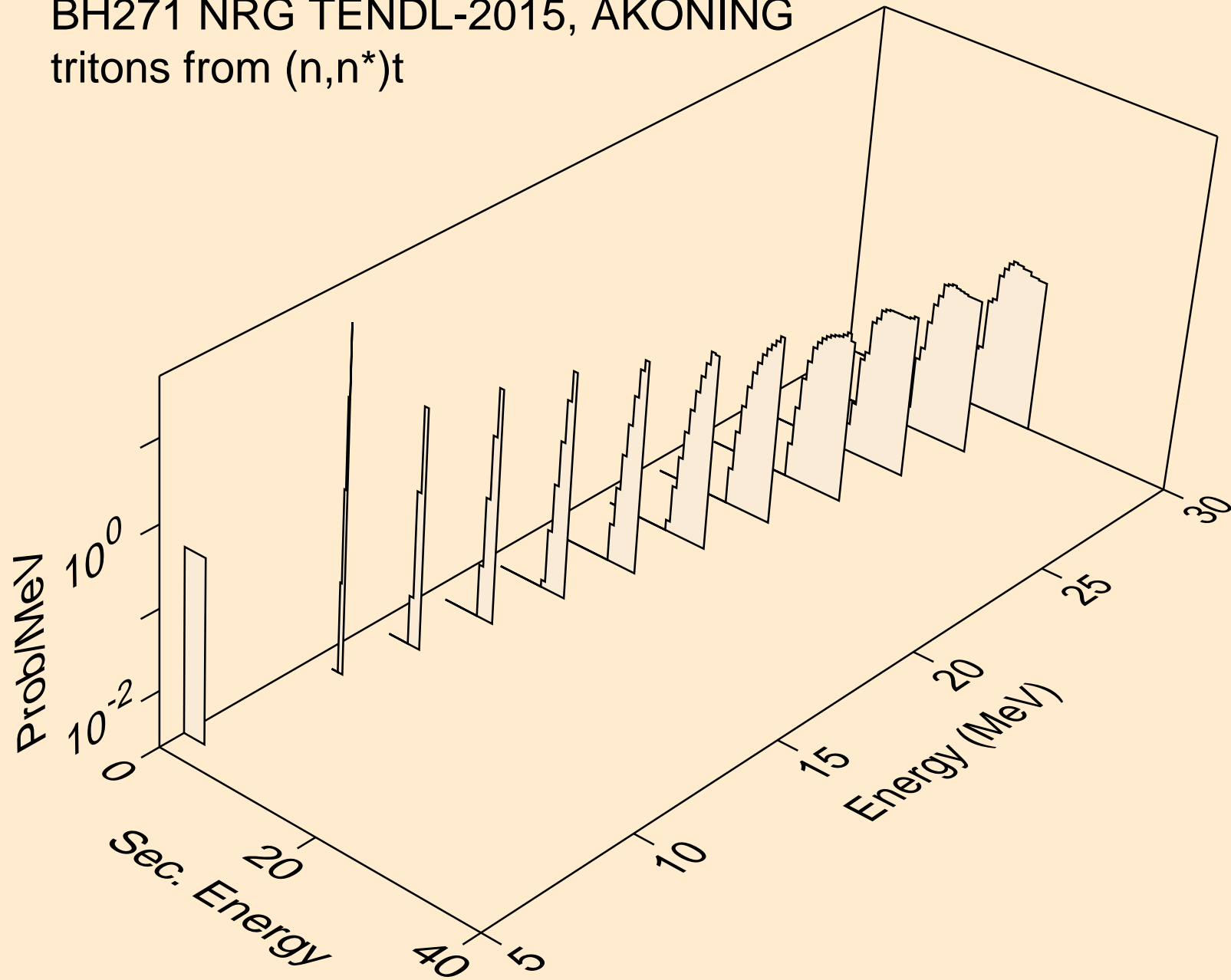

BH271 NRG TENDL-2015, AKONING
tritons from (n,n*)t2a

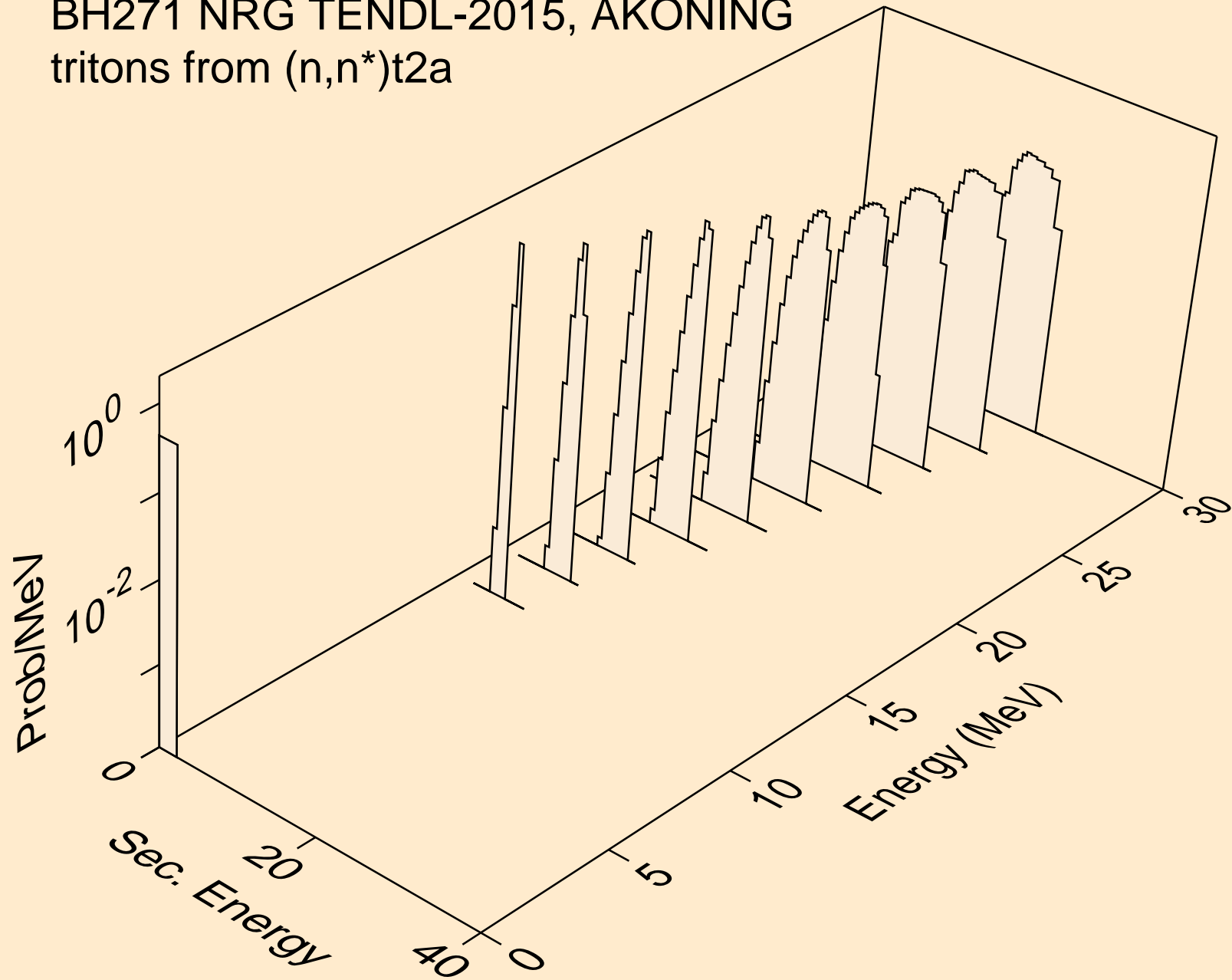

BH271 NRG TENDL-2015, AKONING
tritons from (n,t)

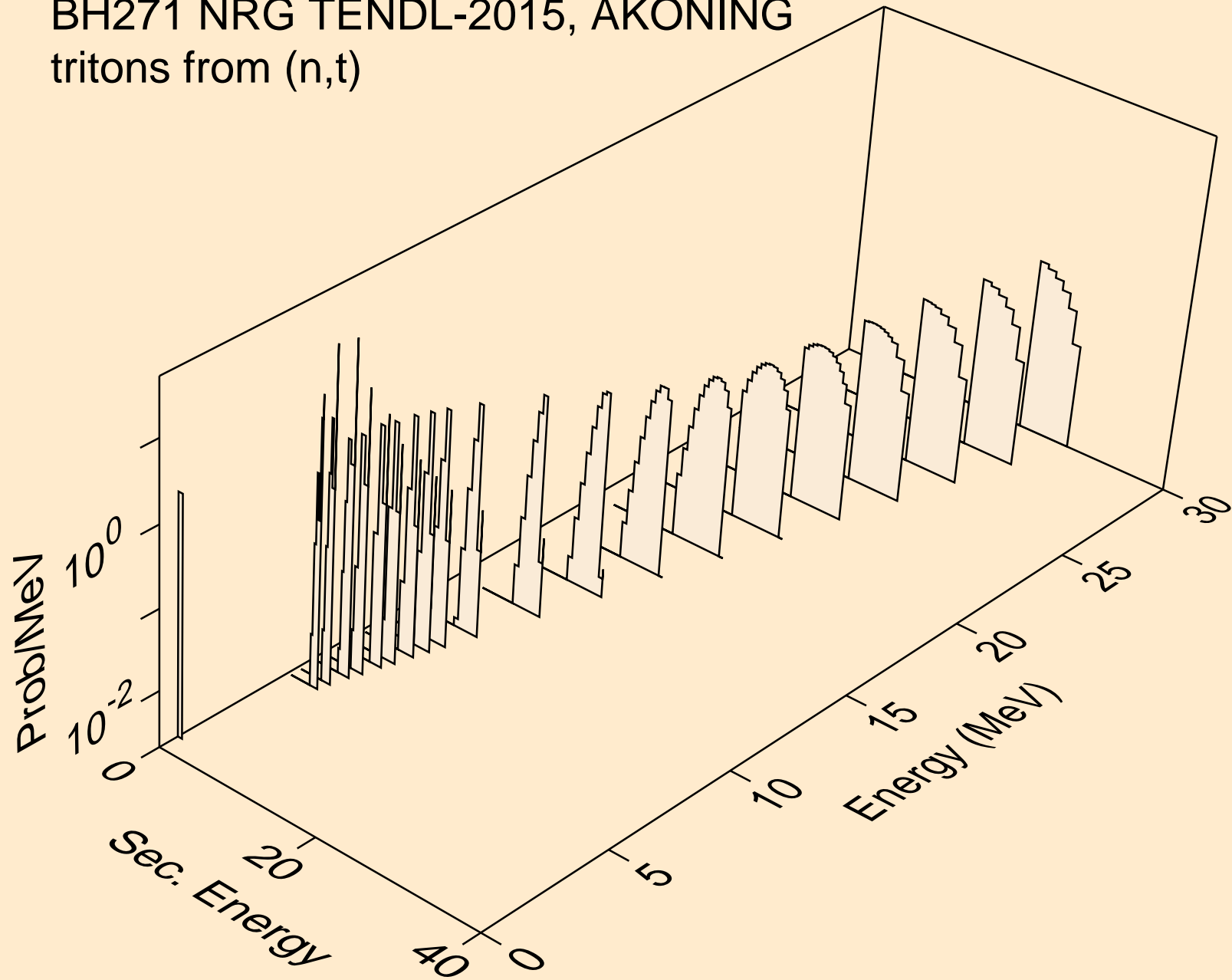

BH271 NRG TENDL-2015, AKONING
tritons from (n,t2a)

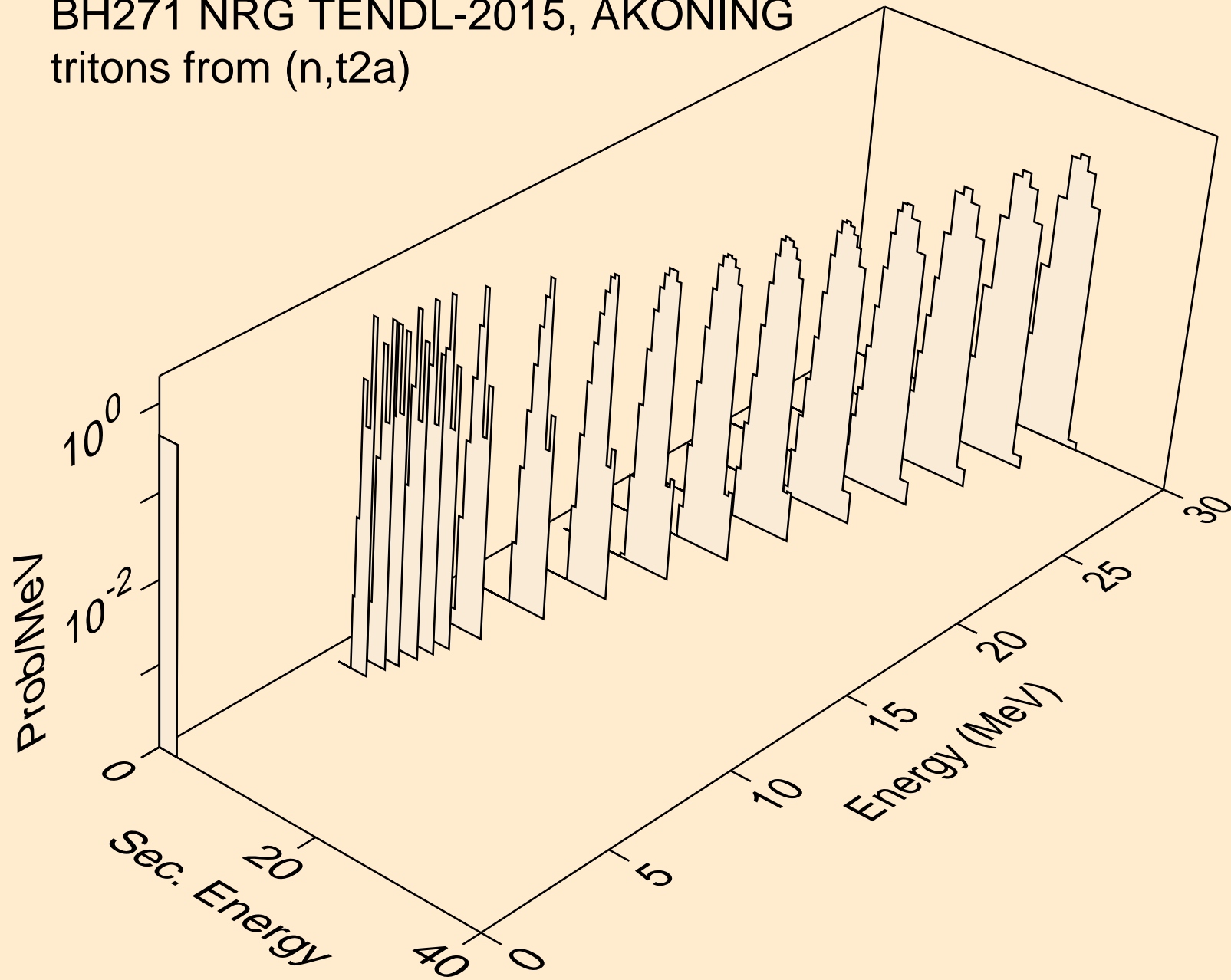

BH271 NRG TENDL-2015, AKONING
he3s from (n,x)

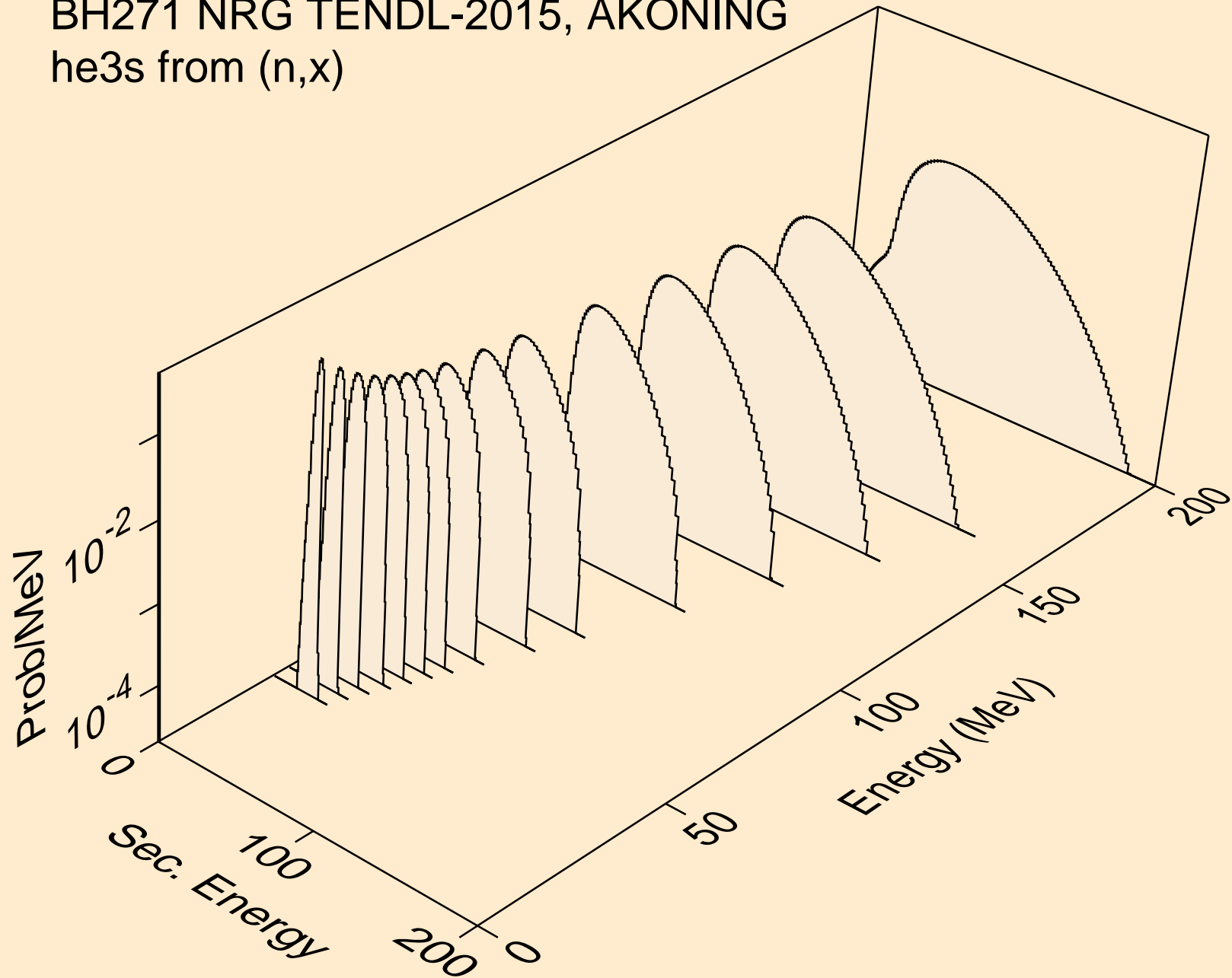

BH271 NRG TENDL-2015, AKONING
he3s from (n,n*)he3

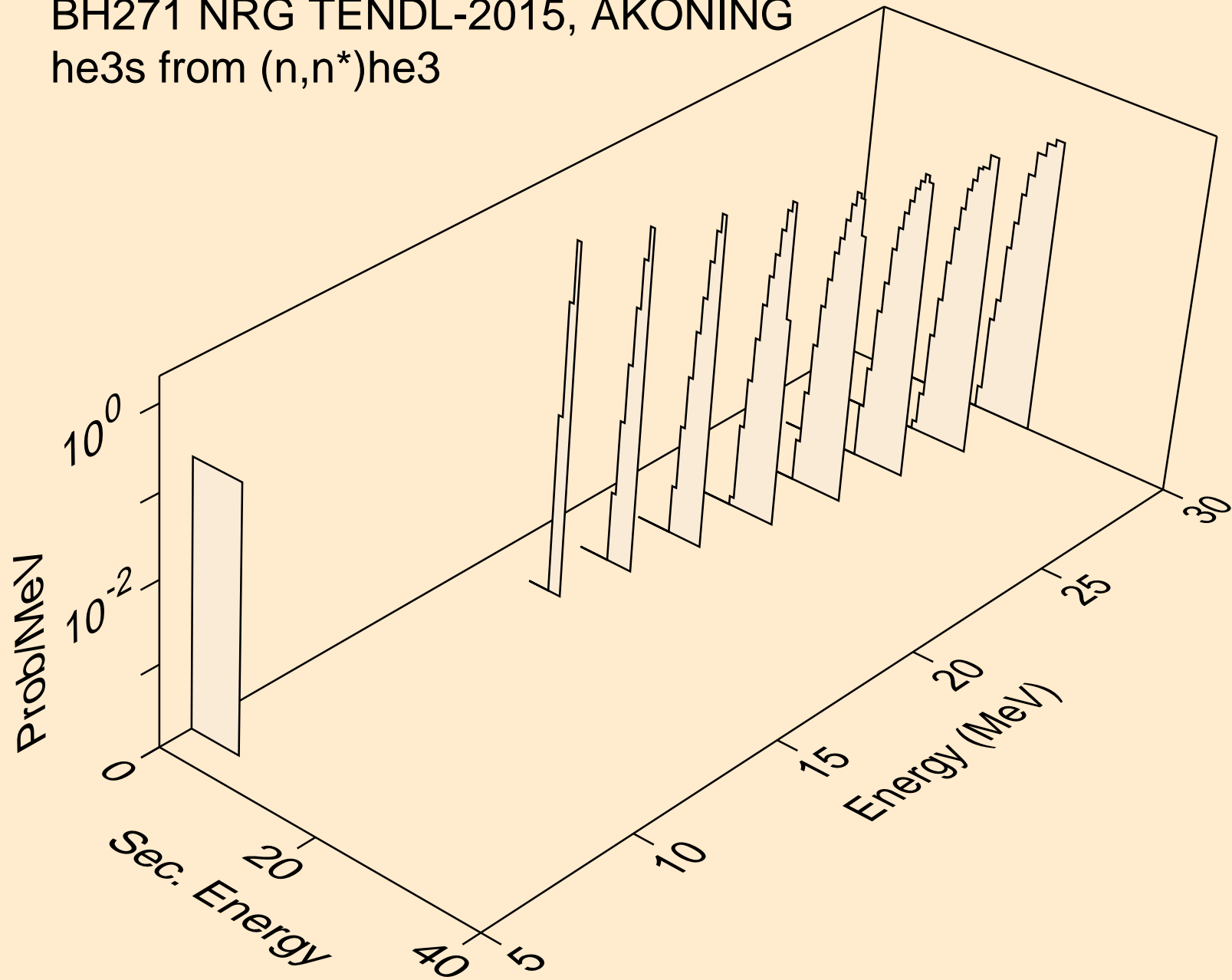

BH271 NRG TENDL-2015, AKONING
he3s from (n,he3)

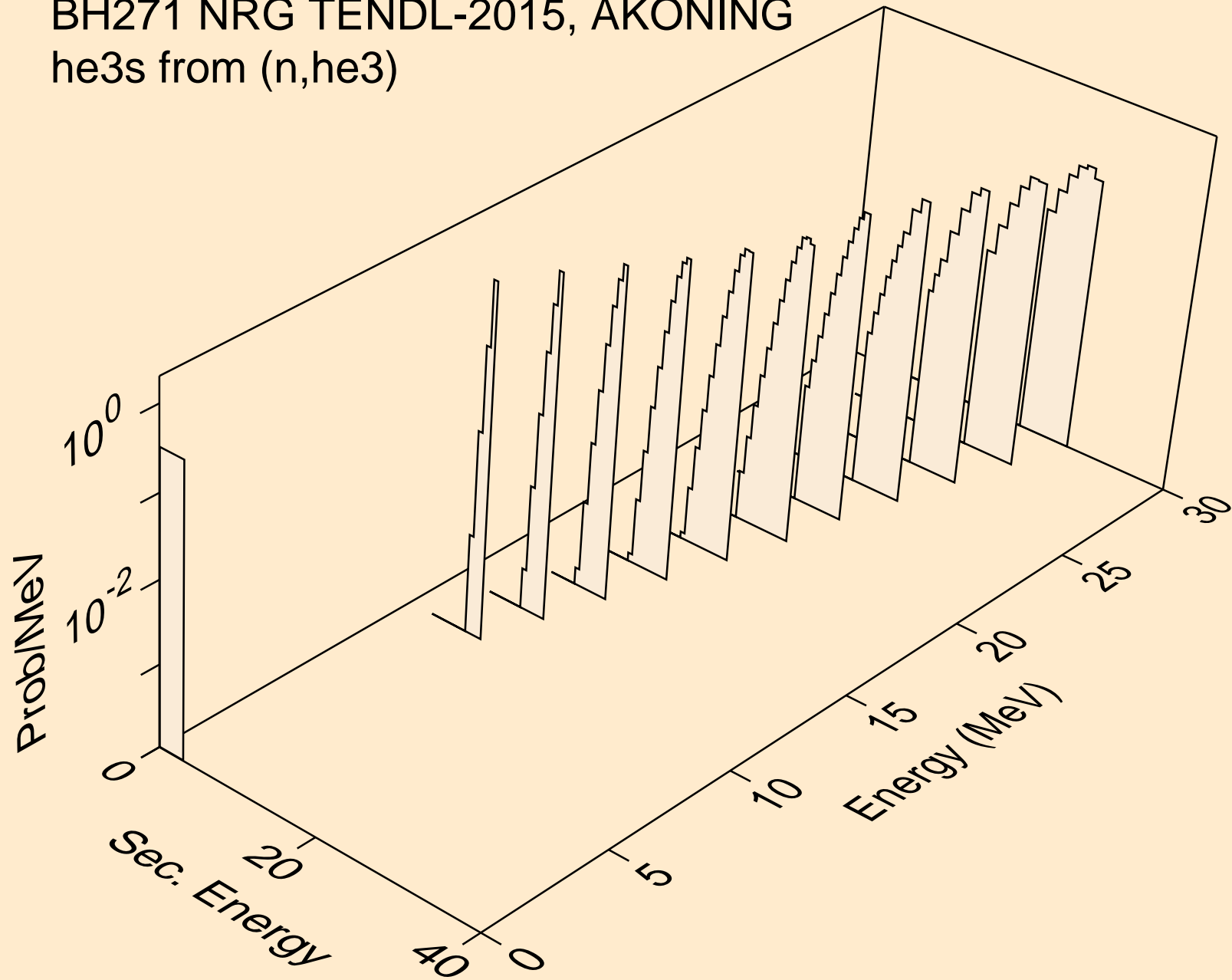

BH271 NRG TENDL-2015, AKONING
alphas from (n,x)

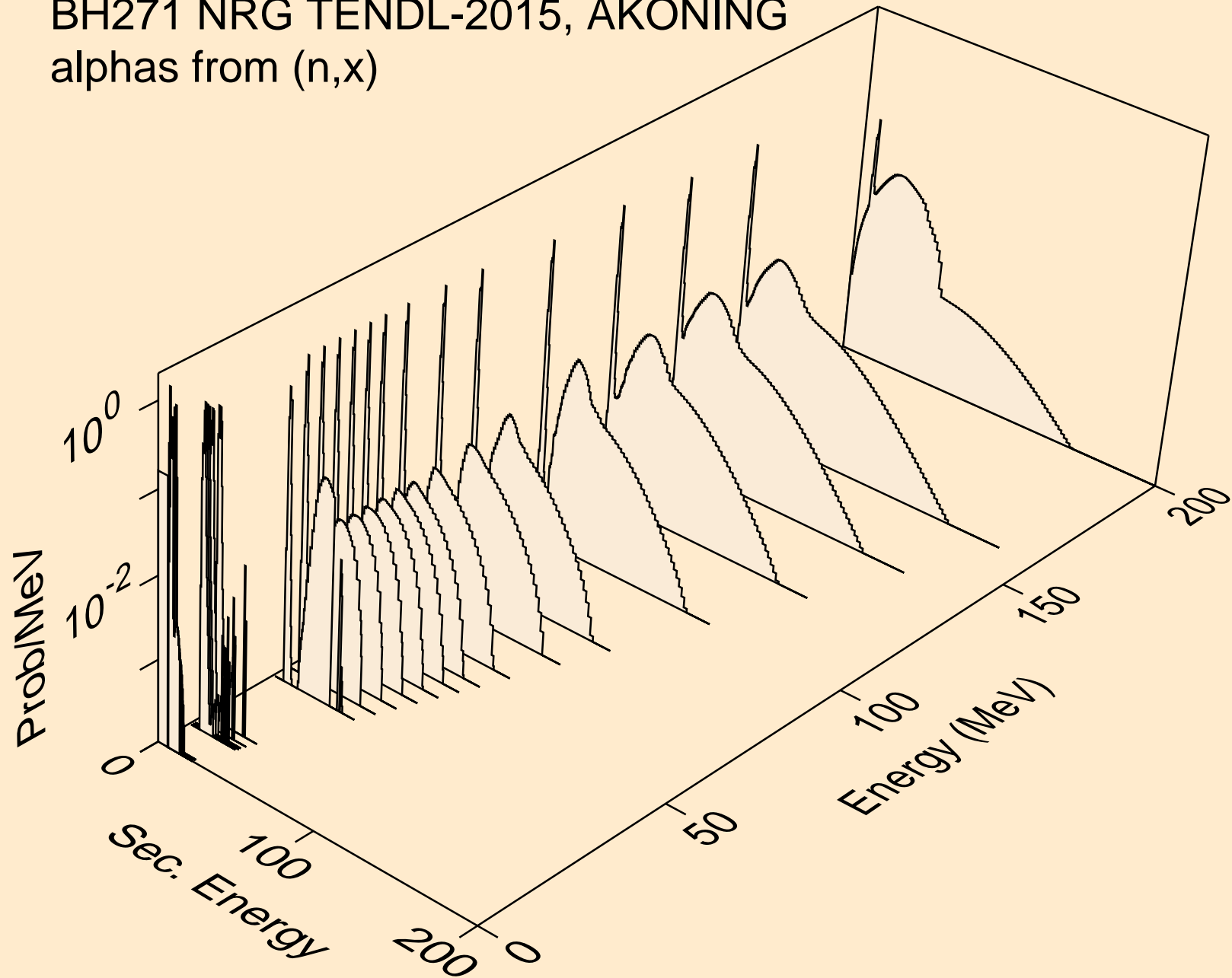

BH271 NRG TENDL-2015, AKONING
alphas from (n,n*)a

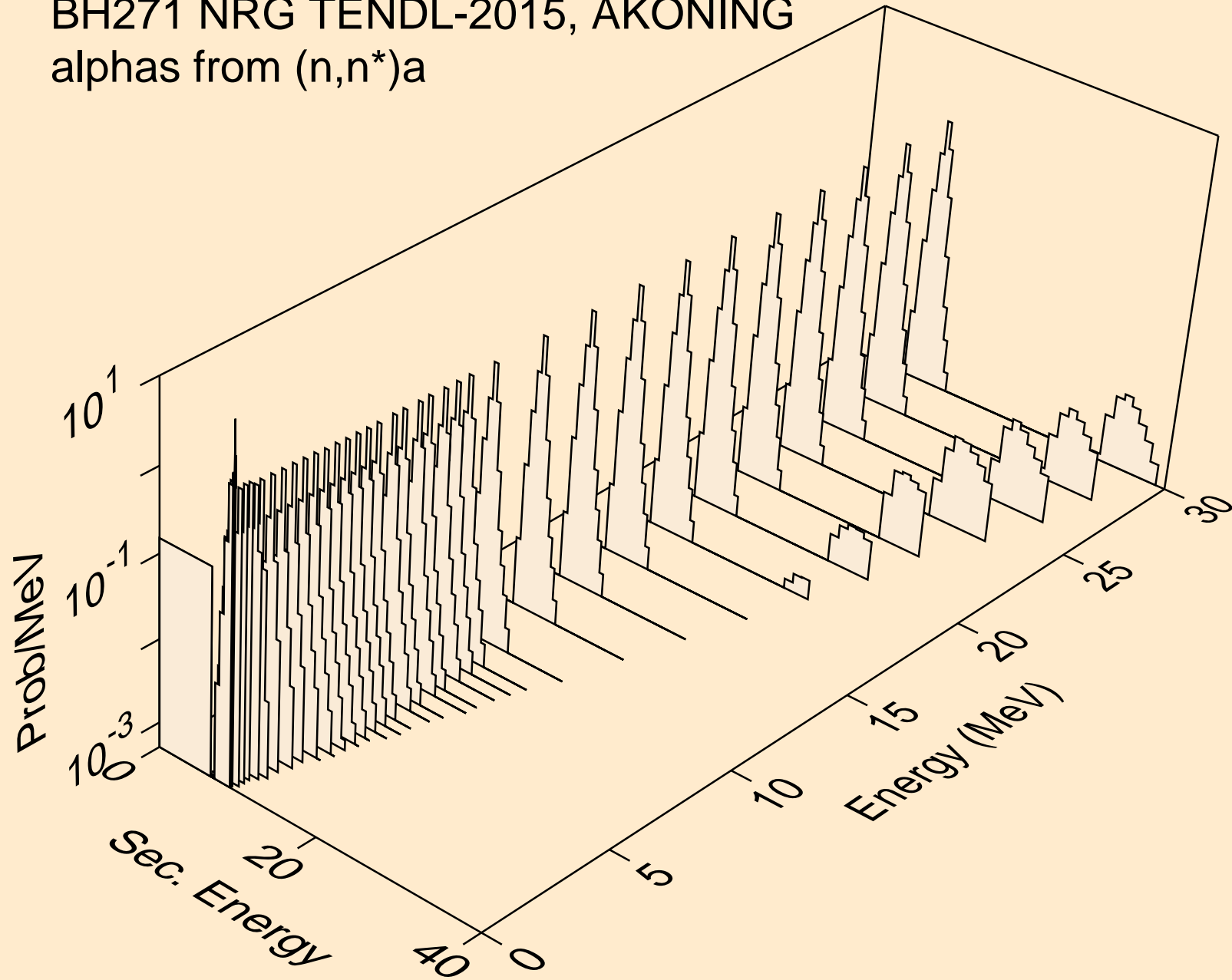

BH271 NRG TENDL-2015, AKONING
alphas from (n,n*)3a

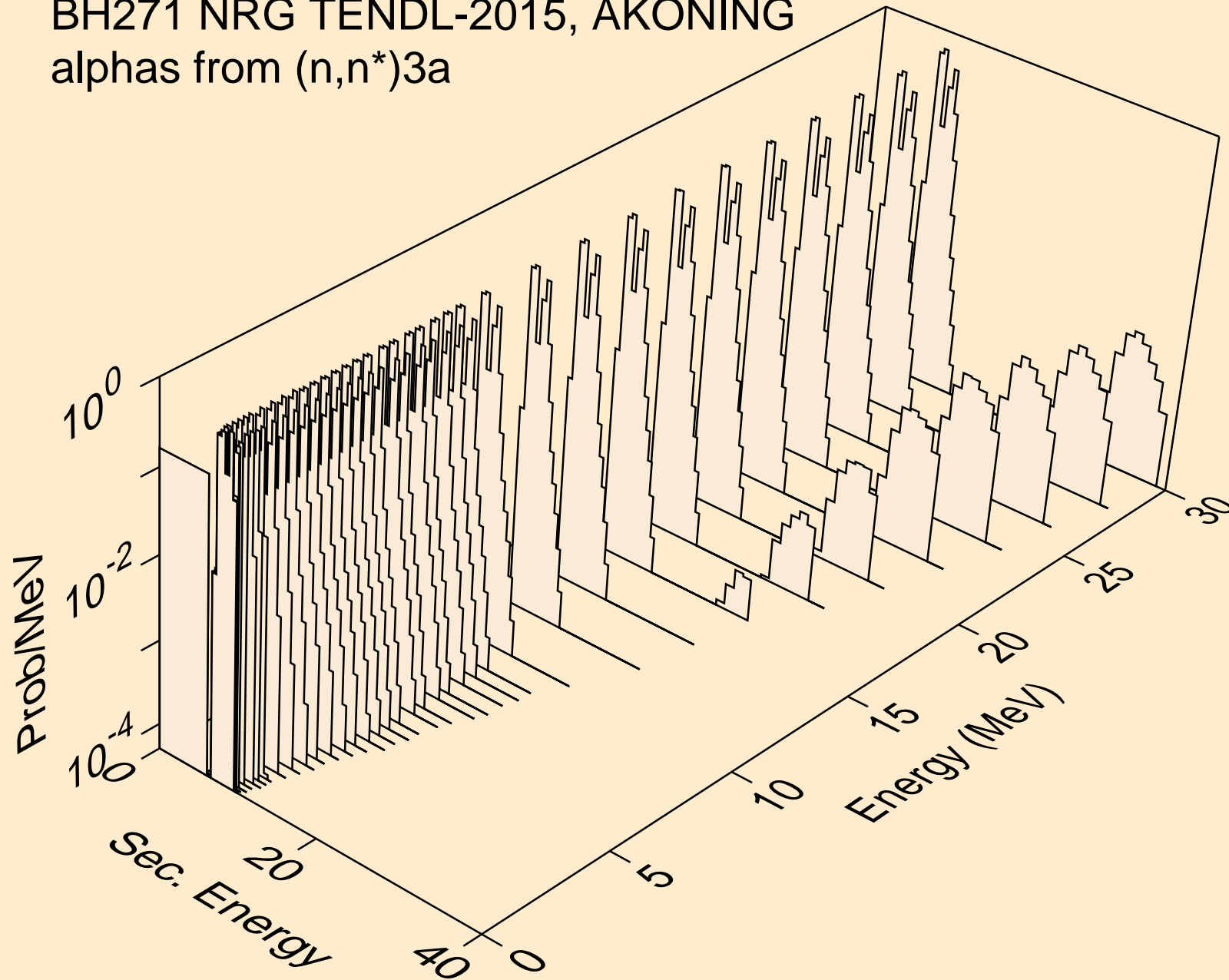

BH271 NRG TENDL-2015, AKONING
alphas from (n,2n)a

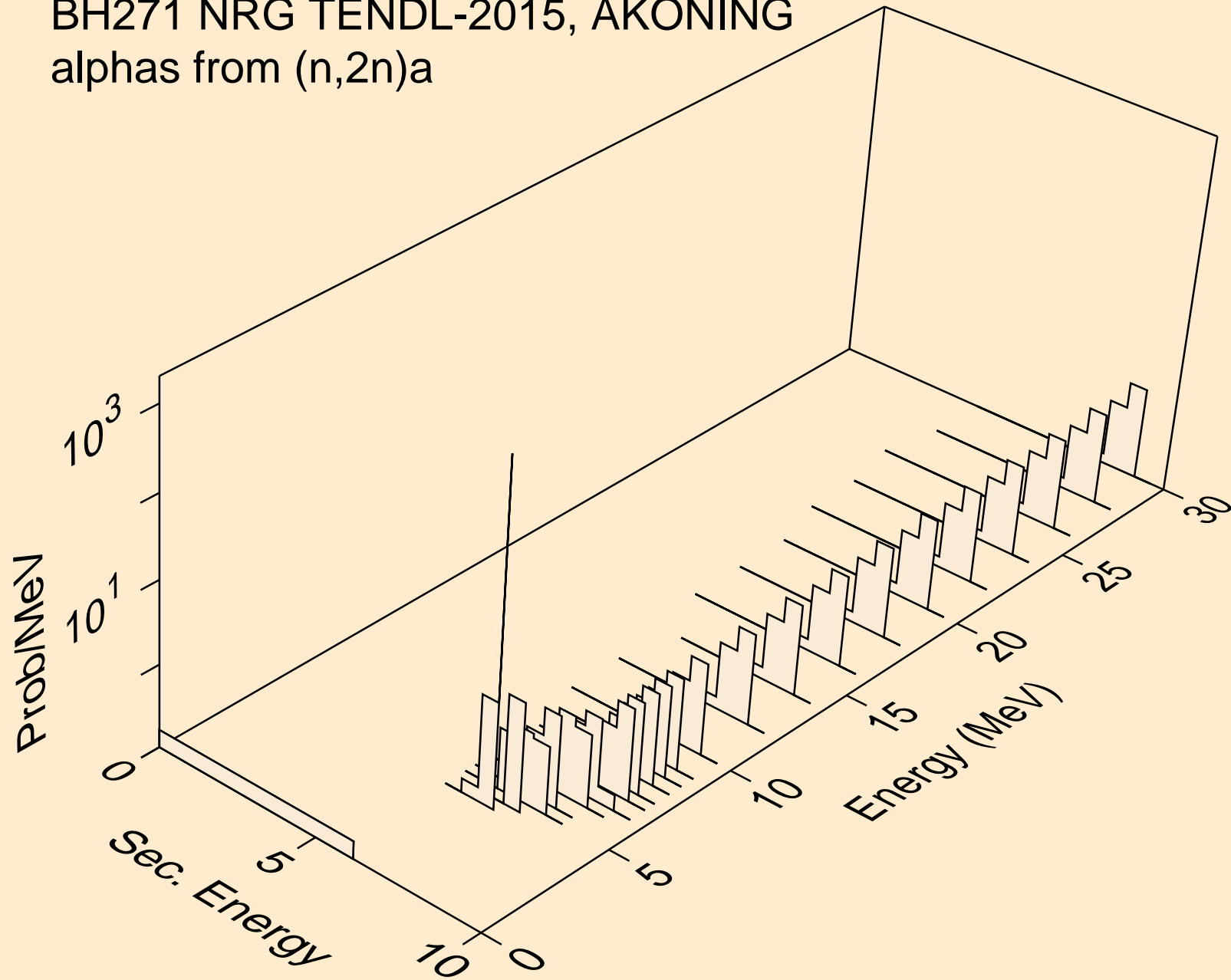

BH271 NRG TENDL-2015, AKONING
alphas from (n,3n)a

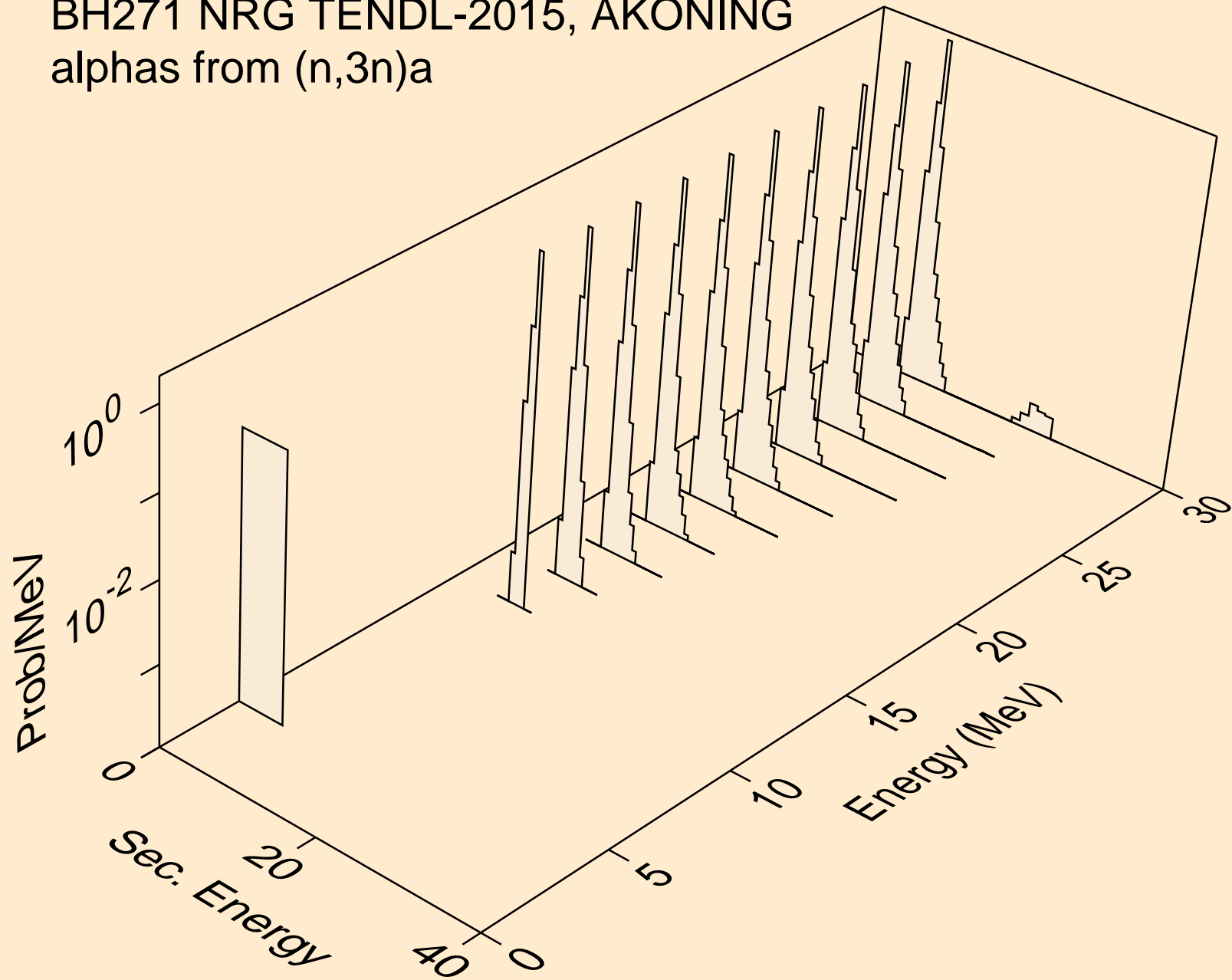

BH271 NRG TENDL-2015, AKONING
alphas from (n,n*)2a

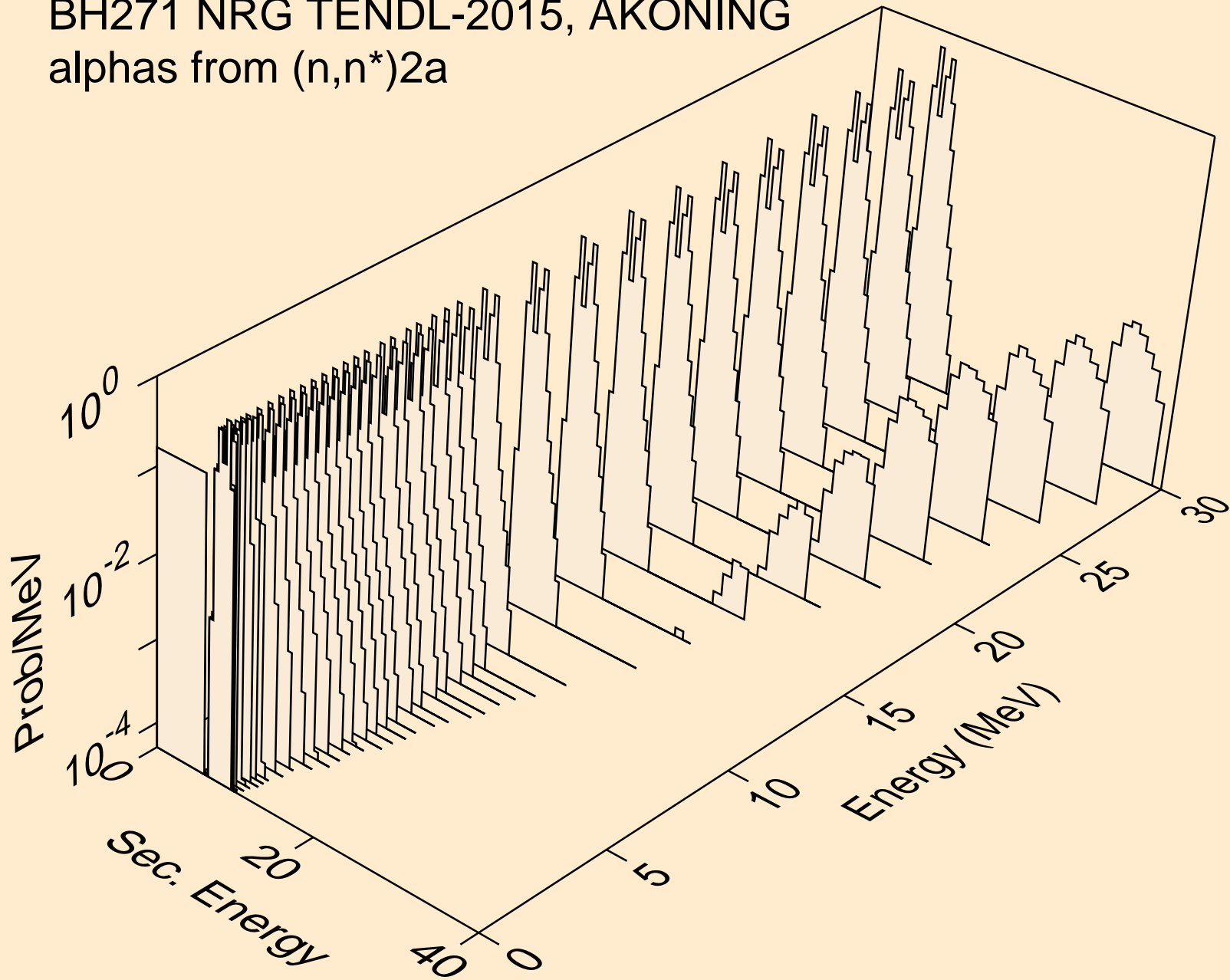

BH271 NRG TENDL-2015, AKONING
alphas from (n,2n)2a

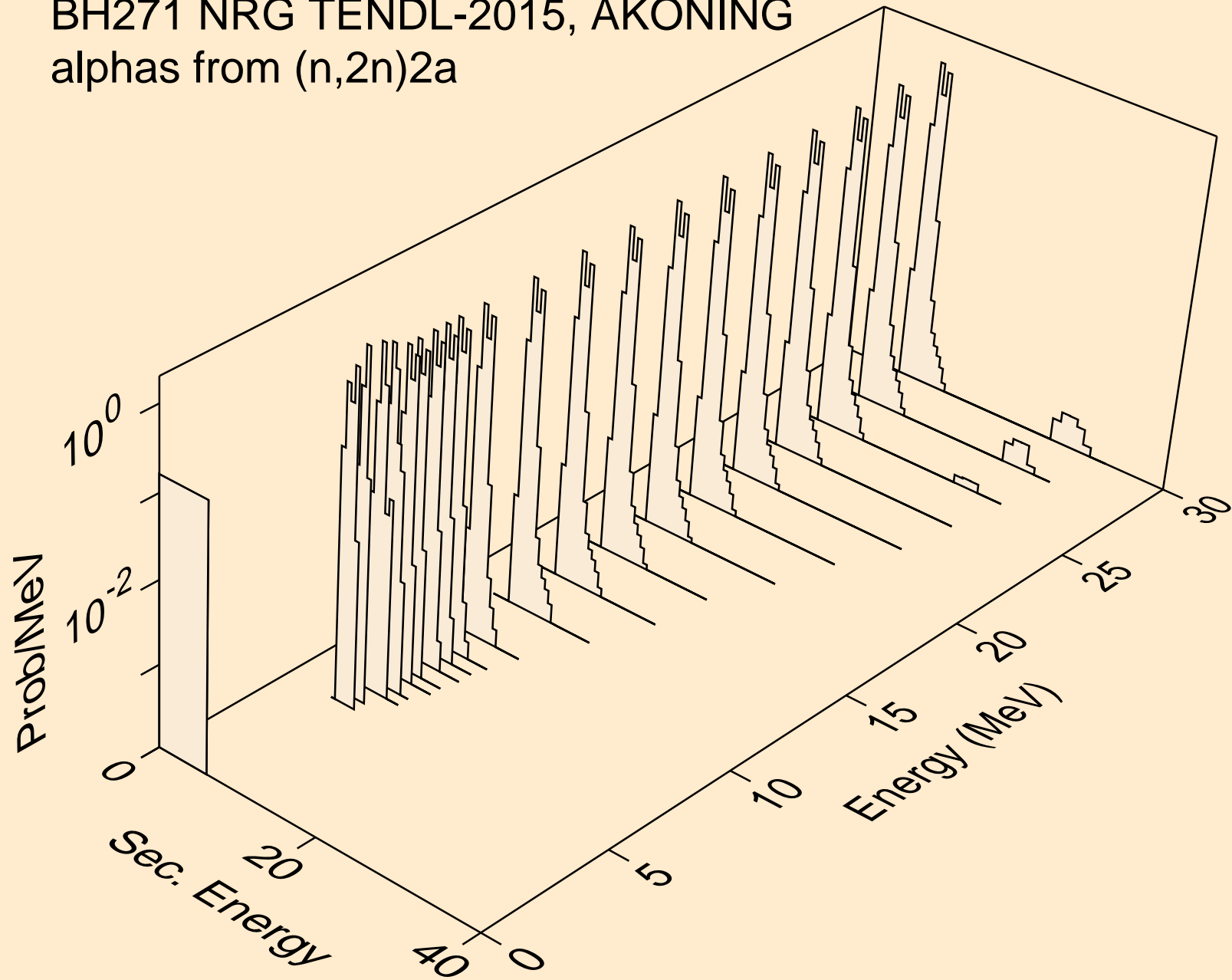

BH271 NRG TENDL-2015, AKONING
alphas from (n,n*)d2a

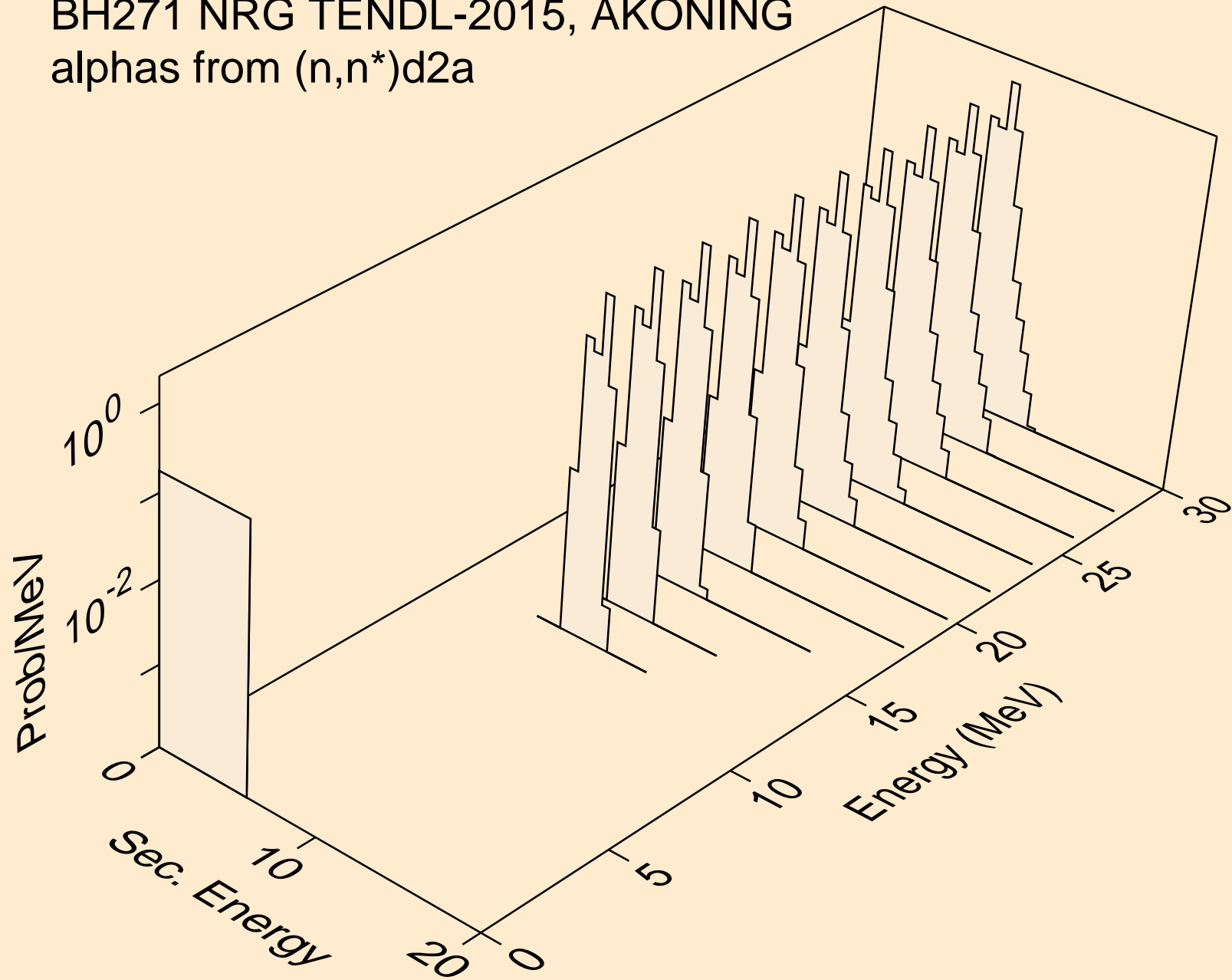

BH271 NRG TENDL-2015, AKONING
alphas from (n,n*)t2a

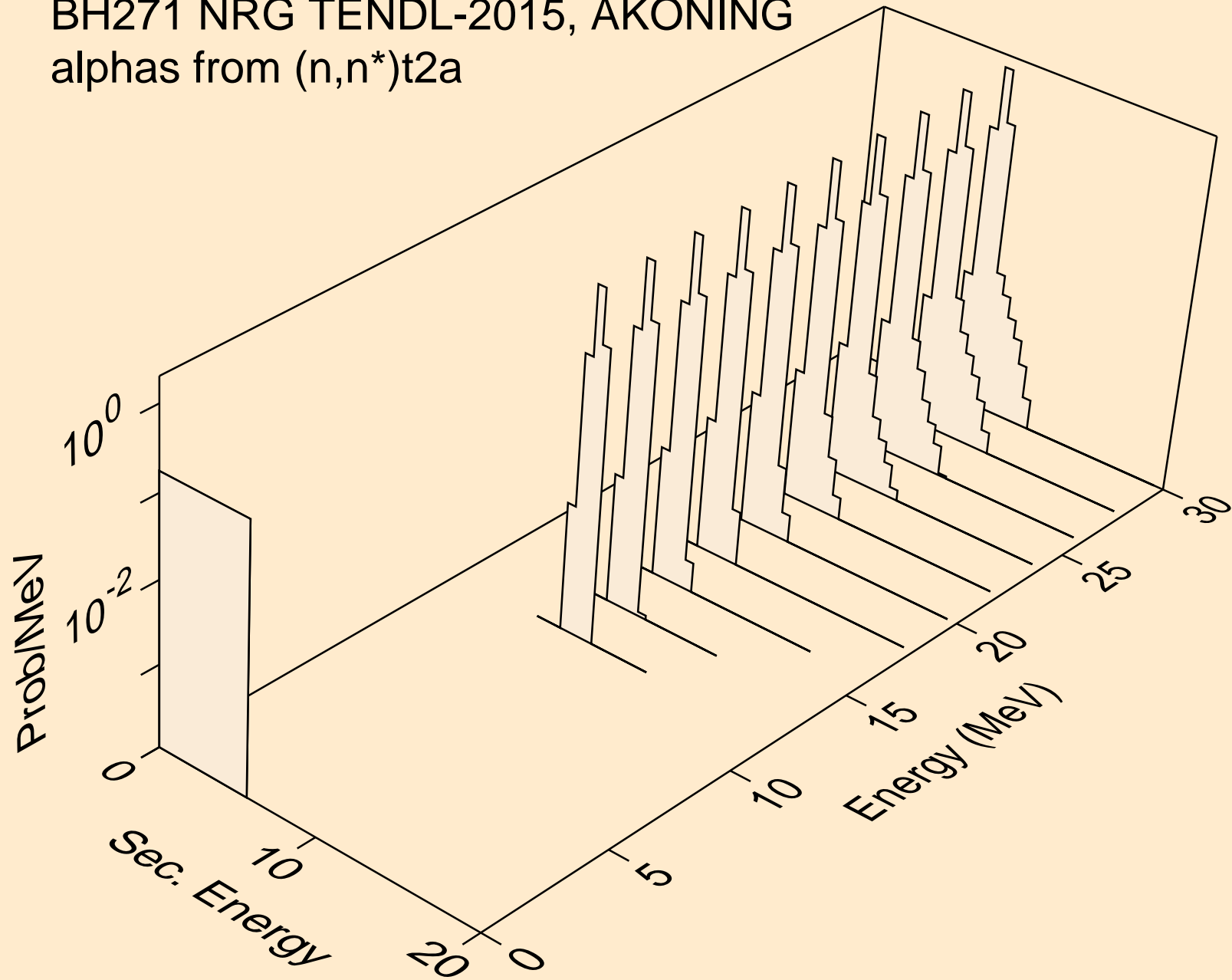

BH271 NRG TENDL-2015, AKONING
alphas from (n,npa)

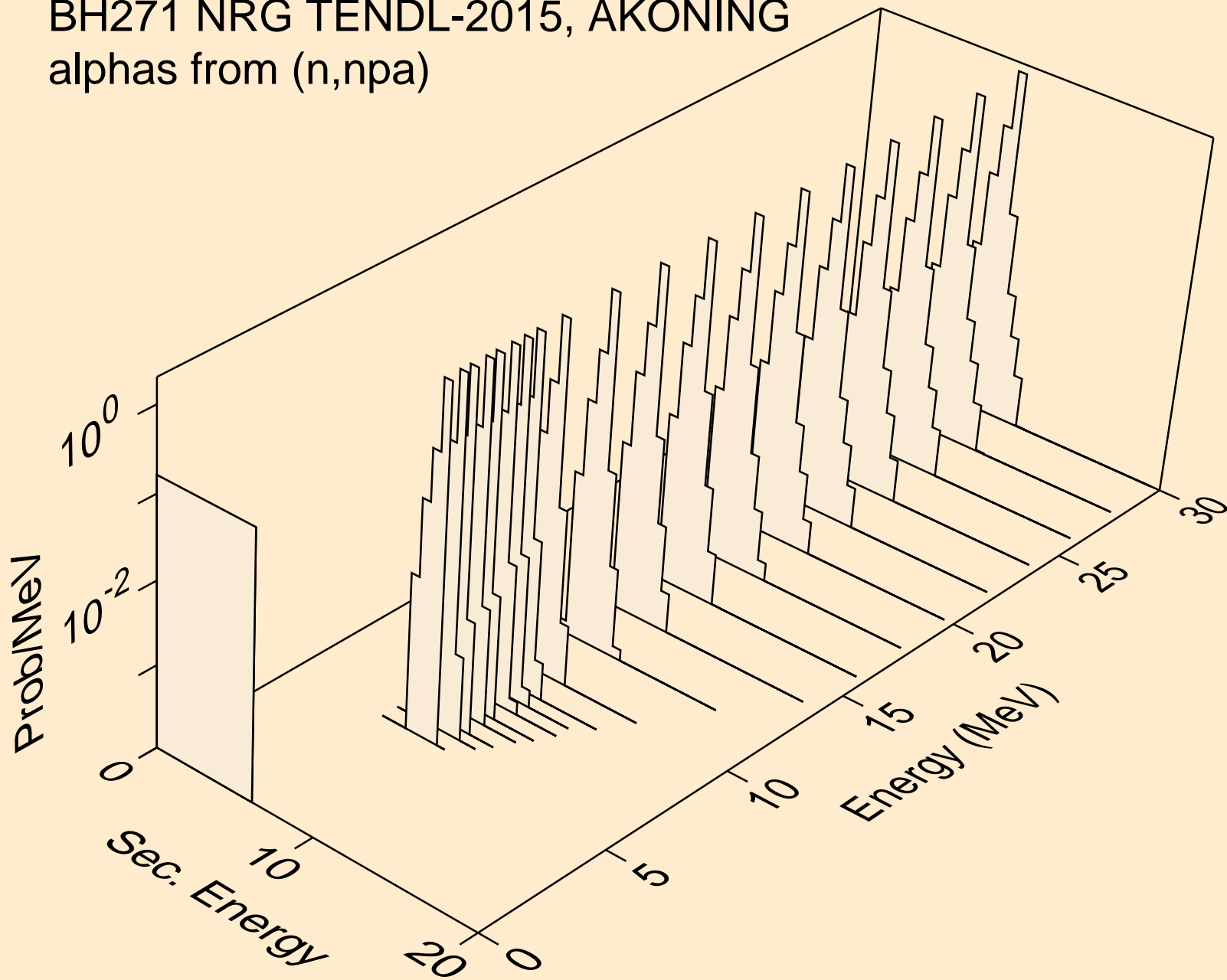

BH271 NRG TENDL-2015, AKONING
alphas from (n,a)

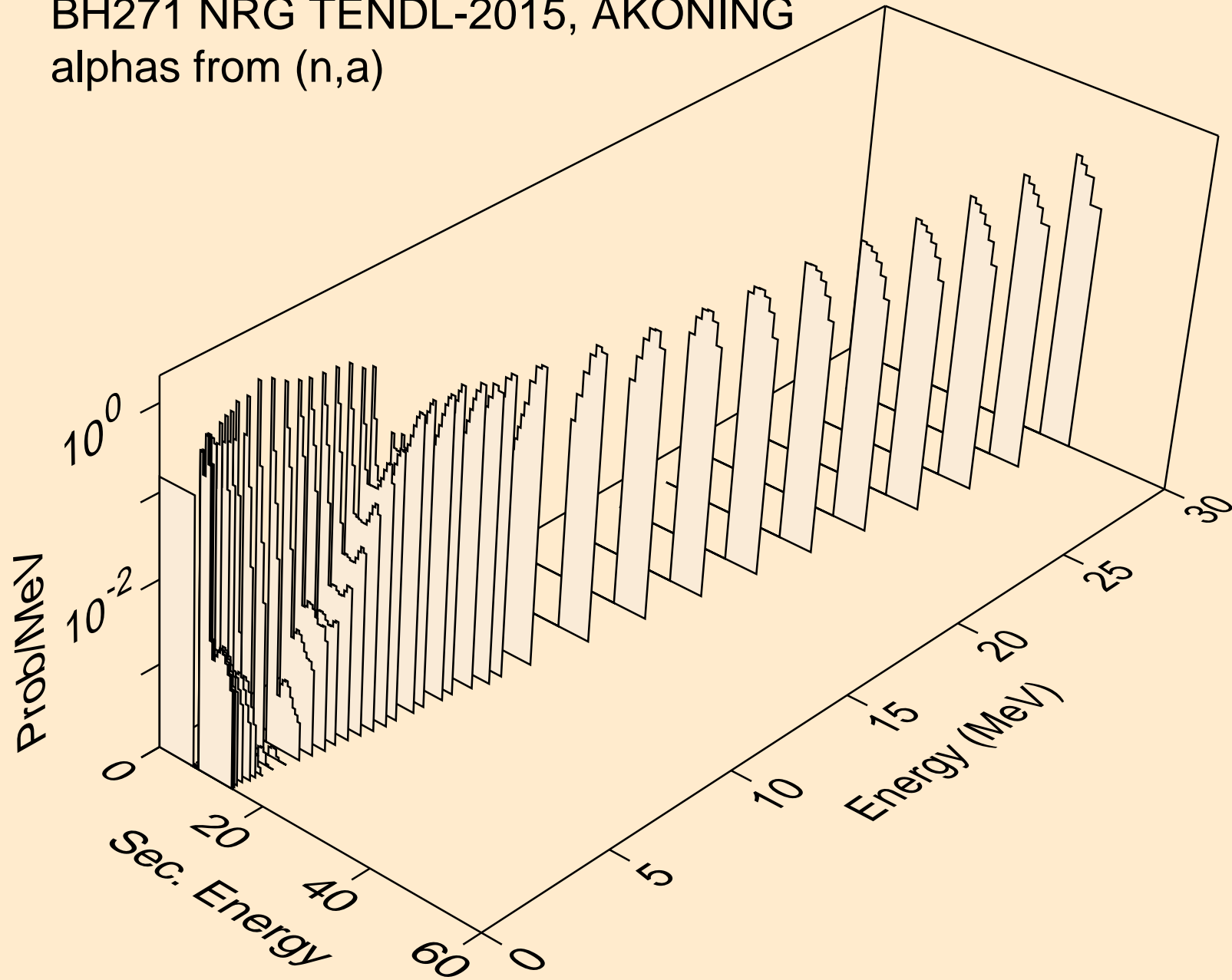

BH271 NRG TENDL-2015, AKONING
alphas from (n,2a)

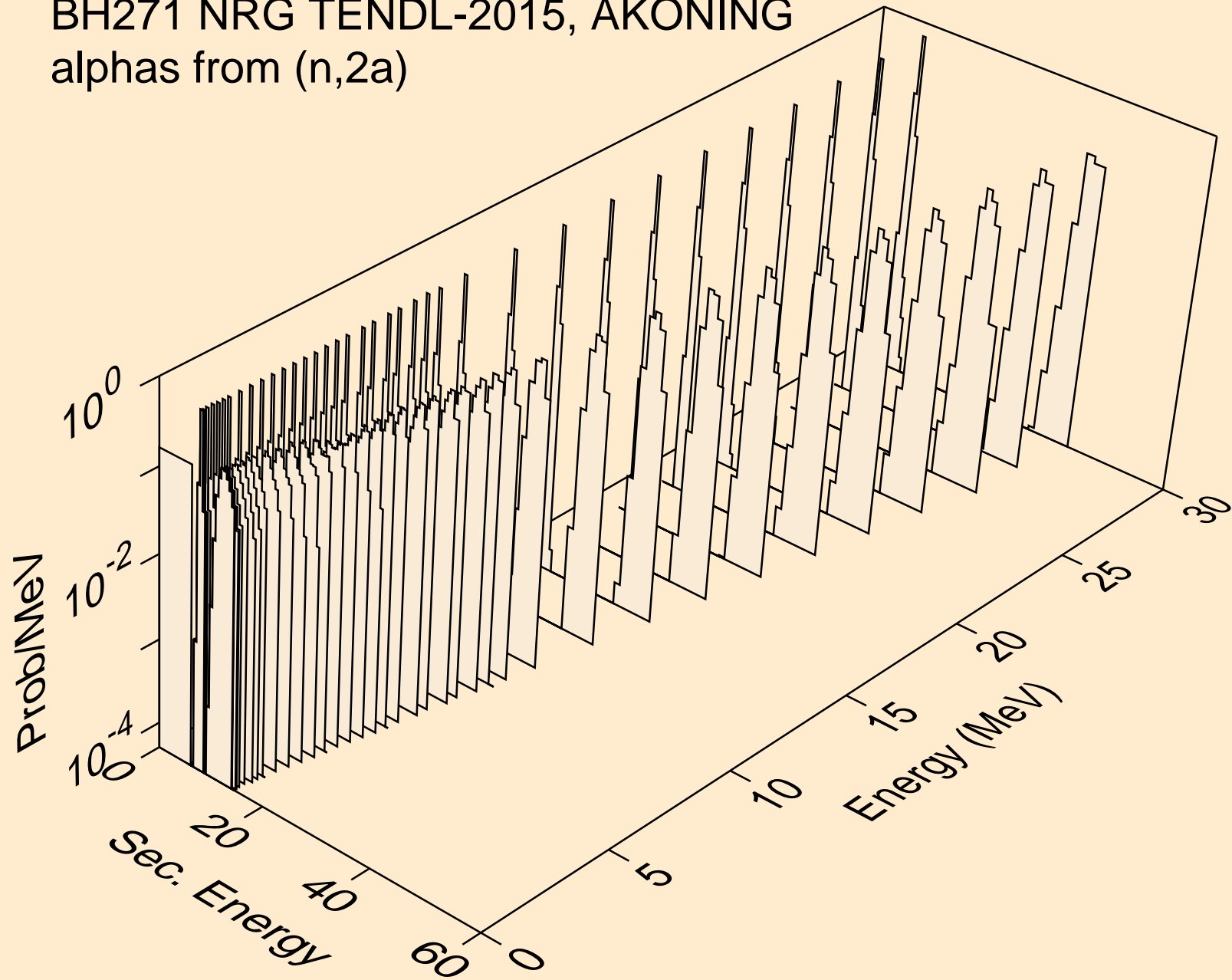

BH271 NRG TENDL-2015, AKONING
alphas from (n,3a)

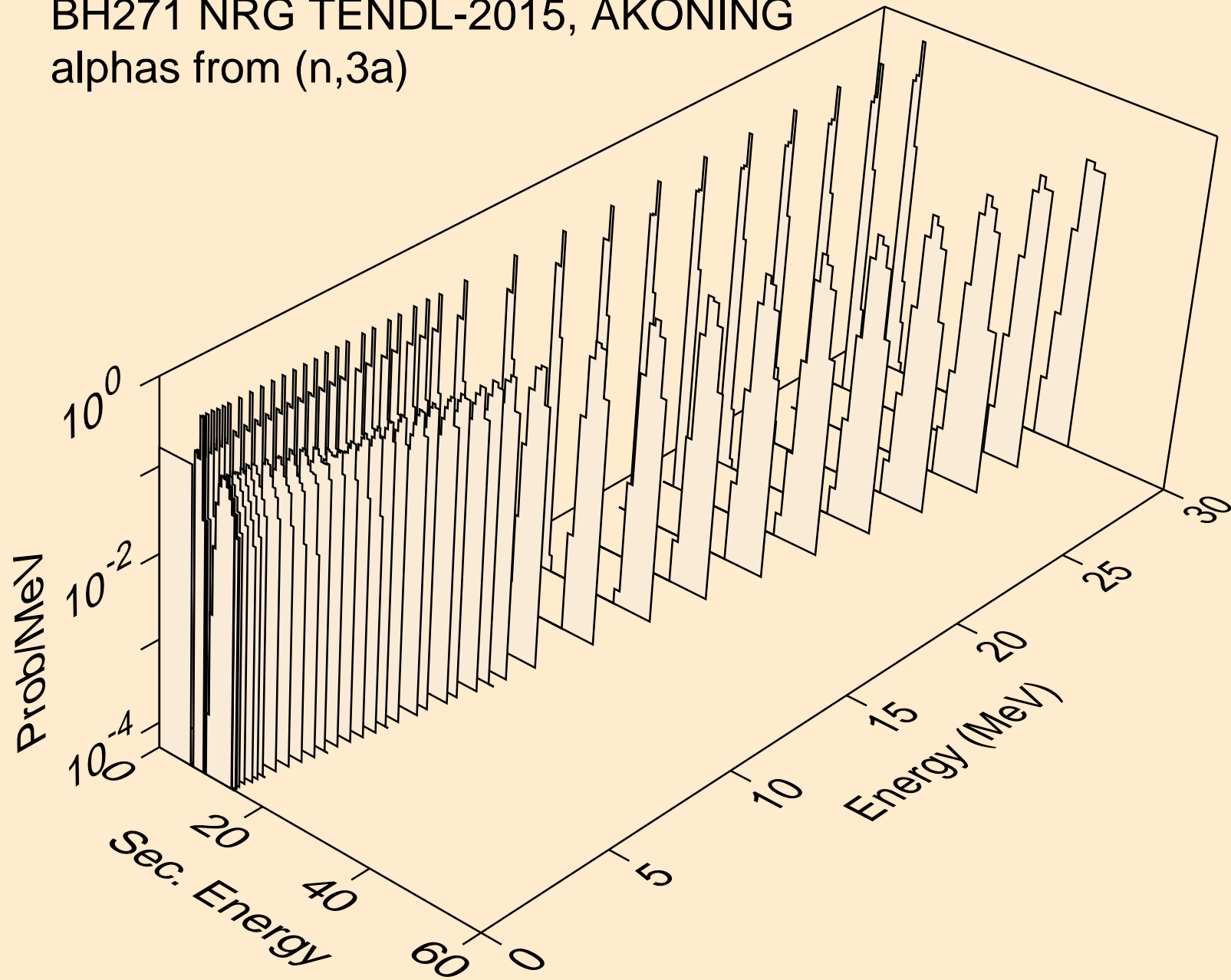

BH271 NRG TENDL-2015, AKONING
alphas from (n,pa)

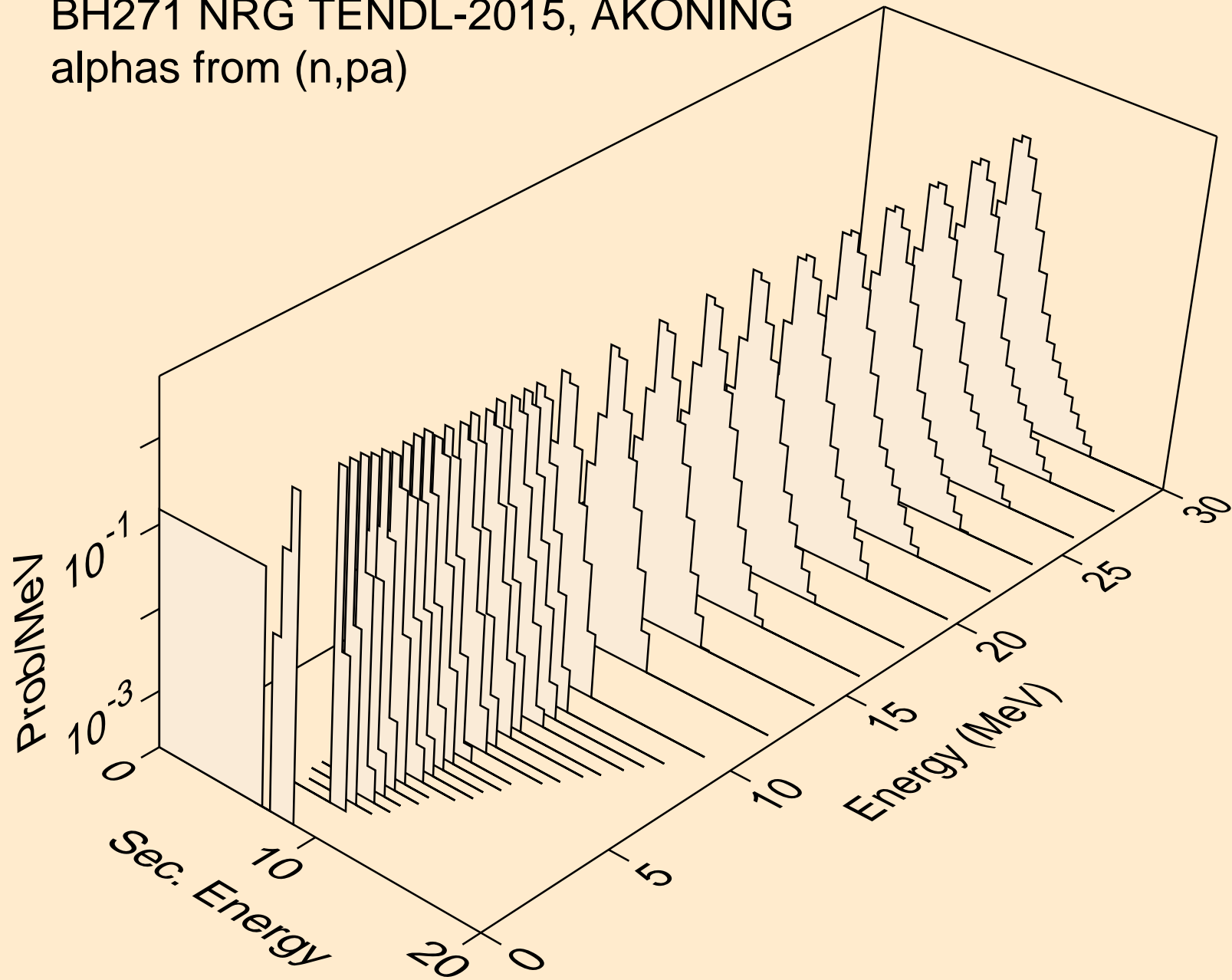

BH271 NRG TENDL-2015, AKONING
alphas from (n,t2a)

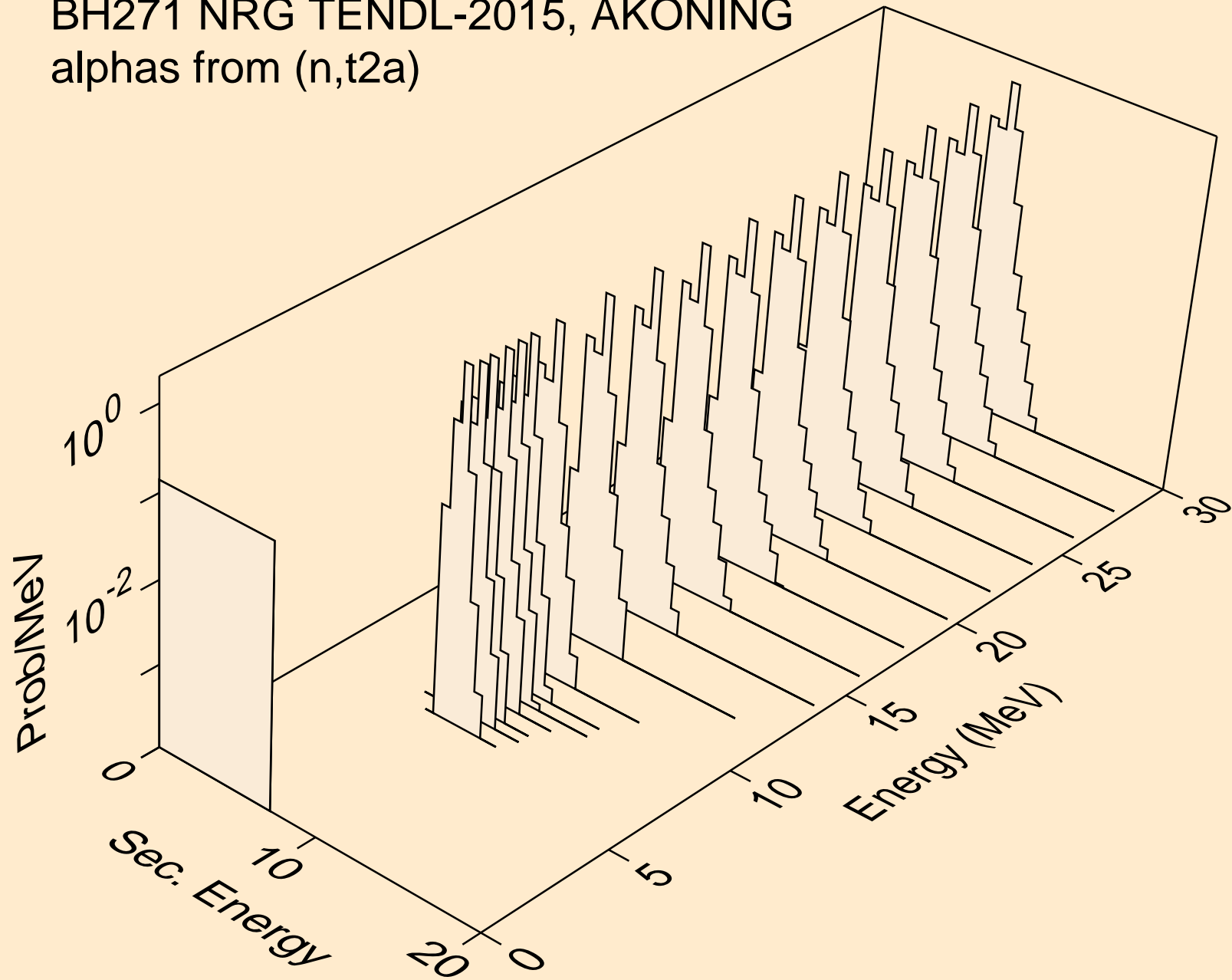

BH271 NRG TENDL-2015, AKONING
alphas from (n,d2a)

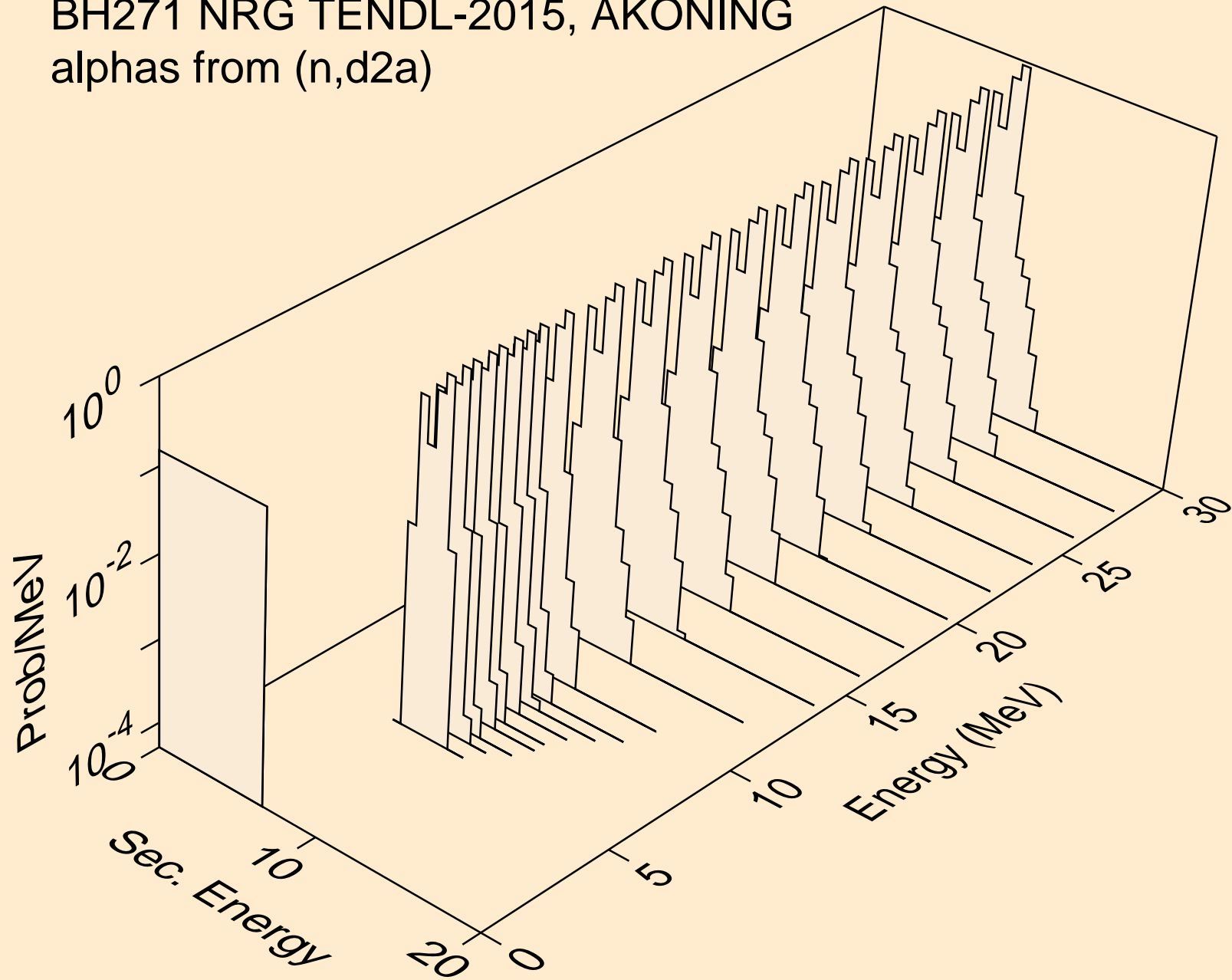

BH271 NRG TENDL-2015, AKONING
alphas from (n,da)

