

BI195M NRG TENDL-2015, AKONING

Principal cross sections

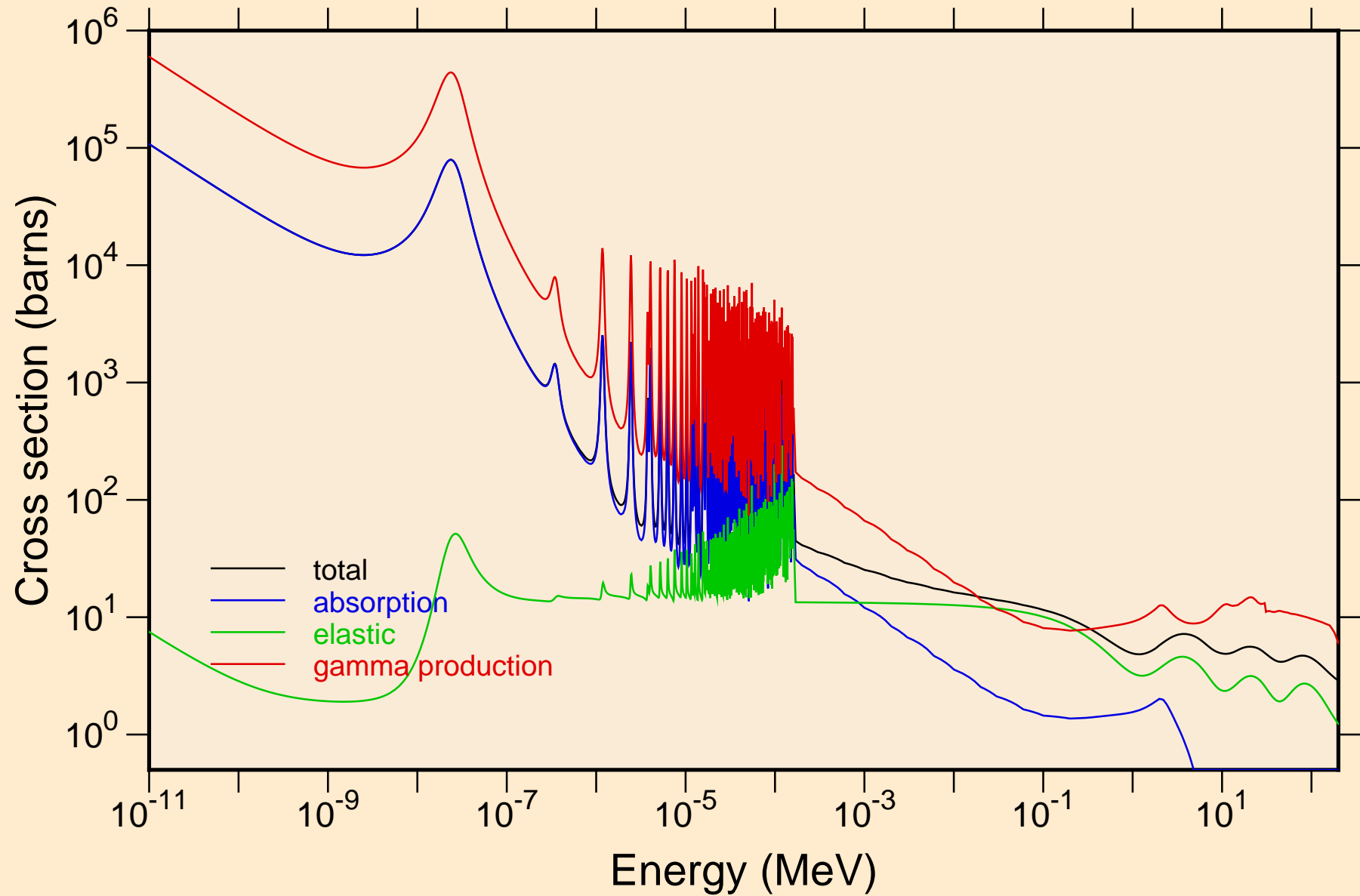

BI195M NRG TENDL-2015, AKONING
resonance total cross section

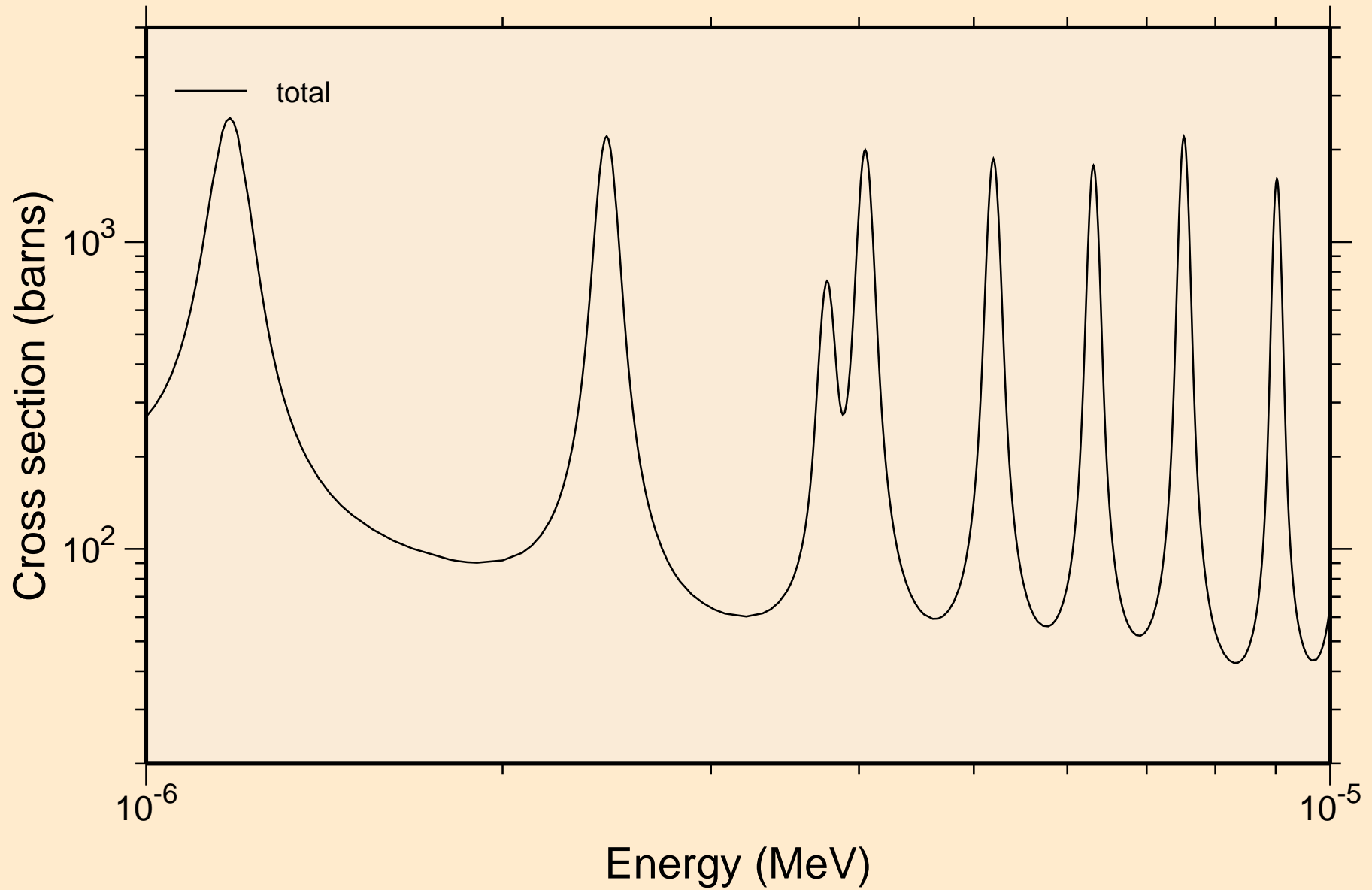

BI195M NRG TENDL-2015, AKONING
resonance total cross section

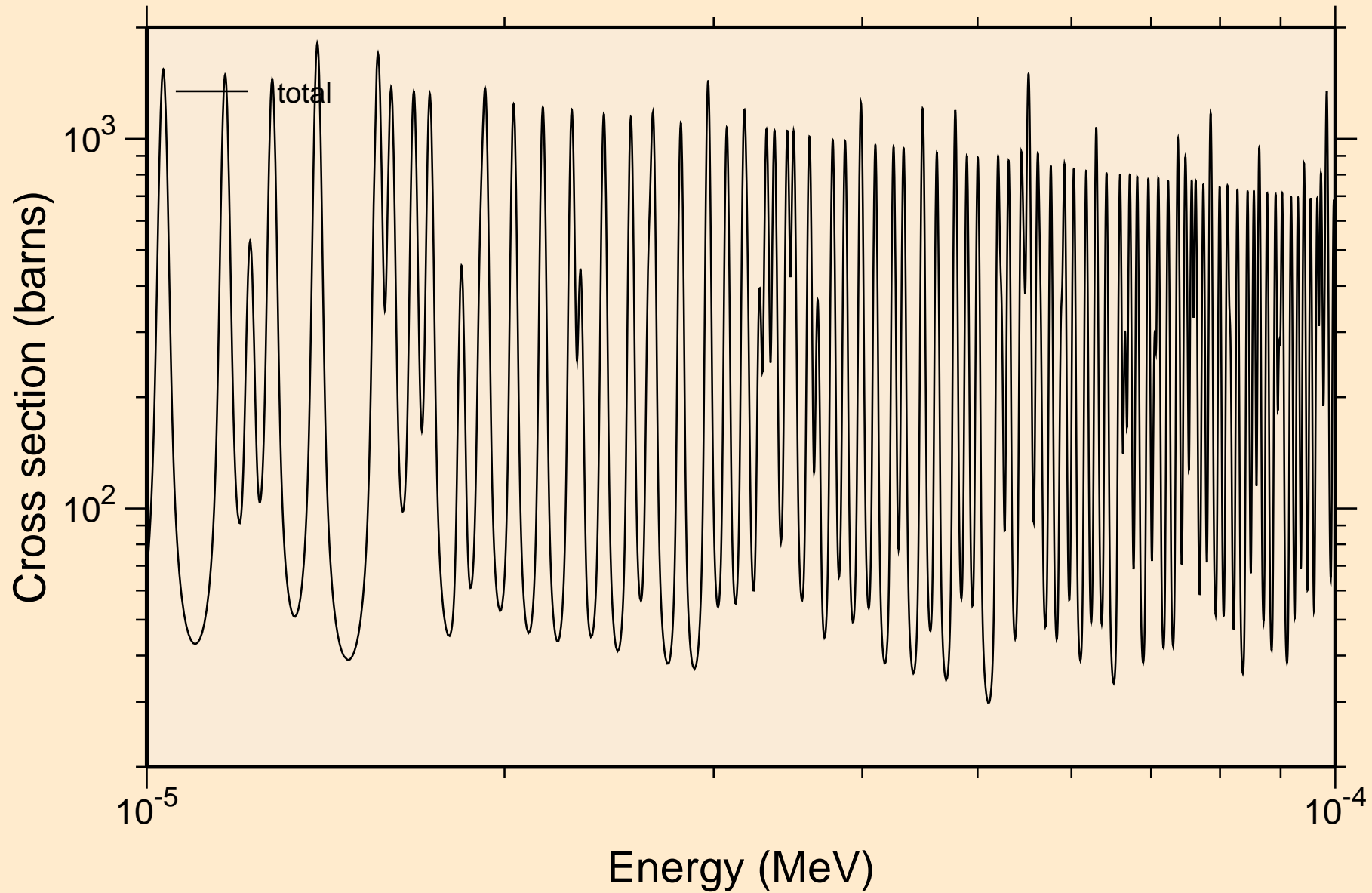

BI195M NRG TENDL-2015, AKONING
resonance total cross section

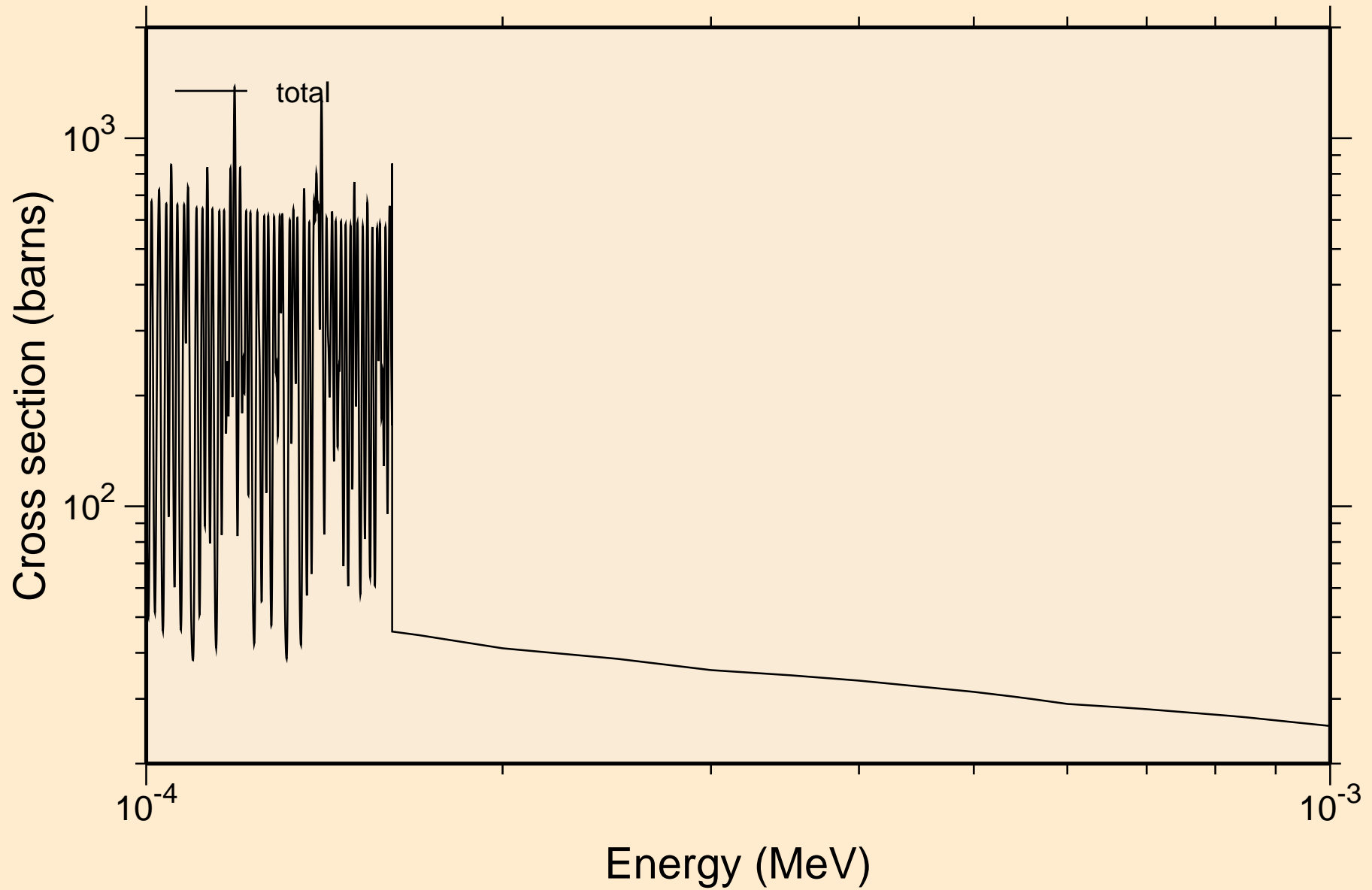

BI195M NRG TENDL-2015, AKONING
resonance total cross section

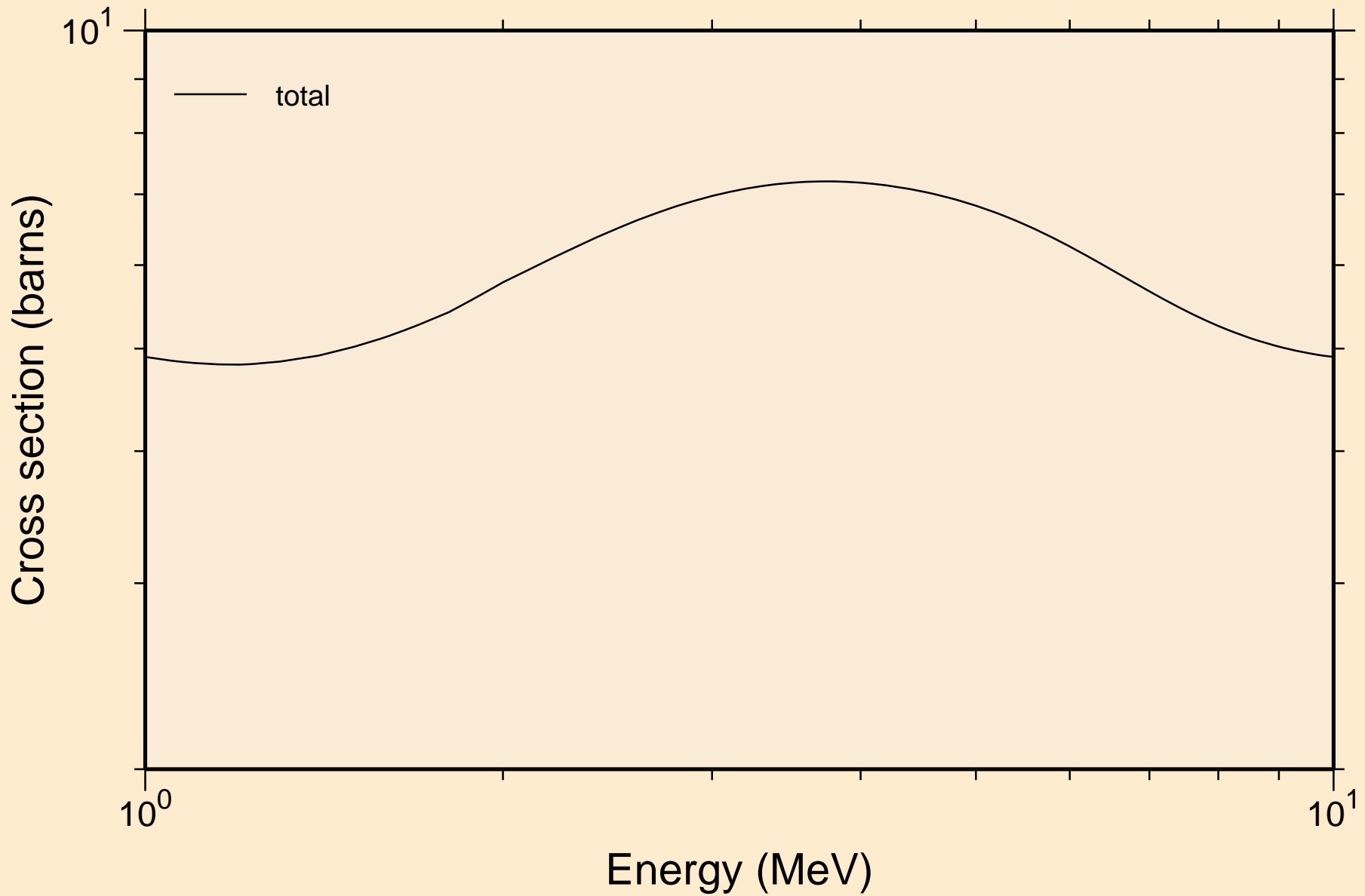

BI195M NRG TENDL-2015, AKONING
resonance absorption cross sections

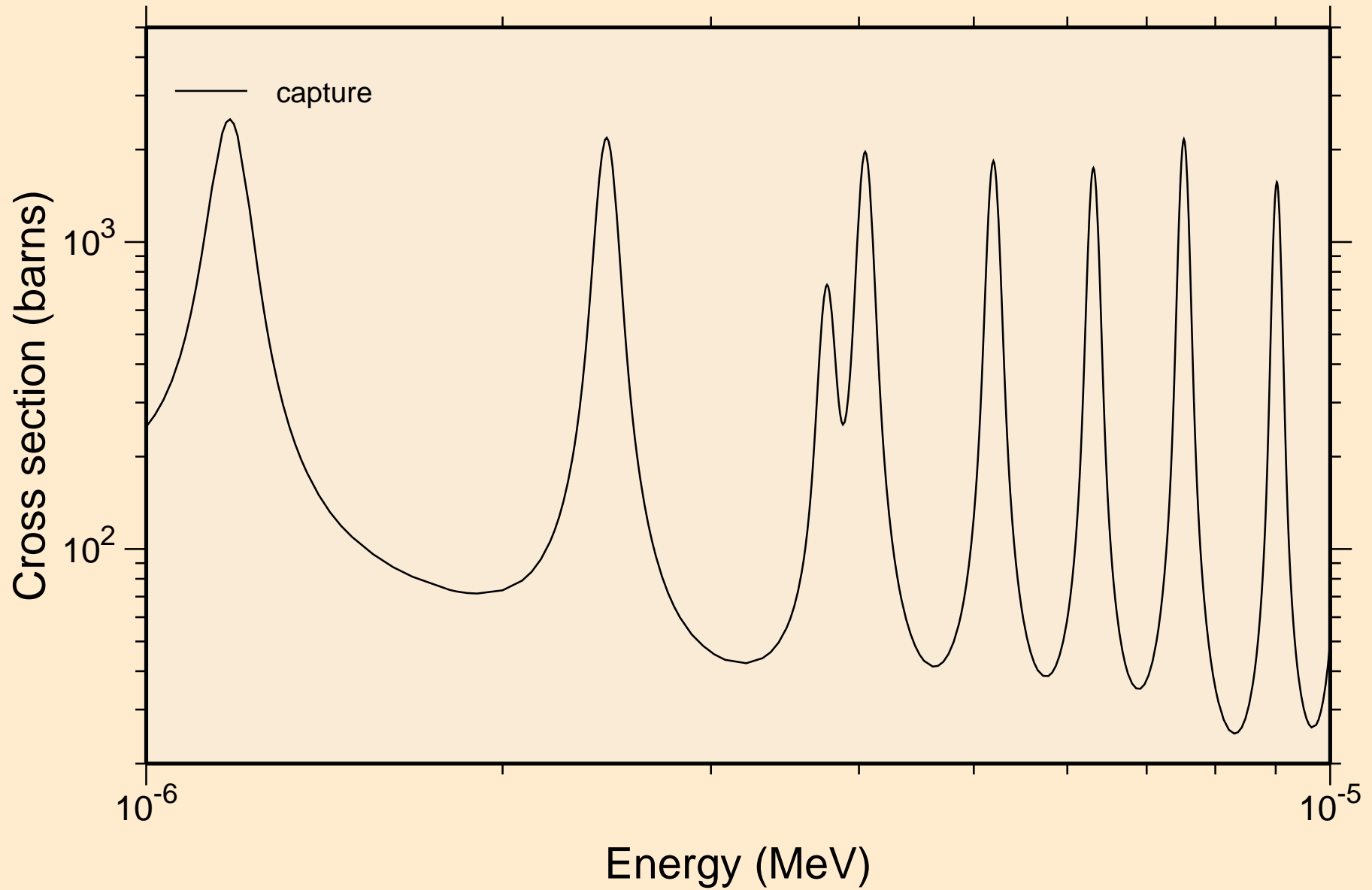

BI195M NRG TENDL-2015, AKONING
resonance absorption cross sections

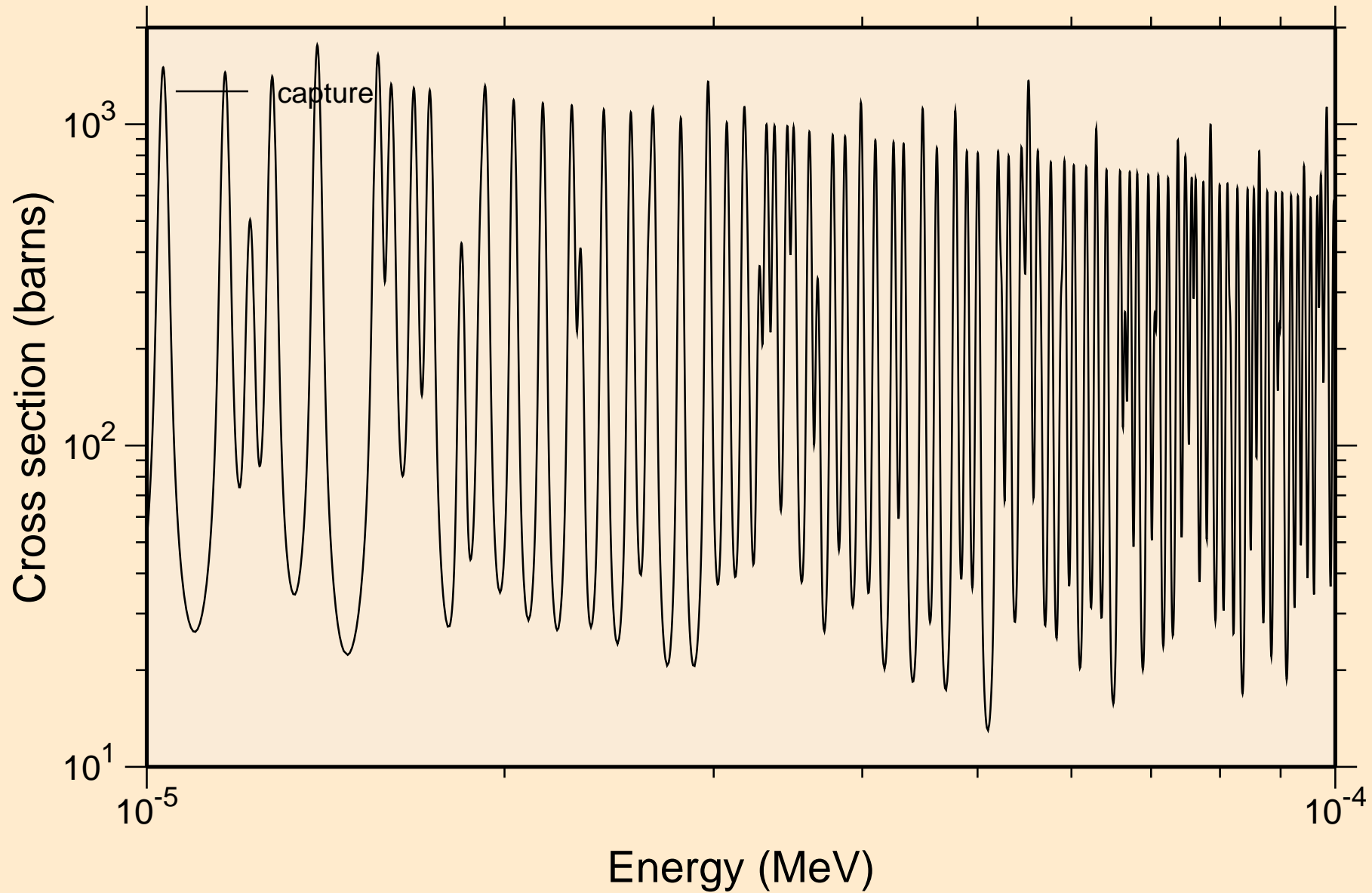

BI195M NRG TENDL-2015, AKONING
resonance absorption cross sections

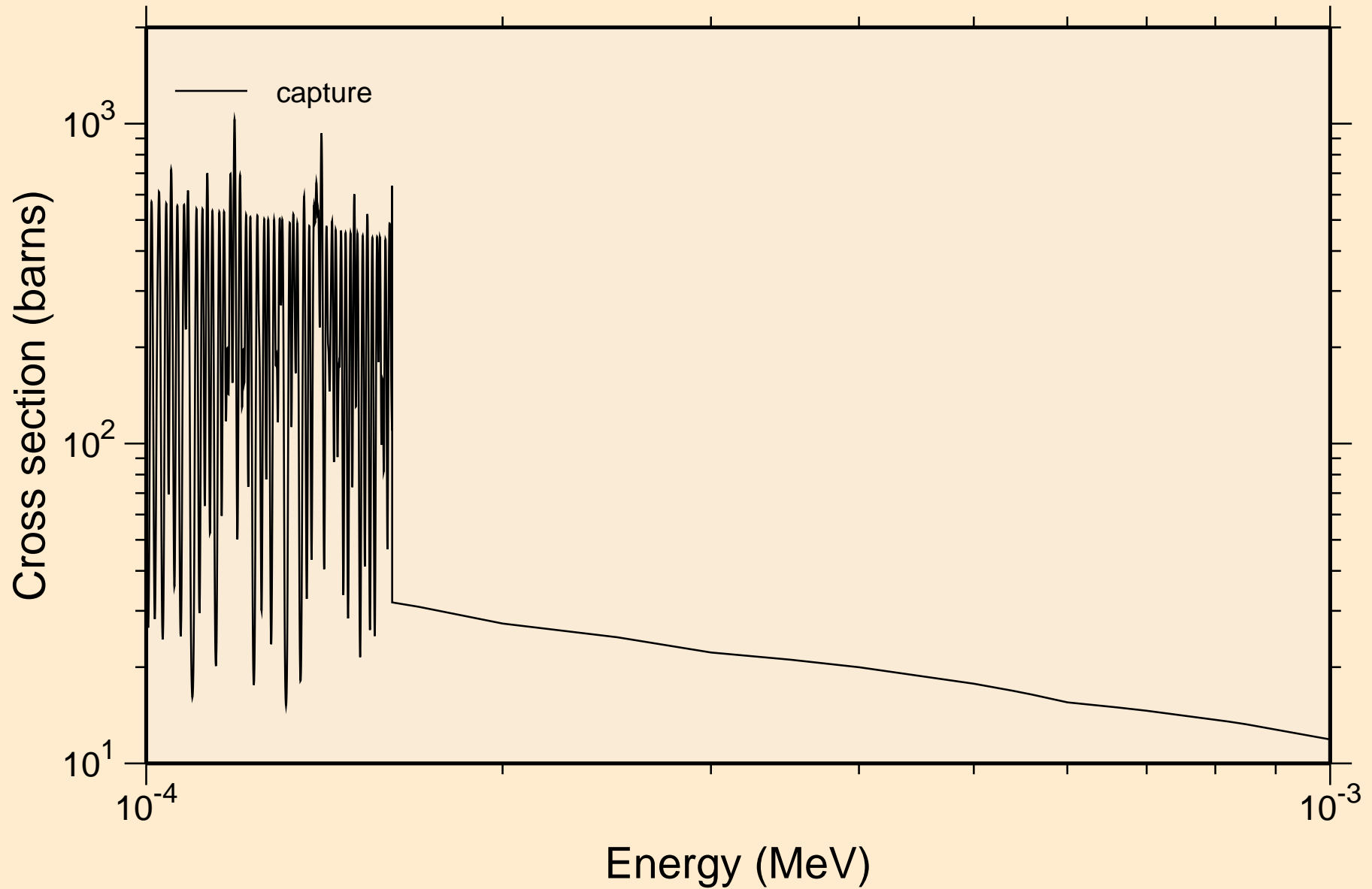

BI195M NRG TENDL-2015, AKONING
resonance absorption cross sections

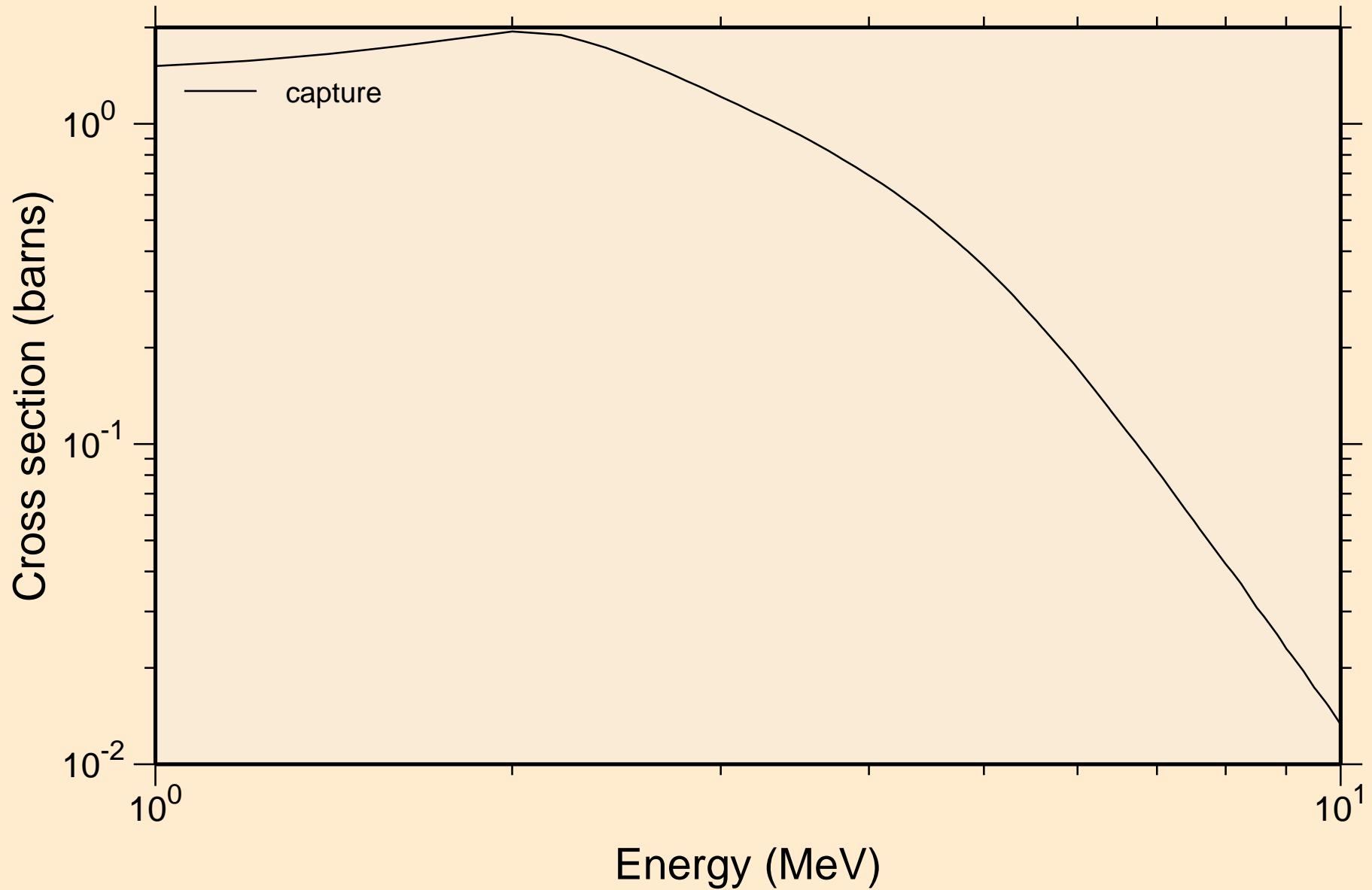

BI195M NRG TENDL-2015, AKONING

Non-threshold reactions

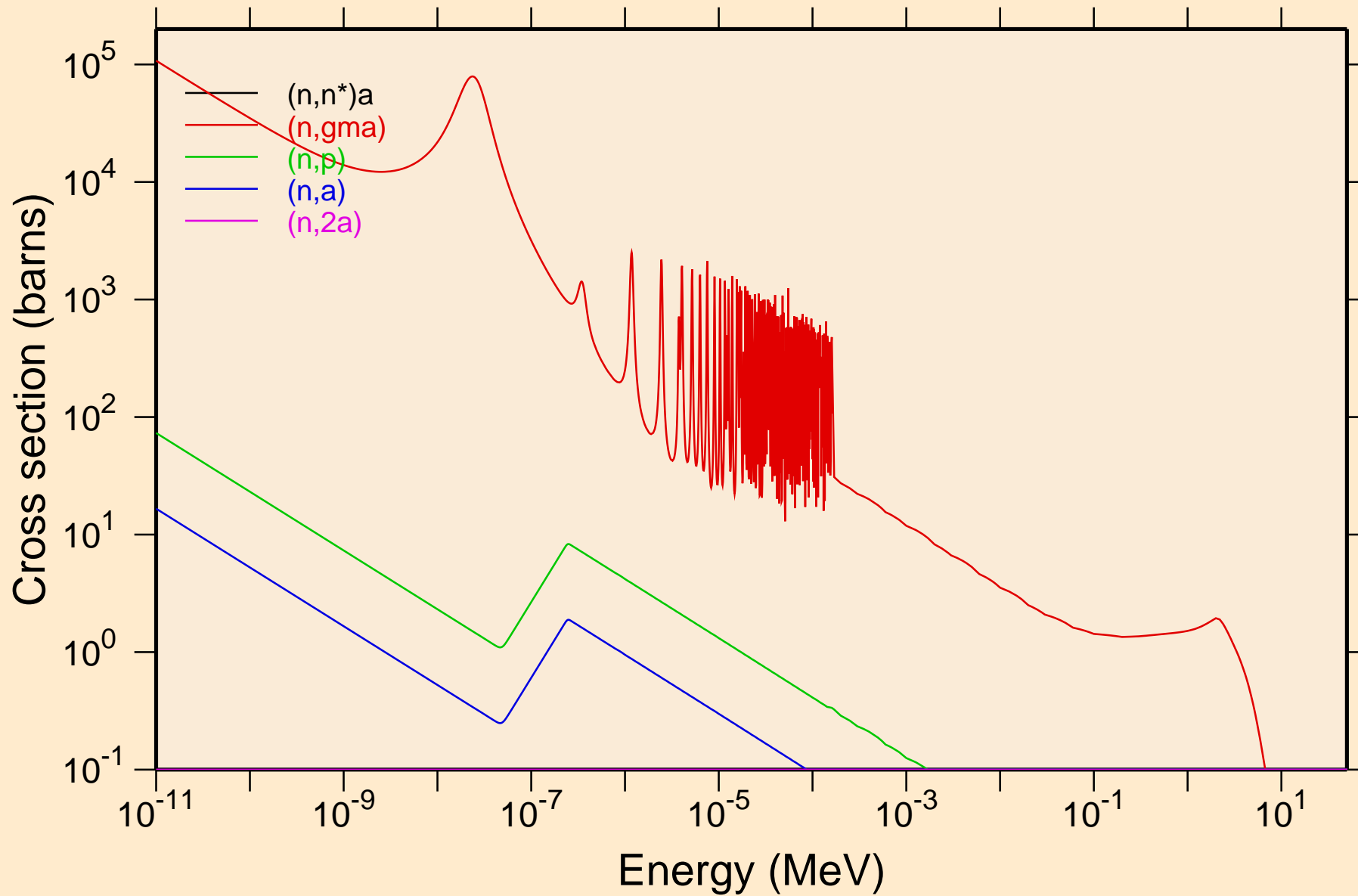

BI195M NRG TENDL-2015, AKONING
Non-threshold reactions

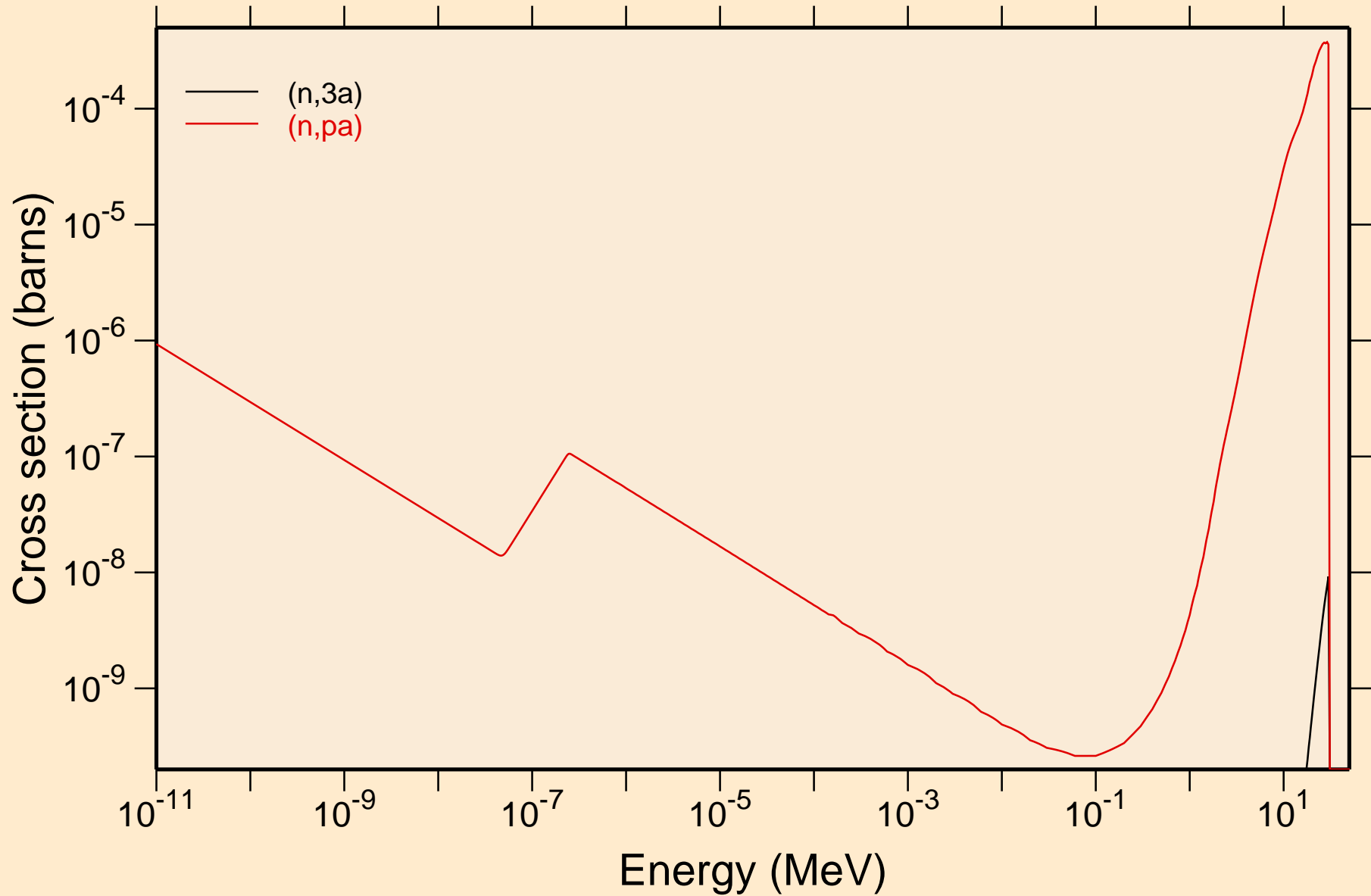

BI195M NRG TENDL-2015, AKONING

Principal cross sections

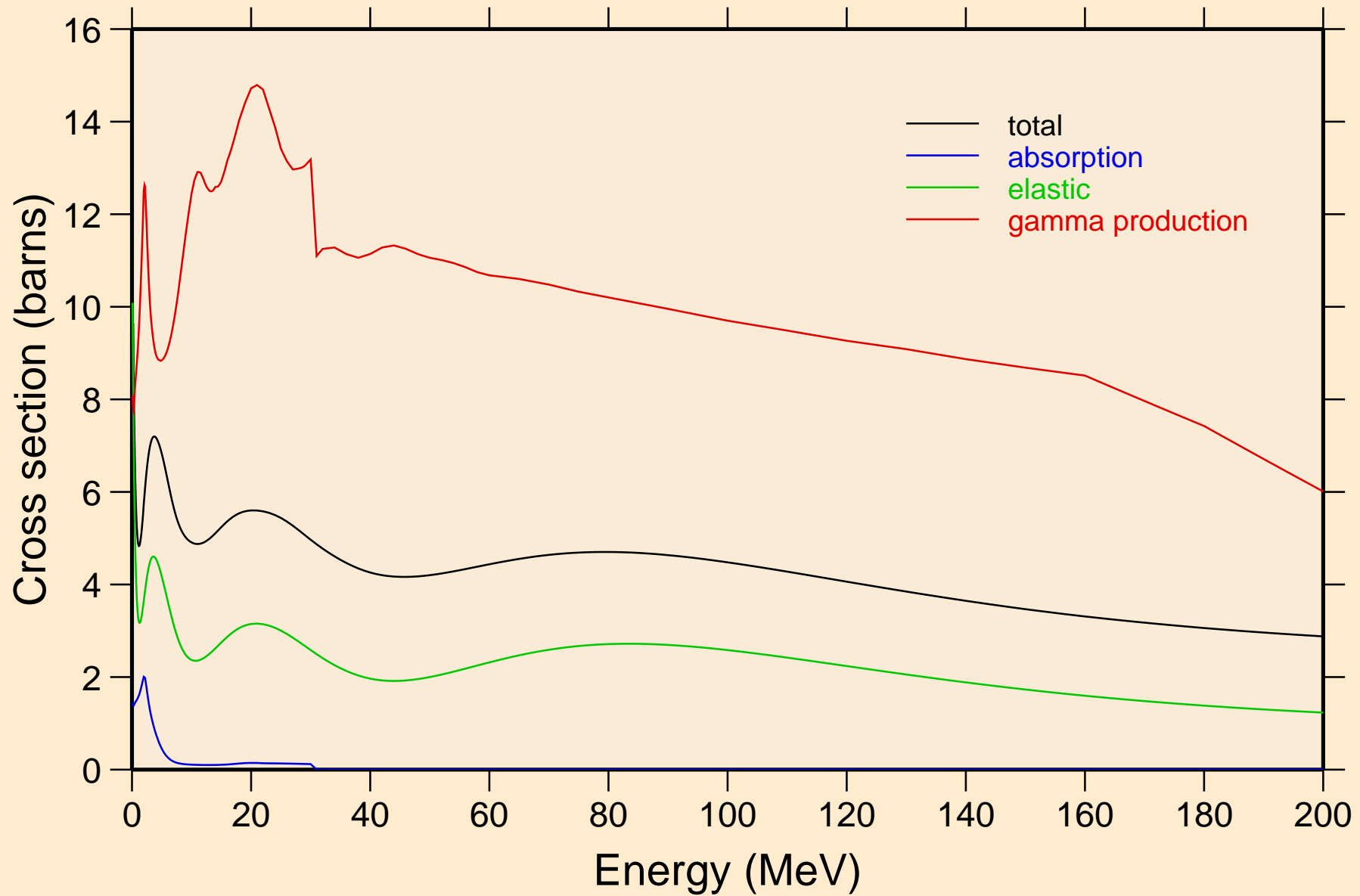

BI195M NRG TENDL-2015, AKONING
Non-threshold reactions

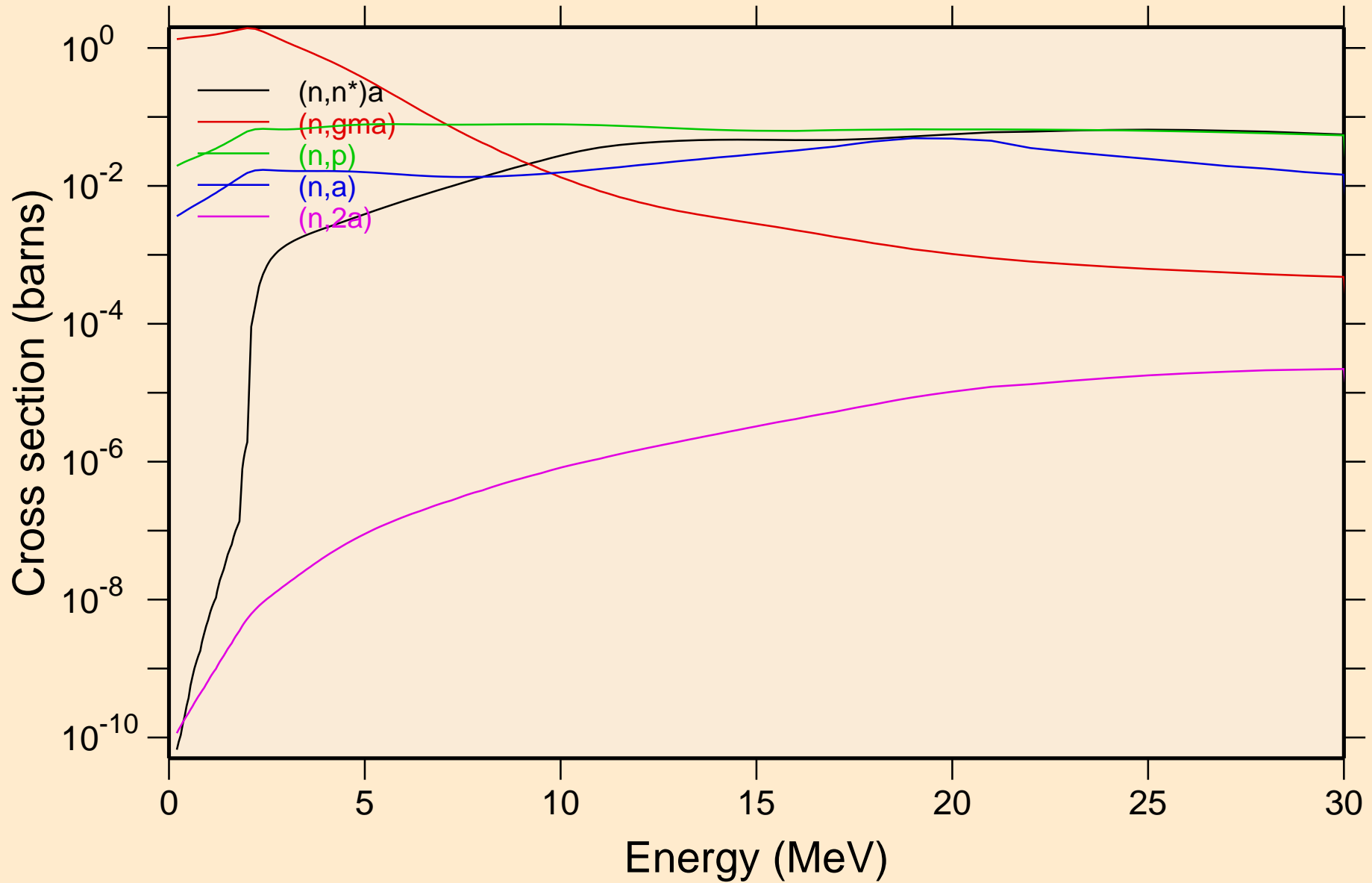

BI195M NRG TENDL-2015, AKONING

Non-threshold reactions

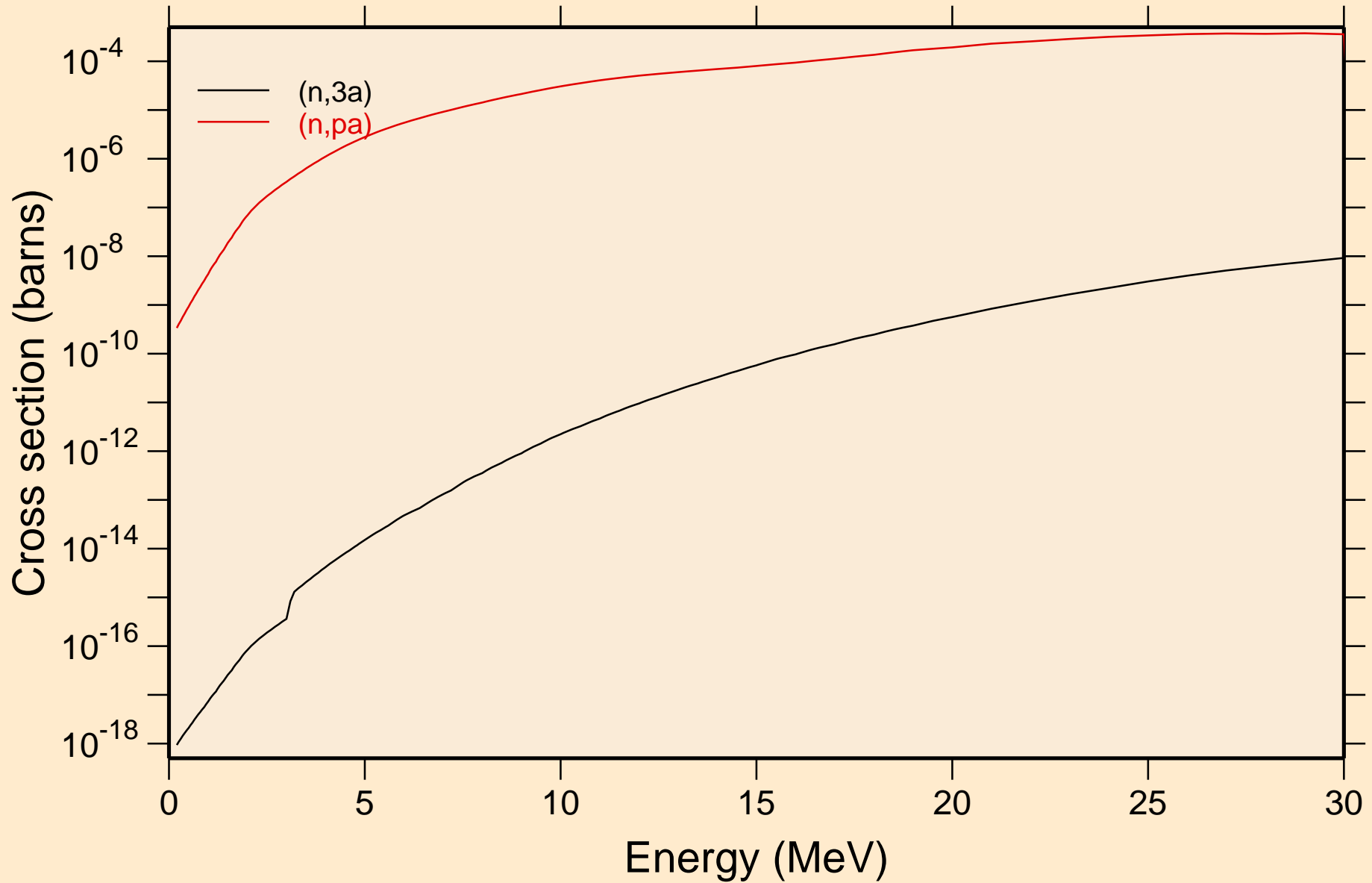

BI195M NRG TENDL-2015, AKONING

Inelastic levels

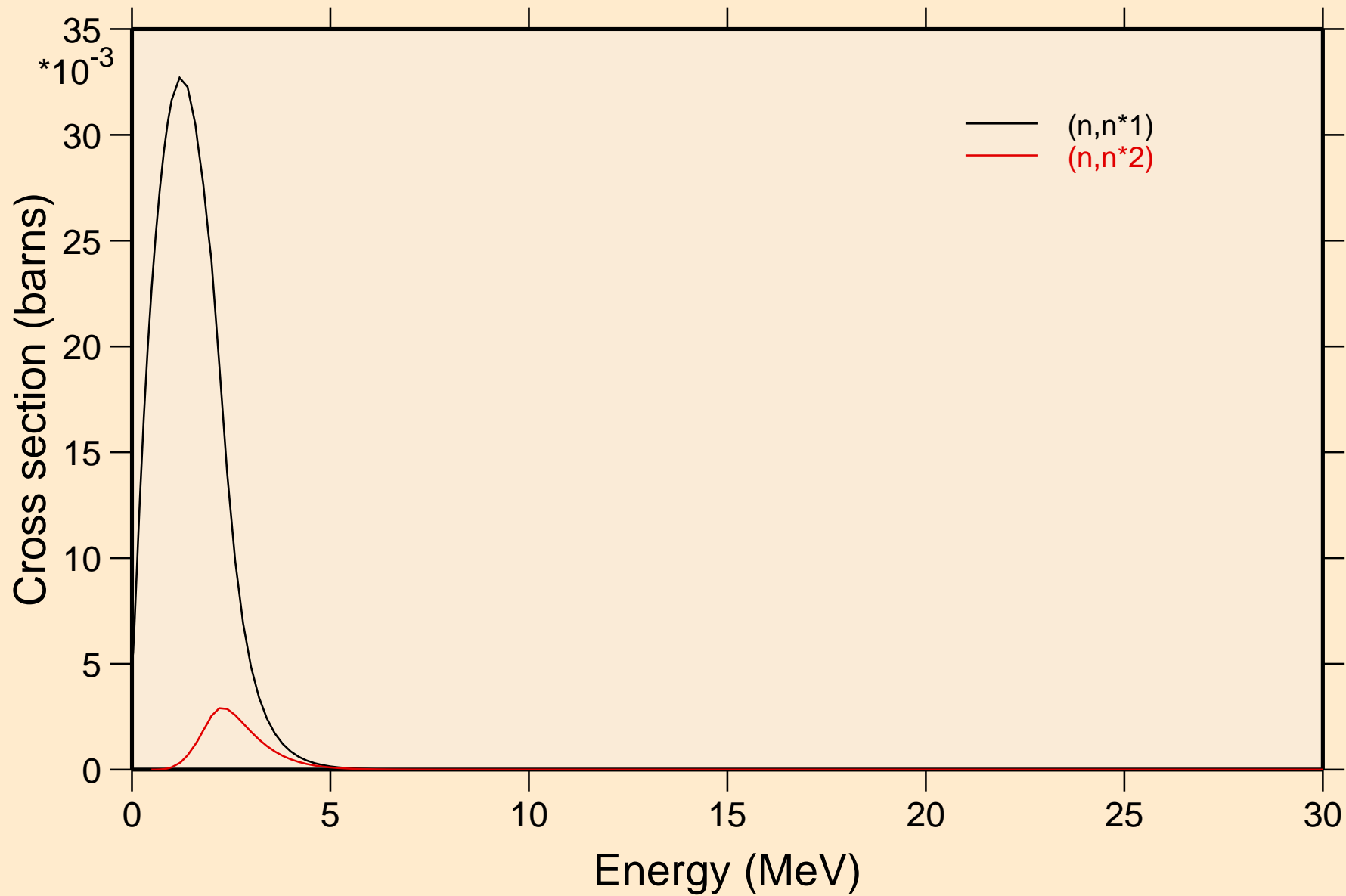

BI195M NRG TENDL-2015, AKONING

Threshold reactions

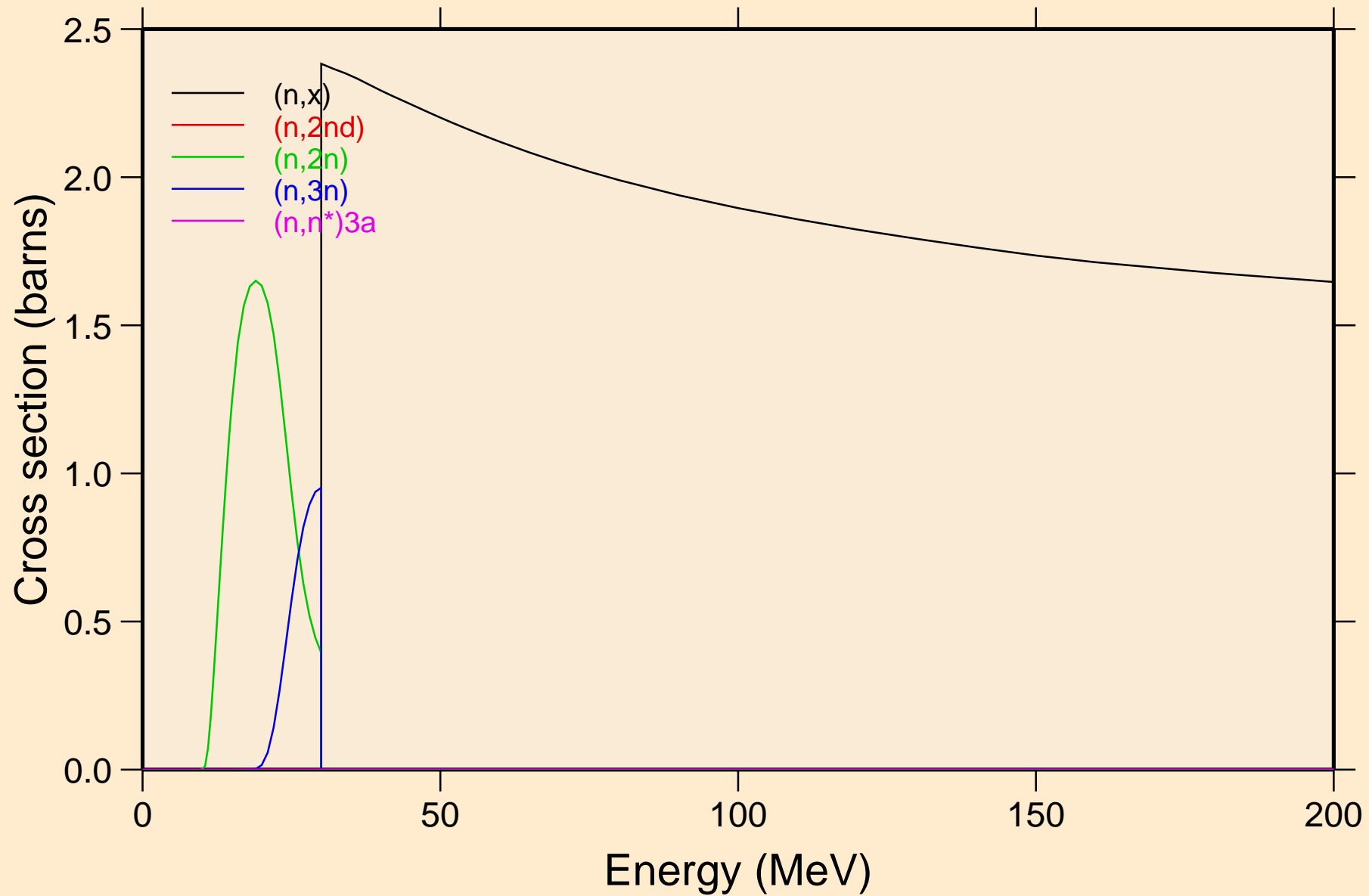

BI195M NRG TENDL-2015, AKONING

Threshold reactions

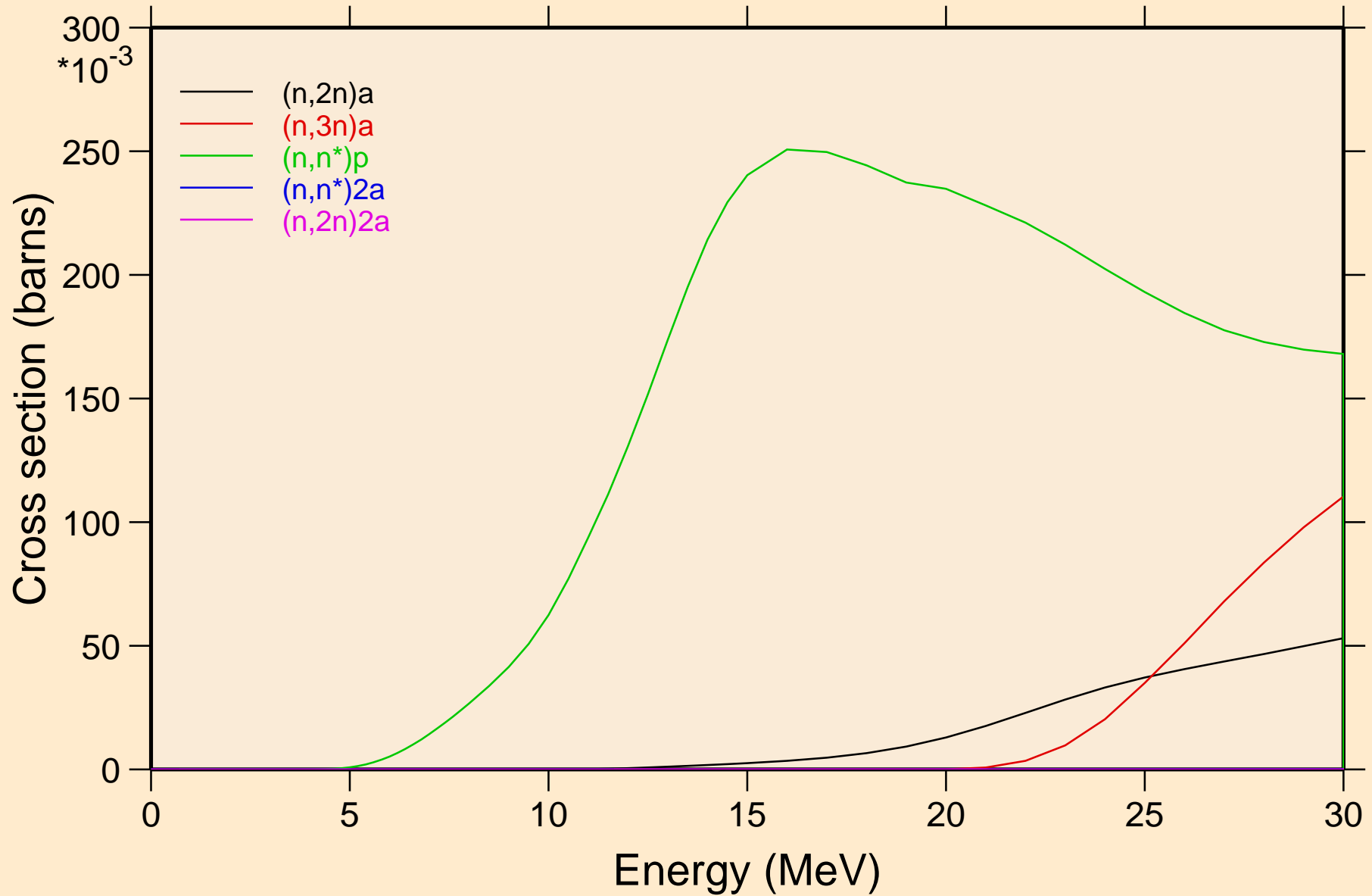

BI195M NRG TENDL-2015, AKONING

Threshold reactions

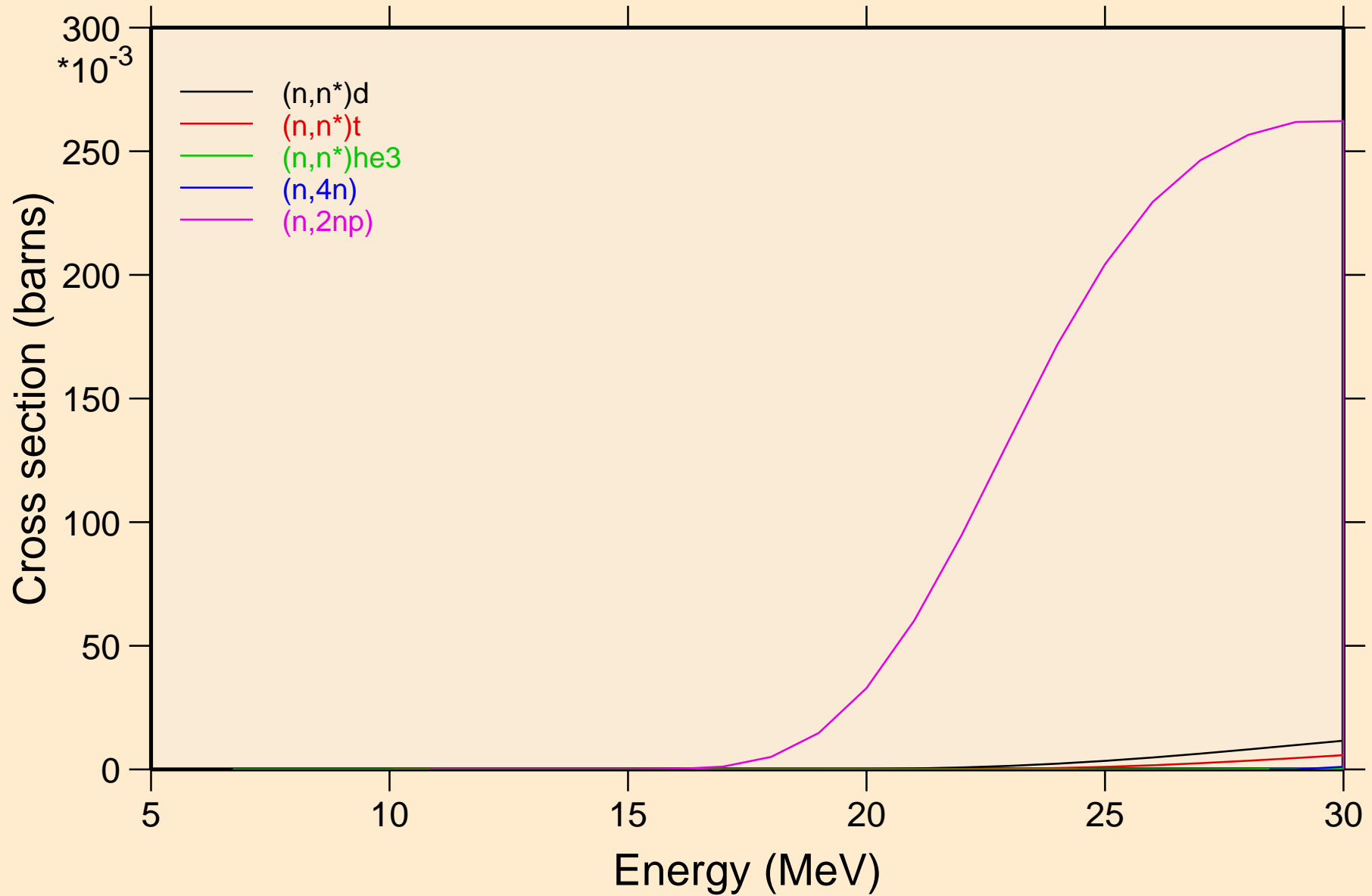

BI195M NRG TENDL-2015, AKONING

Threshold reactions

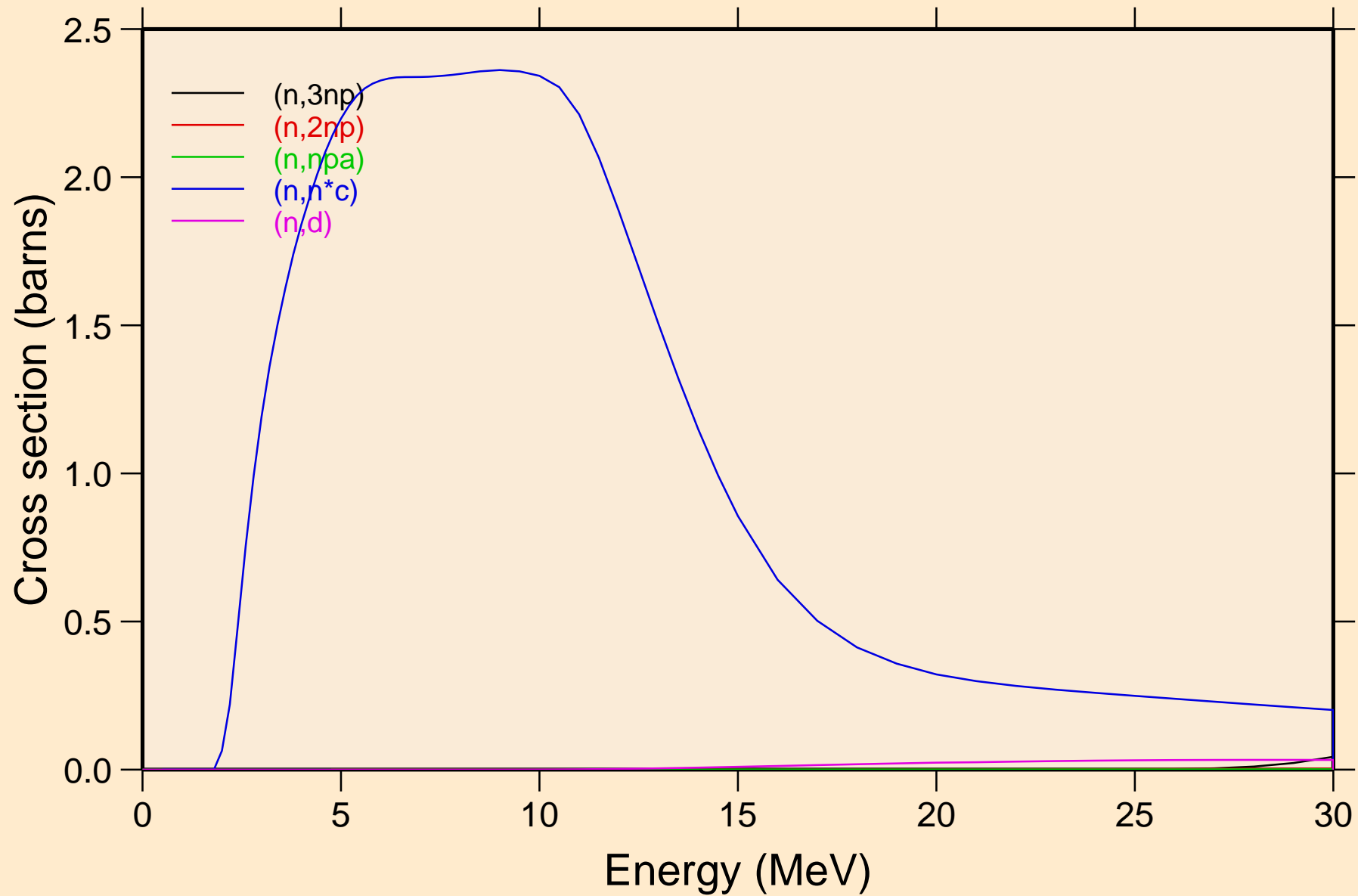

BI195M NRG TENDL-2015, AKONING

Threshold reactions

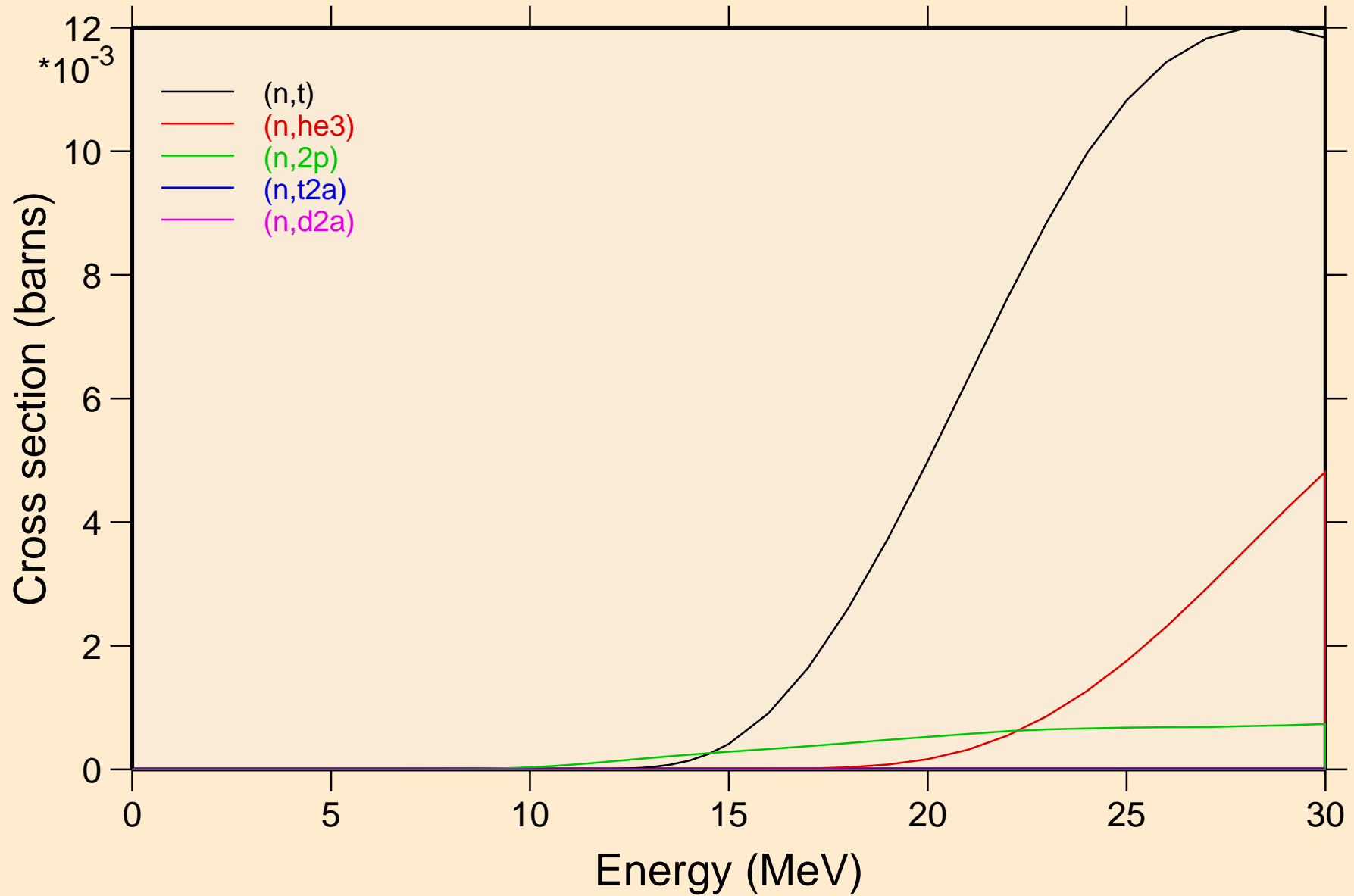

BI195M NRG TENDL-2015, AKONING

Threshold reactions

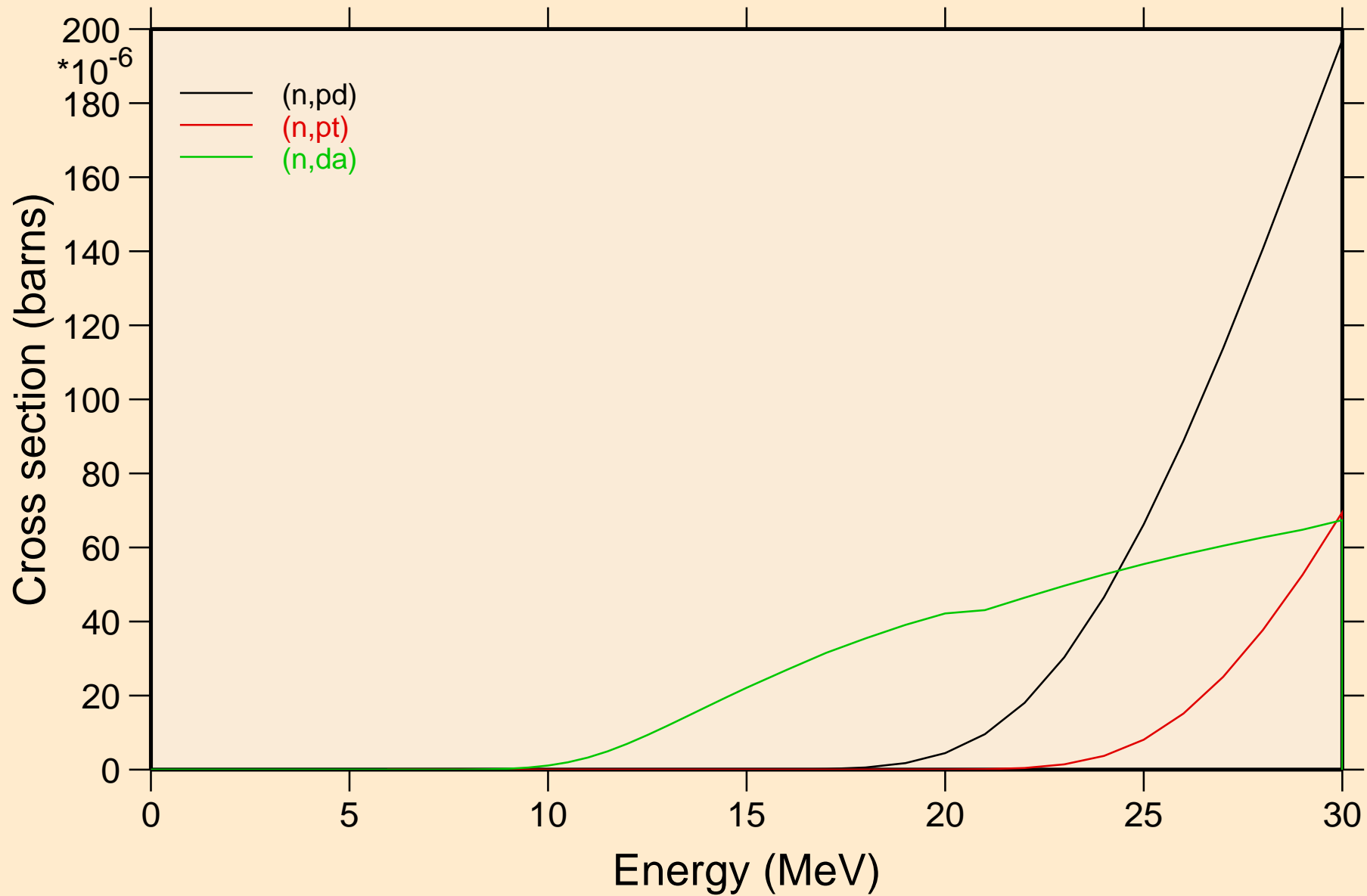

BI195M NRG TENDL-2015, AKONING
angular distribution for elastic

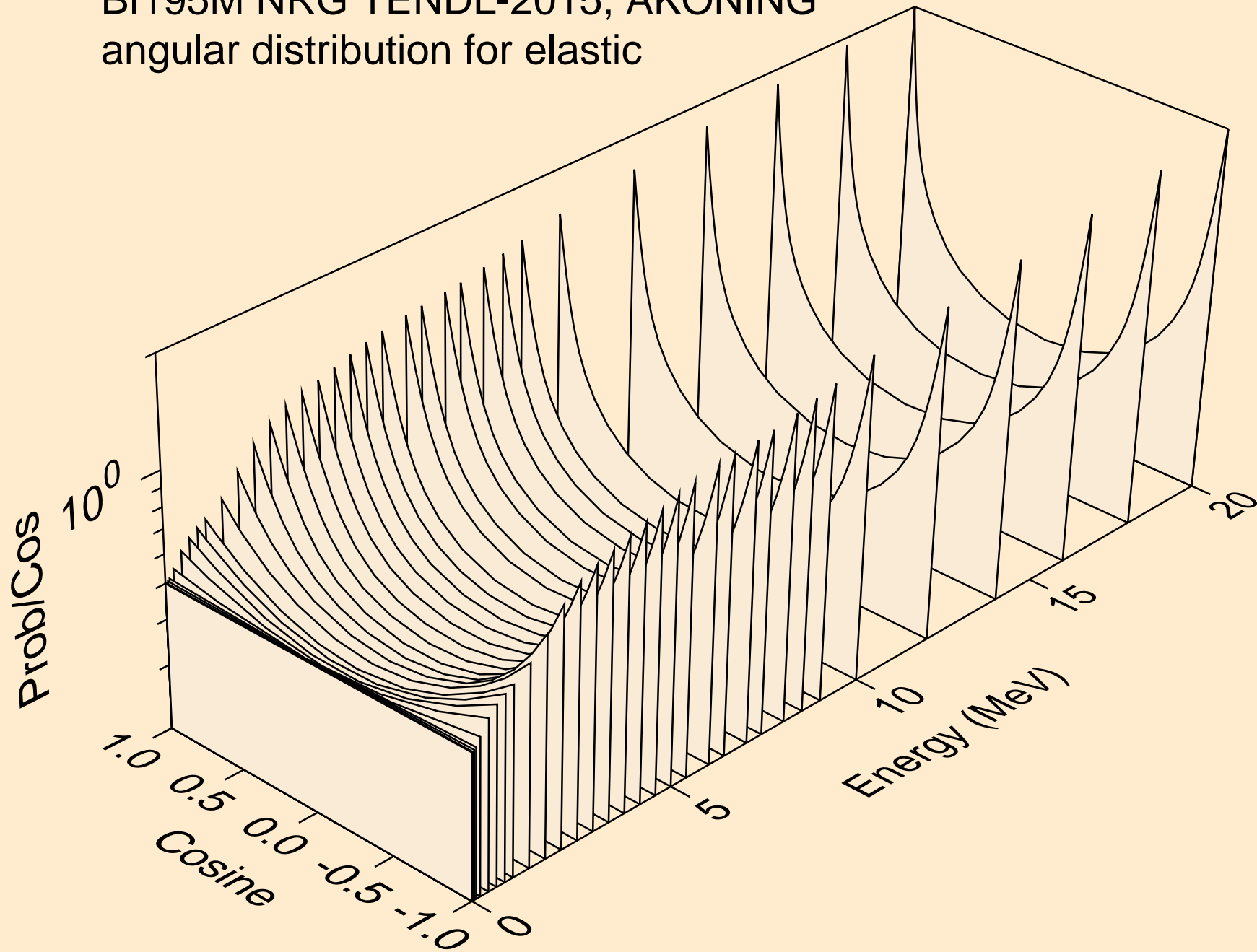

BI195M NRG TENDL-2015, AKONING
angular distribution for elastic

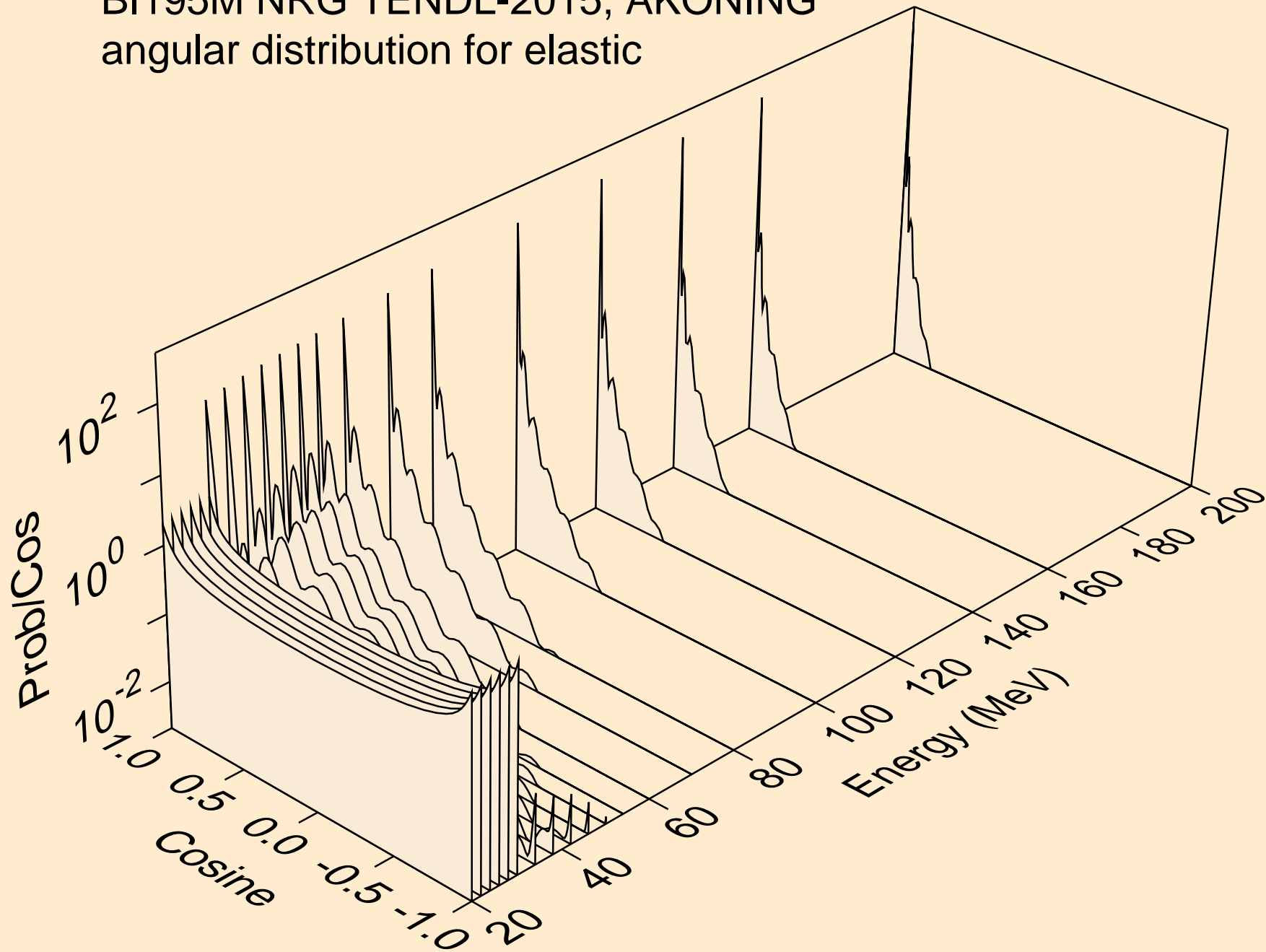

BI195M NRG TENDL-2015, AKONING
angular distribution for (n,n*1)

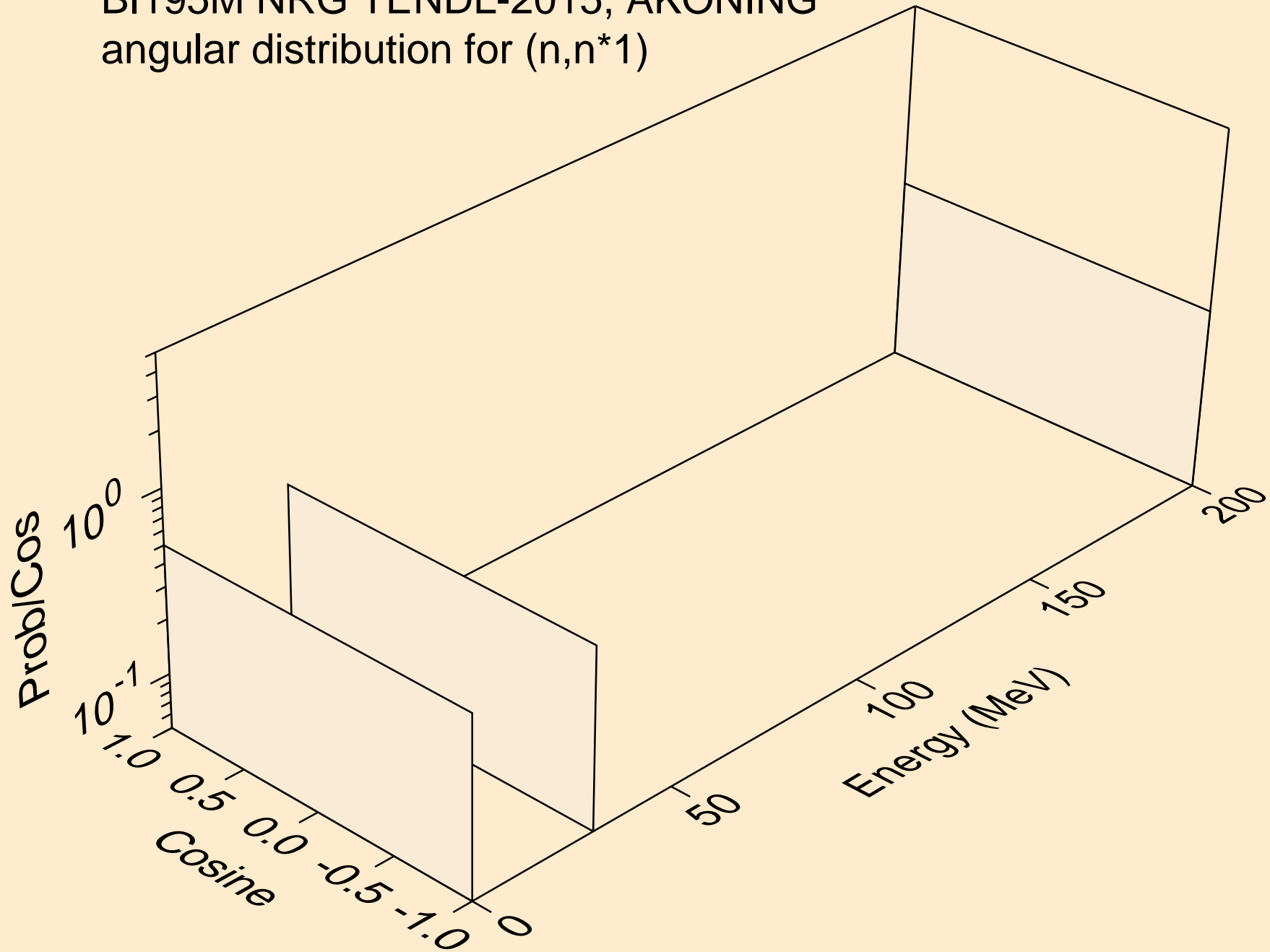

BI195M NRG TENDL-2015, AKONING
angular distribution for (n,n*2)

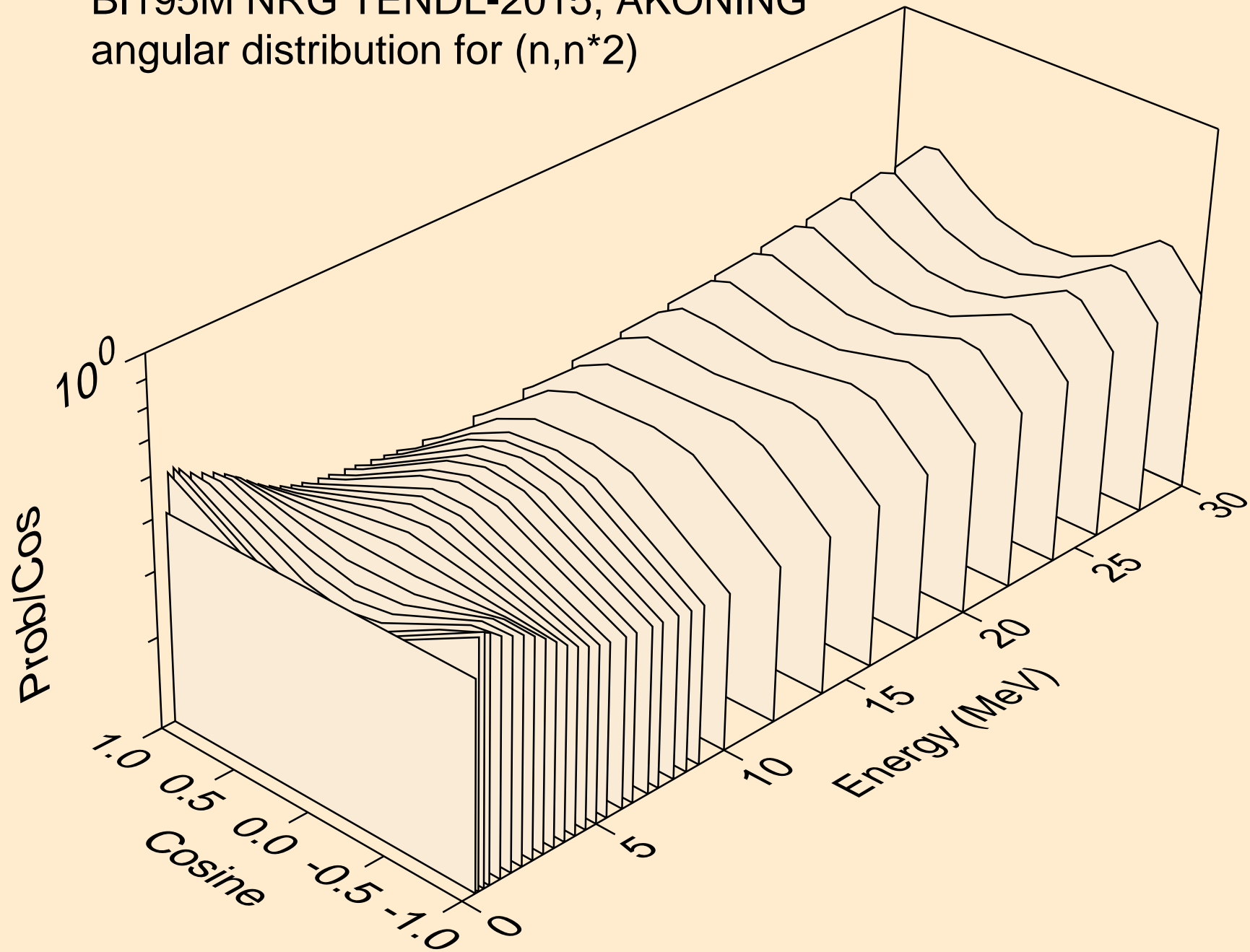

BI195M NRG TENDL-2015, AKONING
Neutron emission for (n,x)

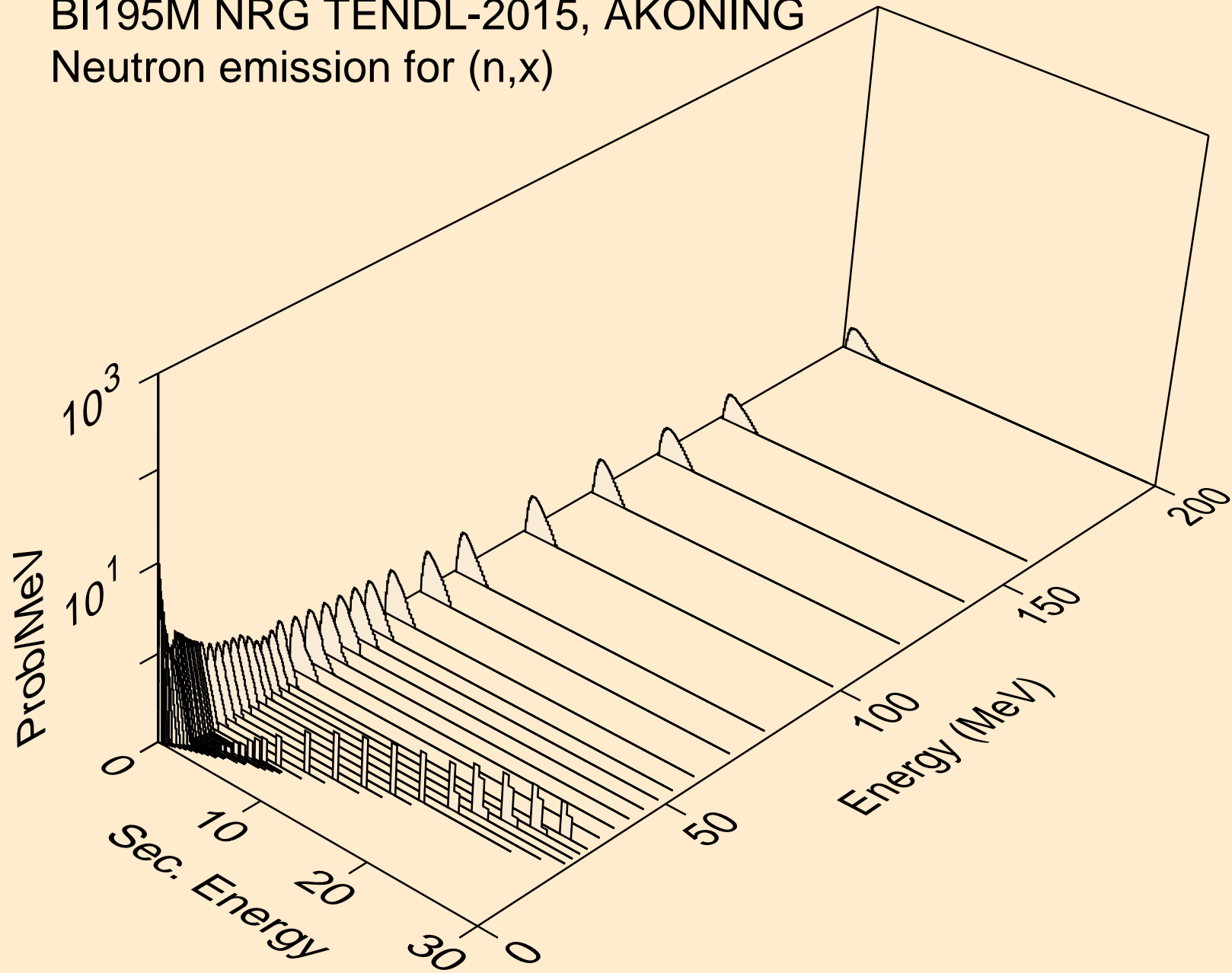

BI195M NRG TENDL-2015, AKONING
Neutron emission for (n,2nd)

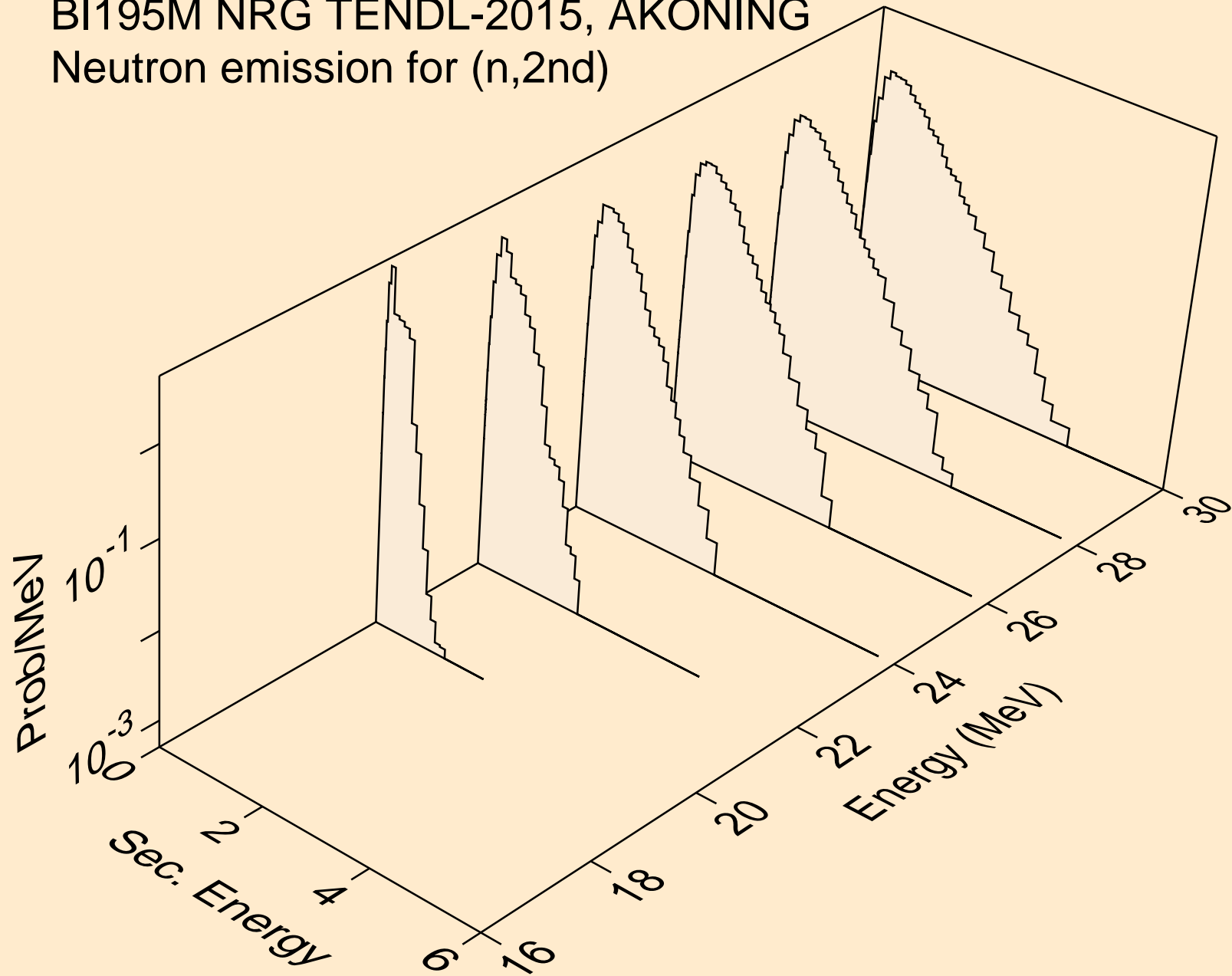

BI195M NRG TENDL-2015, AKONING
Neutron emission for (n,2n)

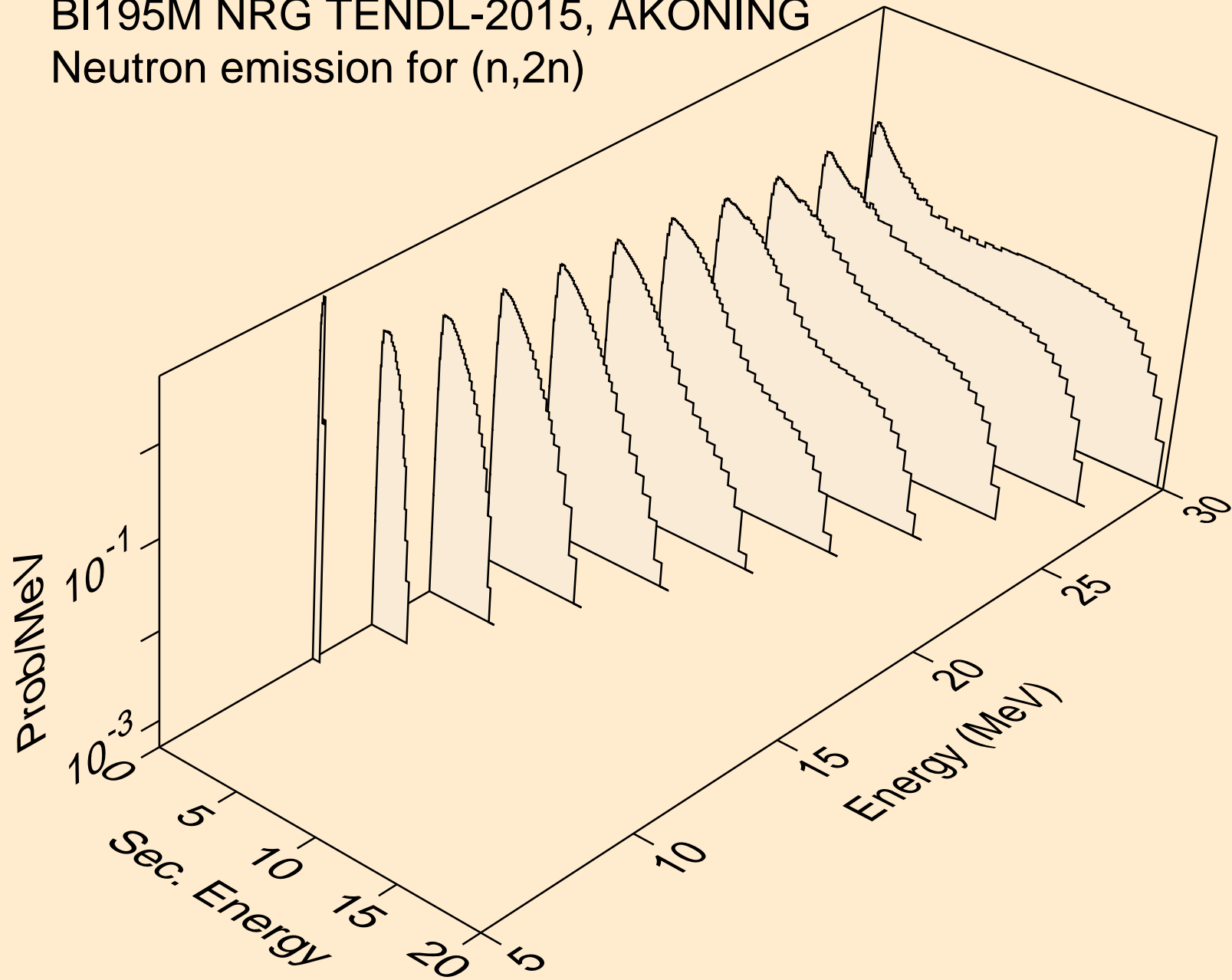

BI195M NRG TENDL-2015, AKONING
Neutron emission for (n,3n)

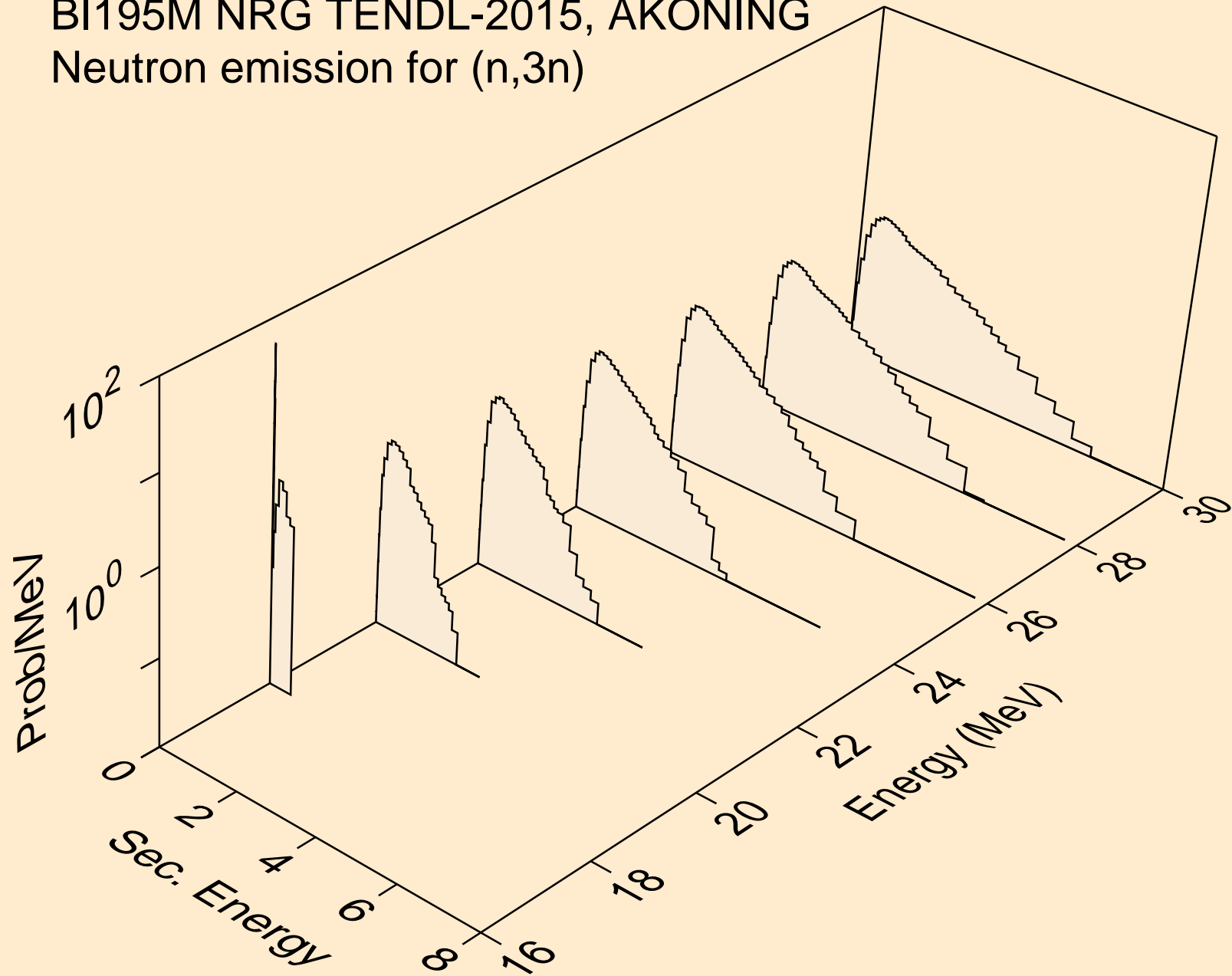

BI195M NRG TENDL-2015, AKONING
Neutron emission for (n,n*)a

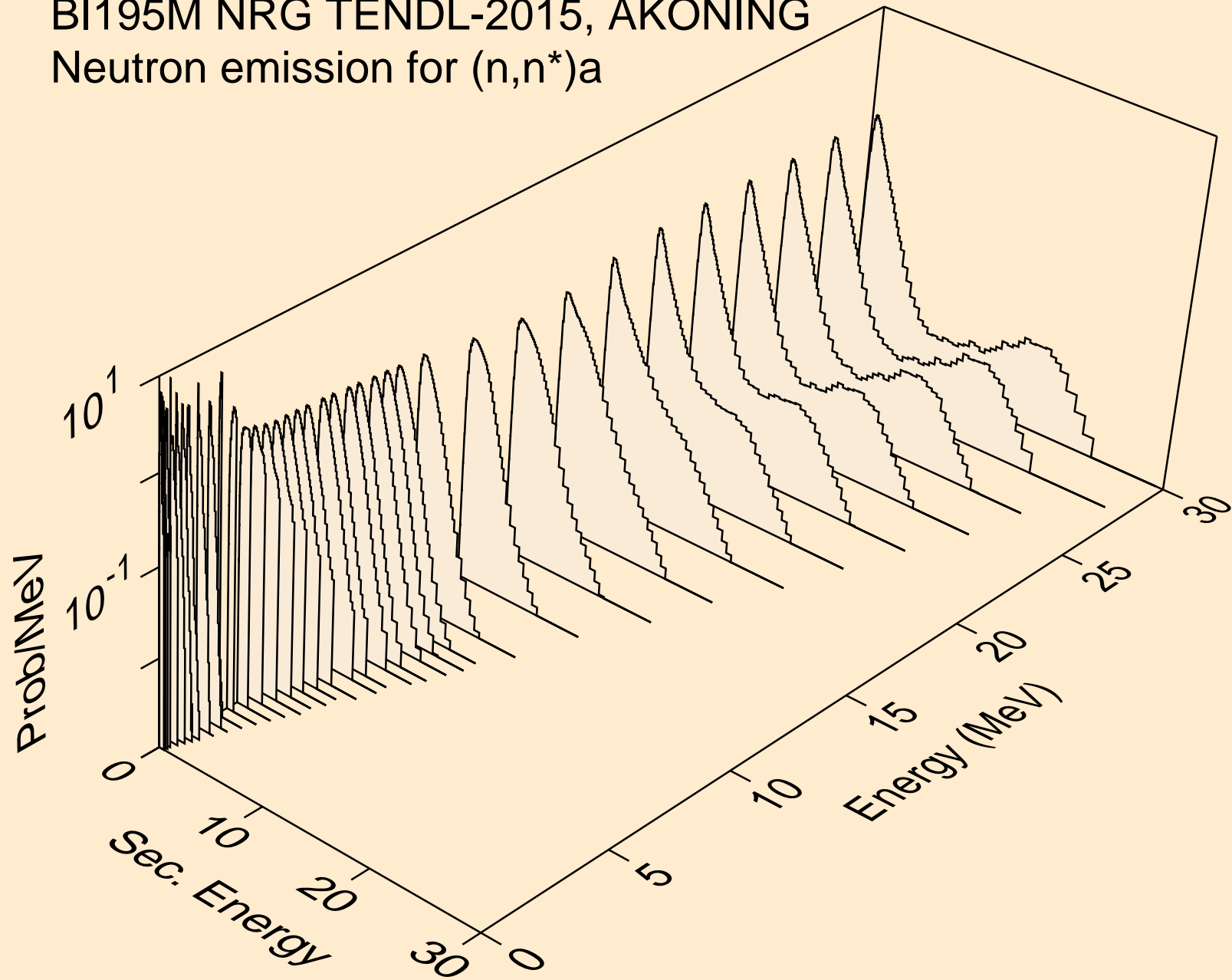

BI195M NRG TENDL-2015, AKONING
Neutron emission for (n,n*)3a

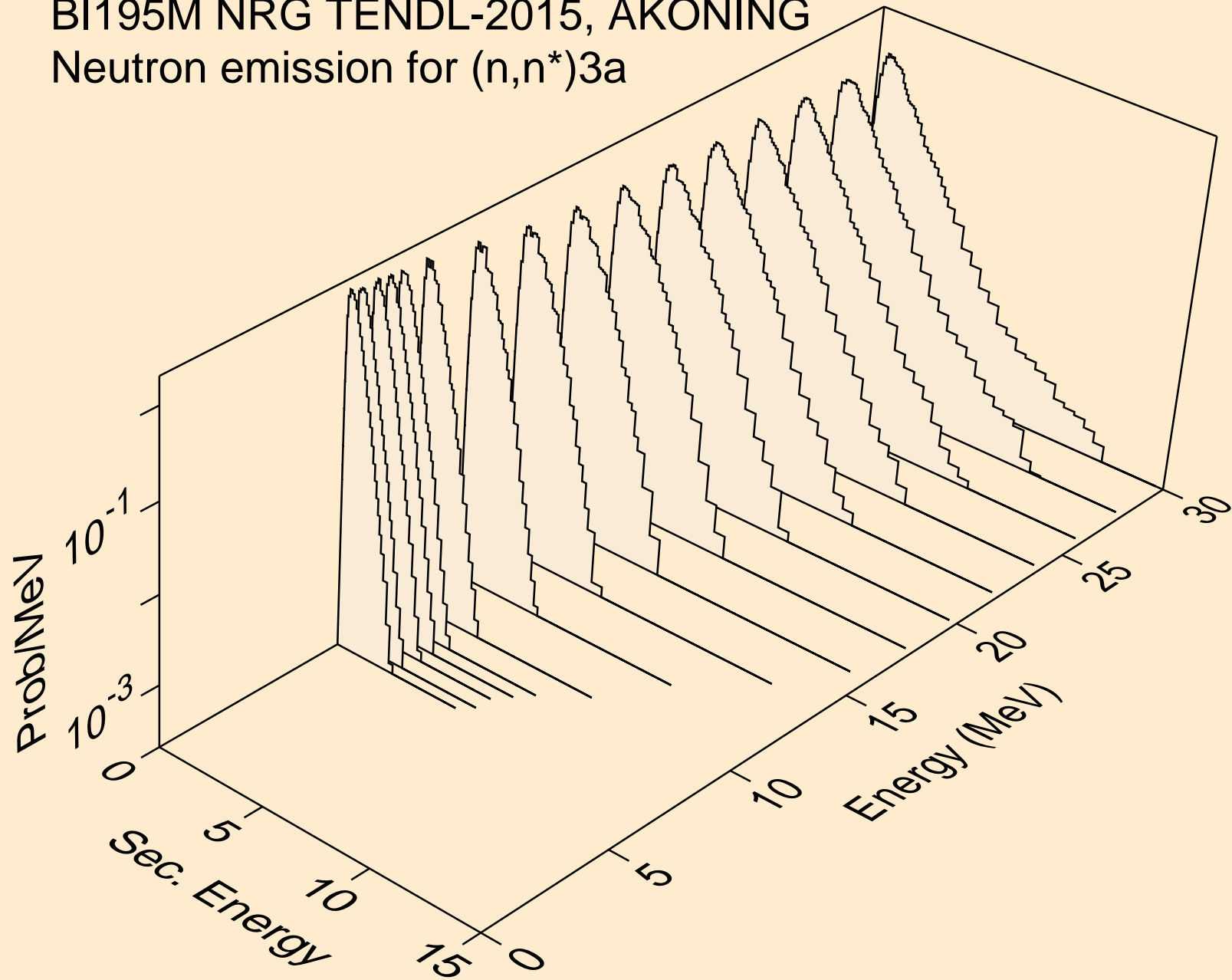

BI195M NRG TENDL-2015, AKONING
Neutron emission for (n,2n)a

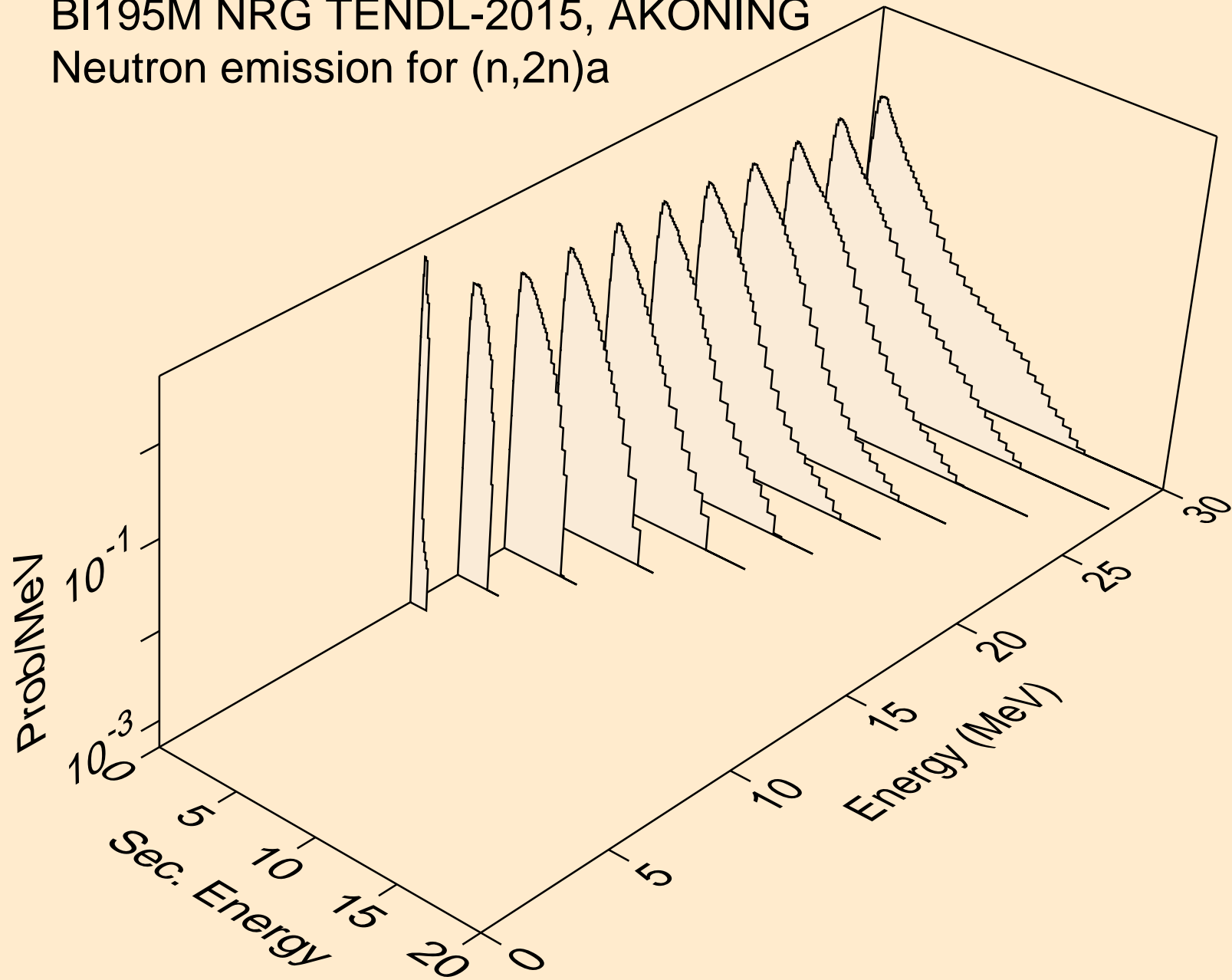

BI195M NRG TENDL-2015, AKONING
Neutron emission for (n,3n)a

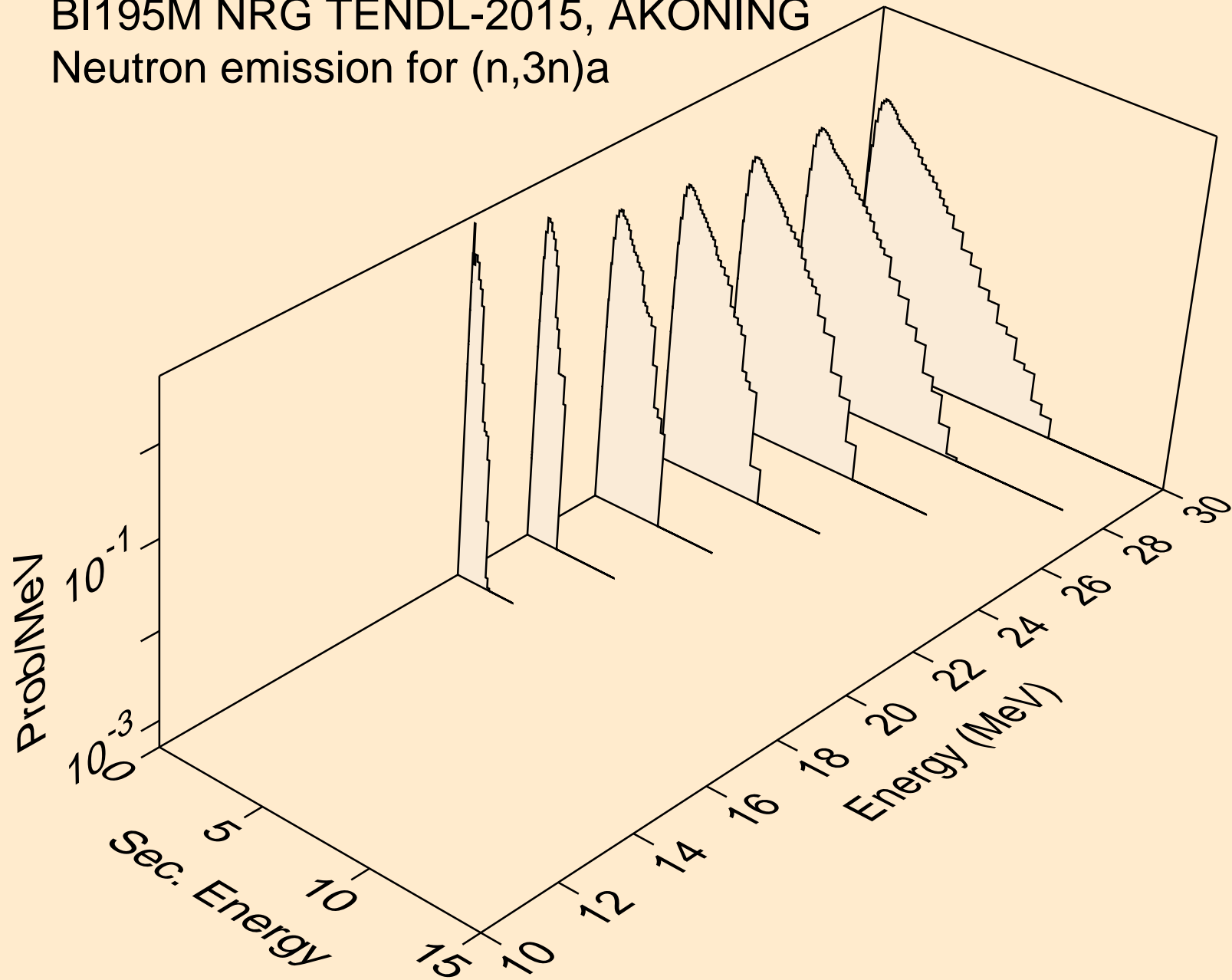

BI195M NRG TENDL-2015, AKONING
Neutron emission for (n,n*)p

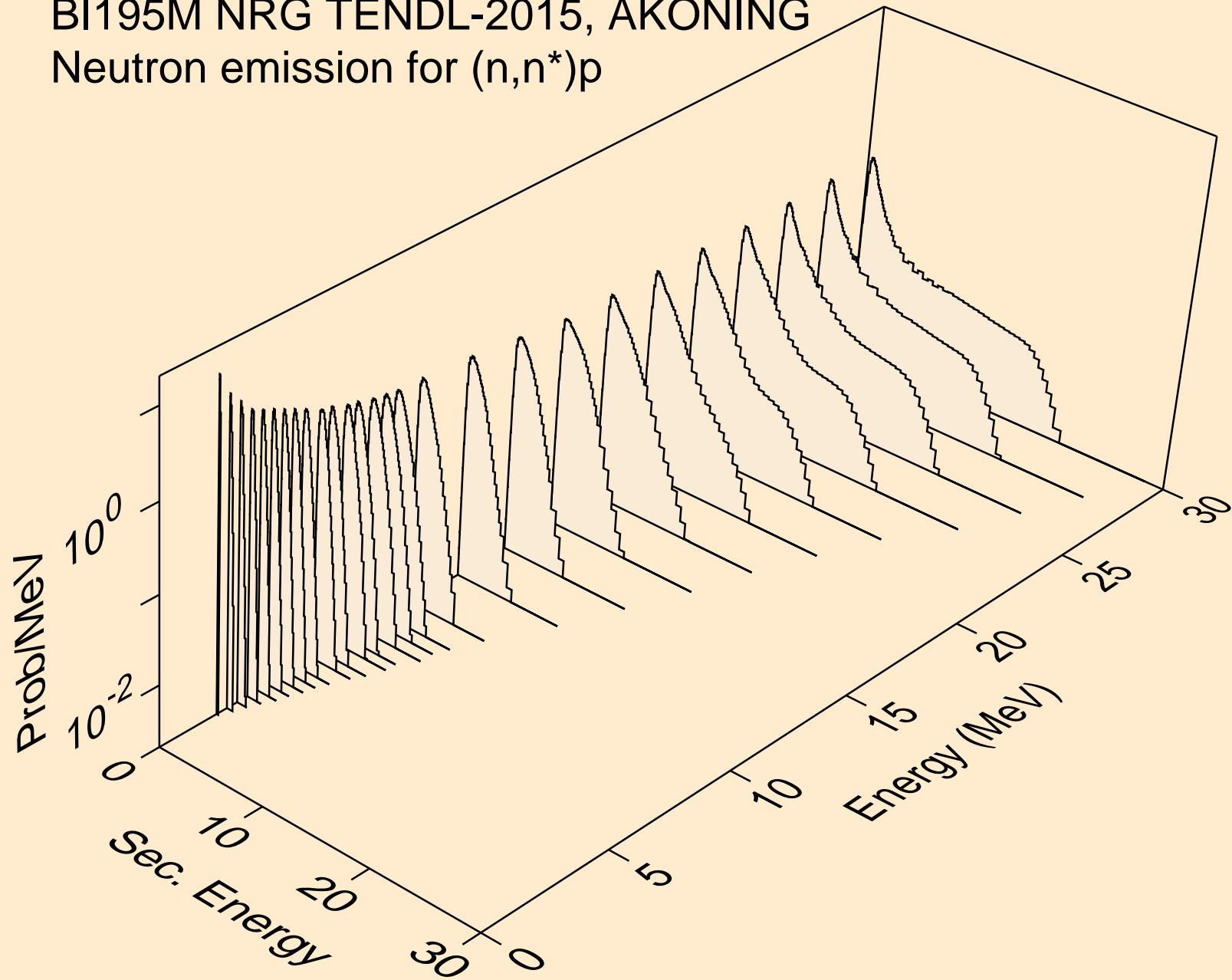

BI195M NRG TENDL-2015, AKONING
Neutron emission for (n,n*)2a

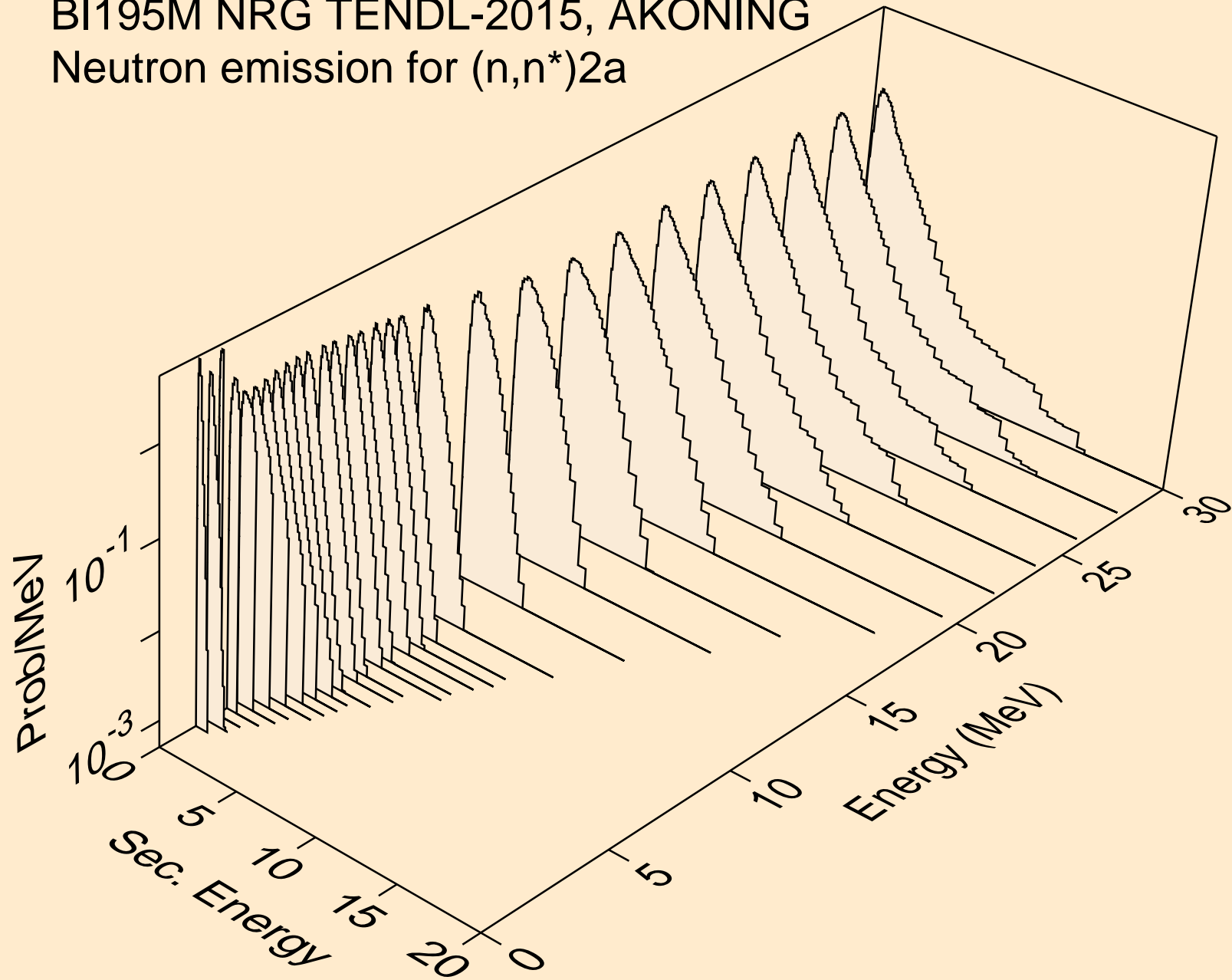

BI195M NRG TENDL-2015, AKONING
Neutron emission for (n,2n)2a

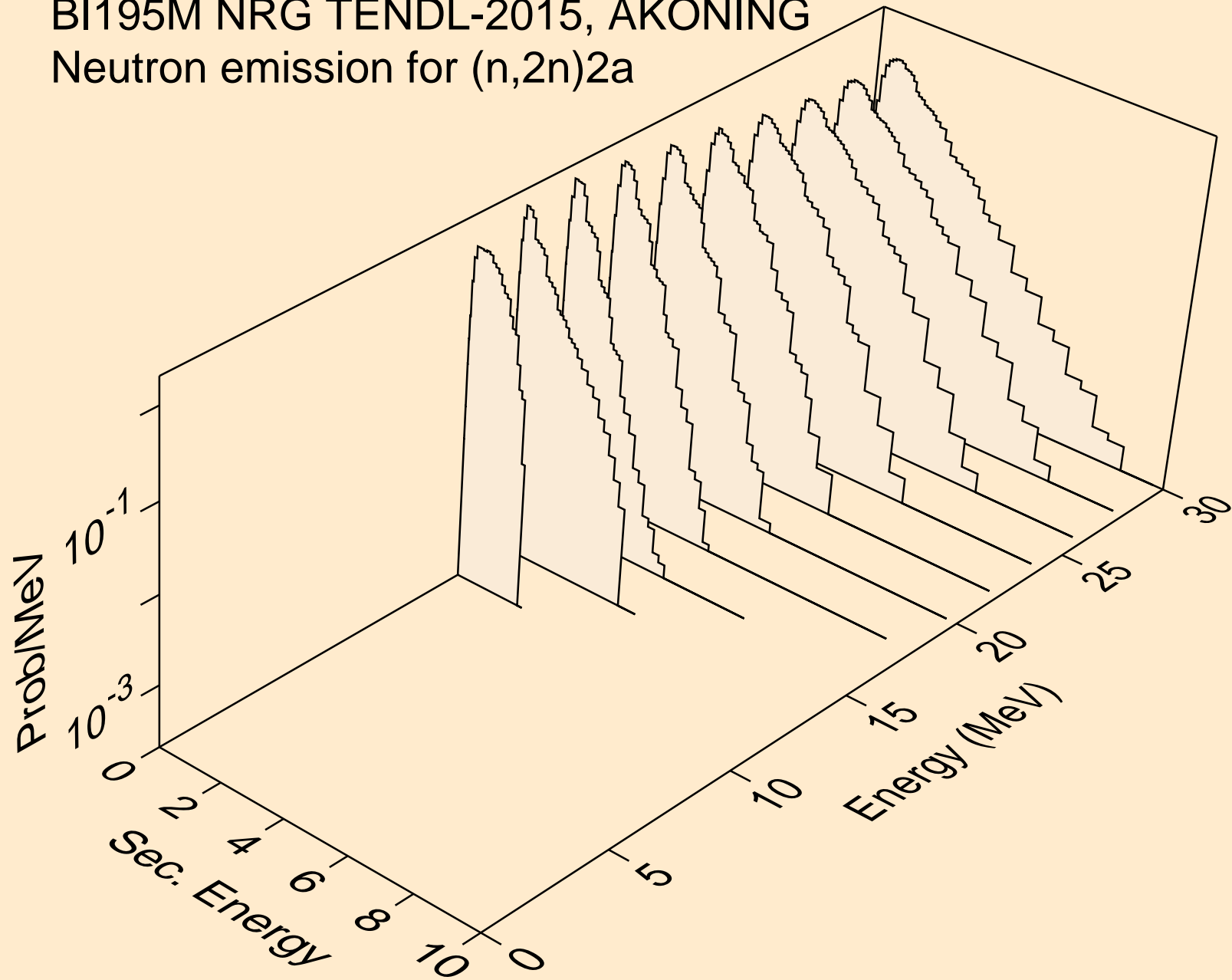

BI195M NRG TENDL-2015, AKONING
Neutron emission for (n,n*)d

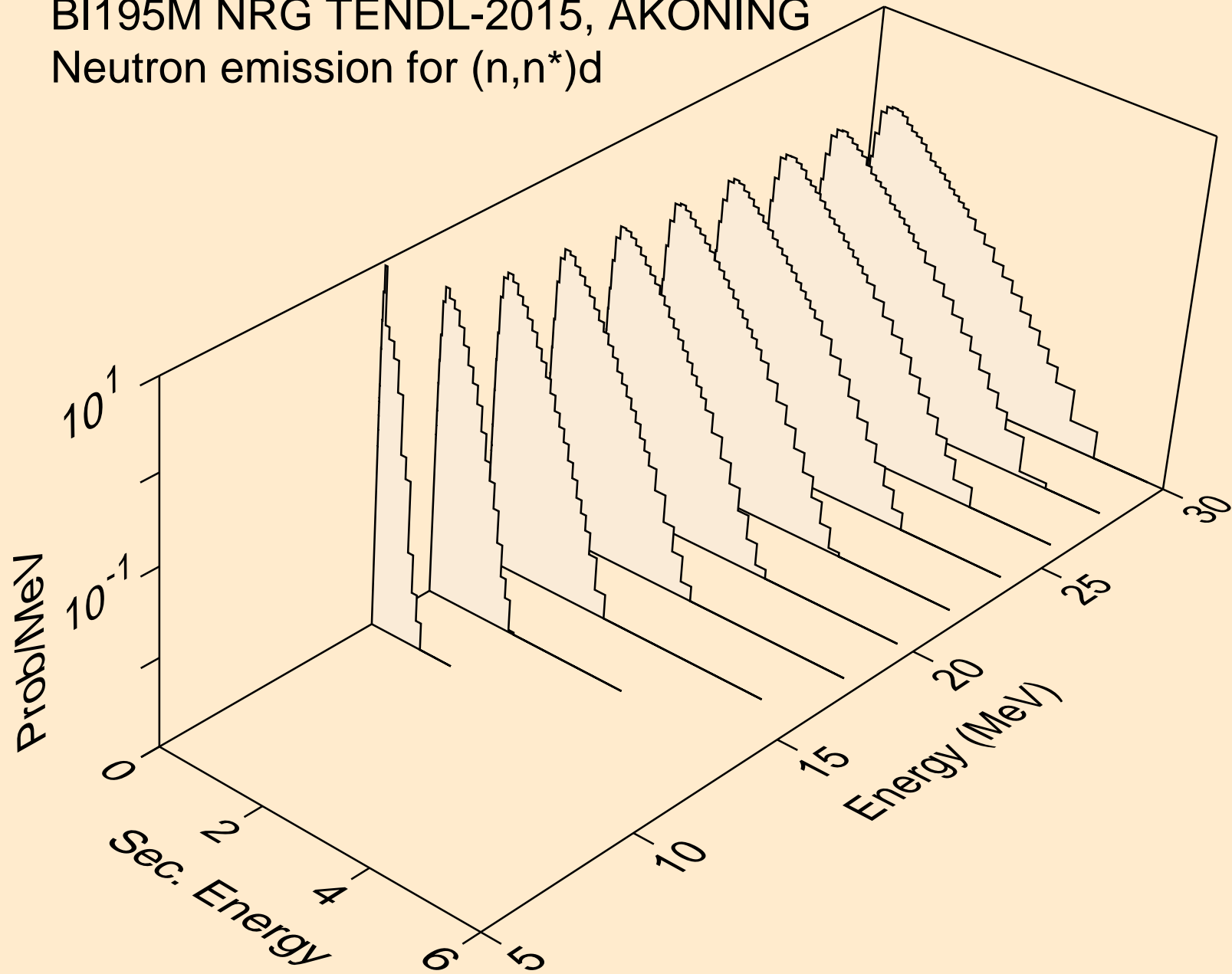

BI195M NRG TENDL-2015, AKONING
Neutron emission for (n,n*)t

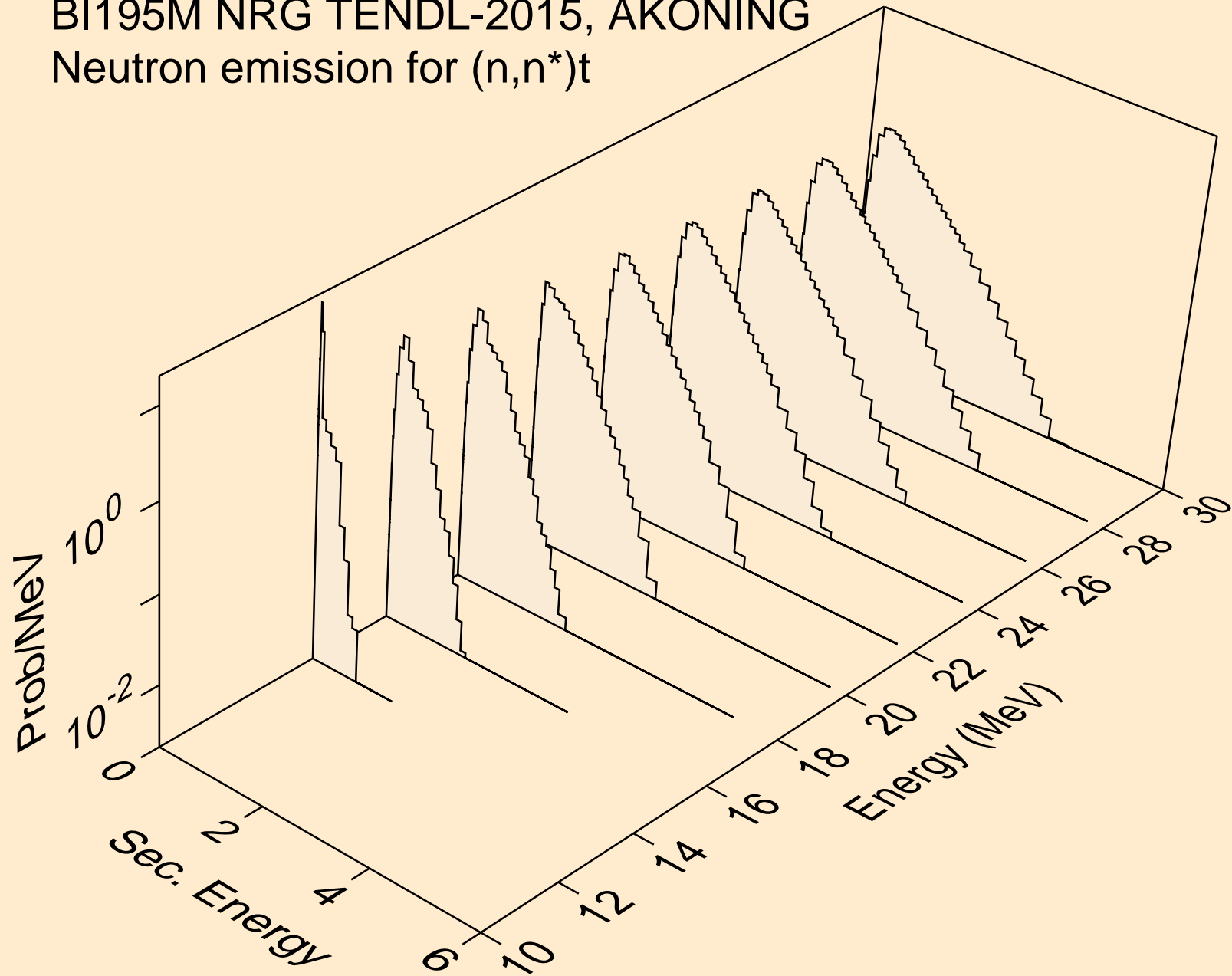

BI195M NRG TENDL-2015, AKONING
Neutron emission for (n,n*)he3

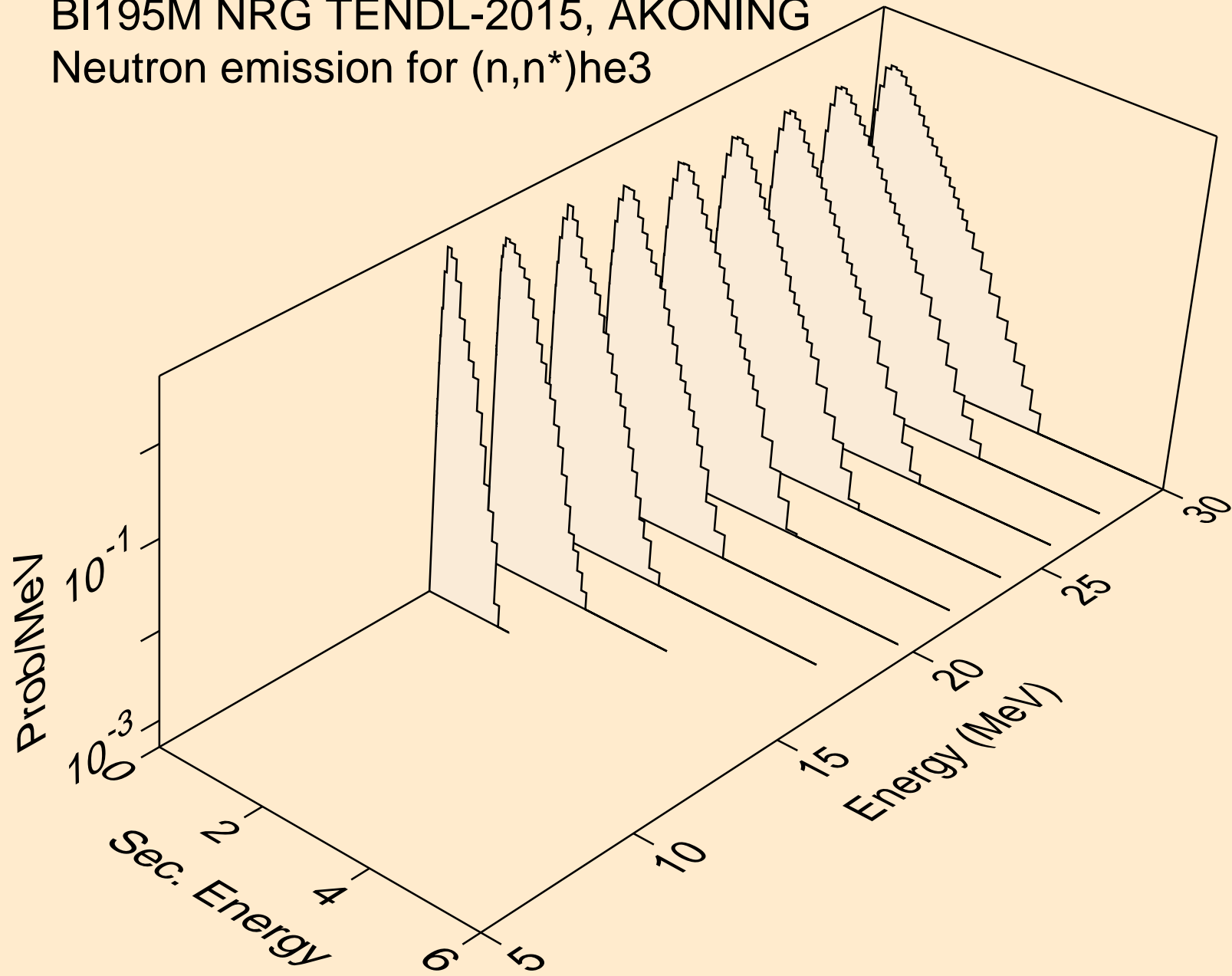

BI195M NRG TENDL-2015, AKONING
Neutron emission for (n,4n)

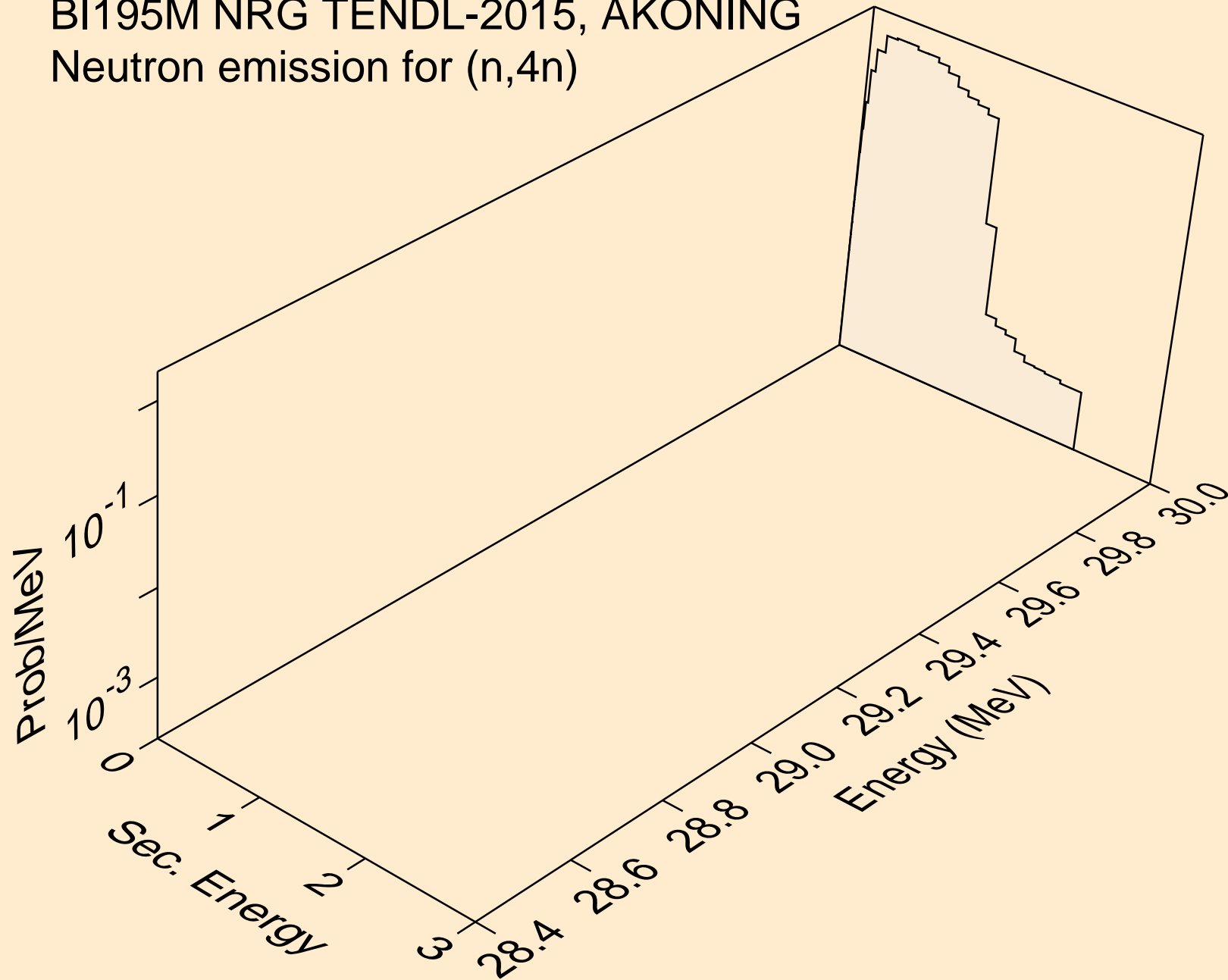

BI195M NRG TENDL-2015, AKONING
Neutron emission for (n,2np)

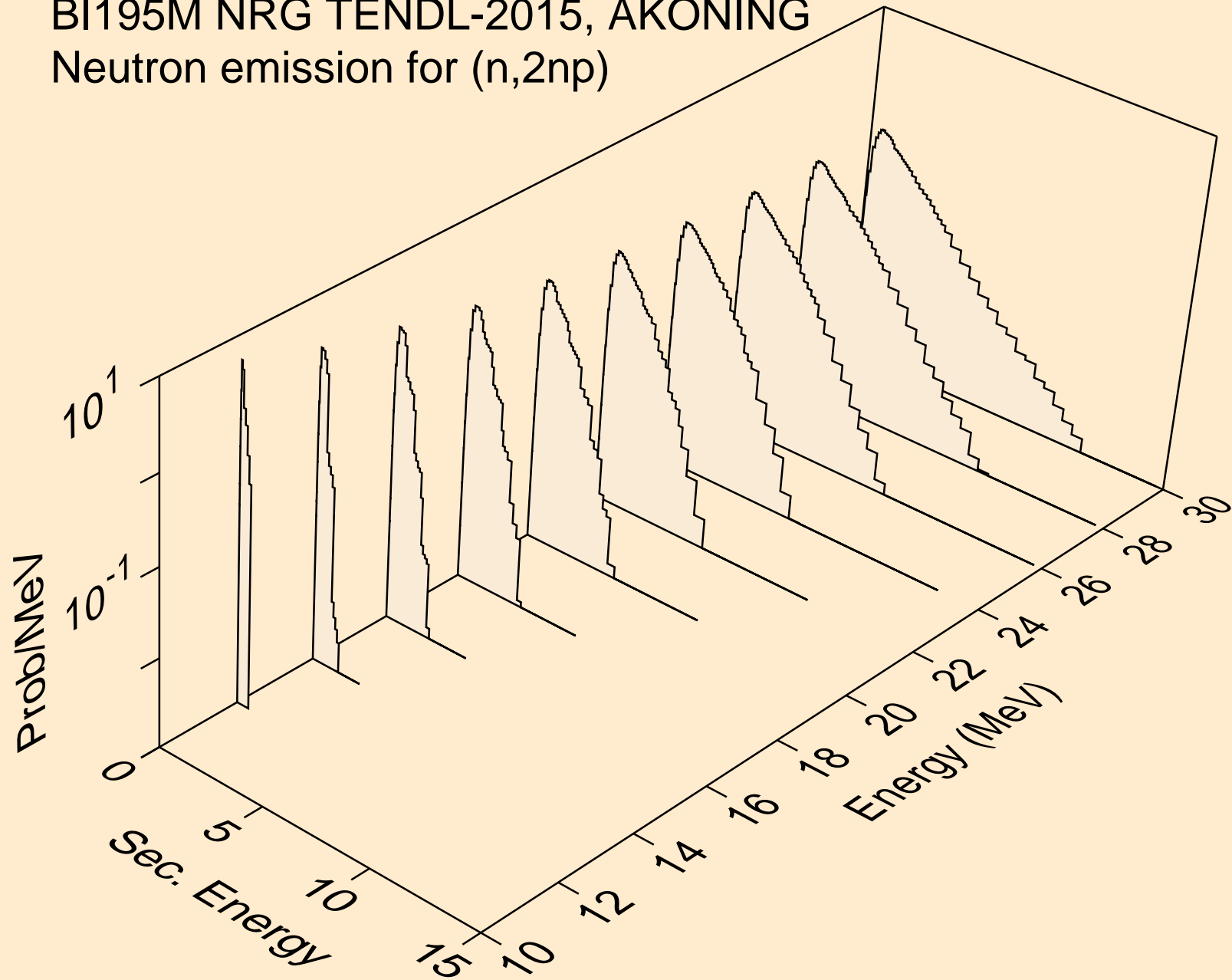

BI195M NRG TENDL-2015, AKONING
Neutron emission for (n,3np)

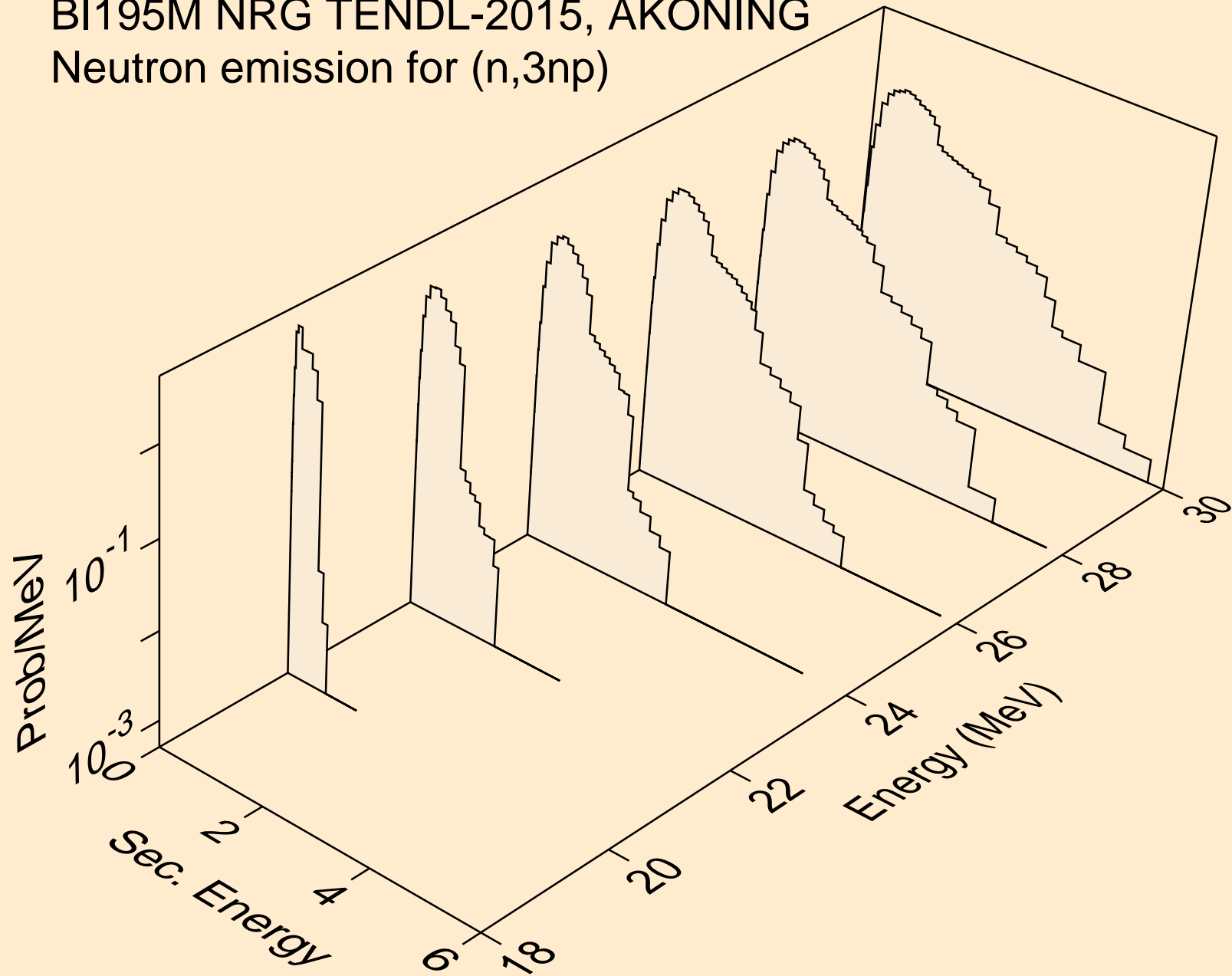

BI195M NRG TENDL-2015, AKONING
Neutron emission for (n,2np)

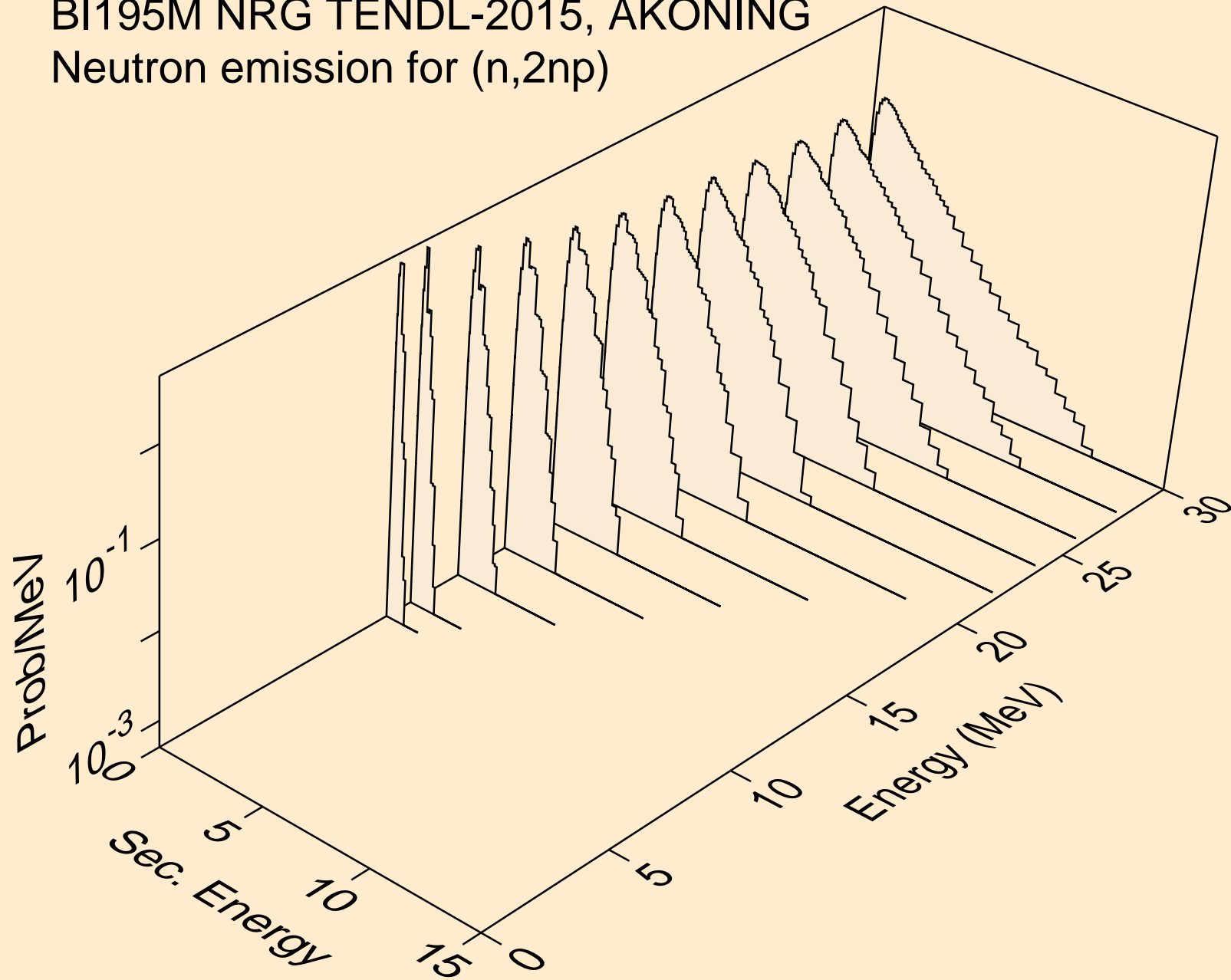

BI195M NRG TENDL-2015, AKONING
Neutron emission for (n,npa)

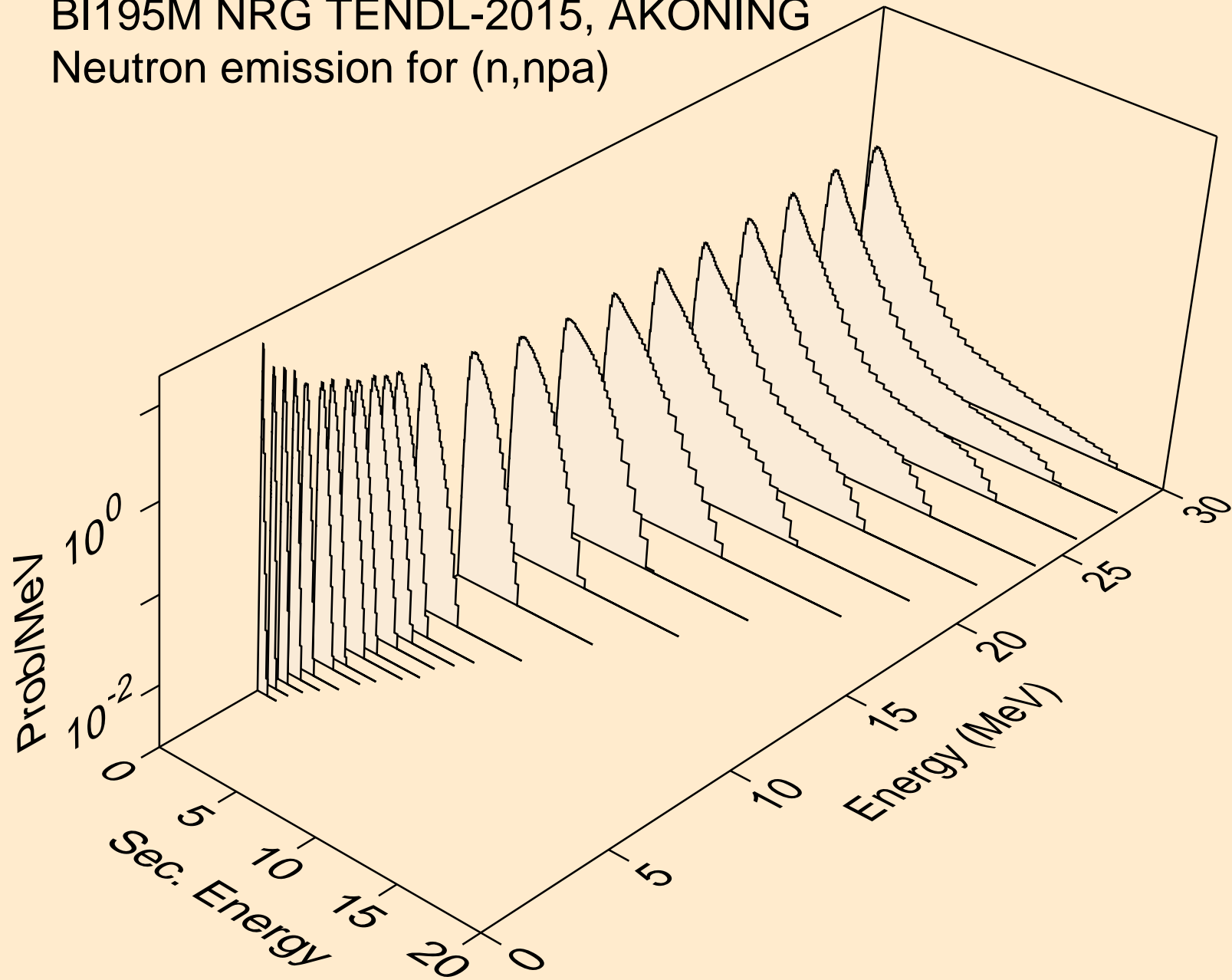

BI195M NRG TENDL-2015, AKONING
Neutron emission for (n,n*c)

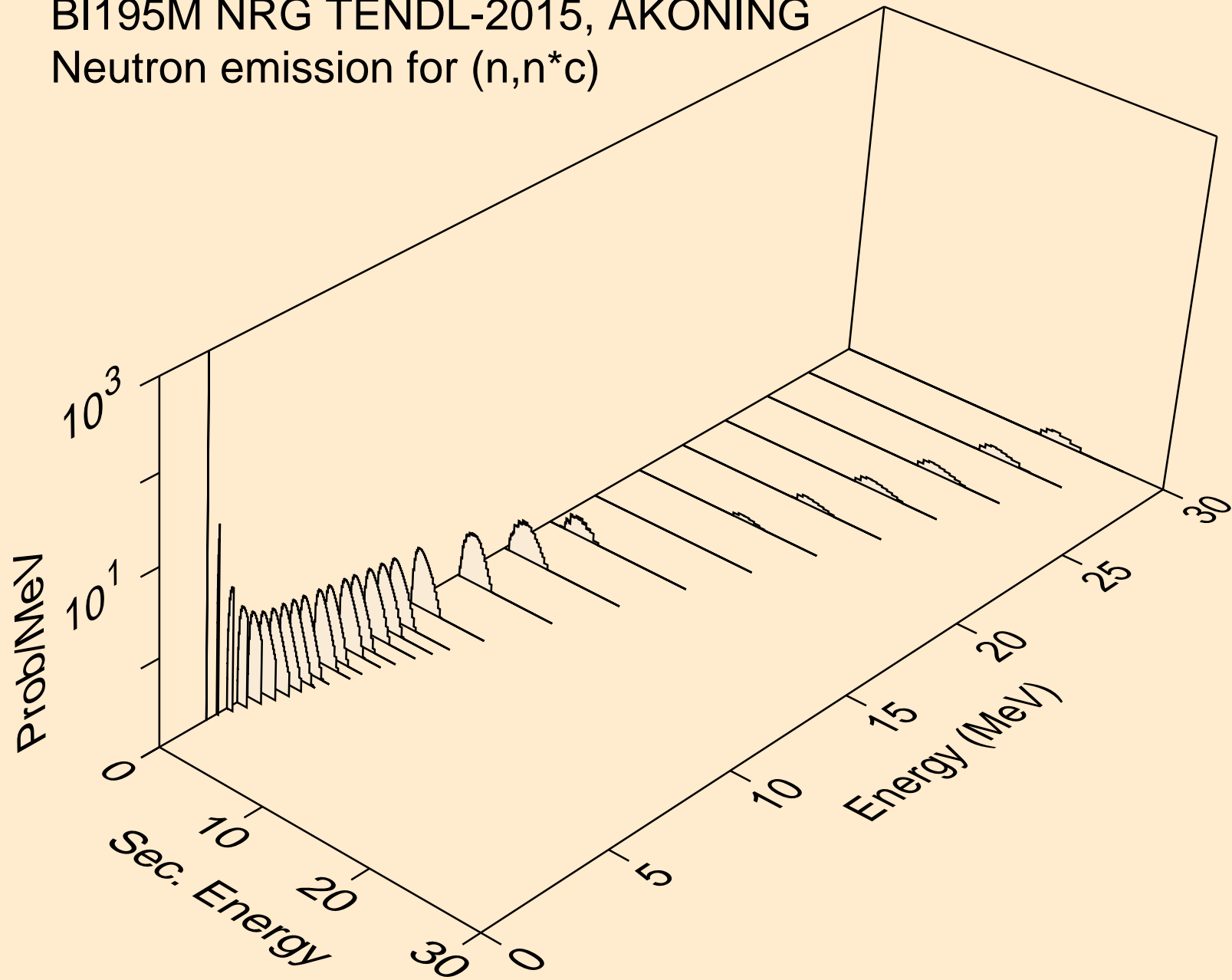

BI195M NRG TENDL-2015, AKONING
Photon emission for (n,x)

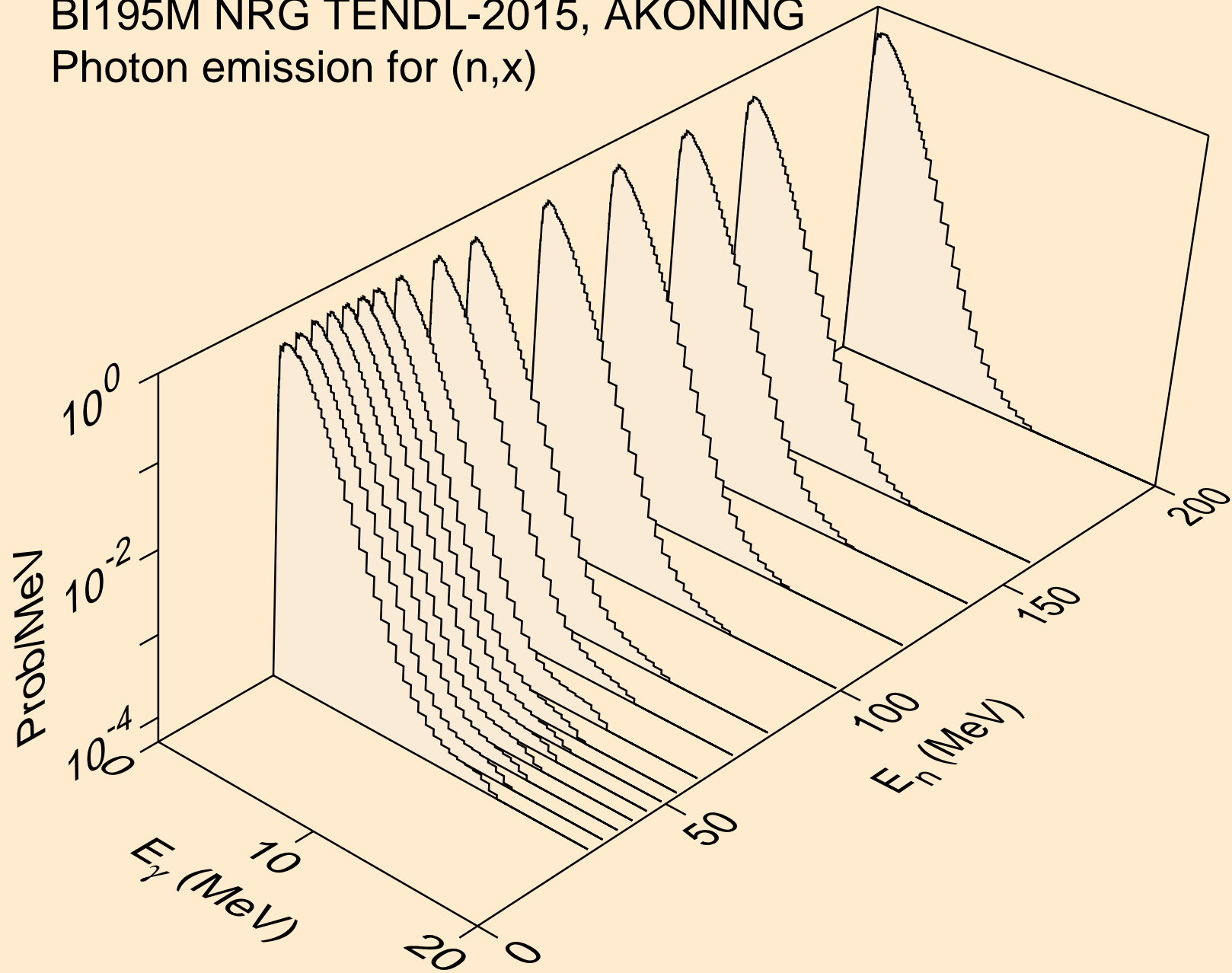

BI195M NRG TENDL-2015, AKONING
Photon emission for (n,2nd)

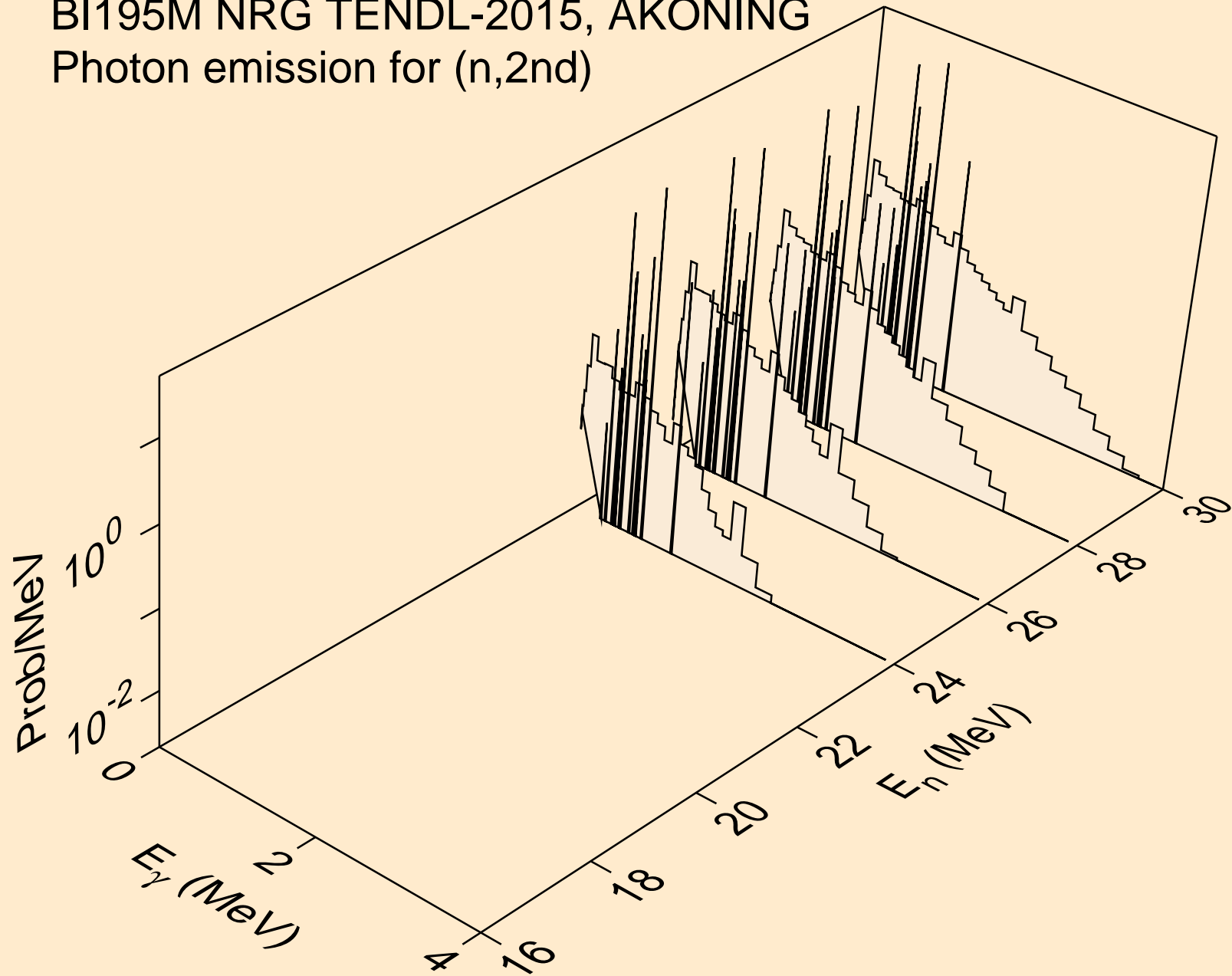

BI195M NRG TENDL-2015, AKONING
Photon emission for (n,2n)

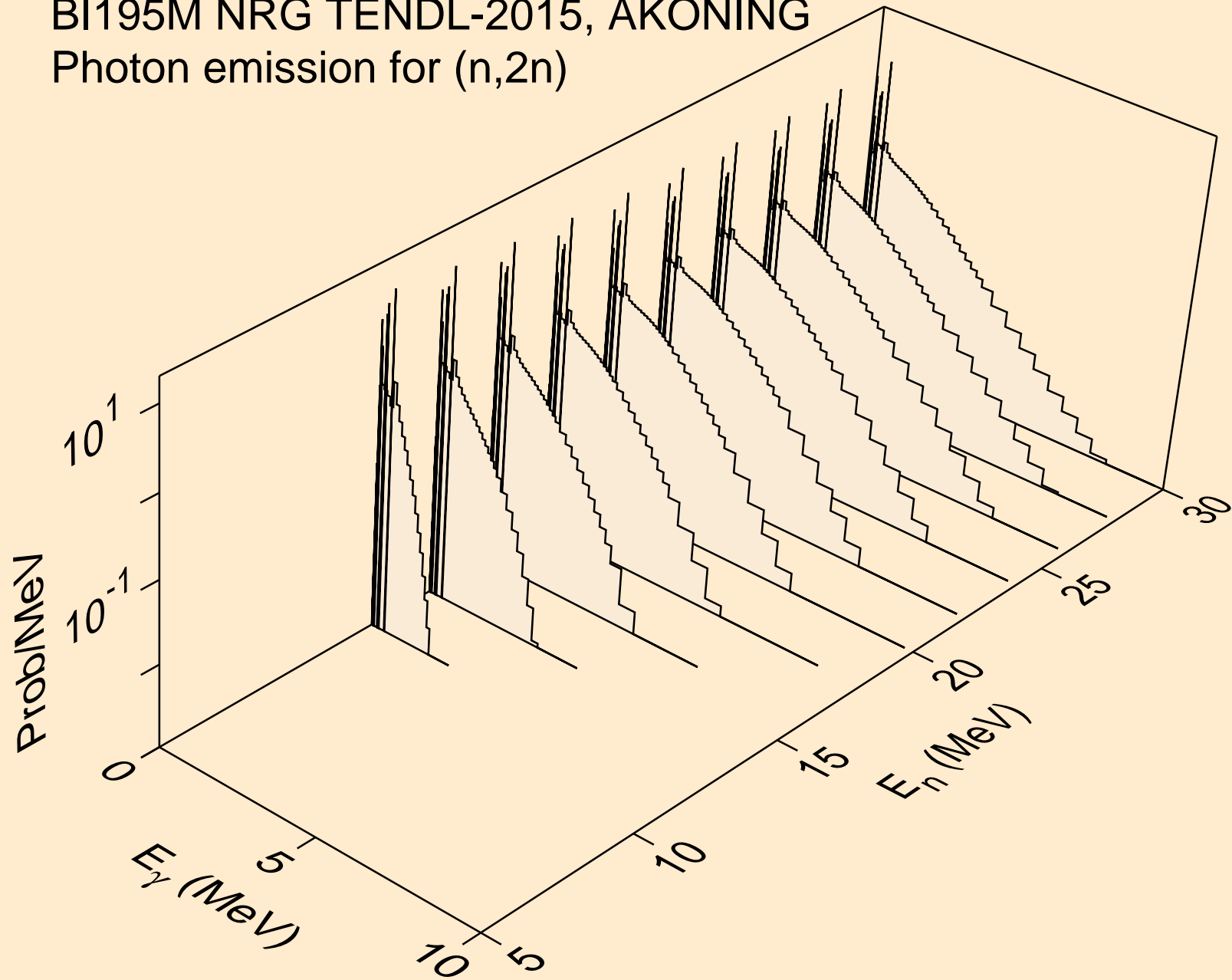

BI195M NRG TENDL-2015, AKONING
Photon emission for (n,3n)

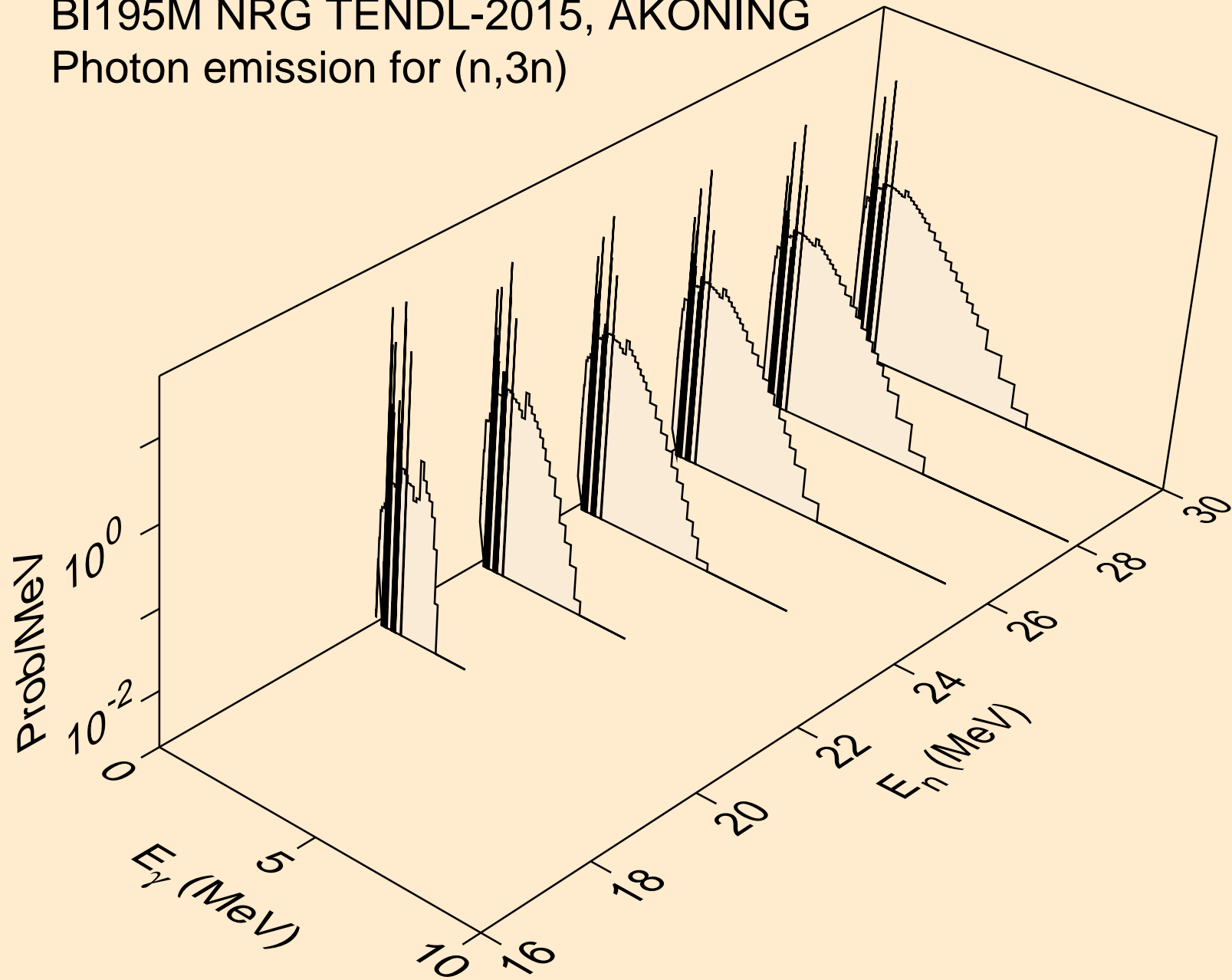

BI195M NRG TENDL-2015, AKONING
Photon emission for (n,n*)a

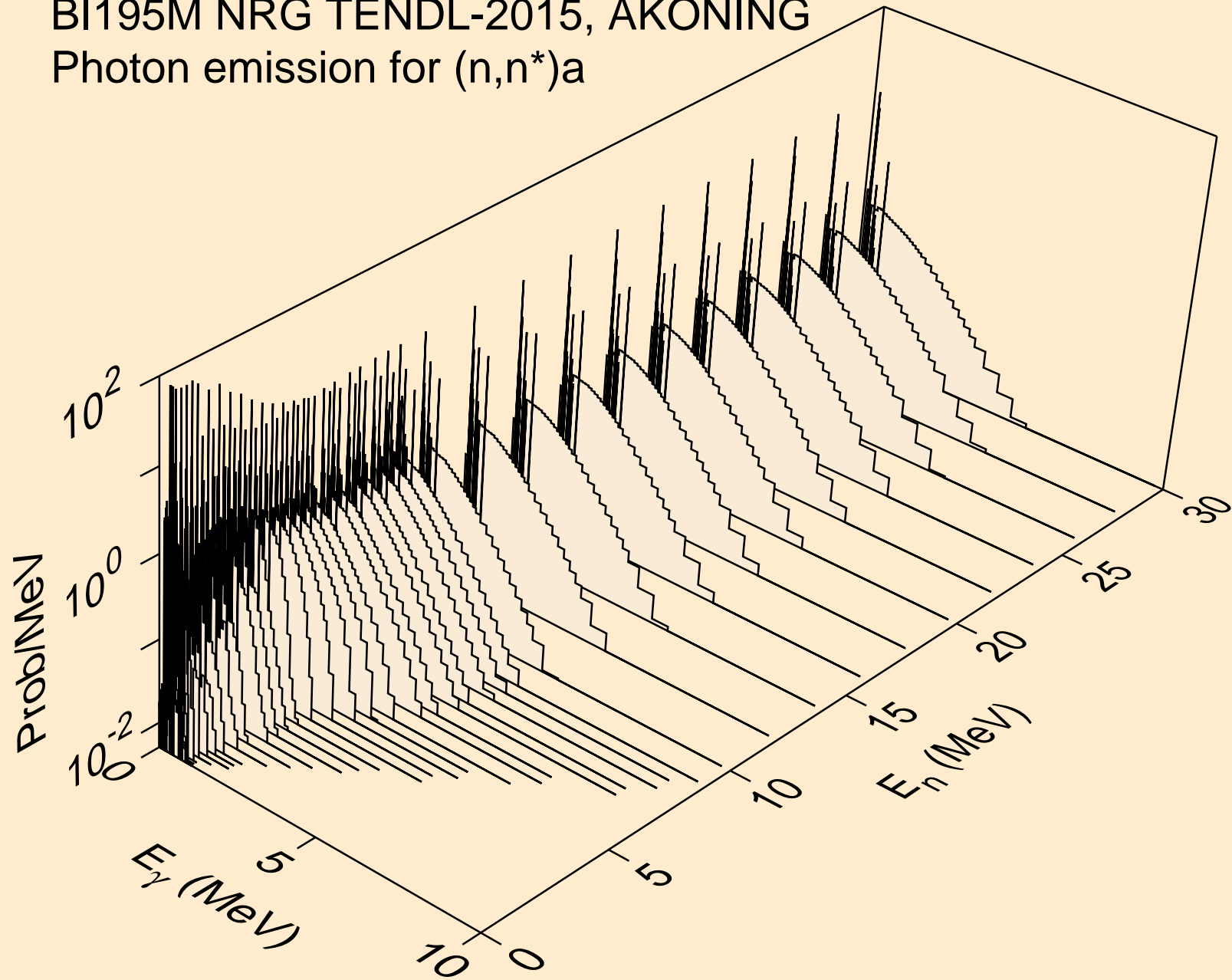

BI195M NRG TENDL-2015, AKONING
Photon emission for (n,n*)3a

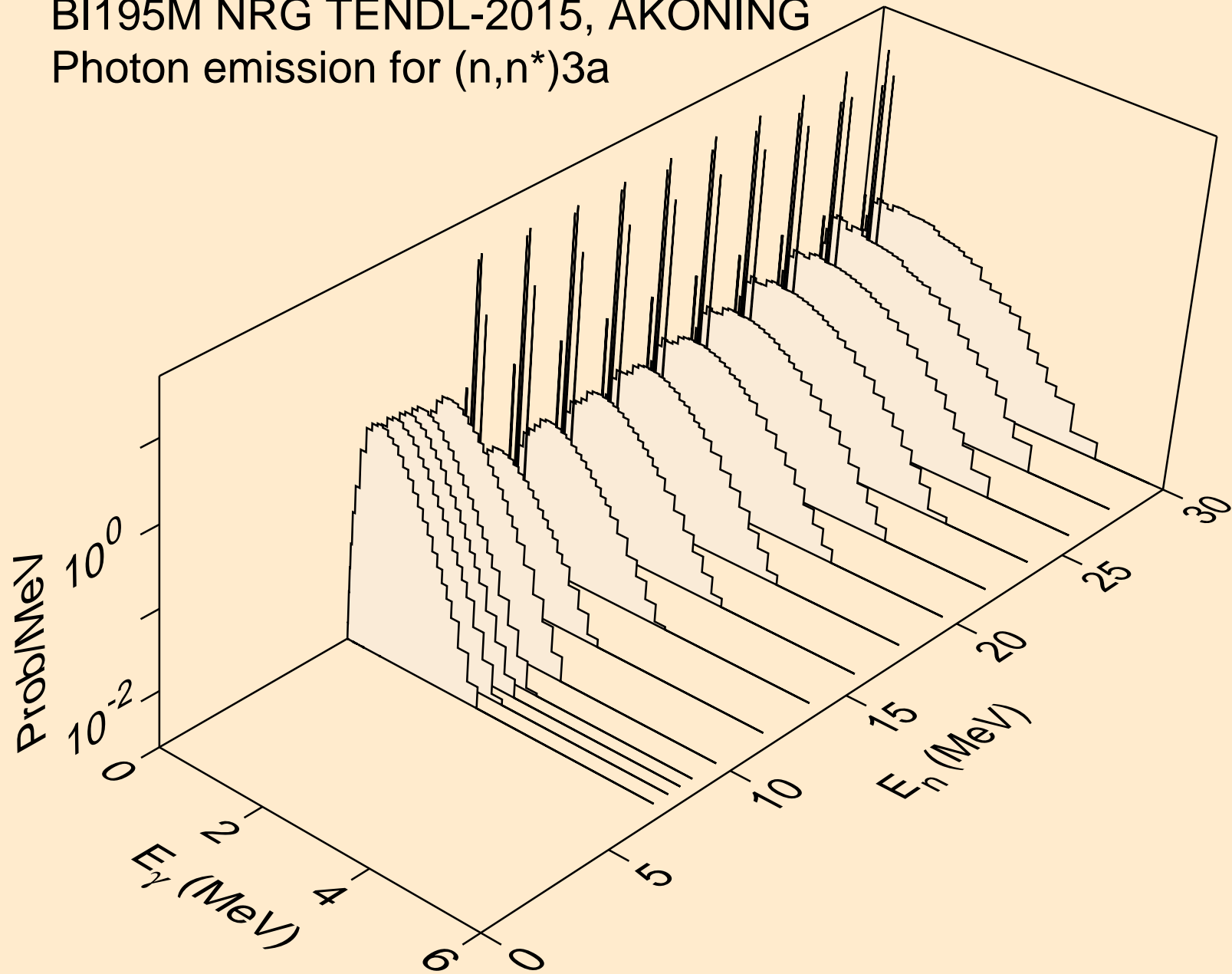

BI195M NRG TENDL-2015, AKONING
Photon emission for (n,2n)_a

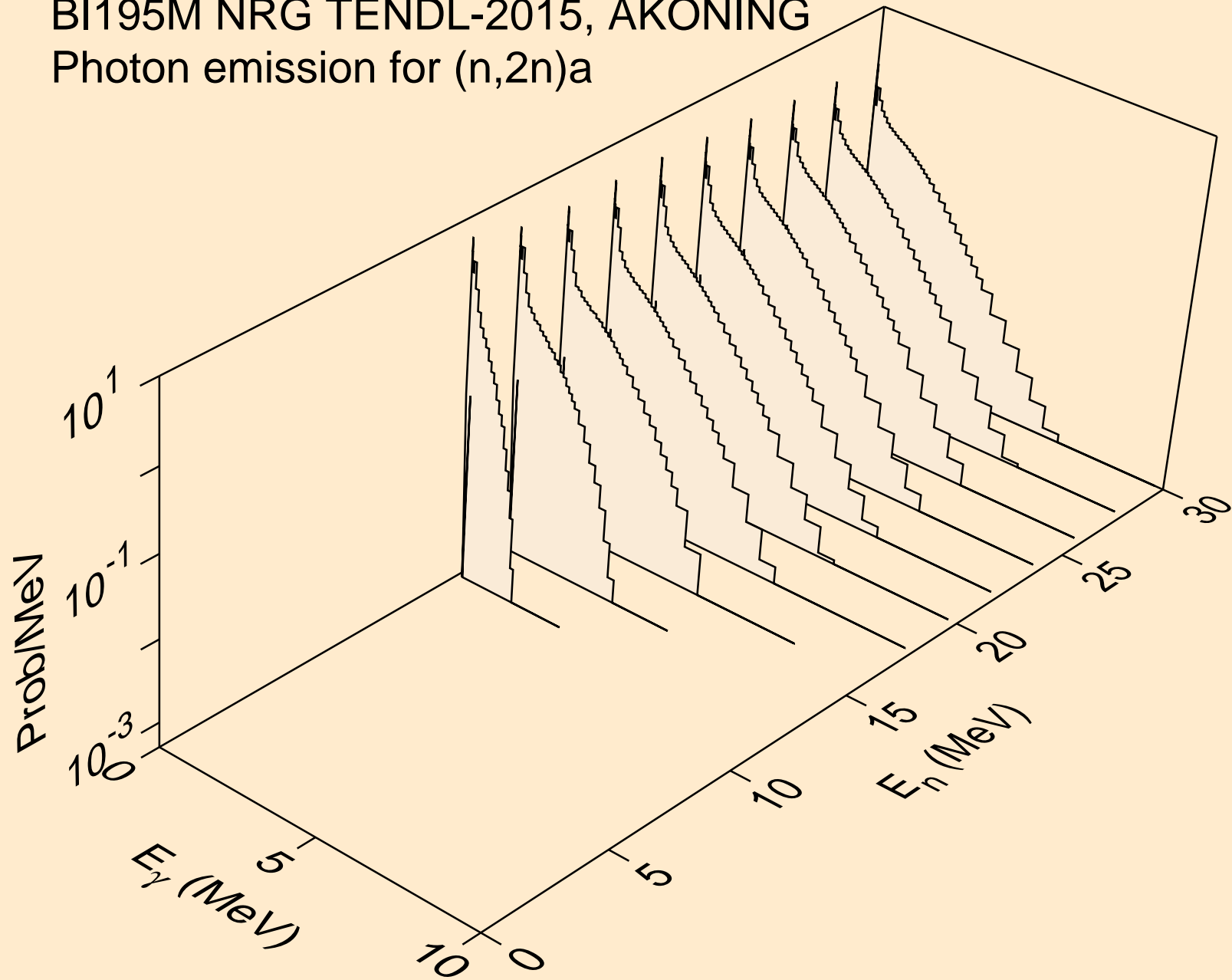

BI195M NRG TENDL-2015, AKONING
Photon emission for (n,3n)a

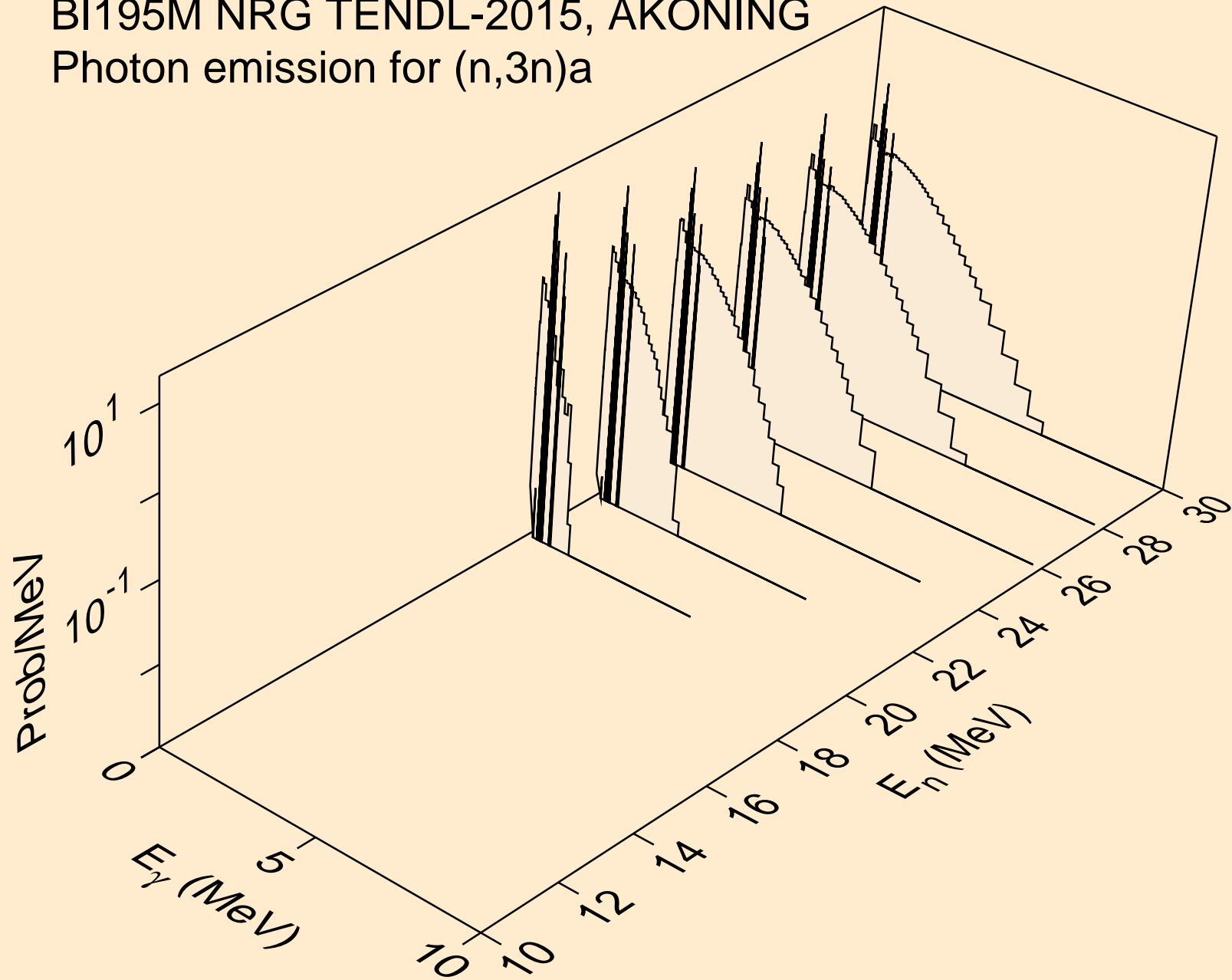

BI195M NRG TENDL-2015, AKONING
Photon emission for (n,n*)p

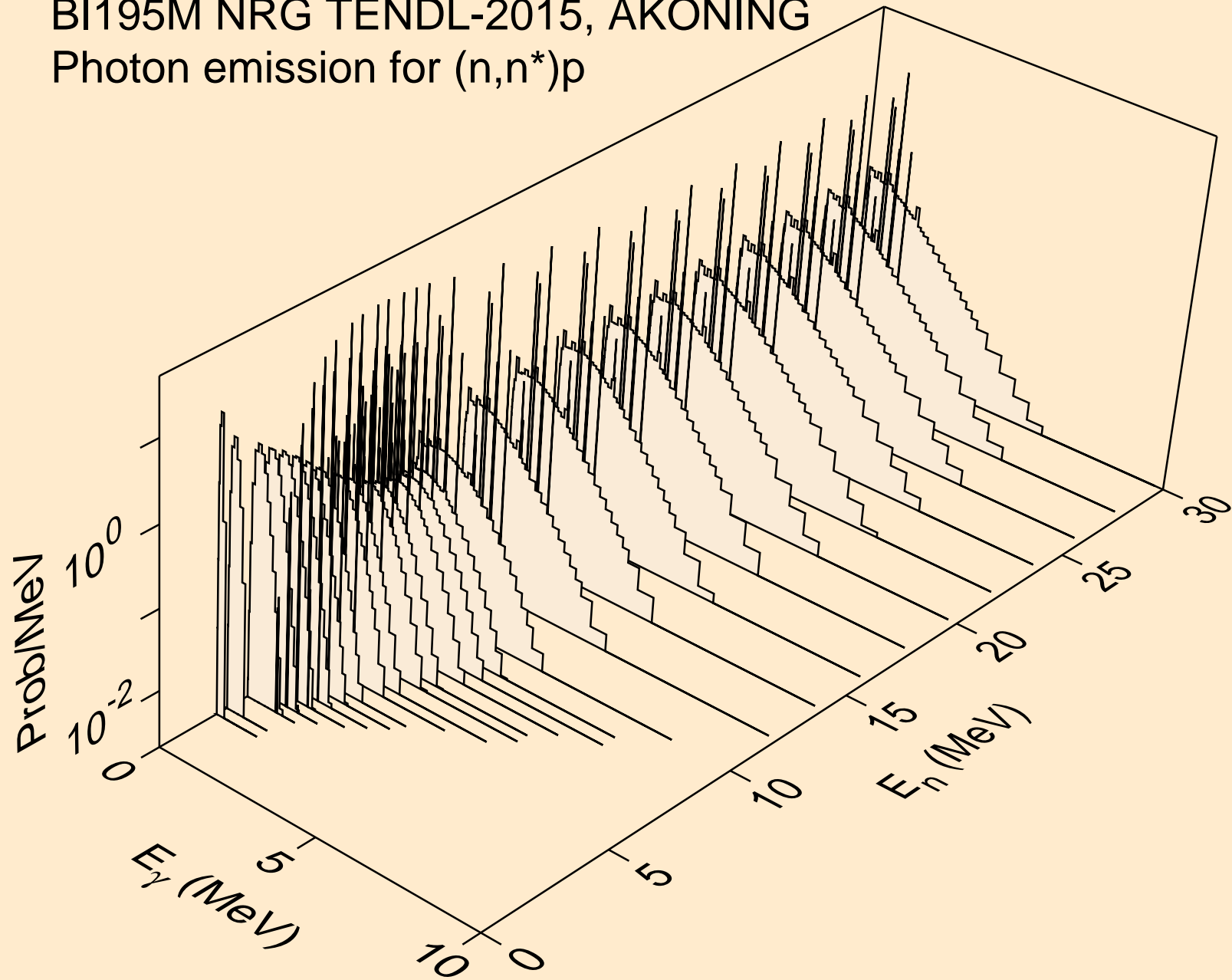

BI195M NRG TENDL-2015, AKONING
Photon emission for (n,n*)2a

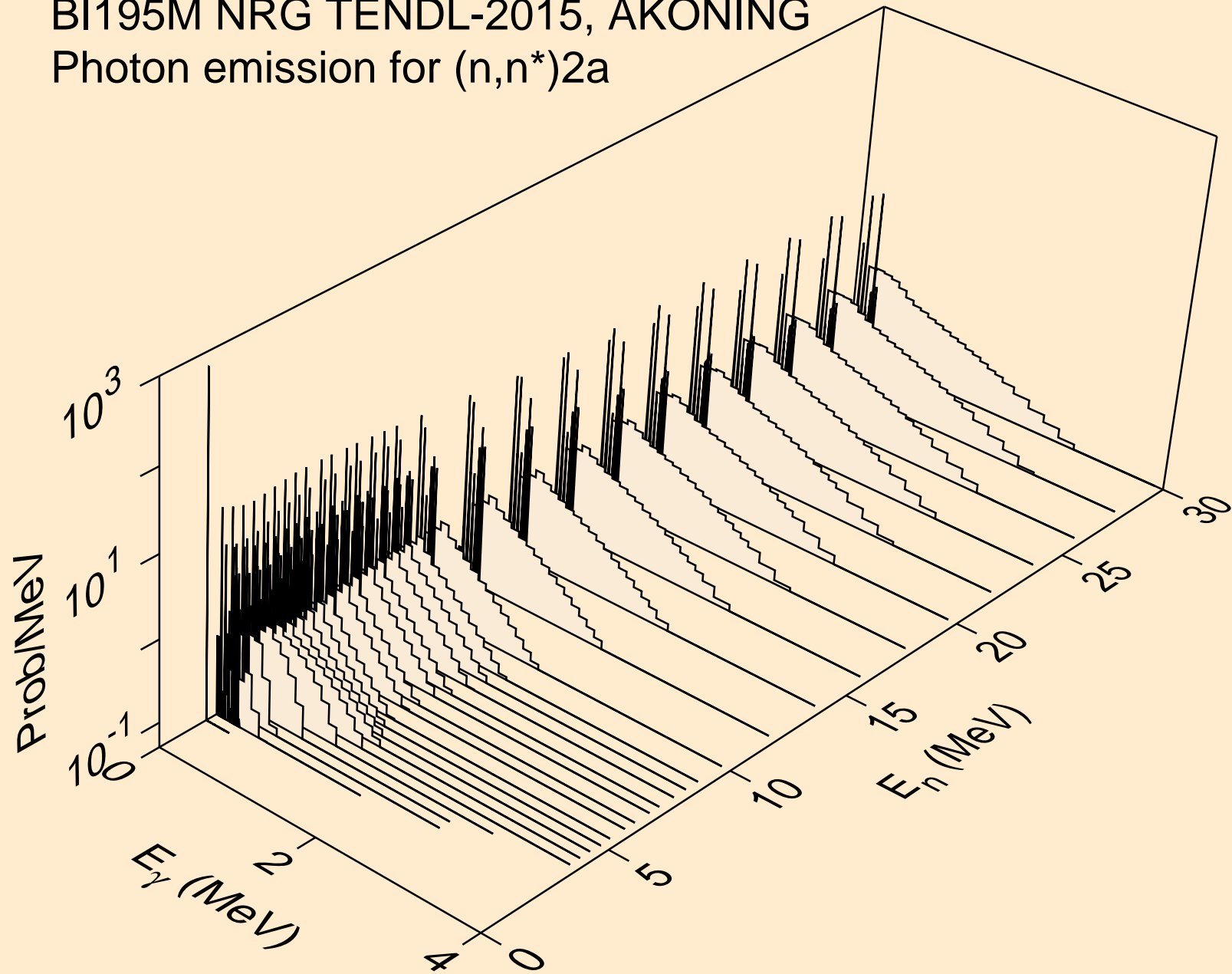

BI195M NRG TENDL-2015, AKONING
Photon emission for (n,2n)2a

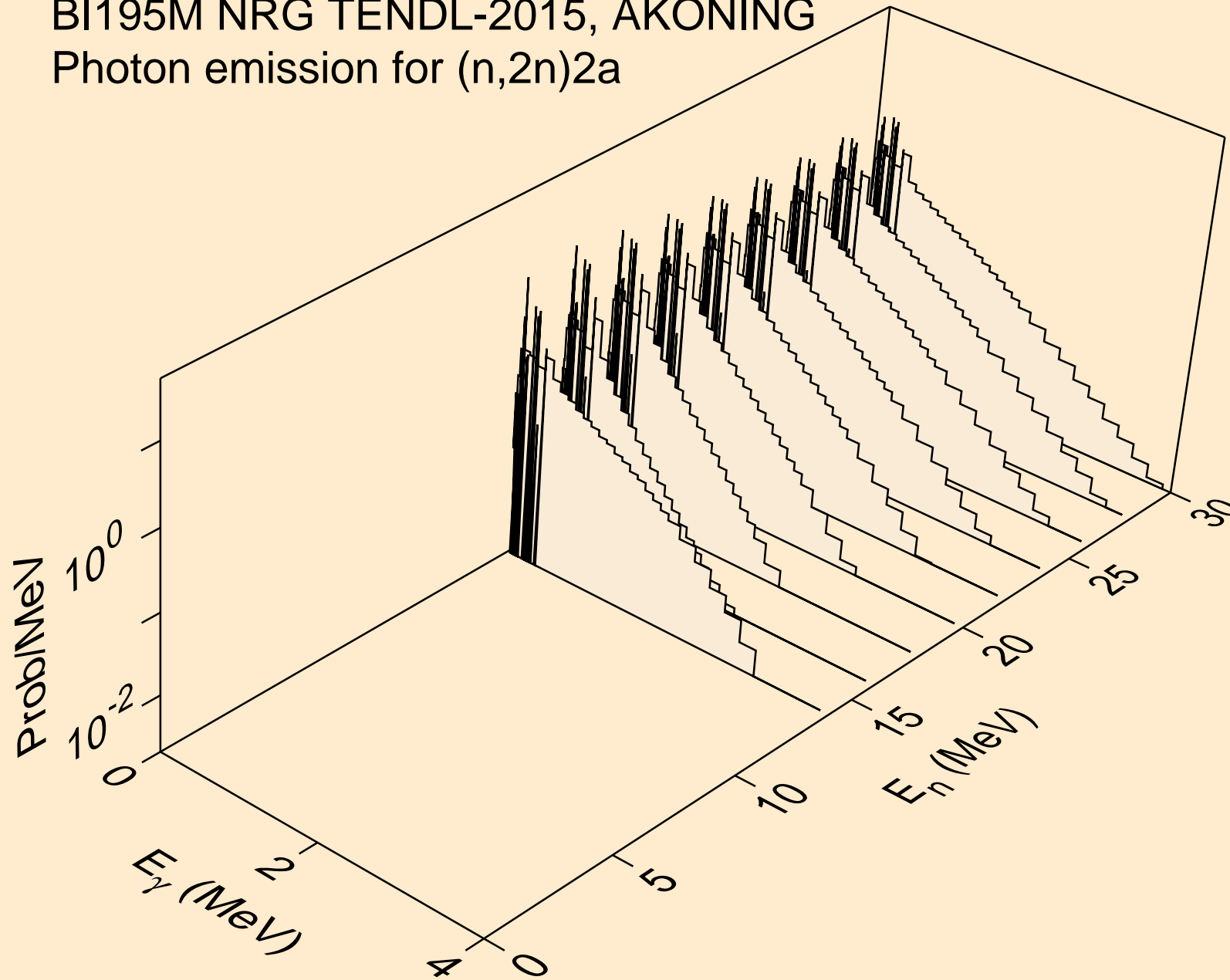

BI195M NRG TENDL-2015, AKONING
Photon emission for (n,n*)d

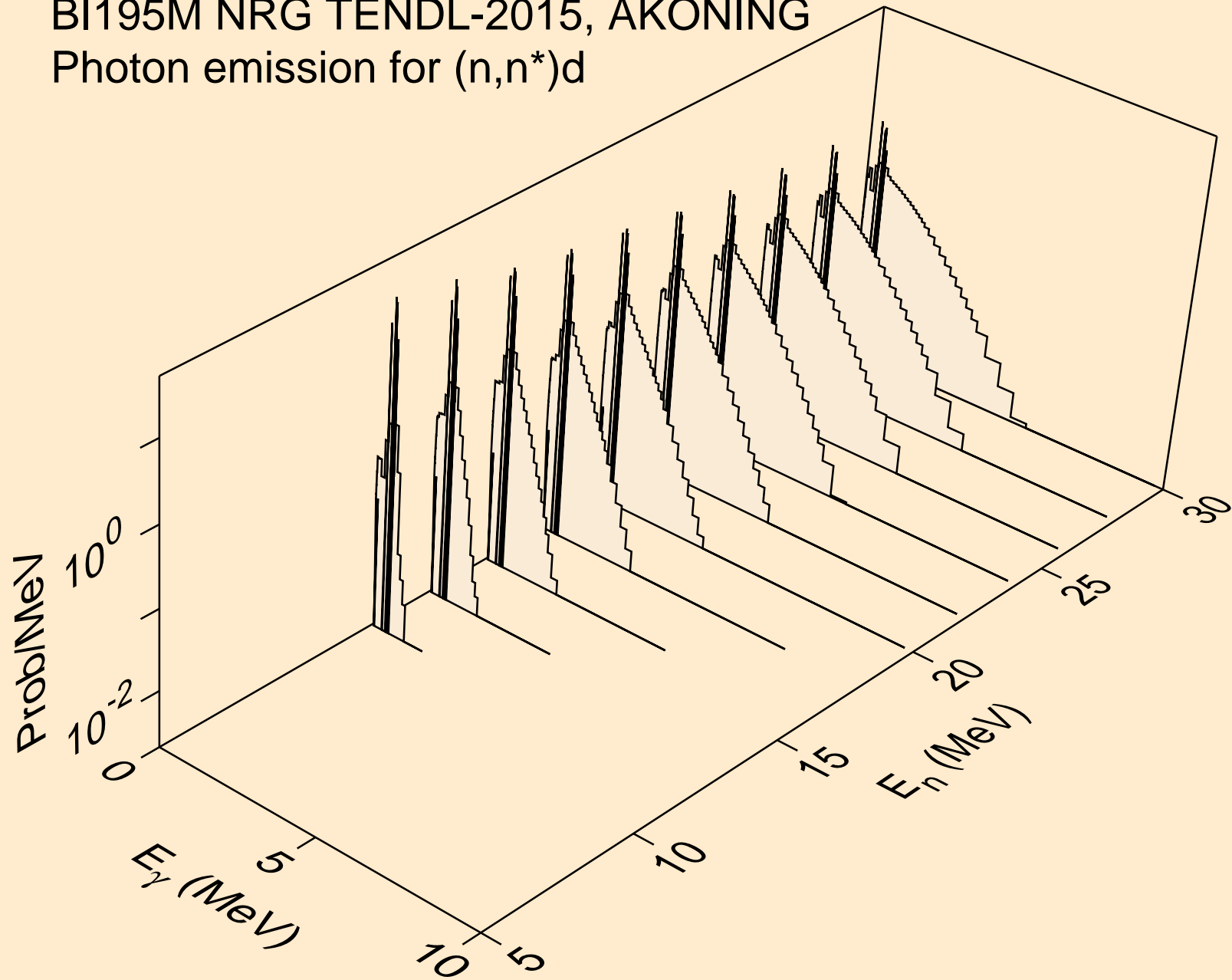

BI195M NRG TENDL-2015, AKONING
Photon emission for (n,n*)t

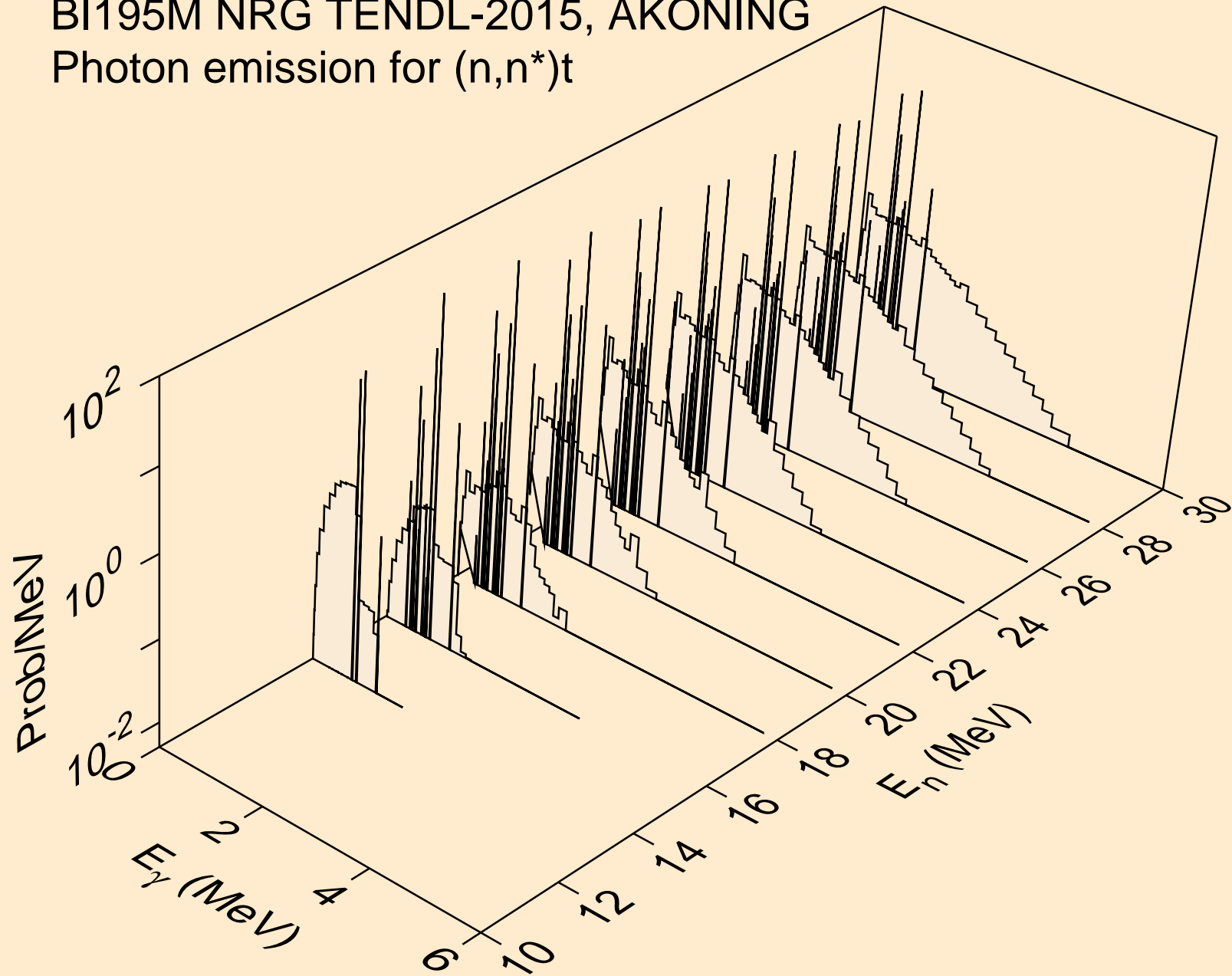

BI195M NRG TENDL-2015, AKONING
Photon emission for (n,n*)he3

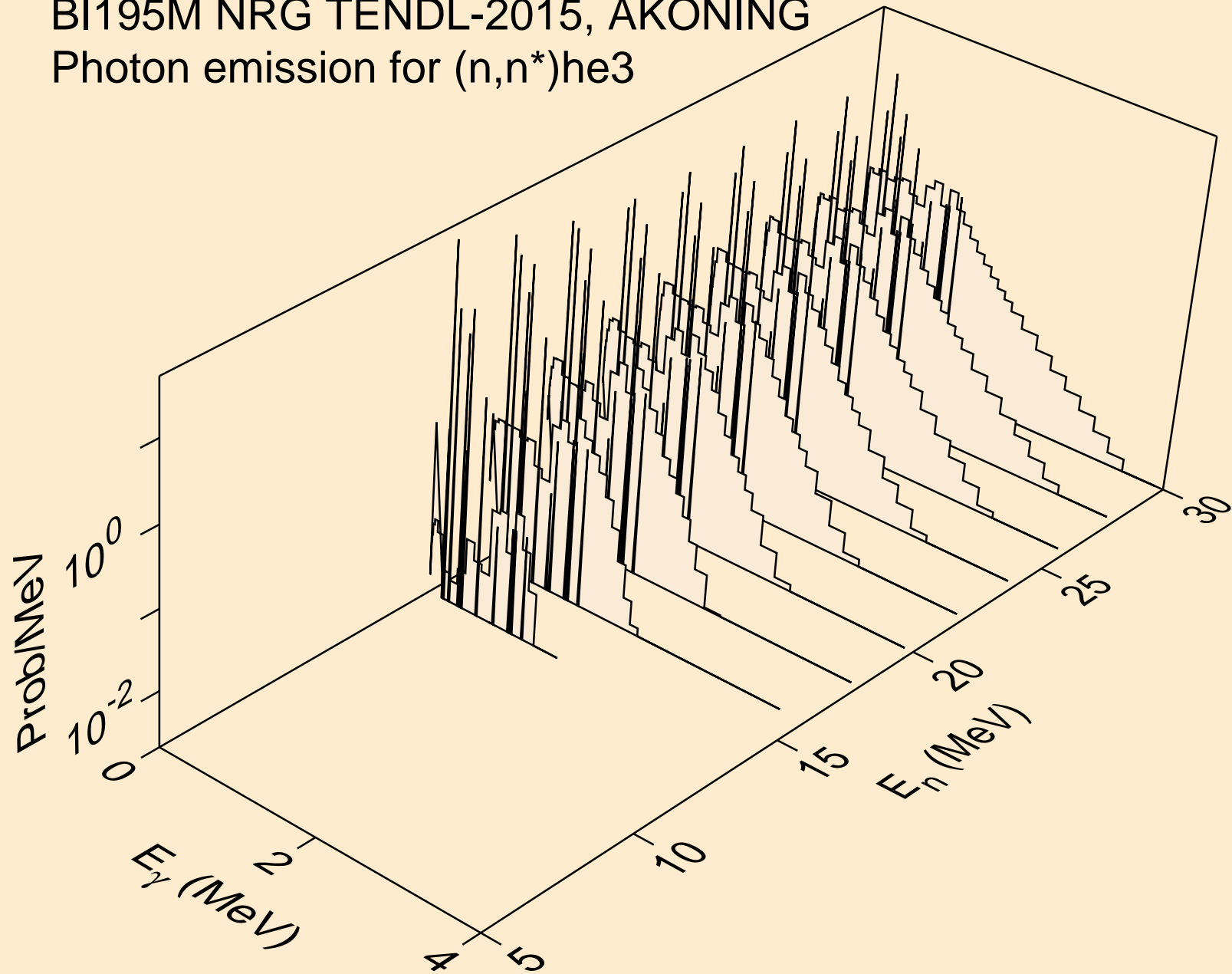

BI195M NRG TENDL-2015, AKONING
Photon emission for (n,4n)

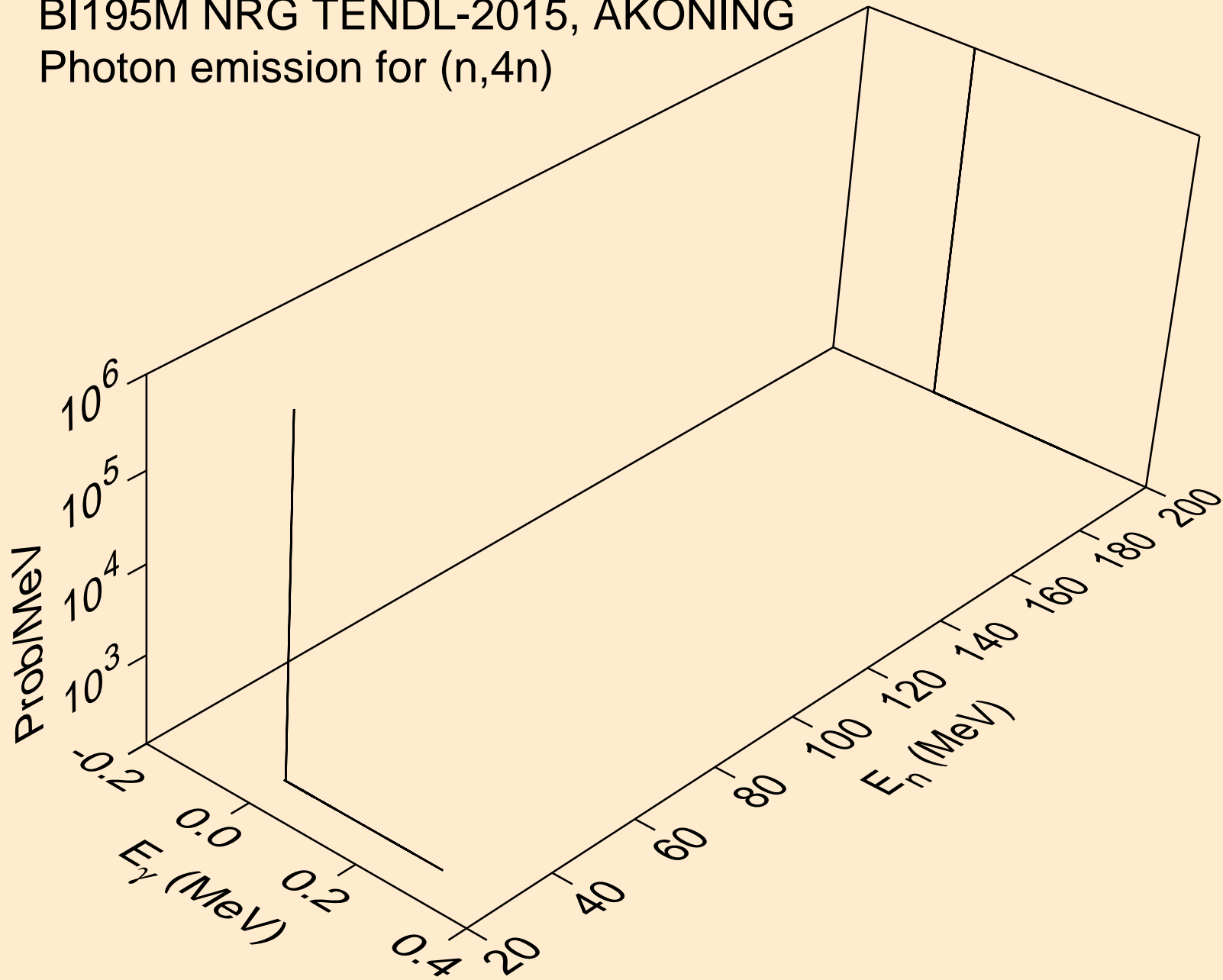

BI195M NRG TENDL-2015, AKONING
Photon emission for (n,2np)

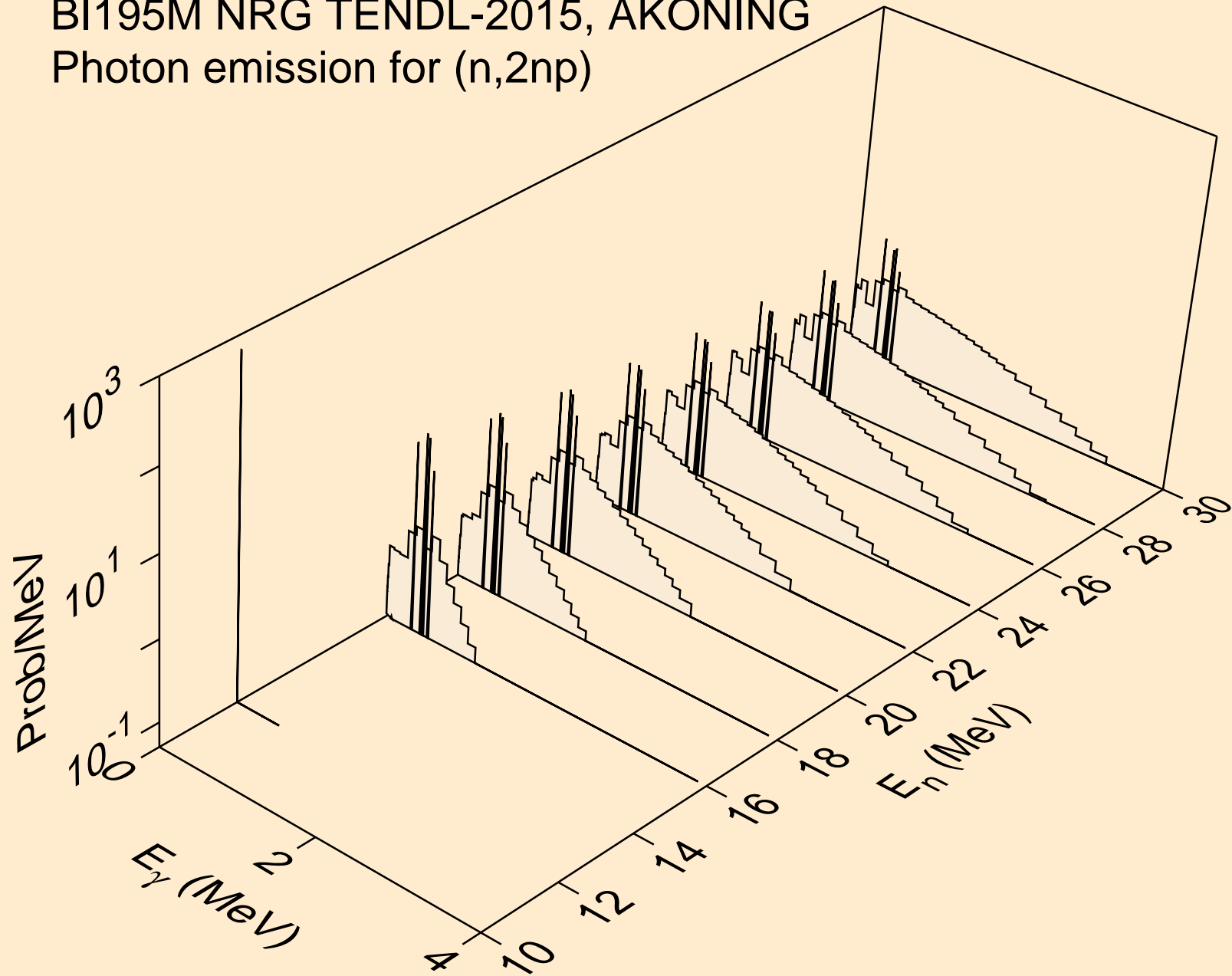

BI195M NRG TENDL-2015, AKONING
Photon emission for (n,3np)

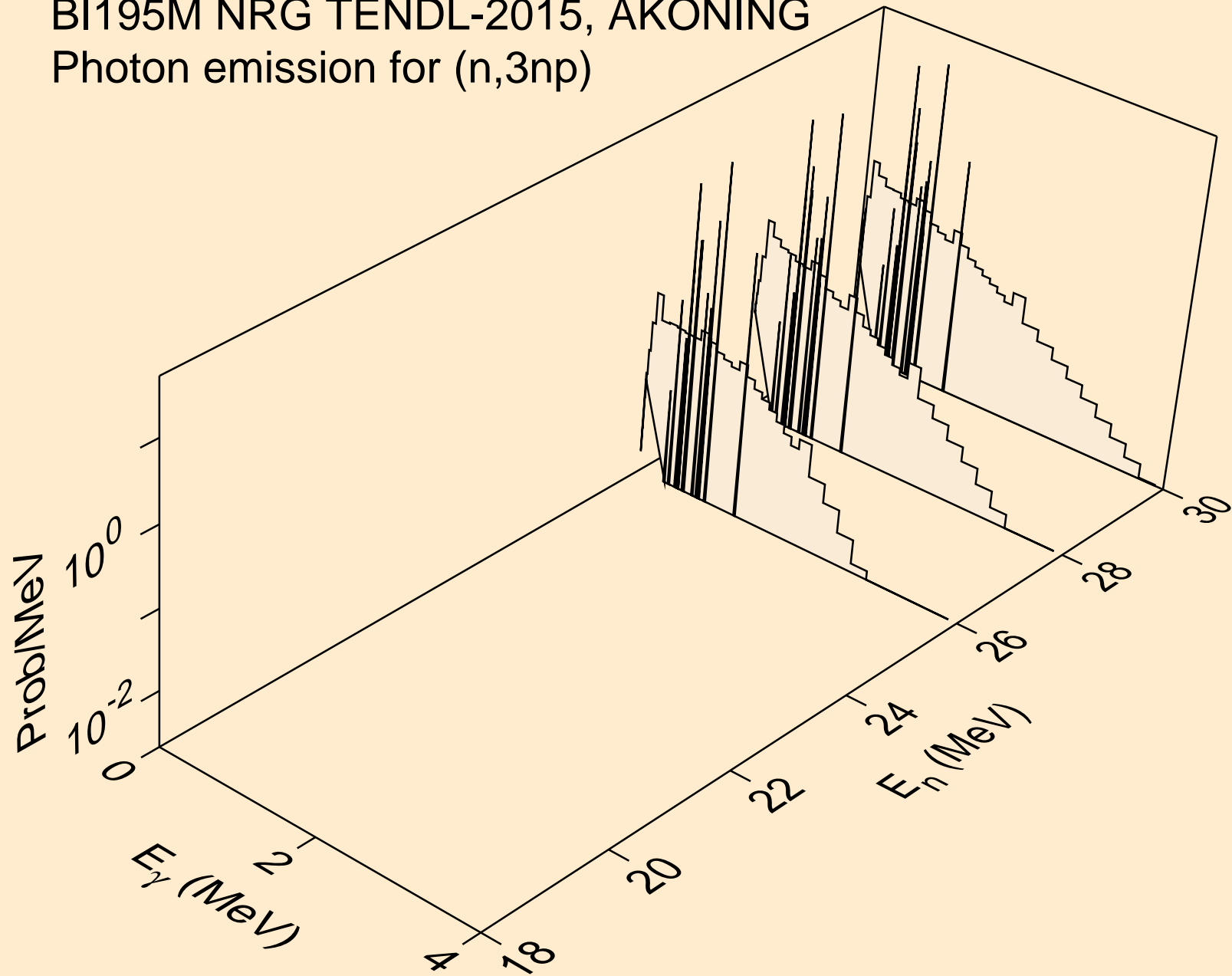

BI195M NRG TENDL-2015, AKONING
Photon emission for (n,2np)

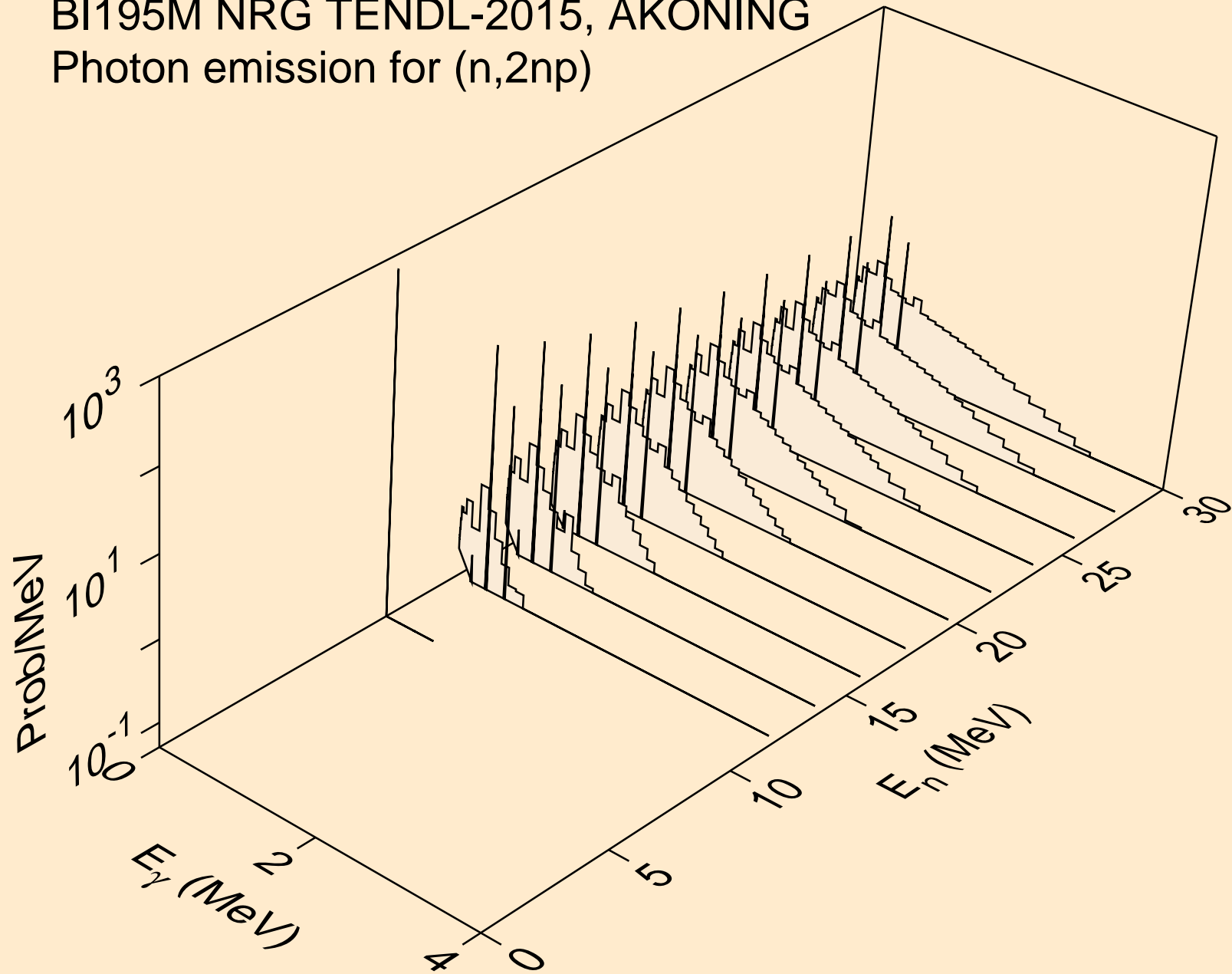

BI195M NRG TENDL-2015, AKONING
Photon emission for (n,npa)

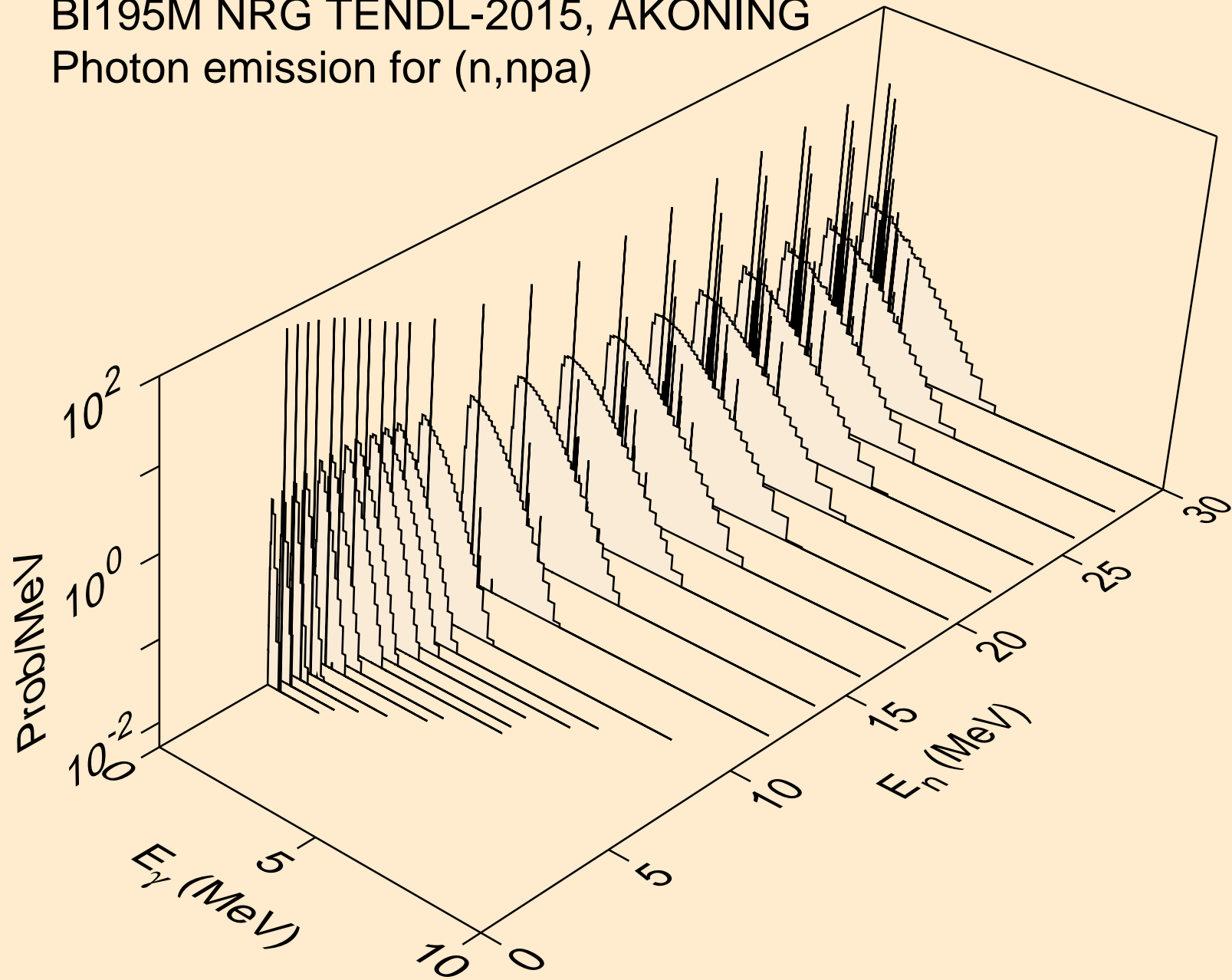

BI195M NRG TENDL-2015, AKONING
Photon emission for (n,n*2)

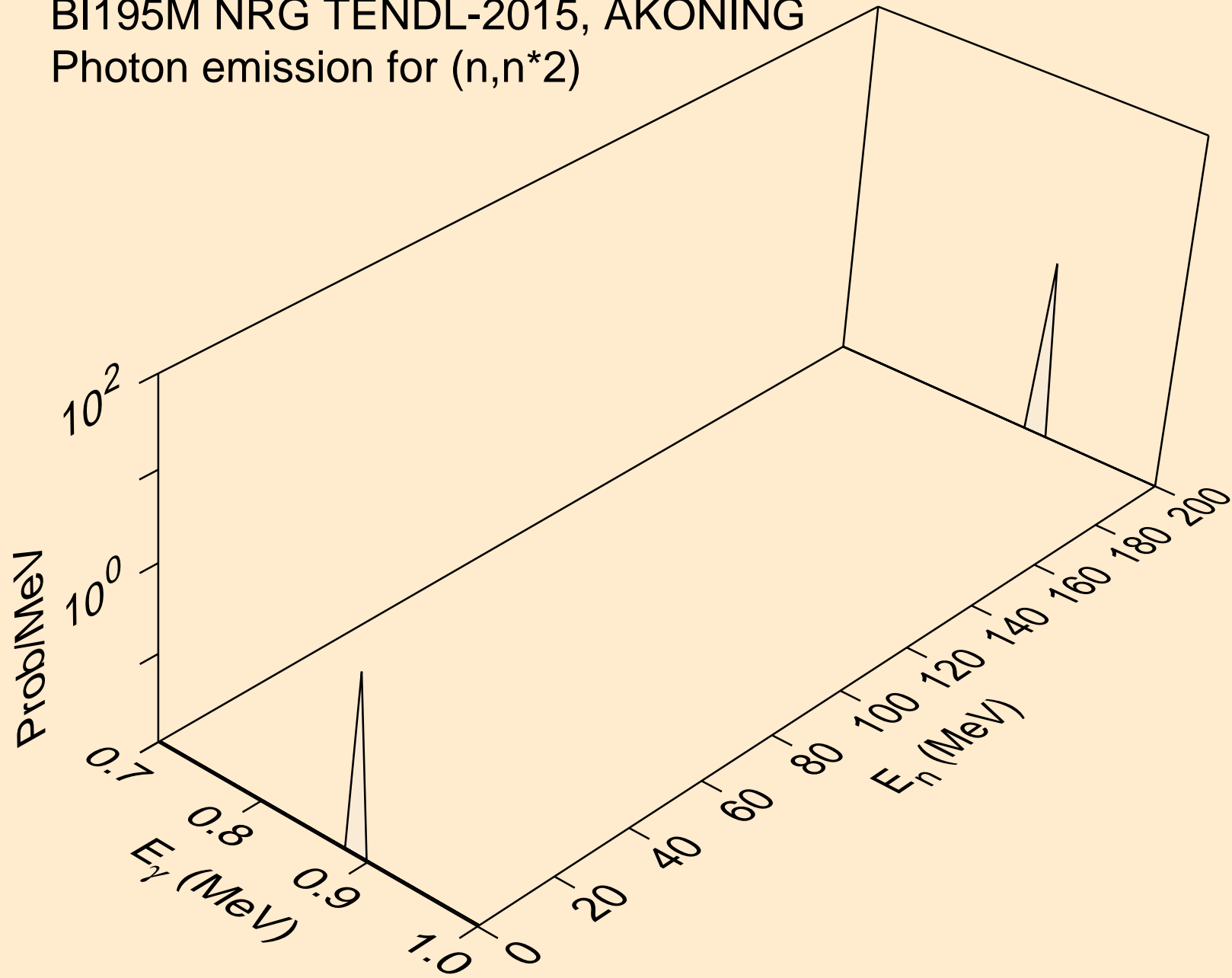

BI195M NRG TENDL-2015, AKONING
Photon emission for (n,n*c)

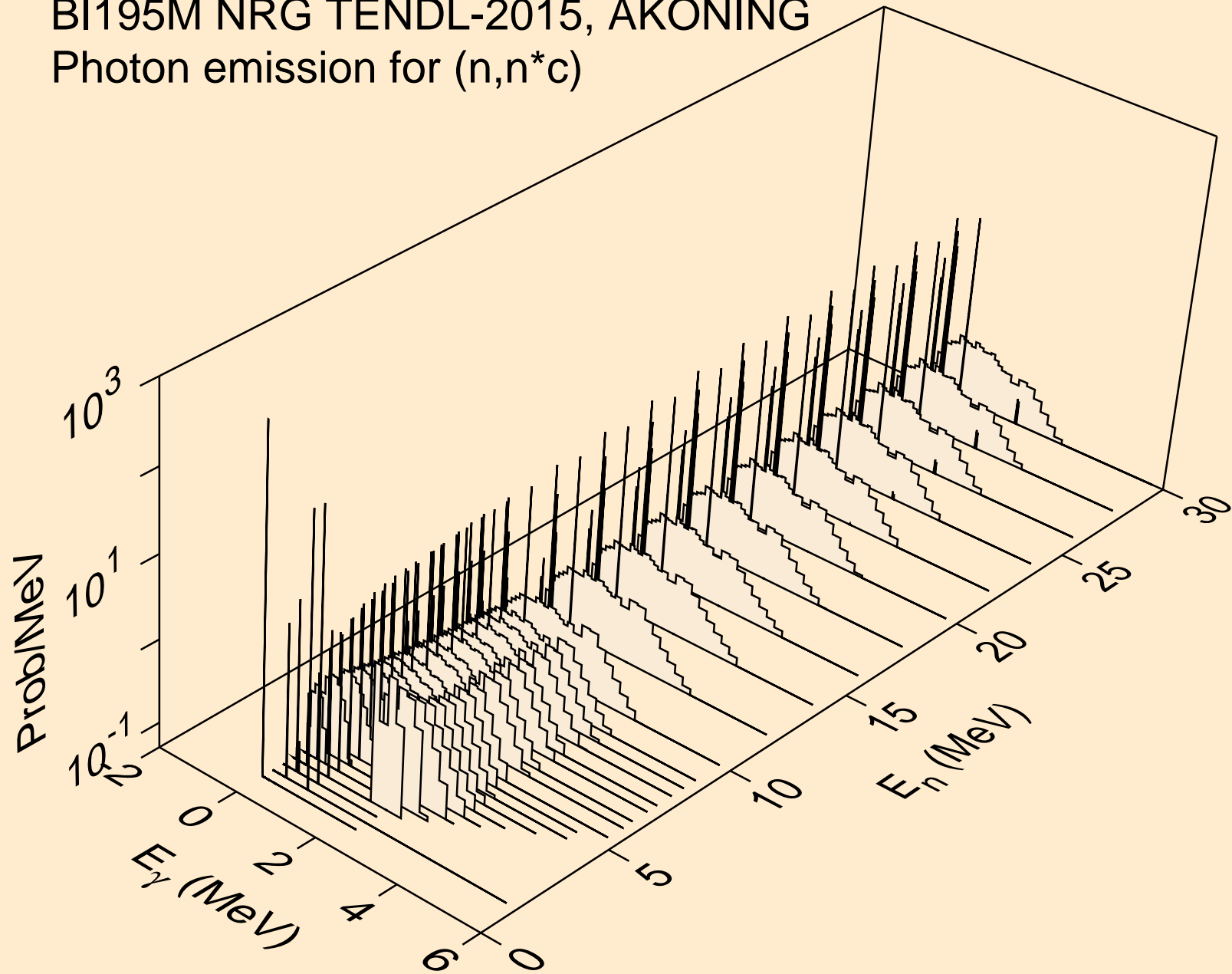

BI195M NRG TENDL-2015, AKONING
Photon emission for (n,gma)

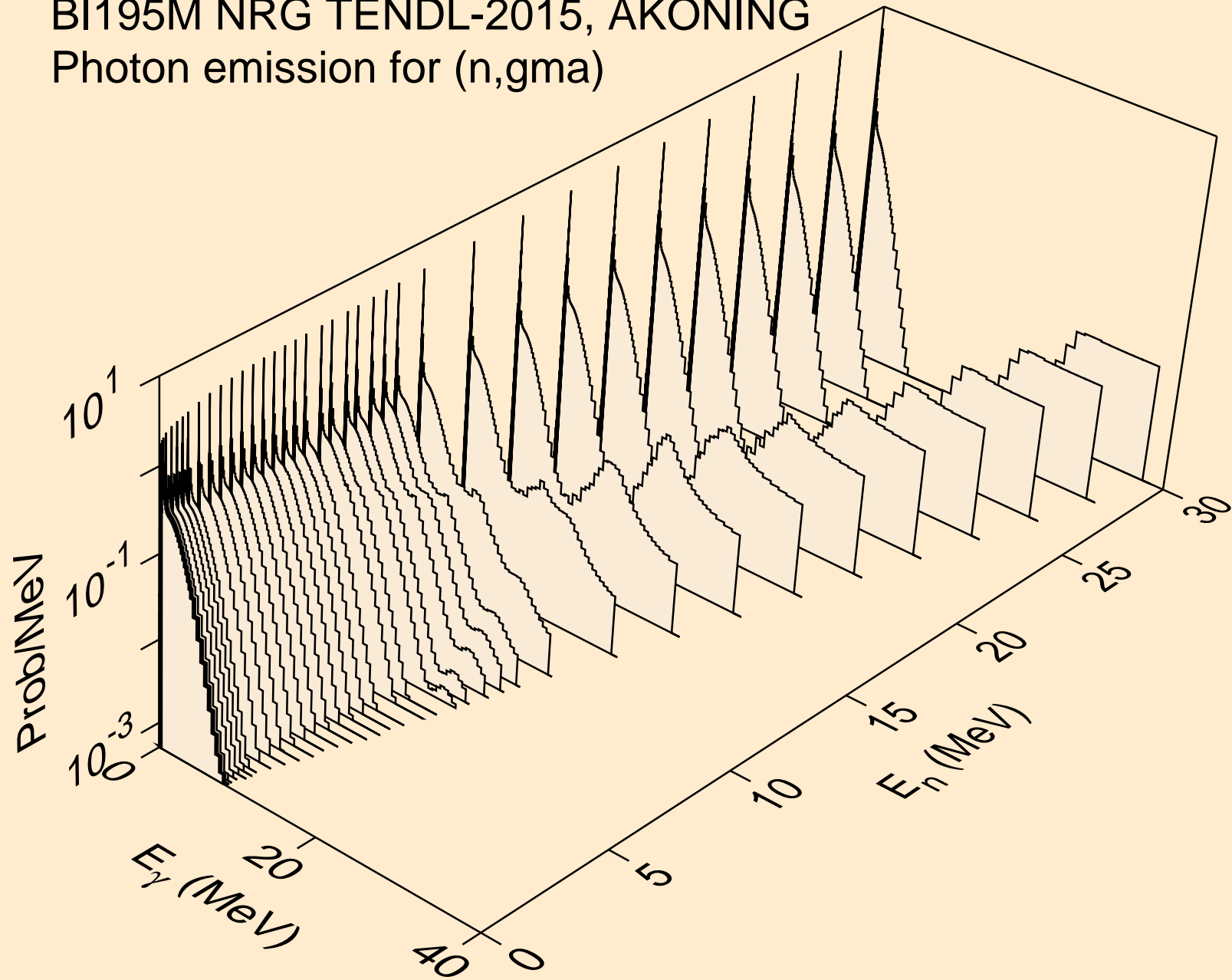

BI195M NRG TENDL-2015, AKONING
Photon emission for (n,p)

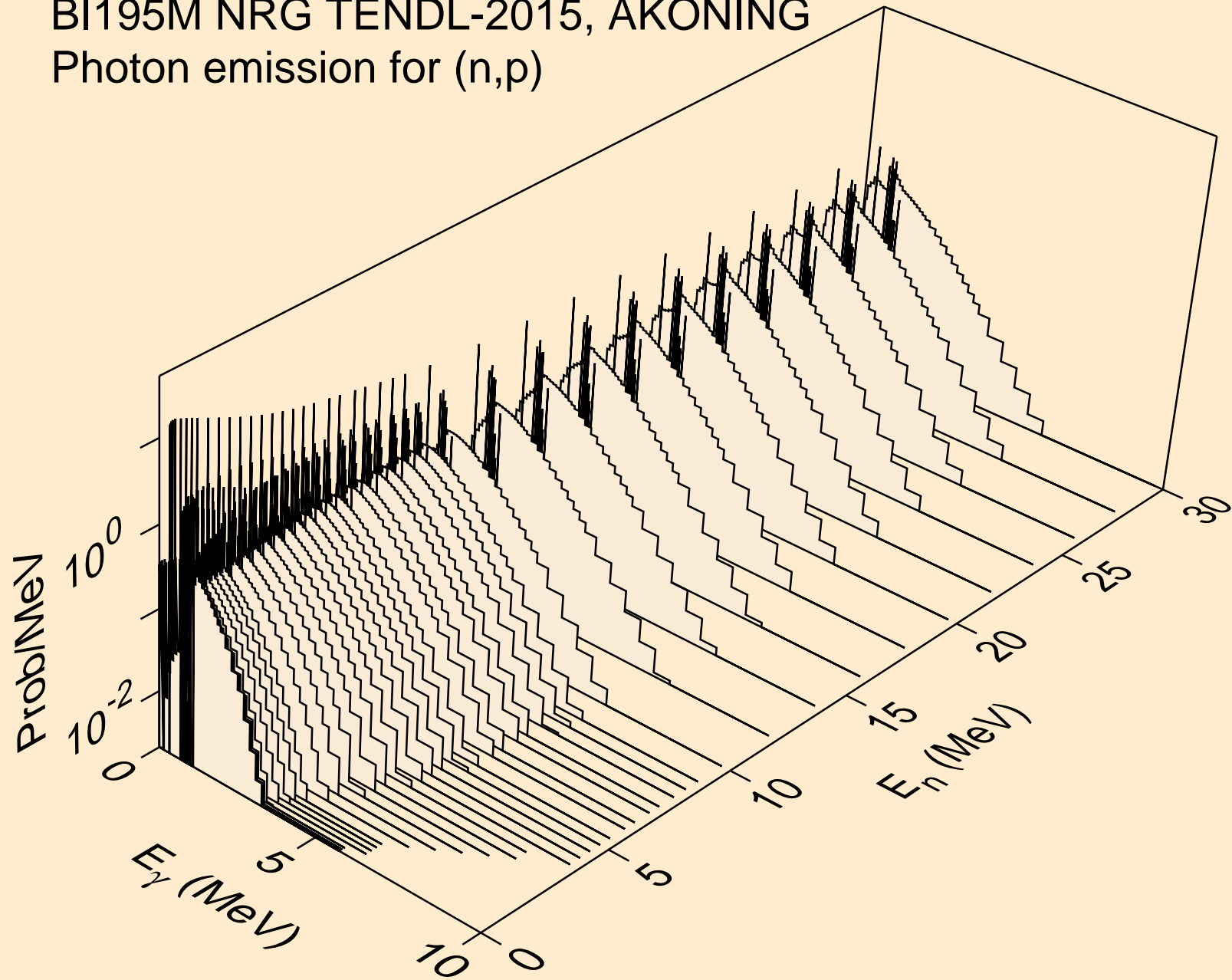

BI195M NRG TENDL-2015, AKONING
Photon emission for (n,d)

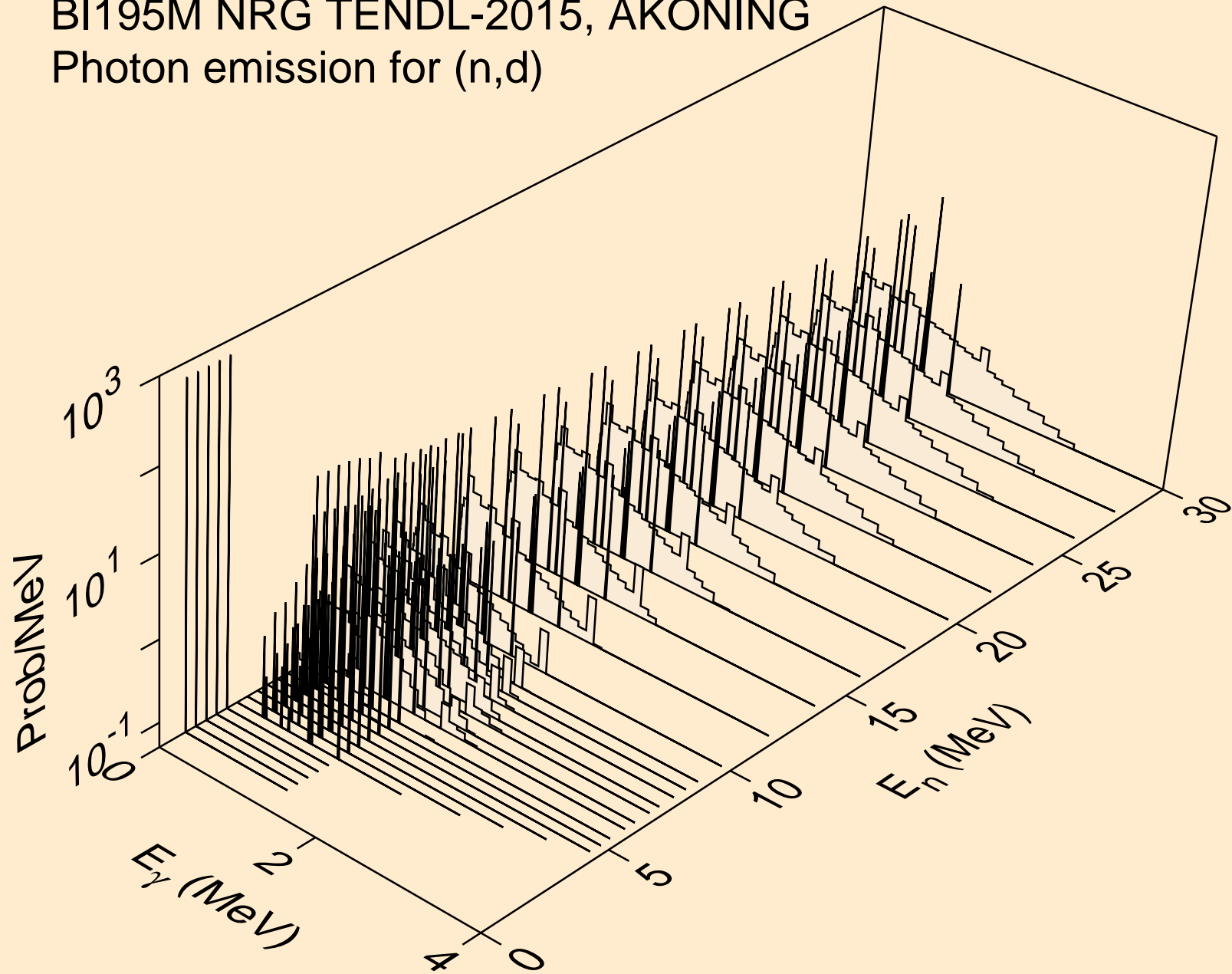

BI195M NRG TENDL-2015, AKONING
Photon emission for (n,t)

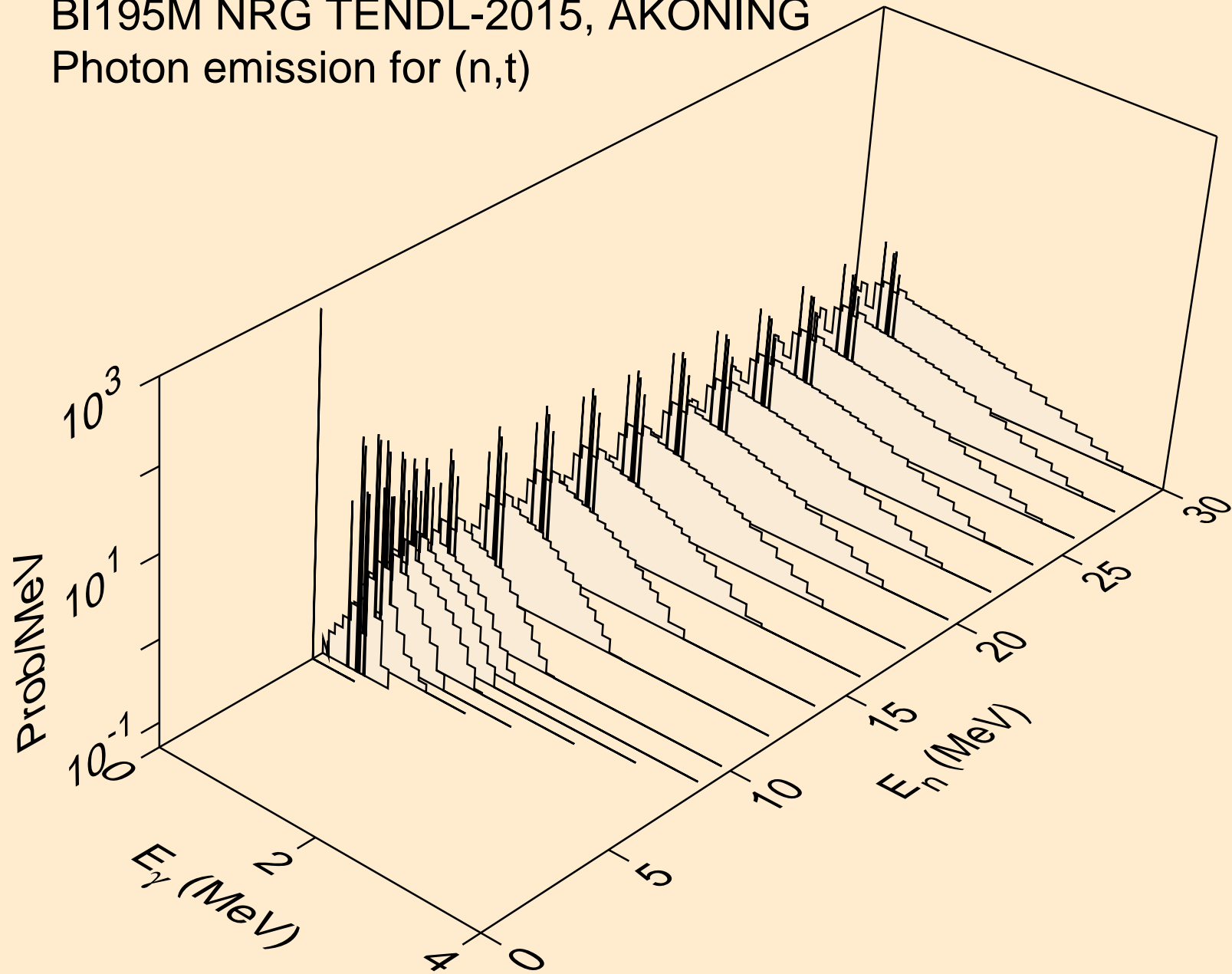

BI195M NRG TENDL-2015, AKONING
Photon emission for (n,he3)

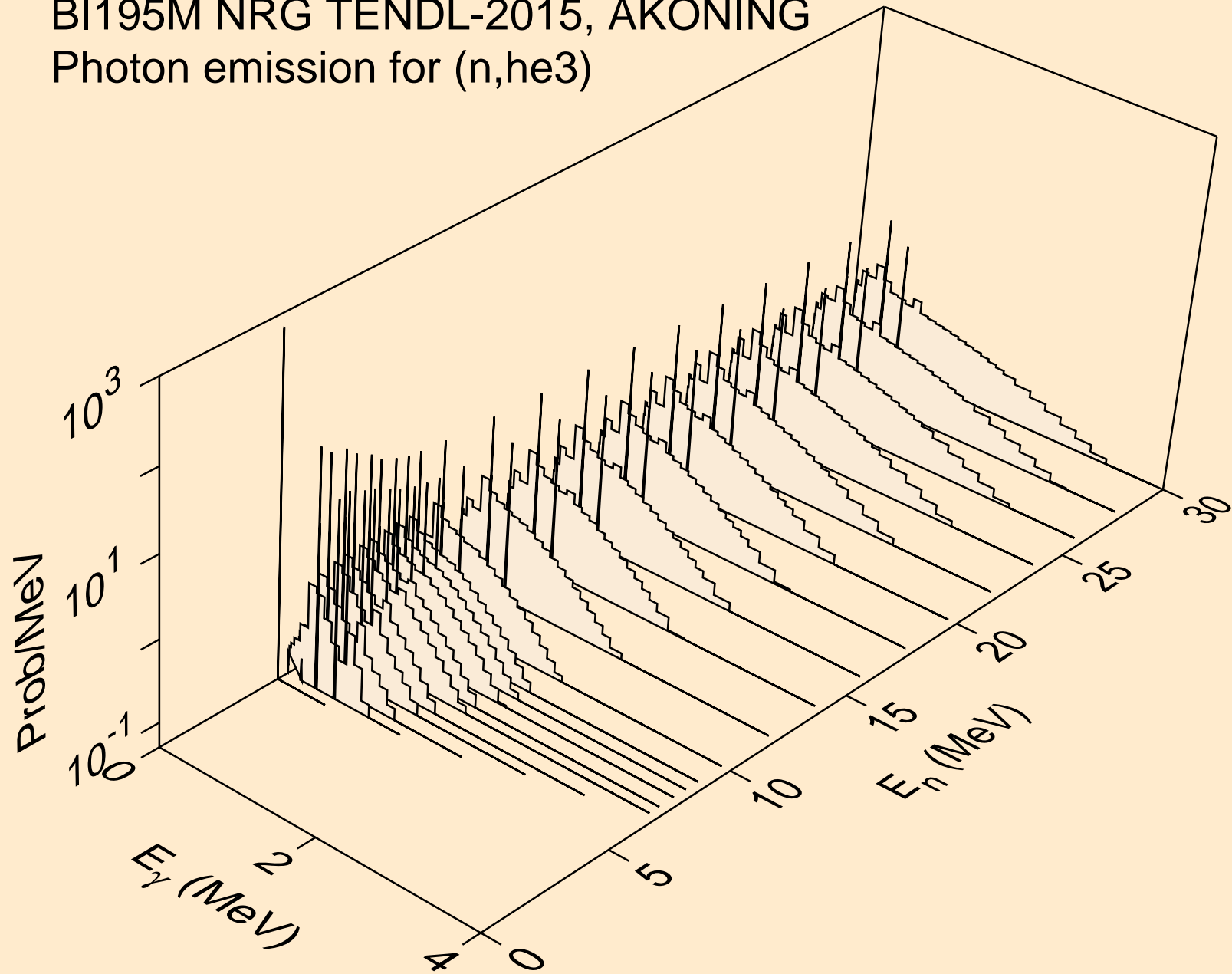

BI195M NRG TENDL-2015, AKONING
Photon emission for (n,a)

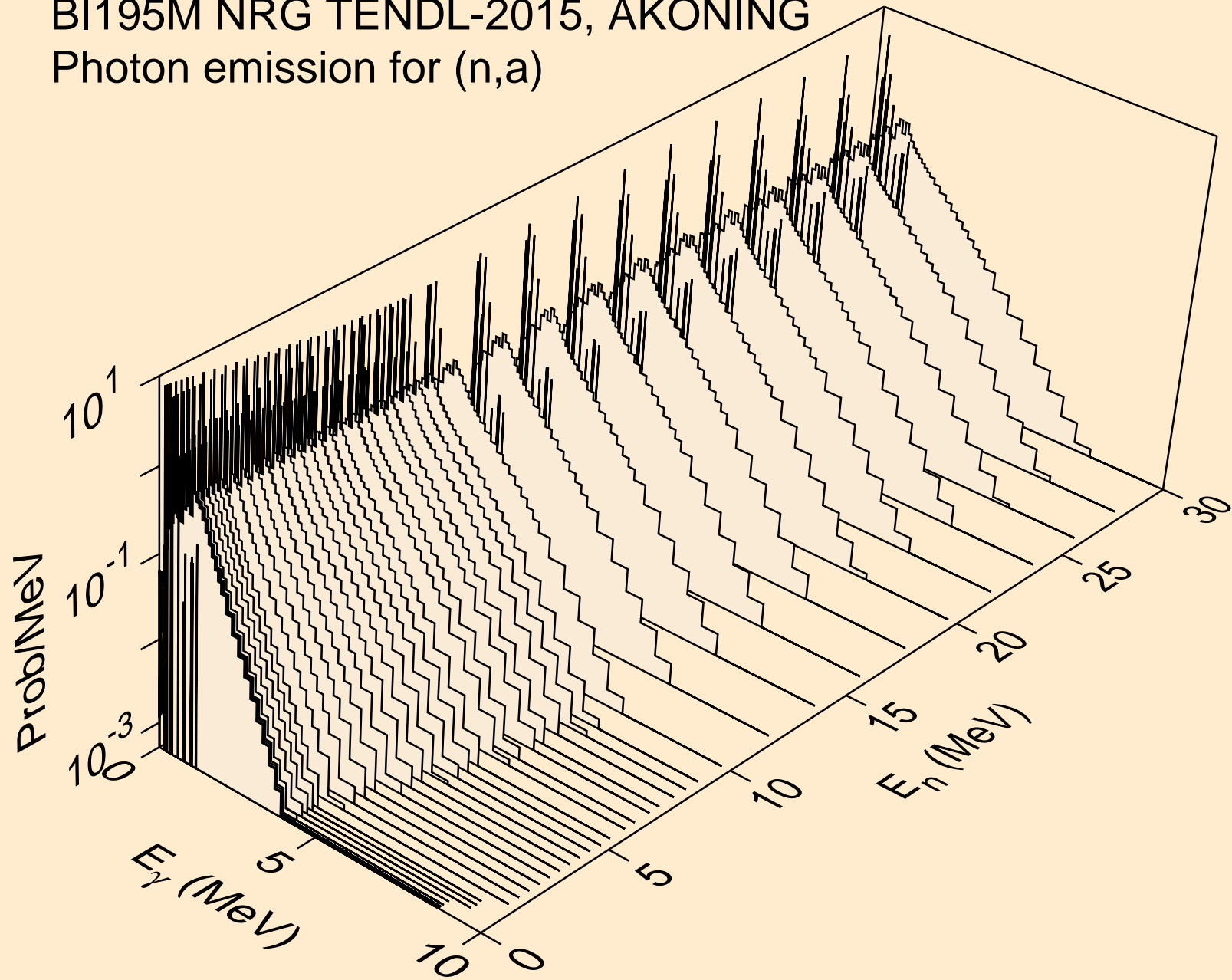

BI195M NRG TENDL-2015, AKONING
Photon emission for (n,2a)

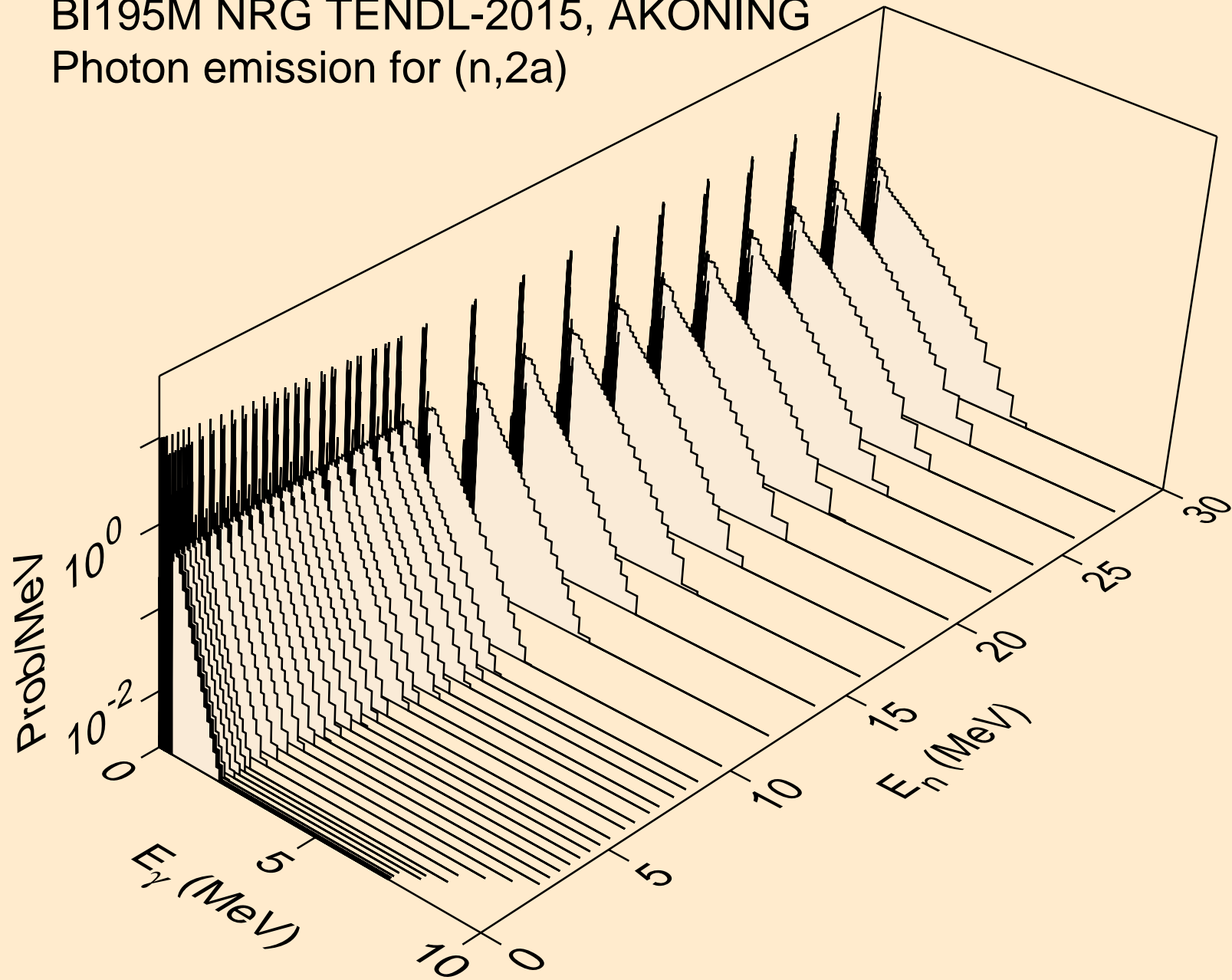

BI195M NRG TENDL-2015, AKONING
Photon emission for (n,3a)

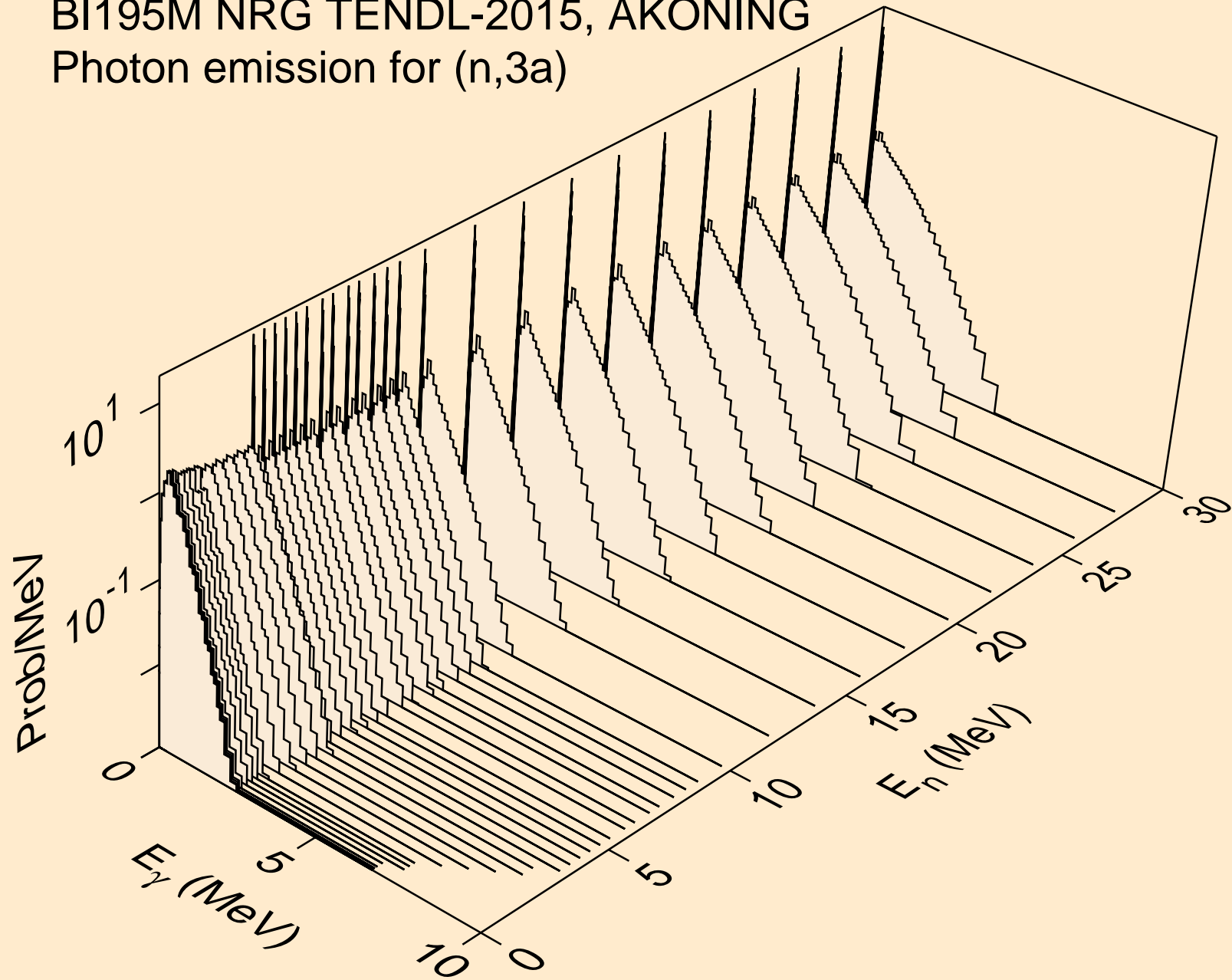

BI195M NRG TENDL-2015, AKONING
Photon emission for (n,2p)

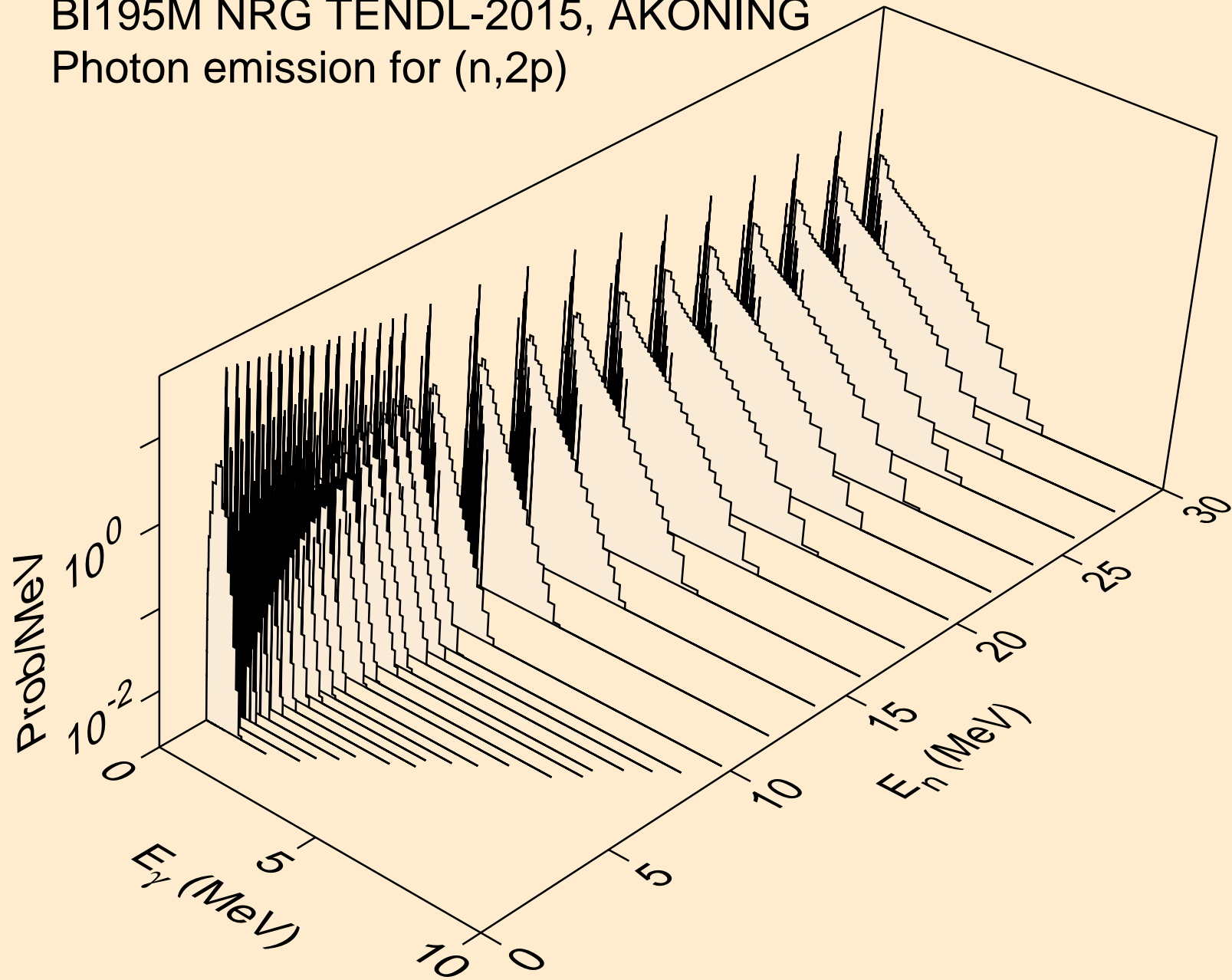

BI195M NRG TENDL-2015, AKONING
Photon emission for (n,p α)

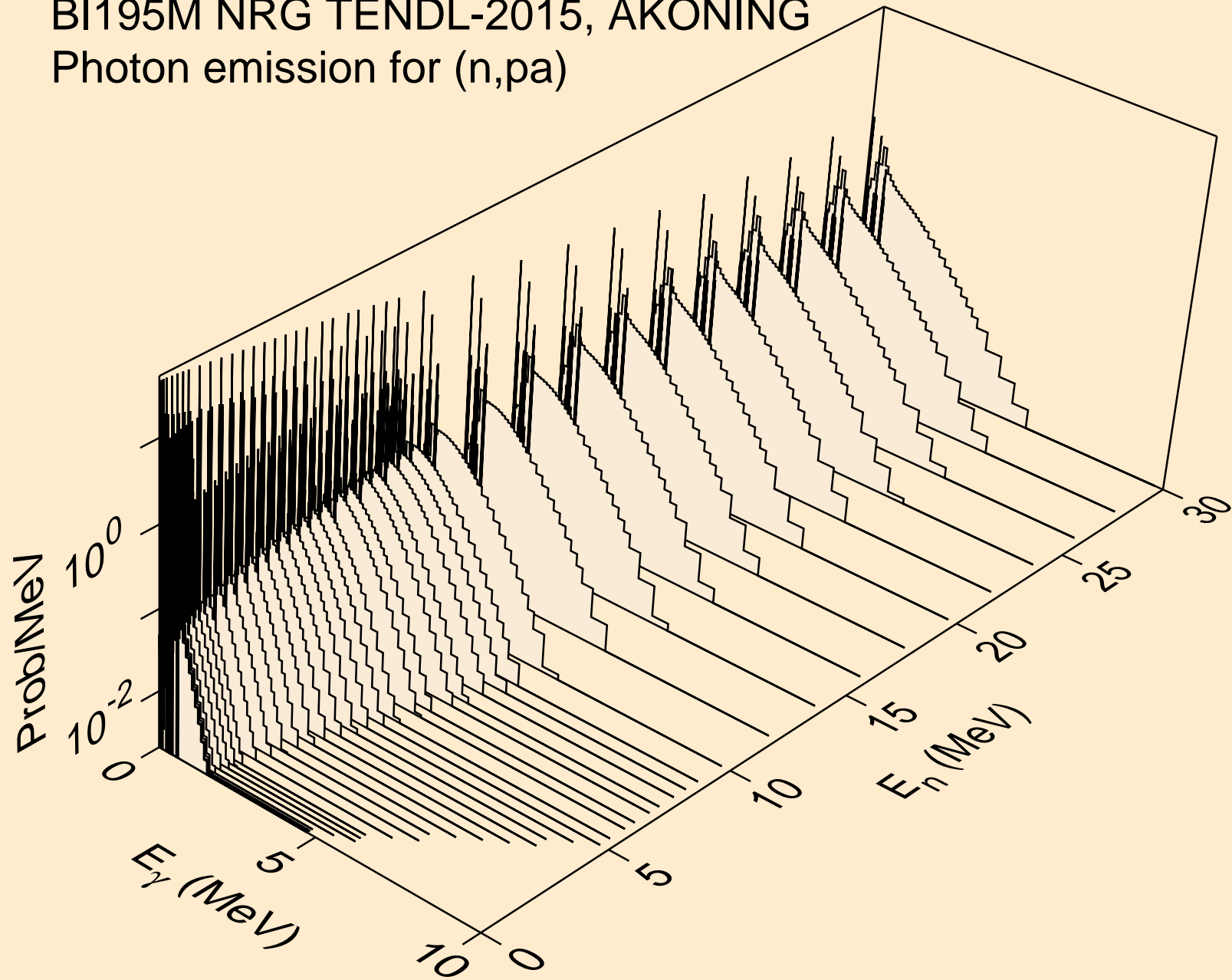

BI195M NRG TENDL-2015, AKONING
Photon emission for (n,t2a)

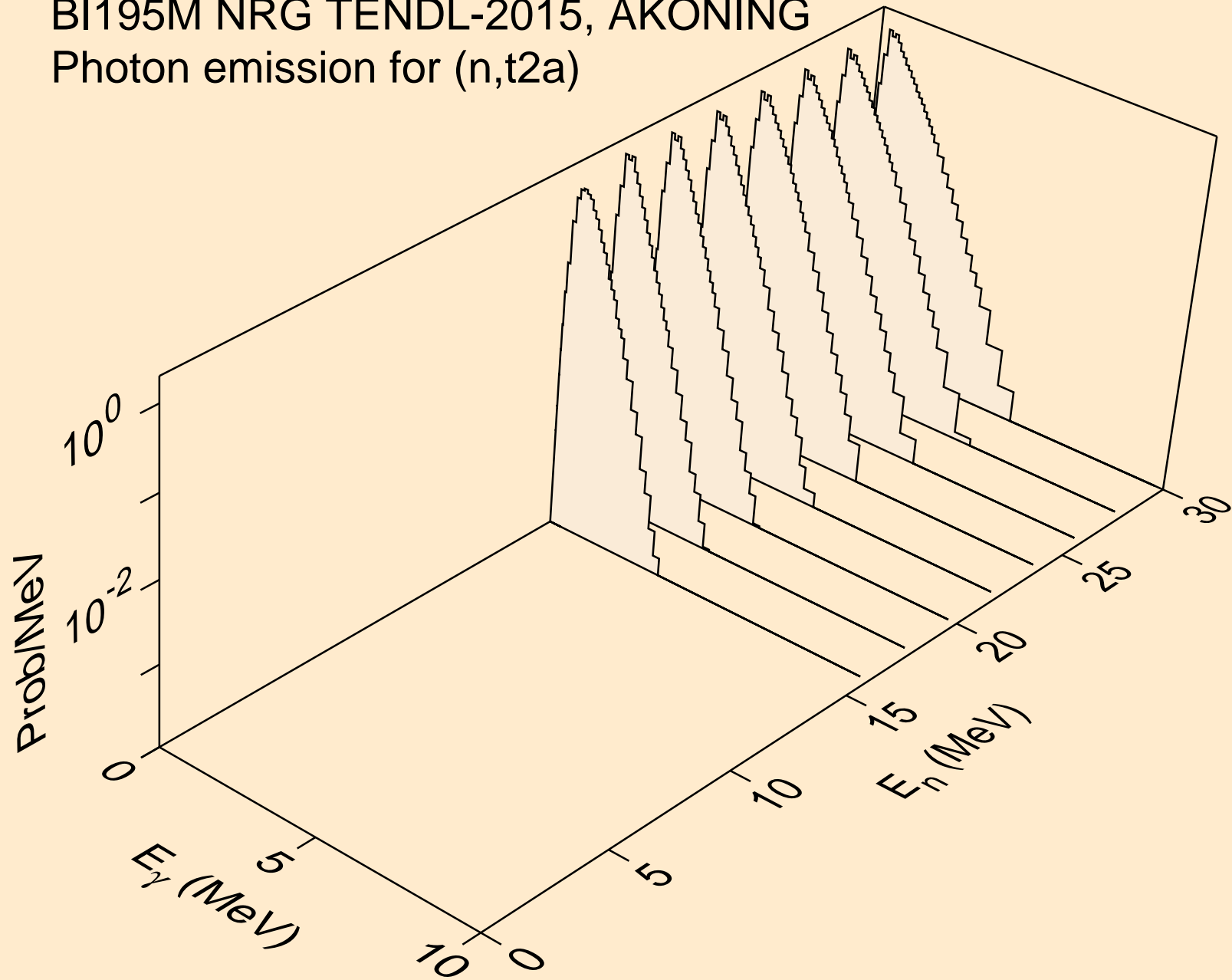

BI195M NRG TENDL-2015, AKONING
Photon emission for (n,d2a)

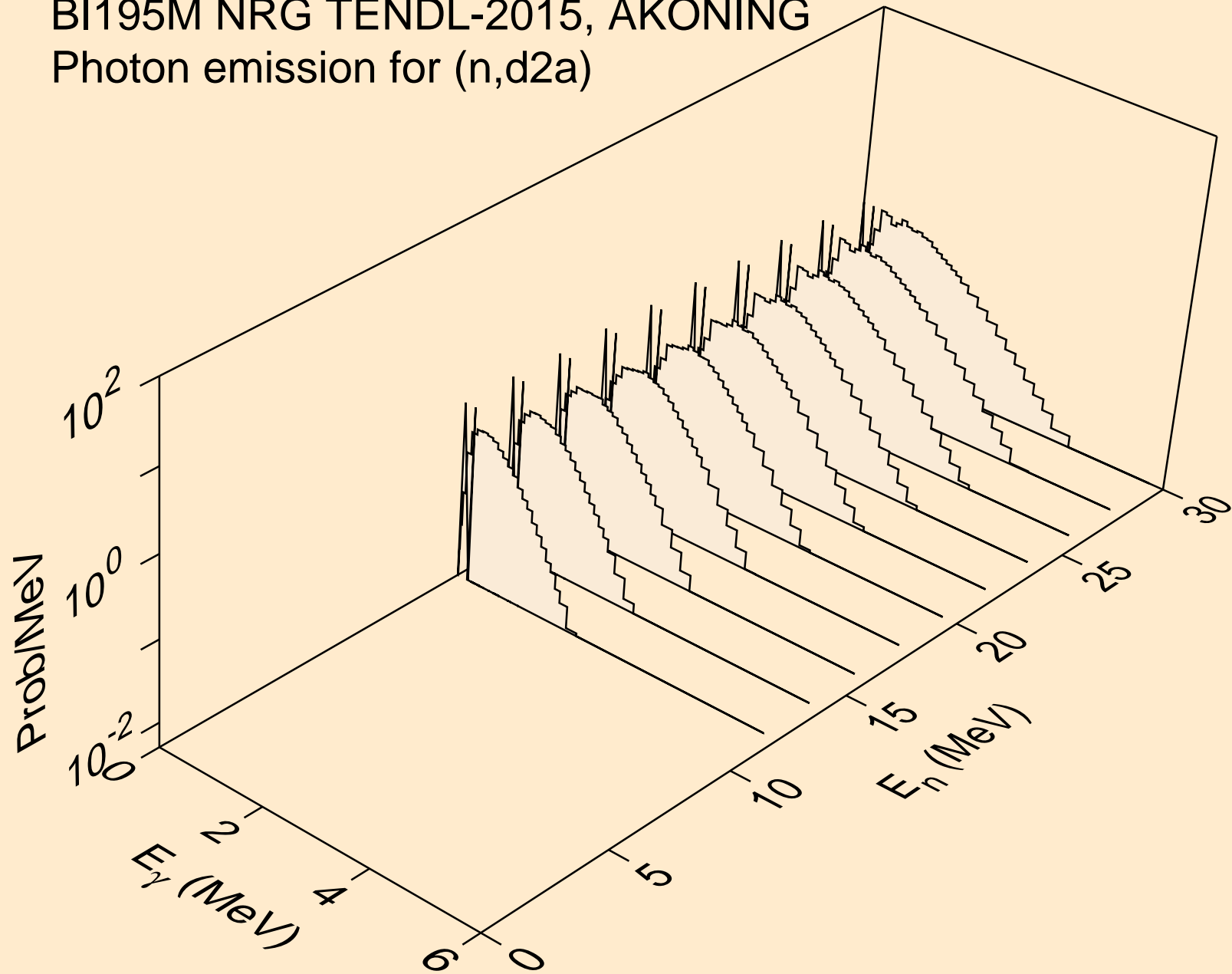

BI195M NRG TENDL-2015, AKONING
Photon emission for (n,pd)

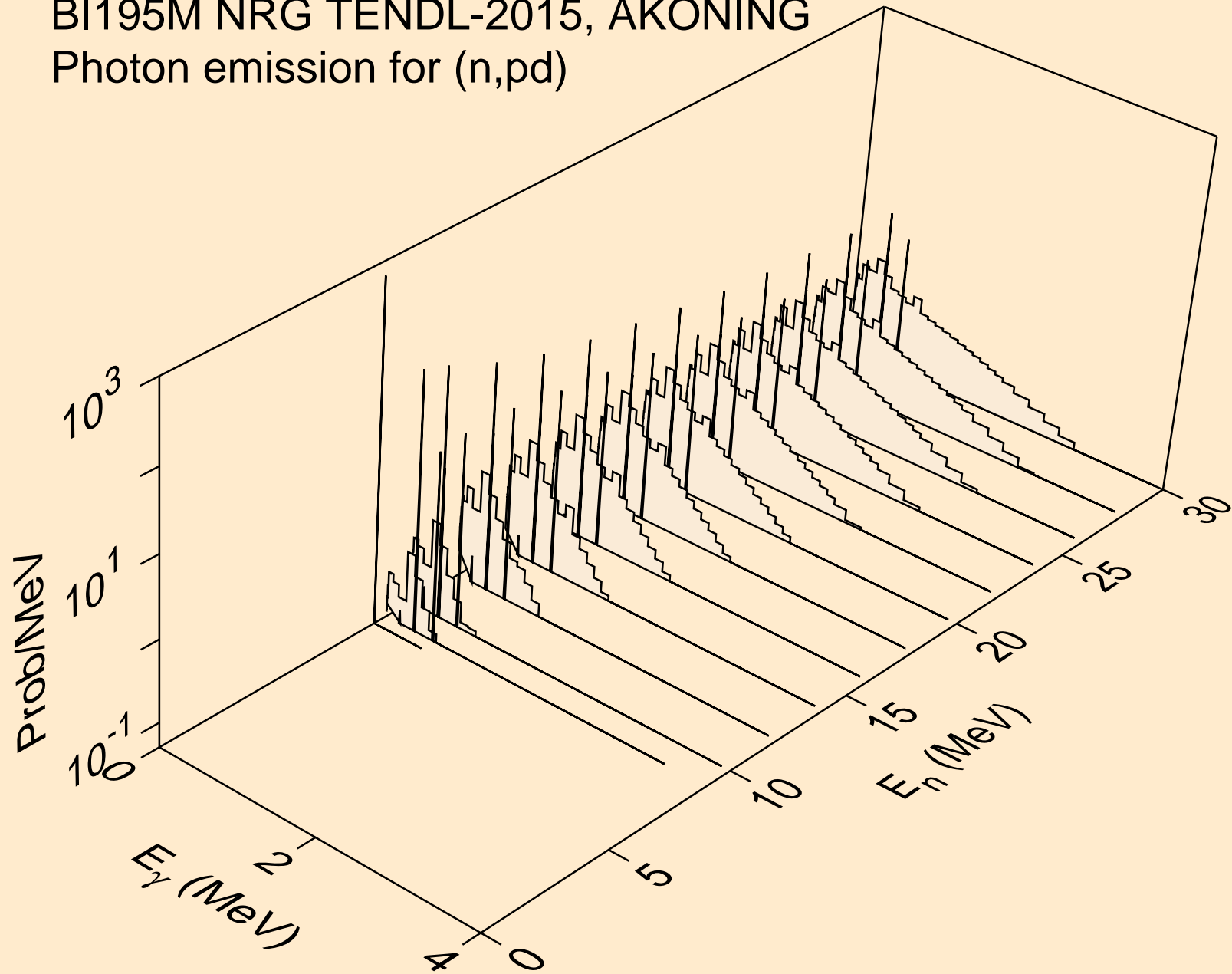

BI195M NRG TENDL-2015, AKONING
Photon emission for (n,pt)

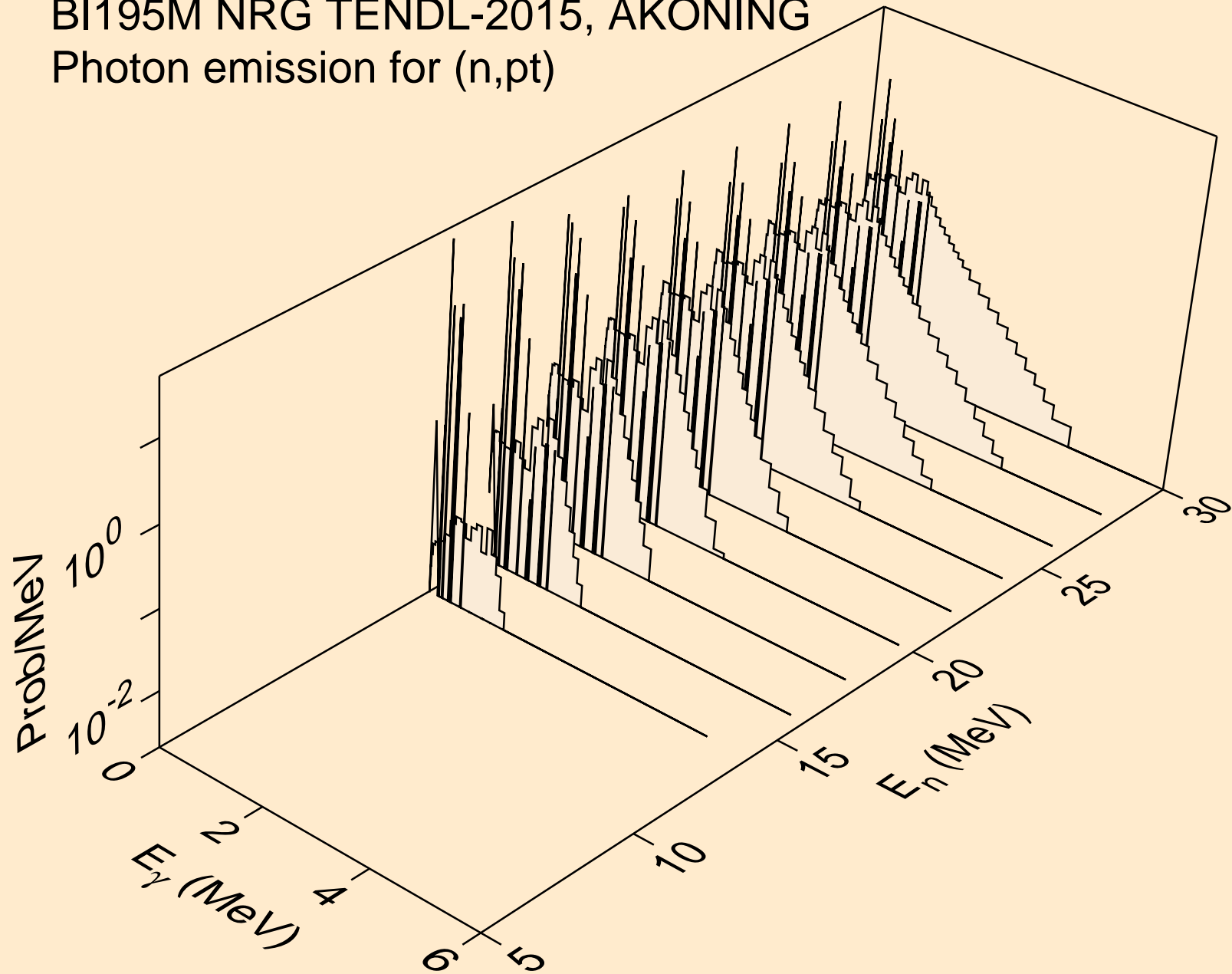

BI195M NRG TENDL-2015, AKONING
Photon emission for (n,da)

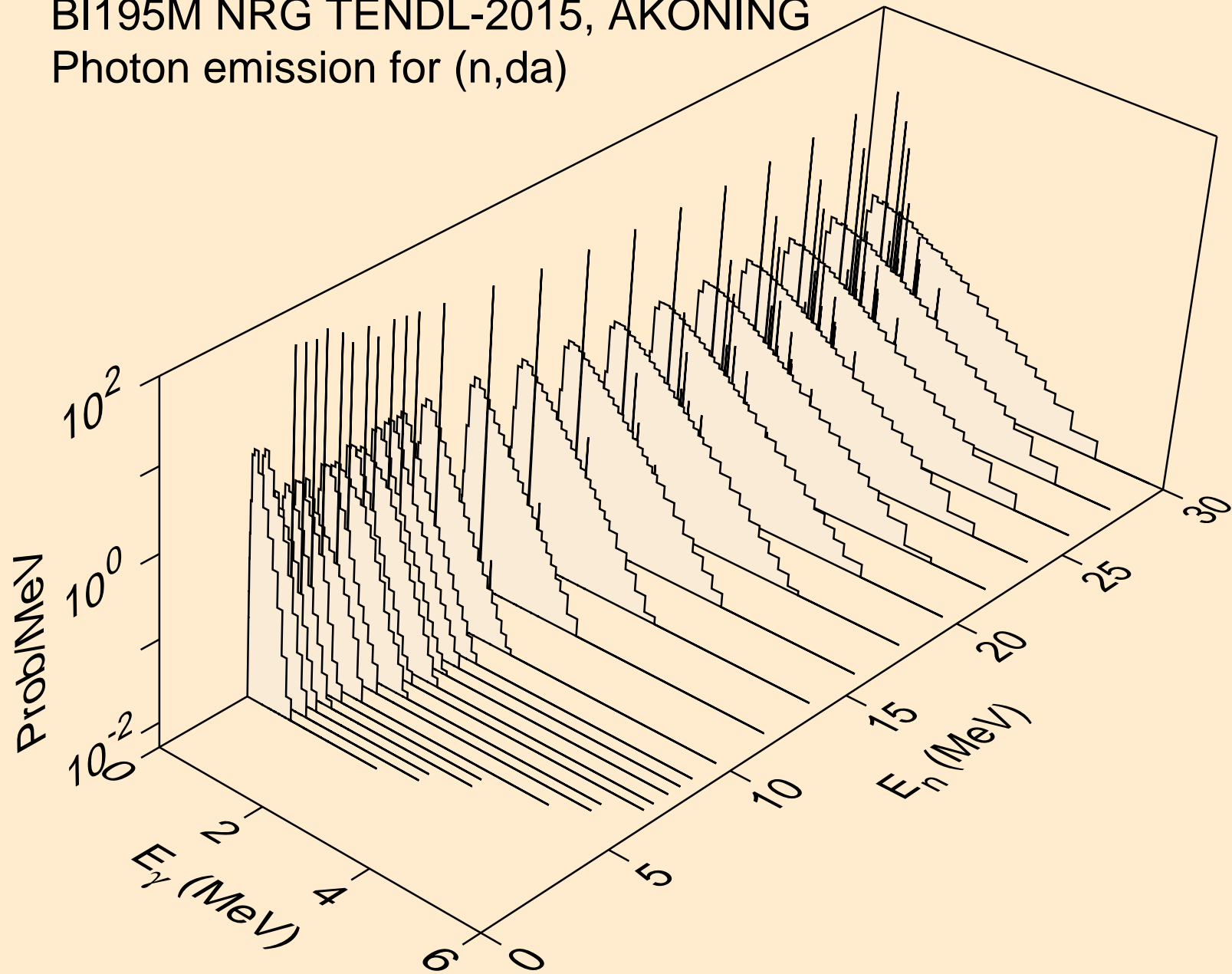

BI195M NRG TENDL-2015, AKONING
thermal capture photon spectrum

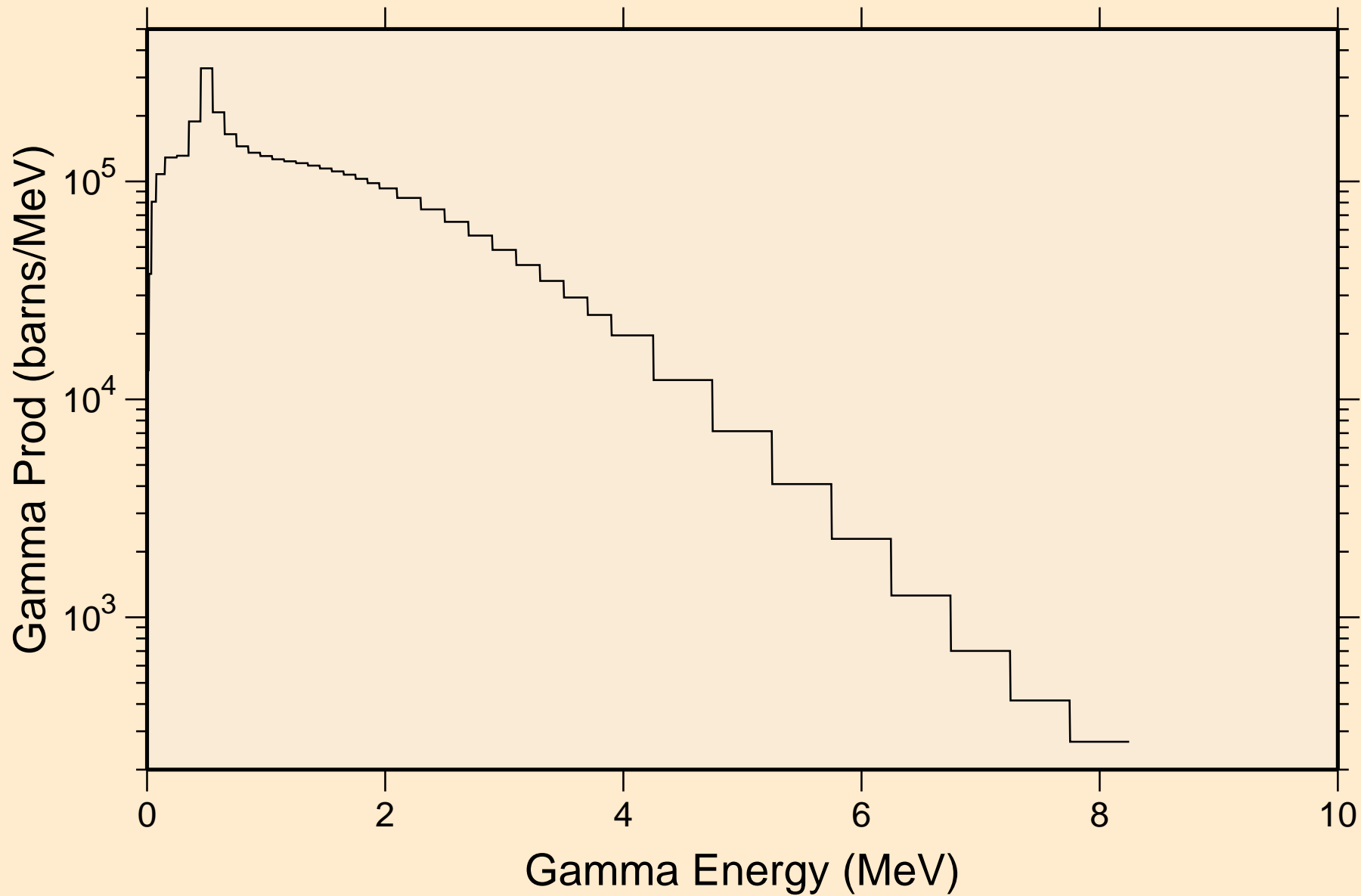

BI195M NRG TENDL-2015, AKONING
14 MeV photon spectrum

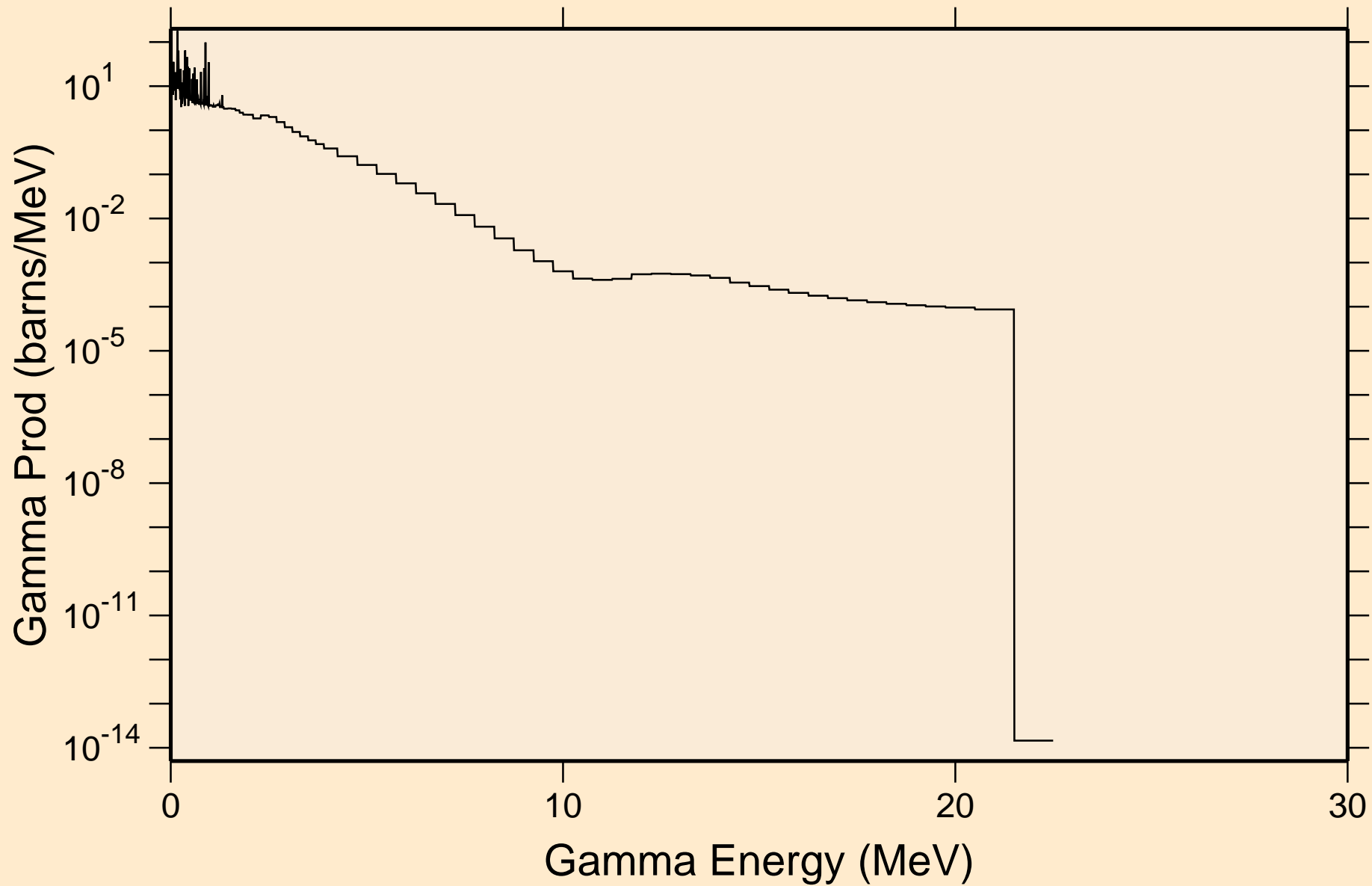

BI195M NRG TENDL-2015, AKONING

Particle heating contributions

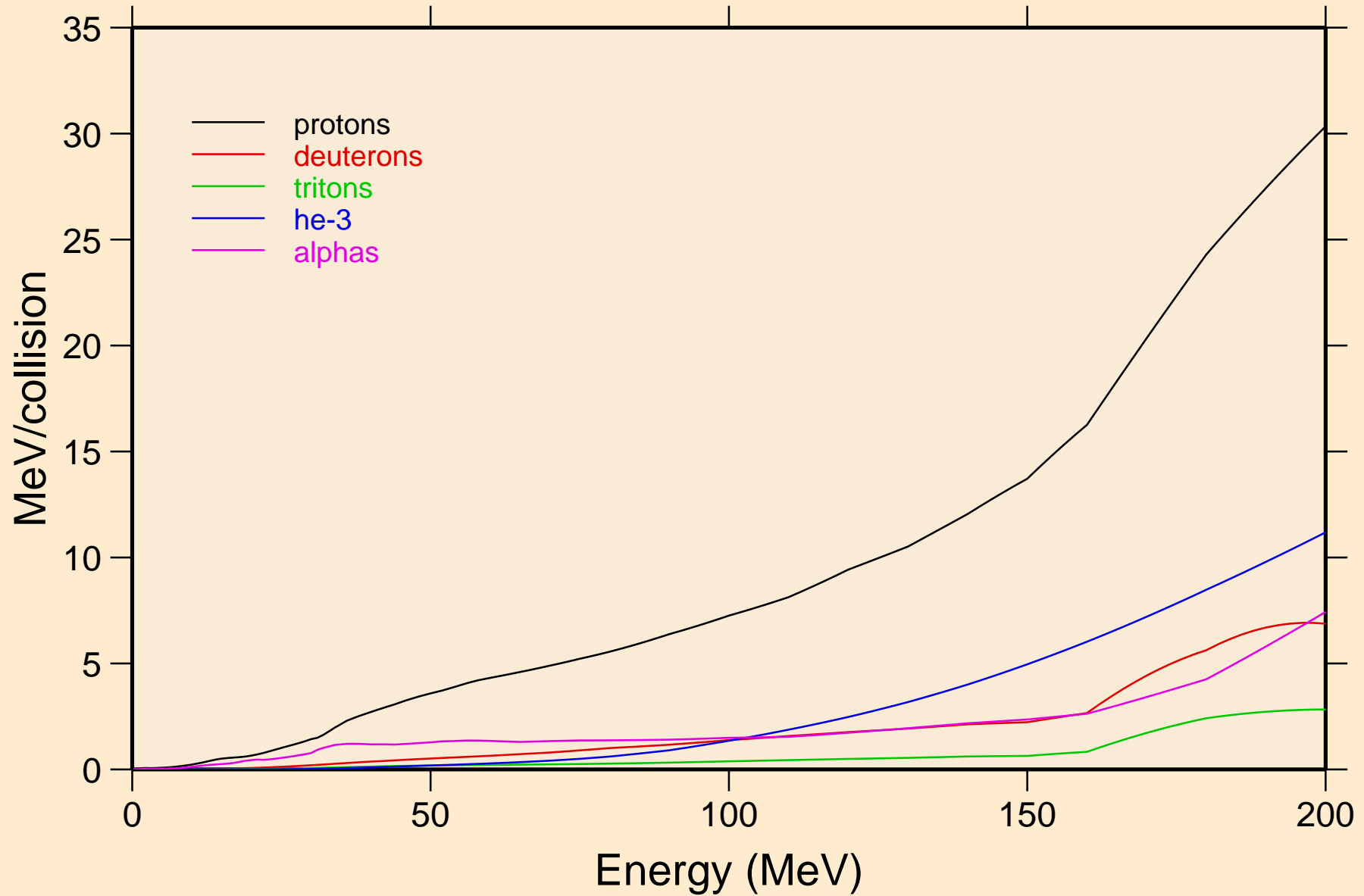

BI195M NRG TENDL-2015, AKONING

Recoil Heating

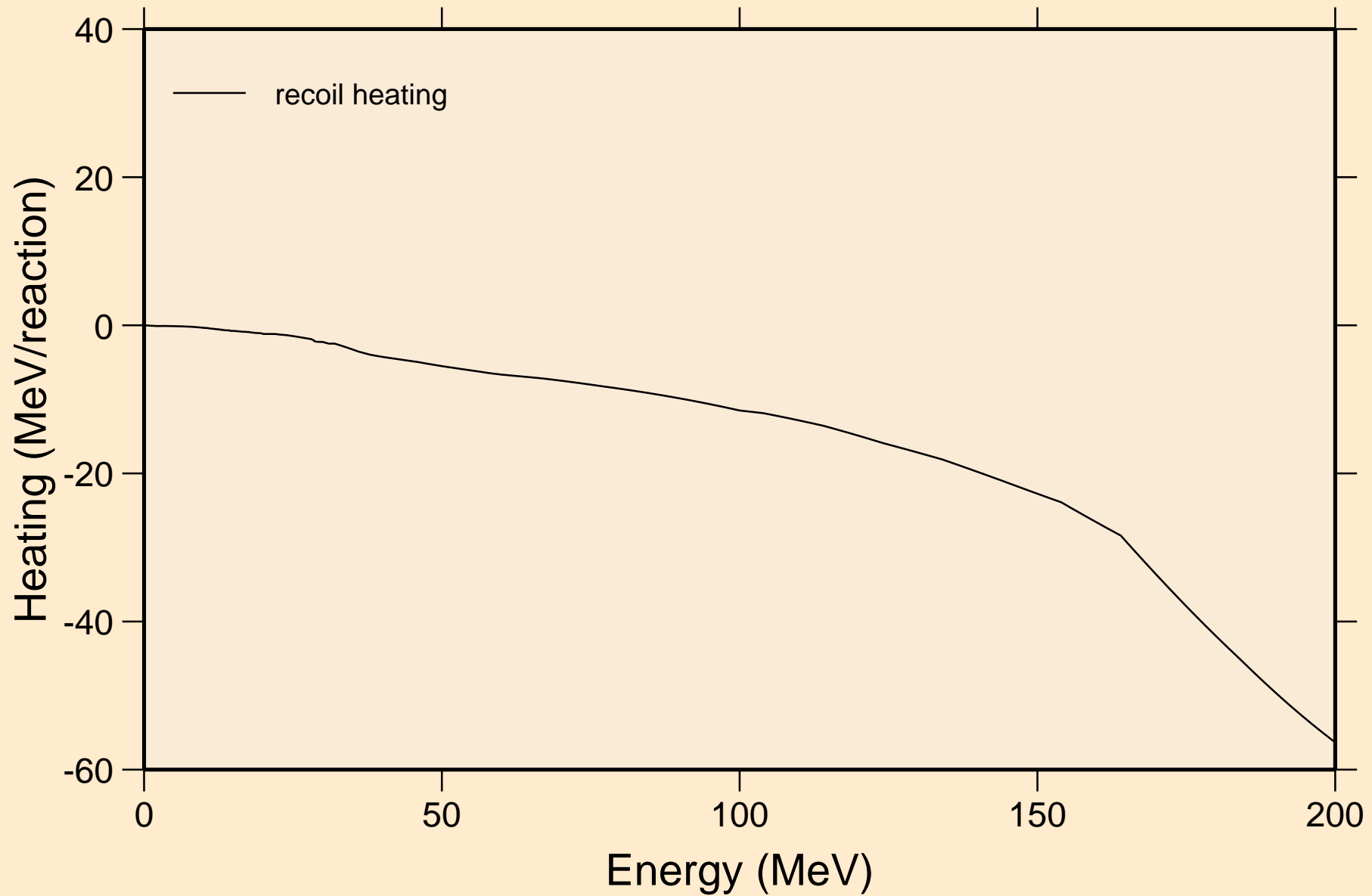

BI195M NRG TENDL-2015, AKONING

Particle production cross sections

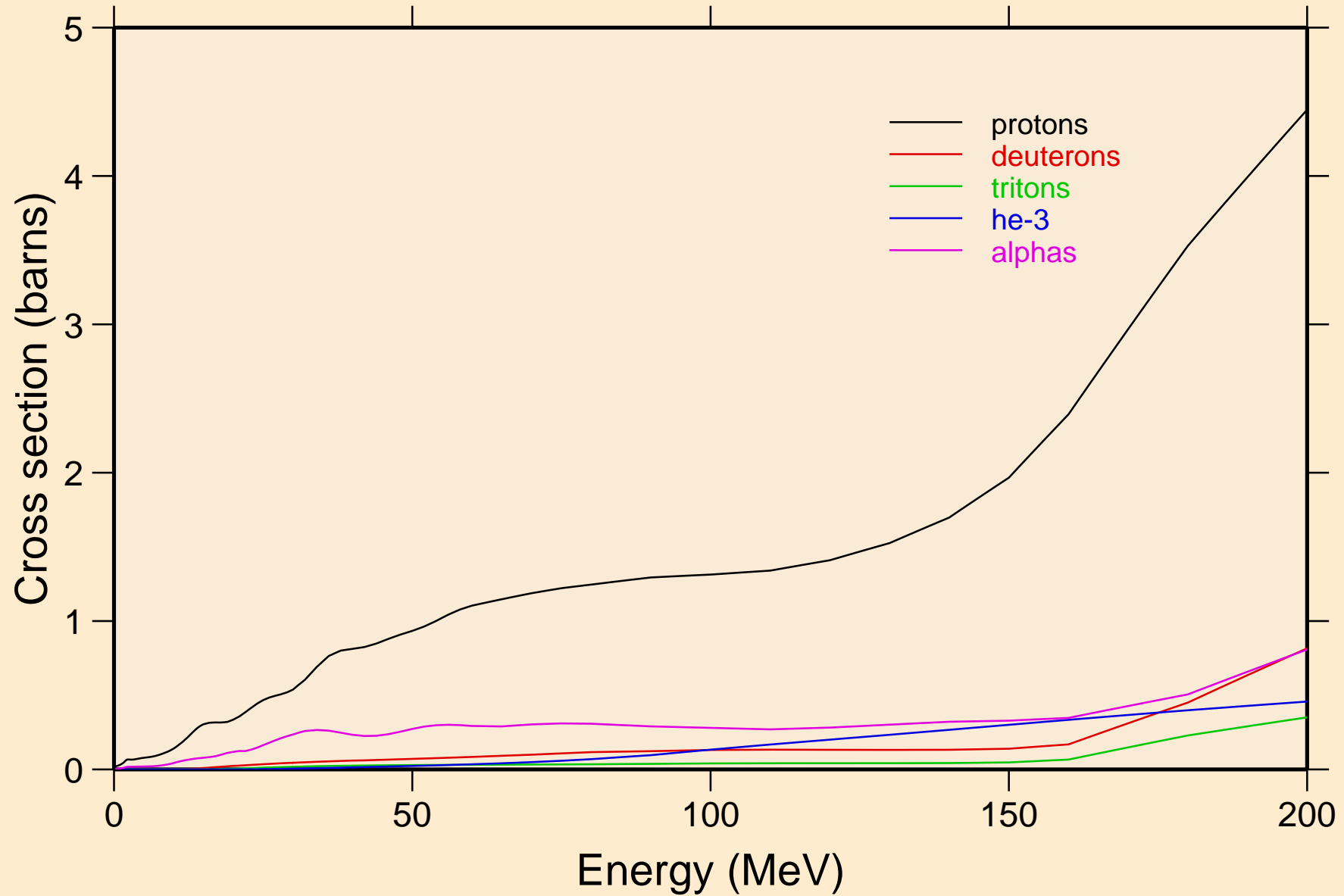

BI195M NRG TENDL-2015, AKONING
protons from (n,x)

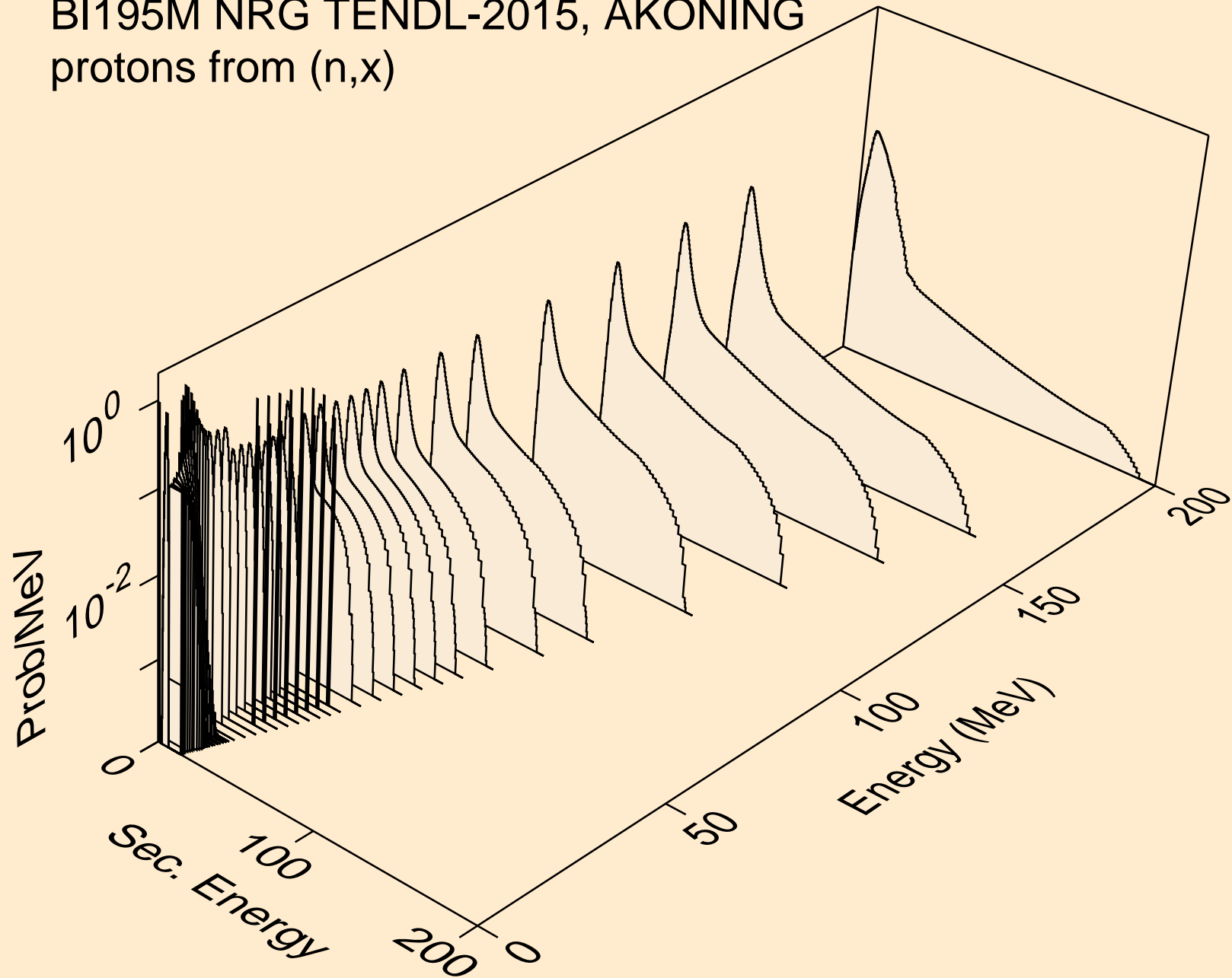

BI195M NRG TENDL-2015, AKONING
protons from (n,n*)p

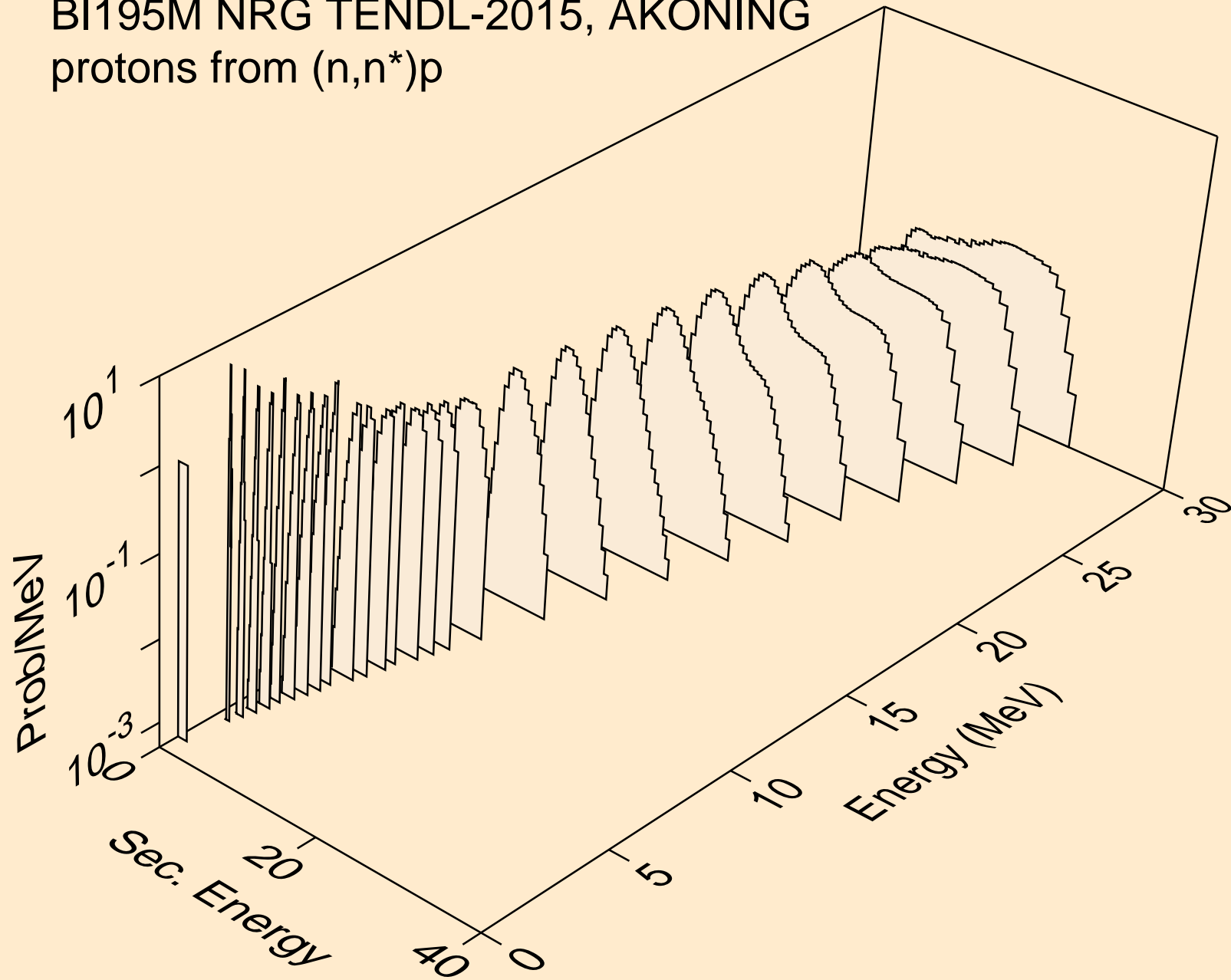

BI195M NRG TENDL-2015, AKONING
protons from (n,2np)

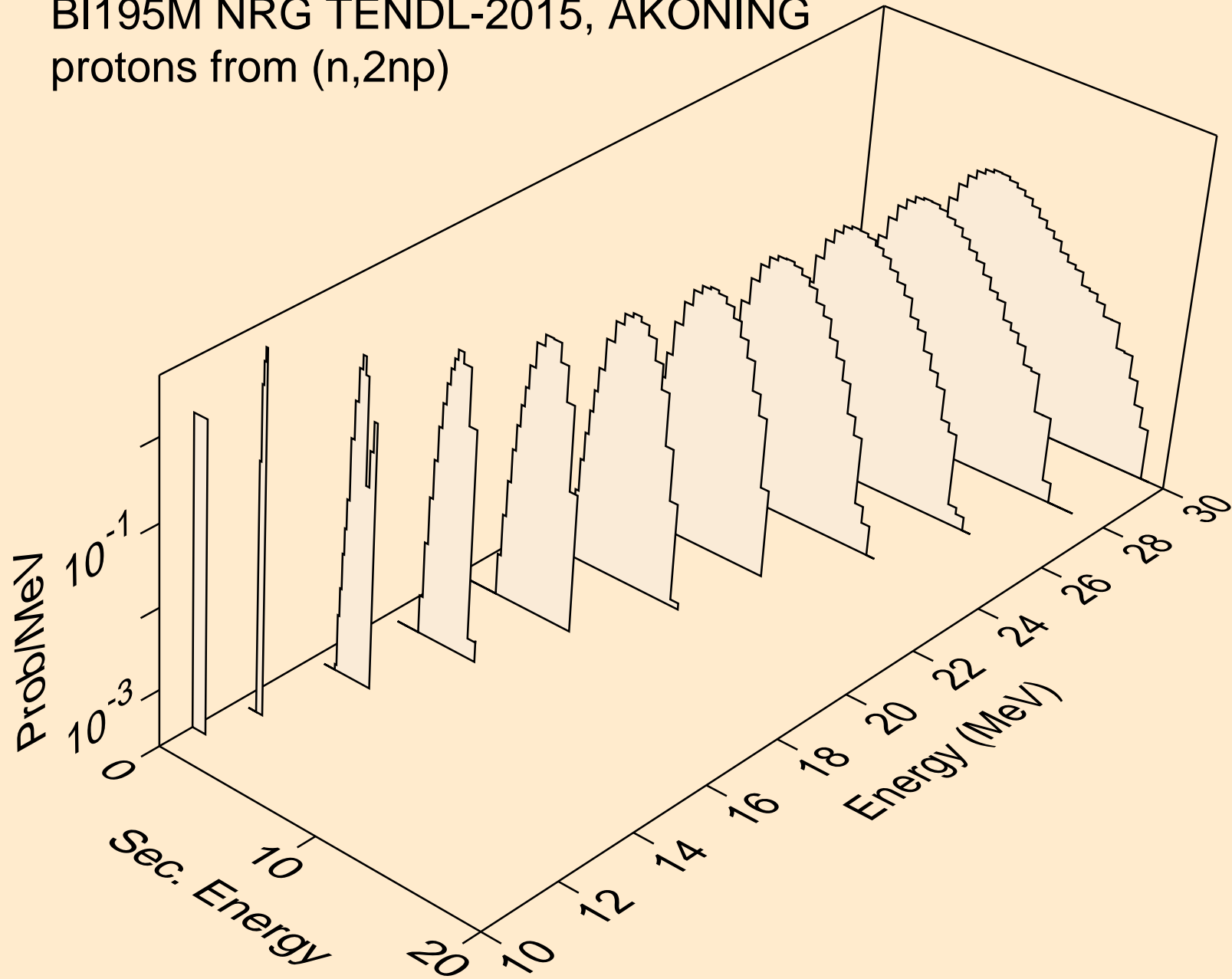

BI195M NRG TENDL-2015, AKONING
protons from (n,3np)

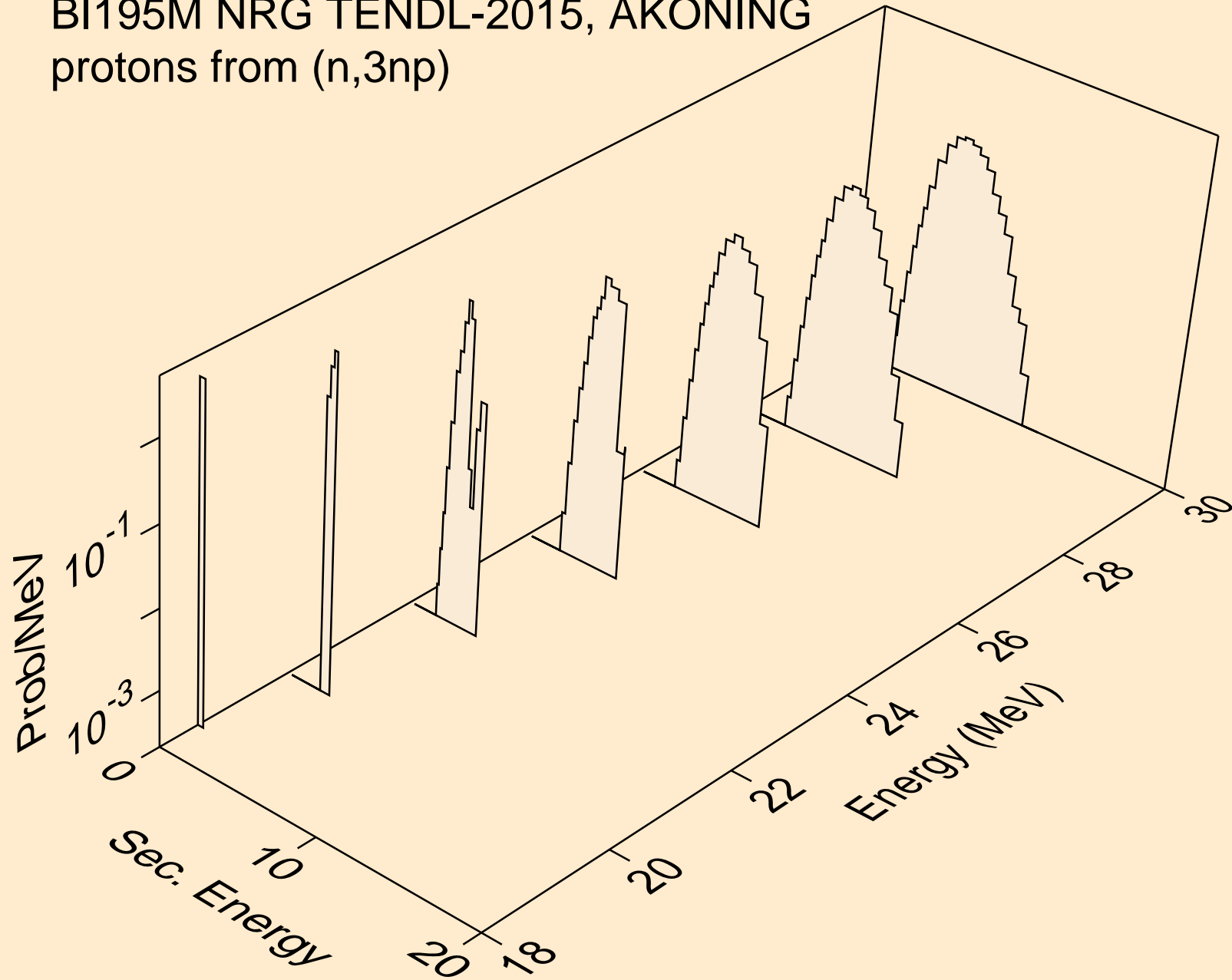

BI195M NRG TENDL-2015, AKONING
protons from (n,2np)

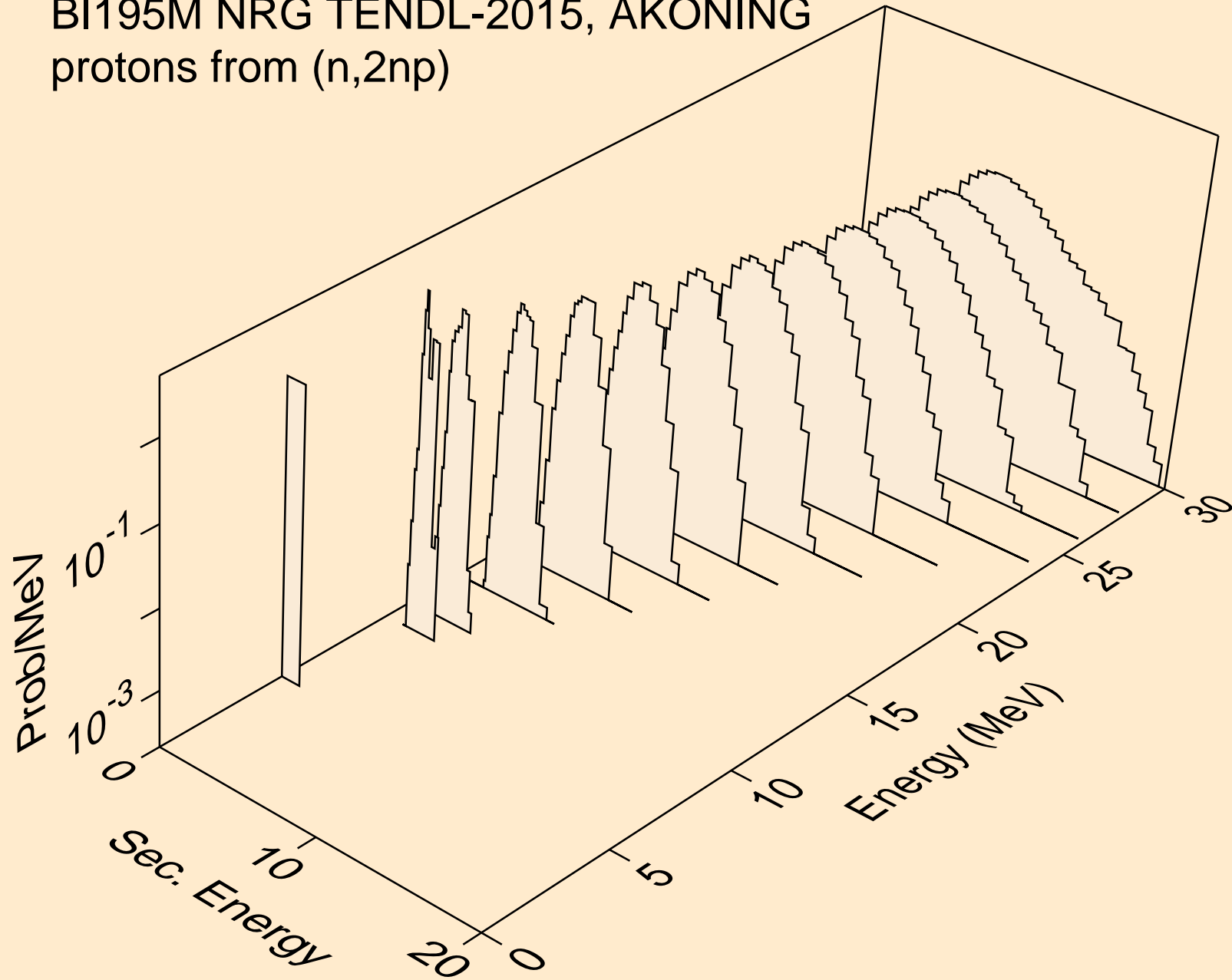

BI195M NRG TENDL-2015, AKONING
protons from (n,npa)

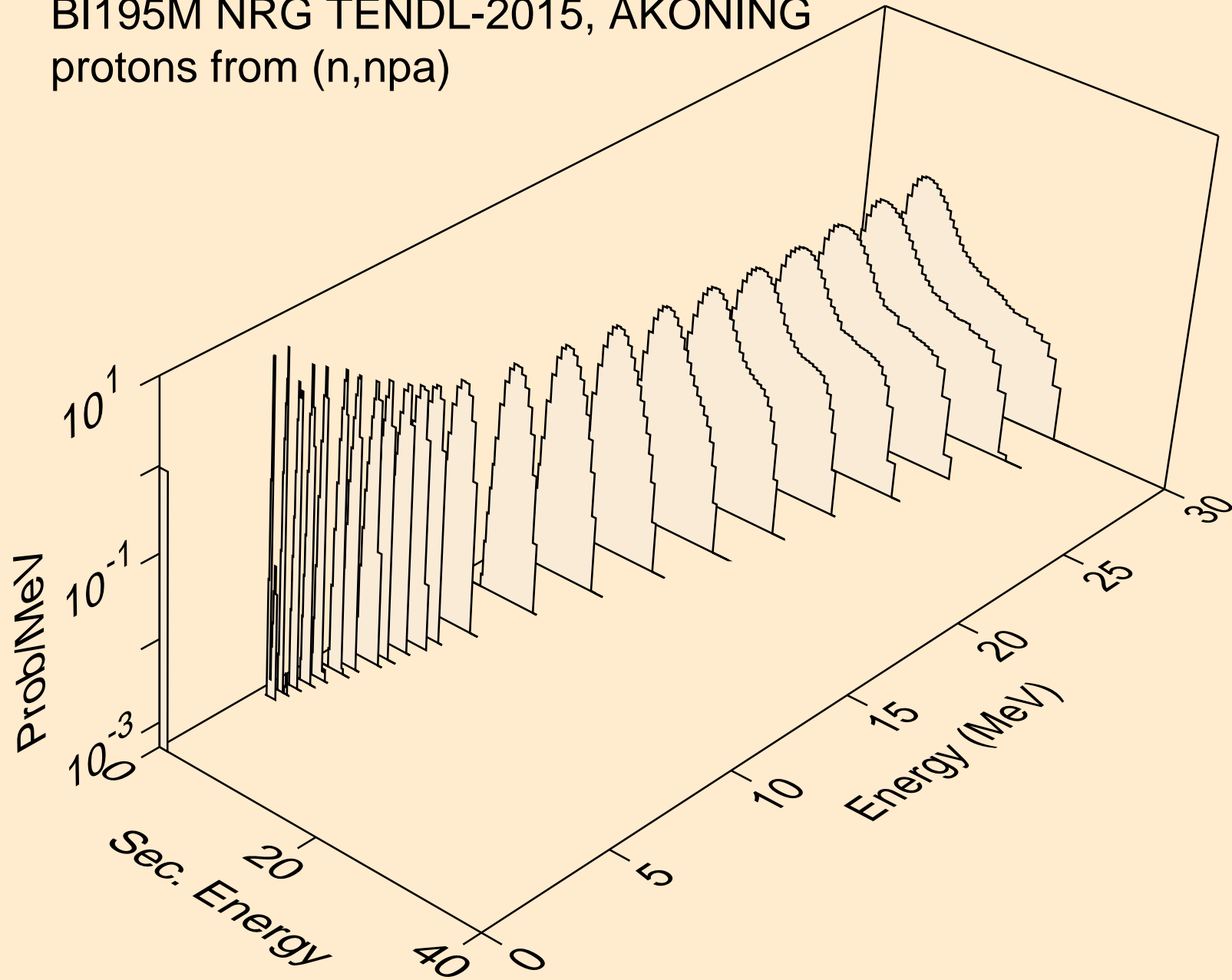

BI195M NRG TENDL-2015, AKONING
protons from (n,p)

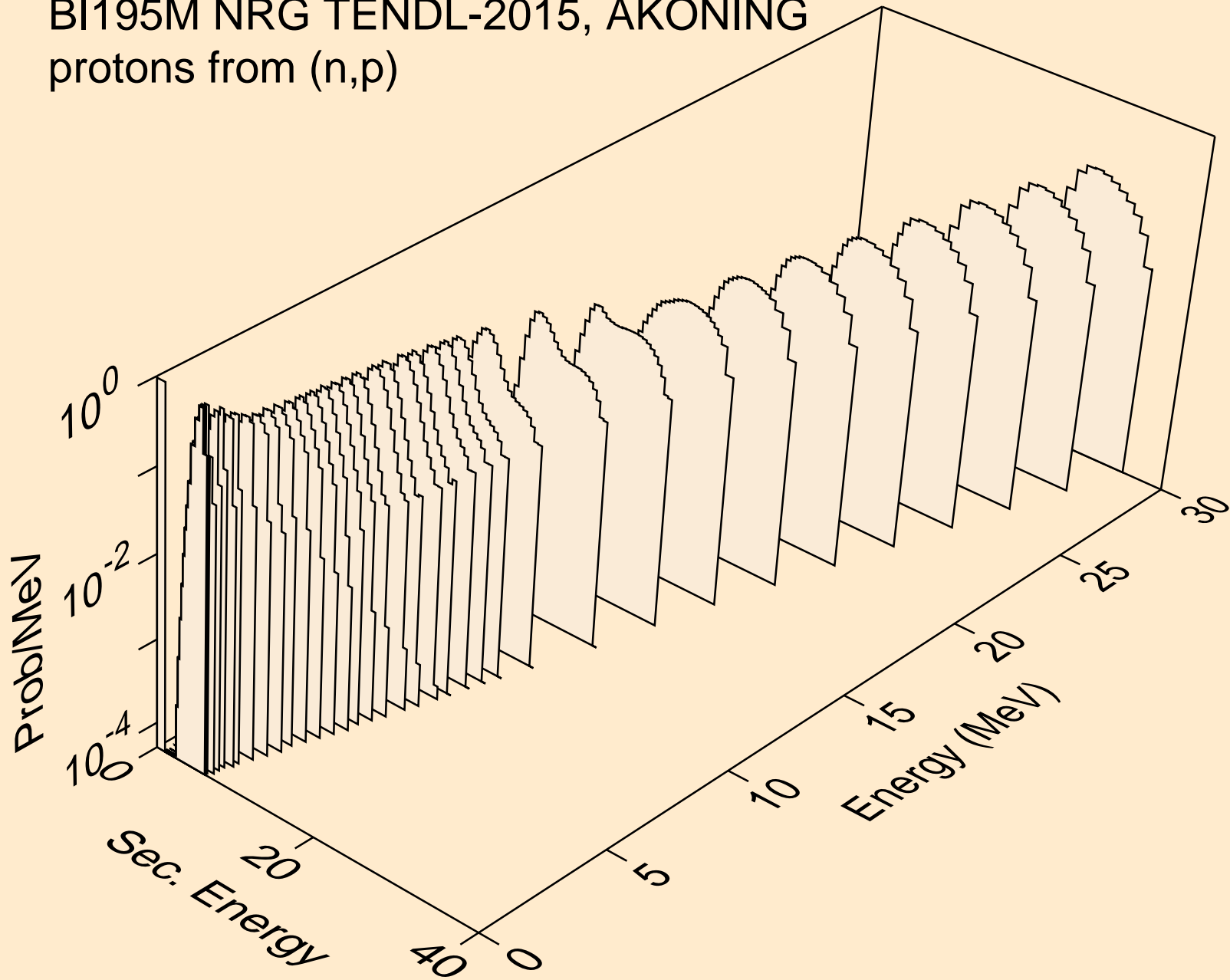

BI195M NRG TENDL-2015, AKONING
protons from (n,2p)

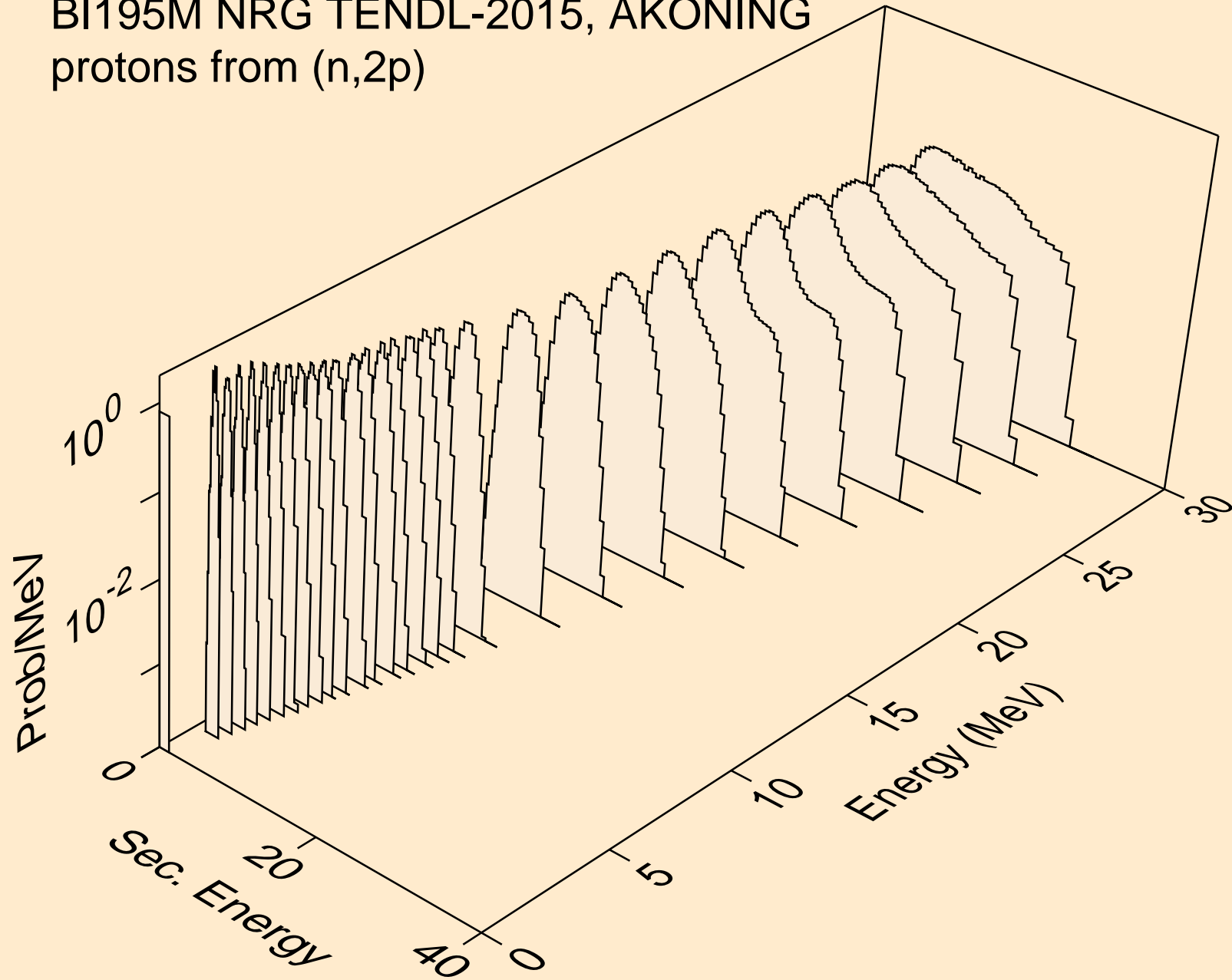

BI195M NRG TENDL-2015, AKONING
protons from (n,pa)

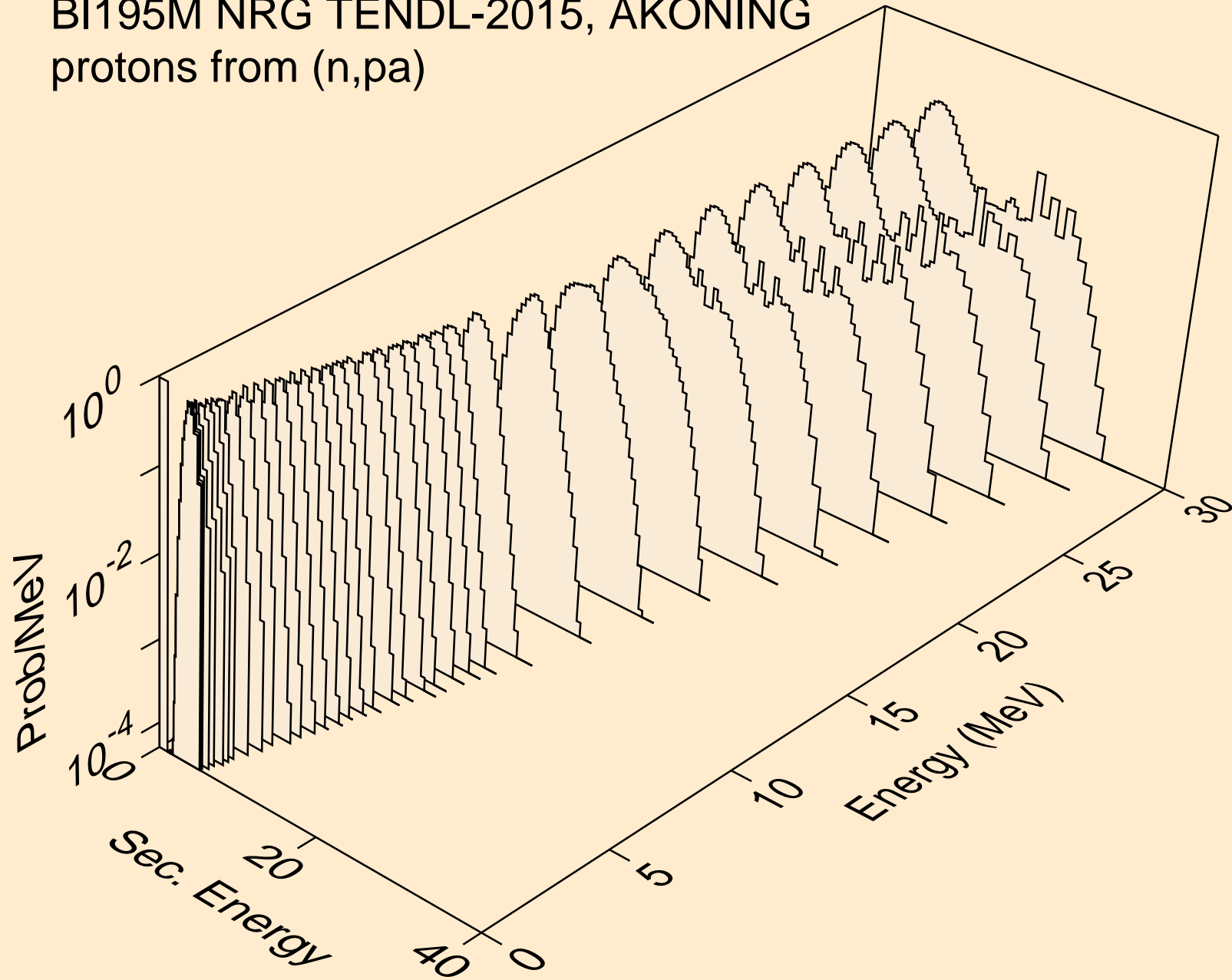

BI195M NRG TENDL-2015, AKONING
protons from (n,pd)

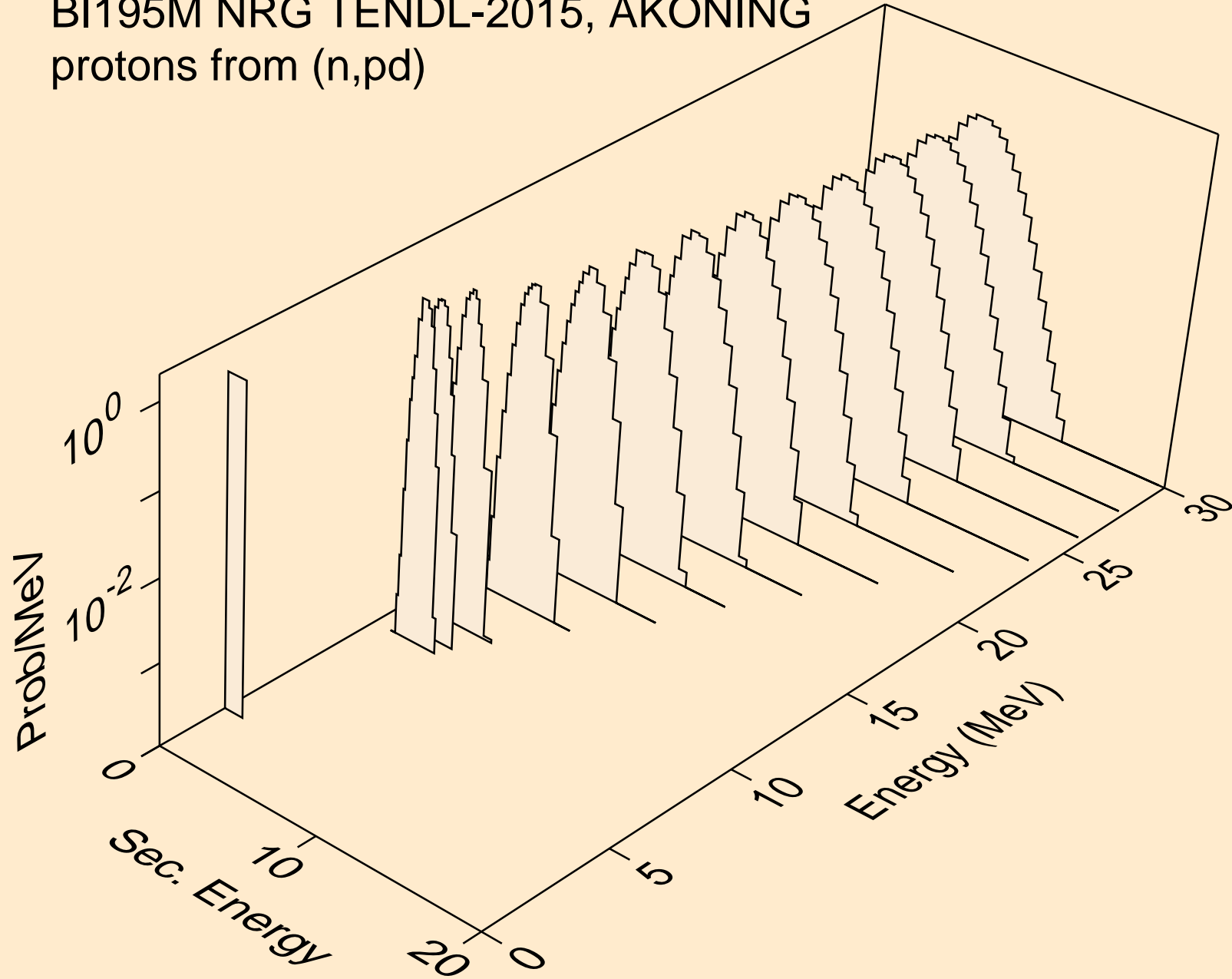

BI195M NRG TENDL-2015, AKONING
protons from (n,pt)

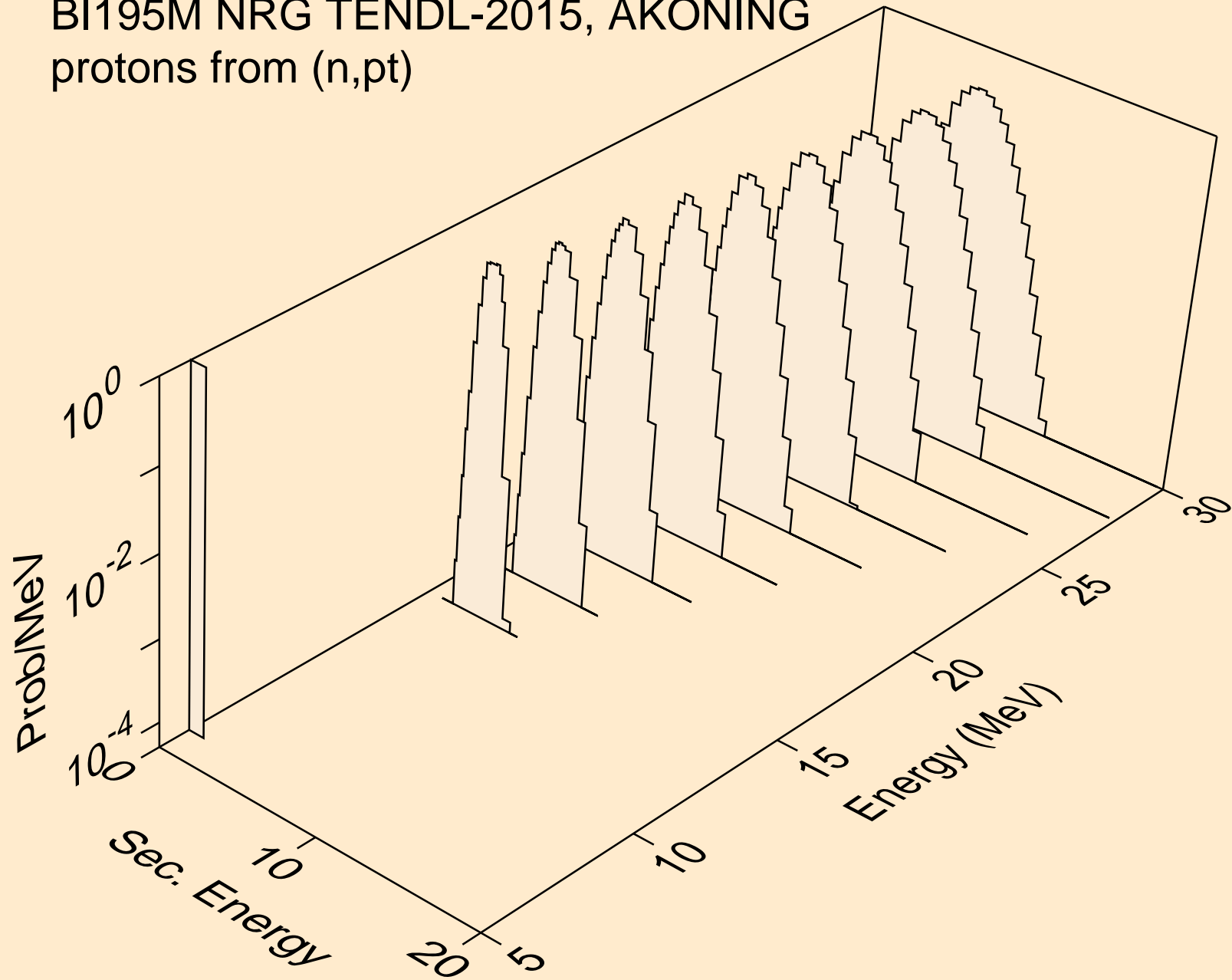

BI195M NRG TENDL-2015, AKONING
deuterons from (n,x)

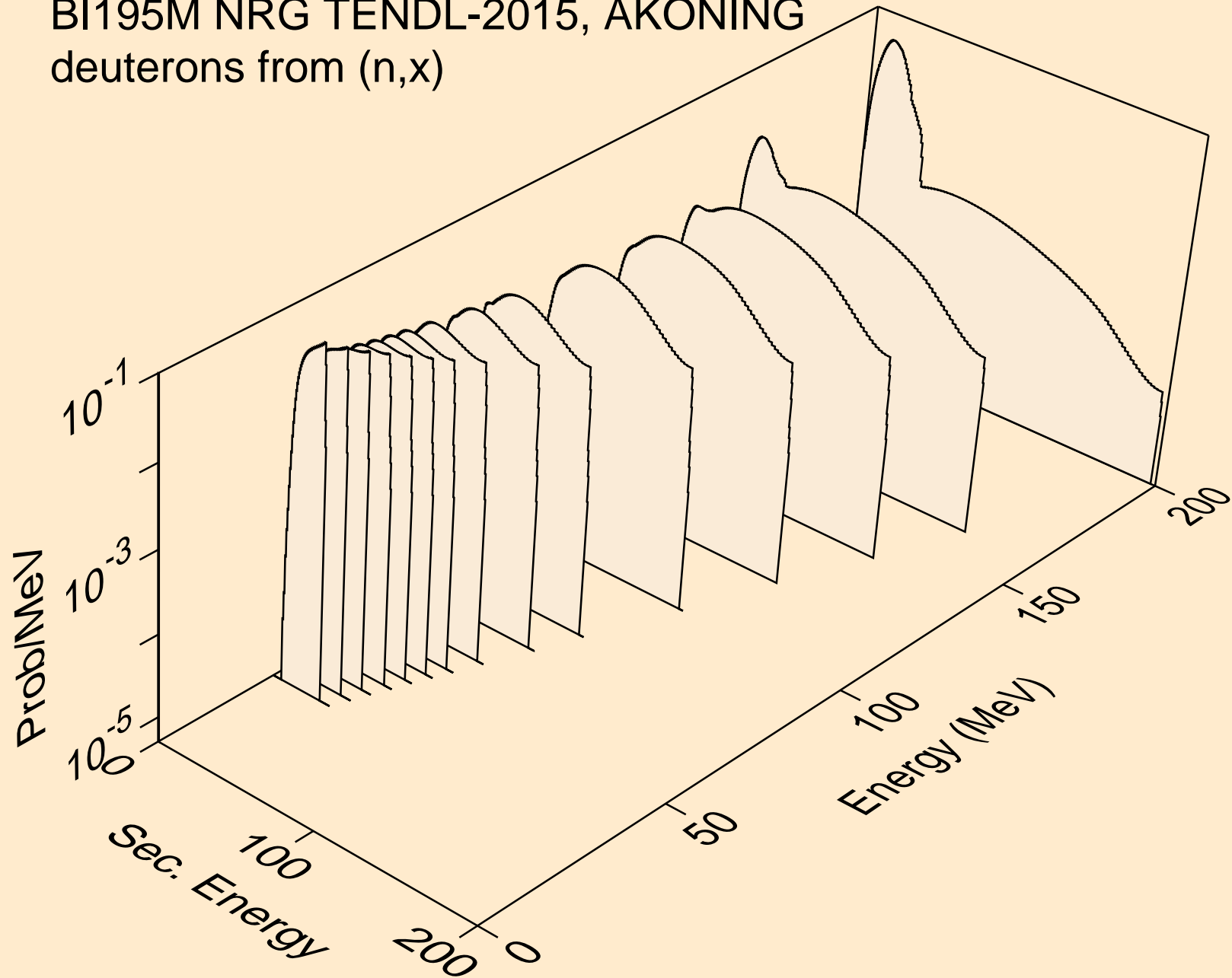

BI195M NRG TENDL-2015, AKONING
deuterons from (n,2nd)

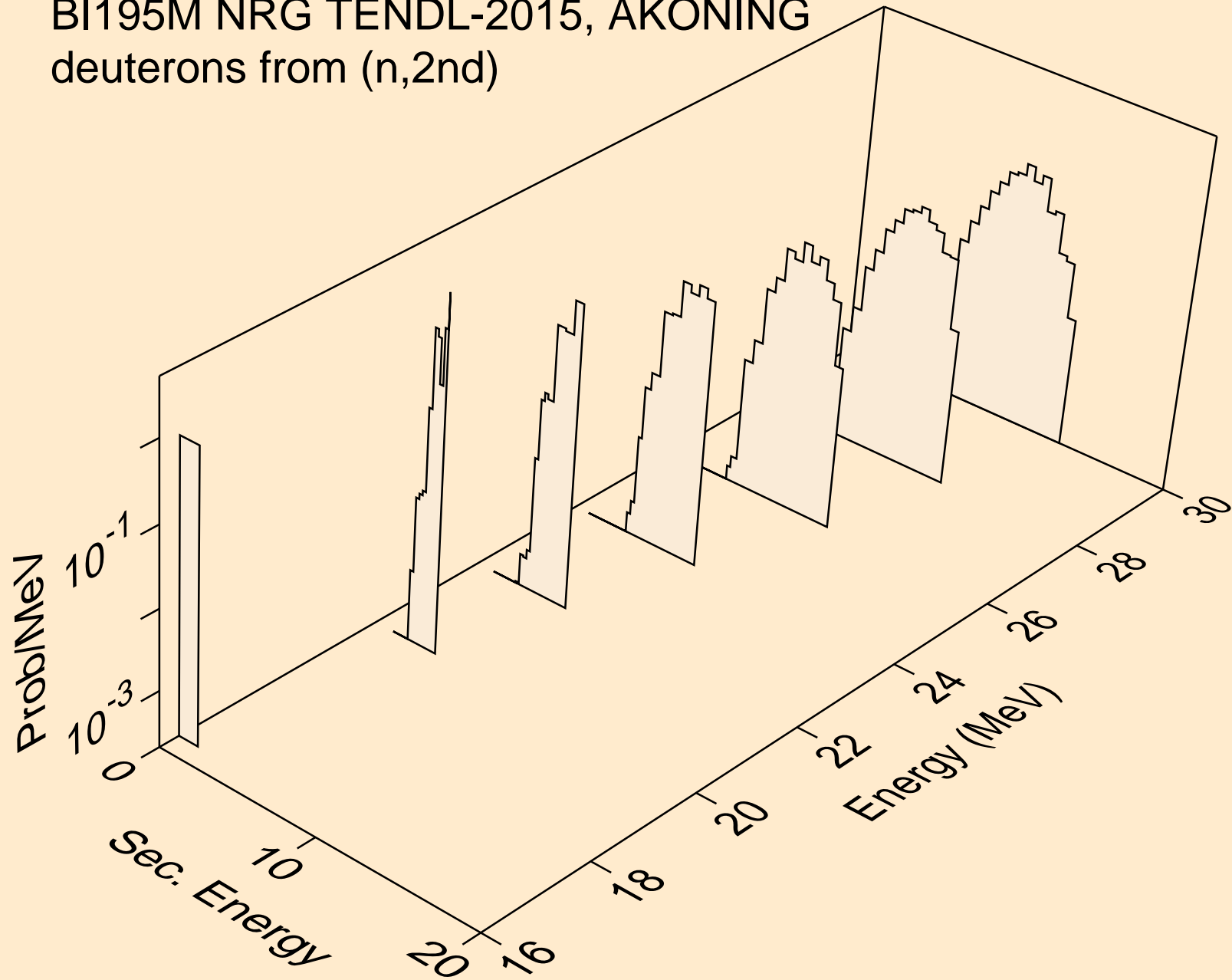

BI195M NRG TENDL-2015, AKONING
deuterons from (n,n*)d

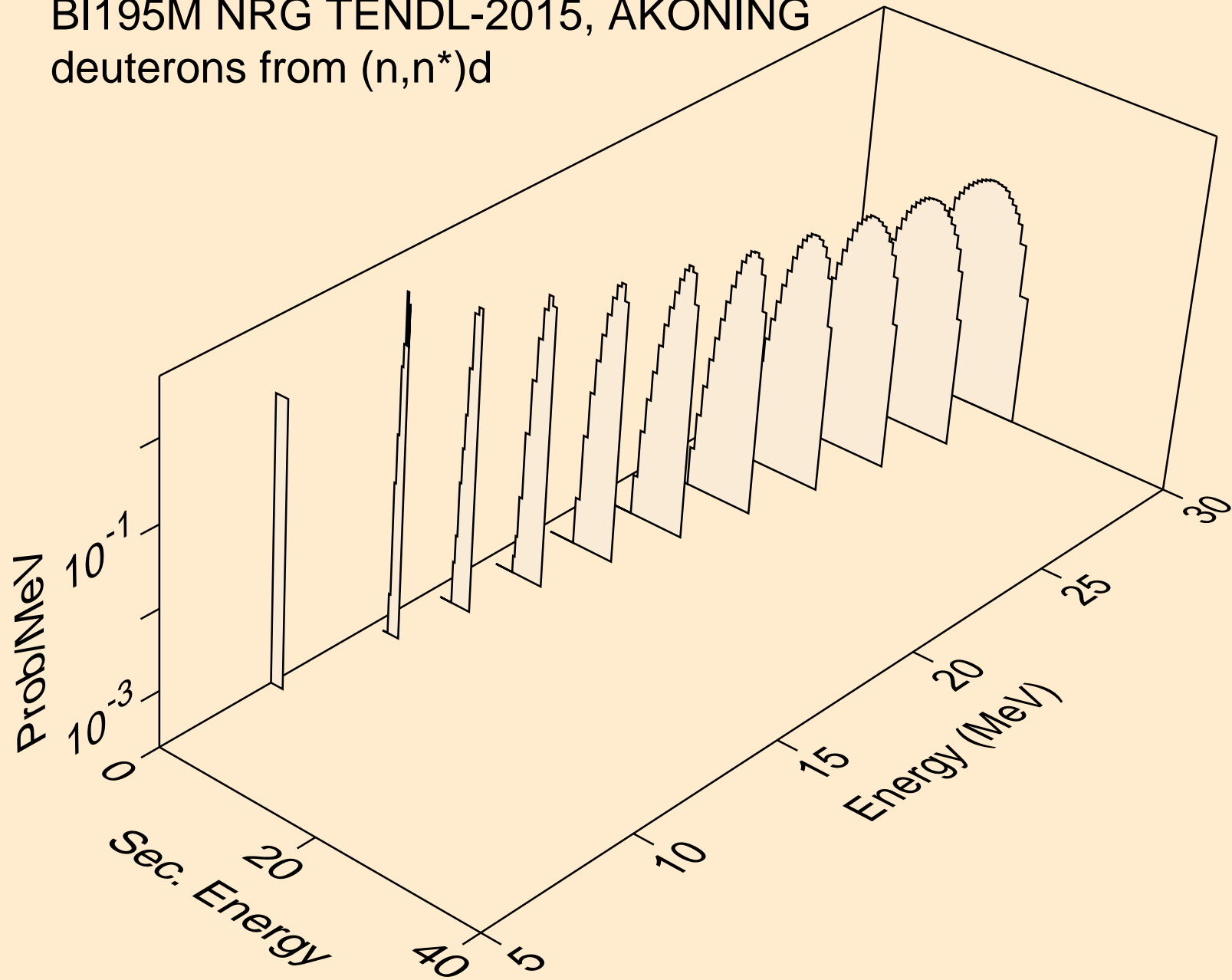

BI195M NRG TENDL-2015, AKONING
deuterons from (n,d)

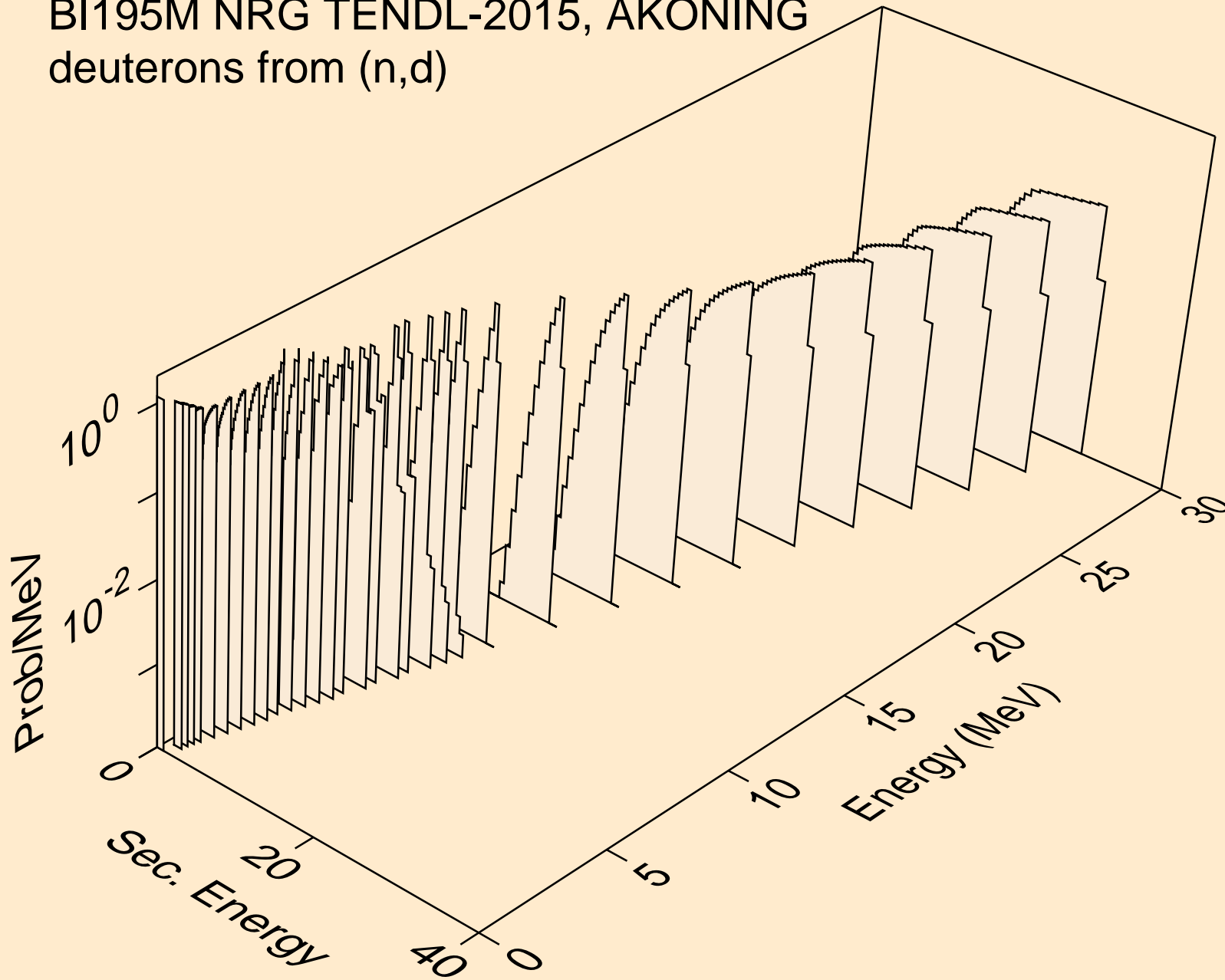

BI195M NRG TENDL-2015, AKONING
deuterons from (n,d2a)

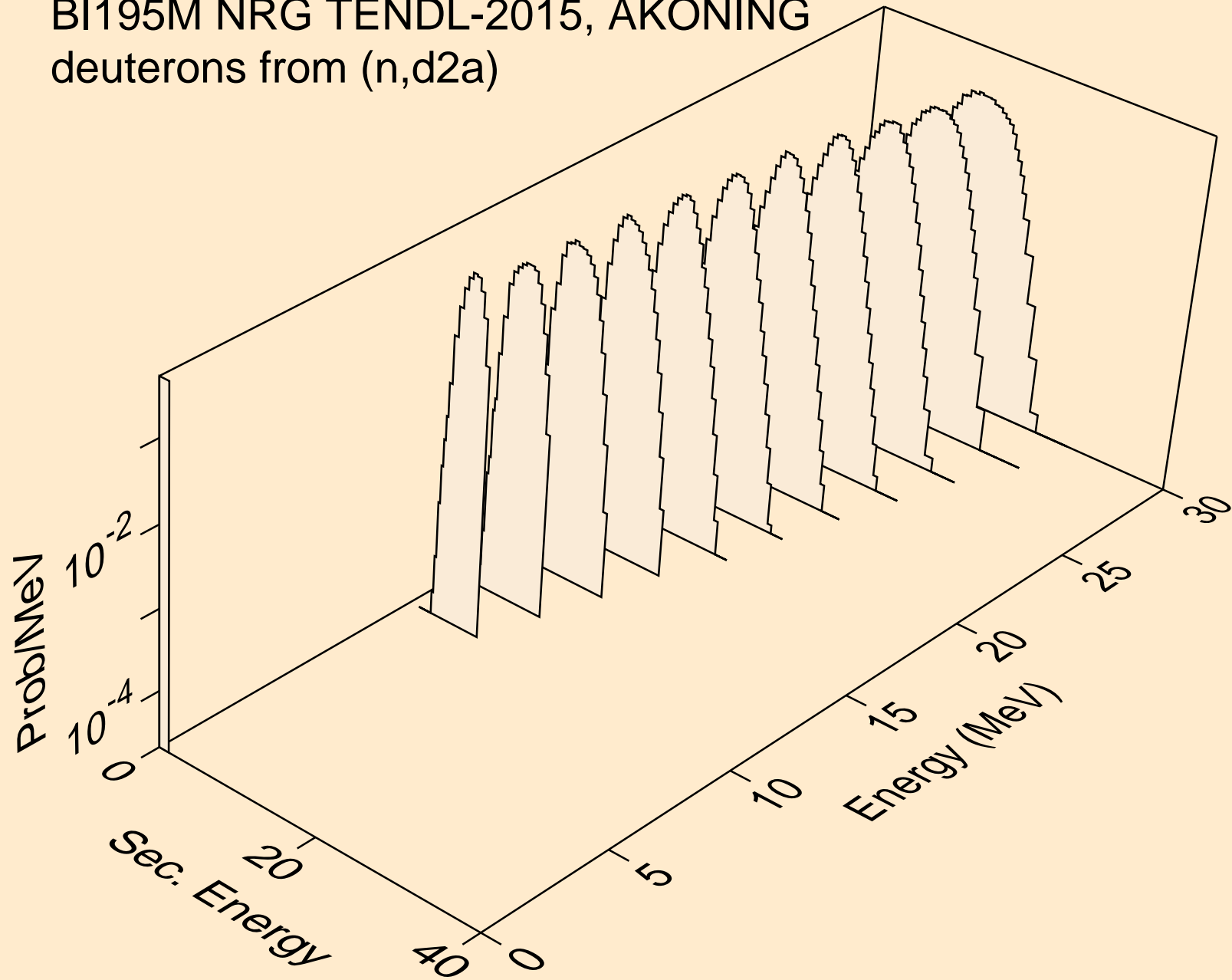

BI195M NRG TENDL-2015, AKONING
deuterons from (n,pd)

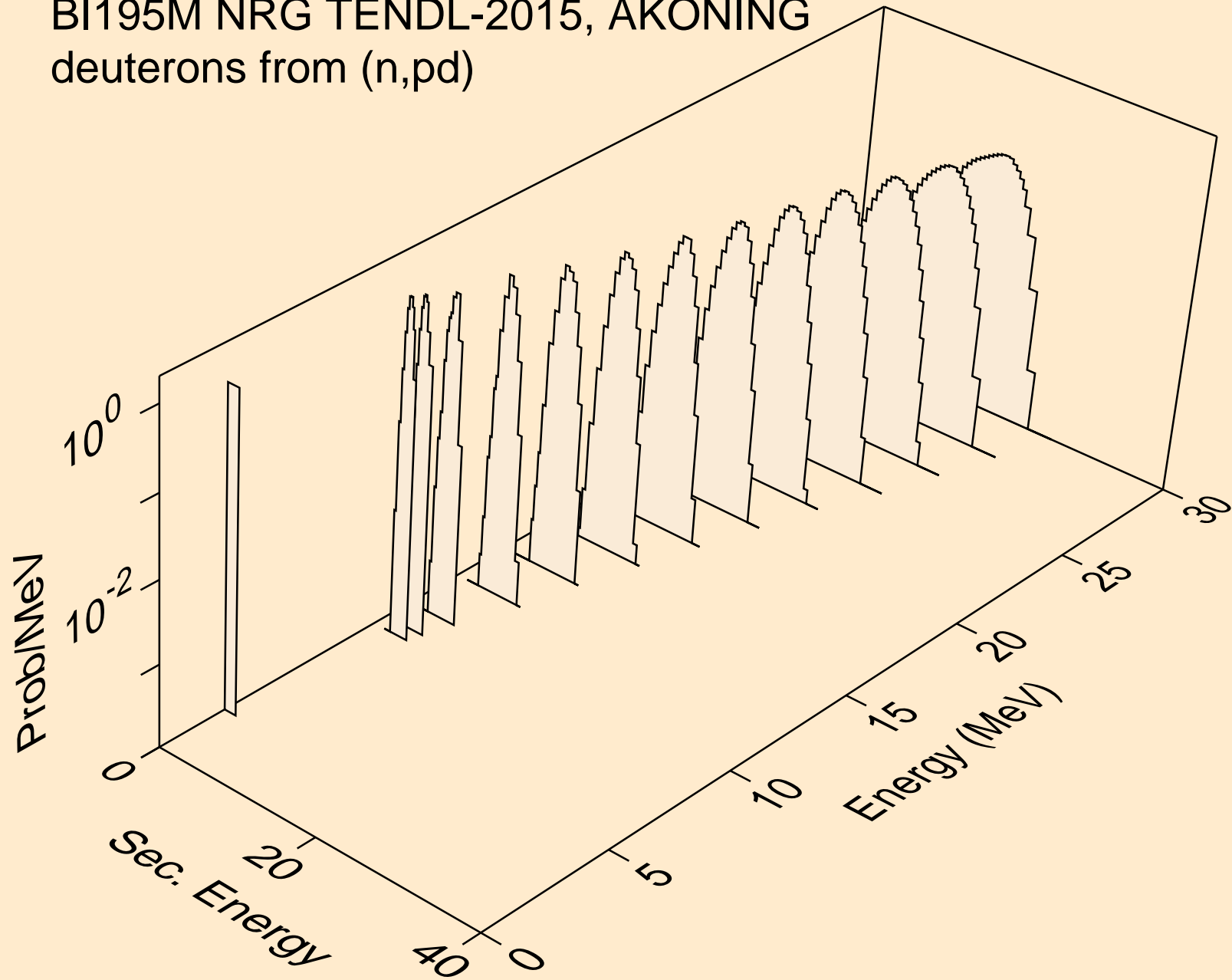

BI195M NRG TENDL-2015, AKONING
deuterons from (n,da)

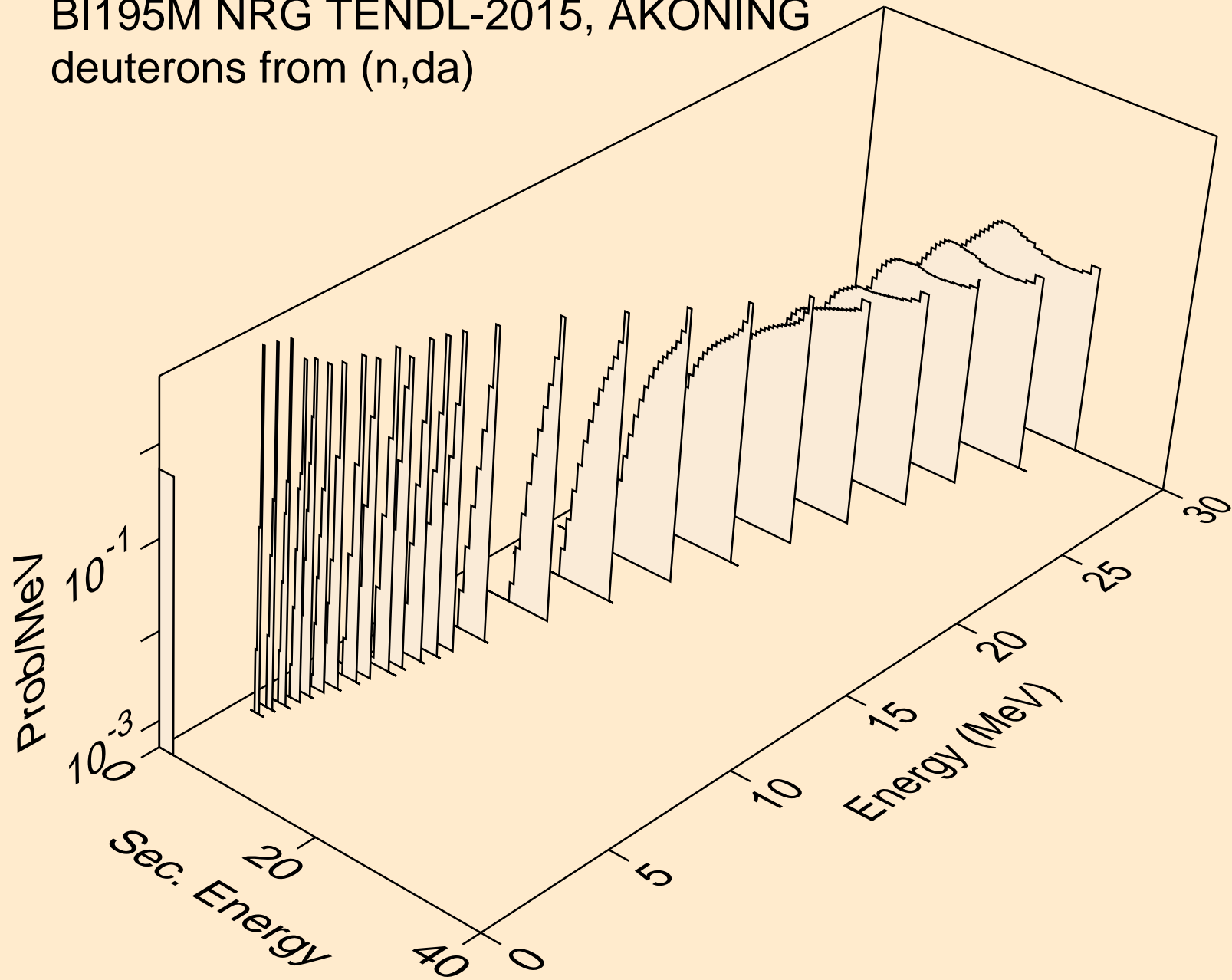

BI195M NRG TENDL-2015, AKONING
tritons from (n,x)

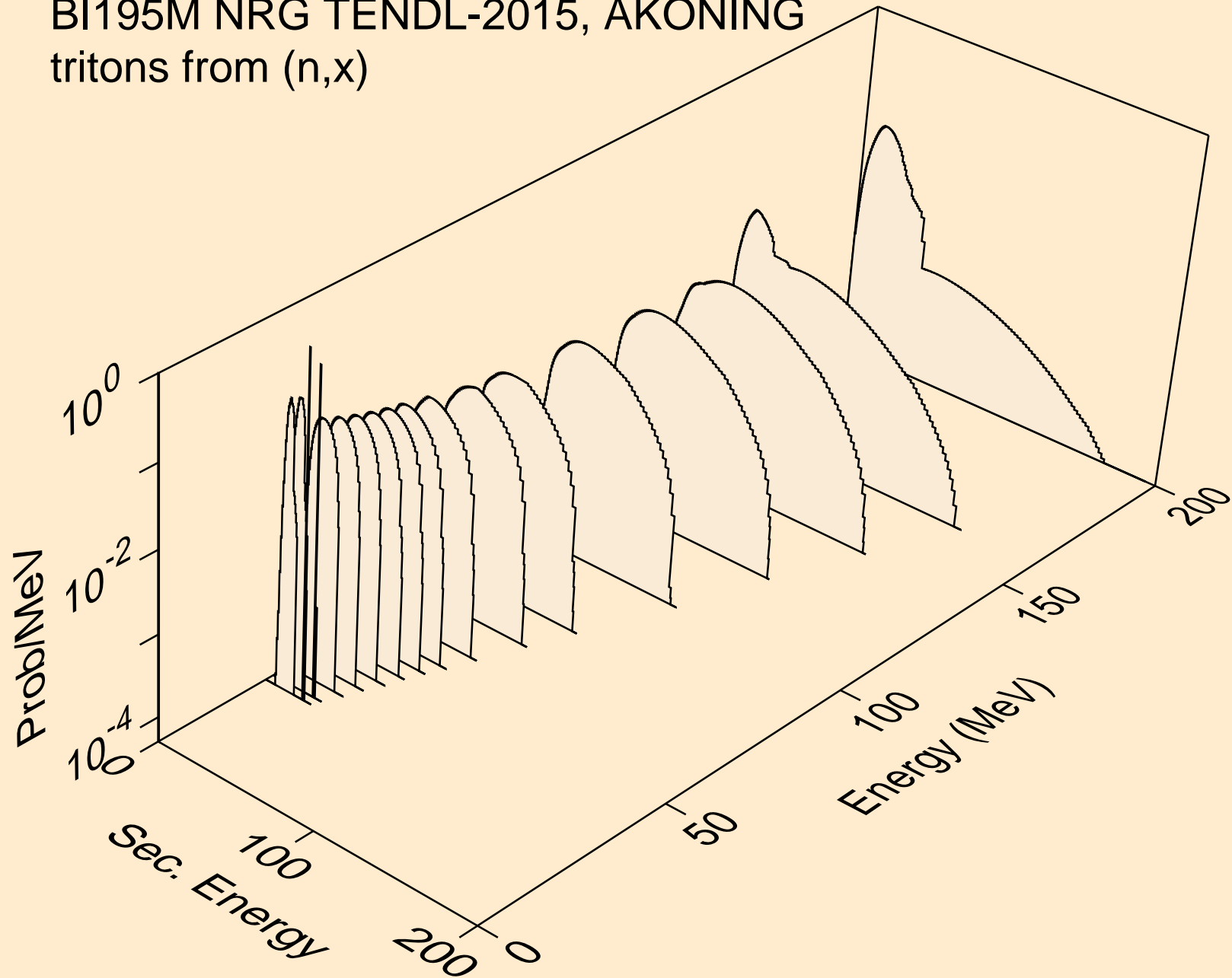

BI195M NRG TENDL-2015, AKONING
tritons from (n,n*)t

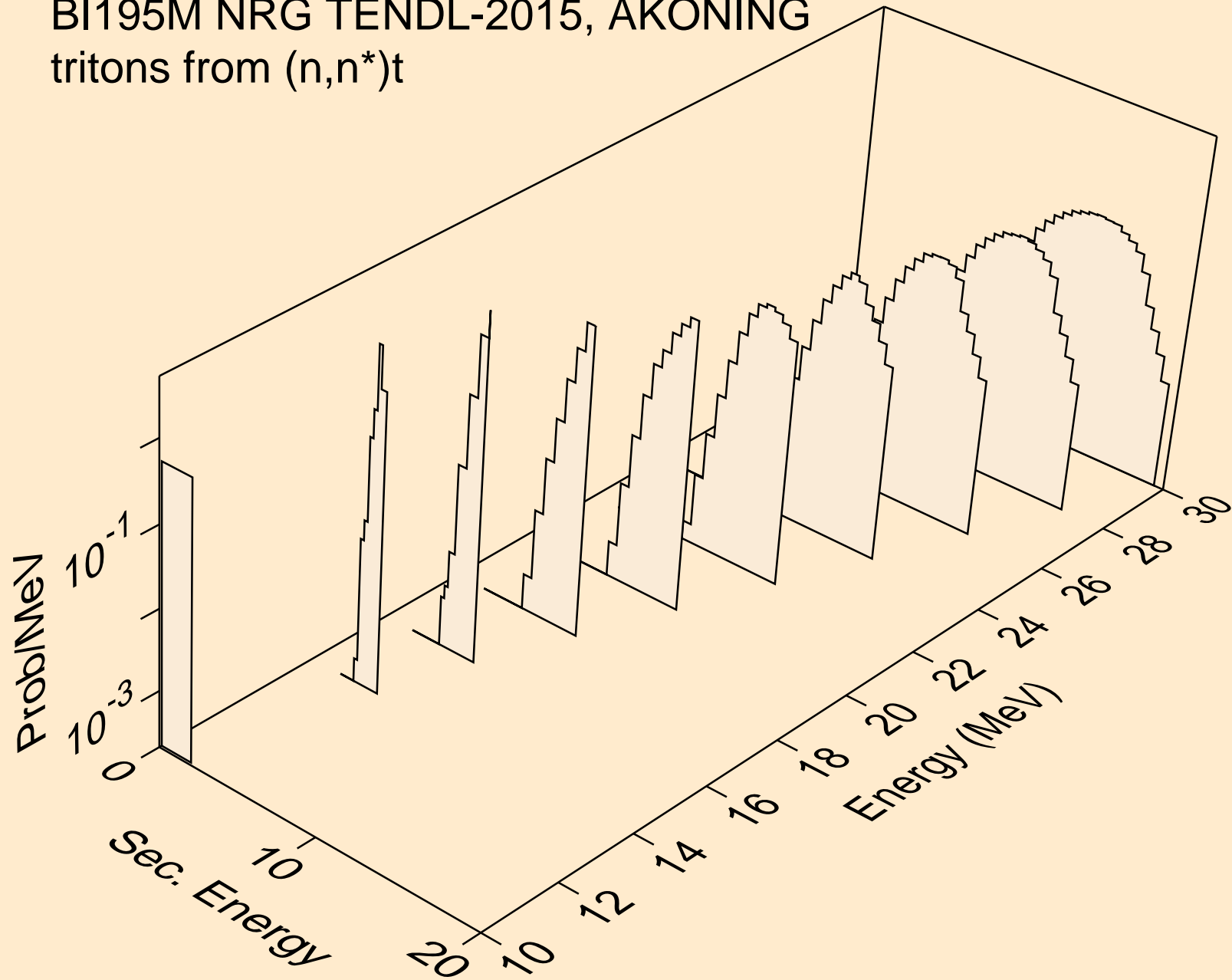

BI195M NRG TENDL-2015, AKONING
tritons from (n,t)

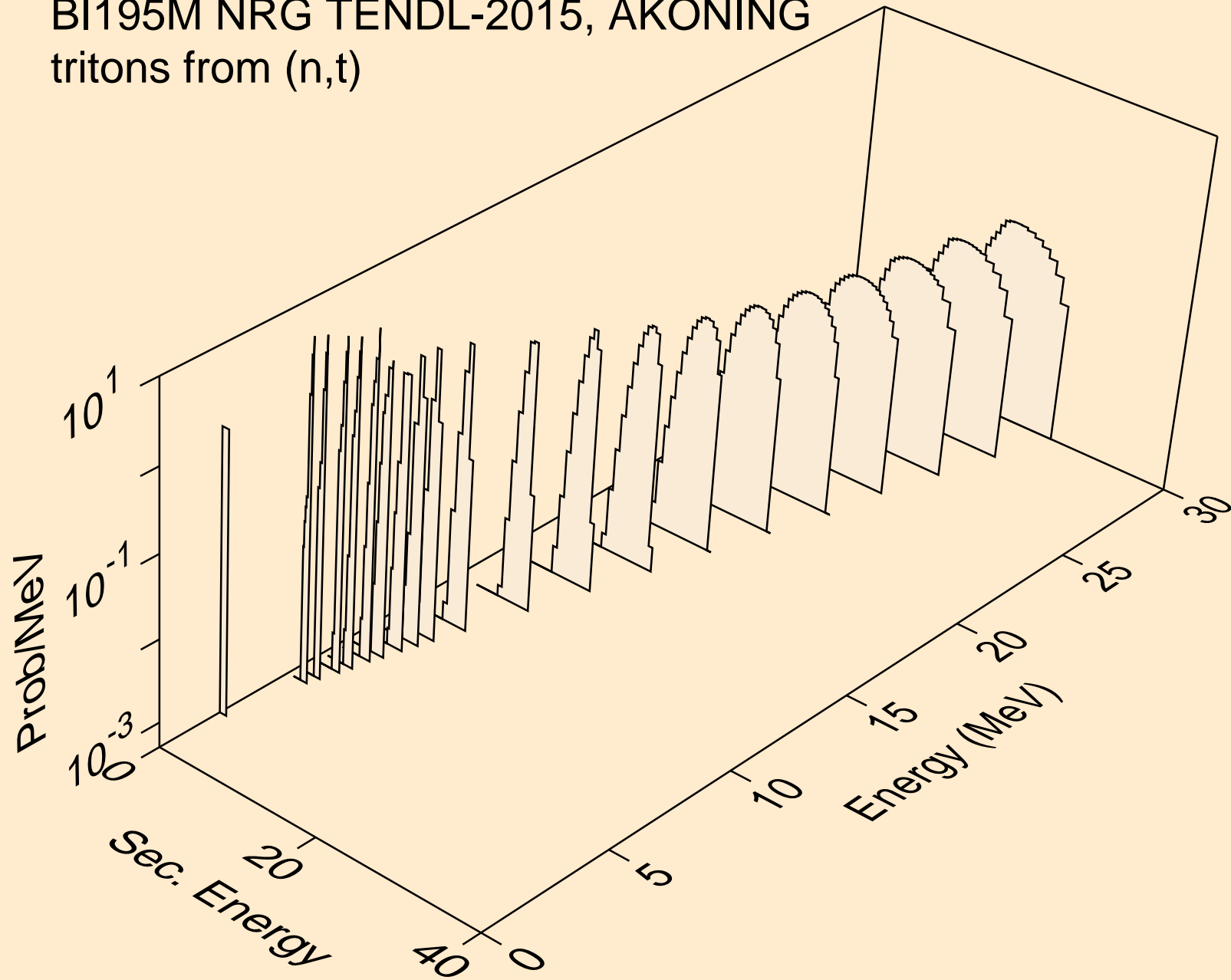

BI195M NRG TENDL-2015, AKONING
tritons from (n,t2a)

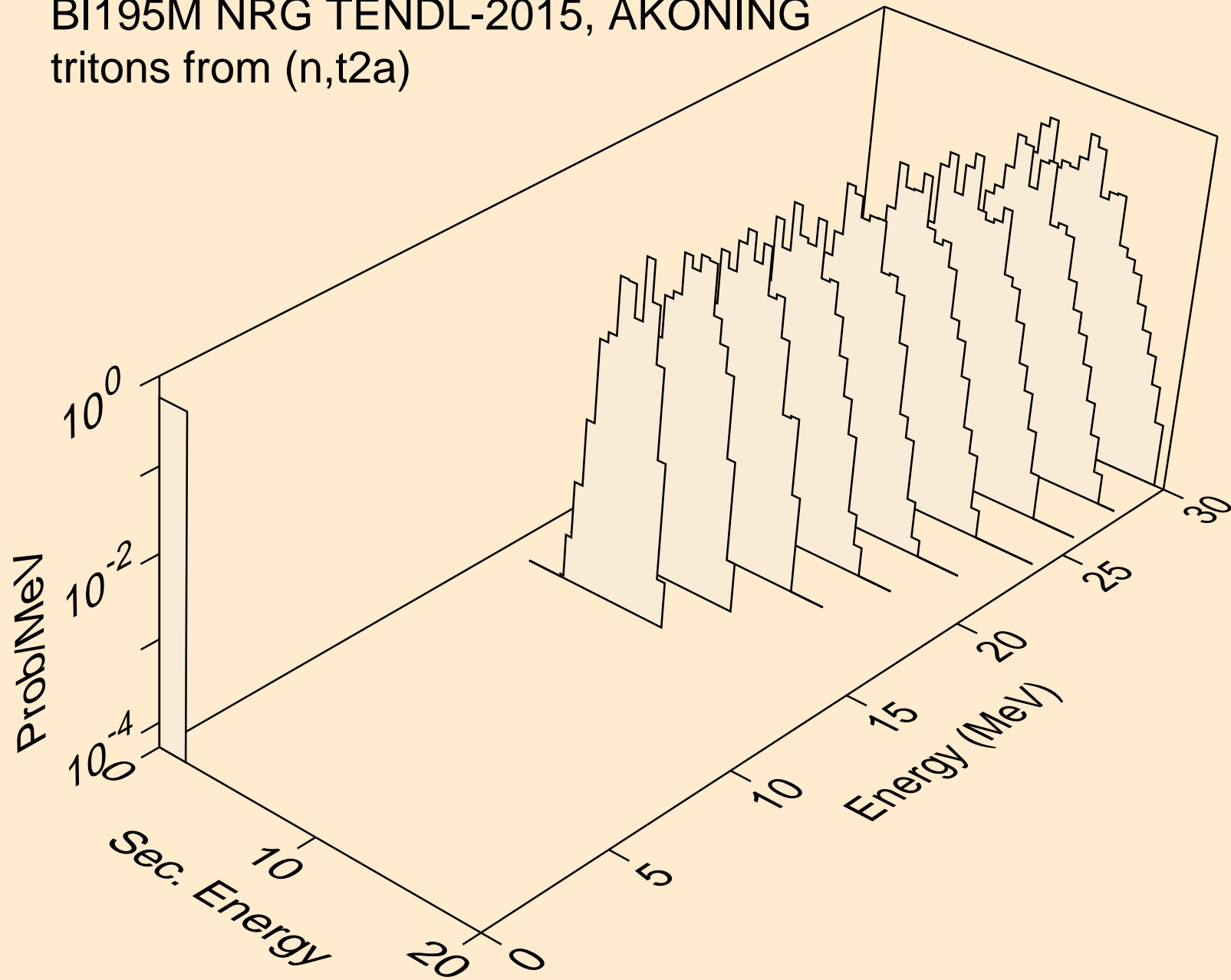

BI195M NRG TENDL-2015, AKONING
tritons from (n,pt)

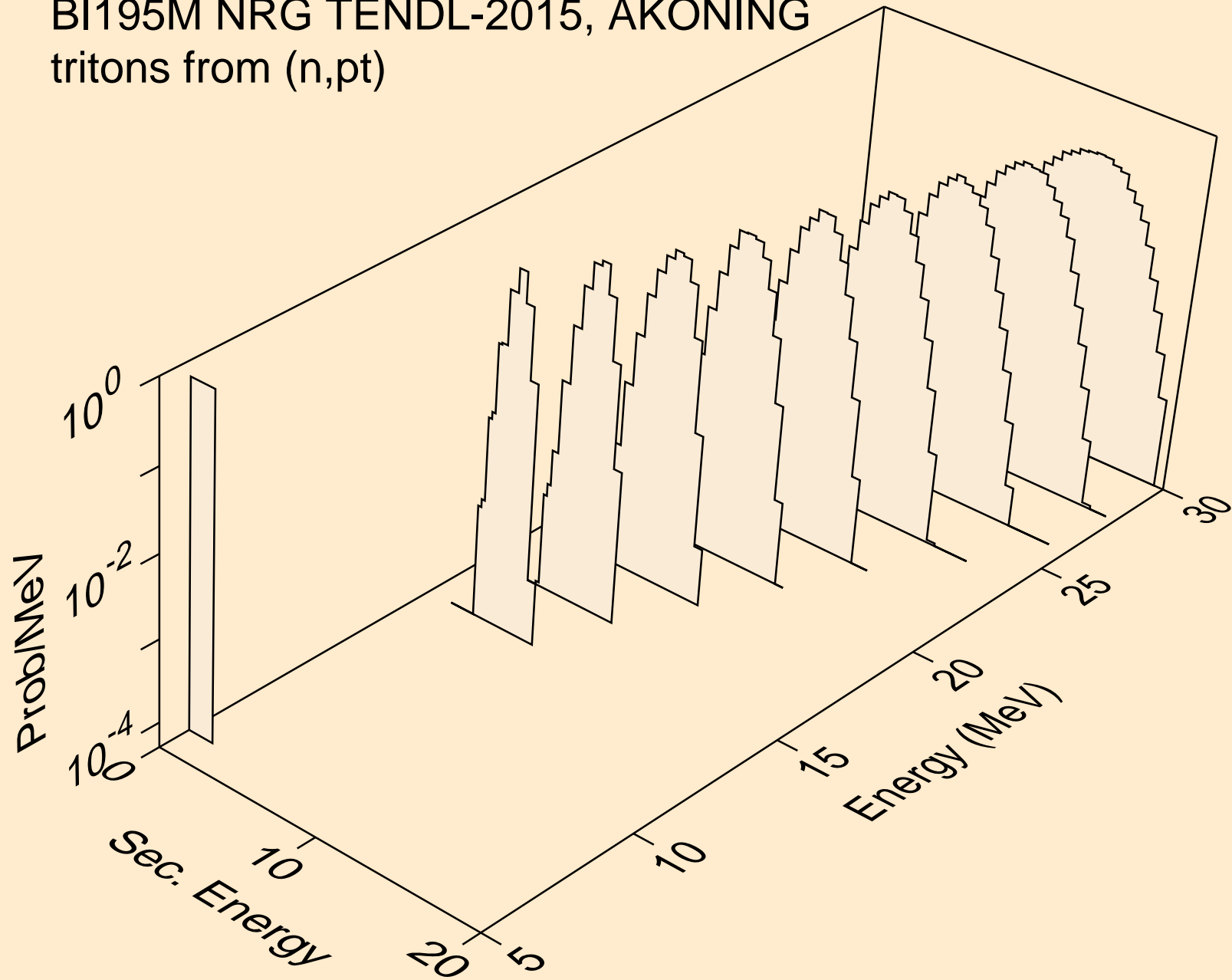

BI195M NRG TENDL-2015, AKONING
he3s from (n,x)

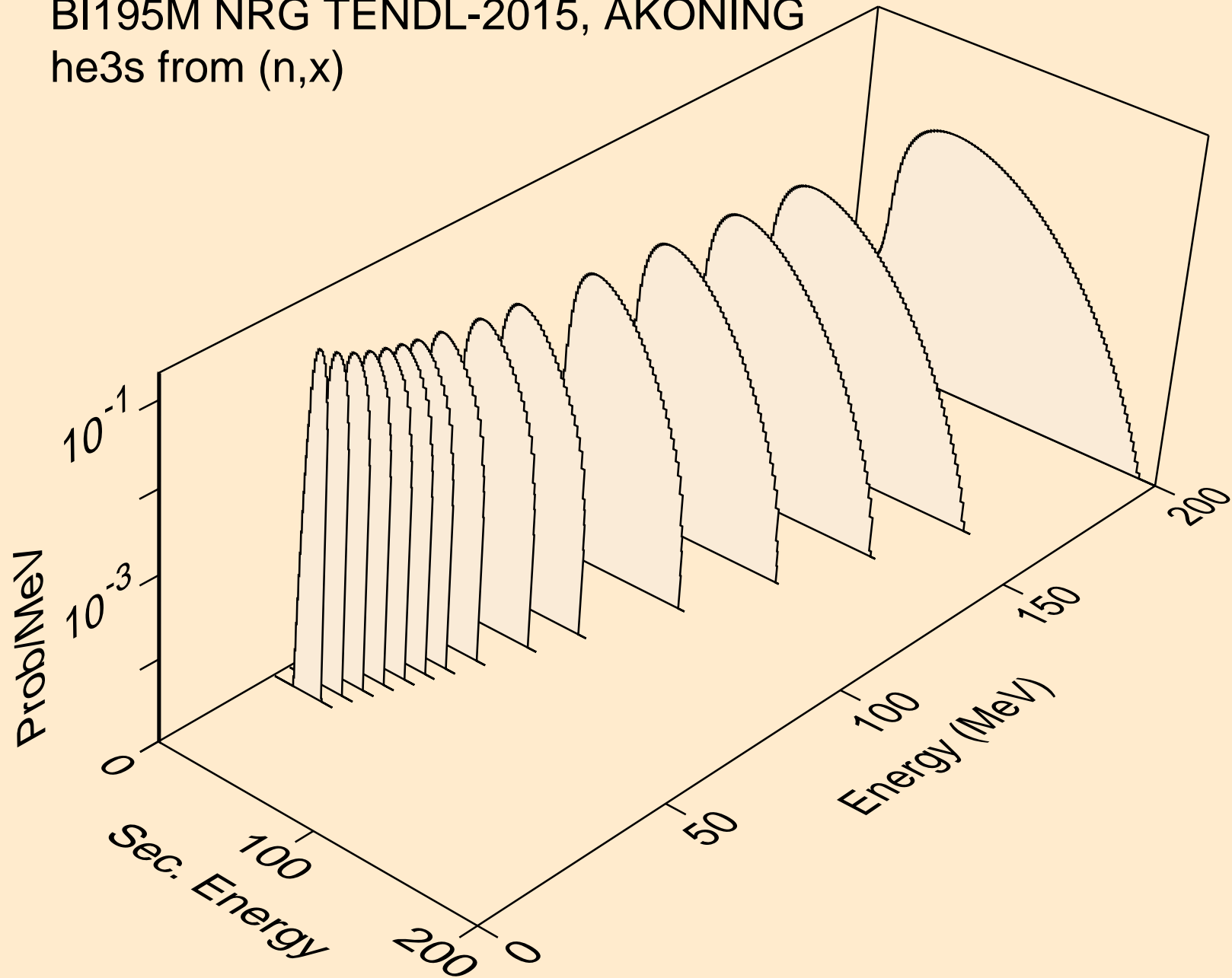

BI195M NRG TENDL-2015, AKONING
he3s from (n,n*)he3

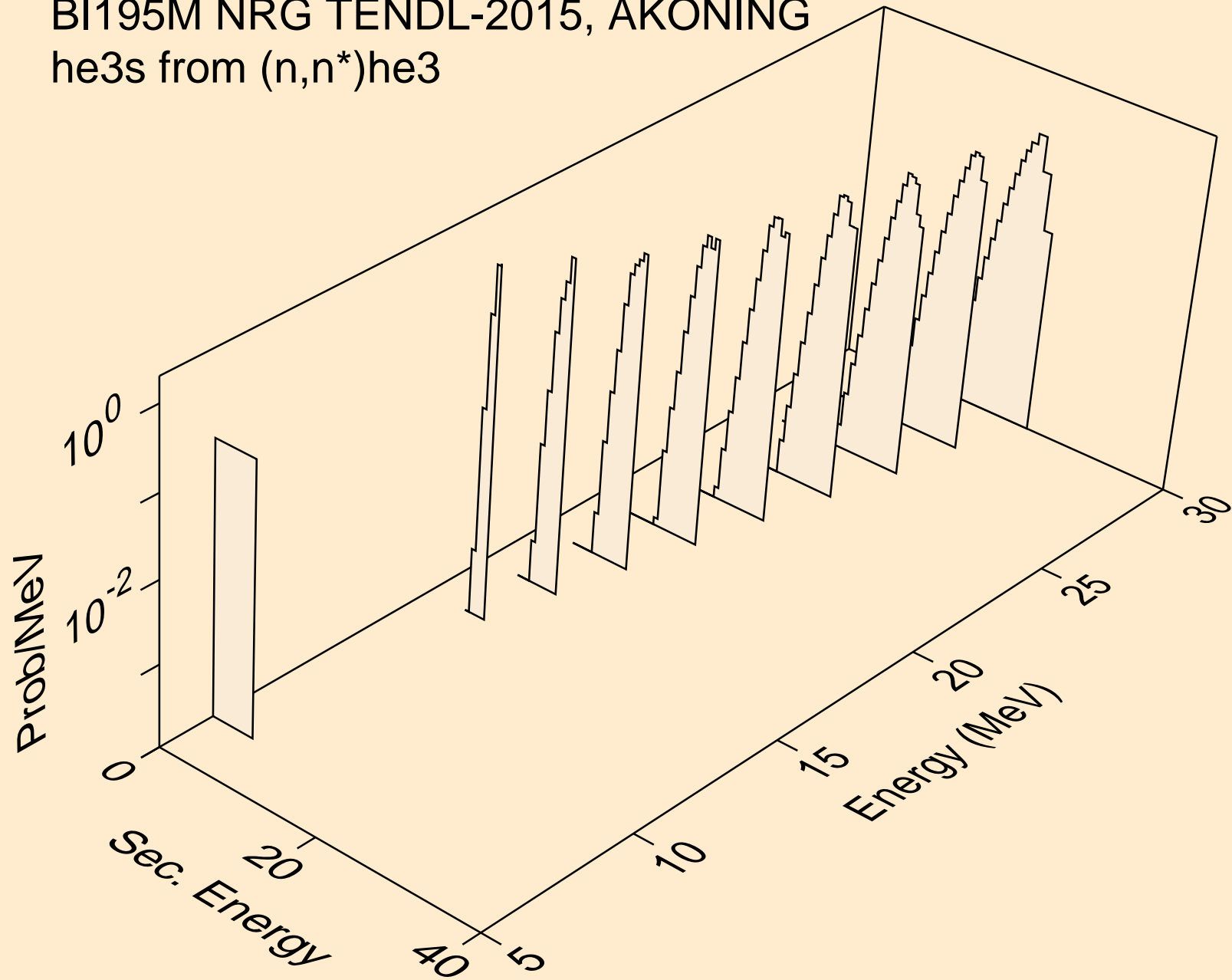

BI195M NRG TENDL-2015, AKONING
he3s from (n,he3)

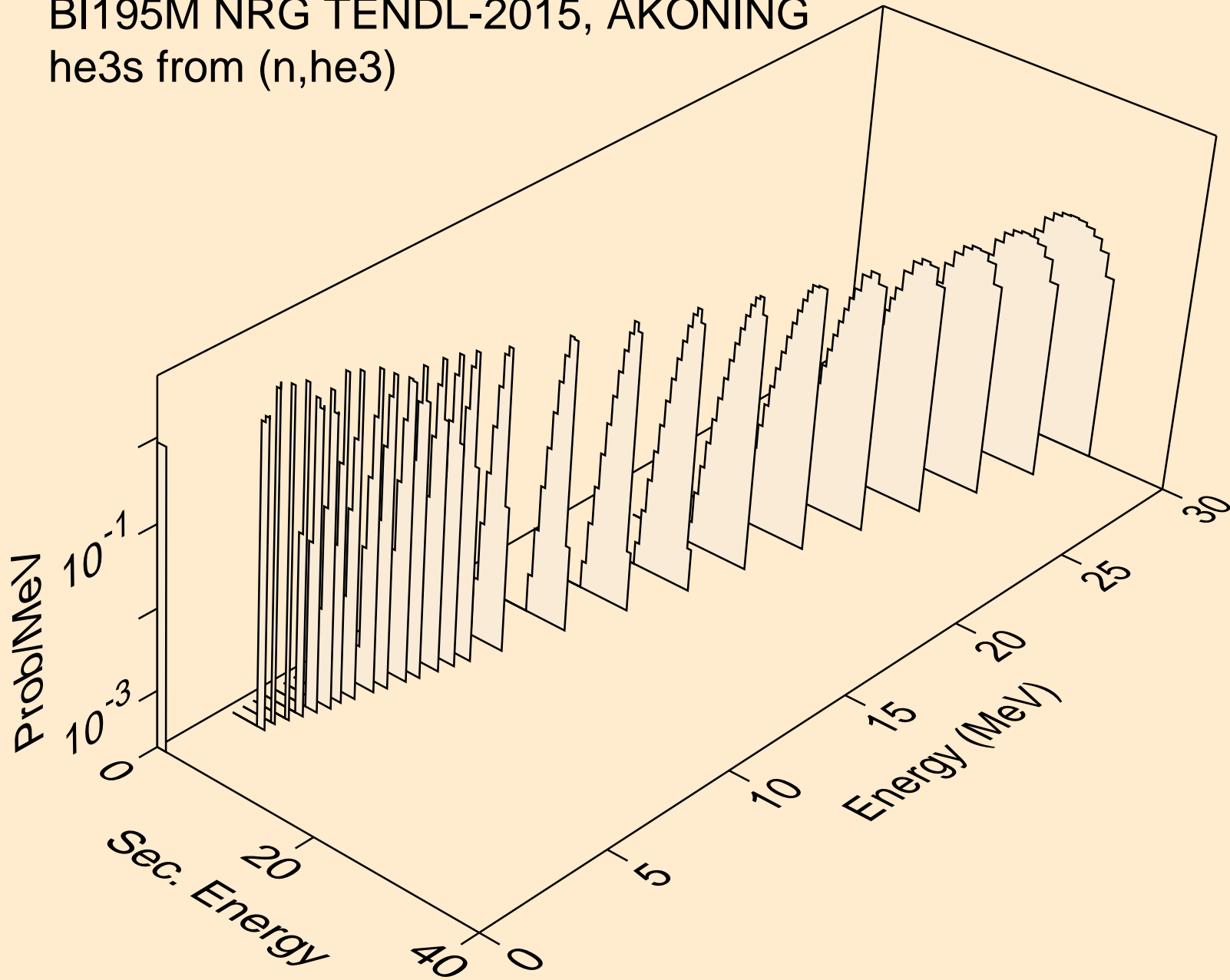

BI195M NRG TENDL-2015, AKONING
alphas from (n,x)

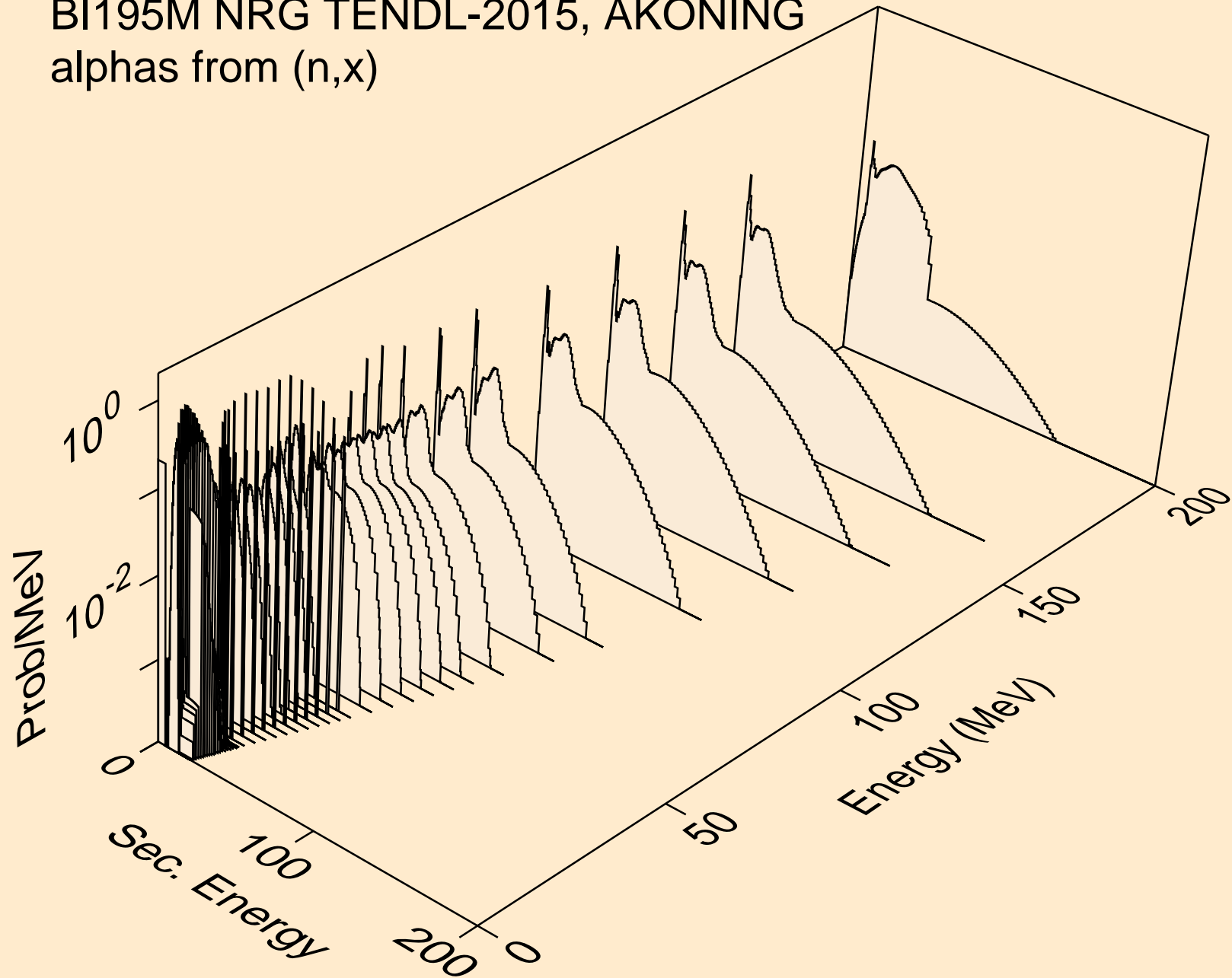

BI195M NRG TENDL-2015, AKONING
alphas from (n,n*)a

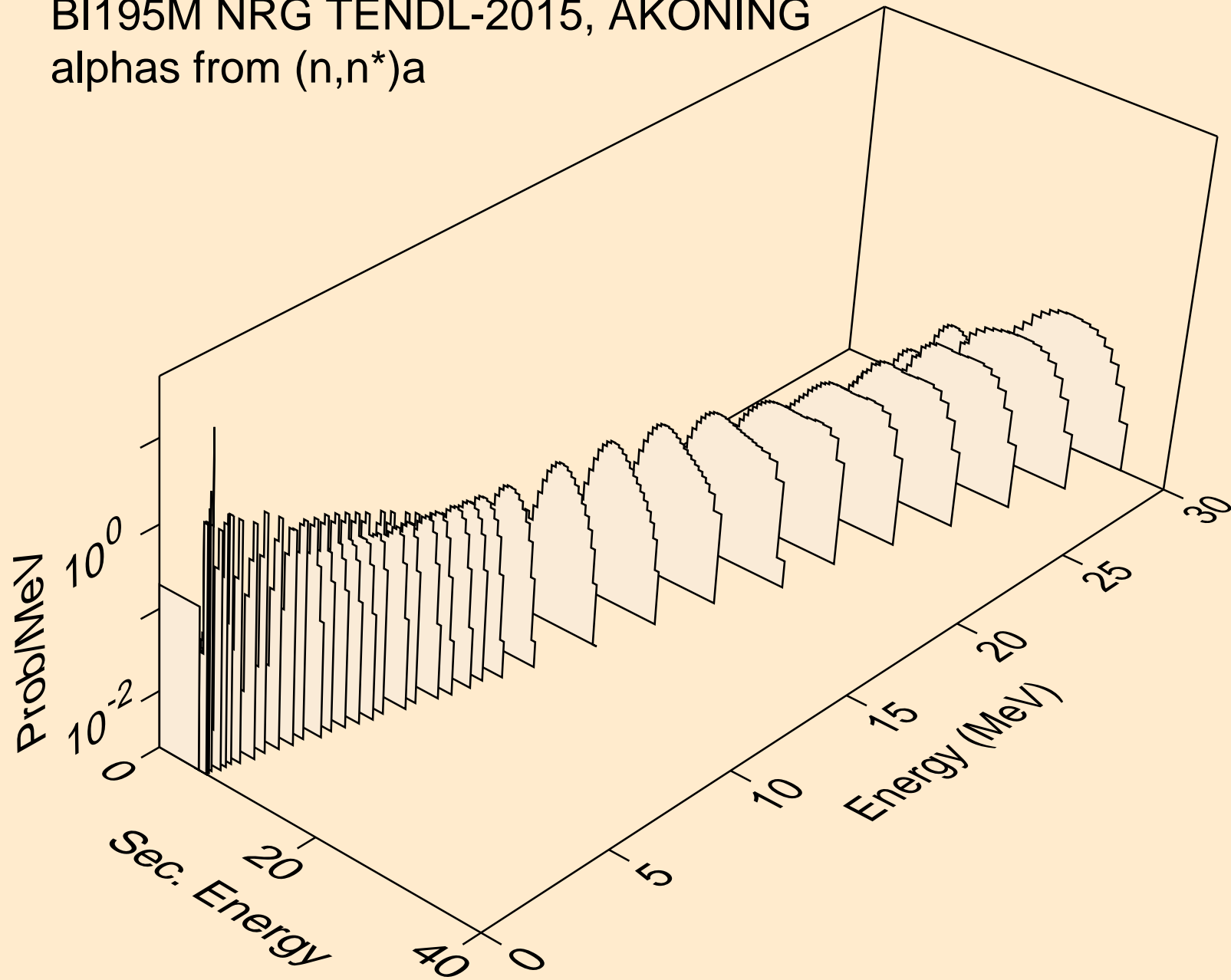

BI195M NRG TENDL-2015, AKONING
alphas from (n,n*)3a

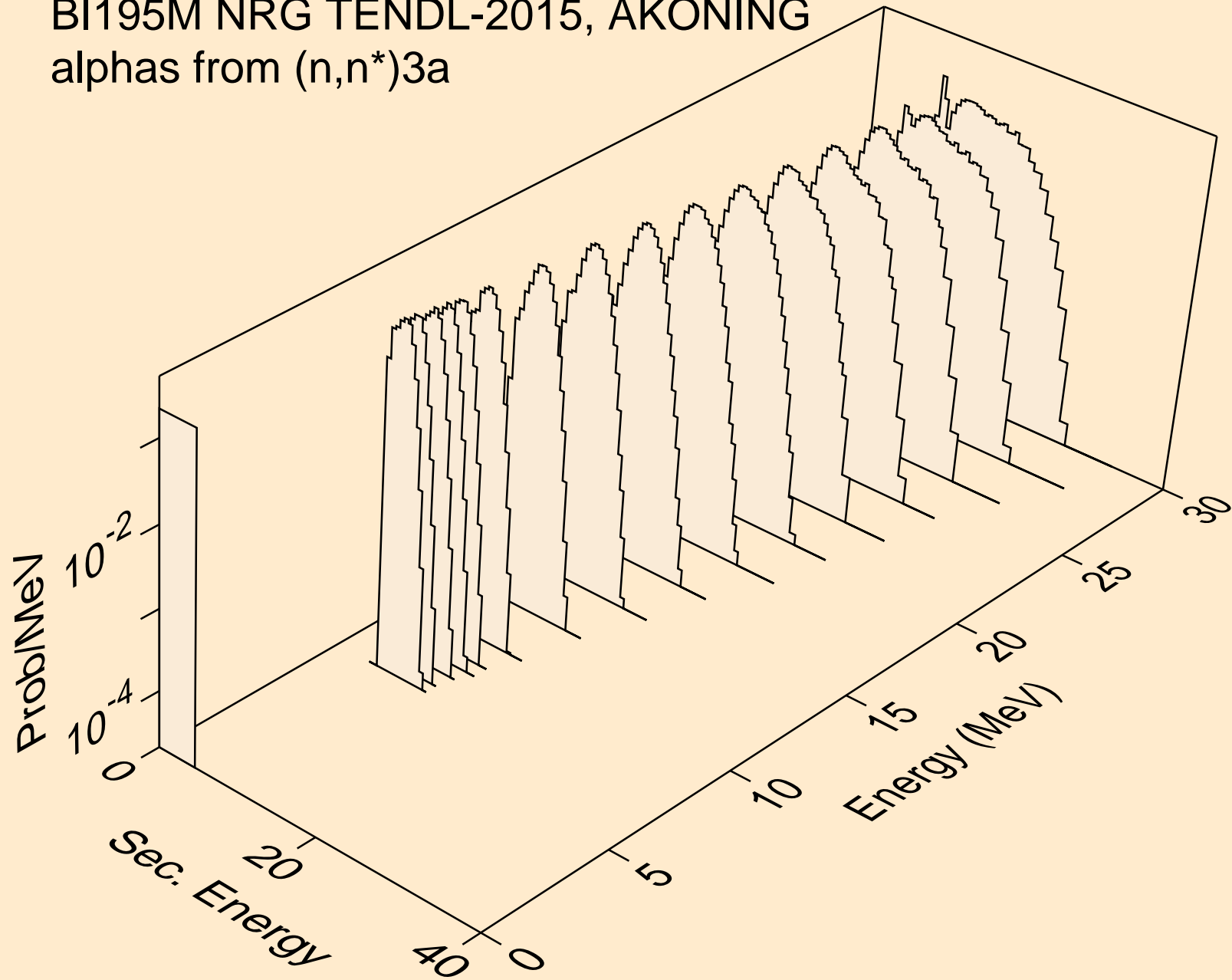

BI195M NRG TENDL-2015, AKONING
alphas from (n,2n)a

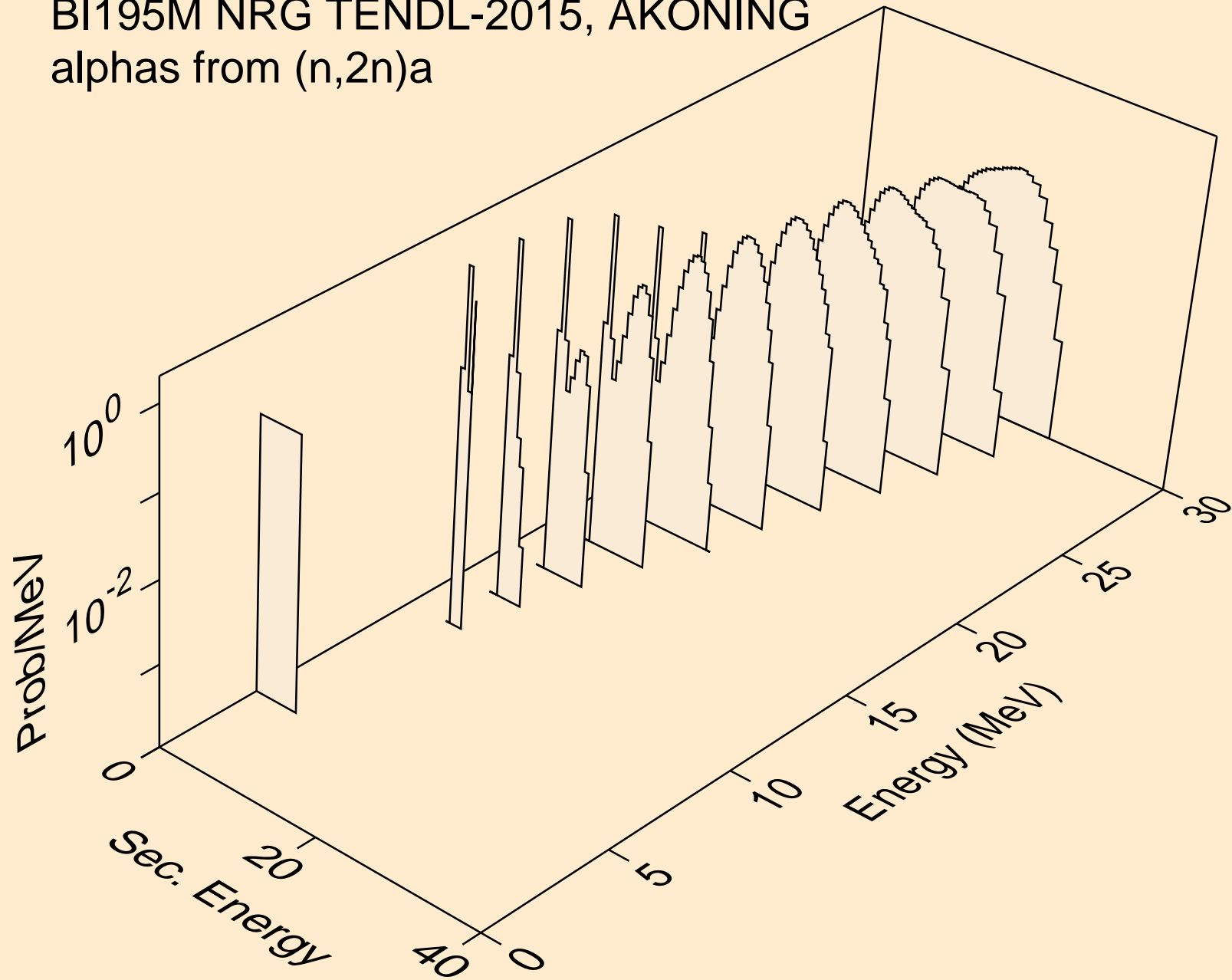

BI195M NRG TENDL-2015, AKONING
alphas from (n,3n)a

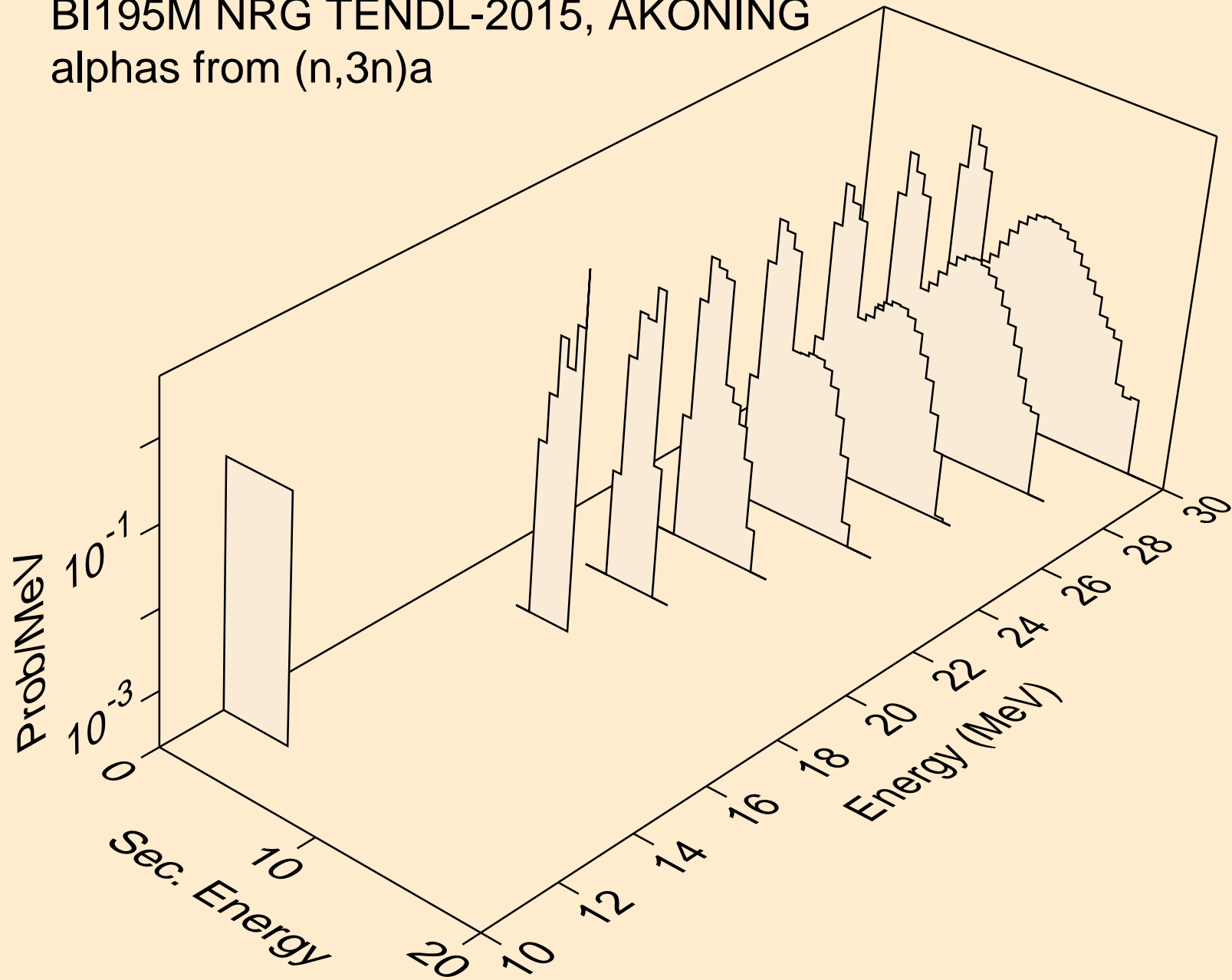

BI195M NRG TENDL-2015, AKONING
alphas from (n,n*)2a

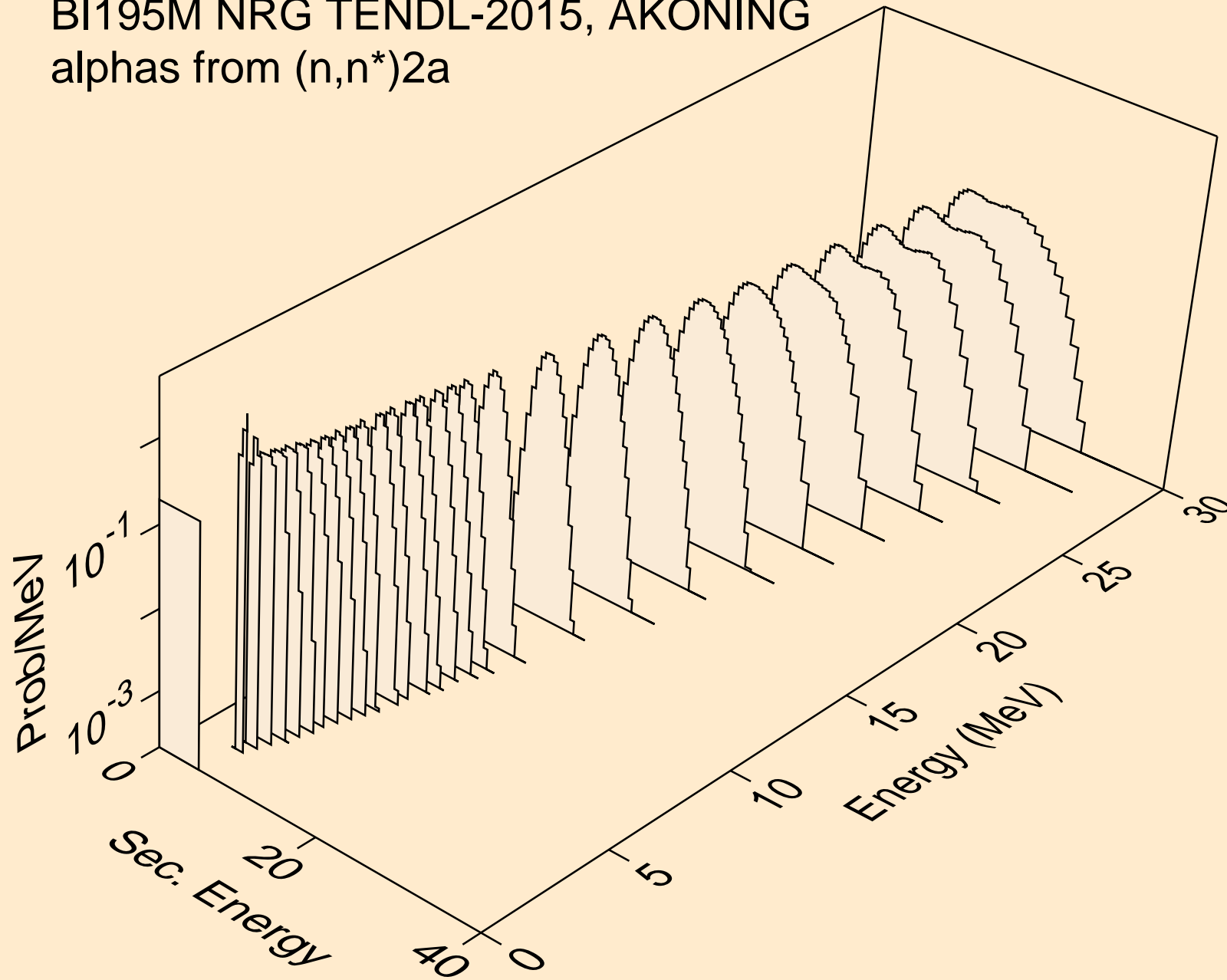

BI195M NRG TENDL-2015, AKONING
alphas from (n,2n)2a

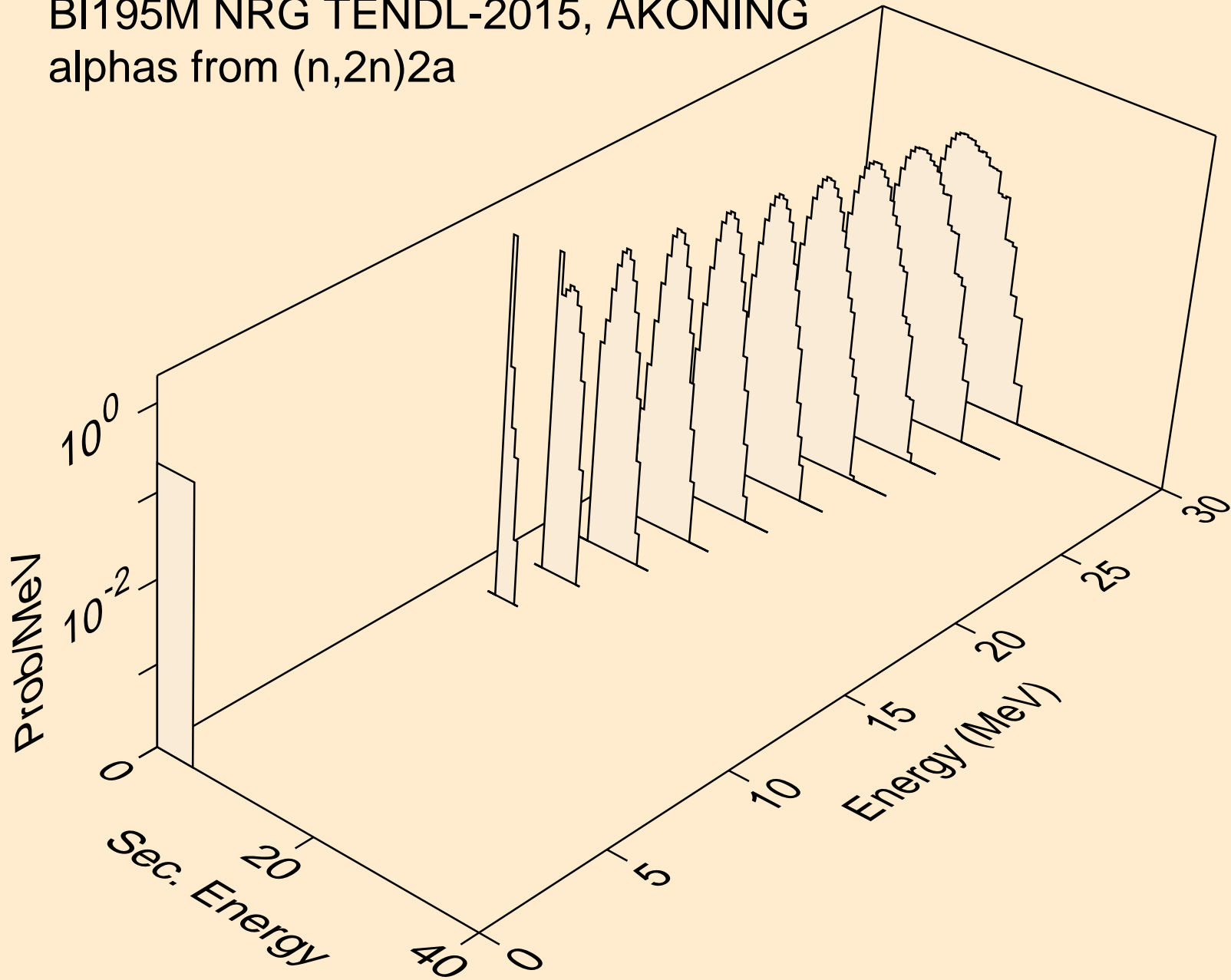

BI195M NRG TENDL-2015, AKONING
alphas from (n,npa)

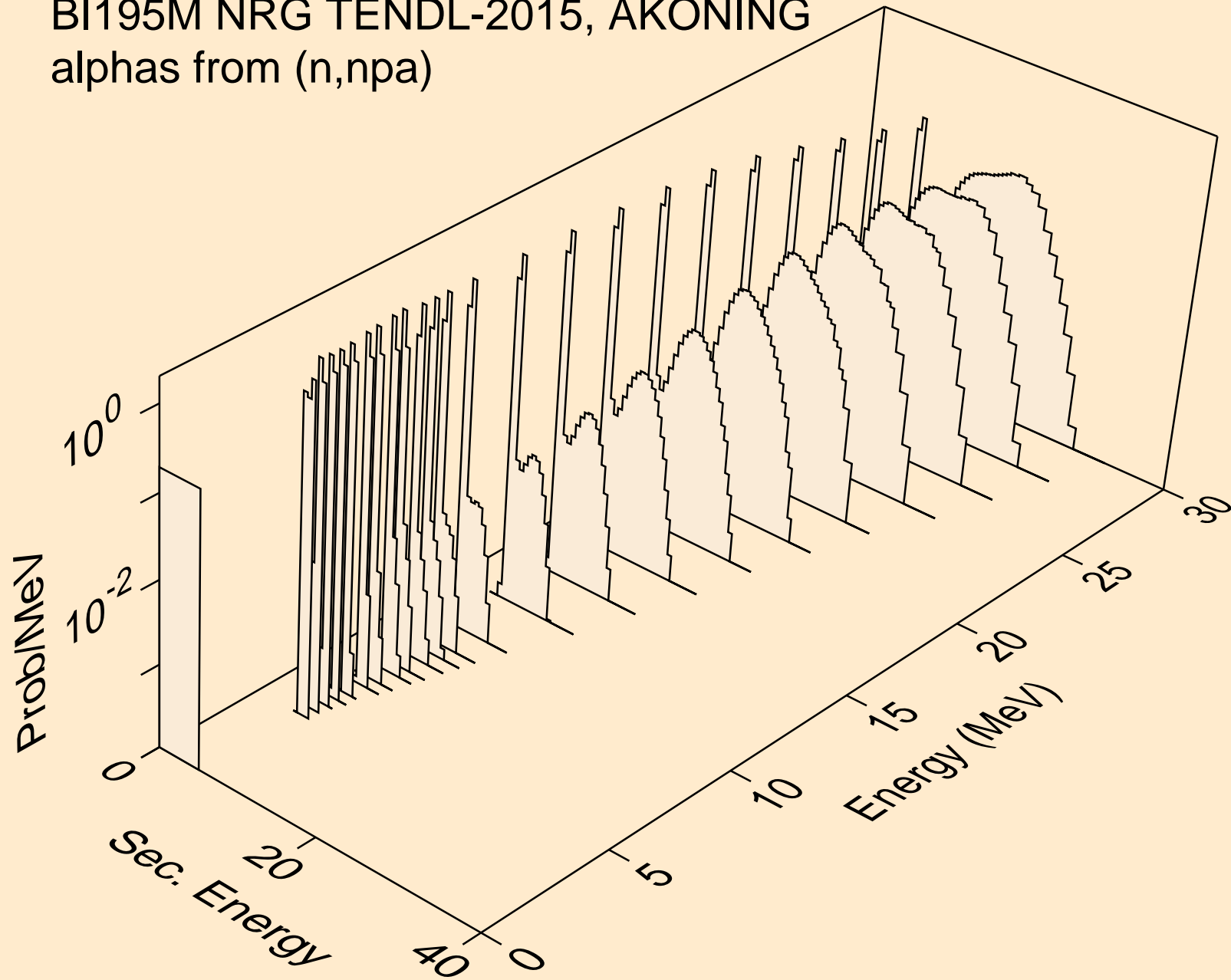

BI195M NRG TENDL-2015, AKONING
alphas from (n,a)

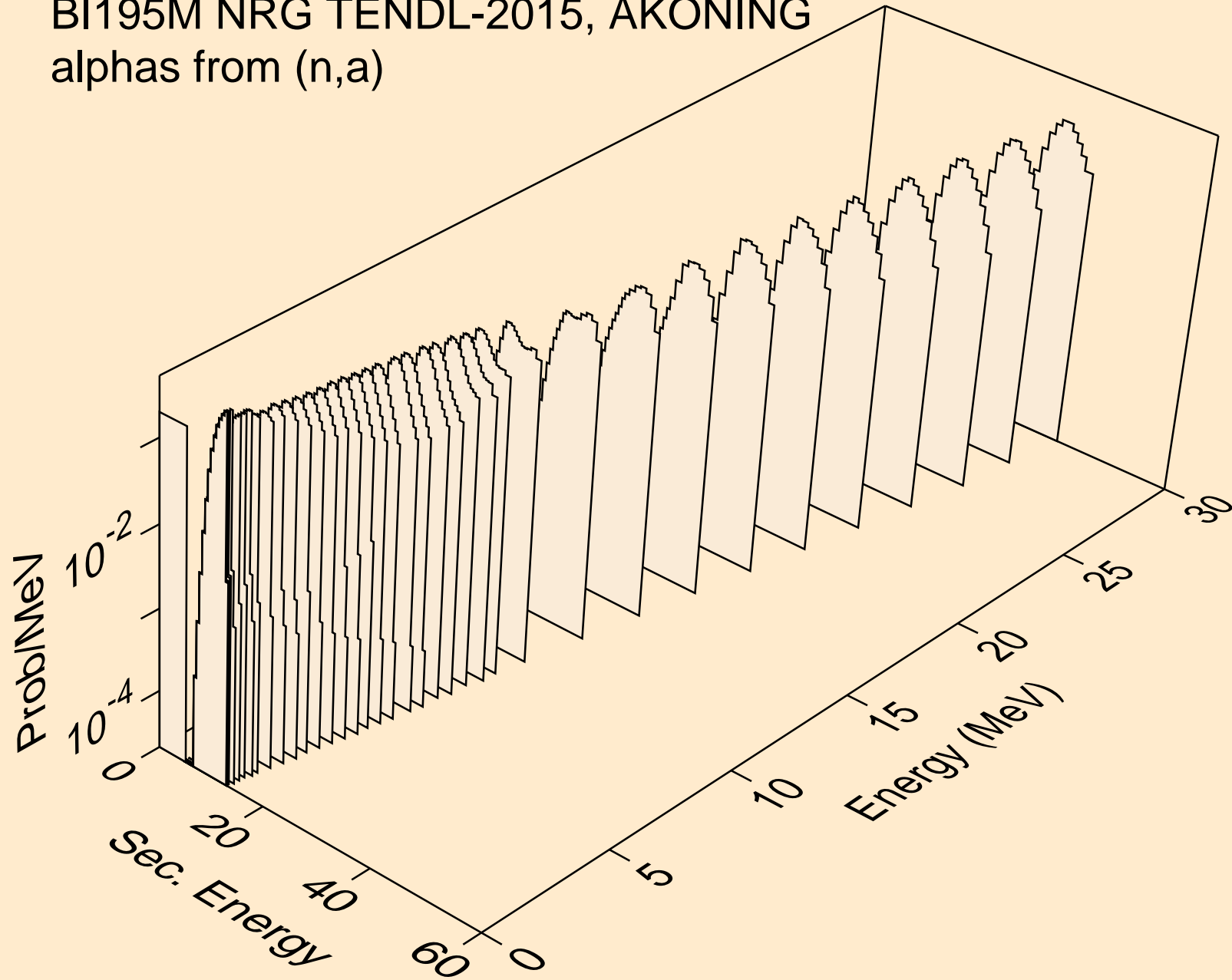

BI195M NRG TENDL-2015, AKONING
alphas from (n,2a)

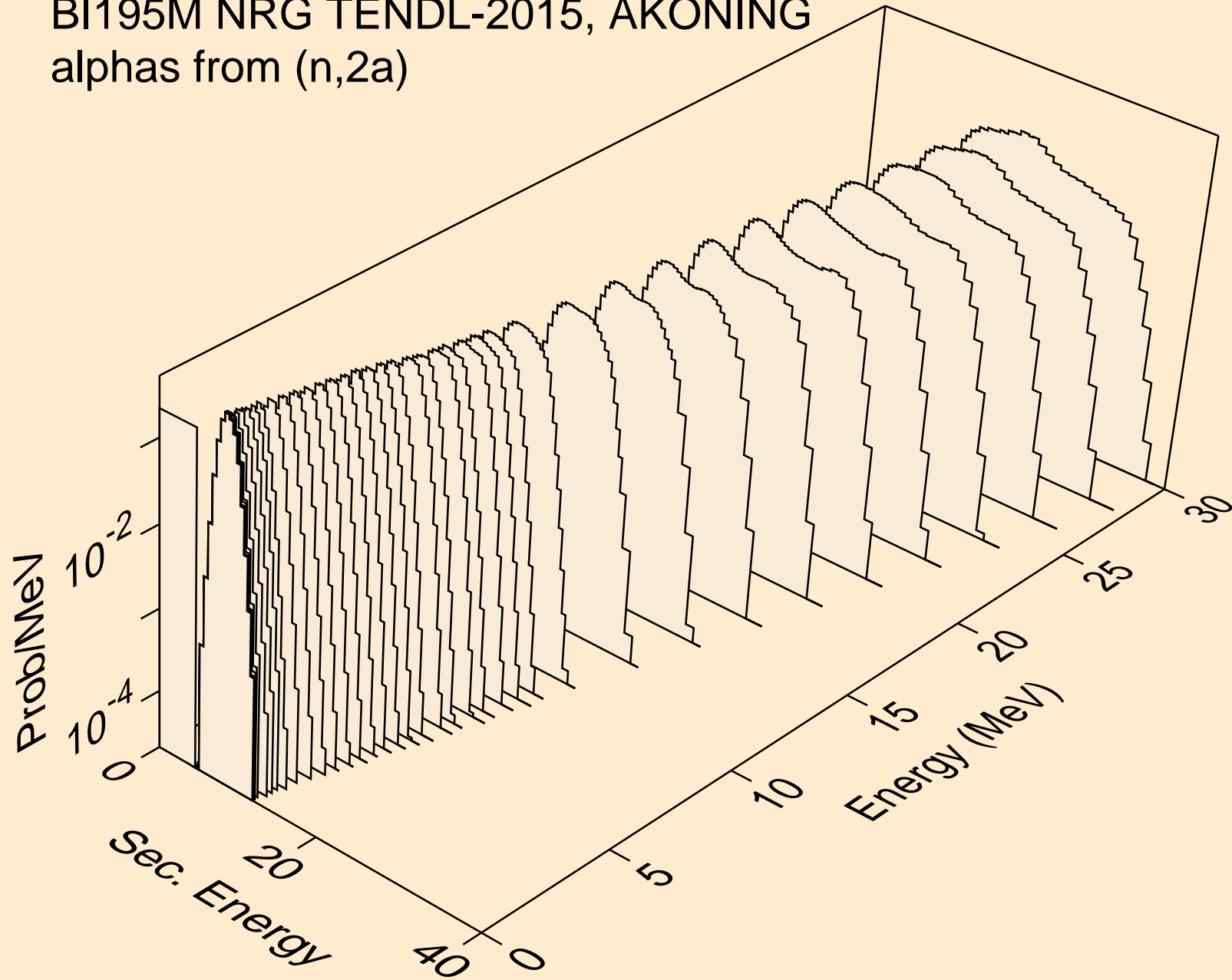

BI195M NRG TENDL-2015, AKONING
alphas from (n,3a)

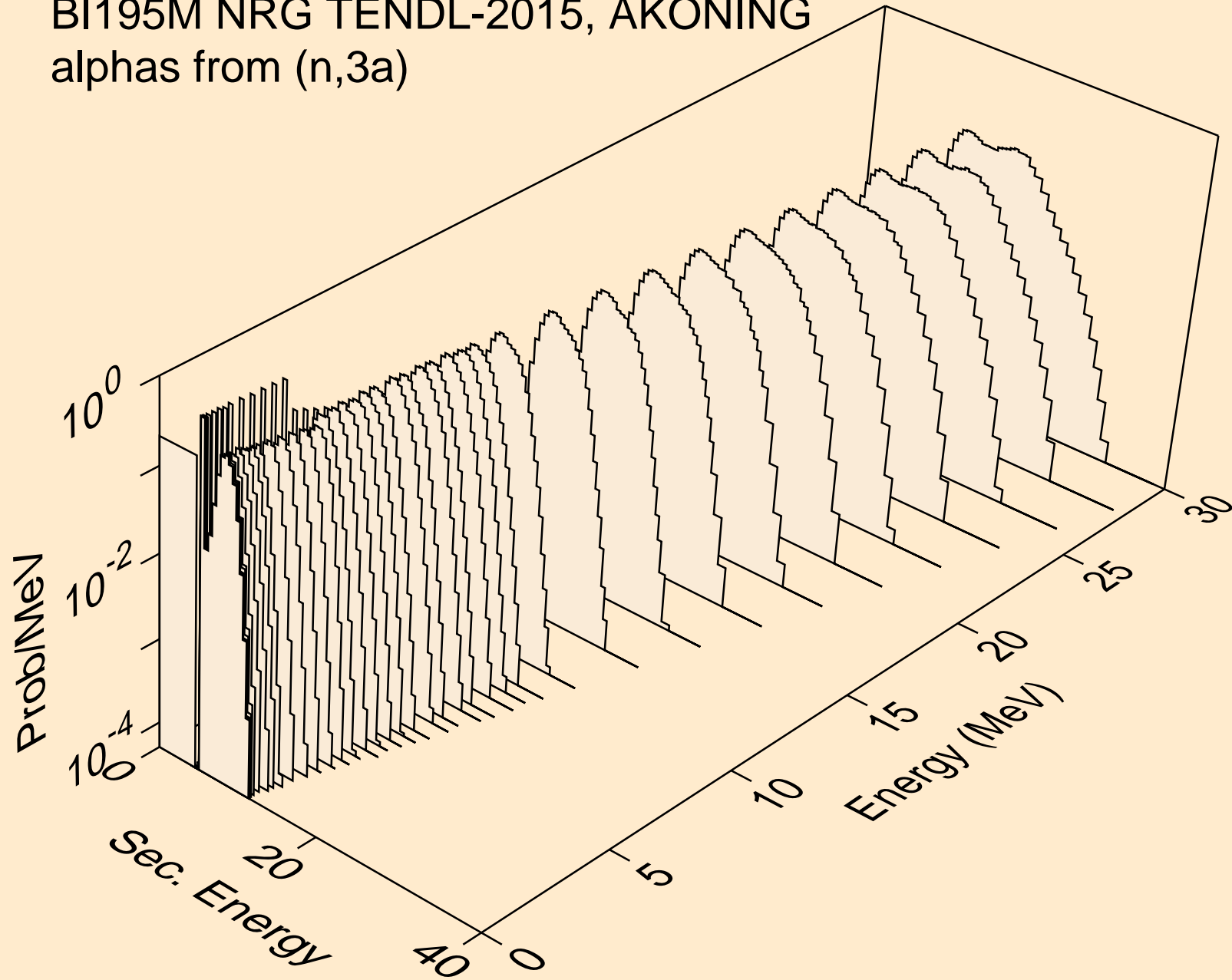

BI195M NRG TENDL-2015, AKONING
alphas from (n,pa)

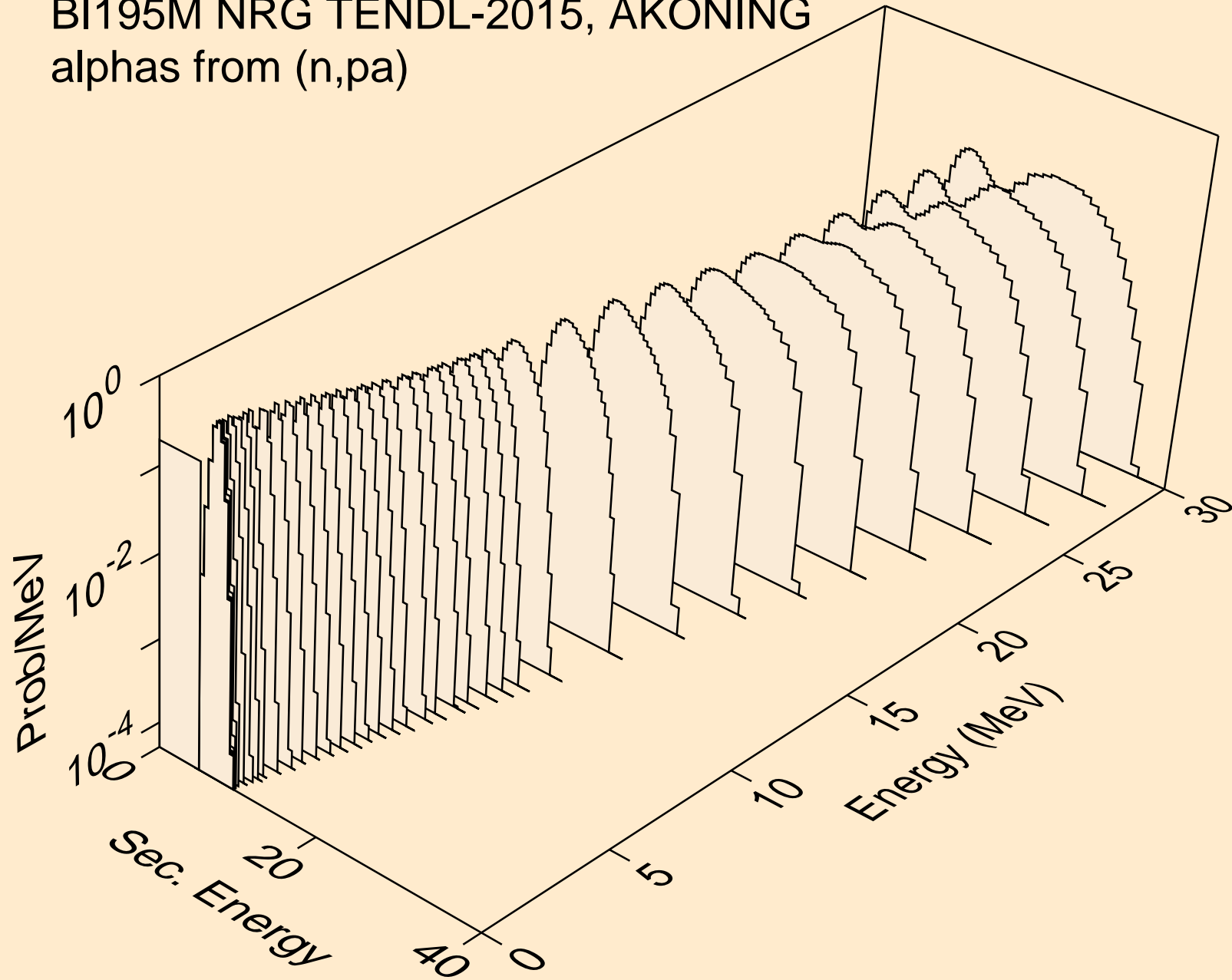

BI195M NRG TENDL-2015, AKONING
alphas from (n,t2a)

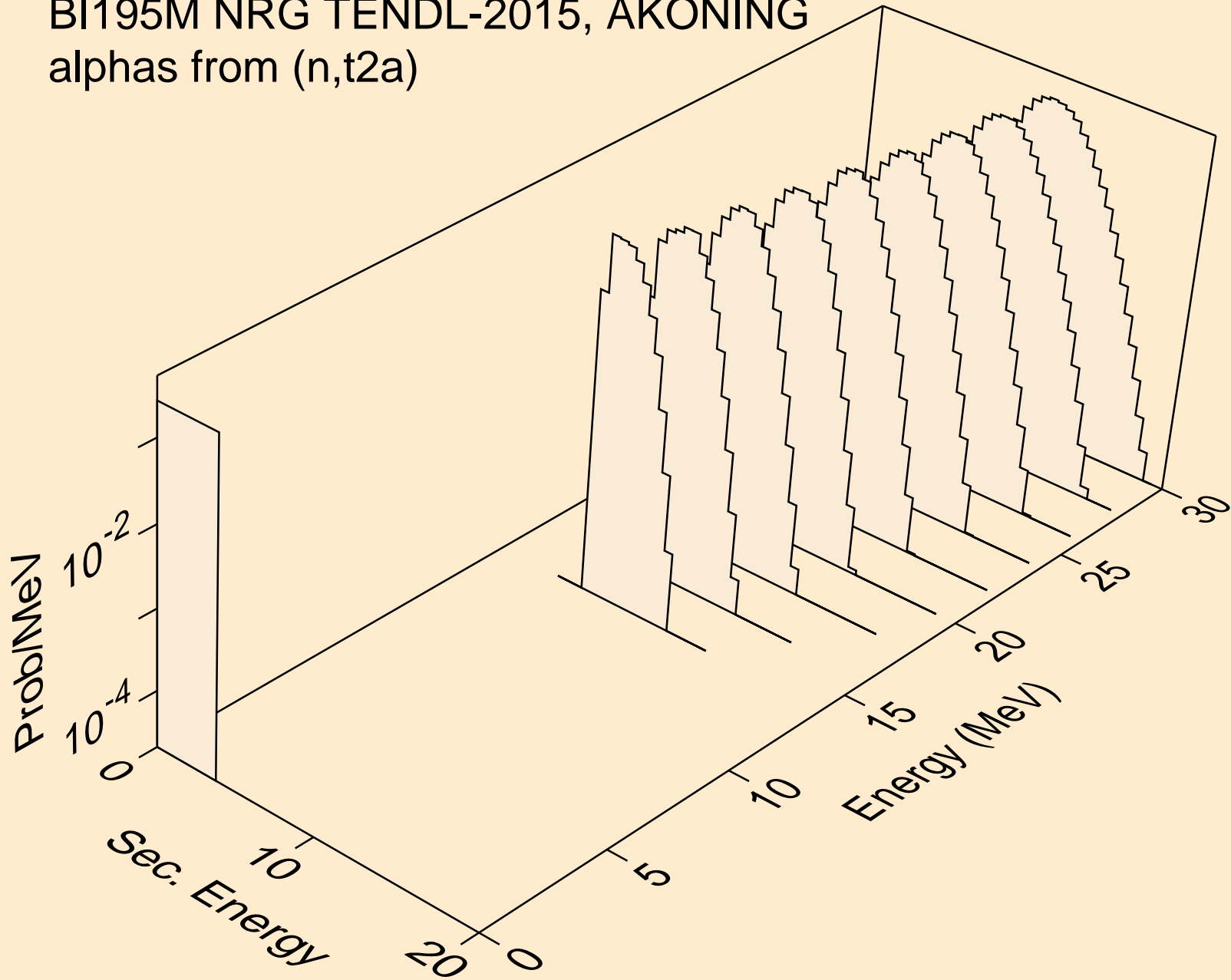

BI195M NRG TENDL-2015, AKONING
alphas from (n,d2a)

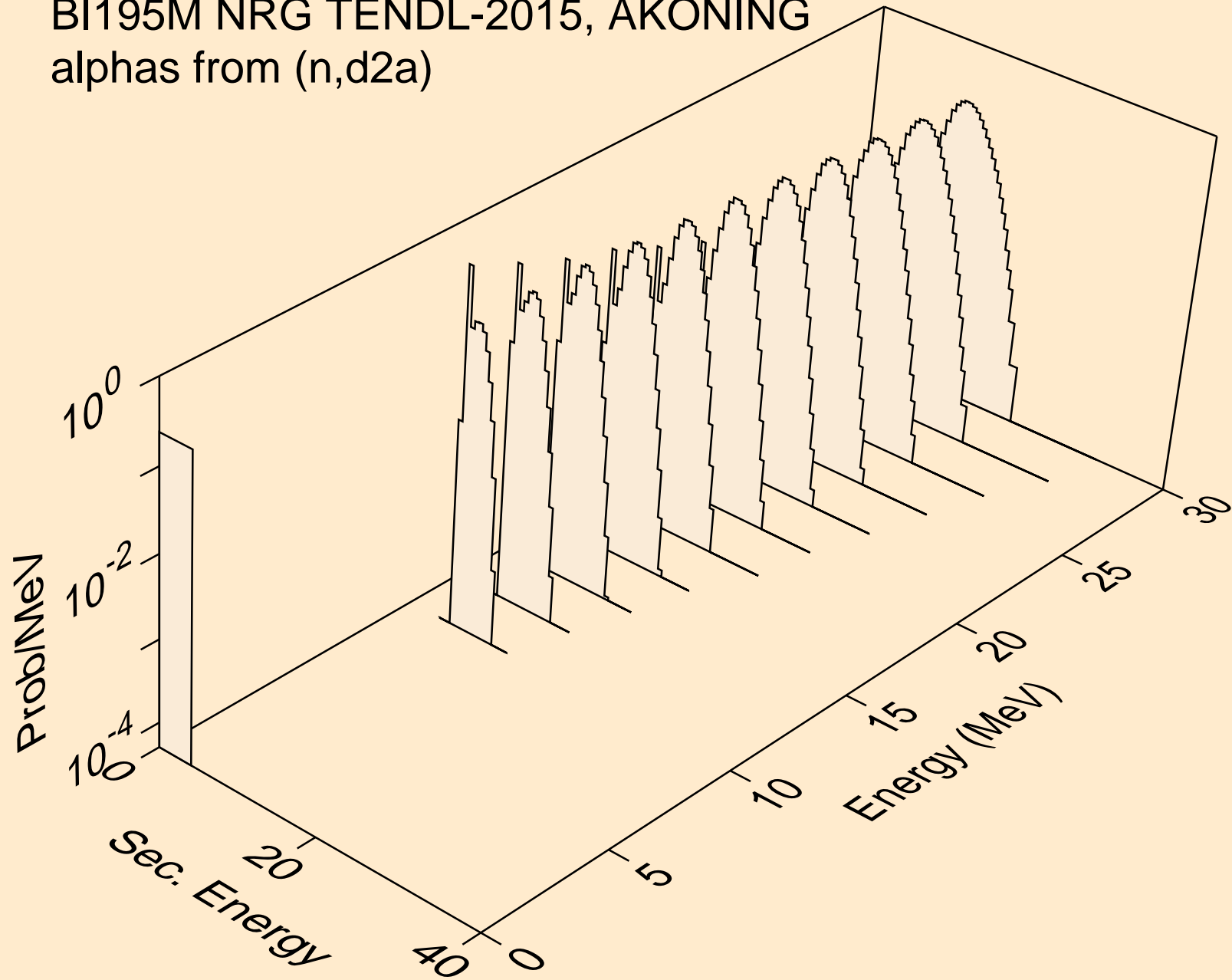

BI195M NRG TENDL-2015, AKONING
alphas from (n,da)

