

BK237 NRG TENDL-2015, AKONING

Principal cross sections

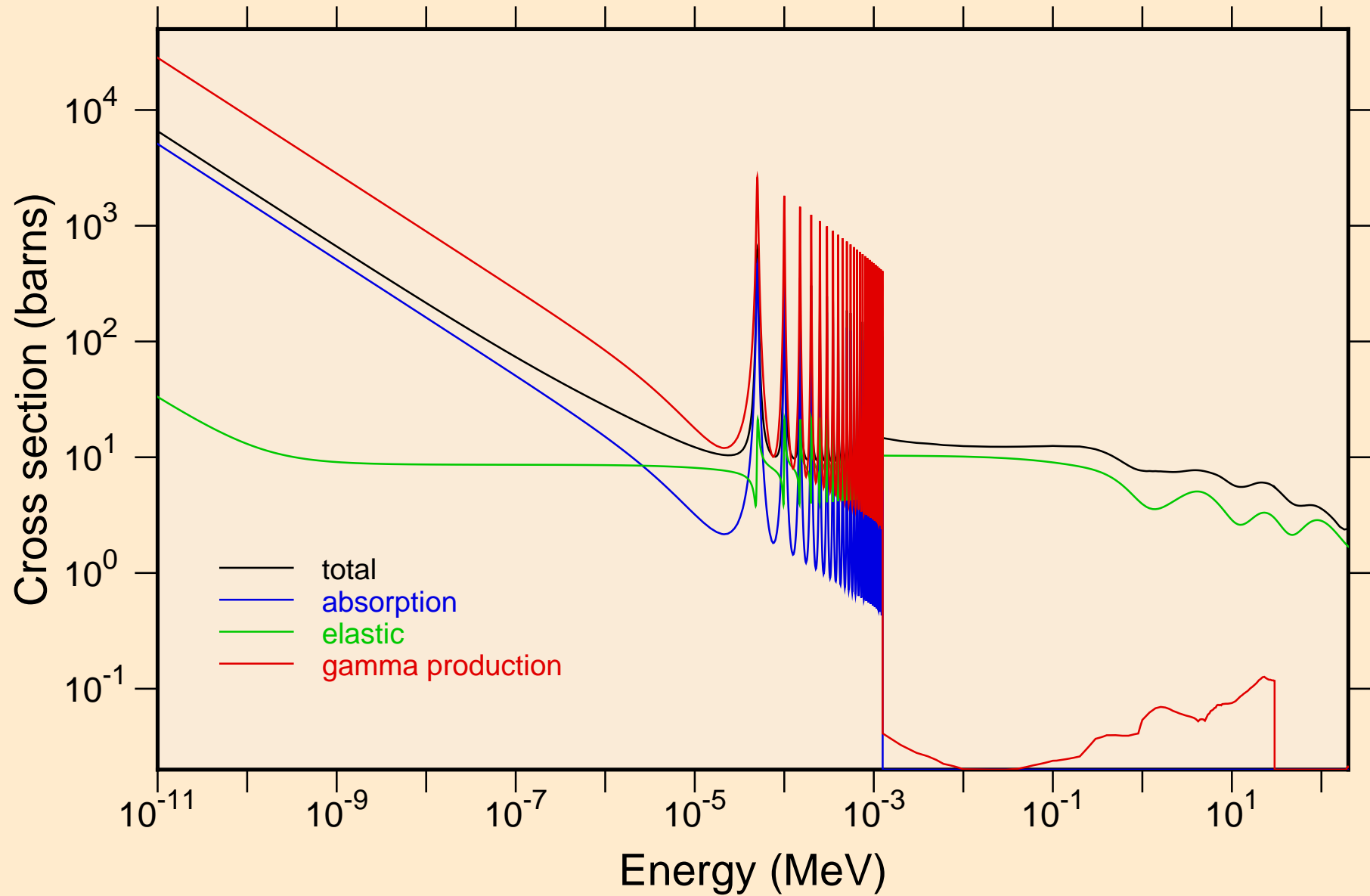

BK237 NRG TENDL-2015, AKONING
resonance total cross section

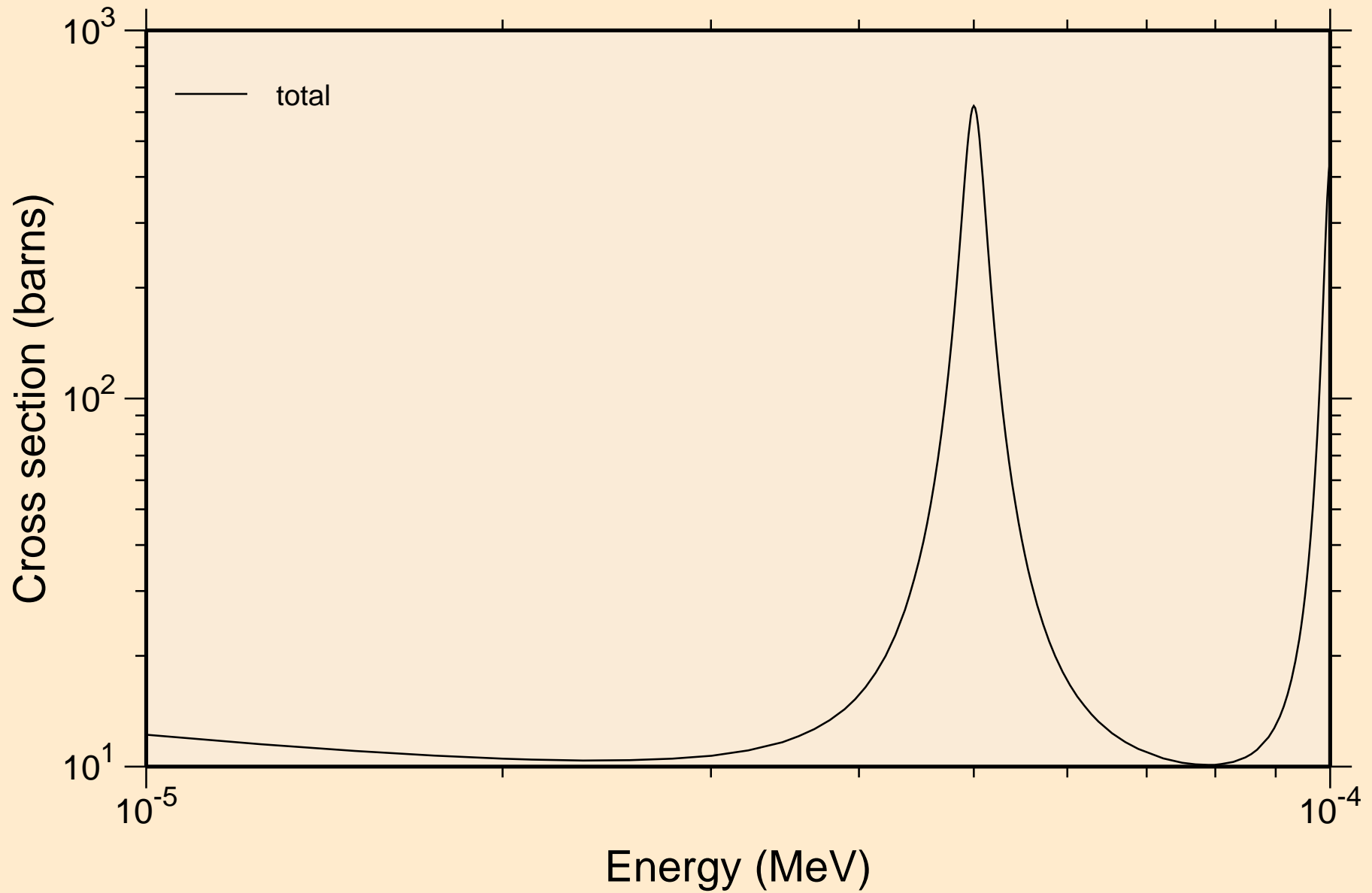

BK237 NRG TENDL-2015, AKONING
resonance total cross section

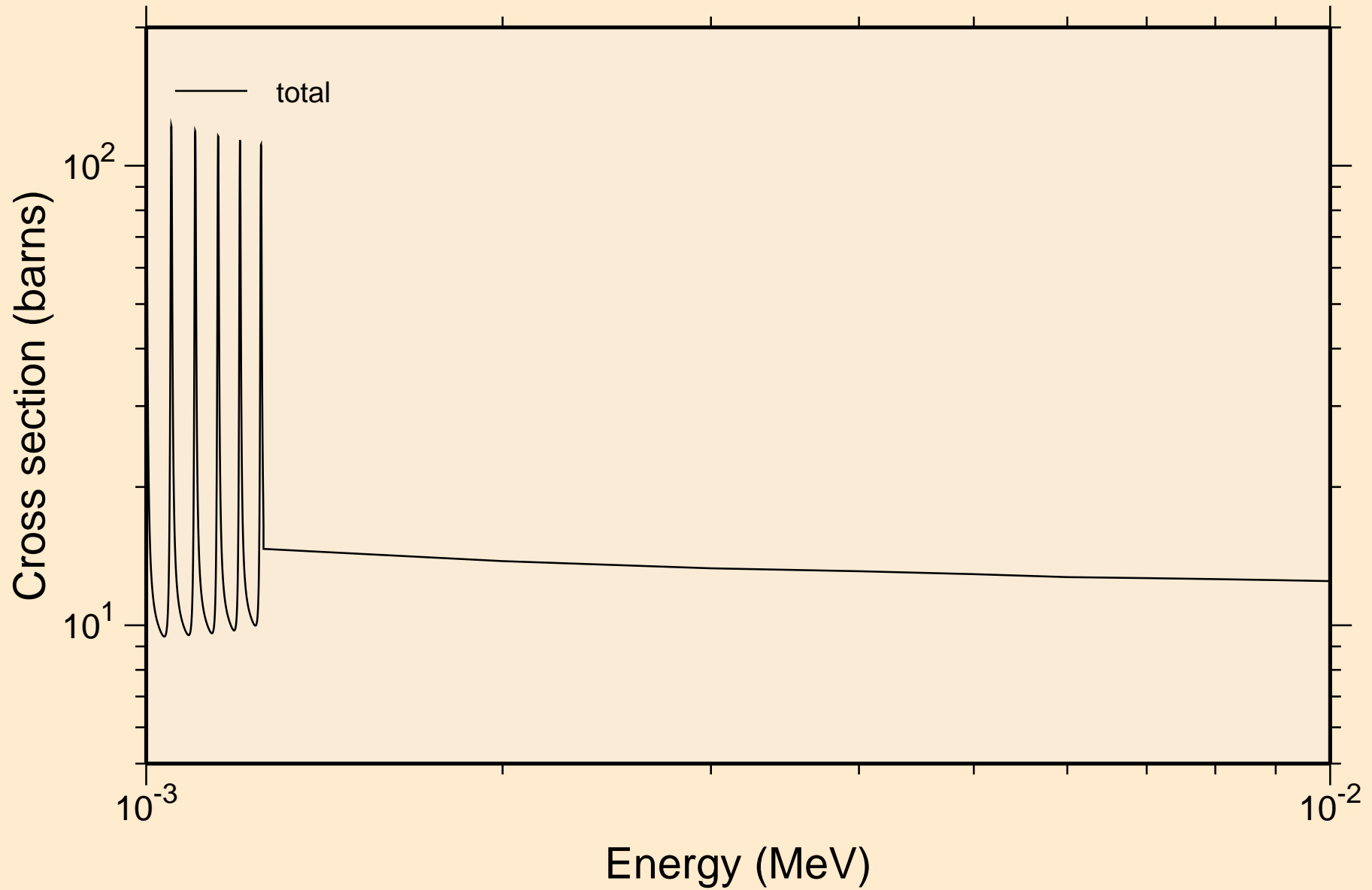

BK237 NRG TENDL-2015, AKONING
resonance total cross section

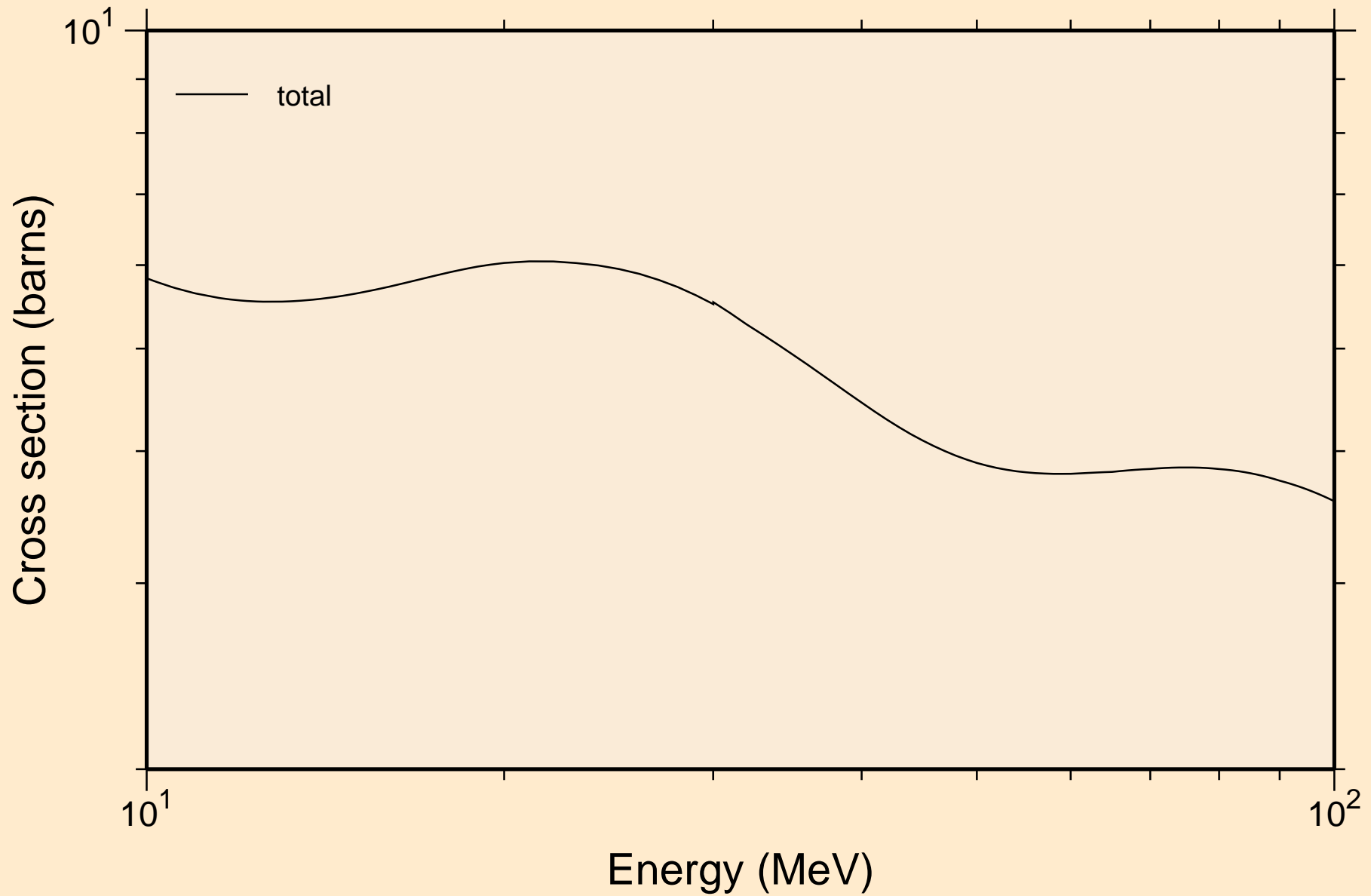

BK237 NRG TENDL-2015, AKONING
resonance absorption cross sections

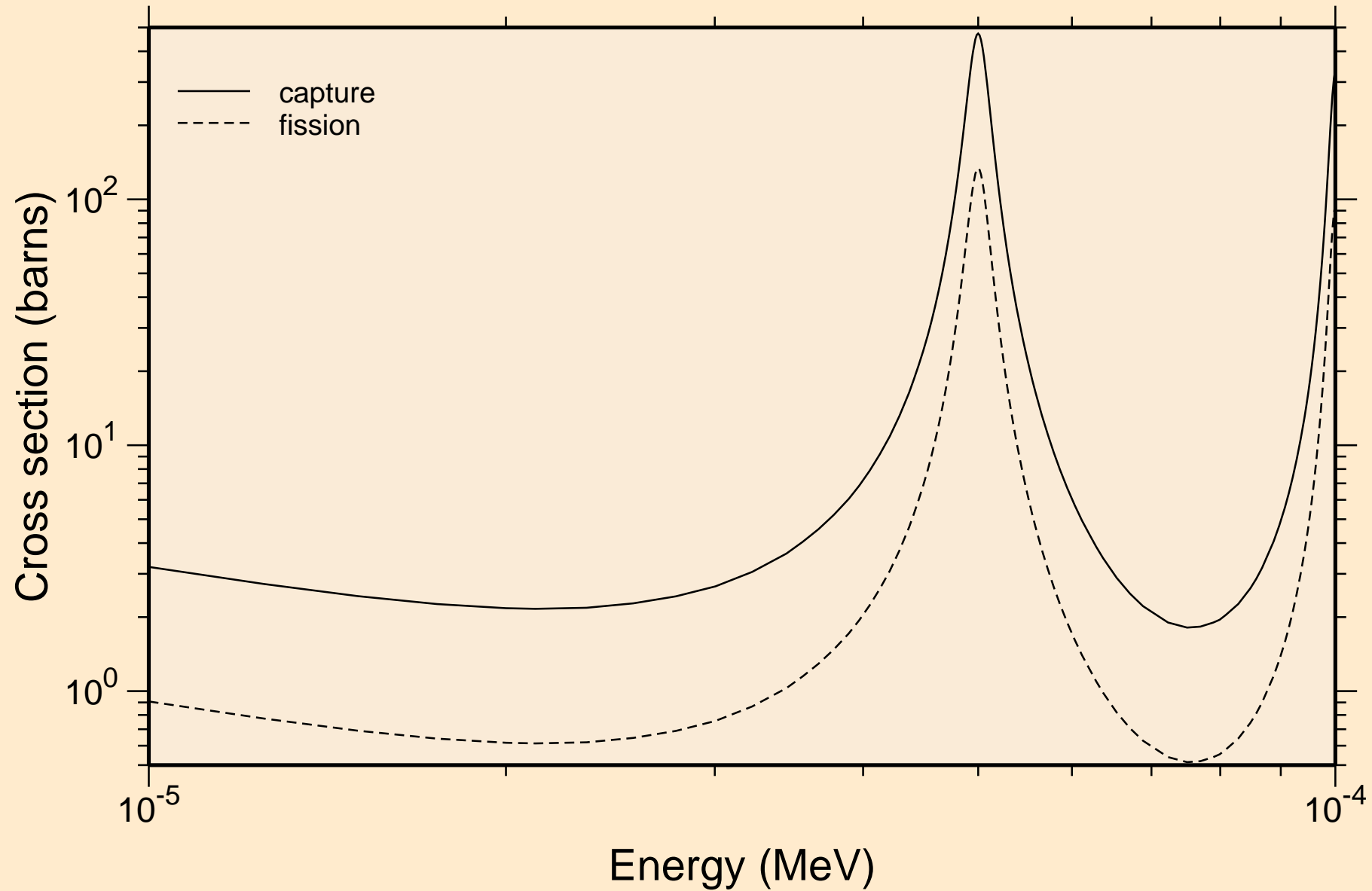

BK237 NRG TENDL-2015, AKONING
resonance absorption cross sections

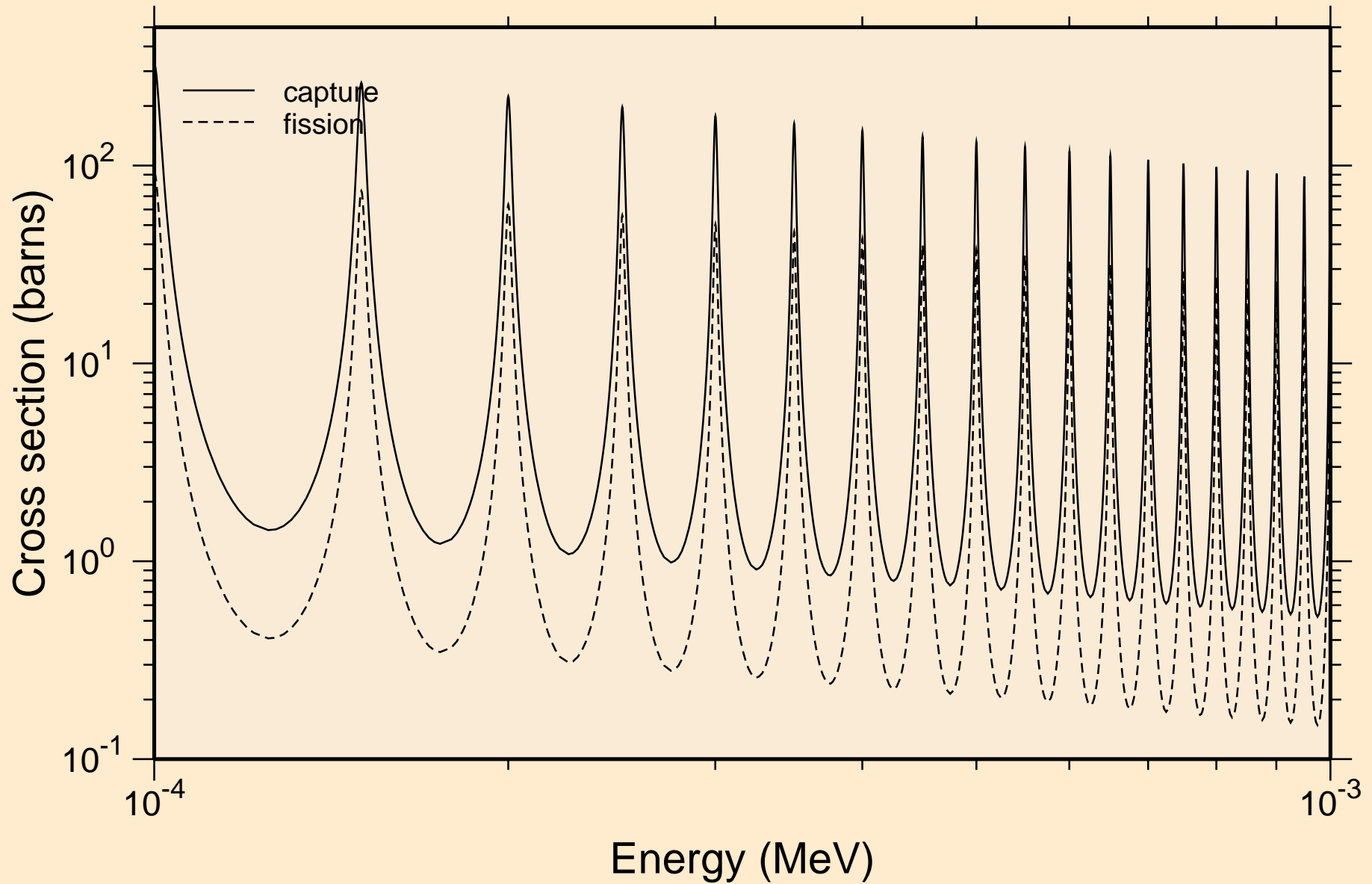

BK237 NRG TENDL-2015, AKONING
resonance absorption cross sections

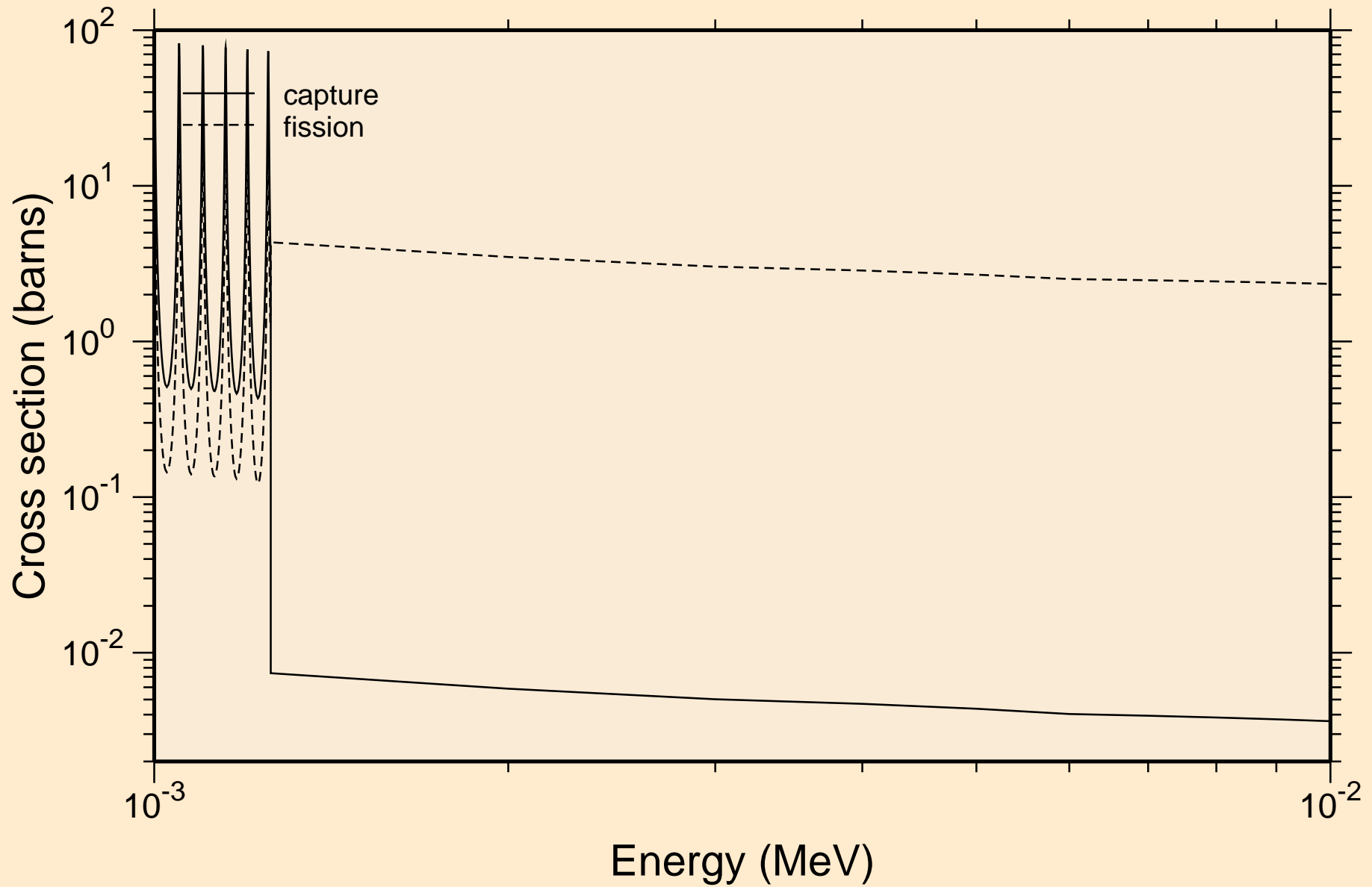

BK237 NRG TENDL-2015, AKONING
resonance absorption cross sections

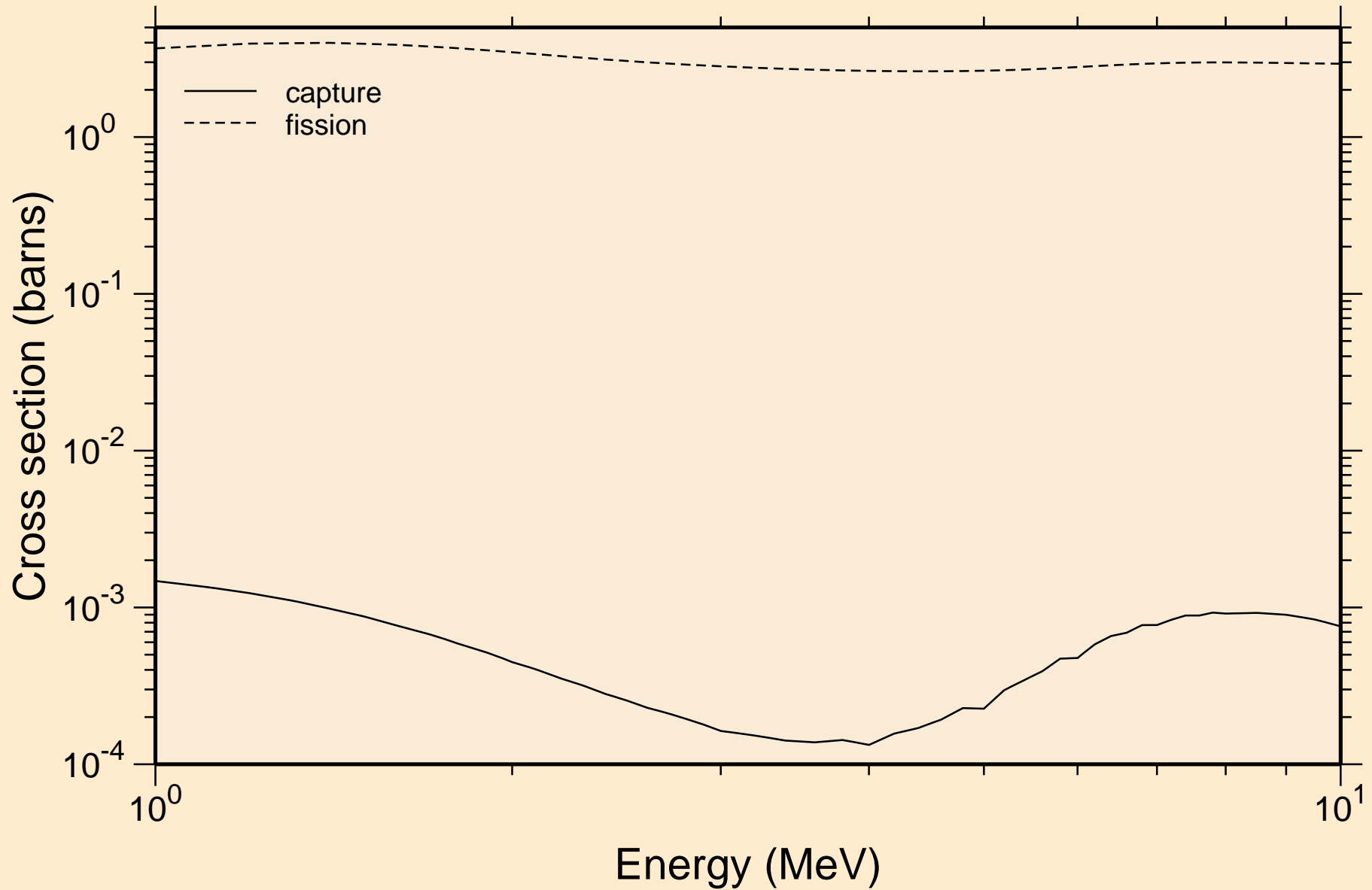

BK237 NRG TENDL-2015, AKONING

Non-threshold reactions

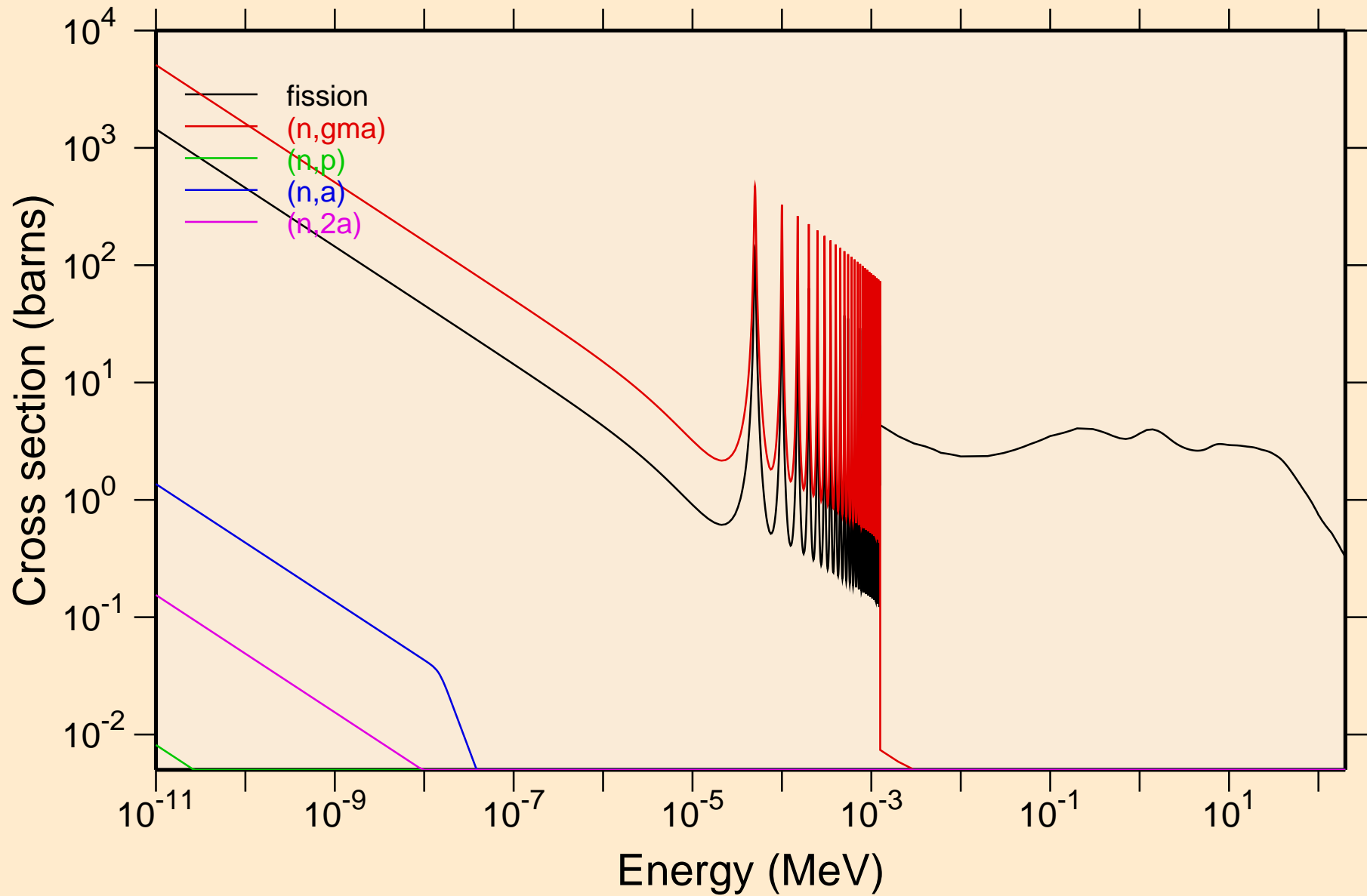

BK237 NRG TENDL-2015, AKONING
Non-threshold reactions

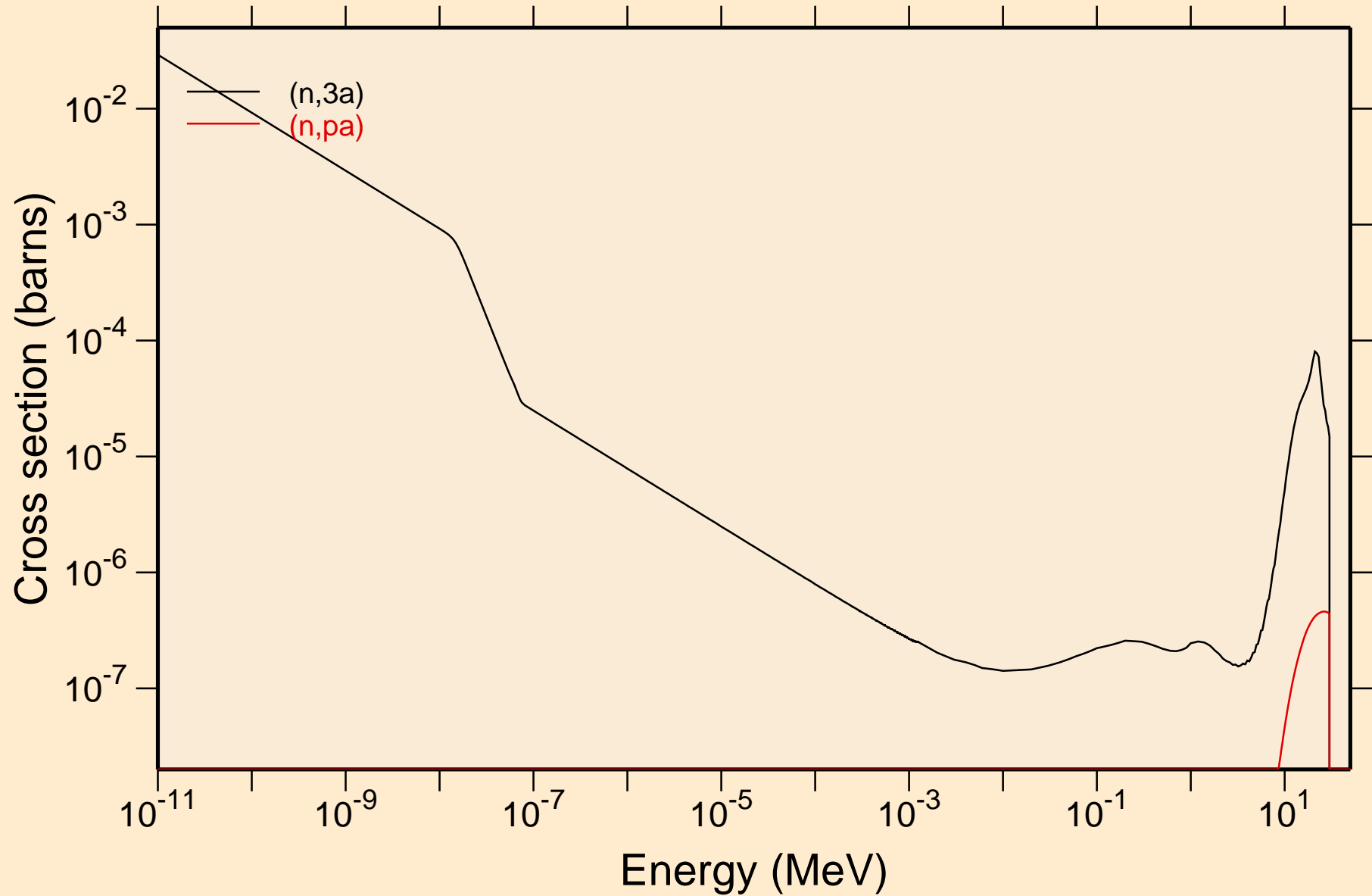

BK237 NRG TENDL-2015, AKONING

Principal cross sections

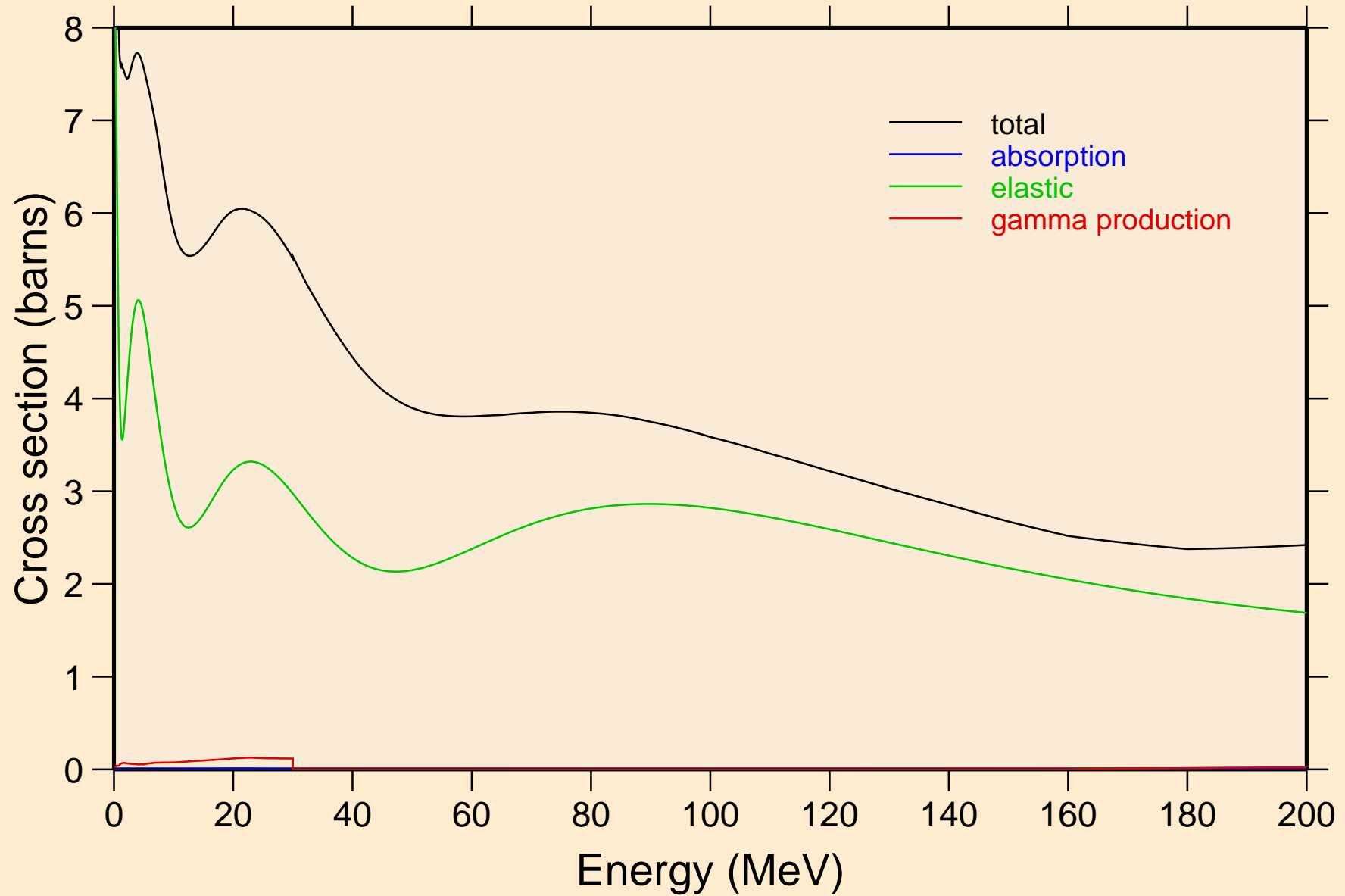

BK237 NRG TENDL-2015, AKONING

Non-threshold reactions

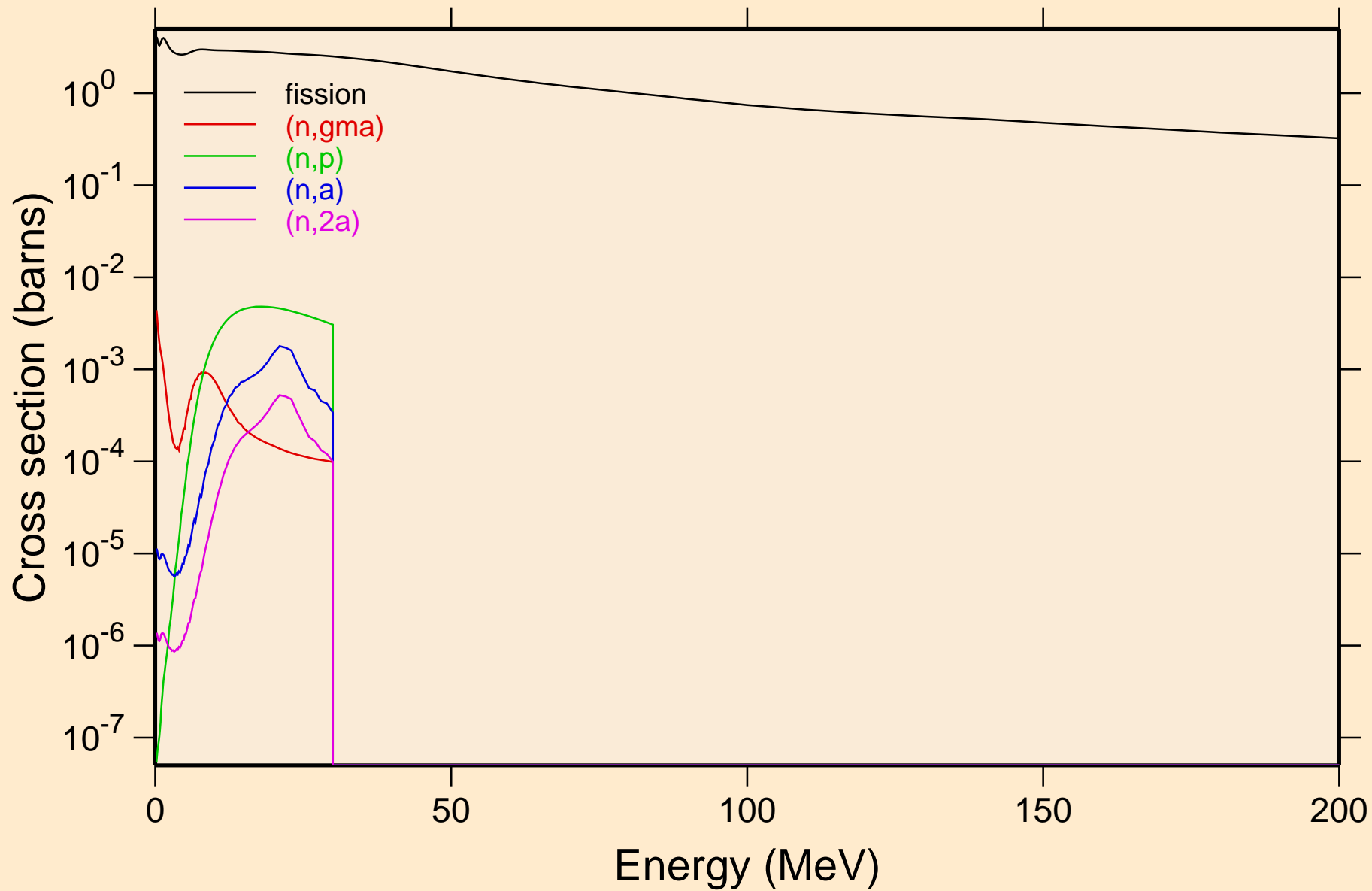

BK237 NRG TENDL-2015, AKONING
Non-threshold reactions

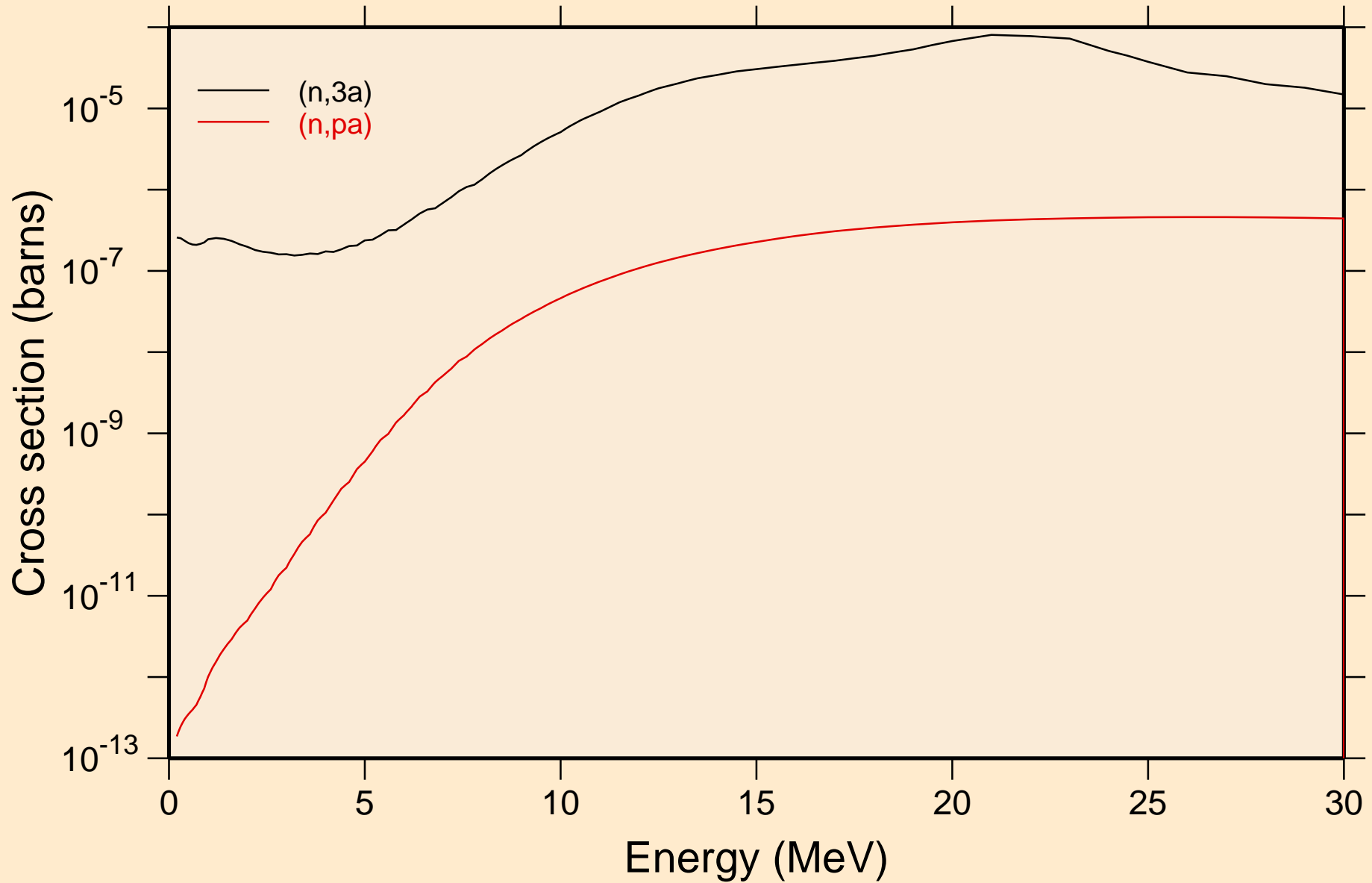

BK237 NRG TENDL-2015, AKONING
Inelastic levels

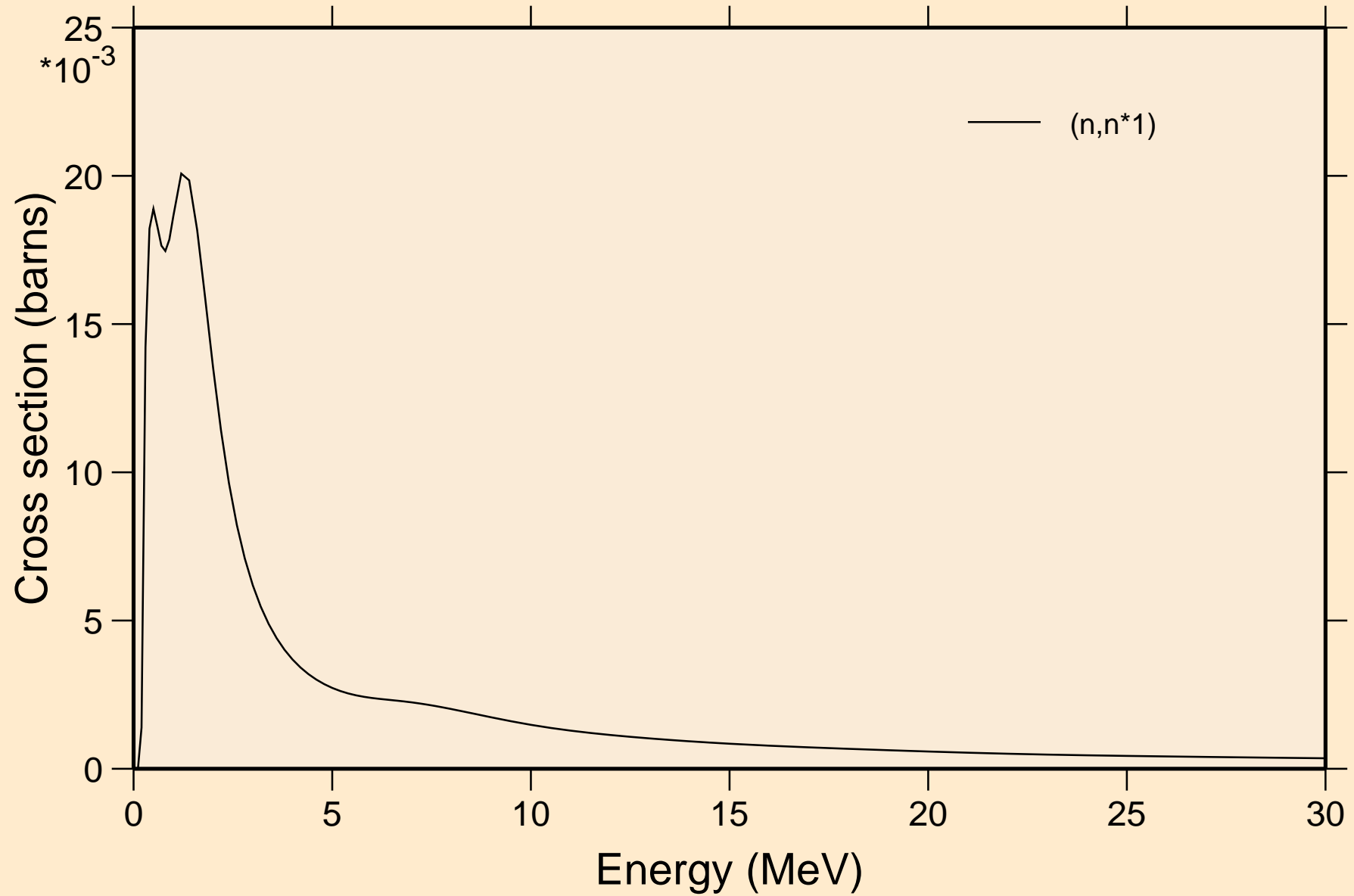

BK237 NRG TENDL-2015, AKONING

Threshold reactions

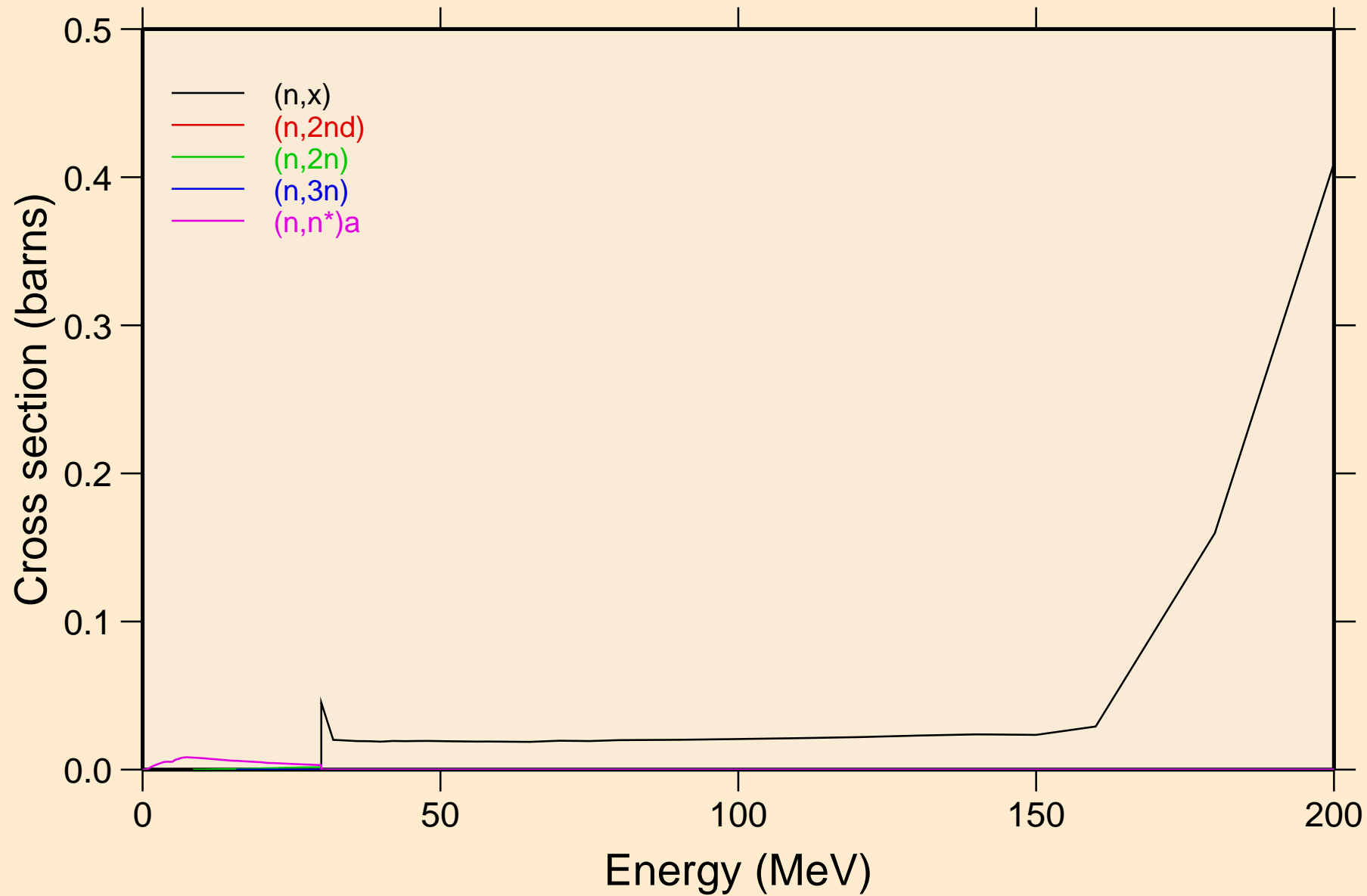

BK237 NRG TENDL-2015, AKONING

Threshold reactions

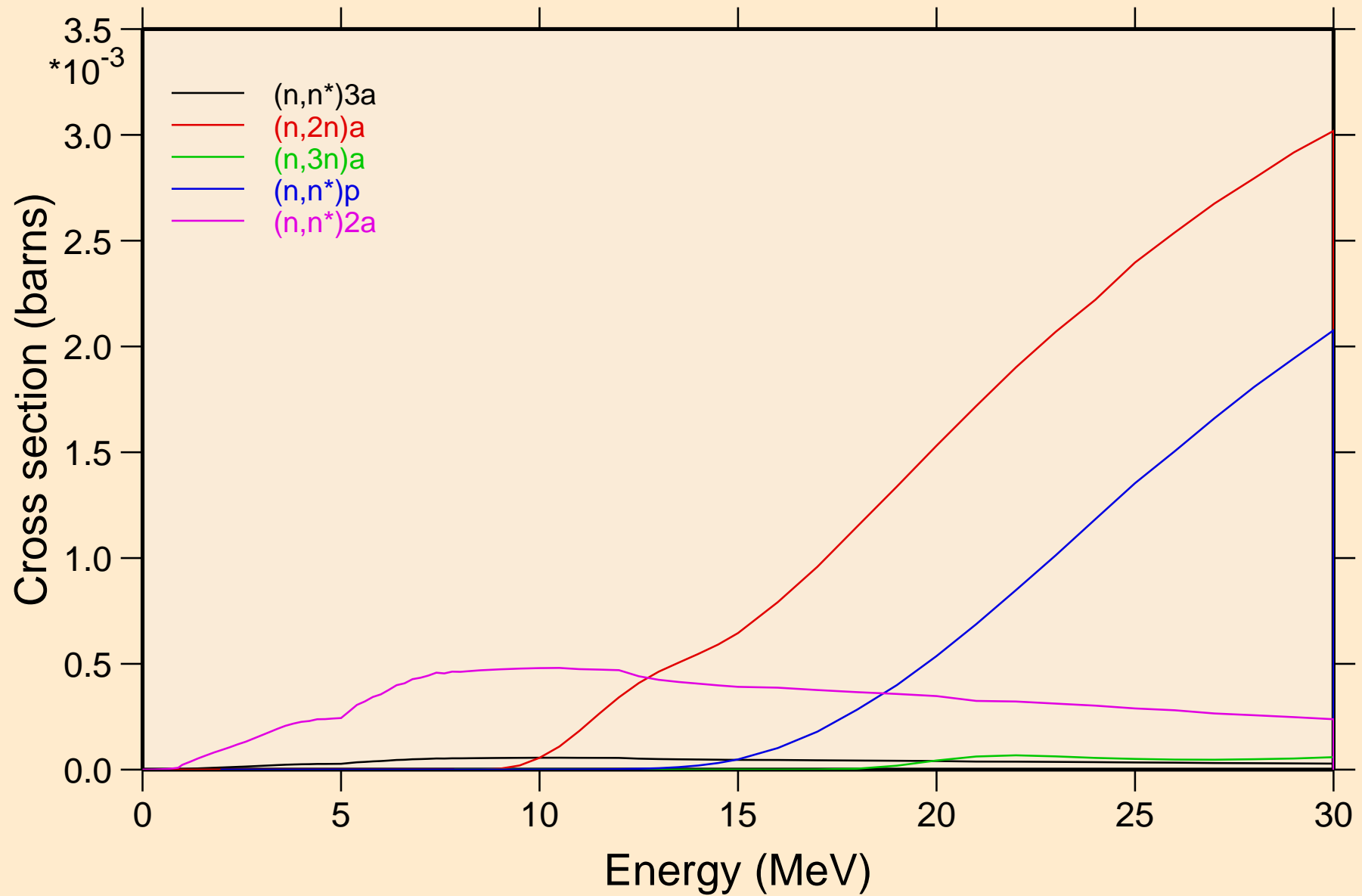

BK237 NRG TENDL-2015, AKONING

Threshold reactions

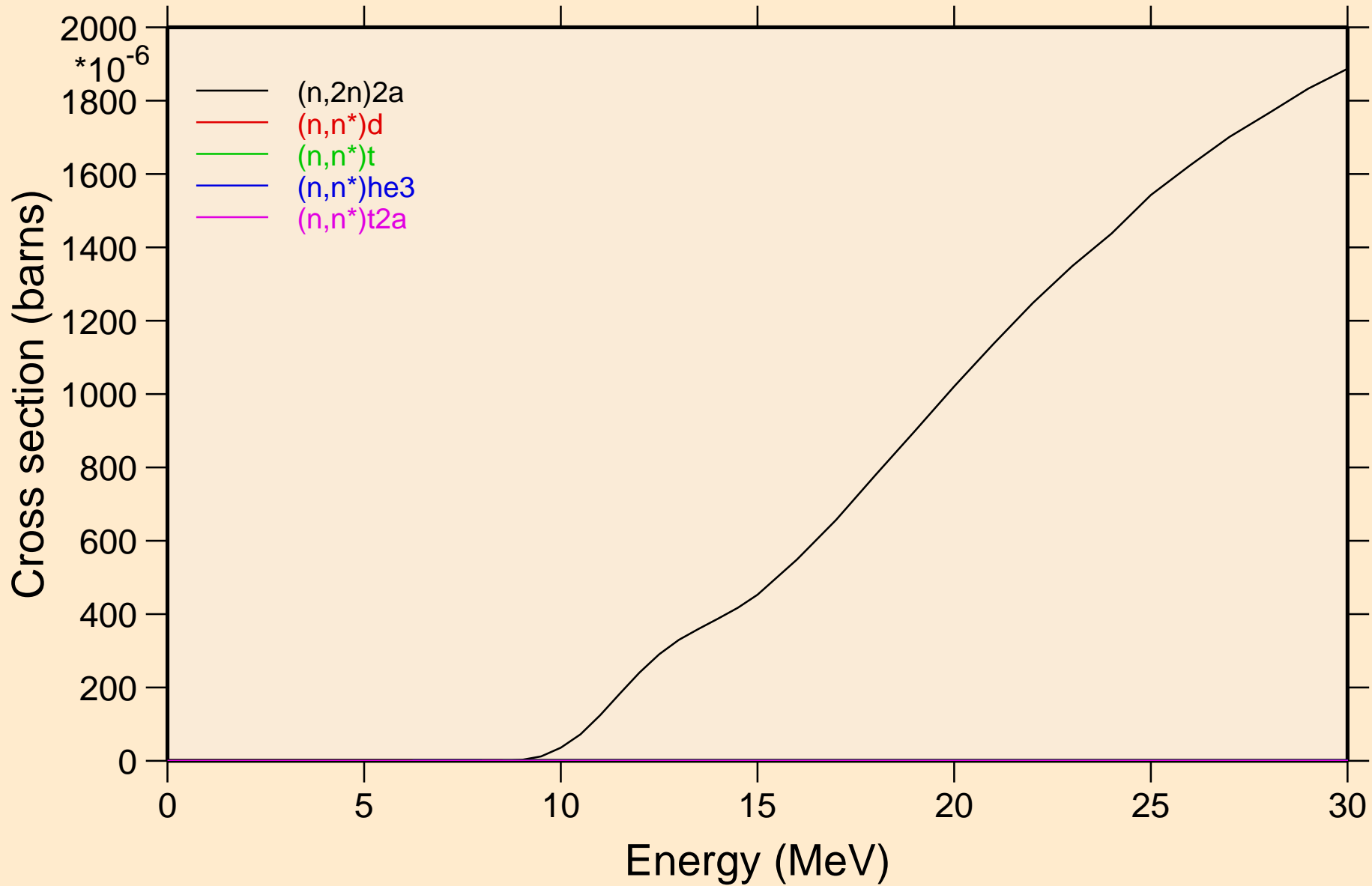

BK237 NRG TENDL-2015, AKONING

Threshold reactions

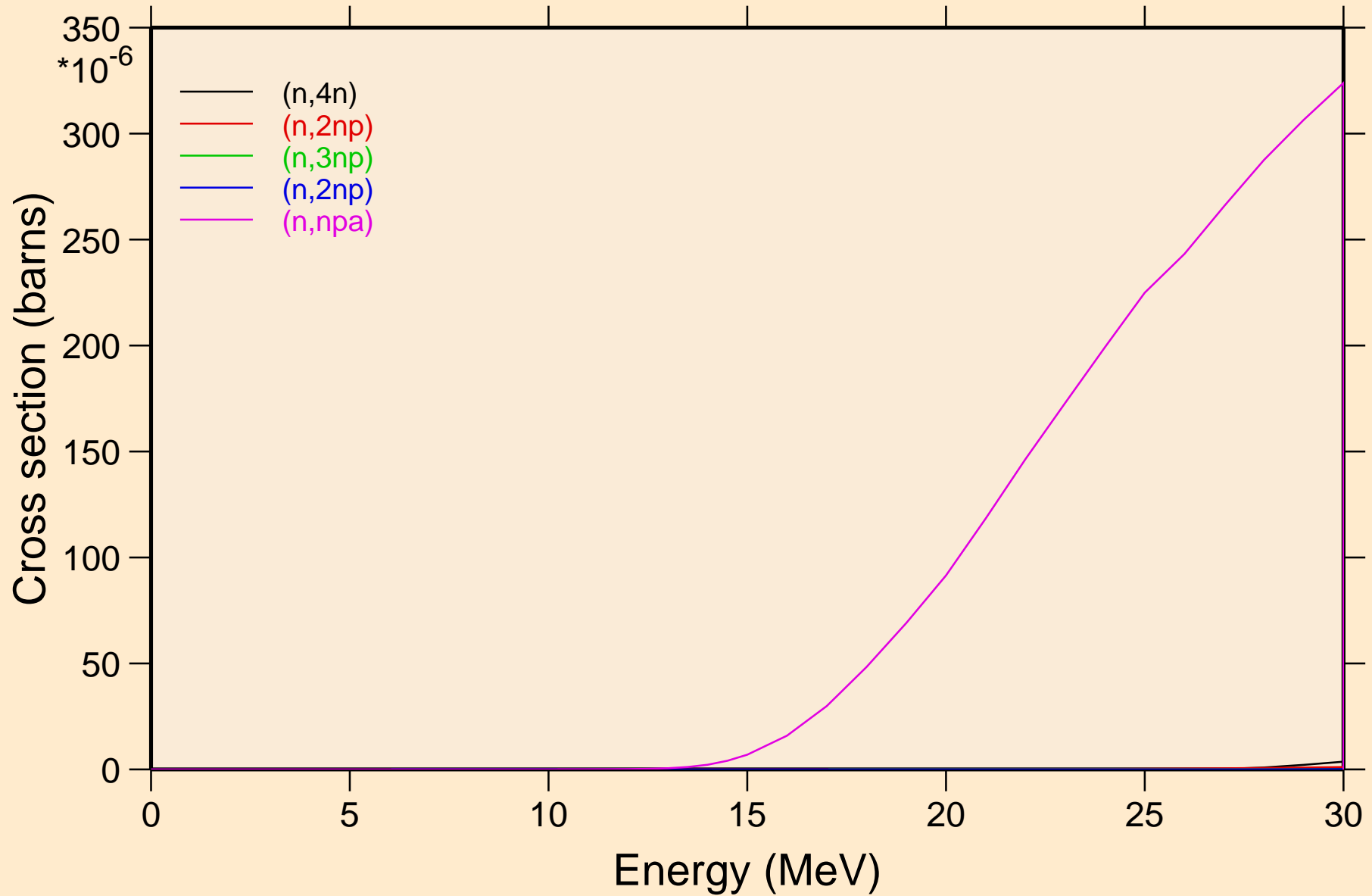

BK237 NRG TENDL-2015, AKONING

Threshold reactions

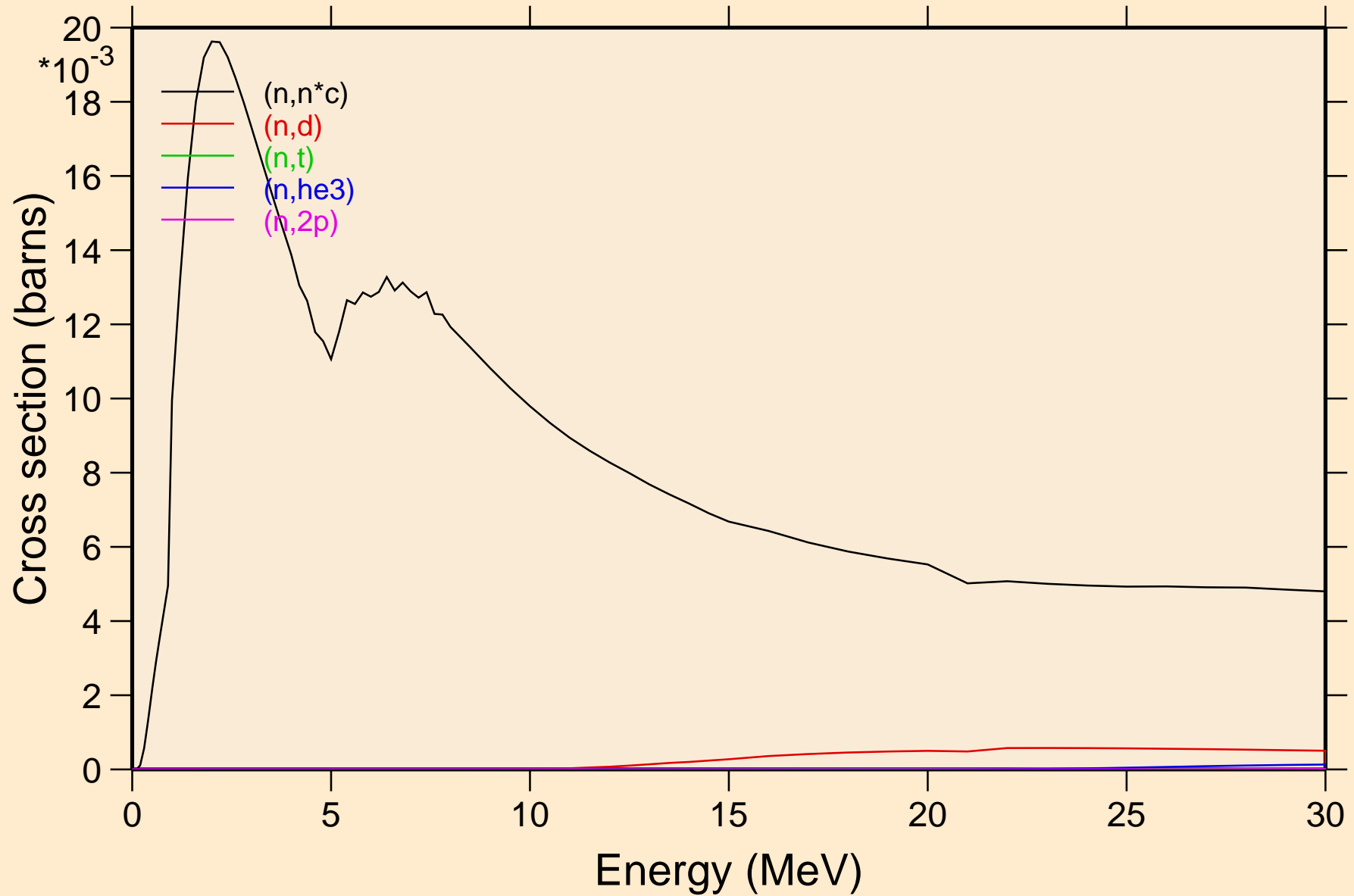

BK237 NRG TENDL-2015, AKONING

Threshold reactions

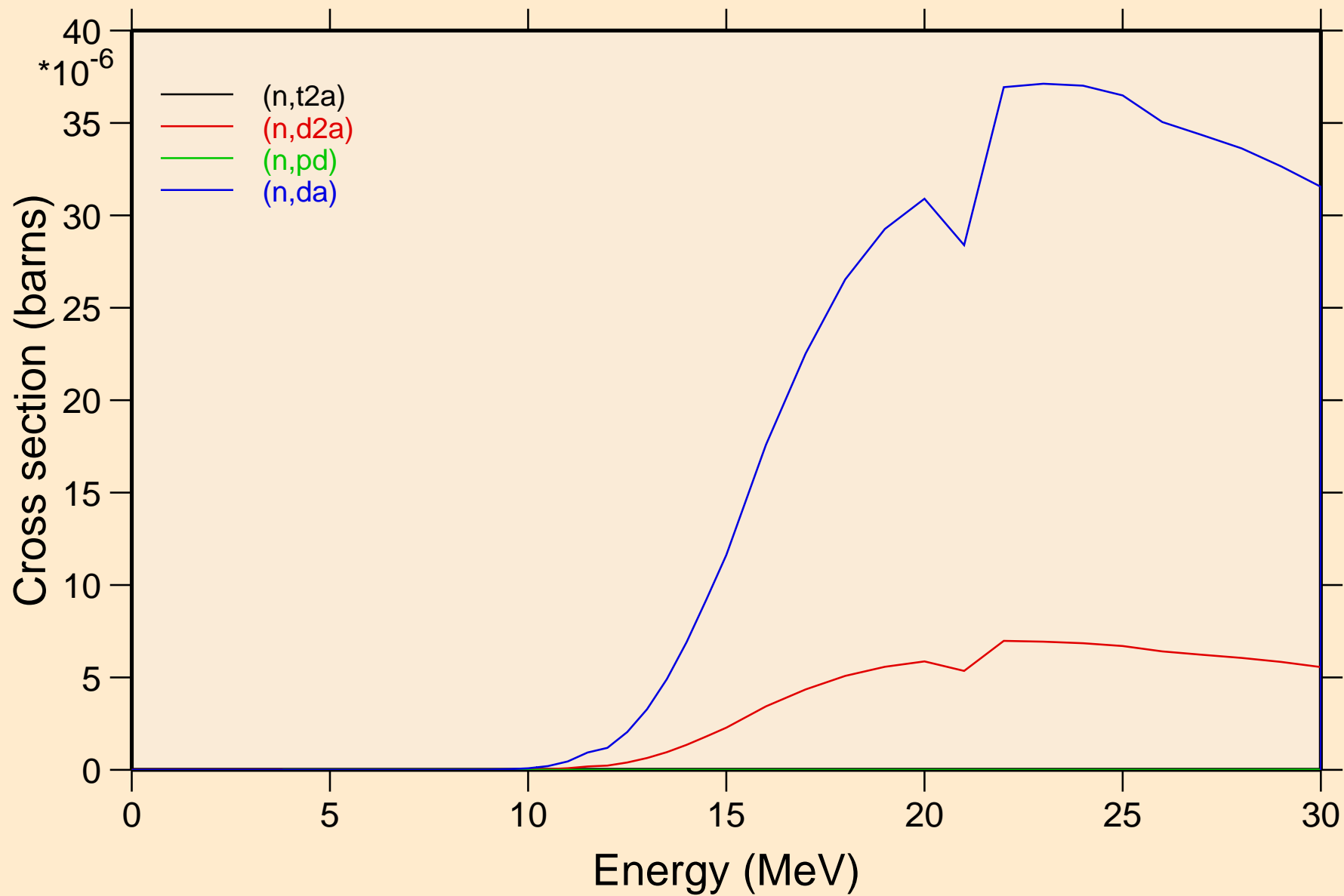

BK237 NRG TENDL-2015, AKONING
angular distribution for elastic

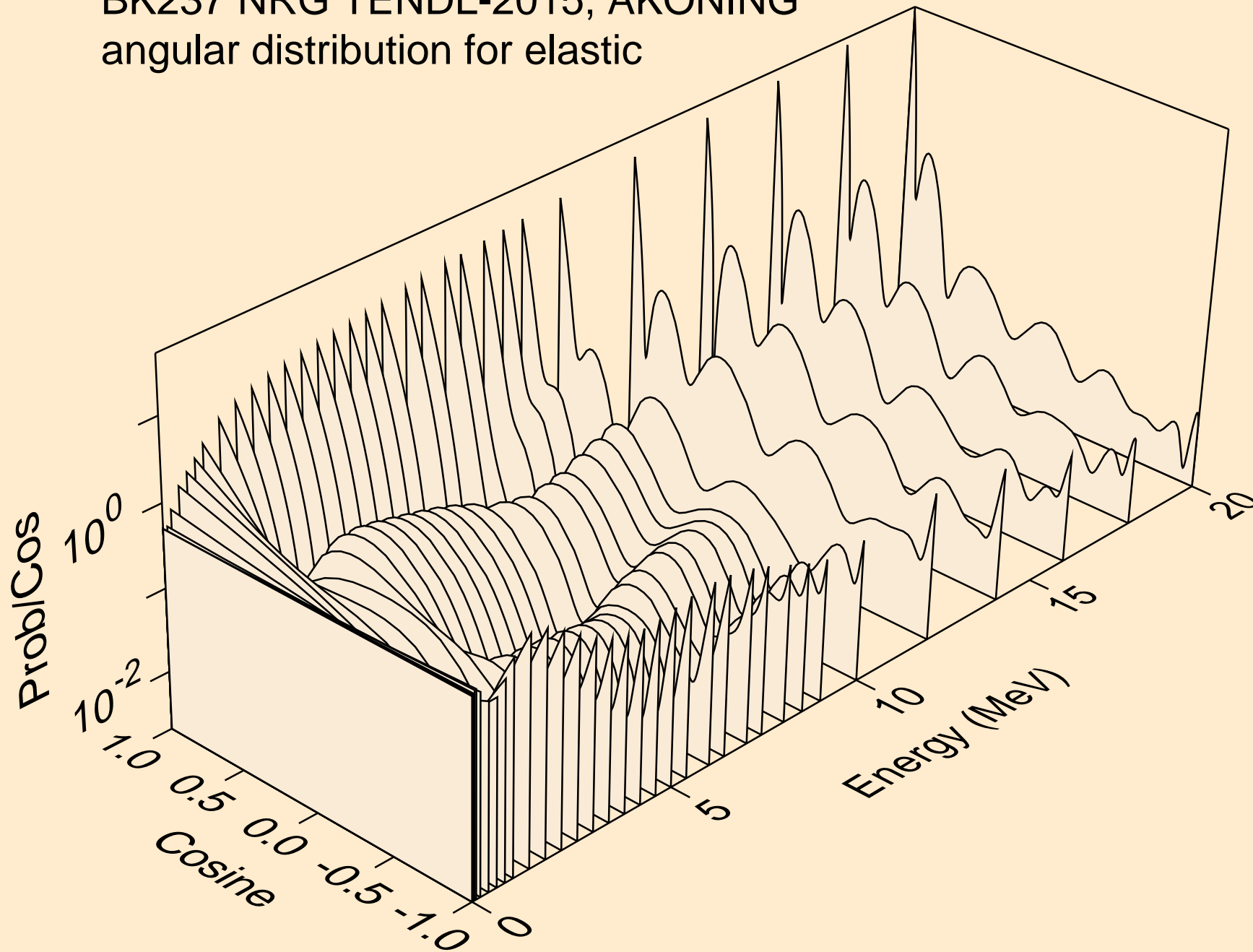

BK237 NRG TENDL-2015, AKONING
angular distribution for elastic

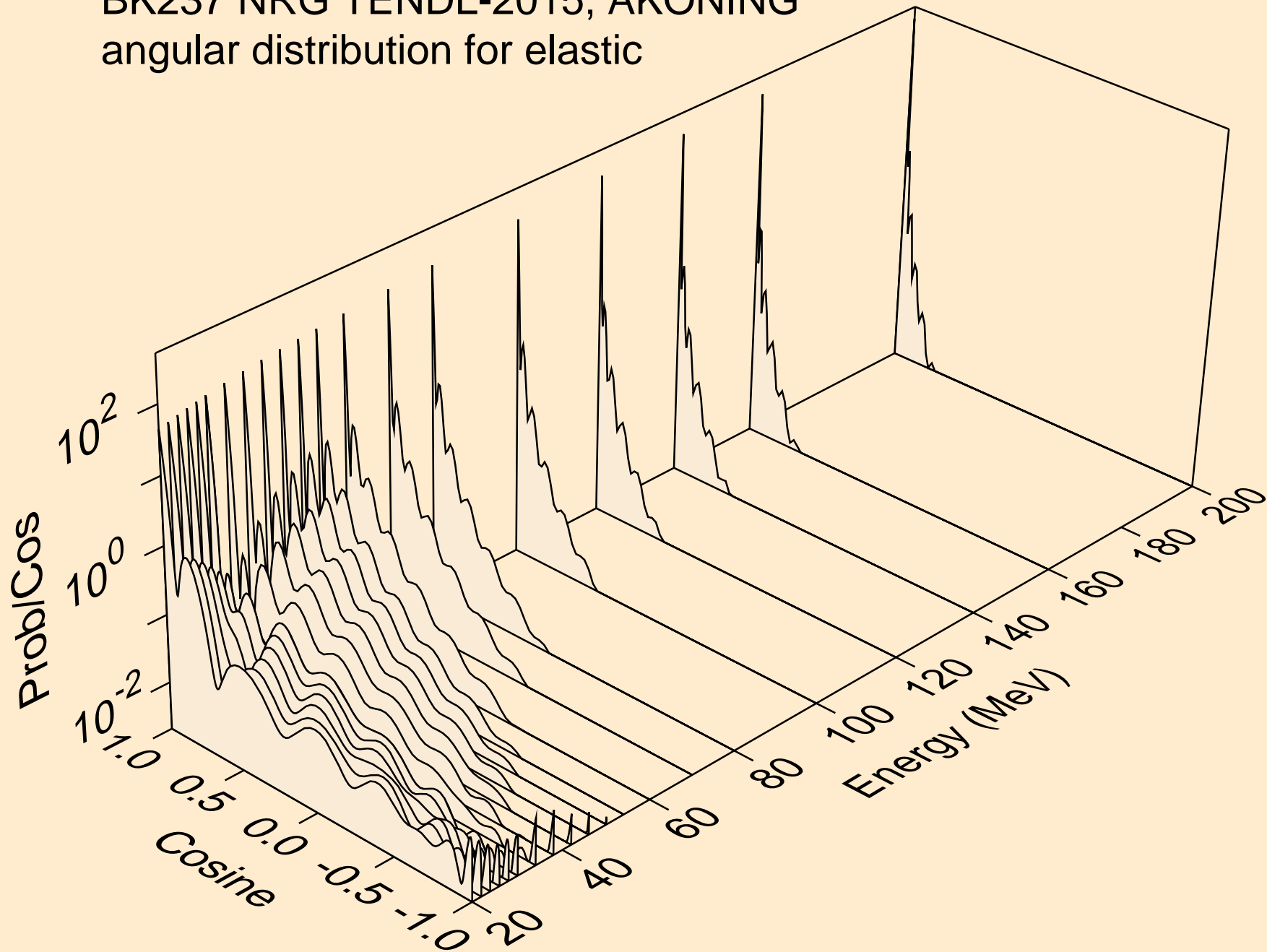

BK237 NRG TENDL-2015, AKONING
angular distribution for (n,n*1)

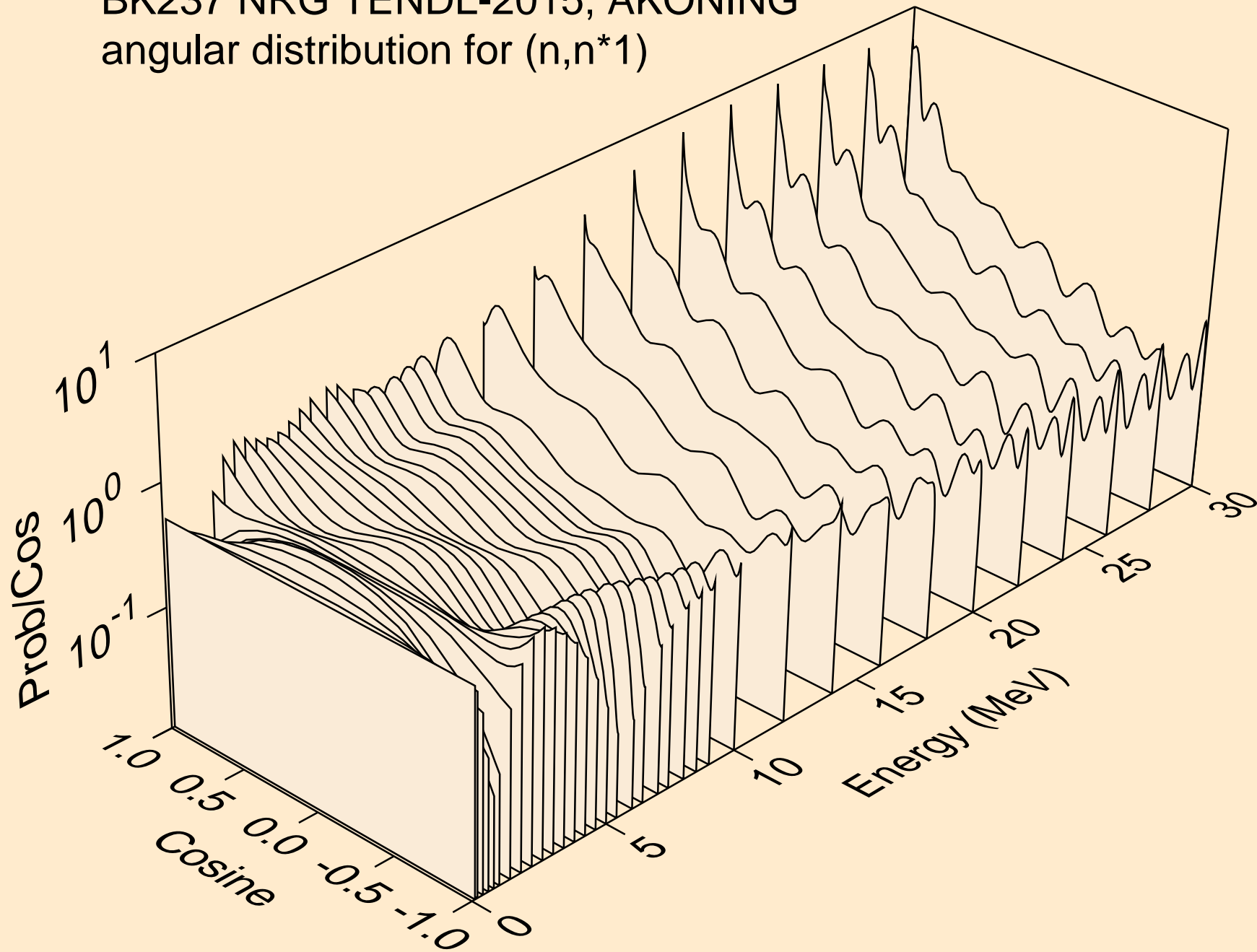

BK237 NRG TENDL-2015, AKONING

Total fission nubar

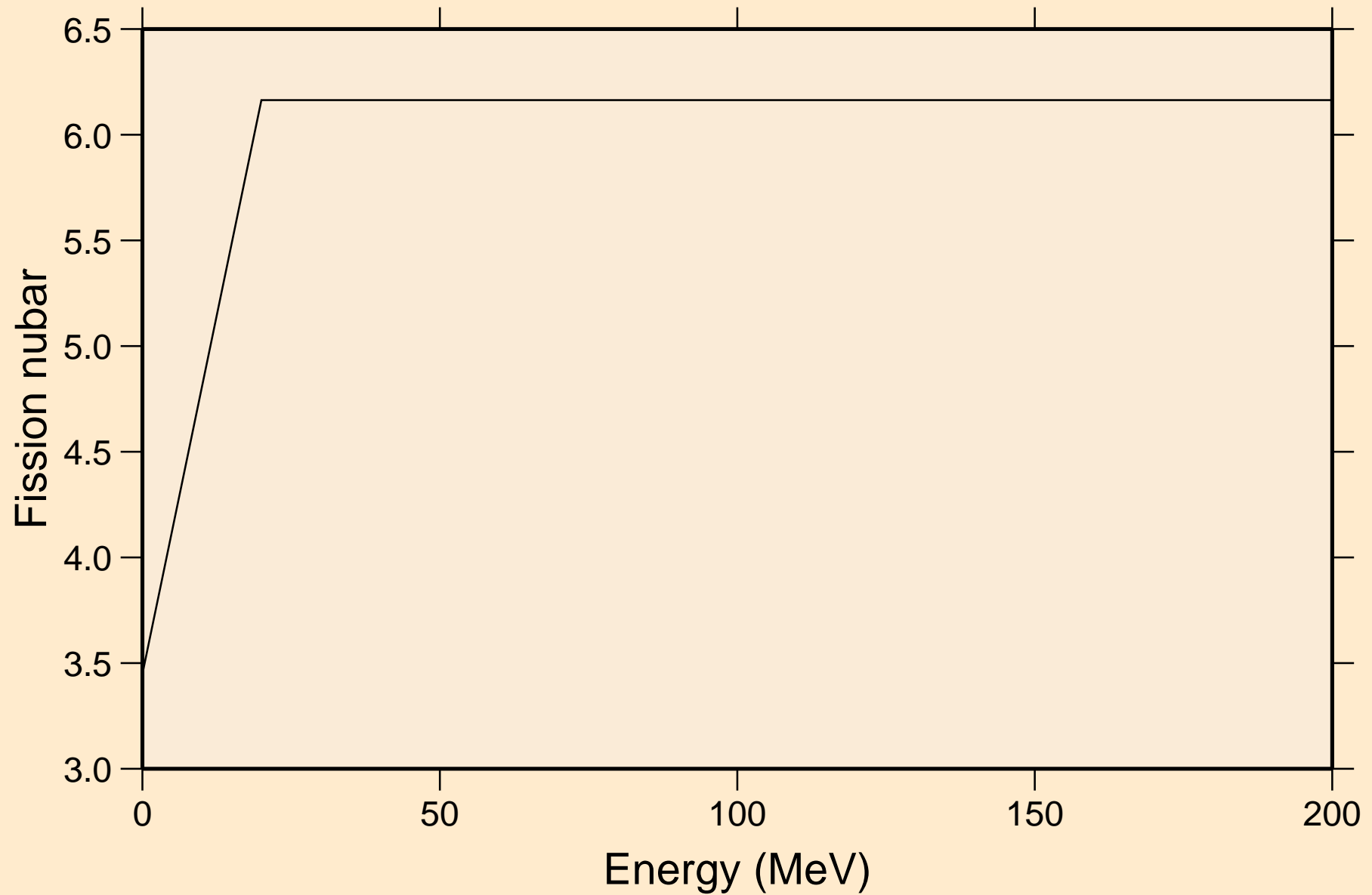

BK237 NRG TENDL-2015, AKONING
Neutron emission for (n,x)

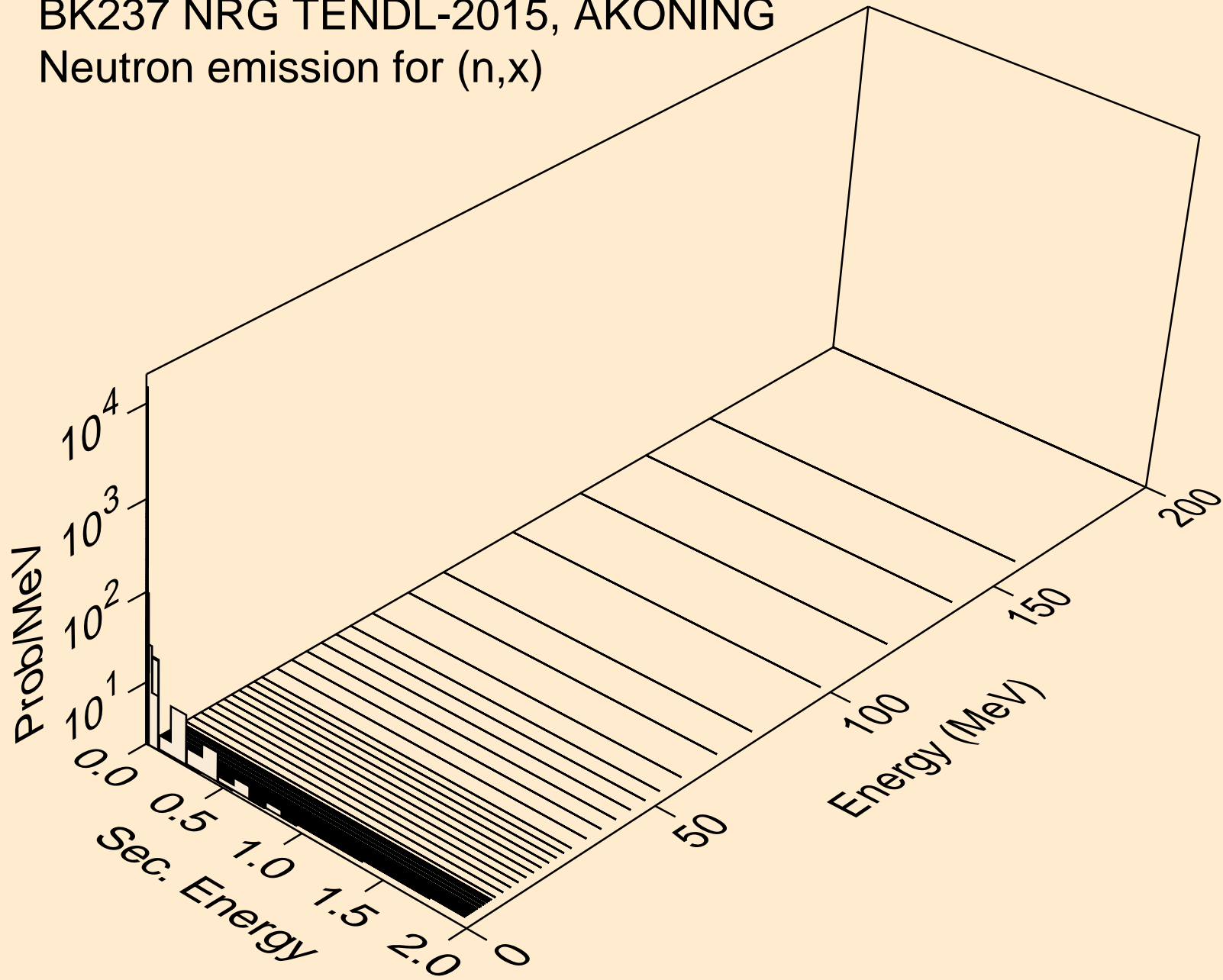

BK237 NRG TENDL-2015, AKONING
Neutron emission for (n,2nd)

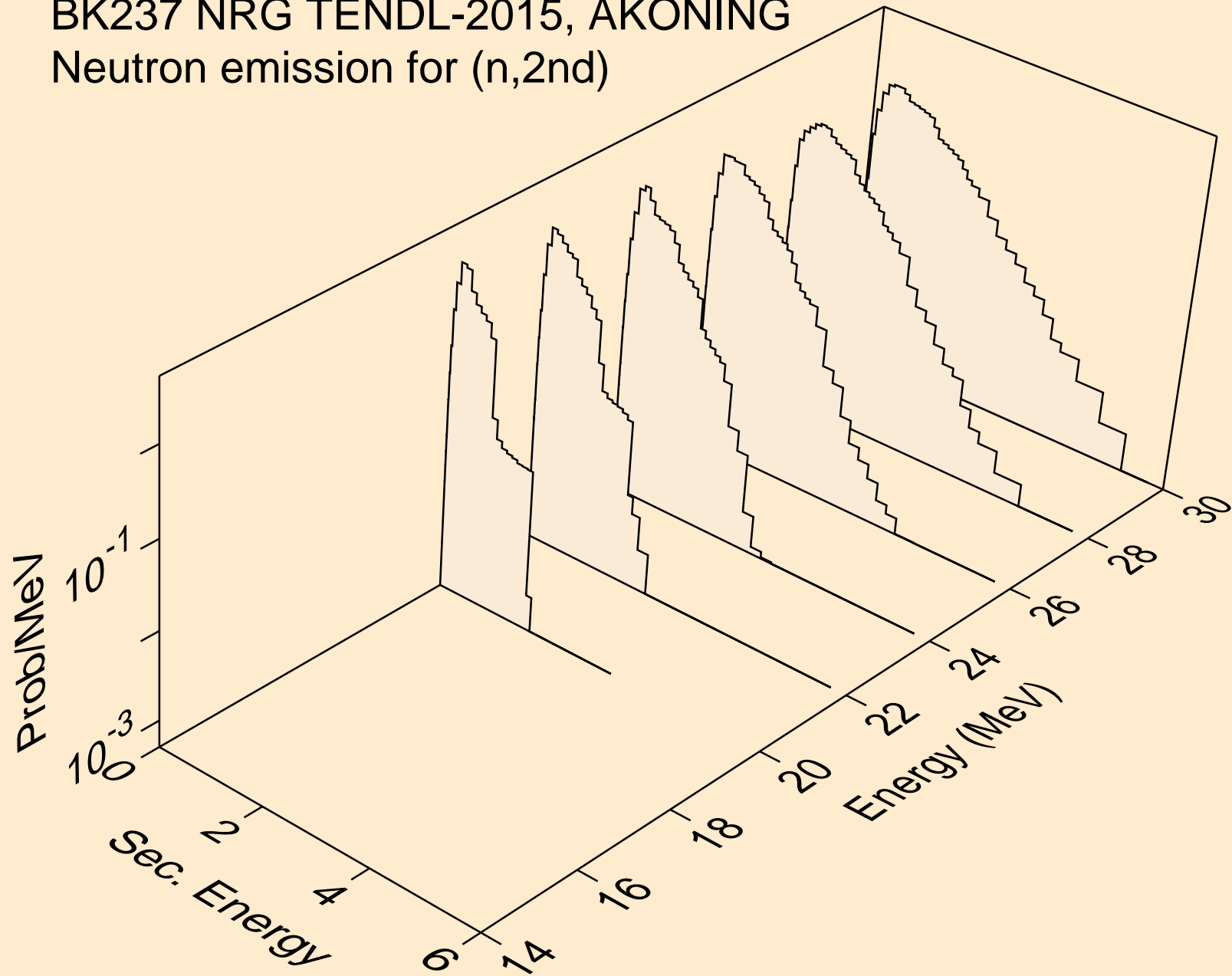

BK237 NRG TENDL-2015, AKONING
Neutron emission for (n,2n)

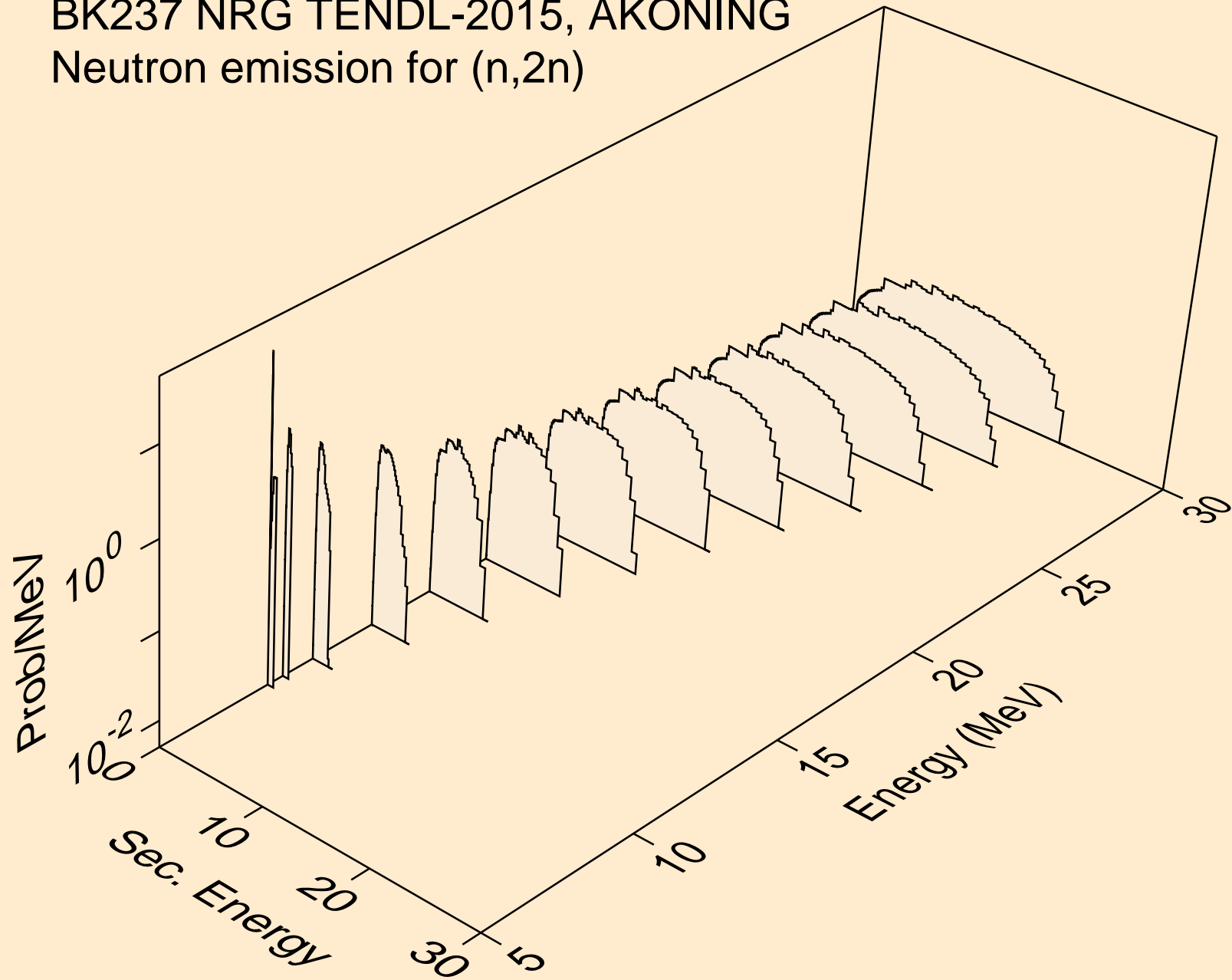

BK237 NRG TENDL-2015, AKONING
Neutron emission for (n,3n)

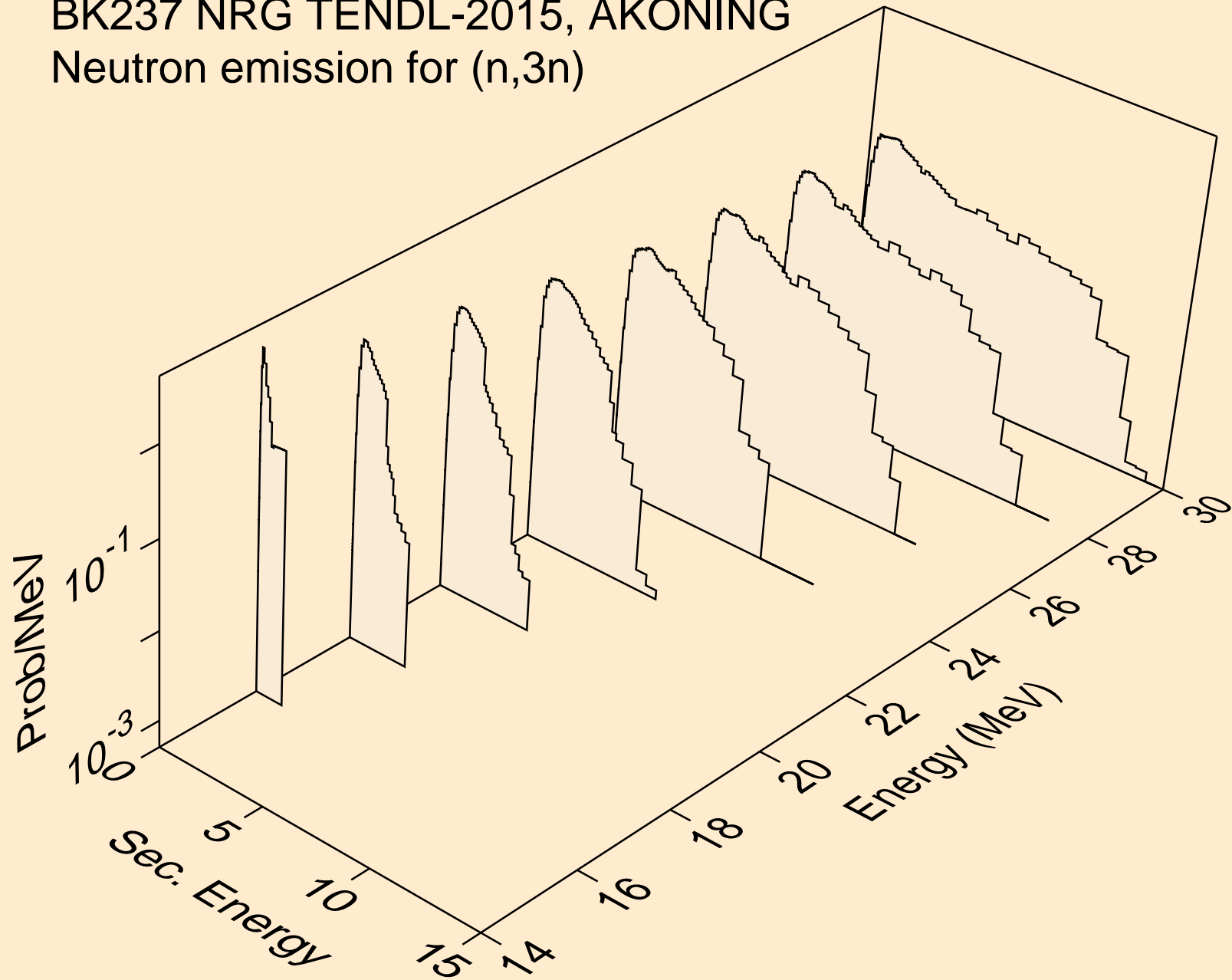

BK237 NRG TENDL-2015, AKONING
Neutron emission for fission

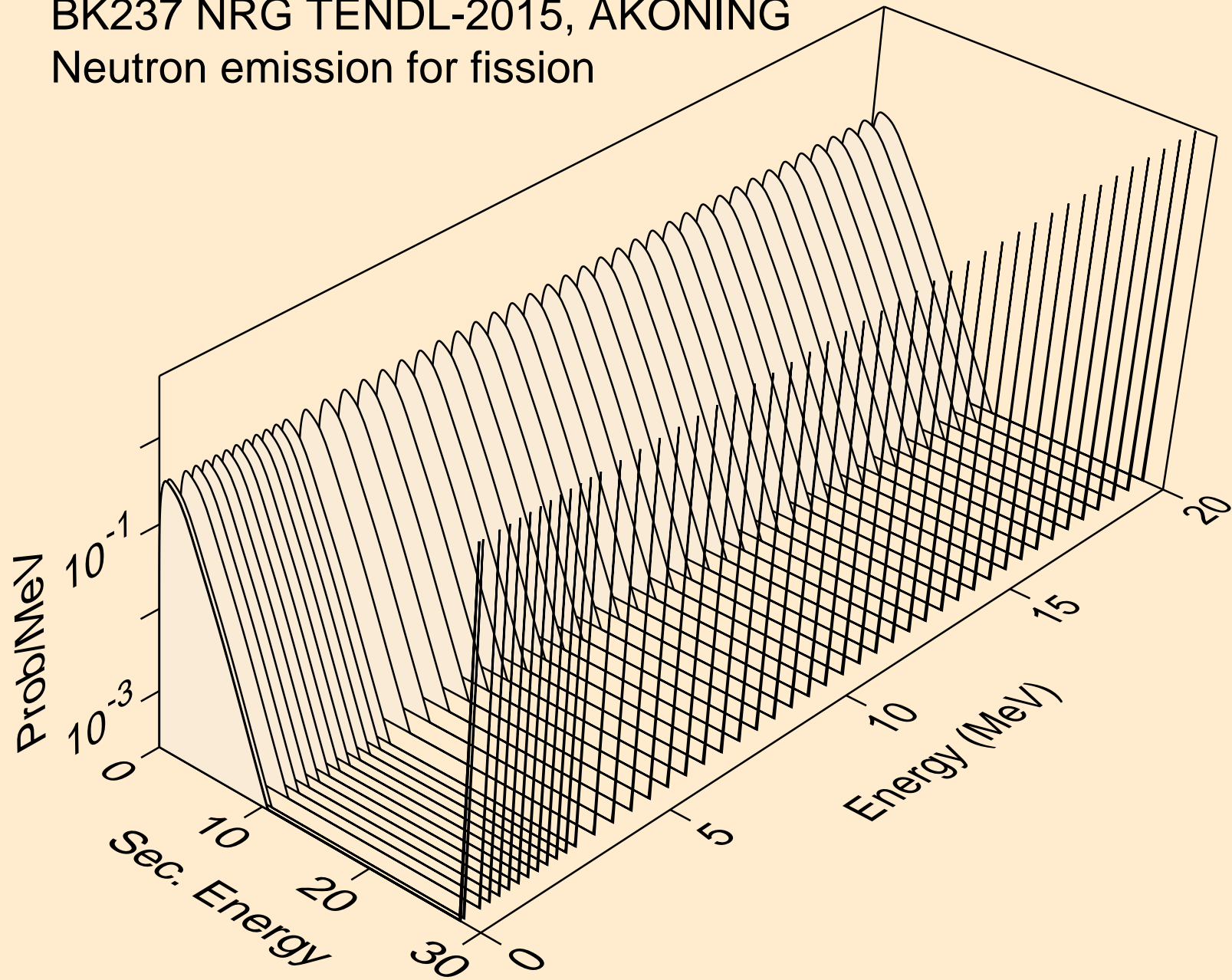

BK237 NRG TENDL-2015, AKONING
Neutron emission for (n,n*)a

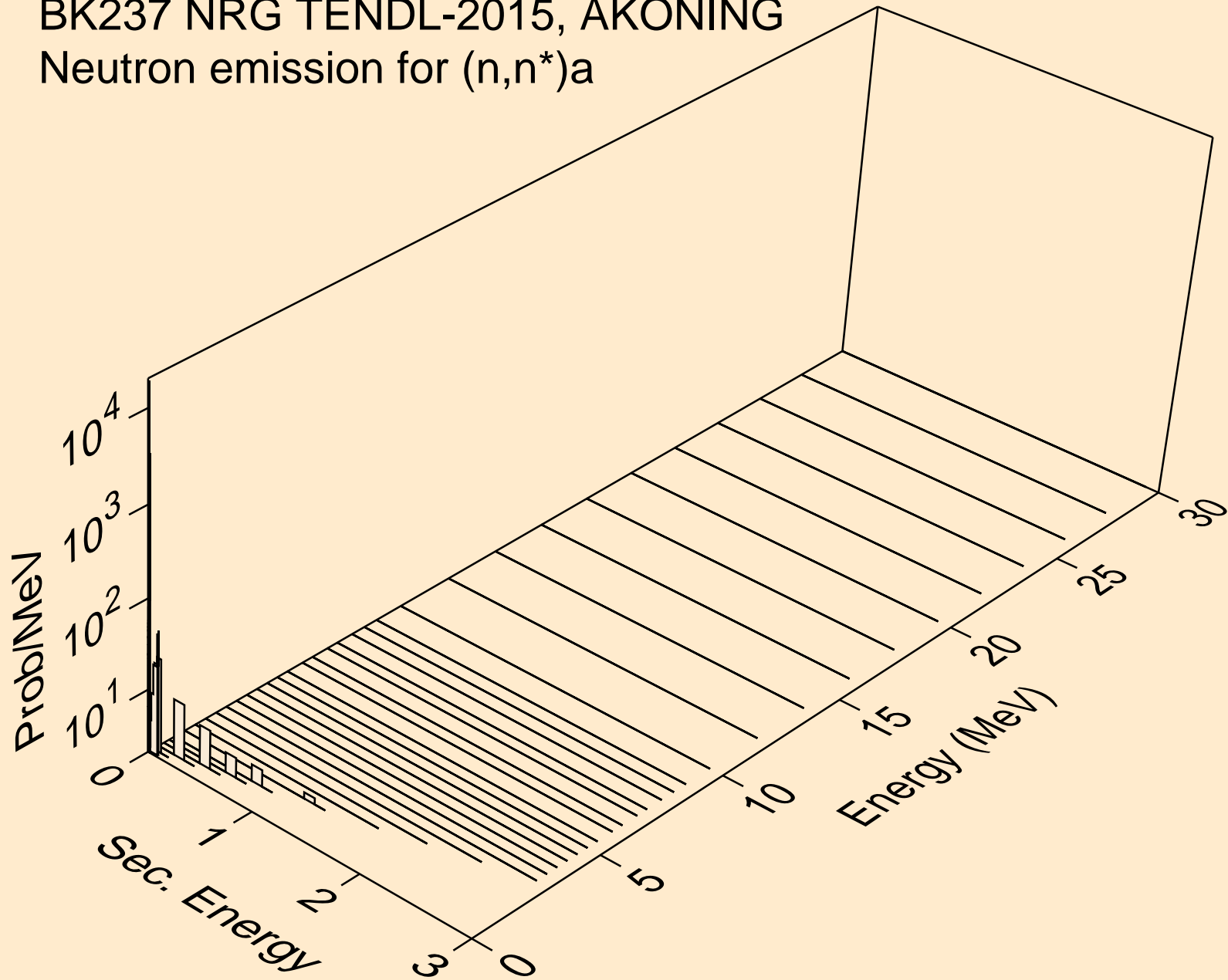

BK237 NRG TENDL-2015, AKONING
Neutron emission for (n,n*)3a

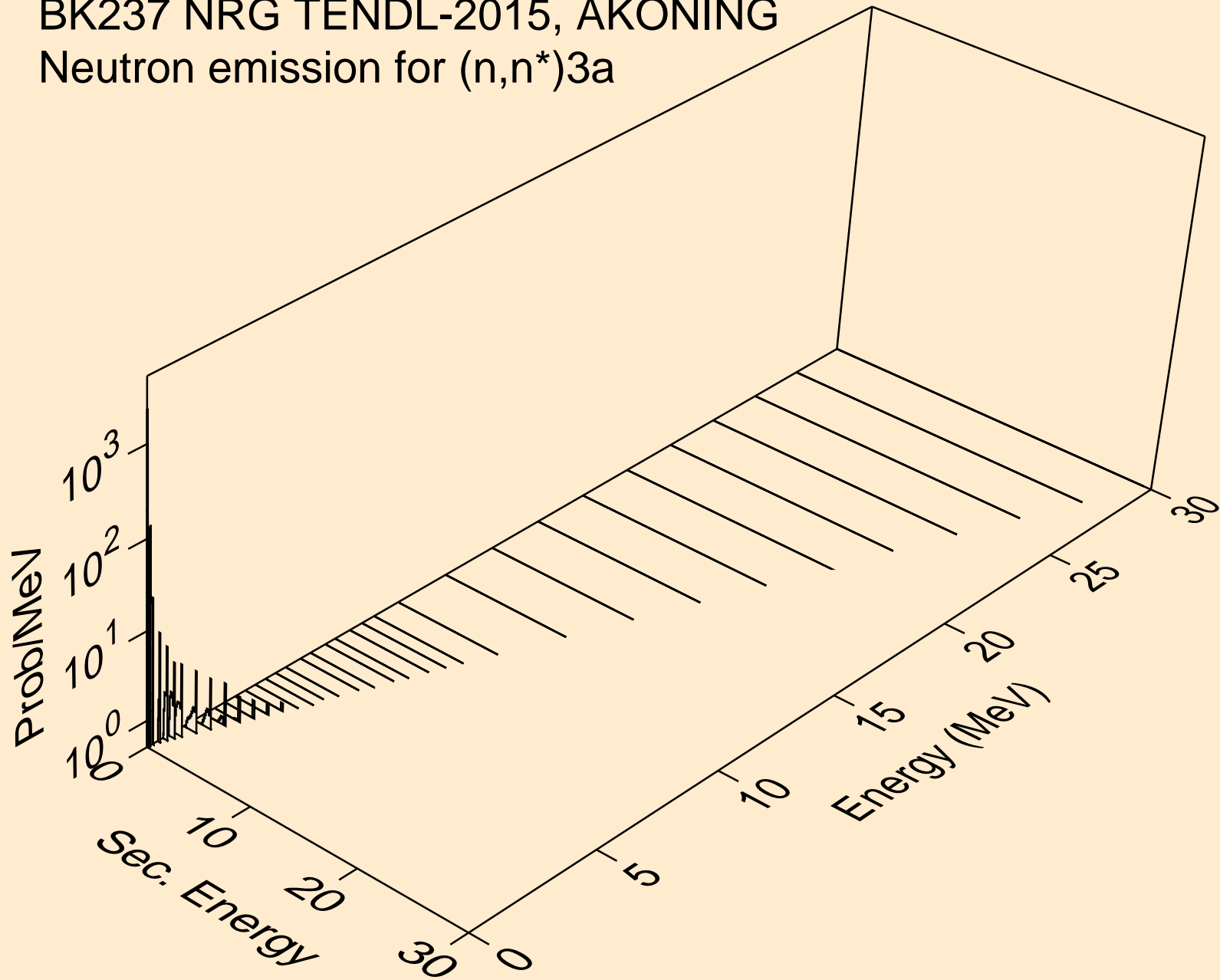

BK237 NRG TENDL-2015, AKONING
Neutron emission for (n,2n)a

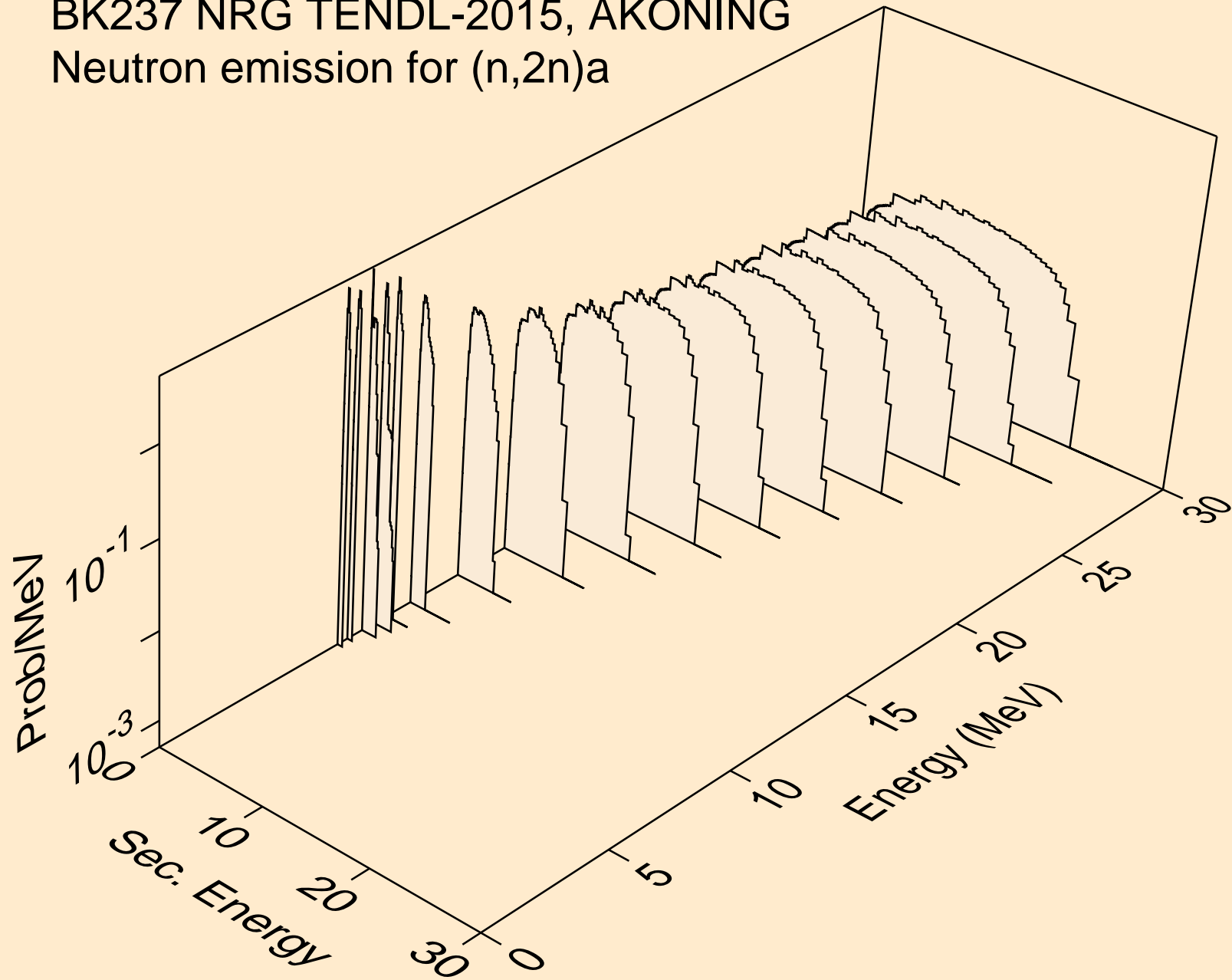

BK237 NRG TENDL-2015, AKONING
Neutron emission for (n,3n)a

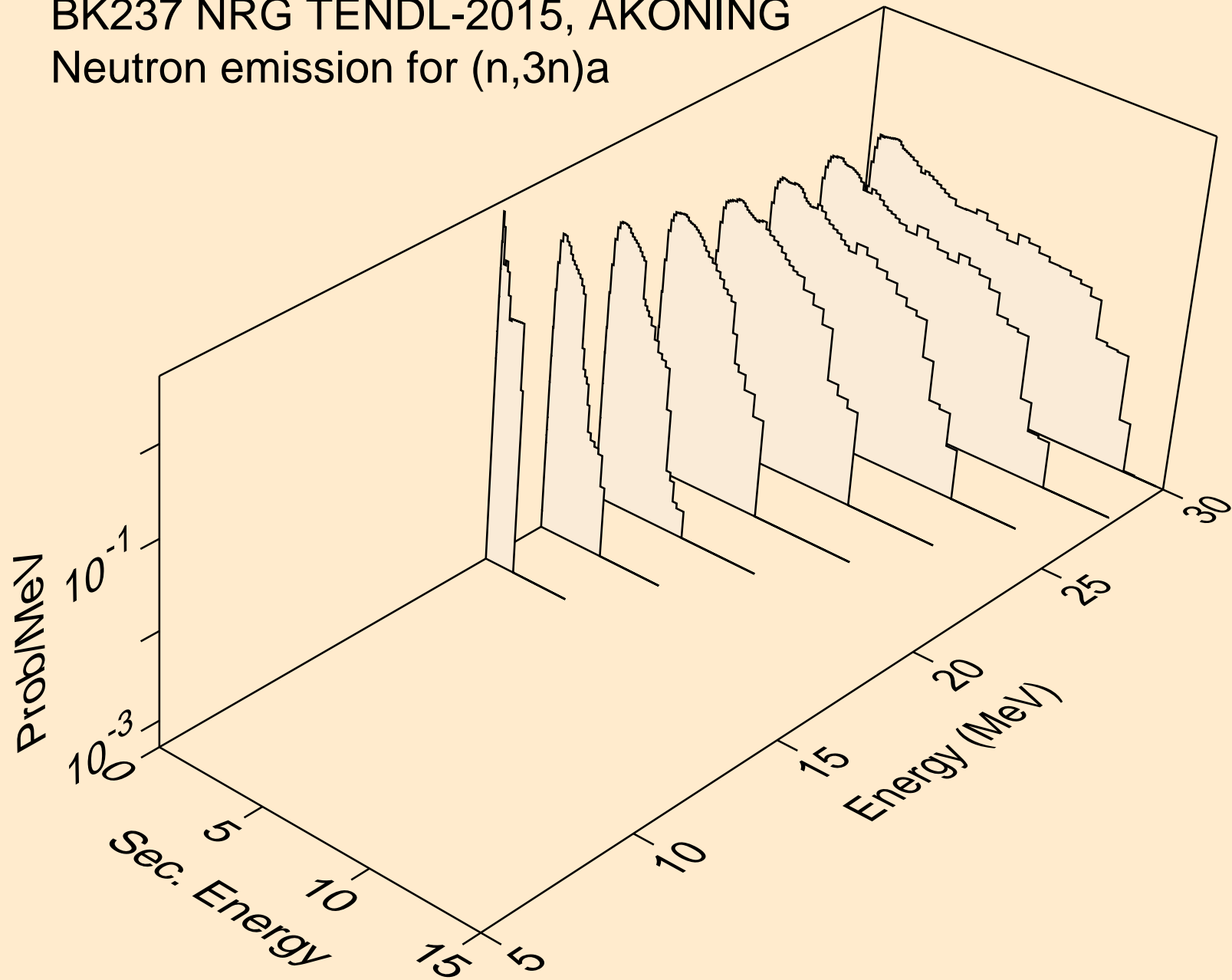

BK237 NRG TENDL-2015, AKONING
Neutron emission for (n,n*)p

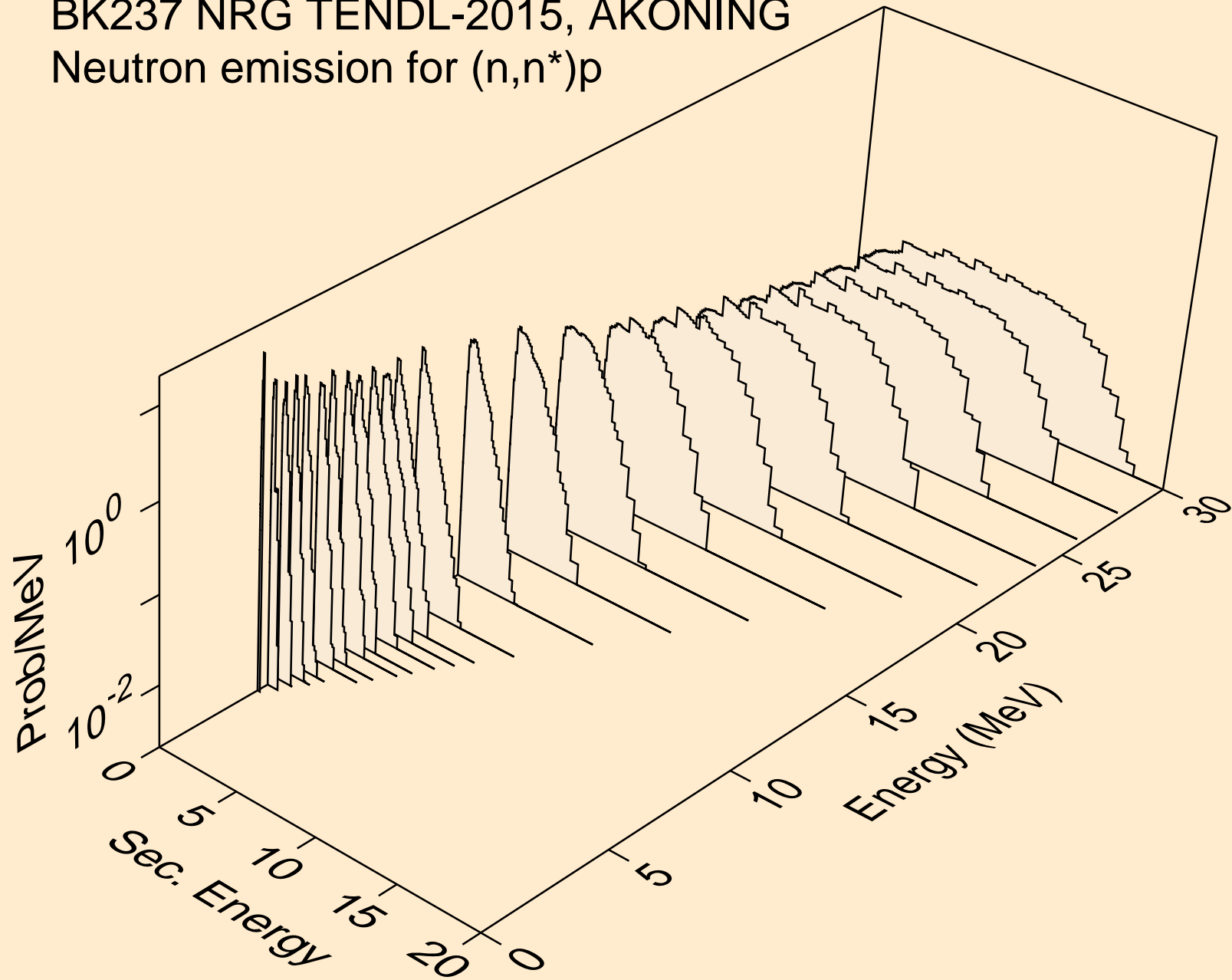

BK237 NRG TENDL-2015, AKONING
Neutron emission for (n,n*)2a

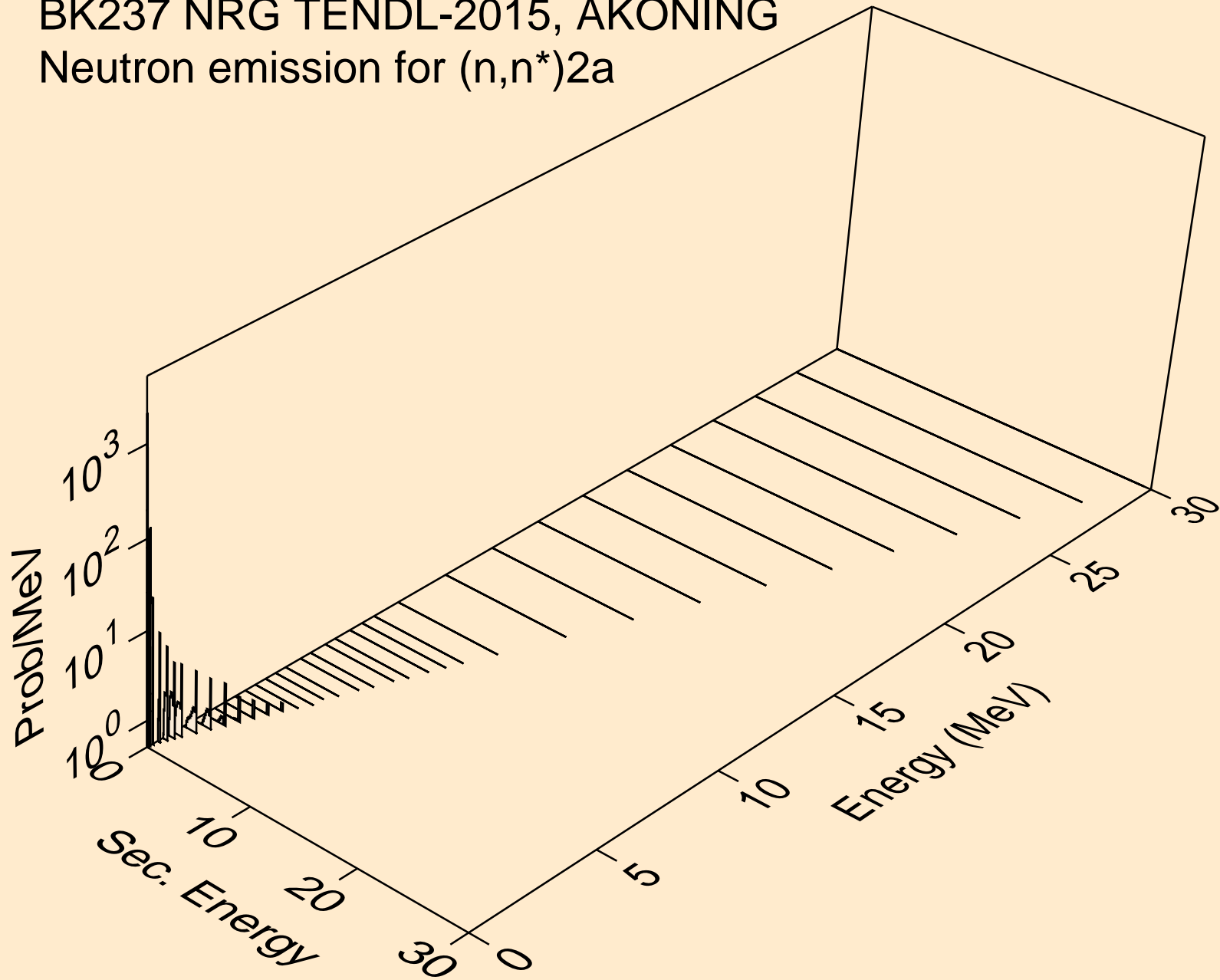

BK237 NRG TENDL-2015, AKONING
Neutron emission for (n,2n)2a

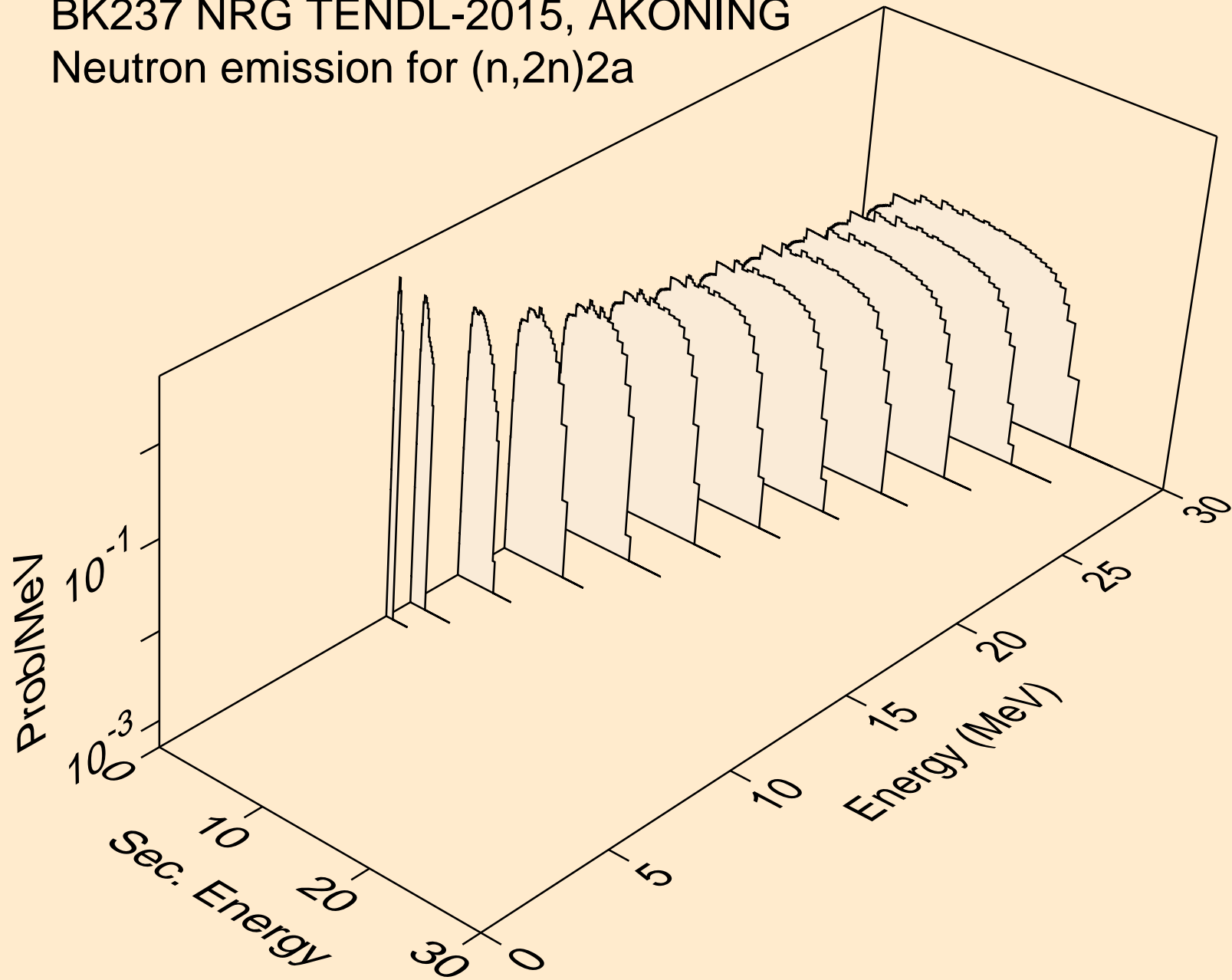

BK237 NRG TENDL-2015, AKONING
Neutron emission for (n,n*)d

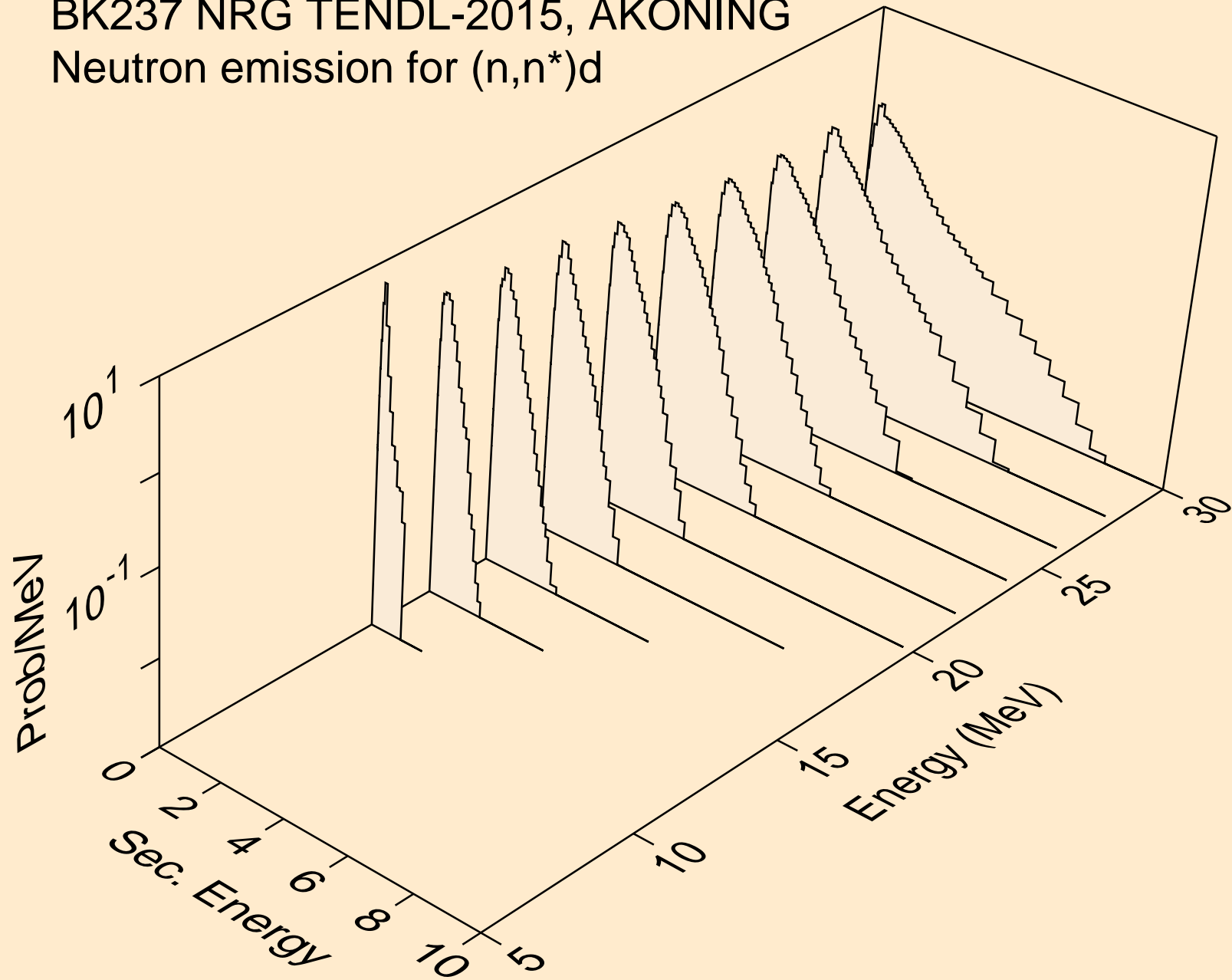

BK237 NRG TENDL-2015, AKONING
Neutron emission for (n,n*)t

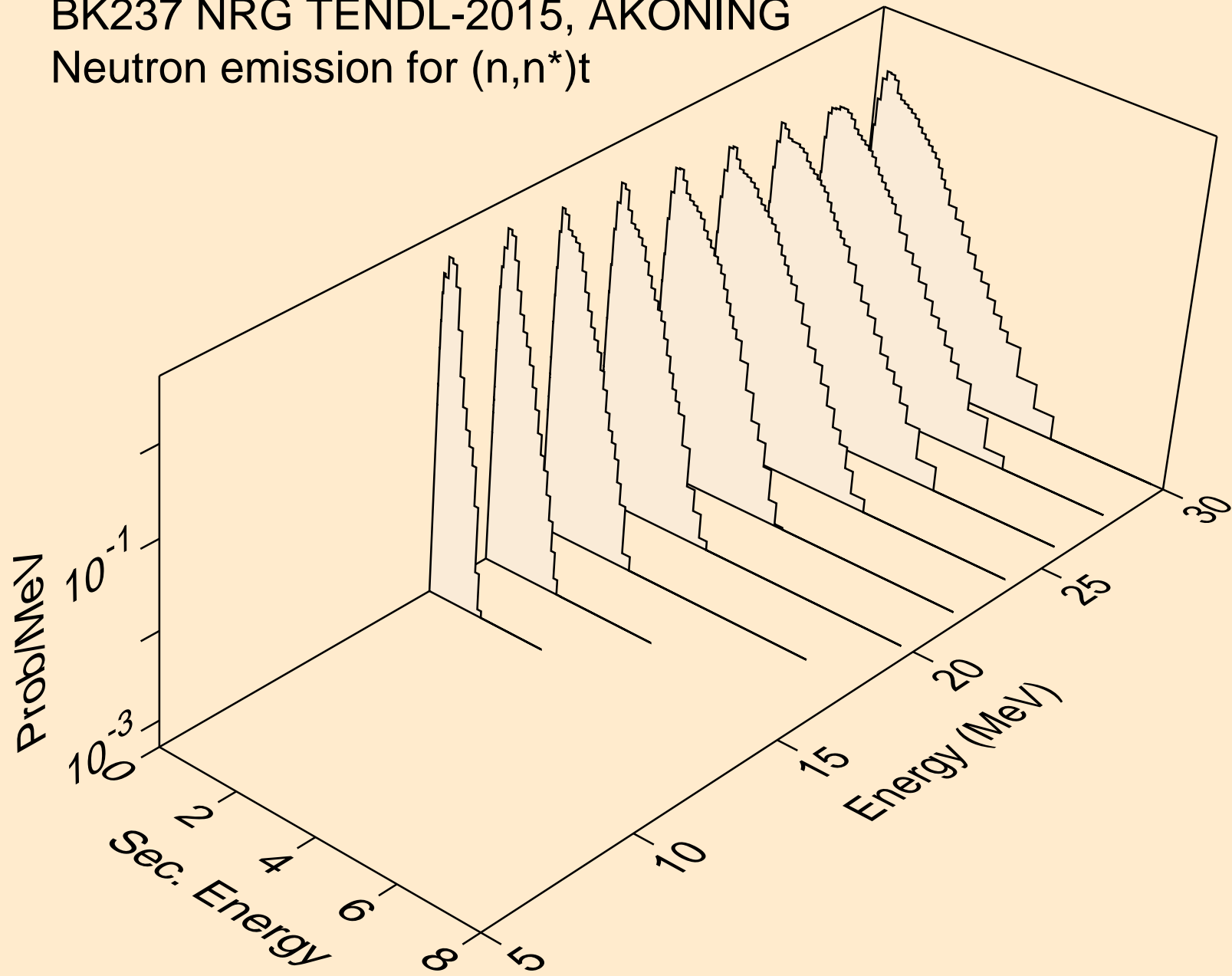

BK237 NRG TENDL-2015, AKONING
Neutron emission for (n,n*)he3

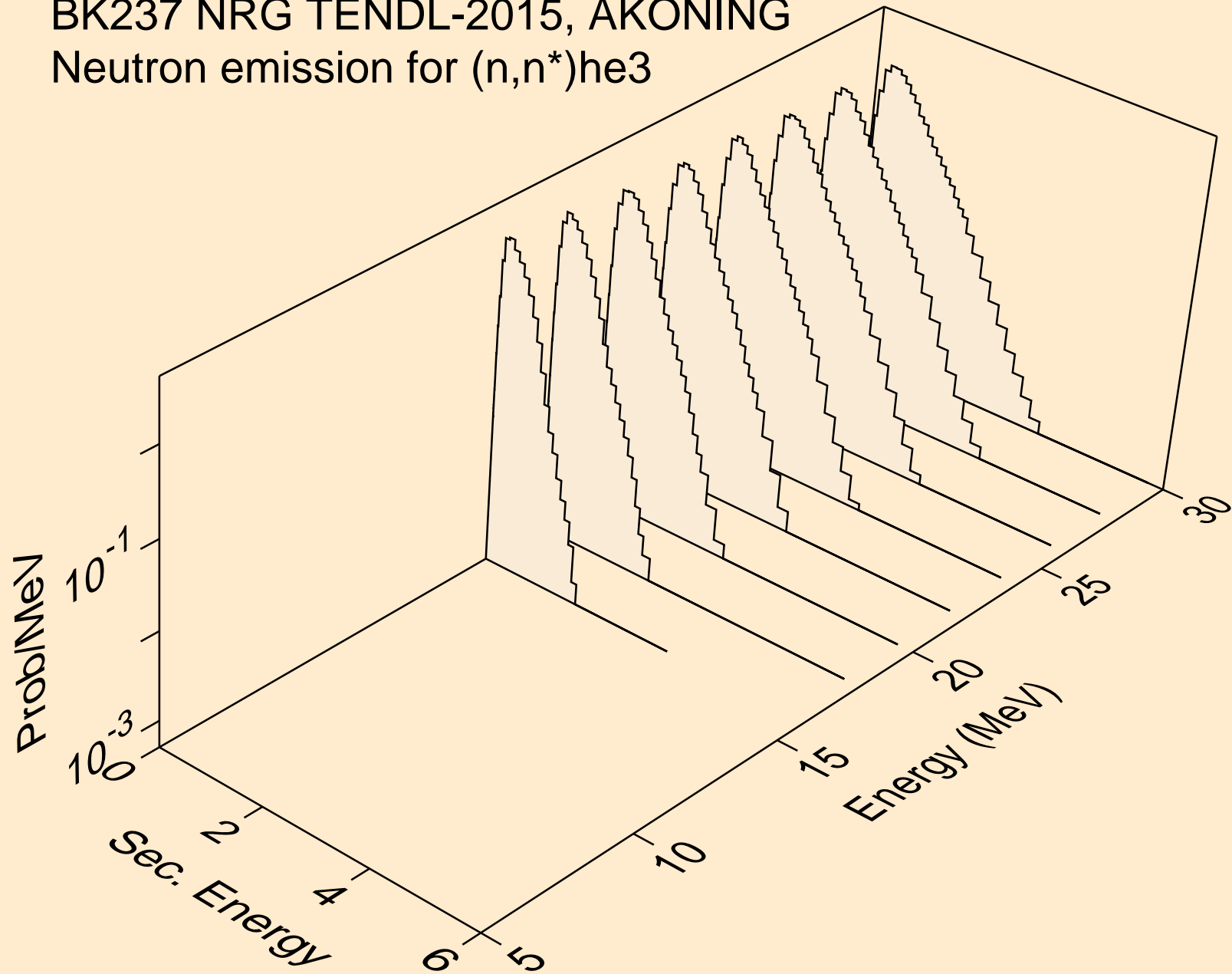

BK237 NRG TENDL-2015, AKONING
Neutron emission for (n,n*)t2a

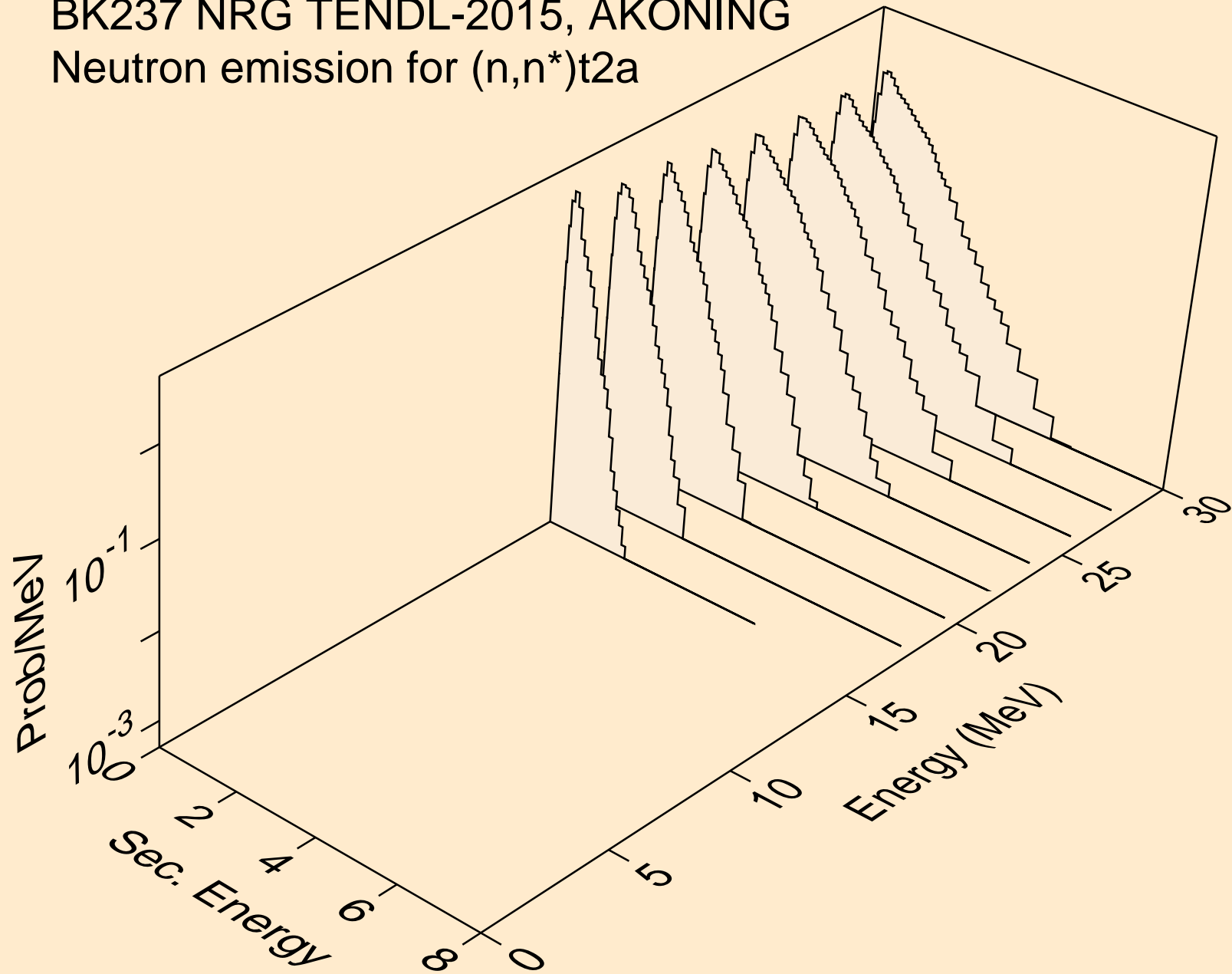

BK237 NRG TENDL-2015, AKONING
Neutron emission for (n,4n)

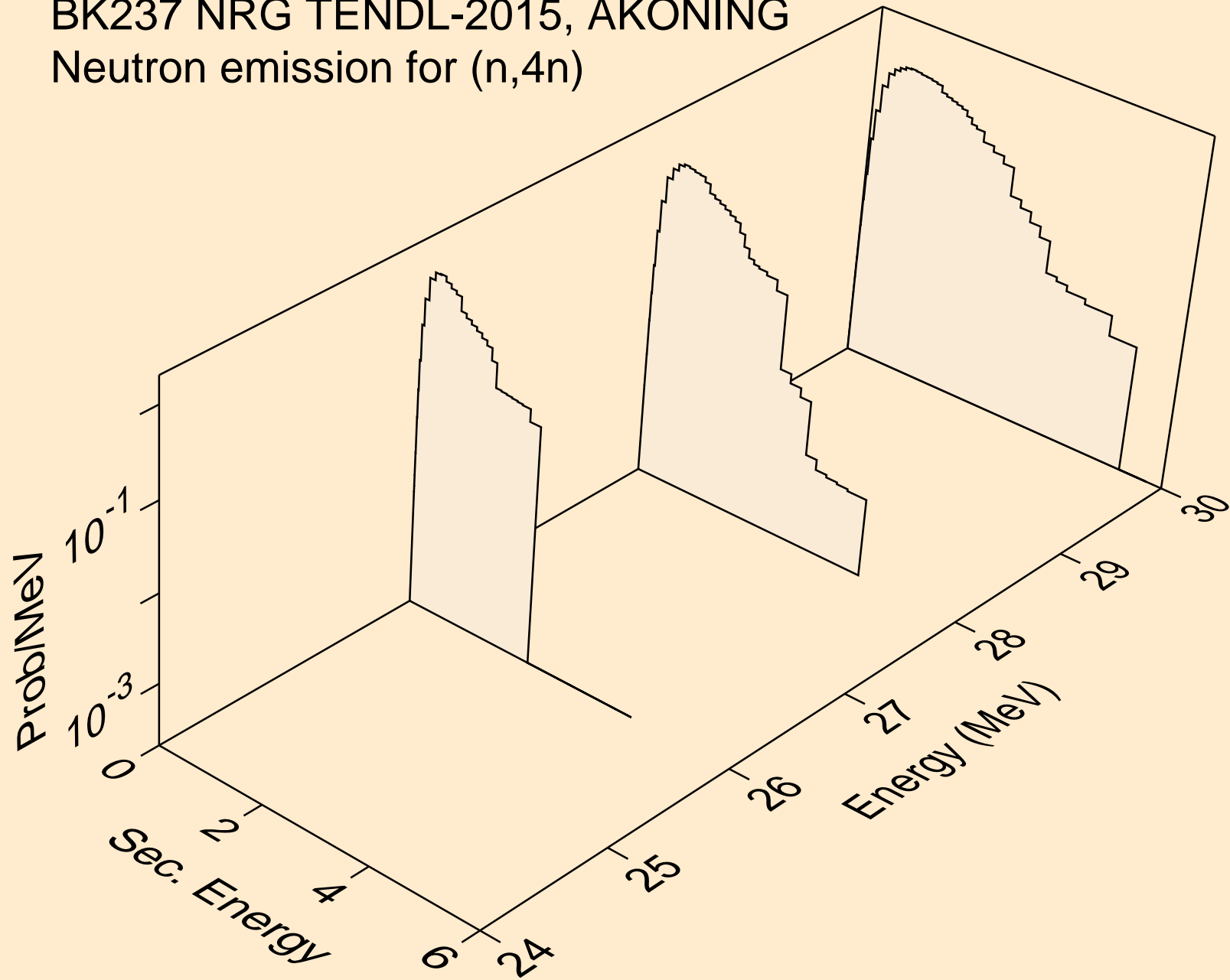

BK237 NRG TENDL-2015, AKONING
Neutron emission for (n,2np)

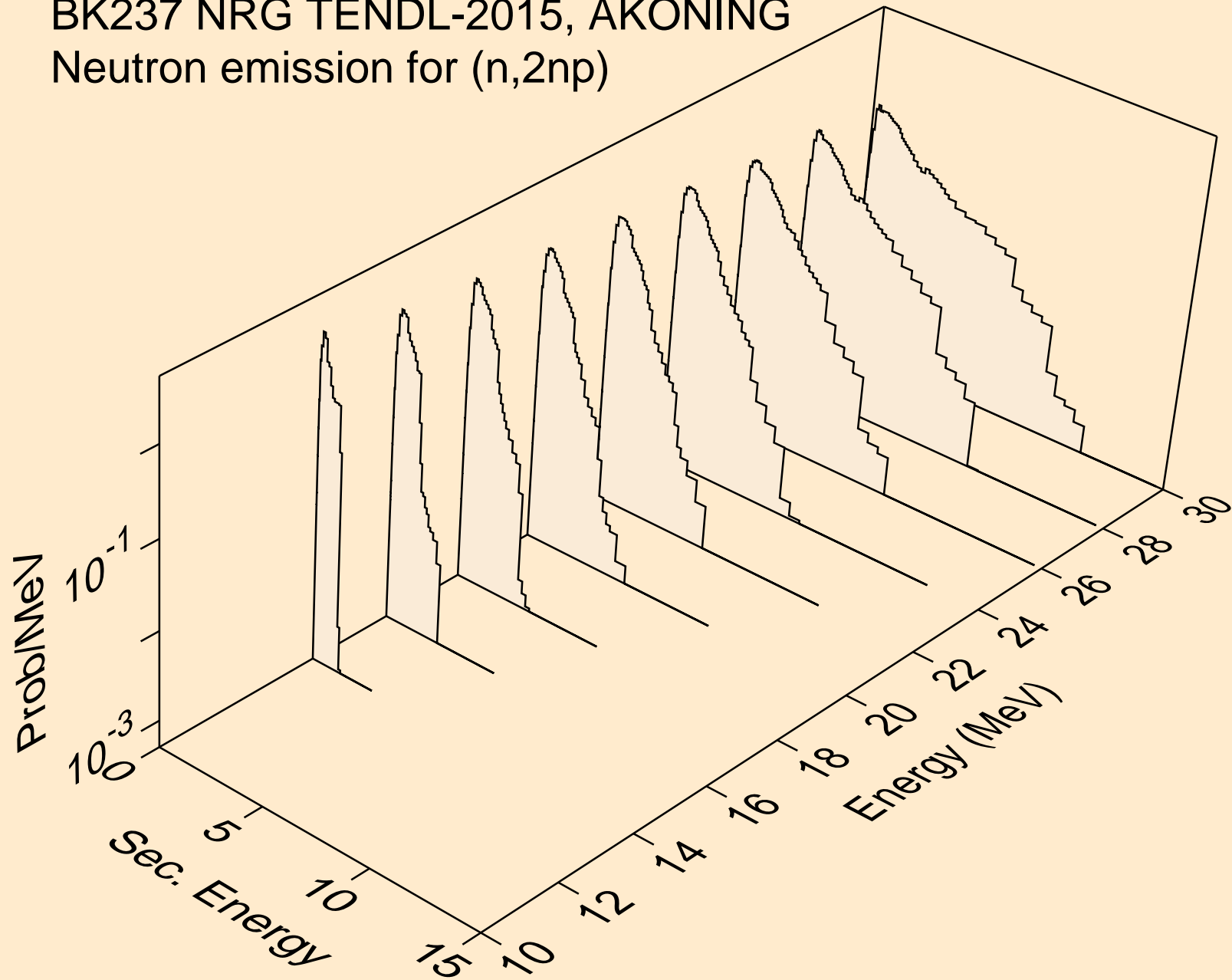

BK237 NRG TENDL-2015, AKONING
Neutron emission for (n,3np)

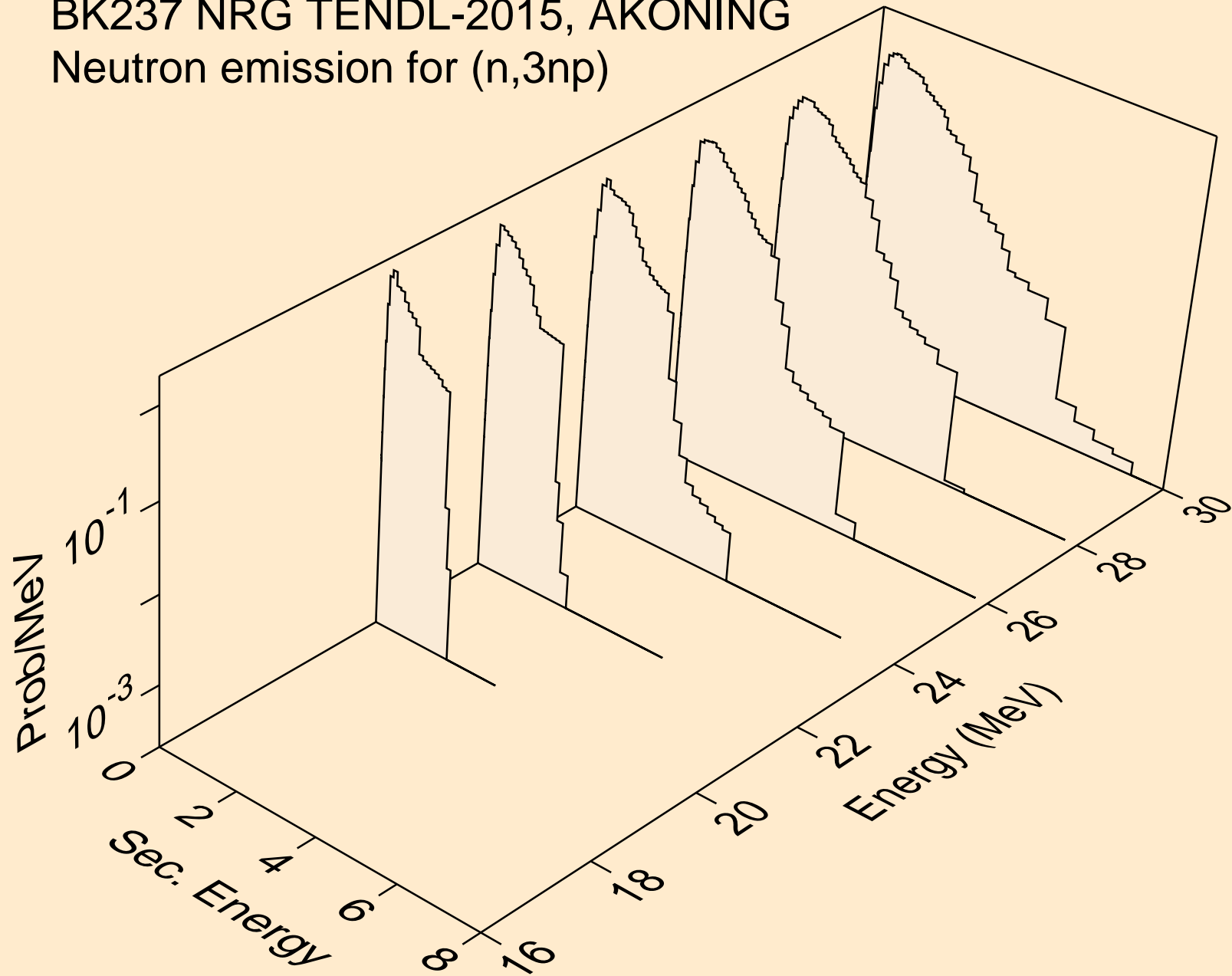

BK237 NRG TENDL-2015, AKONING
Neutron emission for (n,2np)

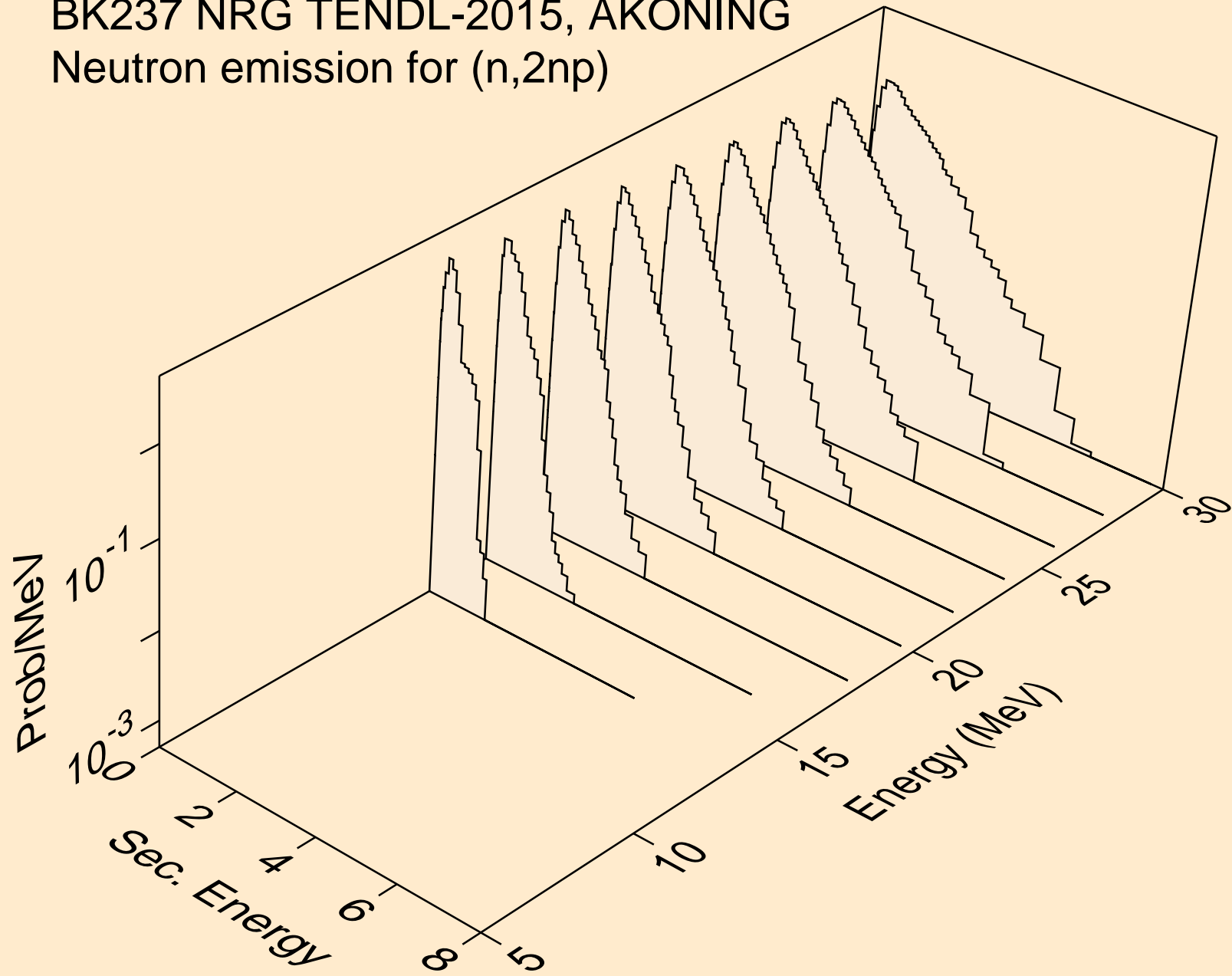

BK237 NRG TENDL-2015, AKONING
Neutron emission for (n,npa)

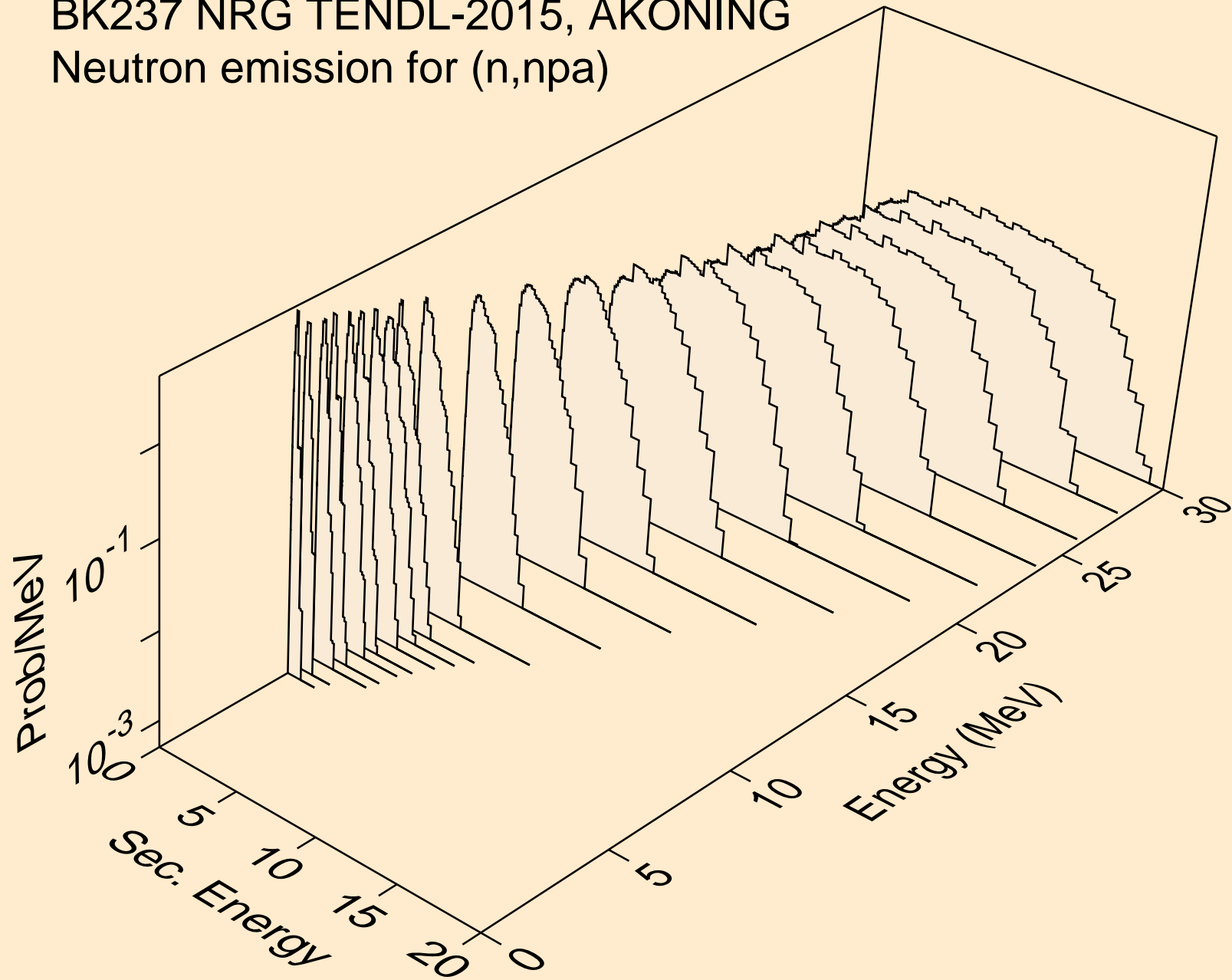

BK237 NRG TENDL-2015, AKONING
Neutron emission for (n,n*c)

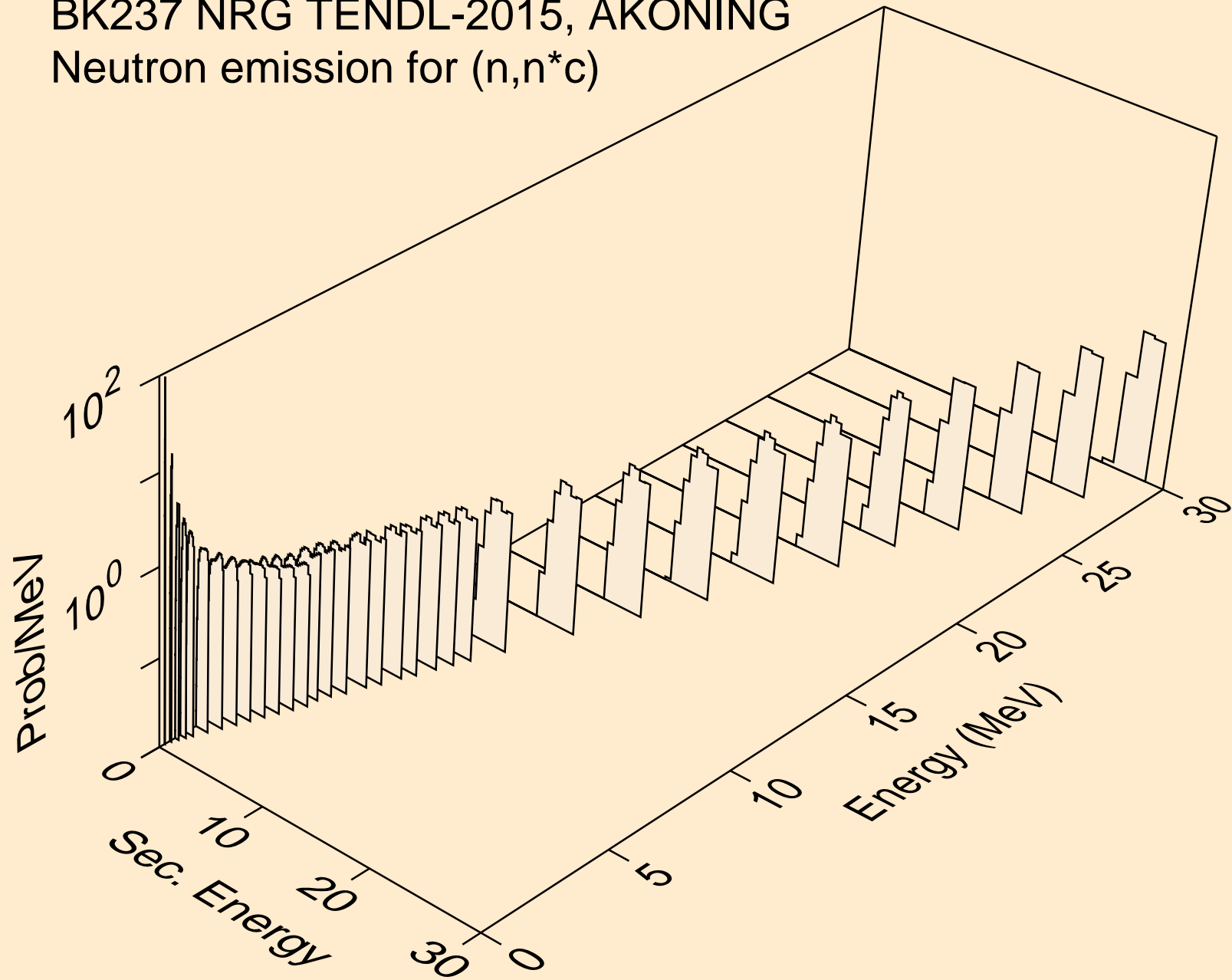

BK237 NRG TENDL-2015, AKONING

Delayed nubar

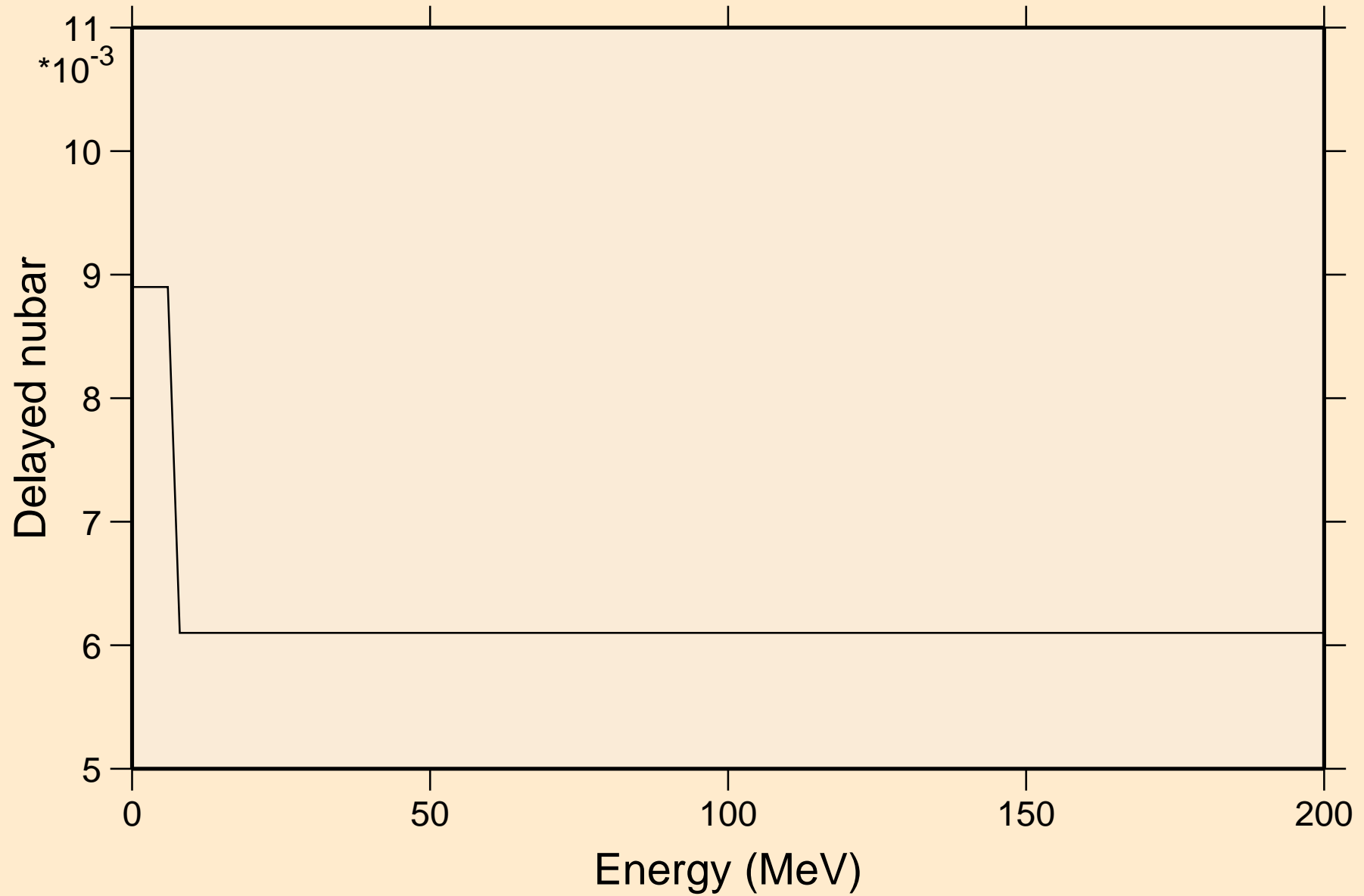

BK237 NRG TENDL-2015, AKONING

Delayed neutron spectra

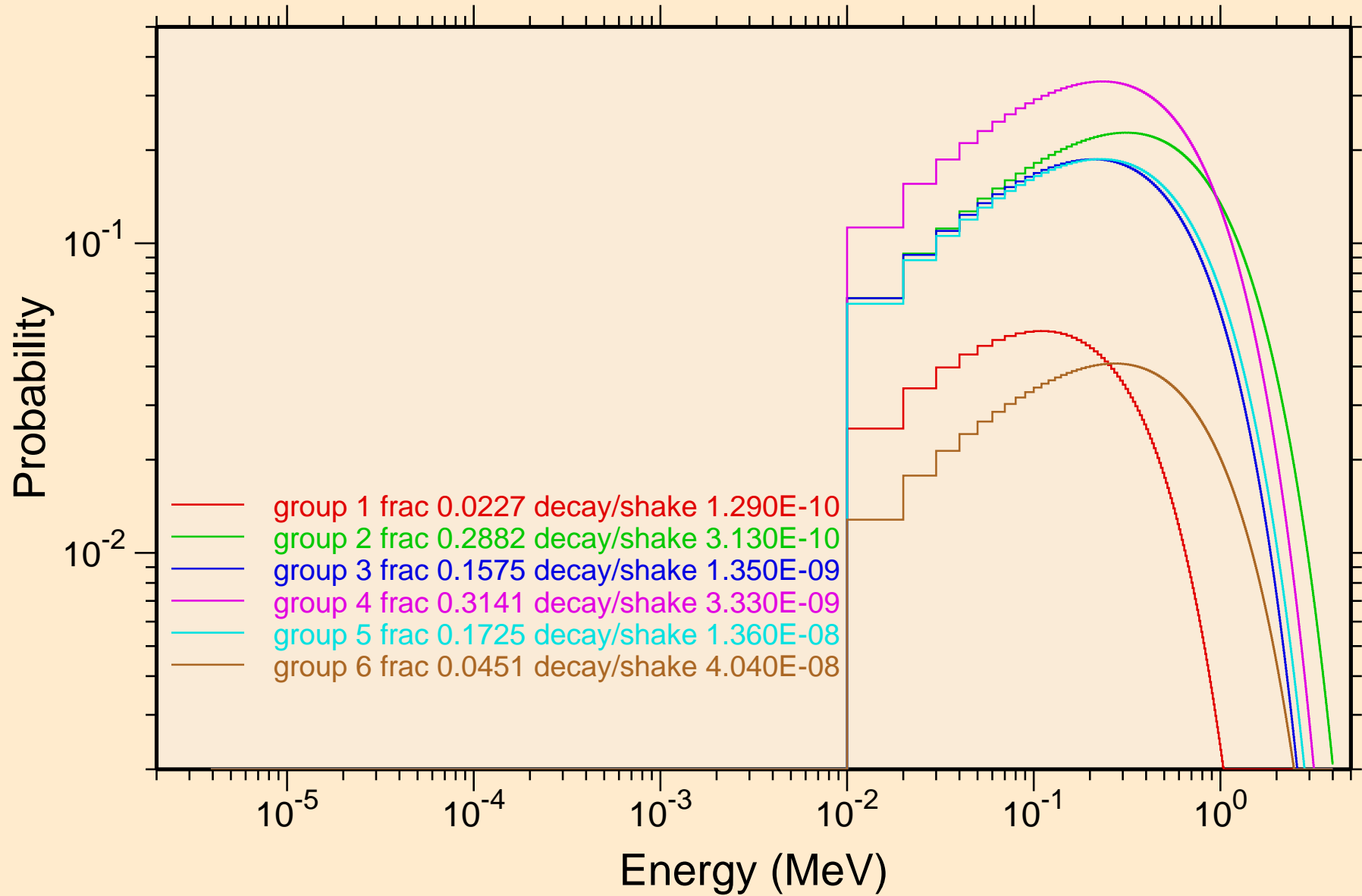

BK237 NRG TENDL-2015, AKONING
Photon emission for (n,x)

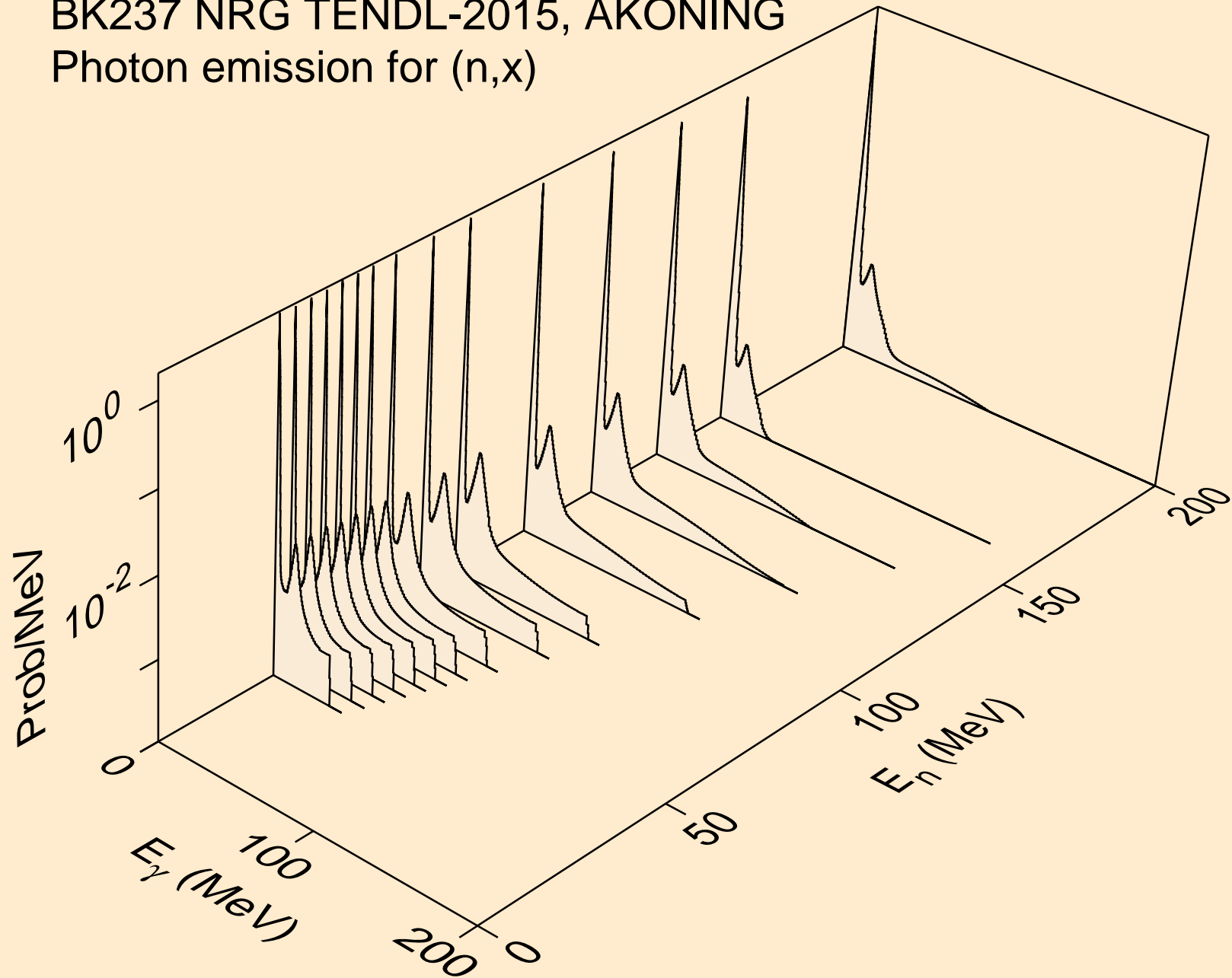

BK237 NRG TENDL-2015, AKONING
Photon emission for (n,2nd)

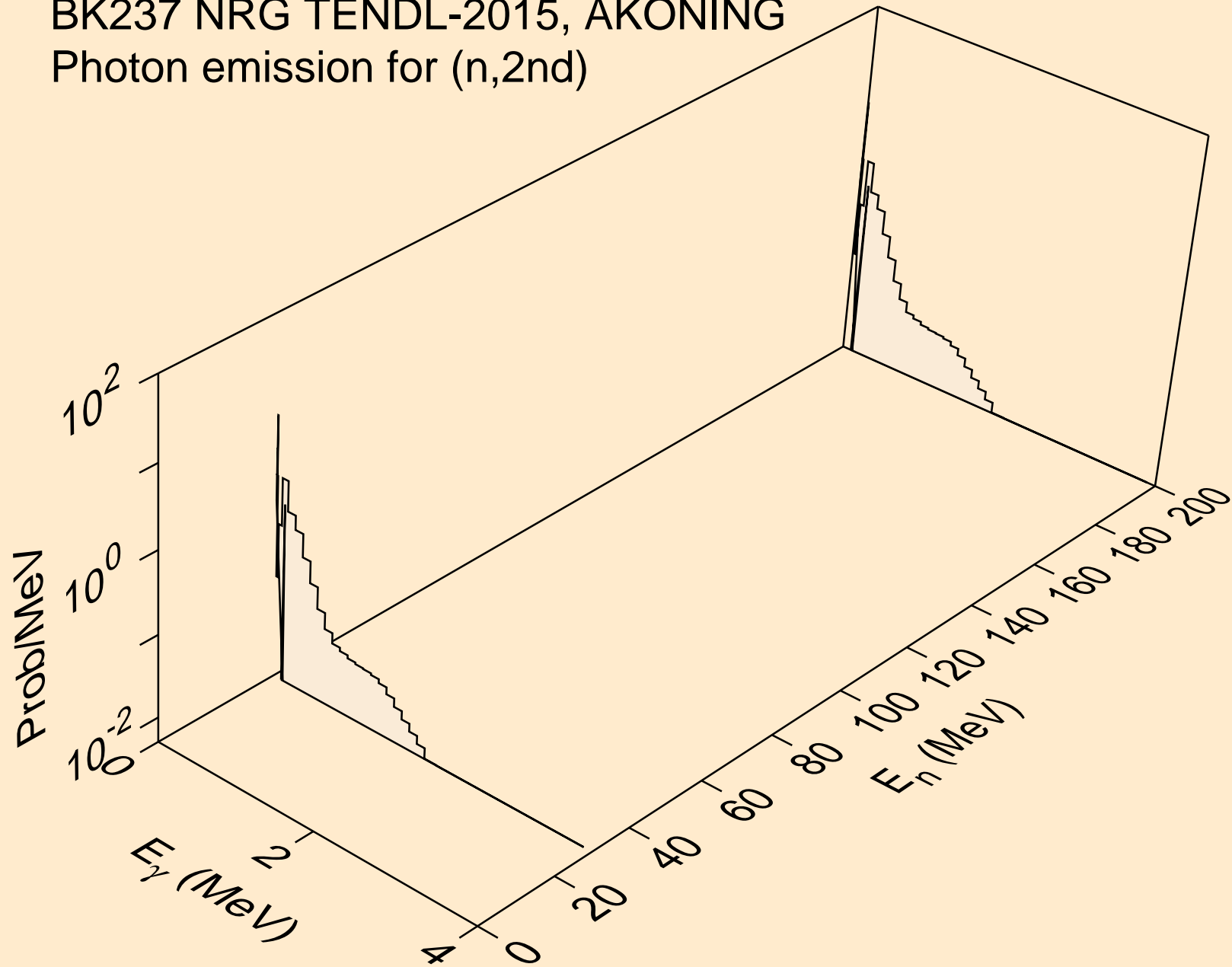

BK237 NRG TENDL-2015, AKONING
Photon emission for (n,2n)

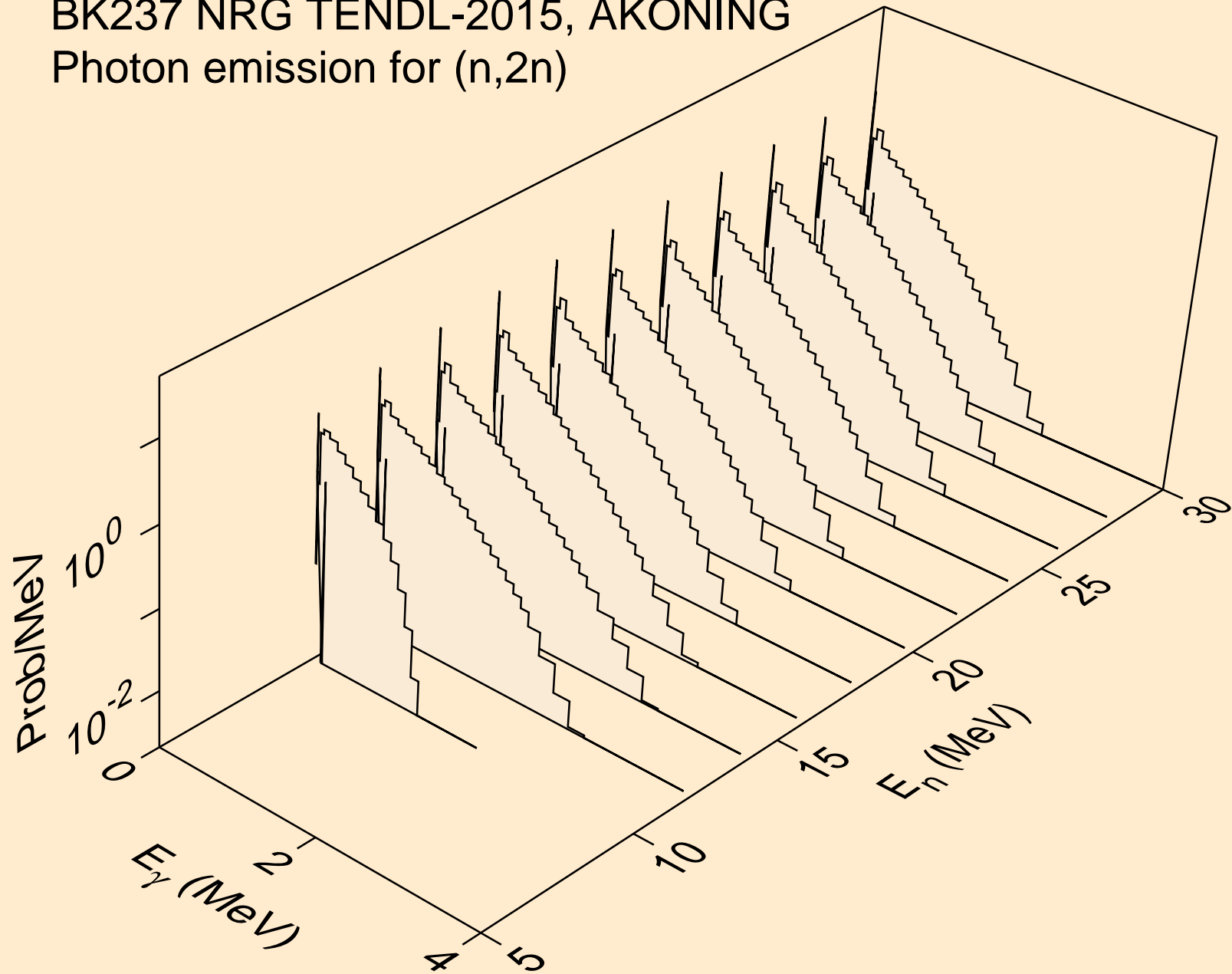

BK237 NRG TENDL-2015, AKONING
Photon emission for (n,3n)

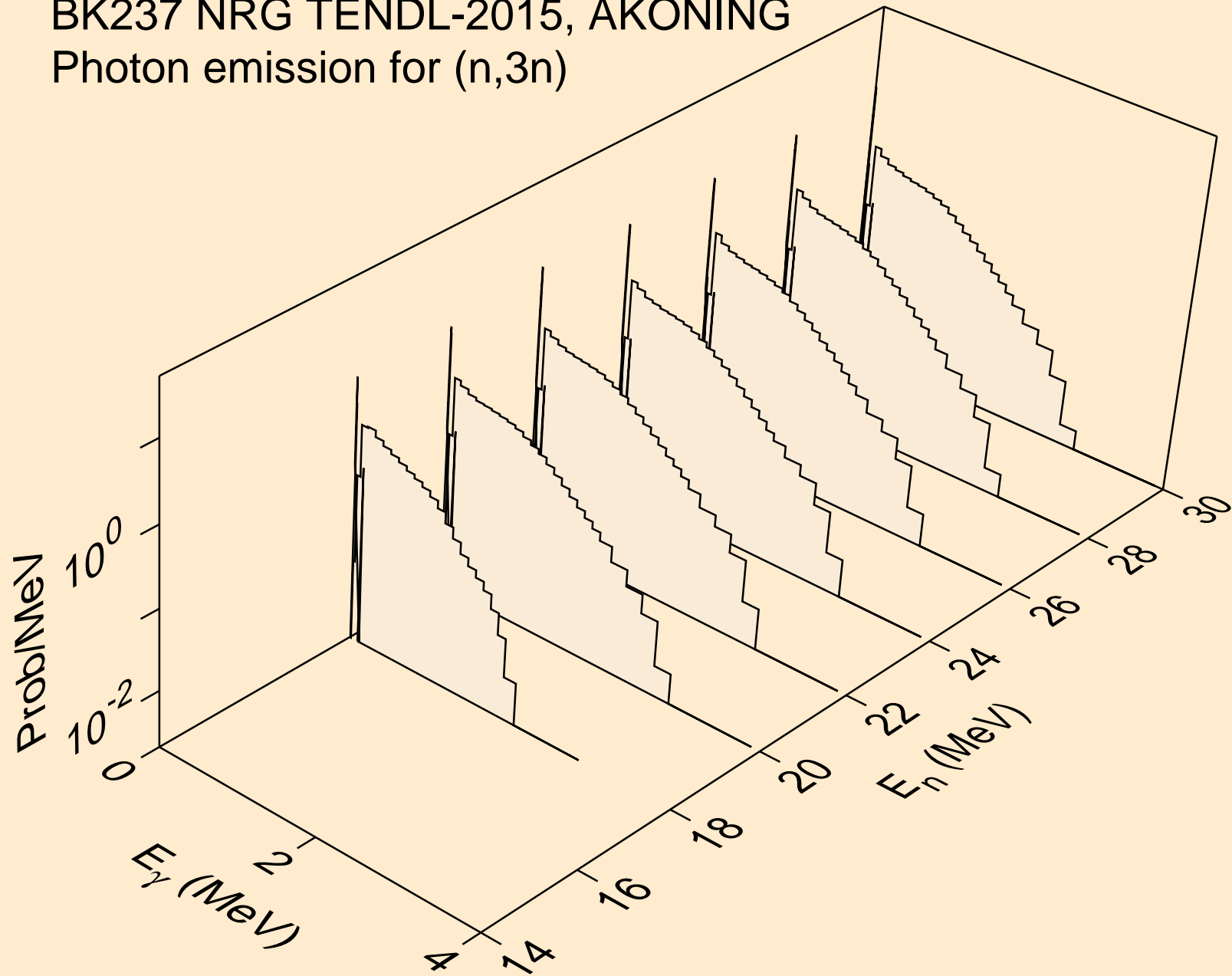

BK237 NRG TENDL-2015, AKONING
Photon emission for (n,n*)a

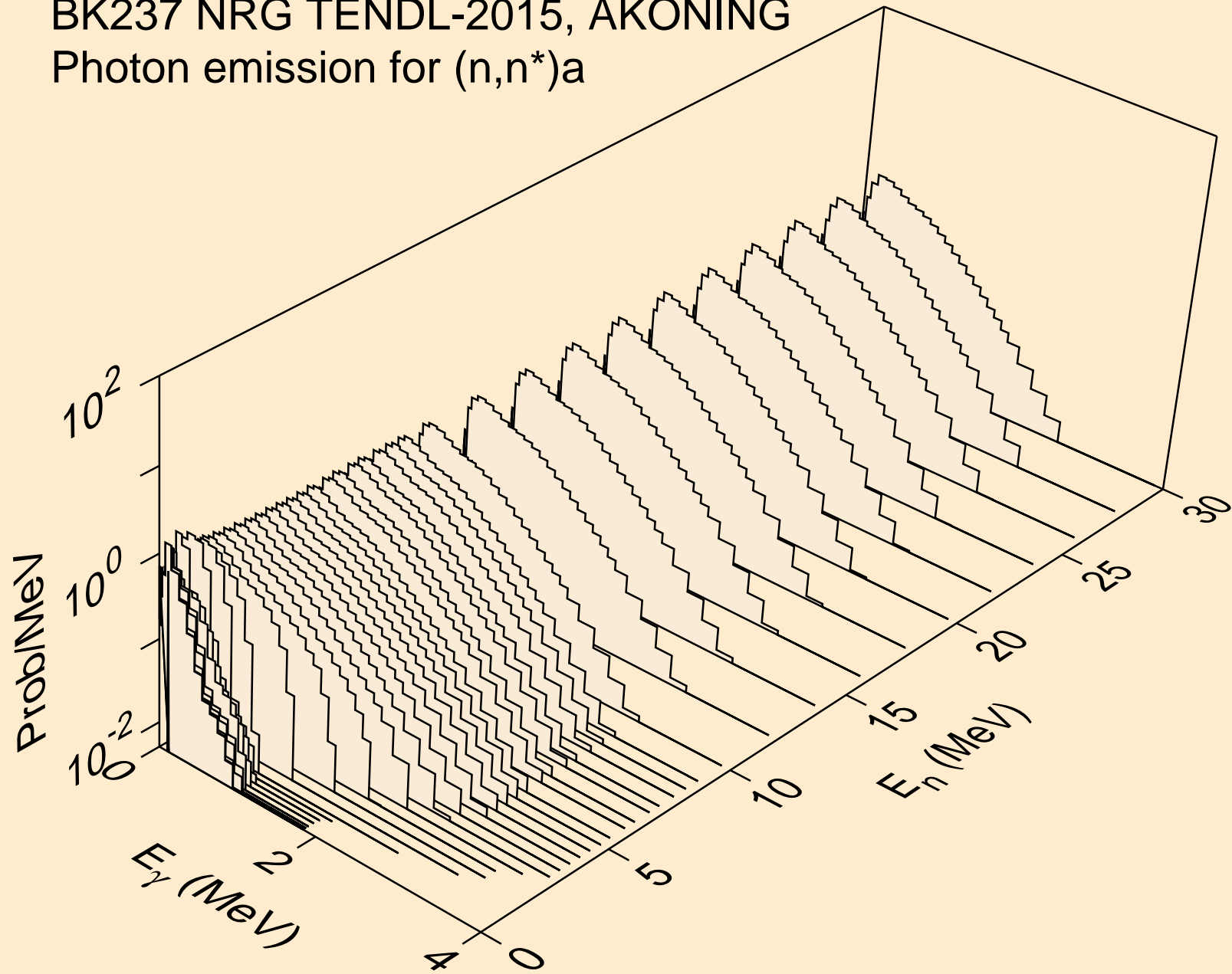

BK237 NRG TENDL-2015, AKONING
Photon emission for (n,n*)3a

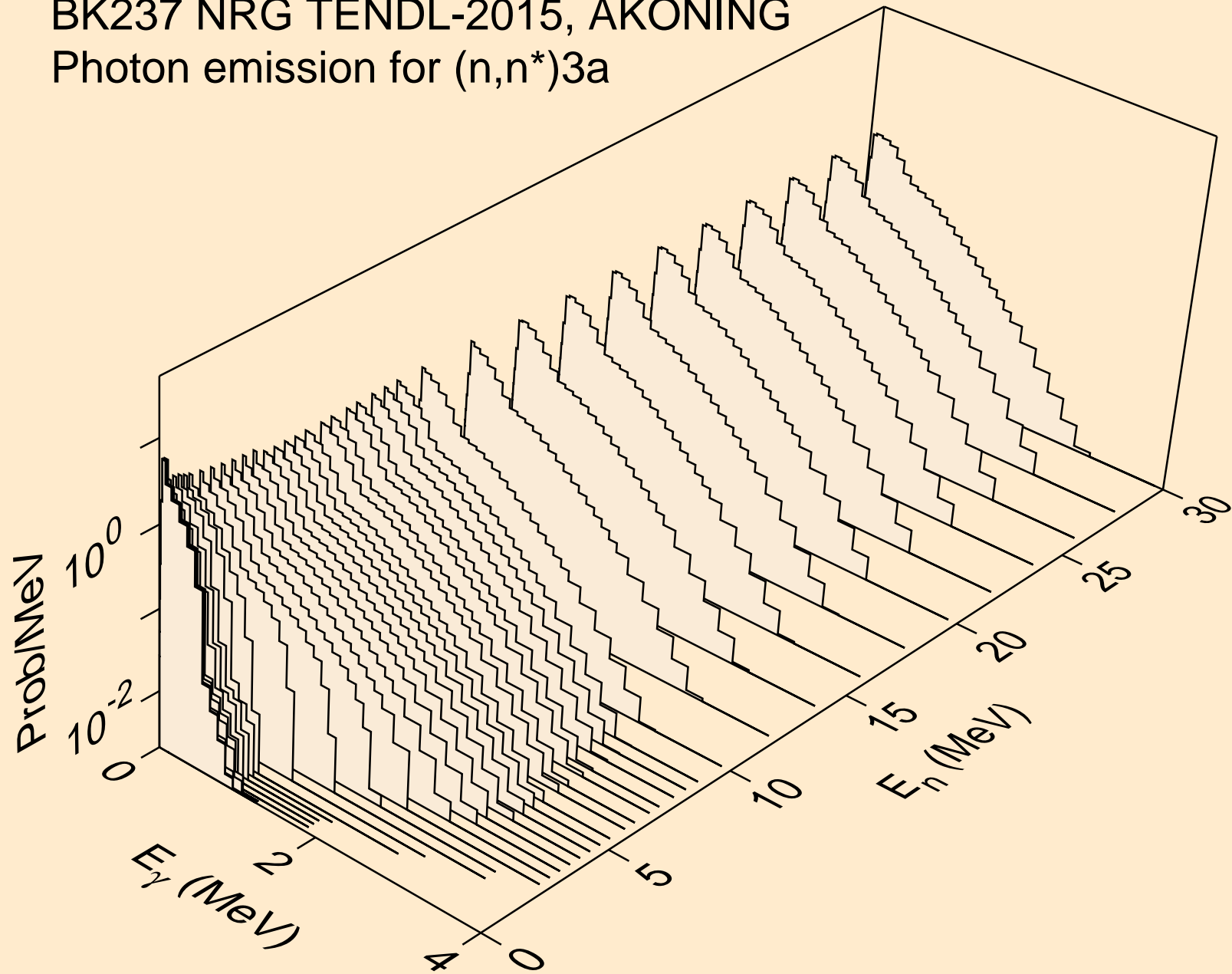

BK237 NRG TENDL-2015, AKONING
Photon emission for (n,2n)a

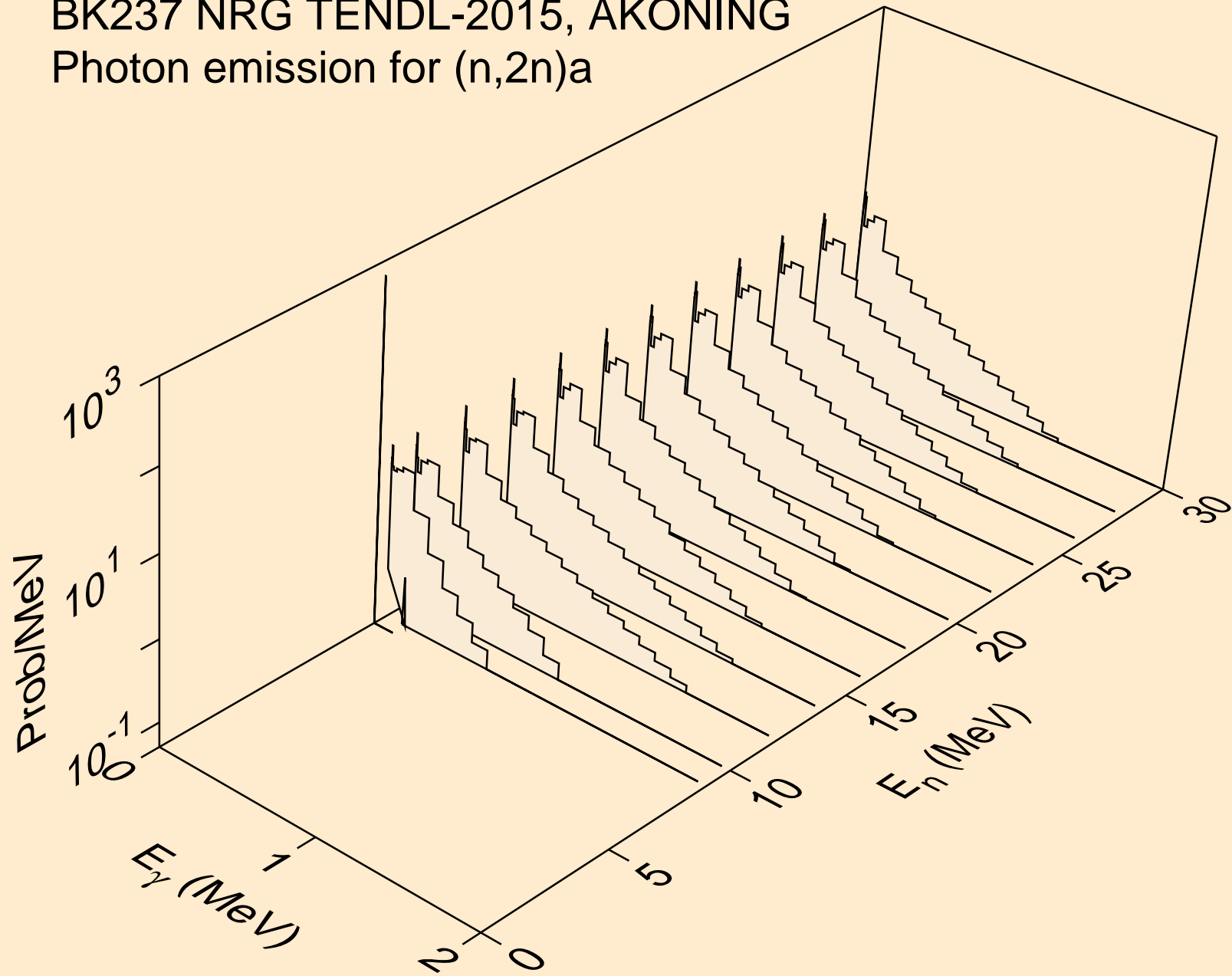

BK237 NRG TENDL-2015, AKONING
Photon emission for (n,3n)a

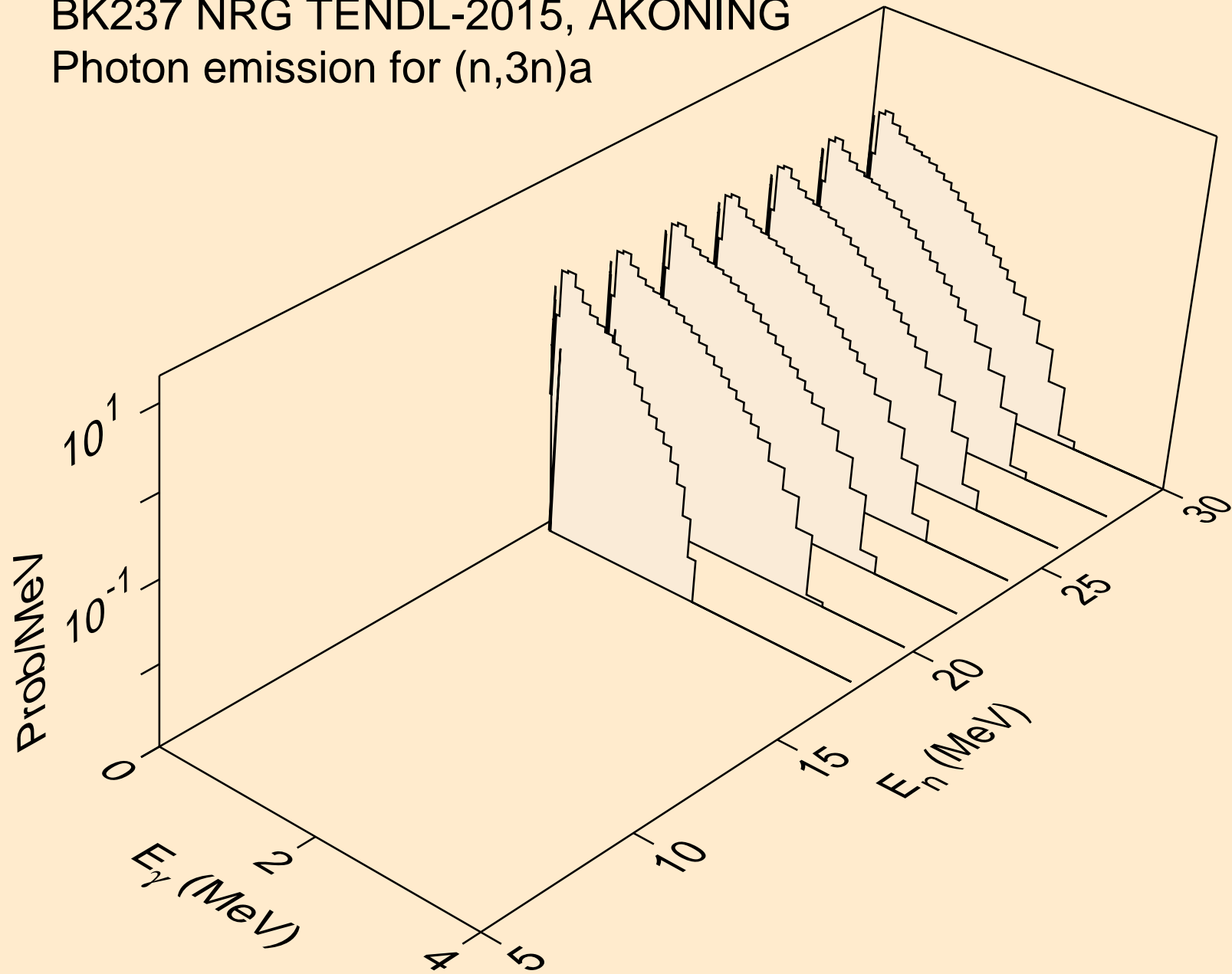

BK237 NRG TENDL-2015, AKONING
Photon emission for (n,n*)p

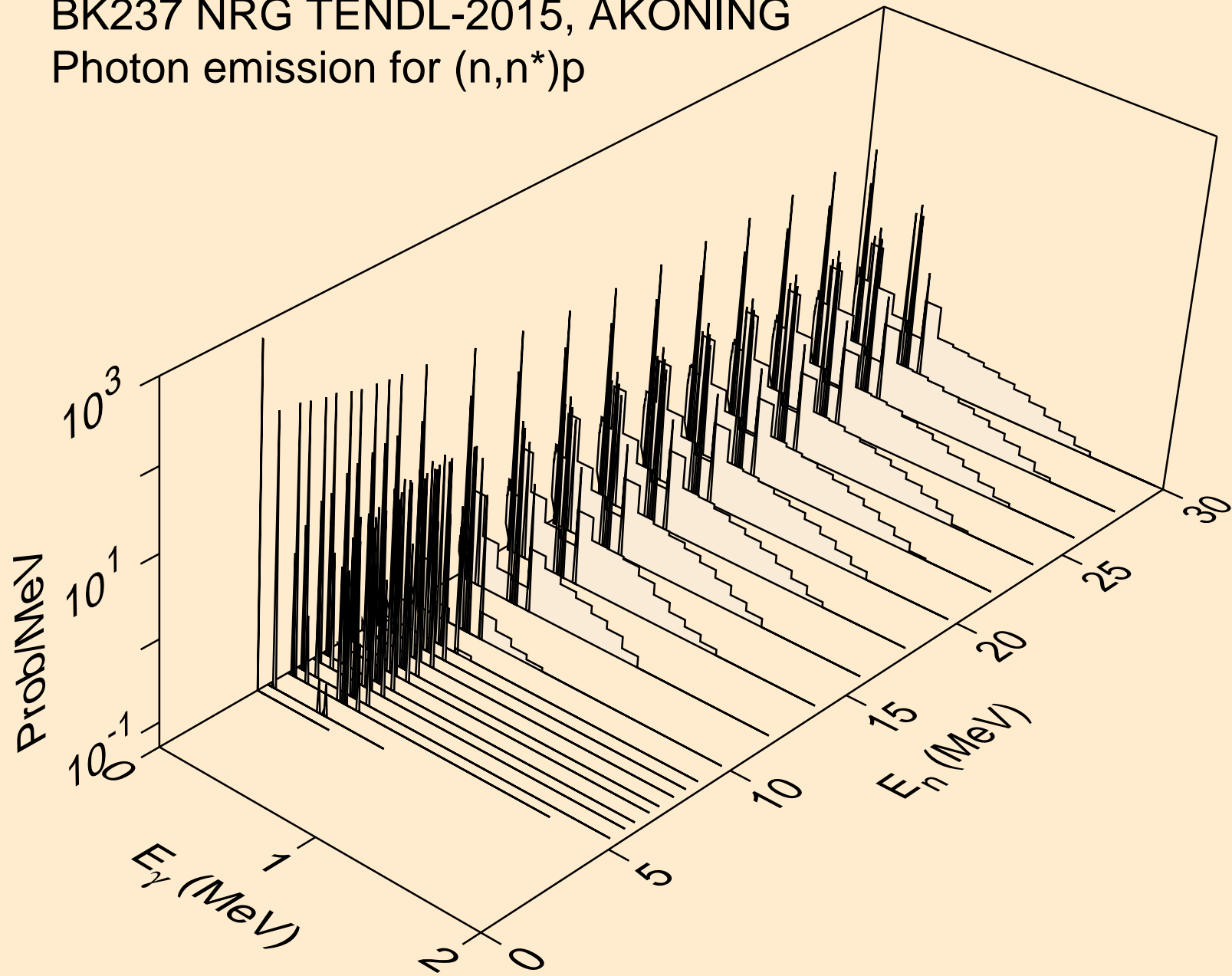

BK237 NRG TENDL-2015, AKONING
Photon emission for (n,n*)2a

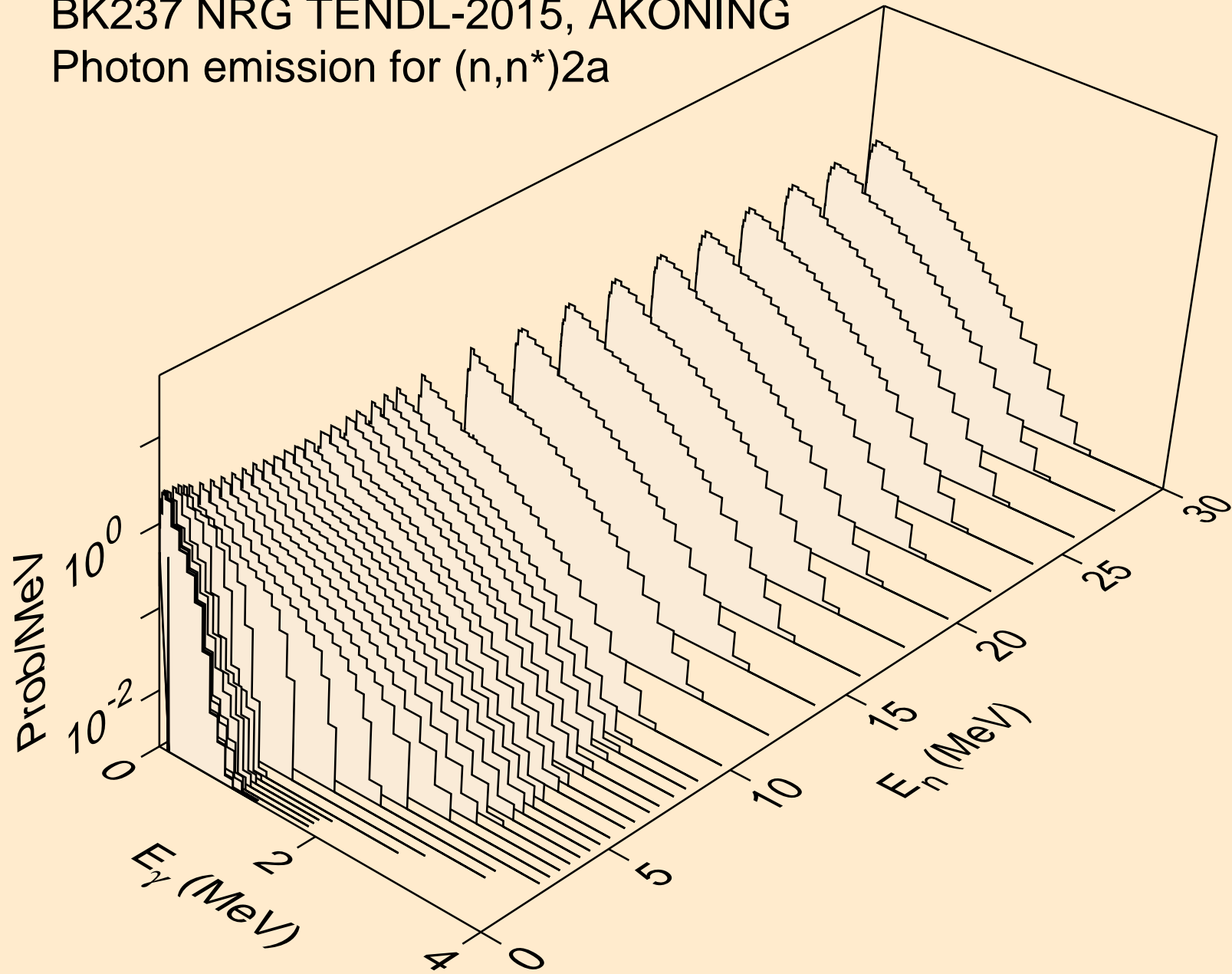

BK237 NRG TENDL-2015, AKONING
Photon emission for (n,2n)2a

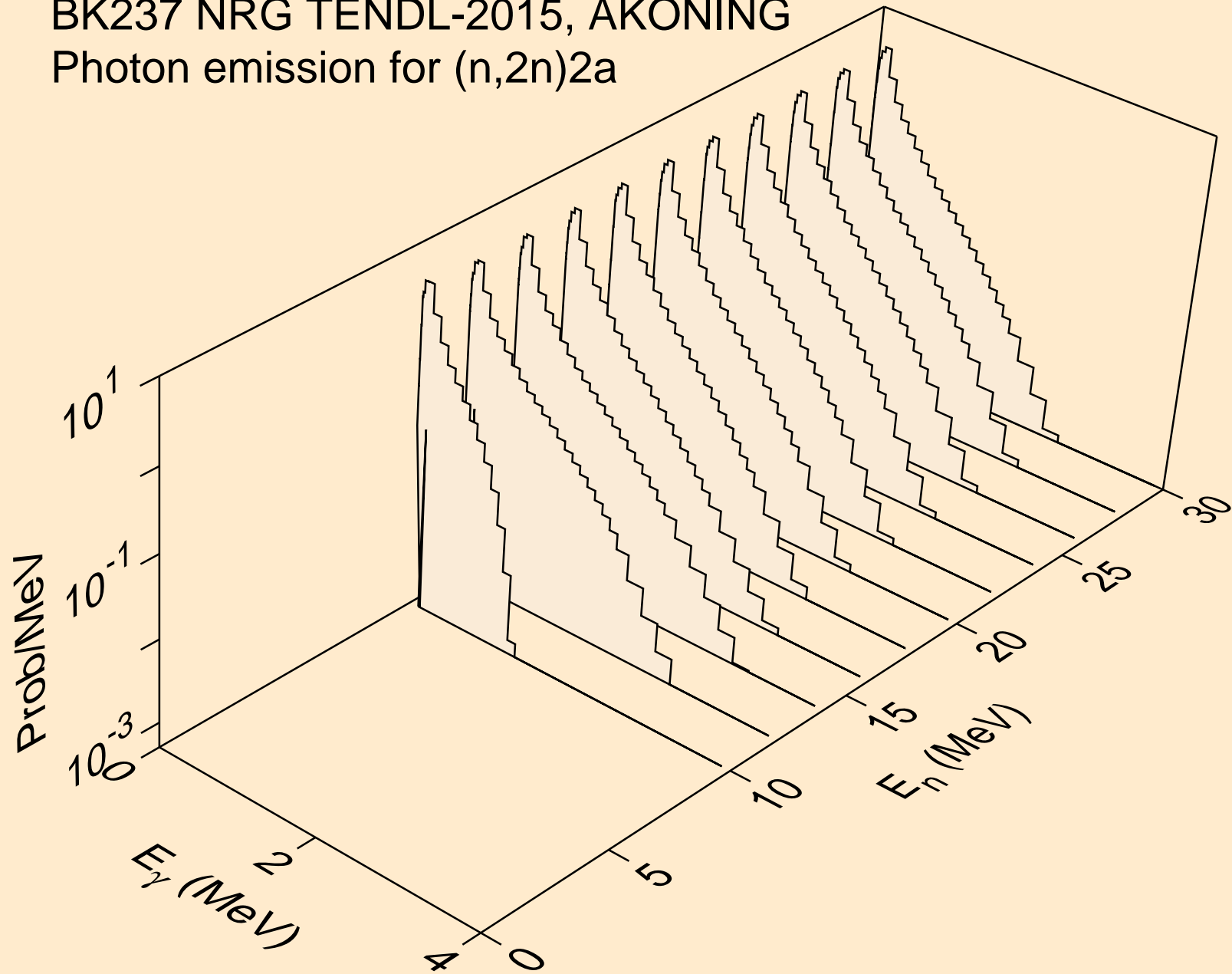

BK237 NRG TENDL-2015, AKONING
Photon emission for (n,n*)d

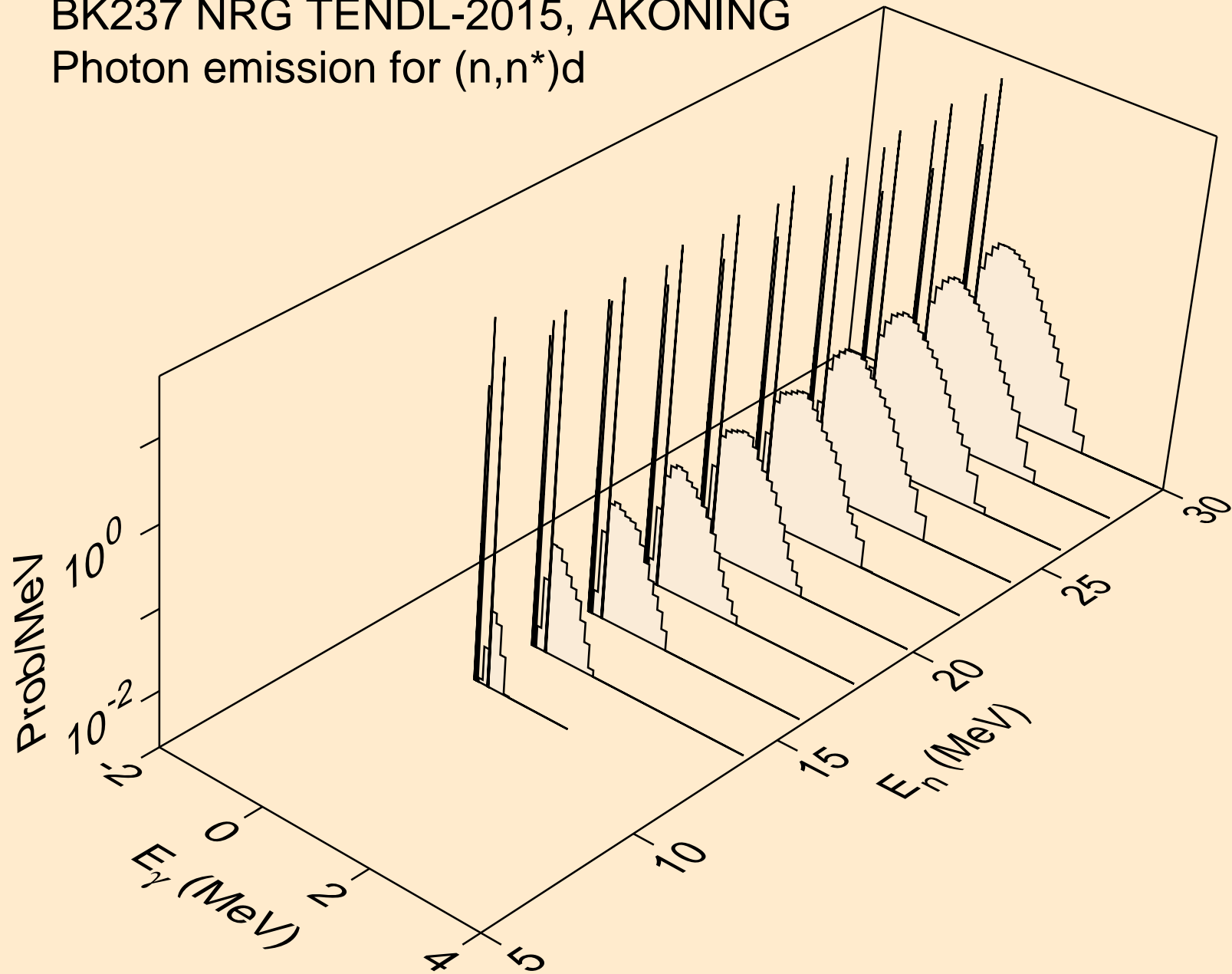

BK237 NRG TENDL-2015, AKONING
Photon emission for (n,n*)t

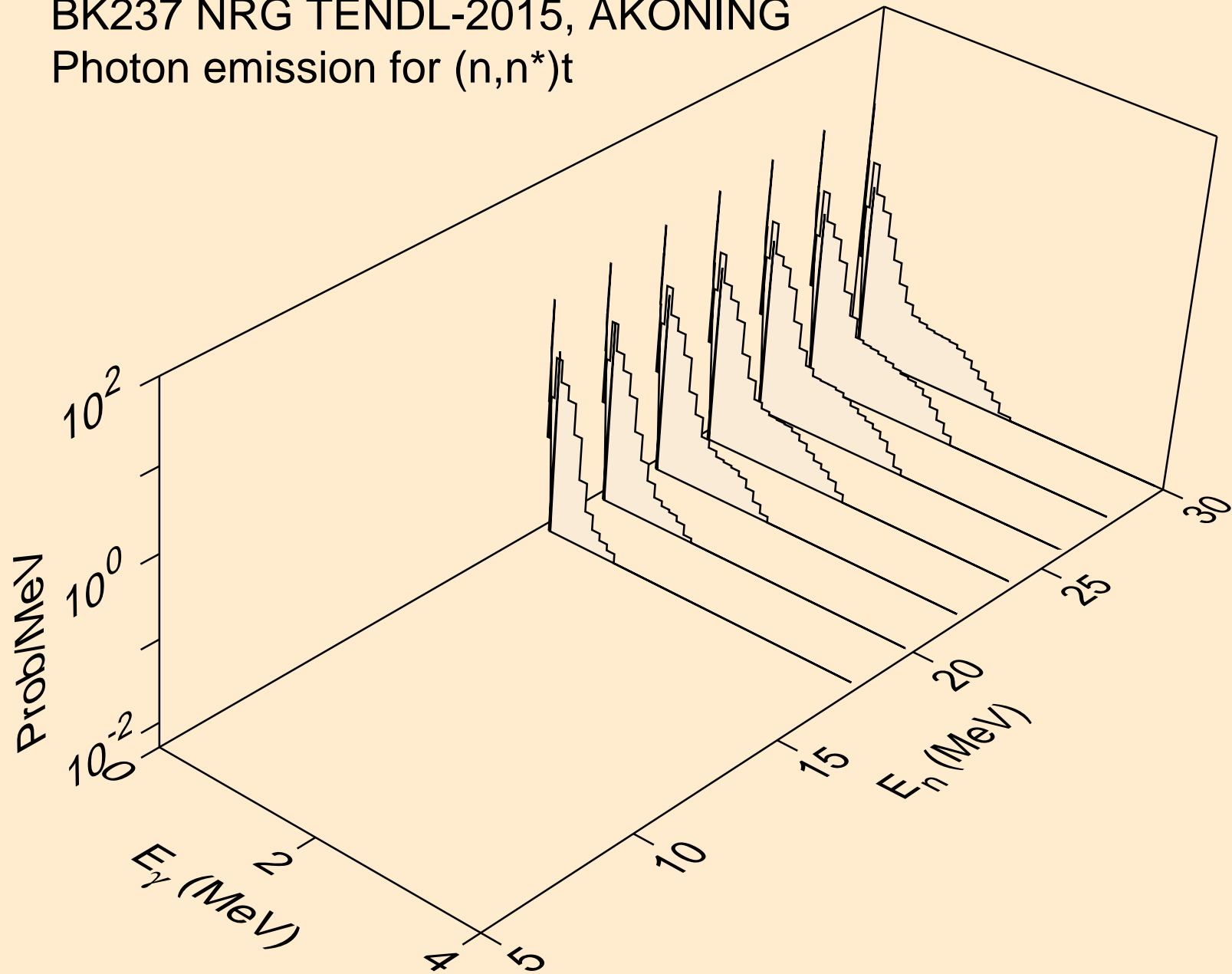

BK237 NRG TENDL-2015, AKONING
Photon emission for (n,n*)he3

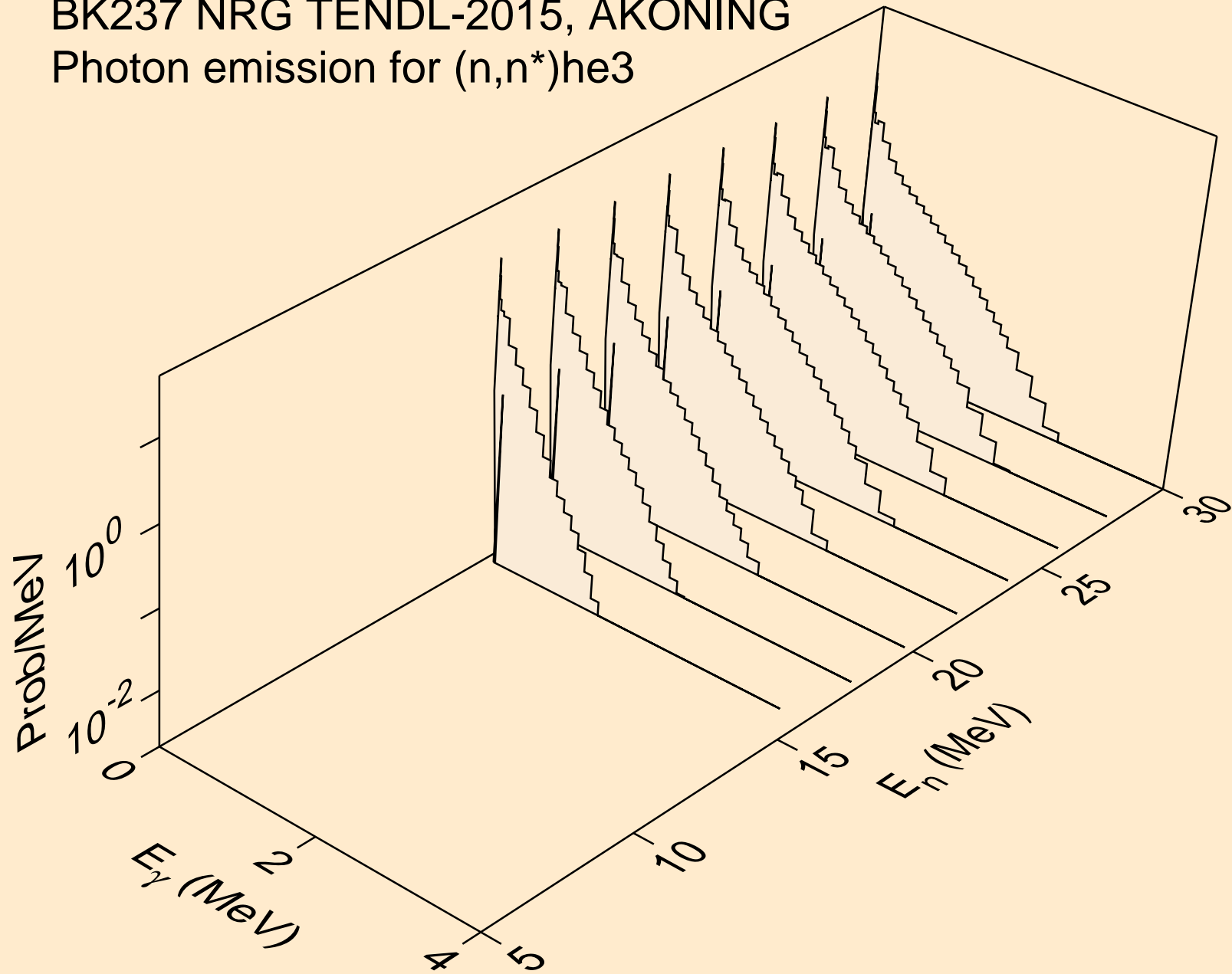

BK237 NRG TENDL-2015, AKONING
Photon emission for (n,n*)t2a

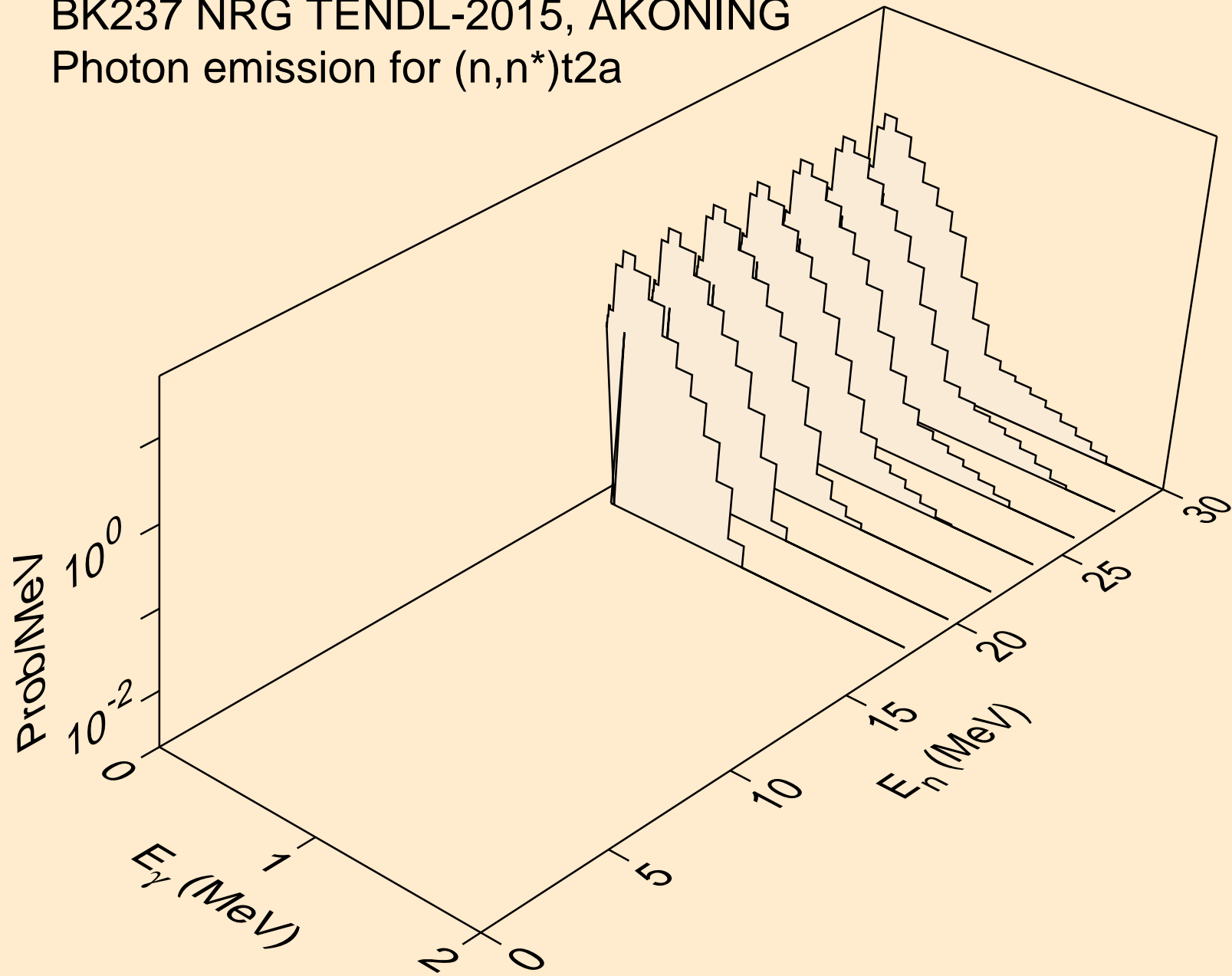

BK237 NRG TENDL-2015, AKONING
Photon emission for (n,4n)

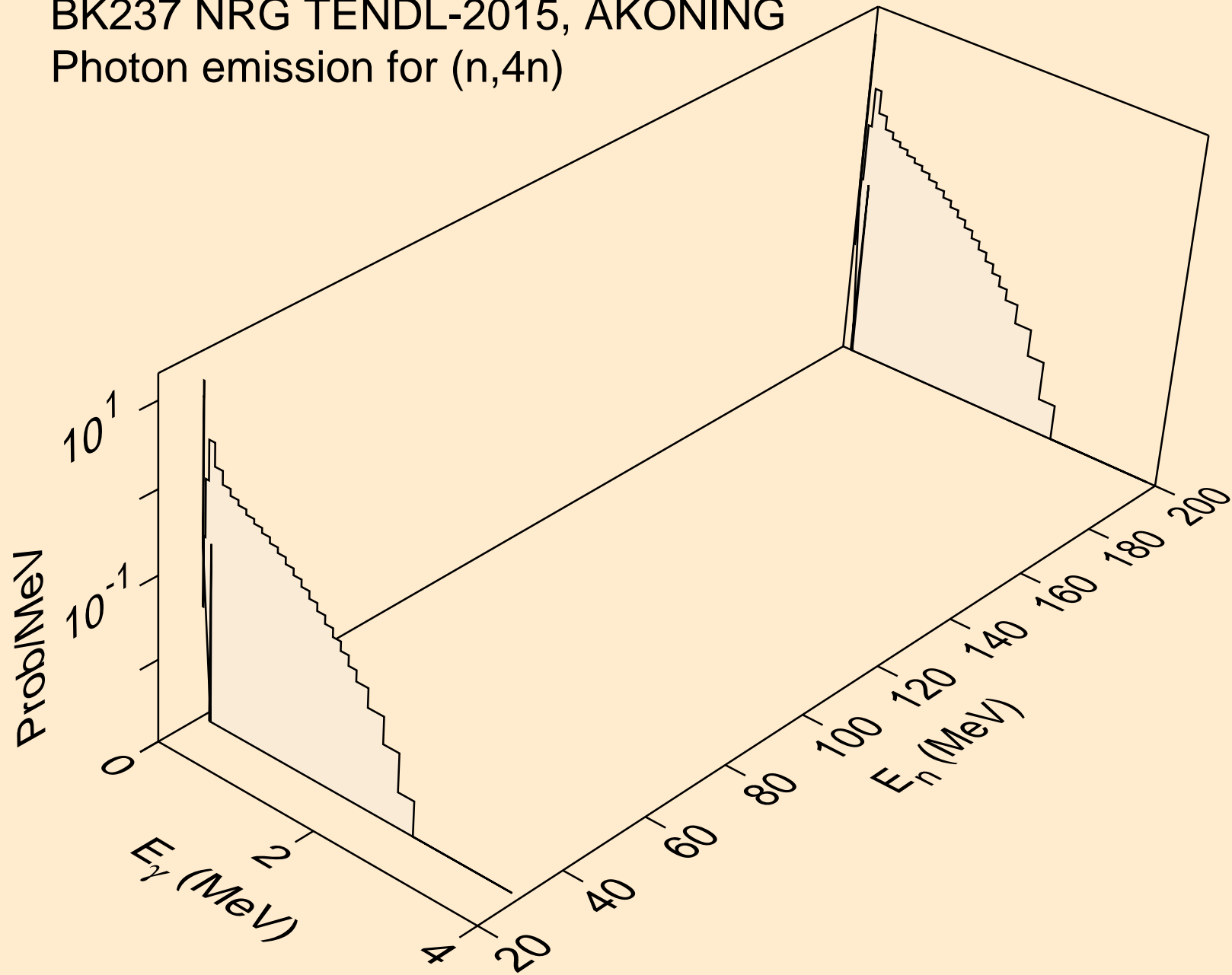

BK237 NRG TENDL-2015, AKONING
Photon emission for (n,2np)

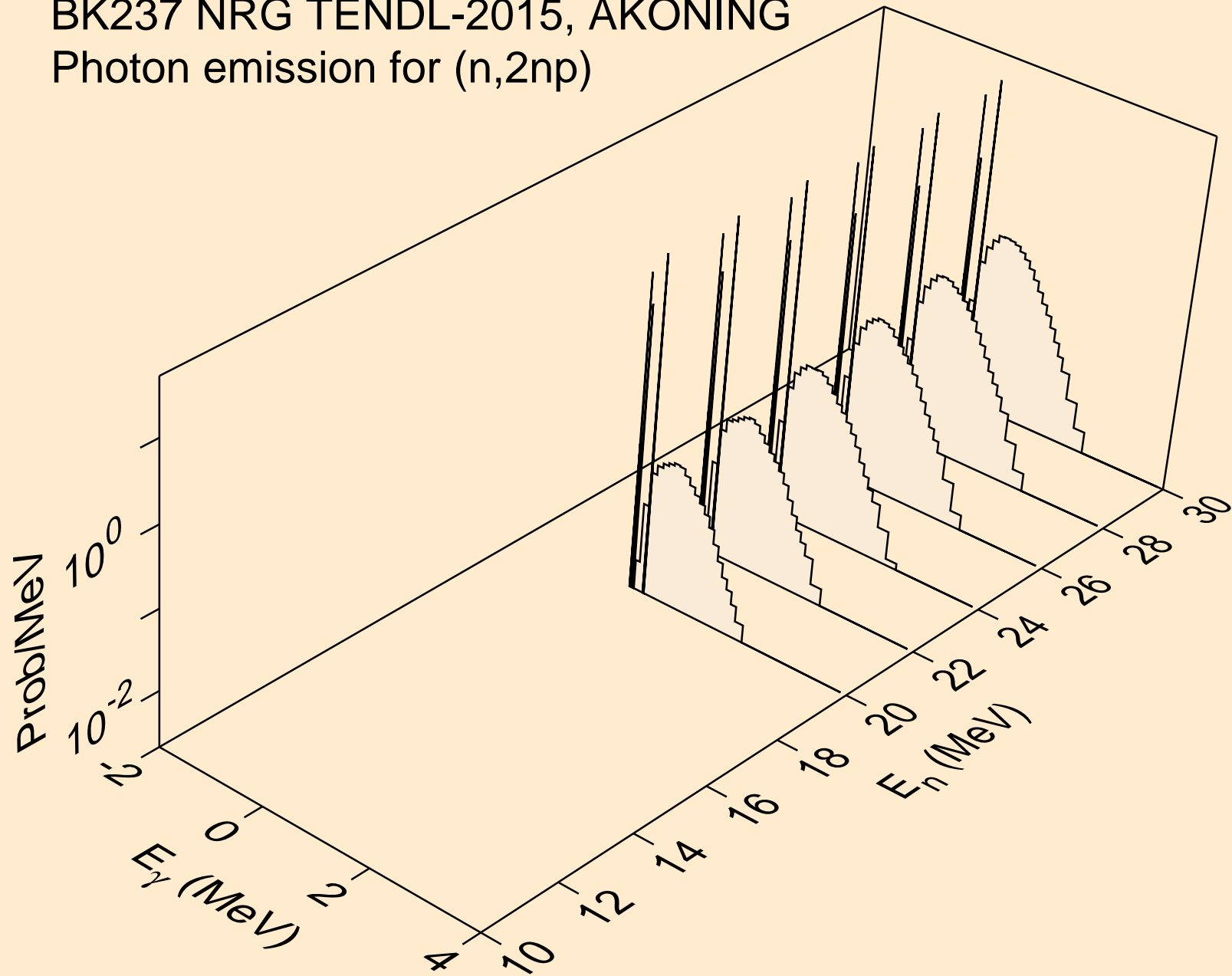

BK237 NRG TENDL-2015, AKONING
Photon emission for (n,3np)

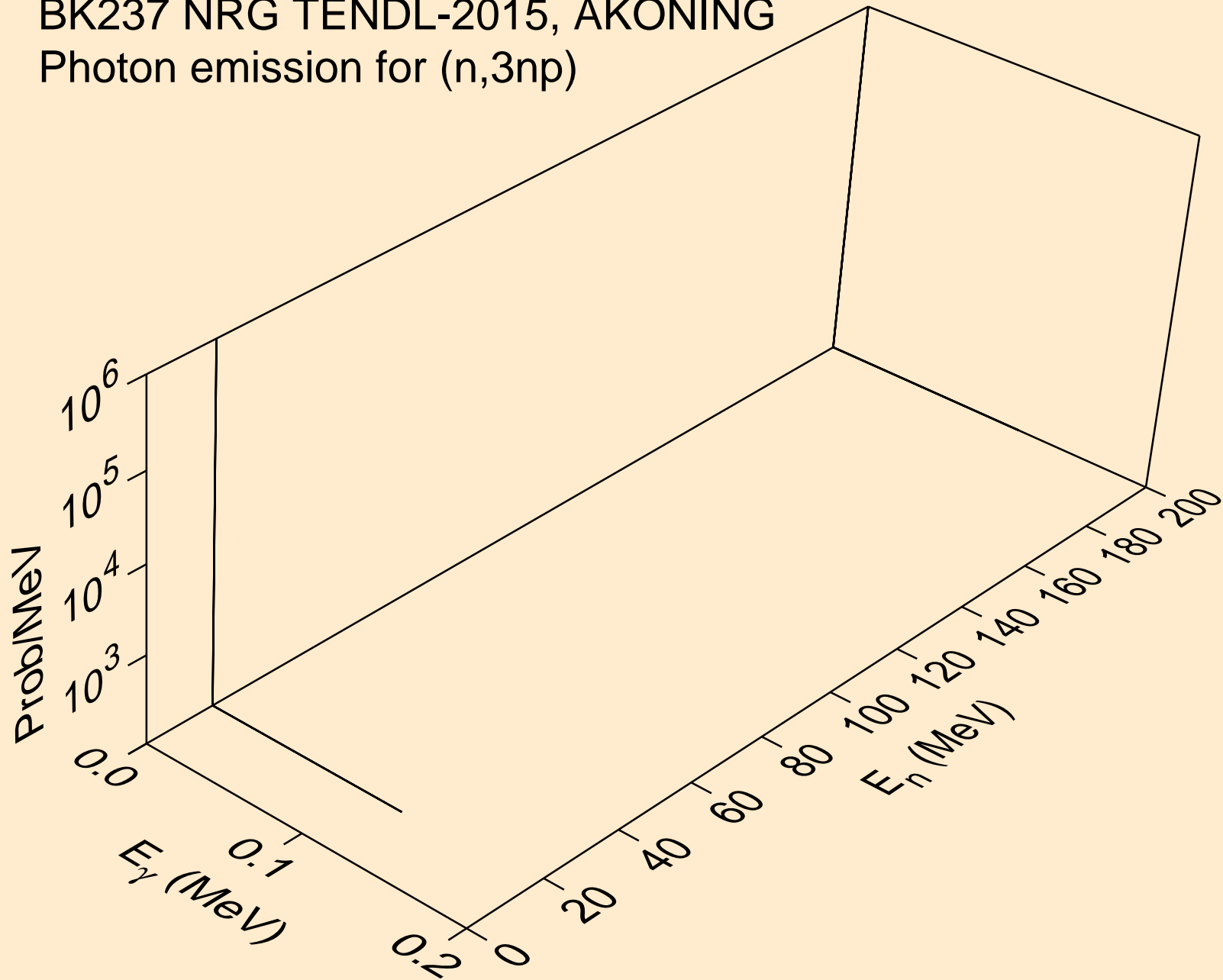

BK237 NRG TENDL-2015, AKONING
Photon emission for (n,2np)

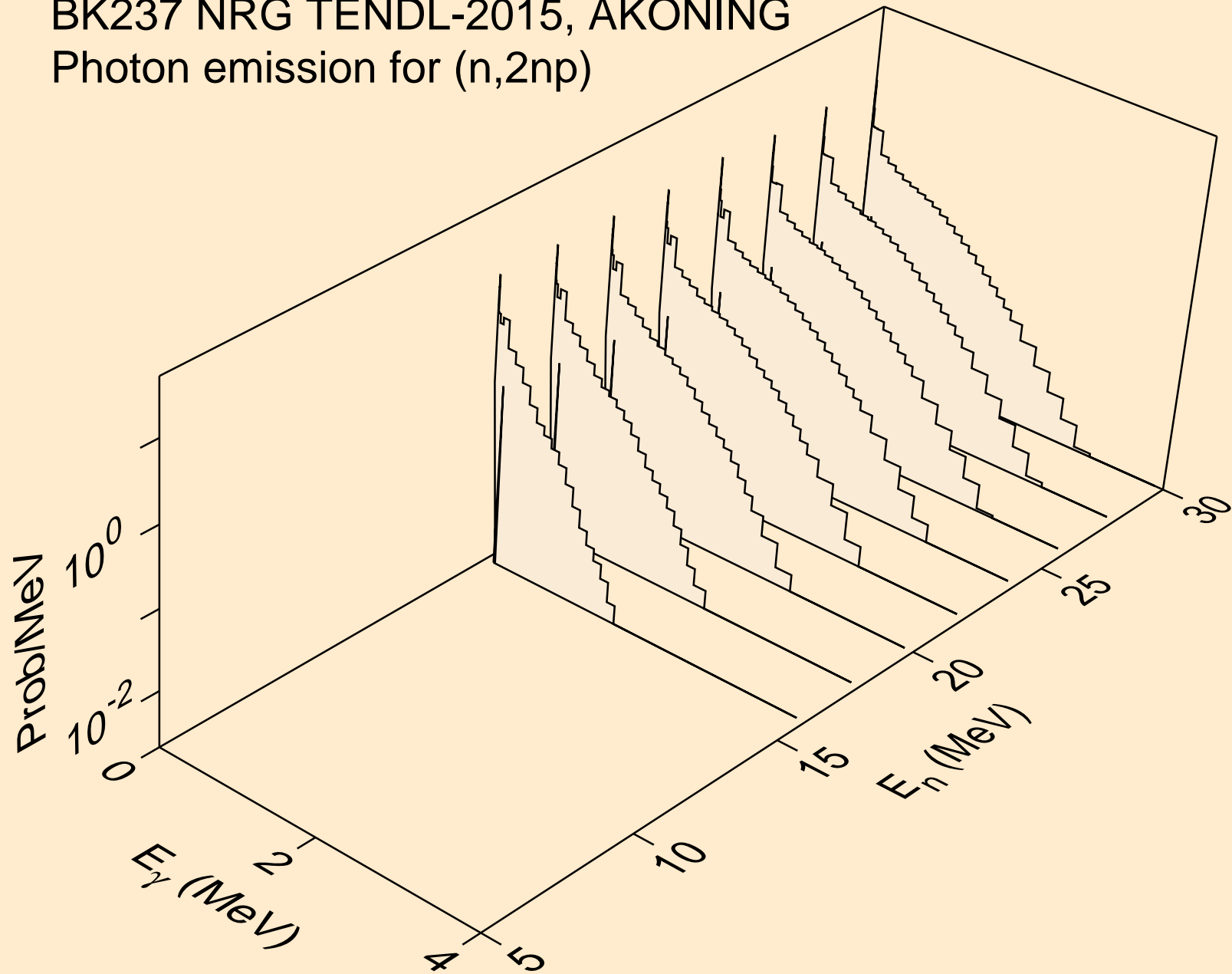

BK237 NRG TENDL-2015, AKONING
Photon emission for (n,npa)

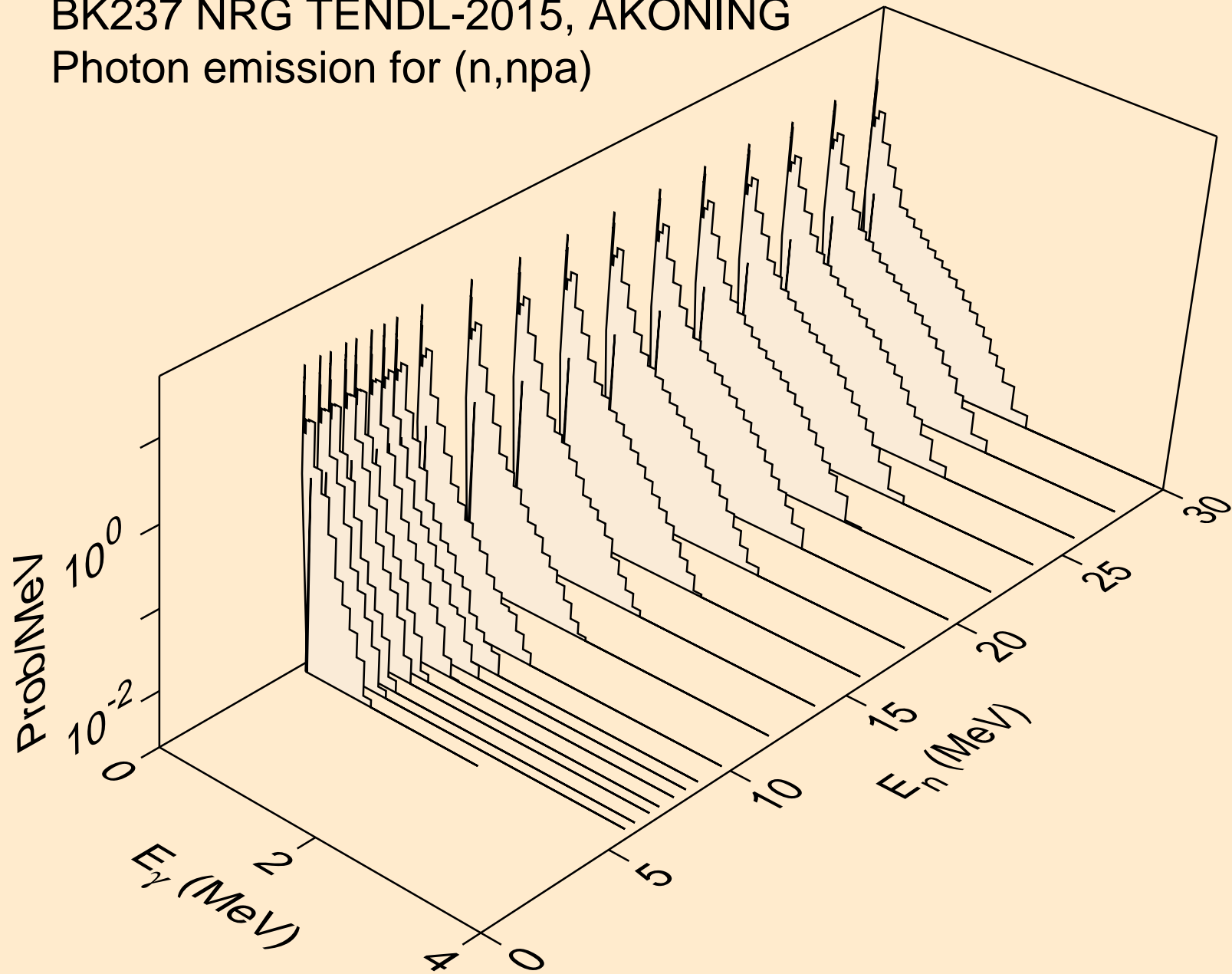

BK237 NRG TENDL-2015, AKONING
Photon emission for (n,n*c)

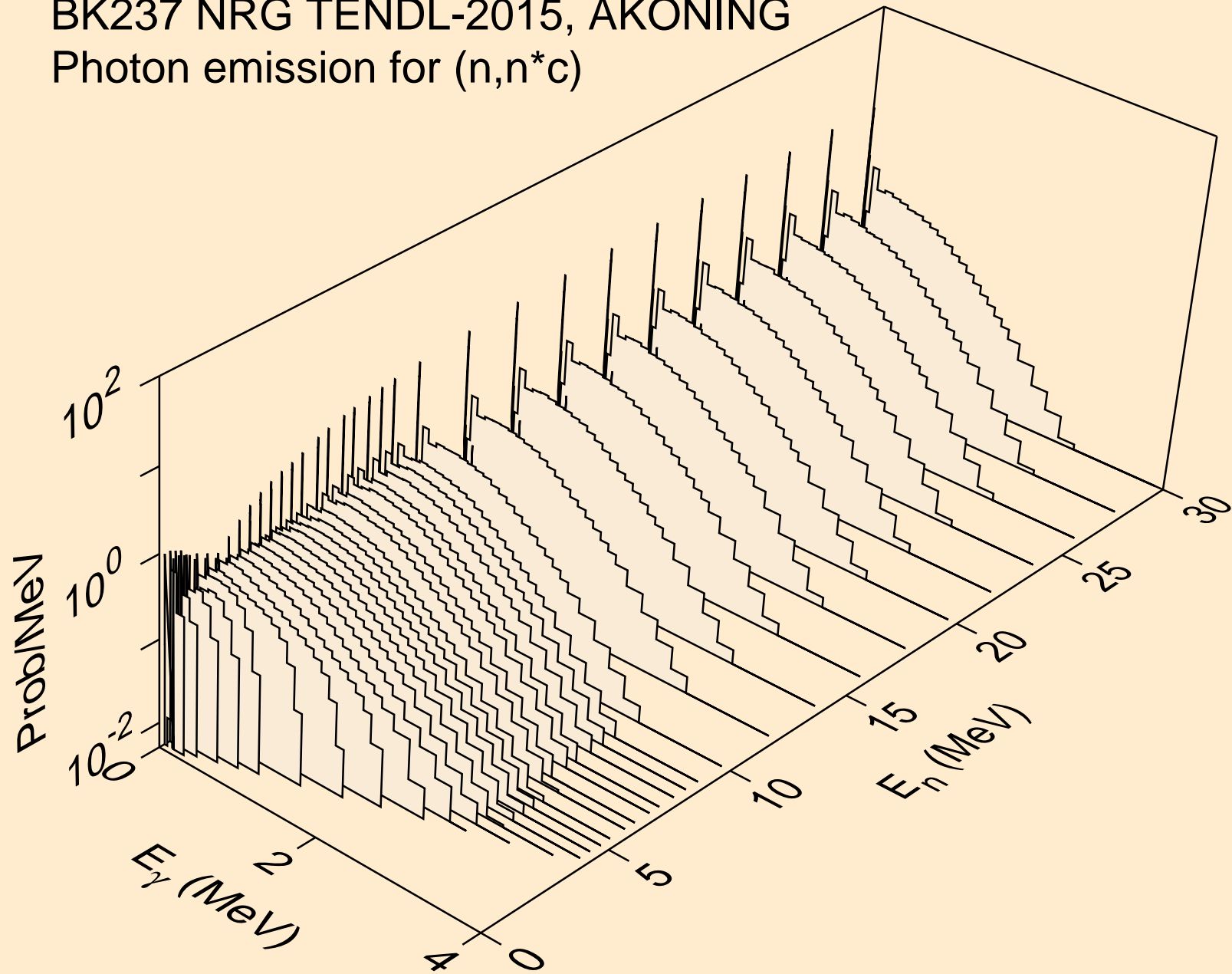

BK237 NRG TENDL-2015, AKONING
Photon emission for (n,gma)

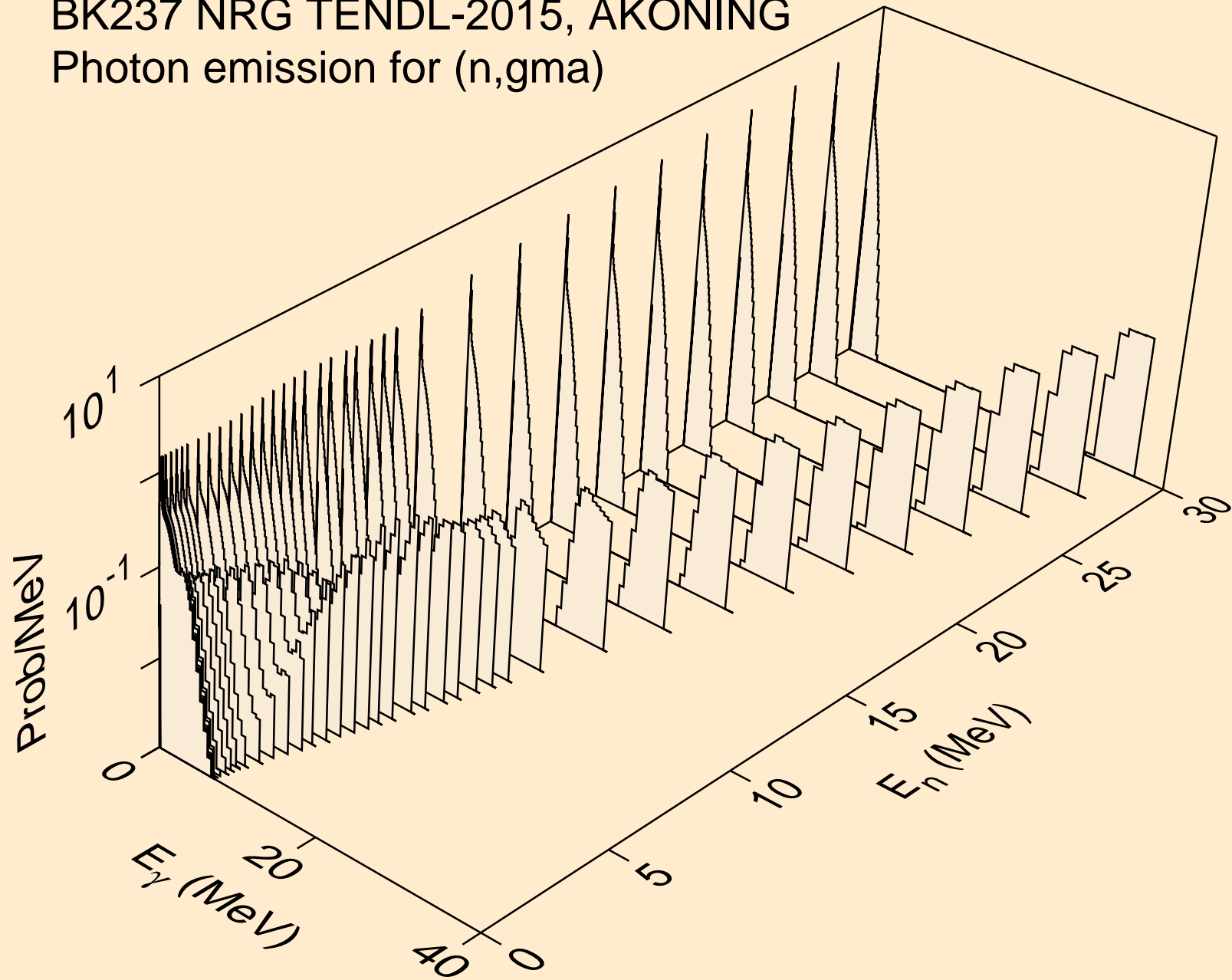

BK237 NRG TENDL-2015, AKONING
Photon emission for (n,p)

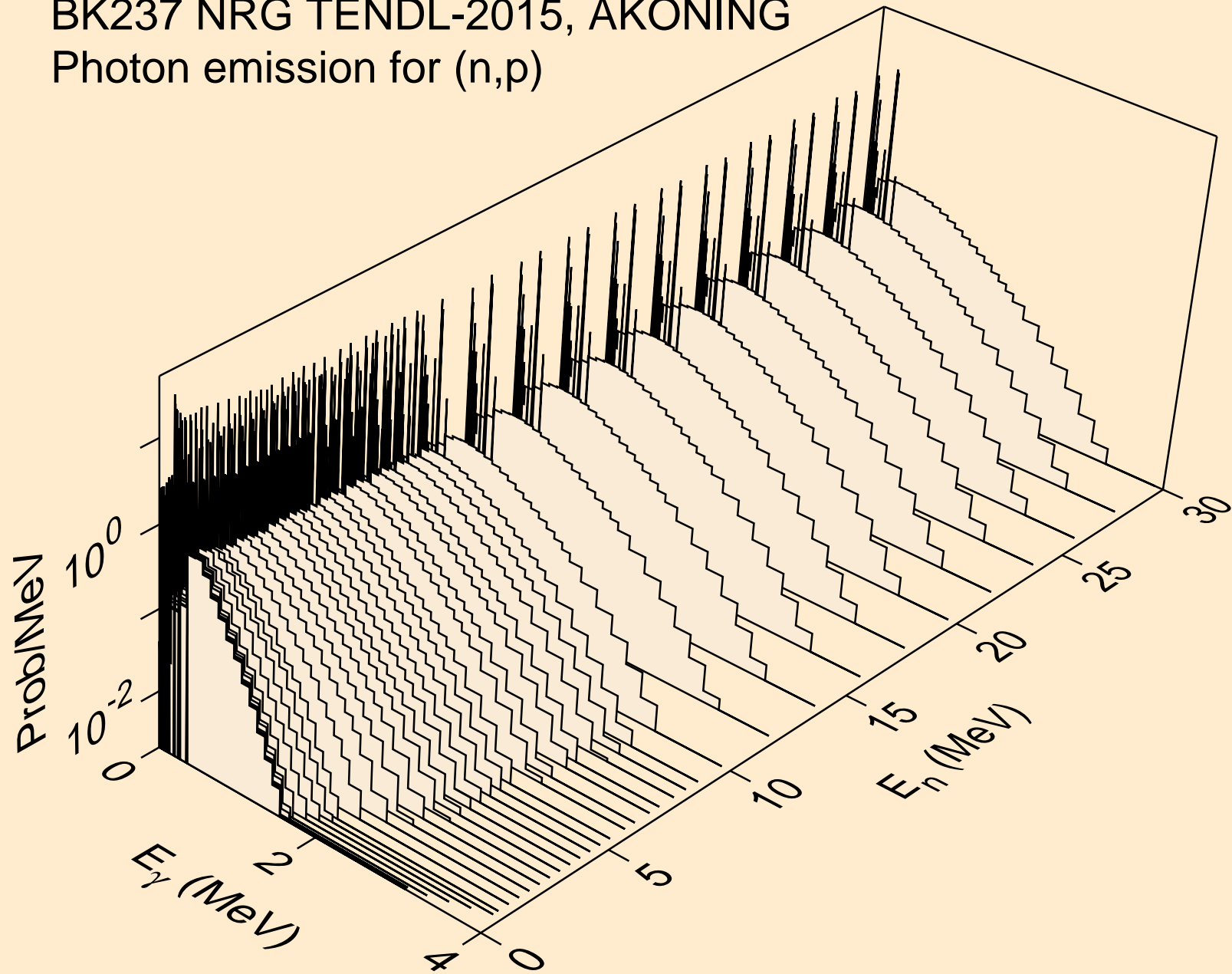

BK237 NRG TENDL-2015, AKONING
Photon emission for (n,d)

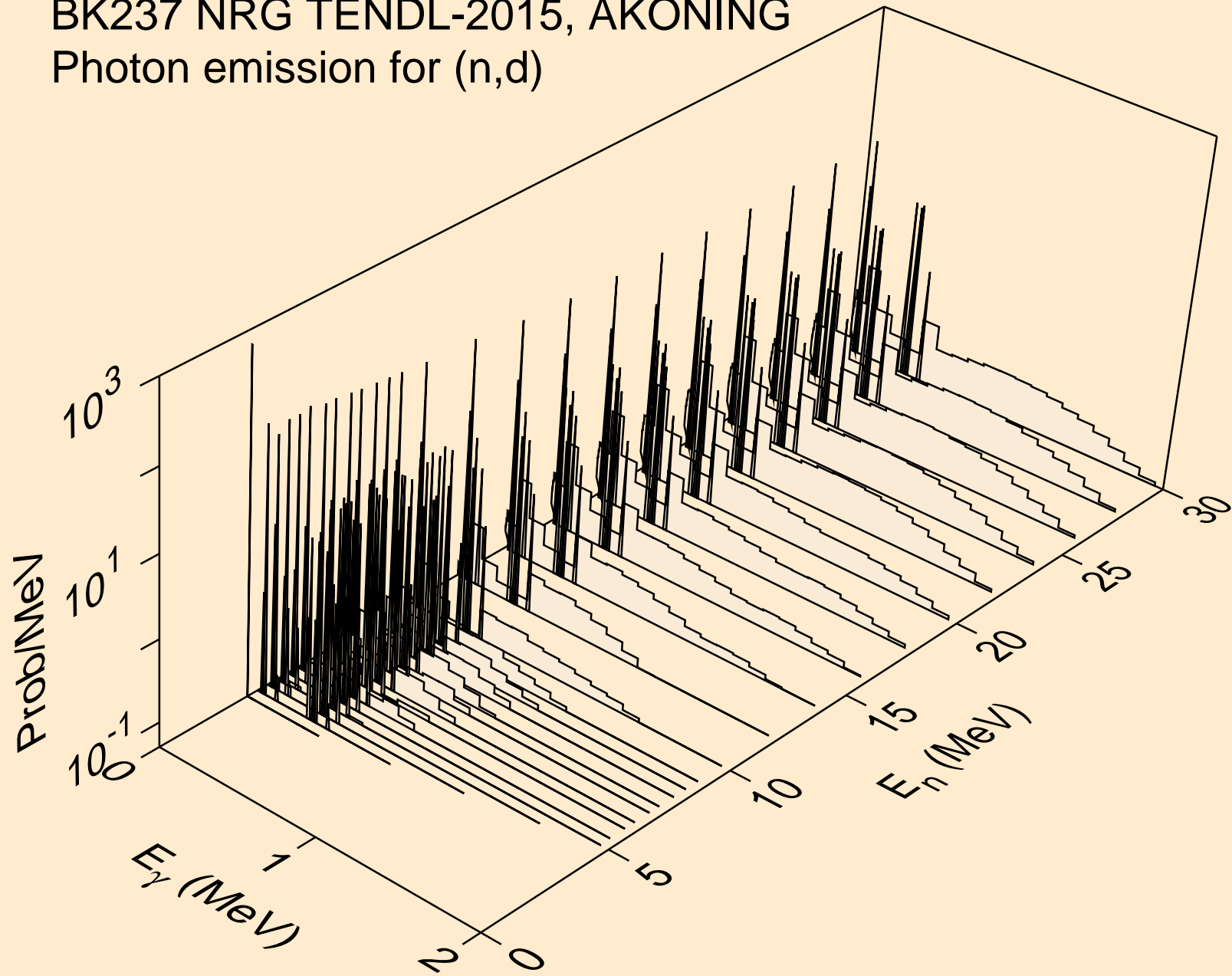

BK237 NRG TENDL-2015, AKONING
Photon emission for (n,t)

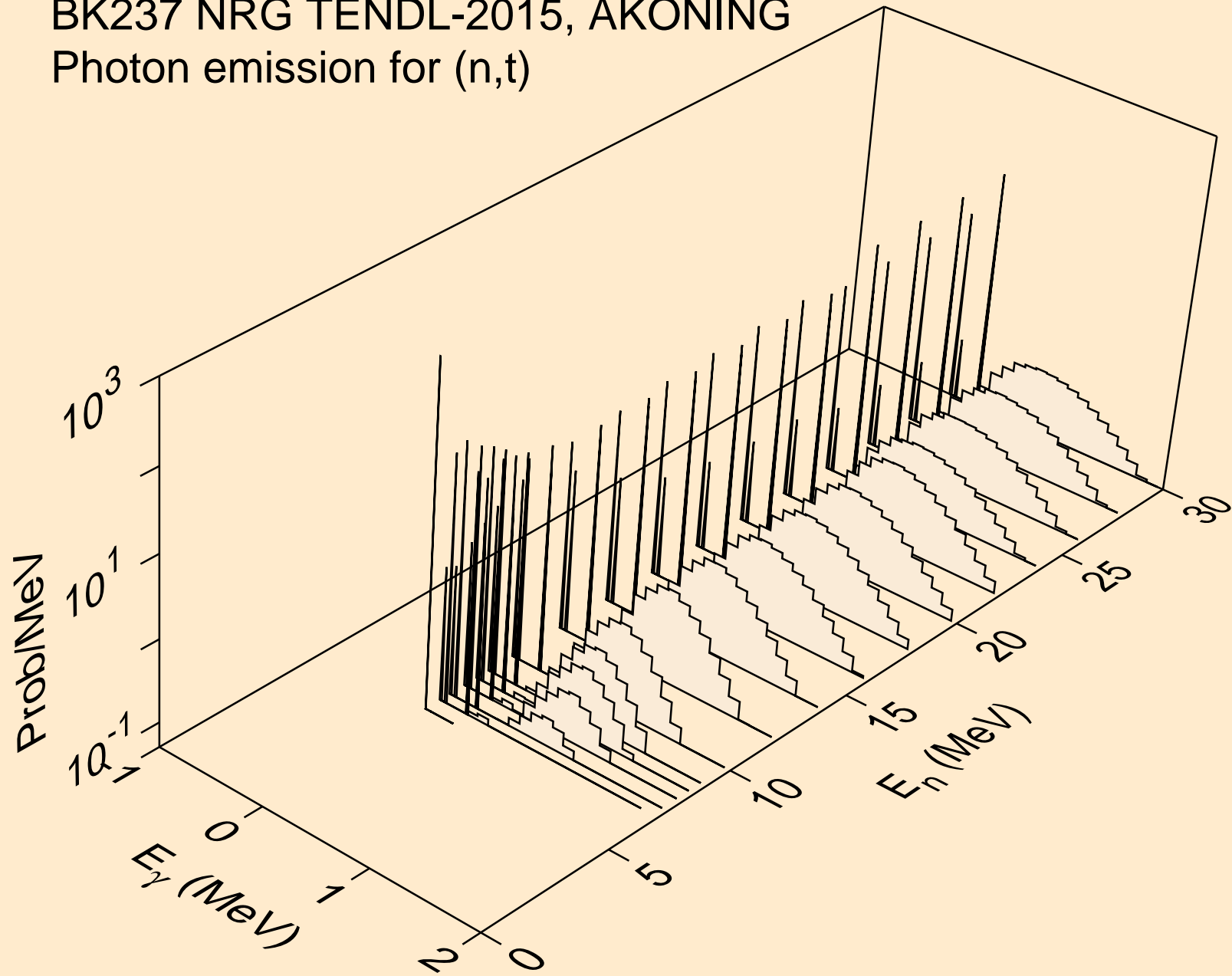

BK237 NRG TENDL-2015, AKONING
Photon emission for (n,he3)

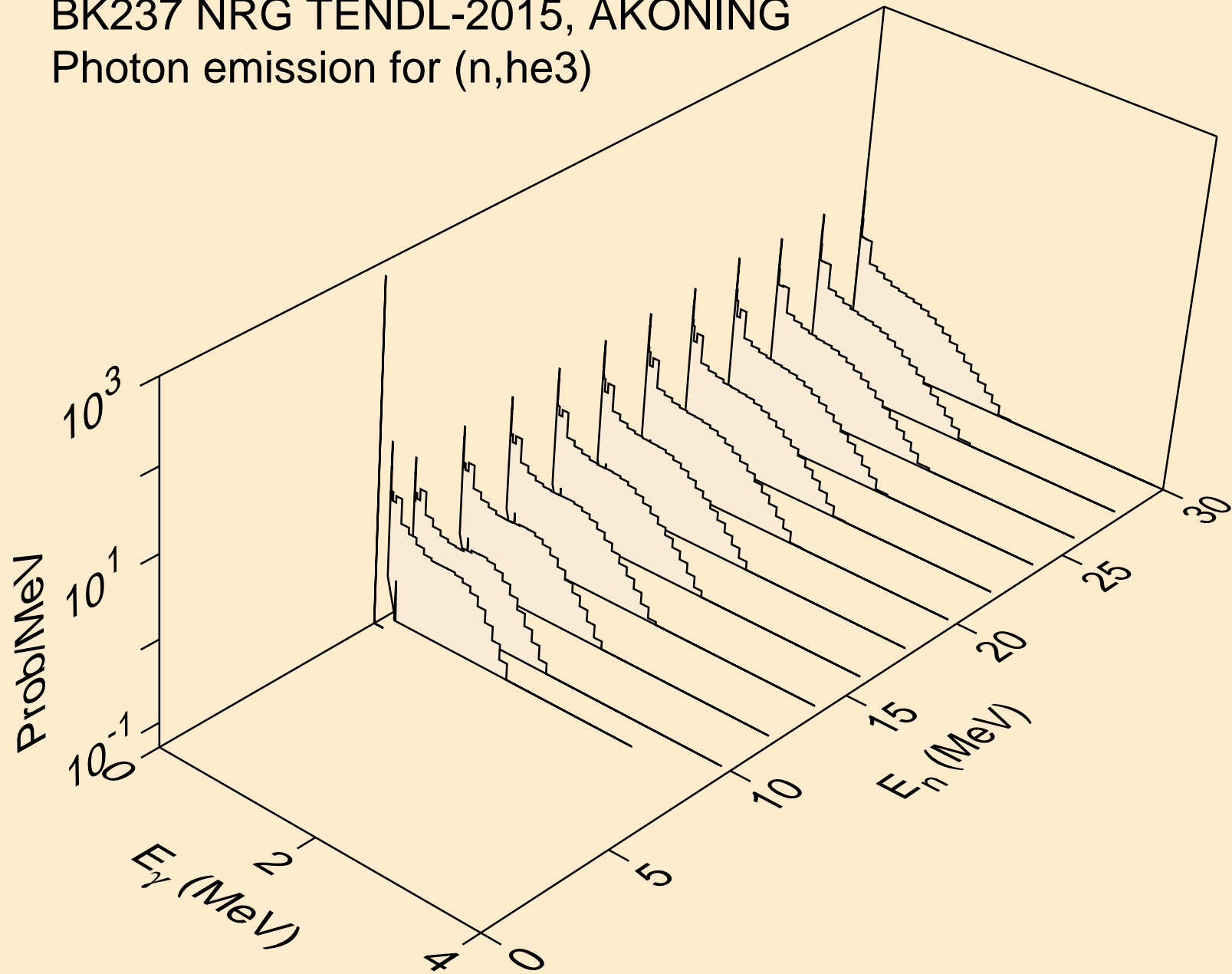

BK237 NRG TENDL-2015, AKONING
Photon emission for (n,a)

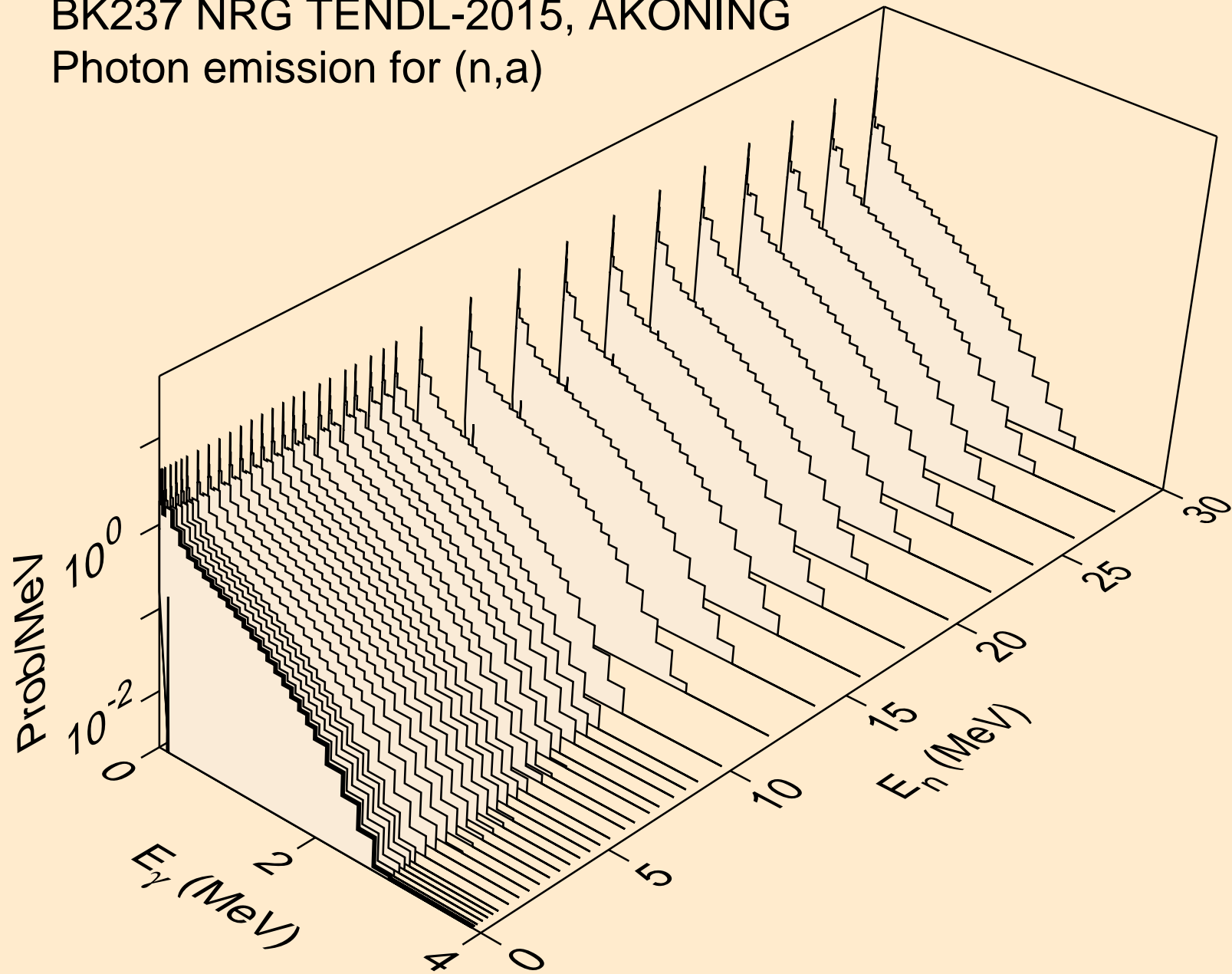

BK237 NRG TENDL-2015, AKONING
Photon emission for (n,2a)

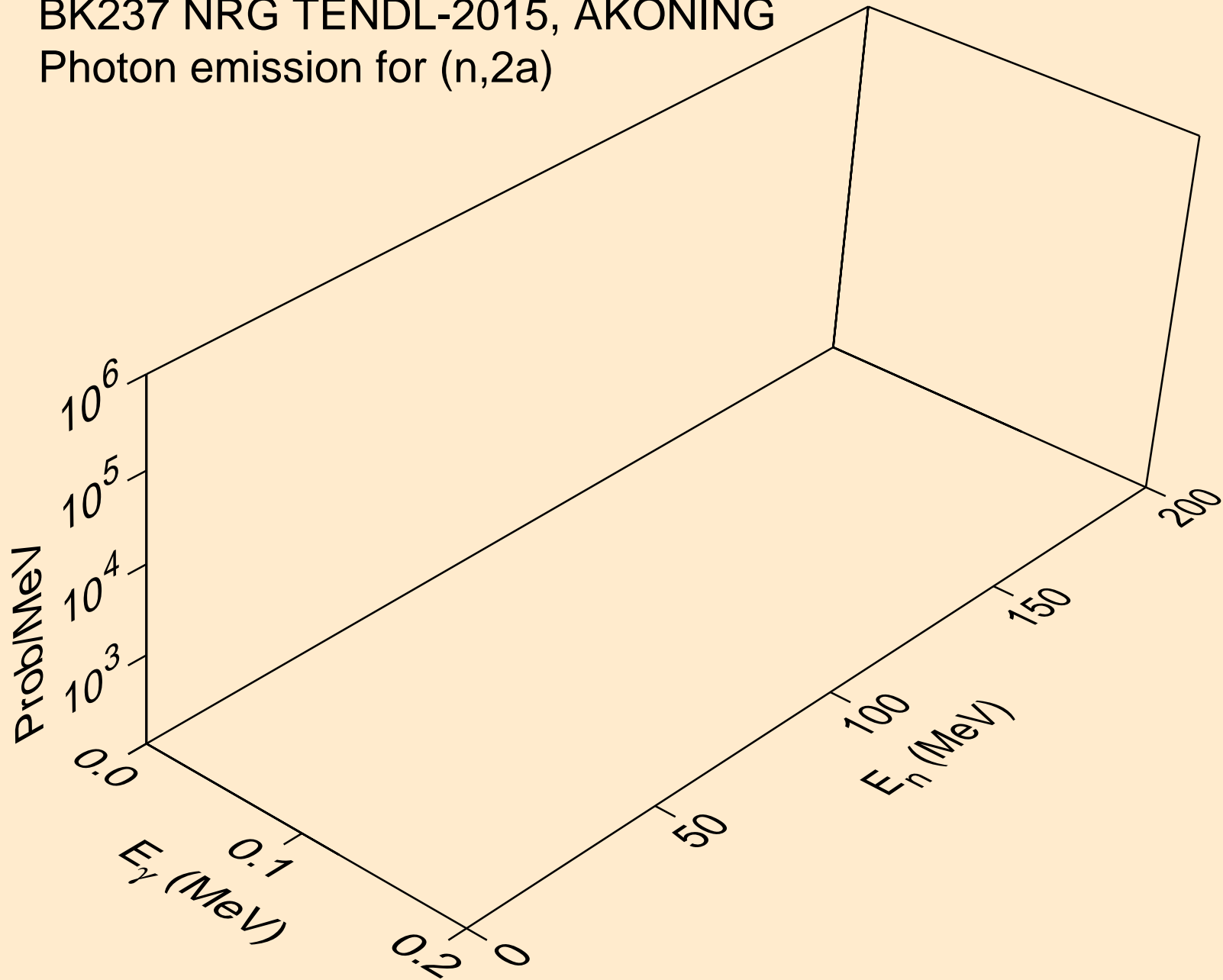

BK237 NRG TENDL-2015, AKONING
Photon emission for (n,3a)

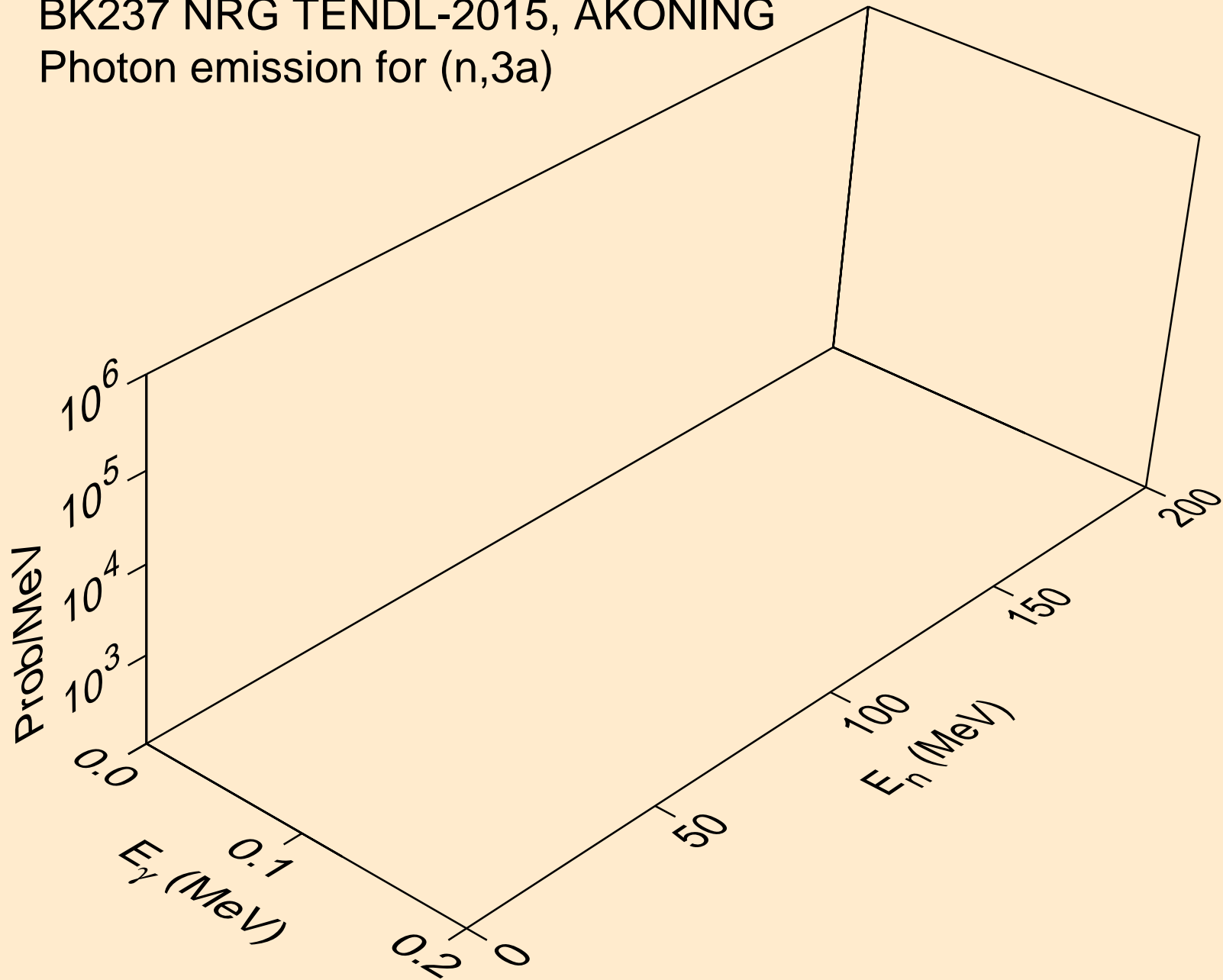

BK237 NRG TENDL-2015, AKONING
Photon emission for (n,2p)

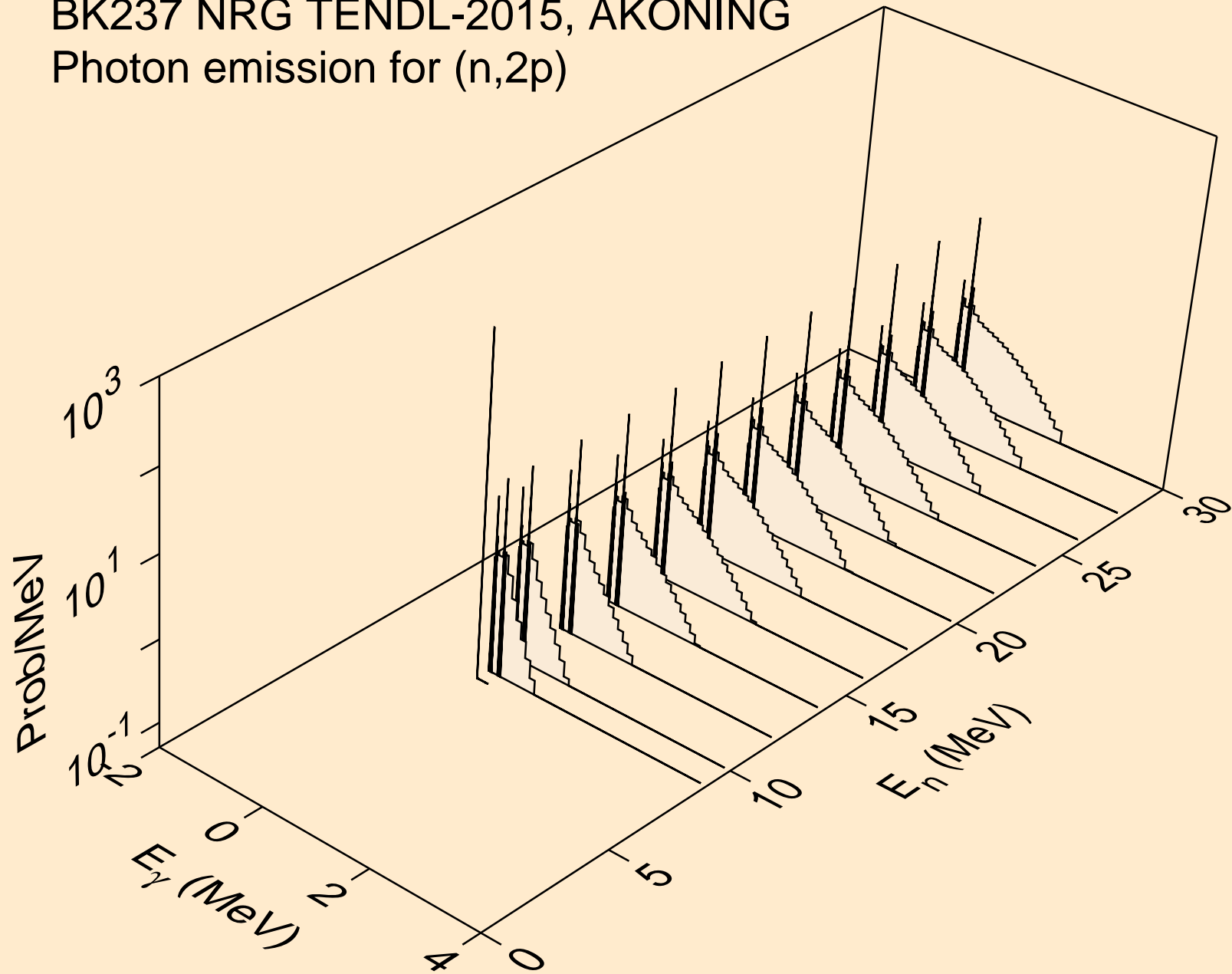

BK237 NRG TENDL-2015, AKONING
Photon emission for (n,p α)

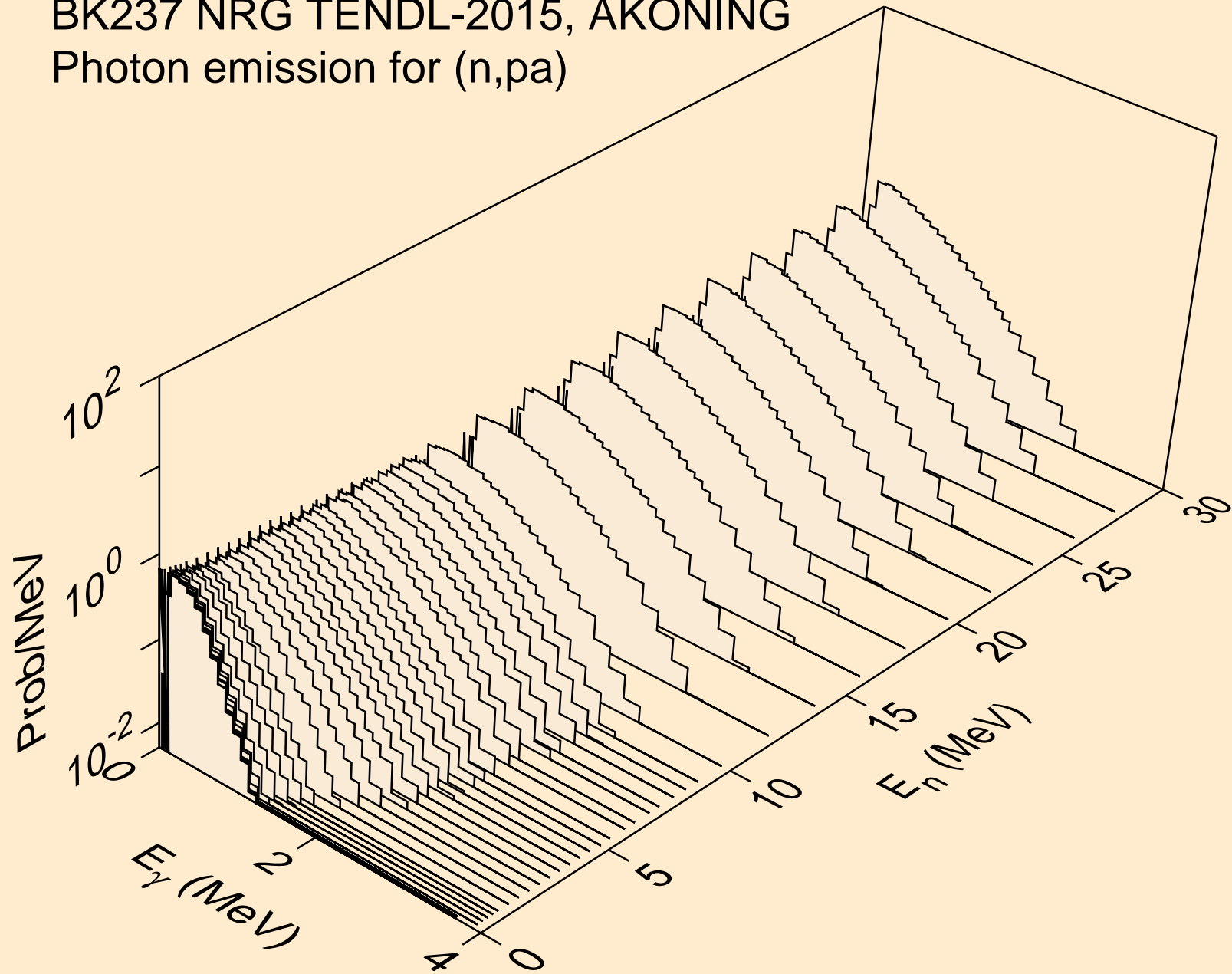

BK237 NRG TENDL-2015, AKONING
Photon emission for (n,t2a)

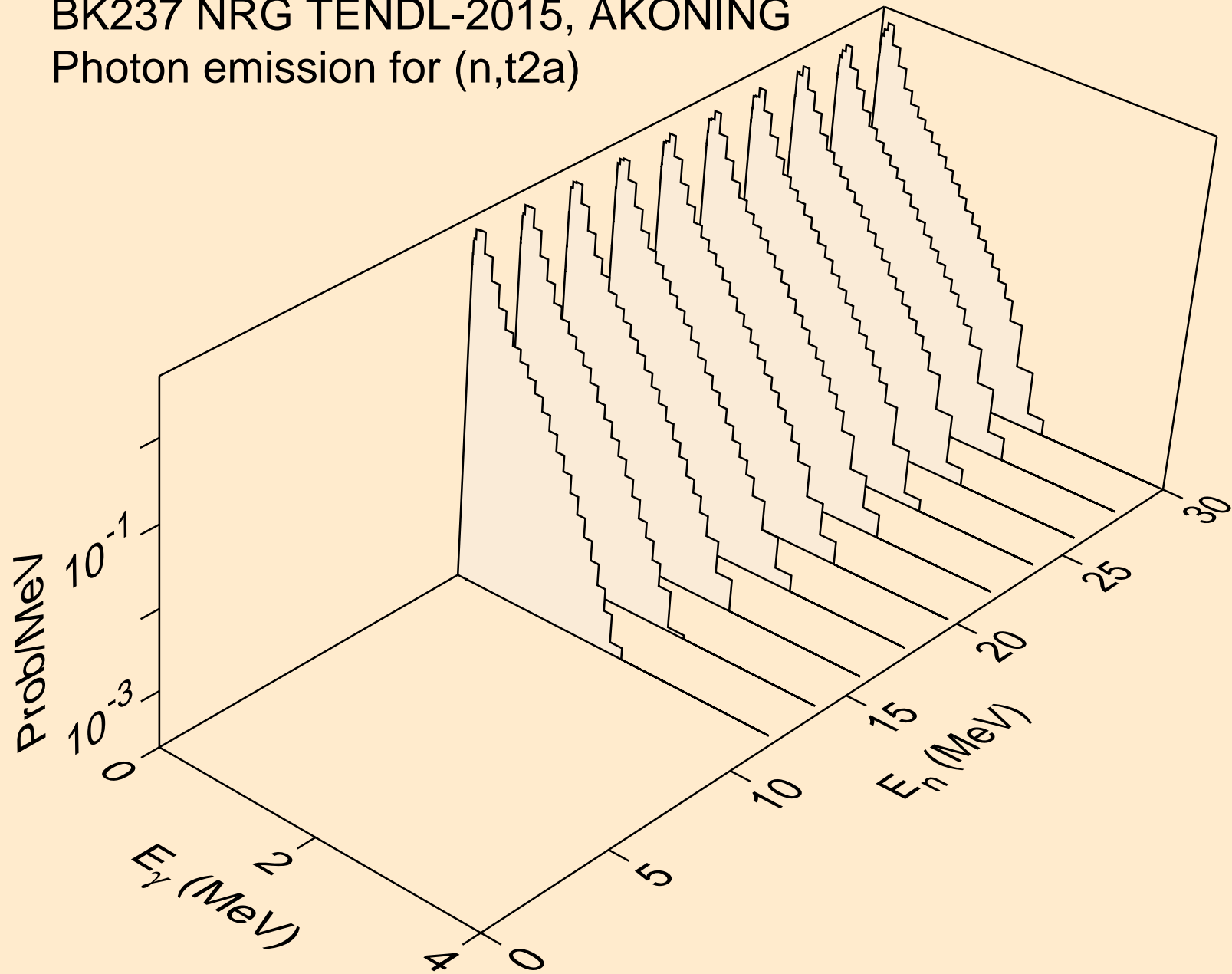

BK237 NRG TENDL-2015, AKONING
Photon emission for (n,d2a)

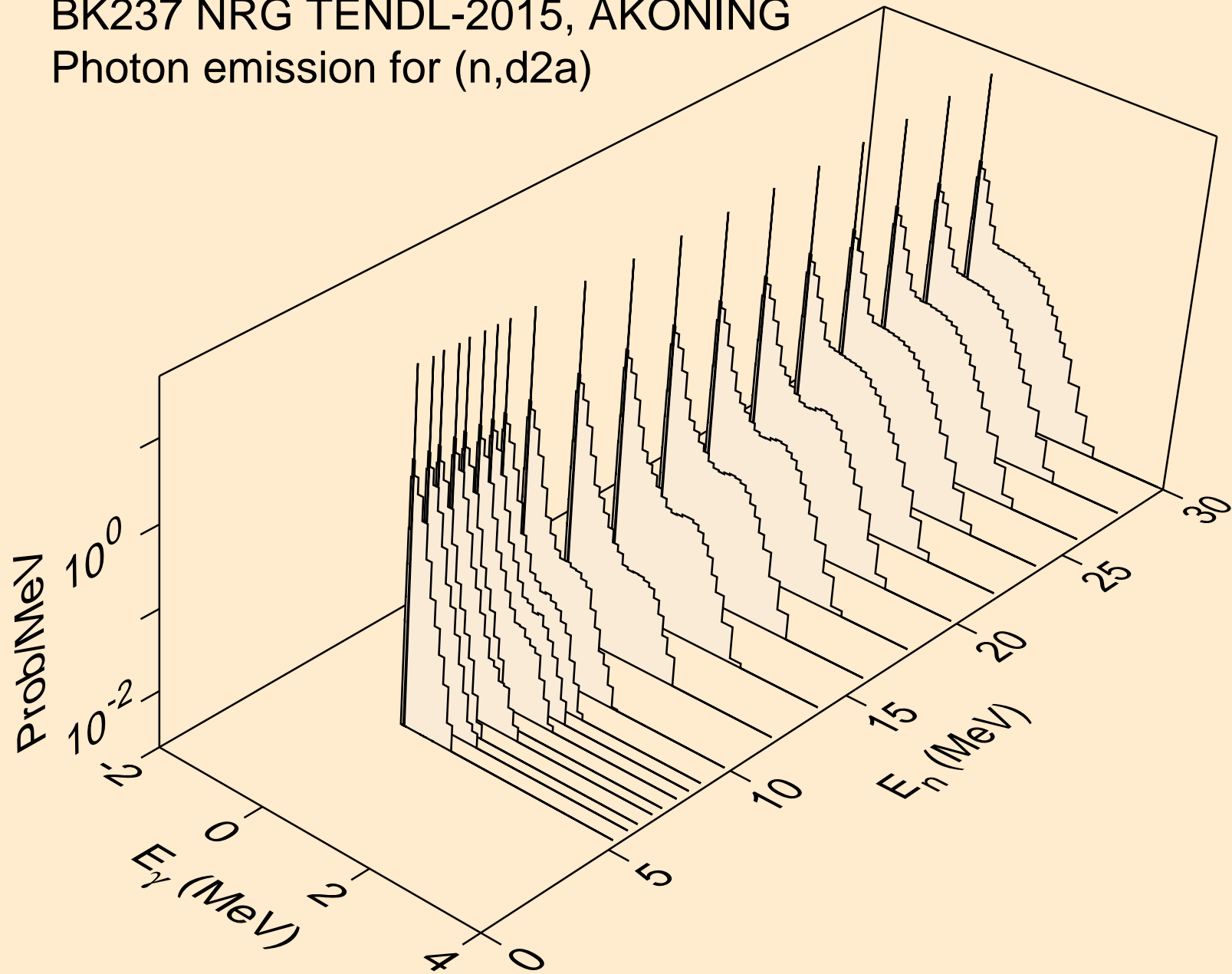

BK237 NRG TENDL-2015, AKONING
Photon emission for (n,pd)

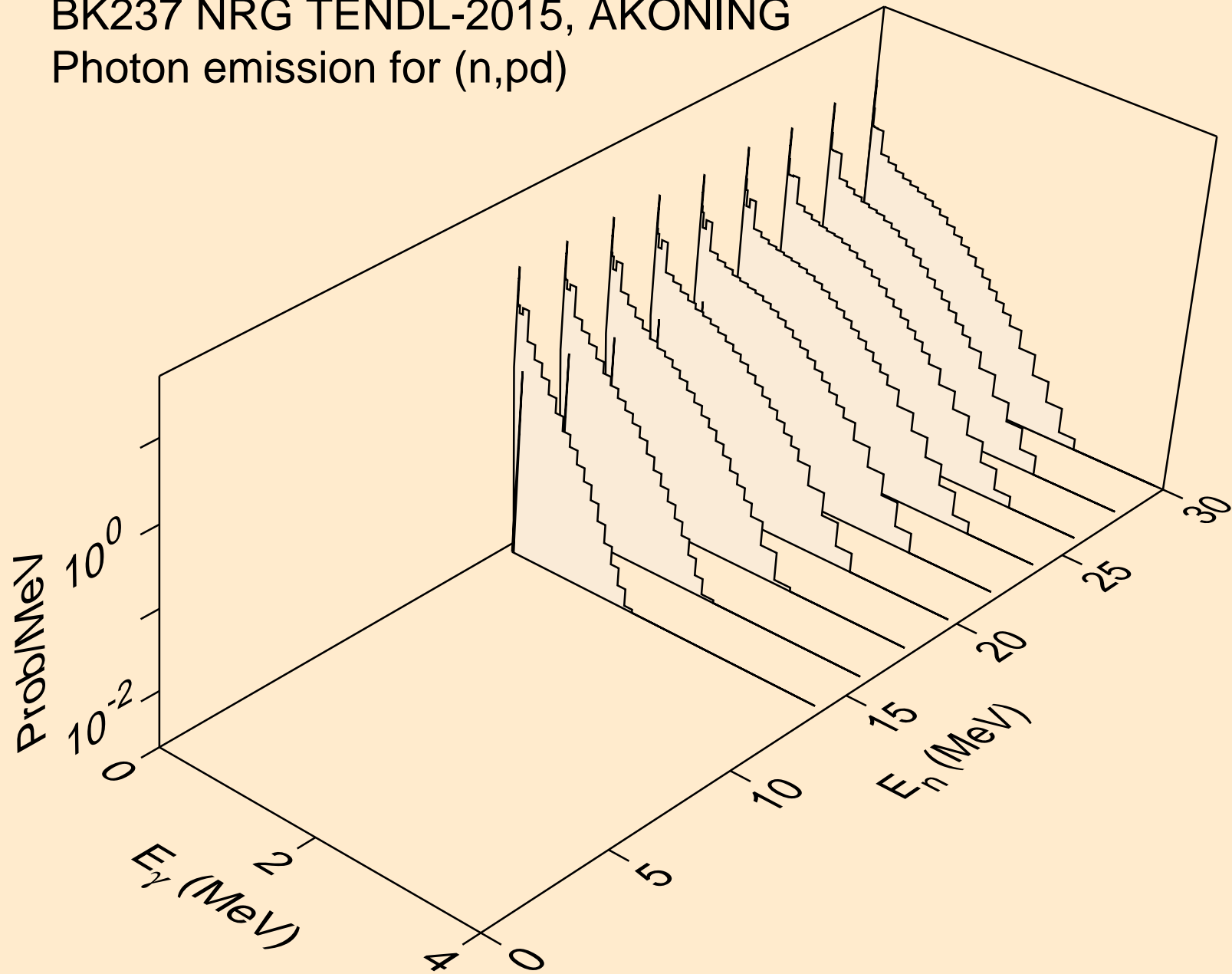

BK237 NRG TENDL-2015, AKONING
Photon emission for (n,da)

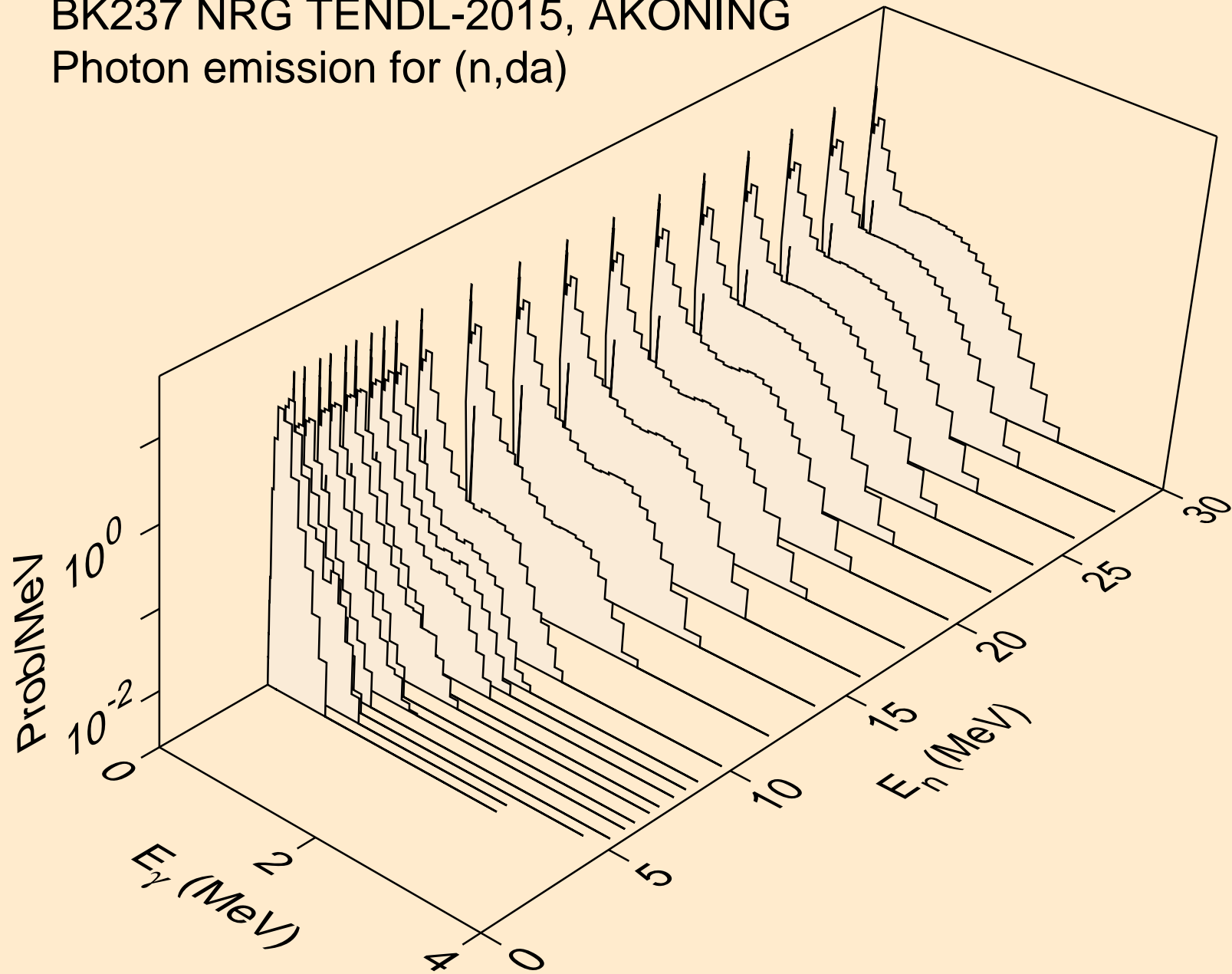

BK237 NRG TENDL-2015, AKONING
thermal capture photon spectrum

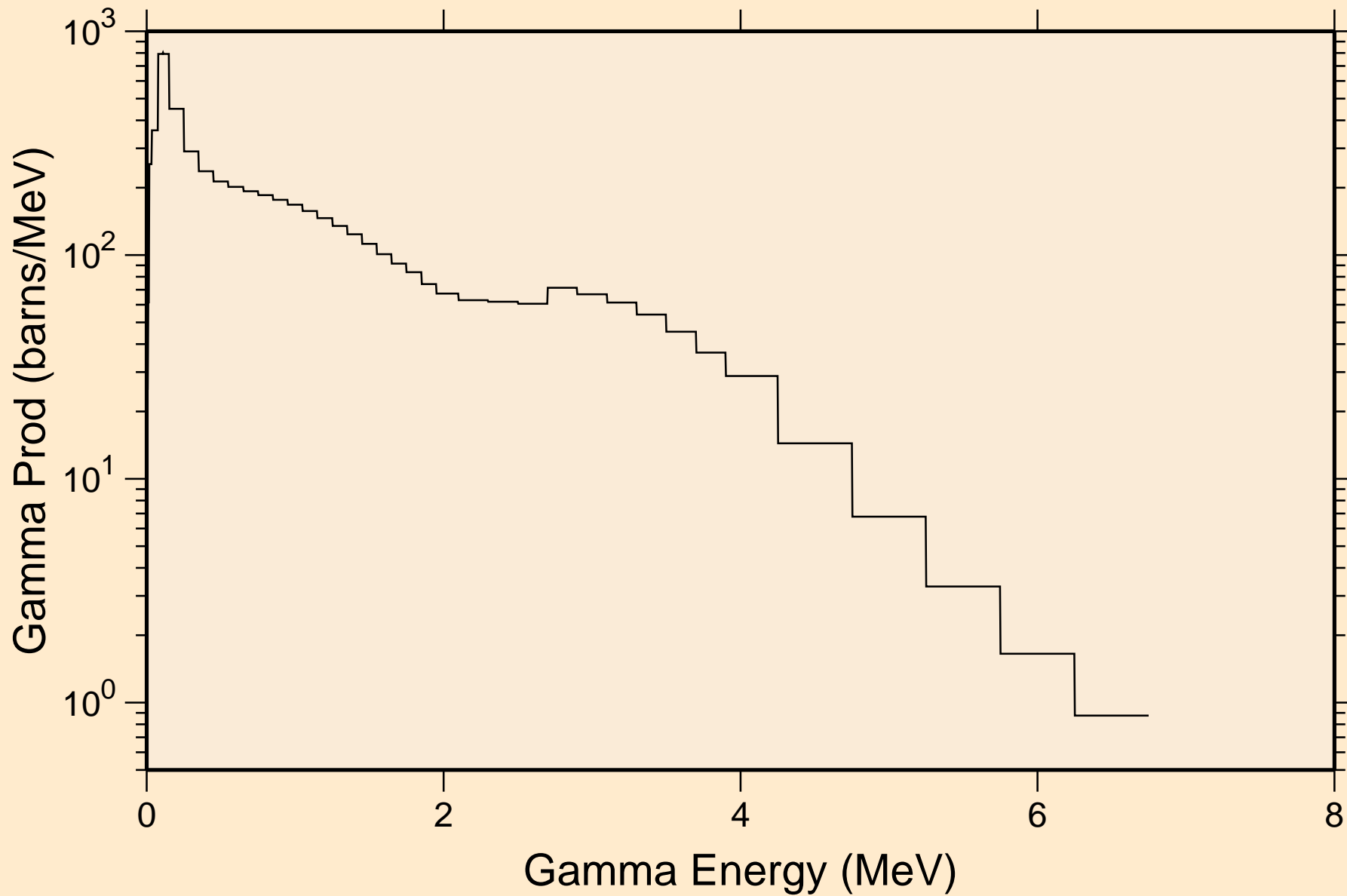

BK237 NRG TENDL-2015, AKONING
14 MeV photon spectrum

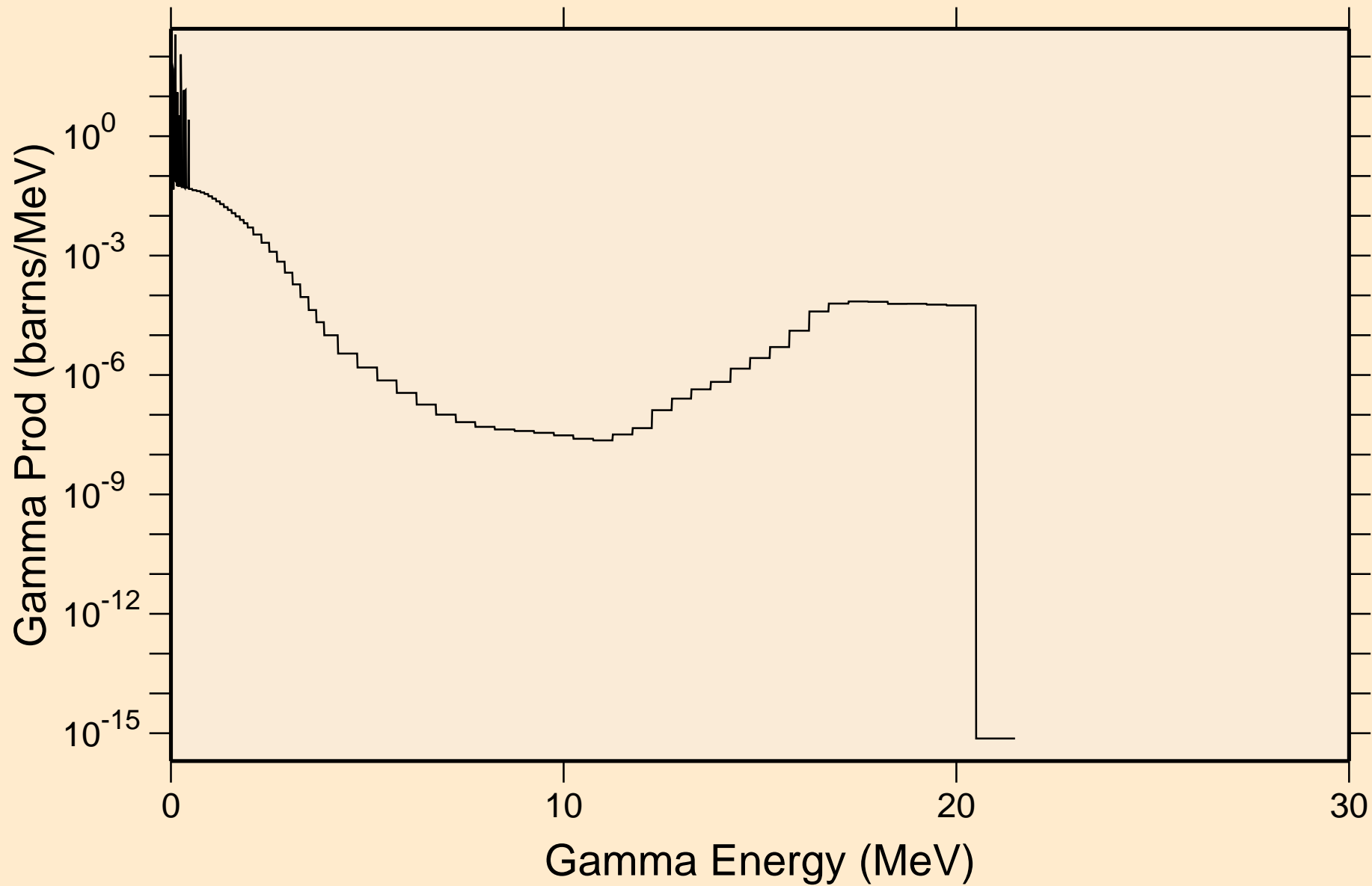

BK237 NRG TENDL-2015, AKONING

Particle heating contributions

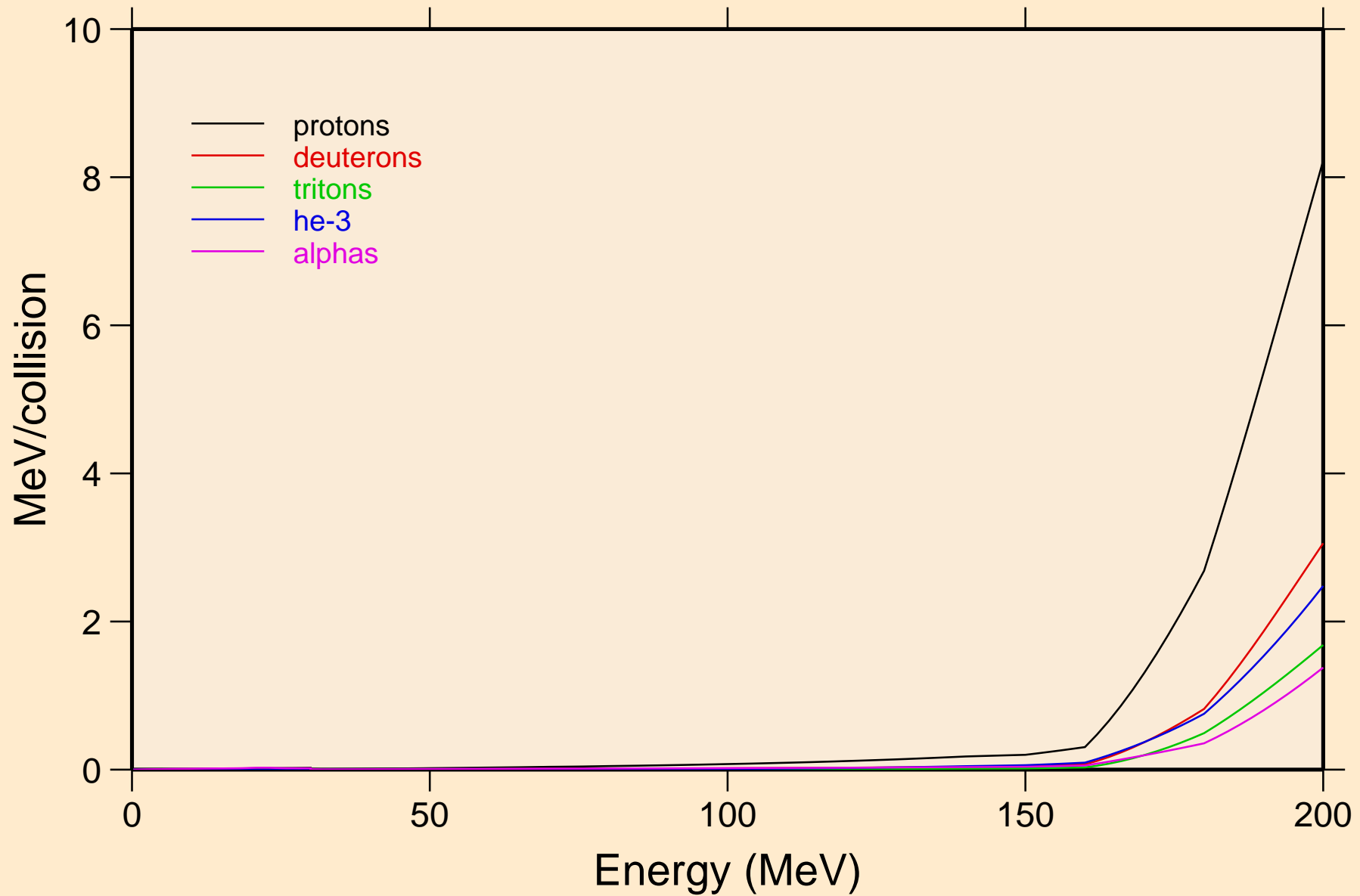

BK237 NRG TENDL-2015, AKONING

Recoil Heating

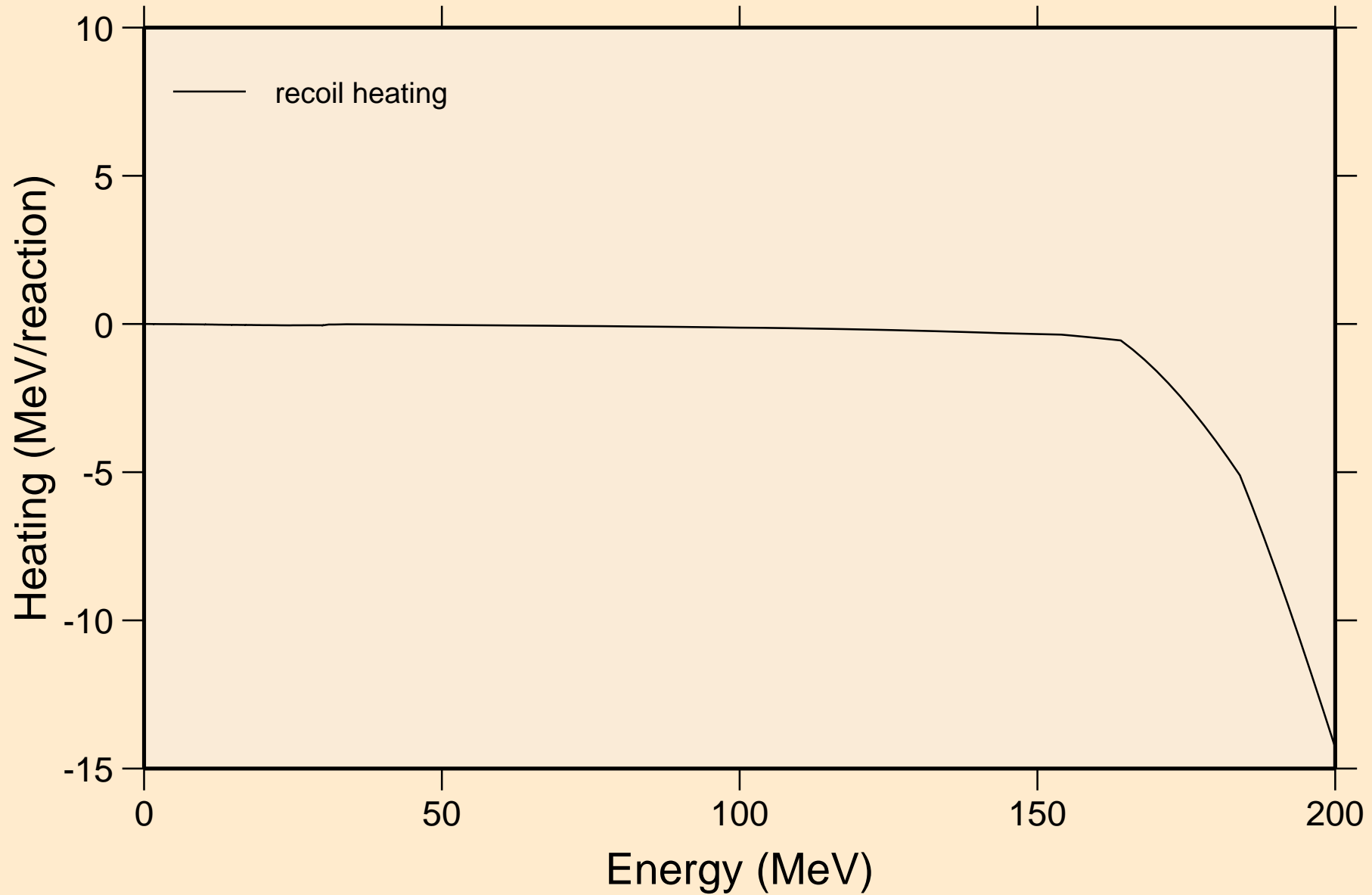

BK237 NRG TENDL-2015, AKONING

Particle production cross sections

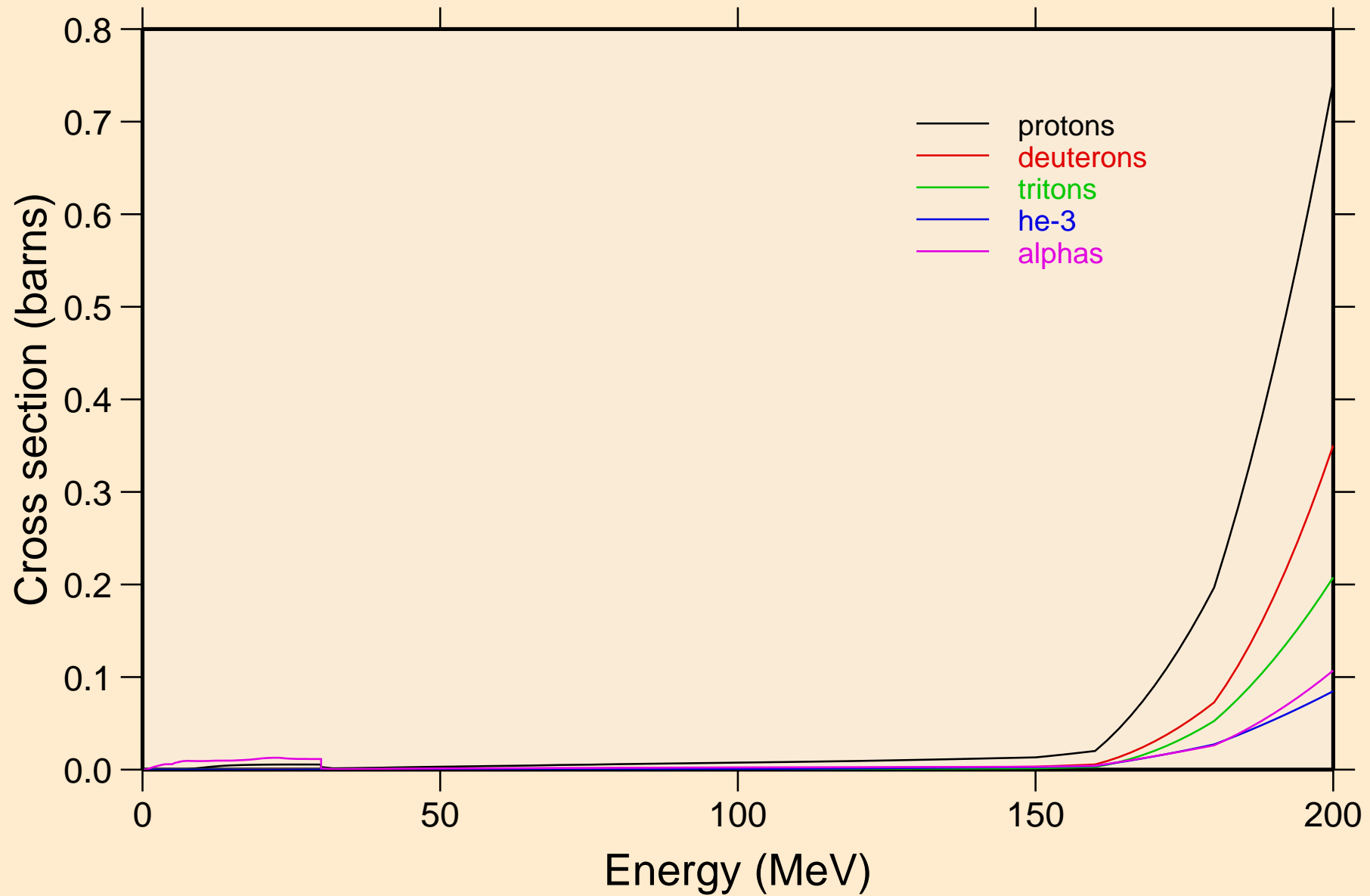

BK237 NRG TENDL-2015, AKONING
protons from (n,x)

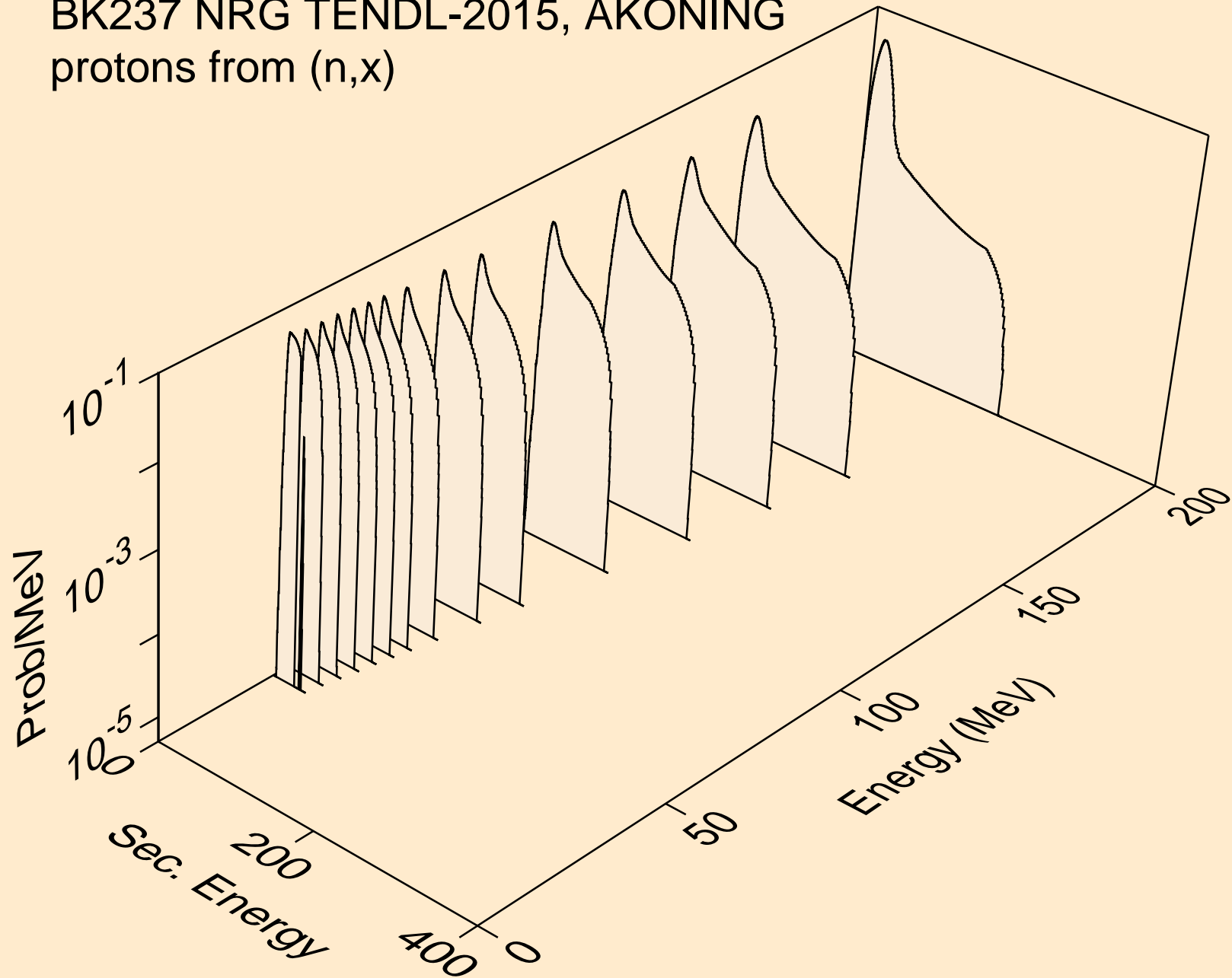

BK237 NRG TENDL-2015, AKONING
protons from (n,n*)p

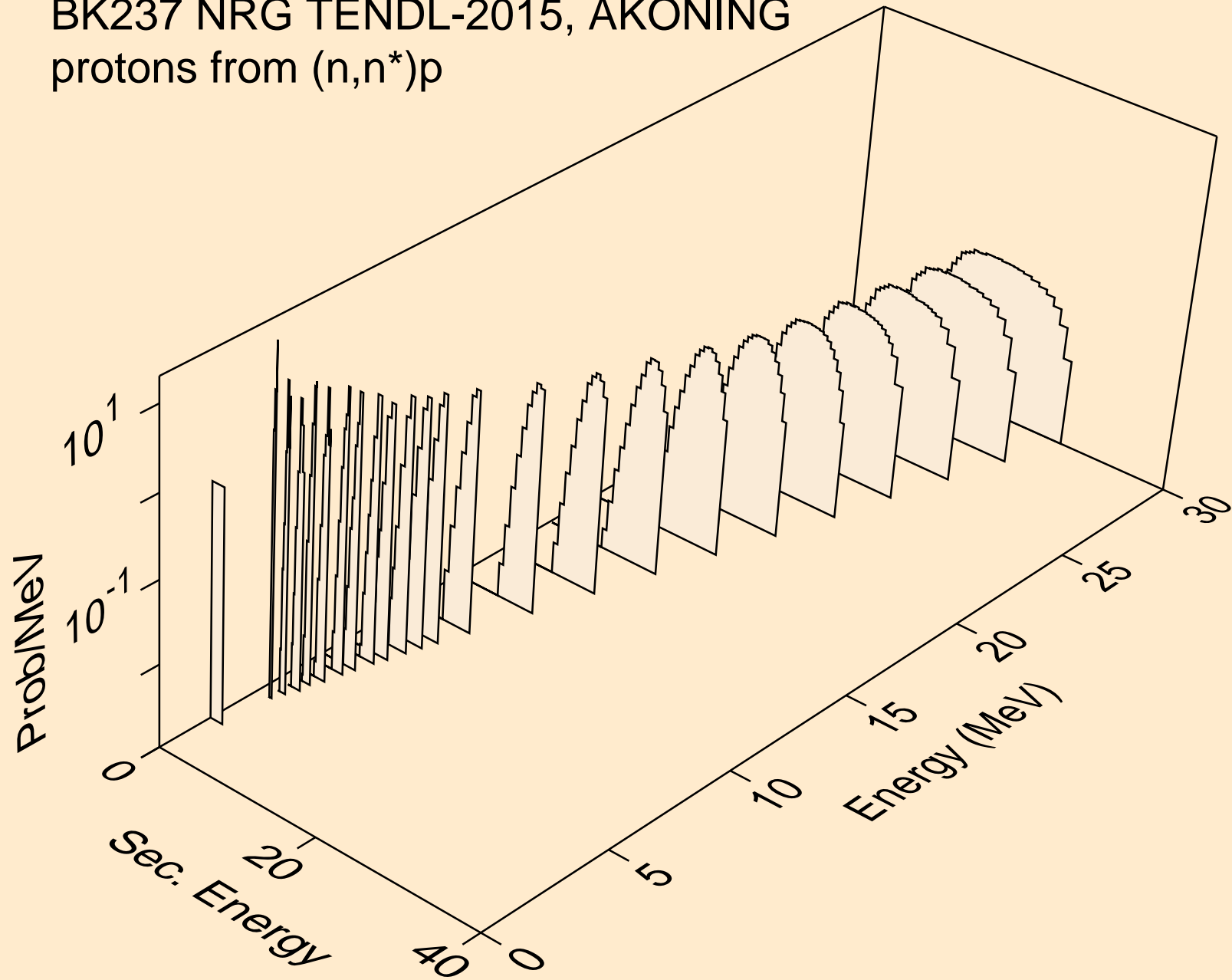

BK237 NRG TENDL-2015, AKONING
protons from (n,2np)

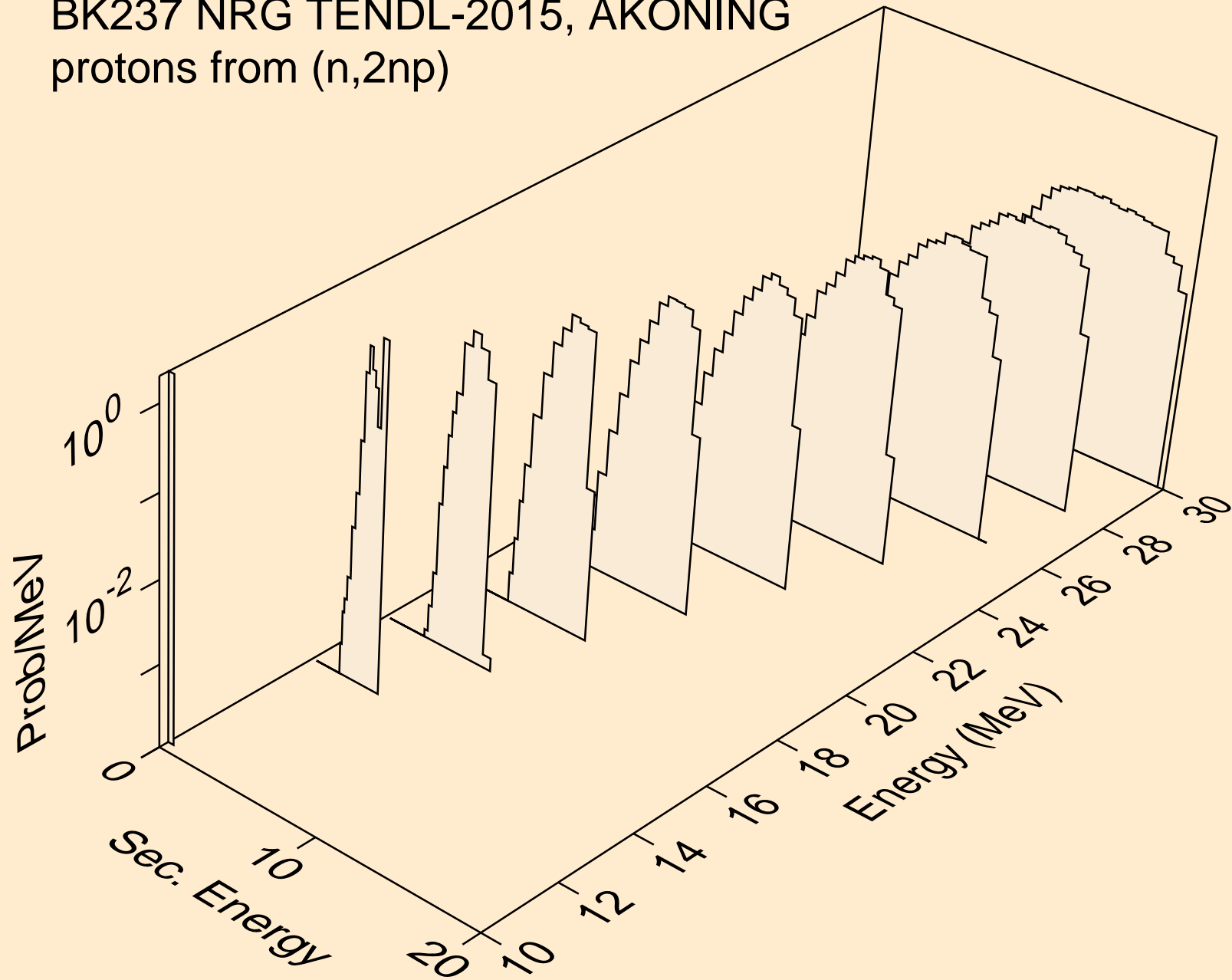

BK237 NRG TENDL-2015, AKONING
protons from (n,3np)

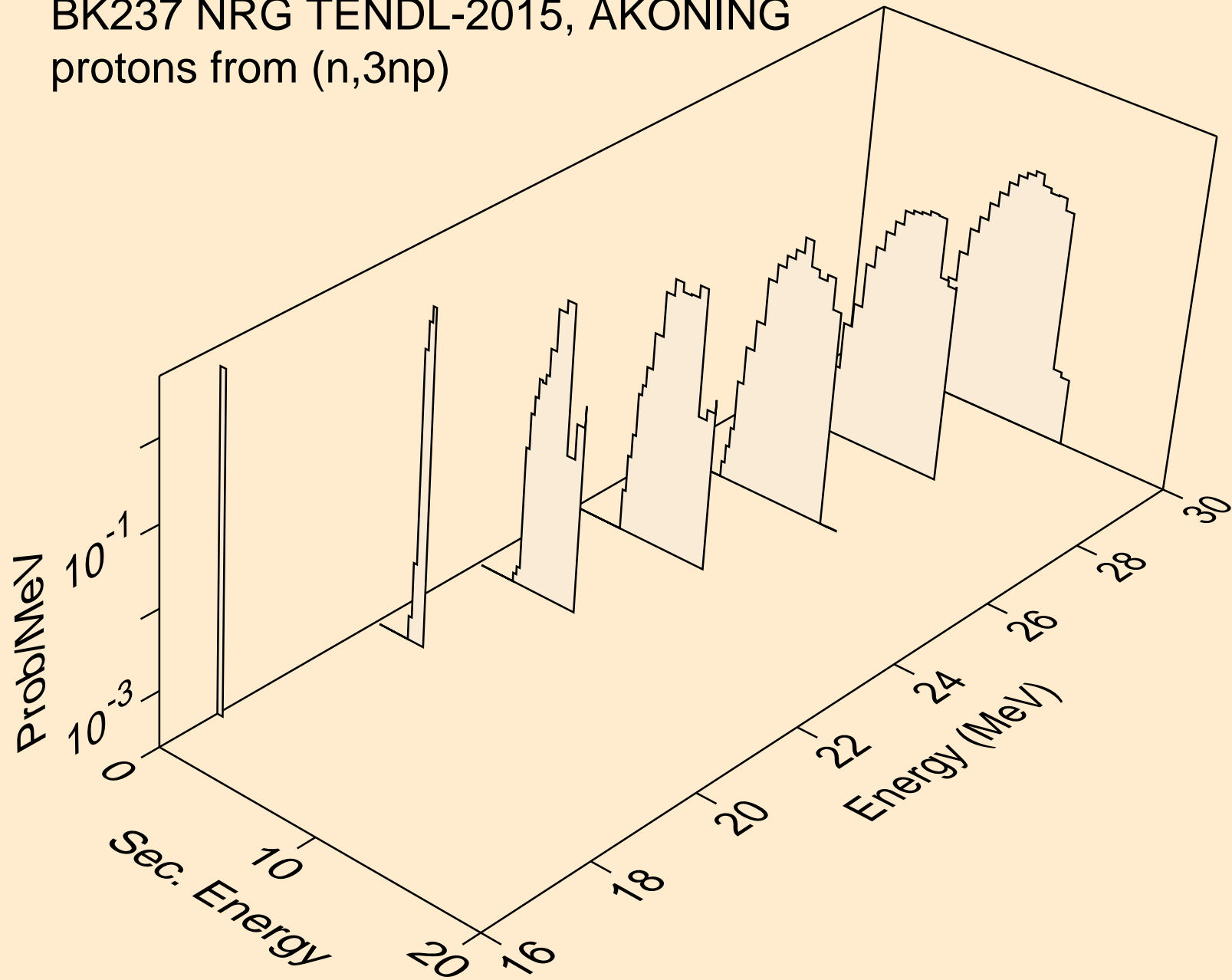

BK237 NRG TENDL-2015, AKONING
protons from (n,2np)

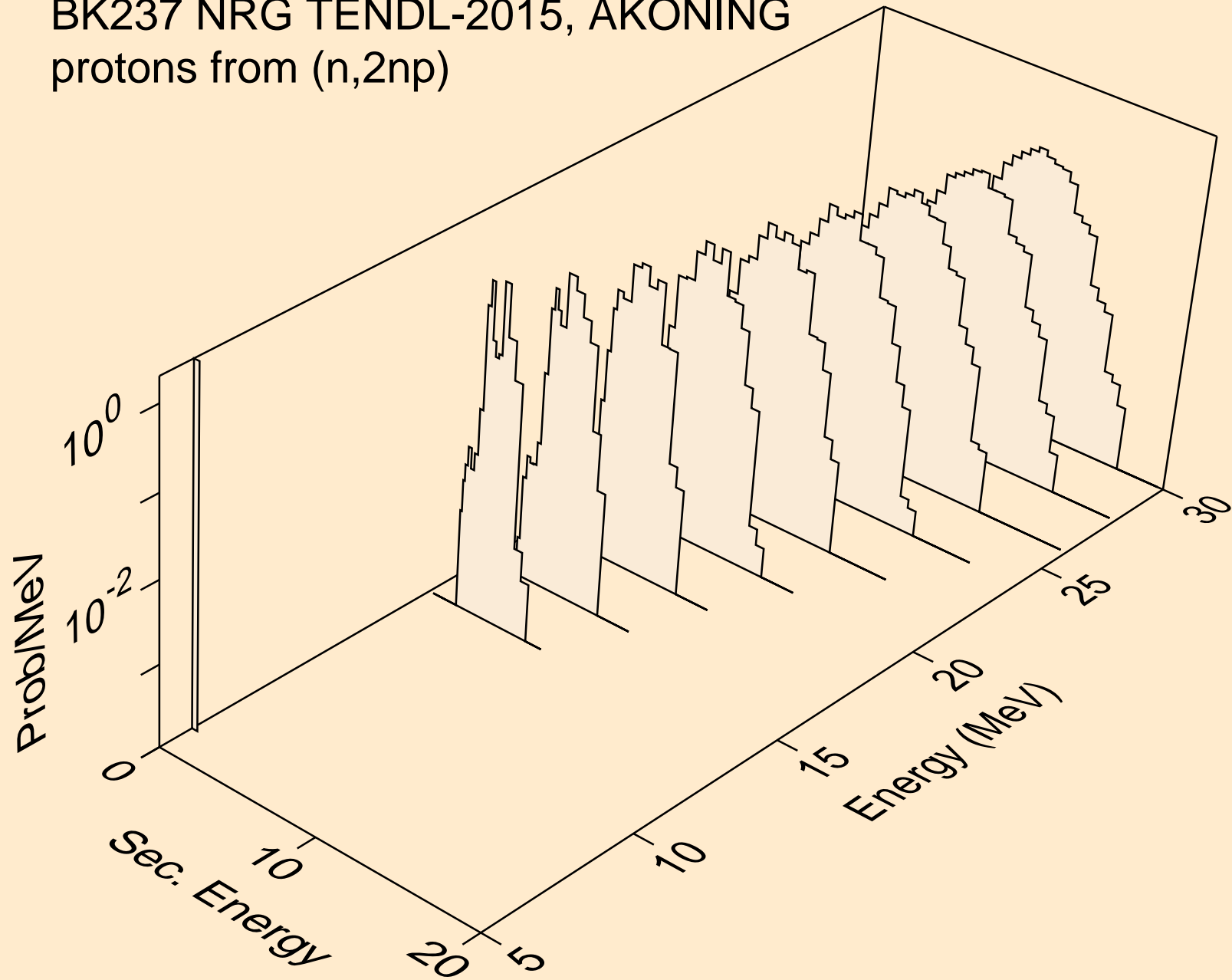

BK237 NRG TENDL-2015, AKONING
protons from (n,npa)

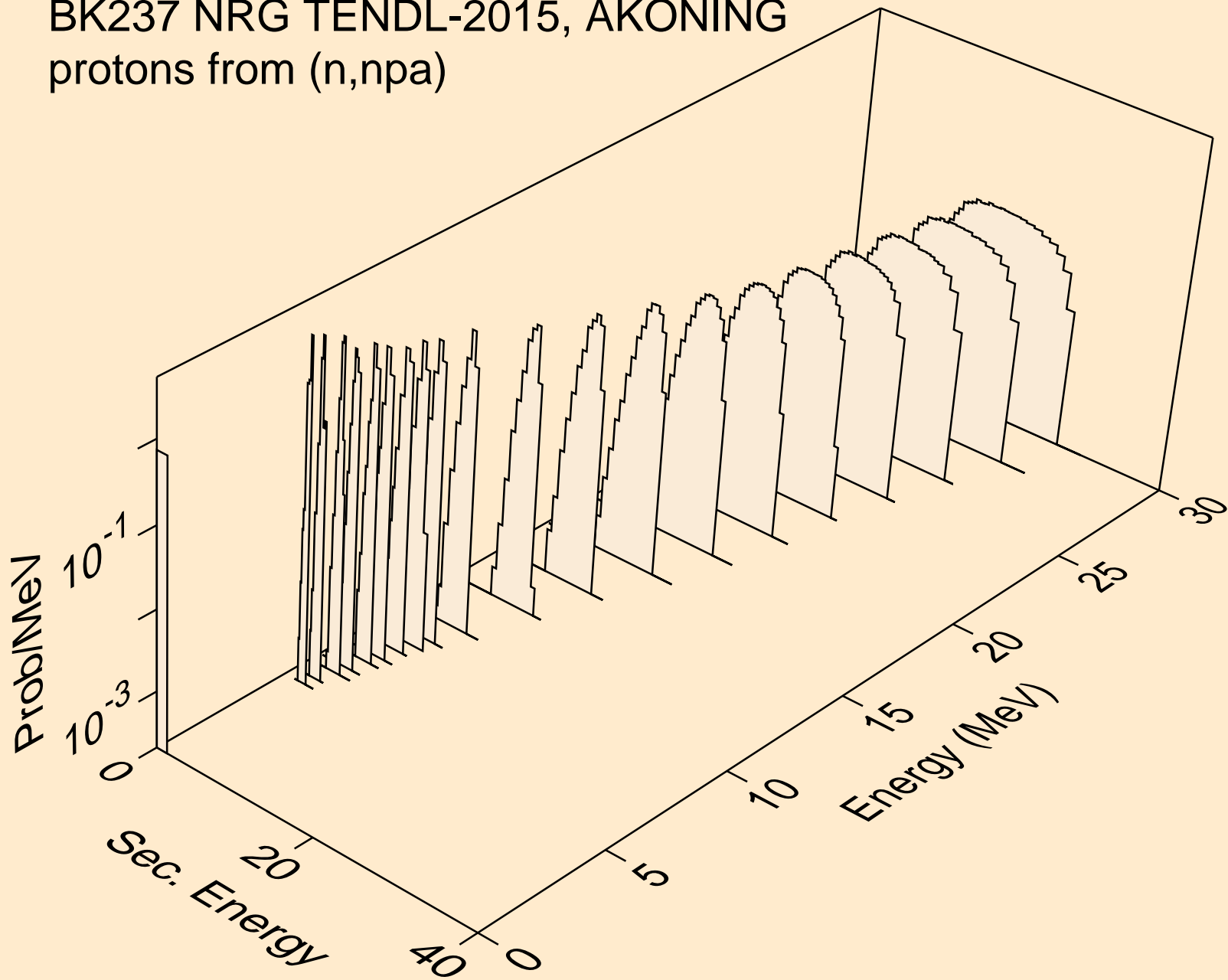

BK237 NRG TENDL-2015, AKONING
protons from (n,p)

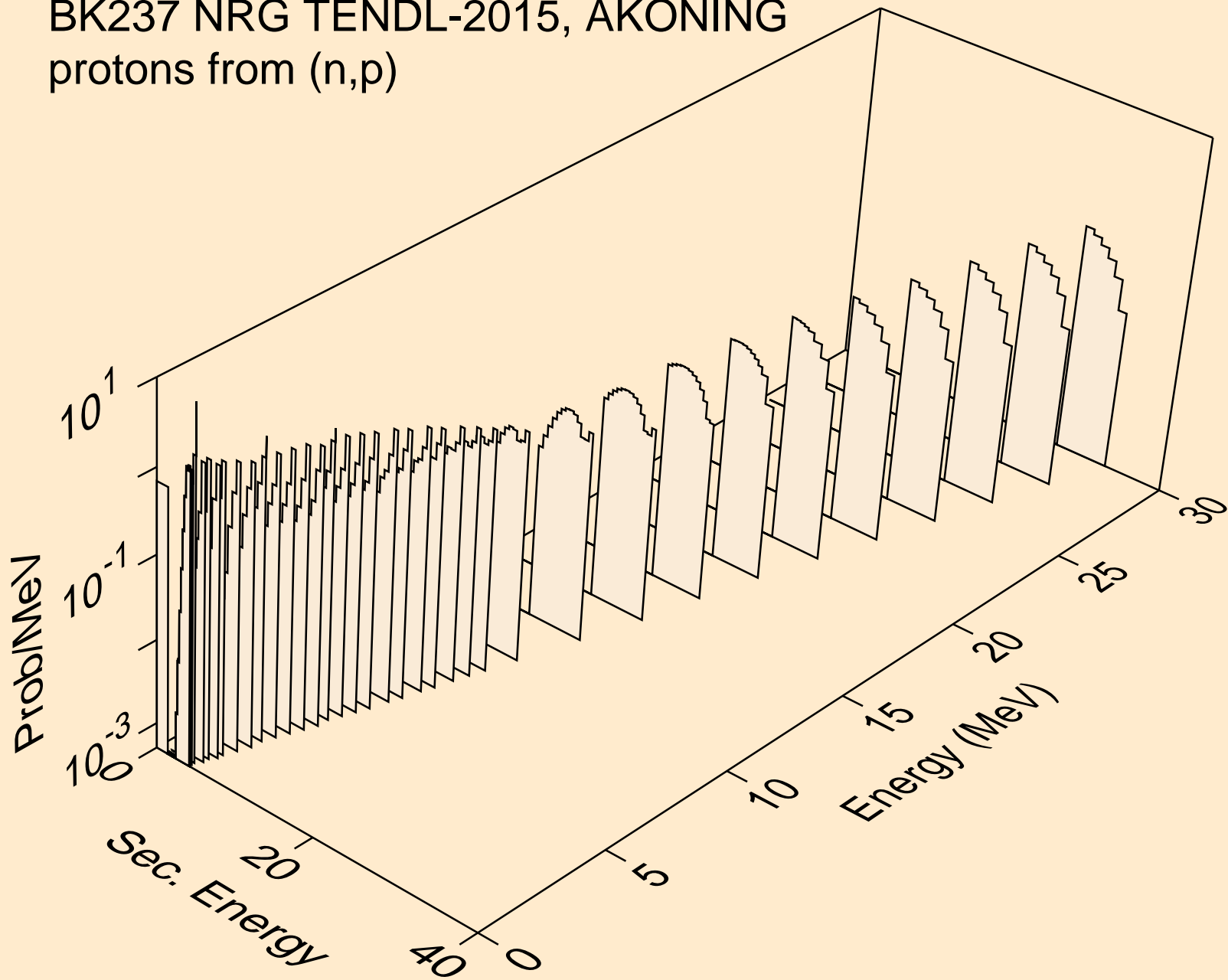

BK237 NRG TENDL-2015, AKONING
protons from (n,2p)

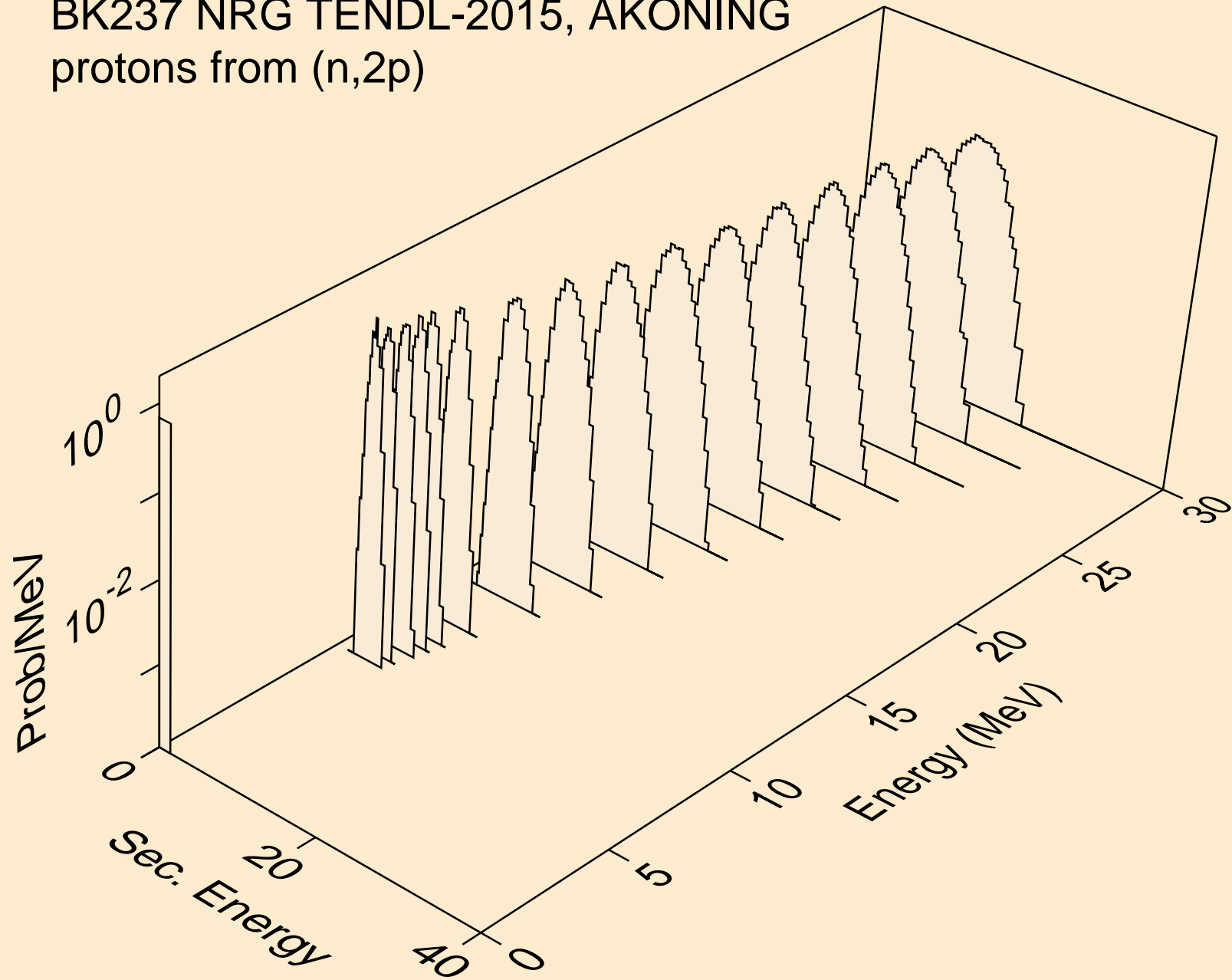

BK237 NRG TENDL-2015, AKONING
protons from (n,pa)

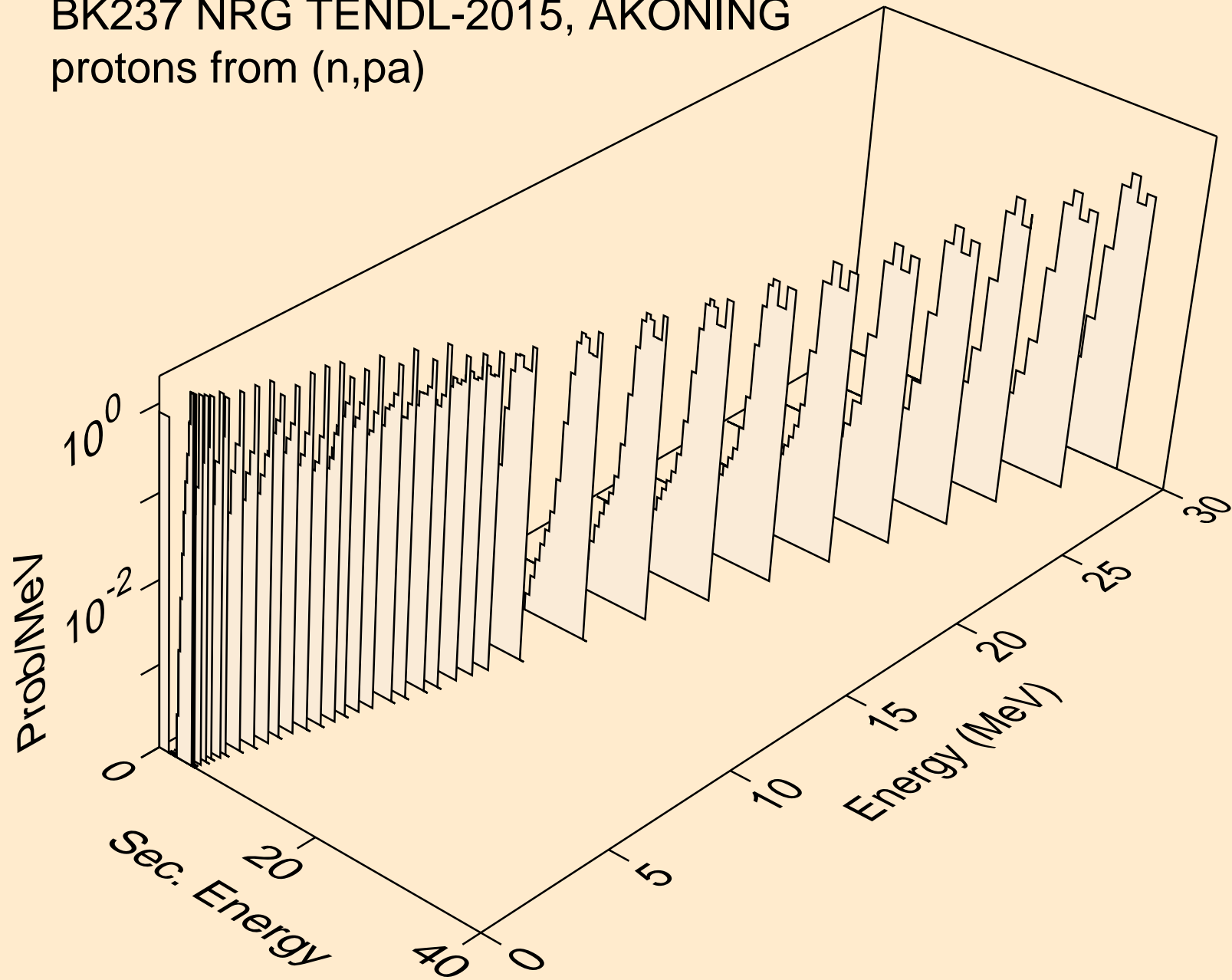

BK237 NRG TENDL-2015, AKONING
protons from (n,pd)

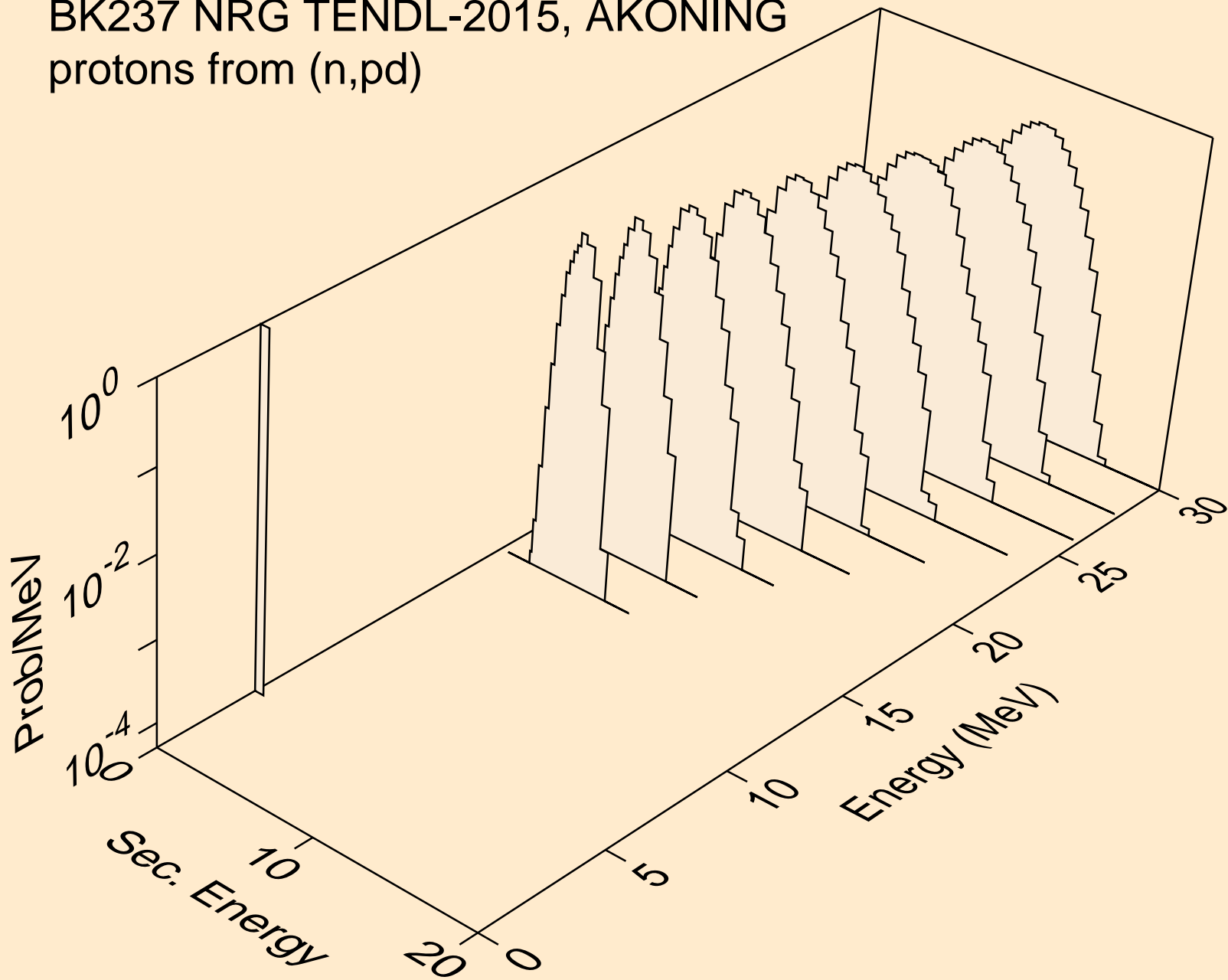

BK237 NRG TENDL-2015, AKONING
deuterons from (n,x)

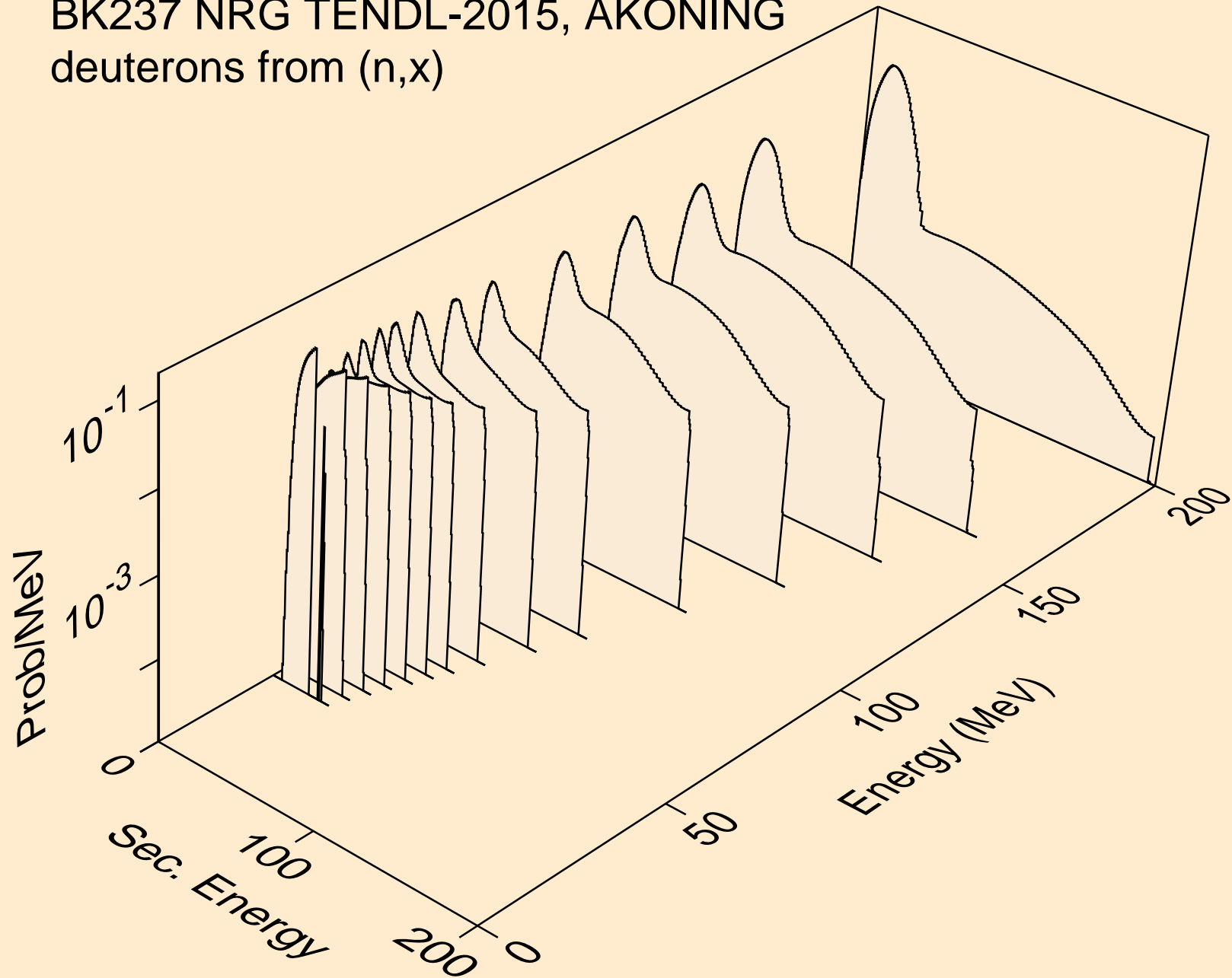

BK237 NRG TENDL-2015, AKONING
deuterons from (n,2nd)

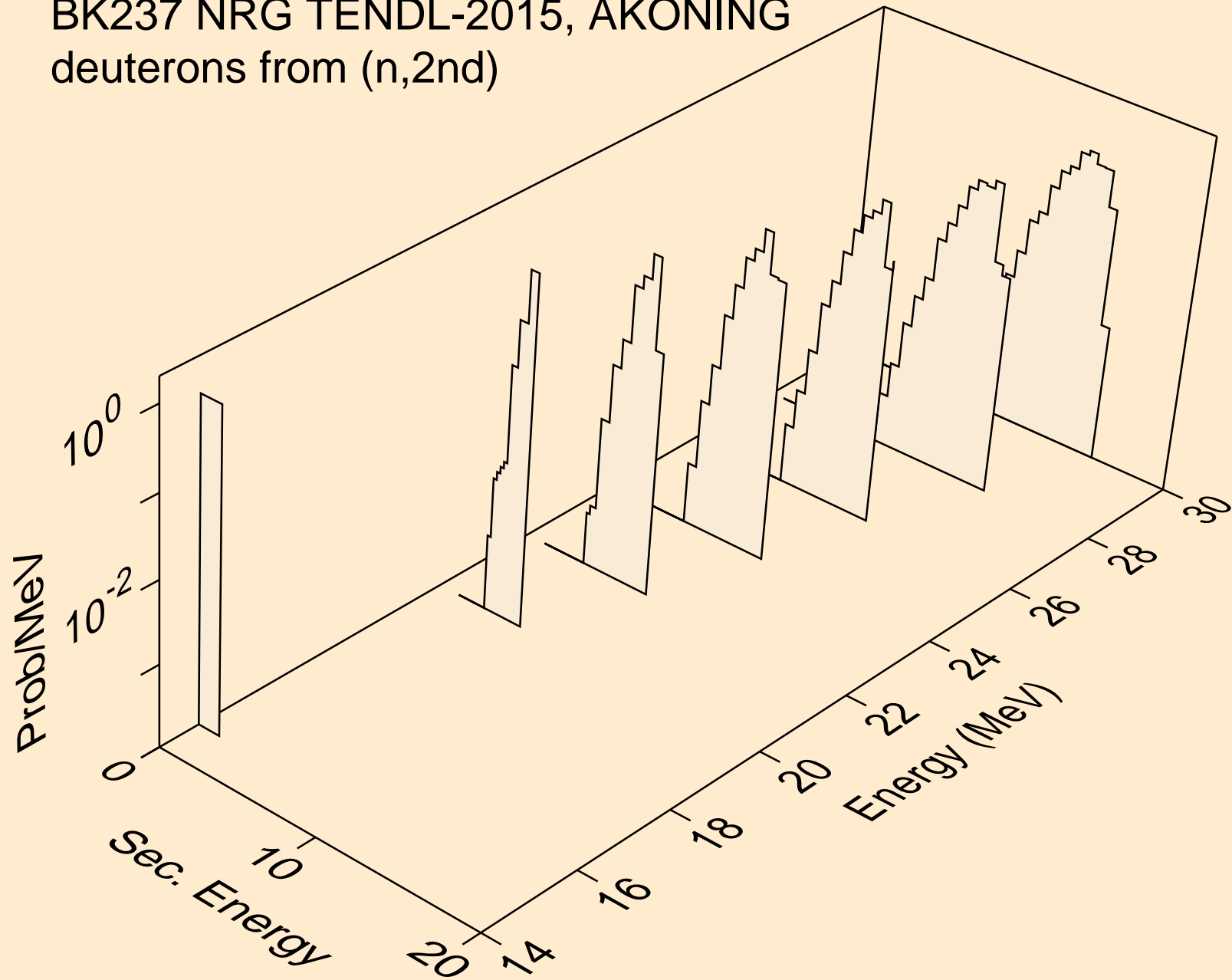

BK237 NRG TENDL-2015, AKONING
deuterons from (n,n*)d

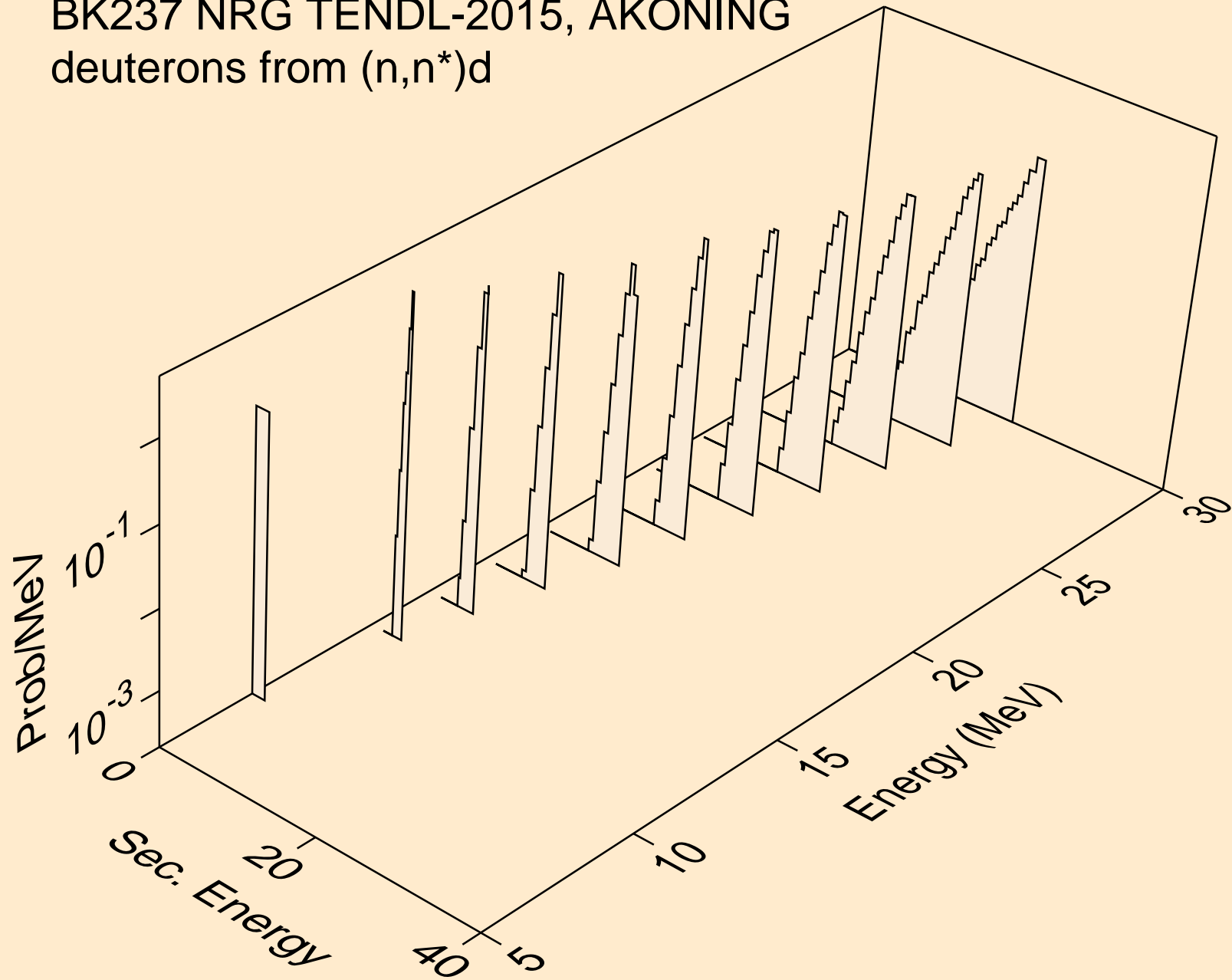

BK237 NRG TENDL-2015, AKONING
deuterons from (n,d)

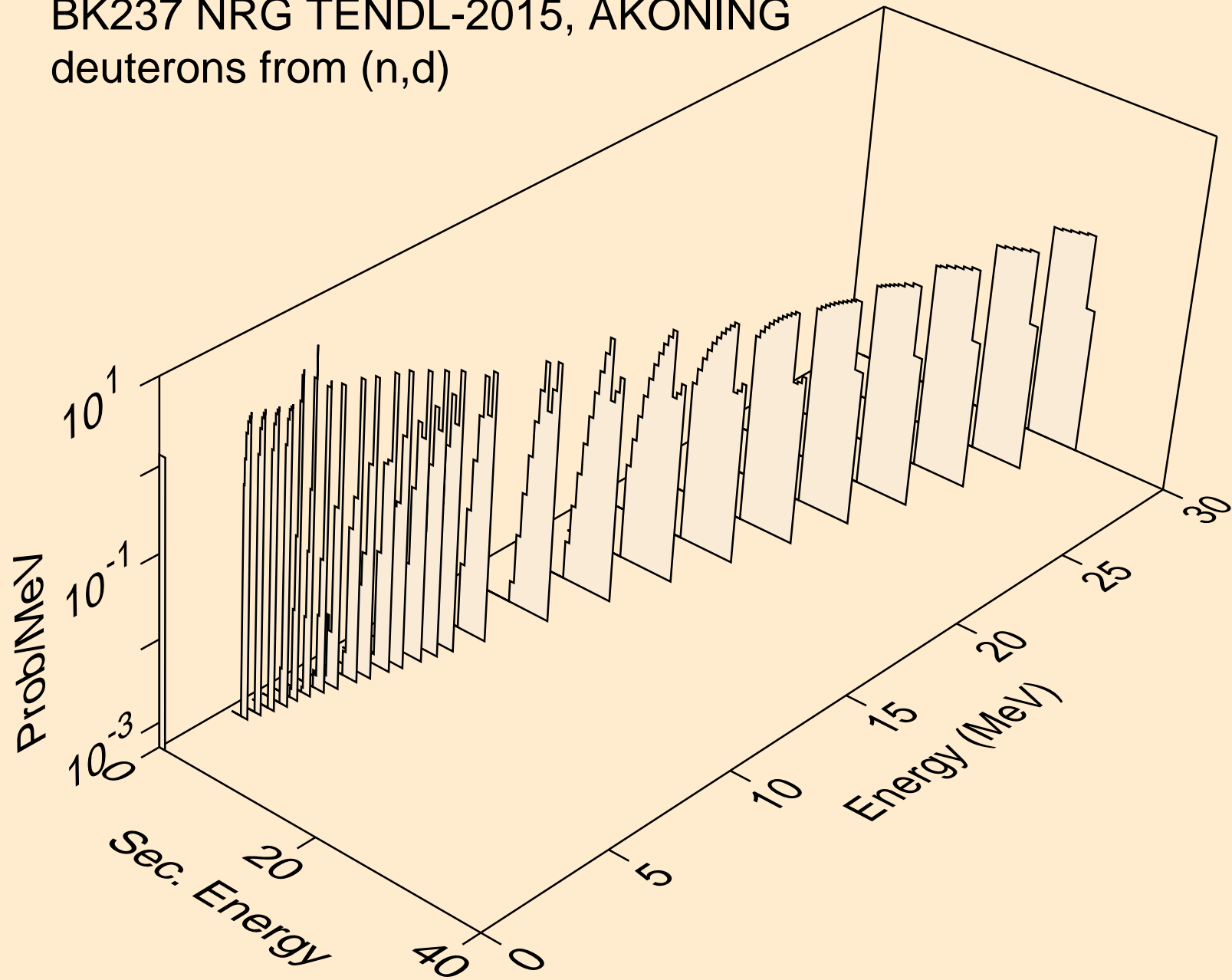

BK237 NRG TENDL-2015, AKONING
deuterons from (n,d2a)

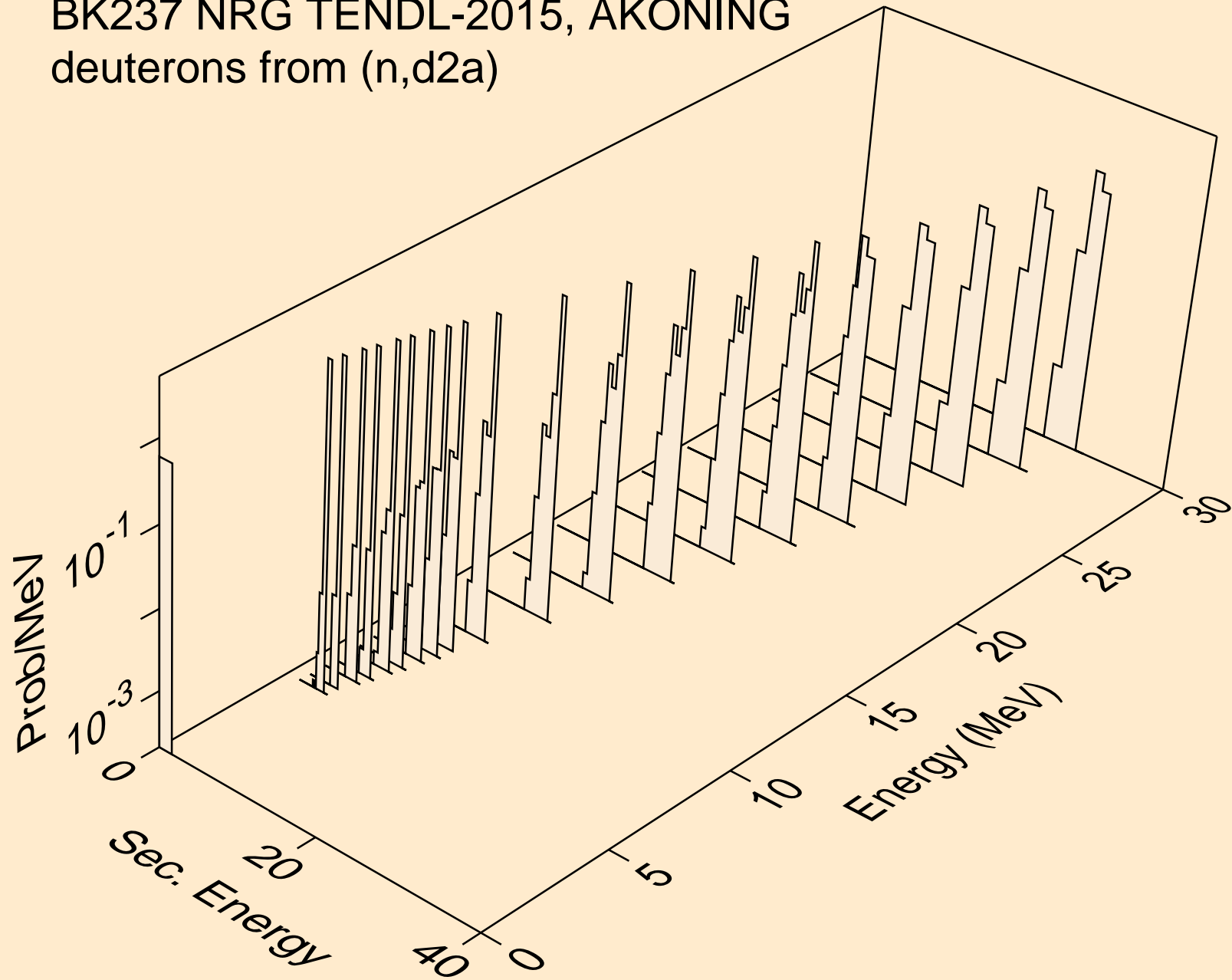

BK237 NRG TENDL-2015, AKONING
deuterons from (n,pd)

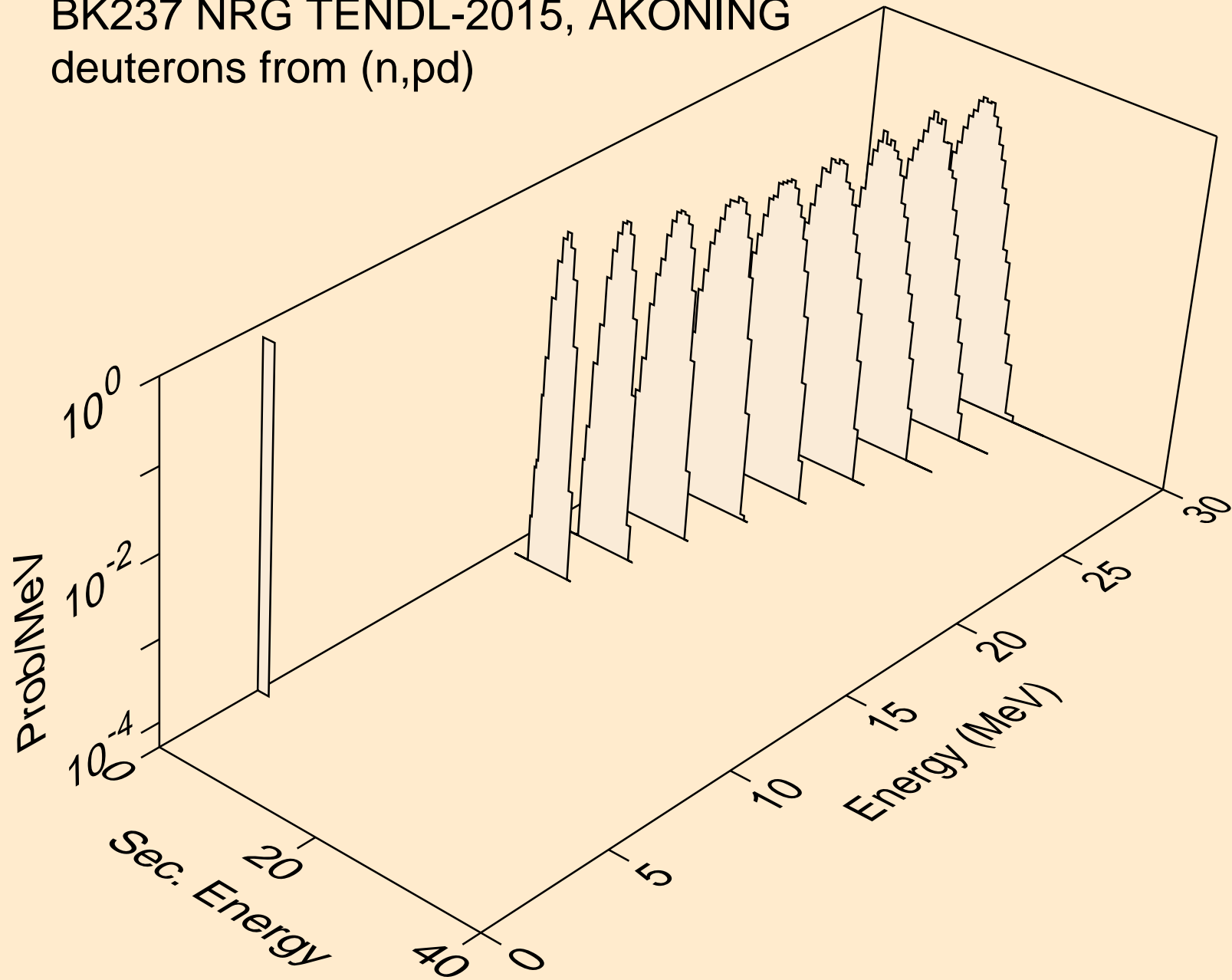

BK237 NRG TENDL-2015, AKONING
deuterons from (n,da)

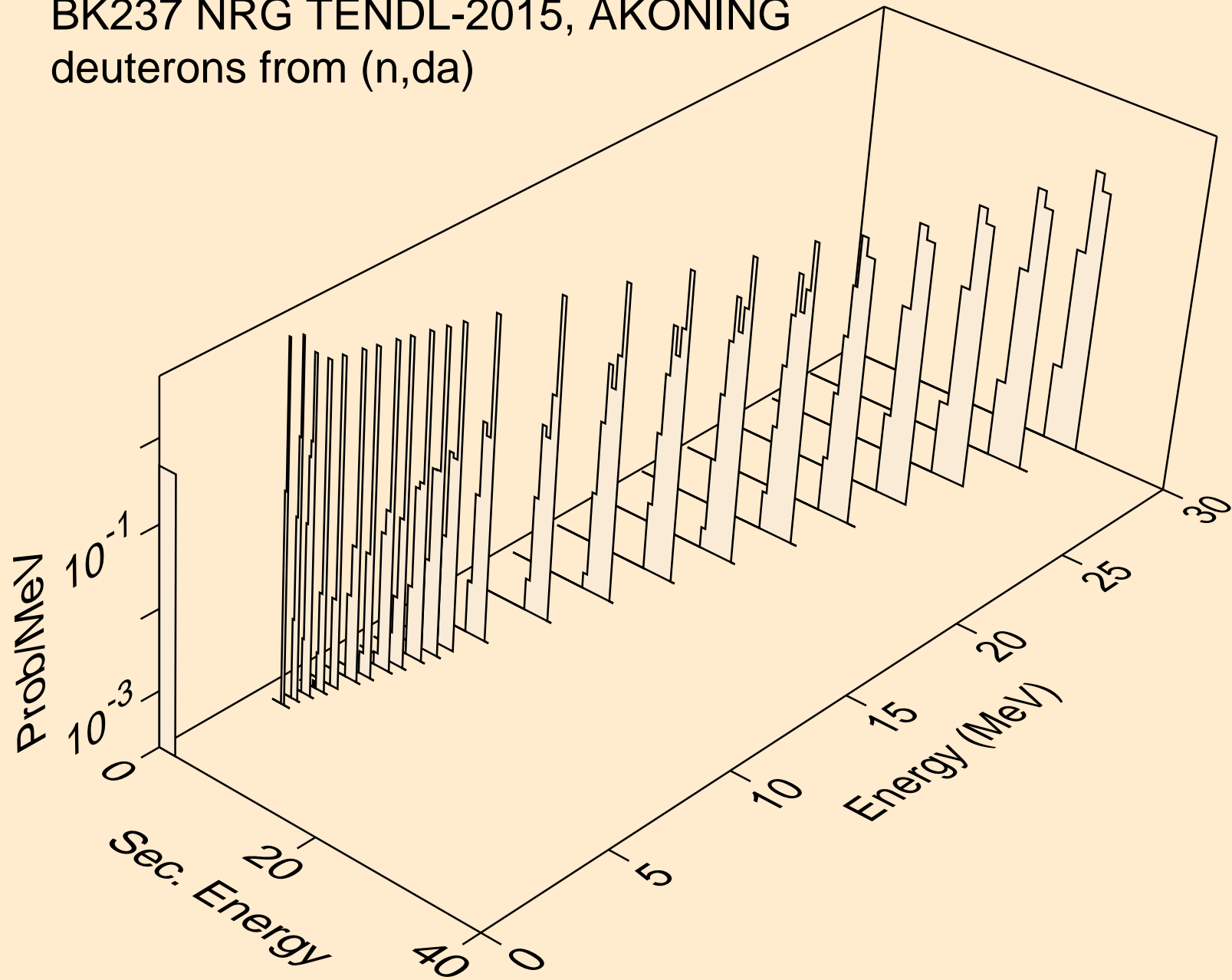

BK237 NRG TENDL-2015, AKONING
tritons from (n,x)

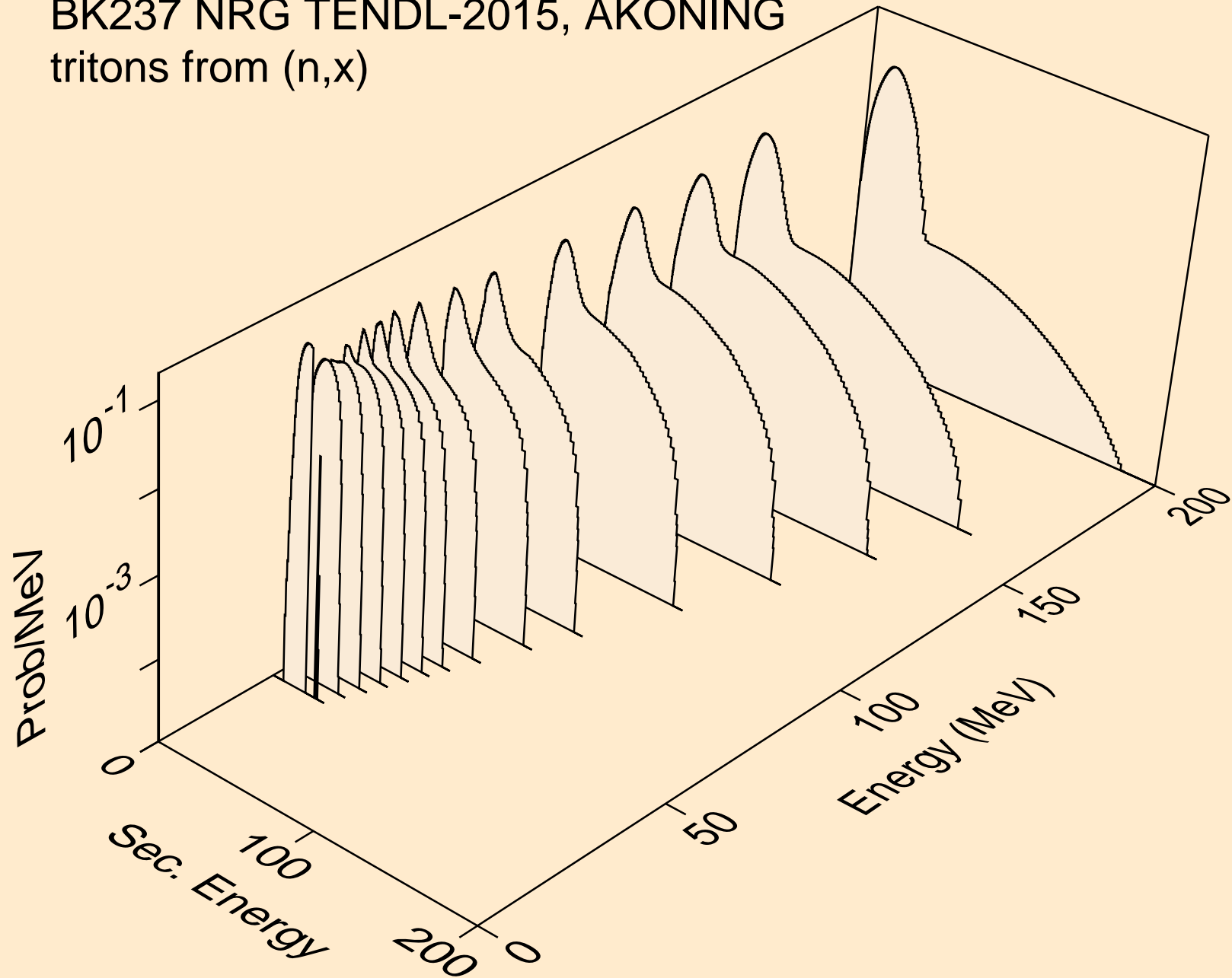

BK237 NRG TENDL-2015, AKONING
tritons from (n,n*)t

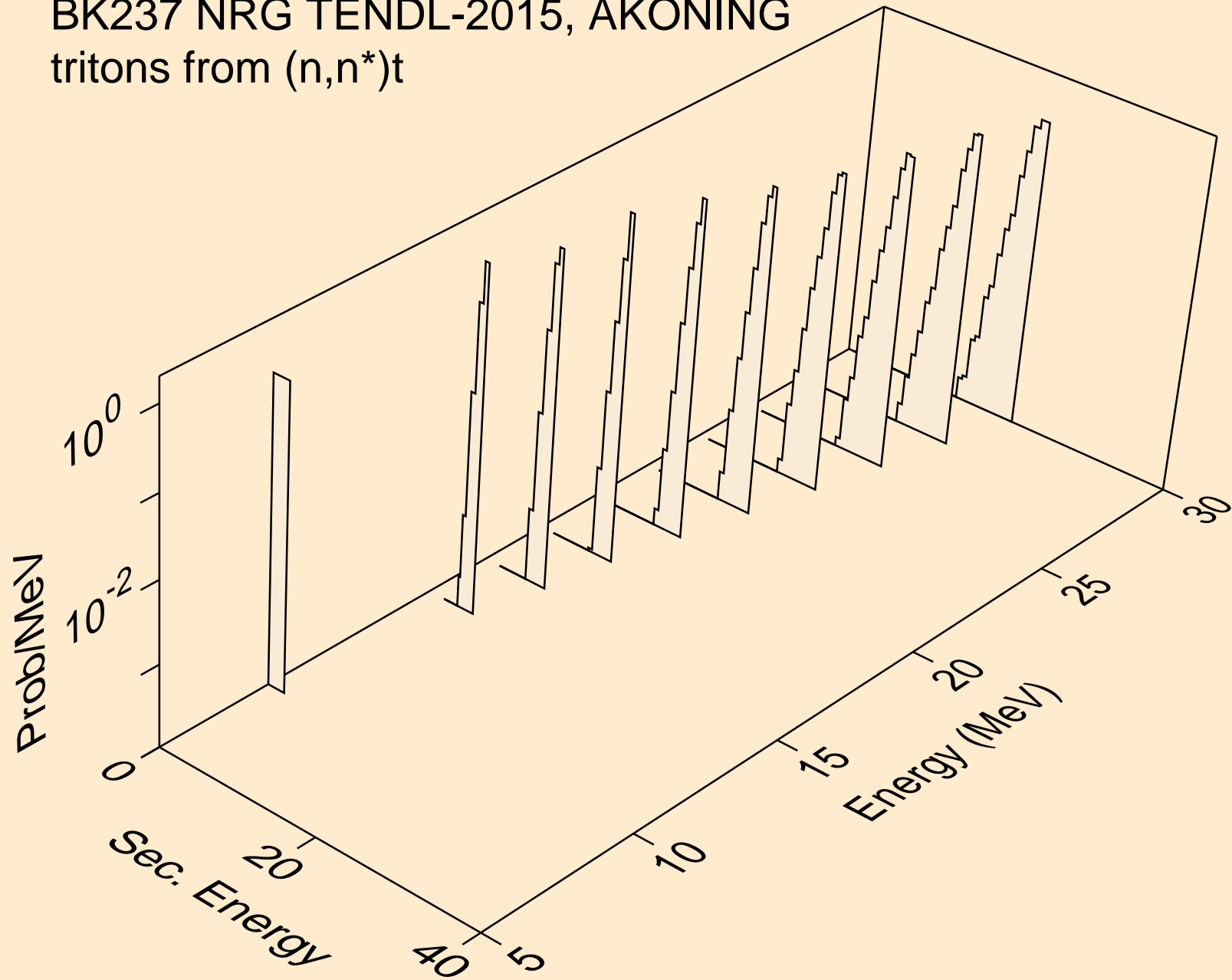

BK237 NRG TENDL-2015, AKONING
tritons from (n,n*)t2a

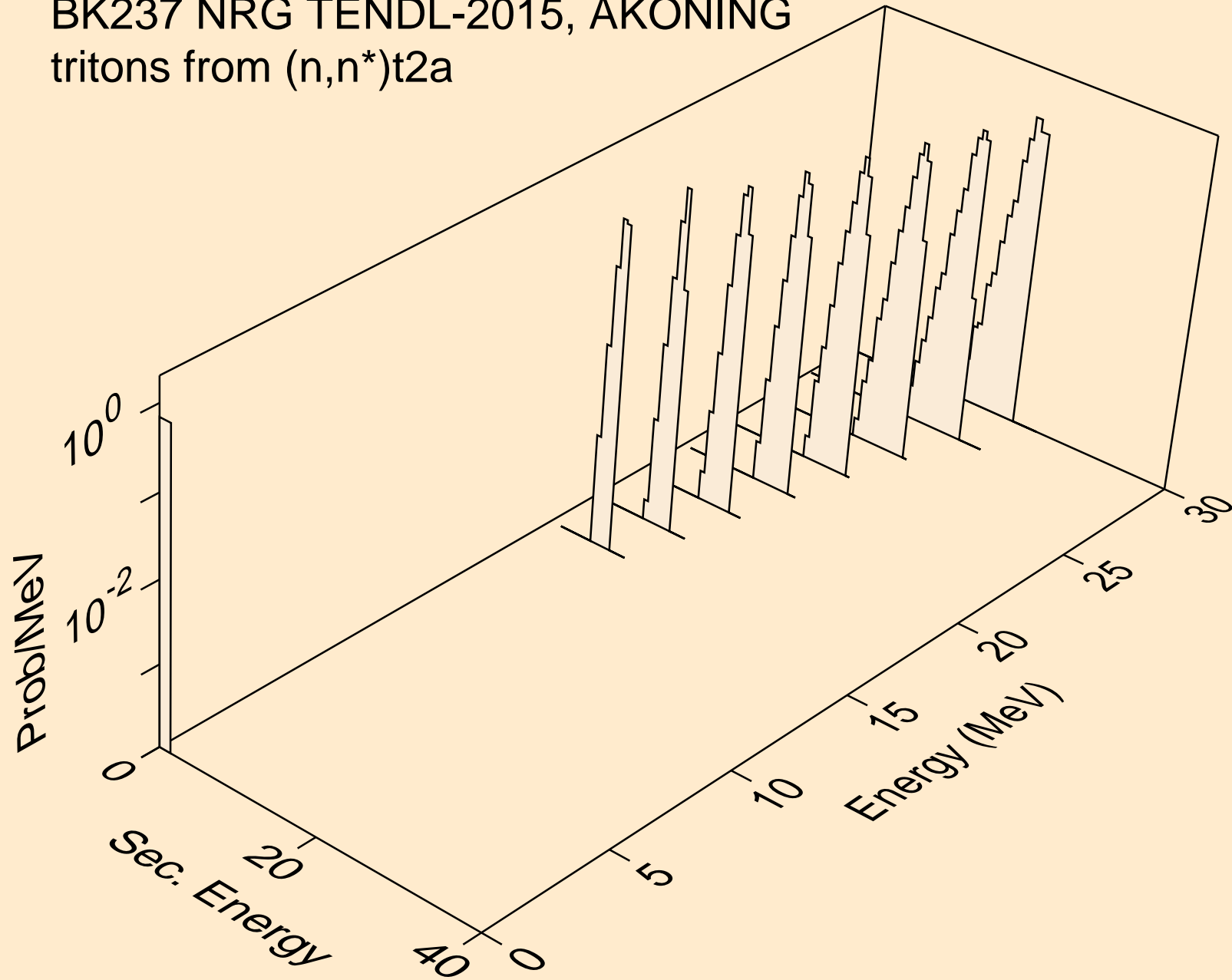

BK237 NRG TENDL-2015, AKONING
tritons from (n,t)

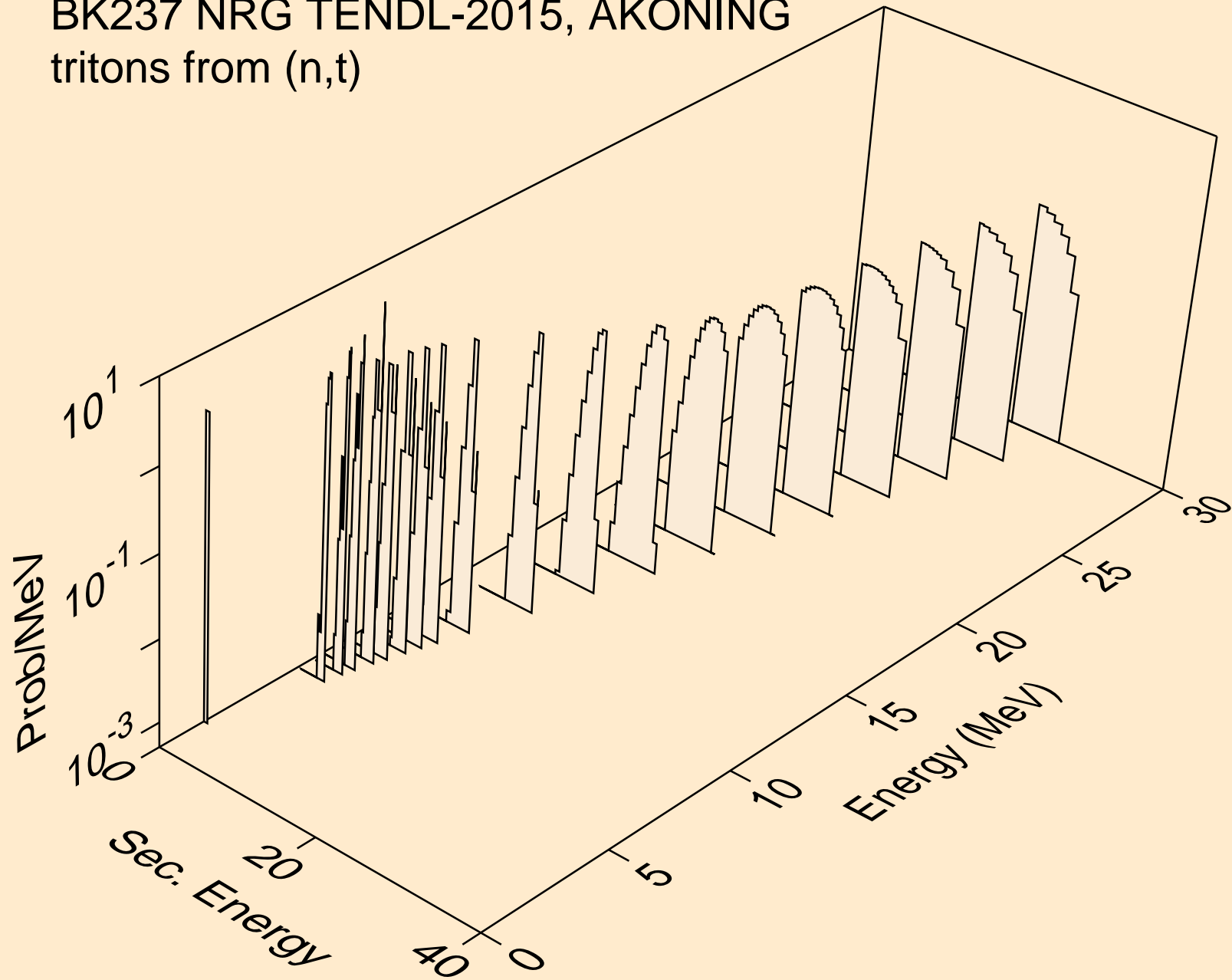

BK237 NRG TENDL-2015, AKONING
tritons from (n,t2a)

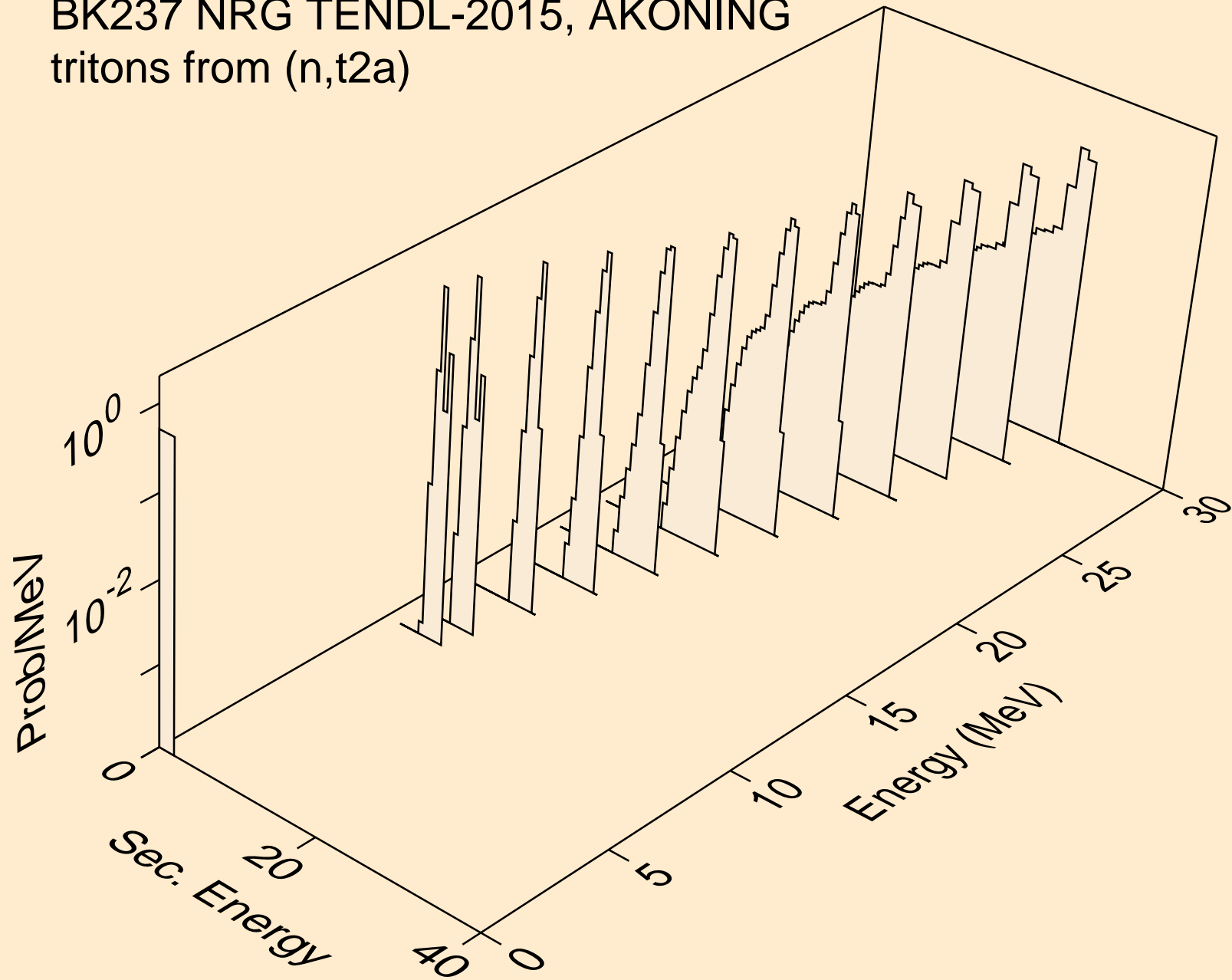

BK237 NRG TENDL-2015, AKONING
he3s from (n,x)

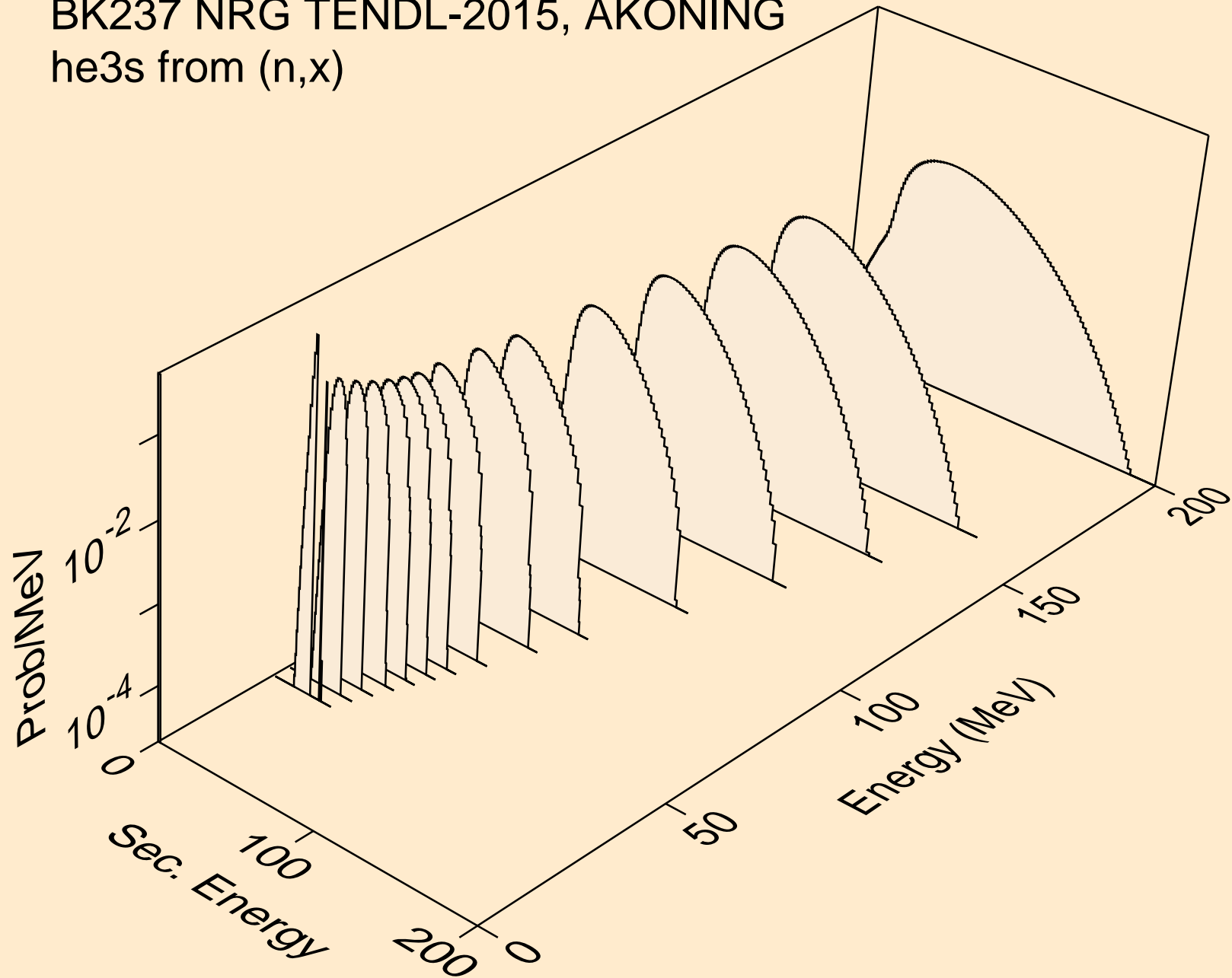

BK237 NRG TENDL-2015, AKONING
he3s from (n,n*)he3

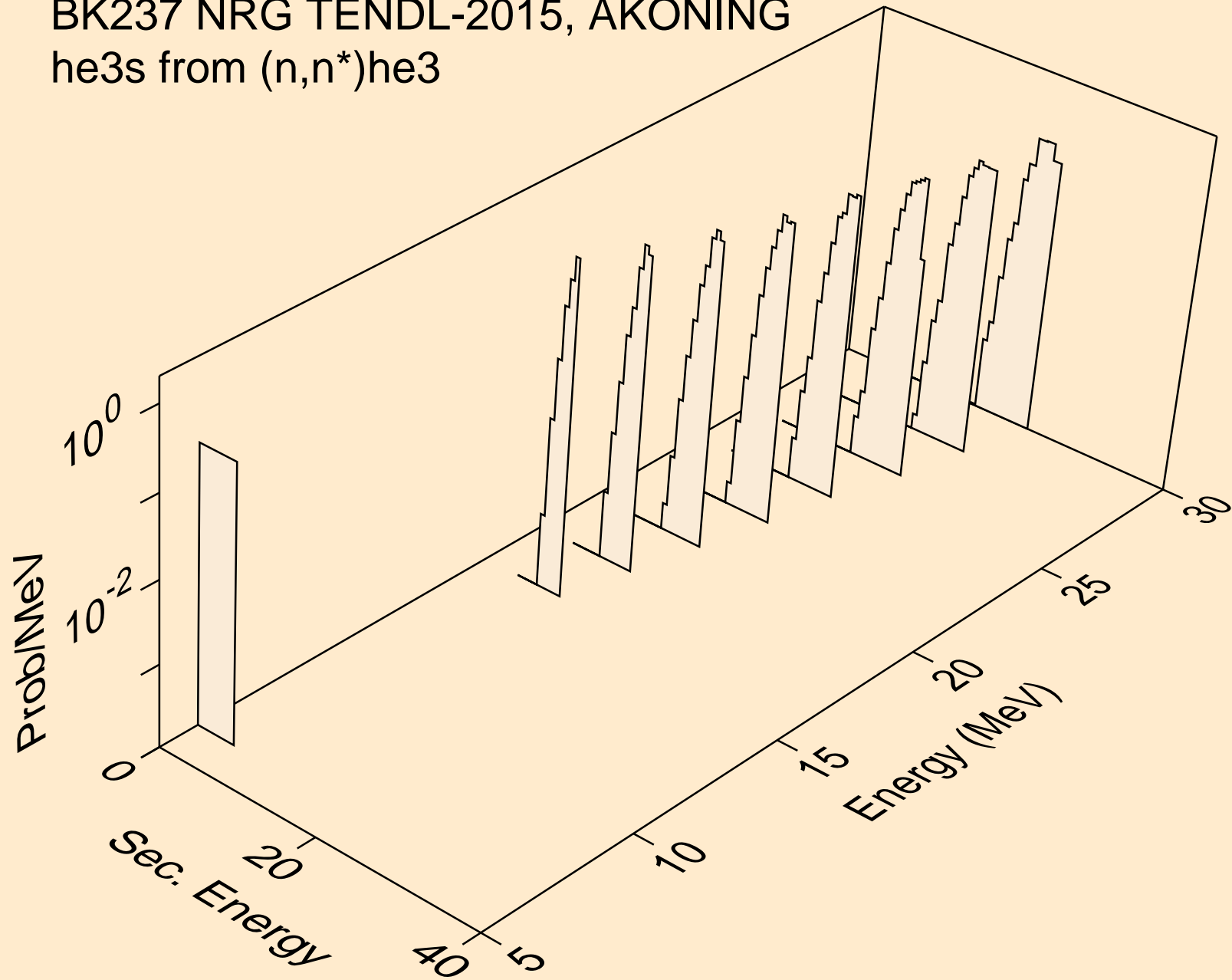

BK237 NRG TENDL-2015, AKONING
he3s from (n,he3)

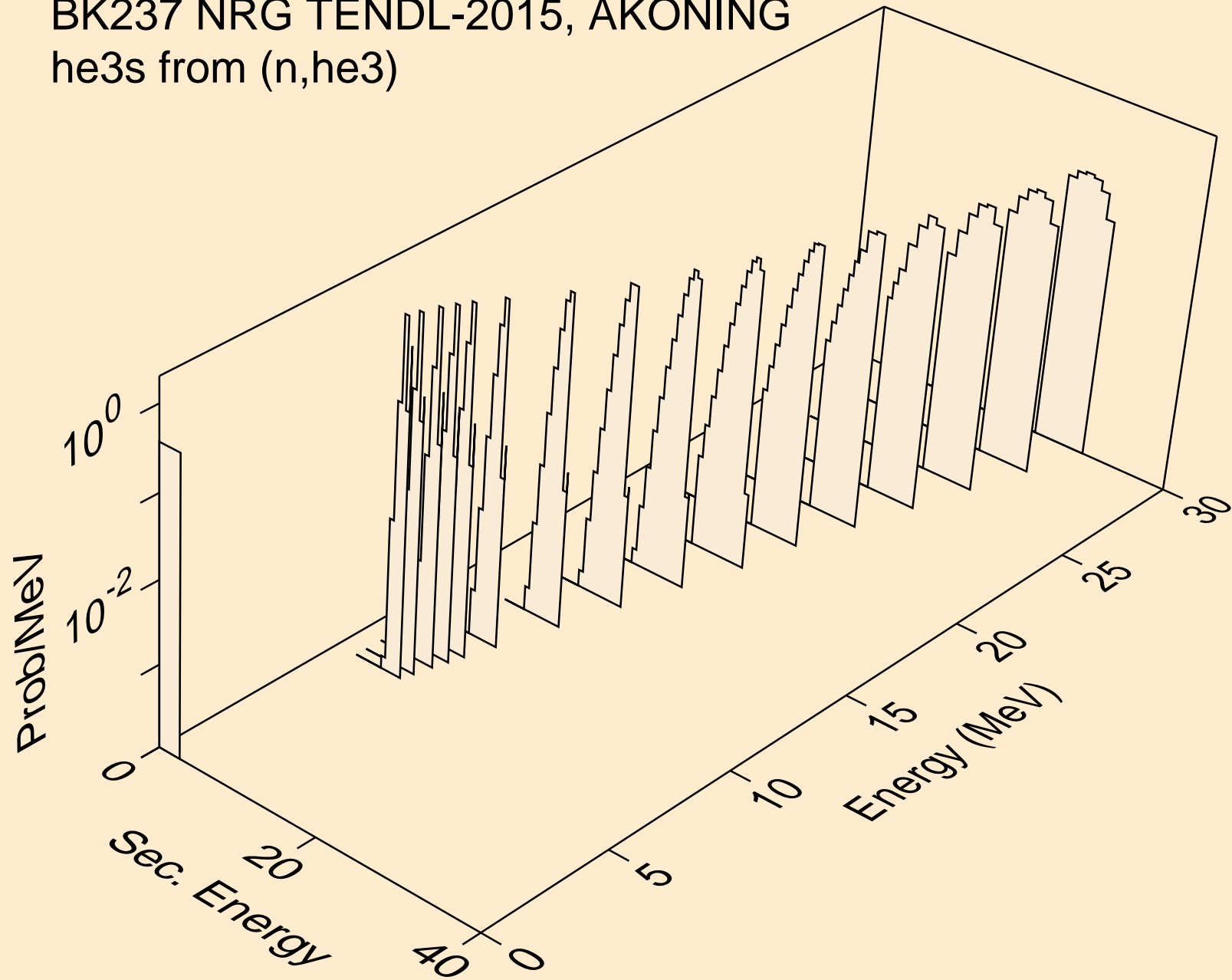

BK237 NRG TENDL-2015, AKONING
alphas from (n,x)

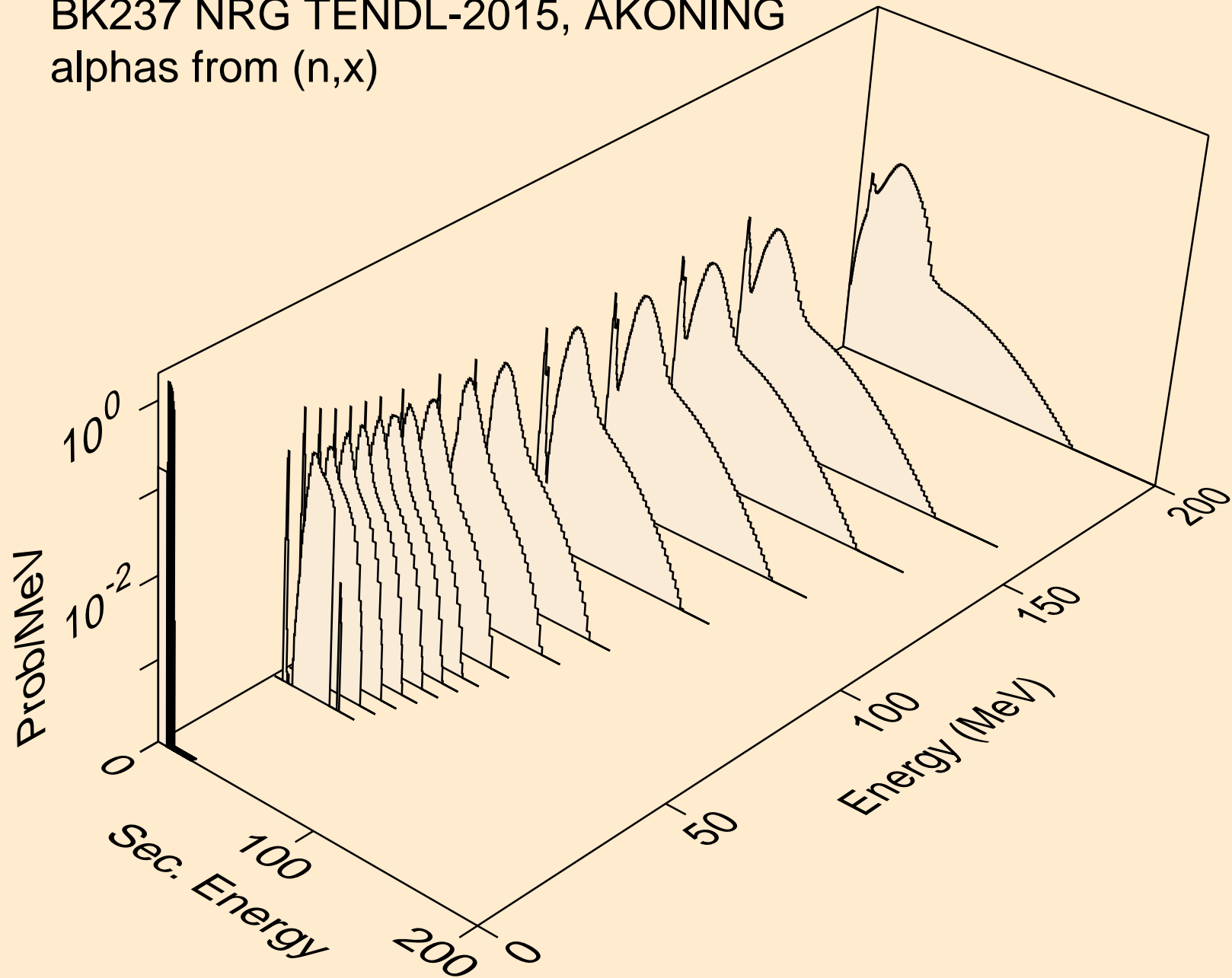

BK237 NRG TENDL-2015, AKONING
alphas from (n,n*)a

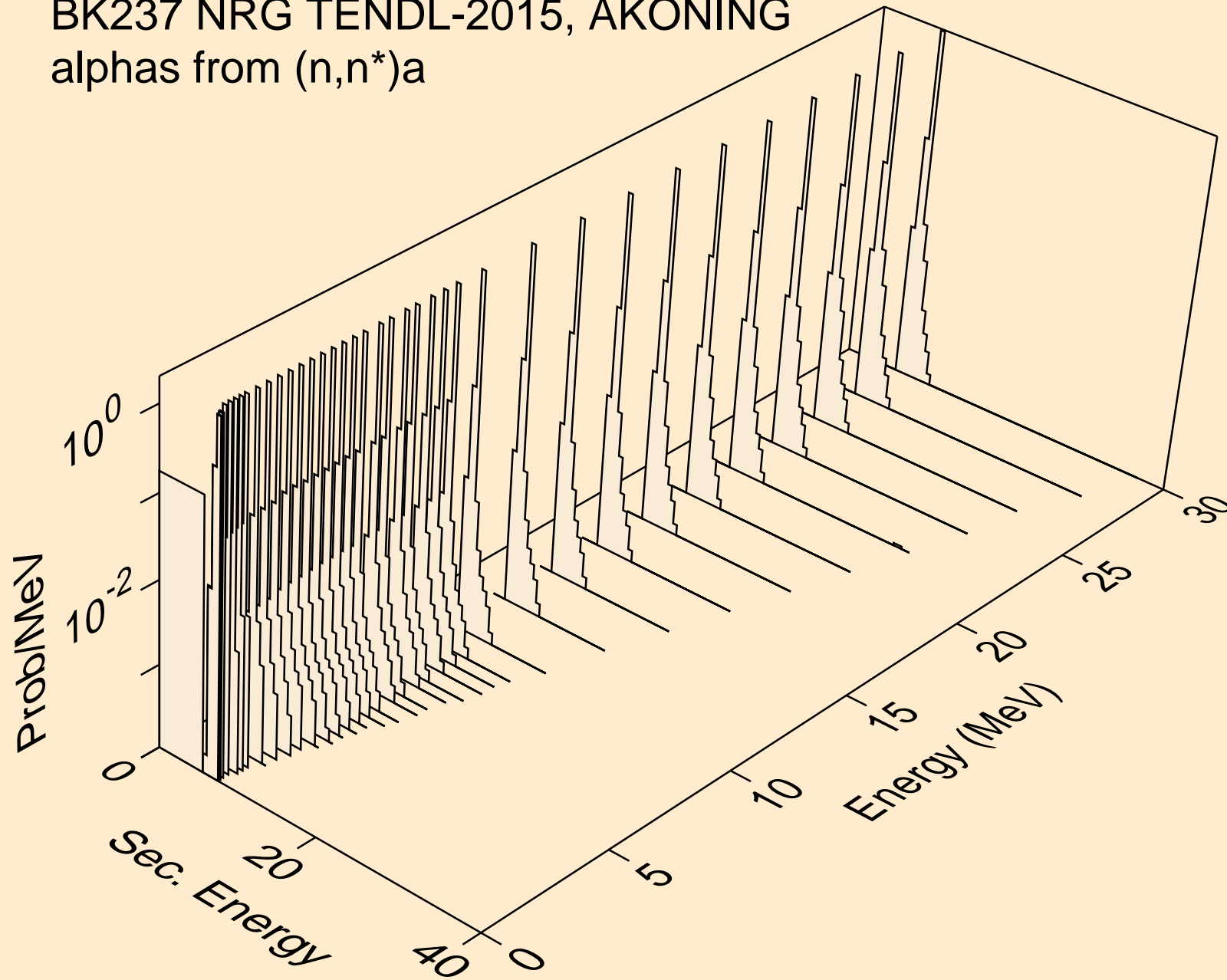

BK237 NRG TENDL-2015, AKONING
alphas from (n,n*)3a

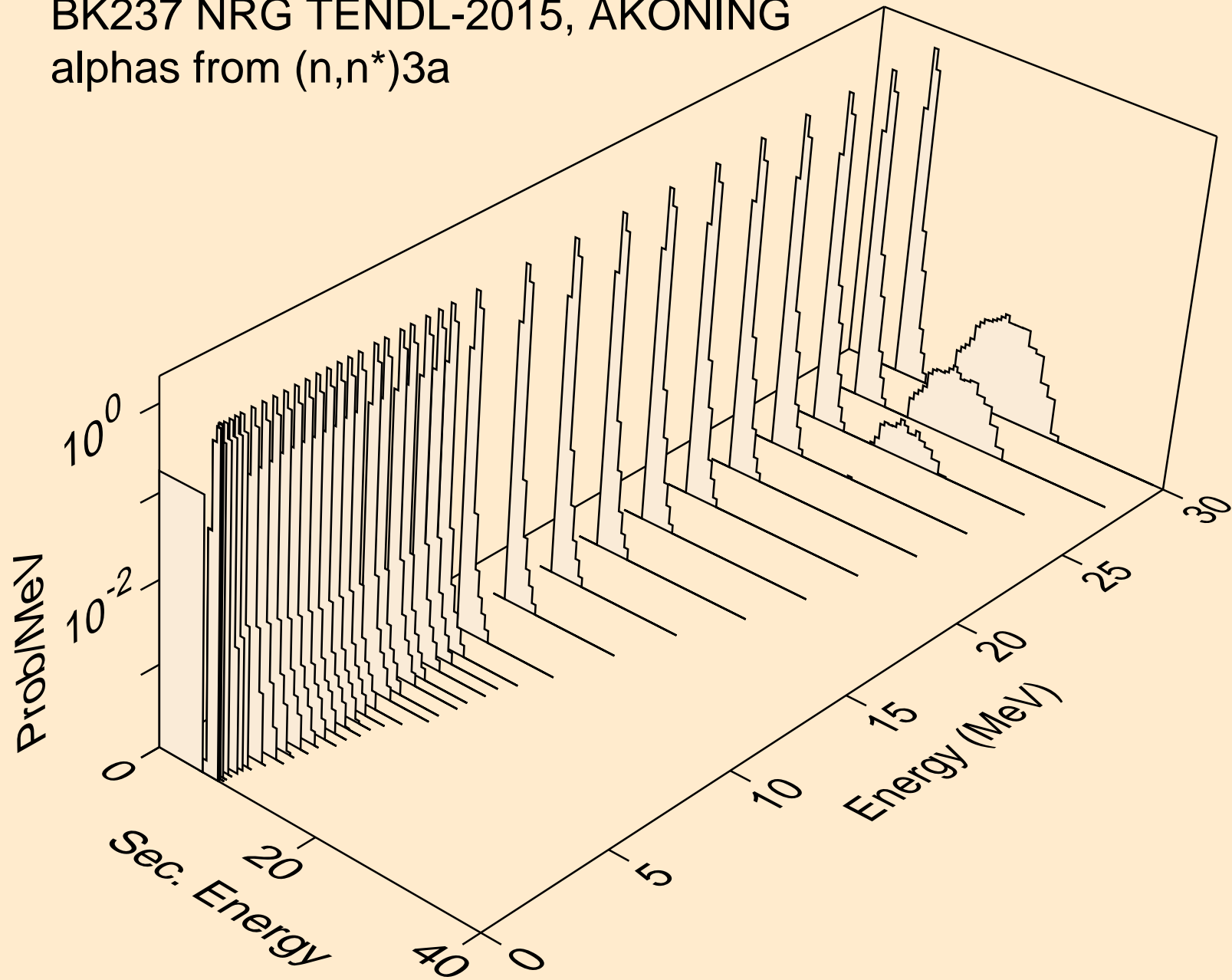

BK237 NRG TENDL-2015, AKONING
alphas from (n,2n)a

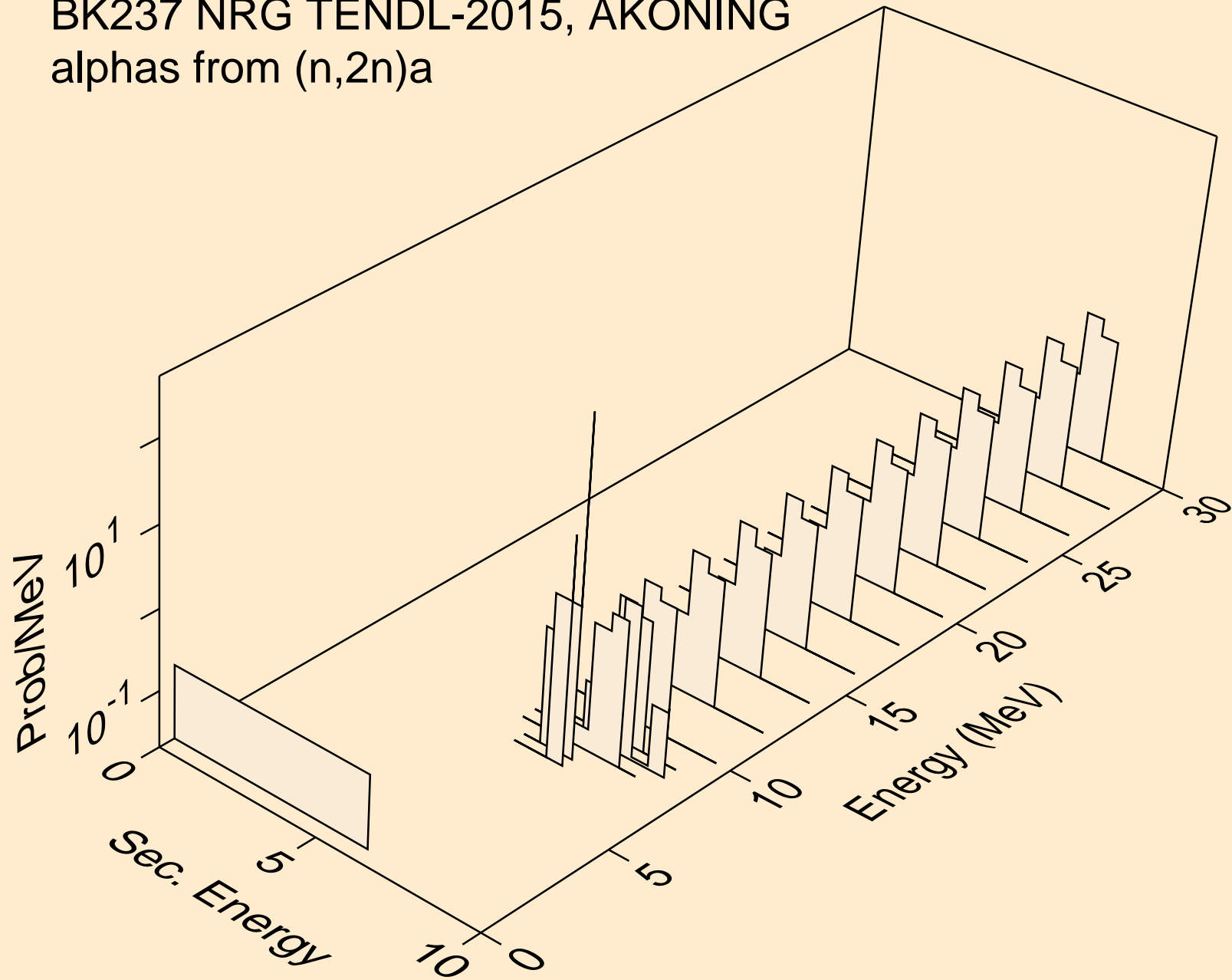

BK237 NRG TENDL-2015, AKONING
alphas from (n,3n)a

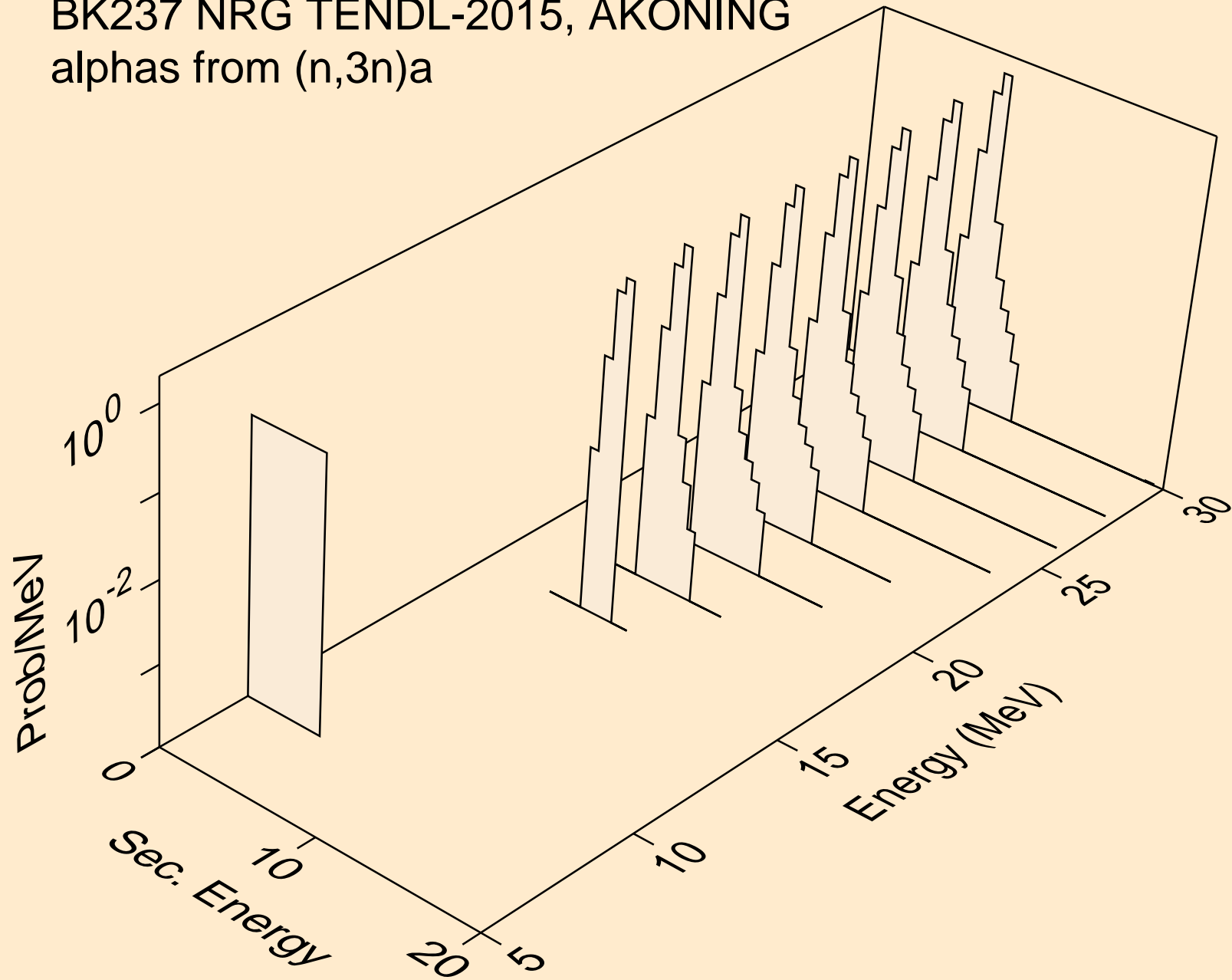

BK237 NRG TENDL-2015, AKONING
alphas from (n,n*)2a

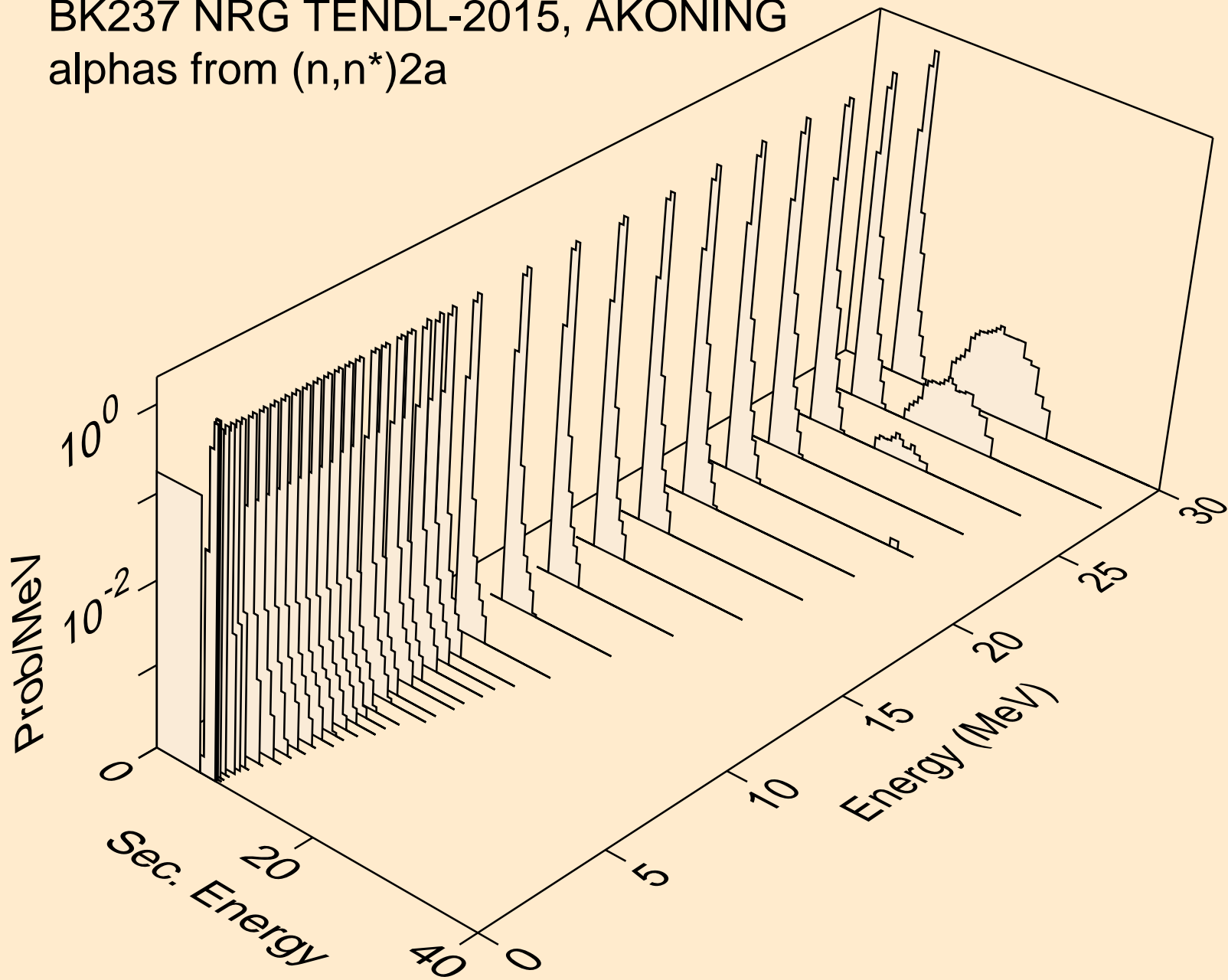

BK237 NRG TENDL-2015, AKONING
alphas from (n,2n)2a

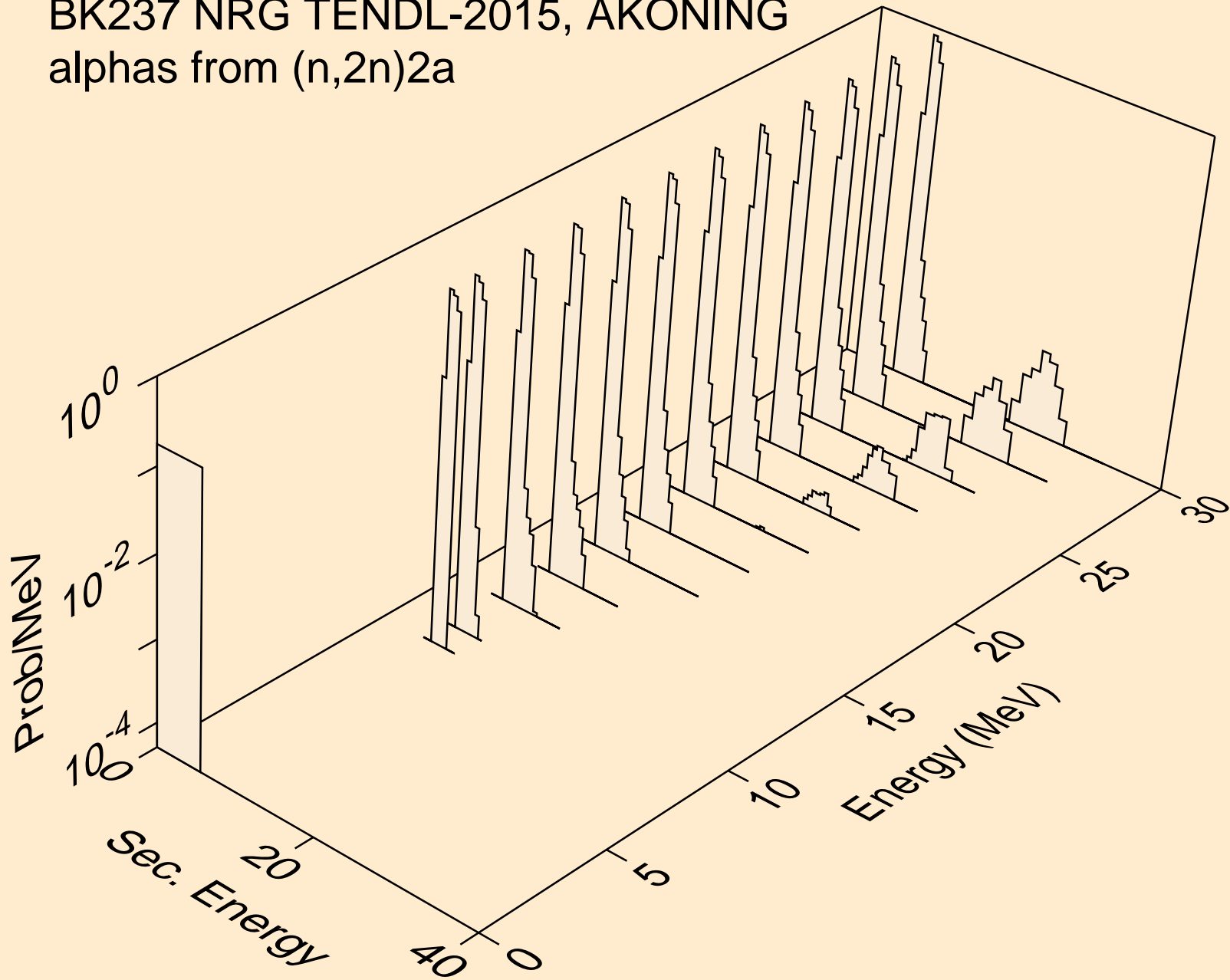

BK237 NRG TENDL-2015, AKONING
alphas from (n,n*)t2a

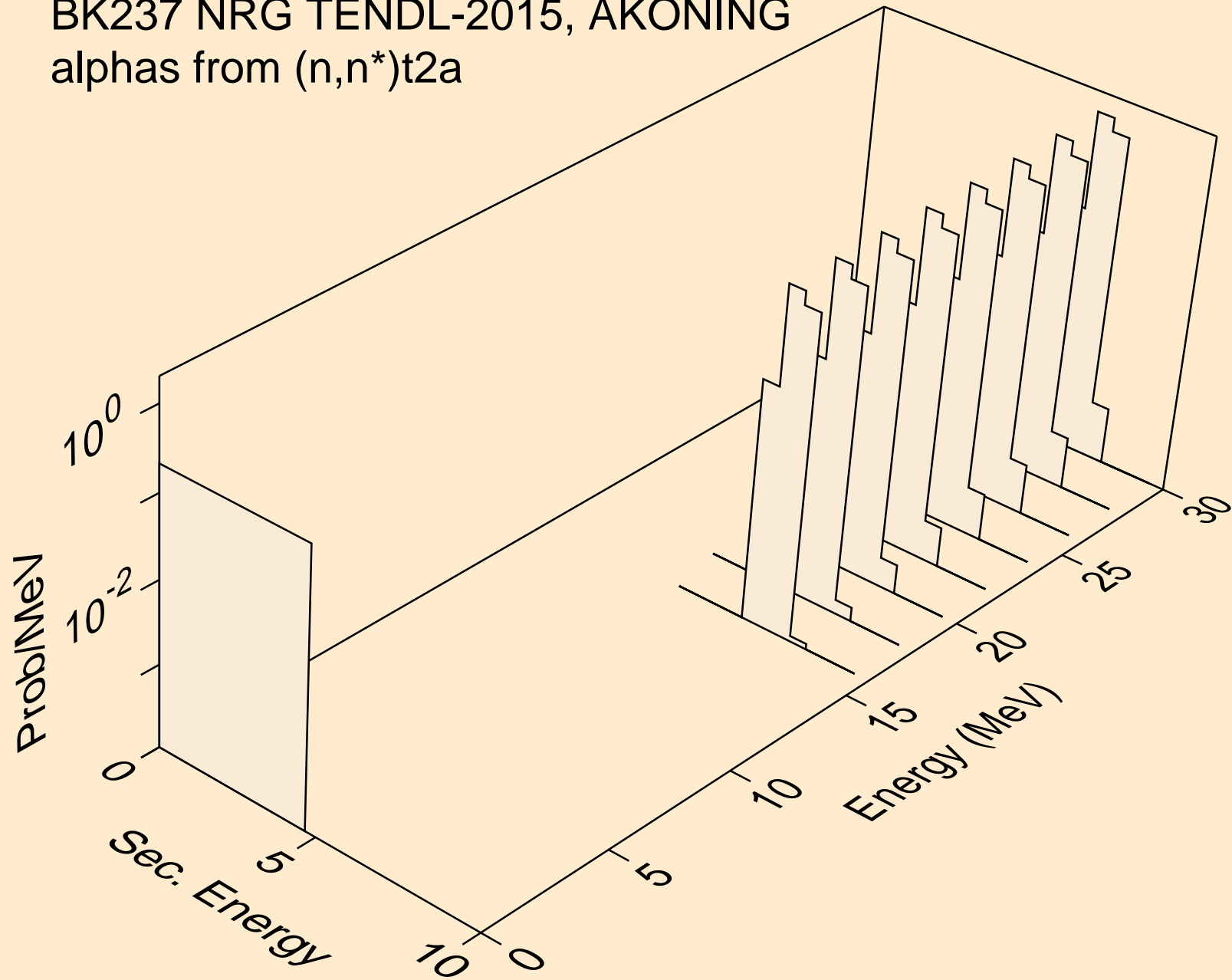

BK237 NRG TENDL-2015, AKONING
alphas from (n,npa)

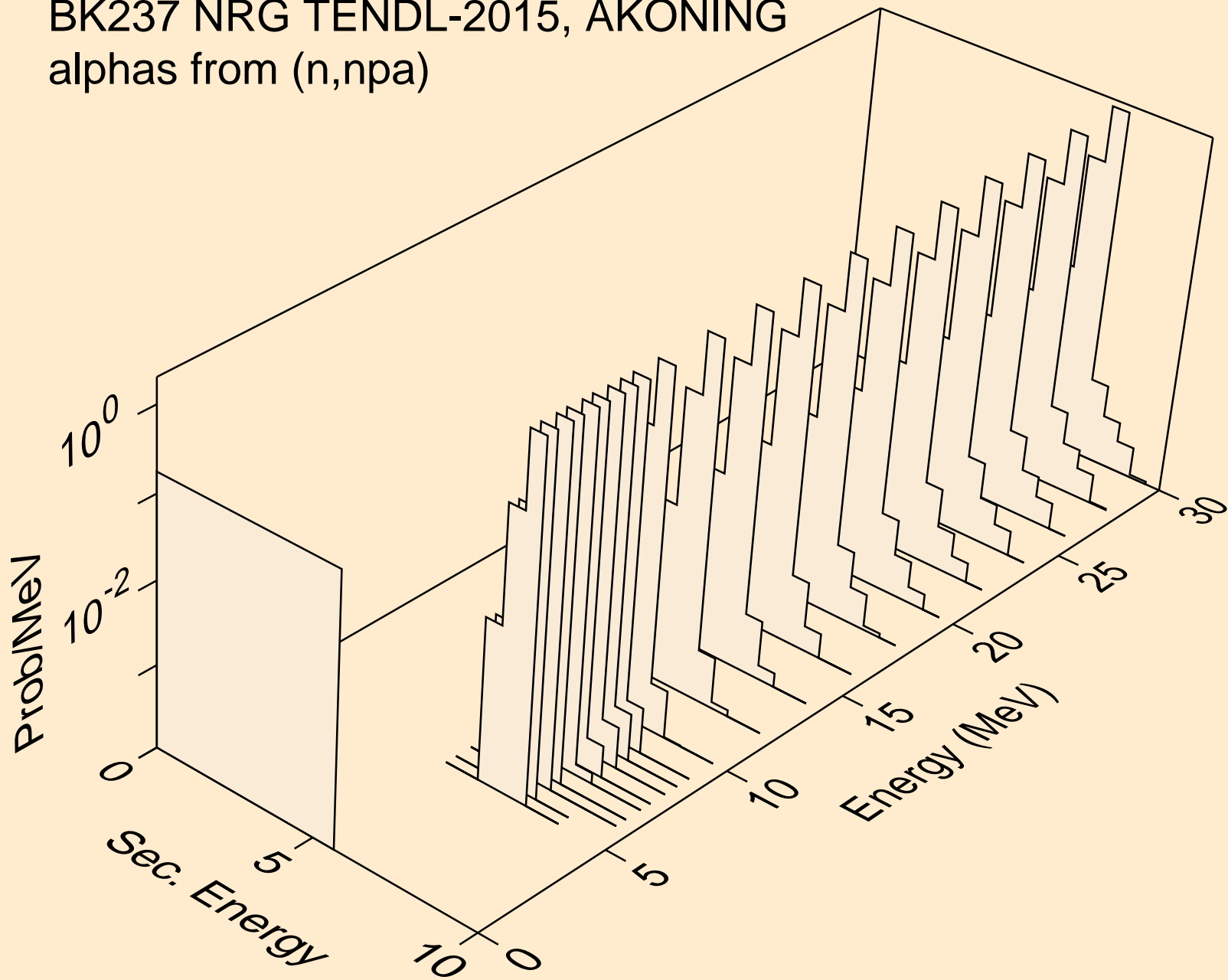

BK237 NRG TENDL-2015, AKONING
alphas from (n,a)

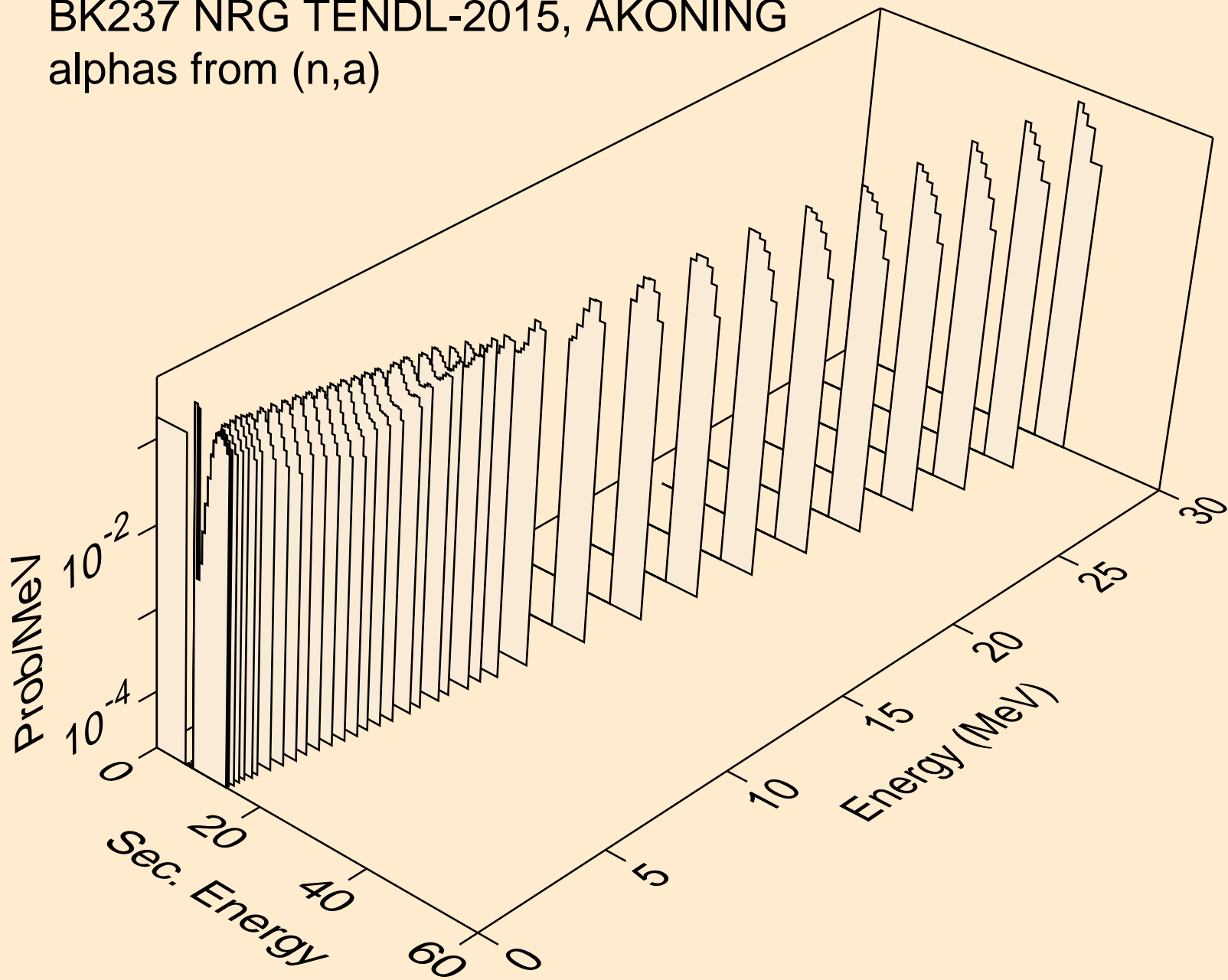

BK237 NRG TENDL-2015, AKONING
alphas from (n,2a)

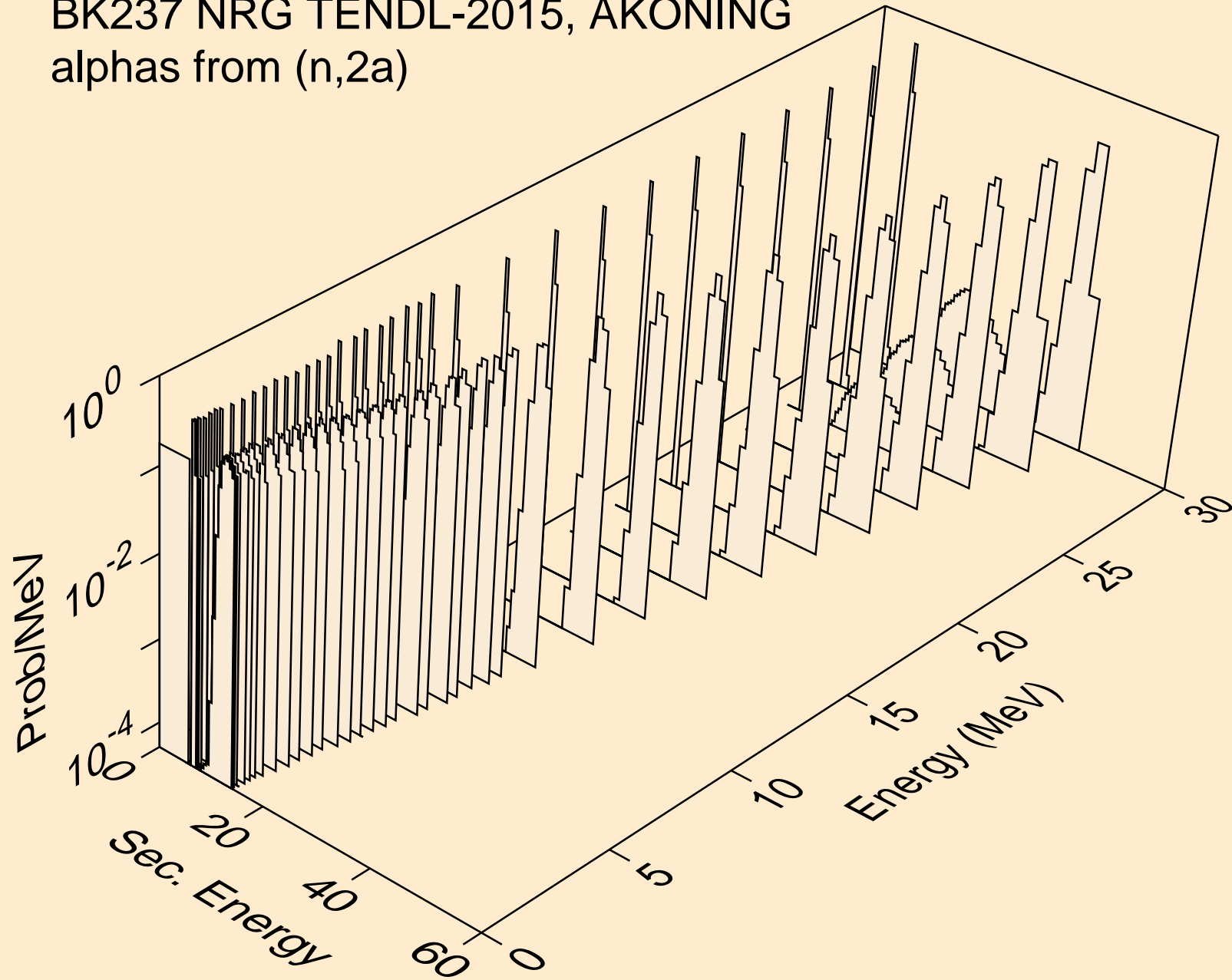

BK237 NRG TENDL-2015, AKONING
alphas from (n,3a)

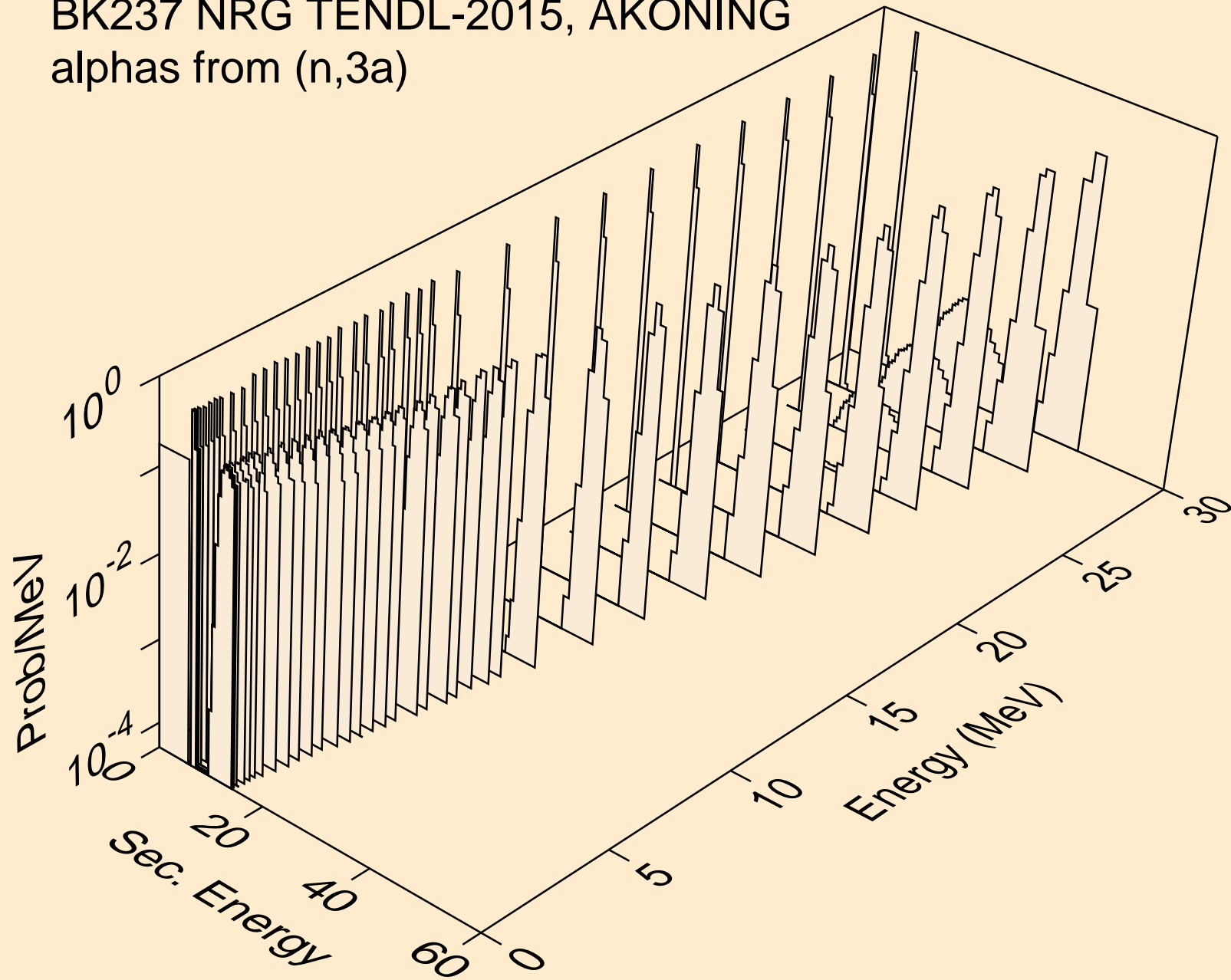

BK237 NRG TENDL-2015, AKONING
alphas from (n,pa)

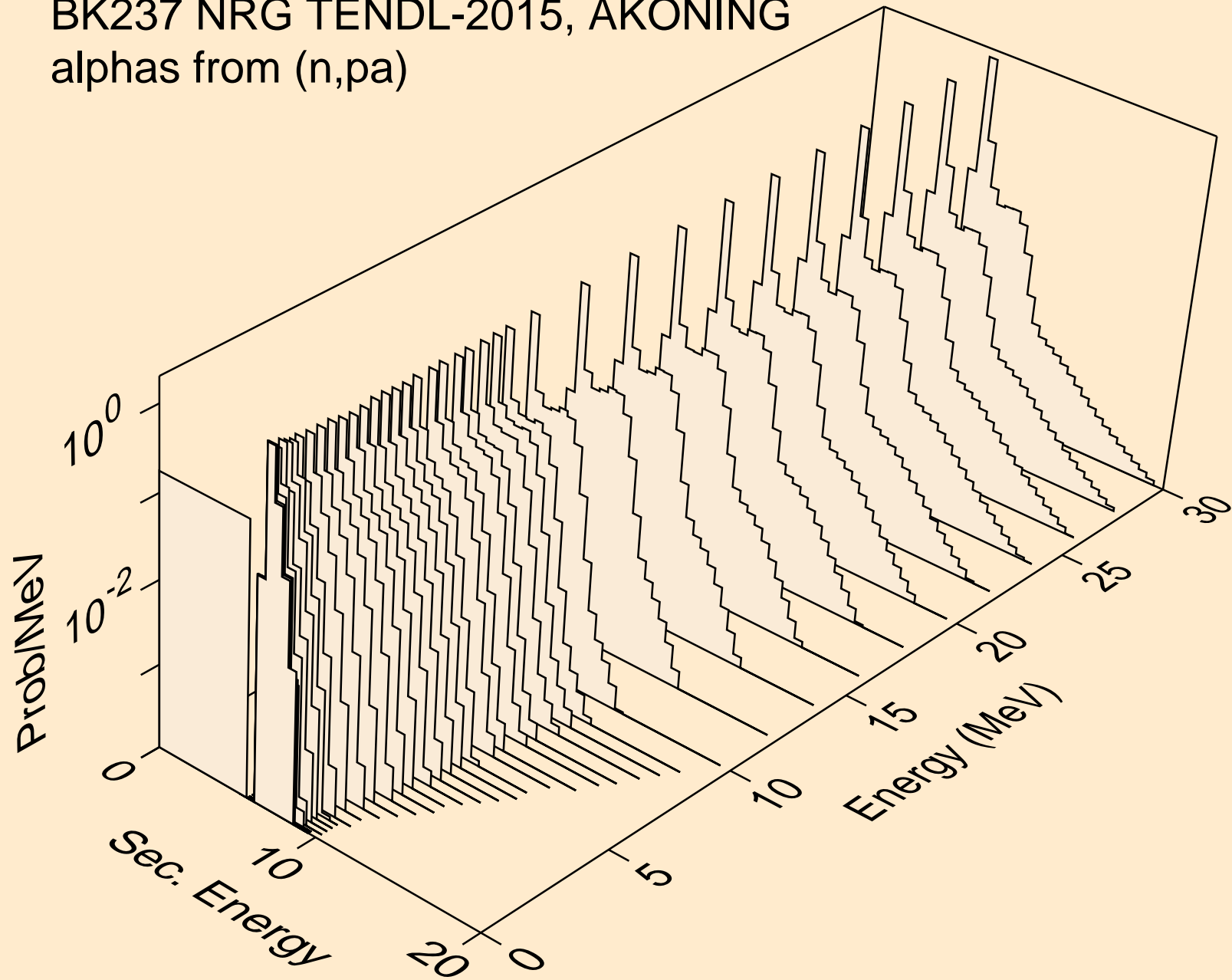

BK237 NRG TENDL-2015, AKONING
alphas from (n,t2a)

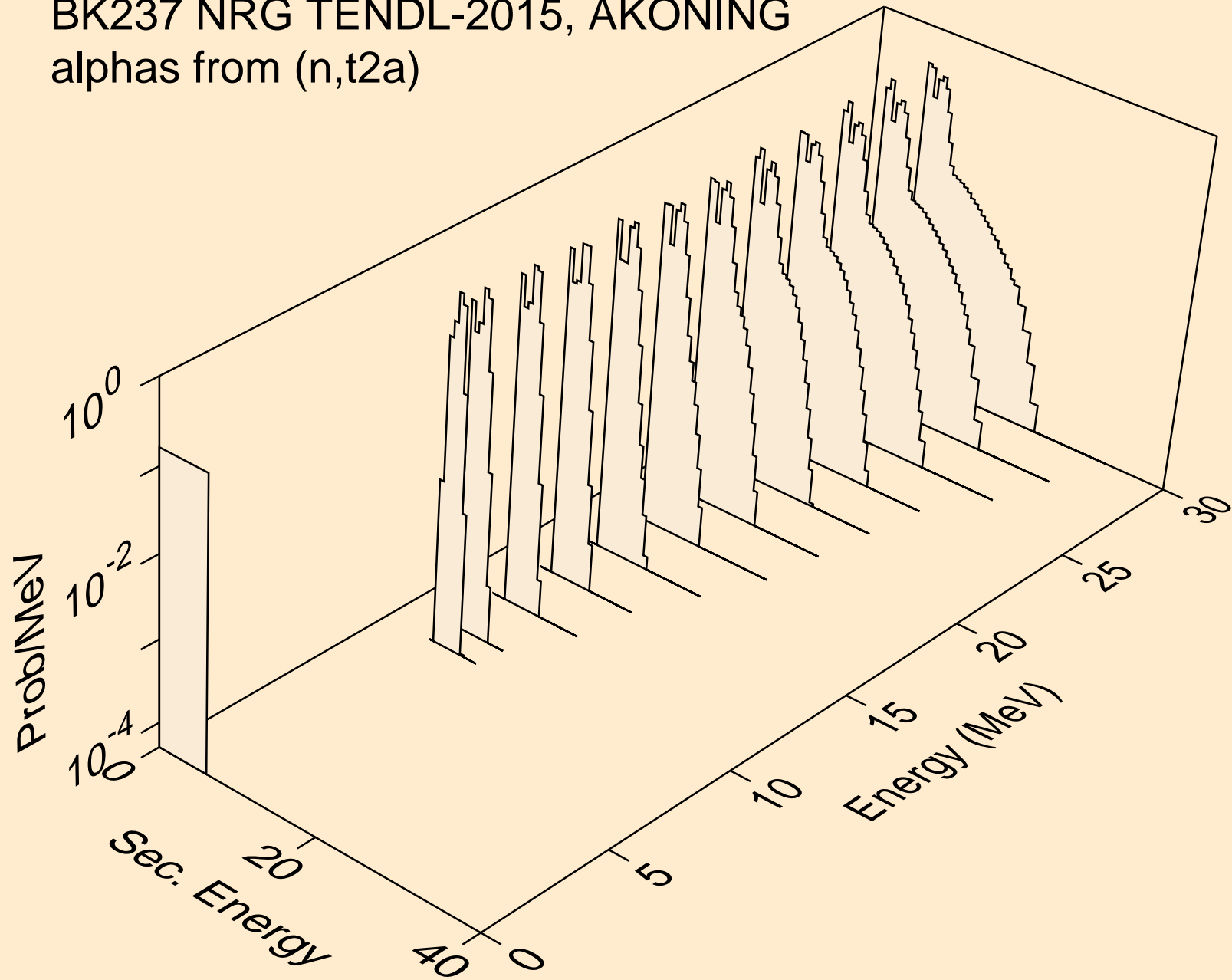

BK237 NRG TENDL-2015, AKONING
alphas from (n,d2a)

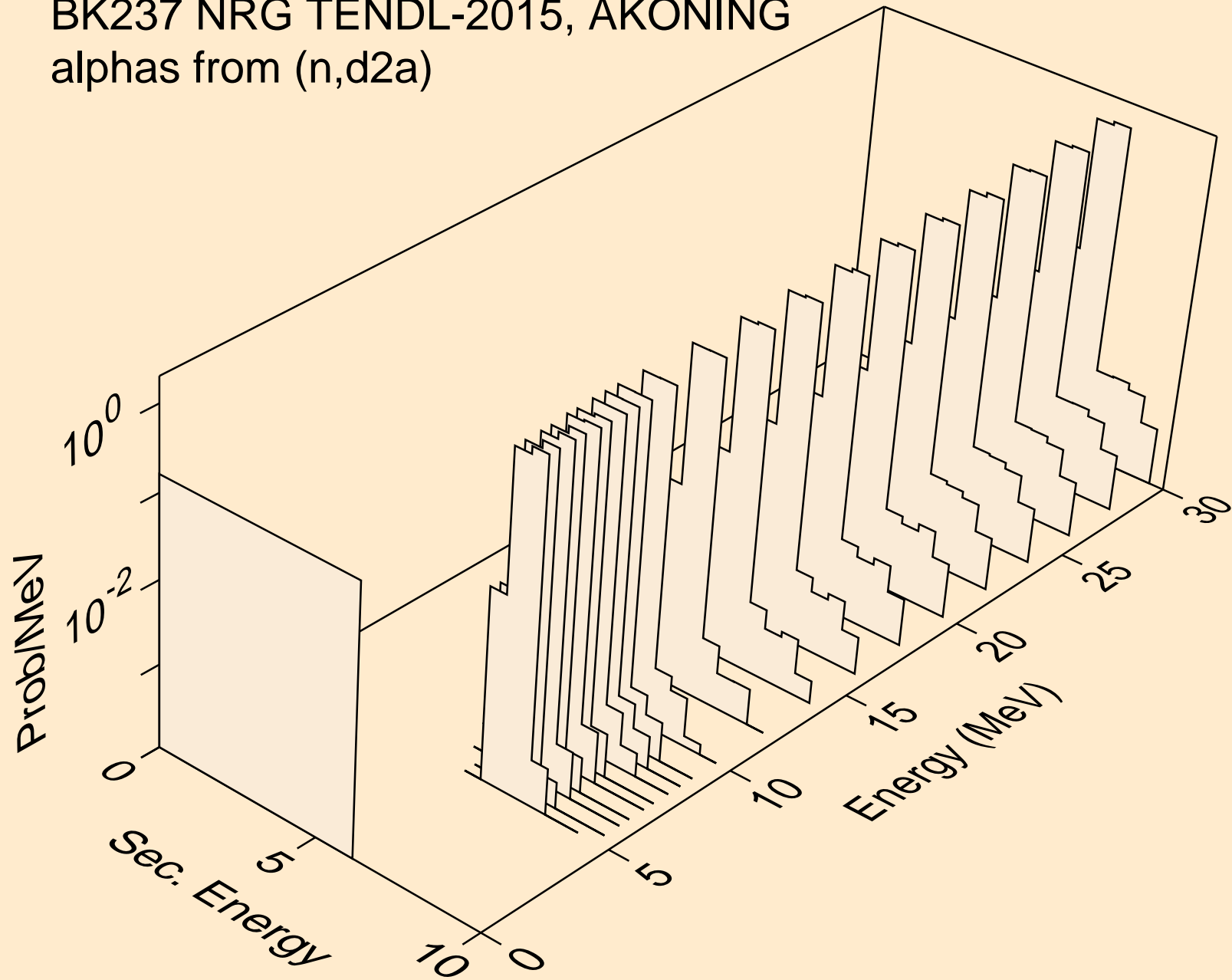

BK237 NRG TENDL-2015, AKONING
alphas from (n,da)

