

Ordinate scales are % relative standard deviation and barns.
 Abscissa scales are energy (eV).

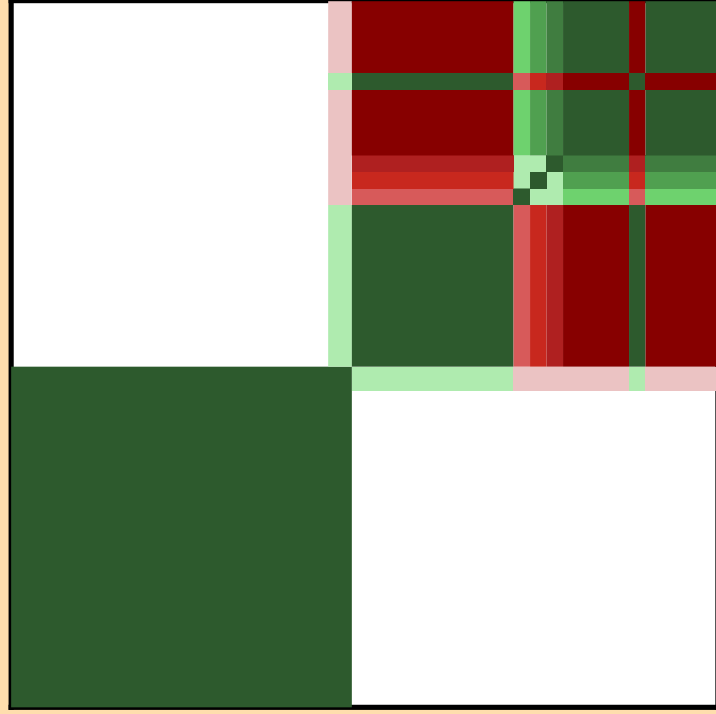

Correlation Matrix

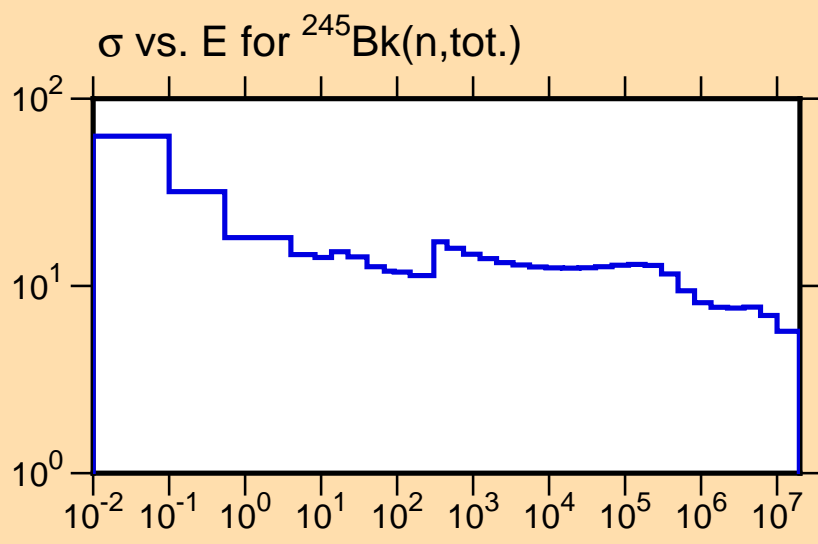

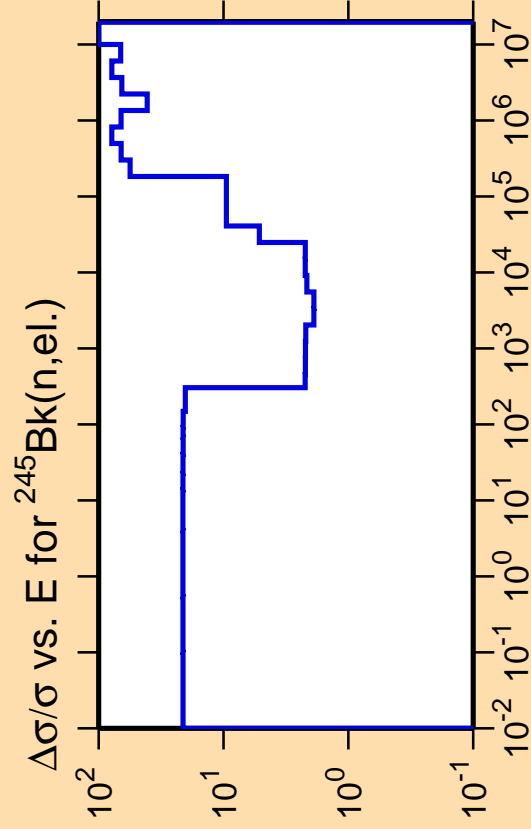

Ordinate scale is %
relative standard deviation.

Abscissa scales are energy (eV).

Warning: some uncertainty
data were suppressed.

$\Delta\sigma/\sigma$ vs. E for $^{245}\text{Bk}(n,\text{tot.})$

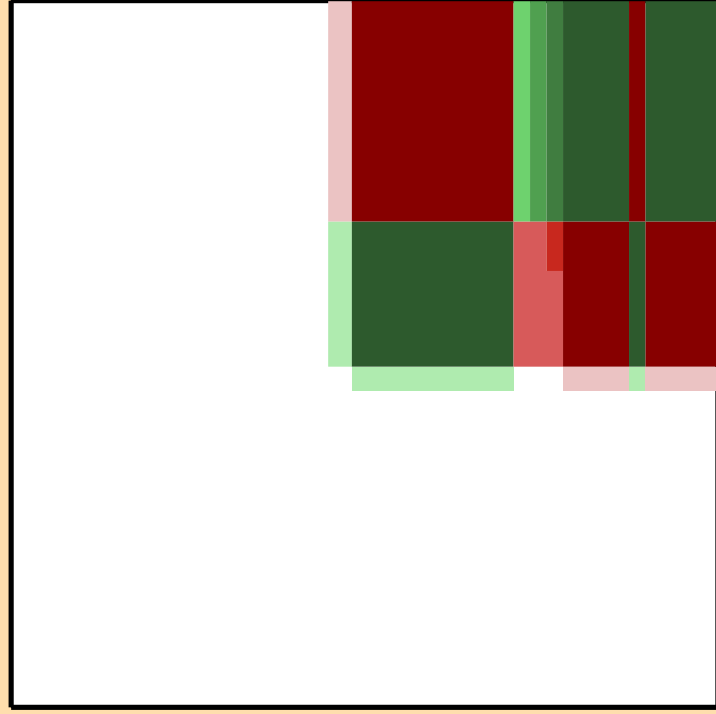
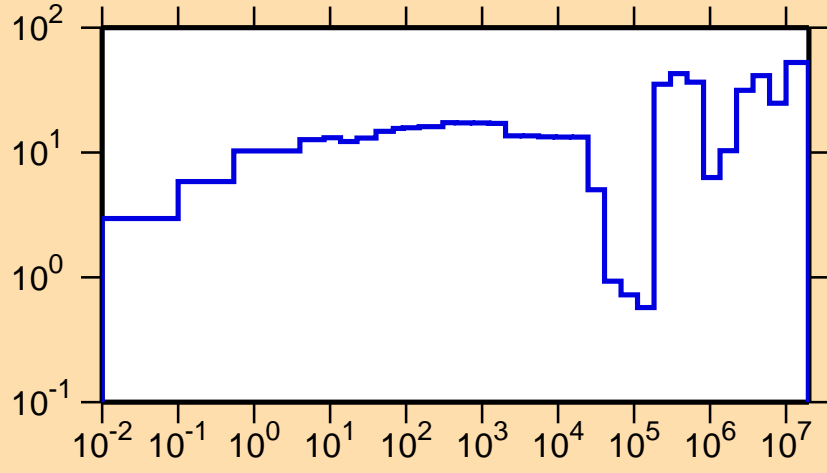

Correlation Matrix



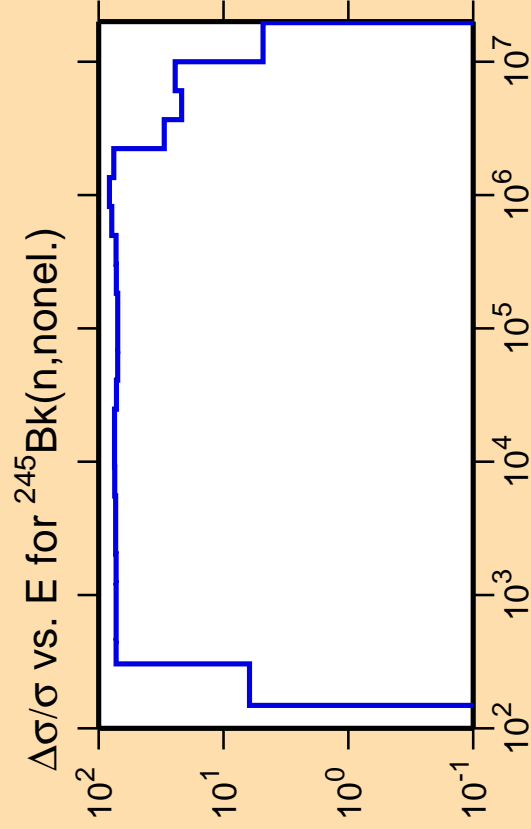

Ordinate scale is %
relative standard deviation.

Abcissa scales are energy (eV).

$\Delta\sigma/\sigma$ vs. E for $^{245}\text{Bk}(n,\text{tot.})$

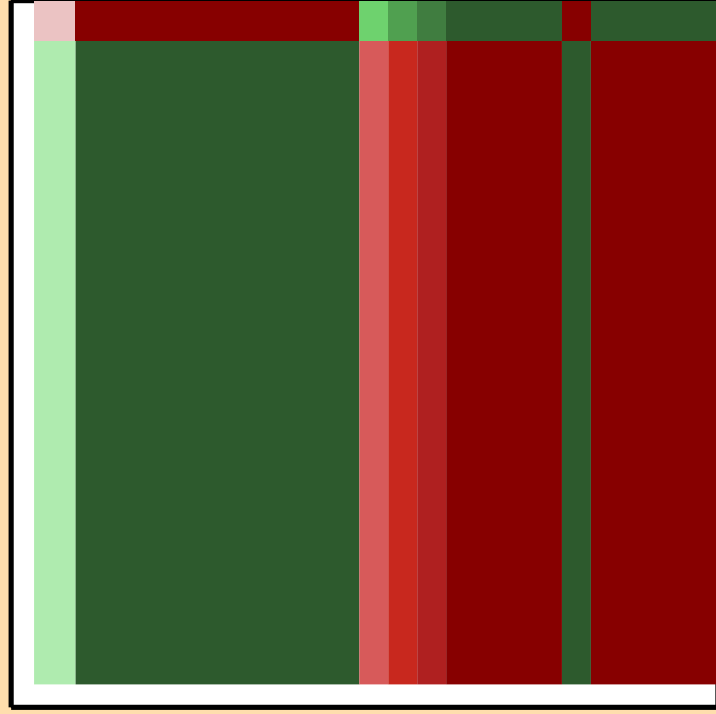
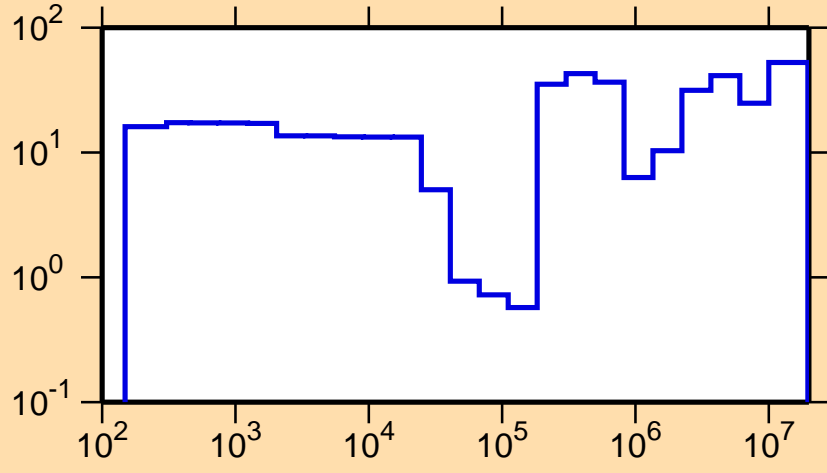

Correlation Matrix



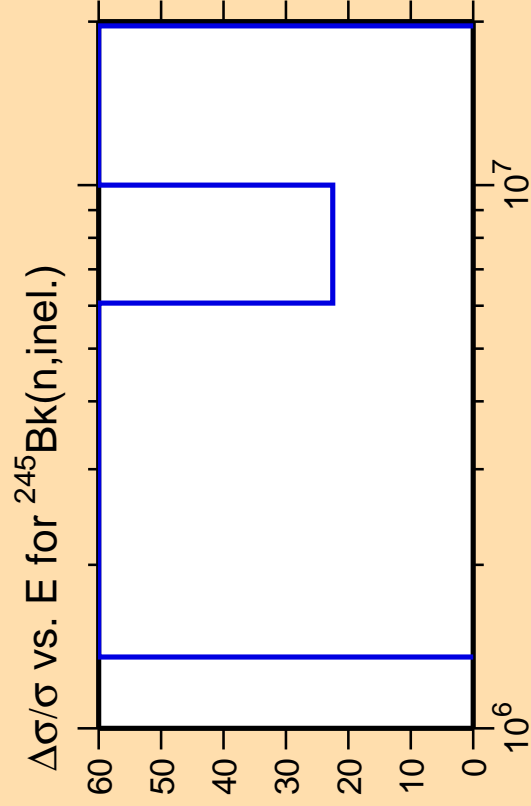

Ordinate scale is %
relative standard deviation.

Abscissa scales are energy (eV).

Warning: some uncertainty
data were suppressed.

$\Delta\sigma/\sigma$ vs. E for $^{245}\text{Bk}(n,\text{tot.})$

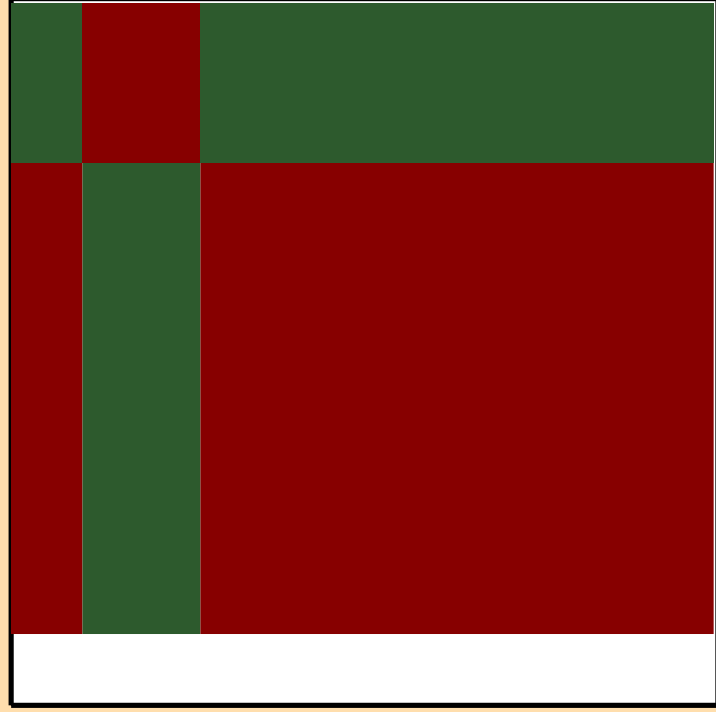
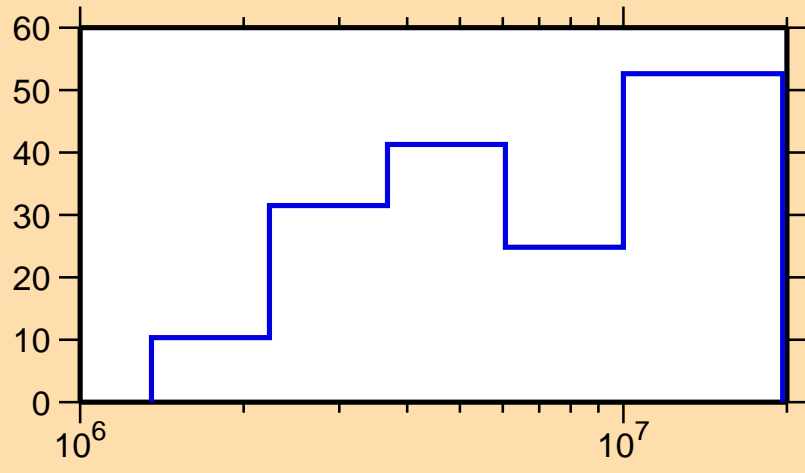

Correlation Matrix



$\Delta\sigma/\sigma$ vs. E for $^{245}\text{Bk}(n,2n)$



Ordinate scale is %
relative standard deviation.

Abscissa scales are energy (eV).

Warning: some uncertainty
data were suppressed.

$\Delta\sigma/\sigma$ vs. E for $^{245}\text{Bk}(n,\text{tot.})$

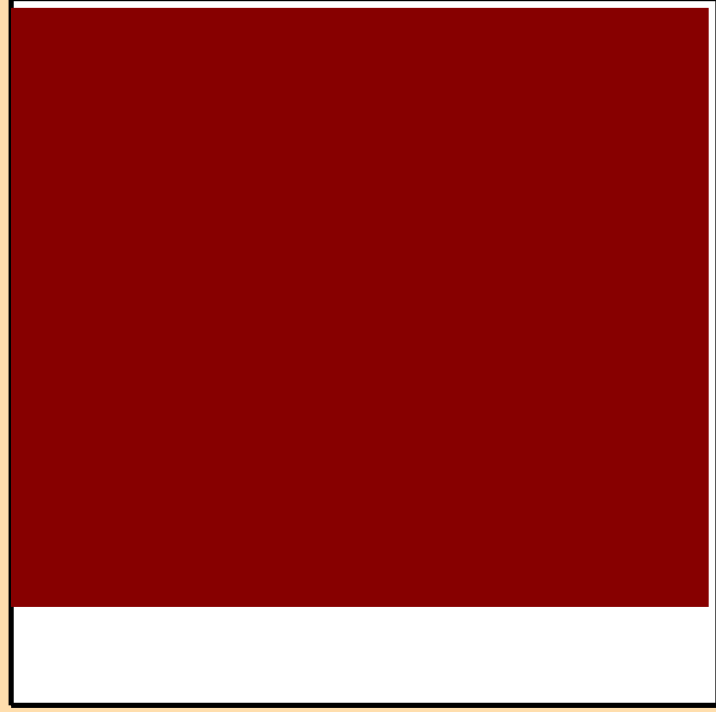
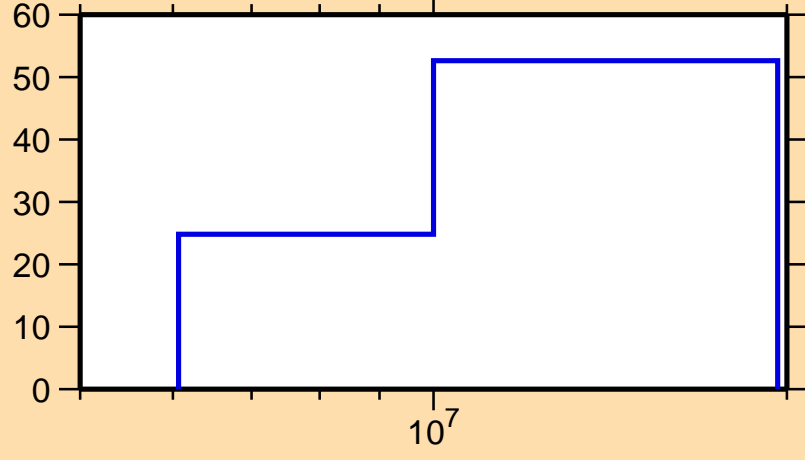

Correlation Matrix



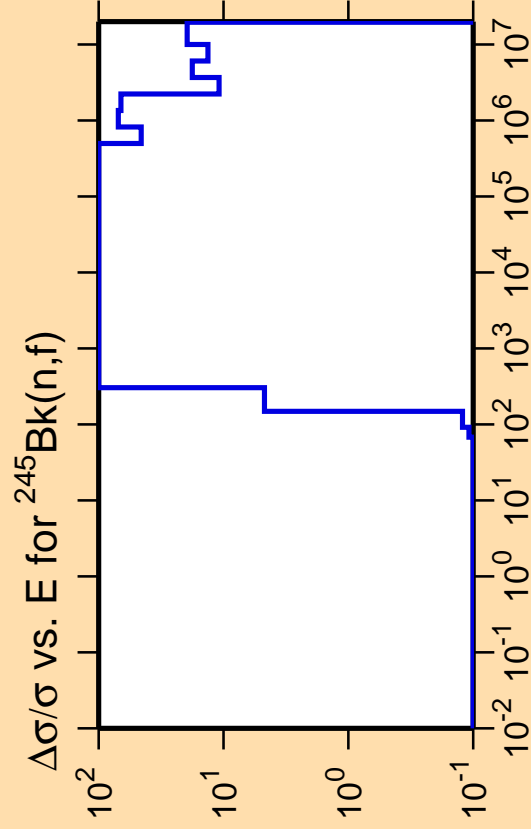

Ordinate scale is %
relative standard deviation.

Abscissa scales are energy (eV).

Warning: some uncertainty
data were suppressed.

$\Delta\sigma/\sigma$ vs. E for $^{245}\text{Bk}(n,\text{tot.})$

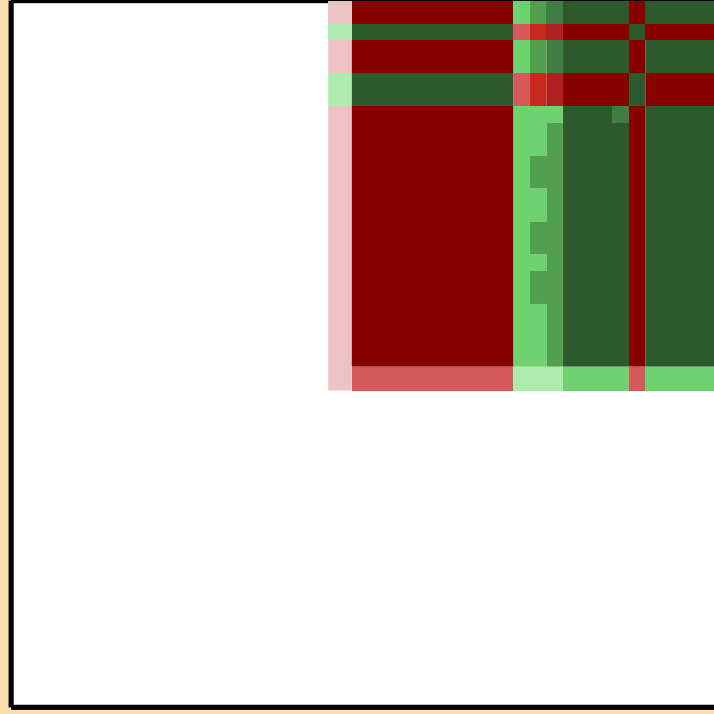
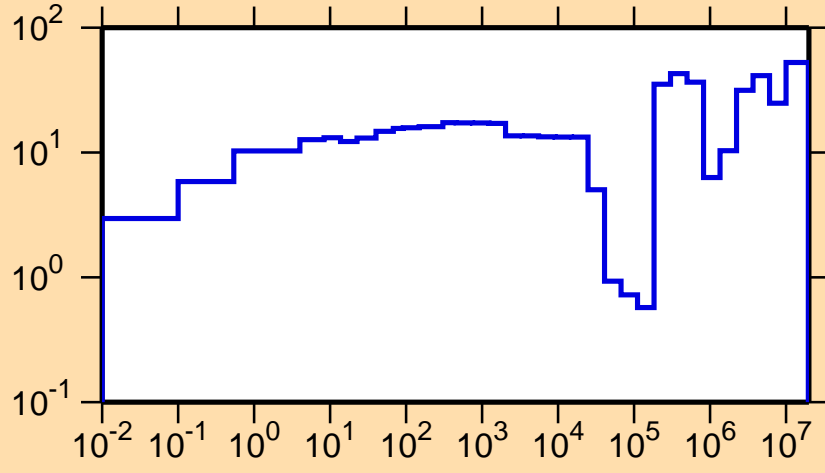

Correlation Matrix



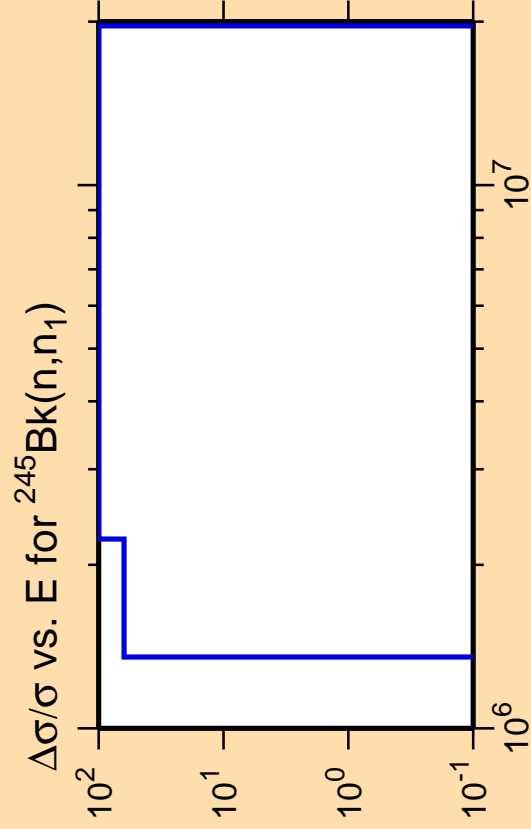

Ordinate scale is %
relative standard deviation.

Abscissa scales are energy (eV).

Warning: some uncertainty
data were suppressed.

$\Delta\sigma/\sigma$ vs. E for $^{245}\text{Bk}(n,\text{tot.})$

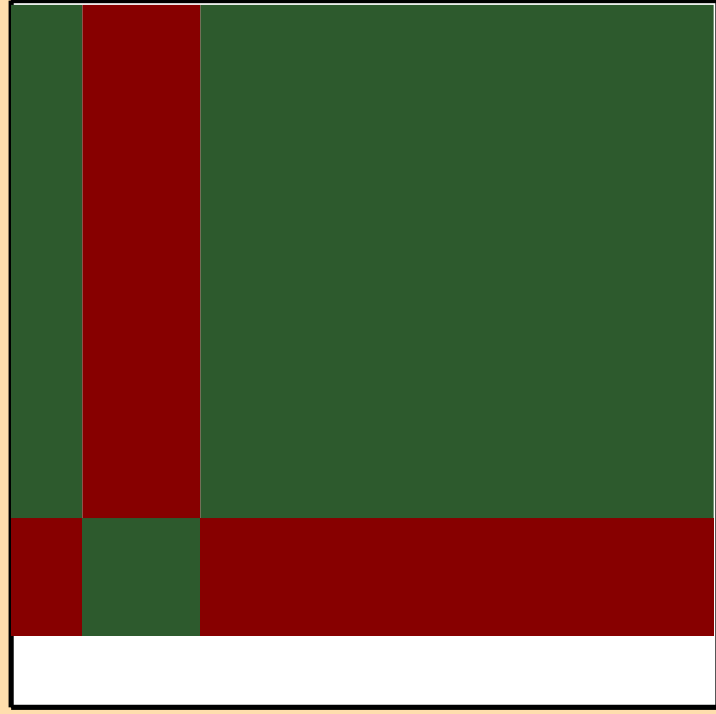
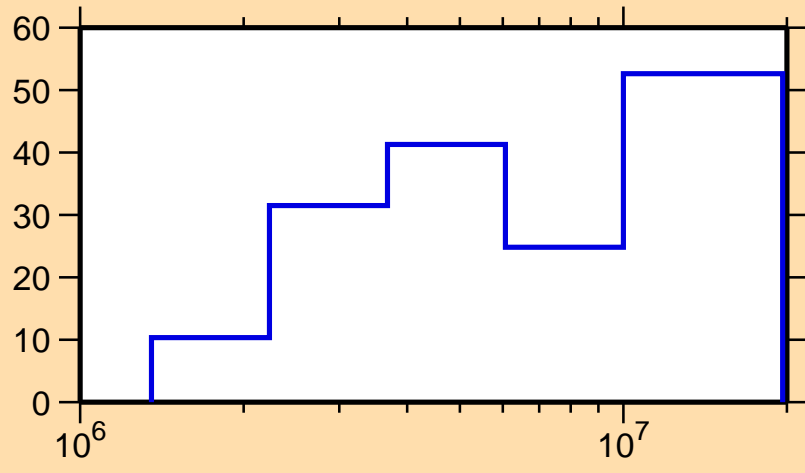

Correlation Matrix



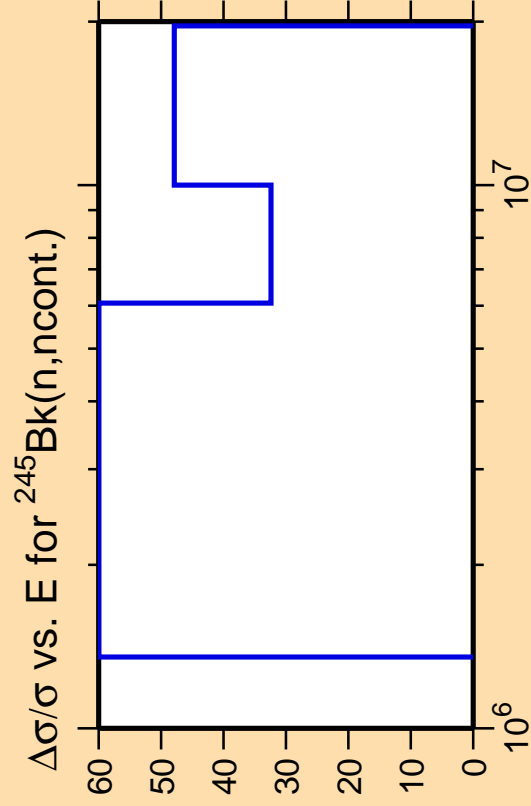

Ordinate scale is %
relative standard deviation.

Abscissa scales are energy (eV).

Warning: some uncertainty
data were suppressed.

$\Delta\sigma/\sigma$ vs. E for $^{245}\text{Bk}(n,\text{tot.})$

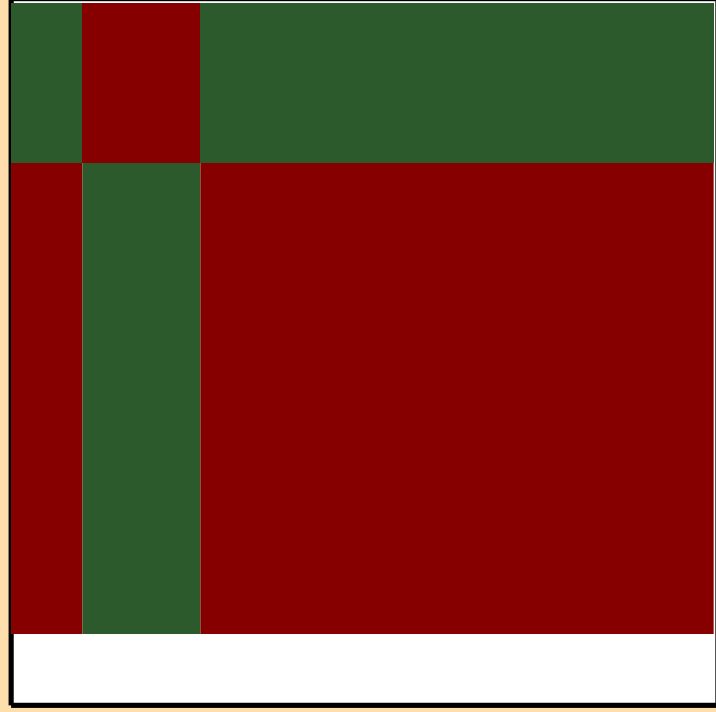
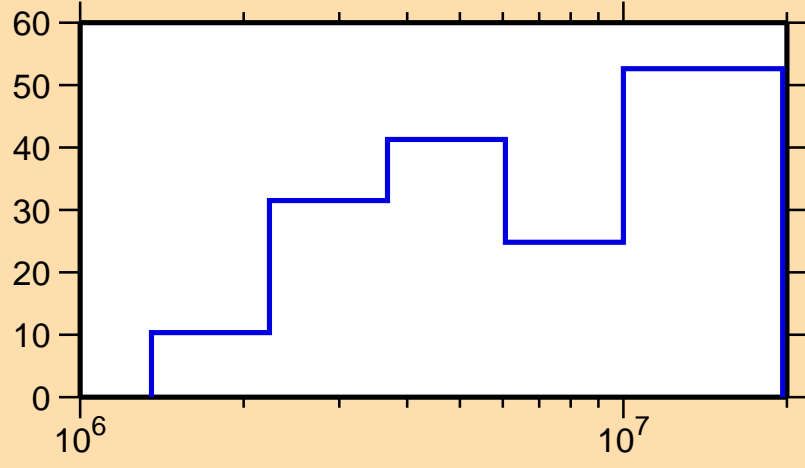

Correlation Matrix



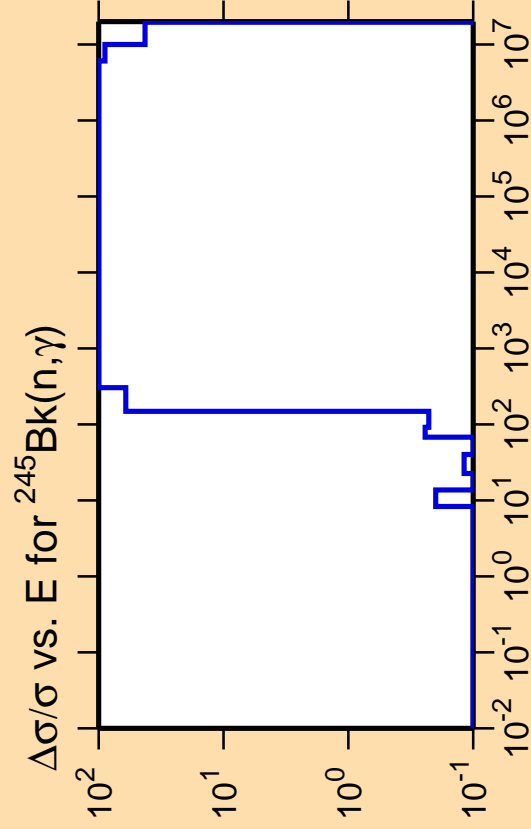

Ordinate scale is %
relative standard deviation.

Abscissa scales are energy (eV).

Warning: some uncertainty
data were suppressed.

$\Delta\sigma/\sigma$ vs. E for $^{245}\text{Bk}(n,\text{tot.})$

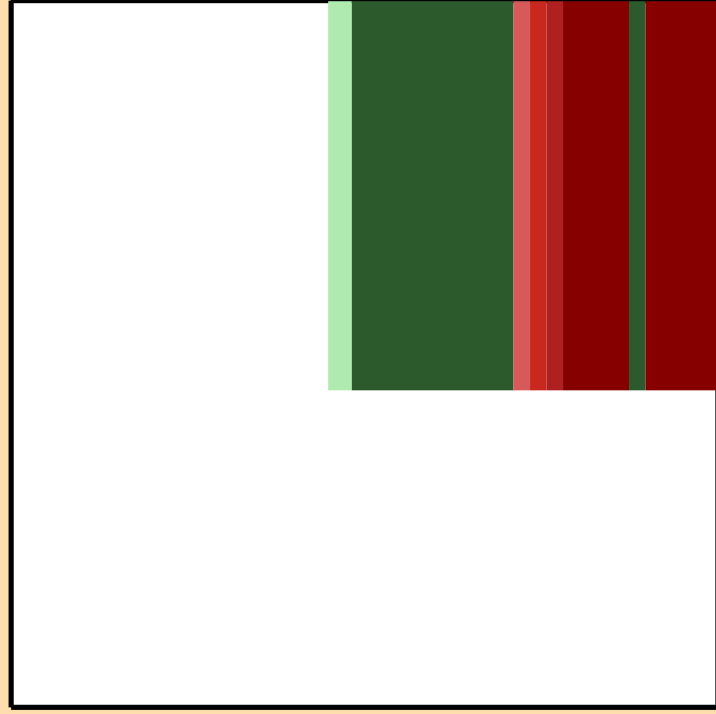
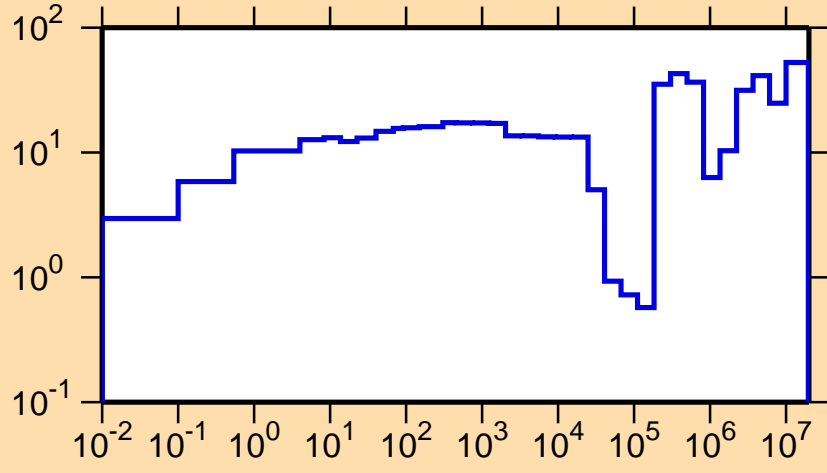

Correlation Matrix



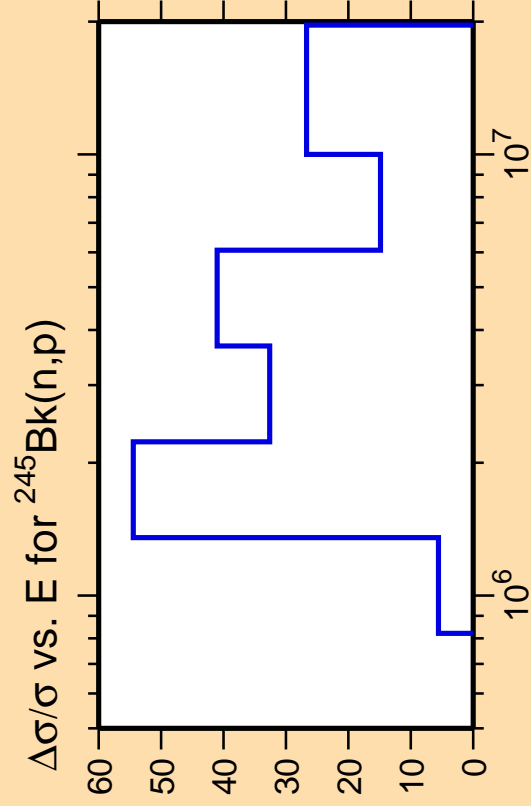

Ordinate scale is %
relative standard deviation.

Abscissa scales are energy (eV).

$\Delta\sigma/\sigma$ vs. E for $^{245}\text{Bk}(n,\text{tot.})$

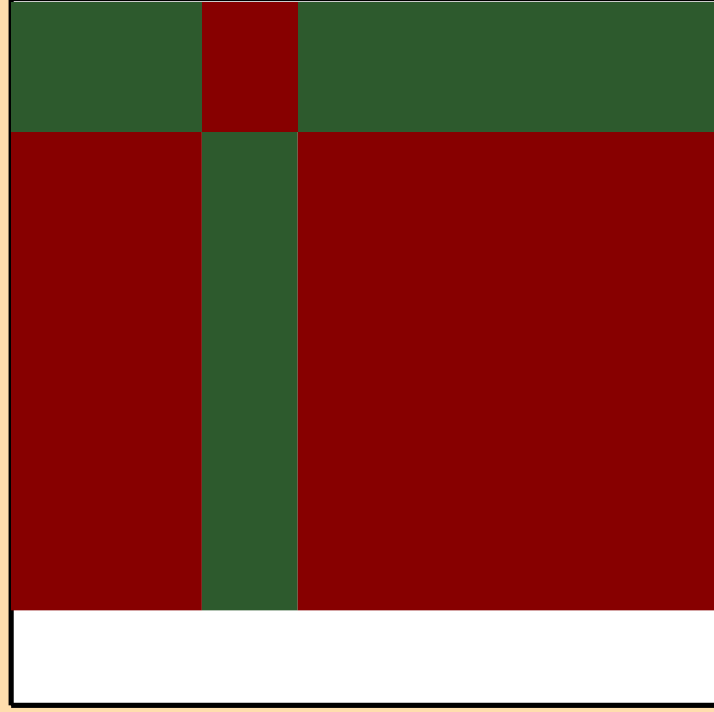
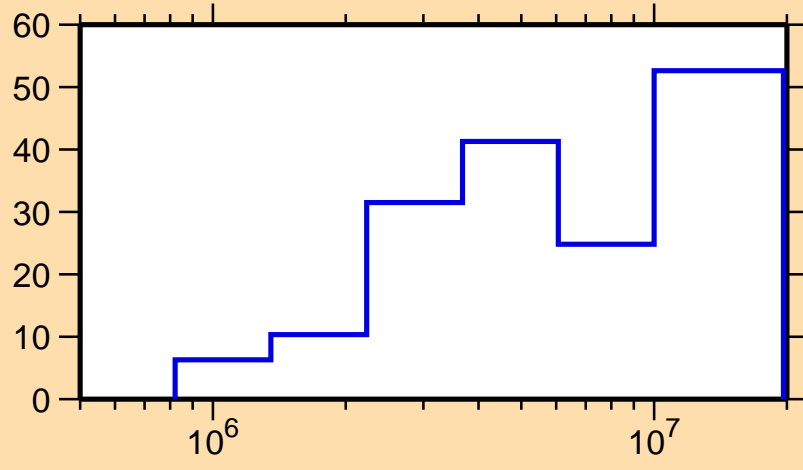

Correlation Matrix



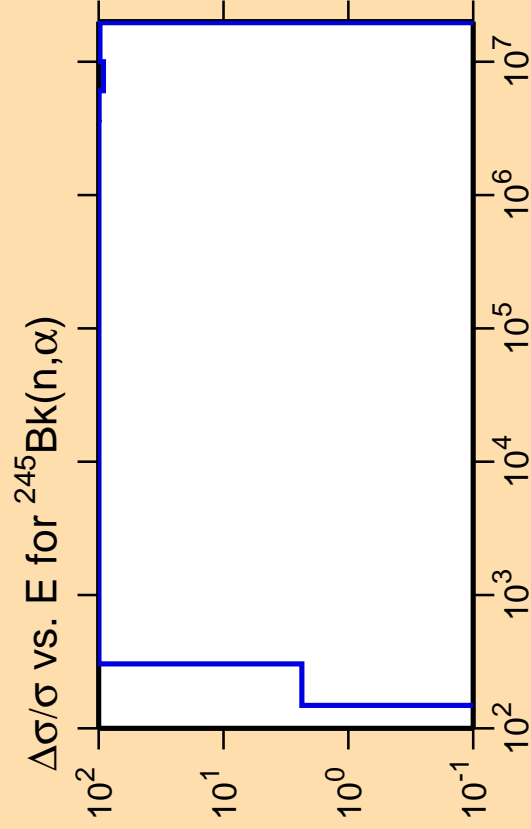

Ordinate scale is %
relative standard deviation.

Abscissa scales are energy (eV).

Warning: some uncertainty
data were suppressed.

$\Delta\sigma/\sigma$ vs. E for $^{245}\text{Bk}(n,\text{tot.})$

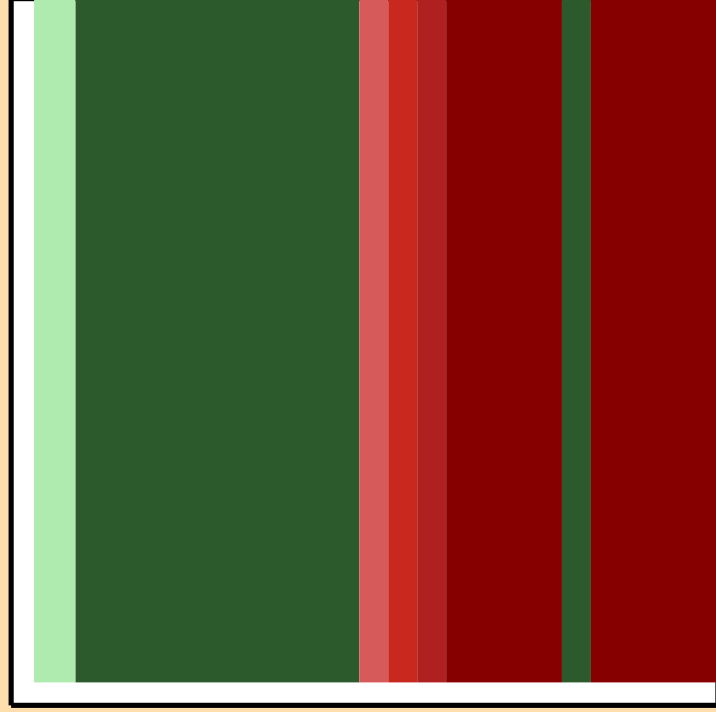
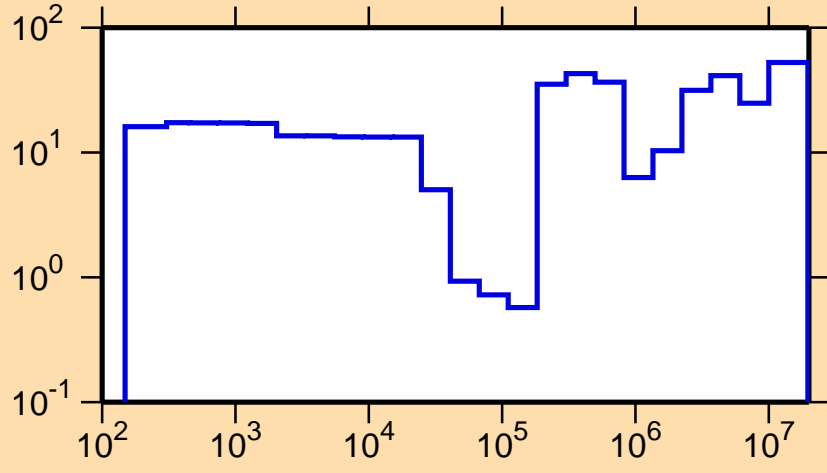

Correlation Matrix



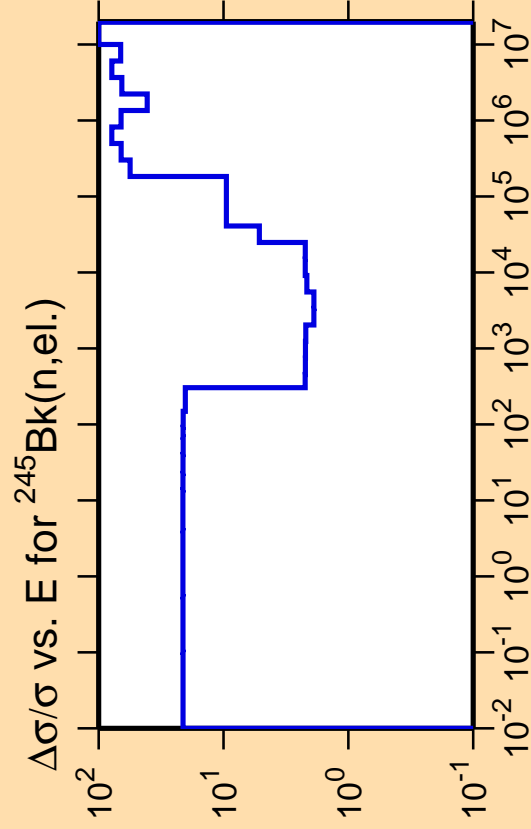

Ordinate scales are % relative standard deviation and barns.

Abscissa scales are energy (eV).

Warning: some uncertainty data were suppressed.

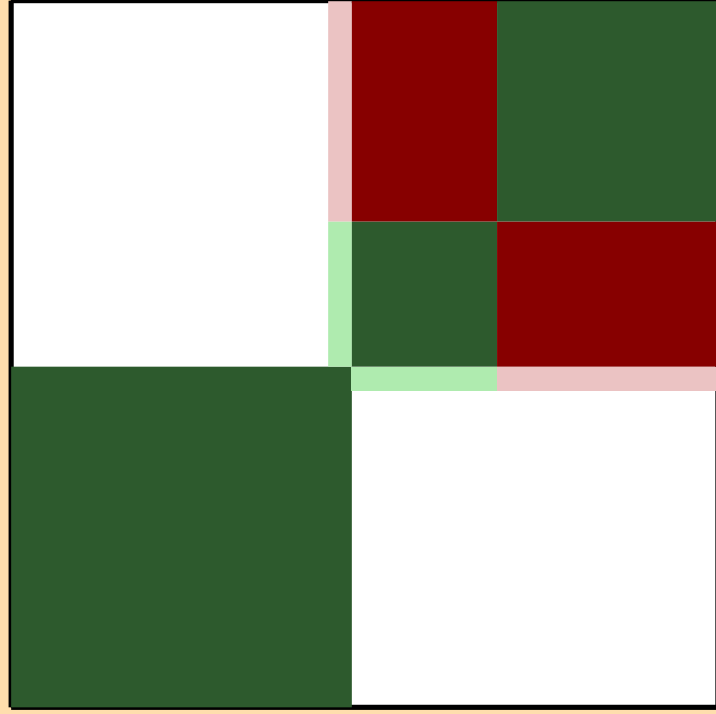
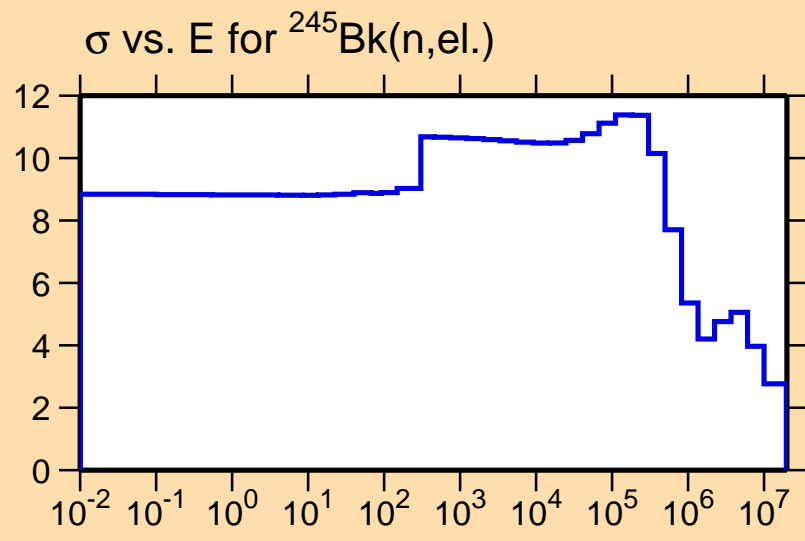

Correlation Matrix



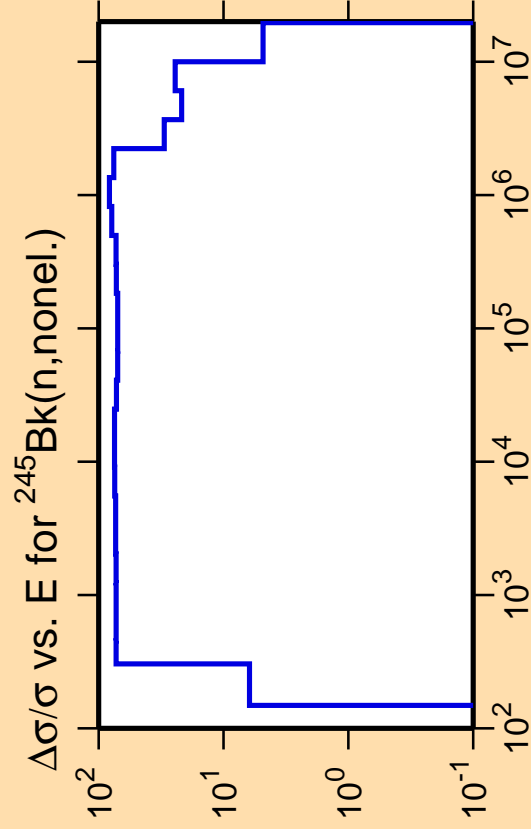

Ordinate scale is %
relative standard deviation.

Abscissa scales are energy (eV).

Warning: some uncertainty
data were suppressed.

$\Delta\sigma/\sigma$ vs. E for $^{245}\text{Bk}(n,\text{el.})$

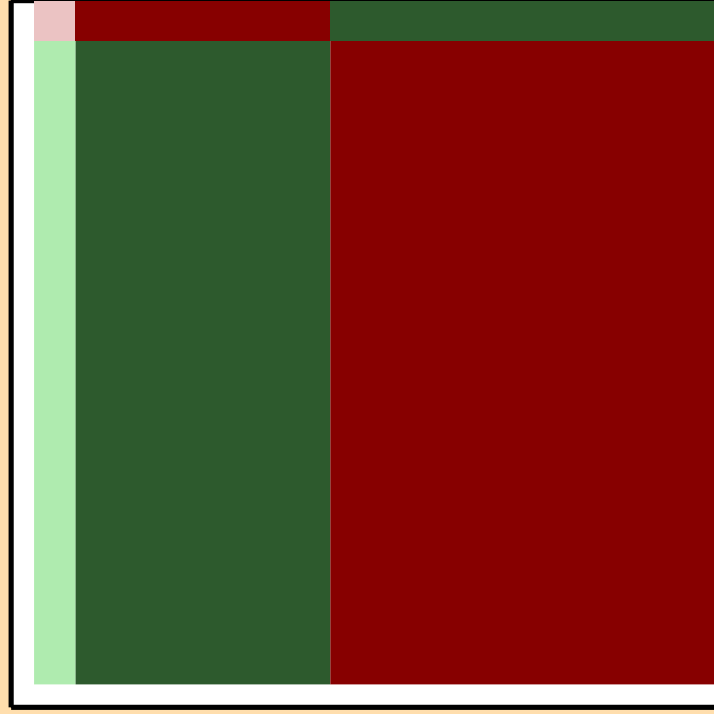
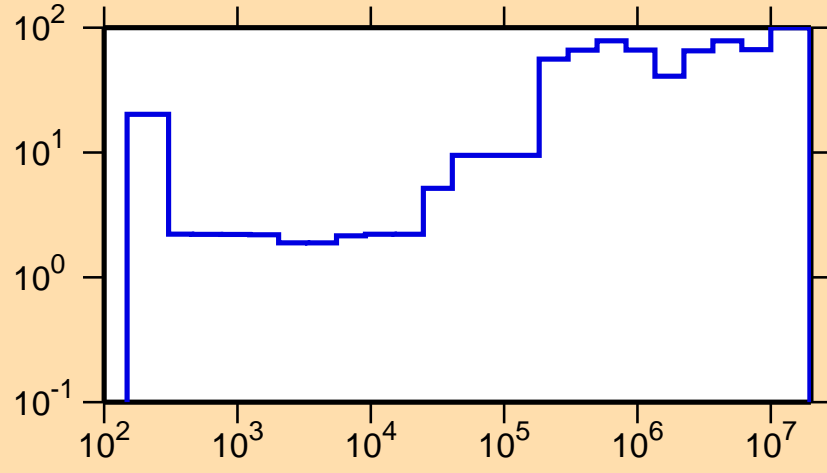

Correlation Matrix



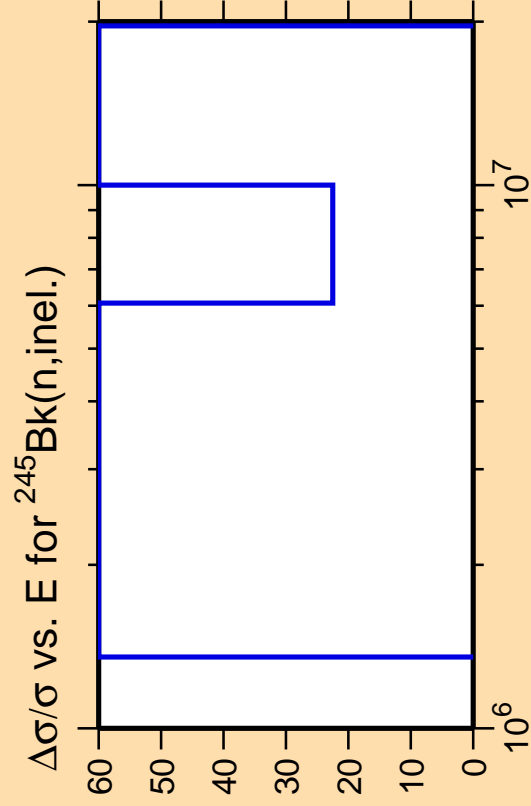

Ordinate scale is %
relative standard deviation.

Abscissa scales are energy (eV).

Warning: some uncertainty
data were suppressed.

$\Delta\sigma/\sigma$ vs. E for $^{245}\text{Bk}(n,\text{el.})$

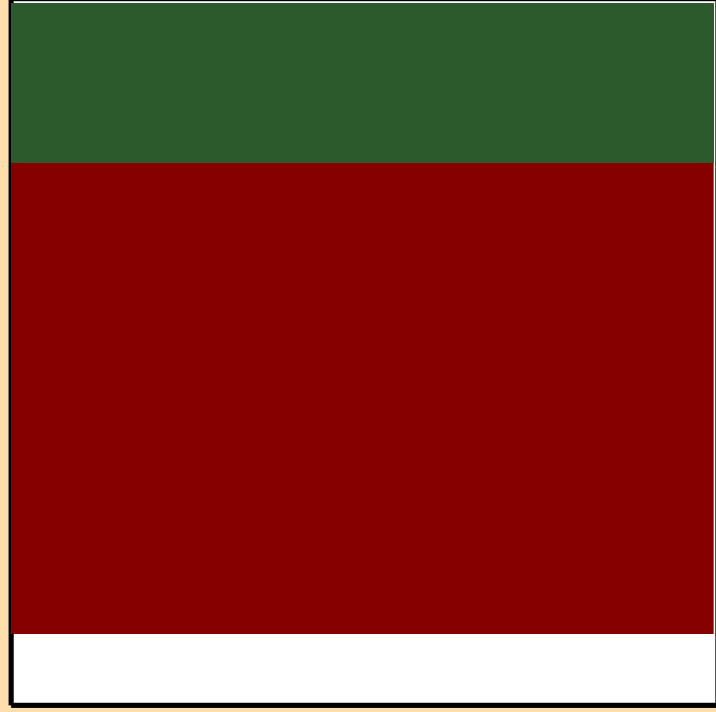
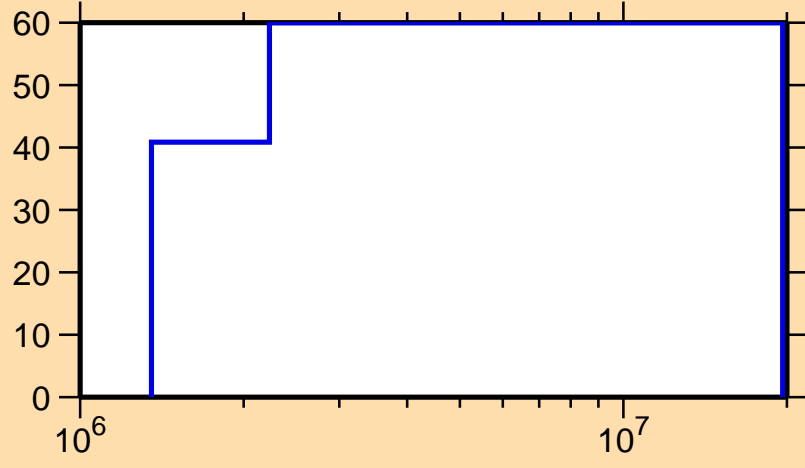

Correlation Matrix



$\Delta\sigma/\sigma$ vs. E for $^{245}\text{Bk}(n,2n)$



Ordinate scale is %
relative standard deviation.

Abscissa scales are energy (eV).

Warning: some uncertainty
data were suppressed.

$\Delta\sigma/\sigma$ vs. E for $^{245}\text{Bk}(n,\text{el.})$

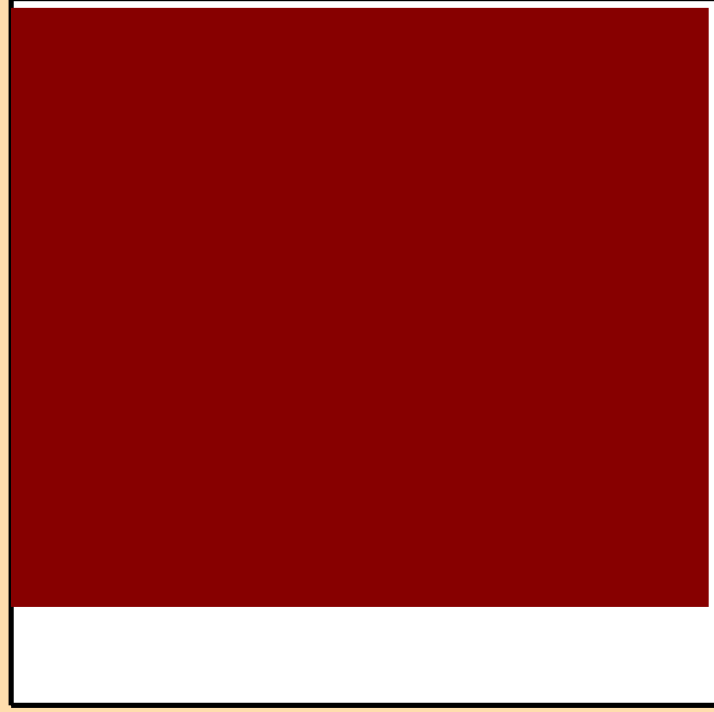
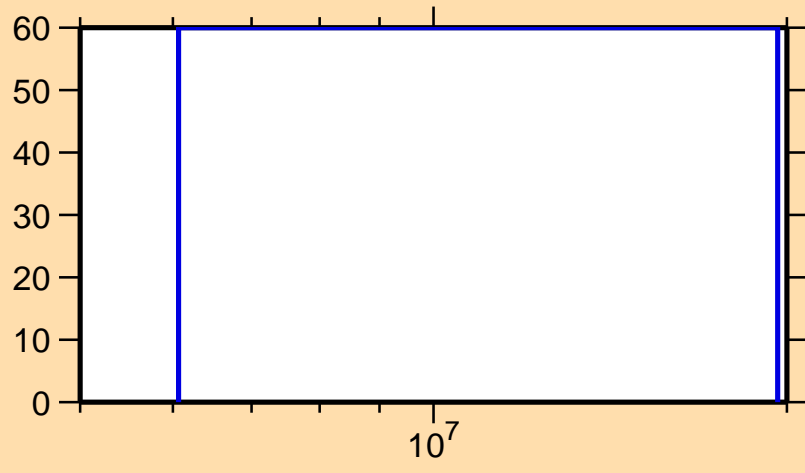

Correlation Matrix



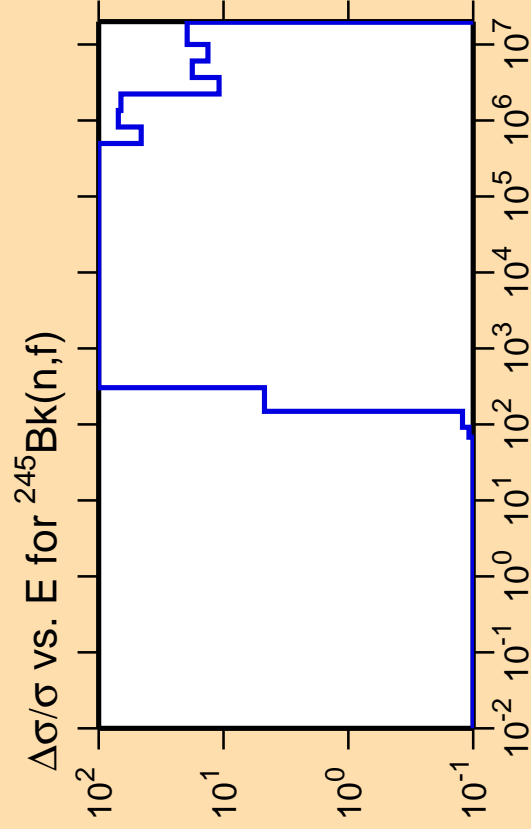

Ordinate scale is %
relative standard deviation.

Abscissa scales are energy (eV).

Warning: some uncertainty
data were suppressed.

$\Delta\sigma/\sigma$ vs. E for $^{245}\text{Bk}(n,el.)$

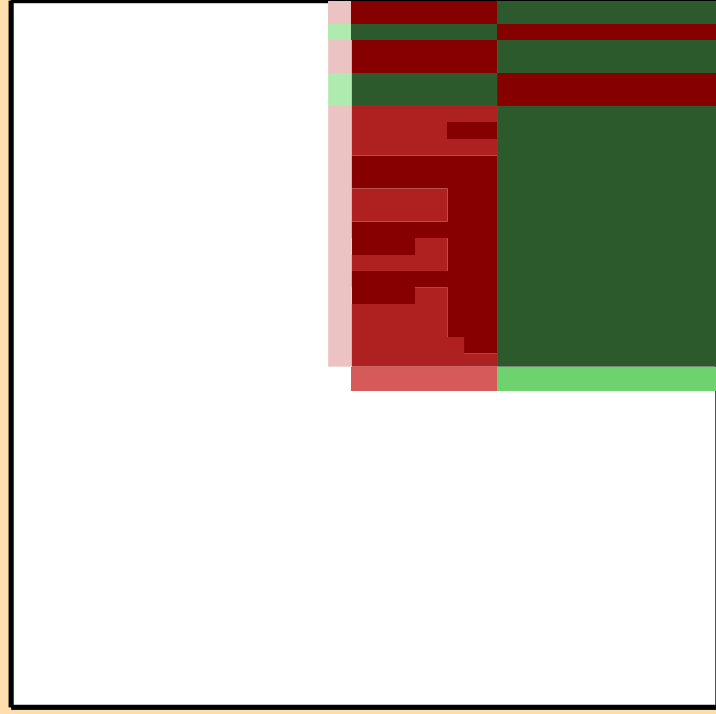
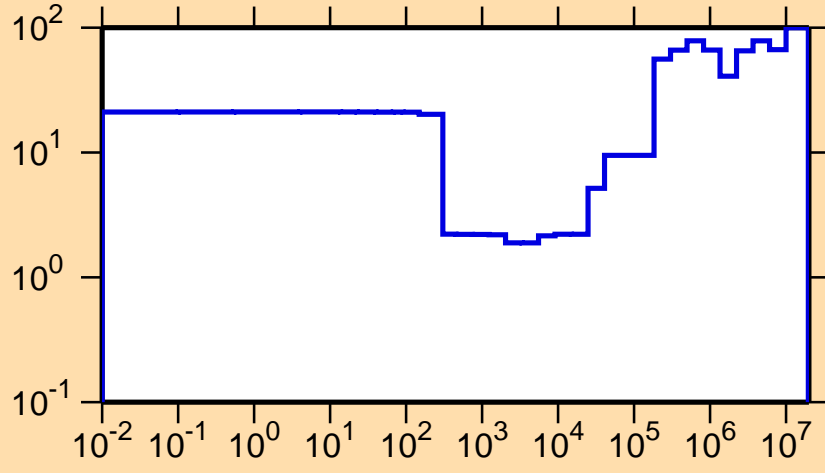

Correlation Matrix



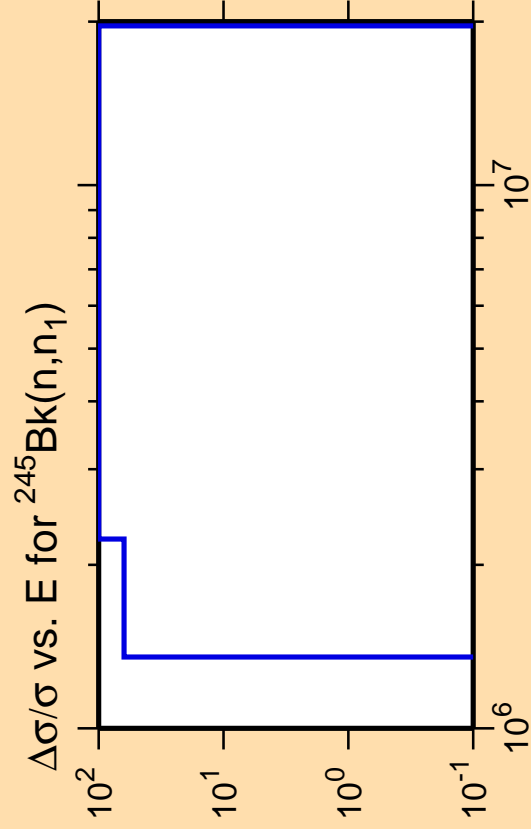

Ordinate scale is %
relative standard deviation.

Abscissa scales are energy (eV).

Warning: some uncertainty
data were suppressed.

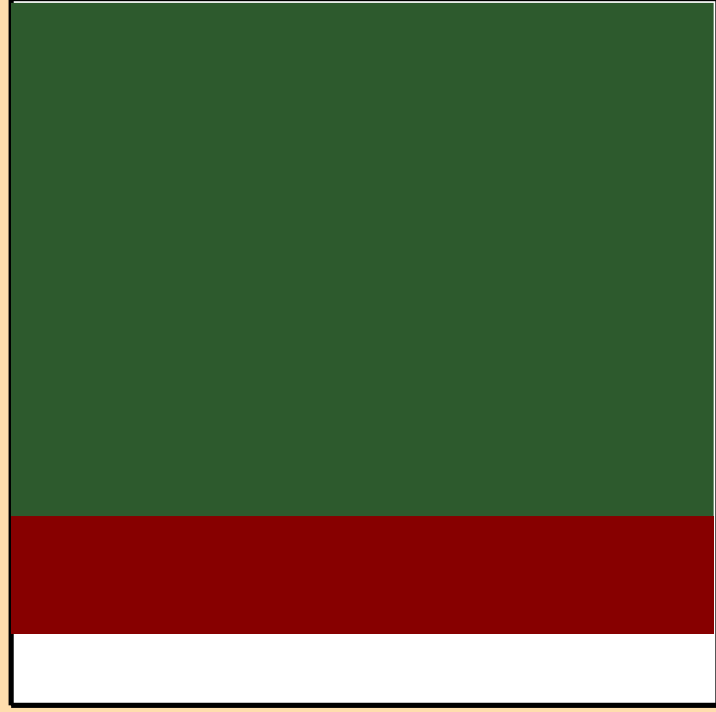
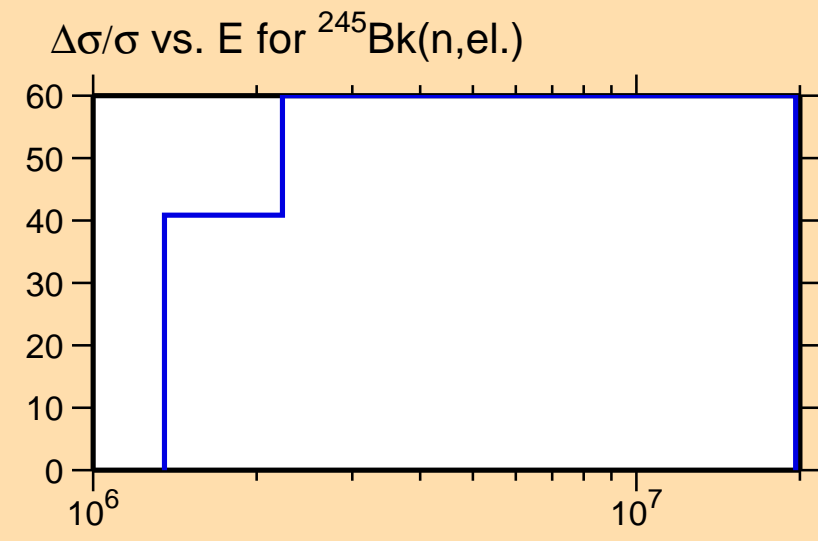

Correlation Matrix



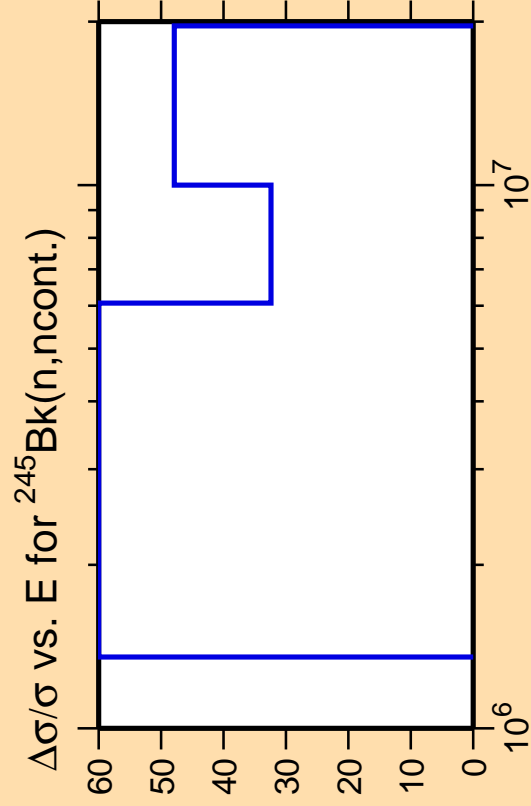

Ordinate scale is %
relative standard deviation.

Abscissa scales are energy (eV).

Warning: some uncertainty
data were suppressed.

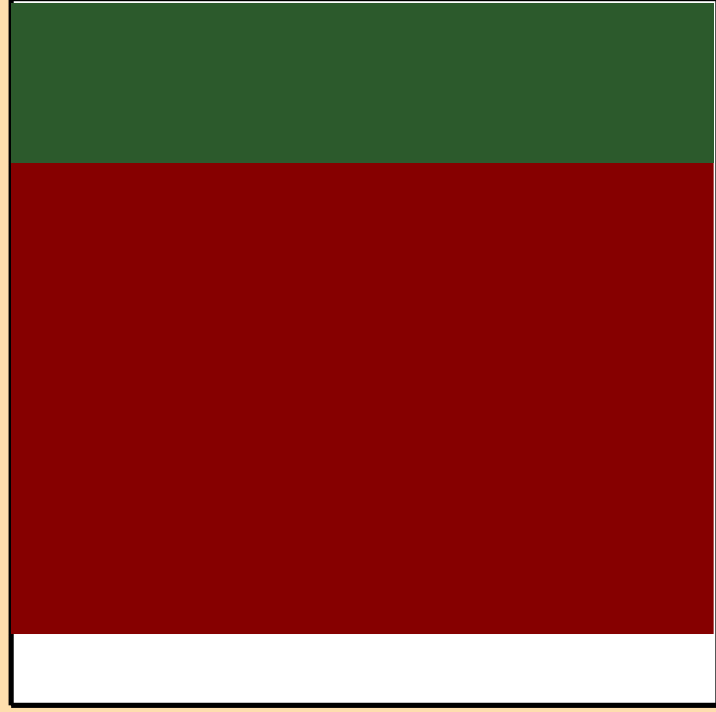
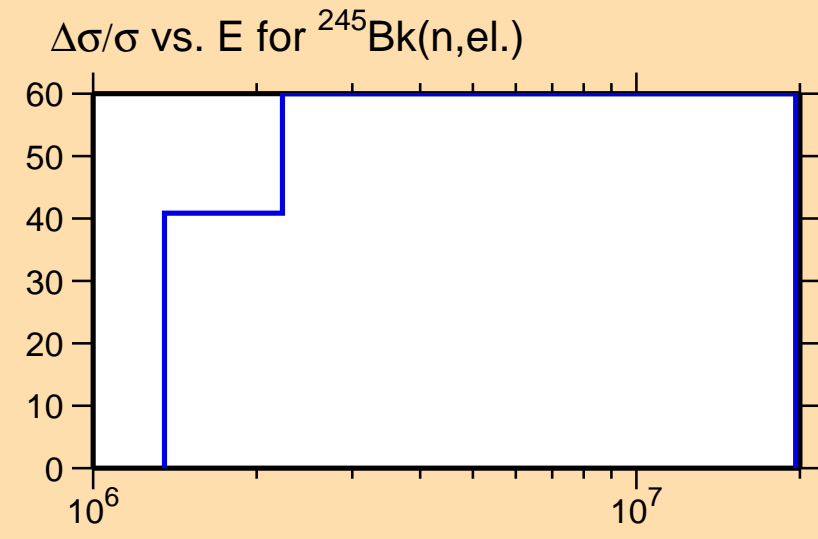

Correlation Matrix



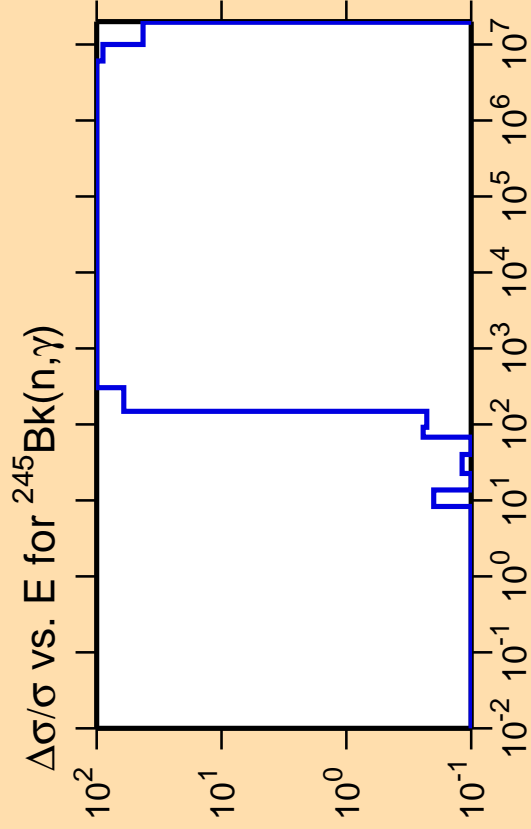

Ordinate scale is %
relative standard deviation.

Abscissa scales are energy (eV).

Warning: some uncertainty
data were suppressed.

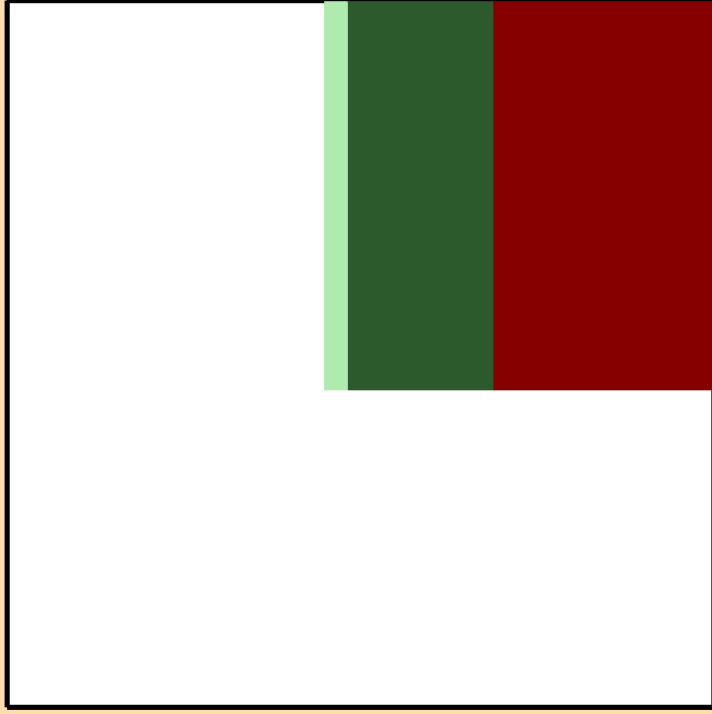
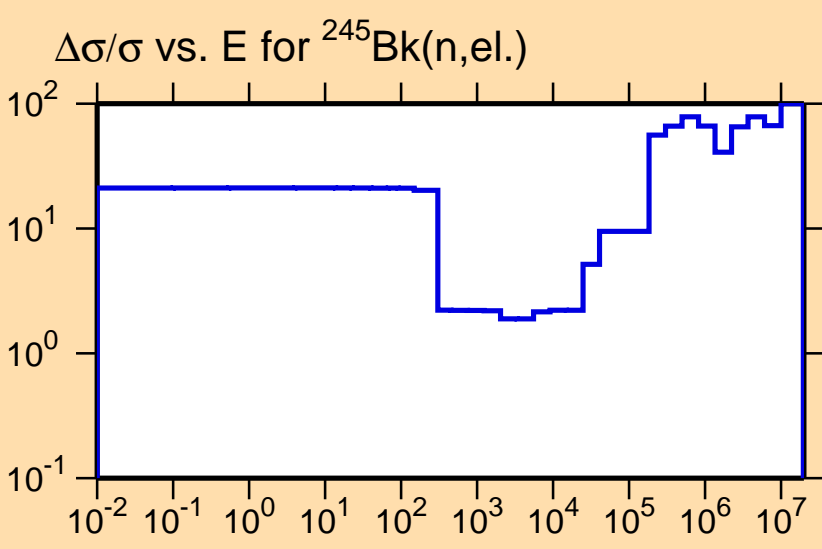

Correlation Matrix



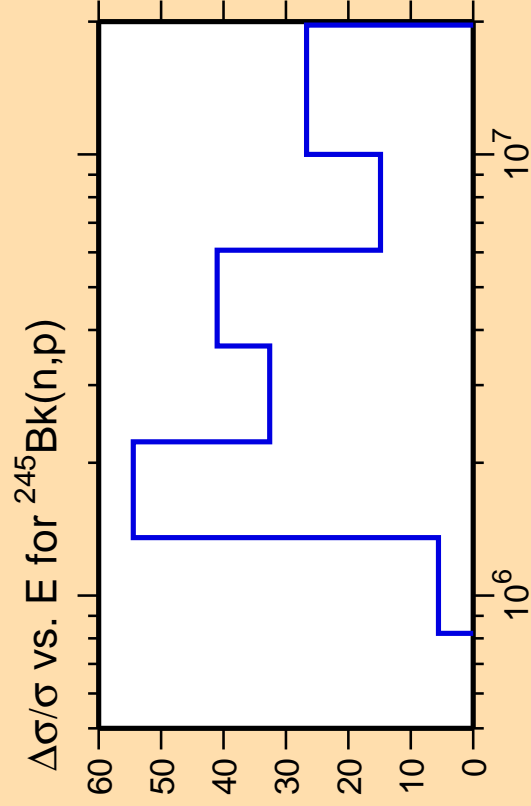

Ordinate scale is %
relative standard deviation.

Abscissa scales are energy (eV).

Warning: some uncertainty
data were suppressed.

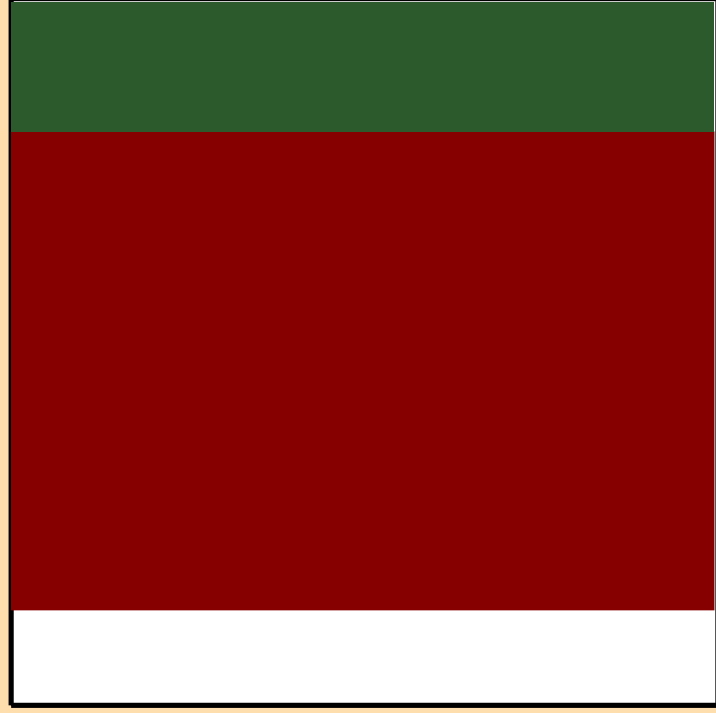
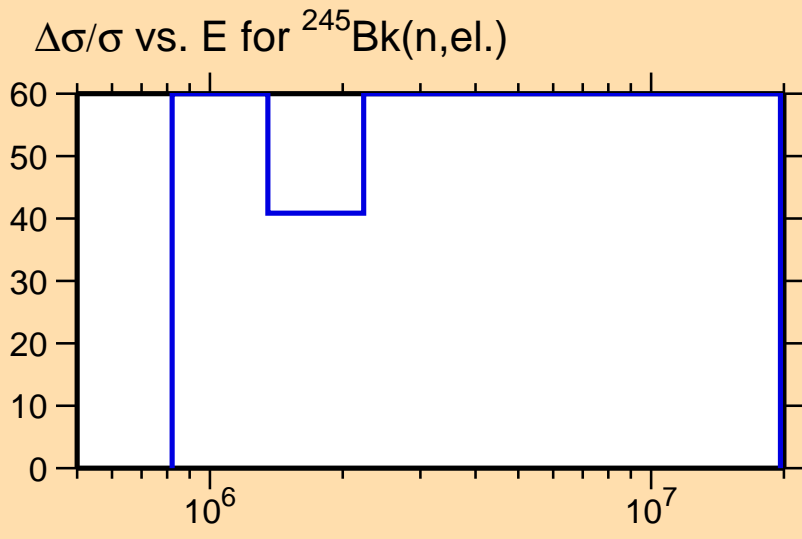

Correlation Matrix



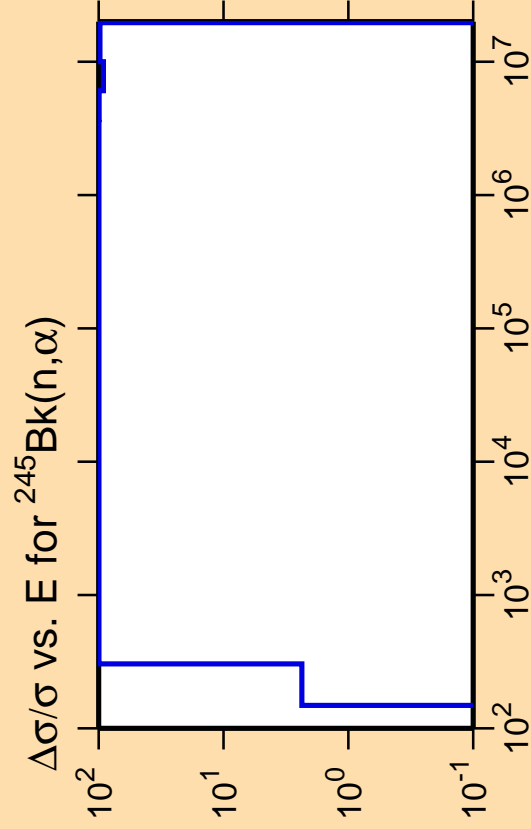

Ordinate scale is %
relative standard deviation.

Abscissa scales are energy (eV).

Warning: some uncertainty
data were suppressed.

$\Delta\sigma/\sigma$ vs. E for $^{245}\text{Bk}(n,\text{el.})$

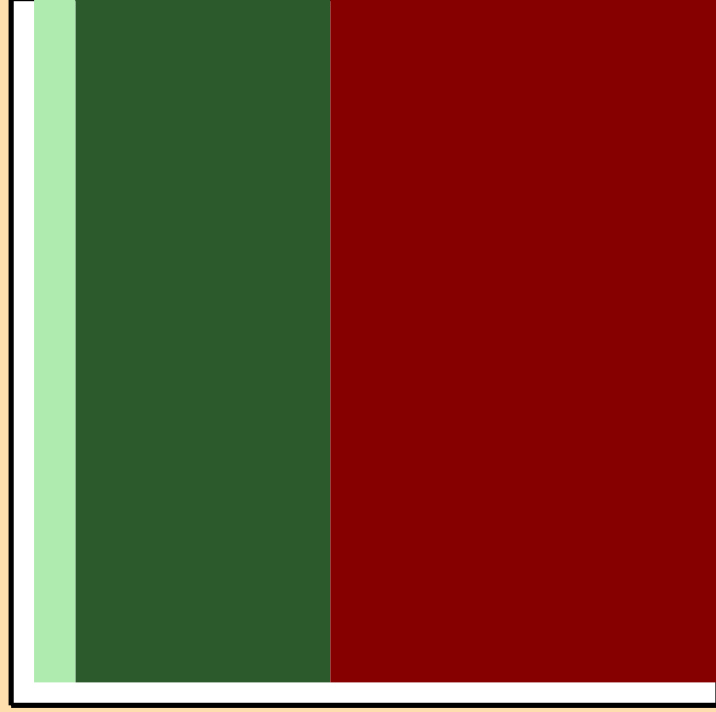
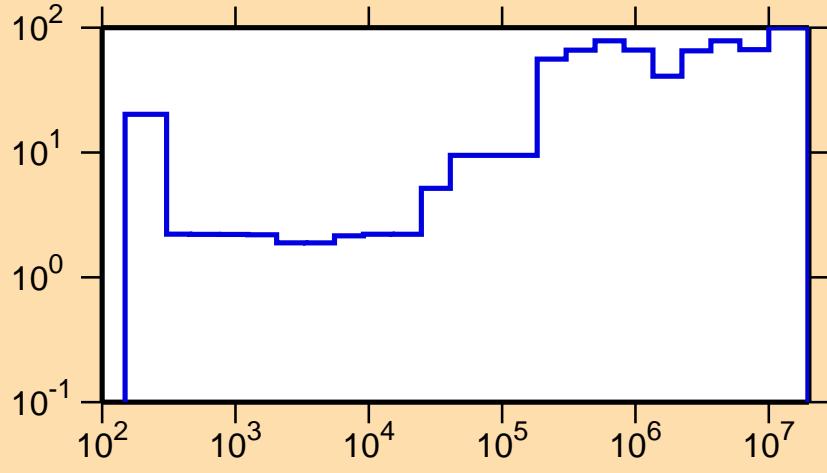

Correlation Matrix



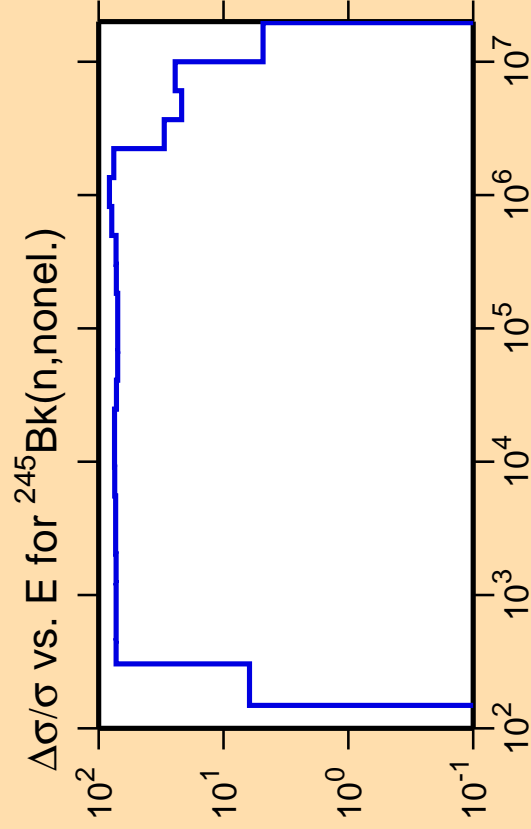

Ordinate scales are % relative standard deviation and barns.

Abscissa scales are energy (eV).

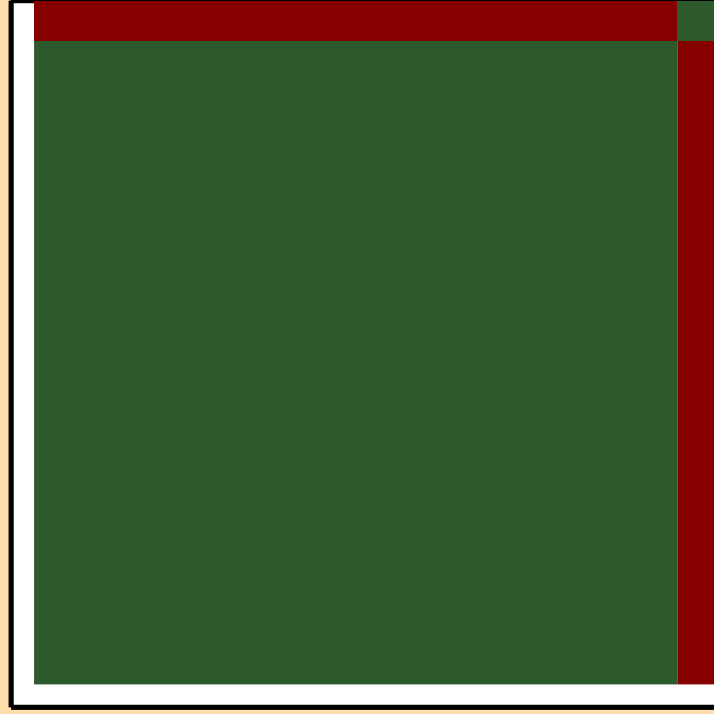
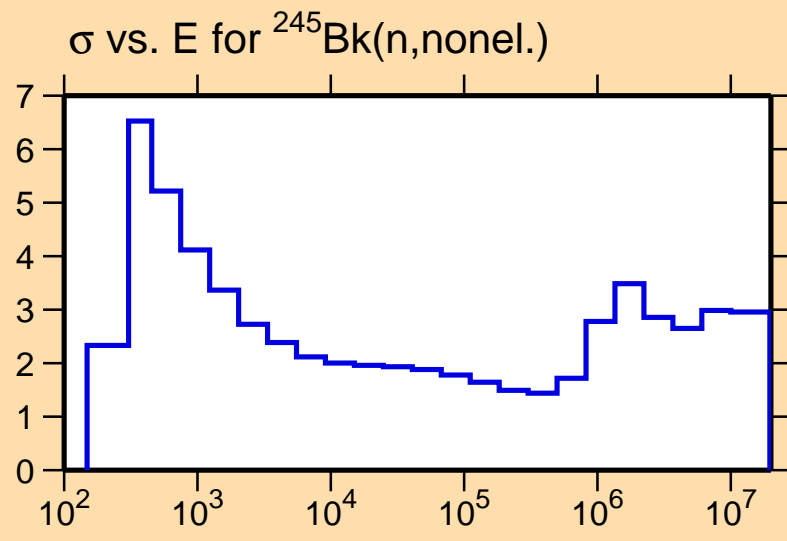

Correlation Matrix



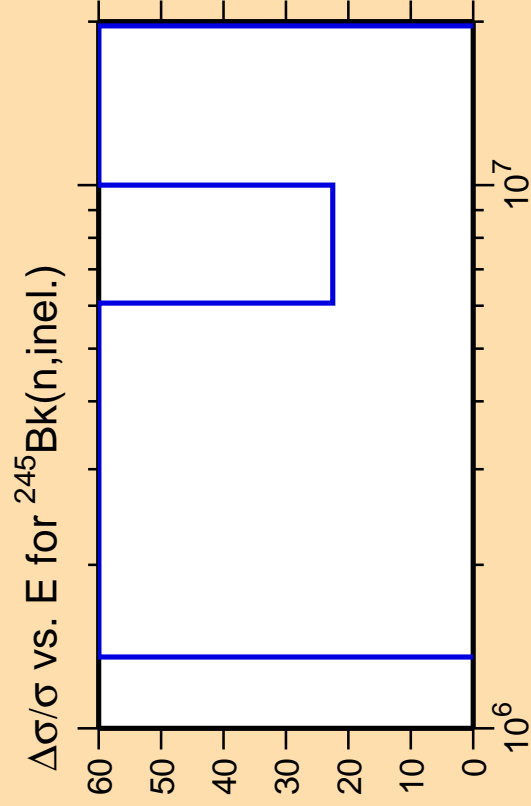

Ordinate scale is %
relative standard deviation.

Abscissa scales are energy (eV).

Warning: some uncertainty
data were suppressed.

$\Delta\sigma/\sigma$ vs. E for $^{245}\text{Bk}(n,\text{nonel.})$

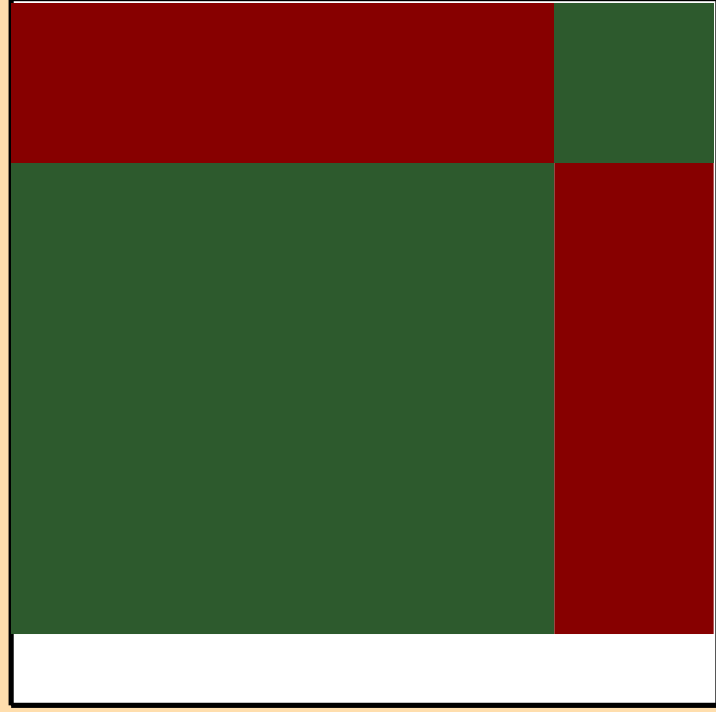
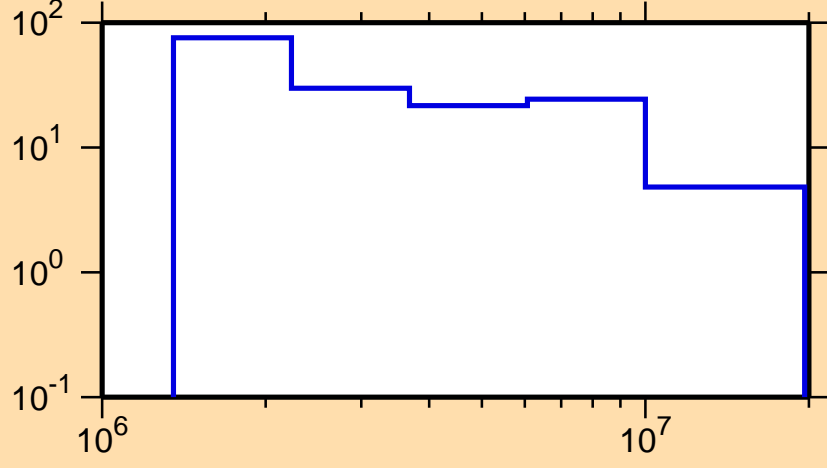

Correlation Matrix



$\Delta\sigma/\sigma$ vs. E for $^{245}\text{Bk}(n,2n)$



Ordinate scale is %
relative standard deviation.

Abscissa scales are energy (eV).

Warning: some uncertainty
data were suppressed.

$\Delta\sigma/\sigma$ vs. E for $^{245}\text{Bk}(n,\text{nonel.})$

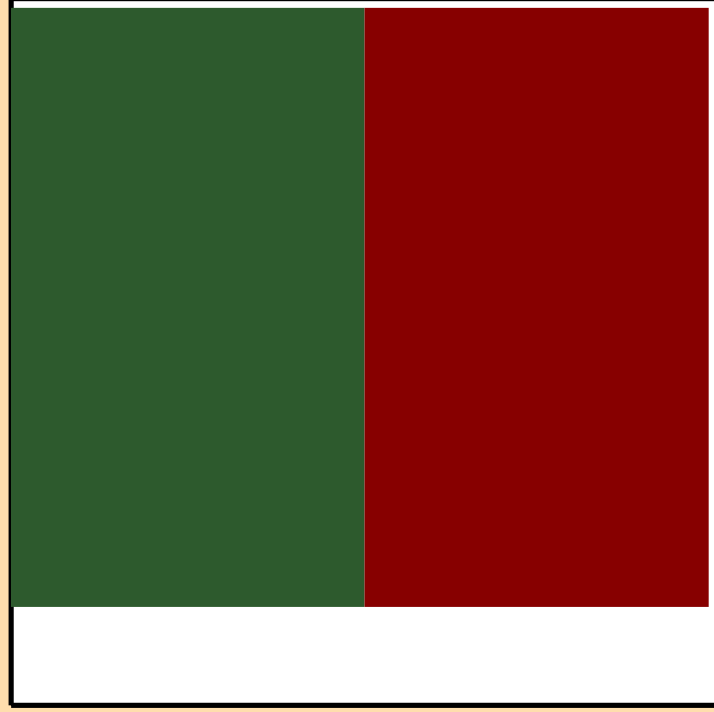
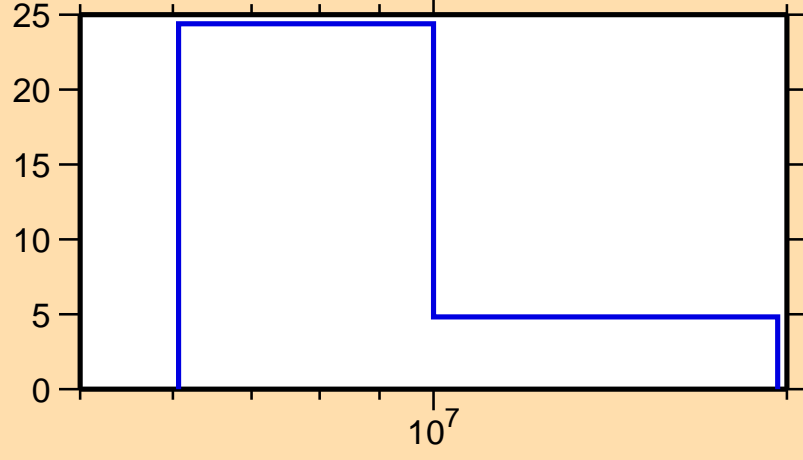

Correlation Matrix



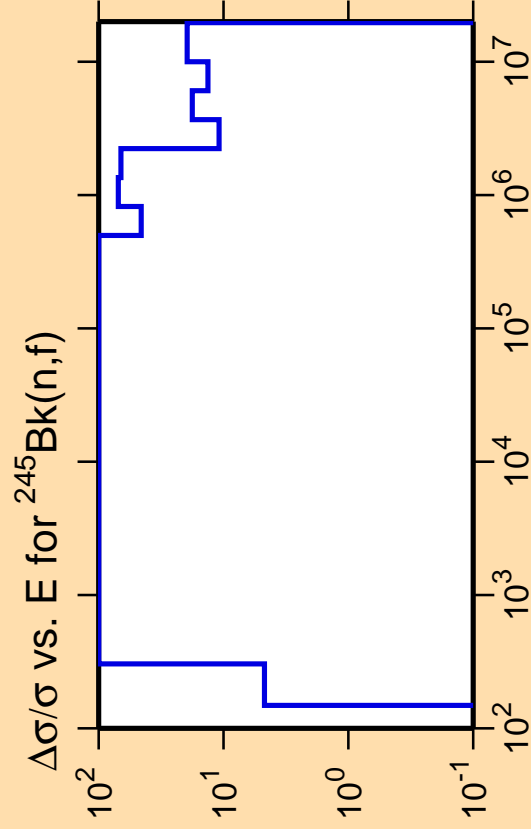

Ordinate scale is %
relative standard deviation.

Abscissa scales are energy (eV).

Warning: some uncertainty
data were suppressed.

$\Delta\sigma/\sigma$ vs. E for $^{245}\text{Bk}(n,\text{nonel.})$

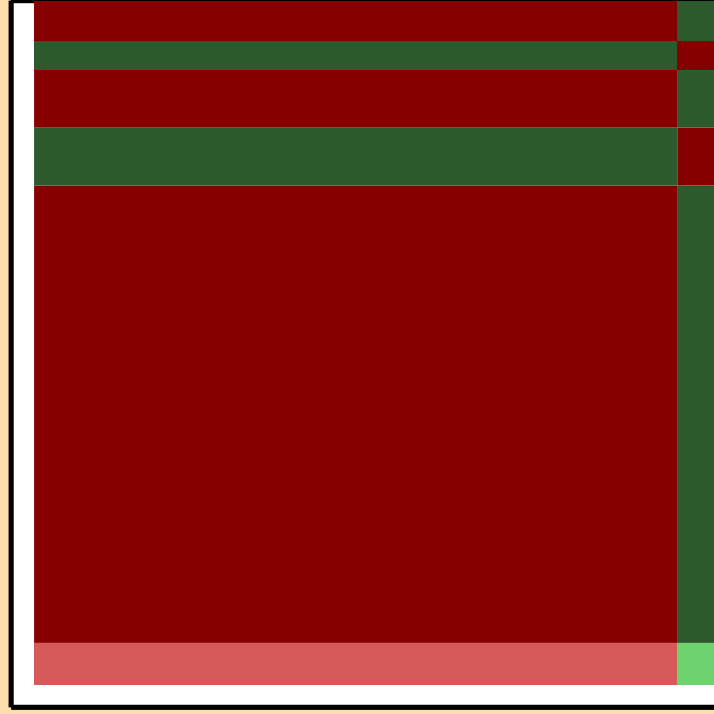
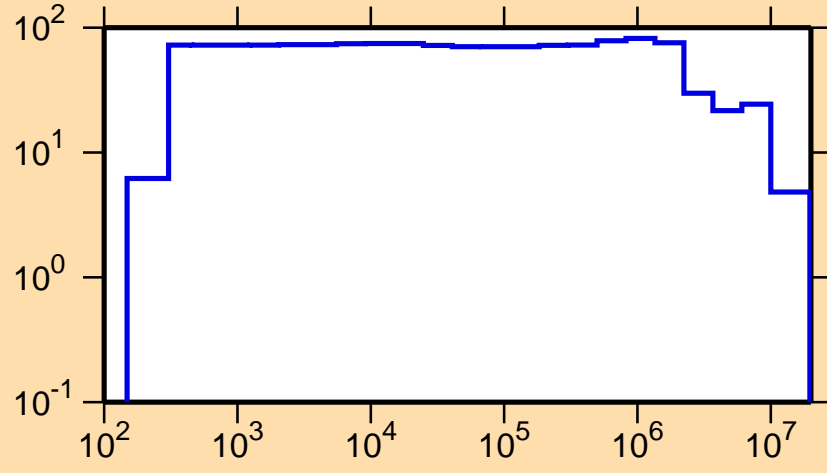

Correlation Matrix



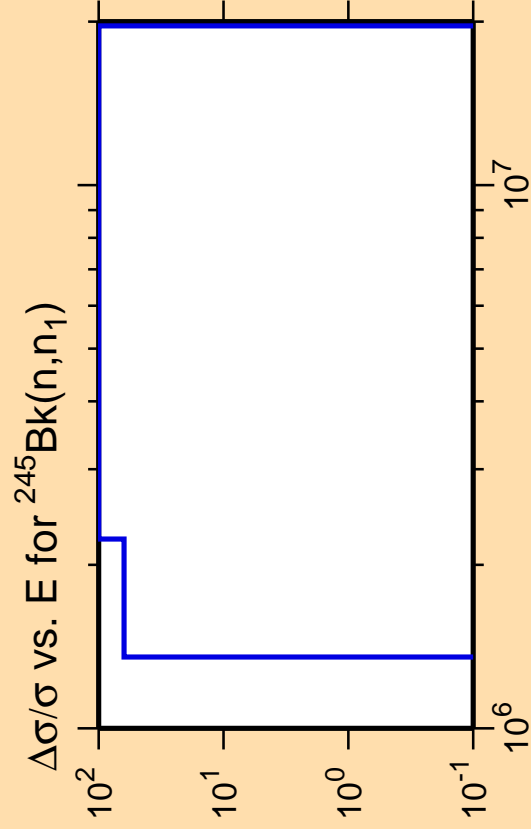

Ordinate scale is %
relative standard deviation.

Abscissa scales are energy (eV).

Warning: some uncertainty
data were suppressed.

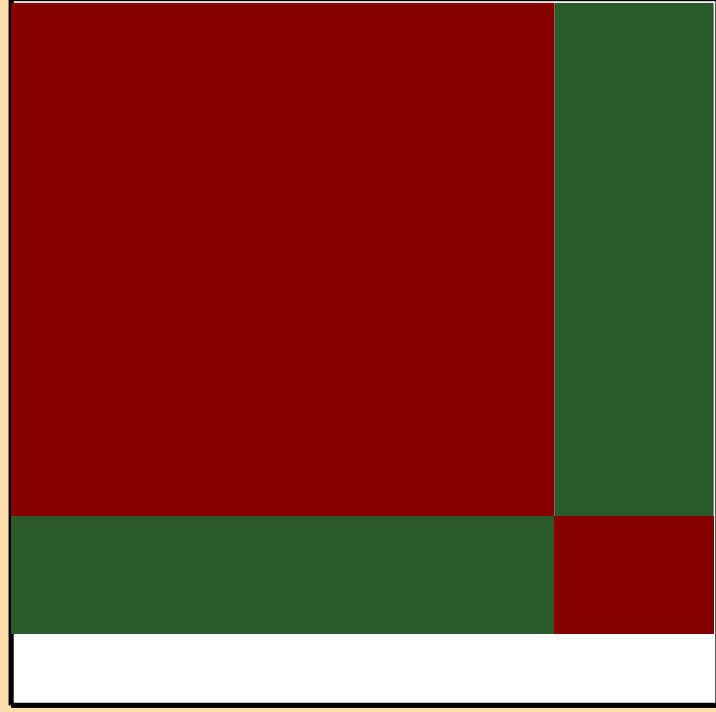
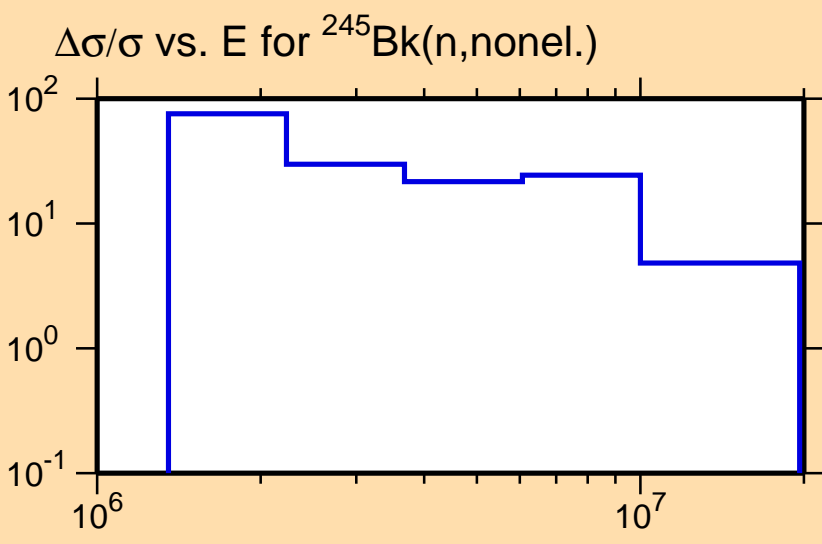

Correlation Matrix



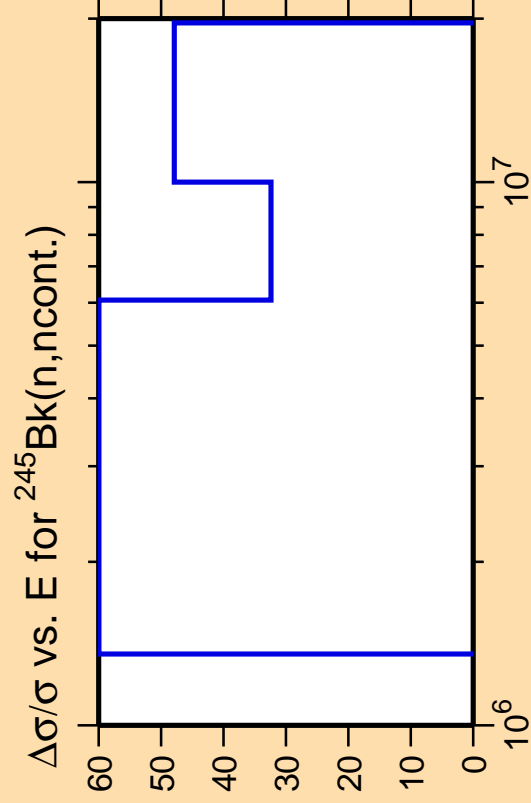

Ordinate scale is %
relative standard deviation.

Abscissa scales are energy (eV).

Warning: some uncertainty
data were suppressed.

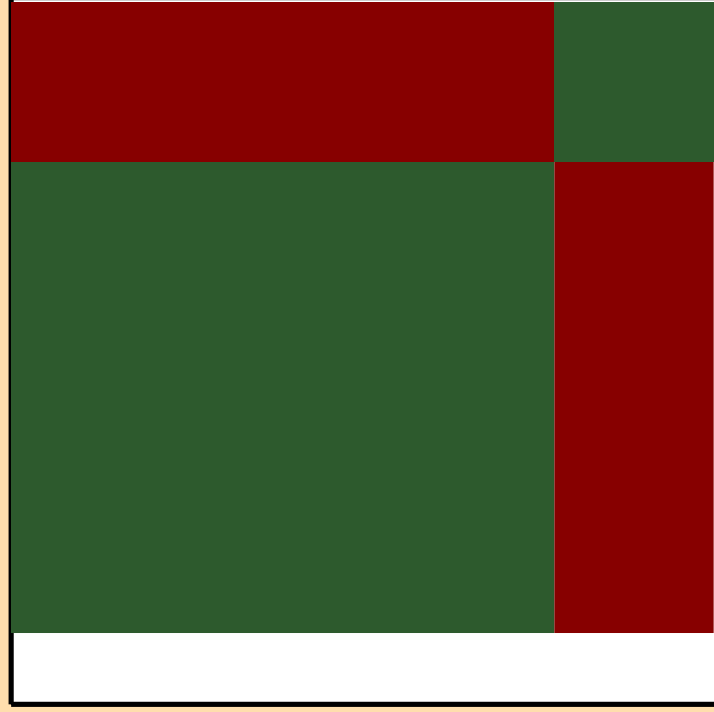
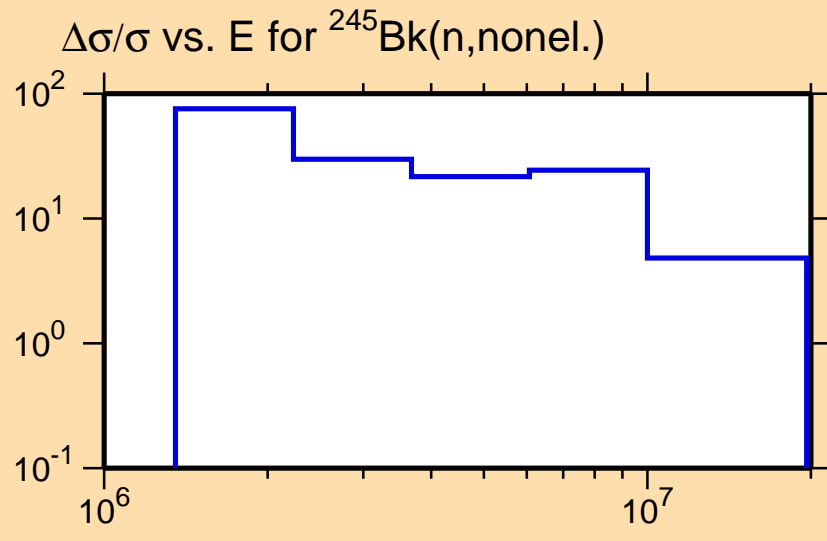

Correlation Matrix

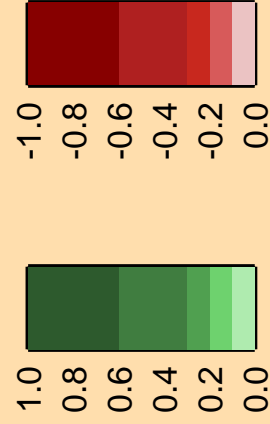

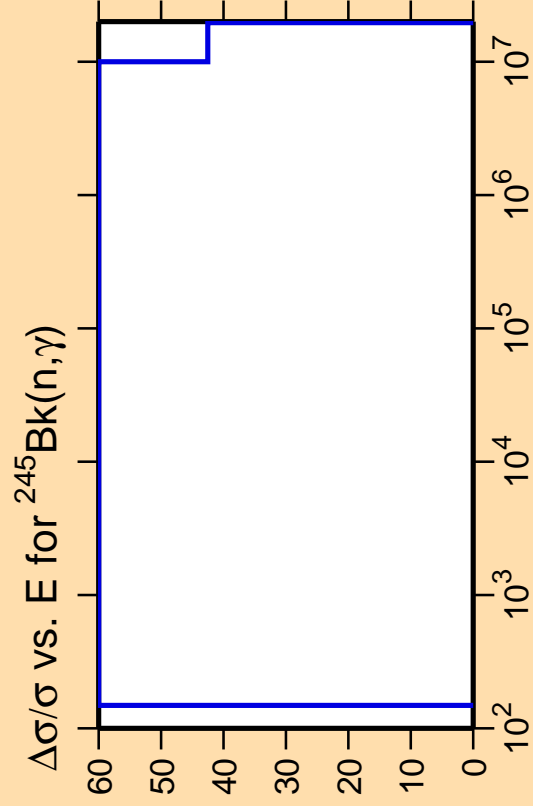

Ordinate scale is %
relative standard deviation.

Abscissa scales are energy (eV).

Warning: some uncertainty
data were suppressed.

$\Delta\sigma/\sigma$ vs. E for $^{245}\text{Bk}(n,\text{nonel.})$

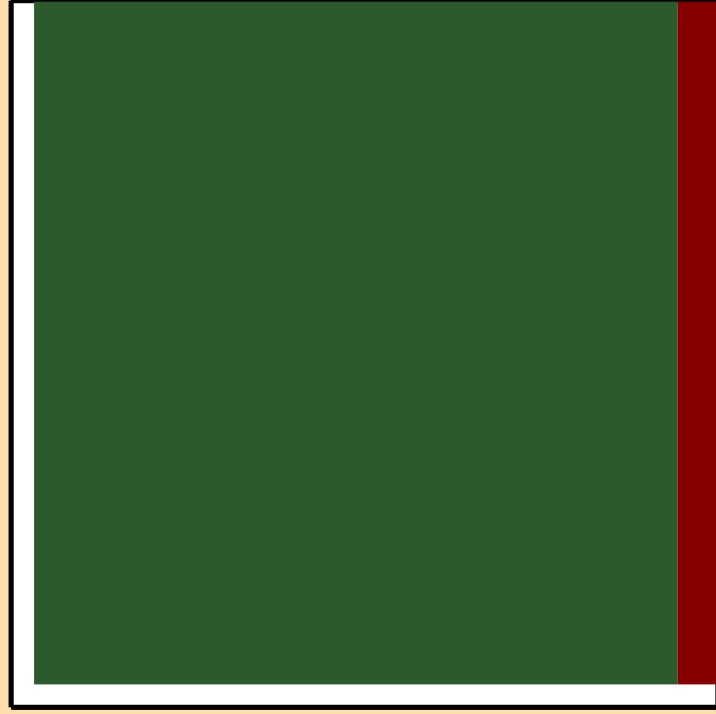
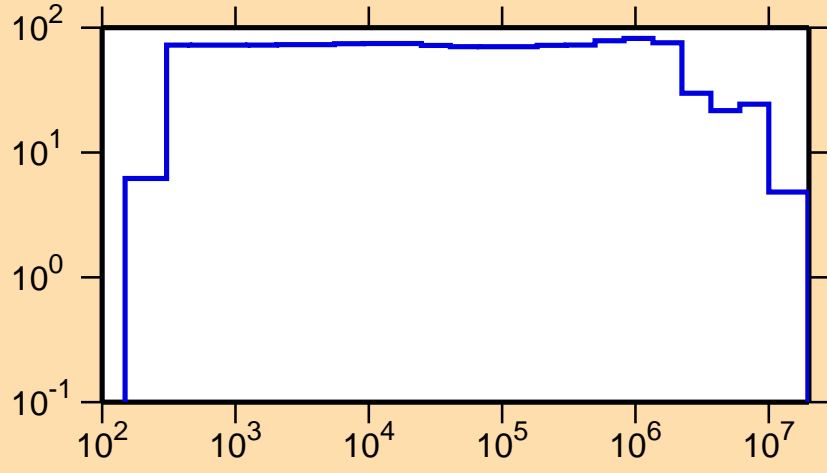

Correlation Matrix



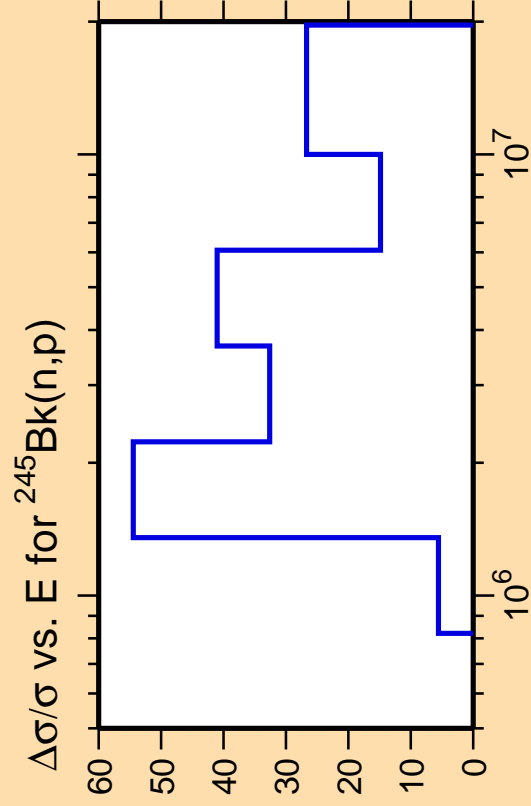

Ordinate scale is %
relative standard deviation.

Abscissa scales are energy (eV).

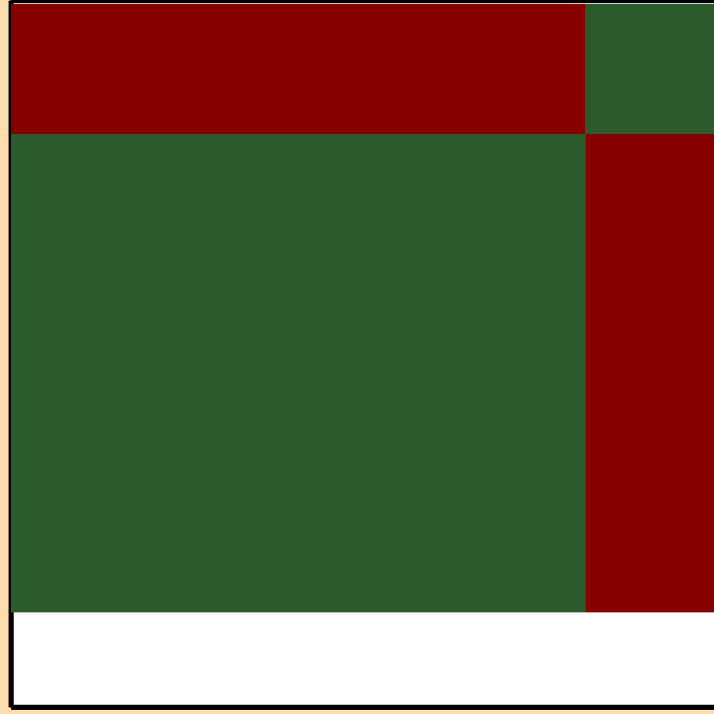
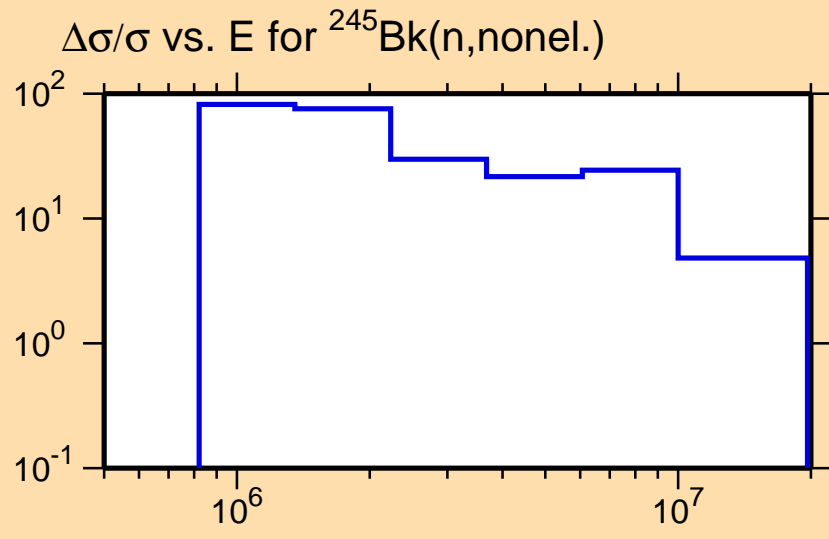

Correlation Matrix



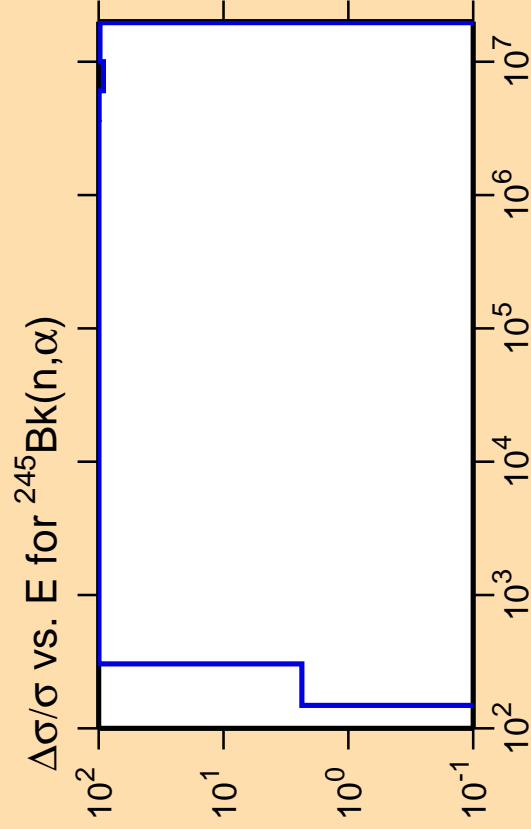

Ordinate scale is %
relative standard deviation.

Abscissa scales are energy (eV).

Warning: some uncertainty
data were suppressed.

$\Delta\sigma/\sigma$ vs. E for $^{245}\text{Bk}(n,\text{nonel.})$

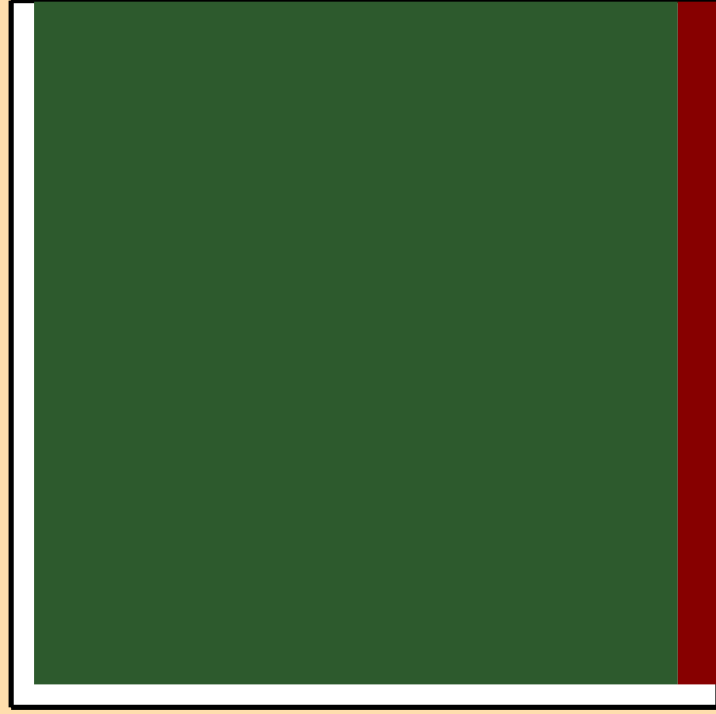
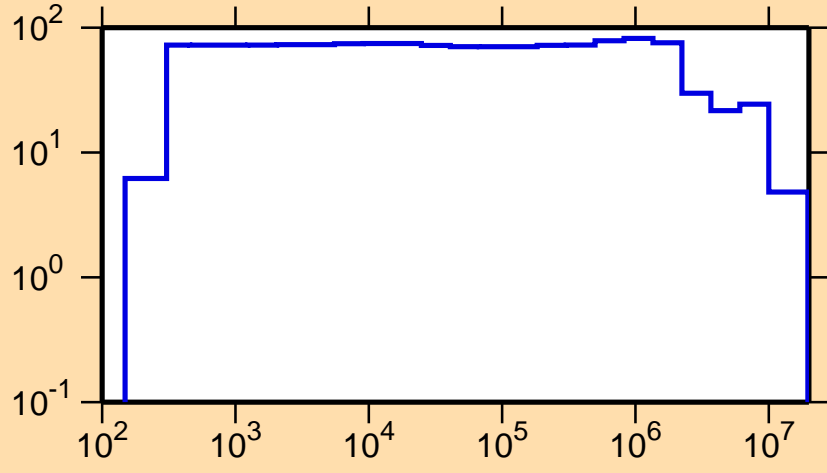

Correlation Matrix



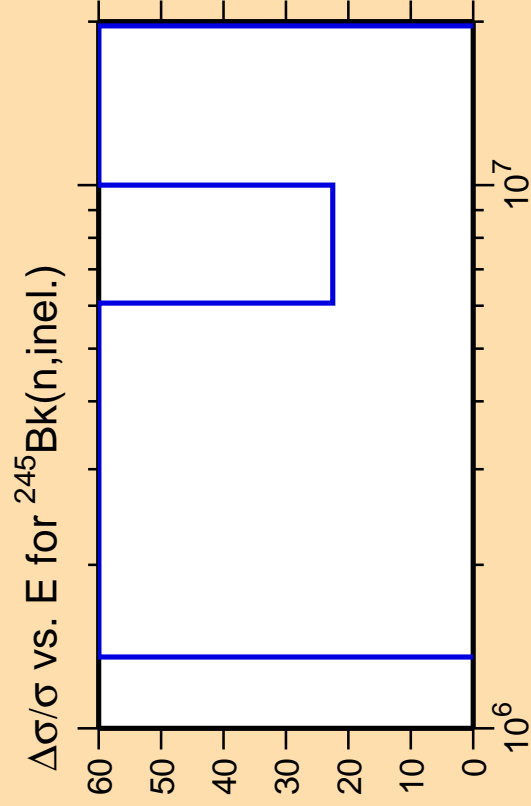

Ordinate scales are % relative standard deviation and barns.

Abscissa scales are energy (eV).

Warning: some uncertainty data were suppressed.

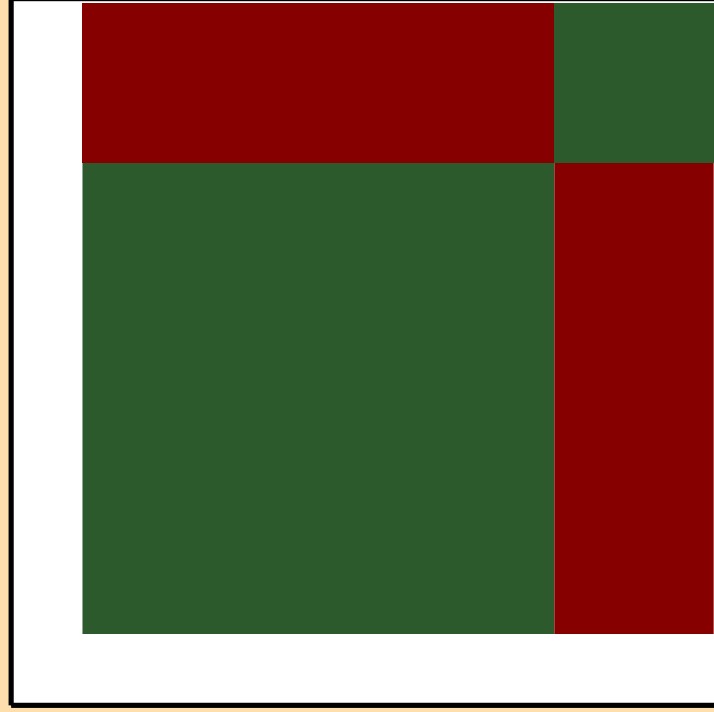
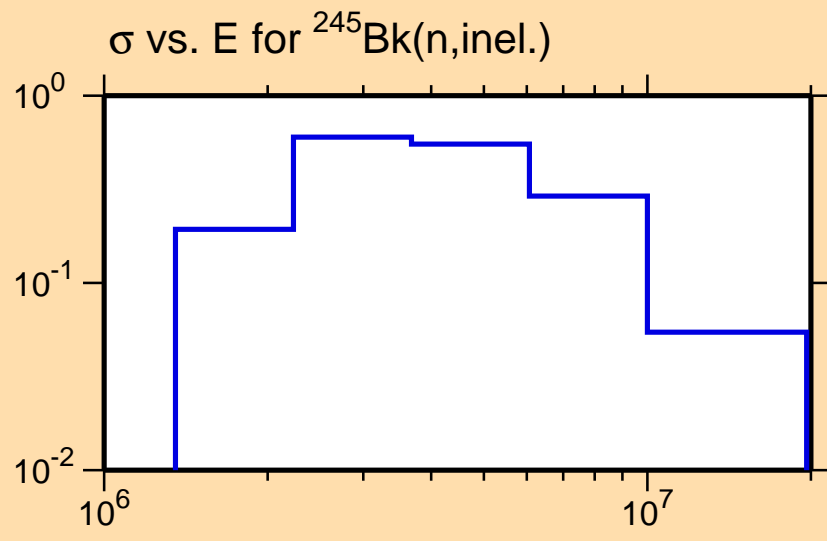

Correlation Matrix



$\Delta\sigma/\sigma$ vs. E for $^{245}\text{Bk}(n,2n)$



Ordinate scale is %
relative standard deviation.

Abscissa scales are energy (eV).

Warning: some uncertainty
data were suppressed.

$\Delta\sigma/\sigma$ vs. E for $^{245}\text{Bk}(n,\text{inel.})$

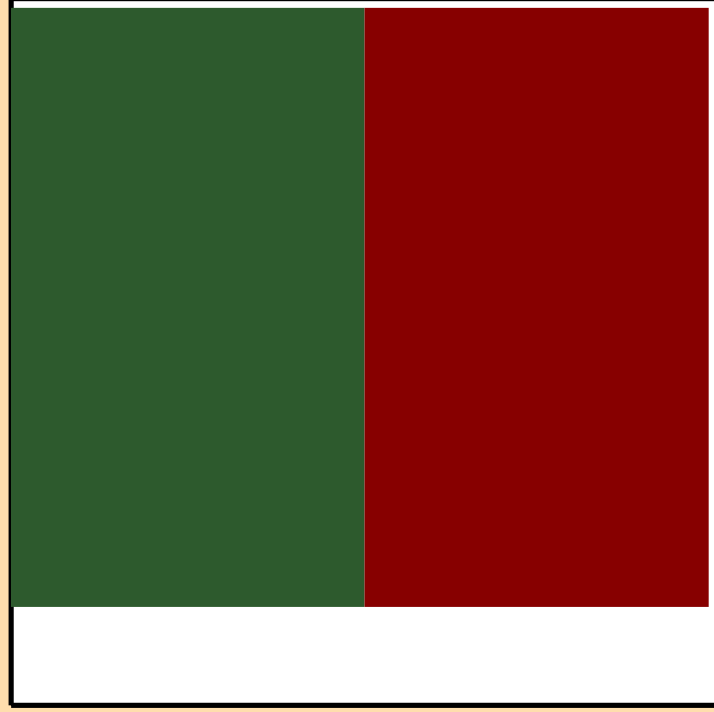
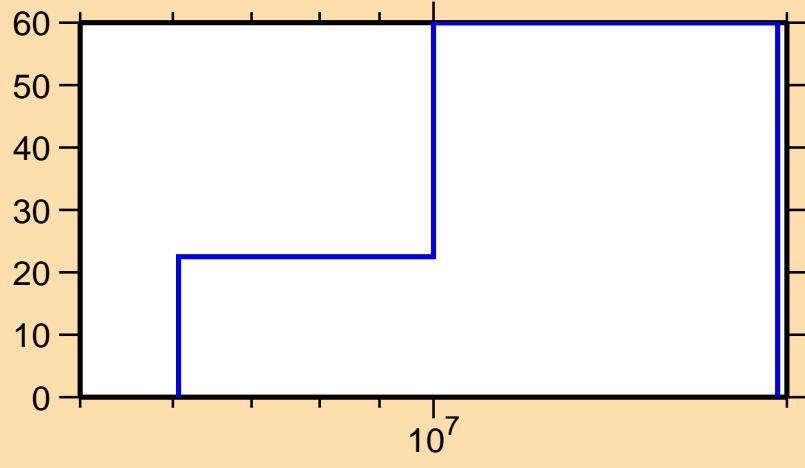

Correlation Matrix



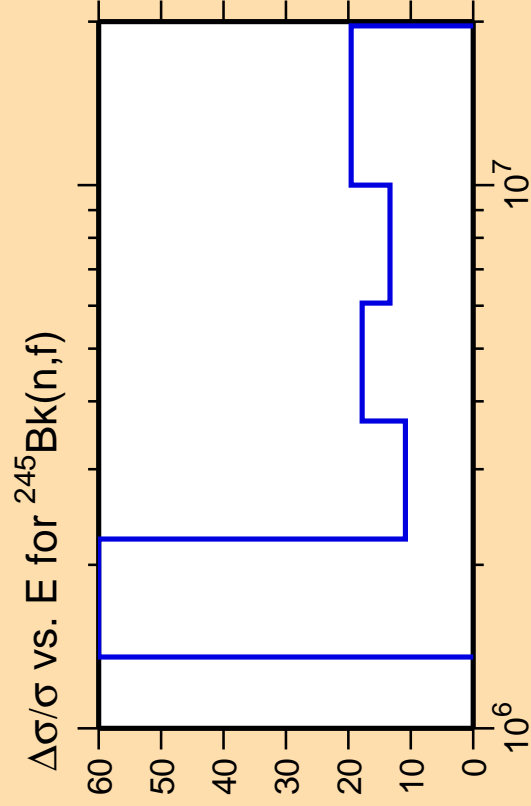

Ordinate scale is %
relative standard deviation.

Abscissa scales are energy (eV).

Warning: some uncertainty
data were suppressed.

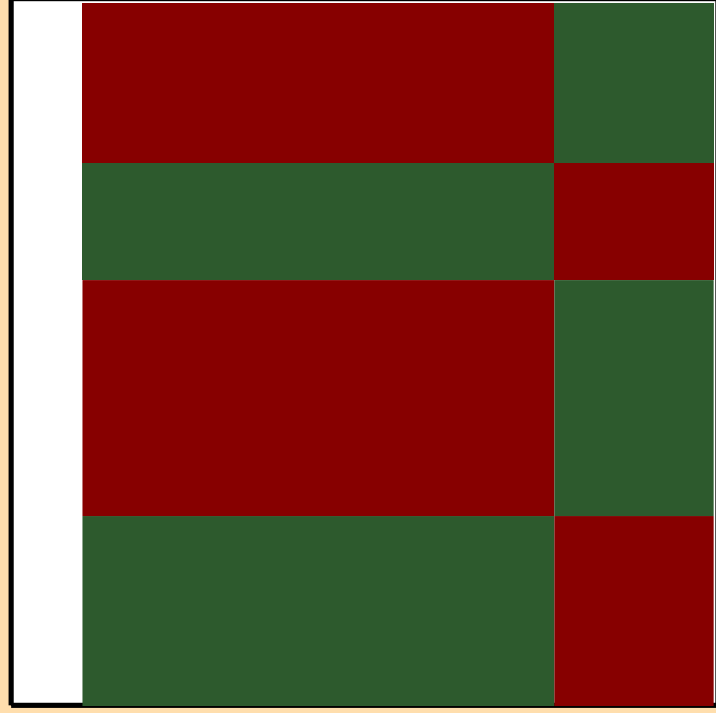
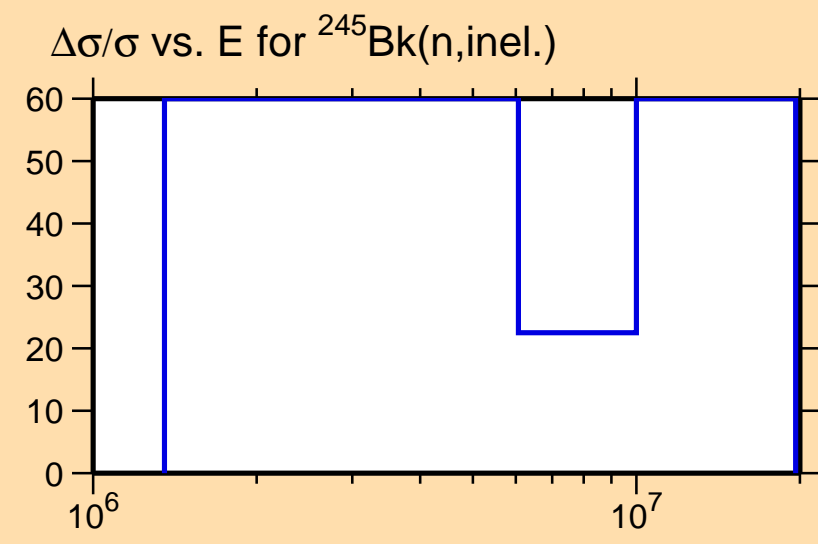

Correlation Matrix



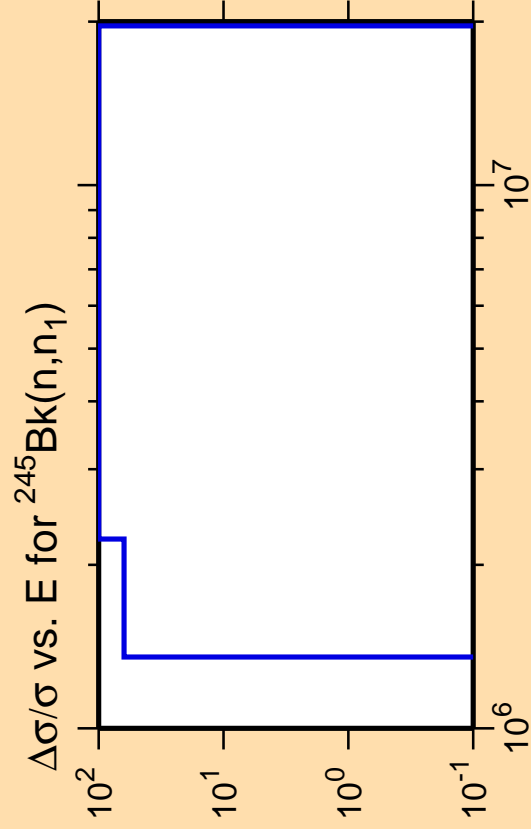

Ordinate scale is %
relative standard deviation.

Abscissa scales are energy (eV).

Warning: some uncertainty
data were suppressed.

$\Delta\sigma/\sigma$ vs. E for $^{245}\text{Bk}(n,\text{inel.})$

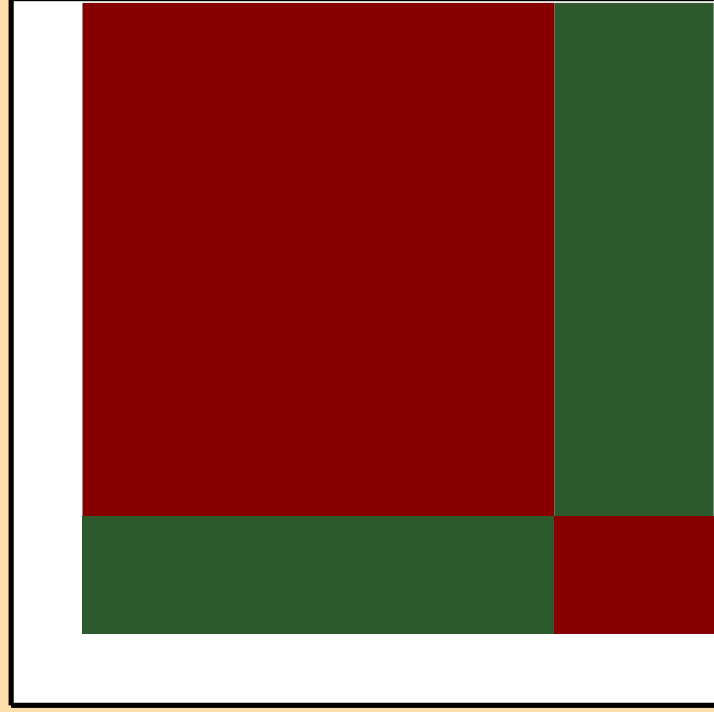
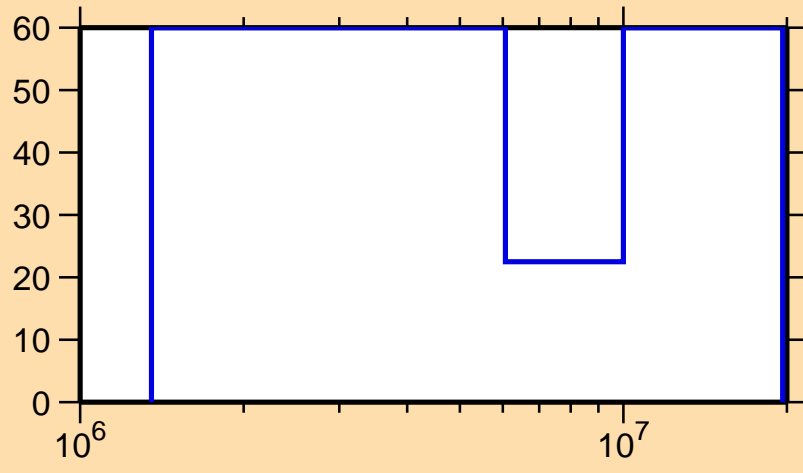

Correlation Matrix



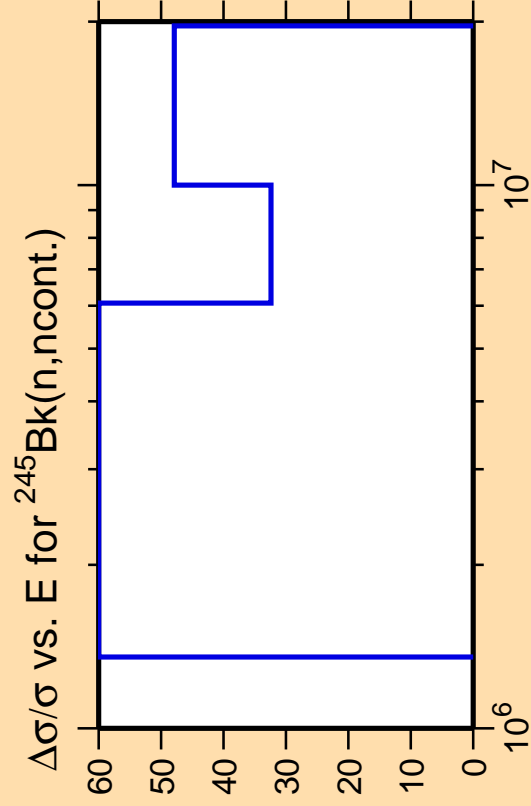

Ordinate scale is %
relative standard deviation.

Abscissa scales are energy (eV).

Warning: some uncertainty
data were suppressed.

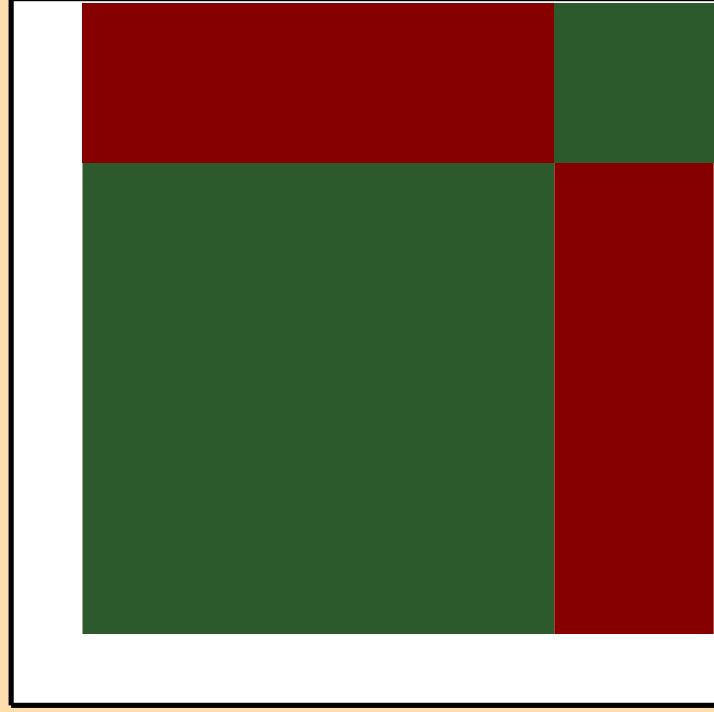
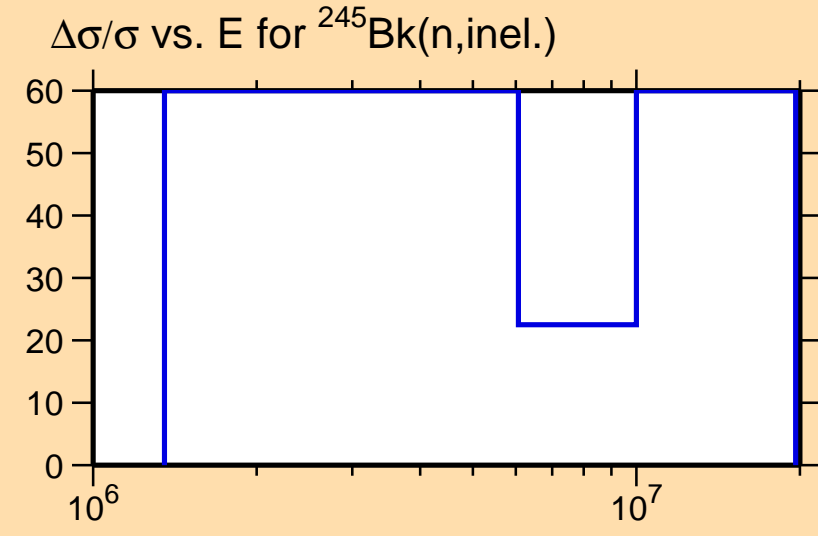

Correlation Matrix



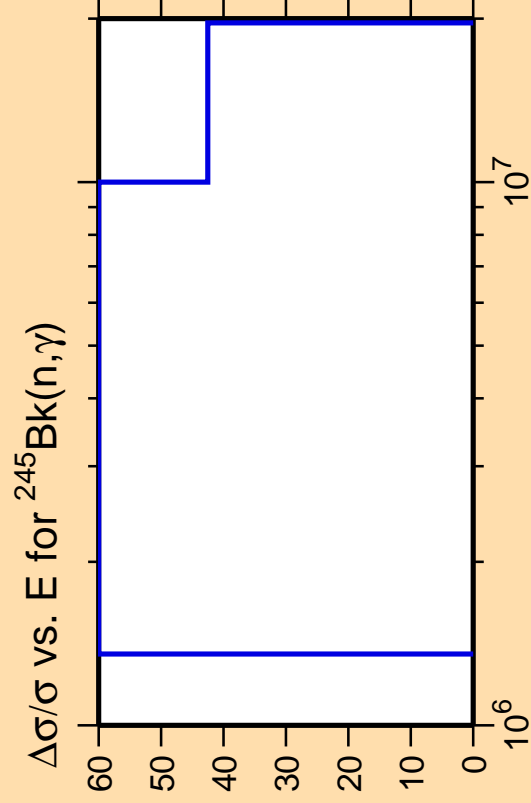

Ordinate scale is %
relative standard deviation.

Abscissa scales are energy (eV).

Warning: some uncertainty
data were suppressed.

$\Delta\sigma/\sigma$ vs. E for $^{245}\text{Bk}(n,\text{inel.})$

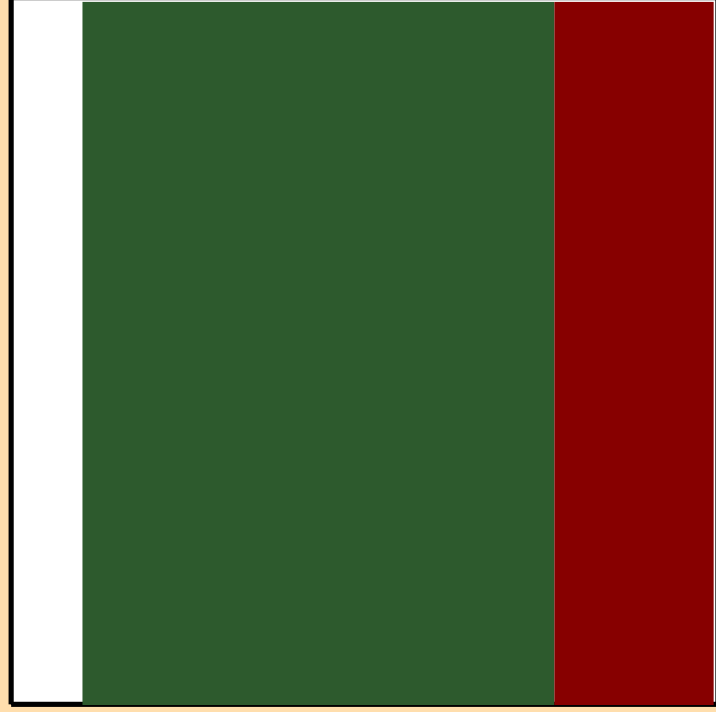
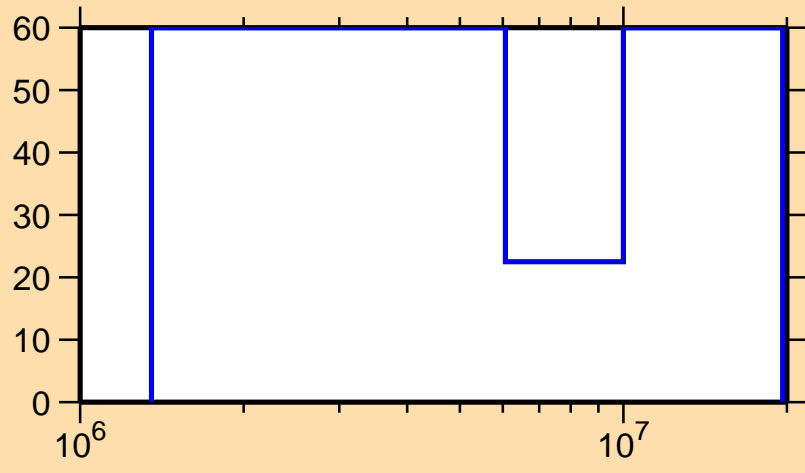

Correlation Matrix



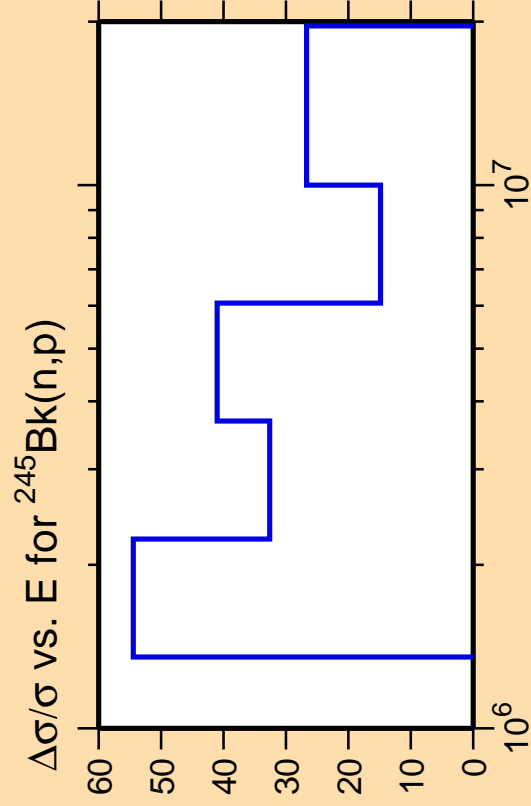

Ordinate scale is %
relative standard deviation.

Abscissa scales are energy (eV).

Warning: some uncertainty
data were suppressed.

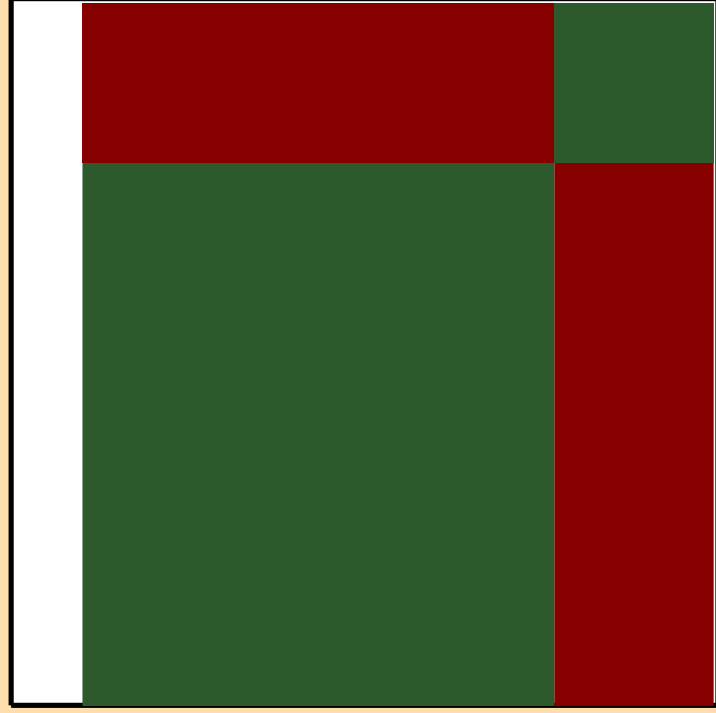
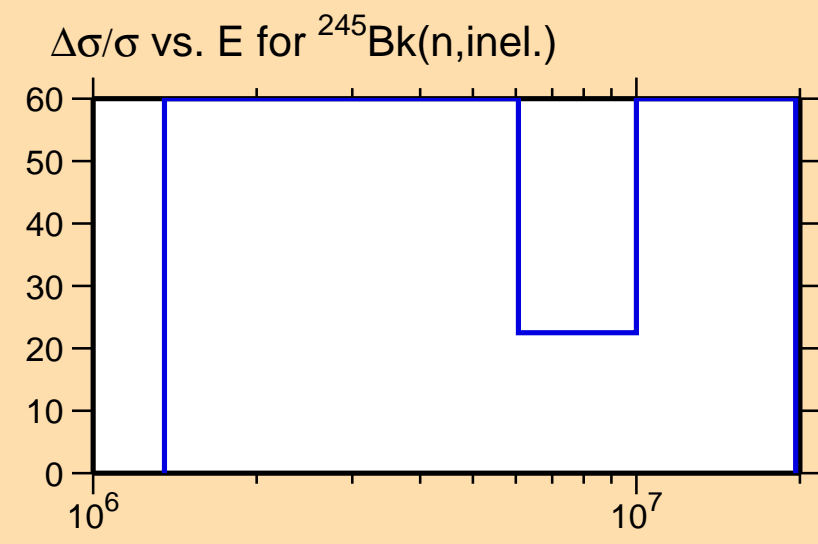

Correlation Matrix



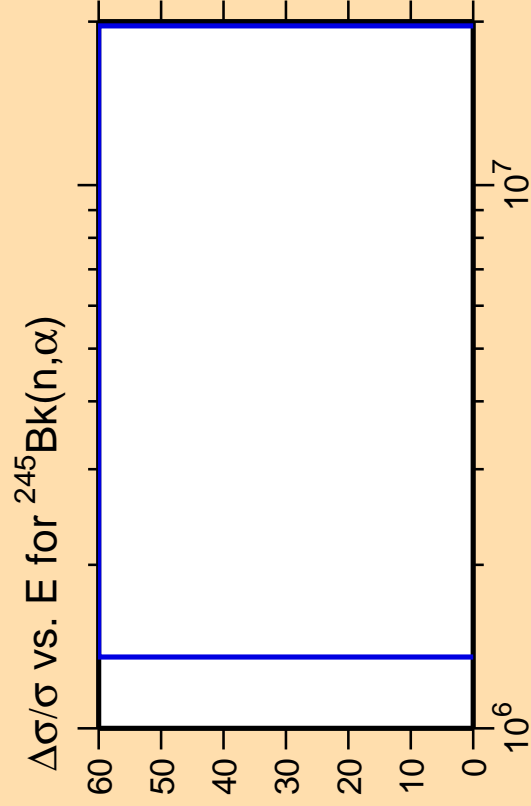

Ordinate scale is %
relative standard deviation.

Abscissa scales are energy (eV).

Warning: some uncertainty
data were suppressed.

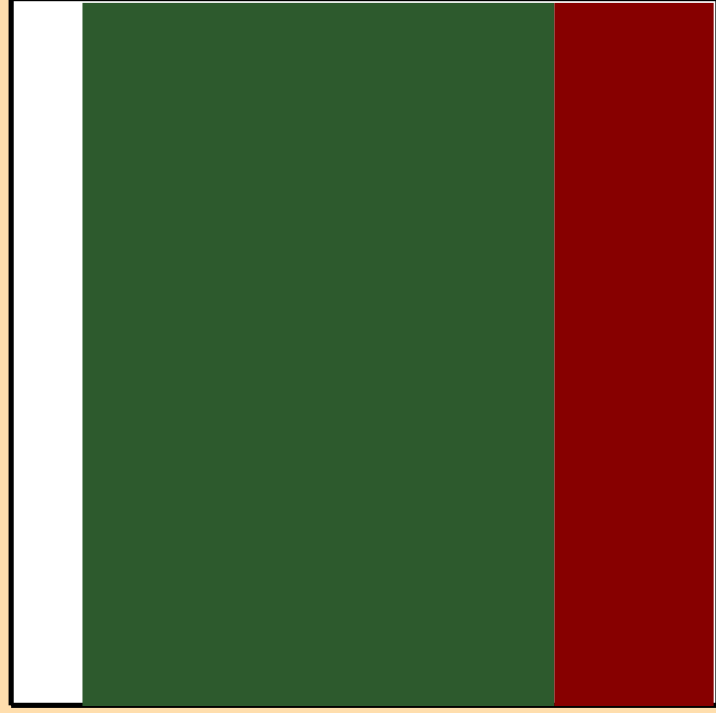
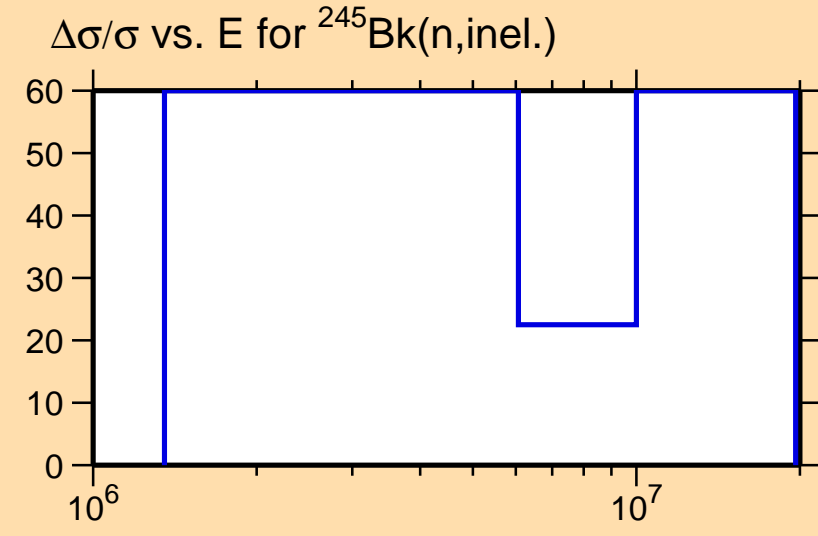

Correlation Matrix



$\Delta\sigma/\sigma$ vs. E for ^{245}Bk (mt 11)

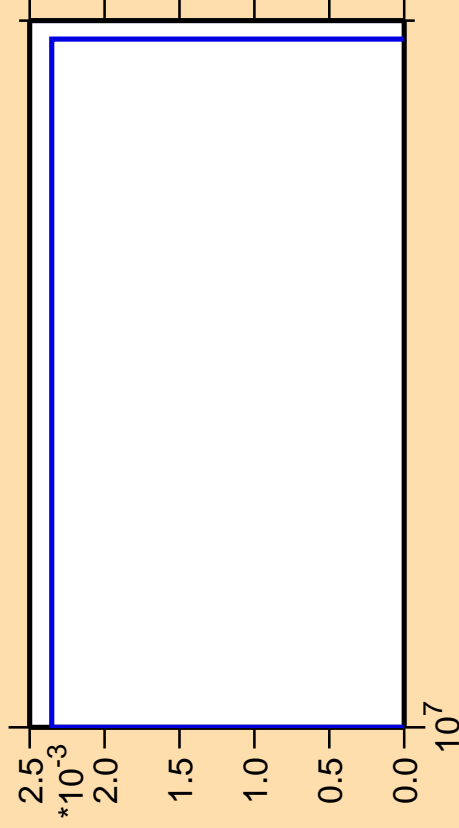

Ordinate scales are % relative standard deviation and barns.

Abscissa scales are energy (eV).

σ vs. E for ^{245}Bk (mt 11)

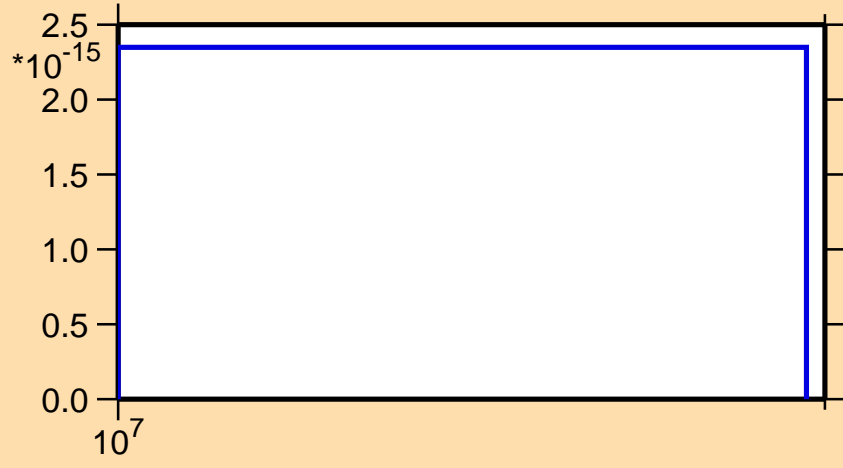

Correlation Matrix



$\Delta\sigma/\sigma$ vs. E for $^{245}\text{Bk}(n,2n)$



Ordinate scales are % relative standard deviation and barns.

Abscissa scales are energy (eV).

Warning: some uncertainty data were suppressed.

σ vs. E for $^{245}\text{Bk}(n,2n)$

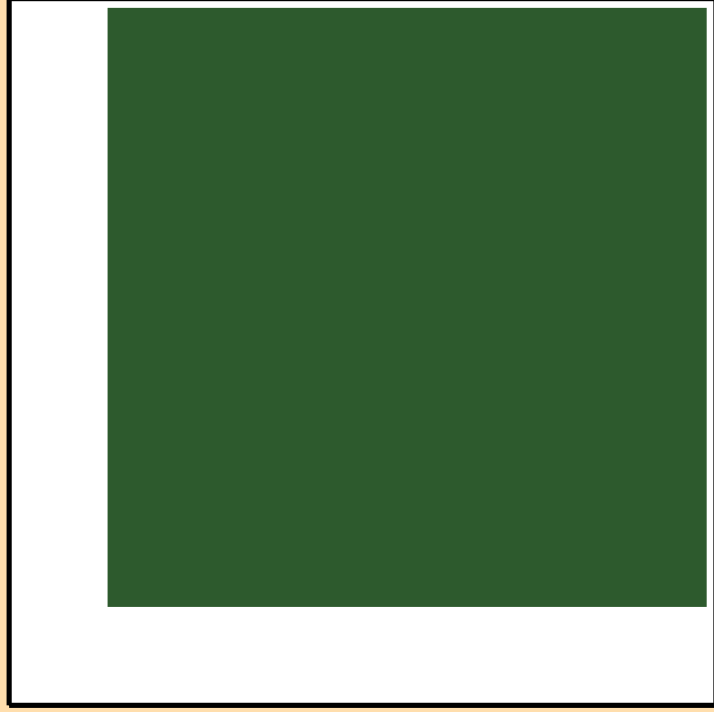
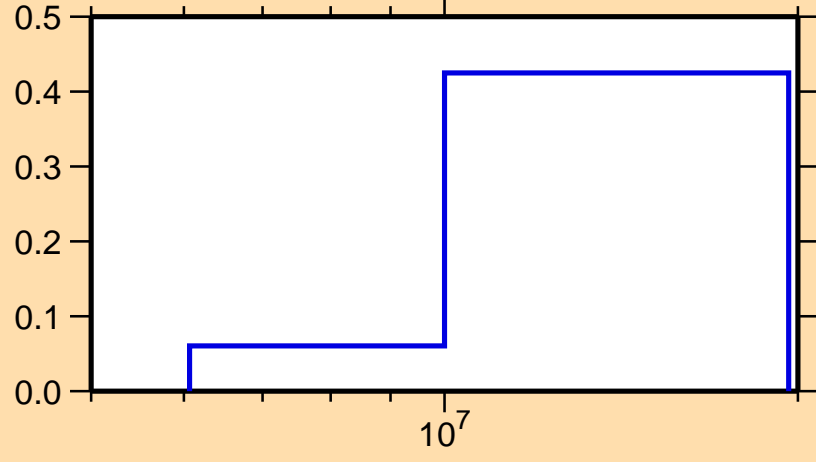

Correlation Matrix



$\Delta\sigma/\sigma$ vs. E for $^{245}\text{Bk}(n,f)$

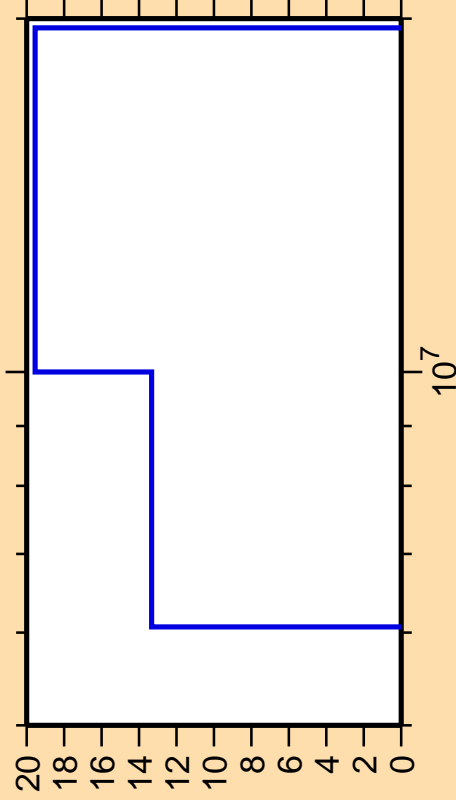

Ordinate scale is %
relative standard deviation.

Abscissa scales are energy (eV).

Warning: some uncertainty
data were suppressed.

$\Delta\sigma/\sigma$ vs. E for $^{245}\text{Bk}(n,2n)$

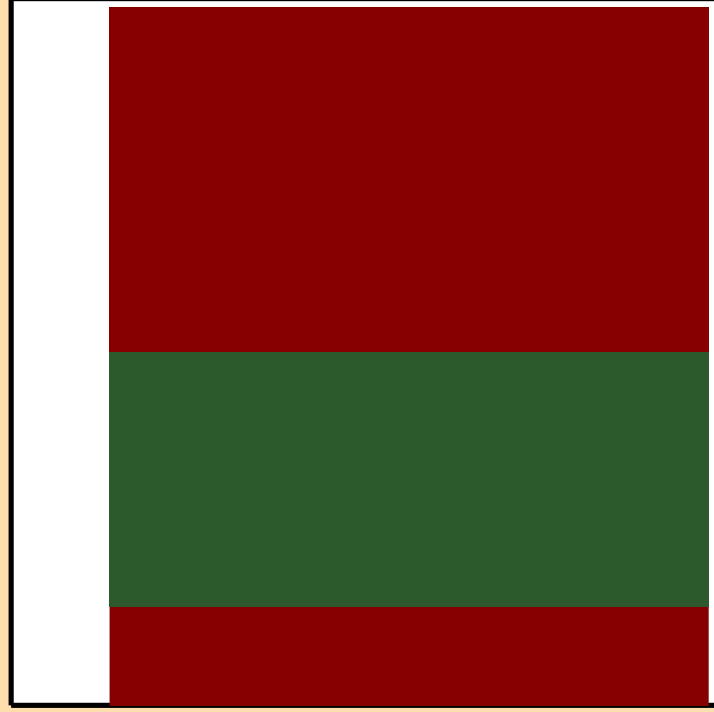
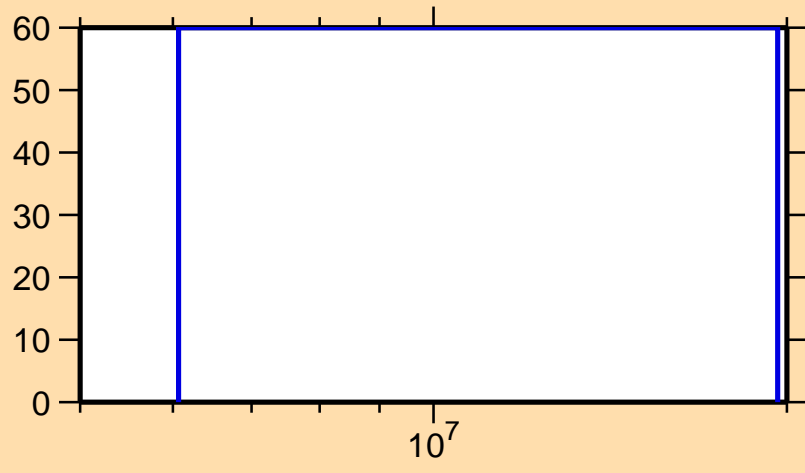

Correlation Matrix



$\Delta\sigma/\sigma$ vs. E for $^{245}\text{Bk}(n,n_1)$



Ordinate scale is %
relative standard deviation.

Abscissa scales are energy (eV).

Warning: some uncertainty
data were suppressed.

$\Delta\sigma/\sigma$ vs. E for $^{245}\text{Bk}(n,2n)$

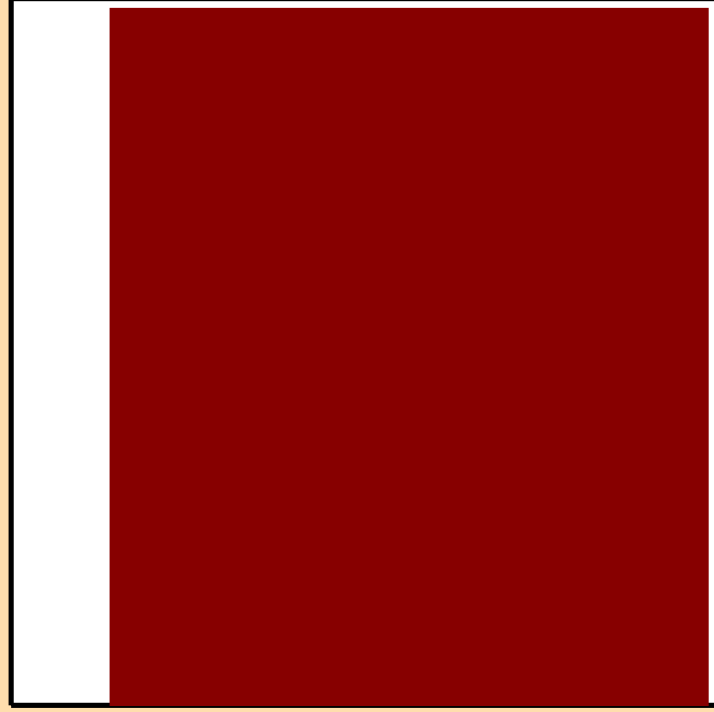
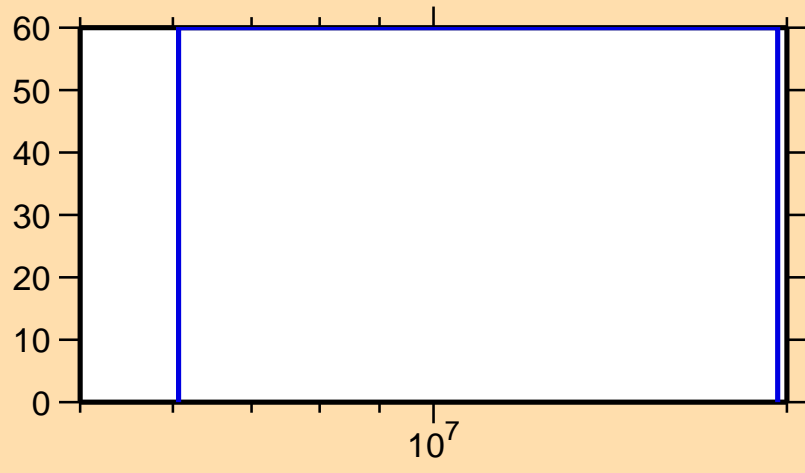

Correlation Matrix



$\Delta\sigma/\sigma$ vs. E for $^{245}\text{Bk}(n,n\text{cont.})$

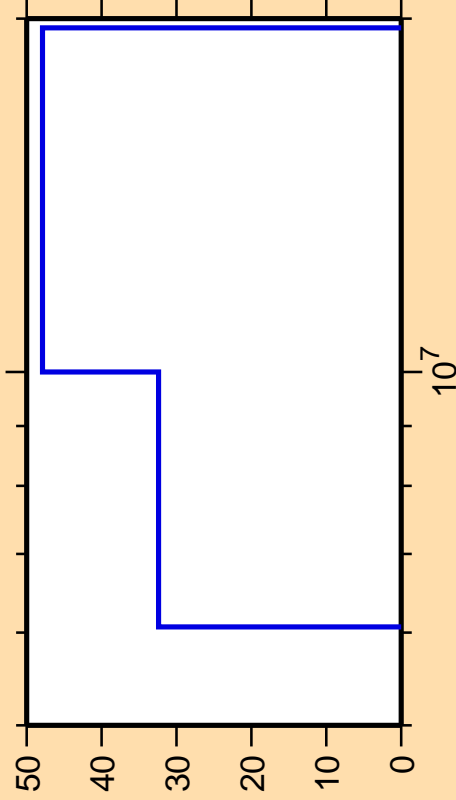

Ordinate scale is %
relative standard deviation.

Abscissa scales are energy (eV).

Warning: some uncertainty
data were suppressed.

$\Delta\sigma/\sigma$ vs. E for $^{245}\text{Bk}(n,2n)$

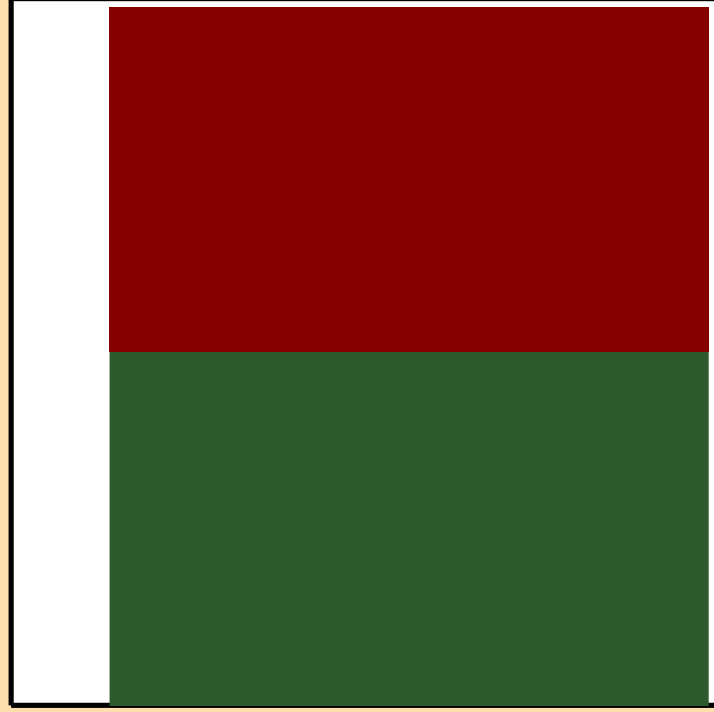
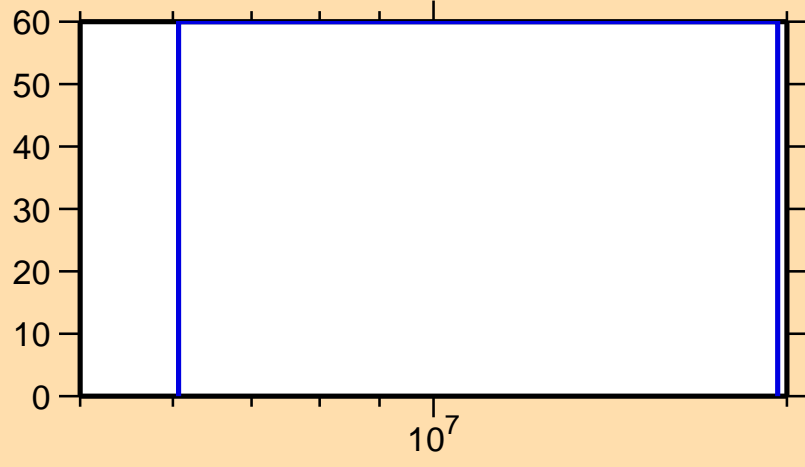

Correlation Matrix



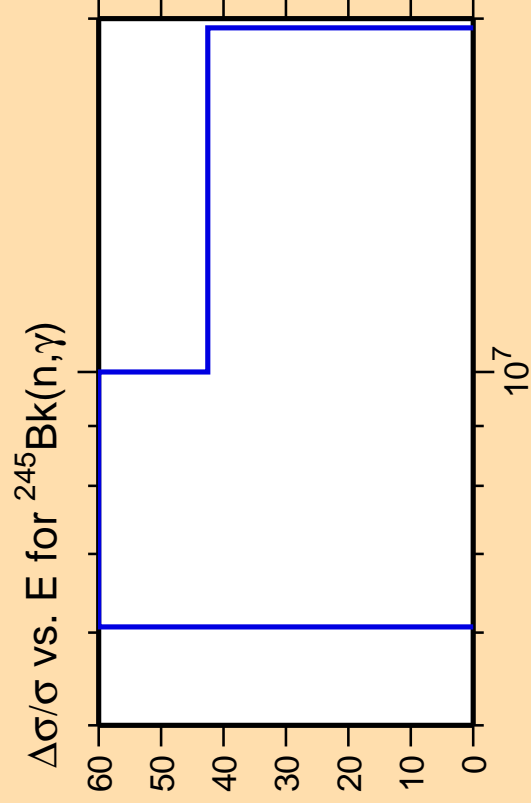

Ordinate scale is %
relative standard deviation.

Abscissa scales are energy (eV).

Warning: some uncertainty
data were suppressed.

$\Delta\sigma/\sigma$ vs. E for $^{245}\text{Bk}(n,2n)$

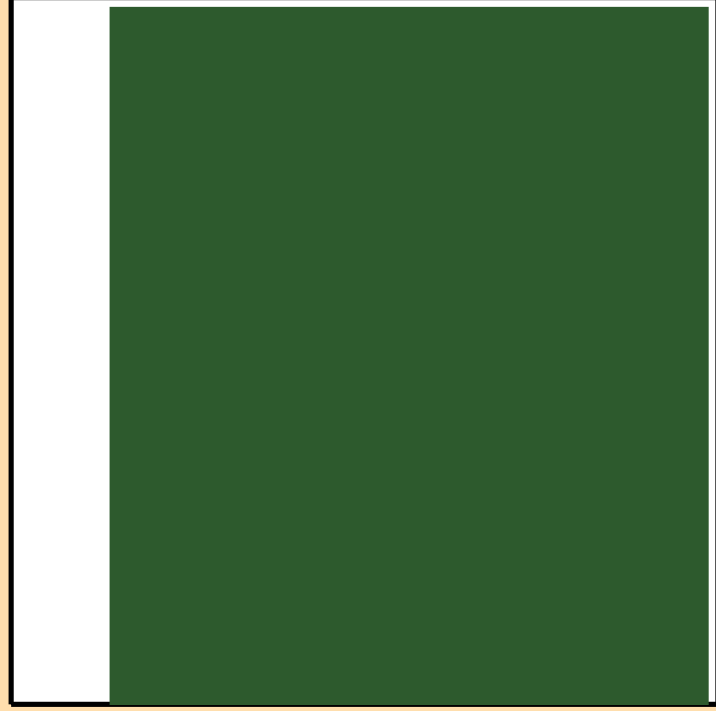
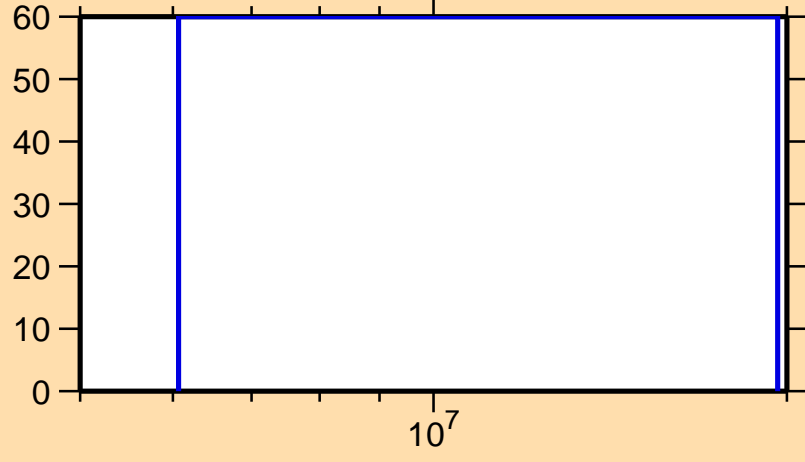

Correlation Matrix



$\Delta\sigma/\sigma$ vs. E for $^{245}\text{Bk}(n,p)$

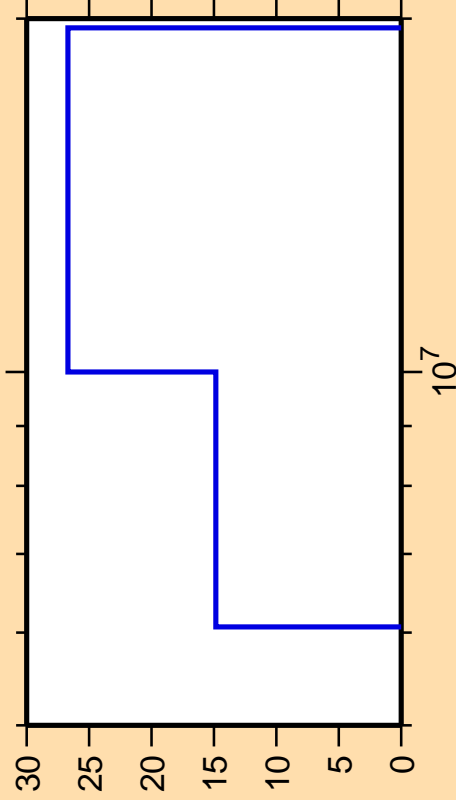

Ordinate scale is %
relative standard deviation.

Abscissa scales are energy (eV).

Warning: some uncertainty
data were suppressed.

$\Delta\sigma/\sigma$ vs. E for $^{245}\text{Bk}(n,2n)$

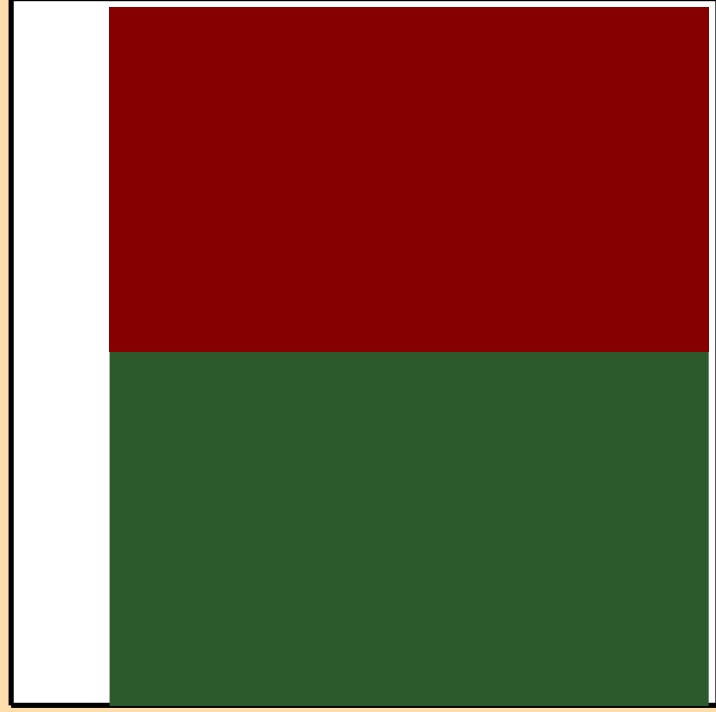
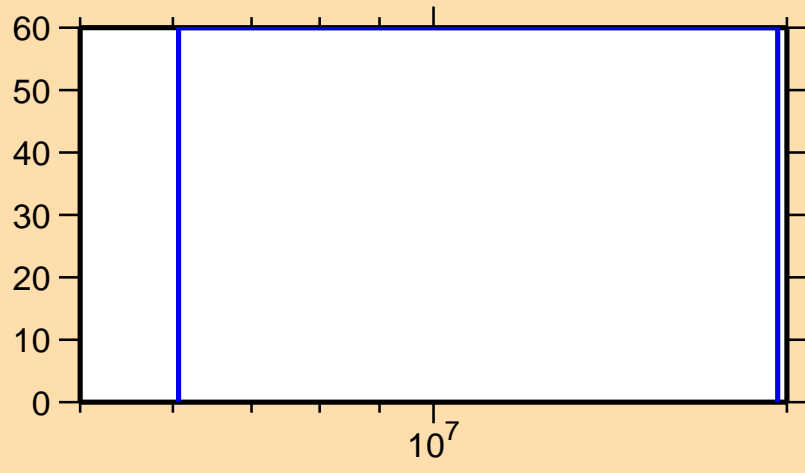

Correlation Matrix



$\Delta\sigma/\sigma$ vs. E for $^{245}\text{Bk}(n,\alpha)$



Ordinate scale is %
relative standard deviation.

Abscissa scales are energy (eV).

Warning: some uncertainty
data were suppressed.

$\Delta\sigma/\sigma$ vs. E for $^{245}\text{Bk}(n,2n)$

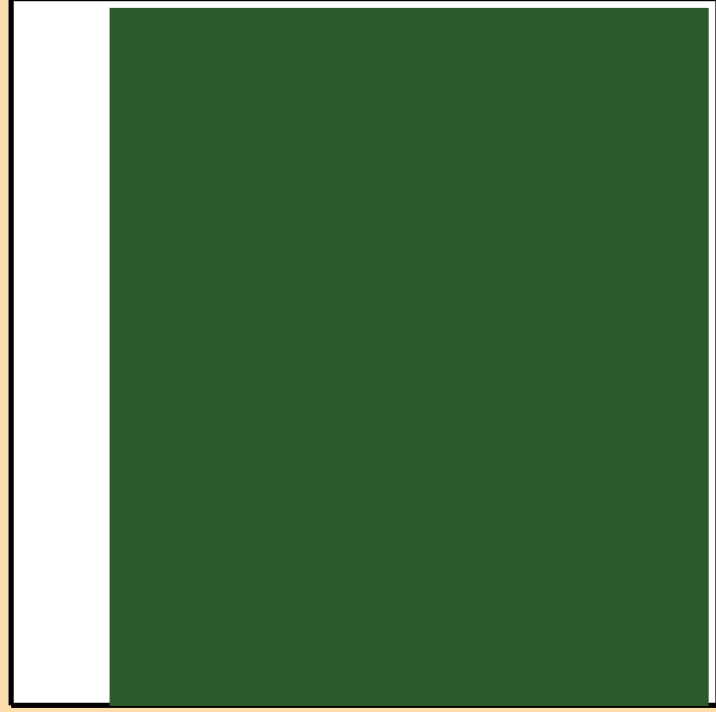
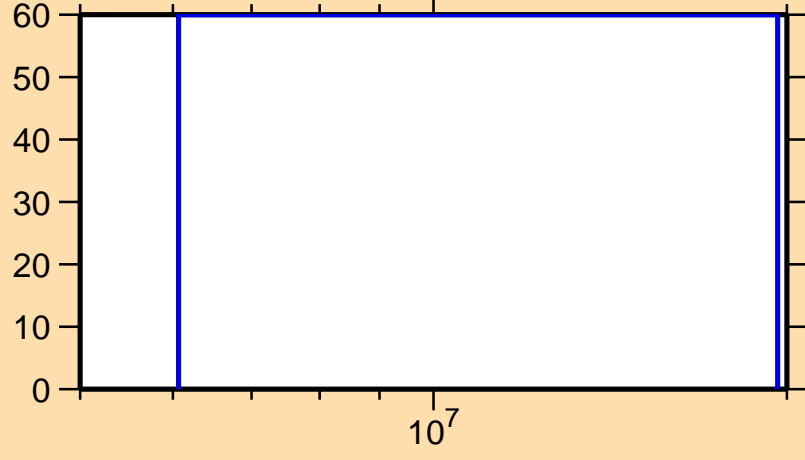

Correlation Matrix



$\Delta\sigma/\sigma$ vs. E for $^{245}\text{Bk}(n,3n)$



Ordinate scales are % relative standard deviation and barns.

Abscissa scales are energy (eV).

Warning: some uncertainty data were suppressed.

σ vs. E for $^{245}\text{Bk}(n,3n)$

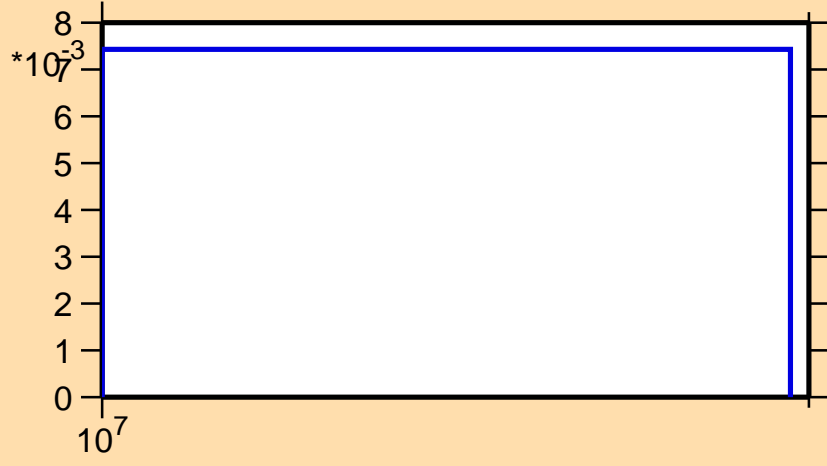

10^7



Correlation Matrix



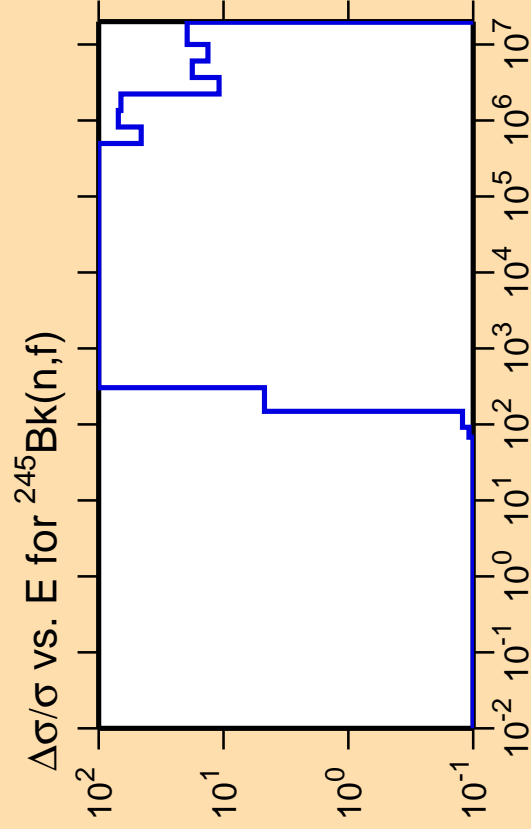

Ordinate scales are % relative standard deviation and barns.

Abscissa scales are energy (eV).

Warning: some uncertainty data were suppressed.

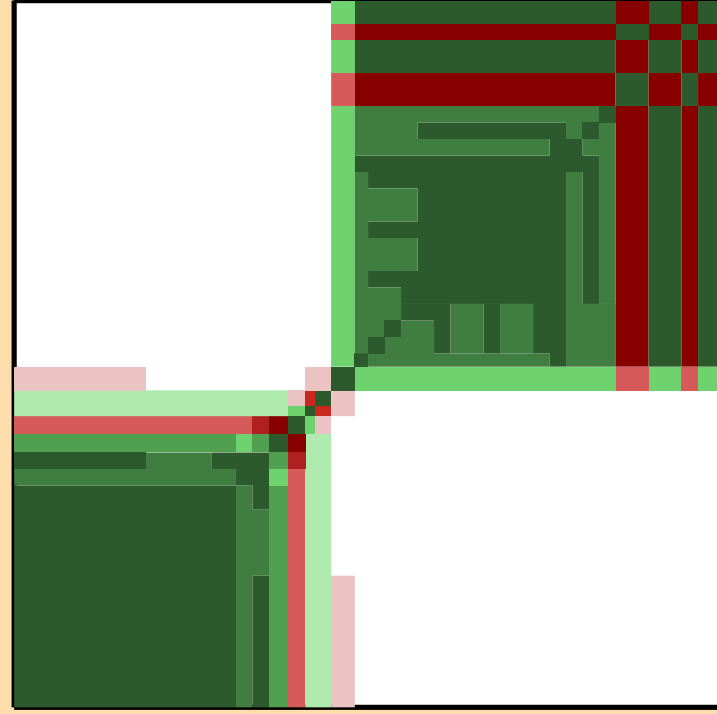
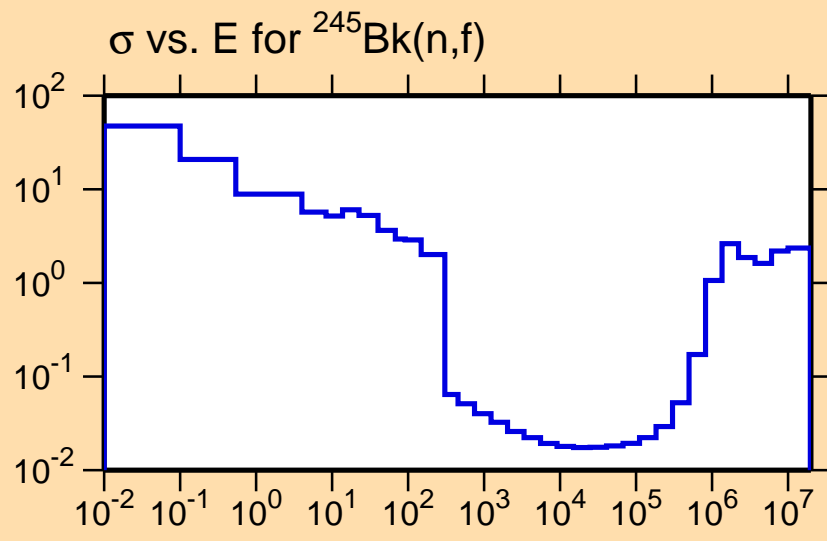

Correlation Matrix



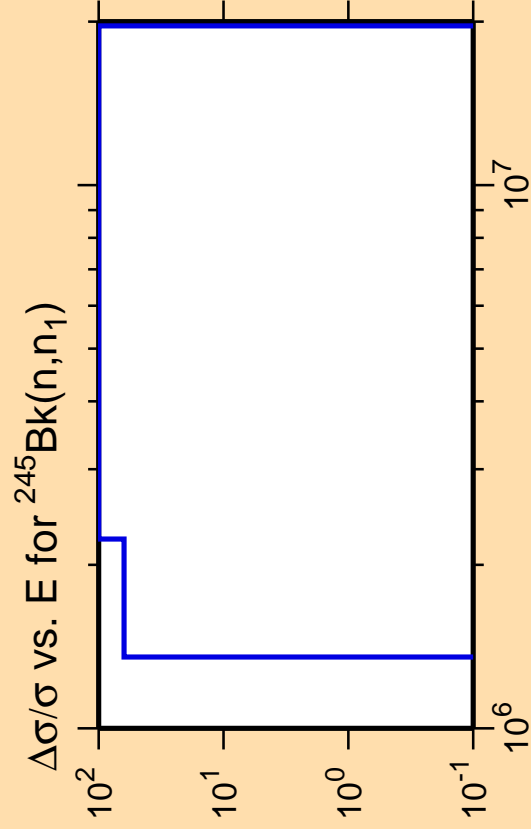

Ordinate scale is %
relative standard deviation.

Abscissa scales are energy (eV).

Warning: some uncertainty
data were suppressed.

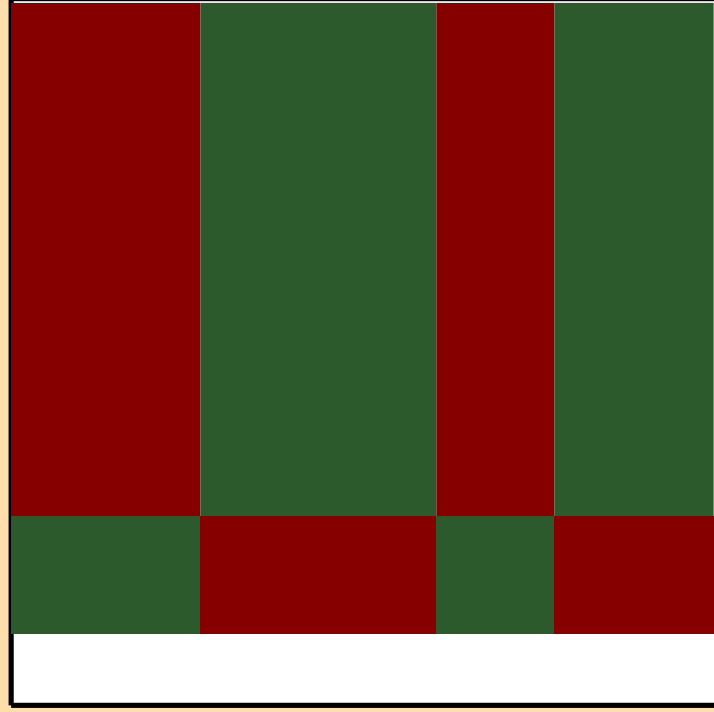
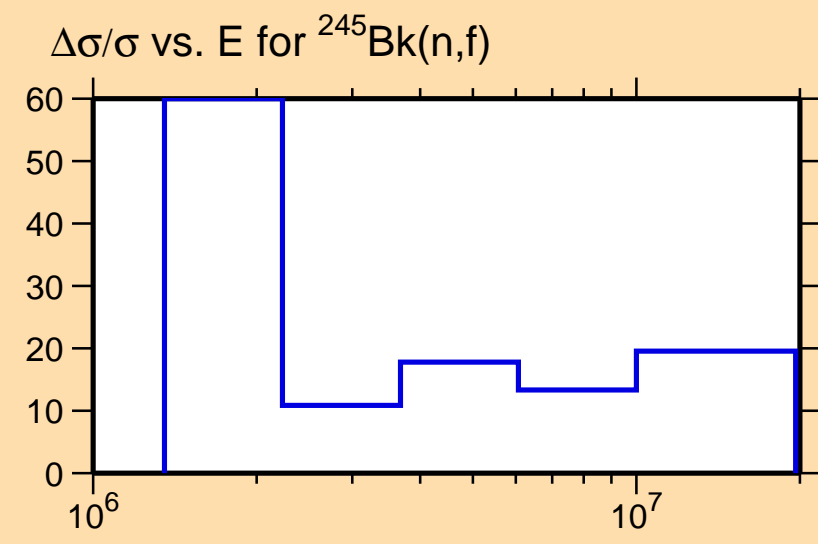

Correlation Matrix



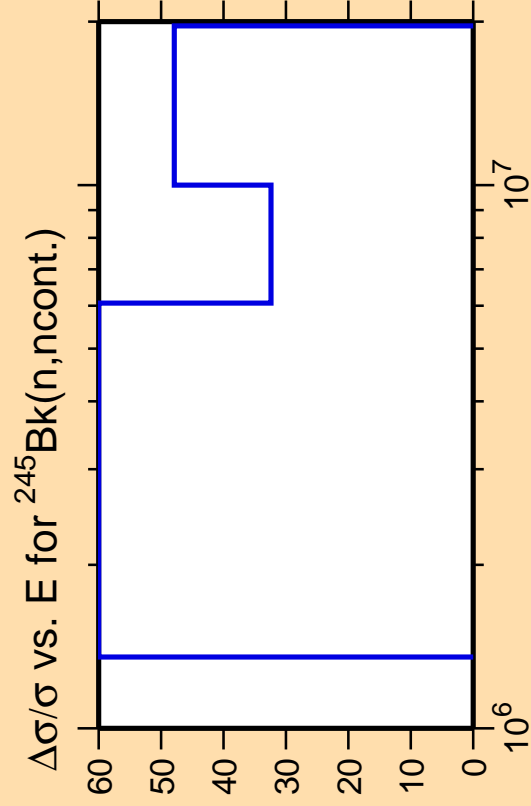

Ordinate scale is %
relative standard deviation.

Abscissa scales are energy (eV).

Warning: some uncertainty
data were suppressed.

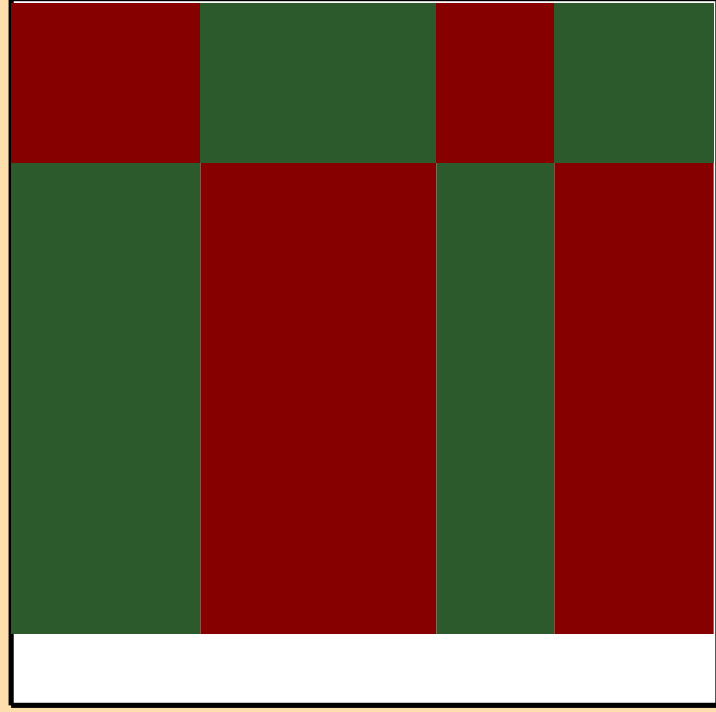
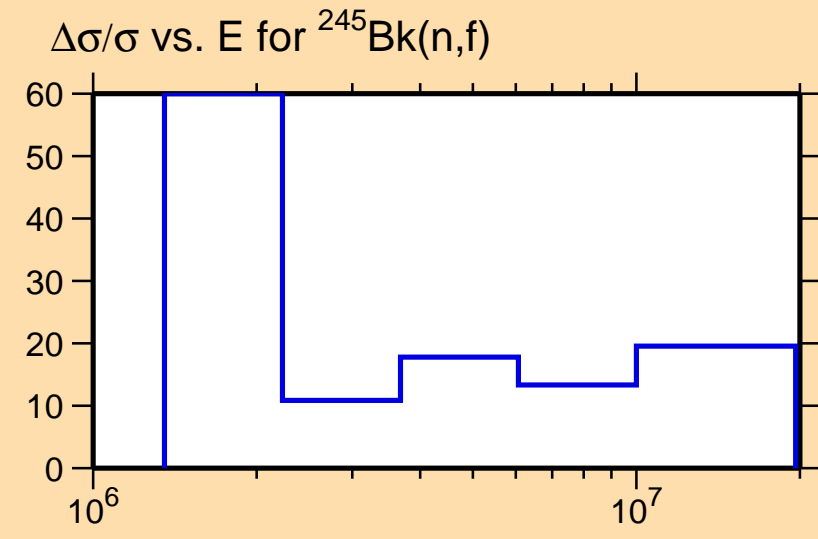

Correlation Matrix



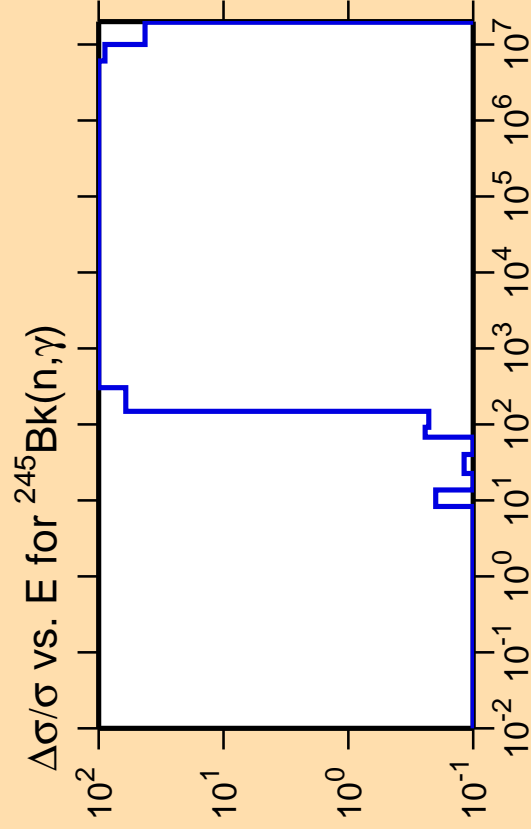

Ordinate scale is %
relative standard deviation.

Abscissa scales are energy (eV).

Warning: some uncertainty
data were suppressed.

$\Delta\sigma/\sigma$ vs. E for $^{245}\text{Bk}(n,f)$

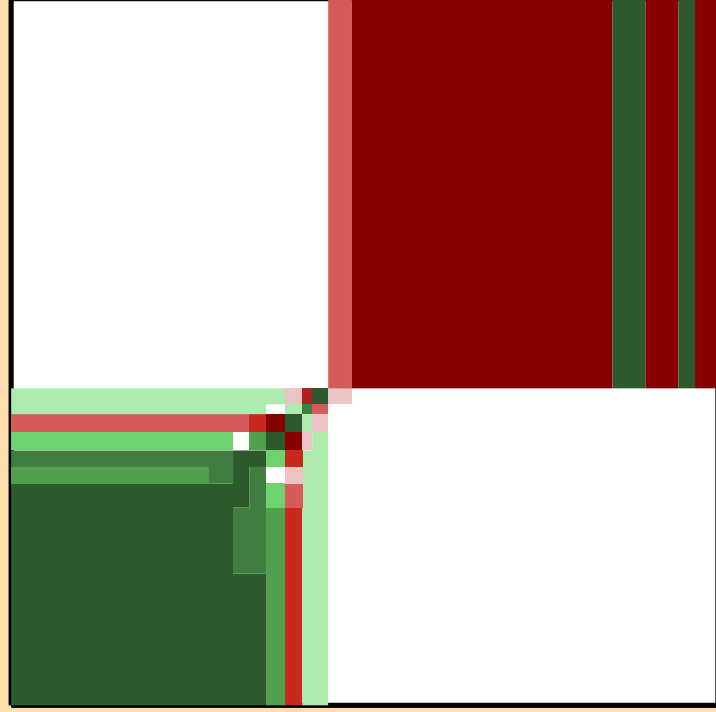
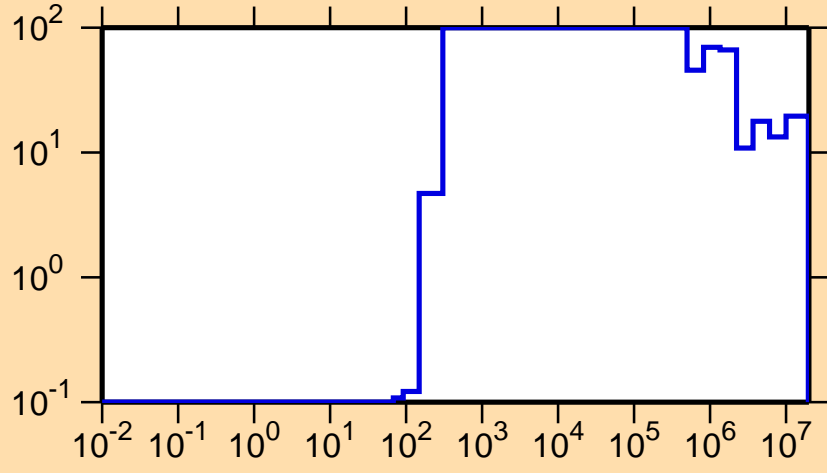

Correlation Matrix



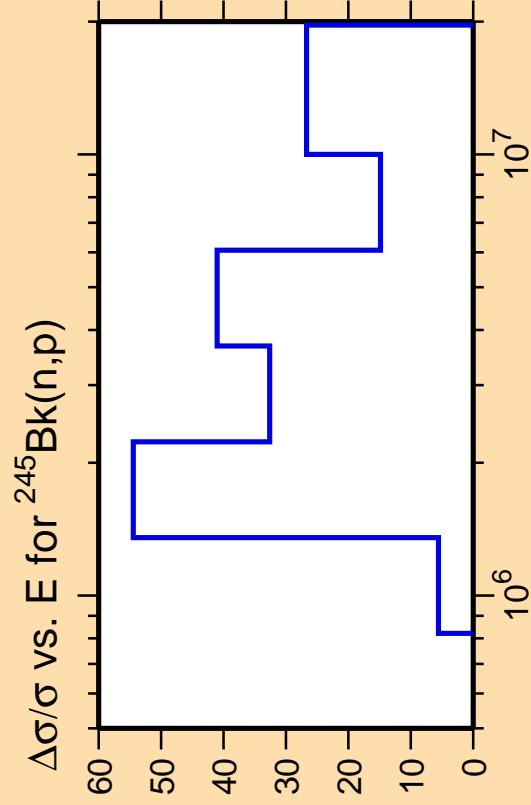

Ordinate scale is %
relative standard deviation.

Abscissa scales are energy (eV).

Warning: some uncertainty
data were suppressed.

$\Delta\sigma/\sigma$ vs. E for $^{245}\text{Bk}(n,f)$

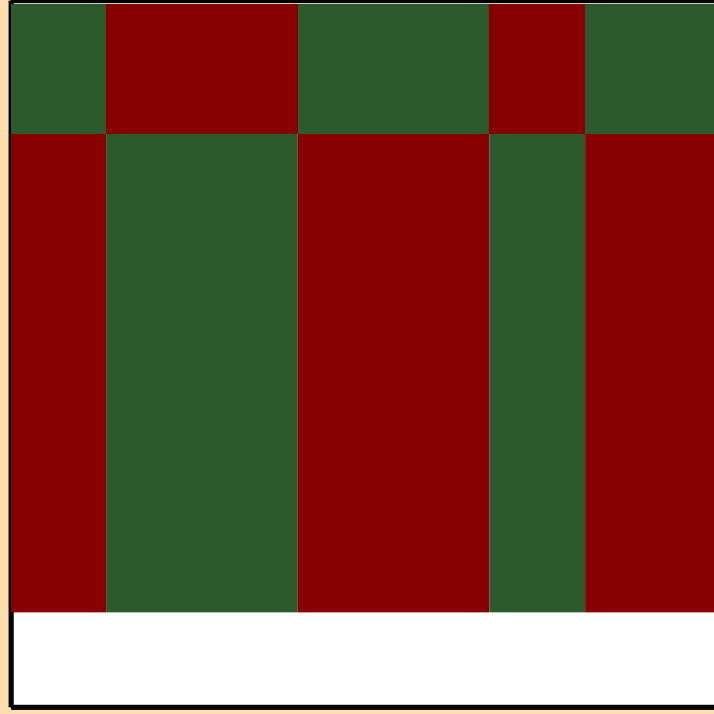
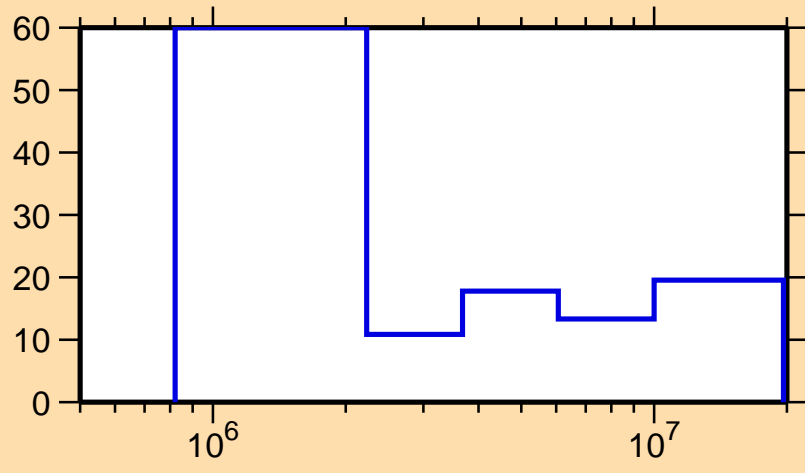

Correlation Matrix



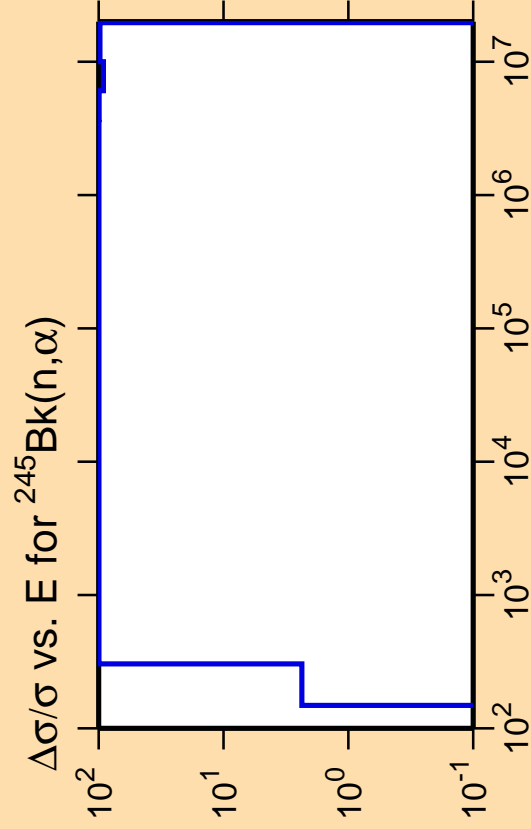

Ordinate scale is %
relative standard deviation.

Abscissa scales are energy (eV).

Warning: some uncertainty
data were suppressed.

$\Delta\sigma/\sigma$ vs. E for $^{245}\text{Bk}(n,f)$

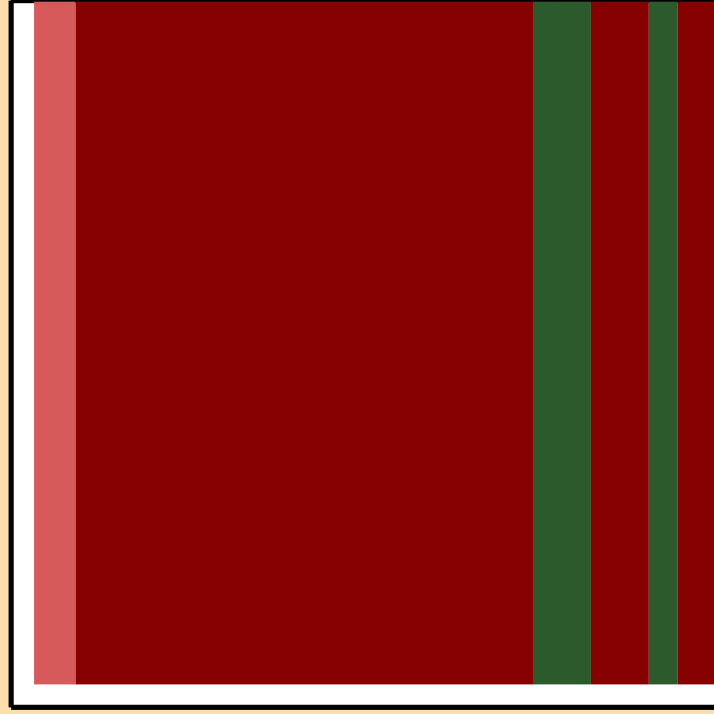
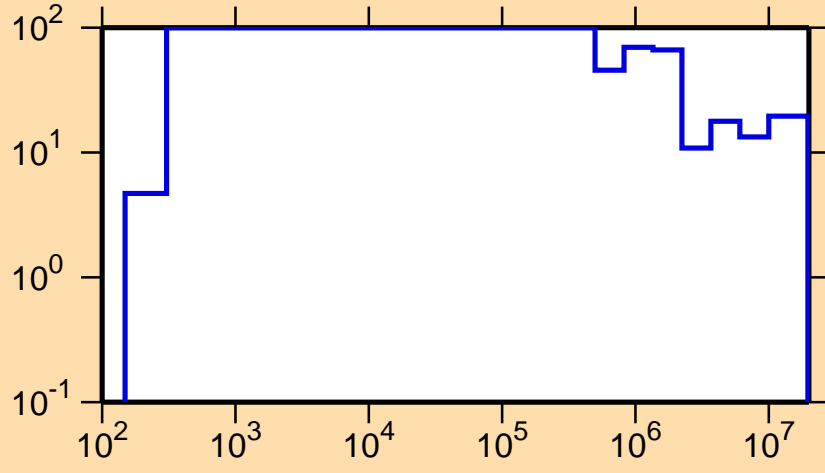

Correlation Matrix



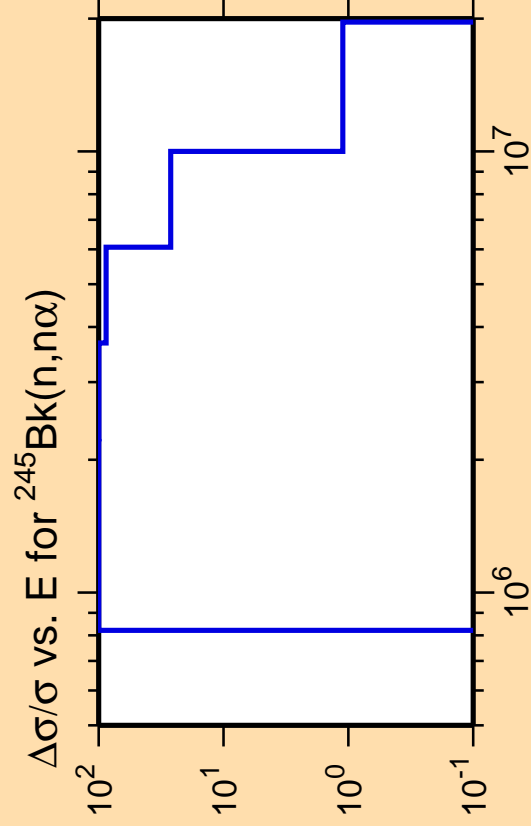

Ordinate scales are % relative standard deviation and barns.

Abscissa scales are energy (eV).

Warning: some uncertainty data were suppressed.

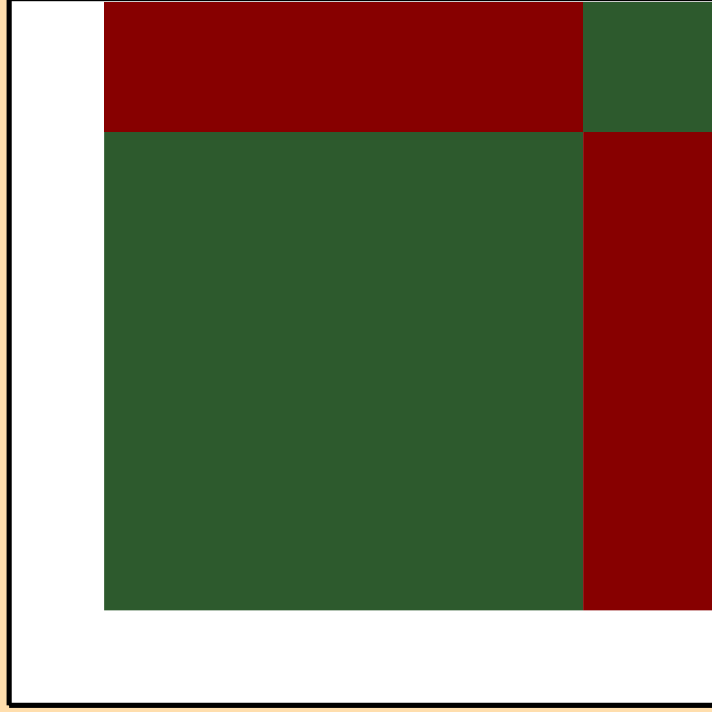
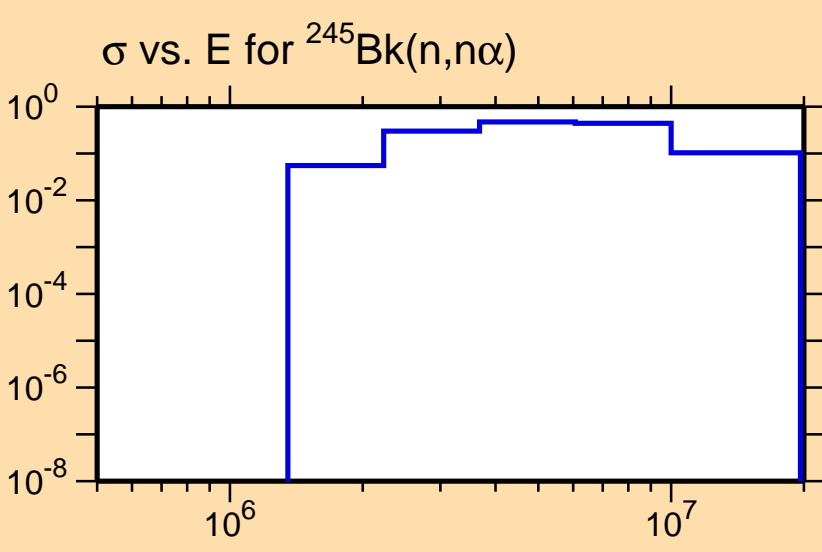

Correlation Matrix



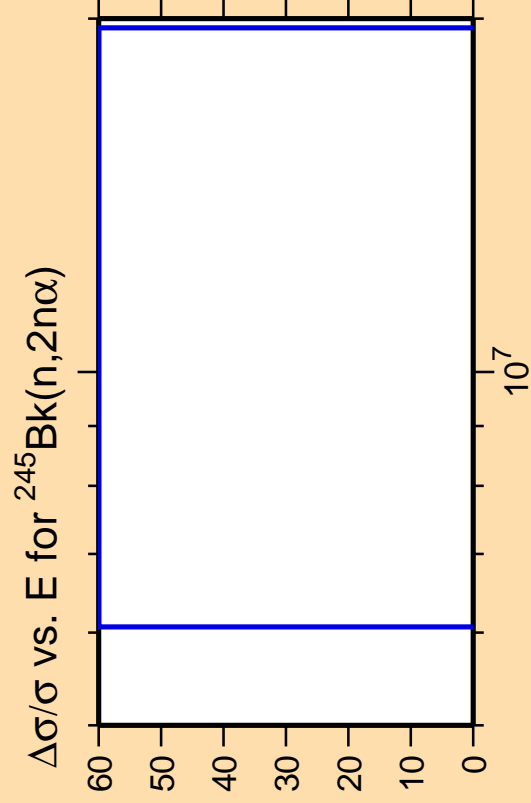

Ordinate scales are % relative standard deviation and barns.

Abscissa scales are energy (eV).

Warning: some uncertainty data were suppressed.

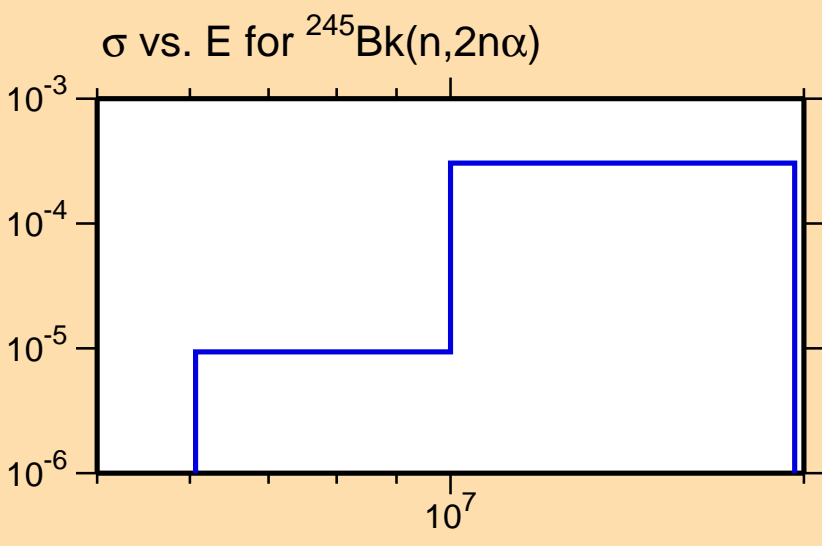

Correlation Matrix



$\Delta\sigma/\sigma$ vs. E for $^{245}\text{Bk}(n,3n\alpha)$



Ordinate scales are % relative standard deviation and barns.

Abscissa scales are energy (eV).

Warning: some uncertainty data were suppressed.

σ vs. E for $^{245}\text{Bk}(n,3n\alpha)$

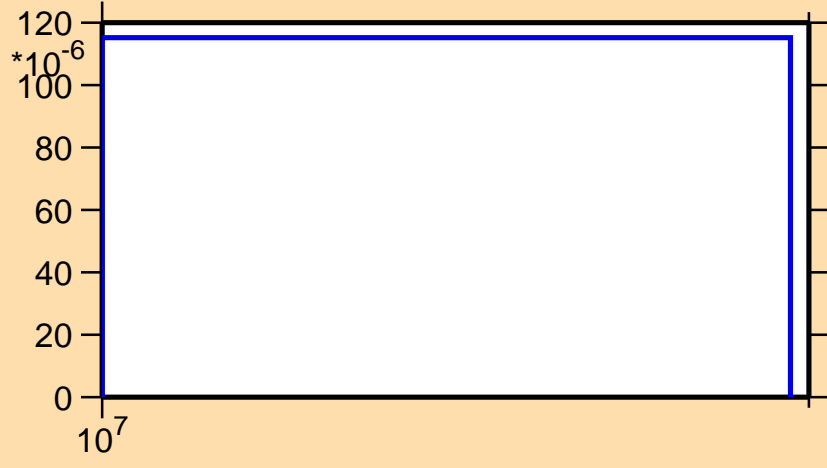

Correlation Matrix



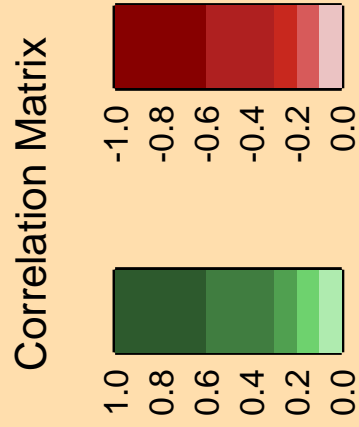
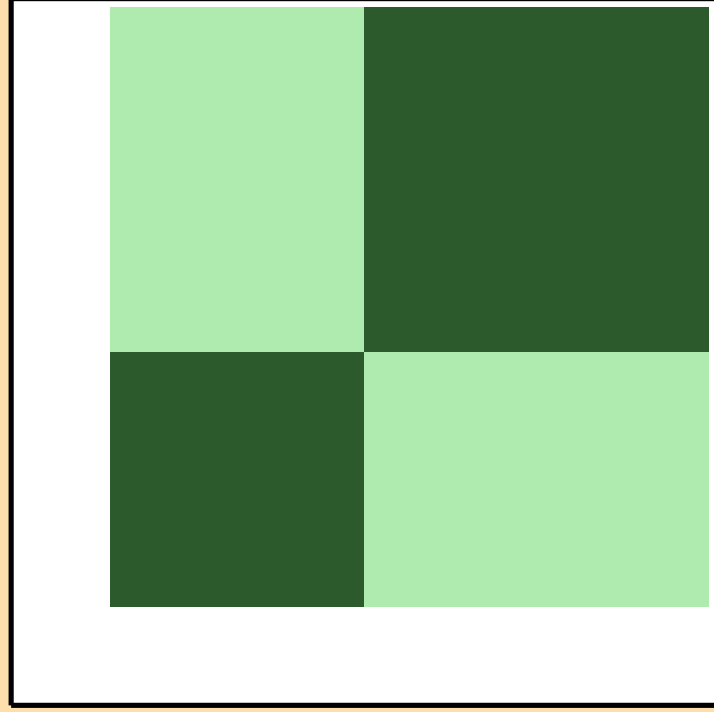
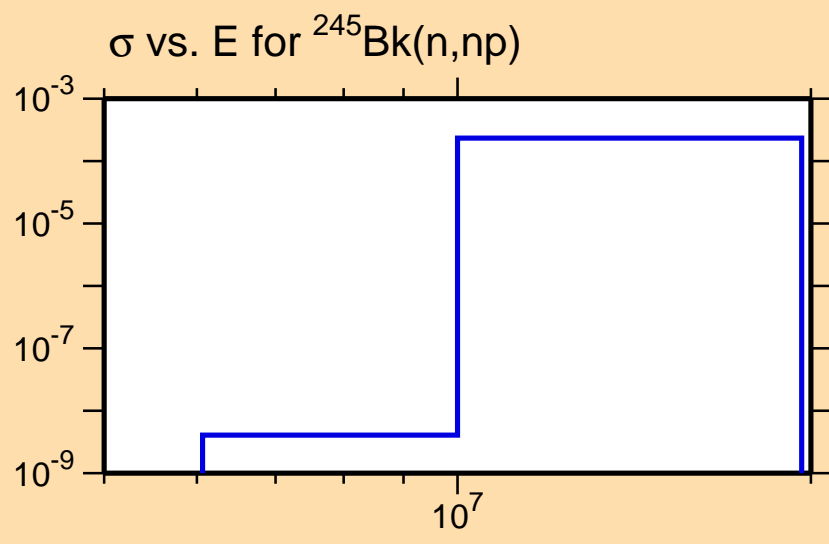
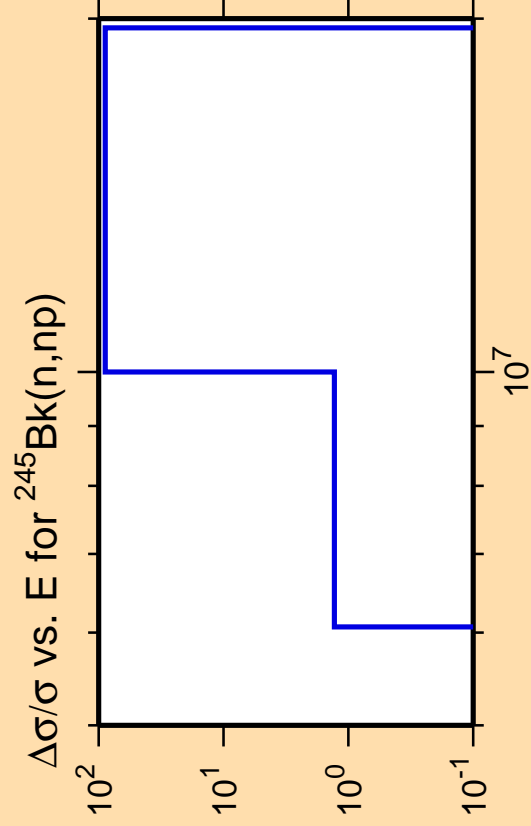

$\Delta\sigma/\sigma$ vs. E for $^{245}\text{Bk}(n,\text{nd})$

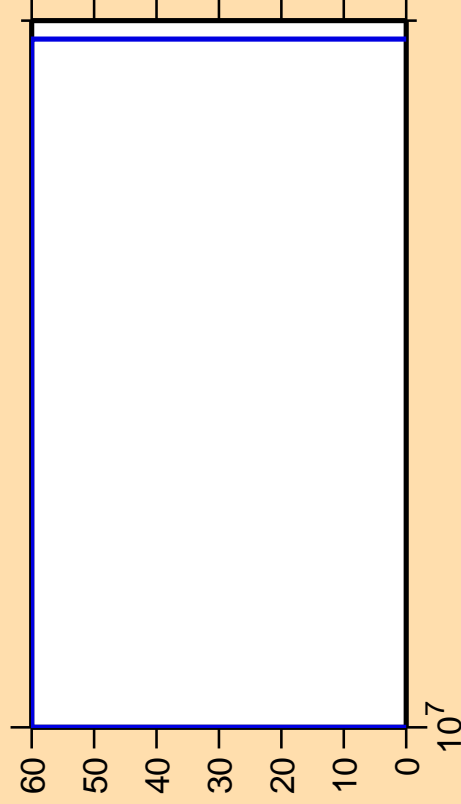

Ordinate scales are % relative standard deviation and barns.

Abscissa scales are energy (eV).

Warning: some uncertainty data were suppressed.

σ vs. E for $^{245}\text{Bk}(n,\text{nd})$

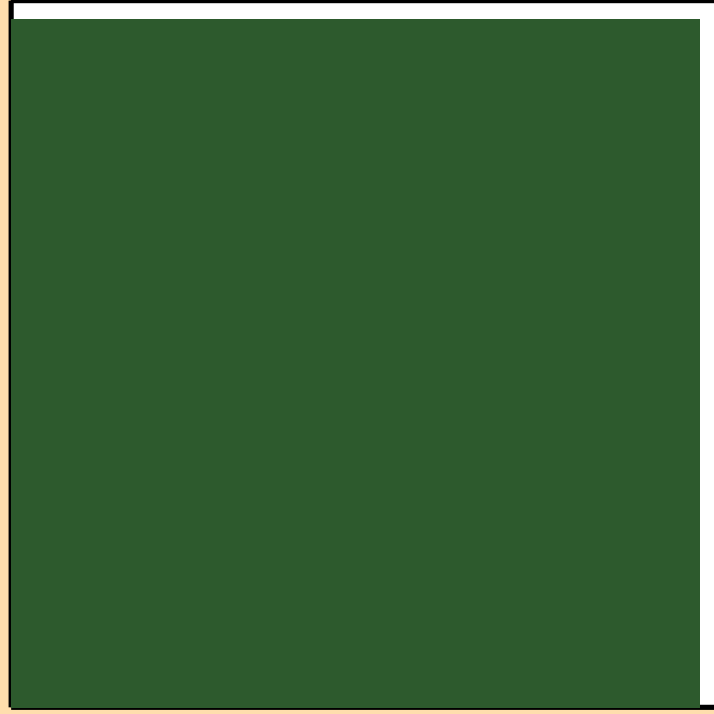
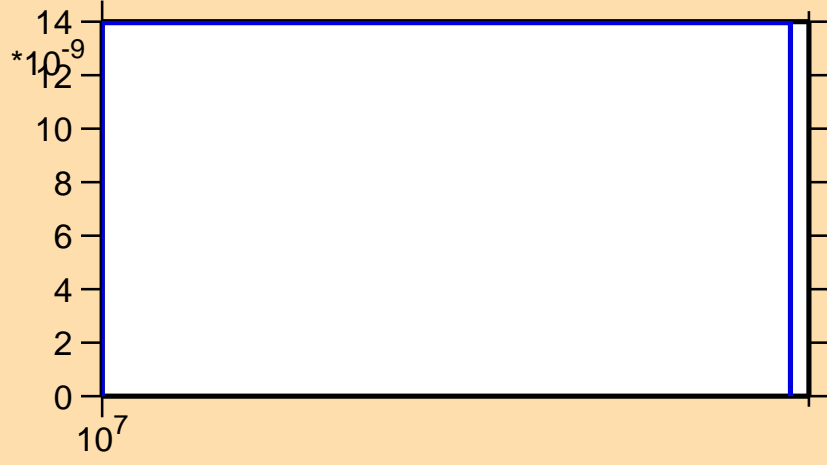

Correlation Matrix

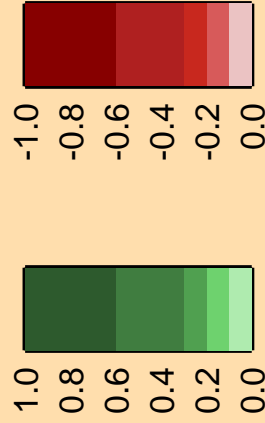

$\Delta\sigma/\sigma$ vs. E for $^{245}\text{Bk}(n,nt)$



Ordinate scales are % relative standard deviation and barns.

Abscissa scales are energy (eV).

Warning: some uncertainty data were suppressed.

σ vs. E for $^{245}\text{Bk}(n,nt)$

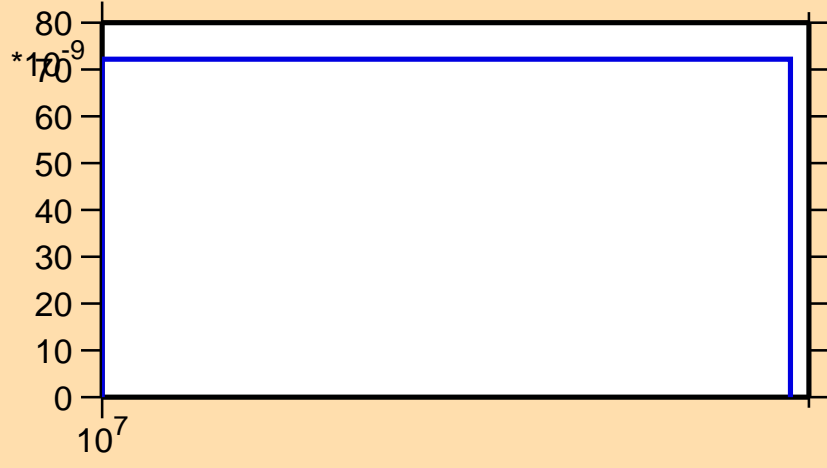

Correlation Matrix



$\Delta\sigma/\sigma$ vs. E for $^{245}\text{Bk}(n,2np)$



Ordinate scales are % relative standard deviation and barns.

Abscissa scales are energy (eV).

Warning: some uncertainty data were suppressed.

σ vs. E for $^{245}\text{Bk}(n,2np)$

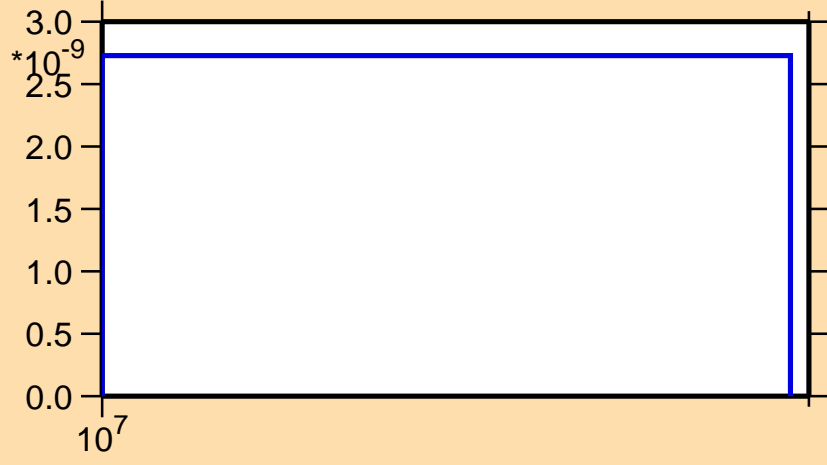

Correlation Matrix



$\Delta\sigma/\sigma$ vs. E for $^{245}\text{Bk}(\text{mt } 45)$

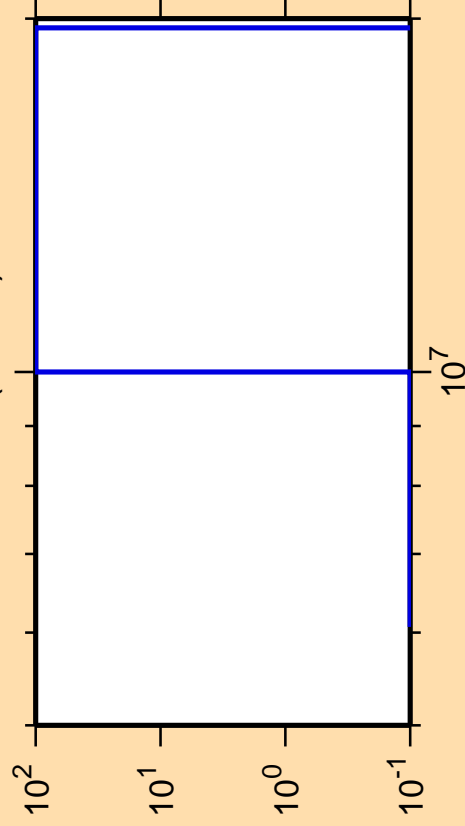

Ordinate scales are % relative standard deviation and barns.

Abscissa scales are energy (eV).

Warning: some uncertainty data were suppressed.

σ vs. E for $^{245}\text{Bk}(\text{mt } 45)$

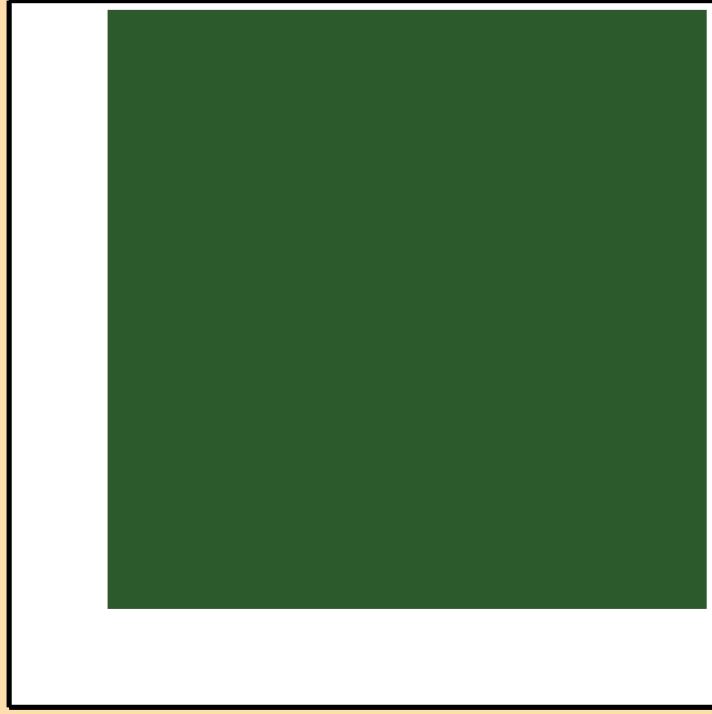
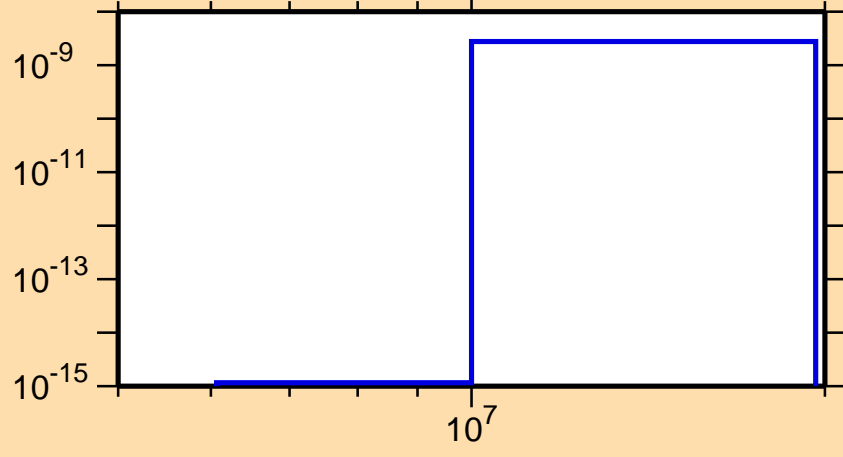

Correlation Matrix



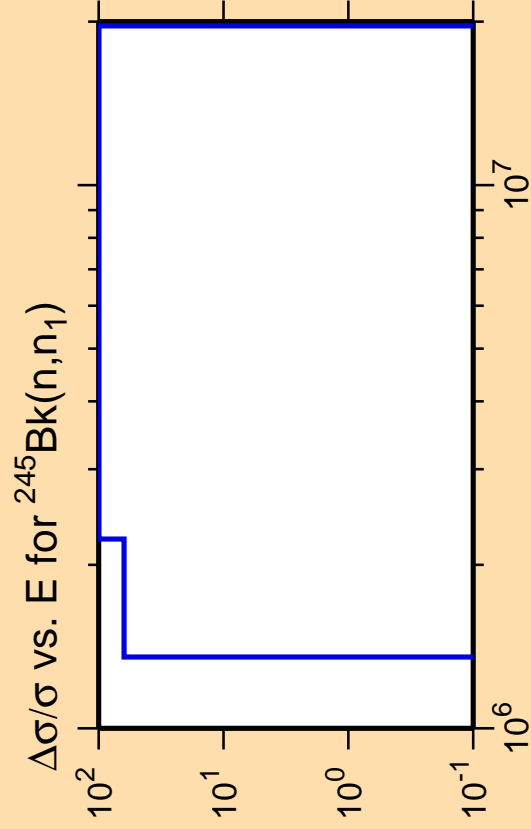

Ordinate scales are % relative standard deviation and barns.

Abscissa scales are energy (eV).

Warning: some uncertainty data were suppressed.

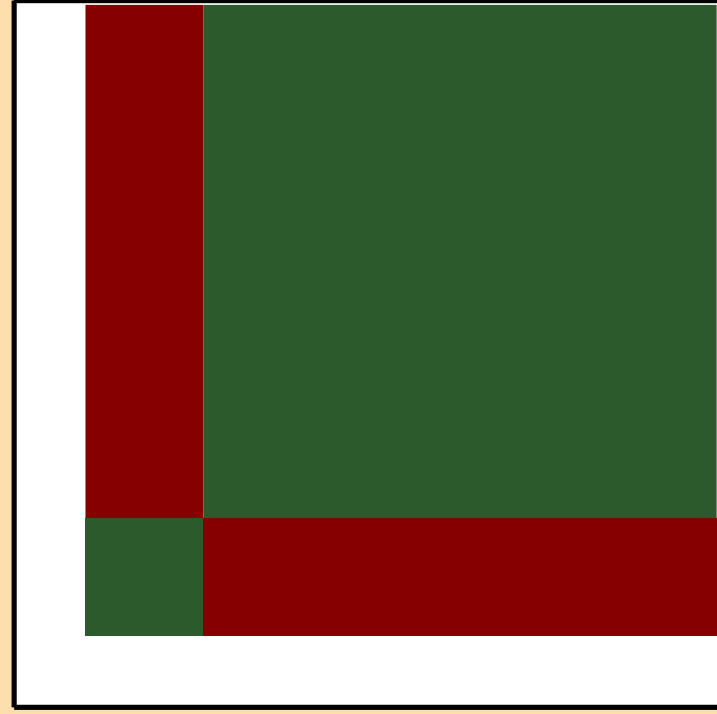

Correlation Matrix



σ vs. E for $^{245}\text{Bk}(n,n_1)$

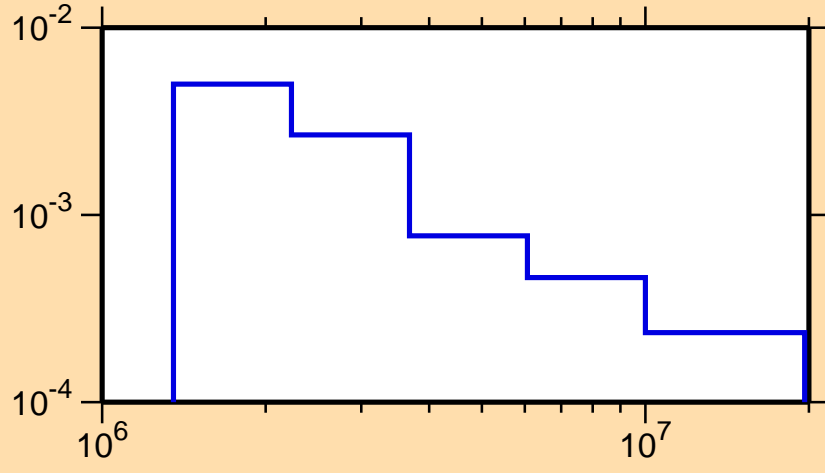

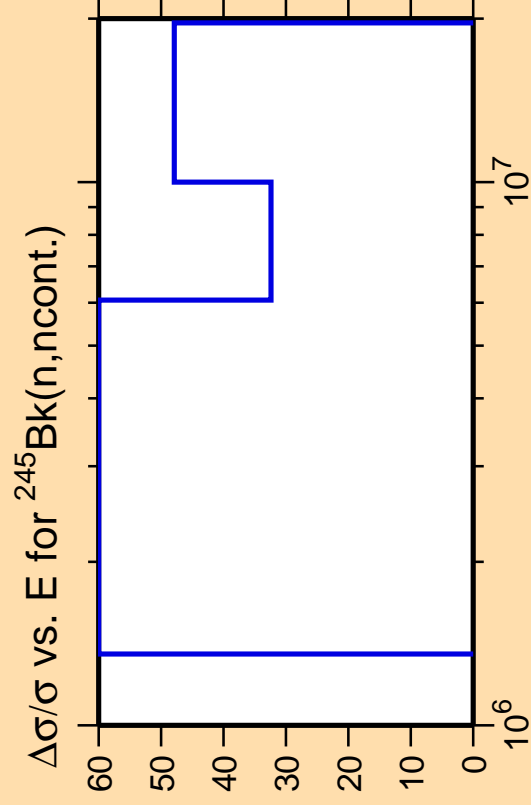

Ordinate scale is %
relative standard deviation.

Abscissa scales are energy (eV).

Warning: some uncertainty
data were suppressed.

$\Delta\sigma/\sigma$ vs. E for $^{245}\text{Bk}(n,n_1)$

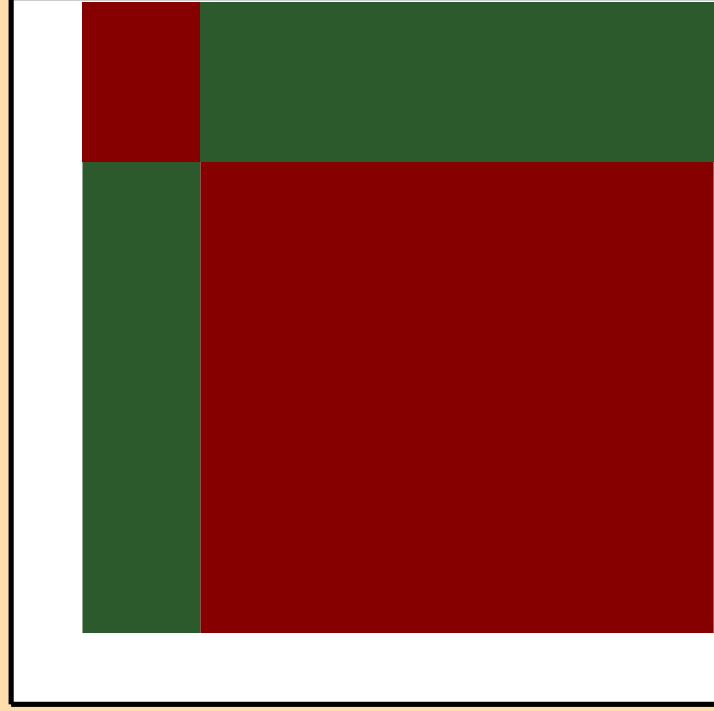
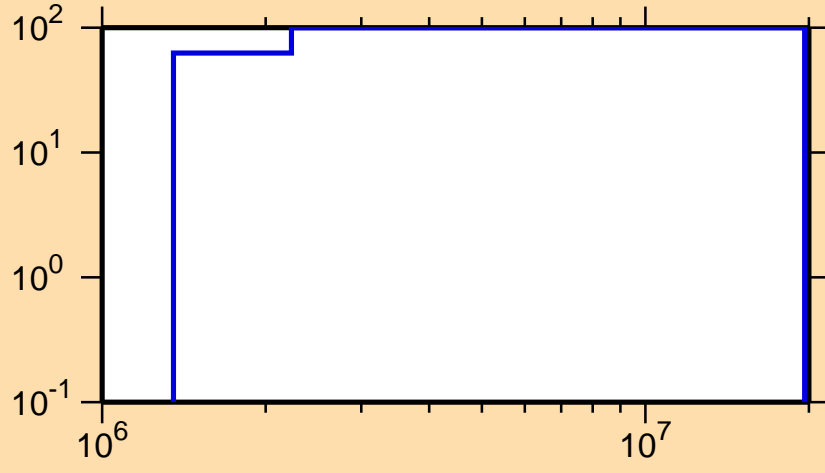

Correlation Matrix



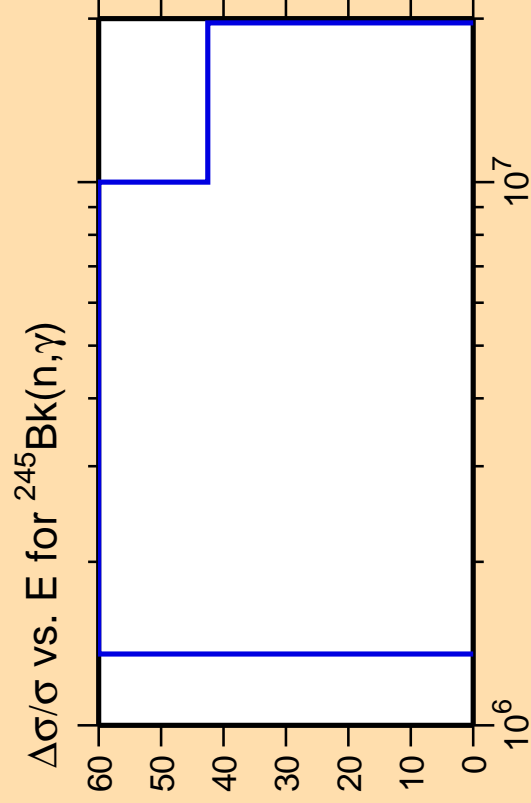

Ordinate scale is %
relative standard deviation.

Abscissa scales are energy (eV).

Warning: some uncertainty
data were suppressed.

$\Delta\sigma/\sigma$ vs. E for $^{245}\text{Bk}(n,n_1)$

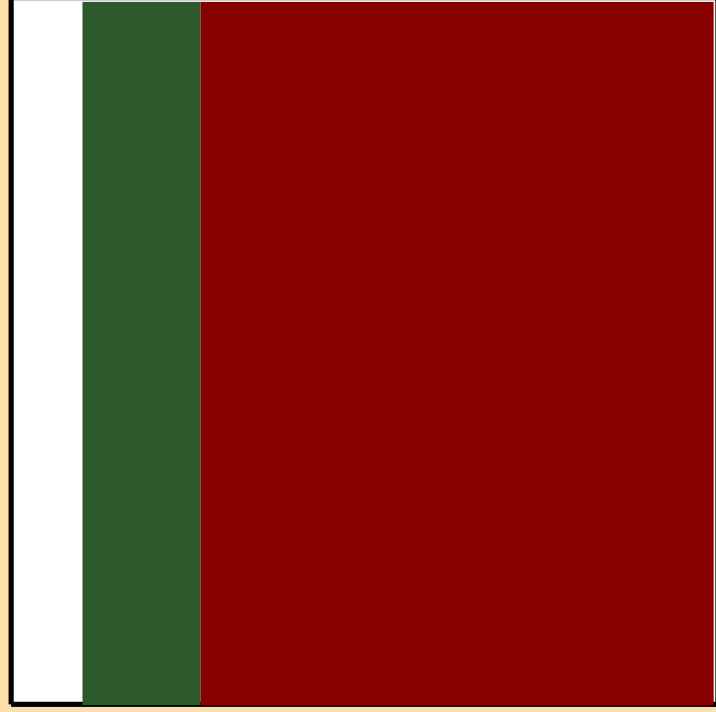
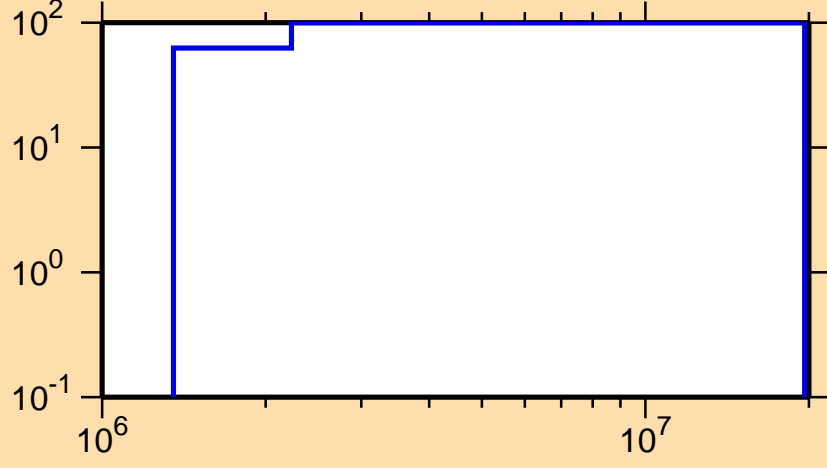

Correlation Matrix



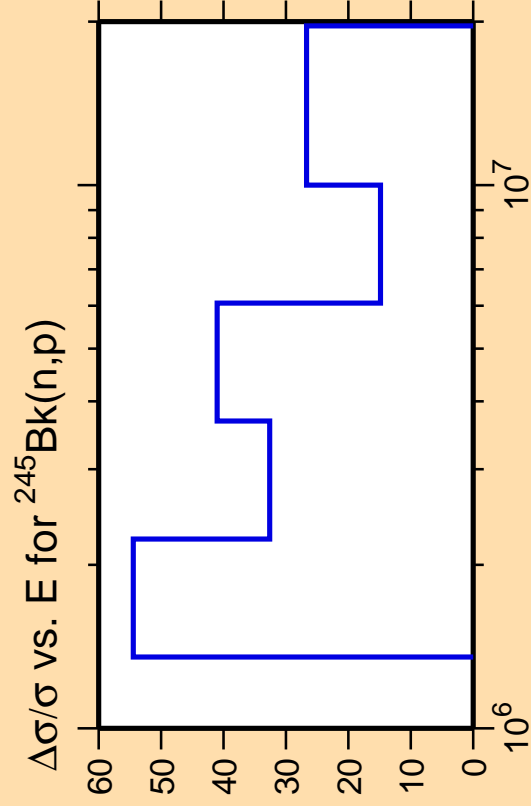

Ordinate scale is %
relative standard deviation.

Abscissa scales are energy (eV).

Warning: some uncertainty
data were suppressed.

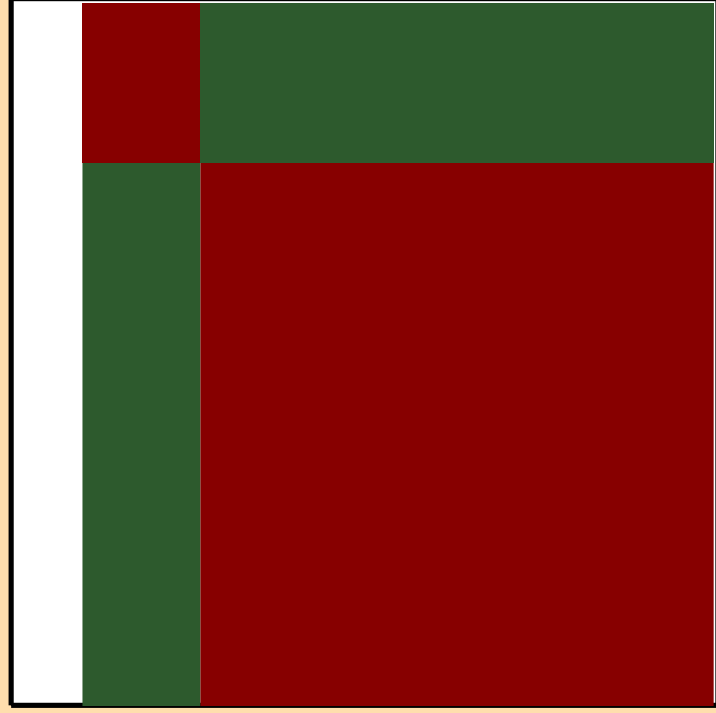
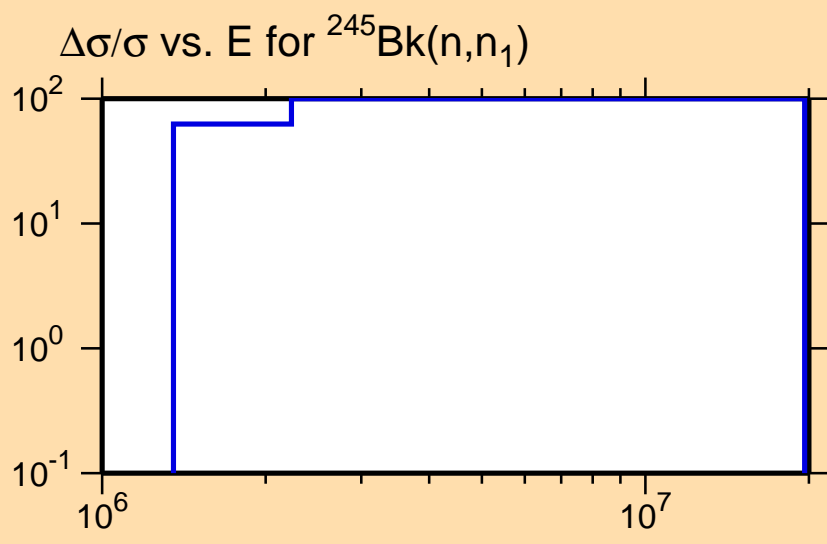

Correlation Matrix



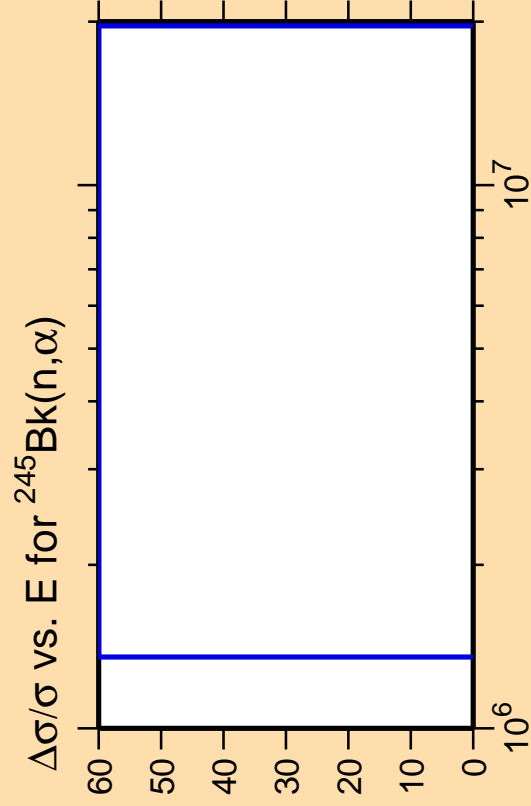

Ordinate scale is %
relative standard deviation.

Abscissa scales are energy (eV).

Warning: some uncertainty
data were suppressed.

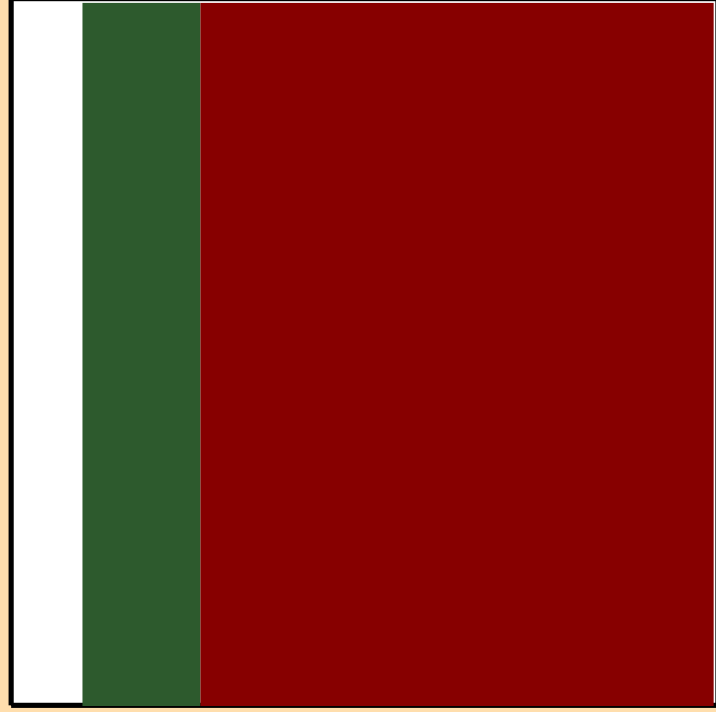
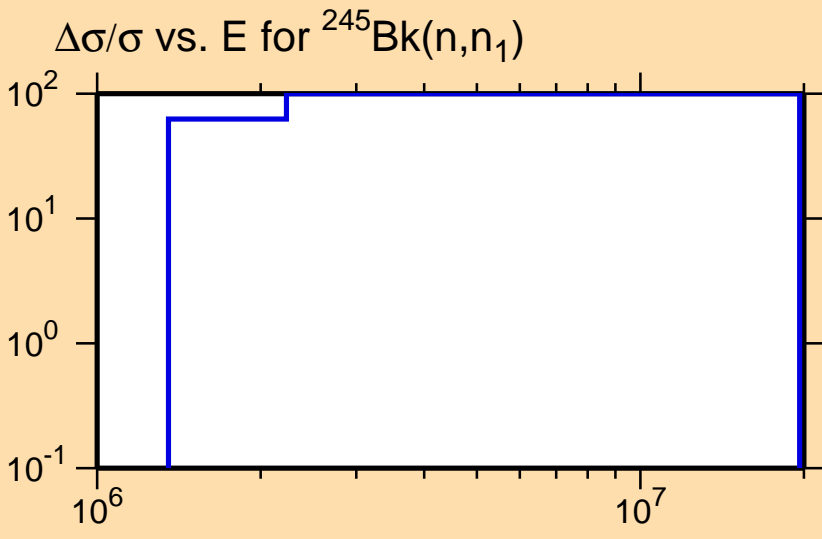

Correlation Matrix



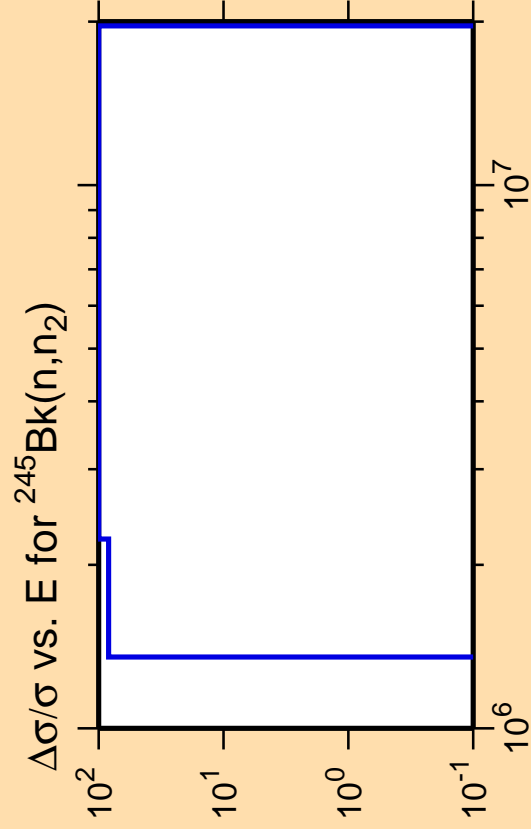

Ordinate scales are % relative standard deviation and barns.

Abscissa scales are energy (eV).

Warning: some uncertainty data were suppressed.

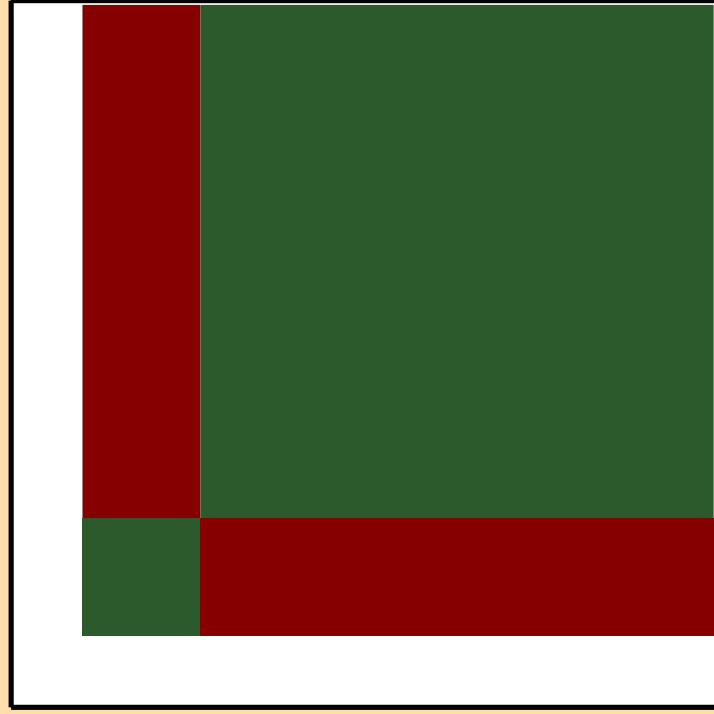
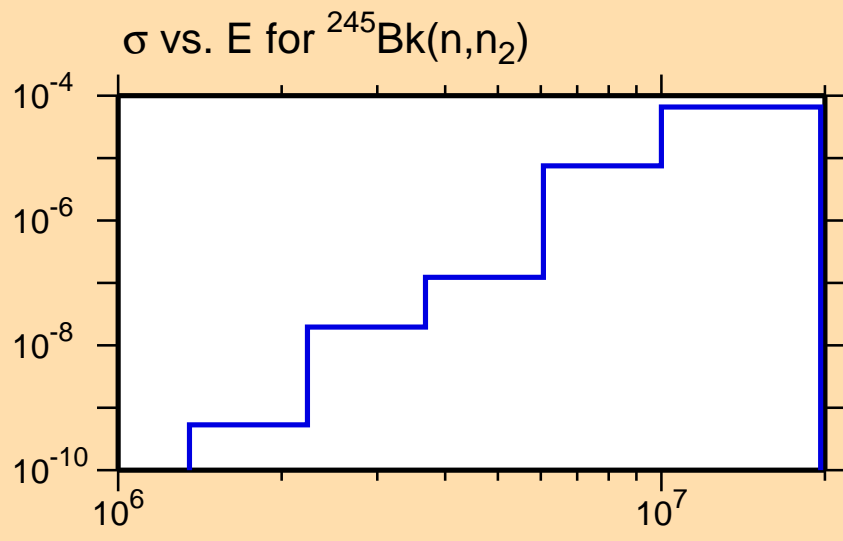

Correlation Matrix



$\Delta\sigma/\sigma$ vs. E for $^{245}\text{Bk}(n,n\text{cont.})$

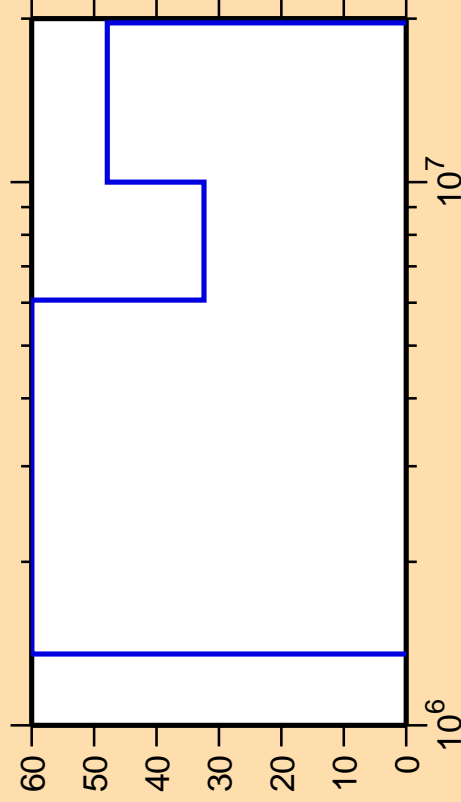

Ordinate scales are % relative standard deviation and barns.

Abscissa scales are energy (eV).

Warning: some uncertainty data were suppressed.

σ vs. E for $^{245}\text{Bk}(n,n\text{cont.})$

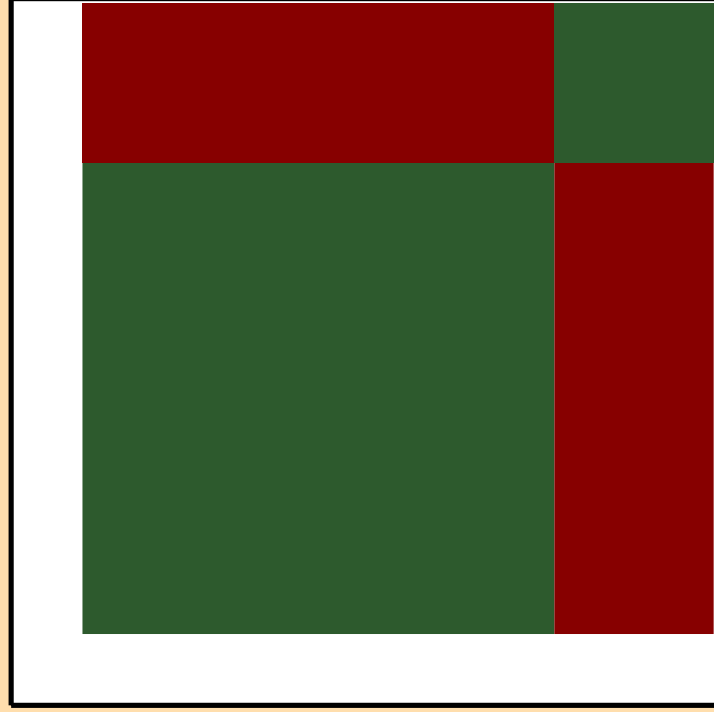
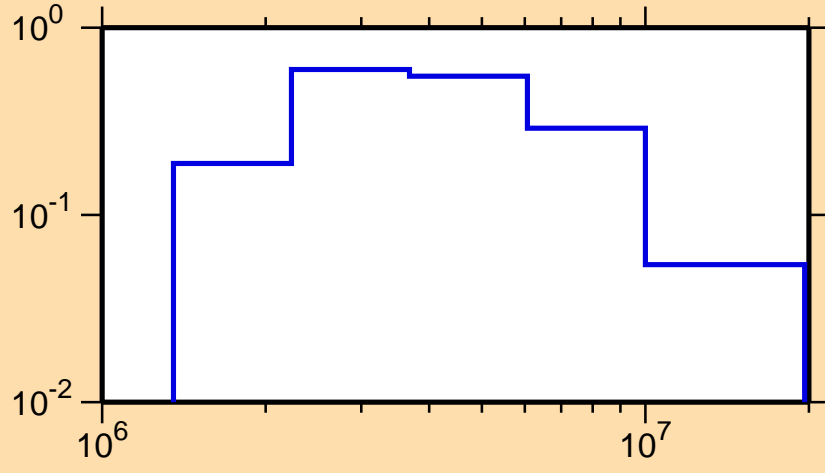

Correlation Matrix



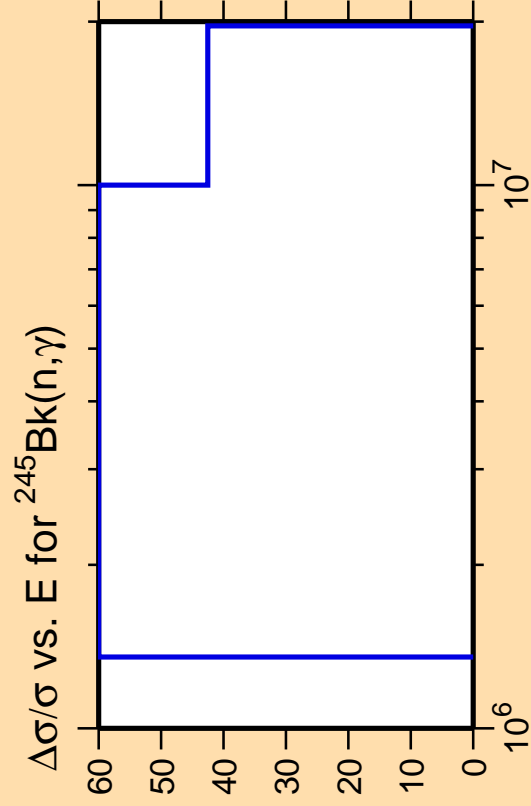

Ordinate scale is %
relative standard deviation.

Abscissa scales are energy (eV).

Warning: some uncertainty
data were suppressed.

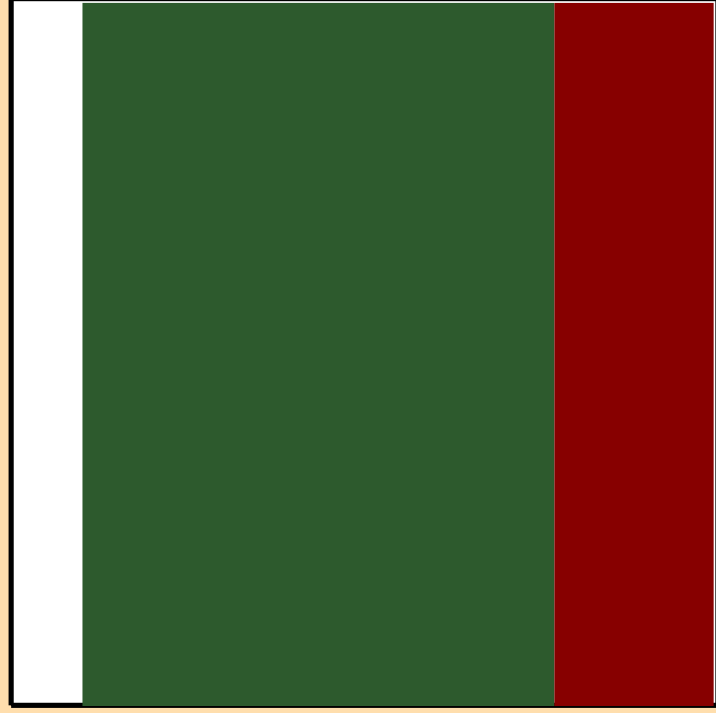
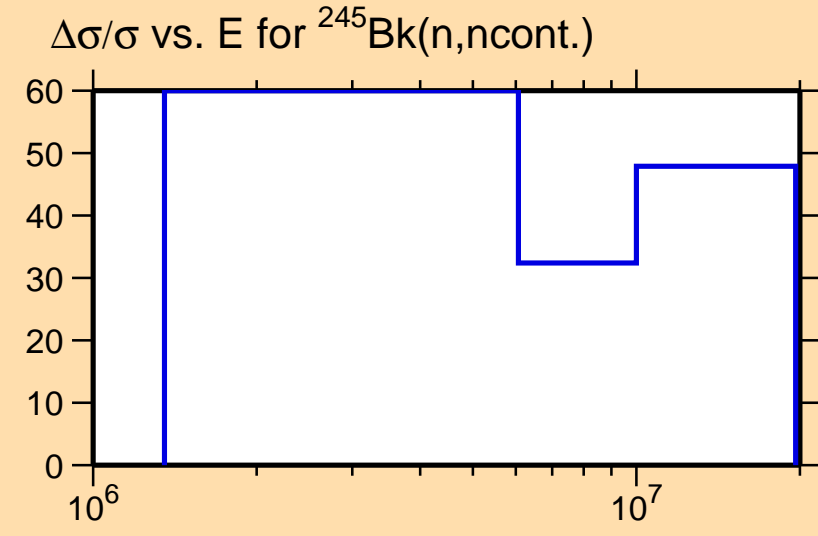

Correlation Matrix



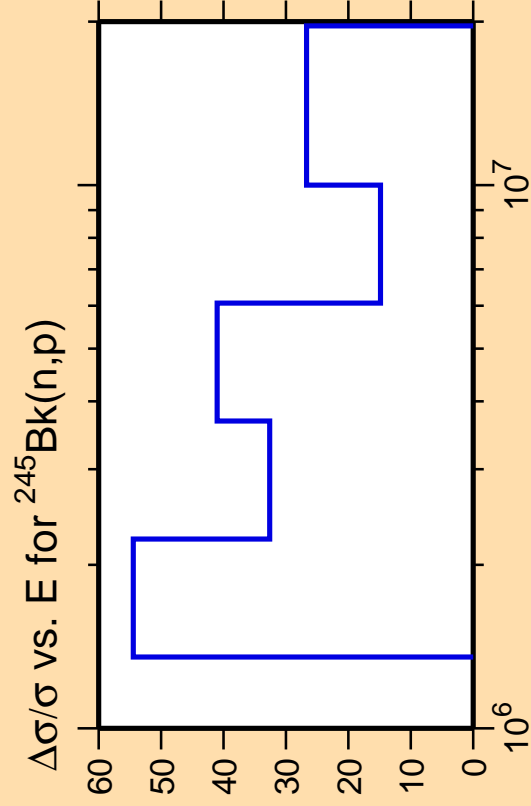

Ordinate scale is %
relative standard deviation.

Abscissa scales are energy (eV).

Warning: some uncertainty
data were suppressed.

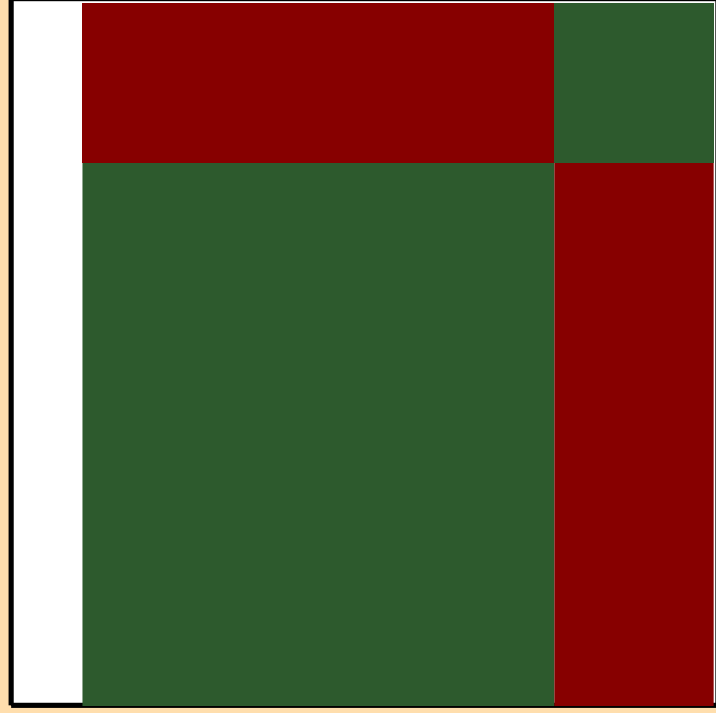
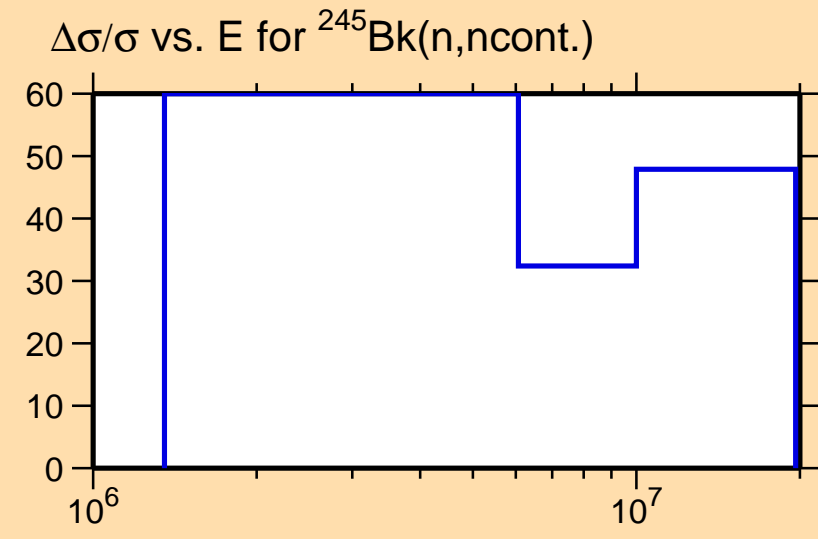

Correlation Matrix



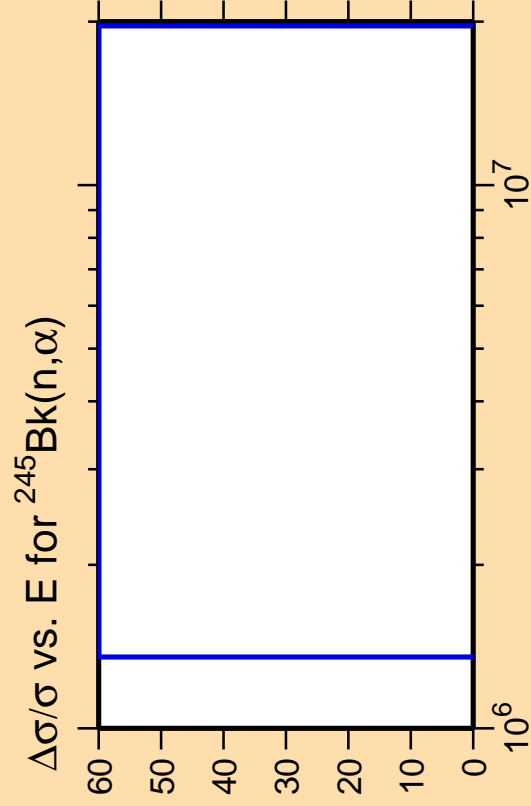

Ordinate scale is %
relative standard deviation.

Abscissa scales are energy (eV).

Warning: some uncertainty
data were suppressed.

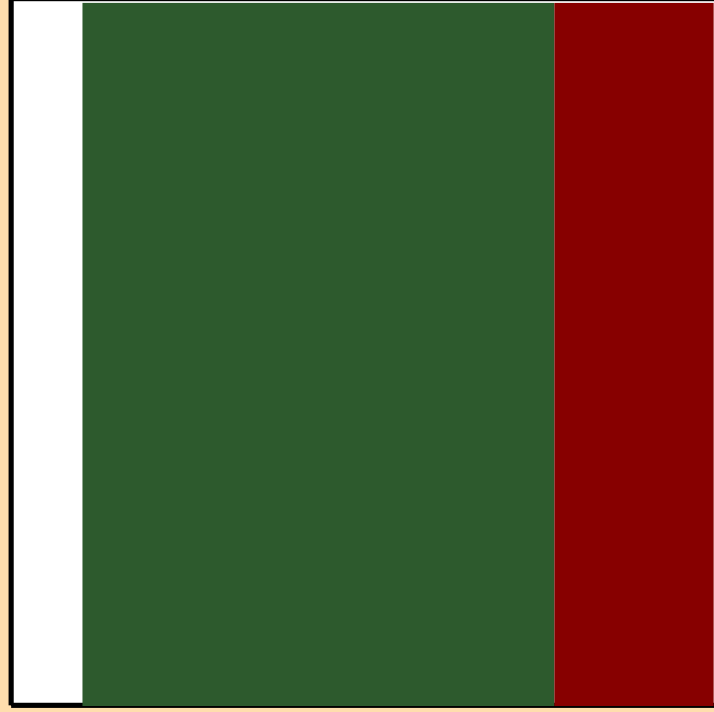
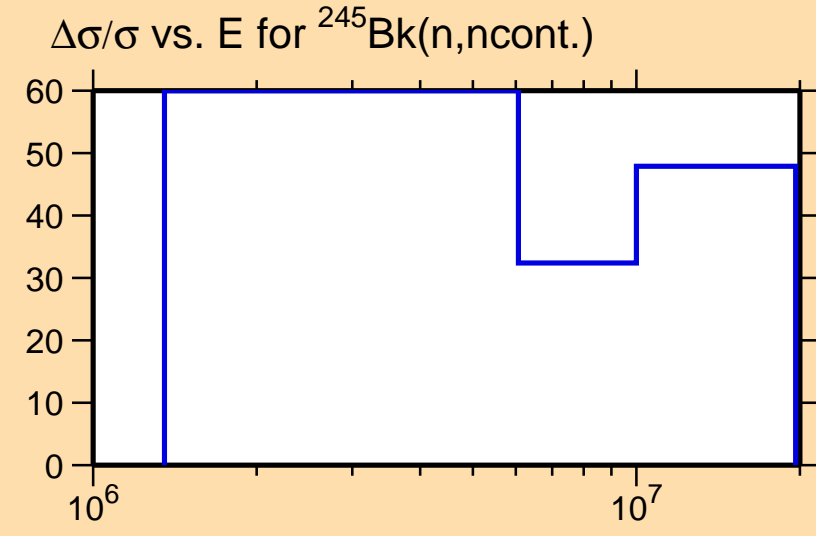

Correlation Matrix



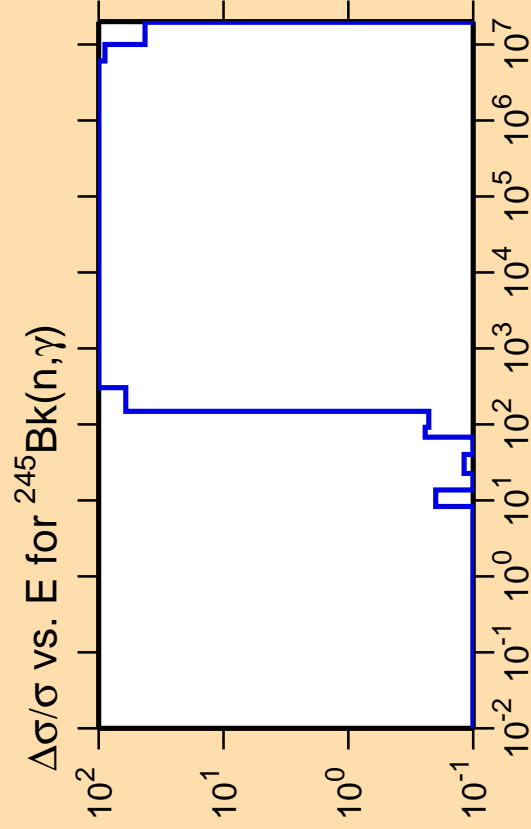

Ordinate scales are % relative standard deviation and barns.

Abscissa scales are energy (eV).

Warning: some uncertainty data were suppressed.

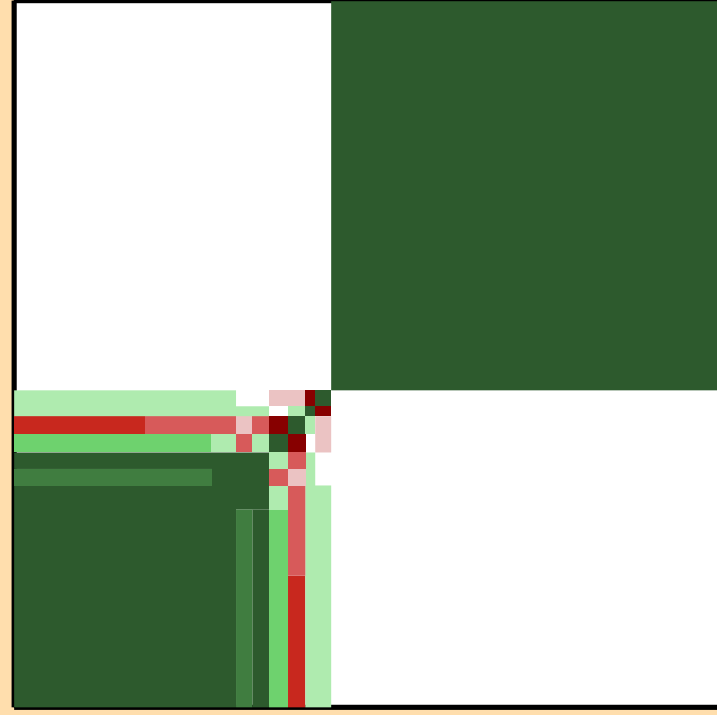
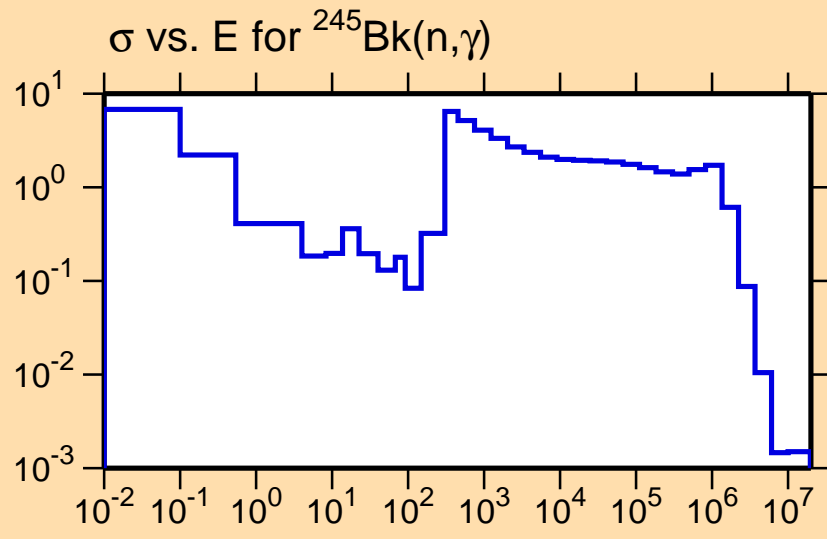

Correlation Matrix



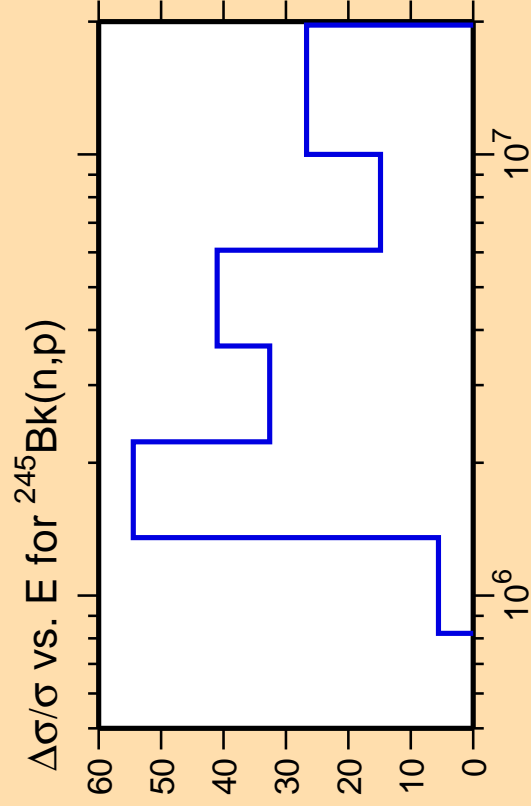

Ordinate scale is %
relative standard deviation.

Abscissa scales are energy (eV).

Warning: some uncertainty
data were suppressed.

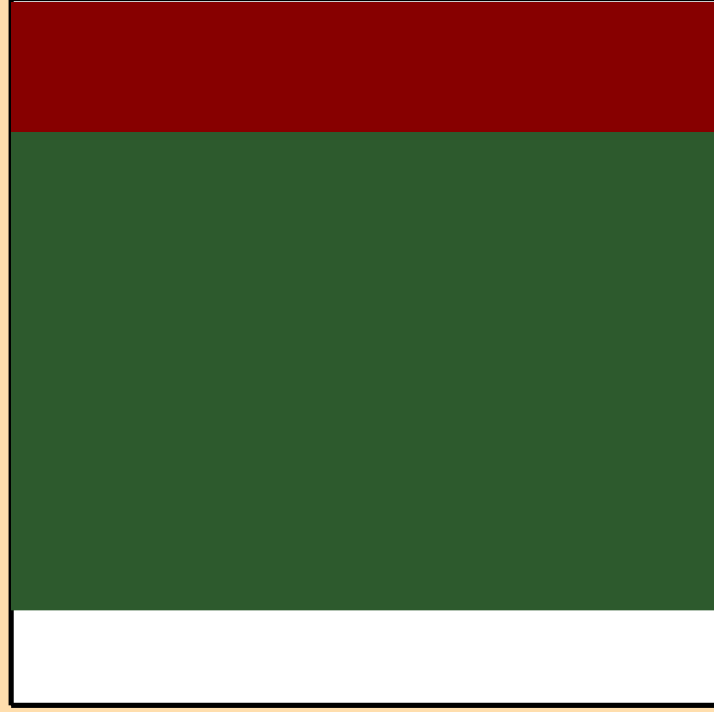
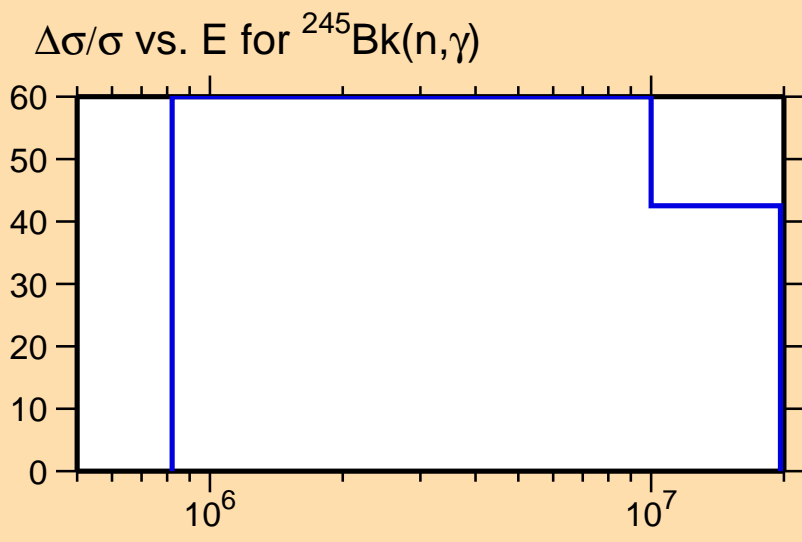

Correlation Matrix



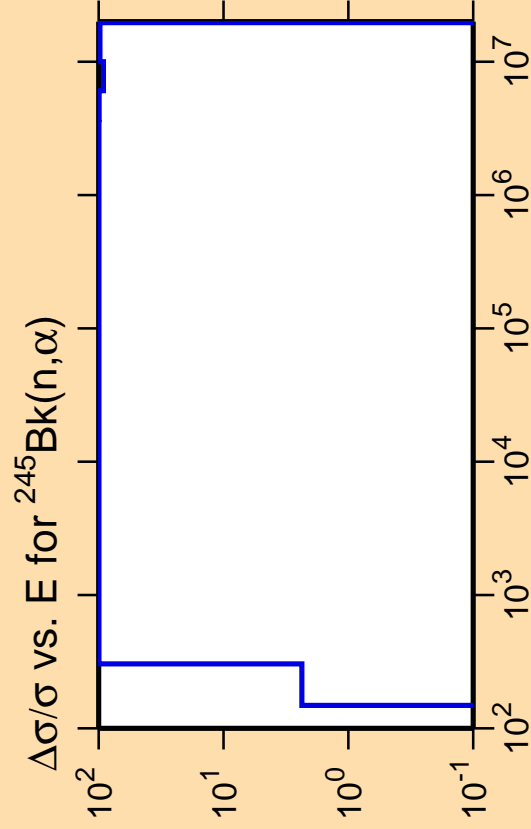

Ordinate scale is %
relative standard deviation.

Abscissa scales are energy (eV).

Warning: some uncertainty
data were suppressed.

$\Delta\sigma/\sigma$ vs. E for $^{245}\text{Bk}(n,\gamma)$

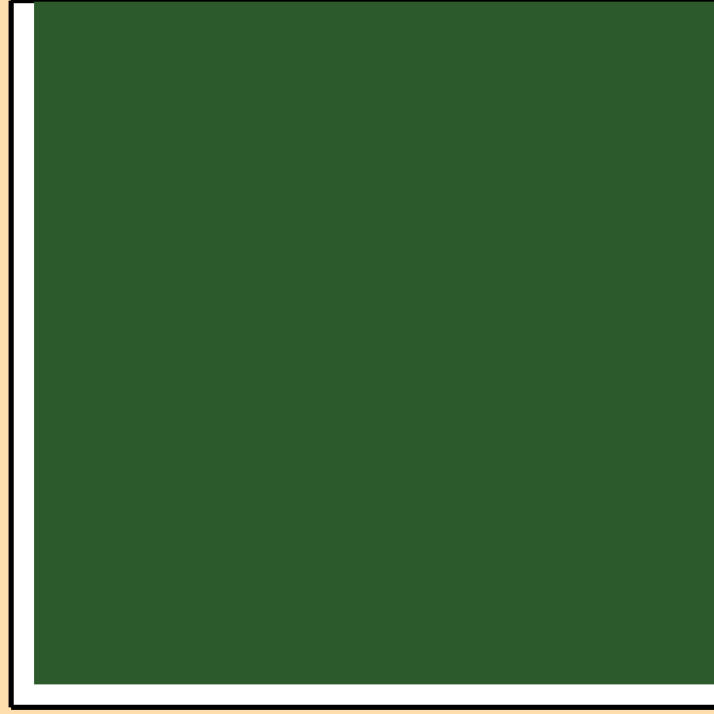
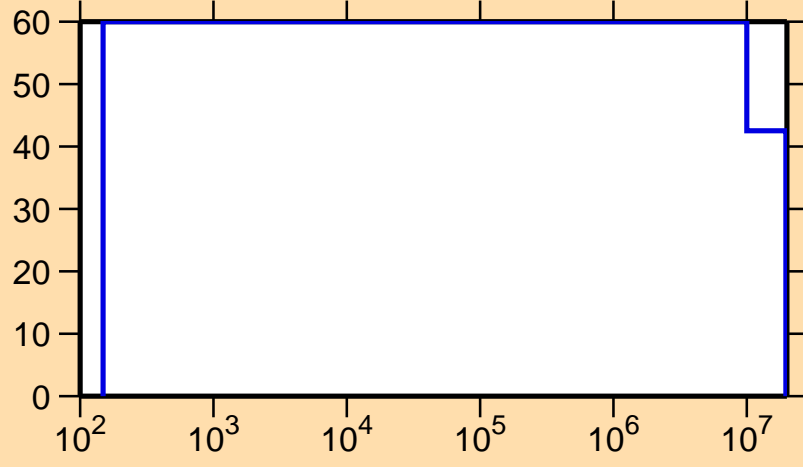

Correlation Matrix

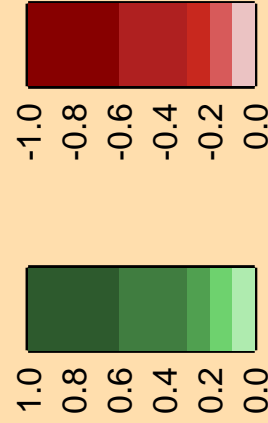

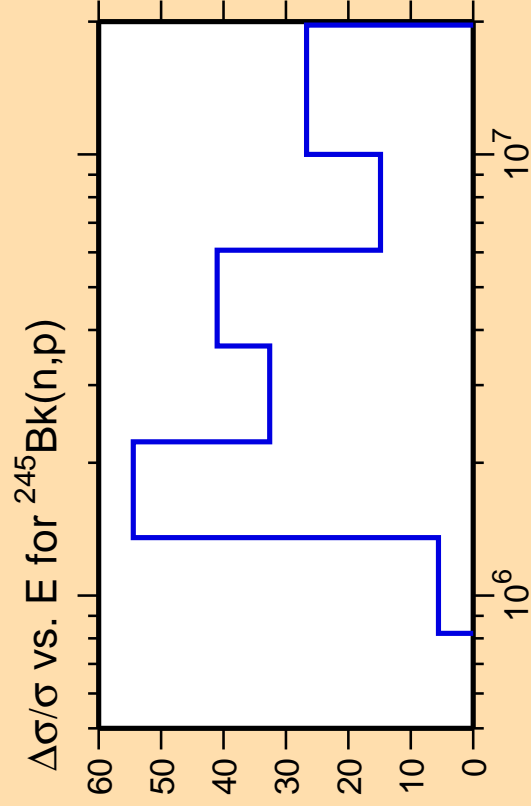

Ordinate scales are % relative standard deviation and barns.

Abscissa scales are energy (eV).

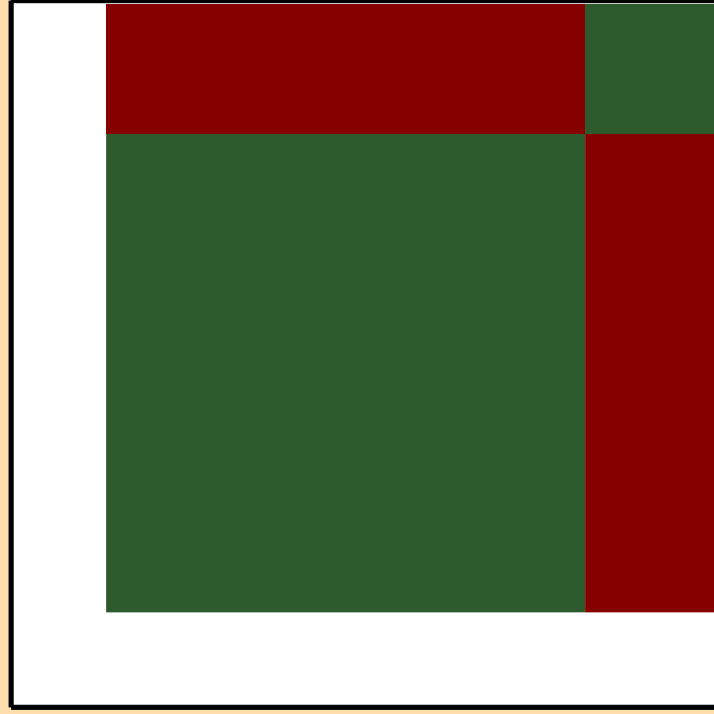
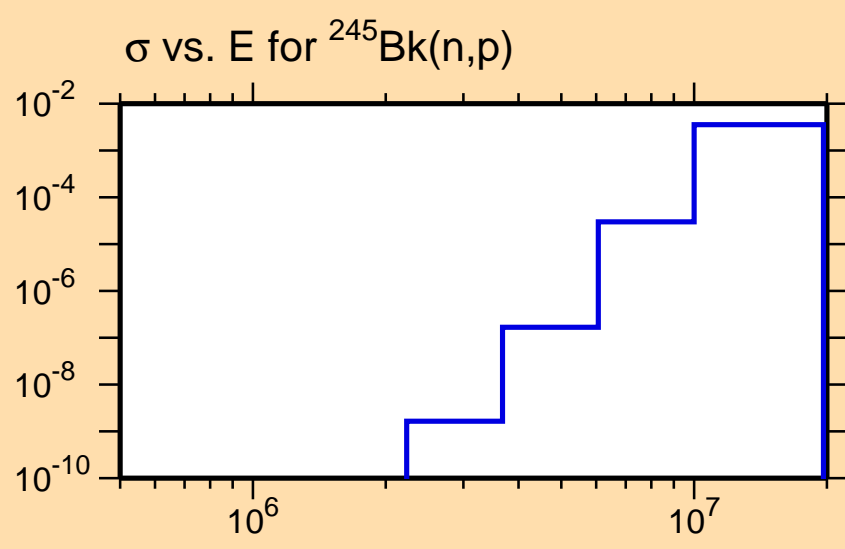

Correlation Matrix



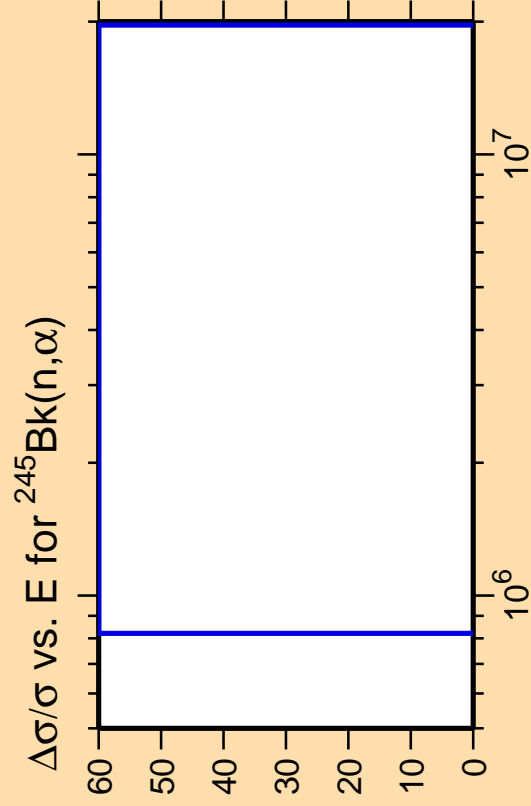

Ordinate scale is %
relative standard deviation.

Abscissa scales are energy (eV).

Warning: some uncertainty
data were suppressed.

$\Delta\sigma/\sigma$ vs. E for $^{245}\text{Bk}(n,p)$

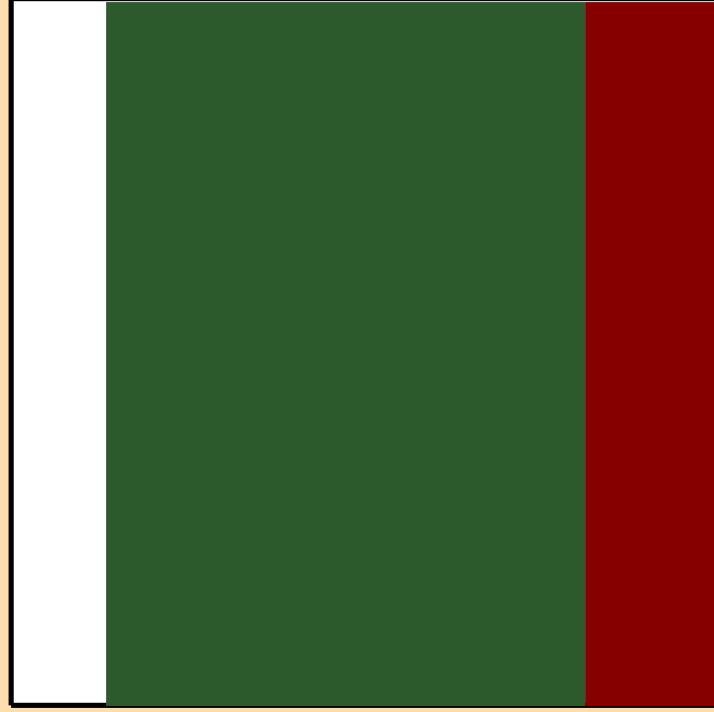
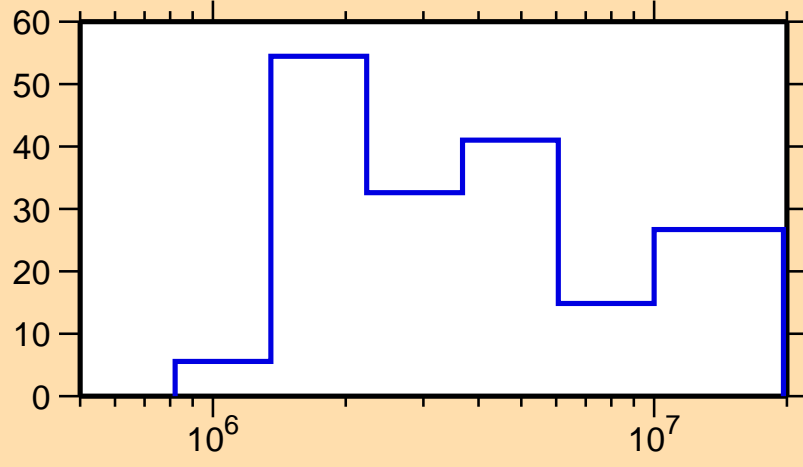

Correlation Matrix



$\Delta\sigma/\sigma$ vs. E for $^{245}\text{Bk}(n,d)$



Ordinate scales are % relative standard deviation and barns.

Abscissa scales are energy (eV).

Warning: some uncertainty data were suppressed.

σ vs. E for $^{245}\text{Bk}(n,d)$

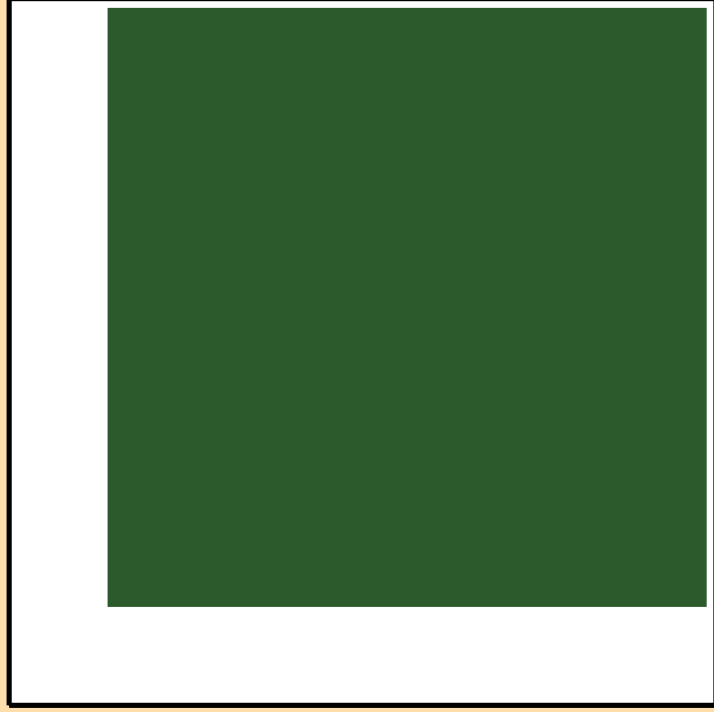
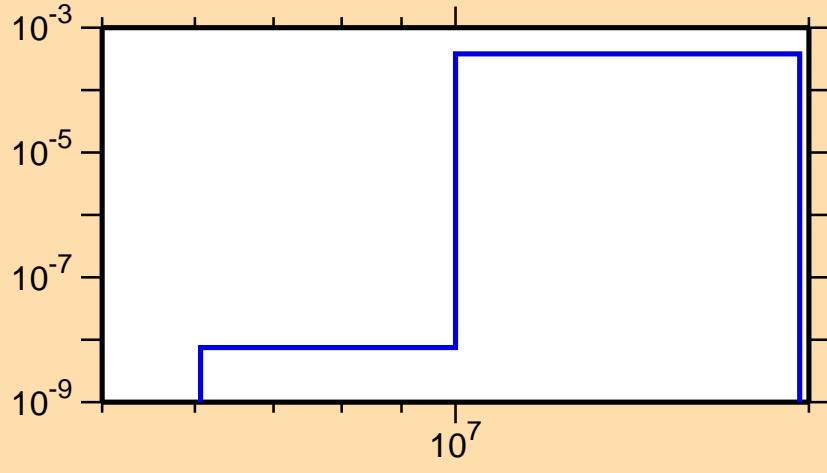

Correlation Matrix



$\Delta\sigma/\sigma$ vs. E for $^{245}\text{Bk}(n,t)$

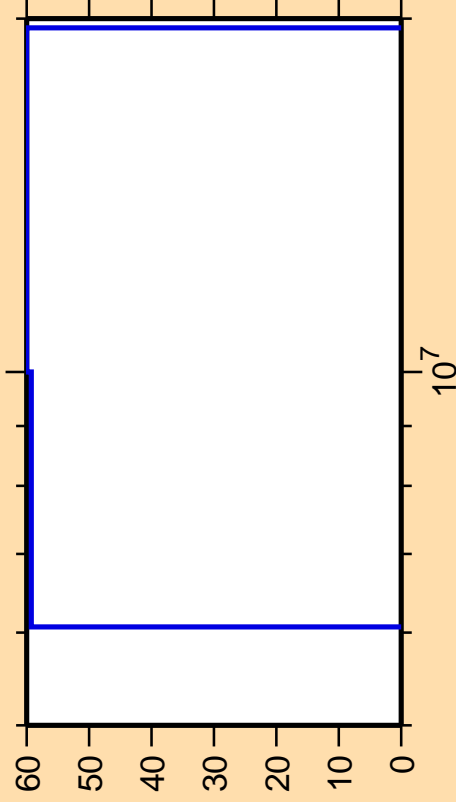

Ordinate scales are % relative standard deviation and barns.

Abscissa scales are energy (eV).

Warning: some uncertainty data were suppressed.

σ vs. E for $^{245}\text{Bk}(n,t)$

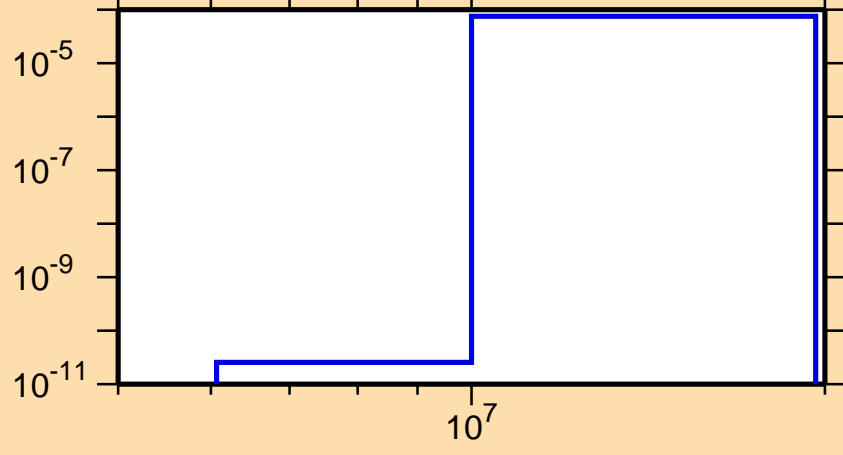

Correlation Matrix

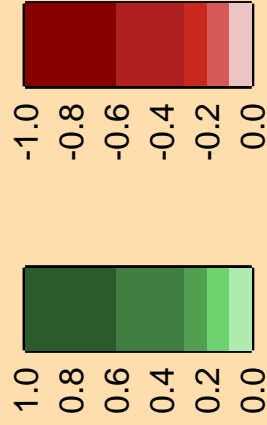

$\Delta\sigma/\sigma$ vs. E for $^{245}\text{Bk}(n,\text{He}3)$

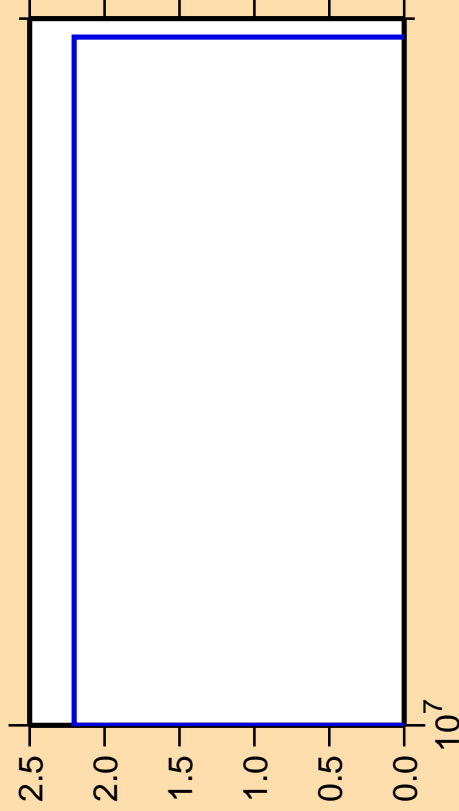

σ vs. E for $^{245}\text{Bk}(n,\text{He}3)$

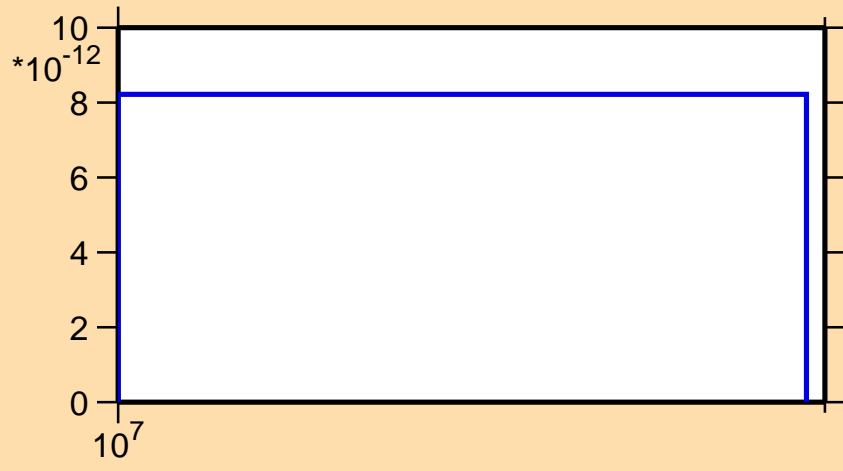

Correlation Matrix



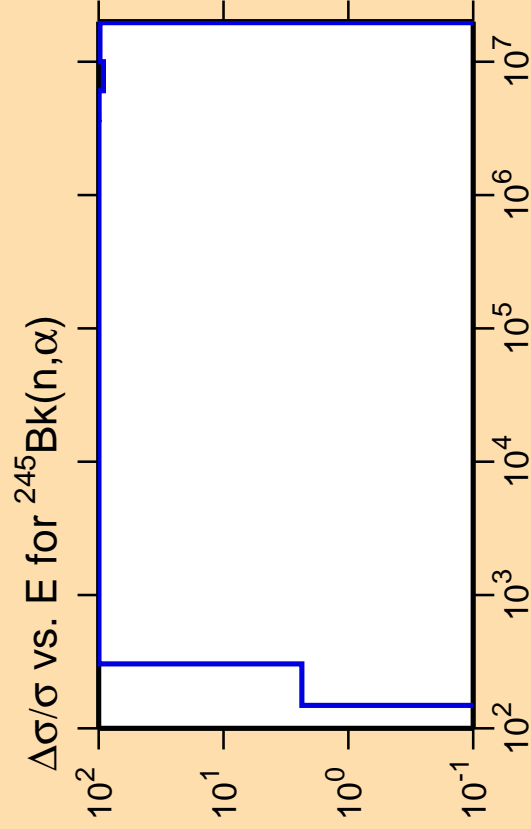

Ordinate scales are % relative standard deviation and barns.

Abscissa scales are energy (eV).

Warning: some uncertainty data were suppressed.

σ vs. E for $^{245}\text{Bk}(n,\alpha)$

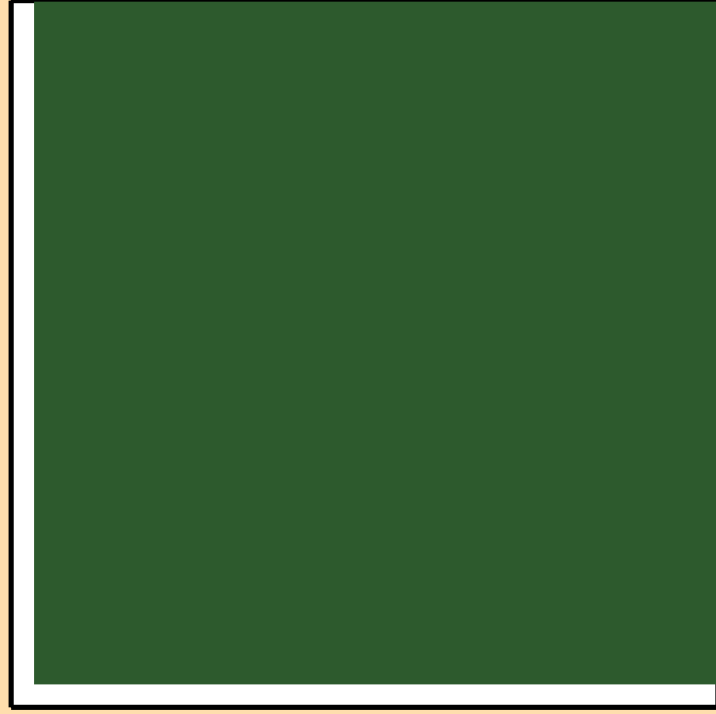
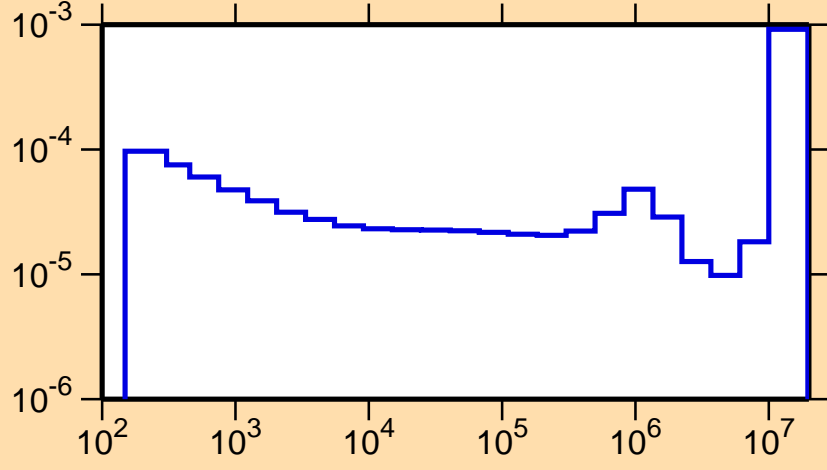

Correlation Matrix



$\Delta\sigma/\sigma$ vs. E for $^{245}\text{Bk}(n,p\alpha)$

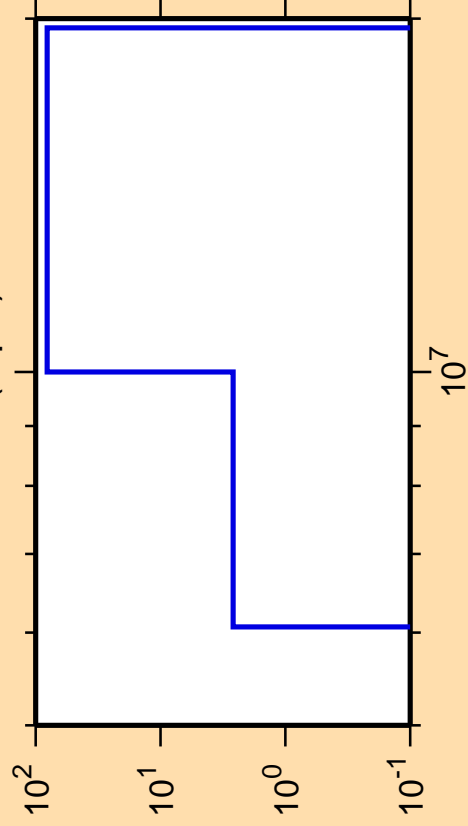

Ordinate scales are % relative standard deviation and barns.

Abscissa scales are energy (eV).

σ vs. E for $^{245}\text{Bk}(n,p\alpha)$

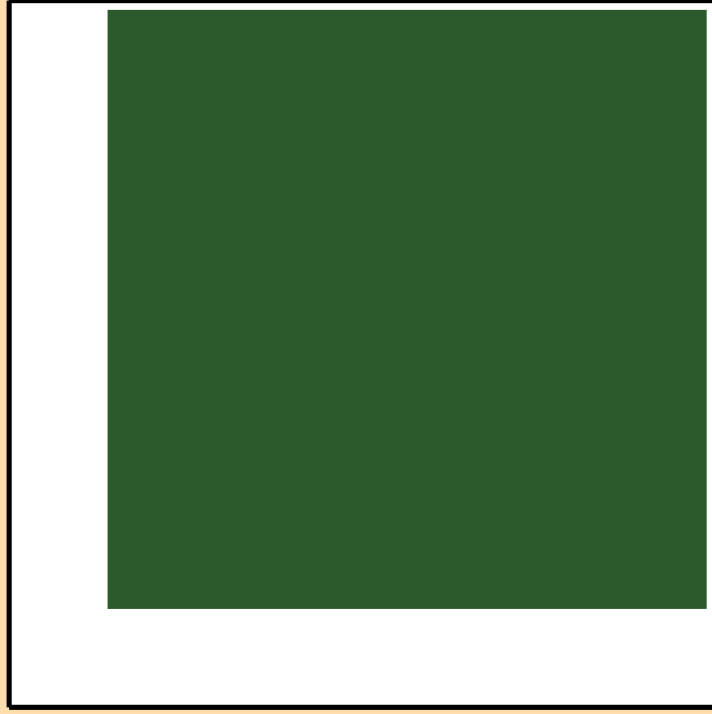
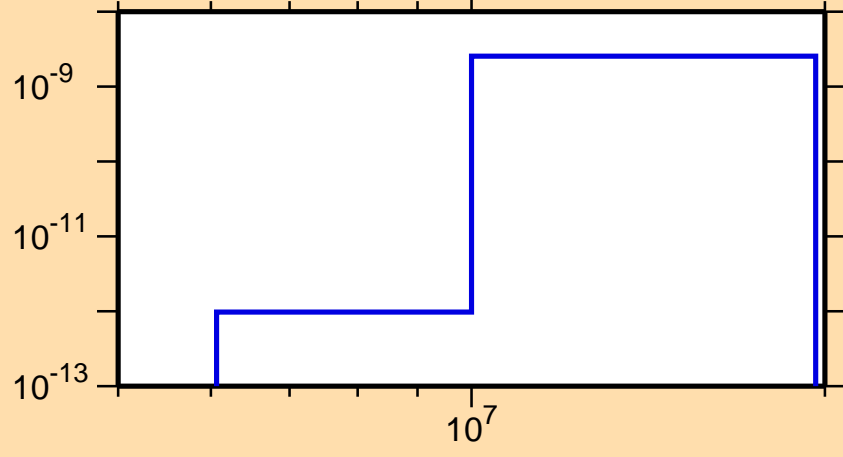

Correlation Matrix

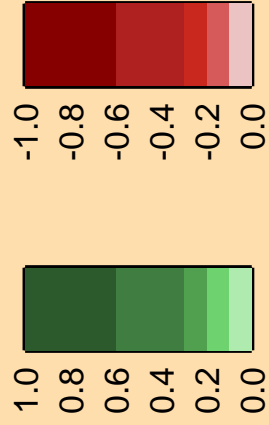

$\Delta\sigma/\sigma$ vs. E for $^{245}\text{Bk}(\text{mt117})$

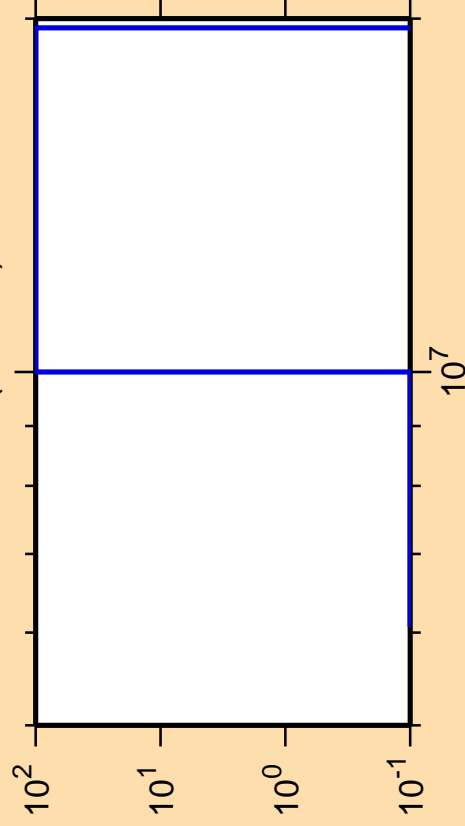

Ordinate scales are % relative standard deviation and barns.

Abscissa scales are energy (eV).

Warning: some uncertainty data were suppressed.

σ vs. E for $^{245}\text{Bk}(\text{mt117})$

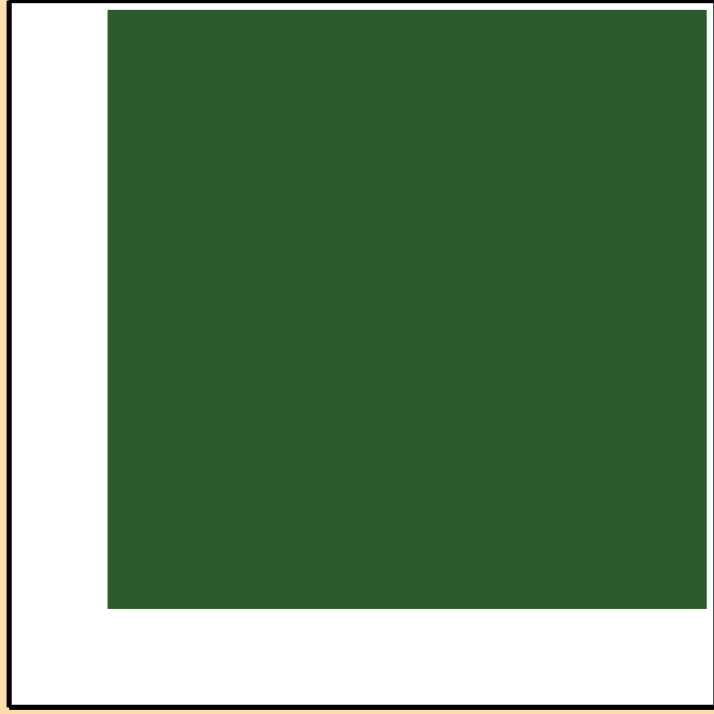
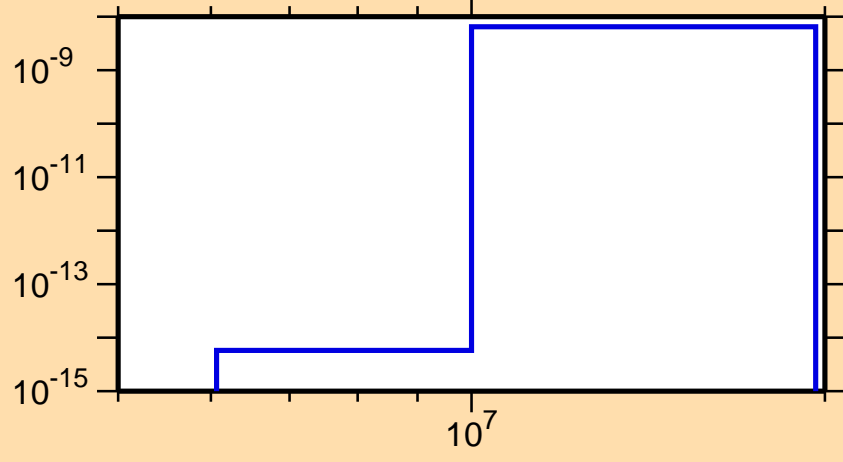

Correlation Matrix

