

BK251 NRG TENDL-2015, AKONING

Principal cross sections

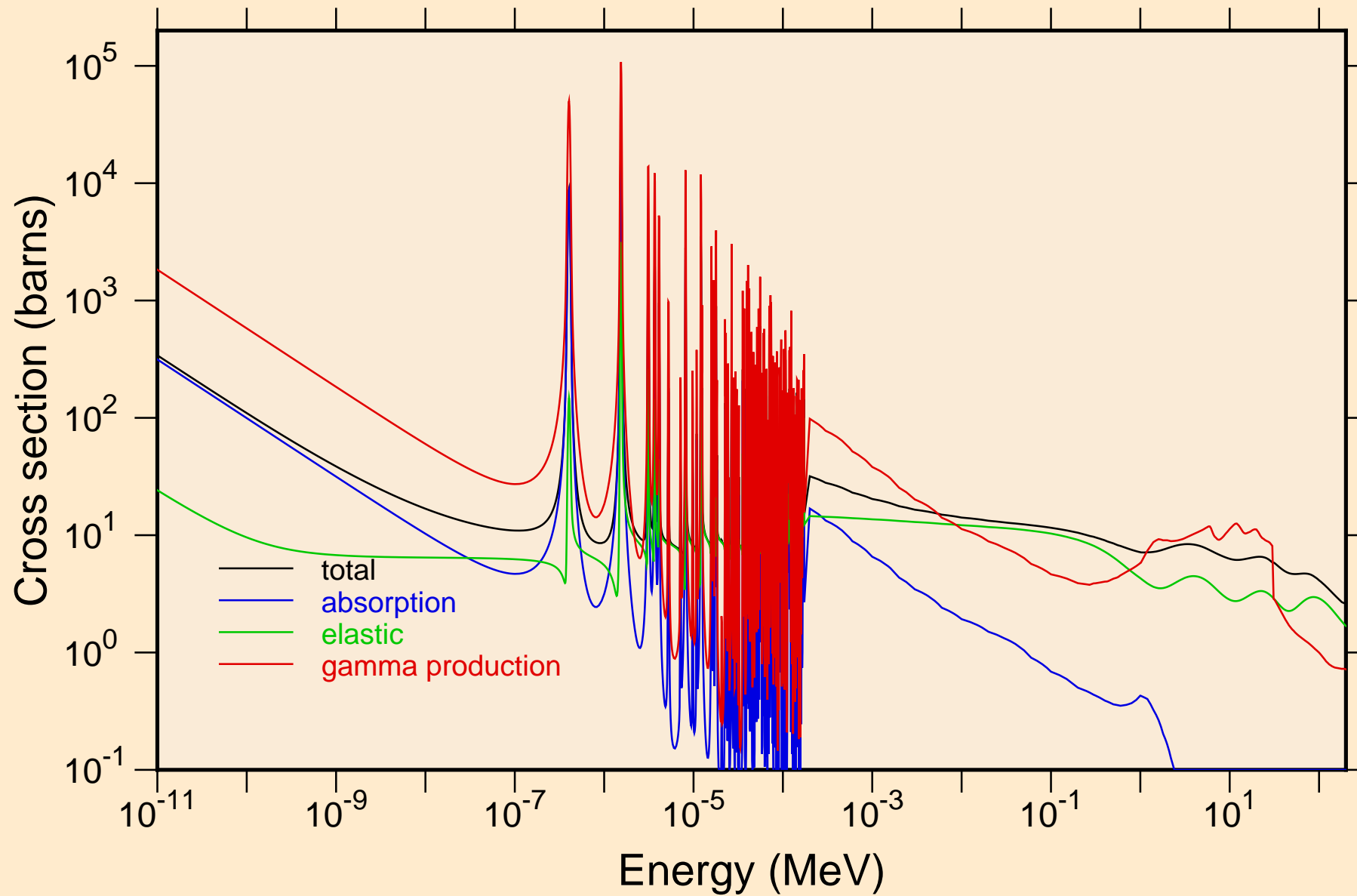

BK251 NRG TENDL-2015, AKONING
resonance total cross section

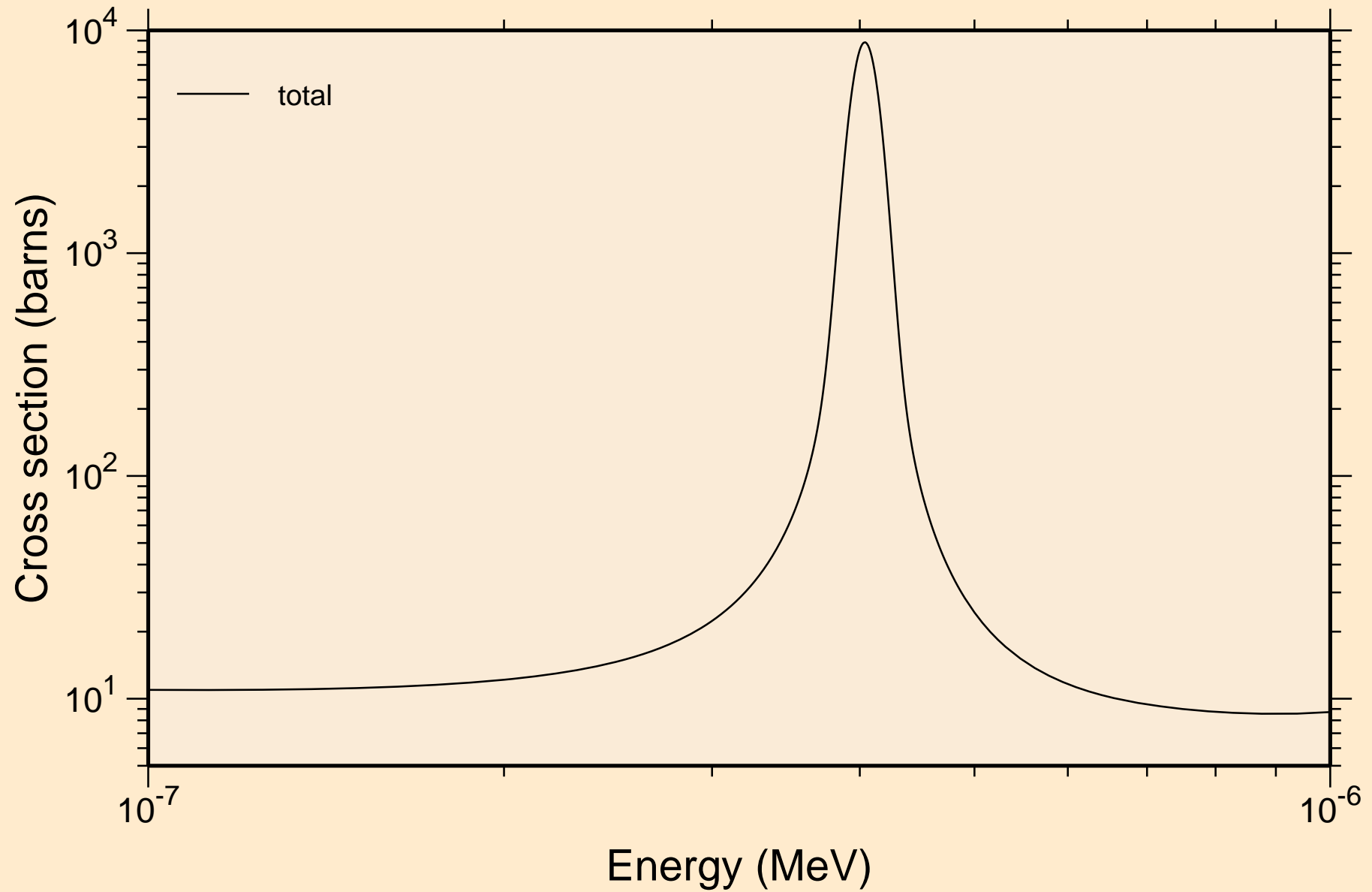

BK251 NRG TENDL-2015, AKONING
resonance total cross section

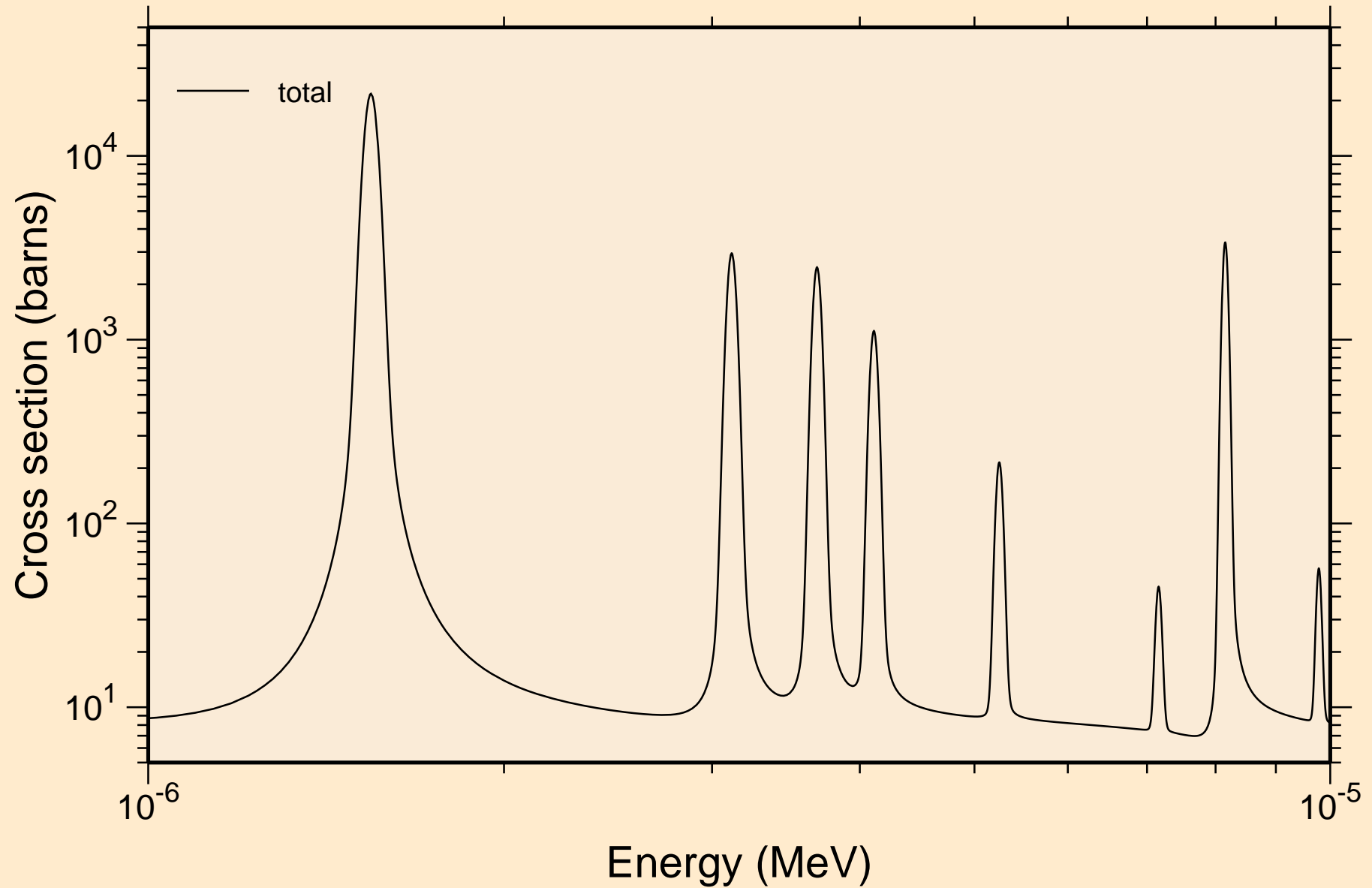

BK251 NRG TENDL-2015, AKONING
resonance total cross section

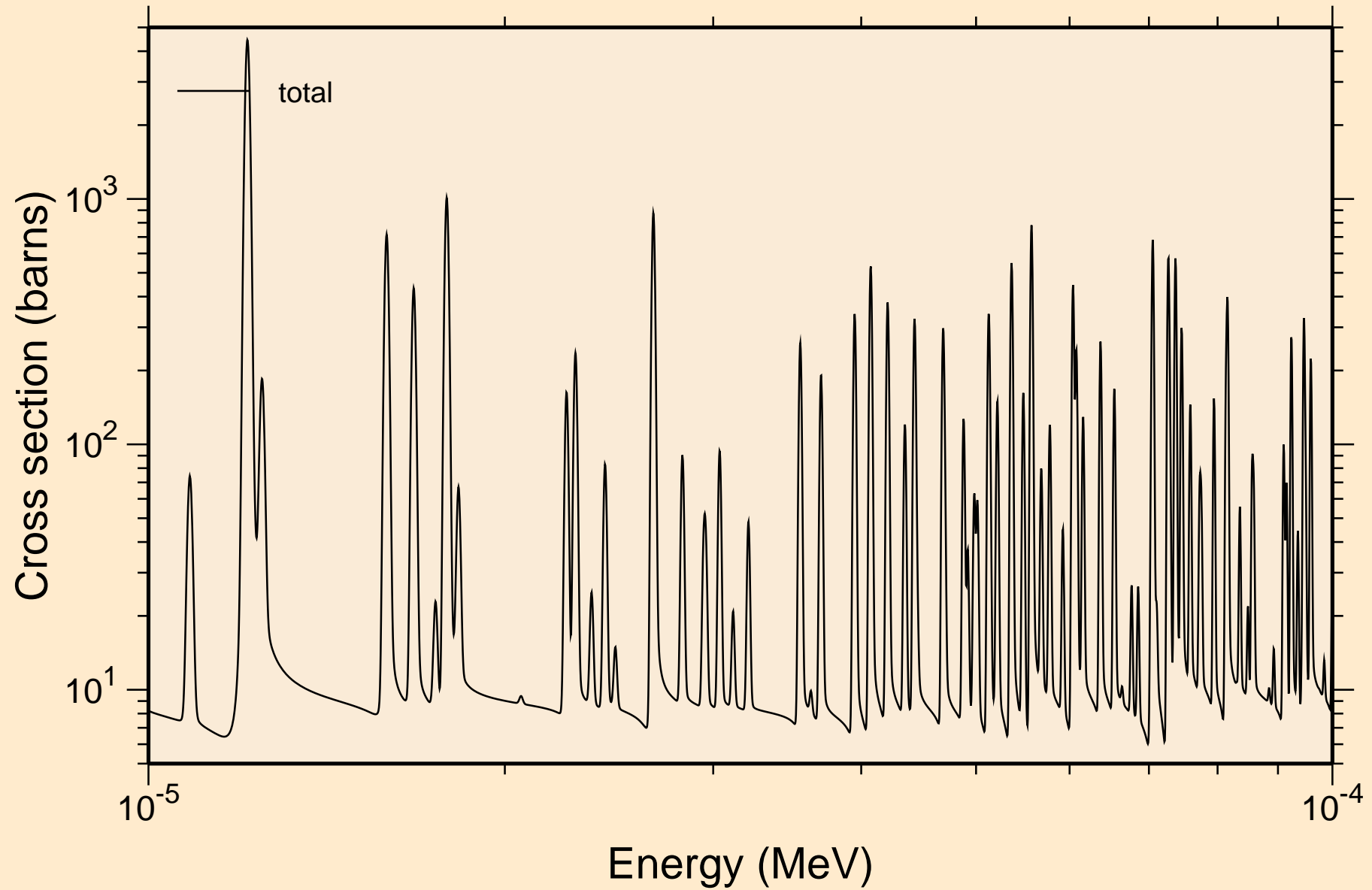

BK251 NRG TENDL-2015, AKONING
resonance total cross section

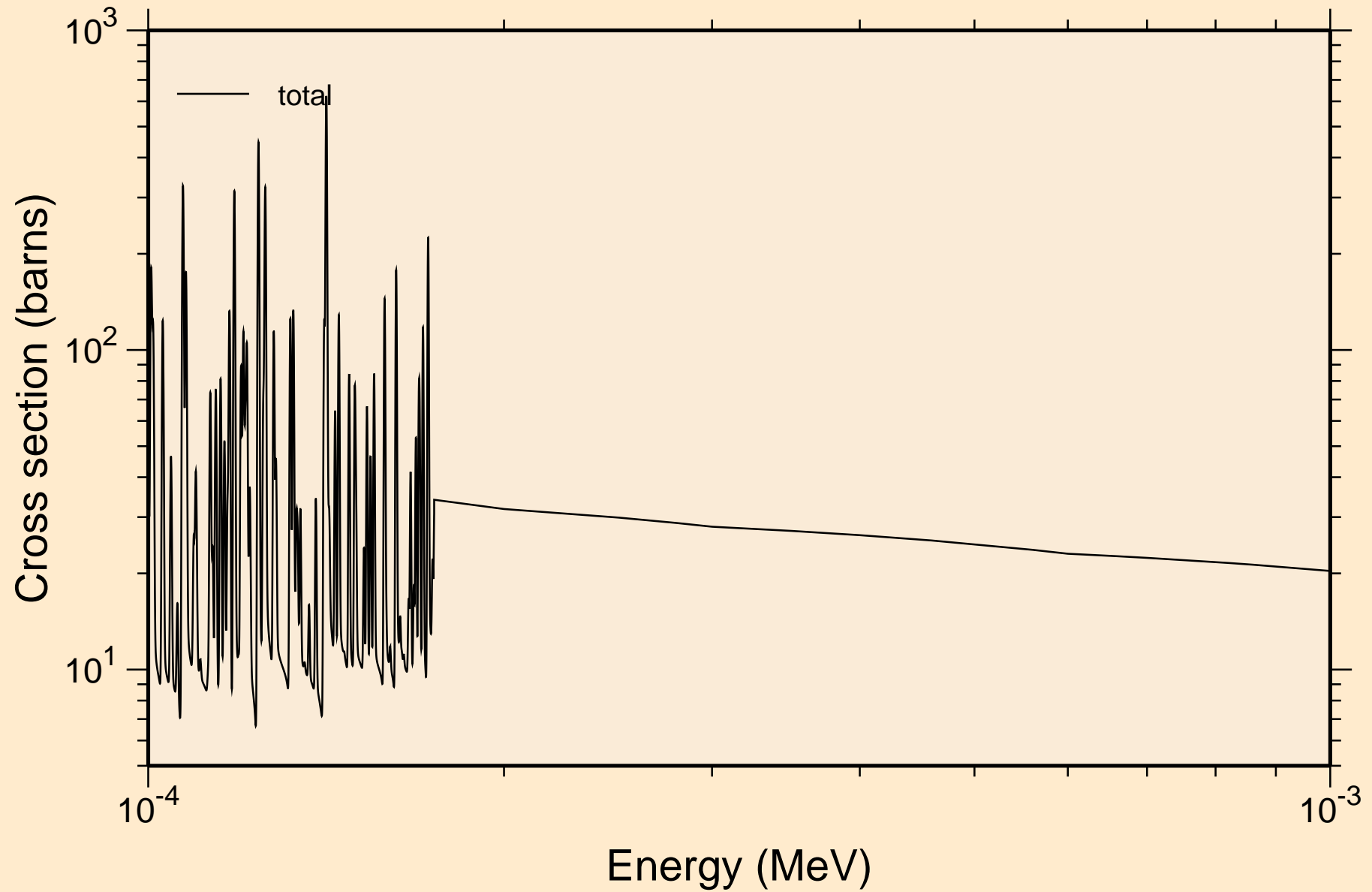

BK251 NRG TENDL-2015, AKONING
resonance total cross section

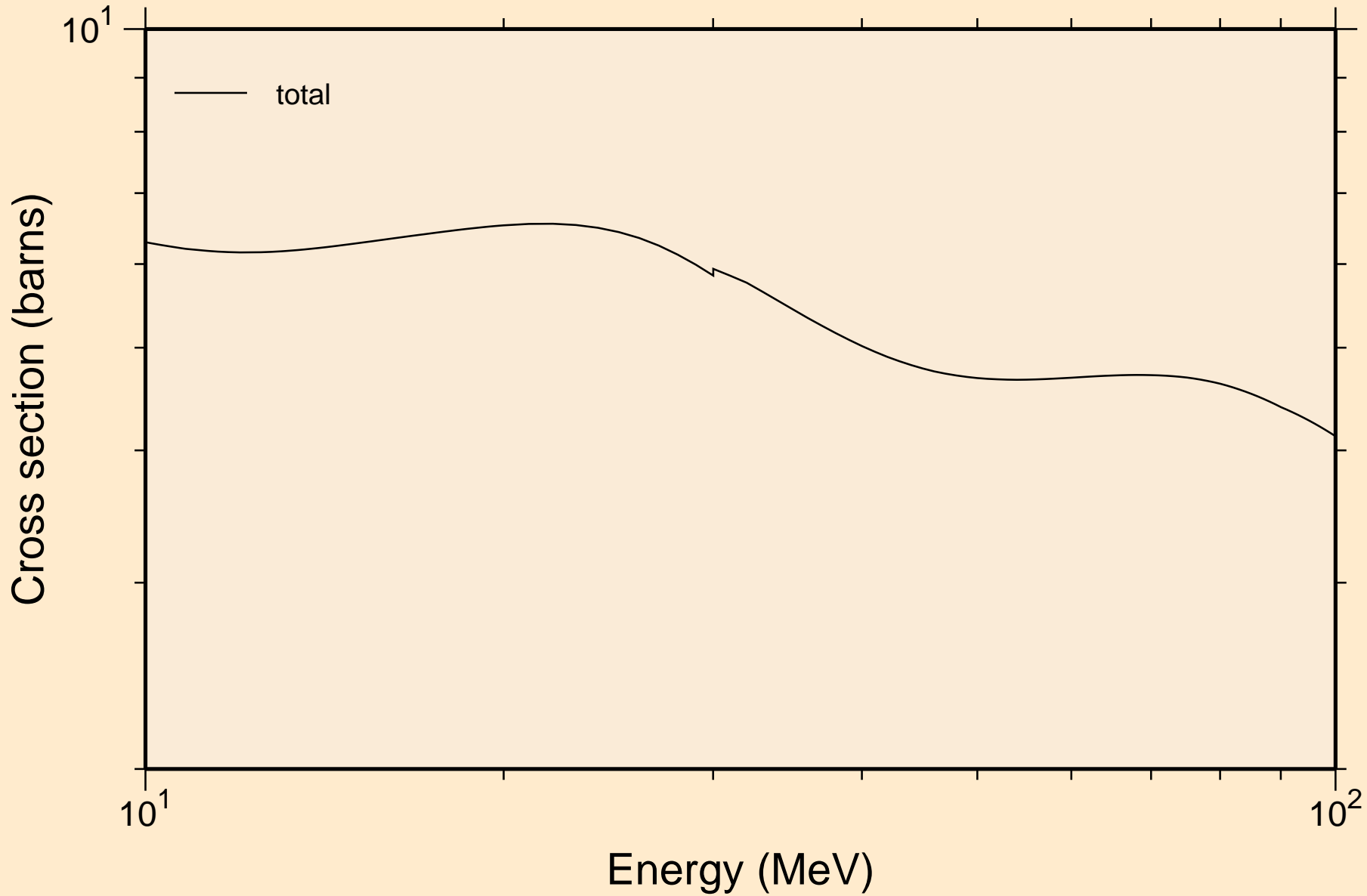

BK251 NRG TENDL-2015, AKONING
resonance absorption cross sections

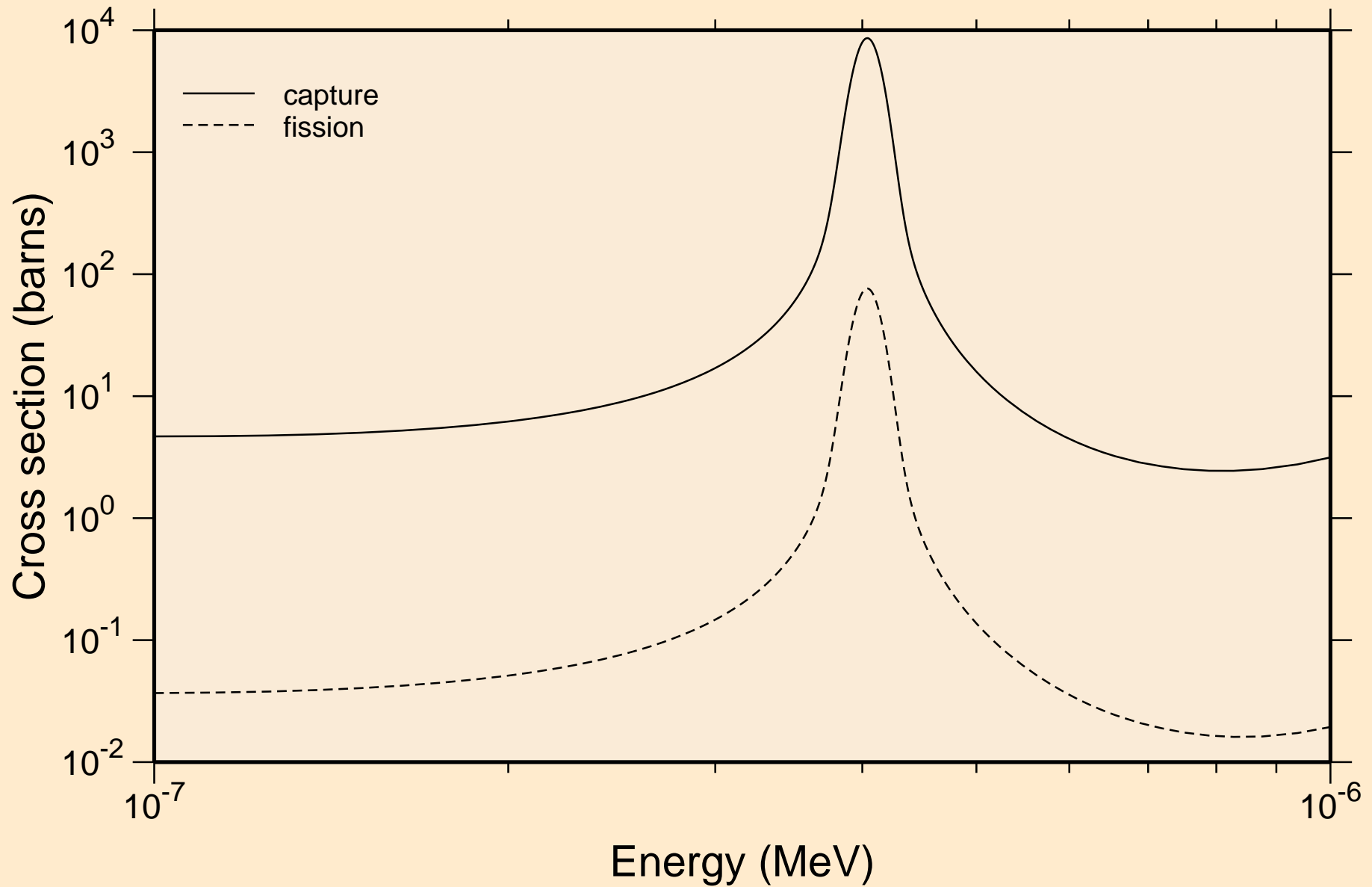

BK251 NRG TENDL-2015, AKONING

resonance absorption cross sections

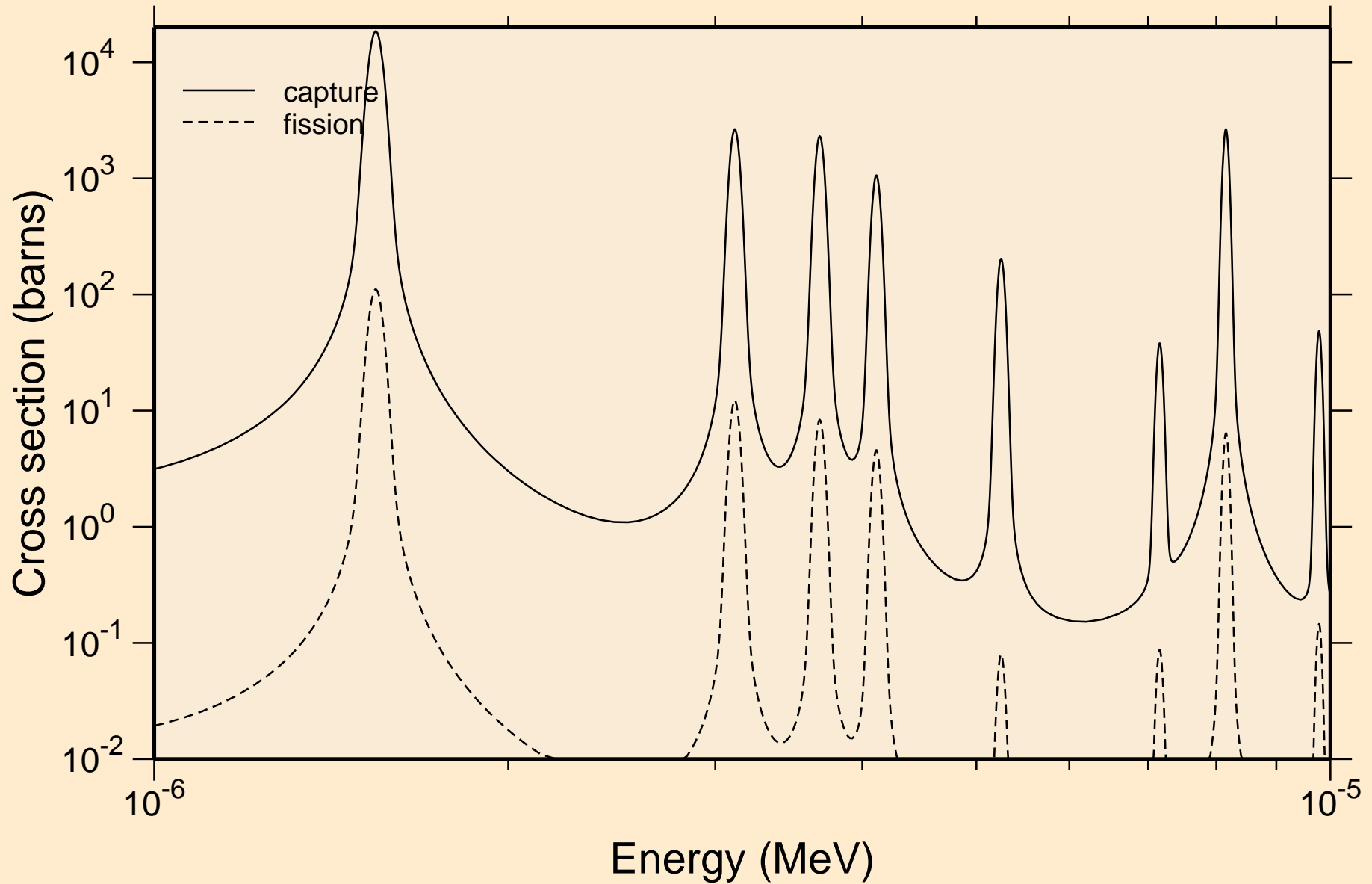

BK251 NRG TENDL-2015, AKONING
resonance absorption cross sections

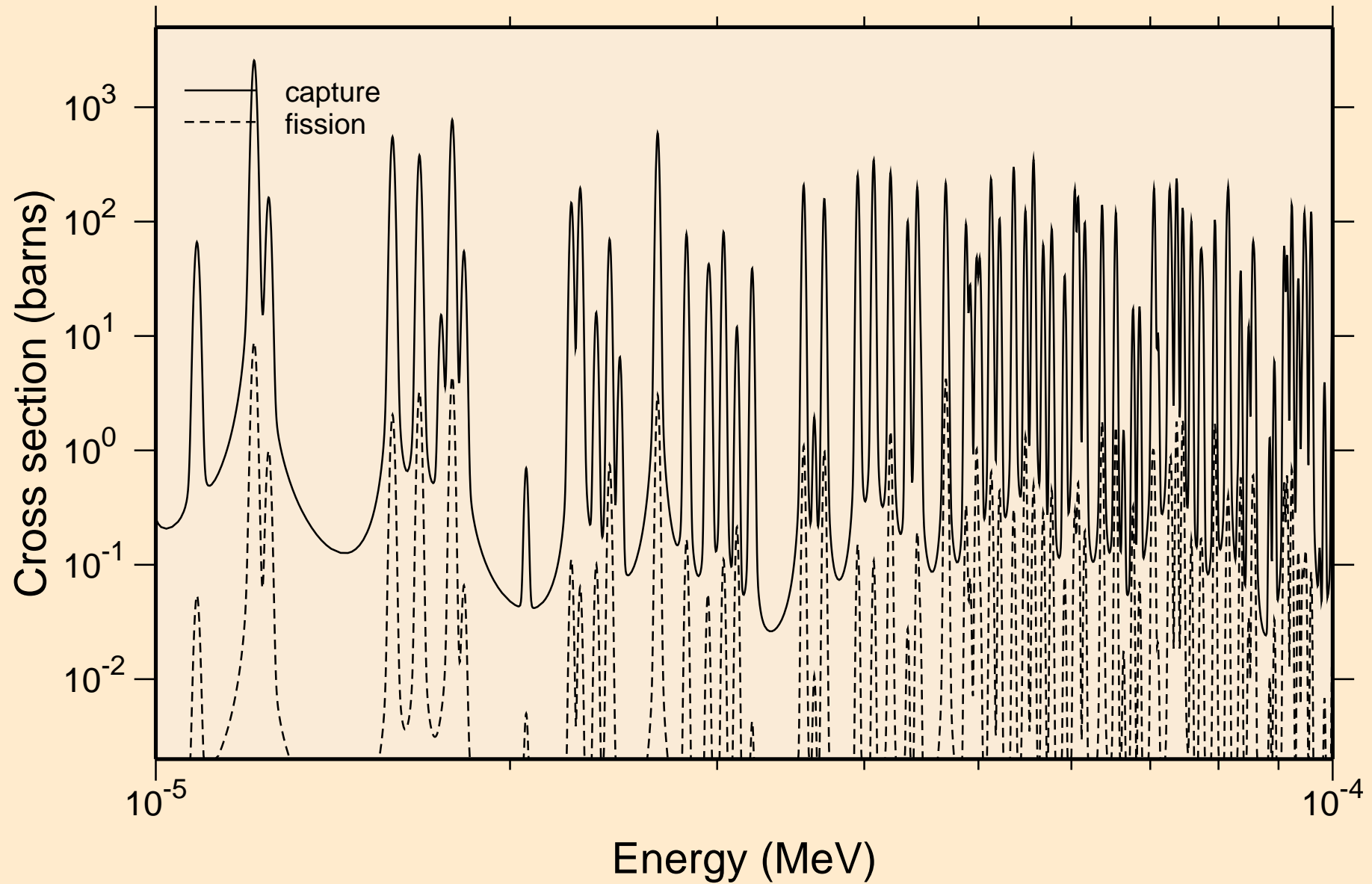

BK251 NRG TENDL-2015, AKONING
resonance absorption cross sections

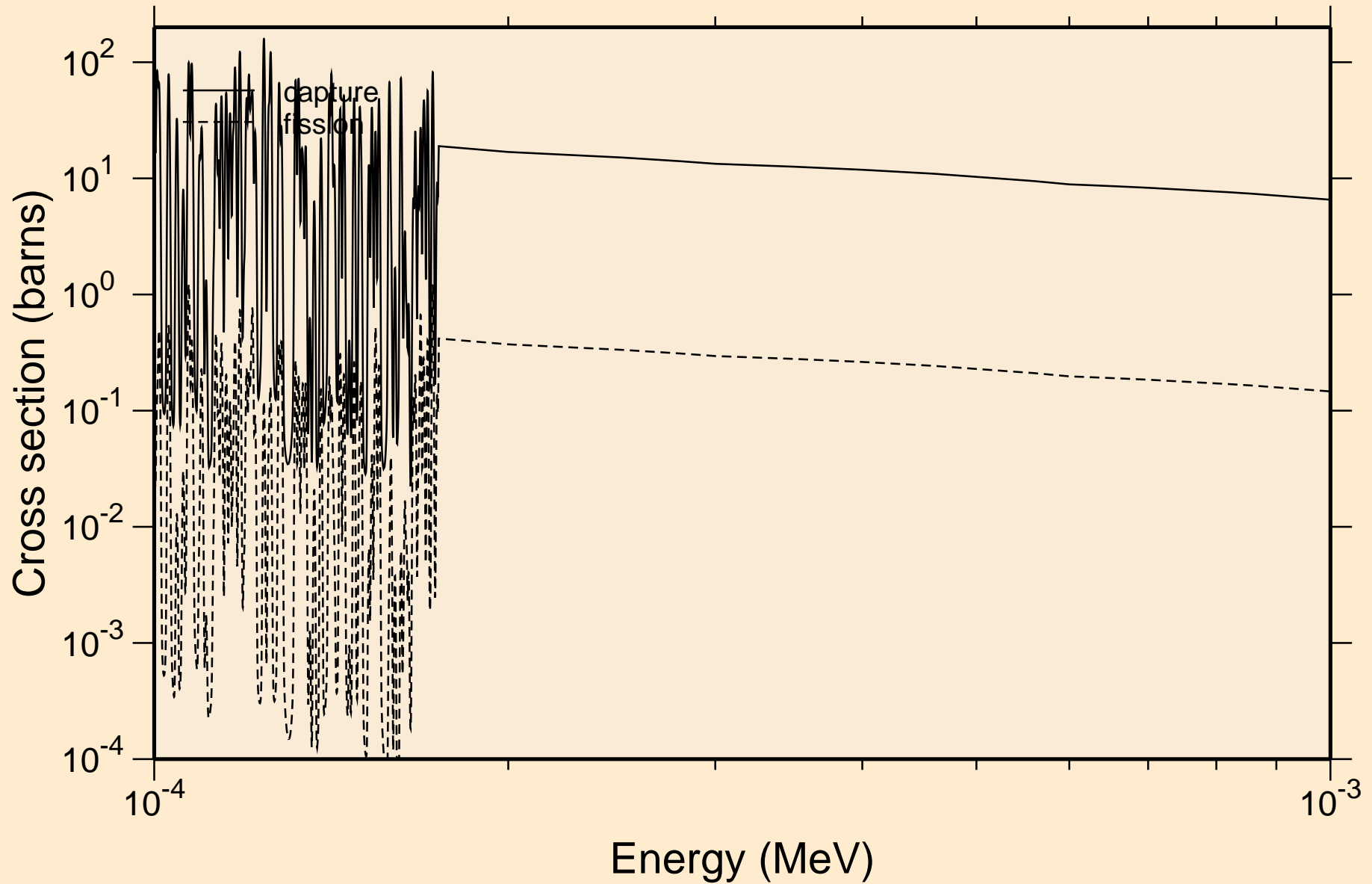

BK251 NRG TENDL-2015, AKONING resonance absorption cross sections

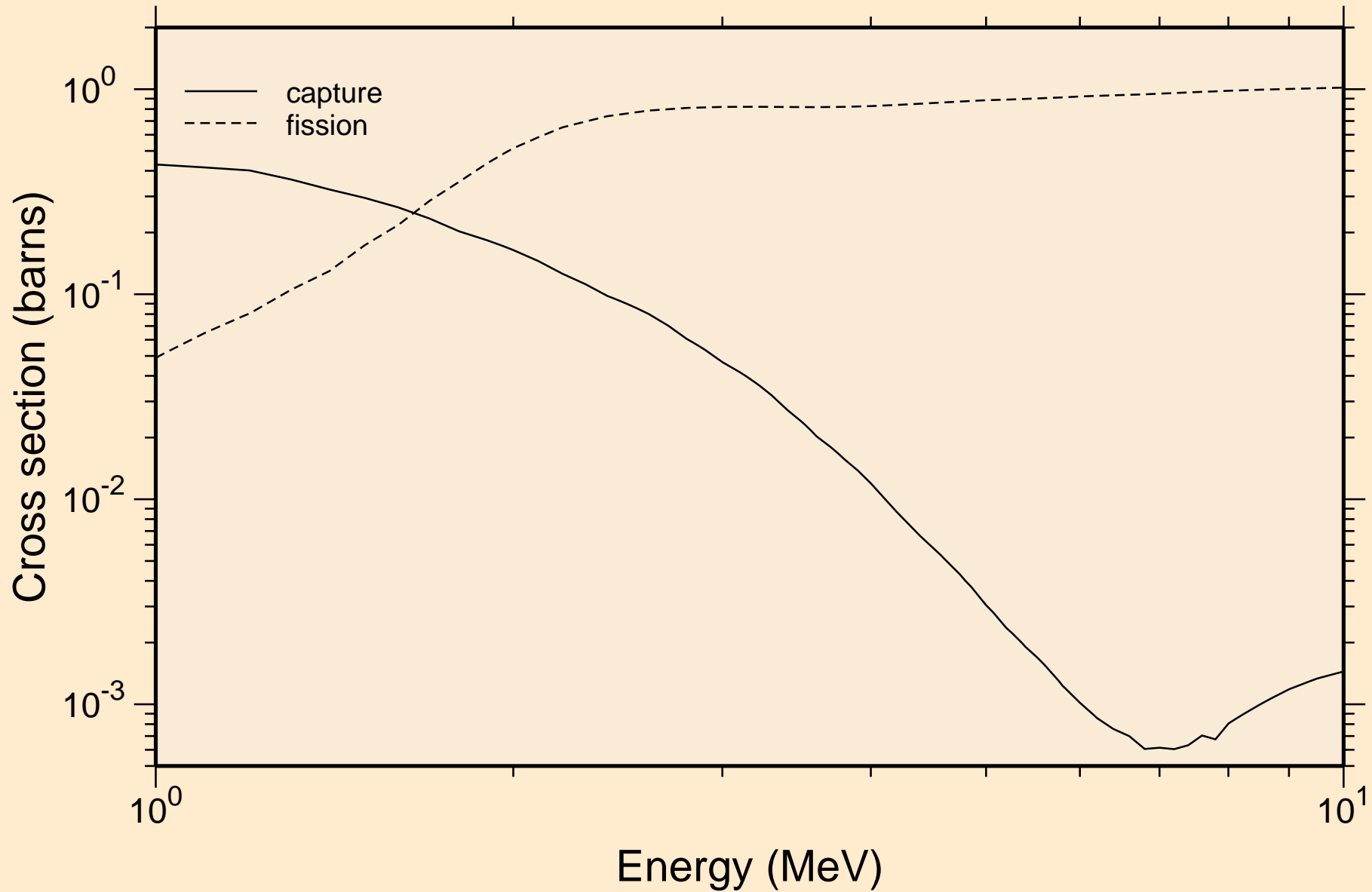

BK251 NRG TENDL-2015, AKONING

Non-threshold reactions

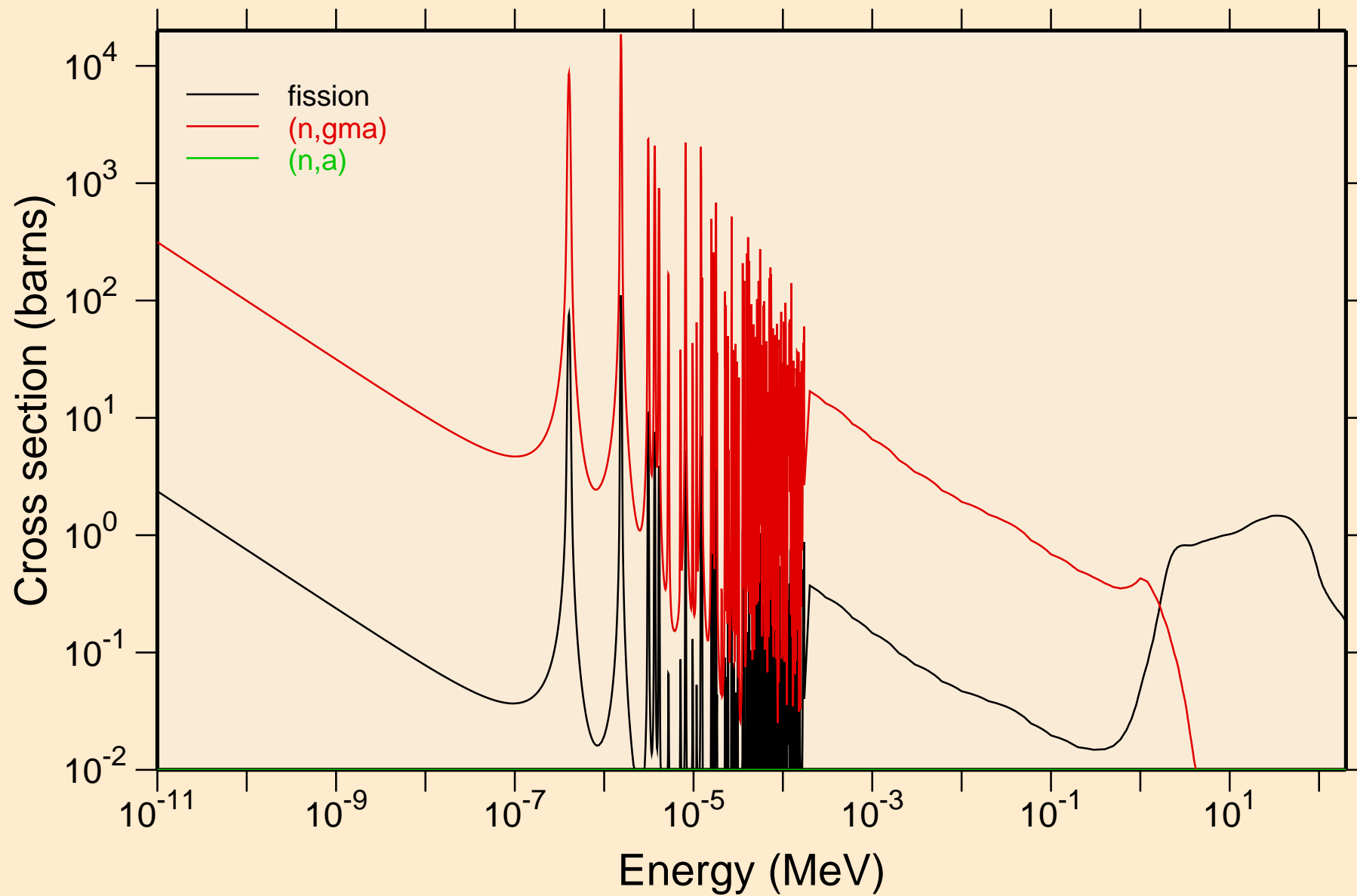

BK251 NRG TENDL-2015, AKONING

Principal cross sections

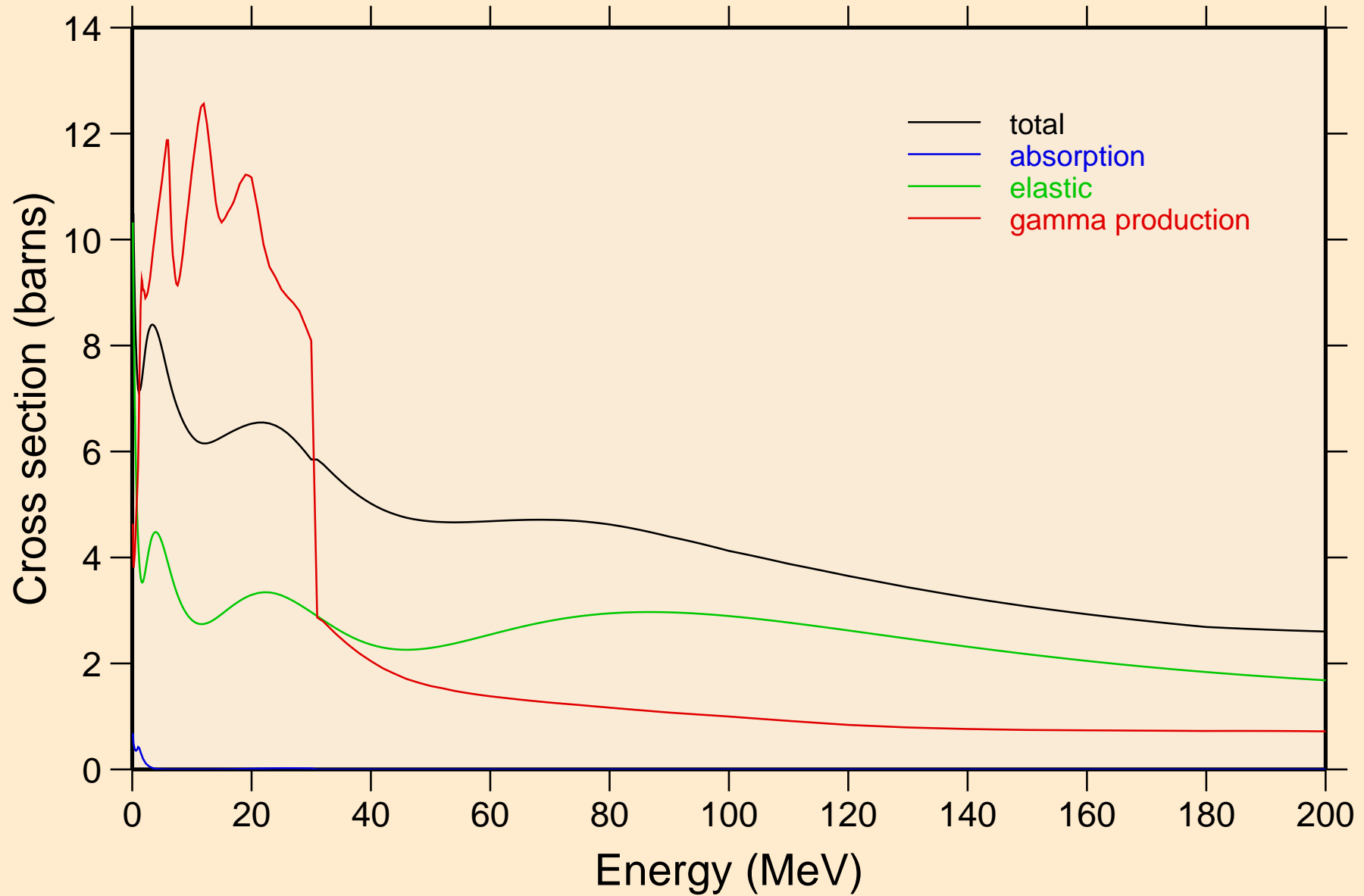

BK251 NRG TENDL-2015, AKONING

Non-threshold reactions

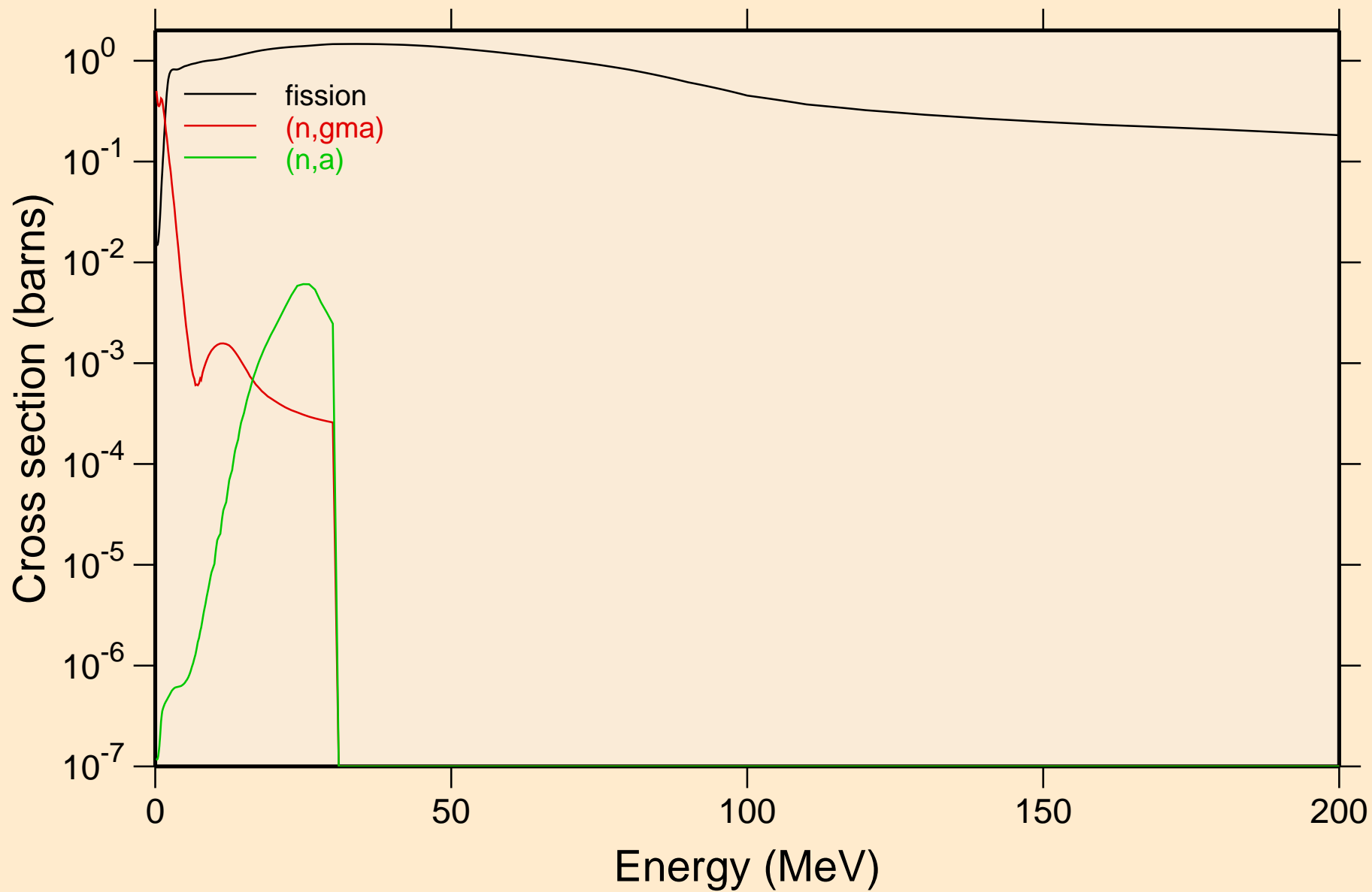

BK251 NRG TENDL-2015, AKONING

Inelastic levels

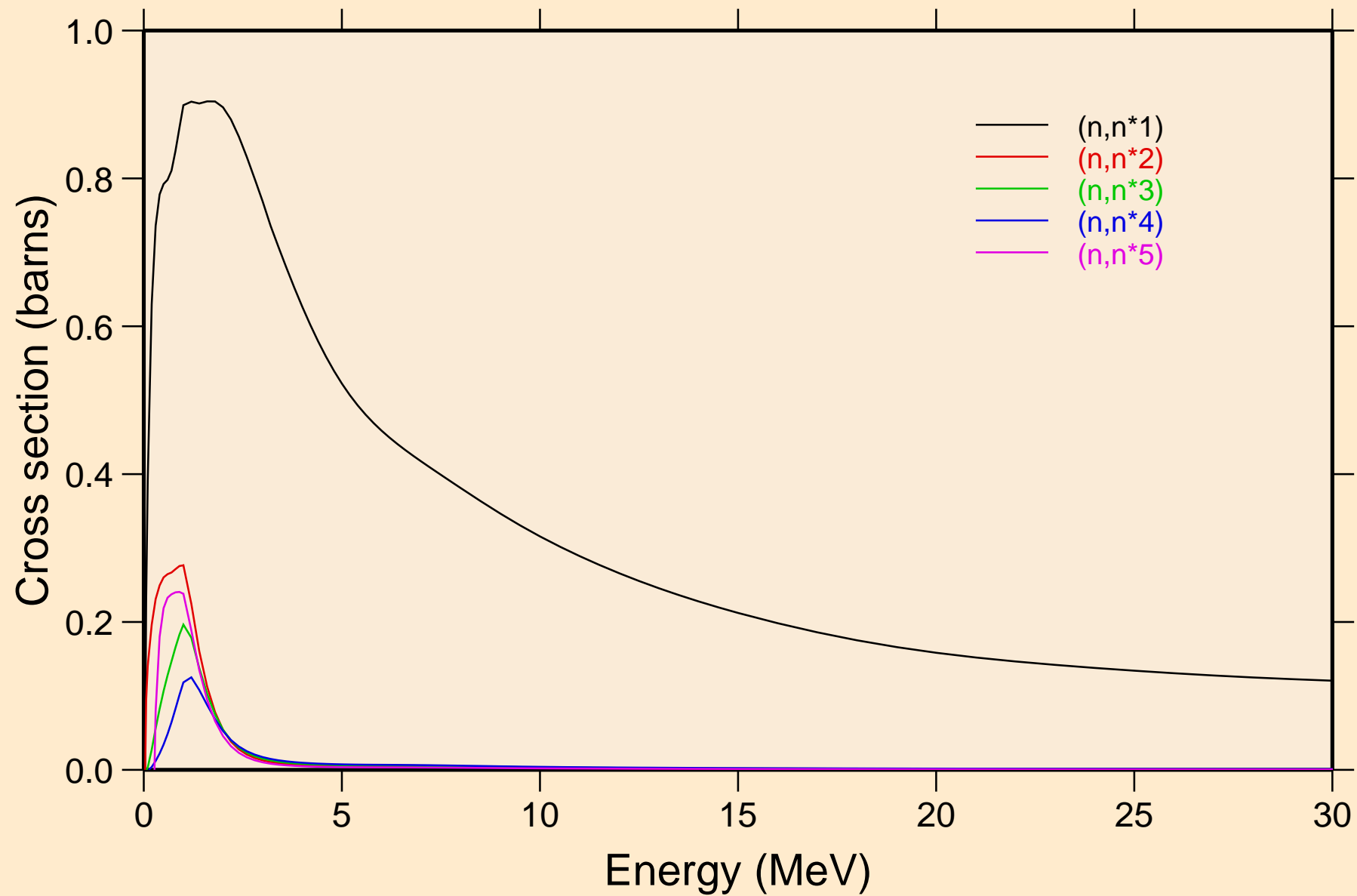

BK251 NRG TENDL-2015, AKONING

Inelastic levels

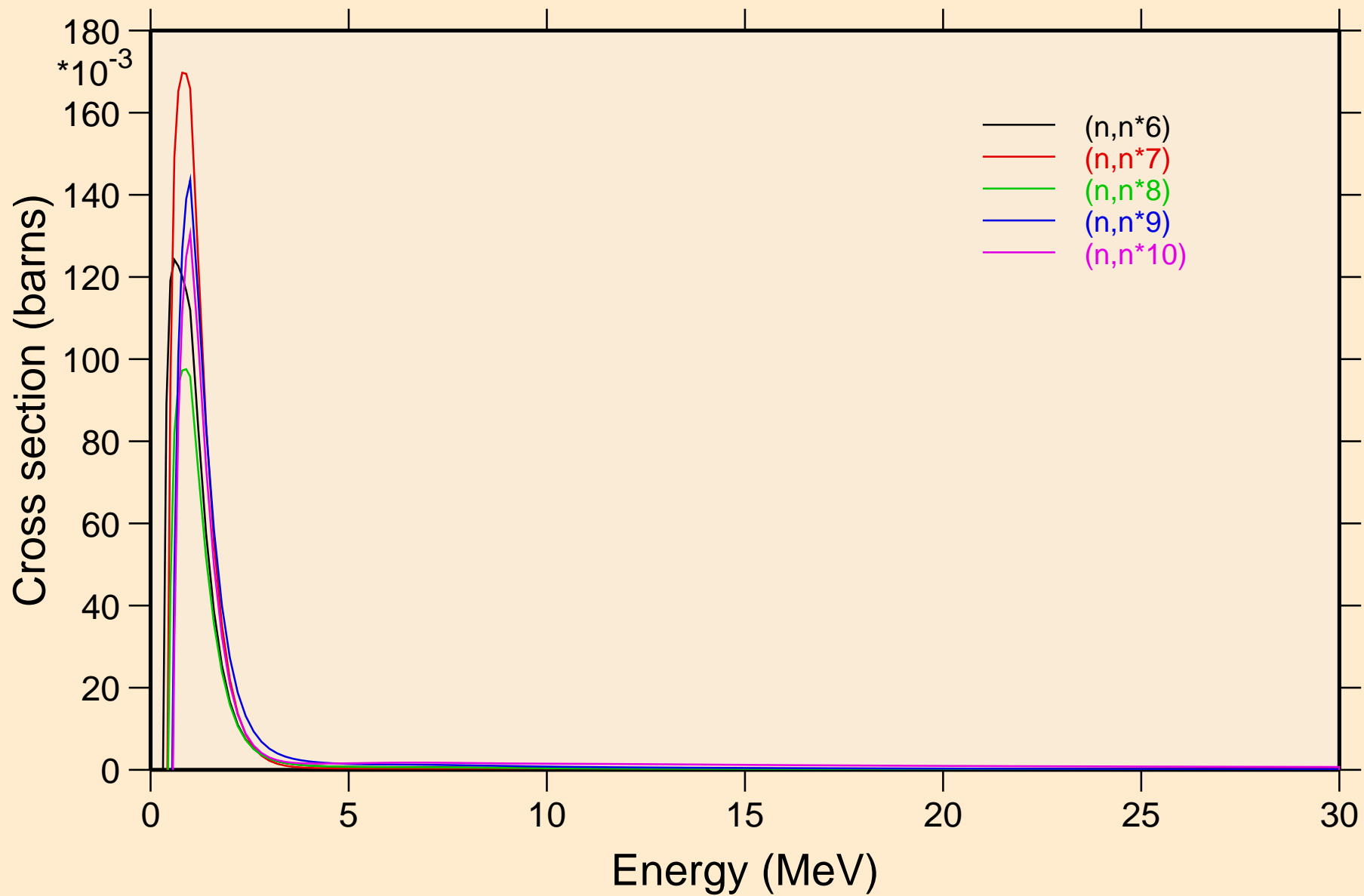

BK251 NRG TENDL-2015, AKONING

Inelastic levels

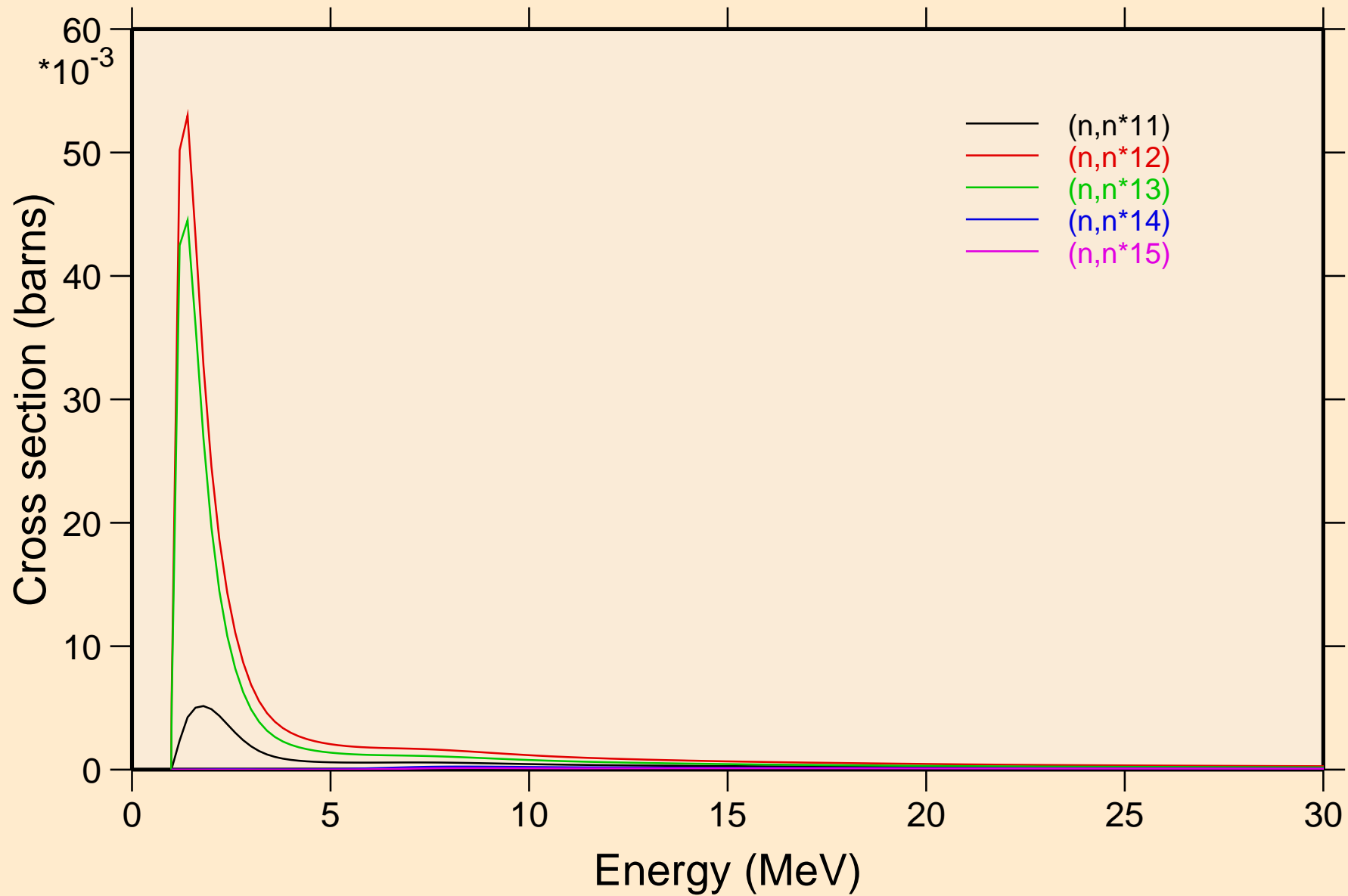

BK251 NRG TENDL-2015, AKONING

Inelastic levels

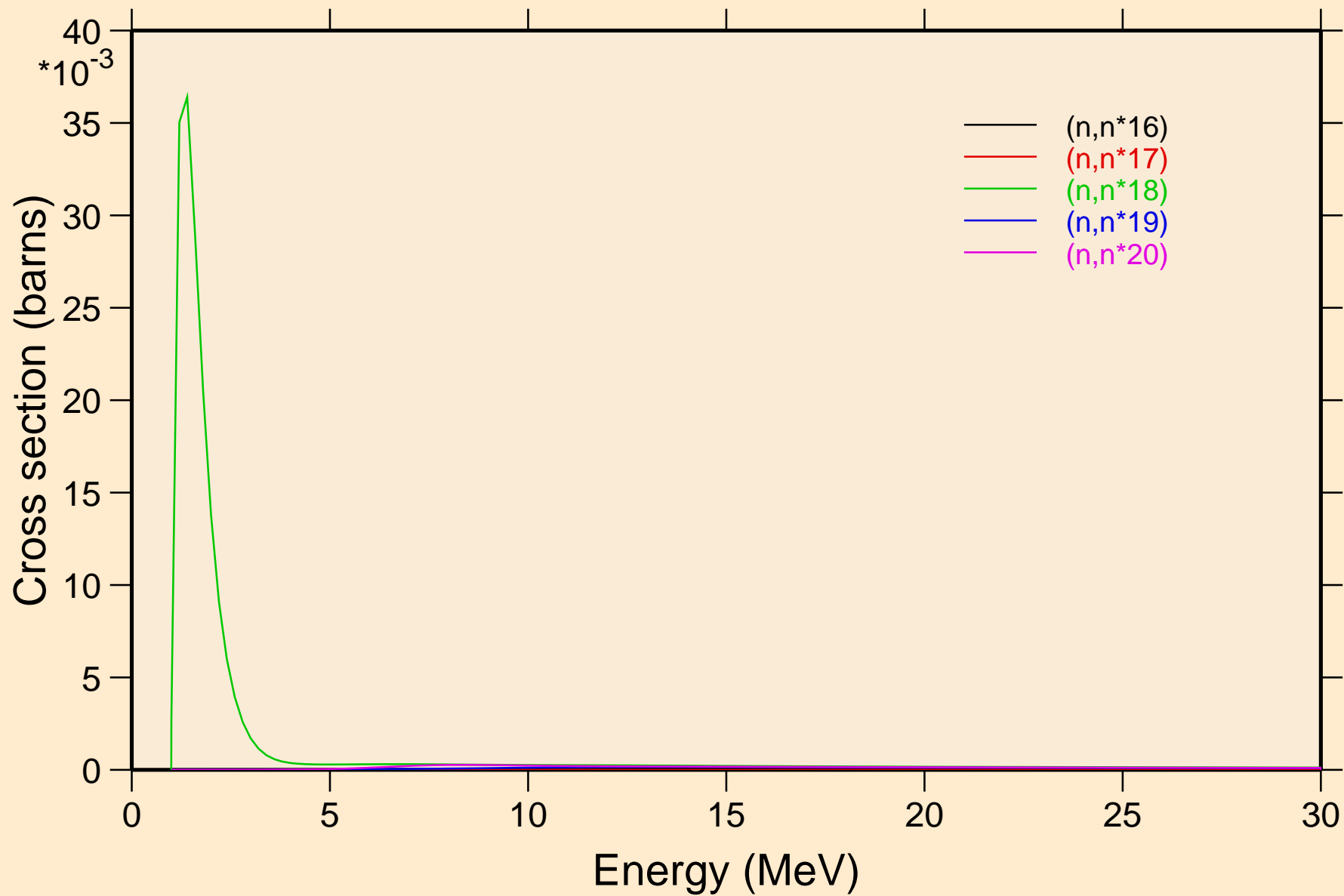

BK251 NRG TENDL-2015, AKONING

Inelastic levels

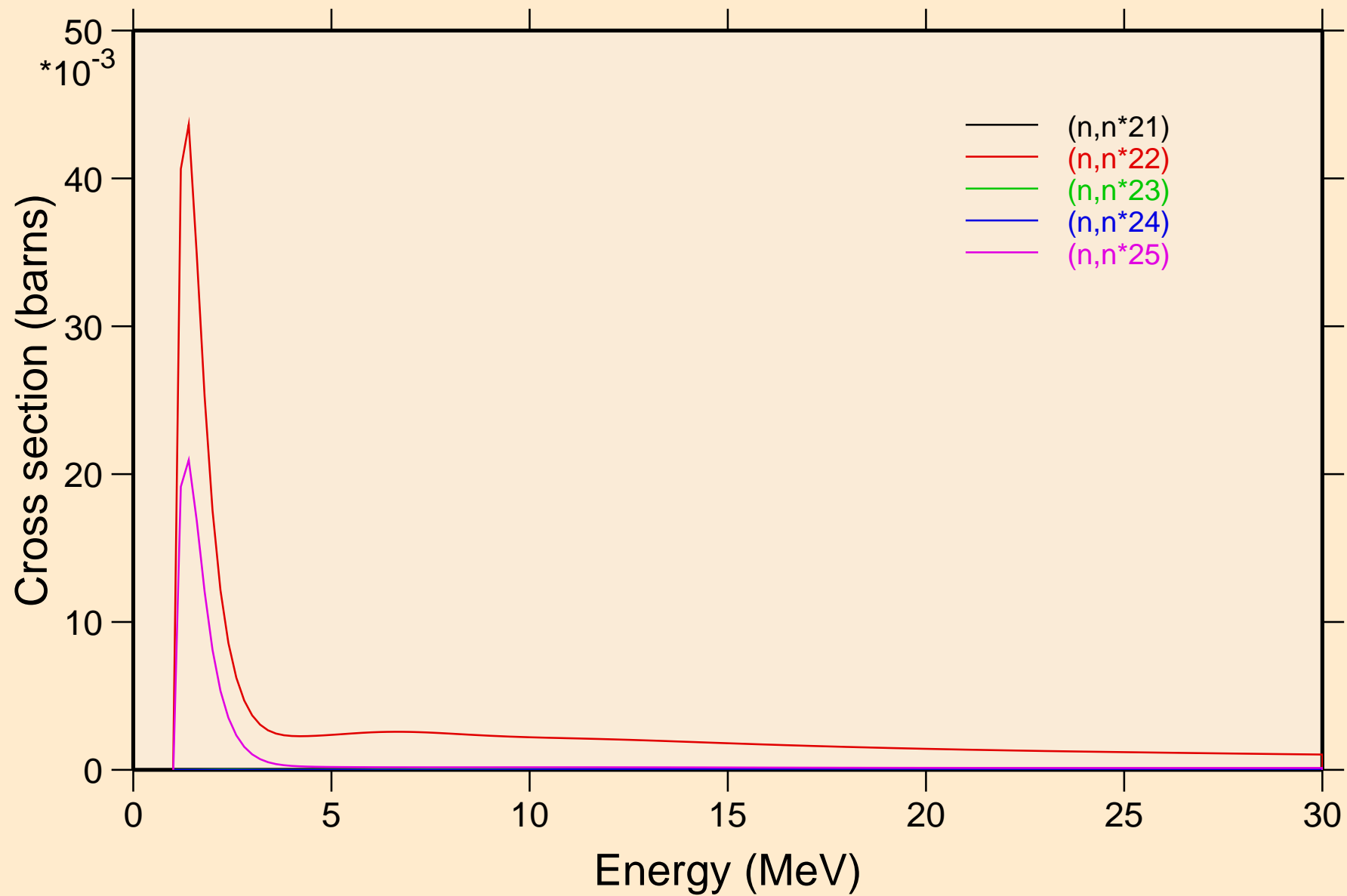

BK251 NRG TENDL-2015, AKONING
Inelastic levels

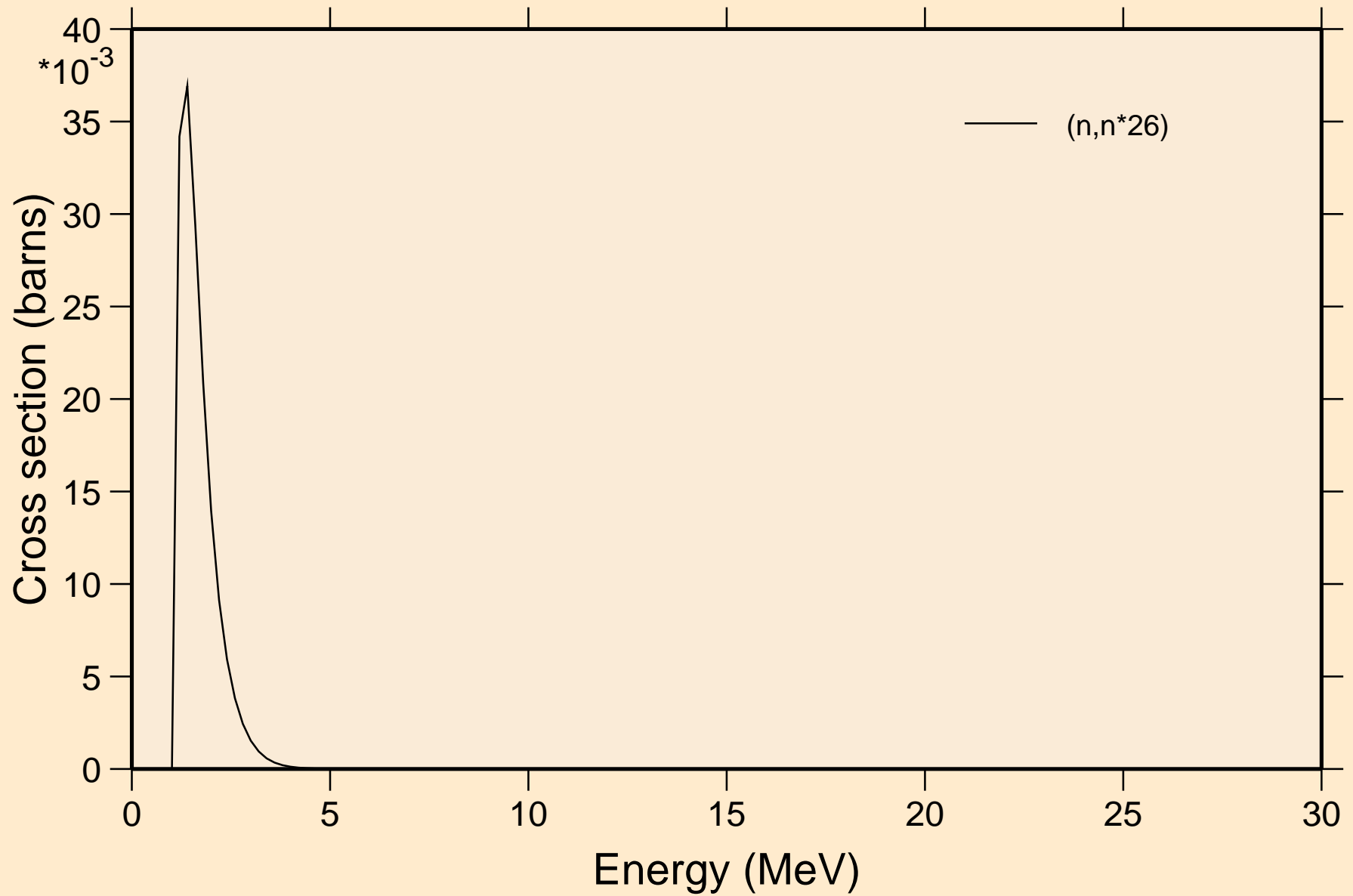

BK251 NRG TENDL-2015, AKONING

Threshold reactions

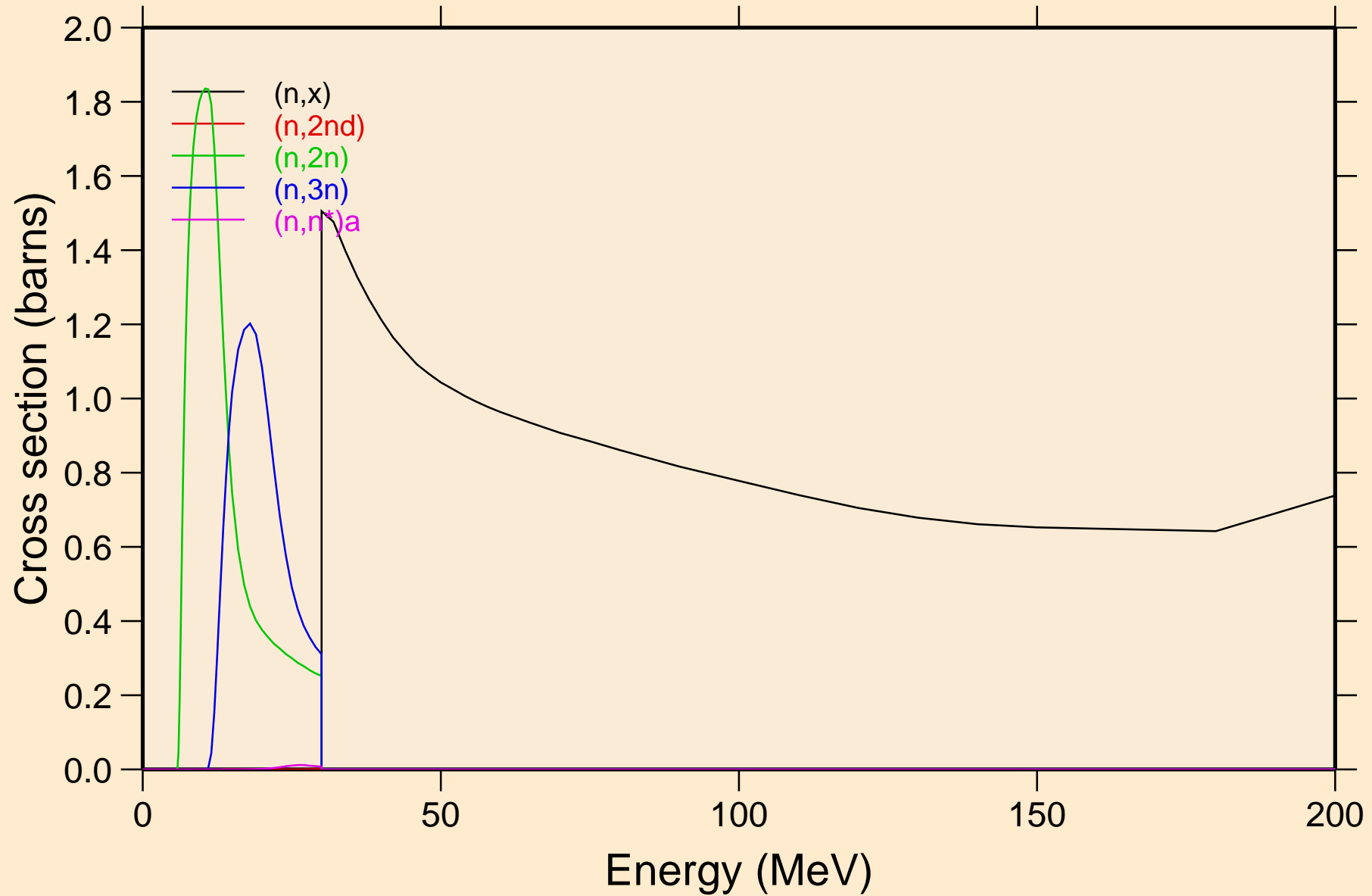

BK251 NRG TENDL-2015, AKONING

Threshold reactions

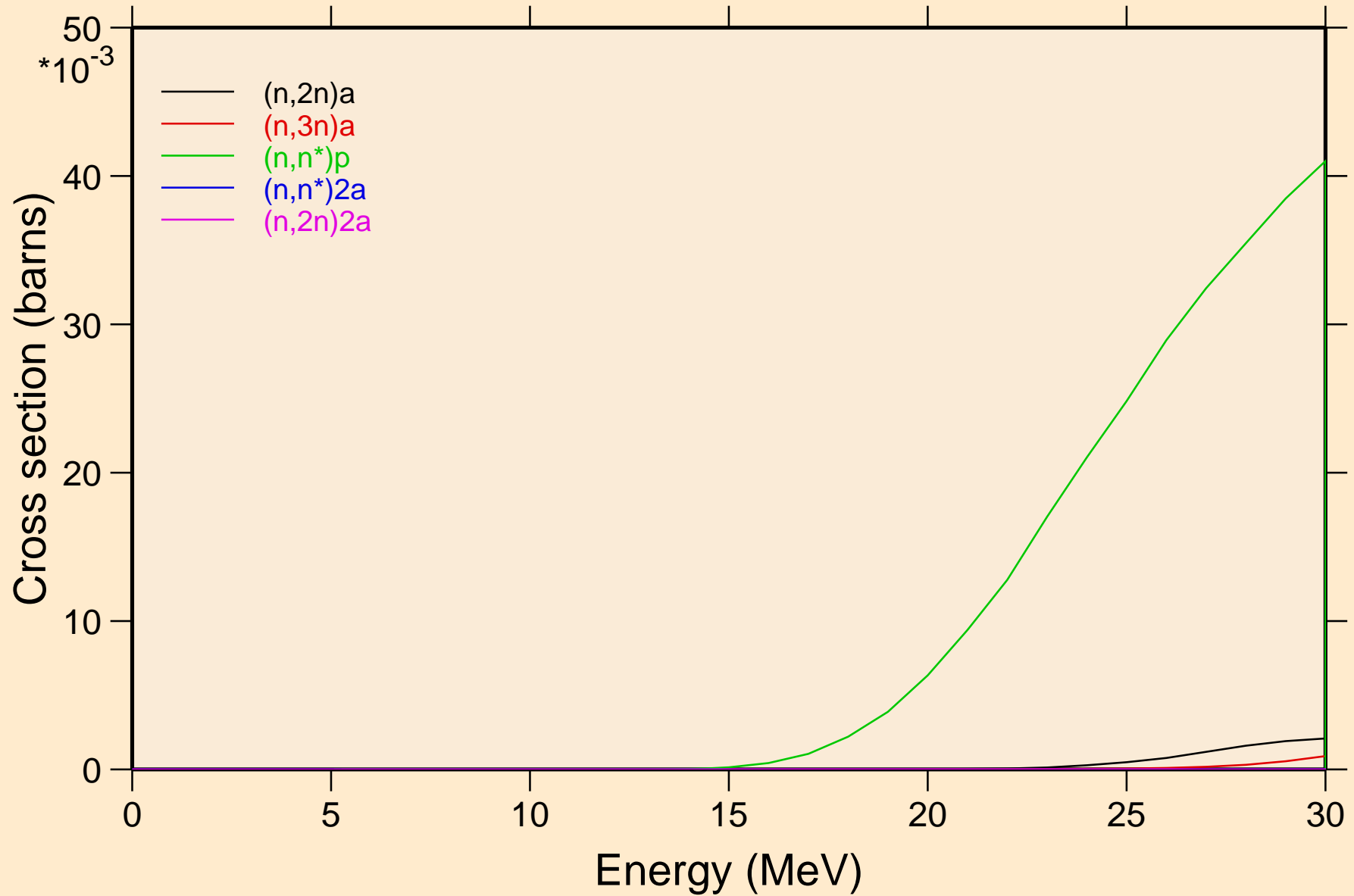

BK251 NRG TENDL-2015, AKONING

Threshold reactions

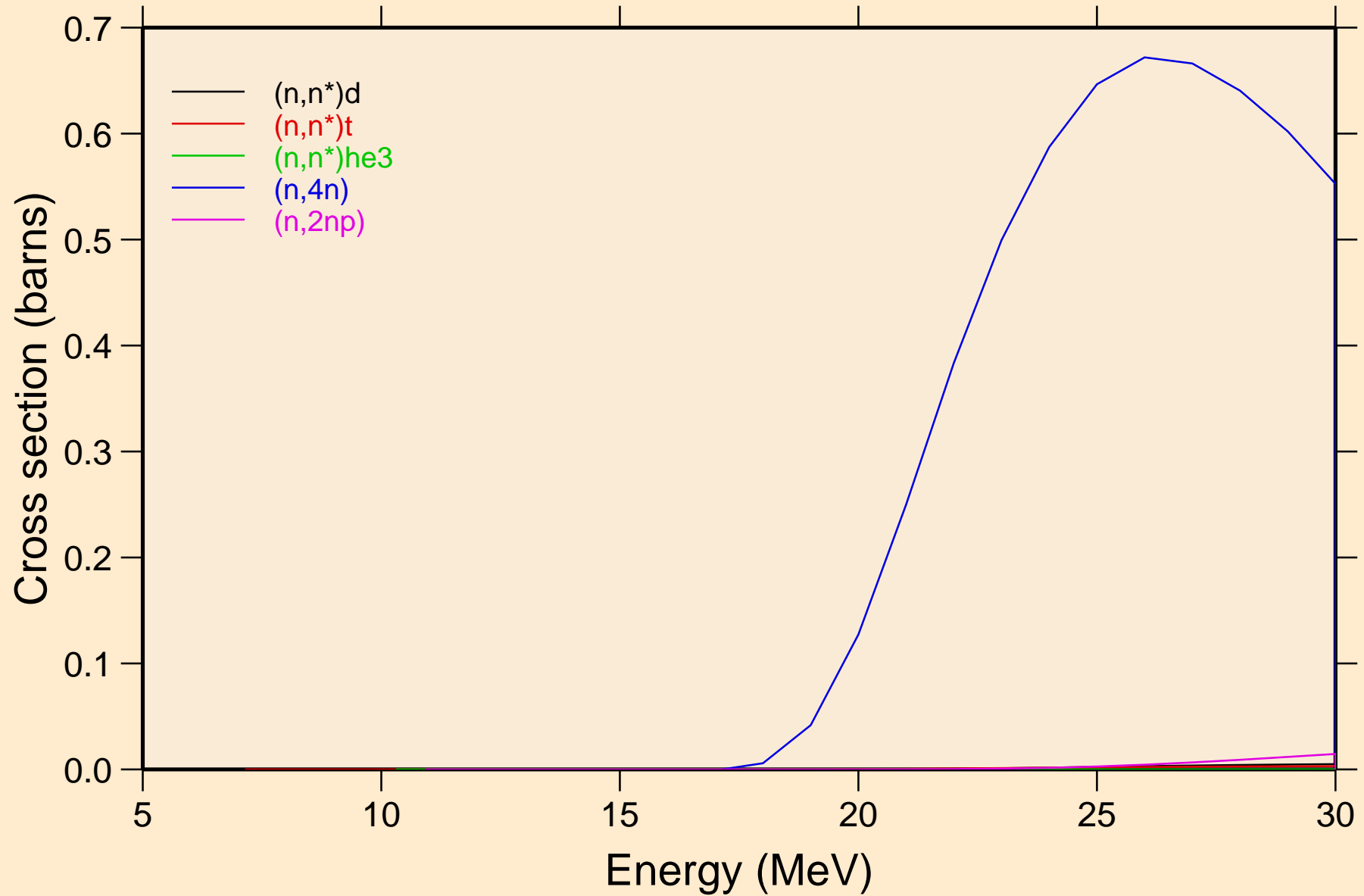

BK251 NRG TENDL-2015, AKONING

Threshold reactions

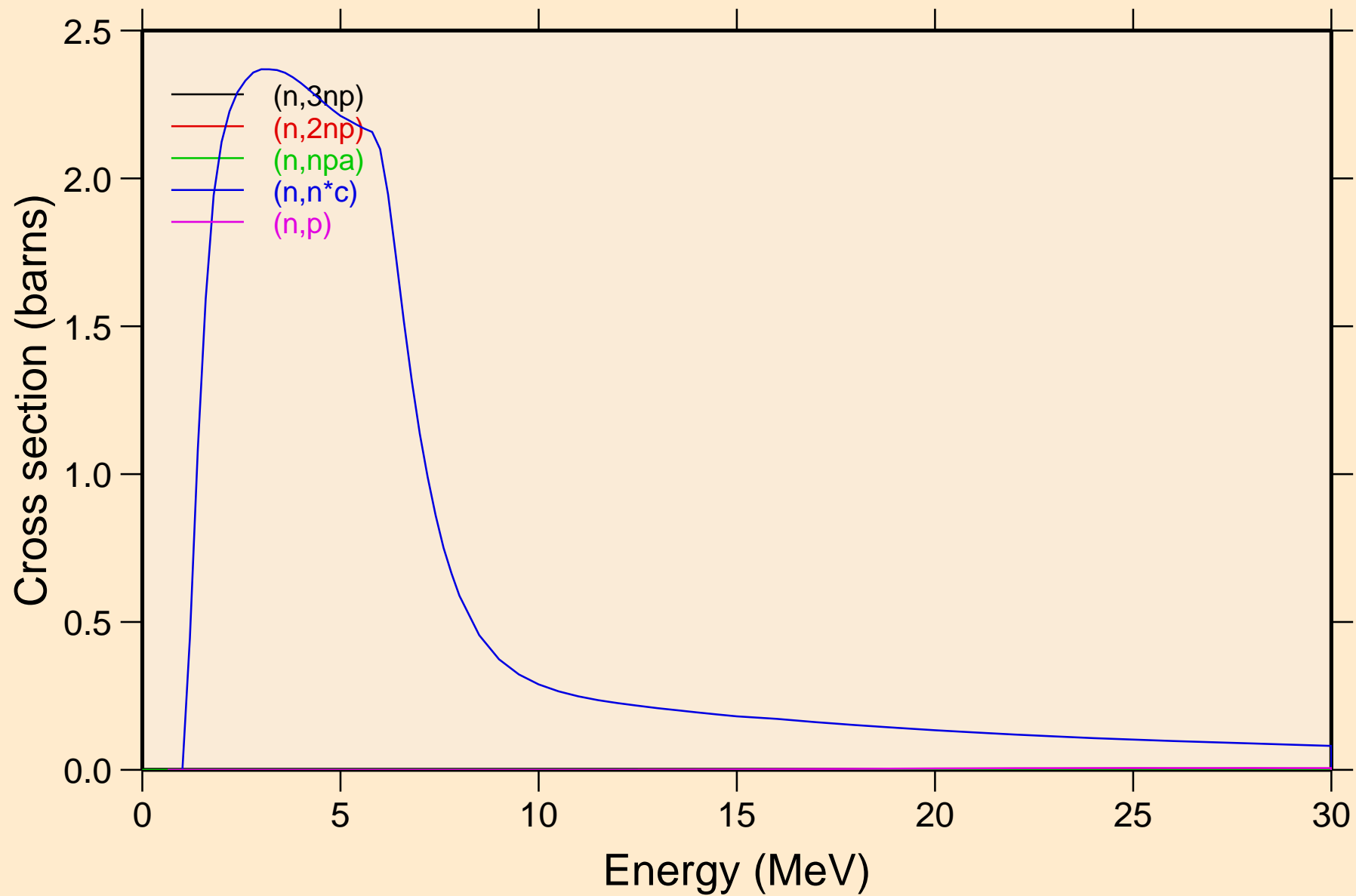

BK251 NRG TENDL-2015, AKONING

Threshold reactions

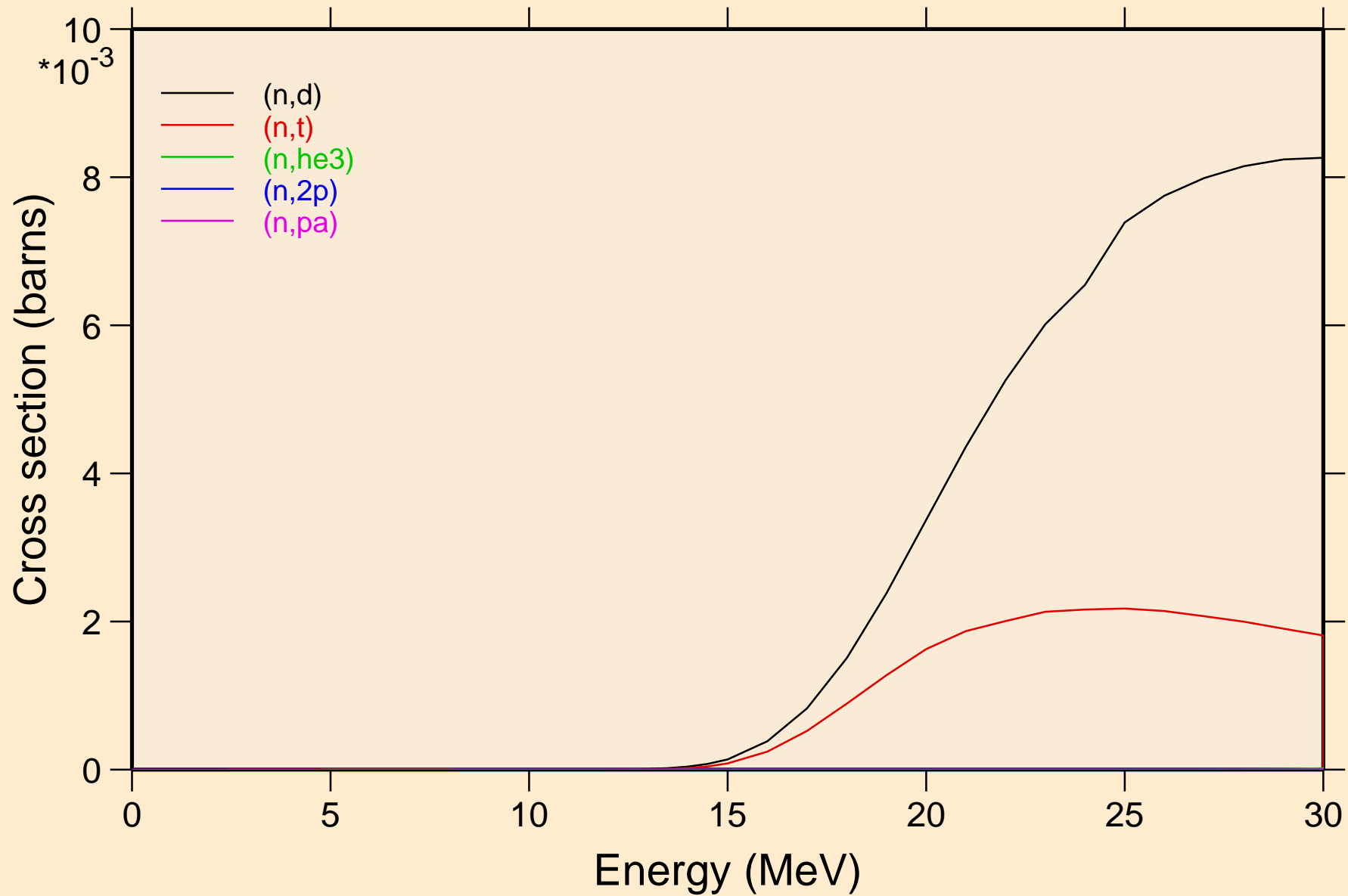

BK251 NRG TENDL-2015, AKONING

Threshold reactions

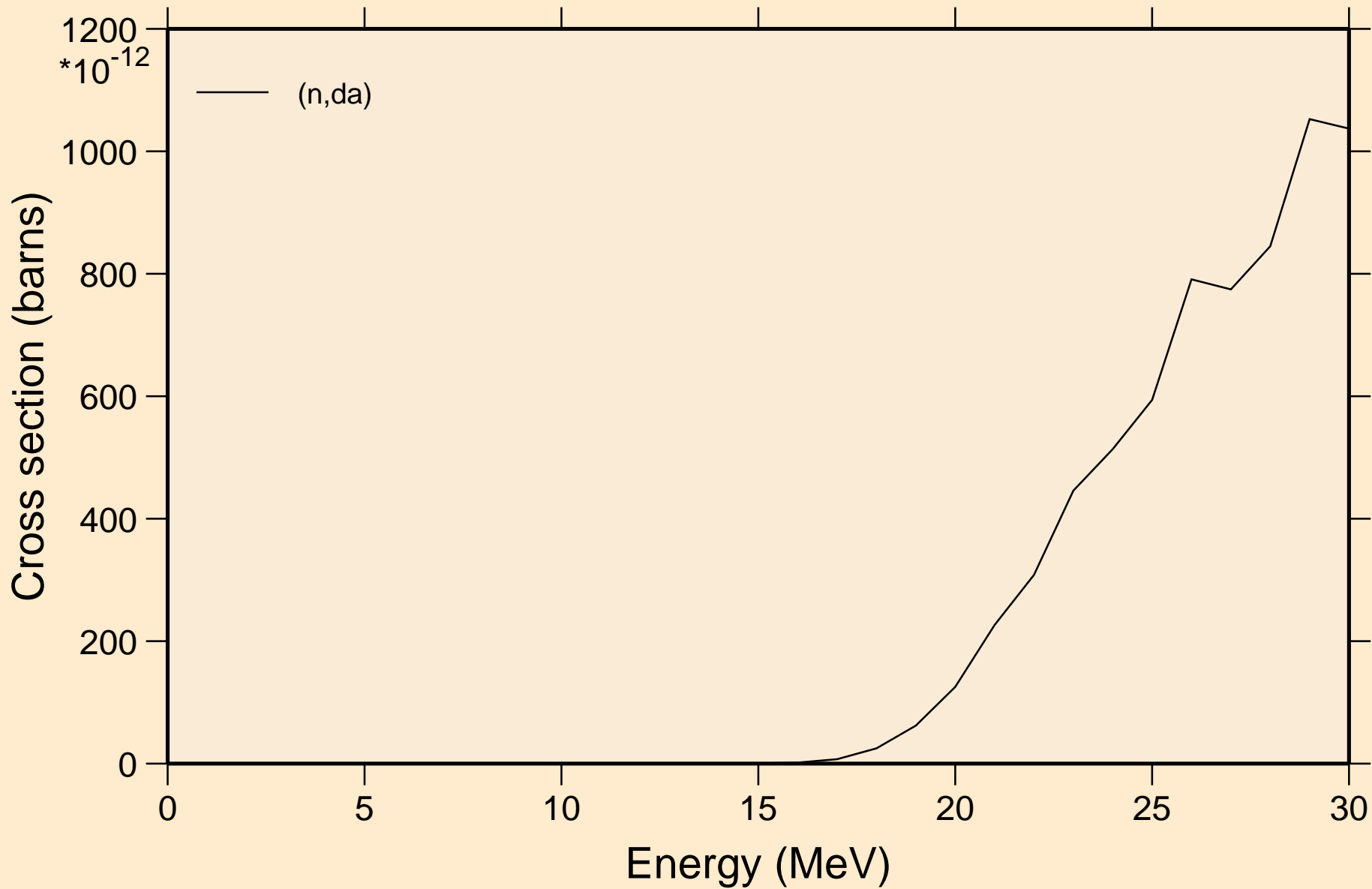

BK251 NRG TENDL-2015, AKONING
angular distribution for elastic

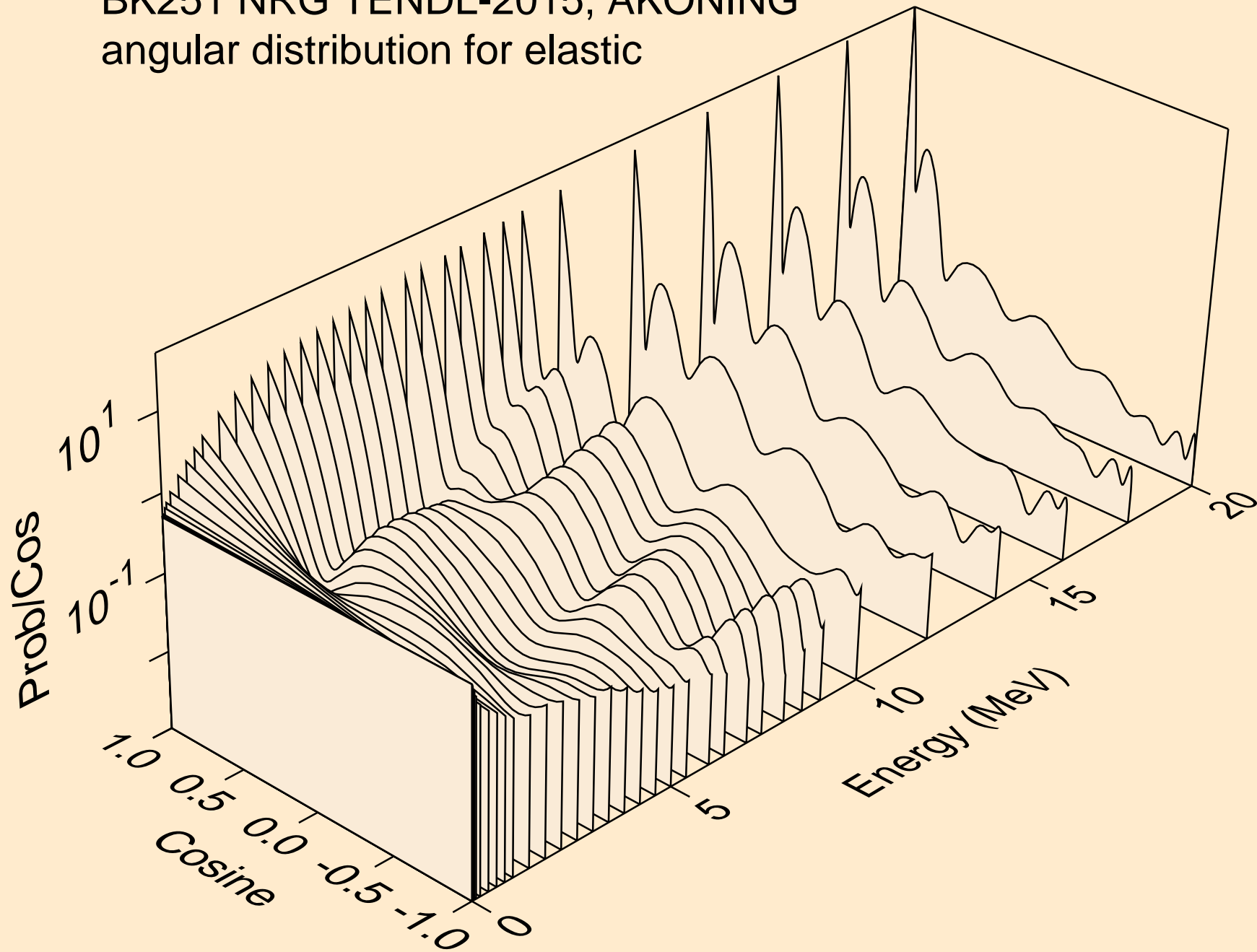

BK251 NRG TENDL-2015, AKONING
angular distribution for elastic

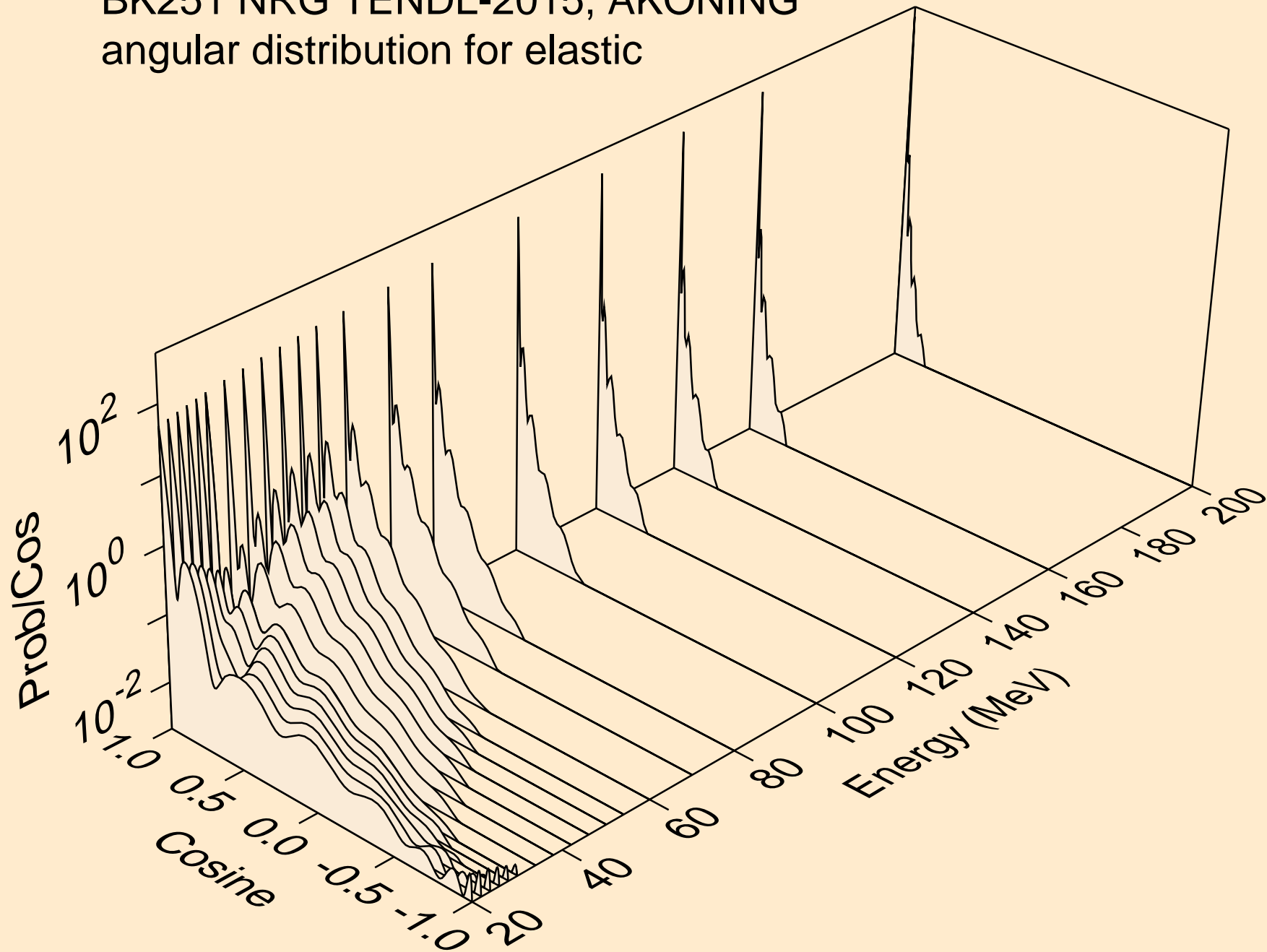

BK251 NRG TENDL-2015, AKONING
angular distribution for (n,n*1)

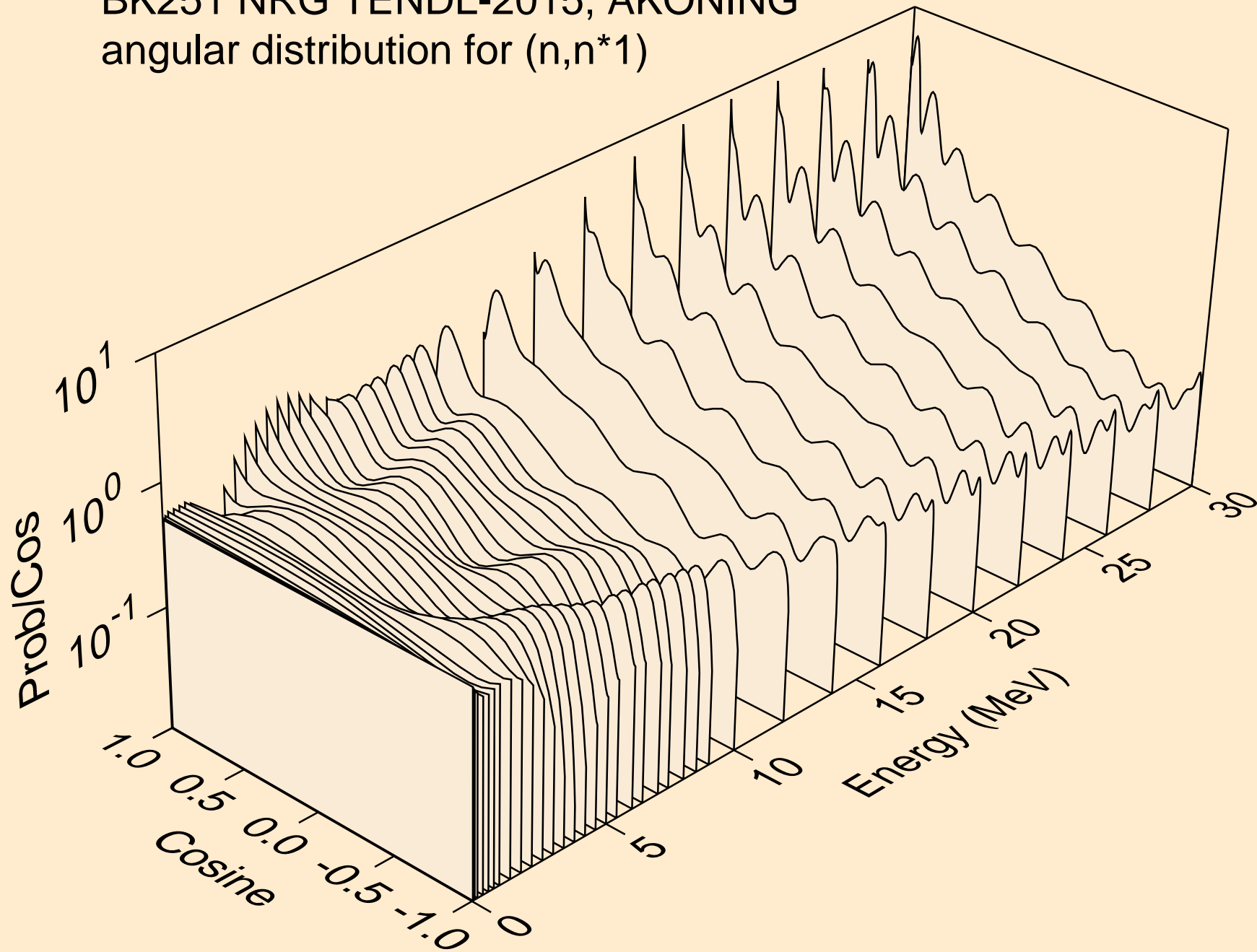

BK251 NRG TENDL-2015, AKONING
angular distribution for (n,n*2)

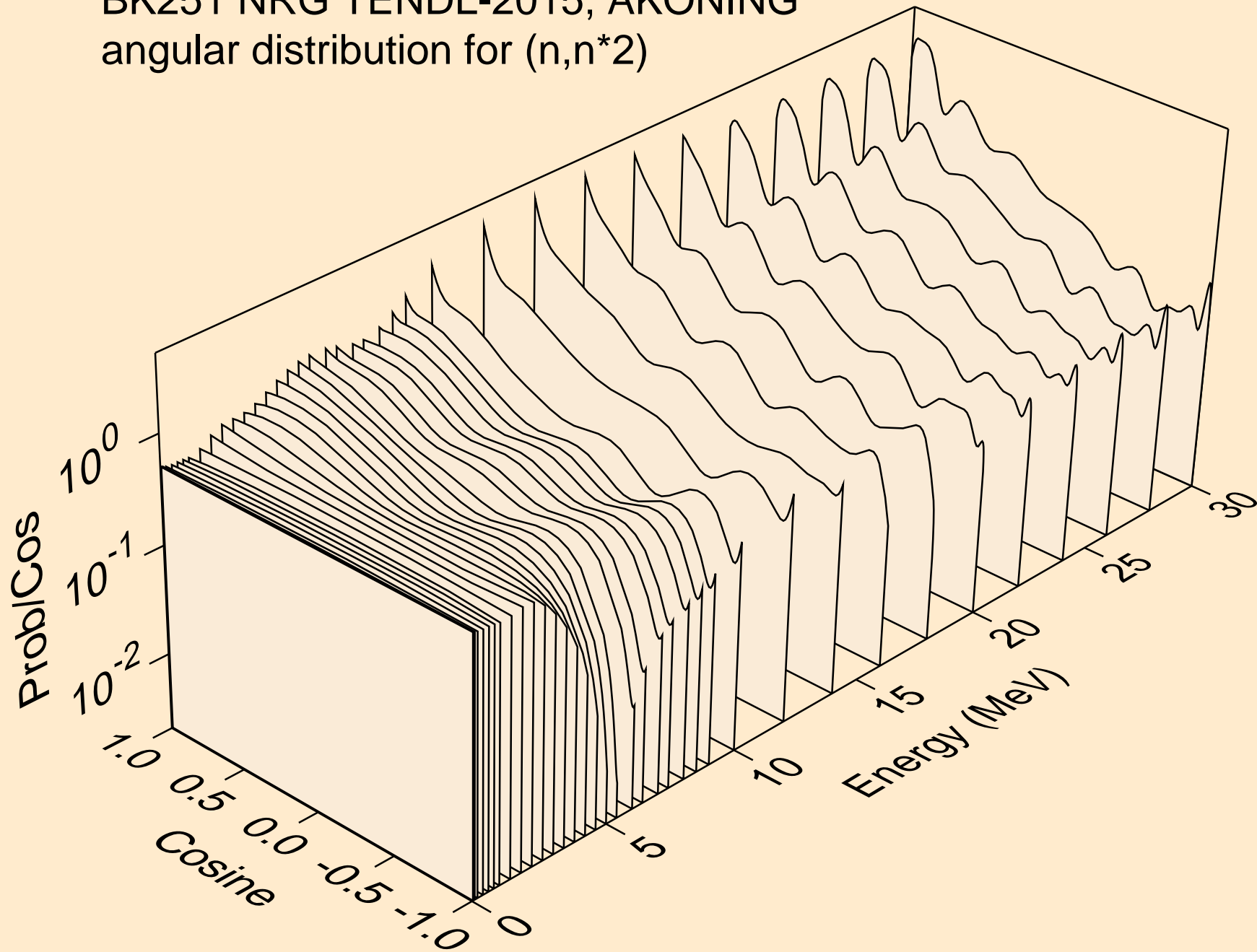

BK251 NRG TENDL-2015, AKONING
angular distribution for (n,n*3)

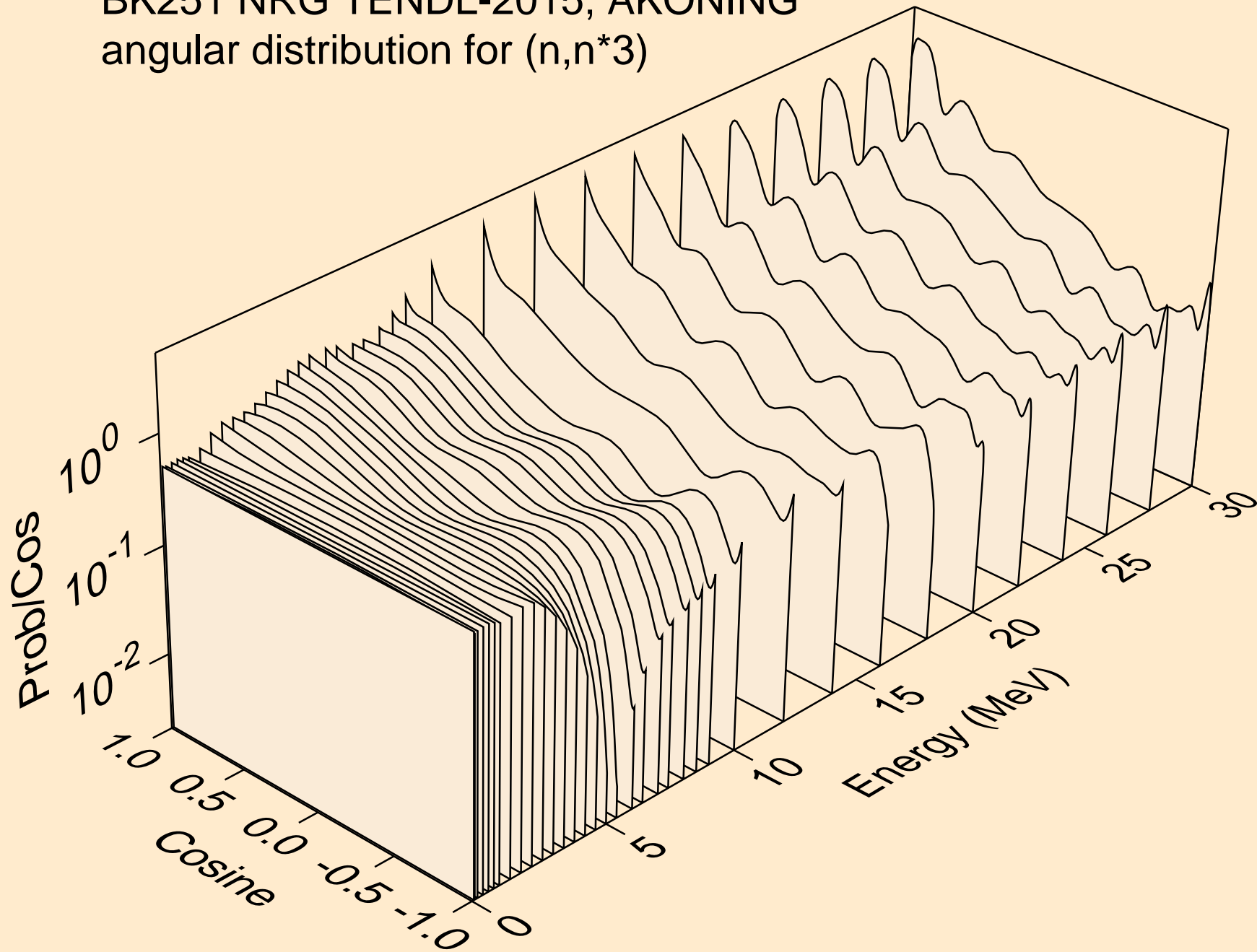

BK251 NRG TENDL-2015, AKONING
angular distribution for (n,n*4)

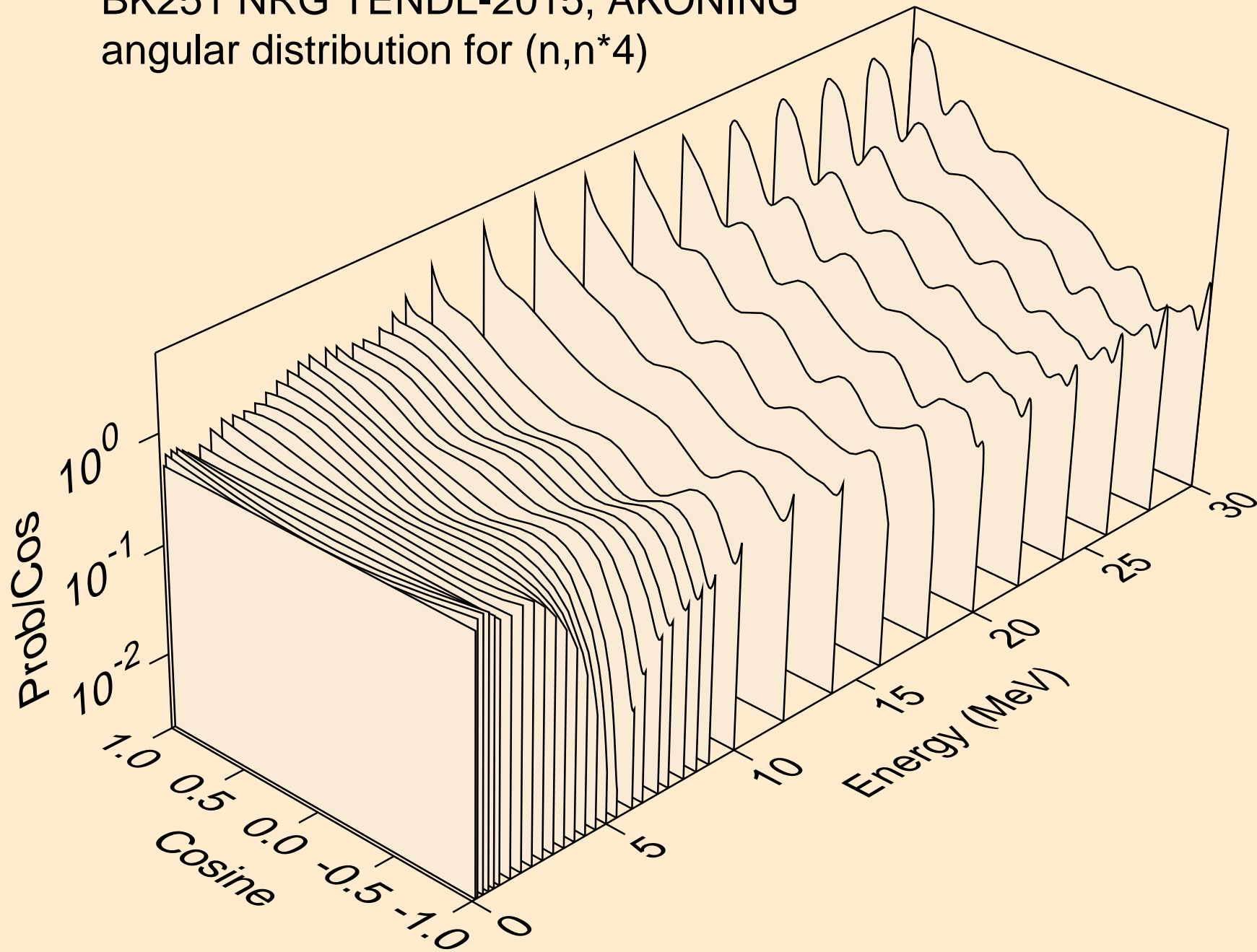

BK251 NRG TENDL-2015, AKONING
angular distribution for (n,n*5)

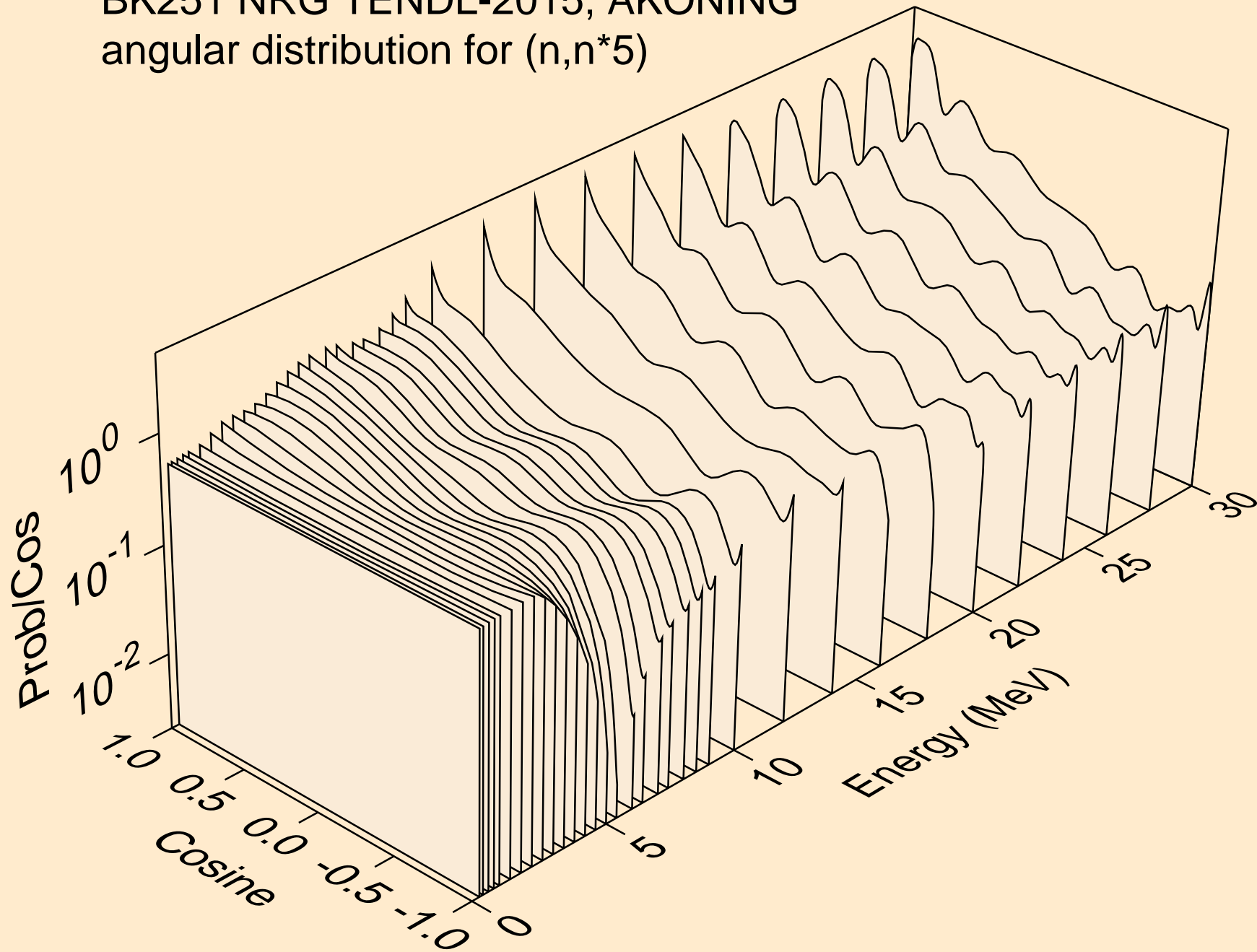

BK251 NRG TENDL-2015, AKONING
angular distribution for (n,n*6)

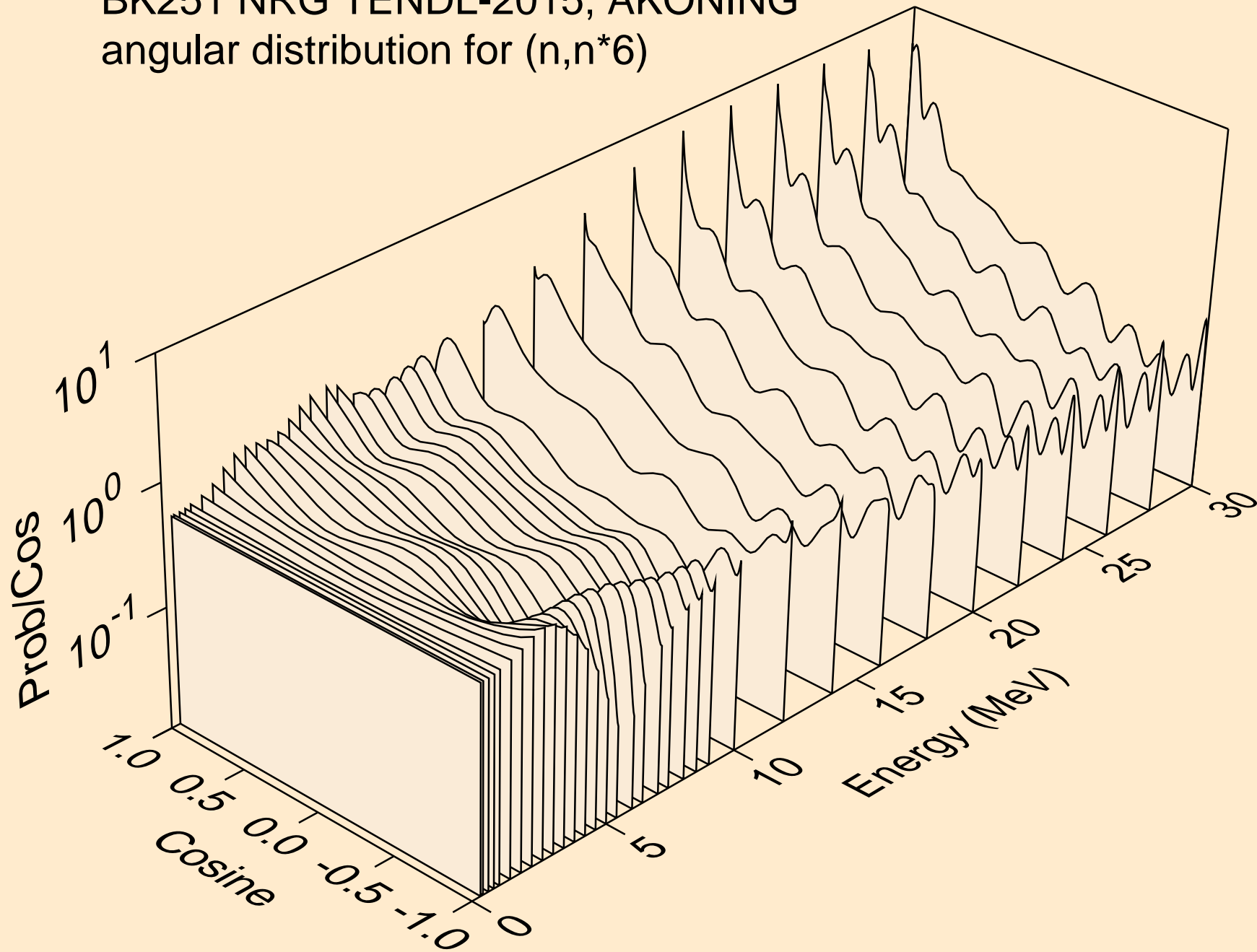

BK251 NRG TENDL-2015, AKONING
angular distribution for (n,n*7)

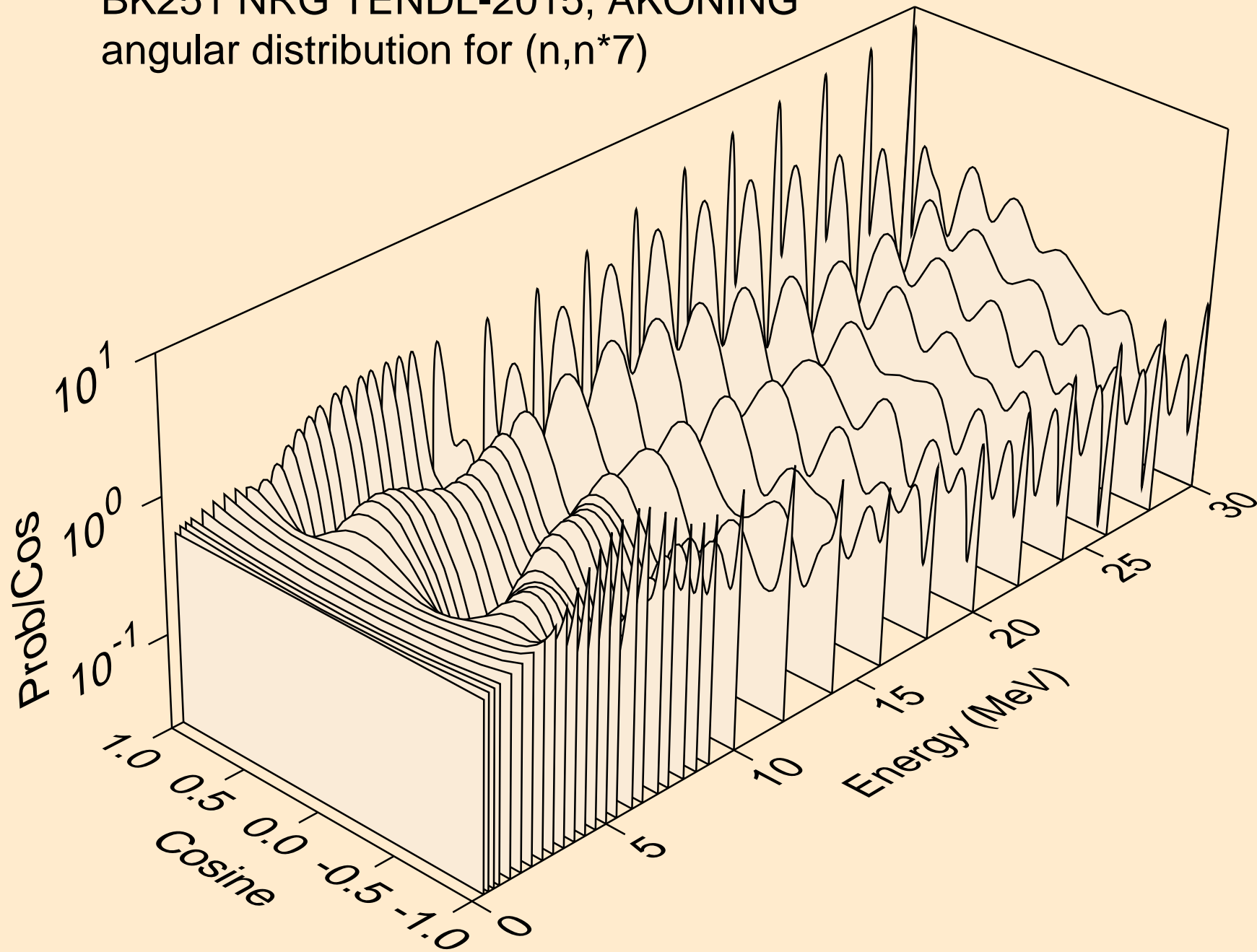

BK251 NRG TENDL-2015, AKONING
angular distribution for (n,n*8)

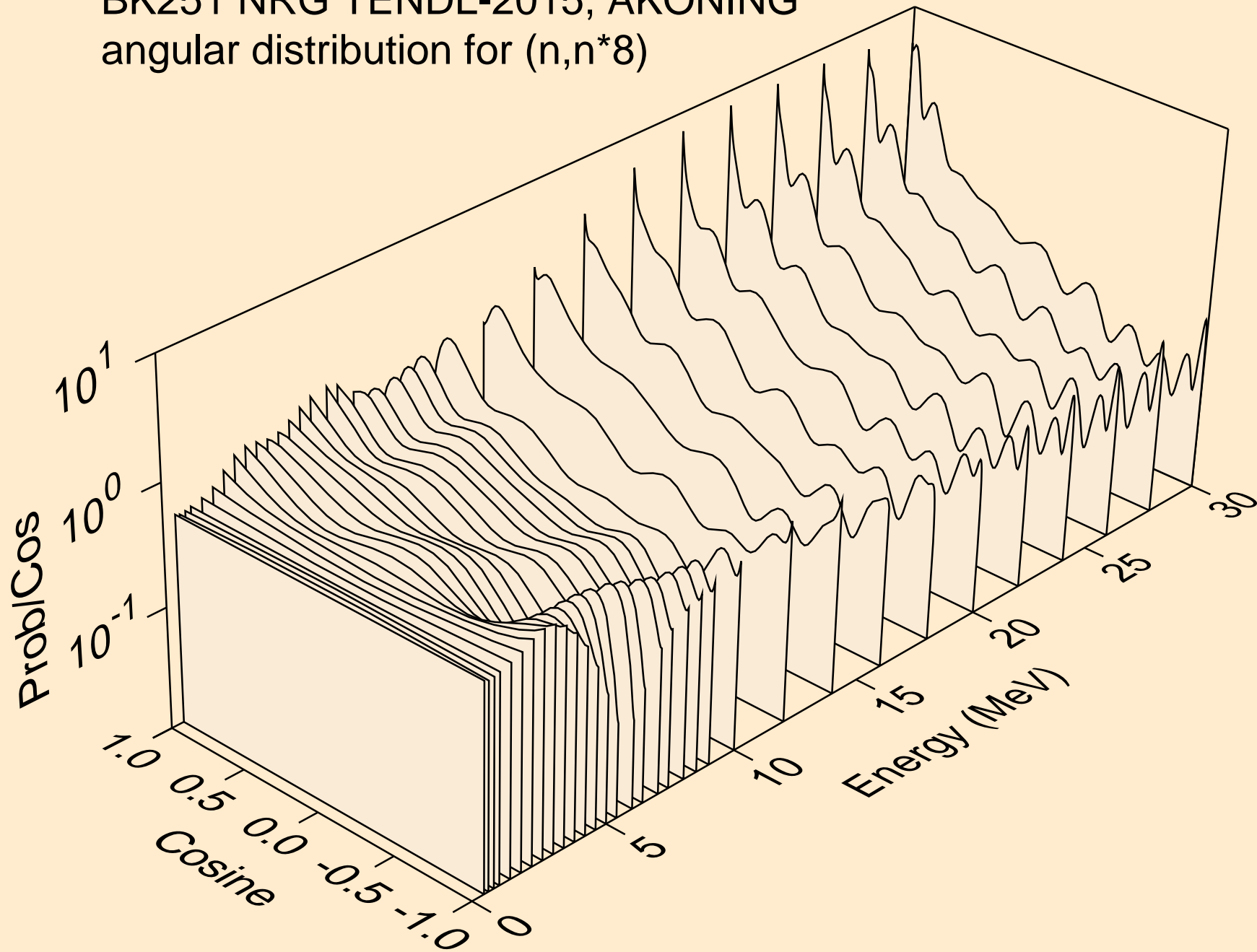

BK251 NRG TENDL-2015, AKONING
angular distribution for (n,n*9)

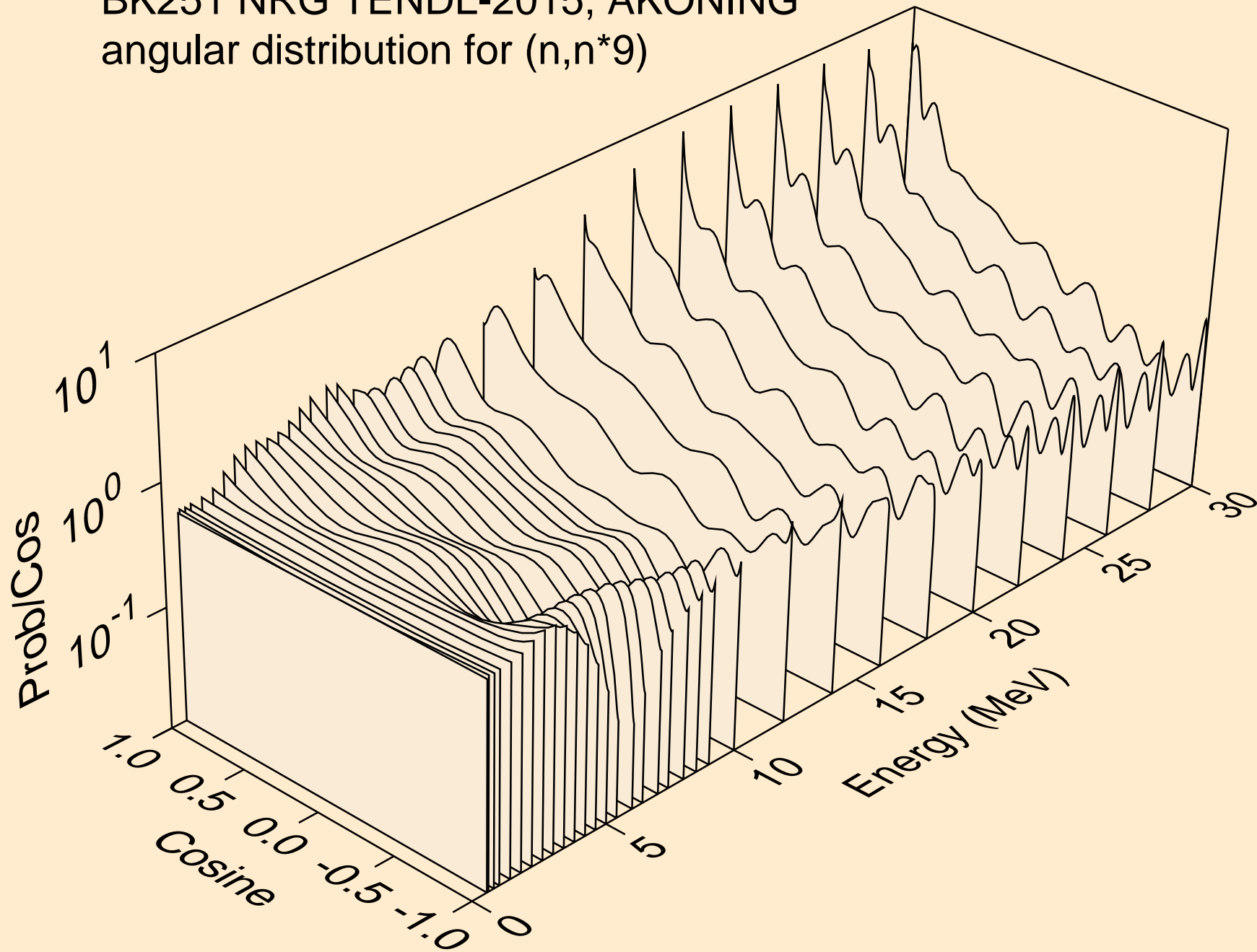

BK251 NRG TENDL-2015, AKONING
angular distribution for (n,n*10)

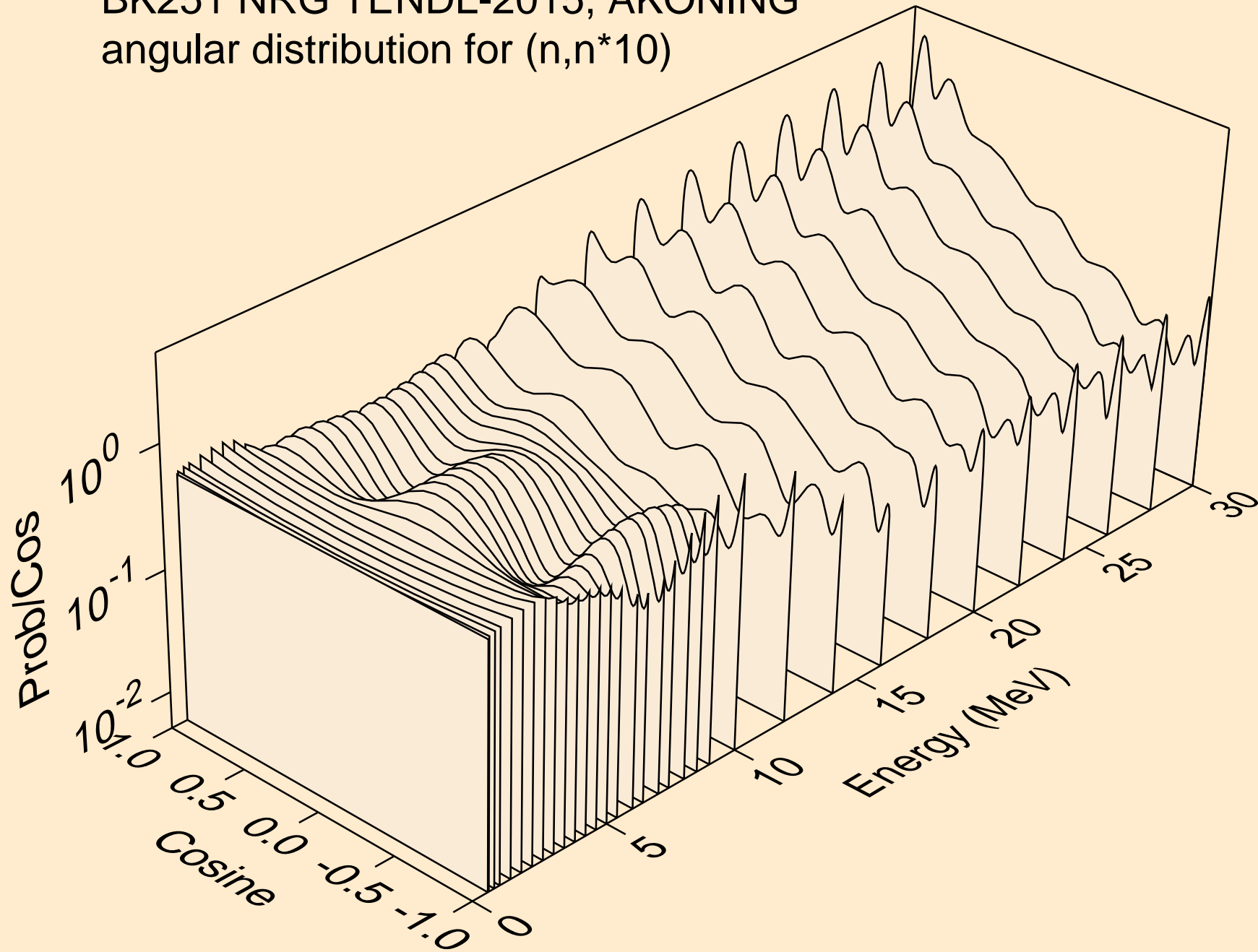

BK251 NRG TENDL-2015, AKONING
angular distribution for (n,n*11)

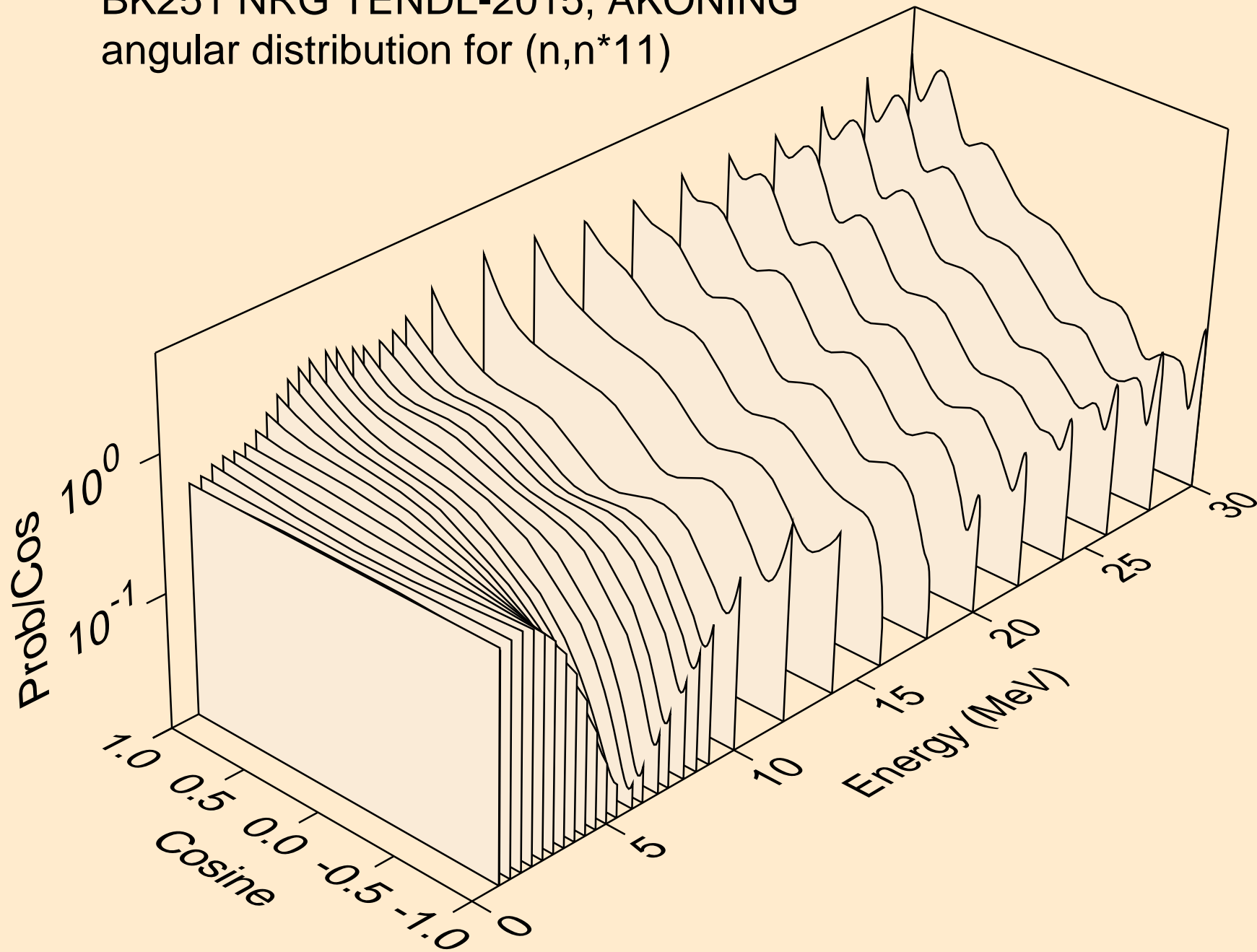

BK251 NRG TENDL-2015, AKONING
angular distribution for (n,n*12)

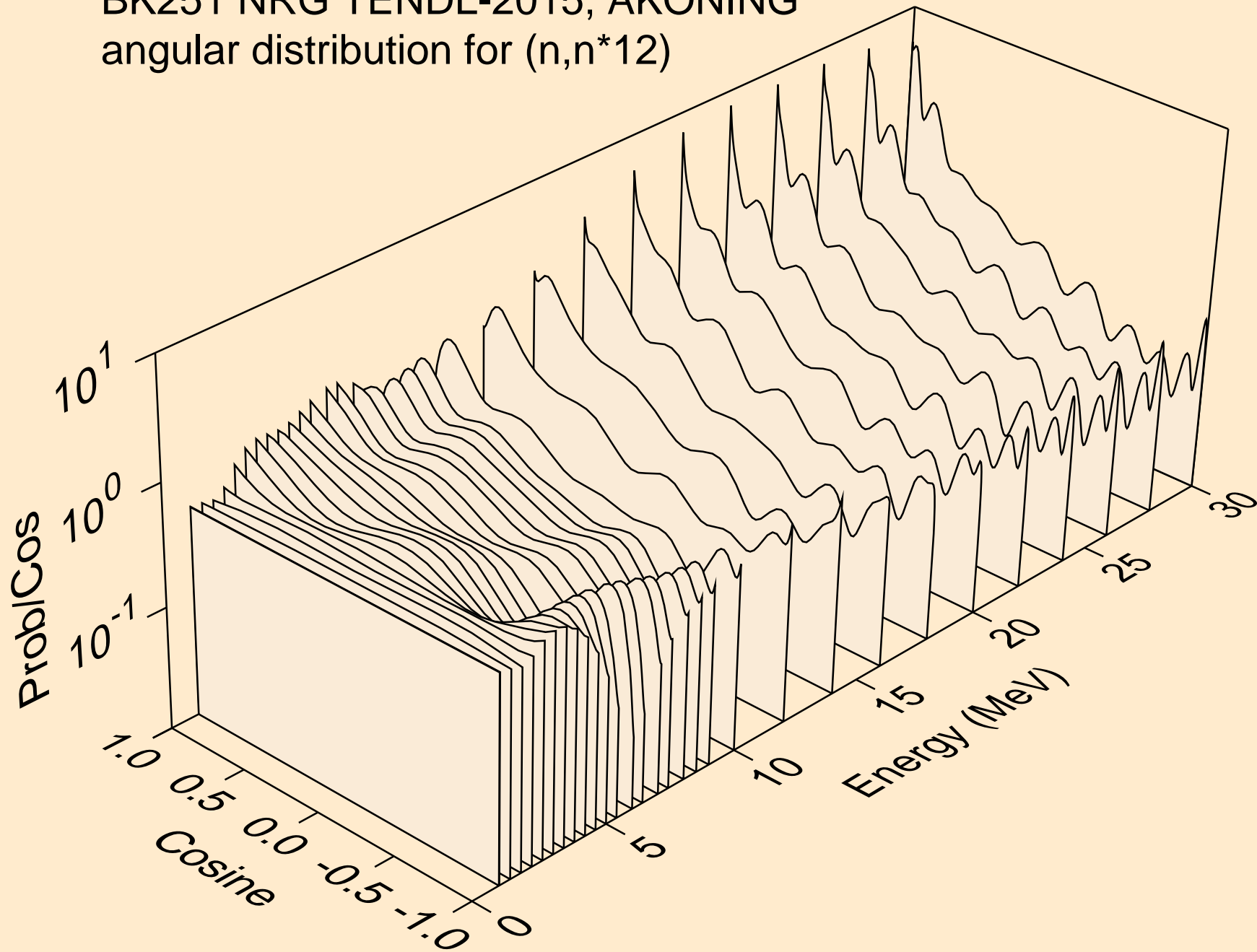

BK251 NRG TENDL-2015, AKONING
angular distribution for (n,n*13)

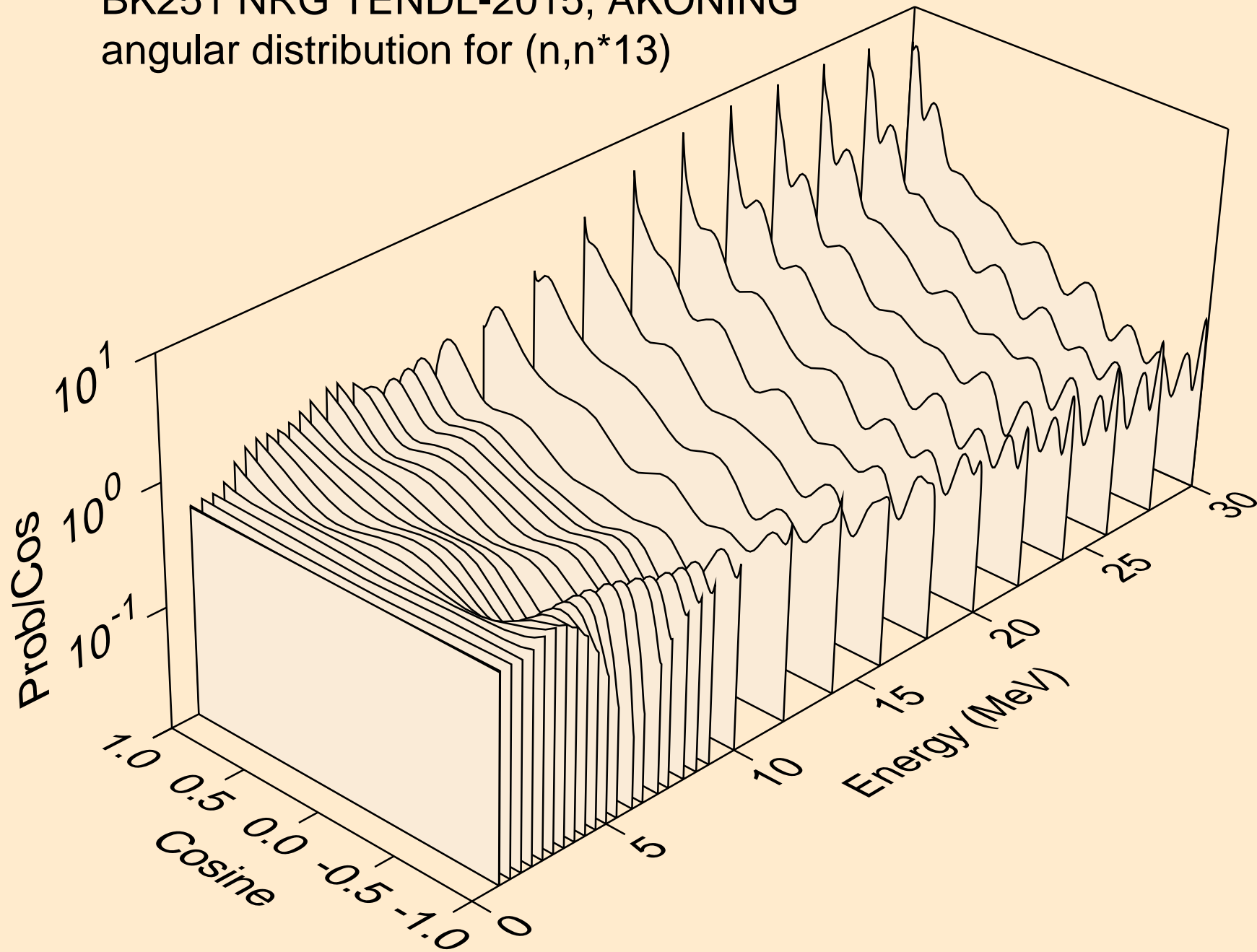

BK251 NRG TENDL-2015, AKONING
angular distribution for (n,n*14)

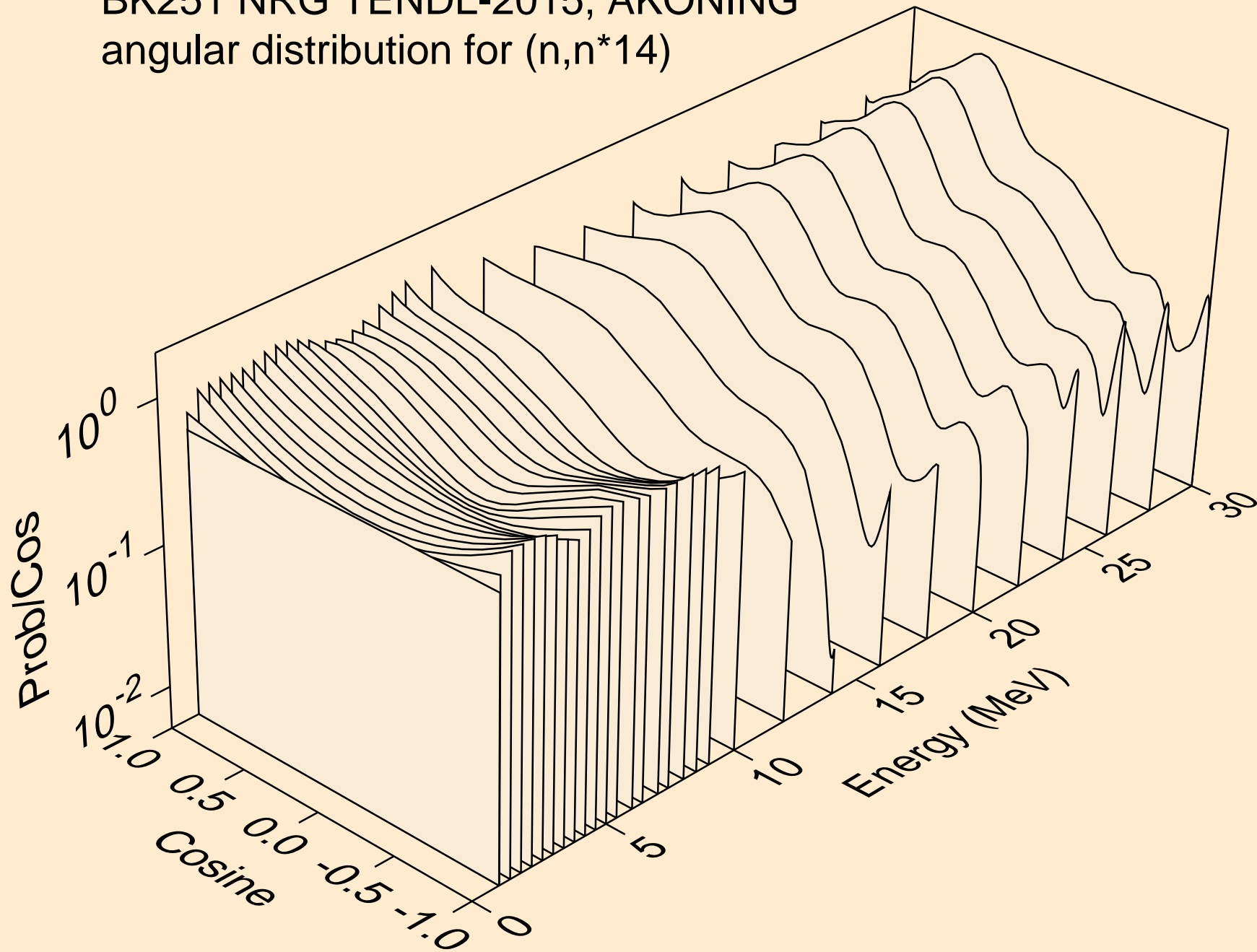

BK251 NRG TENDL-2015, AKONING
angular distribution for (n,n*15)

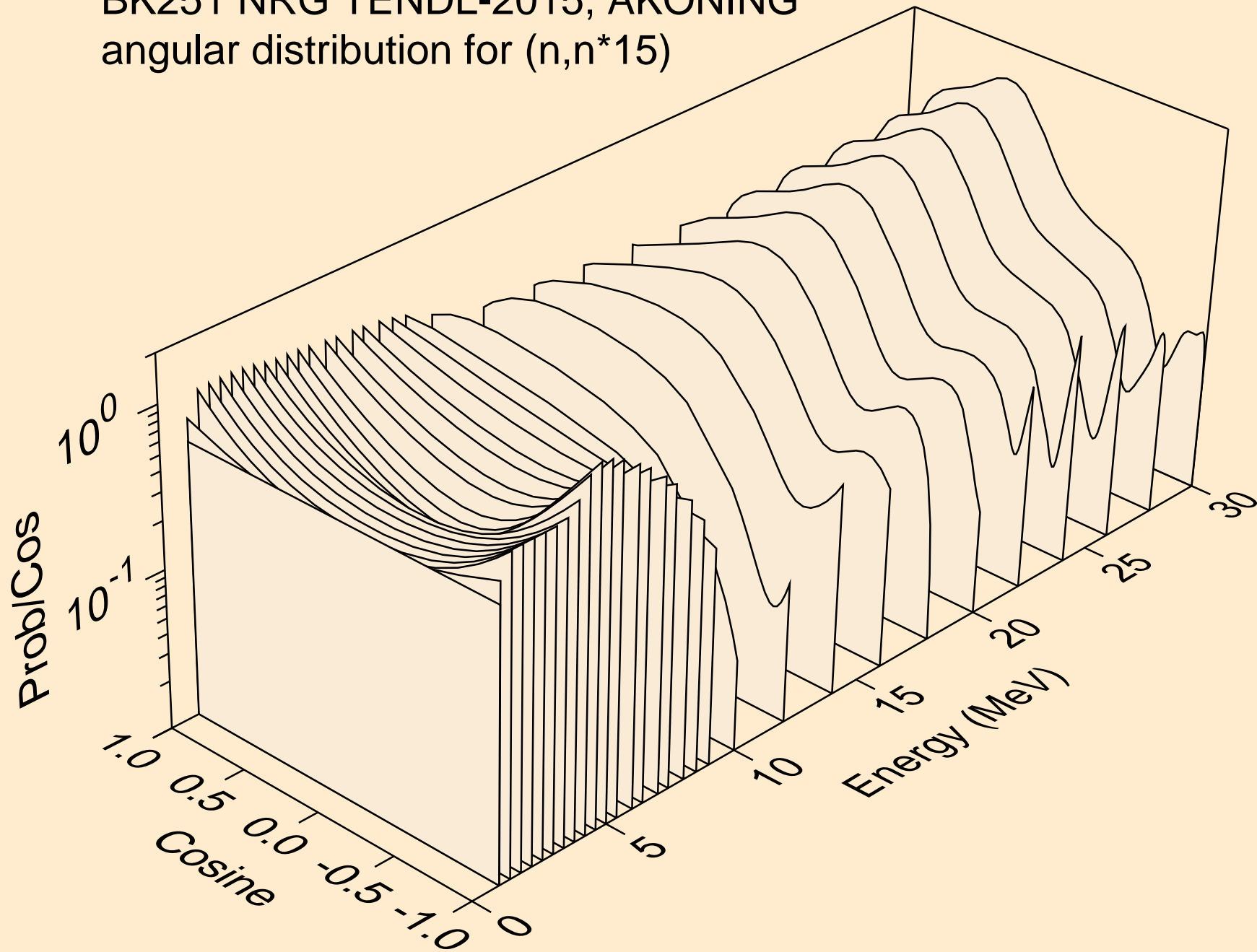

BK251 NRG TENDL-2015, AKONING
angular distribution for (n,n*16)

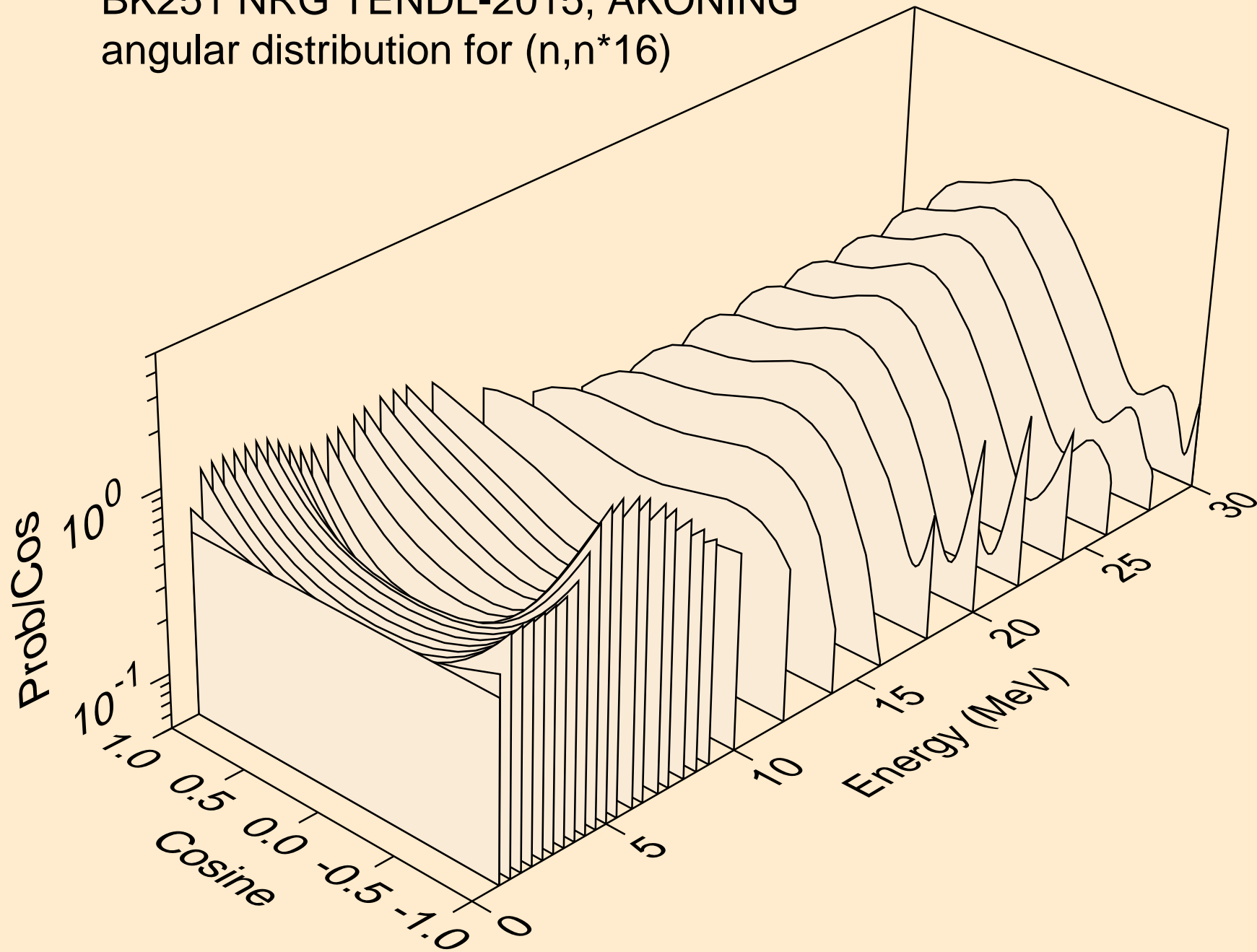

BK251 NRG TENDL-2015, AKONING
angular distribution for (n,n*17)

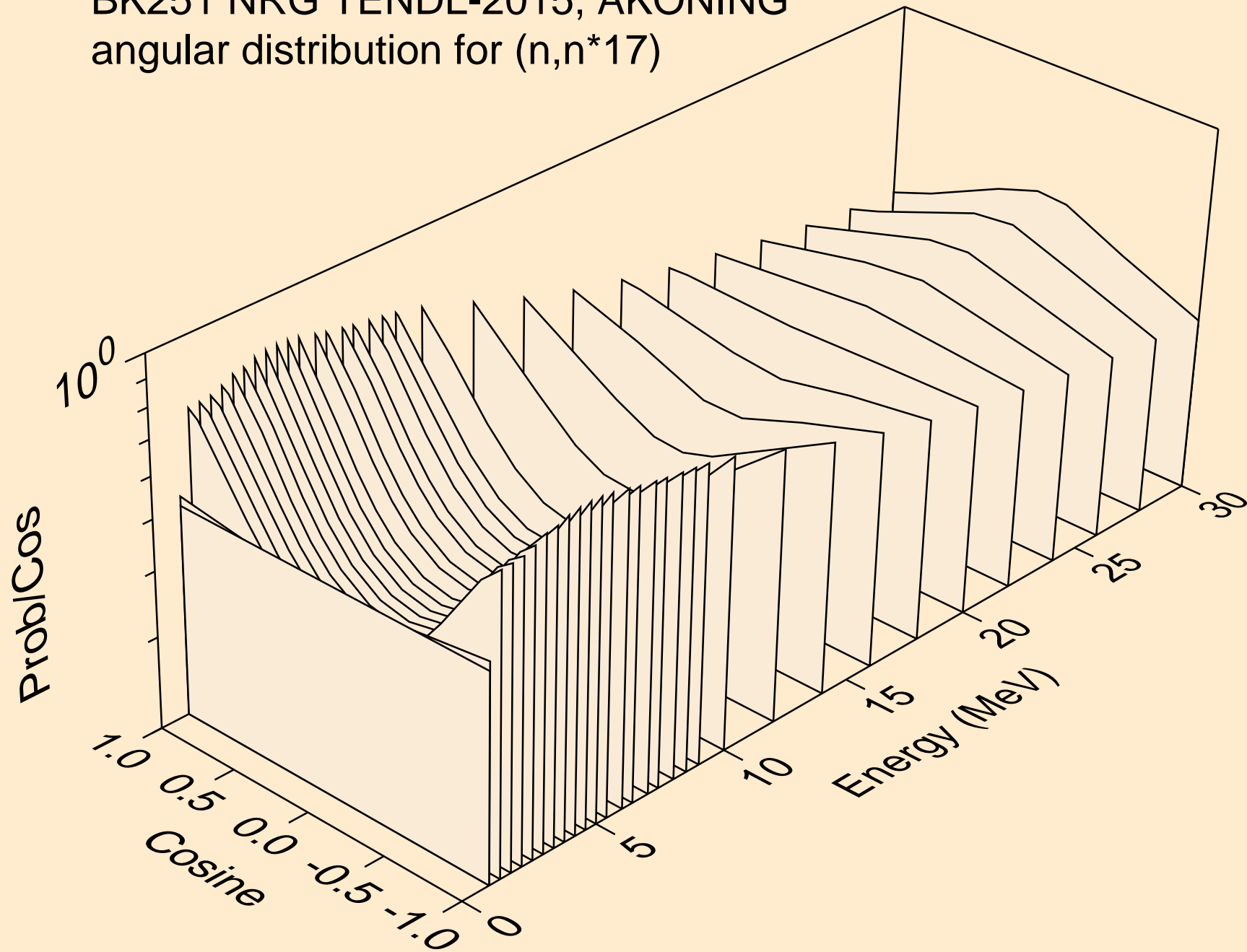

BK251 NRG TENDL-2015, AKONING
angular distribution for (n,n*18)

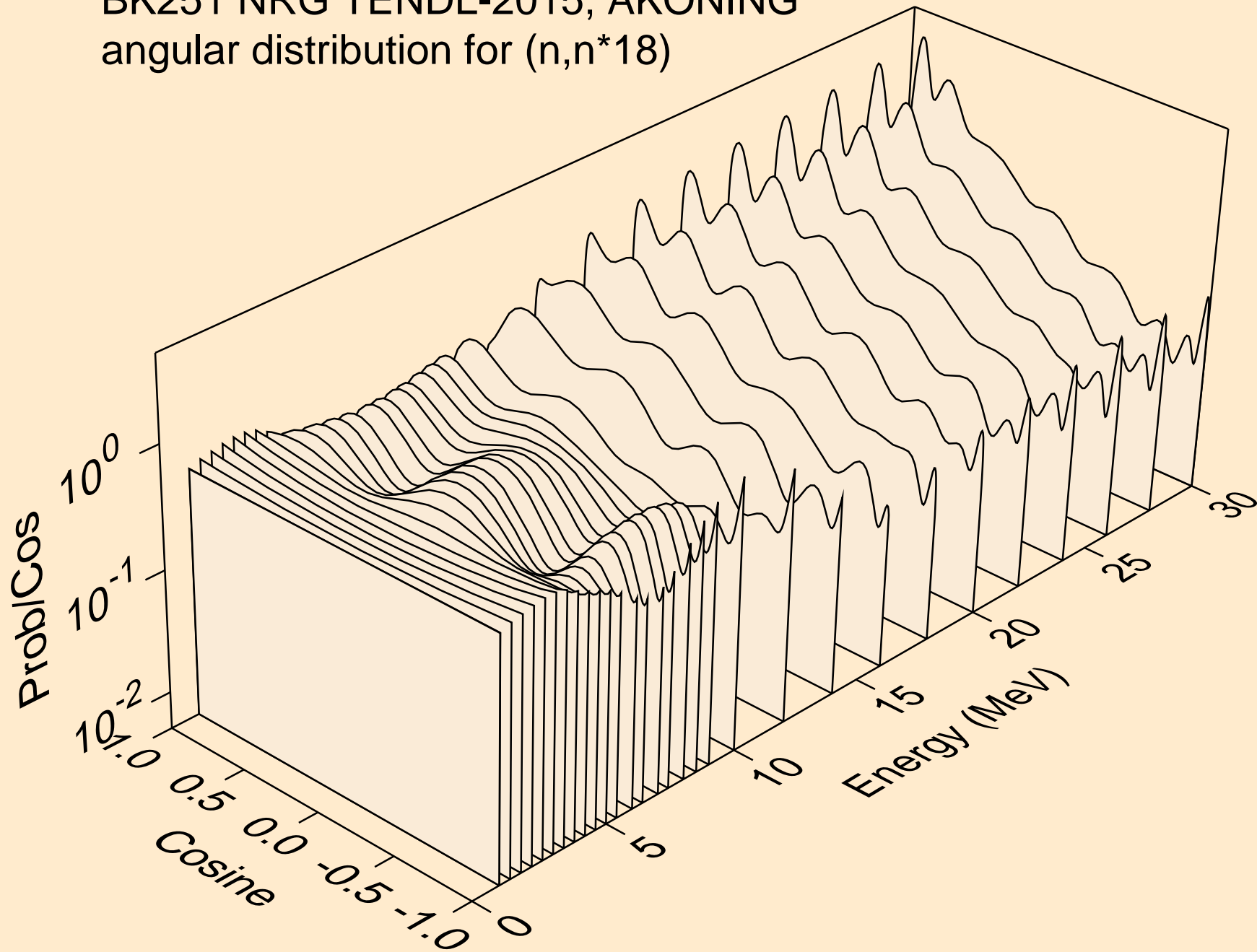

BK251 NRG TENDL-2015, AKONING
angular distribution for (n,n*19)

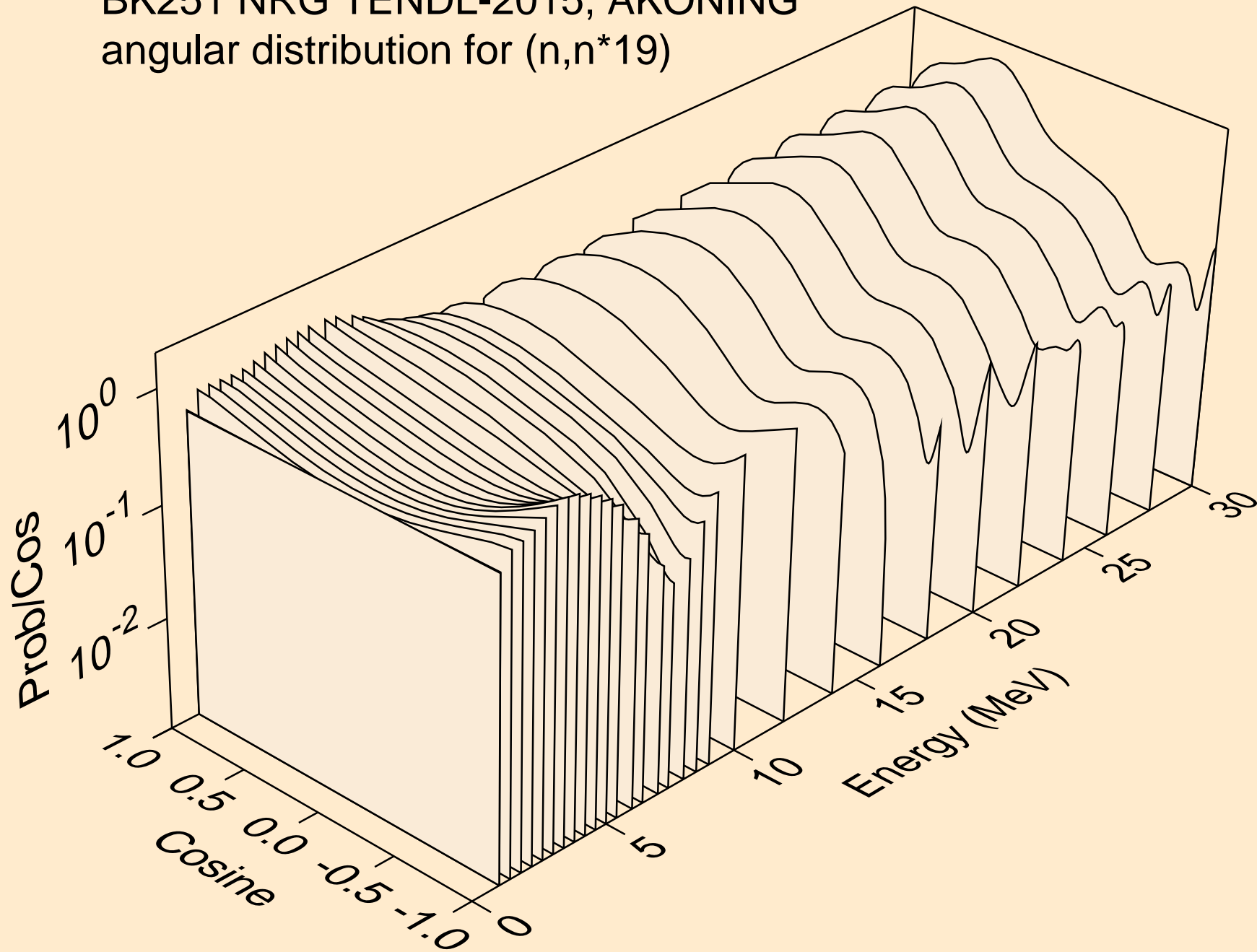

BK251 NRG TENDL-2015, AKONING
angular distribution for (n,n*20)

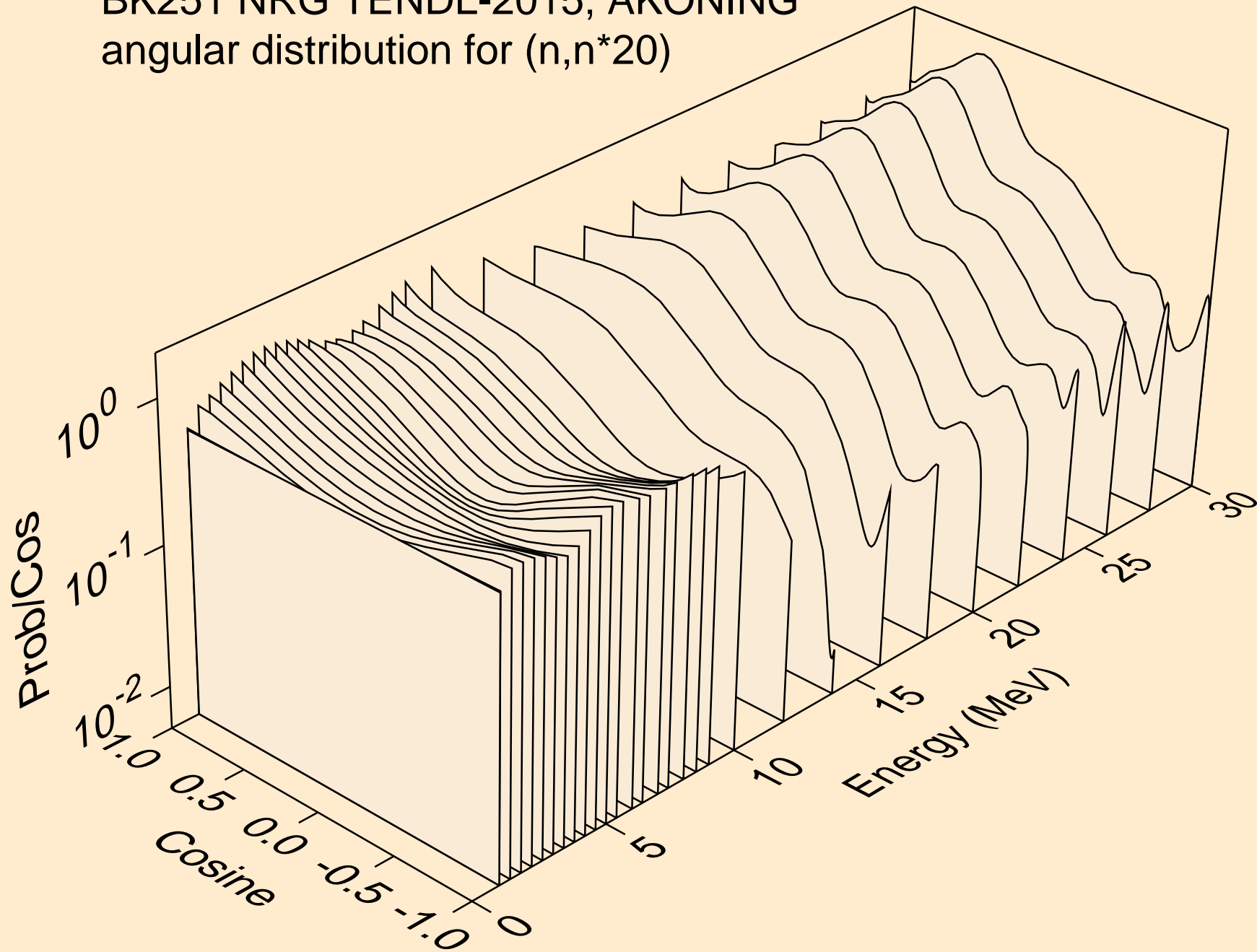

BK251 NRG TENDL-2015, AKONING
angular distribution for (n,n*21)

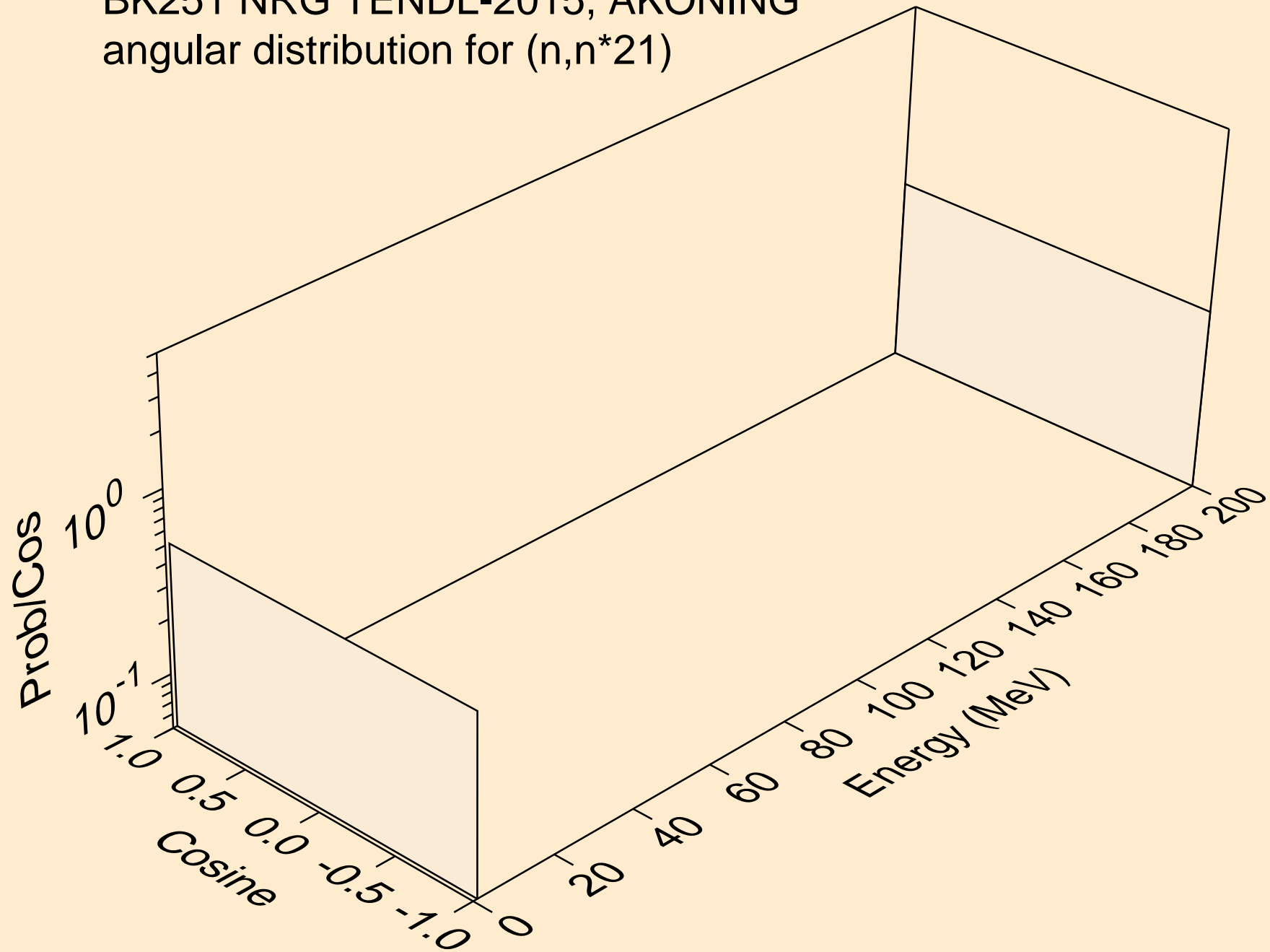

BK251 NRG TENDL-2015, AKONING
angular distribution for (n,n*22)

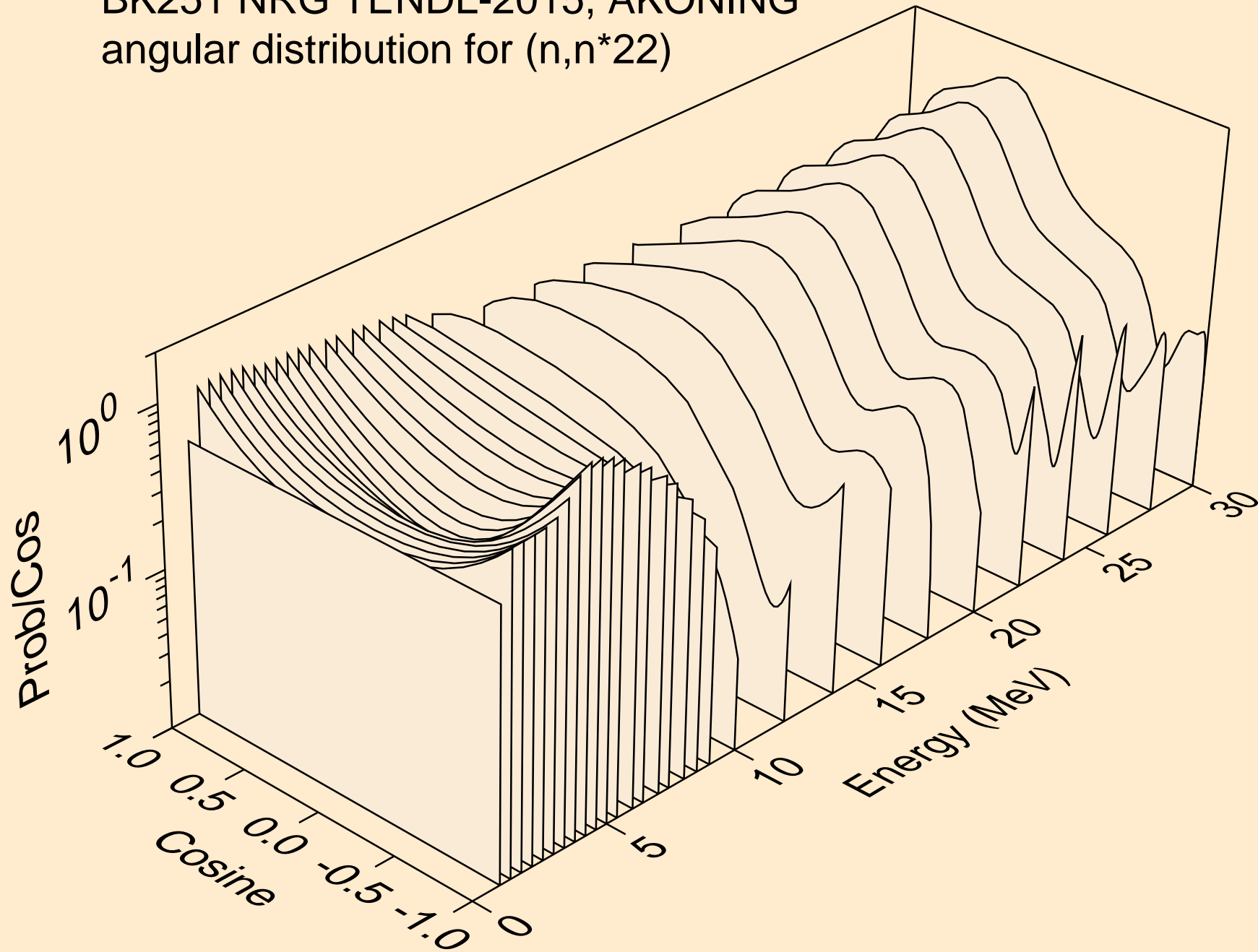

BK251 NRG TENDL-2015, AKONING
angular distribution for (n,n*23)

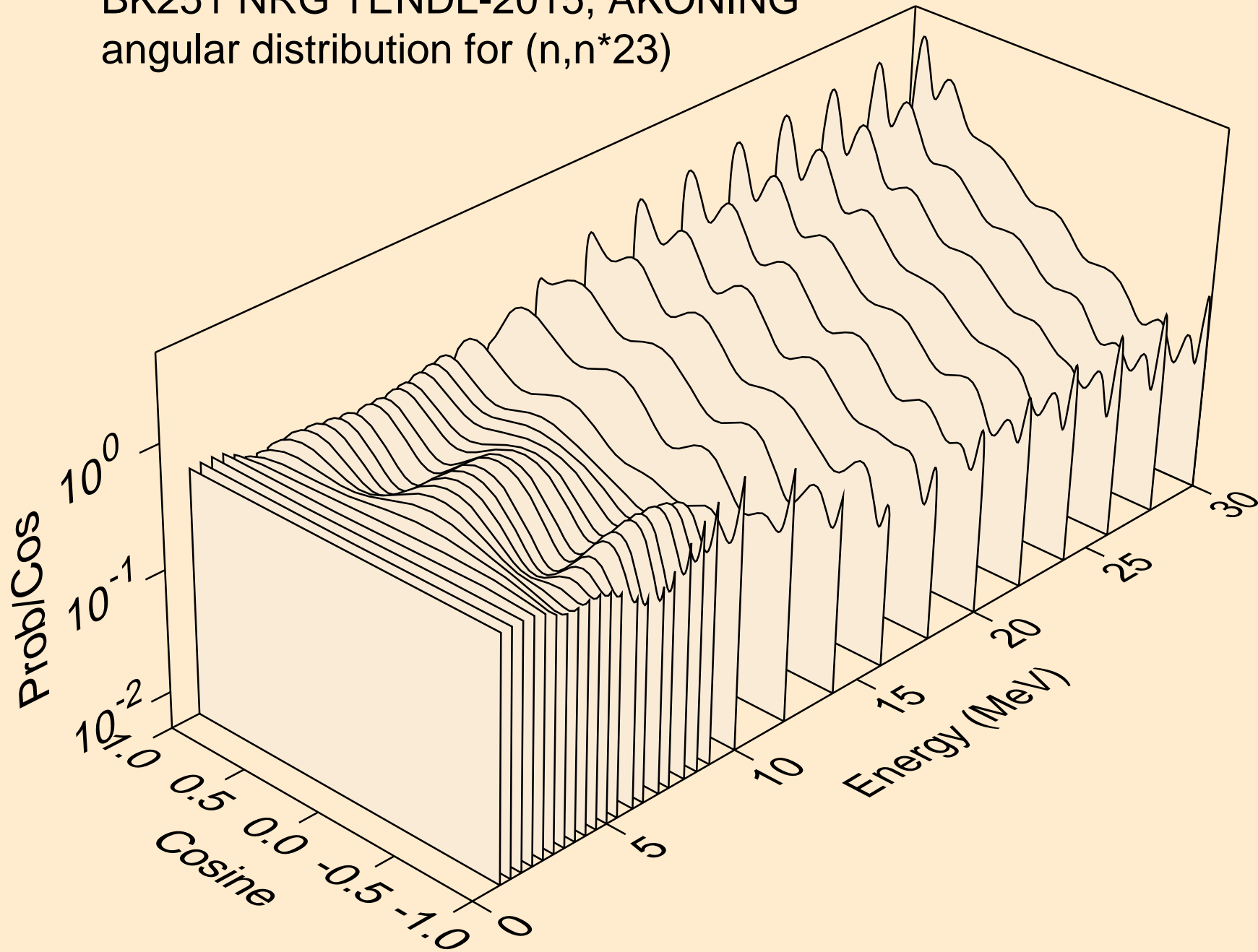

BK251 NRG TENDL-2015, AKONING
angular distribution for (n,n*24)

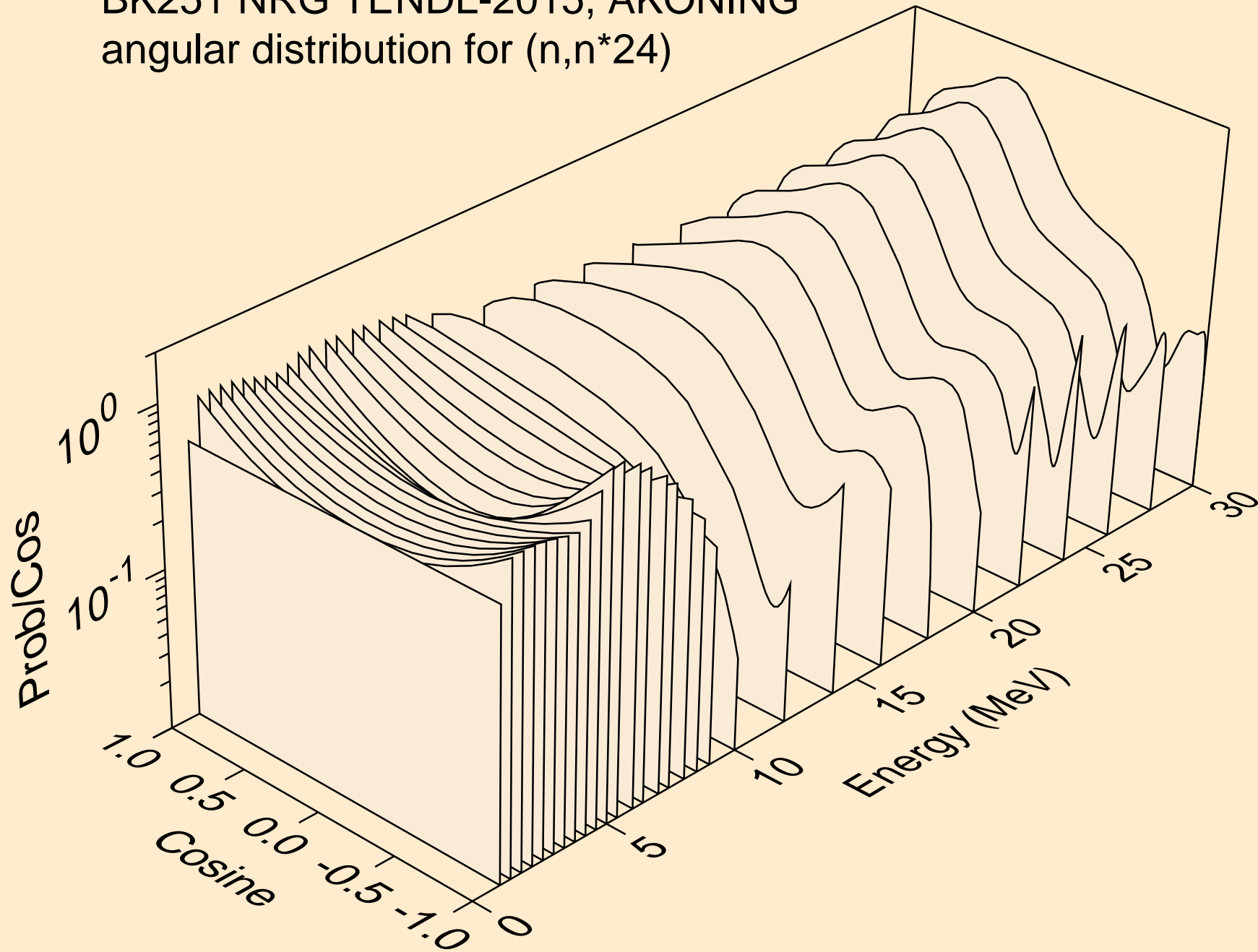

BK251 NRG TENDL-2015, AKONING
angular distribution for (n,n*25)

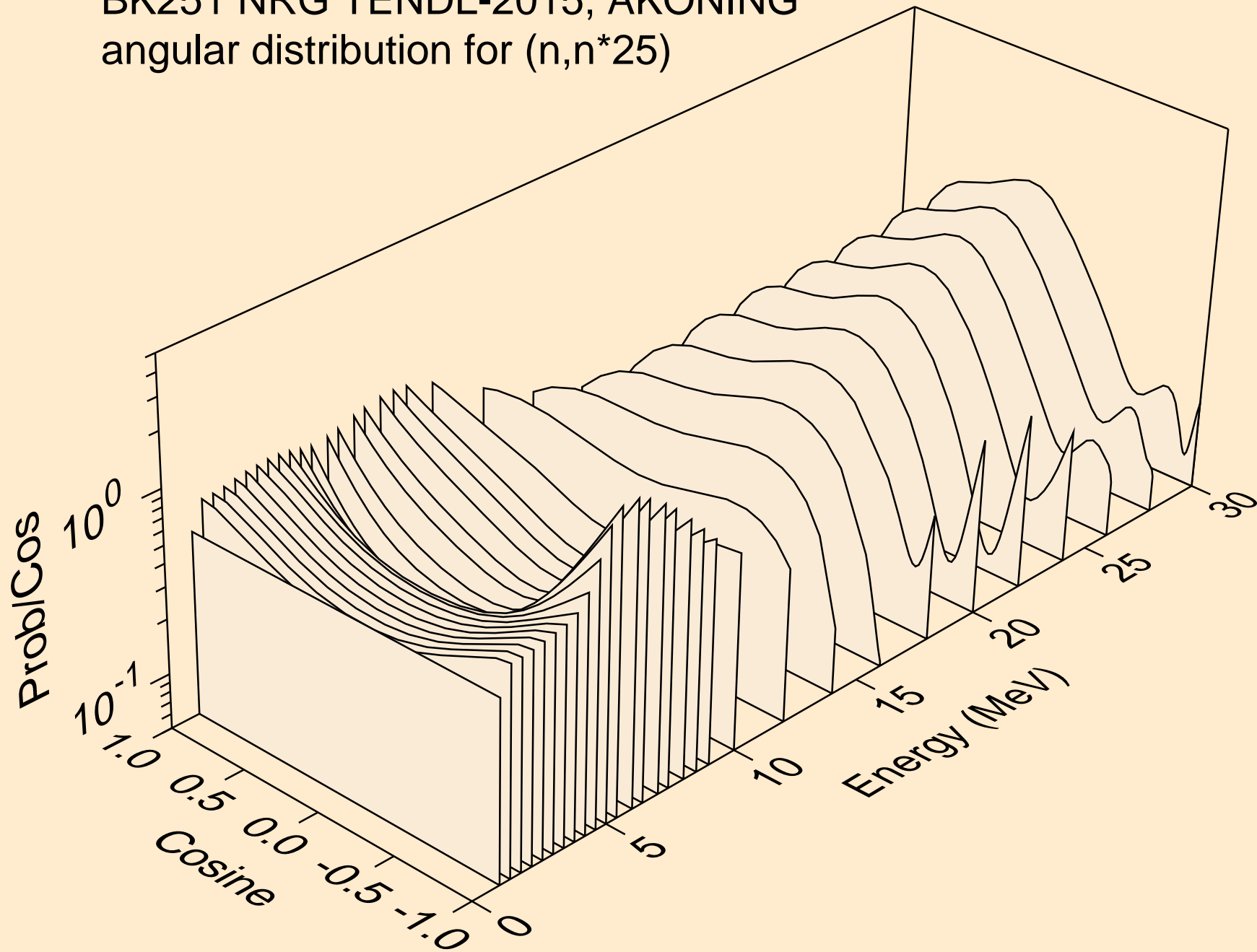

BK251 NRG TENDL-2015, AKONING
angular distribution for (n,n*26)

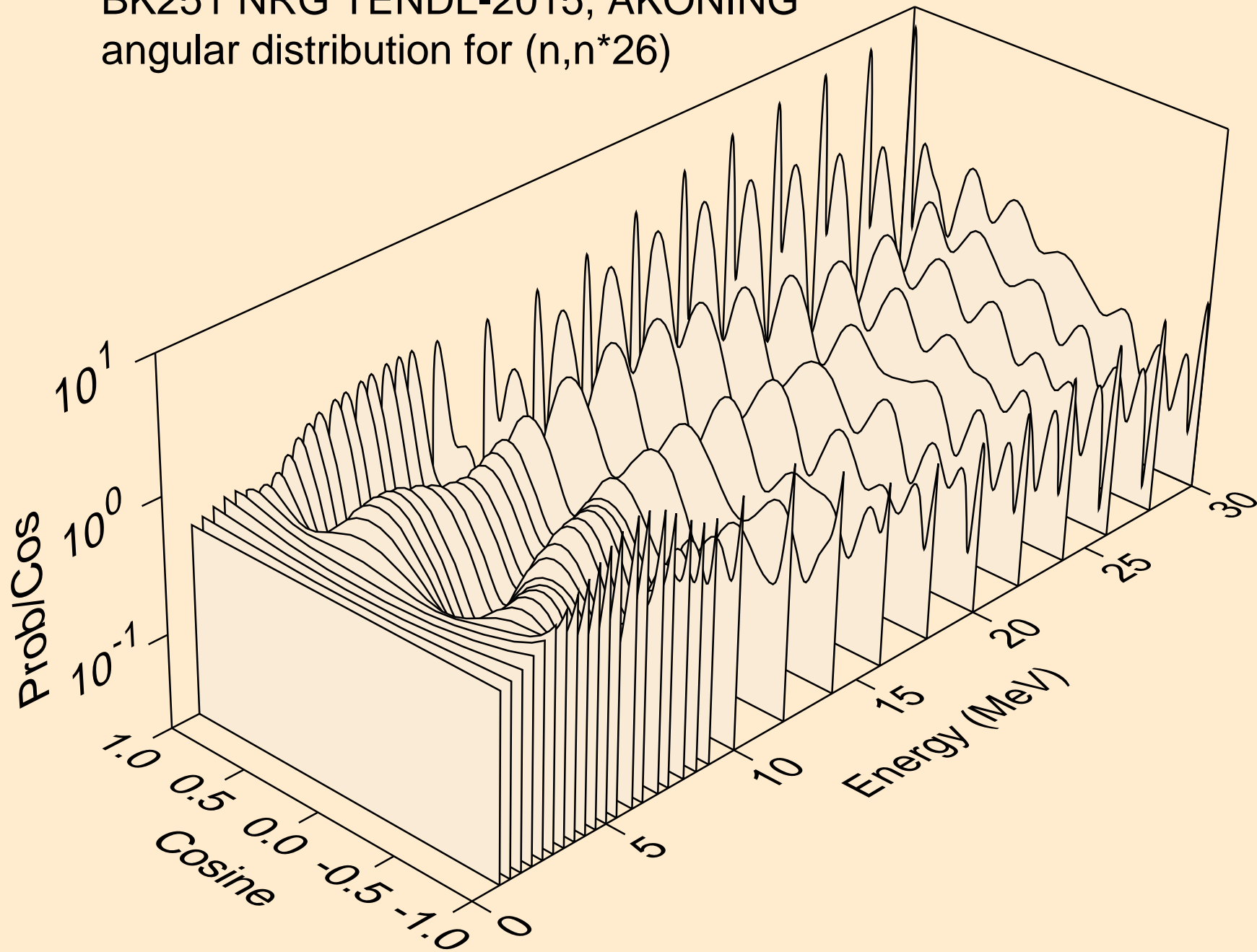

BK251 NRG TENDL-2015, AKONING

Total fission nubar

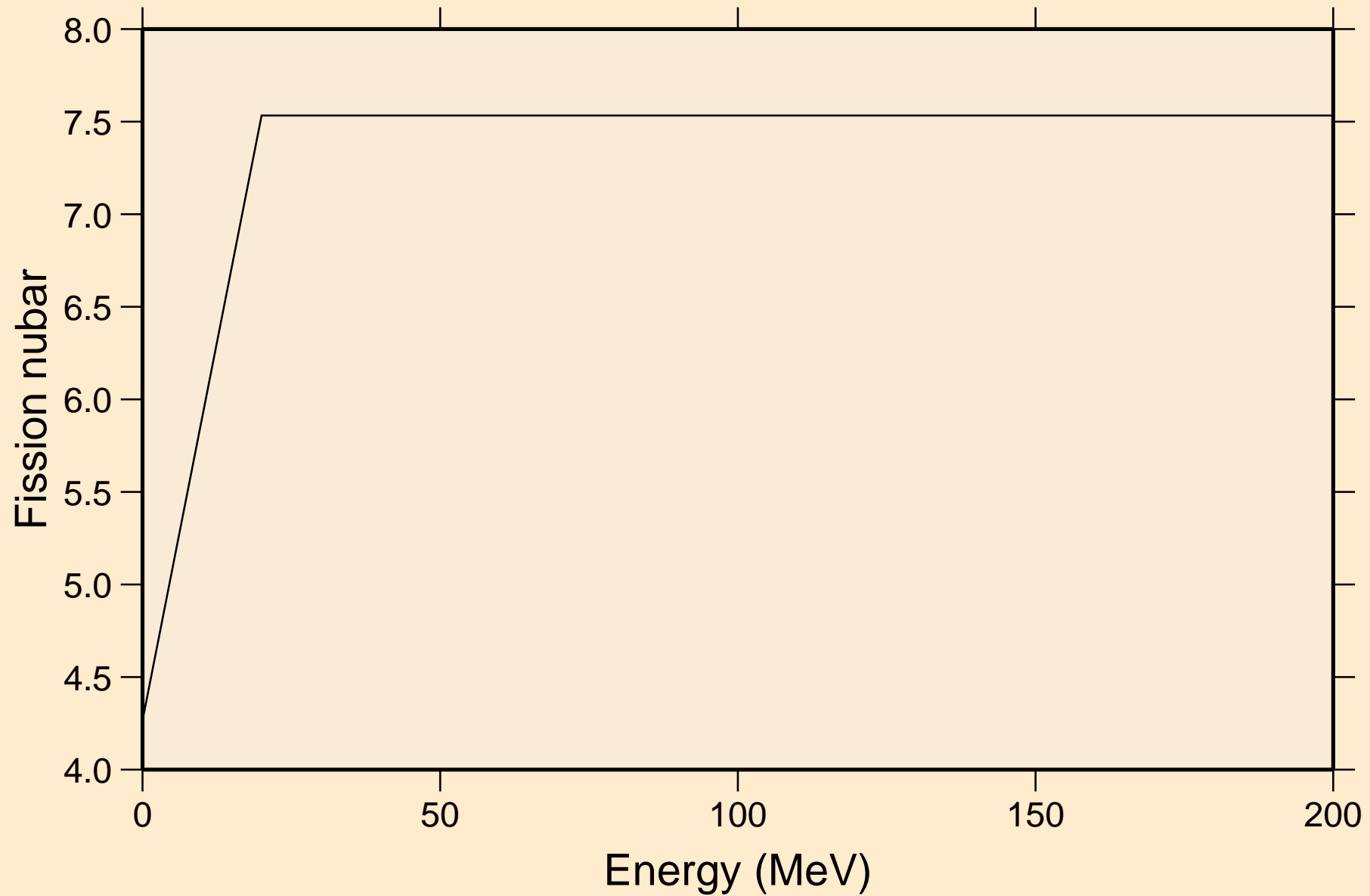

BK251 NRG TENDL-2015, AKONING
Neutron emission for (n,x)

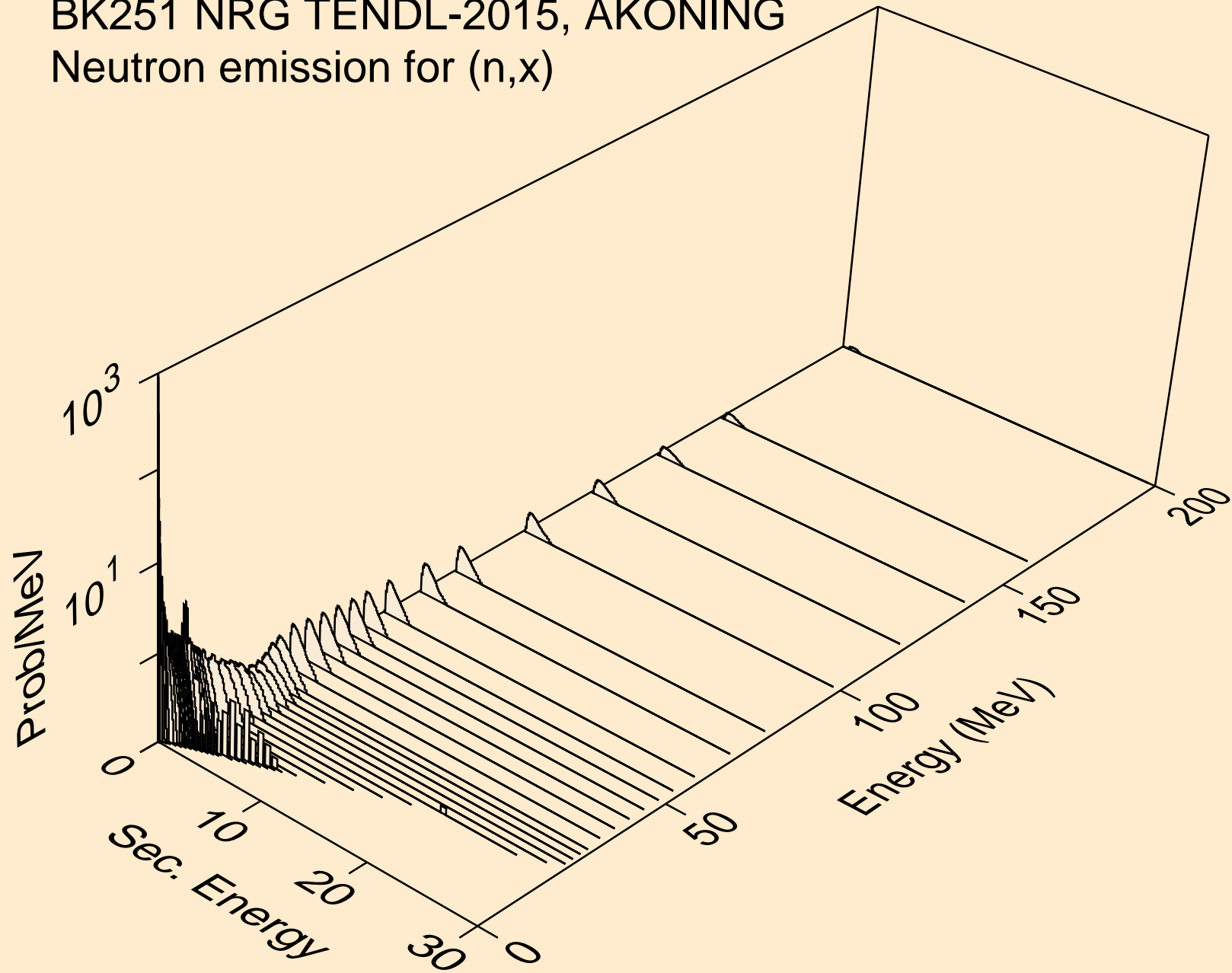

BK251 NRG TENDL-2015, AKONING
Neutron emission for (n,2nd)

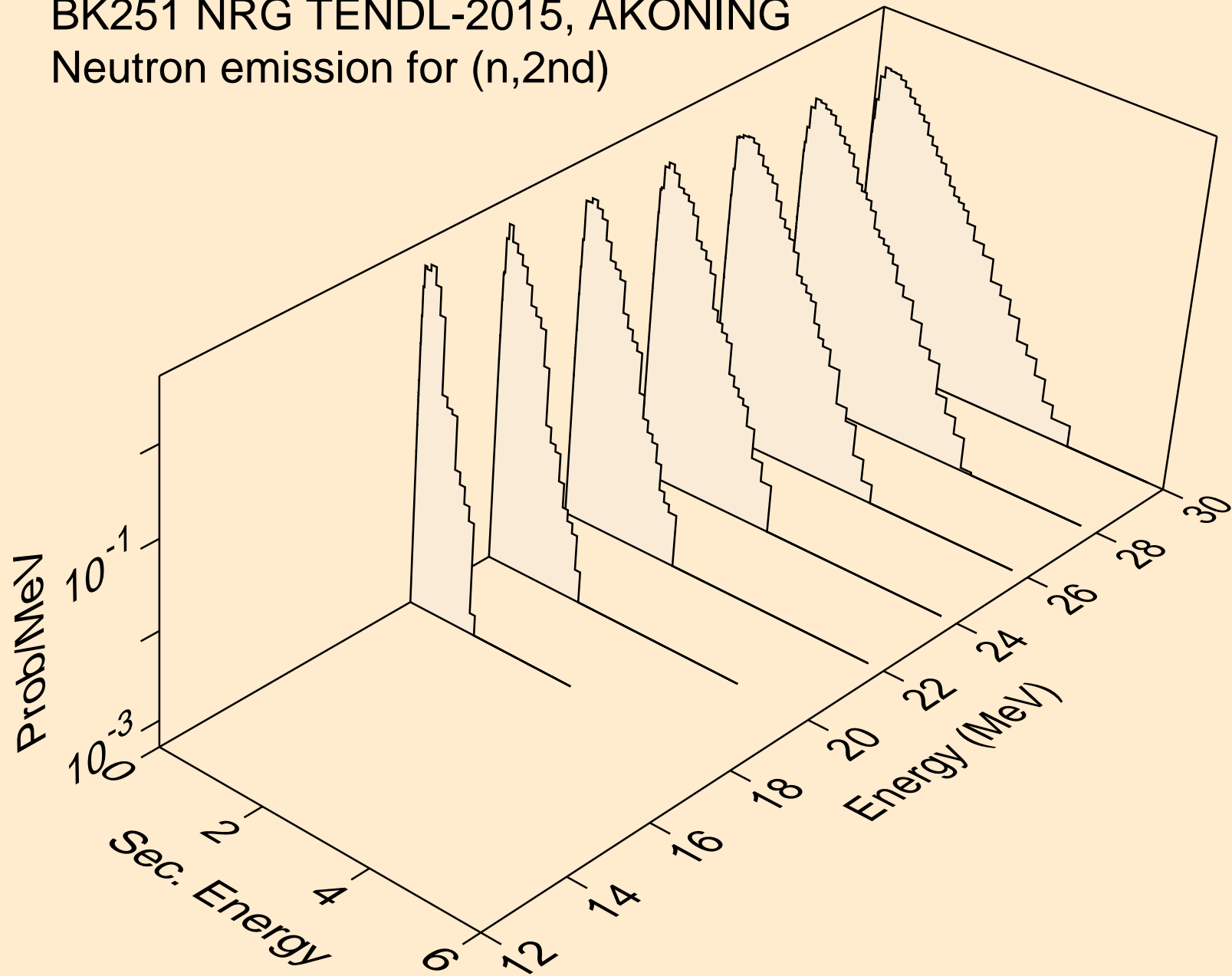

BK251 NRG TENDL-2015, AKONING
Neutron emission for (n,2n)

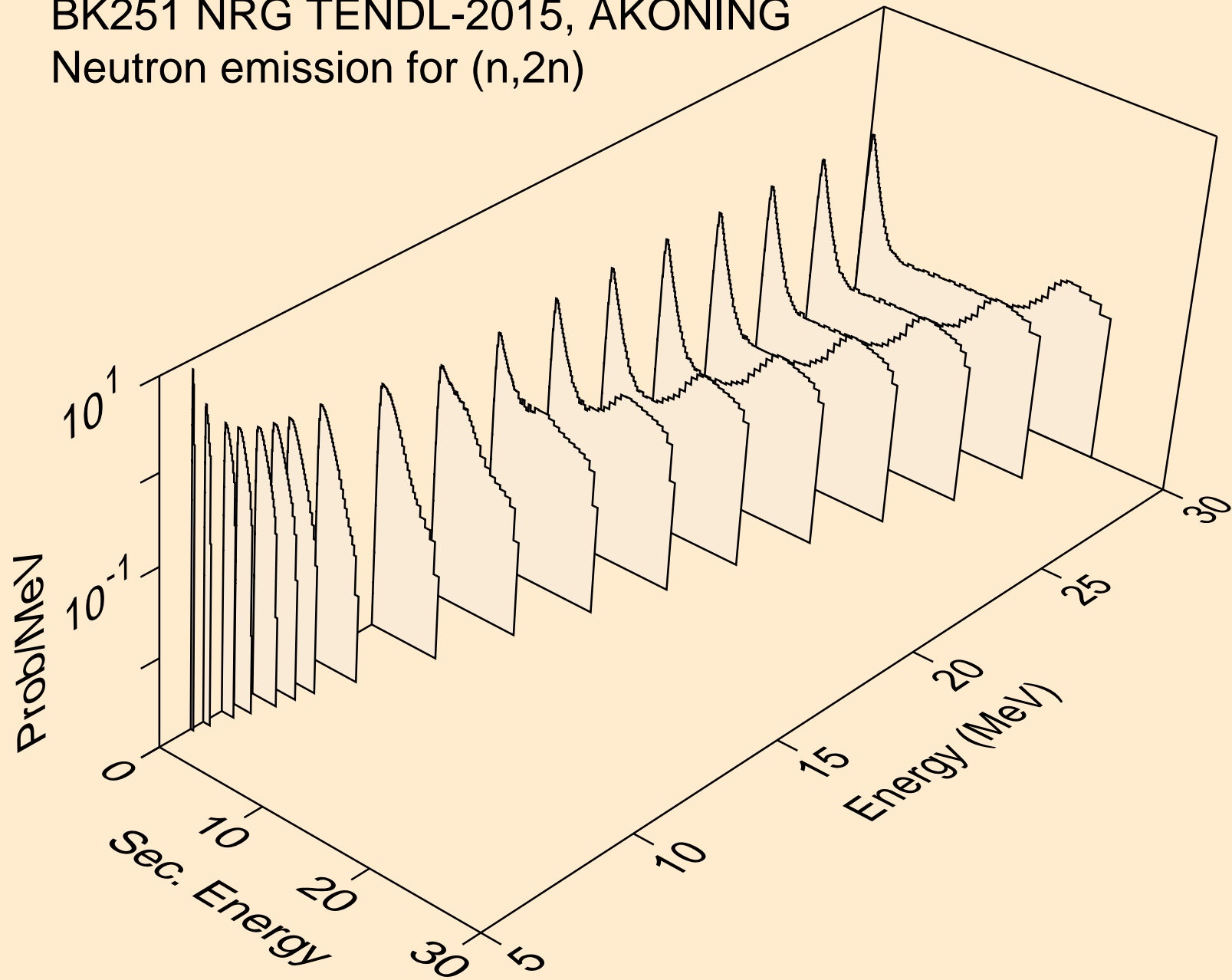

BK251 NRG TENDL-2015, AKONING
Neutron emission for (n,3n)

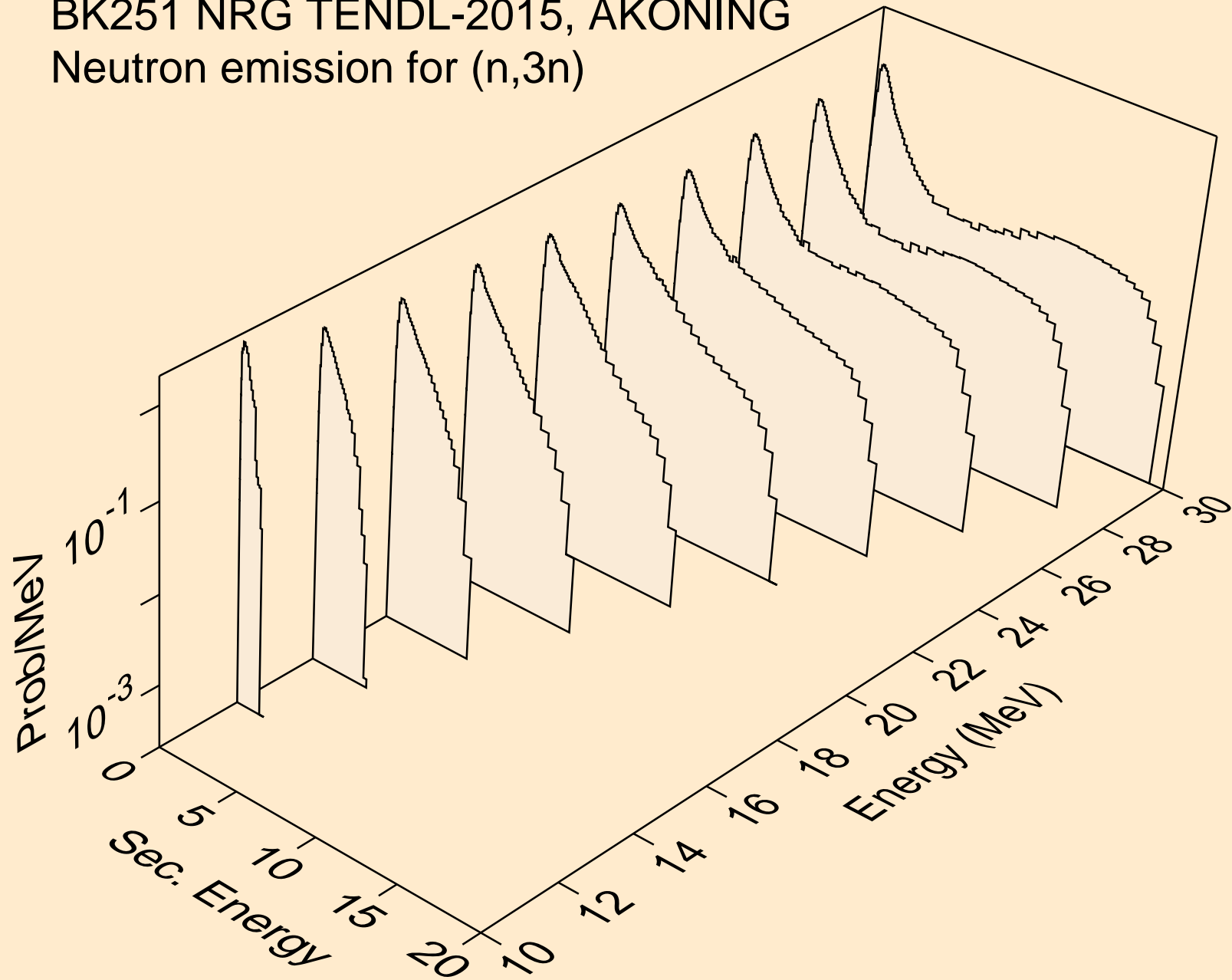

BK251 NRG TENDL-2015, AKONING
Neutron emission for fission

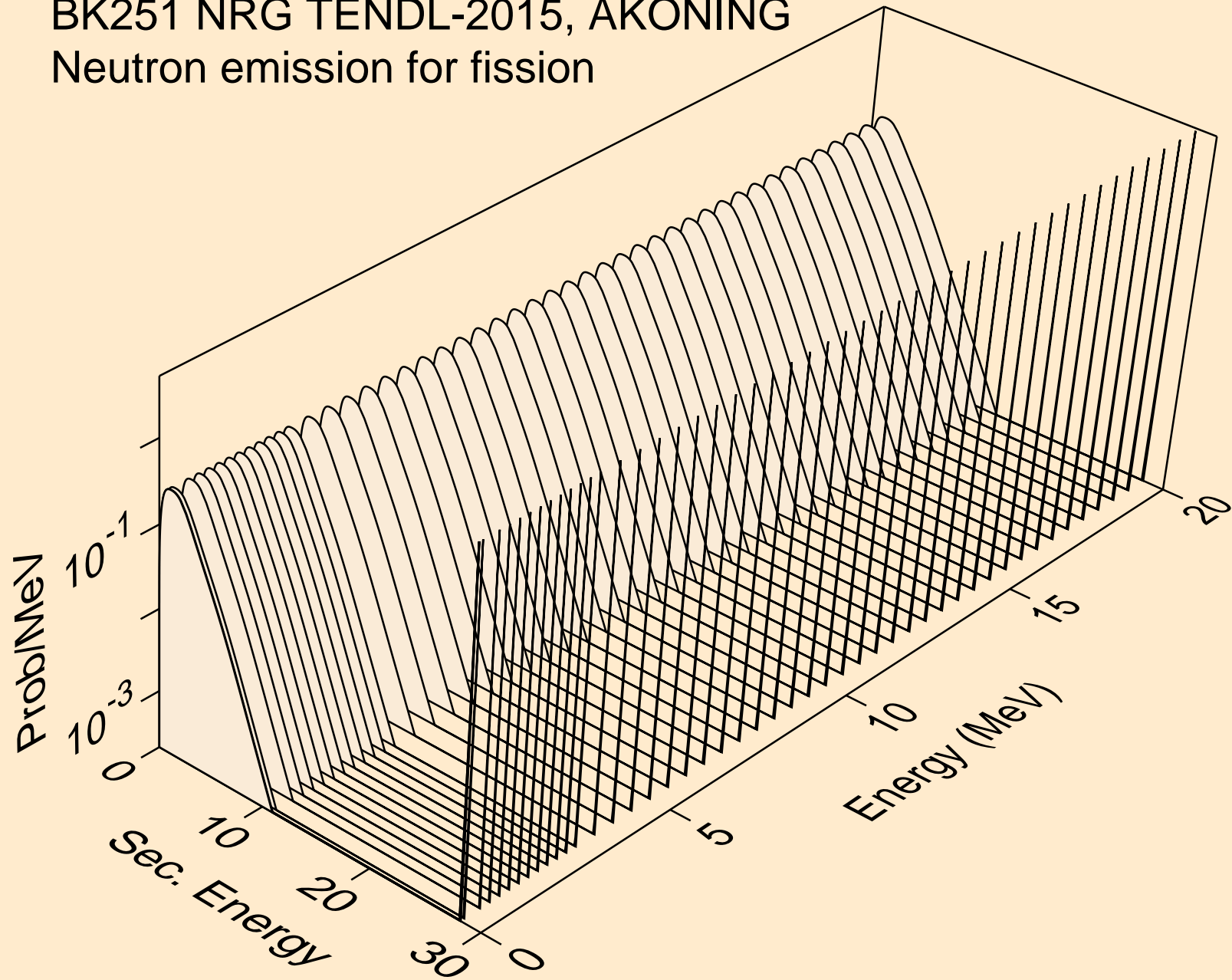

BK251 NRG TENDL-2015, AKONING
Neutron emission for (n,n*)a

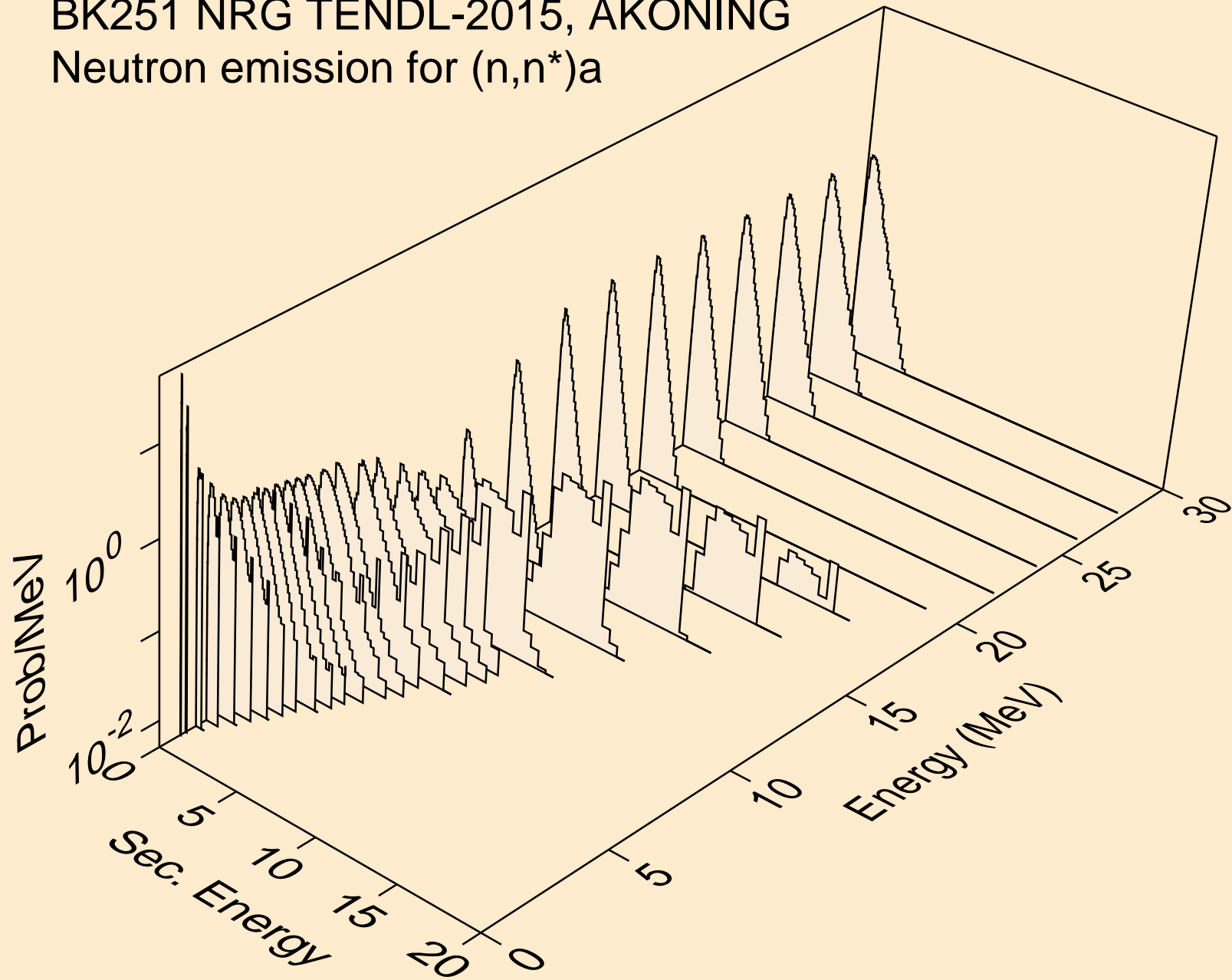

BK251 NRG TENDL-2015, AKONING
Neutron emission for (n,2n)a

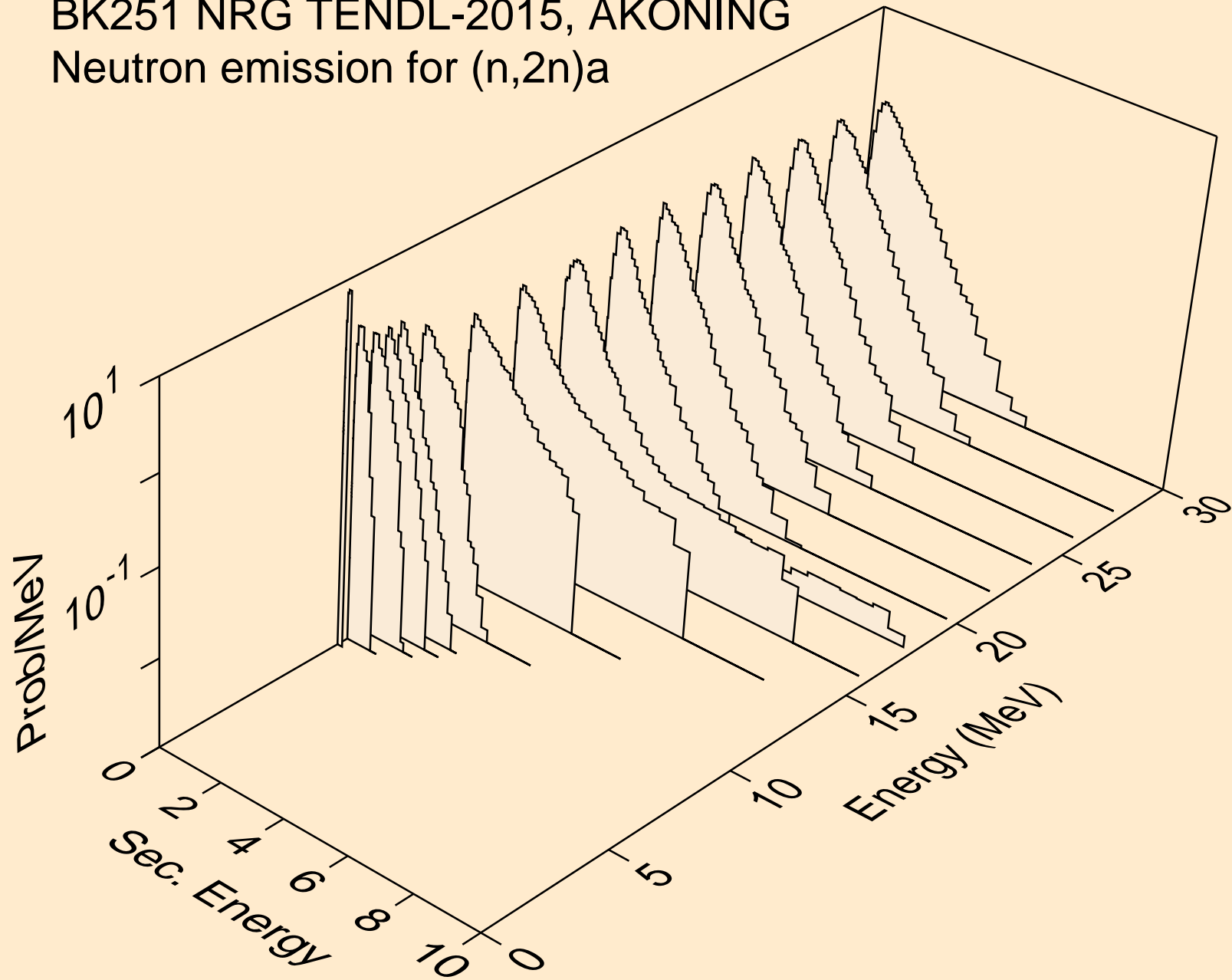

BK251 NRG TENDL-2015, AKONING
Neutron emission for (n,3n)a

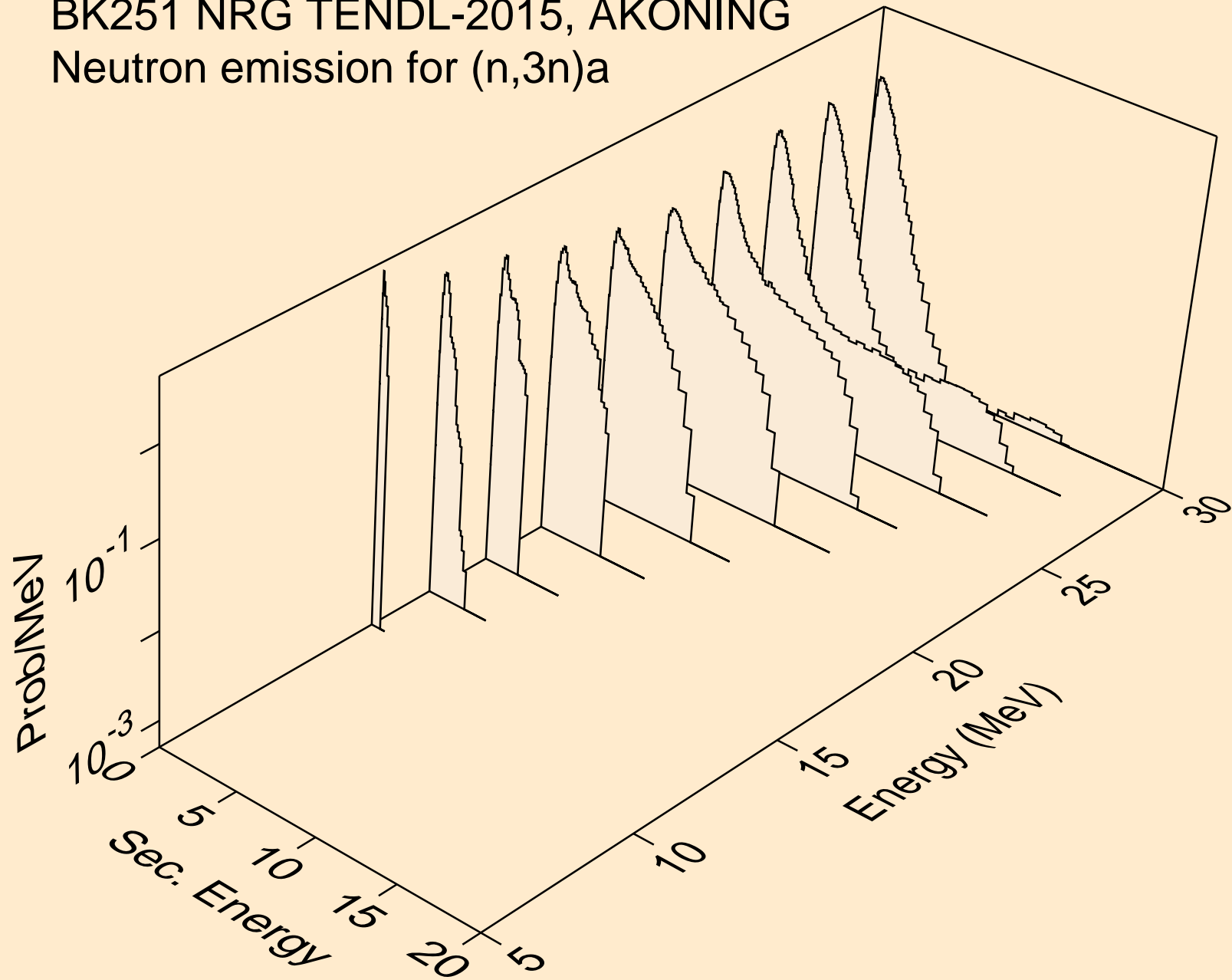

BK251 NRG TENDL-2015, AKONING
Neutron emission for (n,n*)p

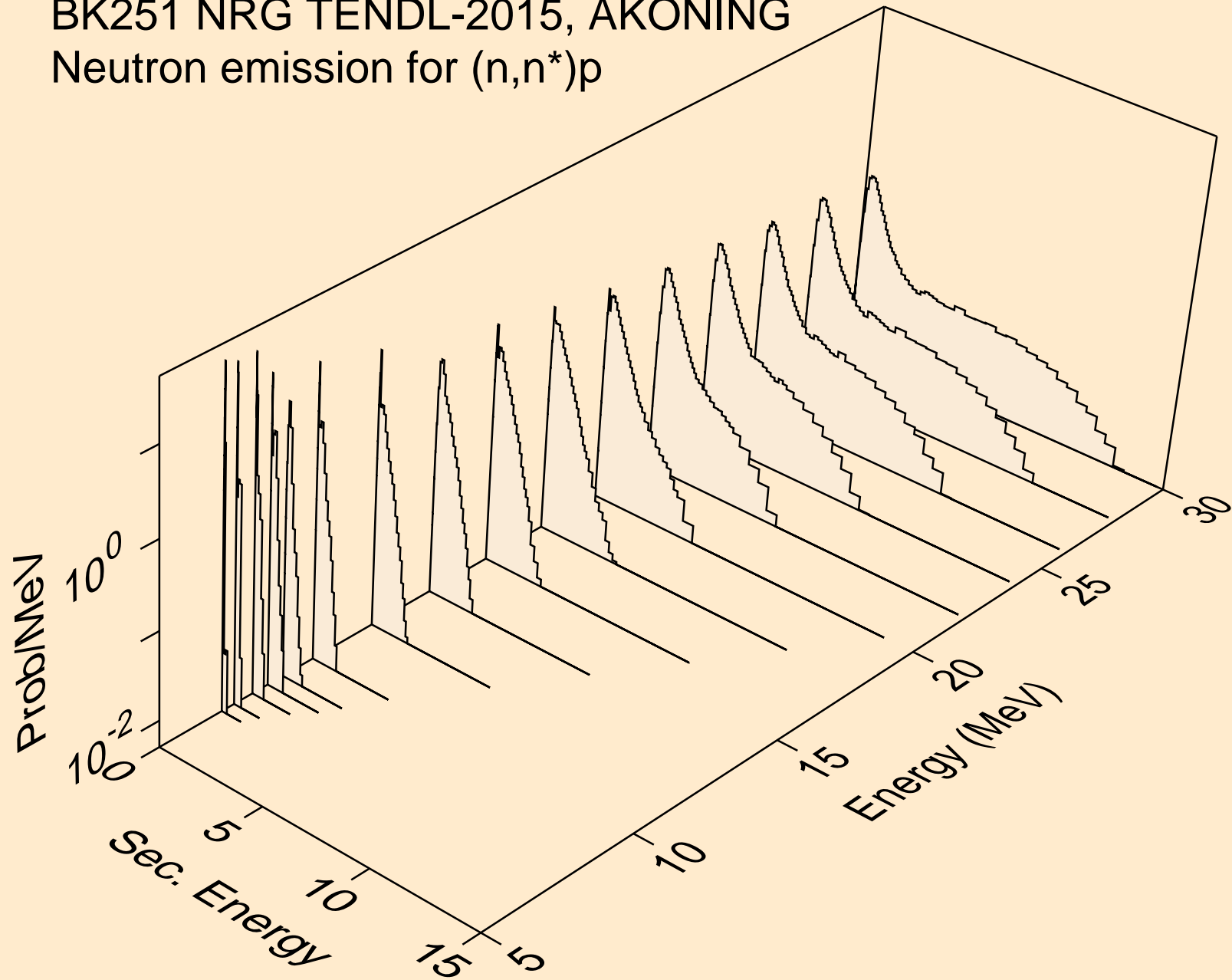

BK251 NRG TENDL-2015, AKONING
Neutron emission for (n,n*)2a

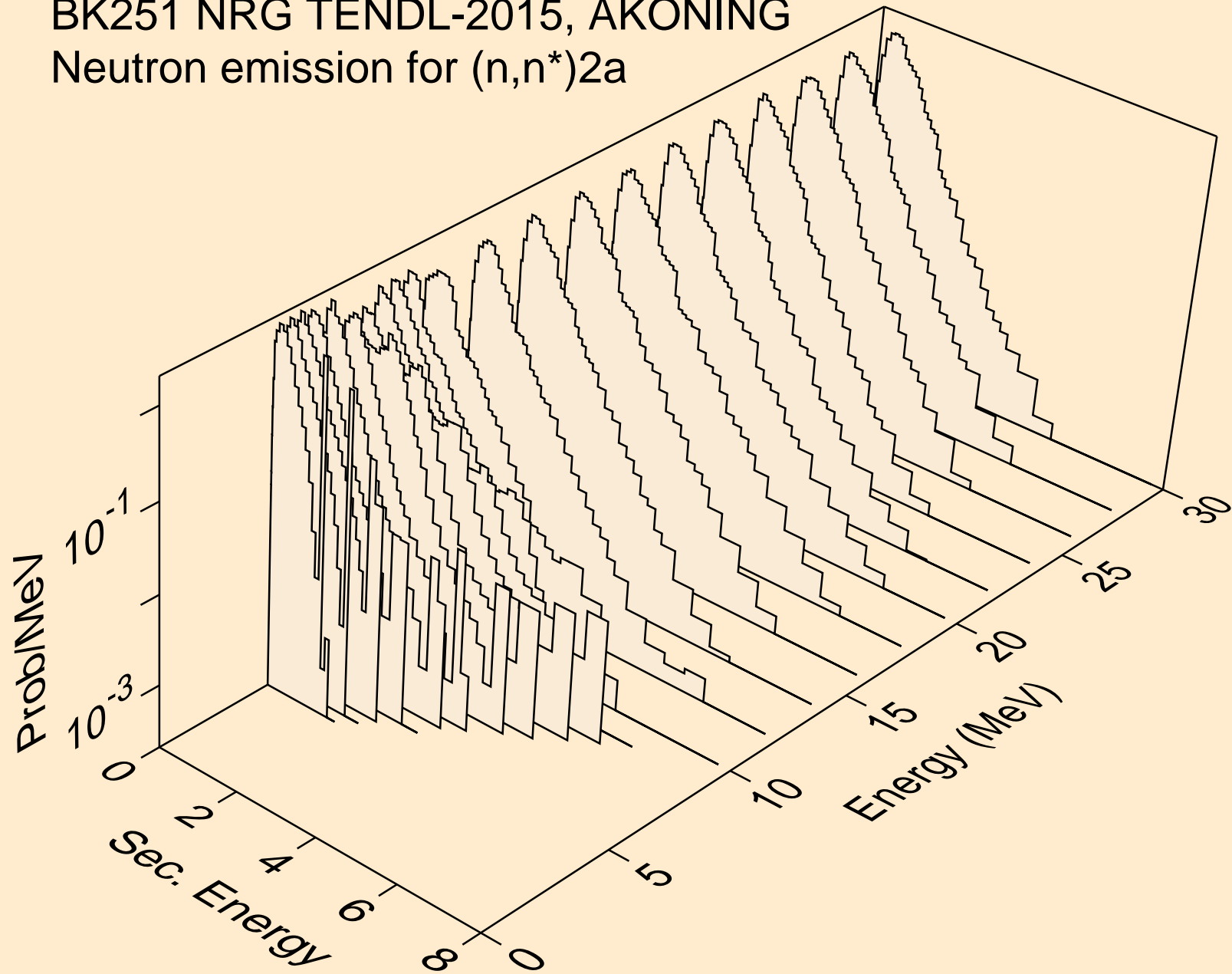

BK251 NRG TENDL-2015, AKONING
Neutron emission for (n,2n)2a

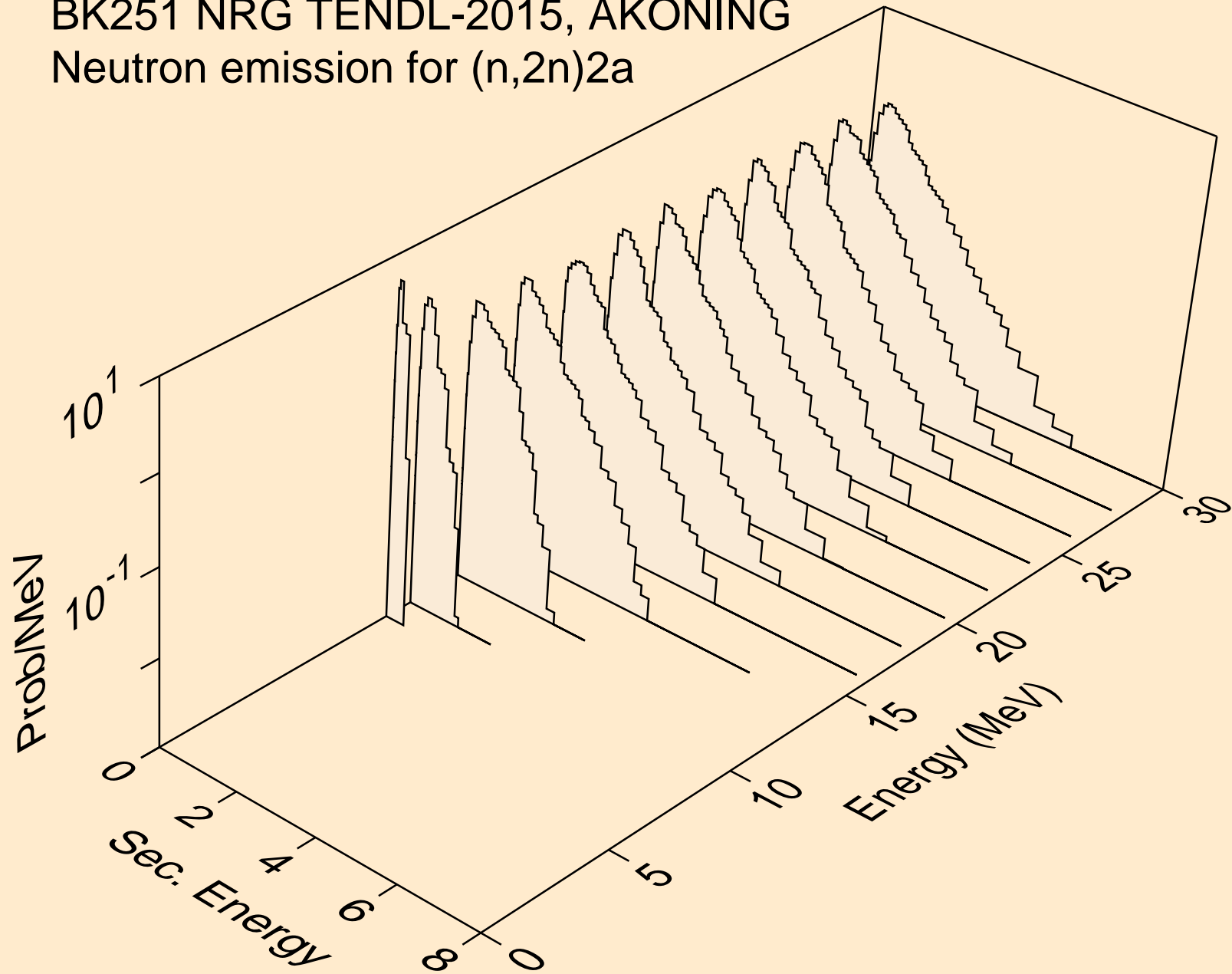

BK251 NRG TENDL-2015, AKONING
Neutron emission for (n,n*)d

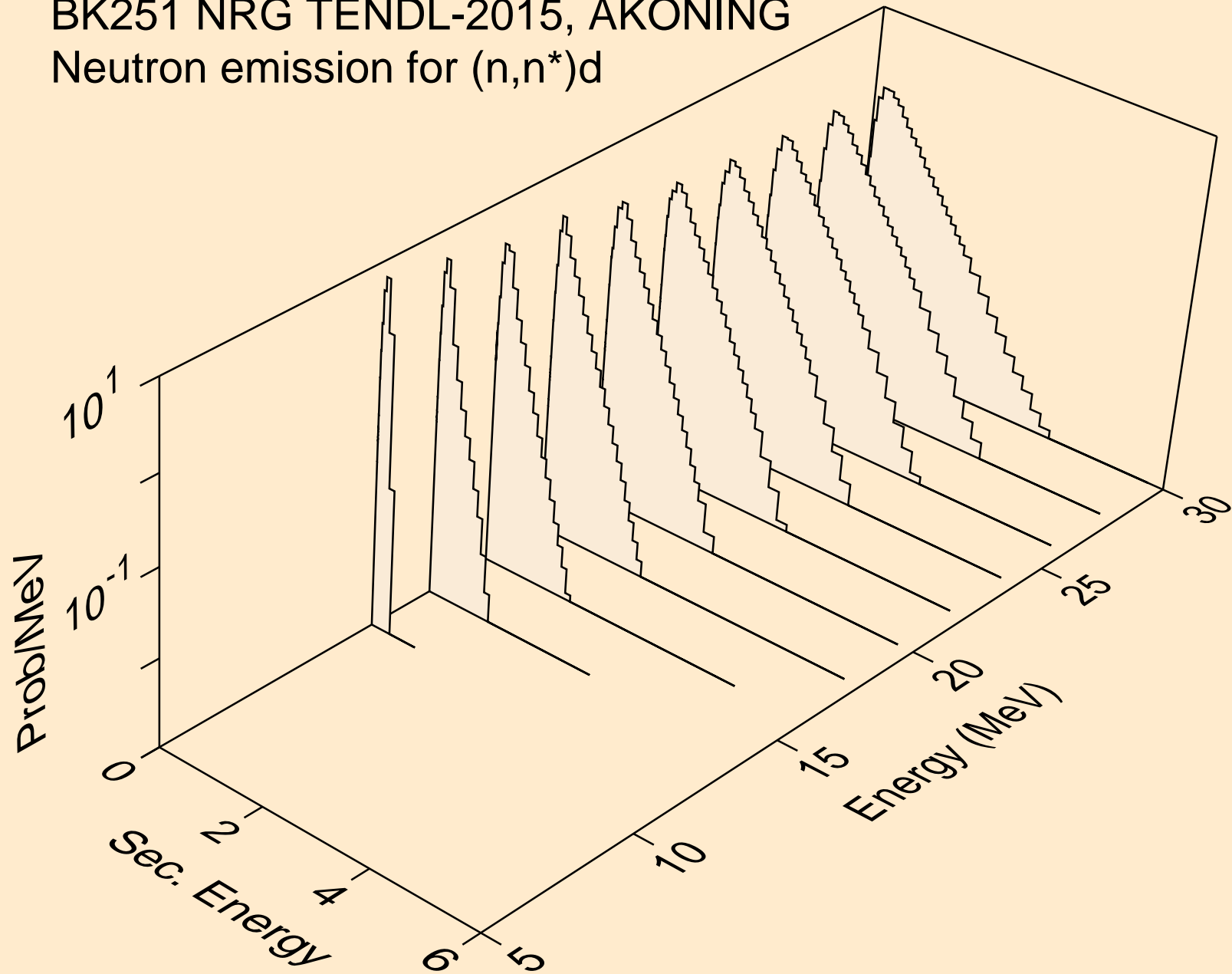

BK251 NRG TENDL-2015, AKONING
Neutron emission for (n,n*)t

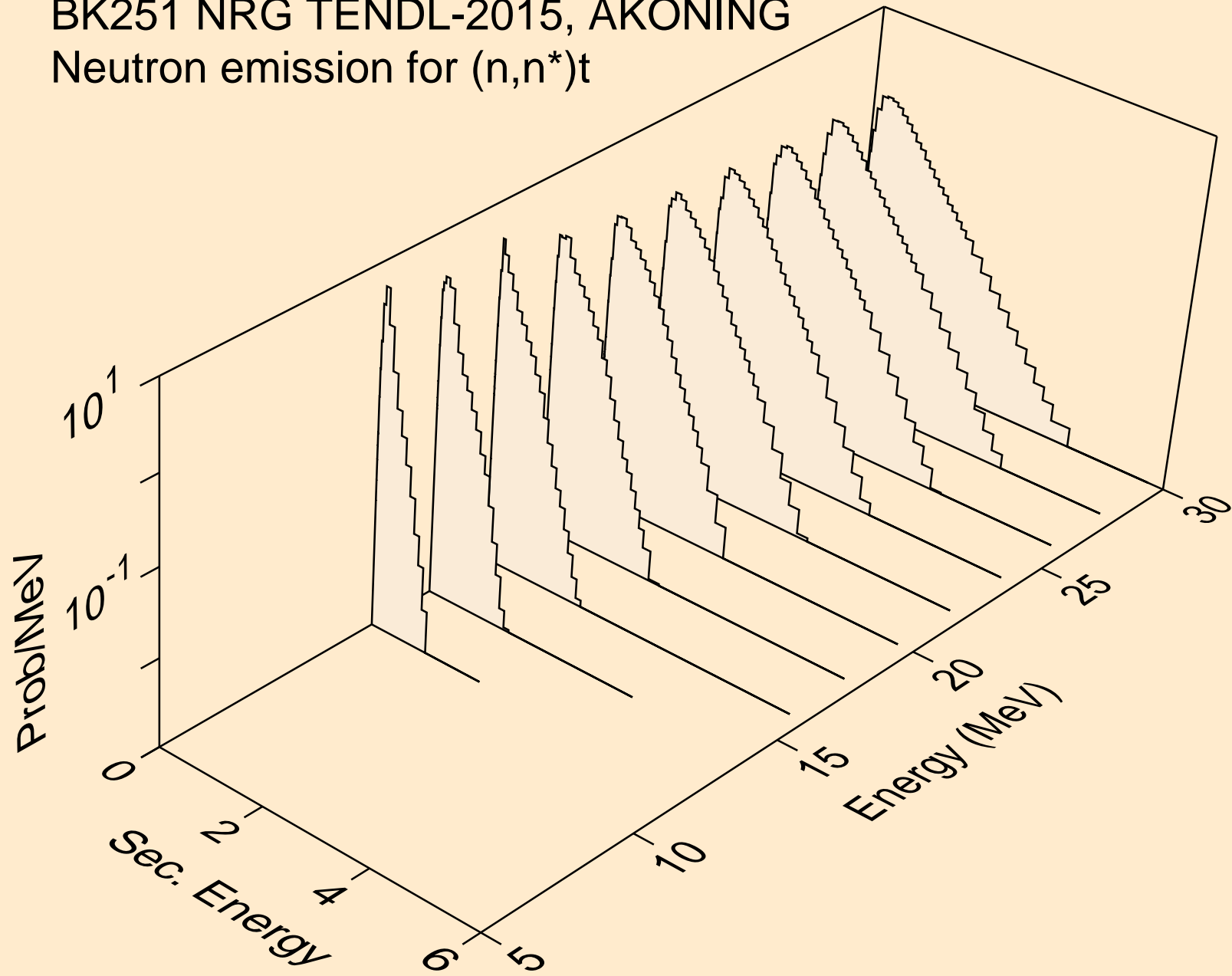

BK251 NRG TENDL-2015, AKONING
Neutron emission for (n,n*)he3

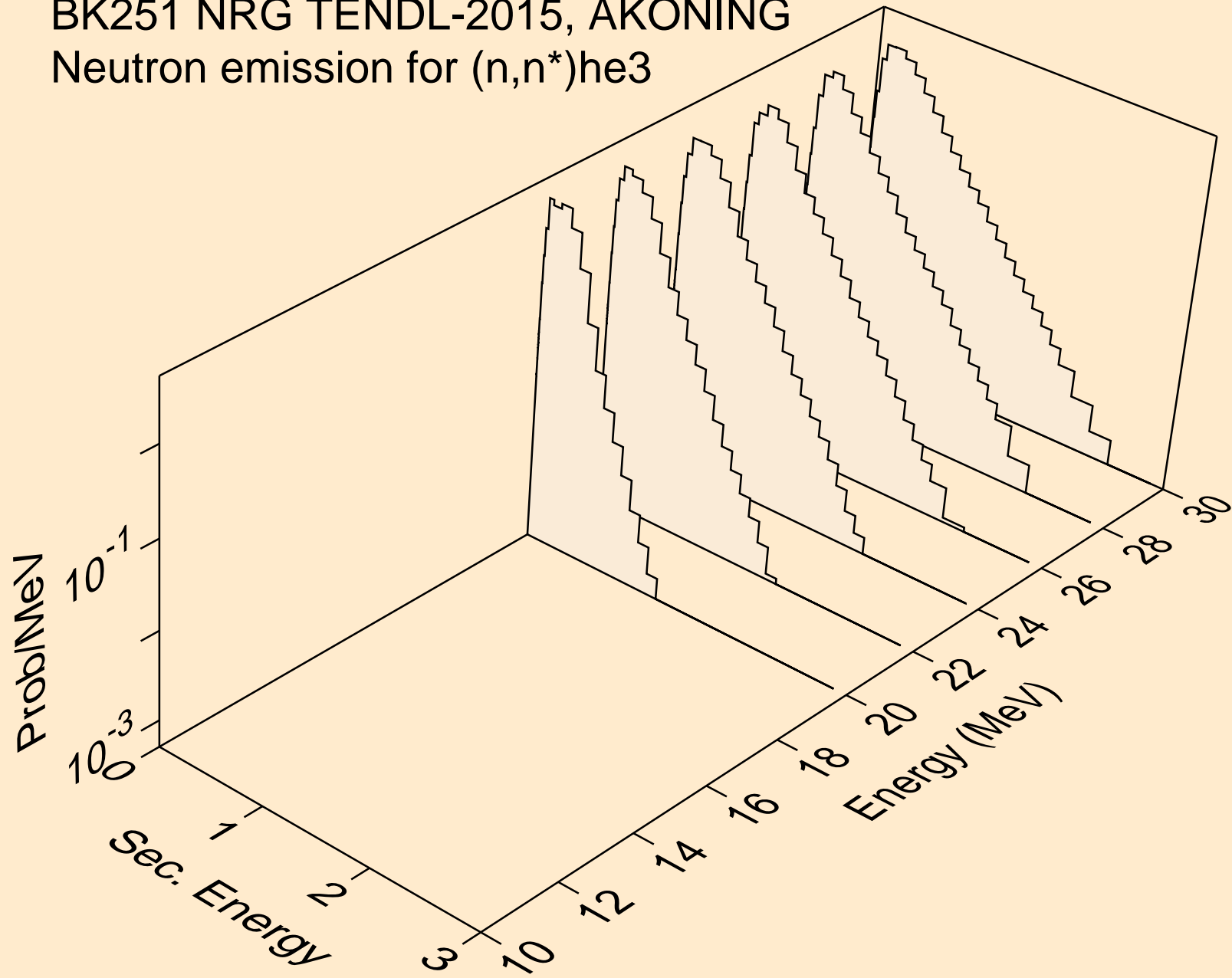

BK251 NRG TENDL-2015, AKONING
Neutron emission for (n,4n)

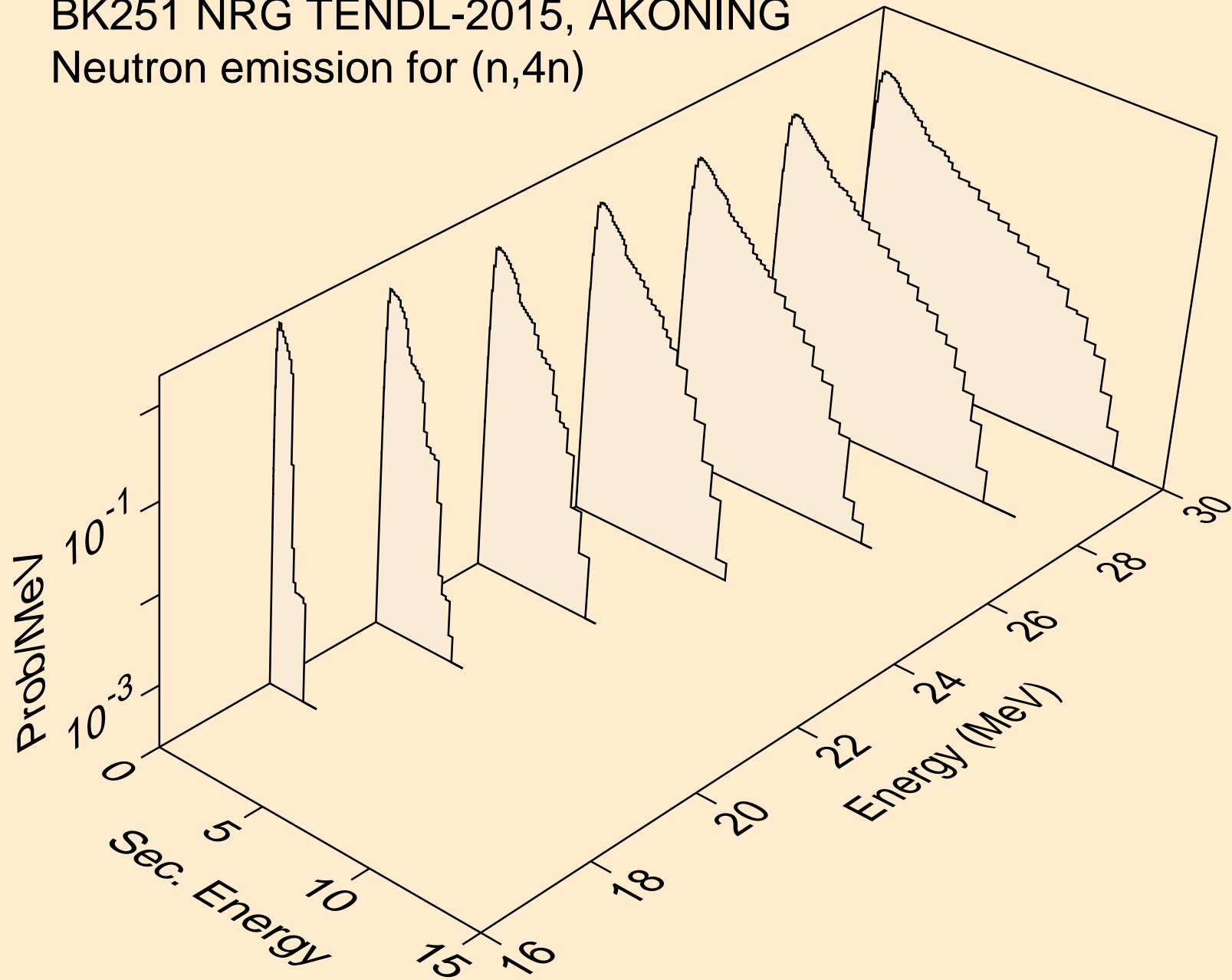

BK251 NRG TENDL-2015, AKONING
Neutron emission for (n,2np)

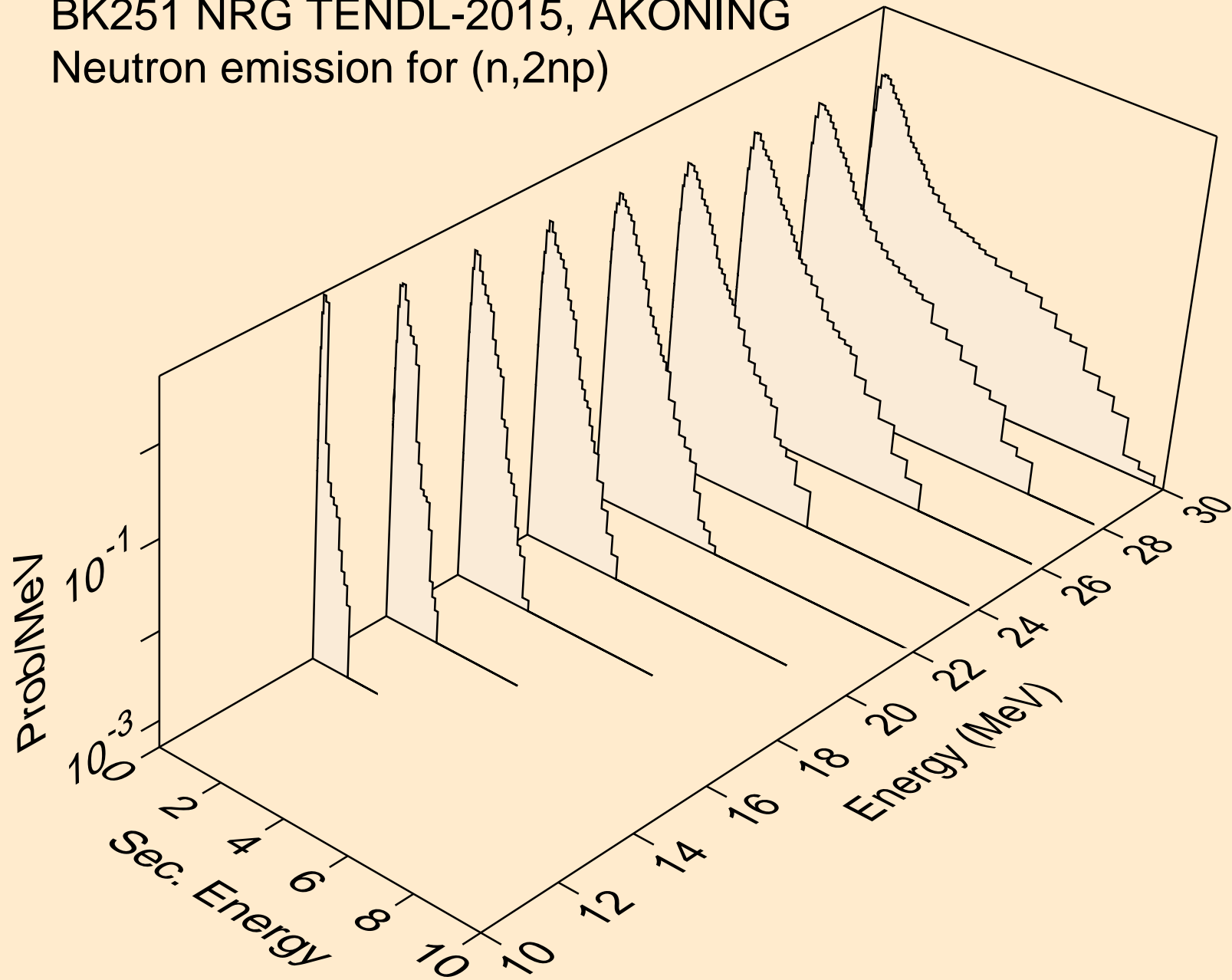

BK251 NRG TENDL-2015, AKONING
Neutron emission for (n,3np)

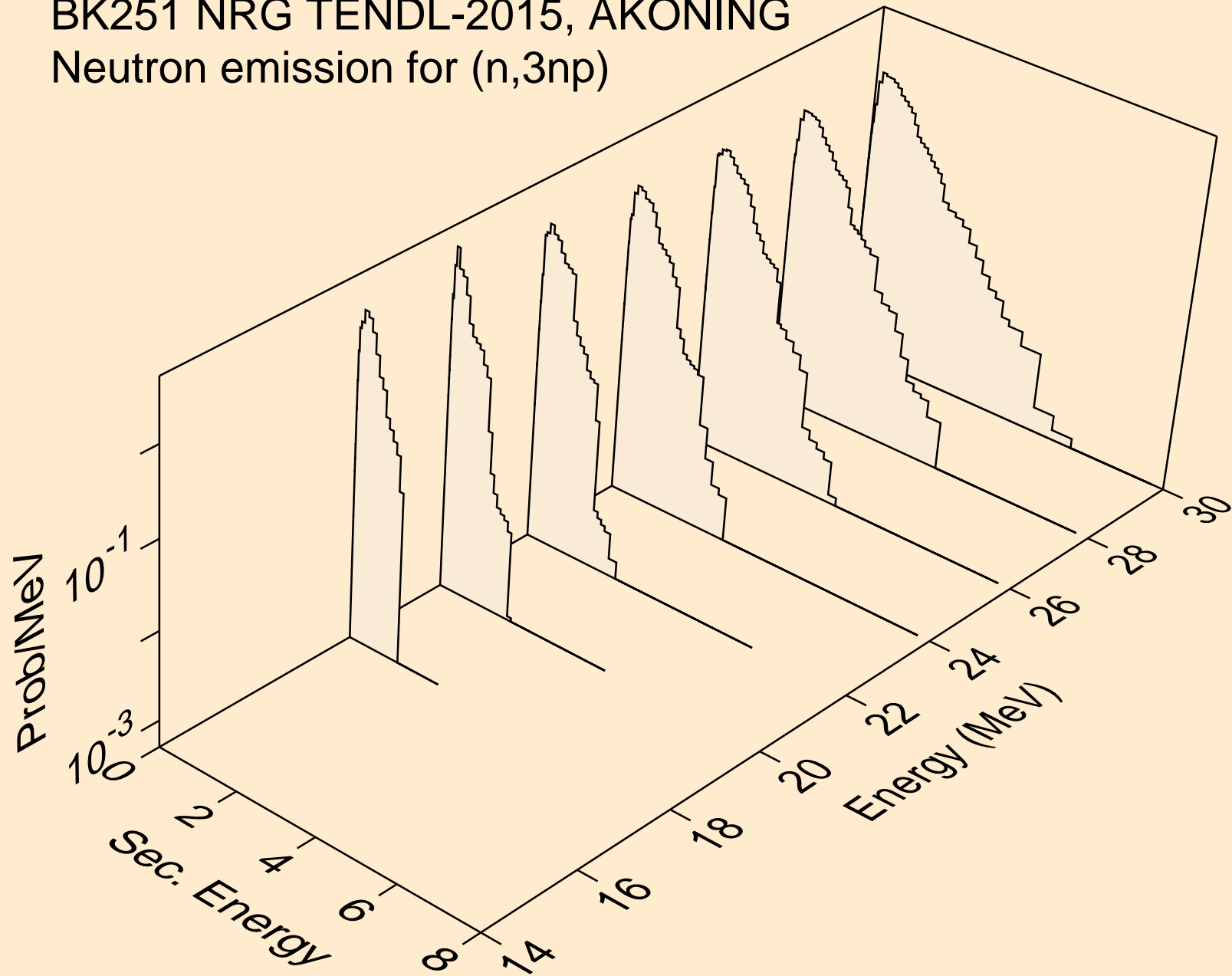

BK251 NRG TENDL-2015, AKONING
Neutron emission for (n,2np)

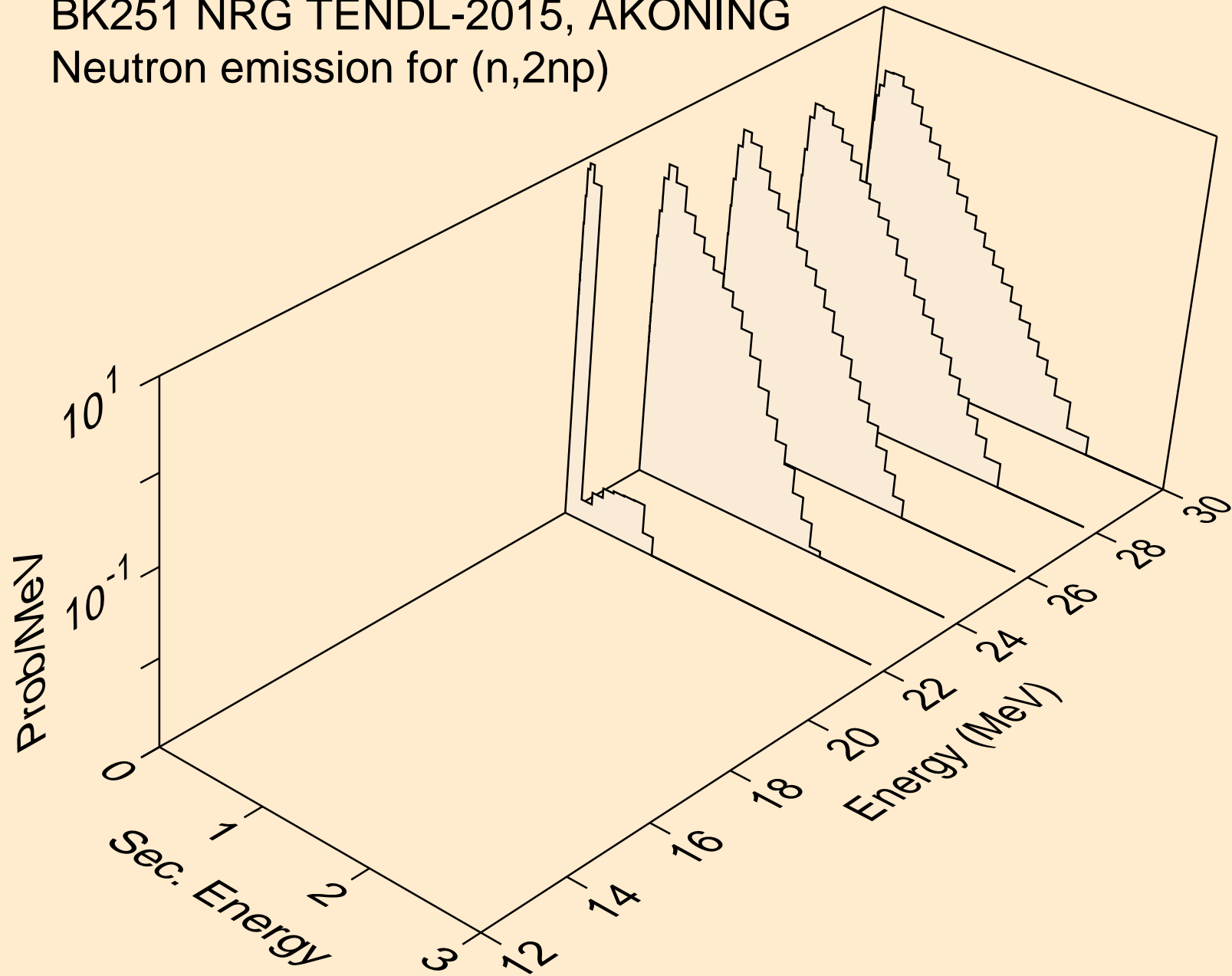

BK251 NRG TENDL-2015, AKONING
Neutron emission for (n,npa)

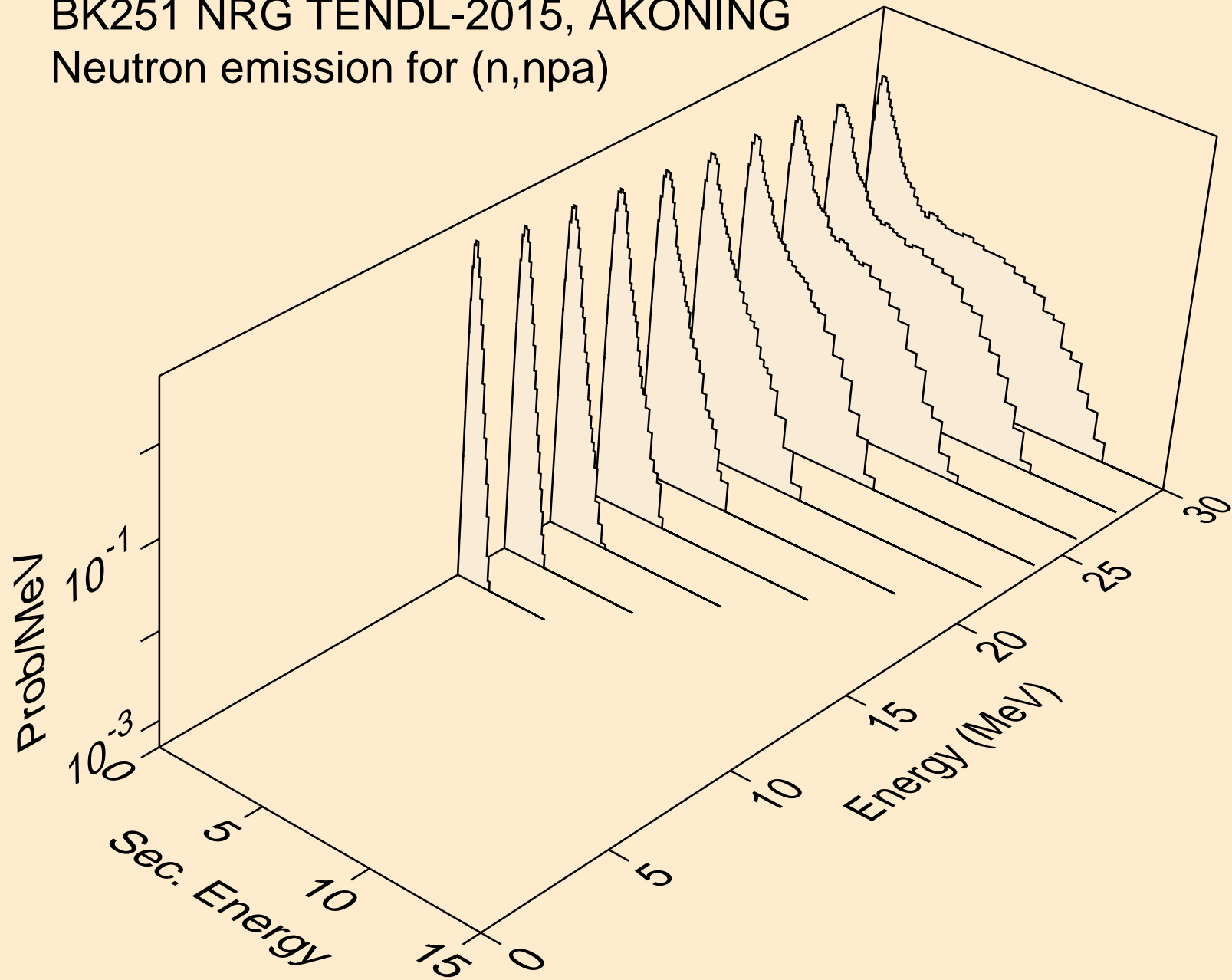

BK251 NRG TENDL-2015, AKONING
Neutron emission for (n,n*c)

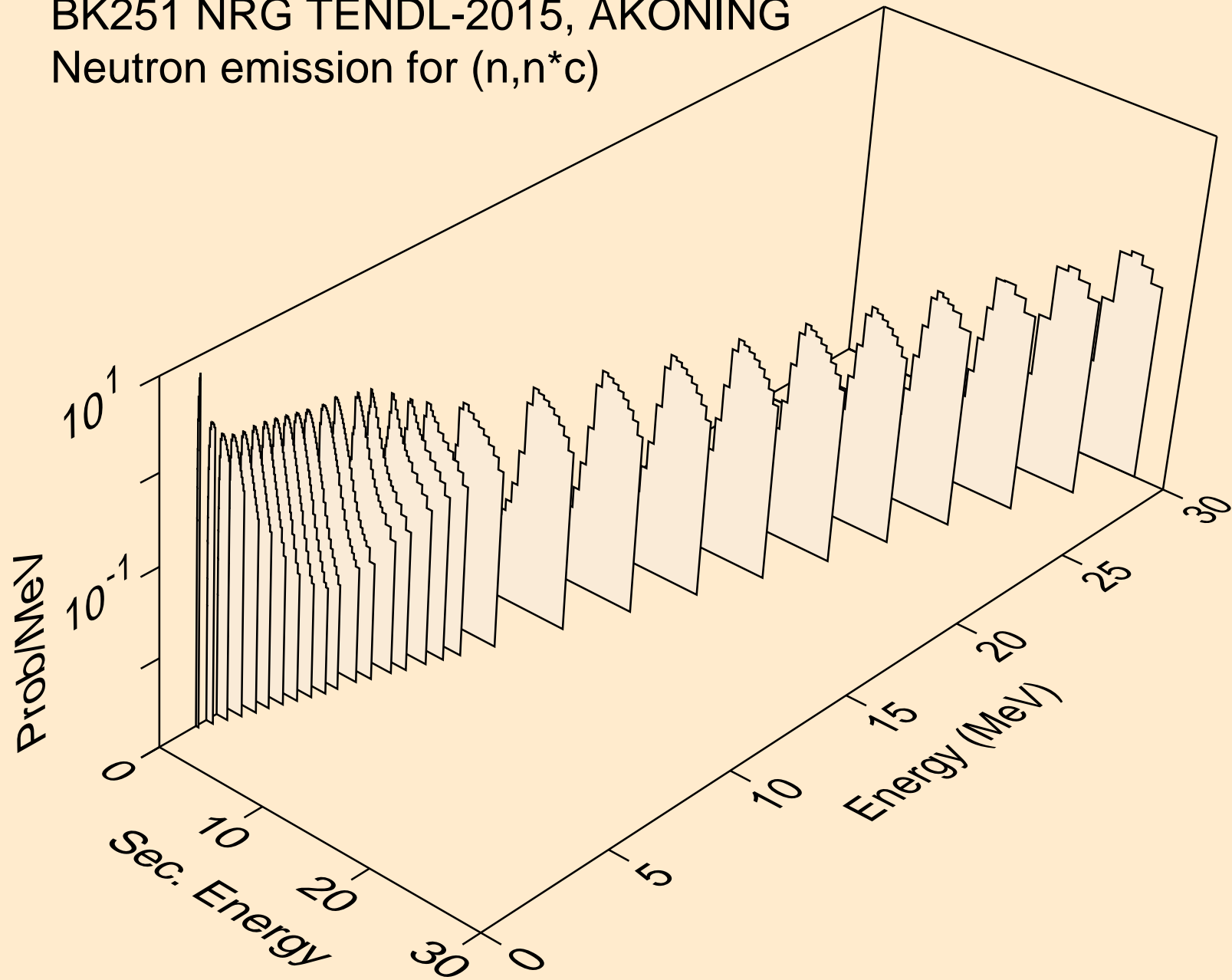

BK251 NRG TENDL-2015, AKONING

Delayed nubar

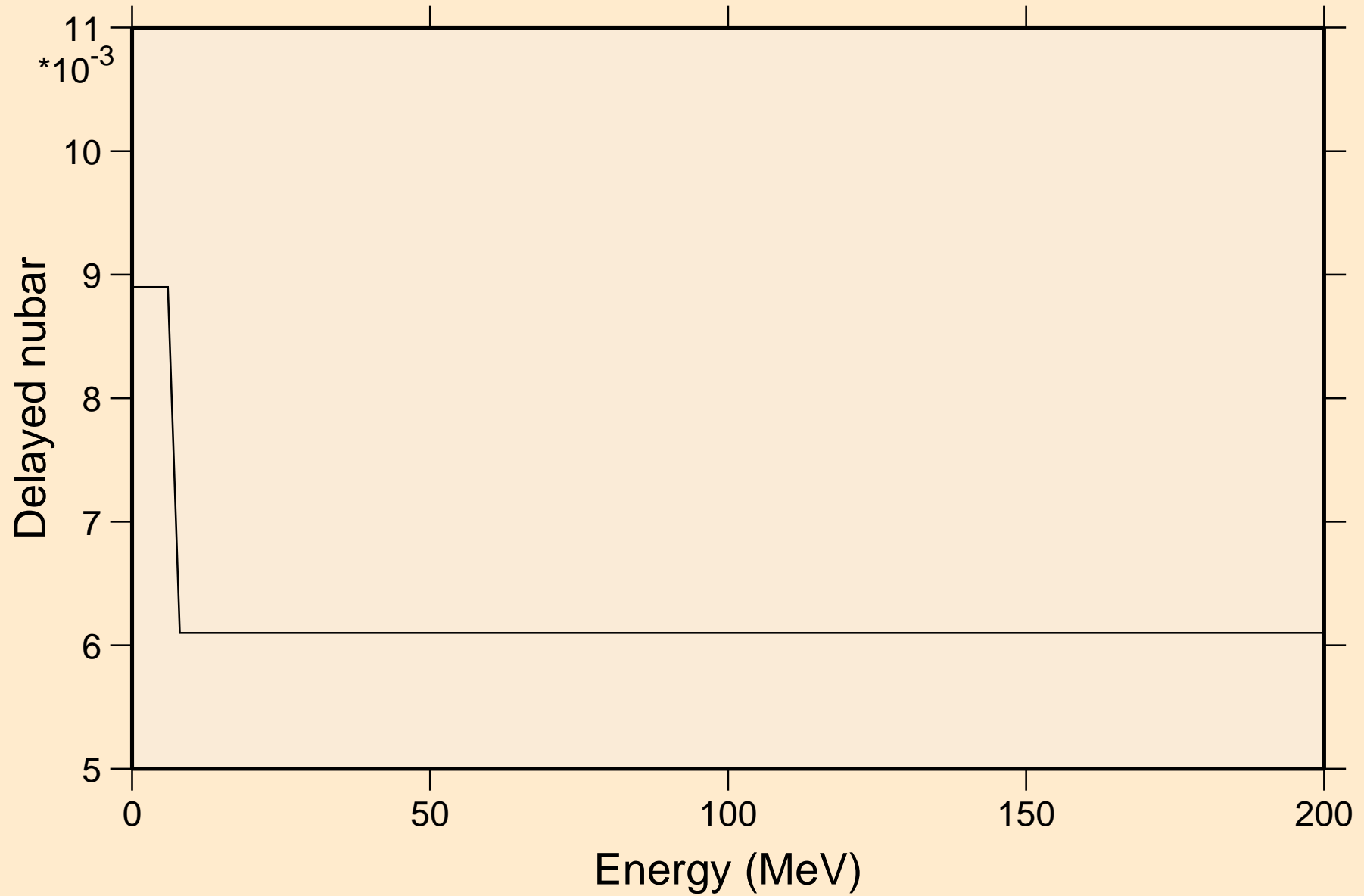

BK251 NRG TENDL-2015, AKONING

Delayed neutron spectra

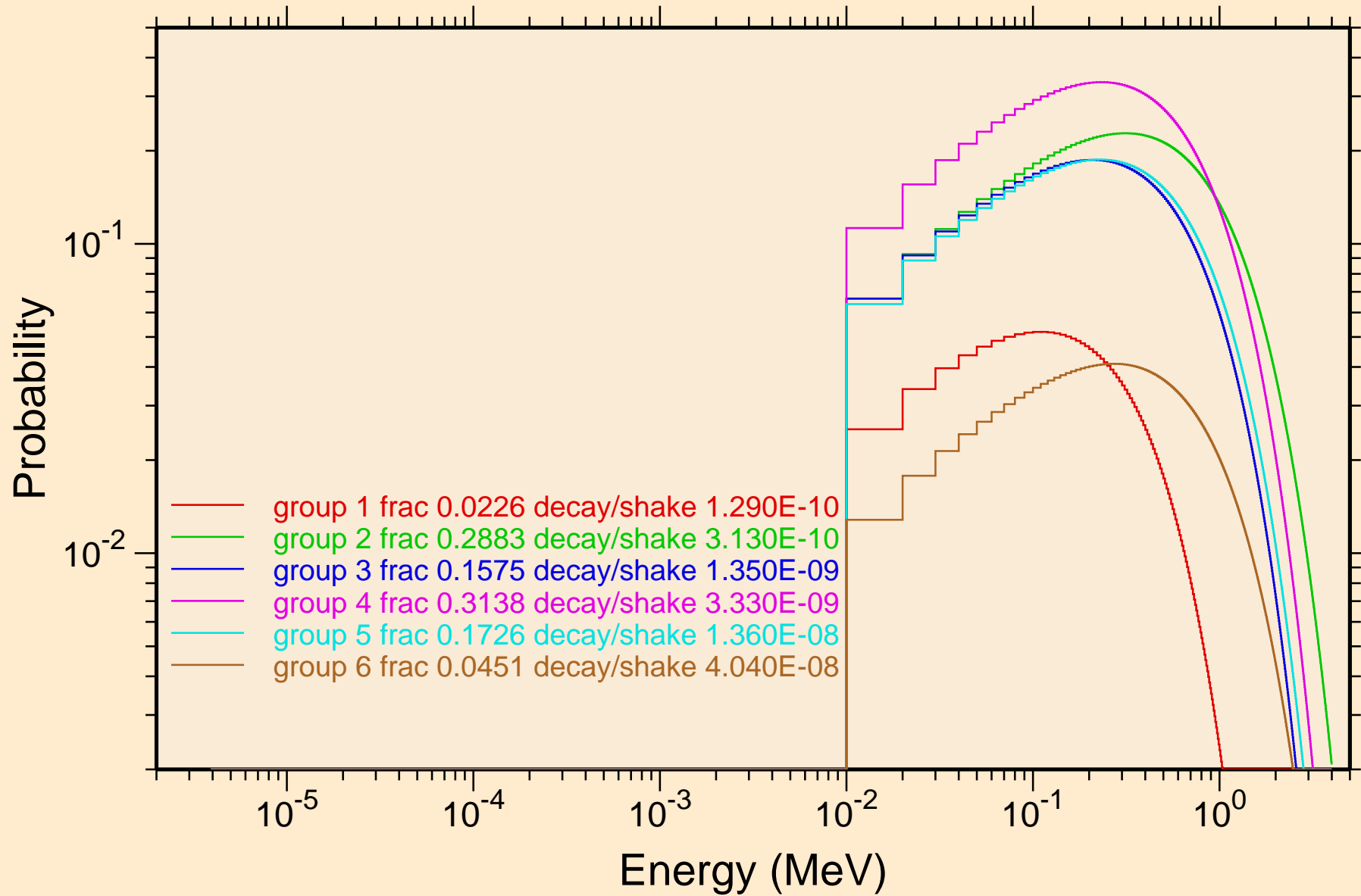

BK251 NRG TENDL-2015, AKONING
Photon emission for (n,x)

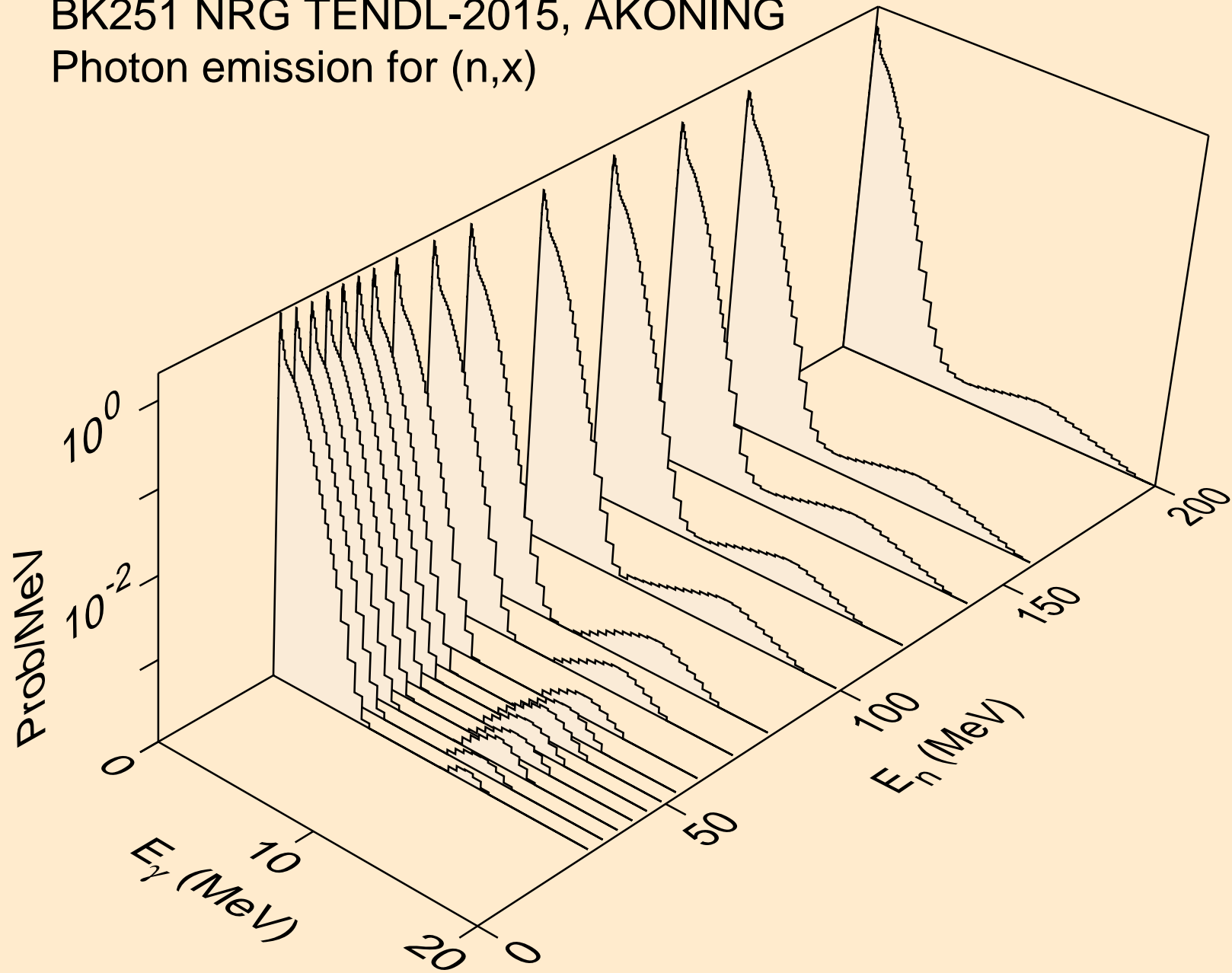

BK251 NRG TENDL-2015, AKONING
Photon emission for (n,2nd)

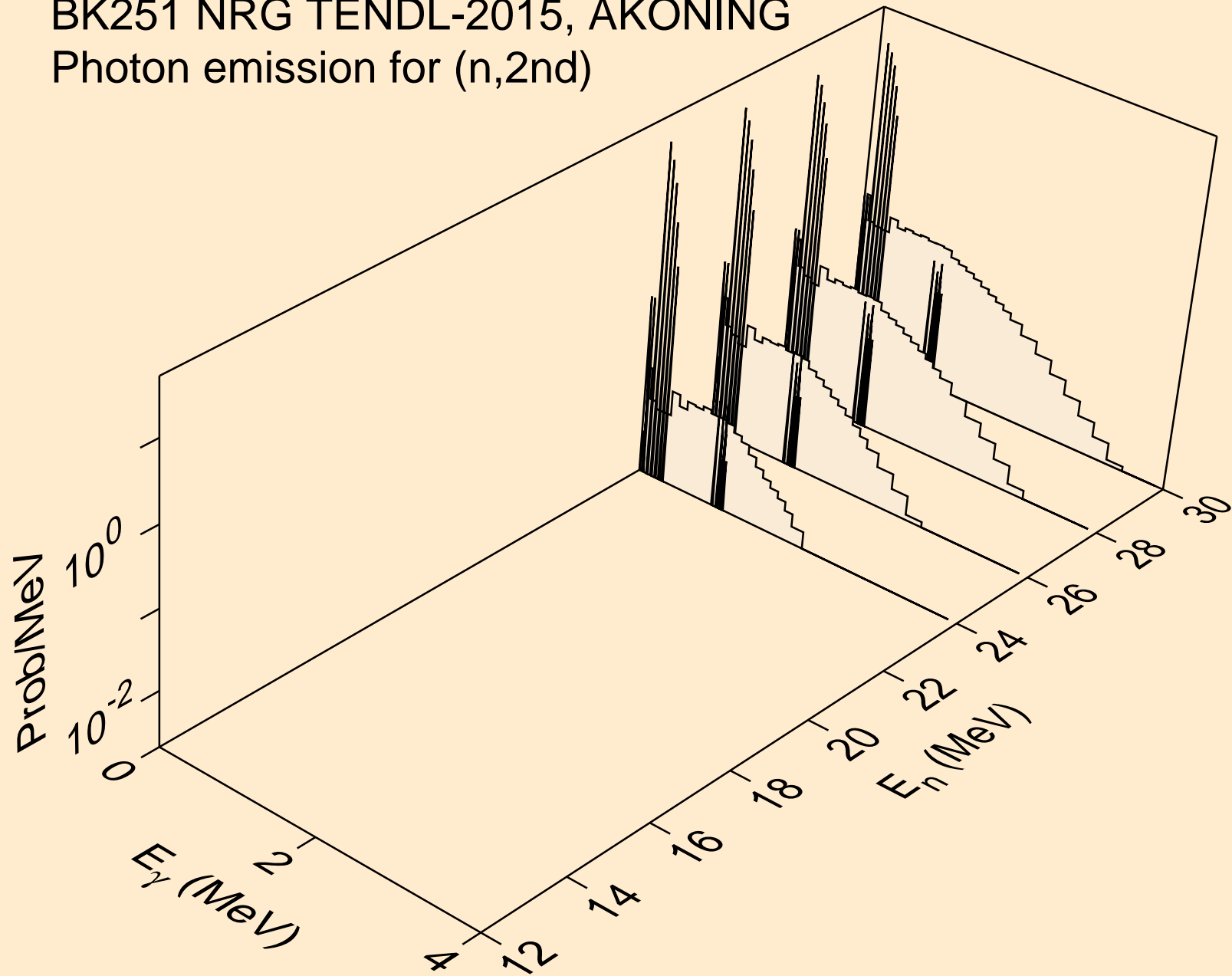

BK251 NRG TENDL-2015, AKONING
Photon emission for (n,2n)

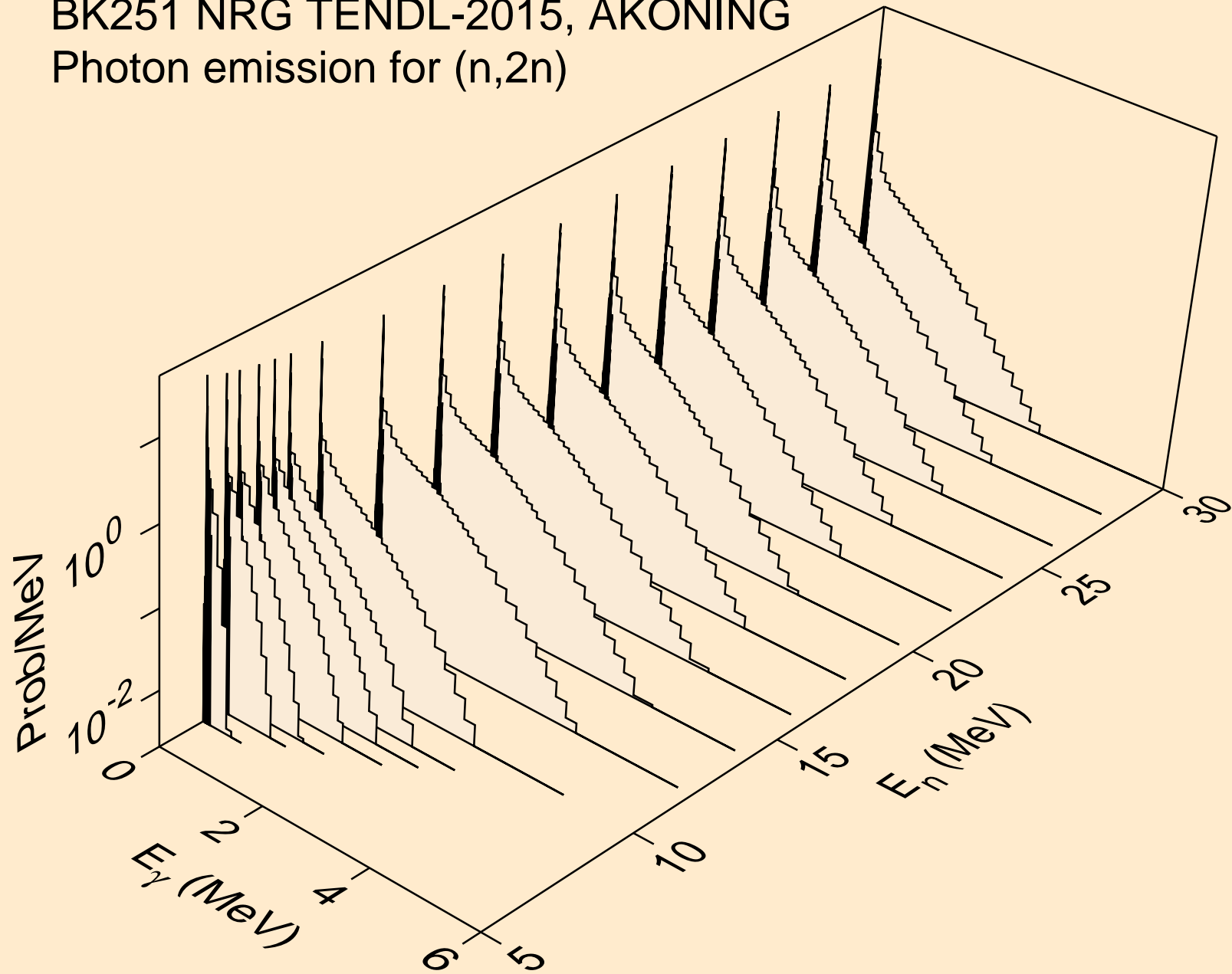

BK251 NRG TENDL-2015, AKONING
Photon emission for (n,3n)

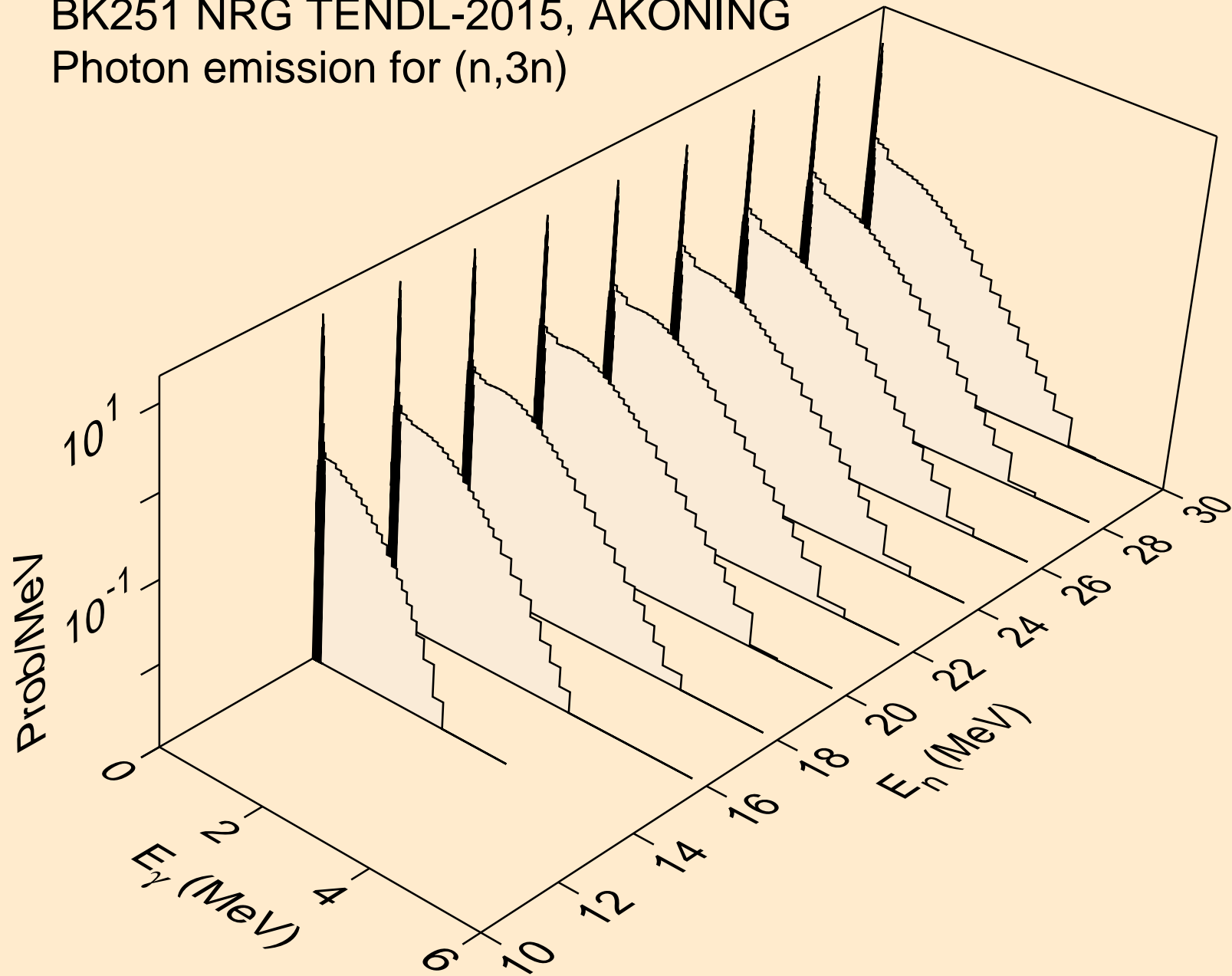

BK251 NRG TENDL-2015, AKONING
Photon emission for (n,n*)a

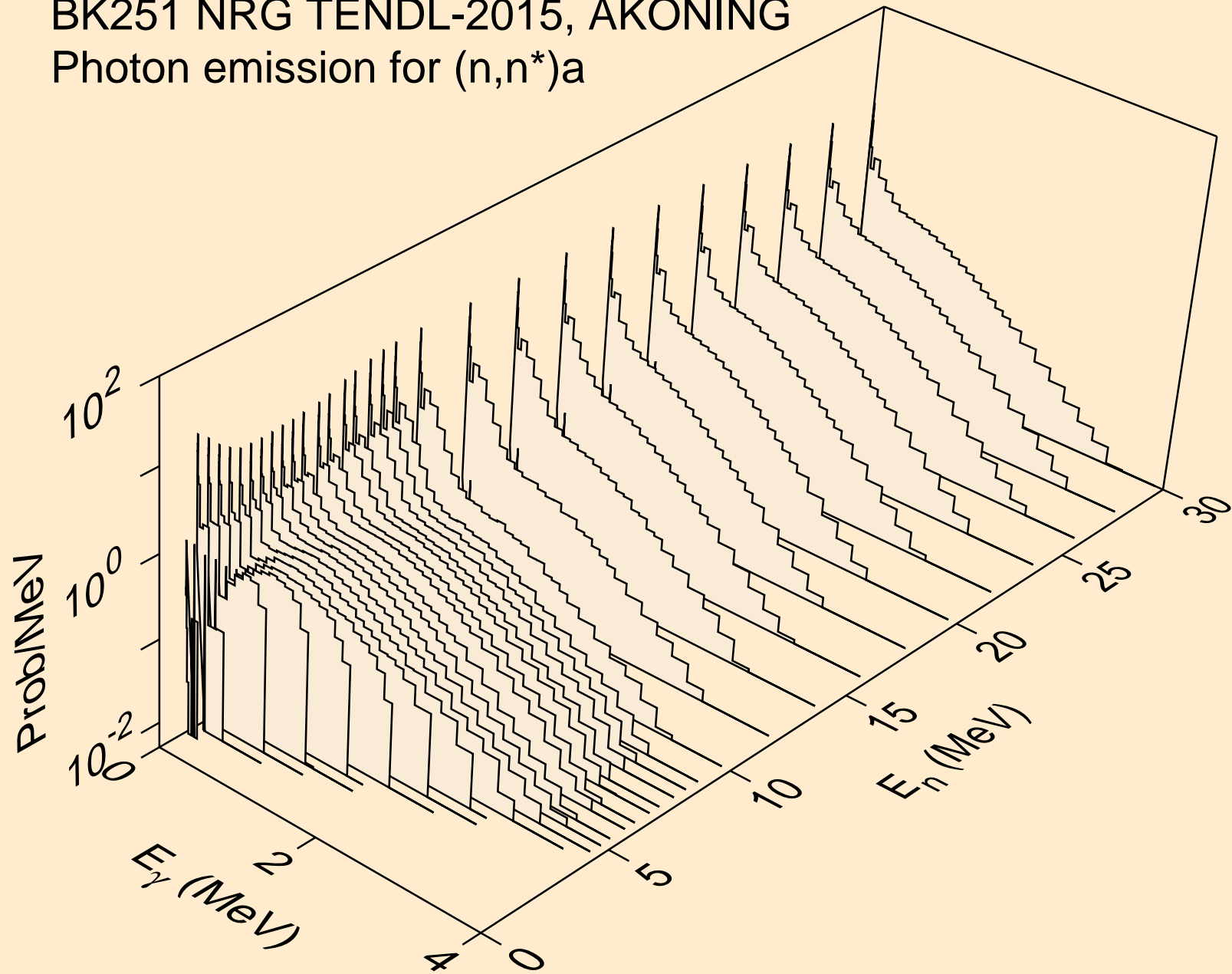

BK251 NRG TENDL-2015, AKONING
Photon emission for (n,2n)a

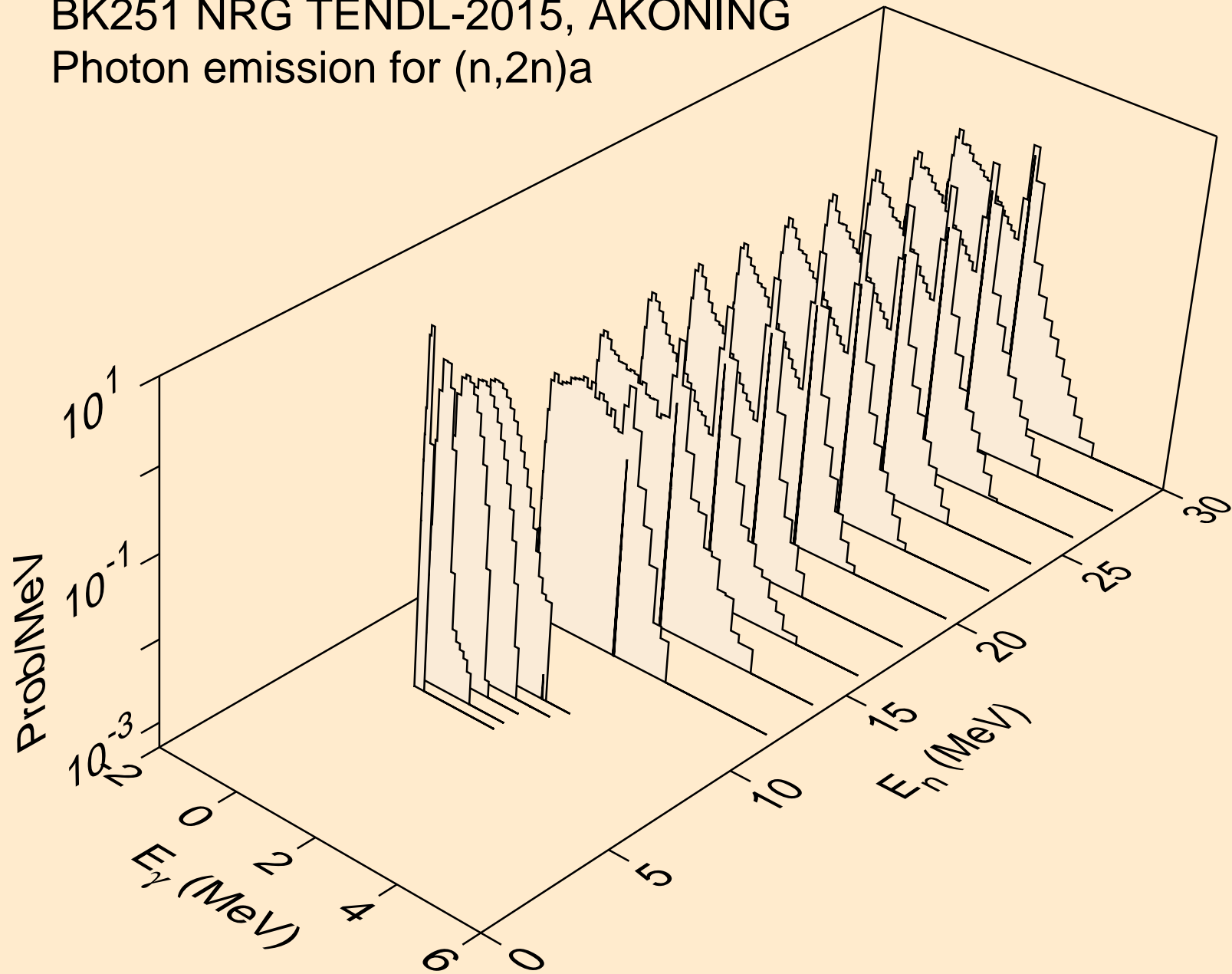

BK251 NRG TENDL-2015, AKONING
Photon emission for (n,3n)a

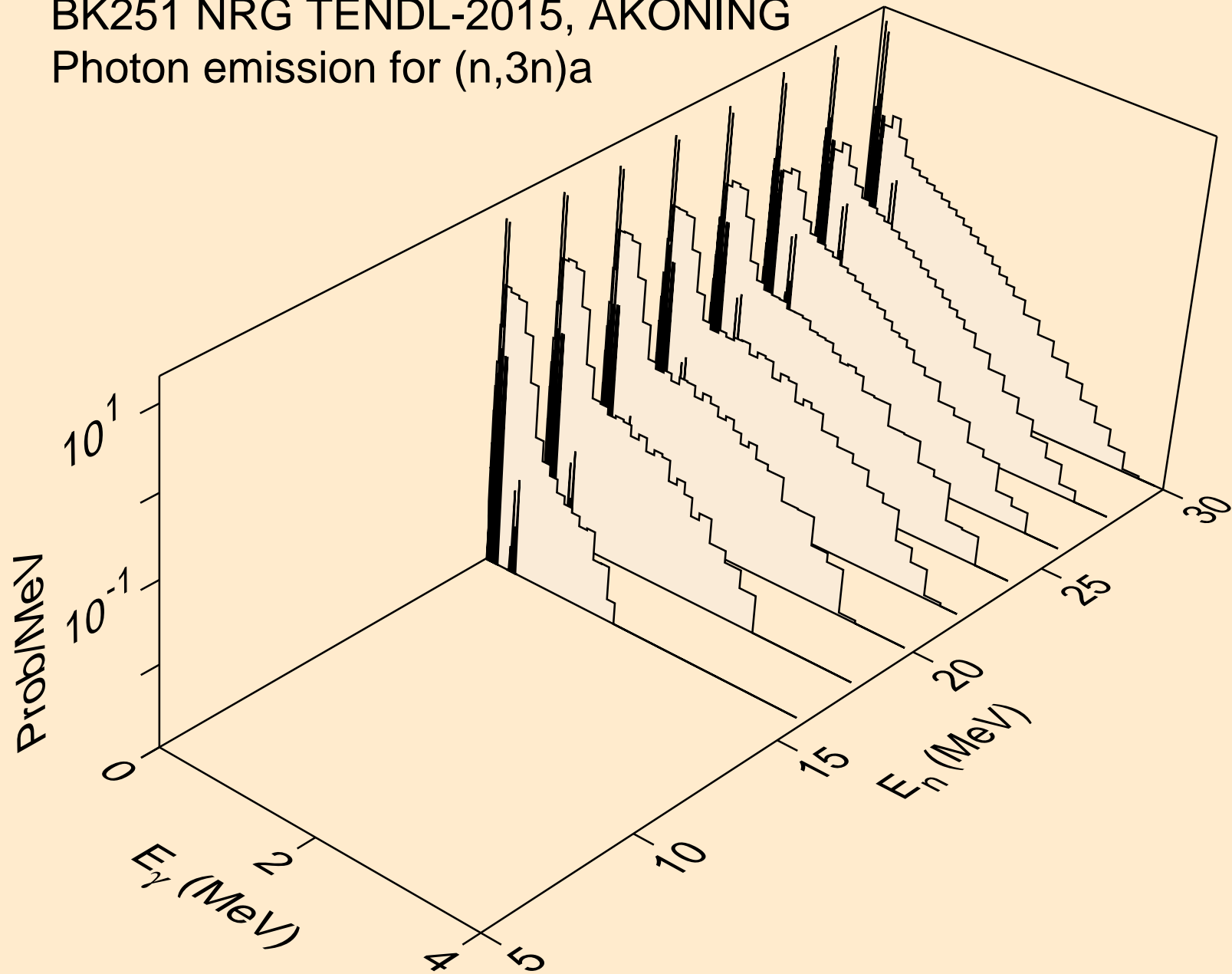

BK251 NRG TENDL-2015, AKONING
Photon emission for (n,n*)p

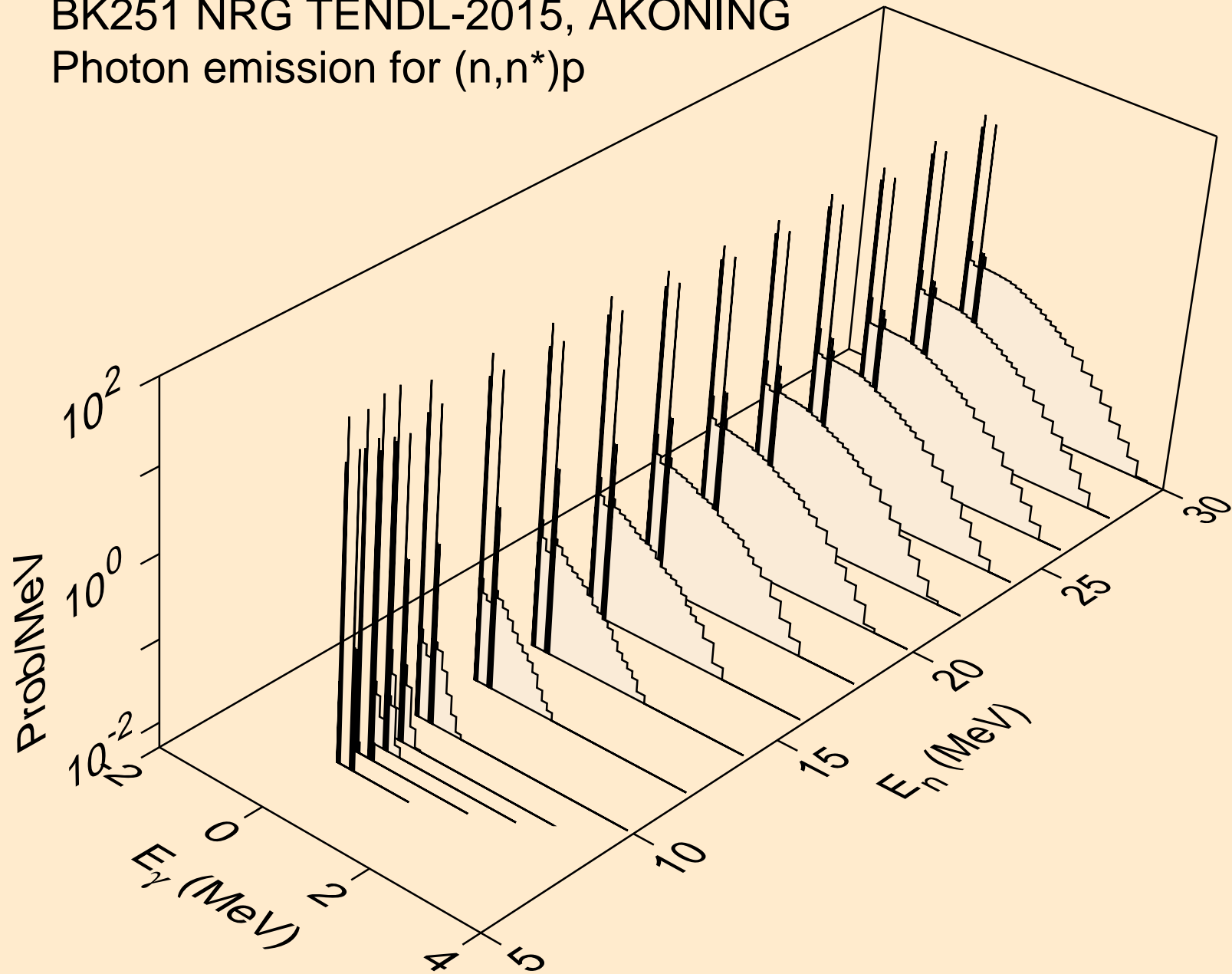

BK251 NRG TENDL-2015, AKONING
Photon emission for (n,n*)2a

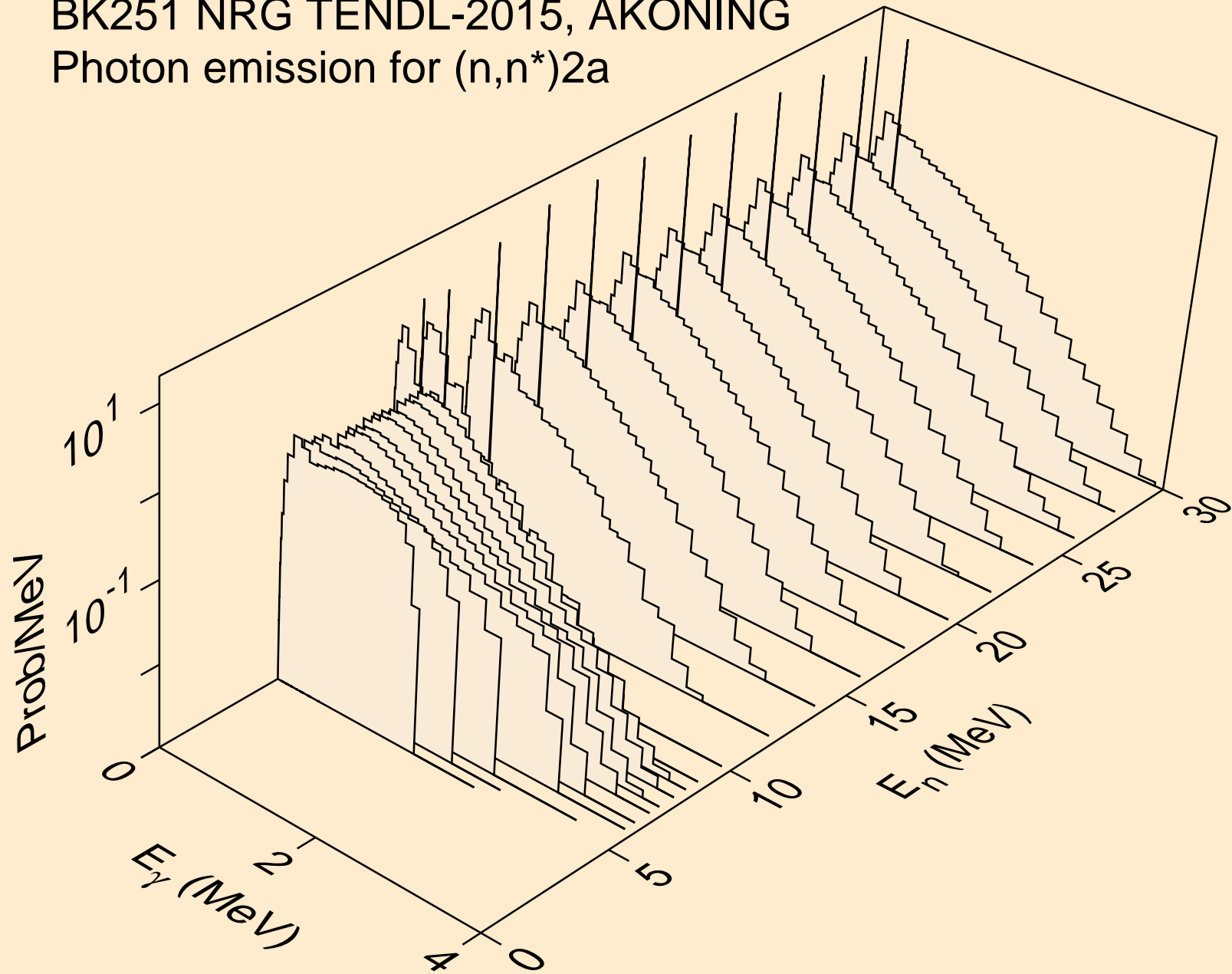

BK251 NRG TENDL-2015, AKONING
Photon emission for (n,2n)2a

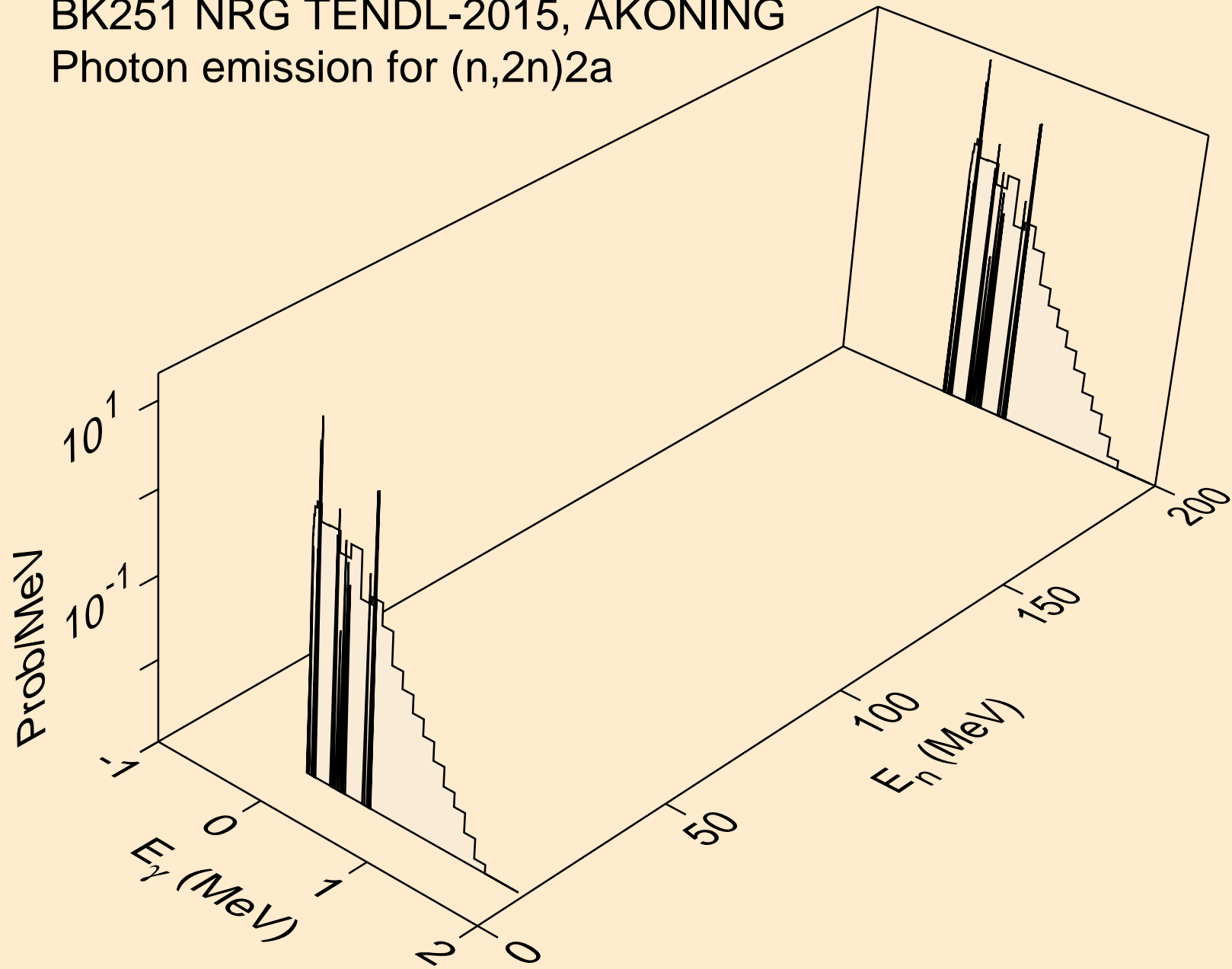

BK251 NRG TENDL-2015, AKONING
Photon emission for (n,n*)d

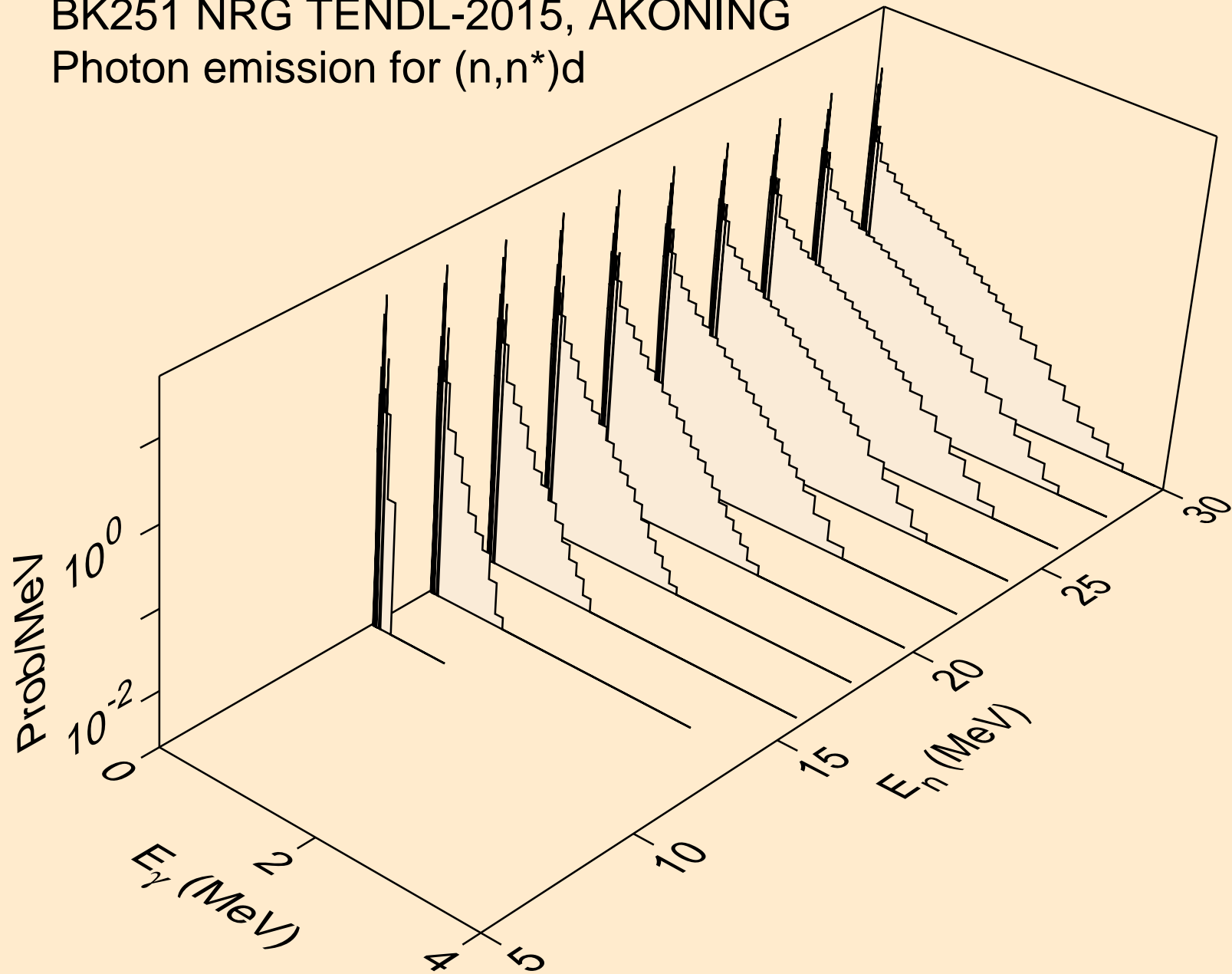

BK251 NRG TENDL-2015, AKONING
Photon emission for (n,n*)t

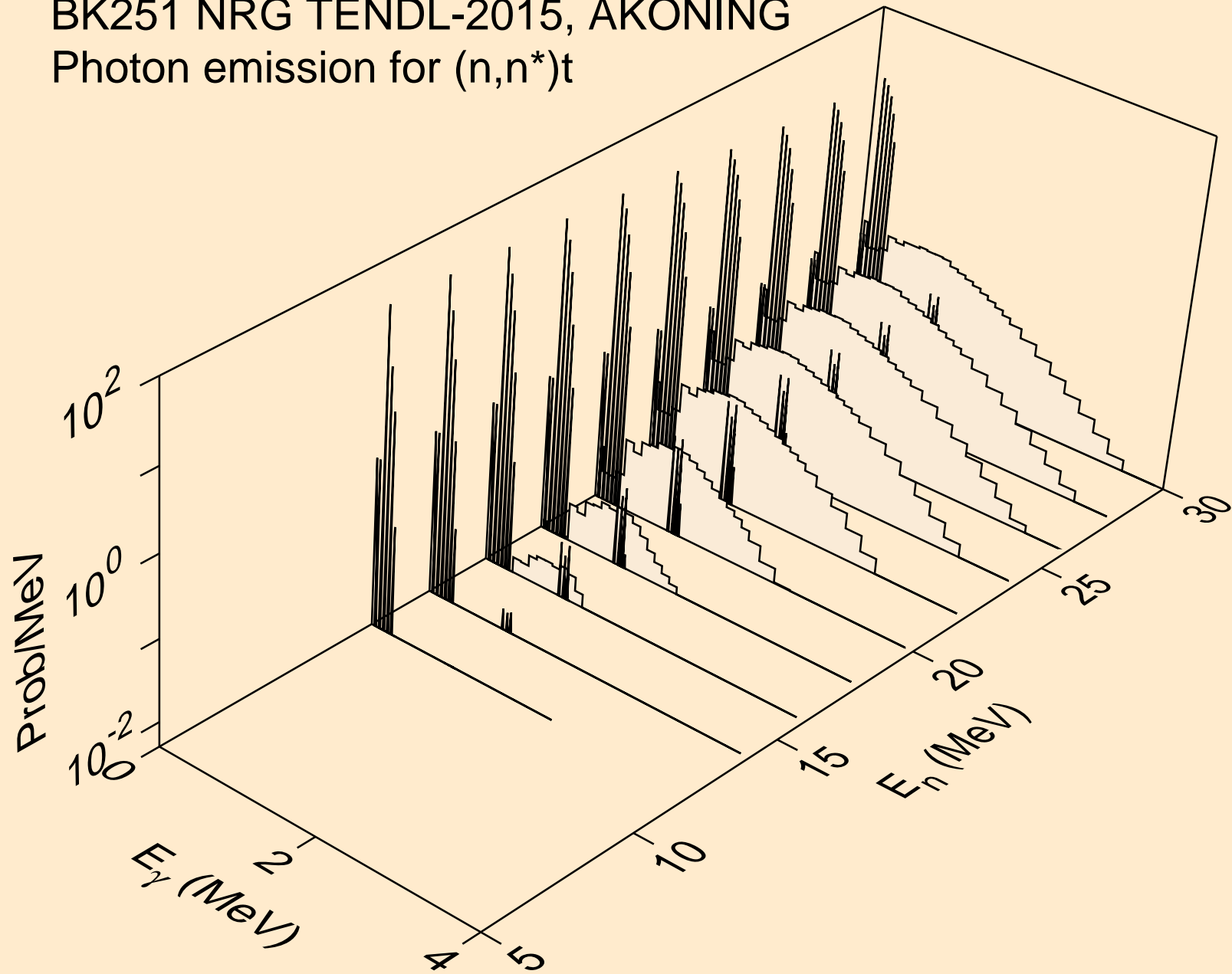

BK251 NRG TENDL-2015, AKONING
Photon emission for (n,n*)he3

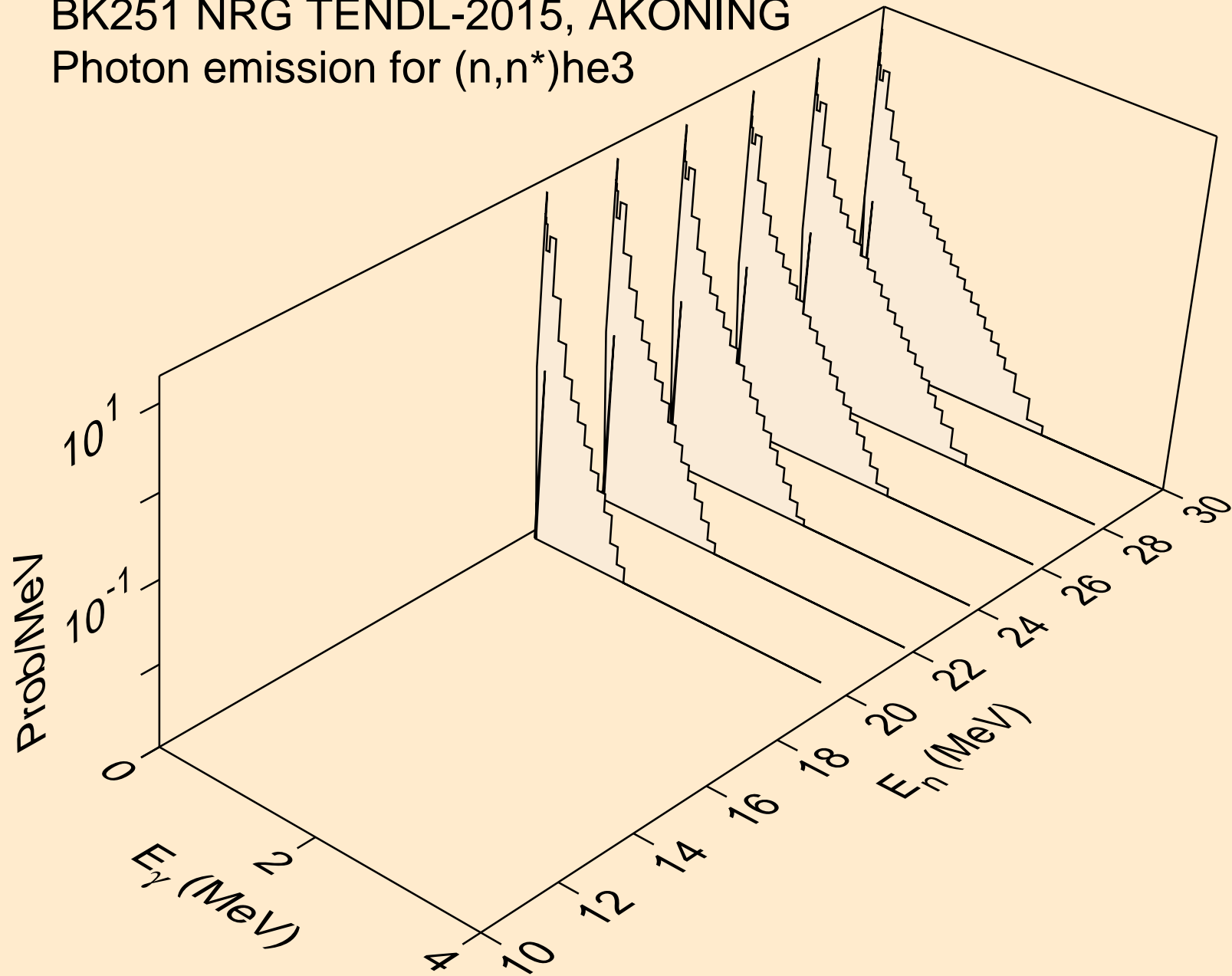

BK251 NRG TENDL-2015, AKONING
Photon emission for (n,4n)

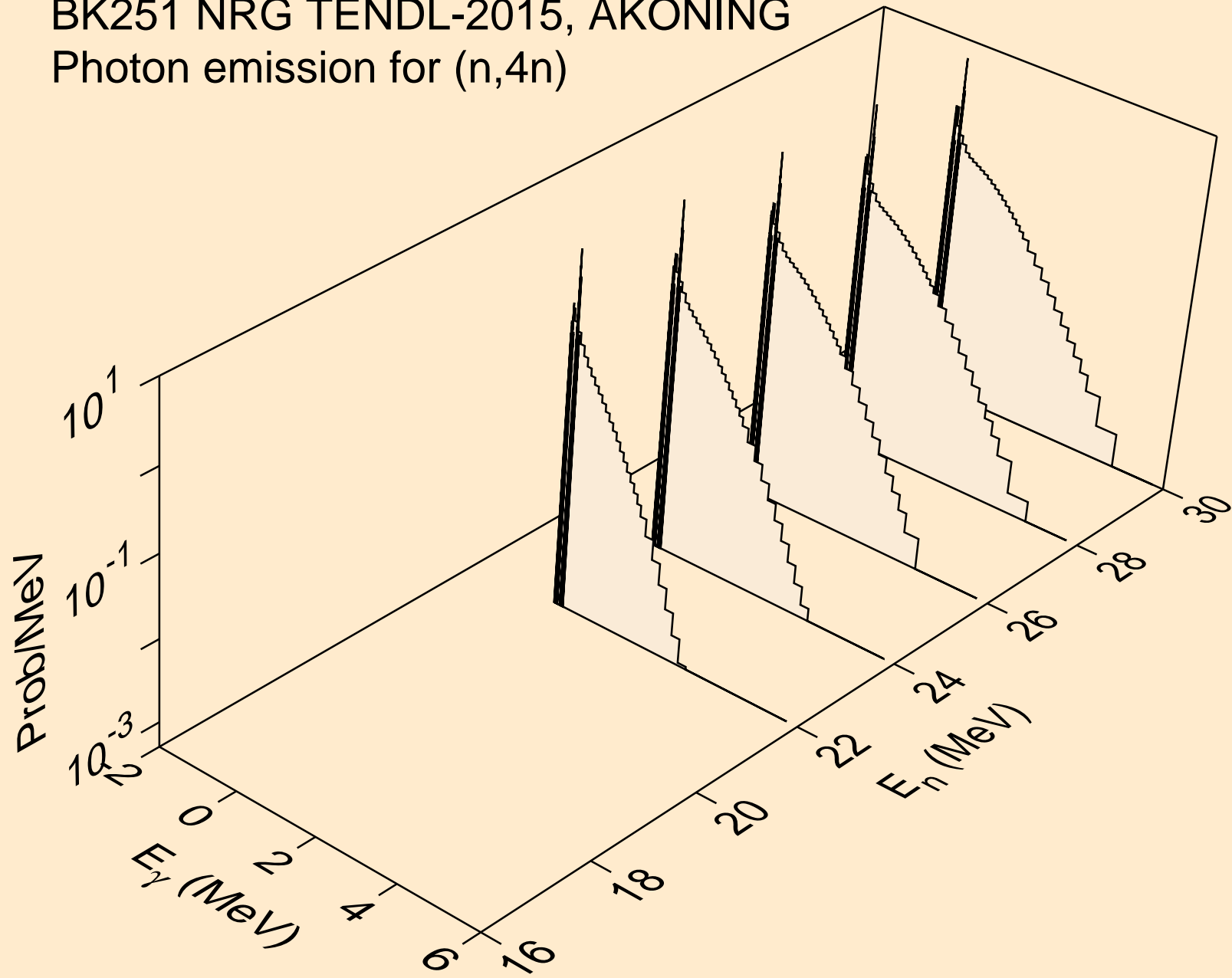

BK251 NRG TENDL-2015, AKONING
Photon emission for (n,2np)

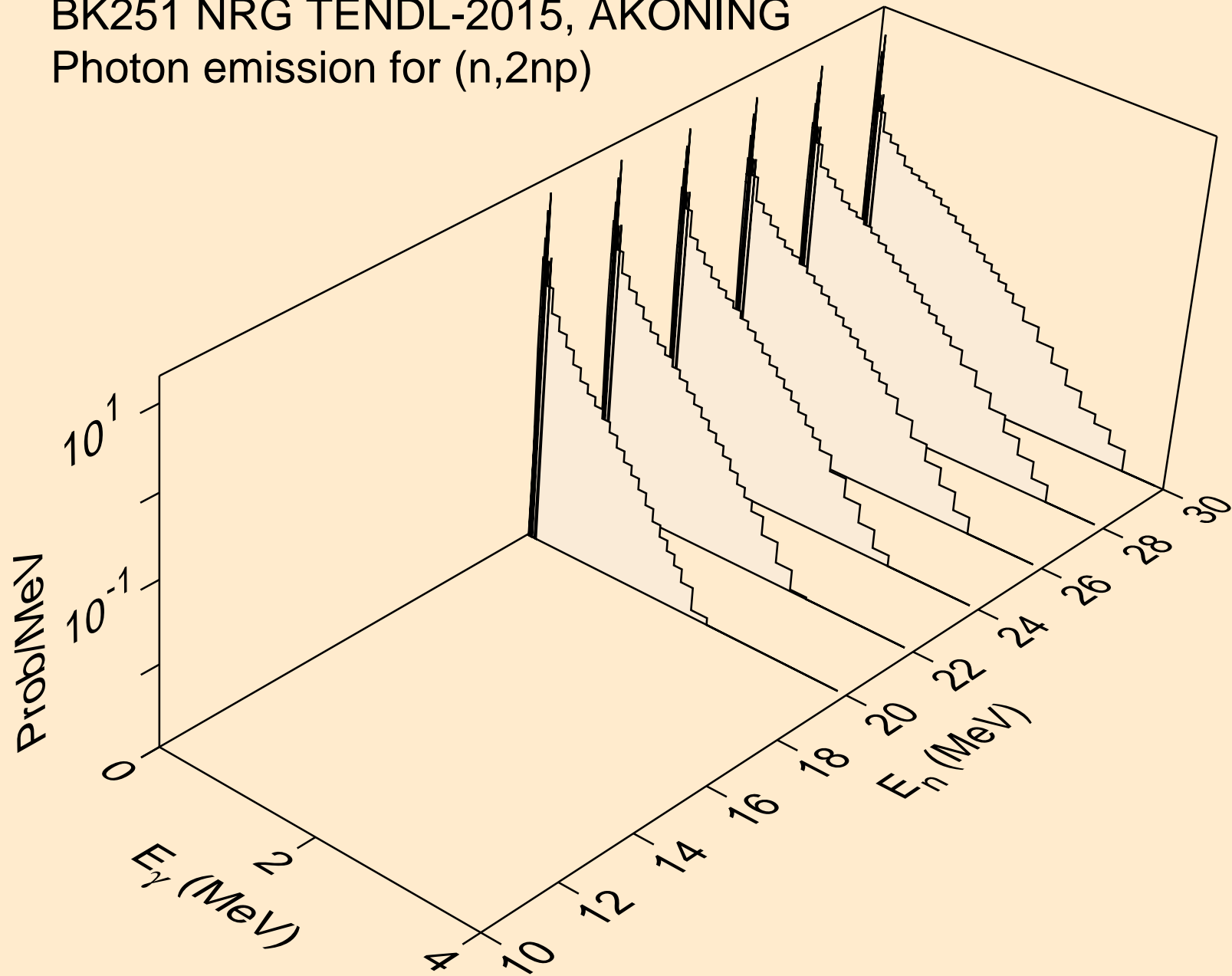

BK251 NRG TENDL-2015, AKONING
Photon emission for (n,3np)

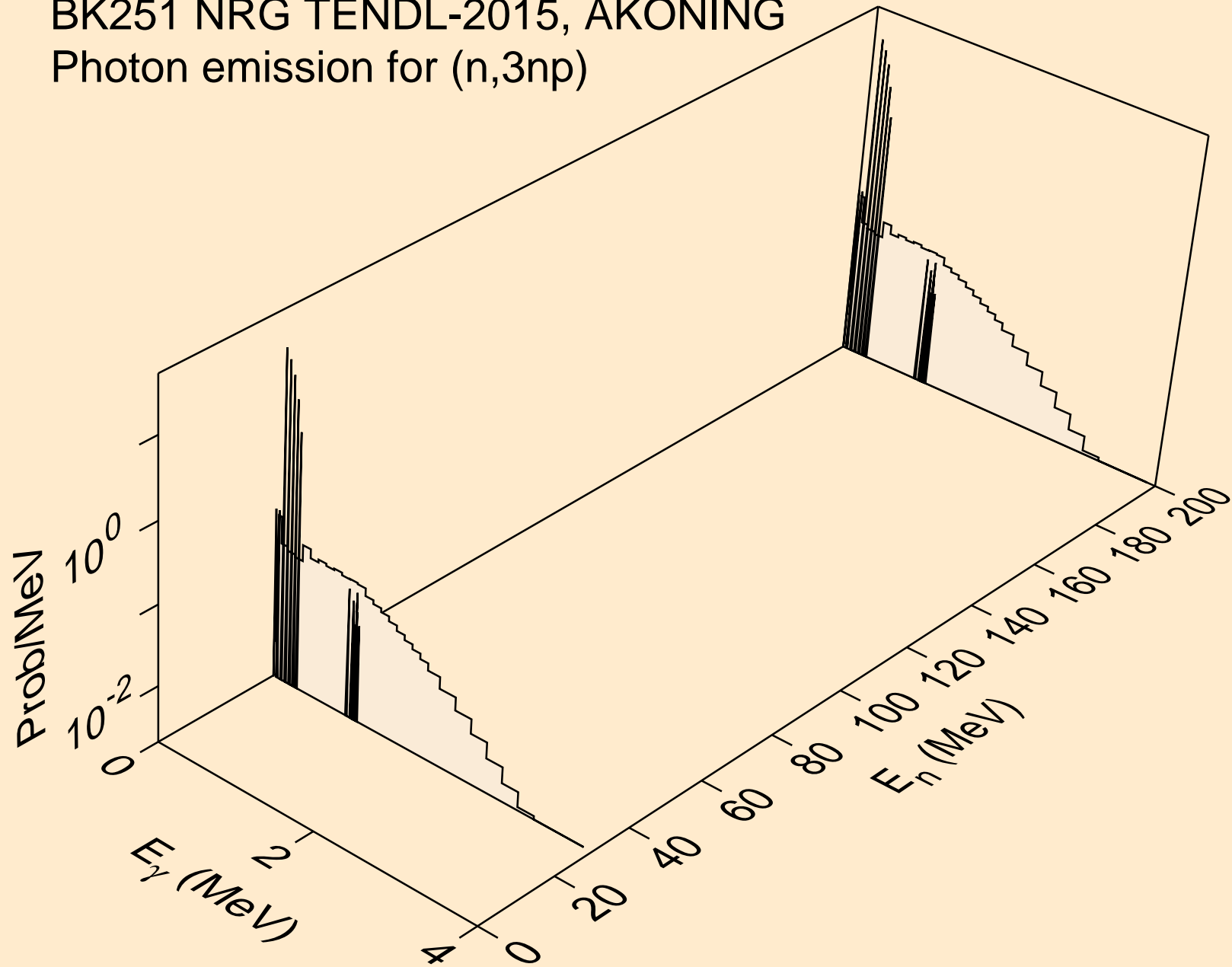

BK251 NRG TENDL-2015, AKONING
Photon emission for (n,2np)

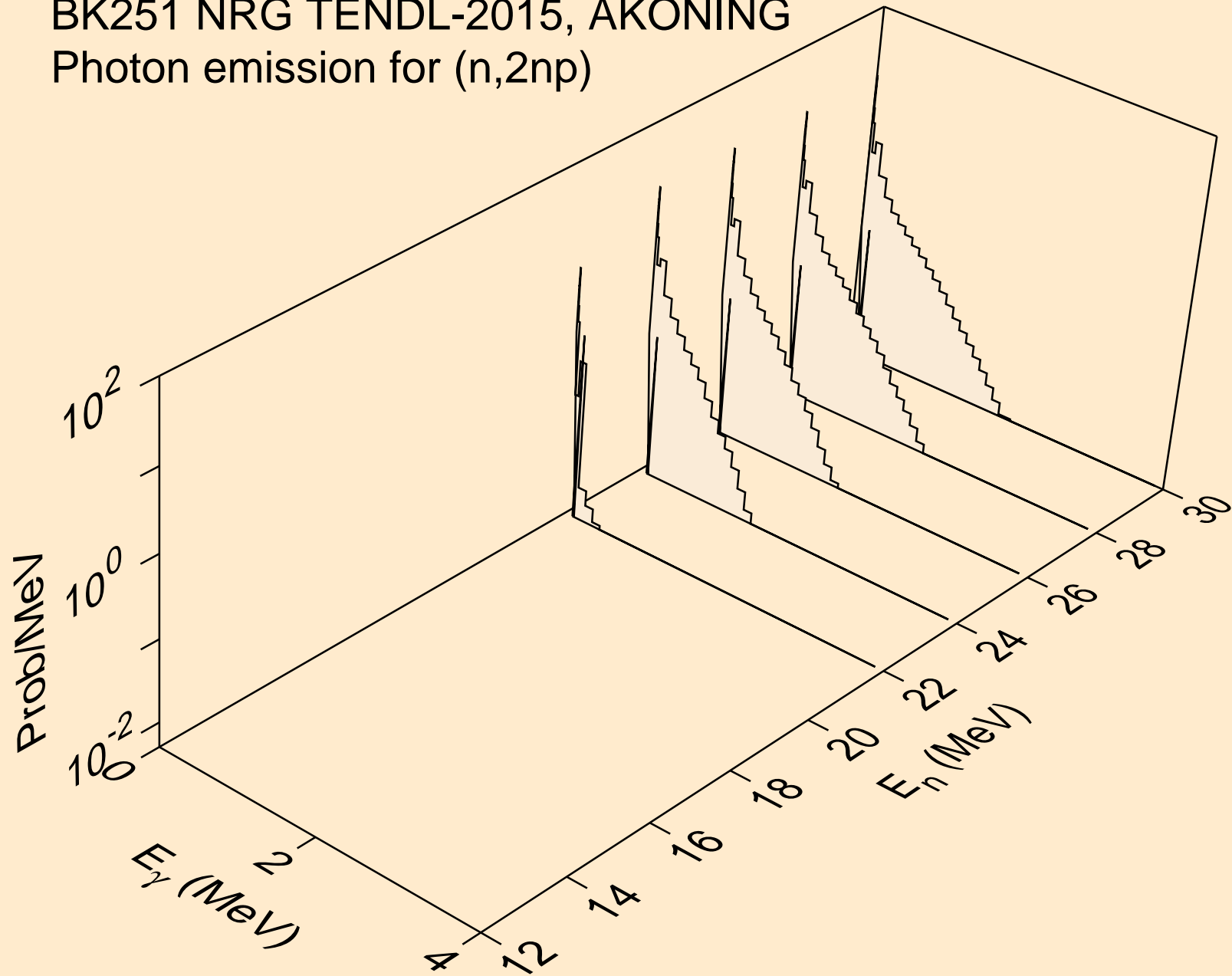

BK251 NRG TENDL-2015, AKONING
Photon emission for (n,npa)

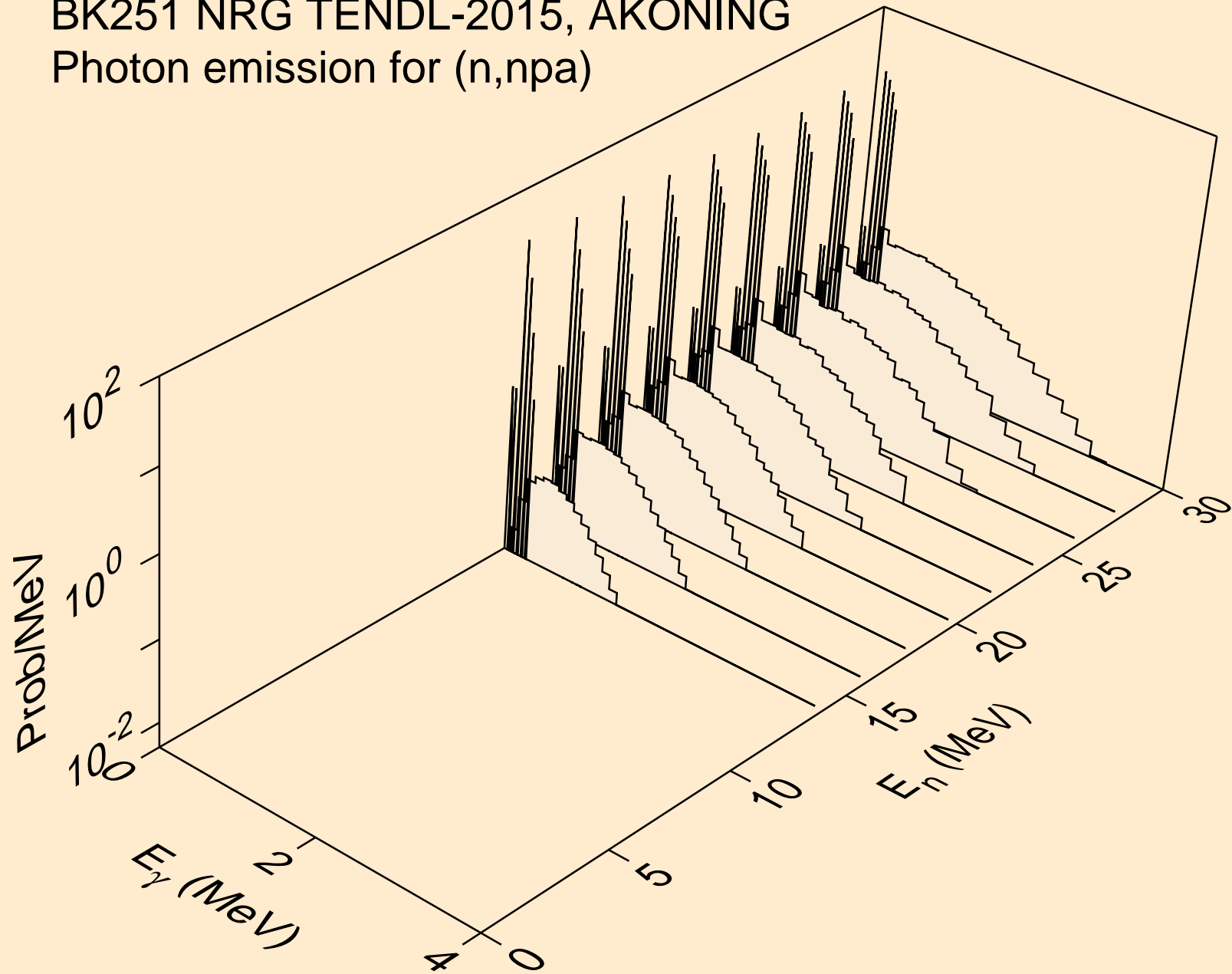

BK251 NRG TENDL-2015, AKONING
Photon emission for (n,n*c)

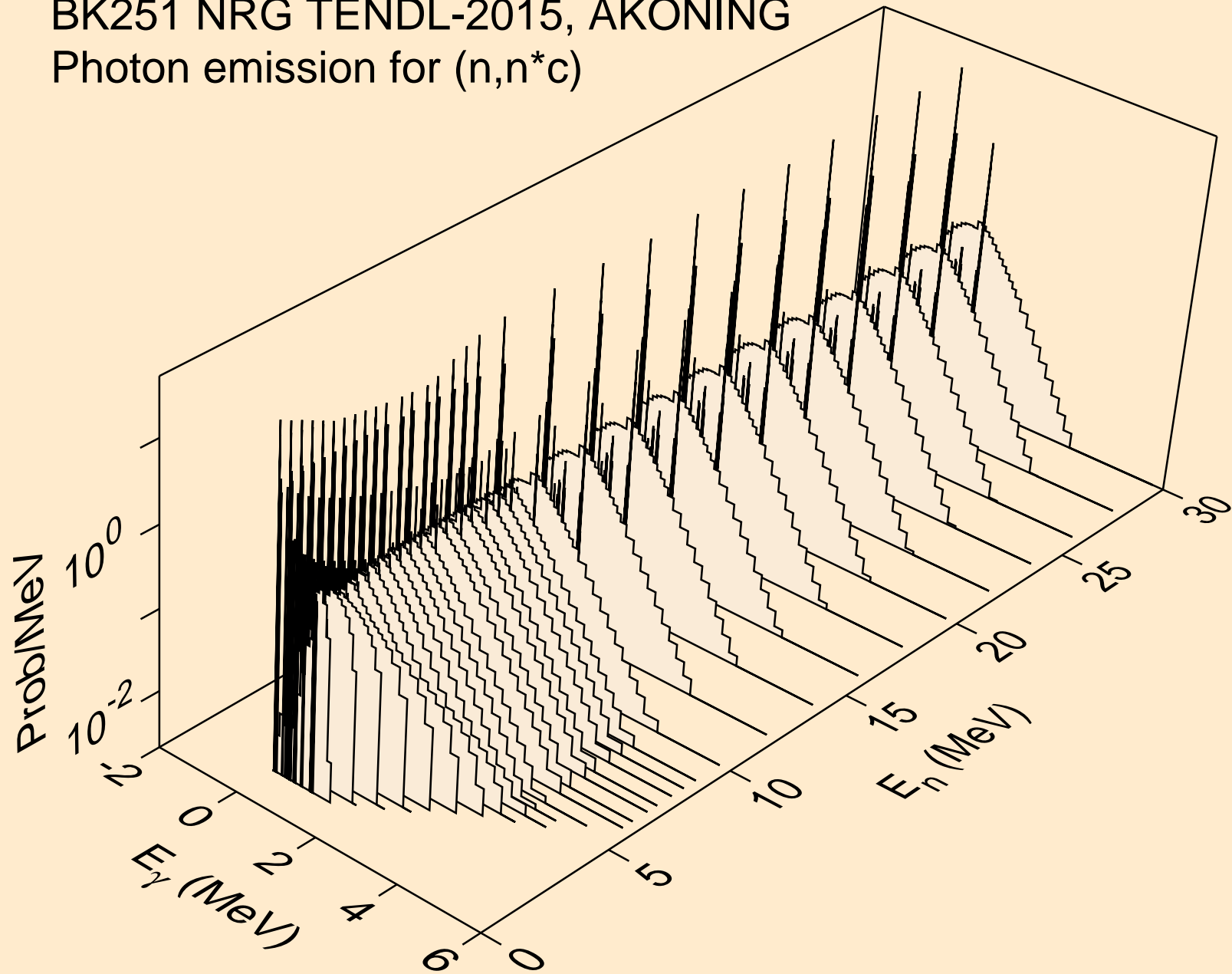

BK251 NRG TENDL-2015, AKONING
Photon emission for (n,gma)

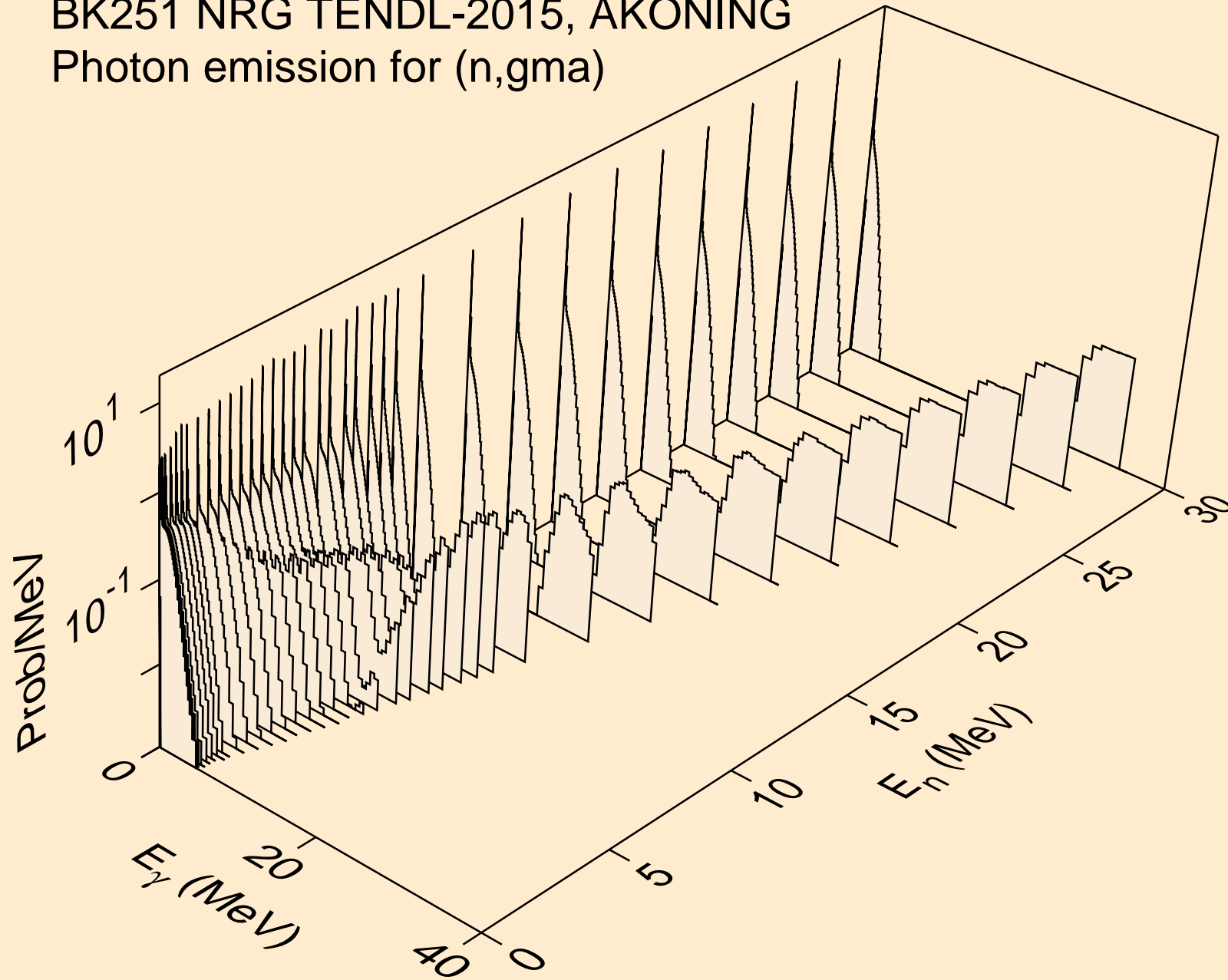

BK251 NRG TENDL-2015, AKONING
Photon emission for (n,p)

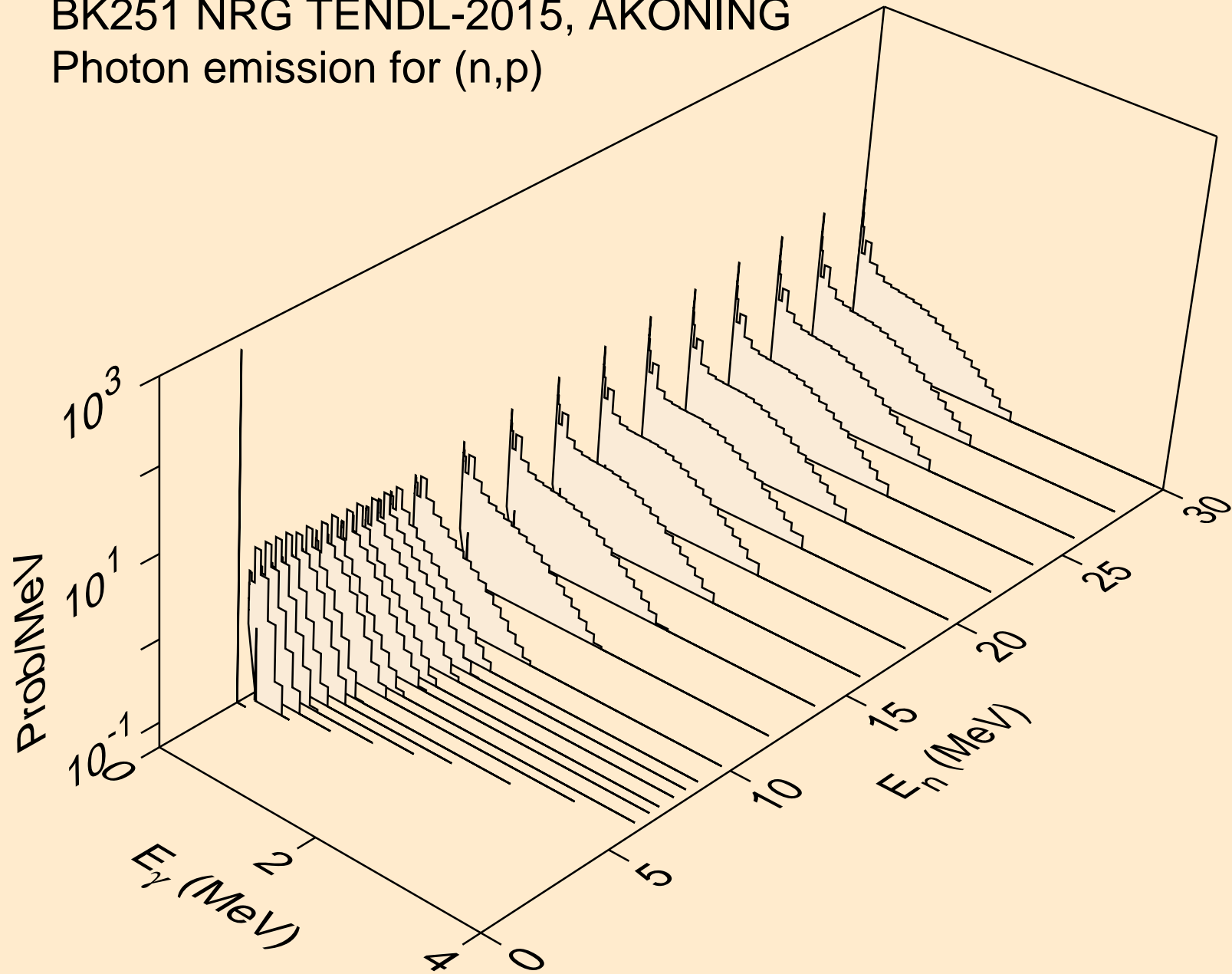

BK251 NRG TENDL-2015, AKONING
Photon emission for (n,d)

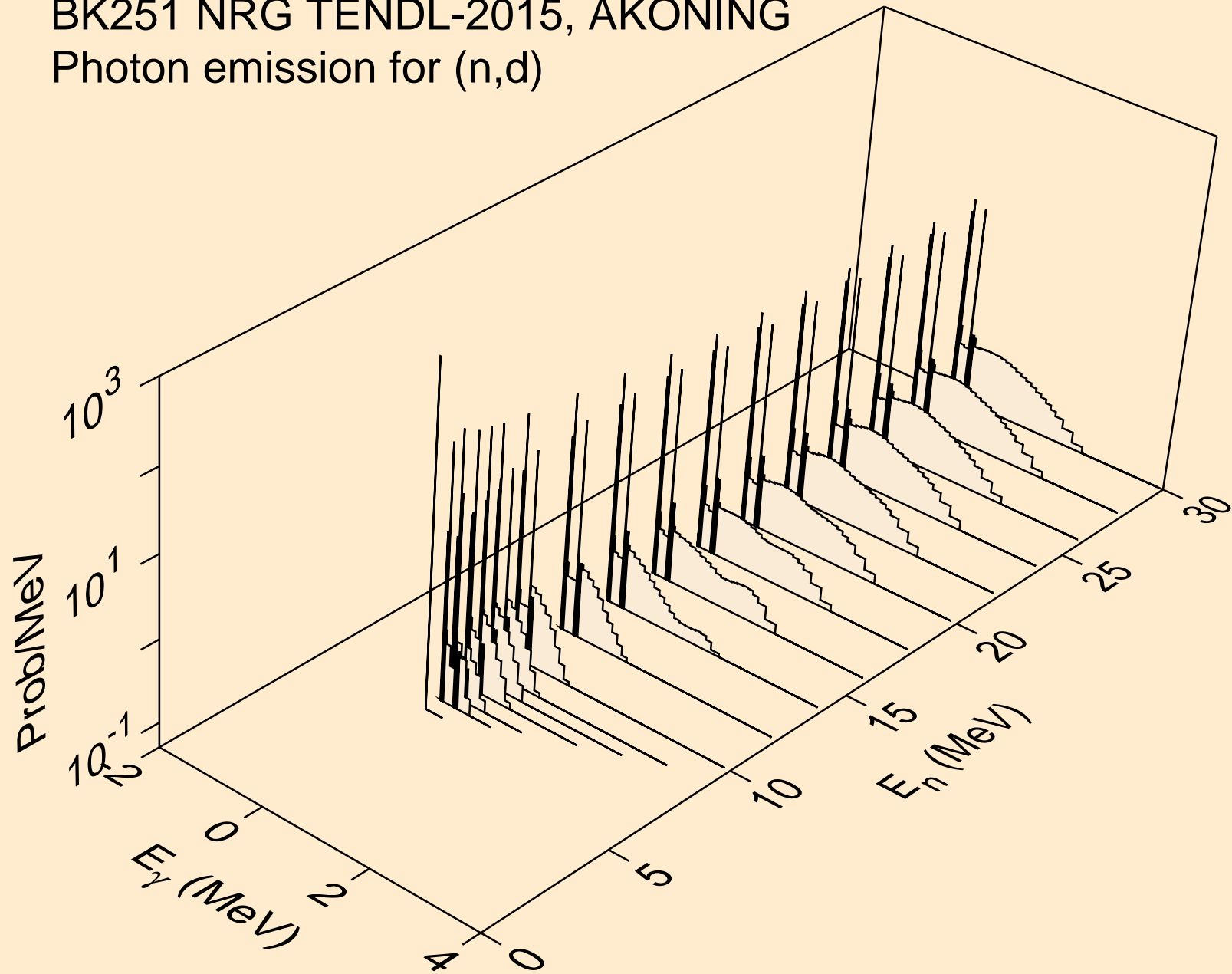

BK251 NRG TENDL-2015, AKONING
Photon emission for (n,t)

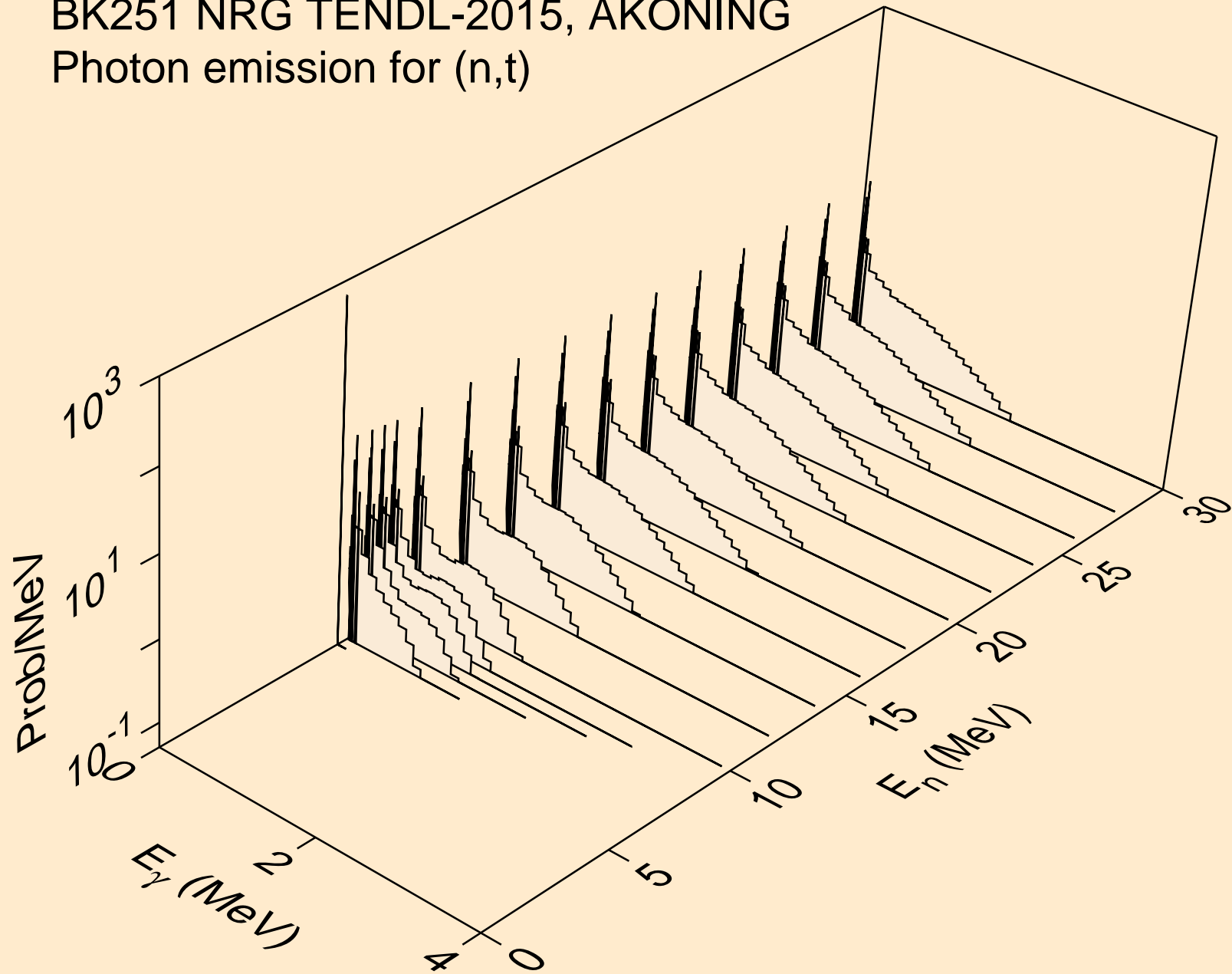

BK251 NRG TENDL-2015, AKONING
Photon emission for (n,he3)

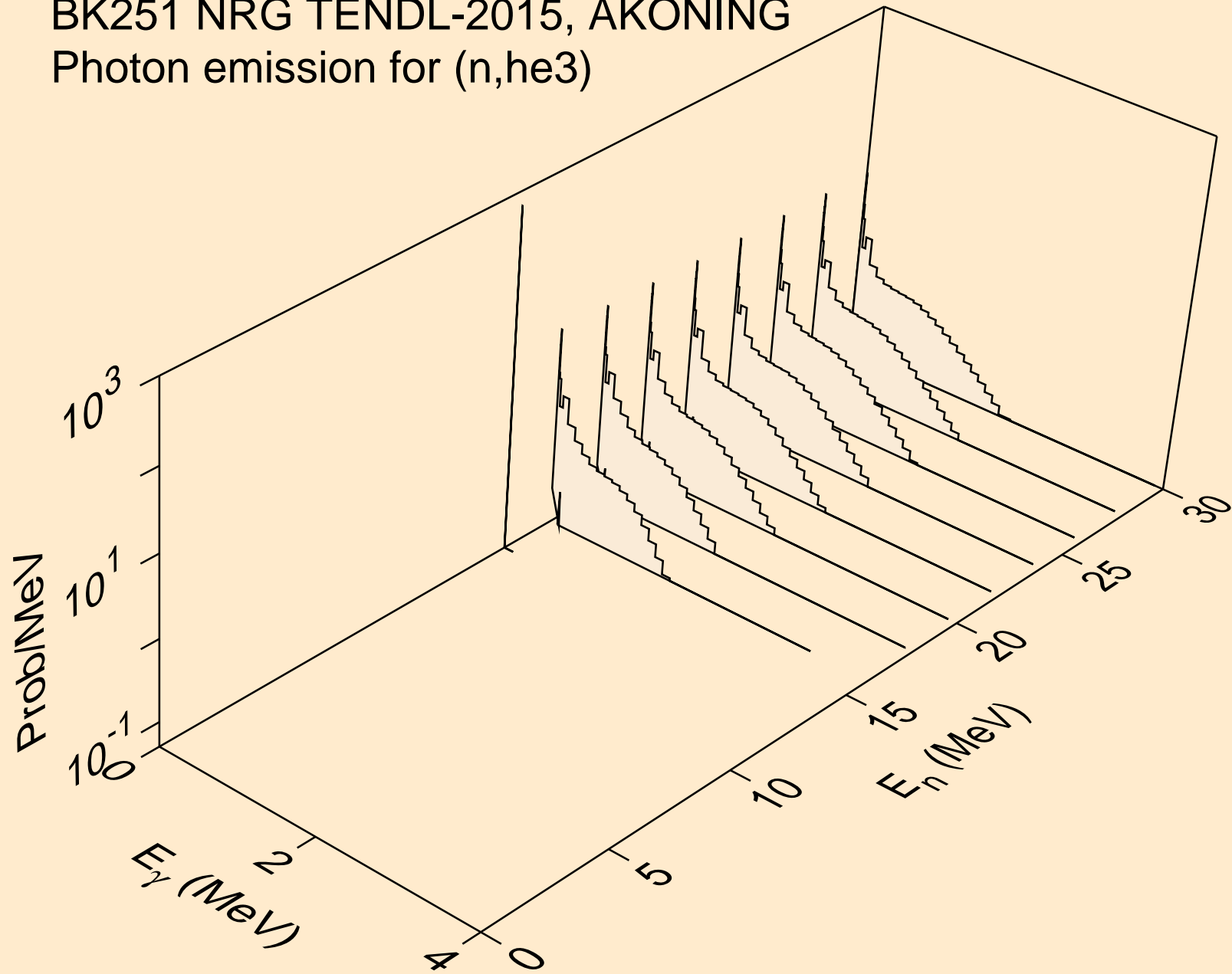

BK251 NRG TENDL-2015, AKONING
Photon emission for (n,a)

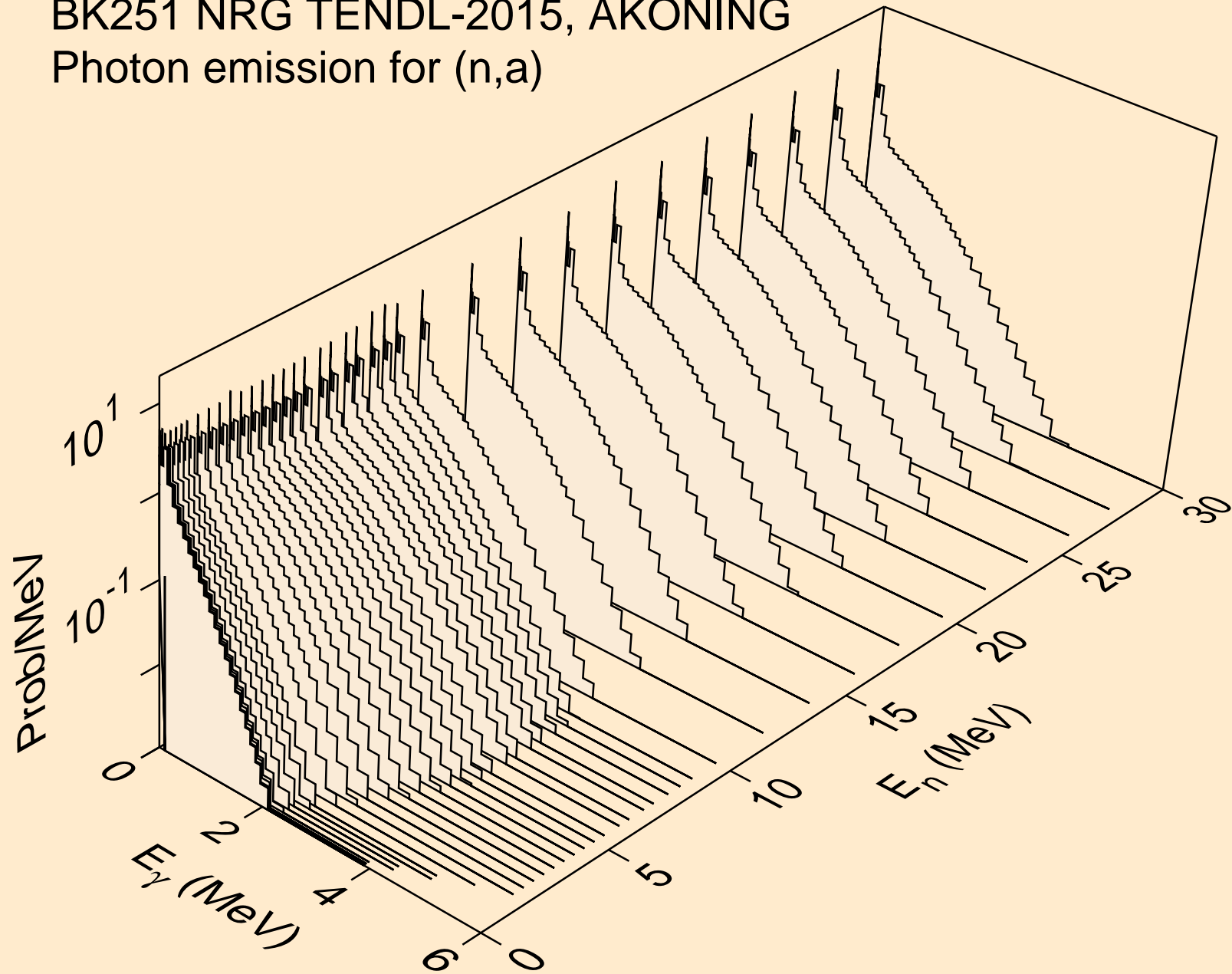

BK251 NRG TENDL-2015, AKONING
Photon emission for (n,2p)

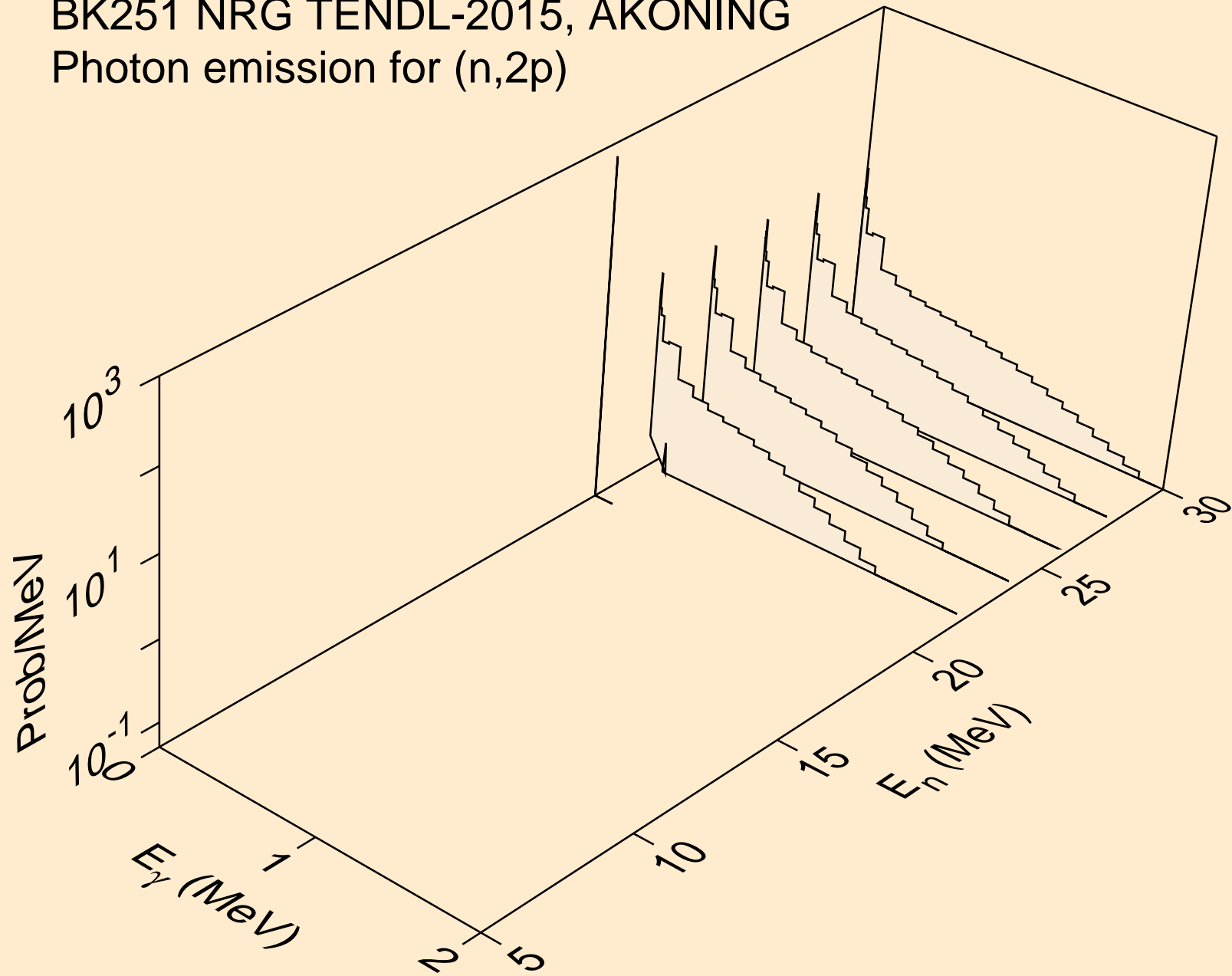

BK251 NRG TENDL-2015, AKONING
Photon emission for (n,p α)

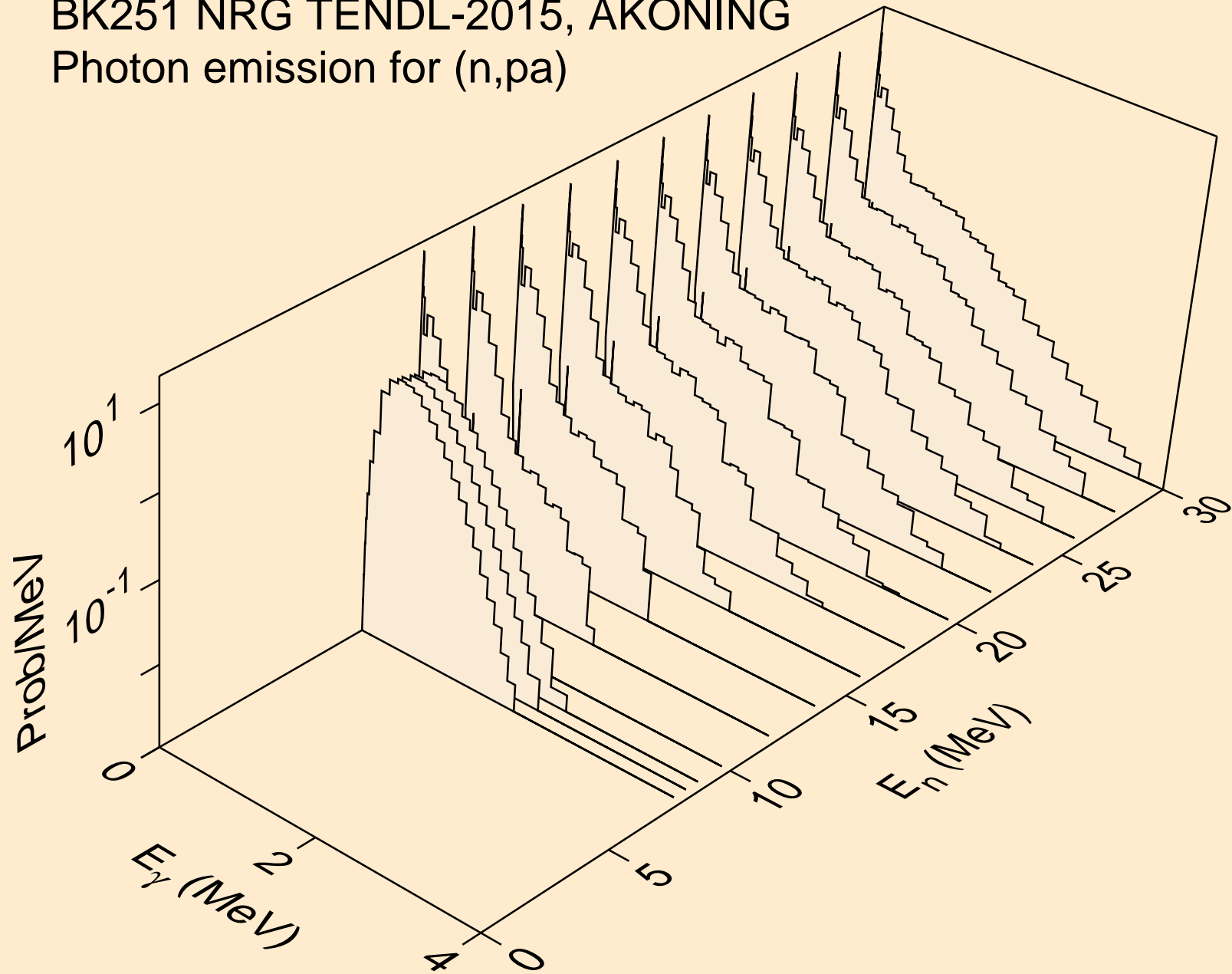

BK251 NRG TENDL-2015, AKONING
Photon emission for (n,da)

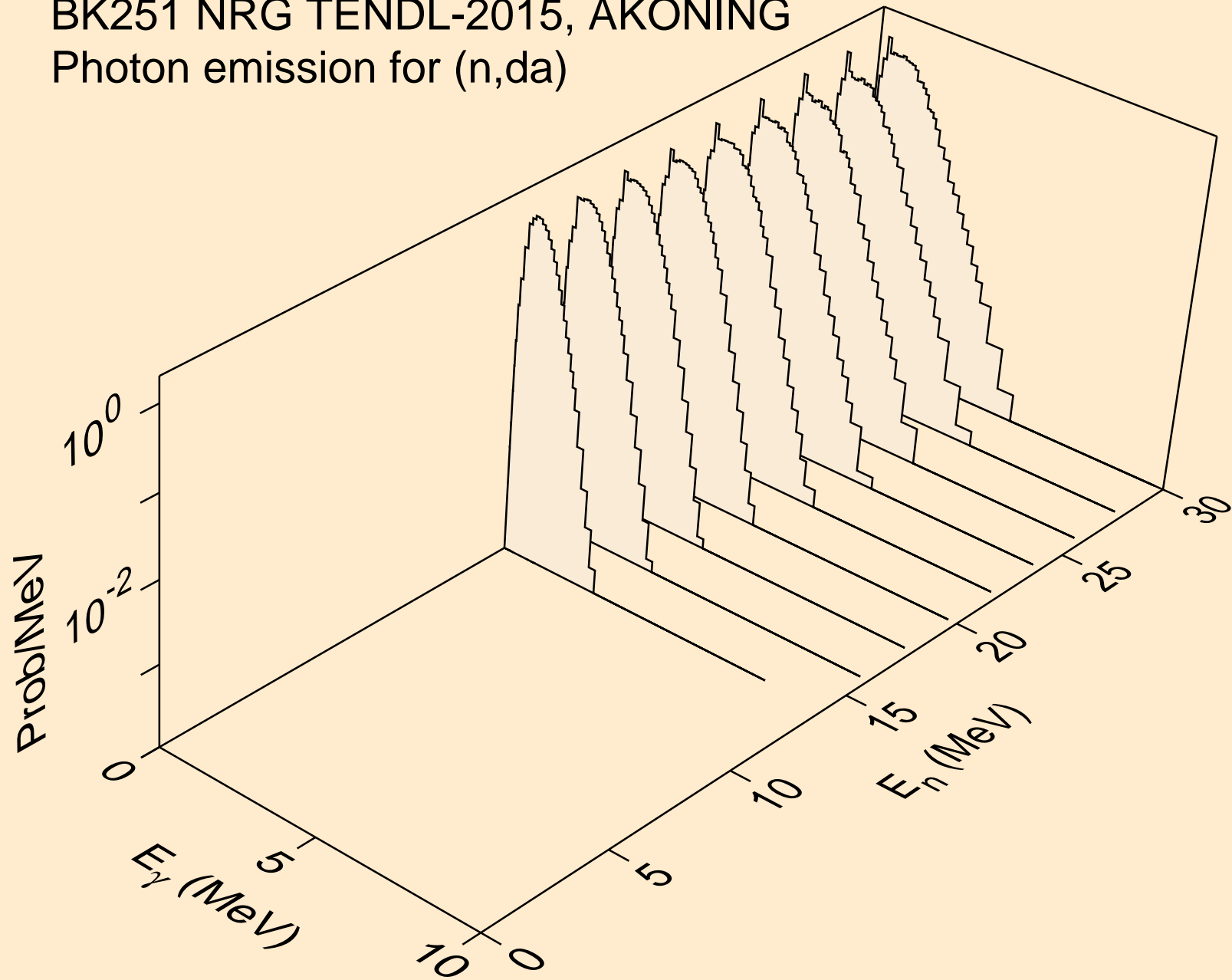

BK251 NRG TENDL-2015, AKONING
thermal capture photon spectrum

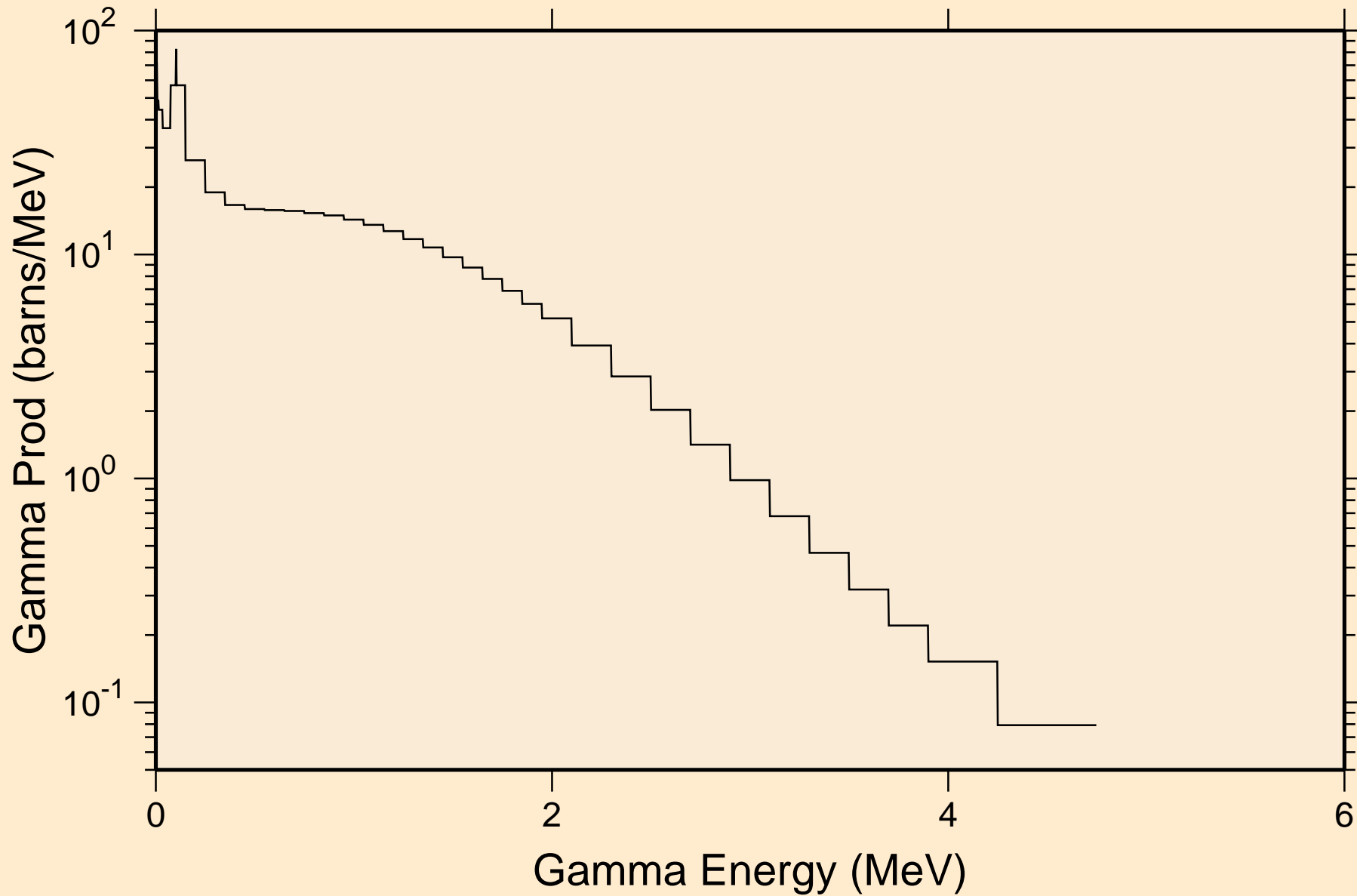

BK251 NRG TENDL-2015, AKONING
14 MeV photon spectrum

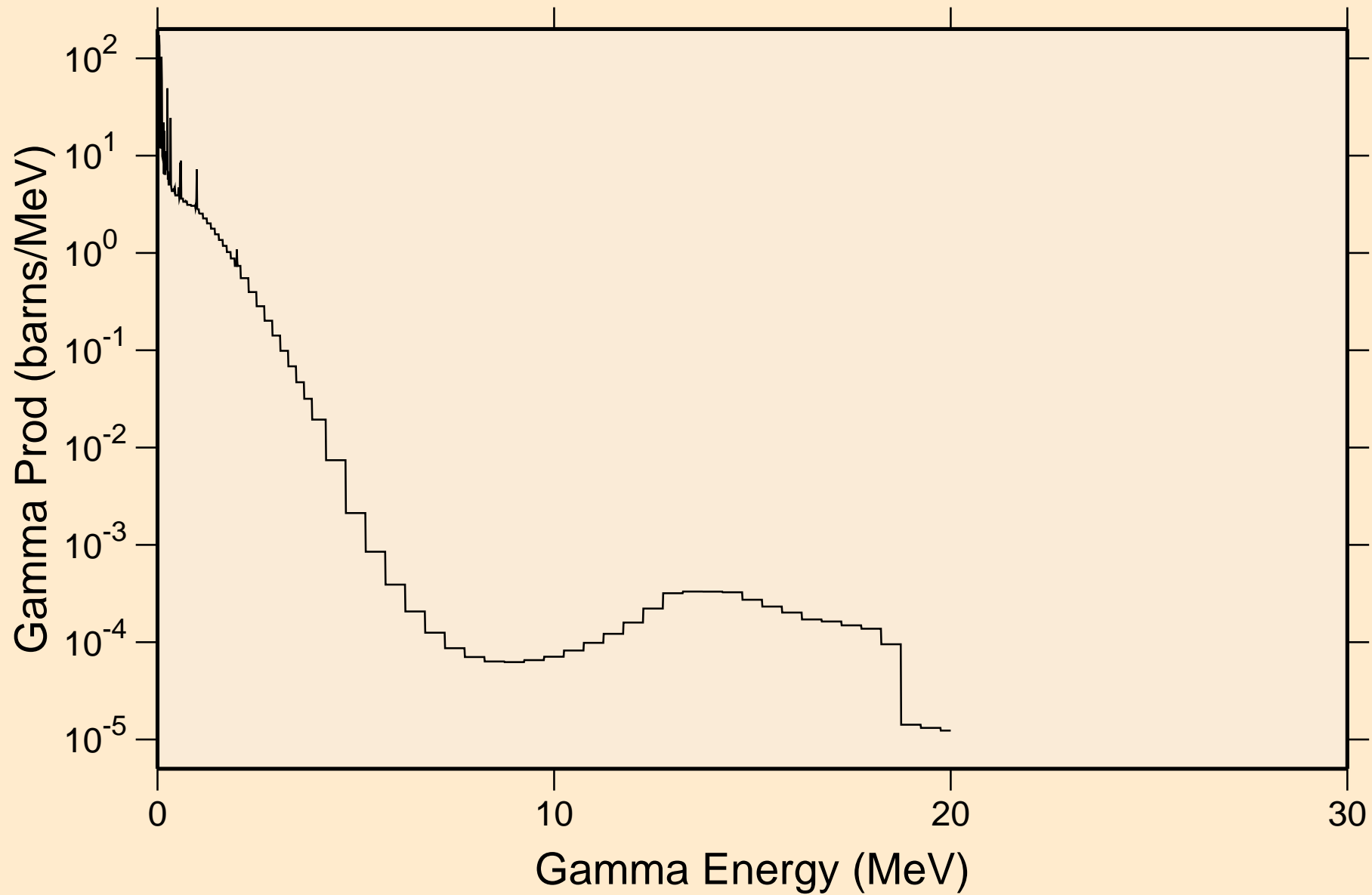

BK251 NRG TENDL-2015, AKONING

Particle heating contributions

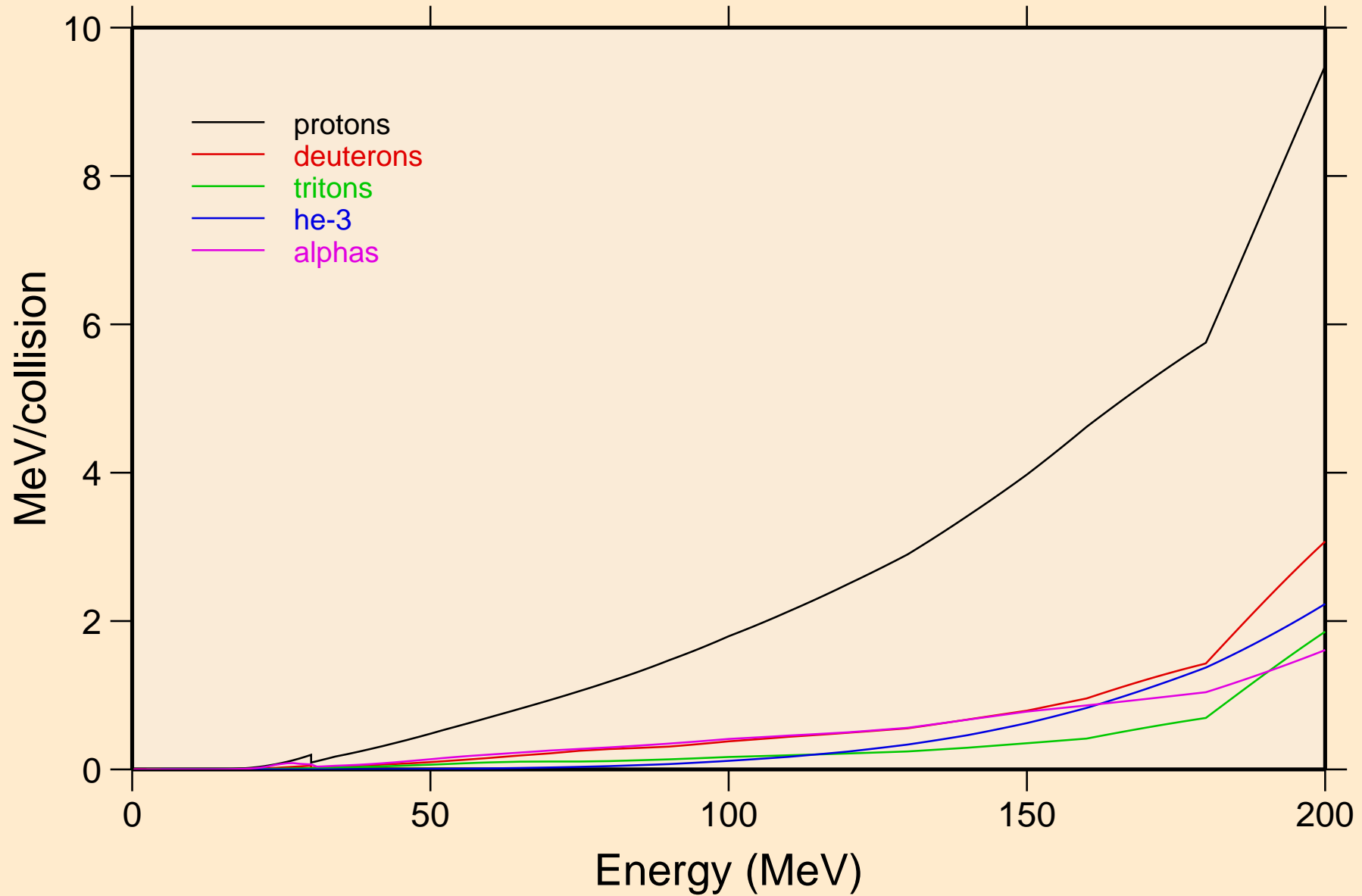

BK251 NRG TENDL-2015, AKONING

Recoil Heating

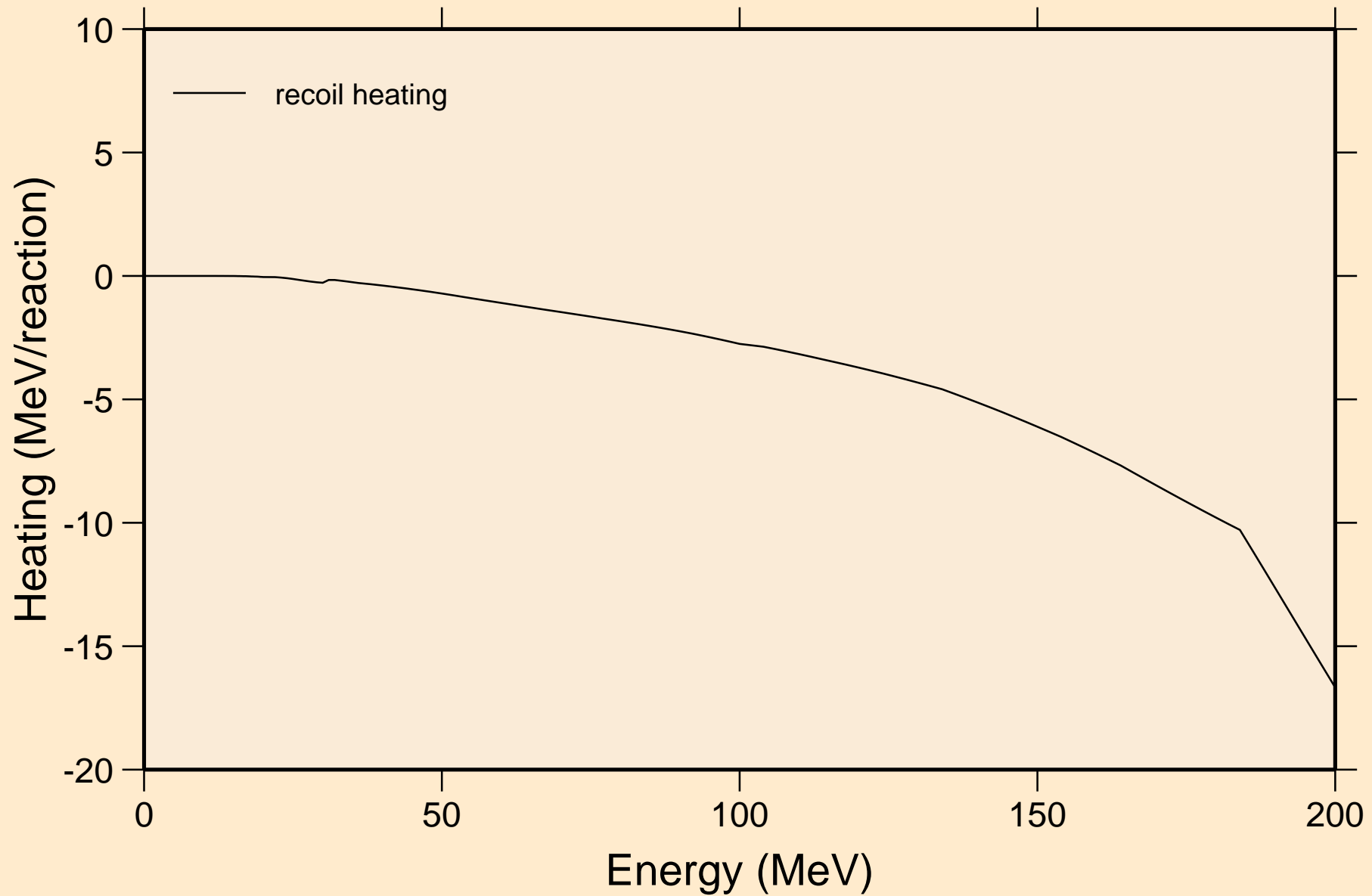

BK251 NRG TENDL-2015, AKONING

Particle production cross sections

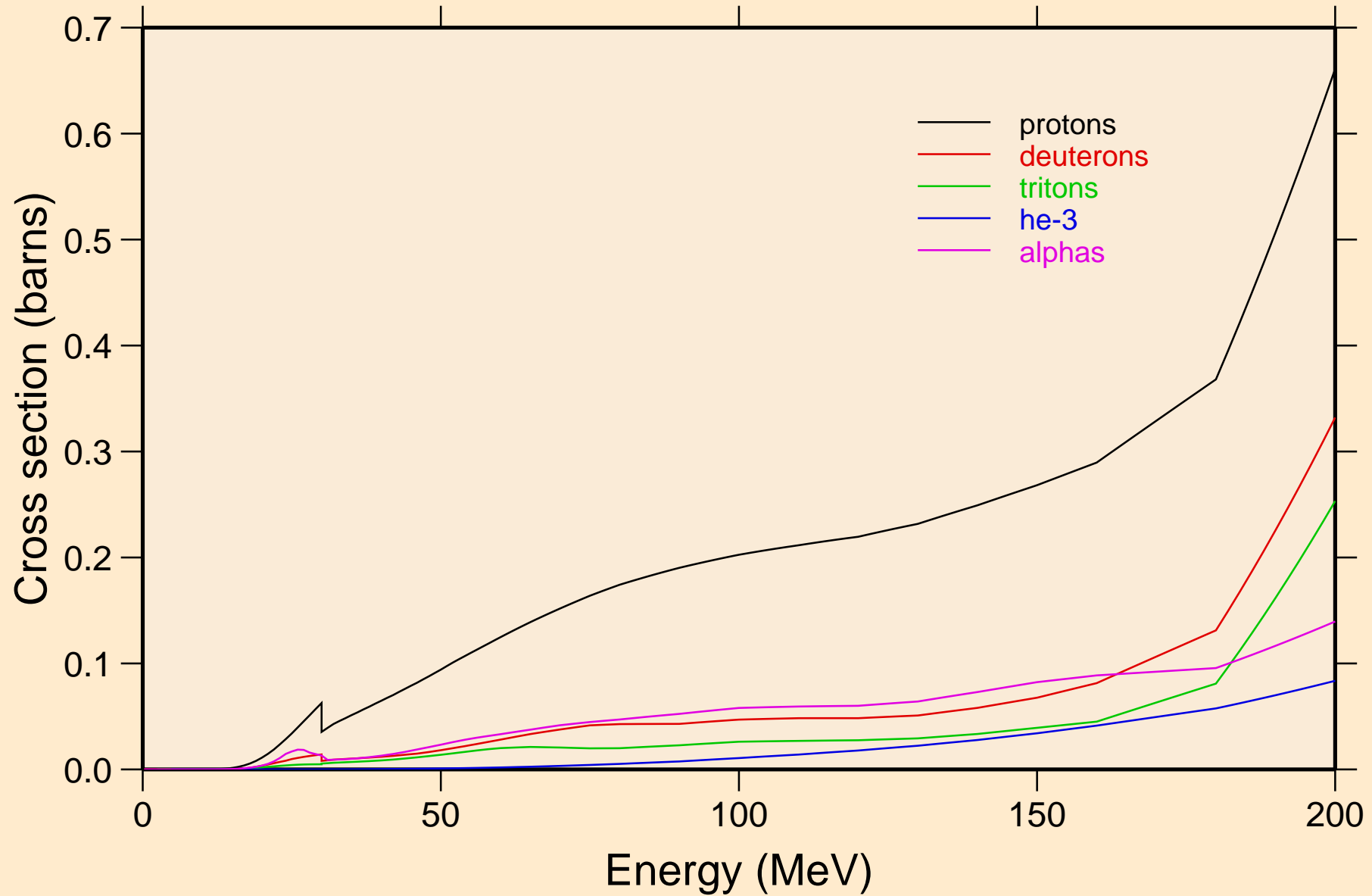

BK251 NRG TENDL-2015, AKONING
protons from (n,x)

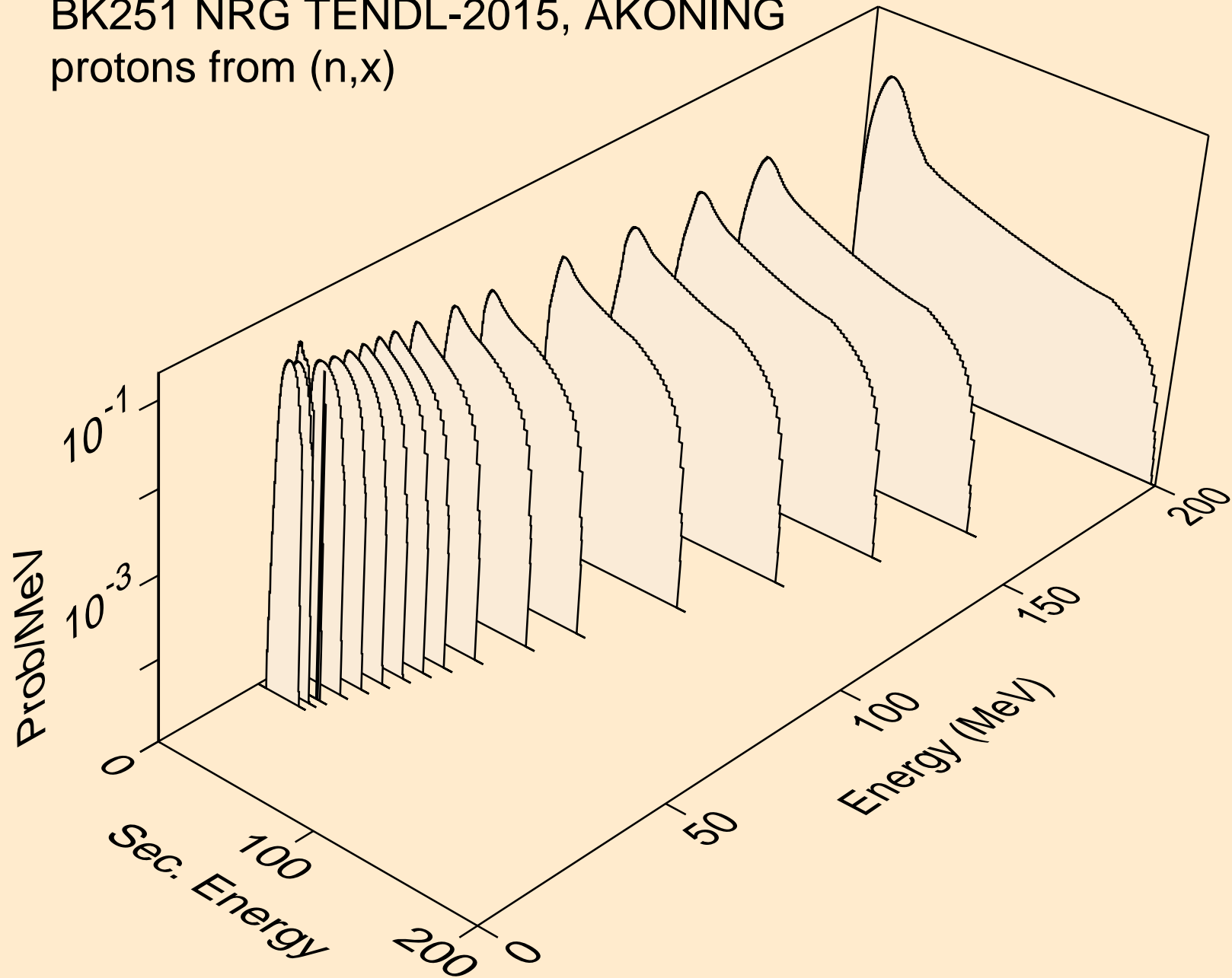

BK251 NRG TENDL-2015, AKONING
protons from (n,n*)p

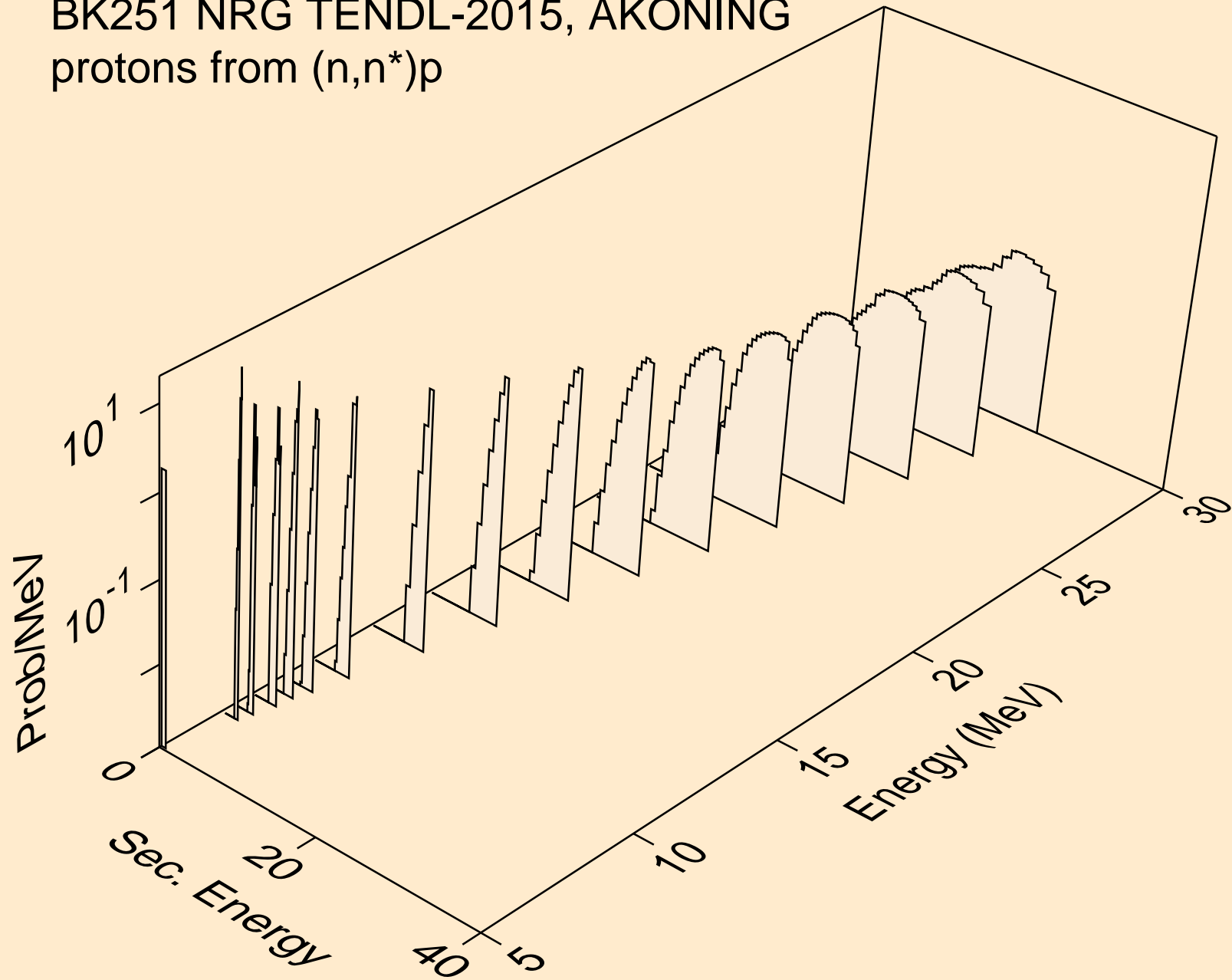

BK251 NRG TENDL-2015, AKONING
protons from (n,2np)

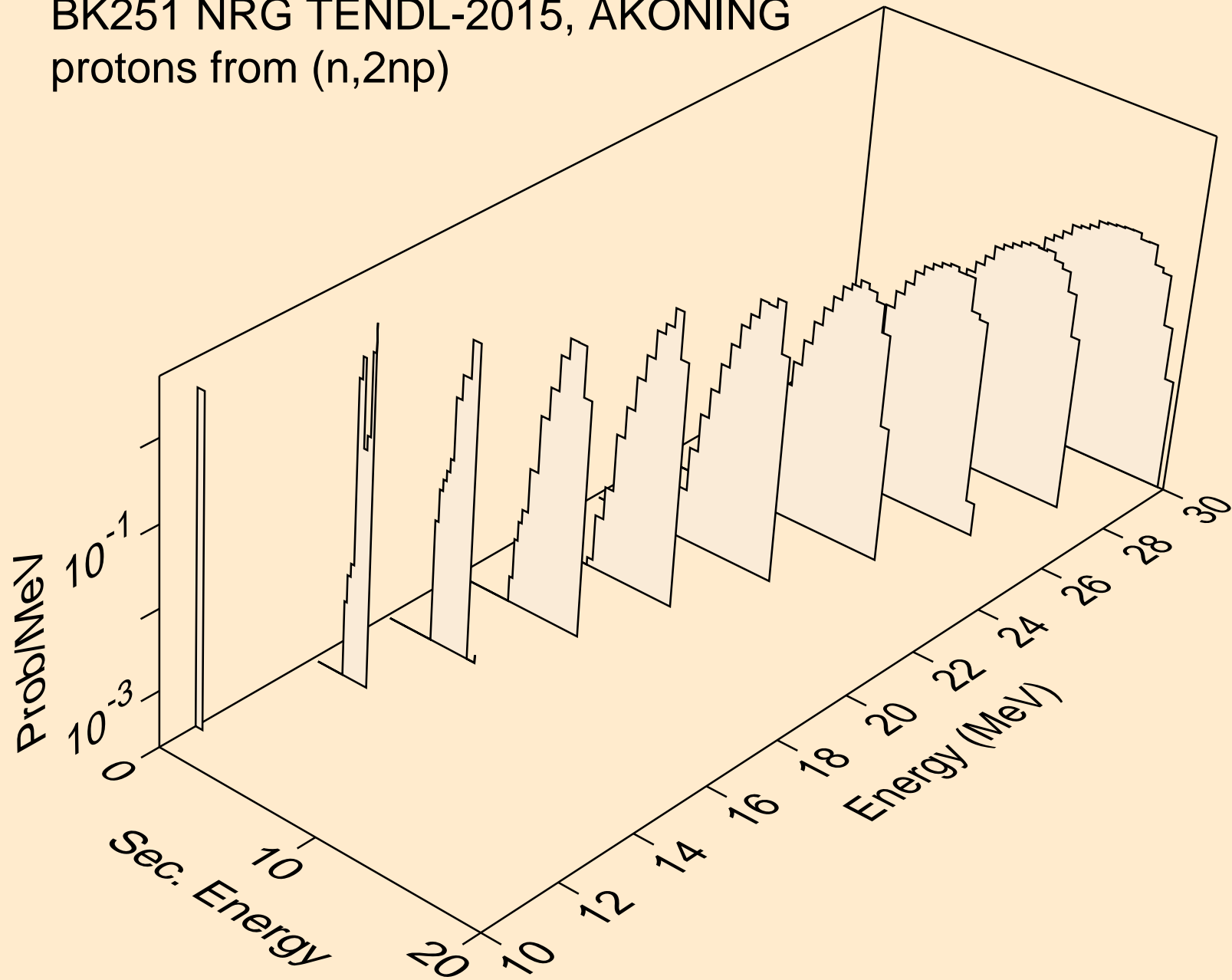

BK251 NRG TENDL-2015, AKONING
protons from (n,3np)

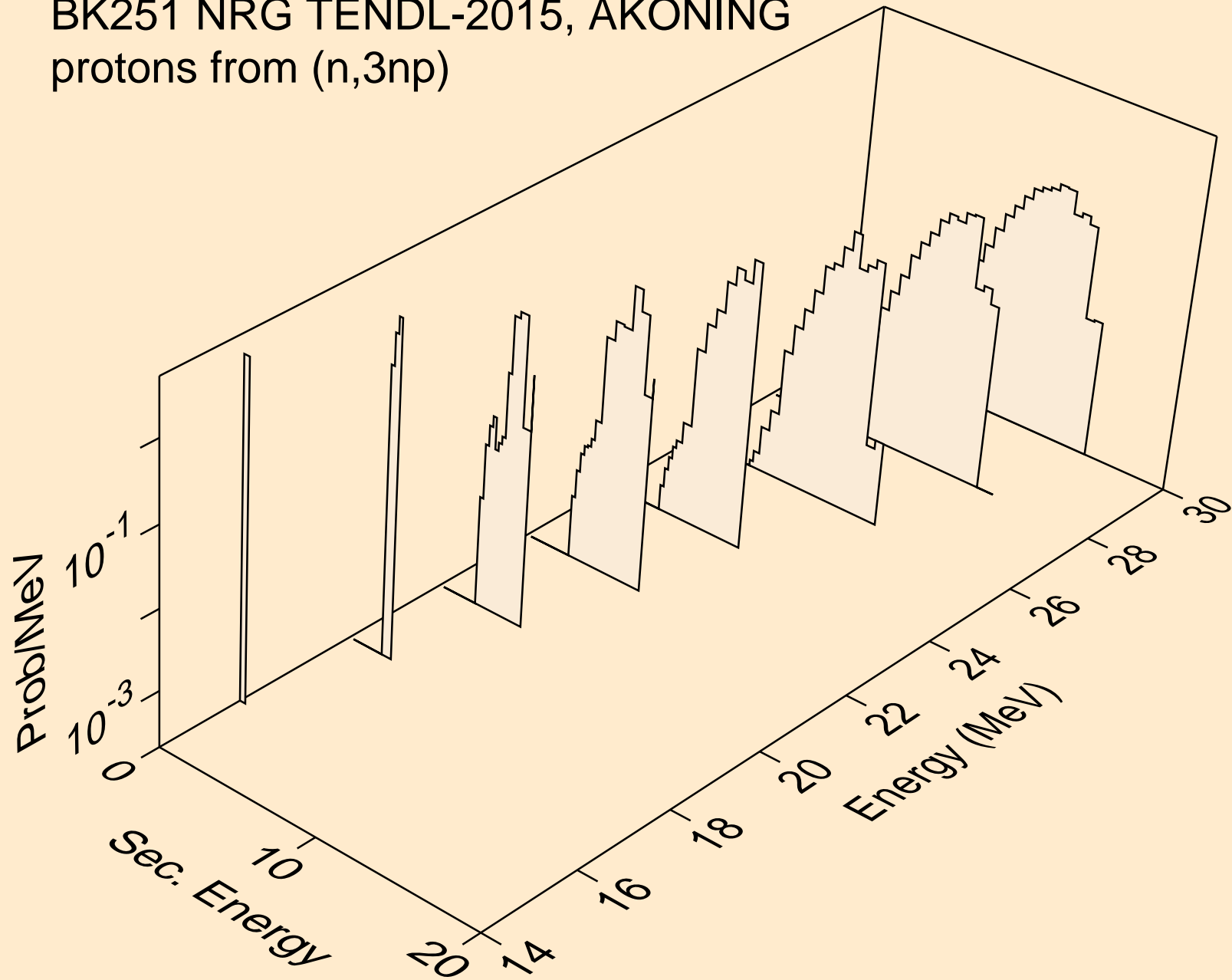

BK251 NRG TENDL-2015, AKONING
protons from (n,2np)

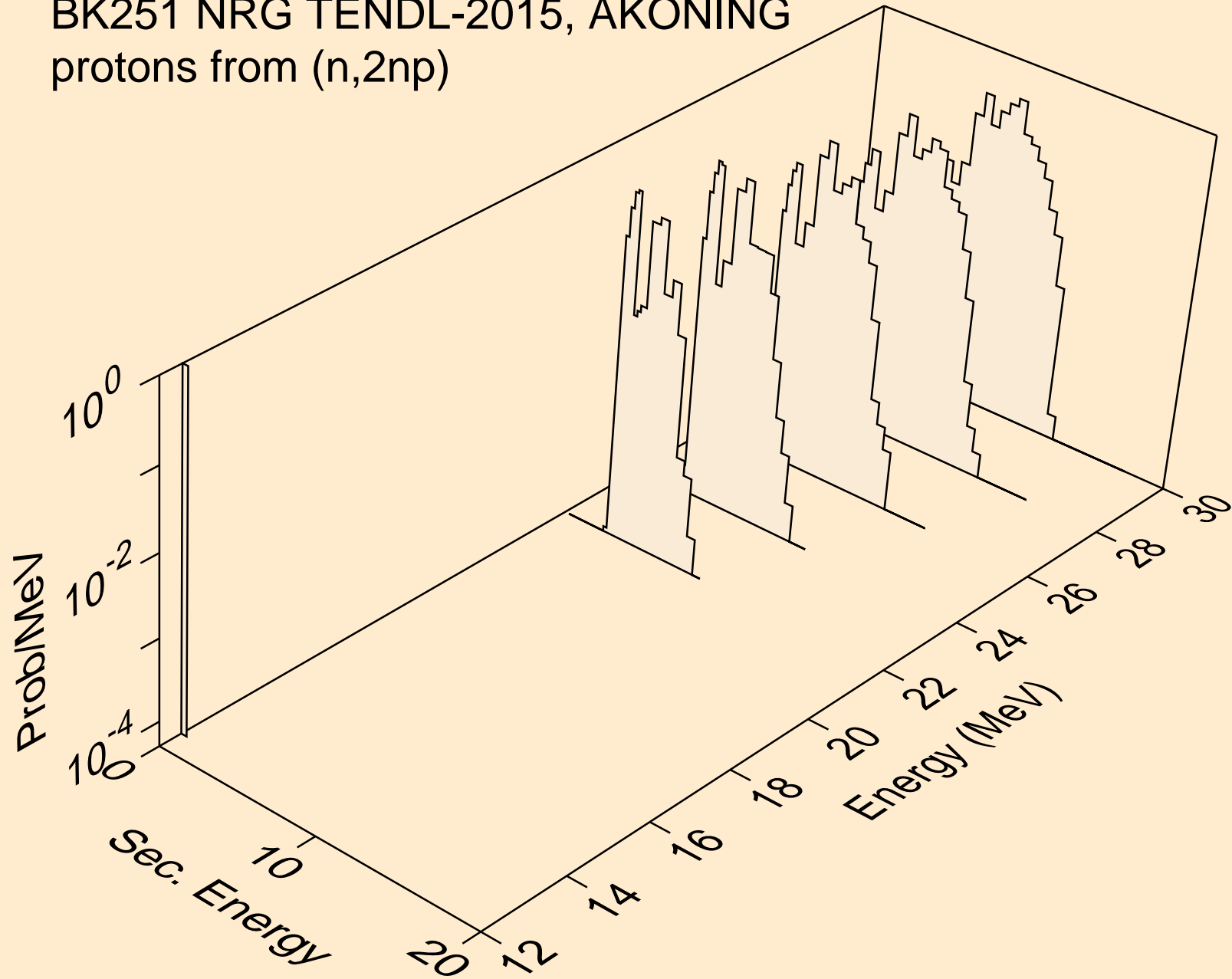

BK251 NRG TENDL-2015, AKONING
protons from (n,npa)

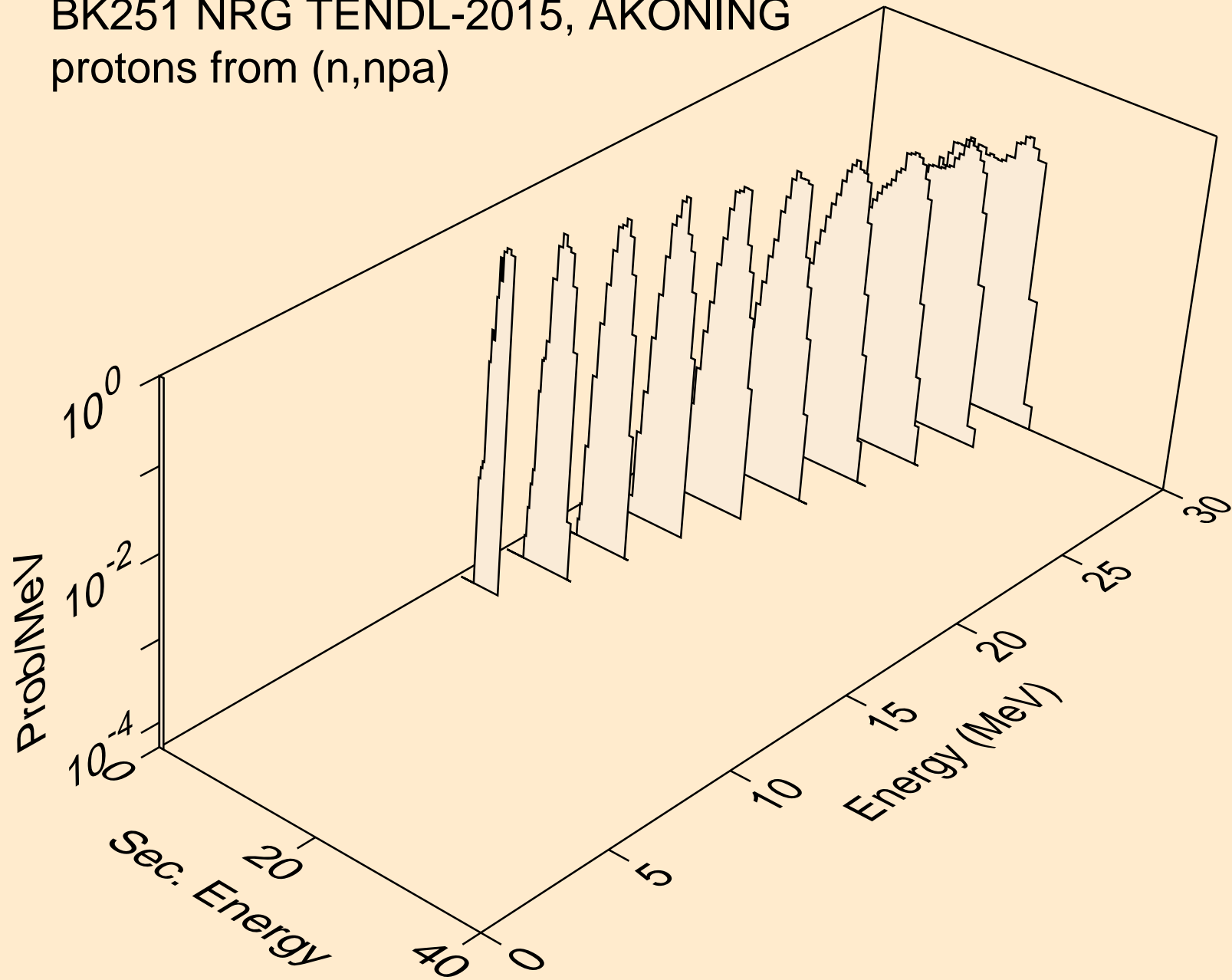

BK251 NRG TENDL-2015, AKONING
protons from (n,p)

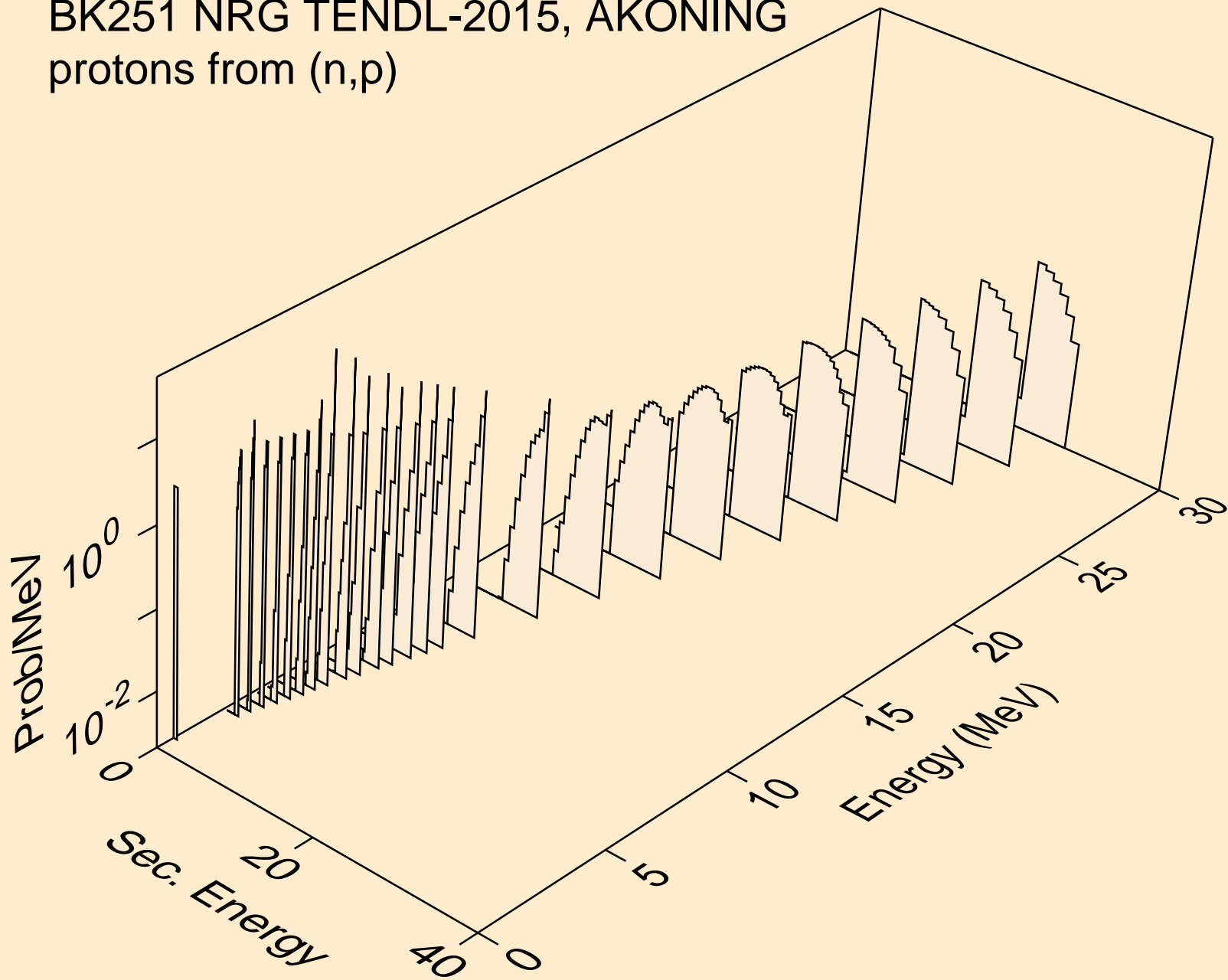

BK251 NRG TENDL-2015, AKONING
protons from (n,2p)

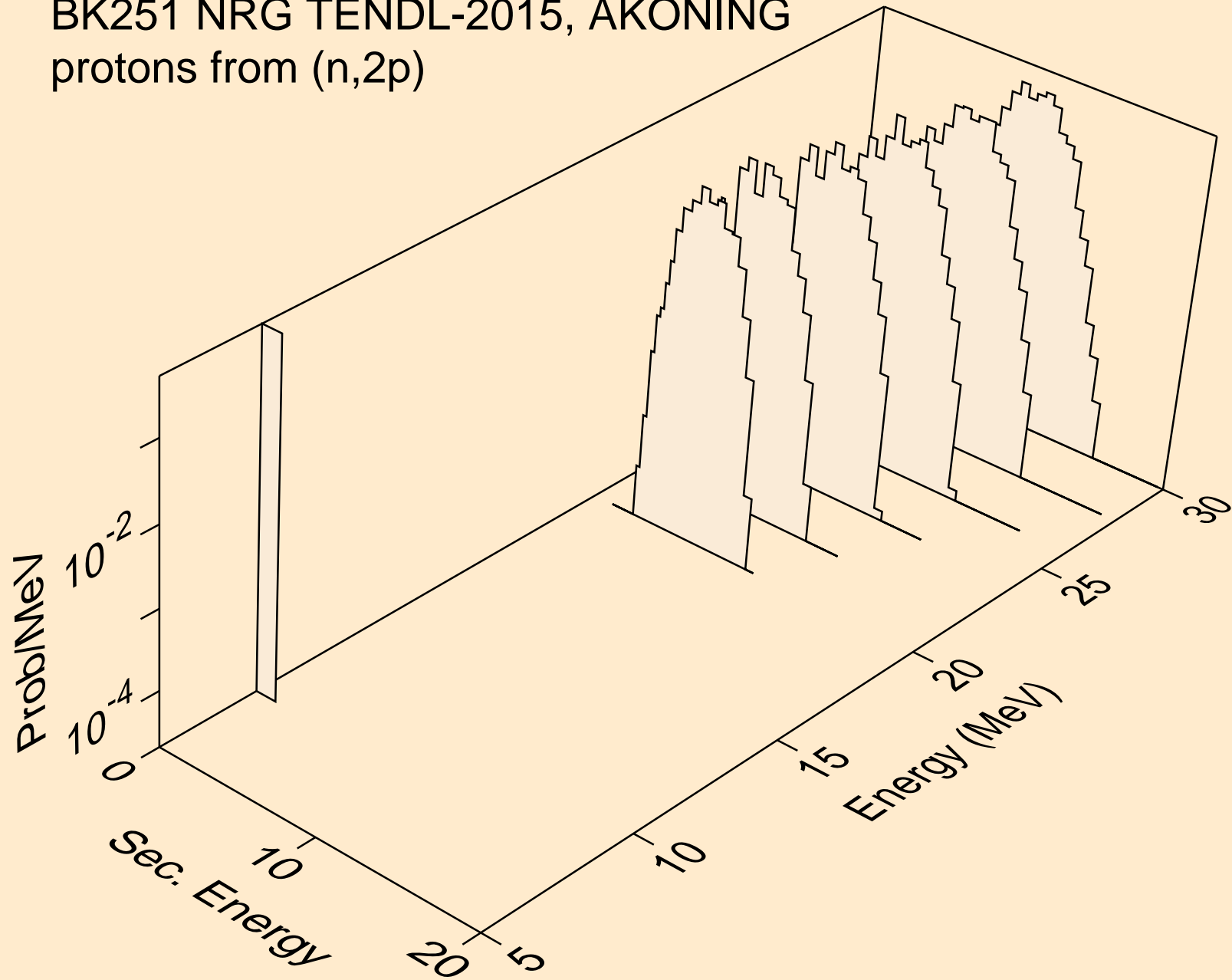

BK251 NRG TENDL-2015, AKONING
protons from (n,pa)

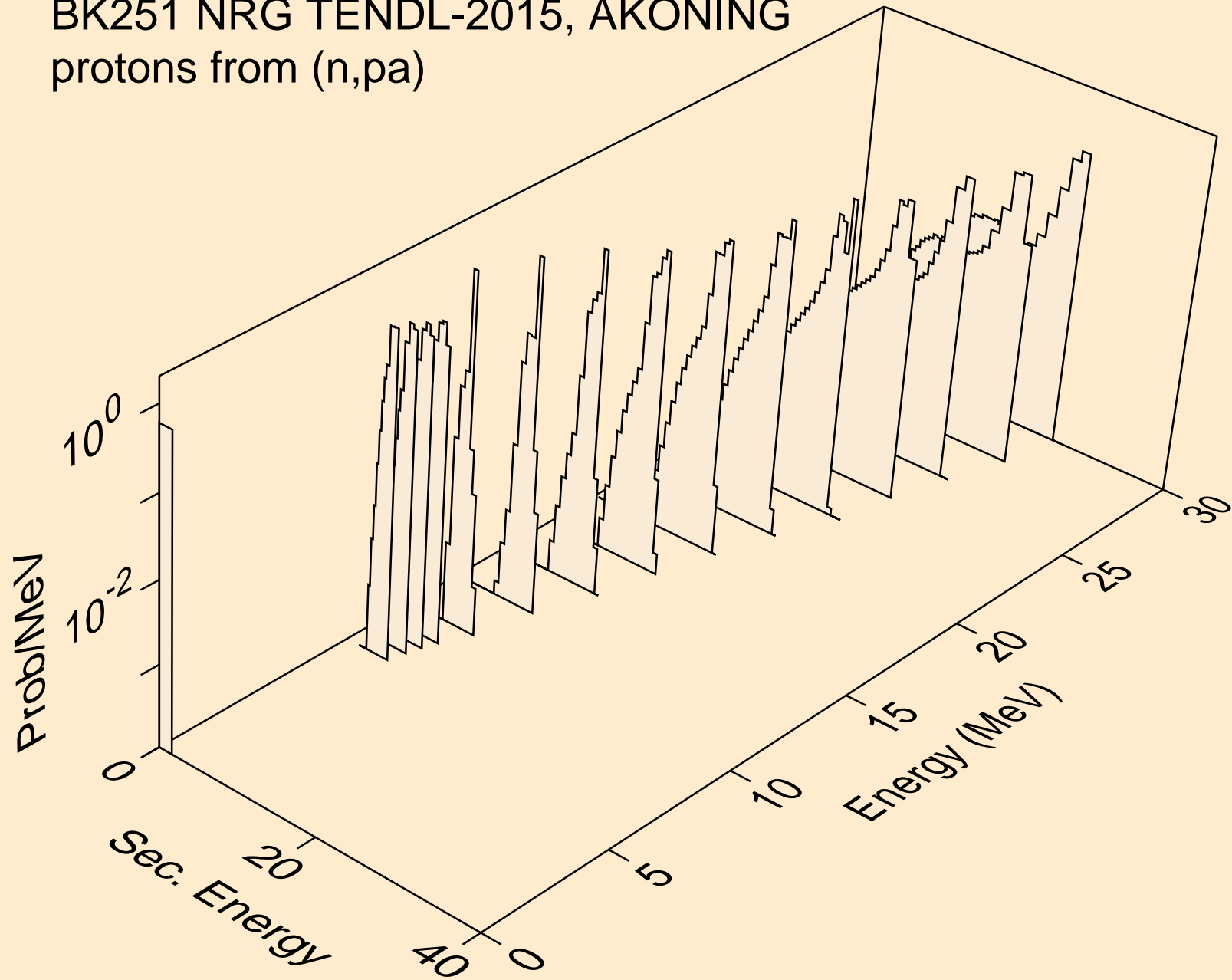

BK251 NRG TENDL-2015, AKONING
deuterons from (n,x)

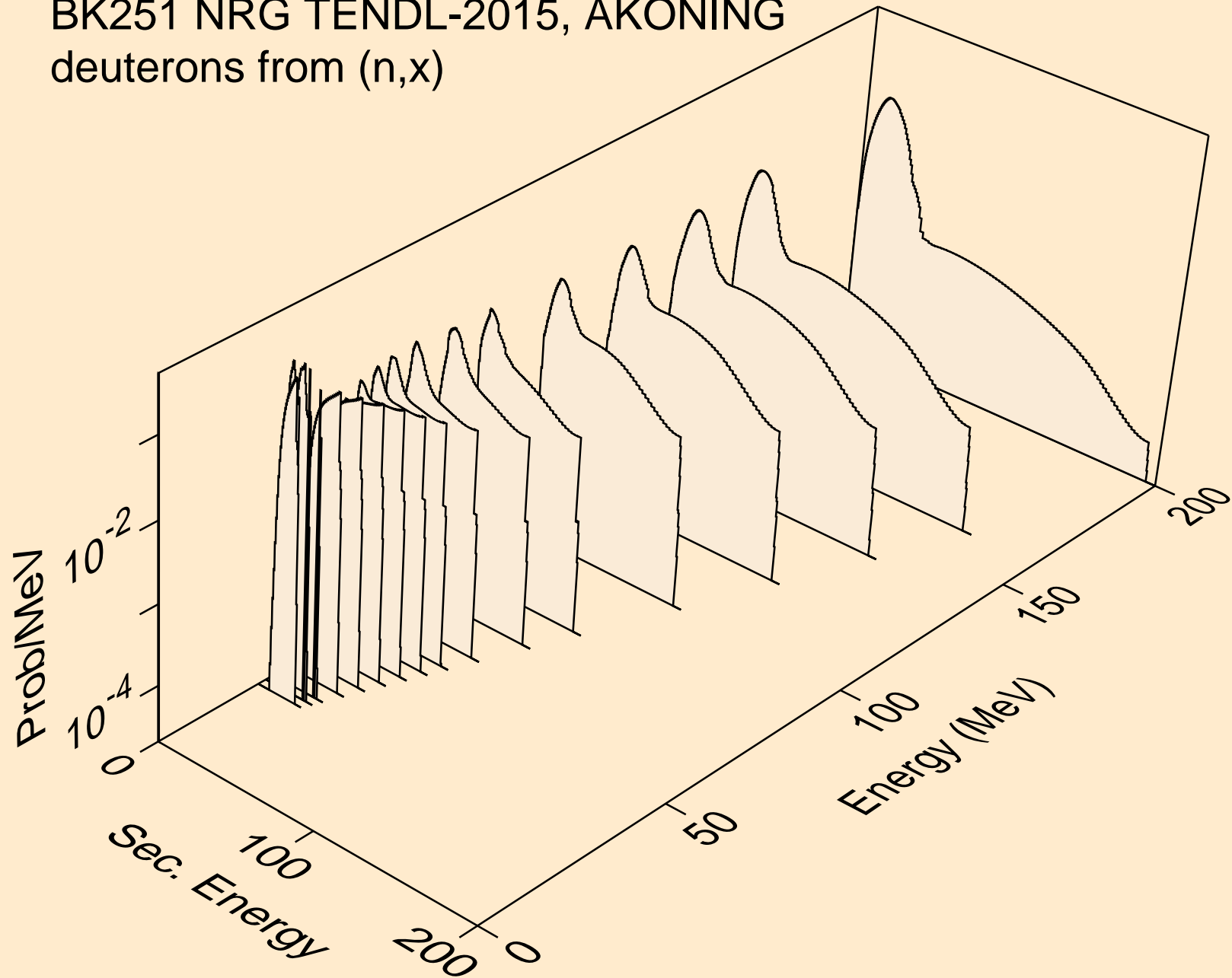

BK251 NRG TENDL-2015, AKONING
deuterons from (n,2nd)

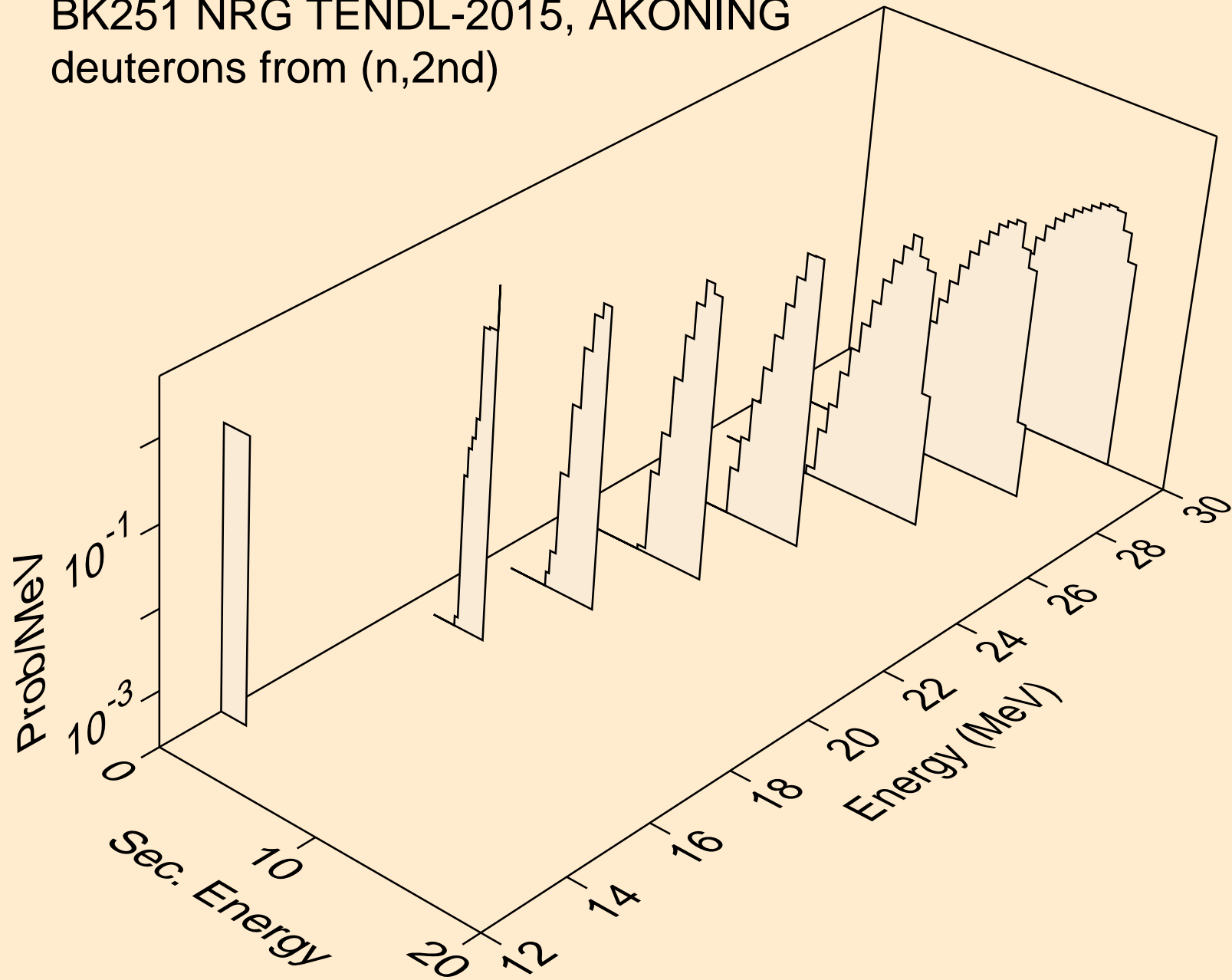

BK251 NRG TENDL-2015, AKONING
deuterons from (n,n*)d

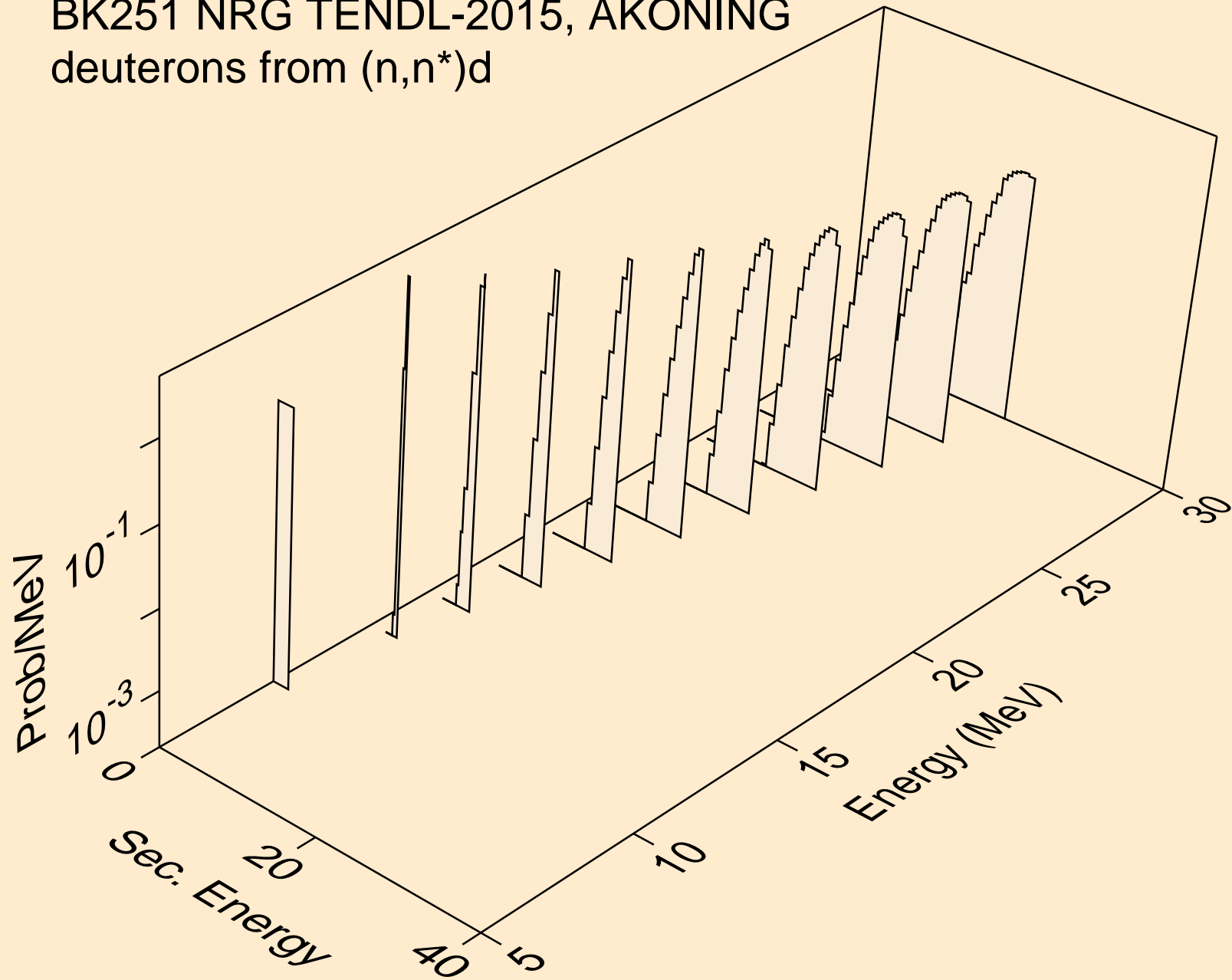

BK251 NRG TENDL-2015, AKONING
deuterons from (n,d)

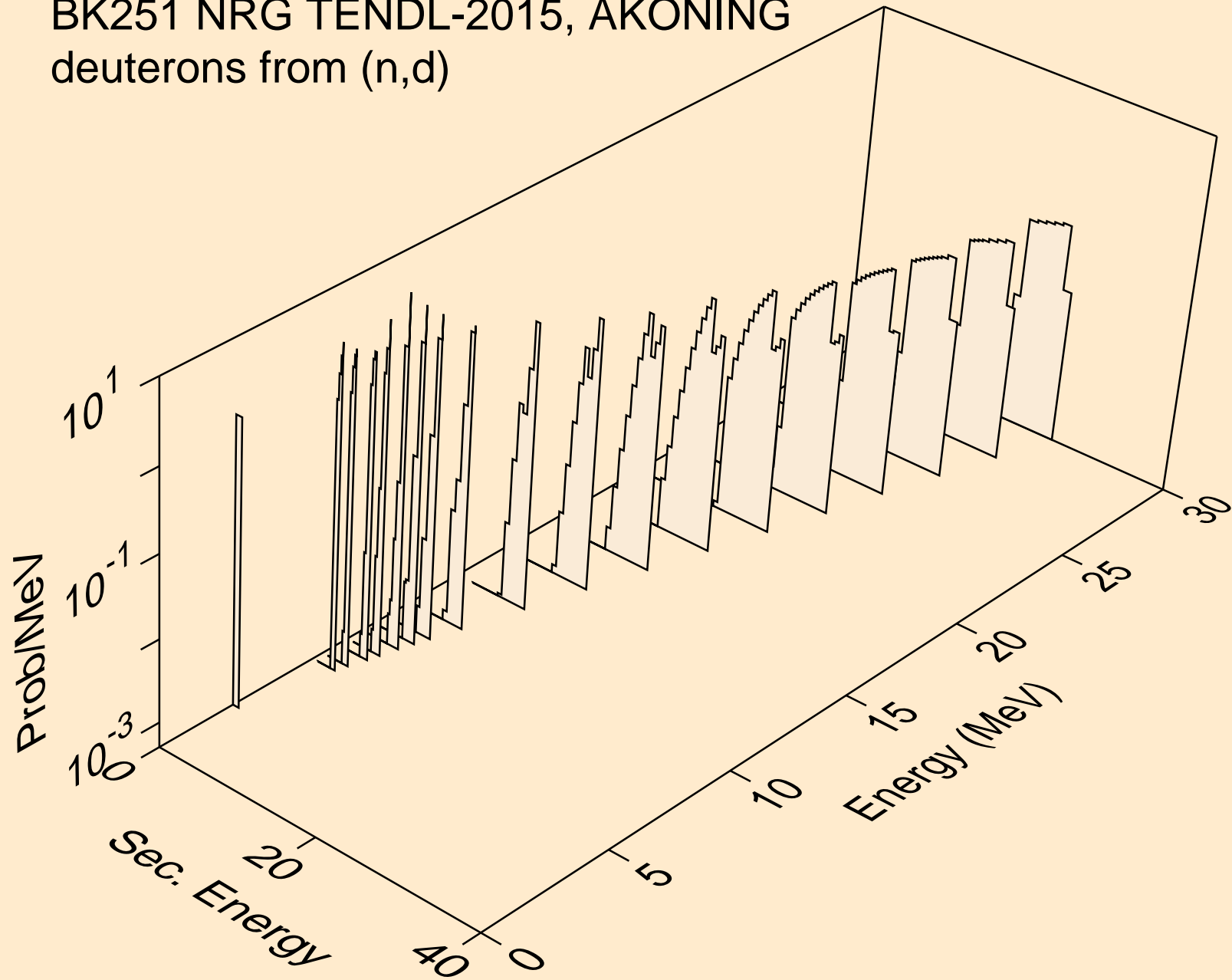

BK251 NRG TENDL-2015, AKONING
deuterons from (n,da)

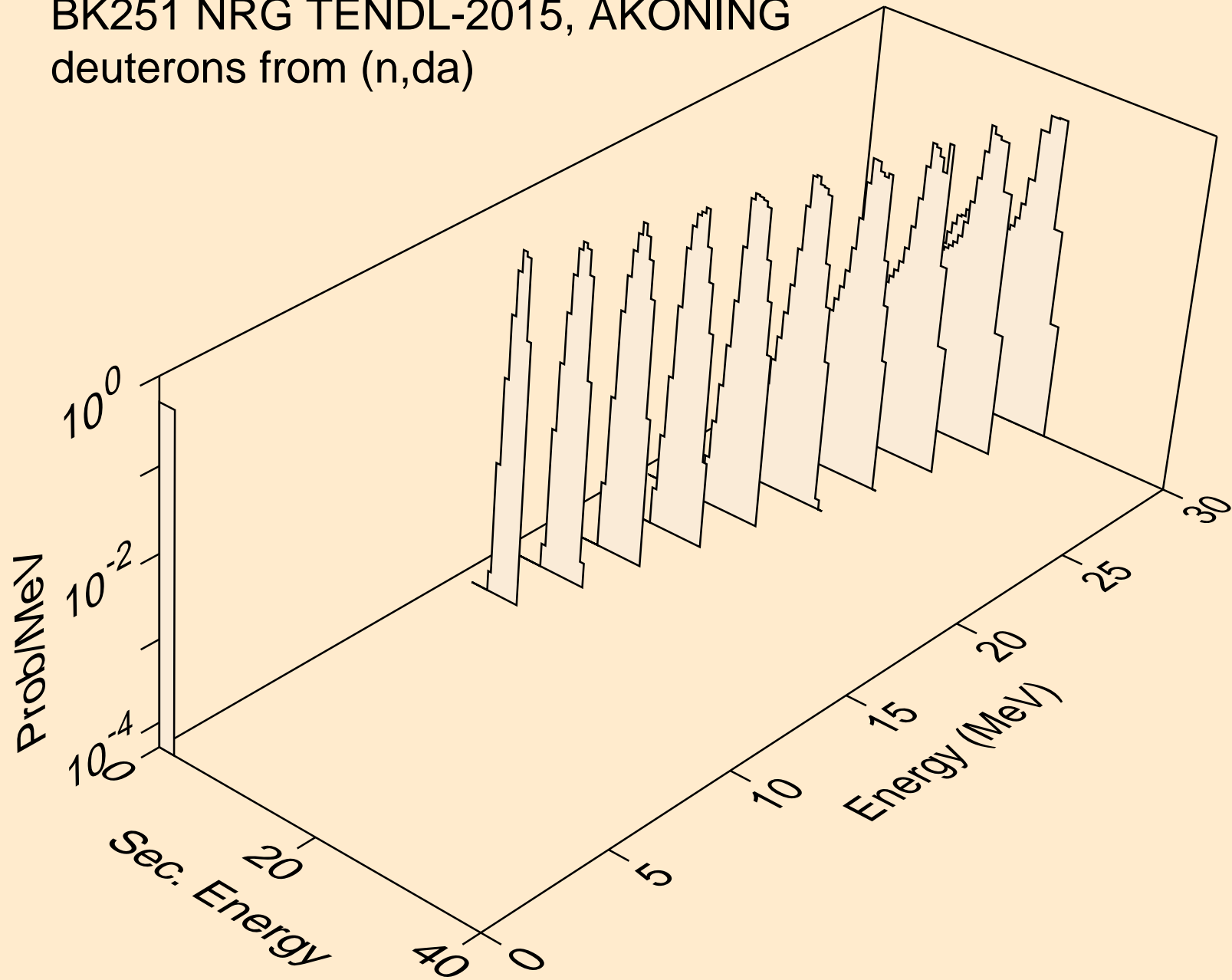

BK251 NRG TENDL-2015, AKONING
tritons from (n,x)

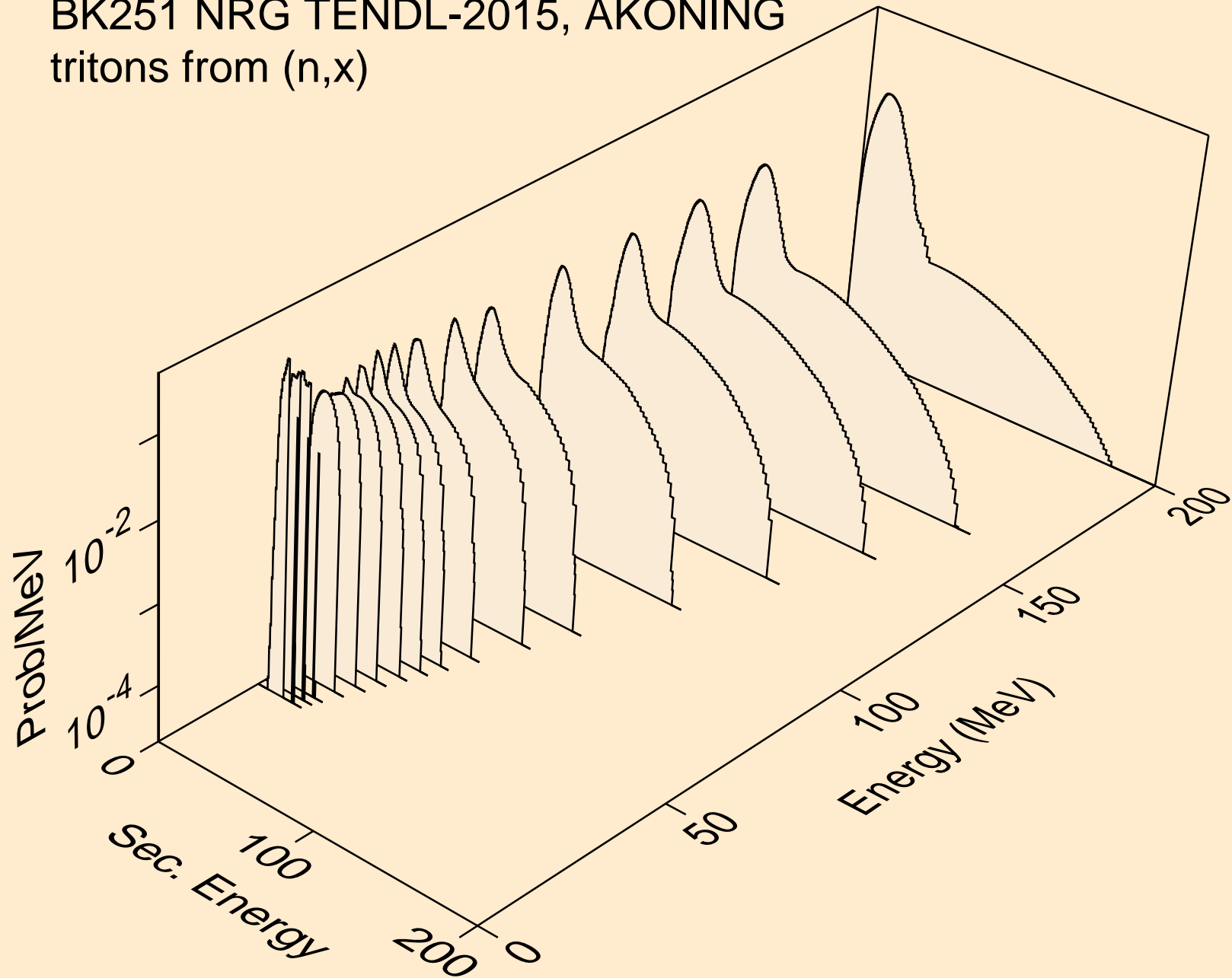

BK251 NRG TENDL-2015, AKONING
tritons from (n,n*)t

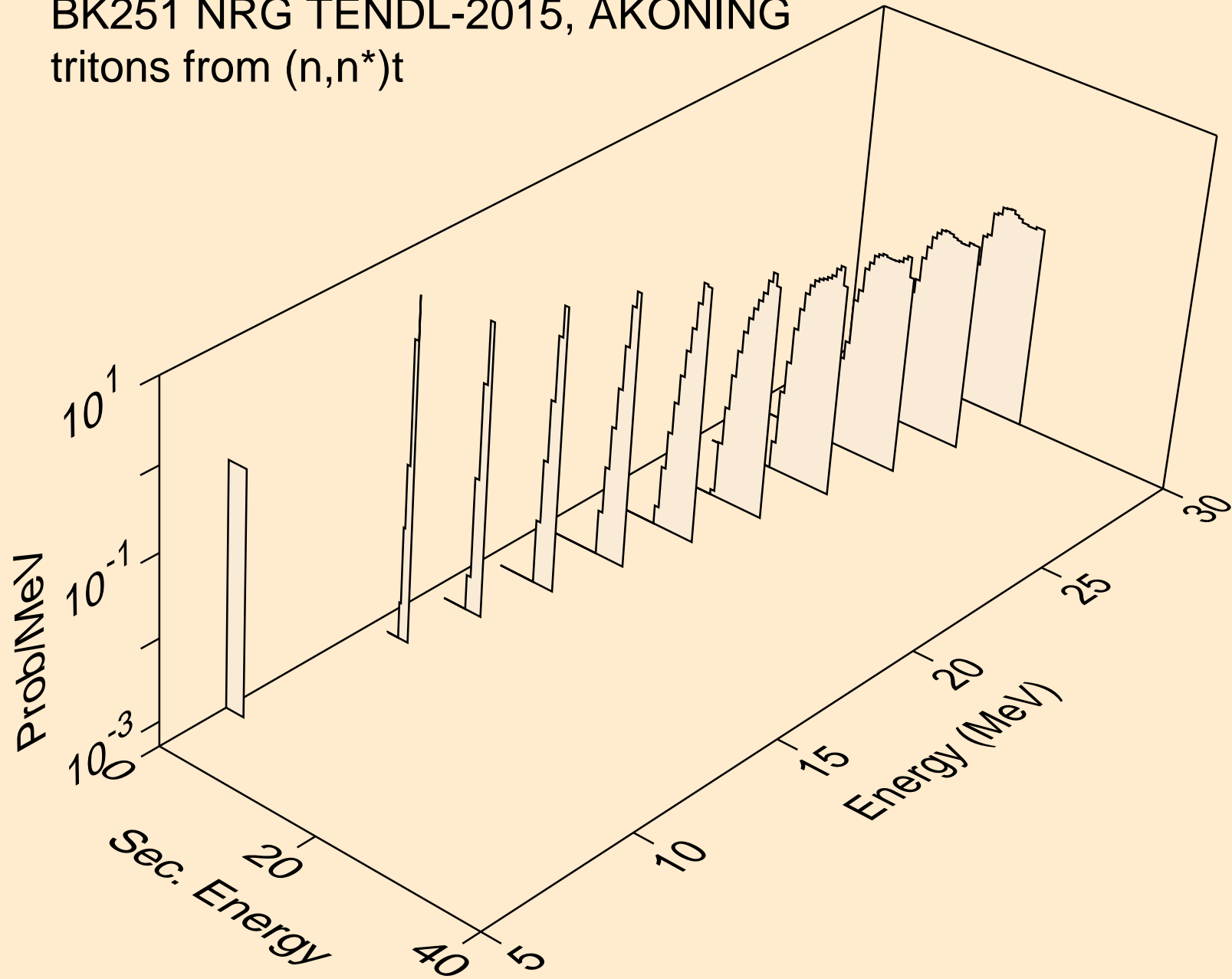

BK251 NRG TENDL-2015, AKONING
tritons from (n,t)

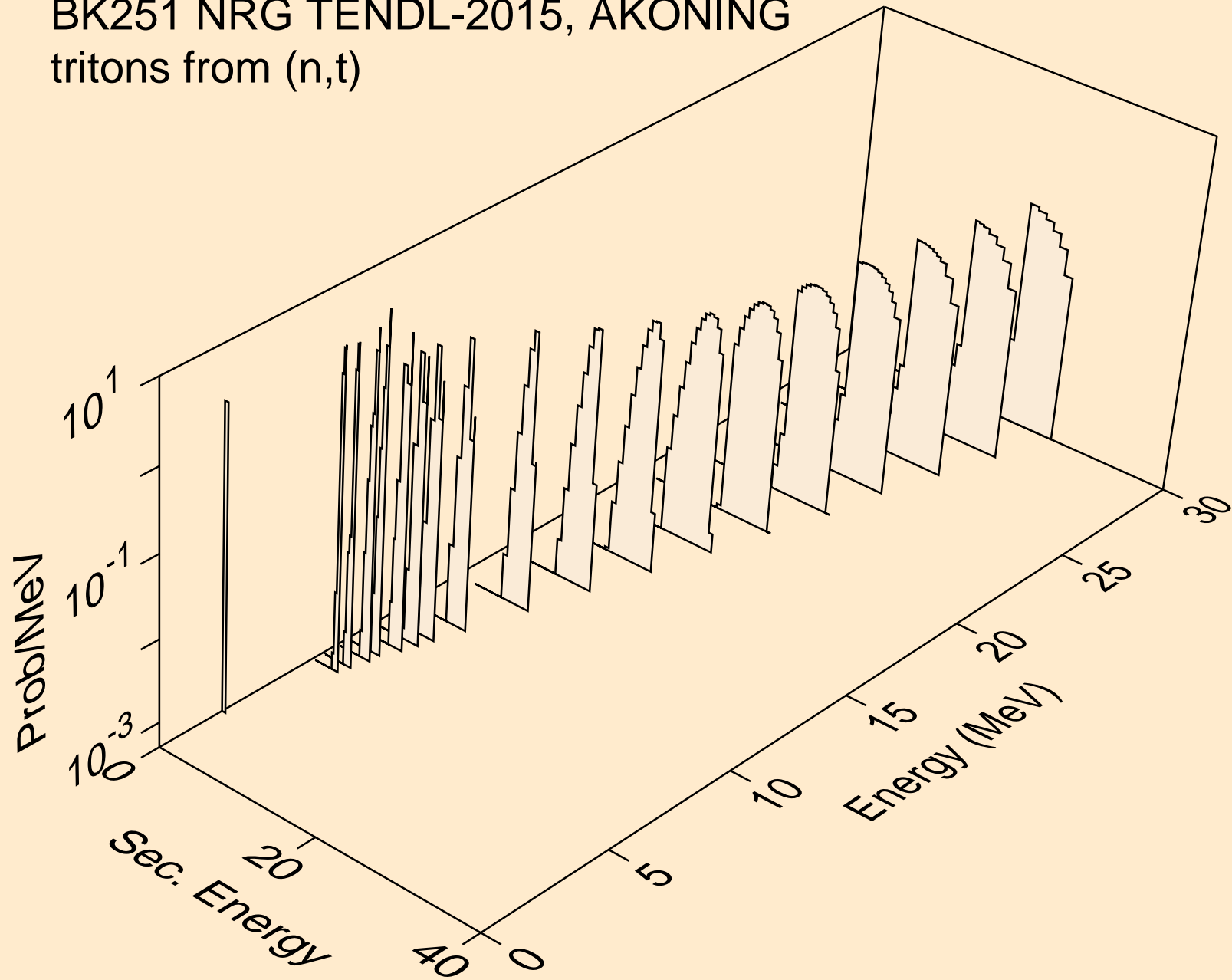

BK251 NRG TENDL-2015, AKONING
he3s from (n,x)

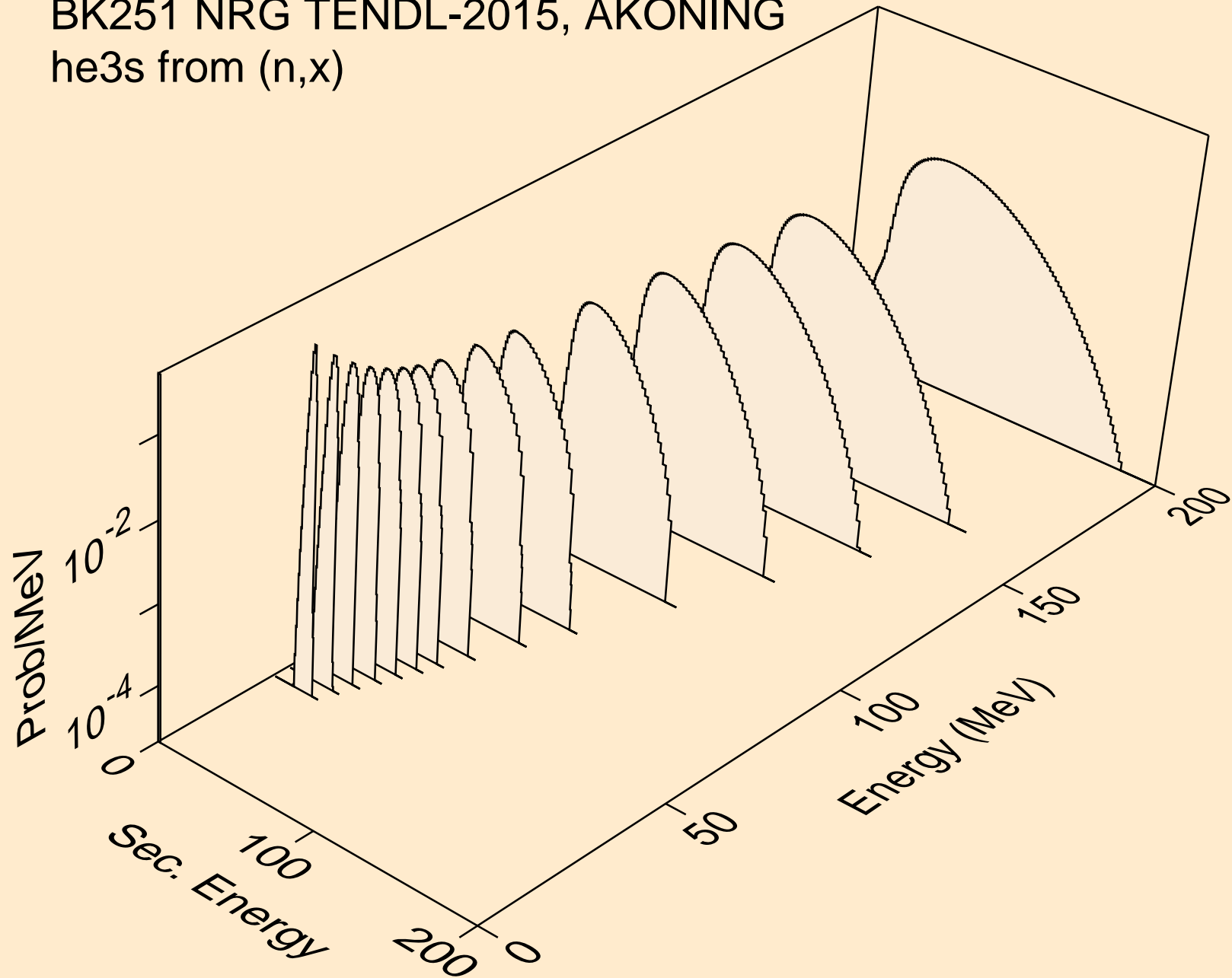

BK251 NRG TENDL-2015, AKONING
he3s from (n,n*)he3

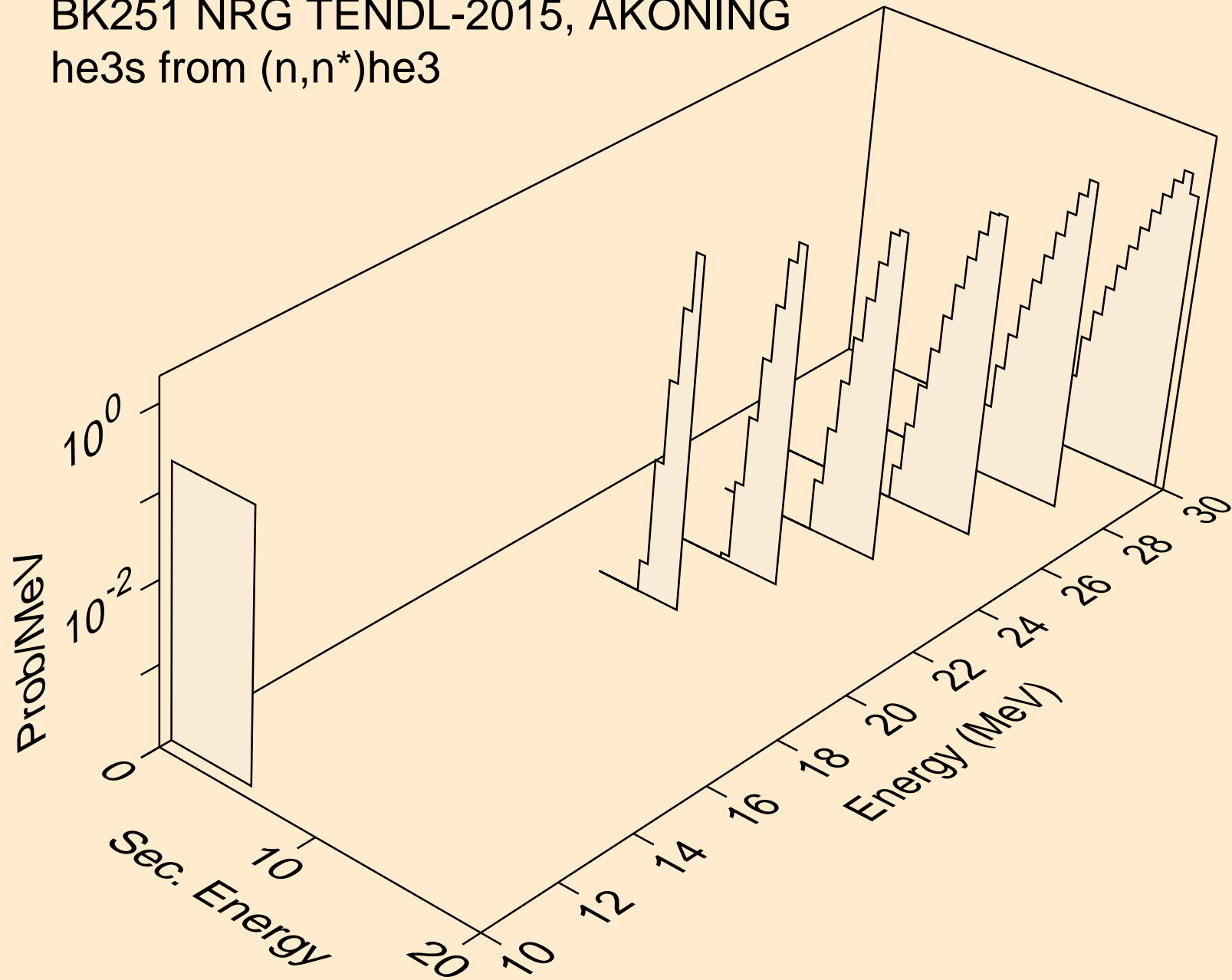

BK251 NRG TENDL-2015, AKONING
he3s from (n,he3)

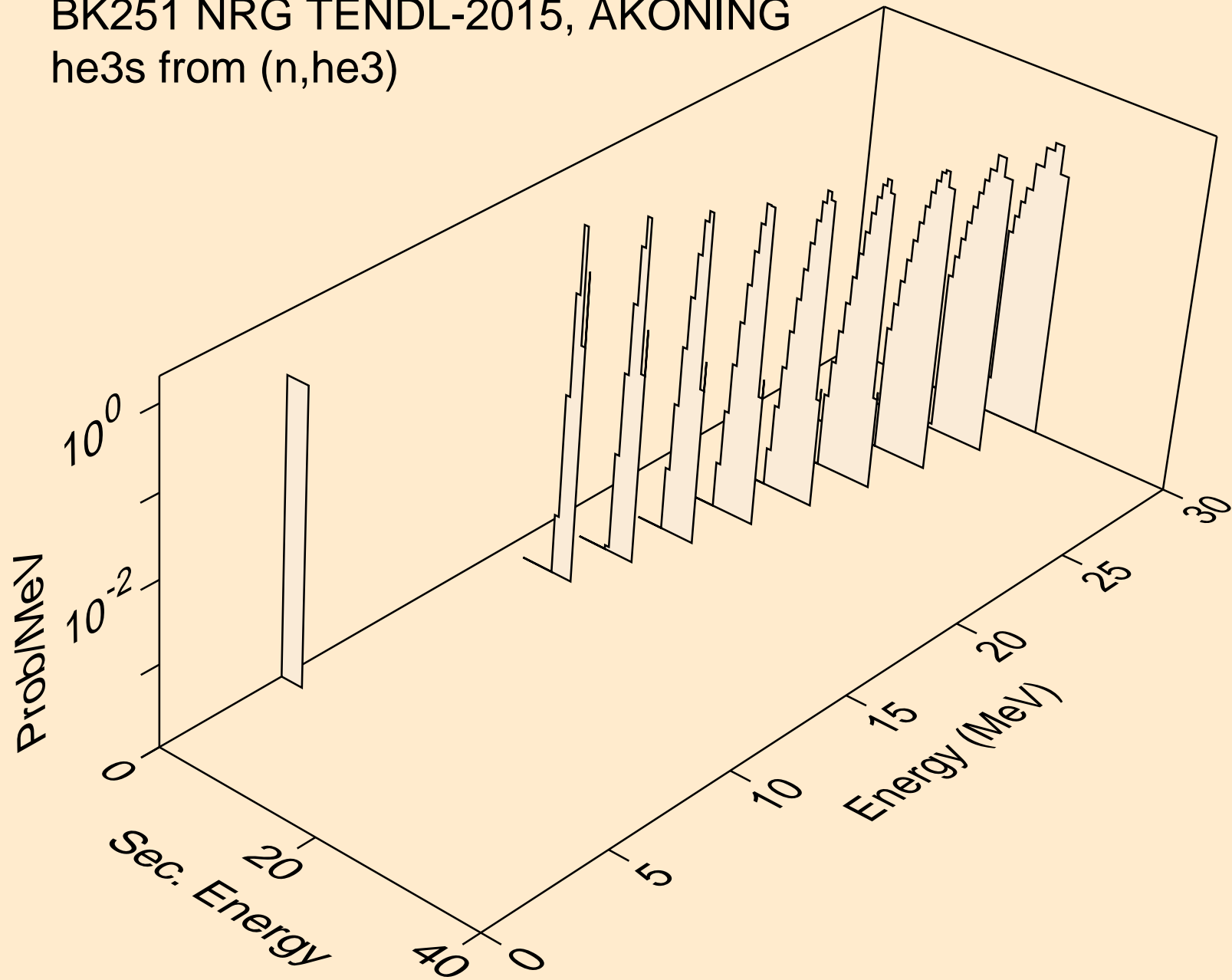

BK251 NRG TENDL-2015, AKONING
alphas from (n,x)

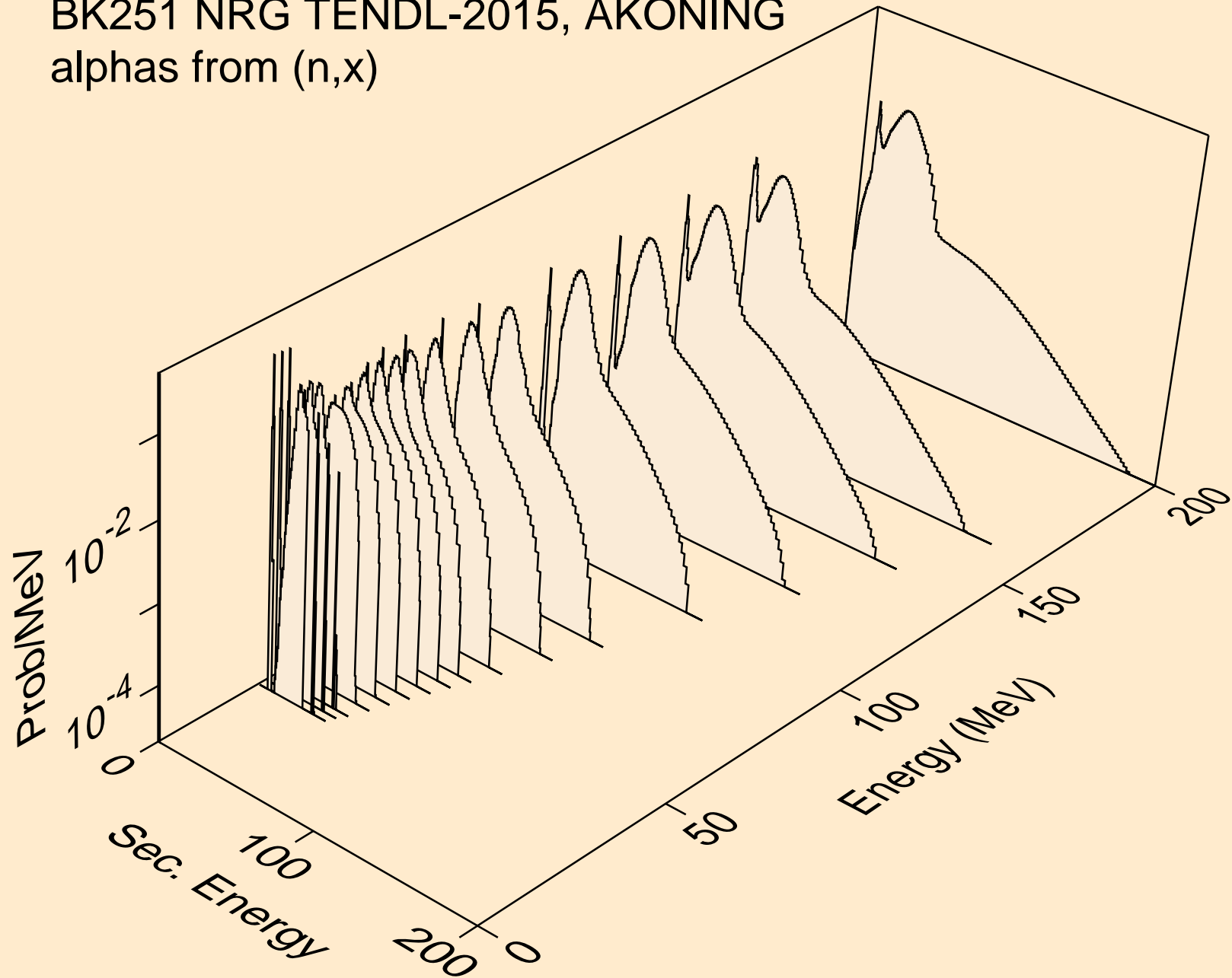

BK251 NRG TENDL-2015, AKONING
alphas from (n,n*)a

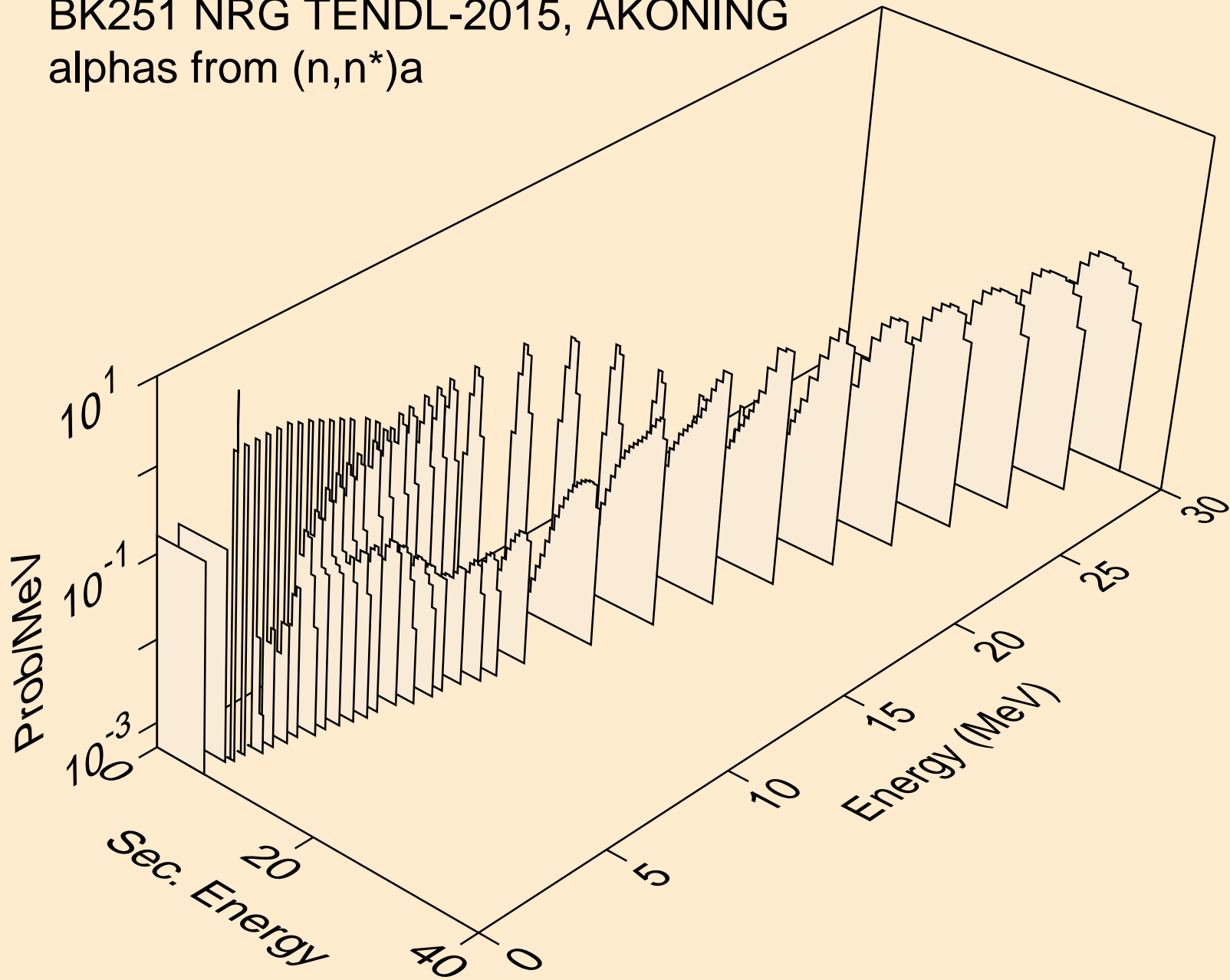

BK251 NRG TENDL-2015, AKONING
alphas from (n,2n)a

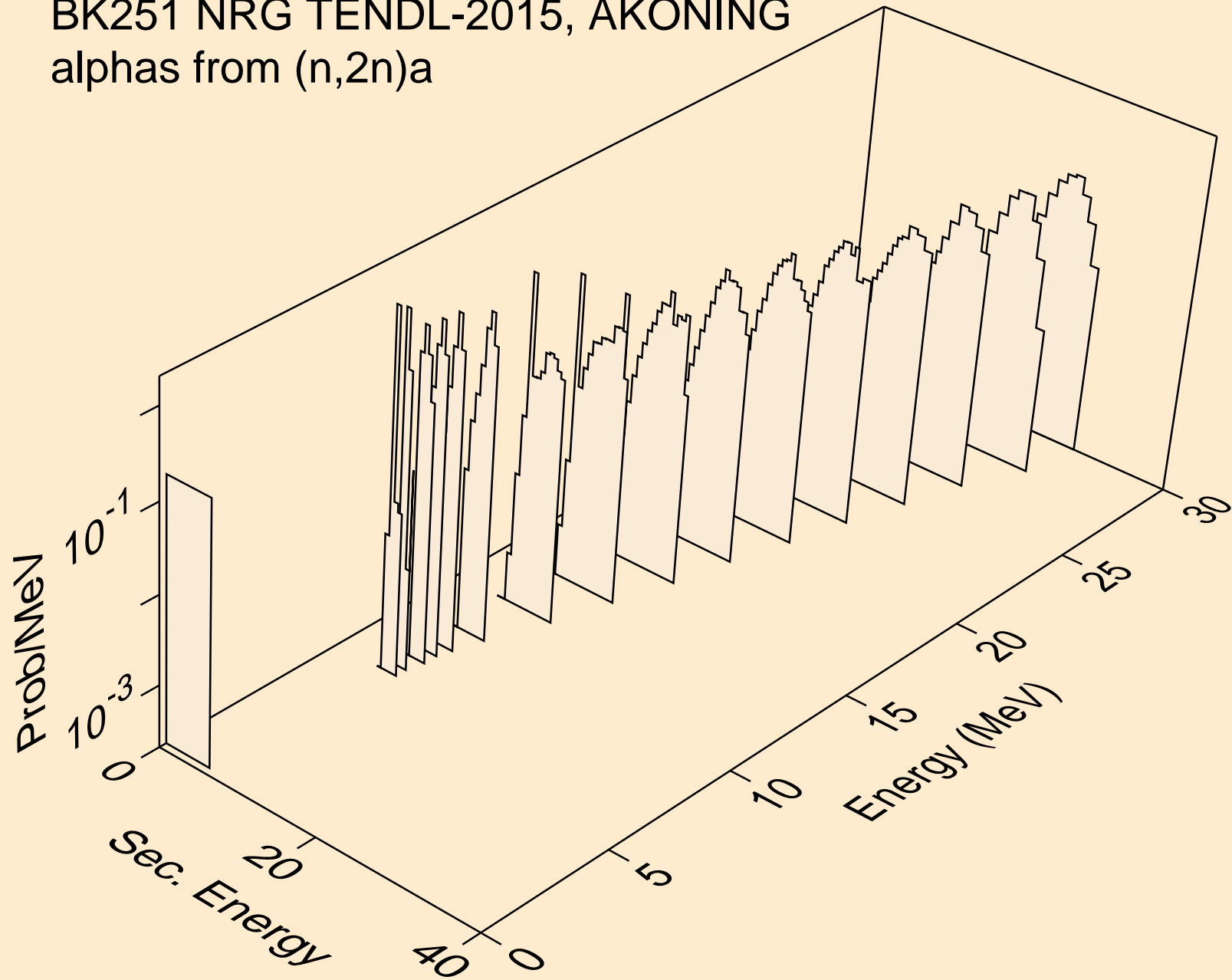

BK251 NRG TENDL-2015, AKONING
alphas from (n,3n)a

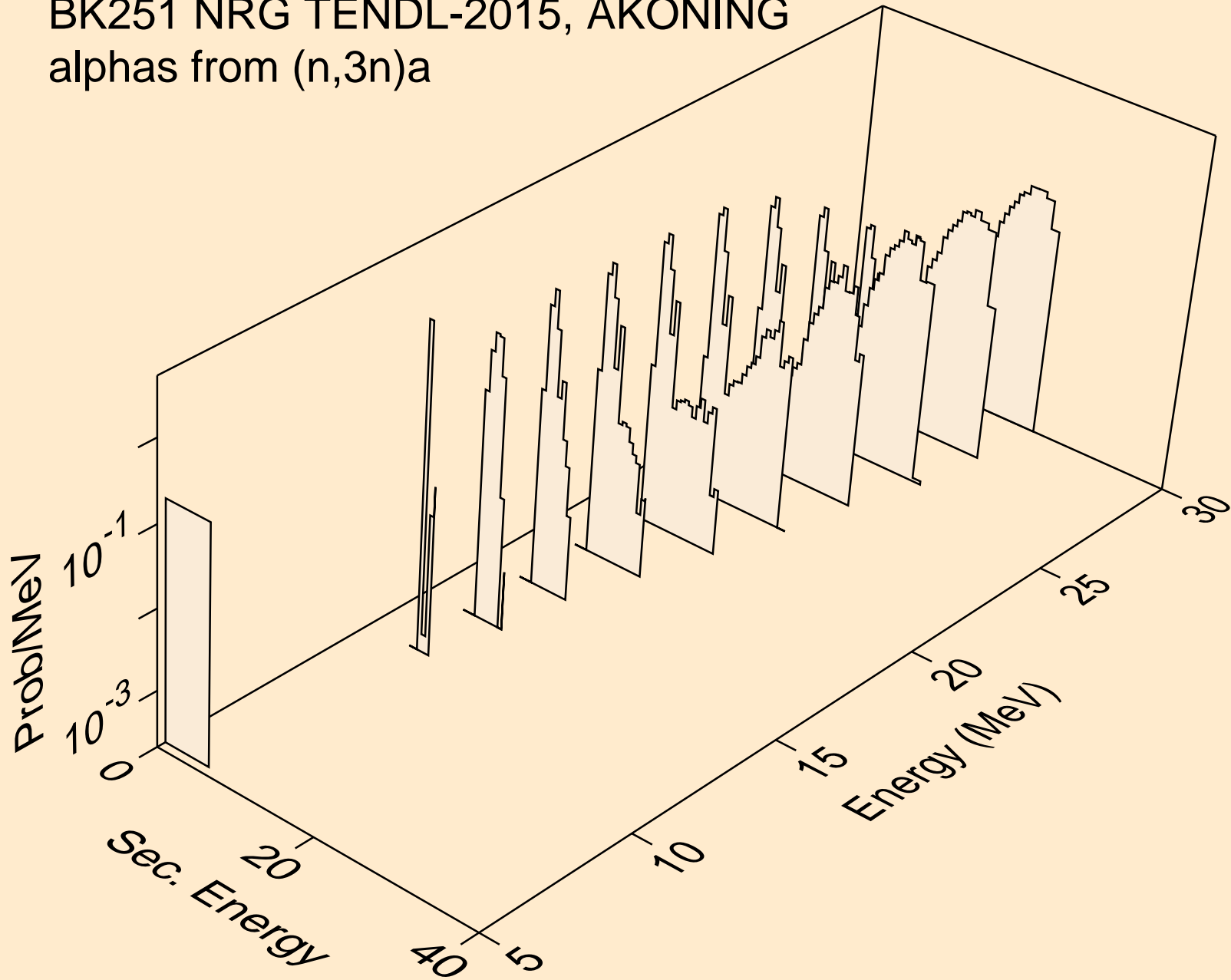

BK251 NRG TENDL-2015, AKONING
alphas from (n,n*)2a

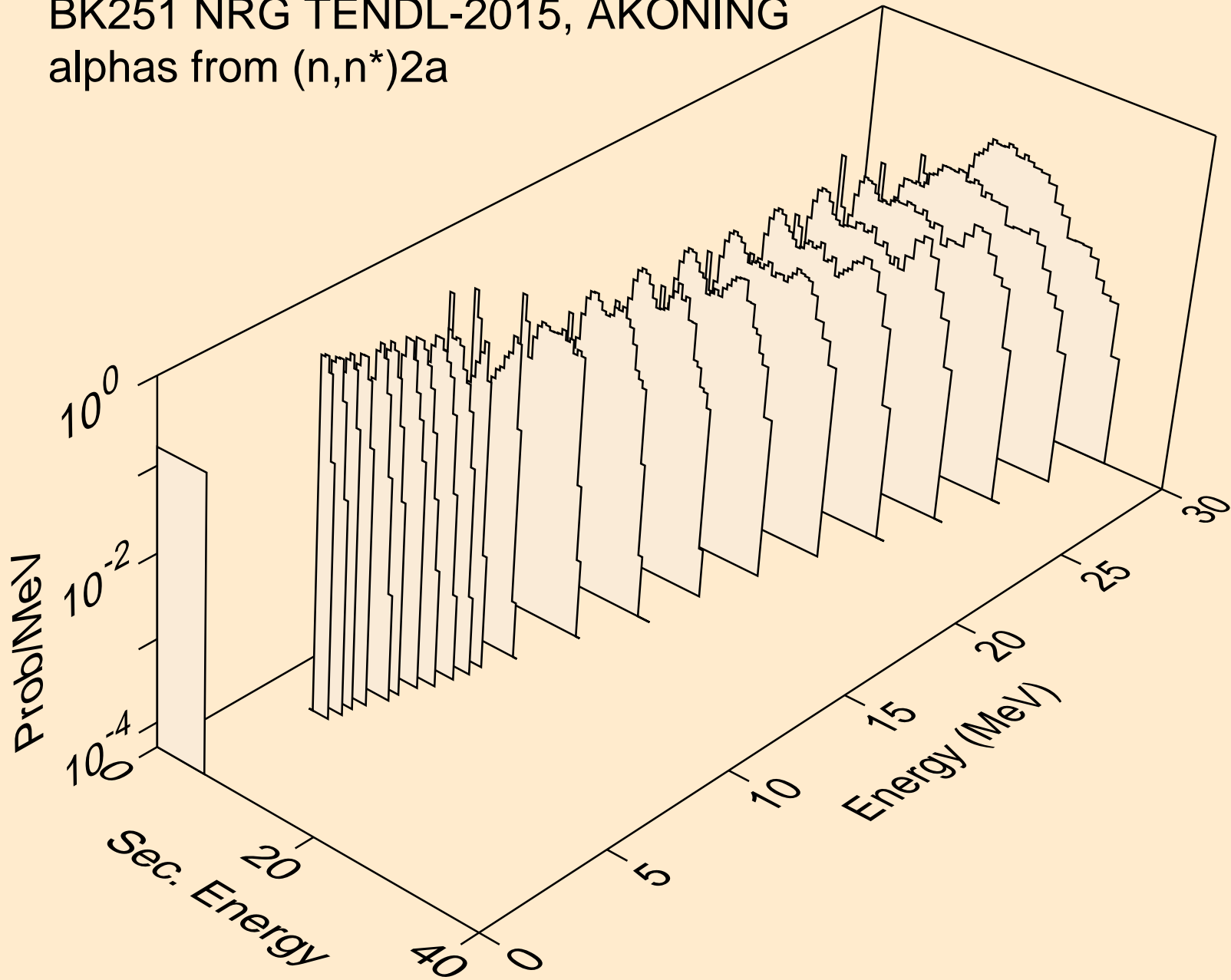

BK251 NRG TENDL-2015, AKONING
alphas from (n,2n)2a

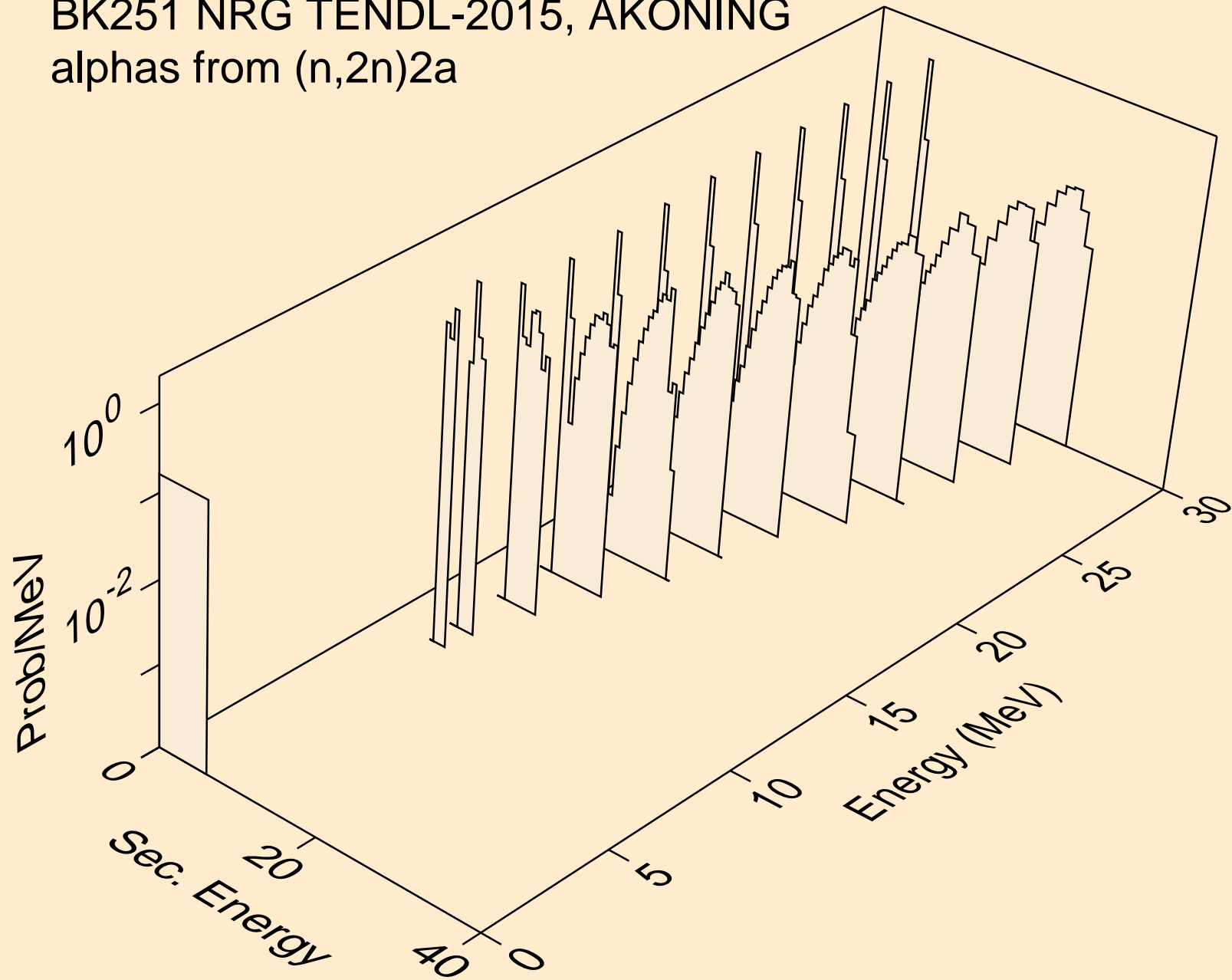

BK251 NRG TENDL-2015, AKONING
alphas from (n,npa)

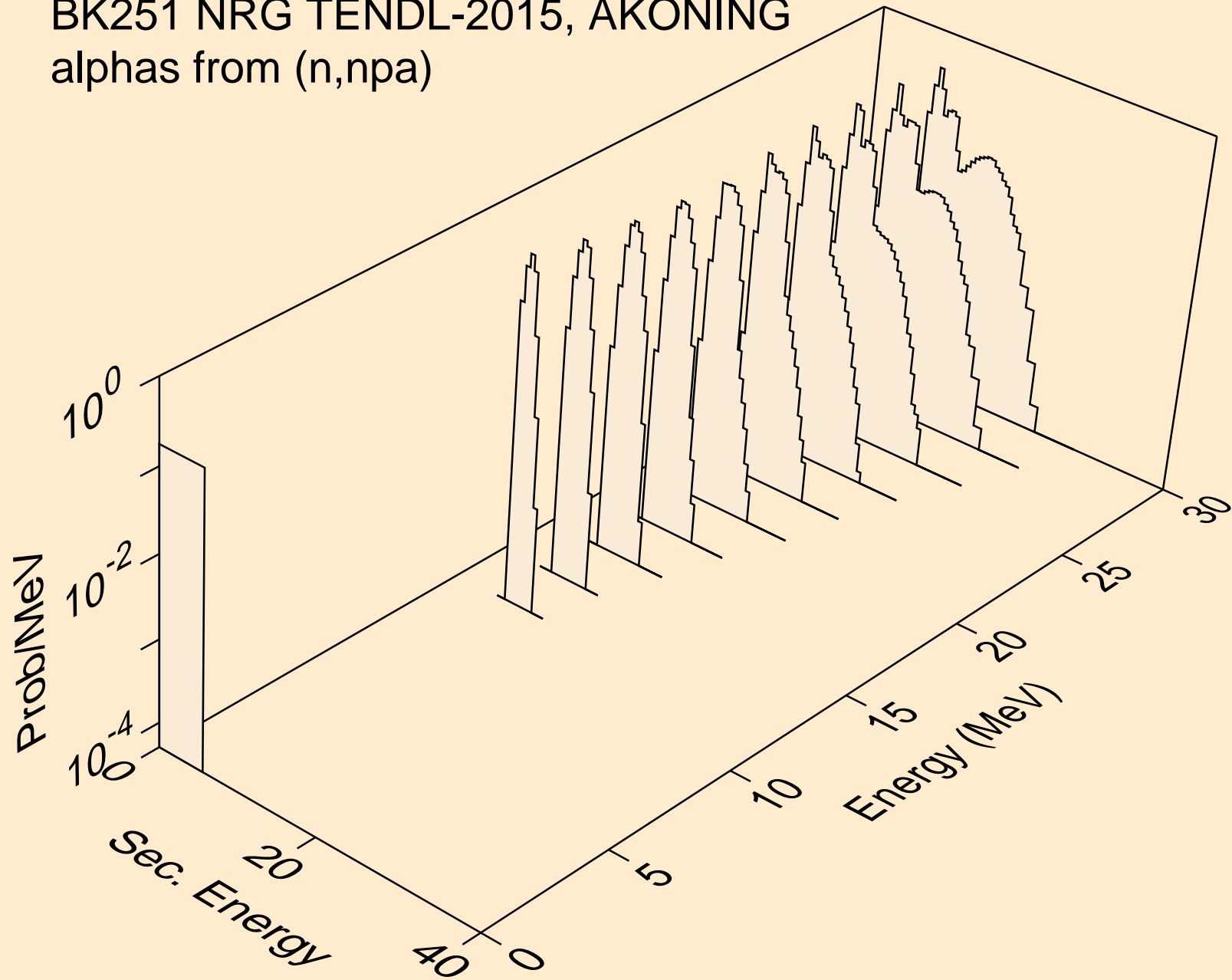

BK251 NRG TENDL-2015, AKONING
alphas from (n,a)

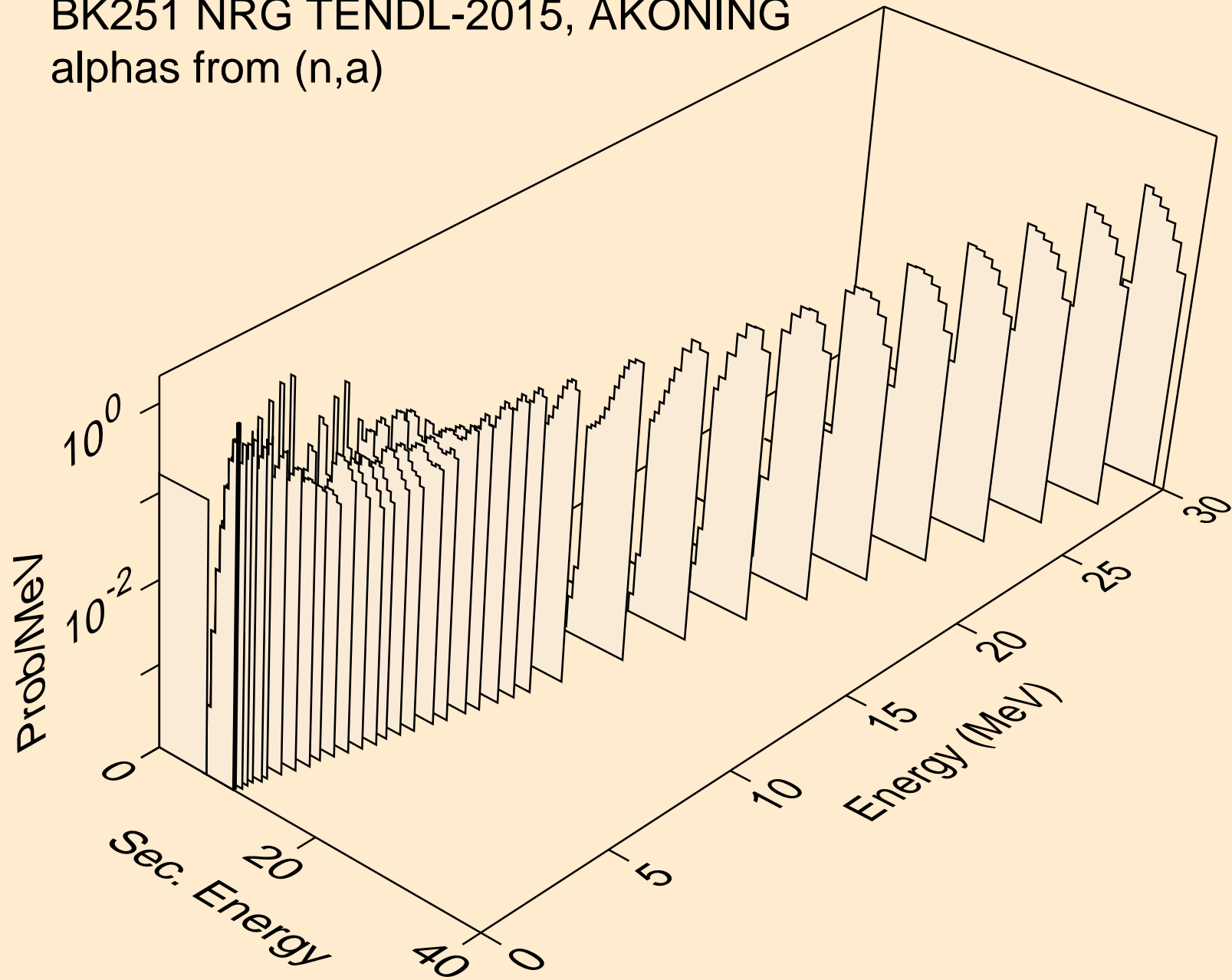

BK251 NRG TENDL-2015, AKONING
alphas from (n,pa)

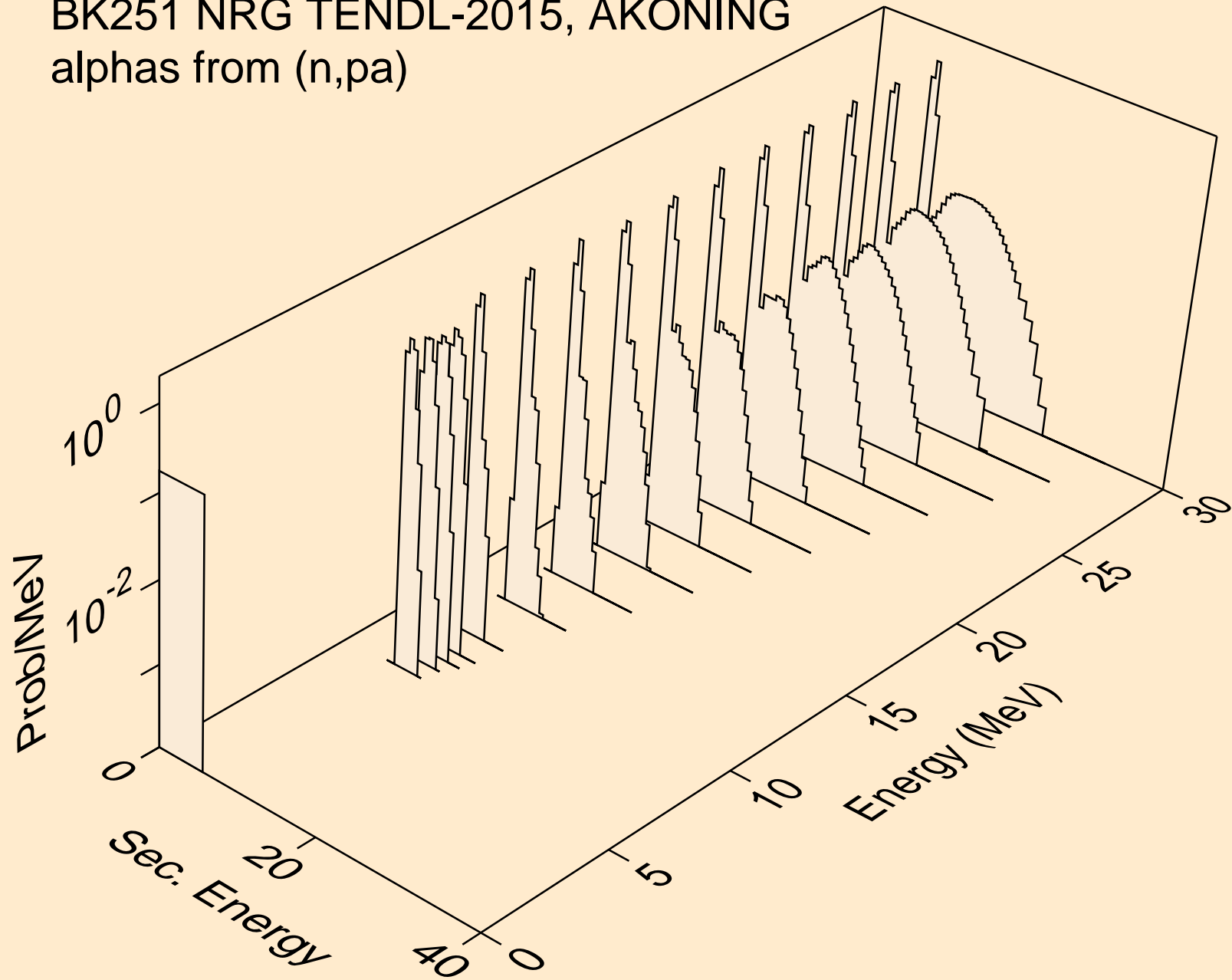

BK251 NRG TENDL-2015, AKONING
alphas from (n,da)

