

C011 NRG TENDL-2015, AKONING

Principal cross sections

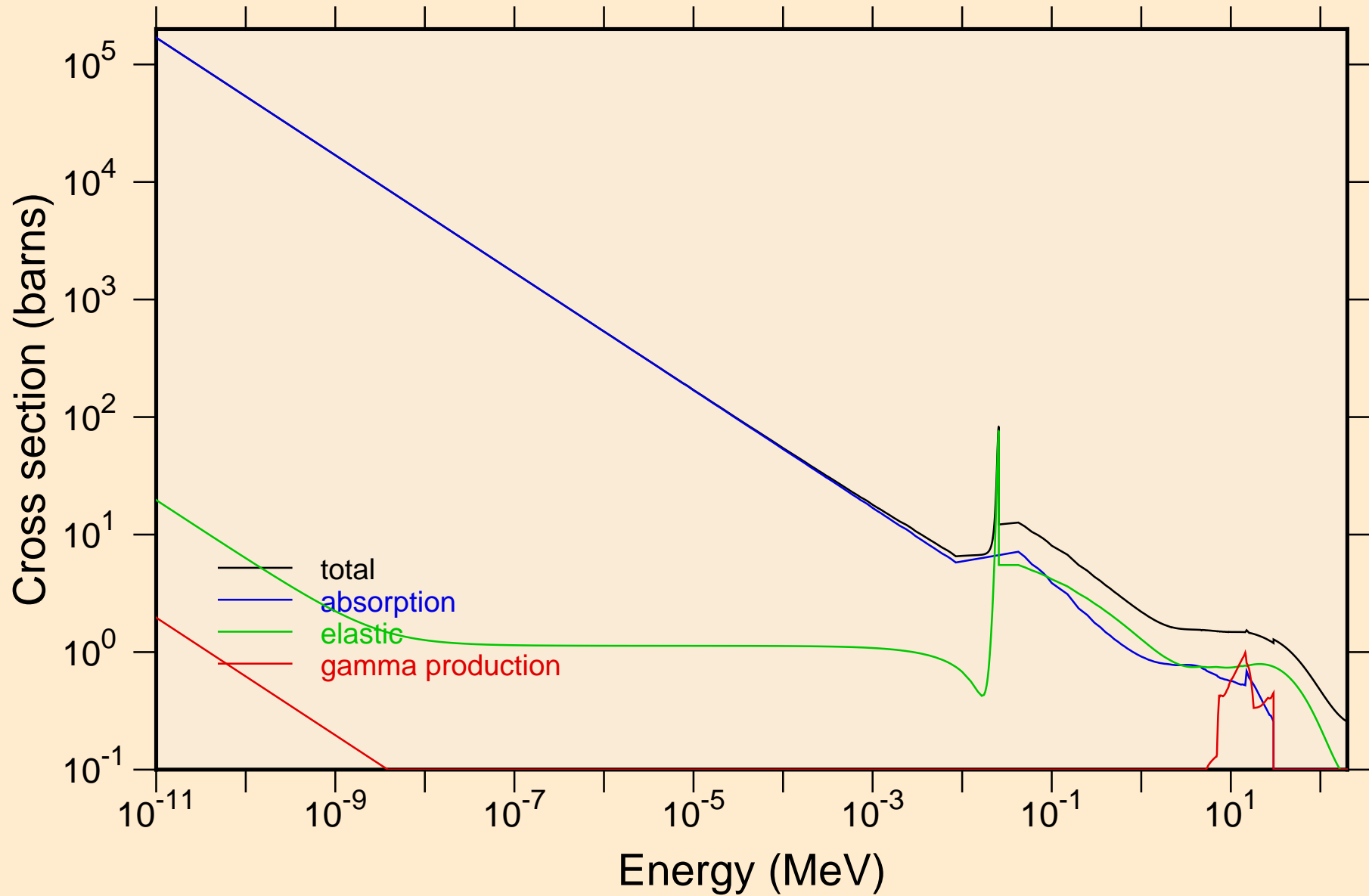

C011 NRG TENDL-2015, AKONING

Non-threshold reactions

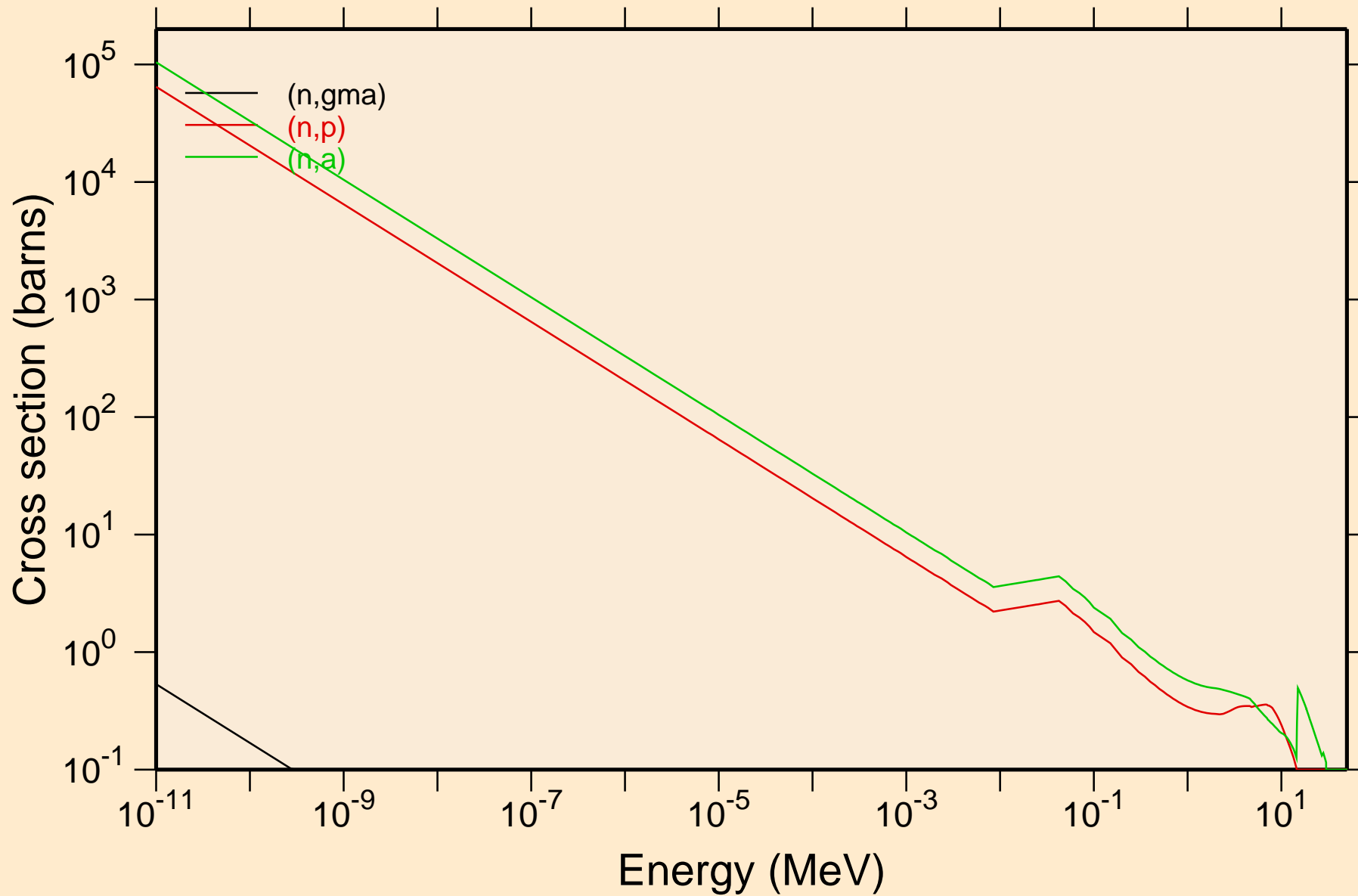

C011 NRG TENDL-2015, AKONING

Principal cross sections

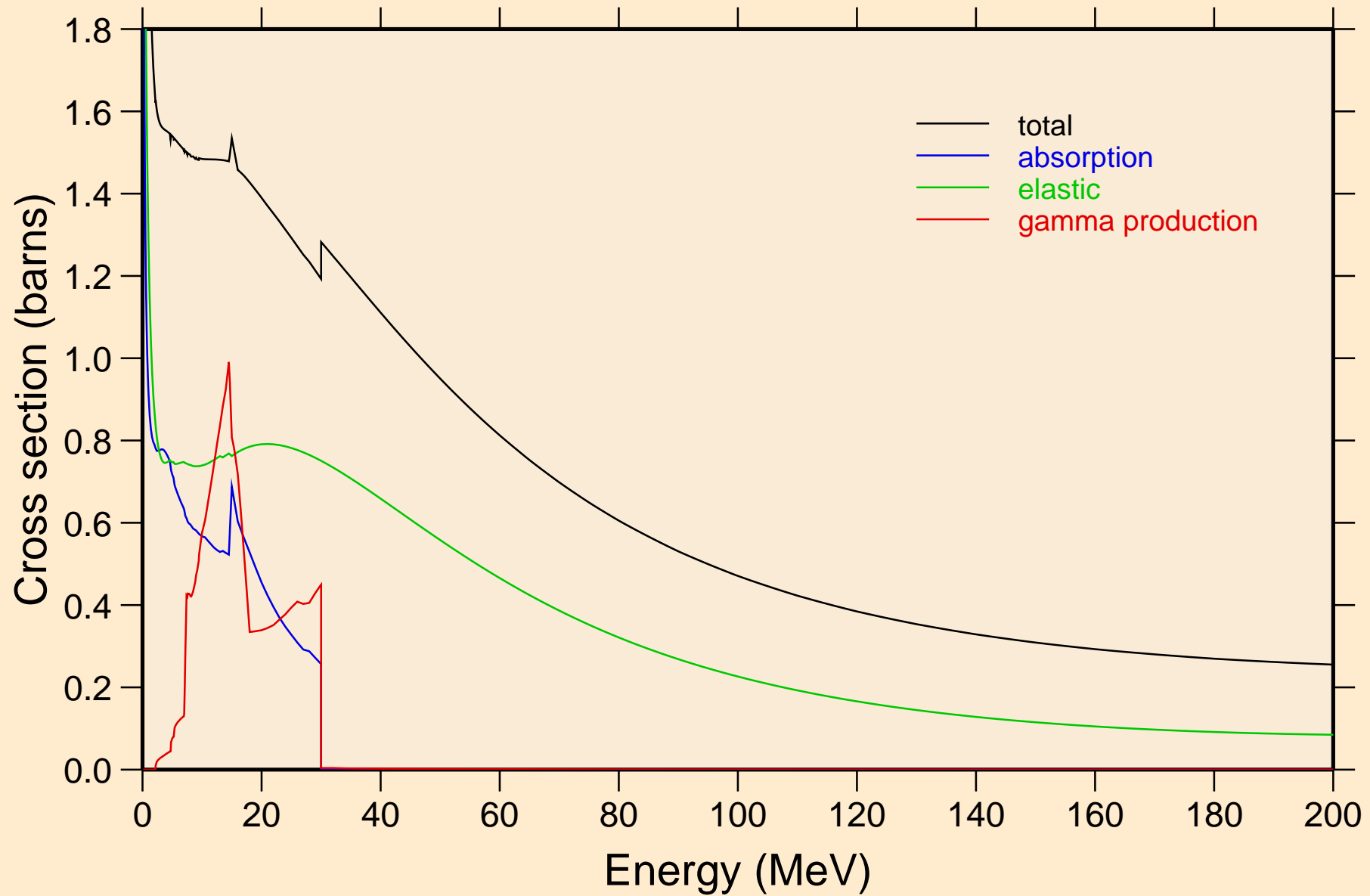

C011 NRG TENDL-2015, AKONING

Non-threshold reactions

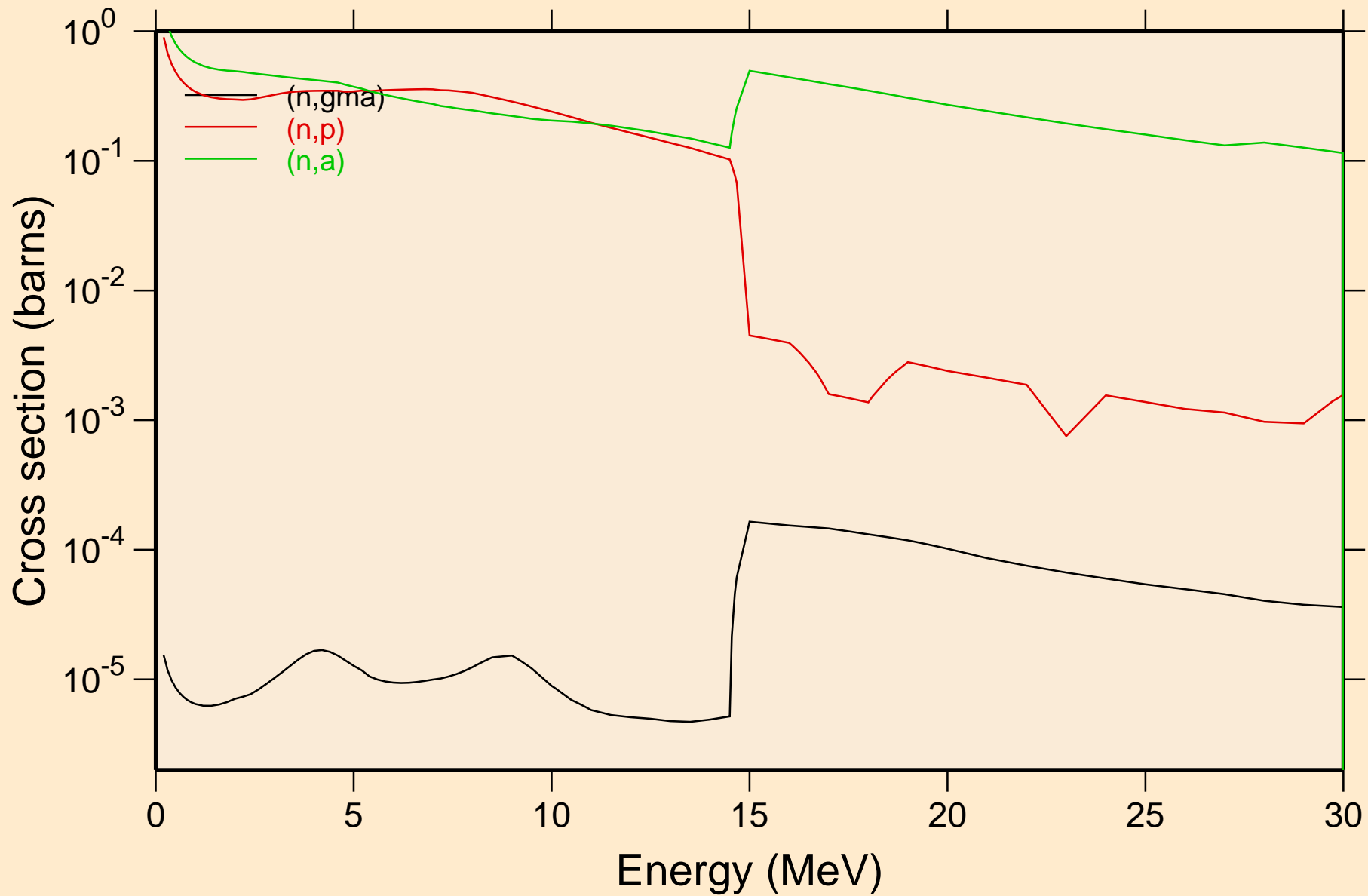

C011 NRG TENDL-2015, AKONING

Inelastic levels

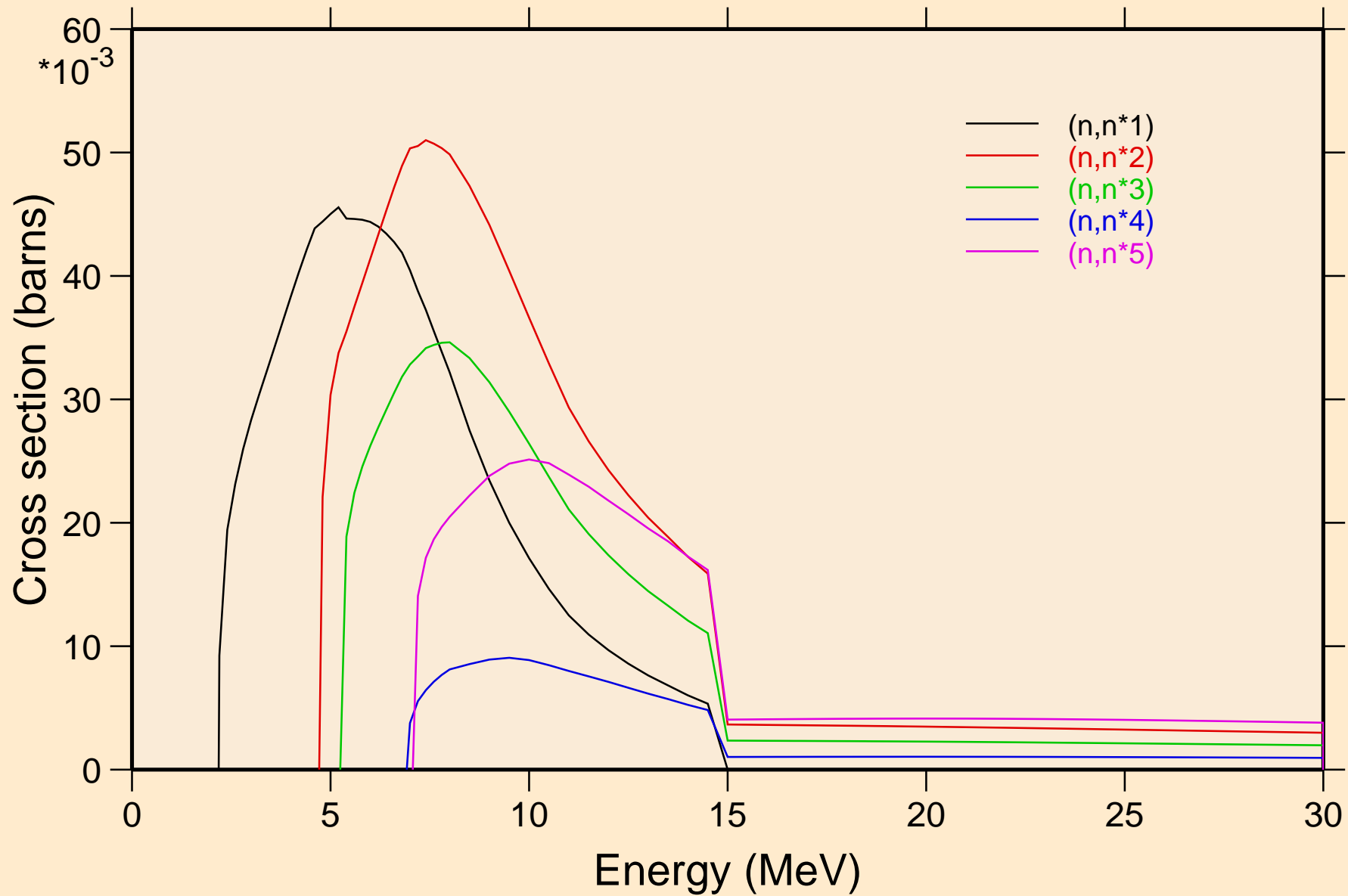

C011 NRG TENDL-2015, AKONING

Inelastic levels

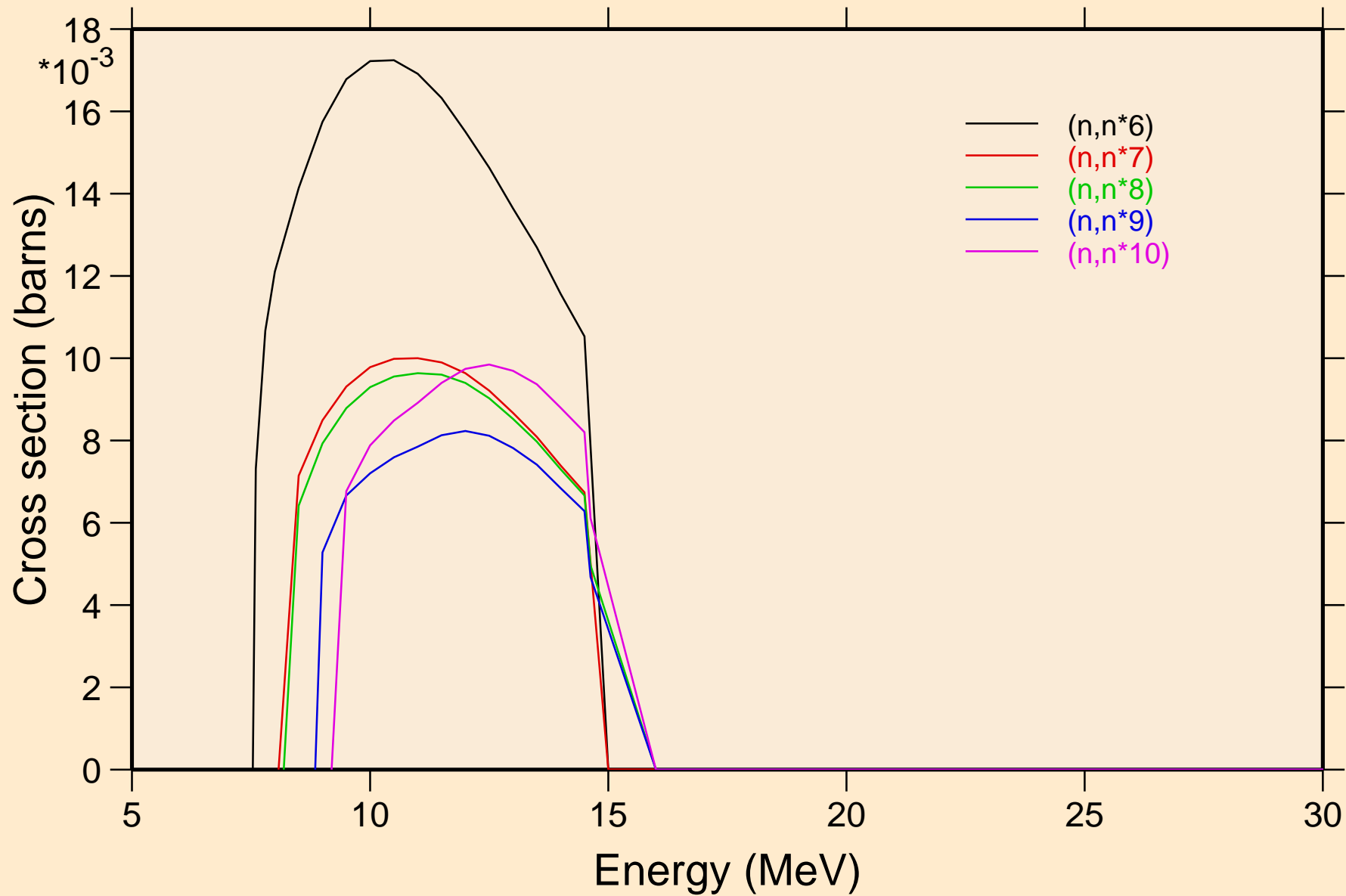

C011 NRG TENDL-2015, AKONING
Inelastic levels

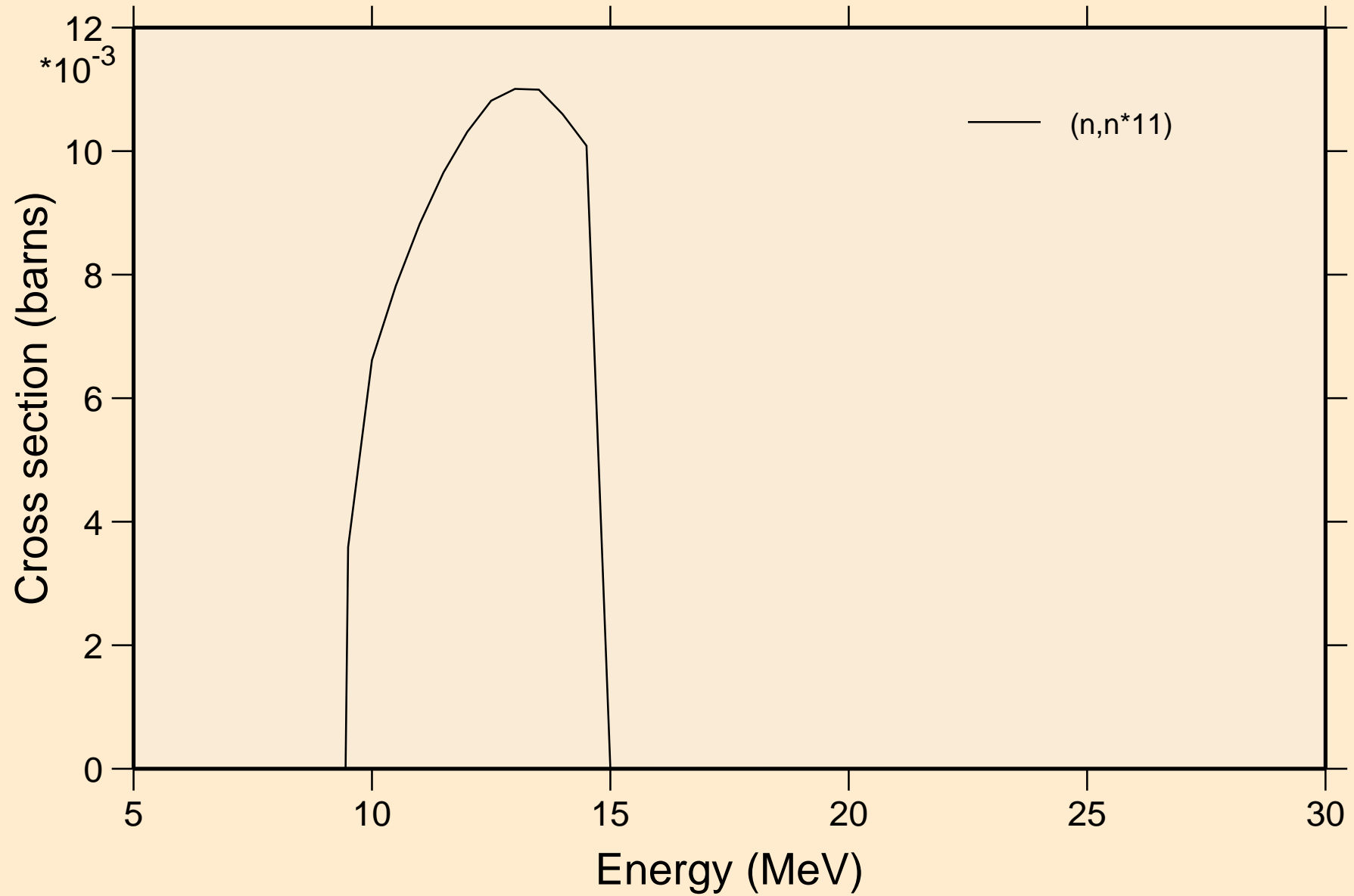

C011 NRG TENDL-2015, AKONING

Threshold reactions

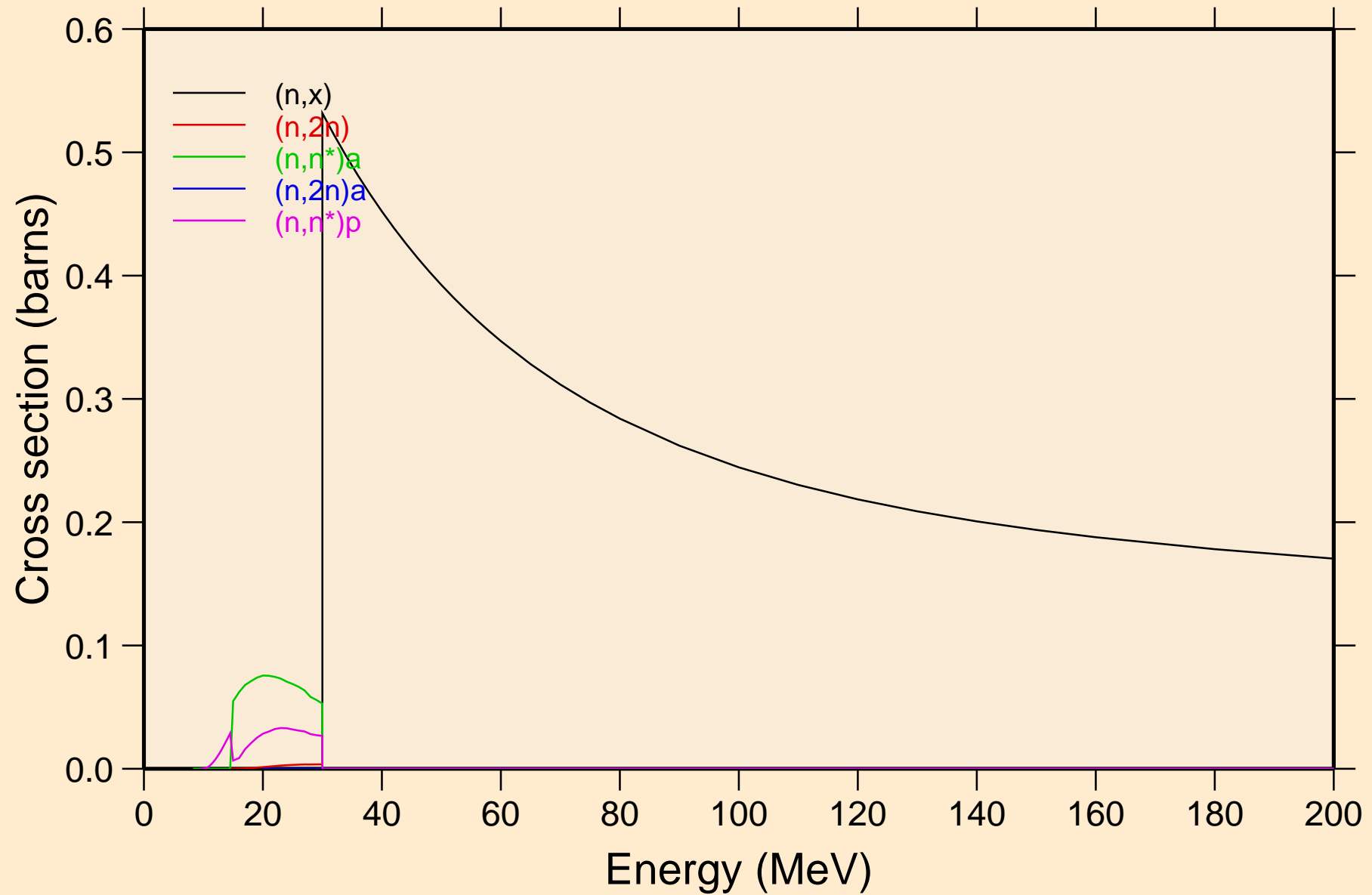

C011 NRG TENDL-2015, AKONING

Threshold reactions

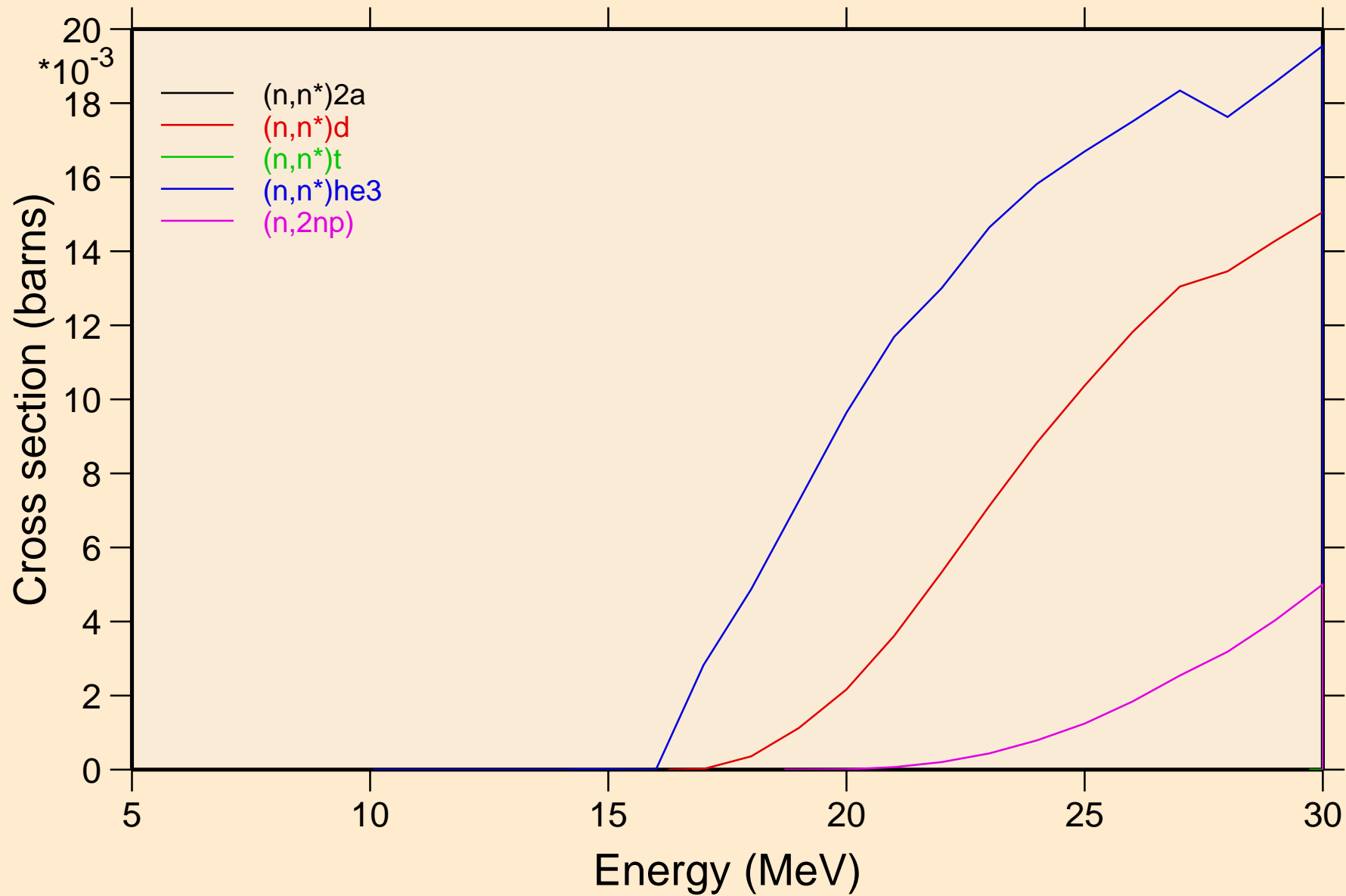

C011 NRG TENDL-2015, AKONING

Threshold reactions

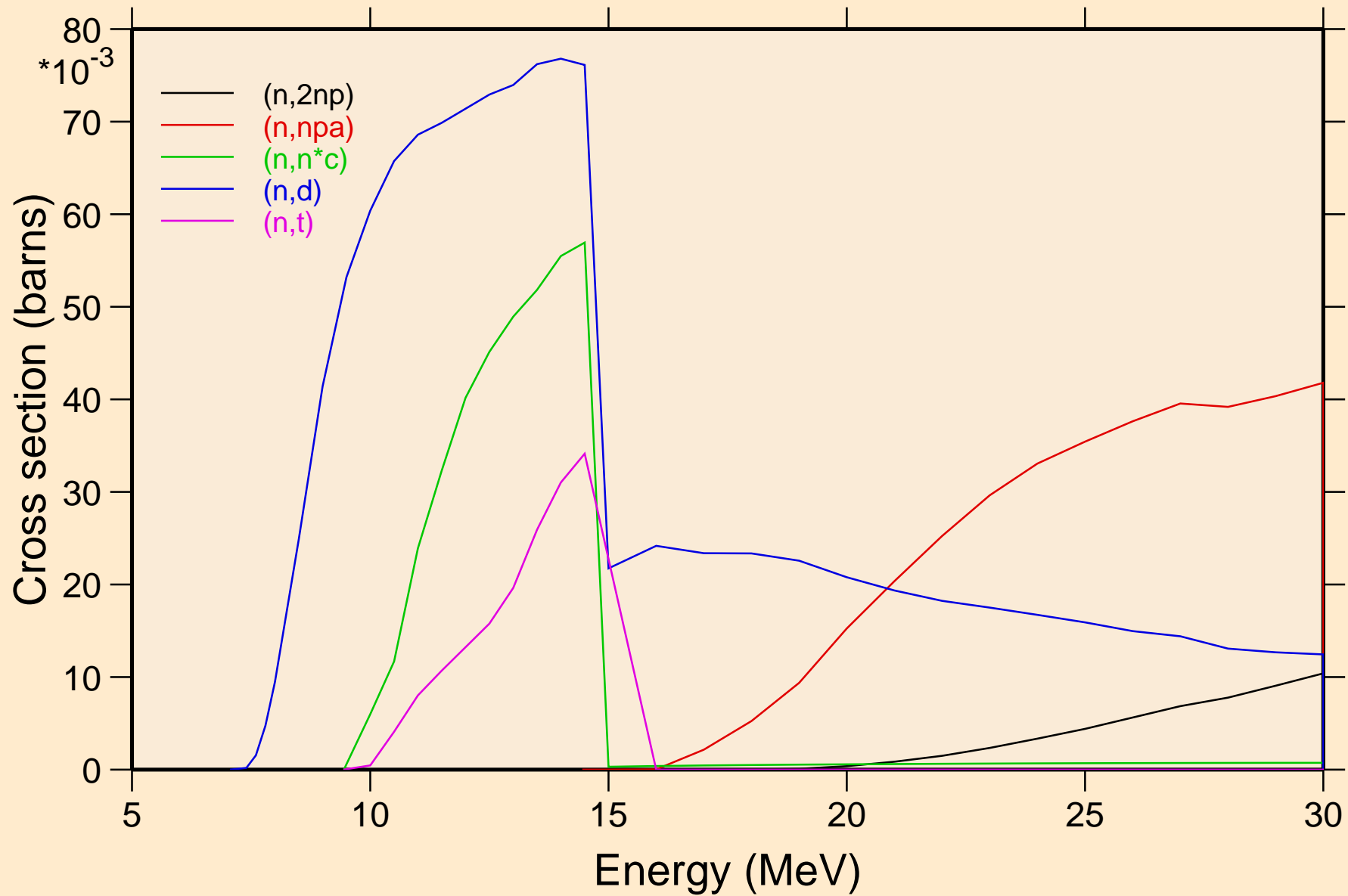

C011 NRG TENDL-2015, AKONING

Threshold reactions

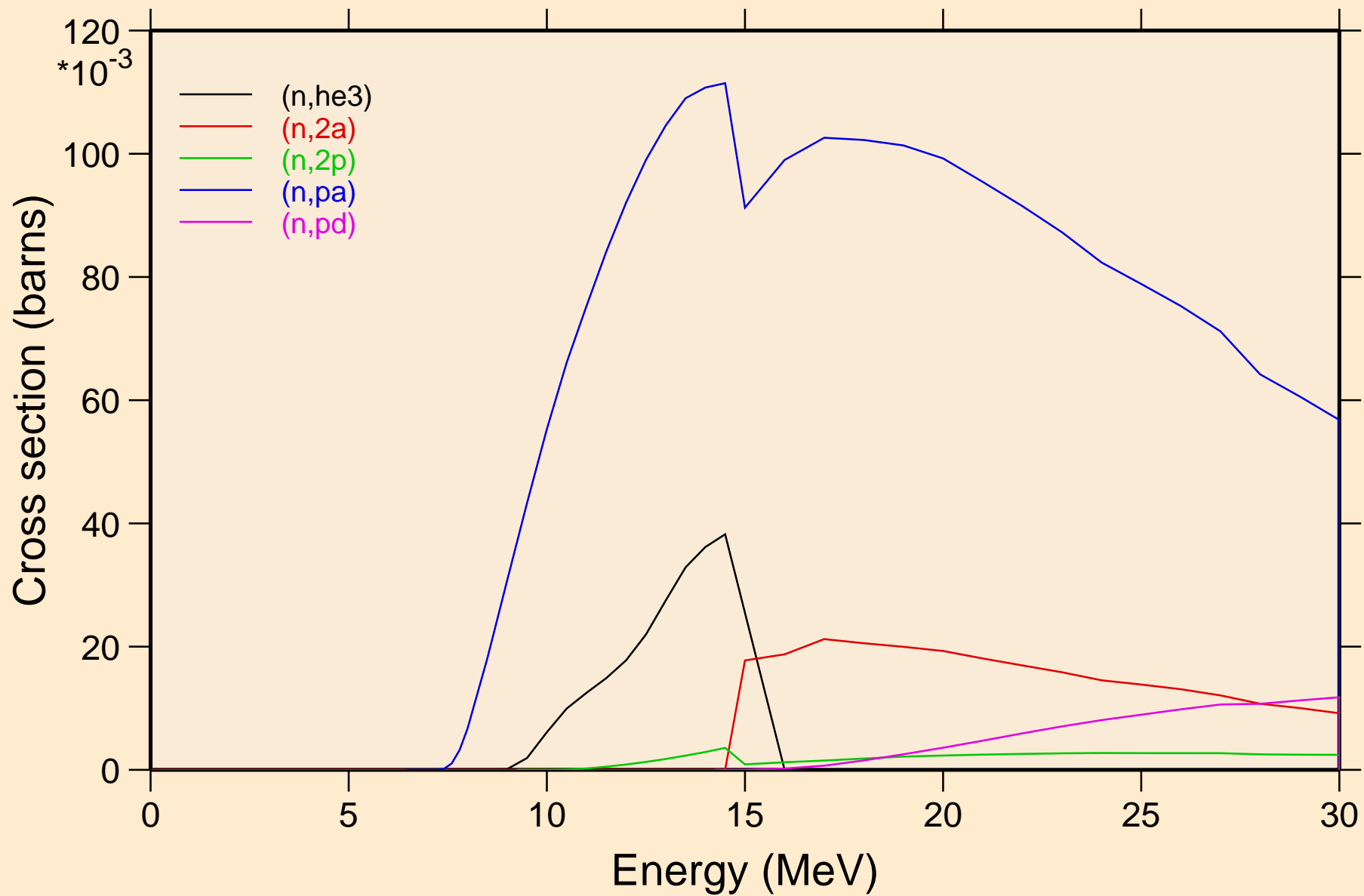

C011 NRG TENDL-2015, AKONING

Threshold reactions

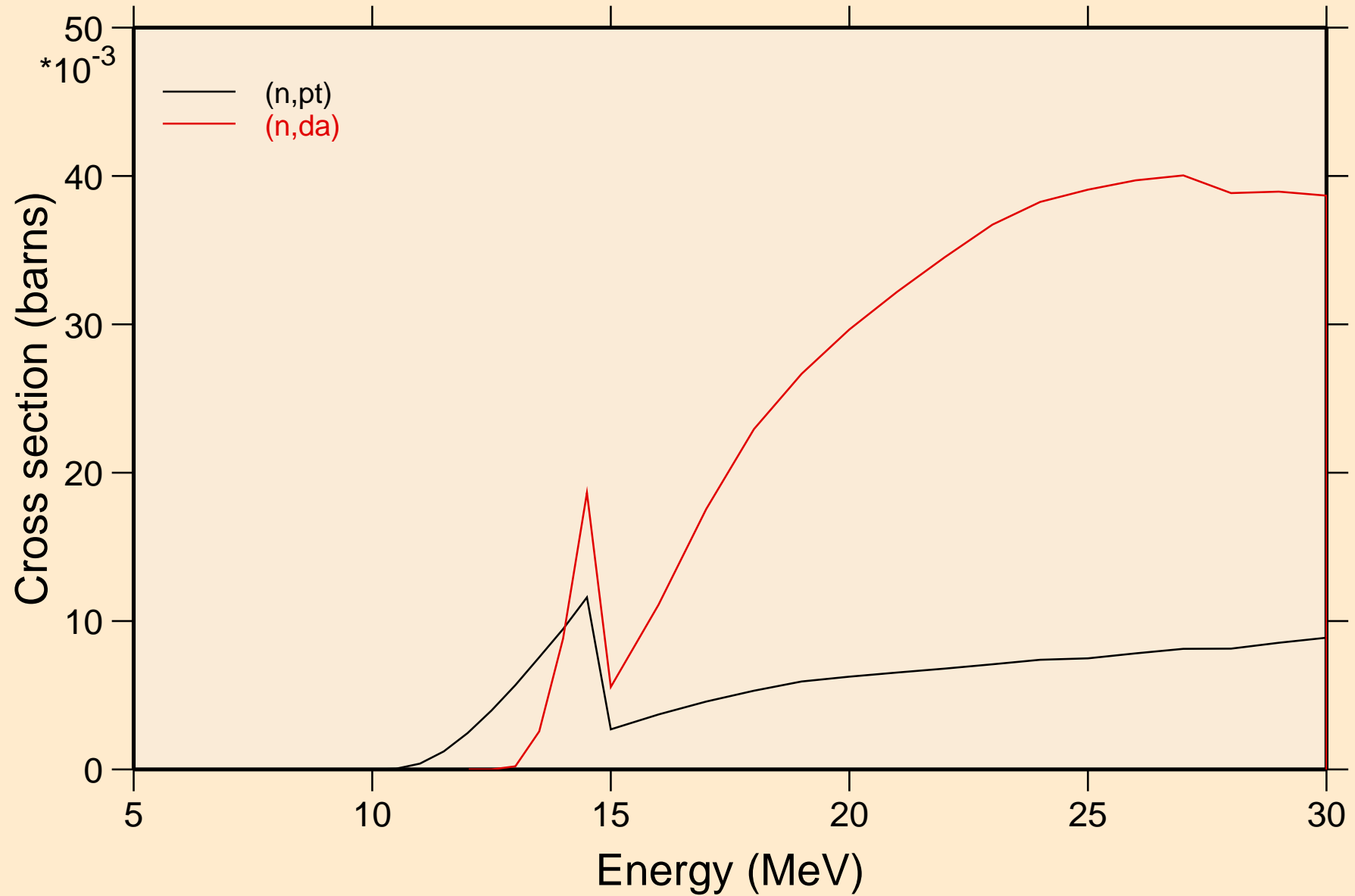

C011 NRG TENDL-2015, AKONING
angular distribution for elastic

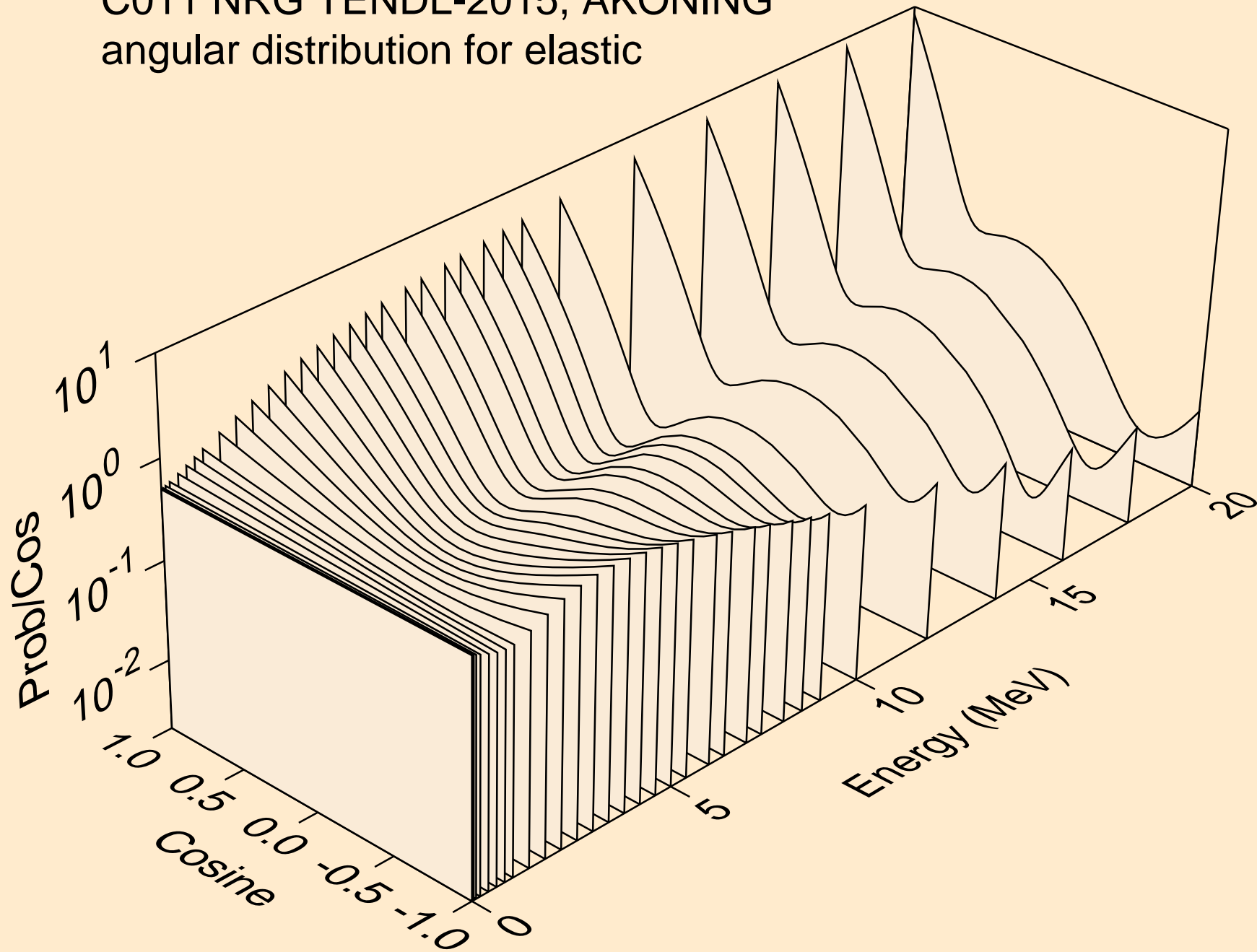

C011 NRG TENDL-2015, AKONING
angular distribution for elastic

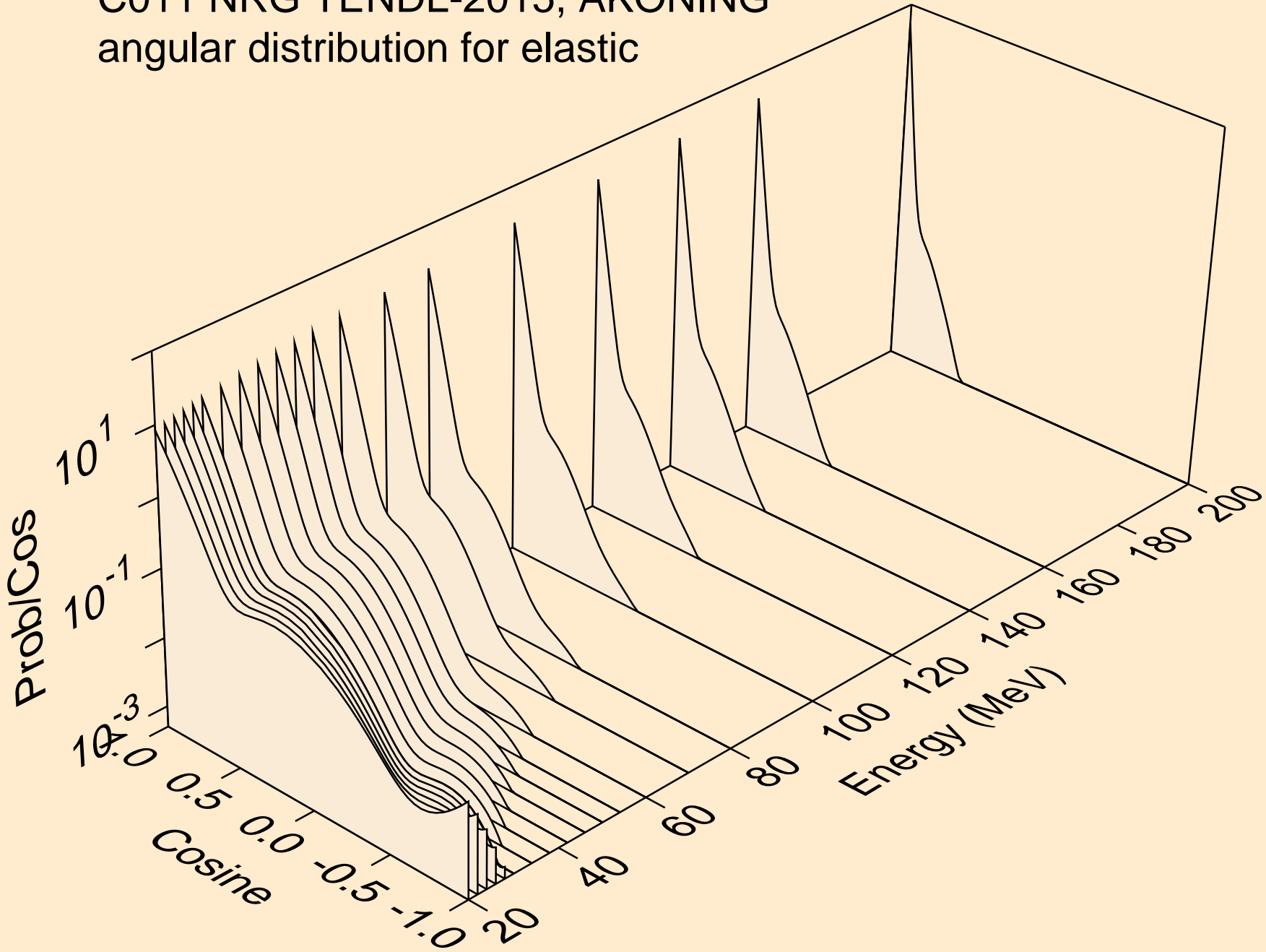

C011 NRG TENDL-2015, AKONING
angular distribution for (n,n*1)

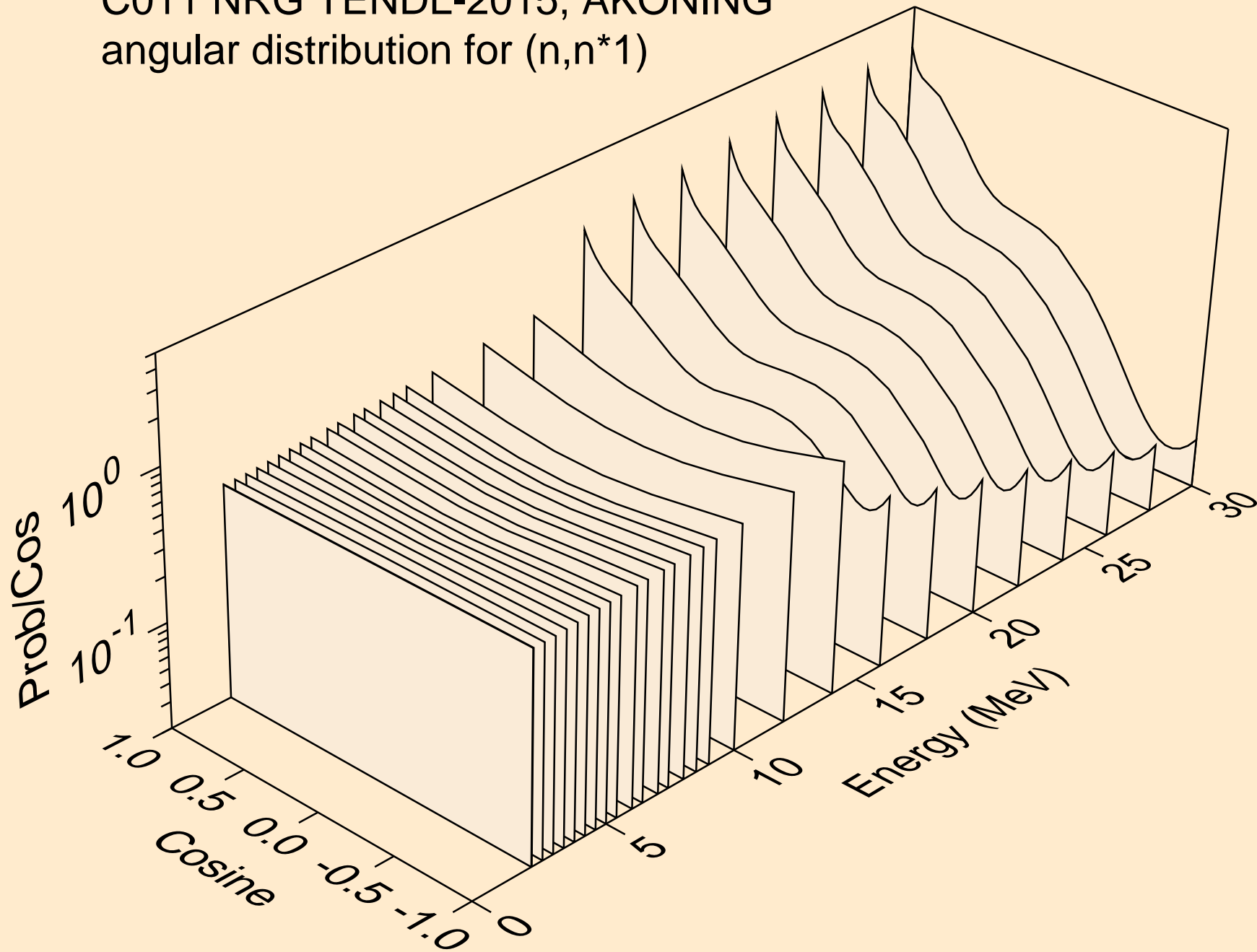

C011 NRG TENDL-2015, AKONING
angular distribution for (n,n*2)

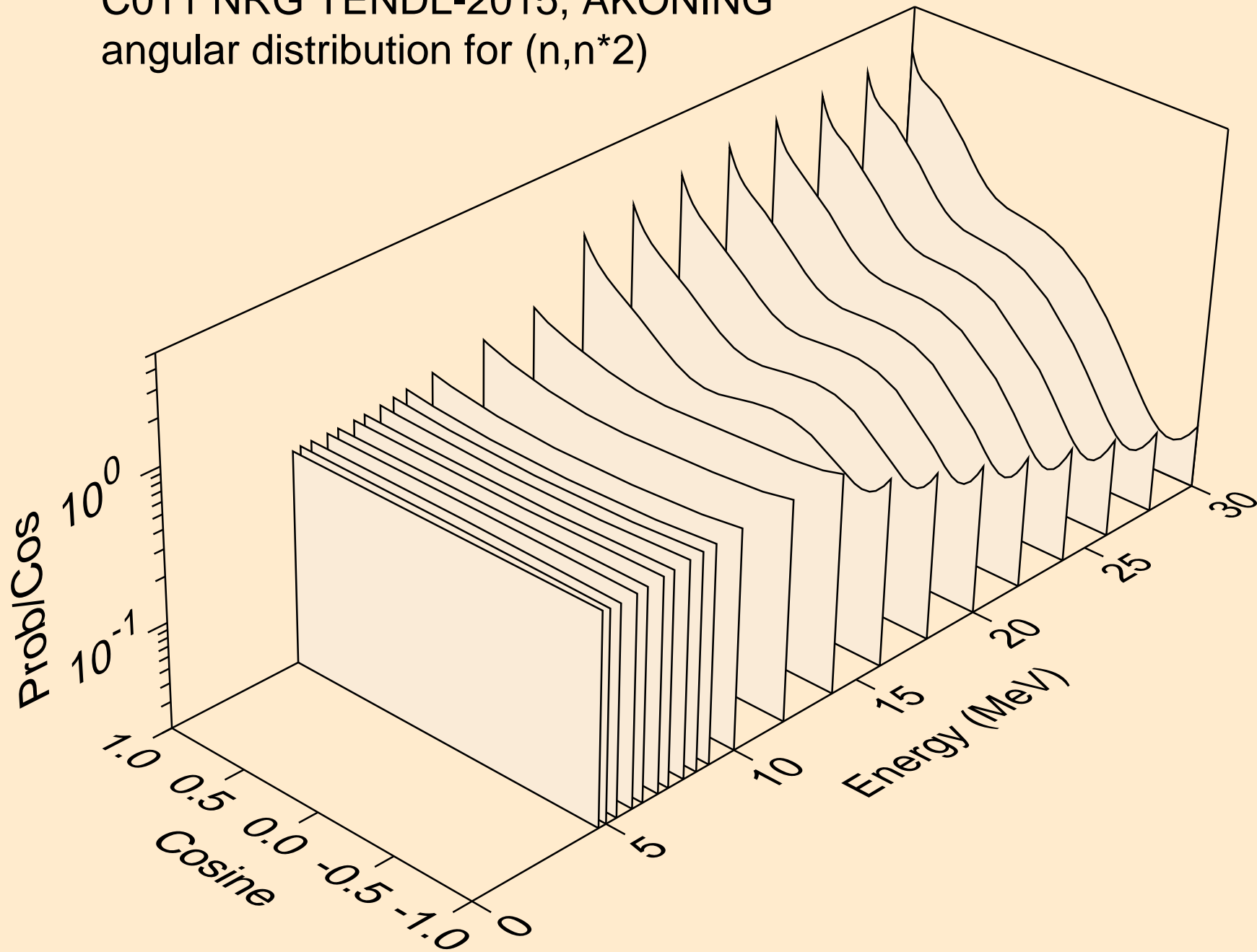

C011 NRG TENDL-2015, AKONING
angular distribution for (n,n*3)

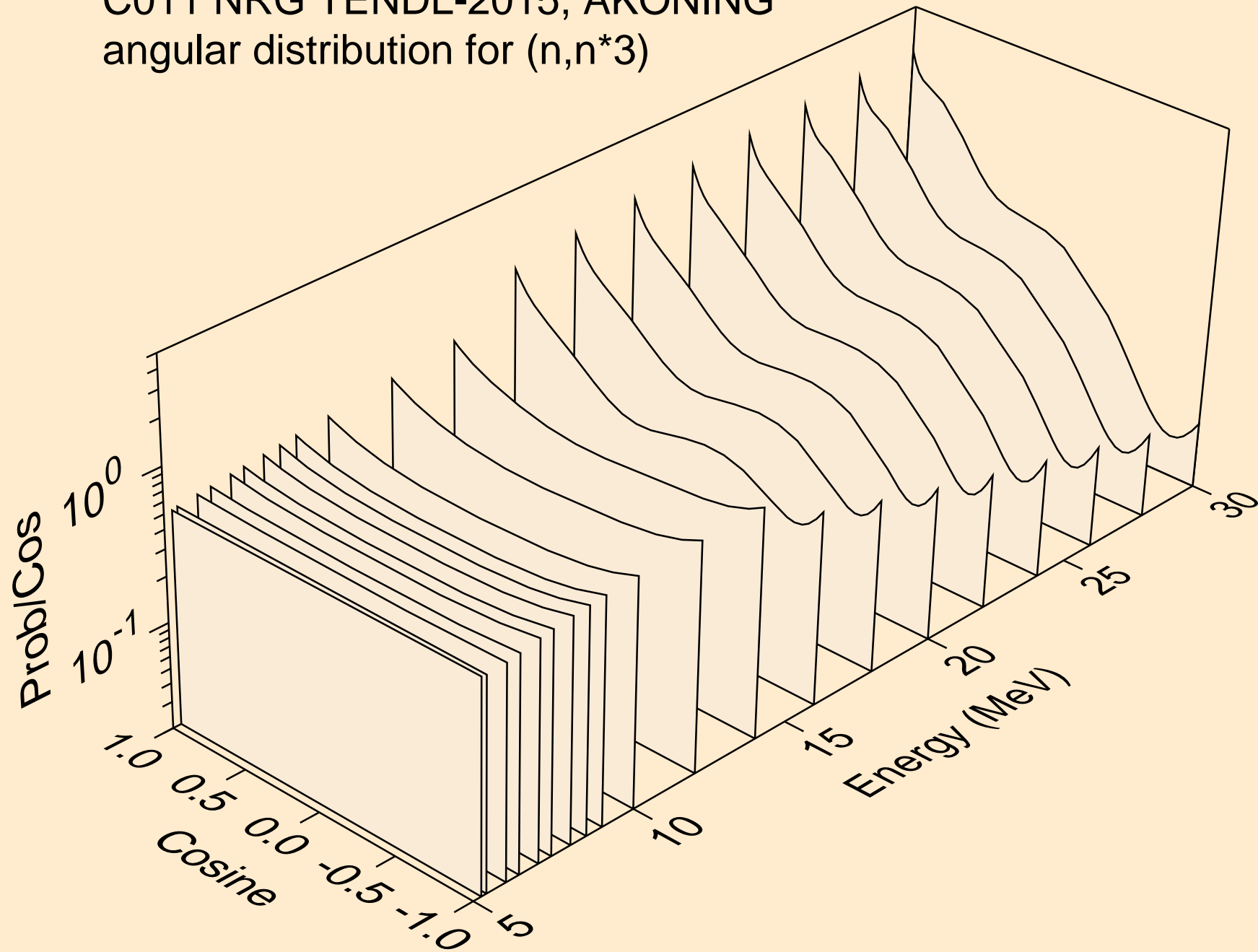

C011 NRG TENDL-2015, AKONING
angular distribution for (n,n*4)

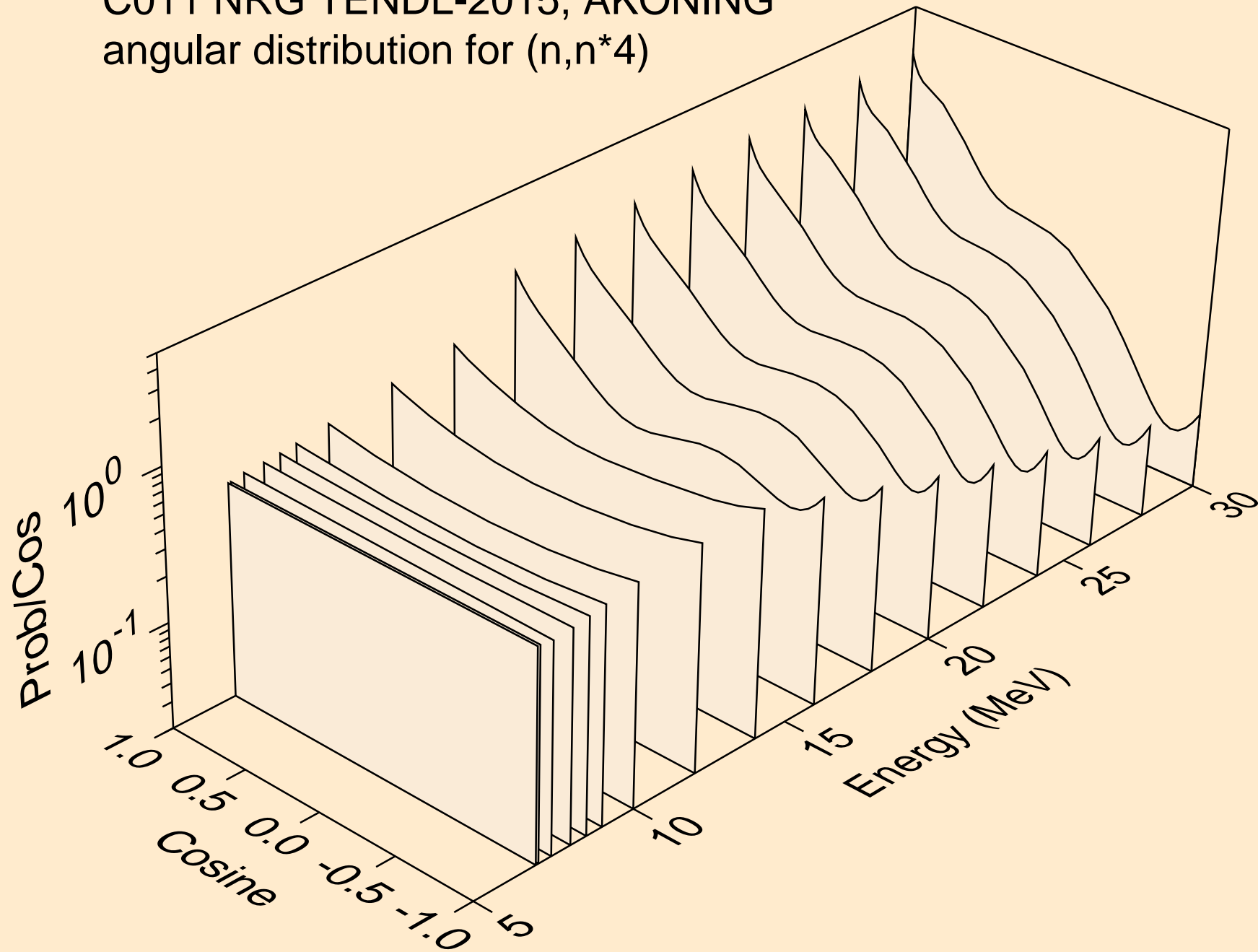

C011 NRG TENDL-2015, AKONING
angular distribution for (n,n*5)

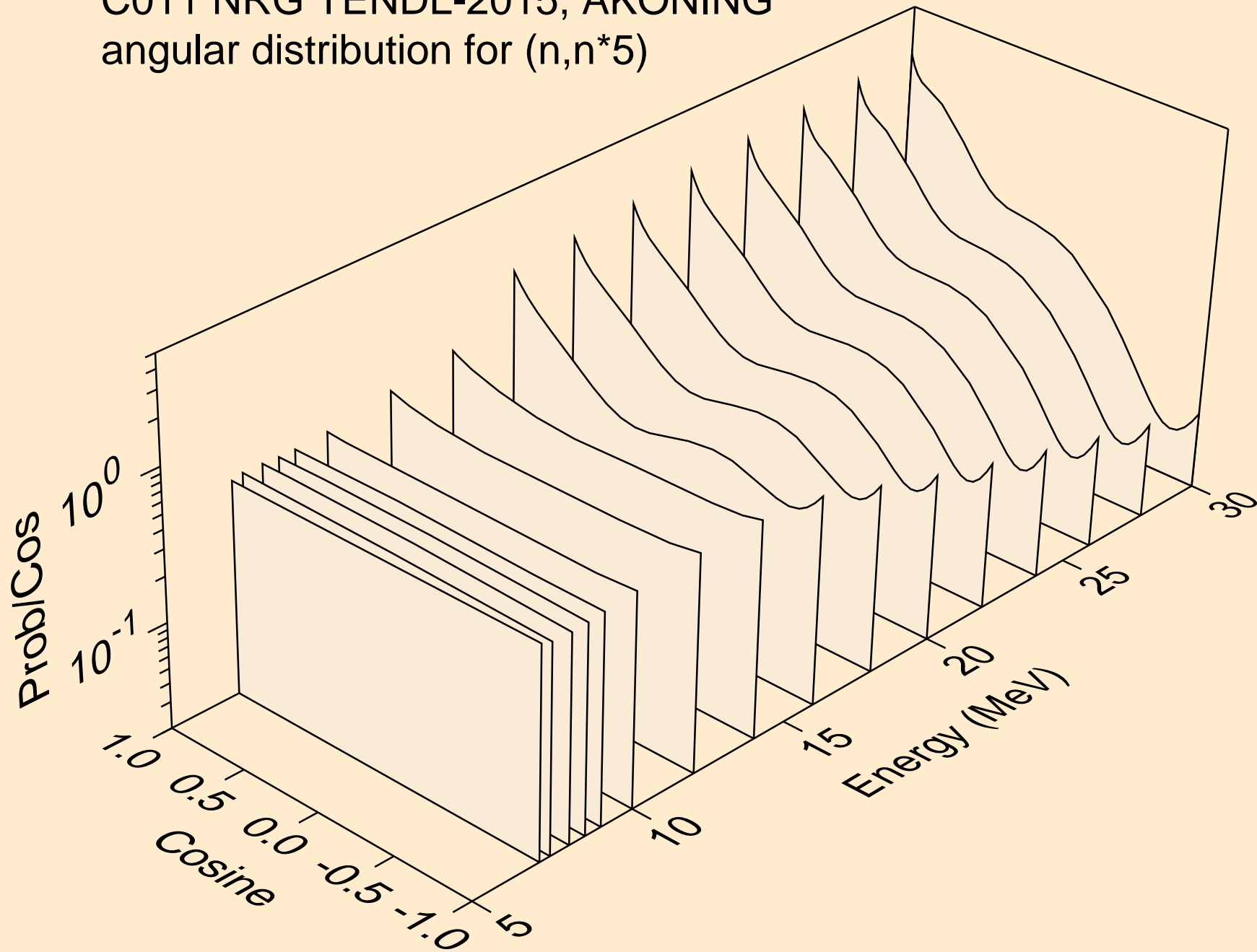

C011 NRG TENDL-2015, AKONING
angular distribution for (n,n*6)

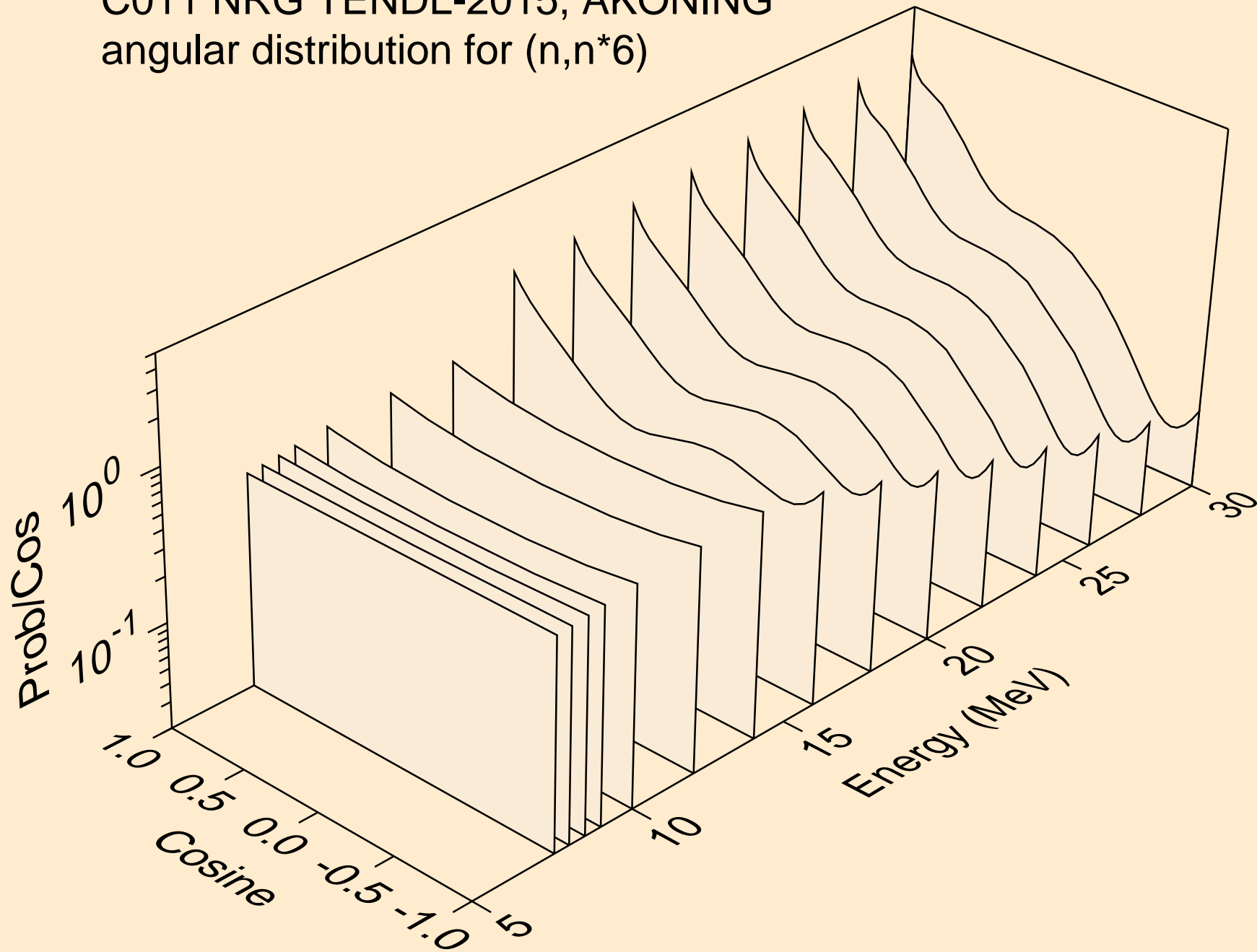

C011 NRG TENDL-2015, AKONING
angular distribution for (n,n*7)

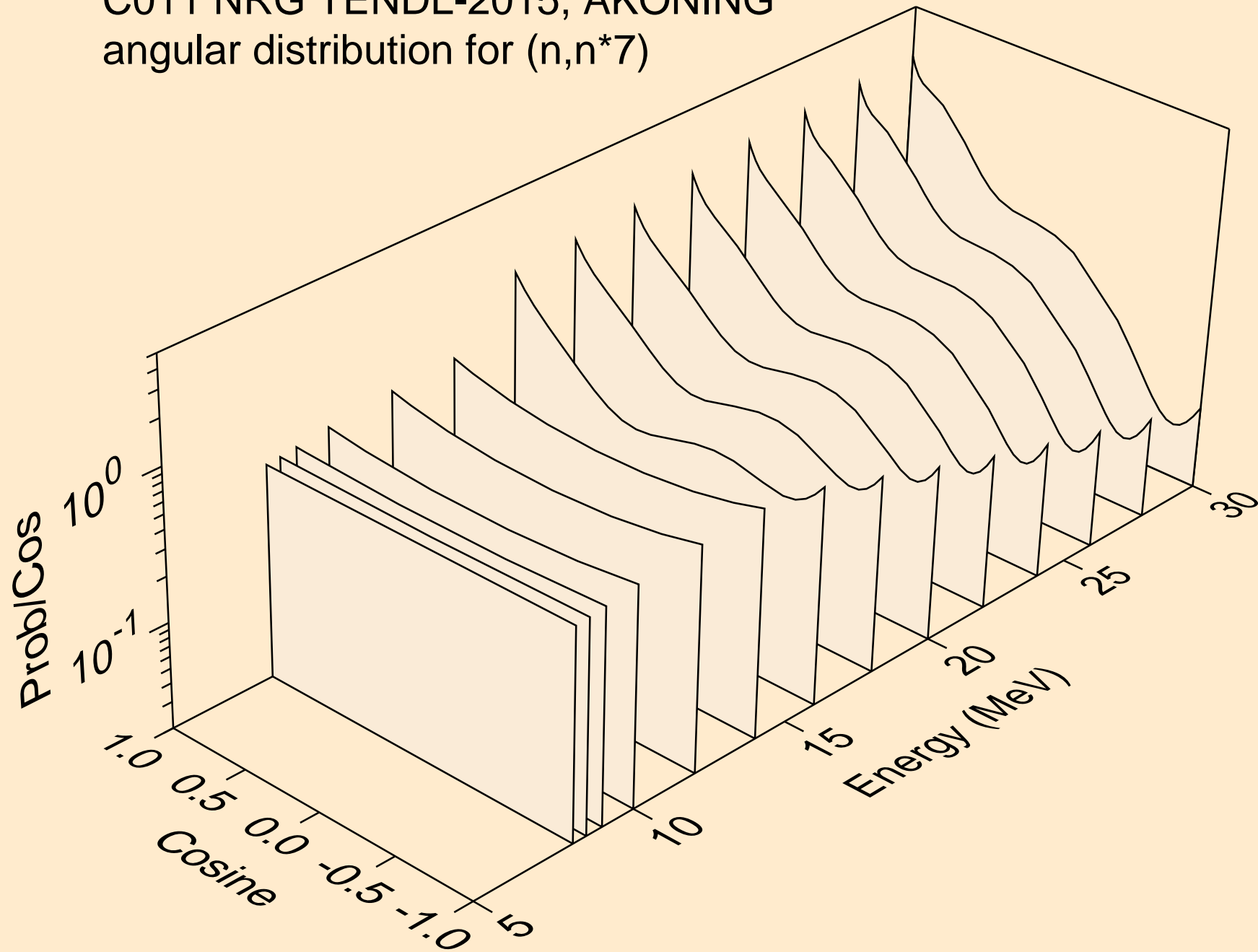

C011 NRG TENDL-2015, AKONING
angular distribution for (n,n*8)

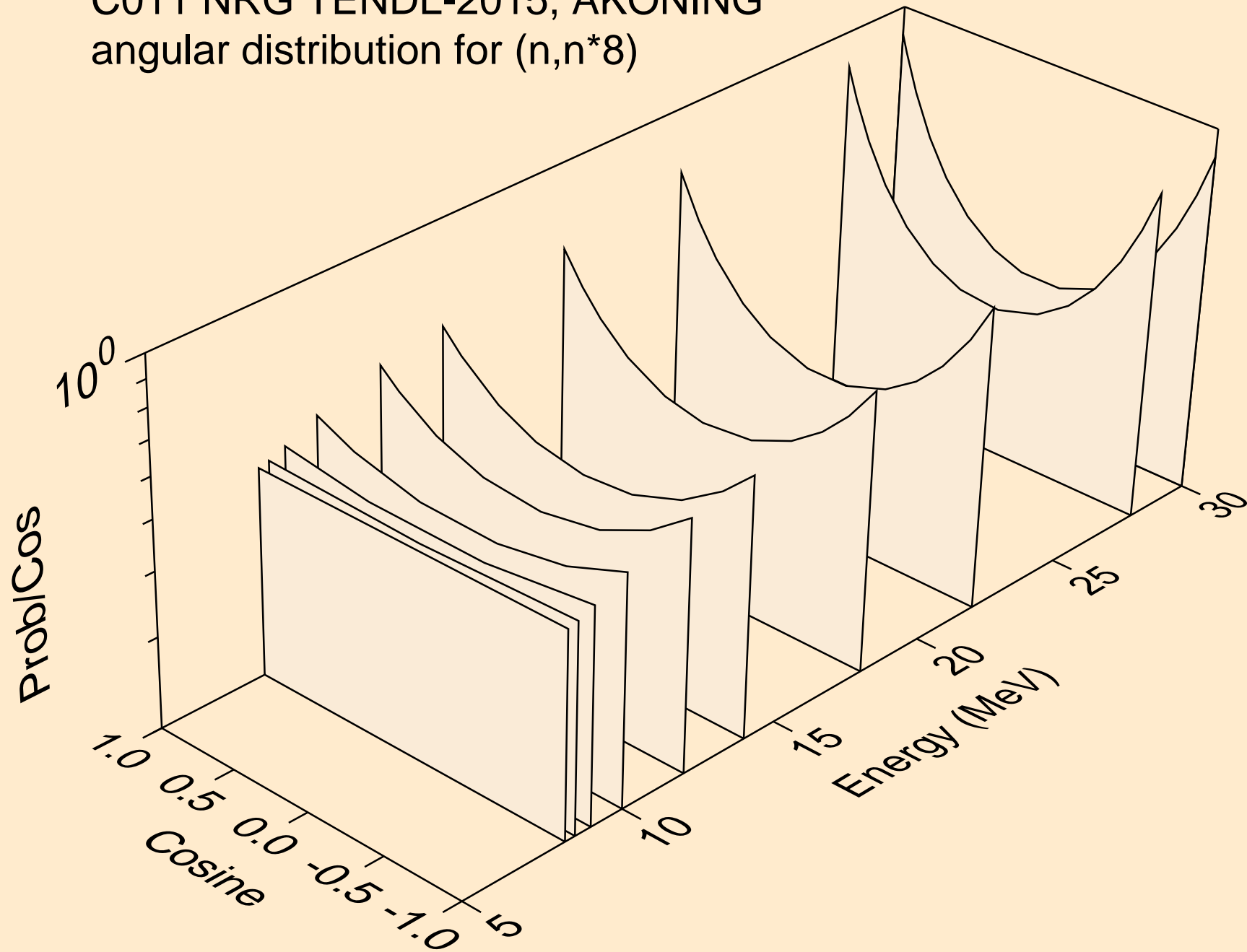

C011 NRG TENDL-2015, AKONING
angular distribution for (n,n*9)

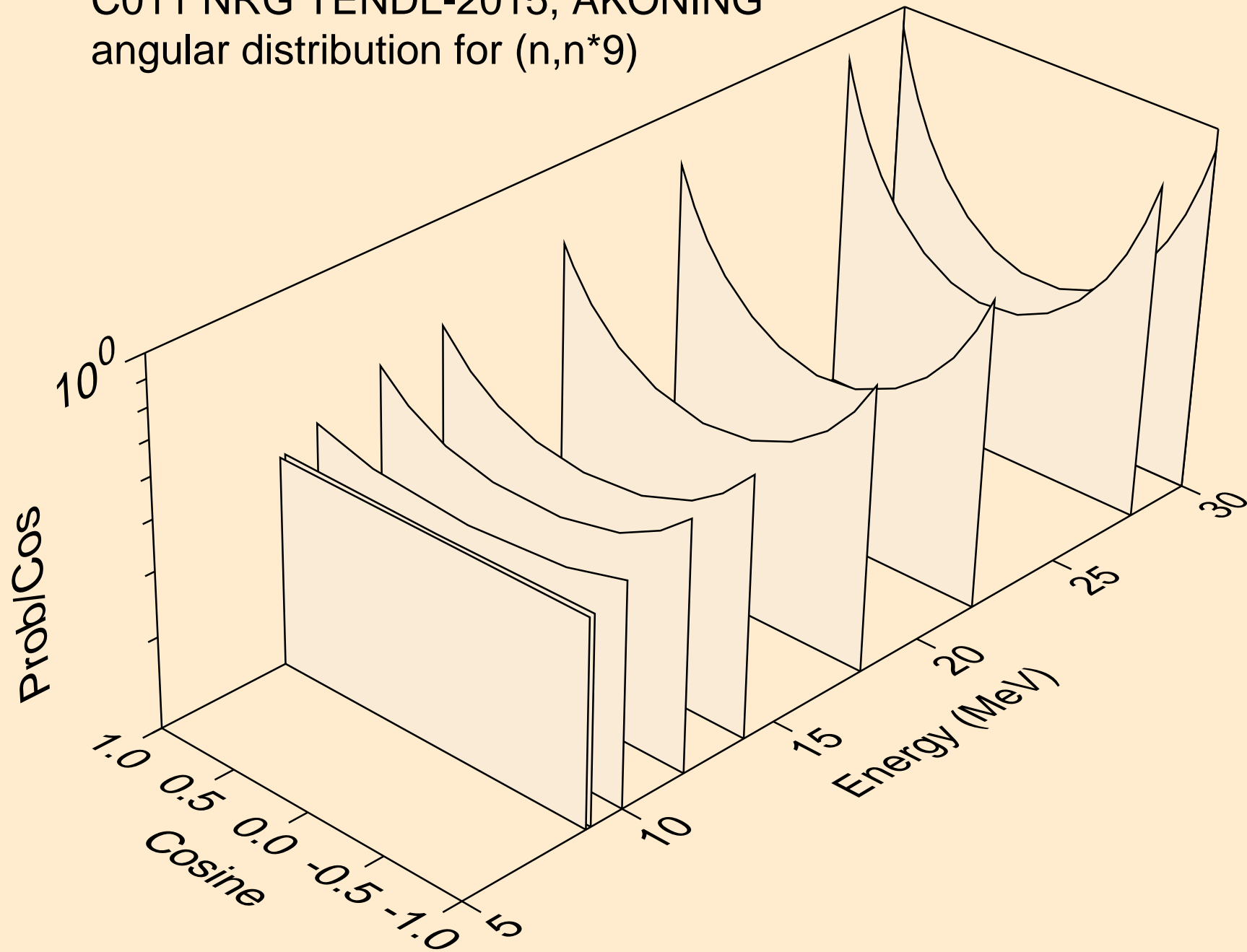

C011 NRG TENDL-2015, AKONING
angular distribution for (n,n*10)

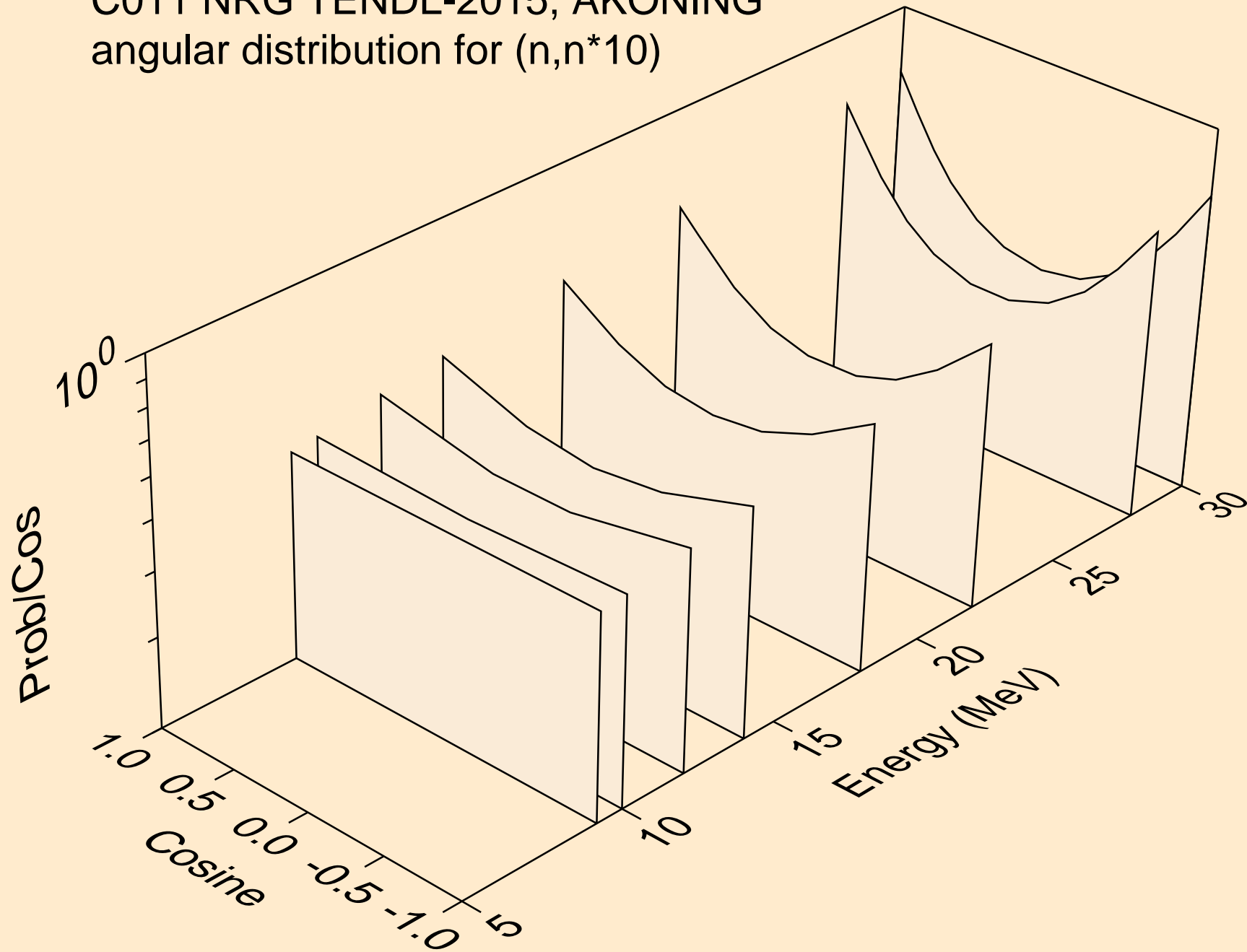

C011 NRG TENDL-2015, AKONING
angular distribution for (n,n*11)

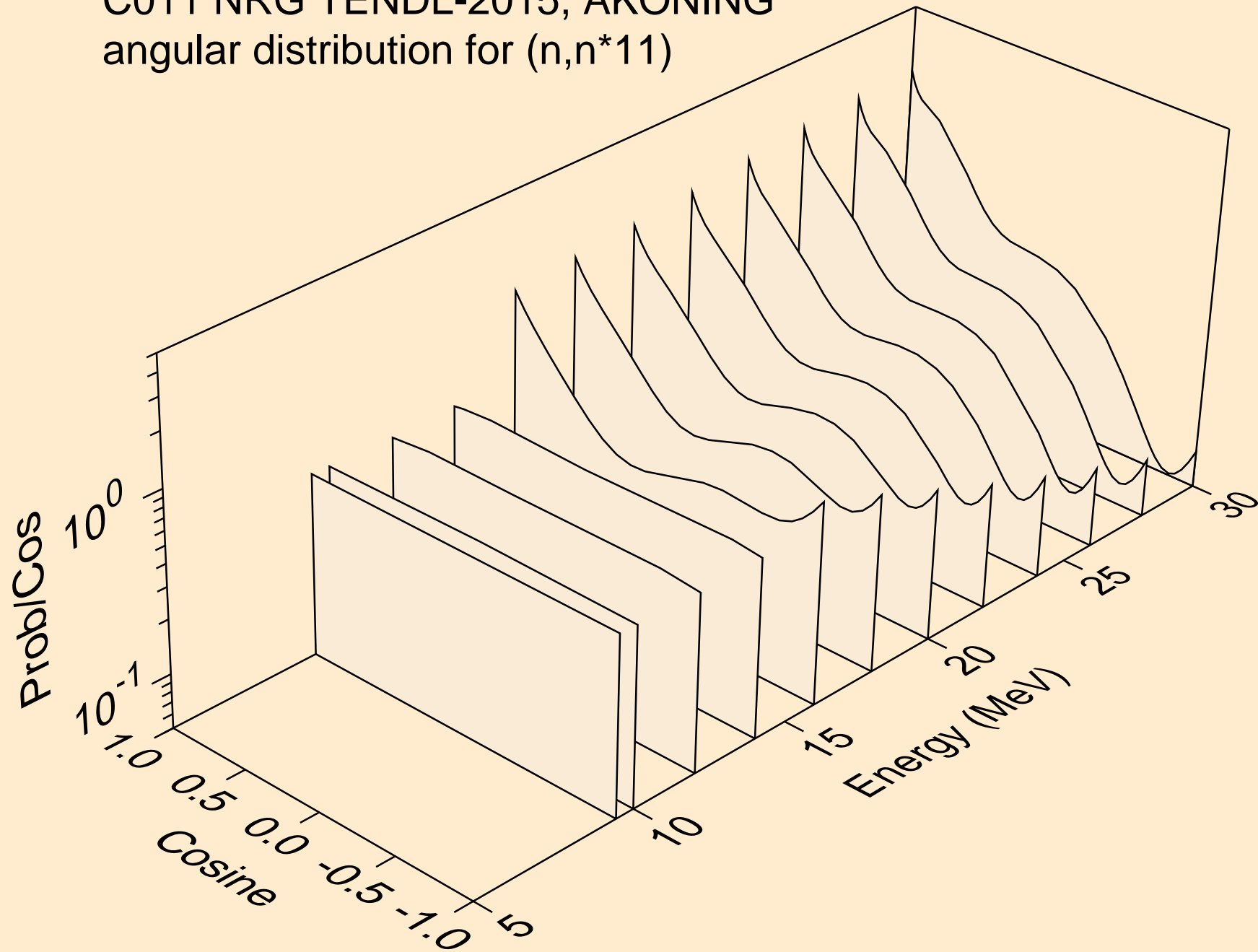

C011 NRG TENDL-2015, AKONING
Neutron emission for (n,x)

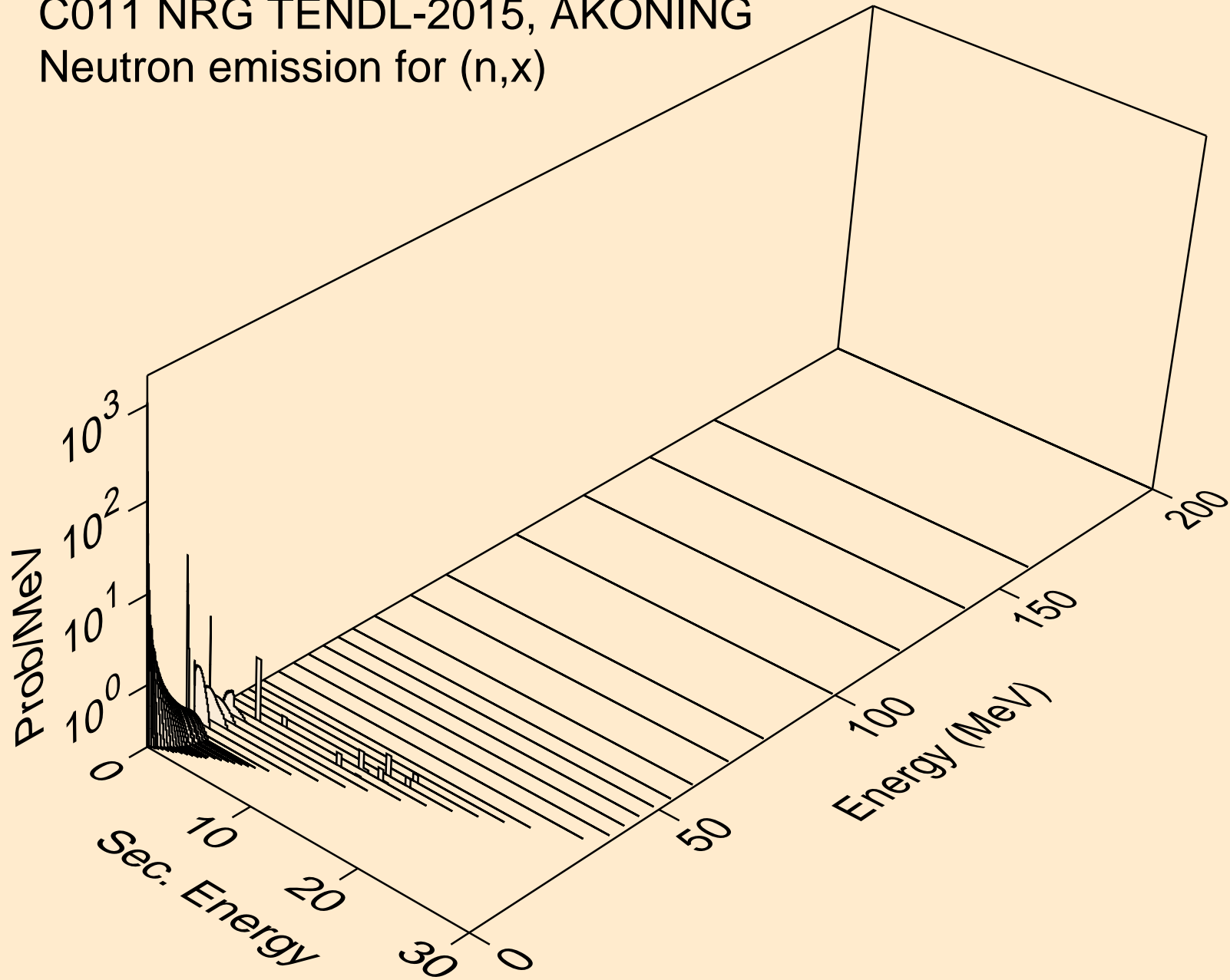

C011 NRG TENDL-2015, AKONING
Neutron emission for (n,2n)

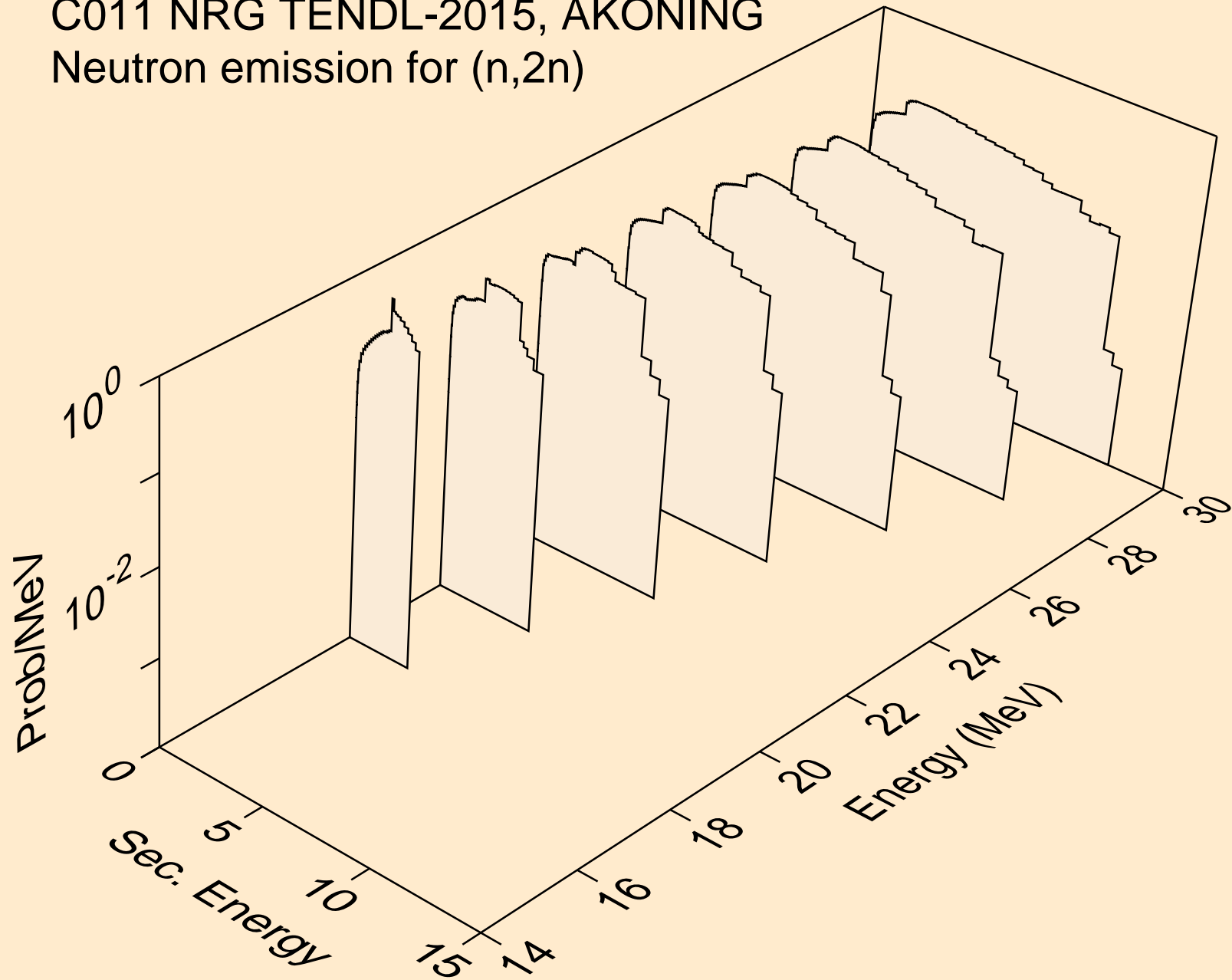

C011 NRG TENDL-2015, AKONING
Neutron emission for (n,n*)a

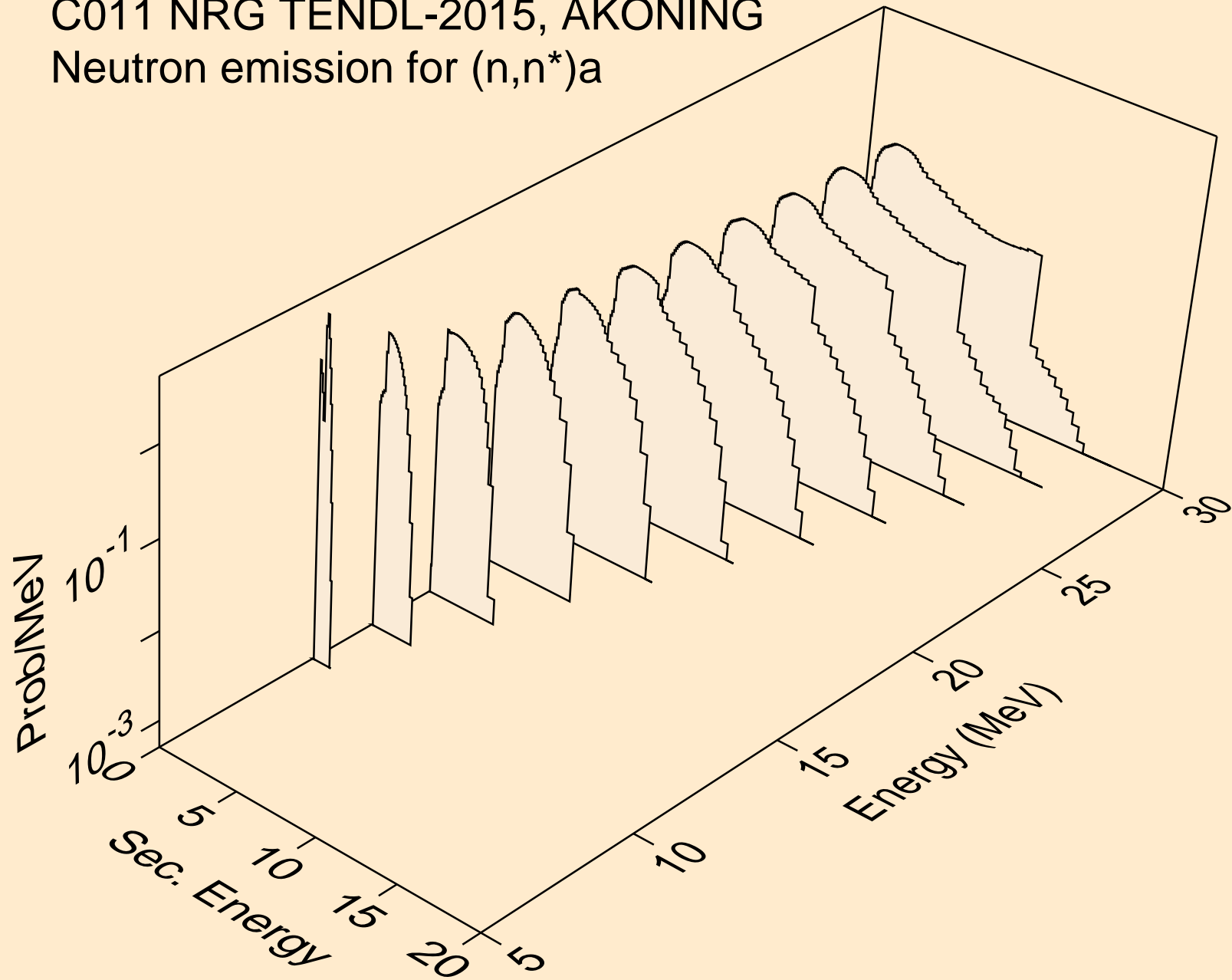

C011 NRG TENDL-2015, AKONING
Neutron emission for (n,2n)a

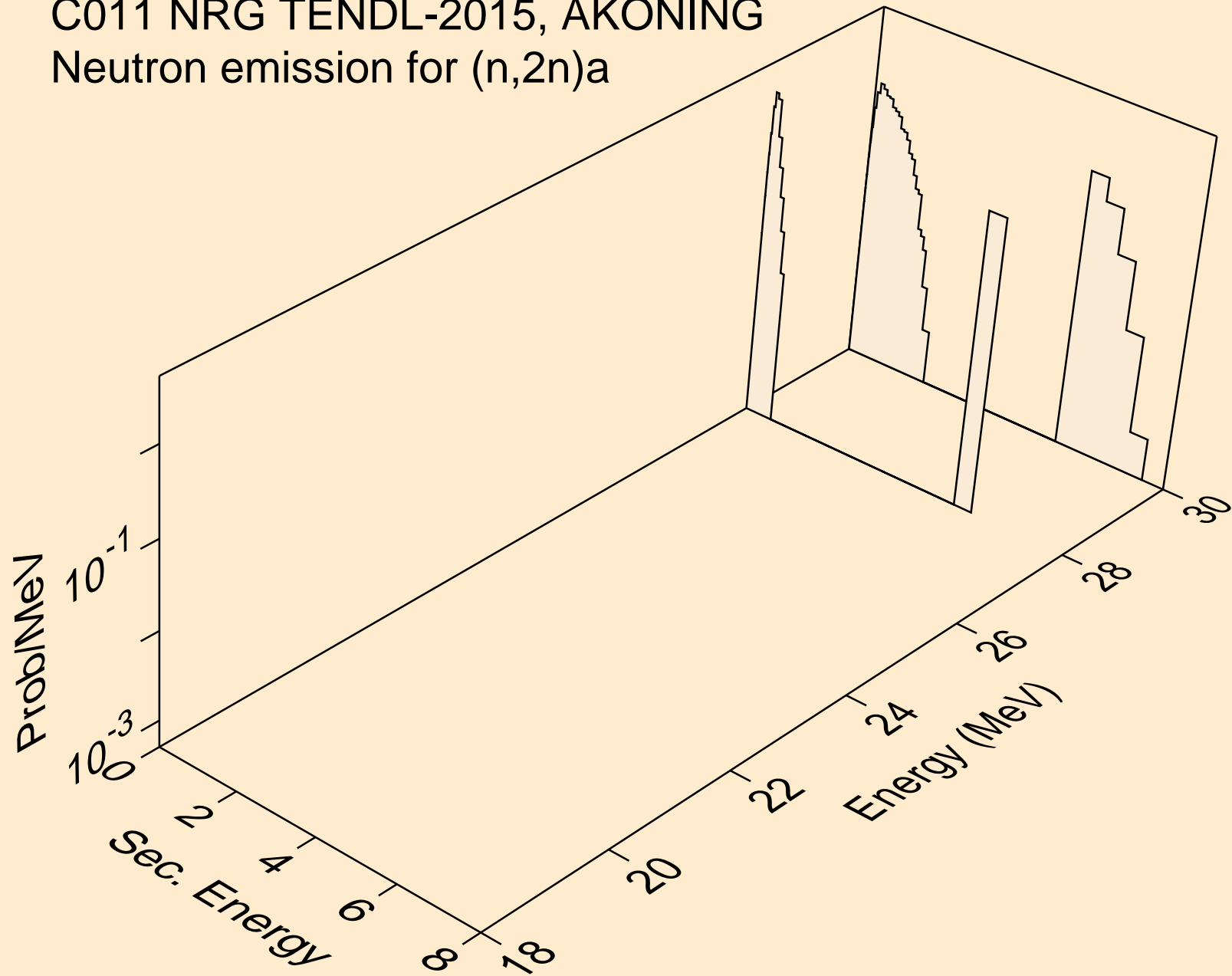

C011 NRG TENDL-2015, AKONING
Neutron emission for (n,n*)p

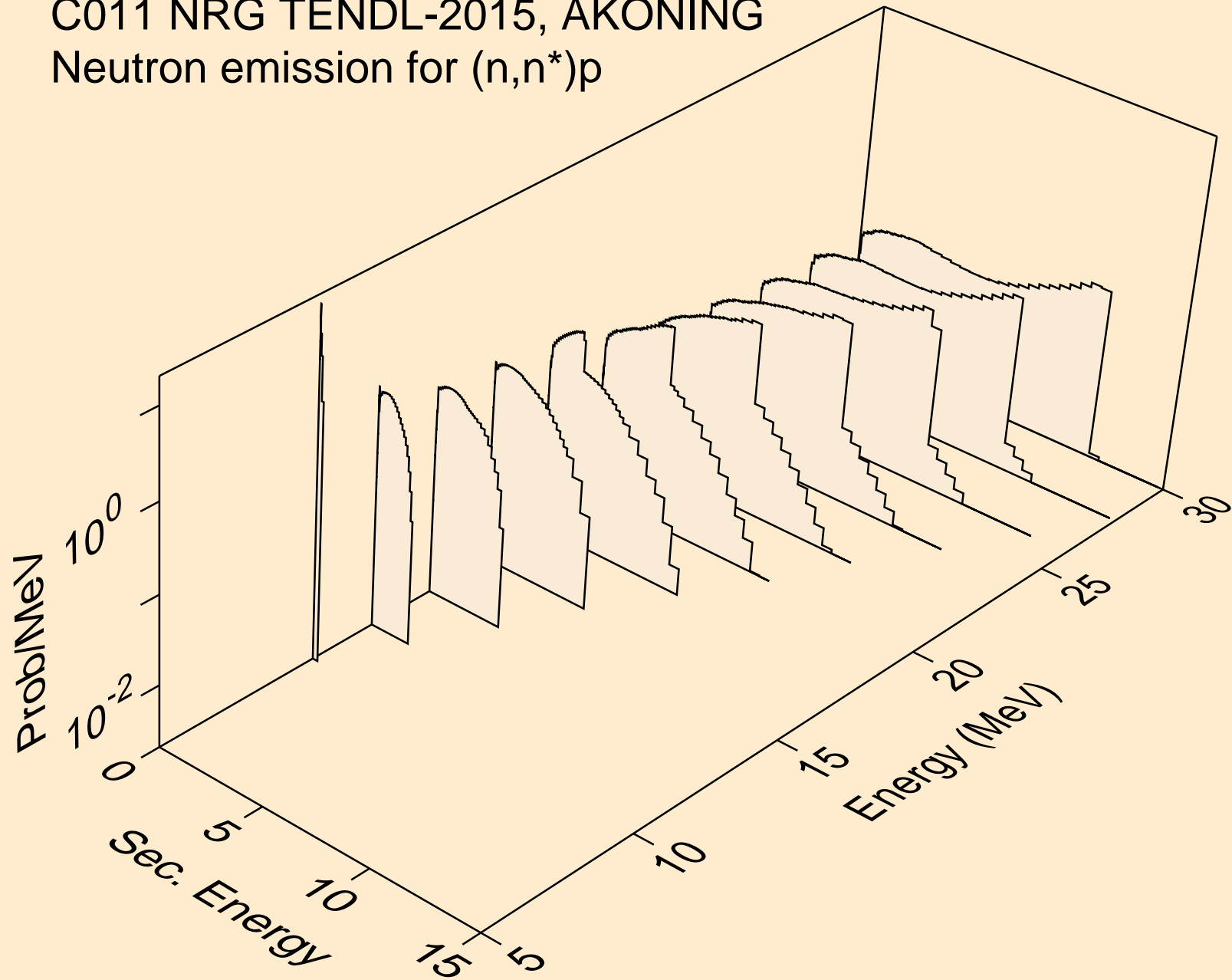

C011 NRG TENDL-2015, AKONING
Neutron emission for (n,n*)2a

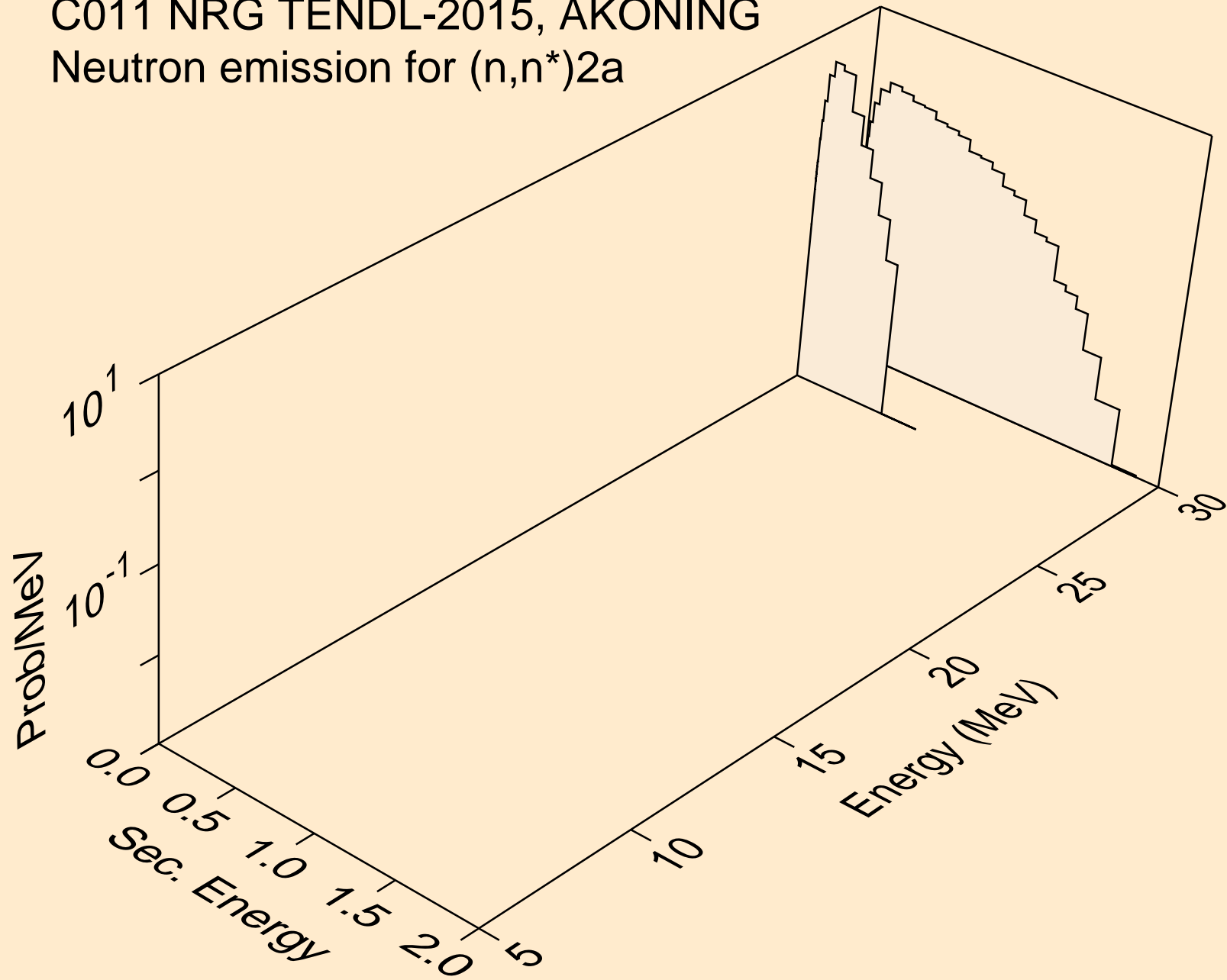

C011 NRG TENDL-2015, AKONING
Neutron emission for (n,n*)d

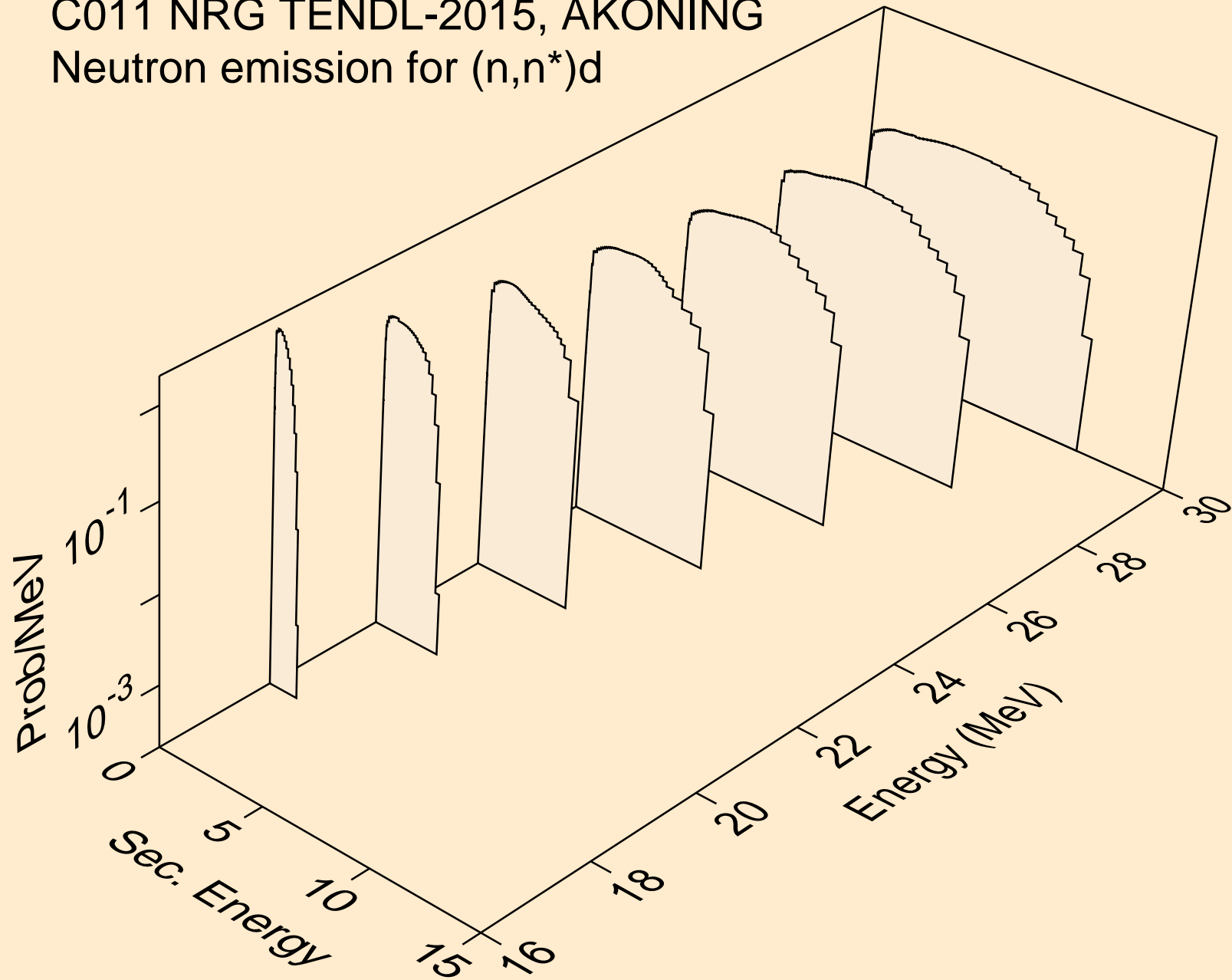

C011 NRG TENDL-2015, AKONING
Neutron emission for (n,n*)t

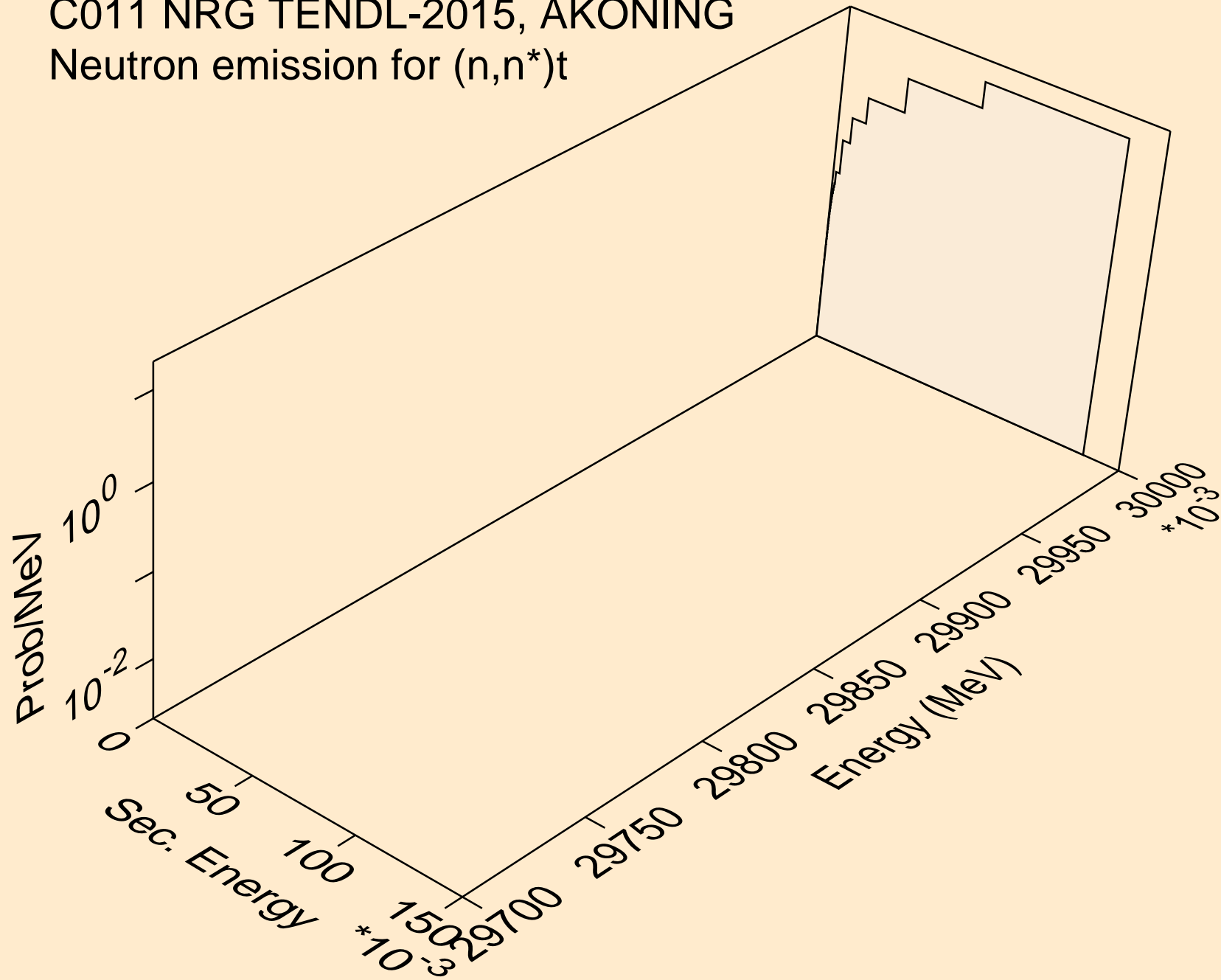

C011 NRG TENDL-2015, AKONING
Neutron emission for (n,n*)he3

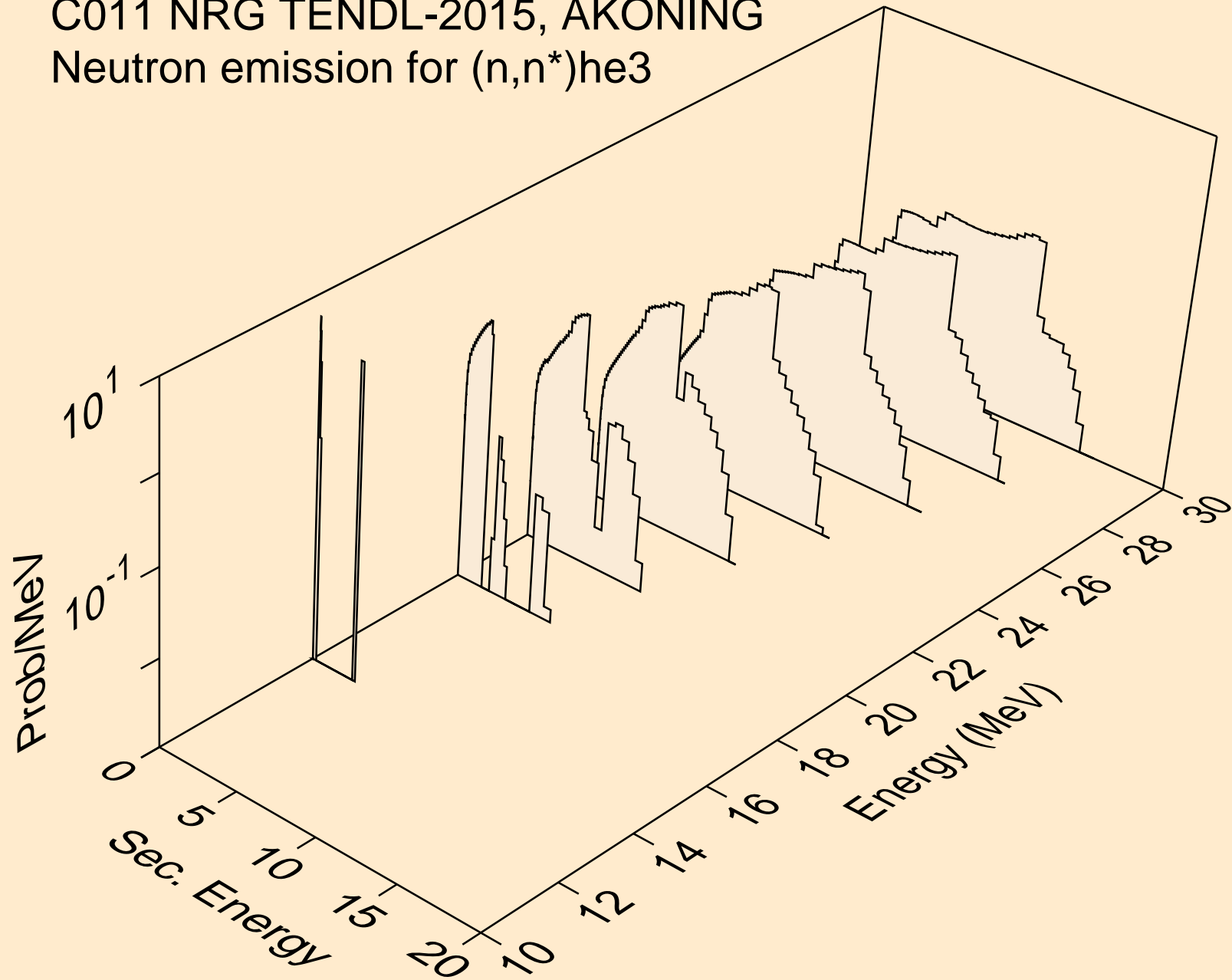

C011 NRG TENDL-2015, AKONING
Neutron emission for (n,2np)

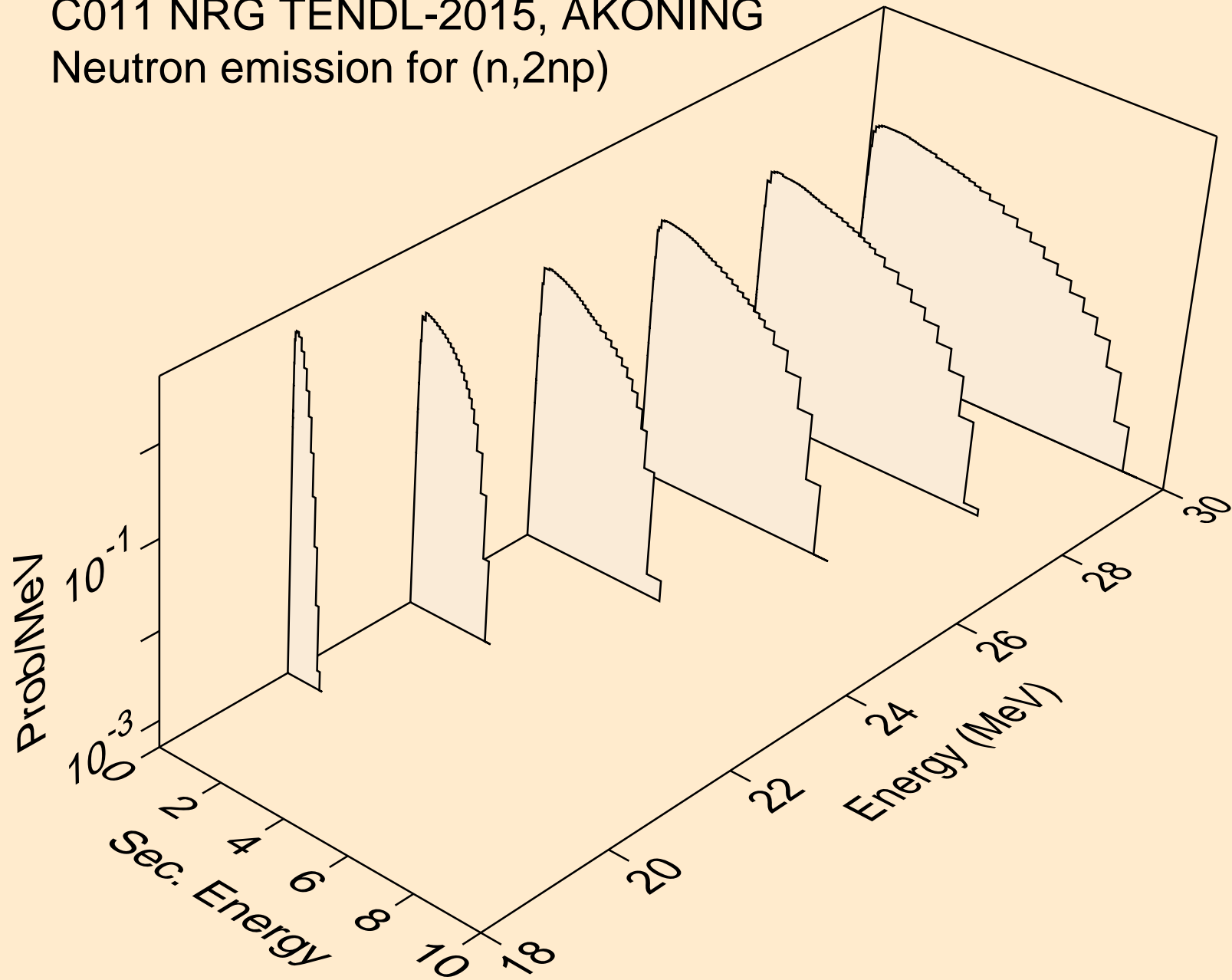

C011 NRG TENDL-2015, AKONING
Neutron emission for (n,2np)

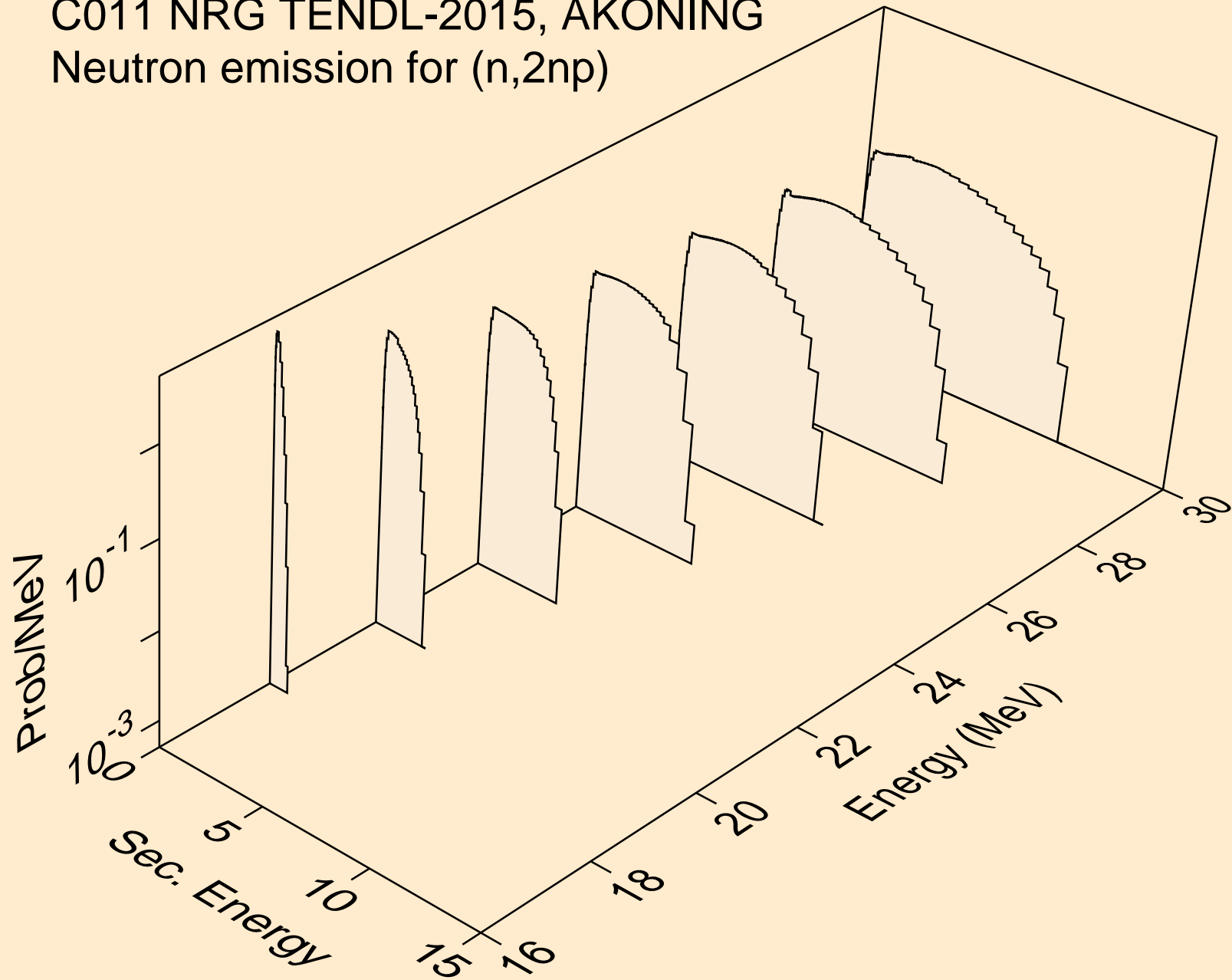

C011 NRG TENDL-2015, AKONING
Neutron emission for (n,npa)

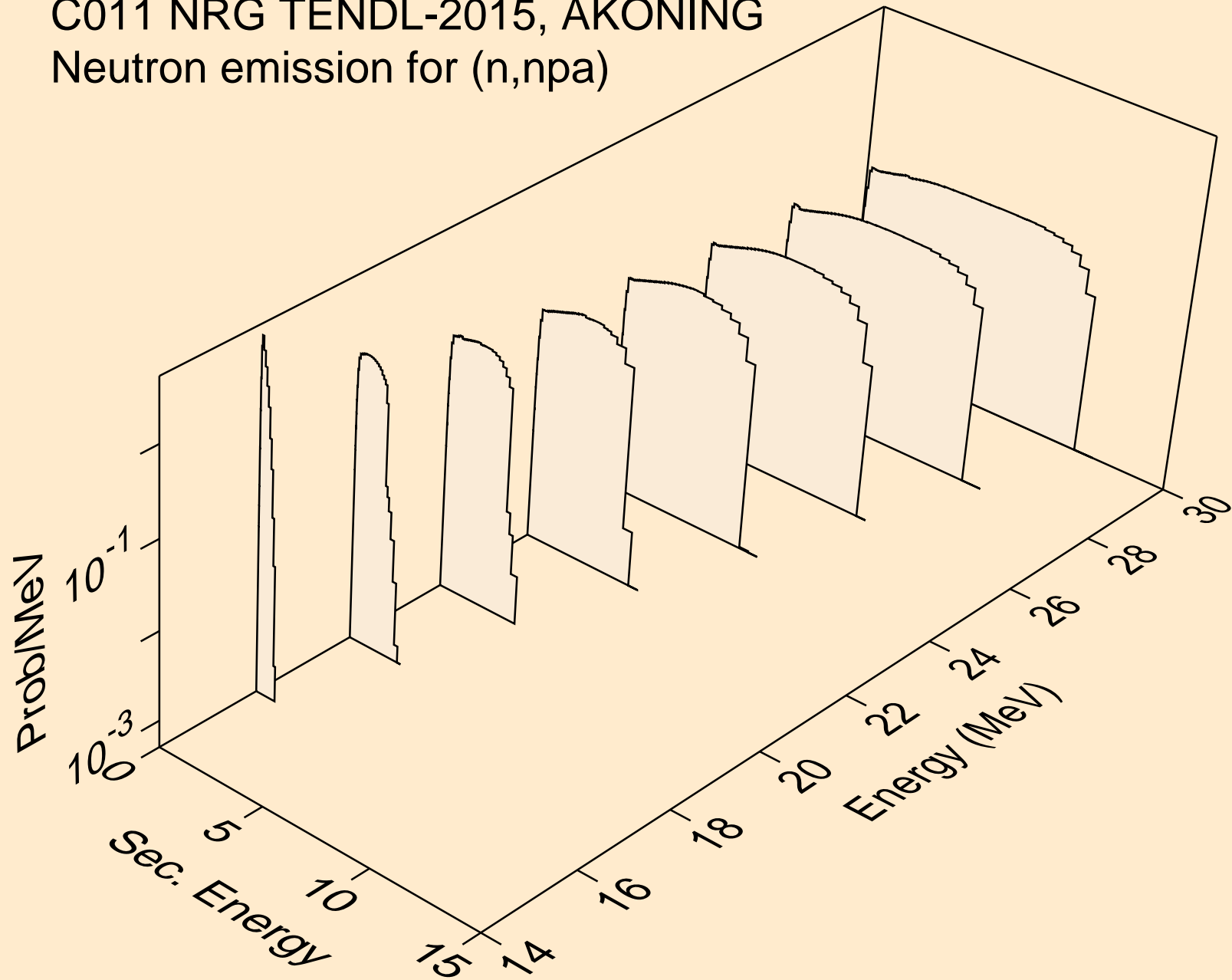

C011 NRG TENDL-2015, AKONING
Neutron emission for (n,n*c)

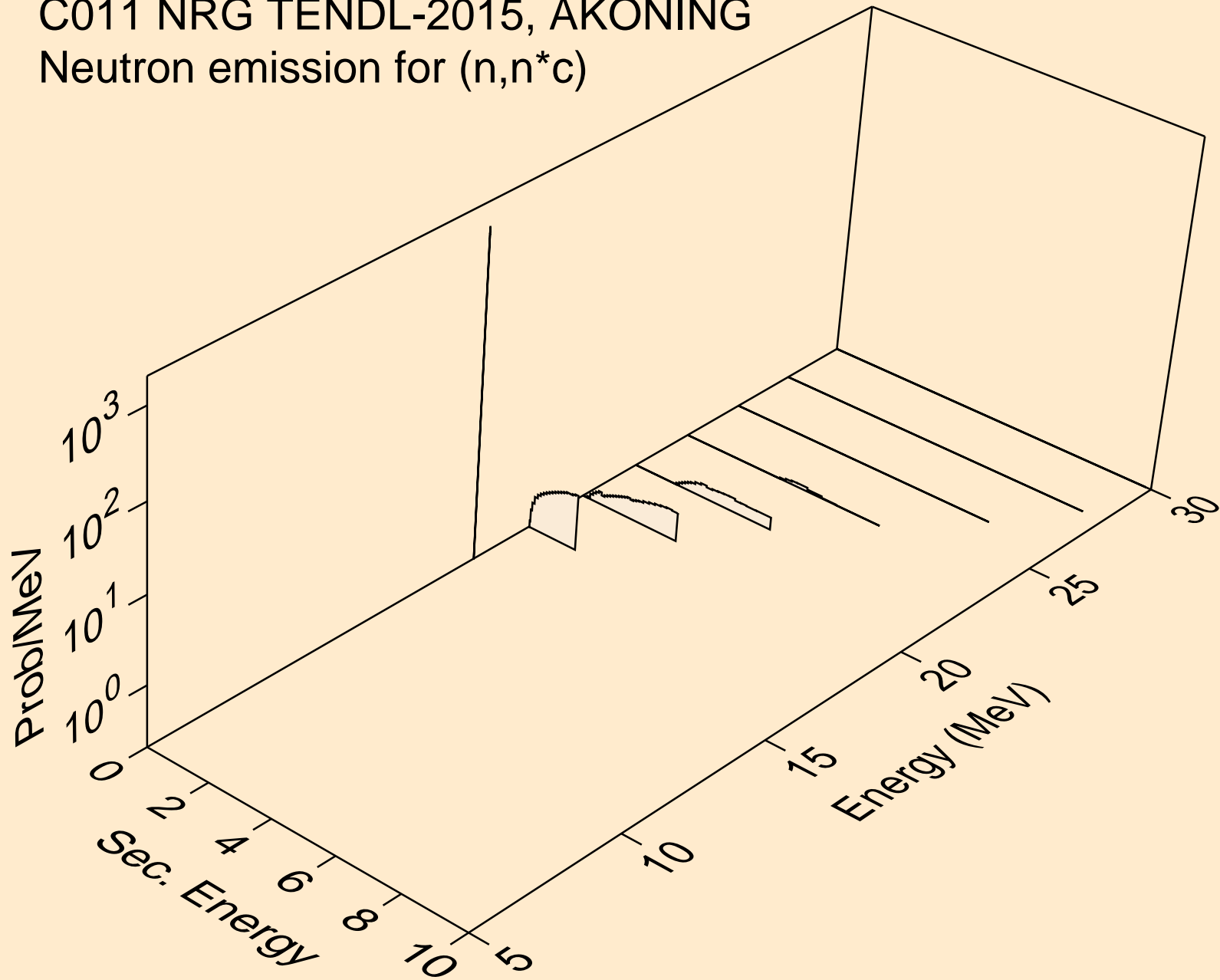

C011 NRG TENDL-2015, AKONING
Photon emission for (n,x)

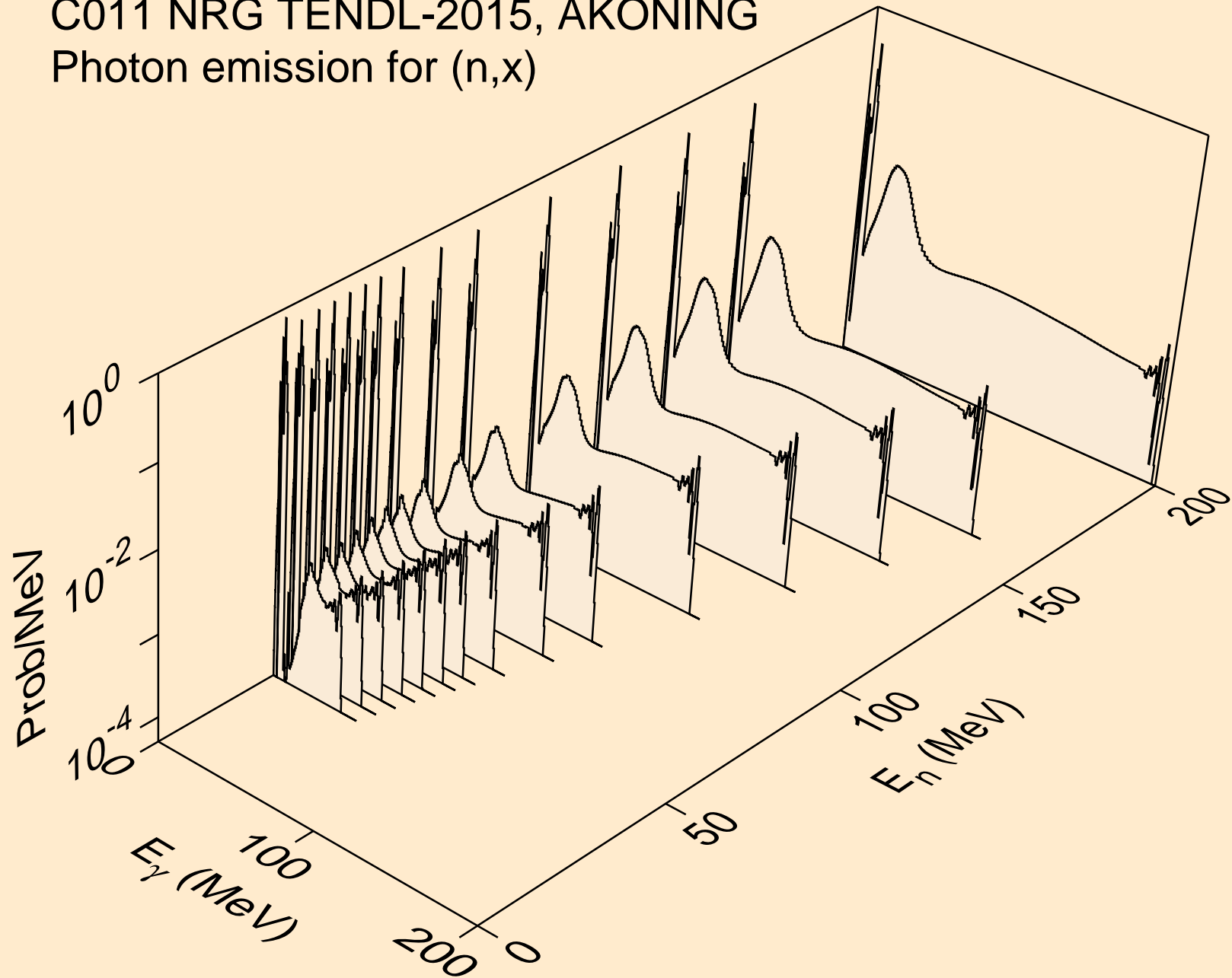

C011 NRG TENDL-2015, AKONING
Photon emission for (n,2n)

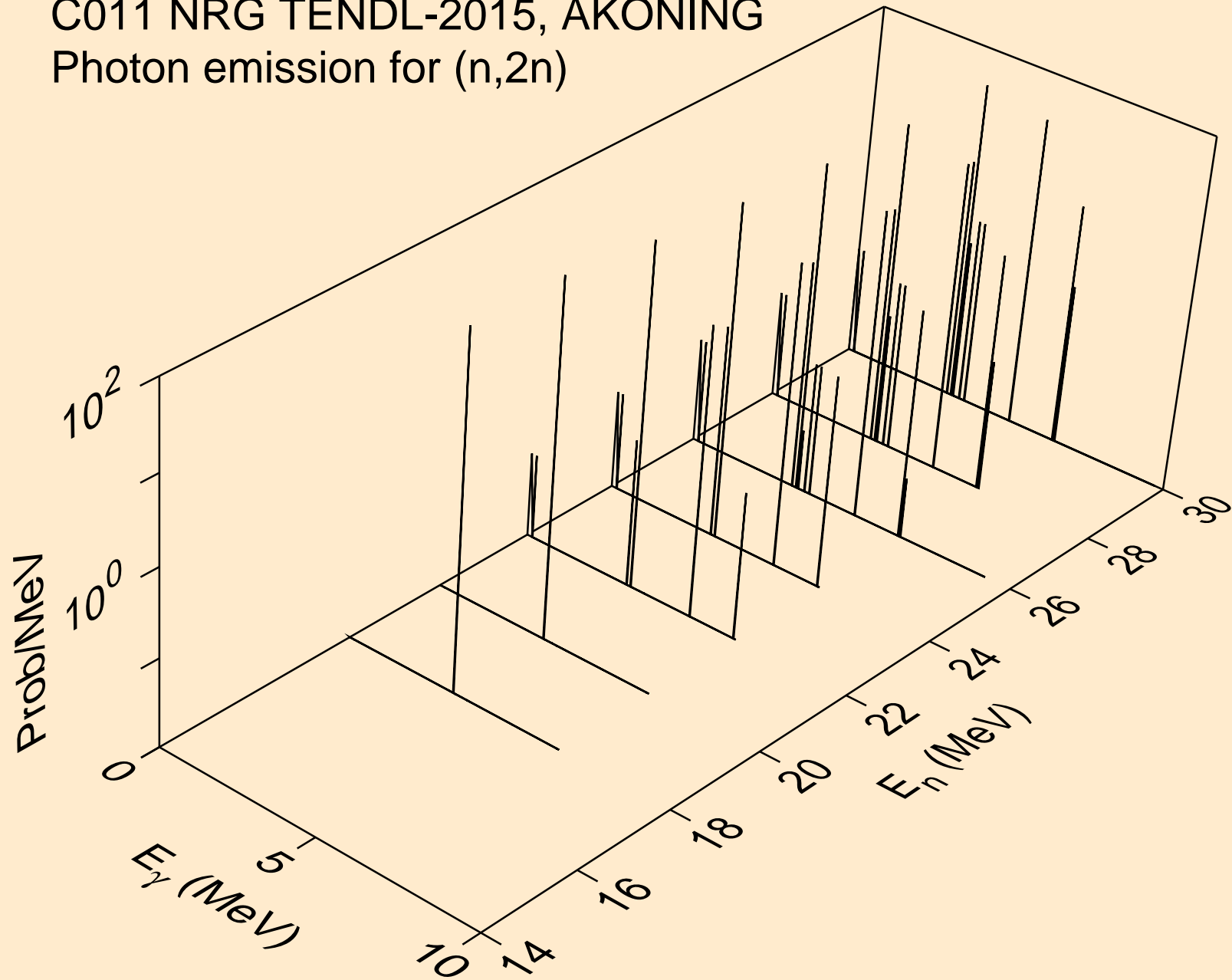

C011 NRG TENDL-2015, AKONING
Photon emission for (n,n*)a

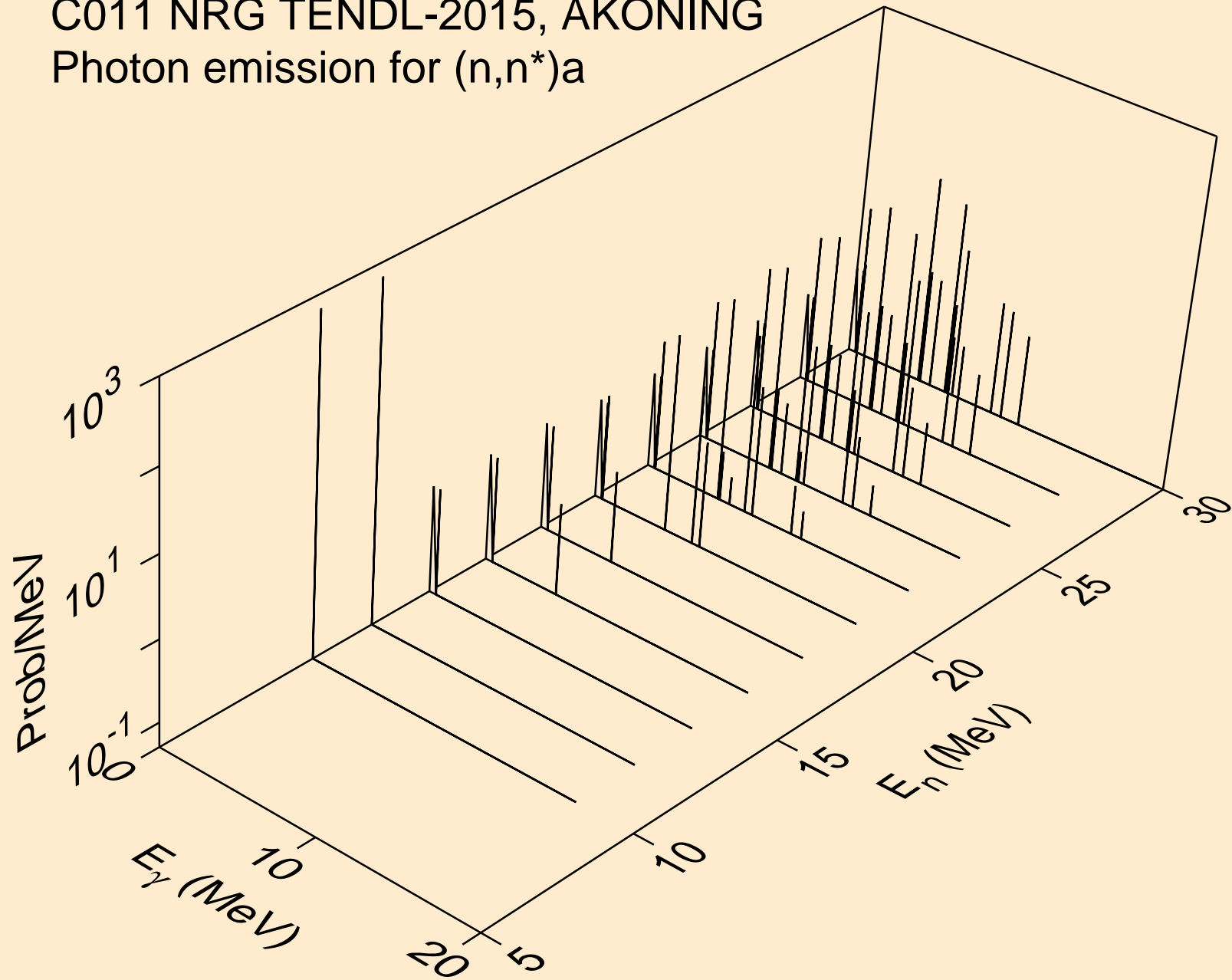

C011 NRG TENDL-2015, AKONING
Photon emission for (n,n*)p

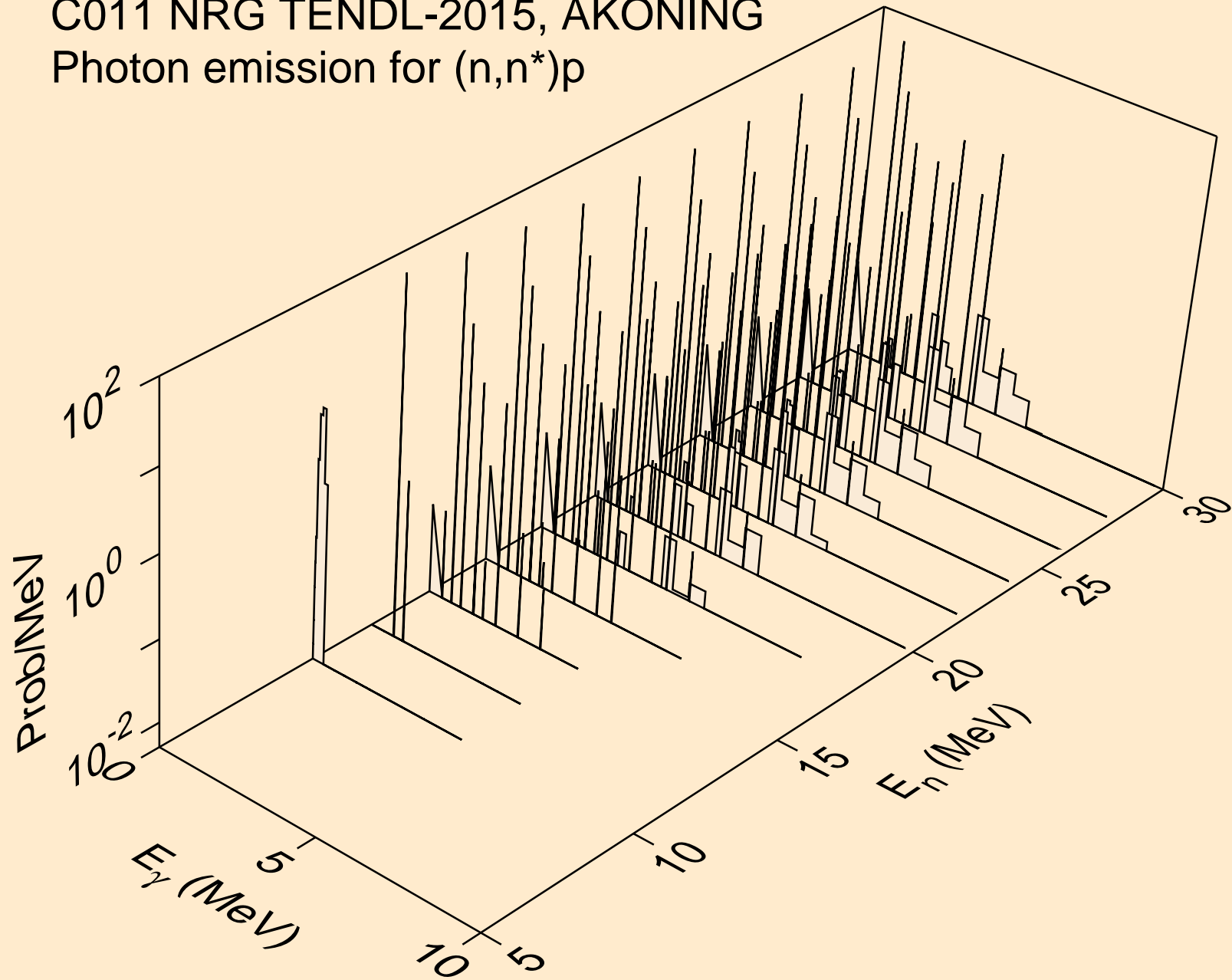

C011 NRG TENDL-2015, AKONING
Photon emission for (n,n*)d

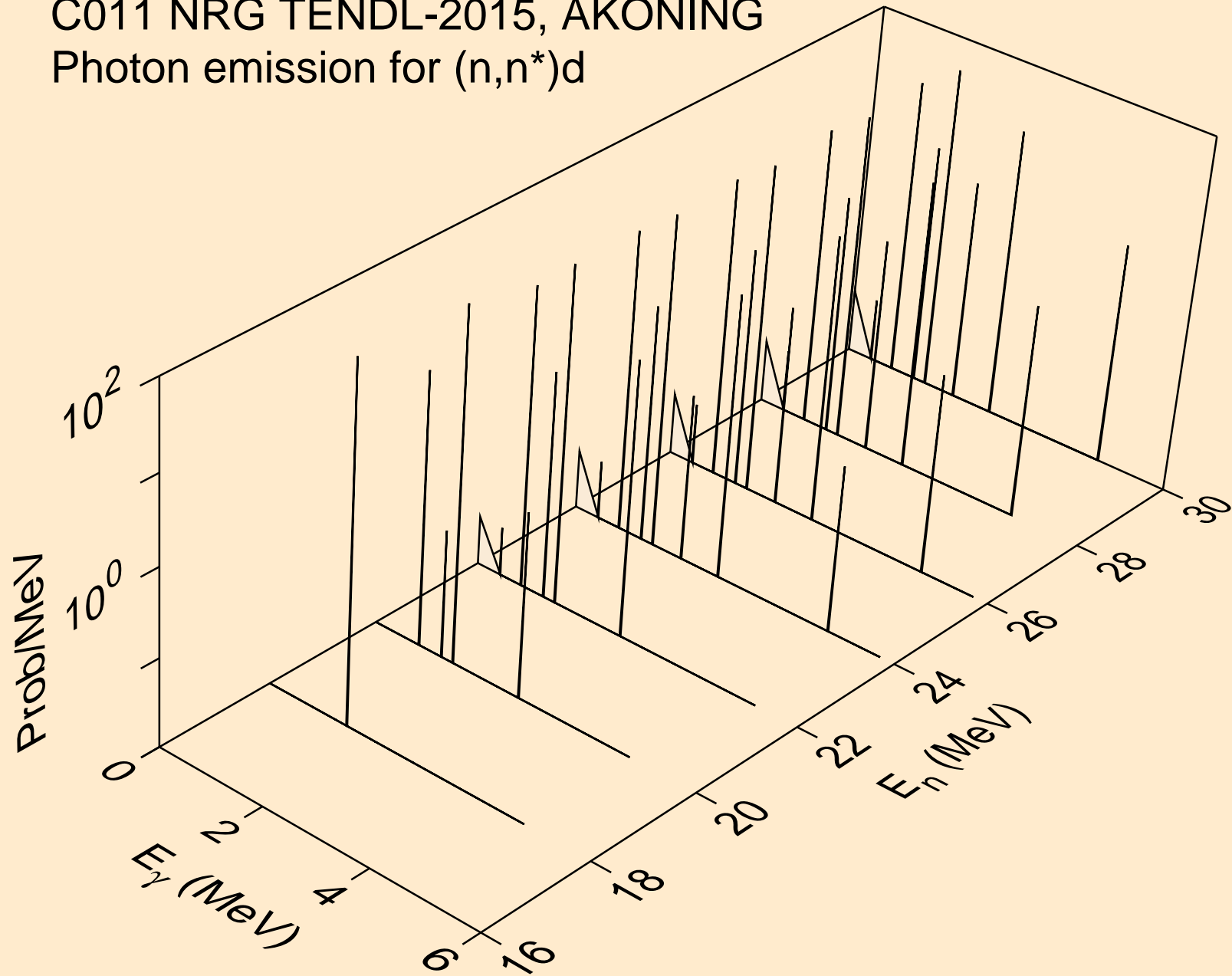

C011 NRG TENDL-2015, AKONING
Photon emission for (n,n*)he3

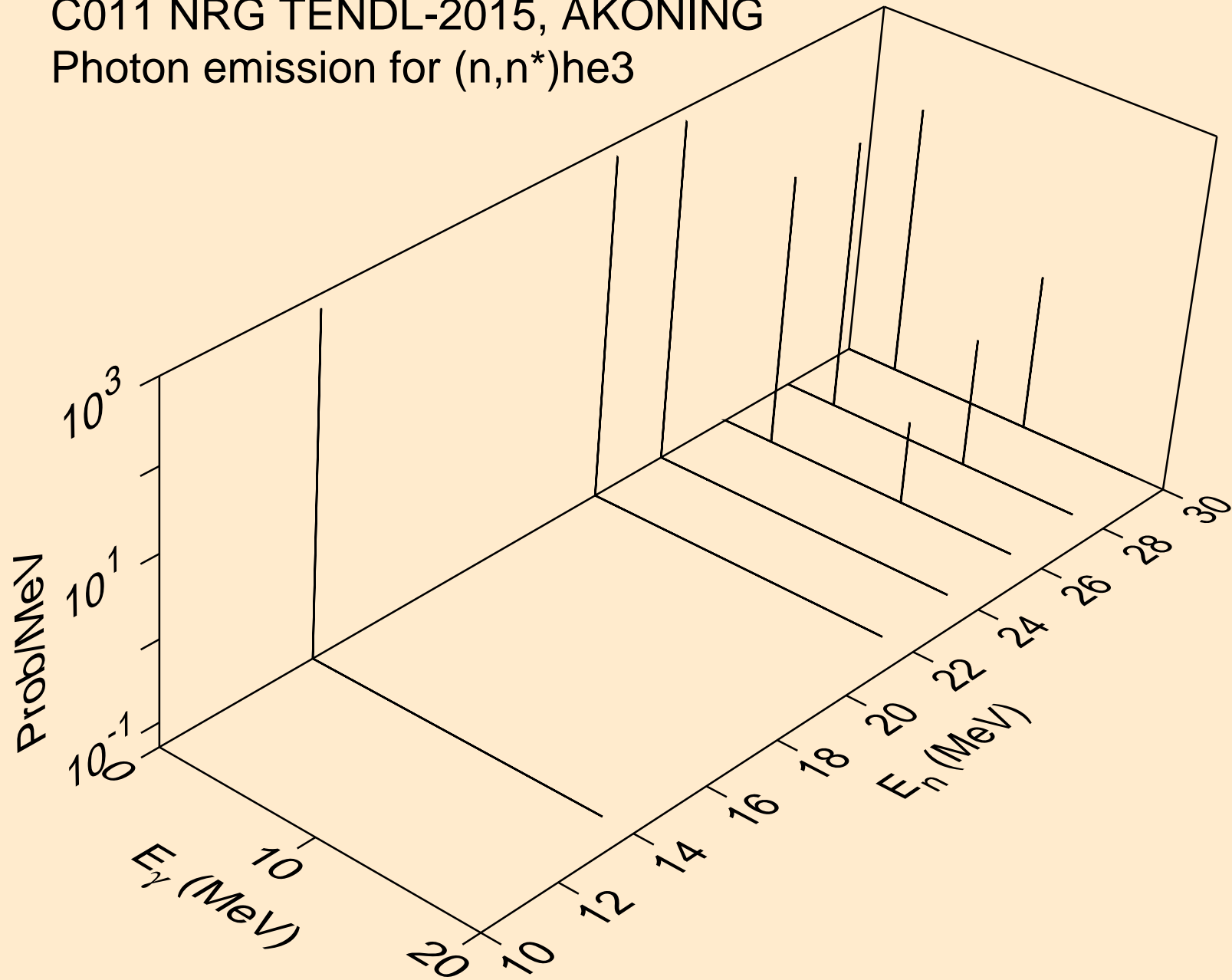

C011 NRG TENDL-2015, AKONING
Photon emission for (n,2np)

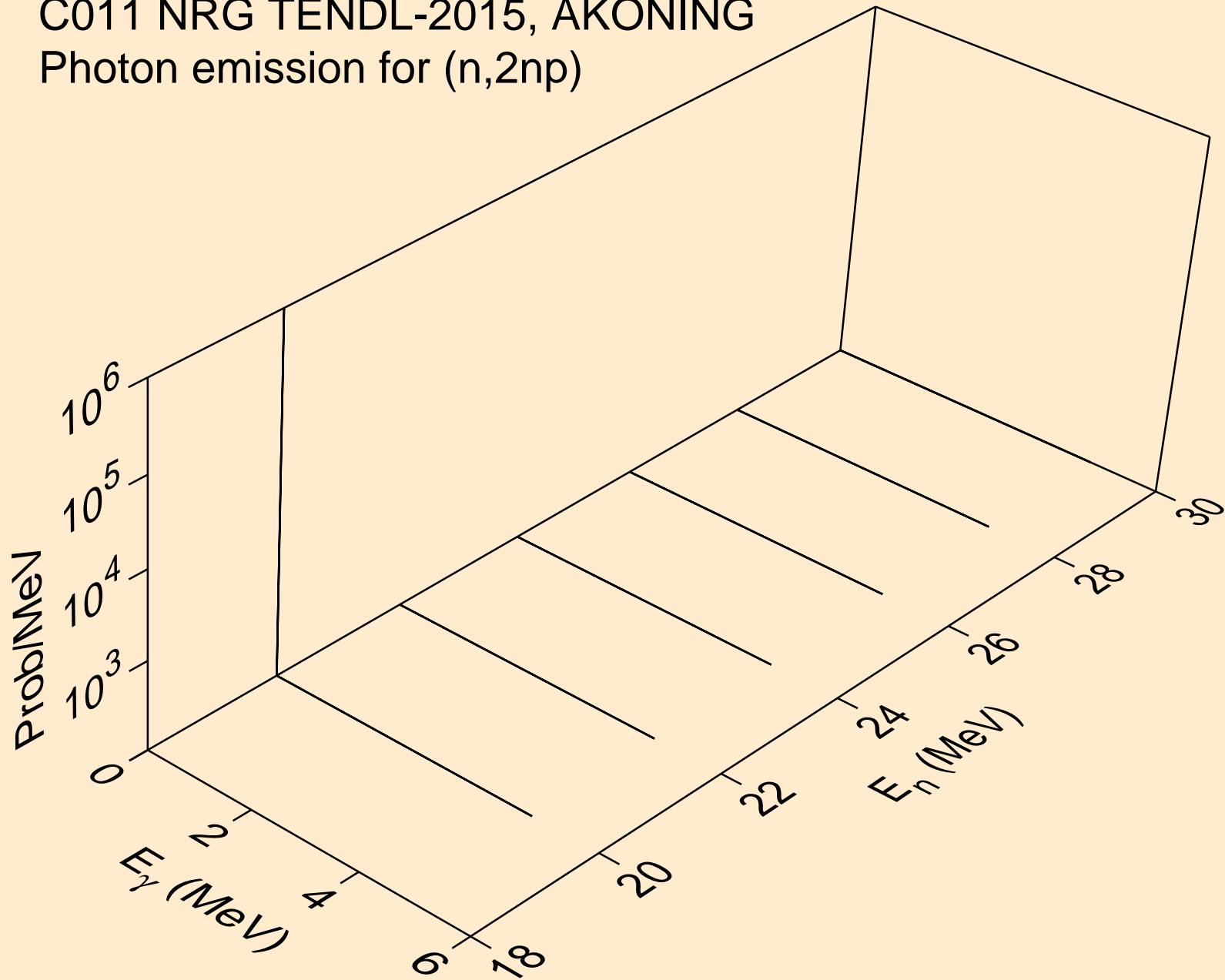

C011 NRG TENDL-2015, AKONING
Photon emission for (n,2np)

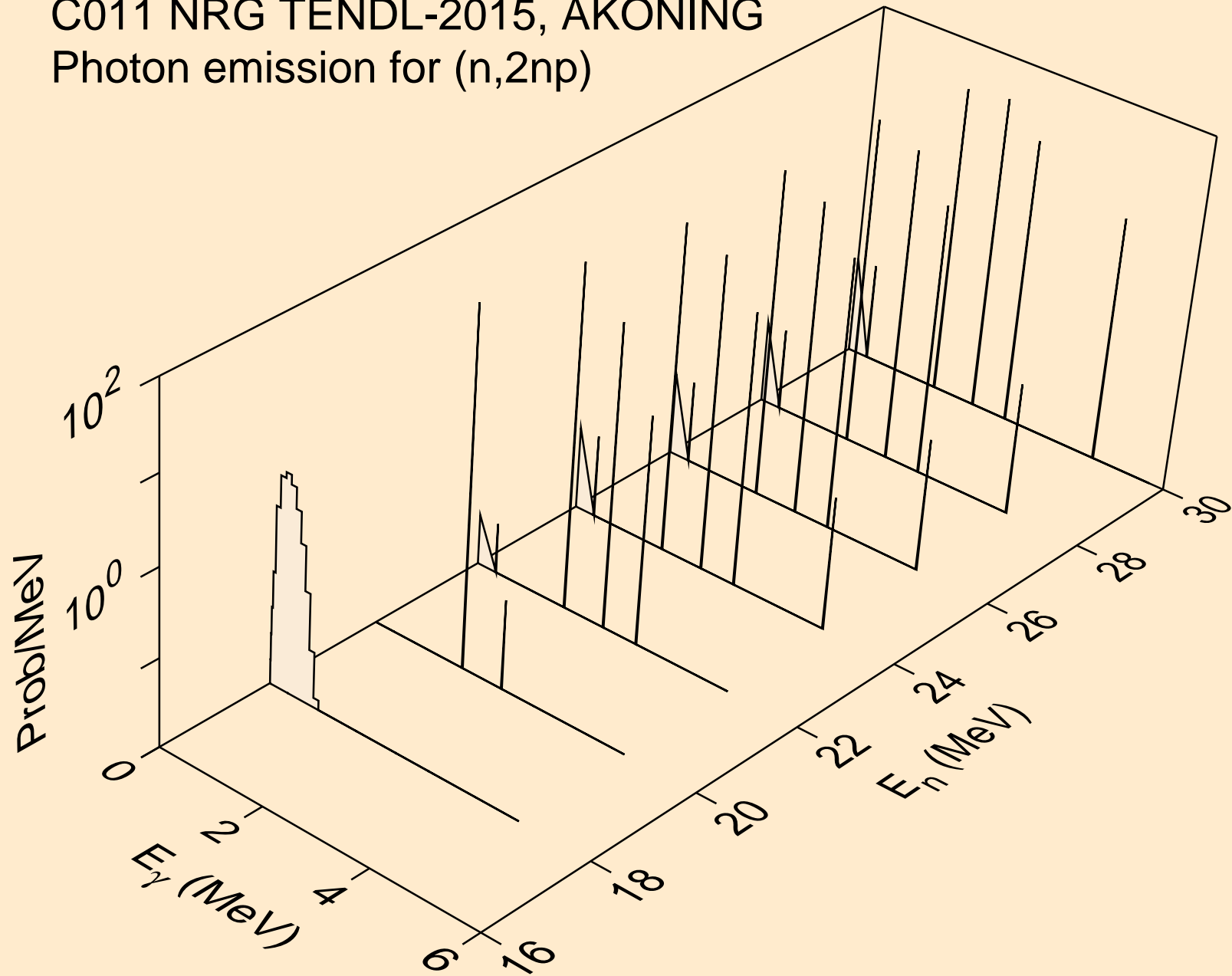

C011 NRG TENDL-2015, AKONING
Photon emission for (n,npa)

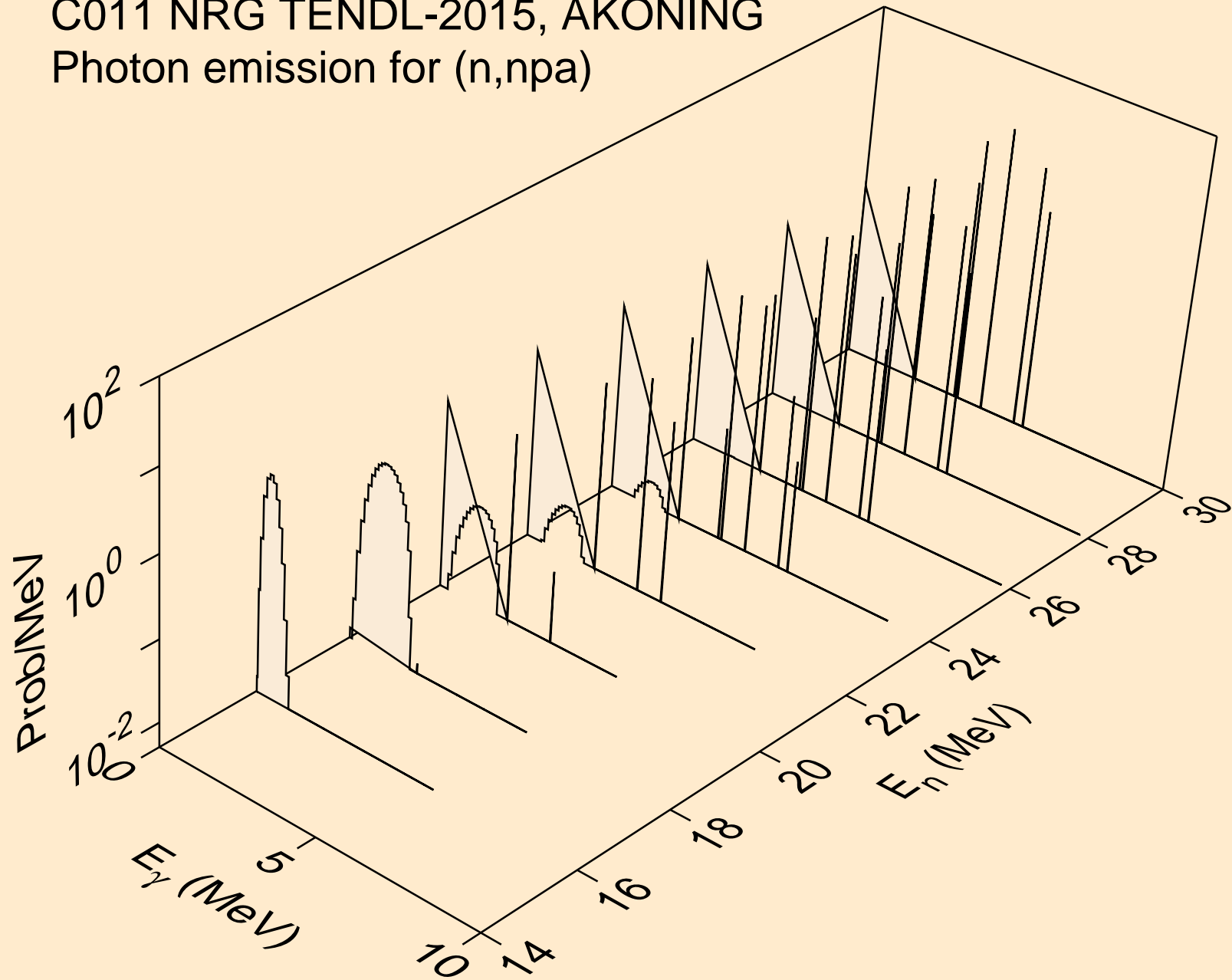

C011 NRG TENDL-2015, AKONING
Photon emission for (n,n*c)

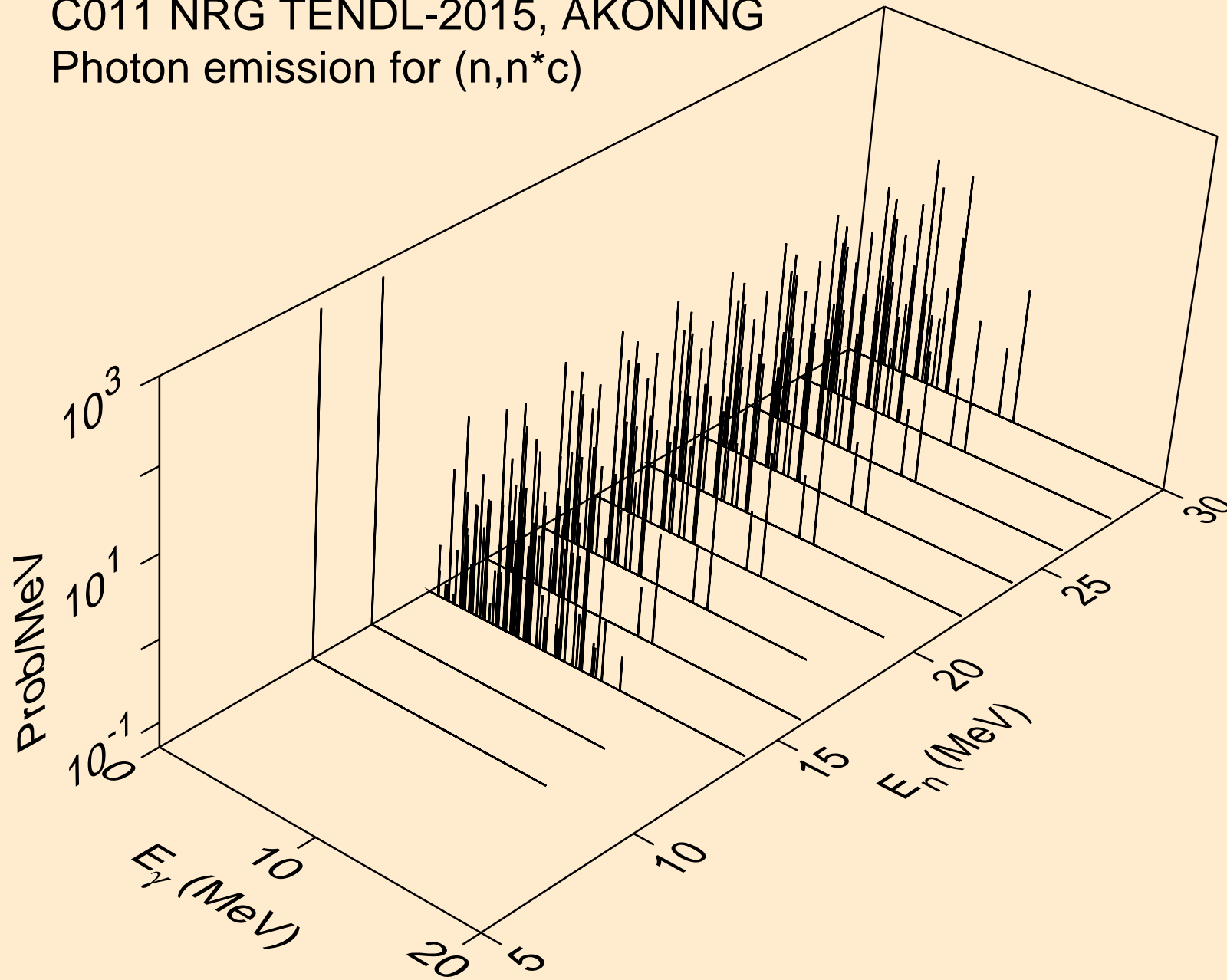

C011 NRG TENDL-2015, AKONING
Photon emission for (n,gma)

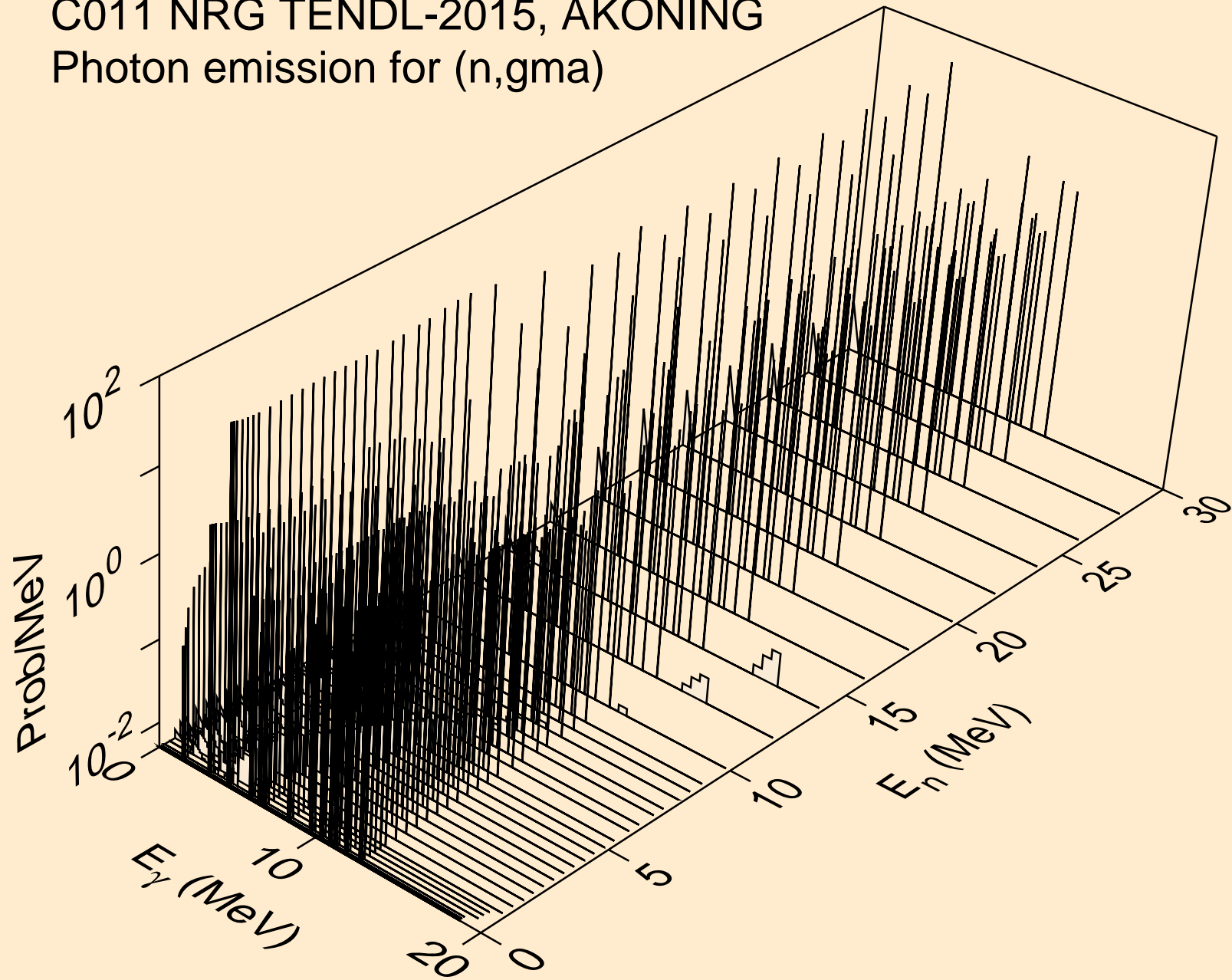

C011 NRG TENDL-2015, AKONING
Photon emission for (n,p)

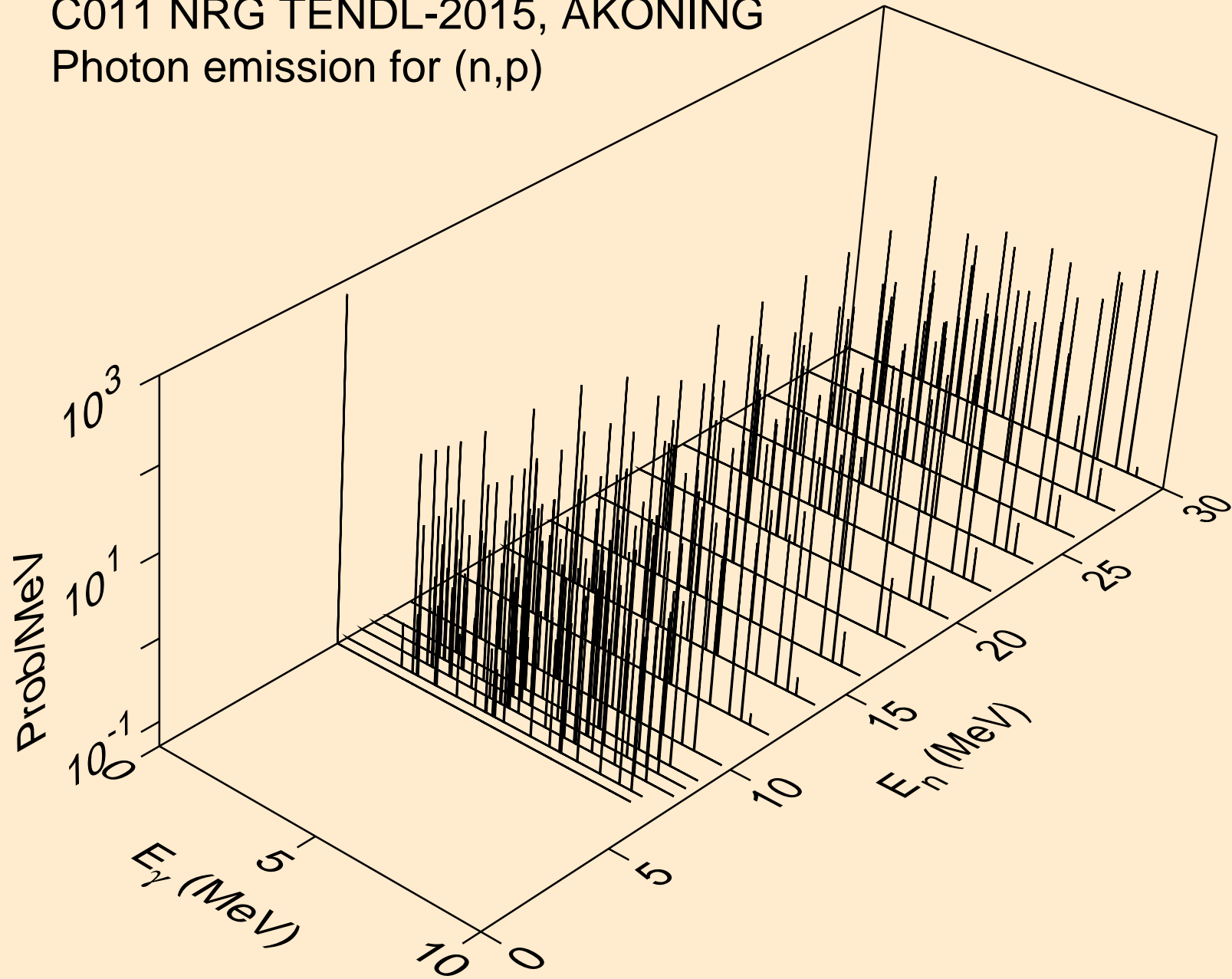

C011 NRG TENDL-2015, AKONING
Photon emission for (n,d)

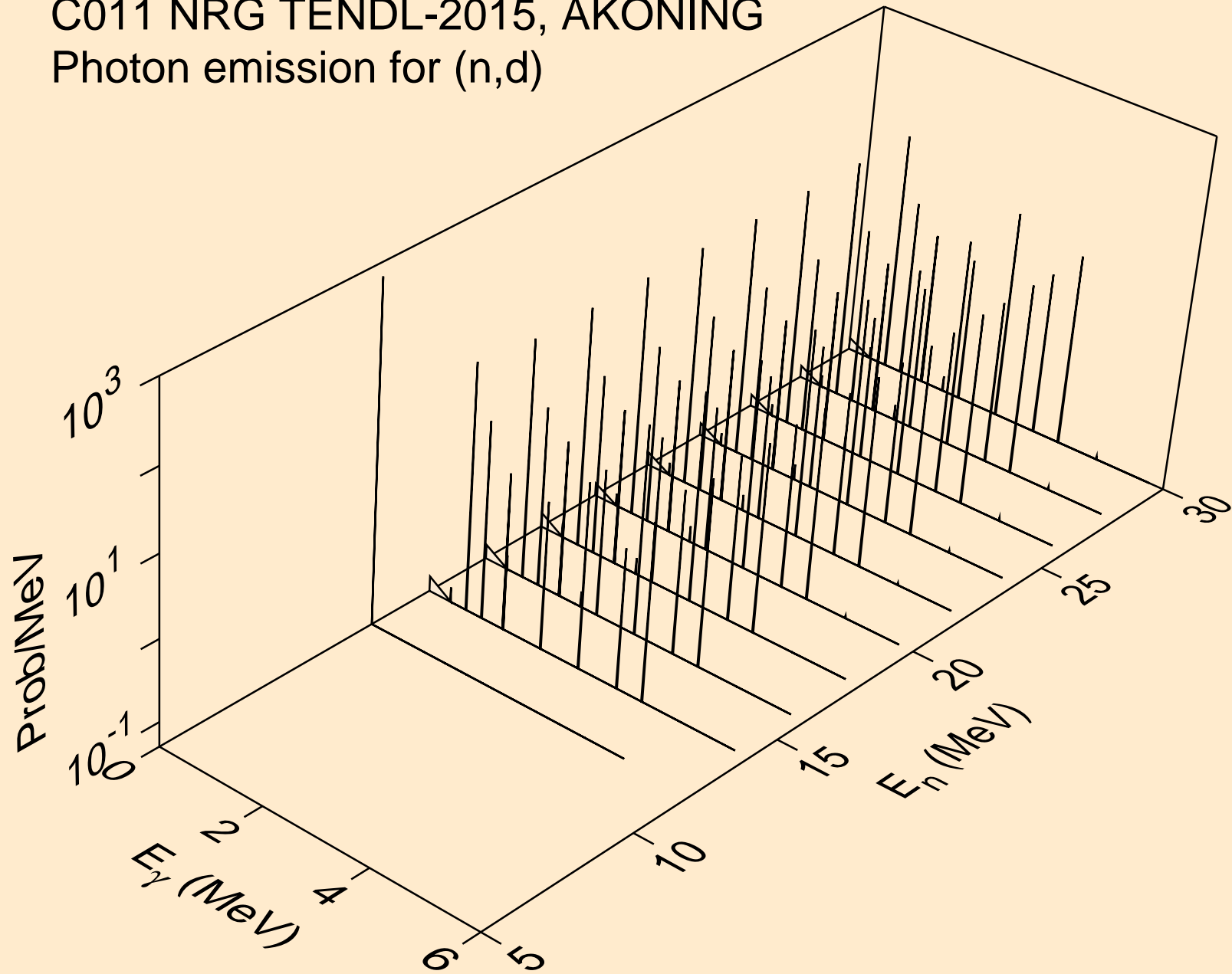

C011 NRG TENDL-2015, AKONING
Photon emission for (n,t)

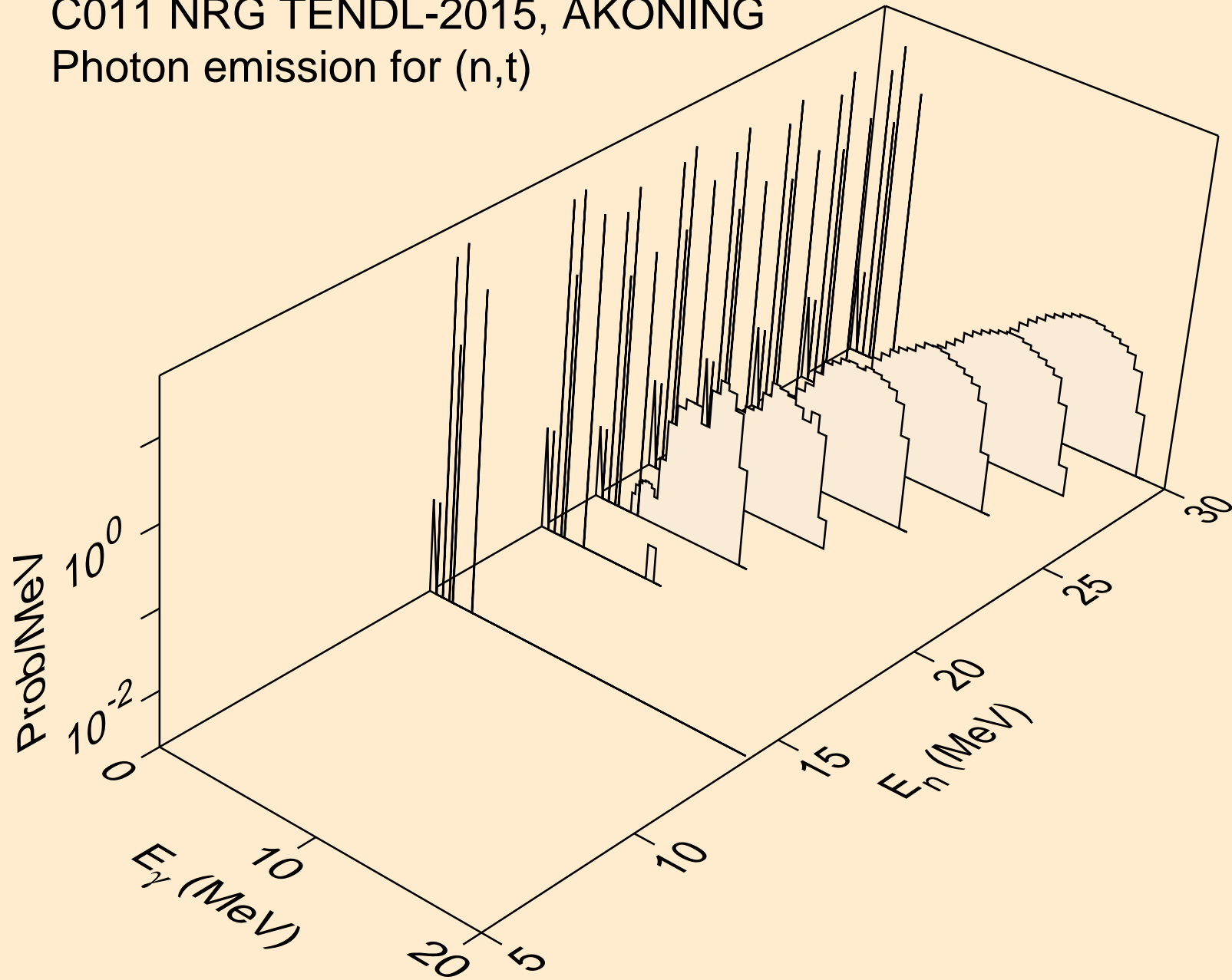

C011 NRG TENDL-2015, AKONING
Photon emission for (n,he3)

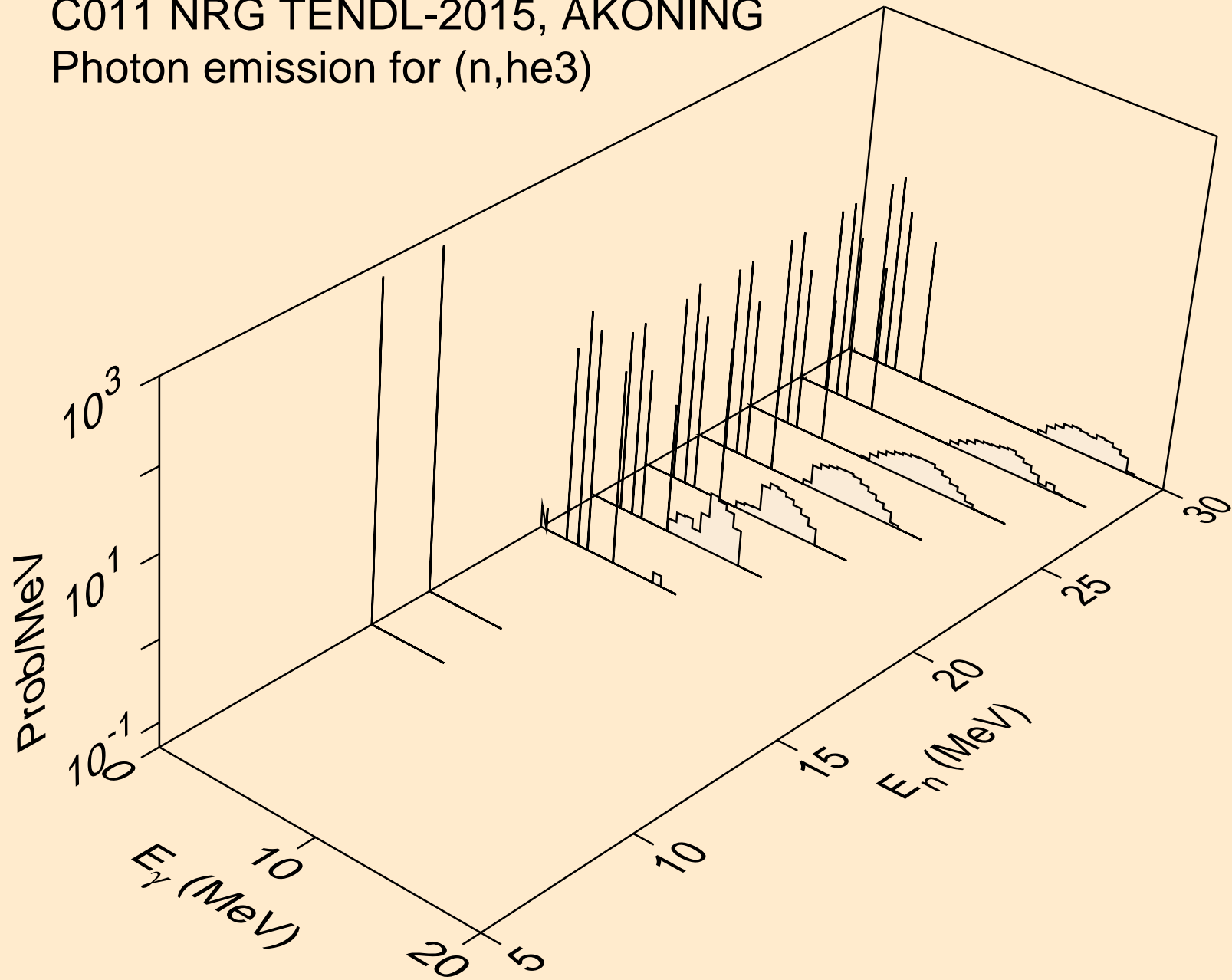

C011 NRG TENDL-2015, AKONING
Photon emission for (n,a)

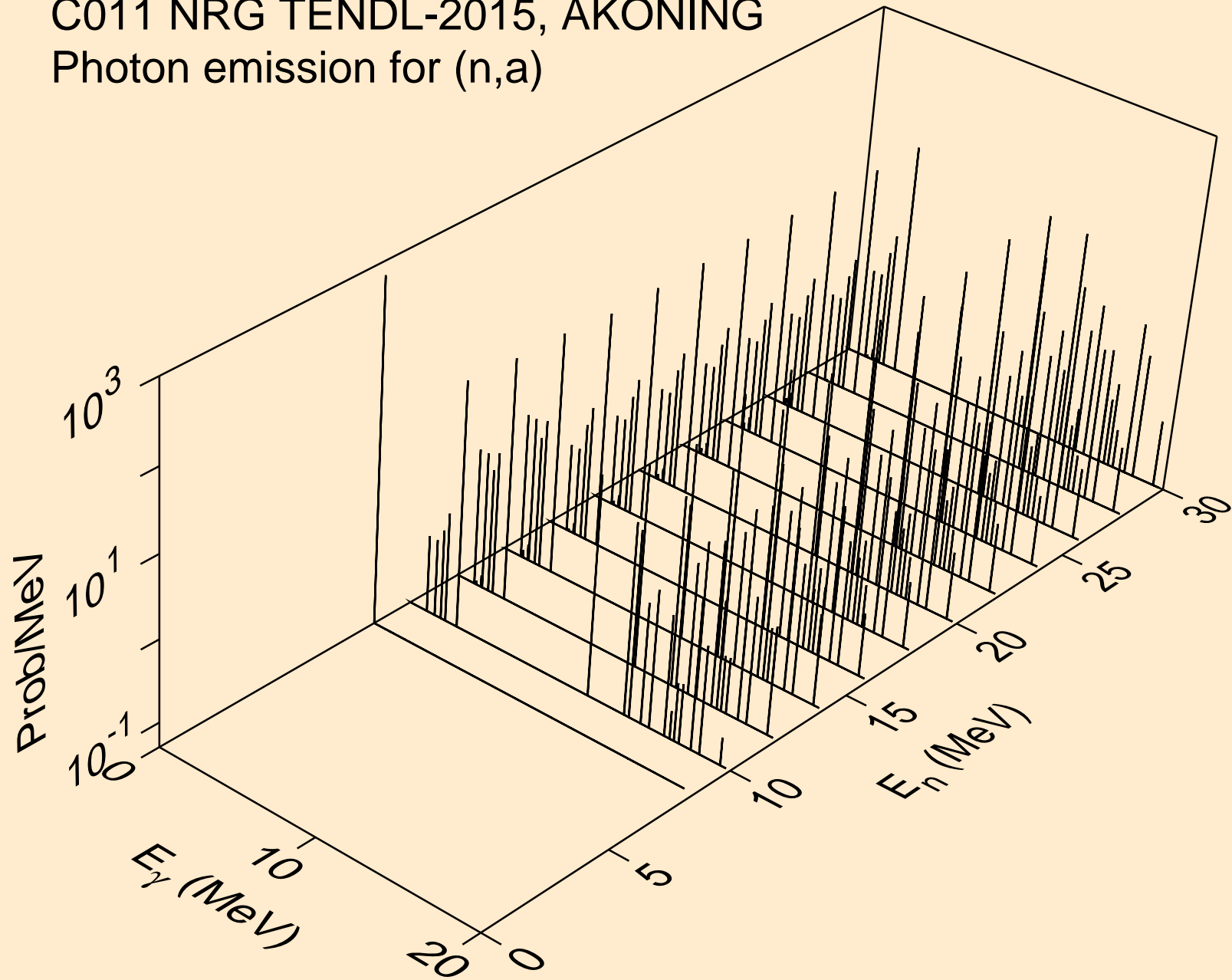

C011 NRG TENDL-2015, AKONING
Photon emission for (n,2p)

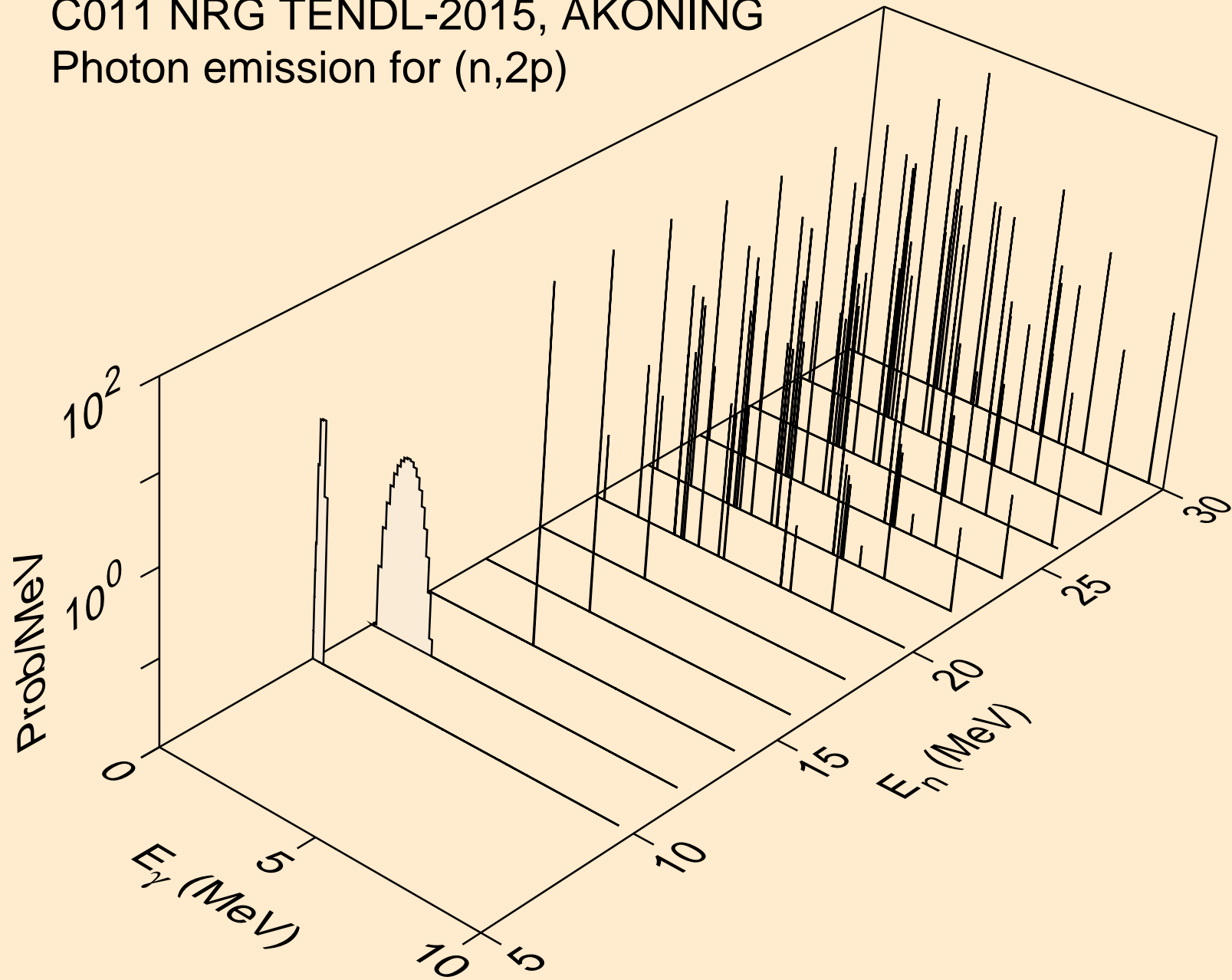

C011 NRG TENDL-2015, AKONING
Photon emission for (n,pa)

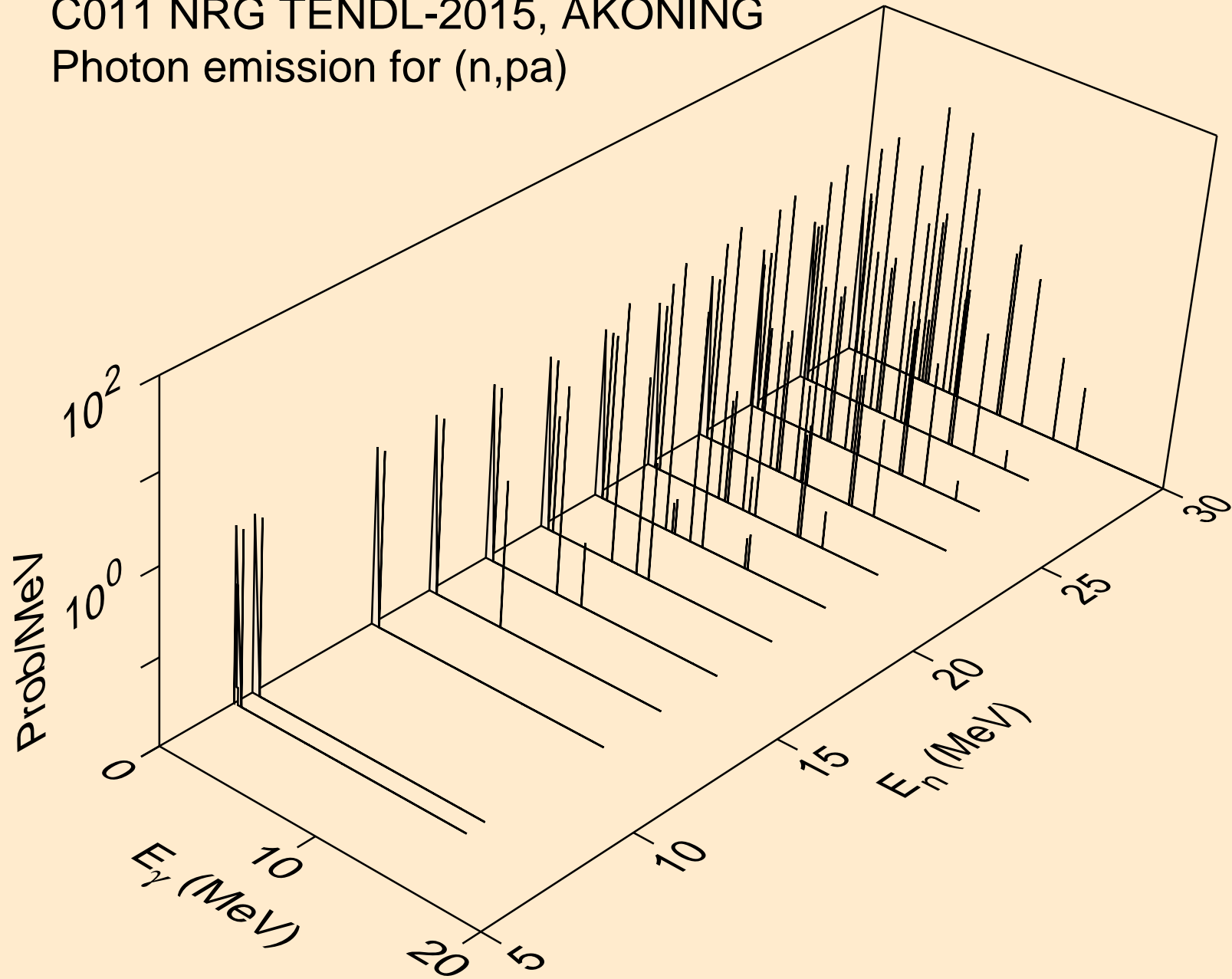

C011 NRG TENDL-2015, AKONING
Photon emission for (n,pd)

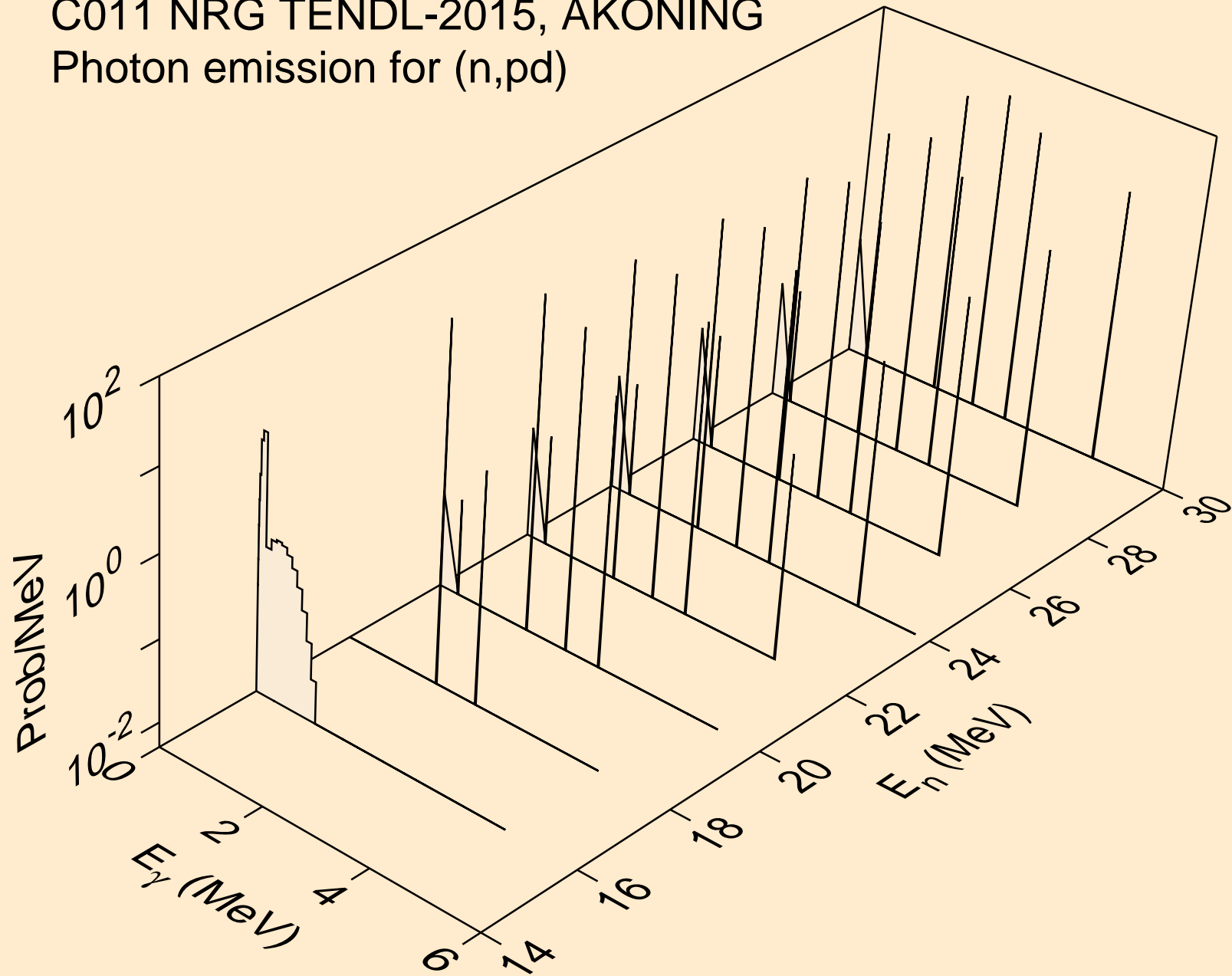

C011 NRG TENDL-2015, AKONING
Photon emission for (n,pt)

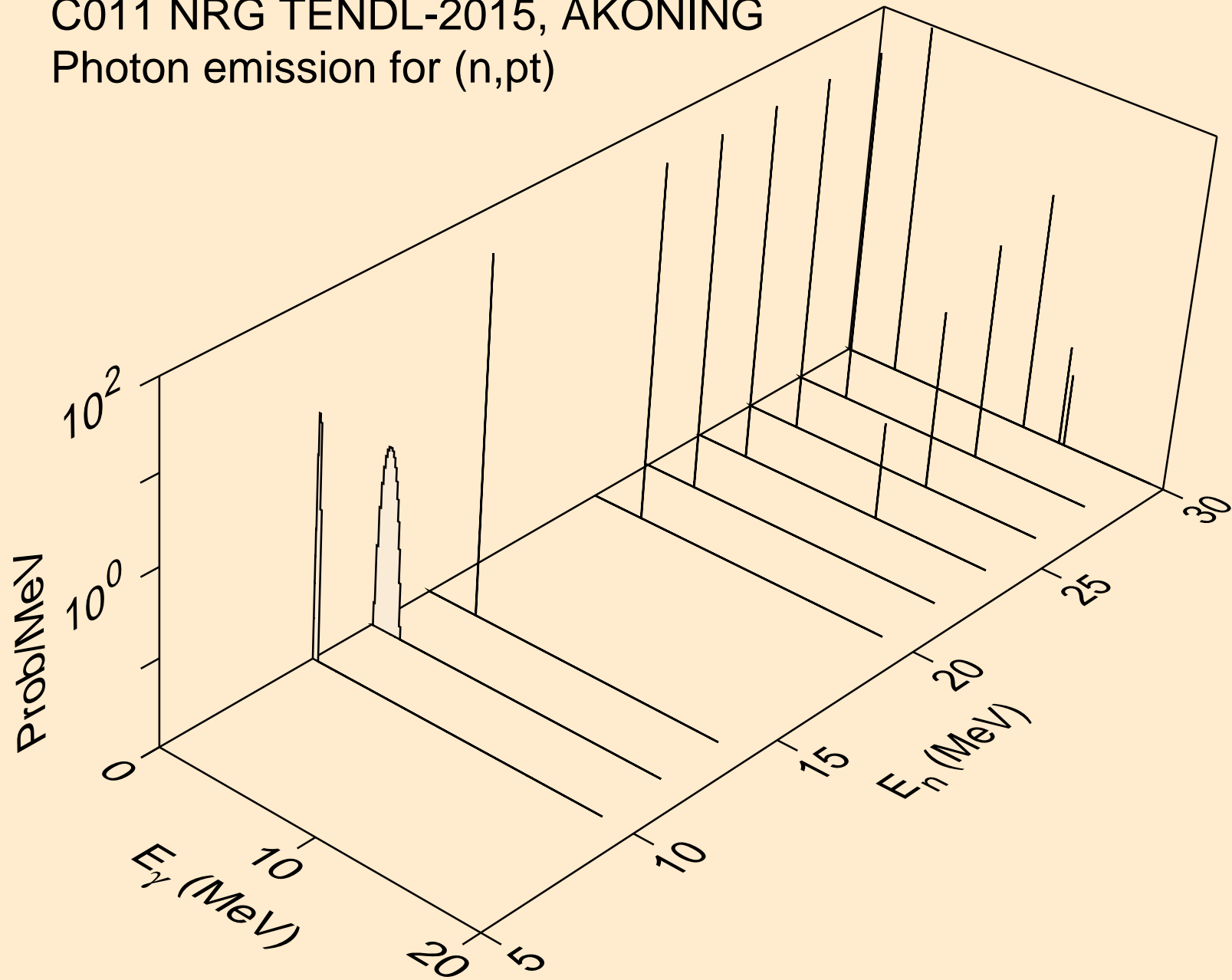

C011 NRG TENDL-2015, AKONING
Photon emission for (n,da)

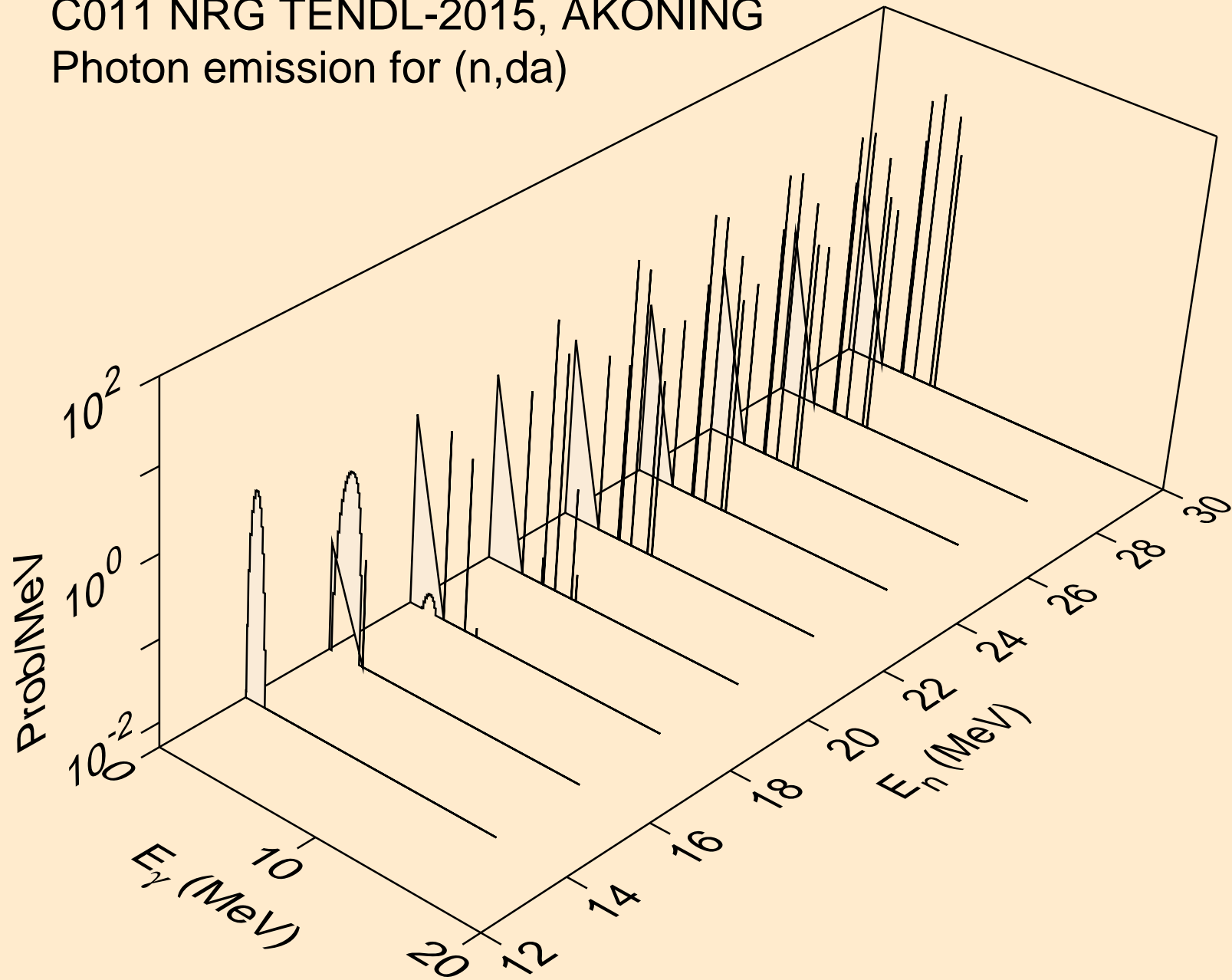

C011 NRG TENDL-2015, AKONING
thermal capture photon spectrum

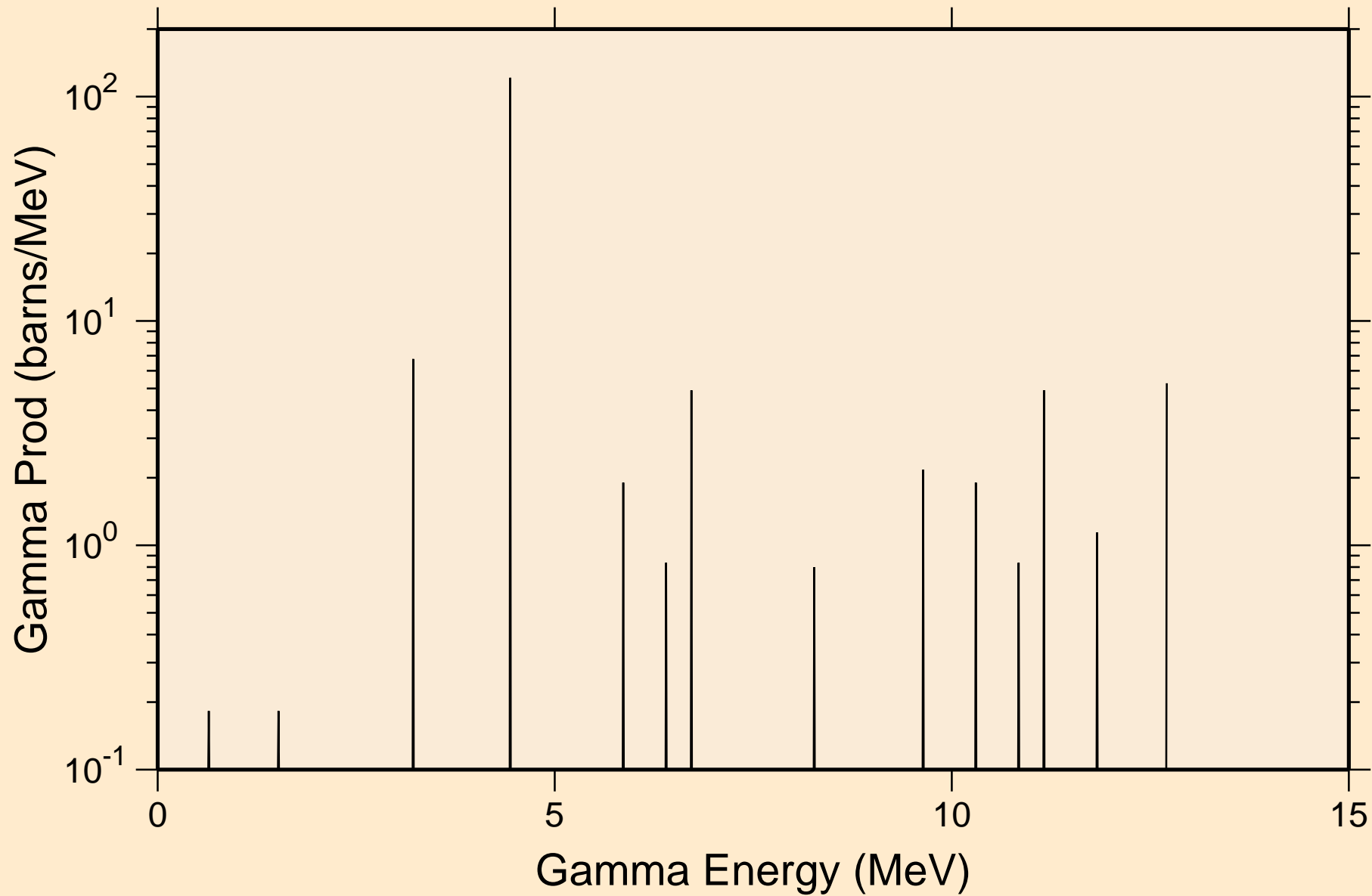

C011 NRG TENDL-2015, AKONING
14 MeV photon spectrum

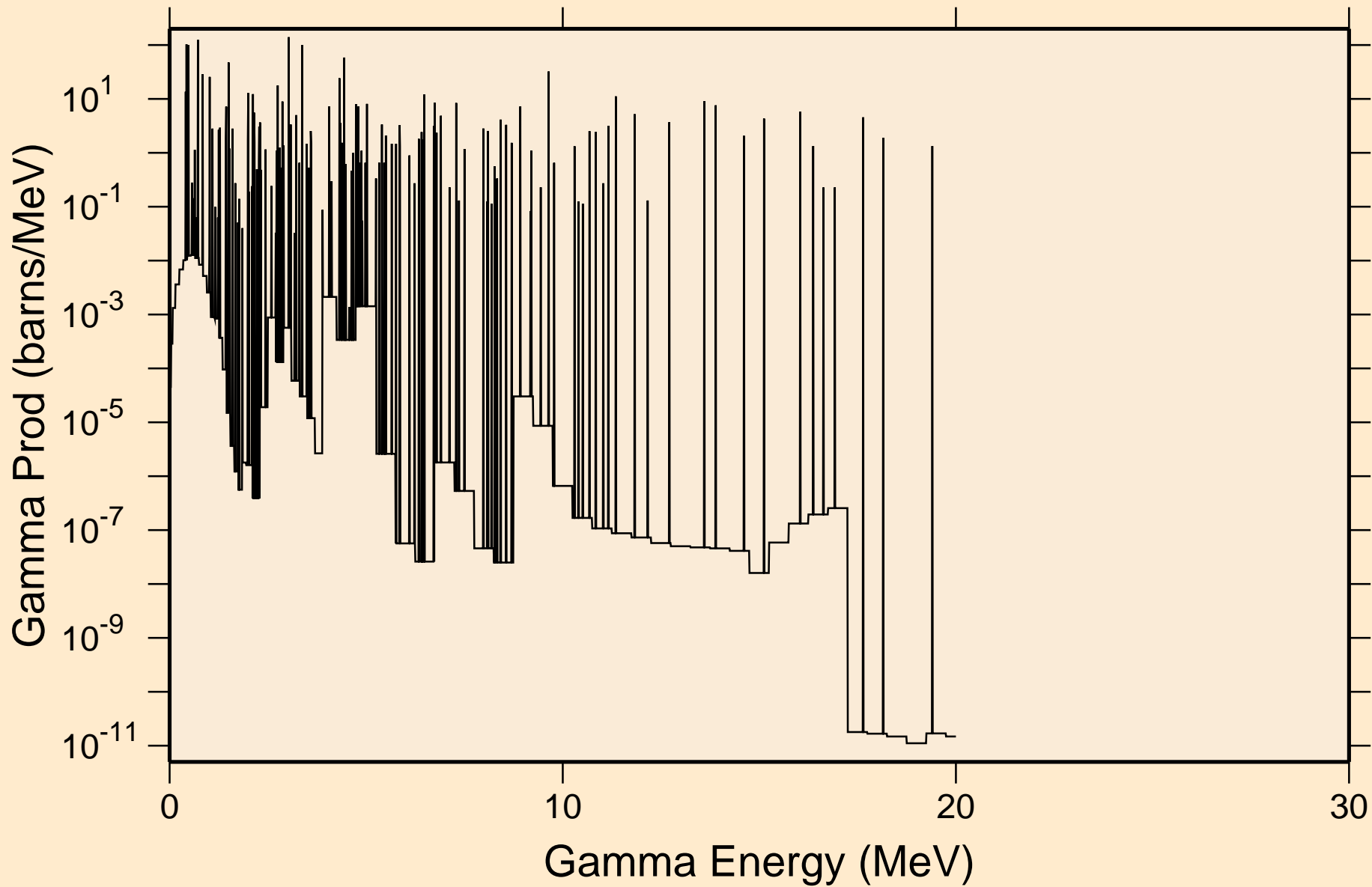

C011 NRG TENDL-2015, AKONING

Particle heating contributions

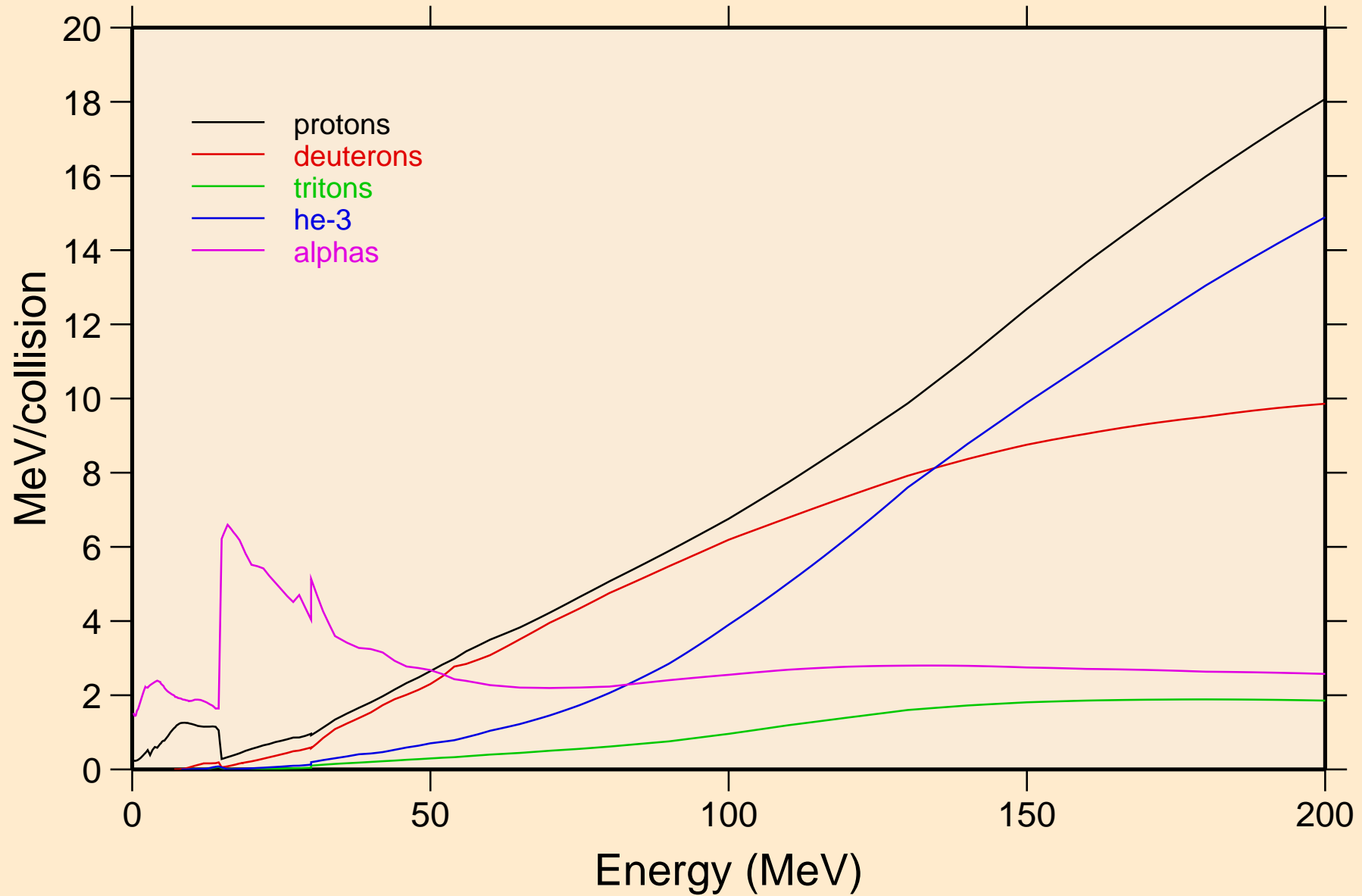

C011 NRG TENDL-2015, AKONING

Recoil Heating

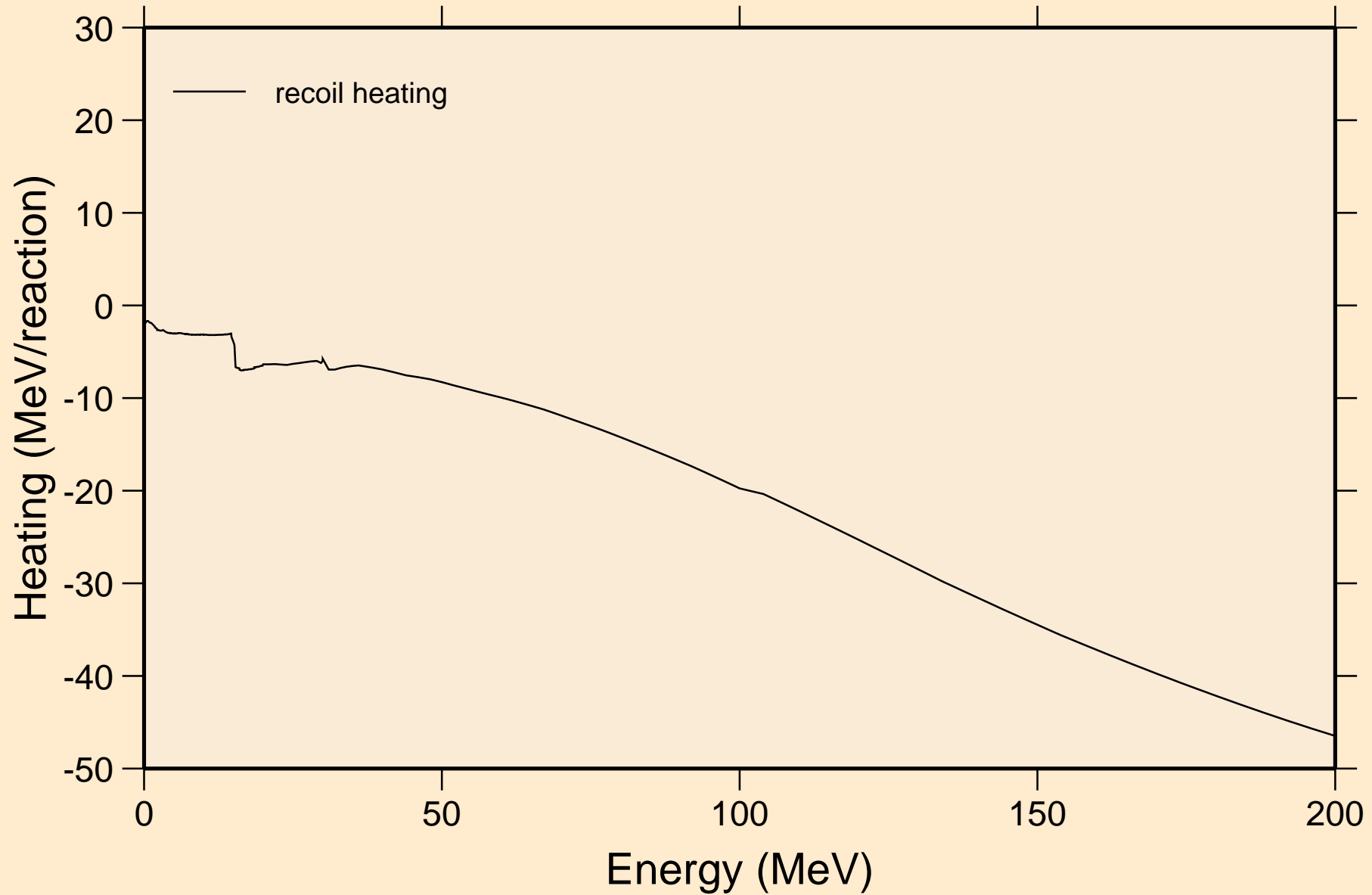

C011 NRG TENDL-2015, AKONING

Particle production cross sections

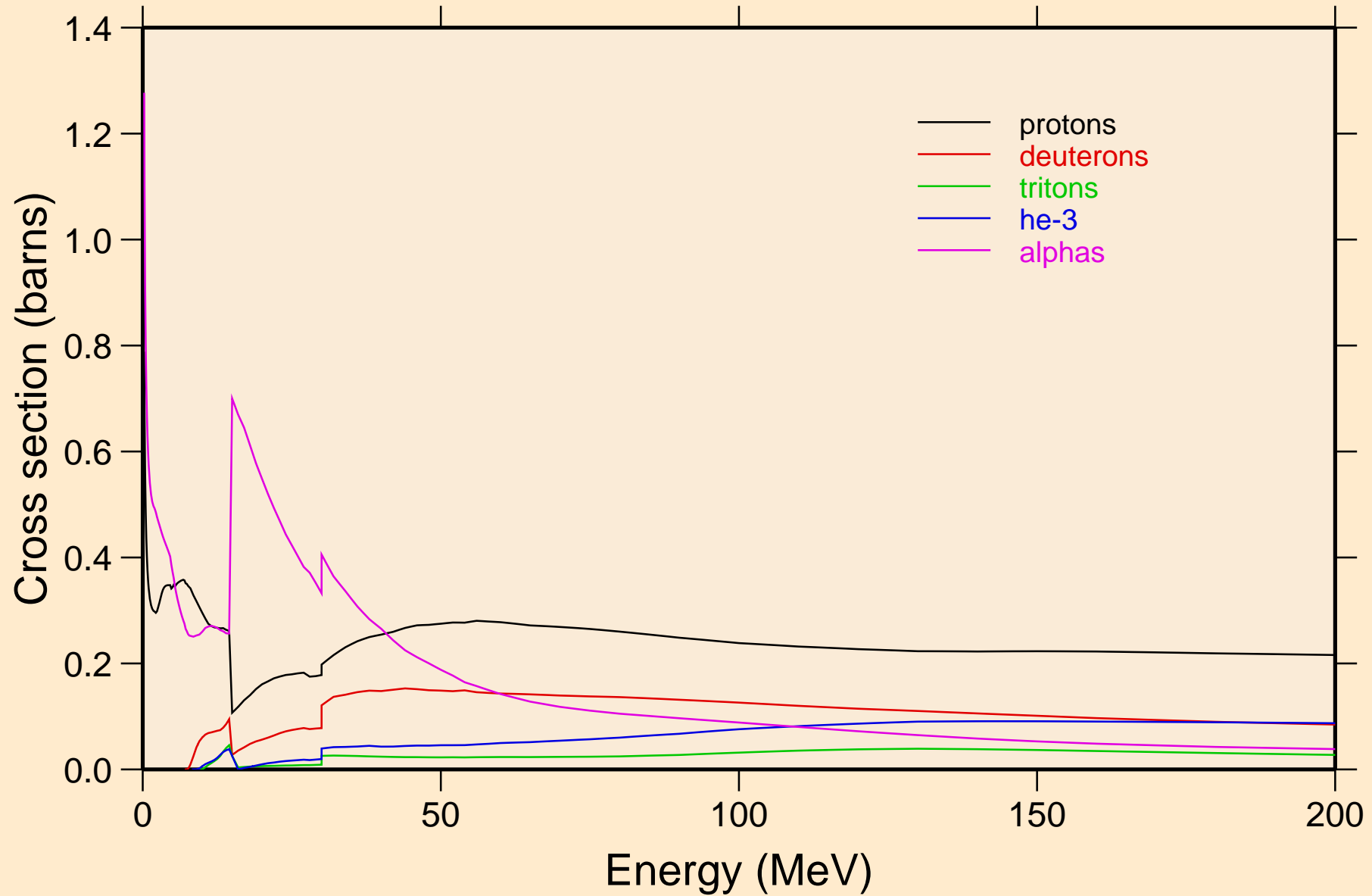

C011 NRG TENDL-2015, AKONING
protons from (n,x)

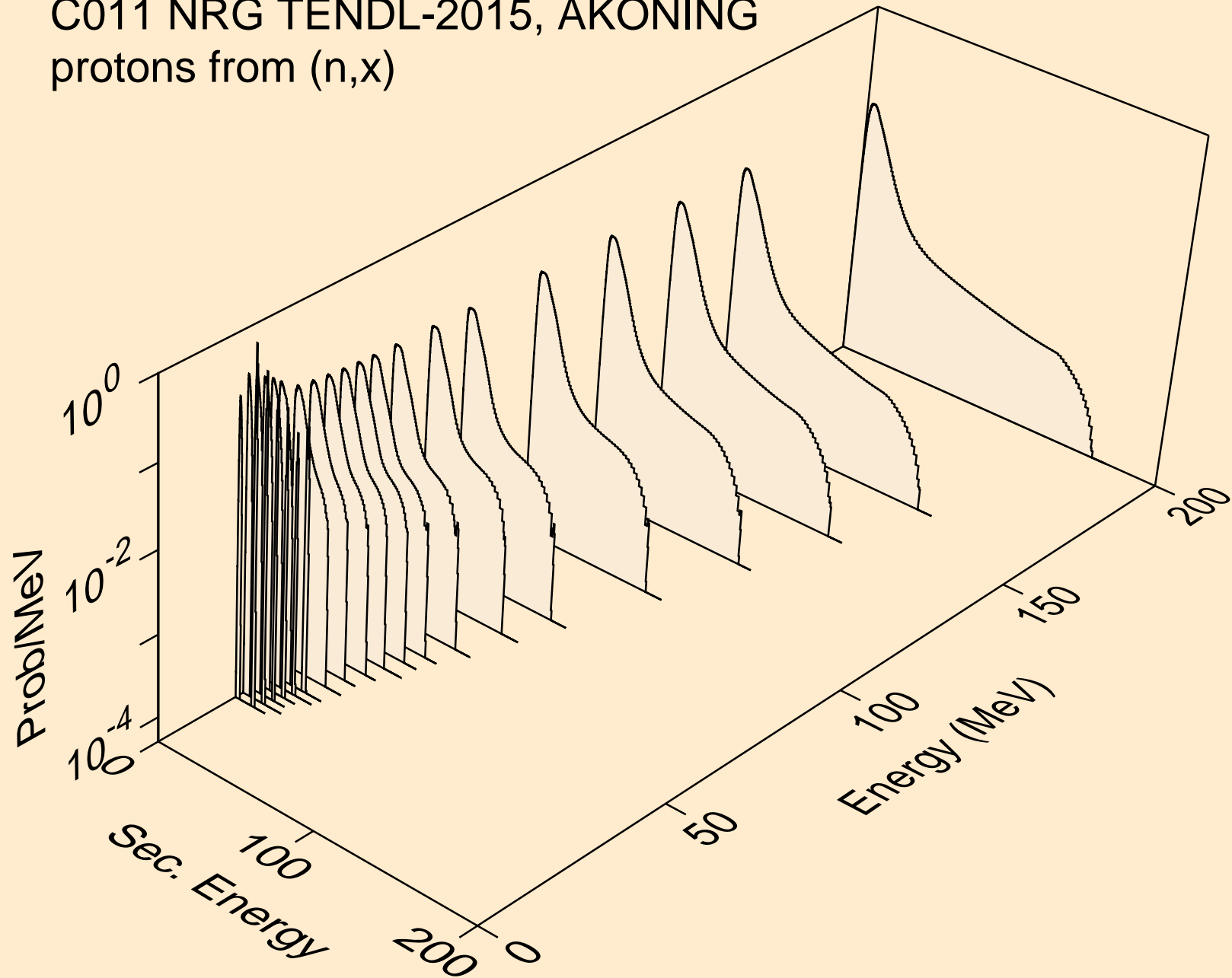

C011 NRG TENDL-2015, AKONING
protons from (n,n*)p

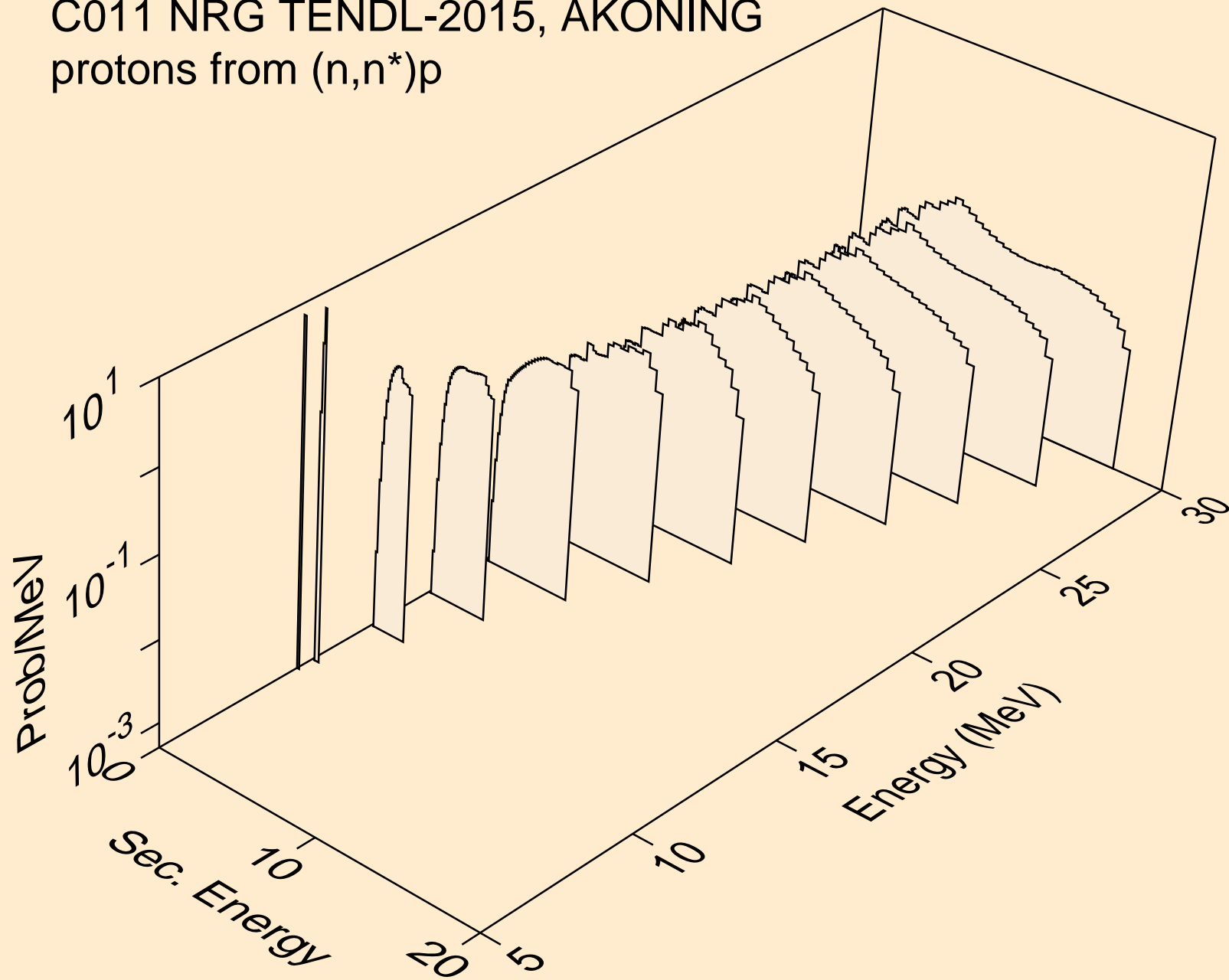

C011 NRG TENDL-2015, AKONING
protons from (n,2np)

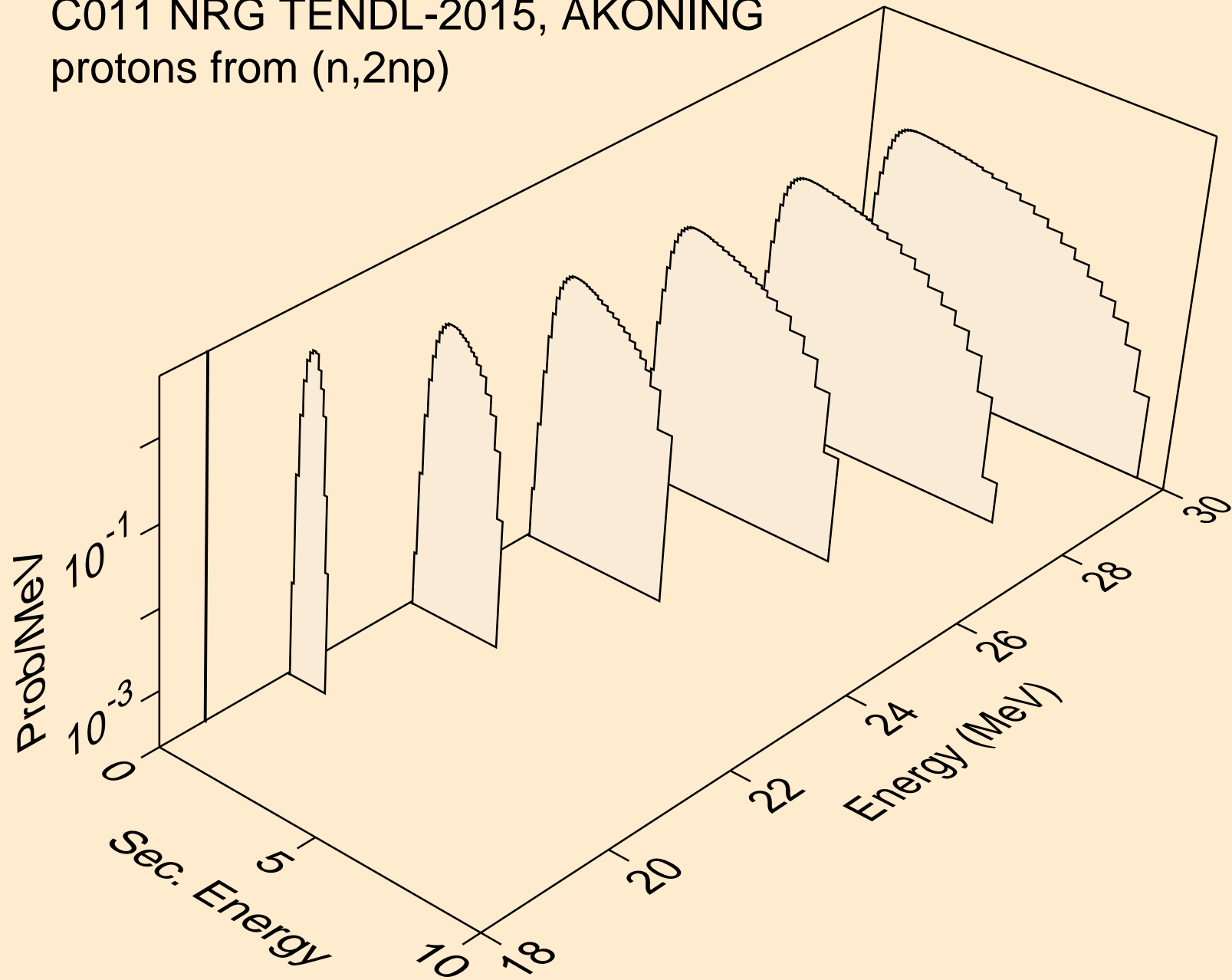

C011 NRG TENDL-2015, AKONING
protons from (n,2np)

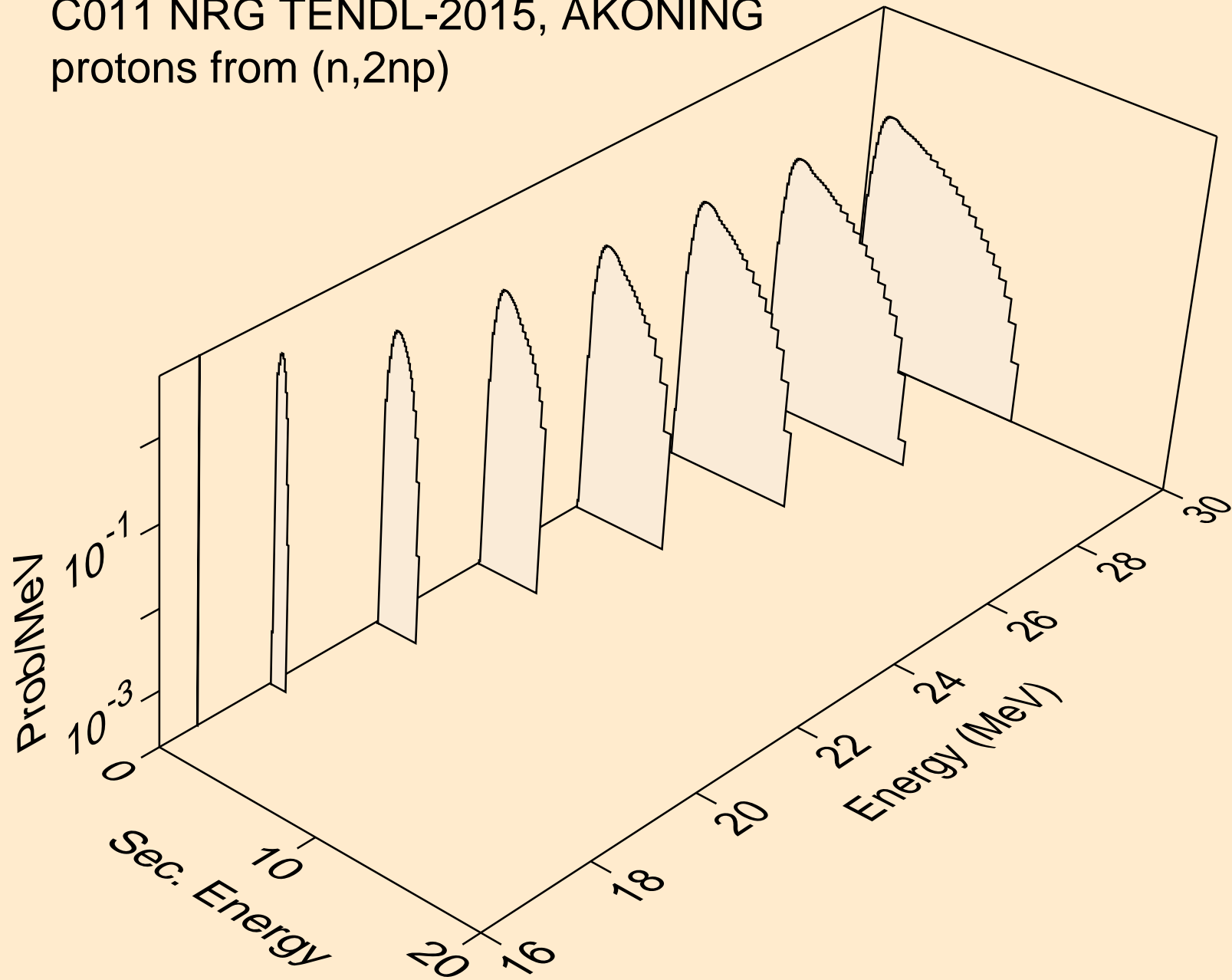

C011 NRG TENDL-2015, AKONING
protons from (n,npa)

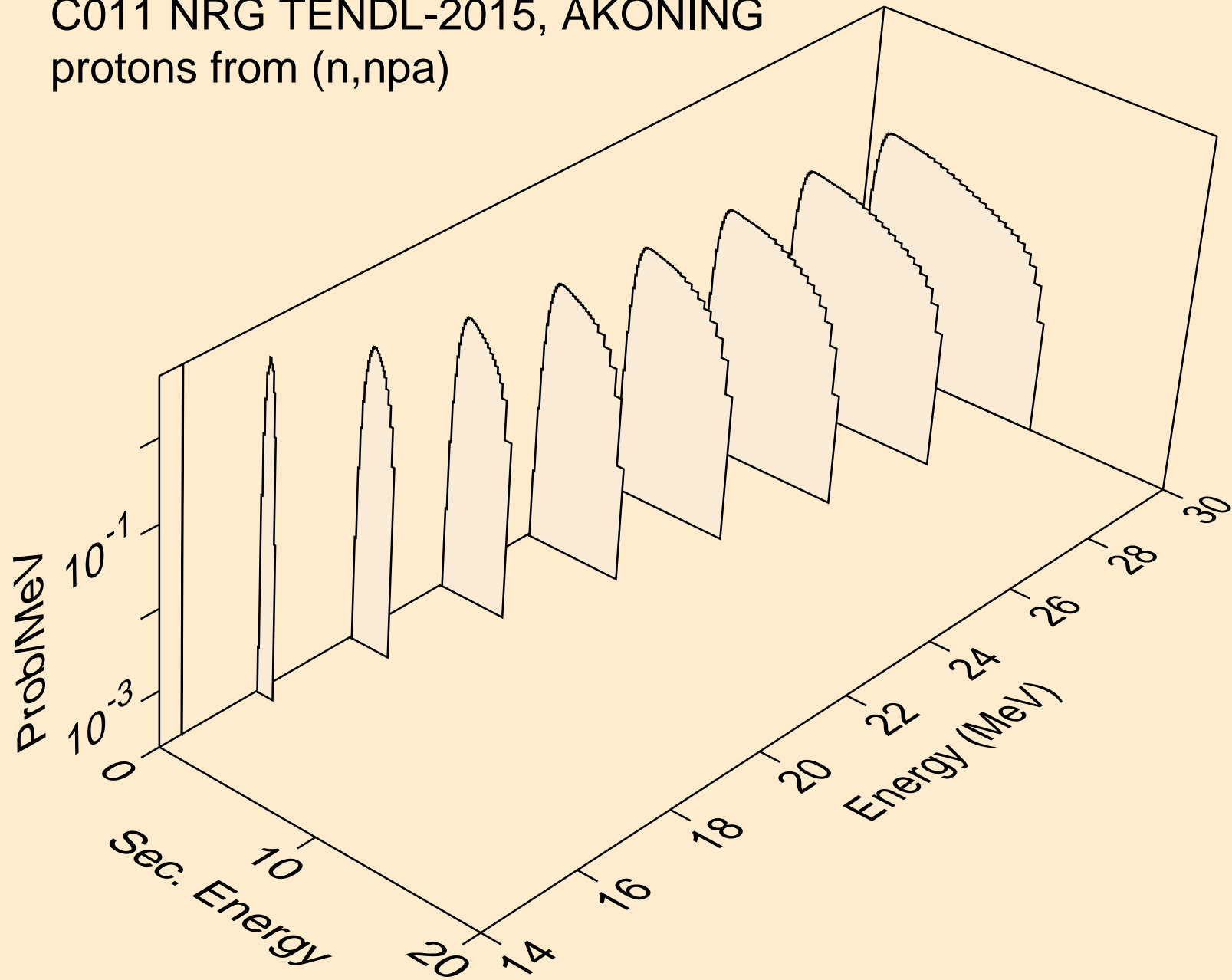

C011 NRG TENDL-2015, AKONING
protons from (n,p)

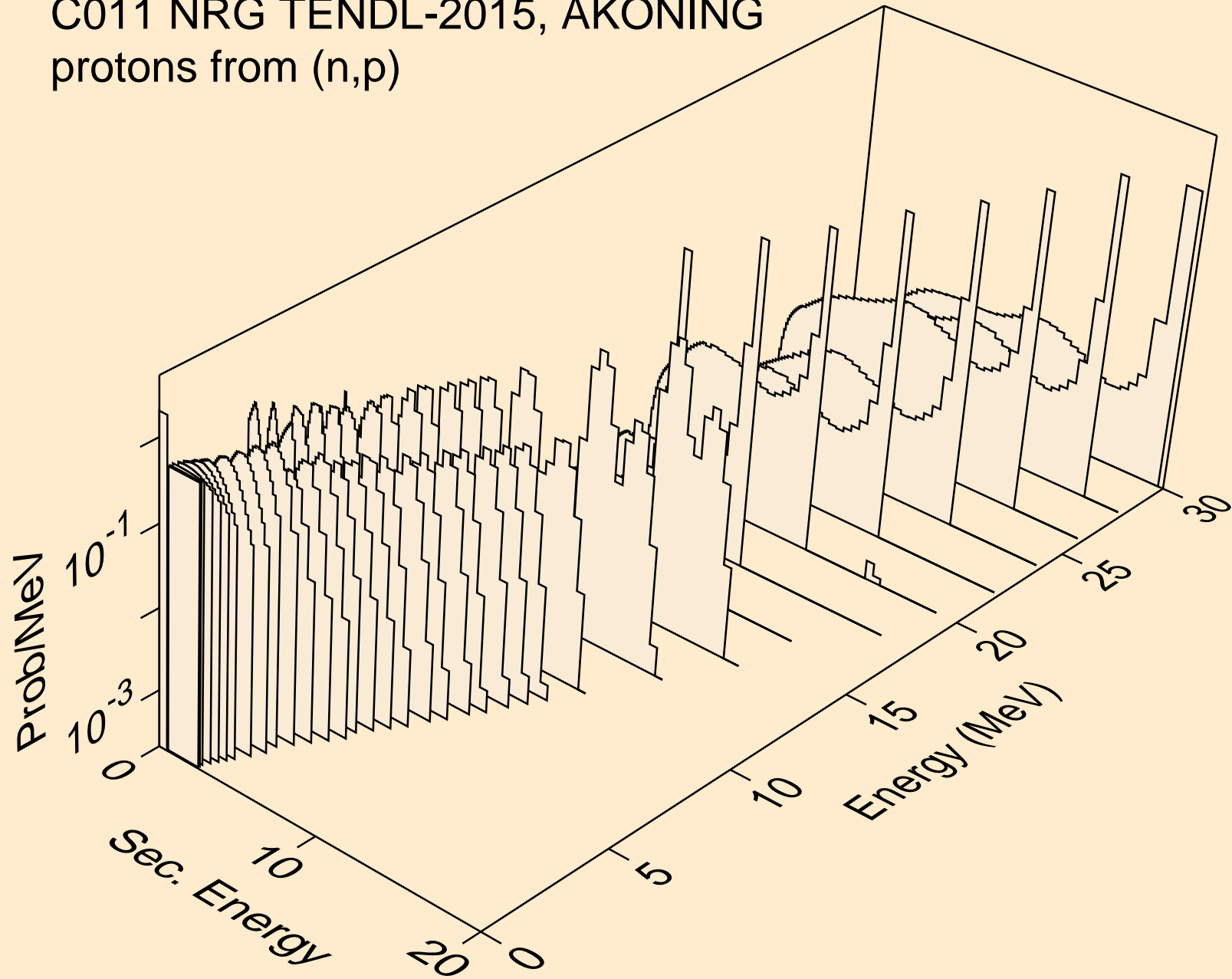

C011 NRG TENDL-2015, AKONING
protons from (n,2p)

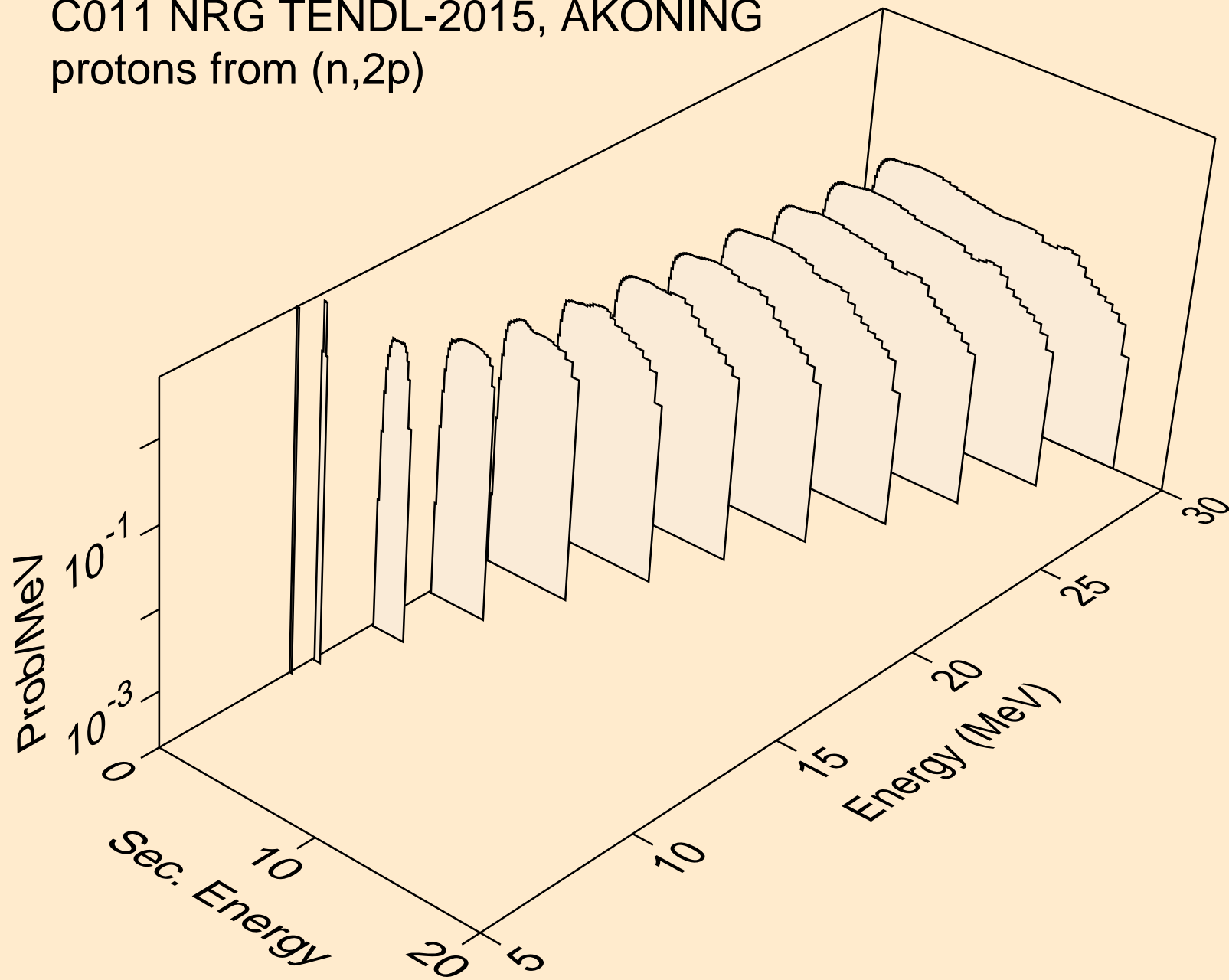

C011 NRG TENDL-2015, AKONING
protons from (n,pa)

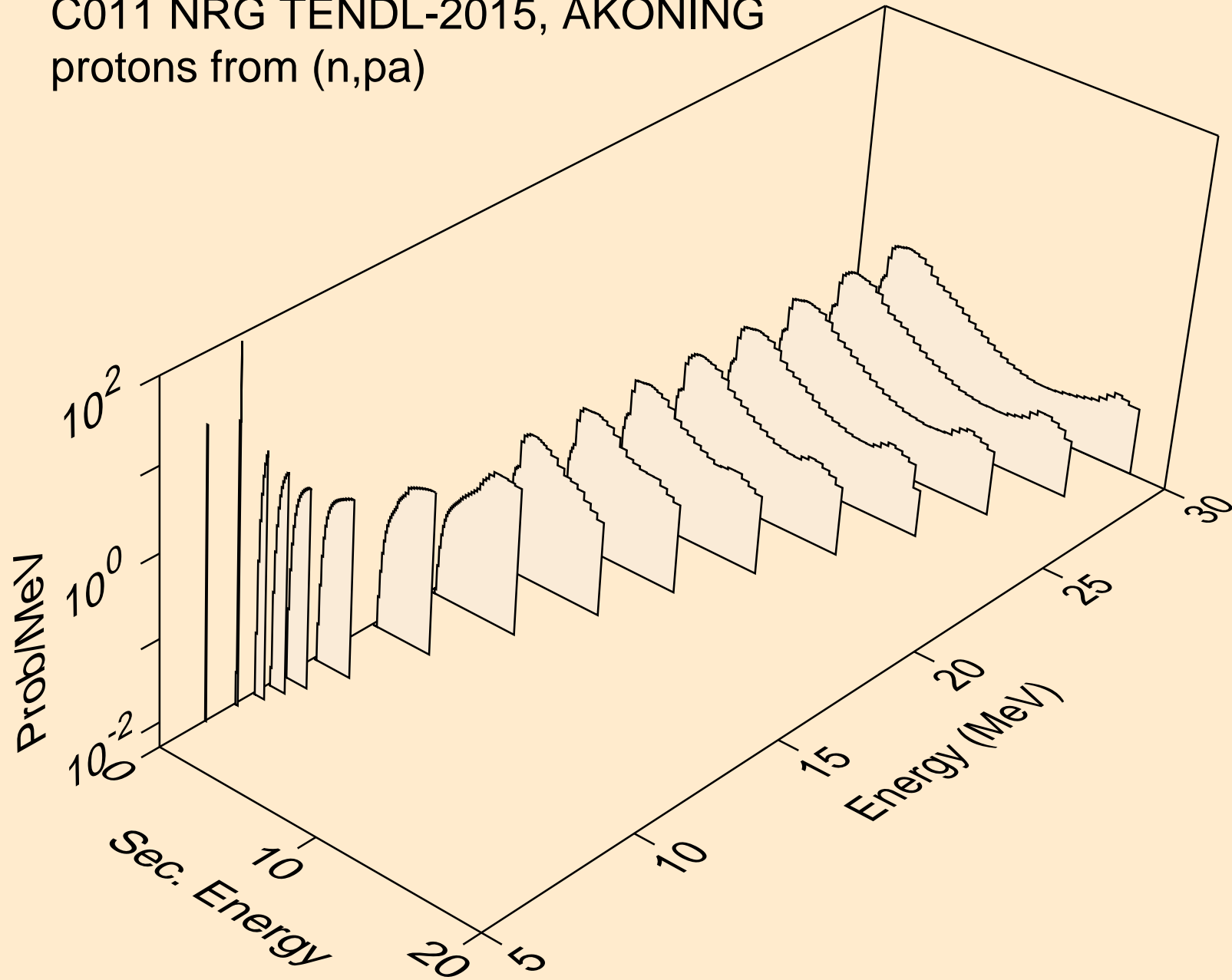

C011 NRG TENDL-2015, AKONING
protons from (n,pd)

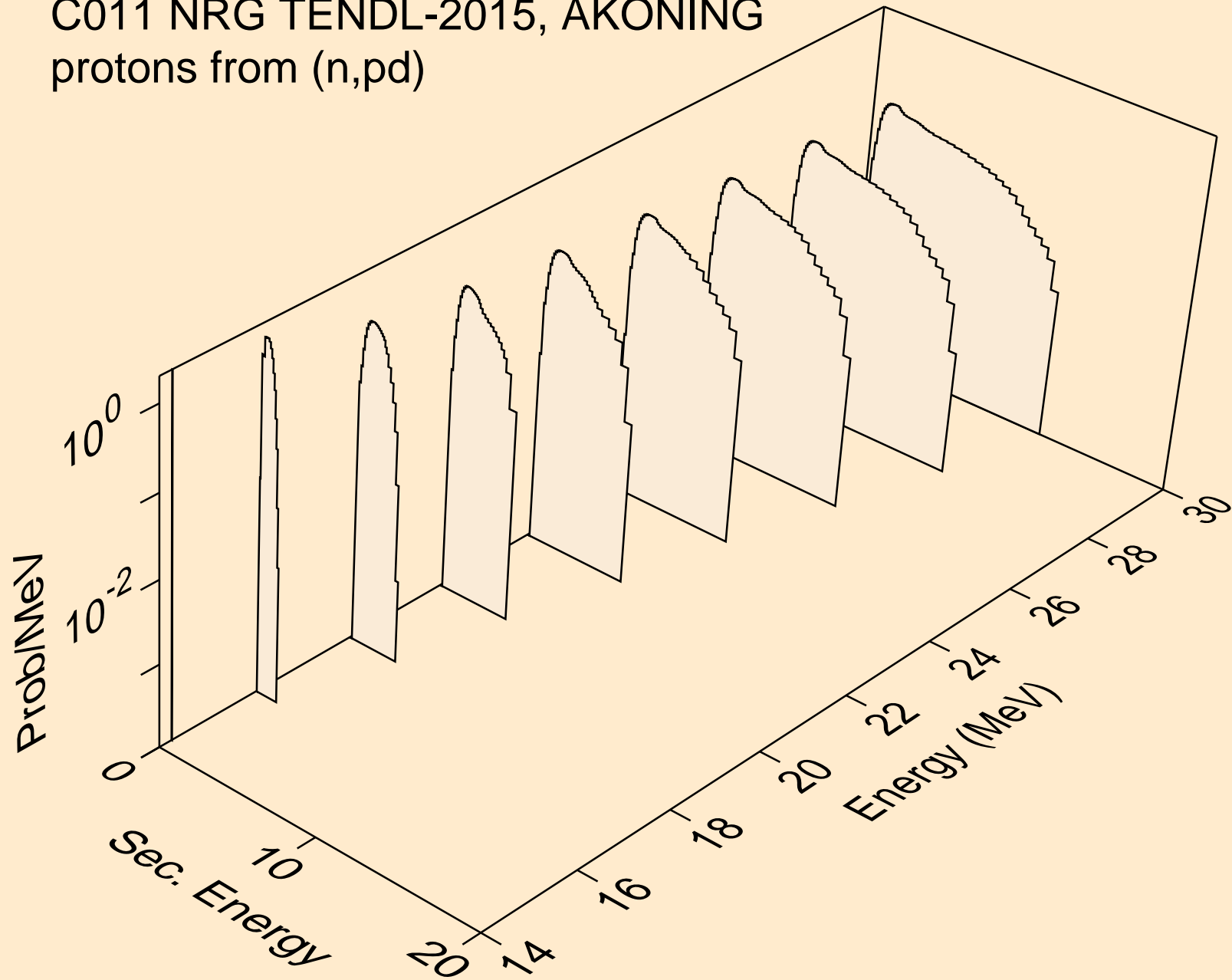

C011 NRG TENDL-2015, AKONING
protons from (n,pt)

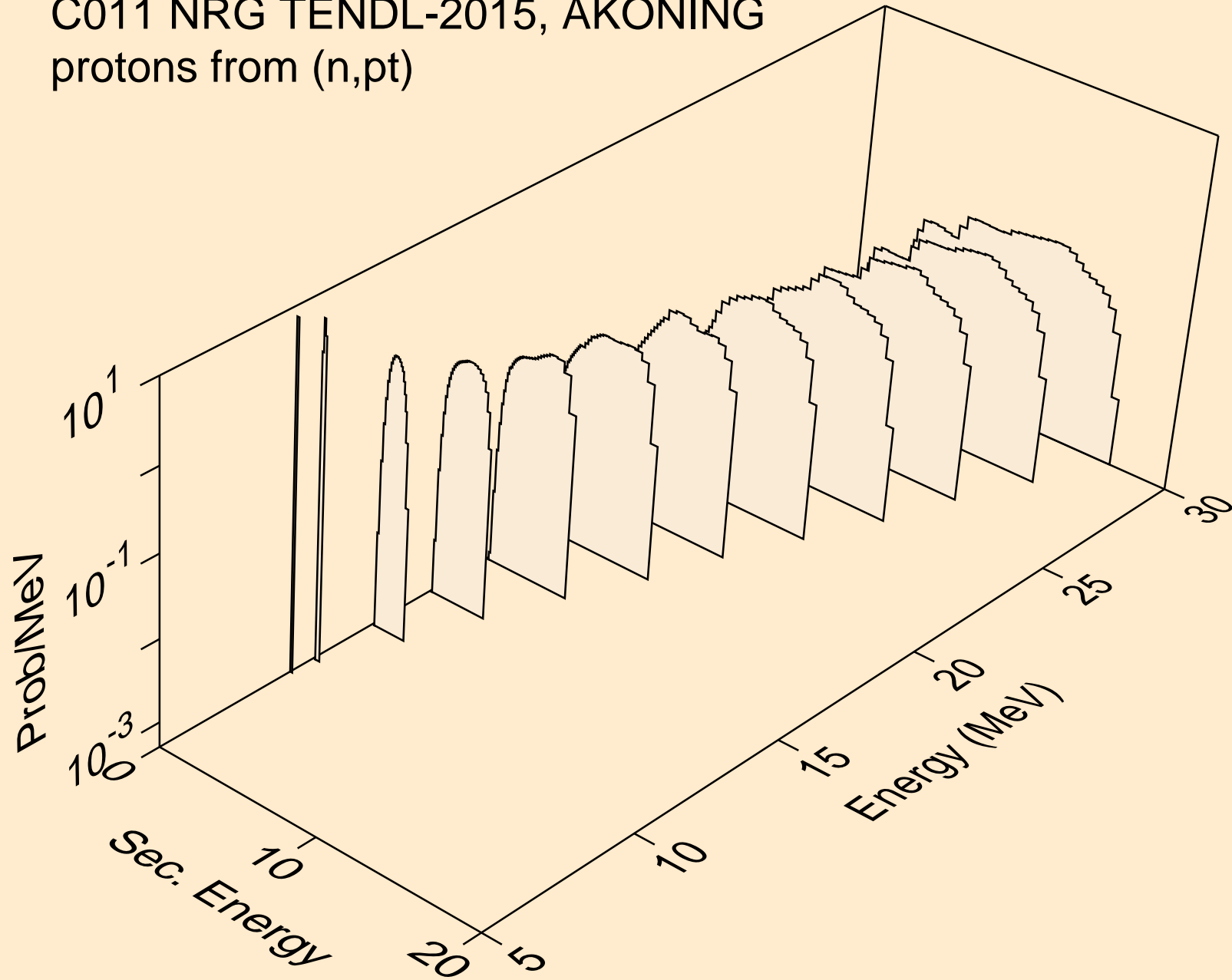

C011 NRG TENDL-2015, AKONING
deuterons from (n,x)

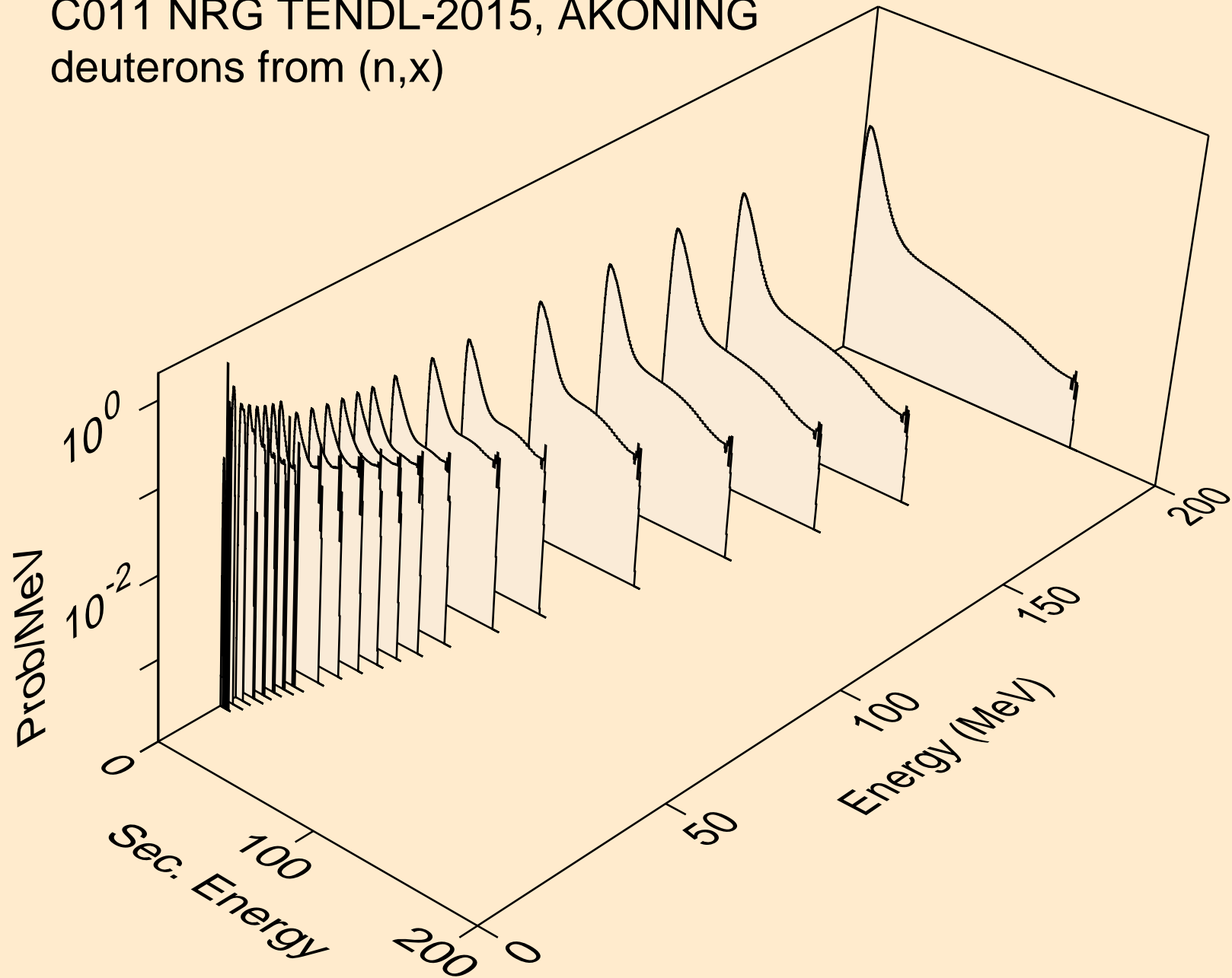

C011 NRG TENDL-2015, AKONING
deuterons from (n,n*)d

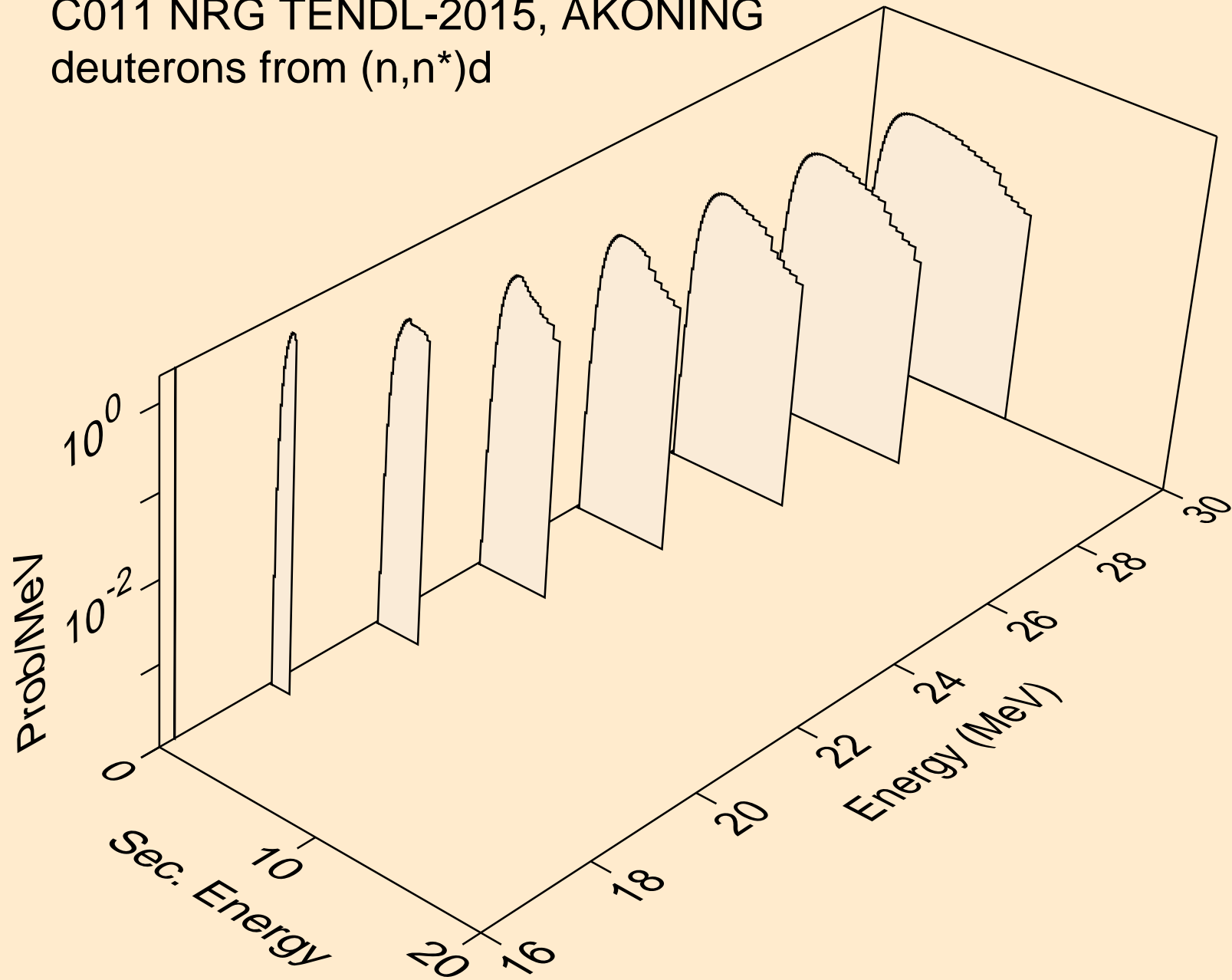

C011 NRG TENDL-2015, AKONING
deuterons from (n,d)

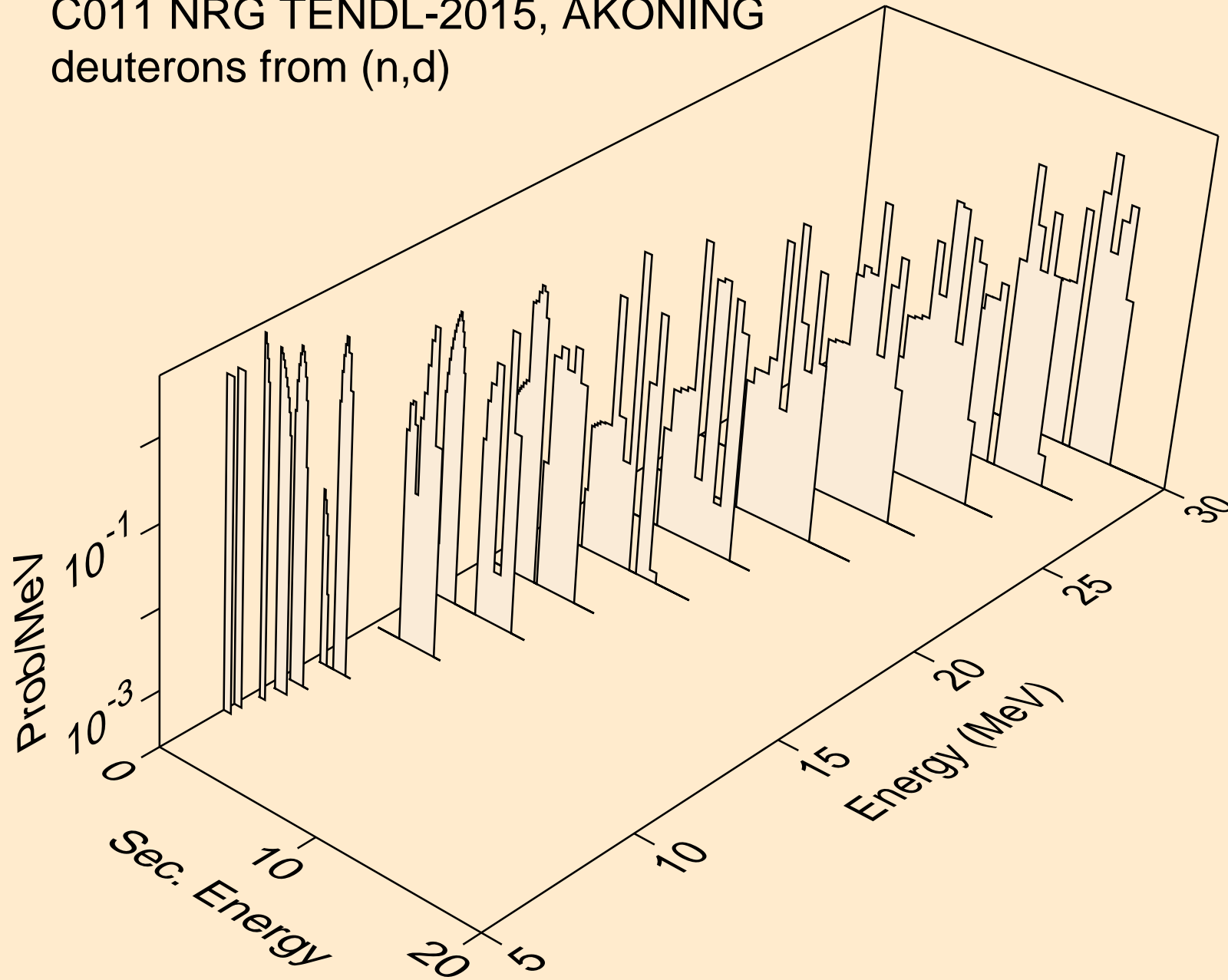

C011 NRG TENDL-2015, AKONING
deuterons from (n,pd)

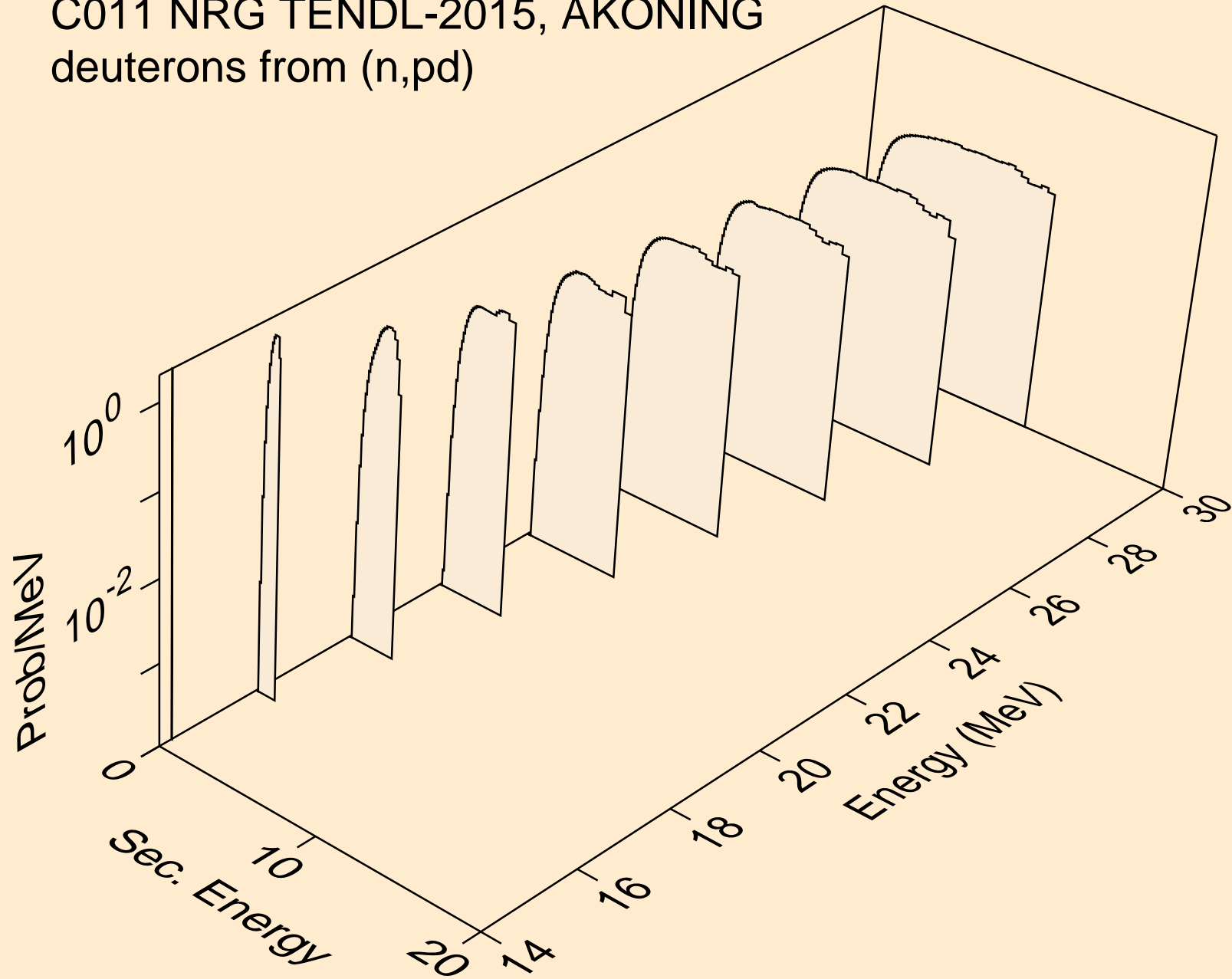

C011 NRG TENDL-2015, AKONING
deuterons from (n,da)

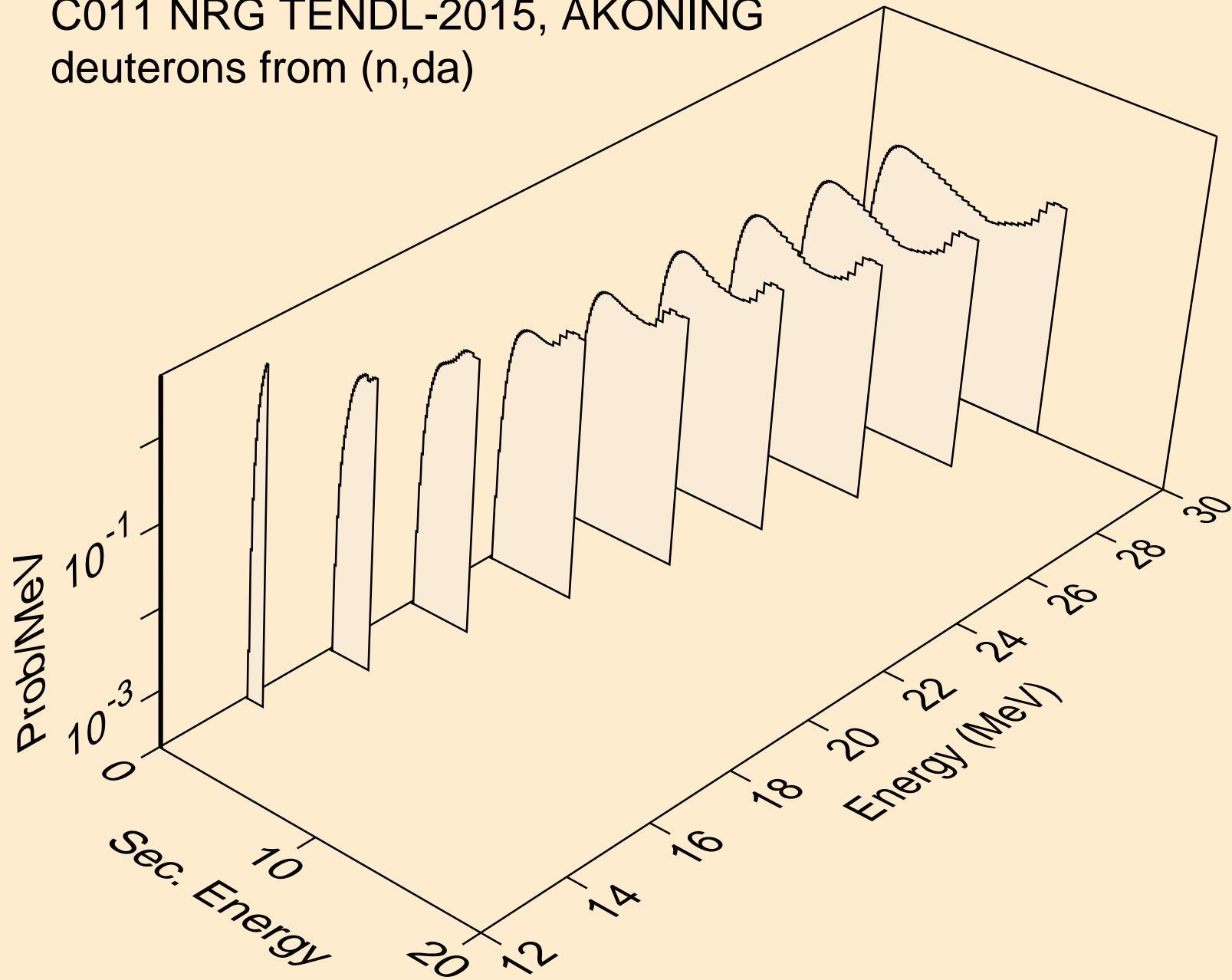

C011 NRG TENDL-2015, AKONING
tritons from (n,x)

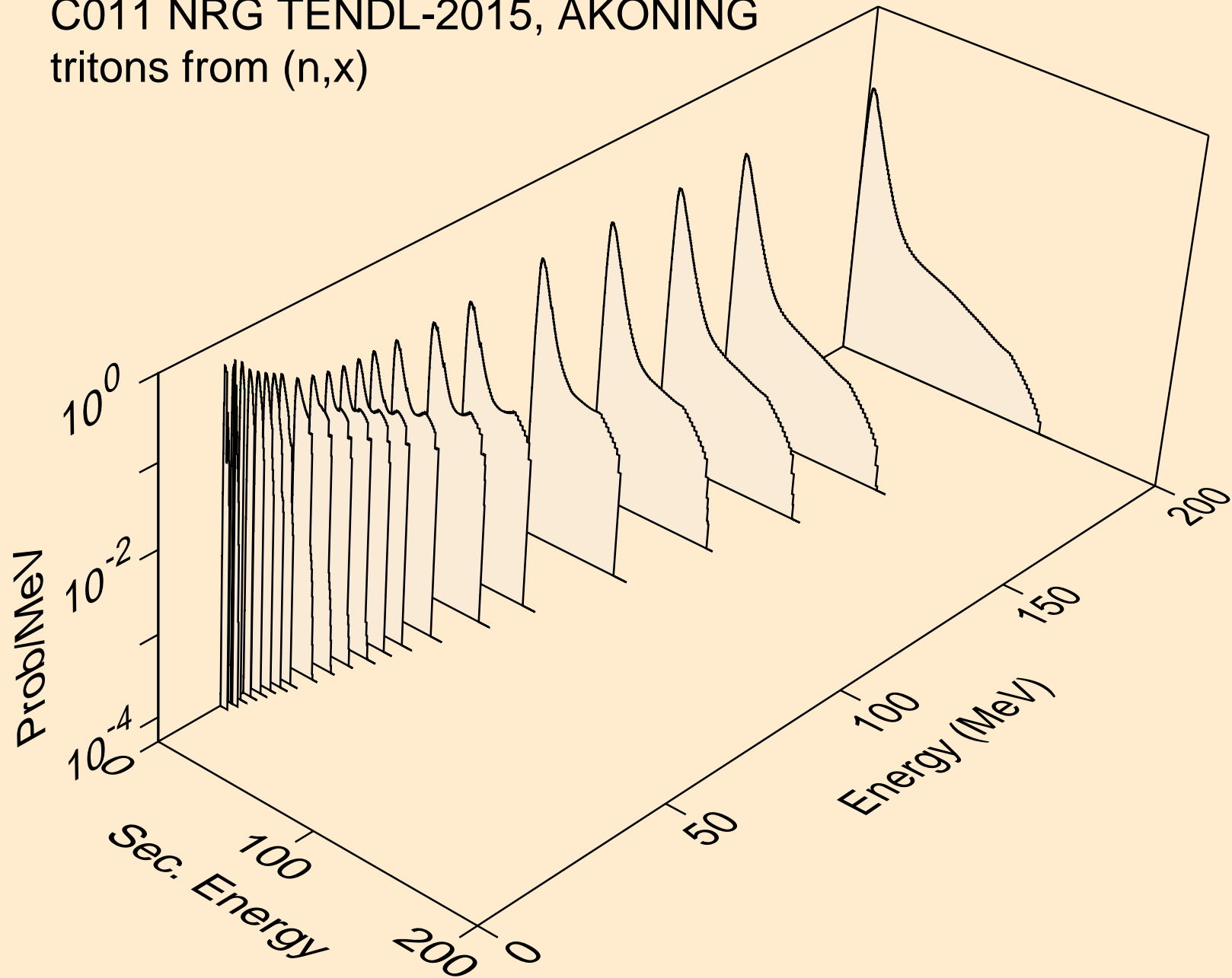

C011 NRG TENDL-2015, AKONING
tritons from (n,n*)t

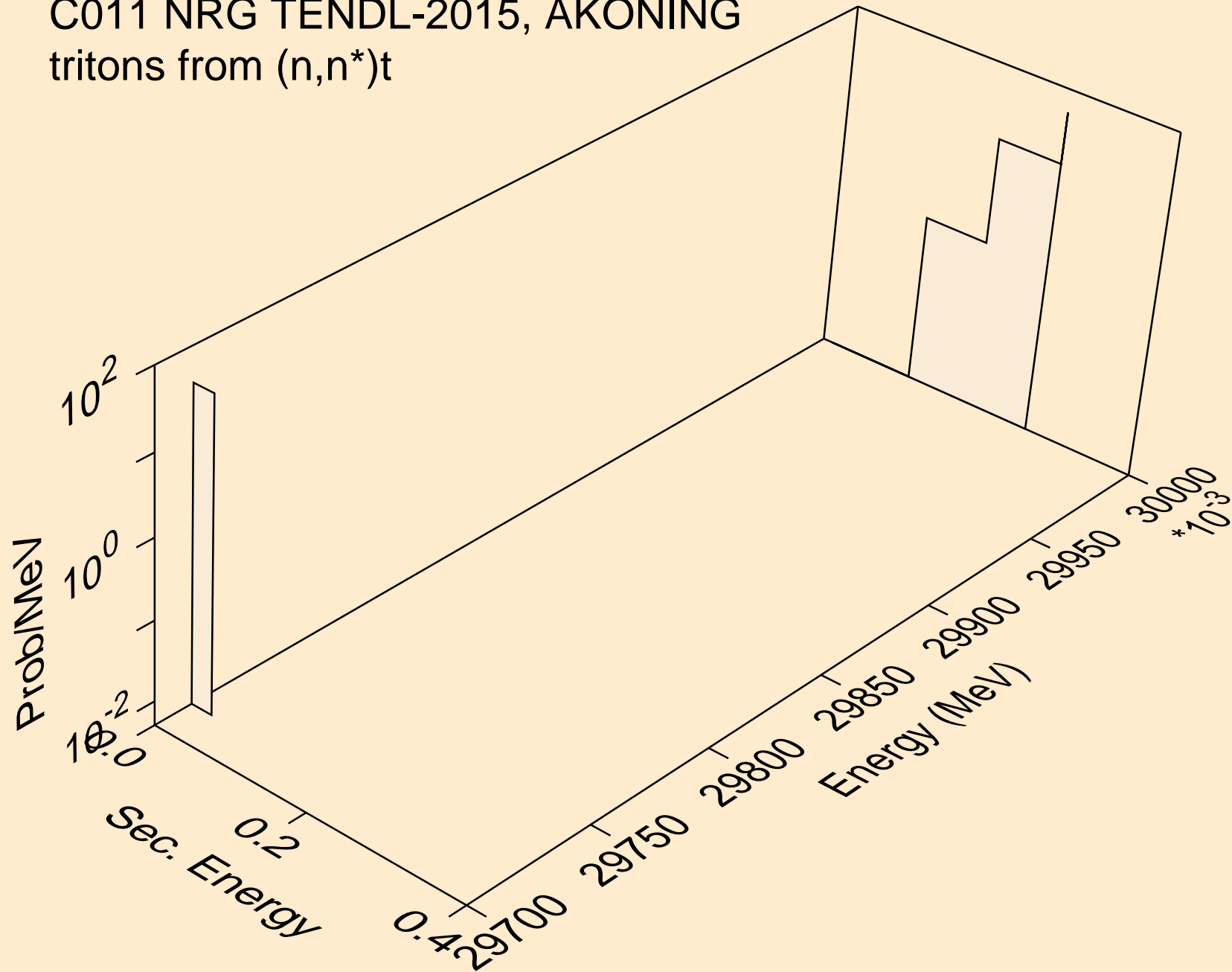

C011 NRG TENDL-2015, AKONING
tritons from (n,t)

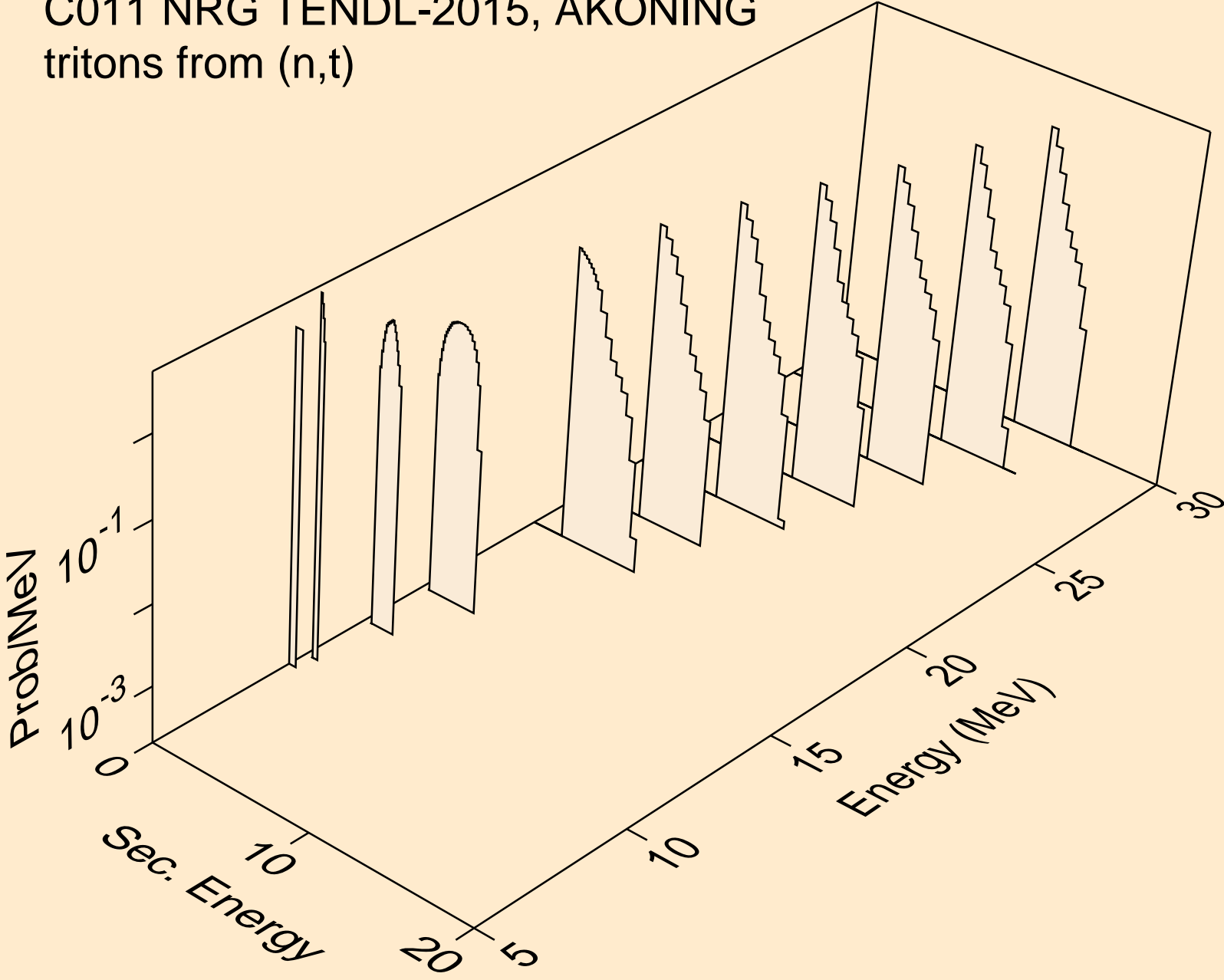

C011 NRG TENDL-2015, AKONING
tritons from (n,pt)

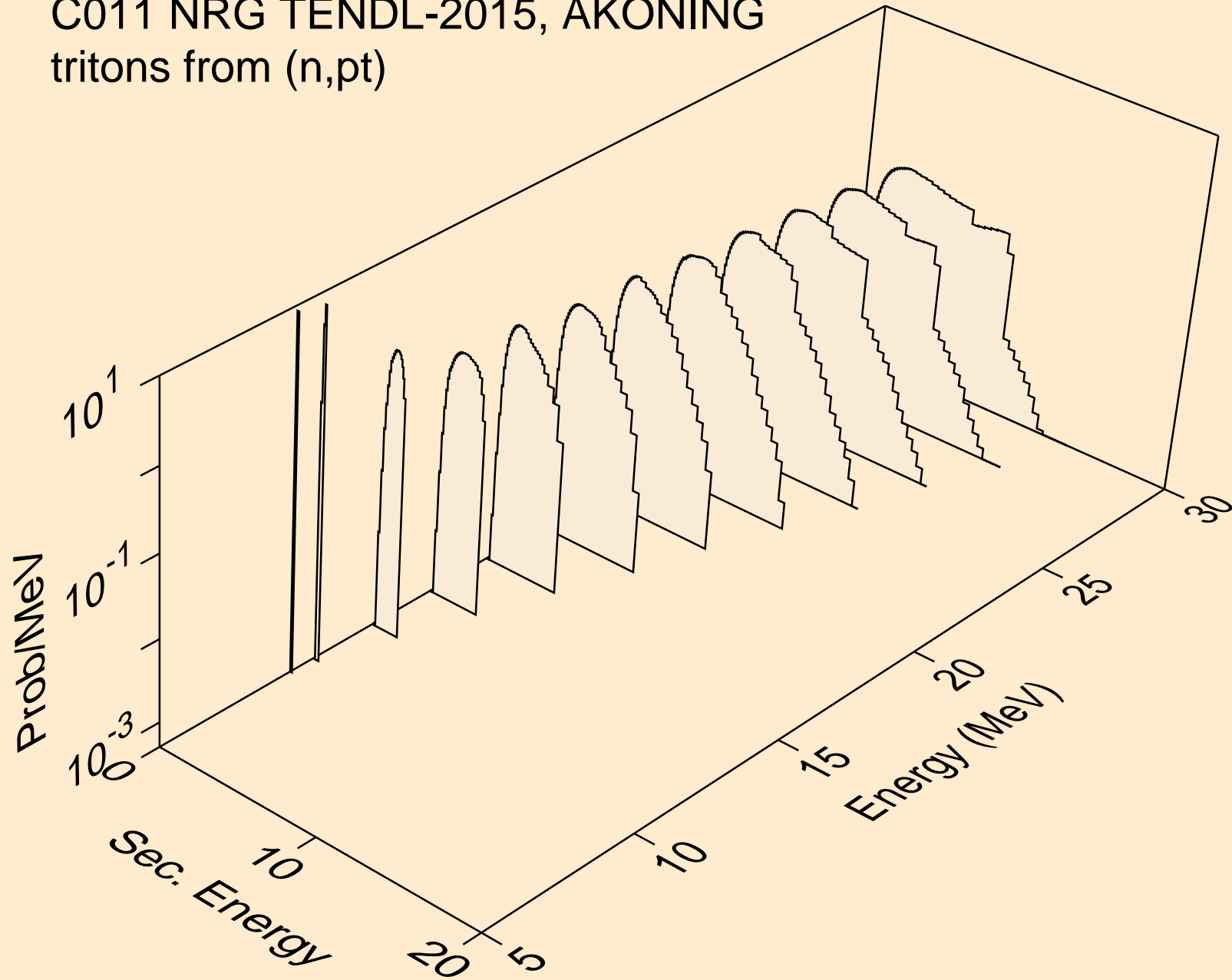

C011 NRG TENDL-2015, AKONING
he3s from (n,x)

