

CF239 NRG TENDL-2015, AKONING

Principal cross sections

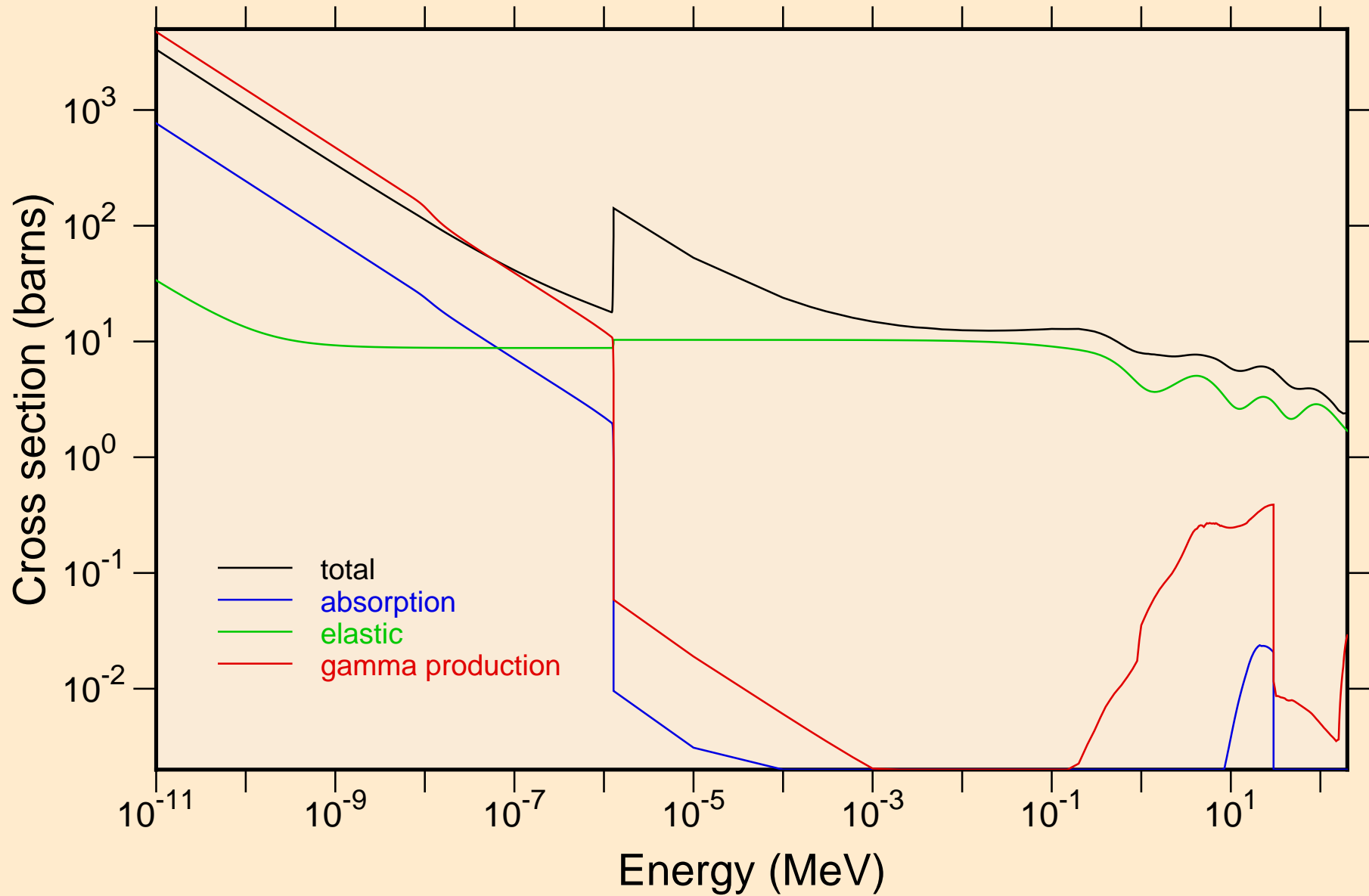

CF239 NRG TENDL-2015, AKONING

Non-threshold reactions

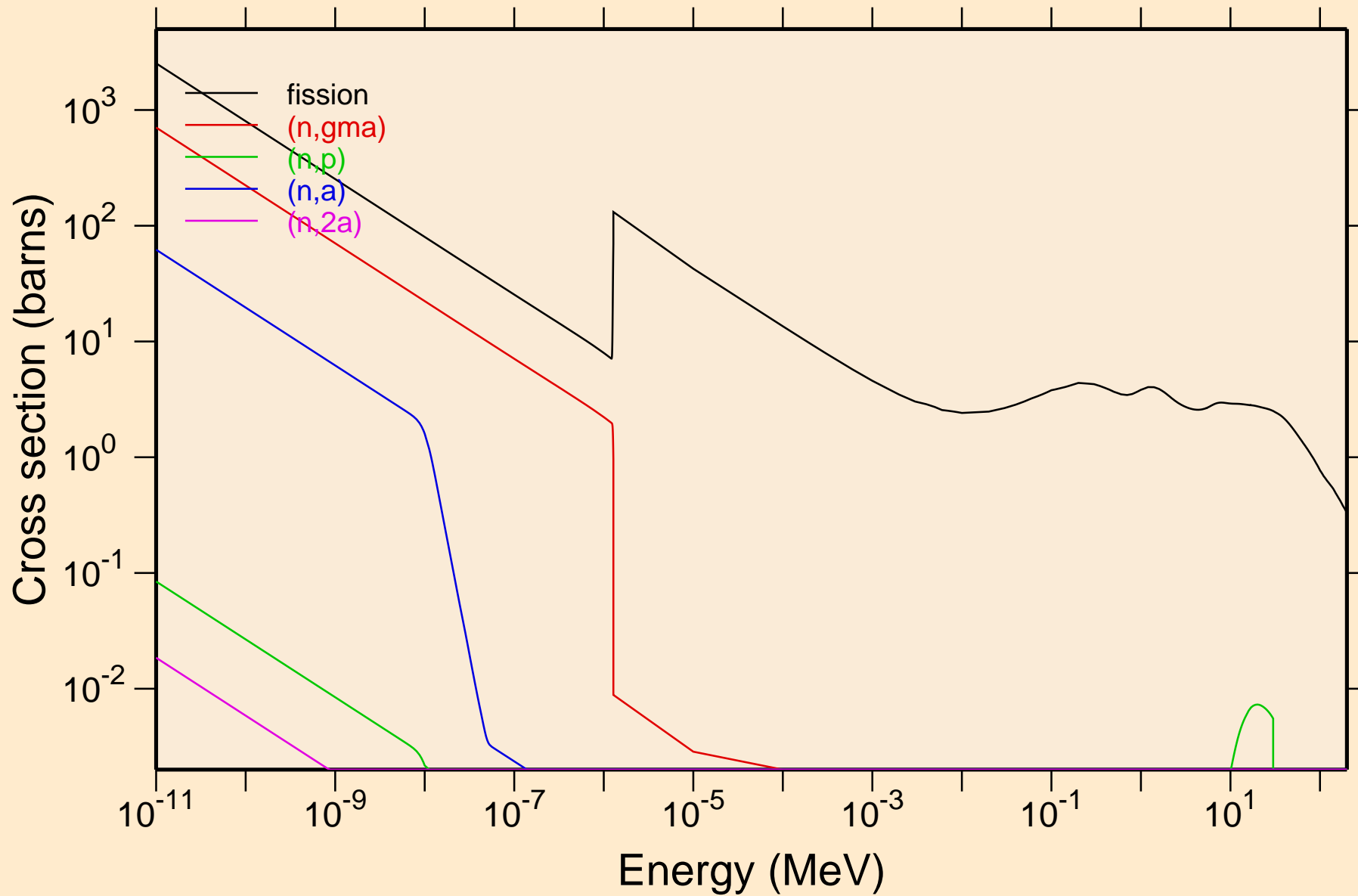

CF239 NRG TENDL-2015, AKONING
Non-threshold reactions

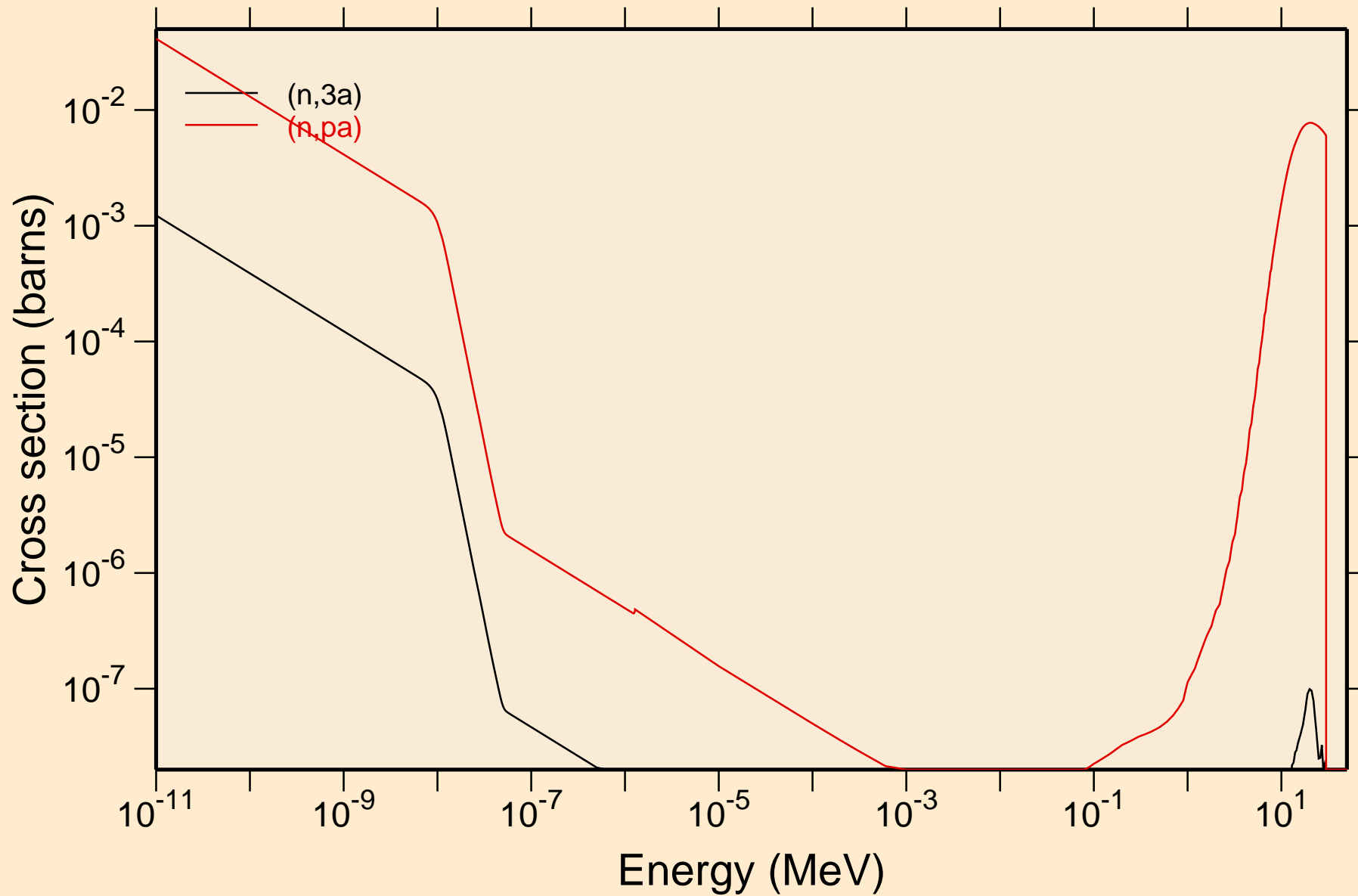

CF239 NRG TENDL-2015, AKONING

Principal cross sections

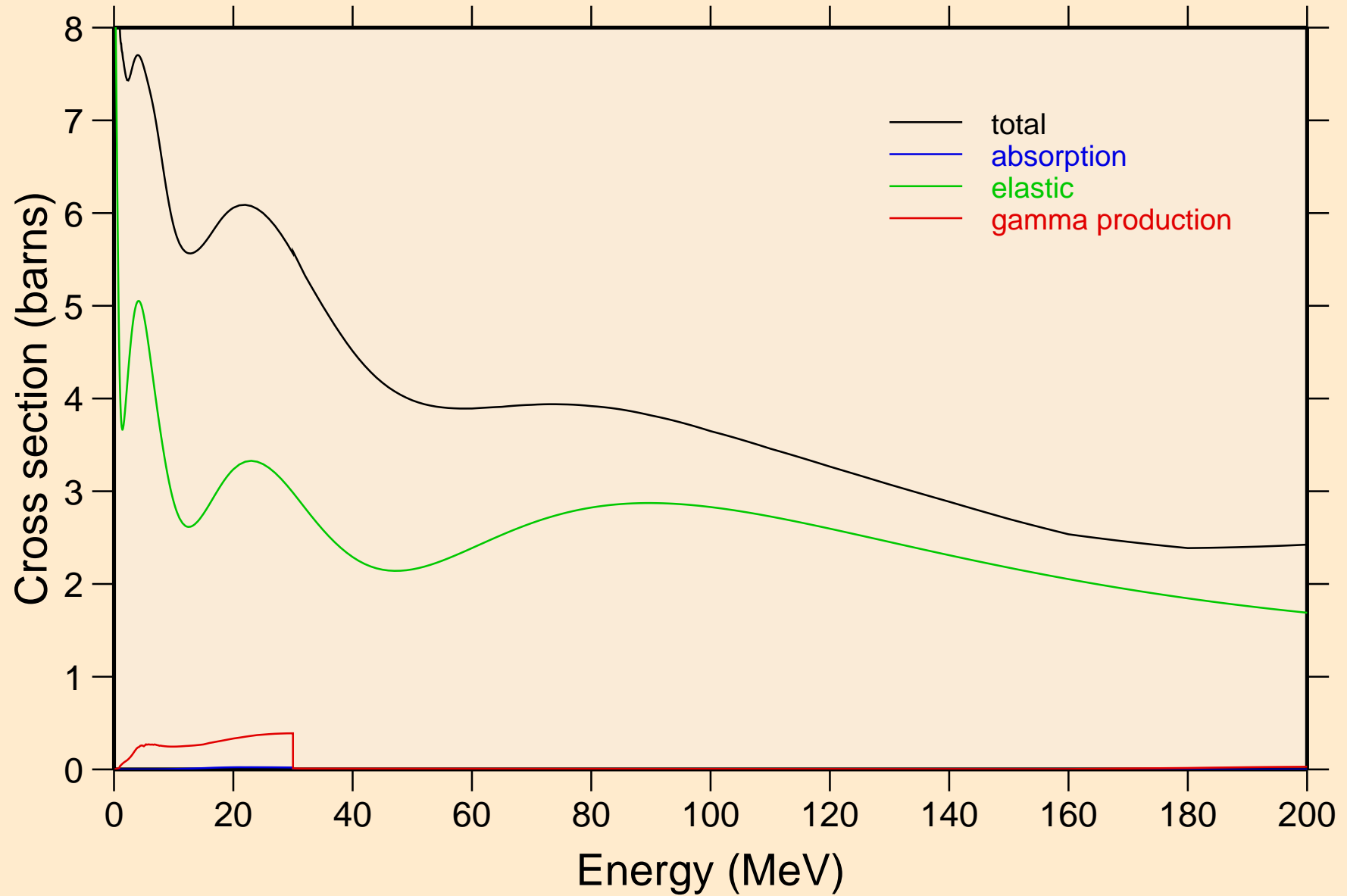

CF239 NRG TENDL-2015, AKONING

Non-threshold reactions

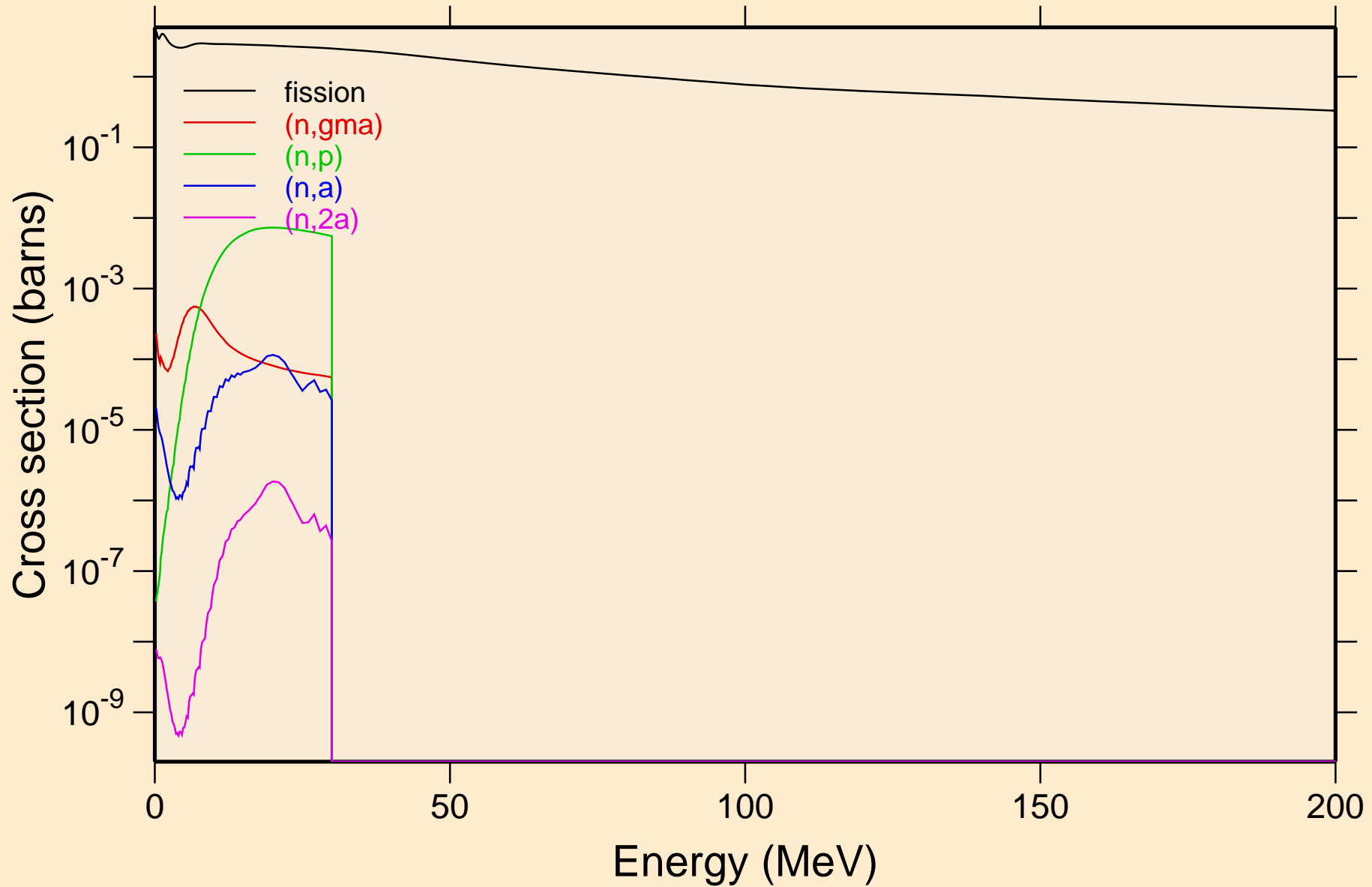

CF239 NRG TENDL-2015, AKONING

Non-threshold reactions

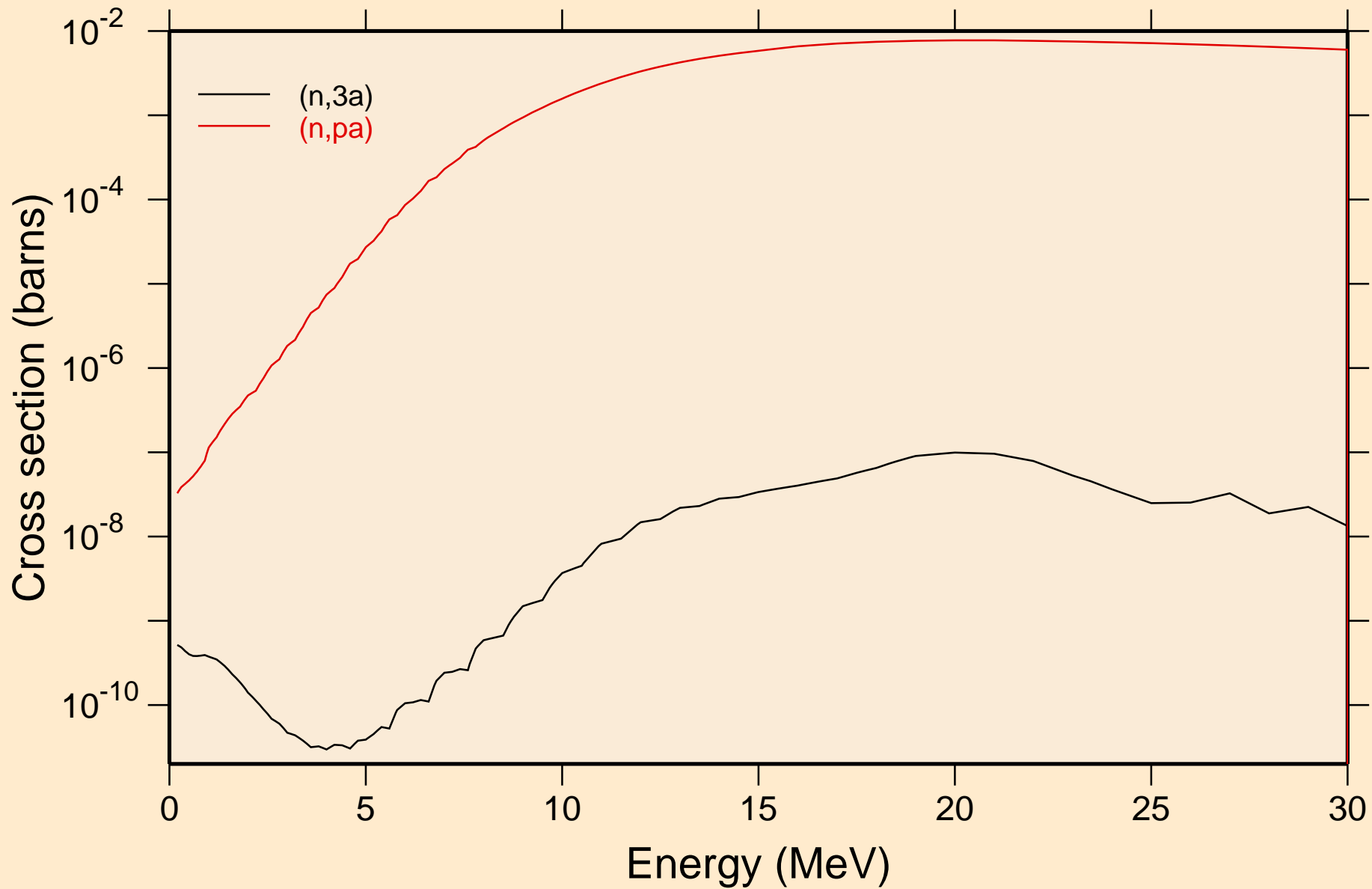

CF239 NRG TENDL-2015, AKONING
Inelastic levels

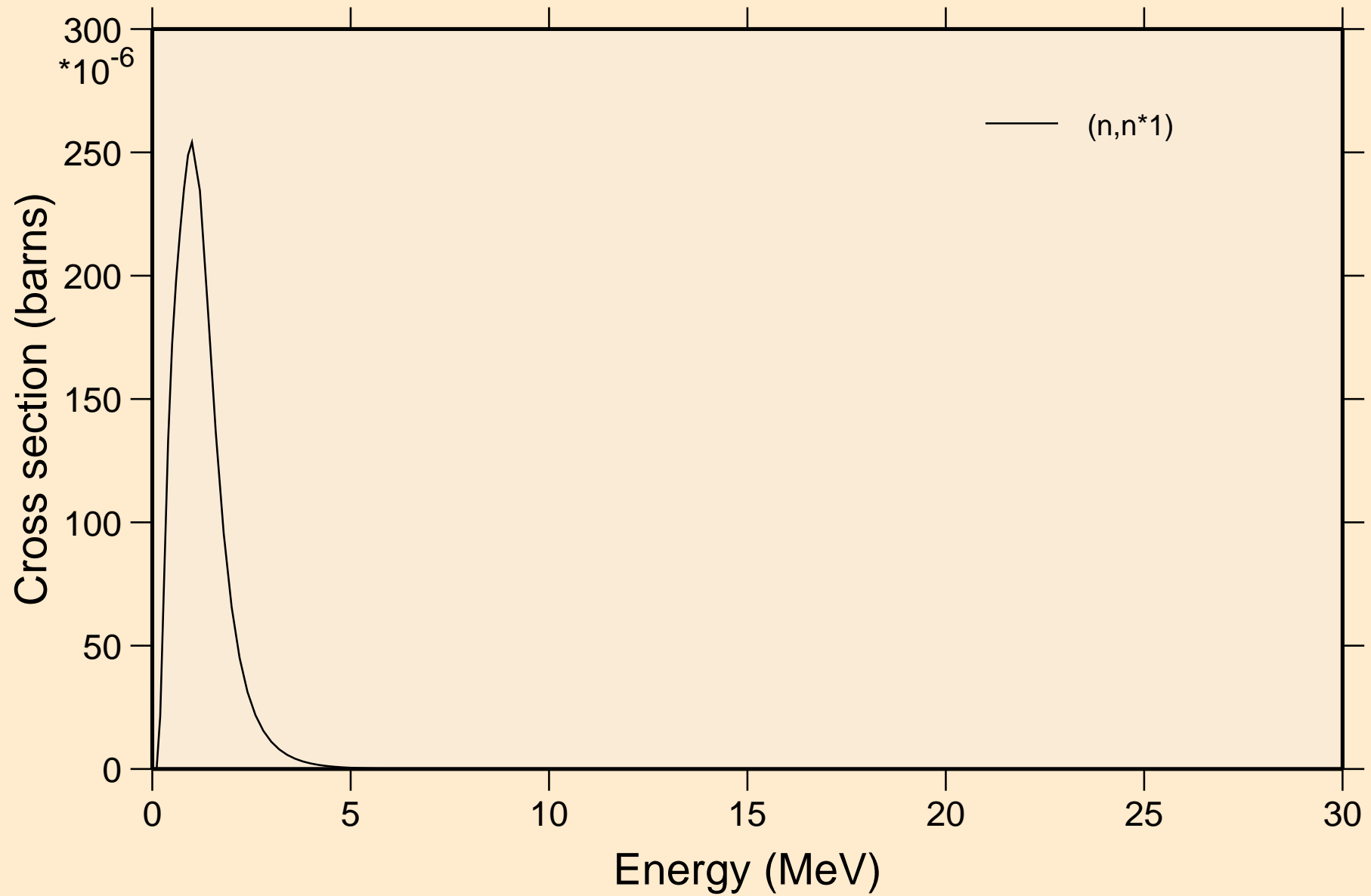

CF239 NRG TENDL-2015, AKONING

Threshold reactions

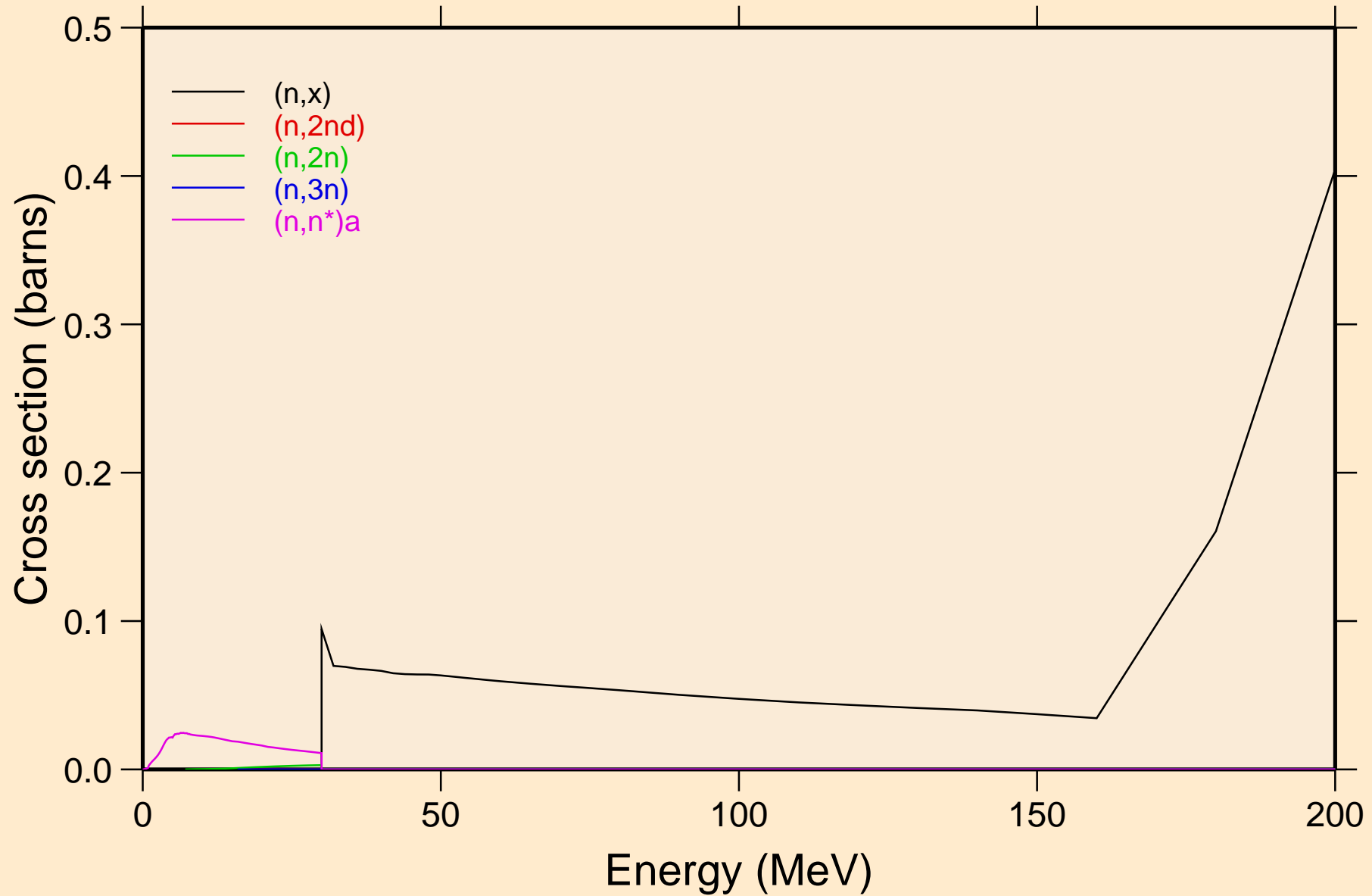

CF239 NRG TENDL-2015, AKONING

Threshold reactions

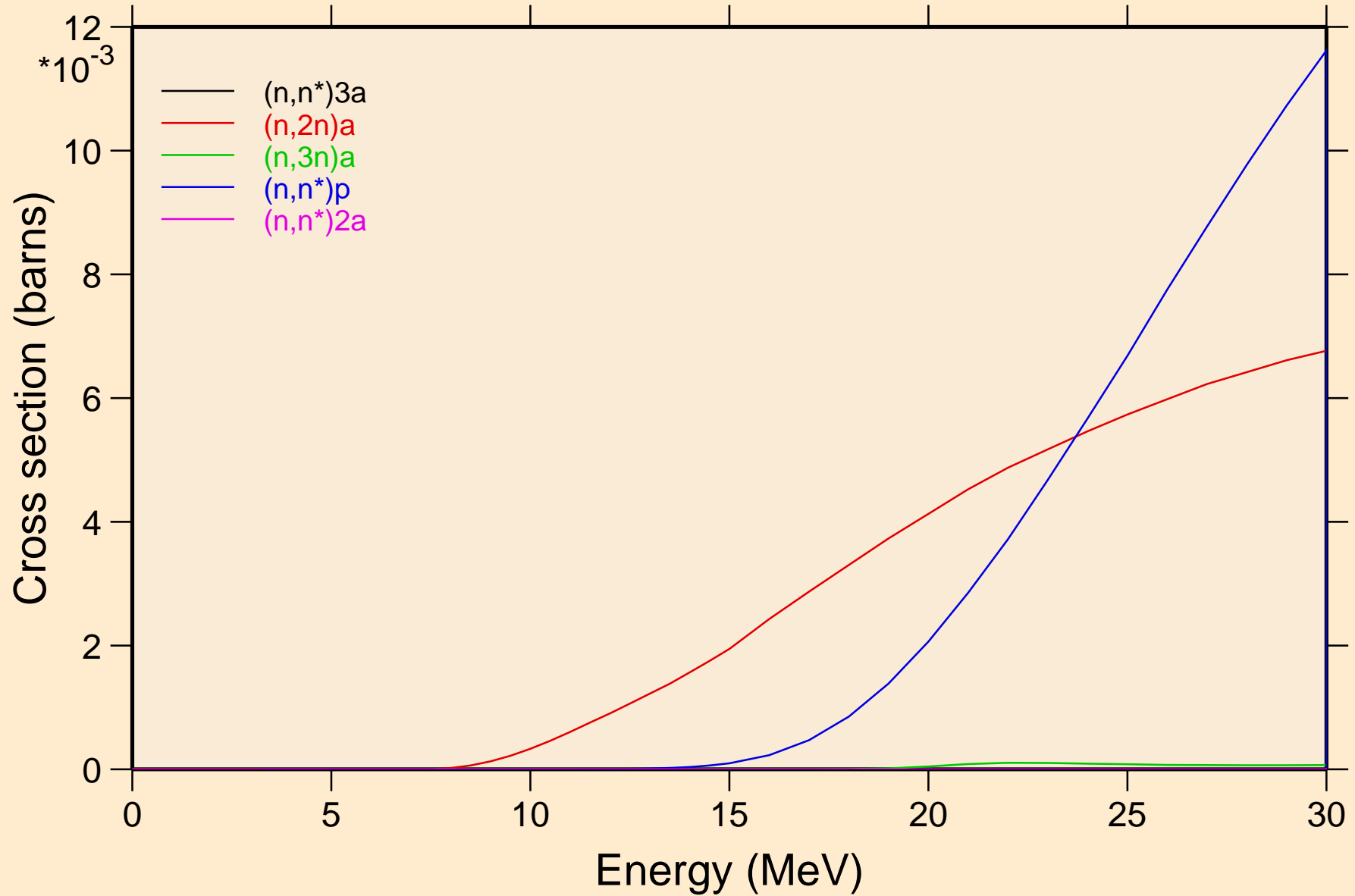

CF239 NRG TENDL-2015, AKONING

Threshold reactions

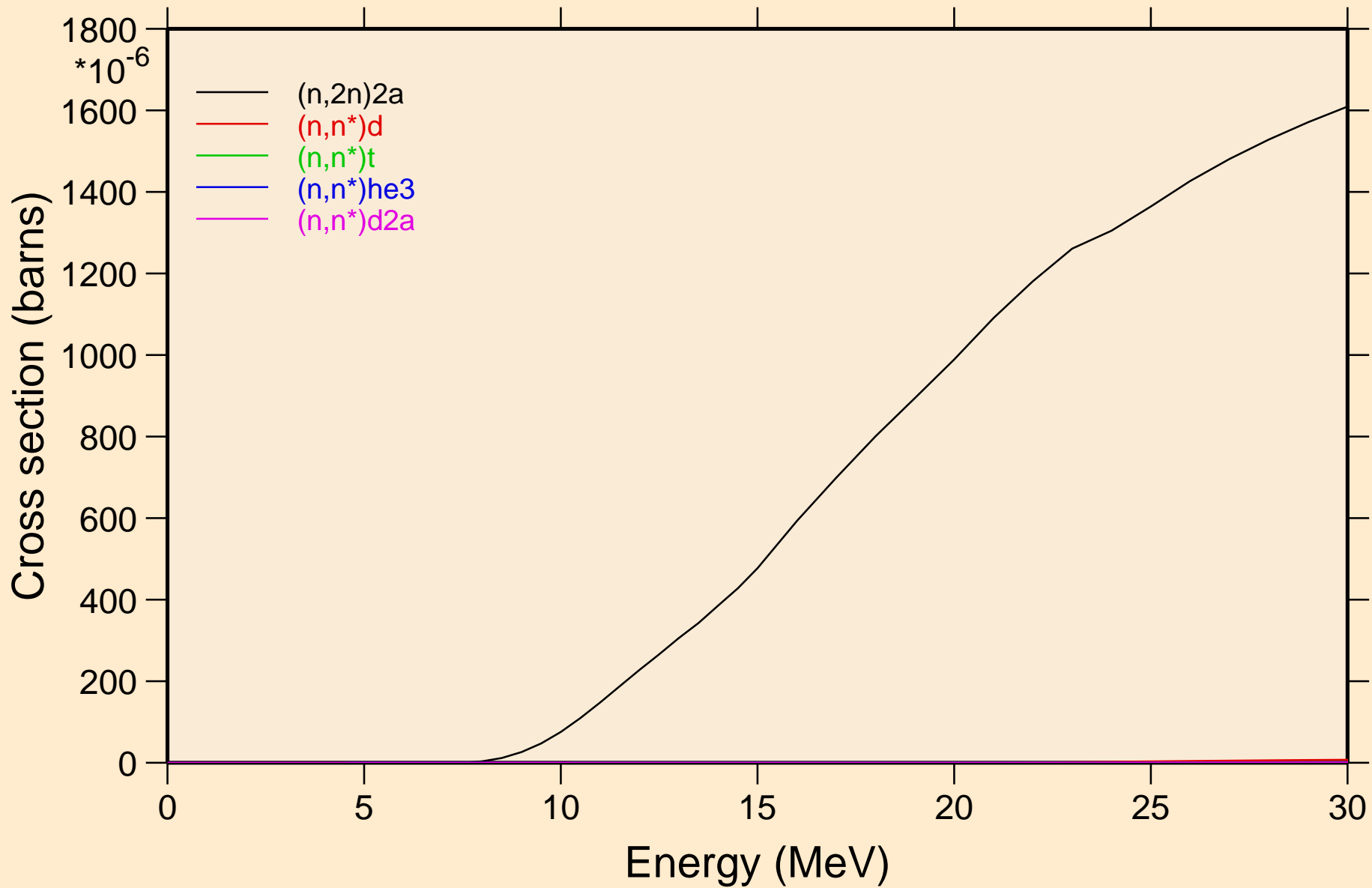

CF239 NRG TENDL-2015, AKONING

Threshold reactions

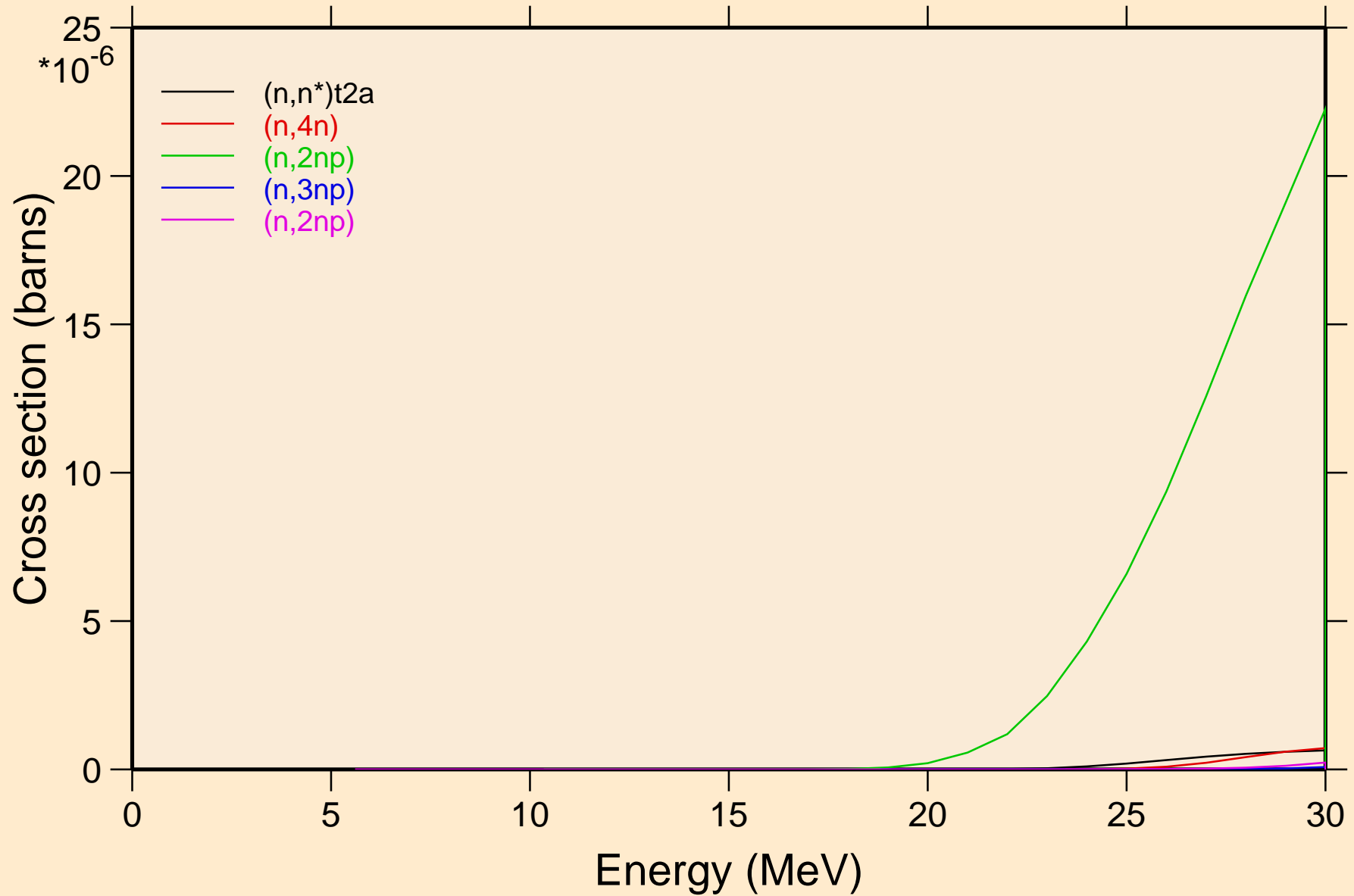

CF239 NRG TENDL-2015, AKONING

Threshold reactions

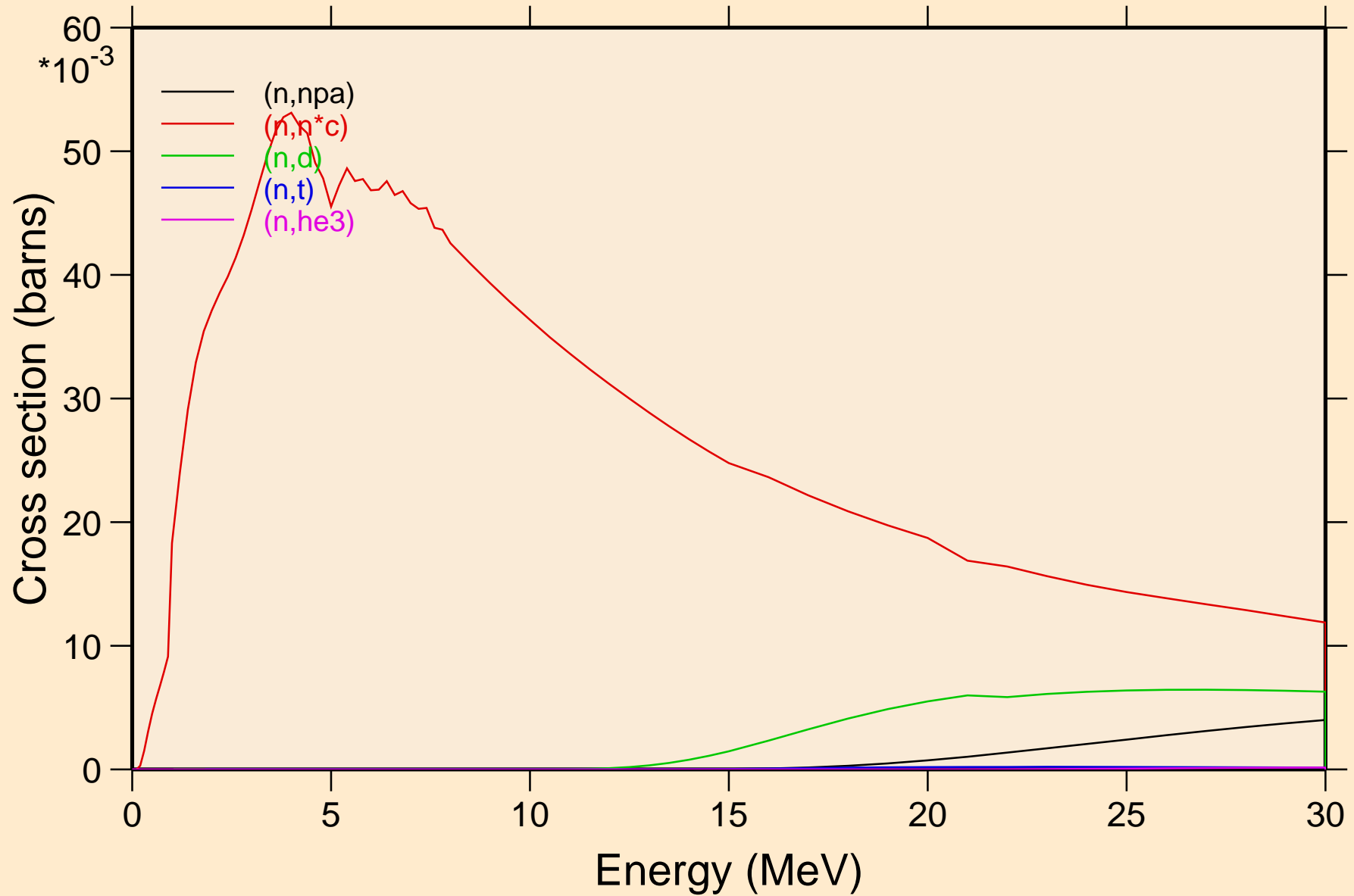

CF239 NRG TENDL-2015, AKONING

Threshold reactions

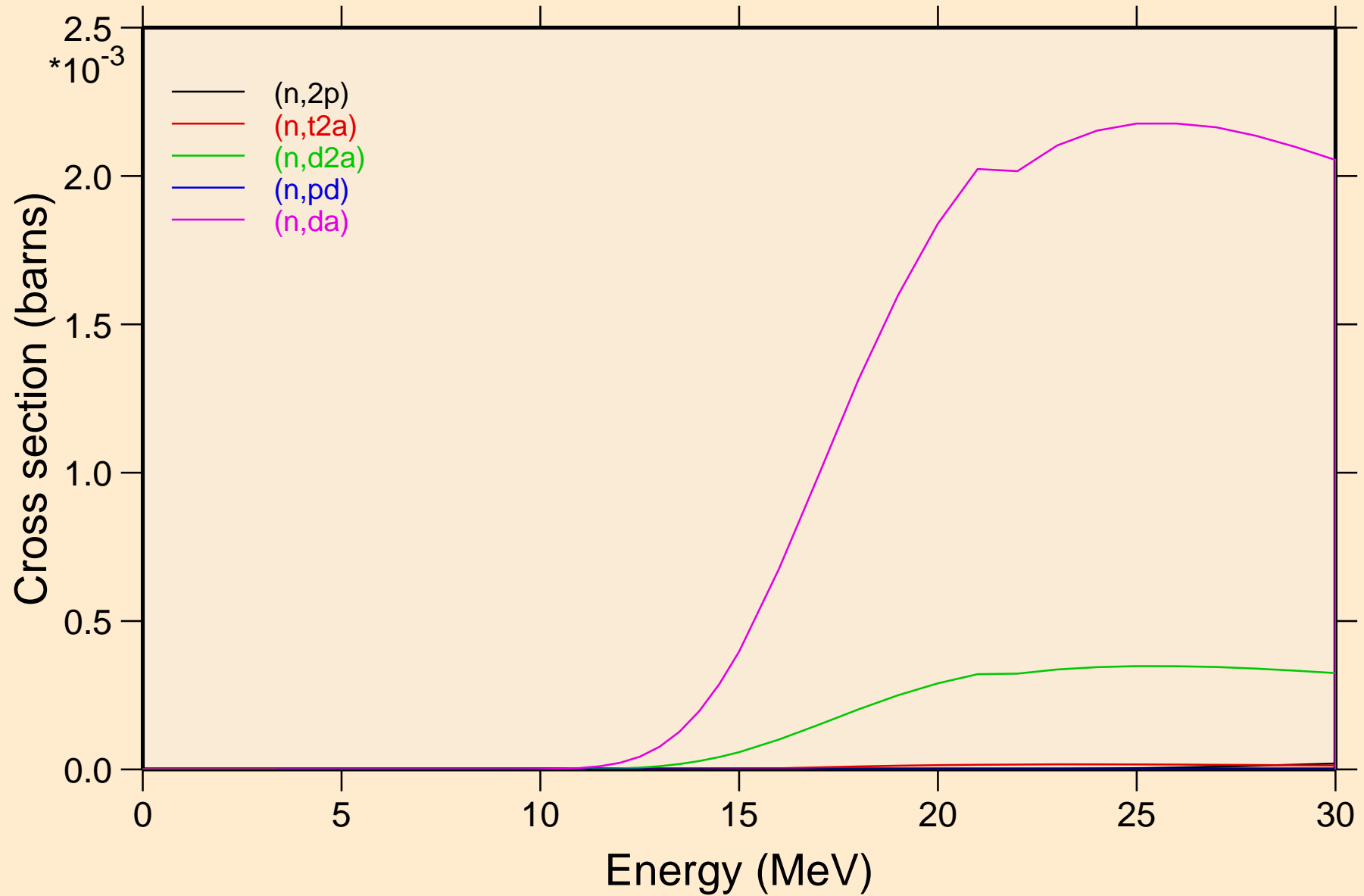

CF239 NRG TENDL-2015, AKONING
angular distribution for elastic

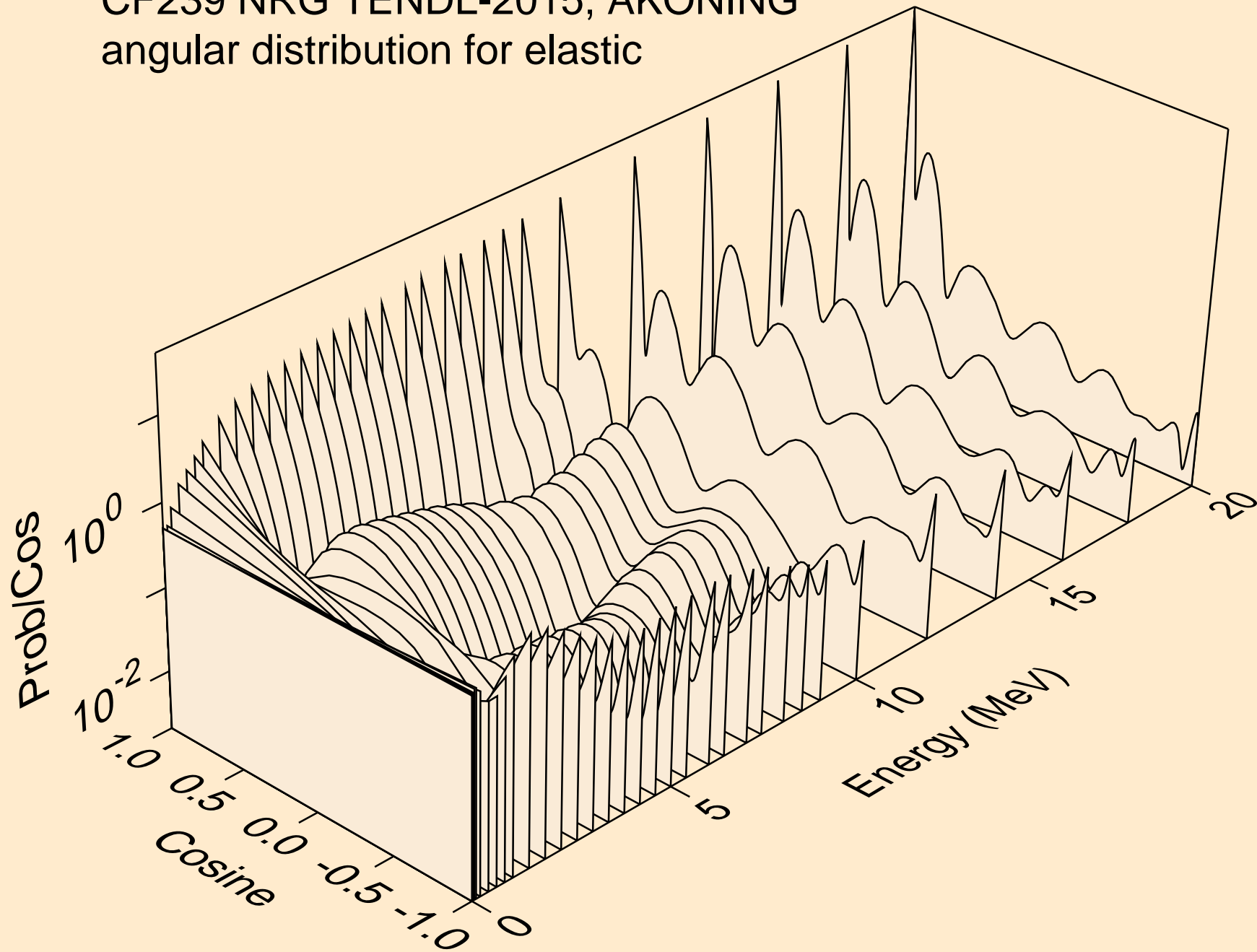

CF239 NRG TENDL-2015, AKONING
angular distribution for elastic

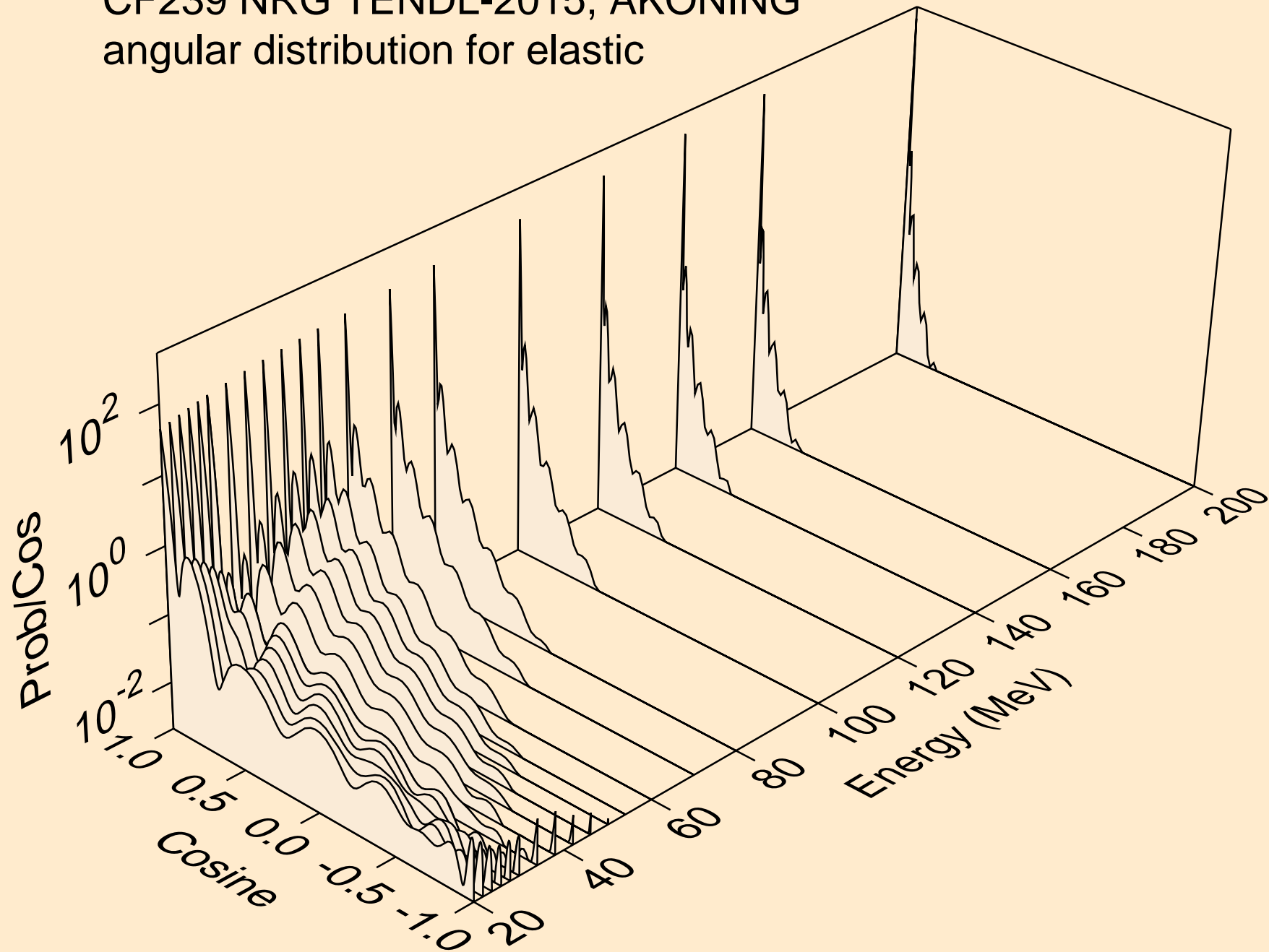

CF239 NRG TENDL-2015, AKONING
angular distribution for (n,n*1)

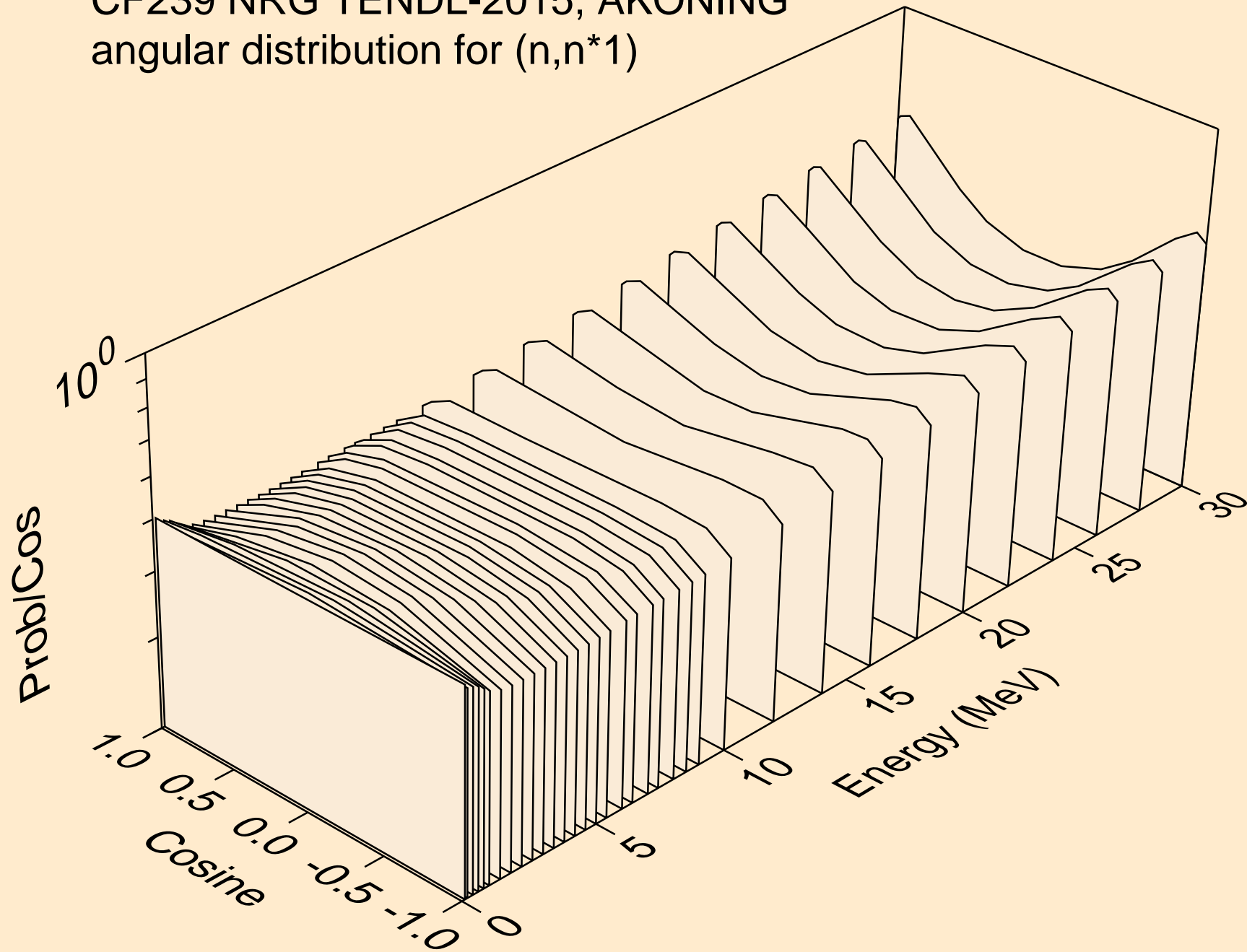

CF239 NRG TENDL-2015, AKONING

Total fission nubar

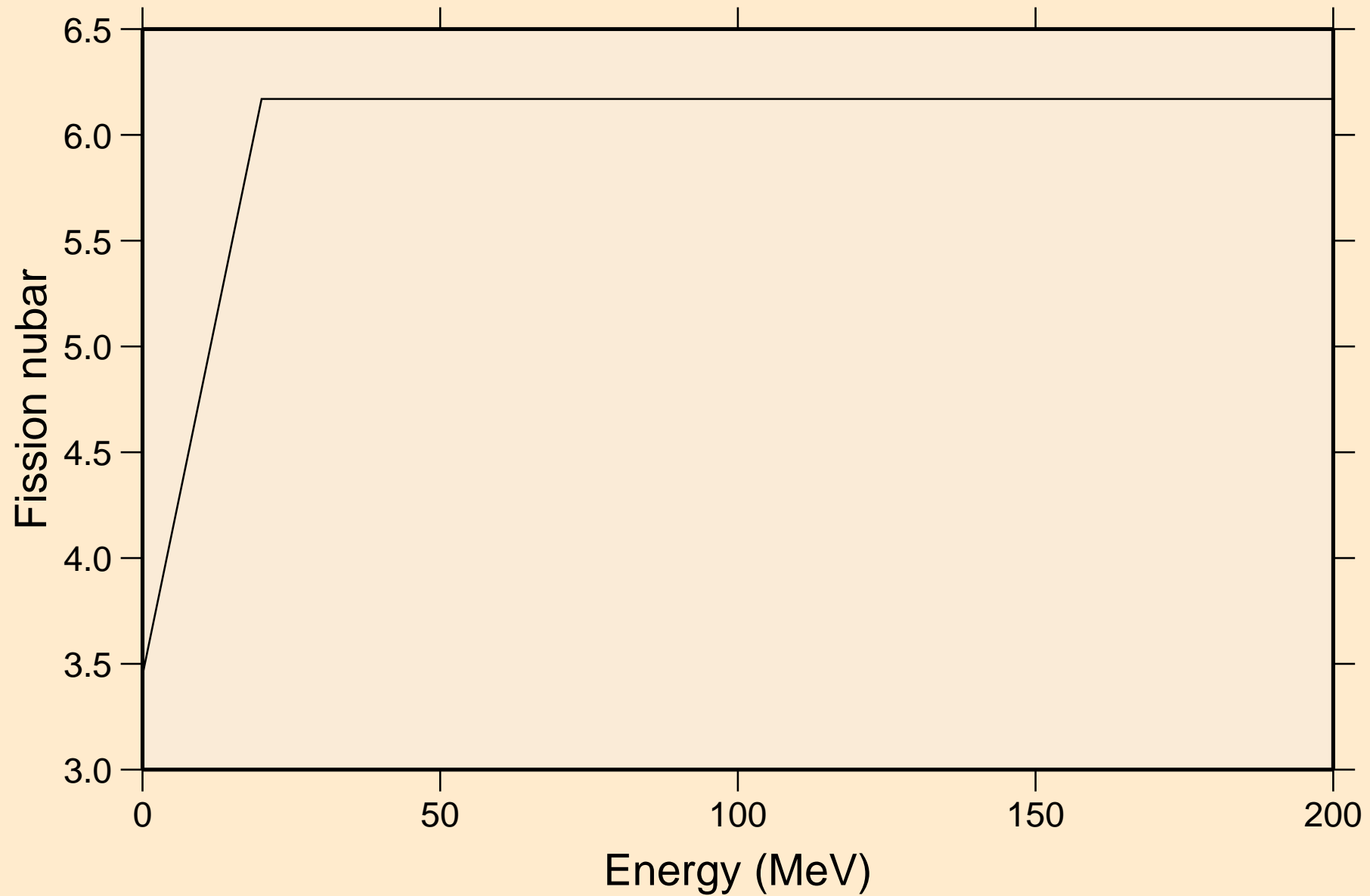

CF239 NRG TENDL-2015, AKONING
Neutron emission for (n,x)

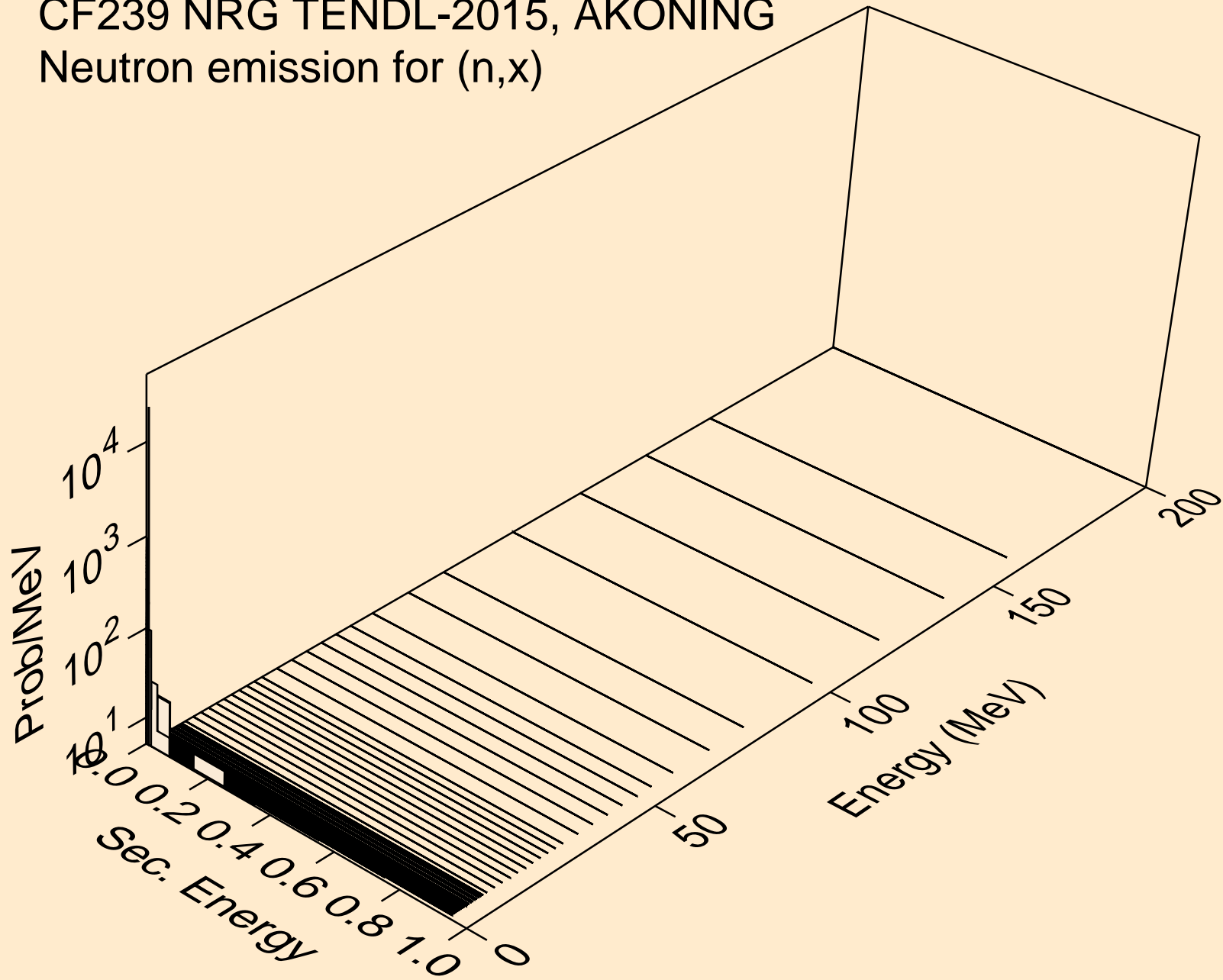

CF239 NRG TENDL-2015, AKONING
Neutron emission for (n,2nd)

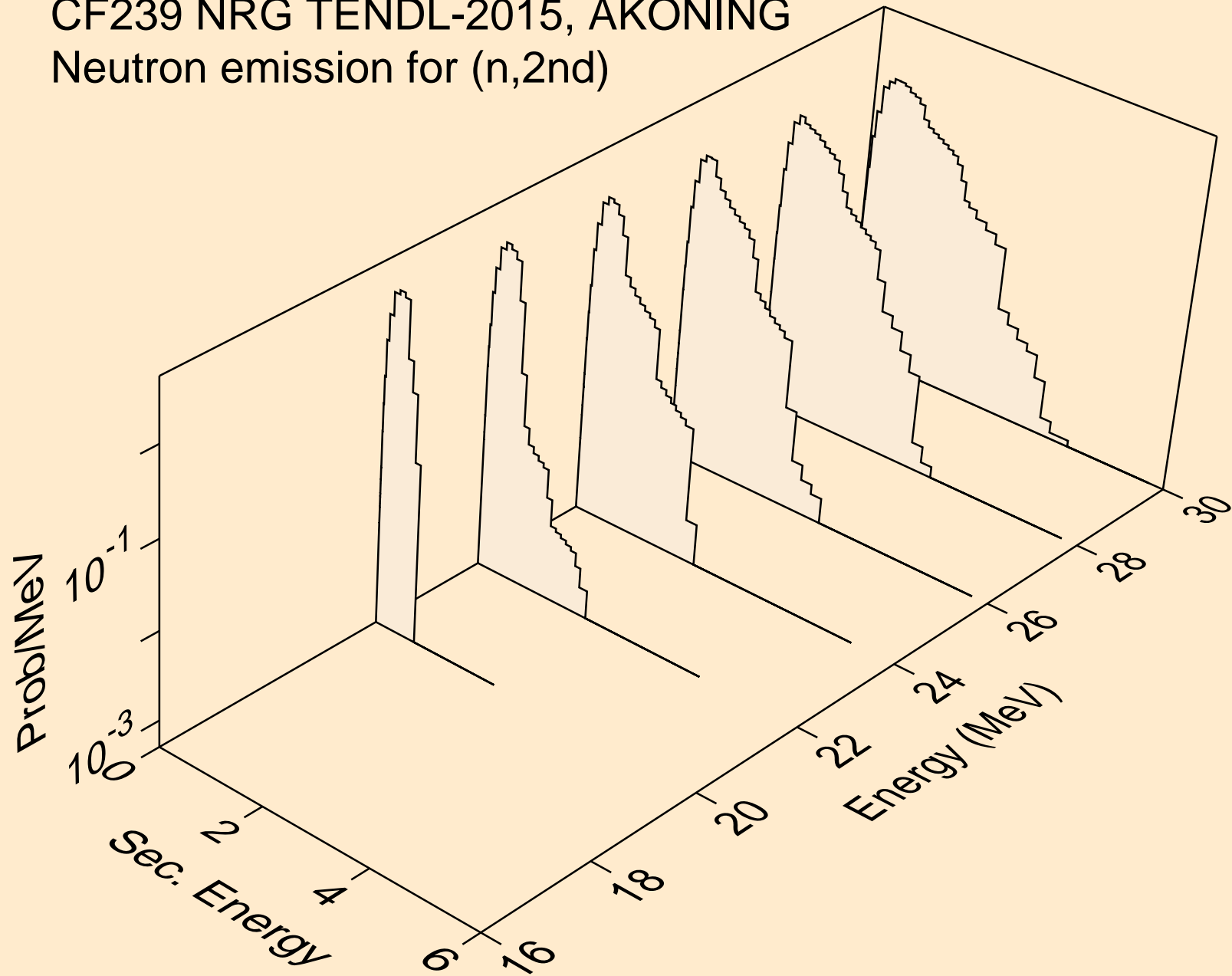

CF239 NRG TENDL-2015, AKONING
Neutron emission for (n,2n)

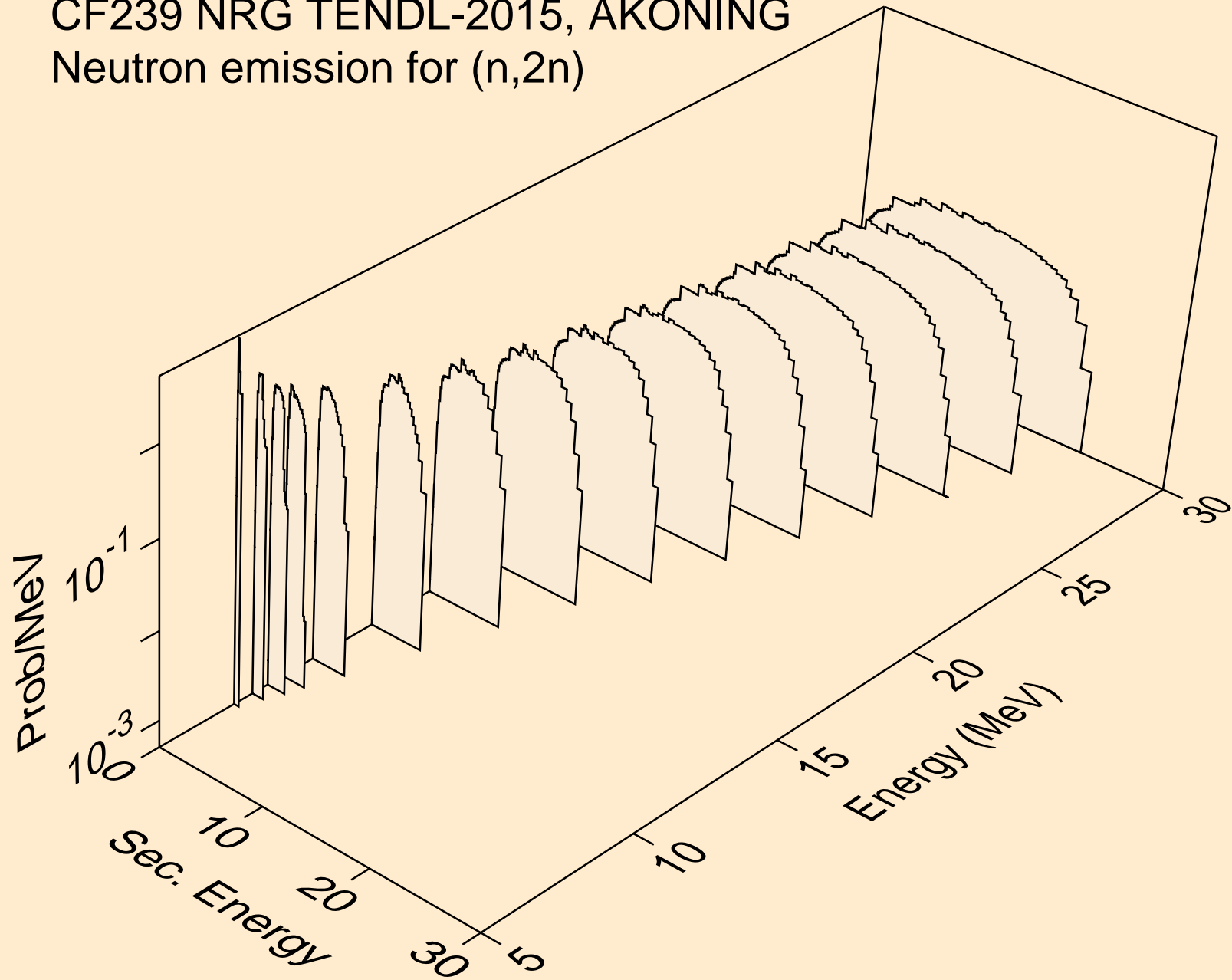

CF239 NRG TENDL-2015, AKONING
Neutron emission for (n,3n)

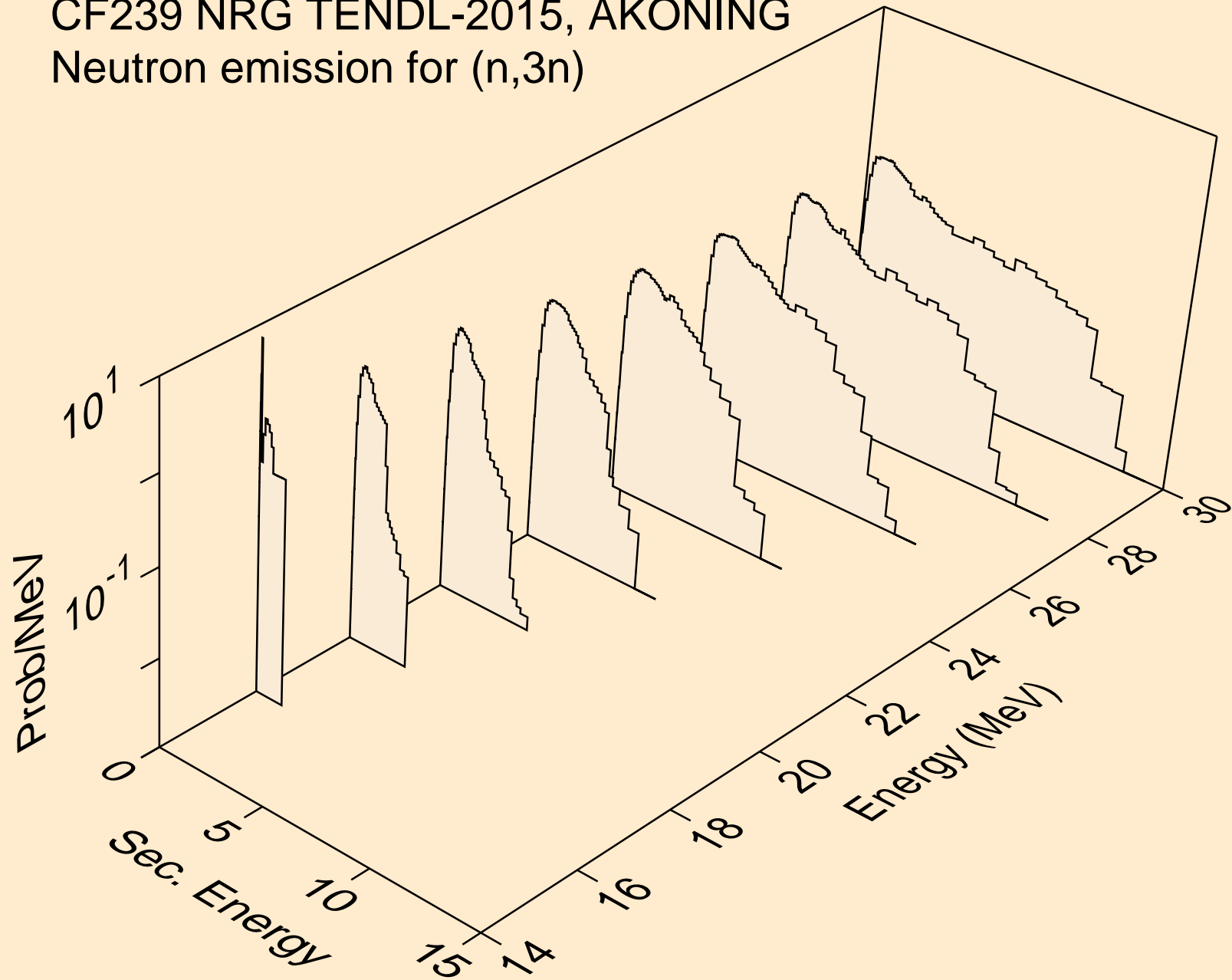

CF239 NRG TENDL-2015, AKONING
Neutron emission for fission

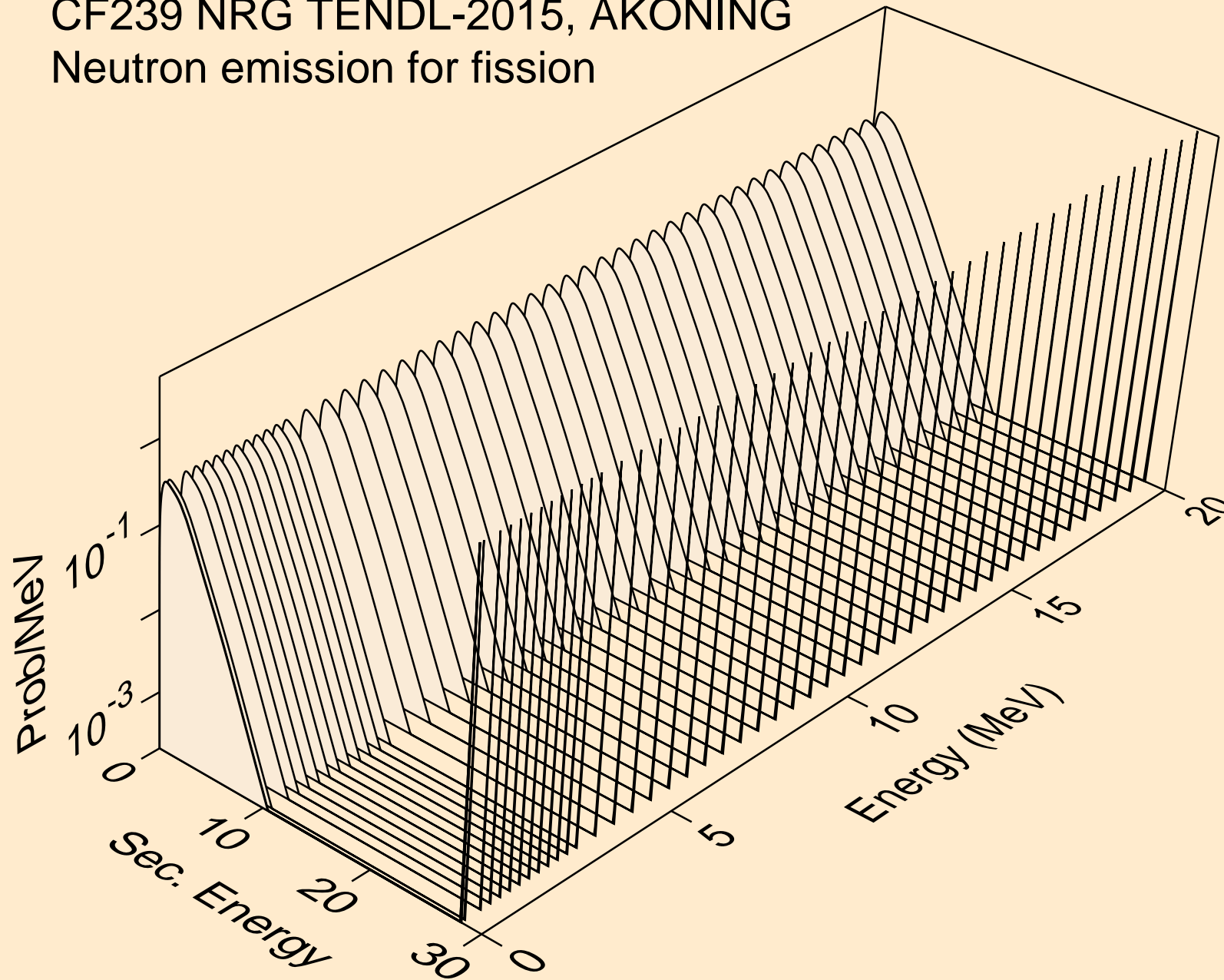

CF239 NRG TENDL-2015, AKONING
Neutron emission for (n,n*)a

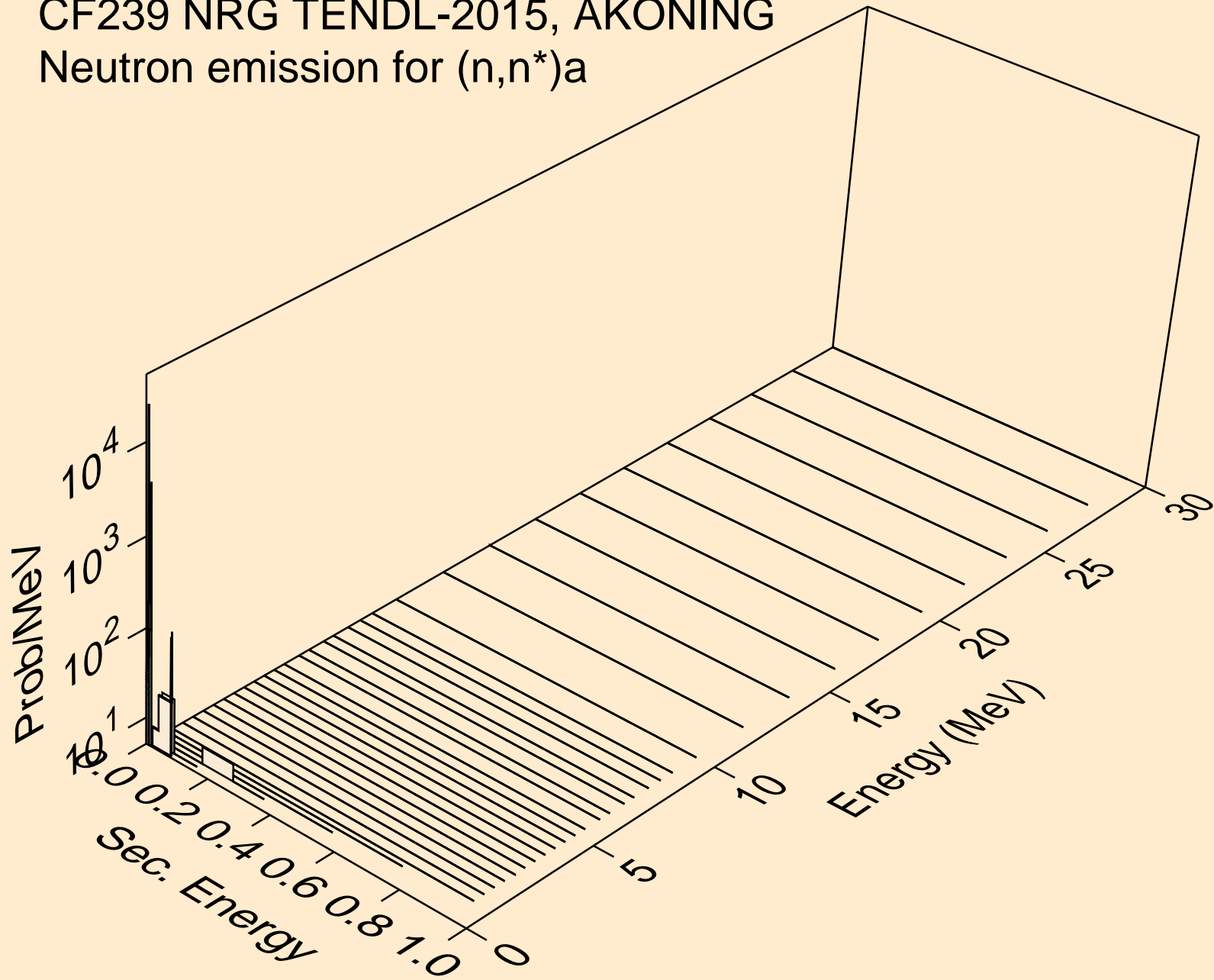

CF239 NRG TENDL-2015, AKONING
Neutron emission for (n,n*)3a

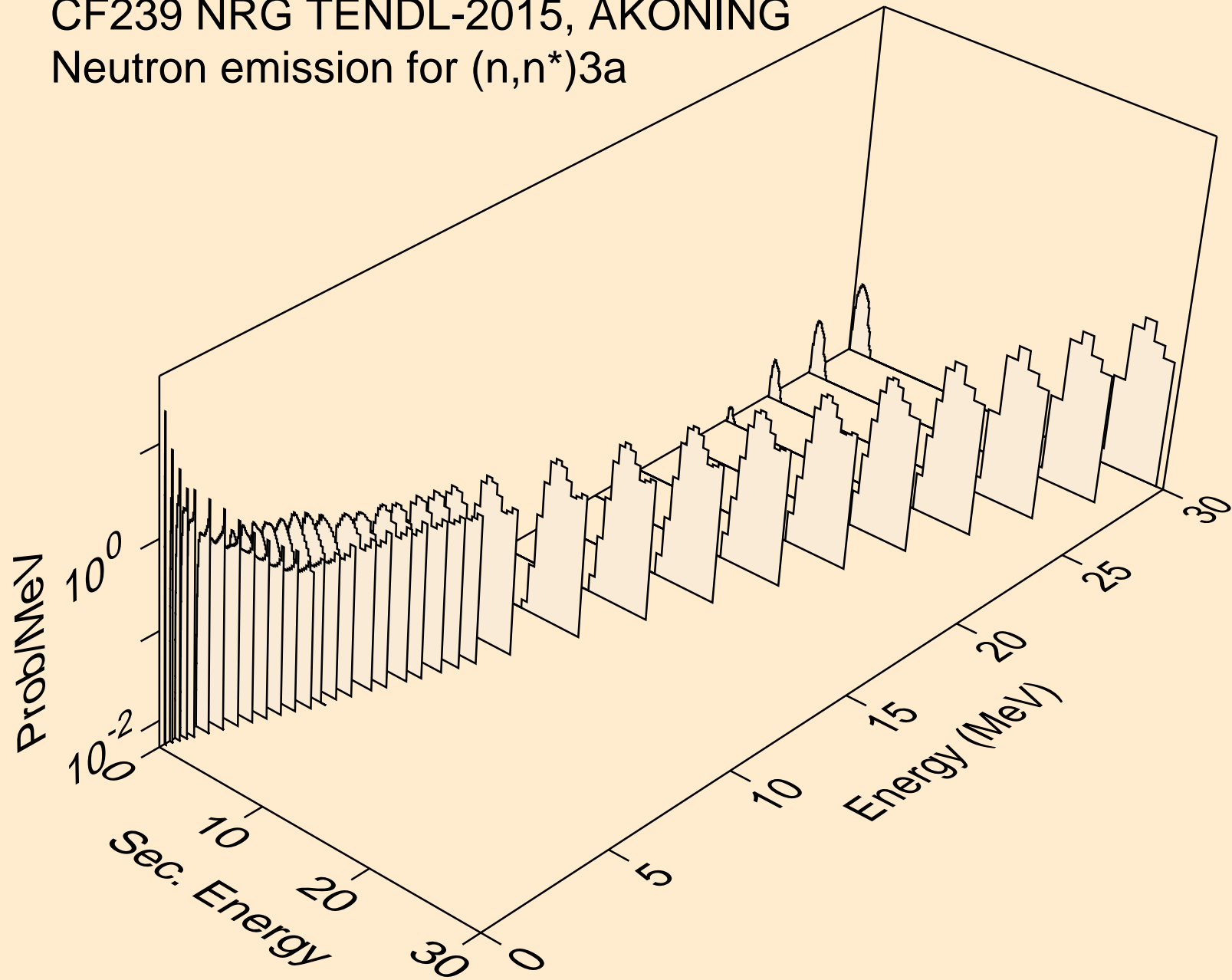

CF239 NRG TENDL-2015, AKONING
Neutron emission for (n,2n)a

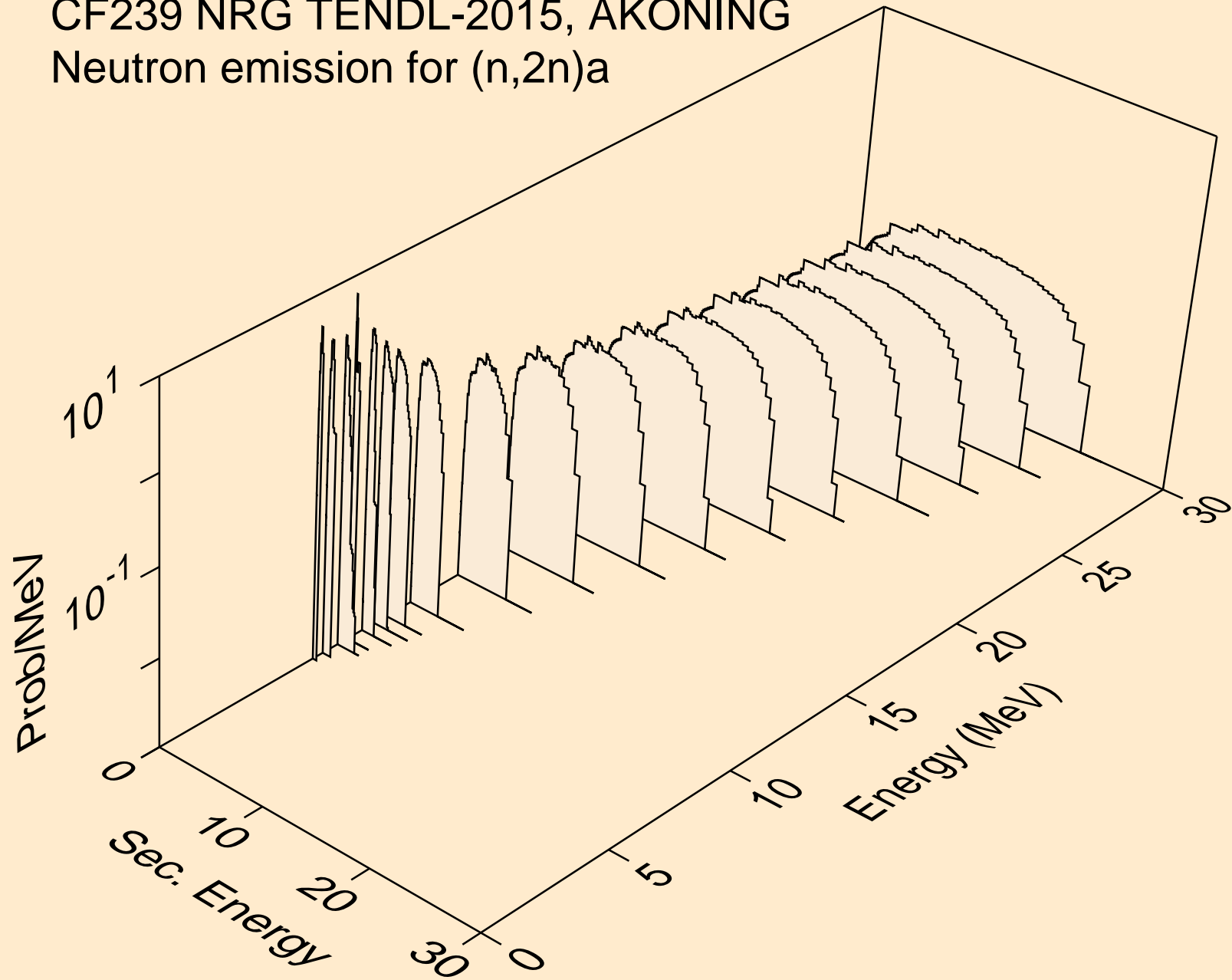

CF239 NRG TENDL-2015, AKONING
Neutron emission for (n,3n)a

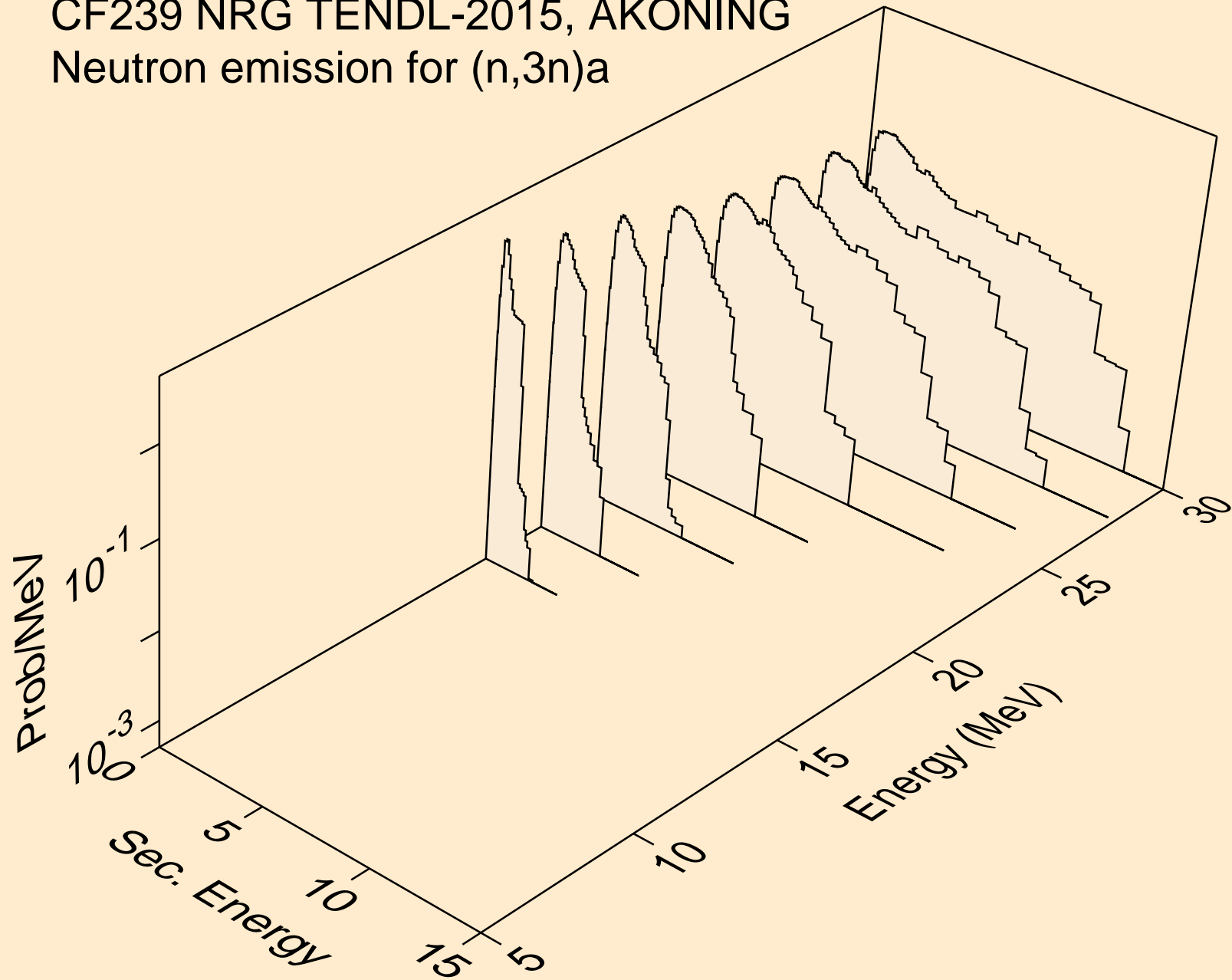

CF239 NRG TENDL-2015, AKONING
Neutron emission for (n,n*)p

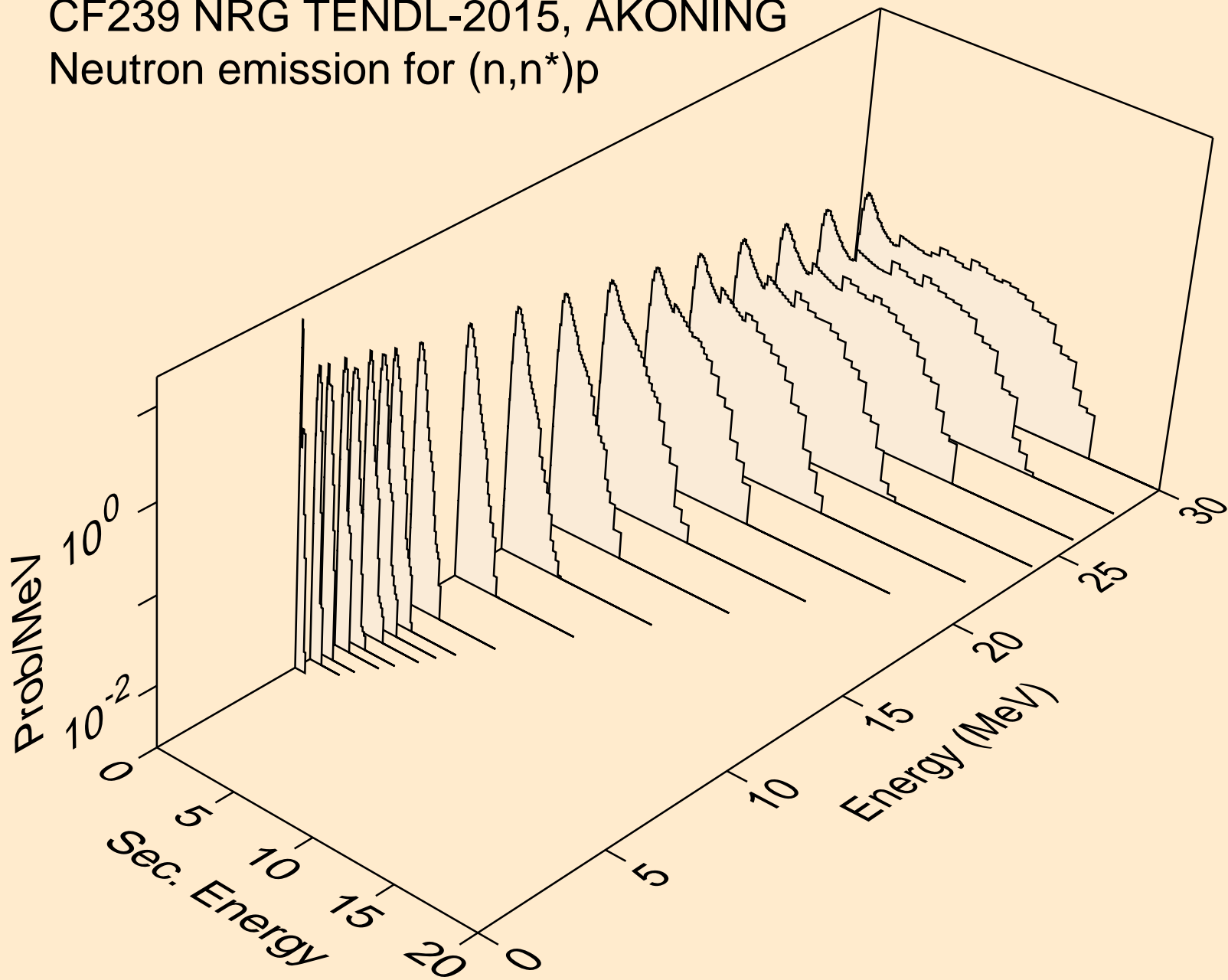

CF239 NRG TENDL-2015, AKONING
Neutron emission for (n,n*)2a

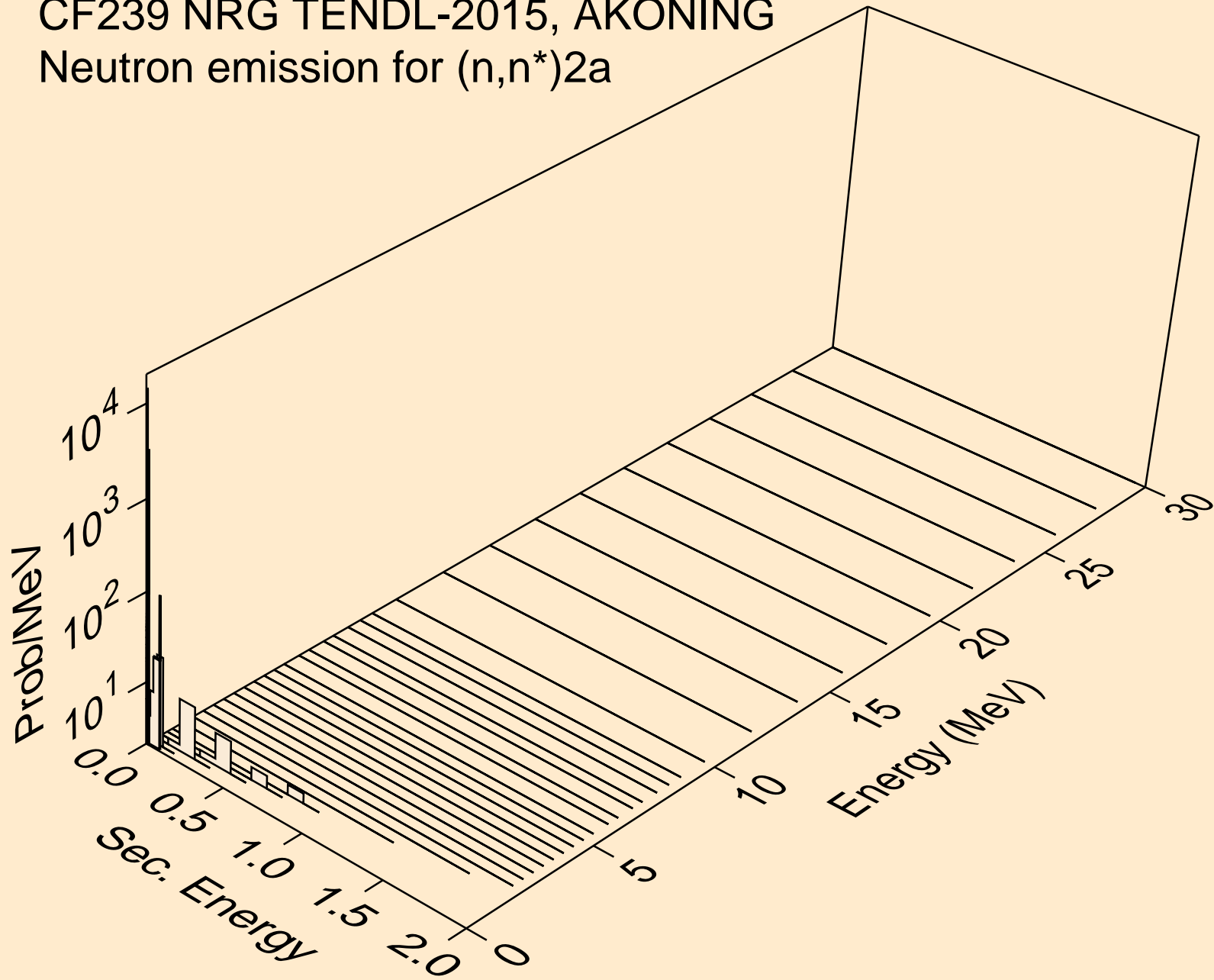

CF239 NRG TENDL-2015, AKONING
Neutron emission for (n,2n)2a

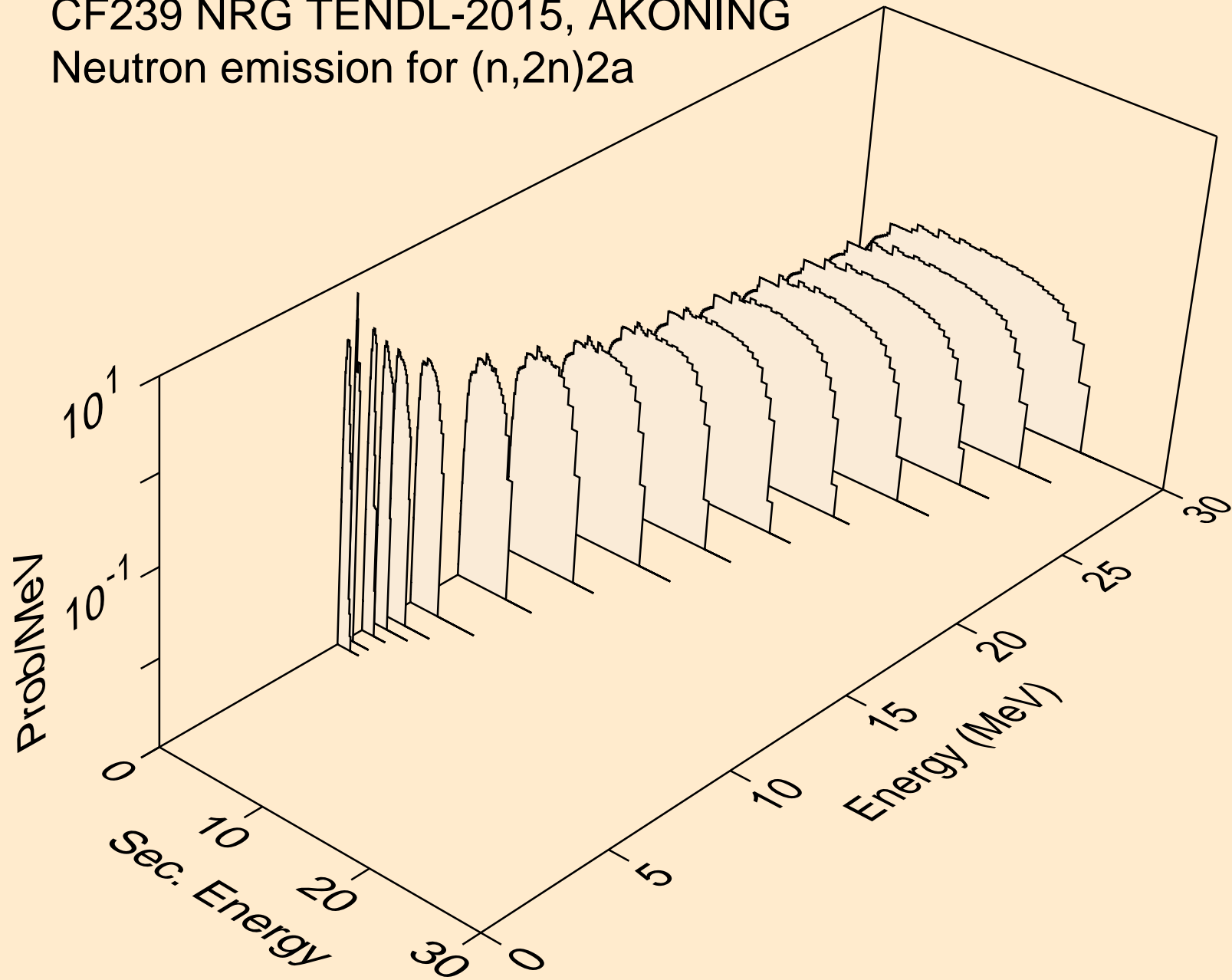

CF239 NRG TENDL-2015, AKONING
Neutron emission for (n,n*)d

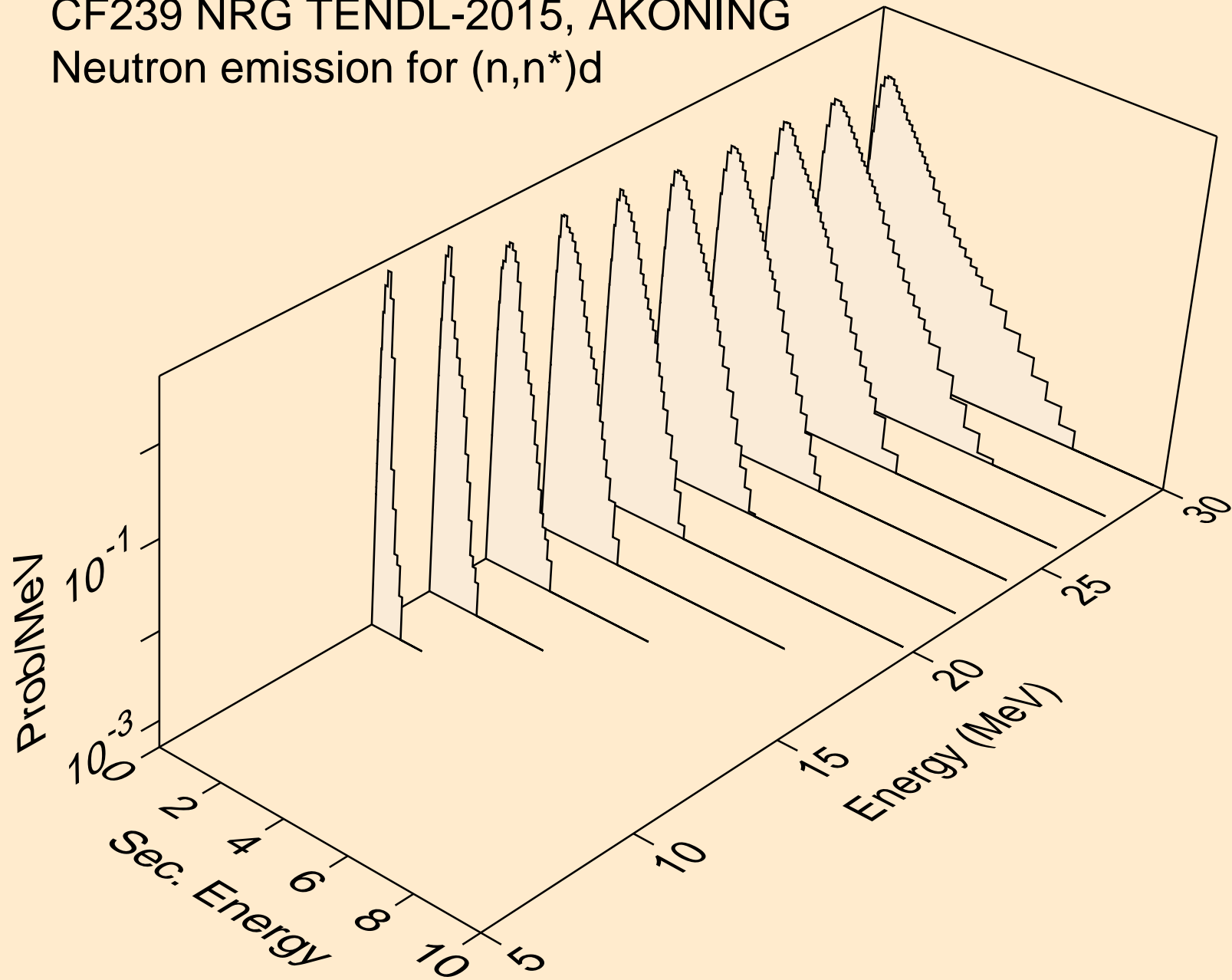

CF239 NRG TENDL-2015, AKONING
Neutron emission for (n,n*)t

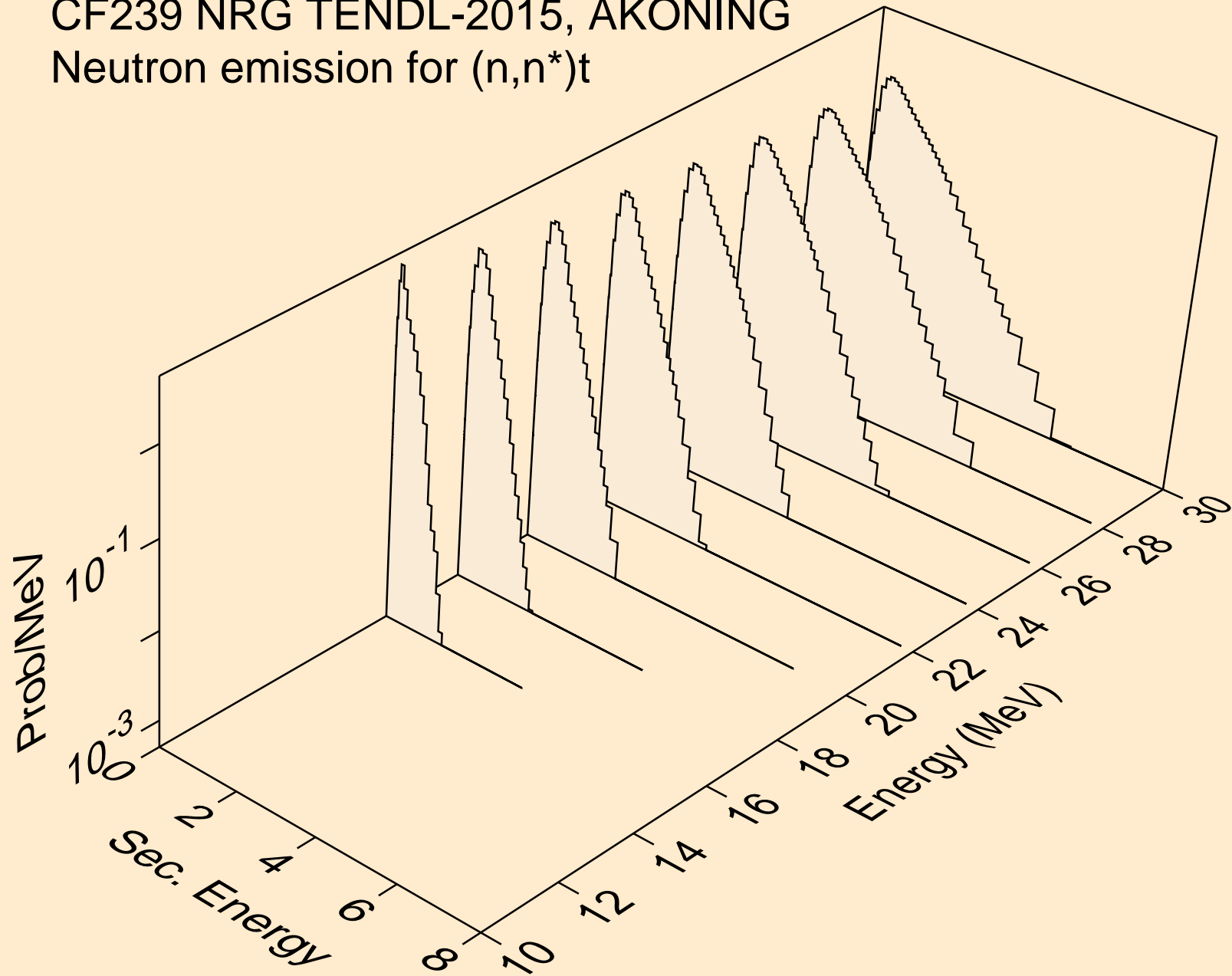

CF239 NRG TENDL-2015, AKONING
Neutron emission for (n,n*)he3

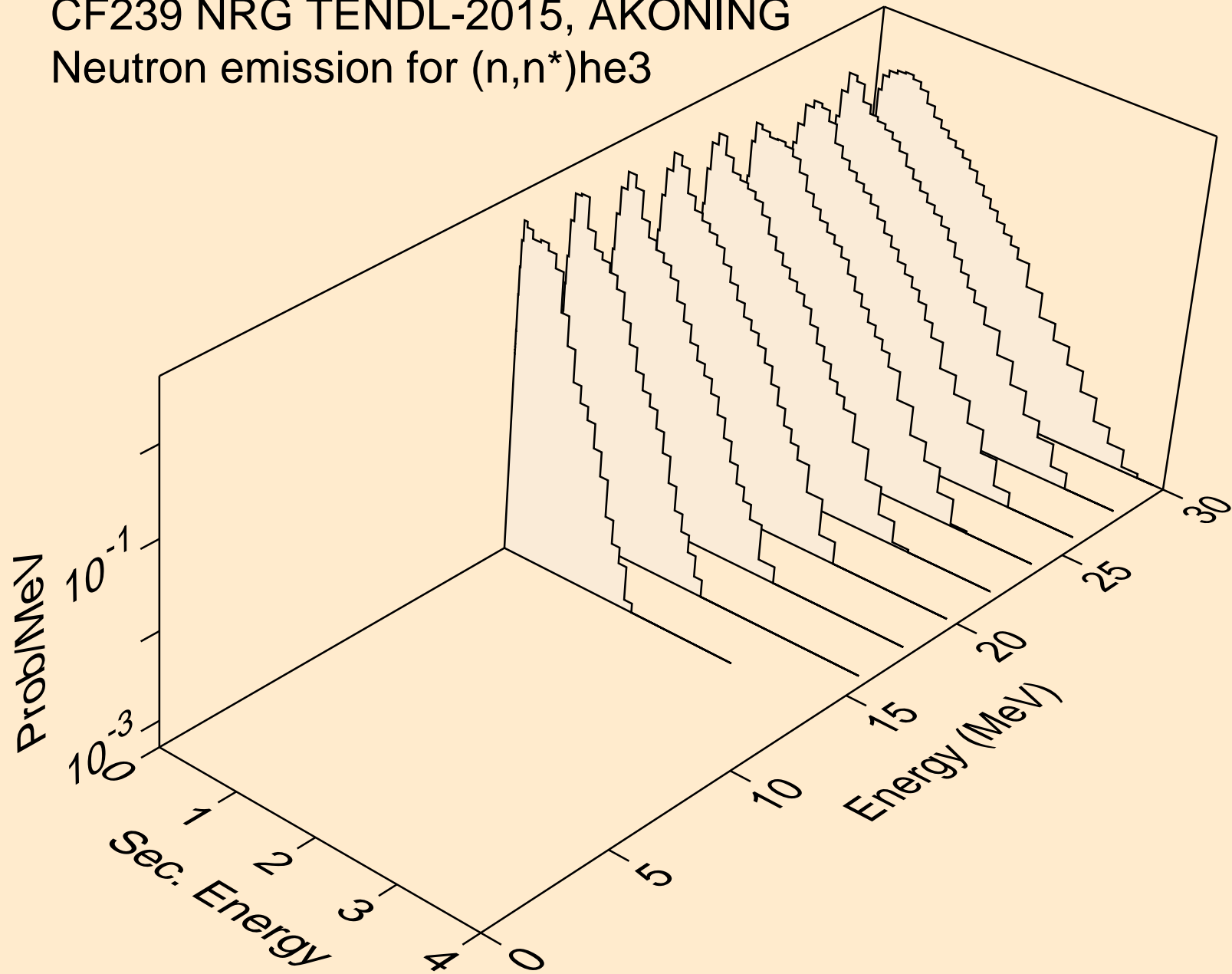

CF239 NRG TENDL-2015, AKONING
Neutron emission for (n,n*)d2a

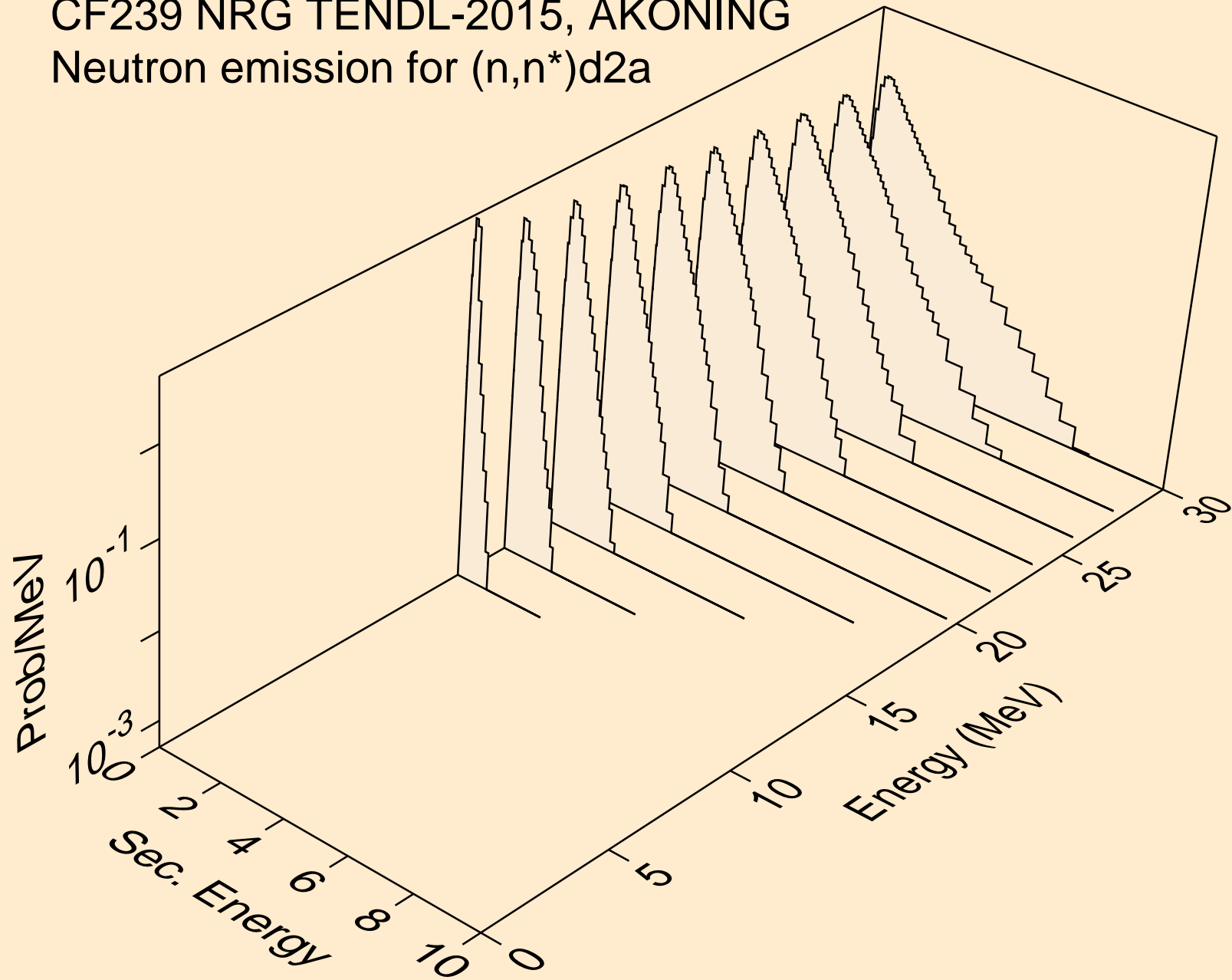

CF239 NRG TENDL-2015, AKONING
Neutron emission for (n,n*)t2a

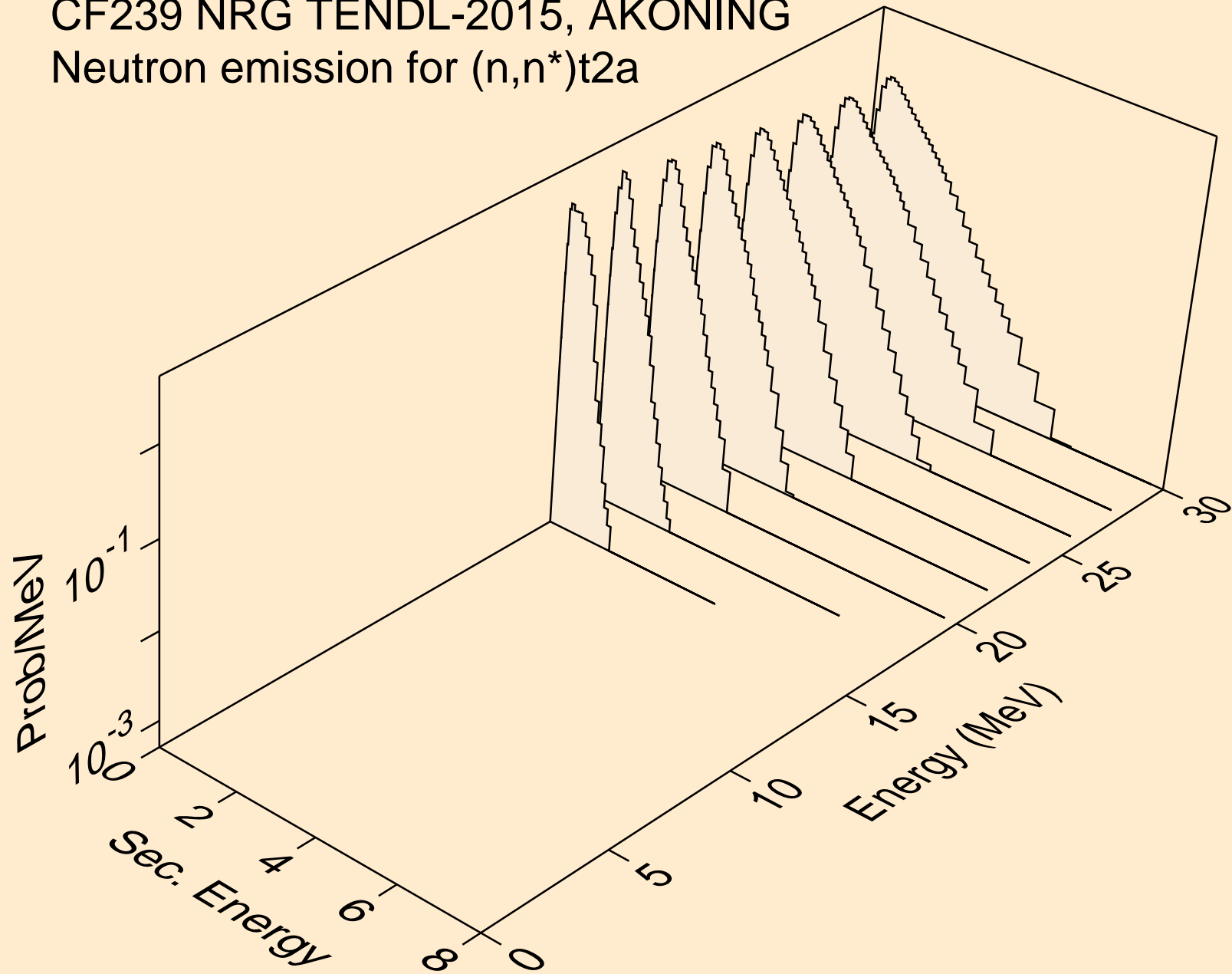

CF239 NRG TENDL-2015, AKONING
Neutron emission for (n,4n)

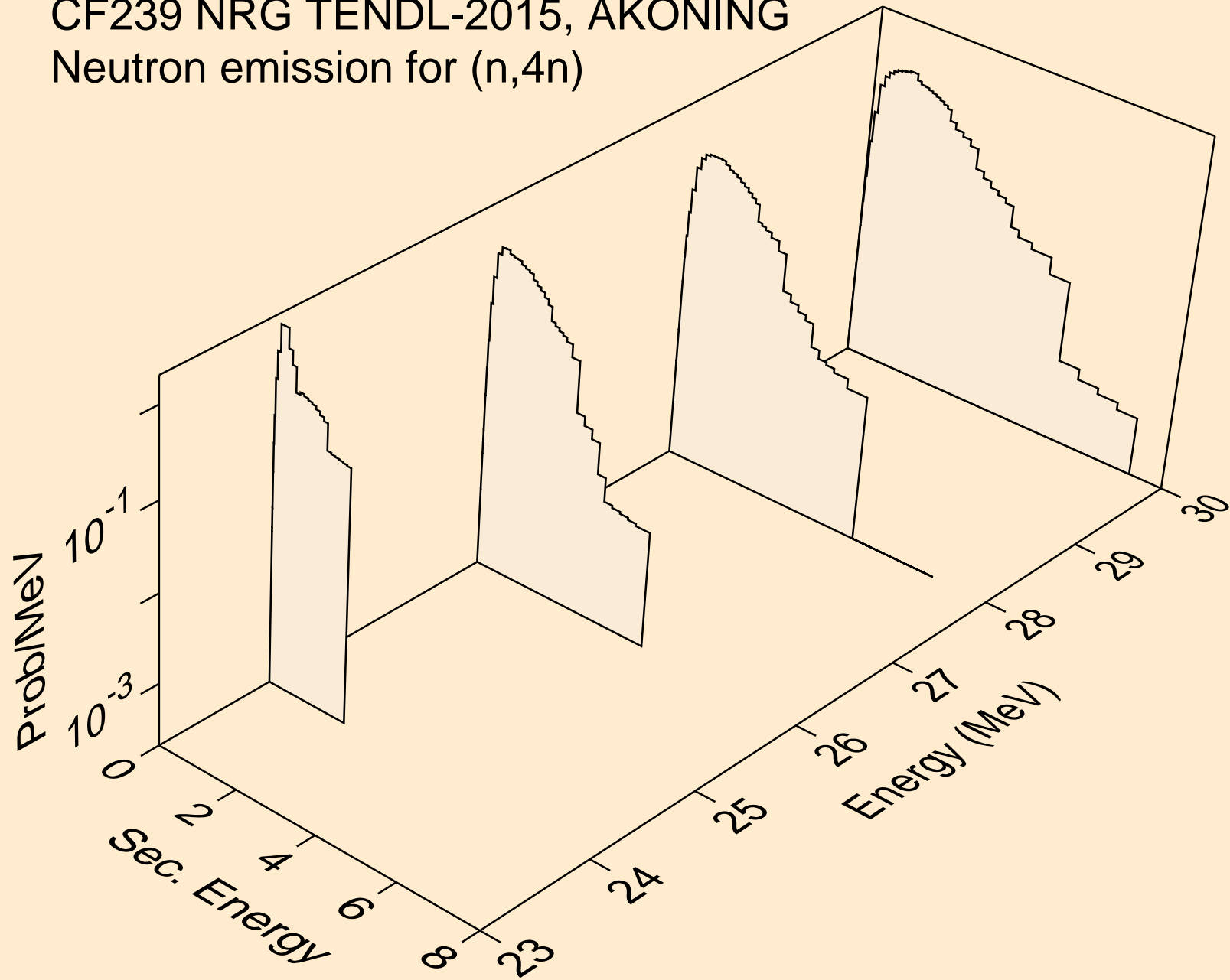

CF239 NRG TENDL-2015, AKONING
Neutron emission for (n,2np)

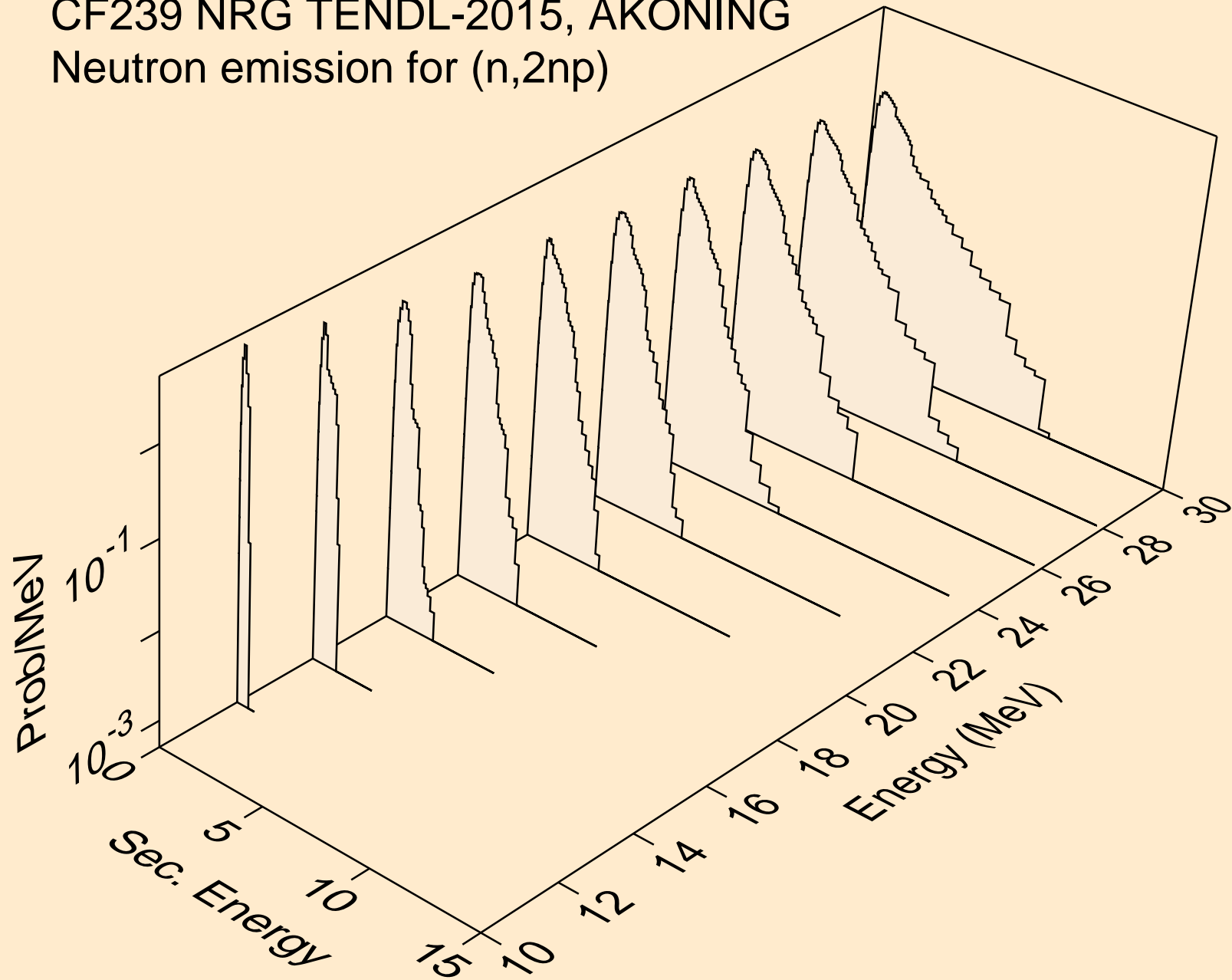

CF239 NRG TENDL-2015, AKONING
Neutron emission for (n,3np)

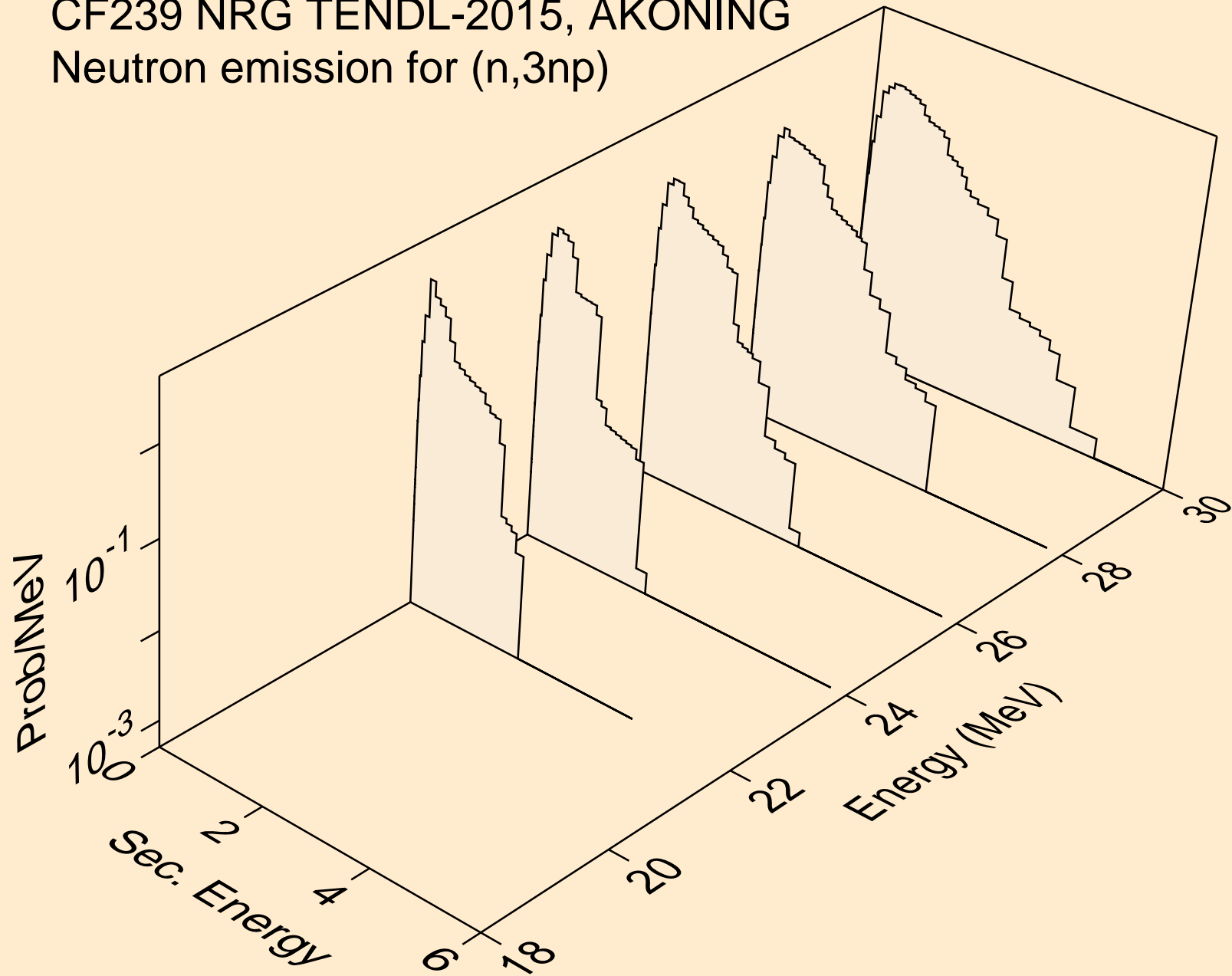

CF239 NRG TENDL-2015, AKONING
Neutron emission for (n,2np)

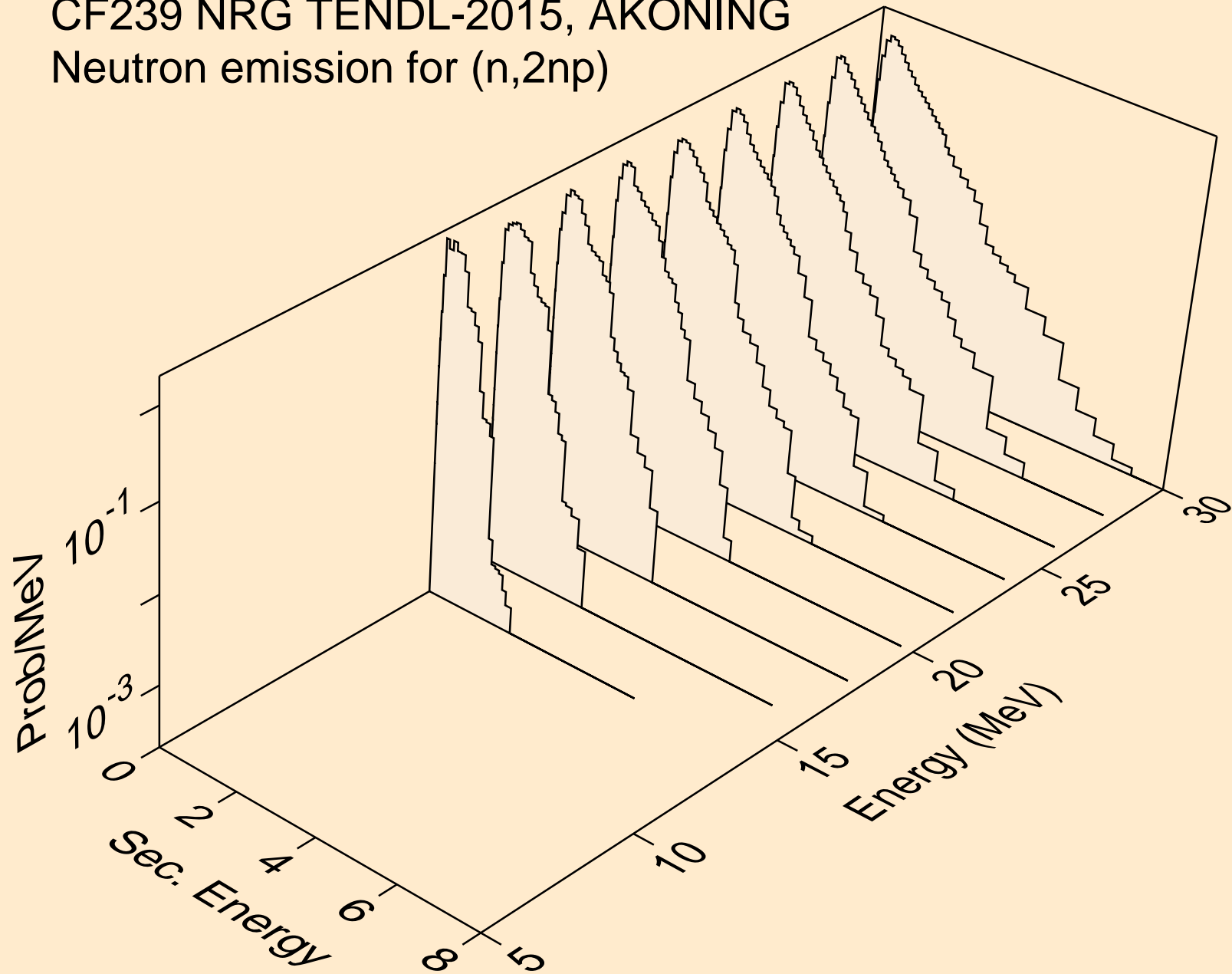

CF239 NRG TENDL-2015, AKONING
Neutron emission for (n,npa)

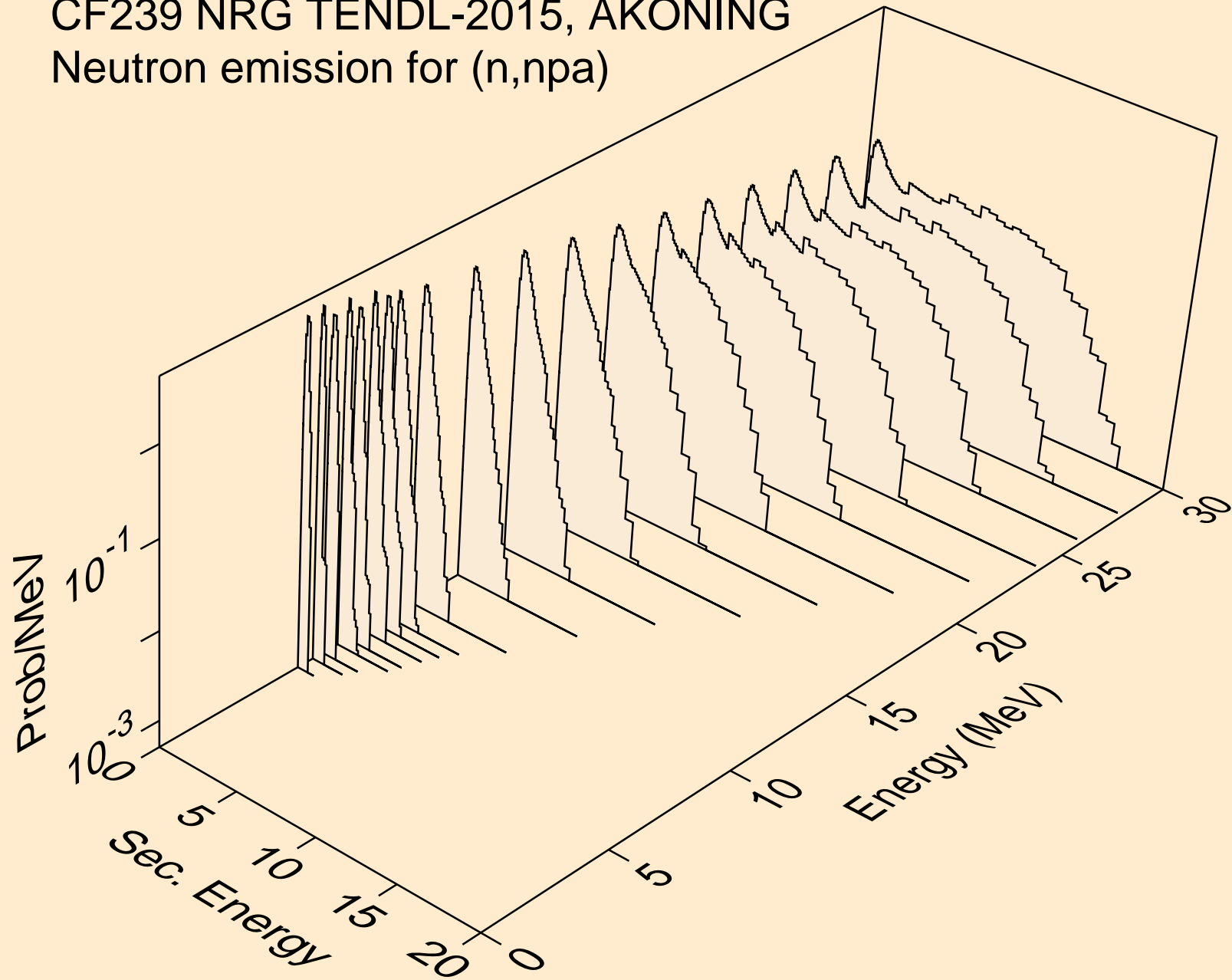

CF239 NRG TENDL-2015, AKONING
Neutron emission for (n,n*c)

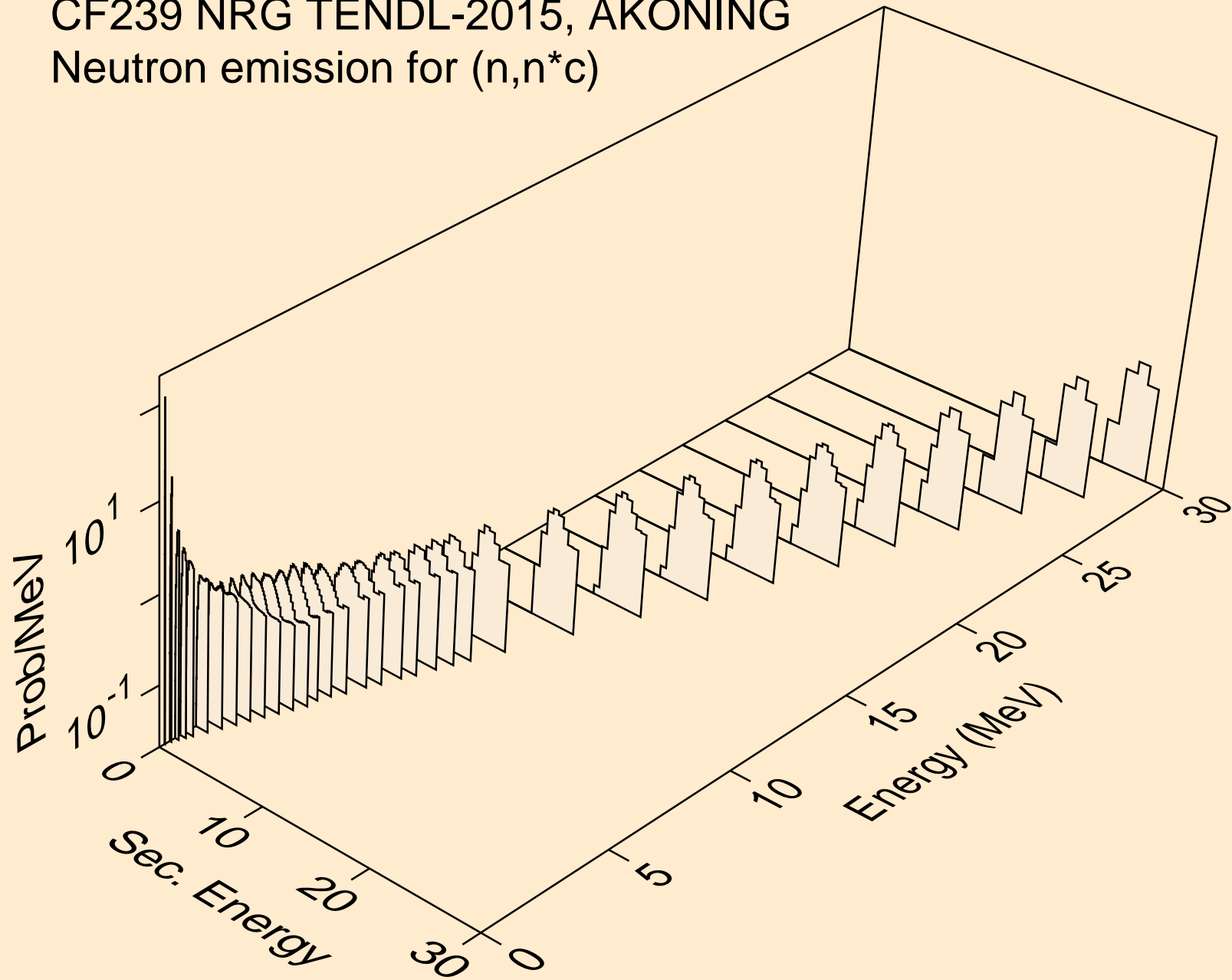

CF239 NRG TENDL-2015, AKONING

Delayed nubar

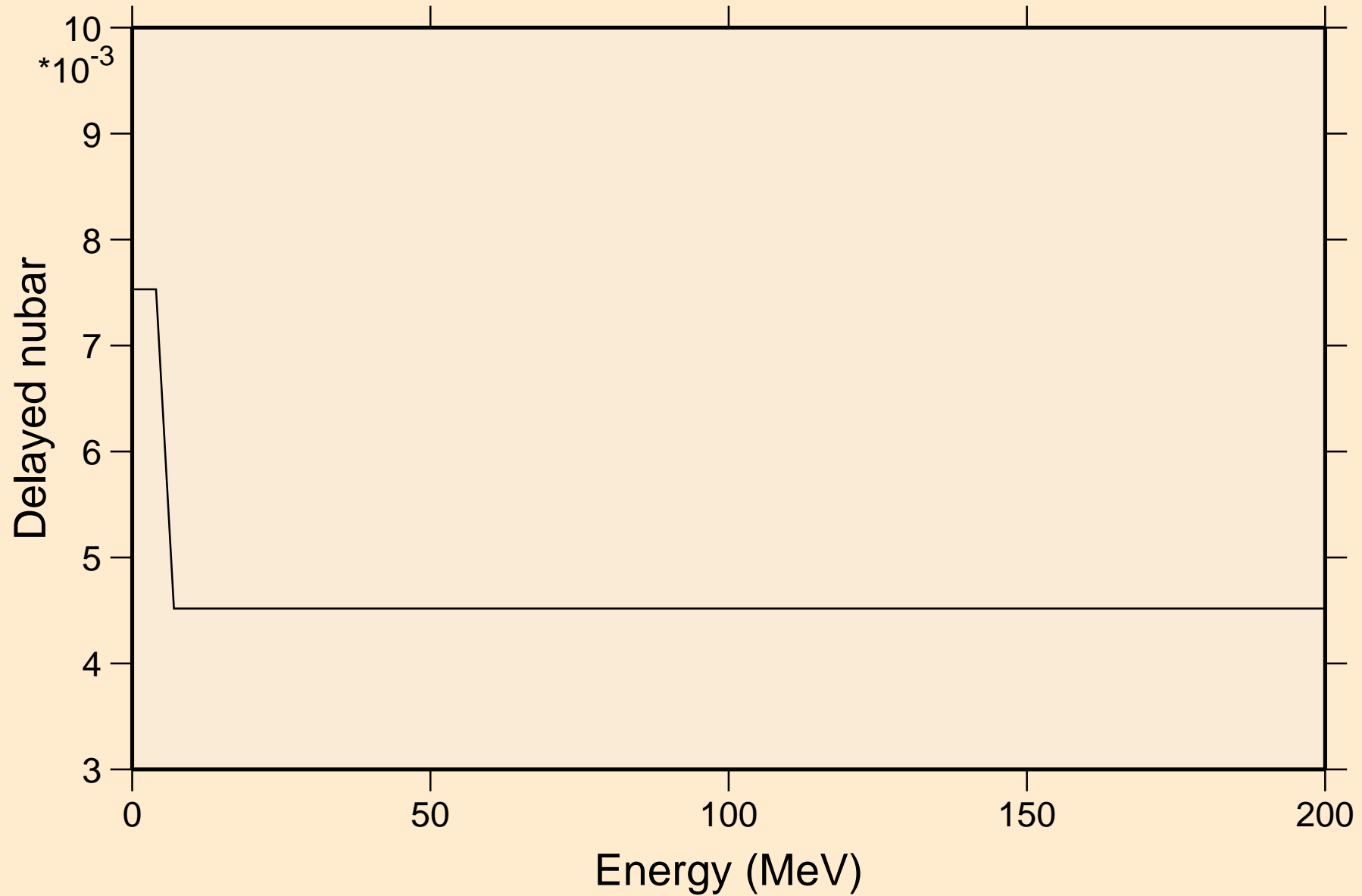

CF239 NRG TENDL-2015, AKONING

Delayed neutron spectra

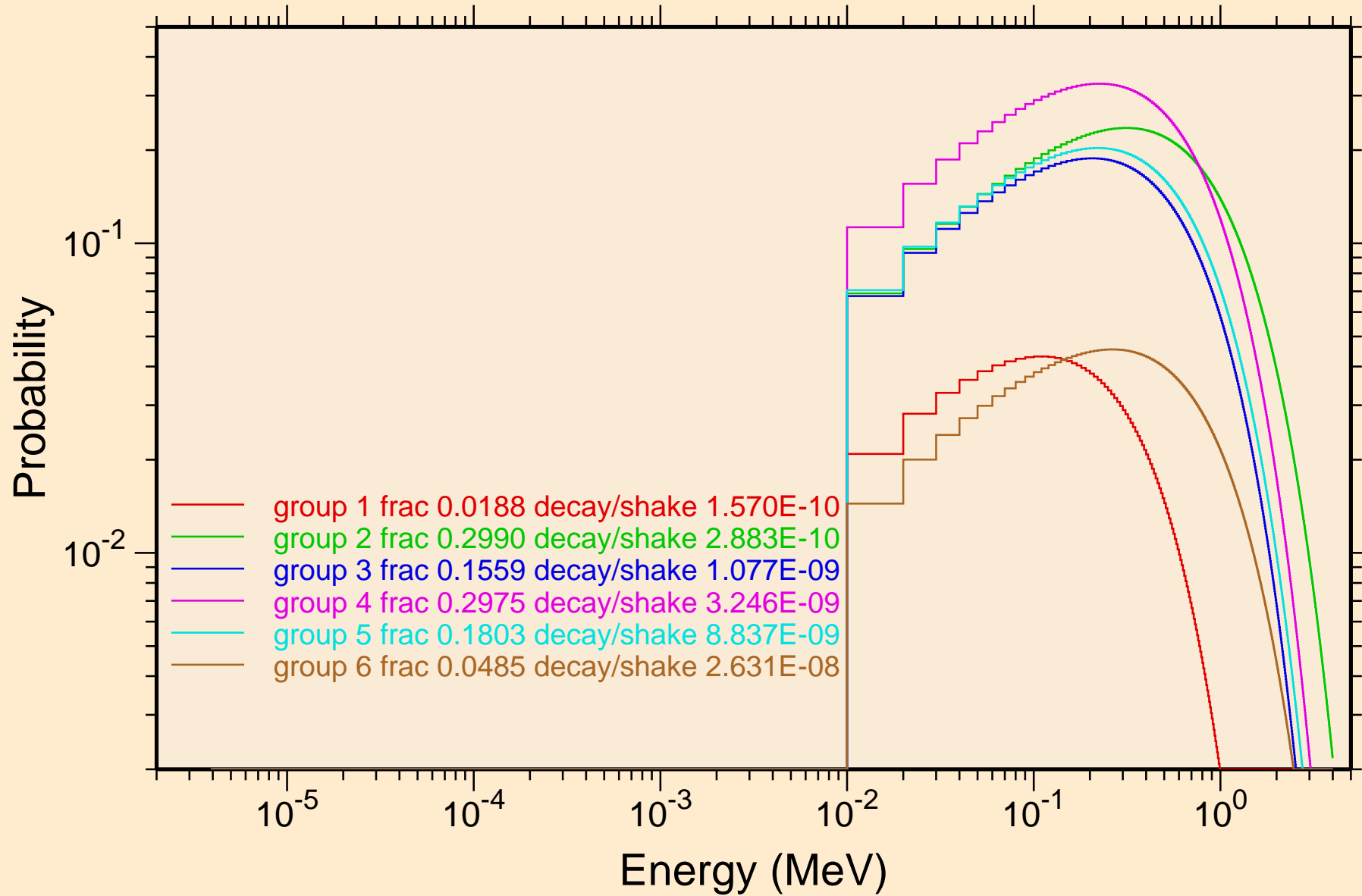

CF239 NRG TENDL-2015, AKONING
Photon emission for (n,x)

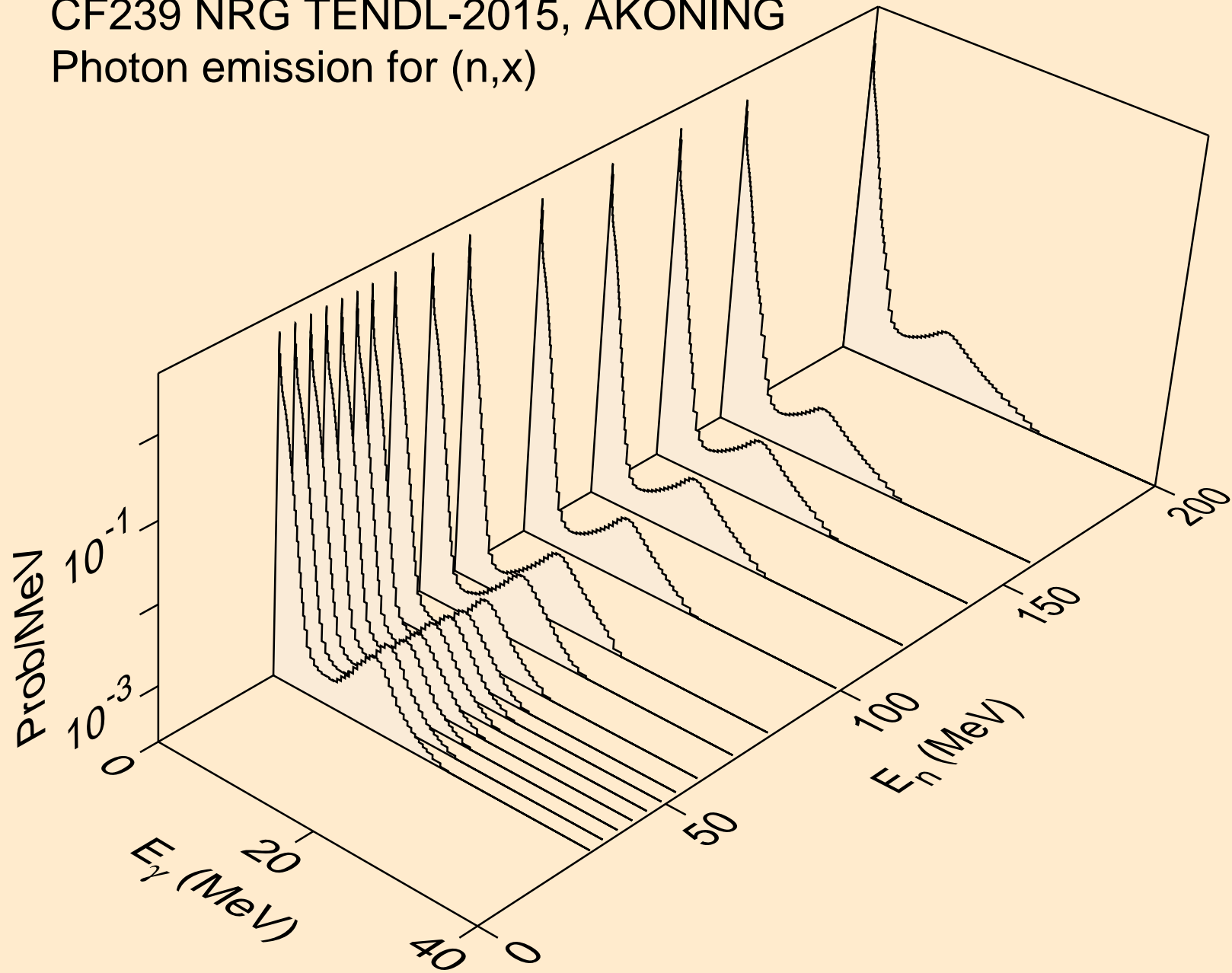

CF239 NRG TENDL-2015, AKONING
Photon emission for (n,2nd)

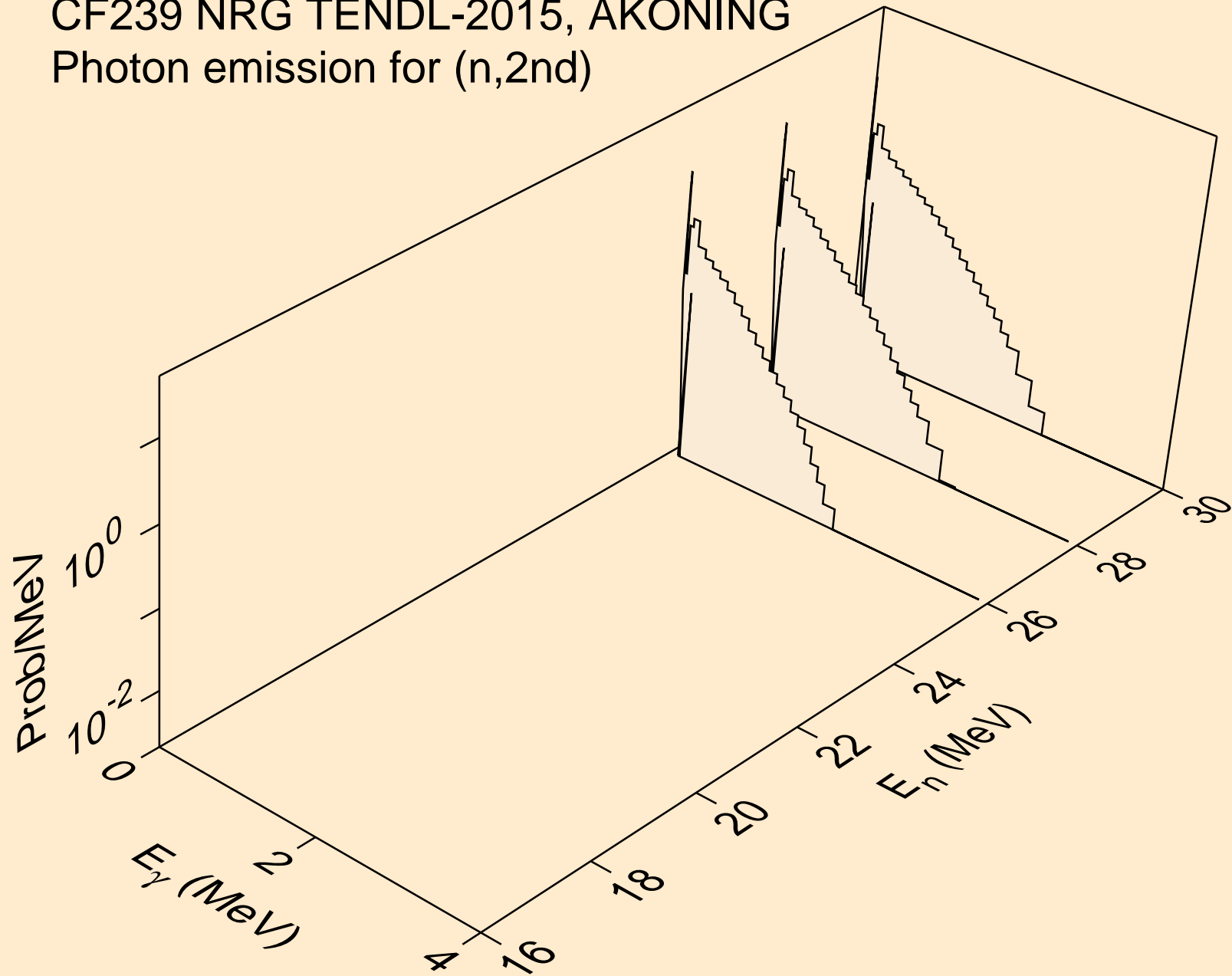

CF239 NRG TENDL-2015, AKONING
Photon emission for (n,2n)

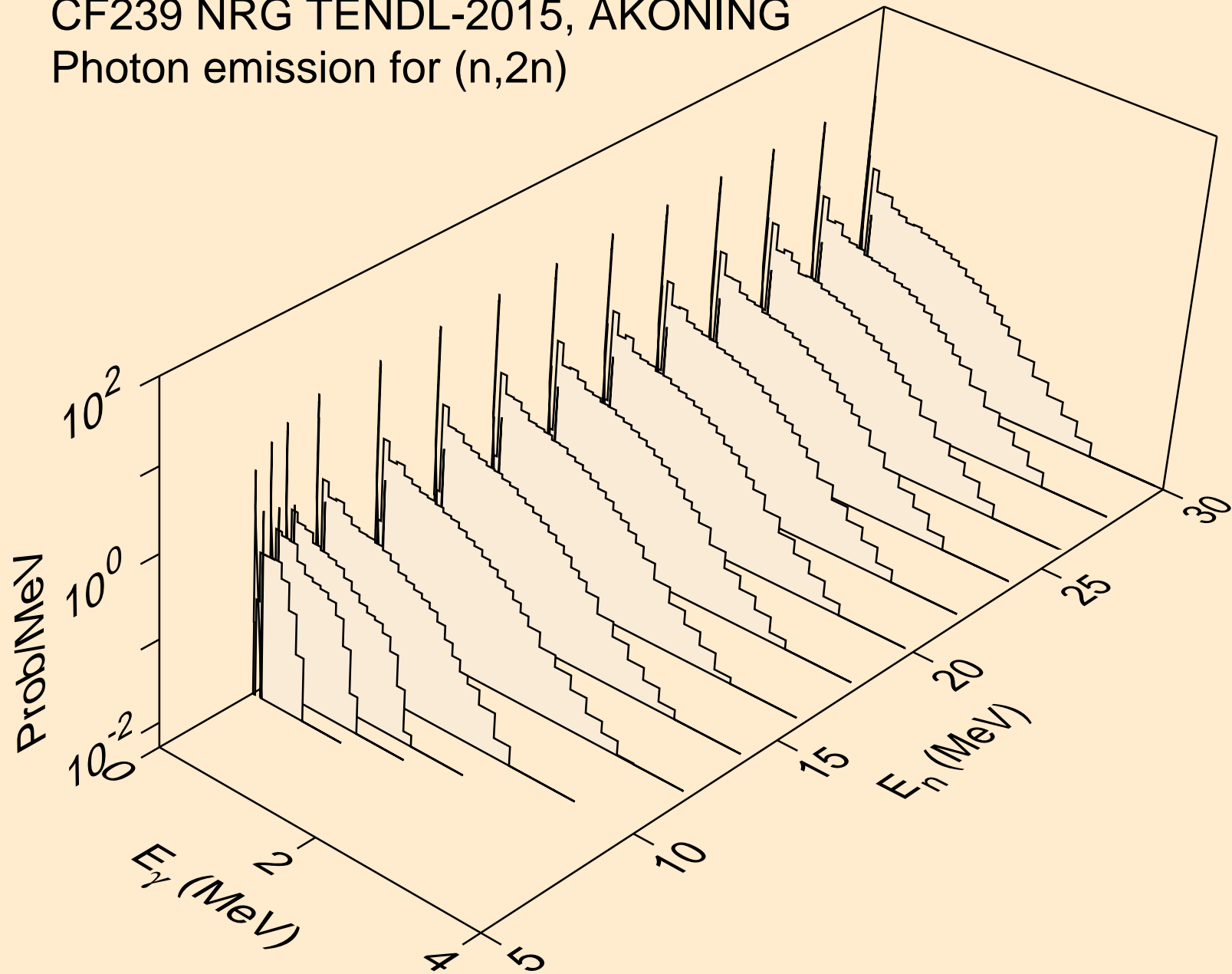

CF239 NRG TENDL-2015, AKONING
Photon emission for (n,3n)

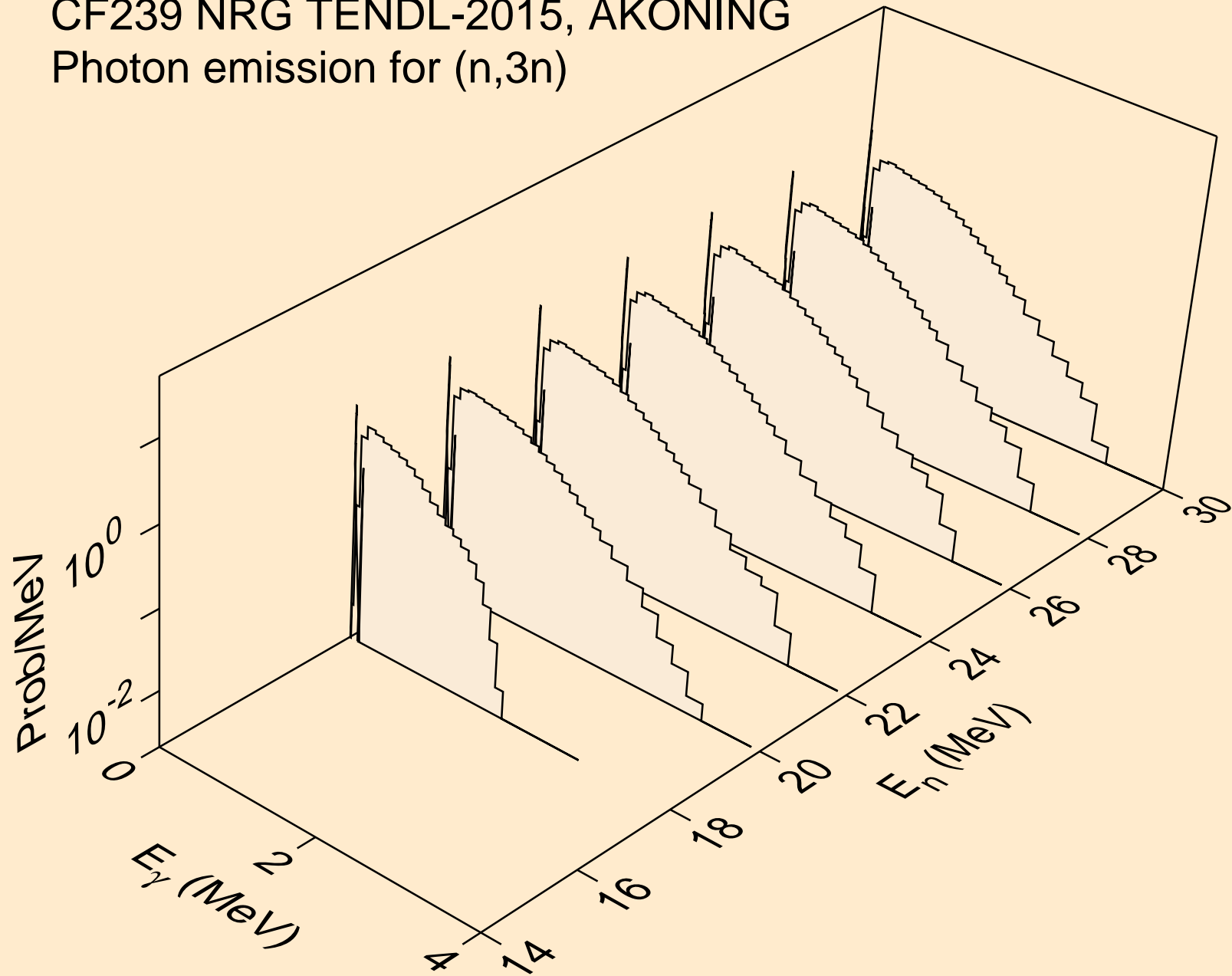

CF239 NRG TENDL-2015, AKONING
Photon emission for (n,n*)a

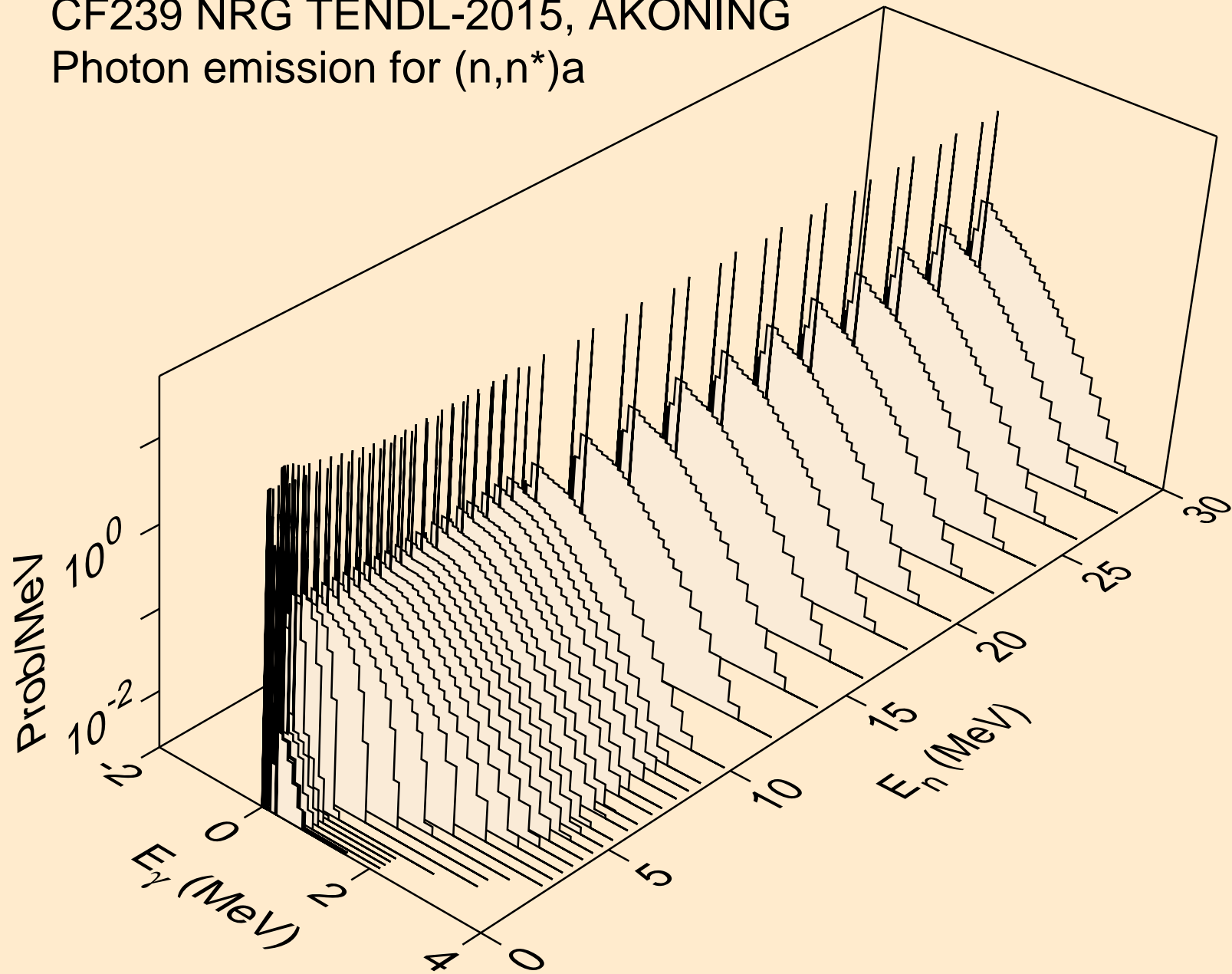

CF239 NRG TENDL-2015, AKONING
Photon emission for (n,n*)3a

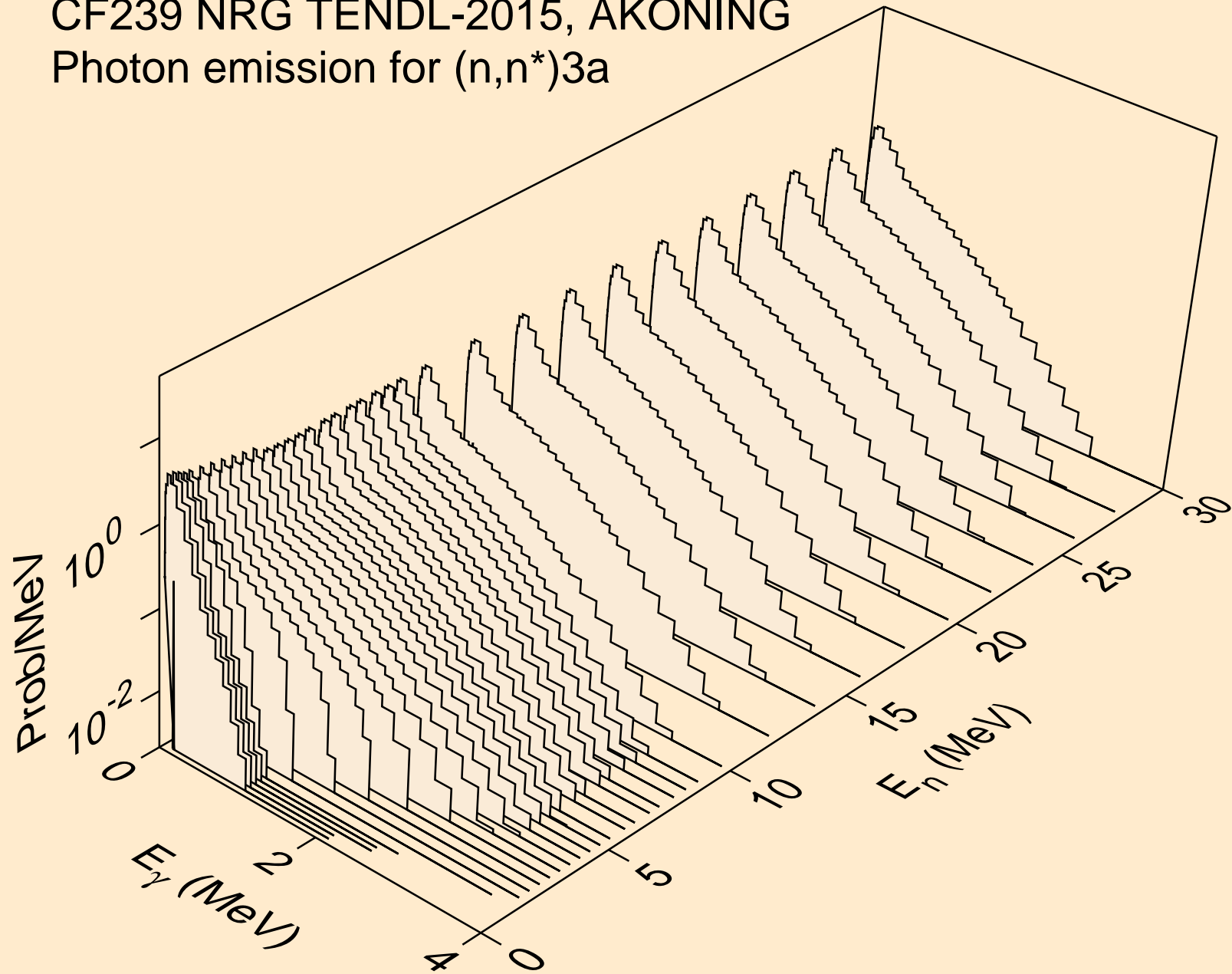

CF239 NRG TENDL-2015, AKONING
Photon emission for (n,2n)a

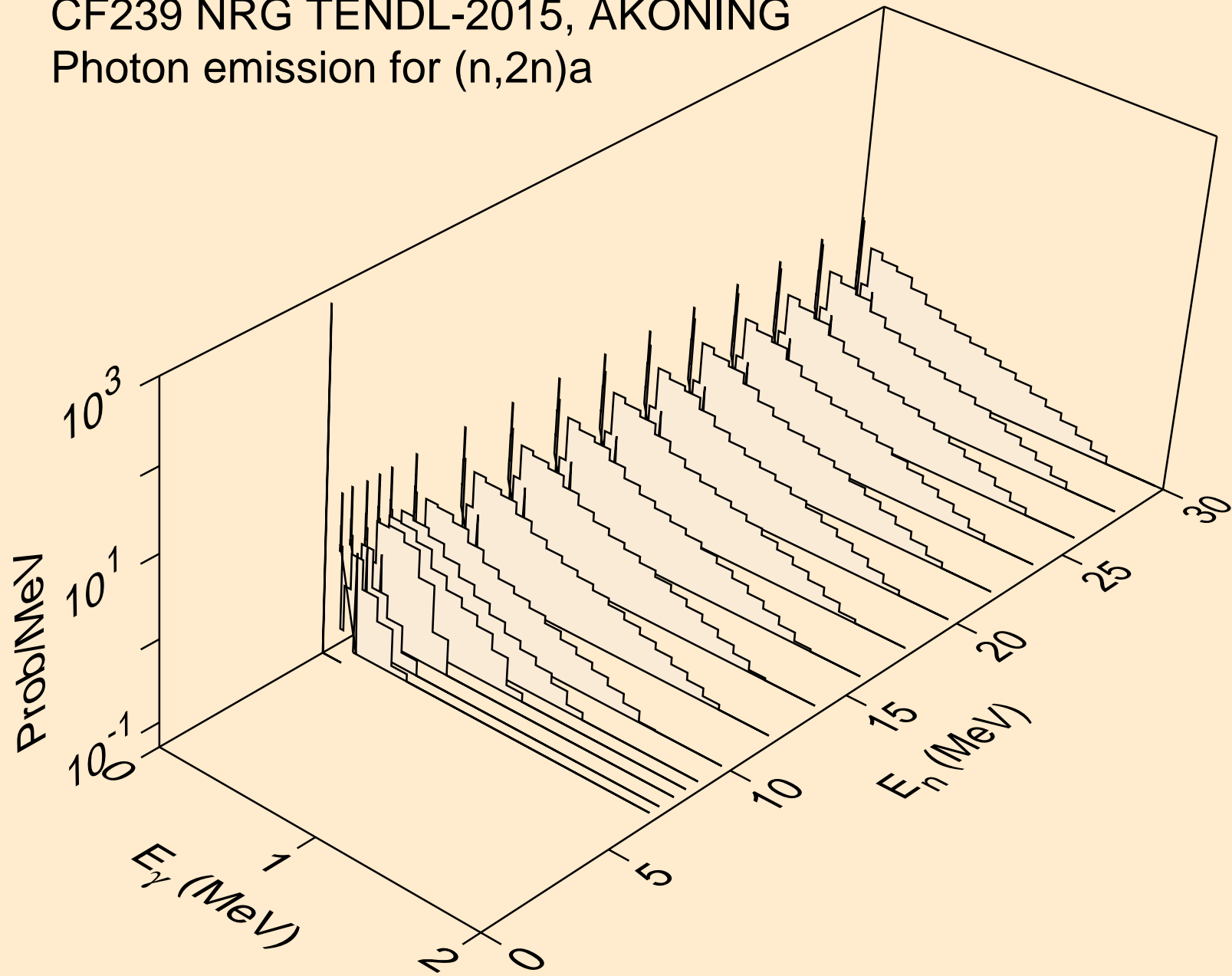

CF239 NRG TENDL-2015, AKONING
Photon emission for (n,3n)a

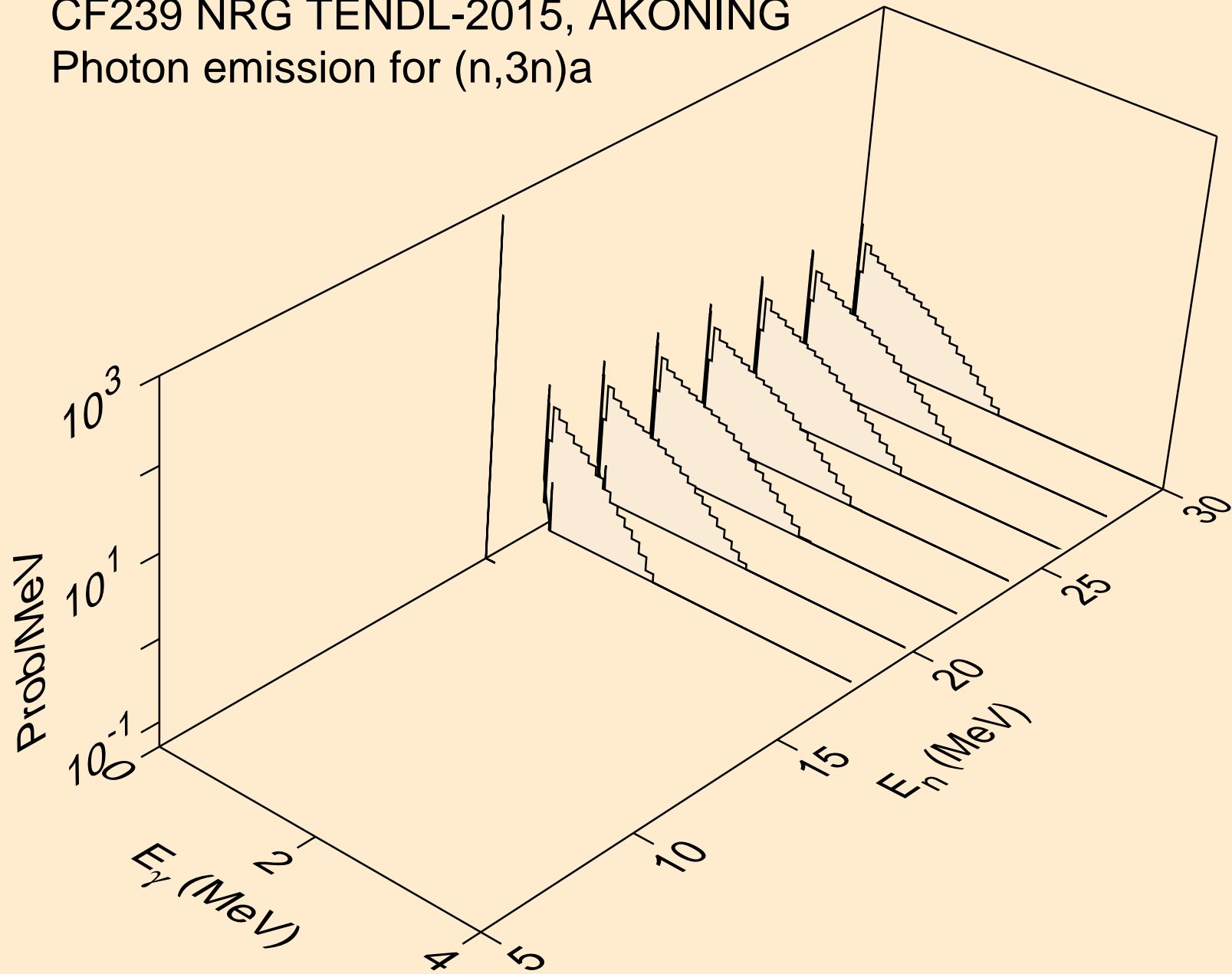

CF239 NRG TENDL-2015, AKONING
Photon emission for (n,n*)p

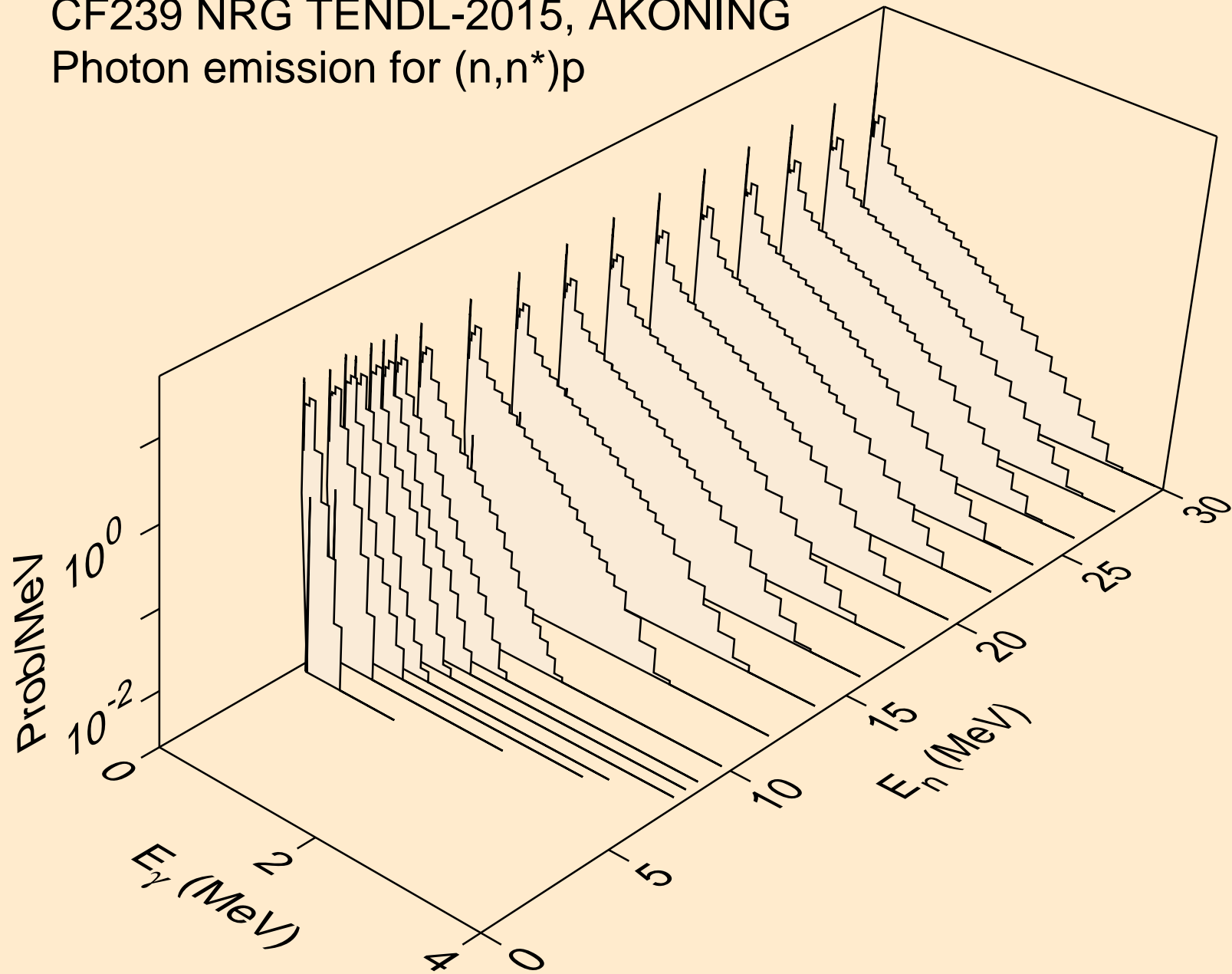

CF239 NRG TENDL-2015, AKONING
Photon emission for (n,n*)2a

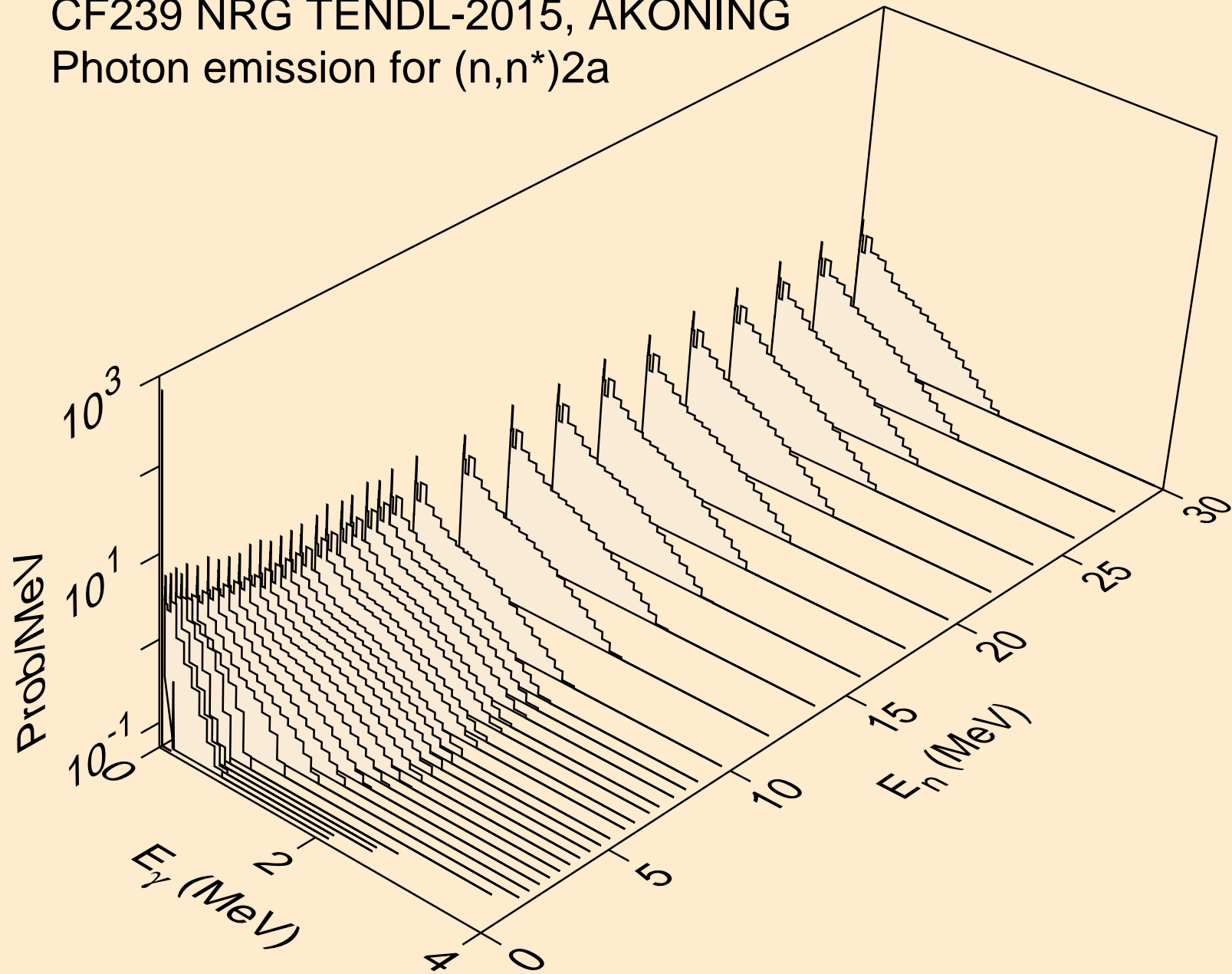

CF239 NRG TENDL-2015, AKONING
Photon emission for (n,2n)2a

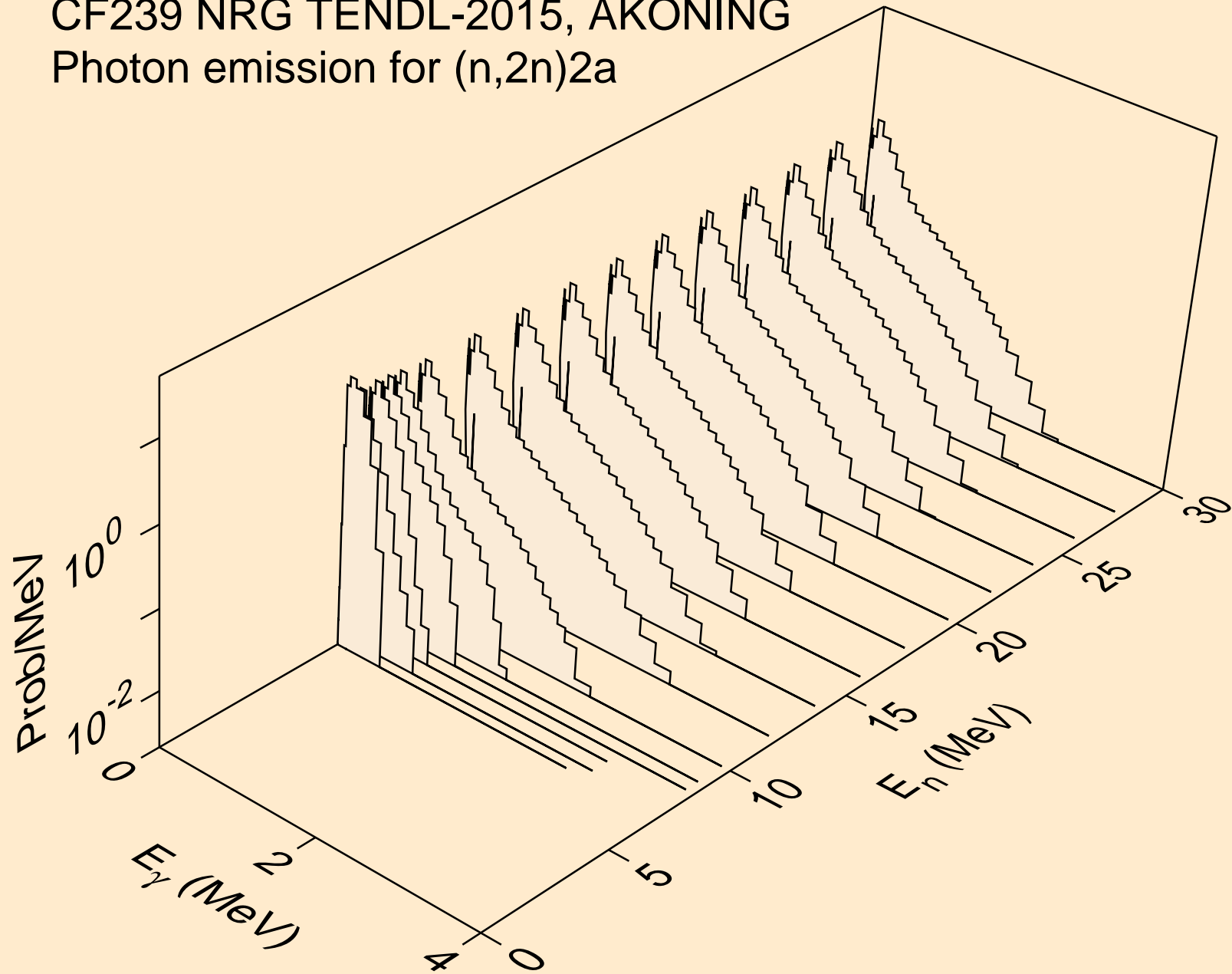

CF239 NRG TENDL-2015, AKONING
Photon emission for (n,n*)d

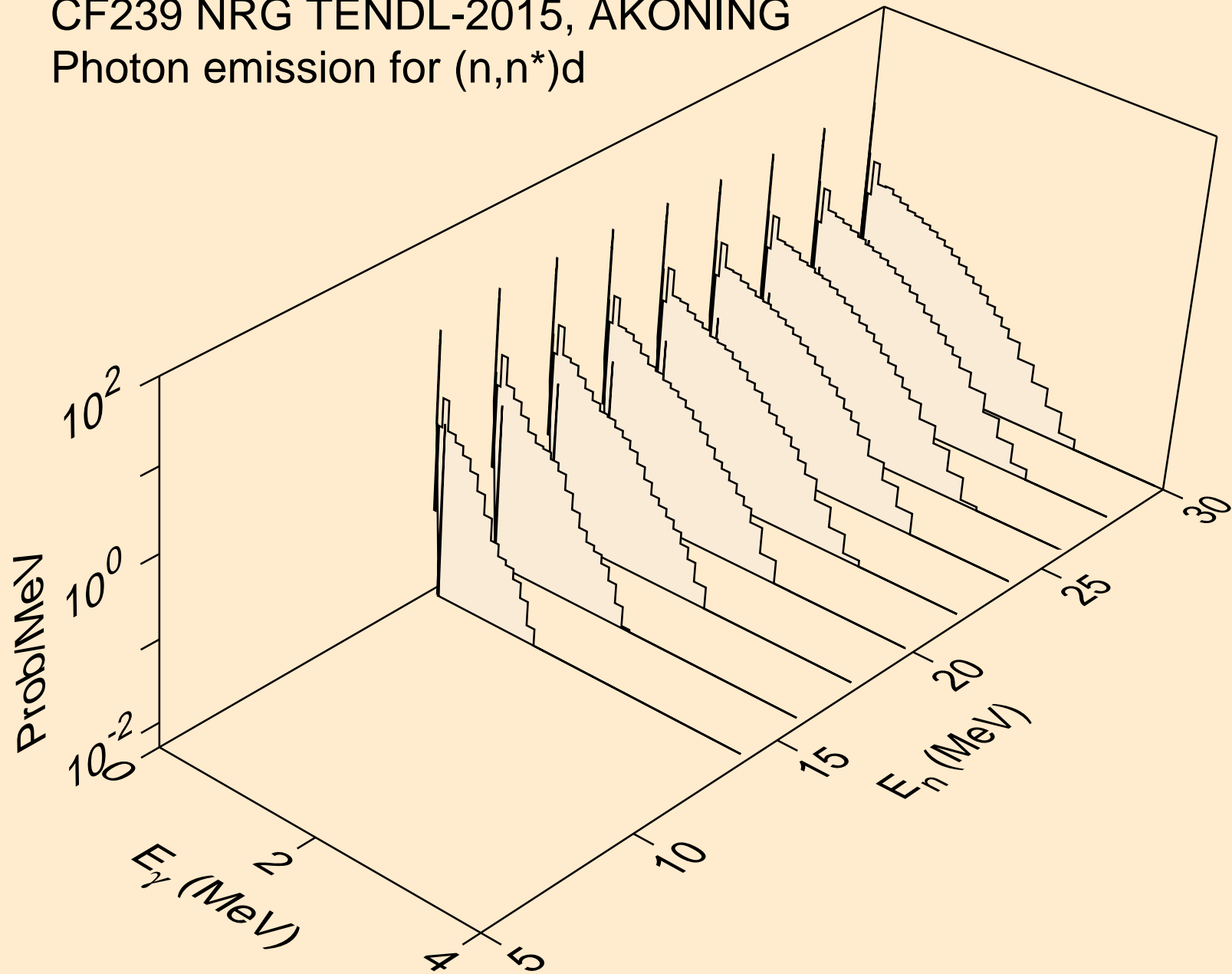

CF239 NRG TENDL-2015, AKONING
Photon emission for (n,n*)t

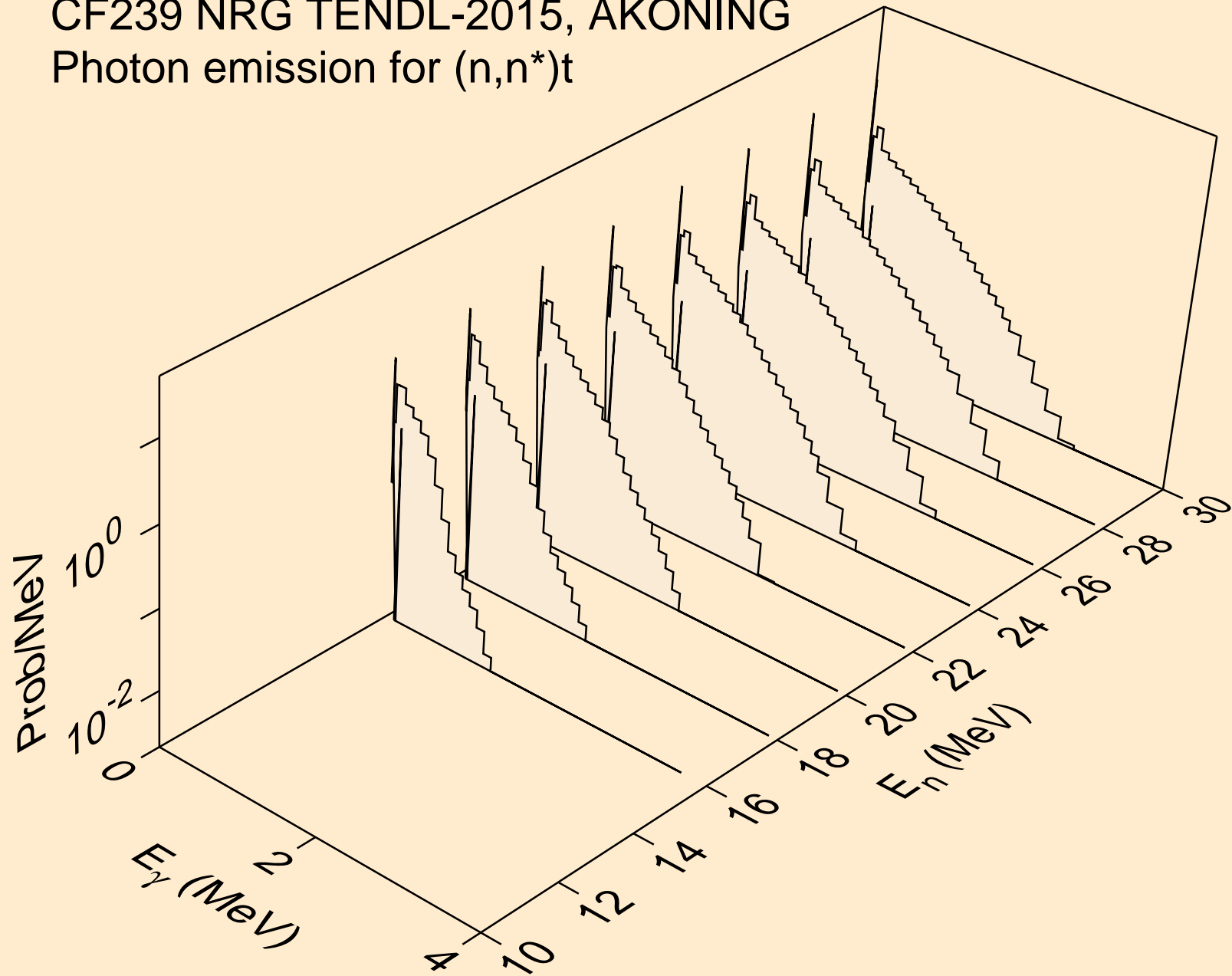

CF239 NRG TENDL-2015, AKONING
Photon emission for (n,n*)he3

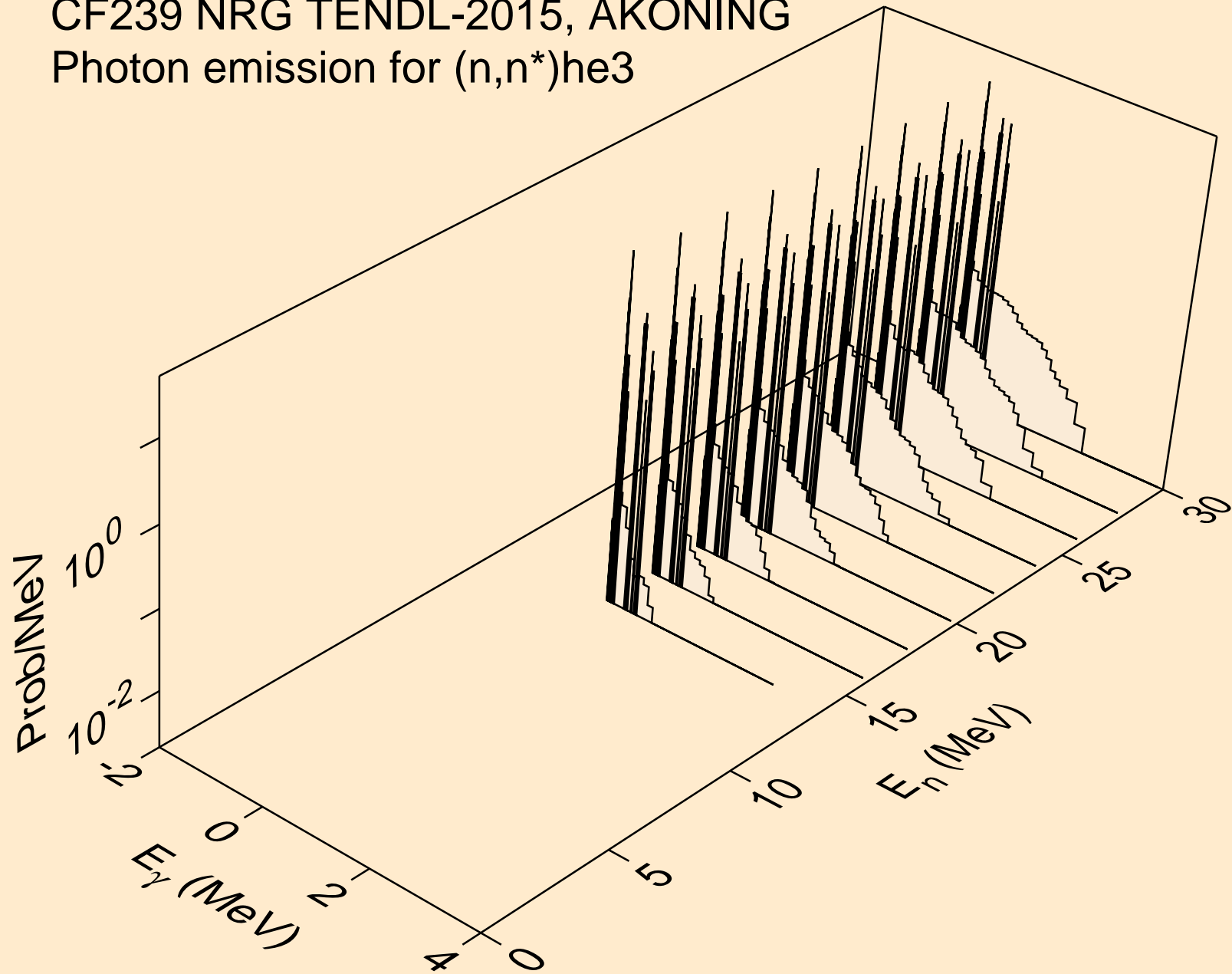

CF239 NRG TENDL-2015, AKONING
Photon emission for (n,n*)d2a

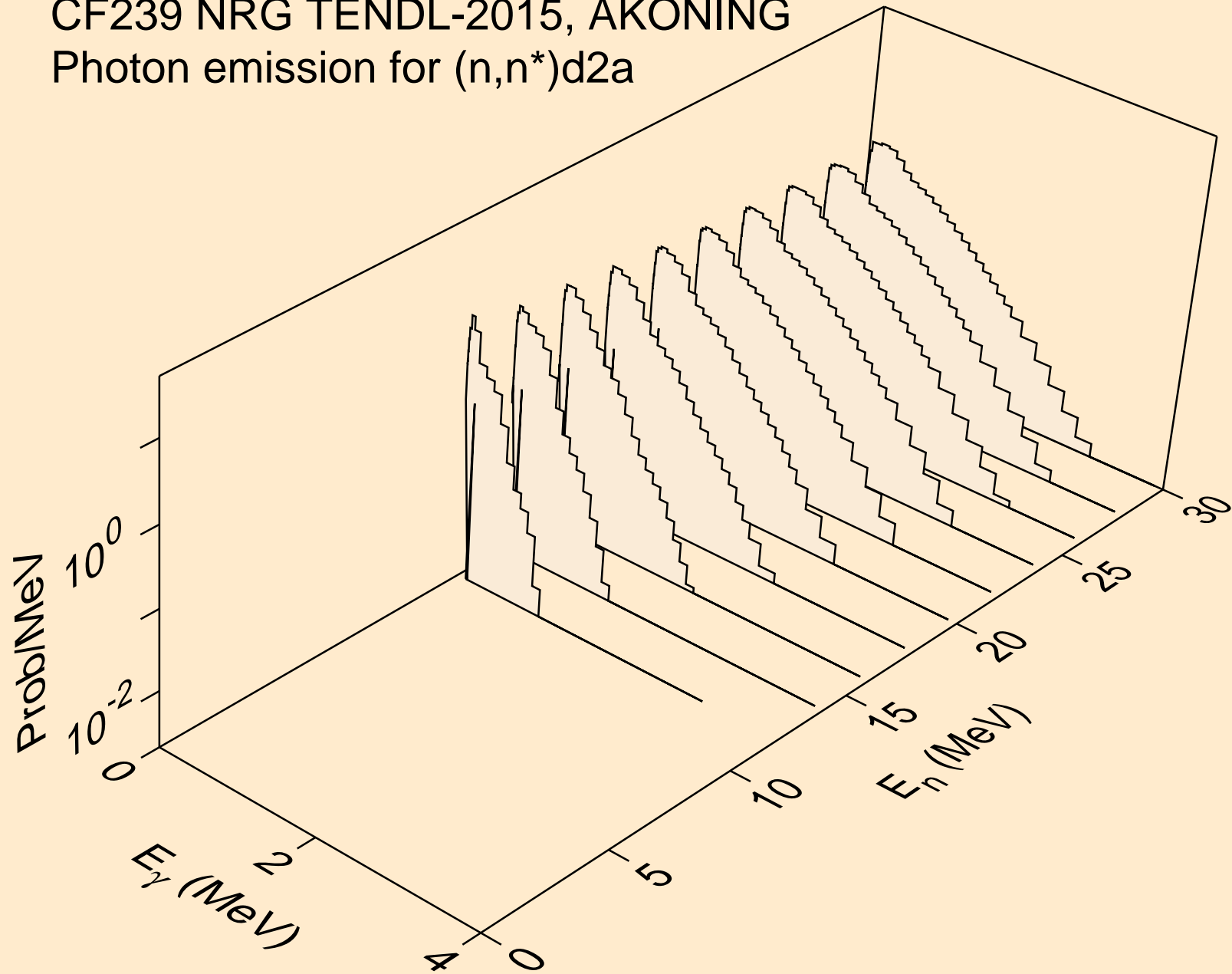

CF239 NRG TENDL-2015, AKONING
Photon emission for (n,n*)t2a

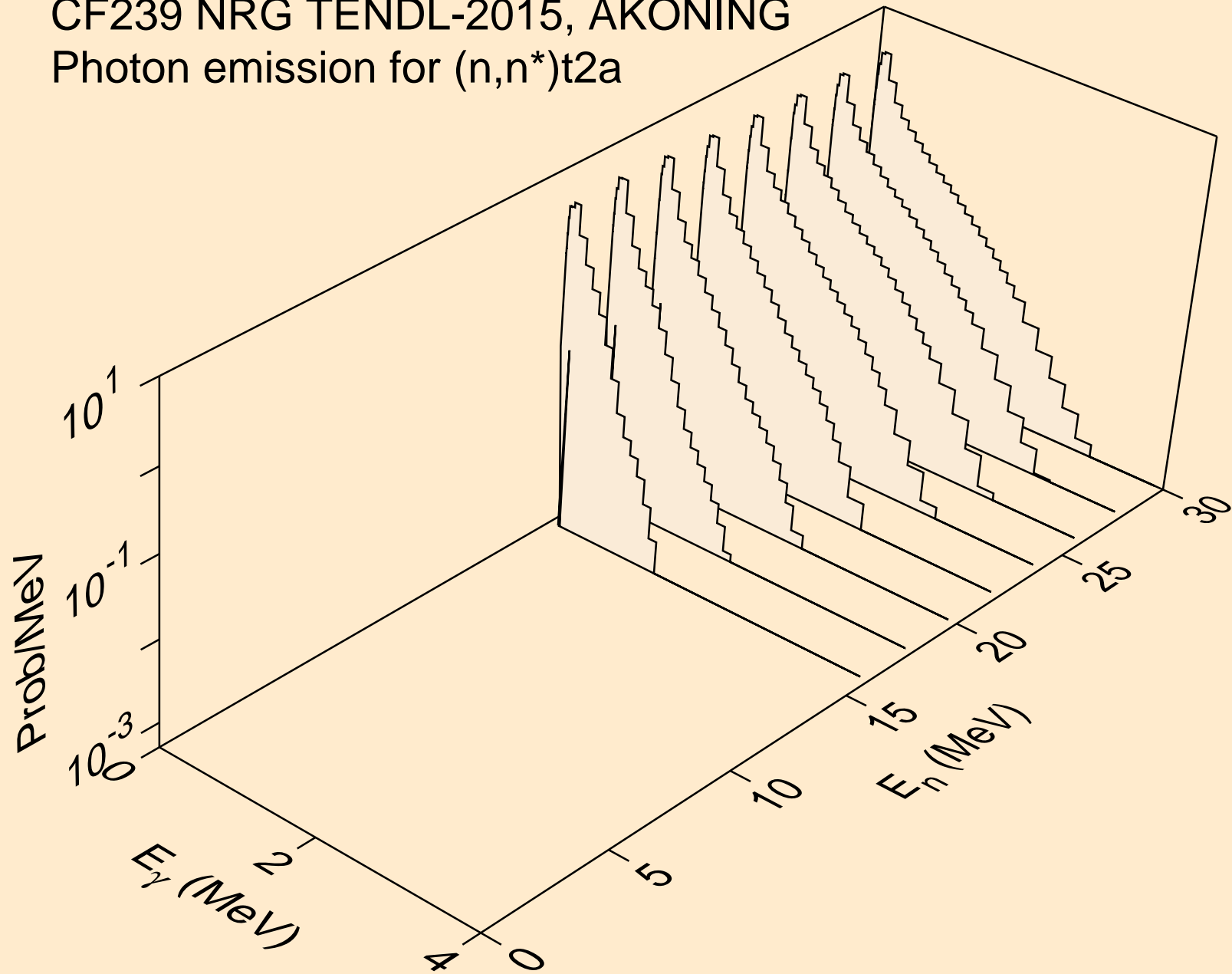

CF239 NRG TENDL-2015, AKONING
Photon emission for (n,4n)

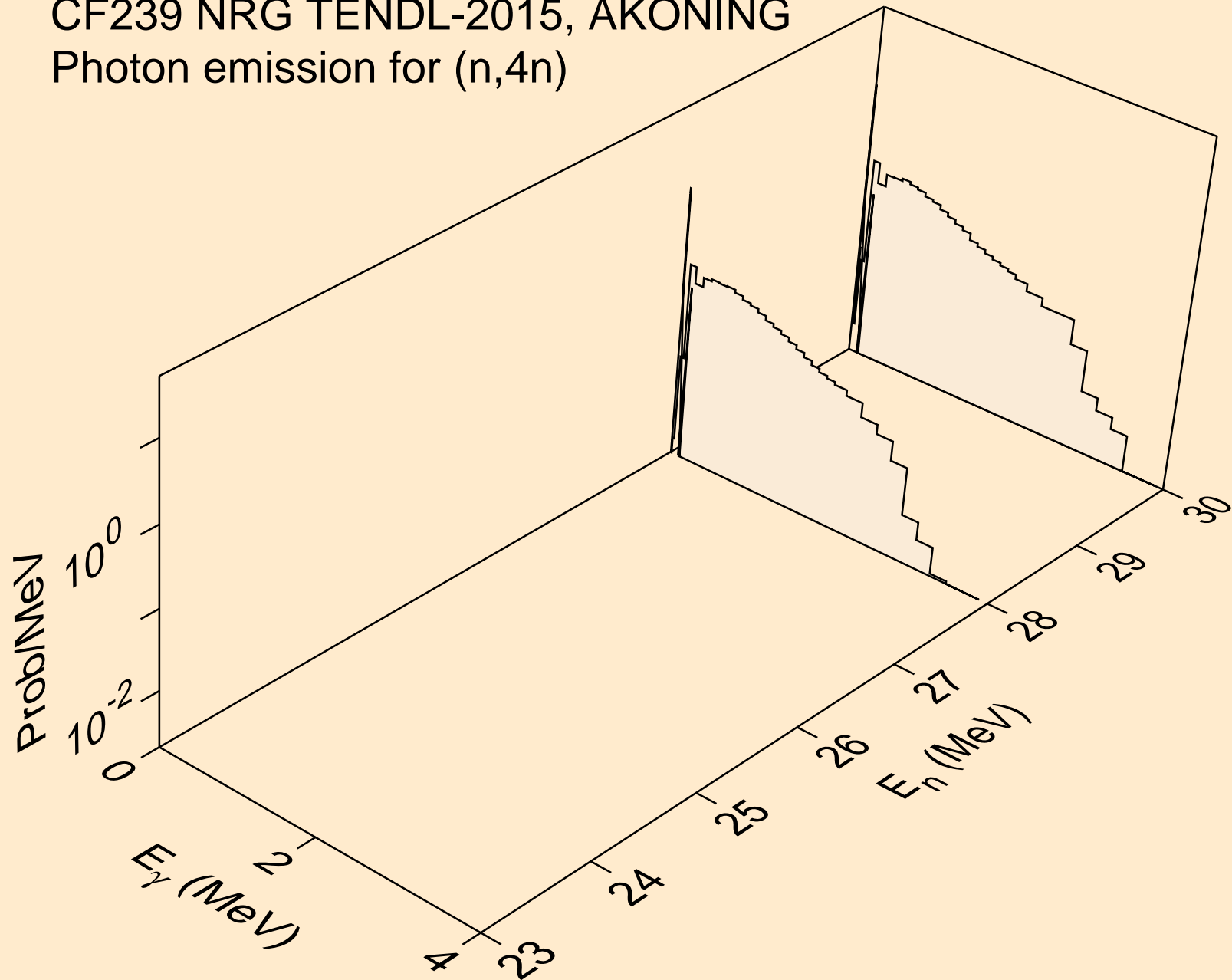

CF239 NRG TENDL-2015, AKONING
Photon emission for (n,2np)

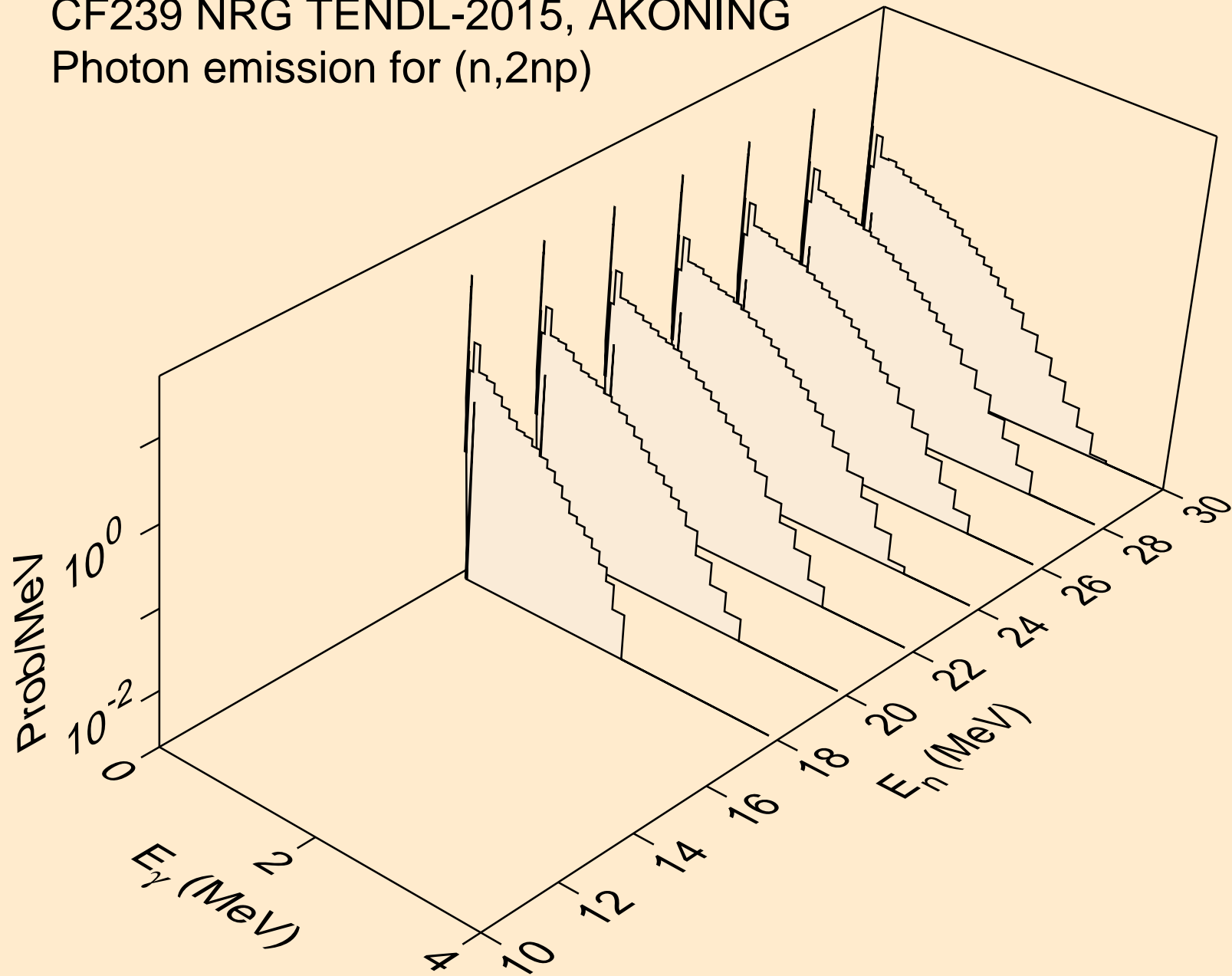

CF239 NRG TENDL-2015, AKONING
Photon emission for (n,3np)

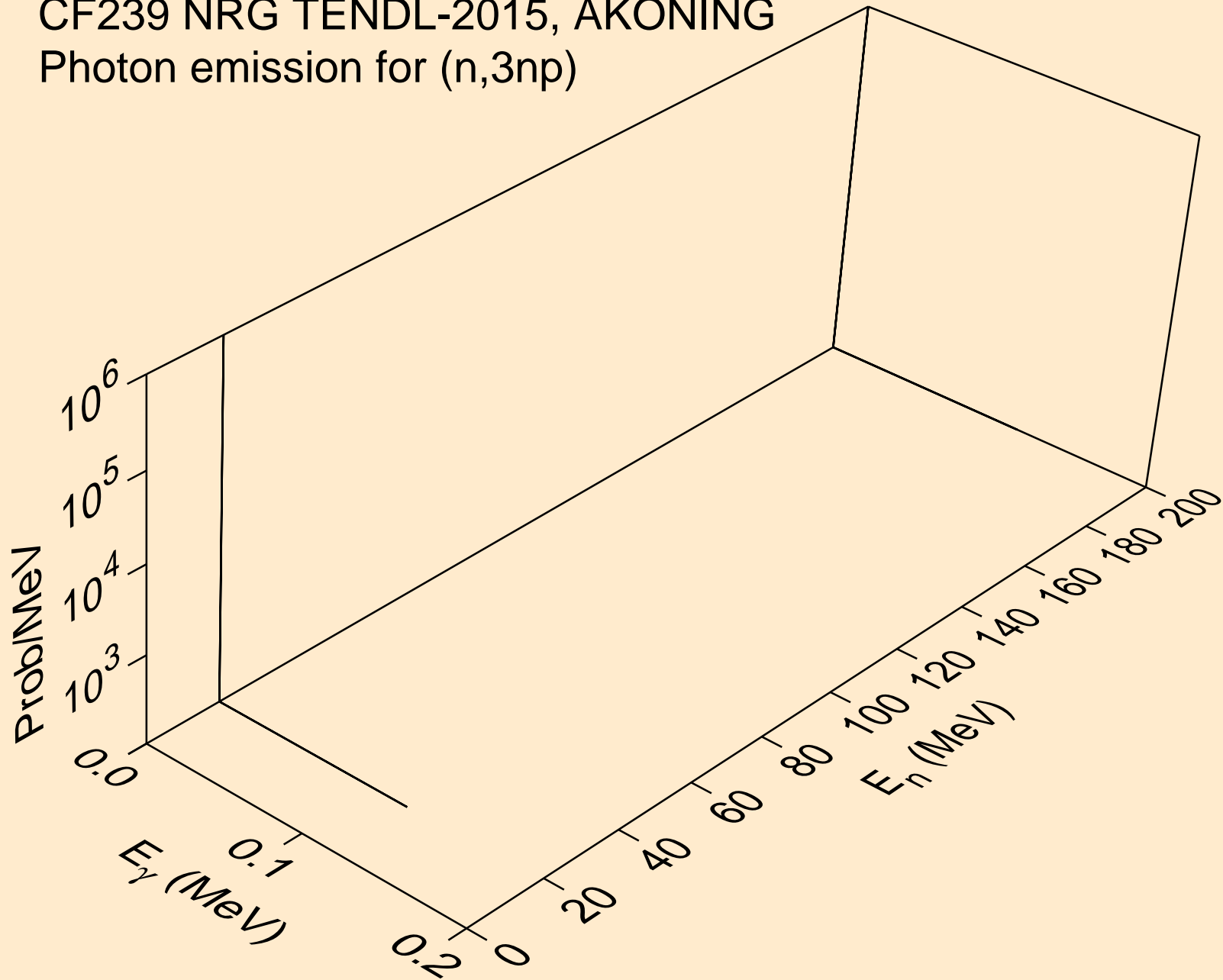

CF239 NRG TENDL-2015, AKONING
Photon emission for (n,2np)

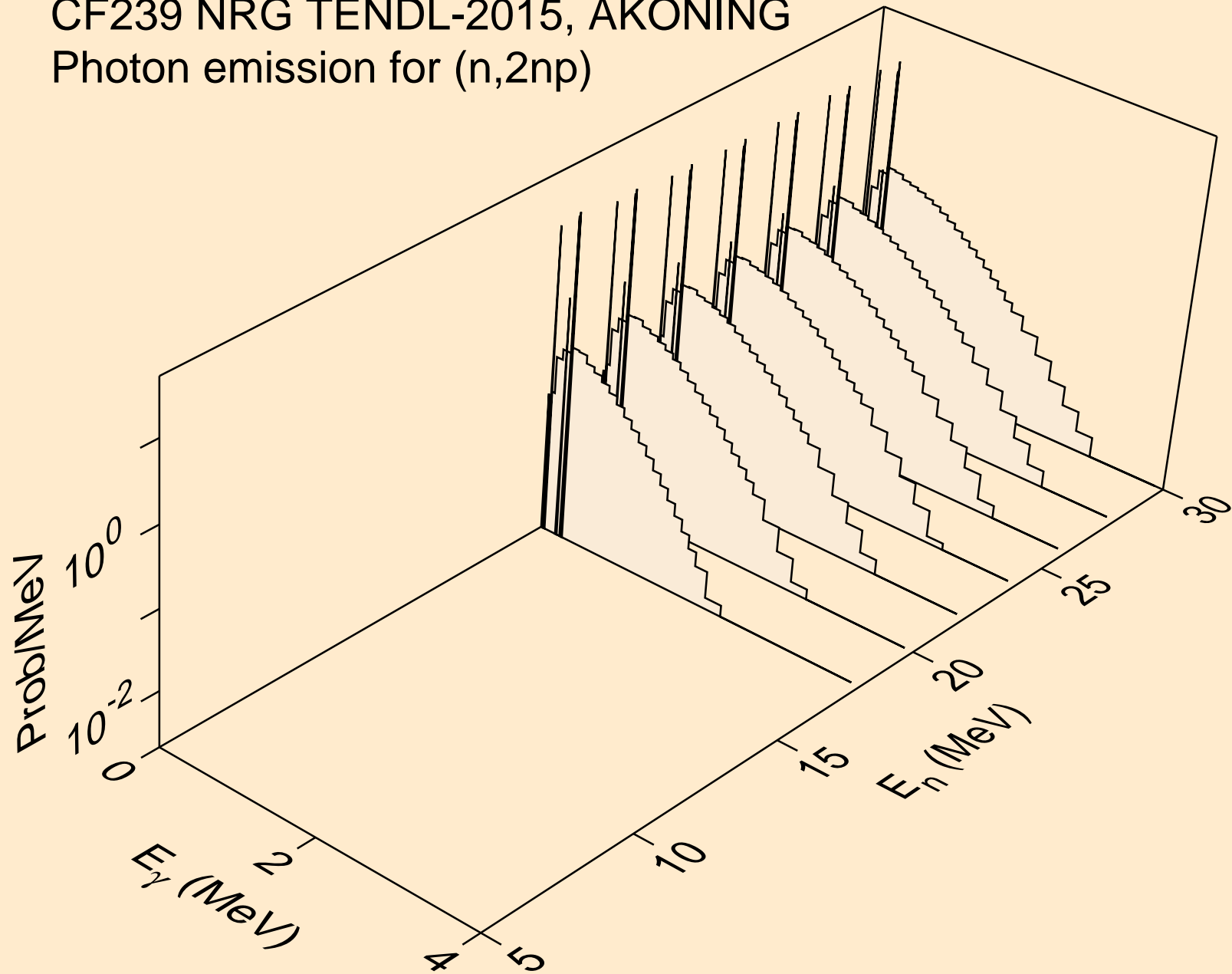

CF239 NRG TENDL-2015, AKONING
Photon emission for (n,npa)

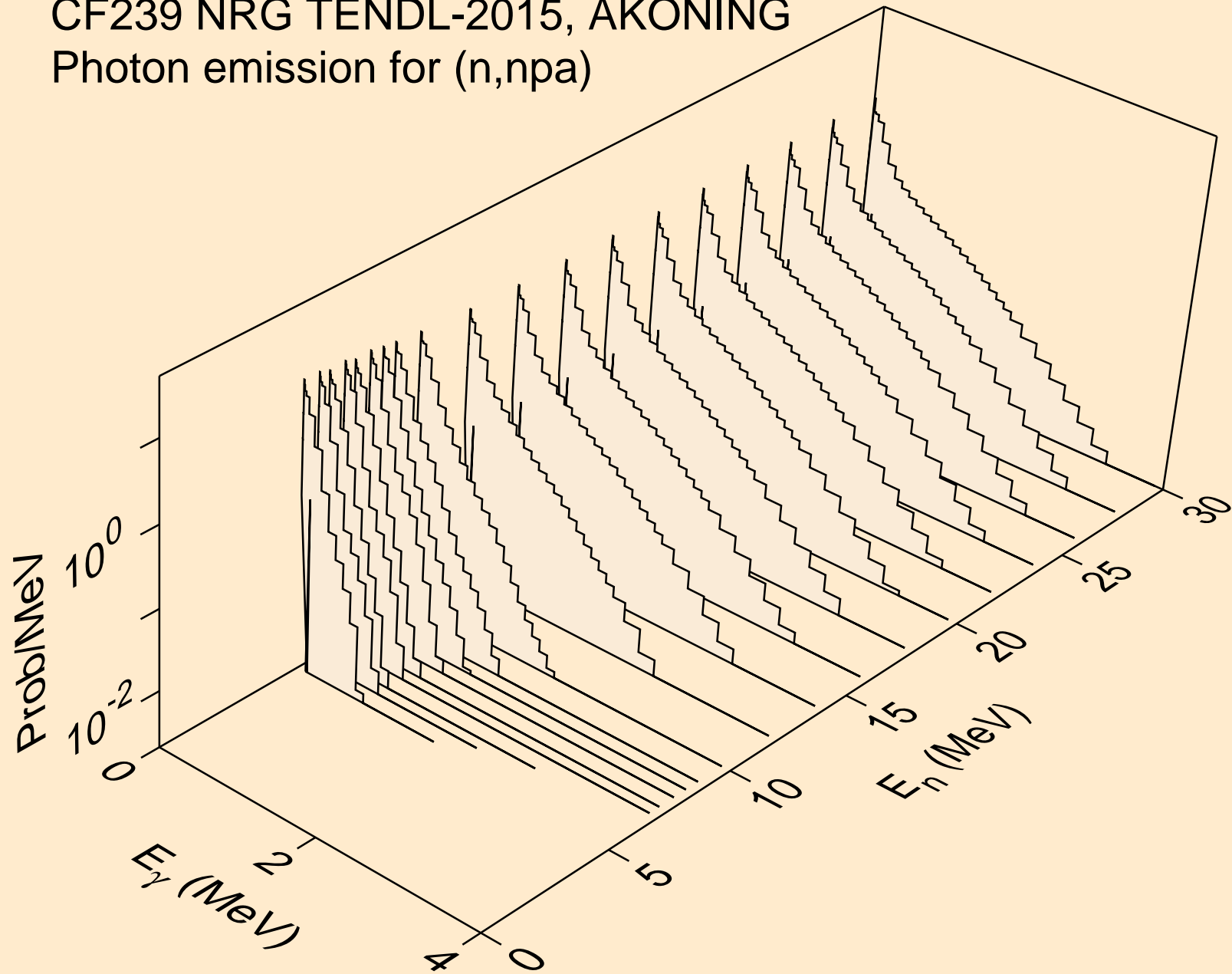

CF239 NRG TENDL-2015, AKONING
Photon emission for (n,n*c)

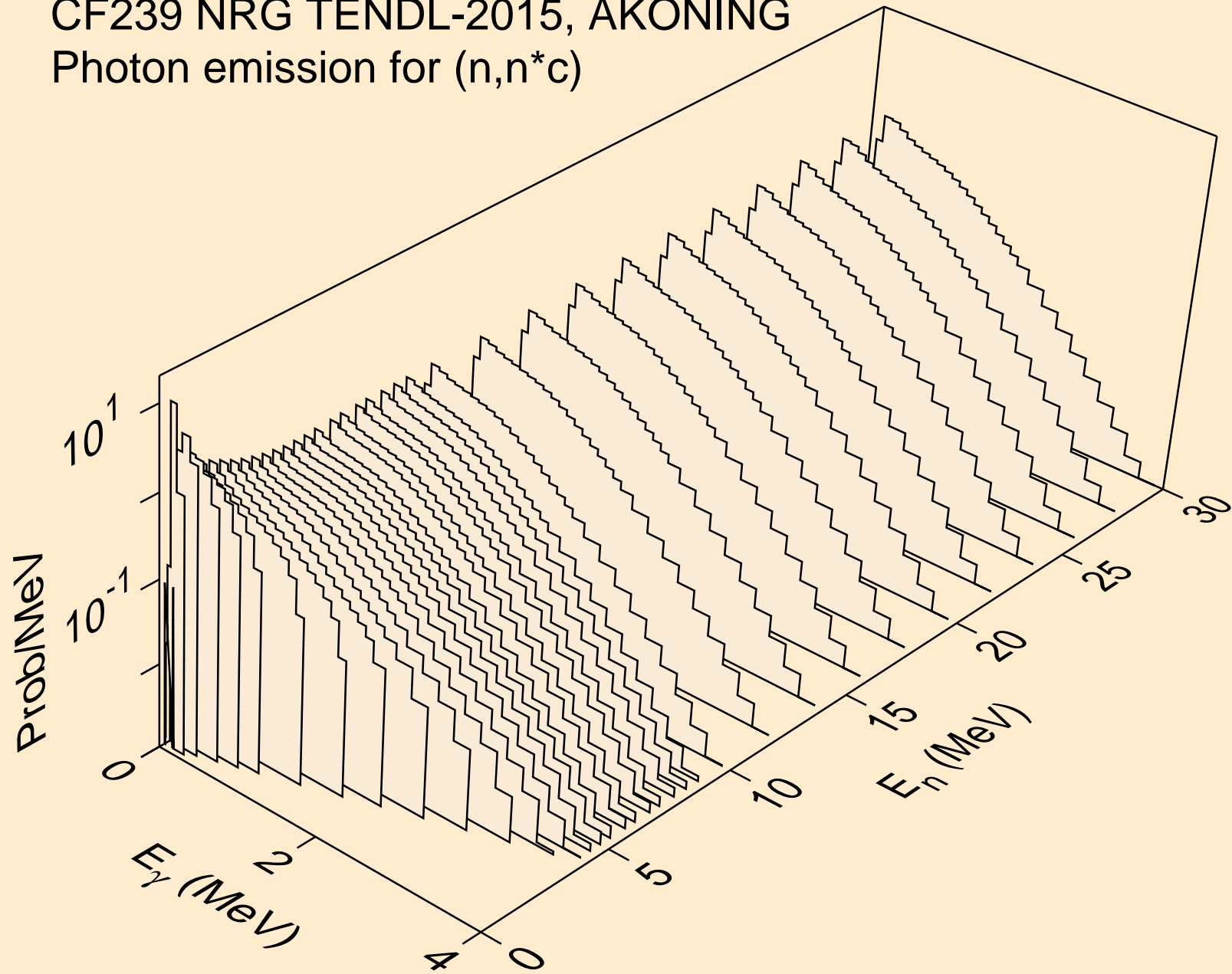

CF239 NRG TENDL-2015, AKONING
Photon emission for (n,gma)

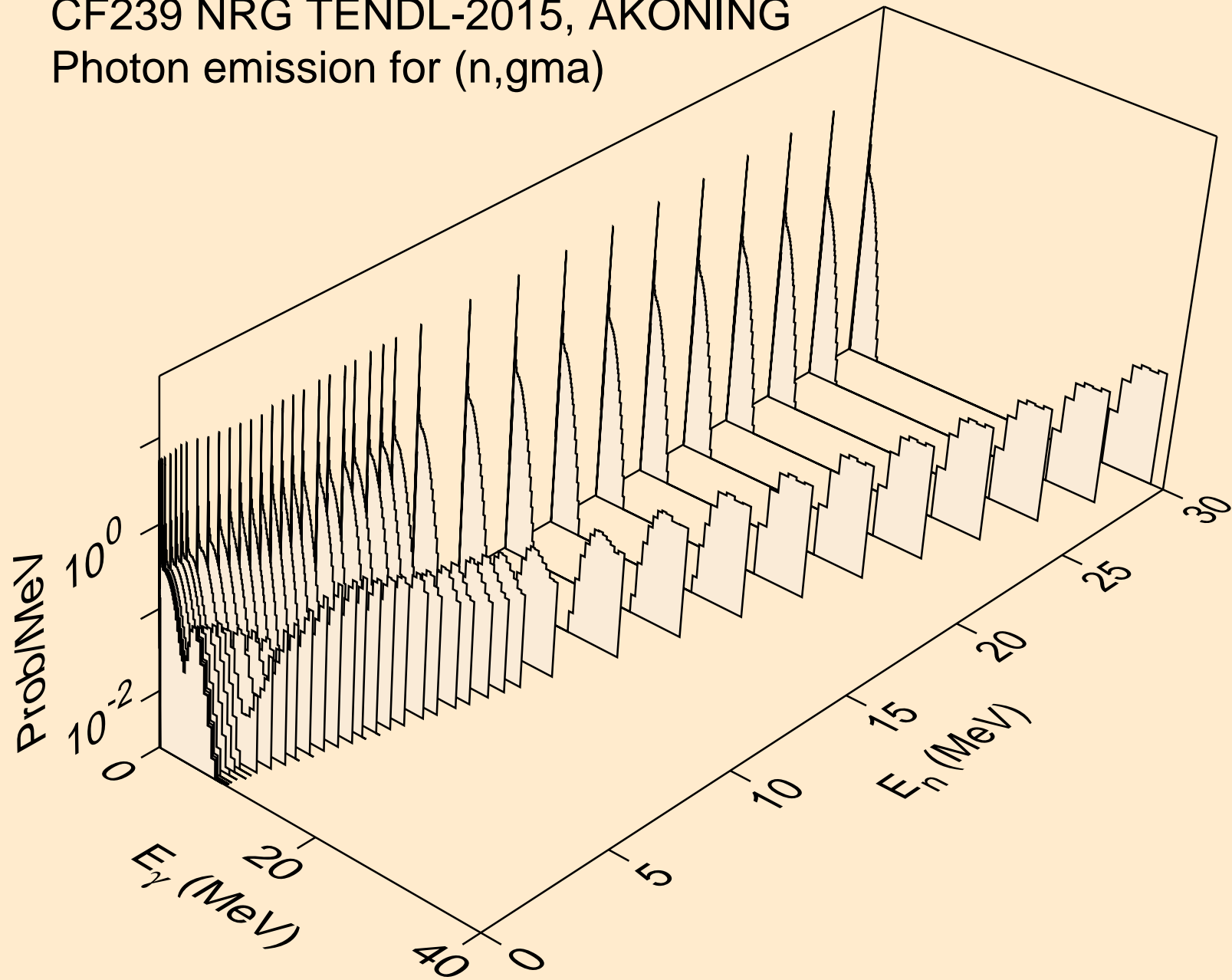

CF239 NRG TENDL-2015, AKONING
Photon emission for (n,p)

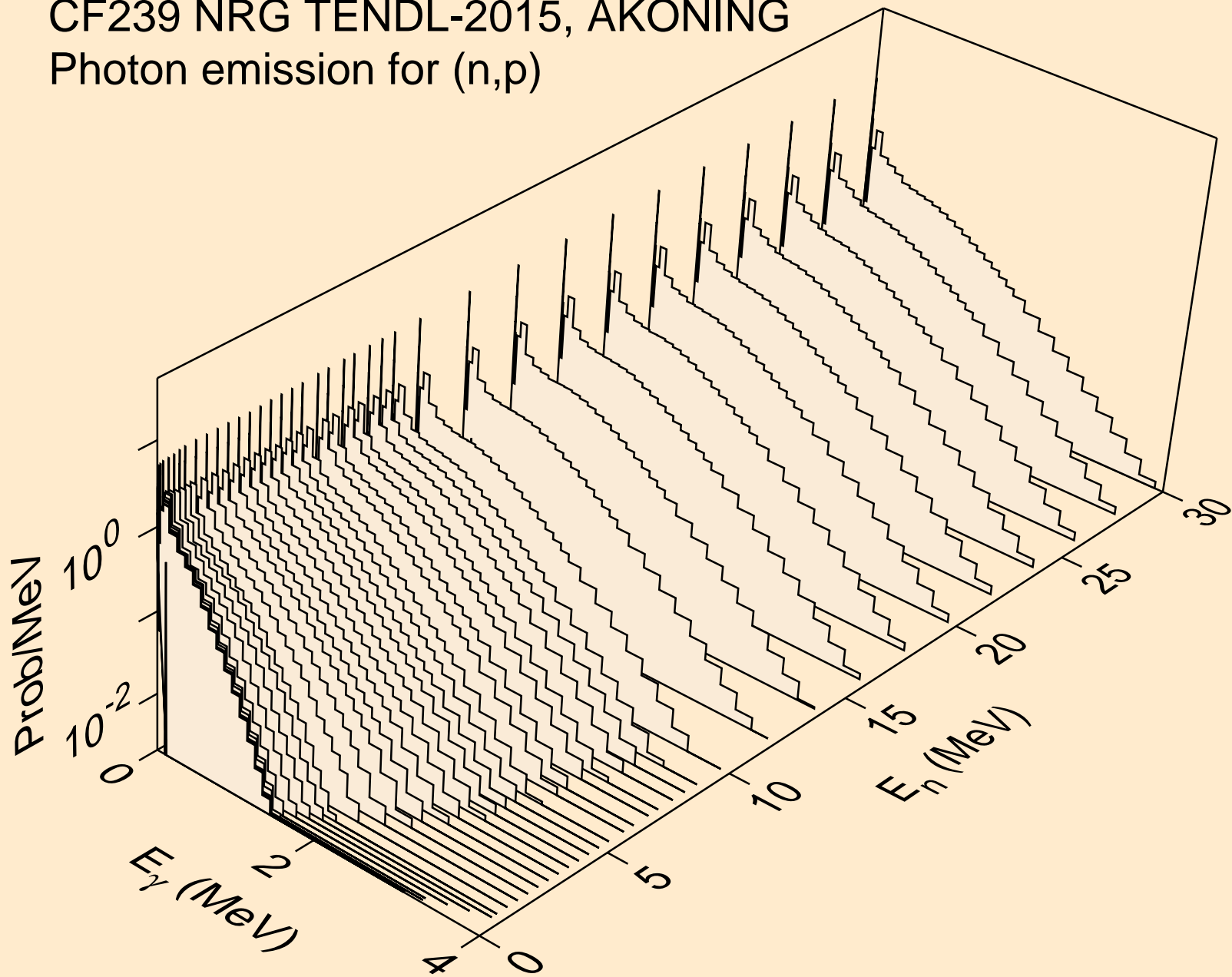

CF239 NRG TENDL-2015, AKONING
Photon emission for (n,d)

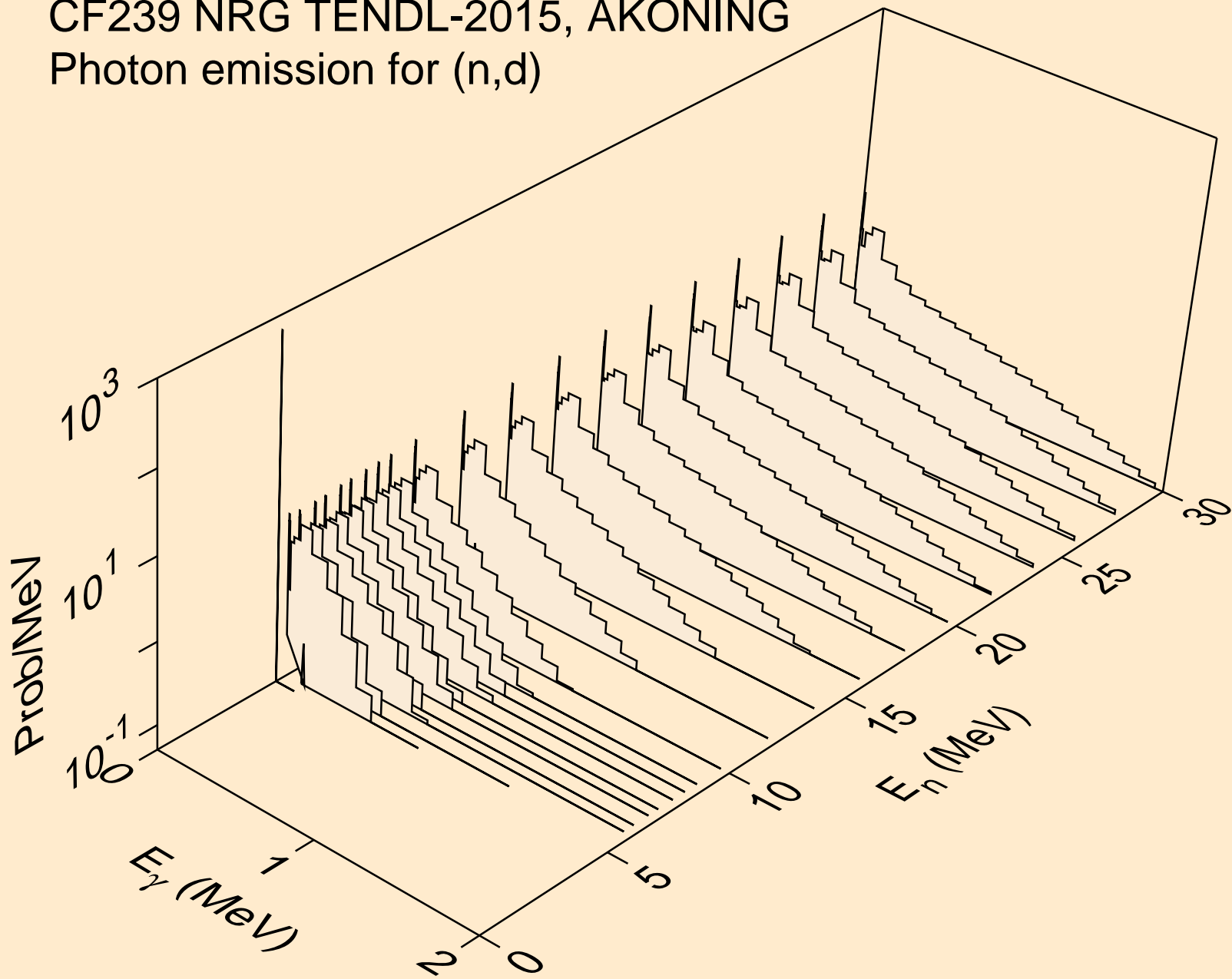

CF239 NRG TENDL-2015, AKONING
Photon emission for (n,t)

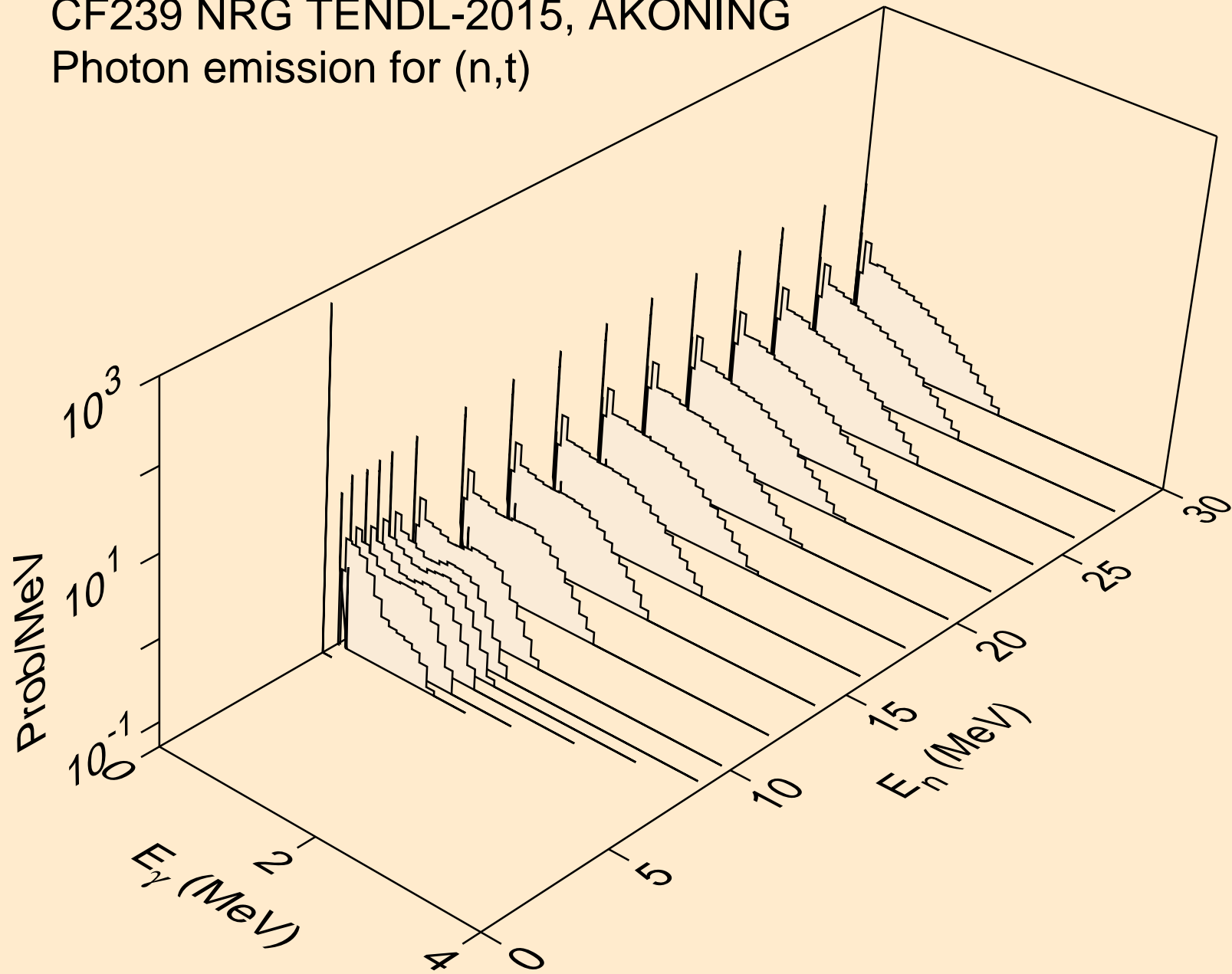

CF239 NRG TENDL-2015, AKONING
Photon emission for (n,he3)

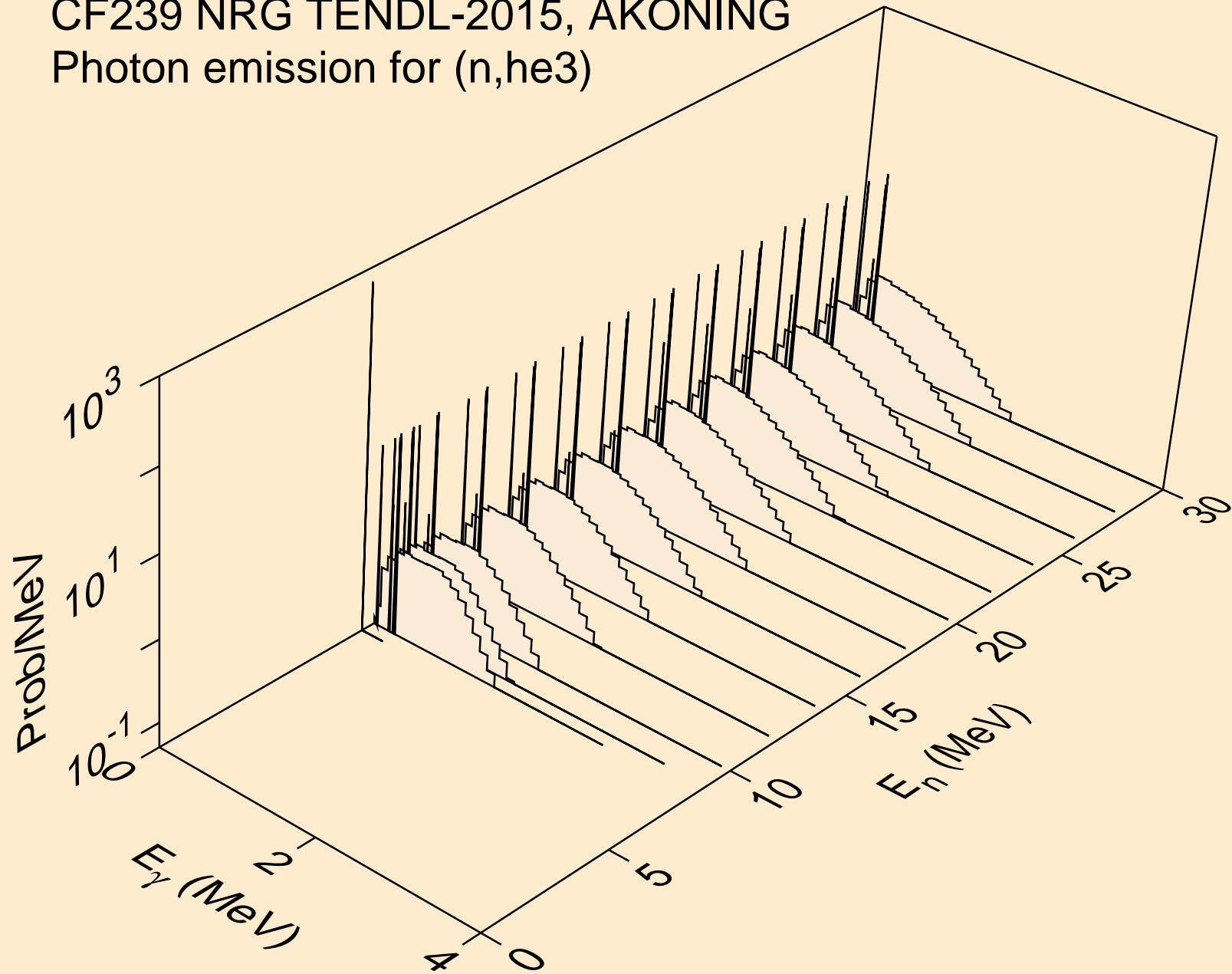

CF239 NRG TENDL-2015, AKONING
Photon emission for (n,a)

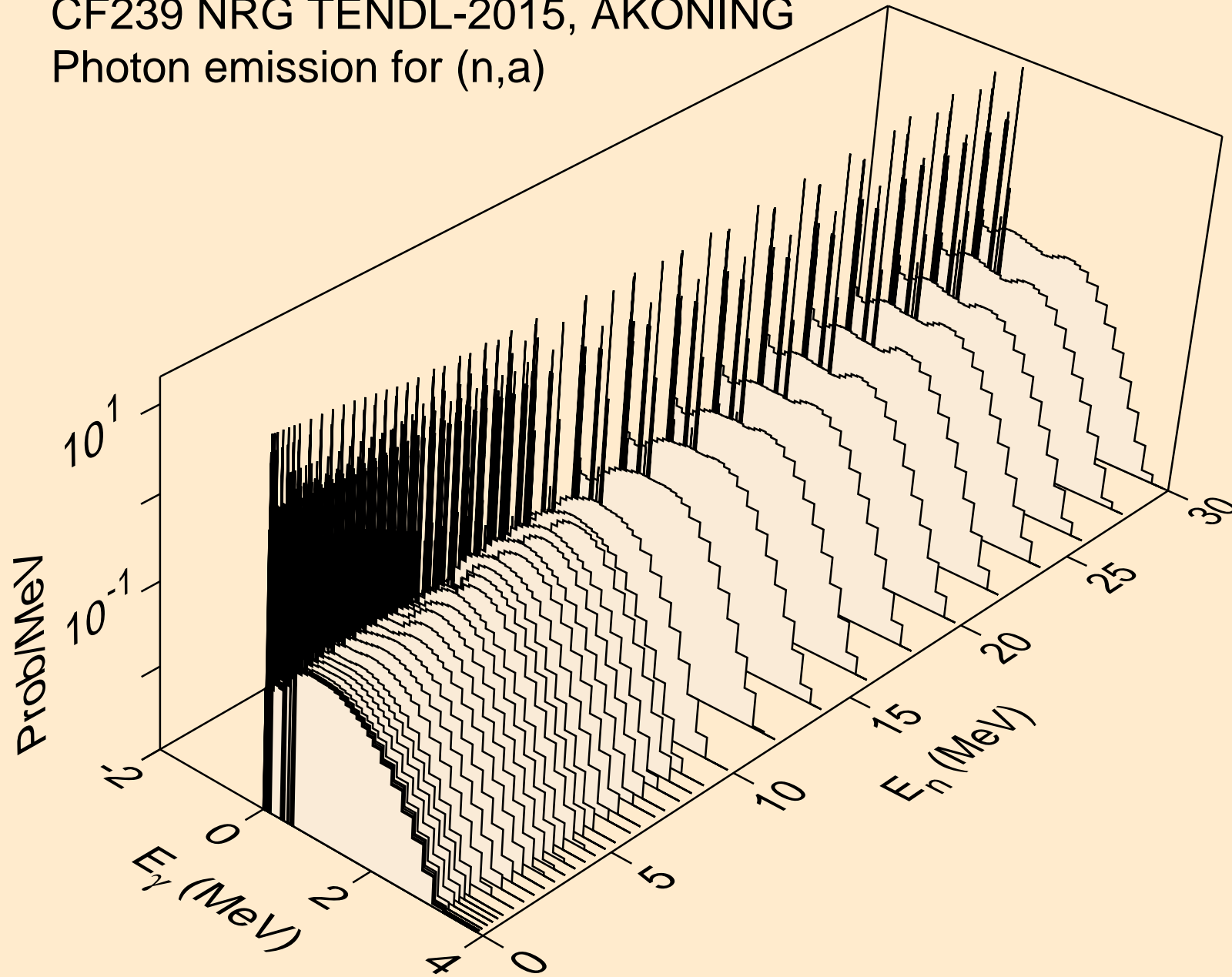

CF239 NRG TENDL-2015, AKONING
Photon emission for (n,2a)

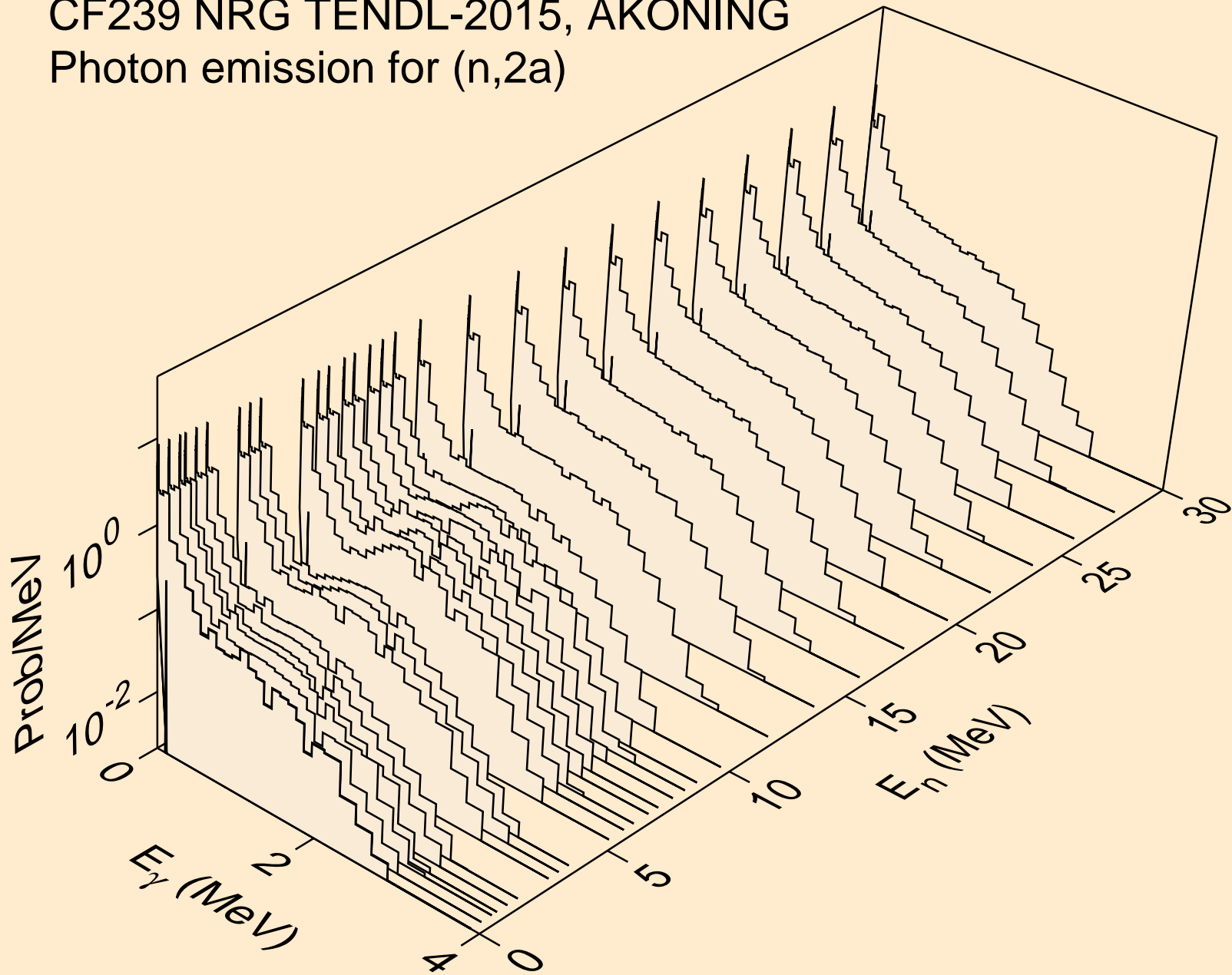

CF239 NRG TENDL-2015, AKONING
Photon emission for (n,3a)

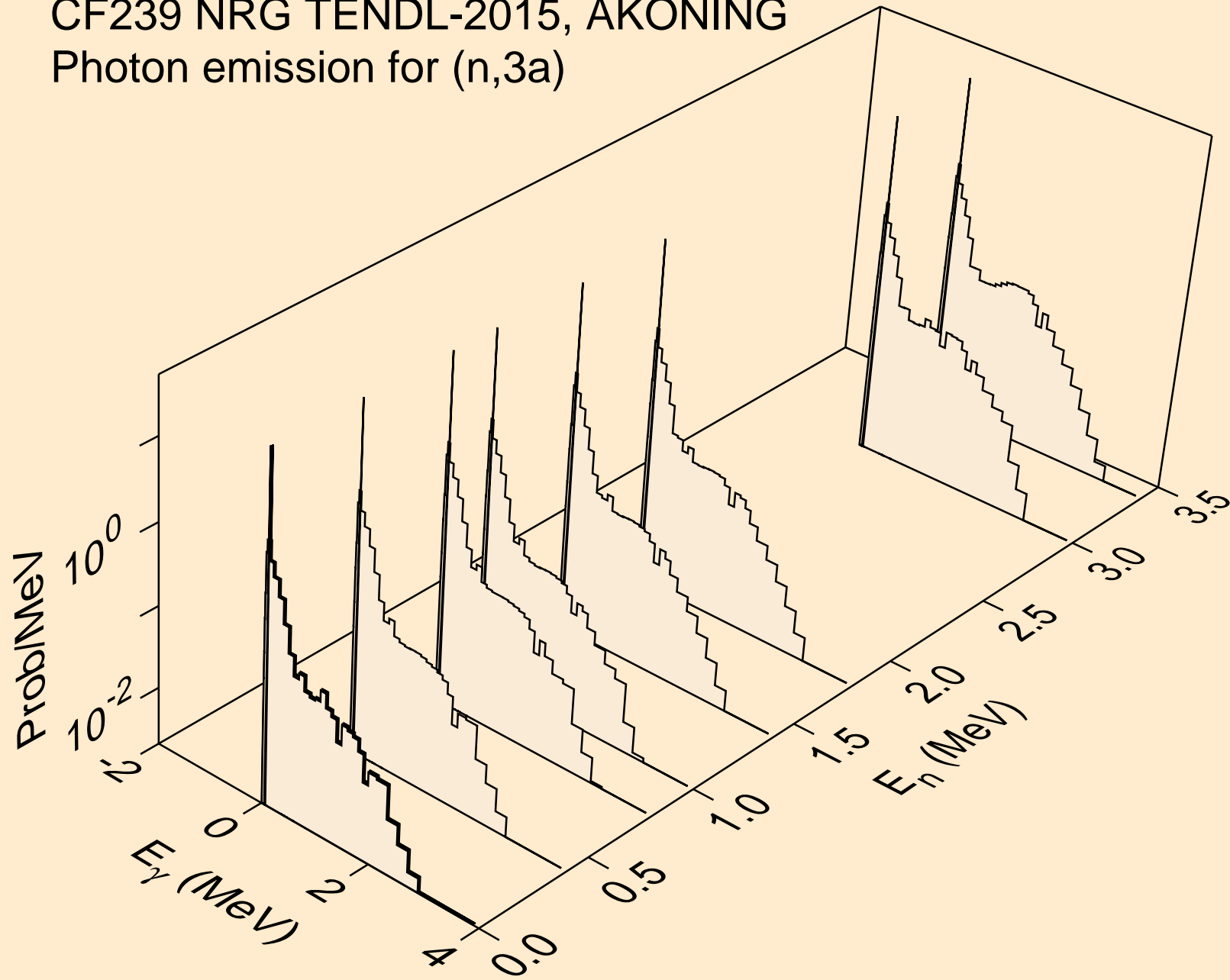

CF239 NRG TENDL-2015, AKONING
Photon emission for (n,2p)

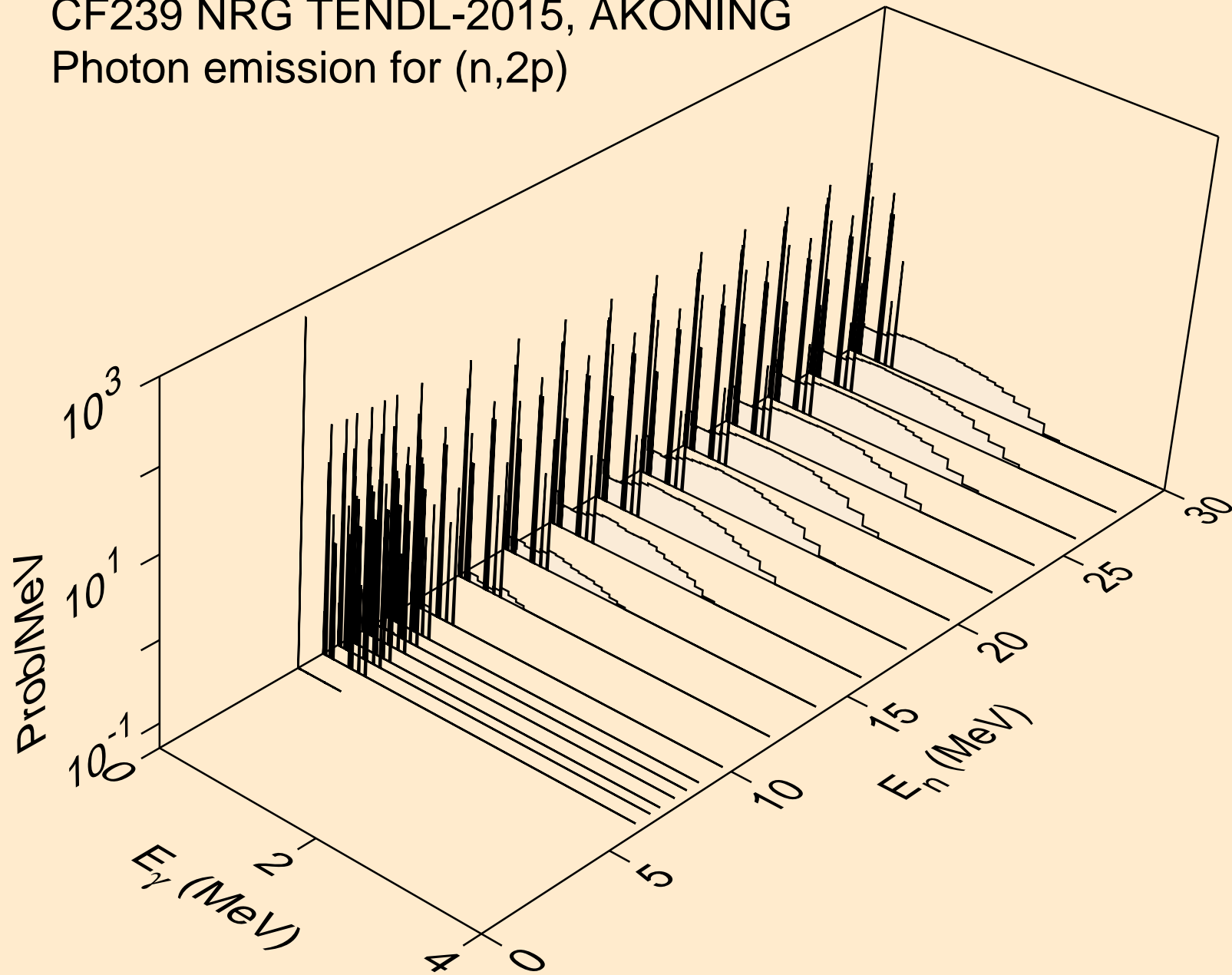

CF239 NRG TENDL-2015, AKONING
Photon emission for (n,pa)

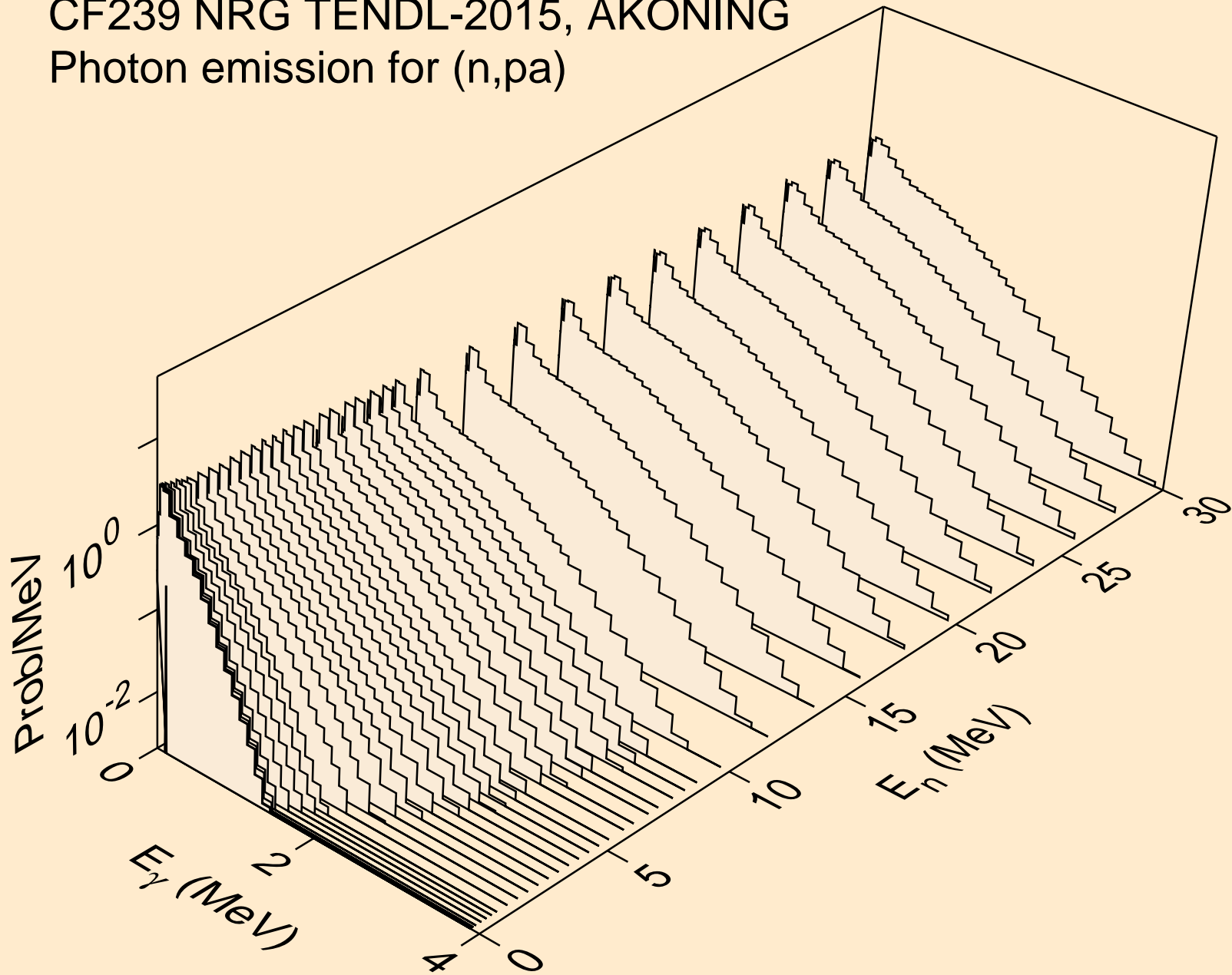

CF239 NRG TENDL-2015, AKONING
Photon emission for (n,t2a)

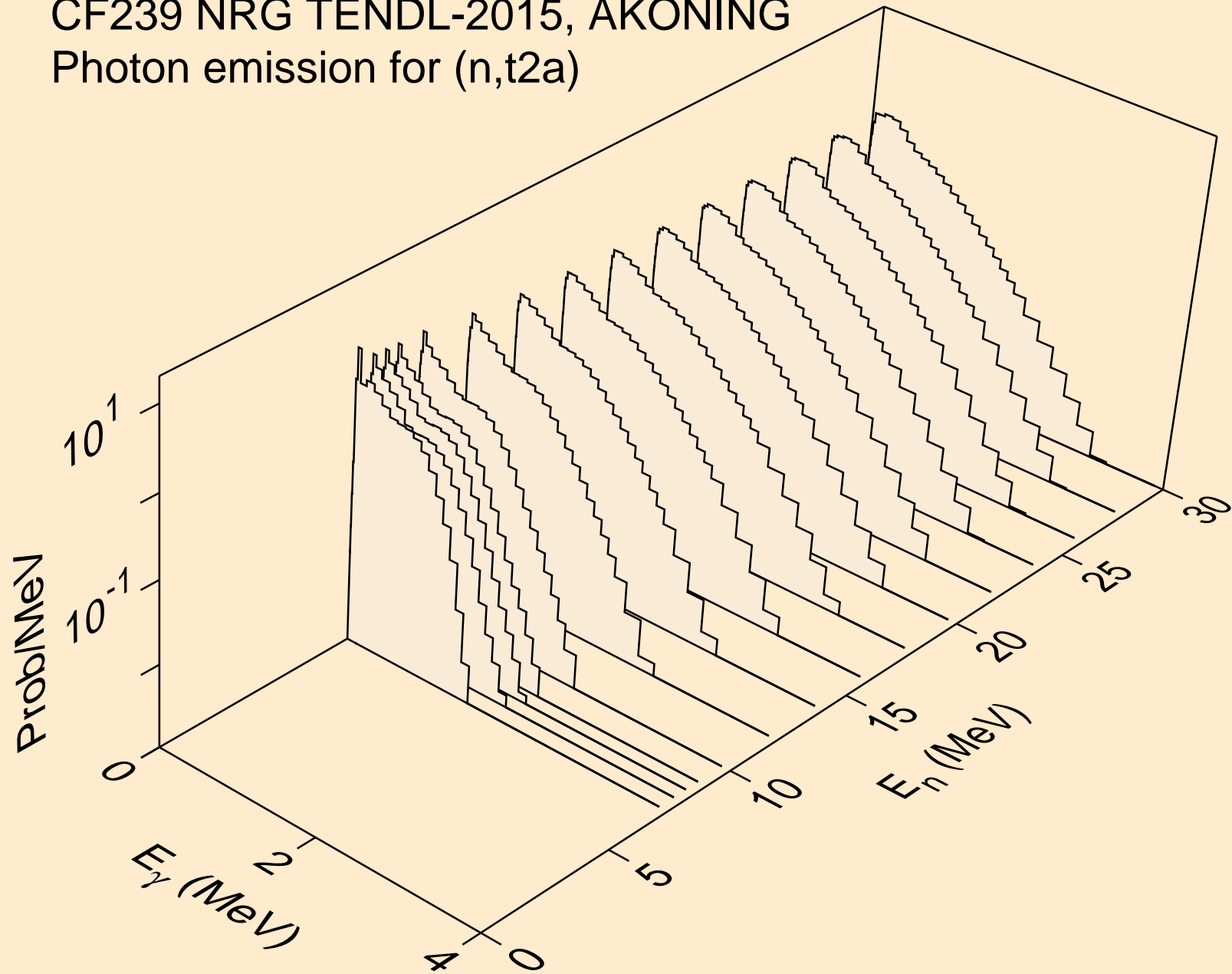

CF239 NRG TENDL-2015, AKONING
Photon emission for (n,d2a)

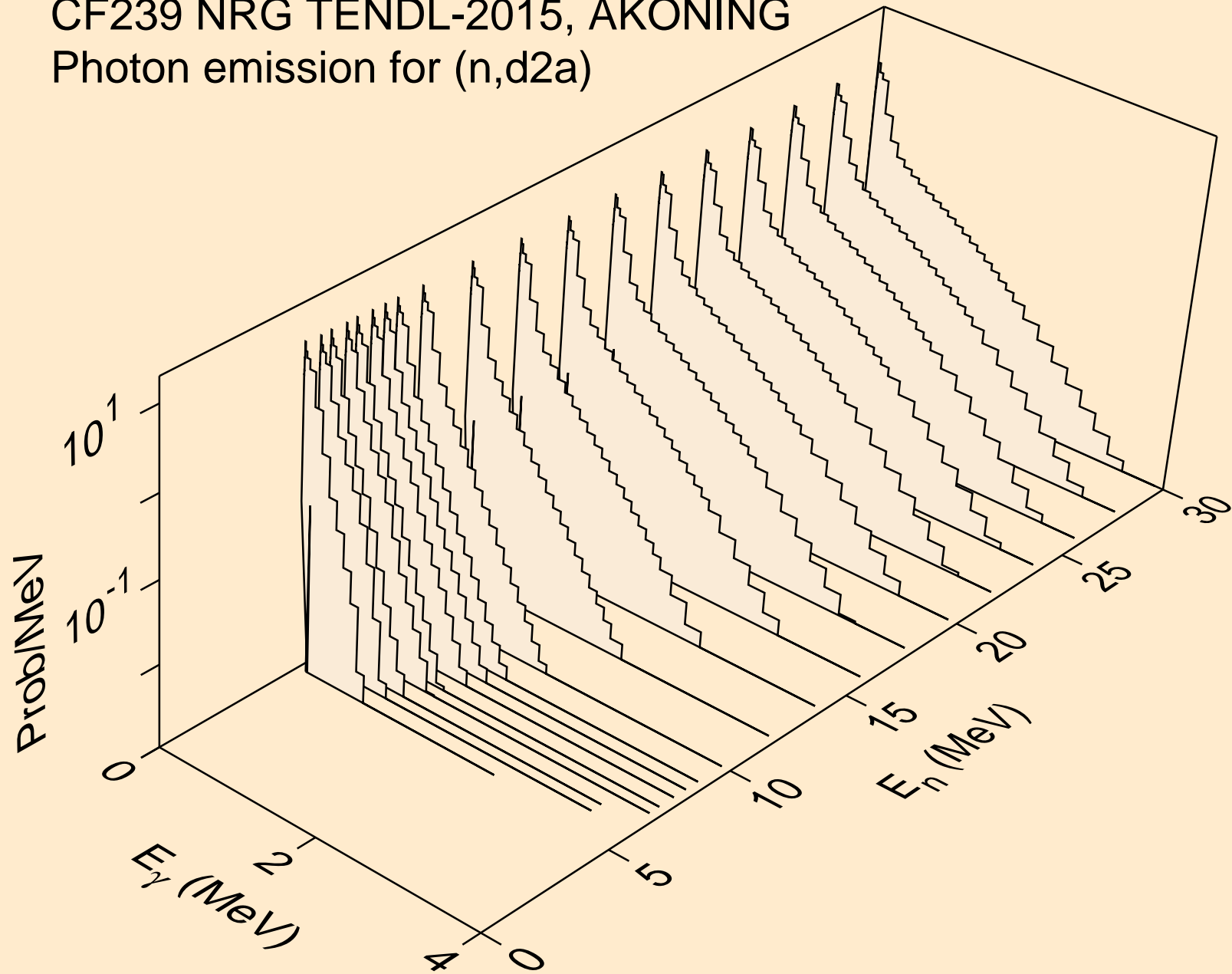

CF239 NRG TENDL-2015, AKONING
Photon emission for (n,pd)

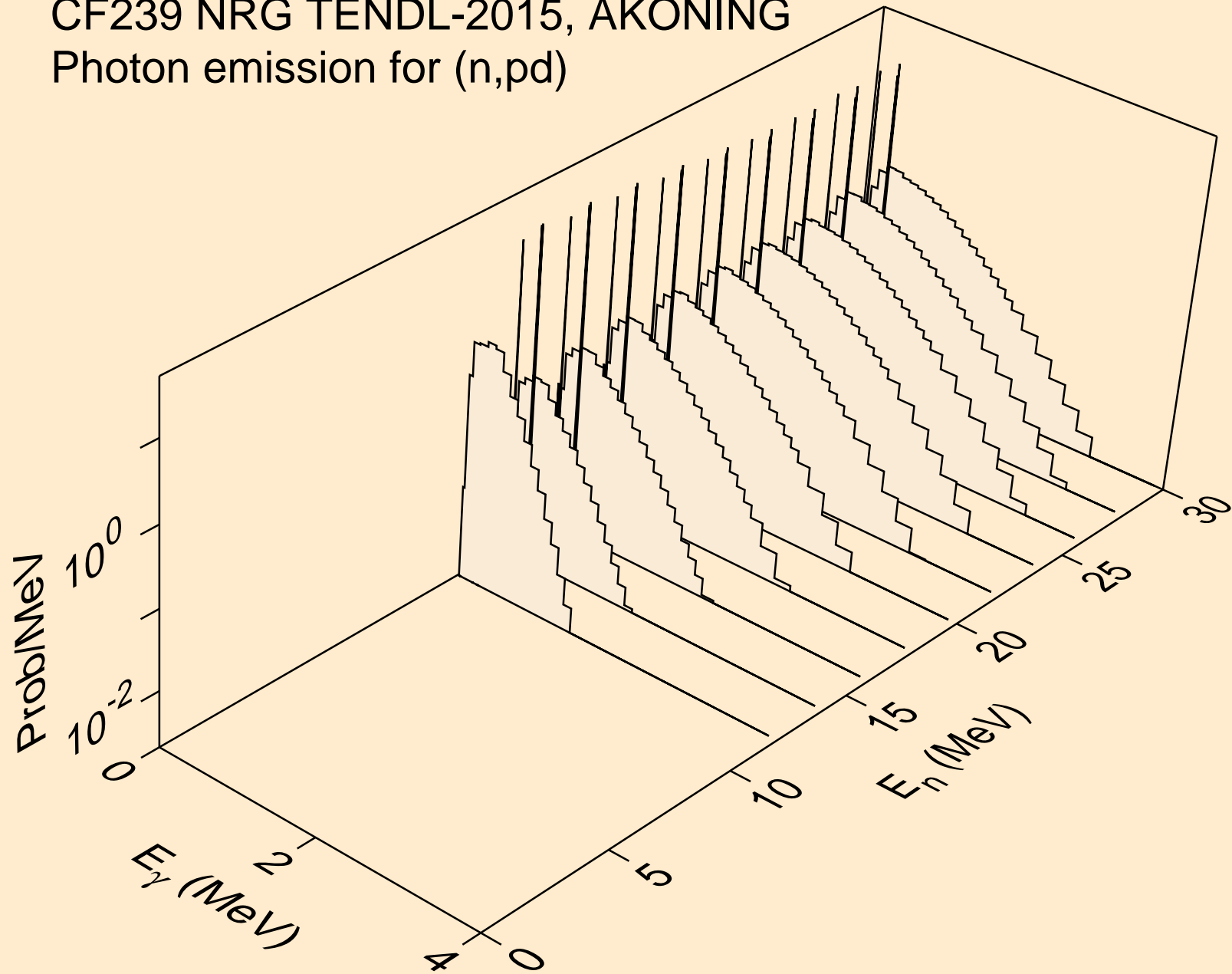

CF239 NRG TENDL-2015, AKONING
Photon emission for (n,da)

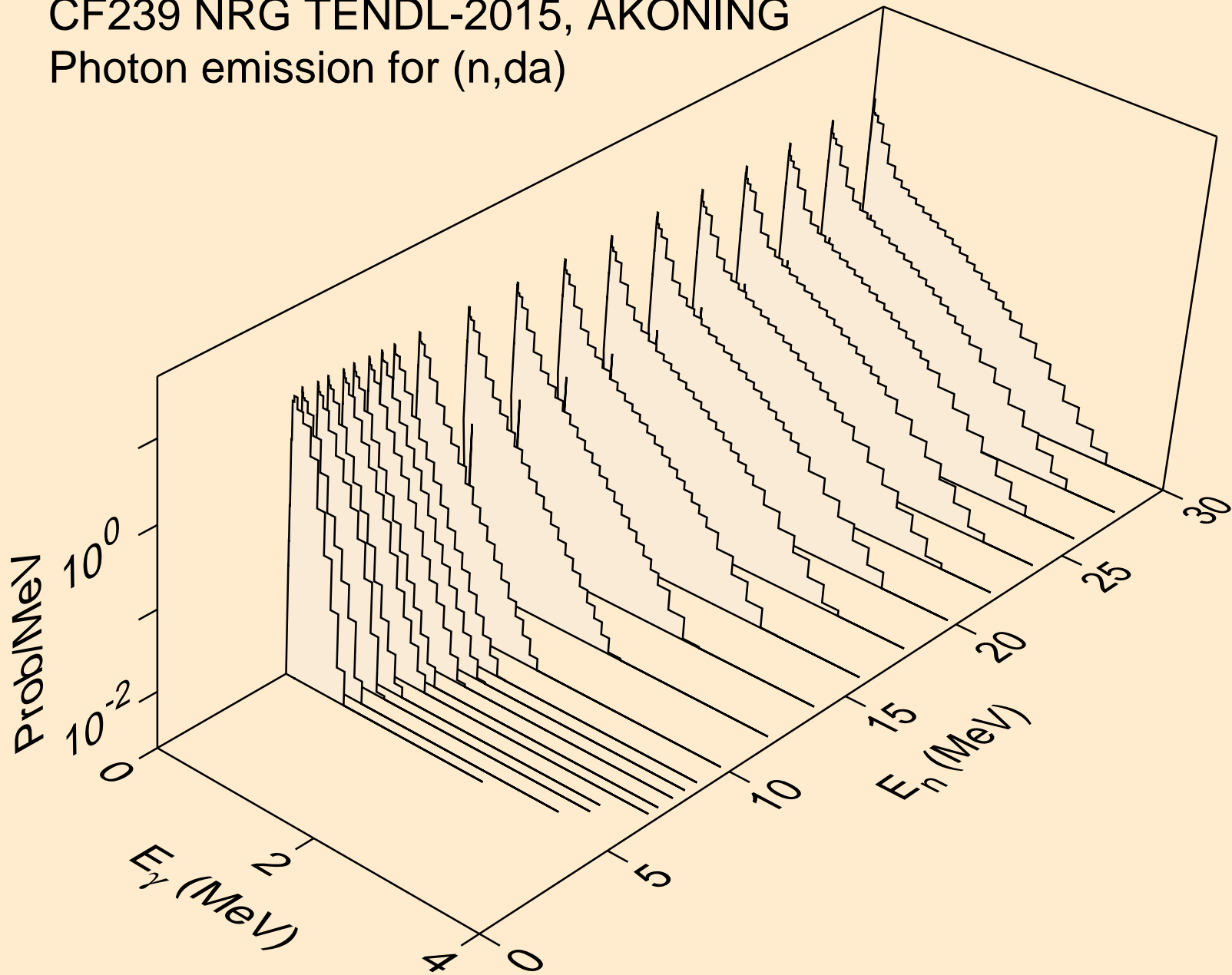

CF239 NRG TENDL-2015, AKONING
thermal capture photon spectrum

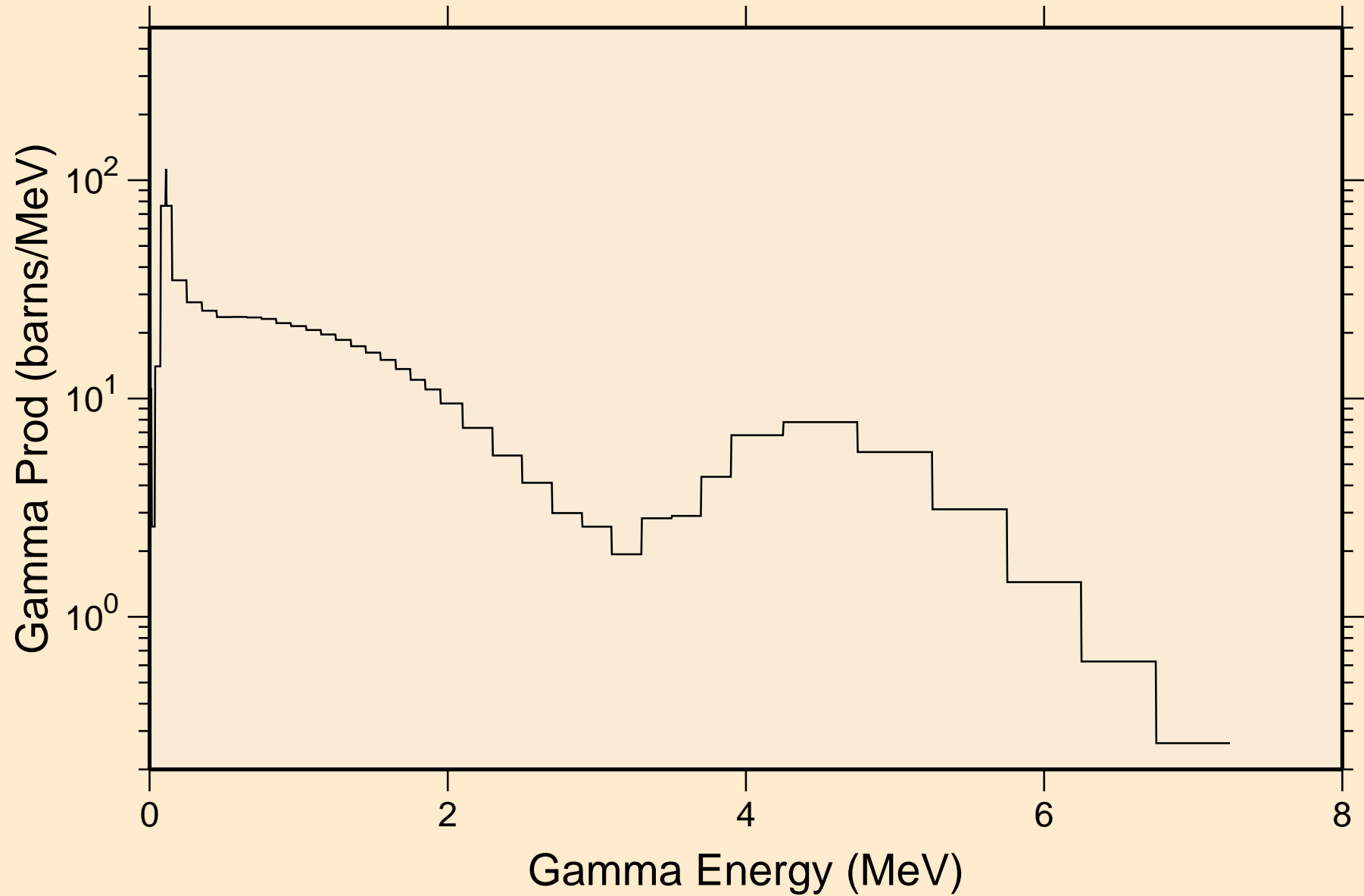

CF239 NRG TENDL-2015, AKONING
14 MeV photon spectrum

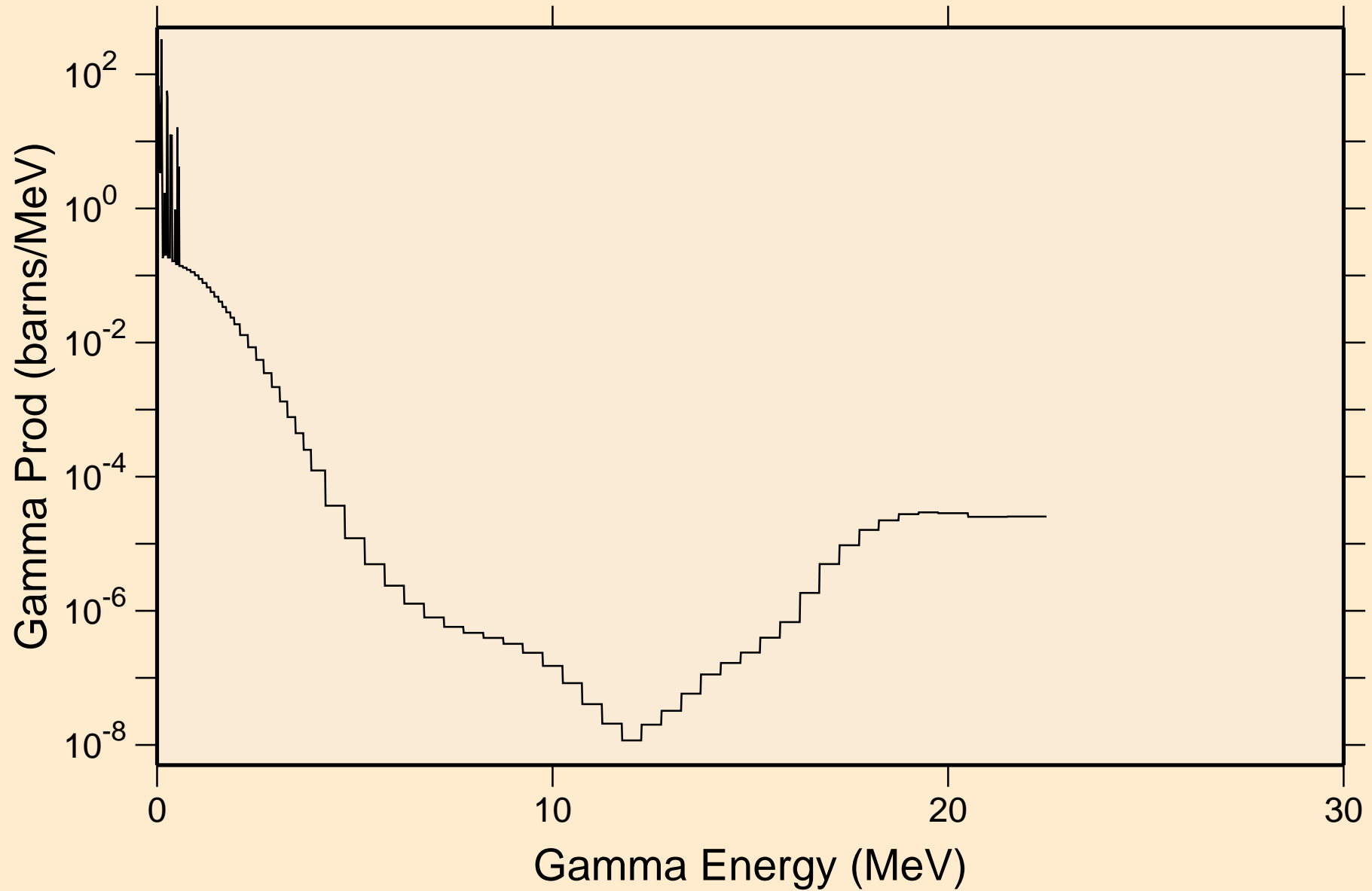

CF239 NRG TENDL-2015, AKONING

Particle heating contributions

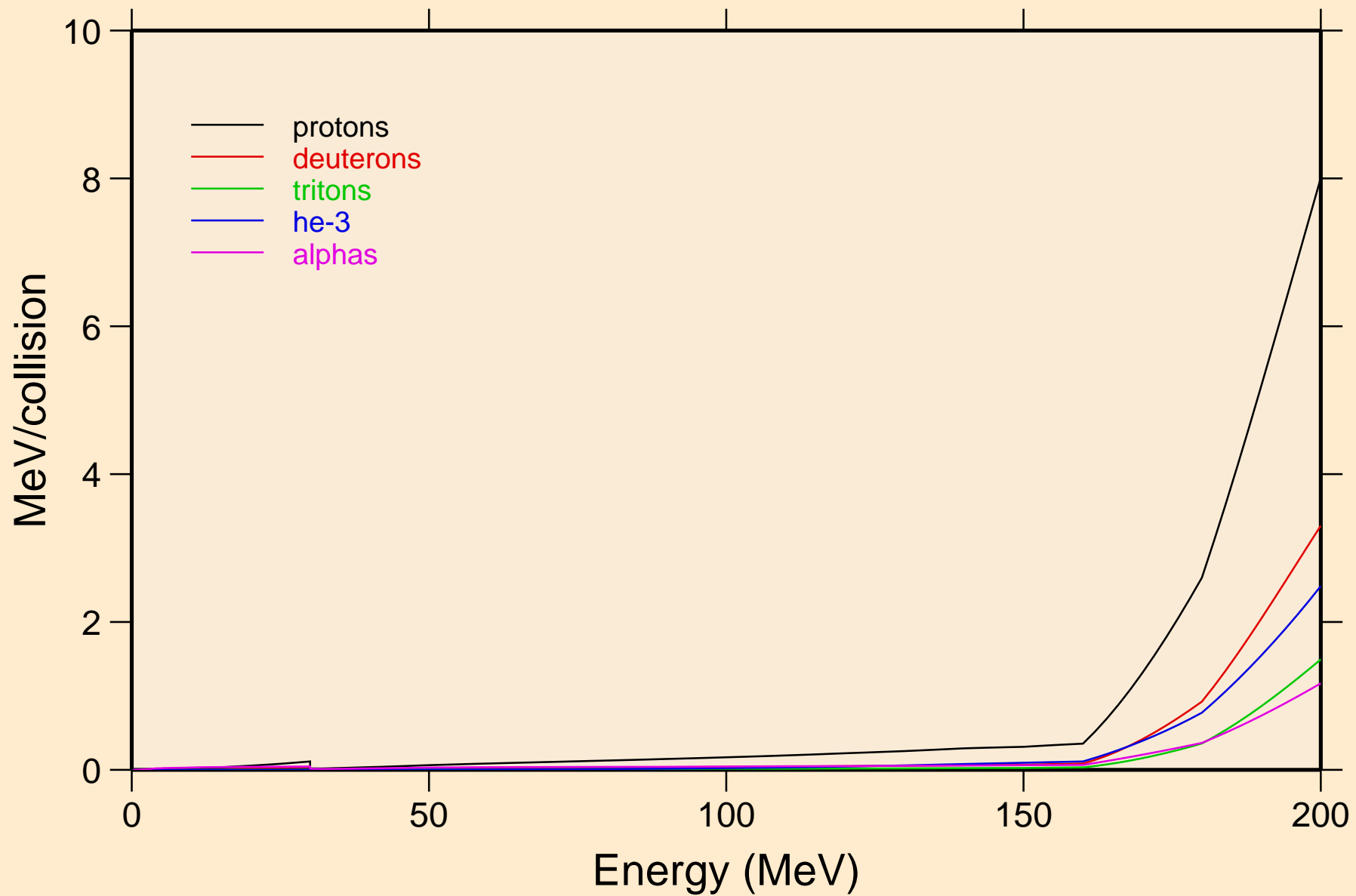

CF239 NRG TENDL-2015, AKONING

Recoil Heating

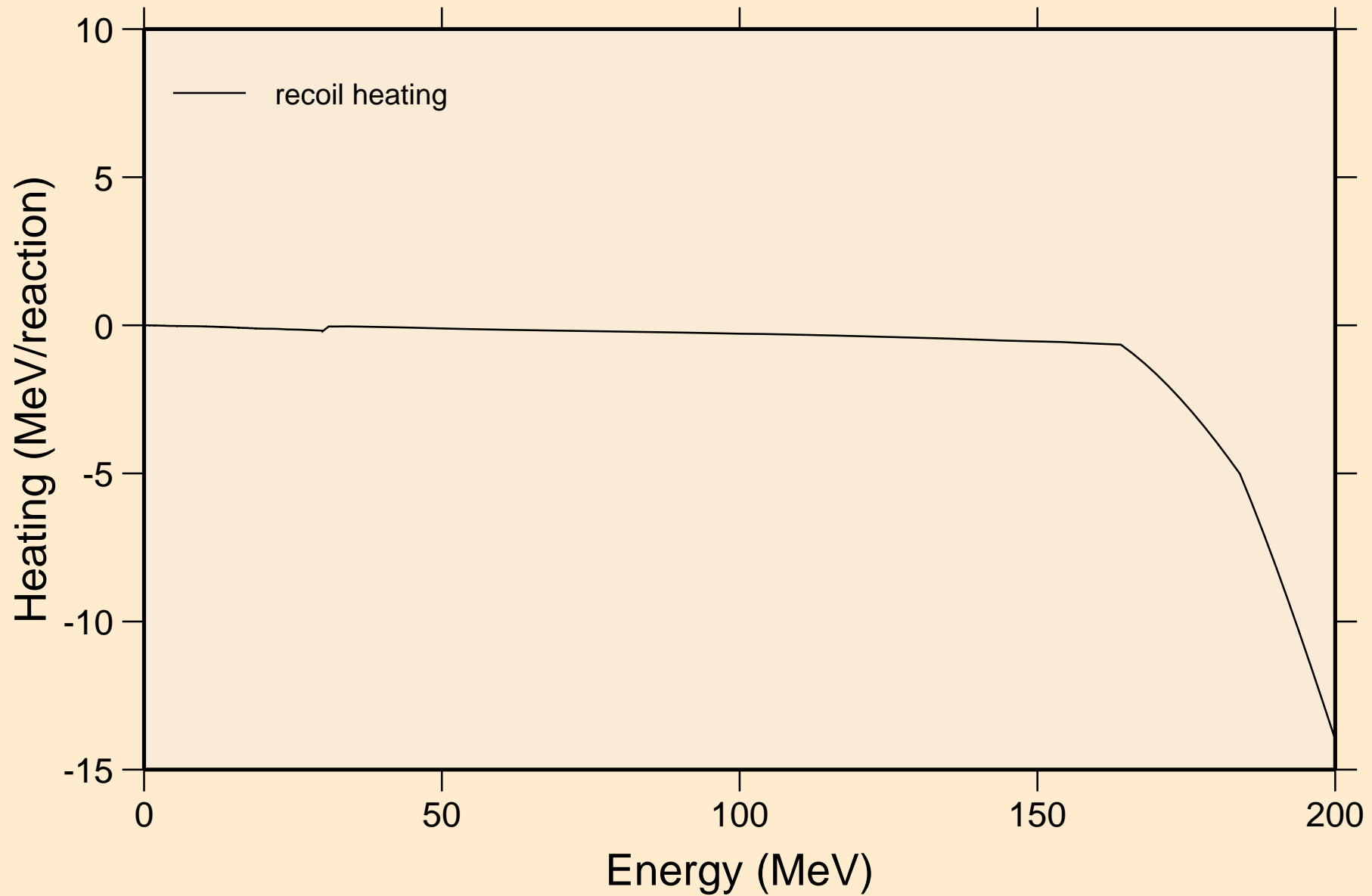

CF239 NRG TENDL-2015, AKONING

Particle production cross sections

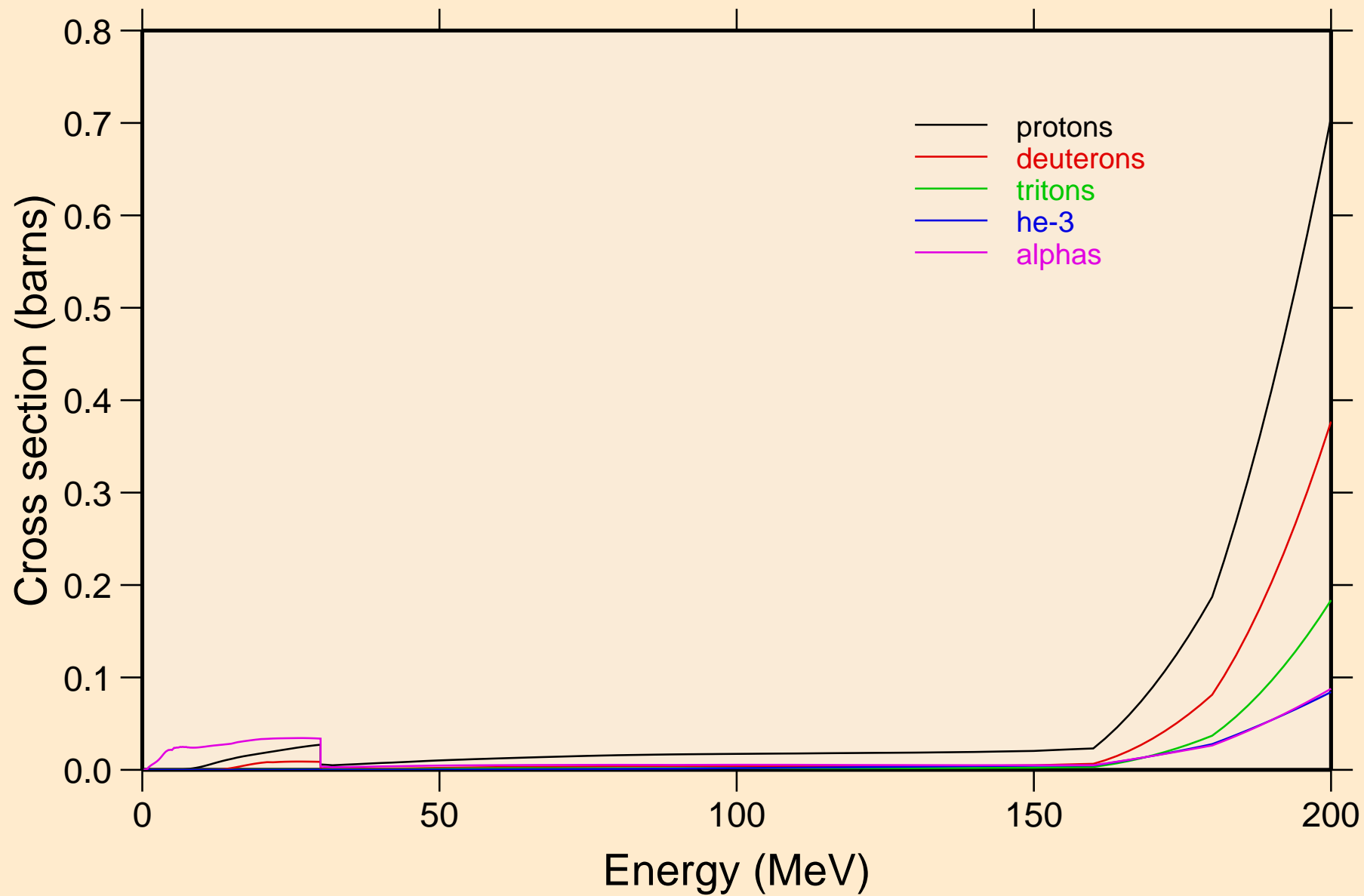

CF239 NRG TENDL-2015, AKONING
protons from (n,x)

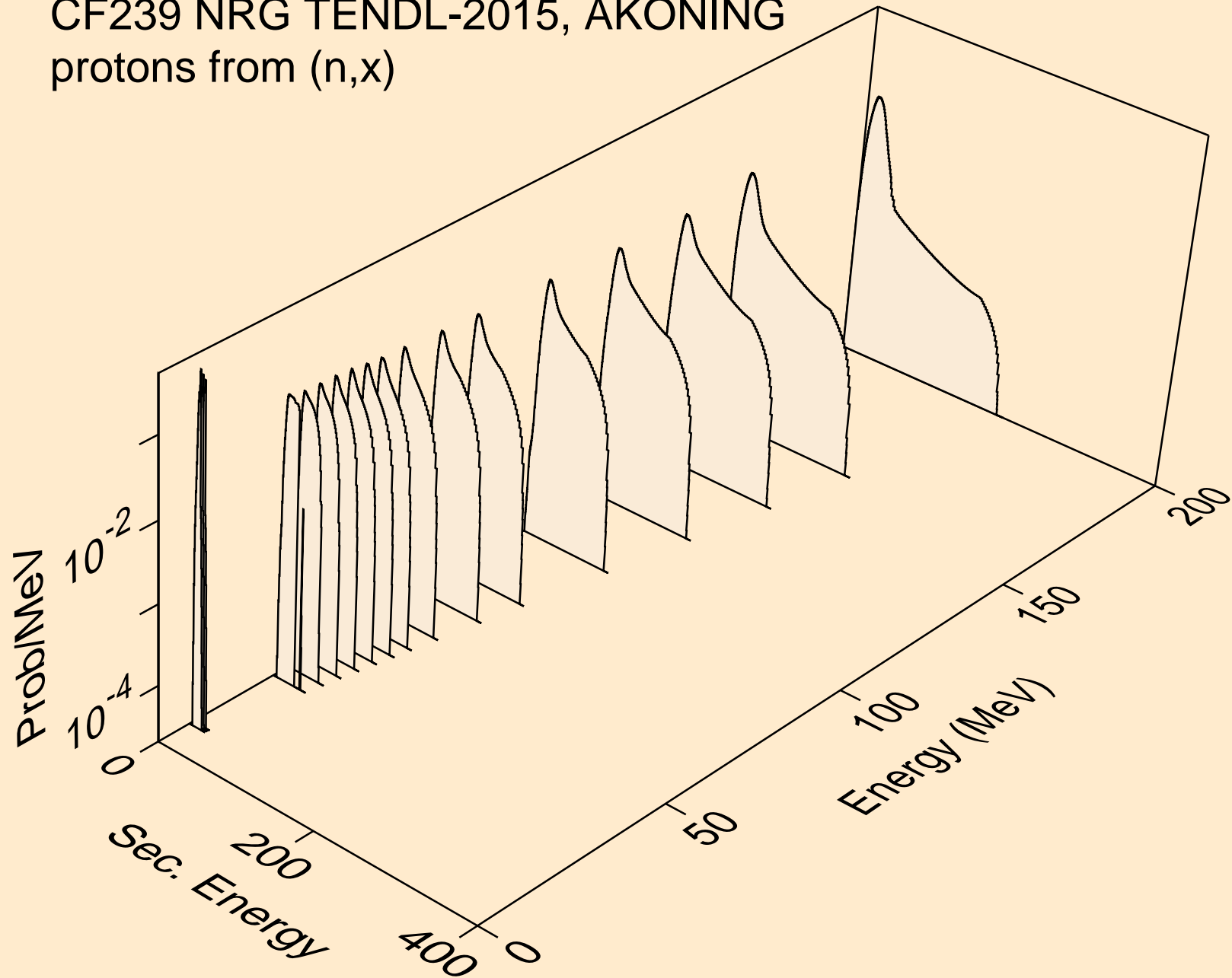

CF239 NRG TENDL-2015, AKONING
protons from (n,n*)p

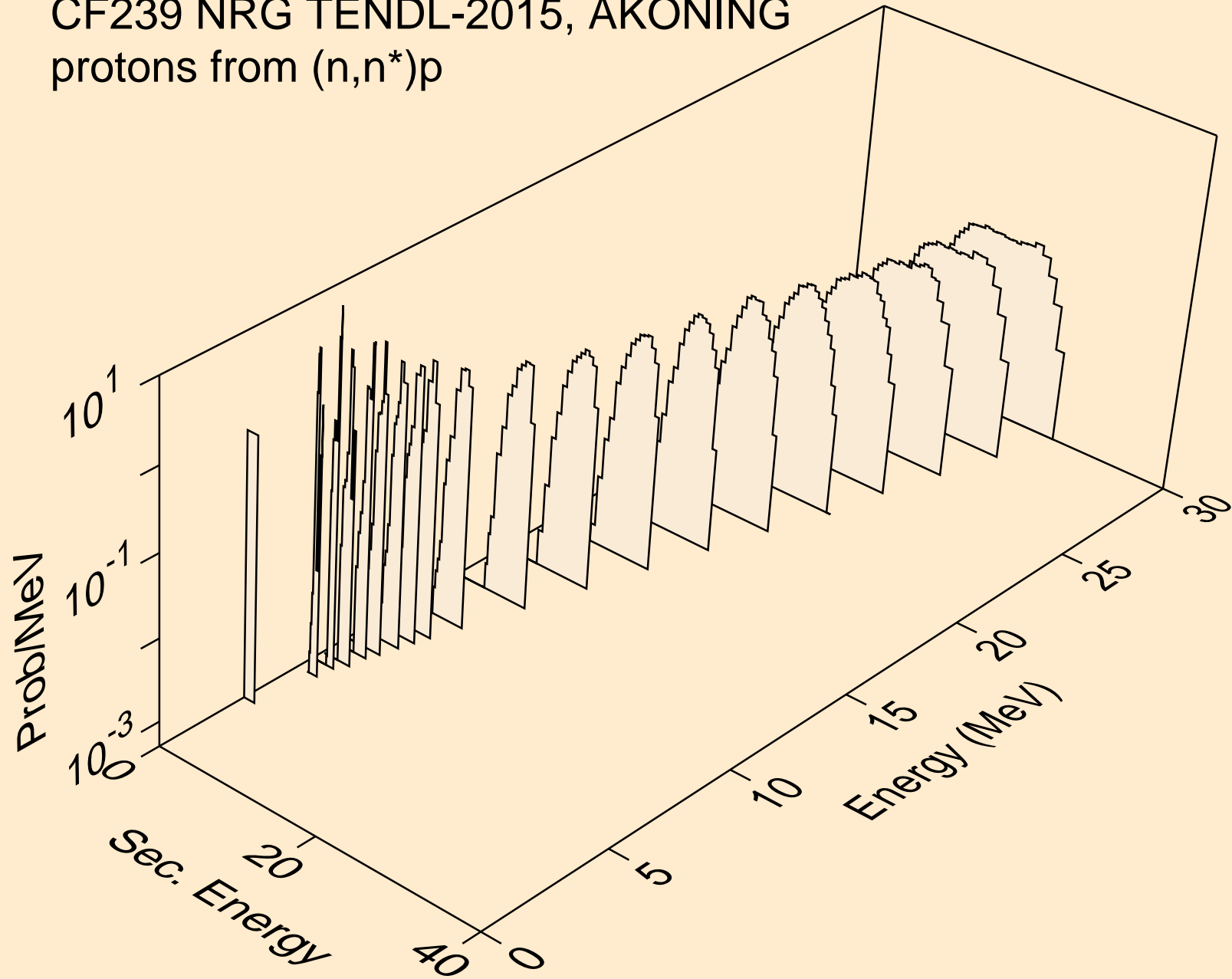

CF239 NRG TENDL-2015, AKONING
protons from (n,2np)

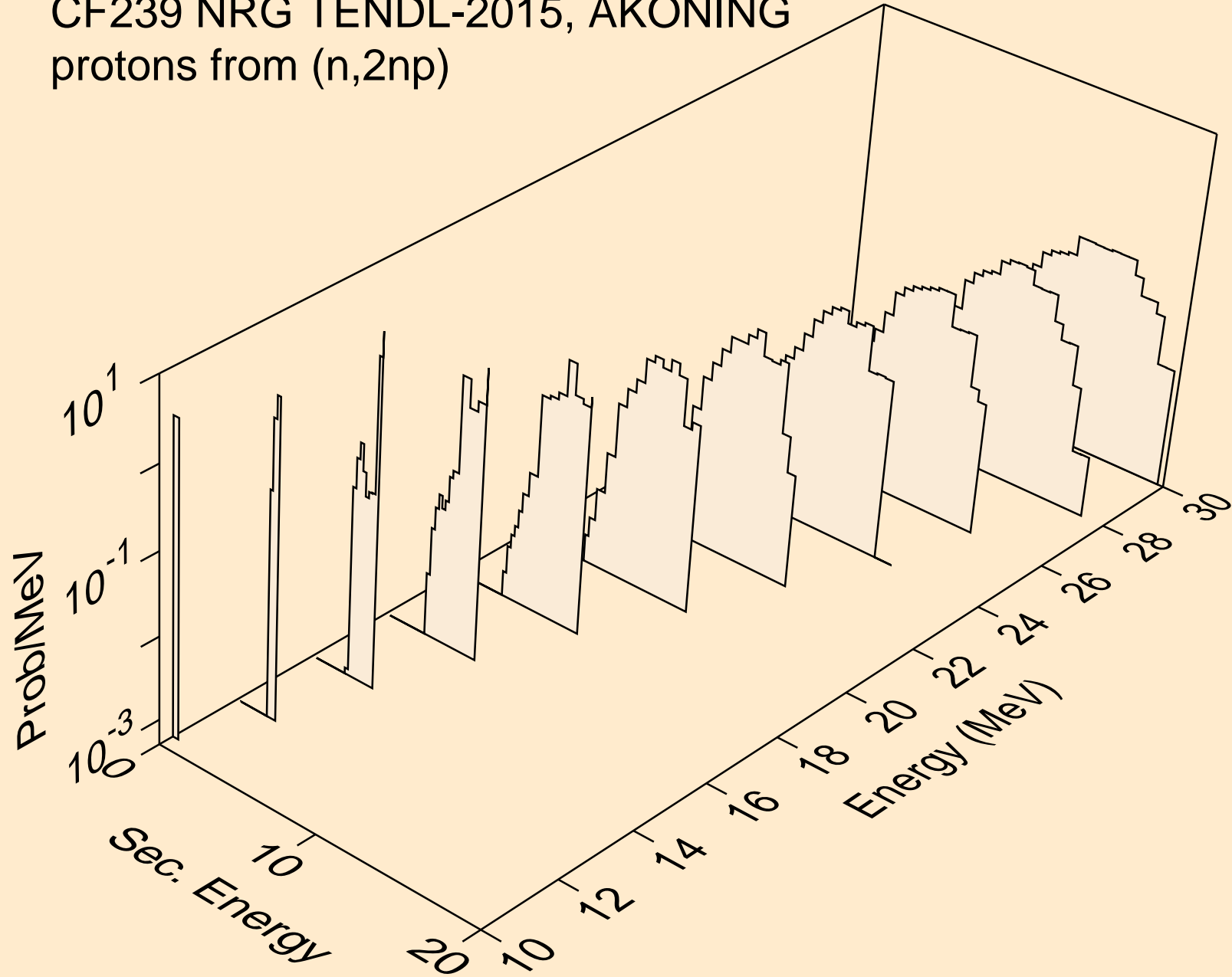

CF239 NRG TENDL-2015, AKONING
protons from (n,3np)

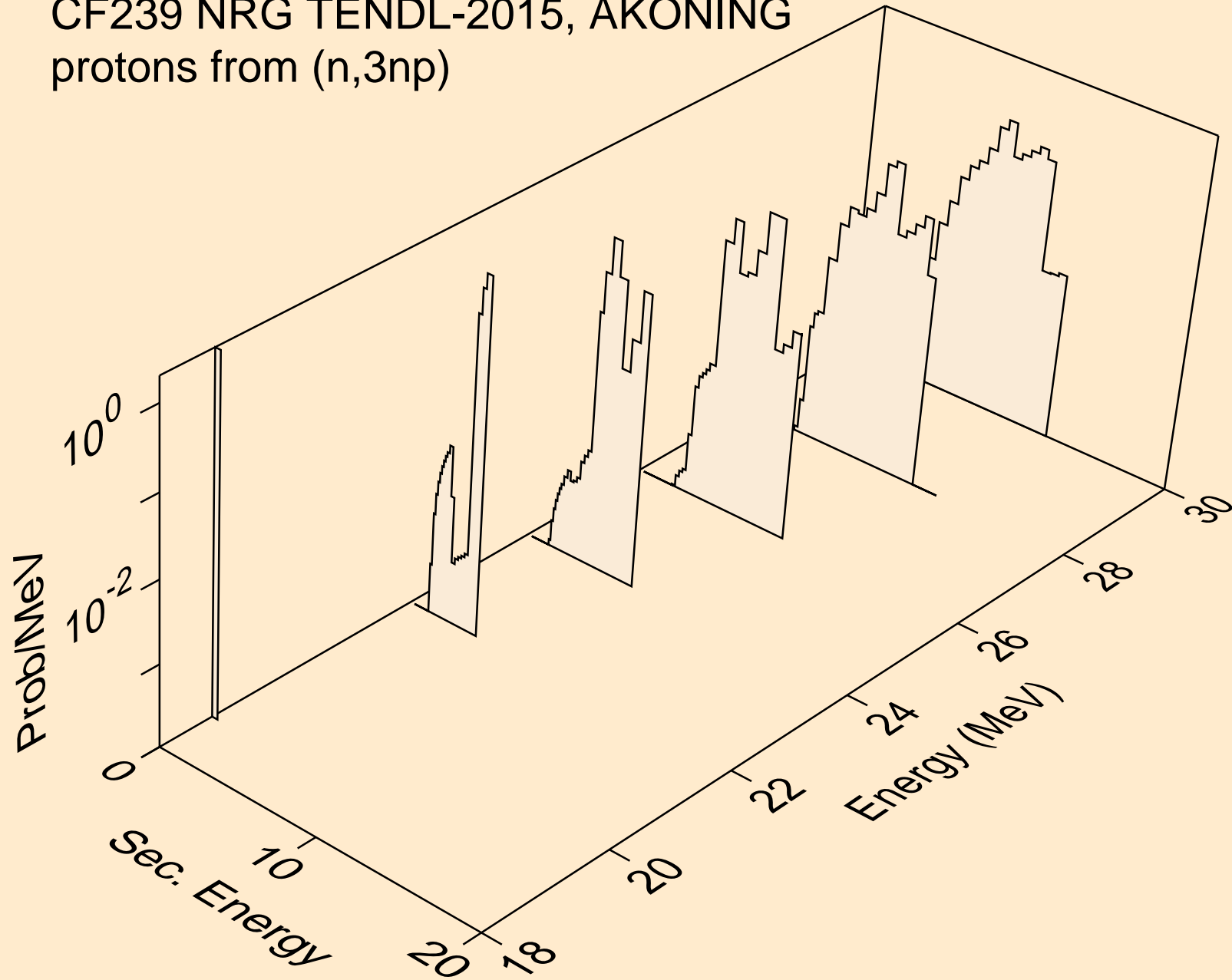

CF239 NRG TENDL-2015, AKONING
protons from (n,2np)

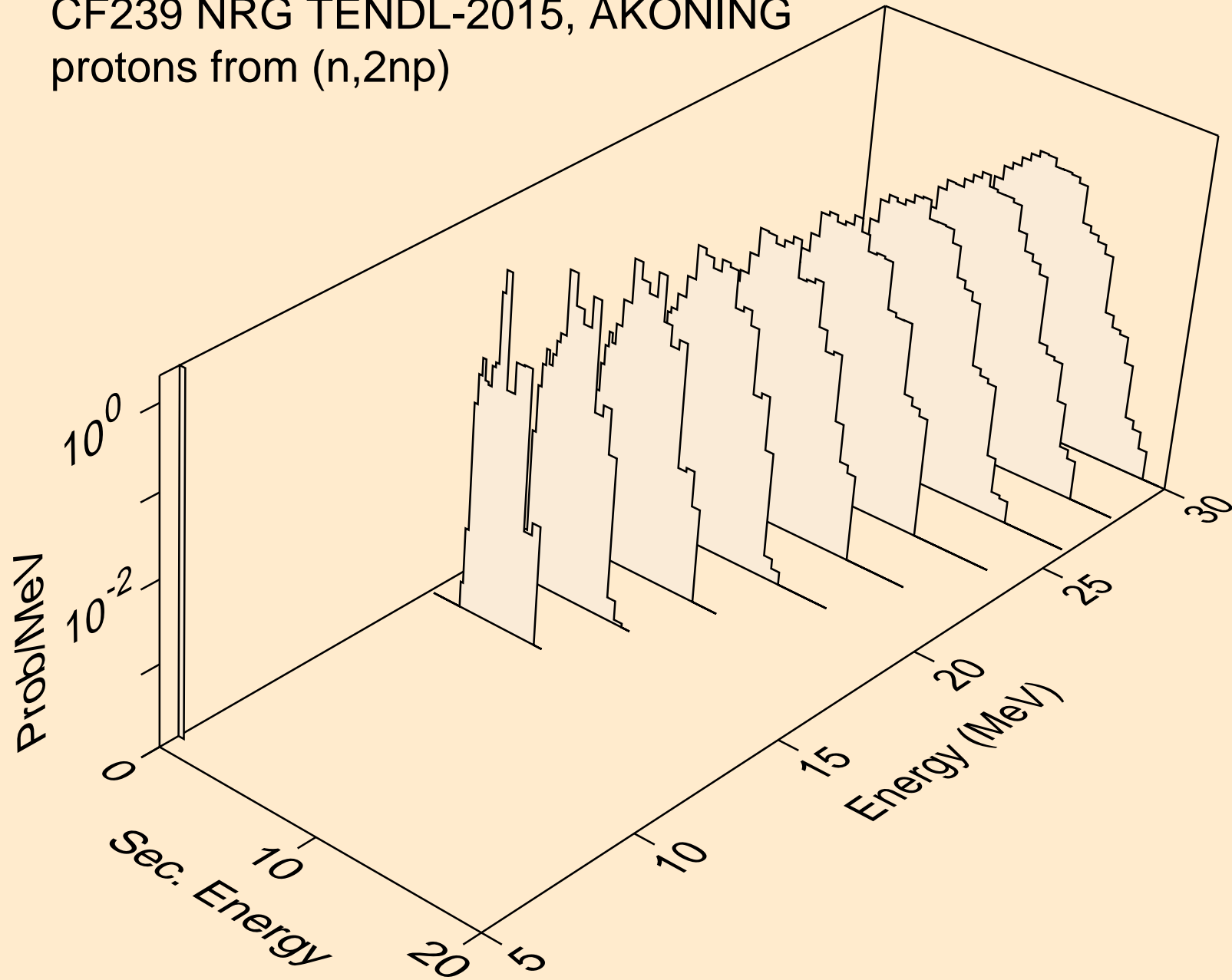

CF239 NRG TENDL-2015, AKONING
protons from (n,npa)

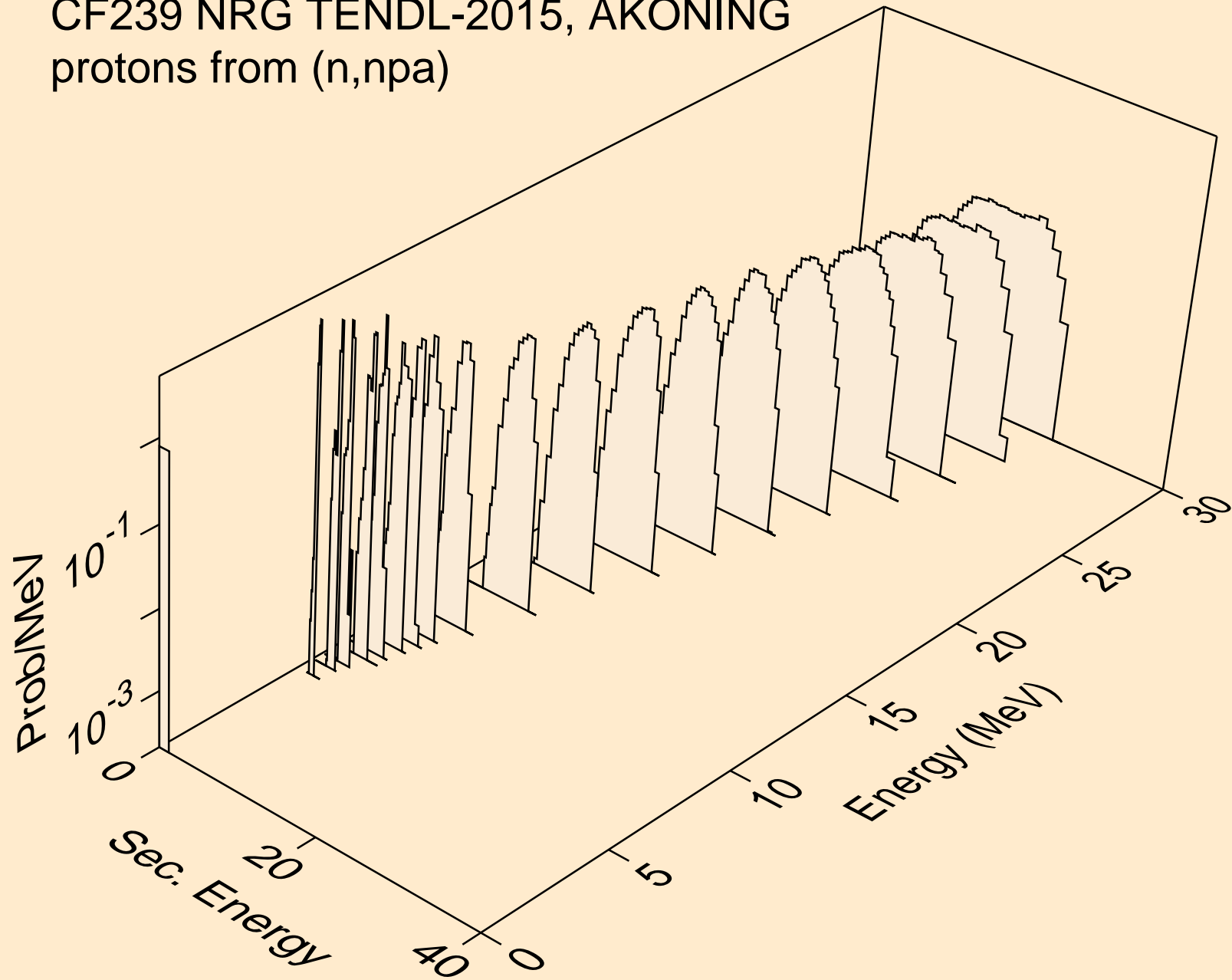

CF239 NRG TENDL-2015, AKONING
protons from (n,p)

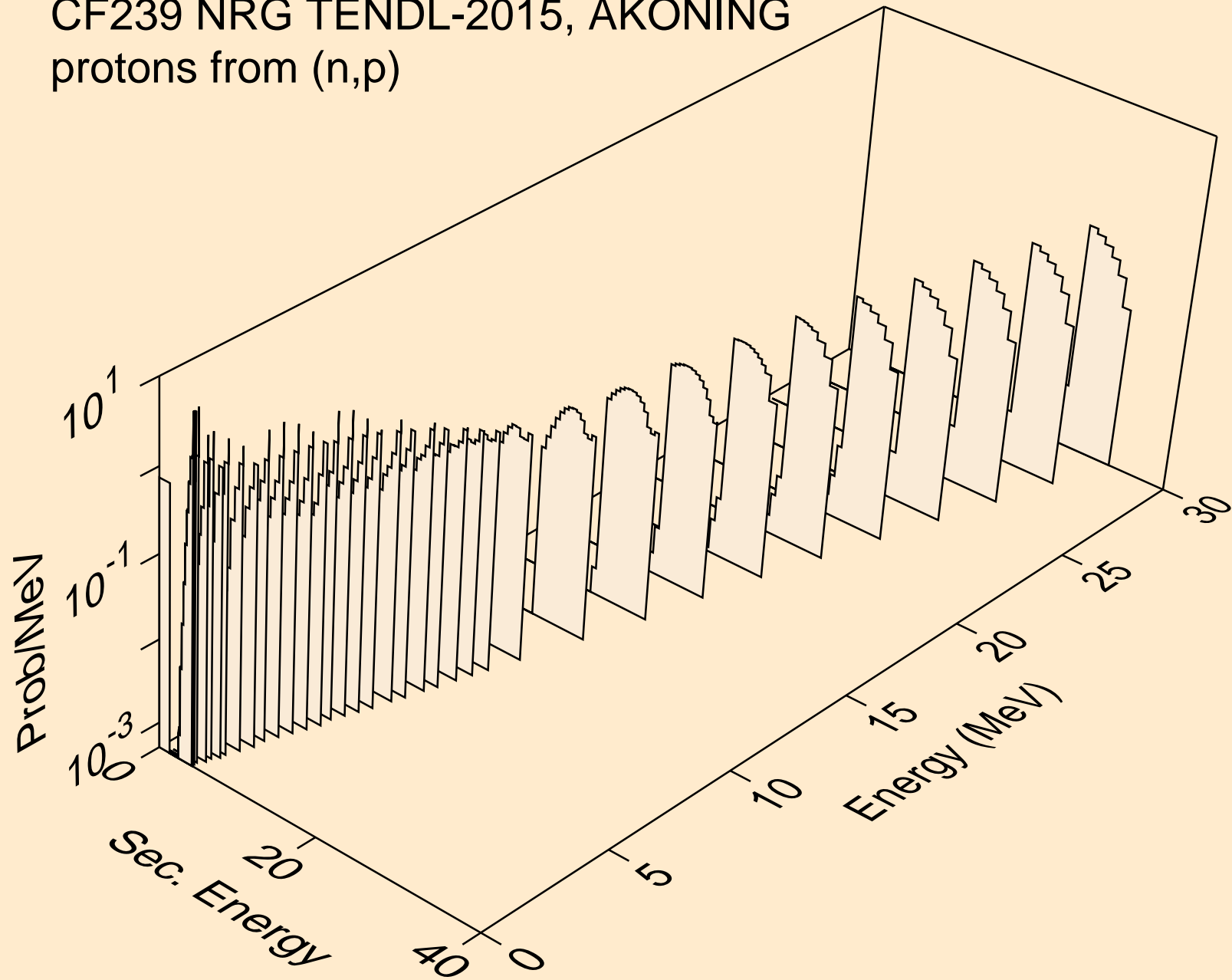

CF239 NRG TENDL-2015, AKONING
protons from (n,2p)

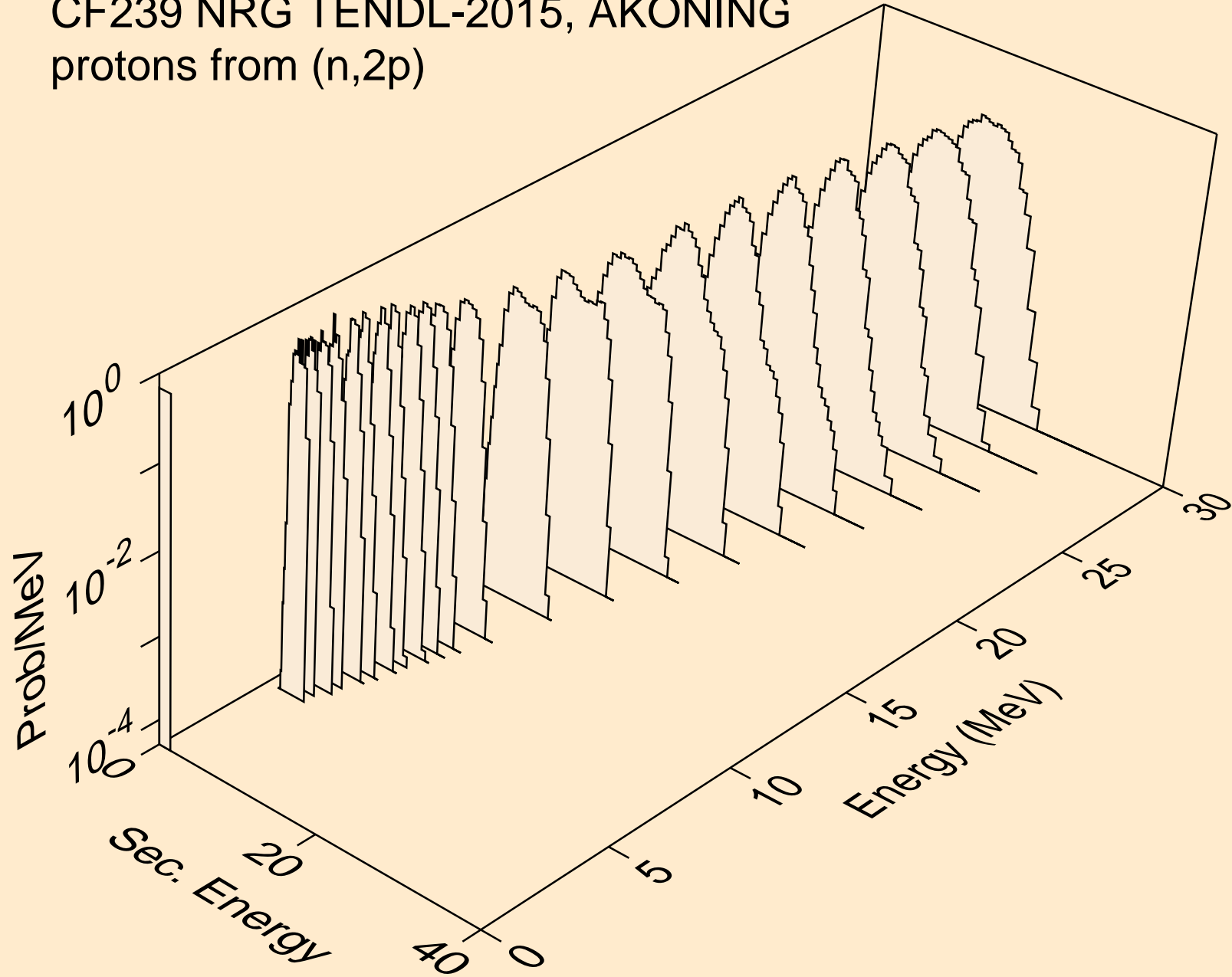

CF239 NRG TENDL-2015, AKONING
protons from (n,pa)

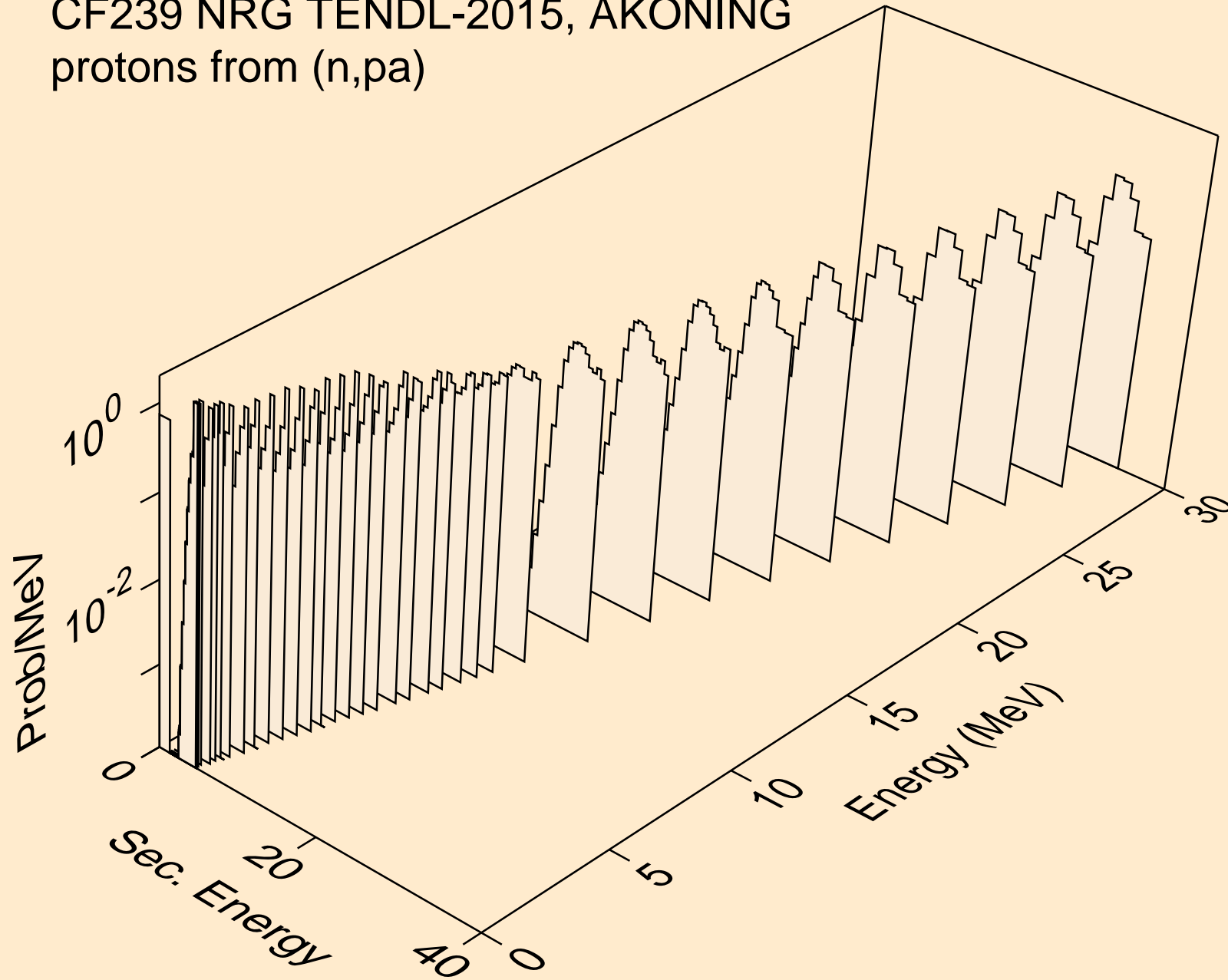

CF239 NRG TENDL-2015, AKONING
protons from (n,pd)

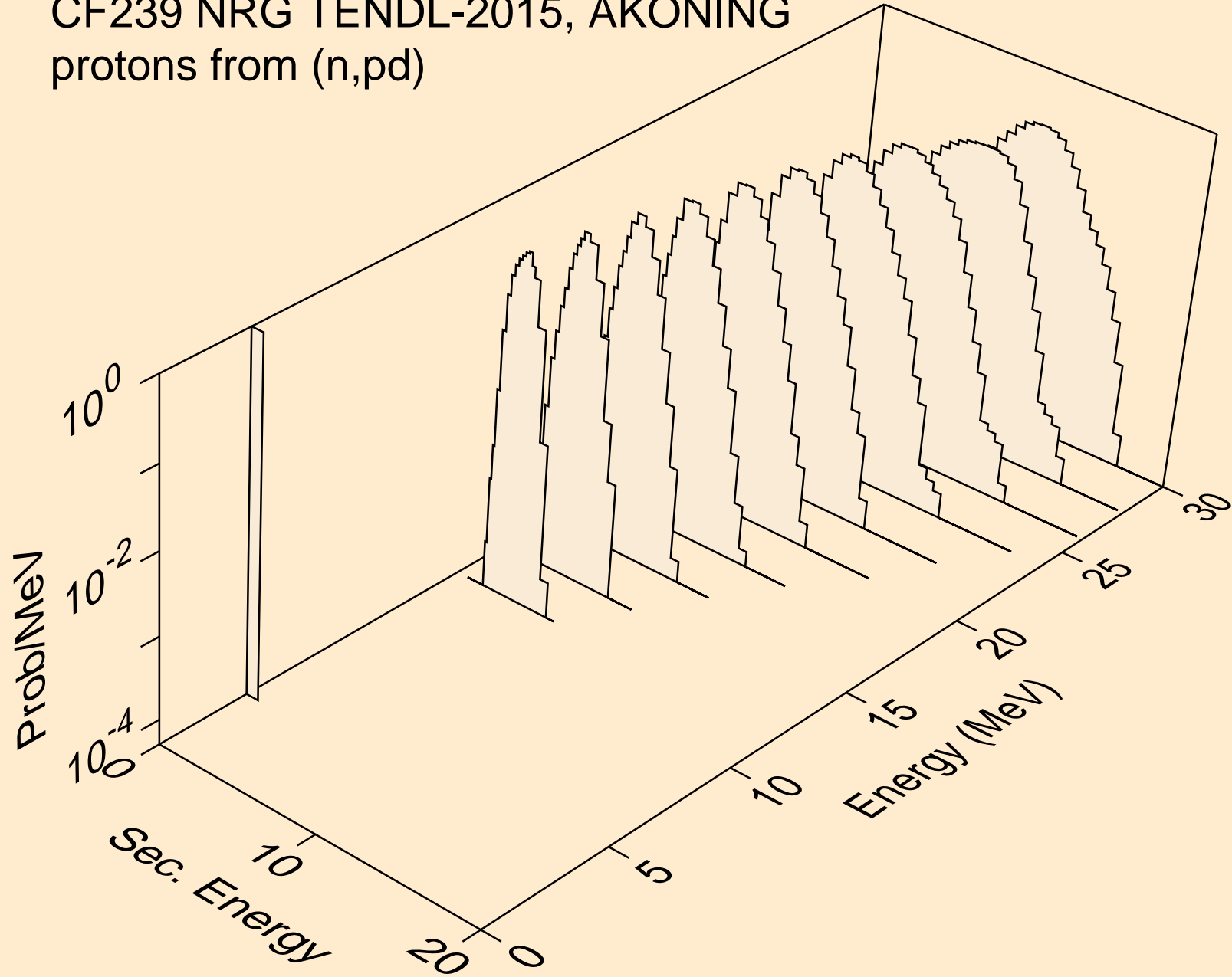

CF239 NRG TENDL-2015, AKONING
deuterons from (n,x)

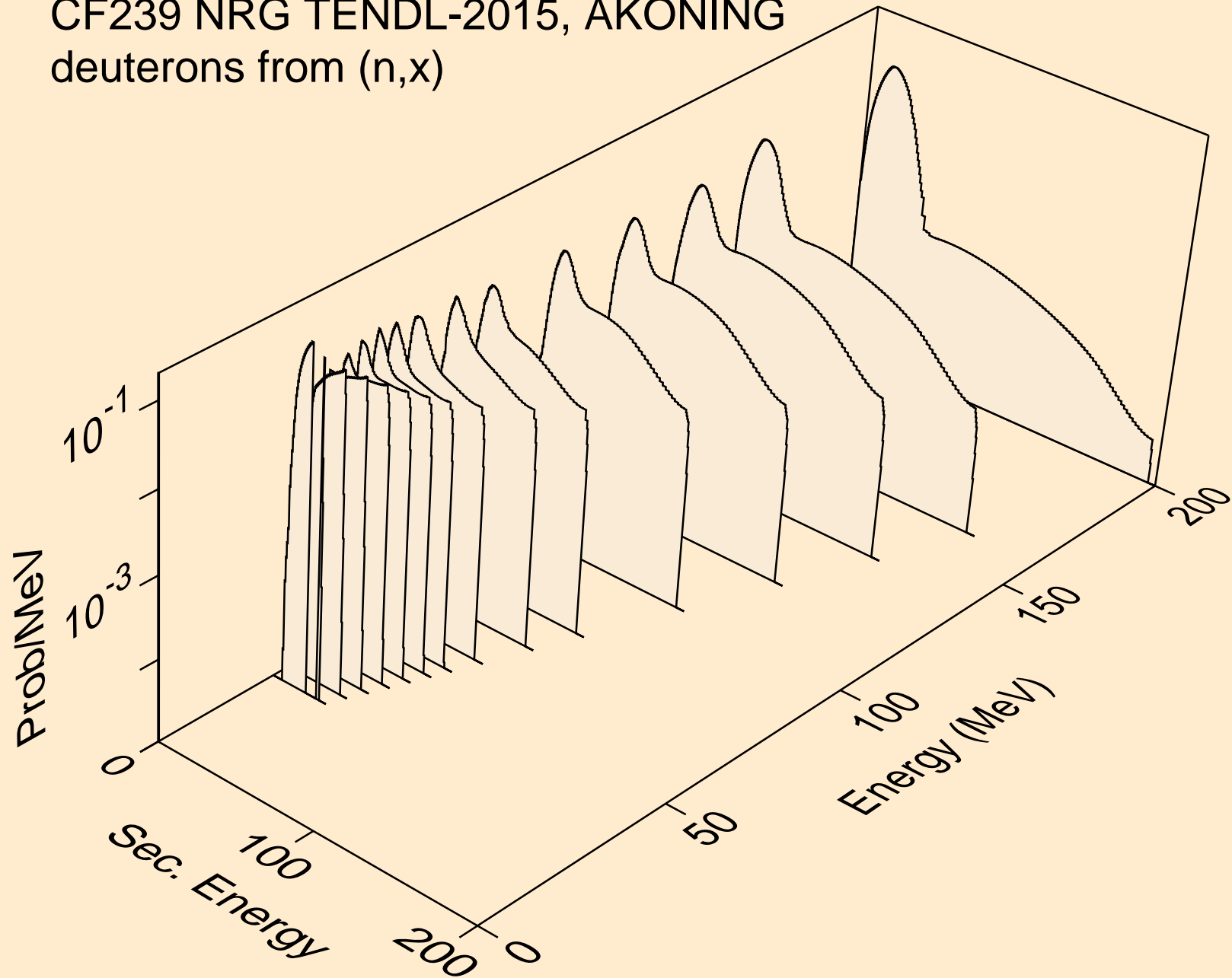

CF239 NRG TENDL-2015, AKONING
deuterons from (n,2nd)

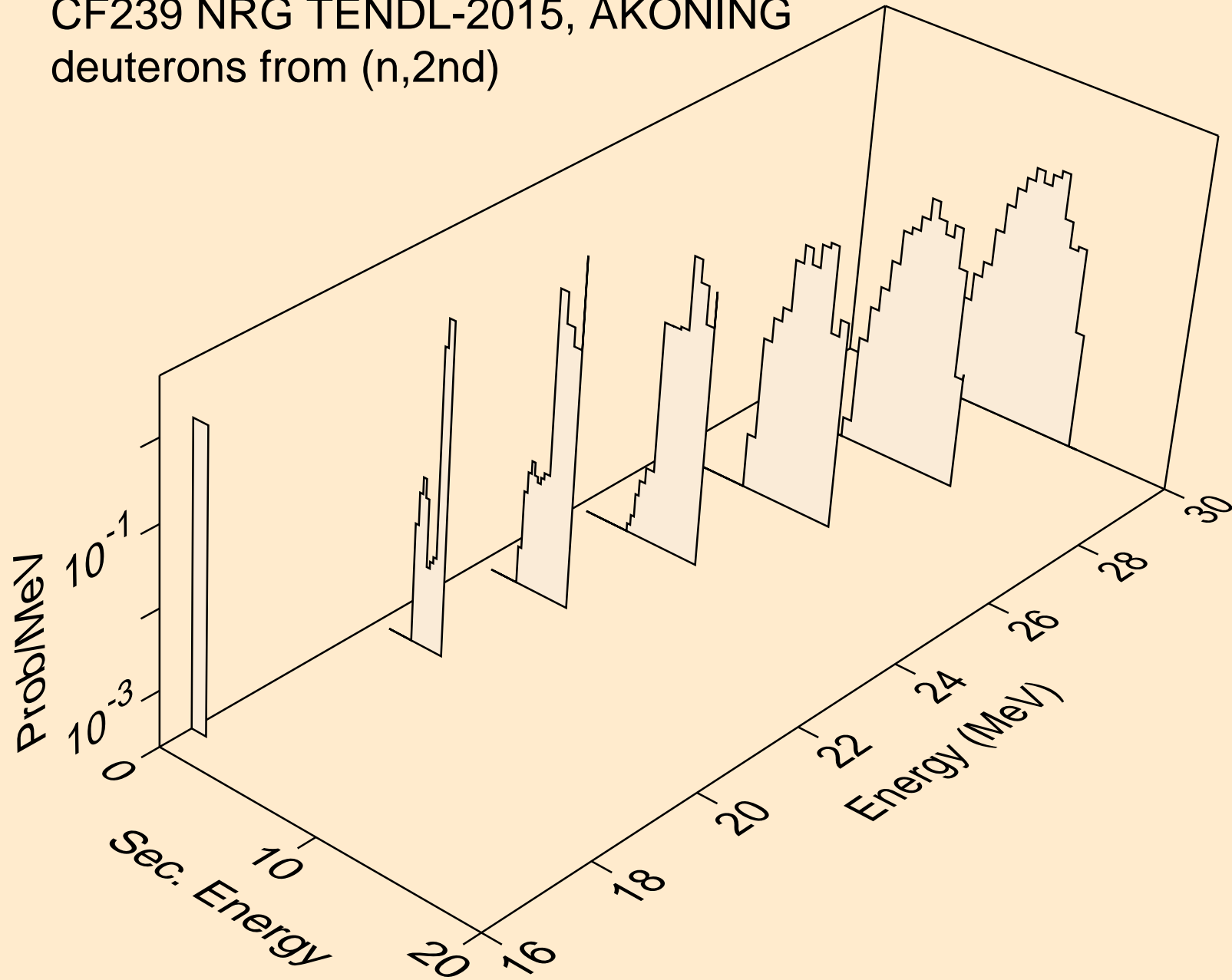

CF239 NRG TENDL-2015, AKONING
deuterons from (n,n*)d

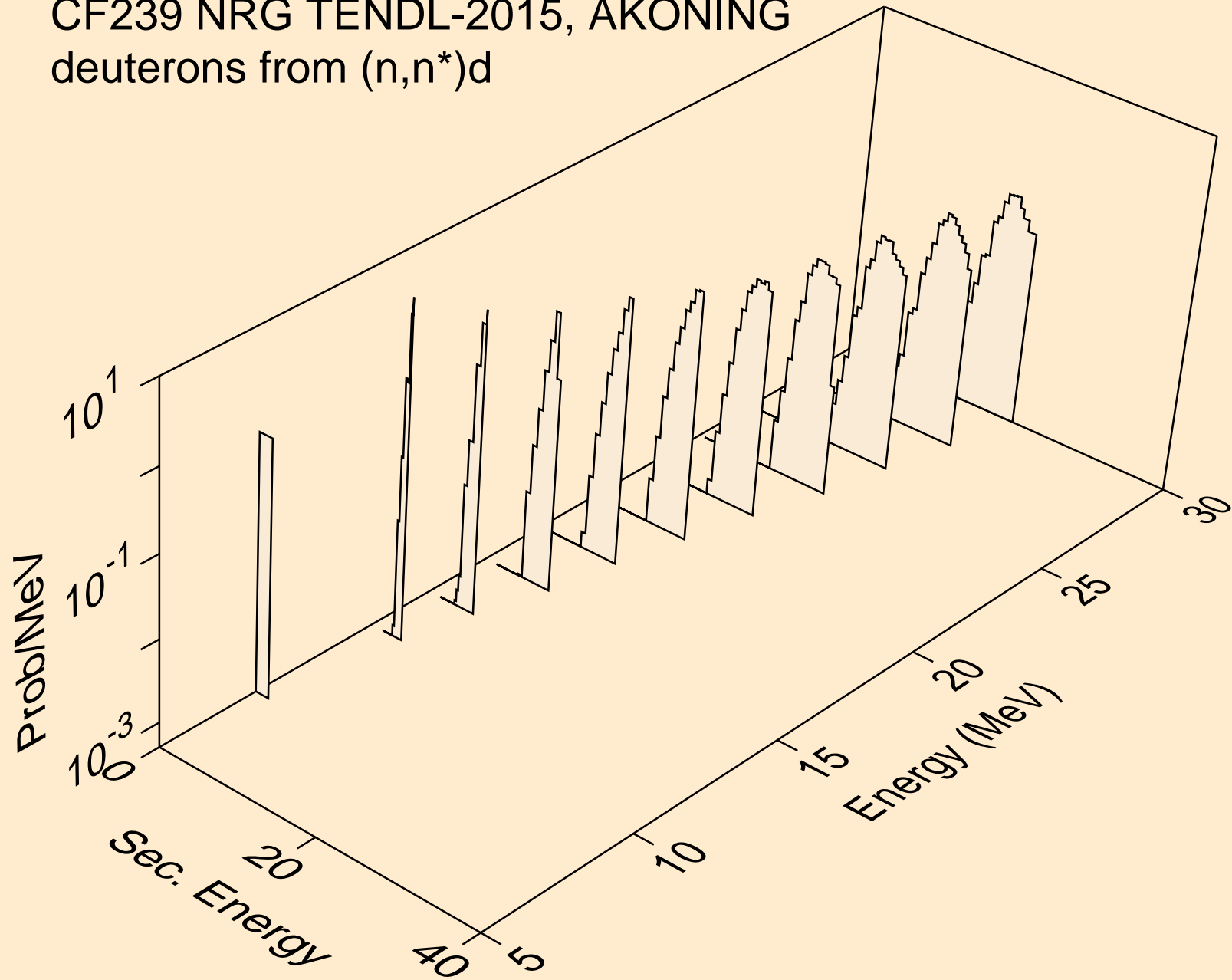

CF239 NRG TENDL-2015, AKONING
deuterons from (n,n*)d2a

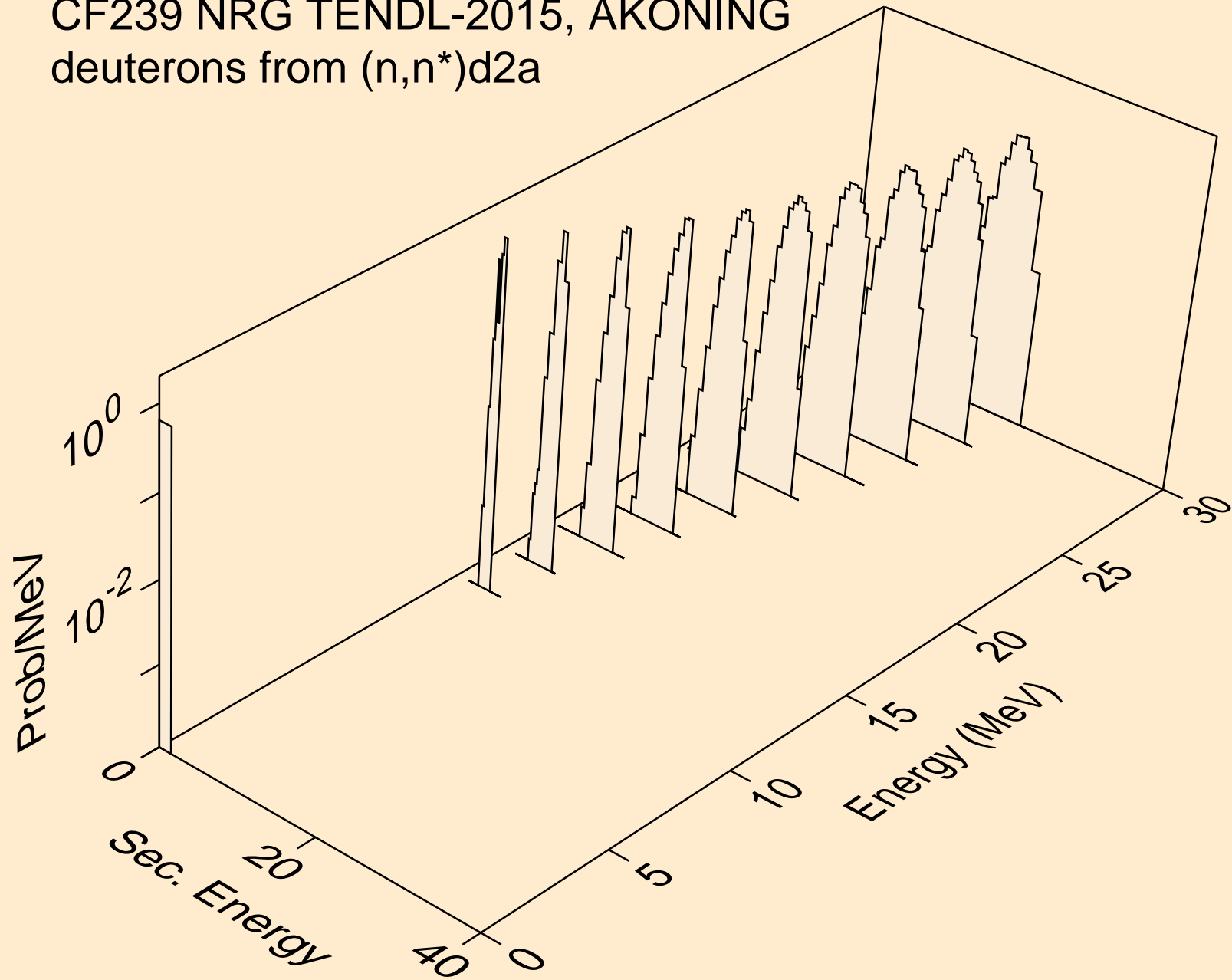

CF239 NRG TENDL-2015, AKONING
deuterons from (n,d)

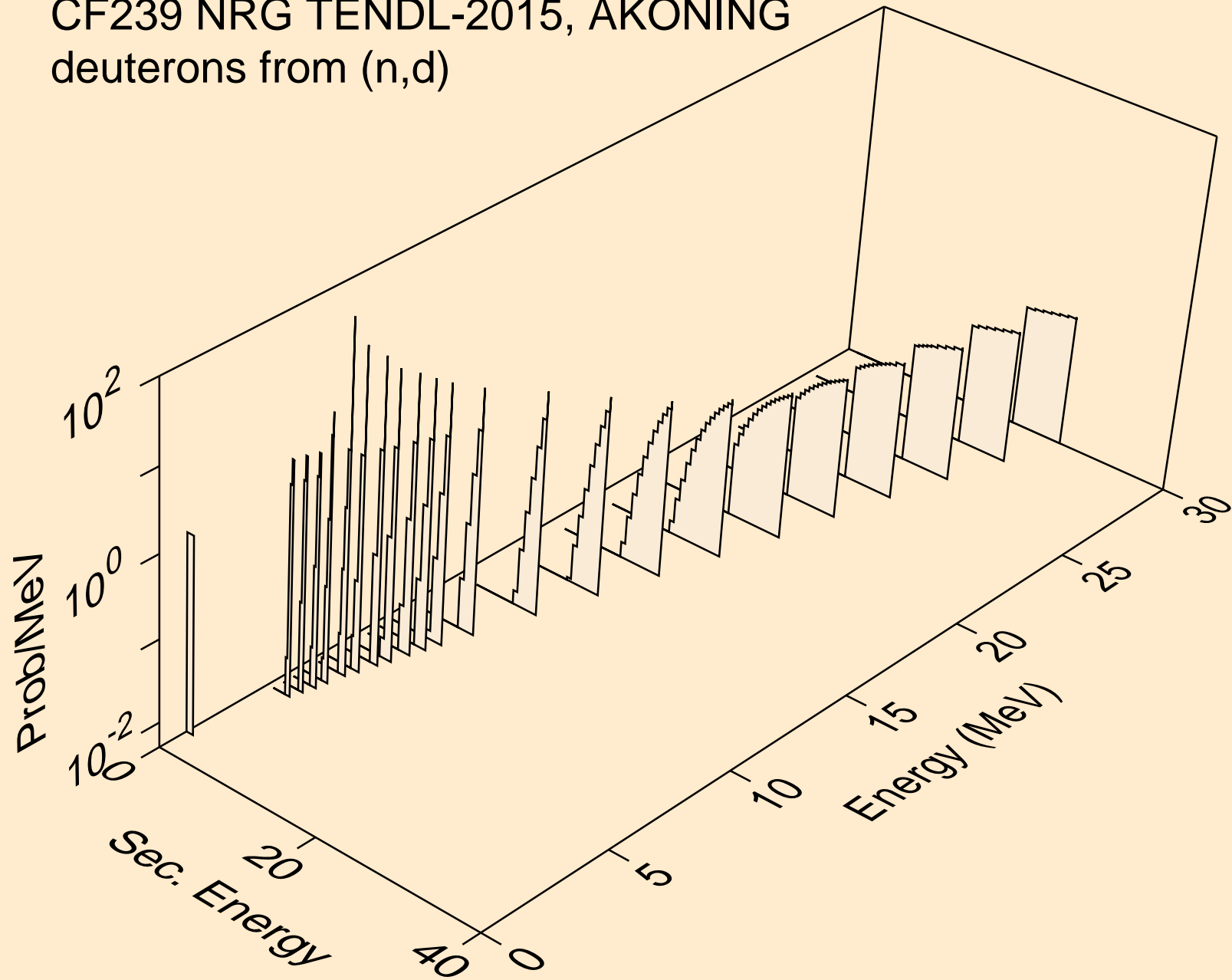

CF239 NRG TENDL-2015, AKONING
deuterons from (n,d2a)

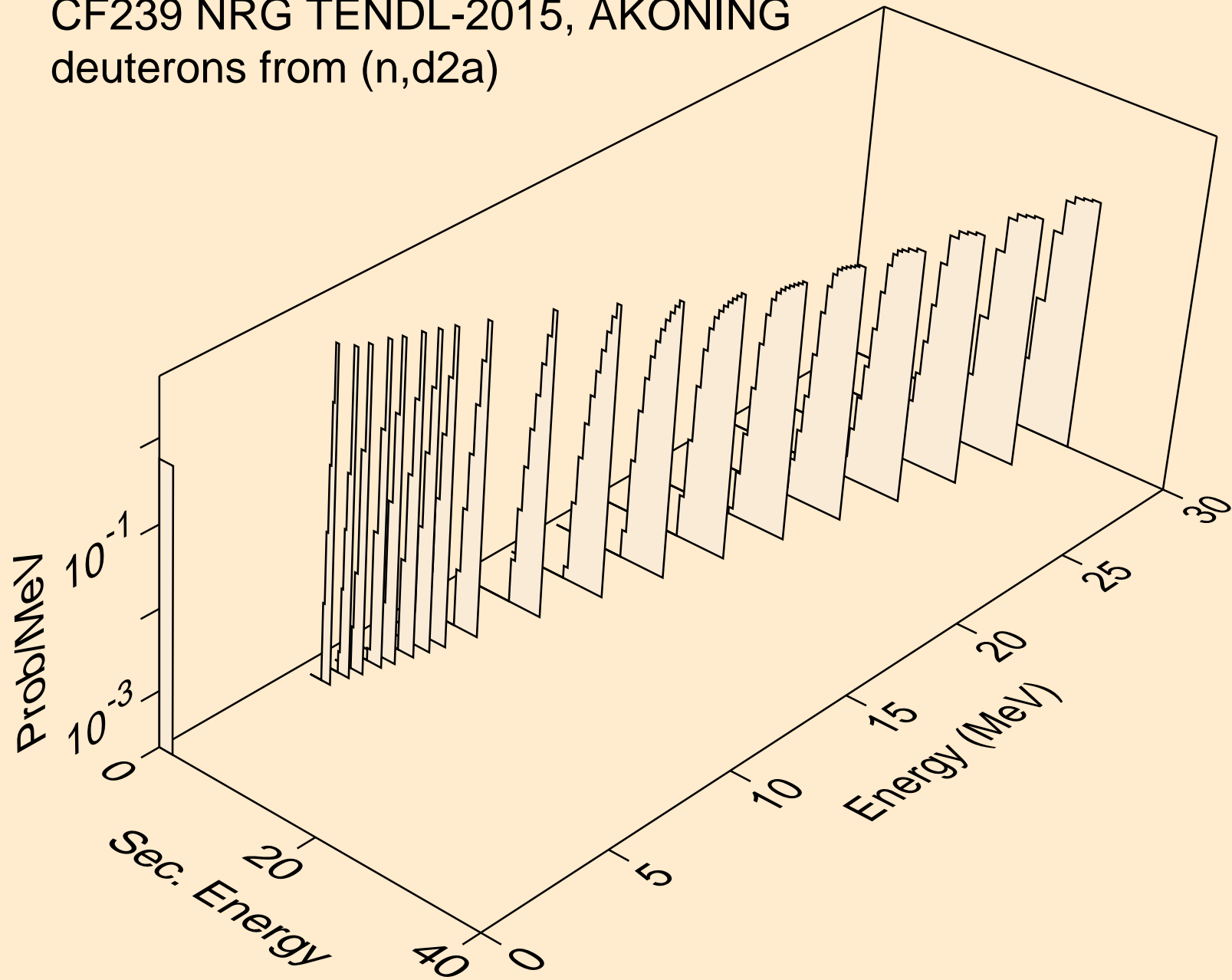

CF239 NRG TENDL-2015, AKONING
deuterons from (n,pd)

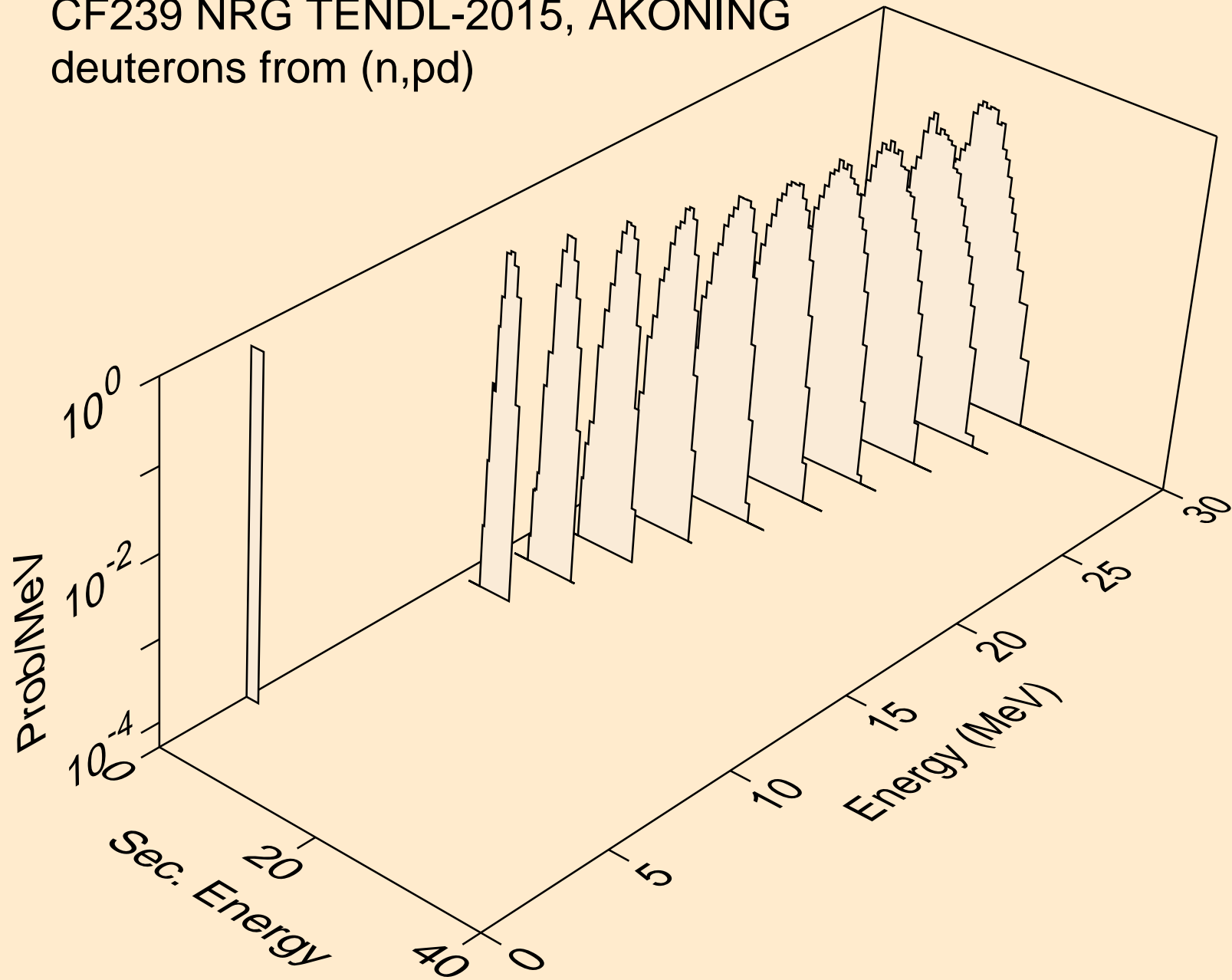

CF239 NRG TENDL-2015, AKONING
deuterons from (n,da)

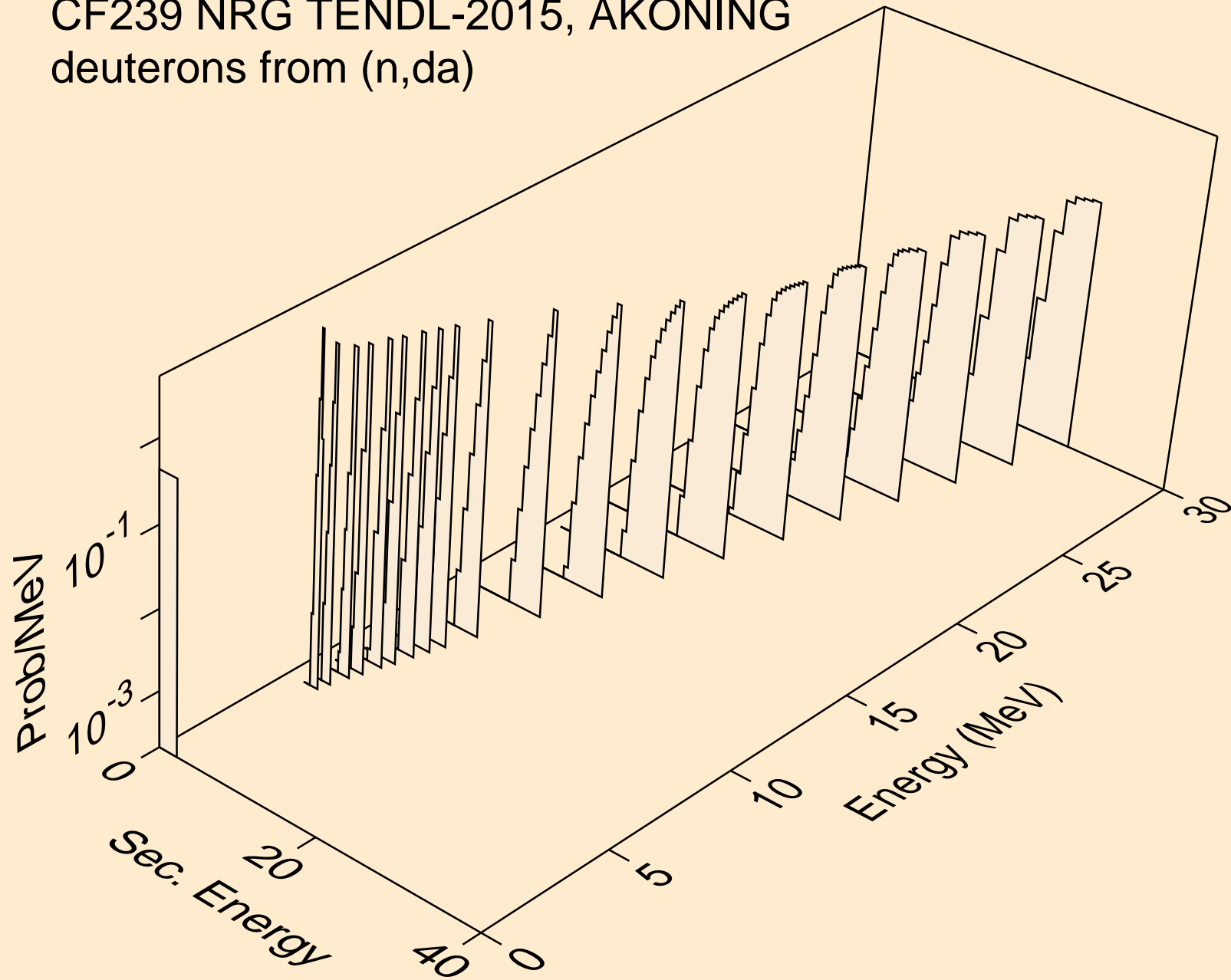

CF239 NRG TENDL-2015, AKONING
tritons from (n,x)

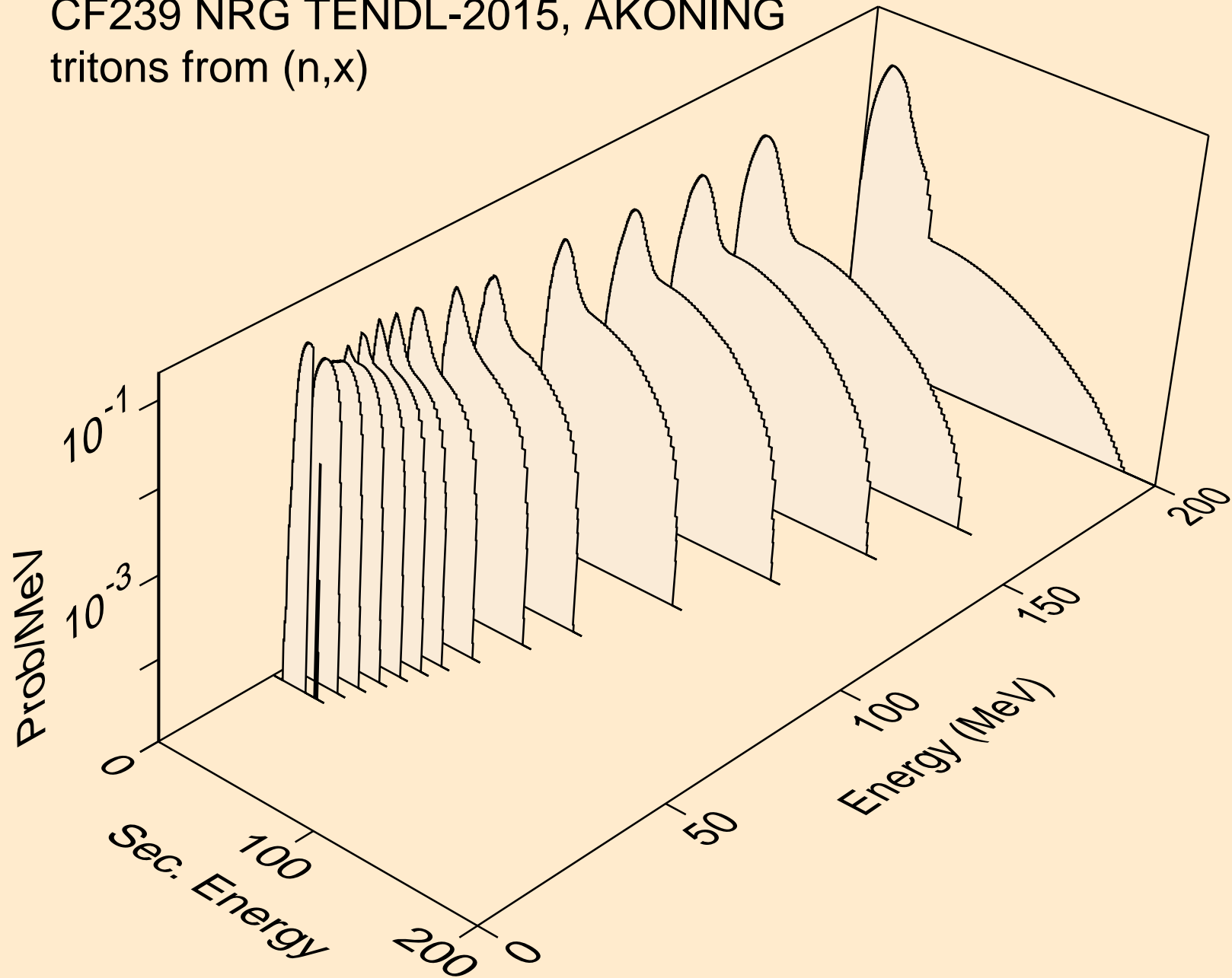

CF239 NRG TENDL-2015, AKONING
tritons from (n,n*)t

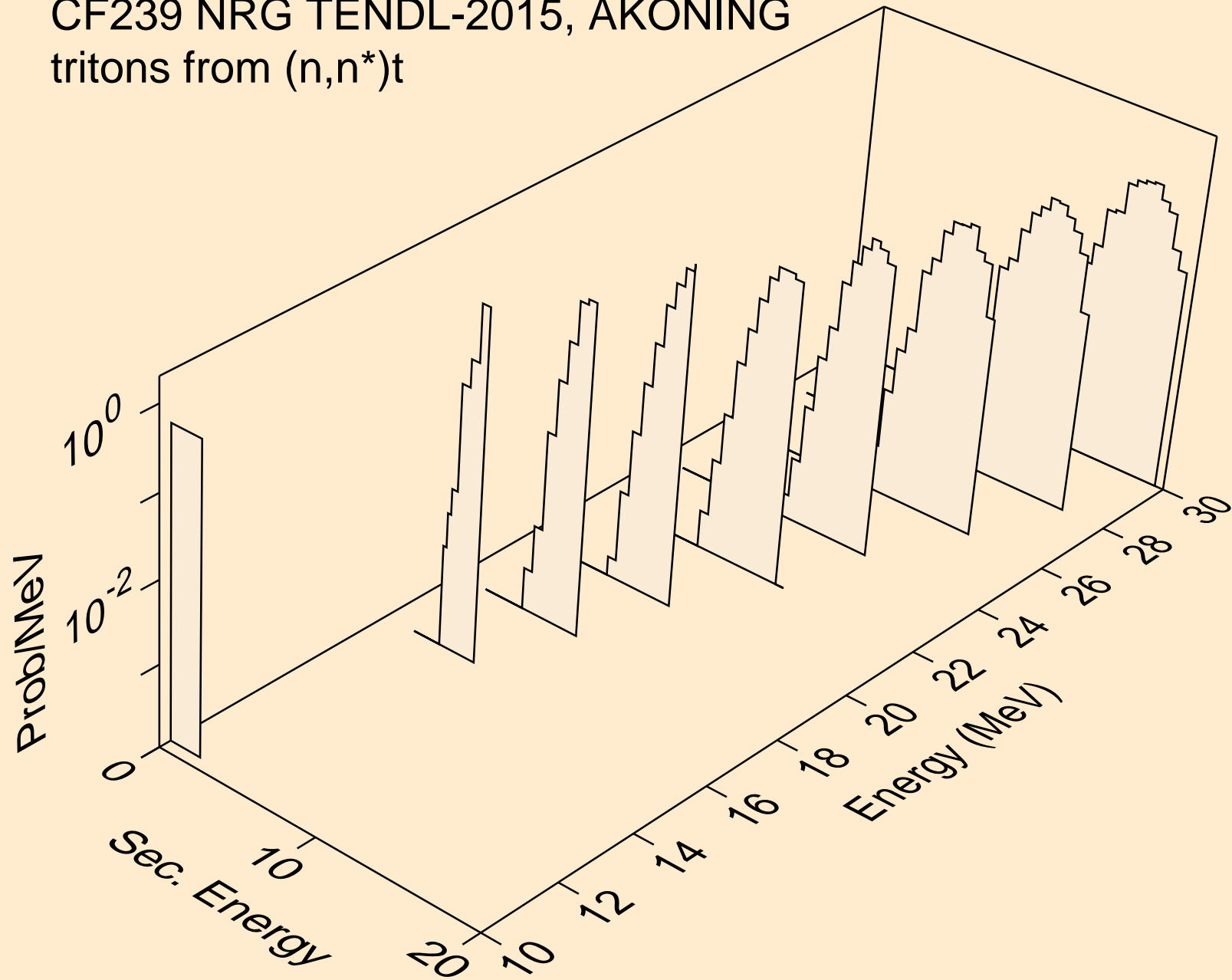

CF239 NRG TENDL-2015, AKONING
tritons from (n,n*)t2a

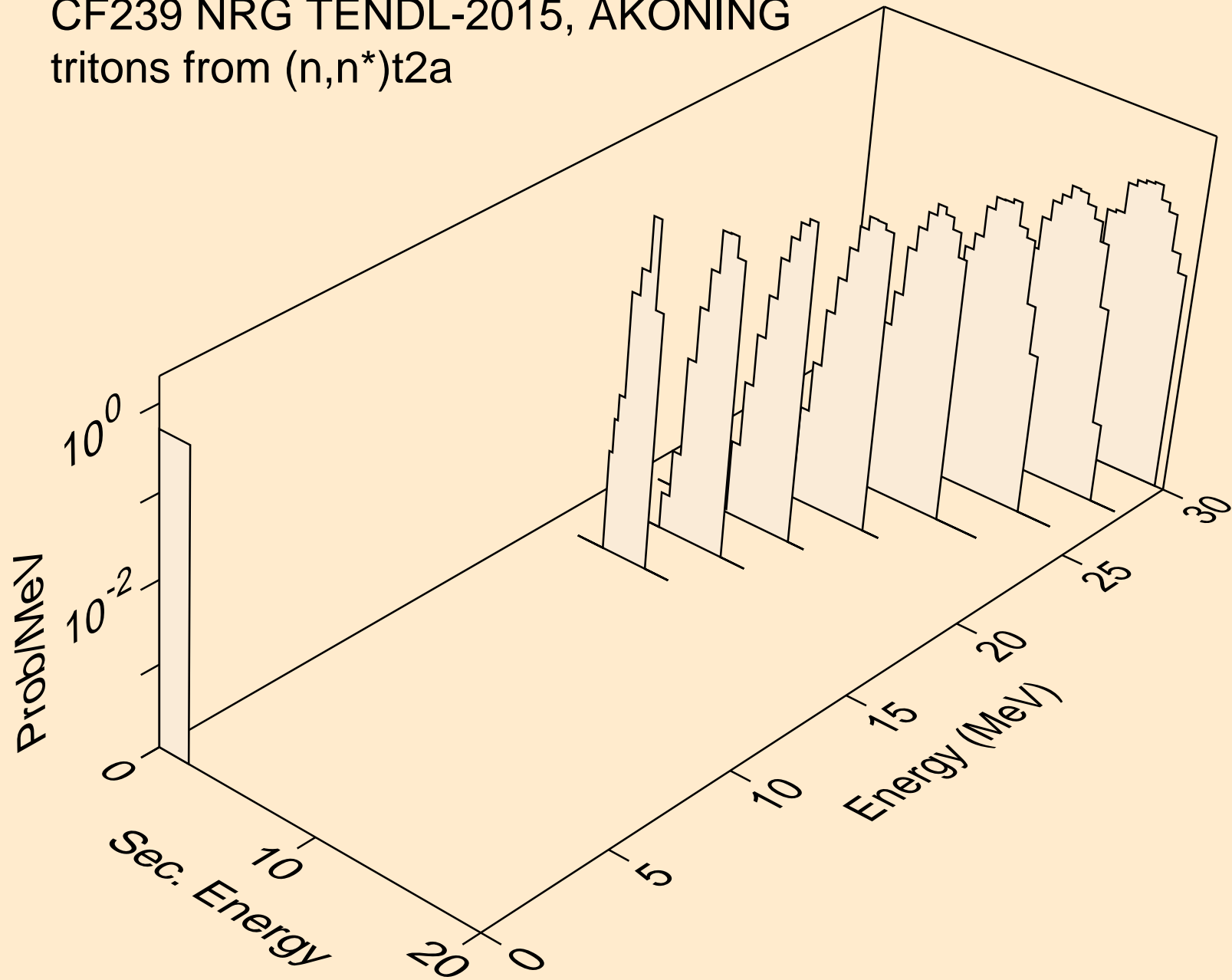

CF239 NRG TENDL-2015, AKONING
tritons from (n,t)

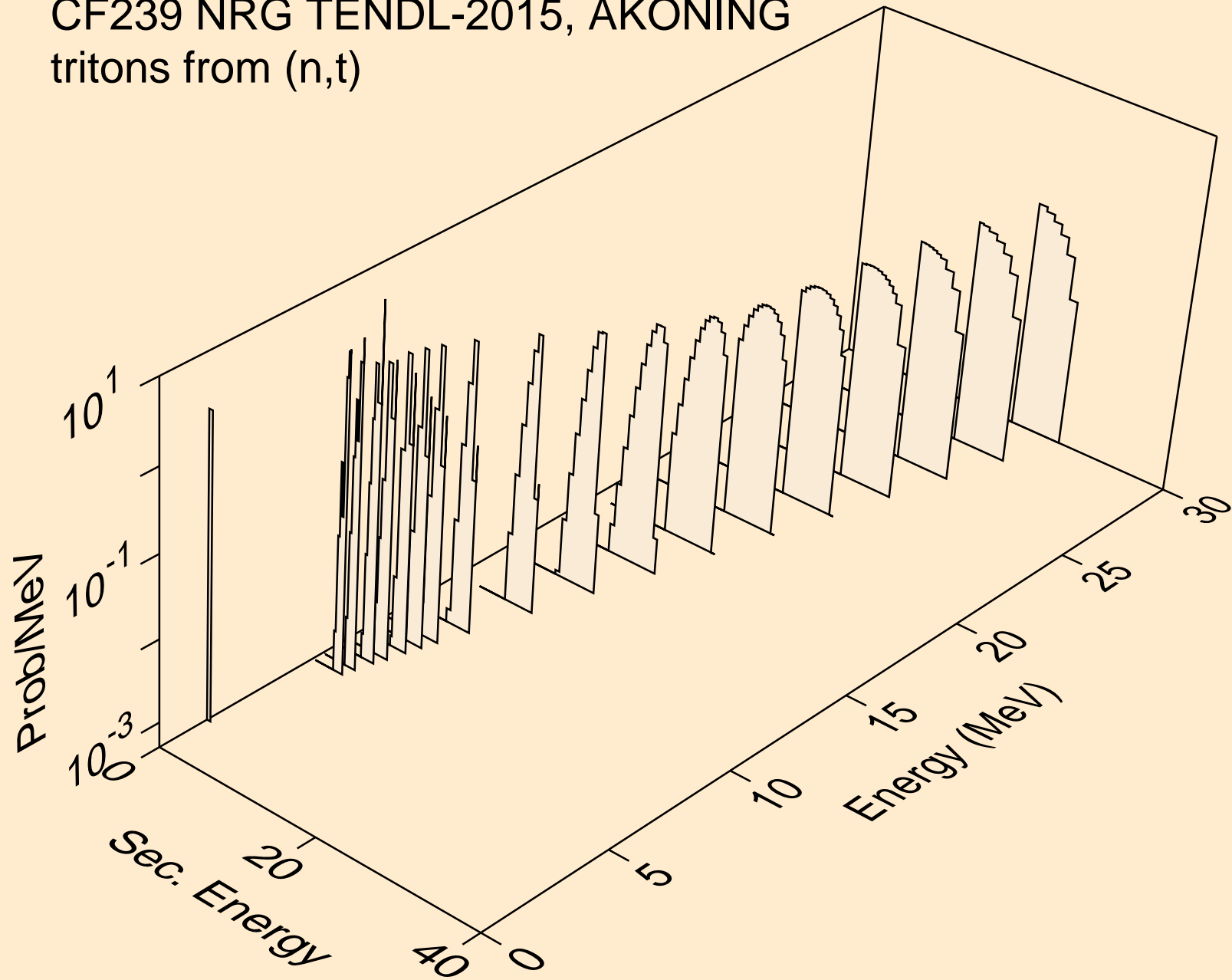

CF239 NRG TENDL-2015, AKONING
tritons from (n,t2a)

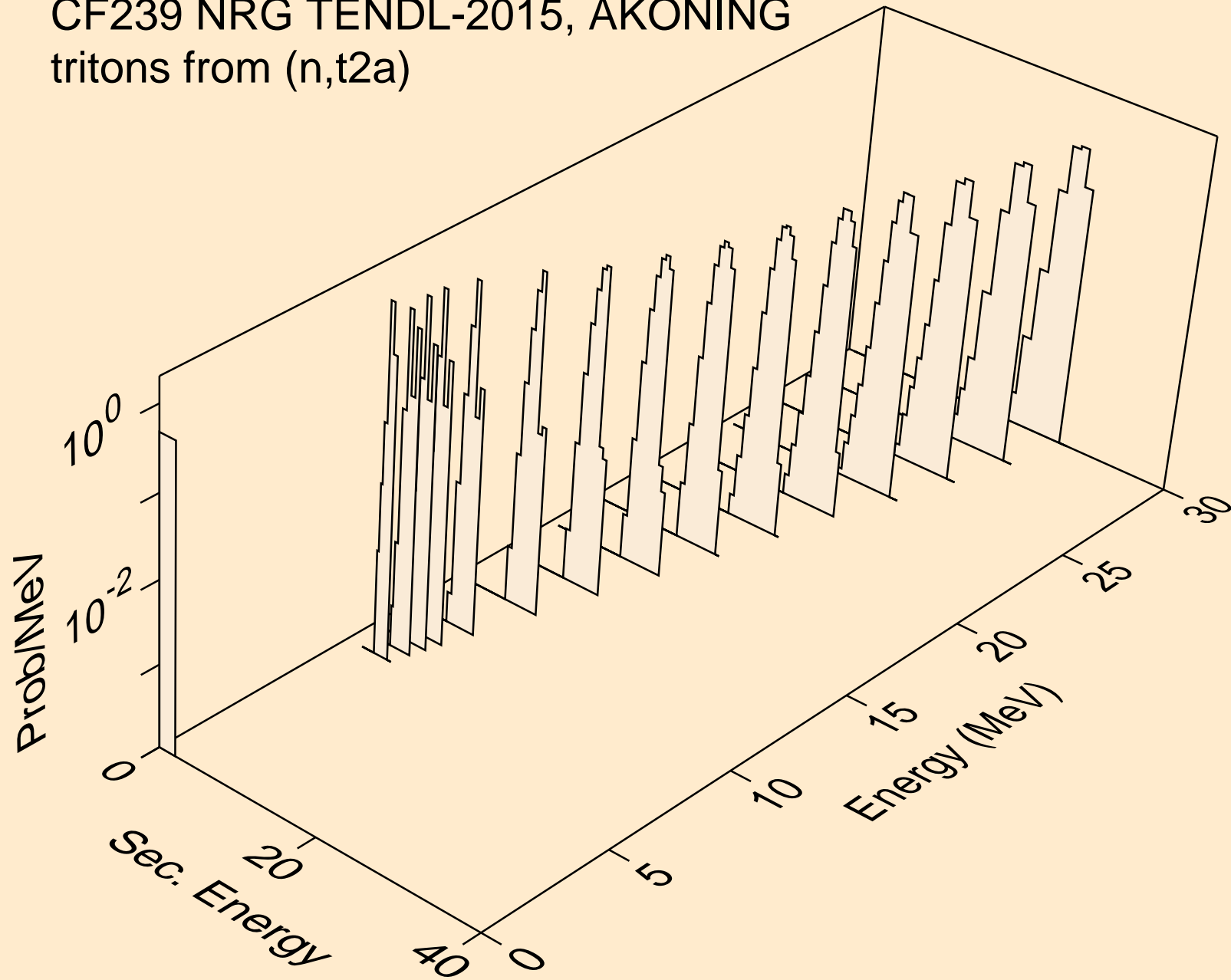

CF239 NRG TENDL-2015, AKONING
he3s from (n,x)

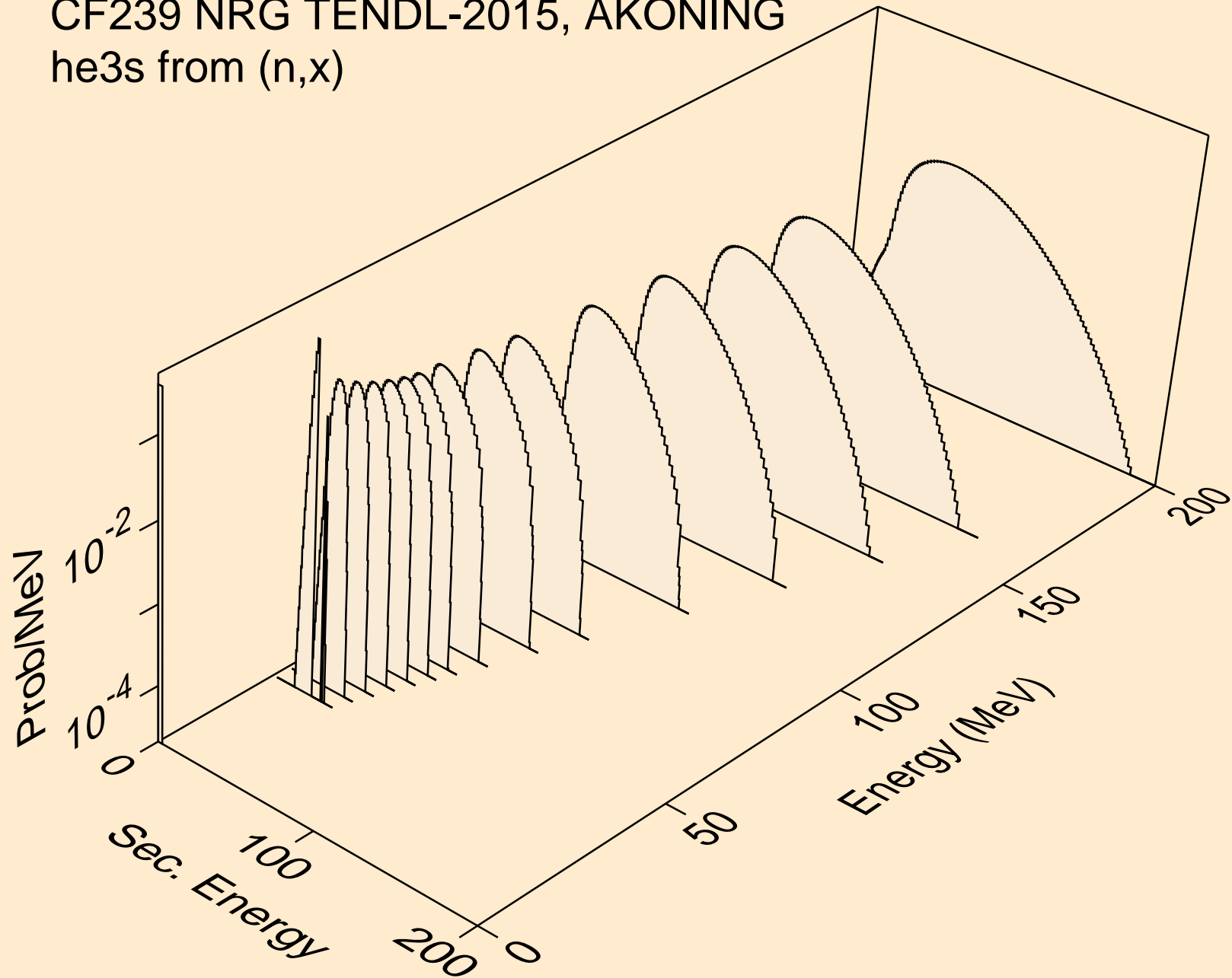

CF239 NRG TENDL-2015, AKONING
he3s from (n,n*)he3

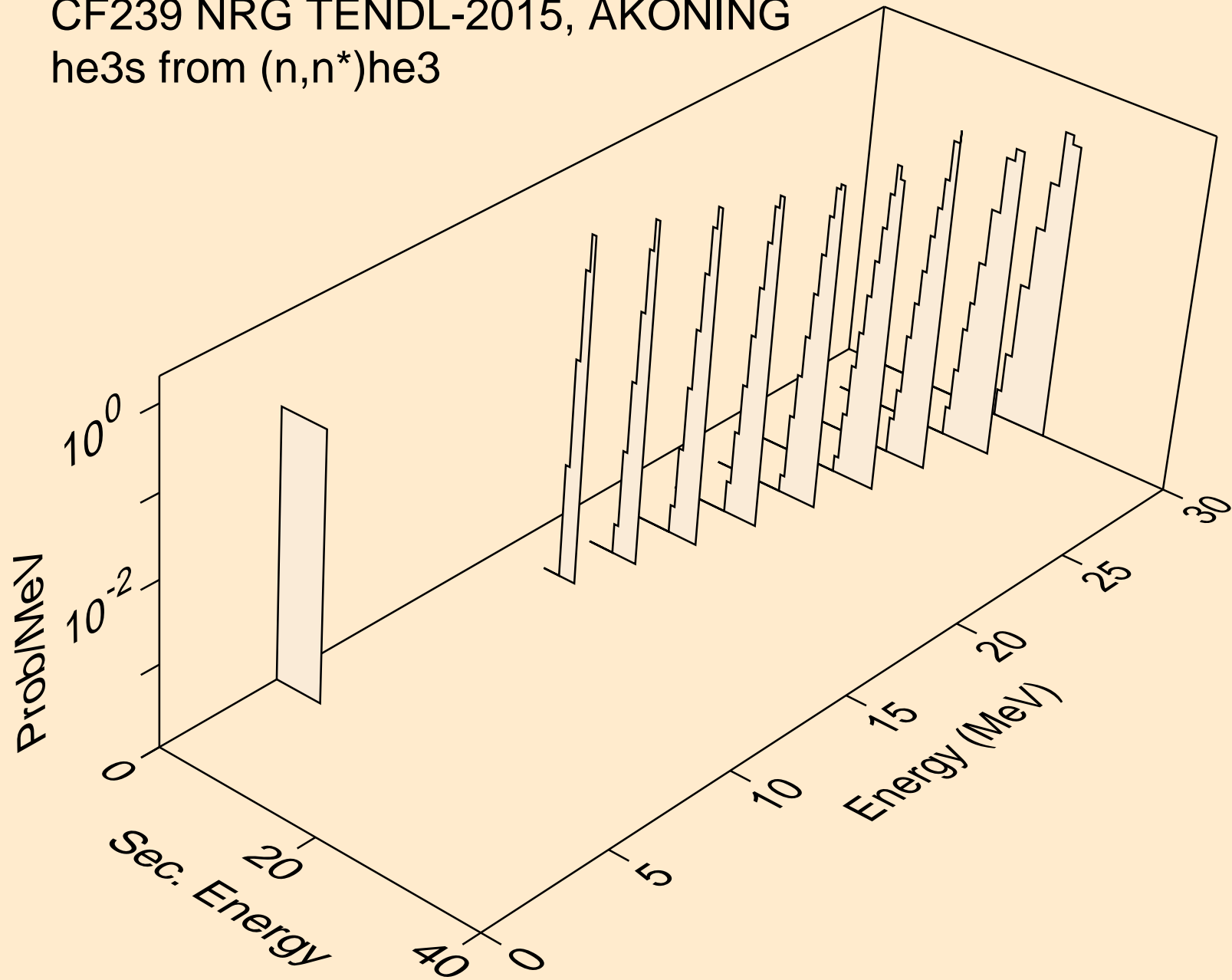

CF239 NRG TENDL-2015, AKONING
he3s from (n,he3)

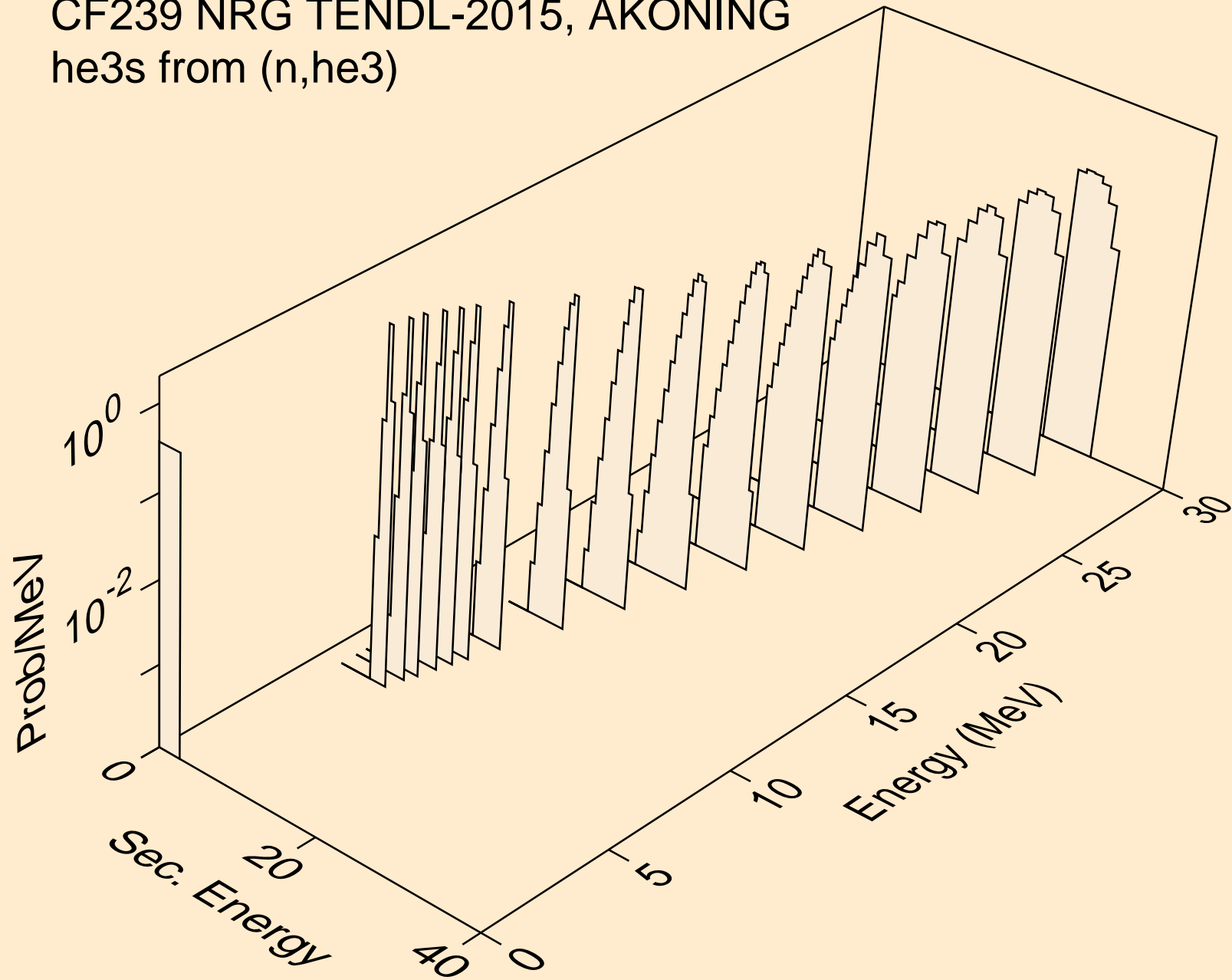

CF239 NRG TENDL-2015, AKONING
alphas from (n,x)

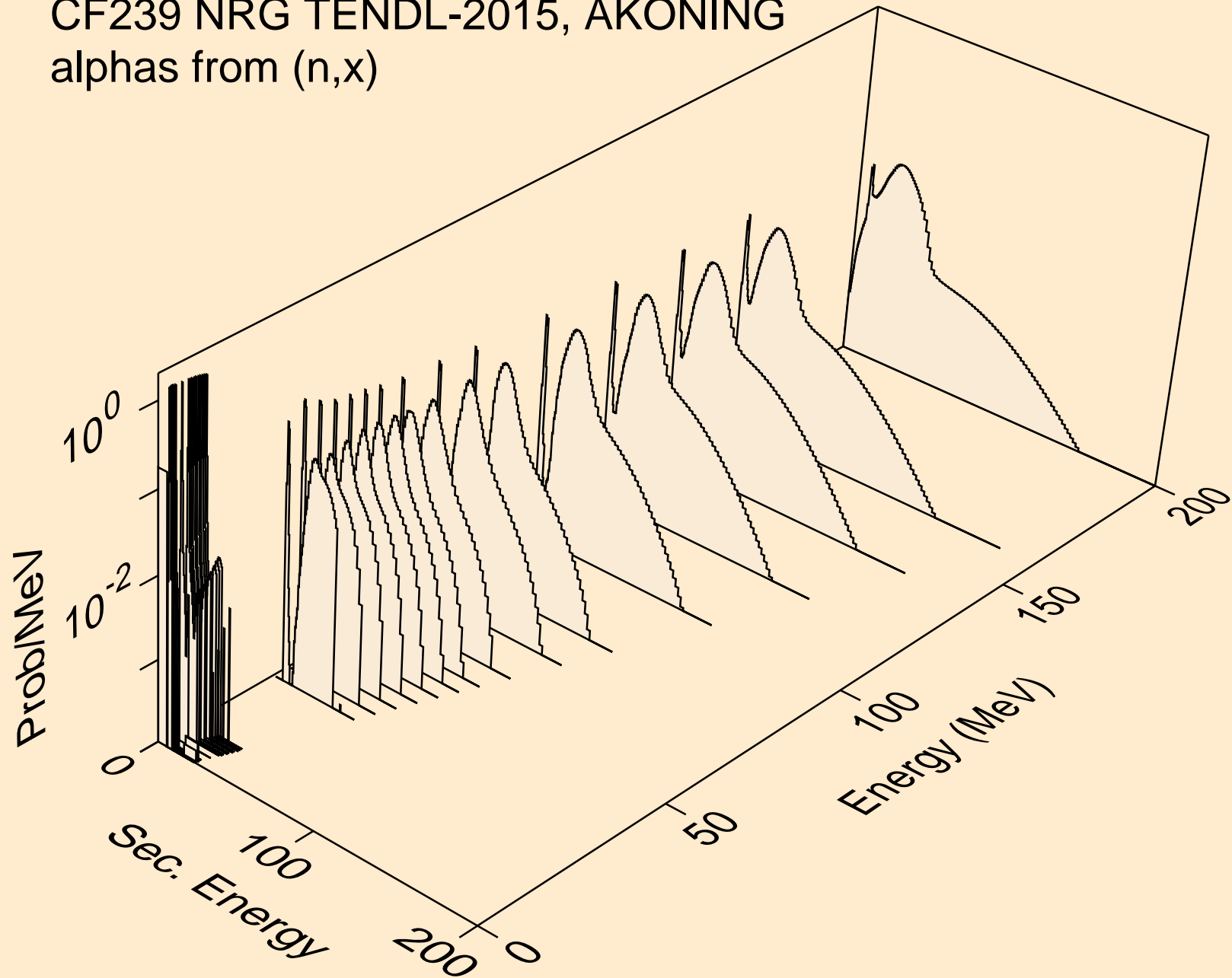

CF239 NRG TENDL-2015, AKONING
alphas from (n,n*)a

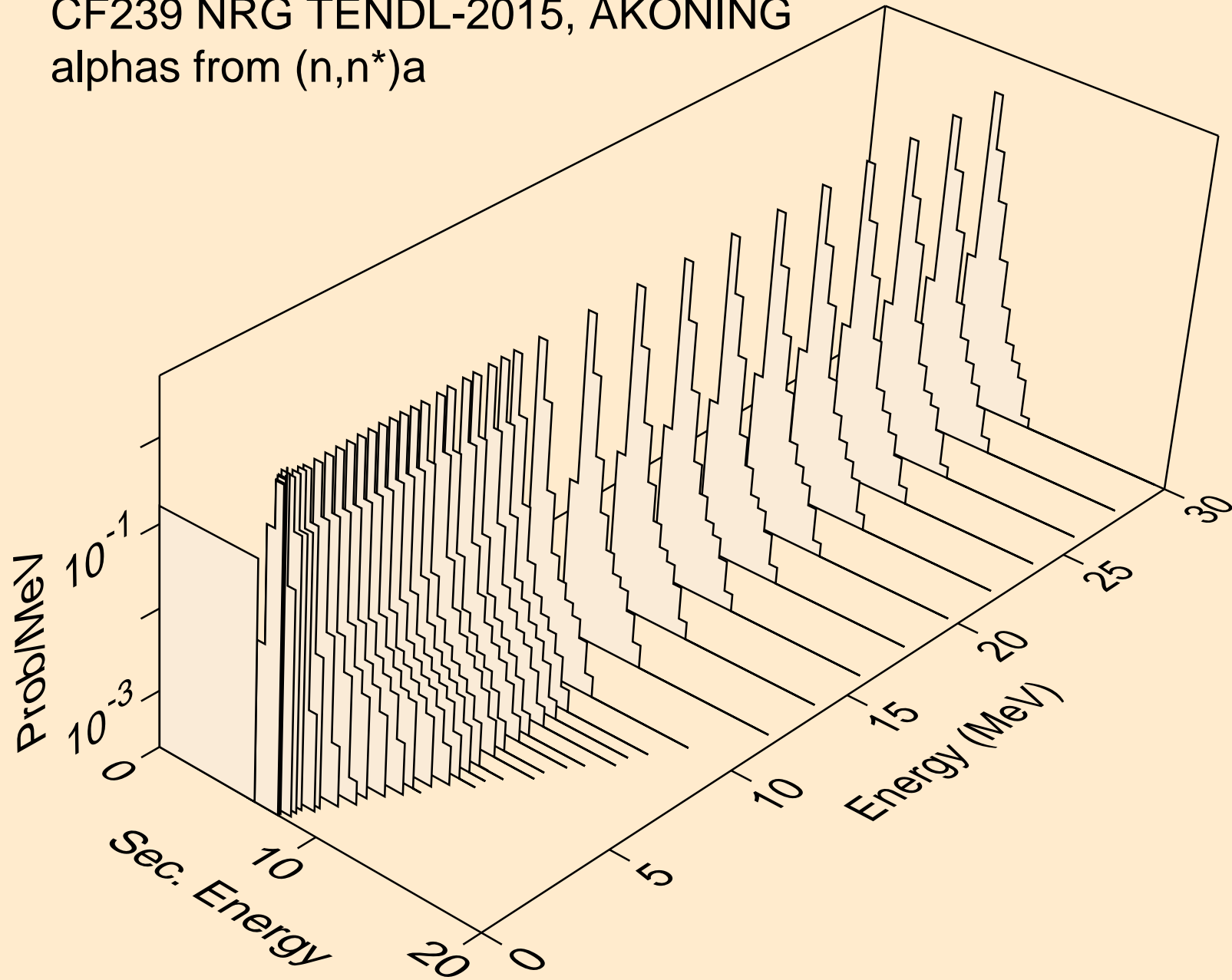

CF239 NRG TENDL-2015, AKONING
alphas from (n,n*)3a

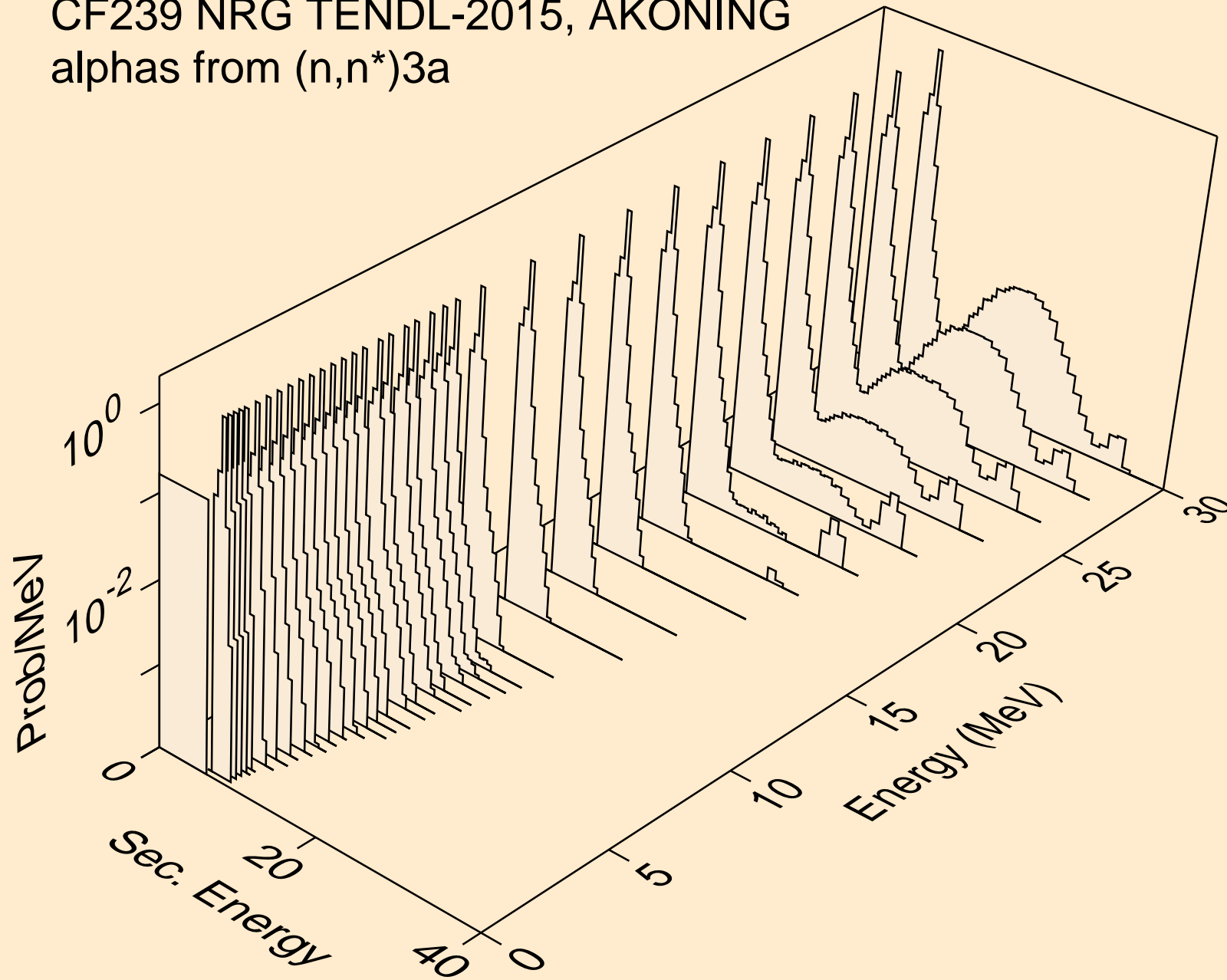

CF239 NRG TENDL-2015, AKONING
alphas from (n,2n)a

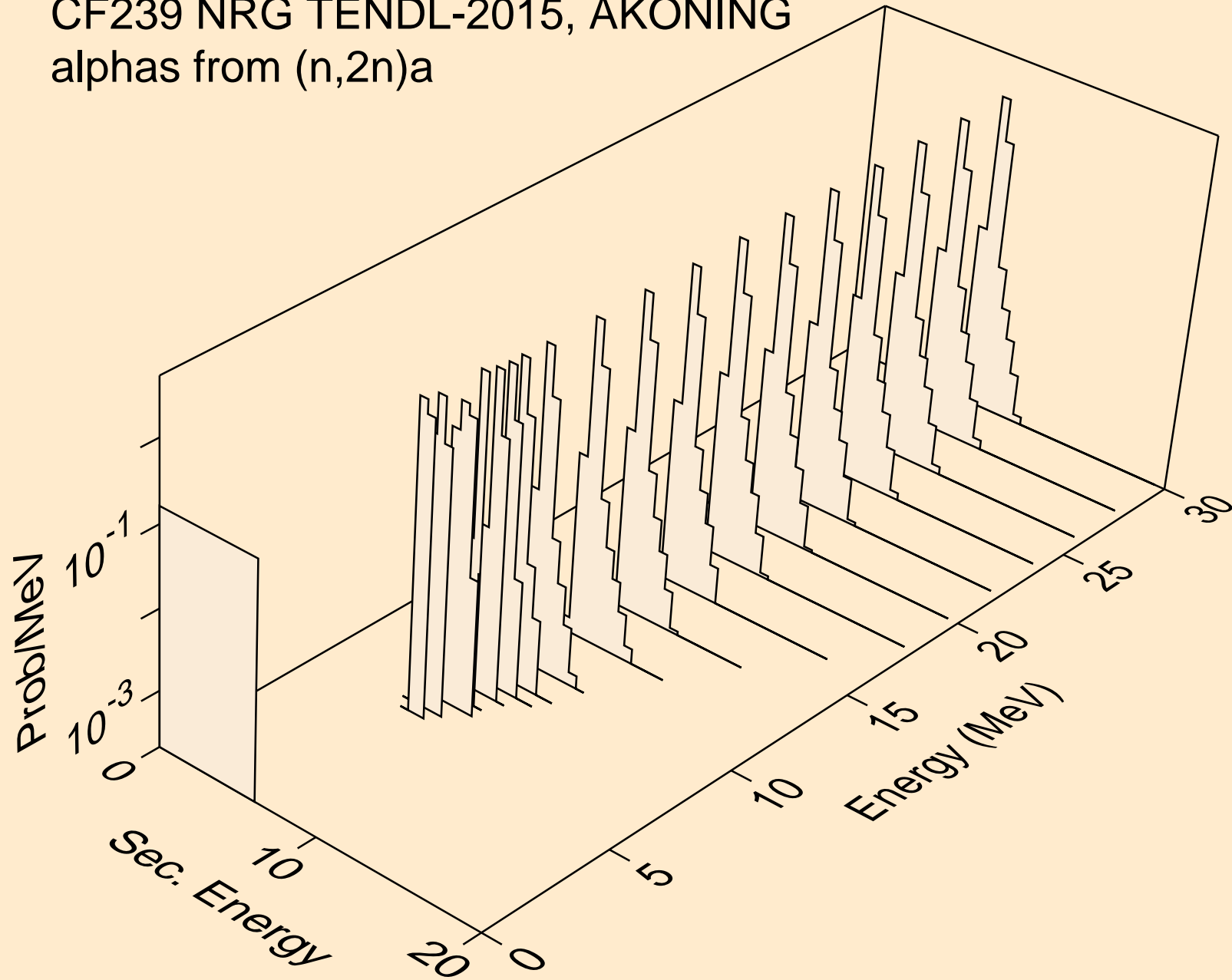

CF239 NRG TENDL-2015, AKONING
alphas from (n,3n)a

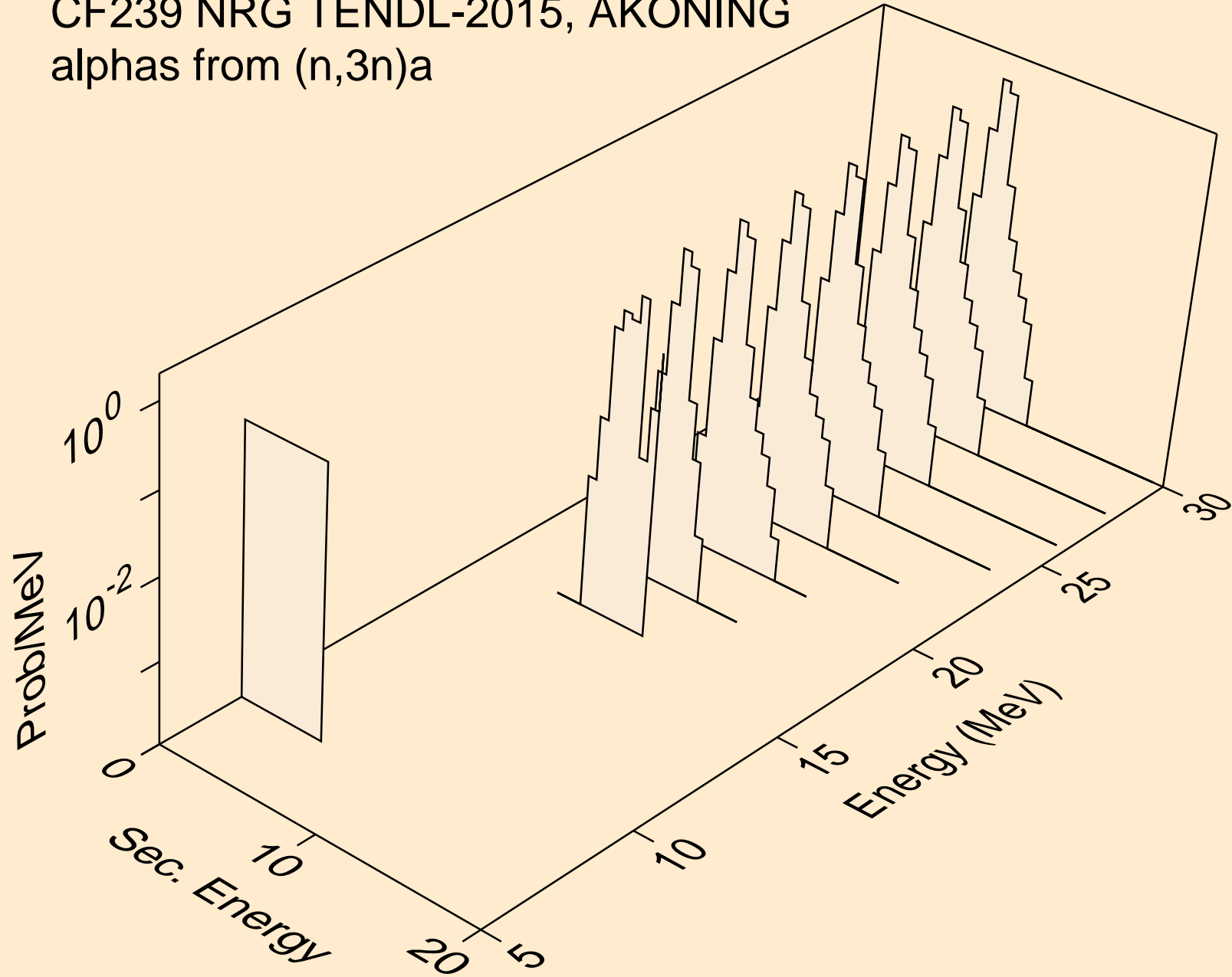

CF239 NRG TENDL-2015, AKONING
alphas from (n,n*)2a

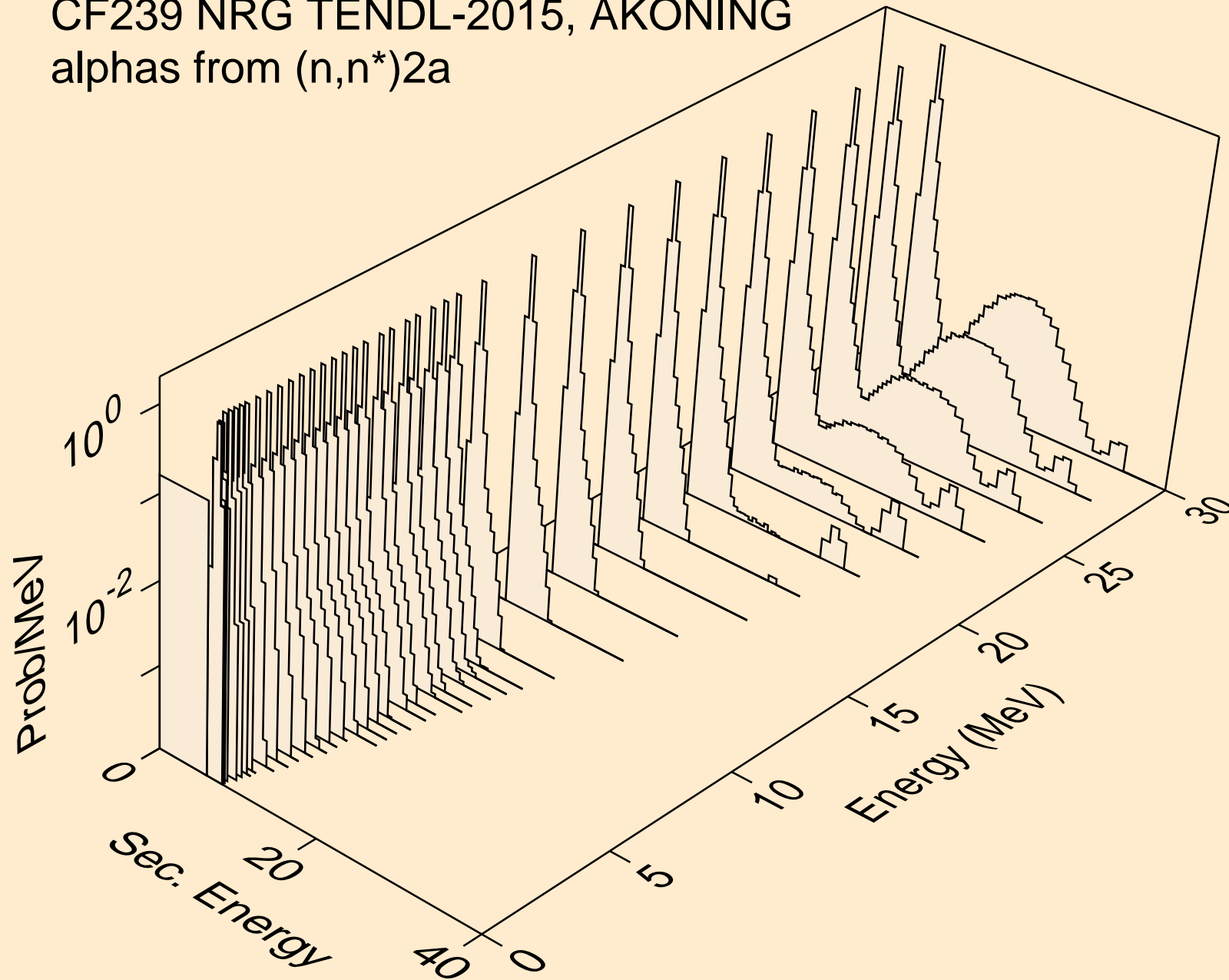

CF239 NRG TENDL-2015, AKONING
alphas from (n,2n)2a

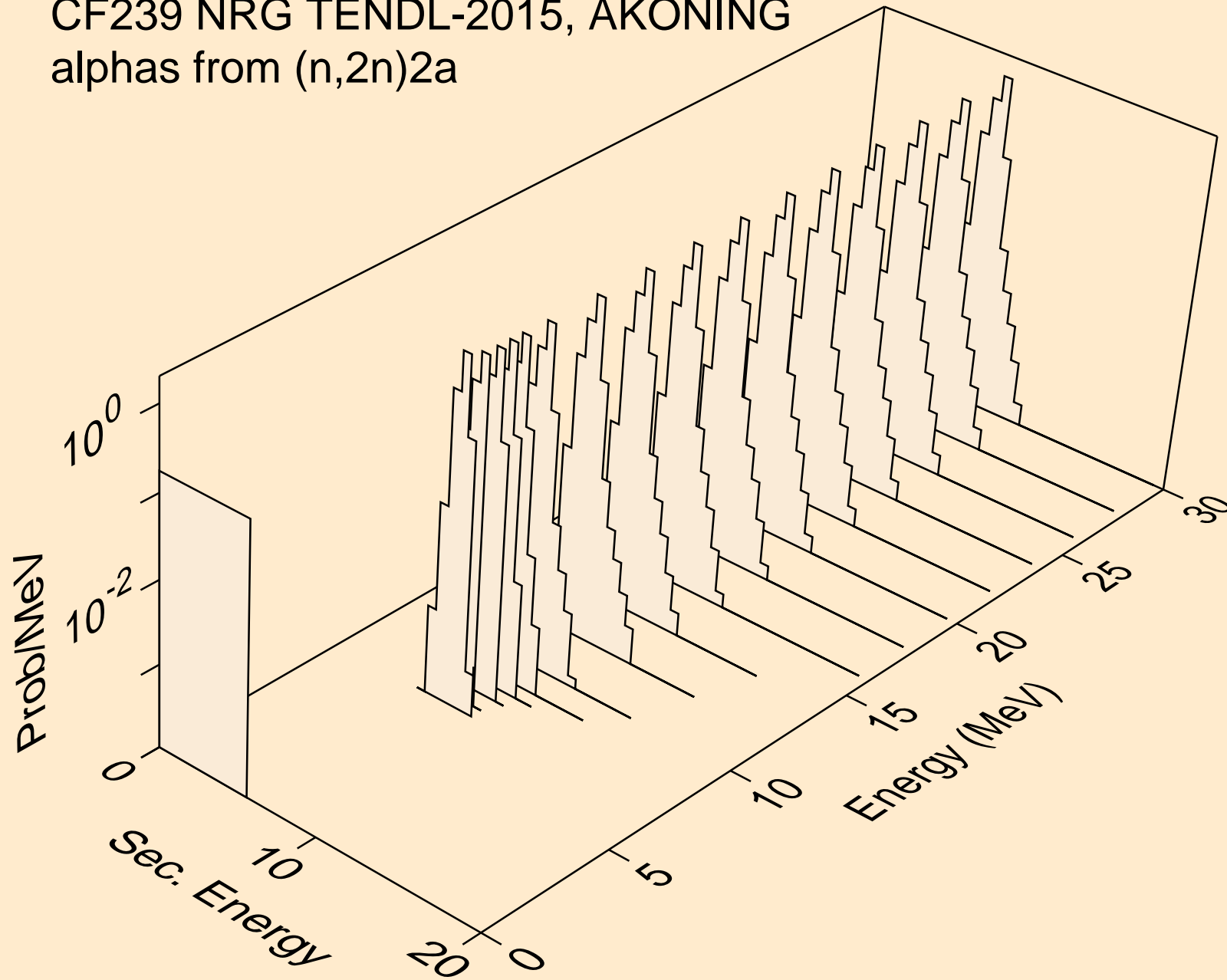

CF239 NRG TENDL-2015, AKONING
alphas from (n,n*)d2a

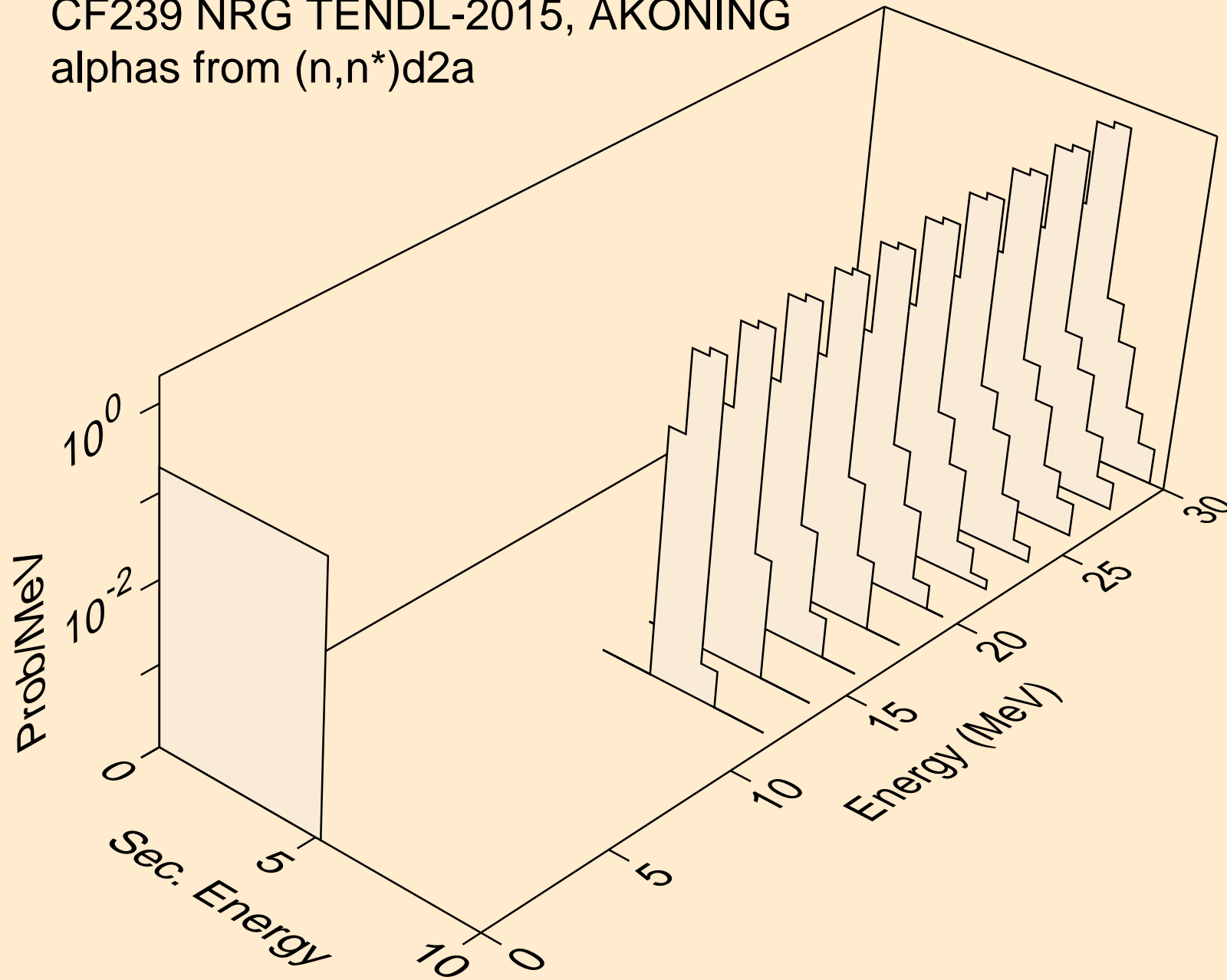

CF239 NRG TENDL-2015, AKONING
alphas from (n,n*)t2a

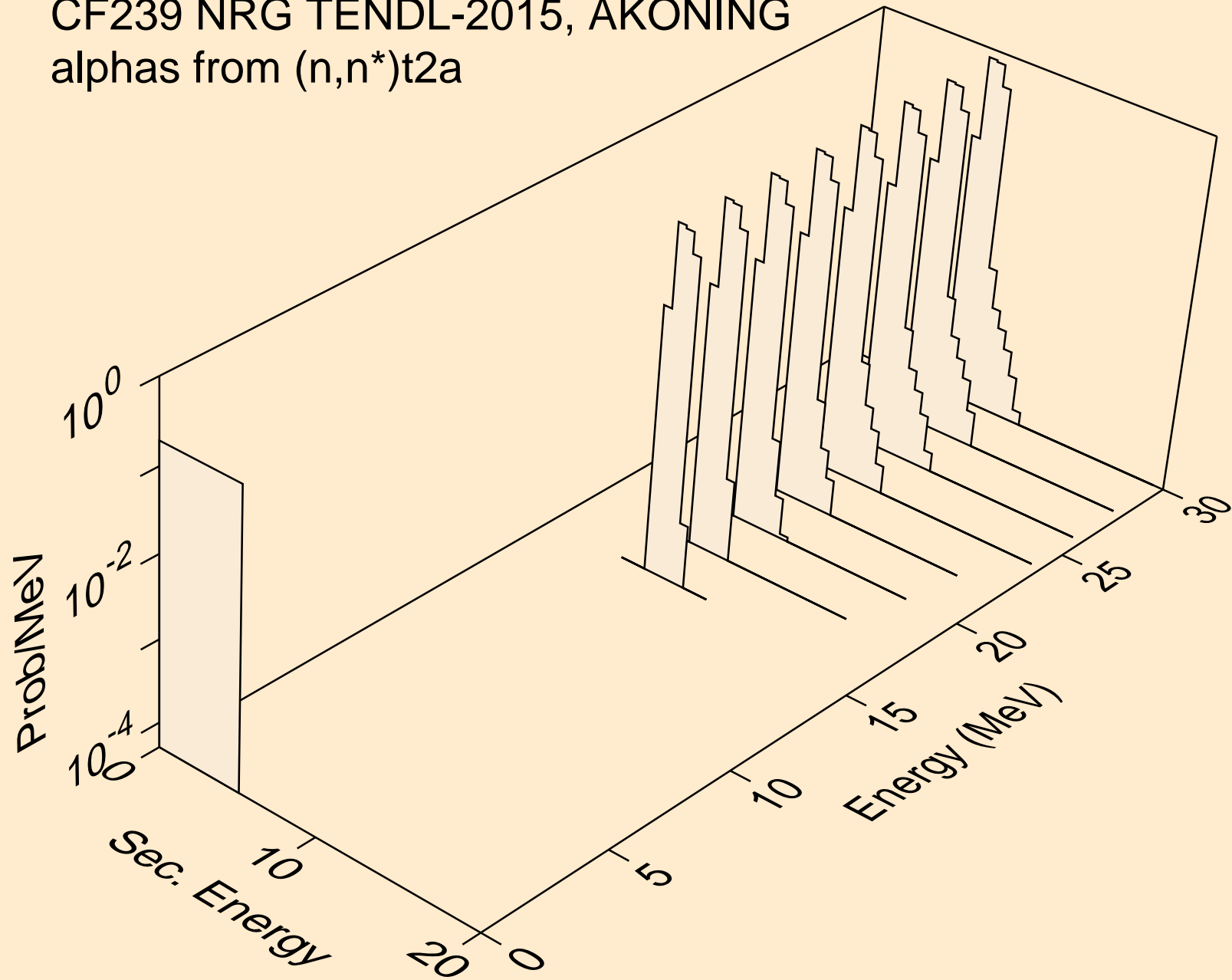

CF239 NRG TENDL-2015, AKONING
alphas from (n,npa)

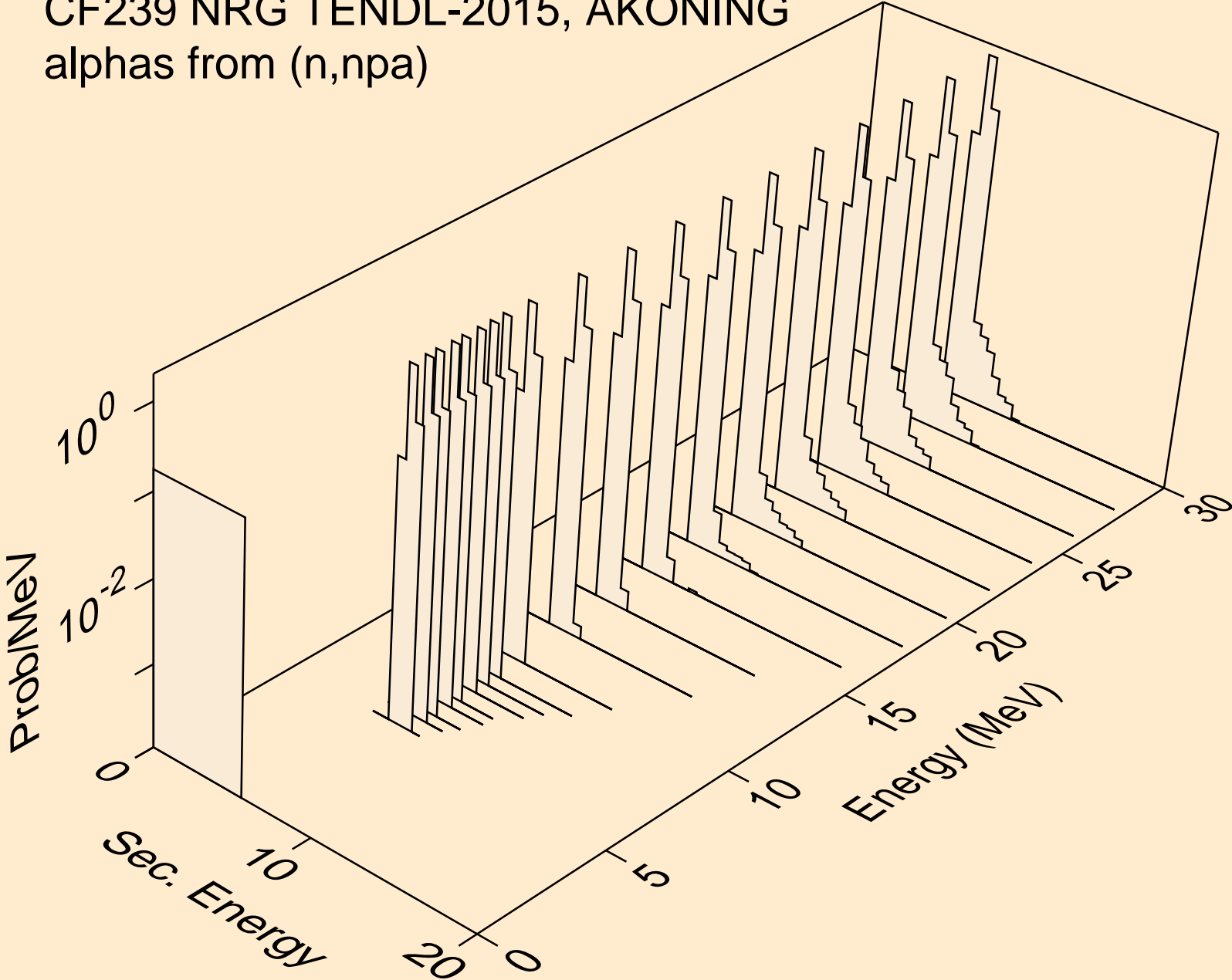

CF239 NRG TENDL-2015, AKONING
alphas from (n,a)

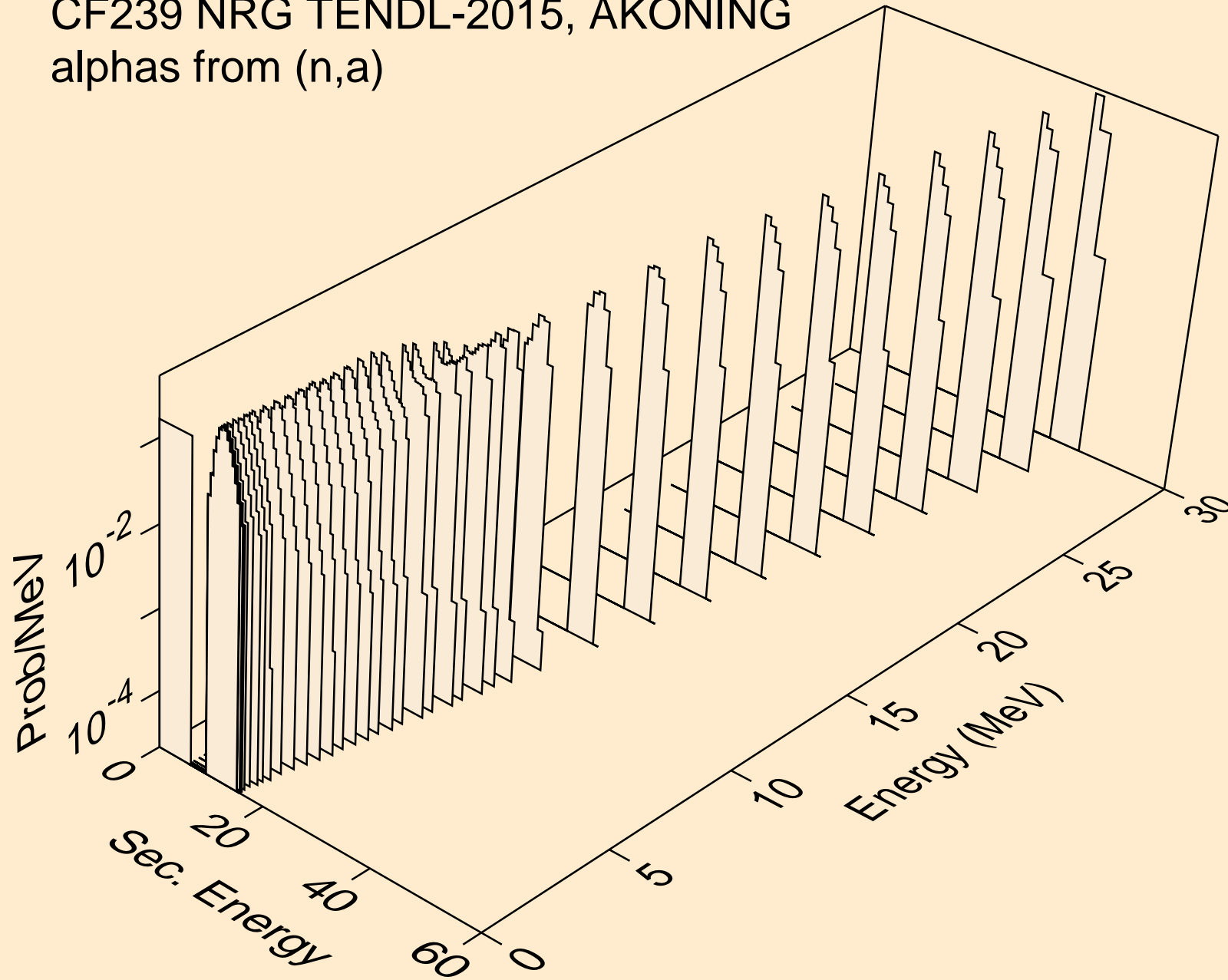

CF239 NRG TENDL-2015, AKONING
alphas from (n,2a)

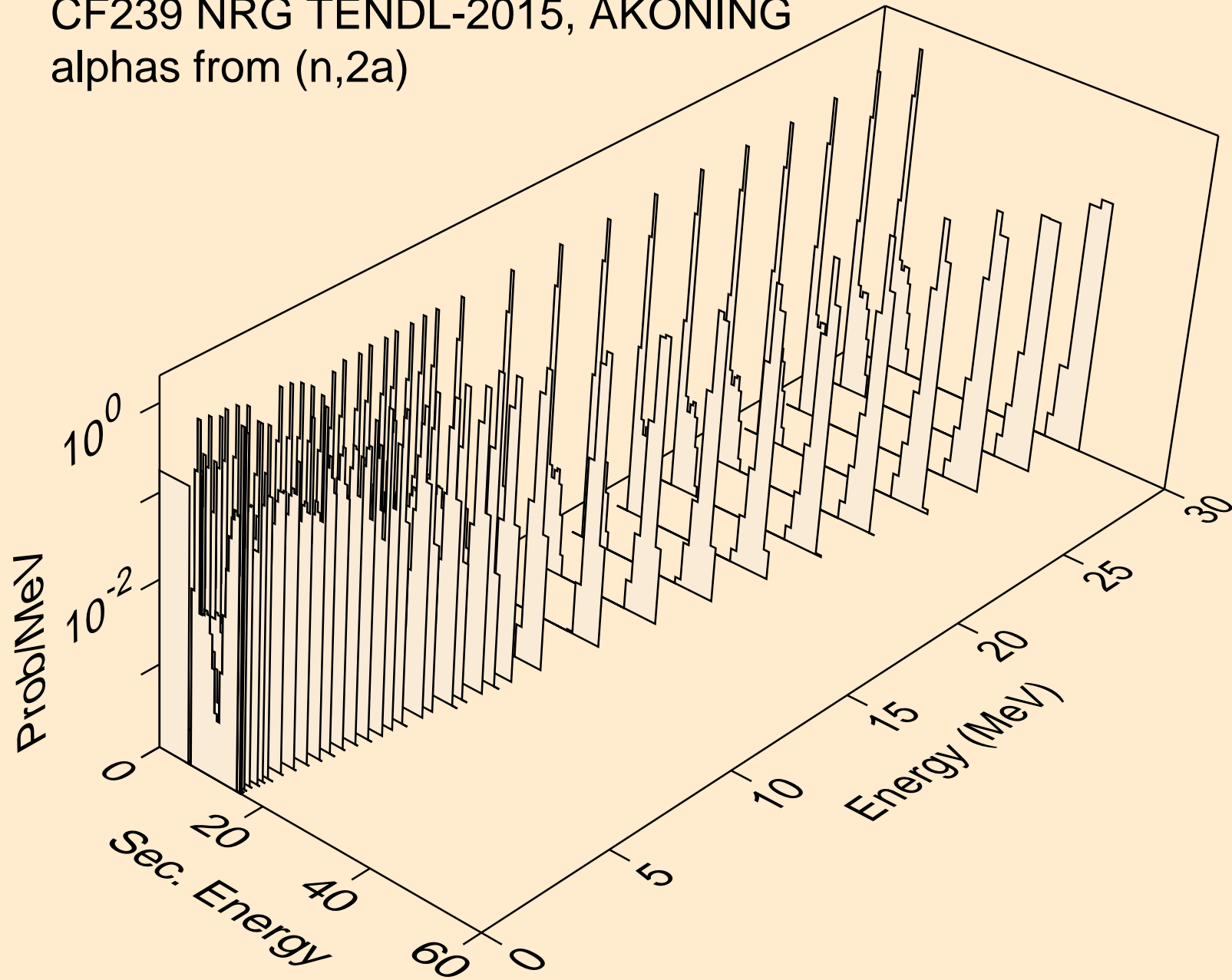

CF239 NRG TENDL-2015, AKONING
alphas from (n,3a)

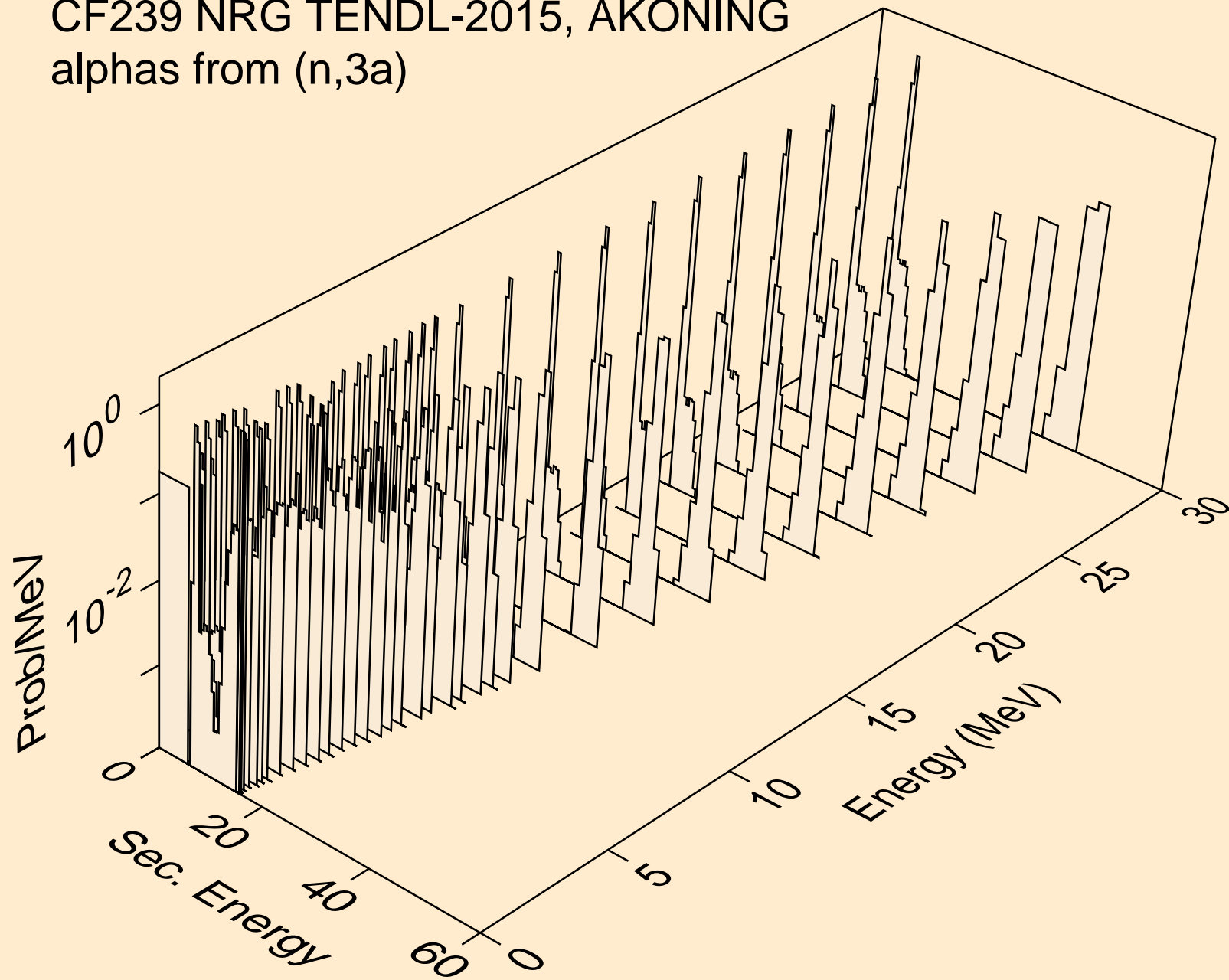

CF239 NRG TENDL-2015, AKONING
alphas from (n,pa)

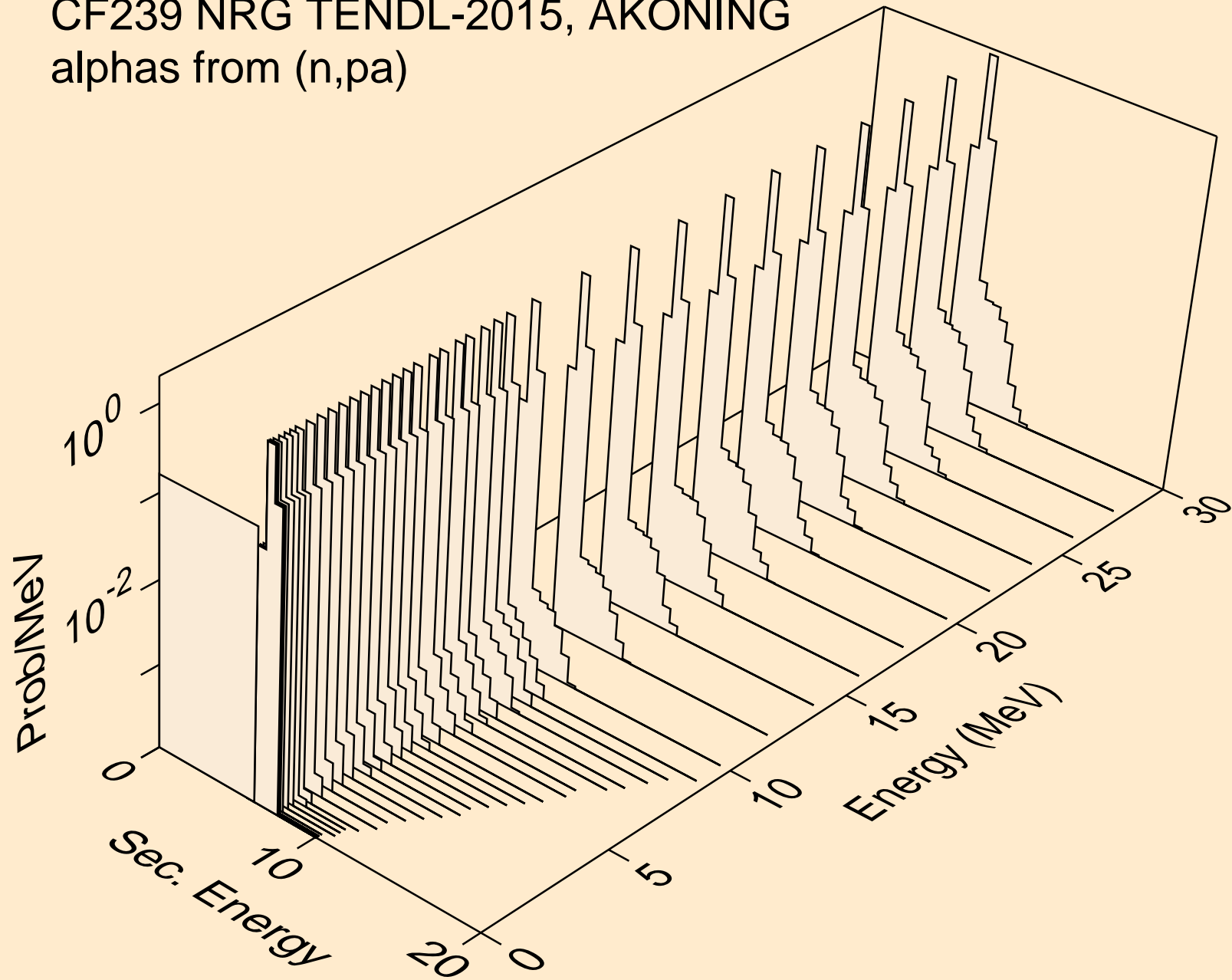

CF239 NRG TENDL-2015, AKONING
alphas from (n,t2a)

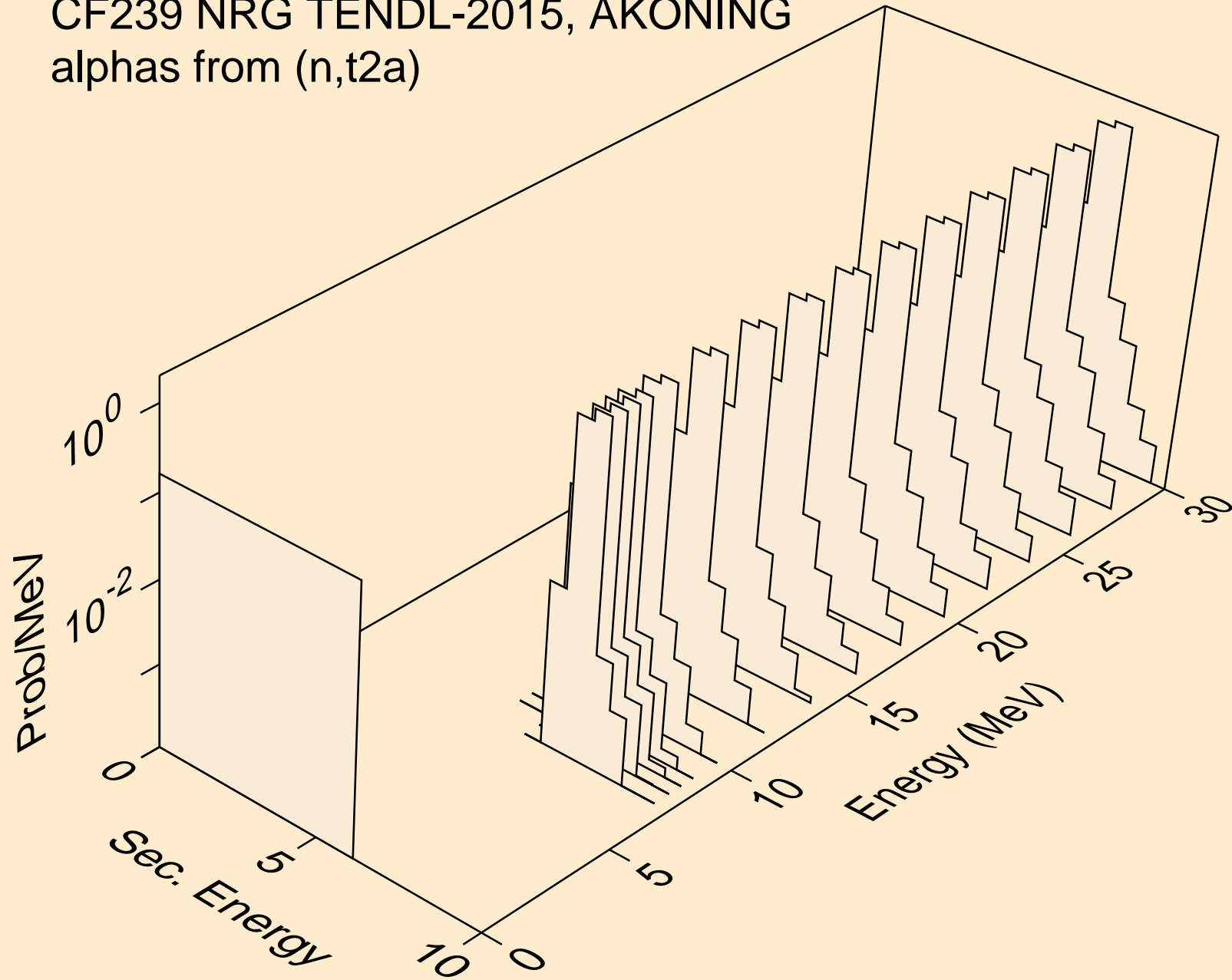

CF239 NRG TENDL-2015, AKONING
alphas from (n,d2a)

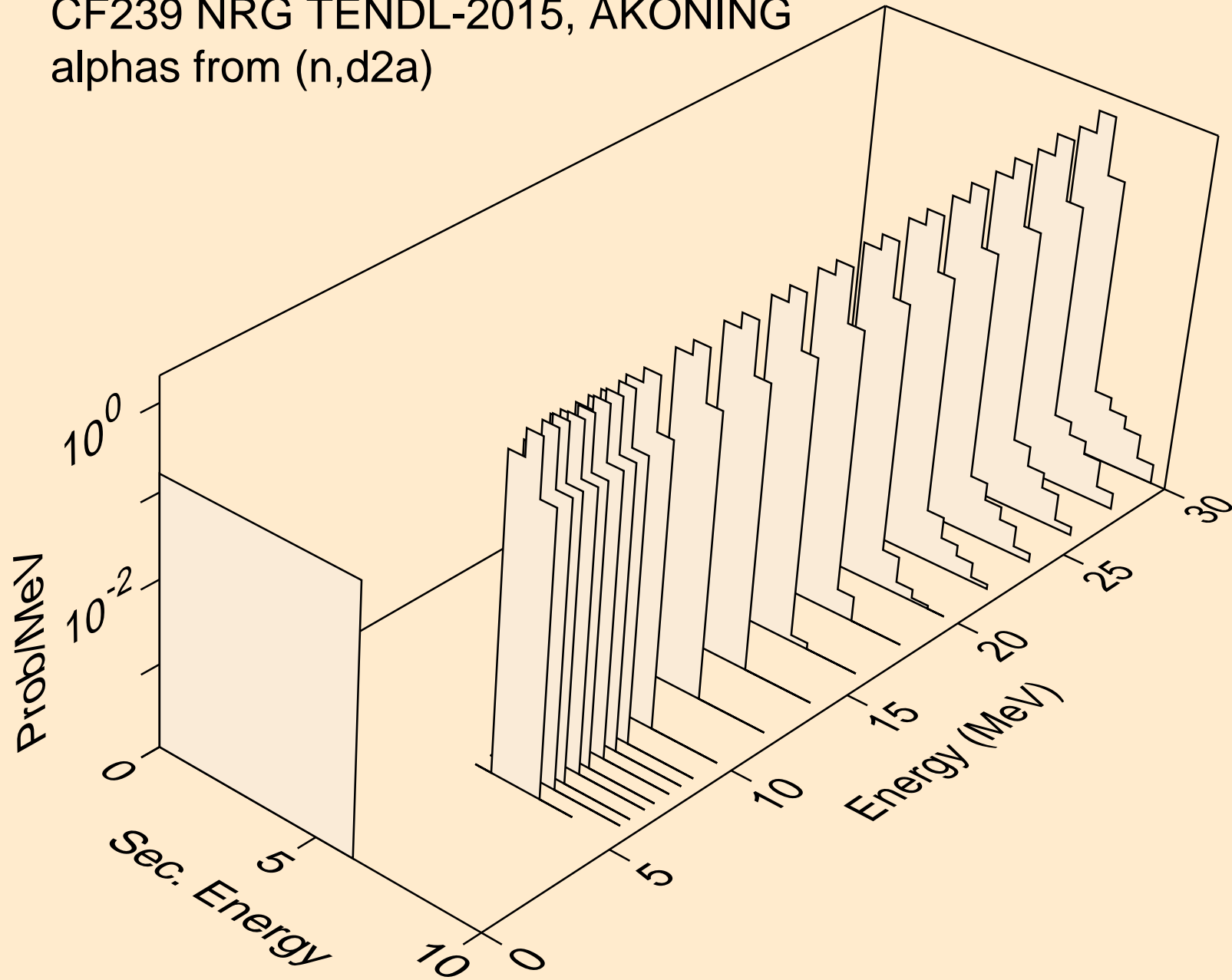

CF239 NRG TENDL-2015, AKONING
alphas from (n,da)

