

CF242 NRG TENDL-2015, AKONING

Principal cross sections

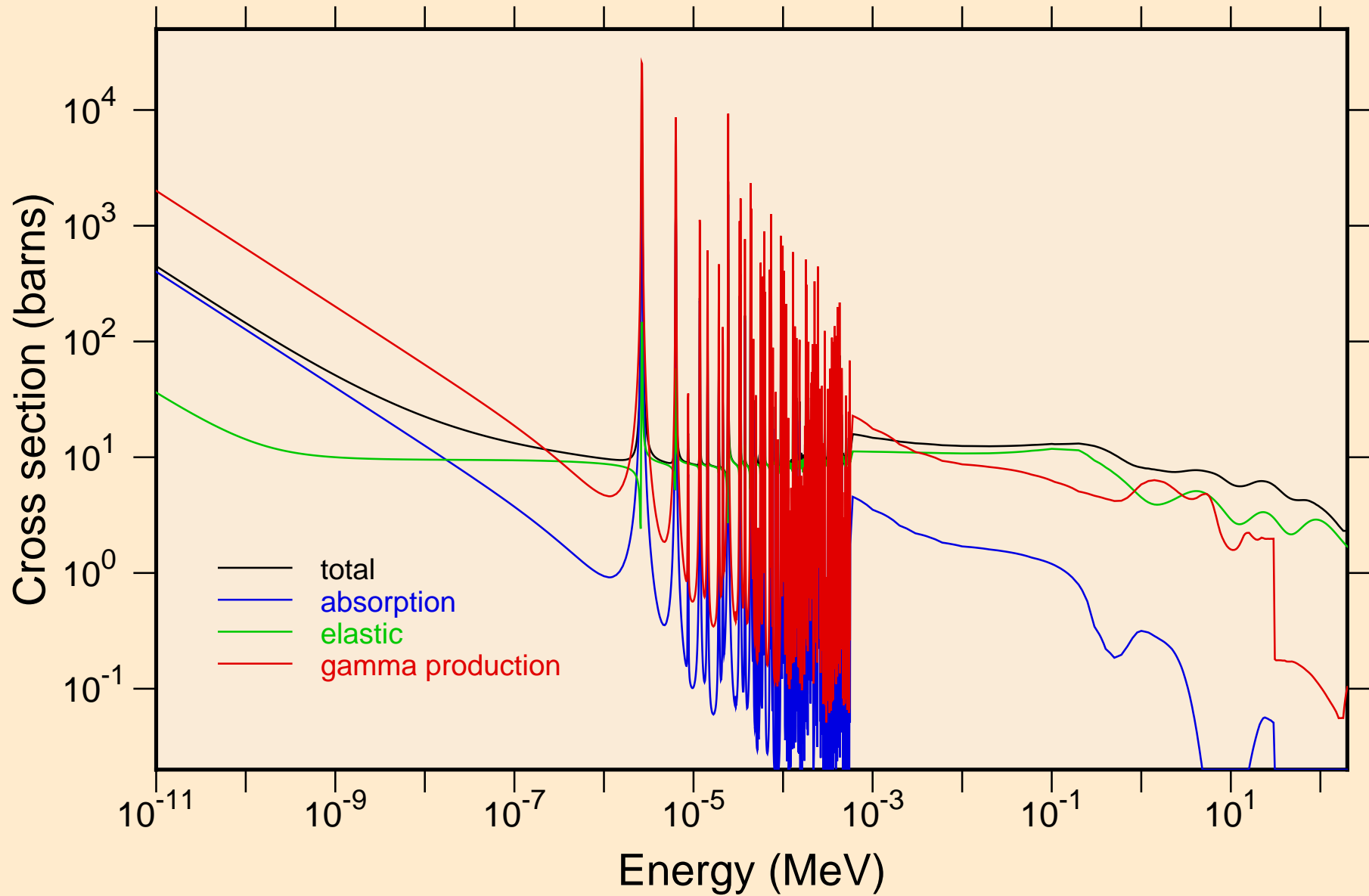

CF242 NRG TENDL-2015, AKONING
resonance total cross section

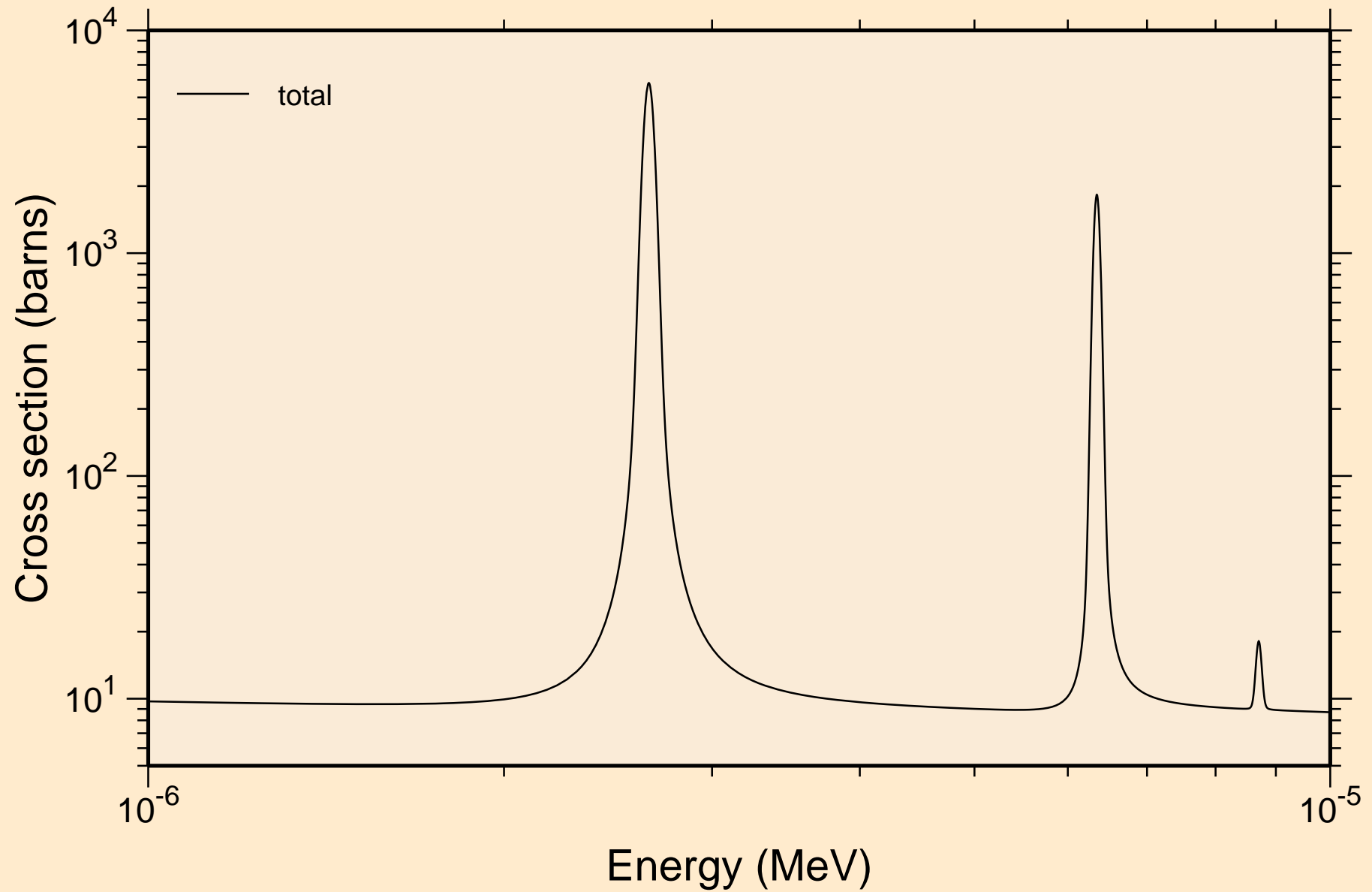

CF242 NRG TENDL-2015, AKONING
resonance total cross section

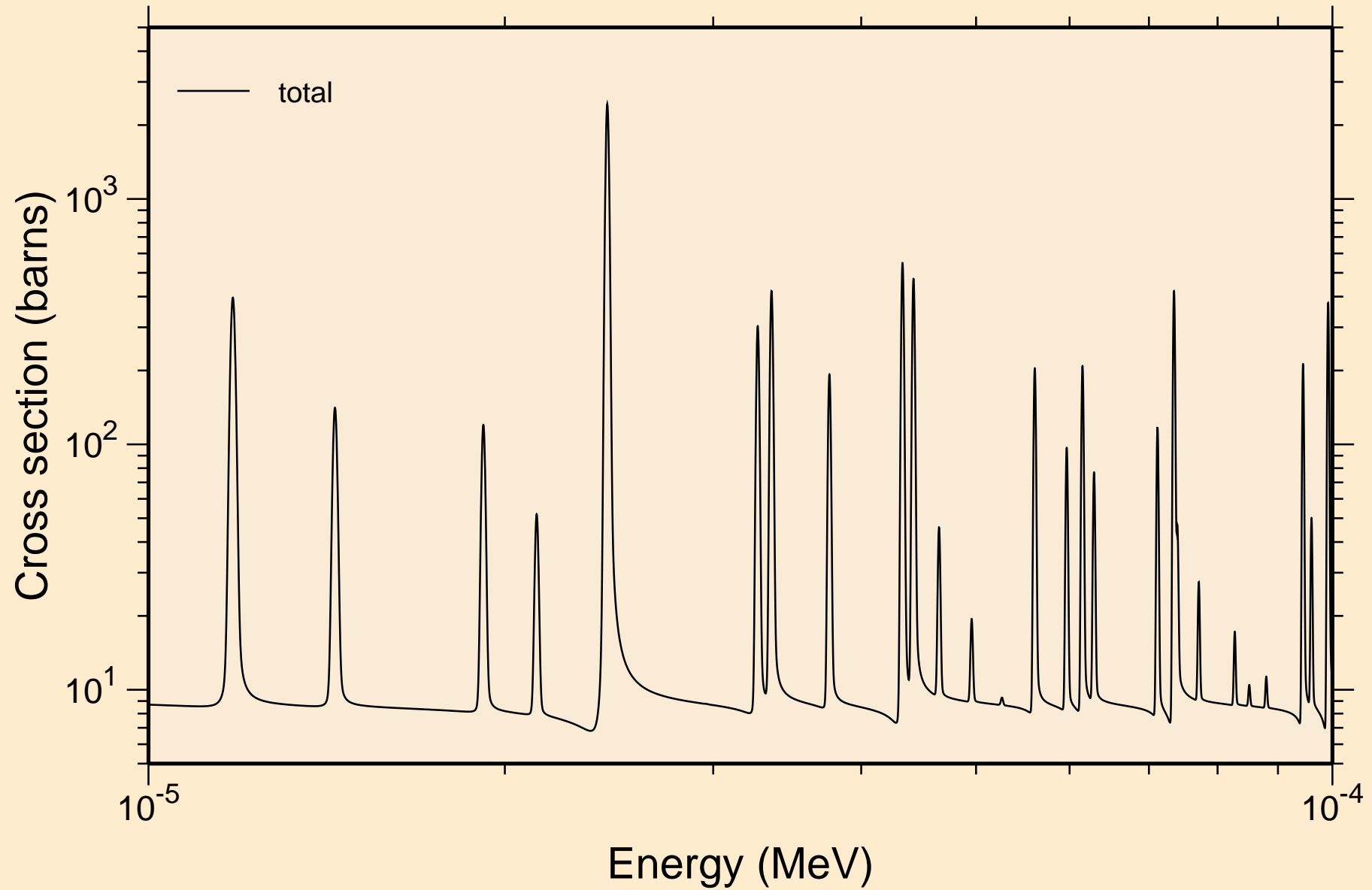

CF242 NRG TENDL-2015, AKONING
resonance total cross section

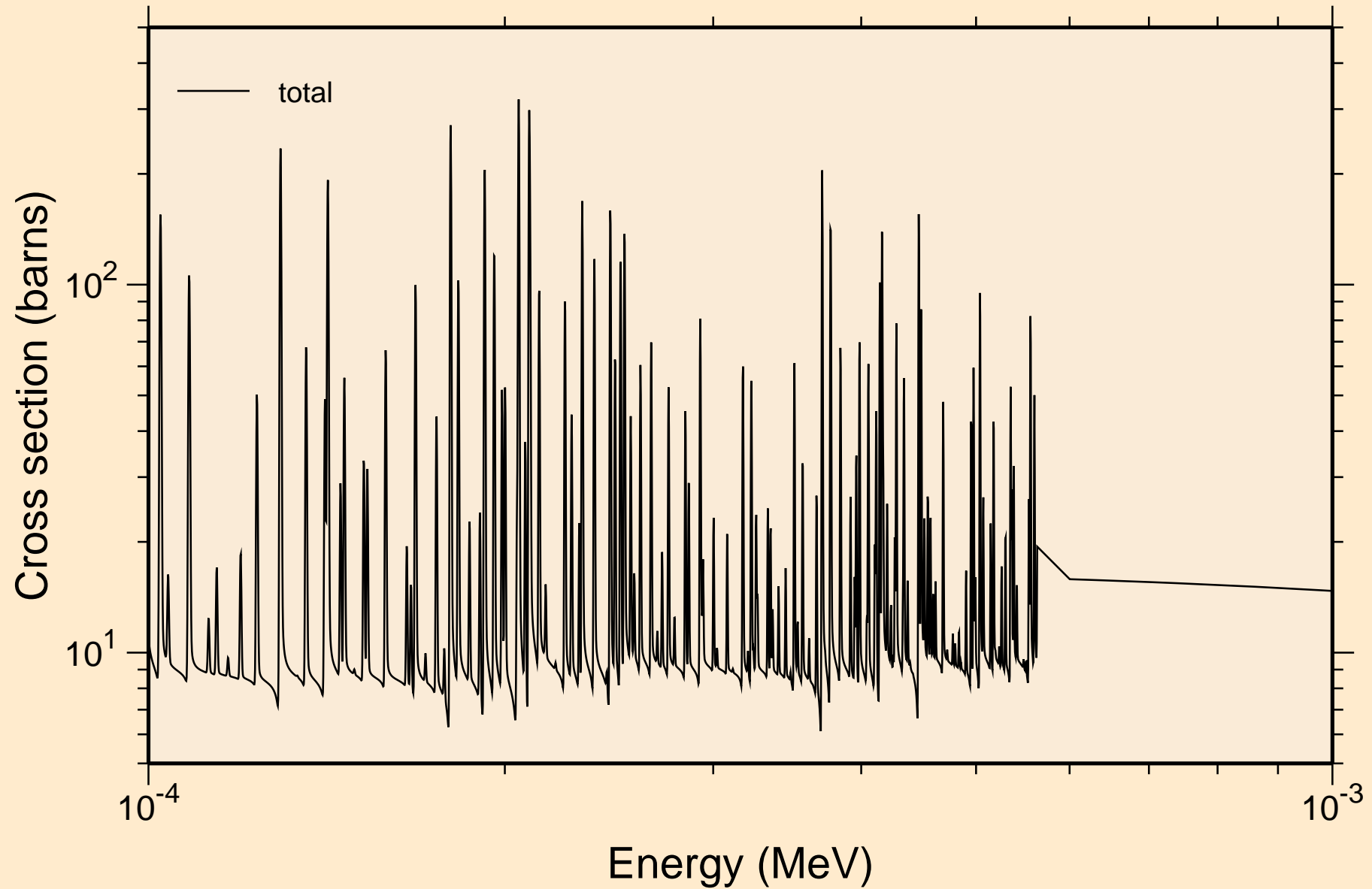

CF242 NRG TENDL-2015, AKONING
resonance total cross section

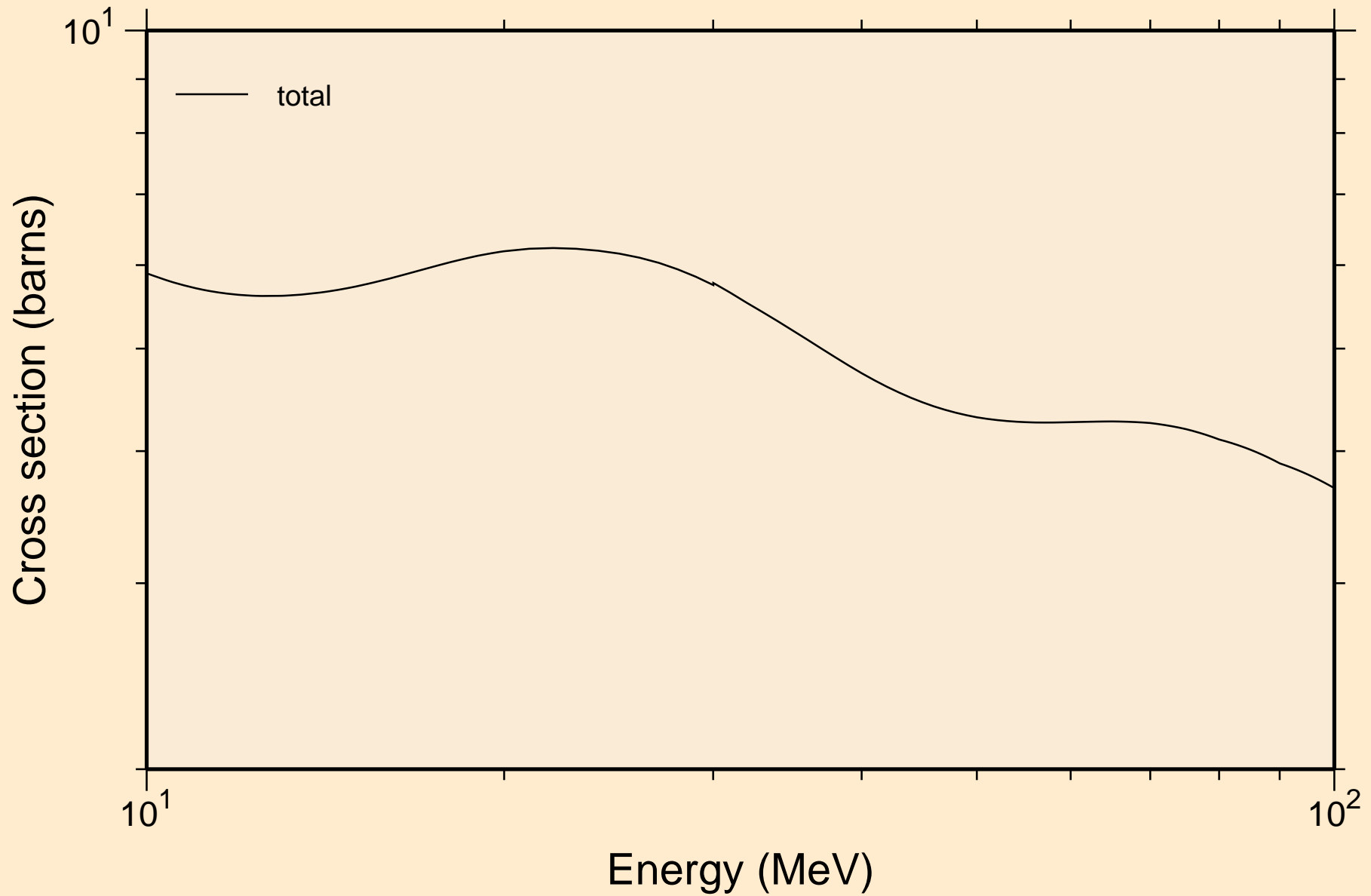

CF242 NRG TENDL-2015, AKONING

resonance absorption cross sections

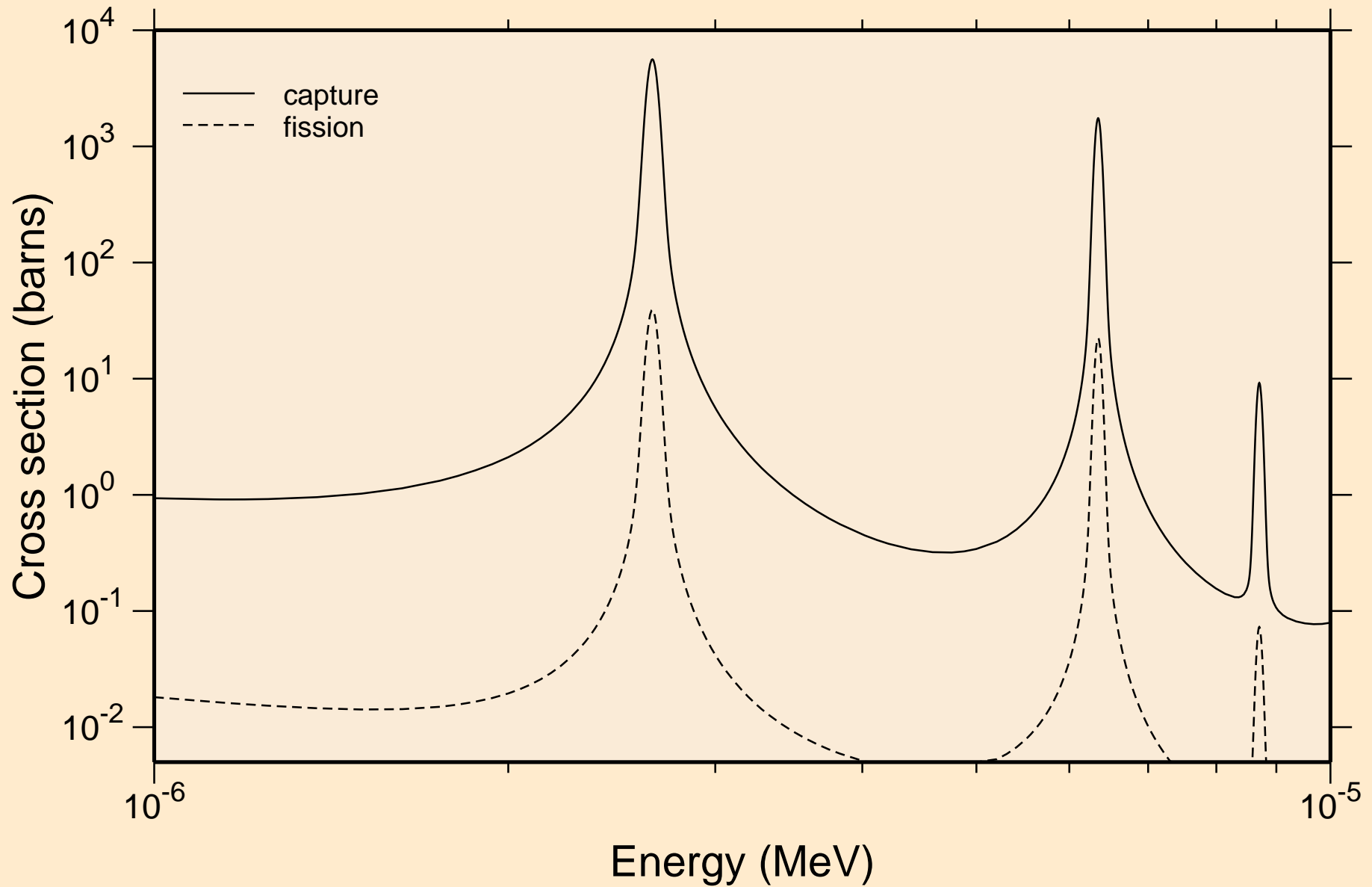

CF242 NRG TENDL-2015, AKONING resonance absorption cross sections

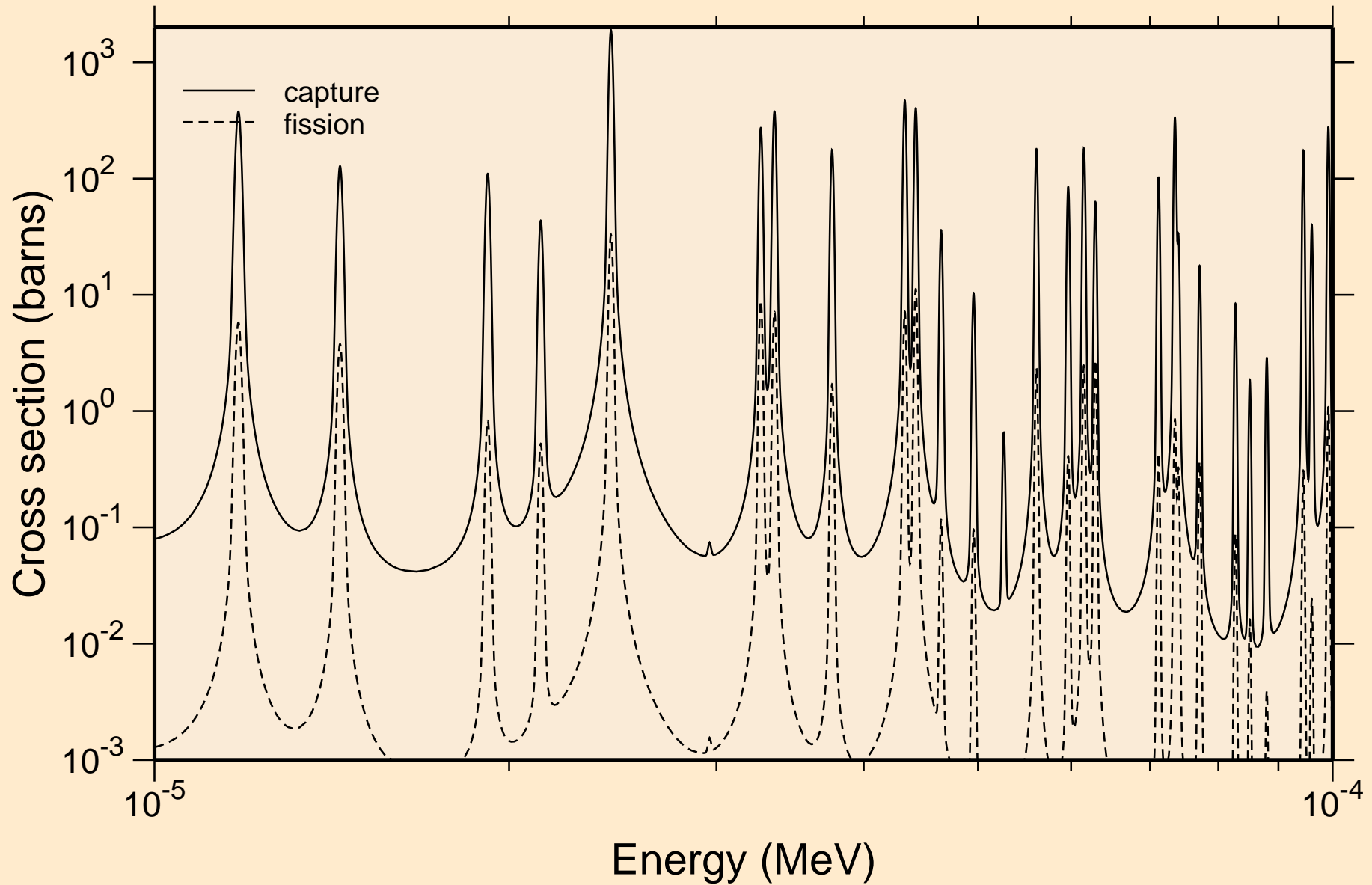

CF242 NRG TENDL-2015, AKONING
resonance absorption cross sections

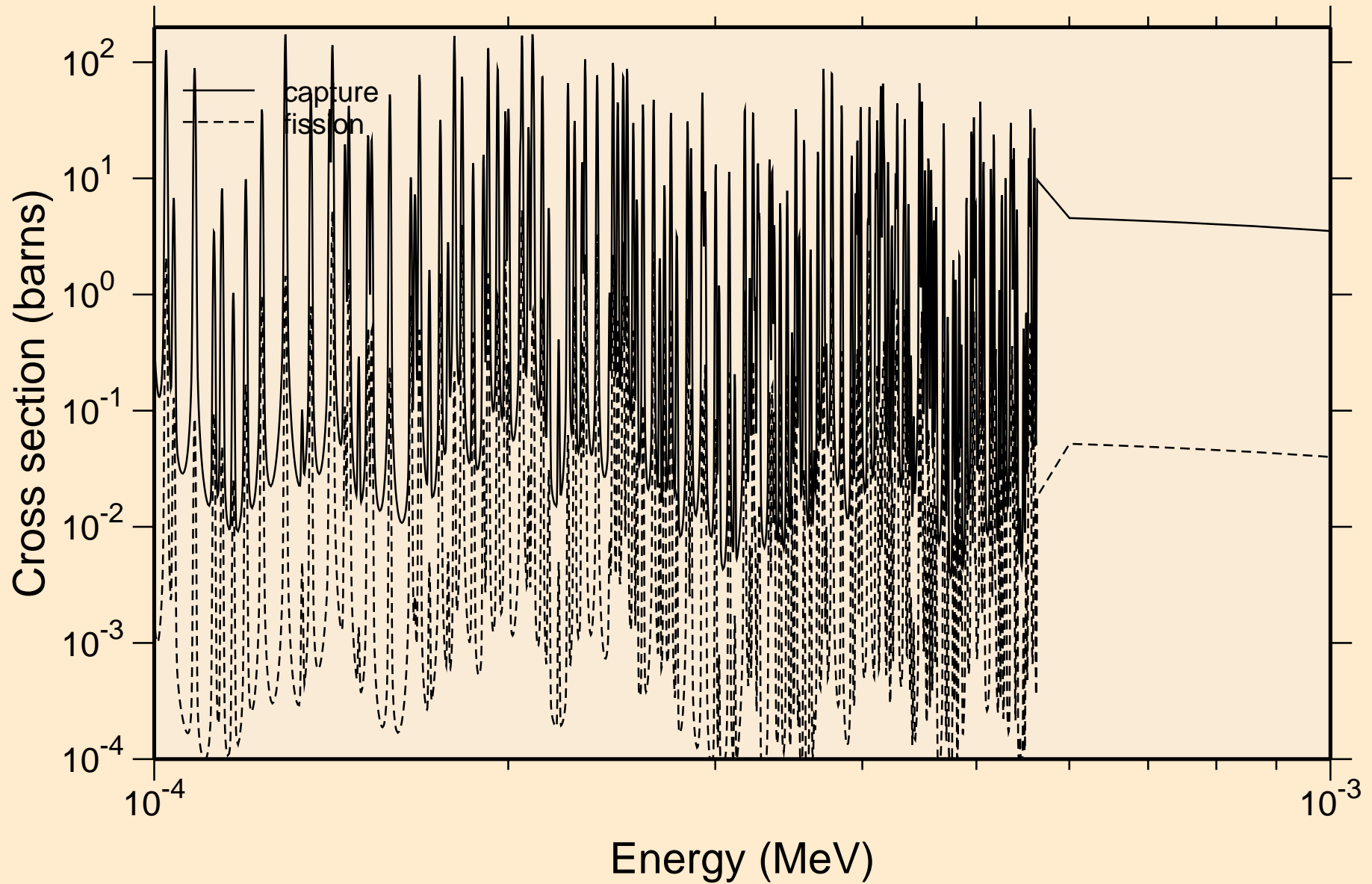

CF242 NRG TENDL-2015, AKONING

resonance absorption cross sections

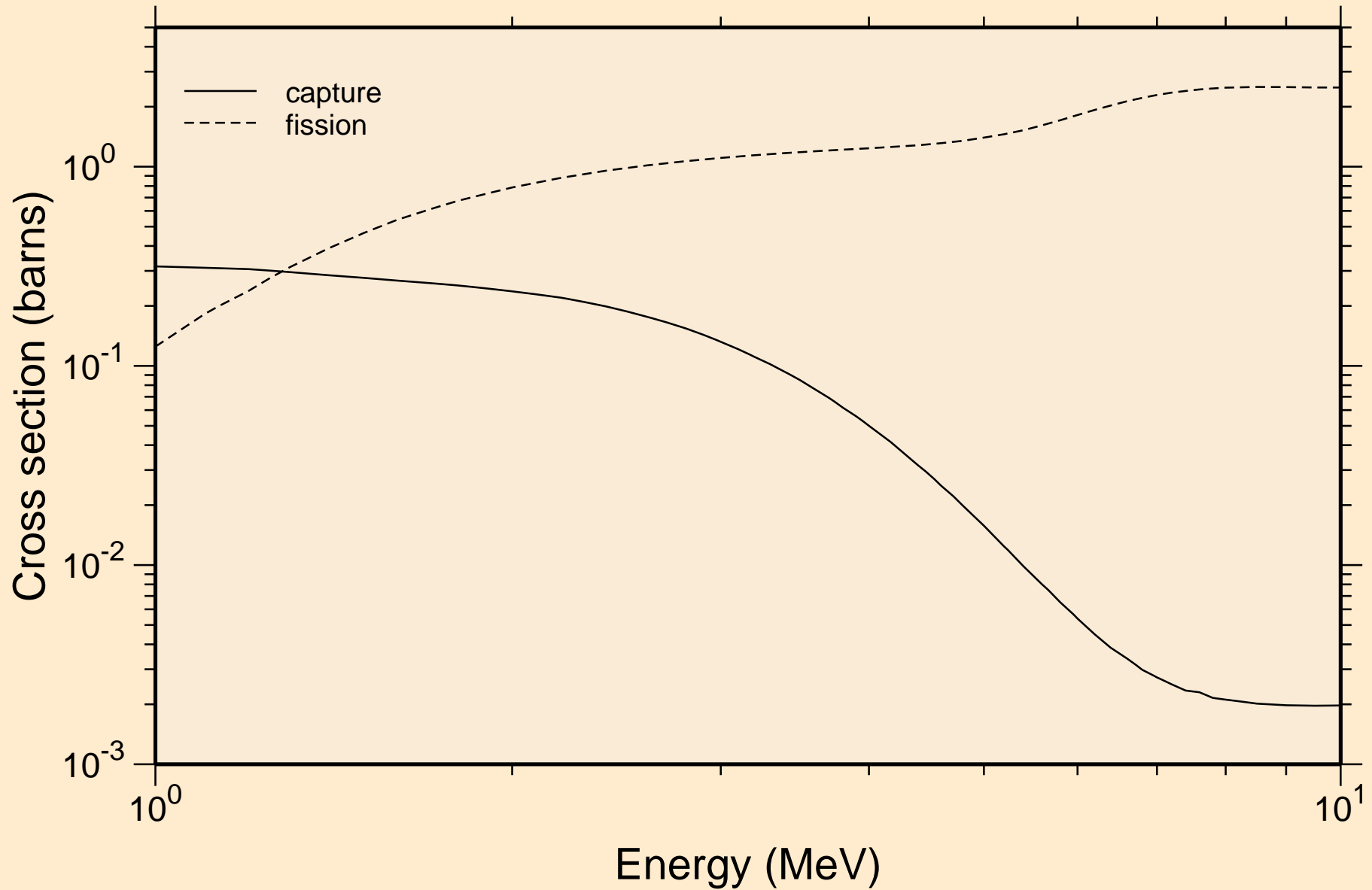

CF242 NRG TENDL-2015, AKONING

Non-threshold reactions

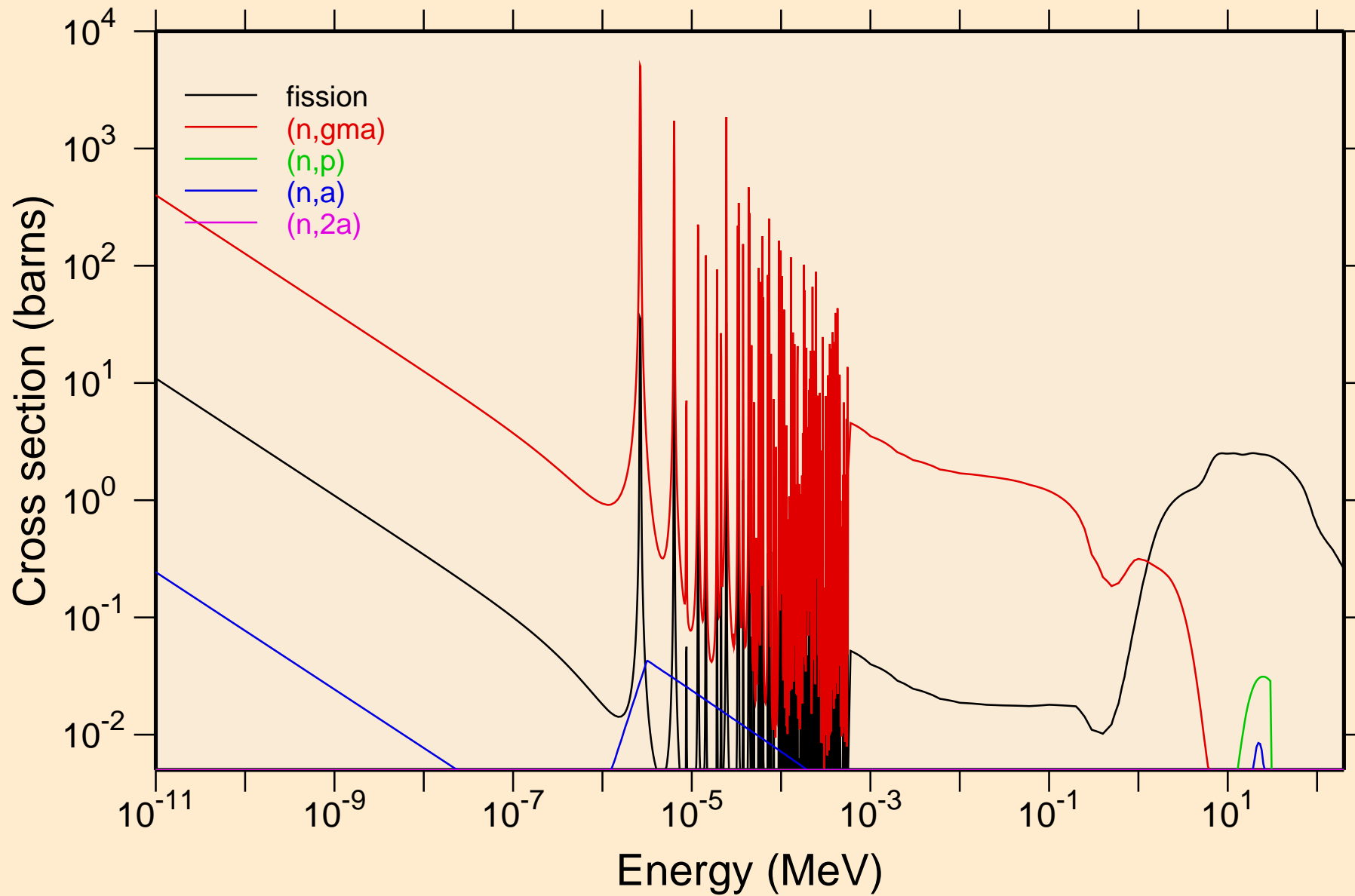

CF242 NRG TENDL-2015, AKONING
Non-threshold reactions

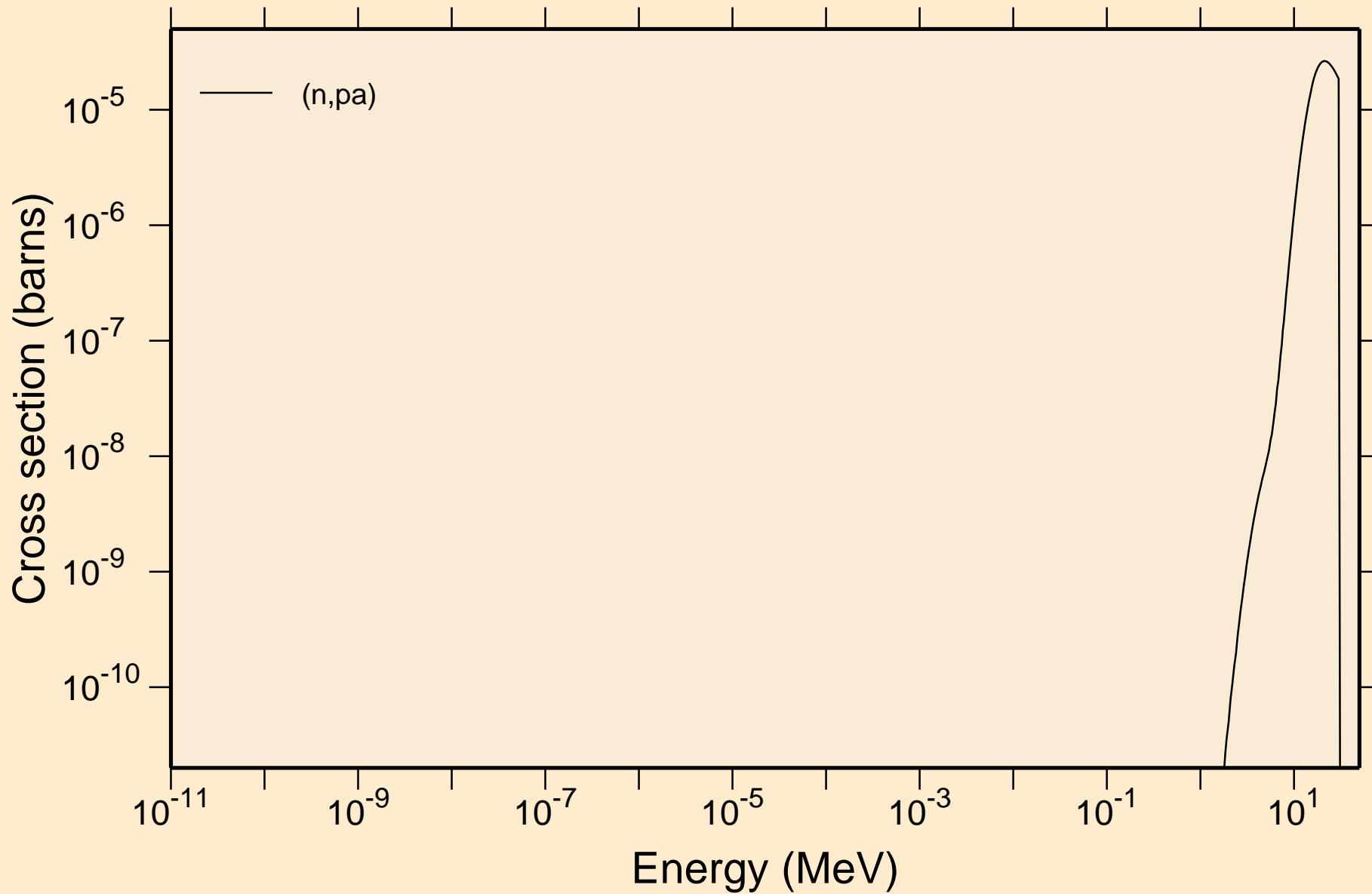

CF242 NRG TENDL-2015, AKONING

Principal cross sections

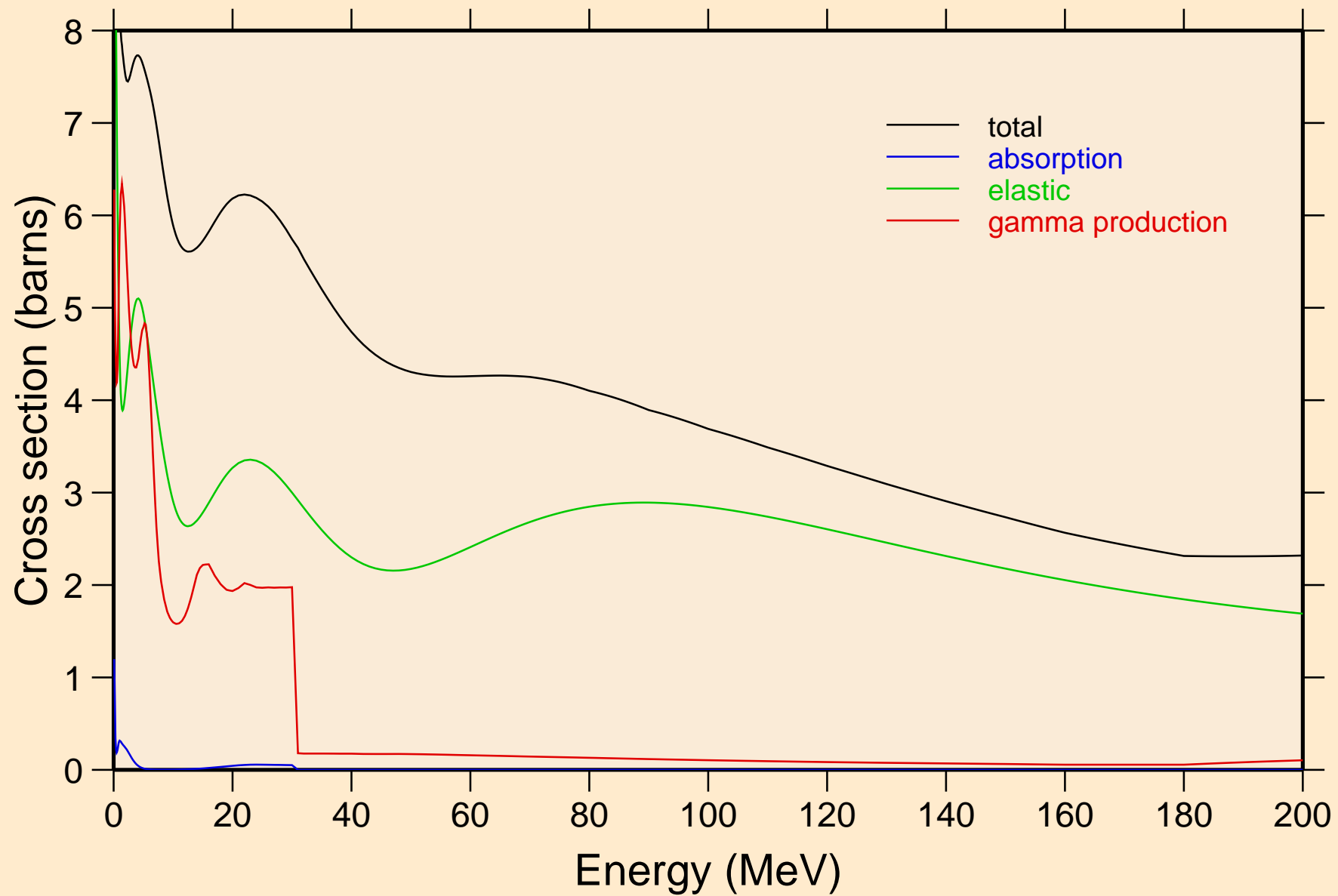

CF242 NRG TENDL-2015, AKONING

Non-threshold reactions

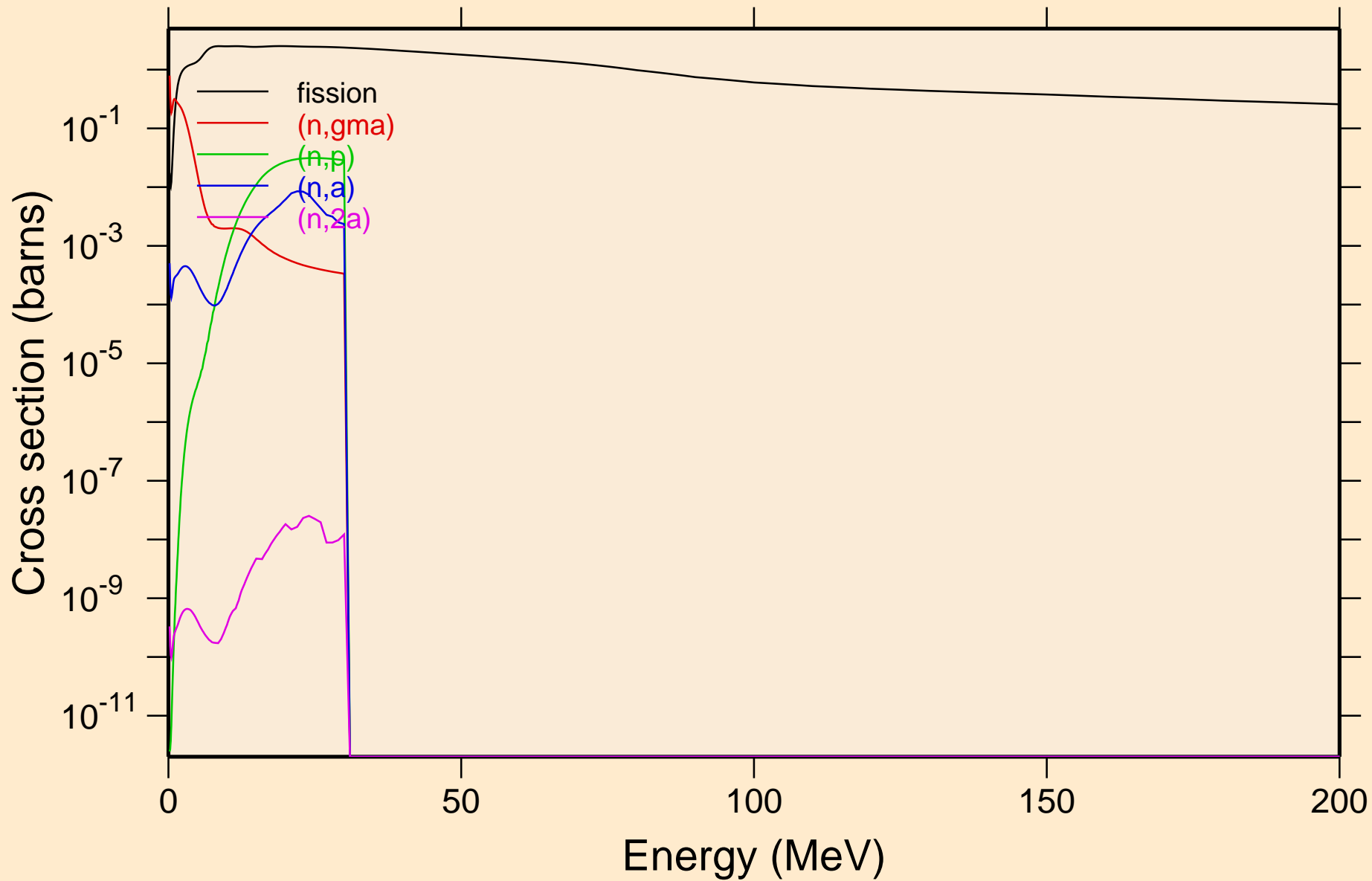

CF242 NRG TENDL-2015, AKONING
Non-threshold reactions

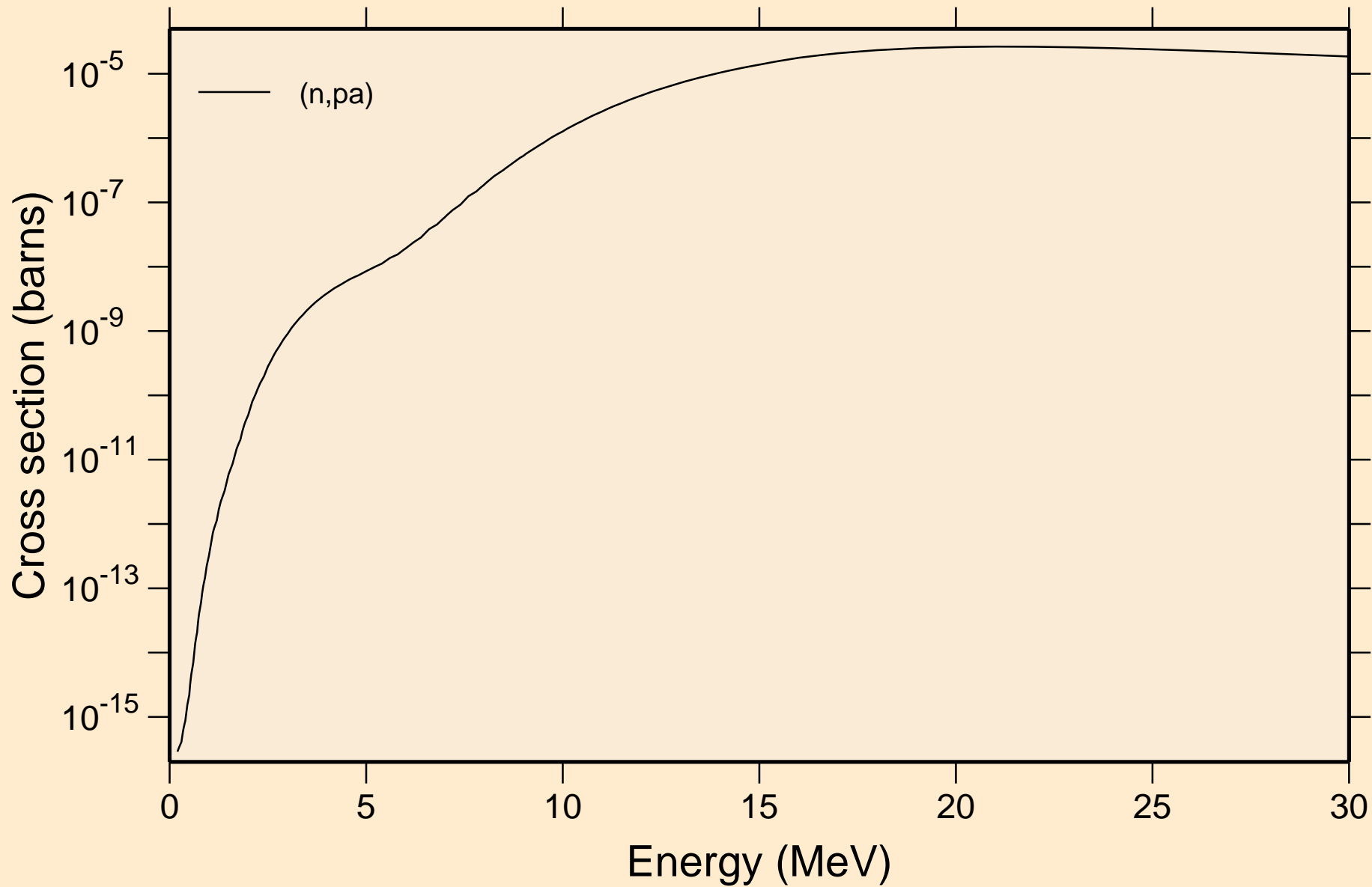

CF242 NRG TENDL-2015, AKONING
Inelastic levels

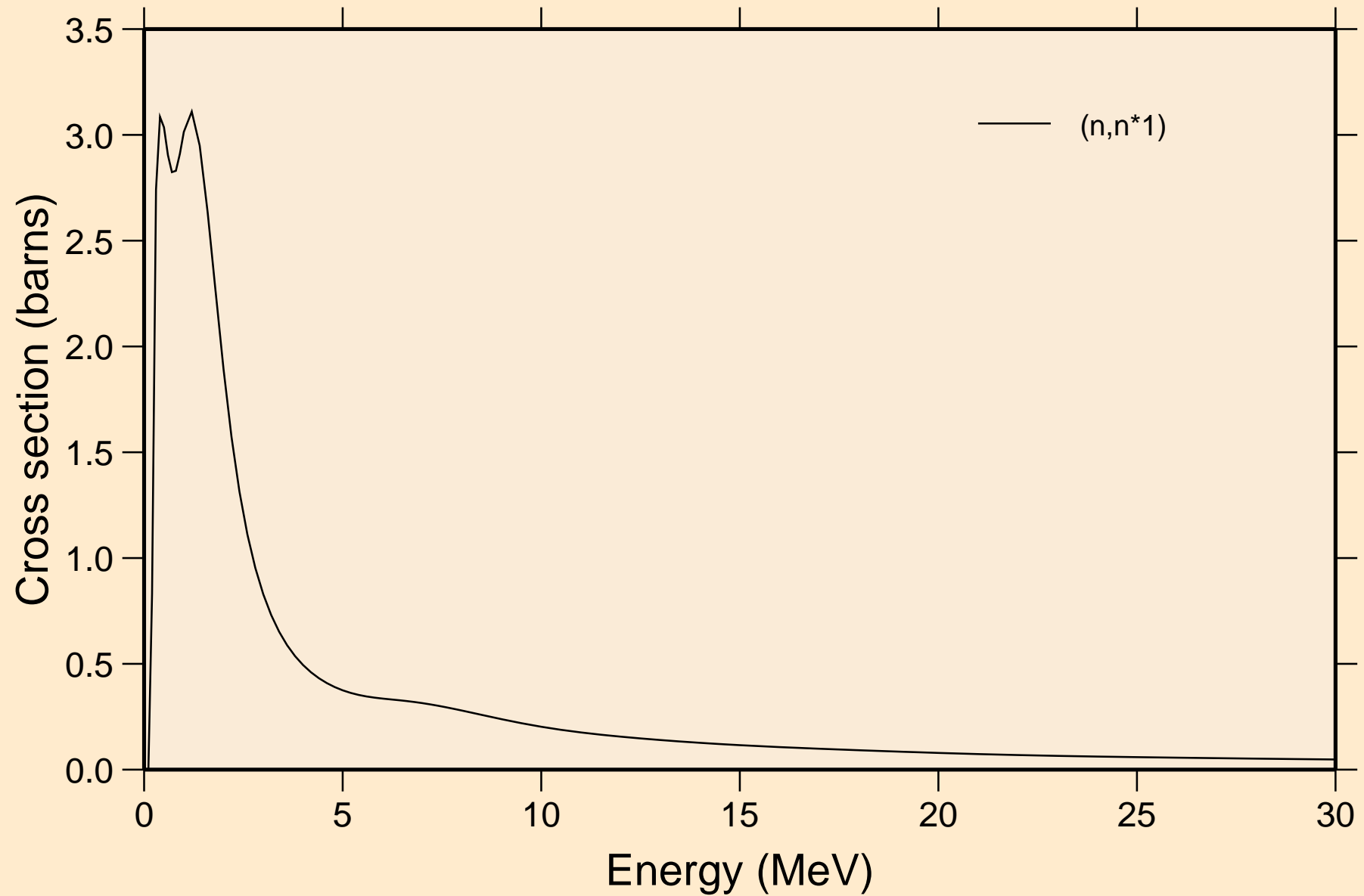

CF242 NRG TENDL-2015, AKONING

Threshold reactions

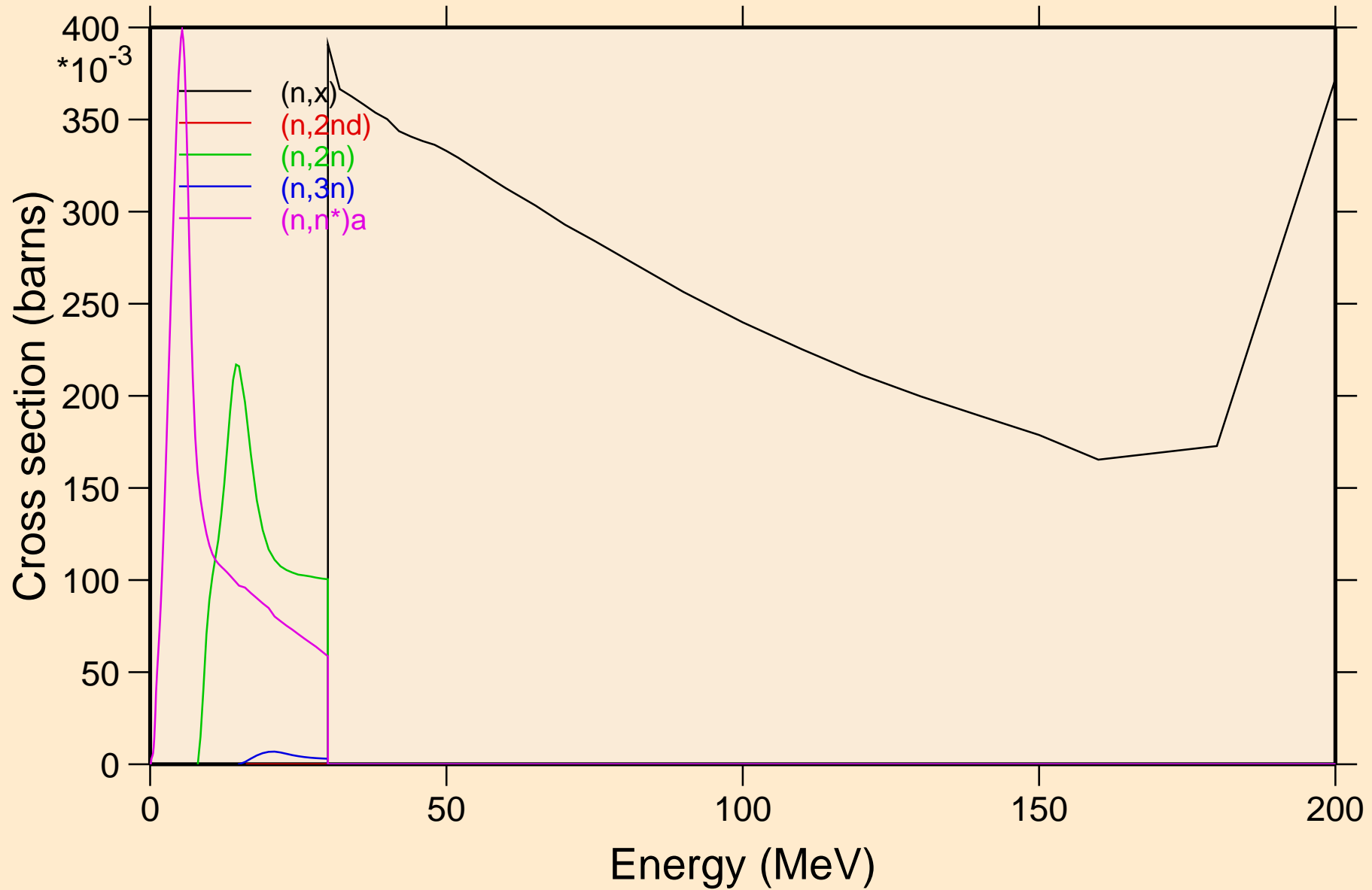

CF242 NRG TENDL-2015, AKONING

Threshold reactions

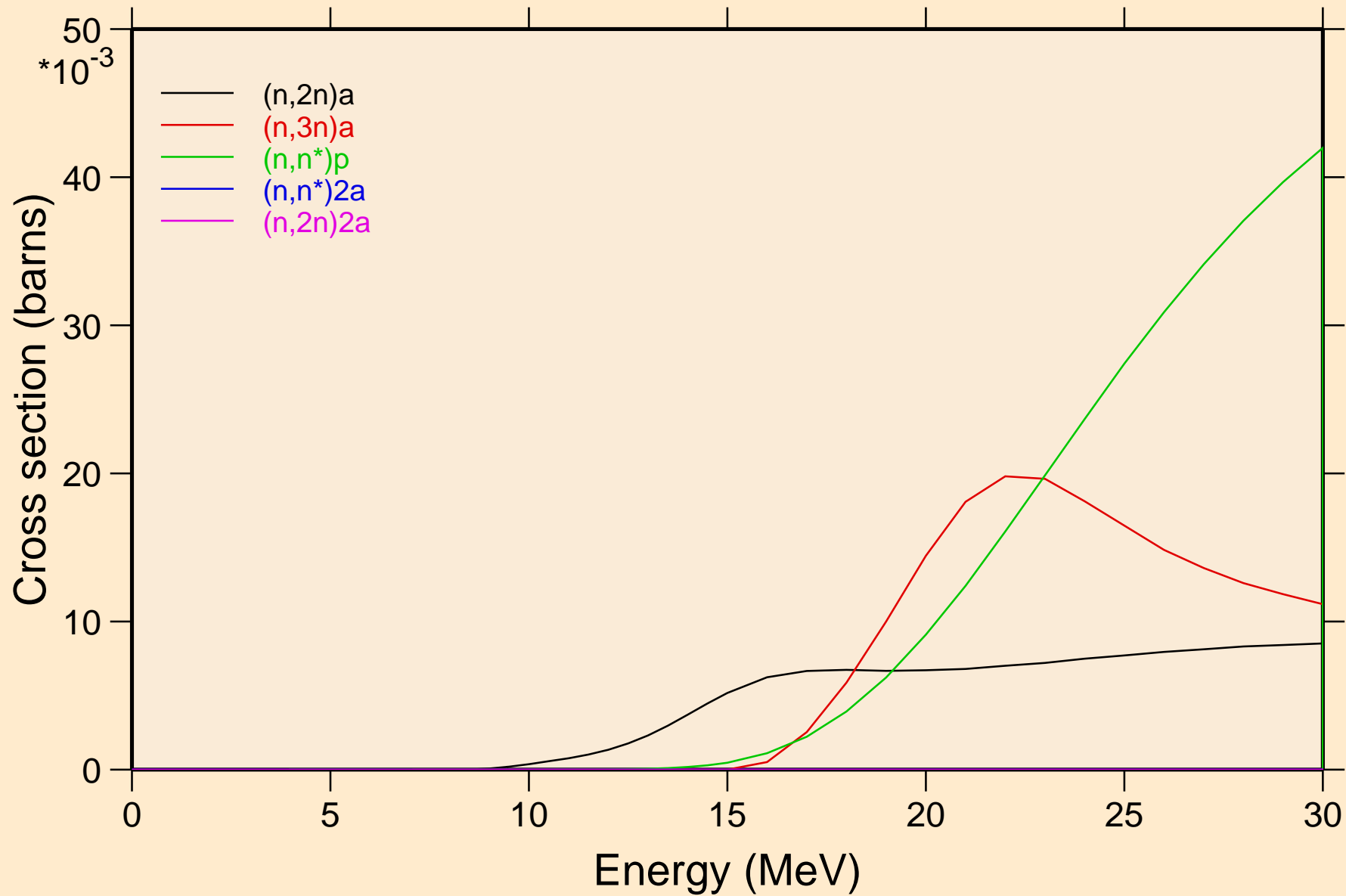

CF242 NRG TENDL-2015, AKONING

Threshold reactions

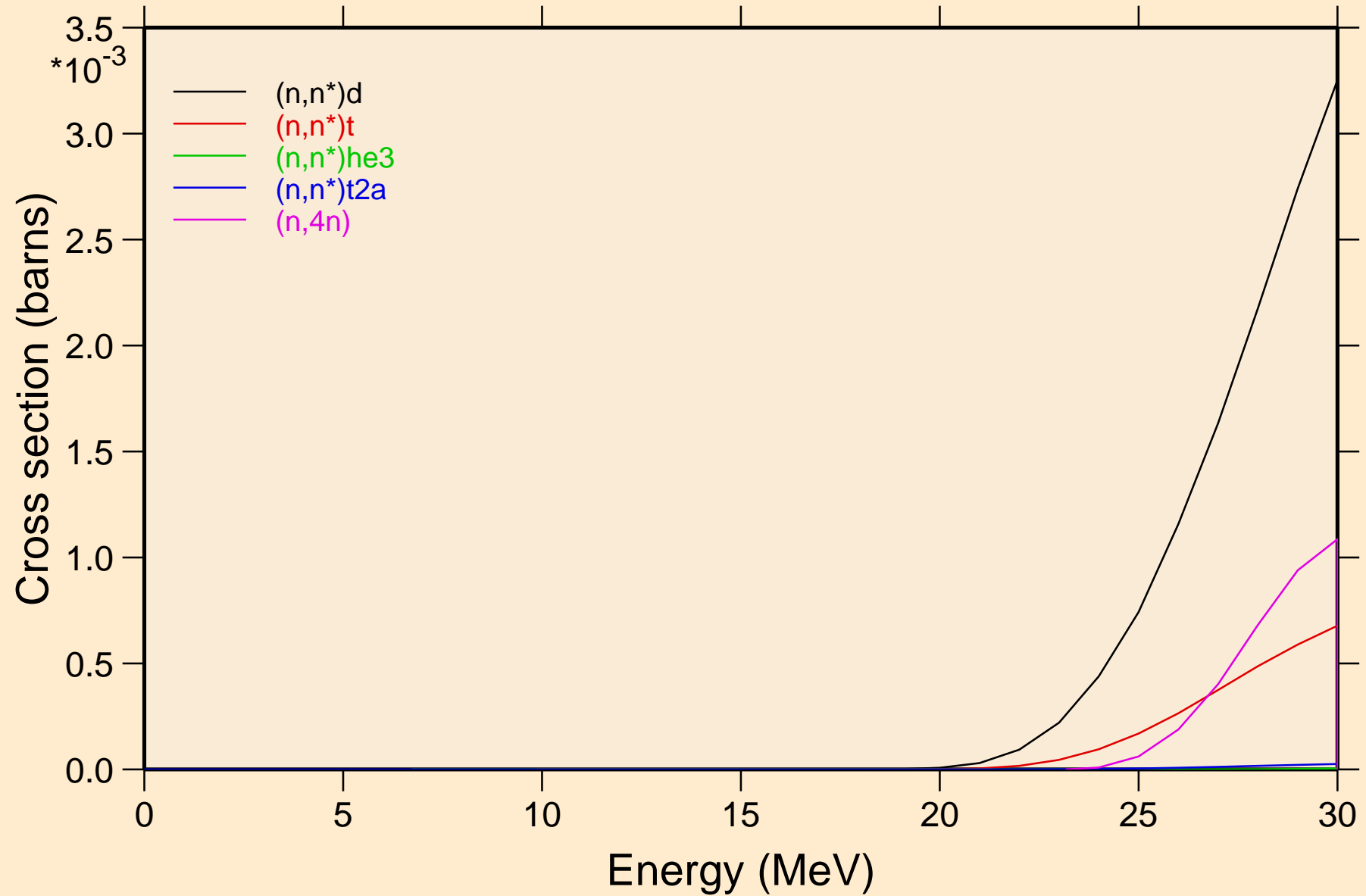

CF242 NRG TENDL-2015, AKONING

Threshold reactions

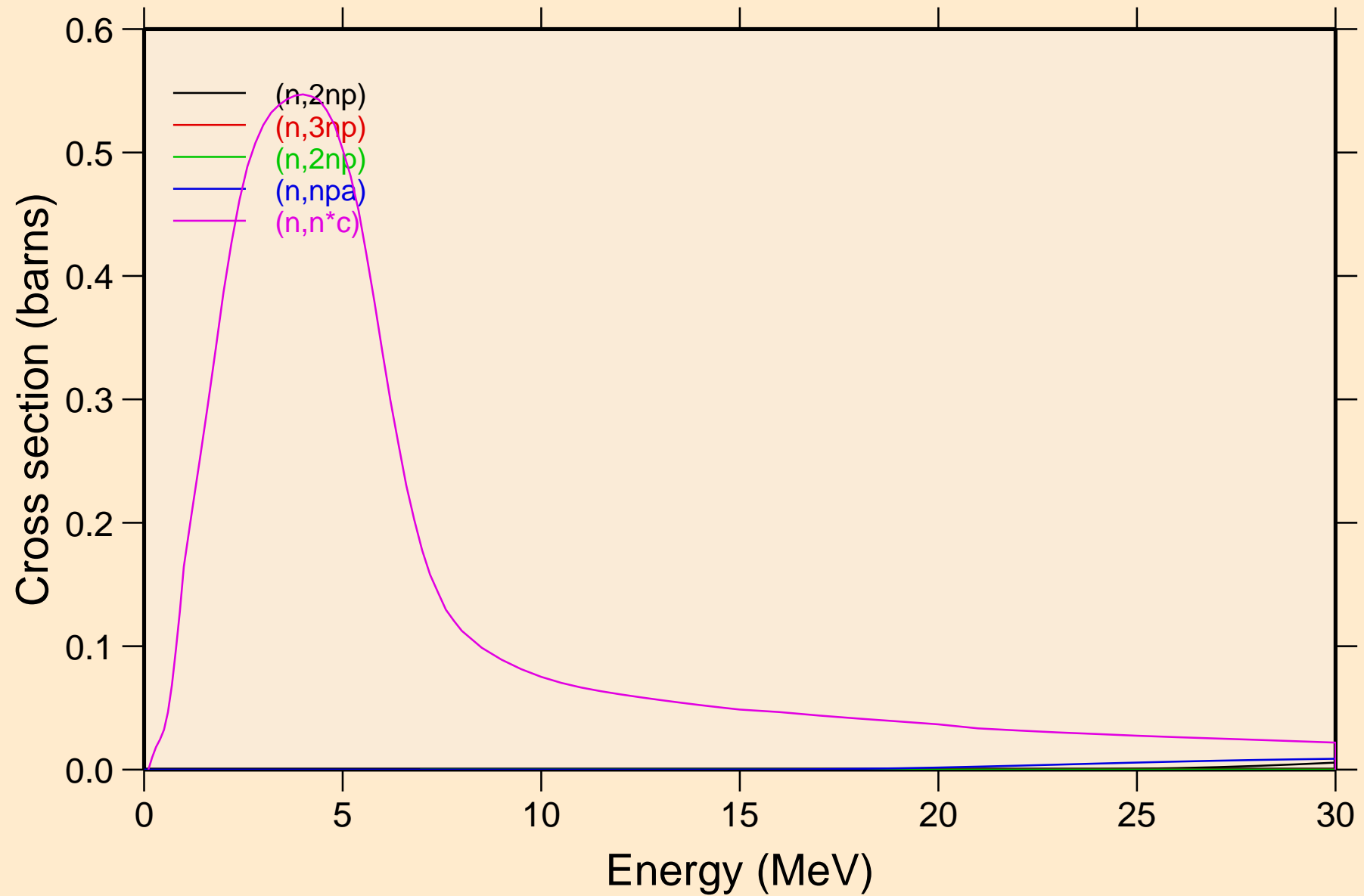

CF242 NRG TENDL-2015, AKONING

Threshold reactions

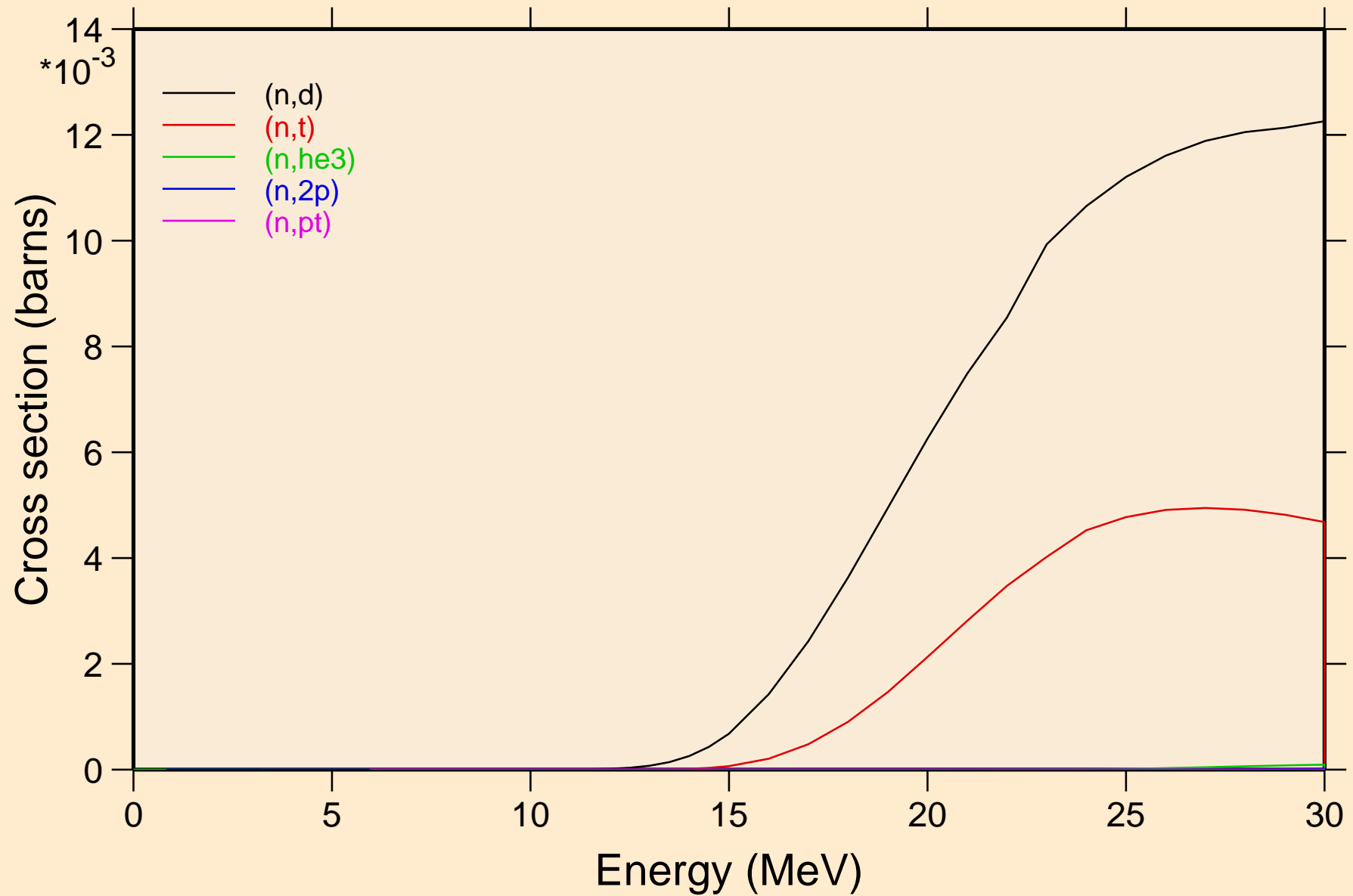

CF242 NRG TENDL-2015, AKONING

Threshold reactions

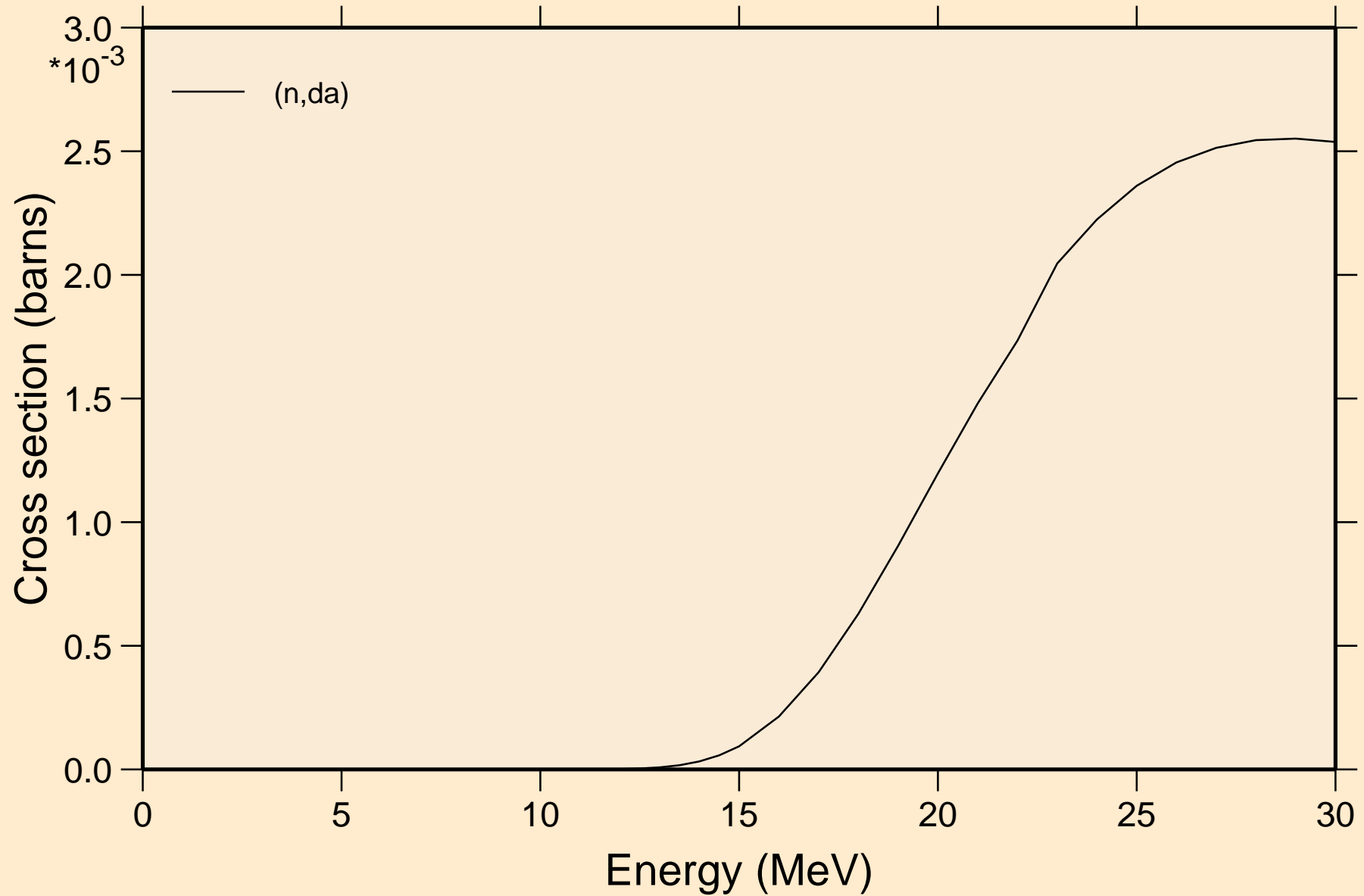

CF242 NRG TENDL-2015, AKONING
angular distribution for elastic

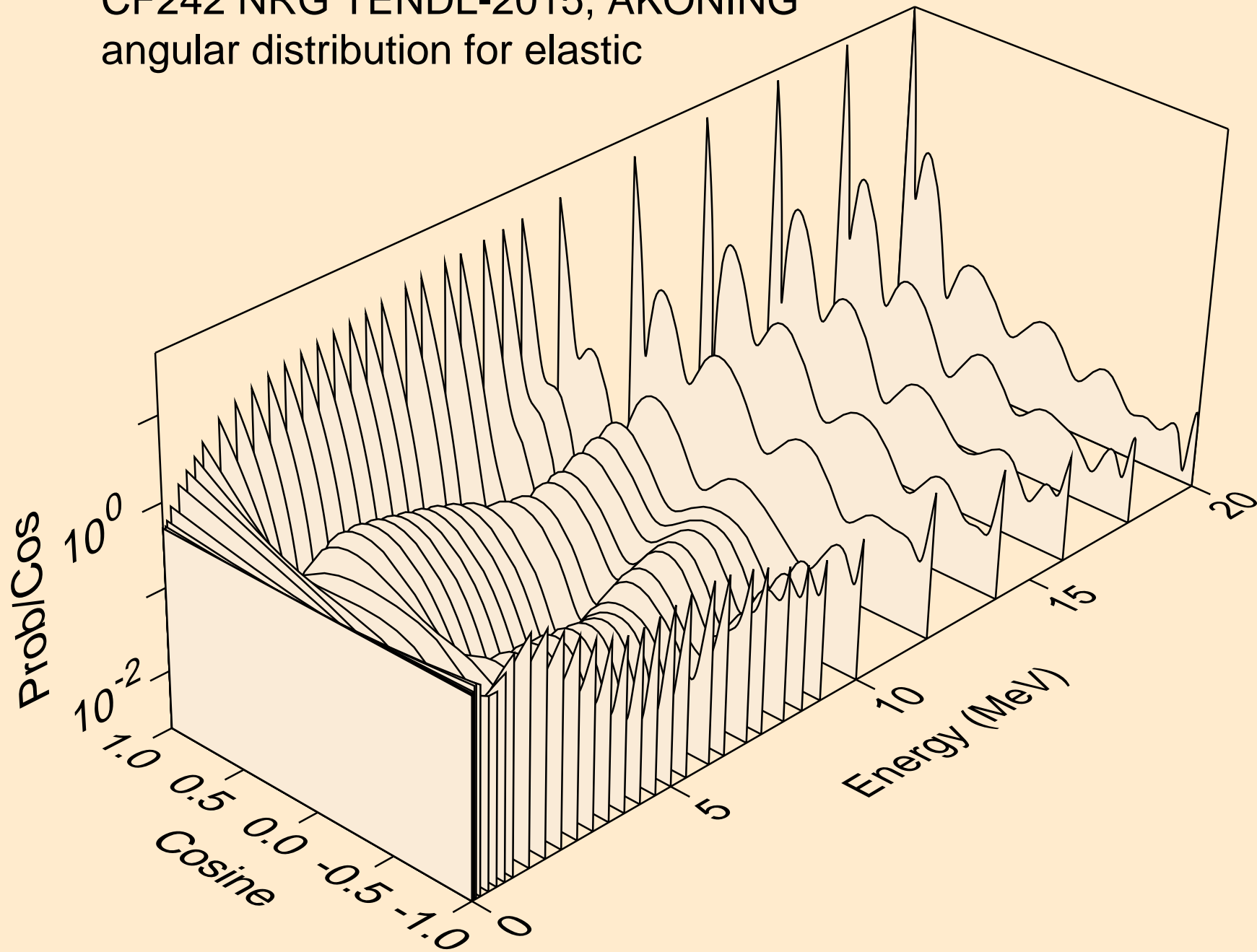

CF242 NRG TENDL-2015, AKONING
angular distribution for elastic

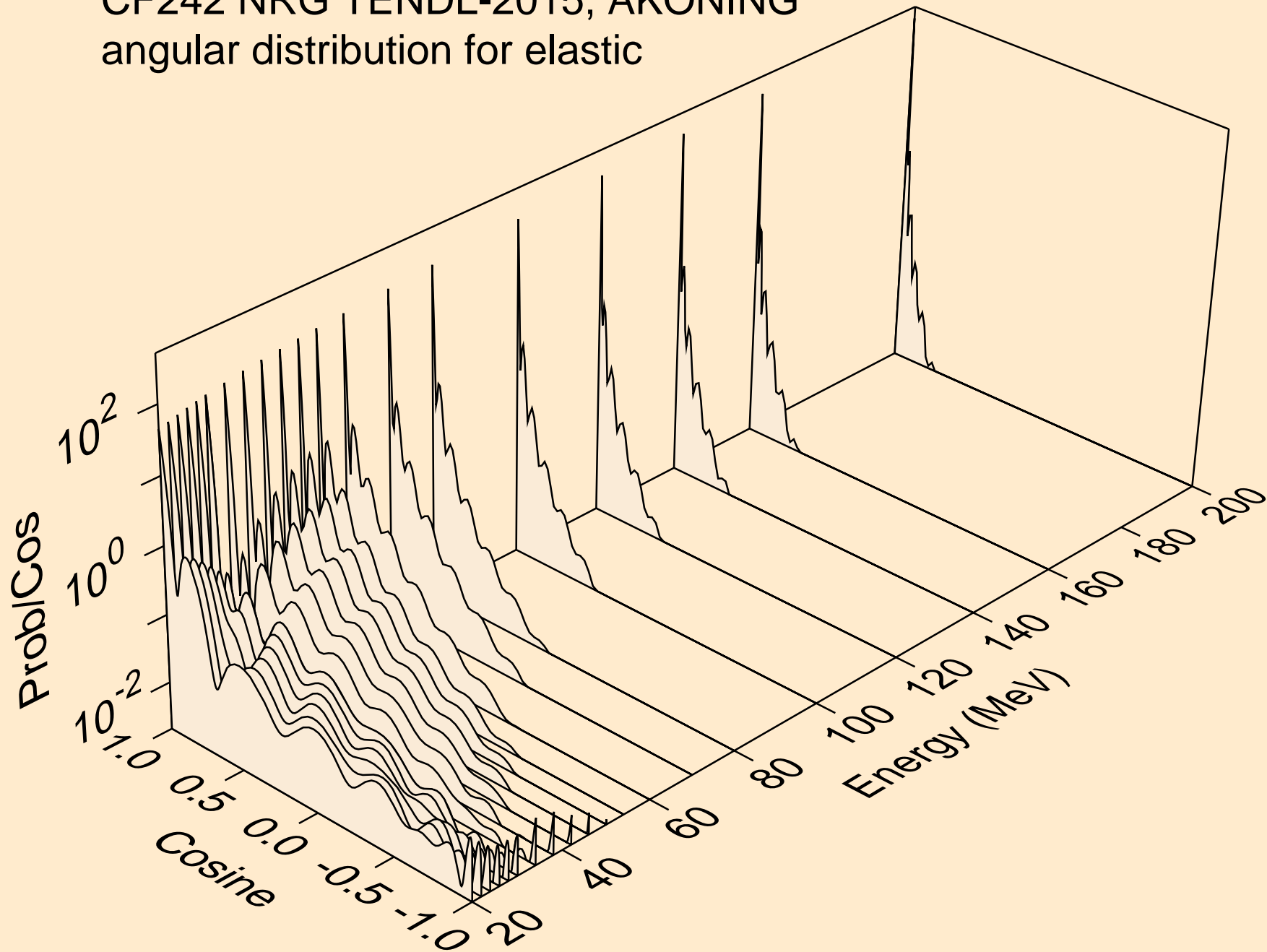

CF242 NRG TENDL-2015, AKONING
angular distribution for (n,n*1)

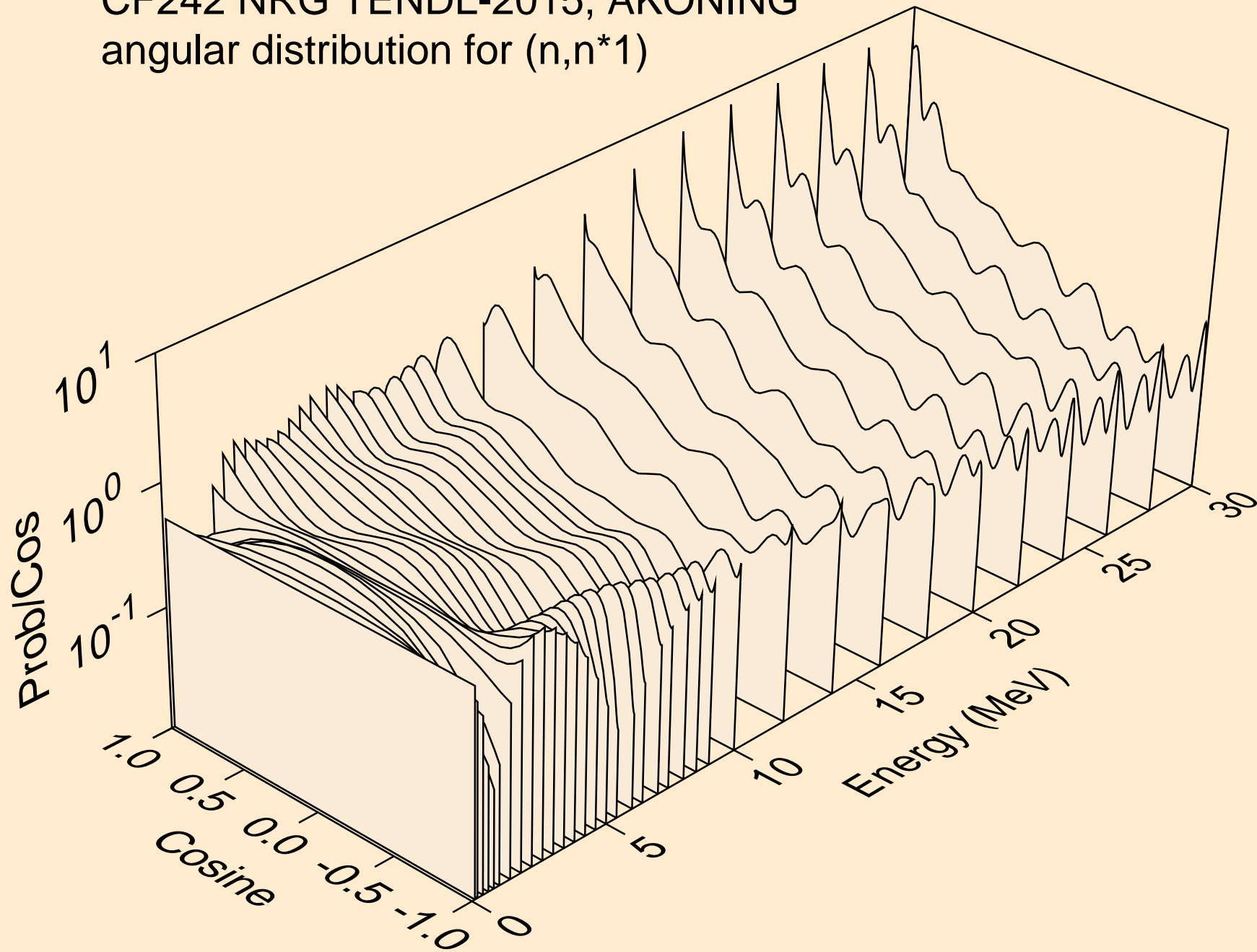

CF242 NRG TENDL-2015, AKONING

Total fission nubar

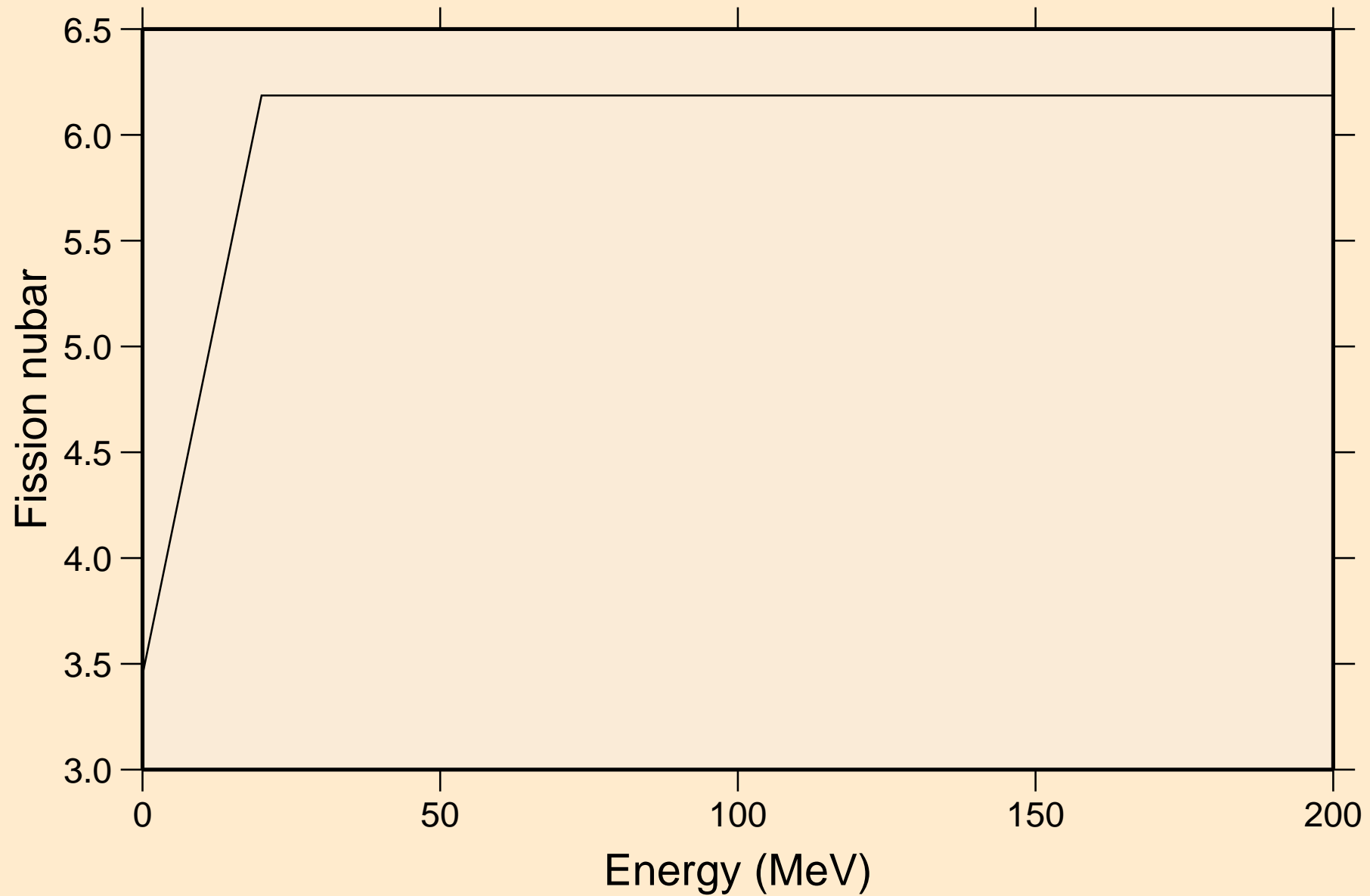

CF242 NRG TENDL-2015, AKONING
Neutron emission for (n,x)

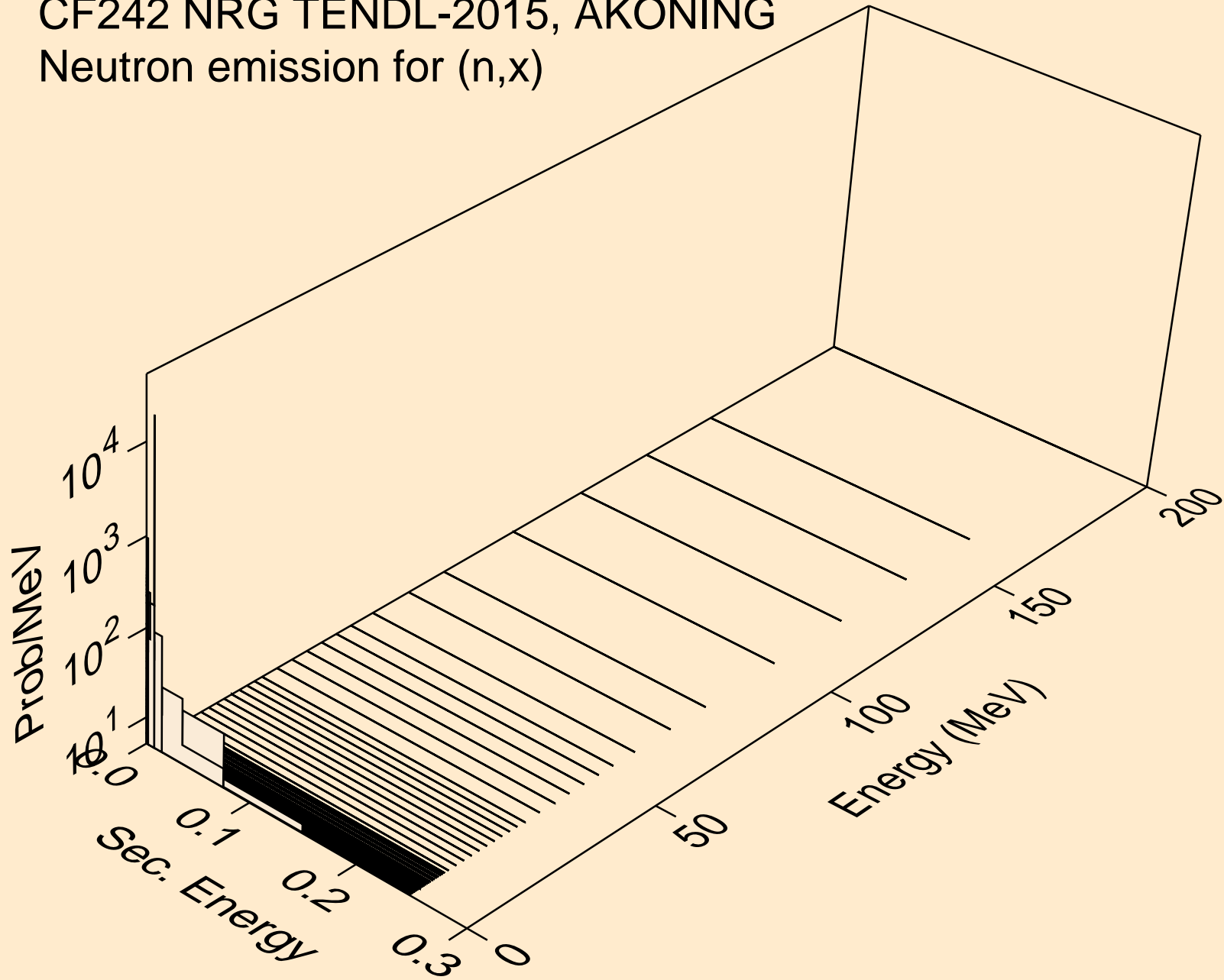

CF242 NRG TENDL-2015, AKONING
Neutron emission for (n,2nd)

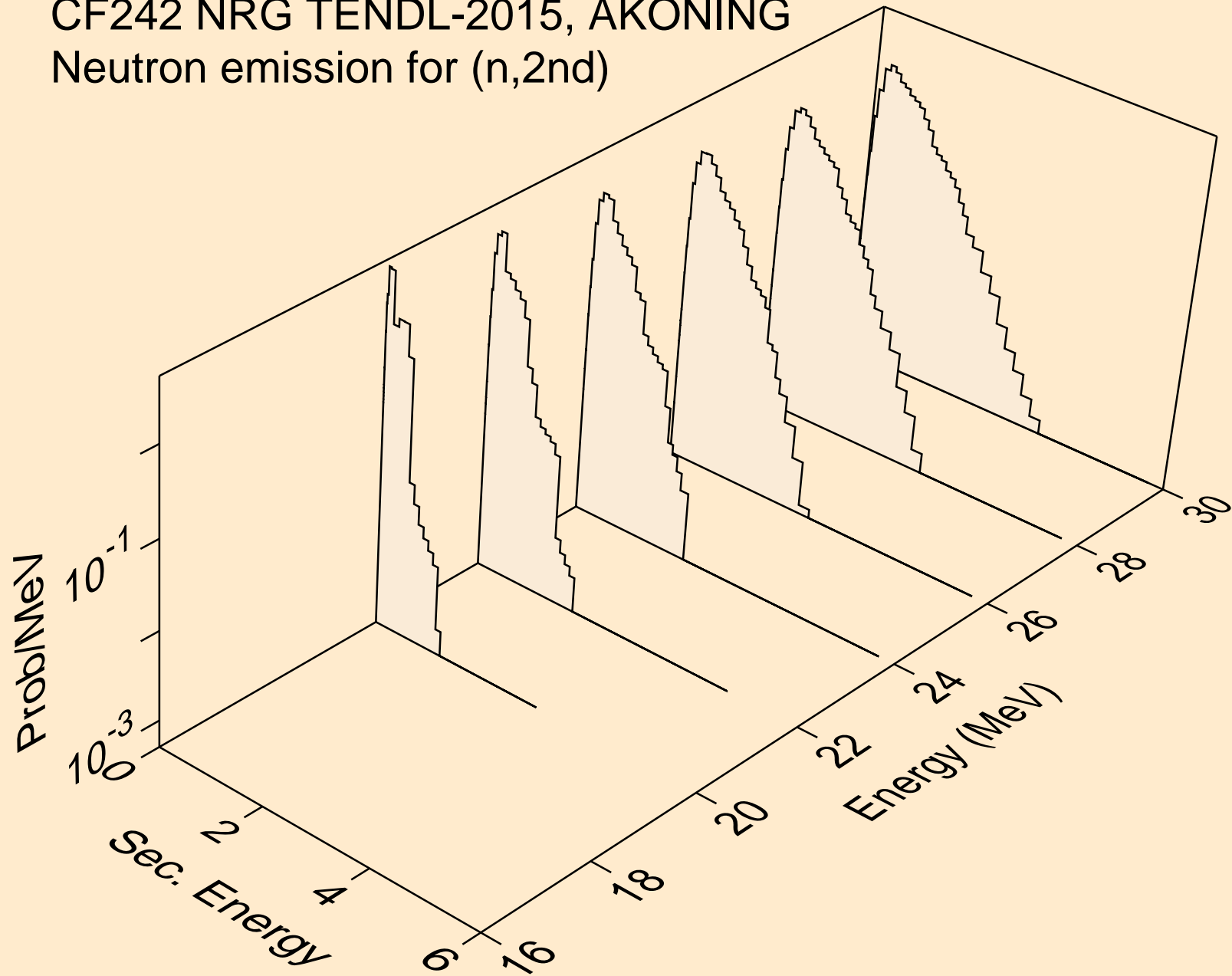

CF242 NRG TENDL-2015, AKONING
Neutron emission for (n,2n)

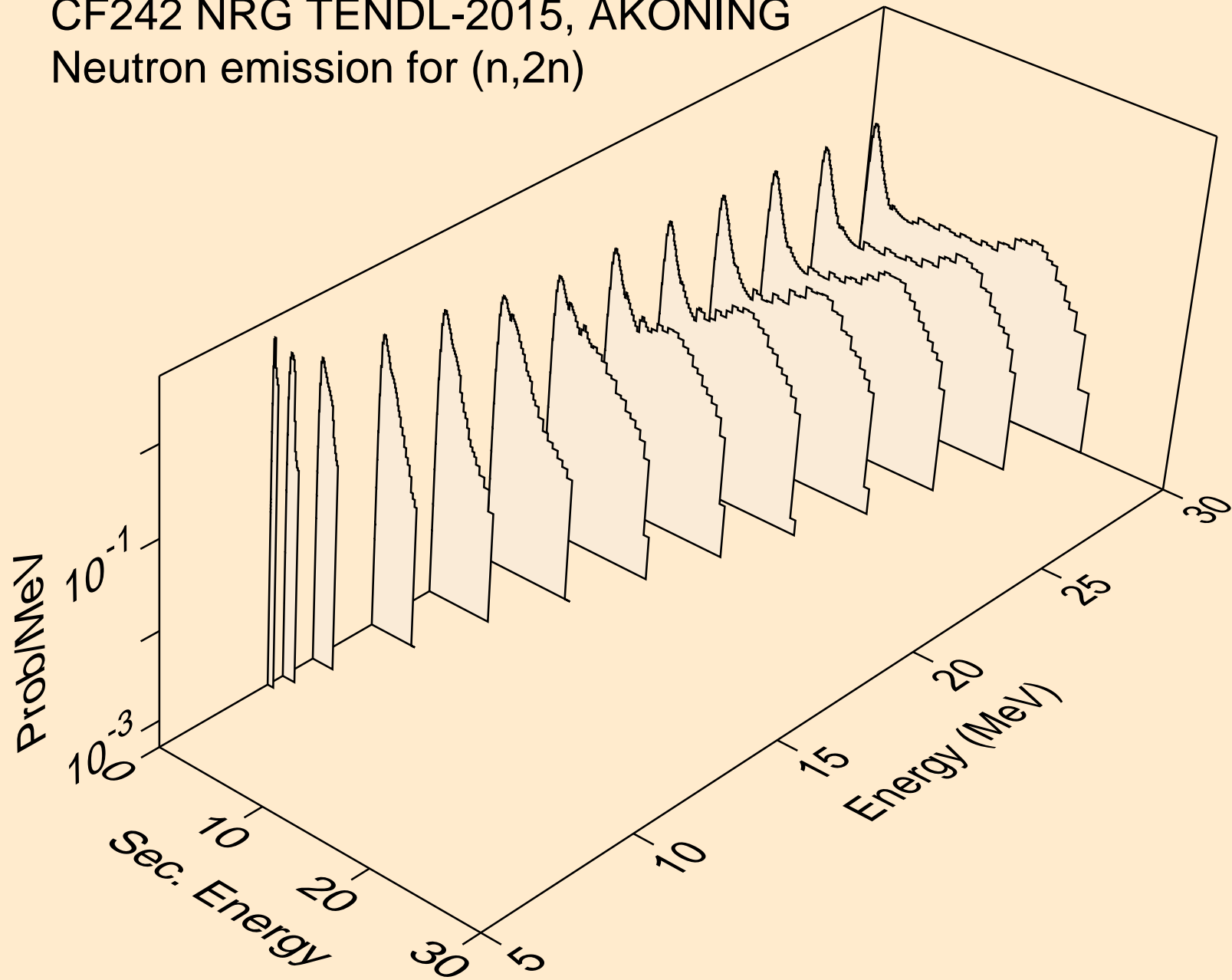

CF242 NRG TENDL-2015, AKONING
Neutron emission for (n,3n)

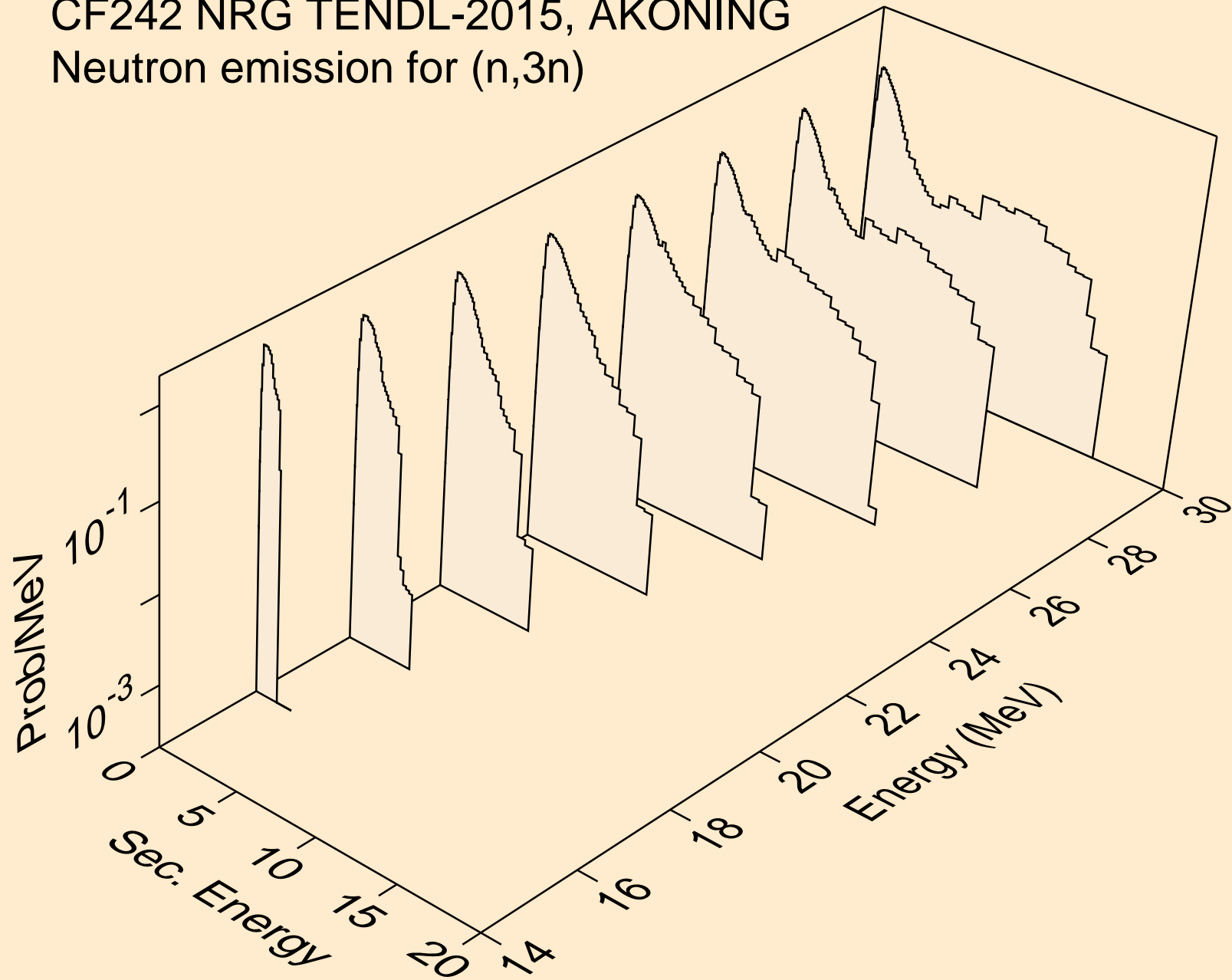

CF242 NRG TENDL-2015, AKONING
Neutron emission for fission

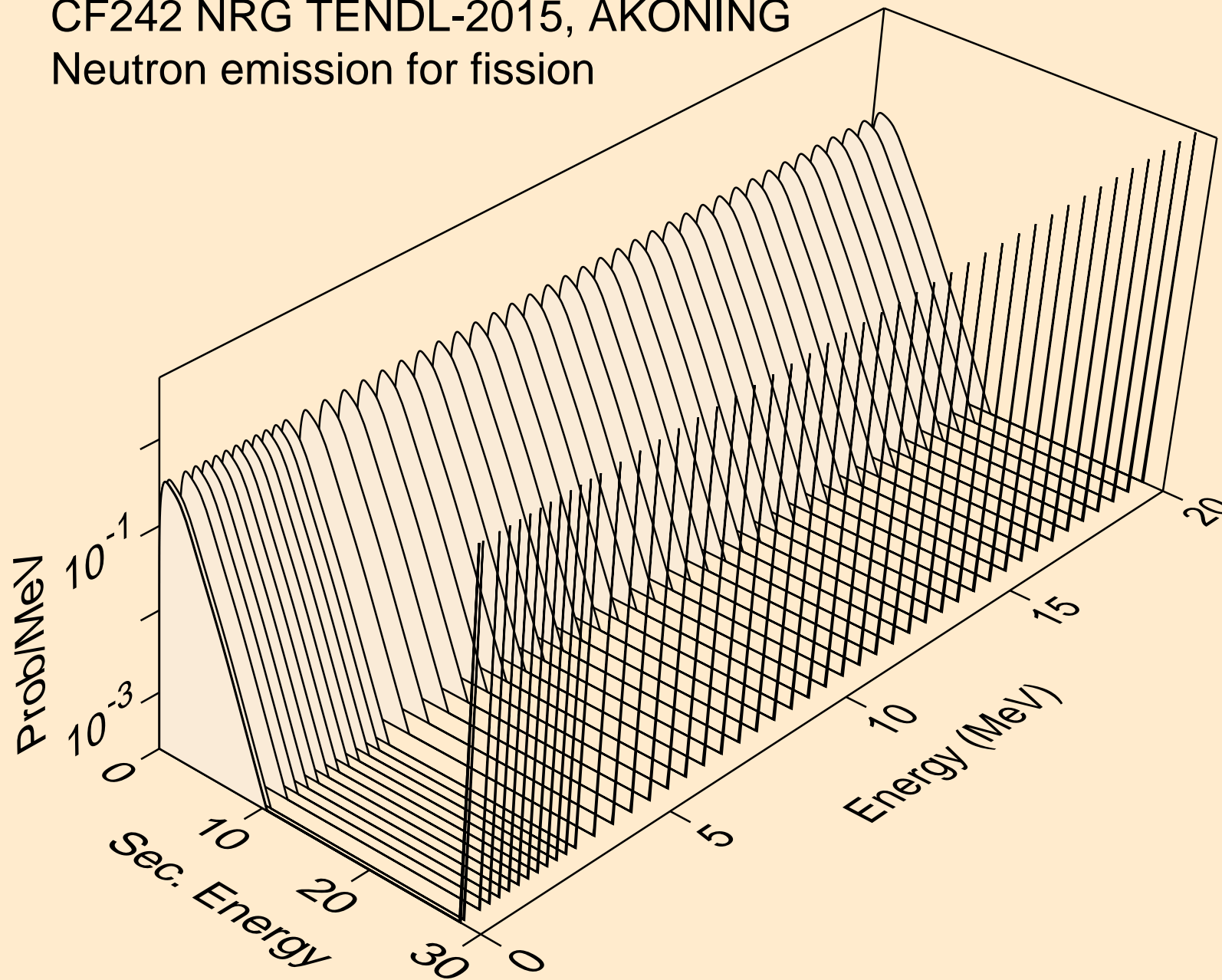

CF242 NRG TENDL-2015, AKONING
Neutron emission for (n,n*)a

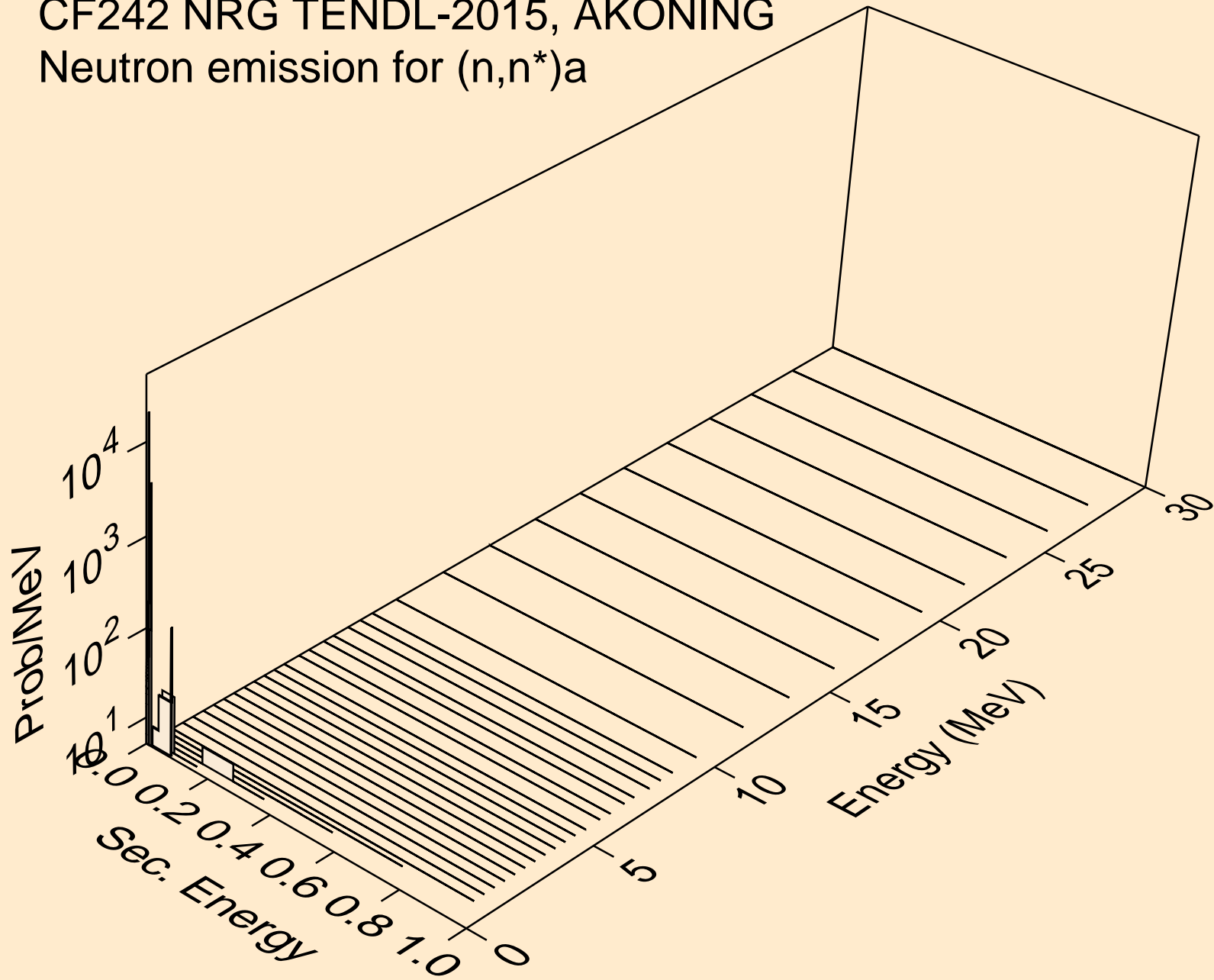

CF242 NRG TENDL-2015, AKONING
Neutron emission for (n,2n)a

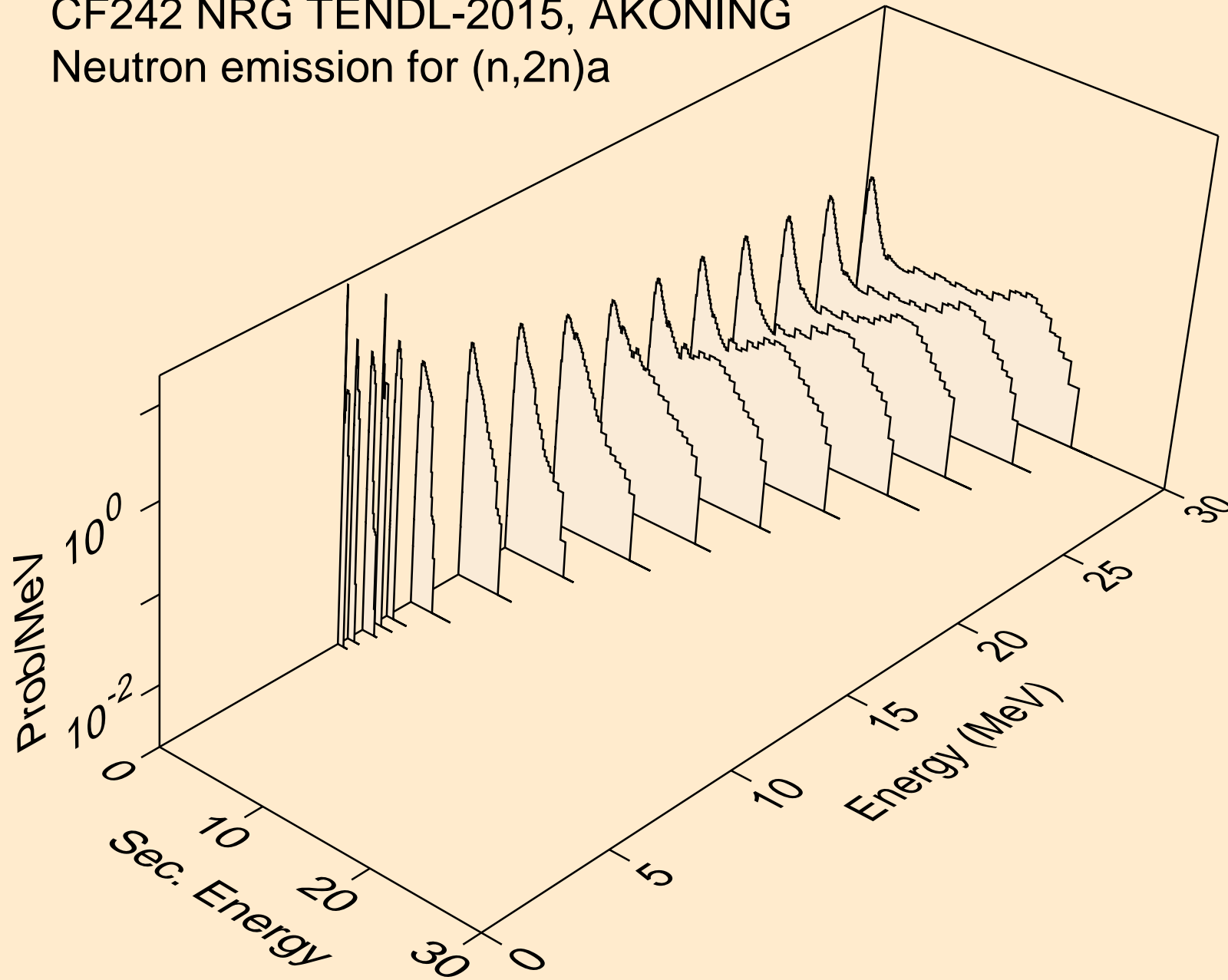

CF242 NRG TENDL-2015, AKONING
Neutron emission for (n,3n)a

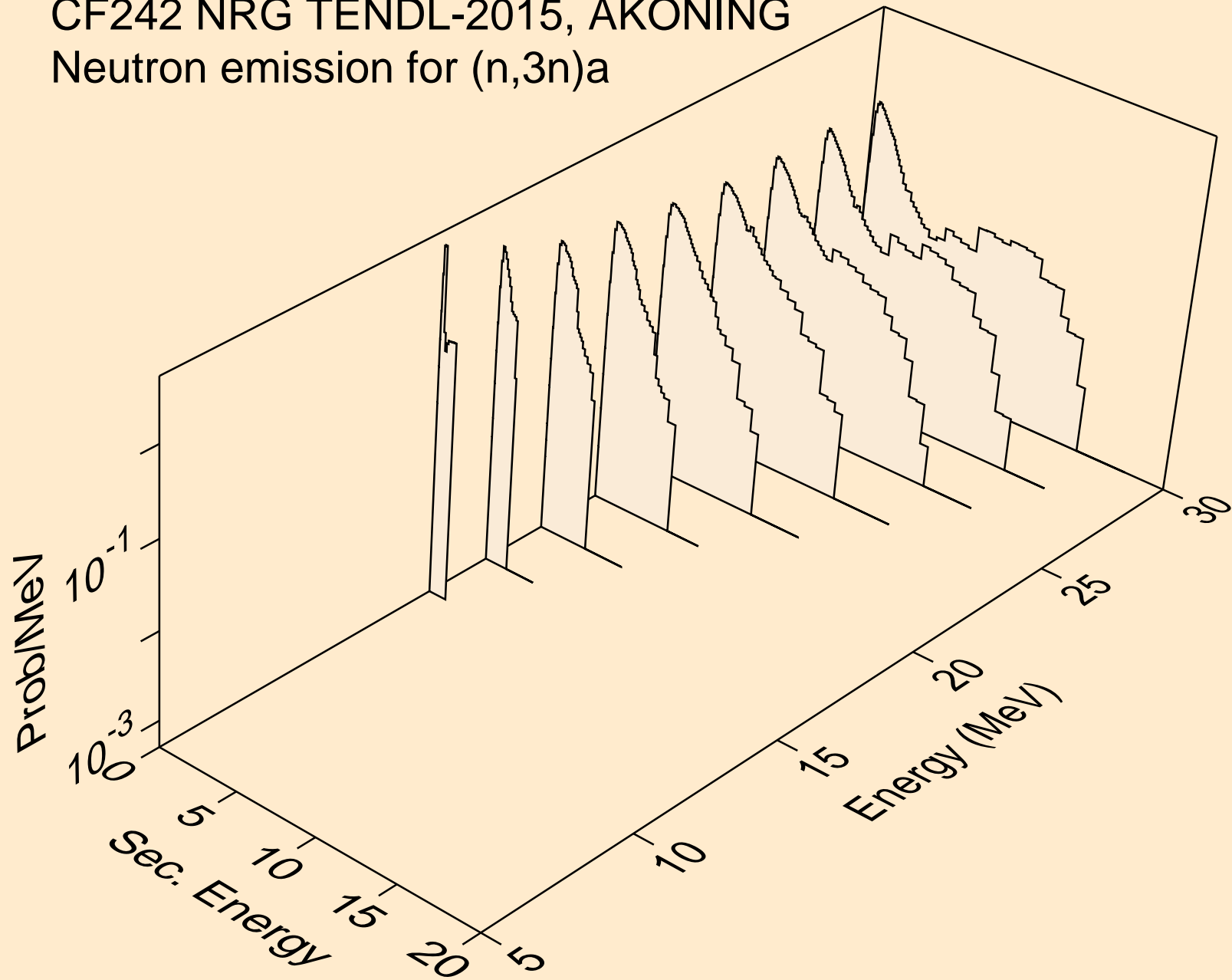

CF242 NRG TENDL-2015, AKONING
Neutron emission for (n,n*)p

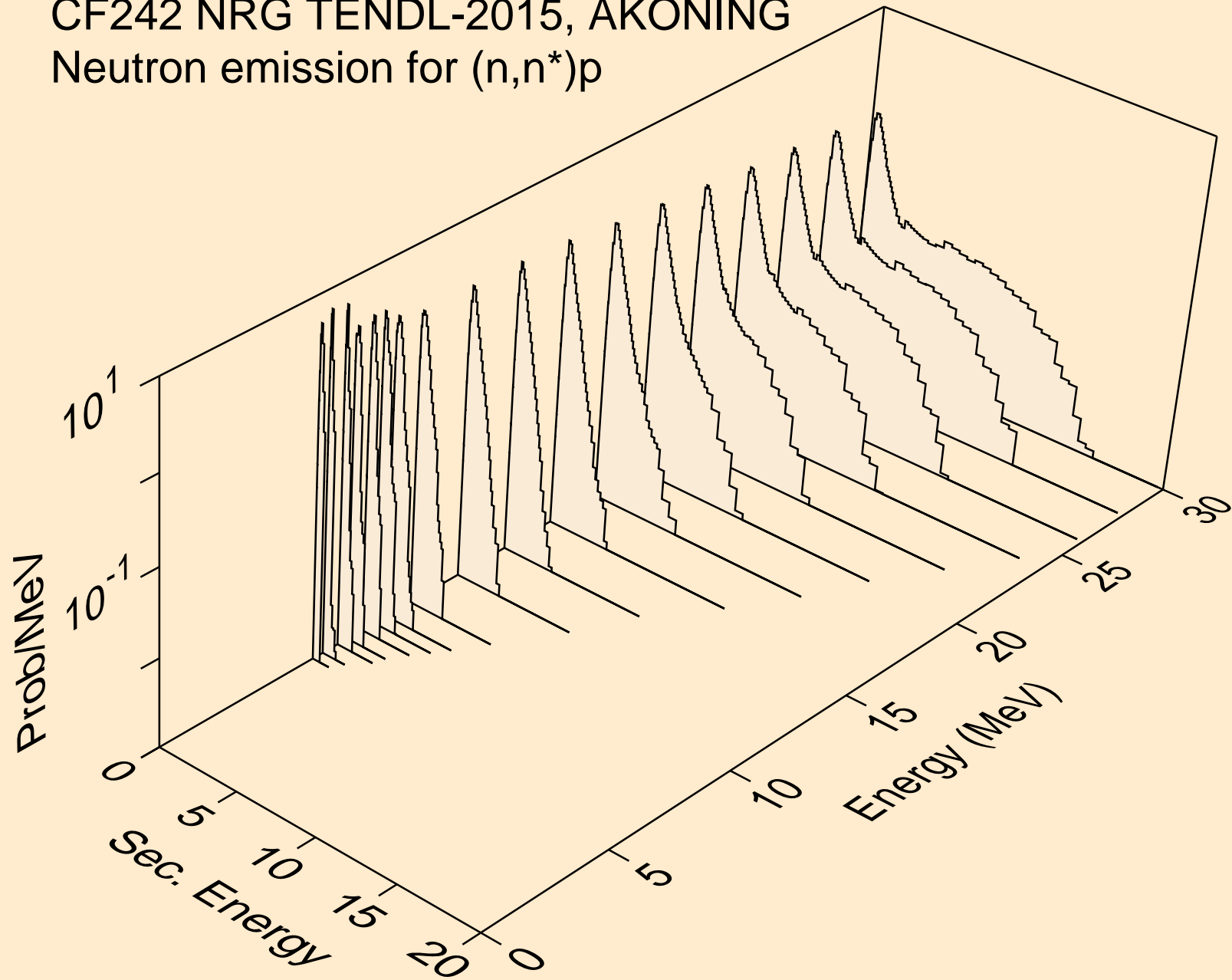

CF242 NRG TENDL-2015, AKONING
Neutron emission for (n,n*)2a

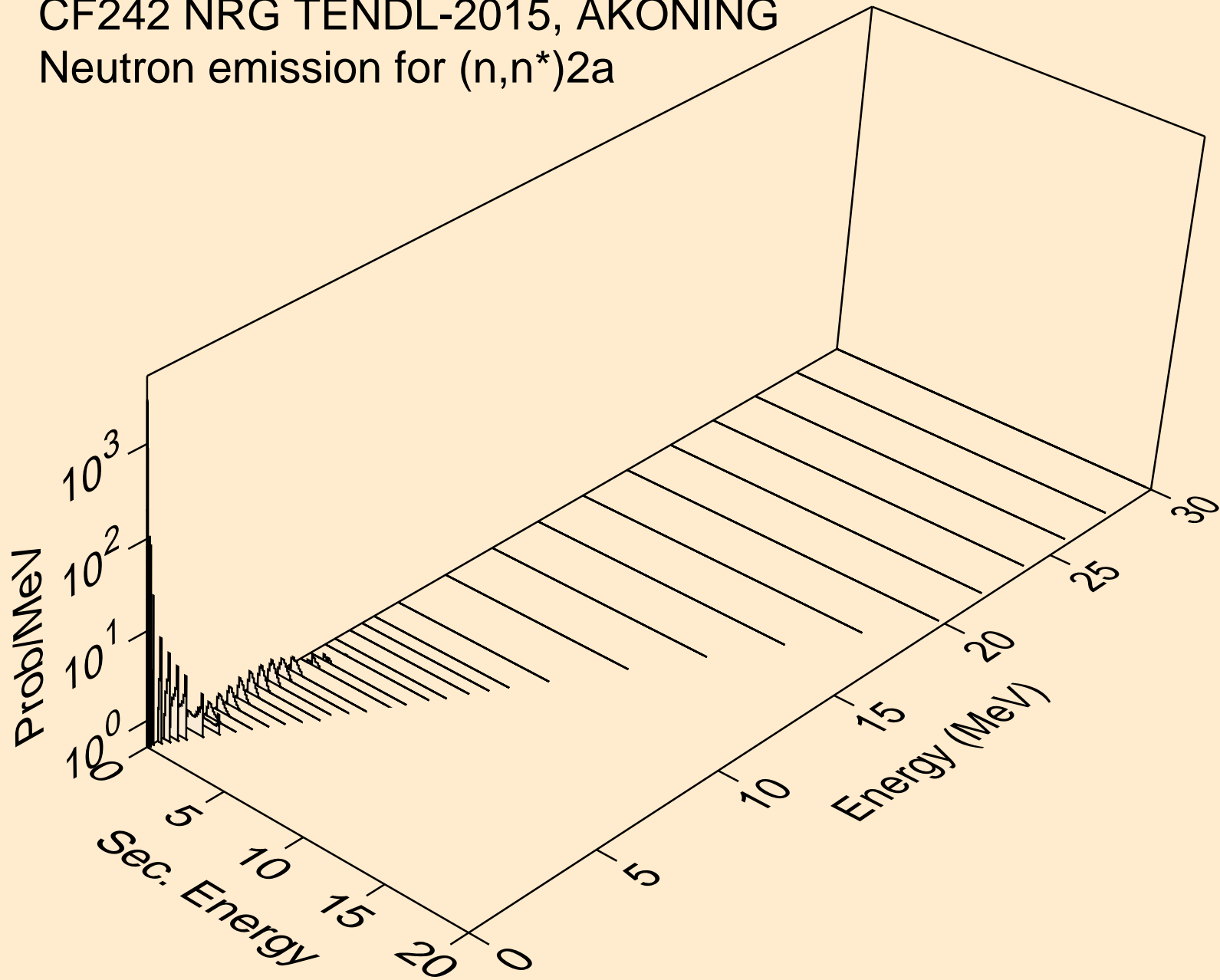

CF242 NRG TENDL-2015, AKONING
Neutron emission for (n,2n)2a

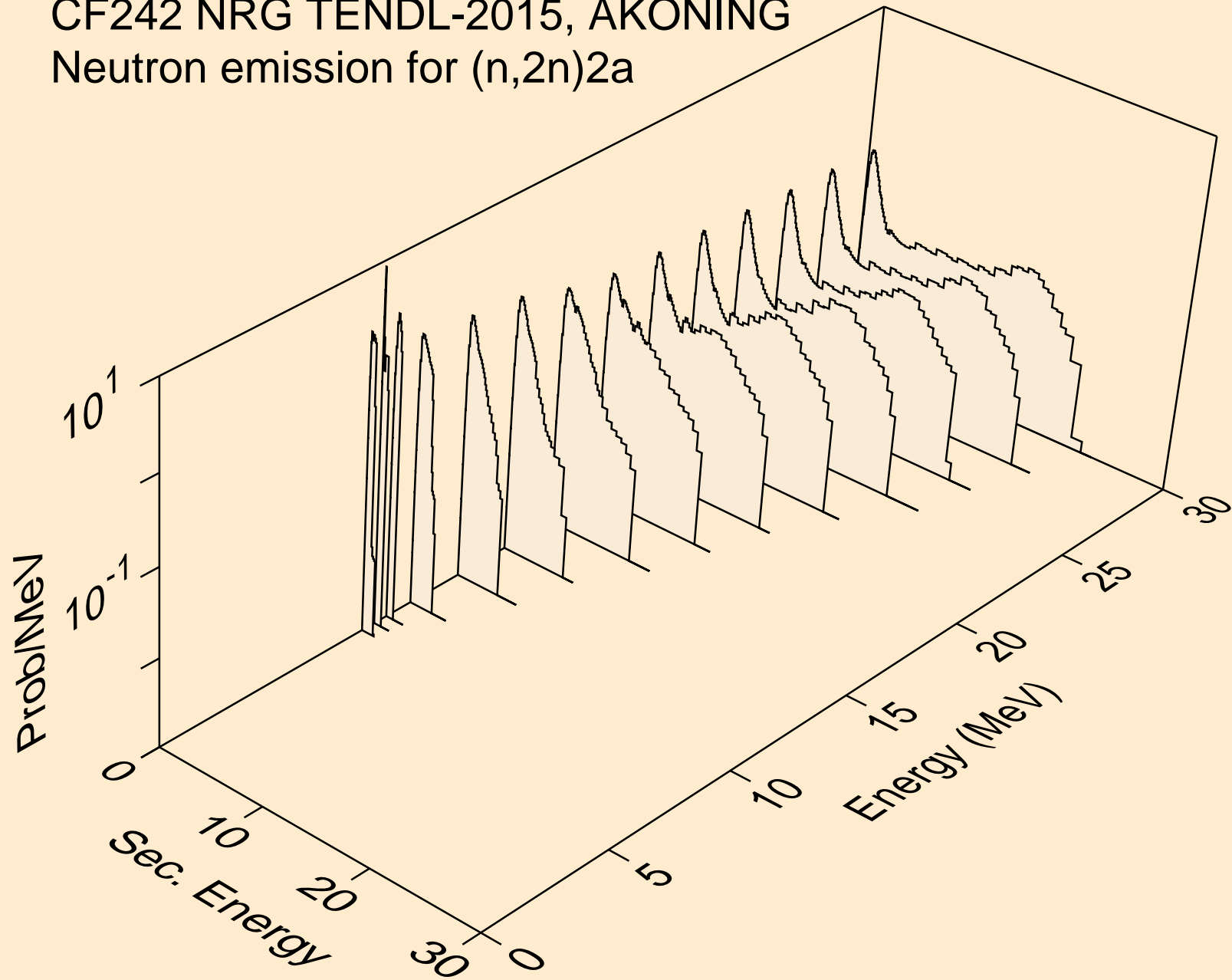

CF242 NRG TENDL-2015, AKONING
Neutron emission for (n,n*)d

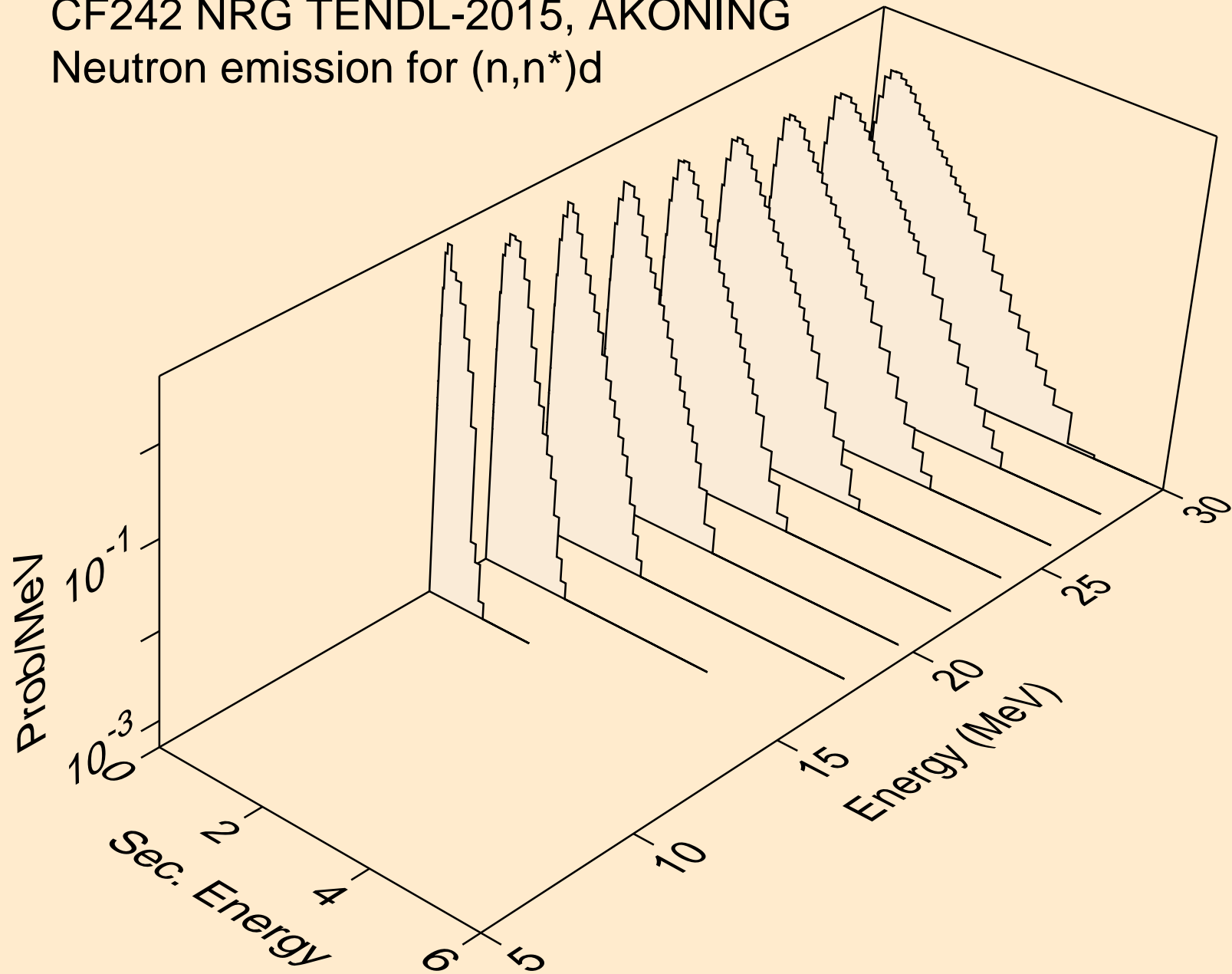

CF242 NRG TENDL-2015, AKONING
Neutron emission for (n,n*)t

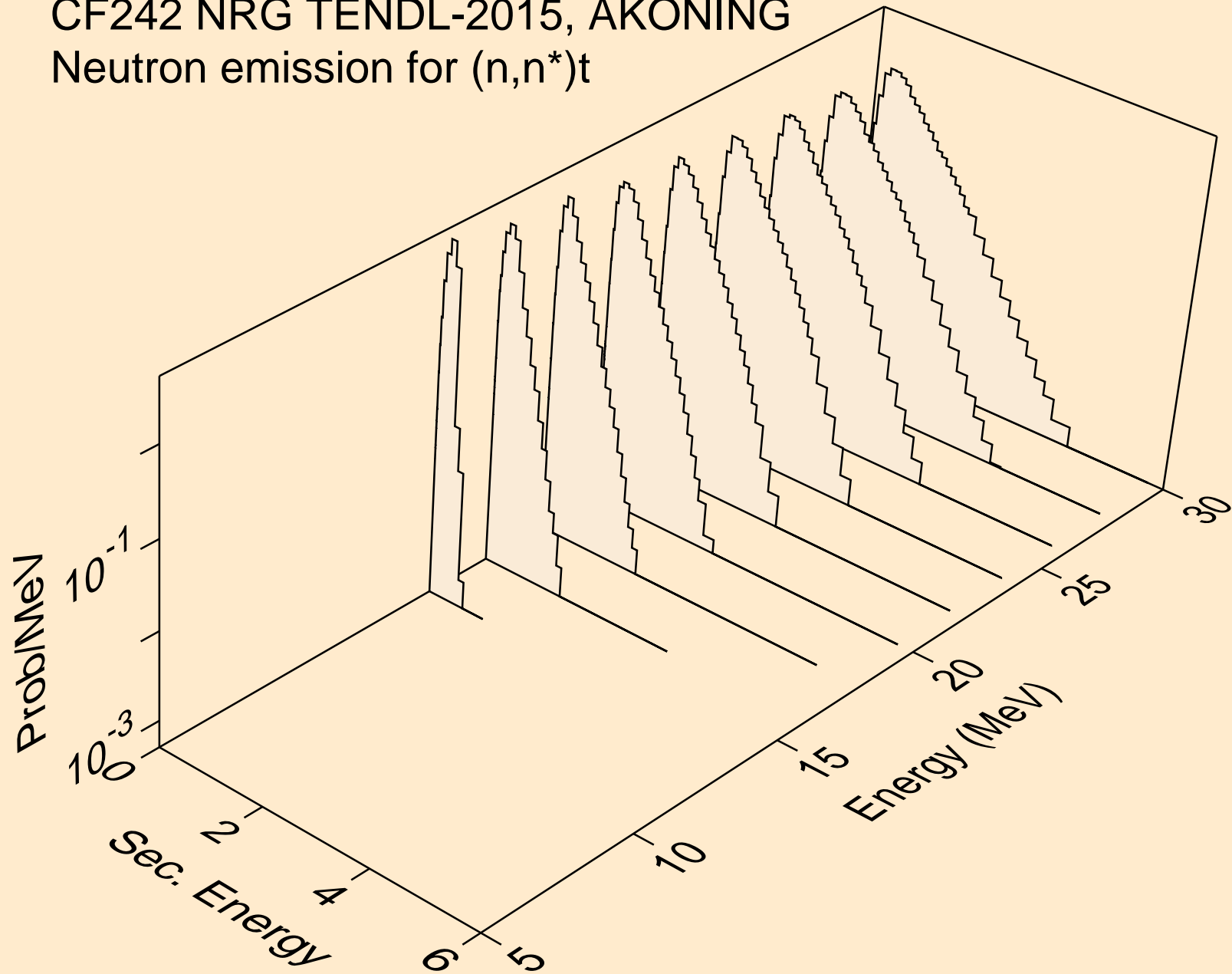

CF242 NRG TENDL-2015, AKONING
Neutron emission for (n,n*)he3

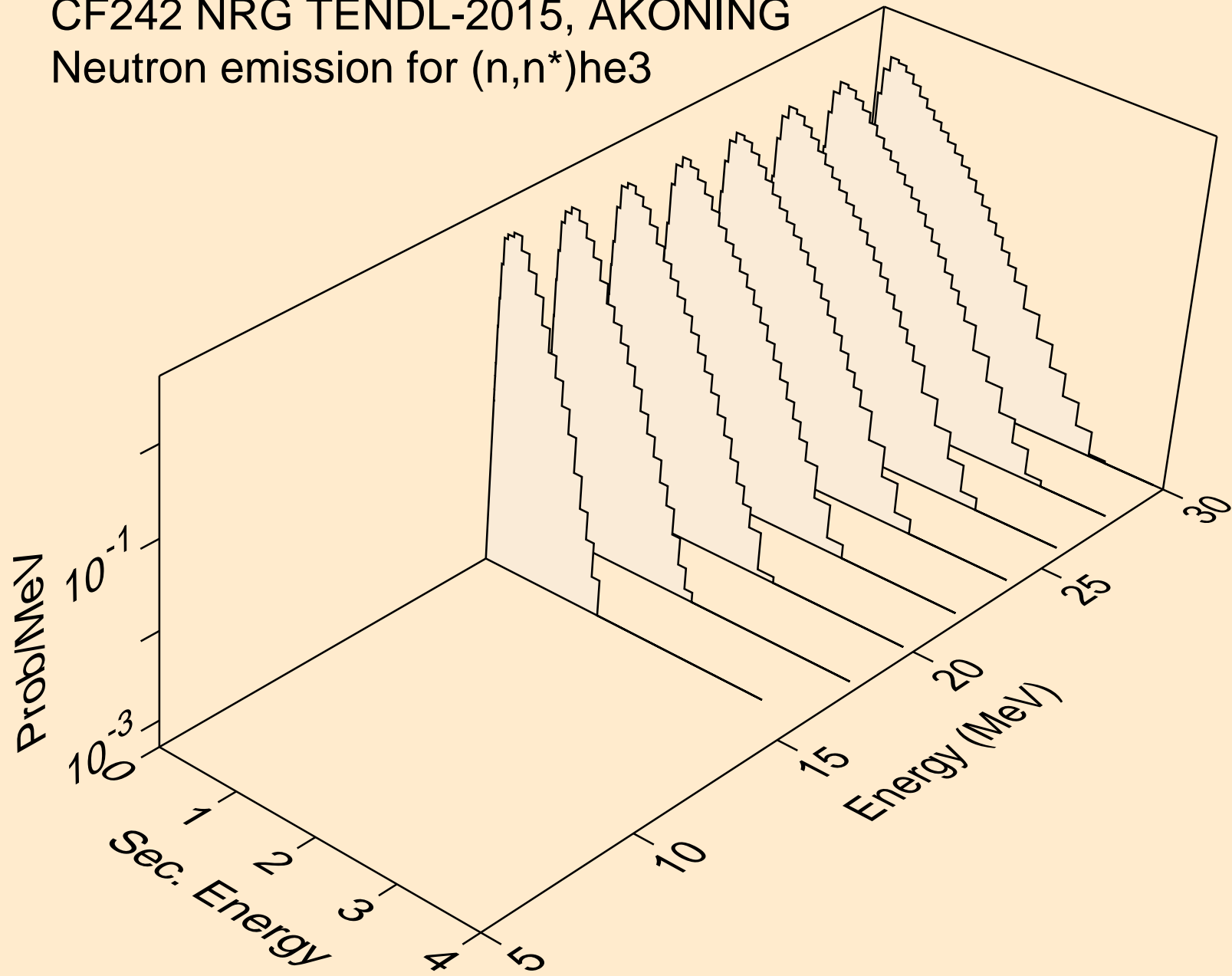

CF242 NRG TENDL-2015, AKONING
Neutron emission for (n,n*)t2a

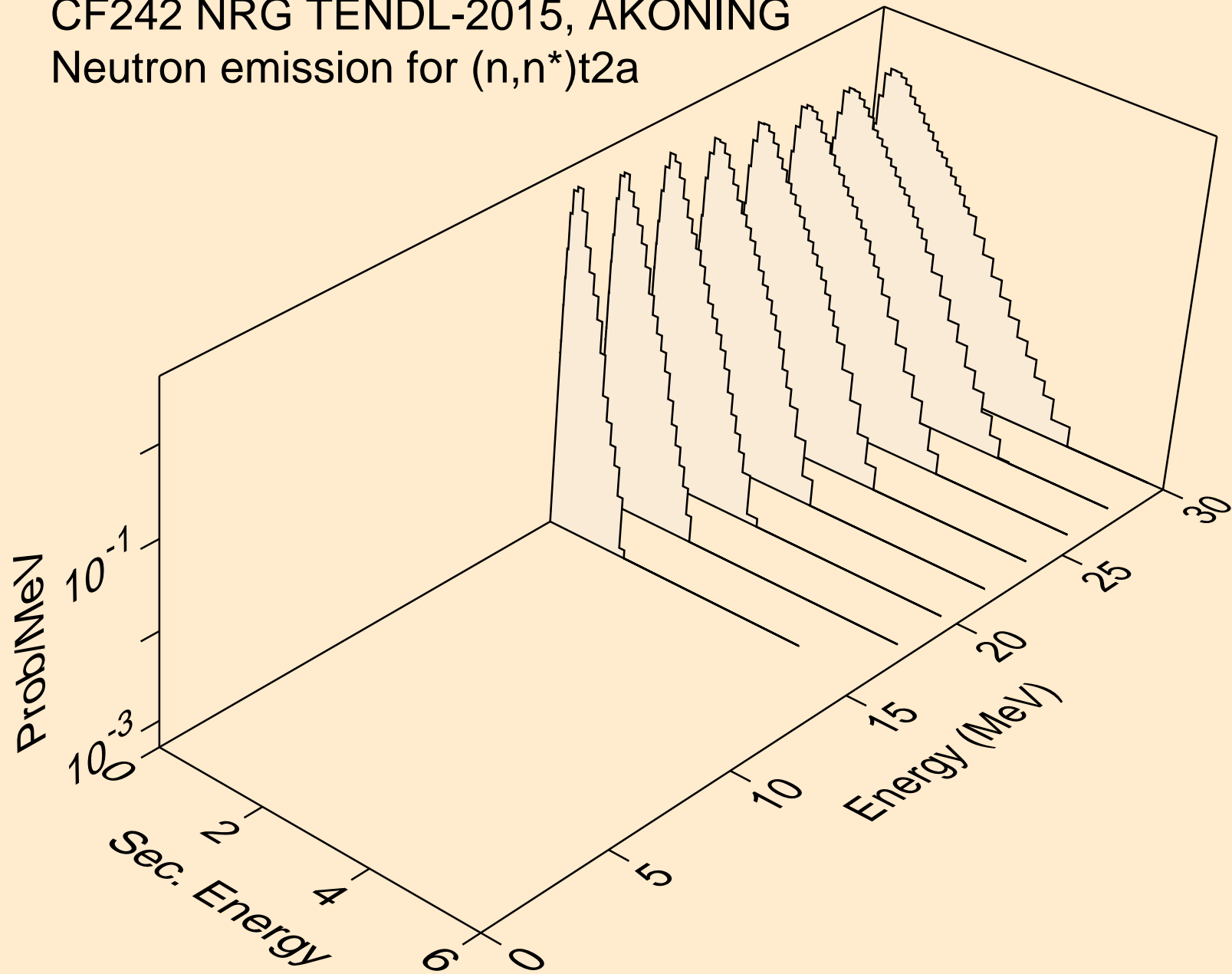

CF242 NRG TENDL-2015, AKONING
Neutron emission for (n,4n)

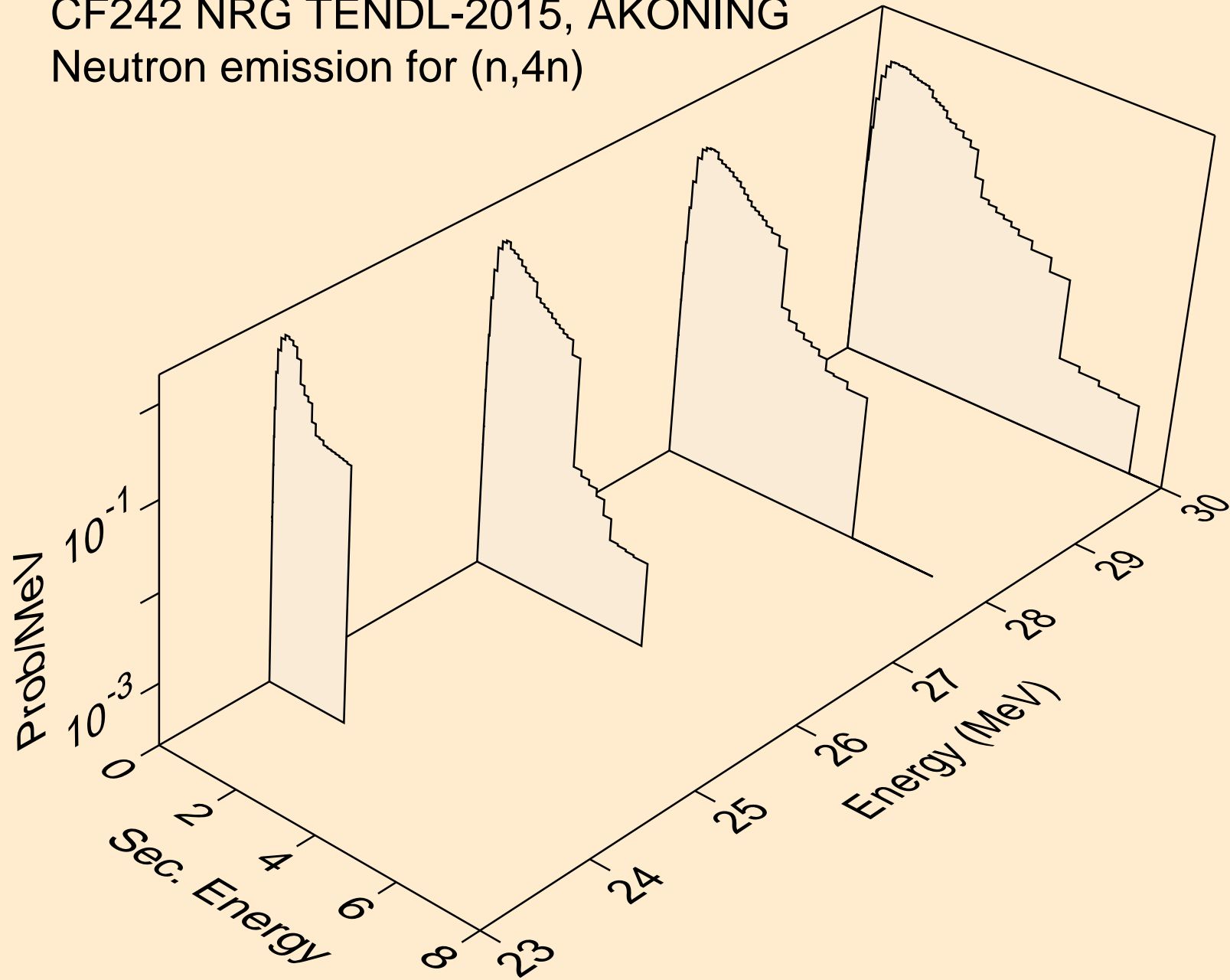

CF242 NRG TENDL-2015, AKONING
Neutron emission for (n,2np)

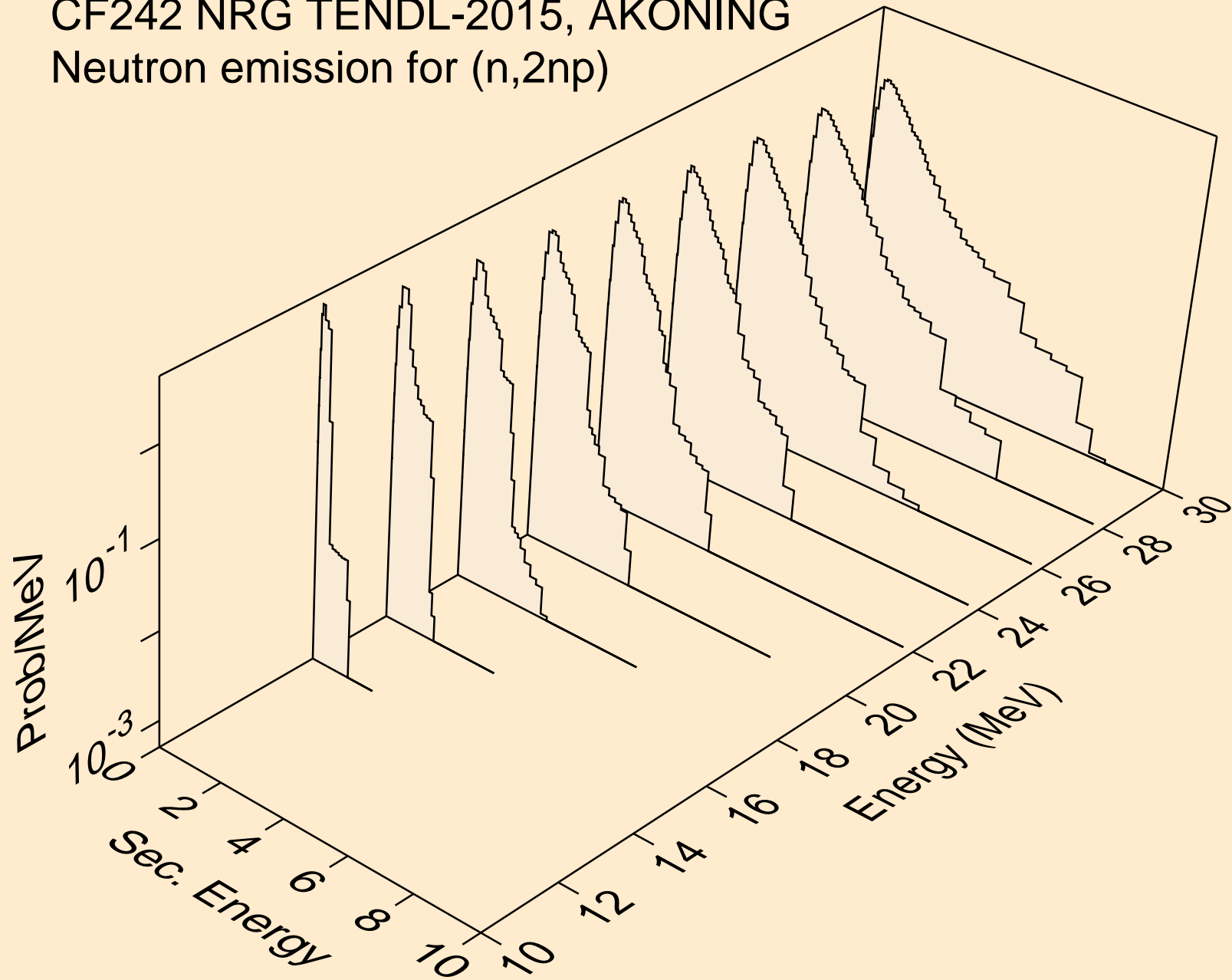

CF242 NRG TENDL-2015, AKONING
Neutron emission for (n,3np)

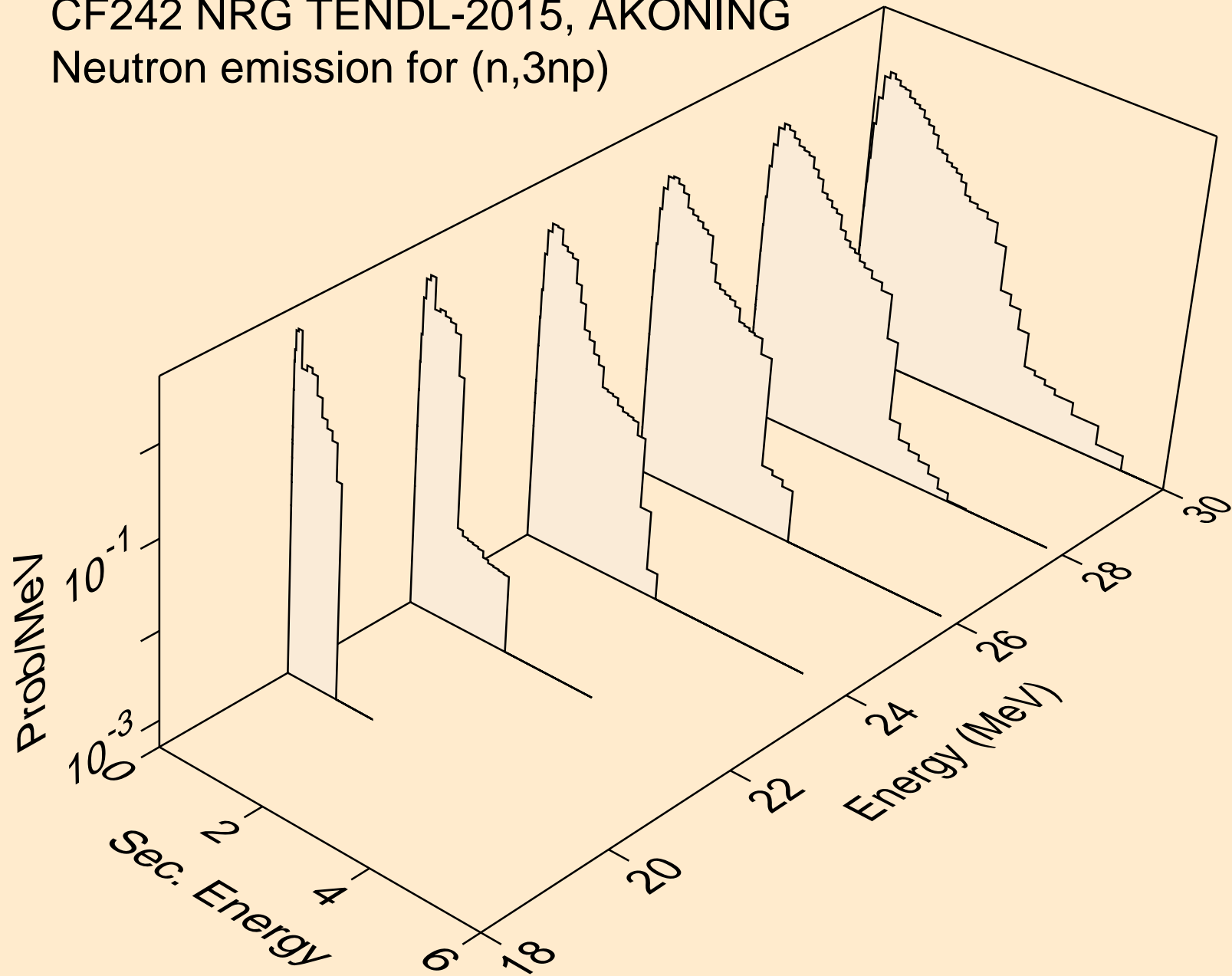

CF242 NRG TENDL-2015, AKONING
Neutron emission for (n,2np)

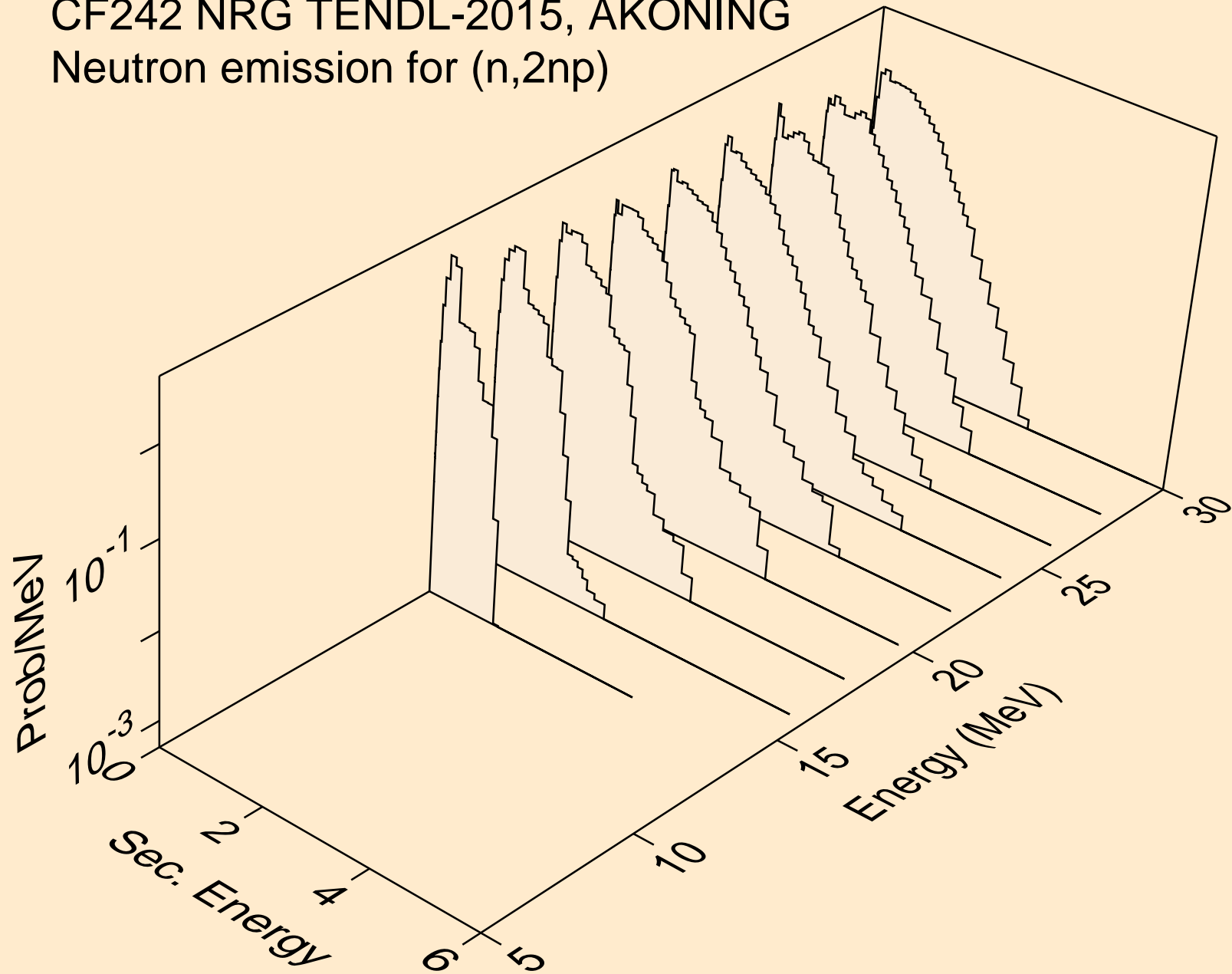

CF242 NRG TENDL-2015, AKONING
Neutron emission for (n,npa)

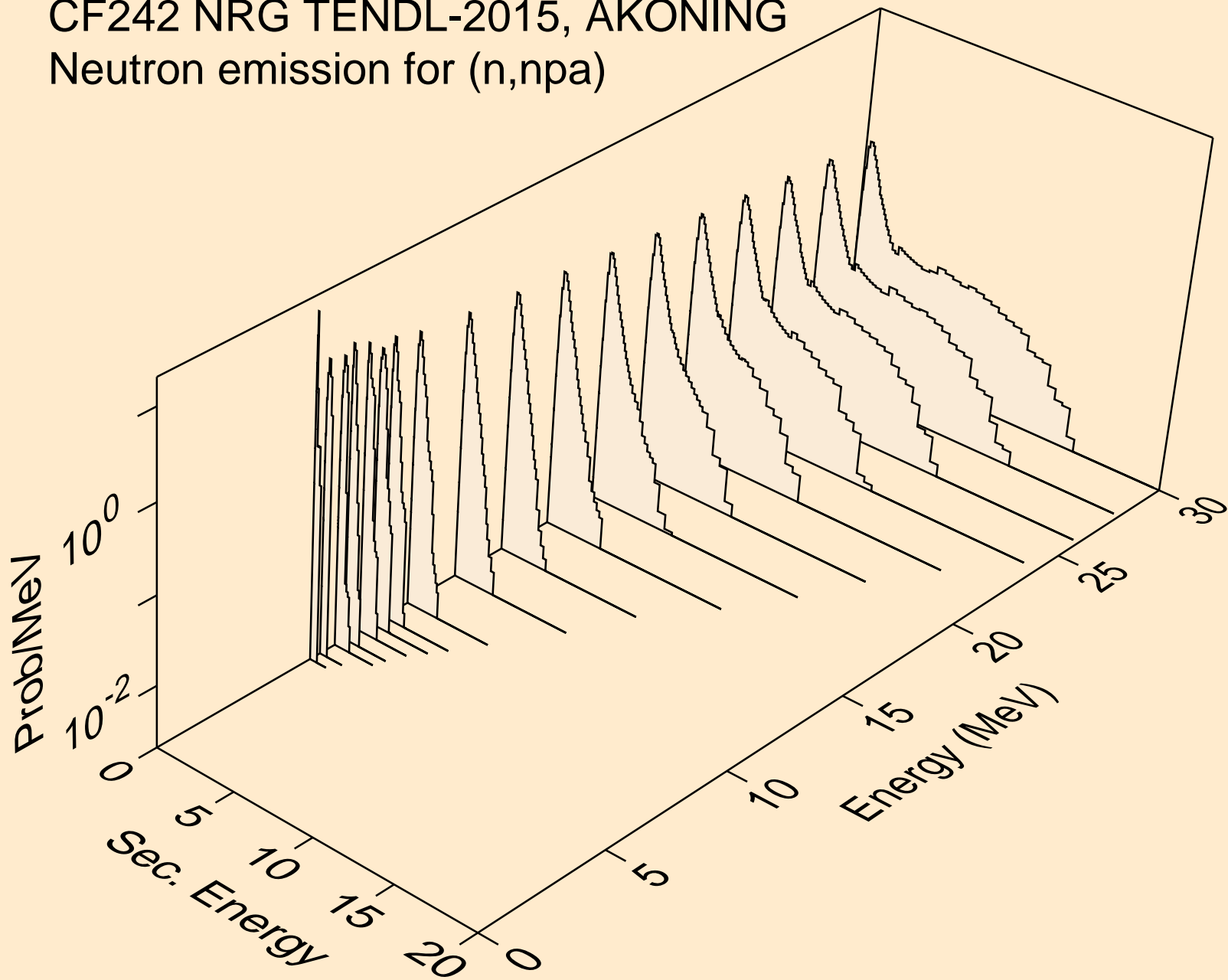

CF242 NRG TENDL-2015, AKONING
Neutron emission for (n,n*c)

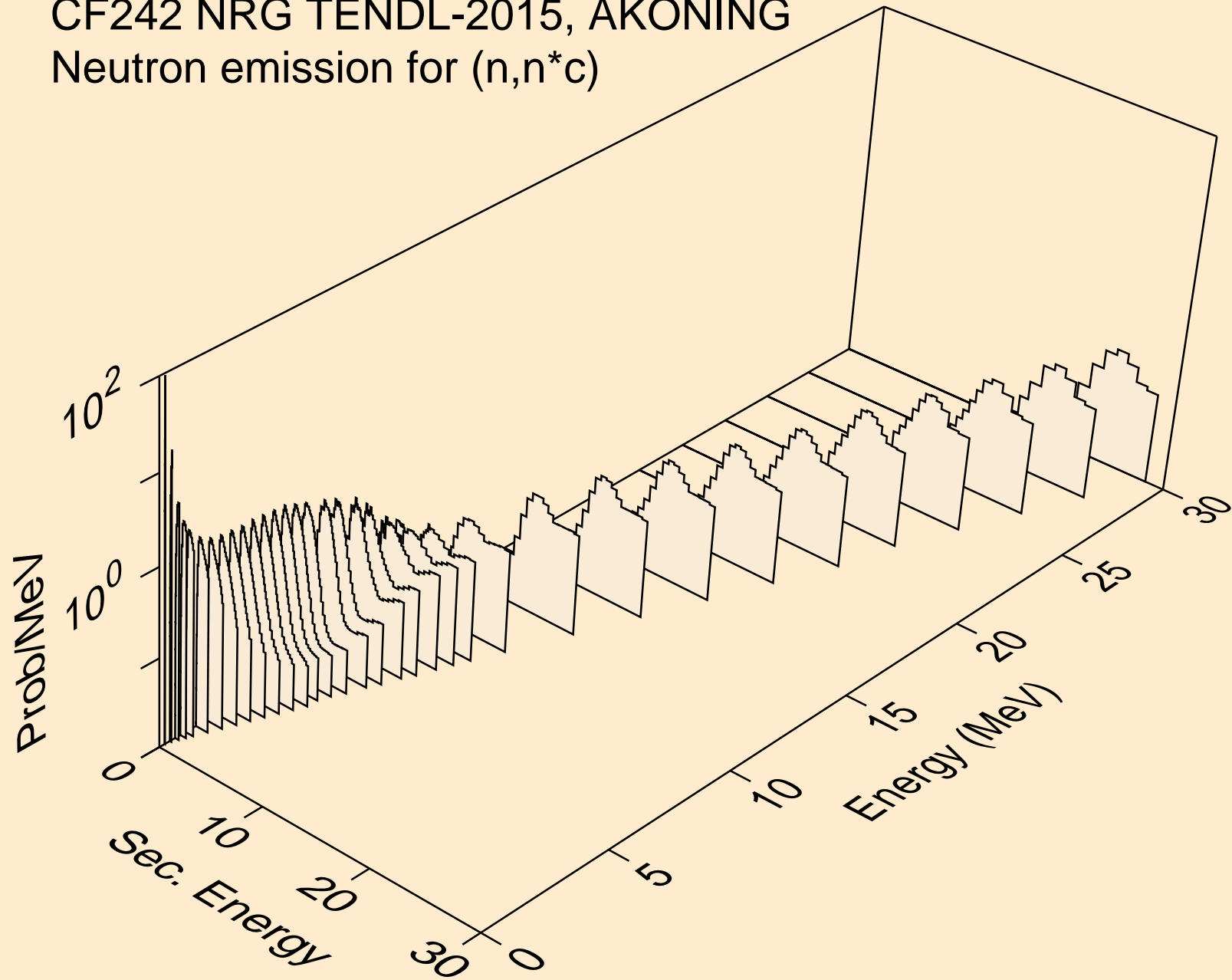

CF242 NRG TENDL-2015, AKONING

Delayed nubar

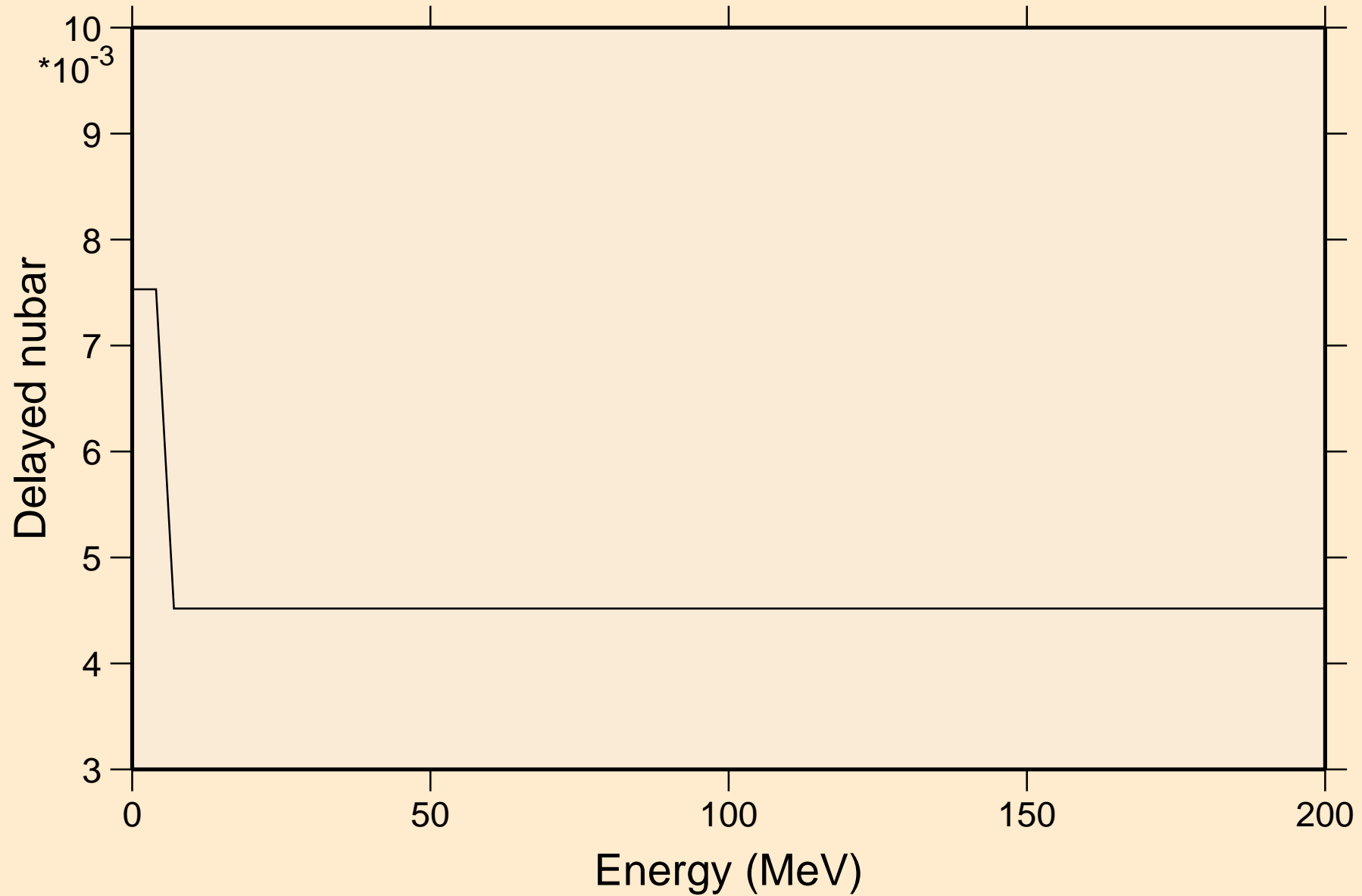

CF242 NRG TENDL-2015, AKONING

Delayed neutron spectra

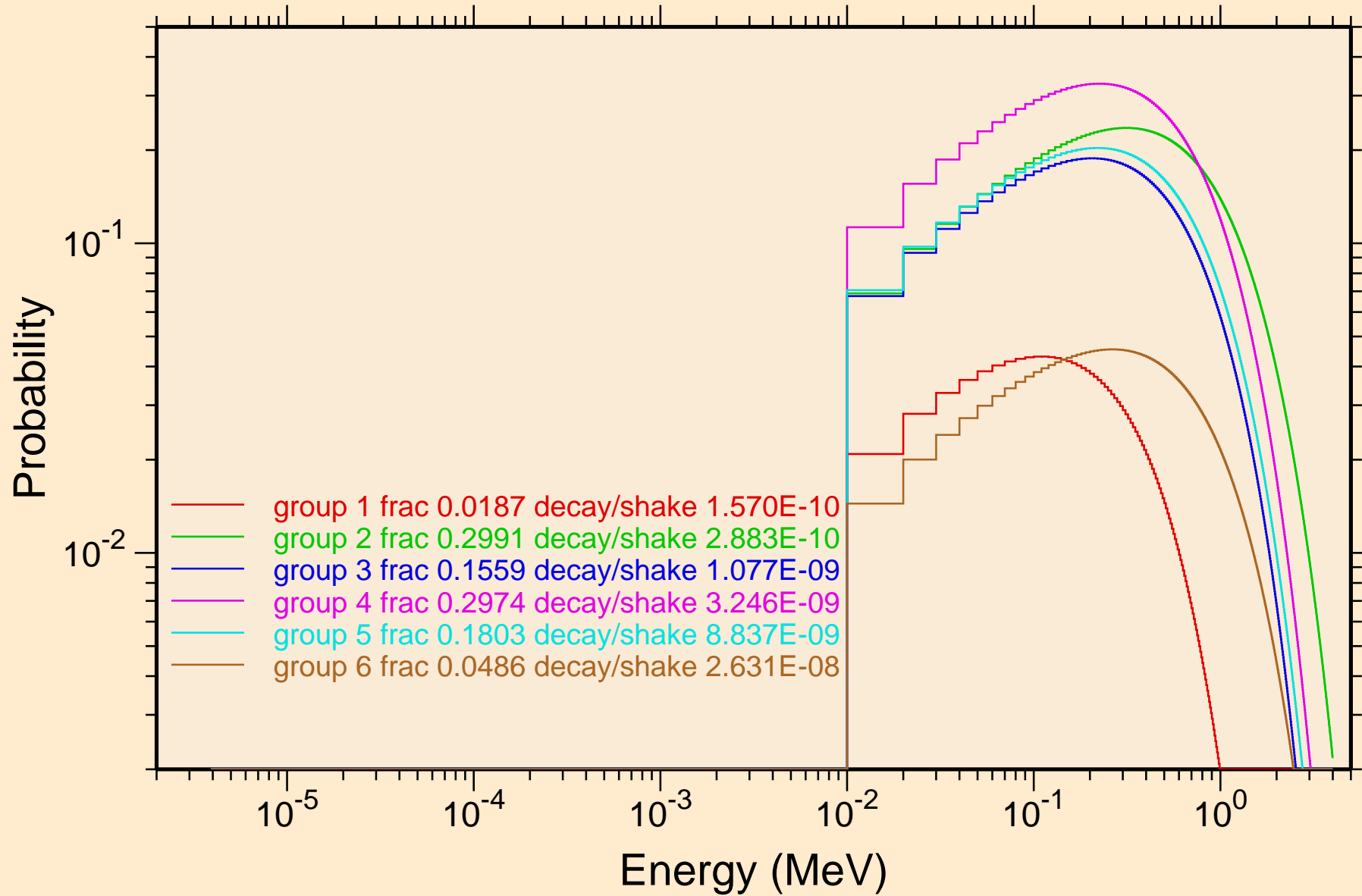

CF242 NRG TENDL-2015, AKONING
Photon emission for (n,x)

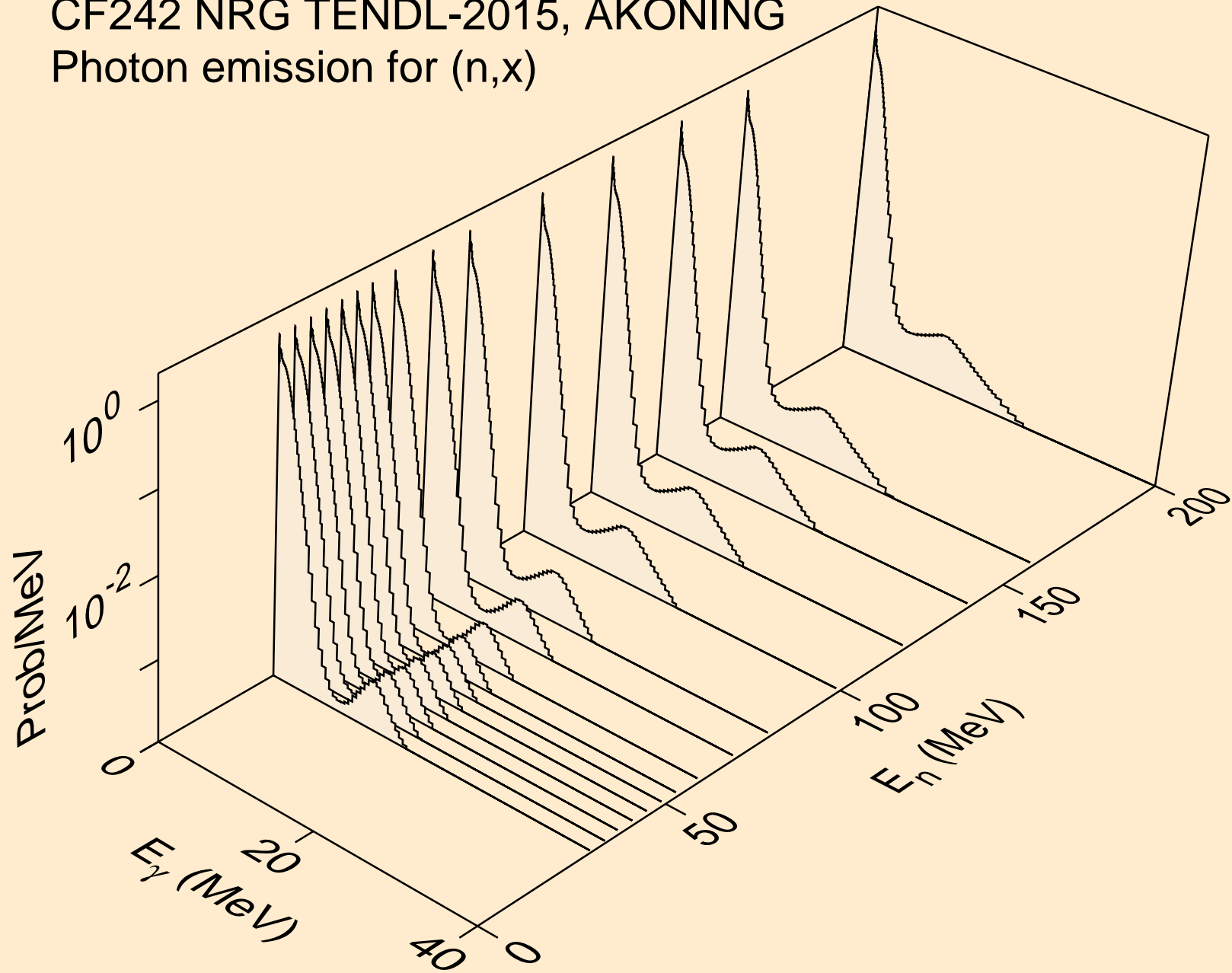

CF242 NRG TENDL-2015, AKONING
Photon emission for (n,2nd)

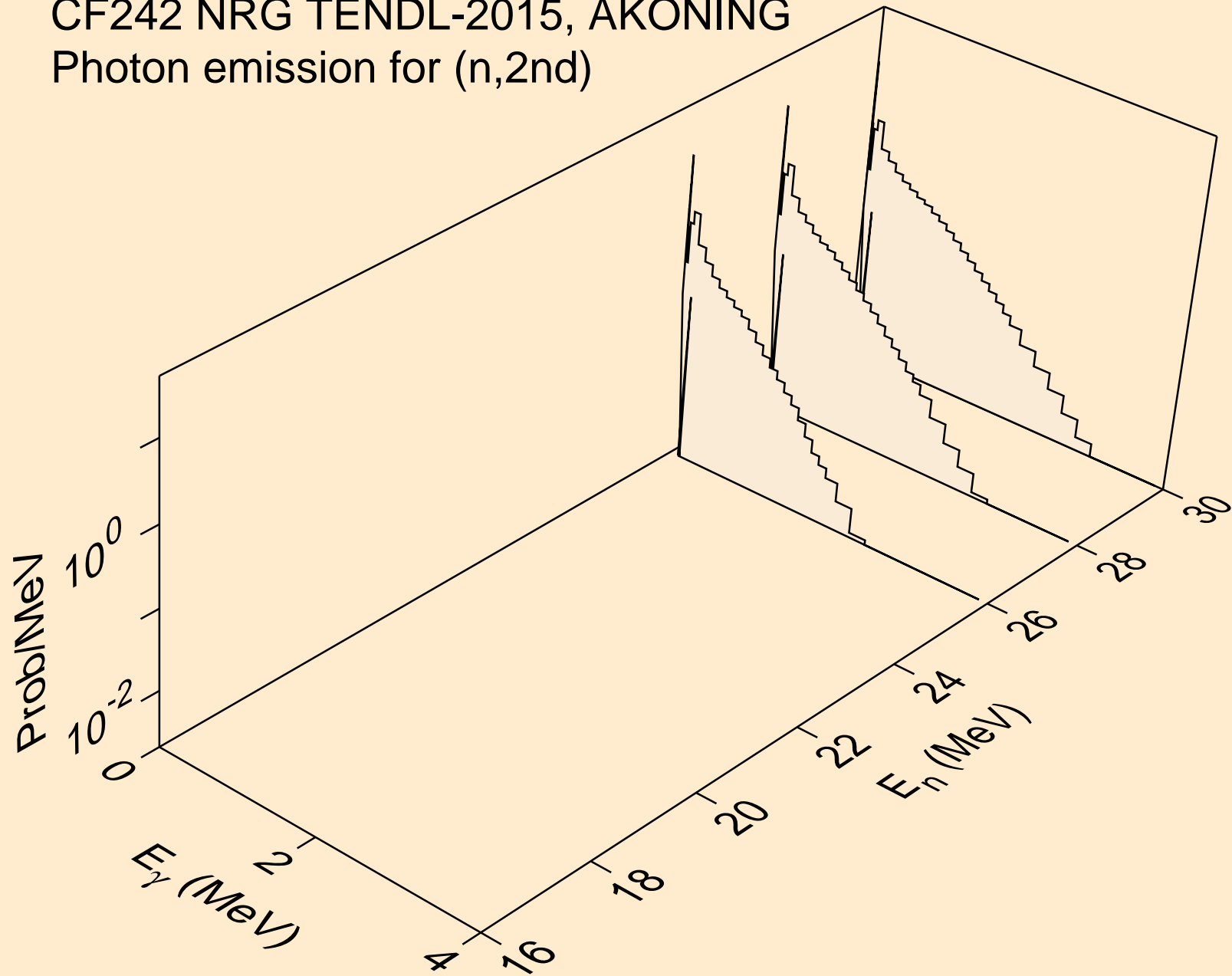

CF242 NRG TENDL-2015, AKONING
Photon emission for (n,2n)

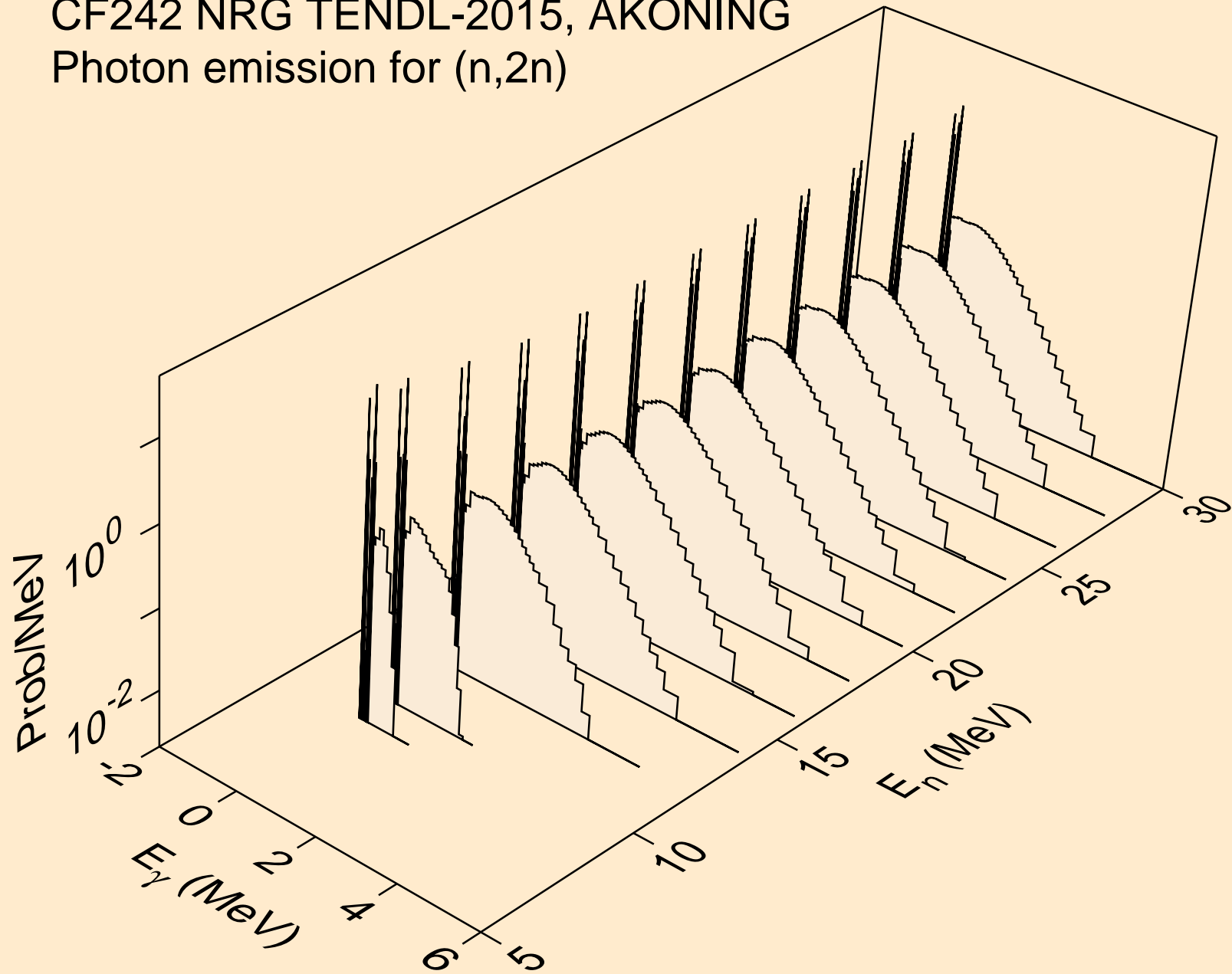

CF242 NRG TENDL-2015, AKONING
Photon emission for (n,3n)

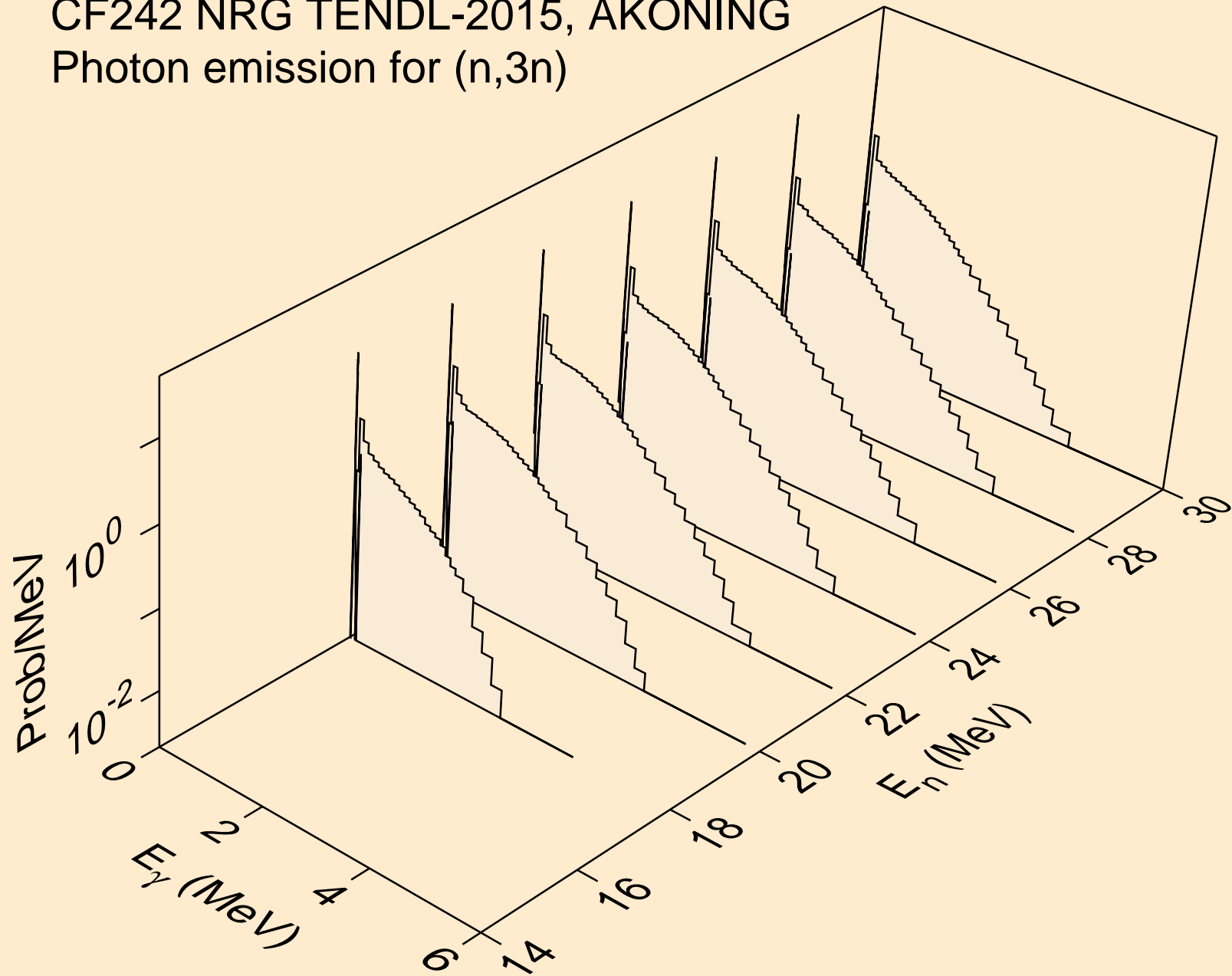

CF242 NRG TENDL-2015, AKONING
Photon emission for (n,n*)a

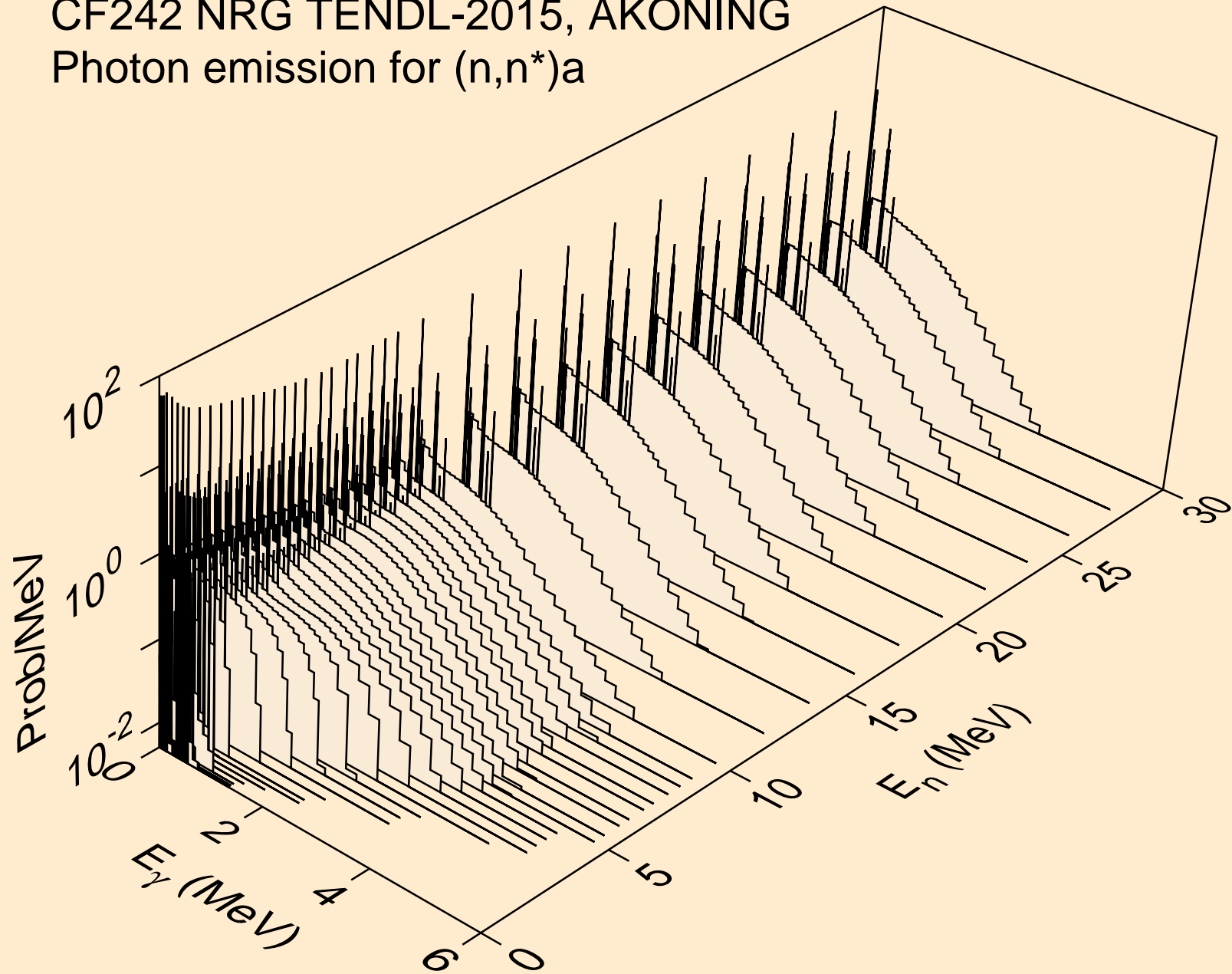

CF242 NRG TENDL-2015, AKONING
Photon emission for (n,2n)a

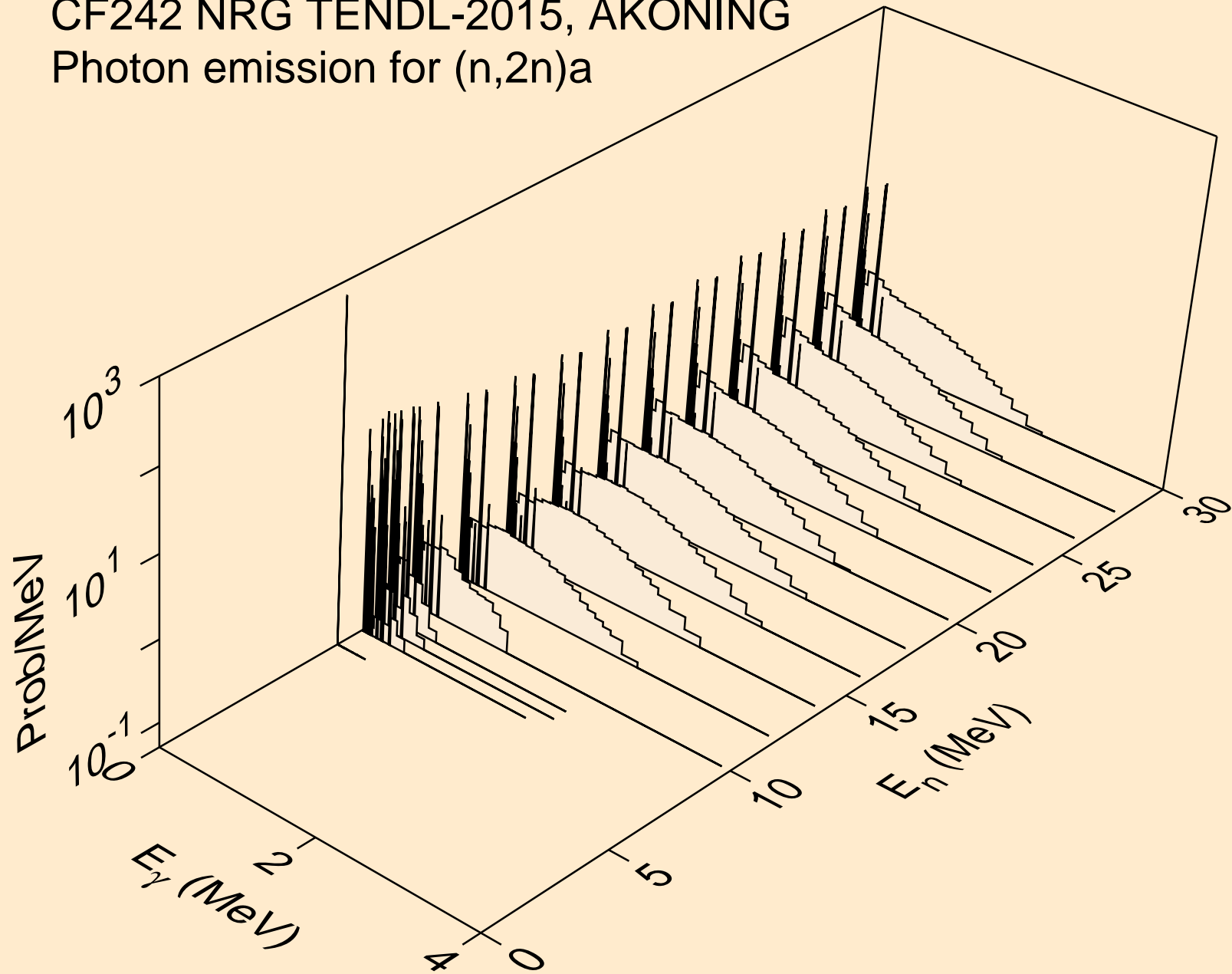

CF242 NRG TENDL-2015, AKONING
Photon emission for (n,3n)a

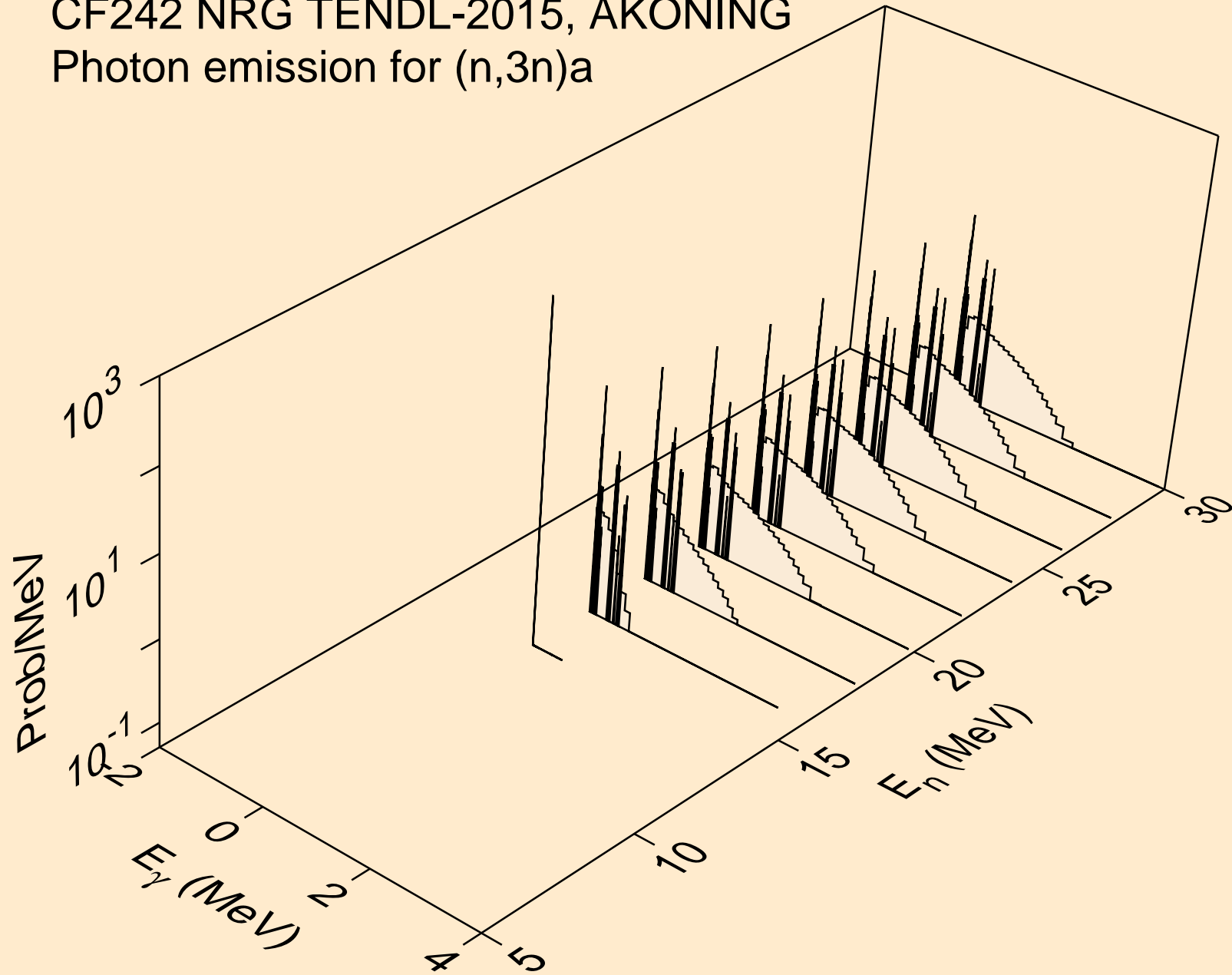

CF242 NRG TENDL-2015, AKONING
Photon emission for (n,n*)p

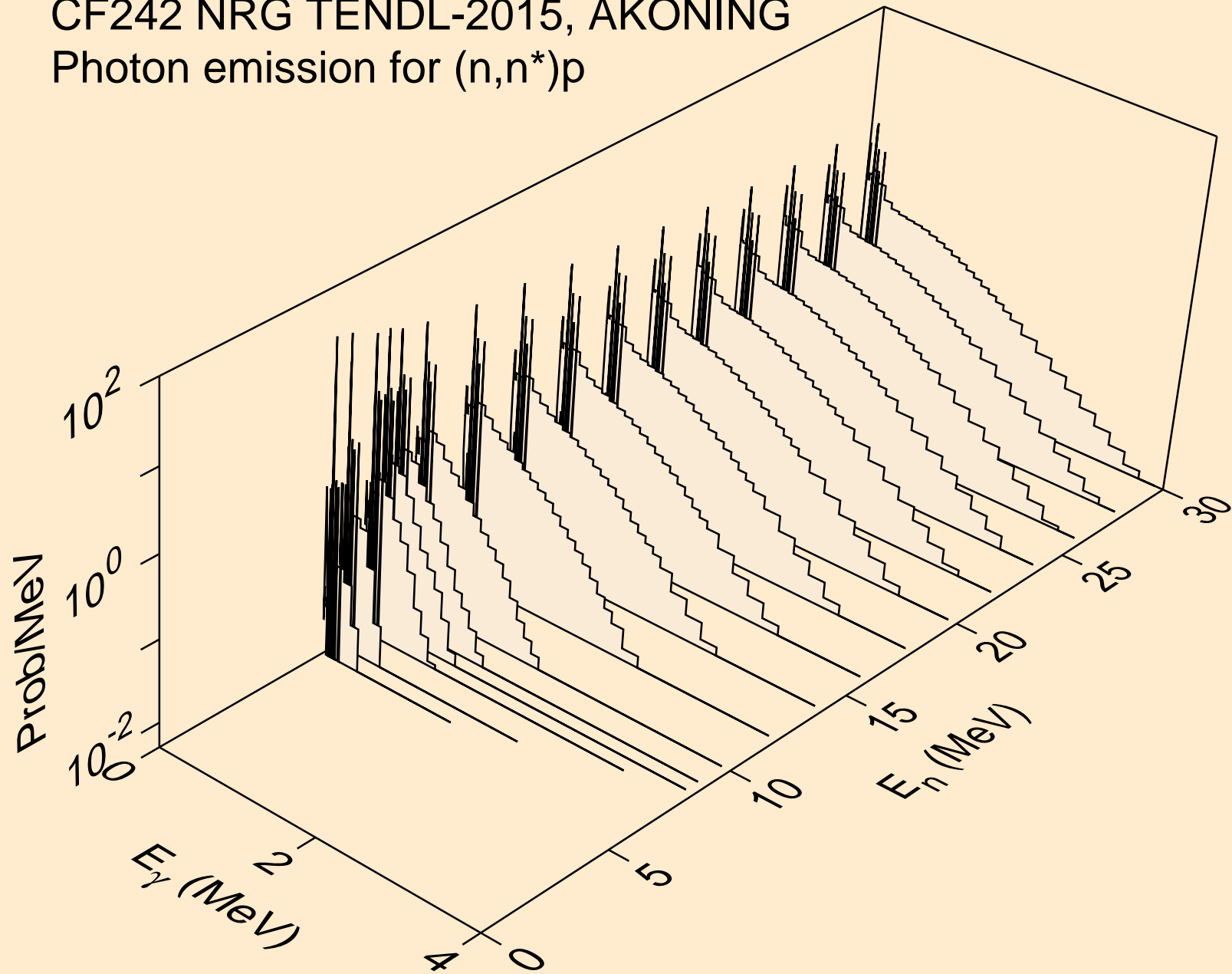

CF242 NRG TENDL-2015, AKONING
Photon emission for (n,n*)2a

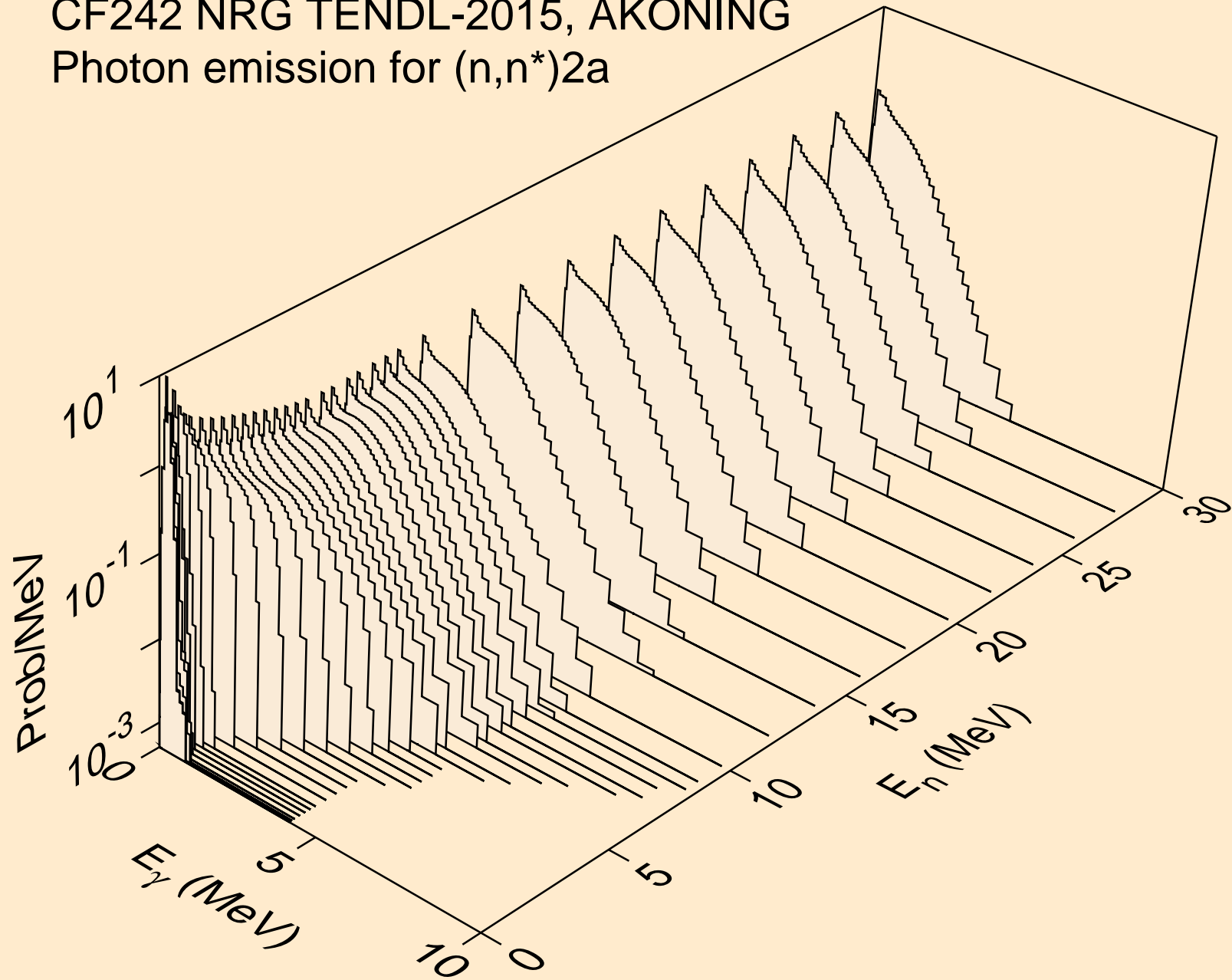

CF242 NRG TENDL-2015, AKONING
Photon emission for (n,2n)2a

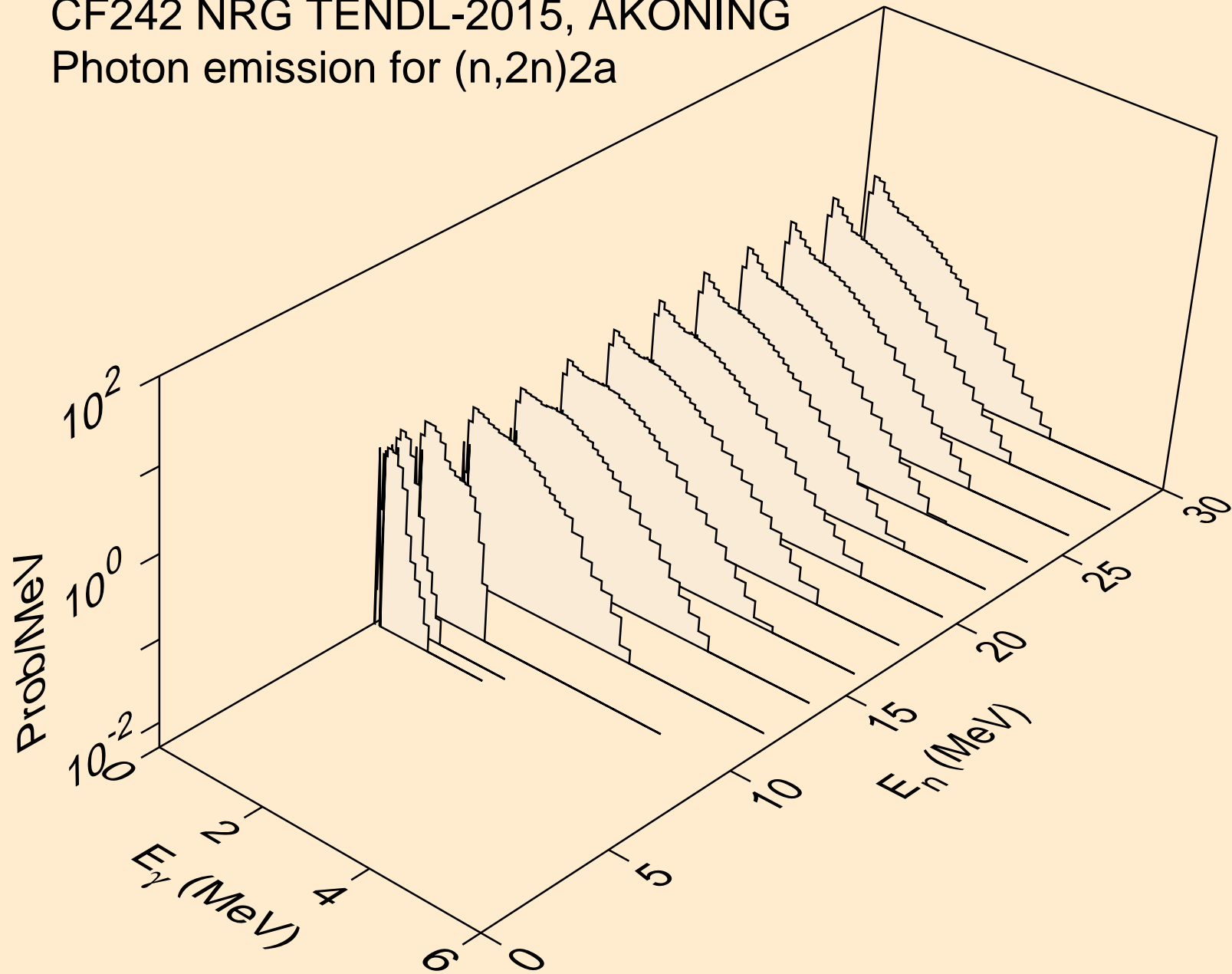

CF242 NRG TENDL-2015, AKONING

Photon emission for (n,n*)d

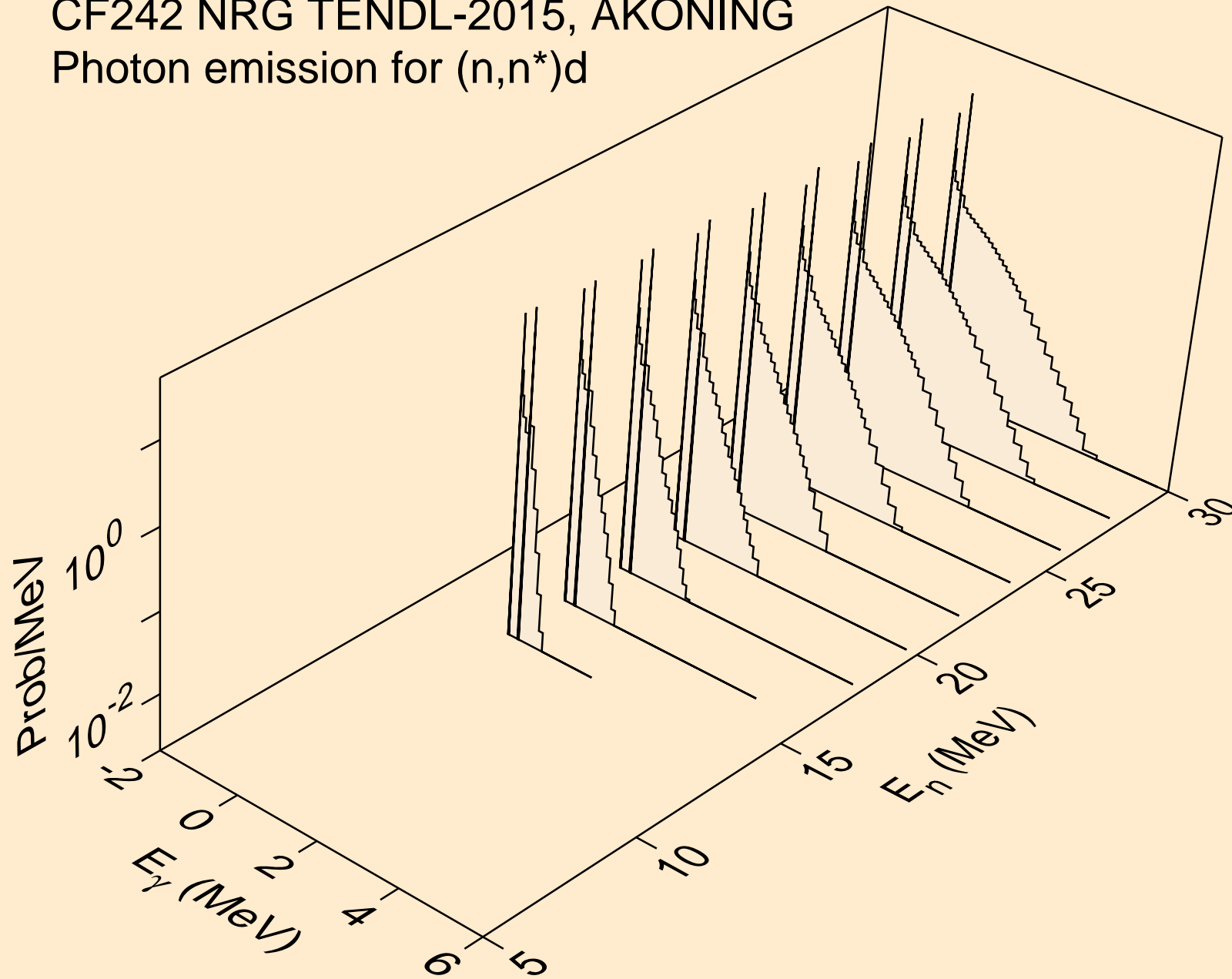

CF242 NRG TENDL-2015, AKONING
Photon emission for (n,n*)t

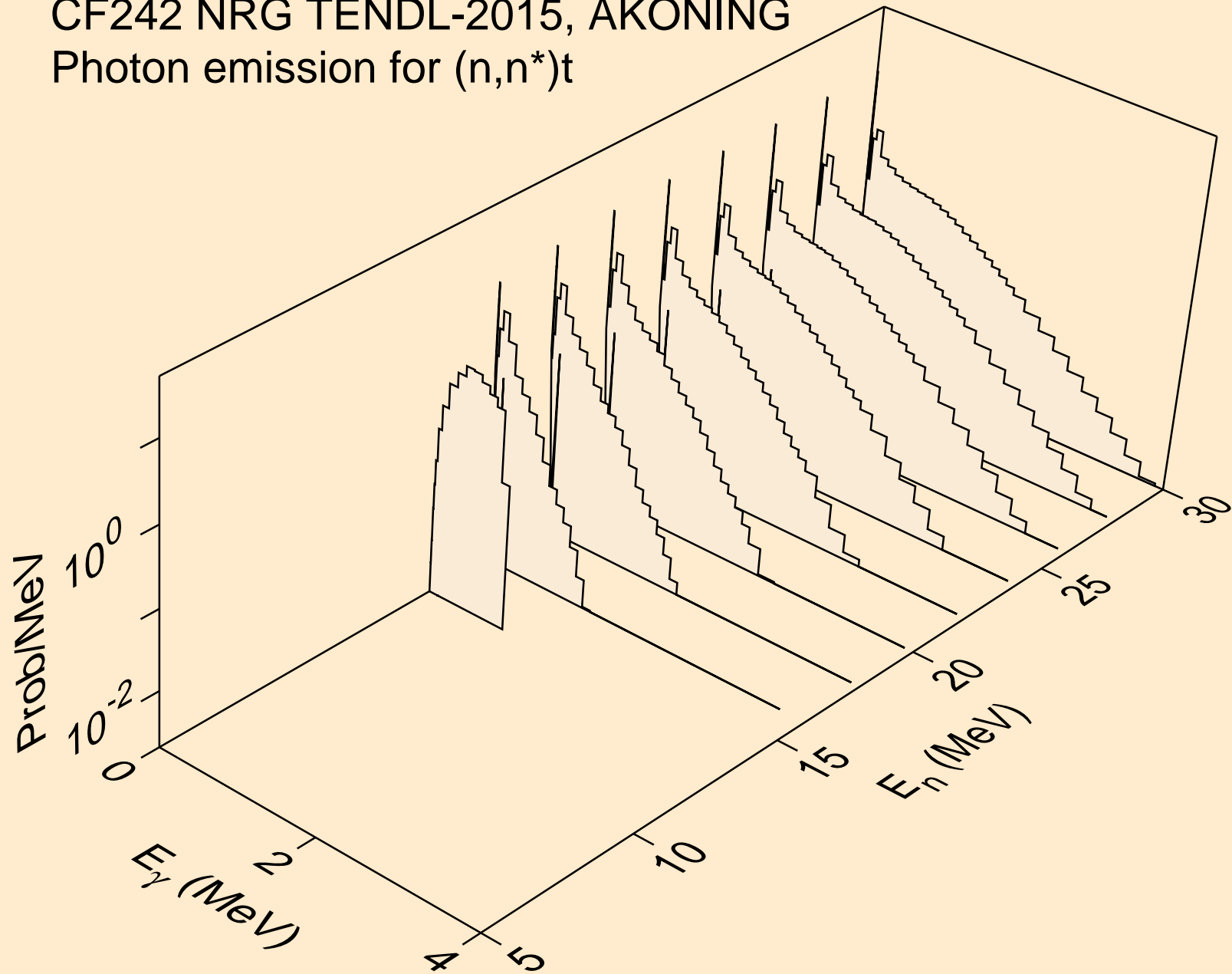

CF242 NRG TENDL-2015, AKONING
Photon emission for (n,n*)he3

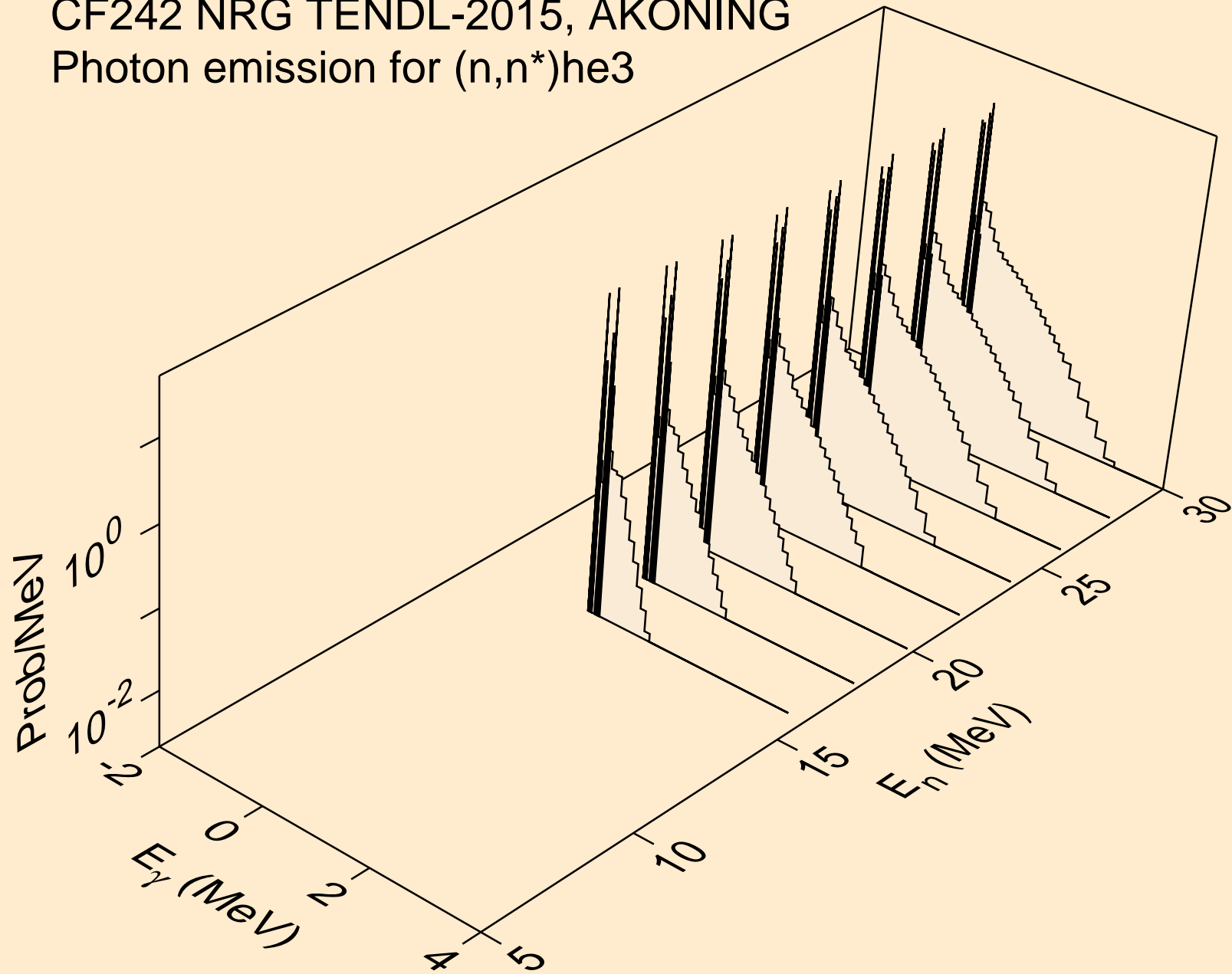

CF242 NRG TENDL-2015, AKONING
Photon emission for (n,n*)t2a

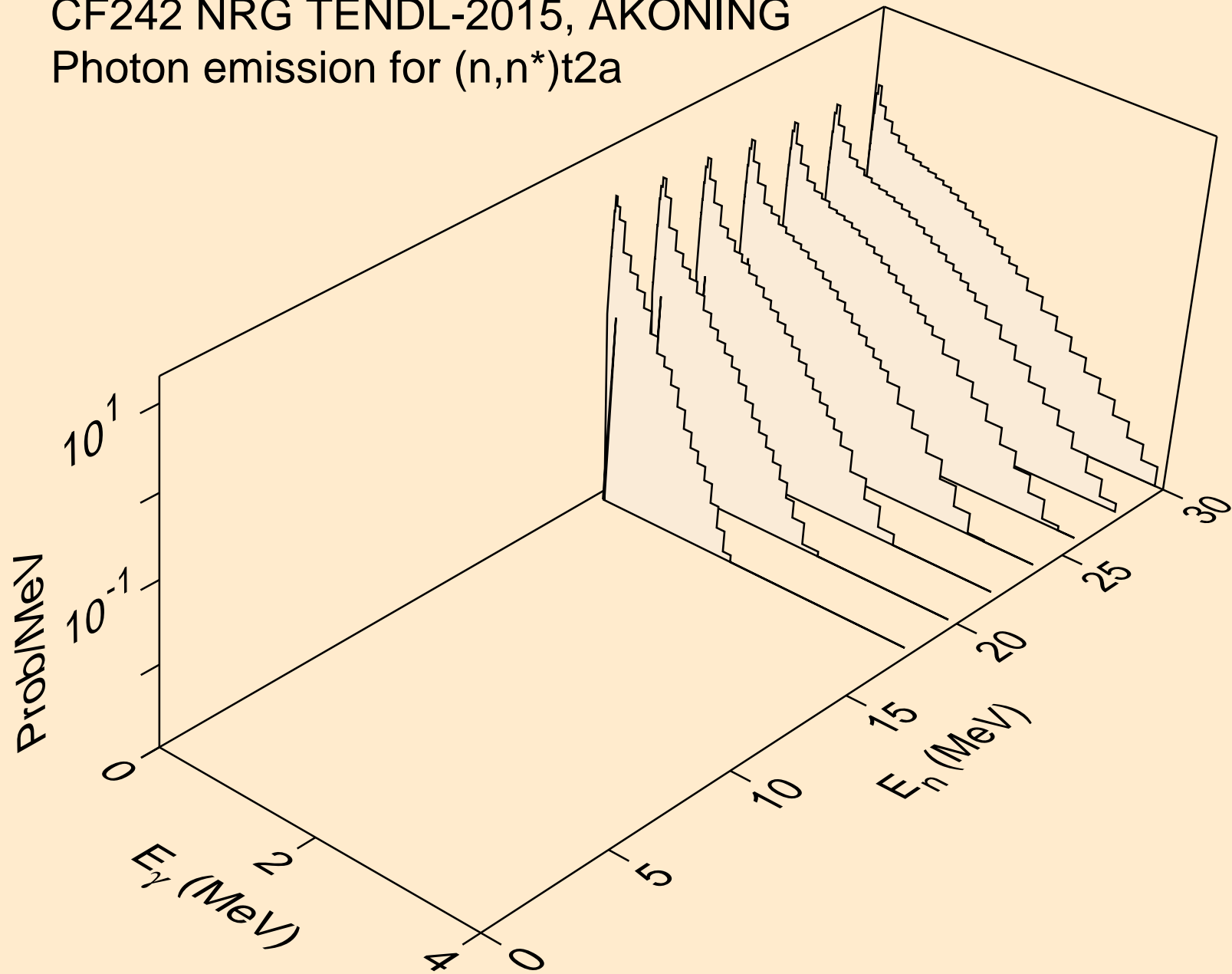

CF242 NRG TENDL-2015, AKONING
Photon emission for (n,4n)

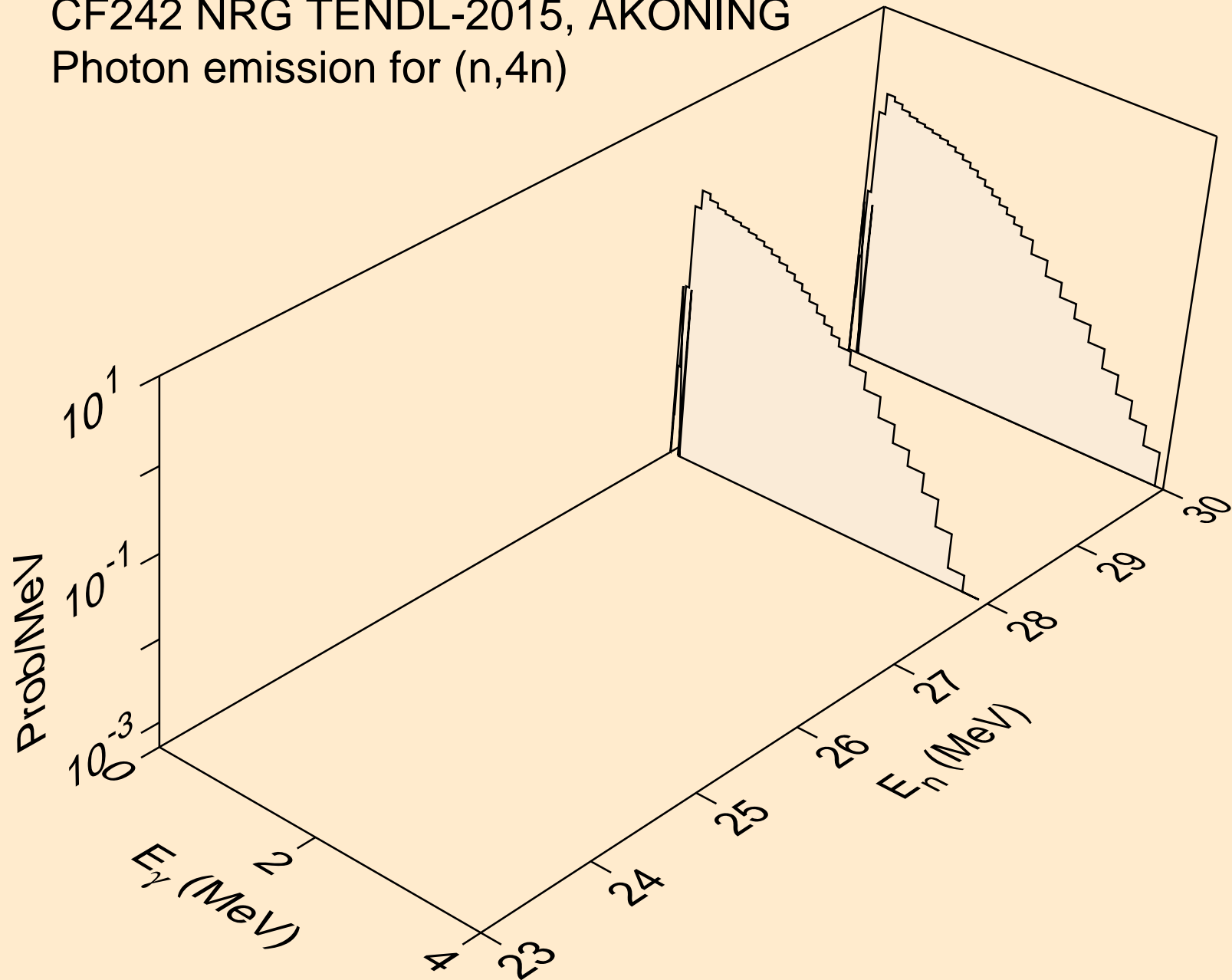

CF242 NRG TENDL-2015, AKONING
Photon emission for (n,2np)

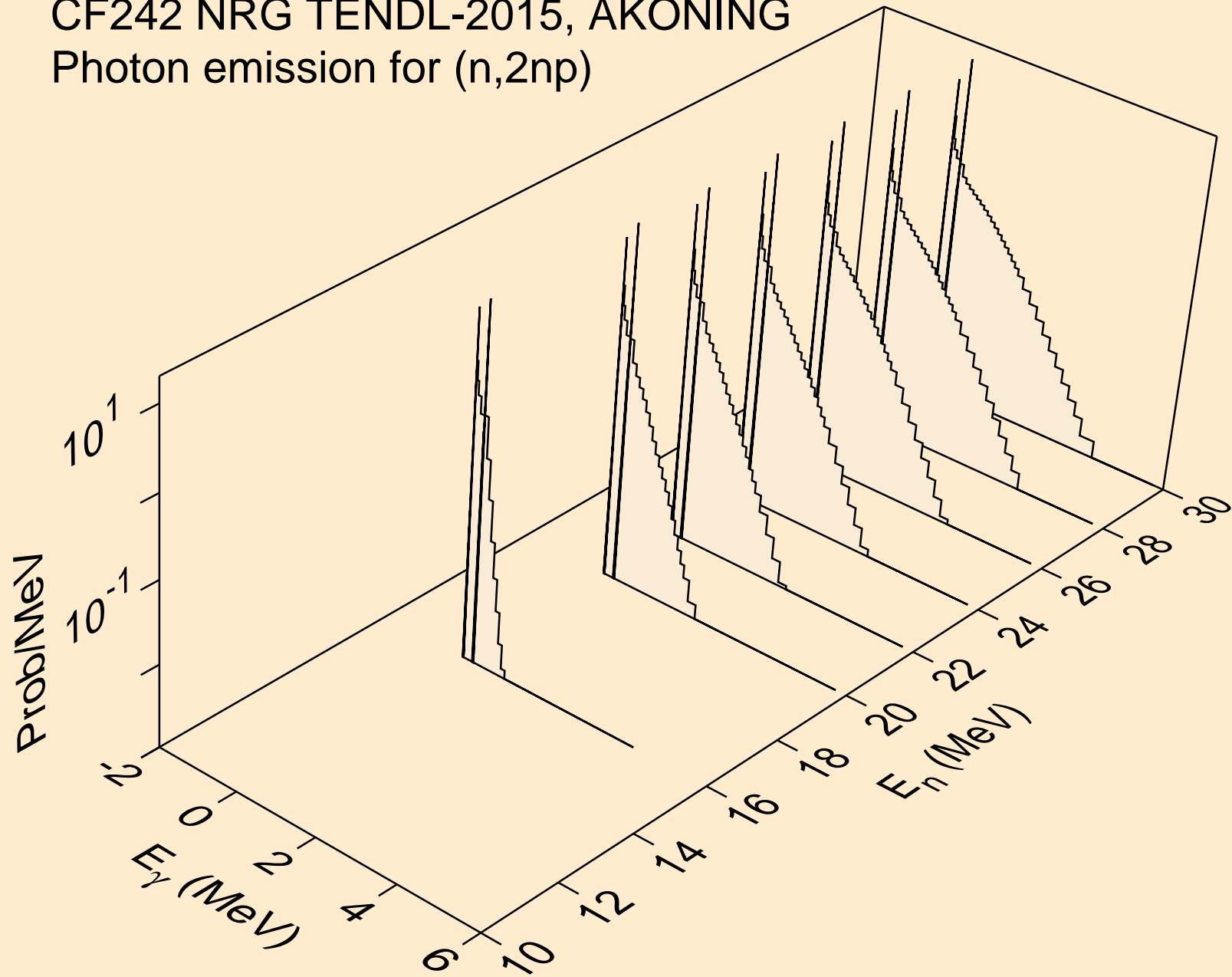

CF242 NRG TENDL-2015, AKONING
Photon emission for (n,3np)

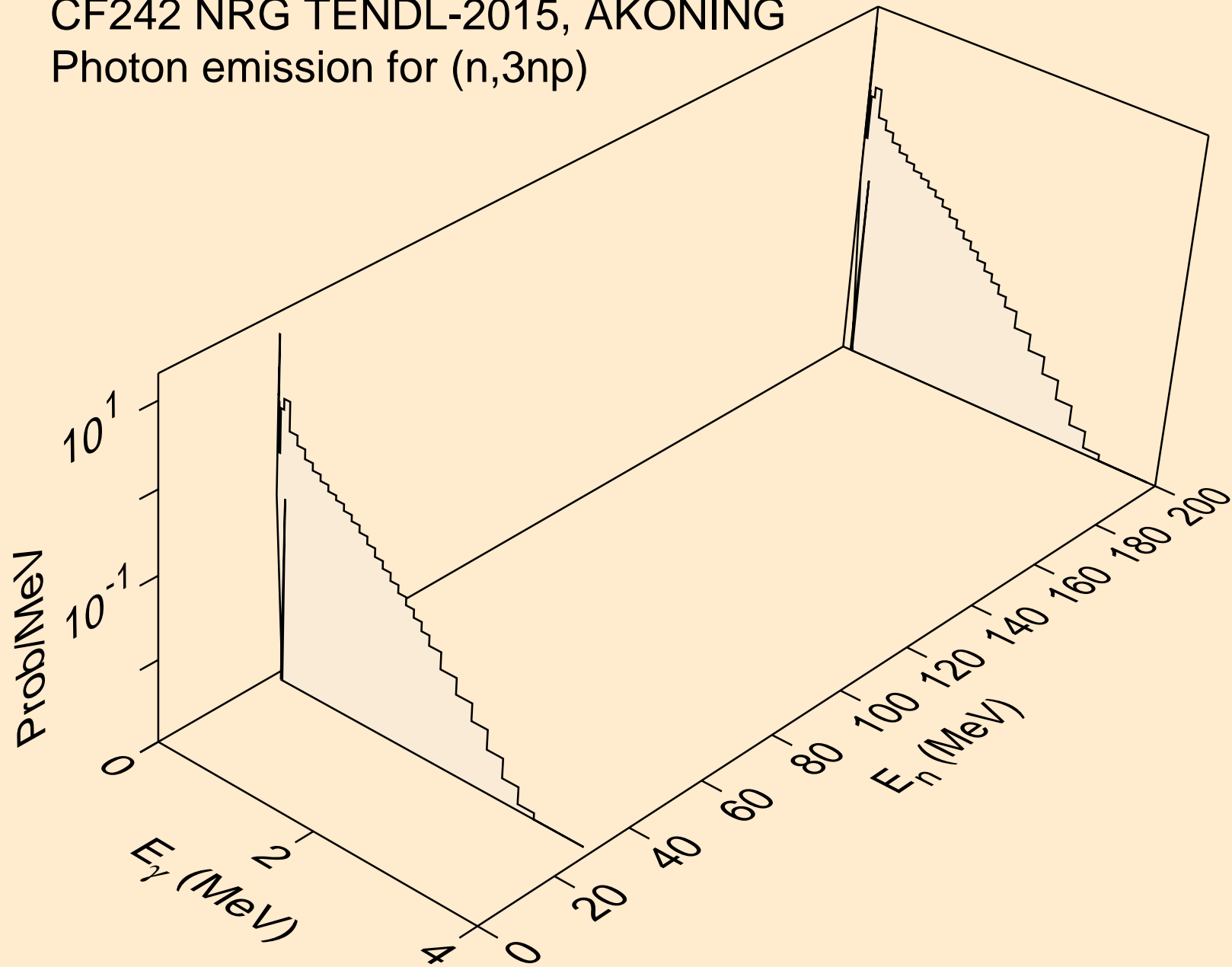

CF242 NRG TENDL-2015, AKONING
Photon emission for (n,2np)

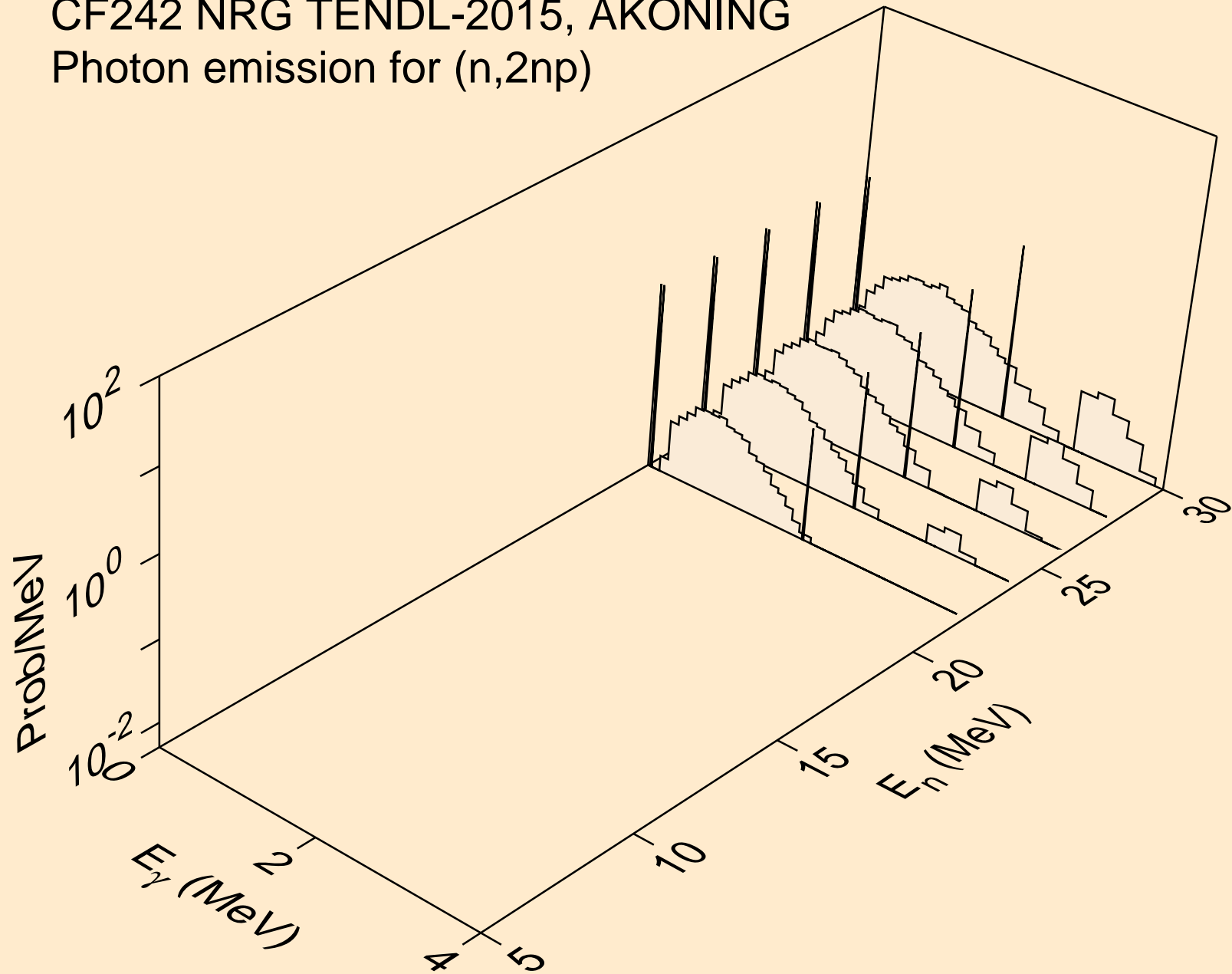

CF242 NRG TENDL-2015, AKONING
Photon emission for (n,npa)

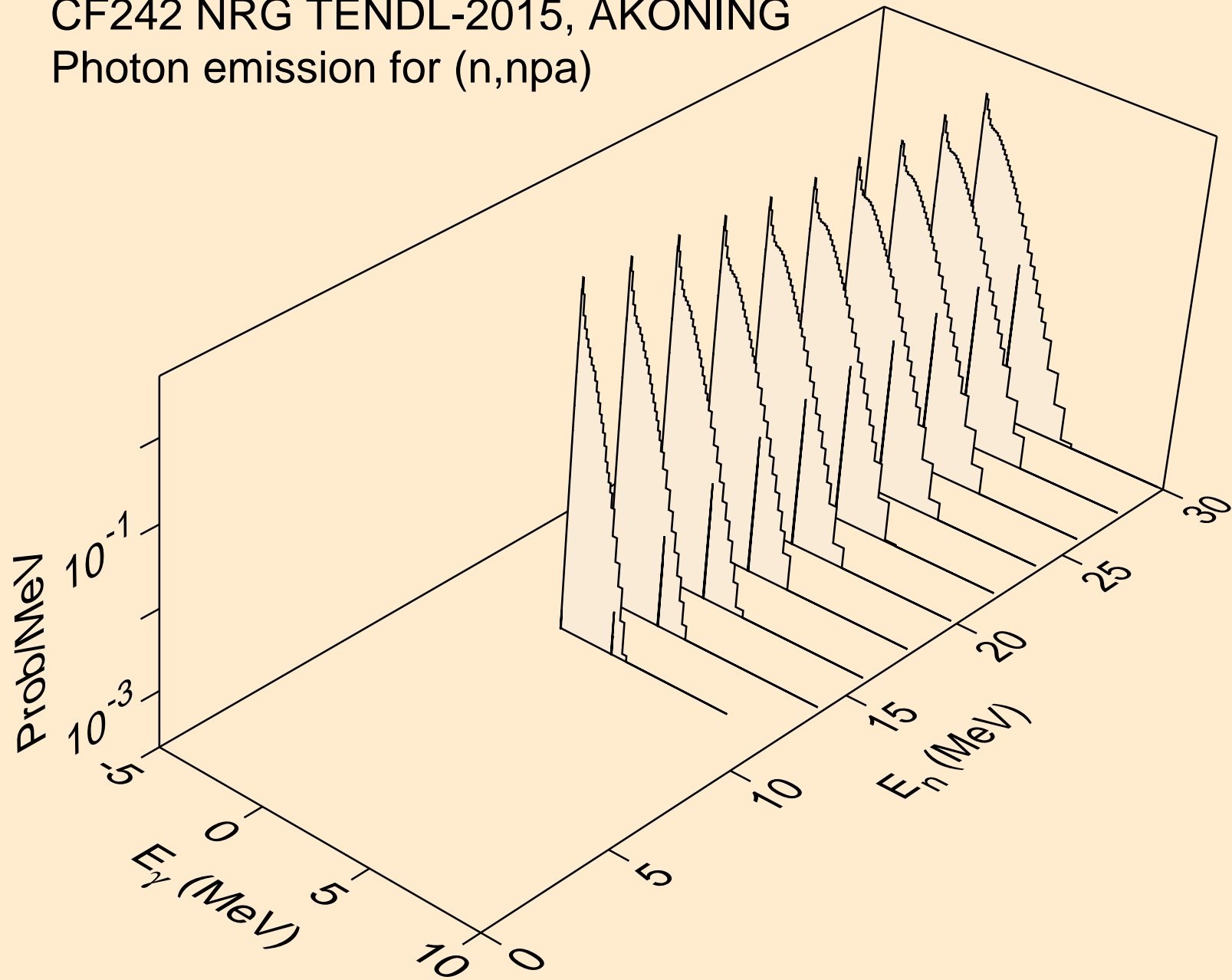

CF242 NRG TENDL-2015, AKONING
Photon emission for (n,n*c)

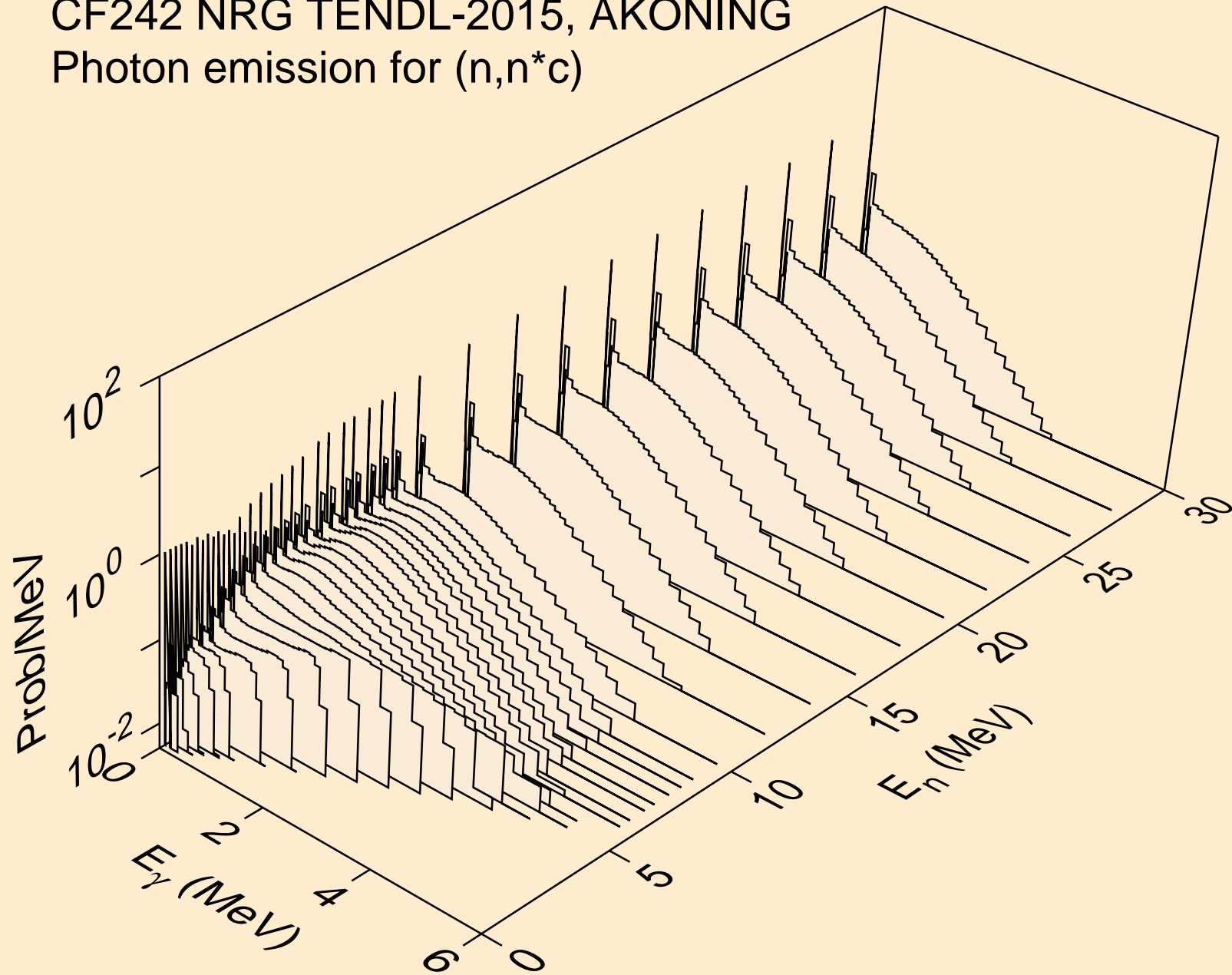

CF242 NRG TENDL-2015, AKONING
Photon emission for (n,gma)

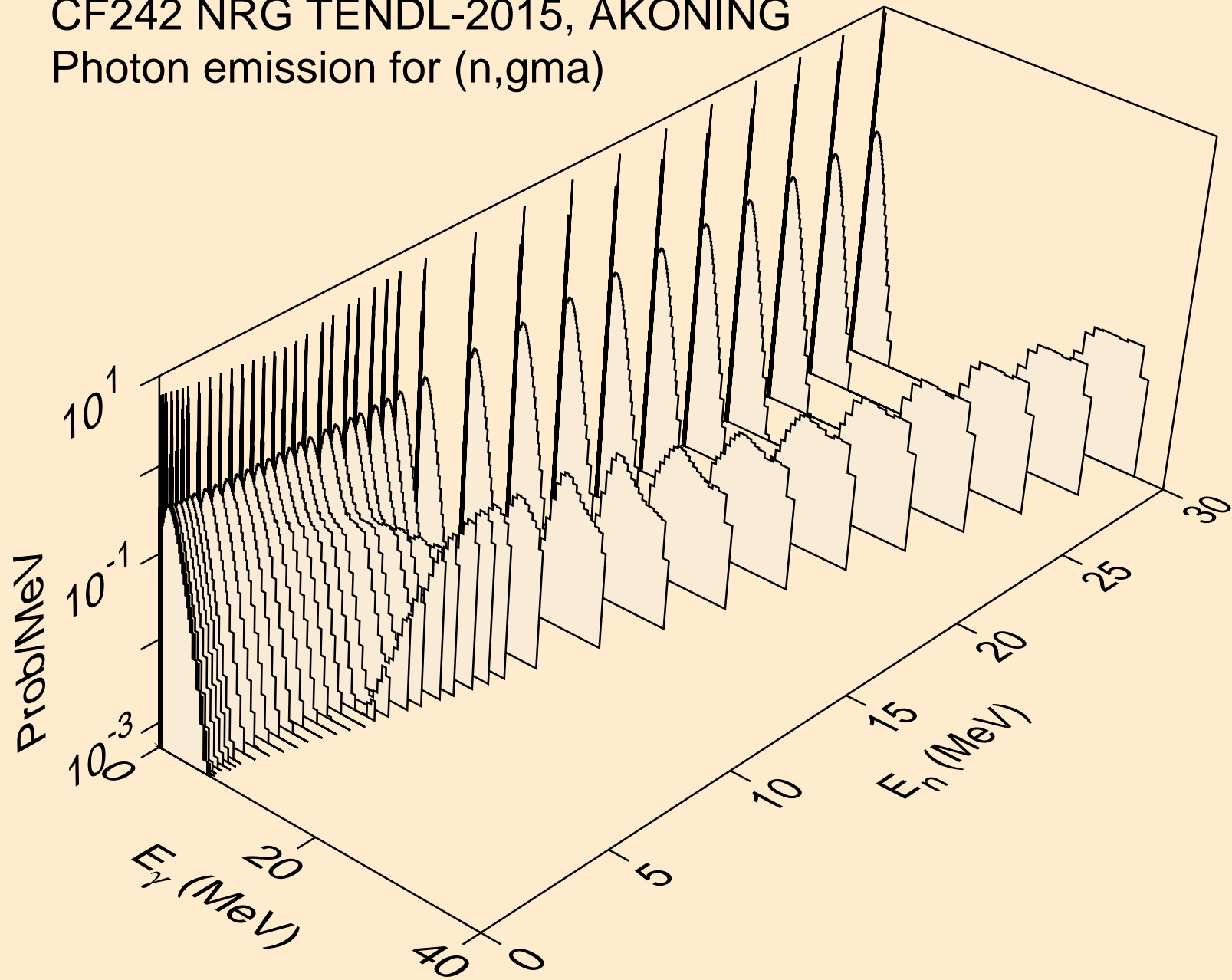

CF242 NRG TENDL-2015, AKONING
Photon emission for (n,p)

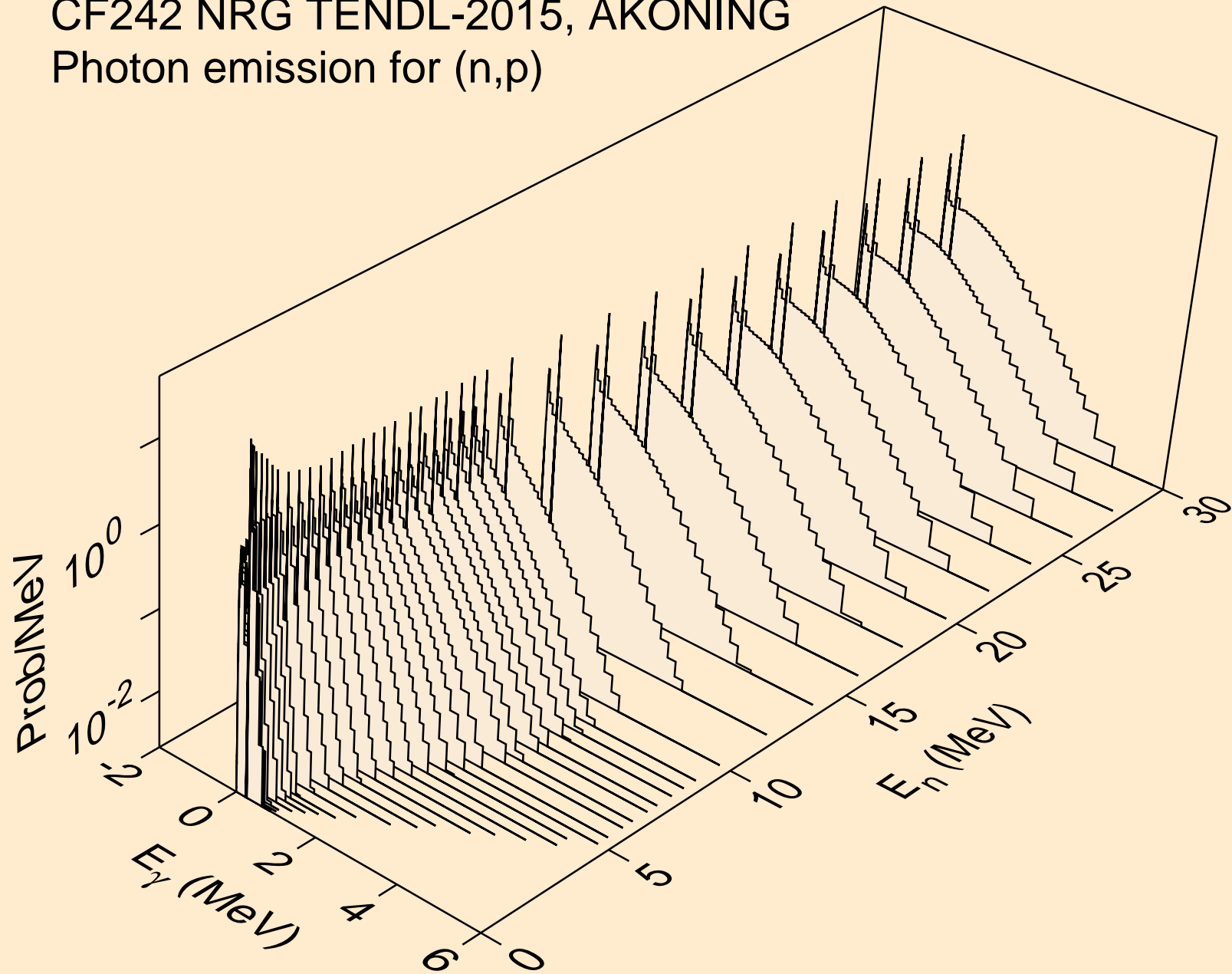

CF242 NRG TENDL-2015, AKONING
Photon emission for (n,d)

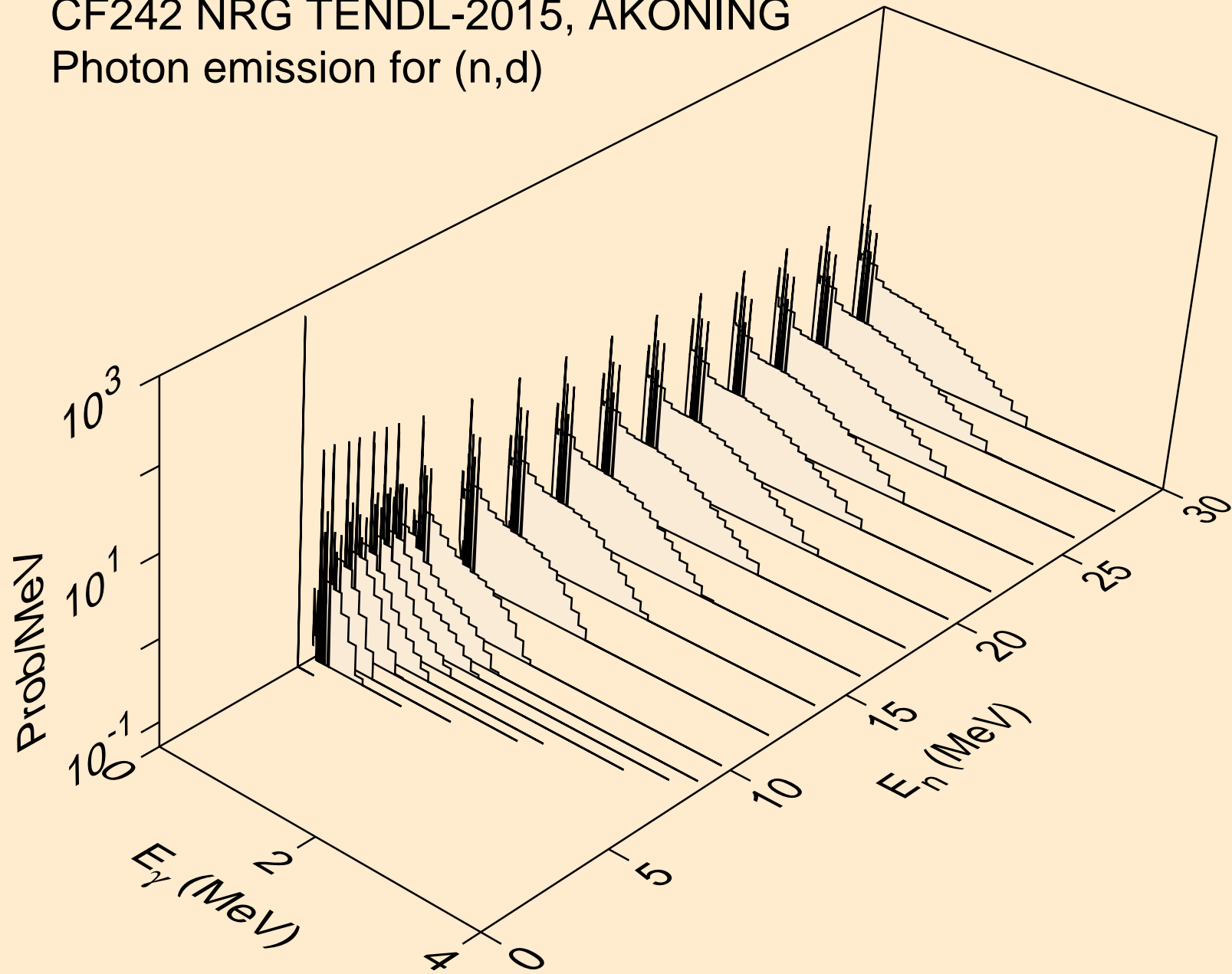

CF242 NRG TENDL-2015, AKONING
Photon emission for (n,t)

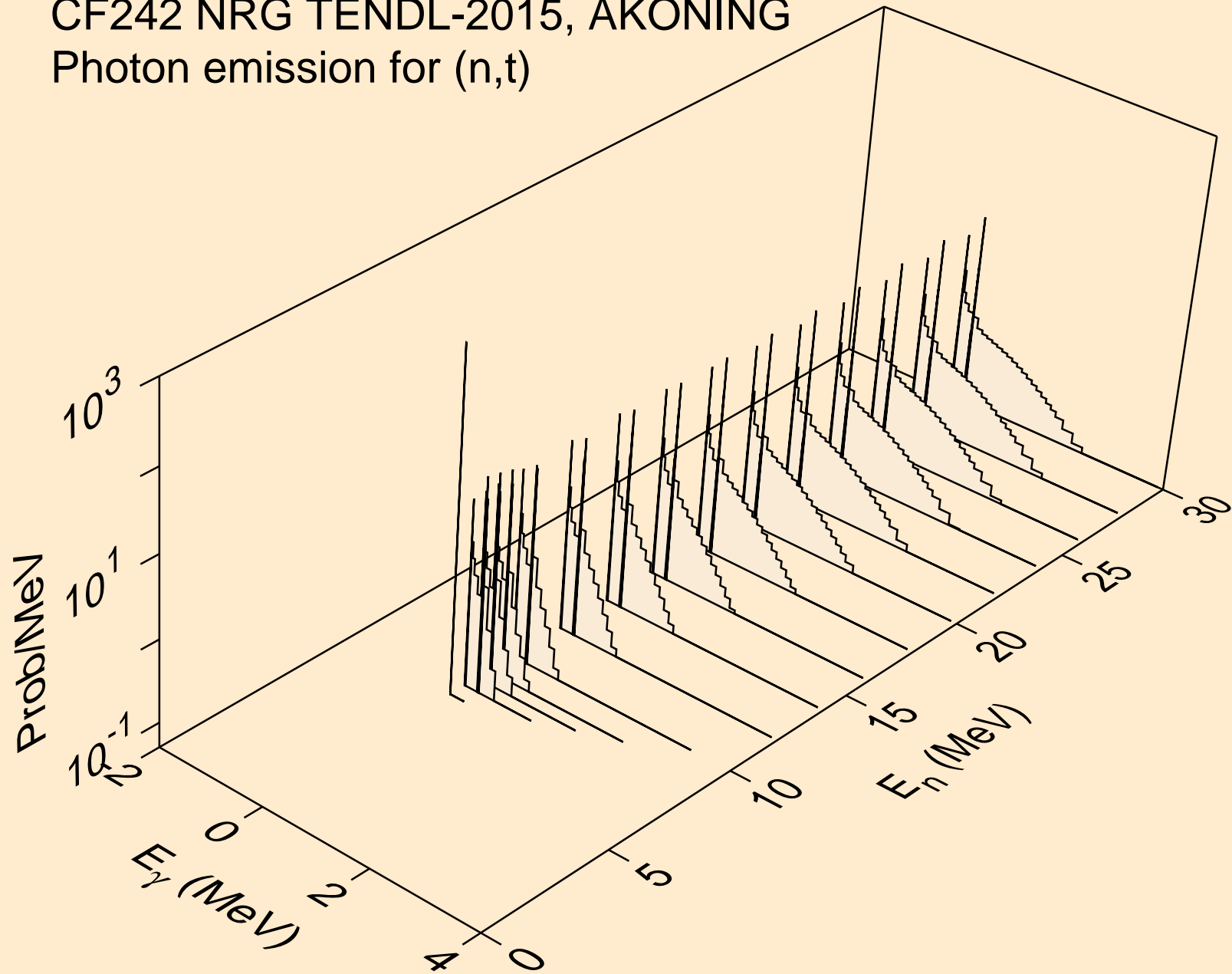

CF242 NRG TENDL-2015, AKONING
Photon emission for (n,he3)

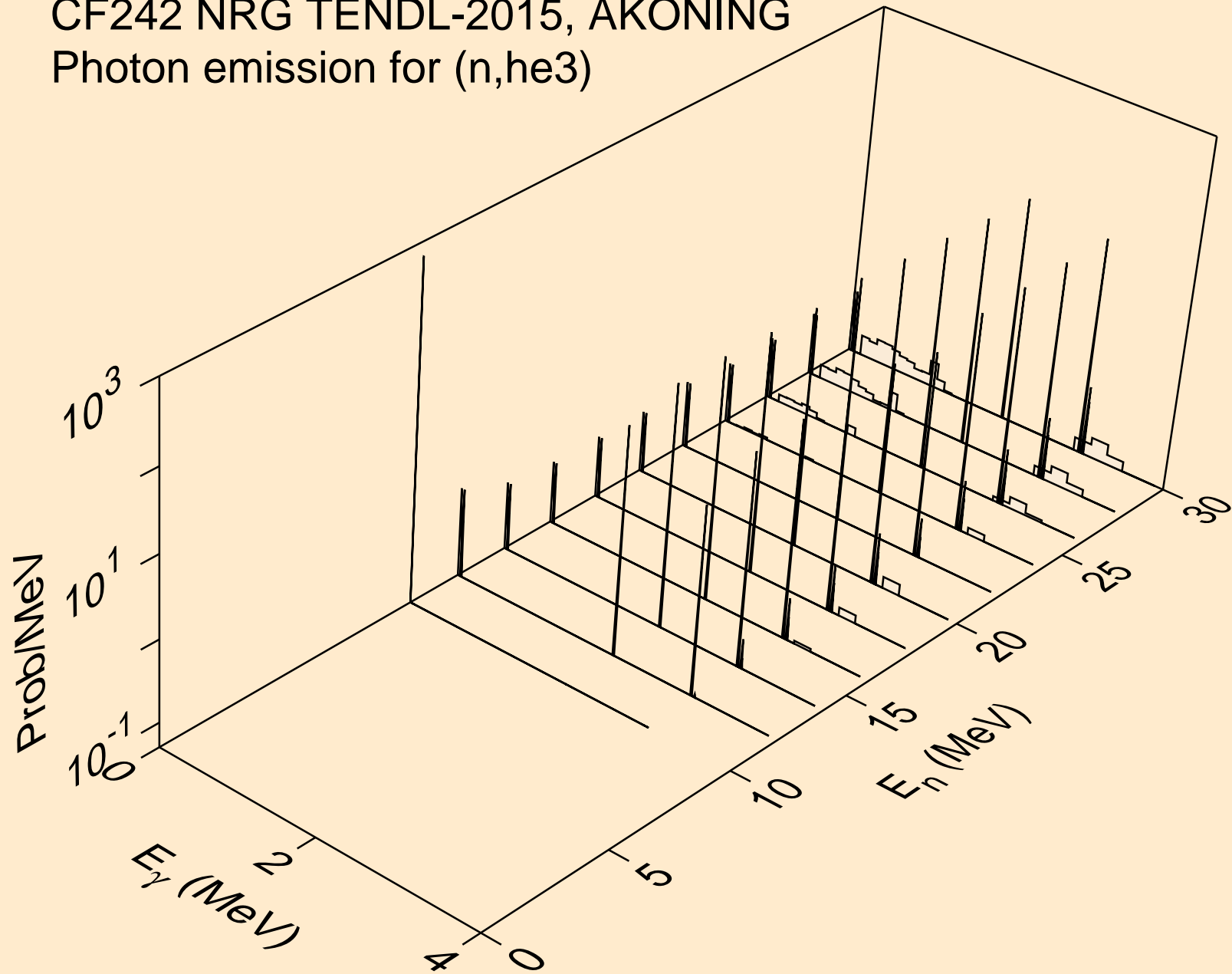

CF242 NRG TENDL-2015, AKONING
Photon emission for (n,a)

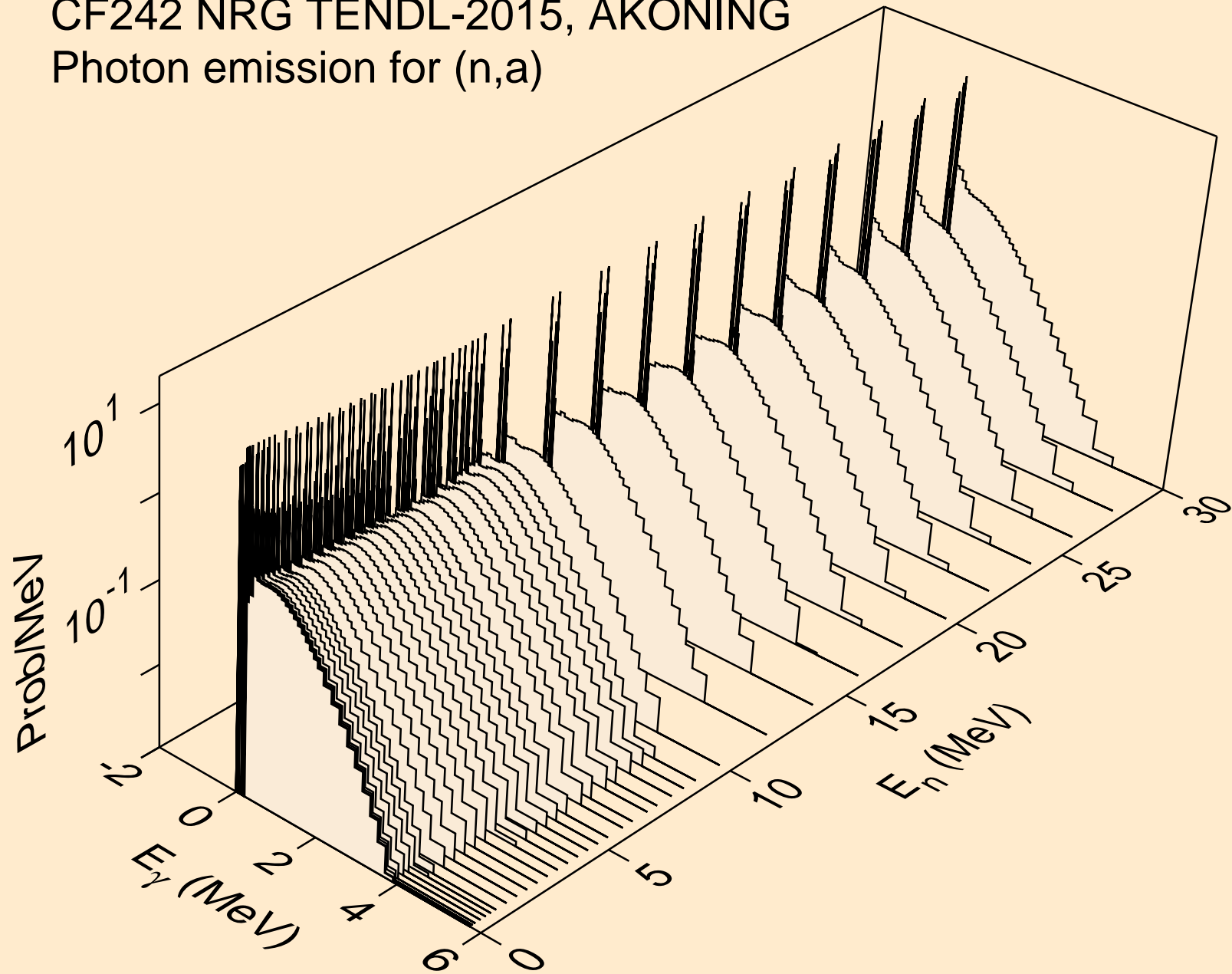

CF242 NRG TENDL-2015, AKONING
Photon emission for (n,2a)

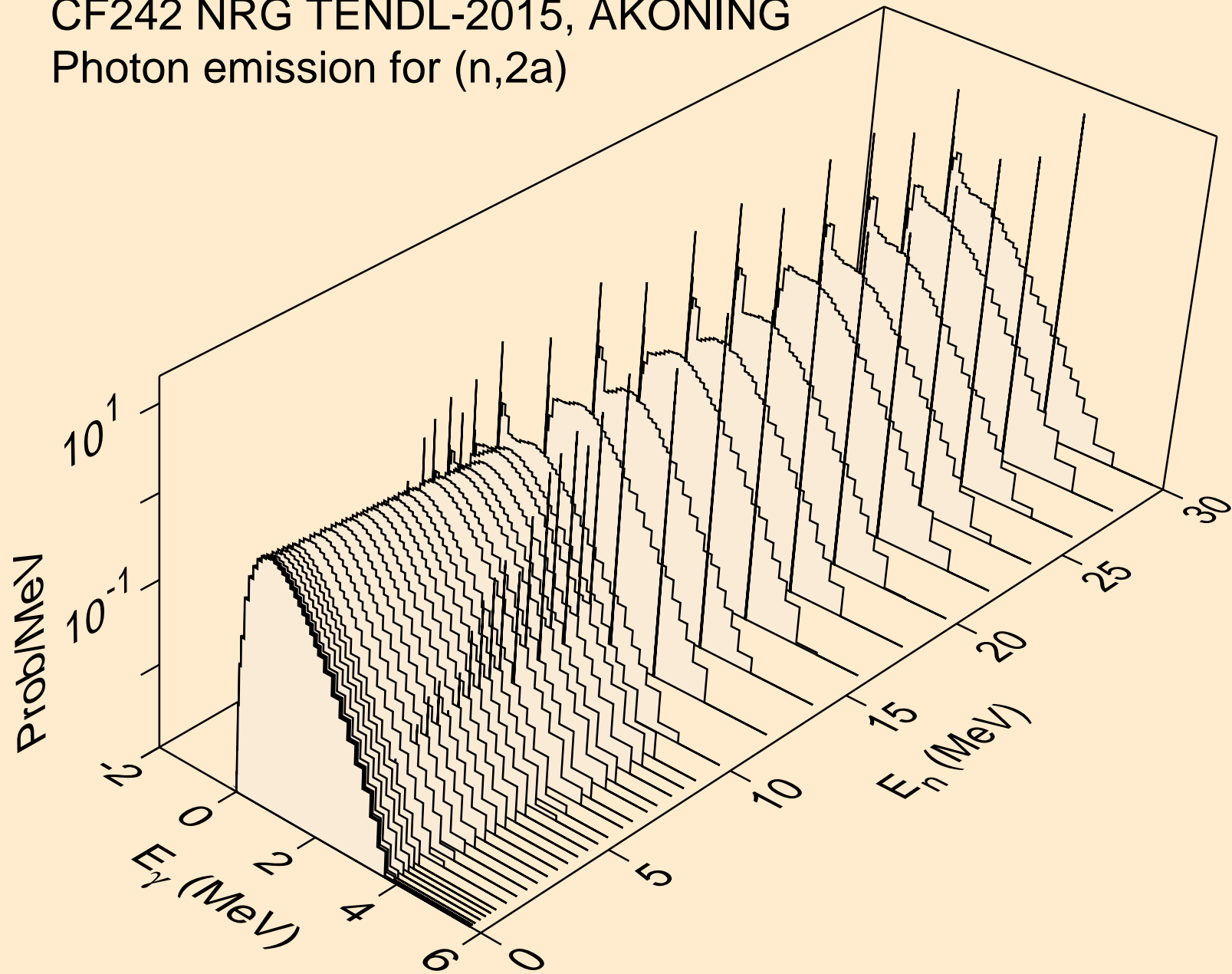

CF242 NRG TENDL-2015, AKONING
Photon emission for (n,2p)

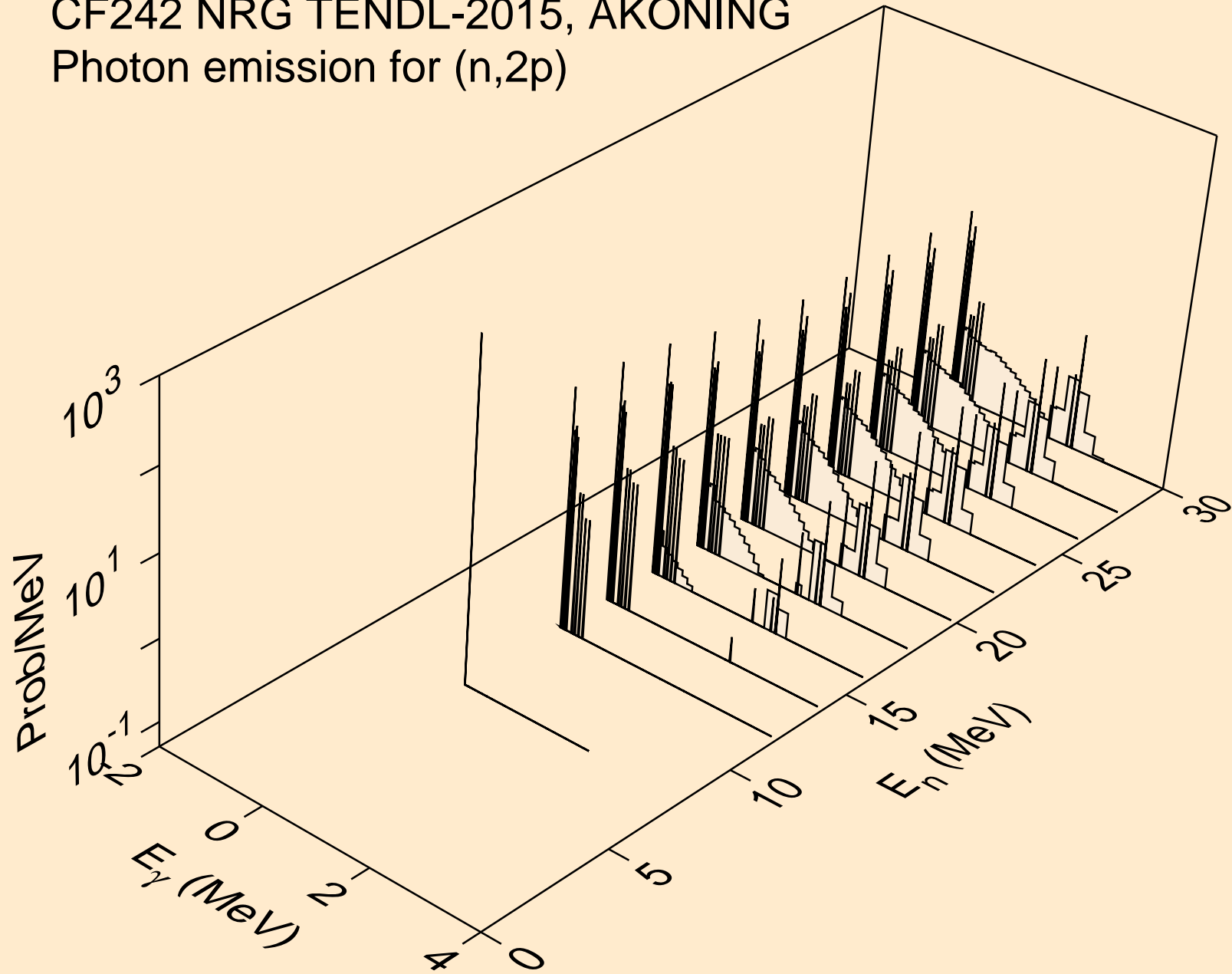

CF242 NRG TENDL-2015, AKONING
Photon emission for (n,p α)

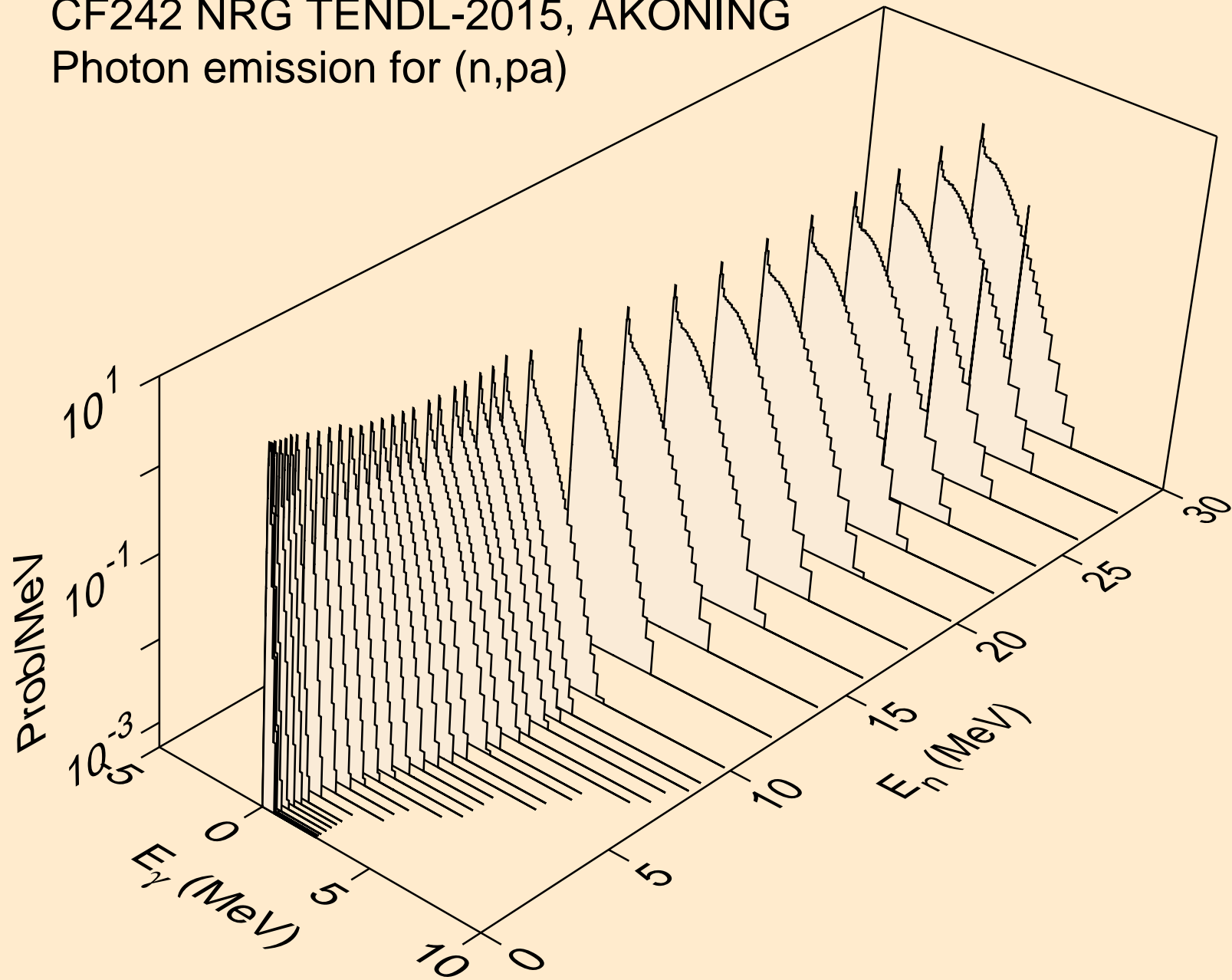

CF242 NRG TENDL-2015, AKONING
Photon emission for (n,pt)

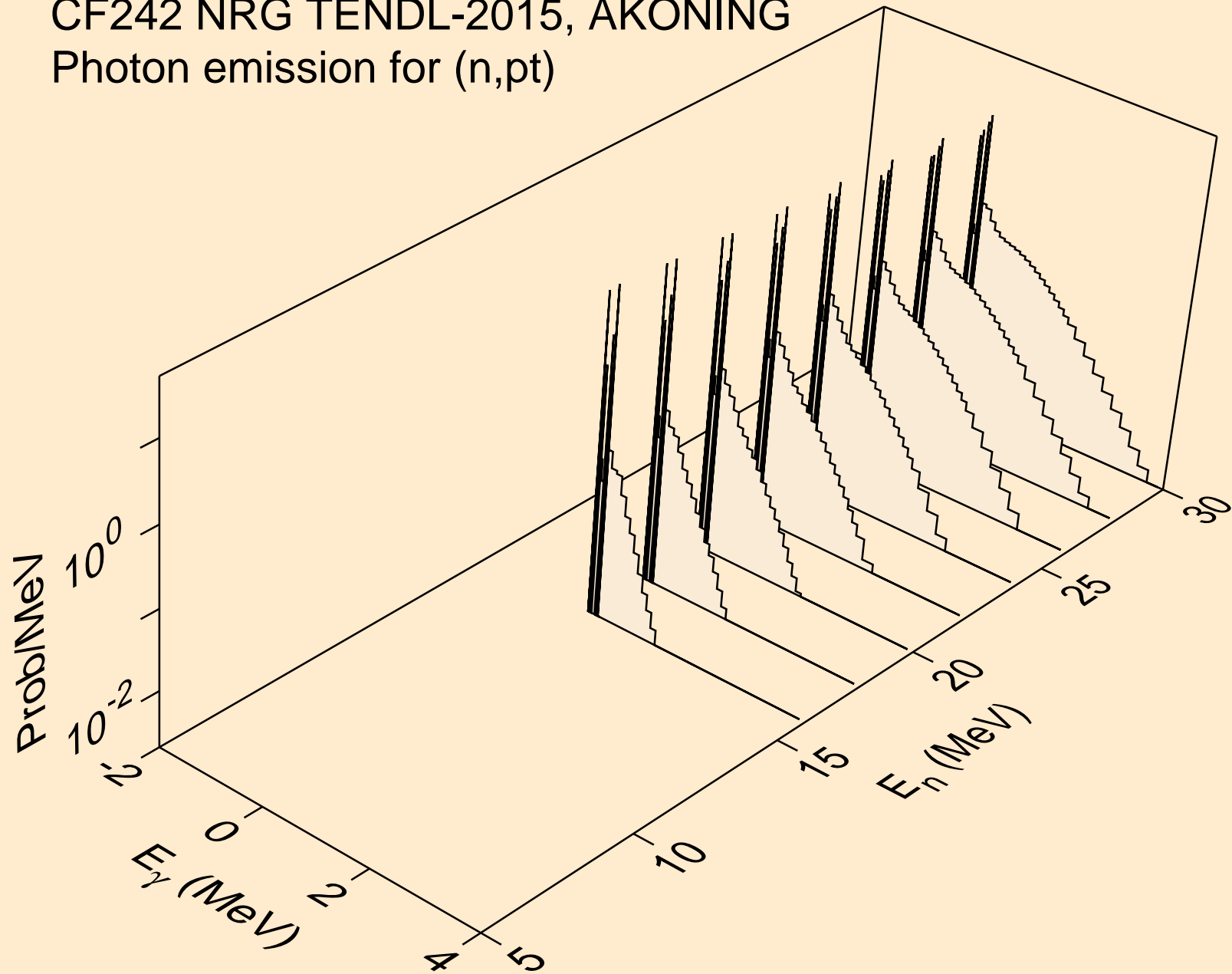

CF242 NRG TENDL-2015, AKONING
Photon emission for (n,da)

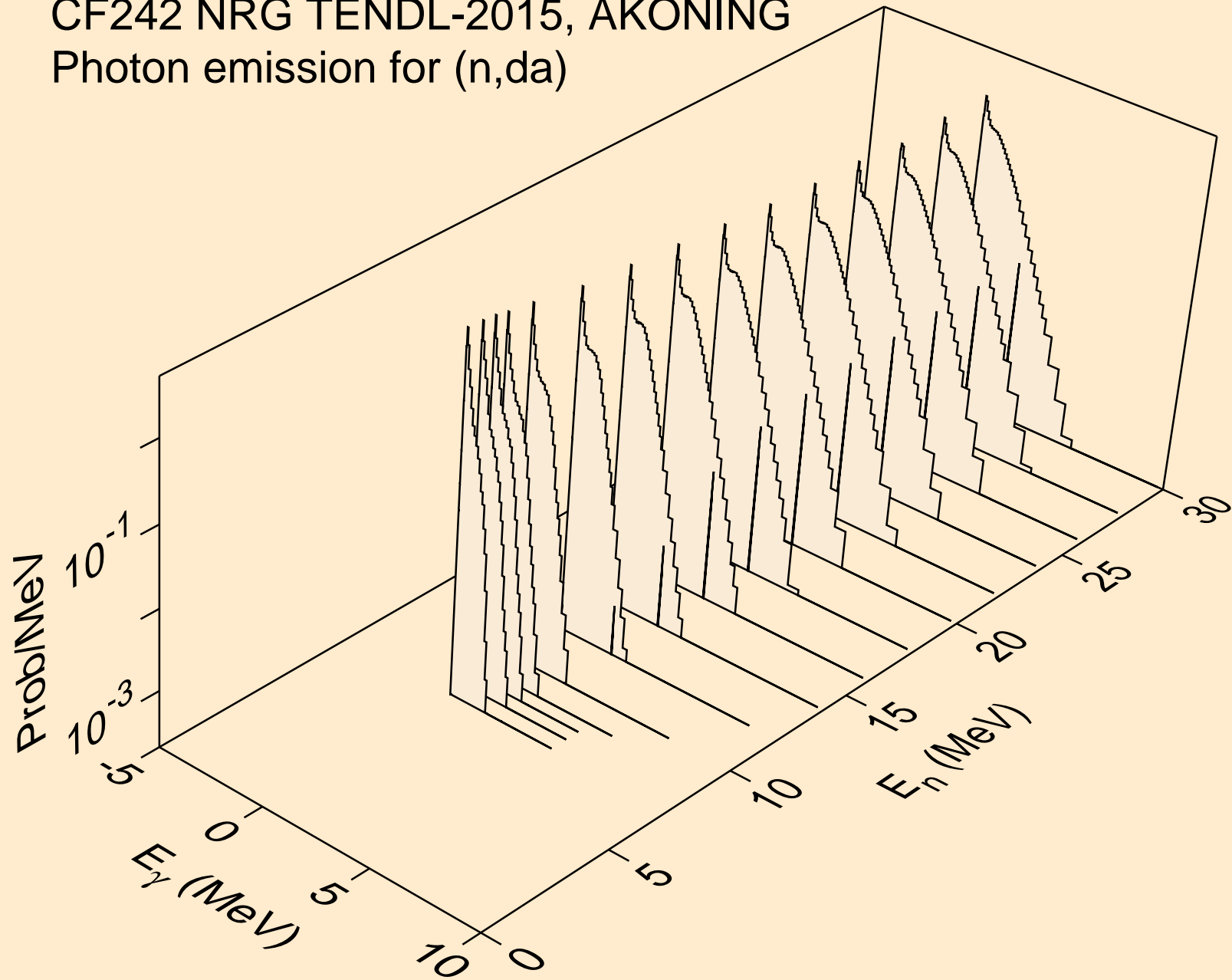

CF242 NRG TENDL-2015, AKONING
thermal capture photon spectrum

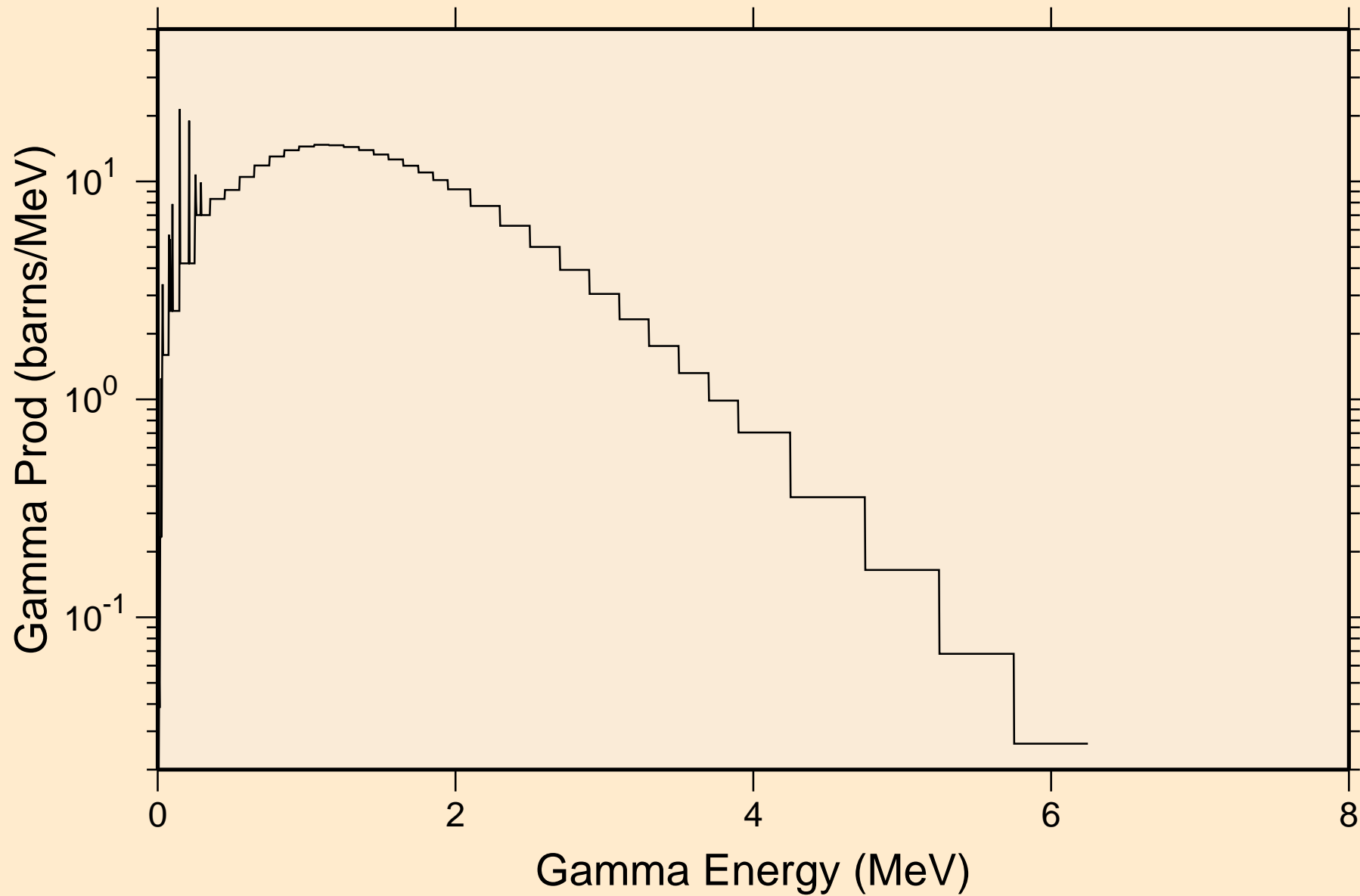

CF242 NRG TENDL-2015, AKONING
14 MeV photon spectrum

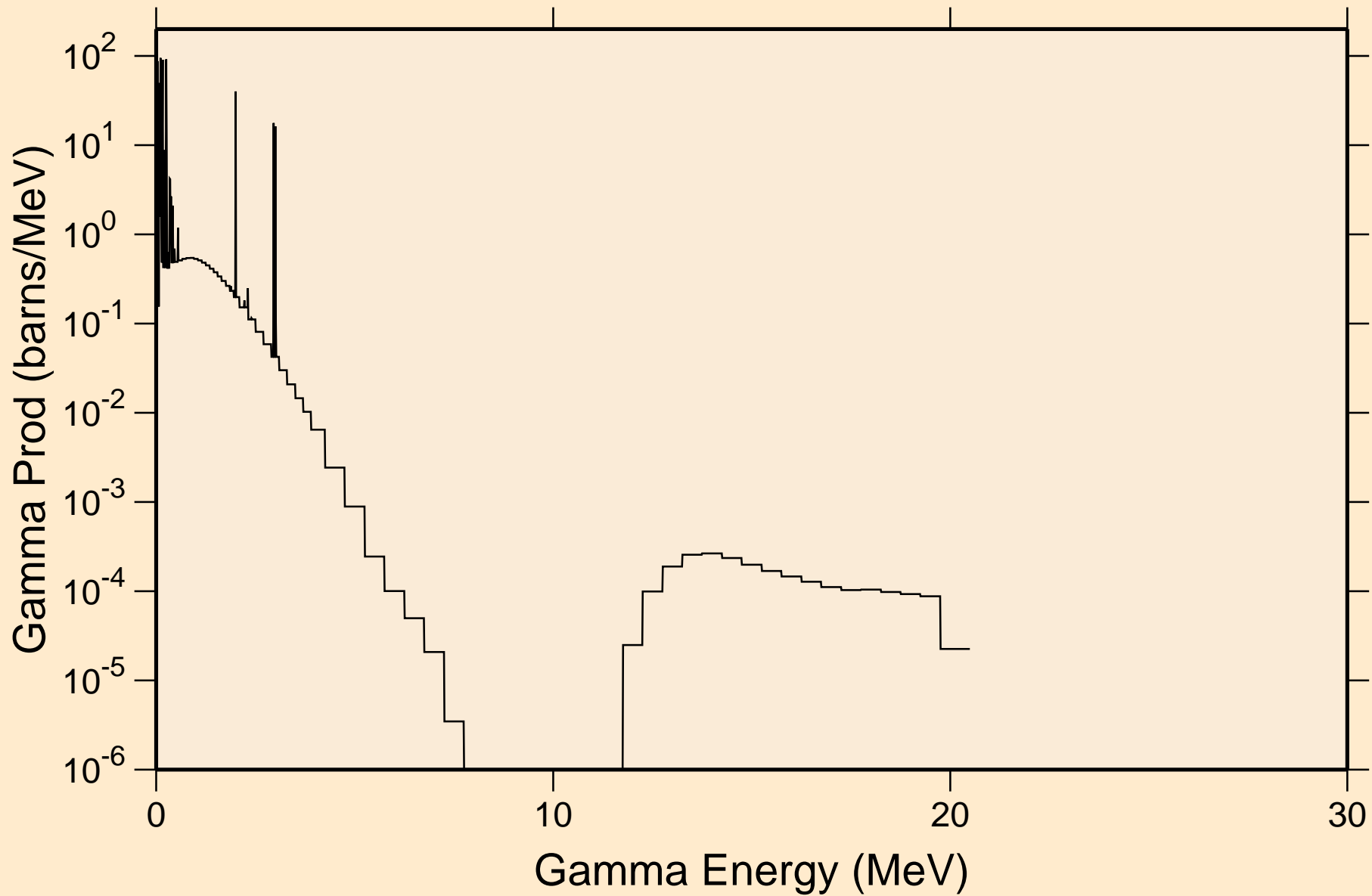

CF242 NRG TENDL-2015, AKONING

Particle heating contributions

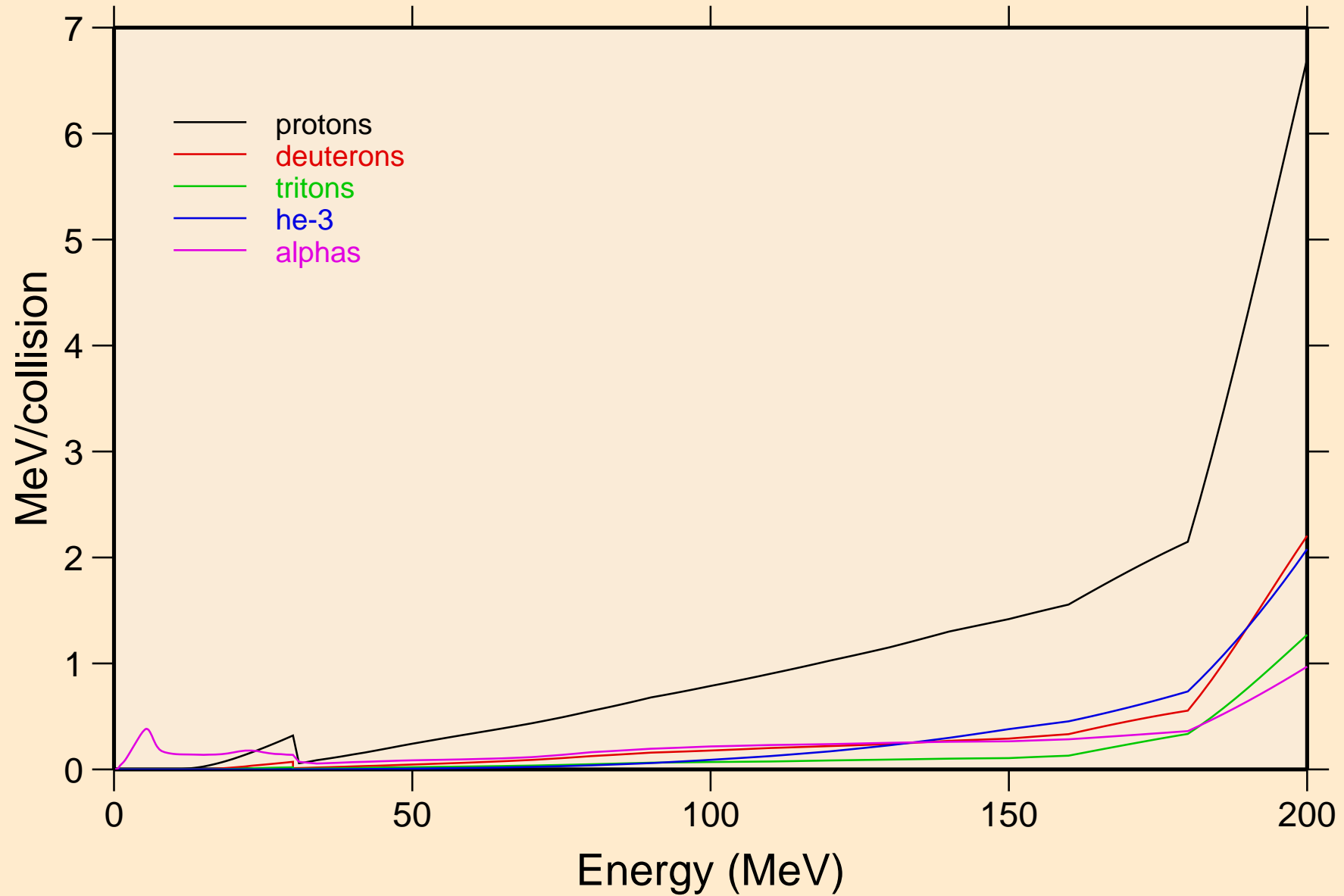

CF242 NRG TENDL-2015, AKONING

Recoil Heating

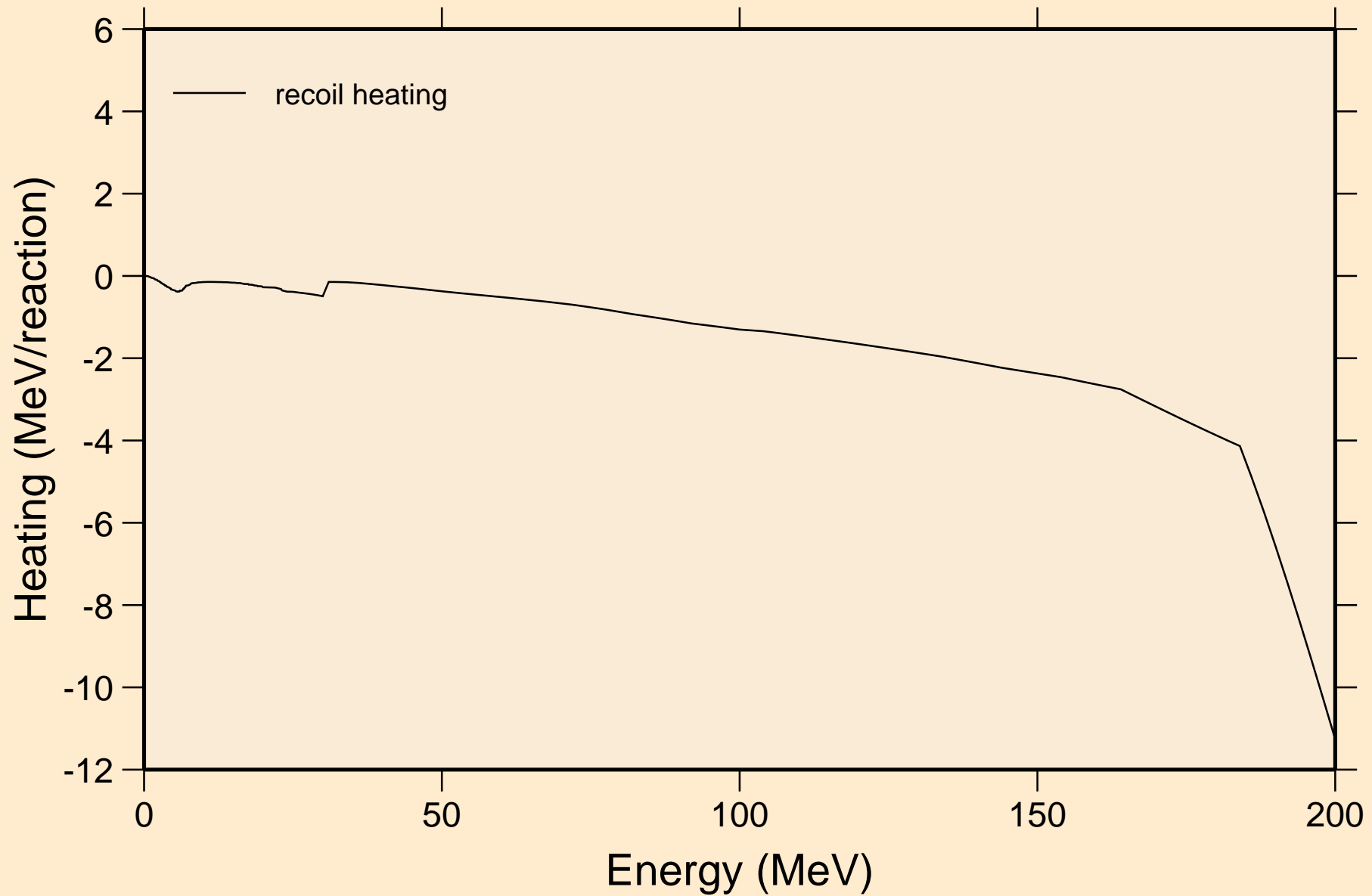

CF242 NRG TENDL-2015, AKONING

Particle production cross sections

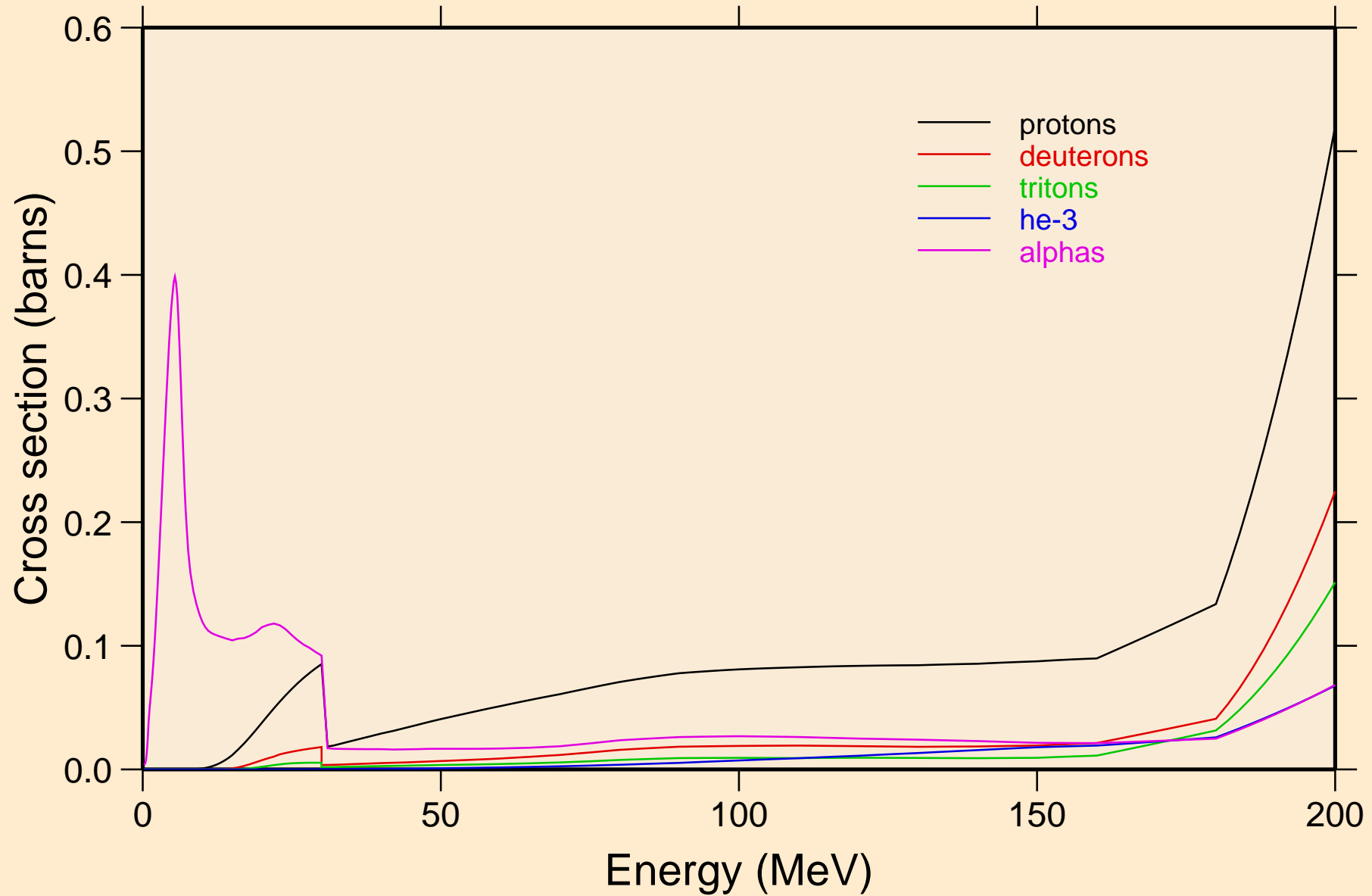

CF242 NRG TENDL-2015, AKONING
protons from (n,x)

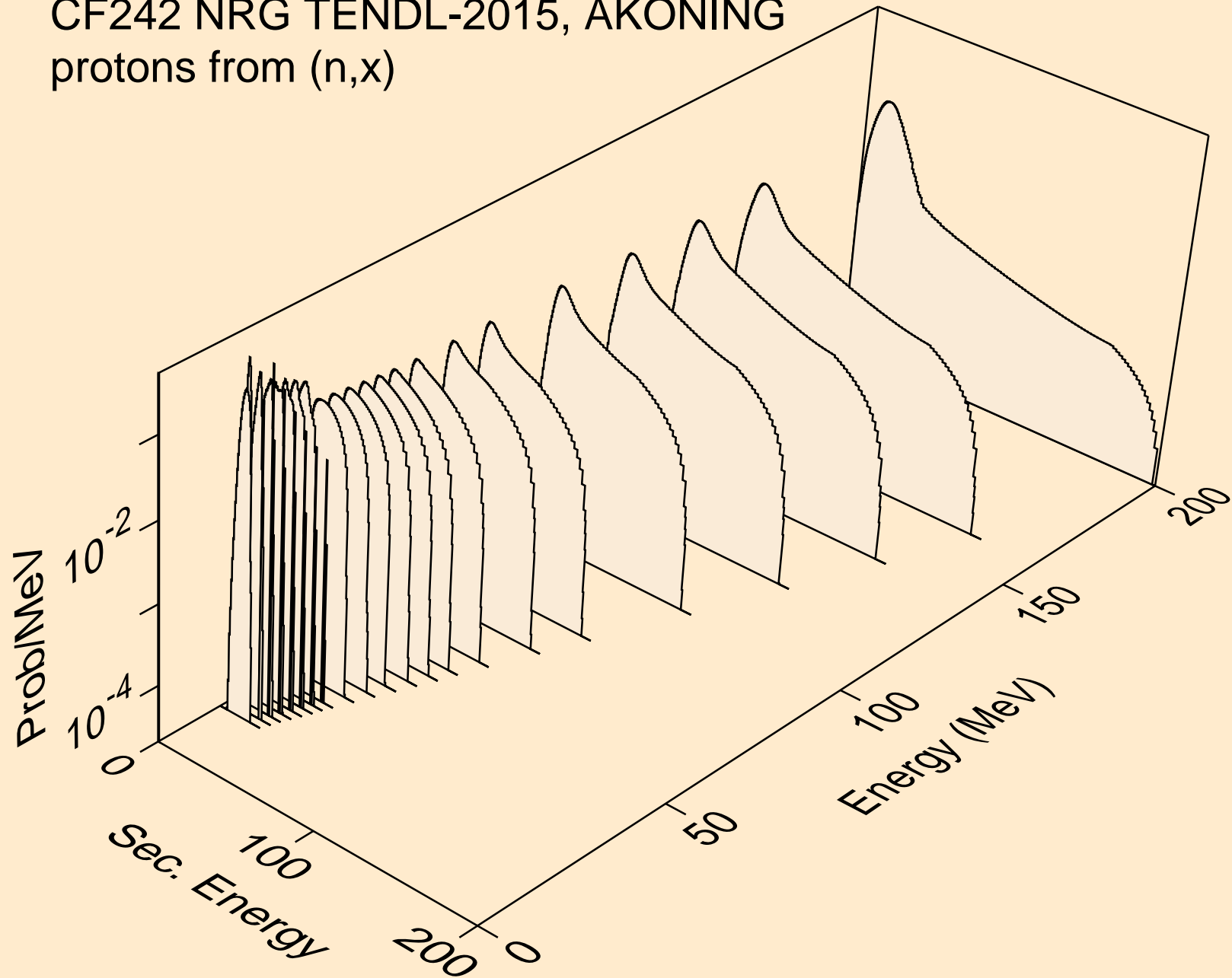

CF242 NRG TENDL-2015, AKONING
protons from (n,n*)p

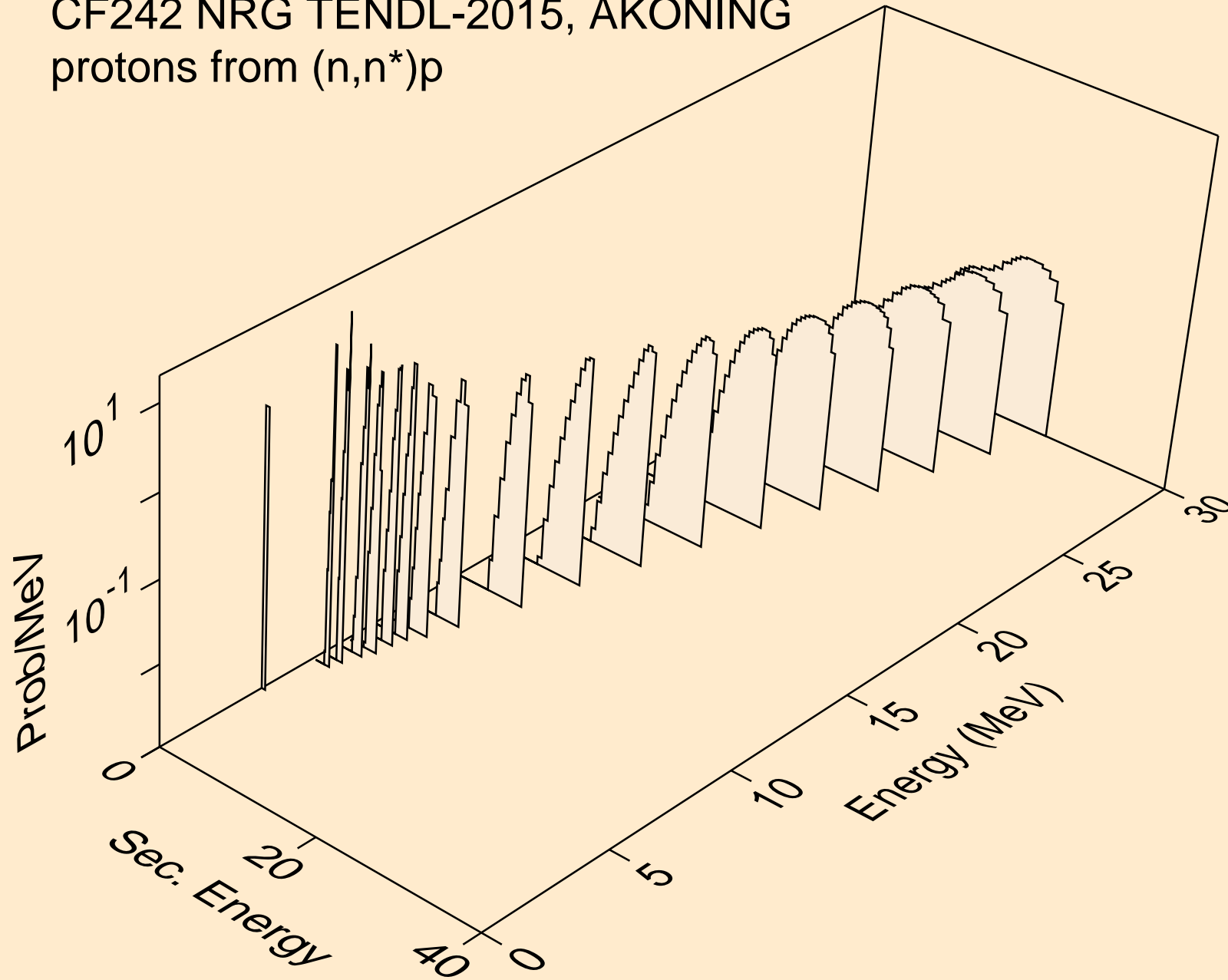

CF242 NRG TENDL-2015, AKONING
protons from (n,2np)

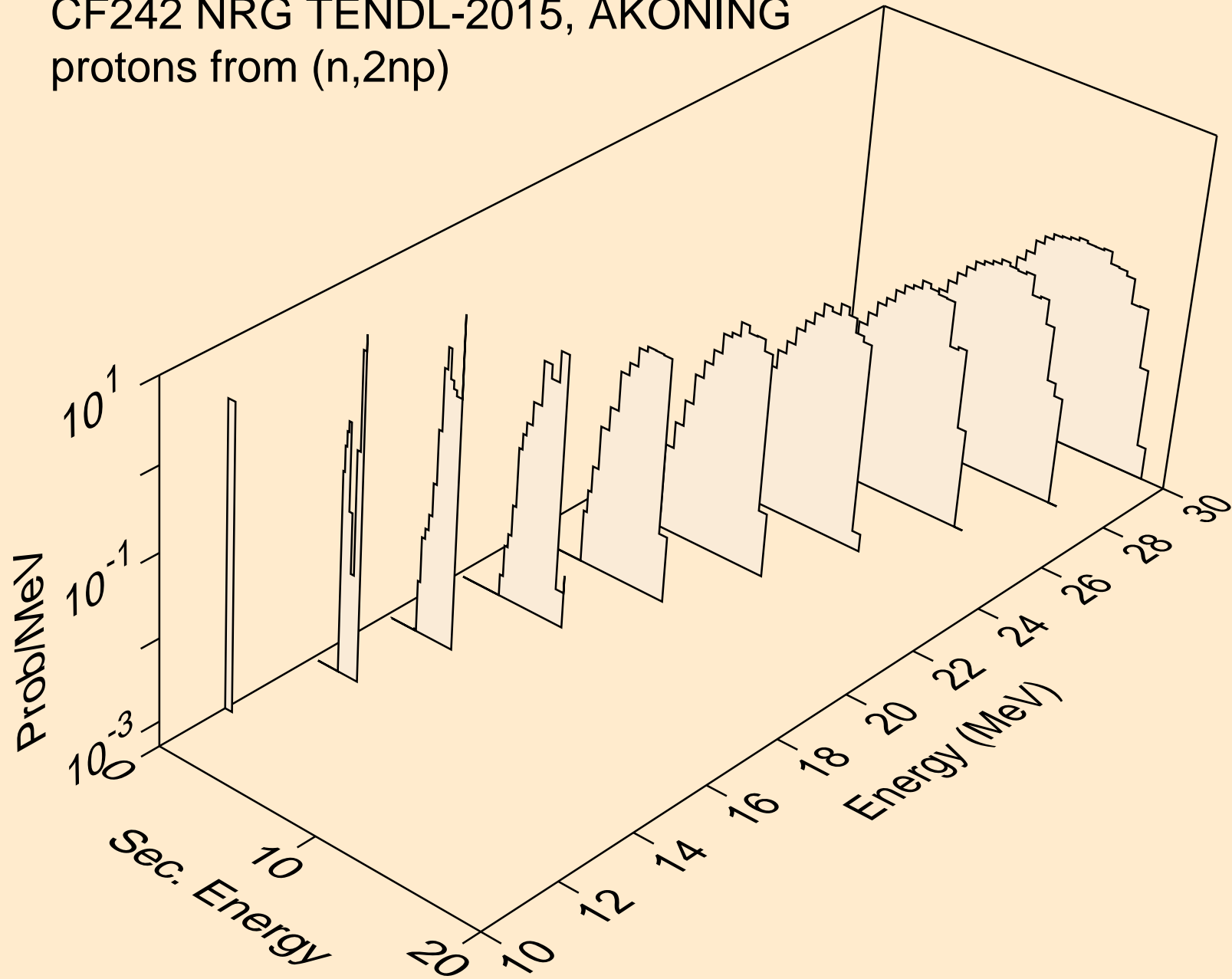

CF242 NRG TENDL-2015, AKONING
protons from (n,3np)

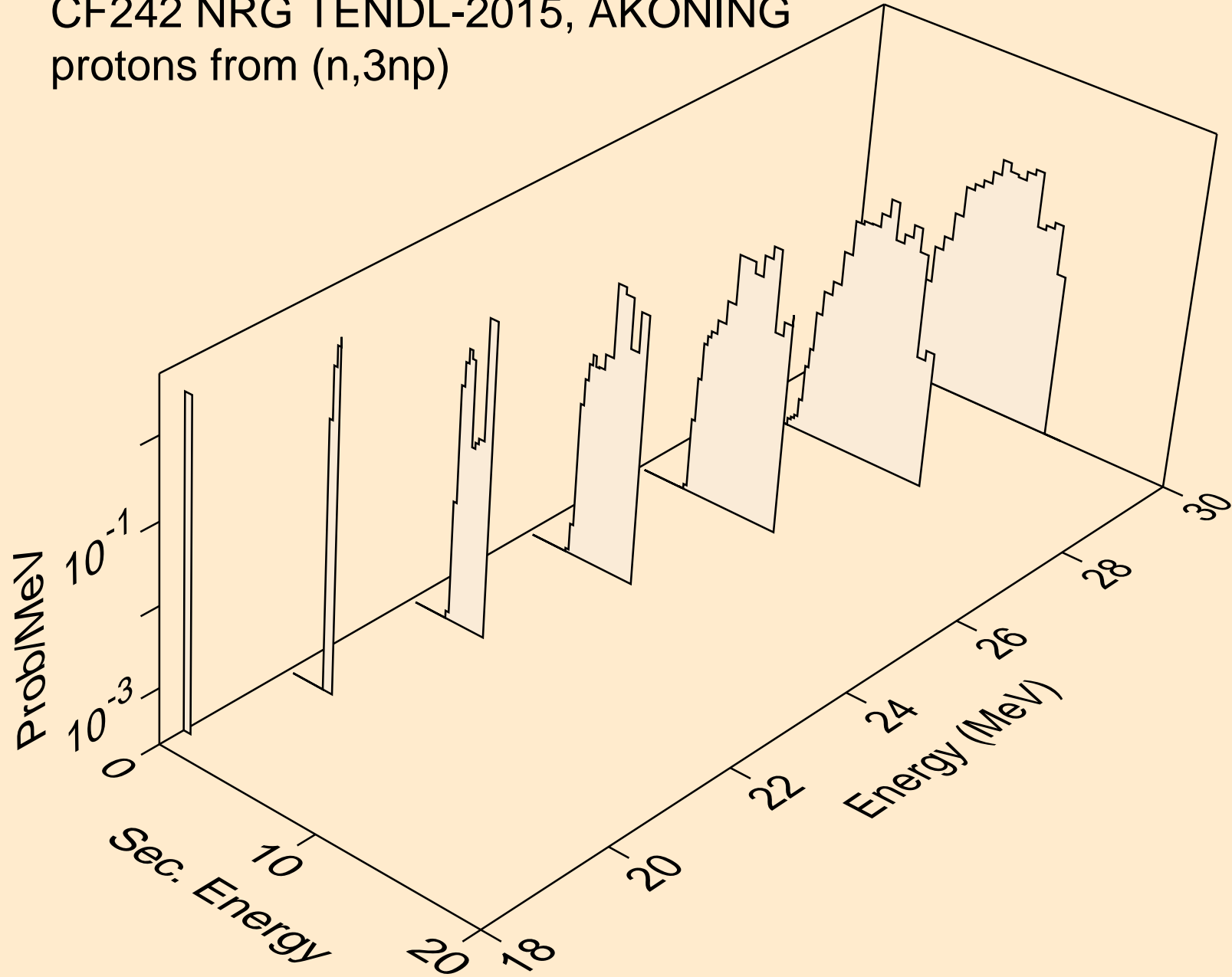

CF242 NRG TENDL-2015, AKONING
protons from (n,2np)

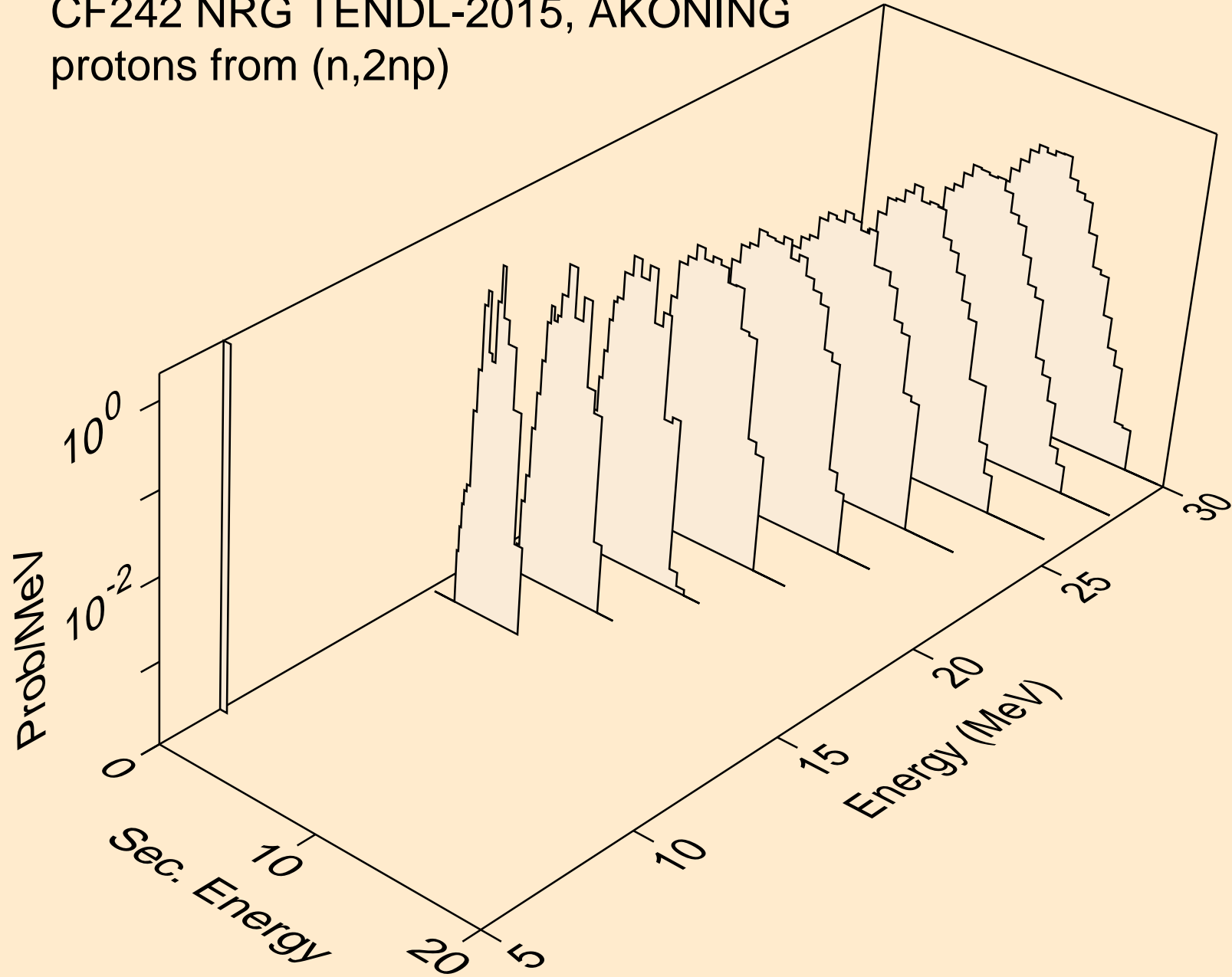

CF242 NRG TENDL-2015, AKONING
protons from (n,npa)

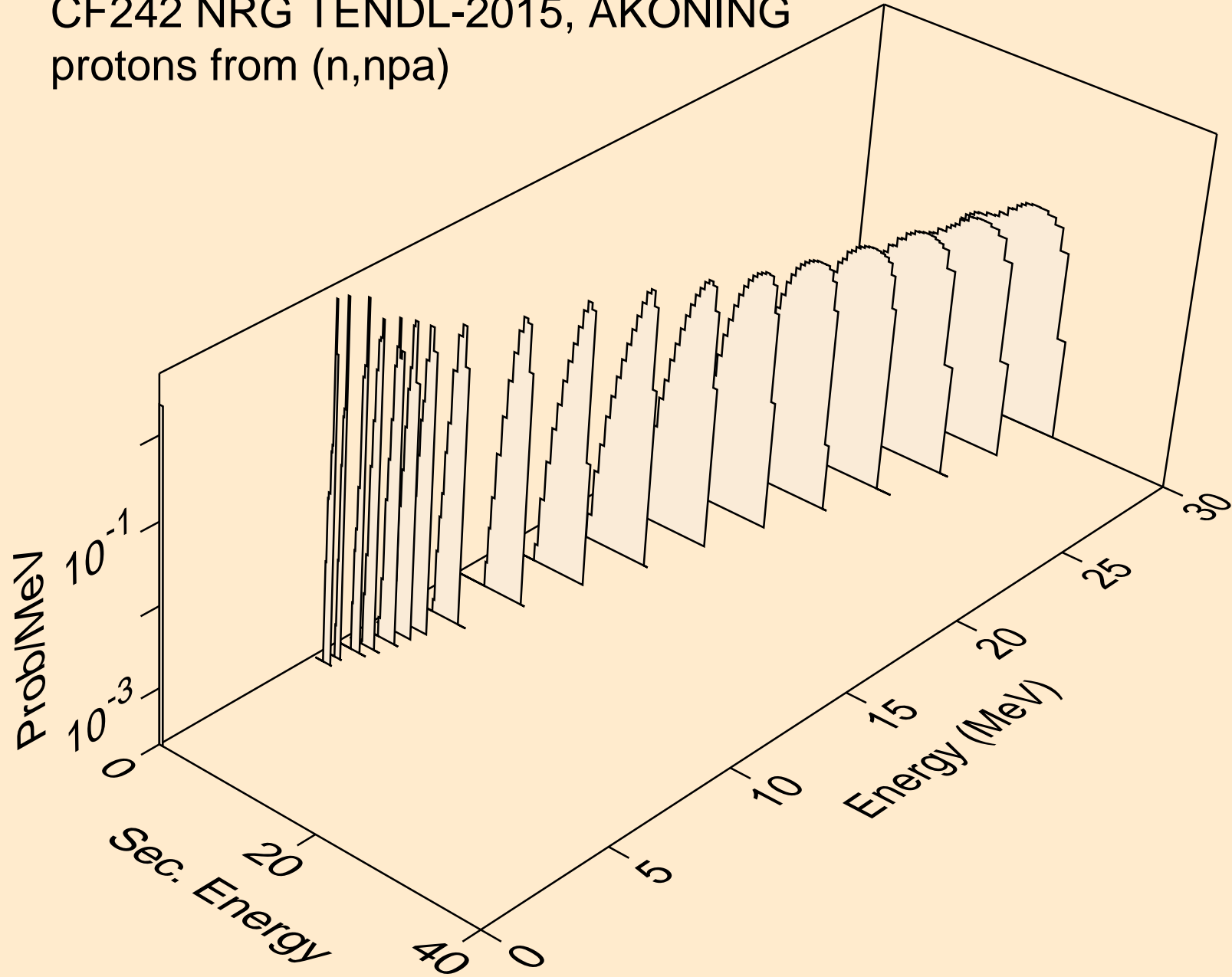

CF242 NRG TENDL-2015, AKONING
protons from (n,p)

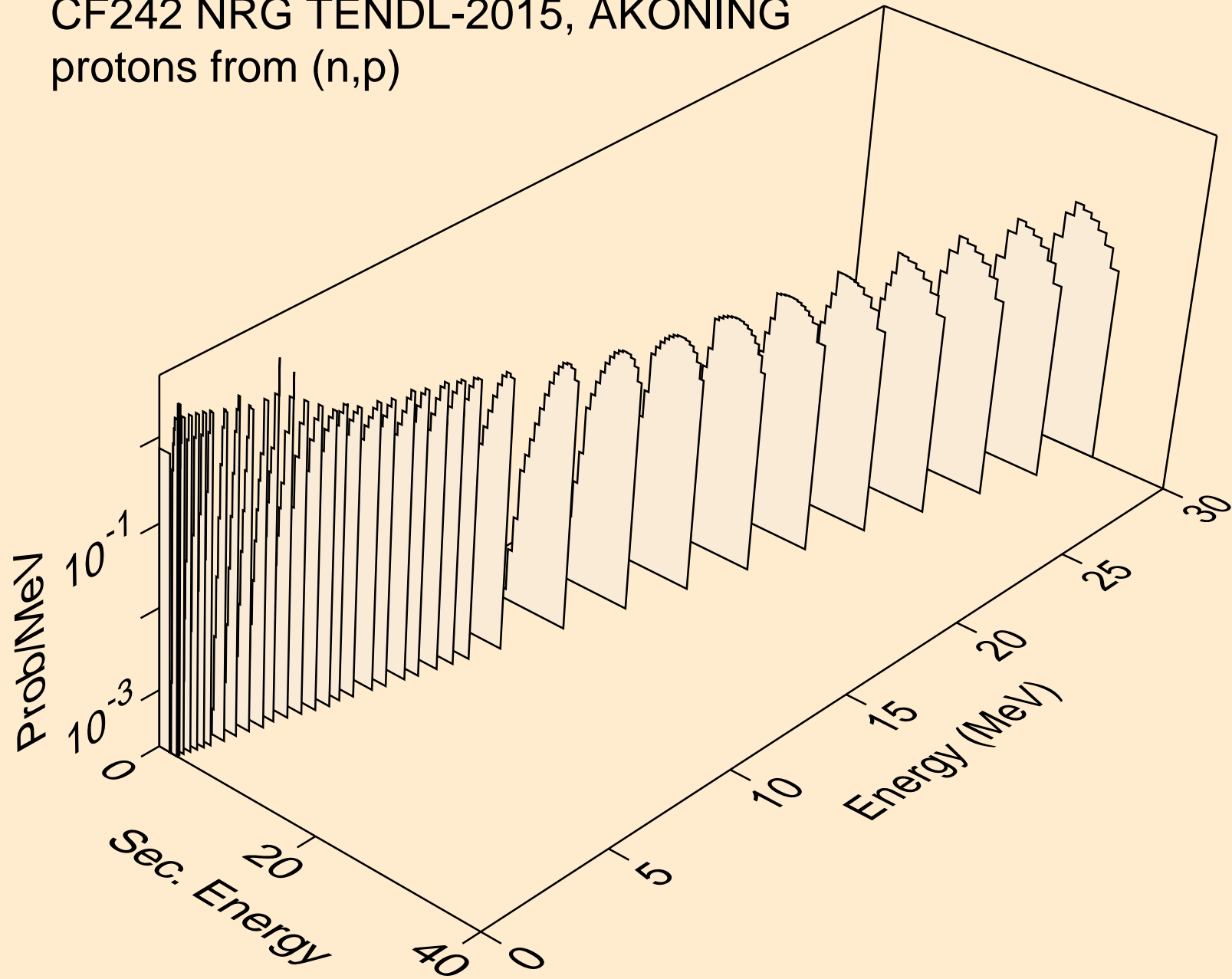

CF242 NRG TENDL-2015, AKONING
protons from (n,2p)

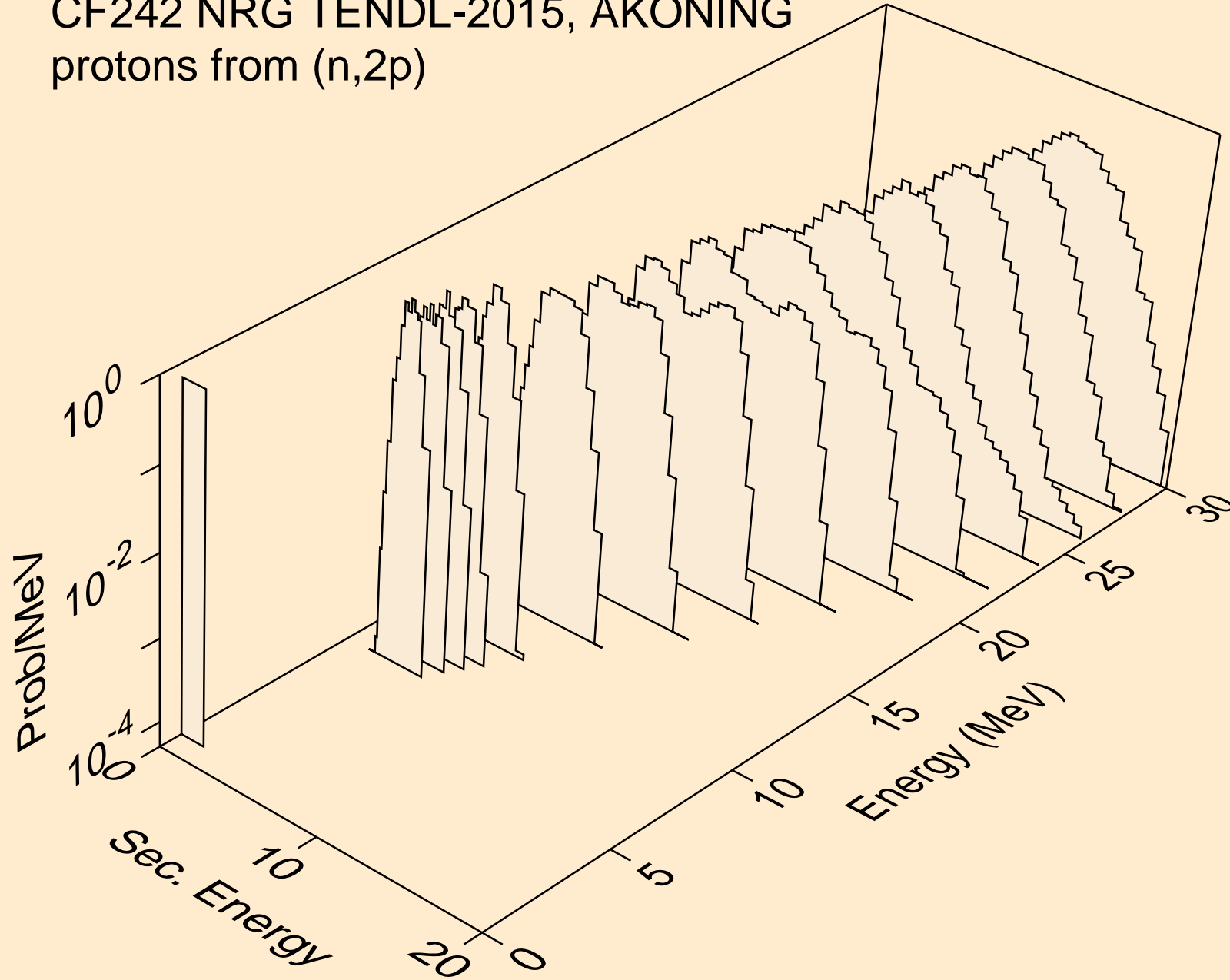

CF242 NRG TENDL-2015, AKONING
protons from (n,pa)

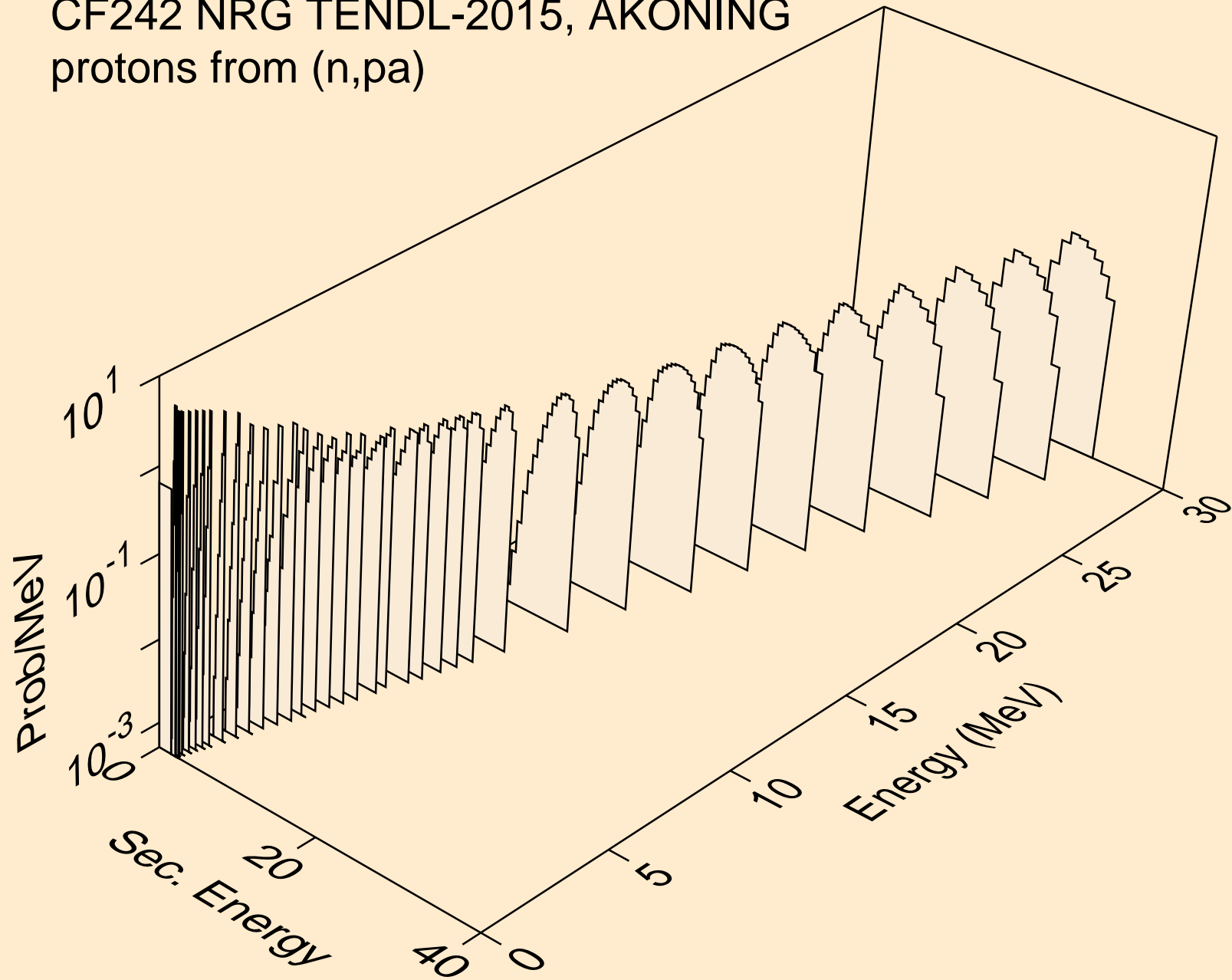

CF242 NRG TENDL-2015, AKONING
protons from (n,pt)

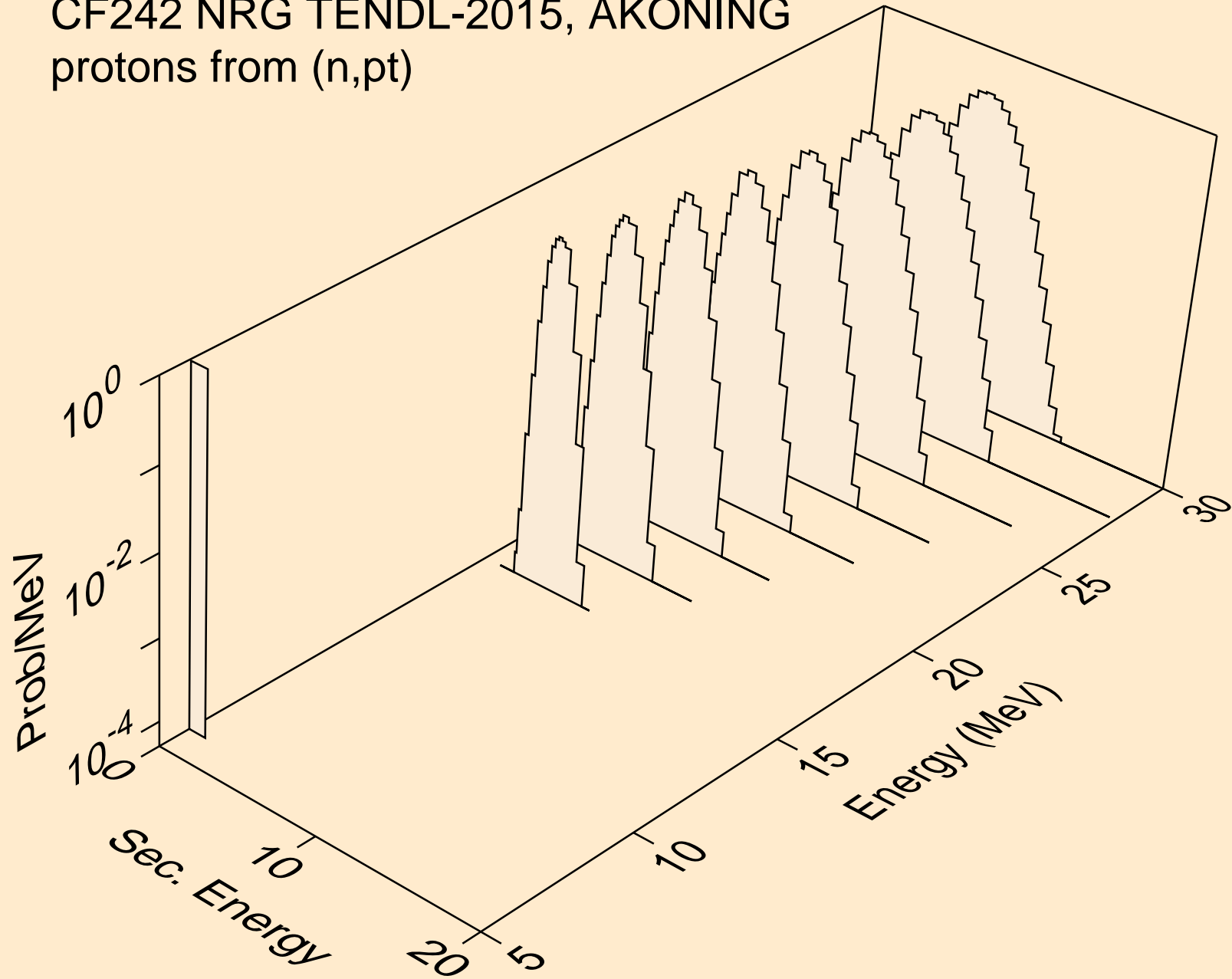

CF242 NRG TENDL-2015, AKONING
deuterons from (n,x)

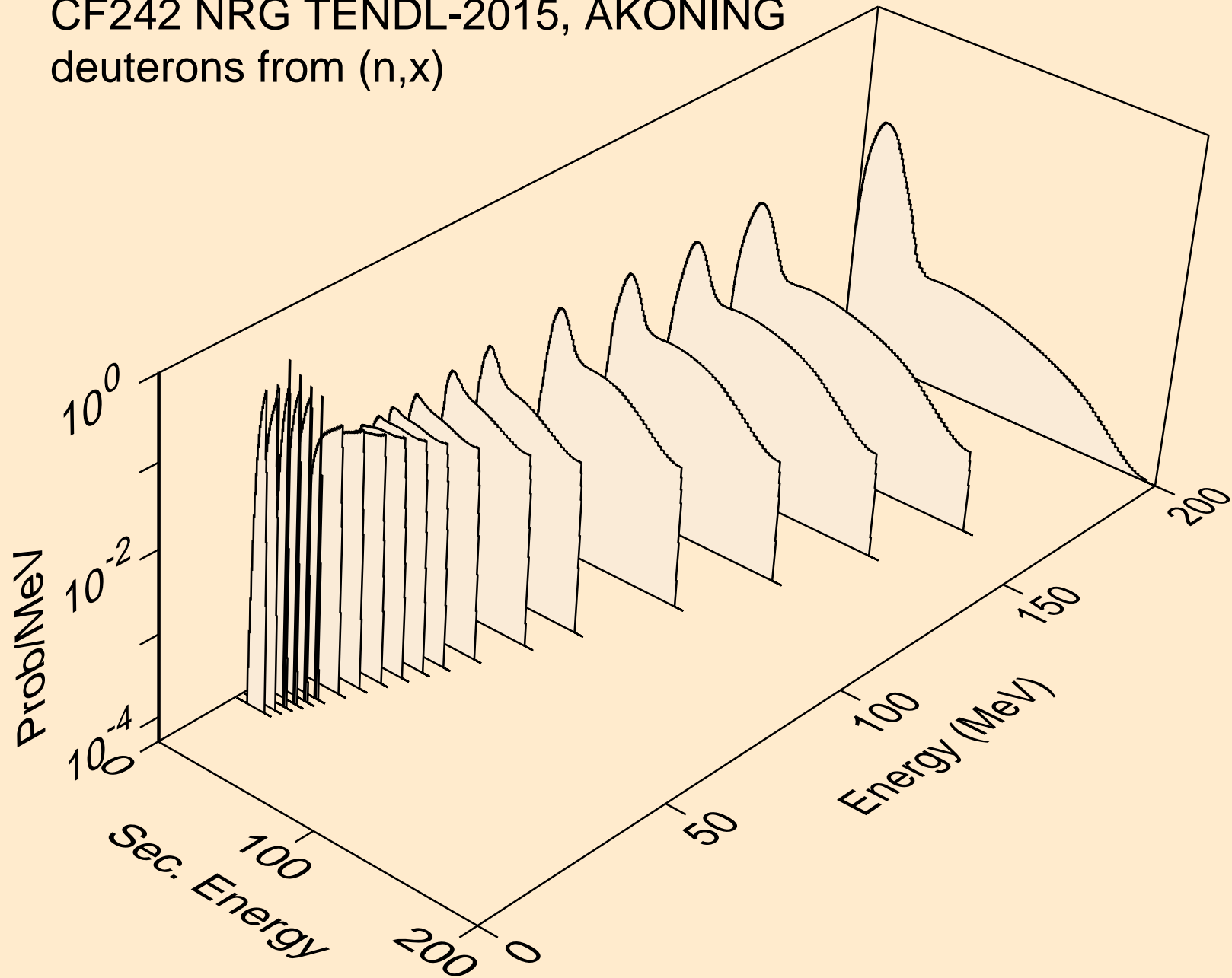

CF242 NRG TENDL-2015, AKONING
deuterons from (n,2nd)

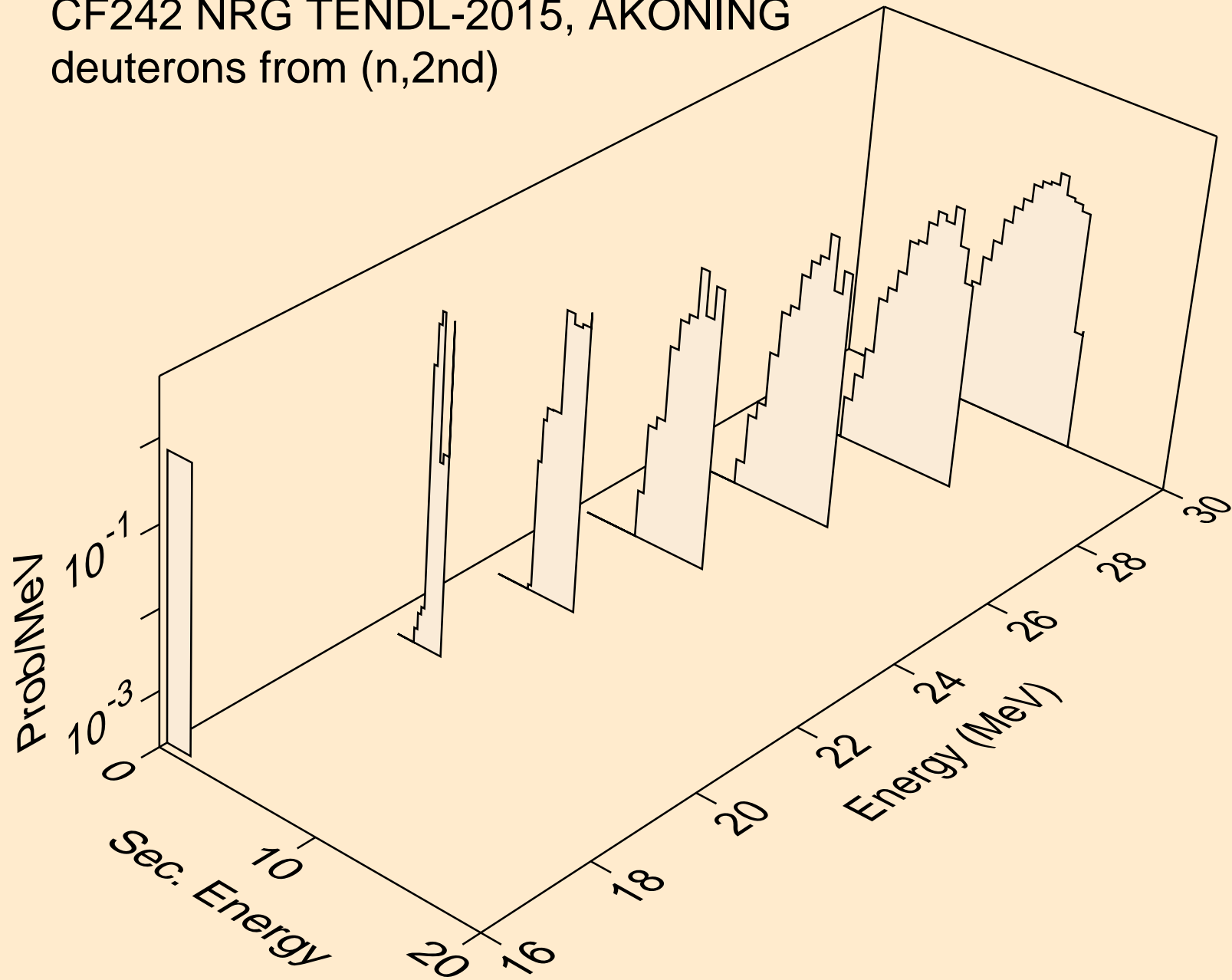

CF242 NRG TENDL-2015, AKONING
deuterons from (n,n*)d

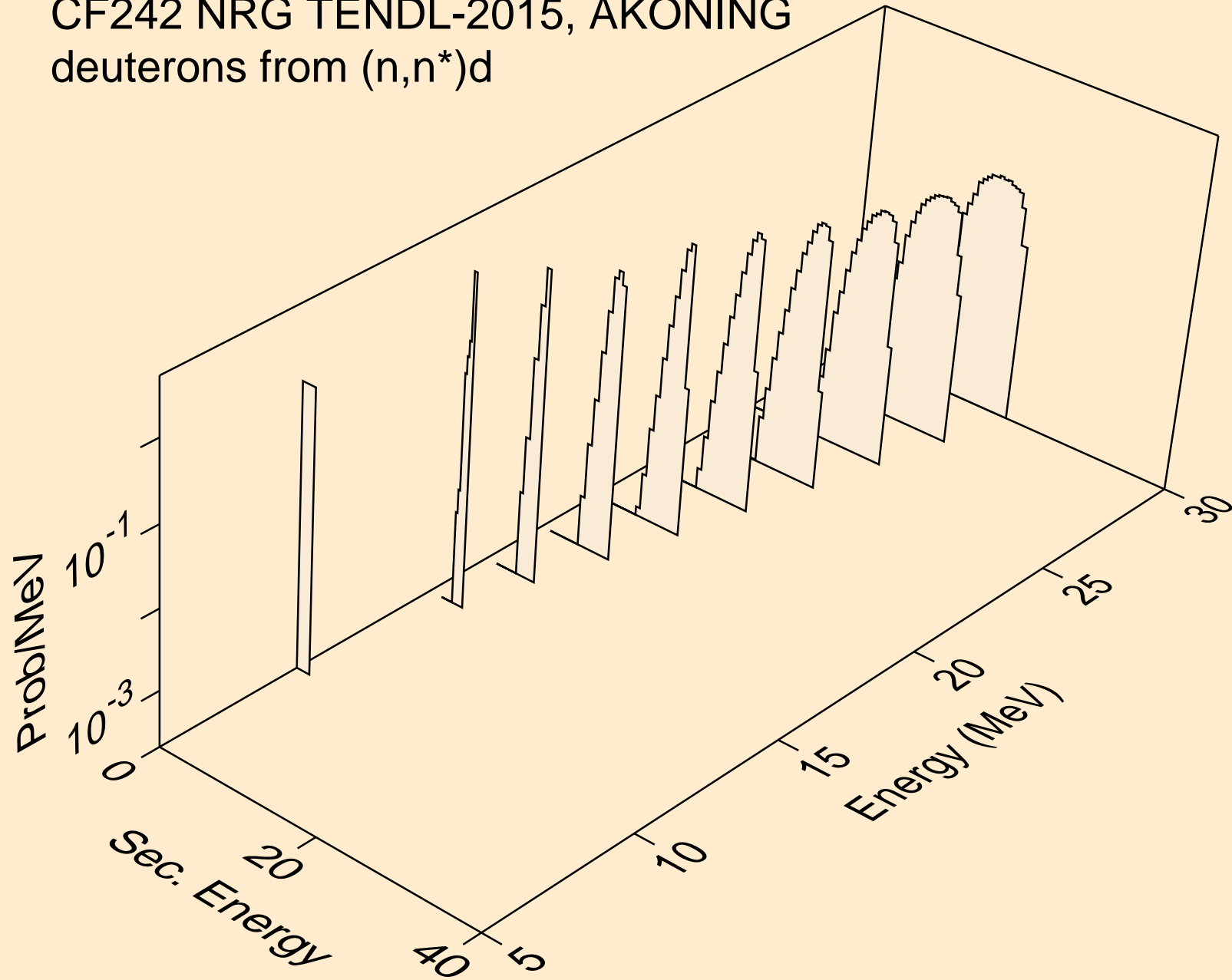

CF242 NRG TENDL-2015, AKONING
deuterons from (n,d)

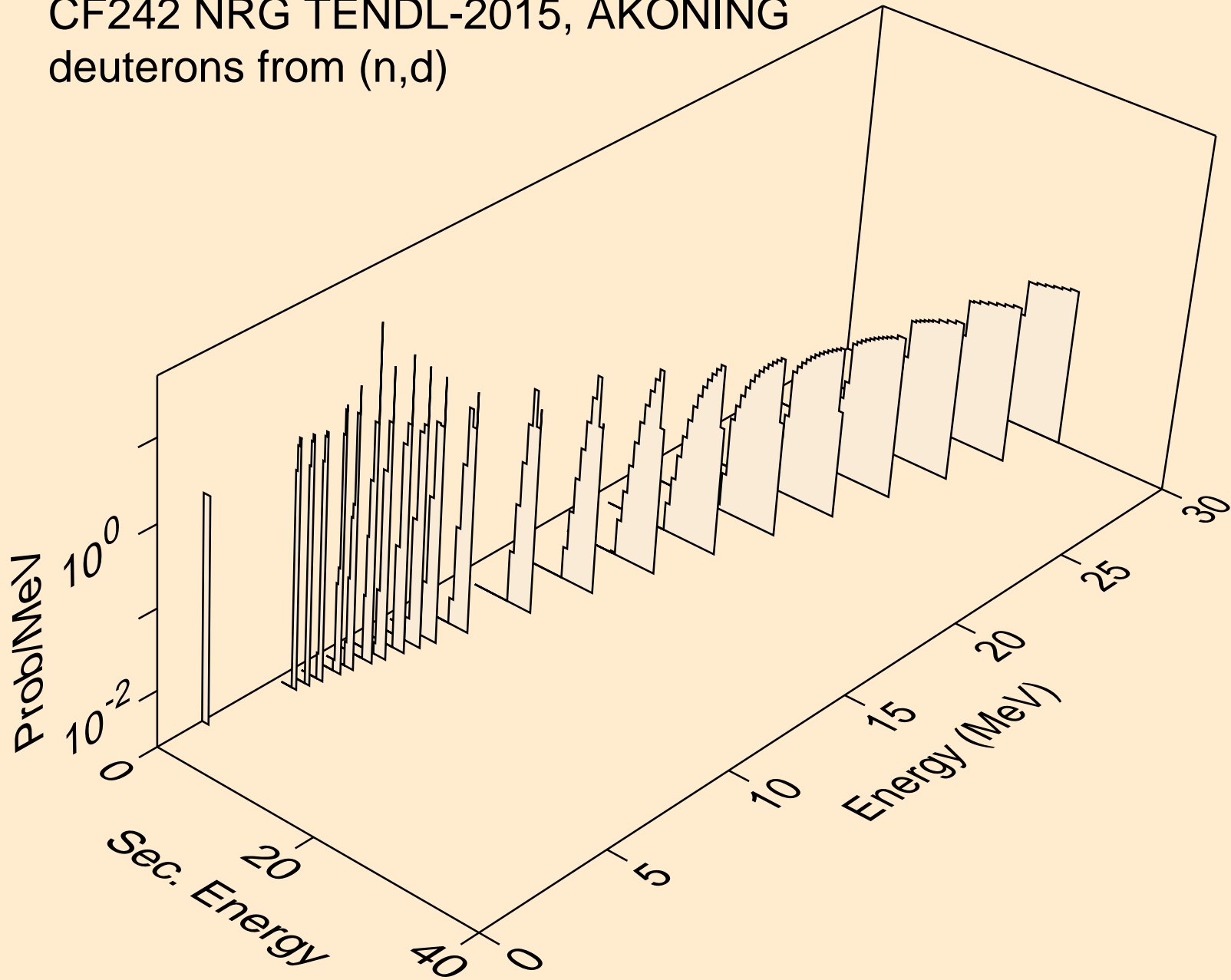

CF242 NRG TENDL-2015, AKONING
deuterons from (n,da)

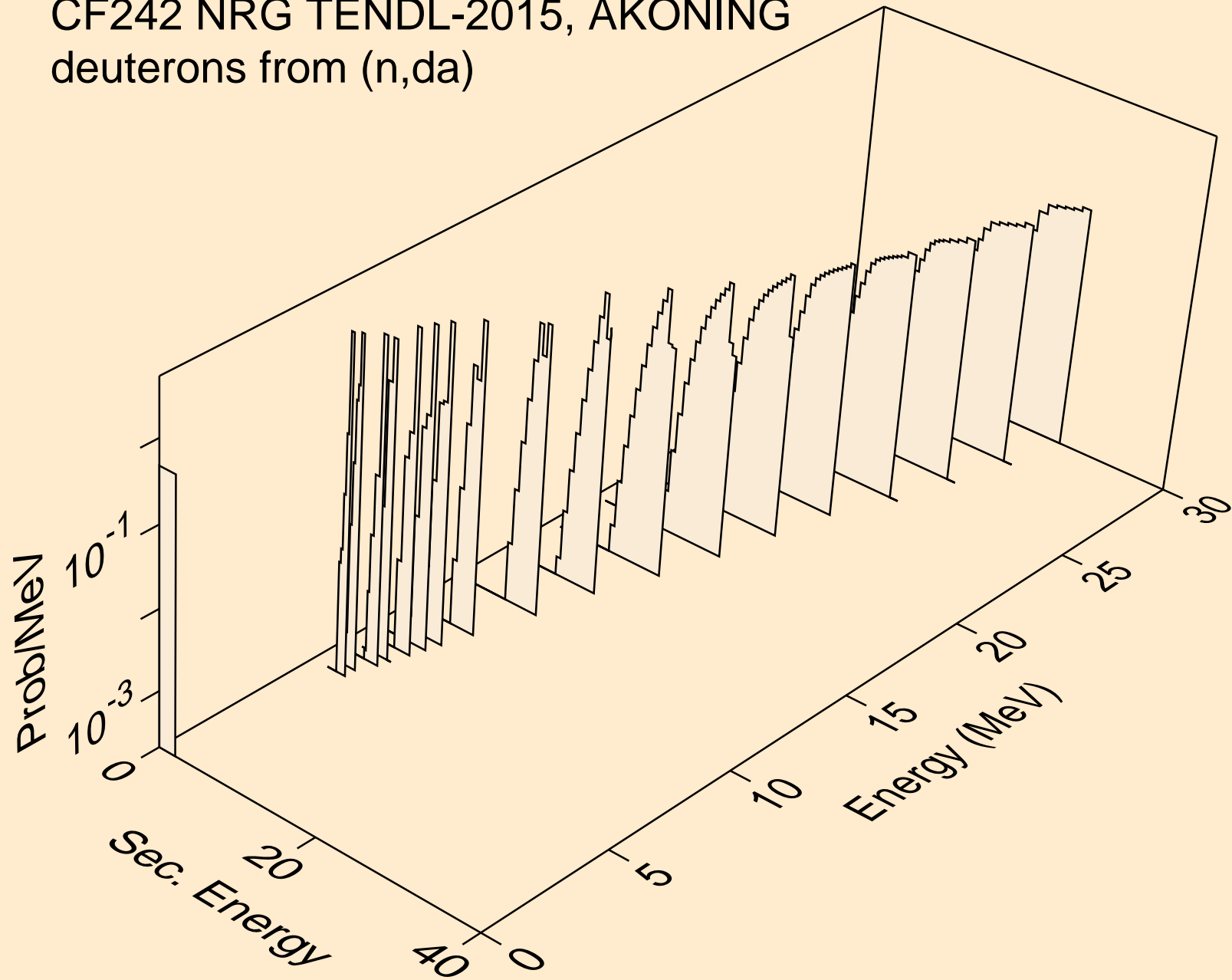

CF242 NRG TENDL-2015, AKONING
tritons from (n,x)

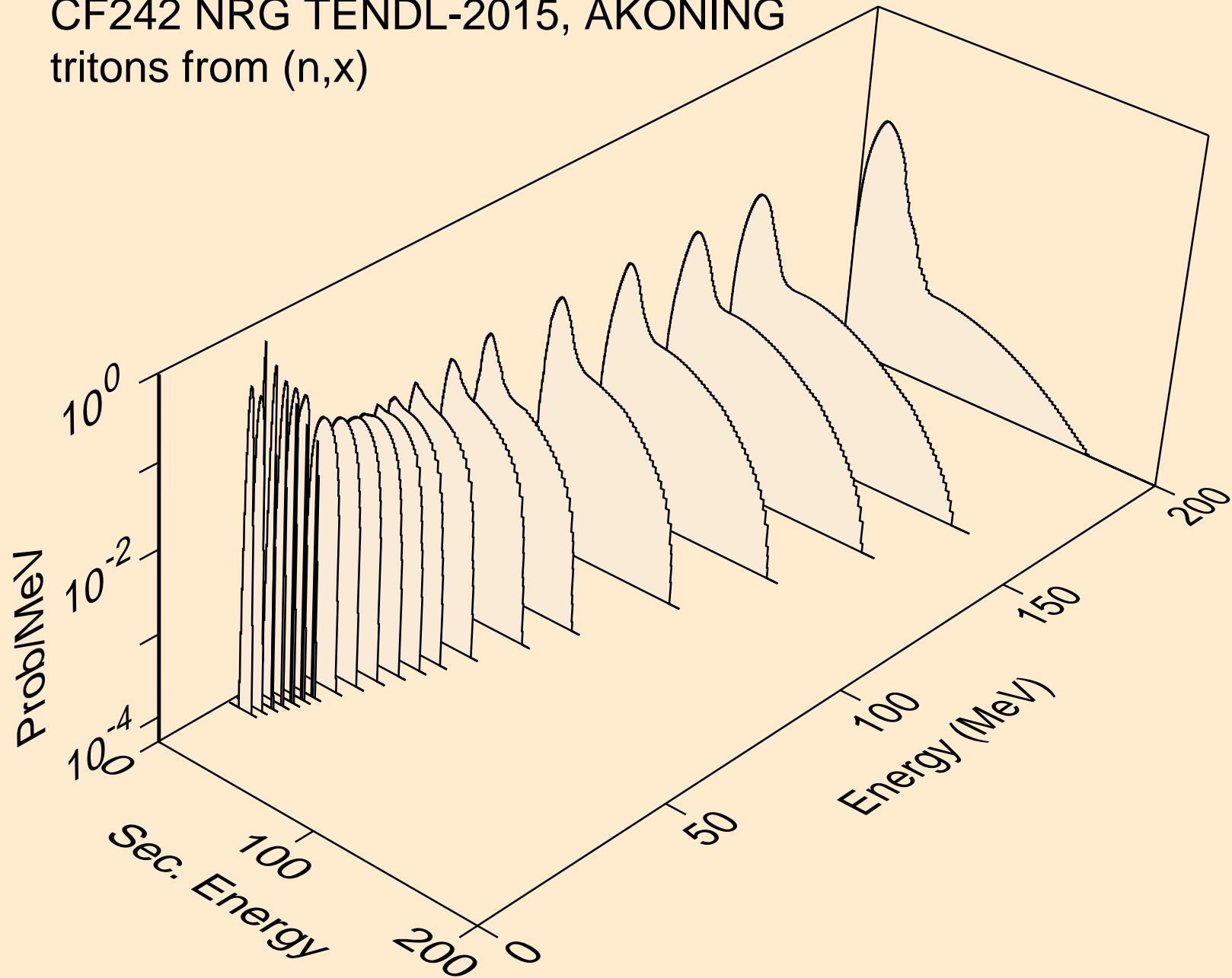

CF242 NRG TENDL-2015, AKONING
tritons from (n,n*)t

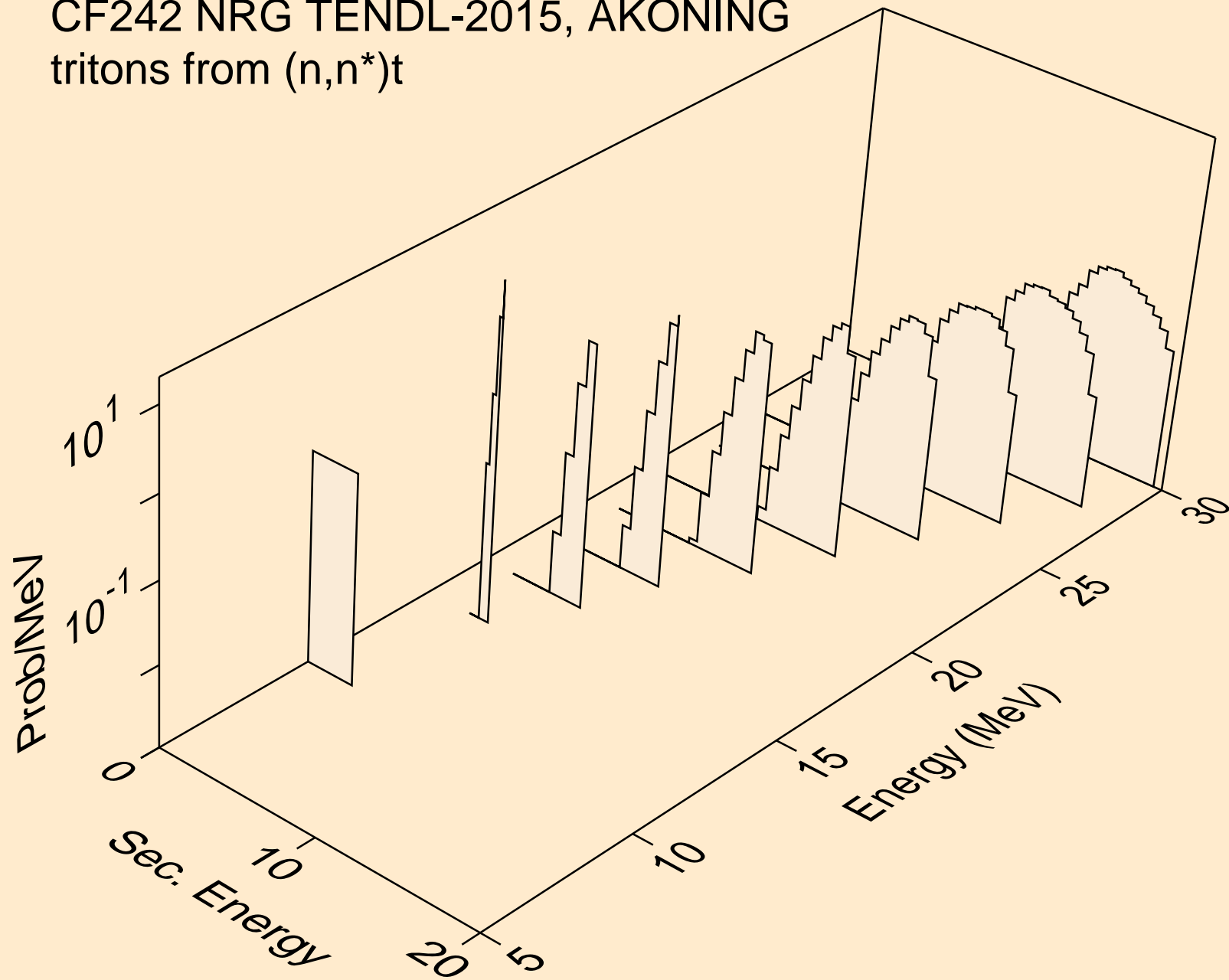

CF242 NRG TENDL-2015, AKONING
tritons from (n,n*)t2a

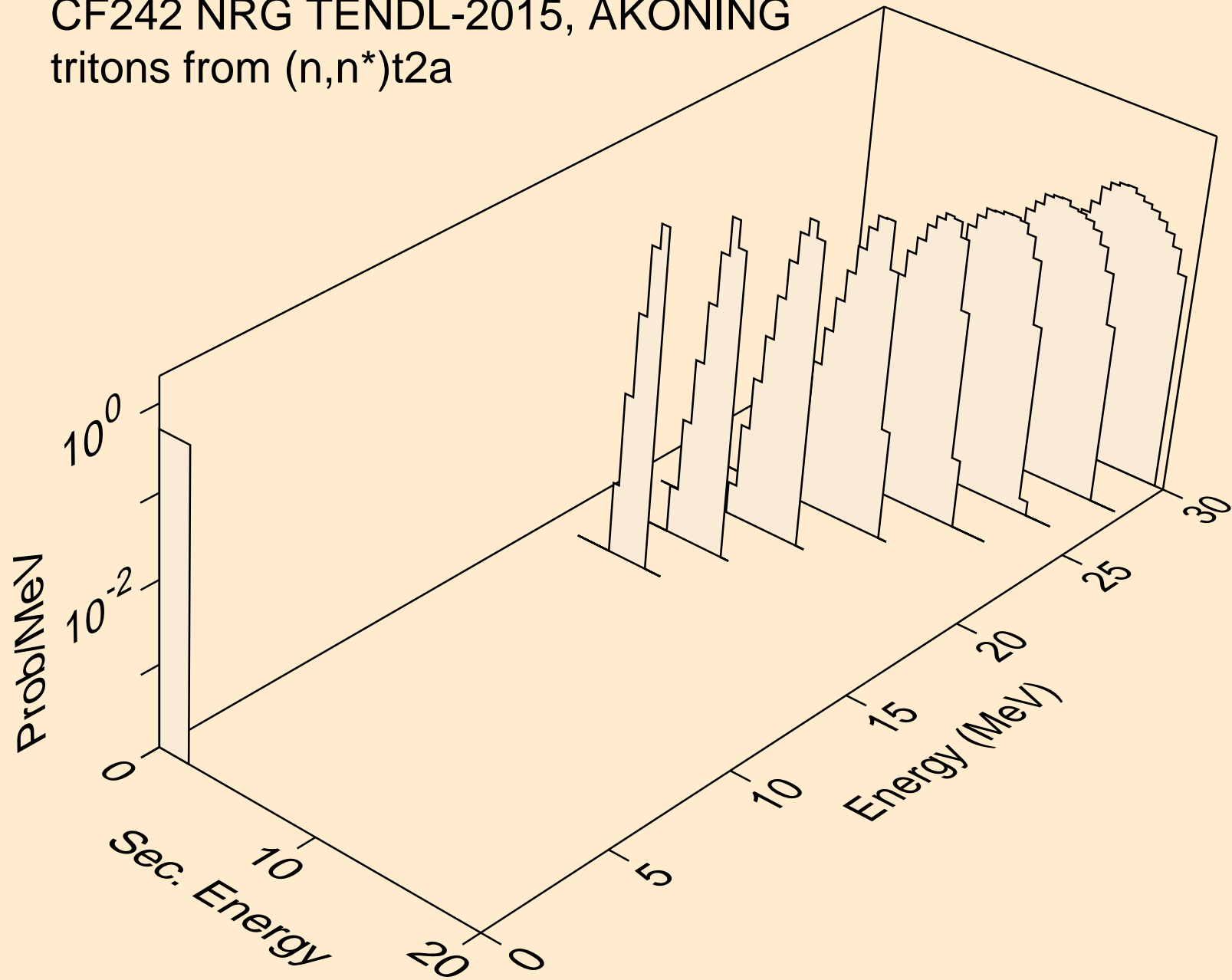

CF242 NRG TENDL-2015, AKONING
tritons from (n,t)

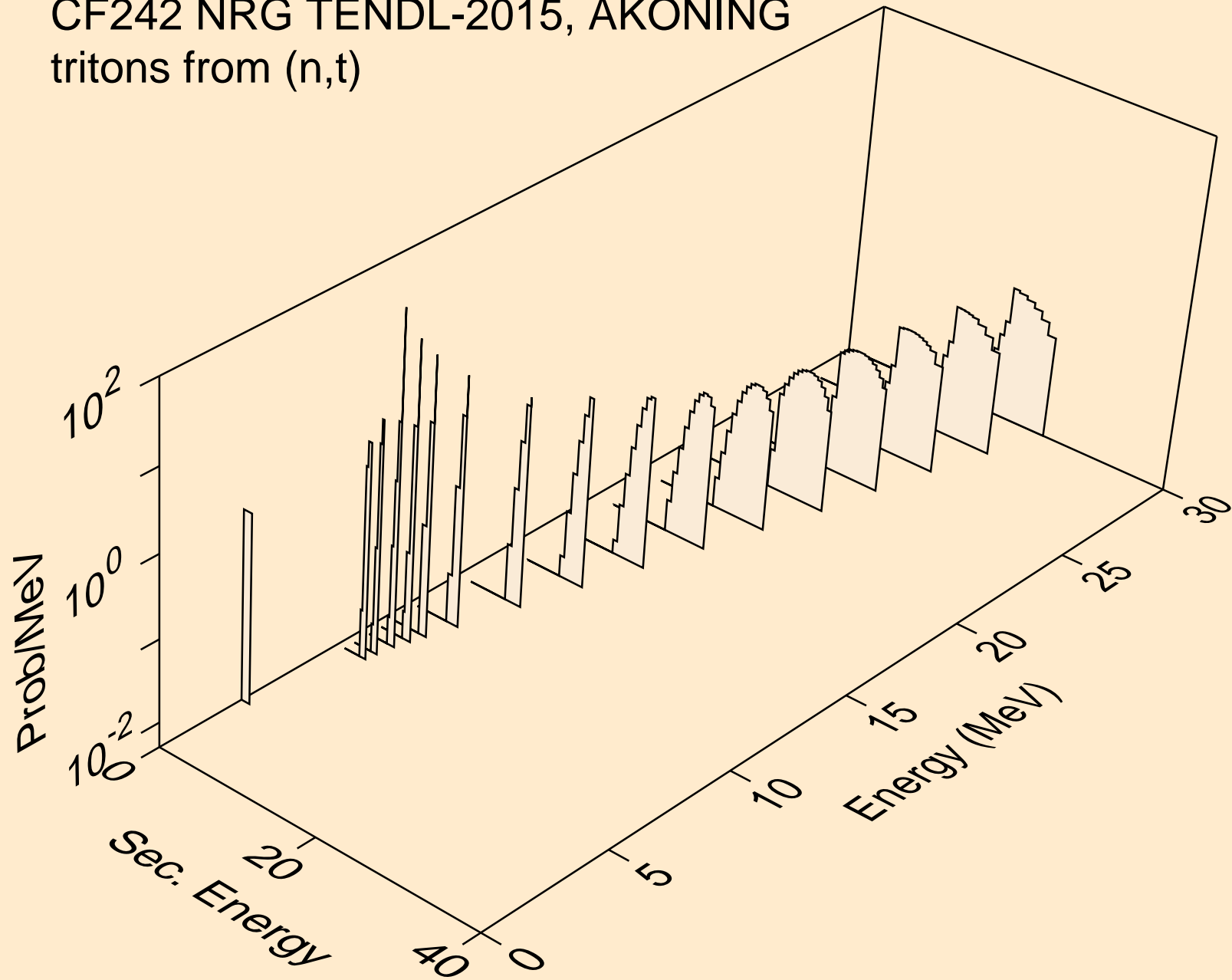

CF242 NRG TENDL-2015, AKONING
tritons from (n,pt)

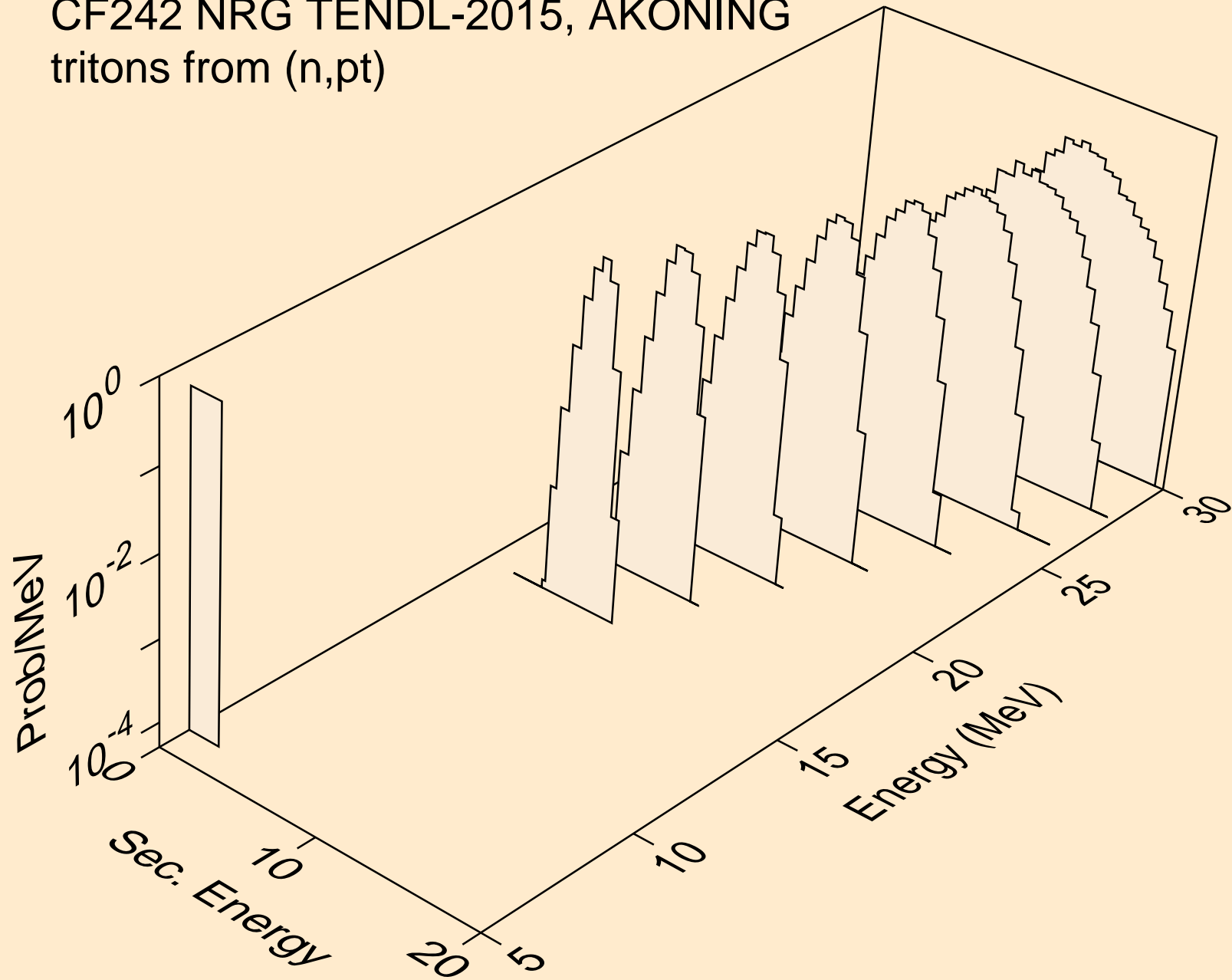

CF242 NRG TENDL-2015, AKONING
he3s from (n,x)

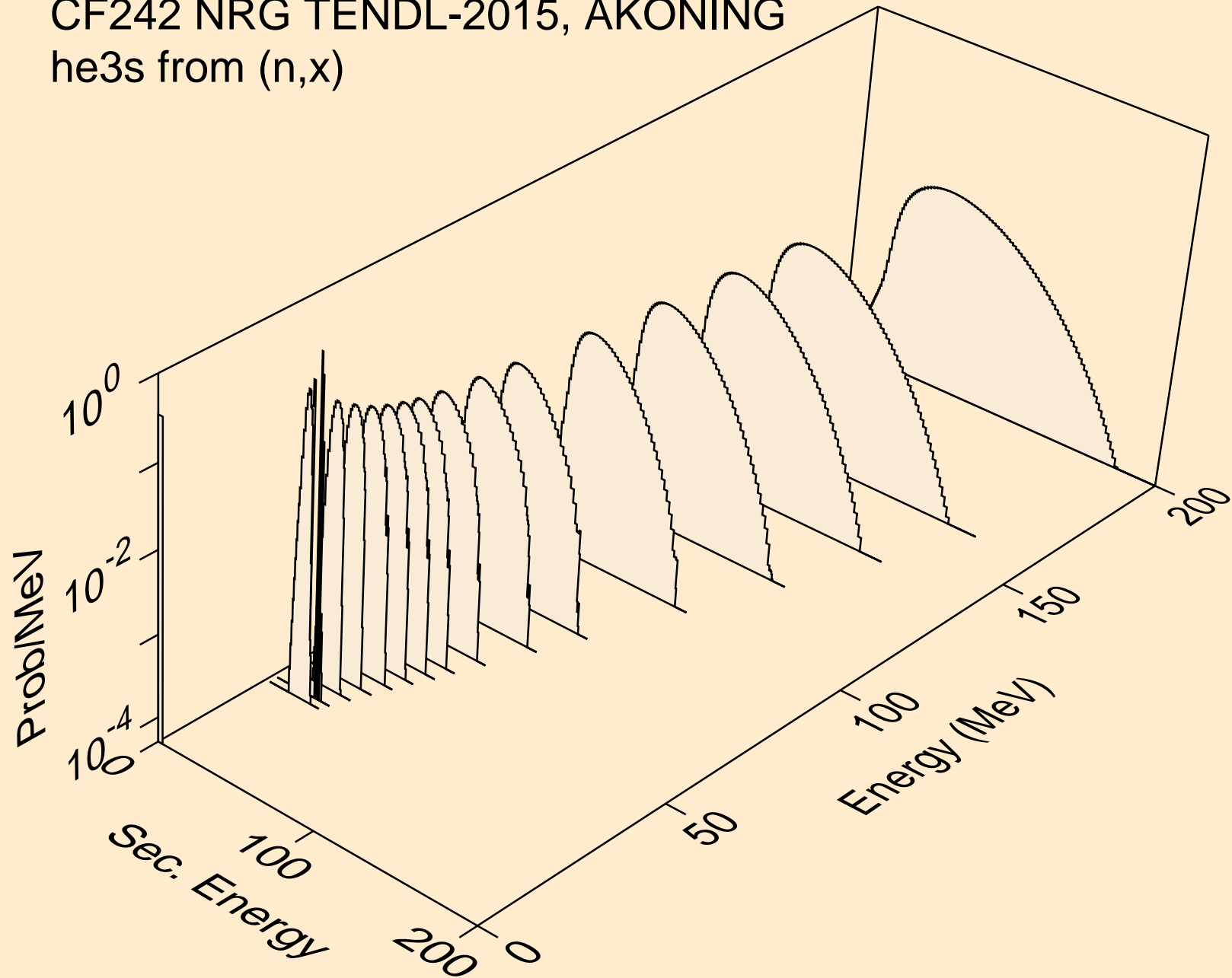

CF242 NRG TENDL-2015, AKONING
he3s from (n,n*)he3

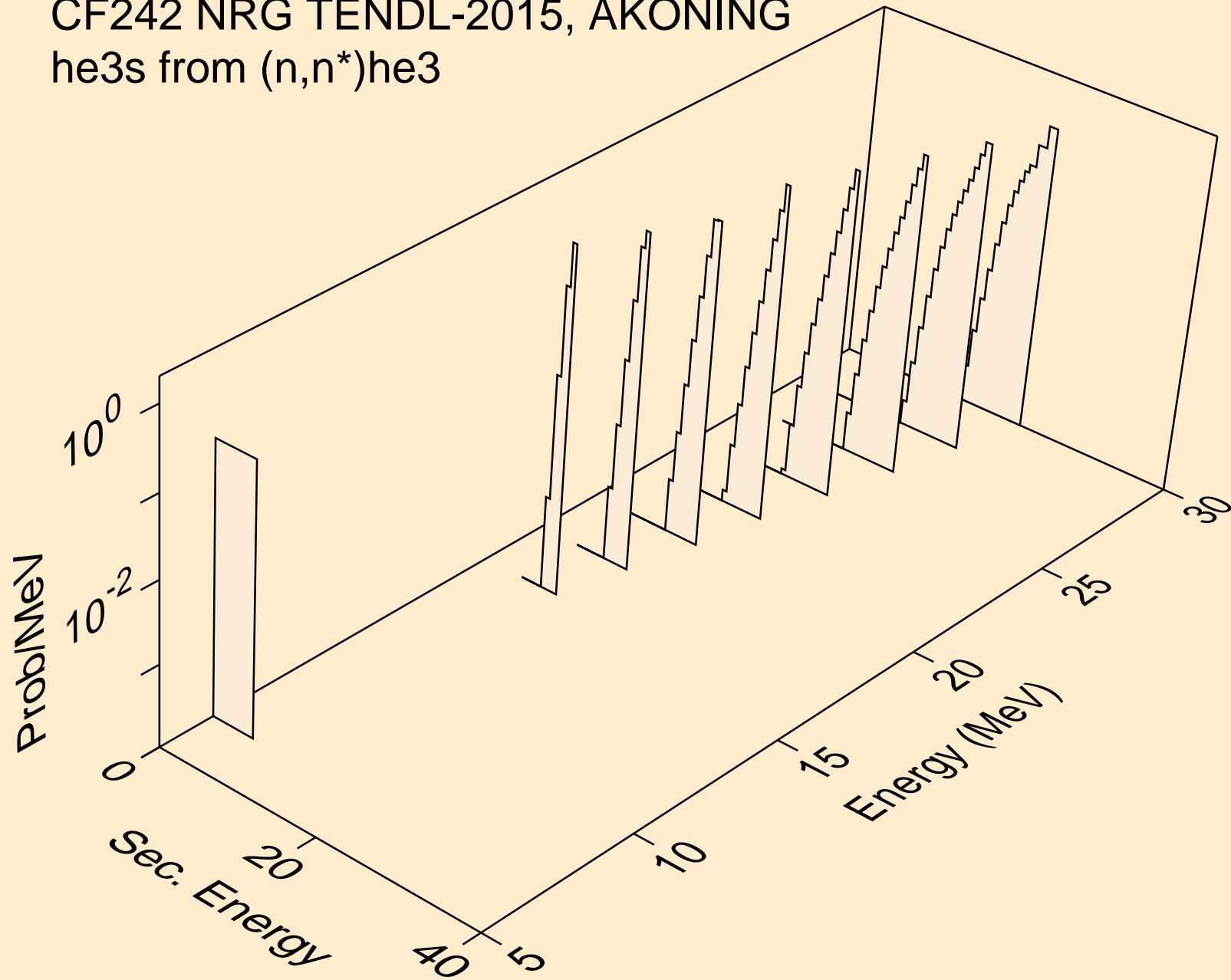

CF242 NRG TENDL-2015, AKONING
he3s from (n,he3)

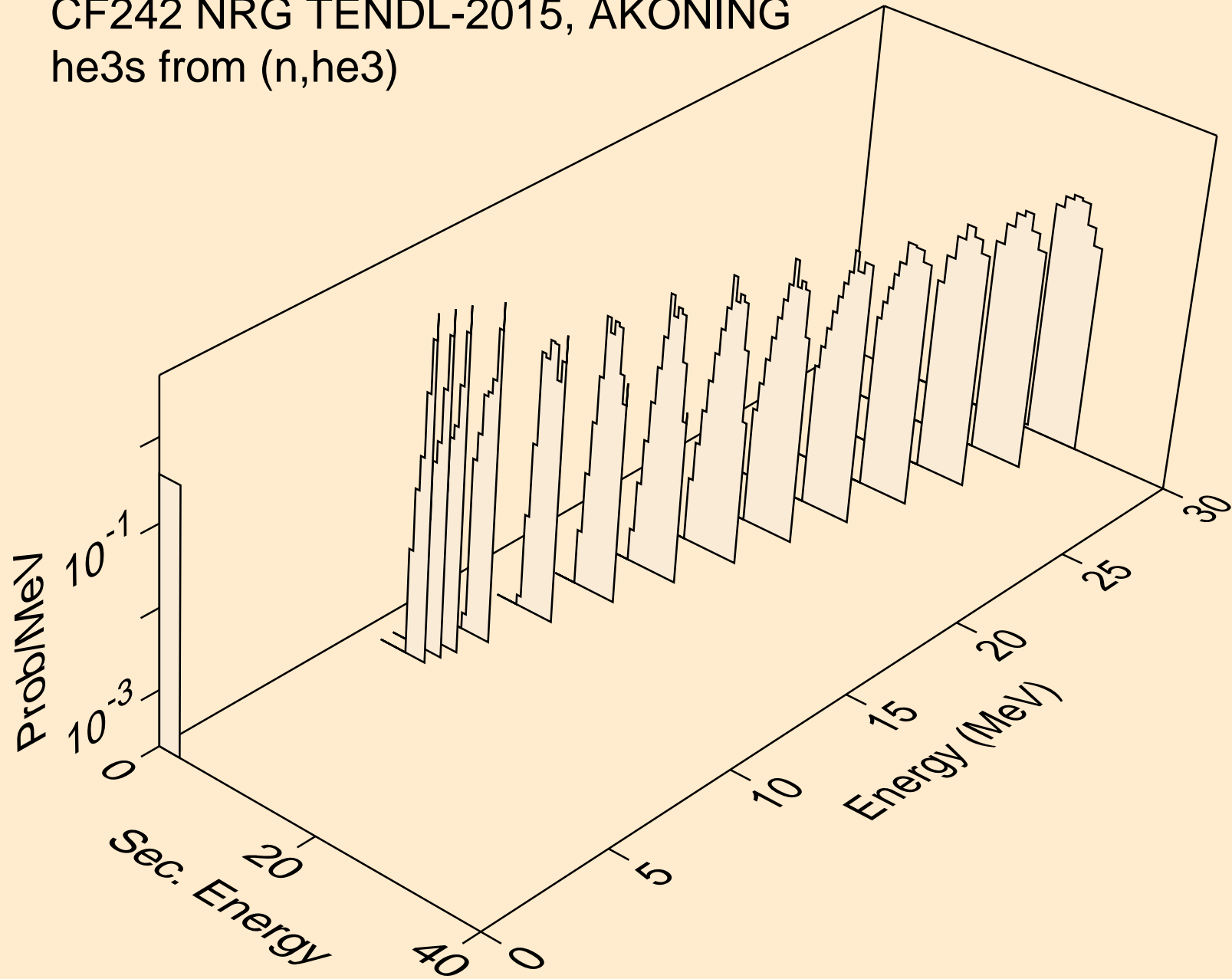

CF242 NRG TENDL-2015, AKONING
alphas from (n,x)

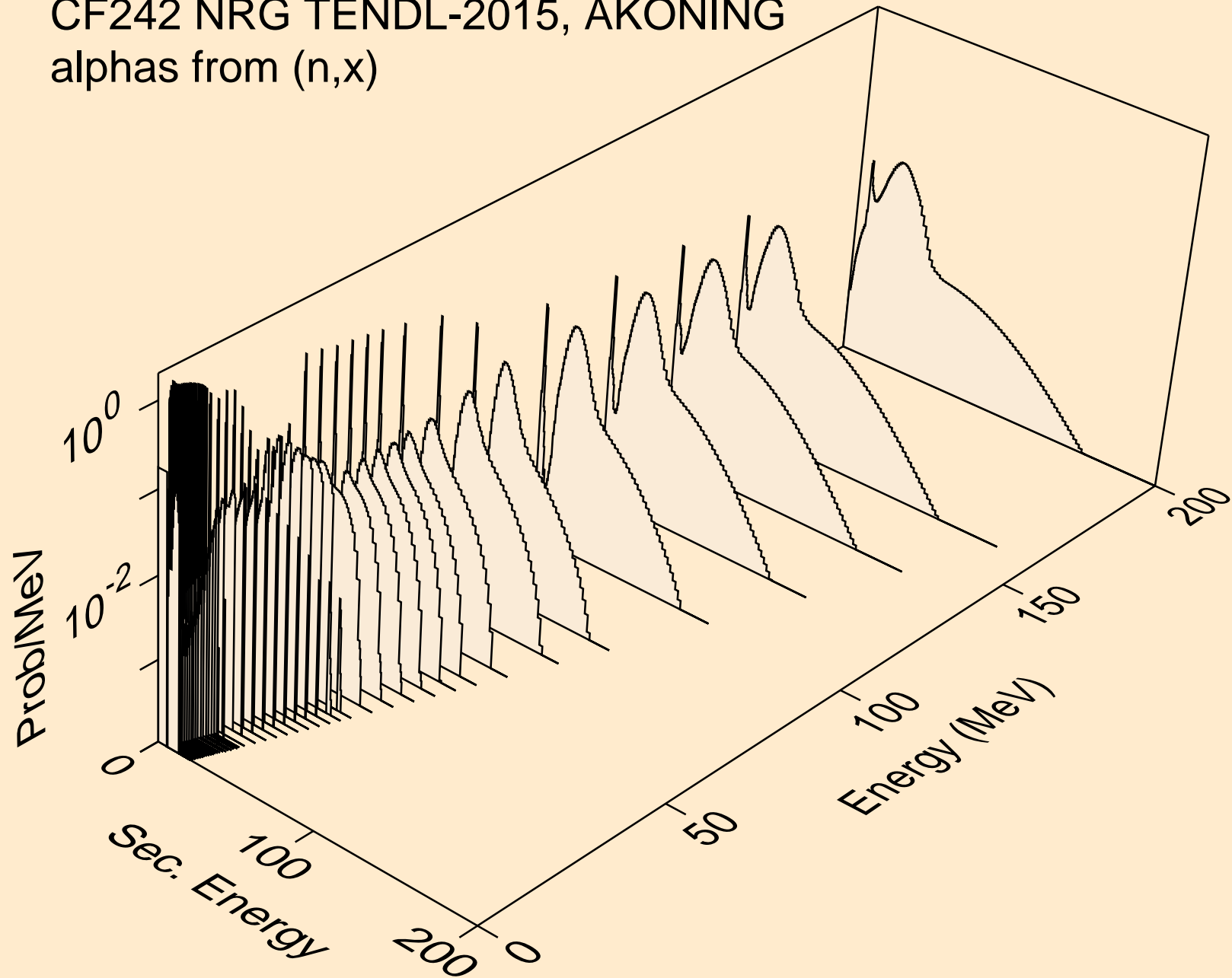

CF242 NRG TENDL-2015, AKONING
alphas from (n,n*)a

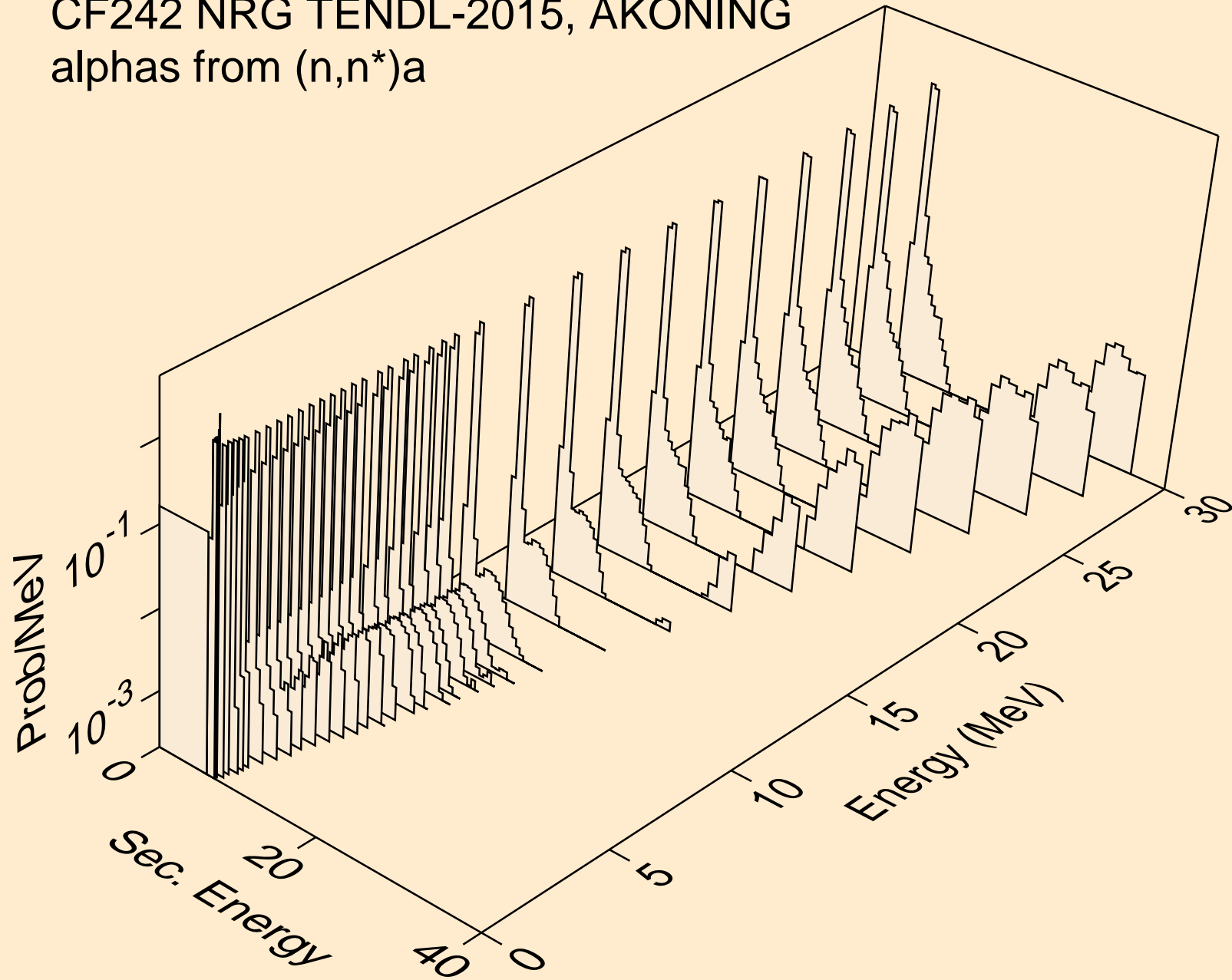

CF242 NRG TENDL-2015, AKONING
alphas from (n,2n)a

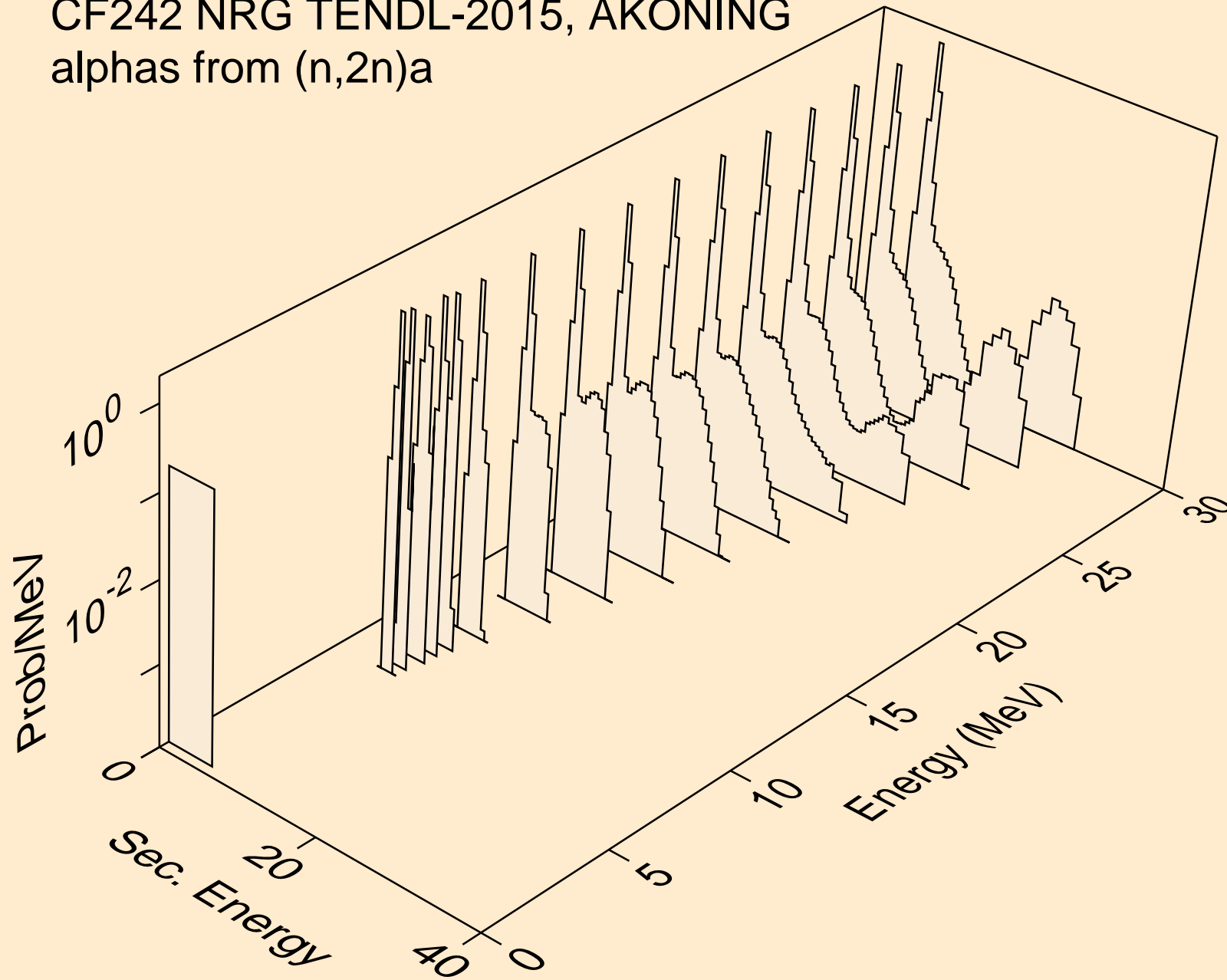

CF242 NRG TENDL-2015, AKONING
alphas from (n,3n)a

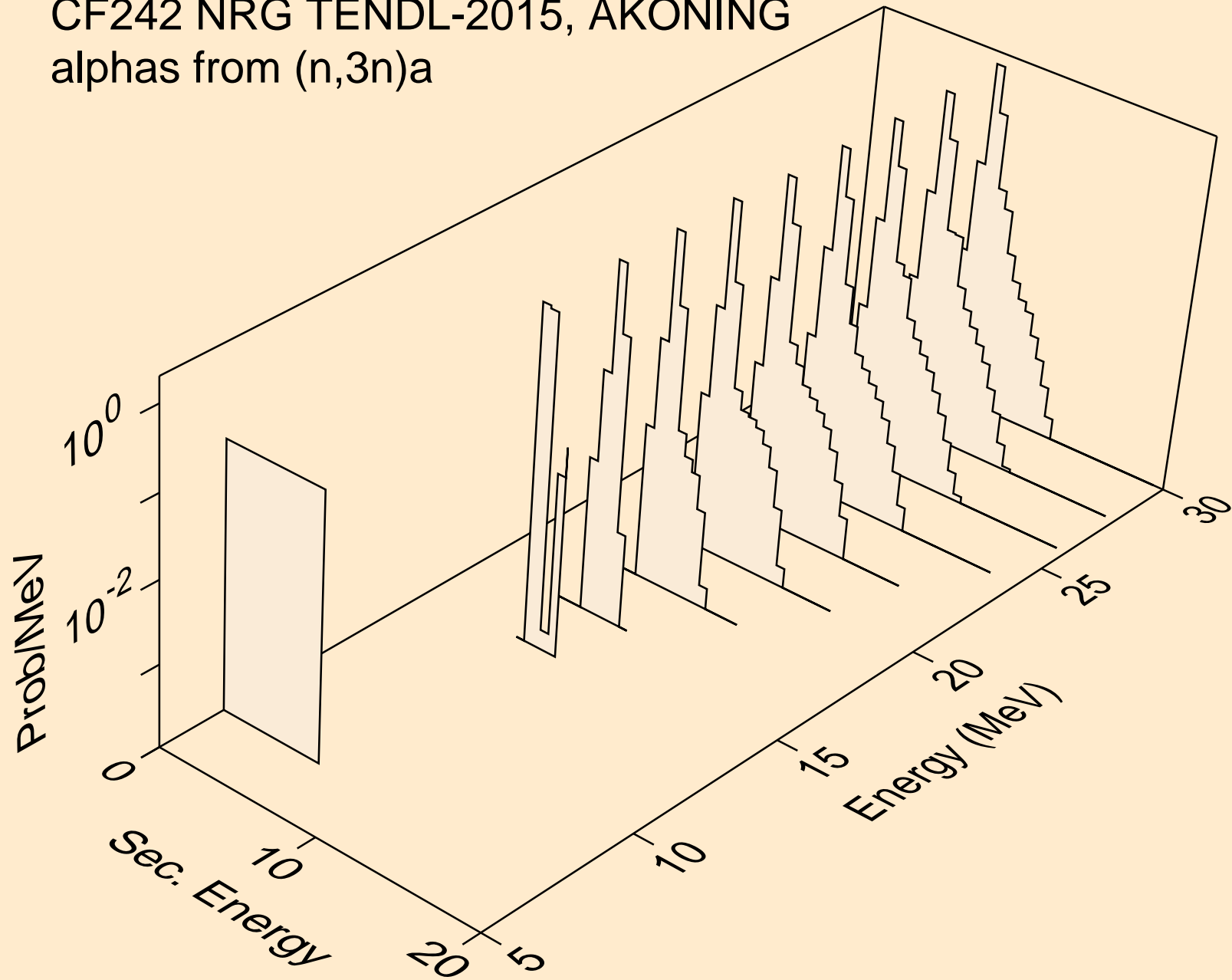

CF242 NRG TENDL-2015, AKONING
alphas from (n,n*)2a

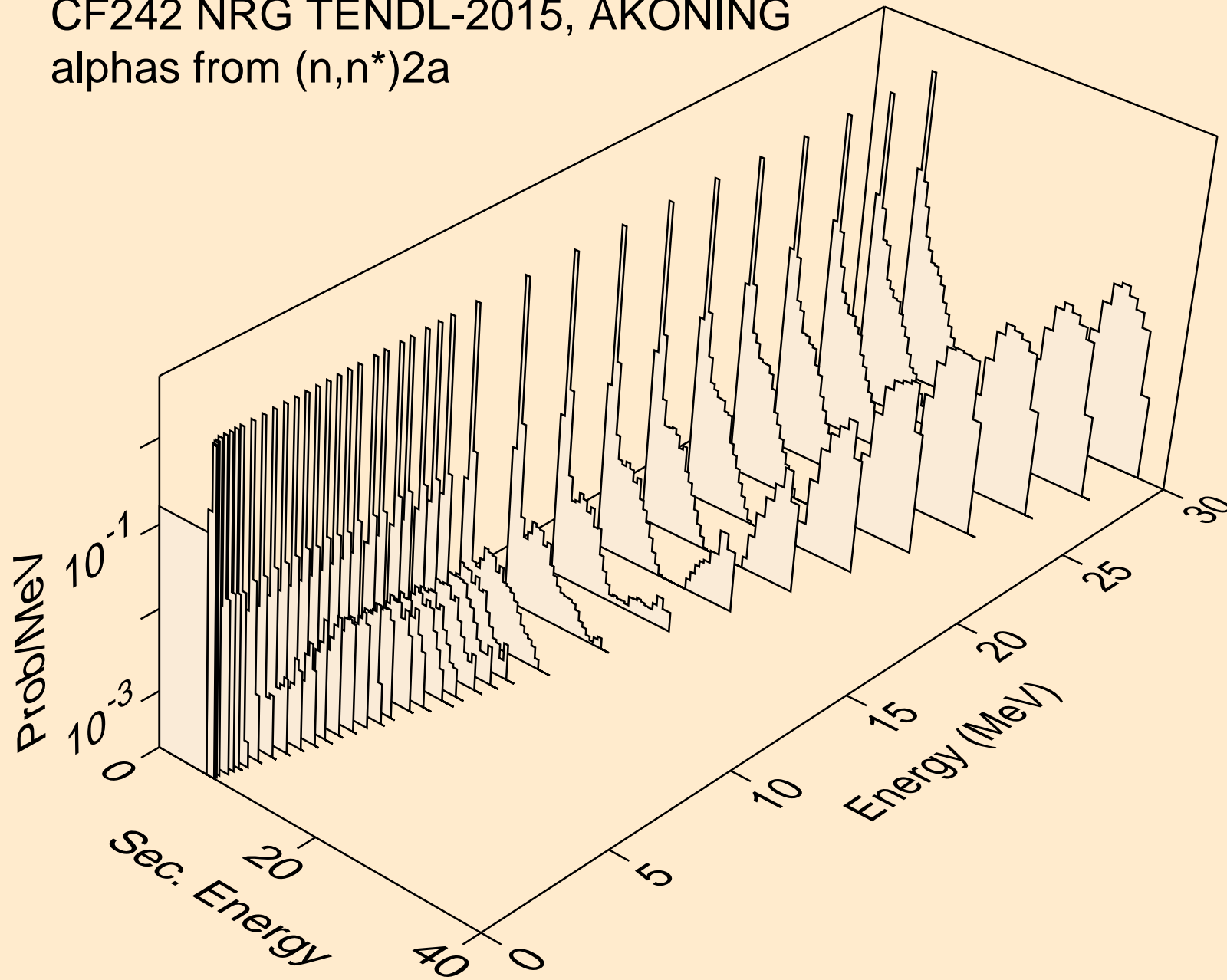

CF242 NRG TENDL-2015, AKONING
alphas from (n,2n)2a

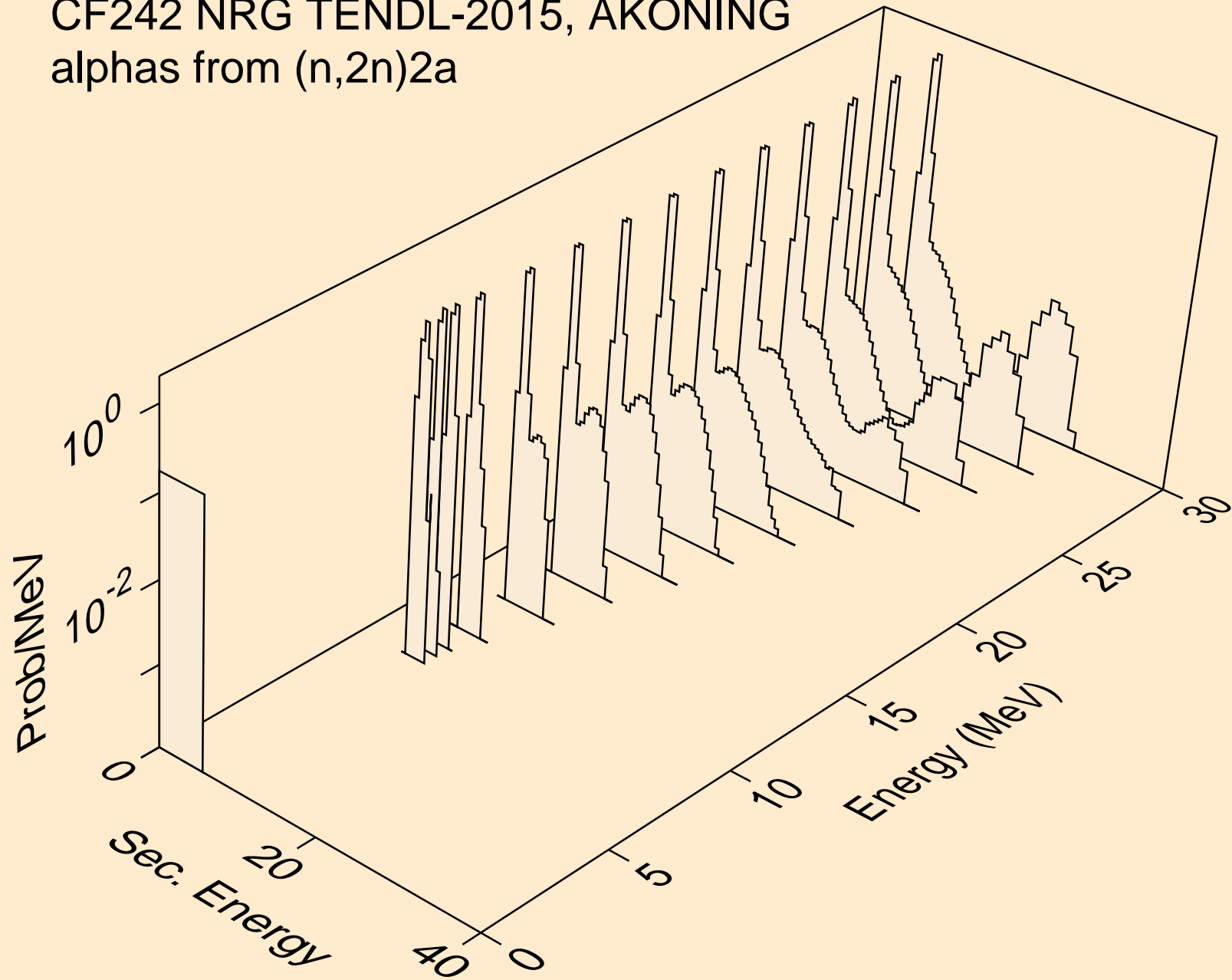

CF242 NRG TENDL-2015, AKONING
alphas from (n,n*)t2a

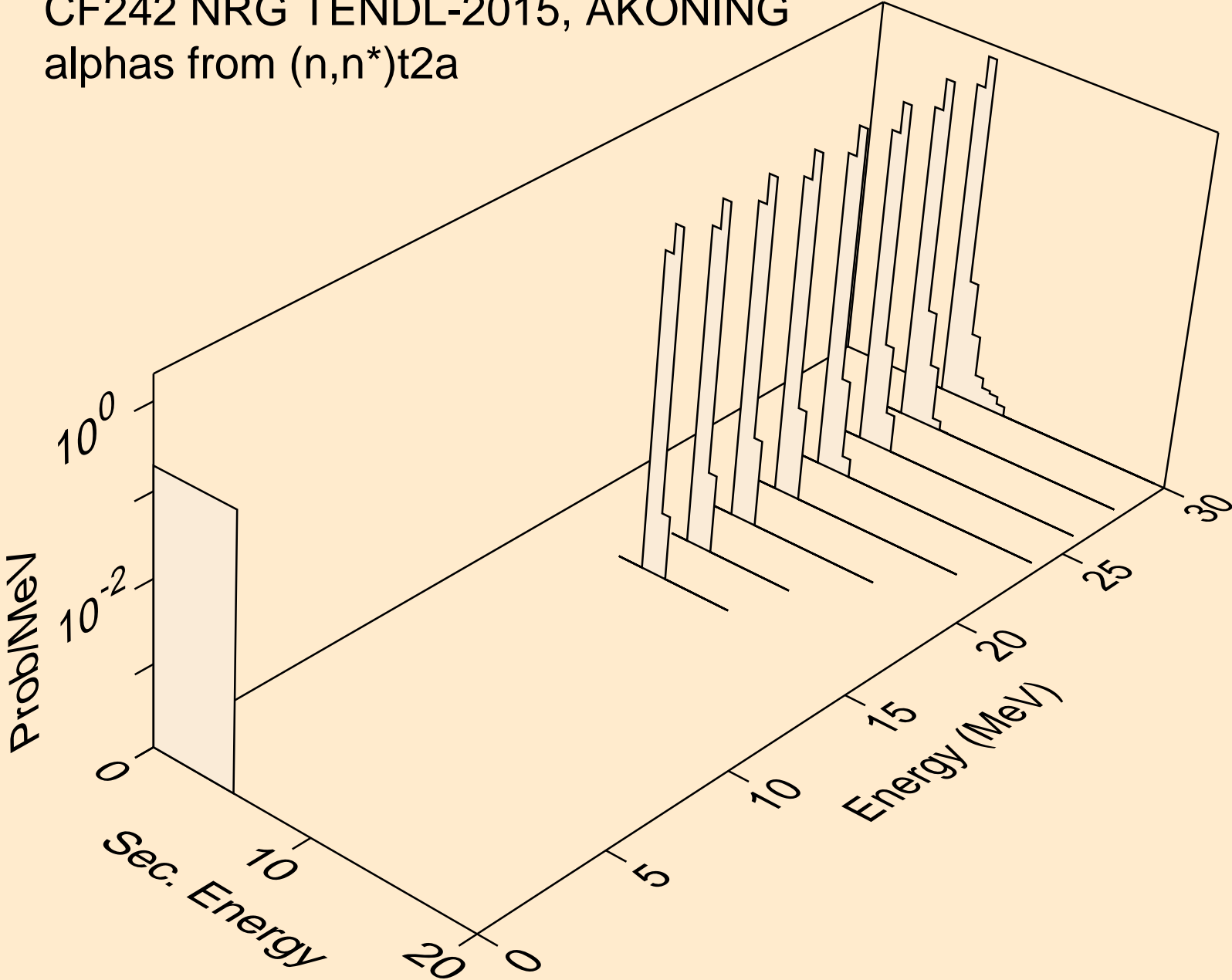

CF242 NRG TENDL-2015, AKONING
alphas from (n,npa)

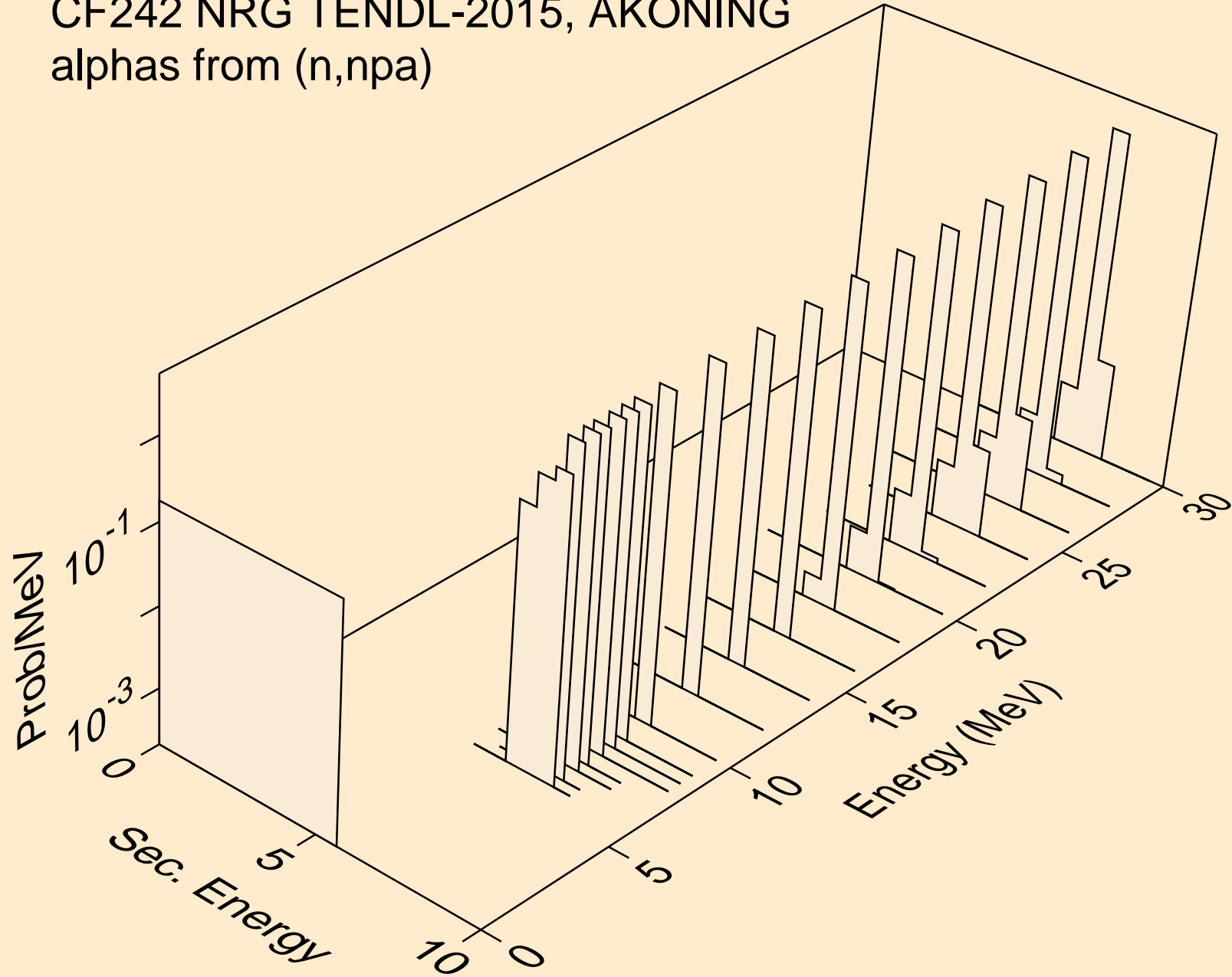

CF242 NRG TENDL-2015, AKONING
alphas from (n,a)

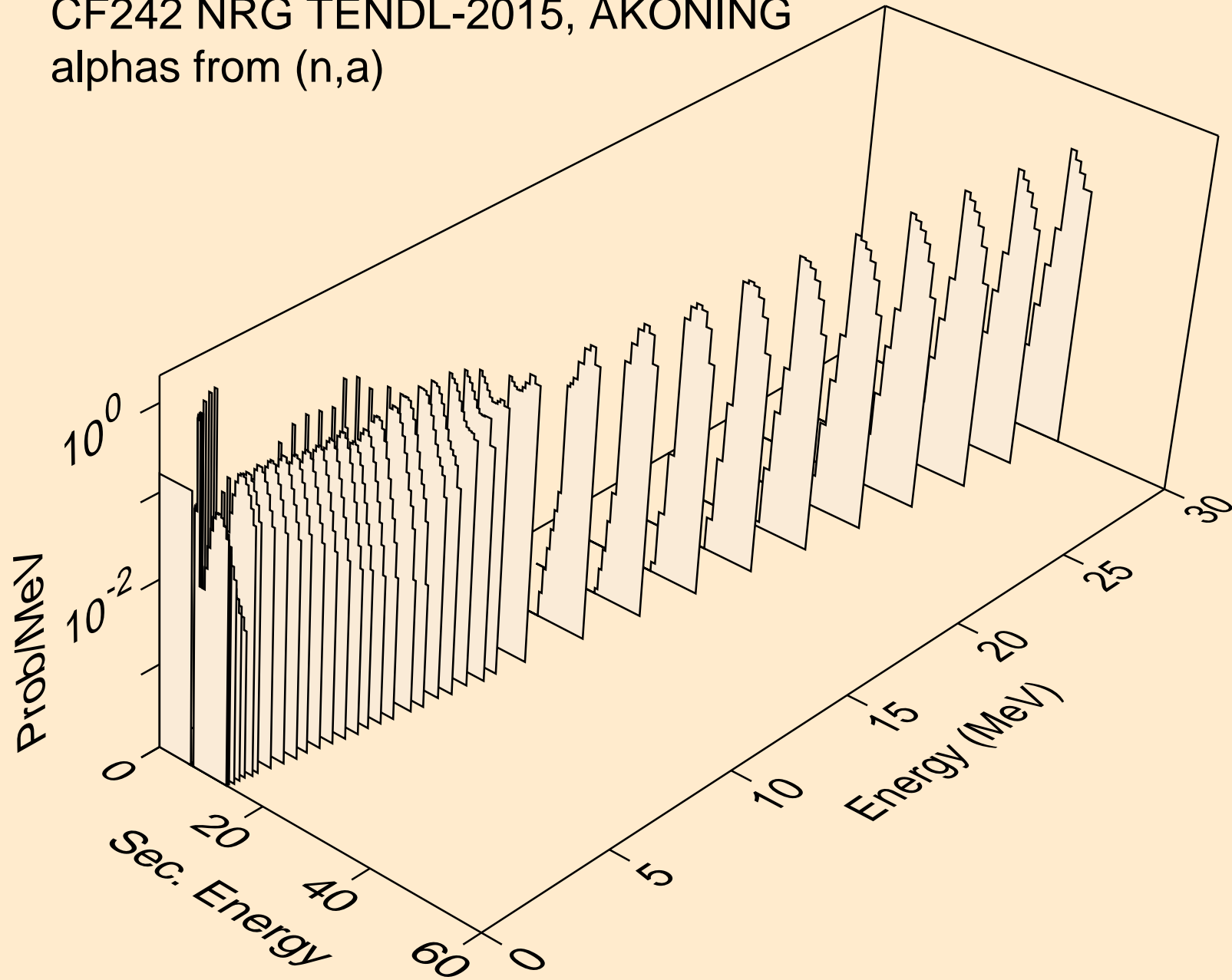

CF242 NRG TENDL-2015, AKONING
alphas from (n,2a)

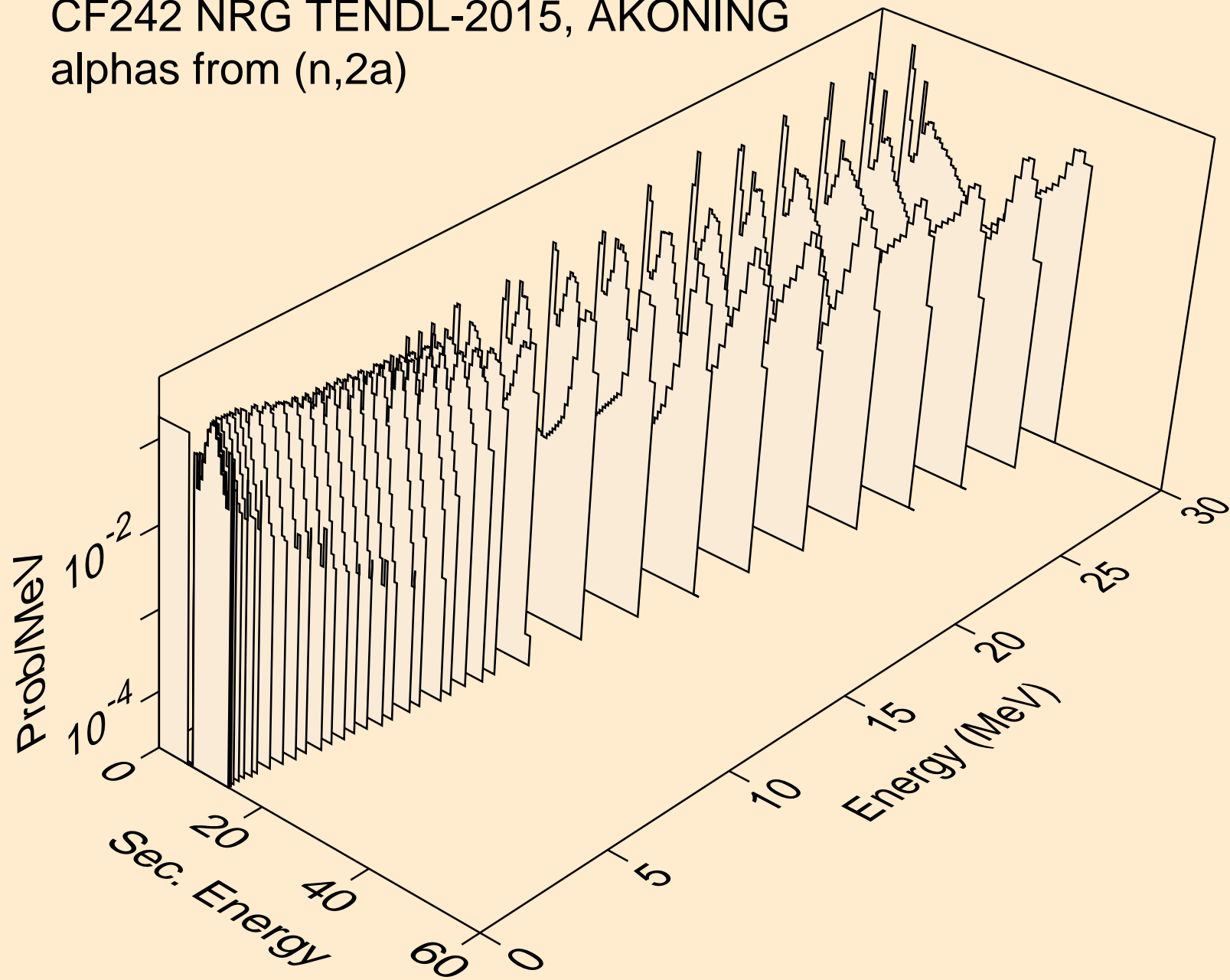

CF242 NRG TENDL-2015, AKONING
alphas from (n,pa)

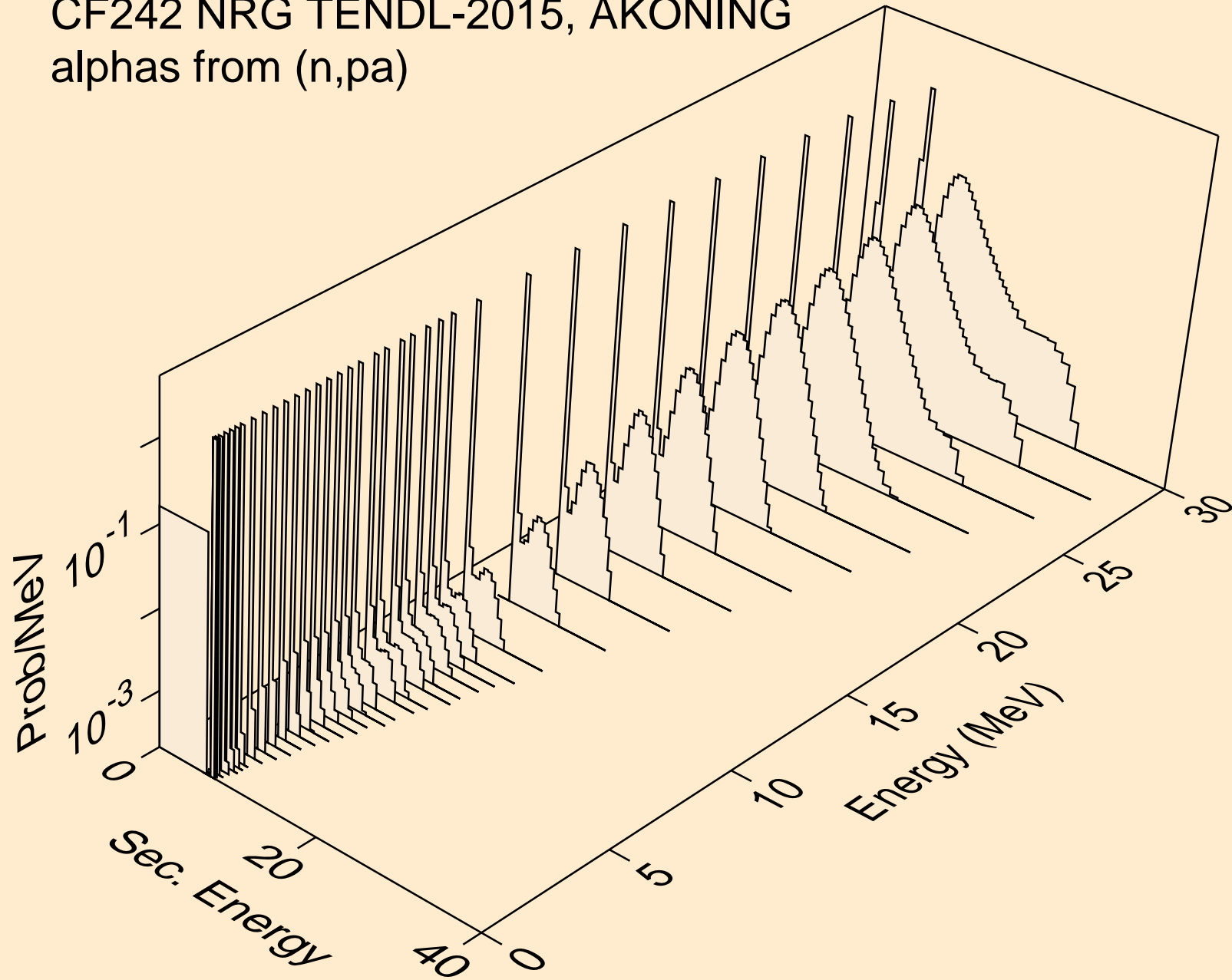

CF242 NRG TENDL-2015, AKONING
alphas from (n,da)

