

# CF255 NRG TENDL-2015, AKONING

## Principal cross sections

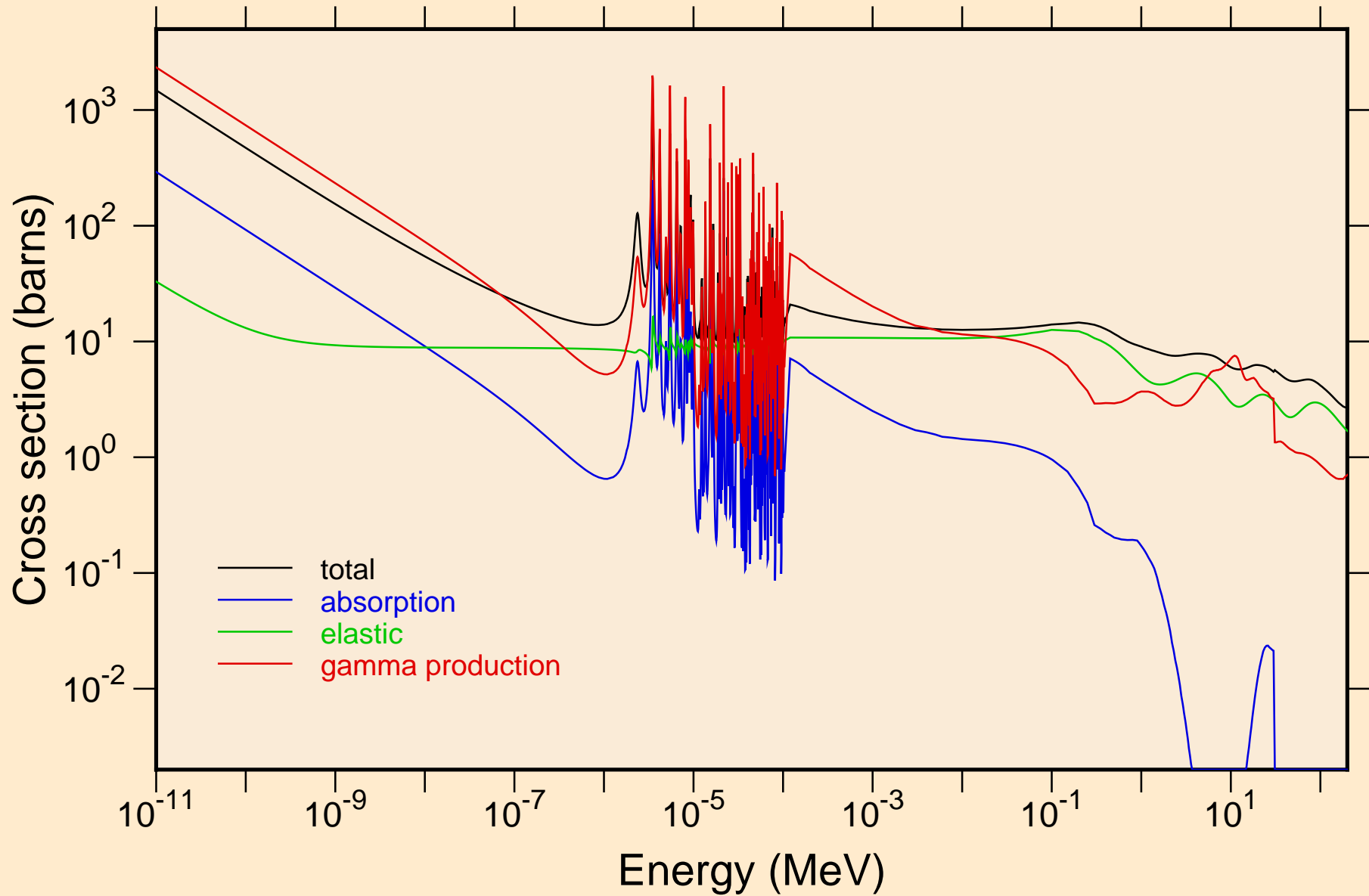

CF255 NRG TENDL-2015, AKONING  
resonance total cross section

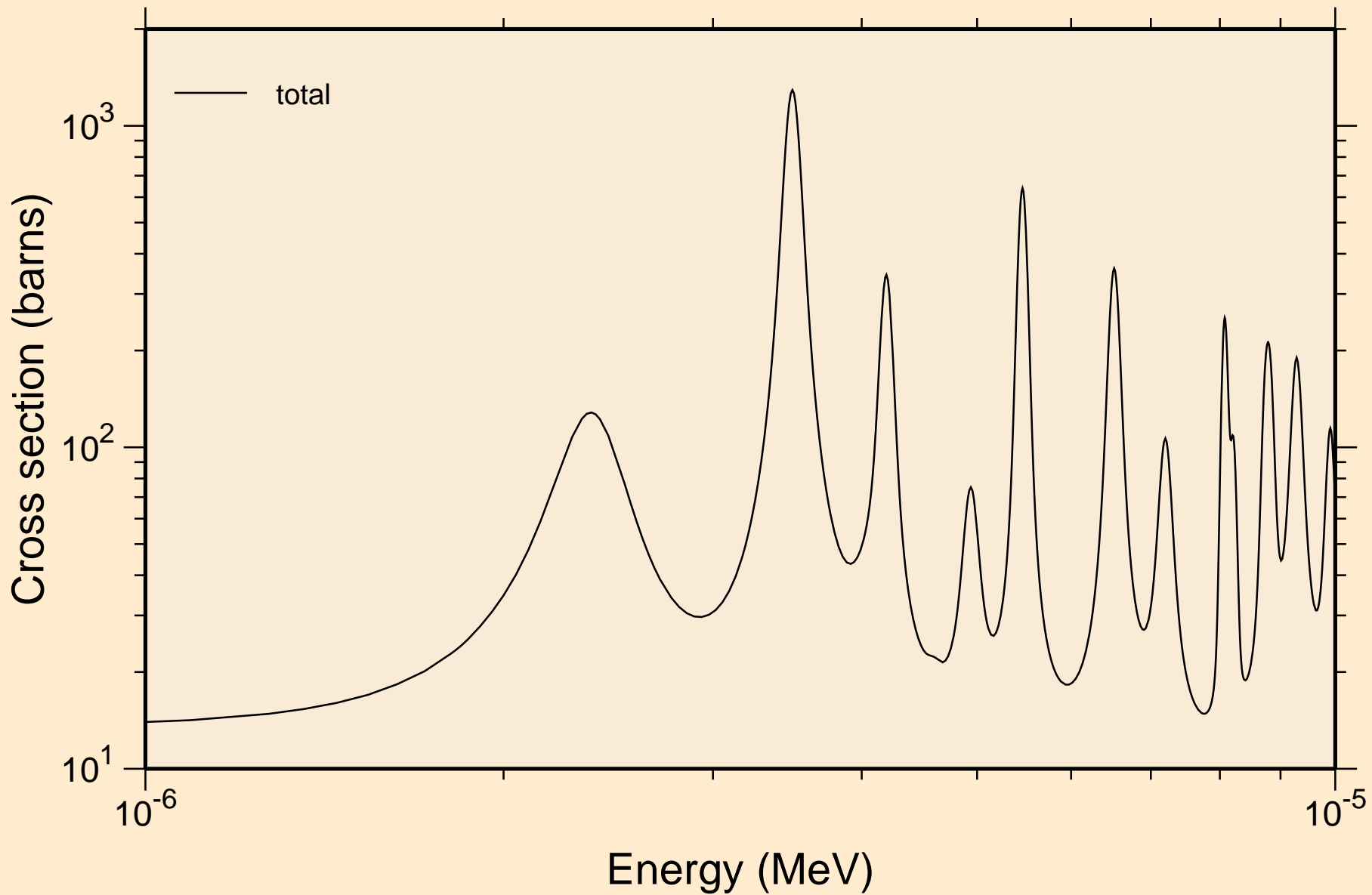

CF255 NRG TENDL-2015, AKONING  
resonance total cross section

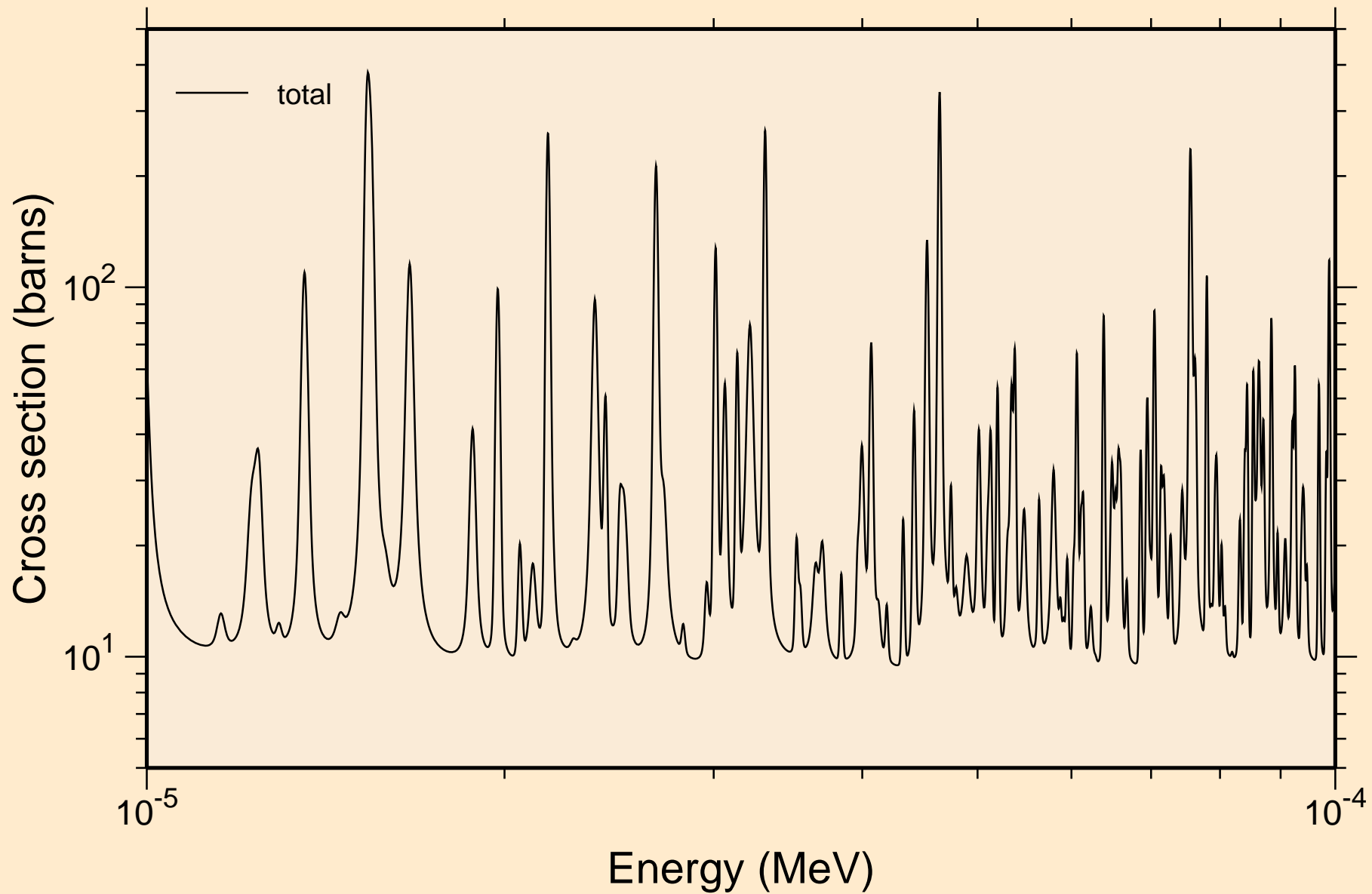

CF255 NRG TENDL-2015, AKONING  
resonance total cross section

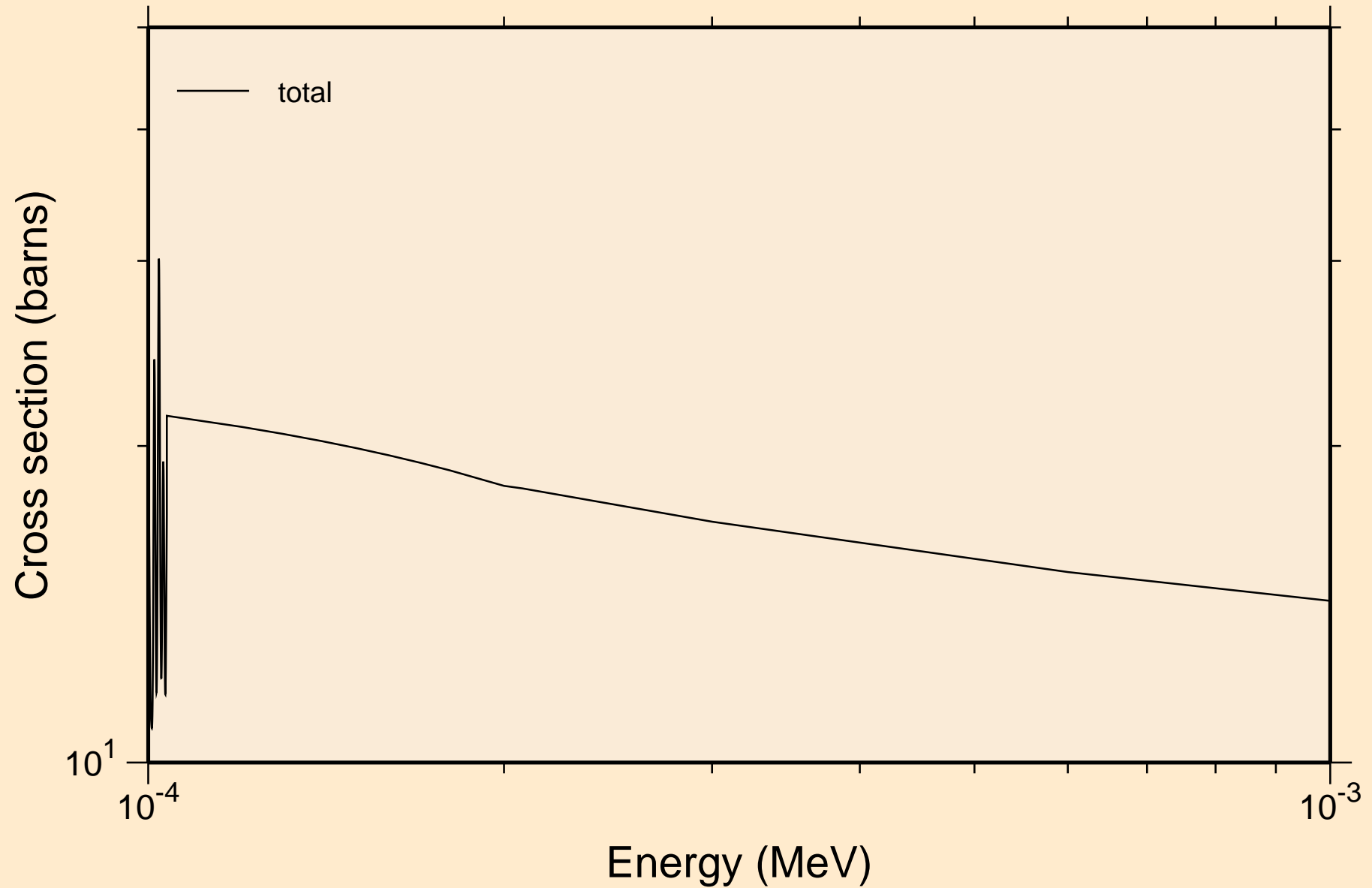

CF255 NRG TENDL-2015, AKONING  
resonance total cross section

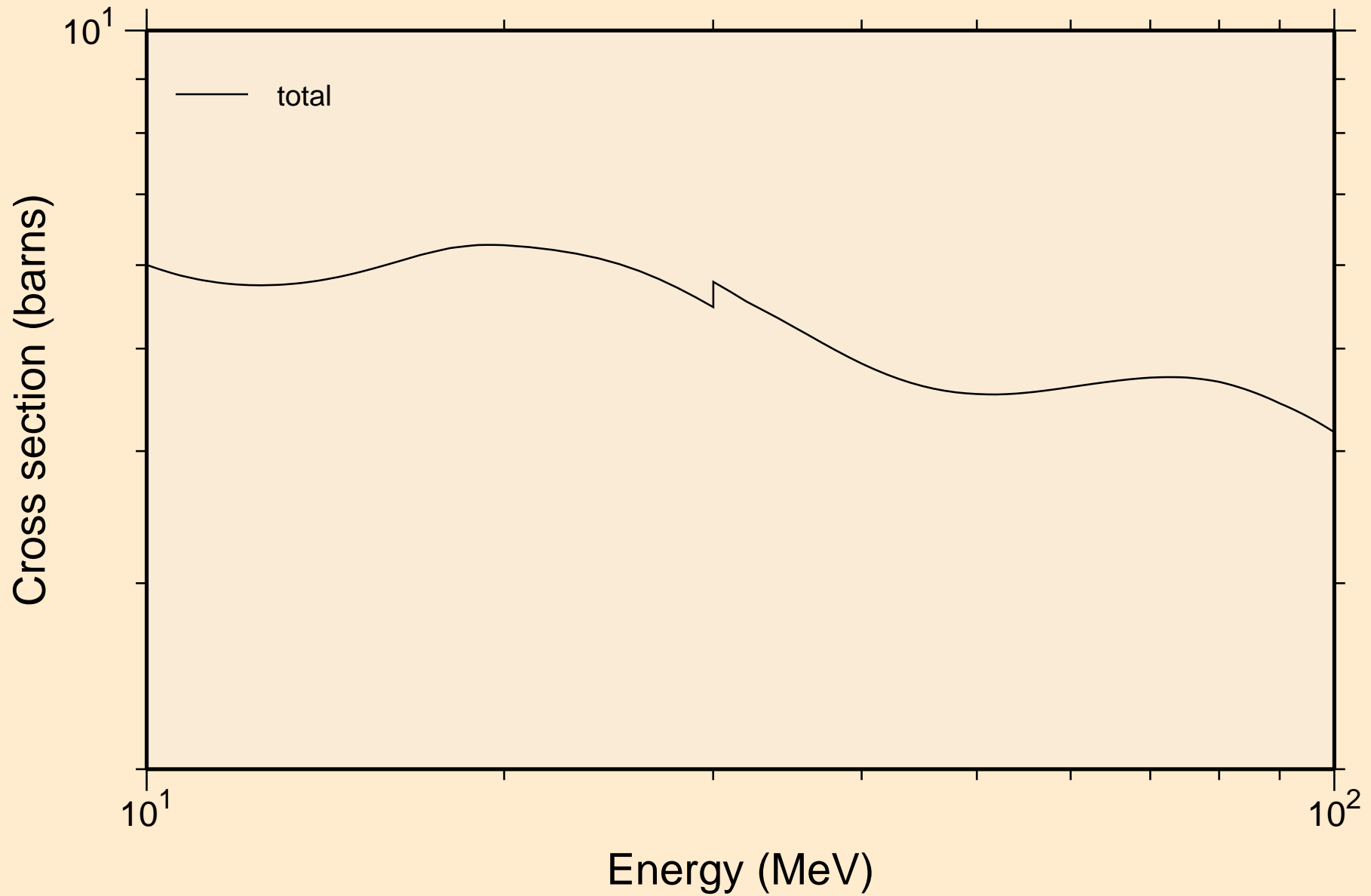

CF255 NRG TENDL-2015, AKONING  
resonance absorption cross sections

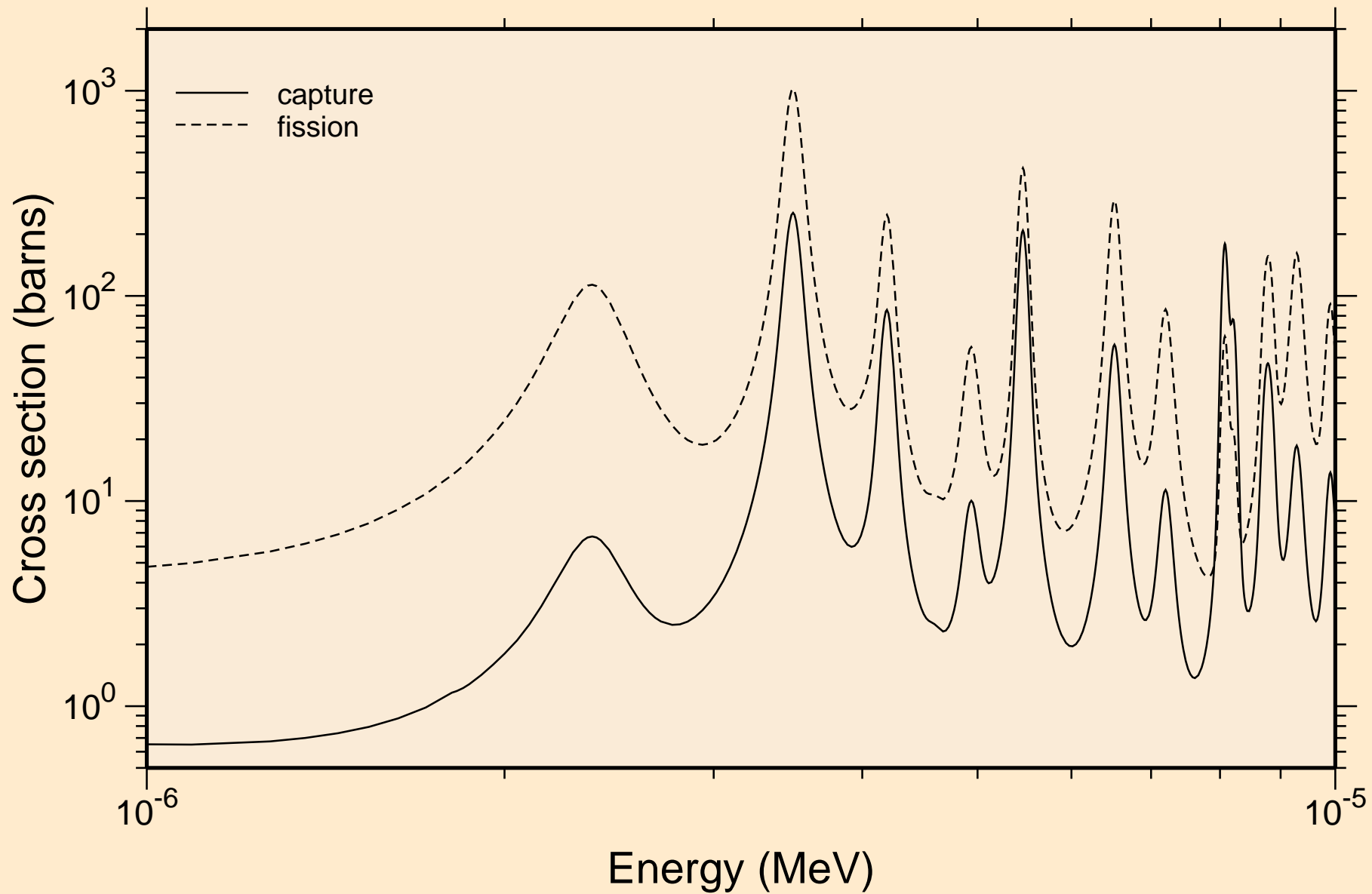

# CF255 NRG TENDL-2015, AKONING

## resonance absorption cross sections

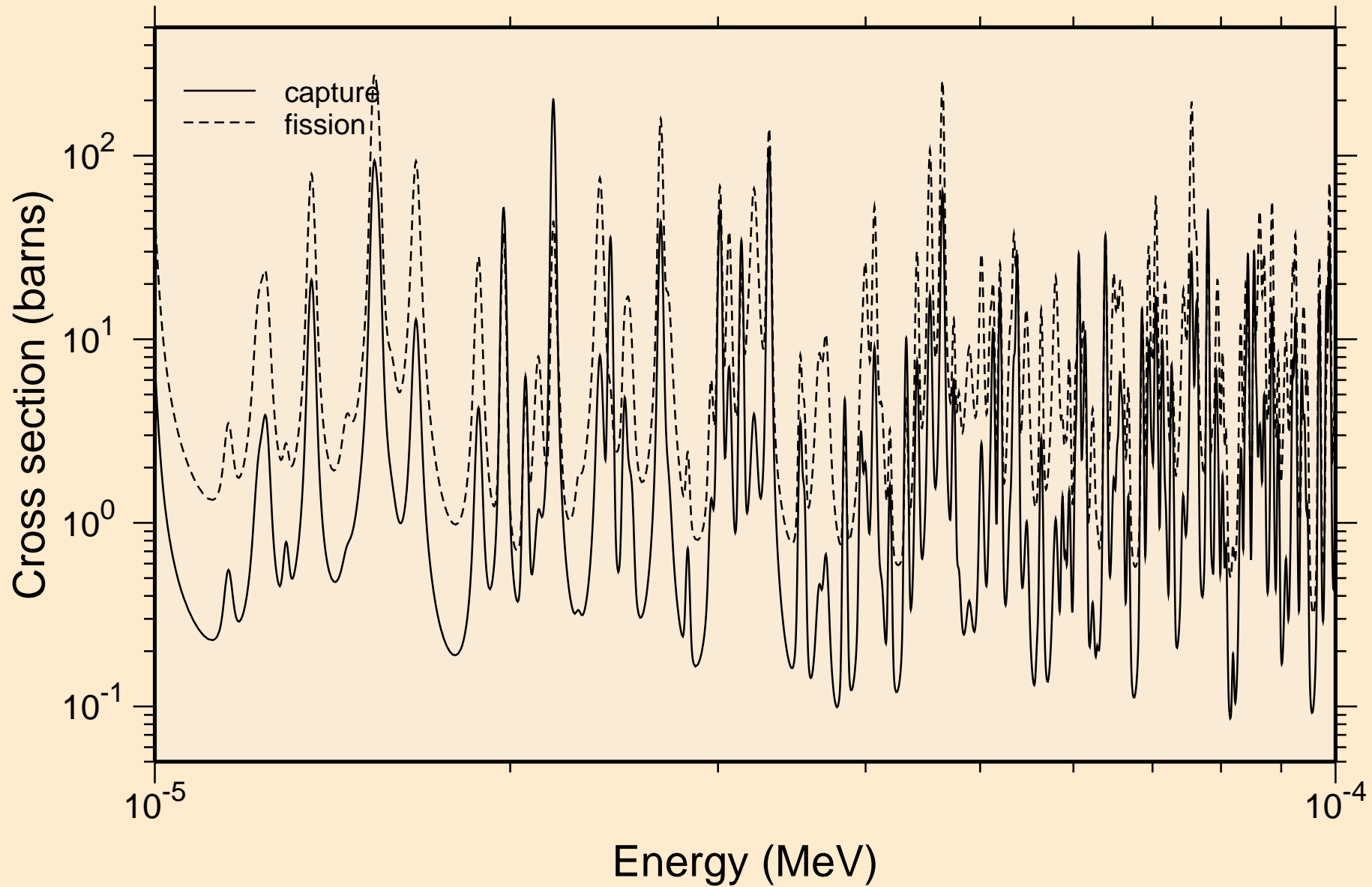

# CF255 NRG TENDL-2015, AKONING

## resonance absorption cross sections

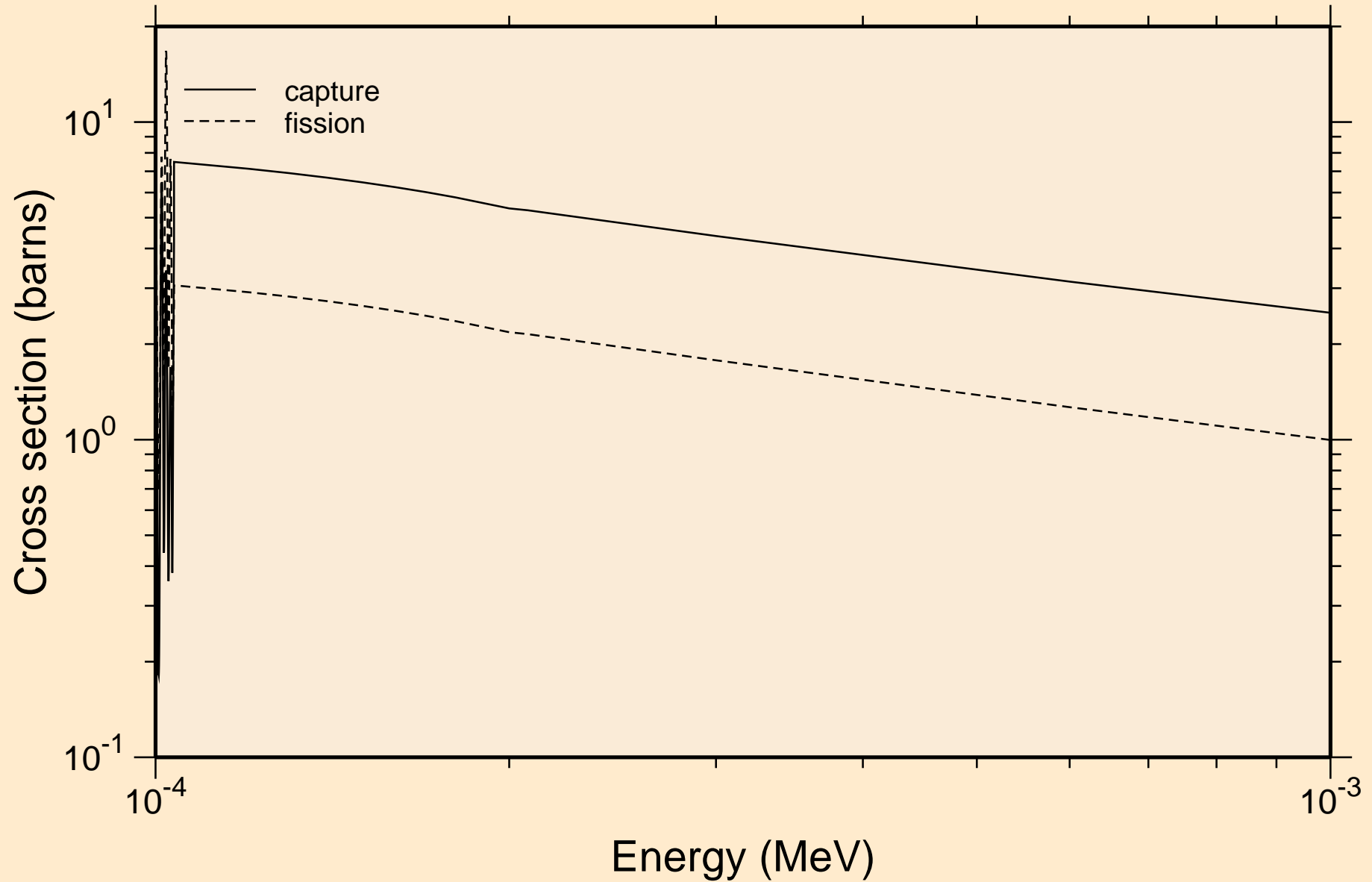



# CF255 NRG TENDL-2015, AKONING

## resonance absorption cross sections

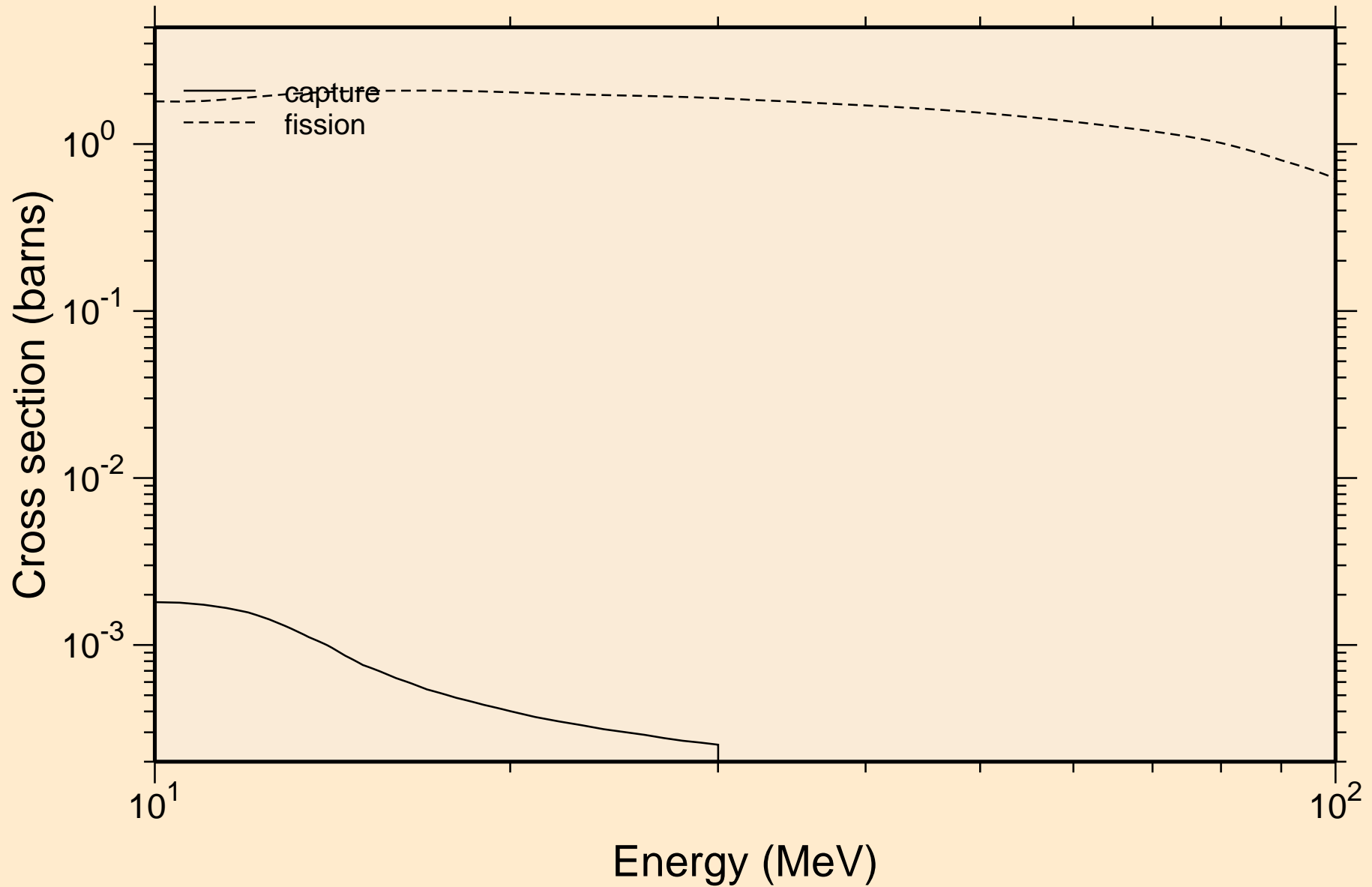

# CF255 NRG TENDL-2015, AKONING

## Non-threshold reactions

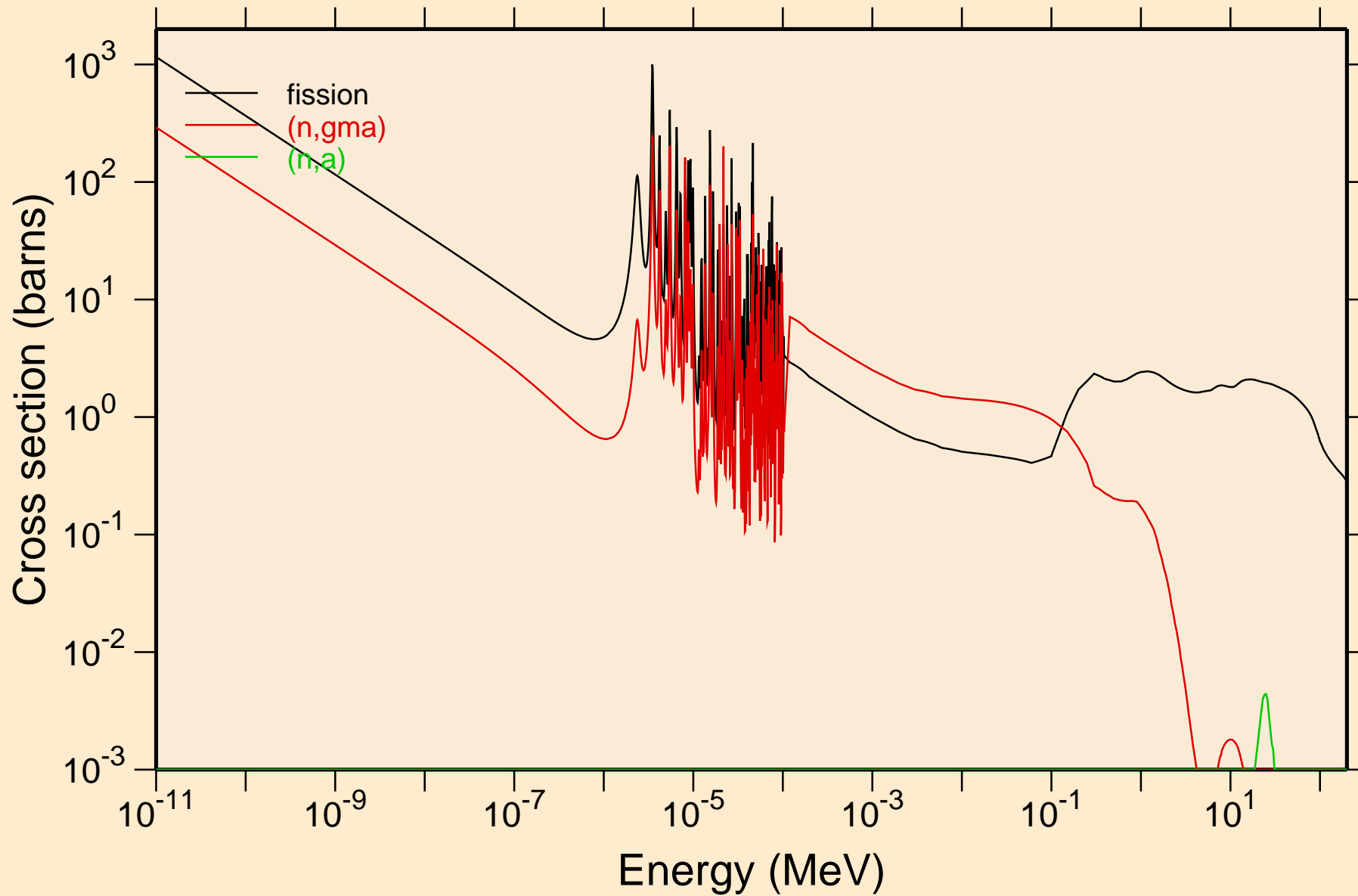

# CF255 NRG TENDL-2015, AKONING

## Principal cross sections

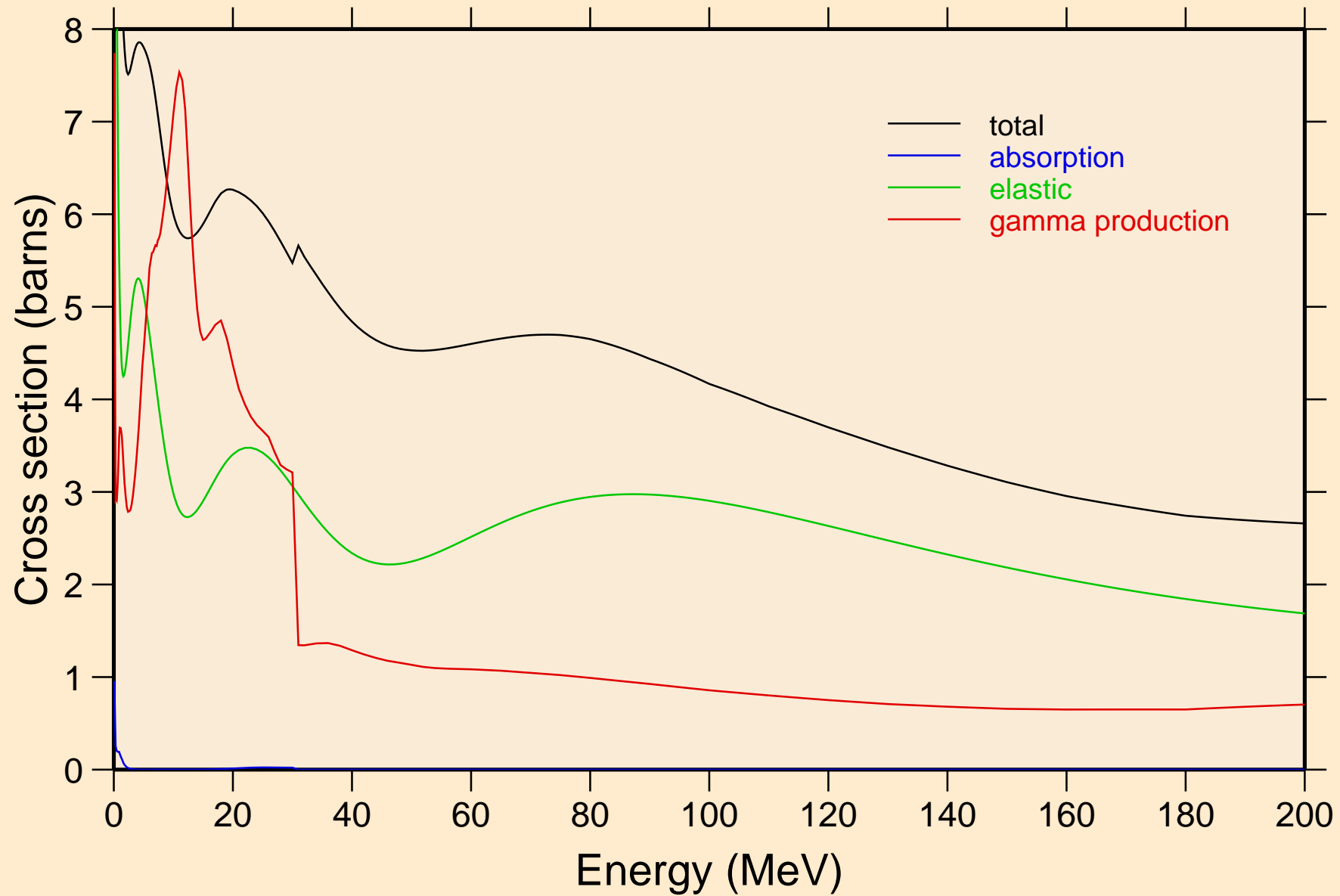

# CF255 NRG TENDL-2015, AKONING

## Non-threshold reactions

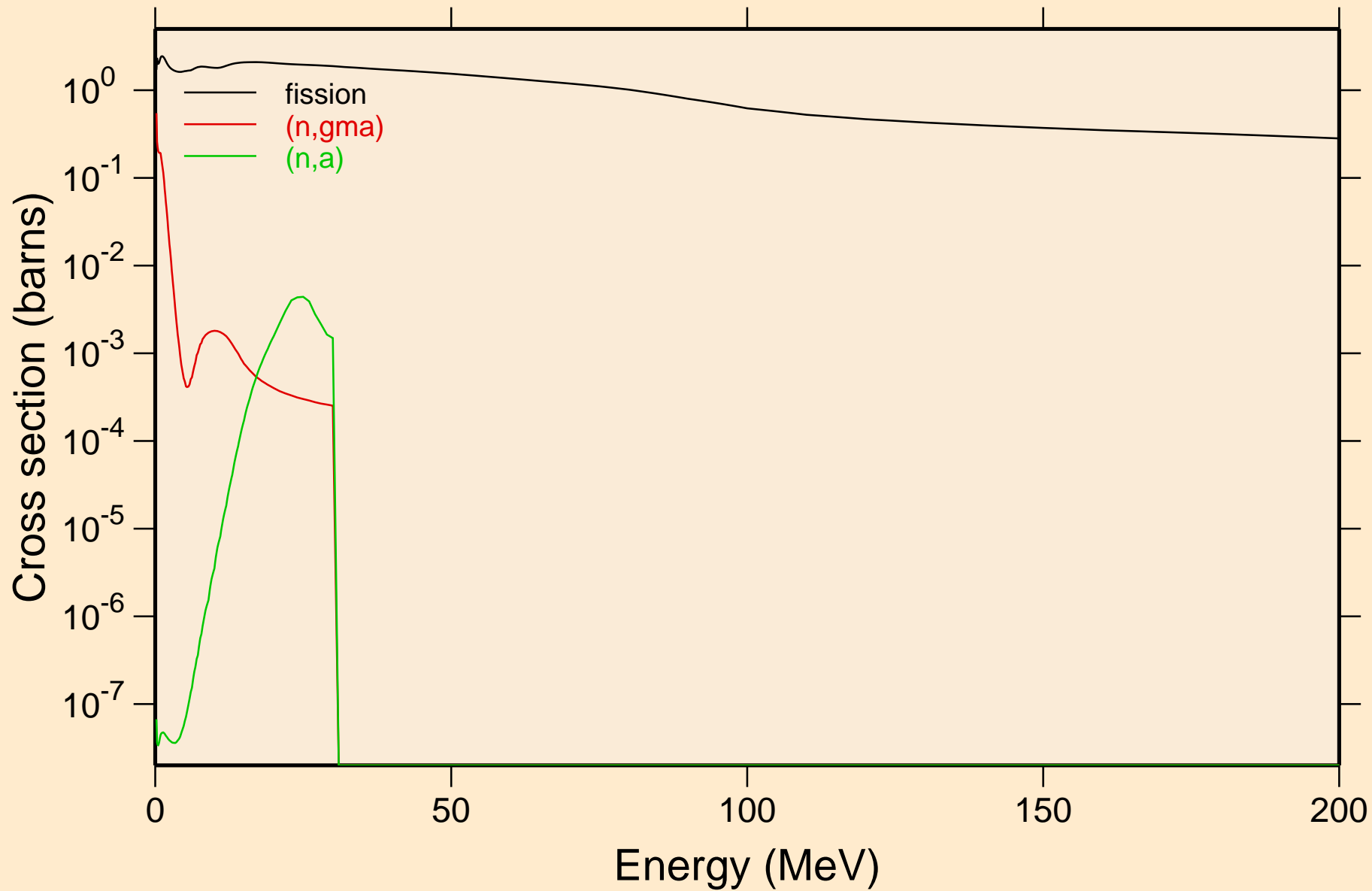

CF255 NRG TENDL-2015, AKONING  
Inelastic levels

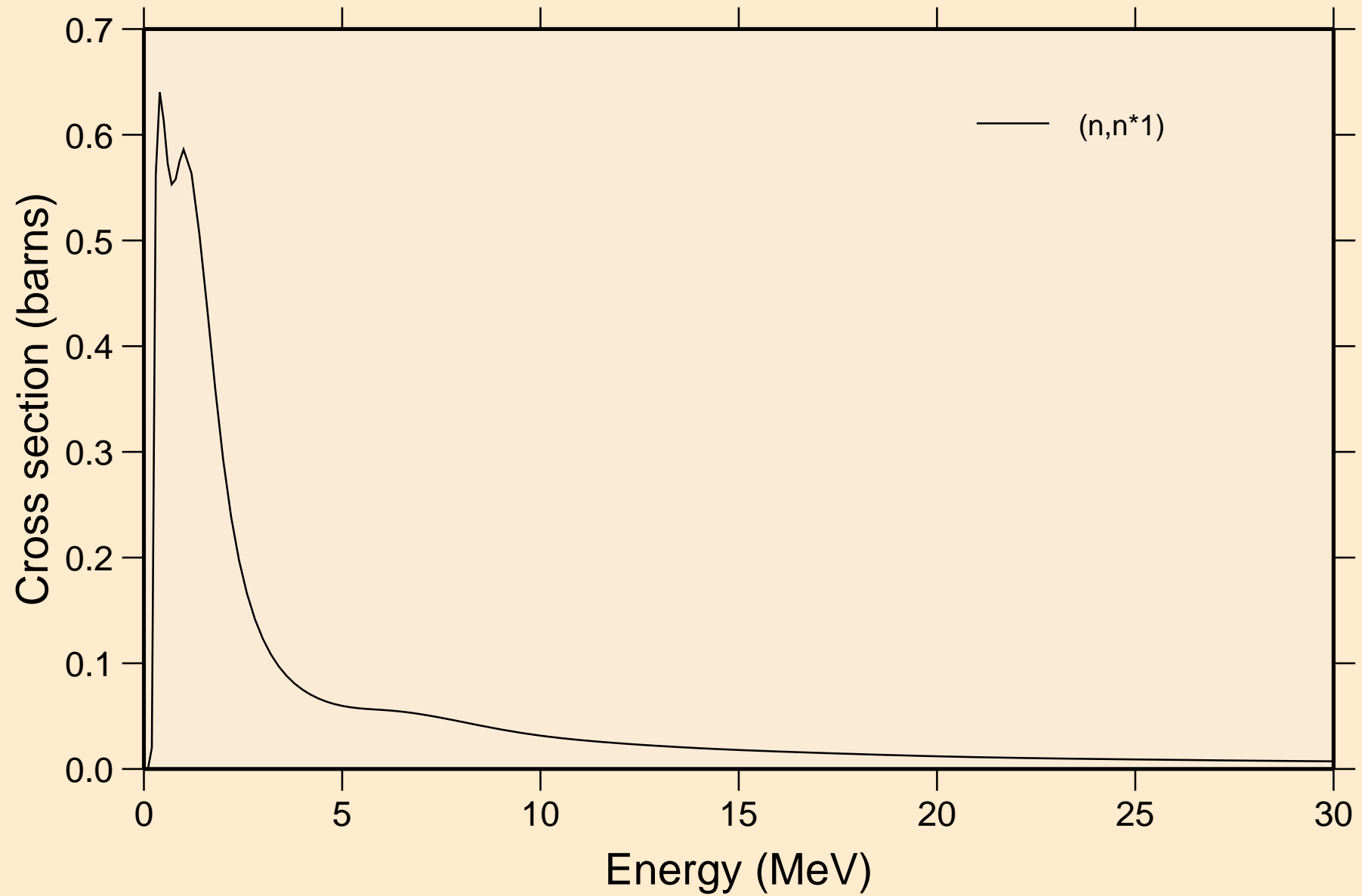

# CF255 NRG TENDL-2015, AKONING

## Threshold reactions

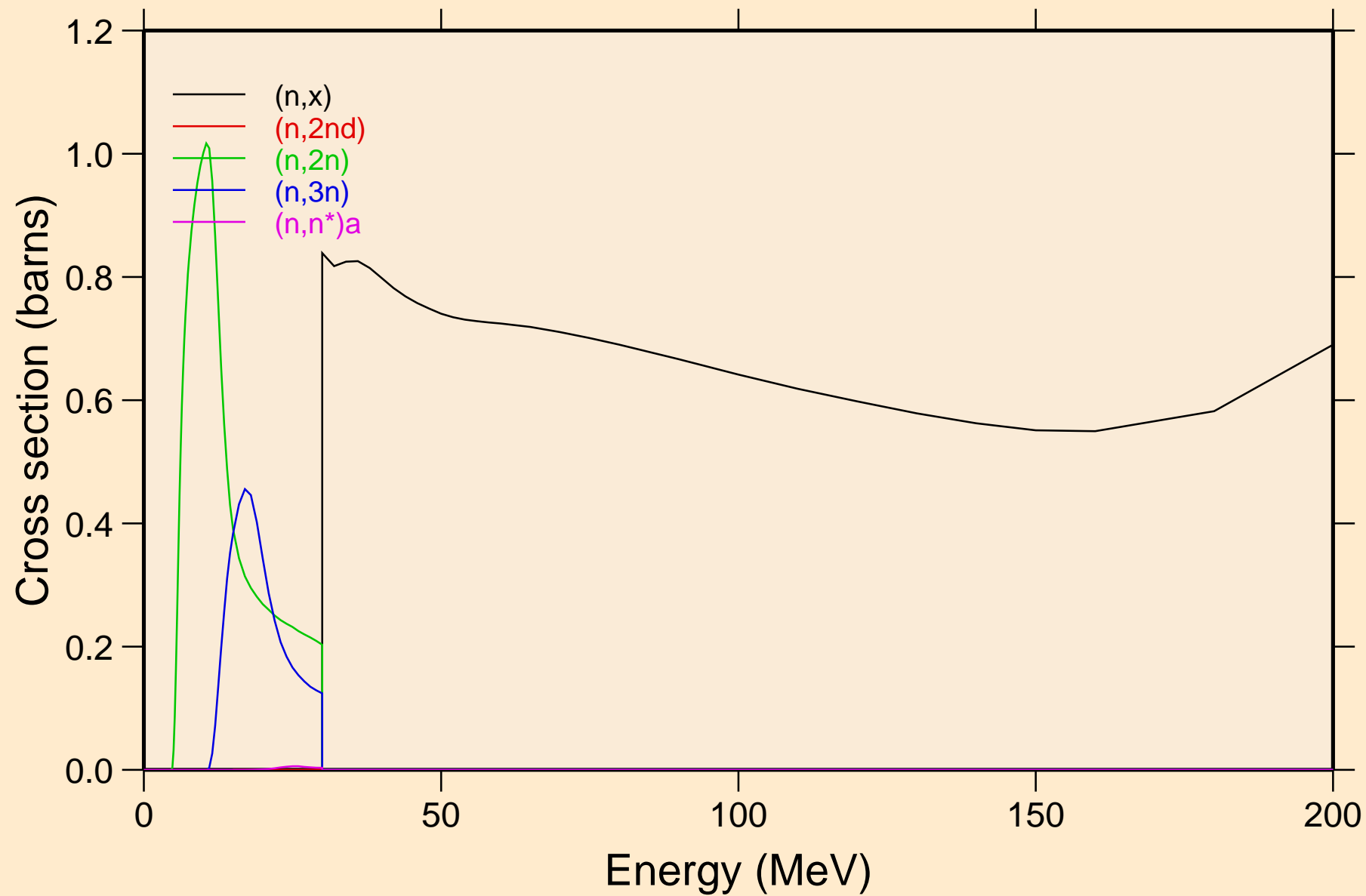

# CF255 NRG TENDL-2015, AKONING

## Threshold reactions

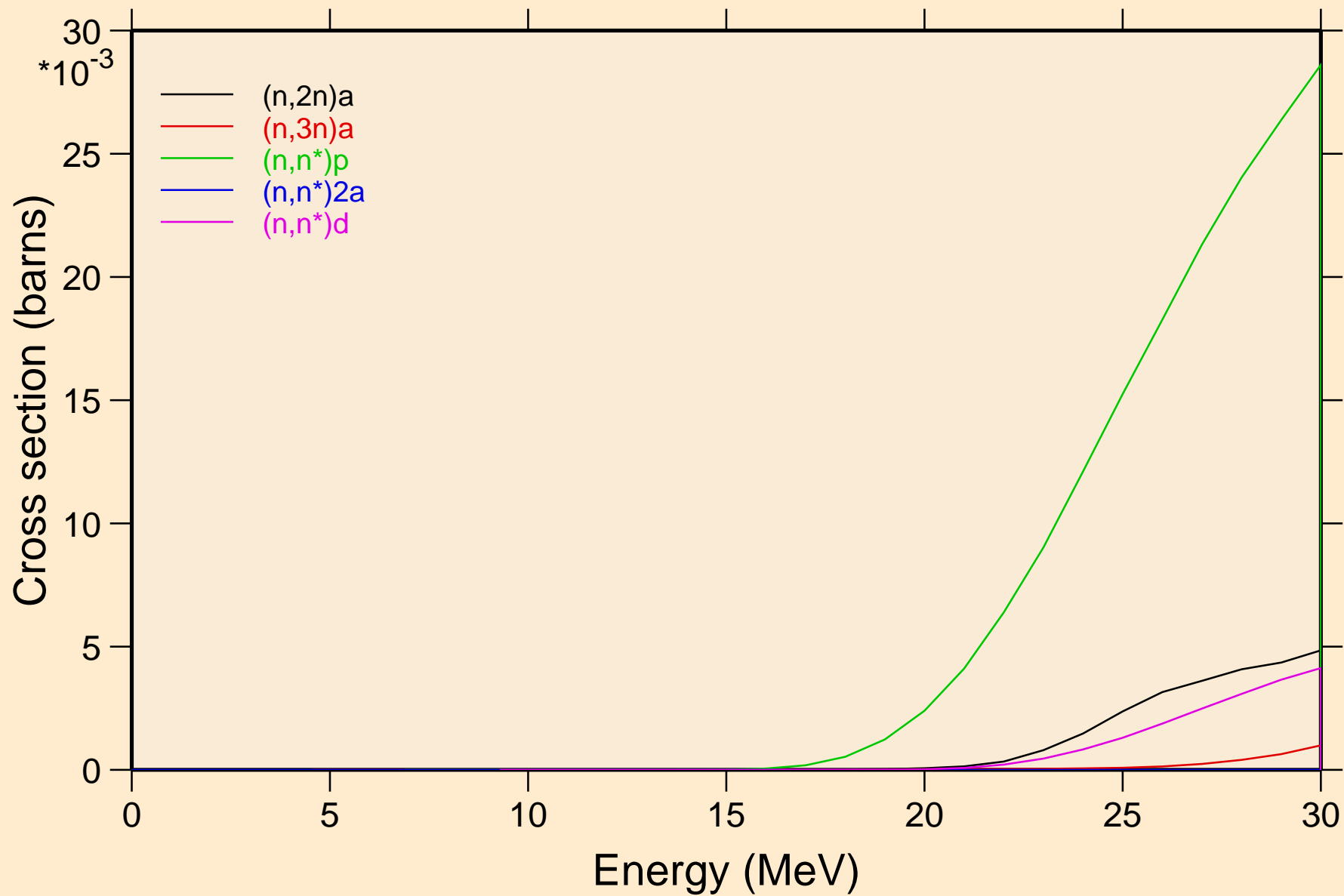

# CF255 NRG TENDL-2015, AKONING

## Threshold reactions

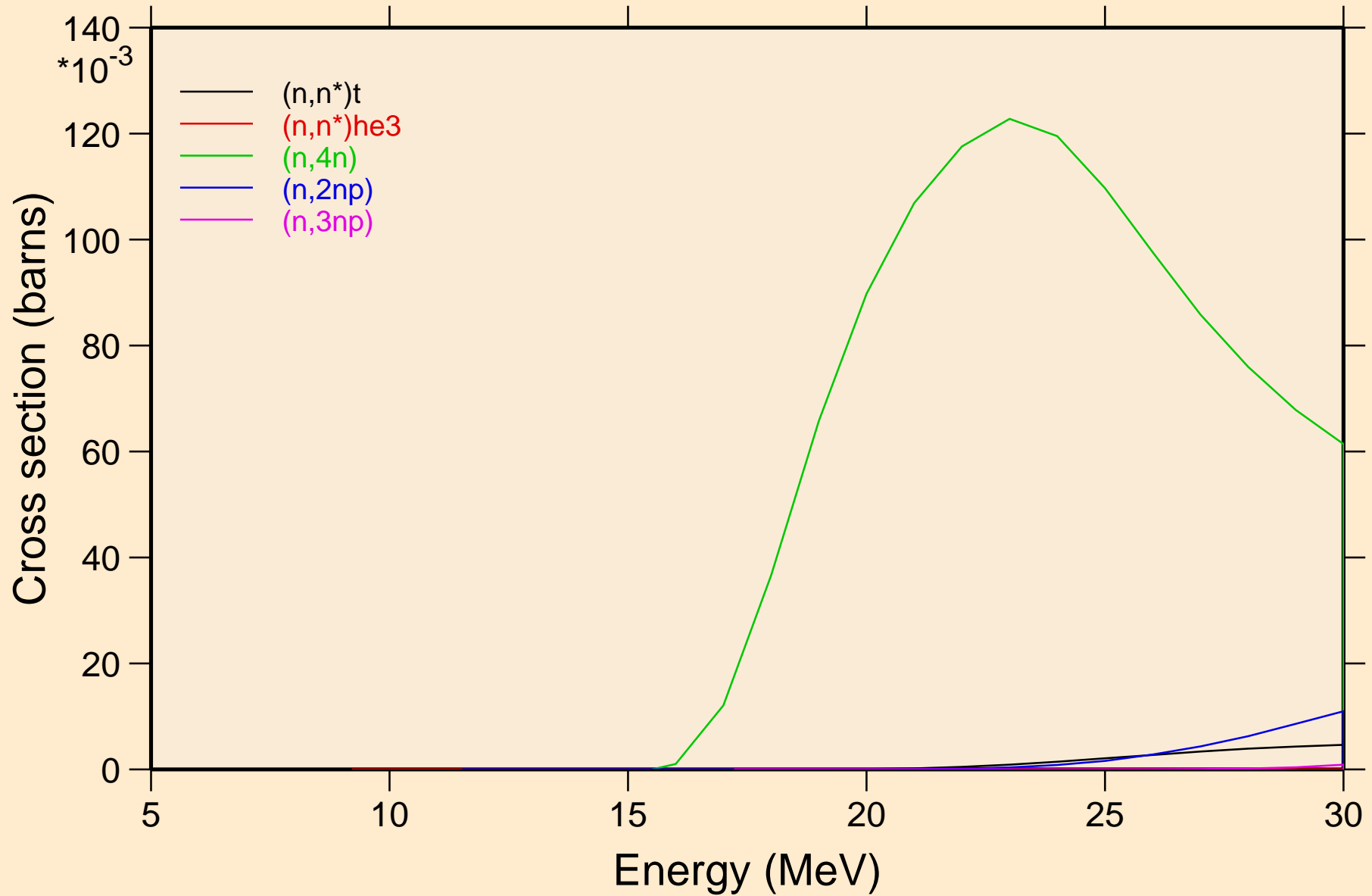



# CF255 NRG TENDL-2015, AKONING

## Threshold reactions

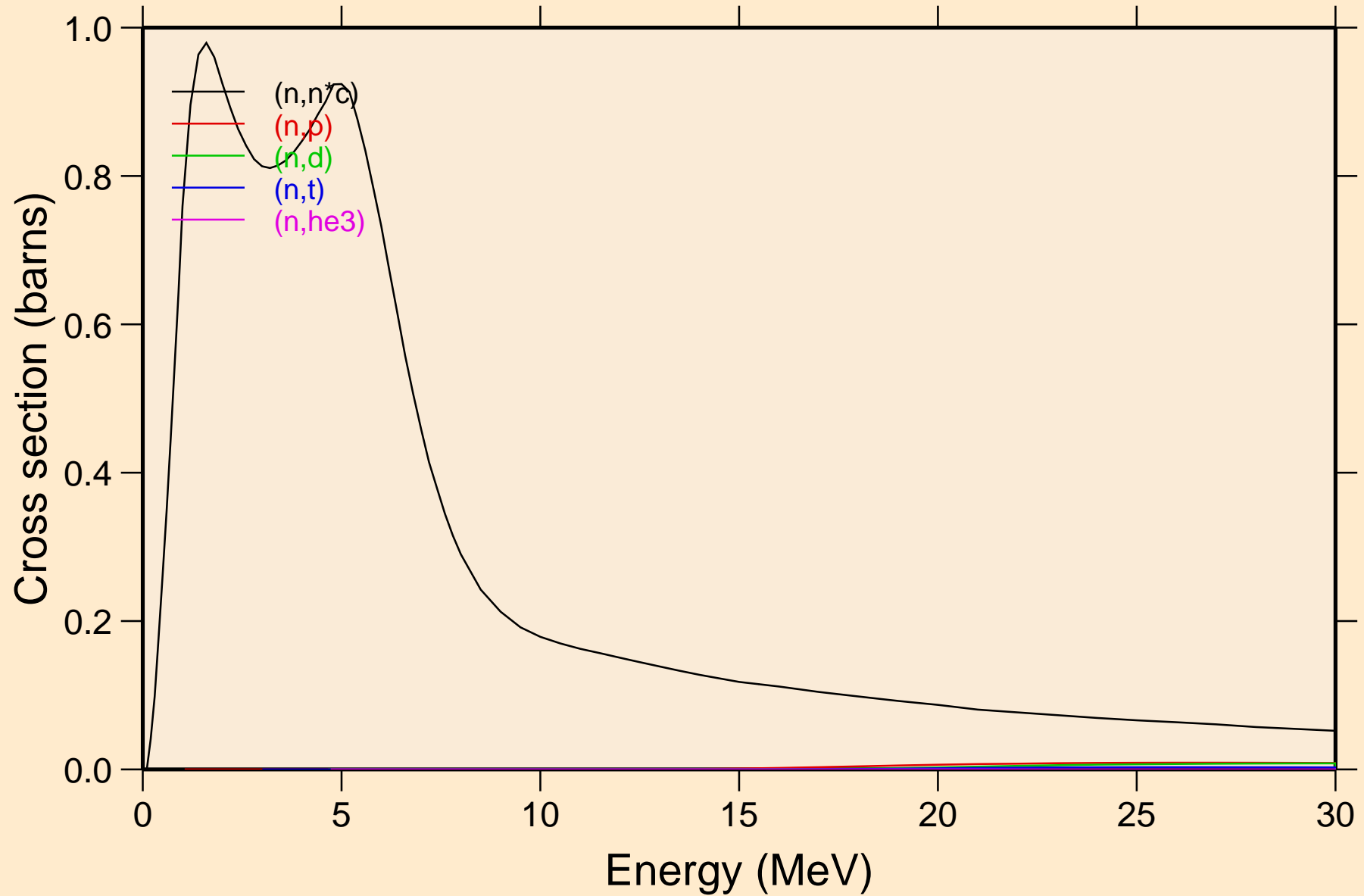

# CF255 NRG TENDL-2015, AKONING

## Threshold reactions

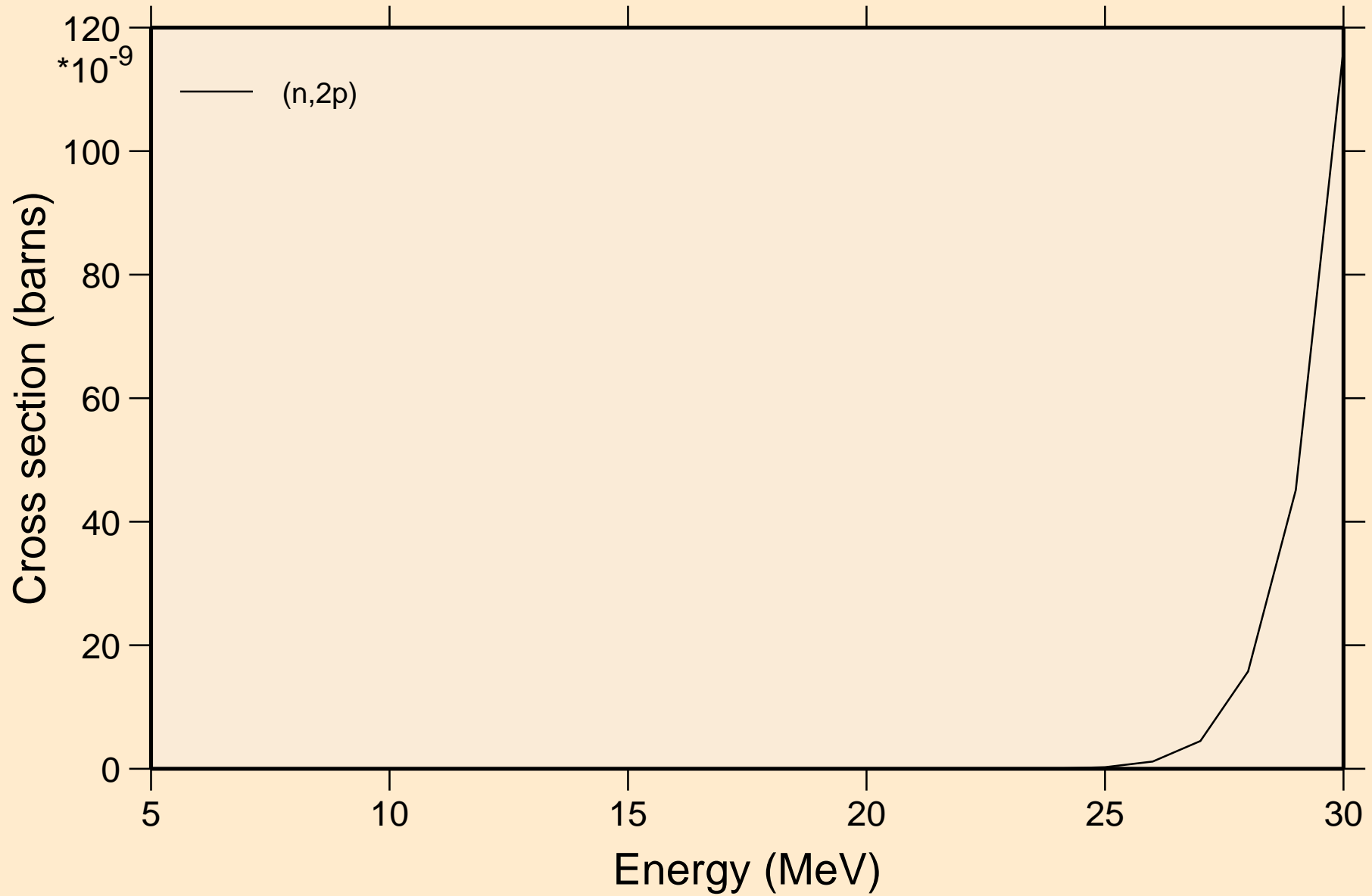

CF255 NRG TENDL-2015, AKONING  
angular distribution for elastic

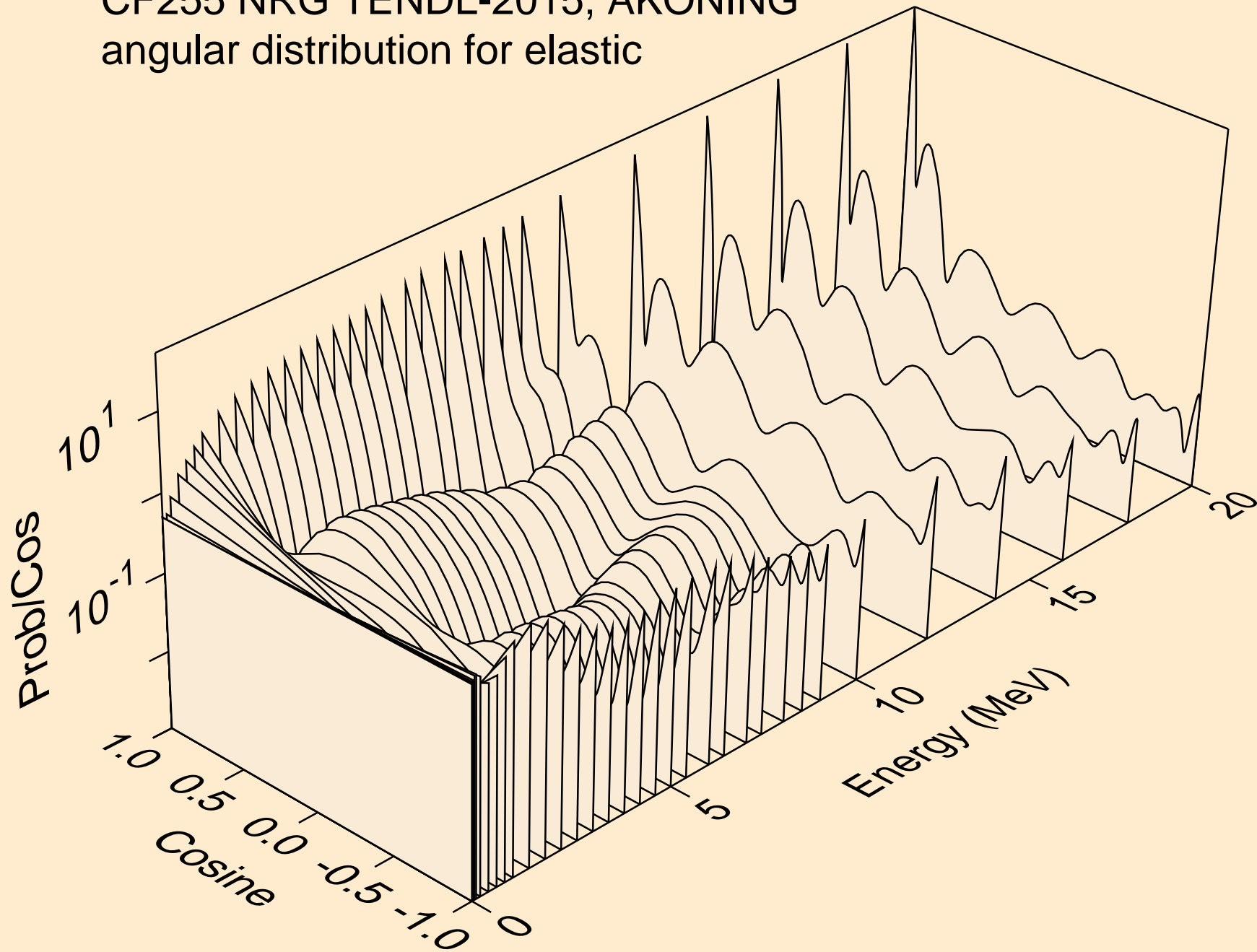

CF255 NRG TENDL-2015, AKONING  
angular distribution for elastic

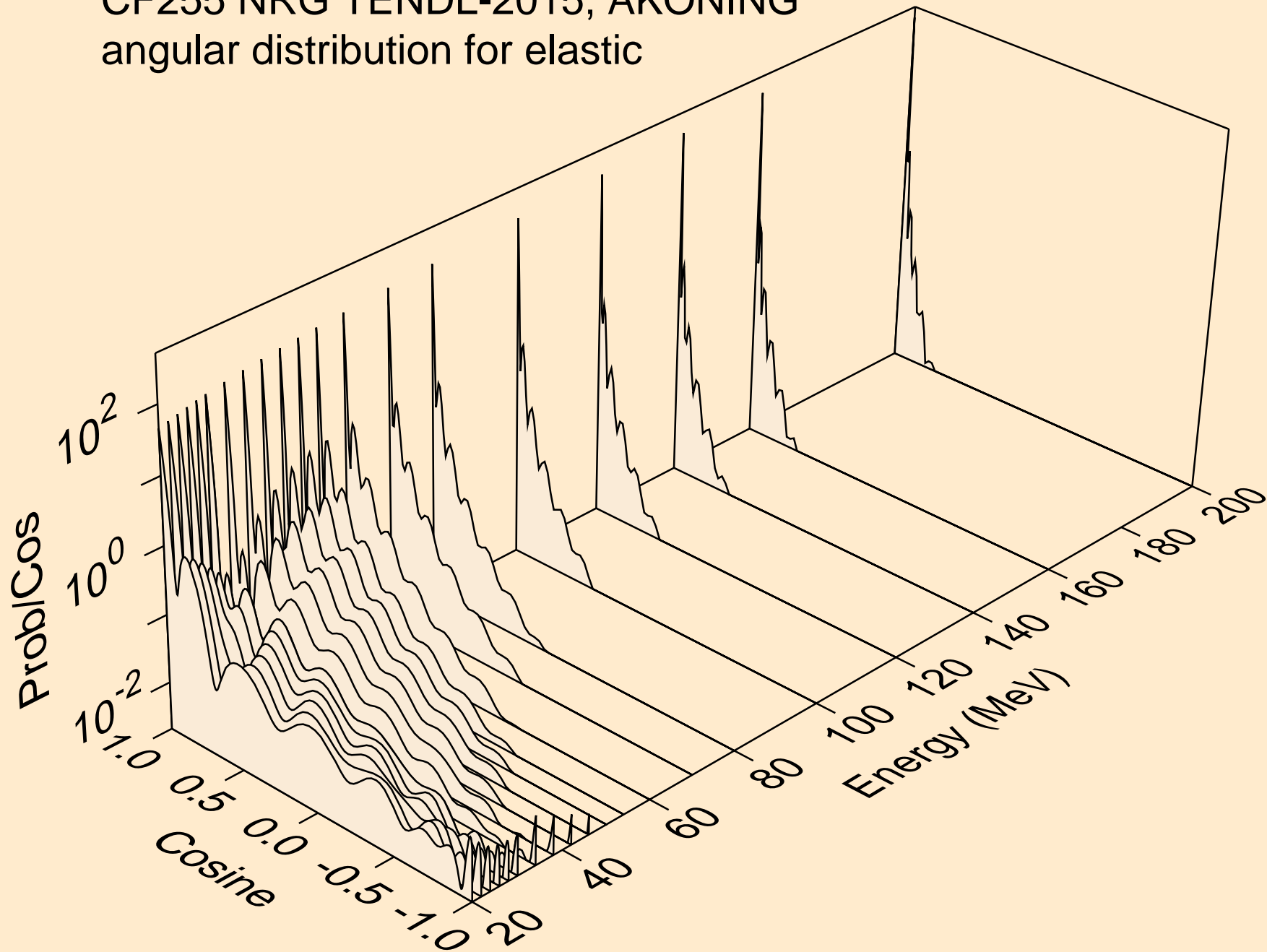

CF255 NRG TENDL-2015, AKONING  
angular distribution for (n,n\*1)

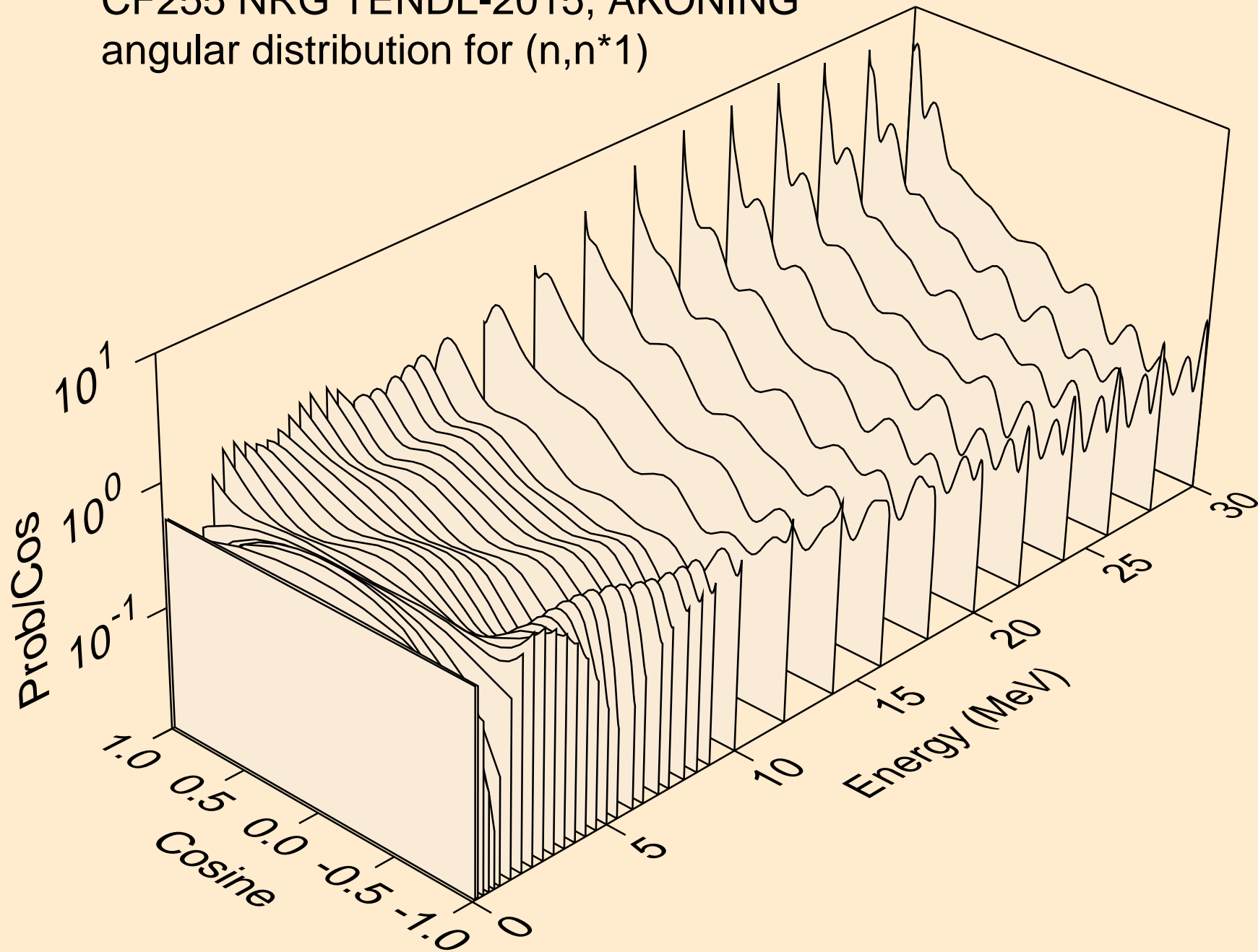

# CF255 NRG TENDL-2015, AKONING

Total fission nubar

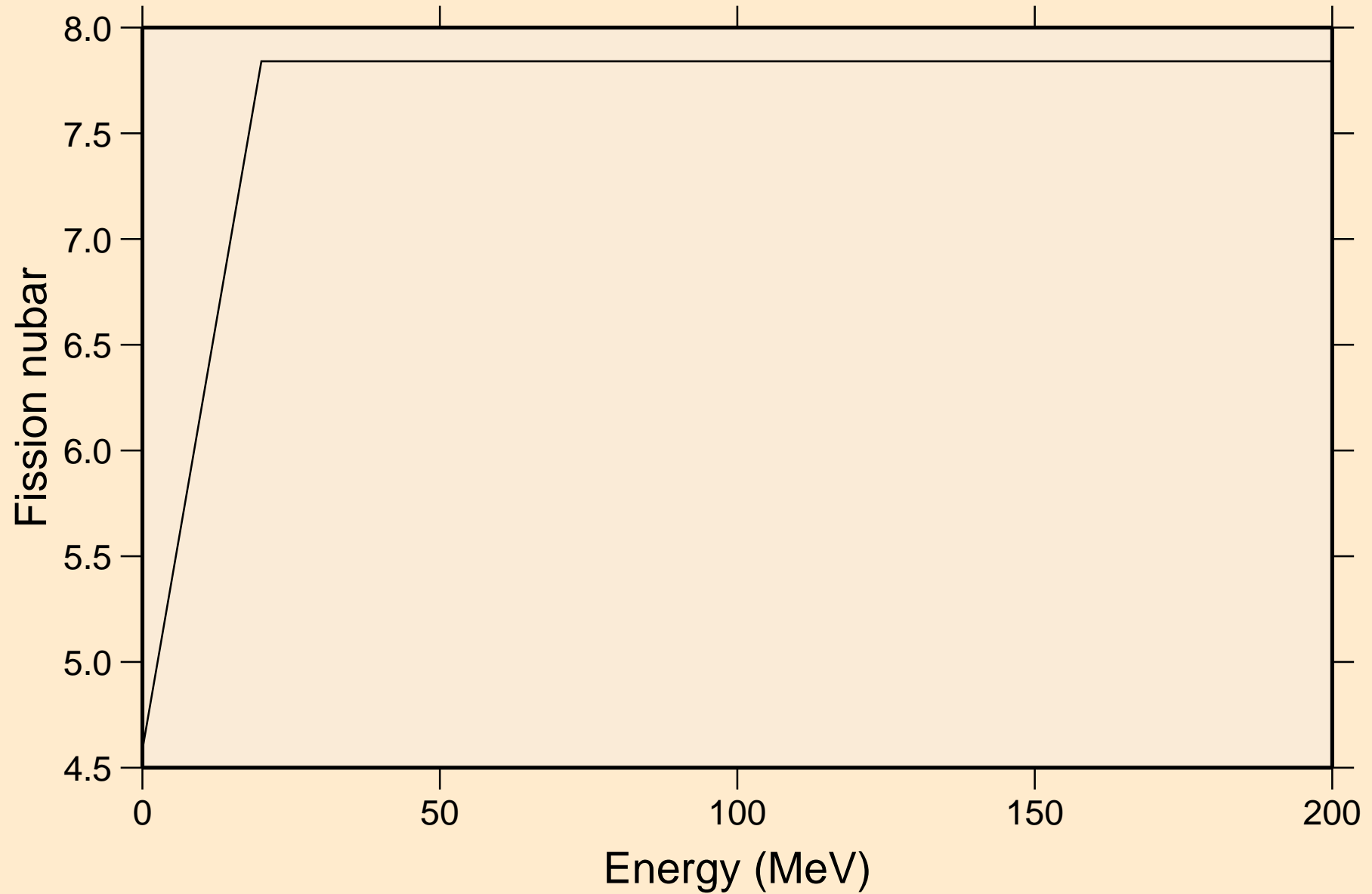

CF255 NRG TENDL-2015, AKONING  
Neutron emission for (n,x)

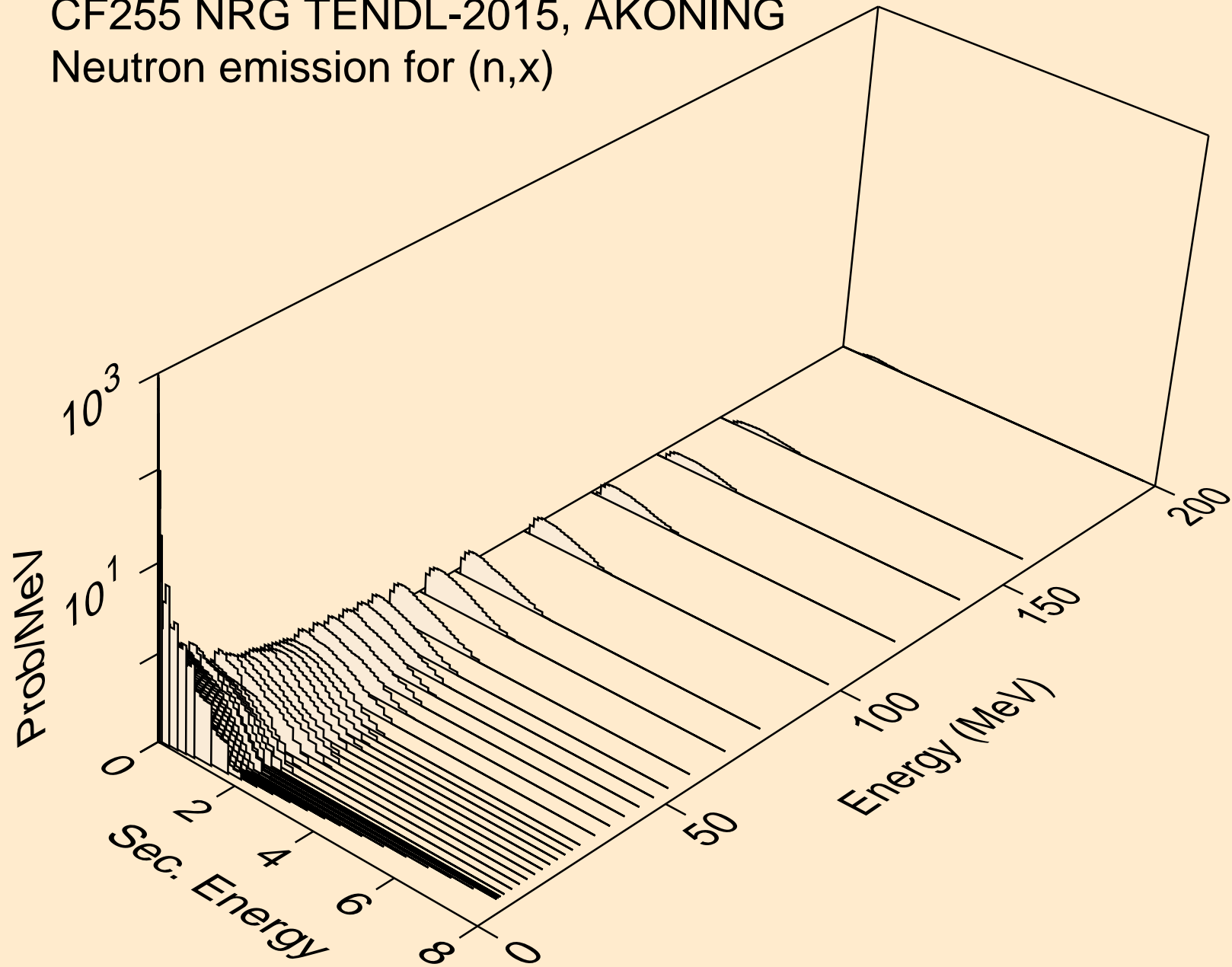

CF255 NRG TENDL-2015, AKONING  
Neutron emission for (n,2nd)

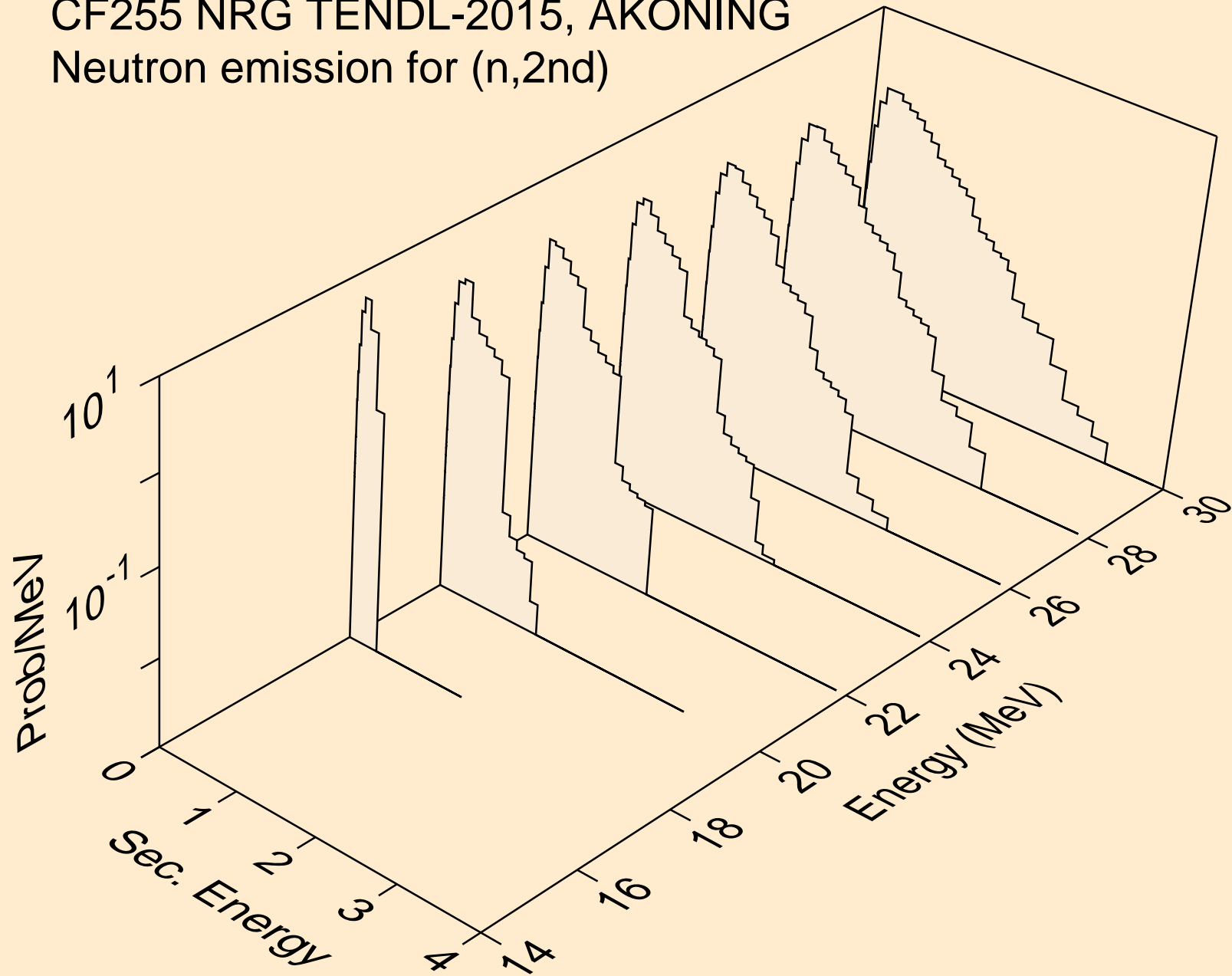



CF255 NRG TENDL-2015, AKONING  
Neutron emission for (n,2n)

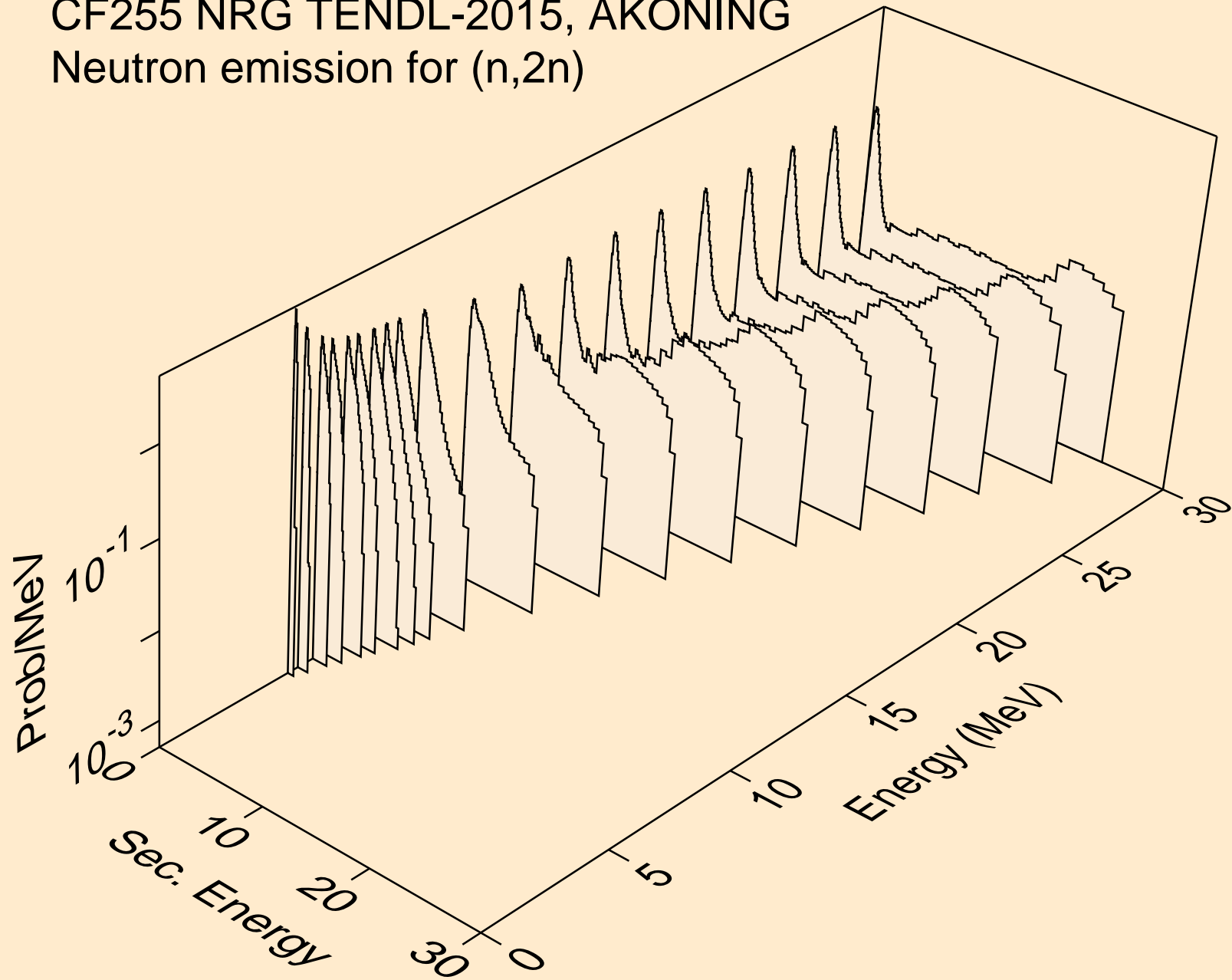

CF255 NRG TENDL-2015, AKONING  
Neutron emission for (n,3n)

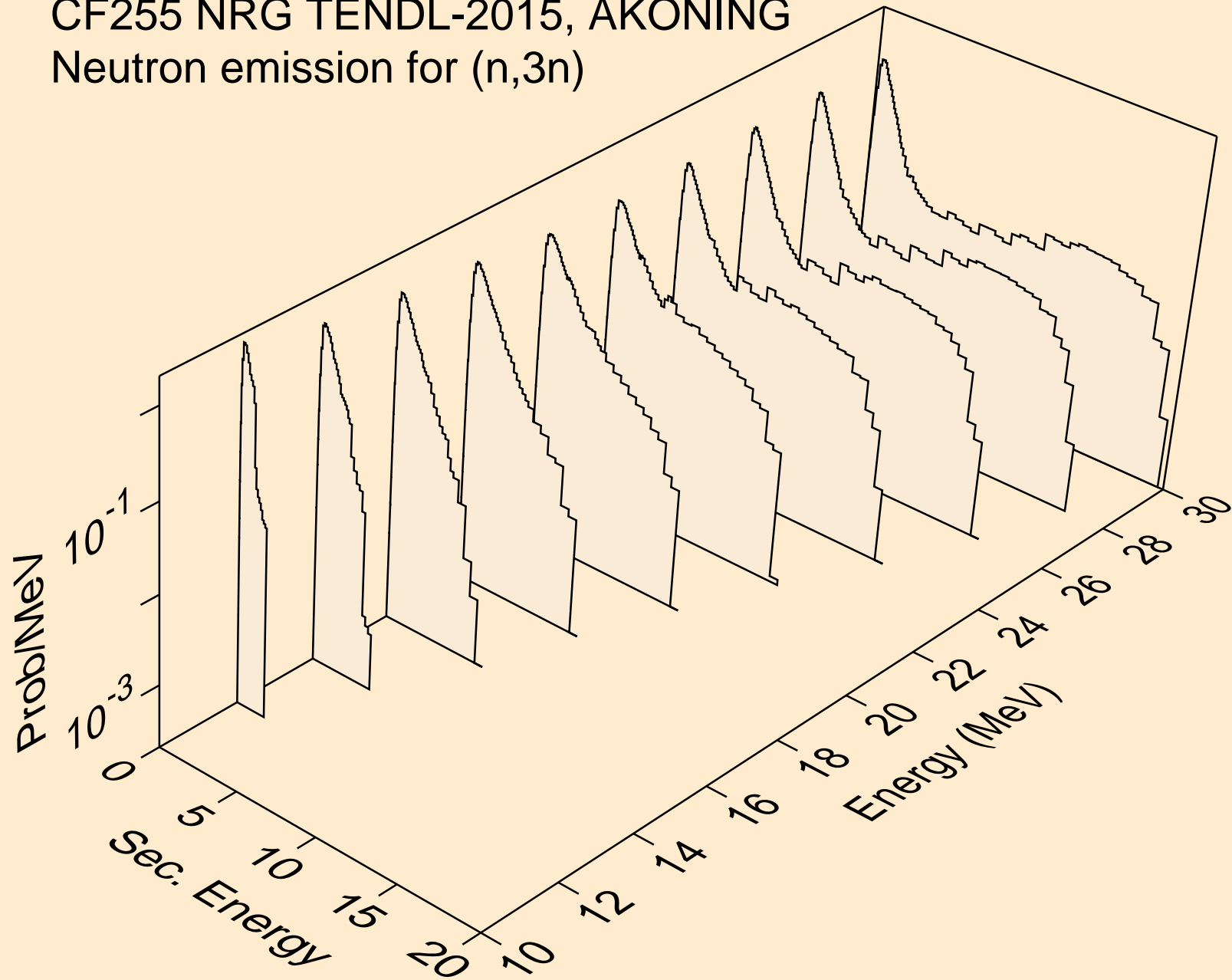

CF255 NRG TENDL-2015, AKONING  
Neutron emission for fission

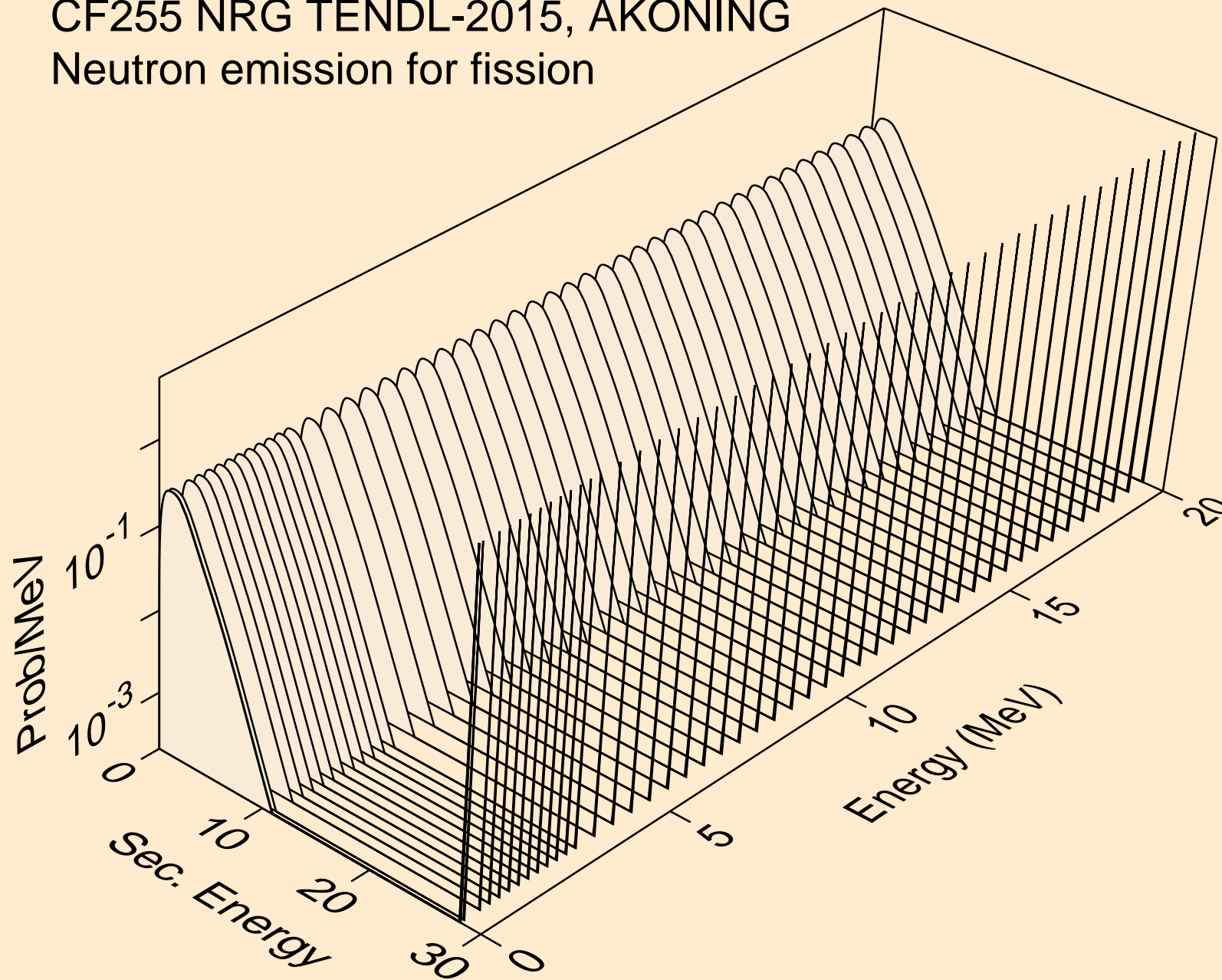

CF255 NRG TENDL-2015, AKONING  
Neutron emission for (n,n\*)a

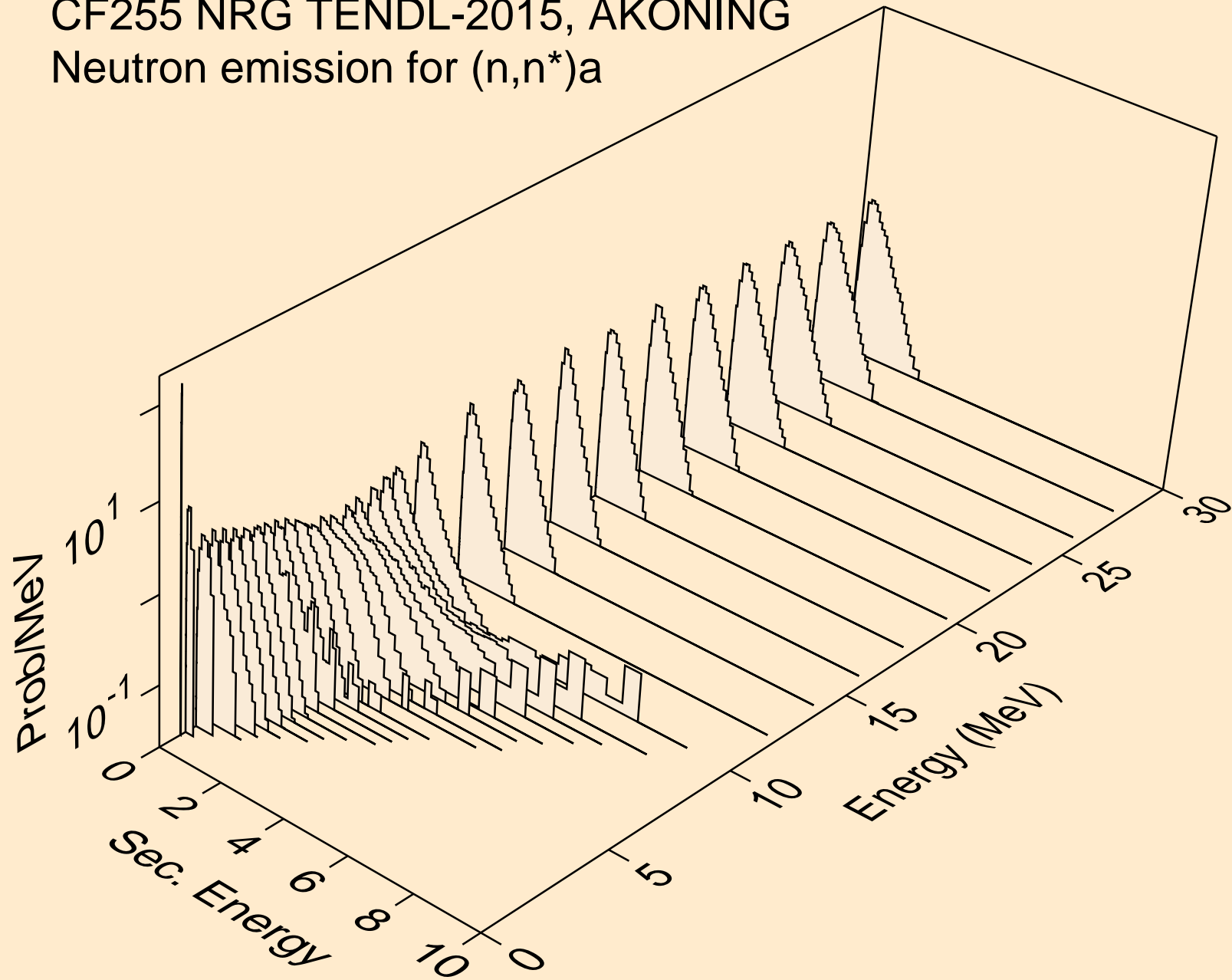

CF255 NRG TENDL-2015, AKONING  
Neutron emission for (n,2n)a

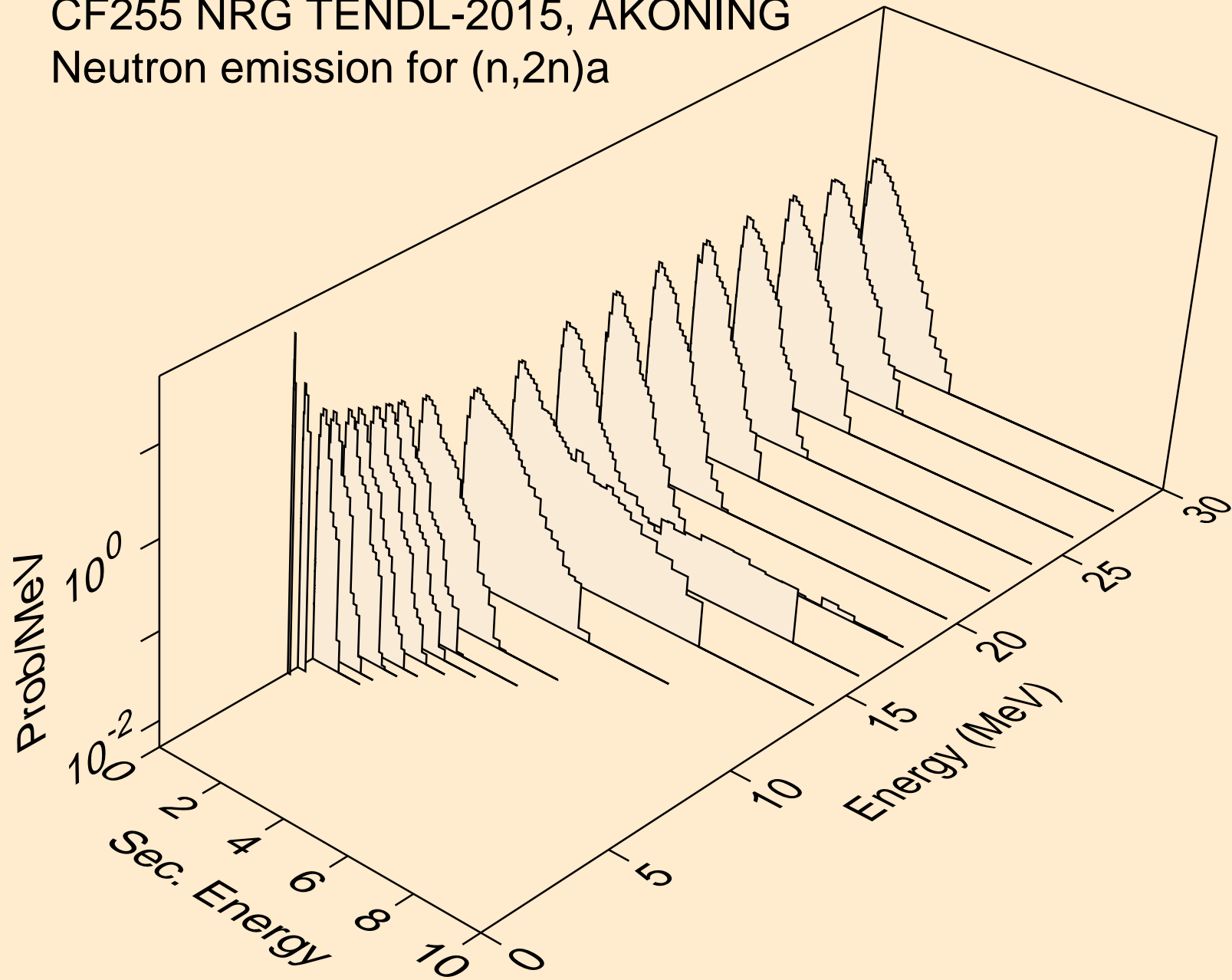

CF255 NRG TENDL-2015, AKONING  
Neutron emission for (n,3n)a

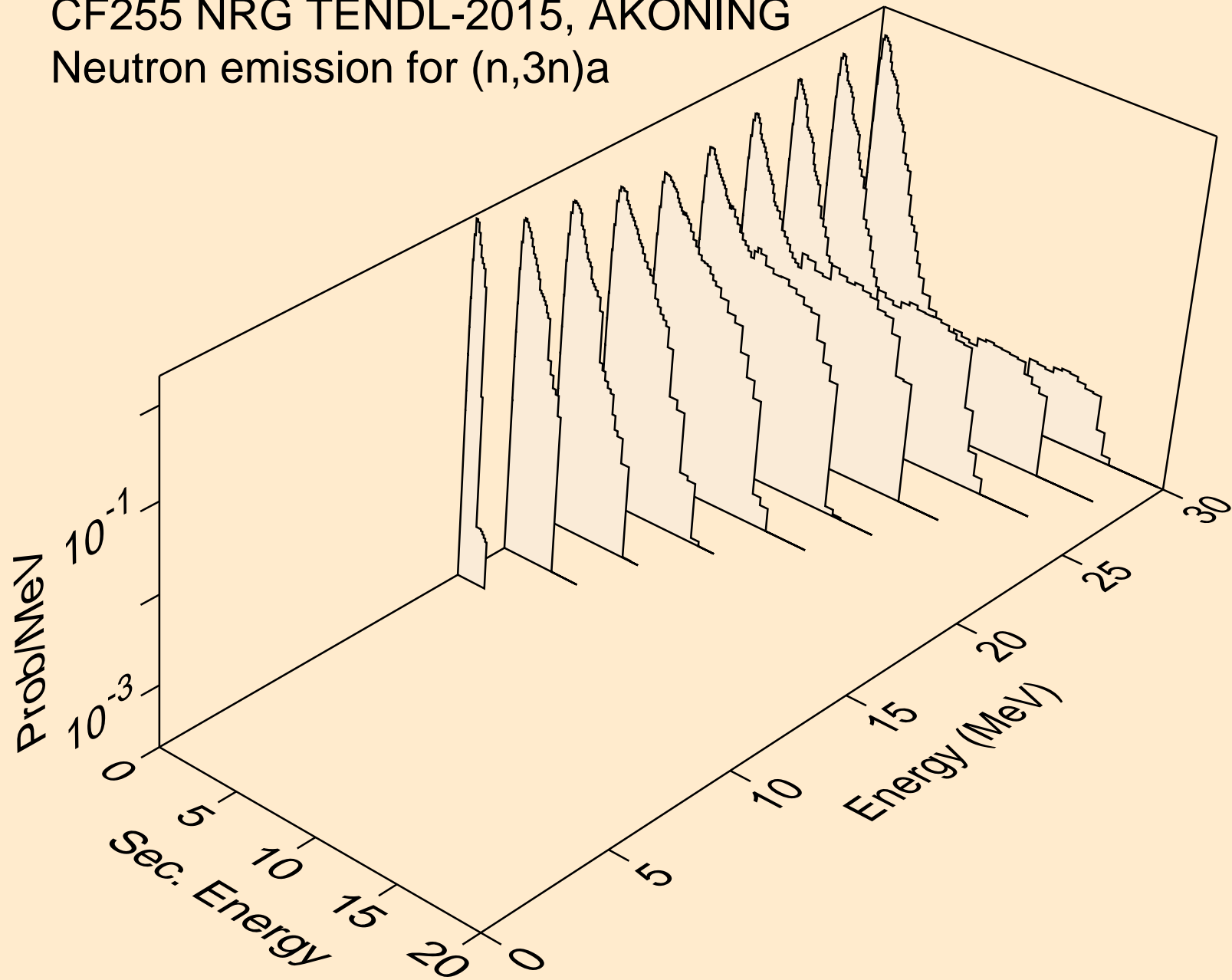

CF255 NRG TENDL-2015, AKONING  
Neutron emission for (n,n\*)p

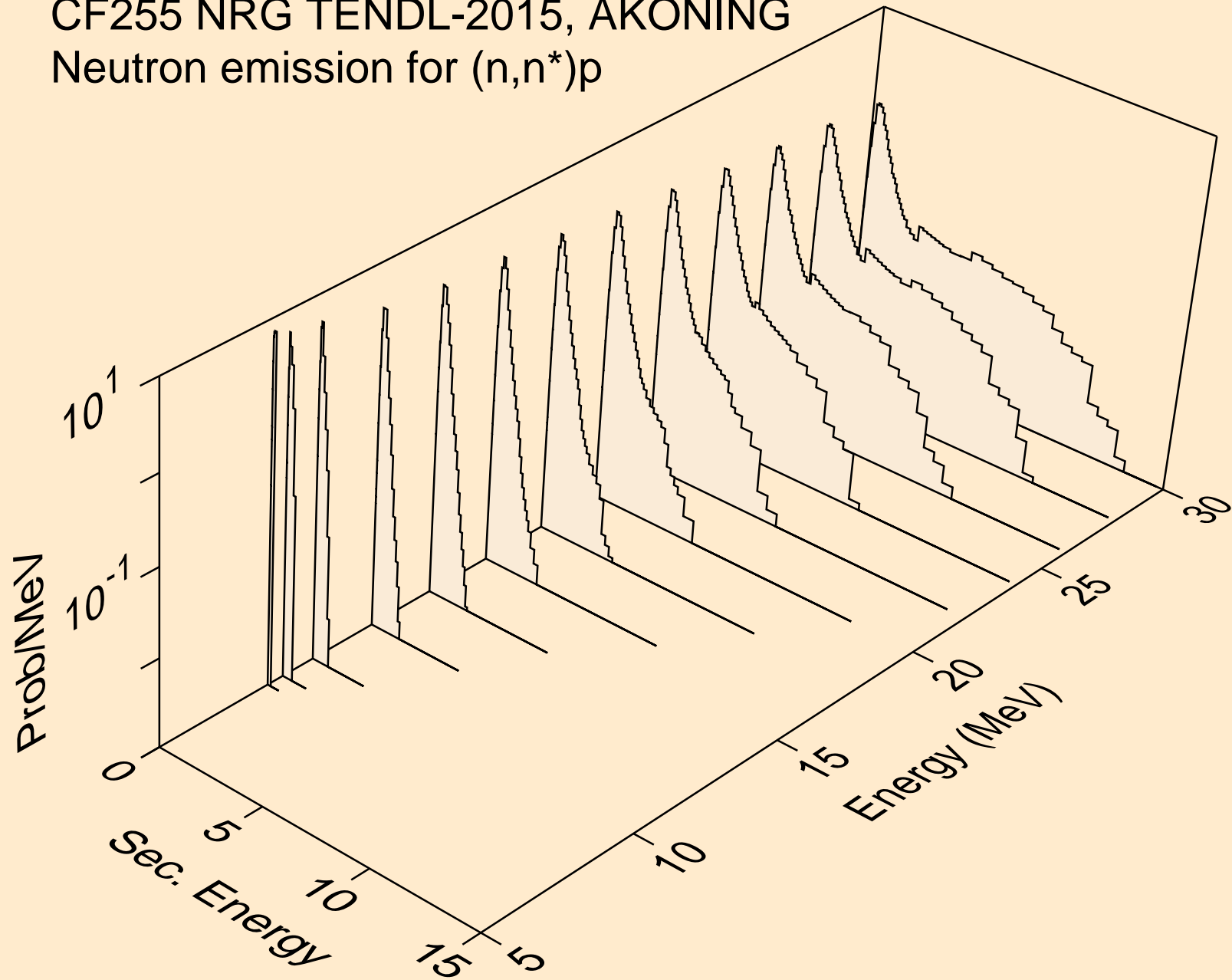

CF255 NRG TENDL-2015, AKONING  
Neutron emission for (n,n\*)2a

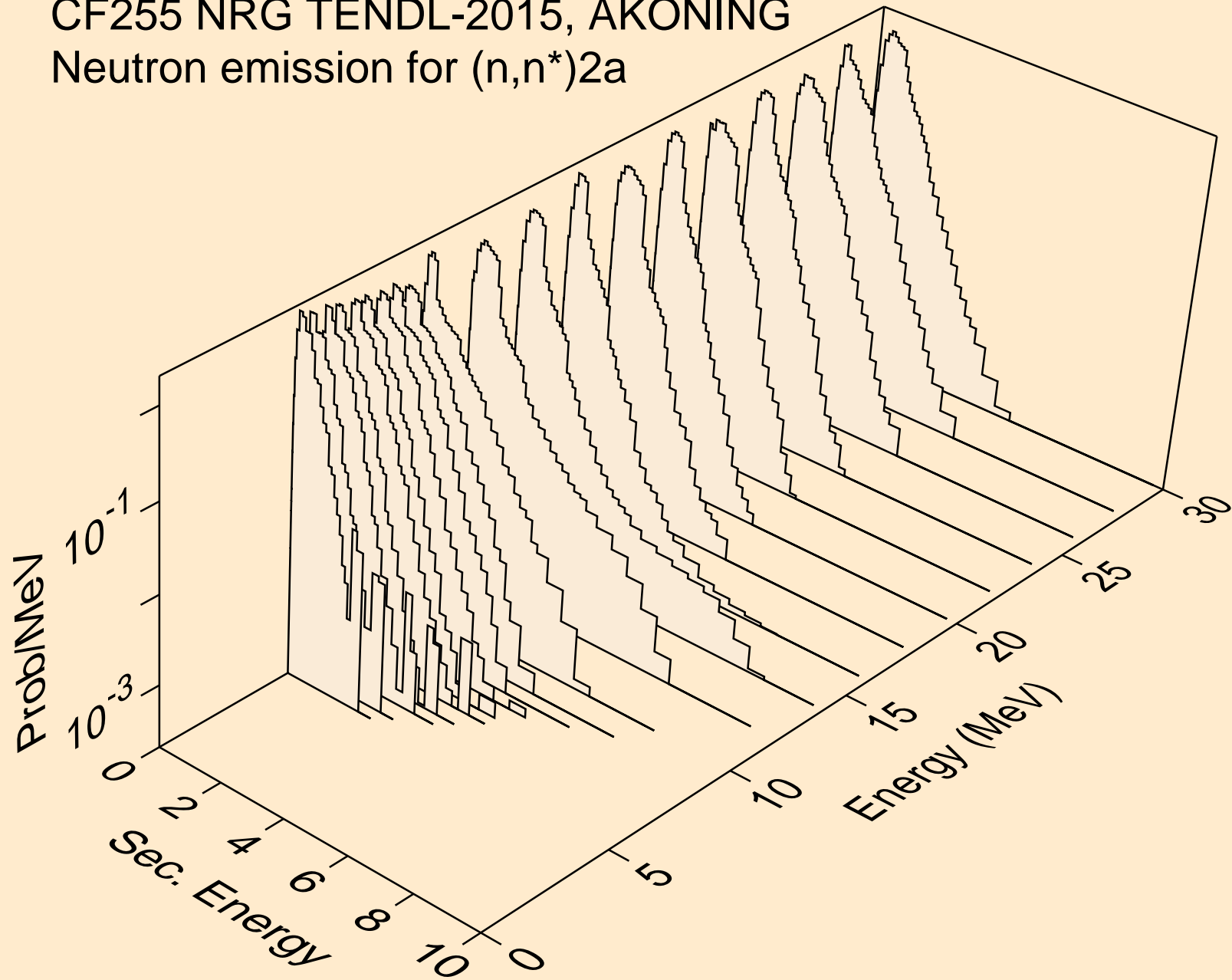



CF255 NRG TENDL-2015, AKONING  
Neutron emission for (n,n\*)d

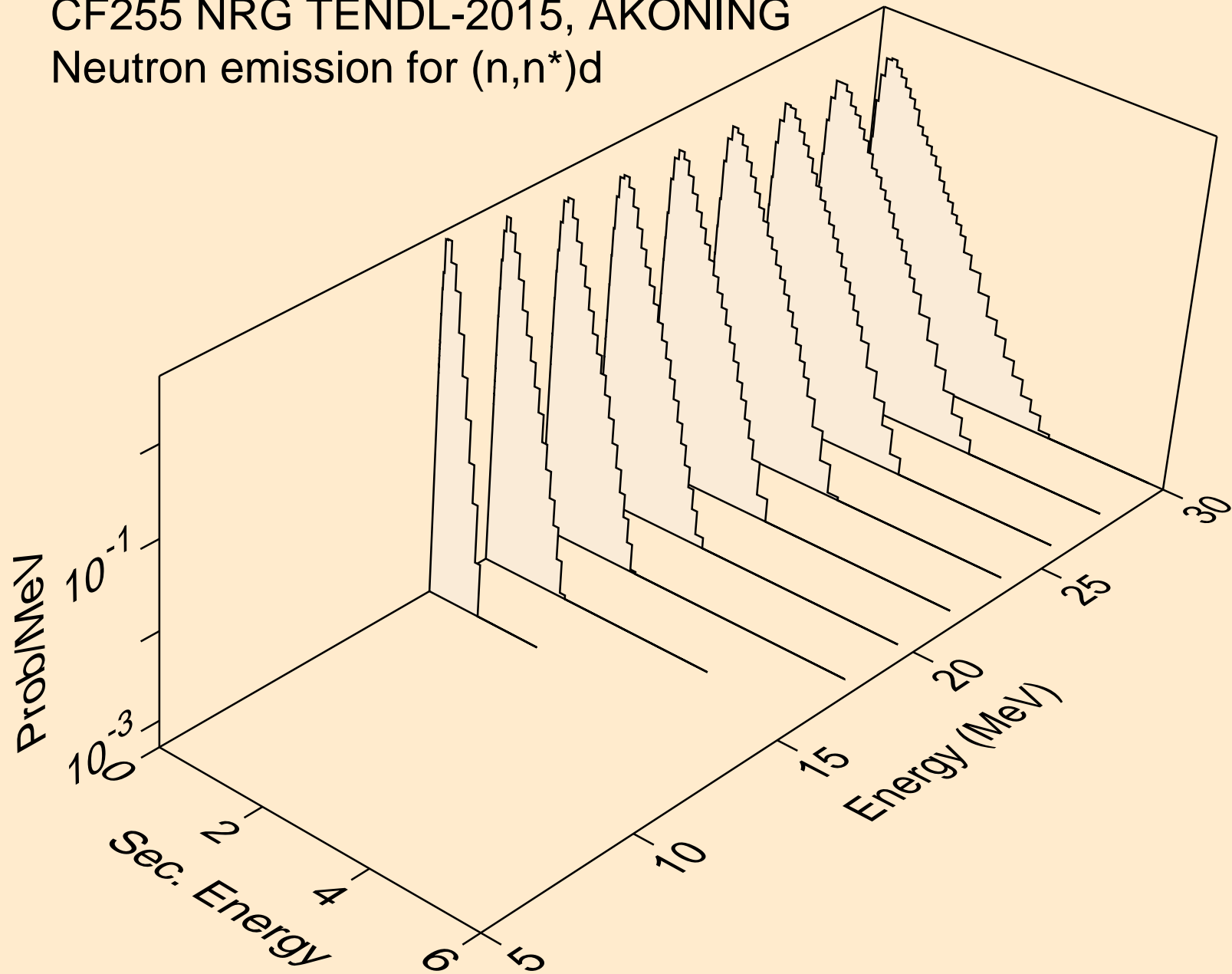

CF255 NRG TENDL-2015, AKONING  
Neutron emission for (n,n\*)t

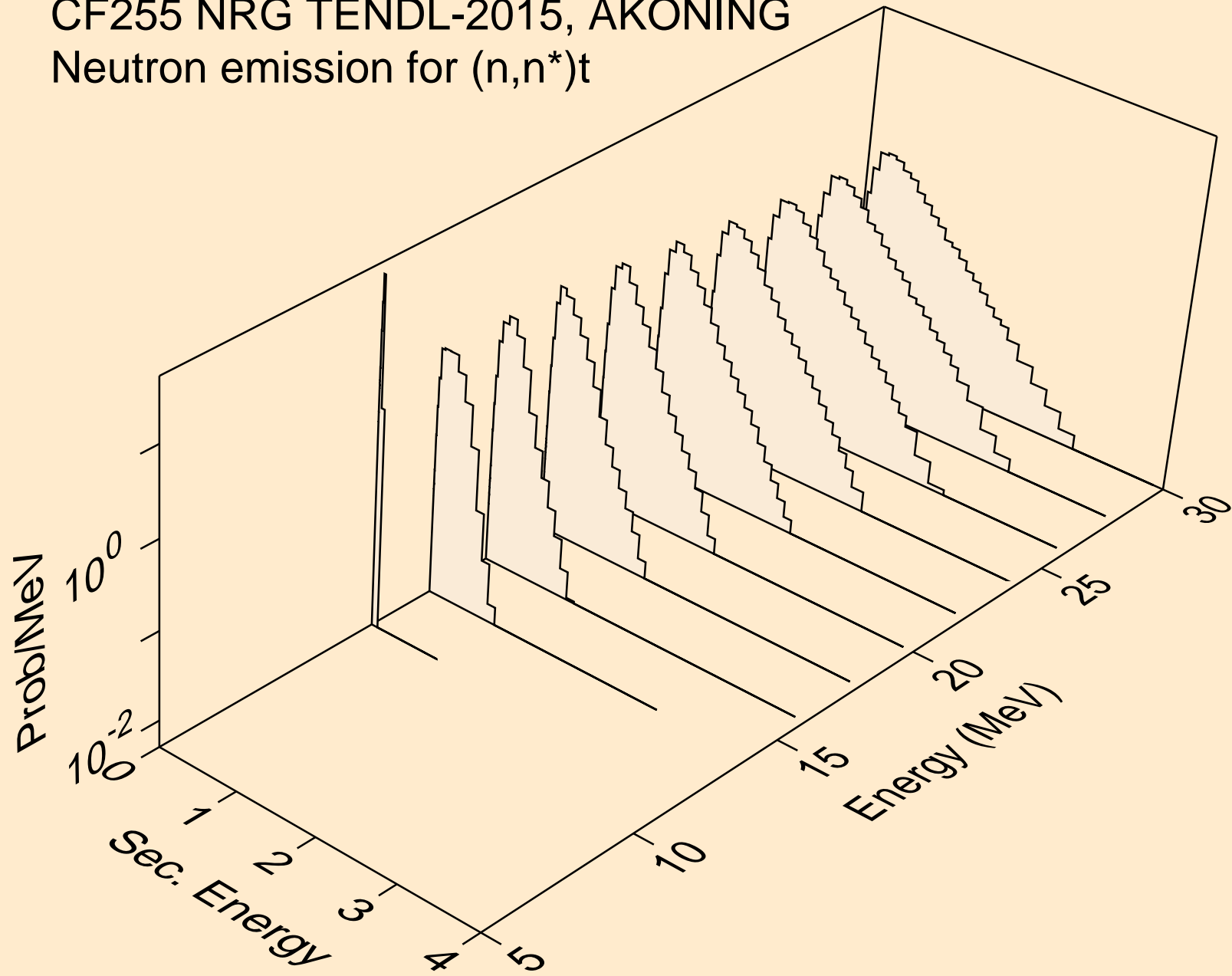

CF255 NRG TENDL-2015, AKONING  
Neutron emission for (n,n\*)he3

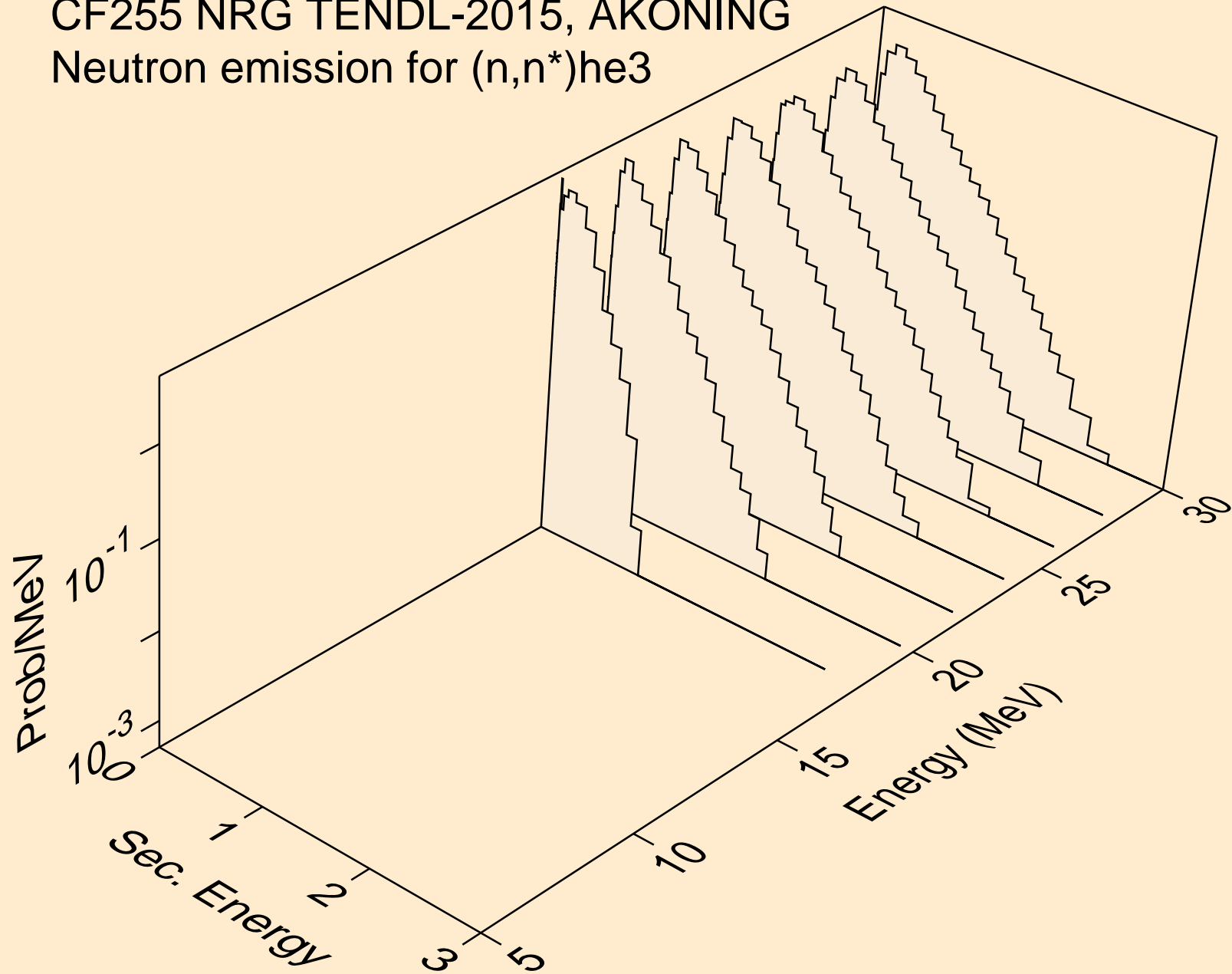

CF255 NRG TENDL-2015, AKONING  
Neutron emission for (n,4n)

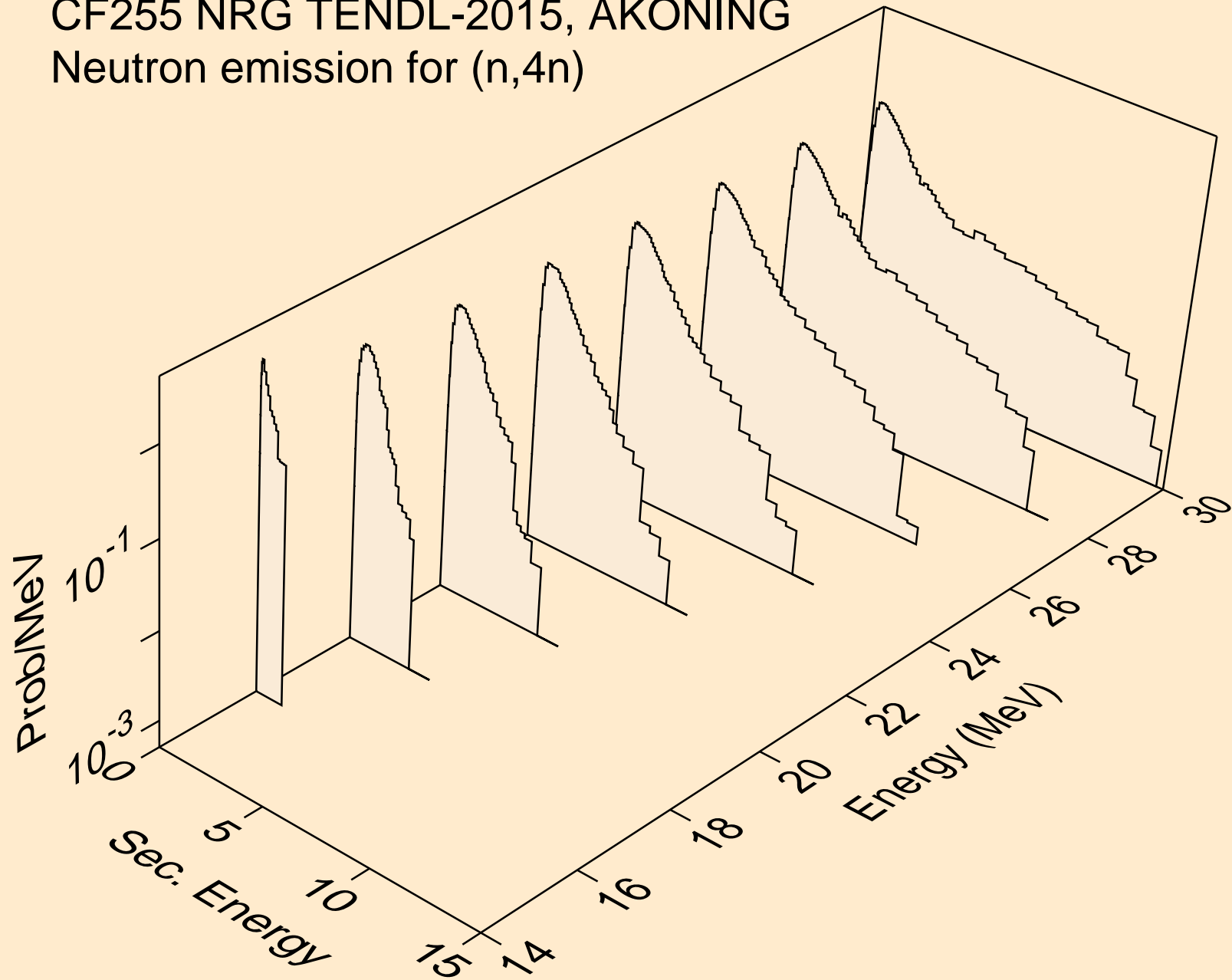

CF255 NRG TENDL-2015, AKONING  
Neutron emission for (n,2np)

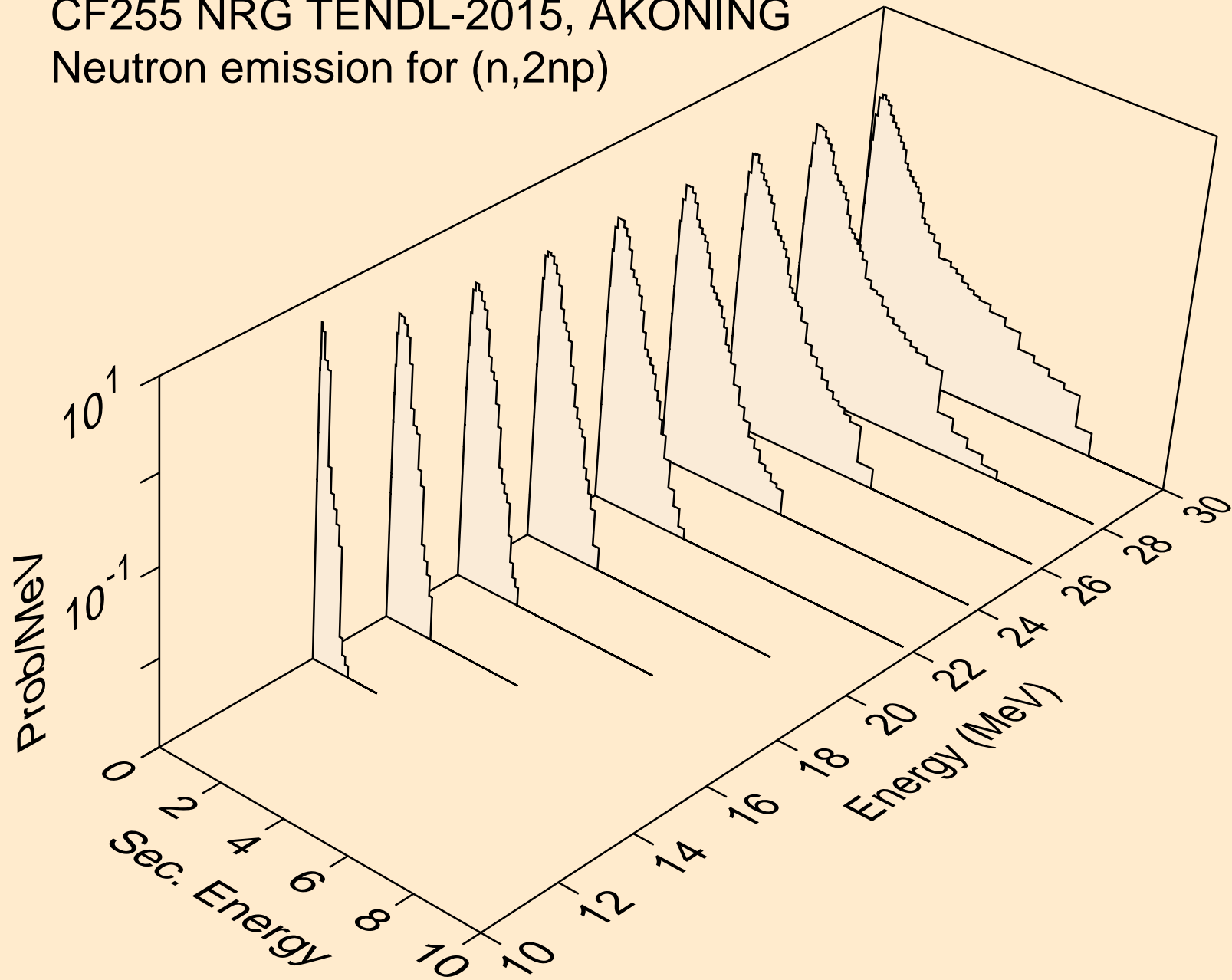

CF255 NRG TENDL-2015, AKONING  
Neutron emission for (n,3np)

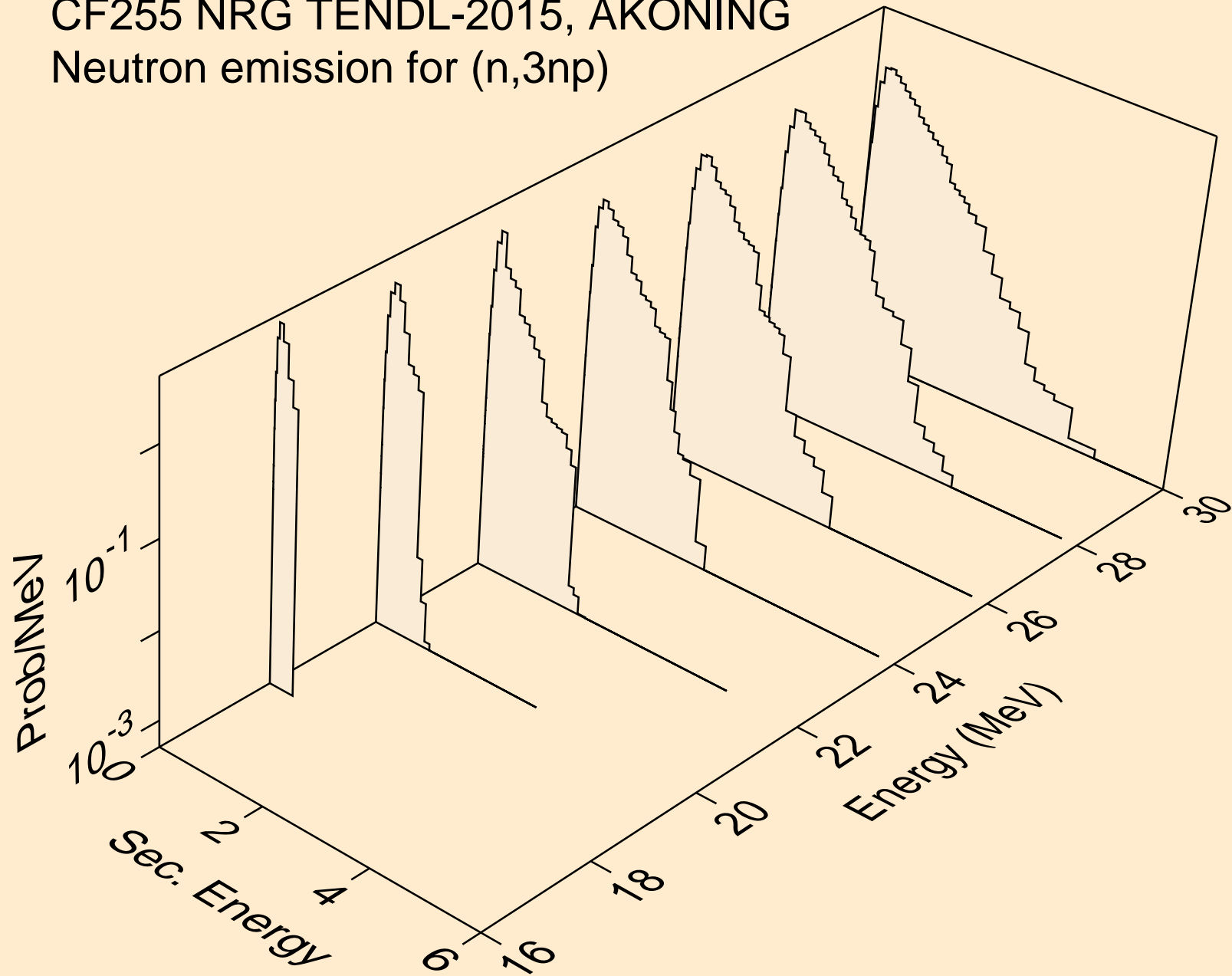

CF255 NRG TENDL-2015, AKONING  
Neutron emission for (n,n\*c)

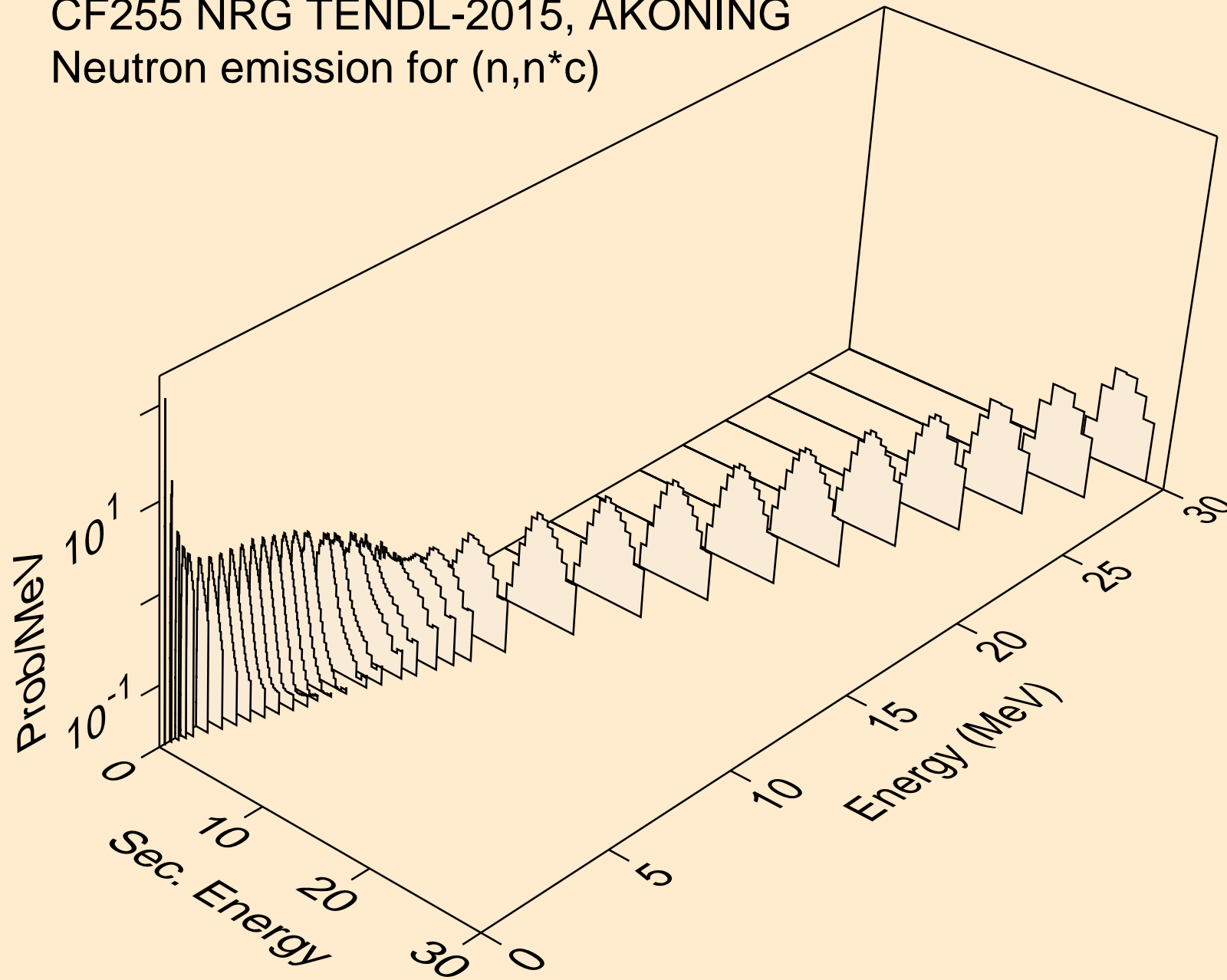

# CF255 NRG TENDL-2015, AKONING

## Delayed nubar

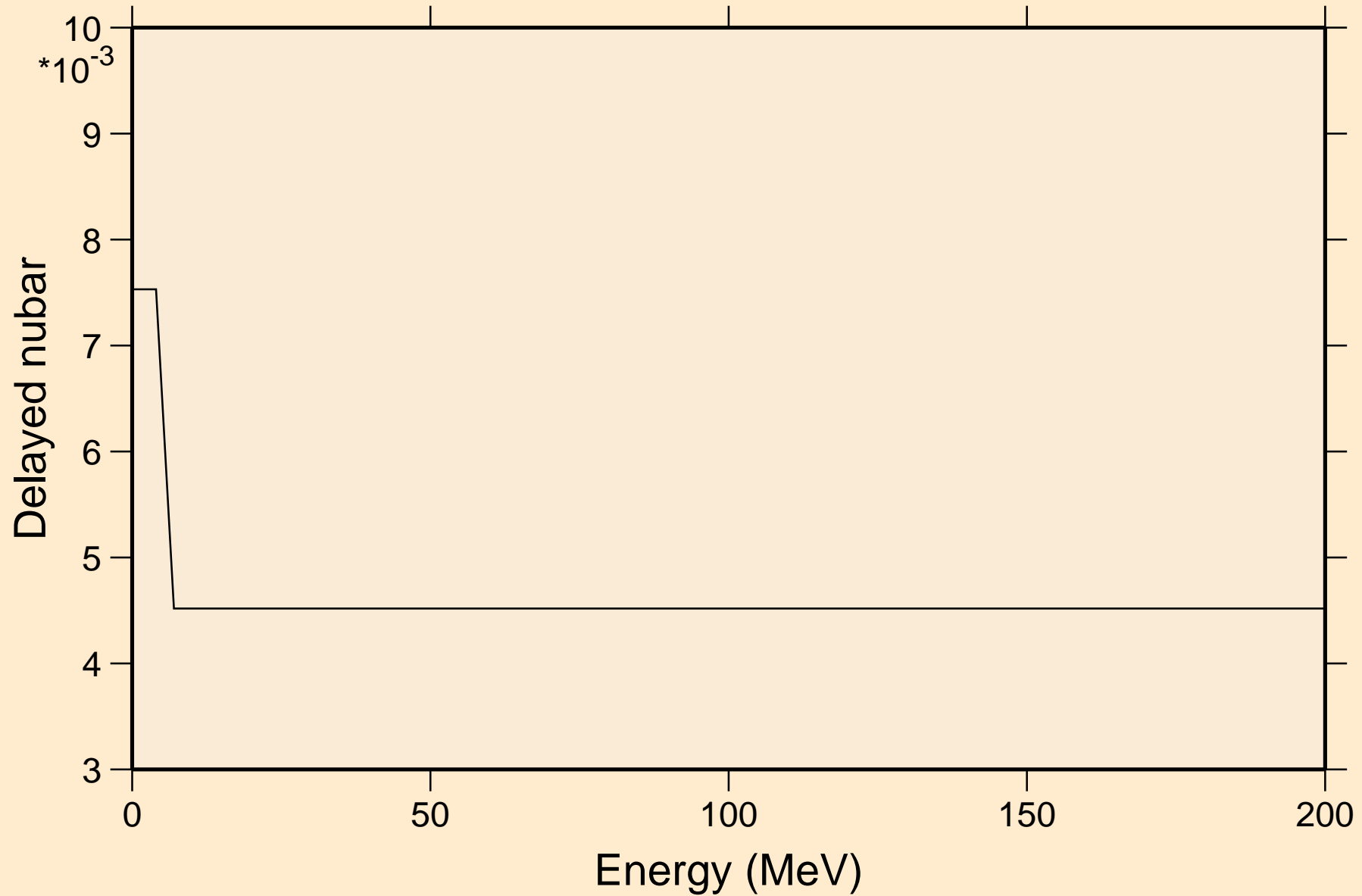



# CF255 NRG TENDL-2015, AKONING

## Delayed neutron spectra

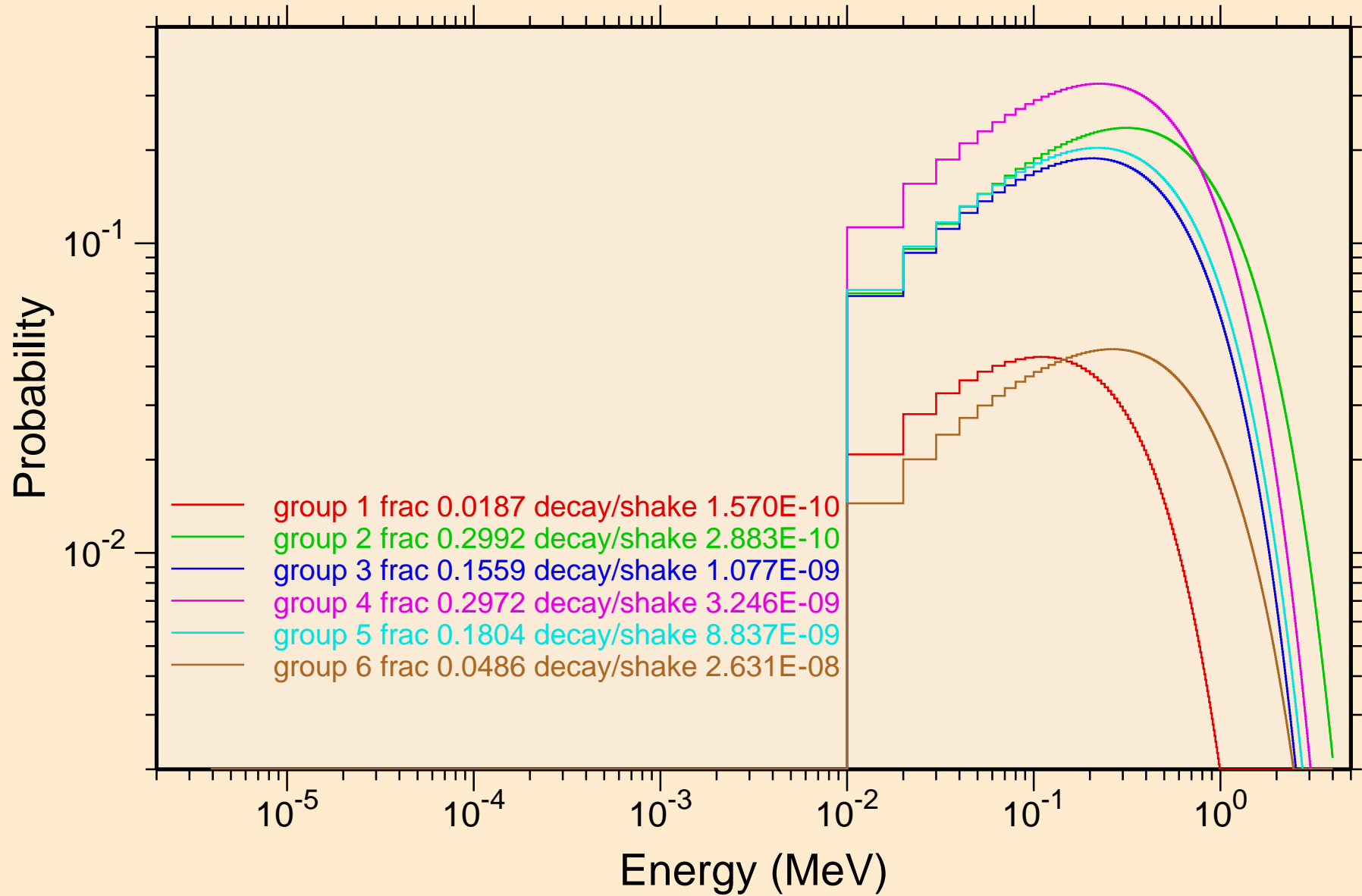

CF255 NRG TENDL-2015, AKONING  
Photon emission for (n,x)

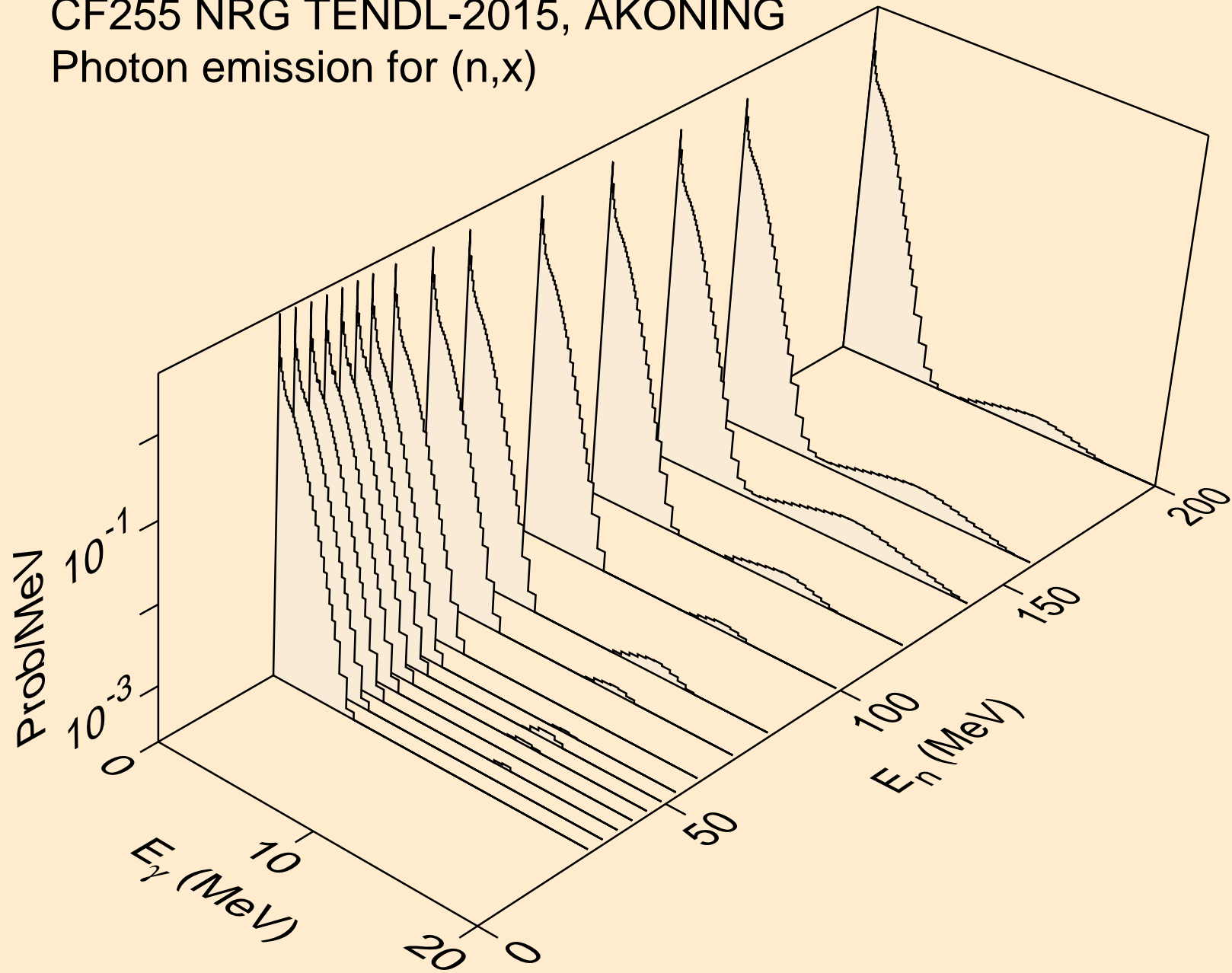

CF255 NRG TENDL-2015, AKONING  
Photon emission for (n,2nd)

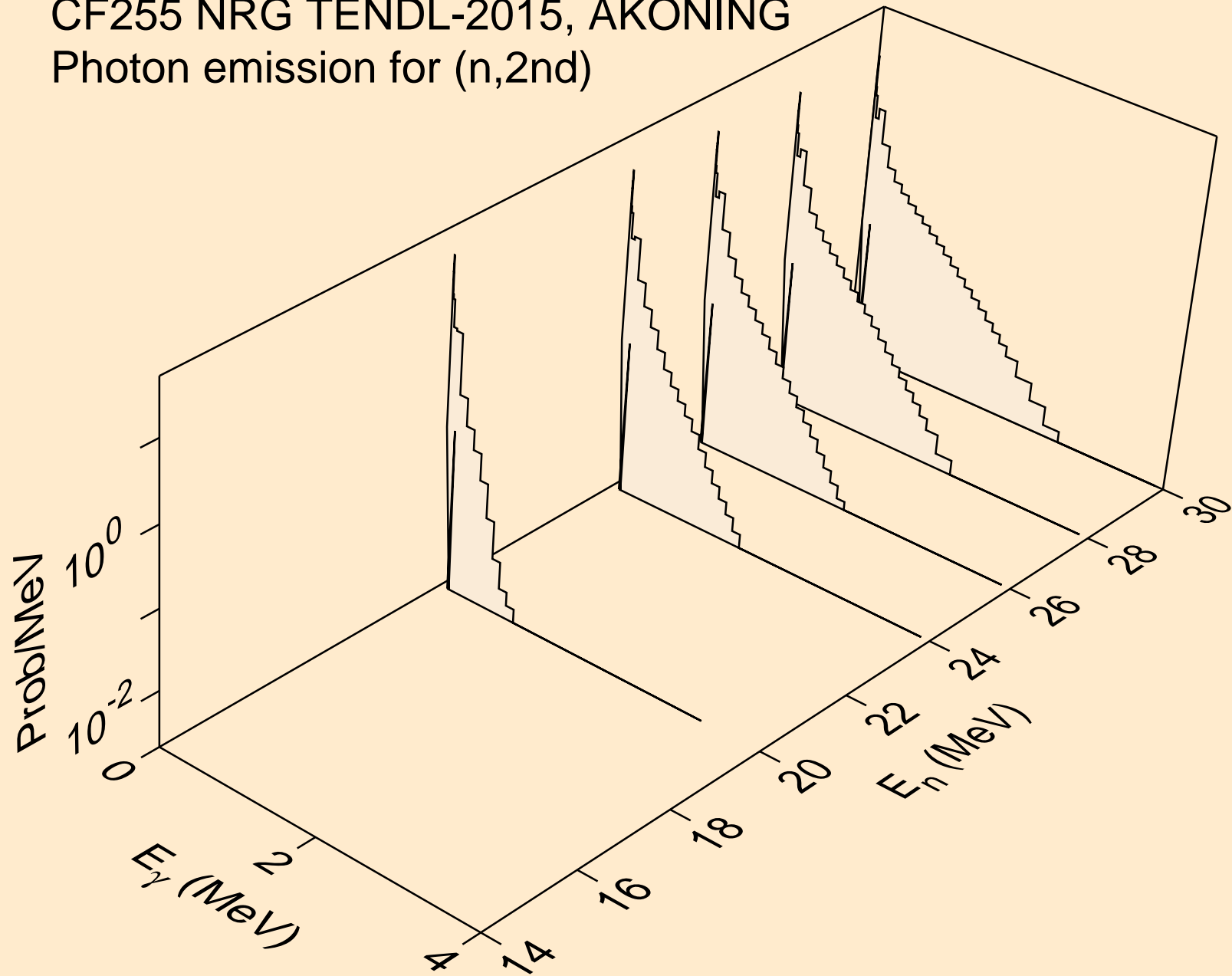

CF255 NRG TENDL-2015, AKONING  
Photon emission for (n,2n)

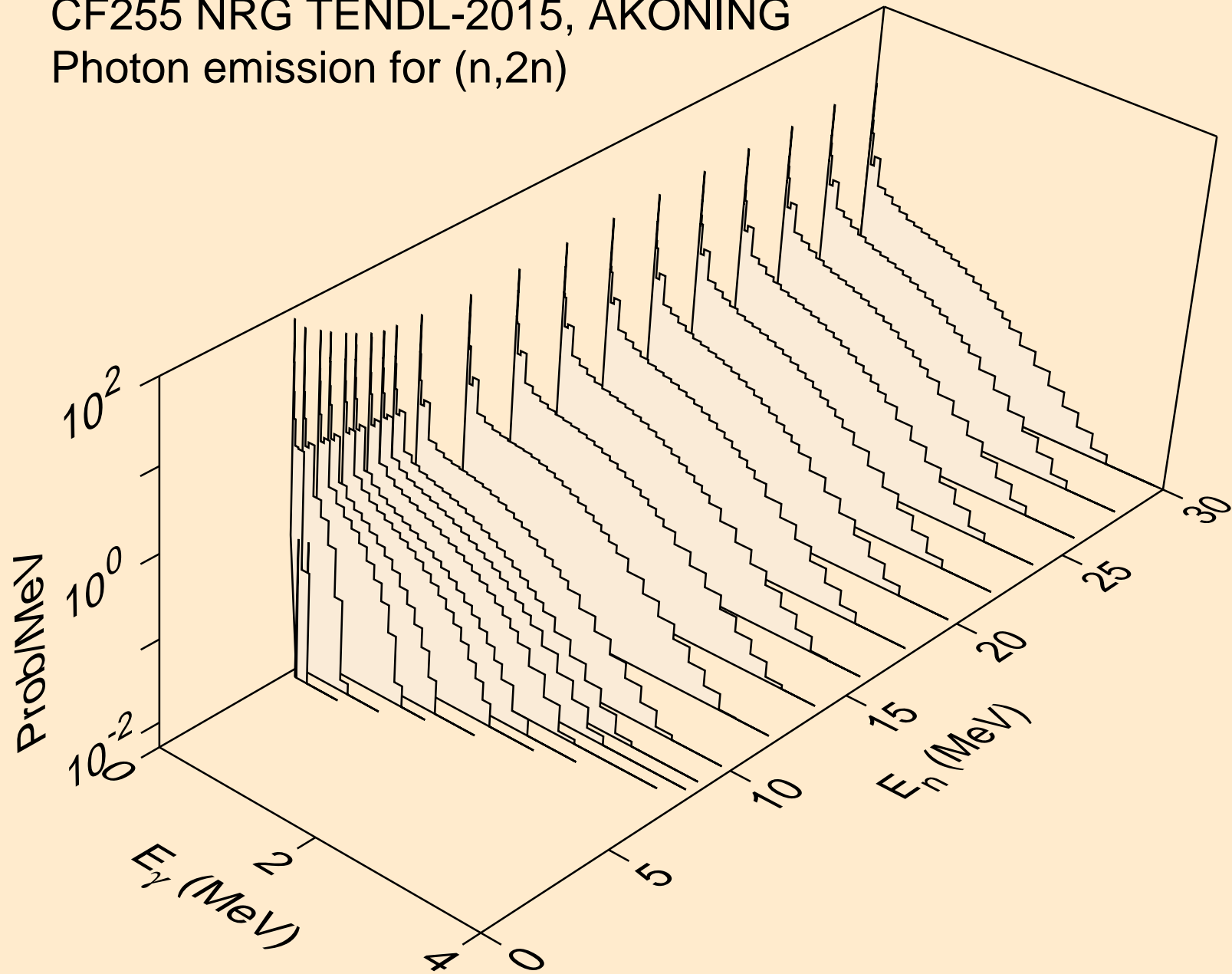

CF255 NRG TENDL-2015, AKONING  
Photon emission for (n,3n)

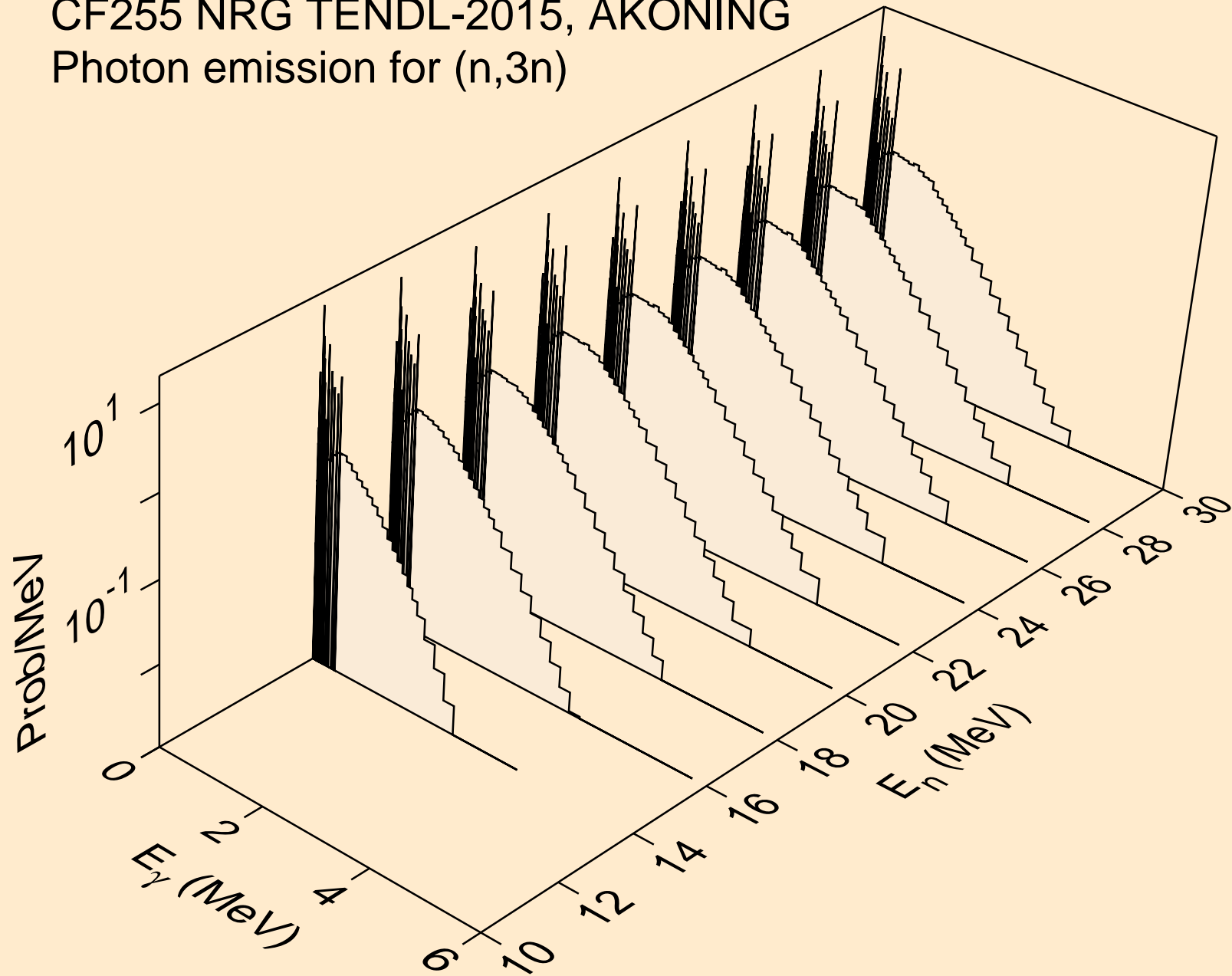

CF255 NRG TENDL-2015, AKONING  
Photon emission for (n,n\*)a

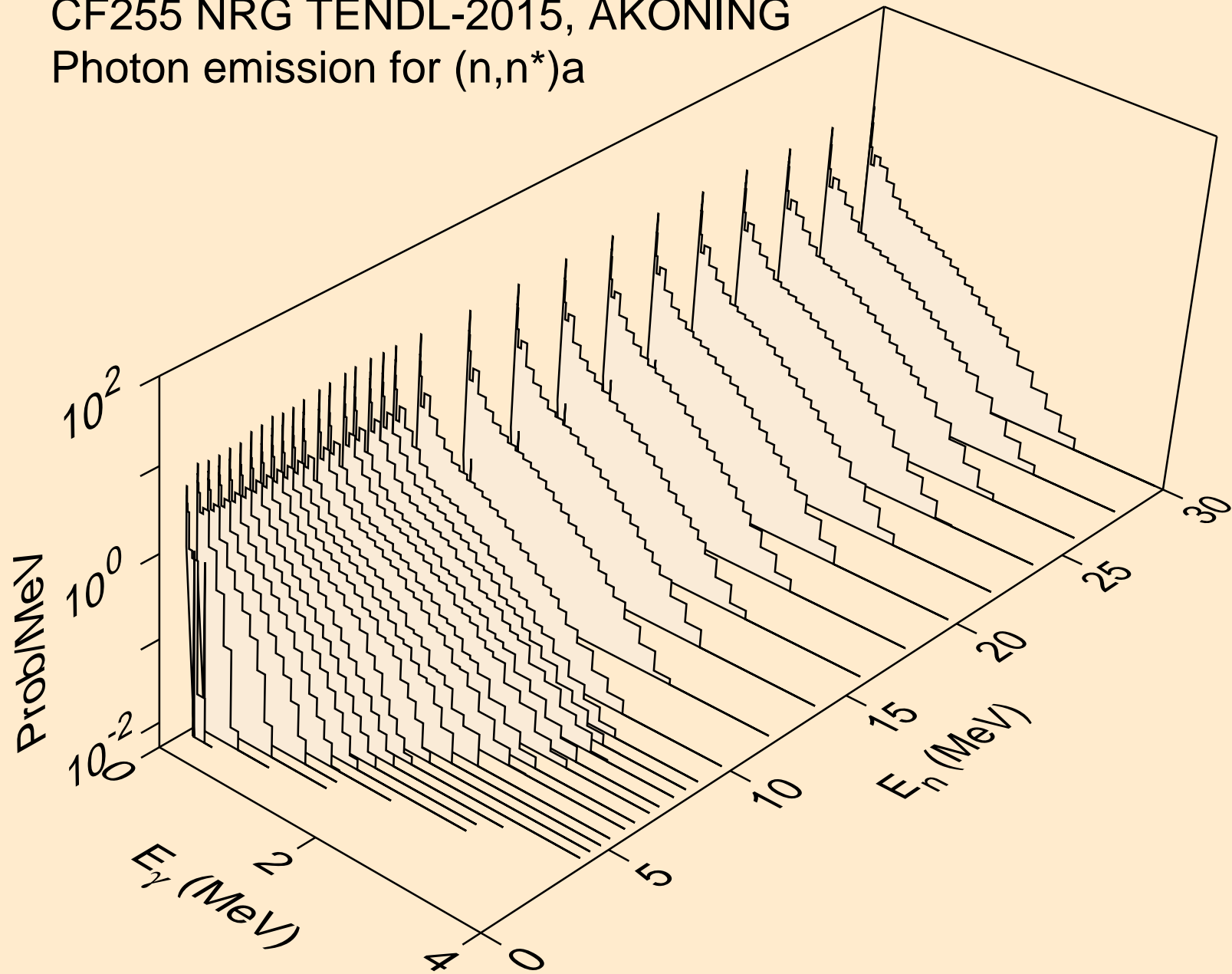

CF255 NRG TENDL-2015, AKONING  
Photon emission for (n,2n)a

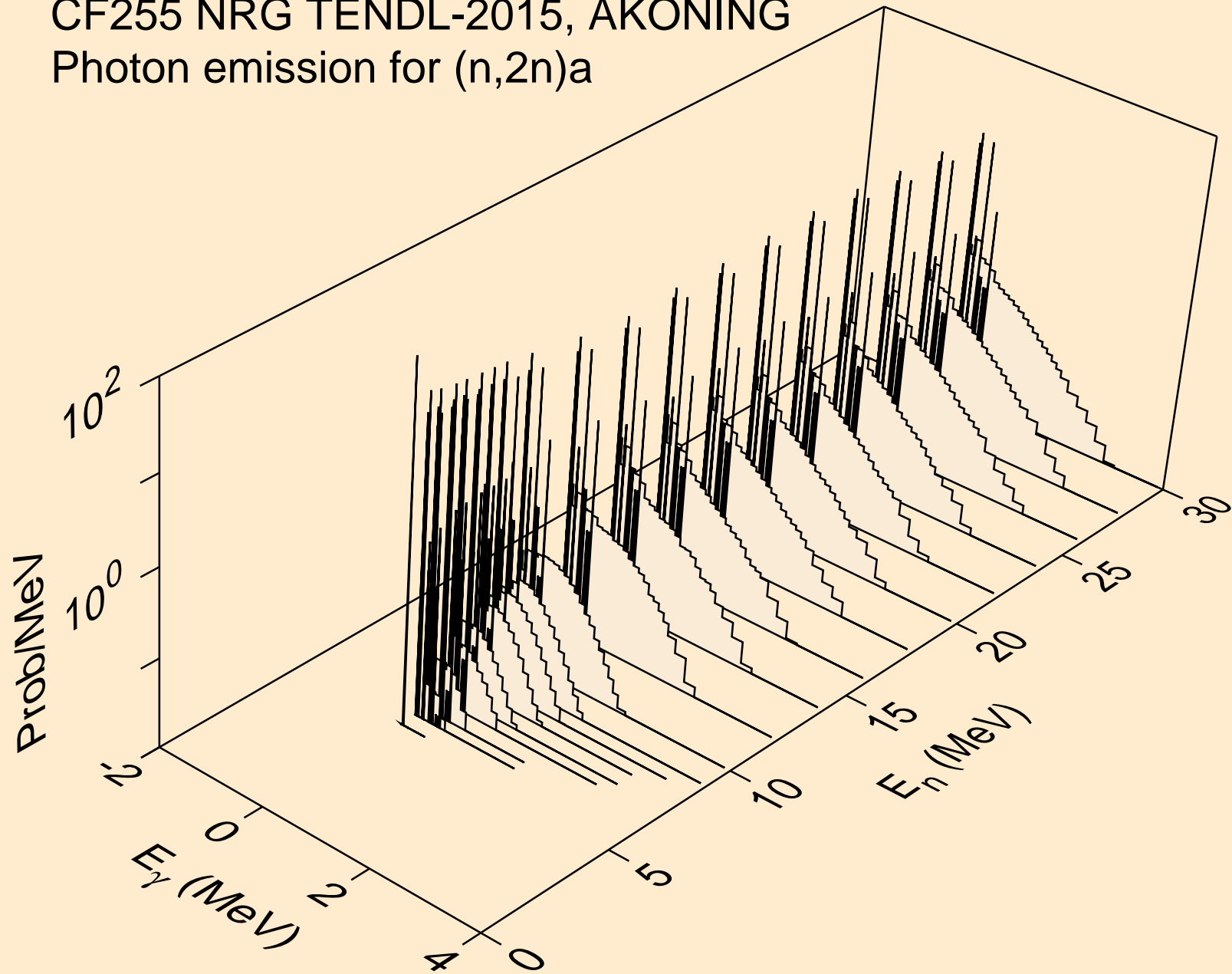

CF255 NRG TENDL-2015, AKONING  
Photon emission for (n,3n)a

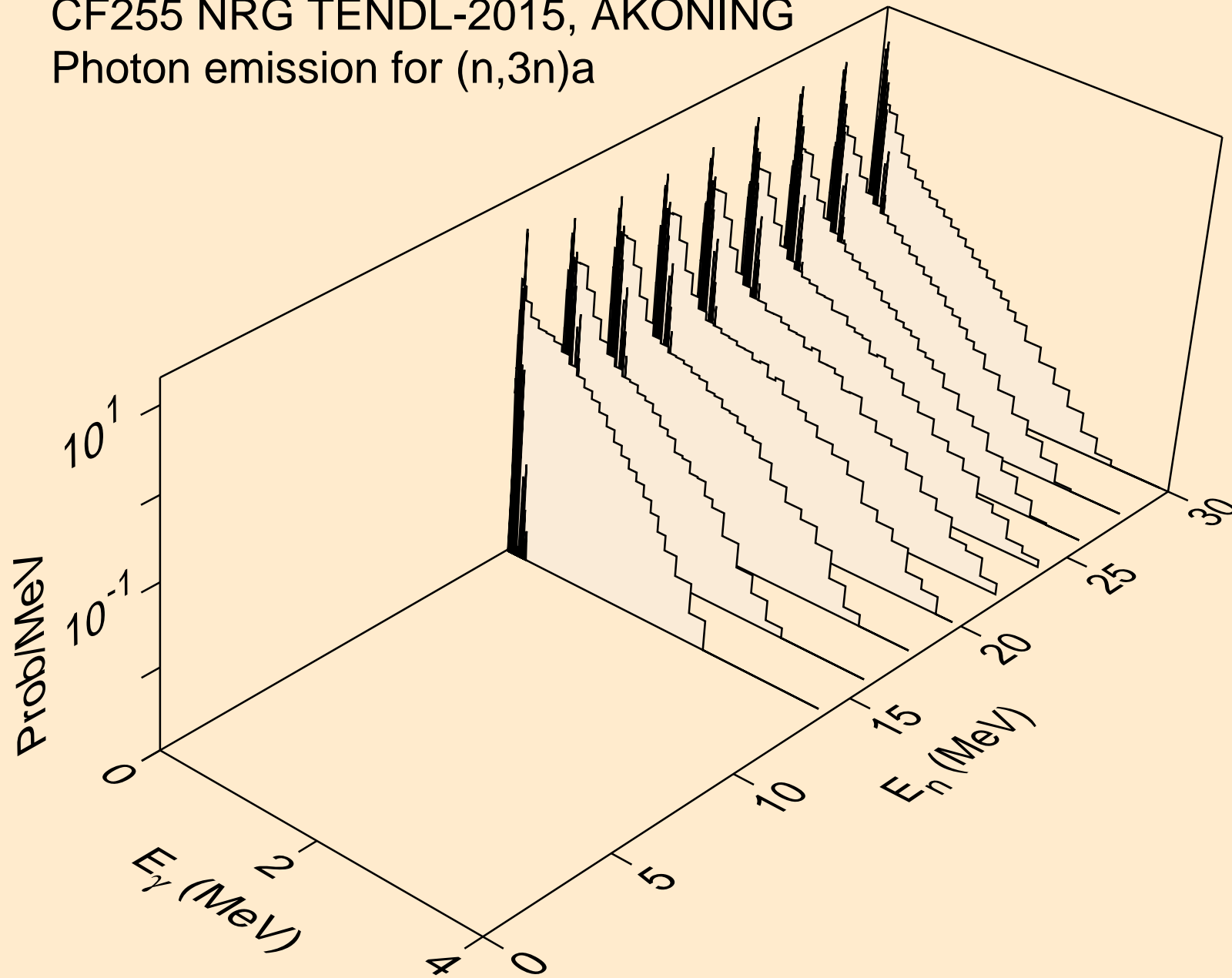



CF255 NRG TENDL-2015, AKONING  
Photon emission for (n,n\*)p

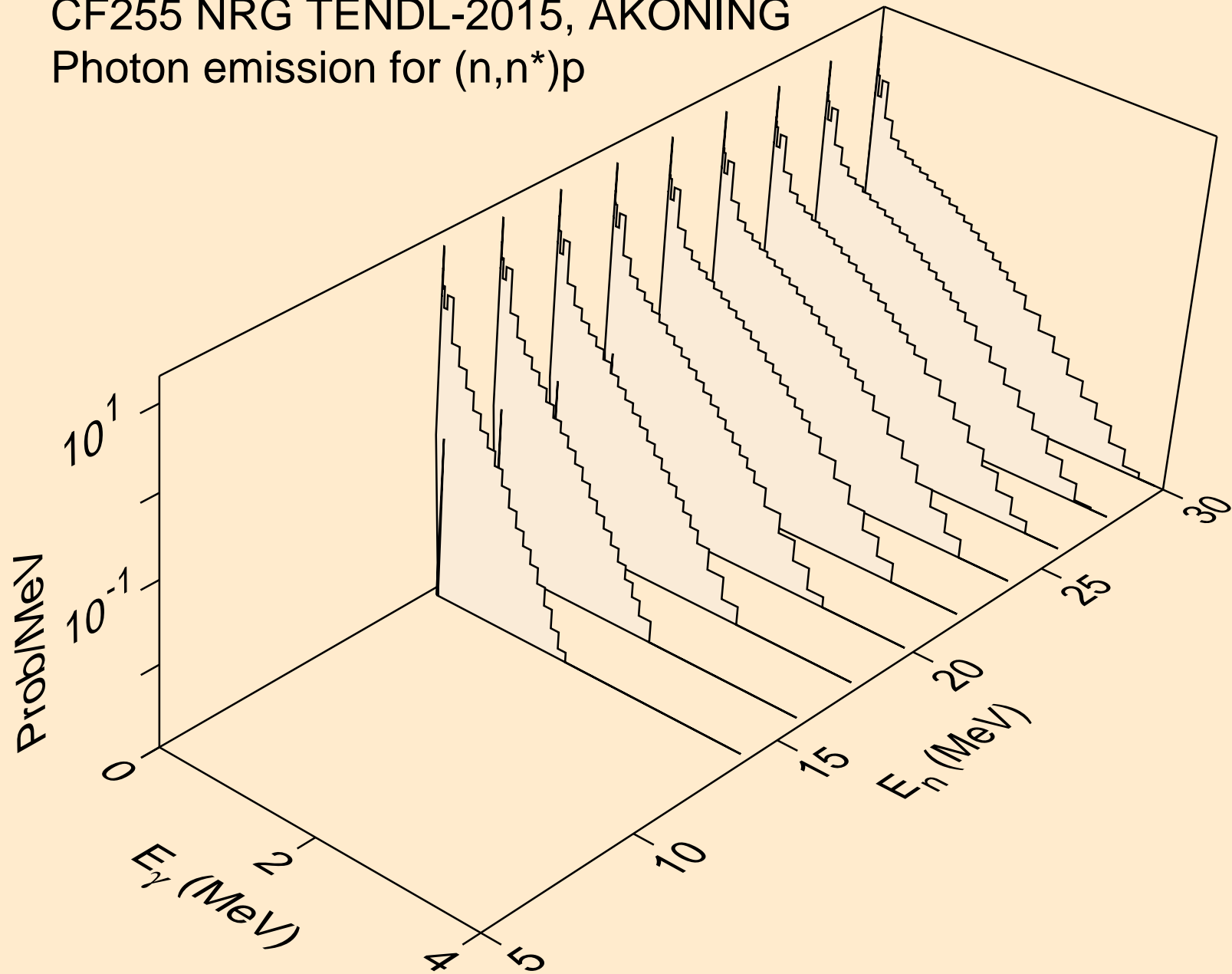

CF255 NRG TENDL-2015, AKONING  
Photon emission for (n,n\*)2a

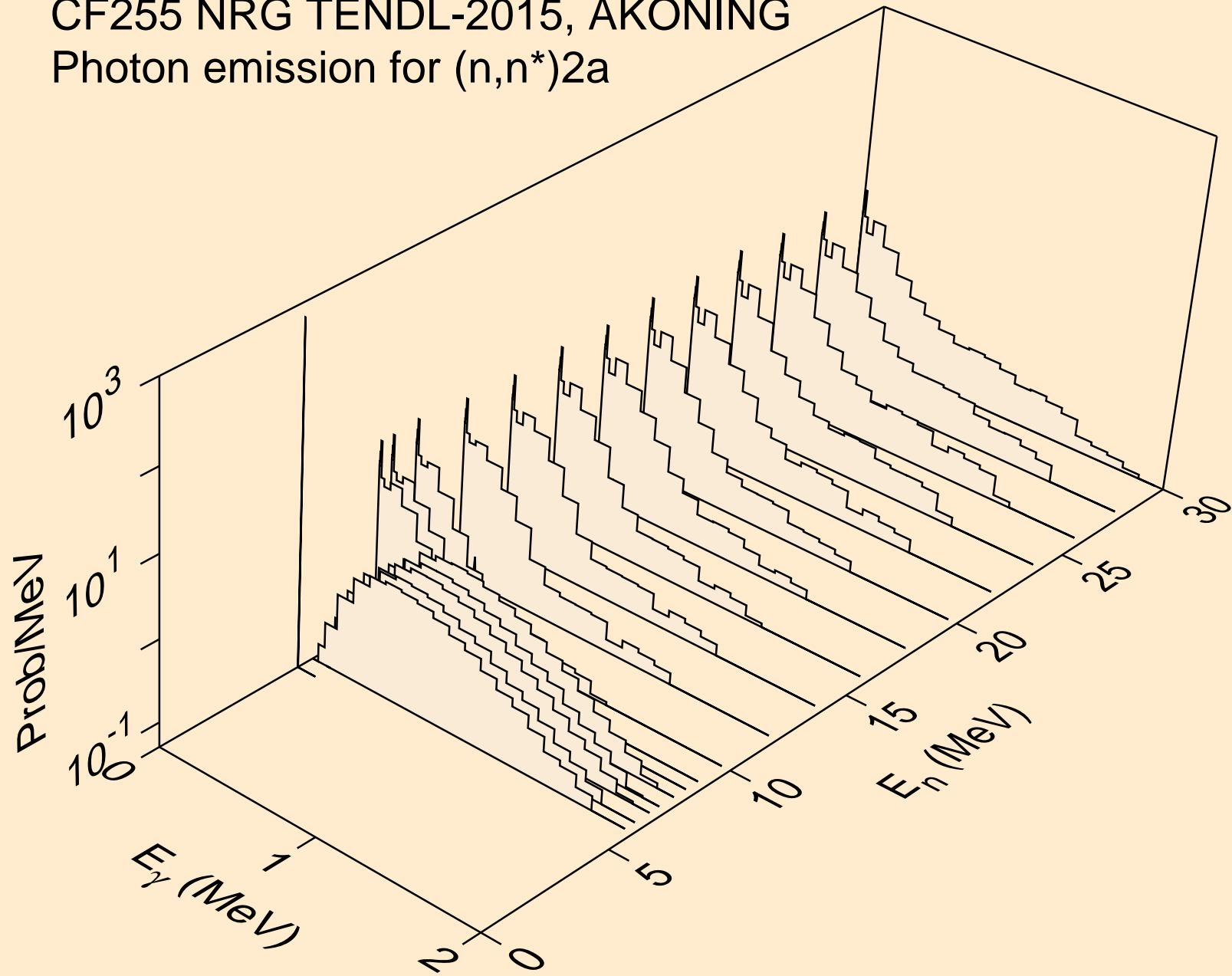

CF255 NRG TENDL-2015, AKONING  
Photon emission for (n,n\*)d

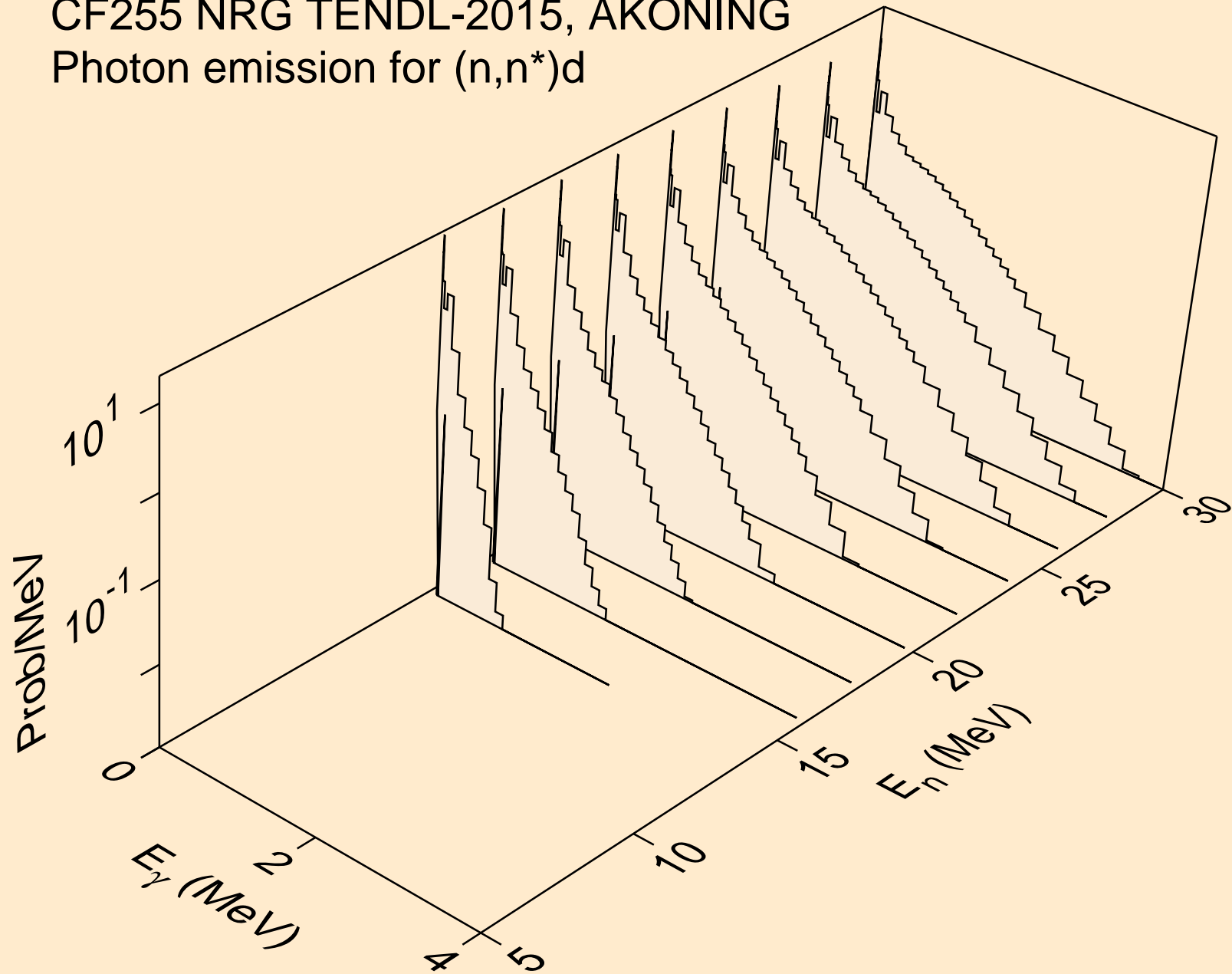

CF255 NRG TENDL-2015, AKONING  
Photon emission for (n,n\*)t

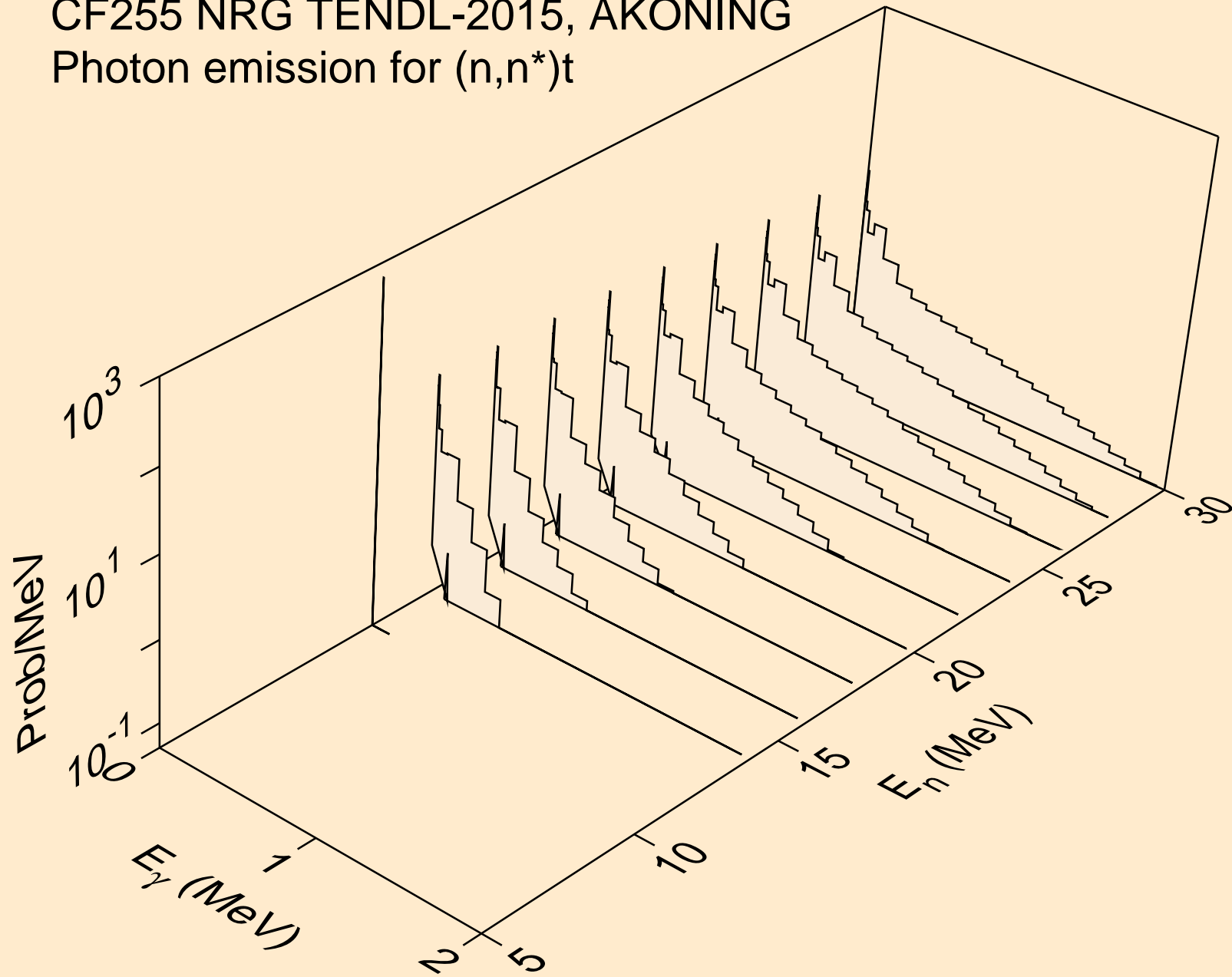

CF255 NRG TENDL-2015, AKONING  
Photon emission for (n,n\*)he3

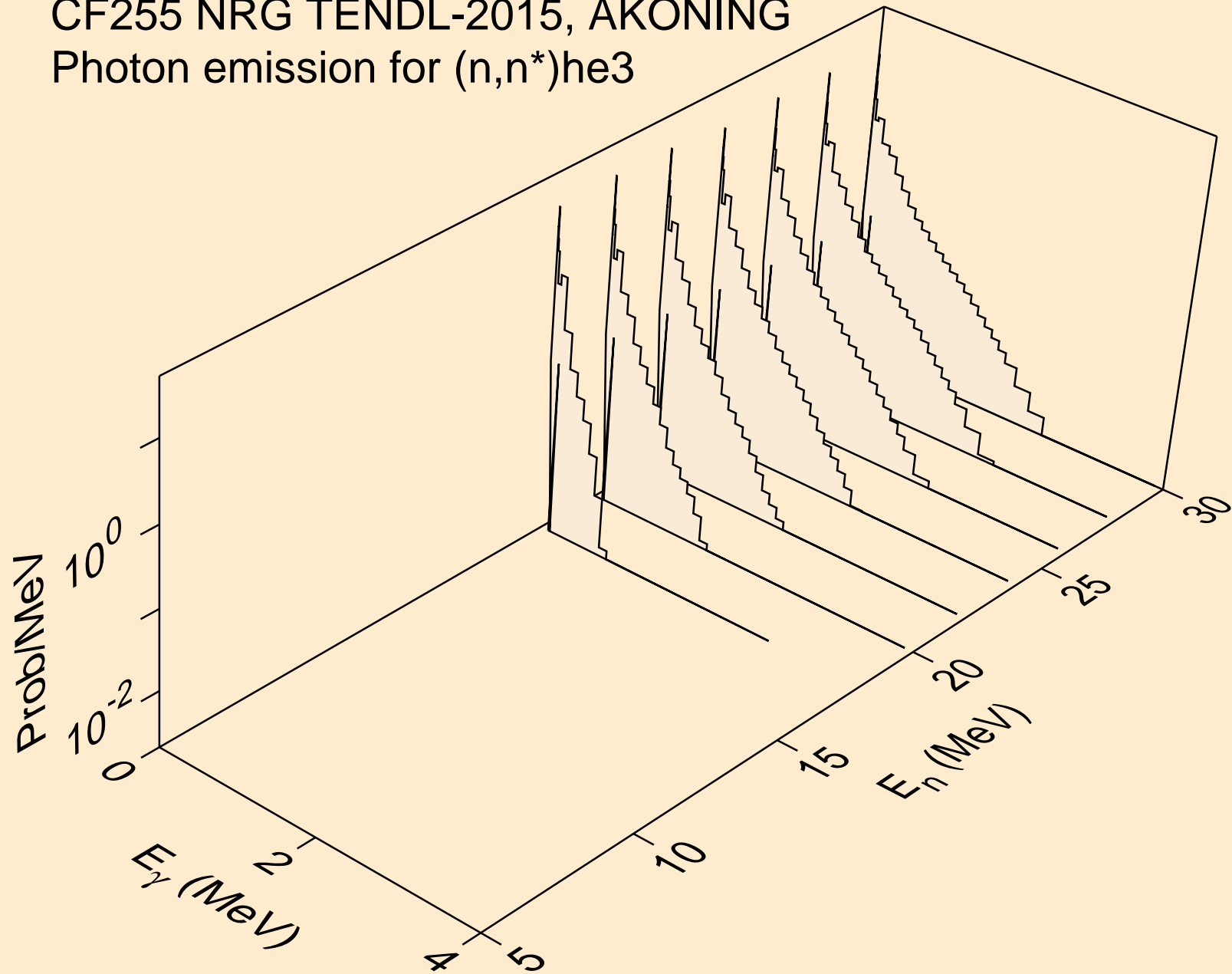

CF255 NRG TENDL-2015, AKONING  
Photon emission for (n,4n)

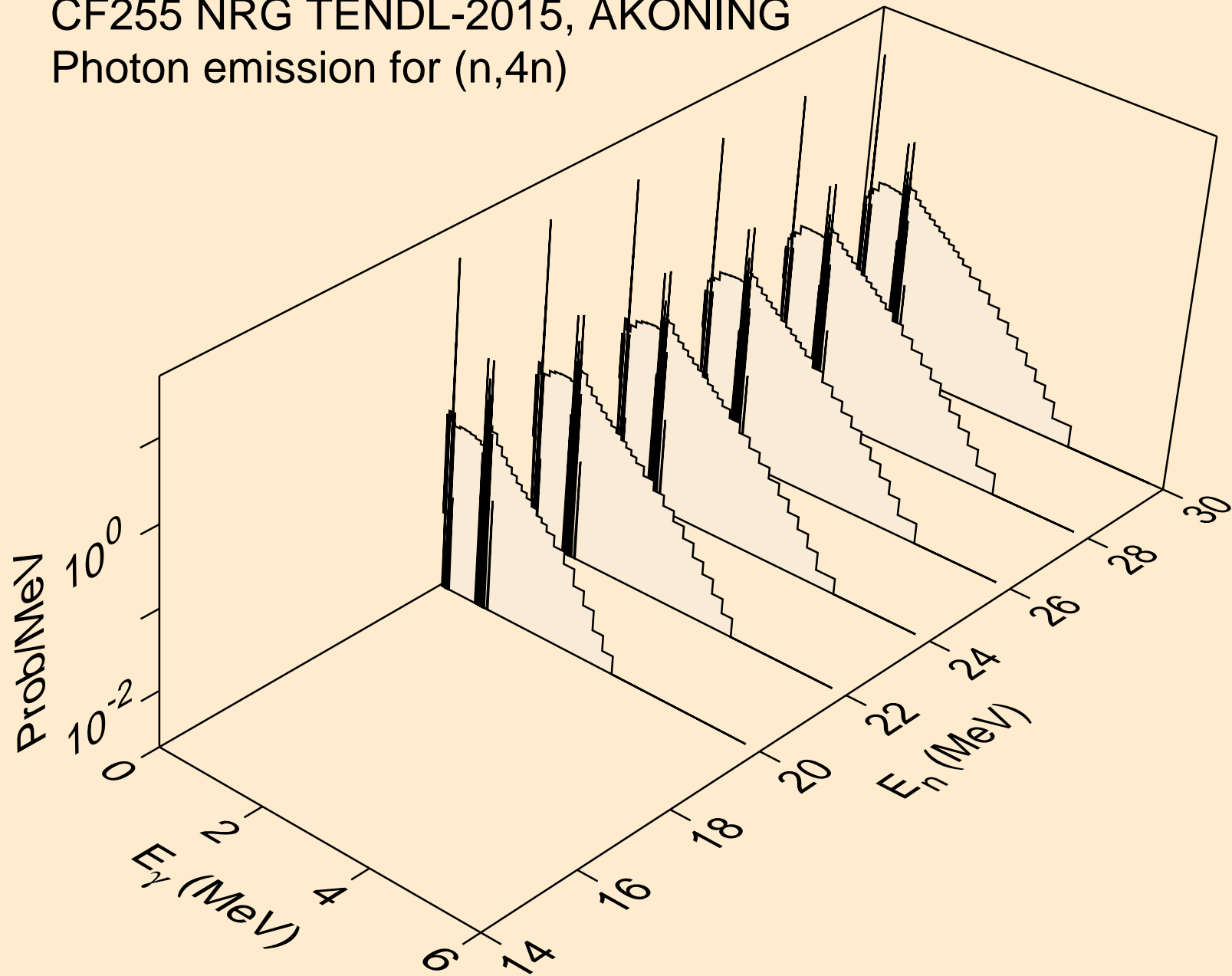

CF255 NRG TENDL-2015, AKONING  
Photon emission for (n,2np)

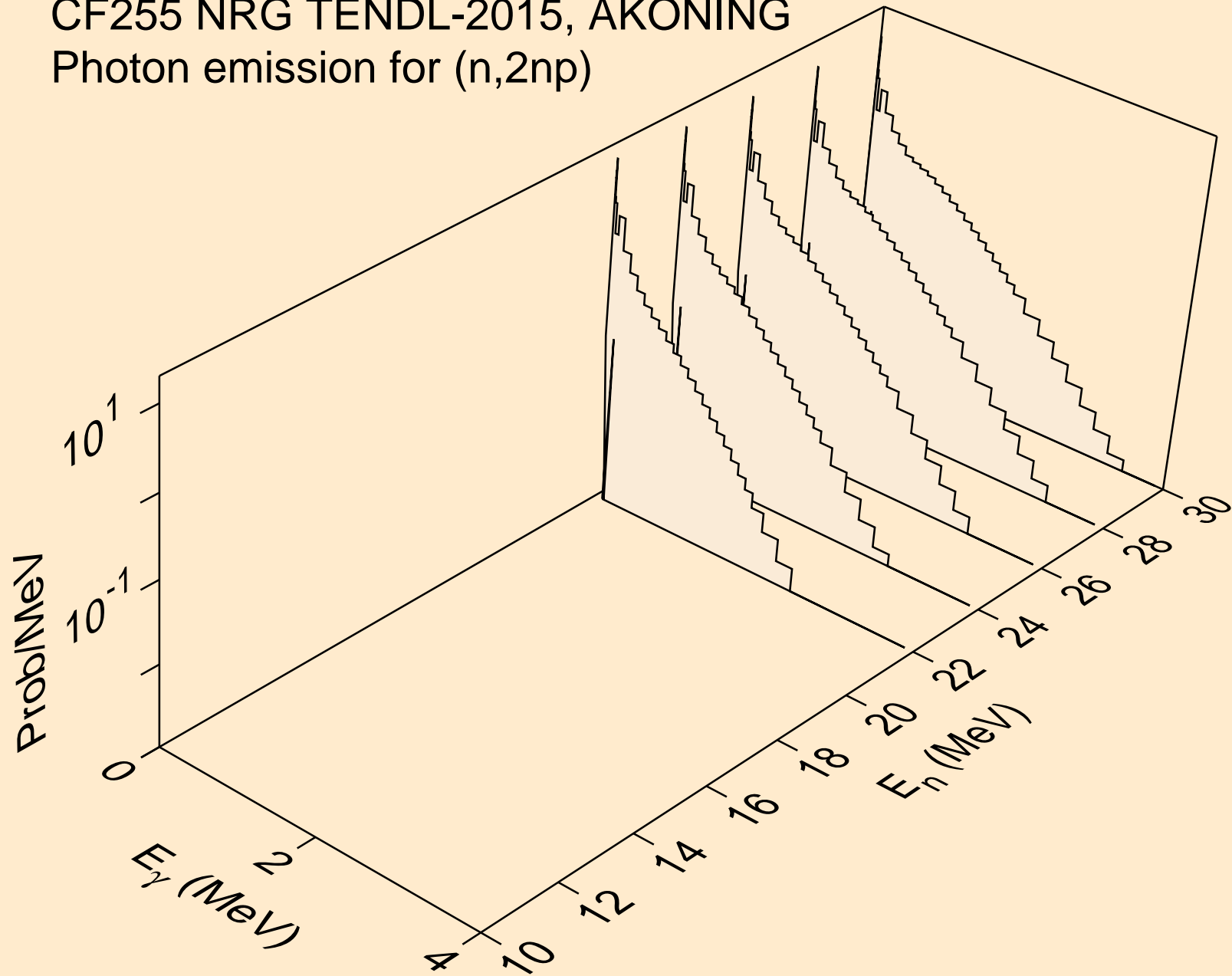

CF255 NRG TENDL-2015, AKONING  
Photon emission for (n,3np)

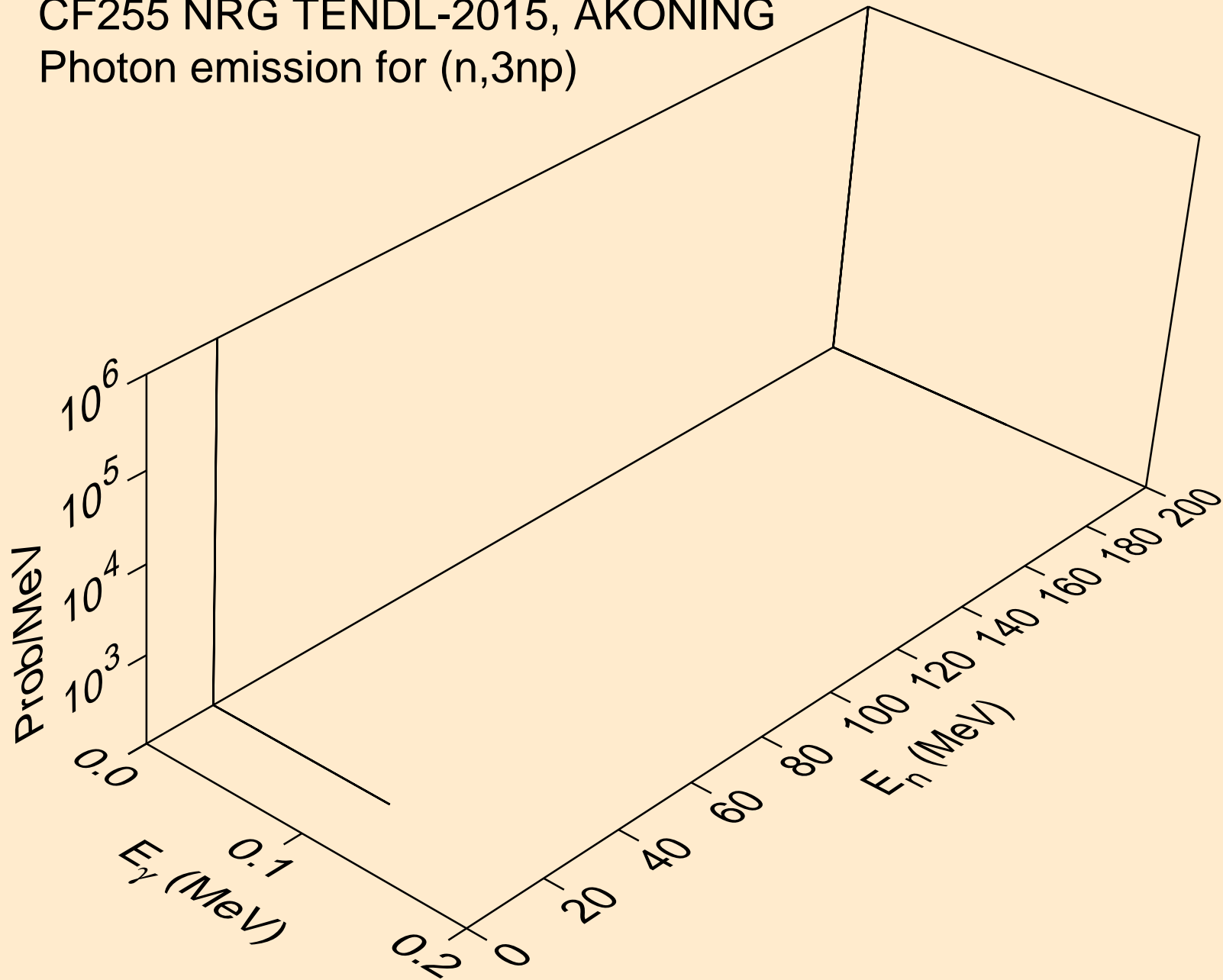



CF255 NRG TENDL-2015, AKONING  
Photon emission for (n,n\*c)

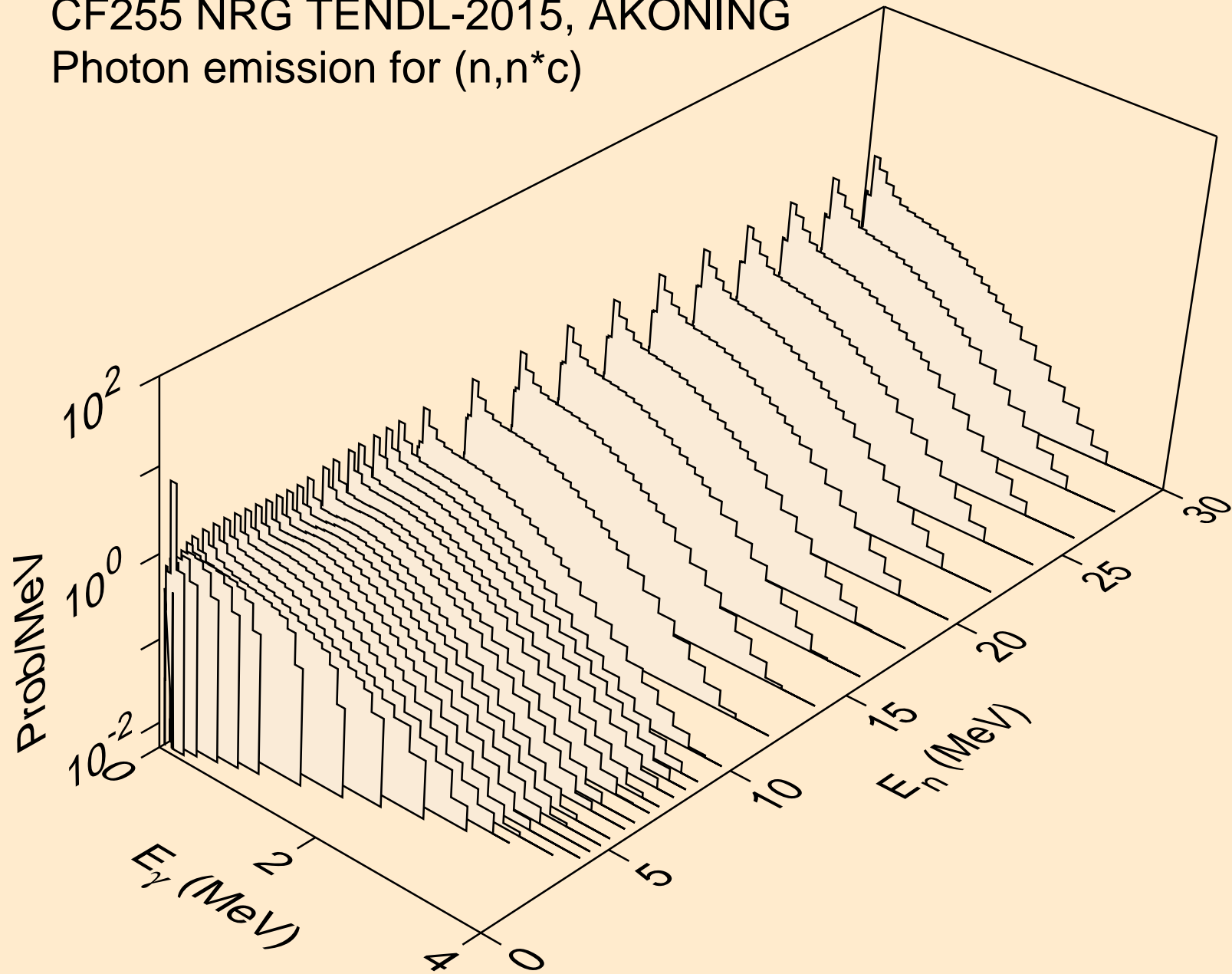

CF255 NRG TENDL-2015, AKONING  
Photon emission for (n,gma)

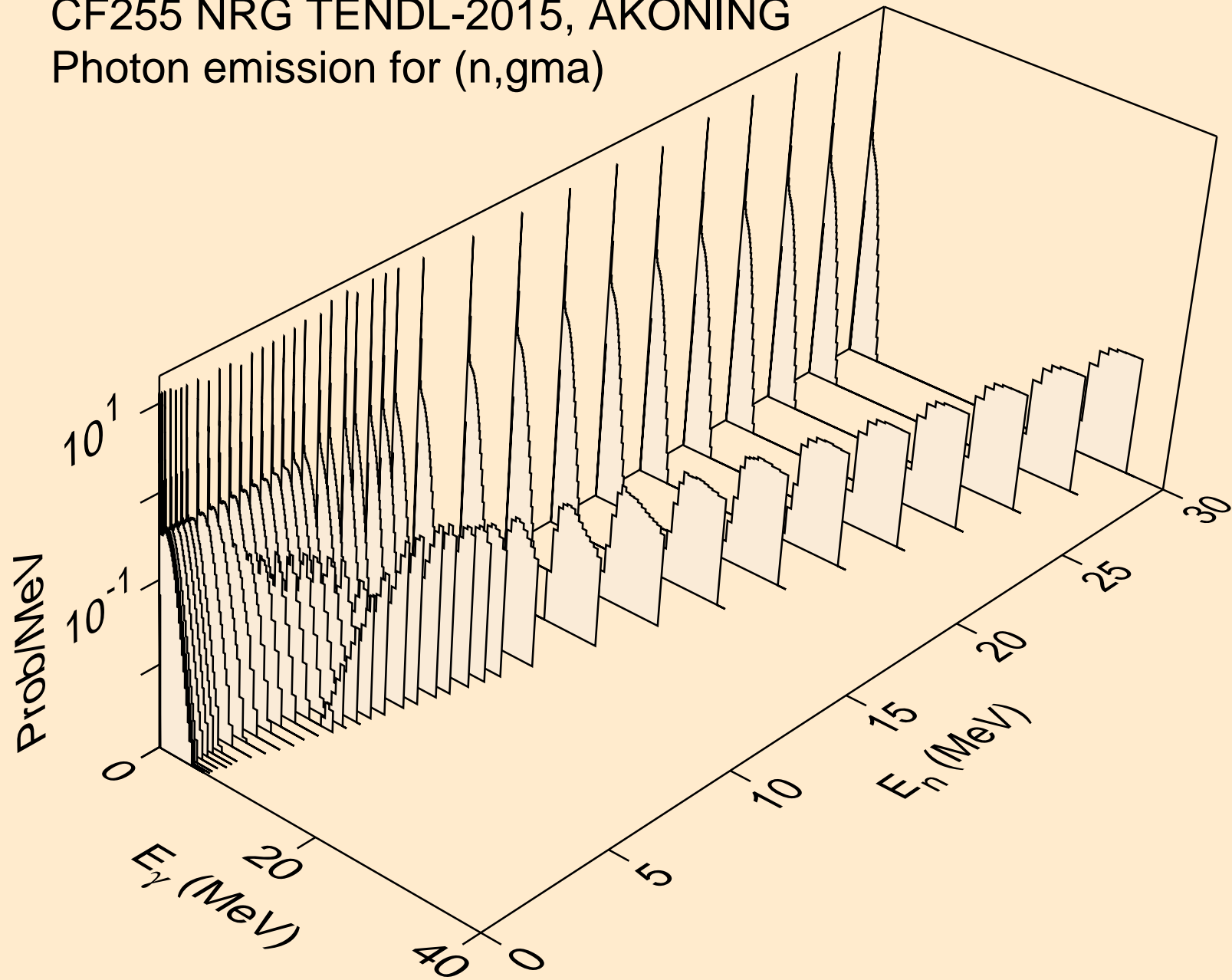

CF255 NRG TENDL-2015, AKONING  
Photon emission for (n,p)

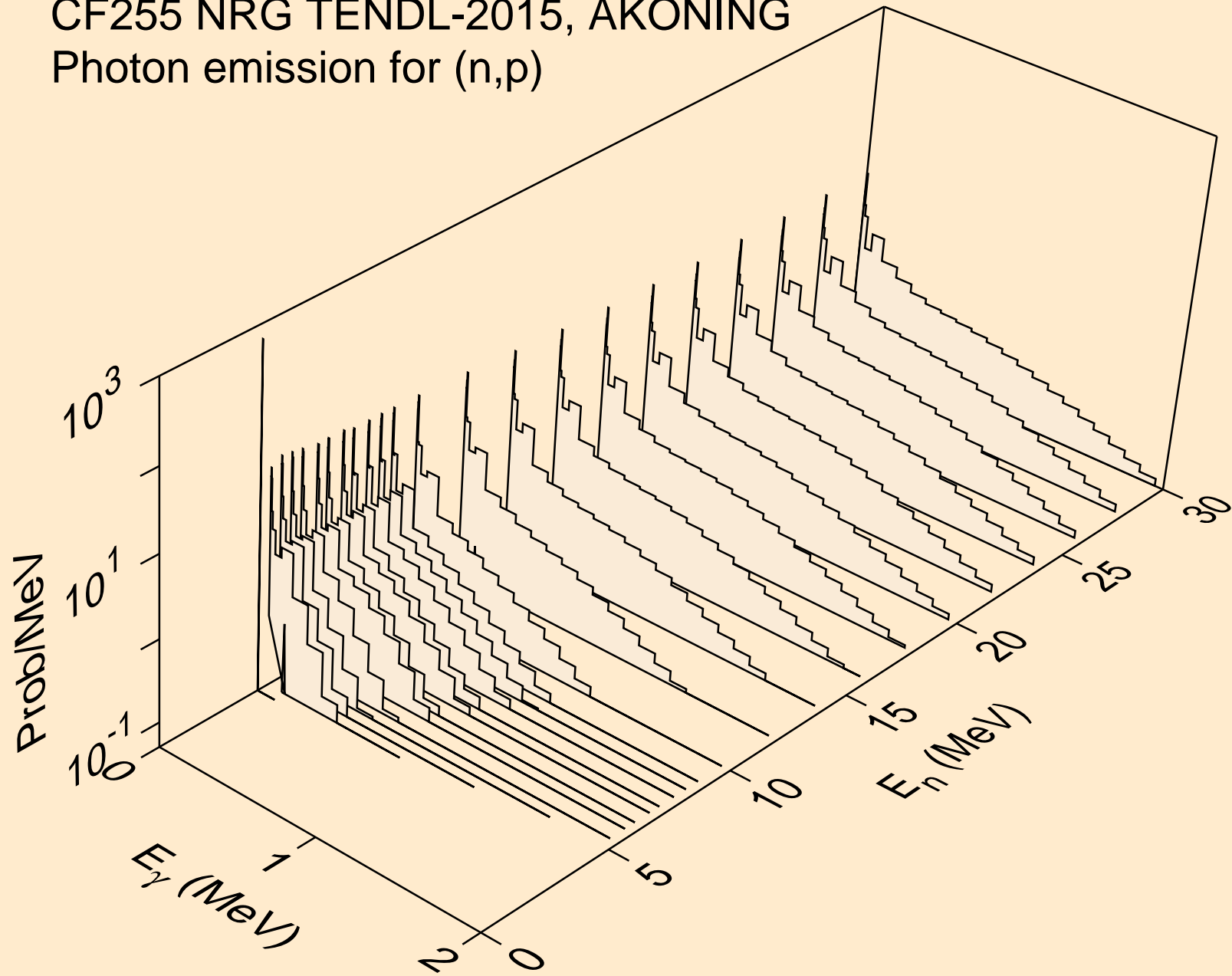

CF255 NRG TENDL-2015, AKONING  
Photon emission for (n,d)

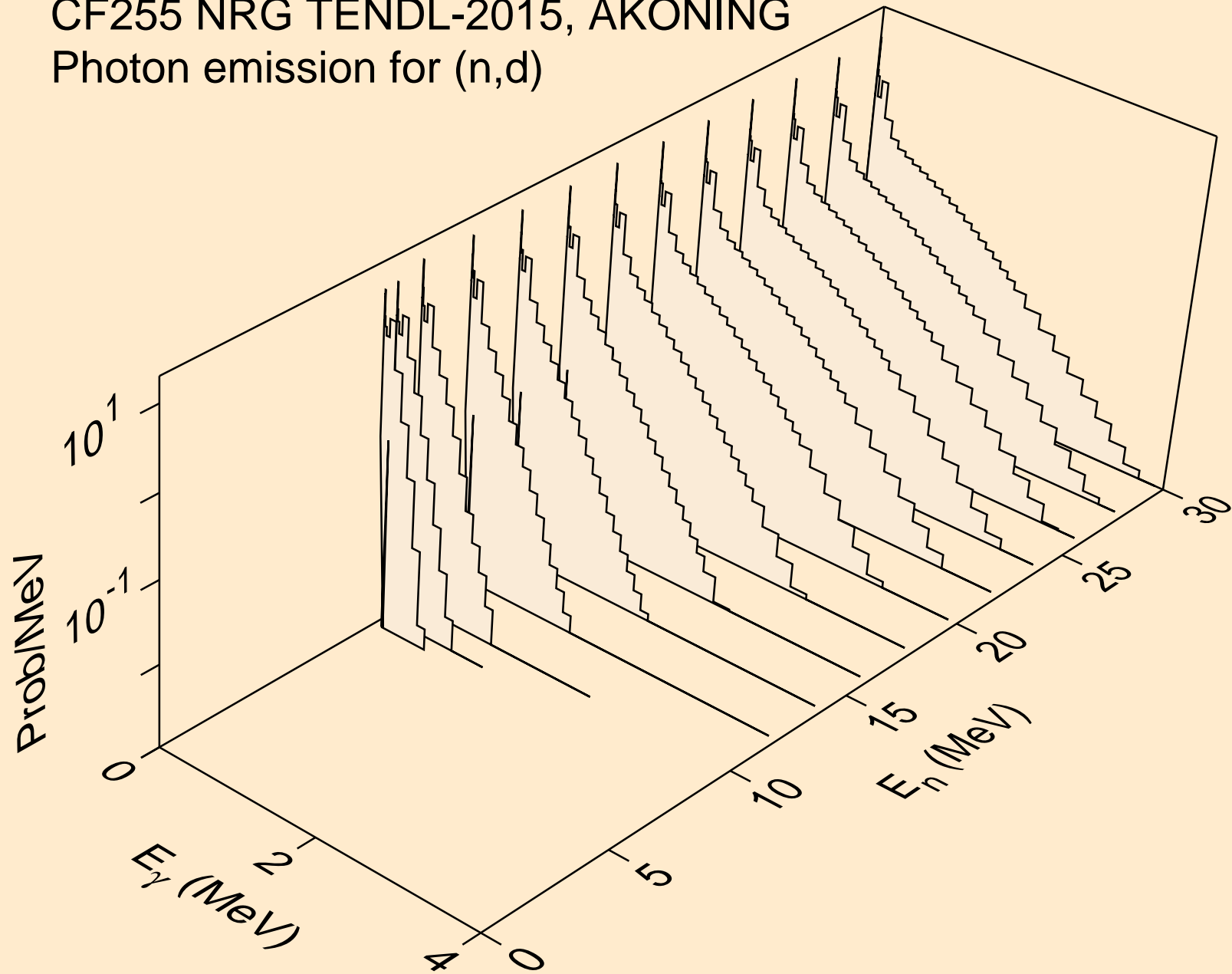

CF255 NRG TENDL-2015, AKONING  
Photon emission for (n,t)

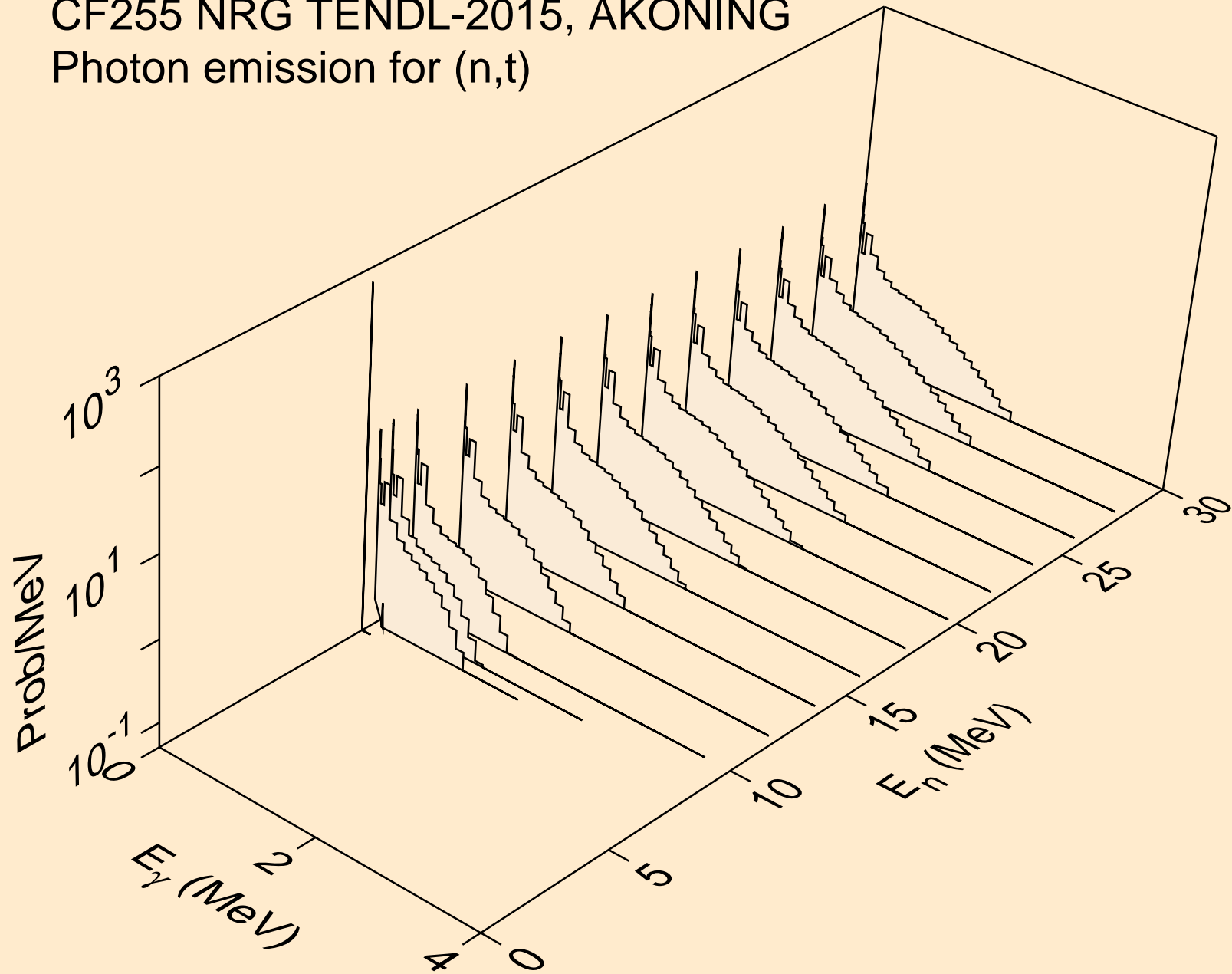

CF255 NRG TENDL-2015, AKONING  
Photon emission for (n,he3)

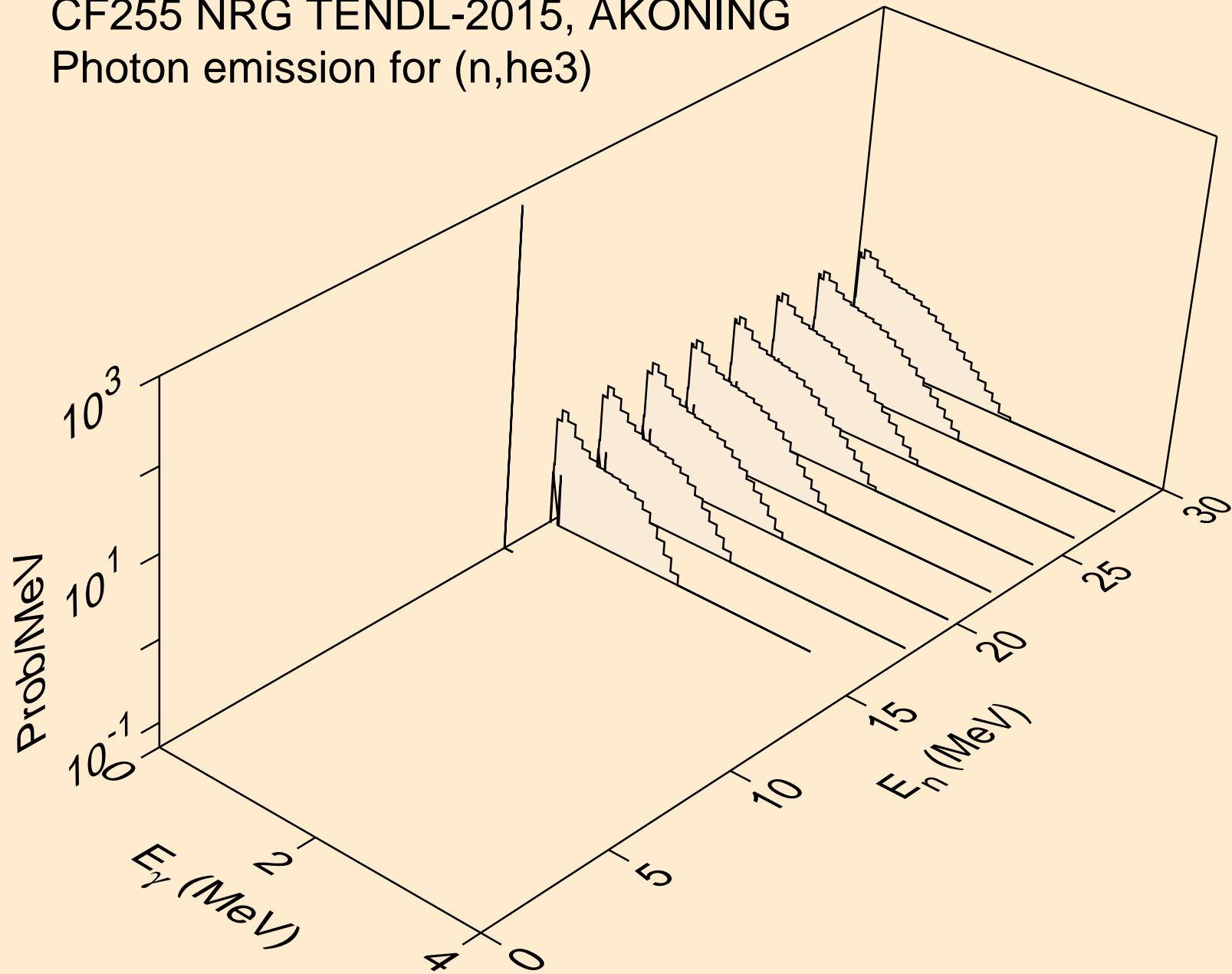

CF255 NRG TENDL-2015, AKONING  
Photon emission for (n,a)

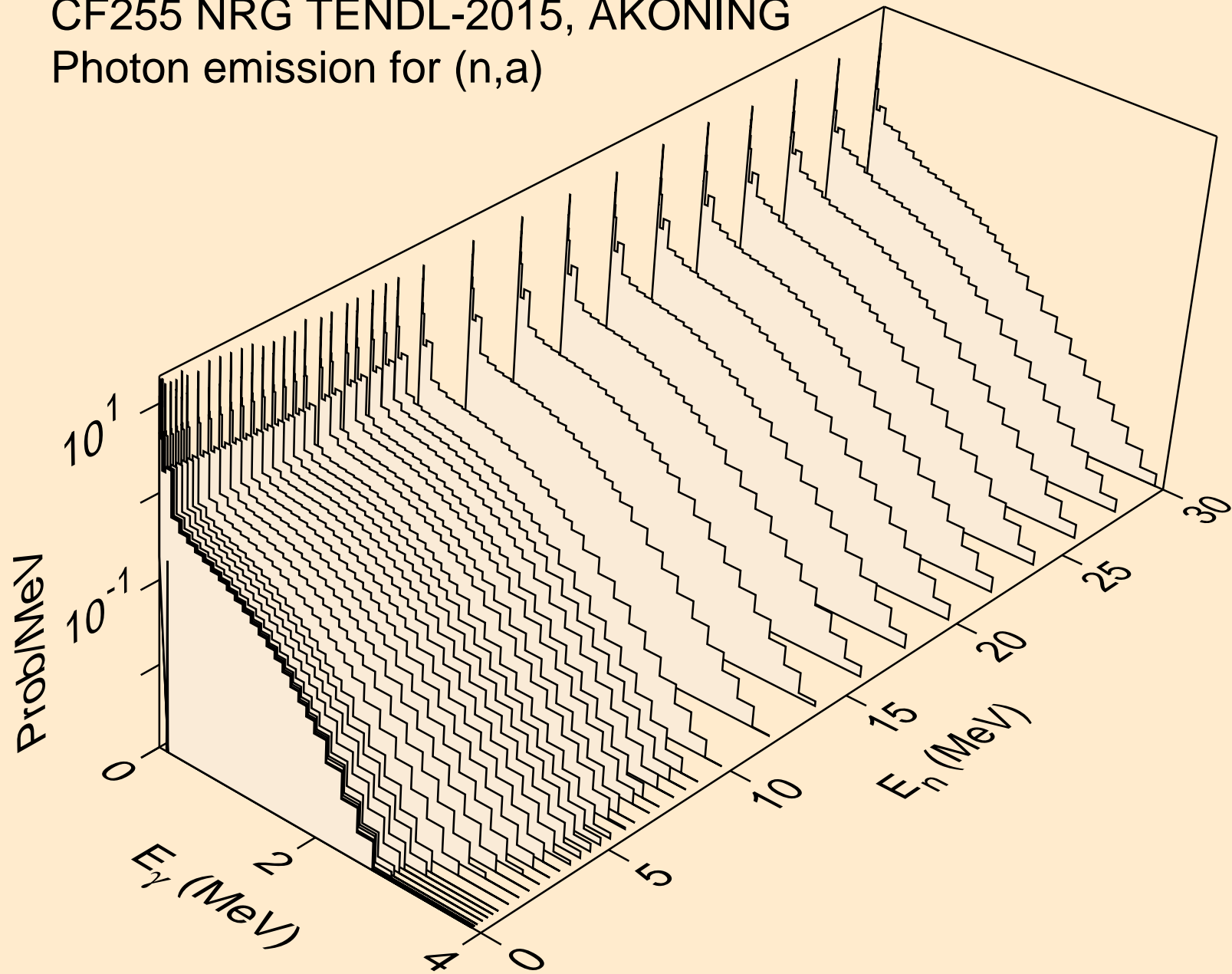

CF255 NRG TENDL-2015, AKONING  
Photon emission for (n,2p)

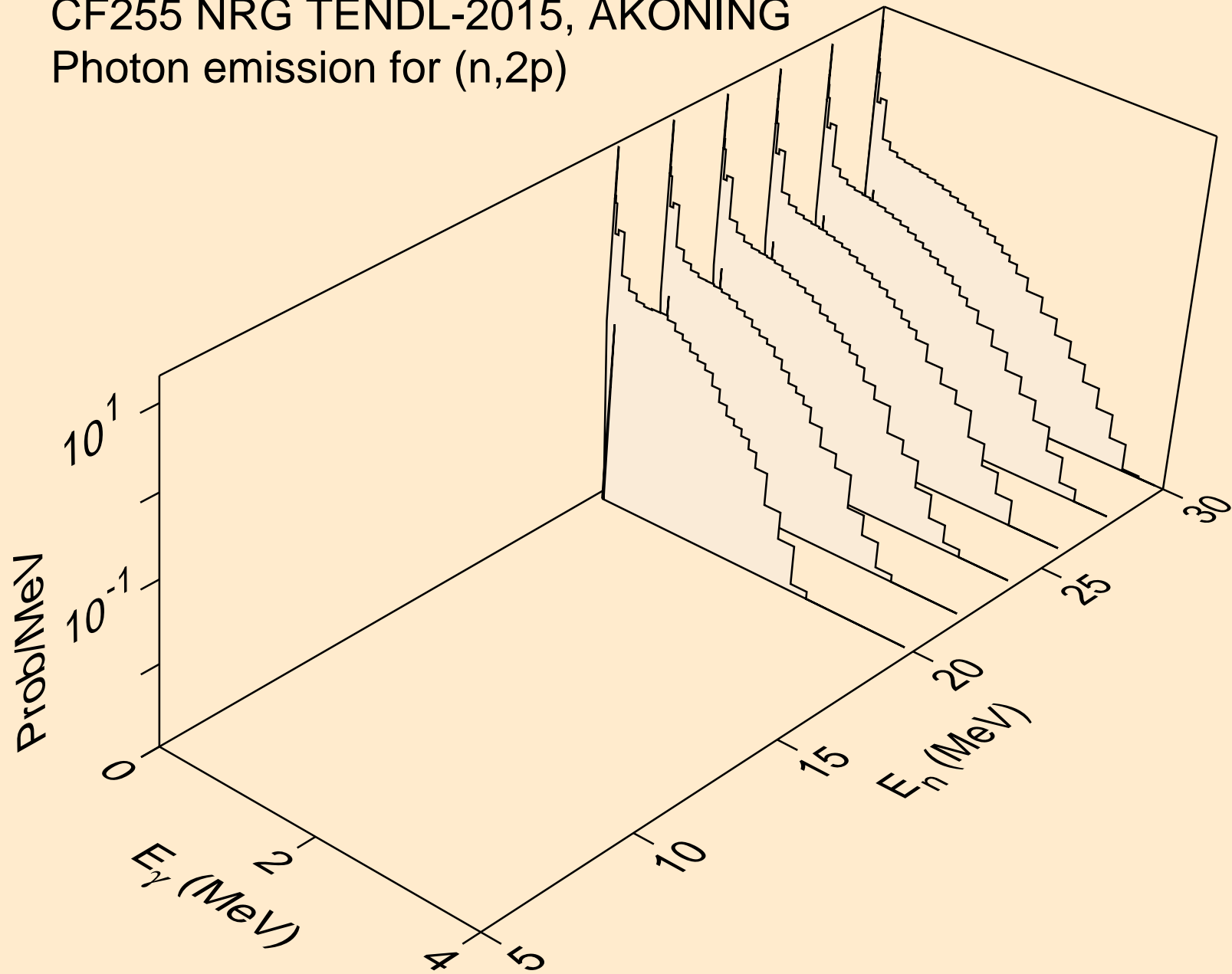



CF255 NRG TENDL-2015, AKONING  
thermal capture photon spectrum

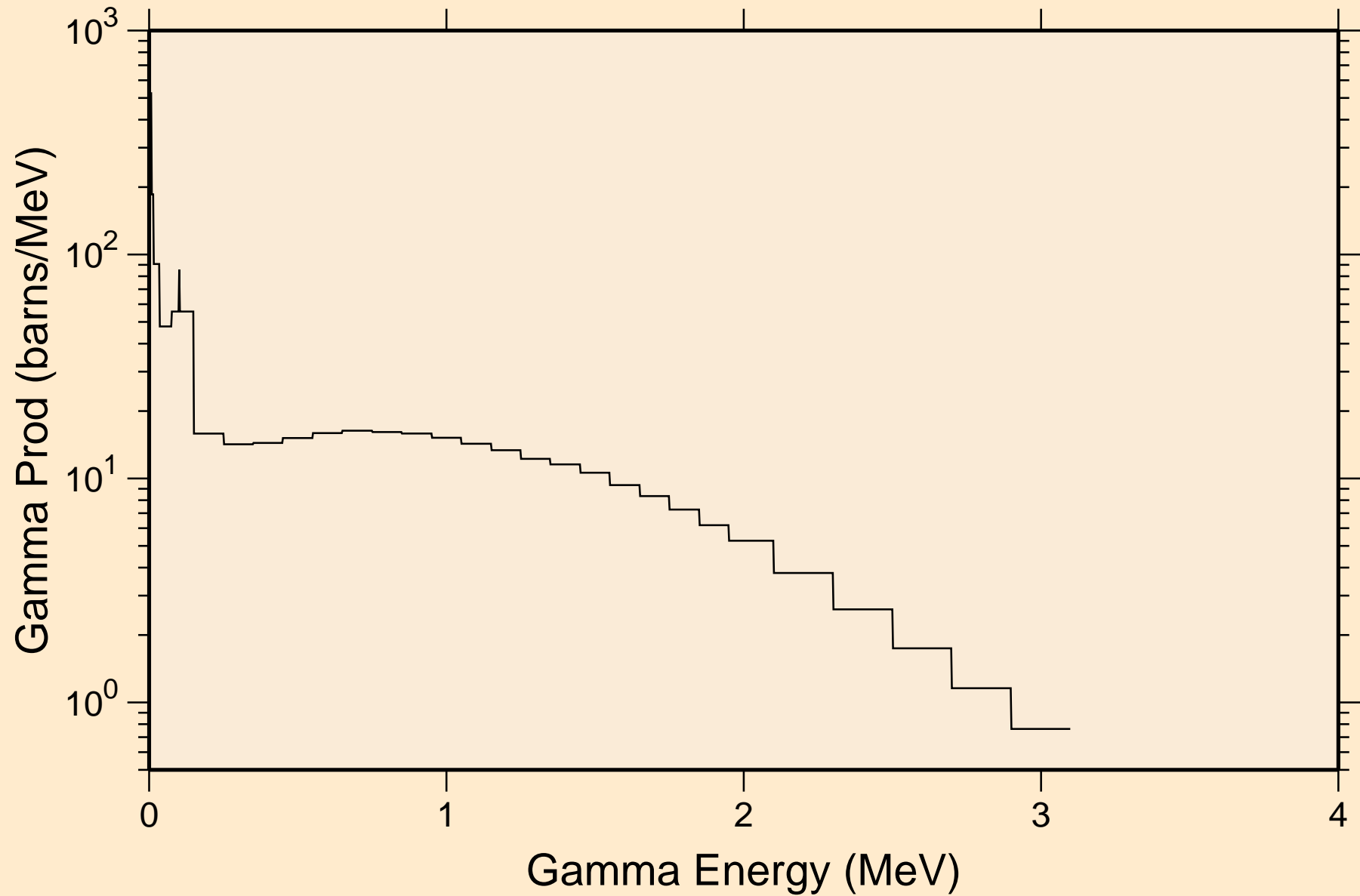

CF255 NRG TENDL-2015, AKONING  
14 MeV photon spectrum

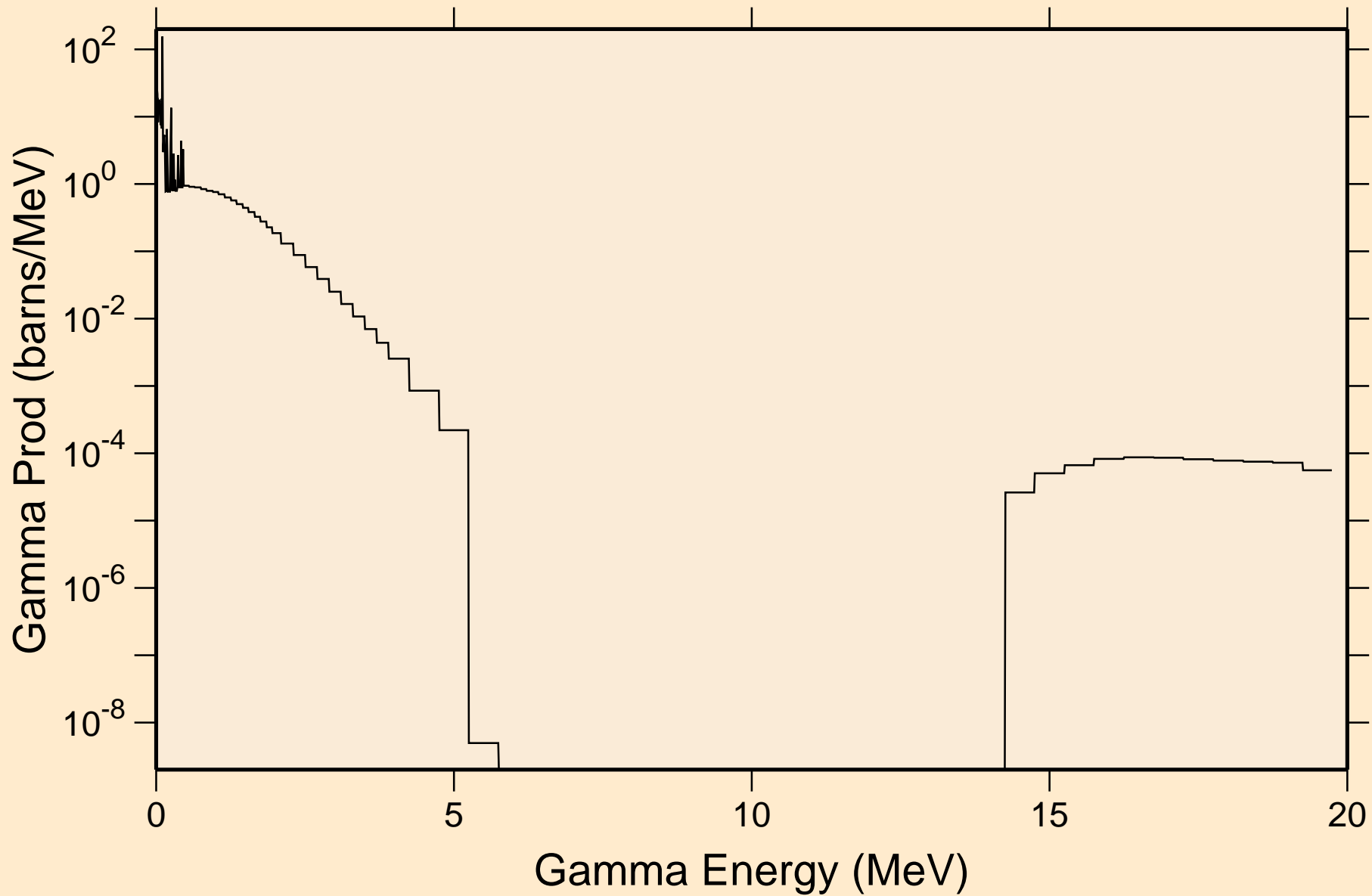

# CF255 NRG TENDL-2015, AKONING

## Particle heating contributions

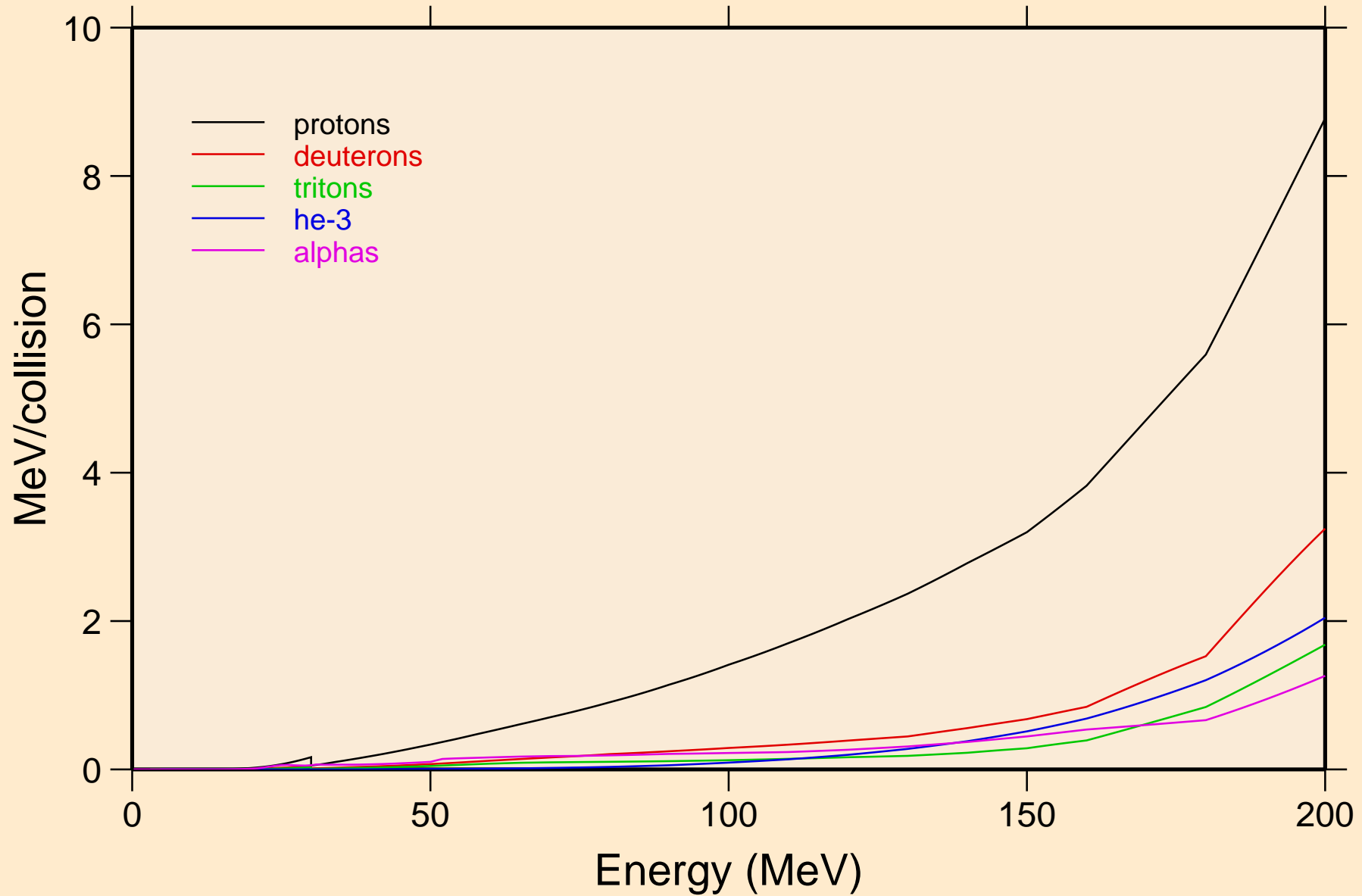

# CF255 NRG TENDL-2015, AKONING

## Recoil Heating

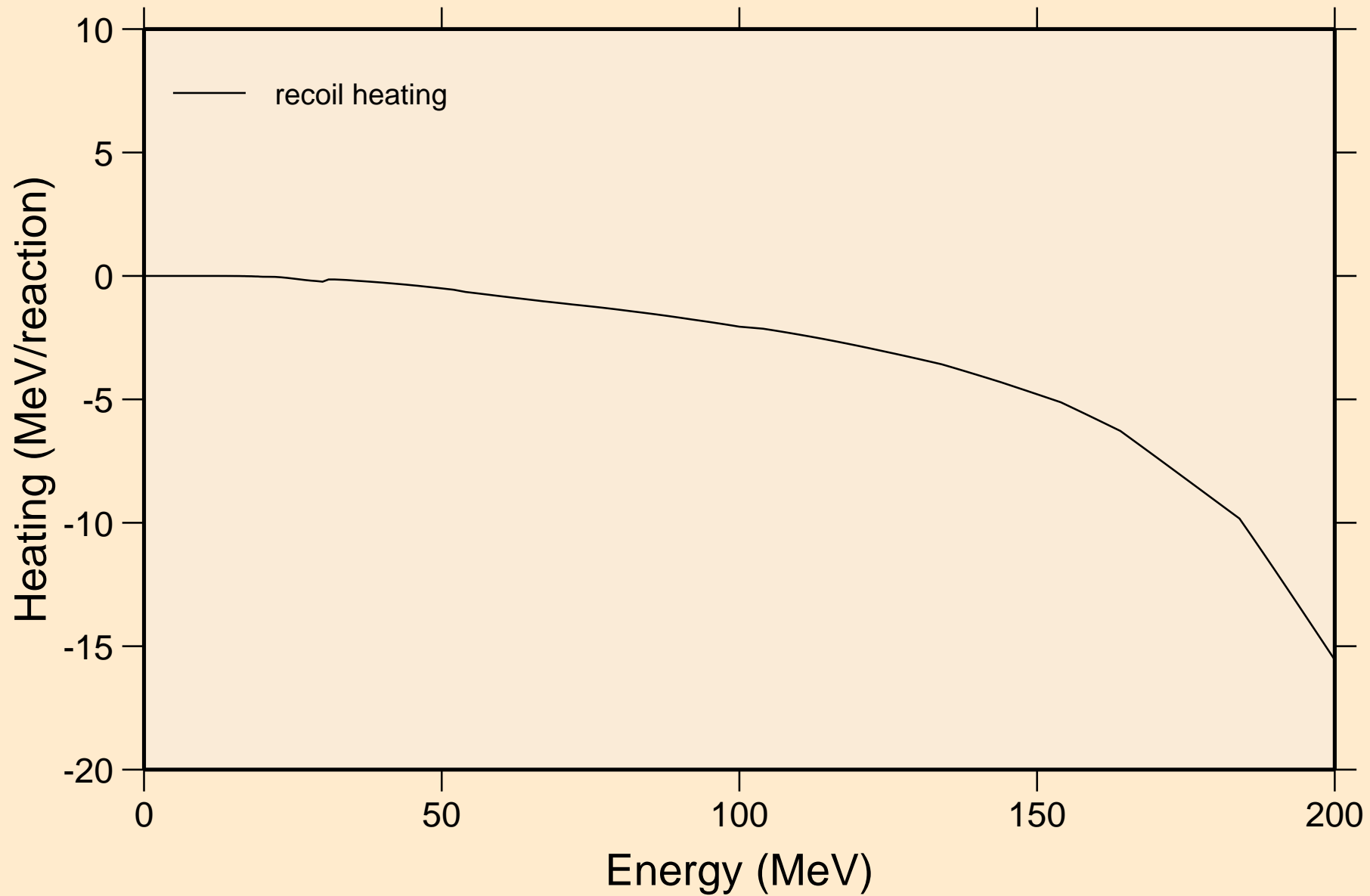

# CF255 NRG TENDL-2015, AKONING

## Particle production cross sections

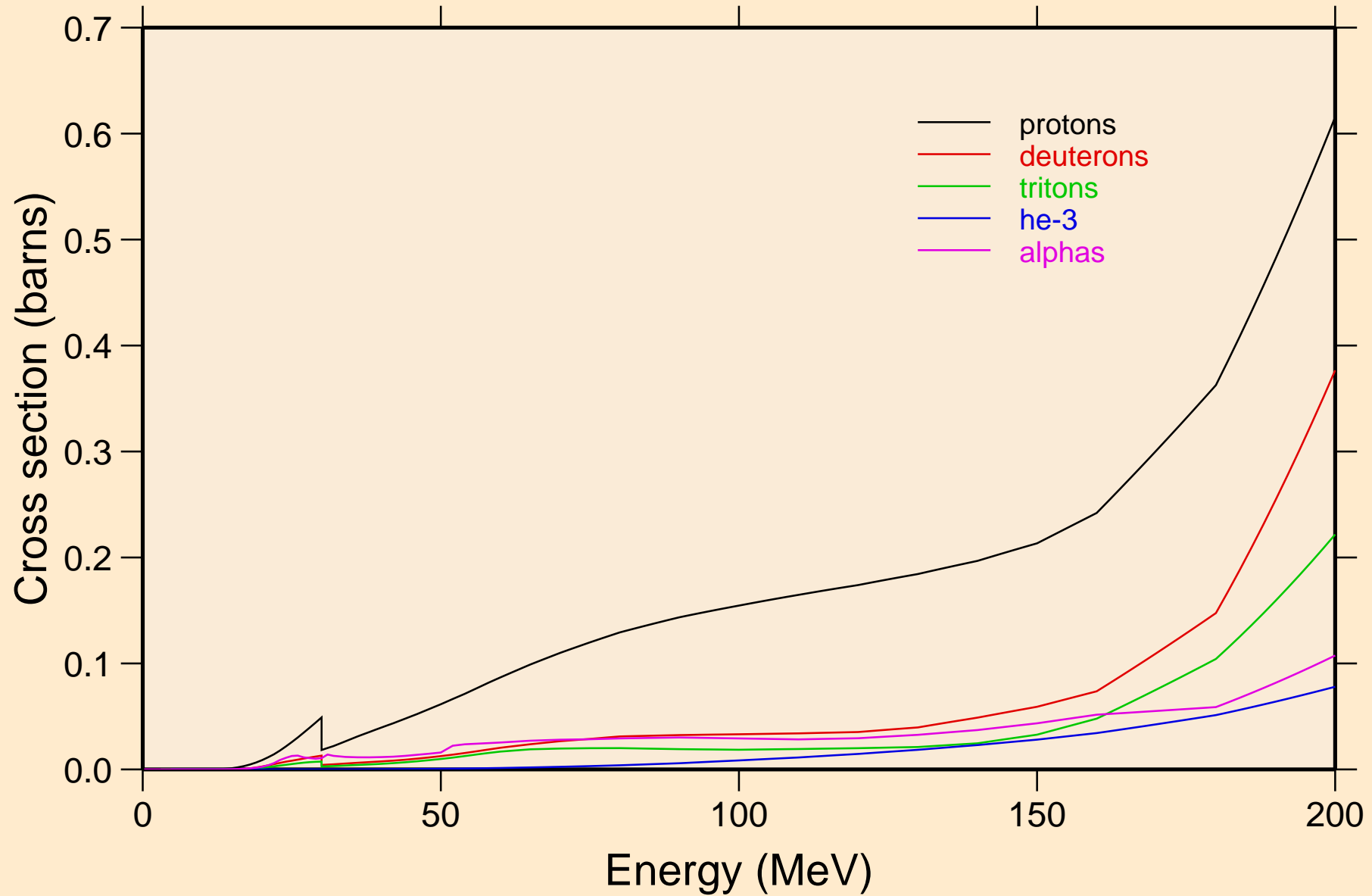

CF255 NRG TENDL-2015, AKONING  
protons from (n,x)

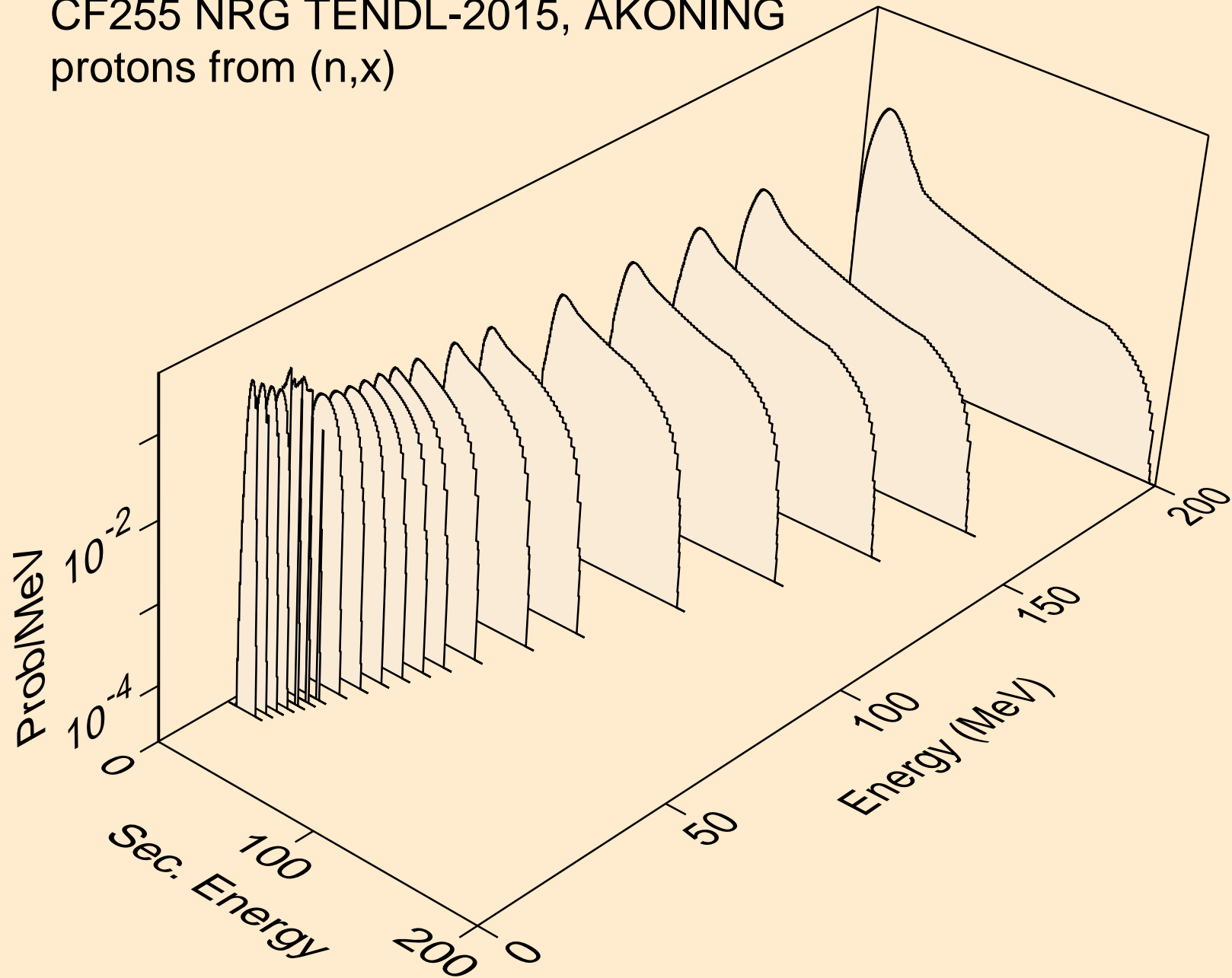

CF255 NRG TENDL-2015, AKONING  
protons from (n,n\*)p

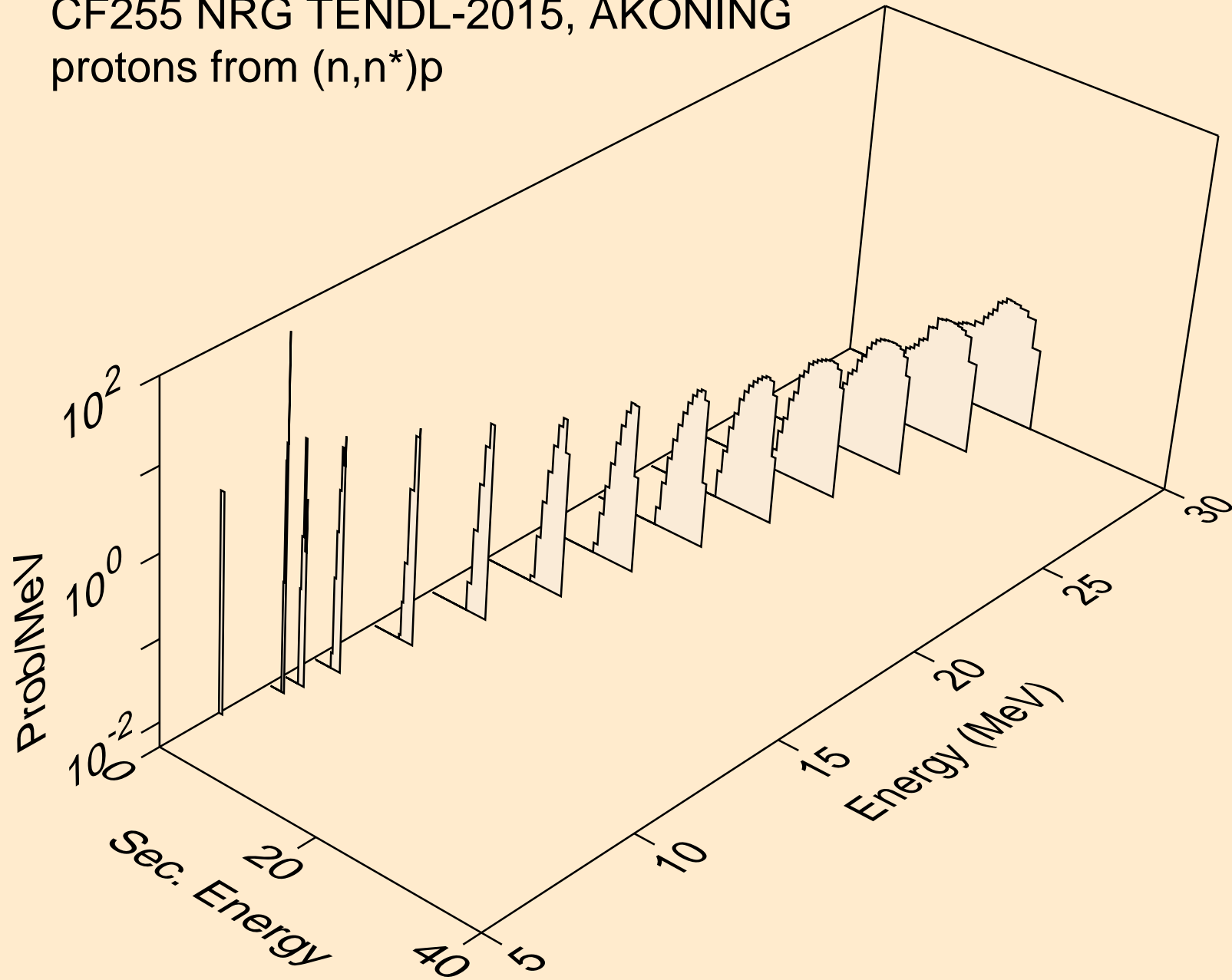

CF255 NRG TENDL-2015, AKONING  
protons from (n,2np)

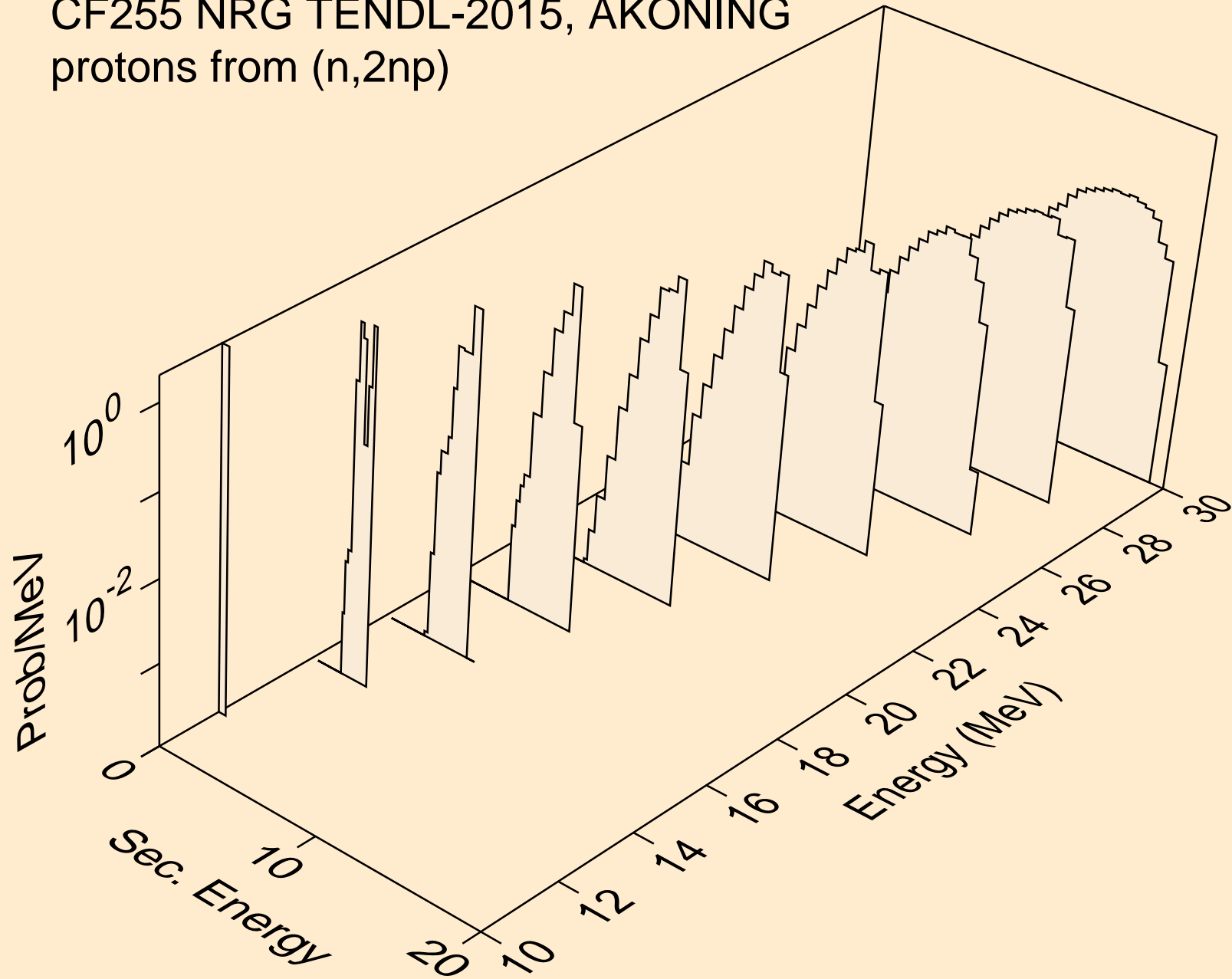



CF255 NRG TENDL-2015, AKONING  
protons from (n,3np)

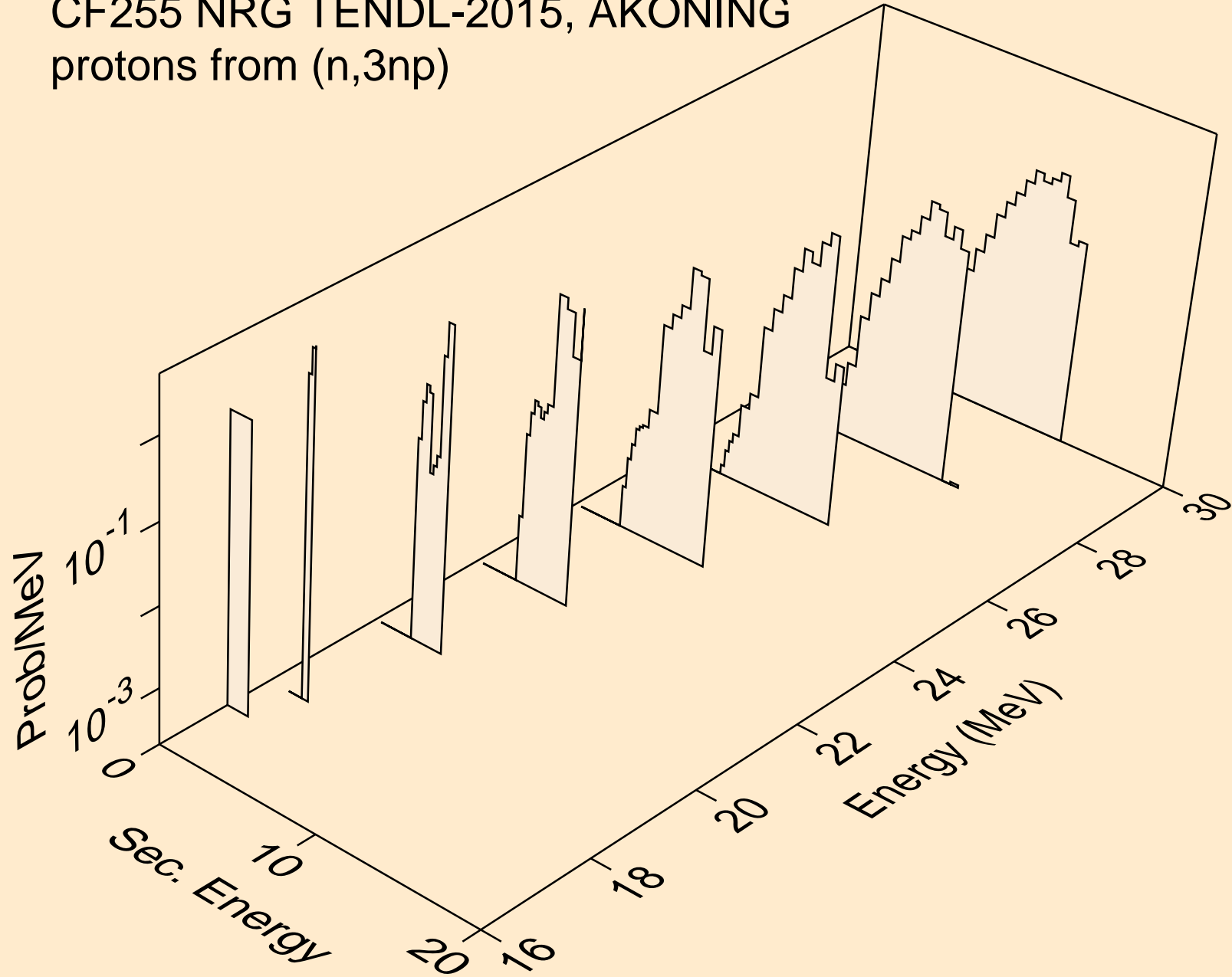

CF255 NRG TENDL-2015, AKONING  
protons from (n,p)

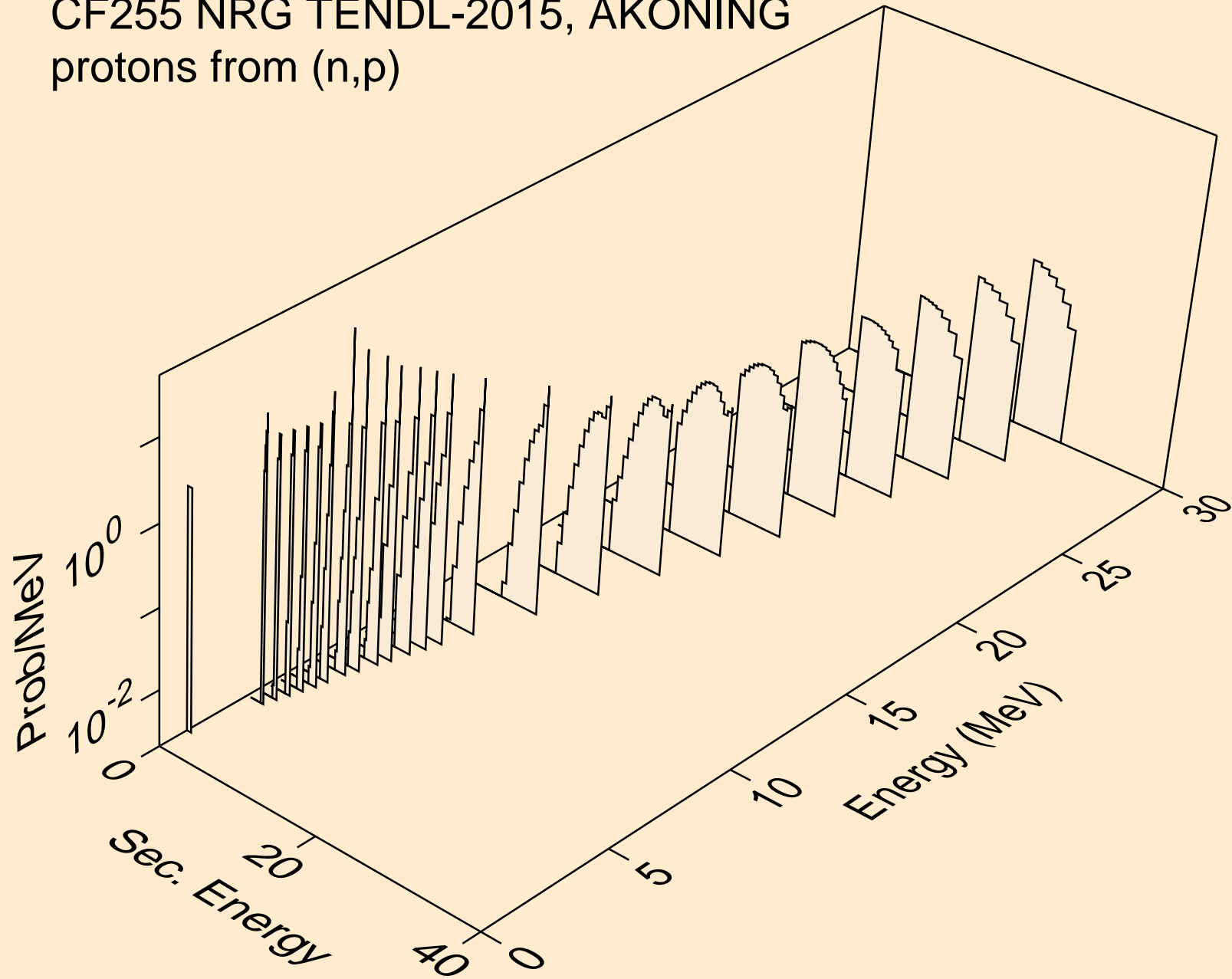

CF255 NRG TENDL-2015, AKONING  
protons from (n,2p)

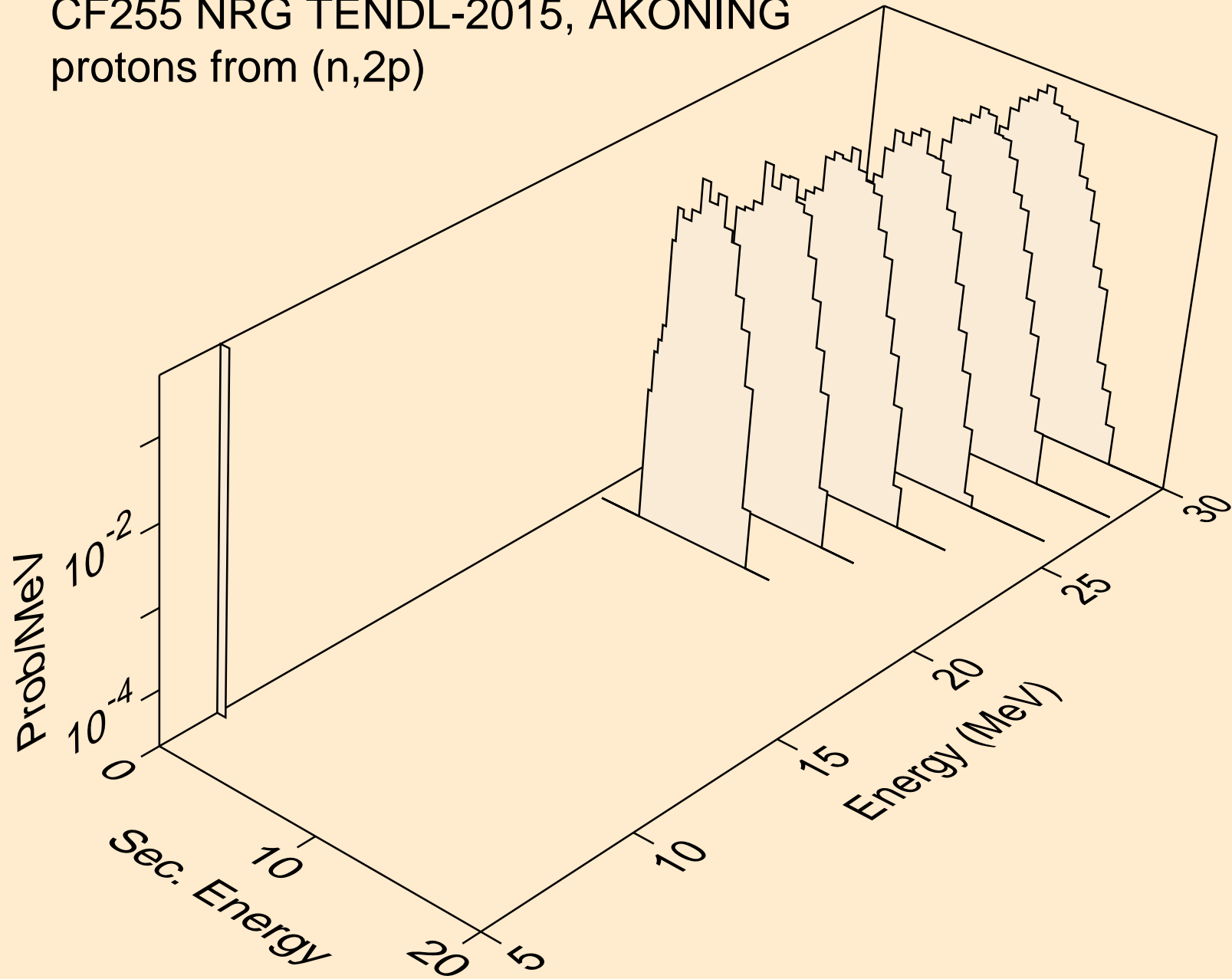

CF255 NRG TENDL-2015, AKONING  
deuterons from (n,x)

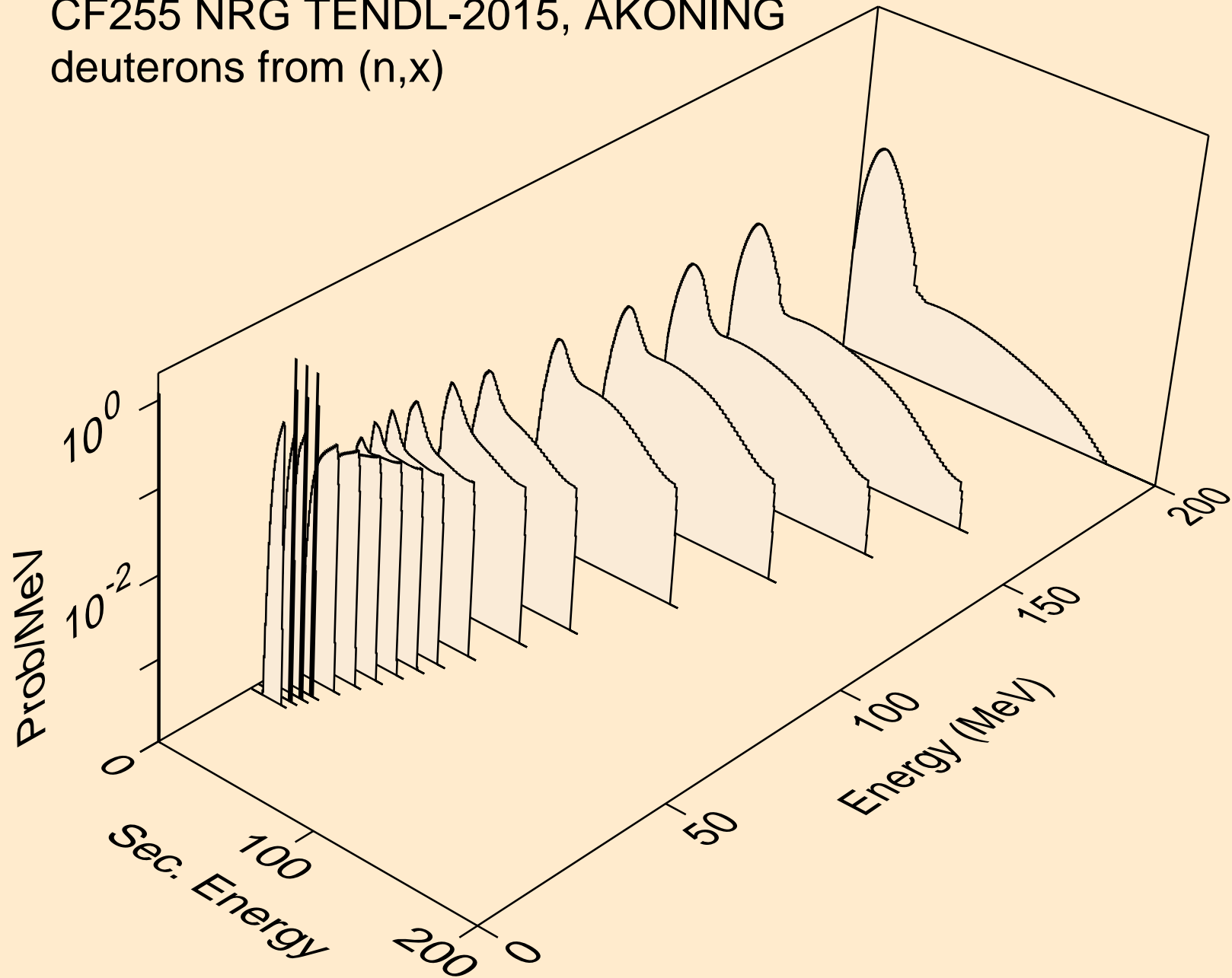

CF255 NRG TENDL-2015, AKONING  
deuterons from (n,2nd)

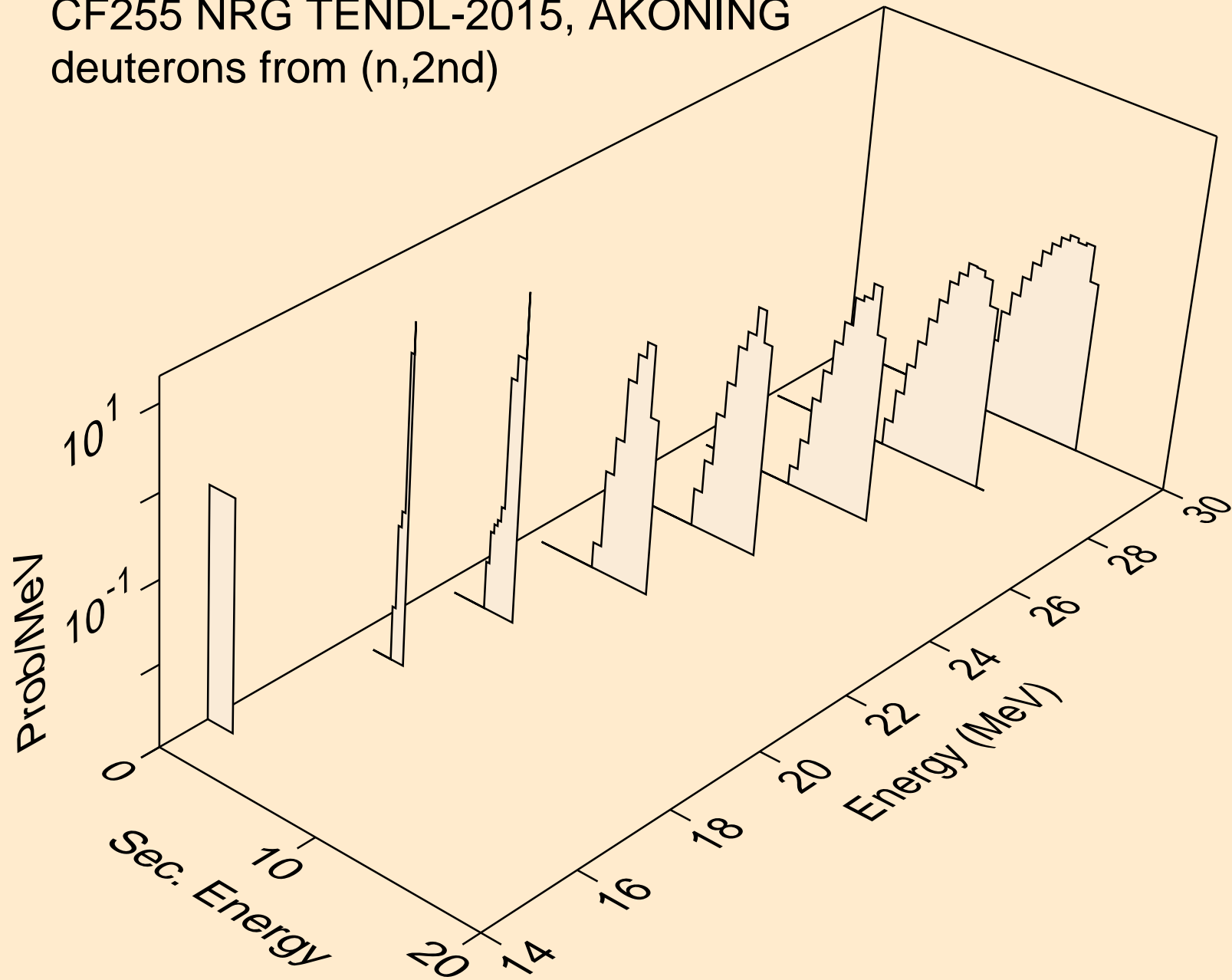

CF255 NRG TENDL-2015, AKONING  
deuterons from (n,n\*)d

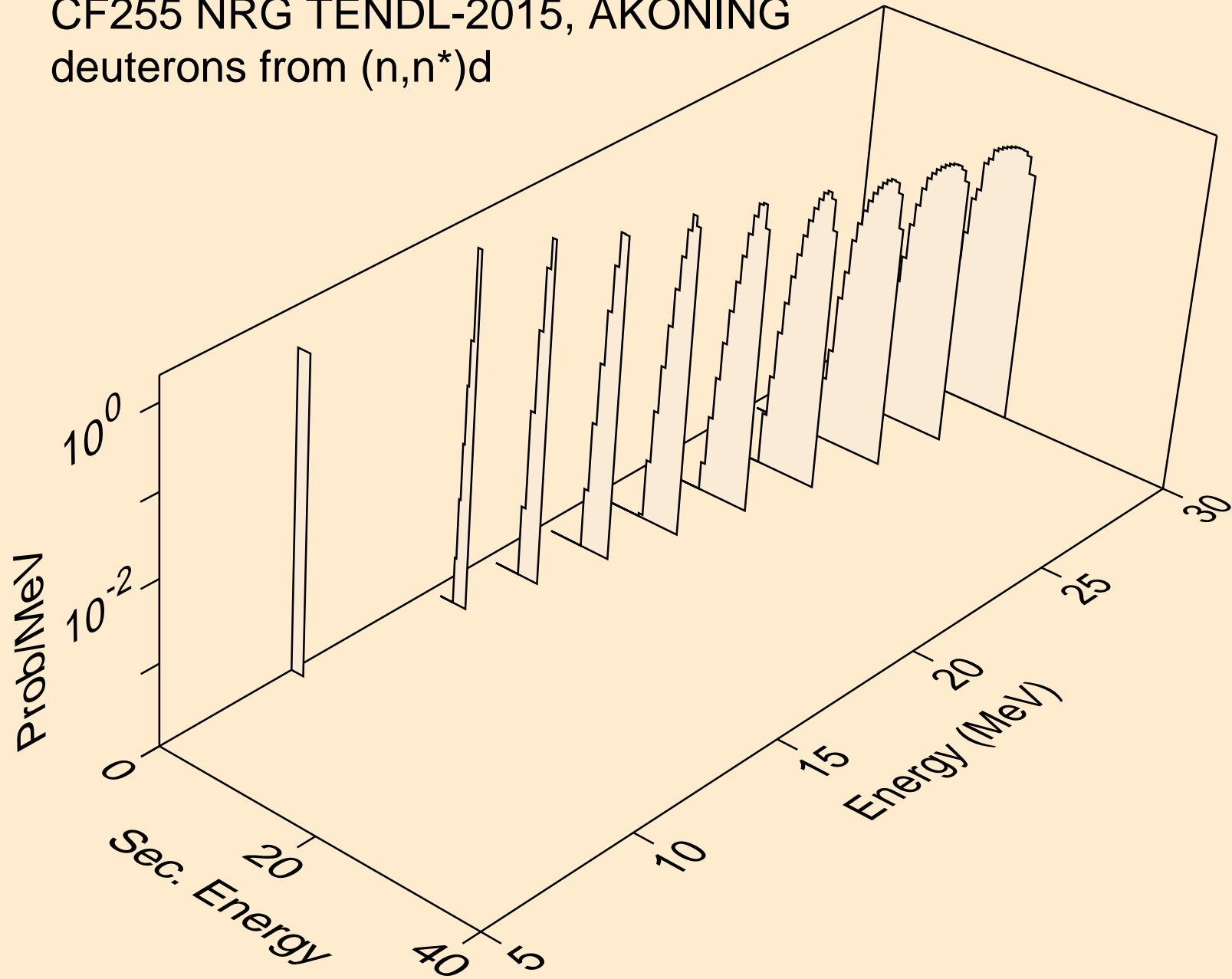

CF255 NRG TENDL-2015, AKONING  
deuterons from (n,d)

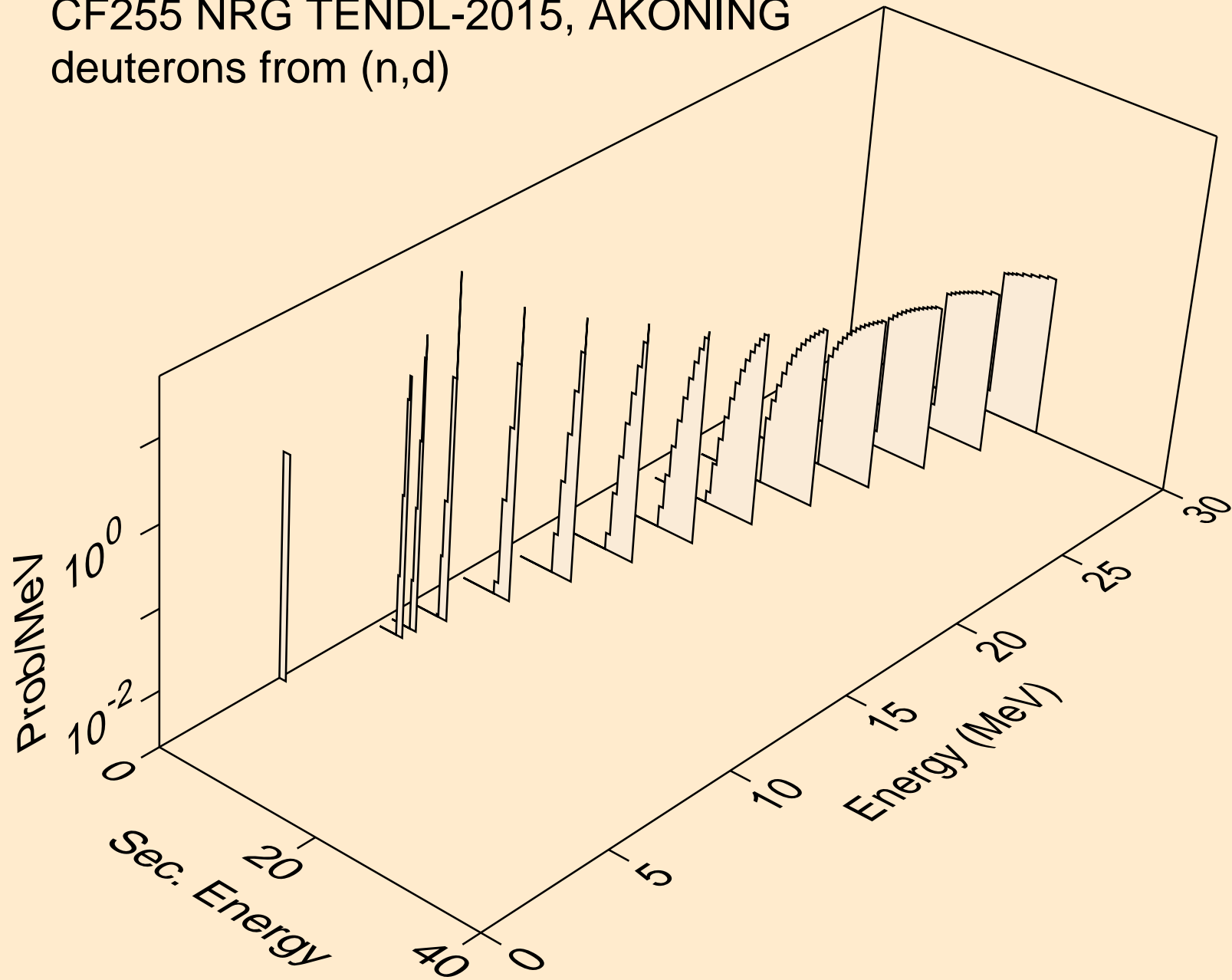

CF255 NRG TENDL-2015, AKONING  
tritons from (n,x)

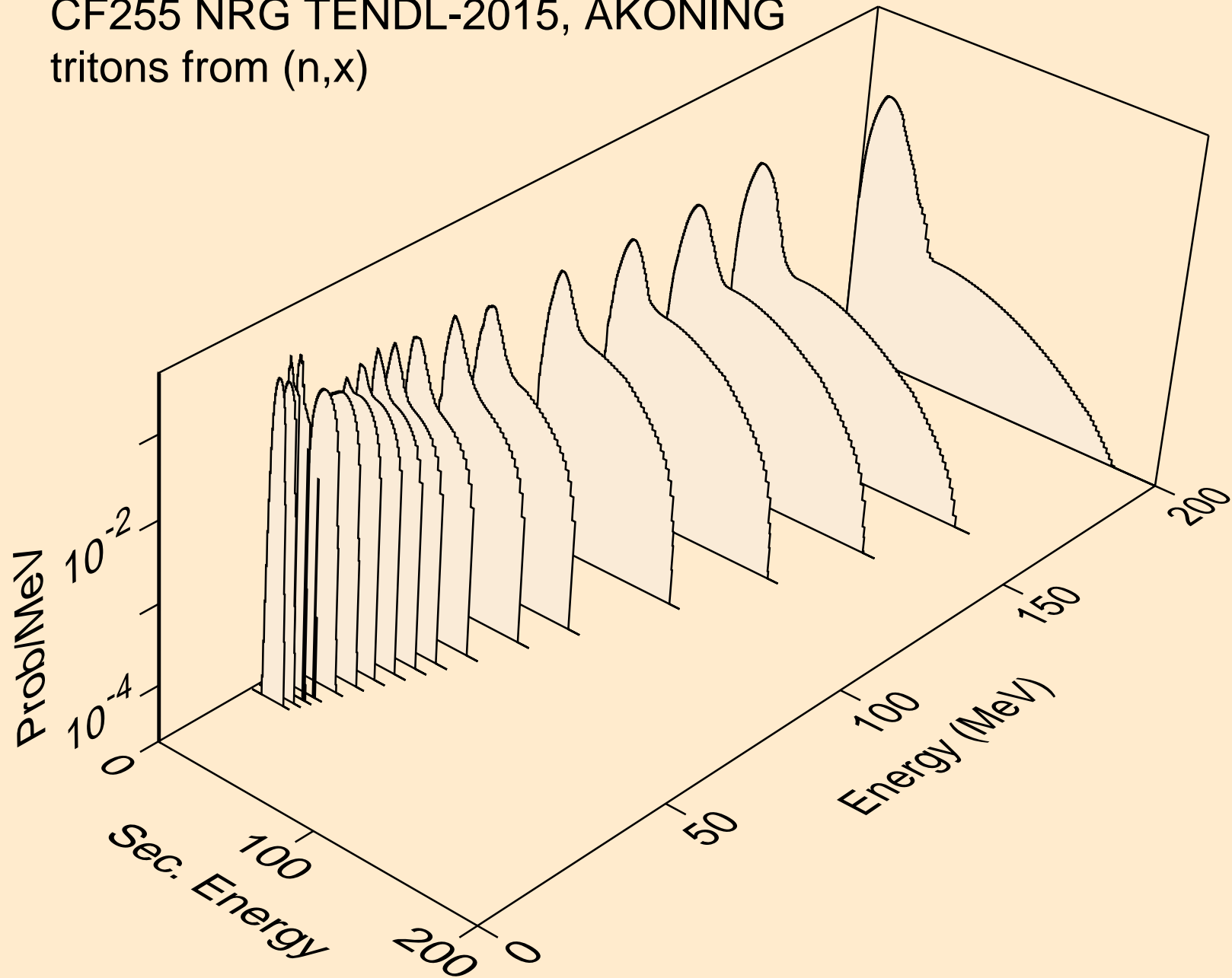



CF255 NRG TENDL-2015, AKONING  
tritons from (n,n\*)t

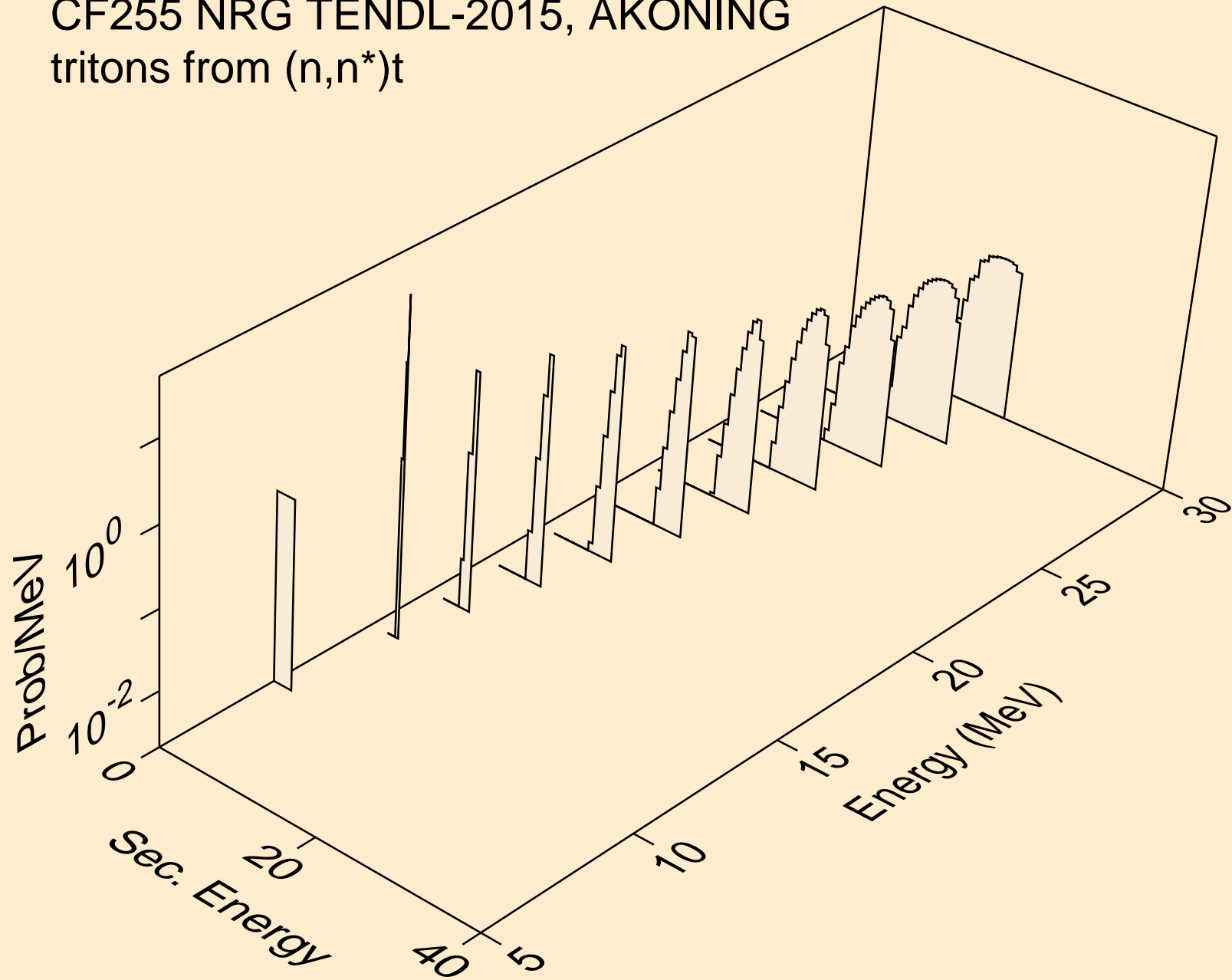

CF255 NRG TENDL-2015, AKONING  
tritons from (n,t)

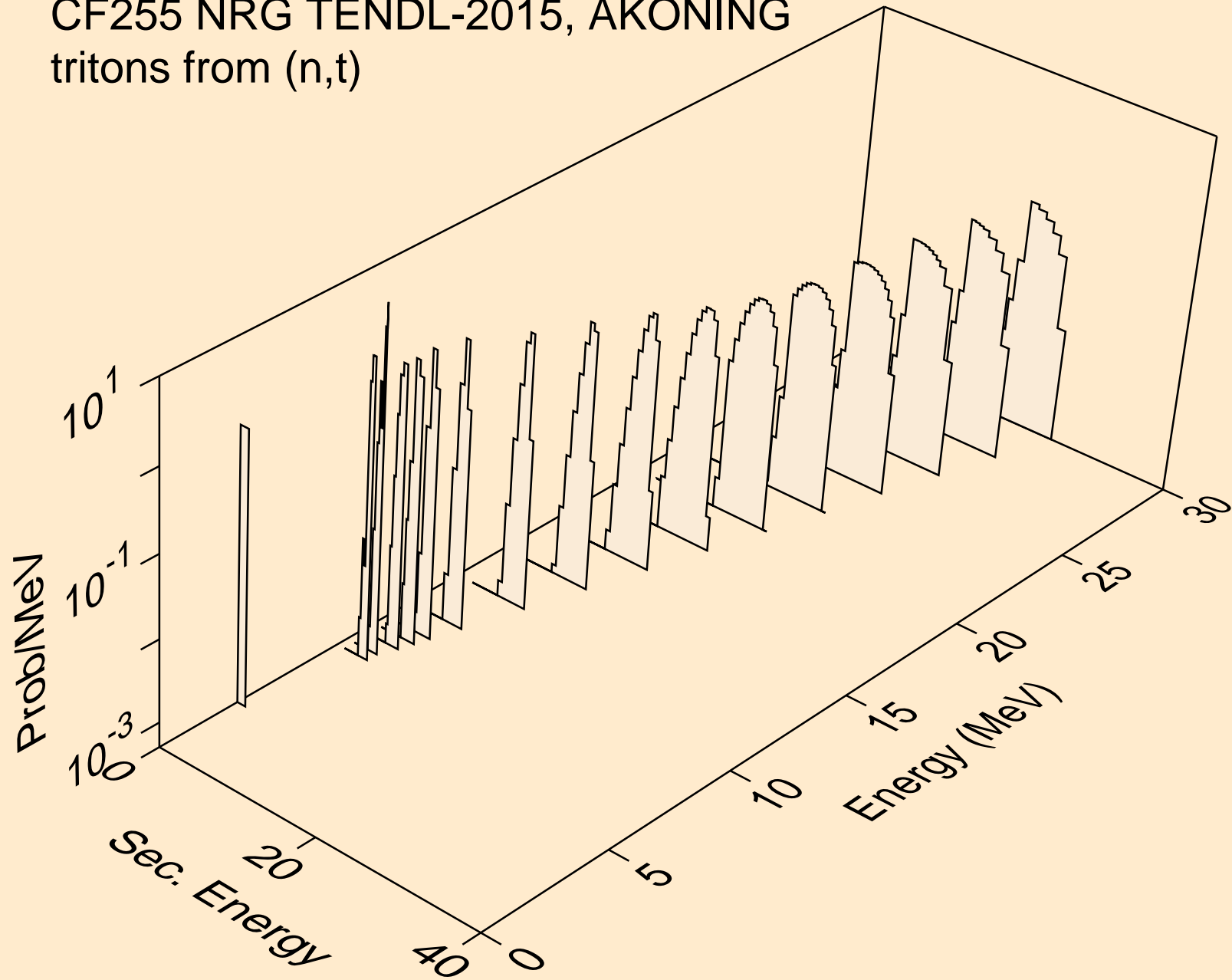

CF255 NRG TENDL-2015, AKONING  
he3s from (n,x)

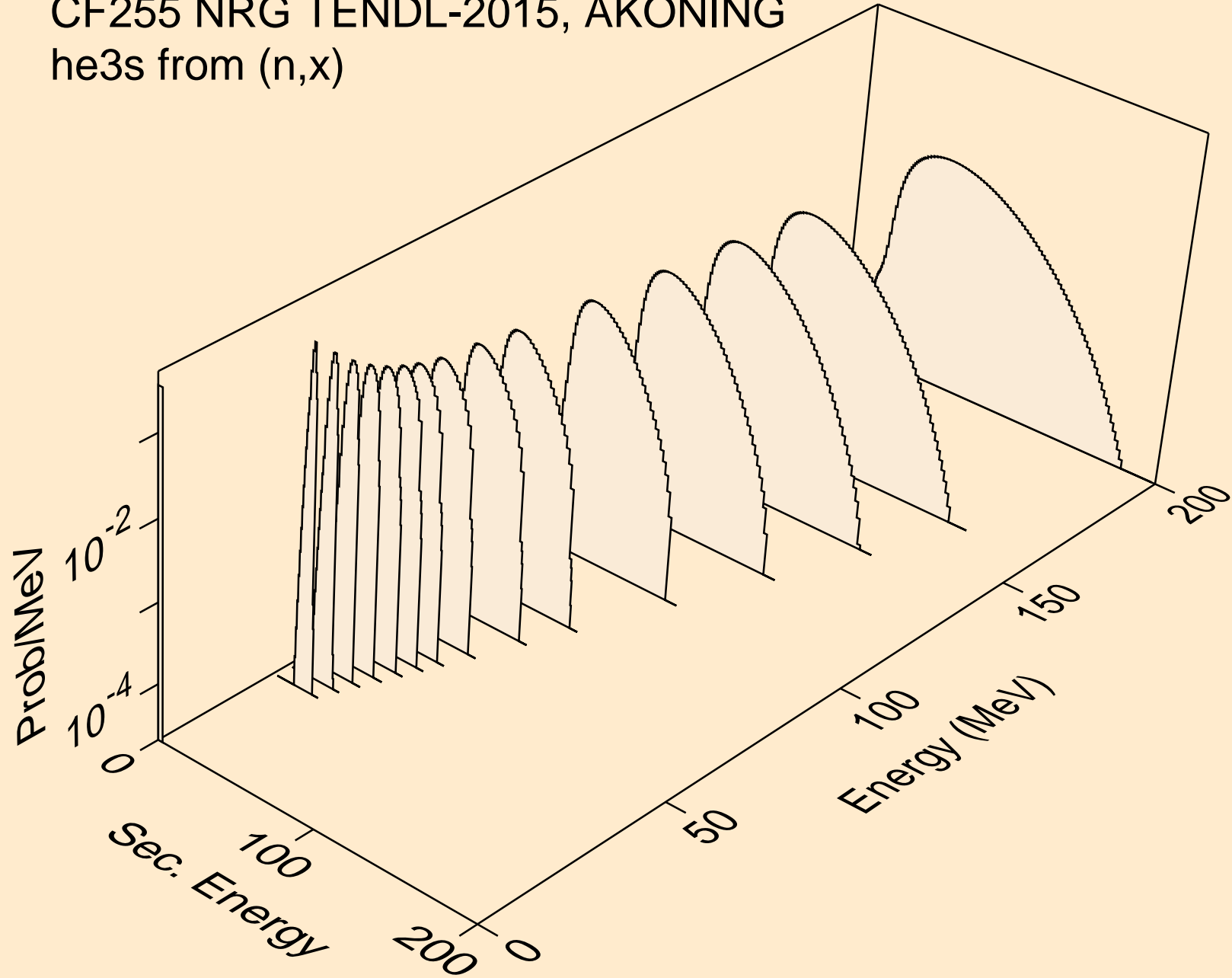

CF255 NRG TENDL-2015, AKONING  
he3s from (n,n\*)he3

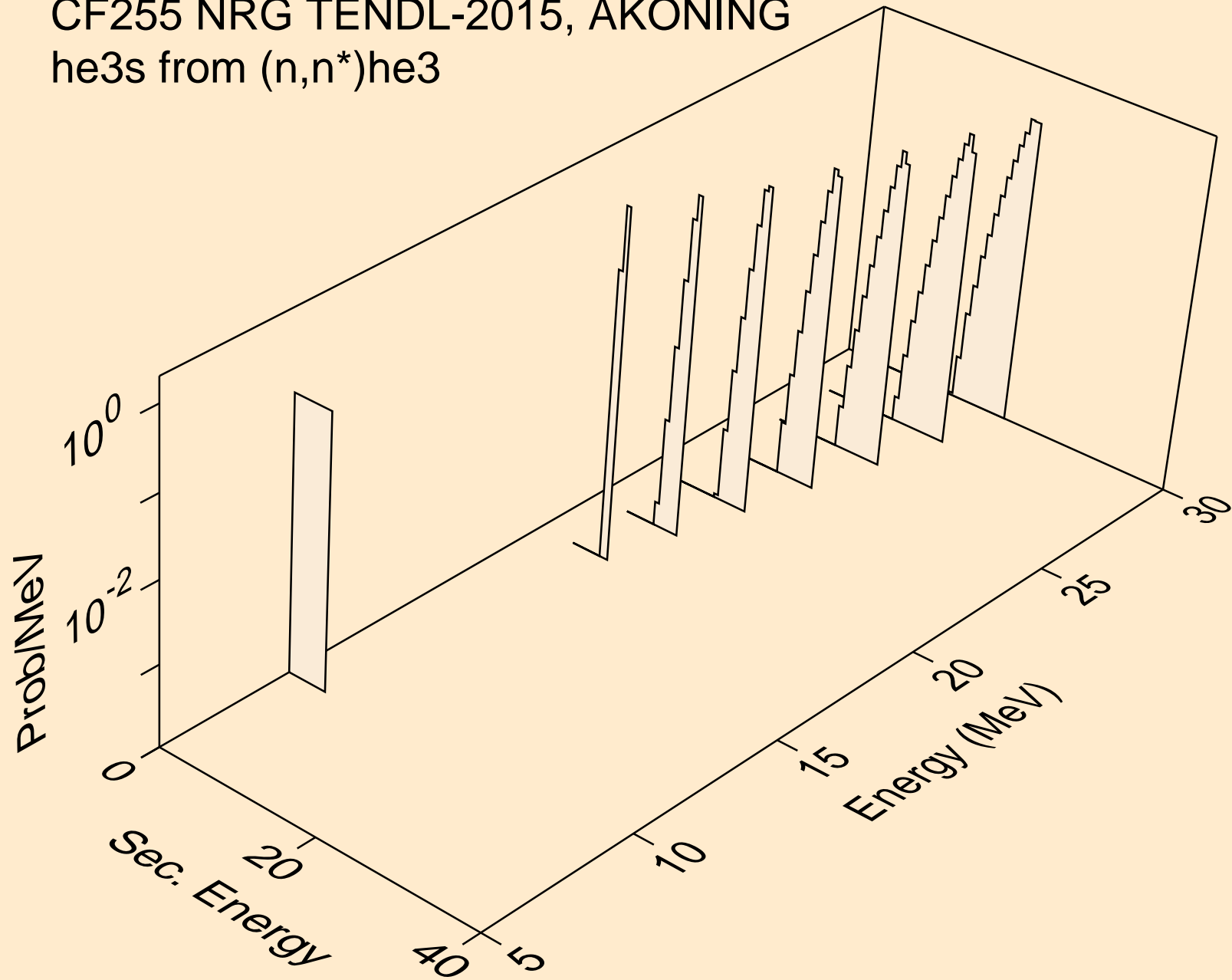

CF255 NRG TENDL-2015, AKONING  
he3s from (n,he3)

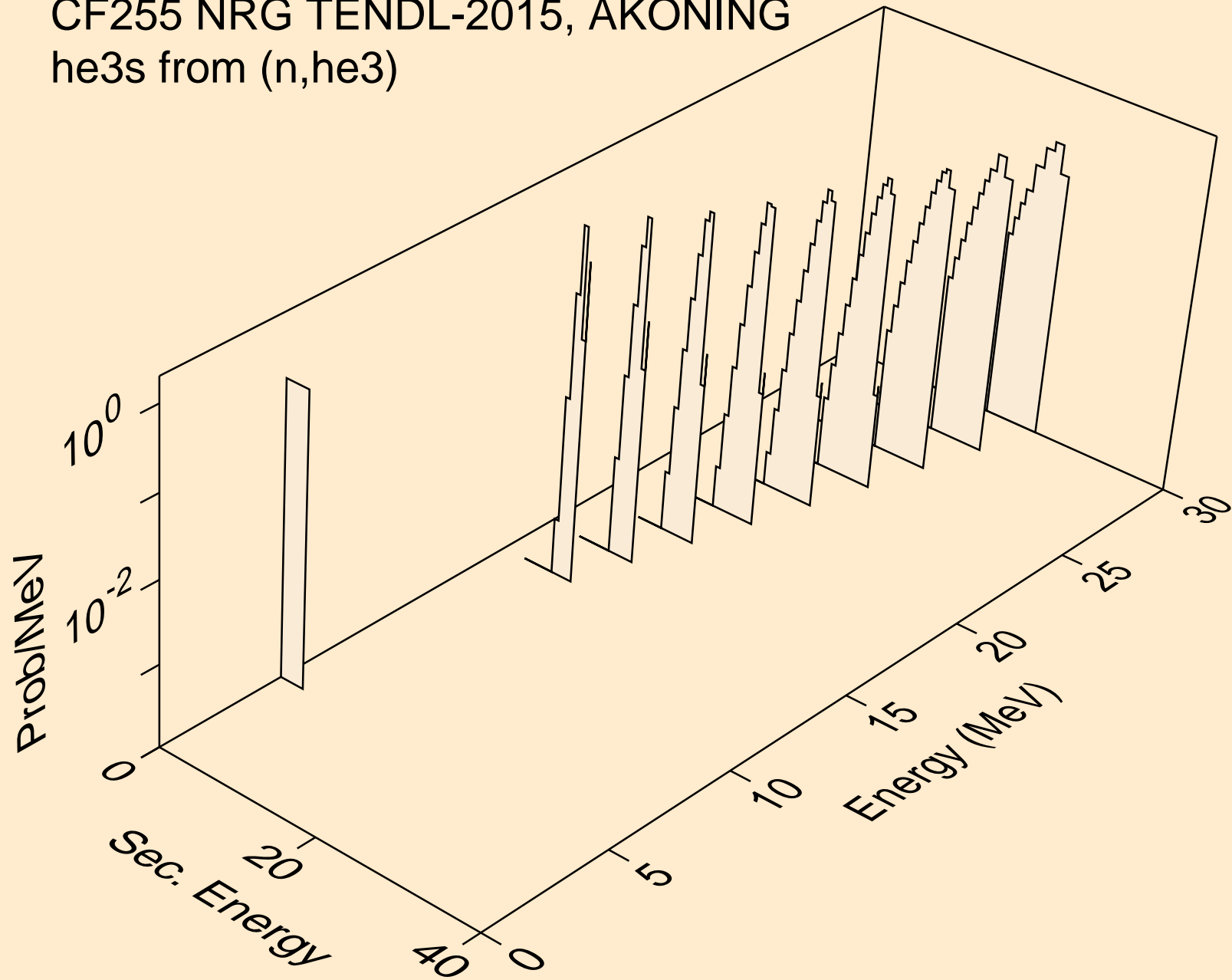

CF255 NRG TENDL-2015, AKONING  
alphas from (n,x)

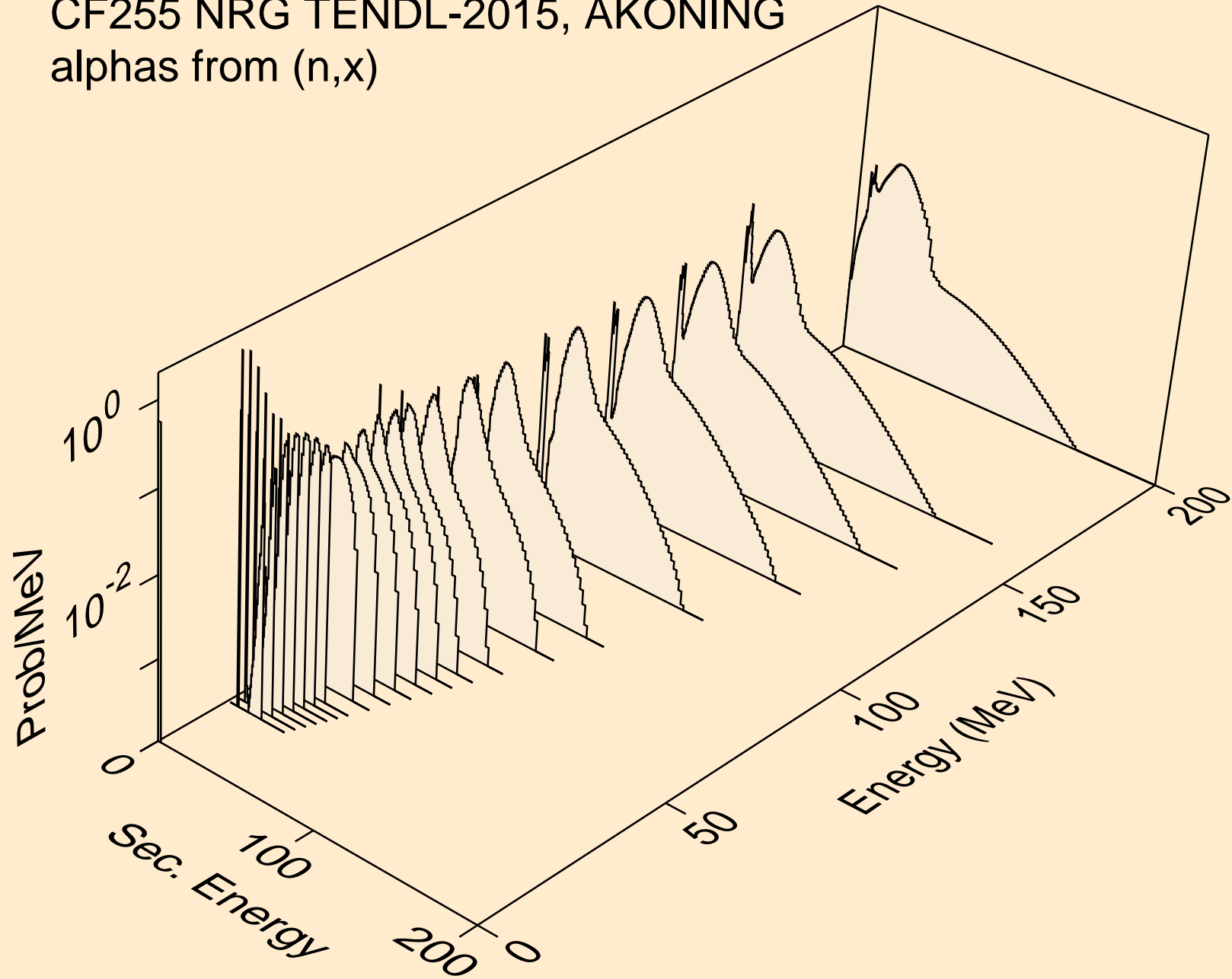

CF255 NRG TENDL-2015, AKONING  
alphas from (n,n\*)a

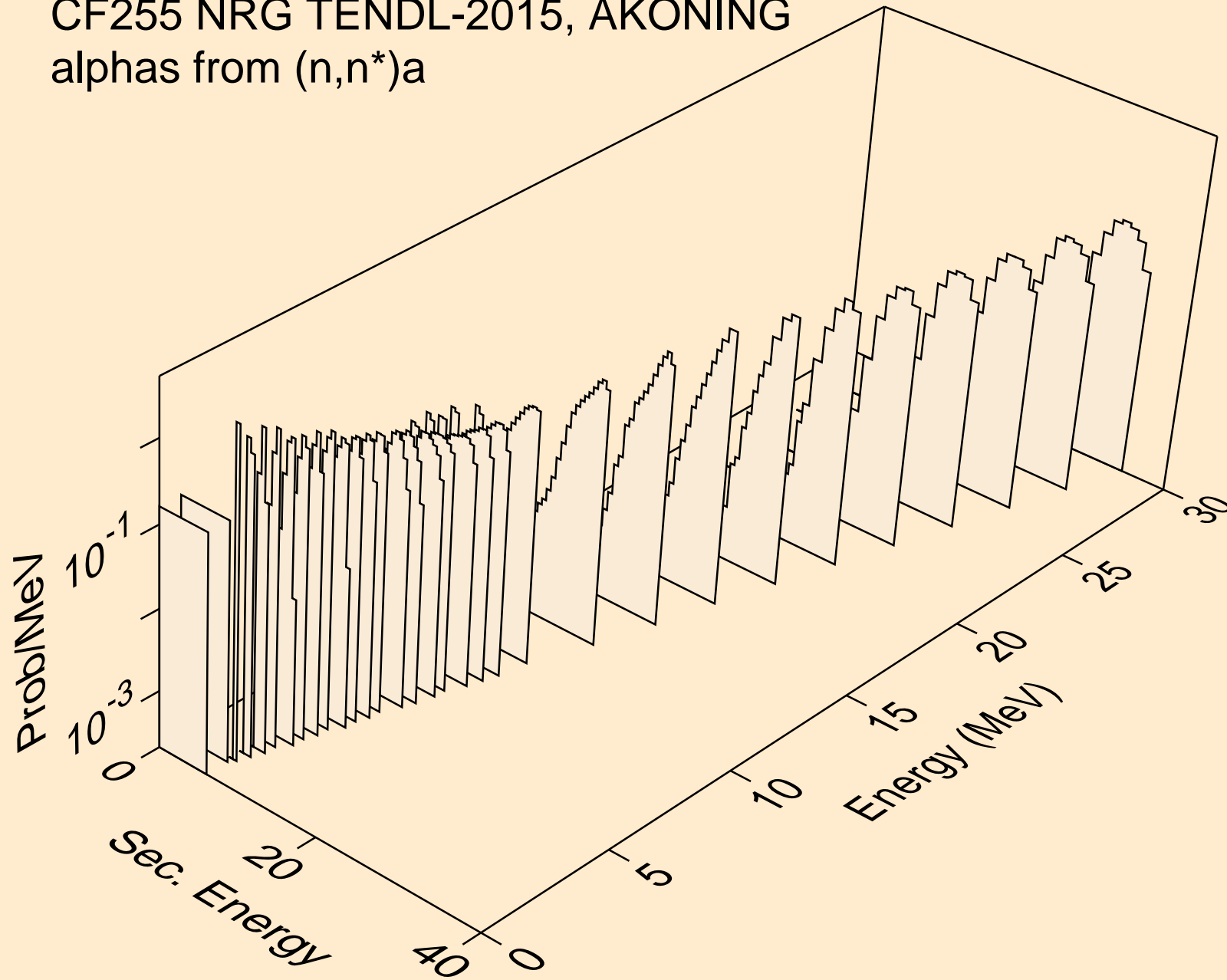

CF255 NRG TENDL-2015, AKONING  
alphas from (n,2n)a

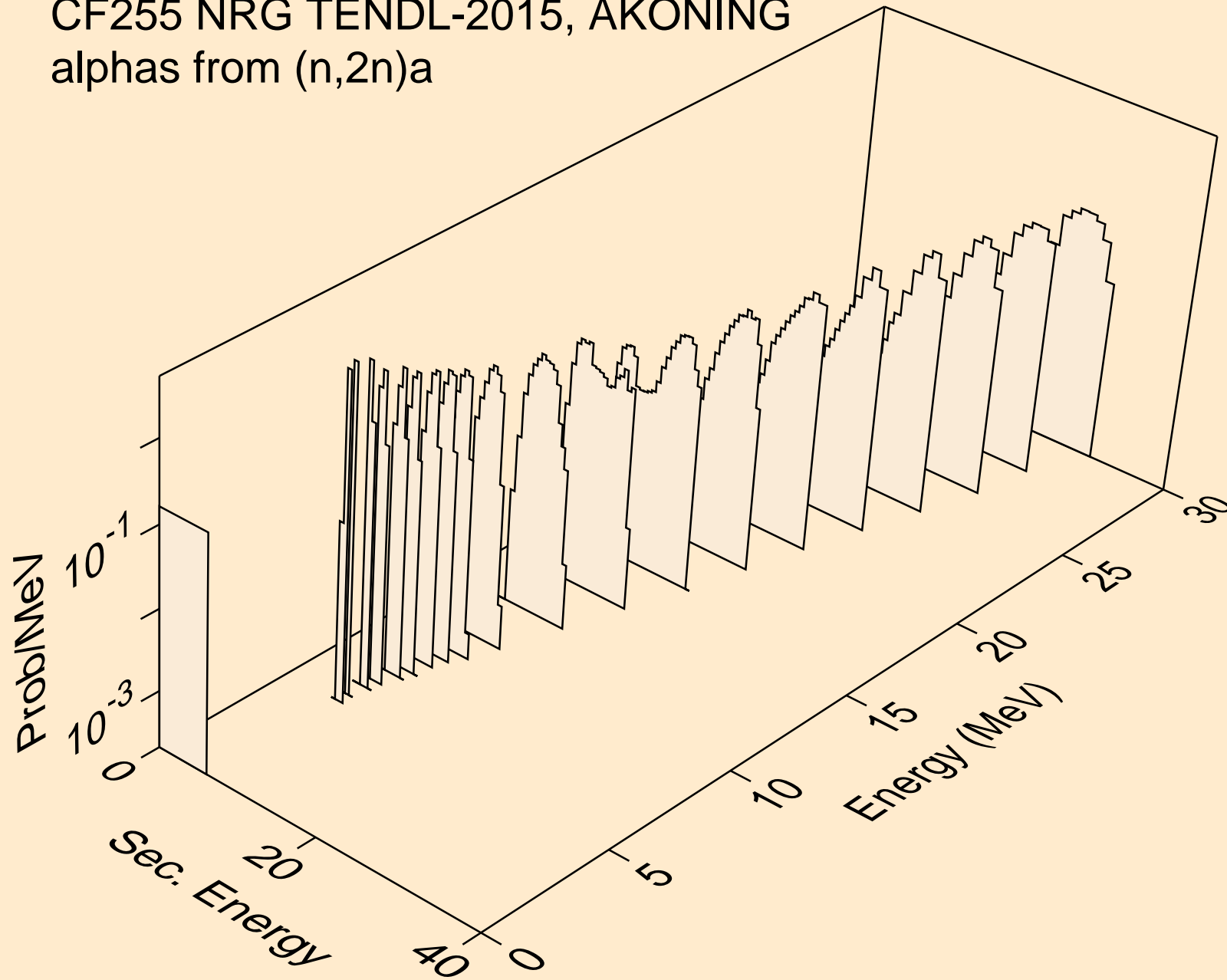



CF255 NRG TENDL-2015, AKONING  
alphas from (n,3n)a

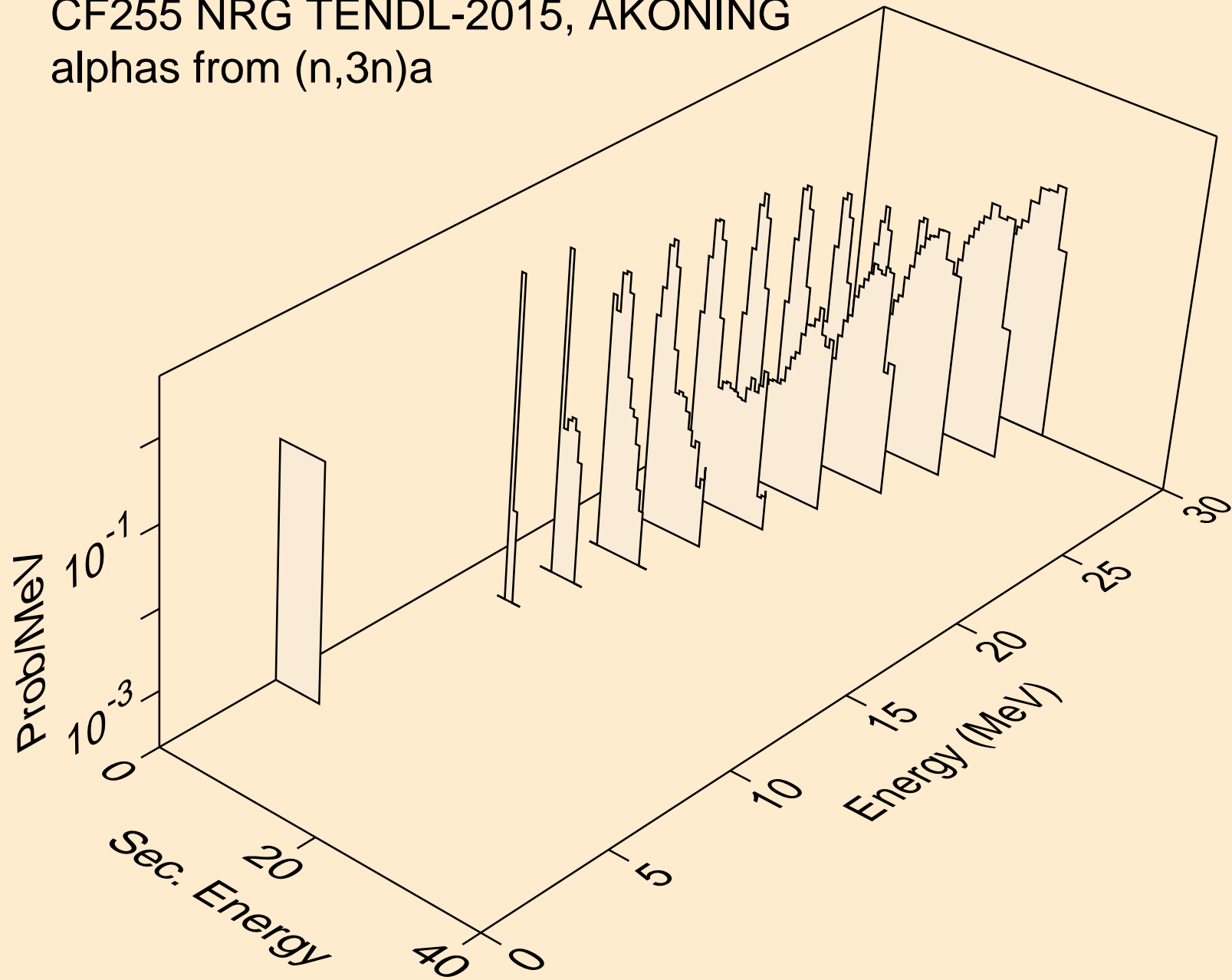

CF255 NRG TENDL-2015, AKONING  
alphas from (n,n\*)2a

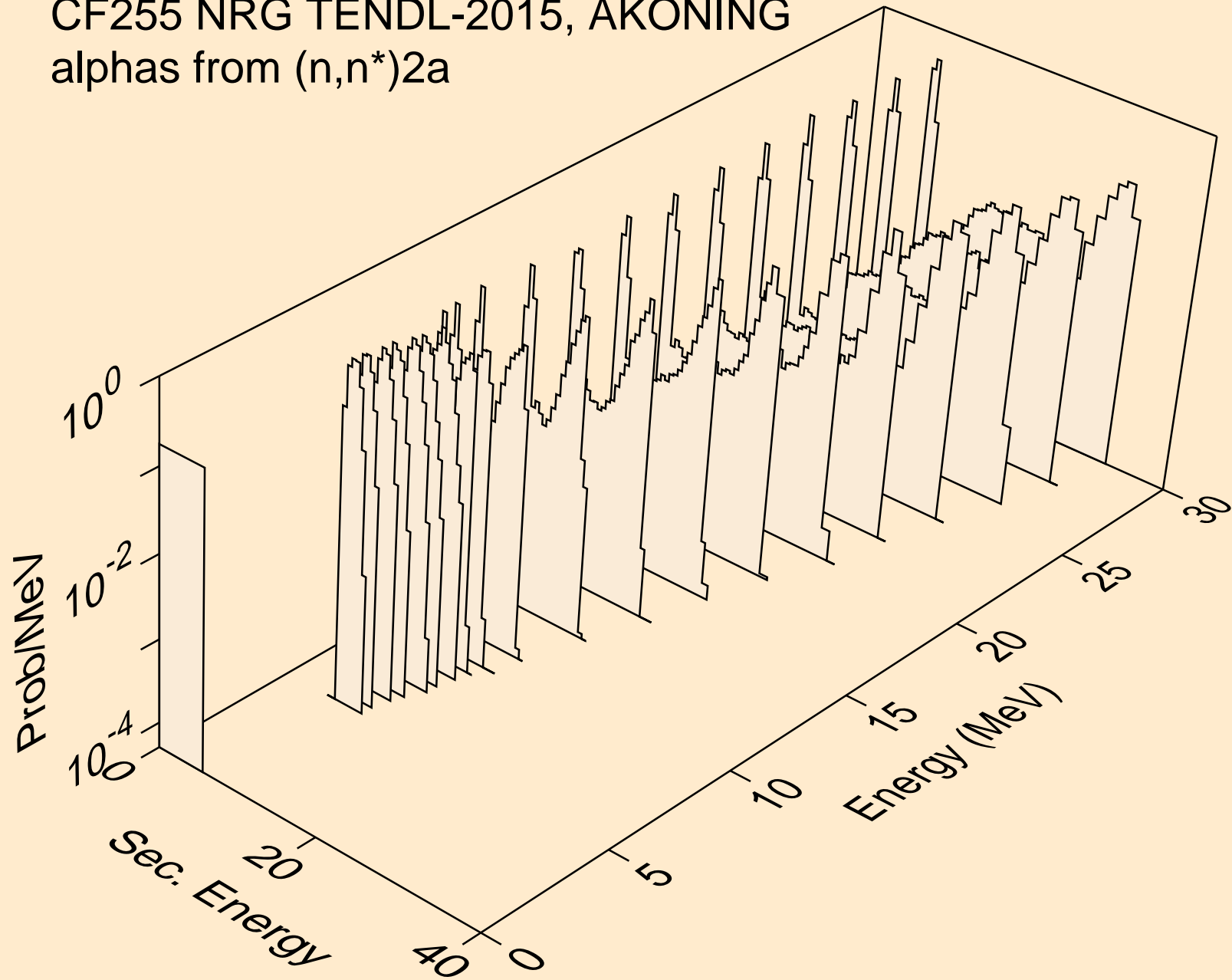

CF255 NRG TENDL-2015, AKONING  
alphas from (n,a)

