

CS115 NRG TENDL-2015, AKONING

Principal cross sections

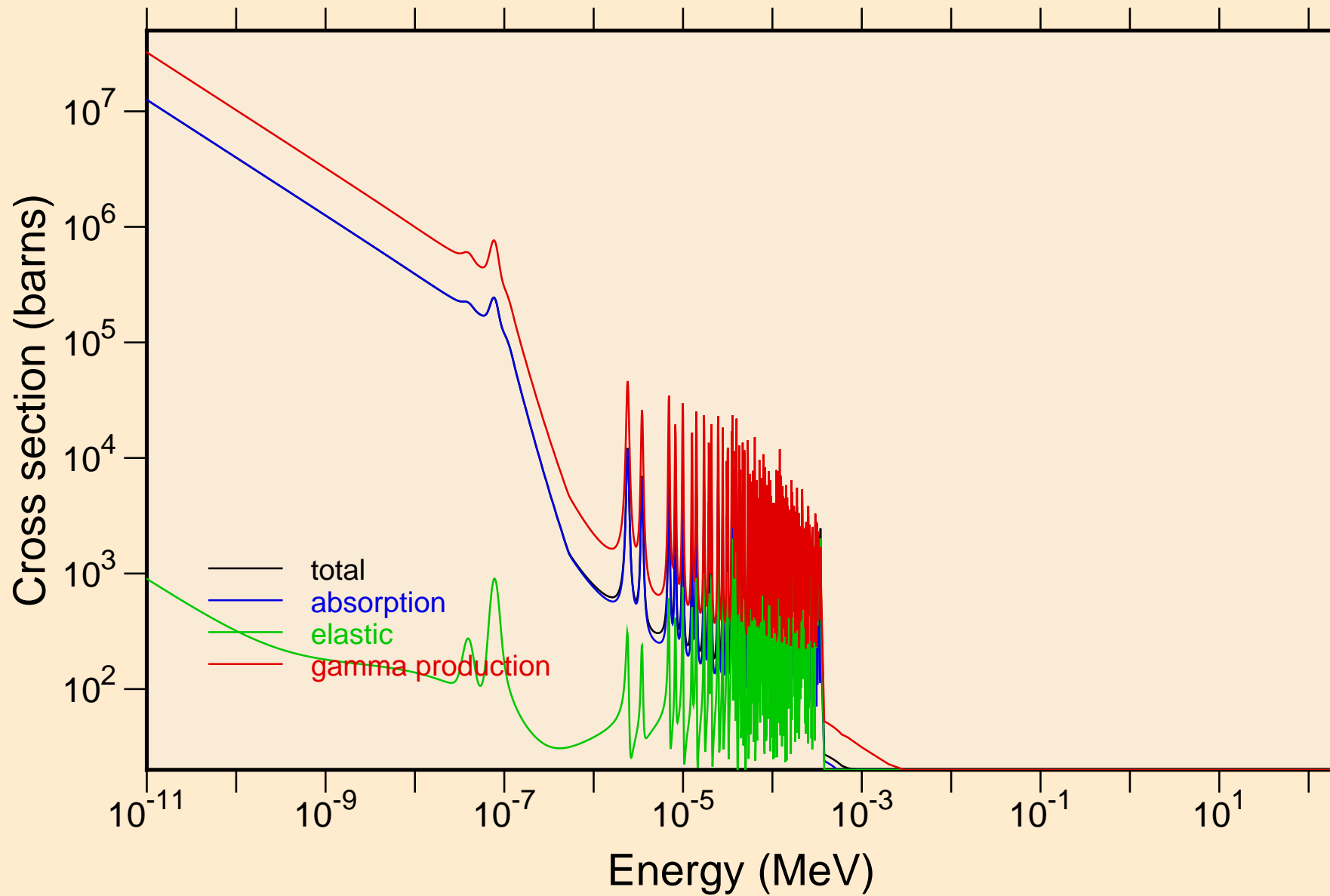

CS115 NRG TENDL-2015, AKONING
resonance total cross section

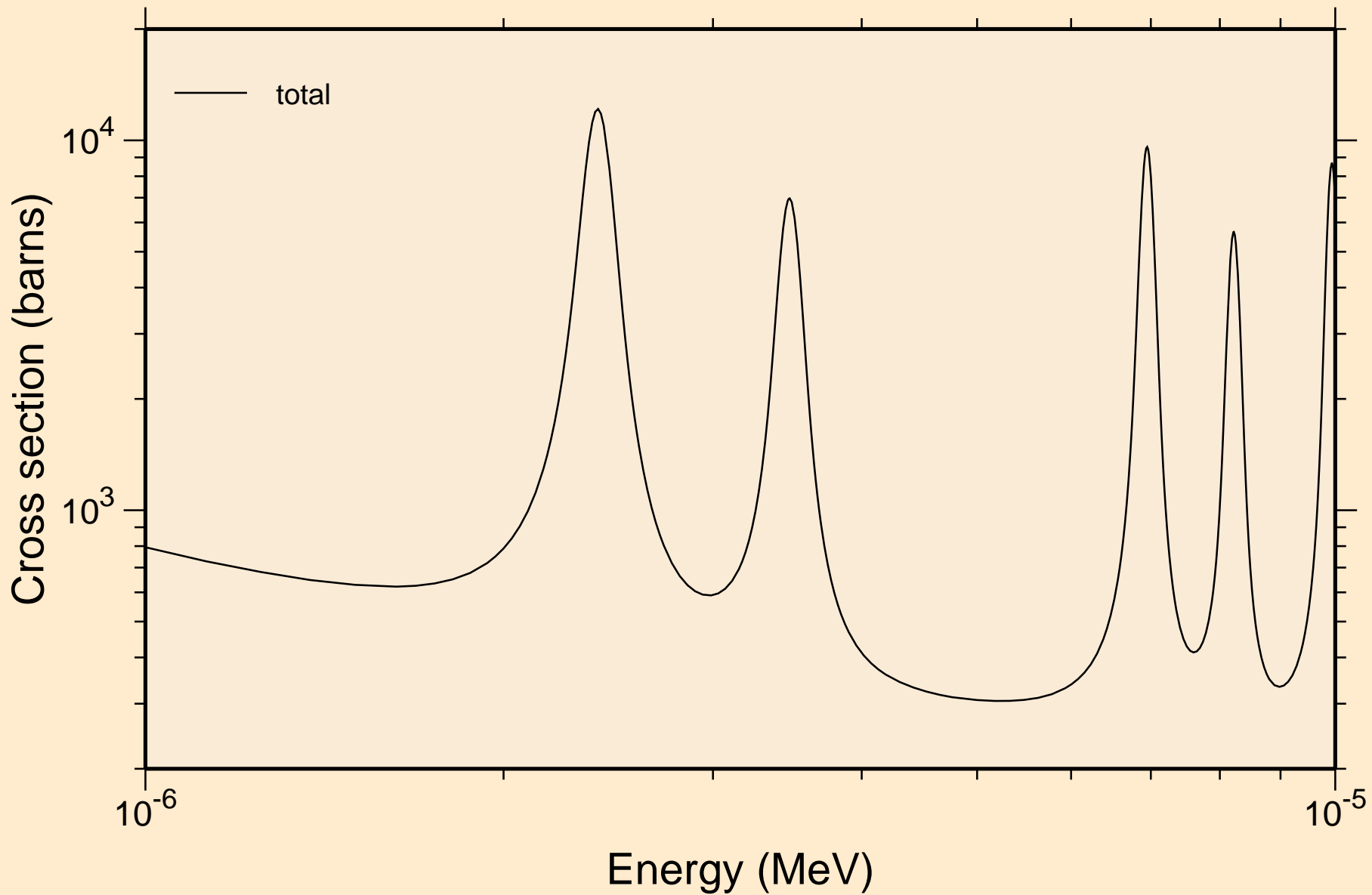

CS115 NRG TENDL-2015, AKONING
resonance total cross section

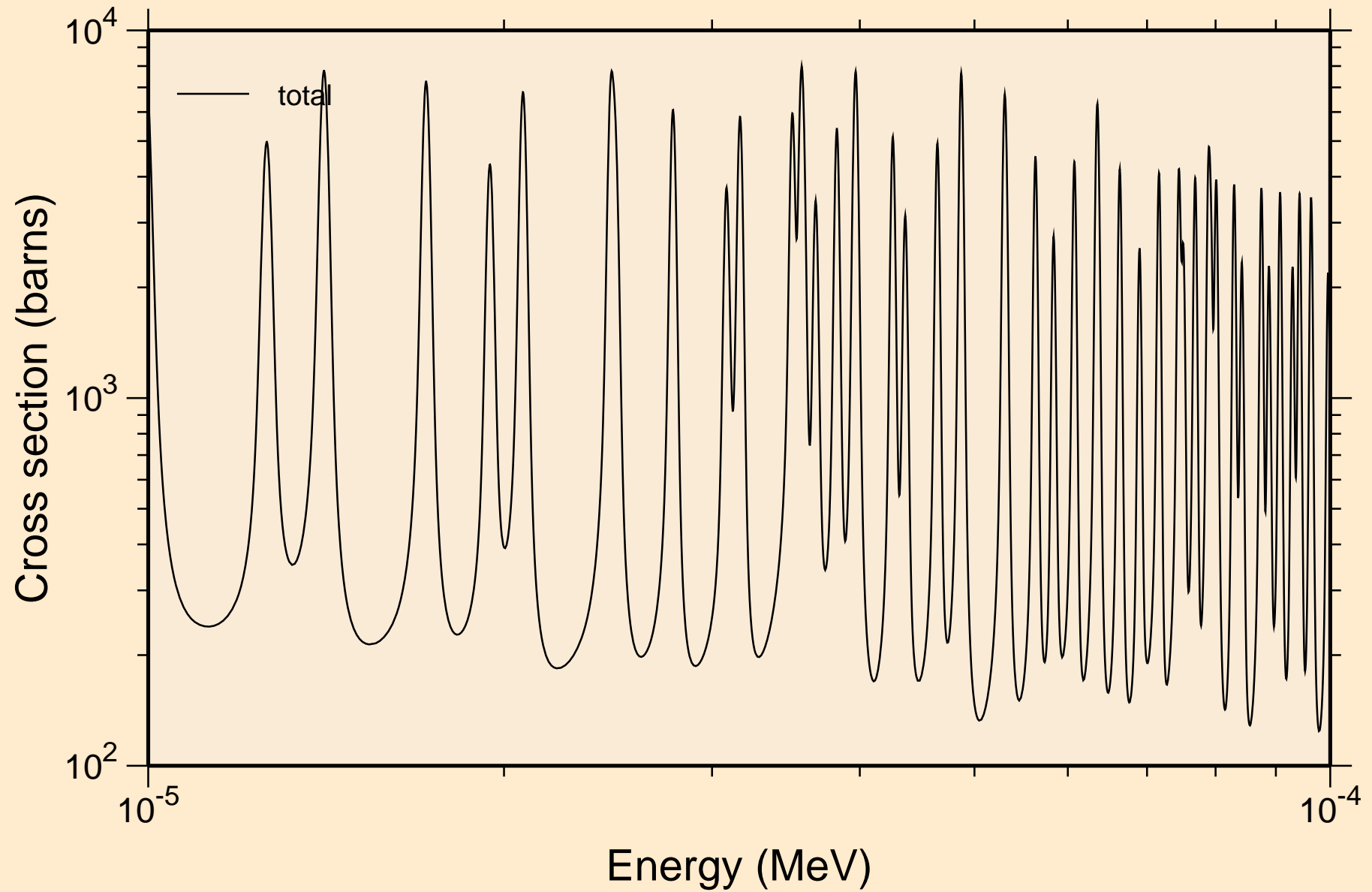

CS115 NRG TENDL-2015, AKONING
resonance total cross section

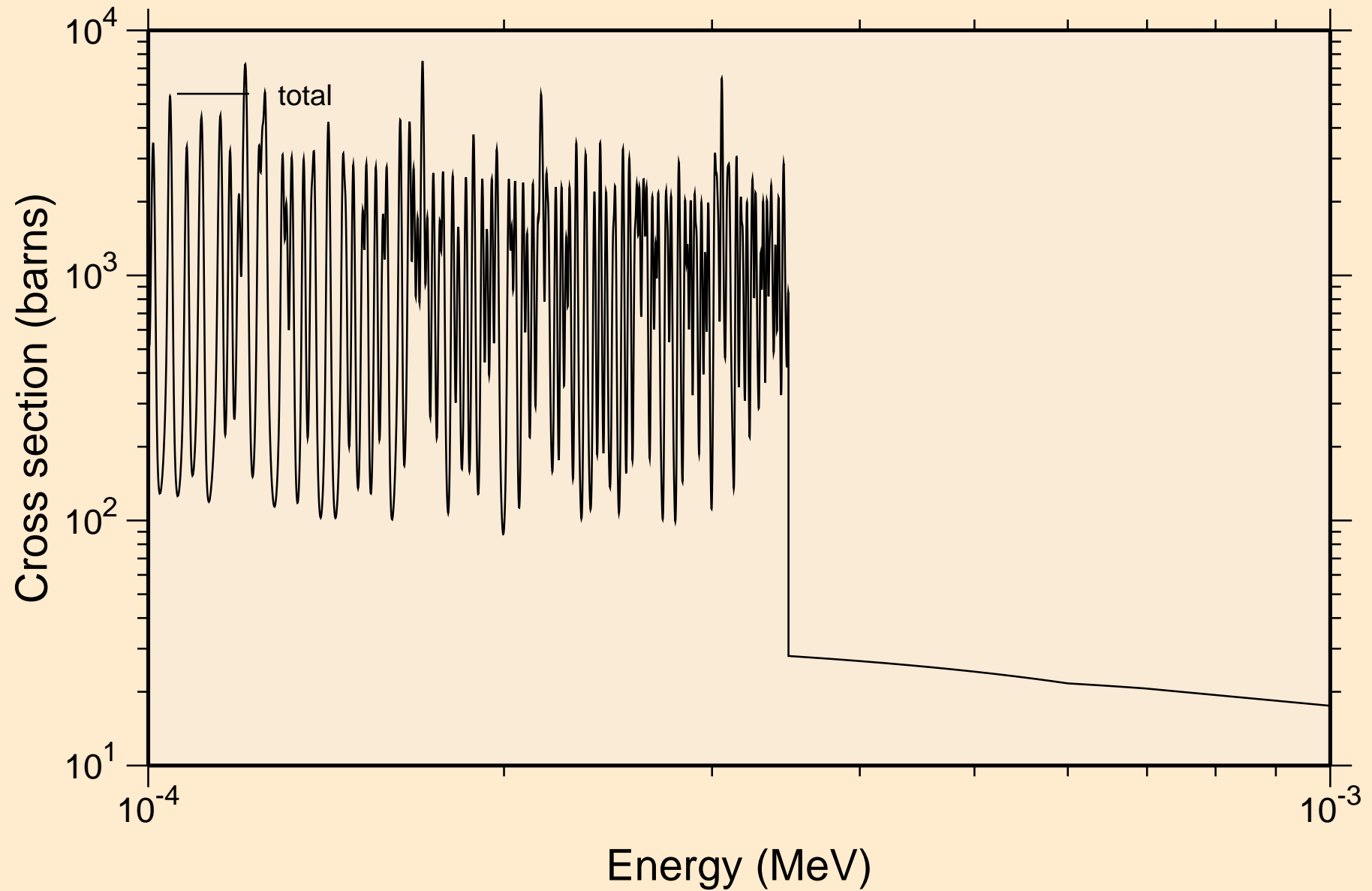

Cs115 NRG TENDL-2015, AKONING

resonance total cross section

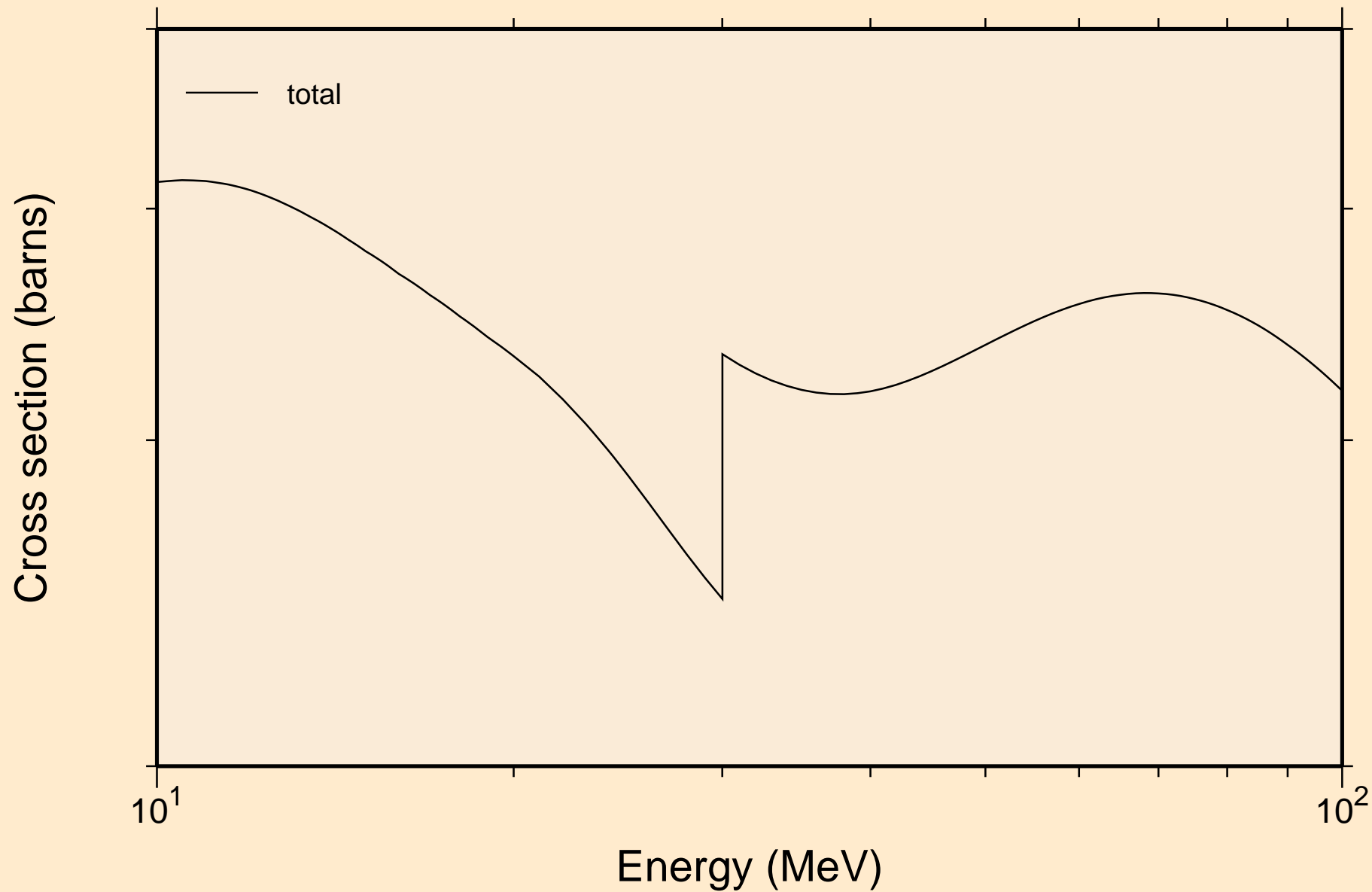

CS115 NRG TENDL-2015, AKONING
resonance absorption cross sections

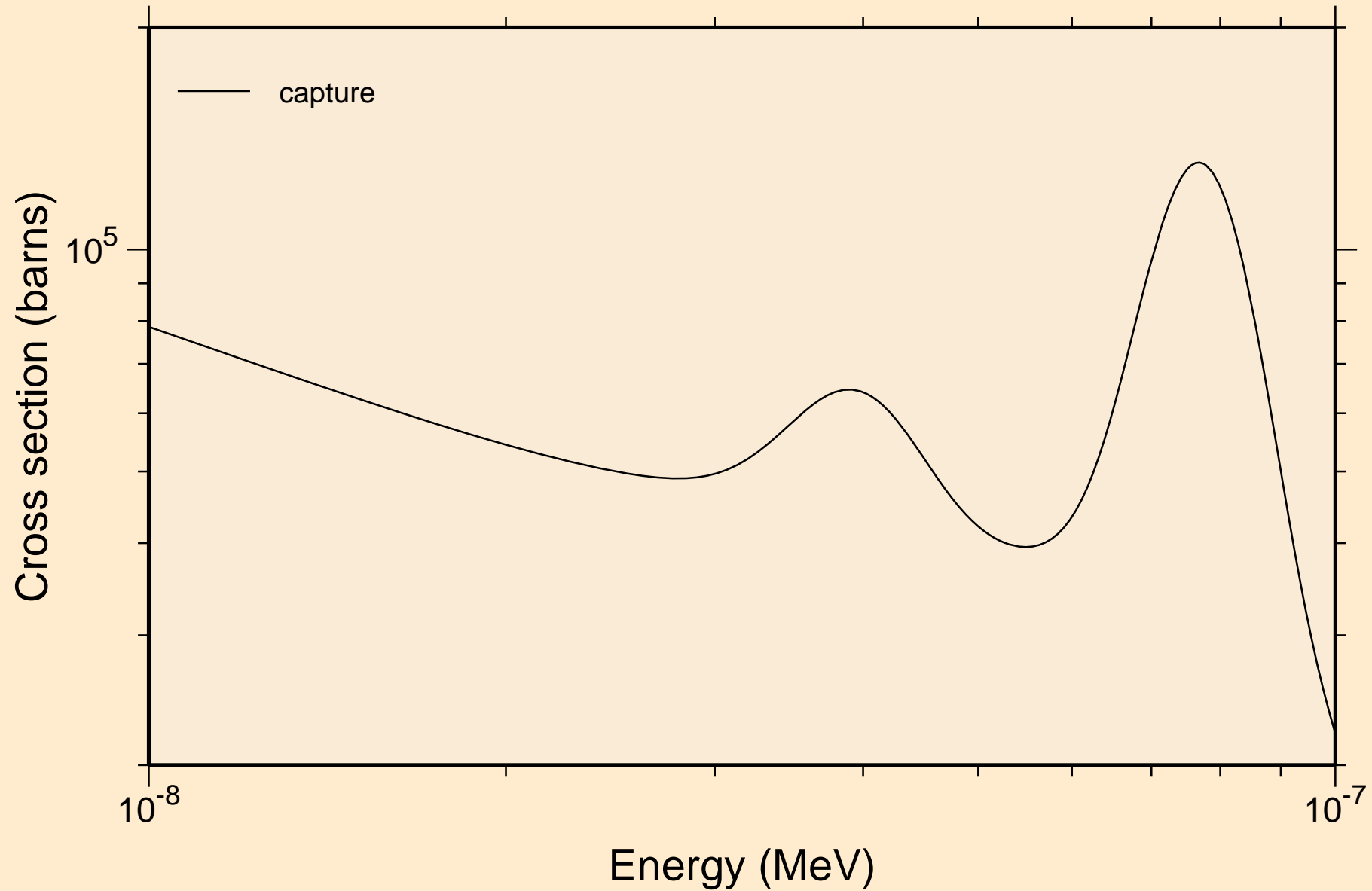

CS115 NRG TENDL-2015, AKONING resonance absorption cross sections

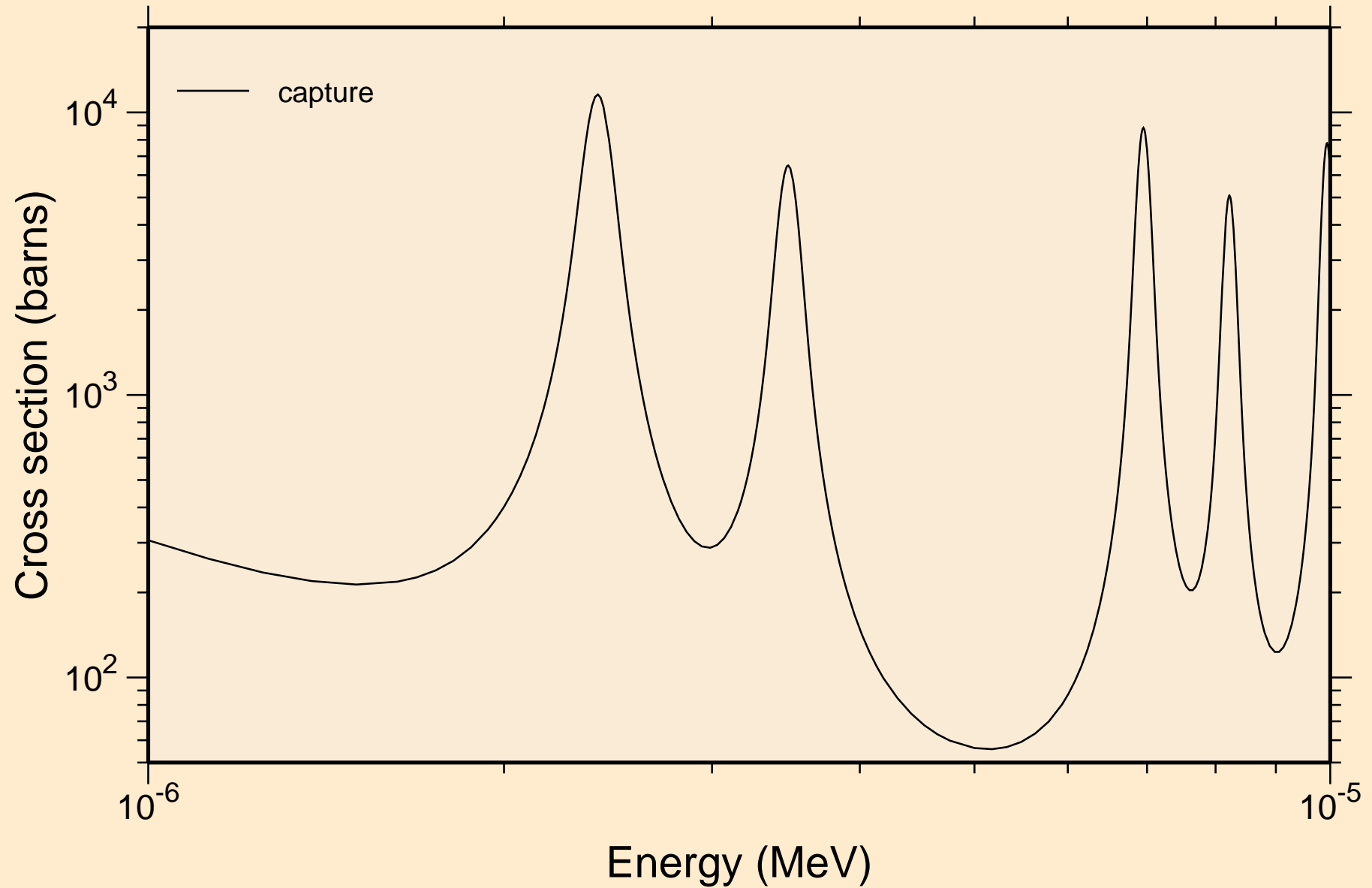

CS115 NRG TENDL-2015, AKONING

resonance absorption cross sections

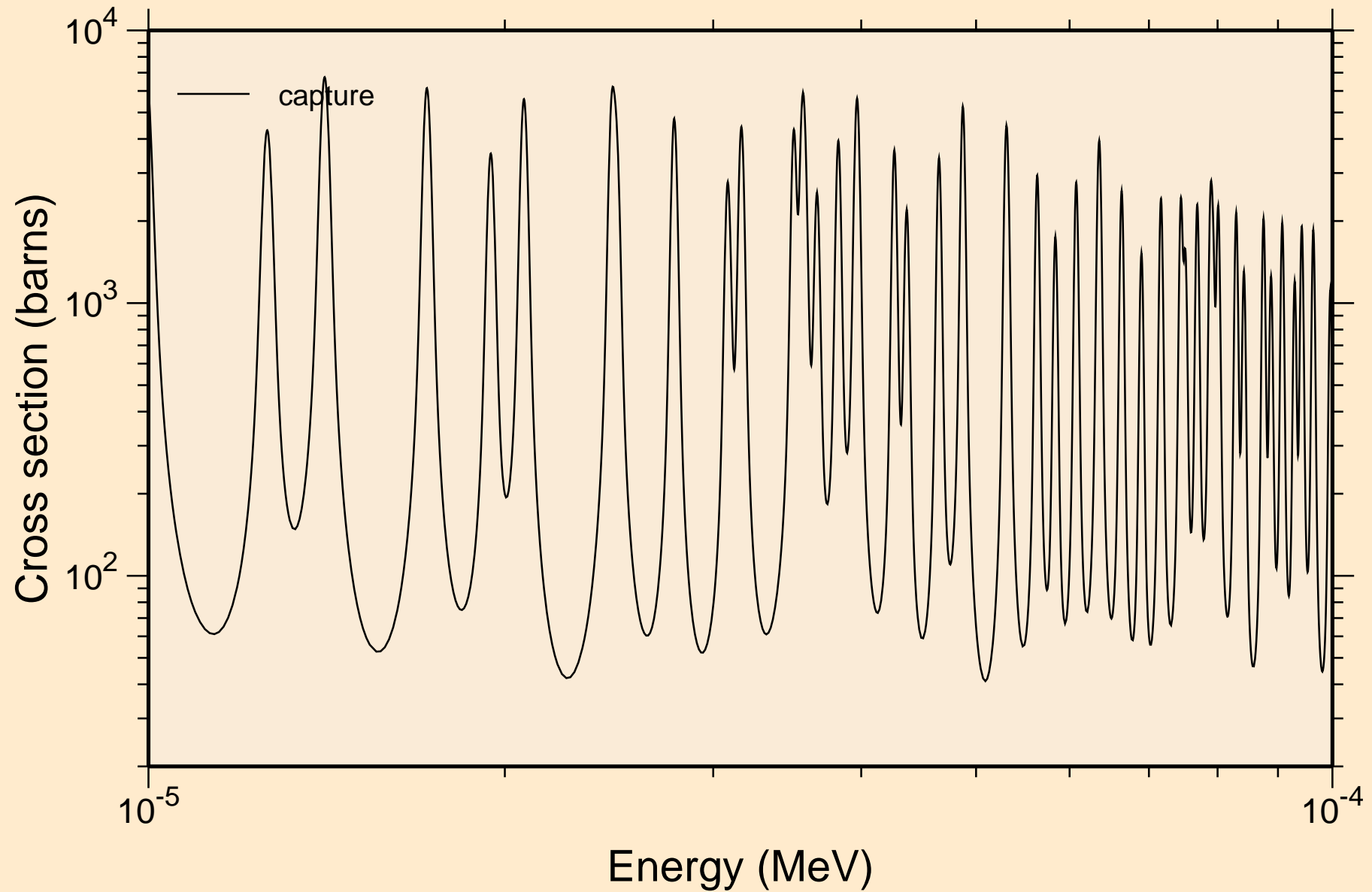

CS115 NRG TENDL-2015, AKONING
resonance absorption cross sections

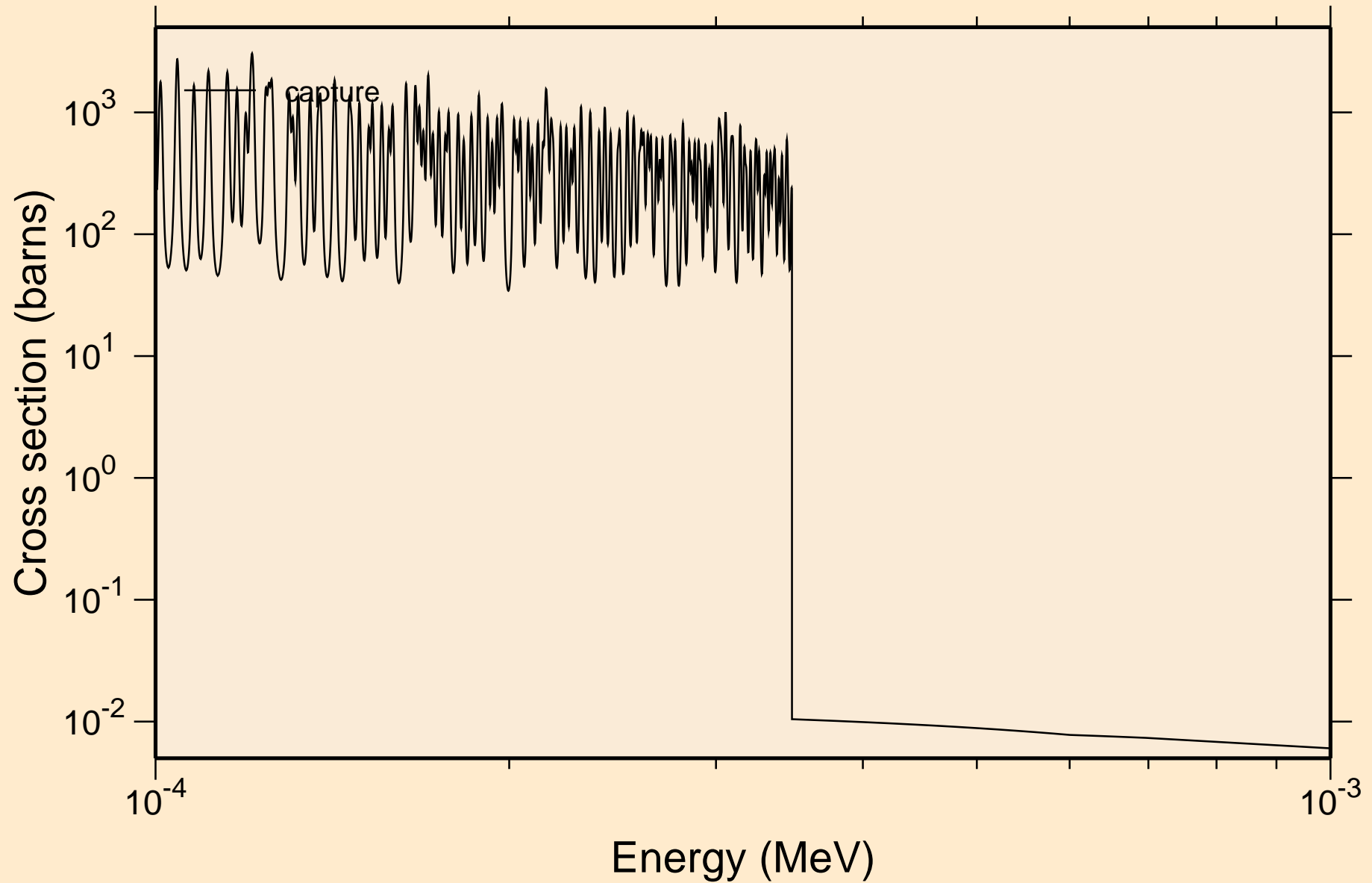

CS115 NRG TENDL-2015, AKONING resonance absorption cross sections

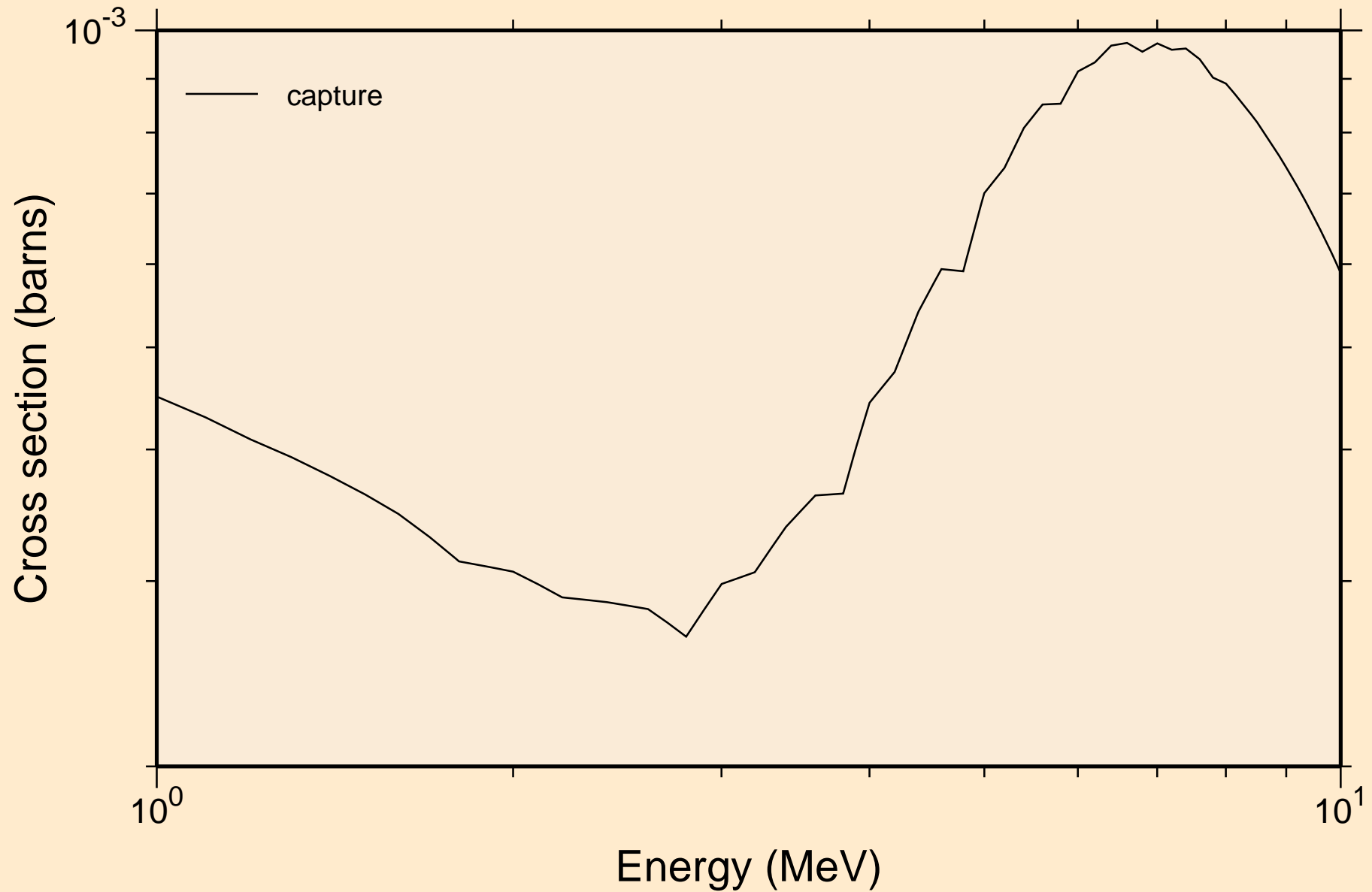

CS115 NRG TENDL-2015, AKONING

Non-threshold reactions

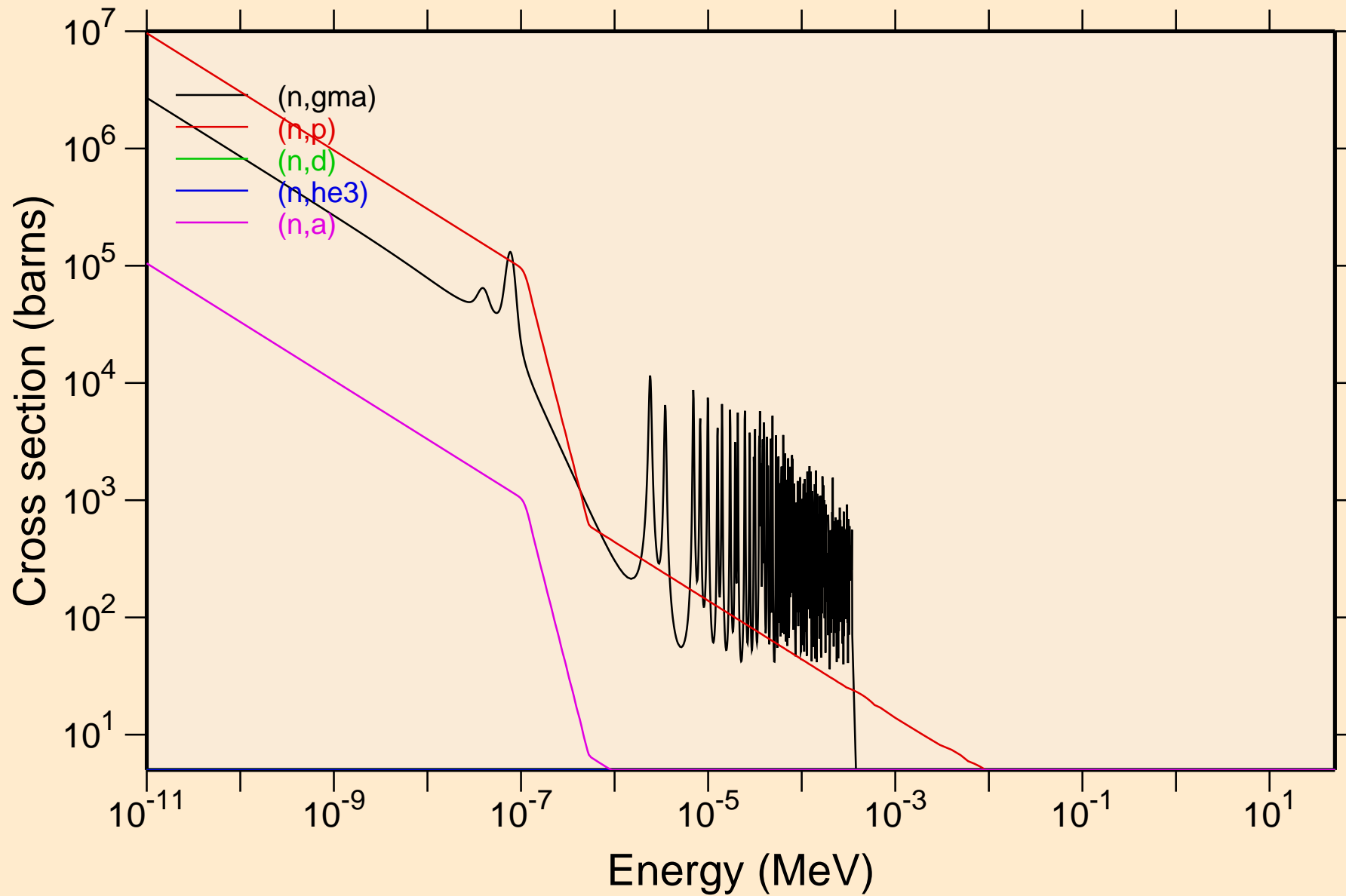

CS115 NRG TENDL-2015, AKONING

Non-threshold reactions

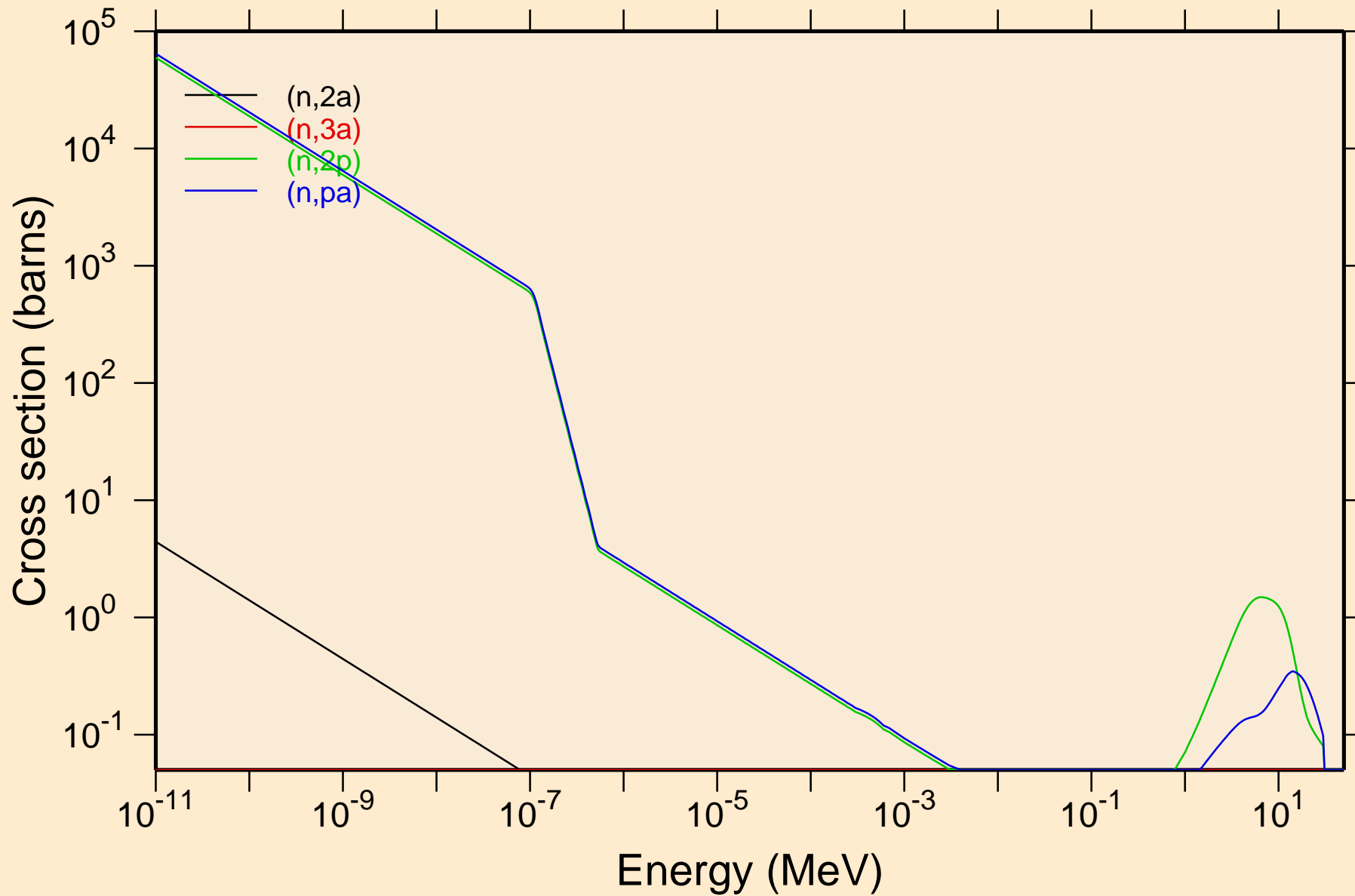

CS115 NRG TENDL-2015, AKONING

Principal cross sections

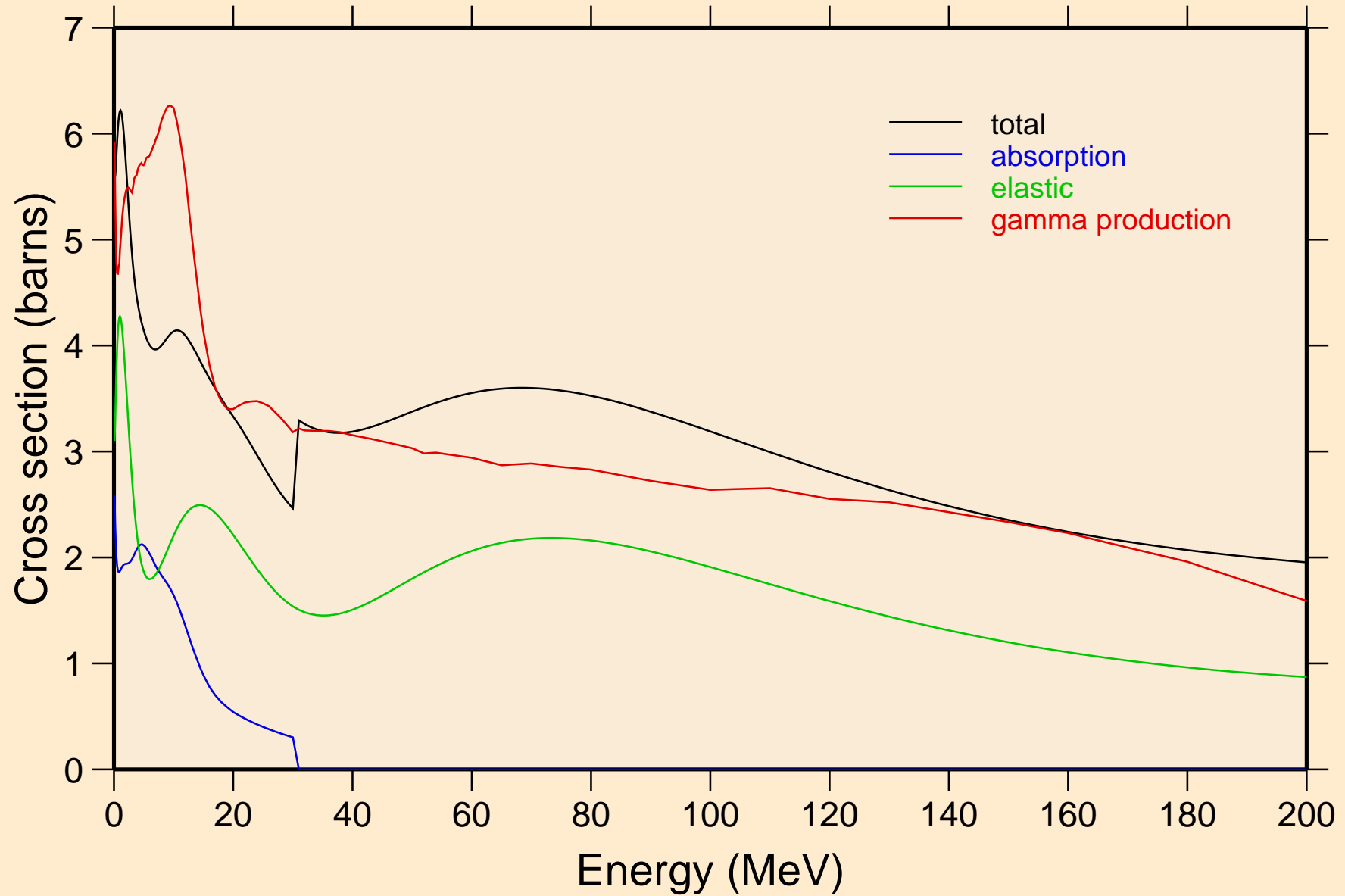

CS115 NRG TENDL-2015, AKONING

Non-threshold reactions

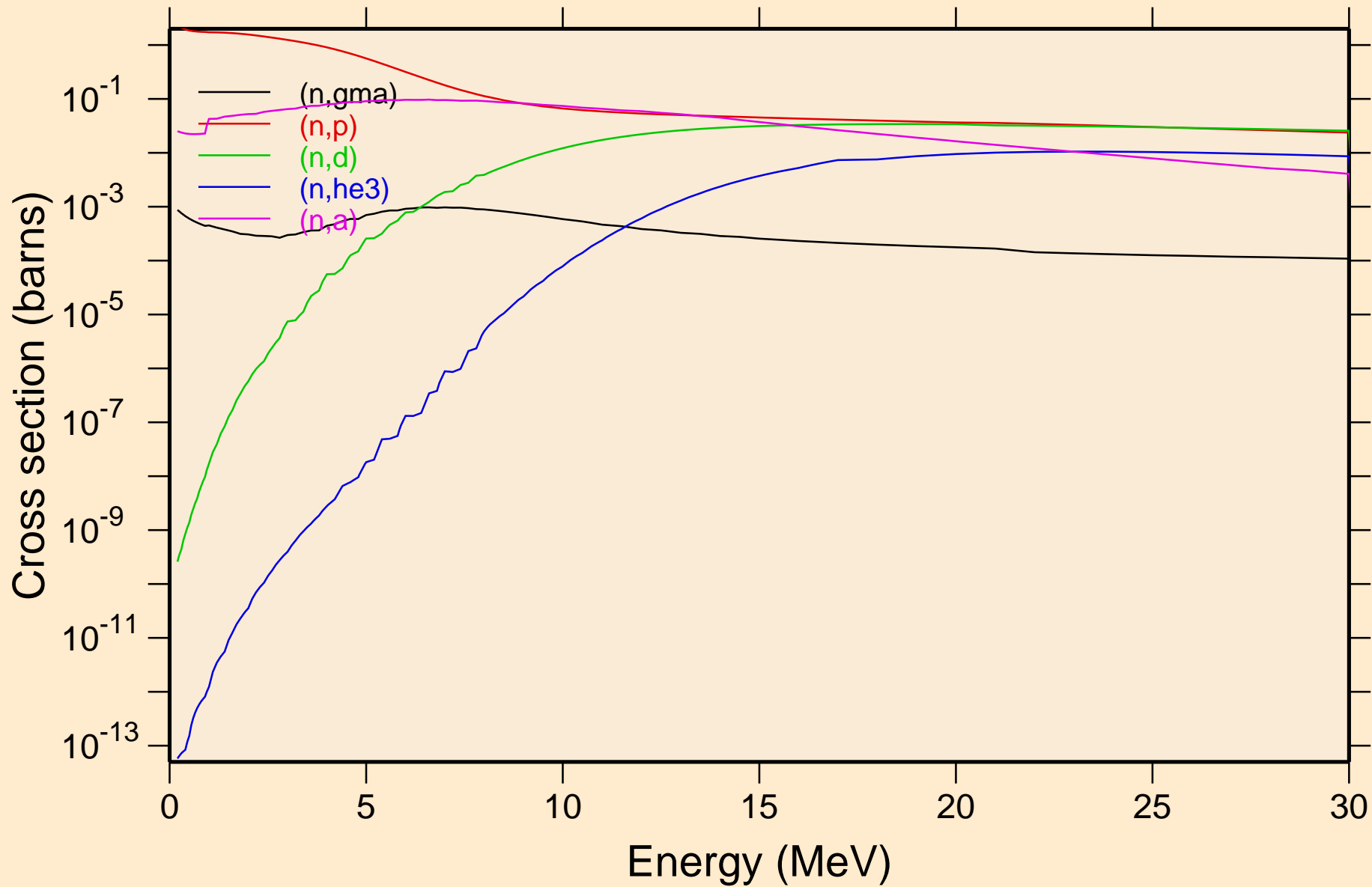

CS115 NRG TENDL-2015, AKONING

Non-threshold reactions

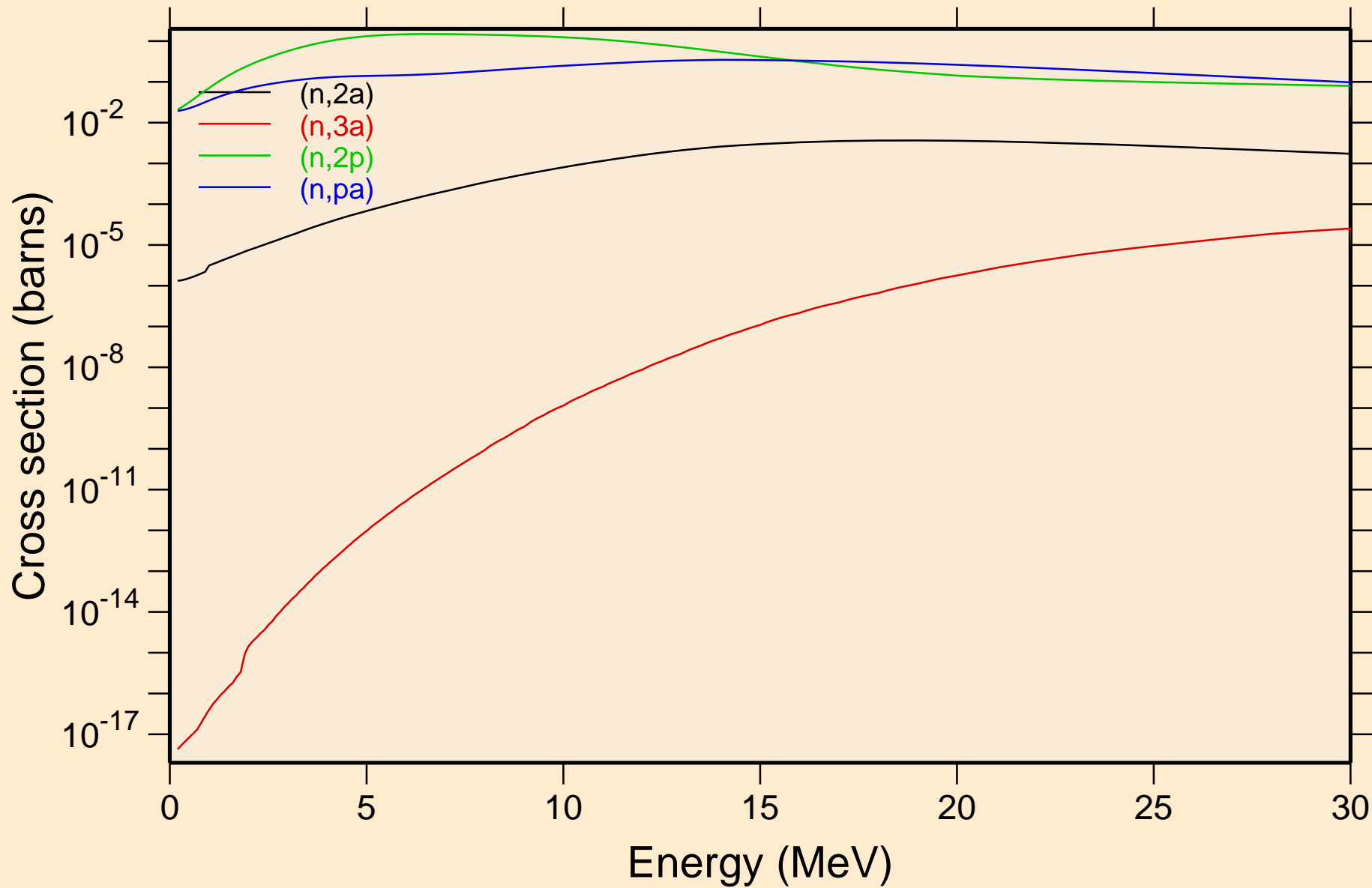

CS115 NRG TENDL-2015, AKONING

Inelastic levels

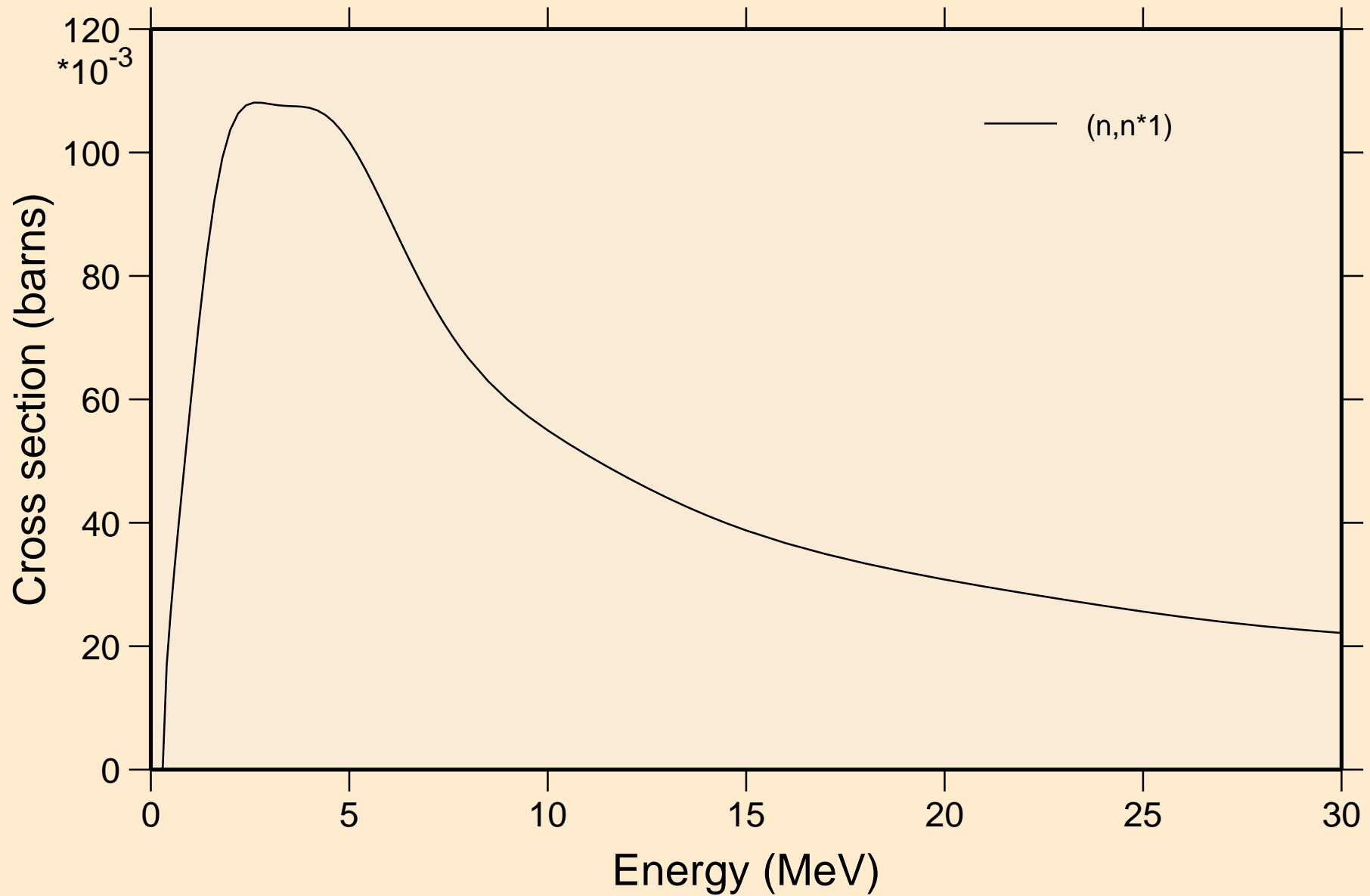

CS115 NRG TENDL-2015, AKONING

Threshold reactions

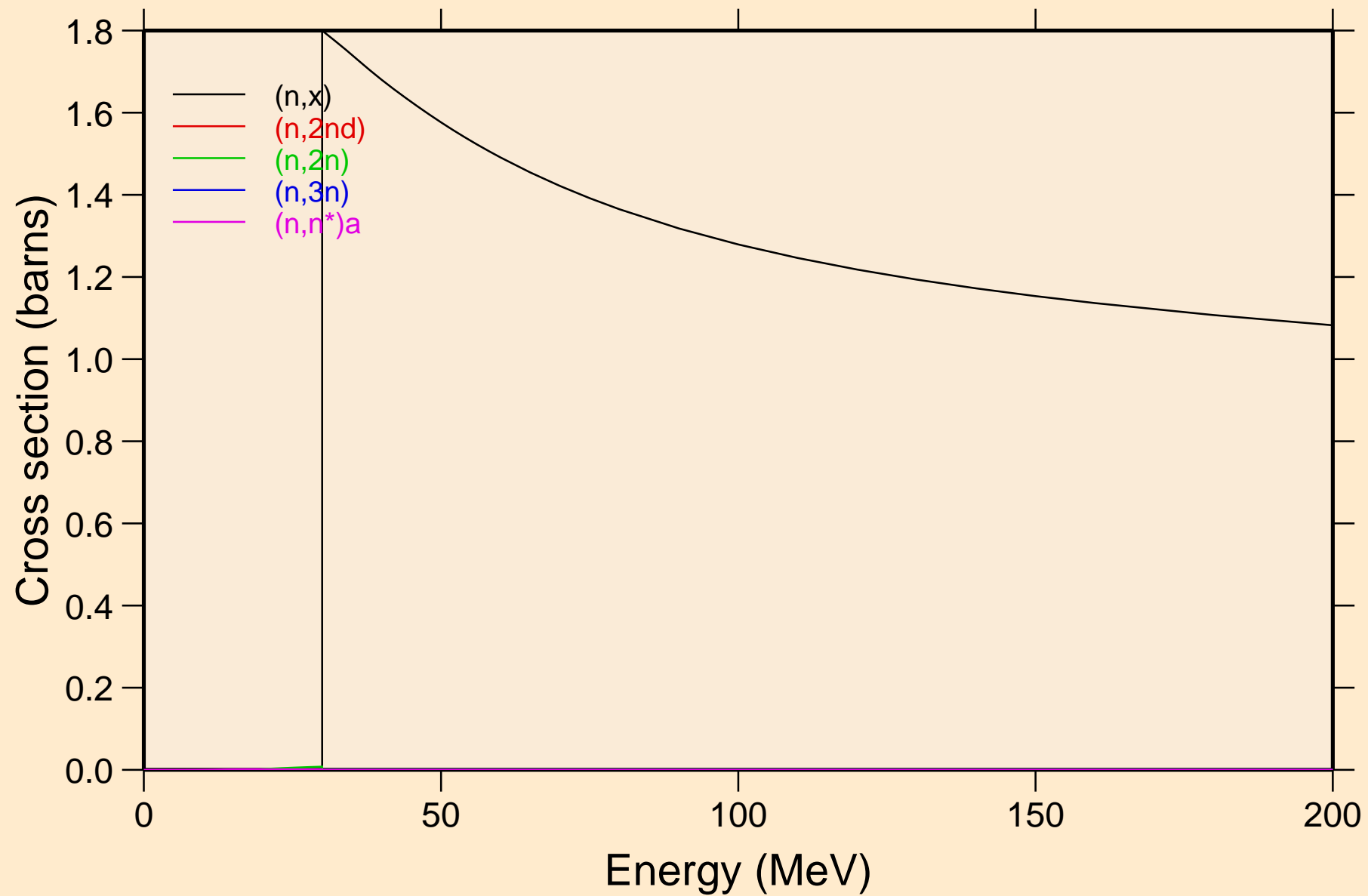

CS115 NRG TENDL-2015, AKONING

Threshold reactions

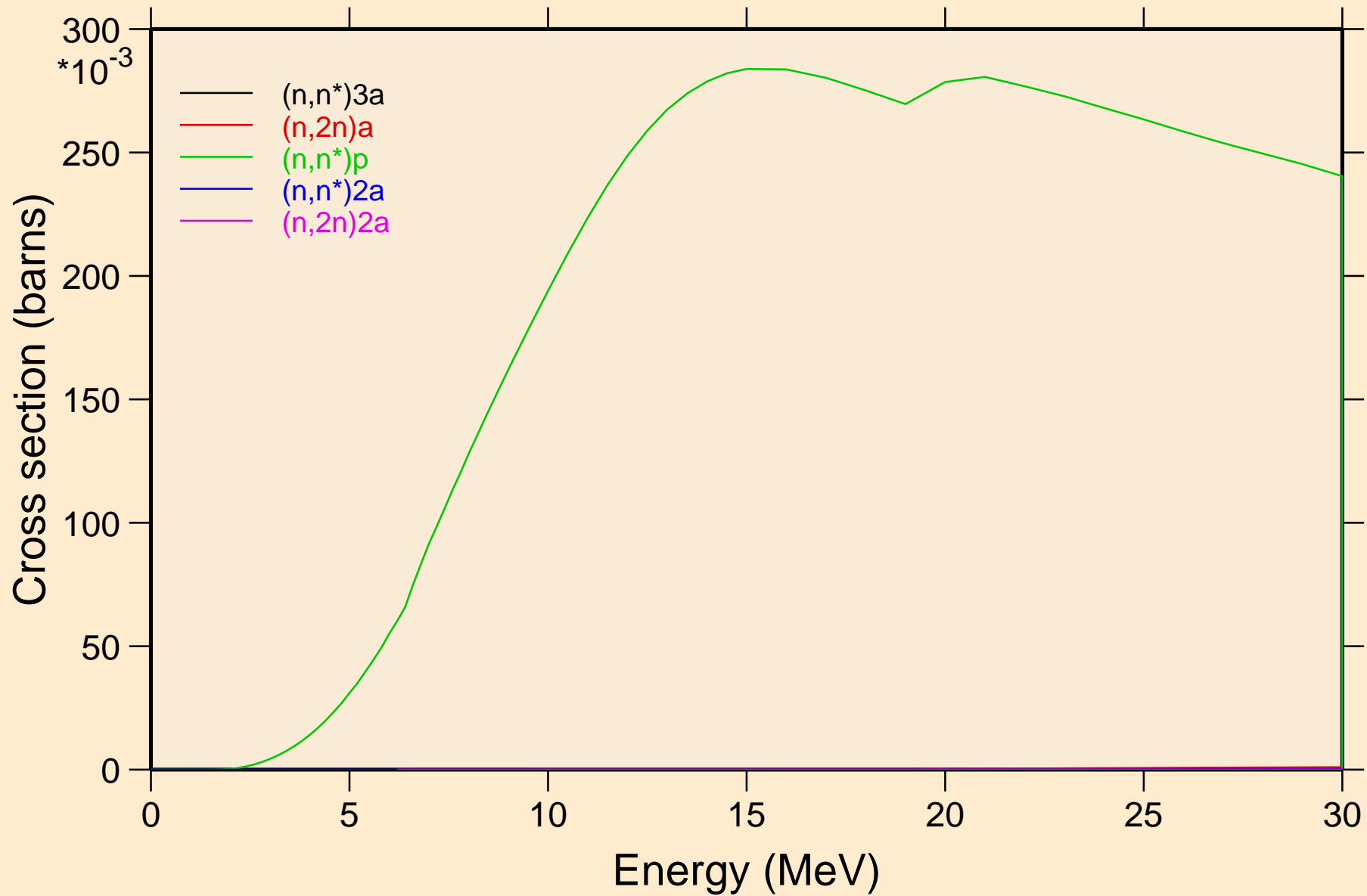

CS115 NRG TENDL-2015, AKONING

Threshold reactions

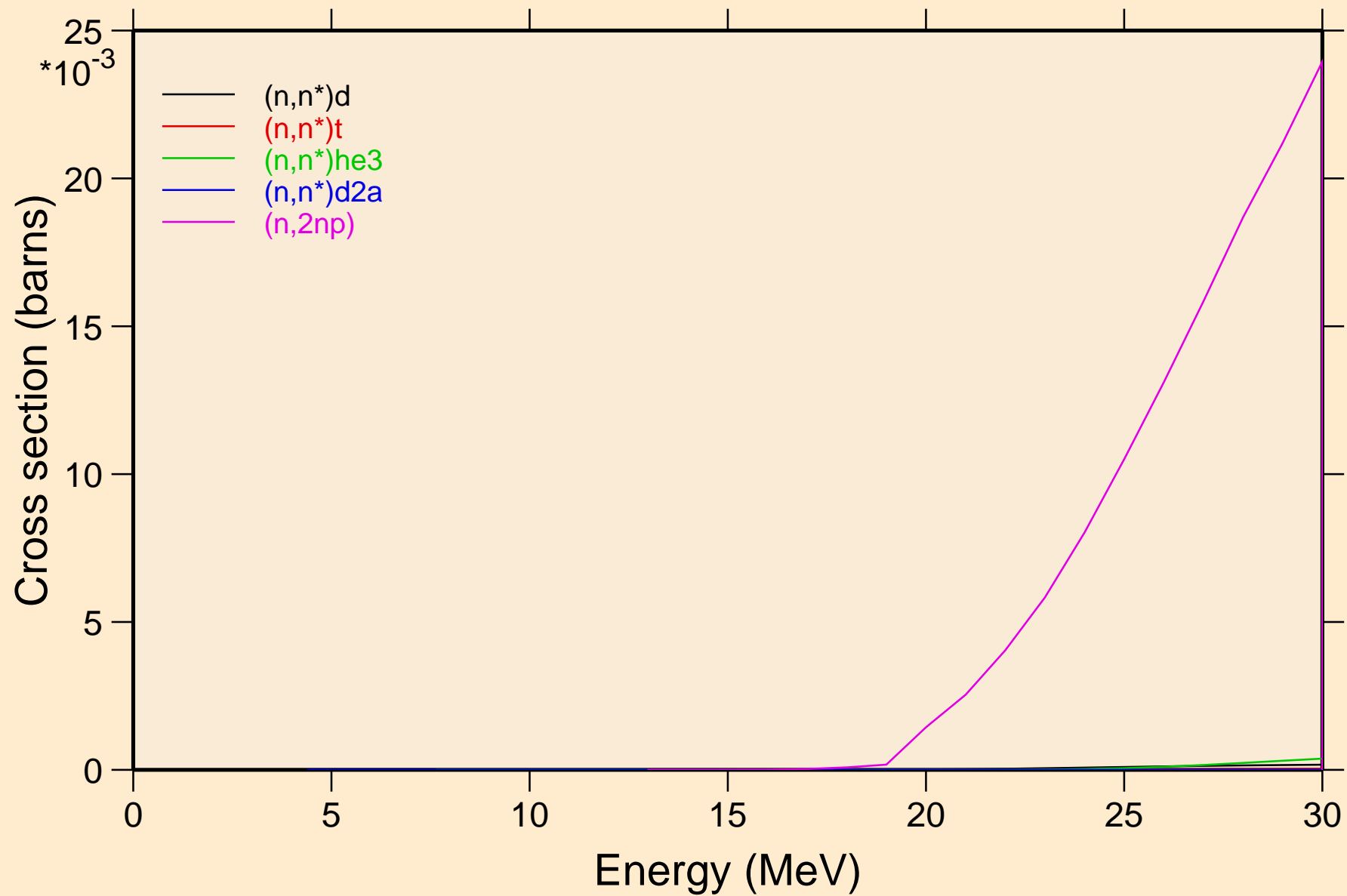

CS115 NRG TENDL-2015, AKONING

Threshold reactions

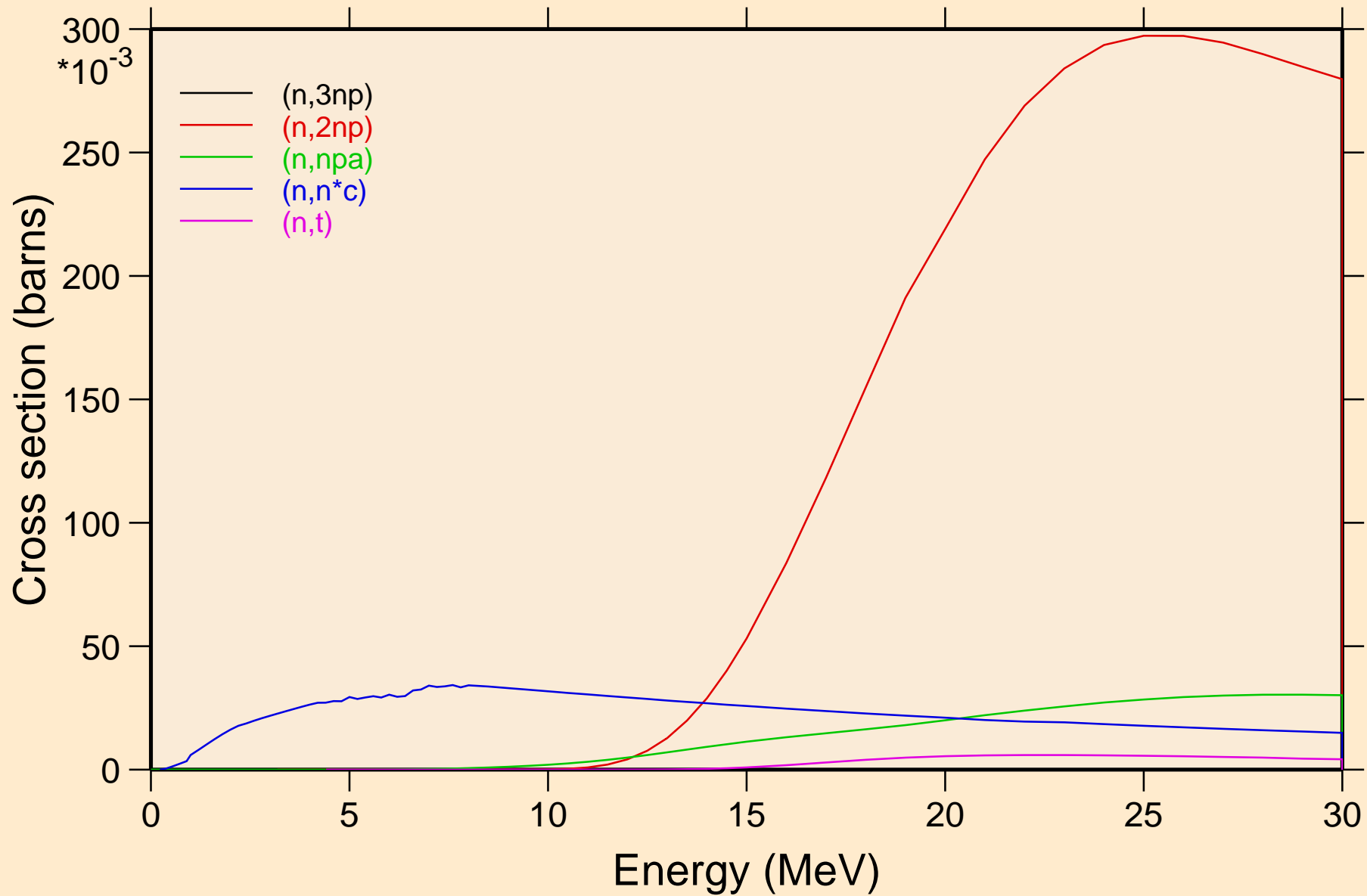

CS115 NRG TENDL-2015, AKONING

Threshold reactions

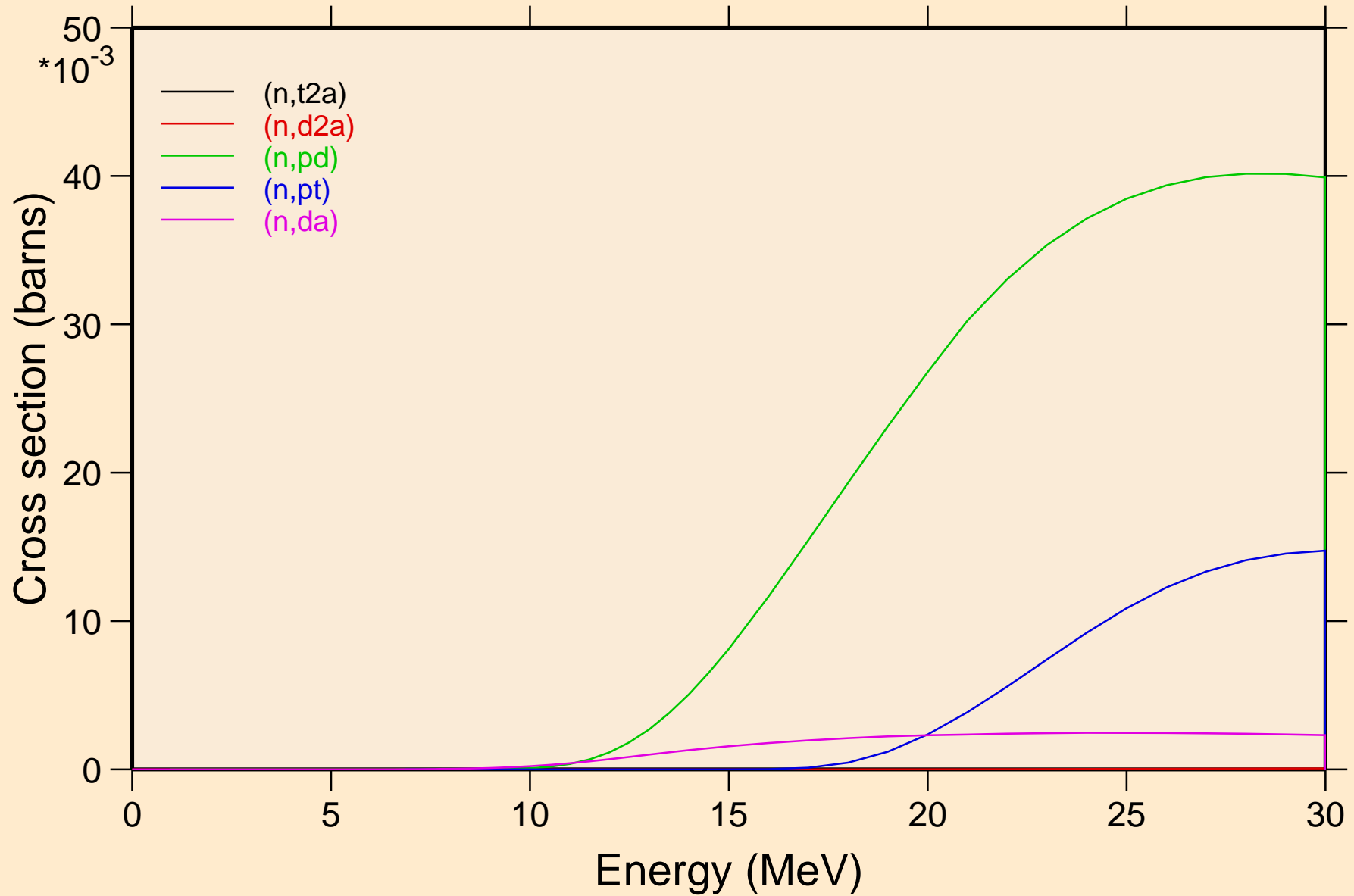

CS115 NRG TENDL-2015, AKONING
angular distribution for elastic

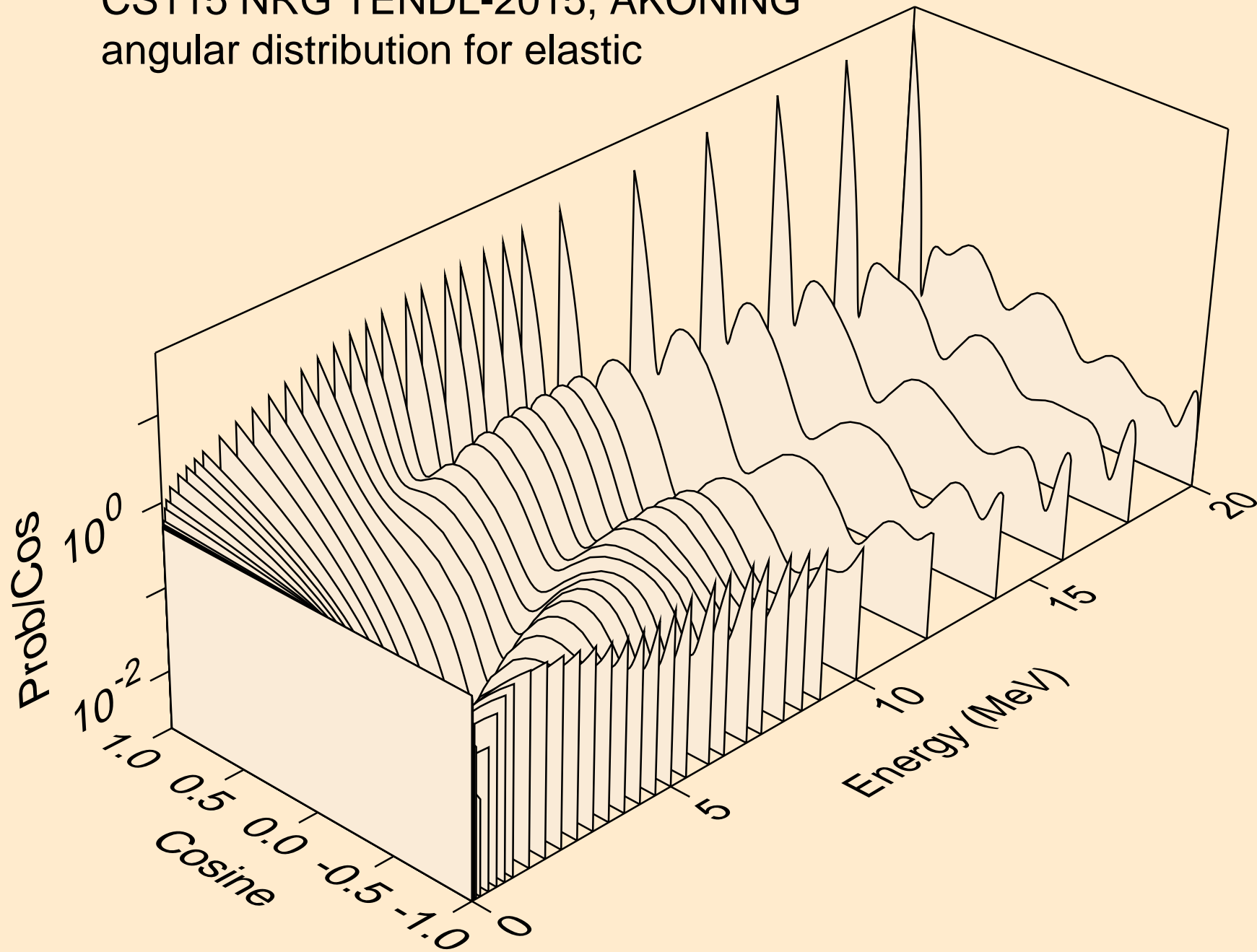

CS115 NRG TENDL-2015, AKONING
angular distribution for elastic

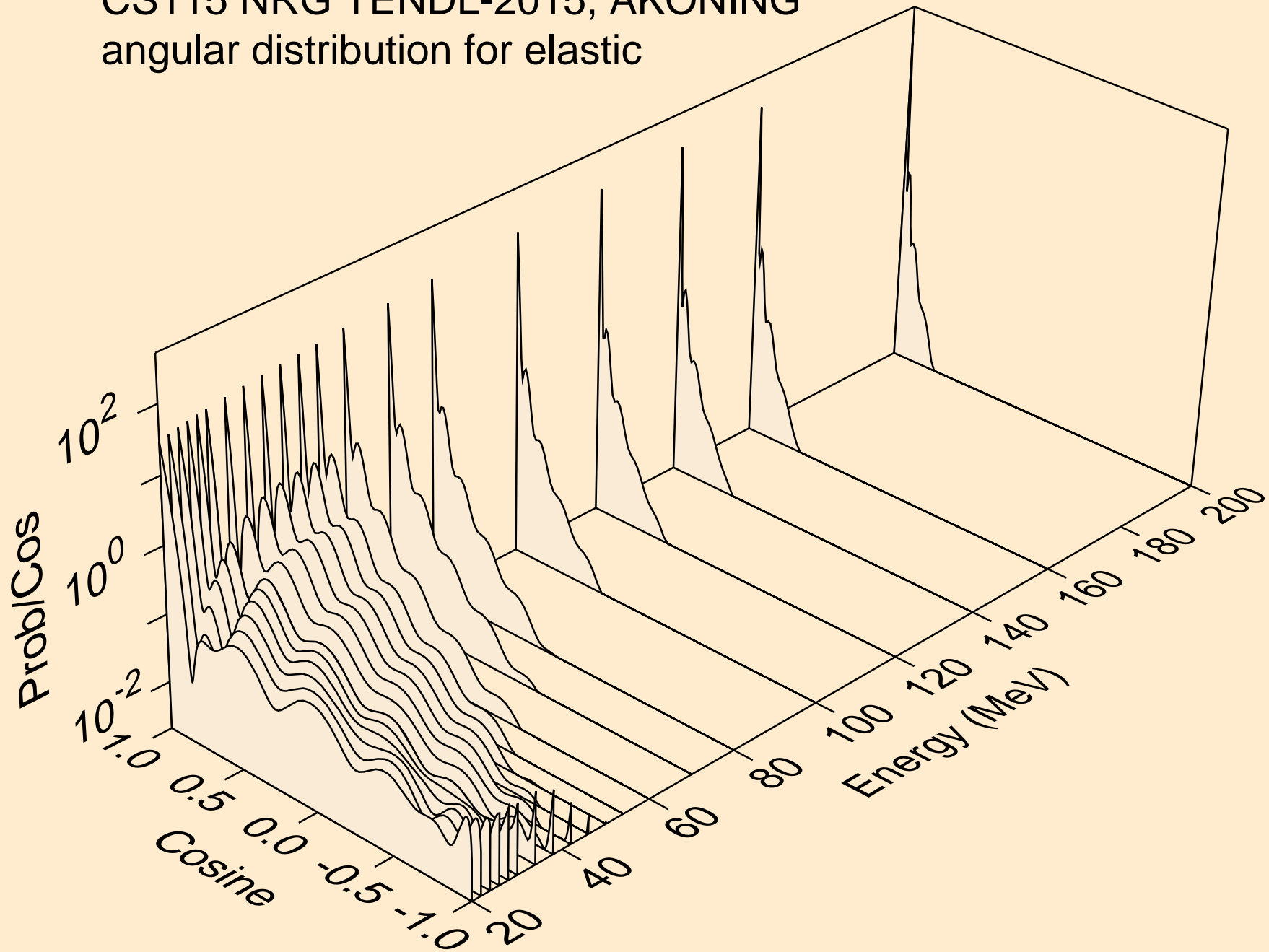

CS115 NRG TENDL-2015, AKONING
angular distribution for (n,n*1)

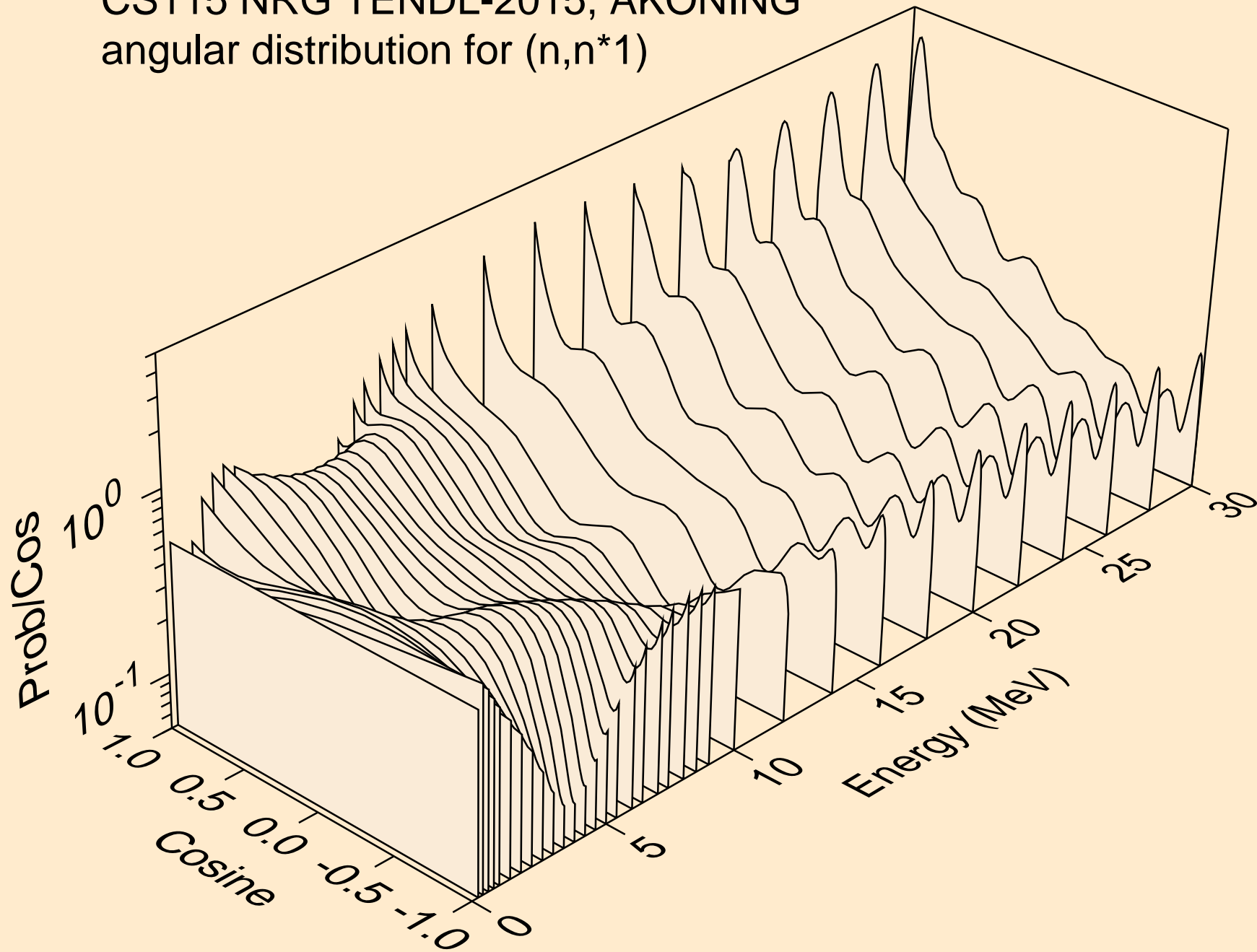

CS115 NRG TENDL-2015, AKONING
Neutron emission for (n,x)

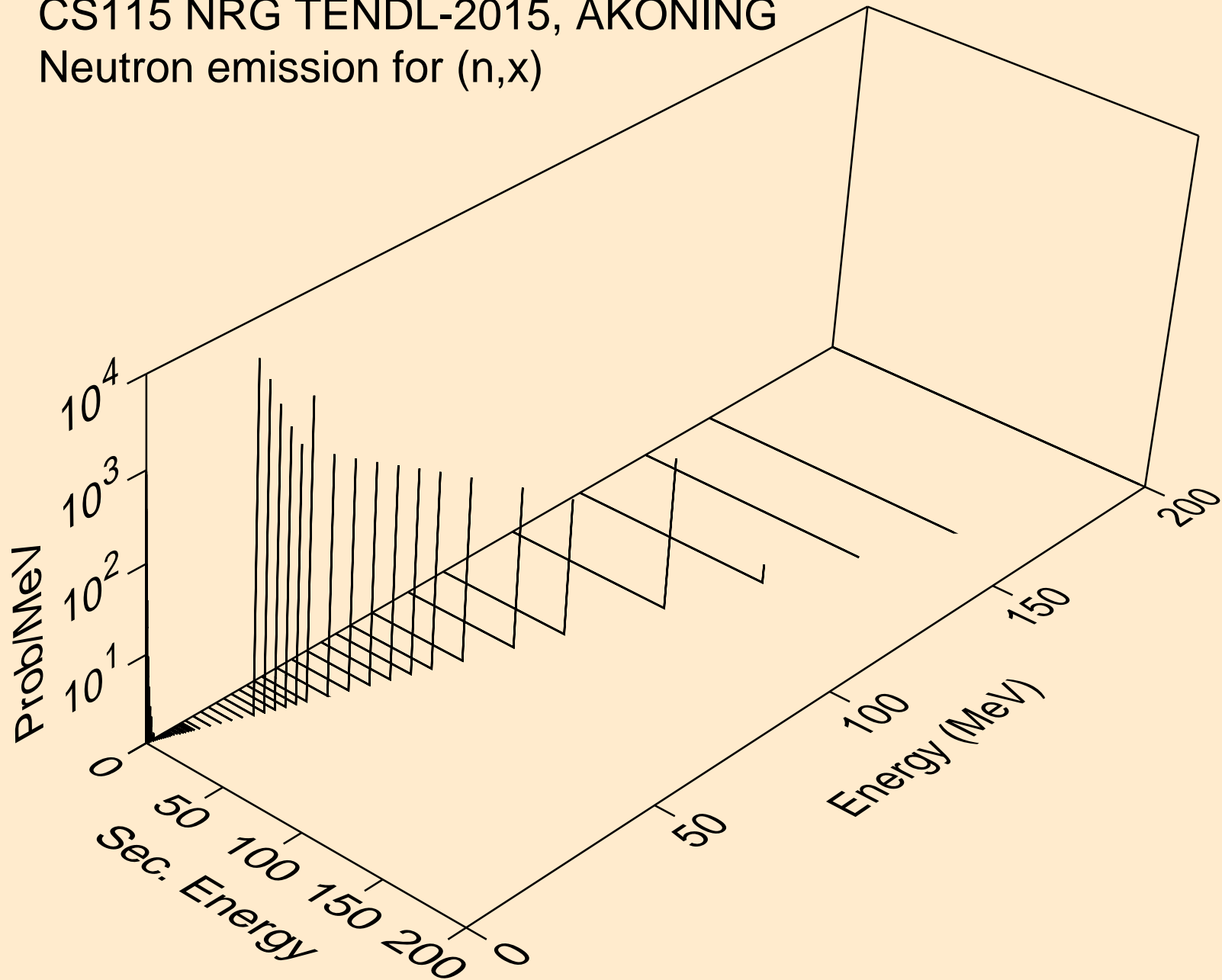

CS115 NRG TENDL-2015, AKONING
Neutron emission for (n,2nd)

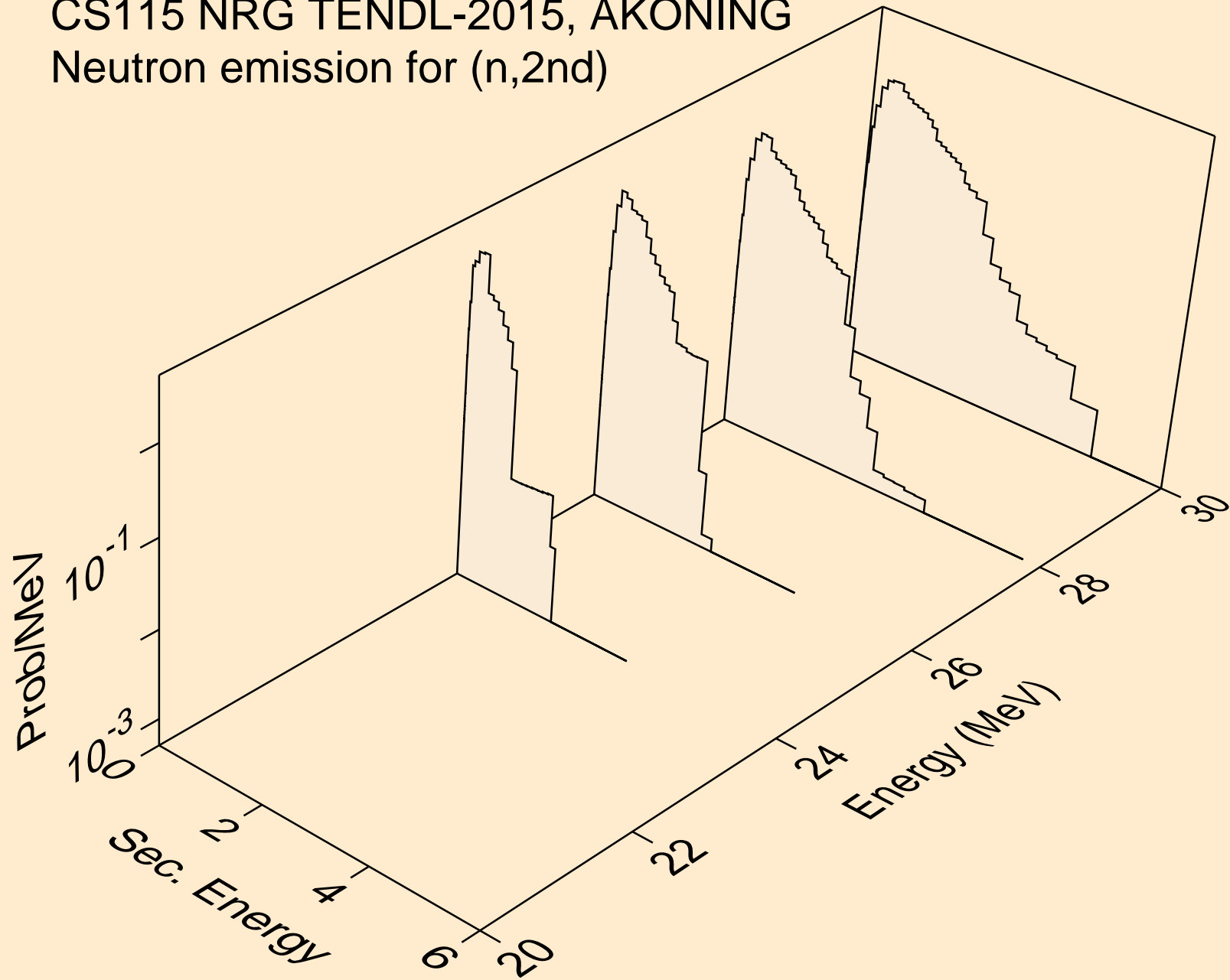

CS115 NRG TENDL-2015, AKONING
Neutron emission for (n,2n)

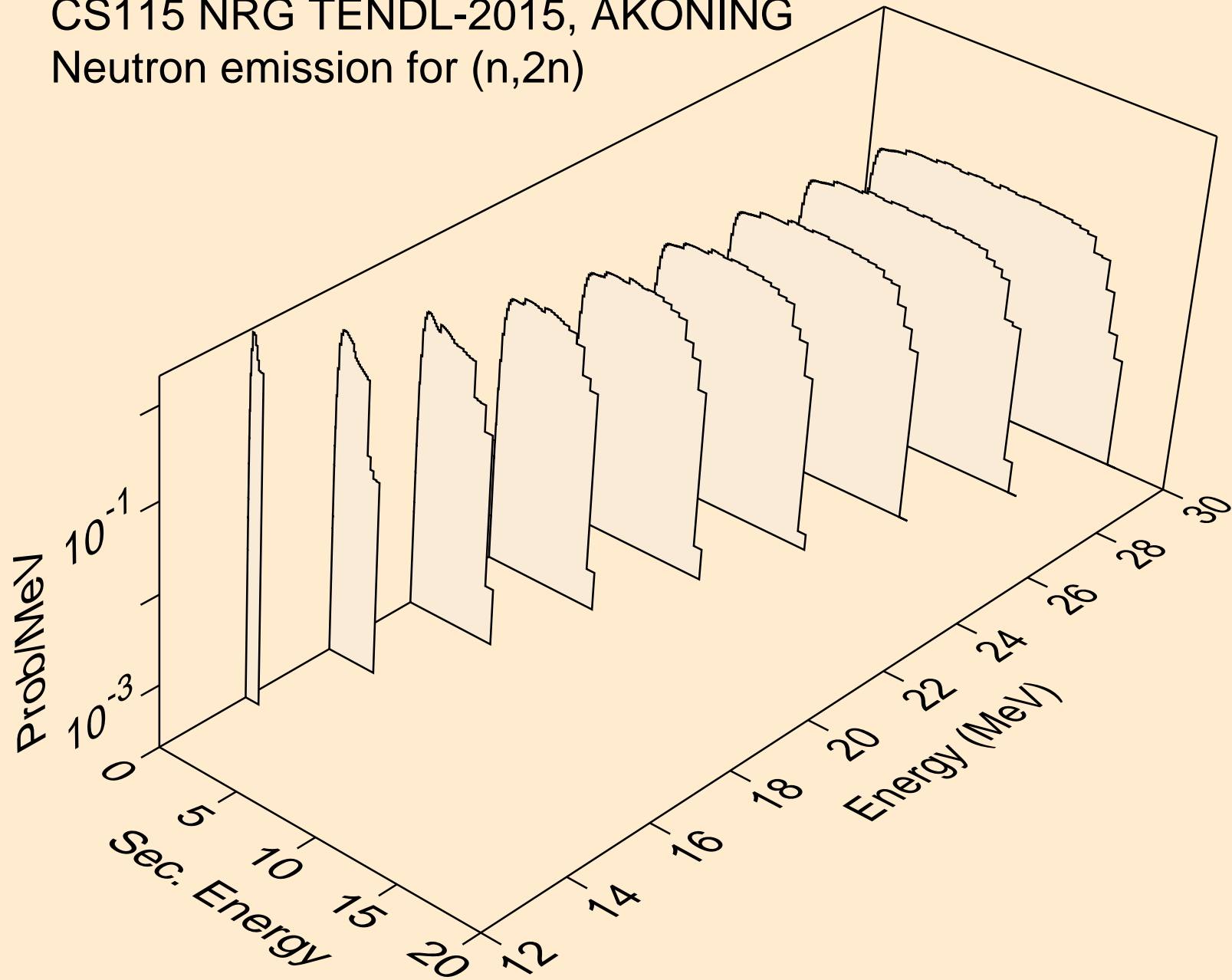

CS115 NRG TENDL-2015, AKONING
Neutron emission for (n,3n)

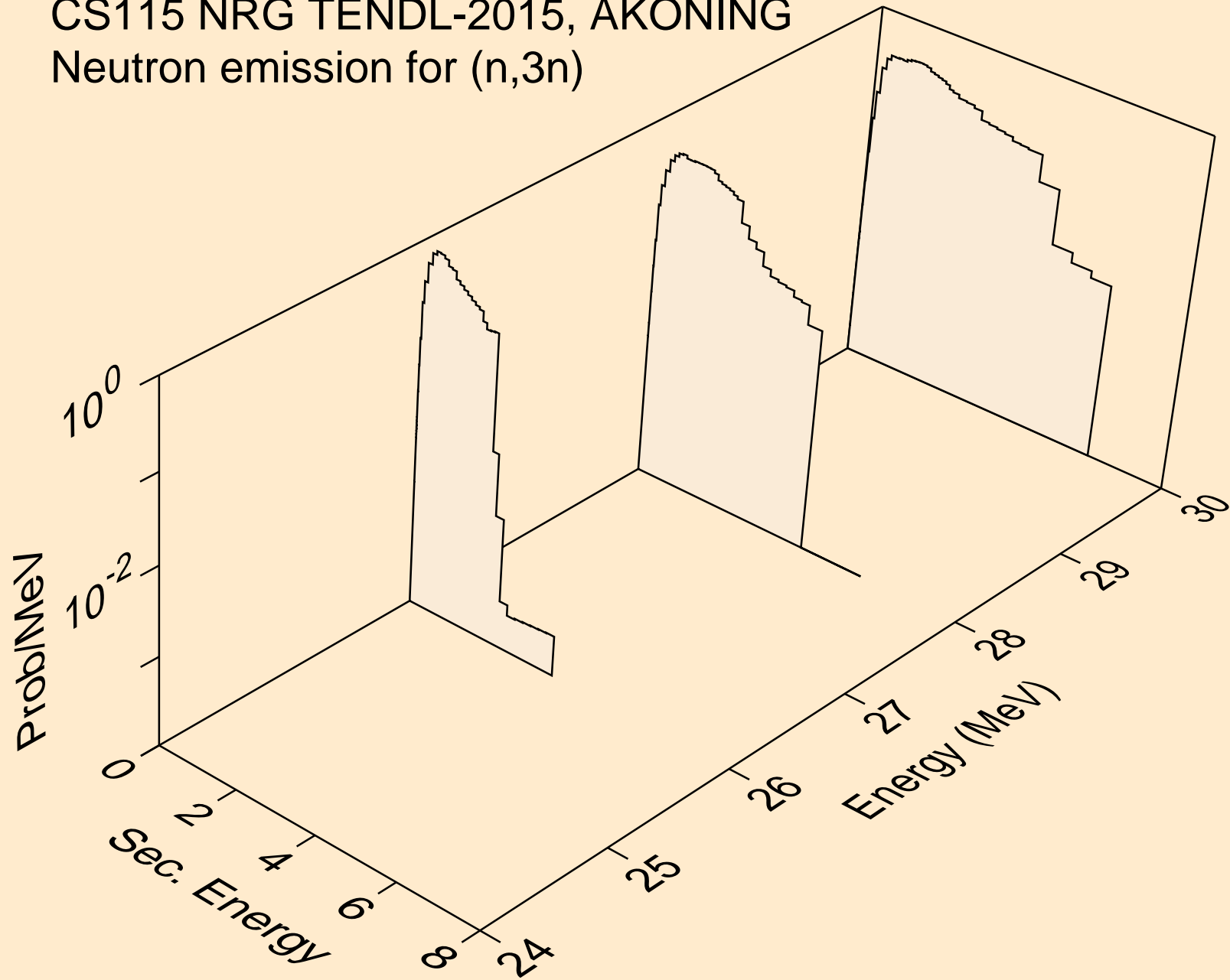

CS115 NRG TENDL-2015, AKONING
Neutron emission for (n,n*)a

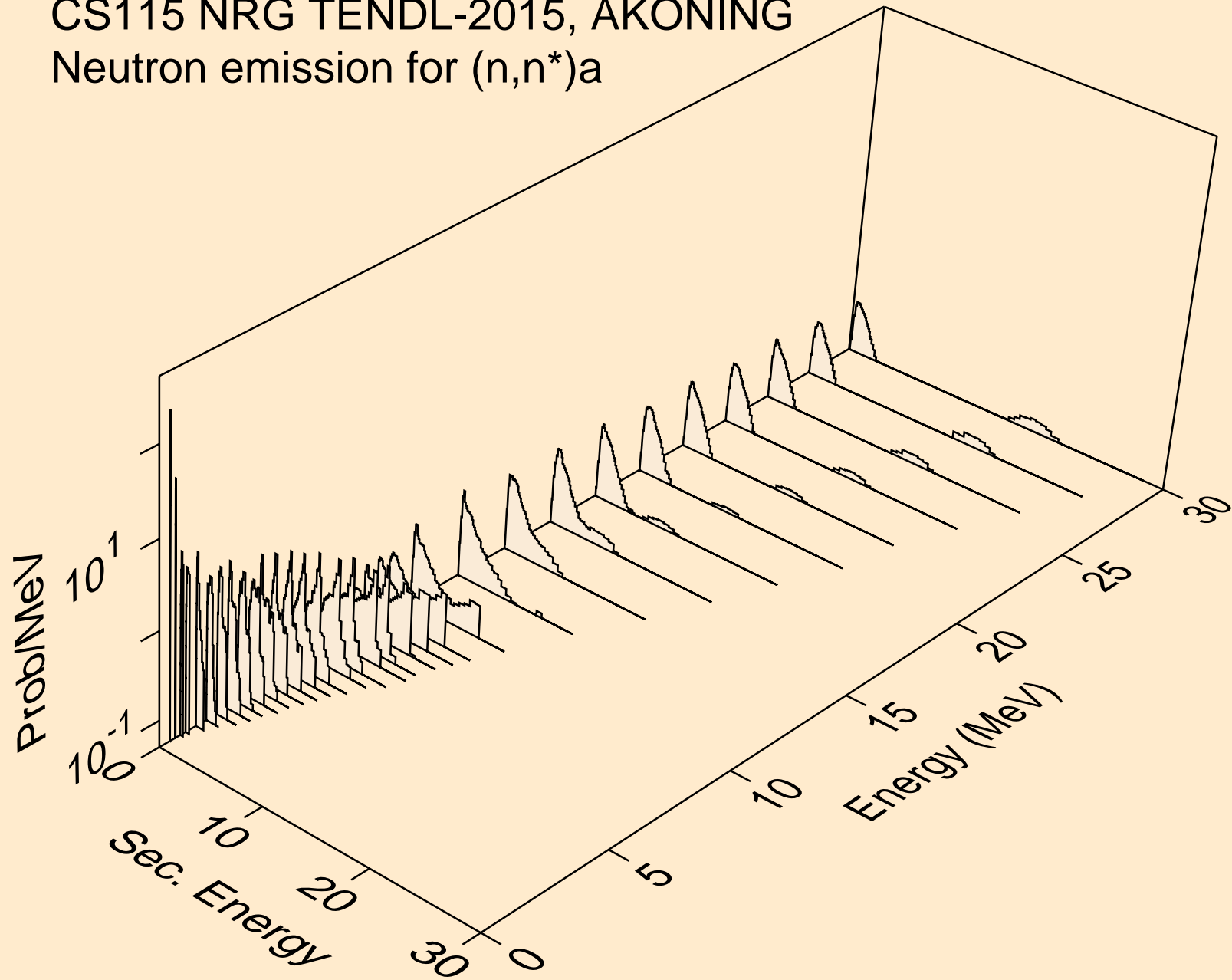

CS115 NRG TENDL-2015, AKONING
Neutron emission for (n,n*)3a

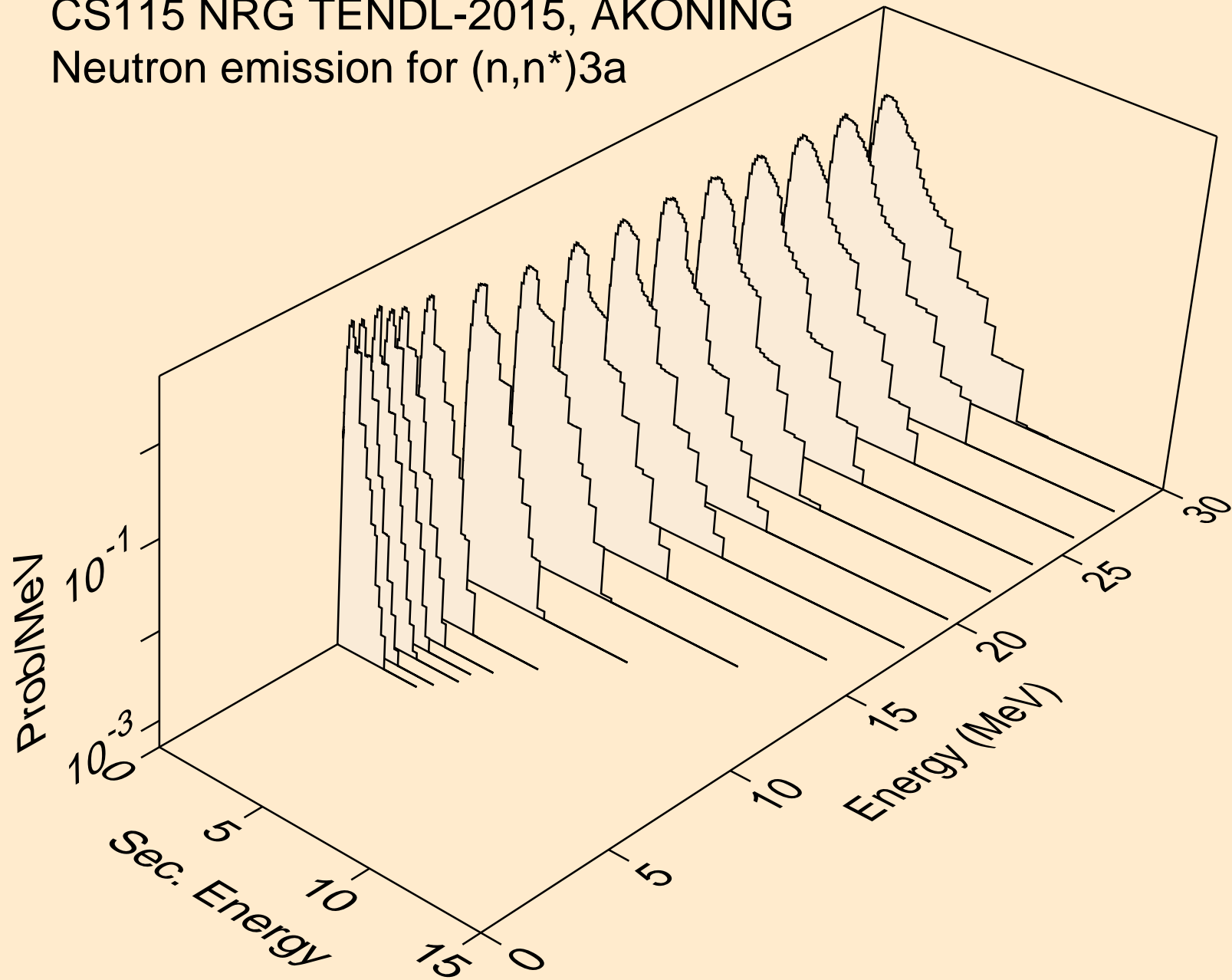

CS115 NRG TENDL-2015, AKONING
Neutron emission for (n,2n)a

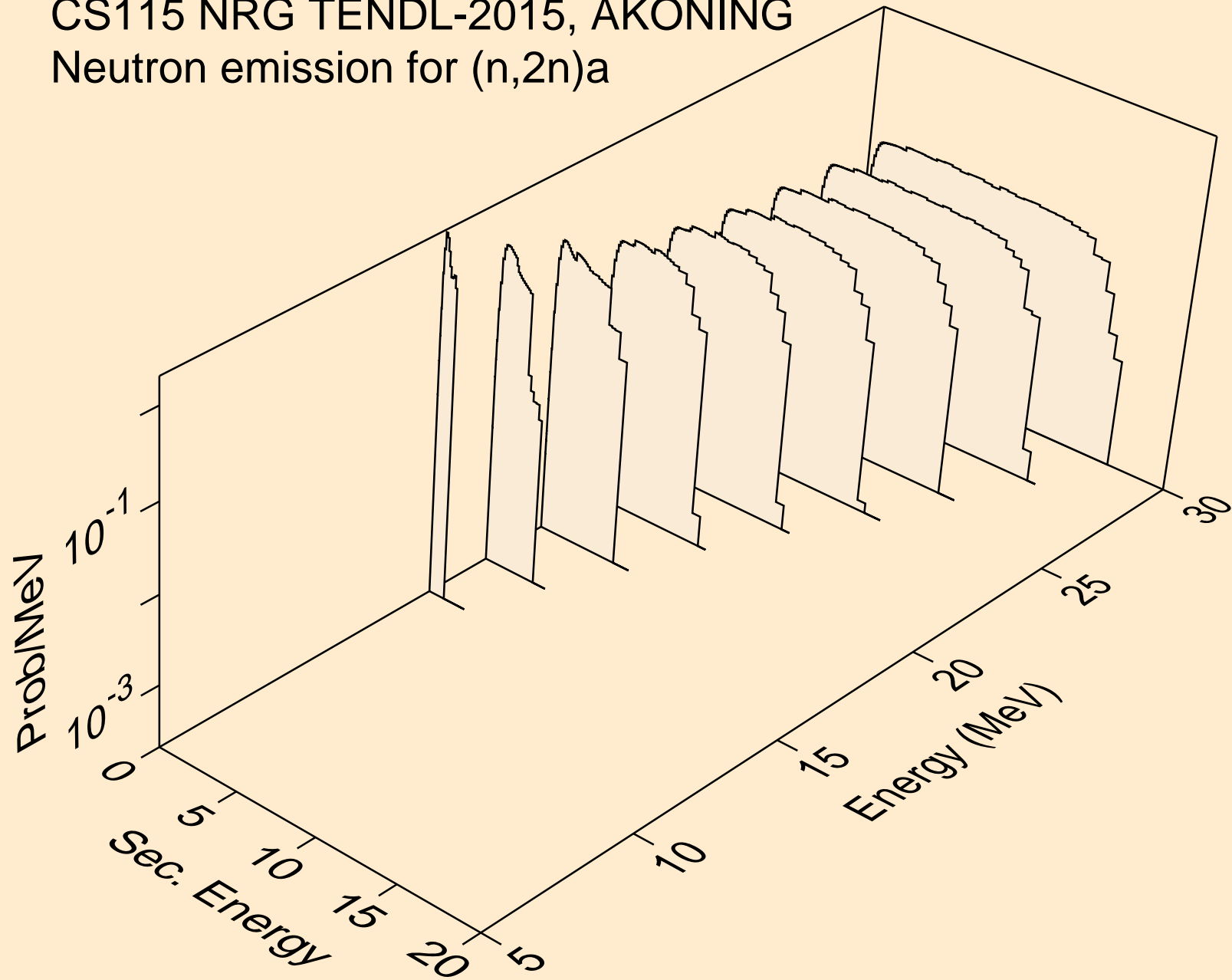

CS115 NRG TENDL-2015, AKONING
Neutron emission for (n,n*)p

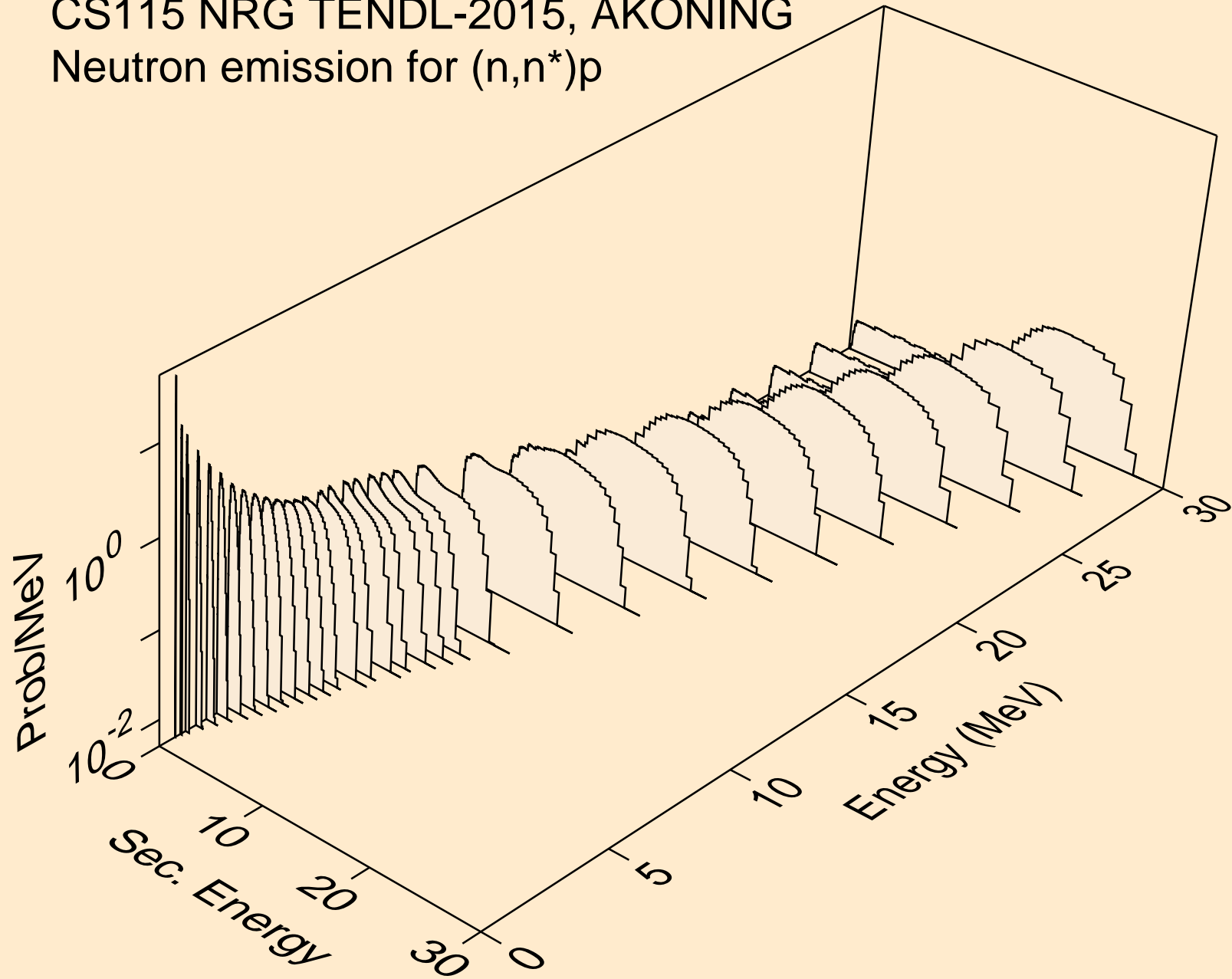

CS115 NRG TENDL-2015, AKONING
Neutron emission for (n,n*)2a

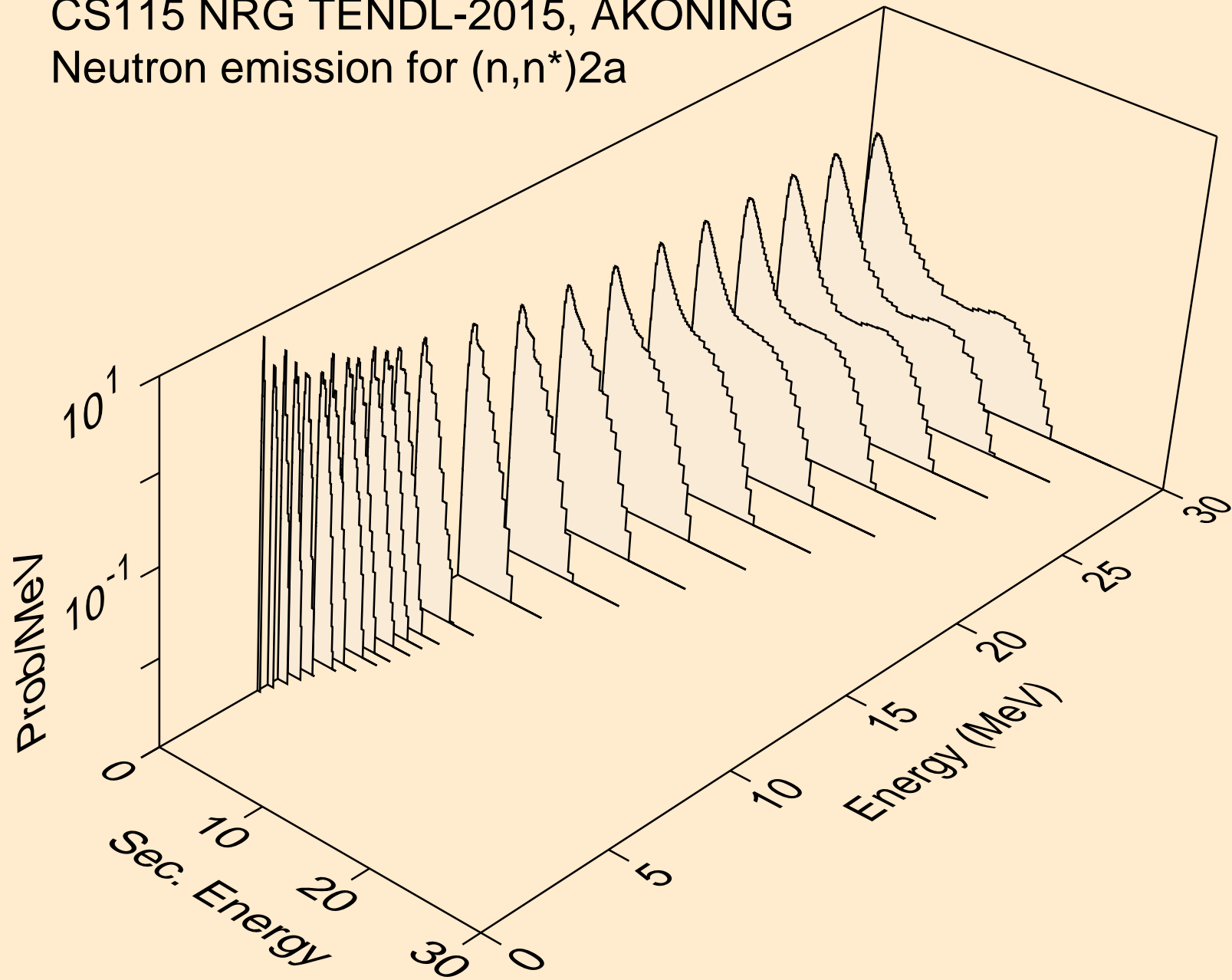

CS115 NRG TENDL-2015, AKONING
Neutron emission for (n,2n)2a

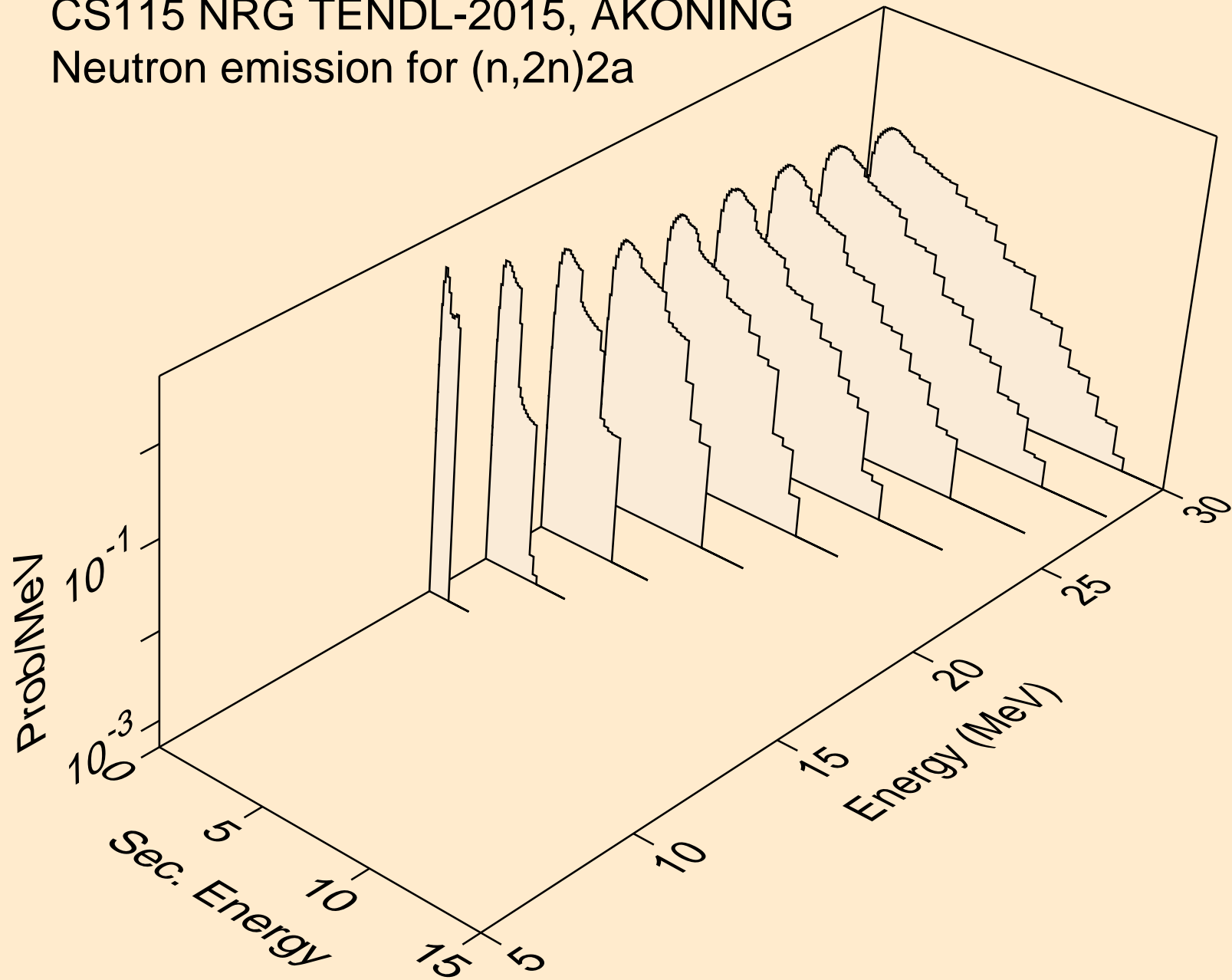

CS115 NRG TENDL-2015, AKONING
Neutron emission for (n,n*)d

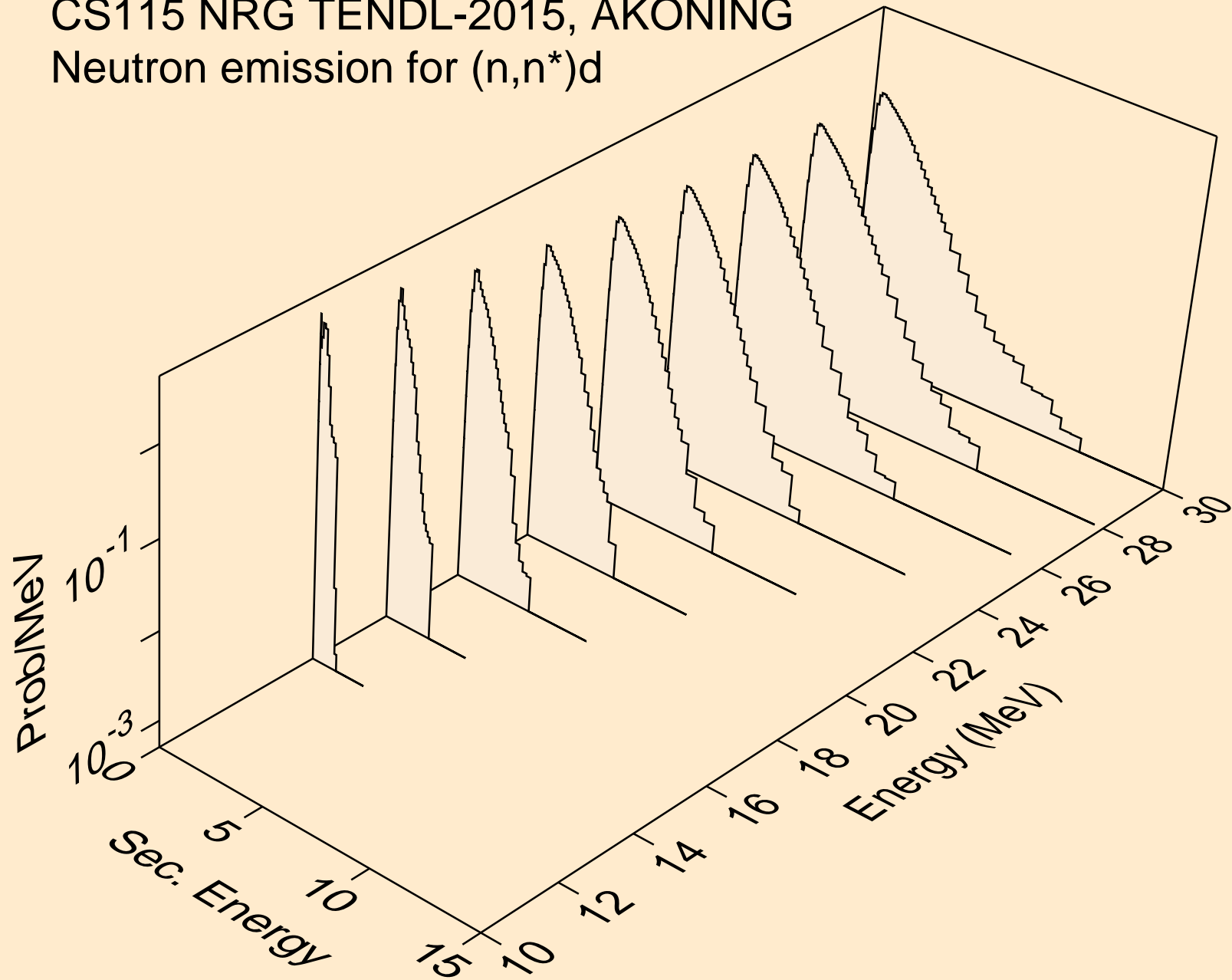

CS115 NRG TENDL-2015, AKONING
Neutron emission for (n,n*)t

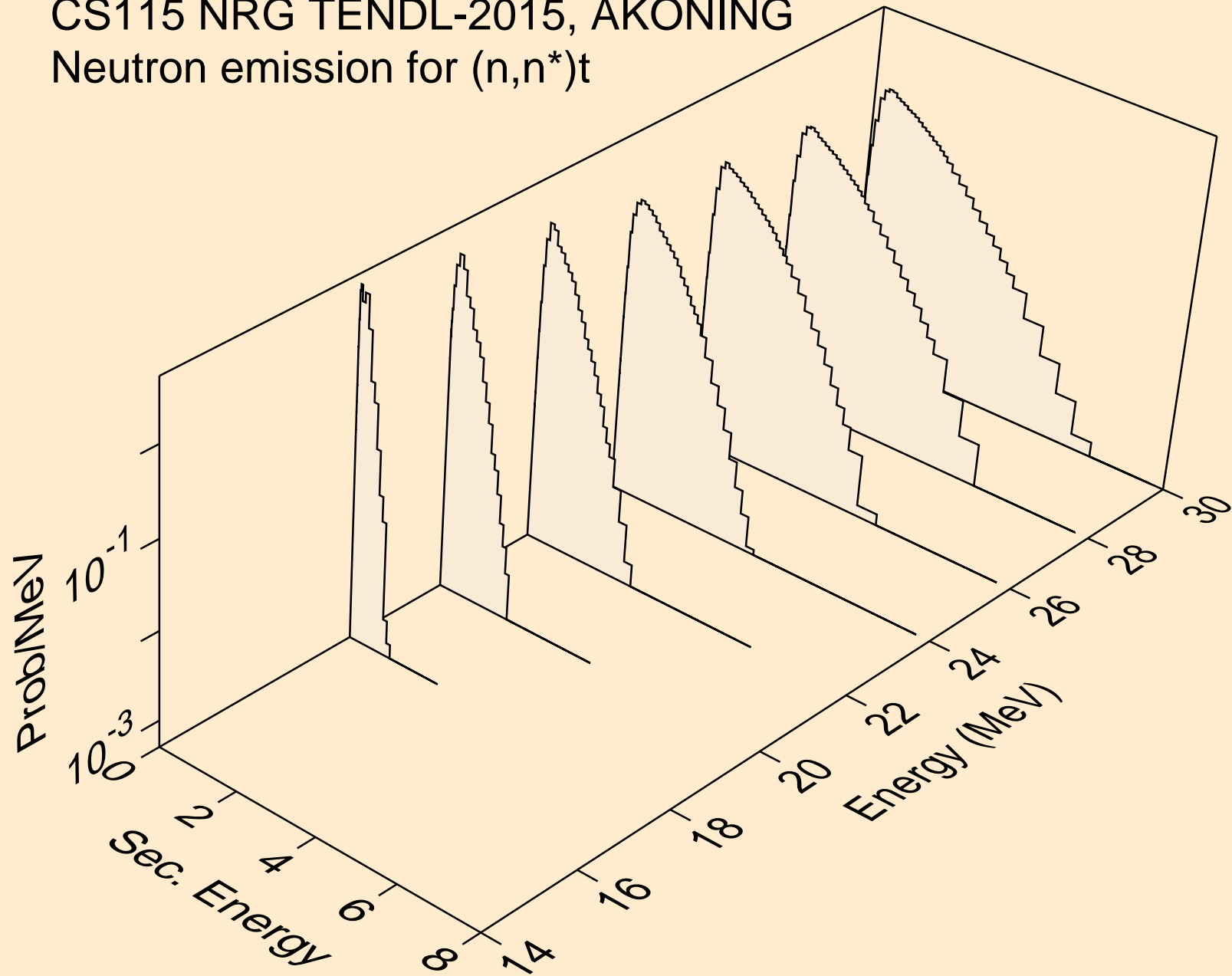

CS115 NRG TENDL-2015, AKONING
Neutron emission for (n,n*)he3

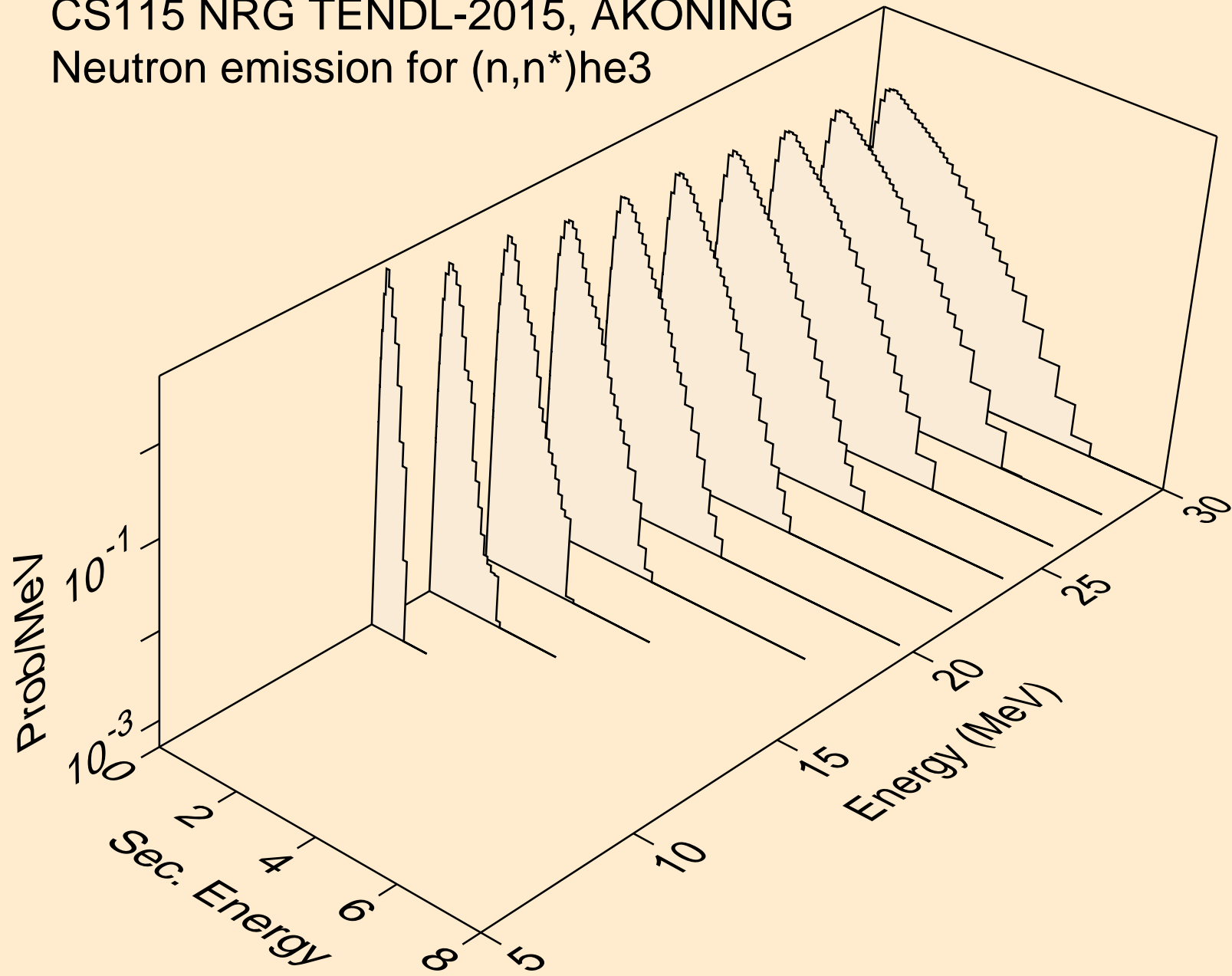

CS115 NRG TENDL-2015, AKONING
Neutron emission for (n,n*)d2a

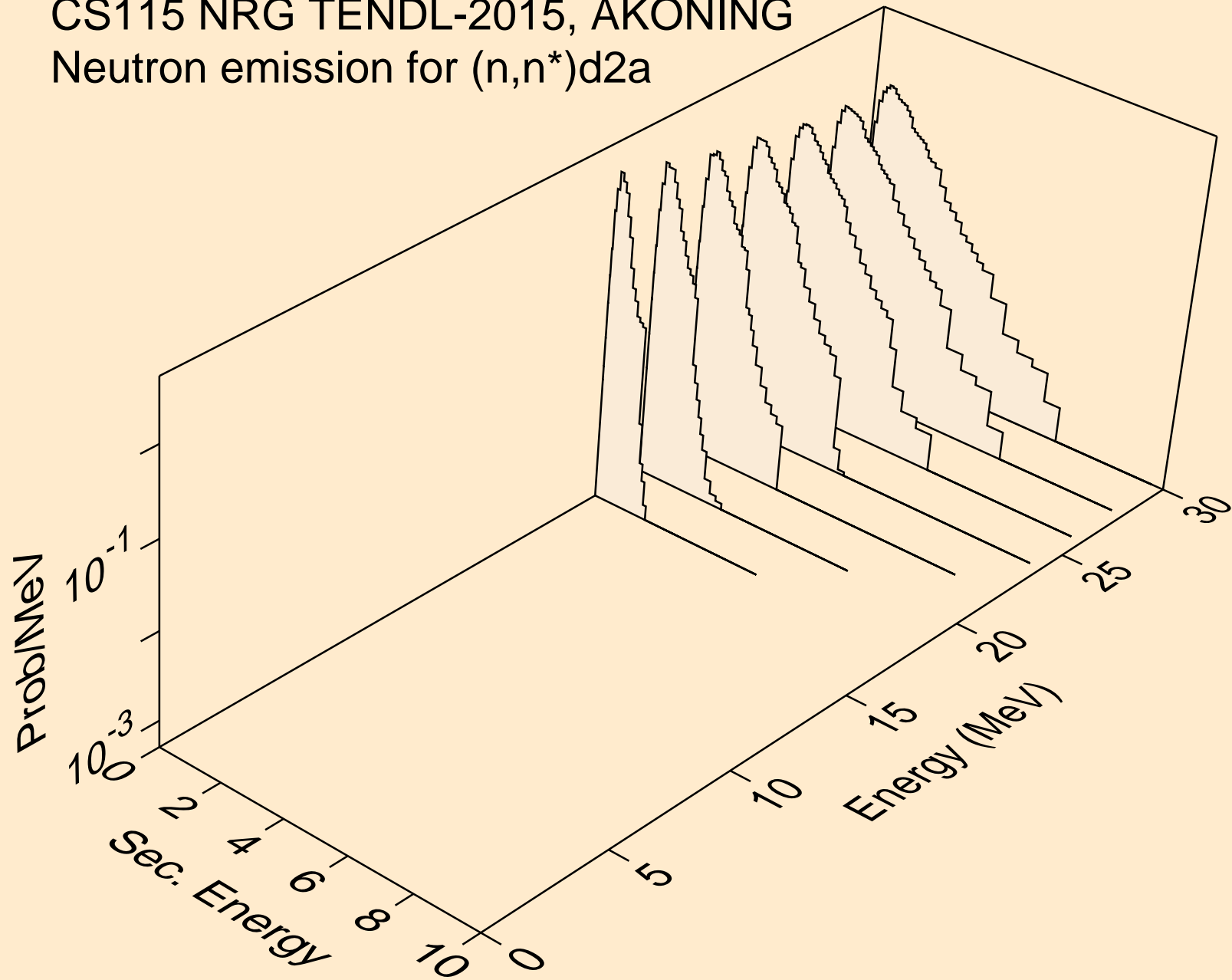

CS115 NRG TENDL-2015, AKONING
Neutron emission for (n,2np)

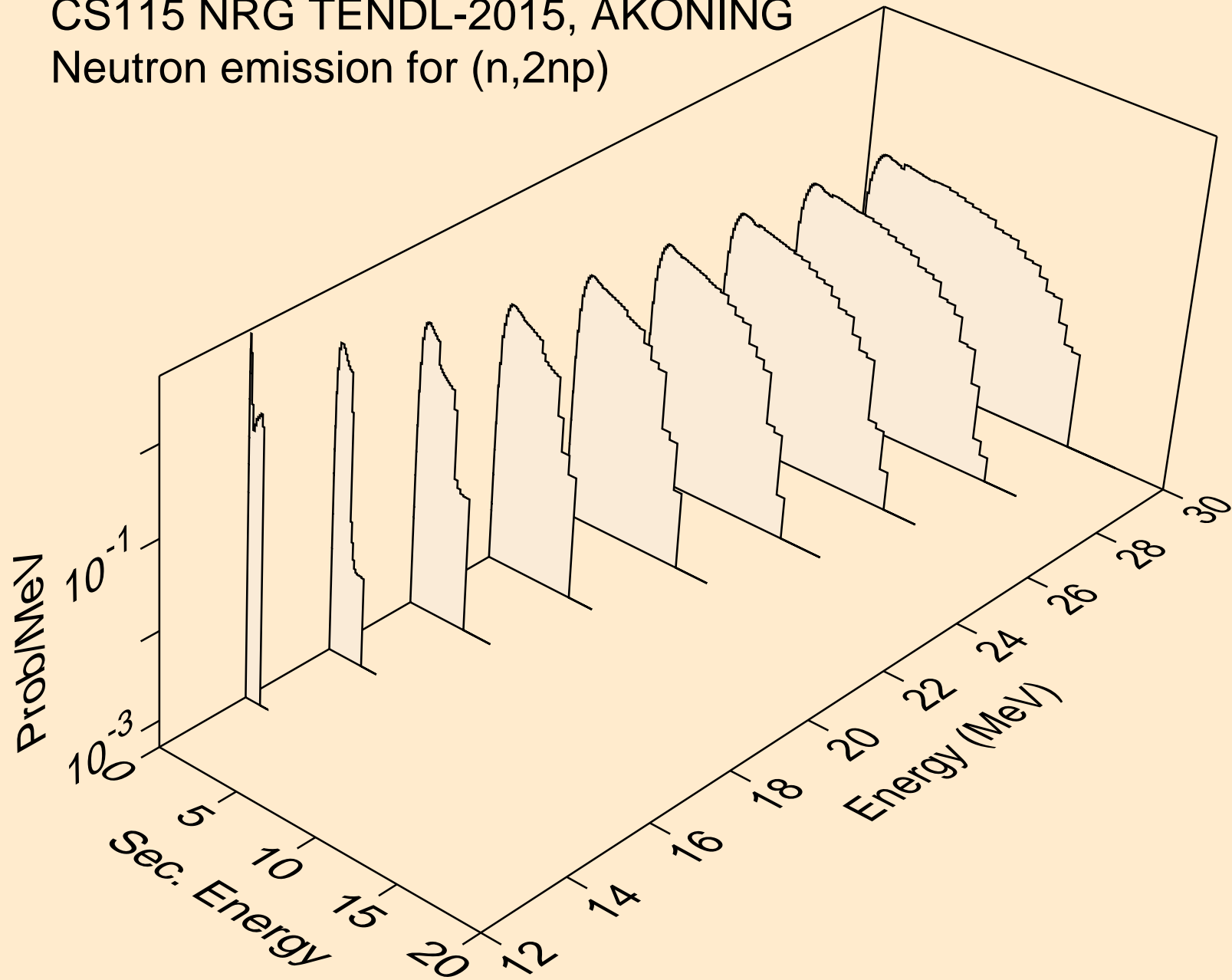

CS115 NRG TENDL-2015, AKONING
Neutron emission for (n,3np)

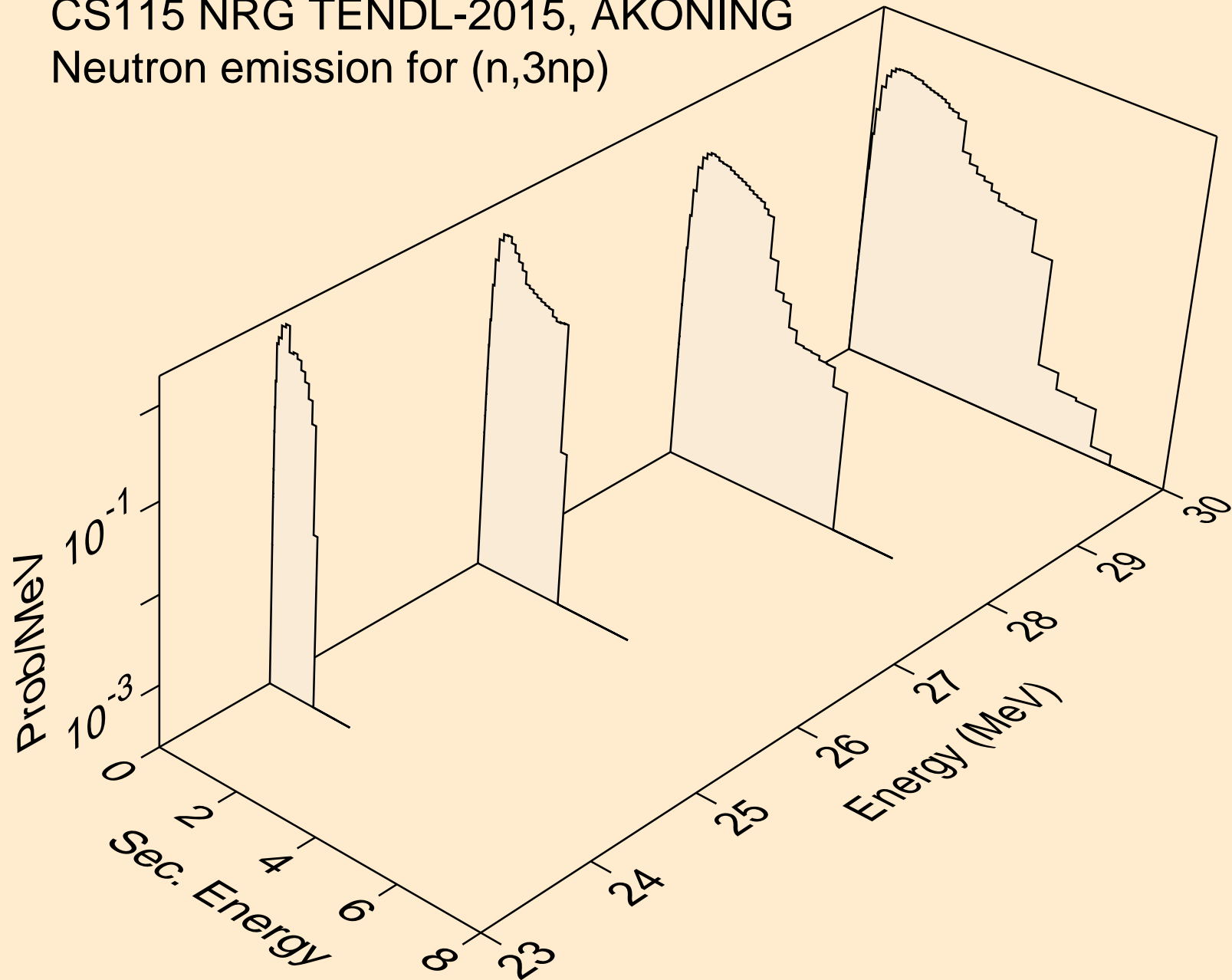

CS115 NRG TENDL-2015, AKONING
Neutron emission for (n,2np)

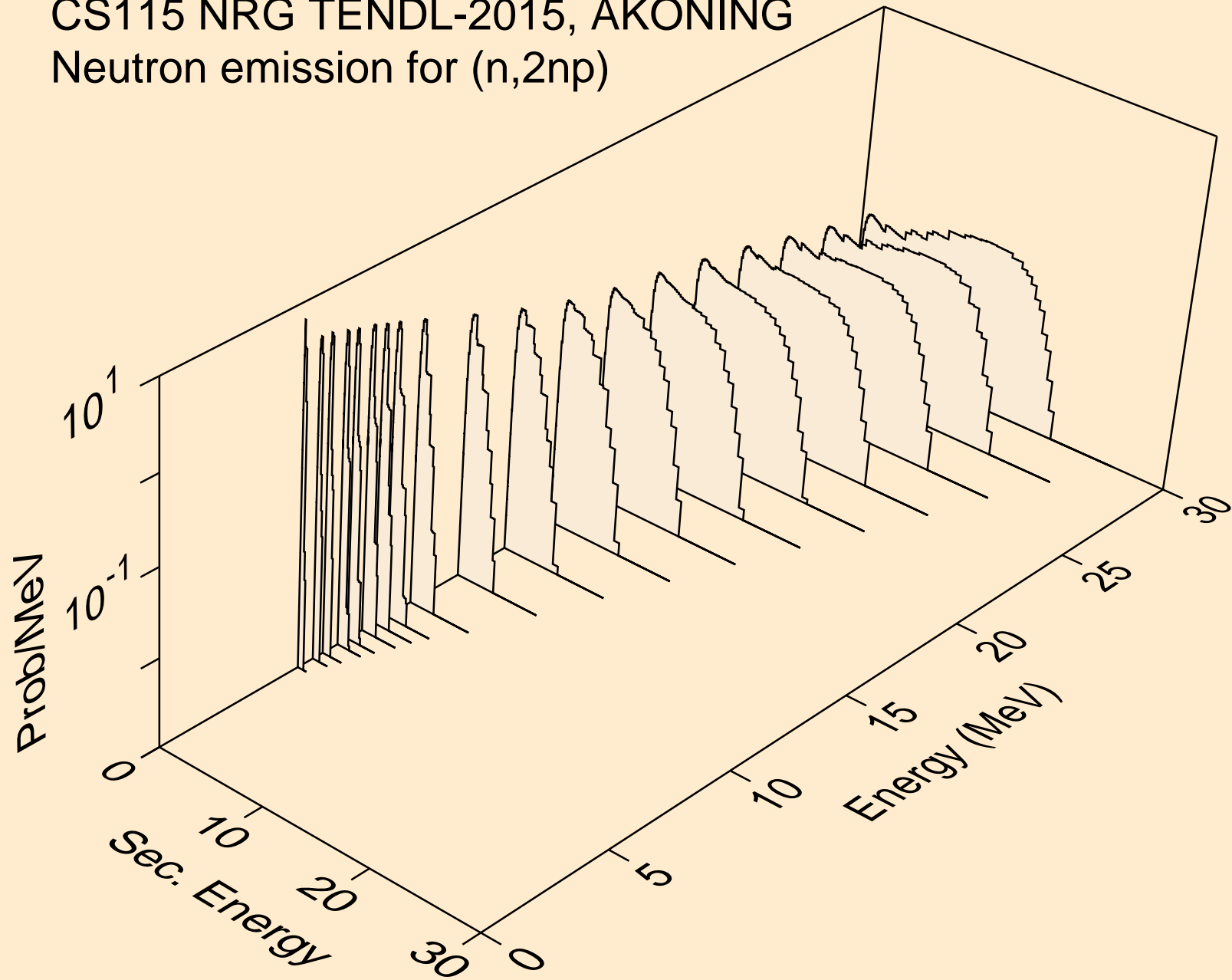

CS115 NRG TENDL-2015, AKONING
Neutron emission for (n,npa)

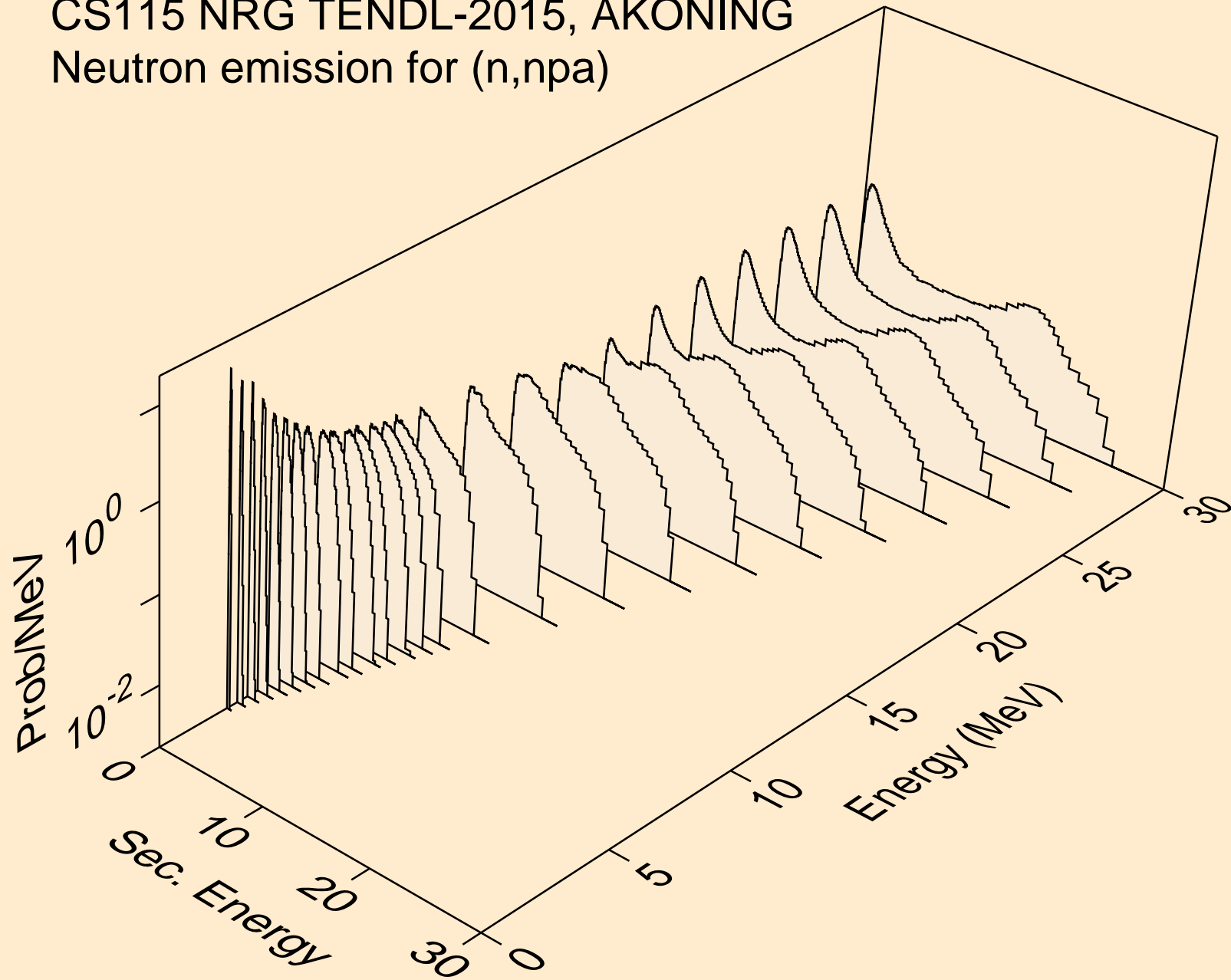

CS115 NRG TENDL-2015, AKONING
Neutron emission for (n,n*c)

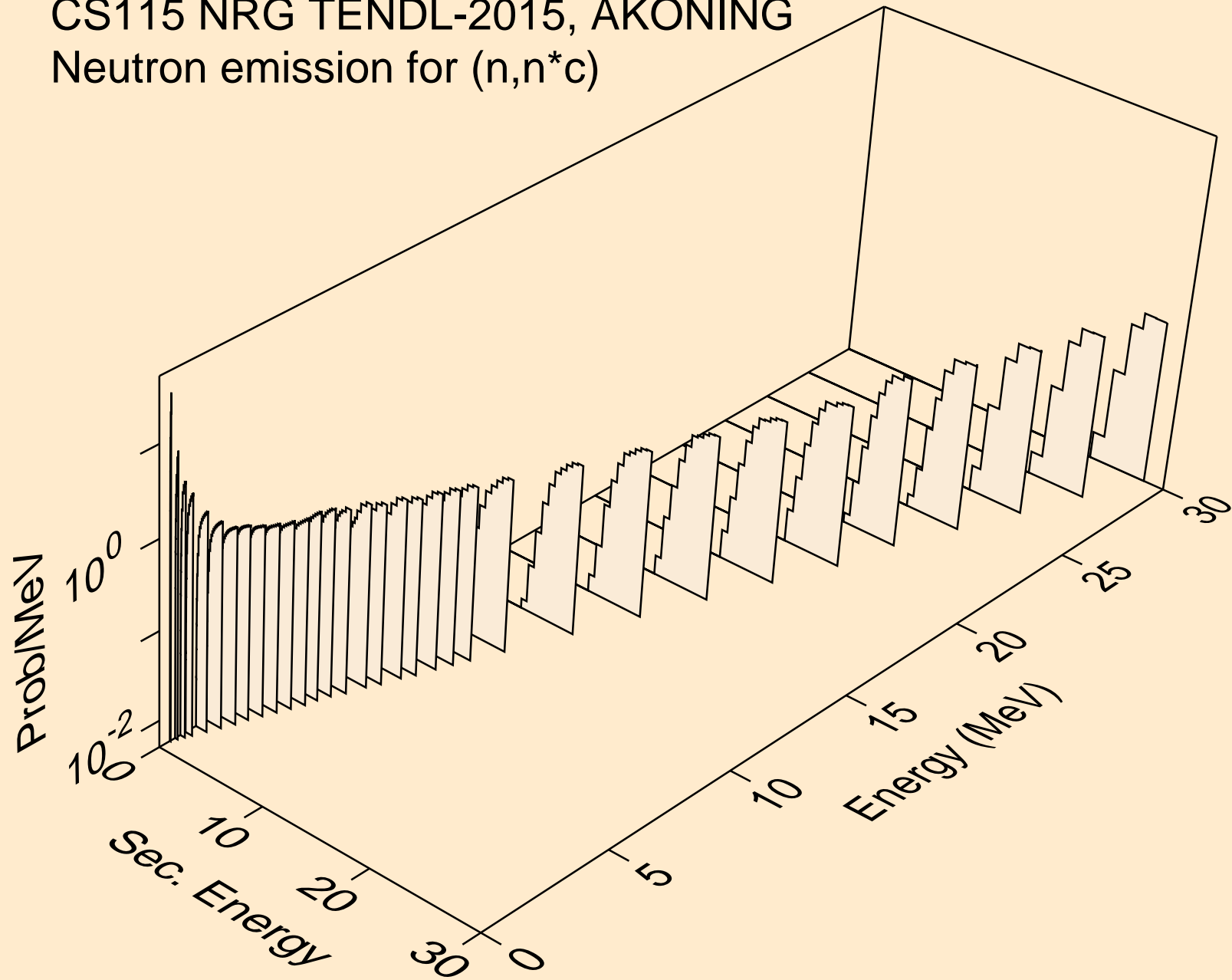

CS115 NRG TENDL-2015, AKONING
Photon emission for (n,x)

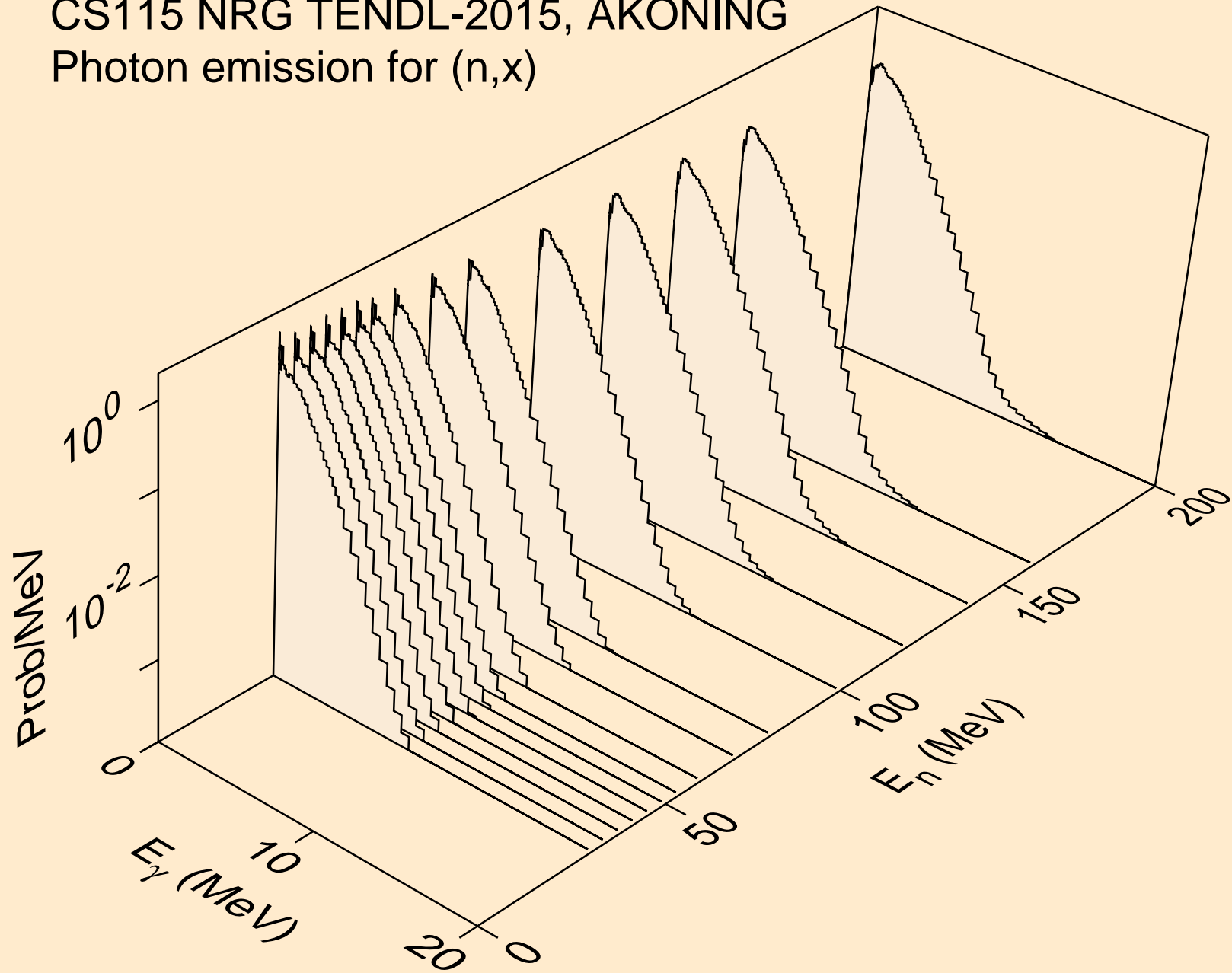

CS115 NRG TENDL-2015, AKONING
Photon emission for (n,2nd)

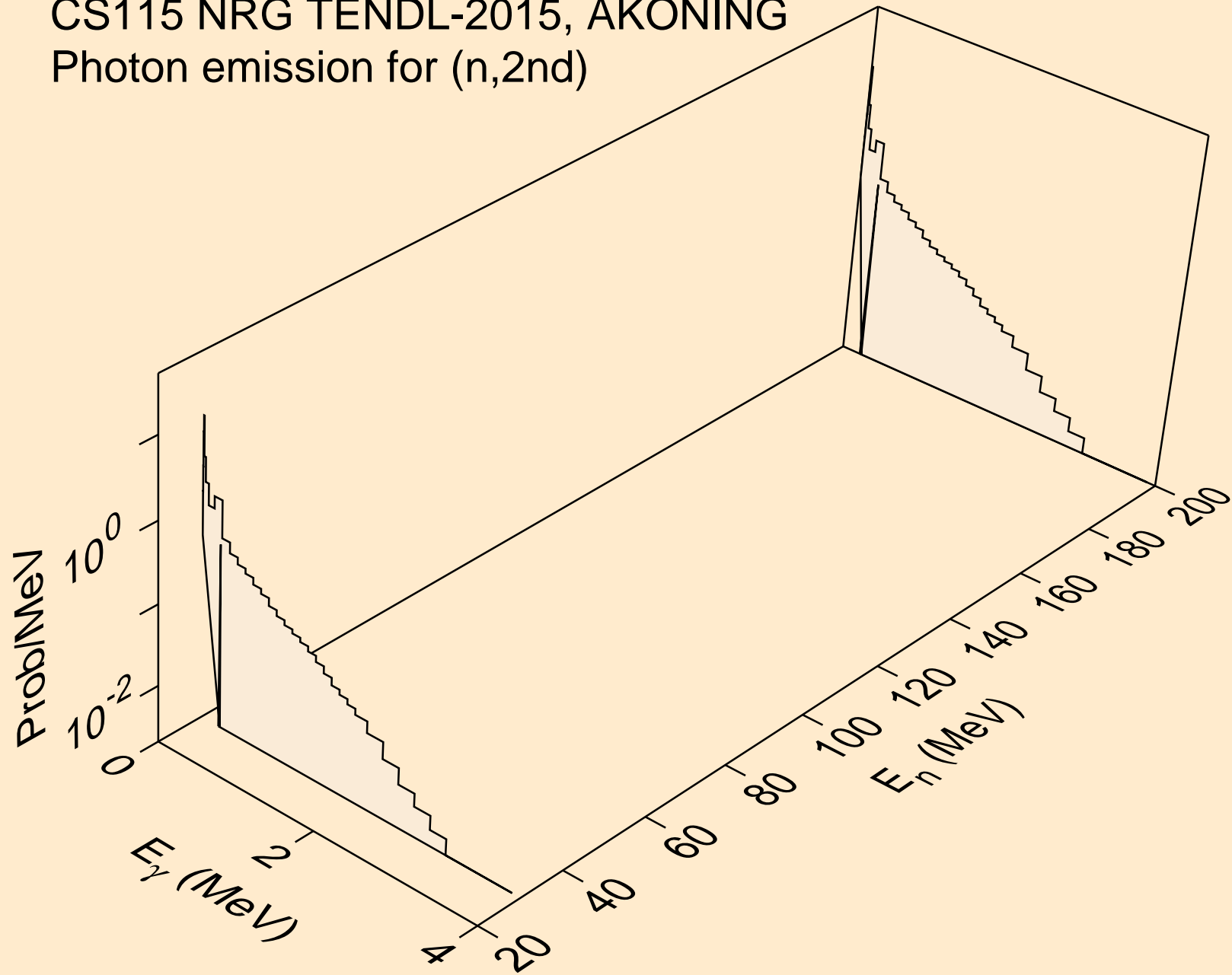

CS115 NRG TENDL-2015, AKONING
Photon emission for (n,2n)

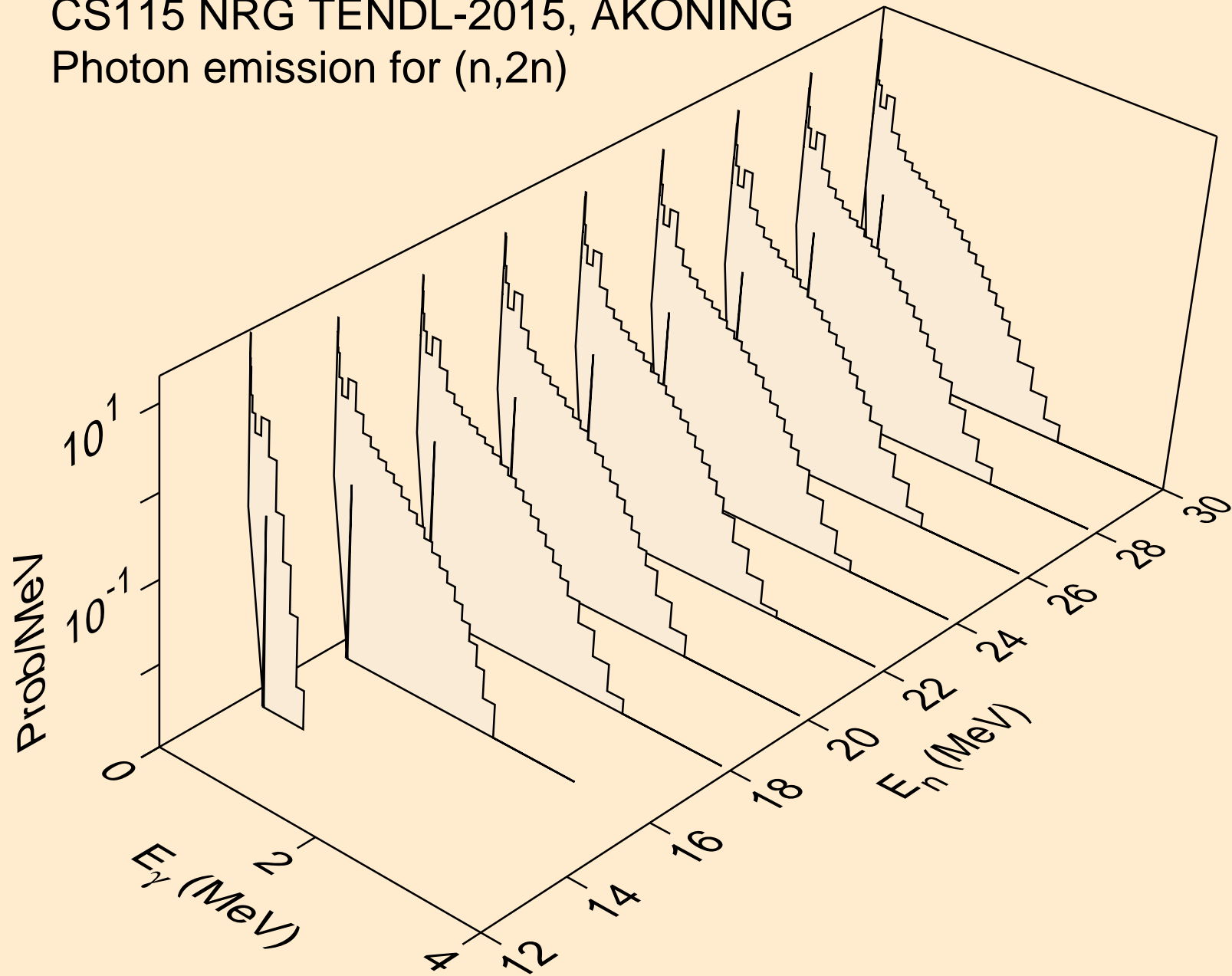

CS115 NRG TENDL-2015, AKONING
Photon emission for (n,3n)

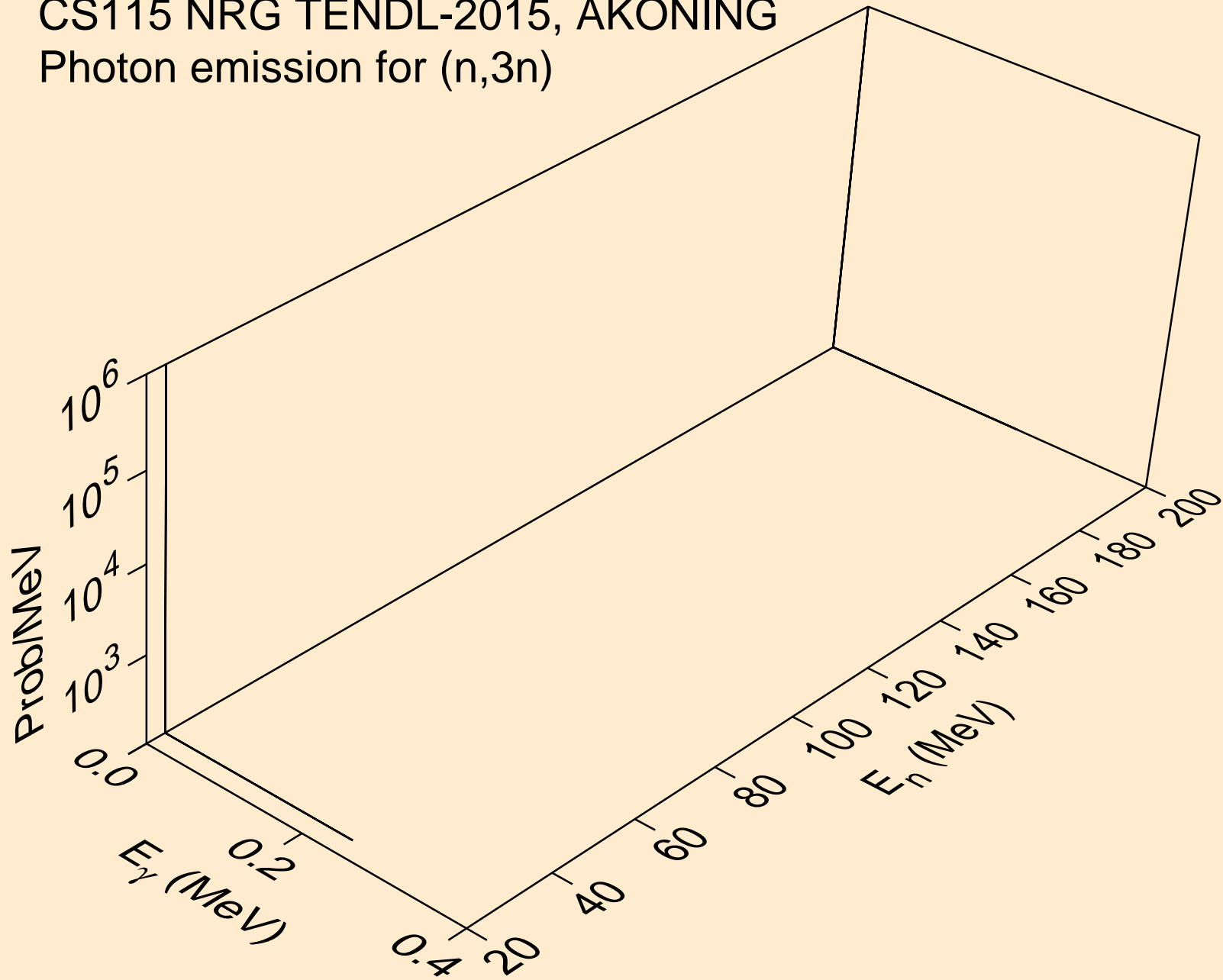

CS115 NRG TENDL-2015, AKONING
Photon emission for (n,n*)a

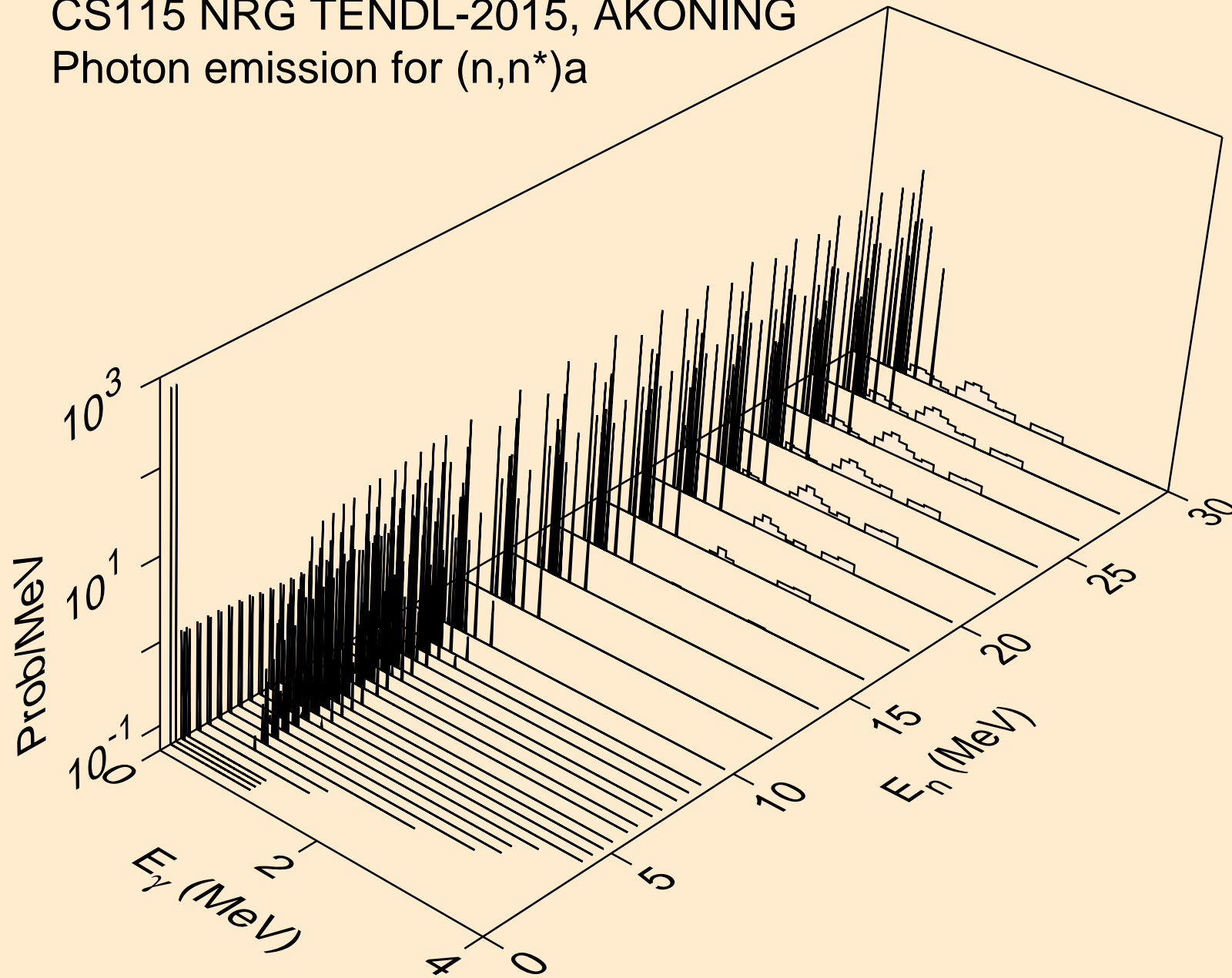

CS115 NRG TENDL-2015, AKONING
Photon emission for (n,n*)3a

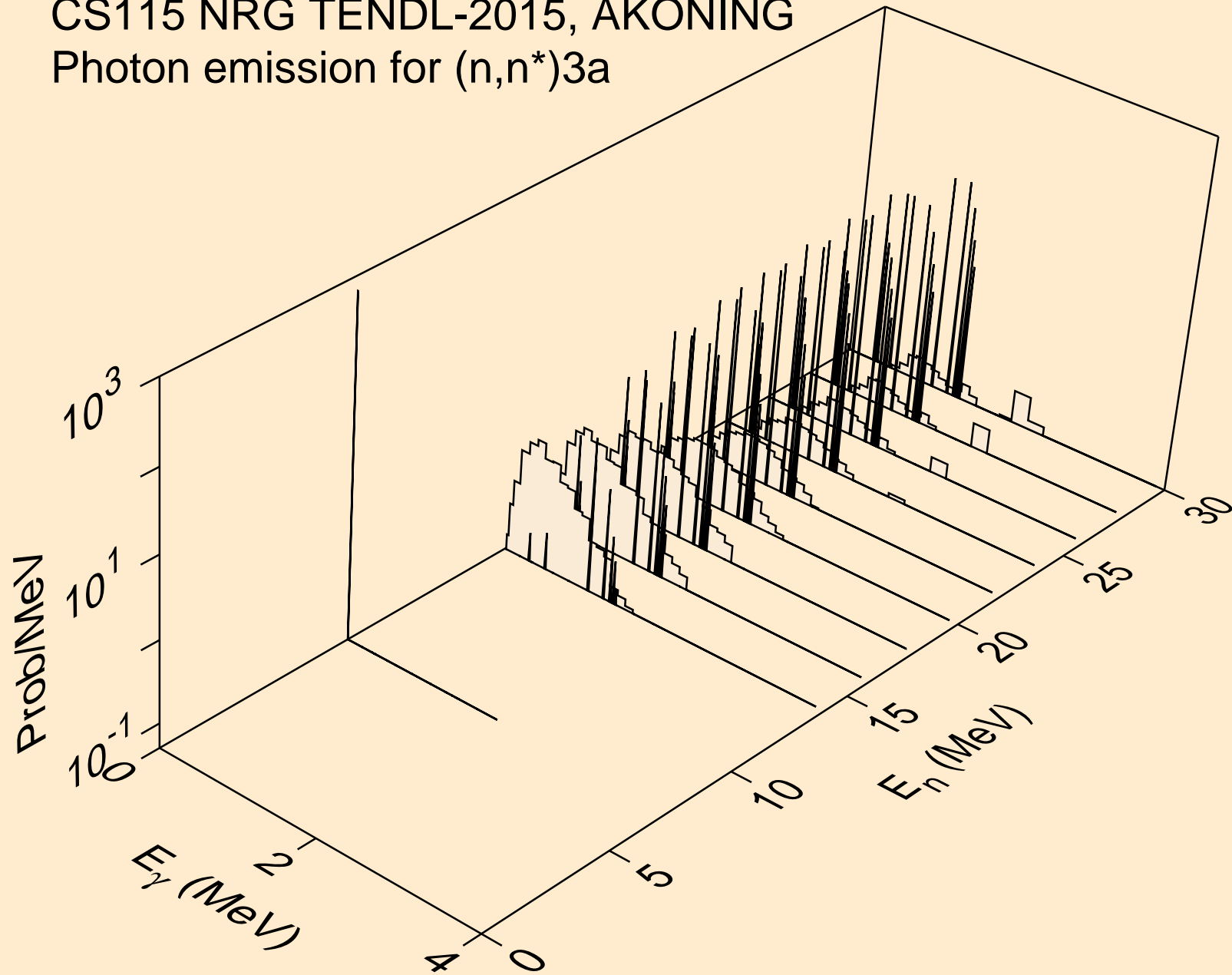

CS115 NRG TENDL-2015, AKONING

Photon emission for (n,2n) α

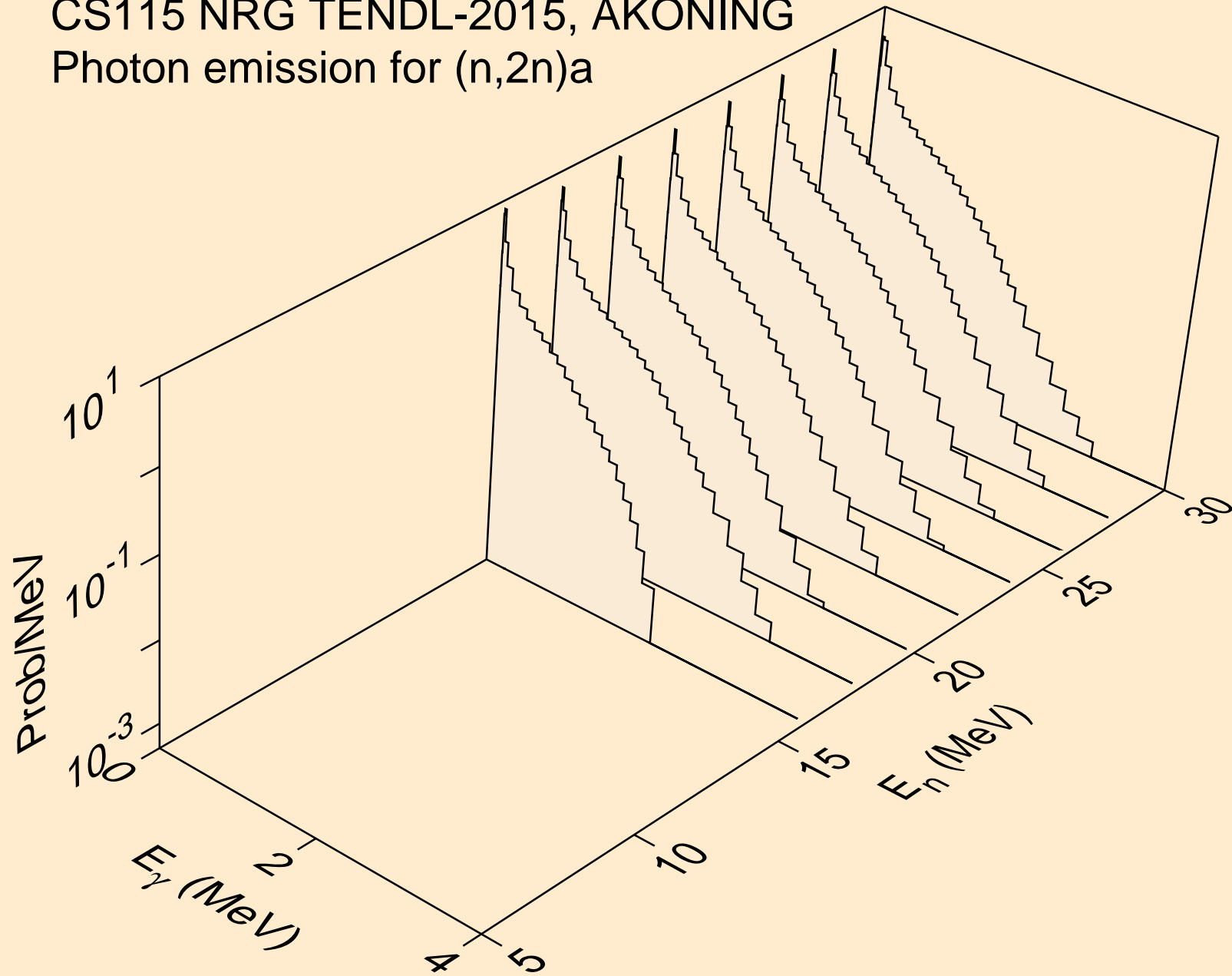

CS115 NRG TENDL-2015, AKONING
Photon emission for (n,n*)p

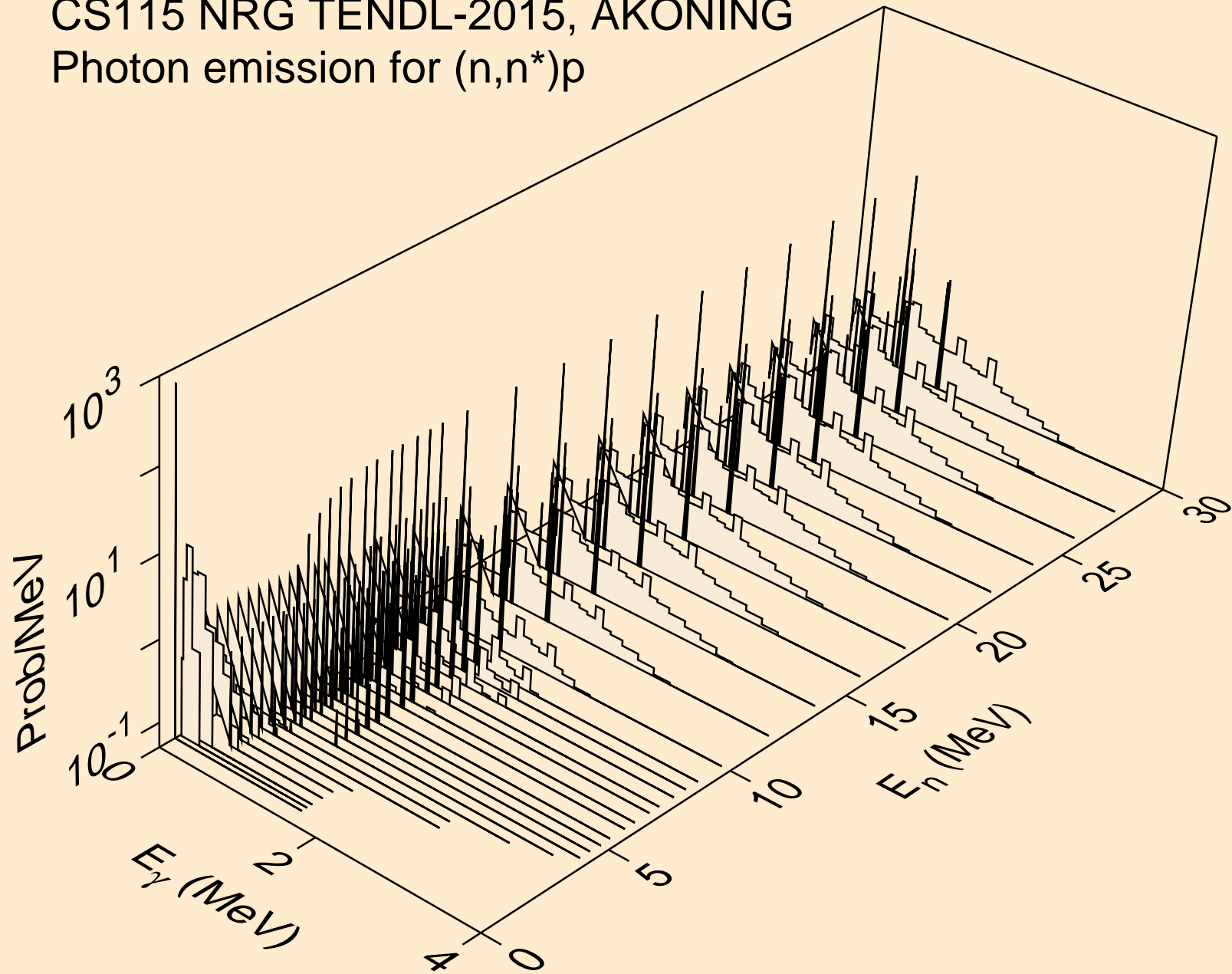

CS115 NRG TENDL-2015, AKONING
Photon emission for (n,n*)2a

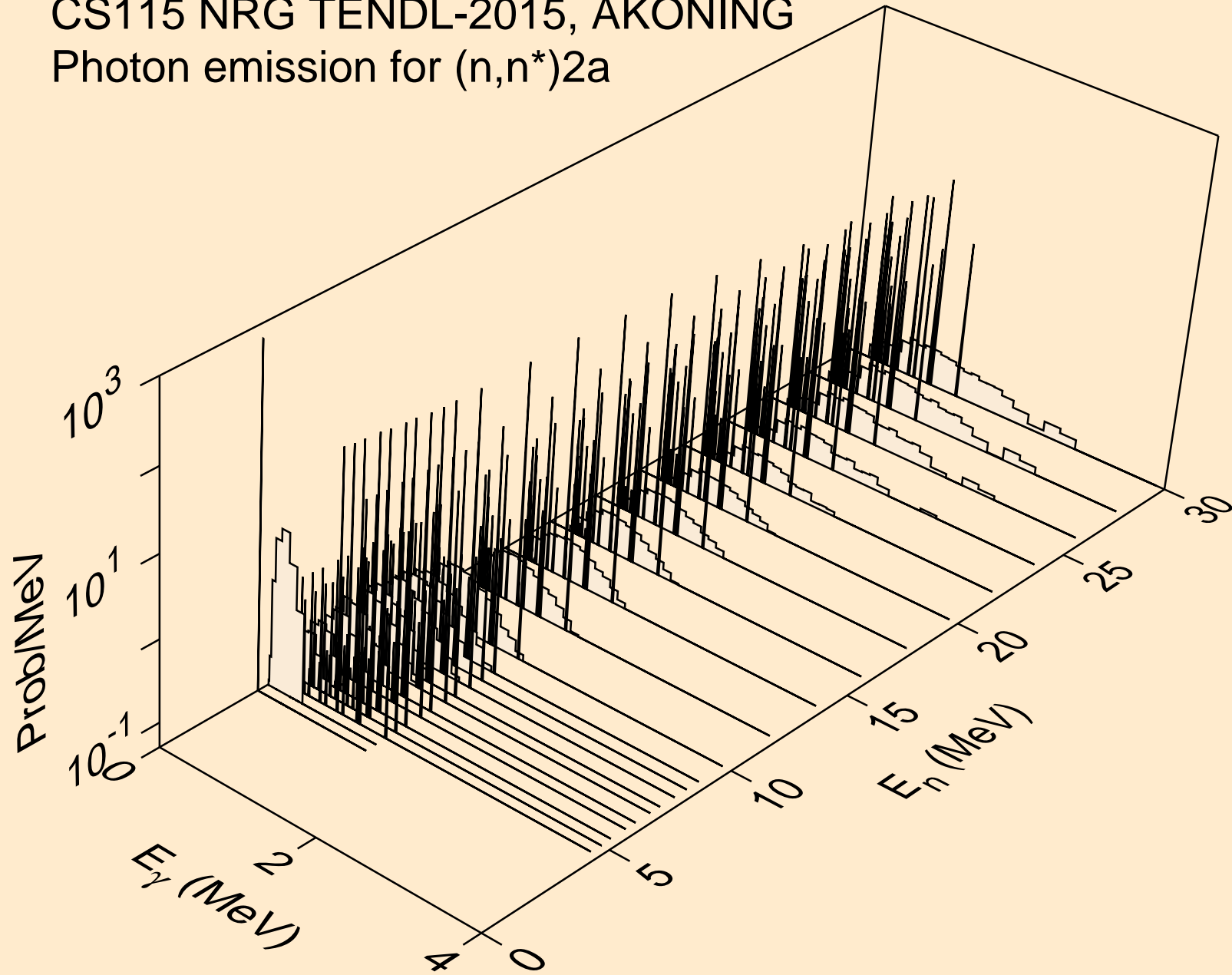

CS115 NRG TENDL-2015, AKONING
Photon emission for (n,2n)2a

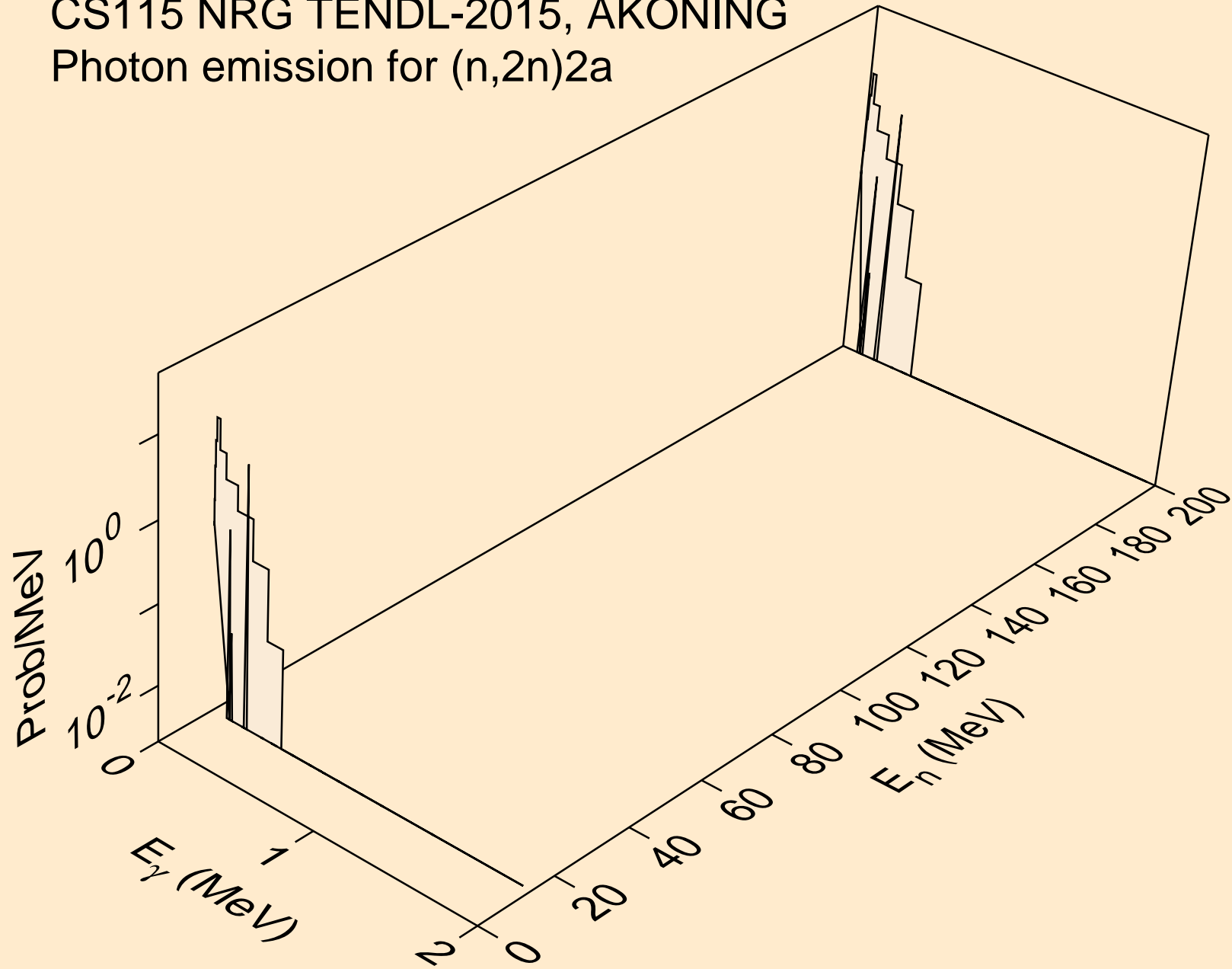

CS115 NRG TENDL-2015, AKONING
Photon emission for (n,n*)d

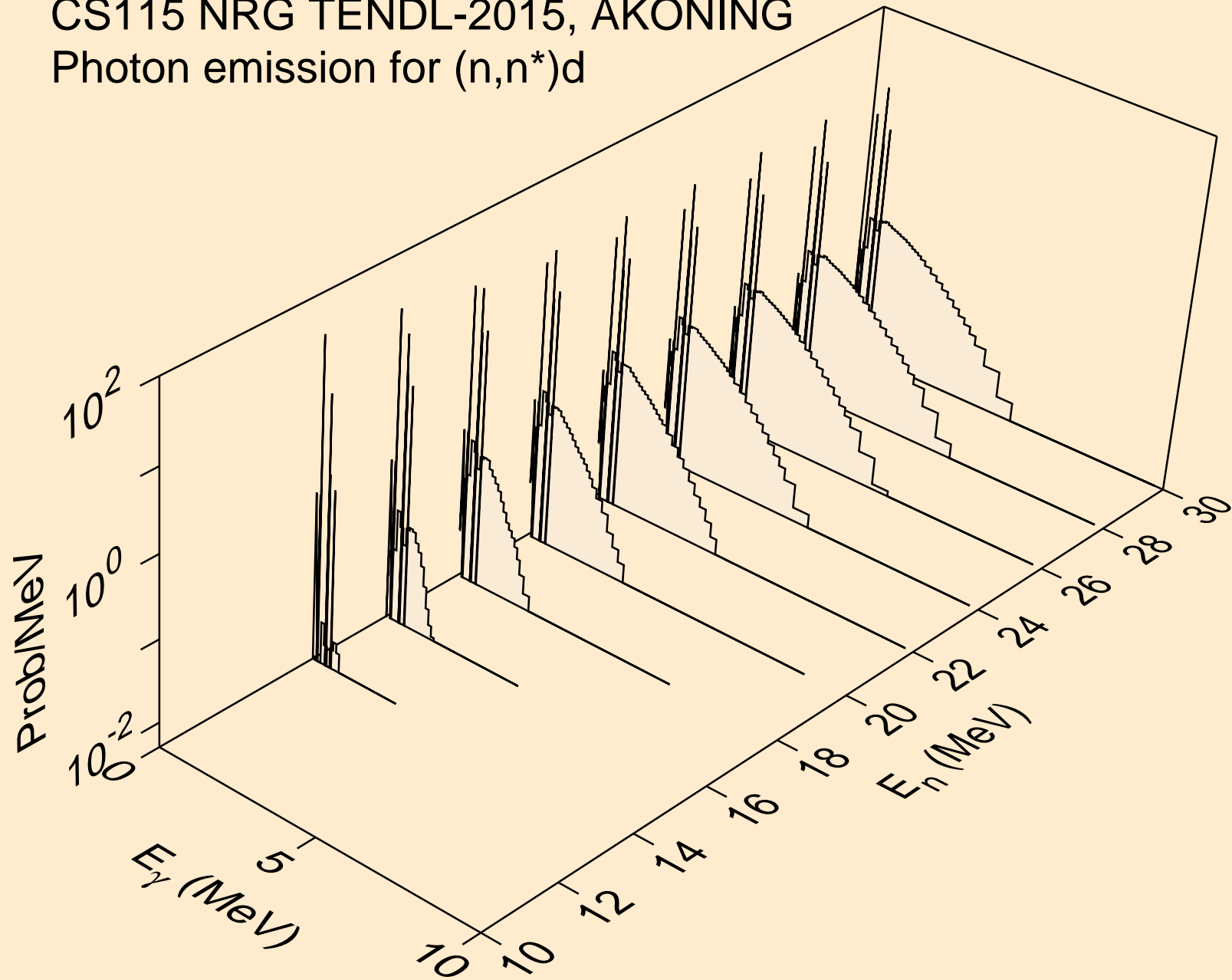

CS115 NRG TENDL-2015, AKONING

Photon emission for (n,n*)t

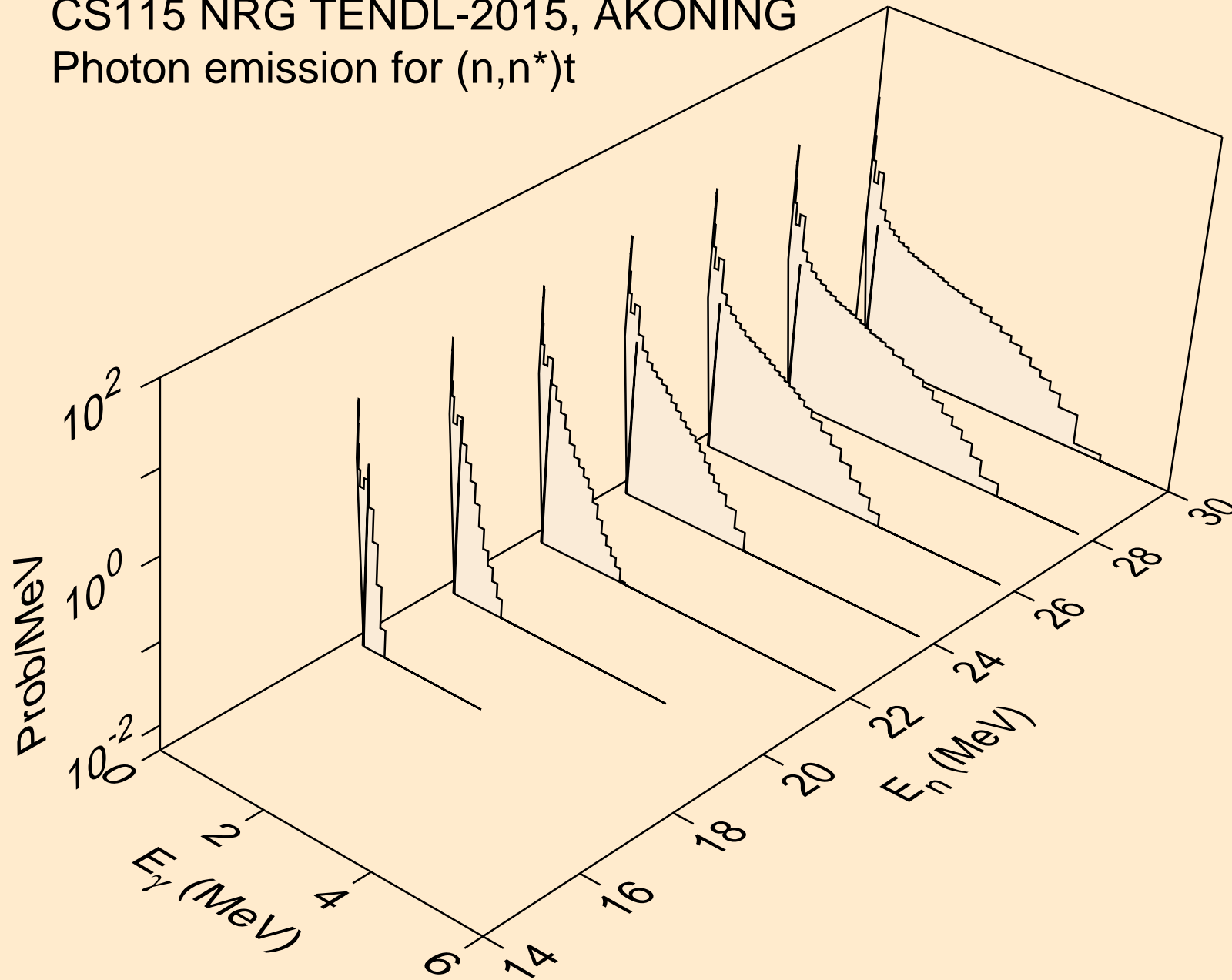

CS115 NRG TENDL-2015, AKONING
Photon emission for (n,n*)he3

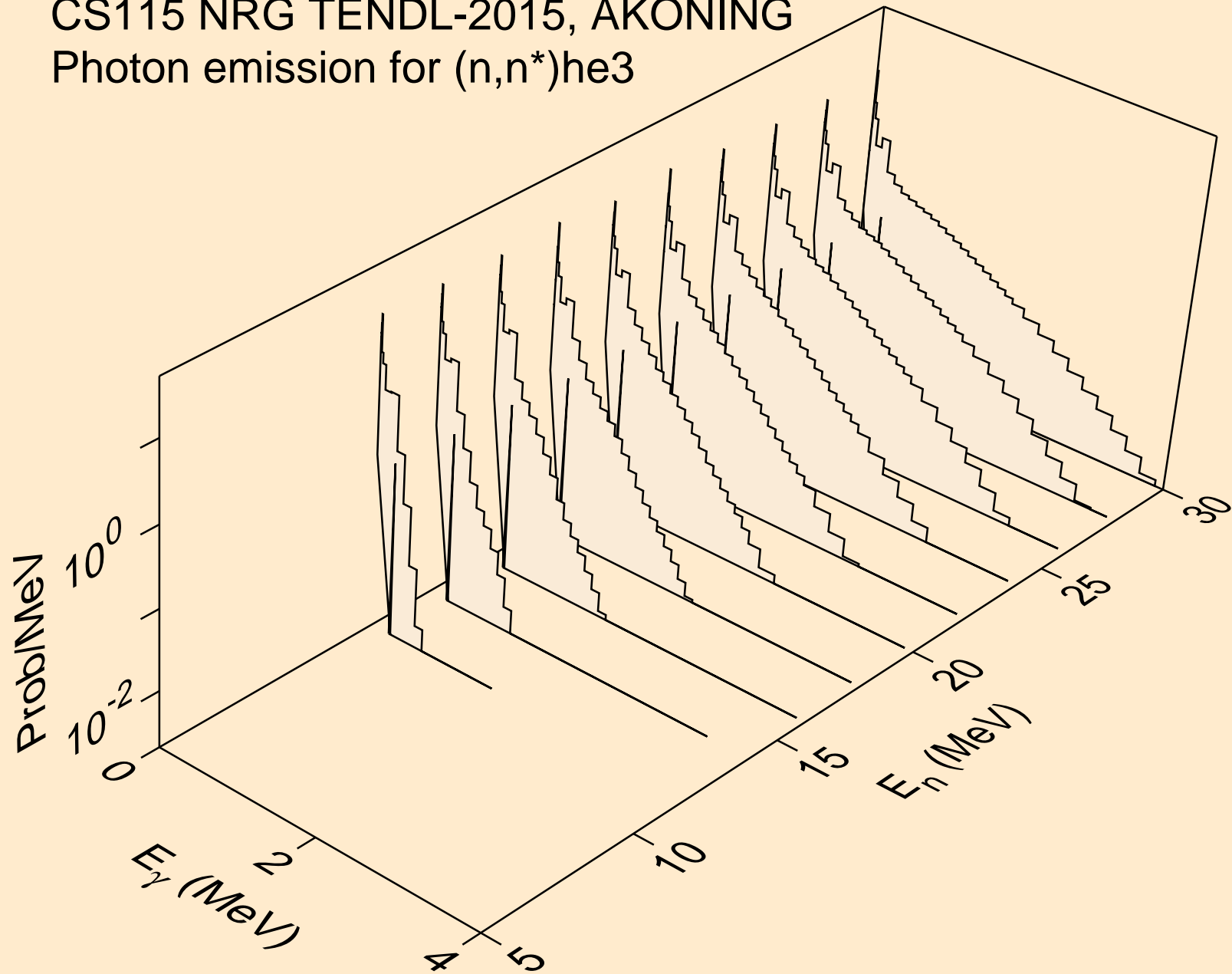

CS115 NRG TENDL-2015, AKONING
Photon emission for (n,n*)d2a

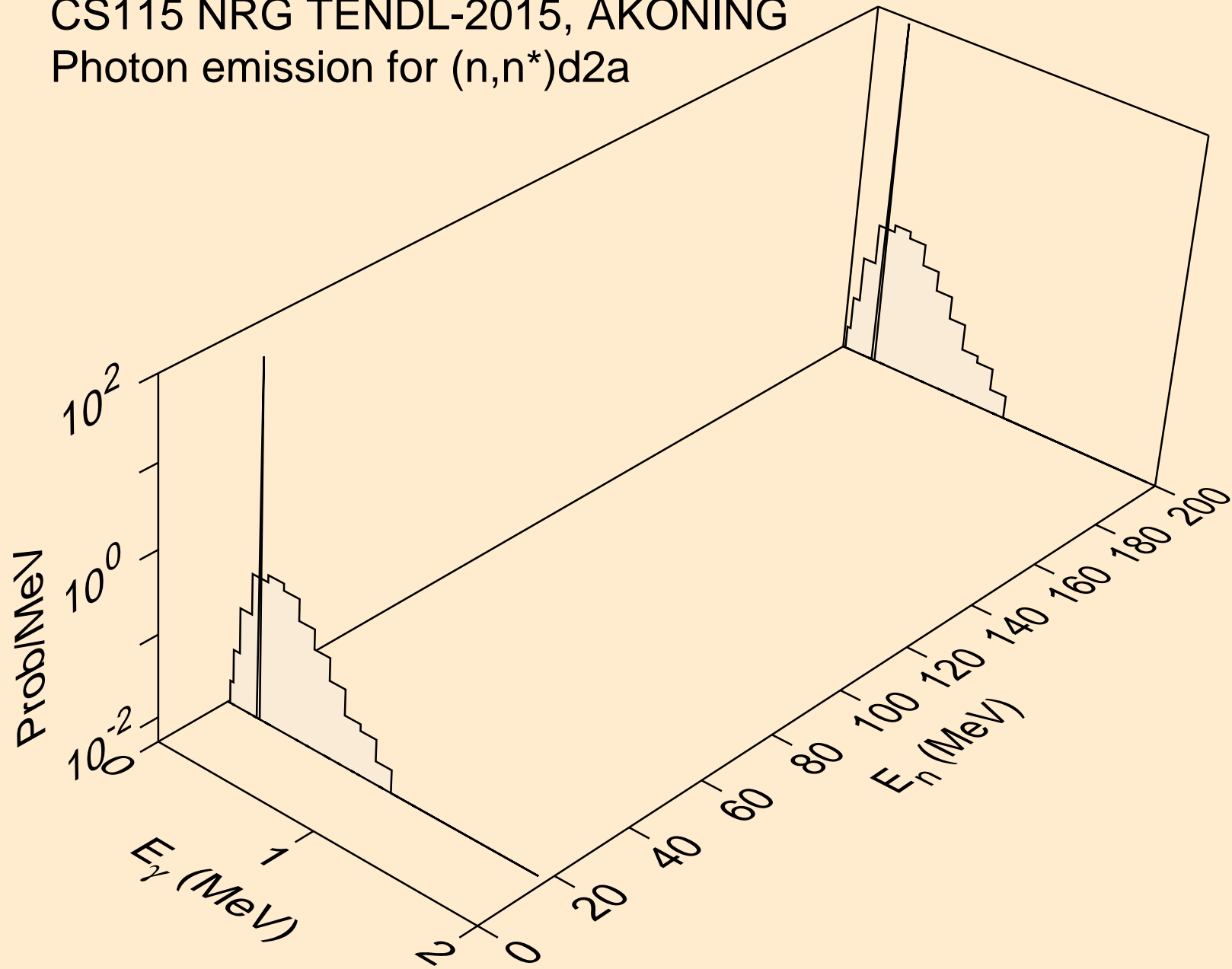

CS115 NRG TENDL-2015, AKONING
Photon emission for (n,2np)

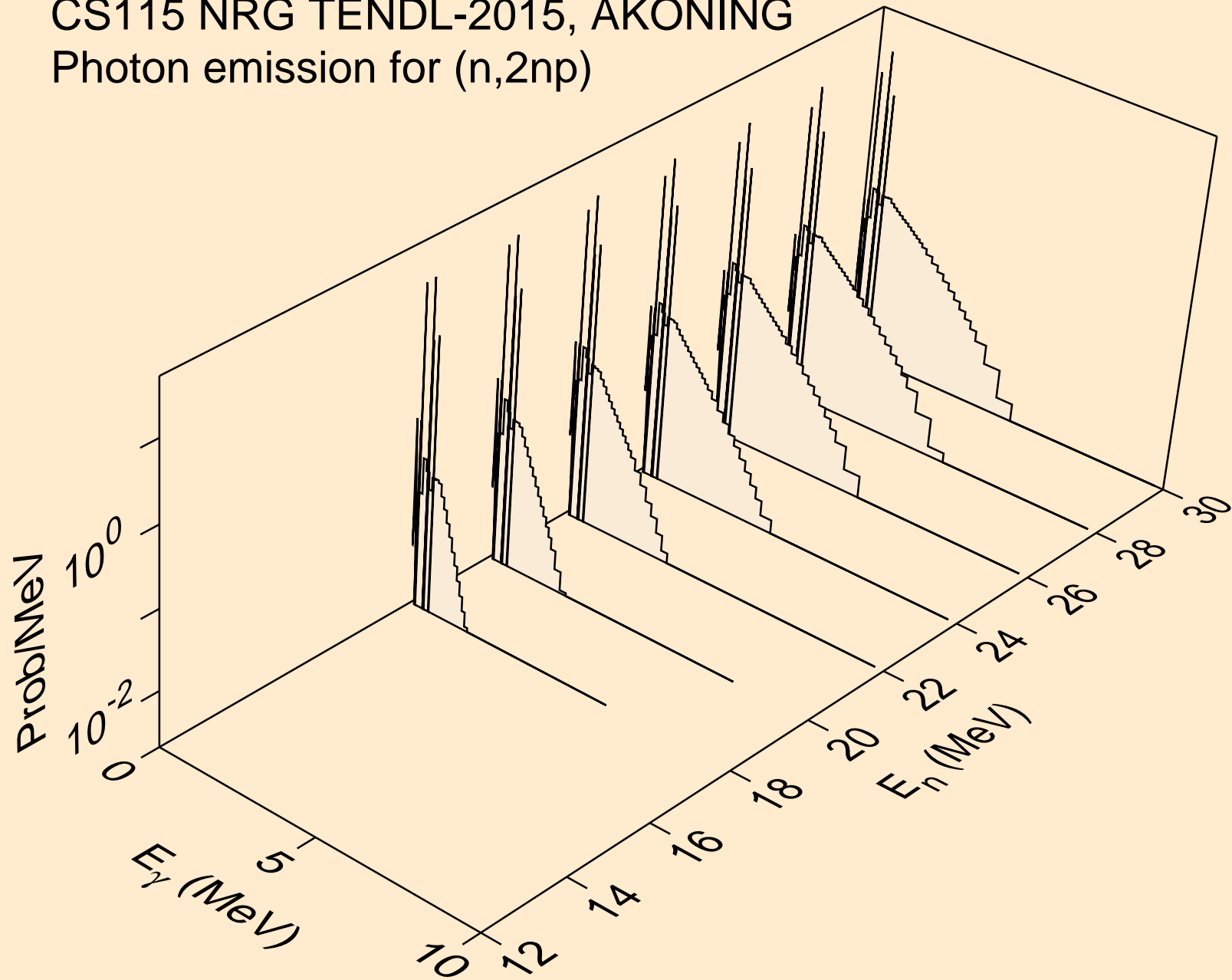

CS115 NRG TENDL-2015, AKONING
Photon emission for (n,3np)

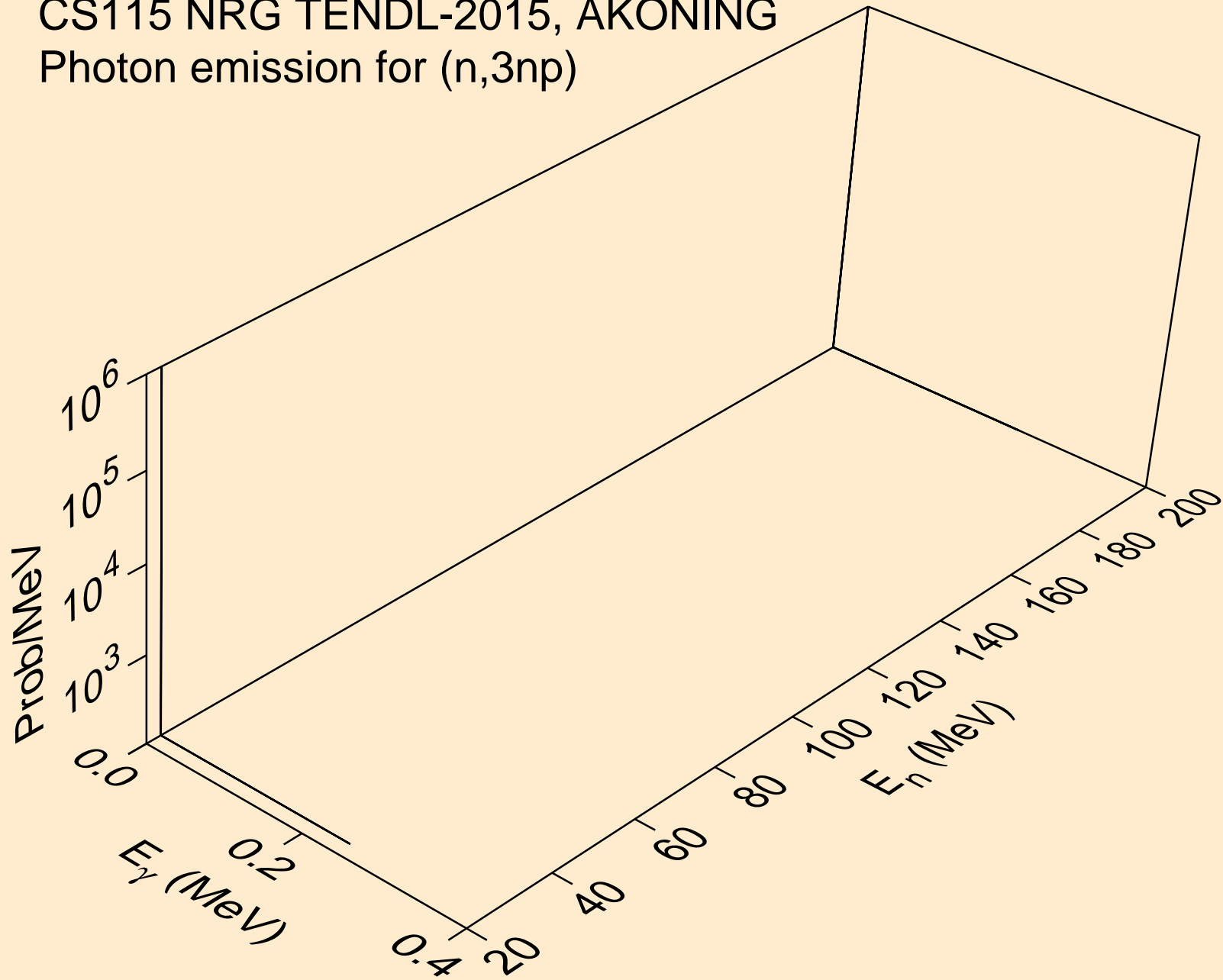

CS115 NRG TENDL-2015, AKONING
Photon emission for (n,2np)

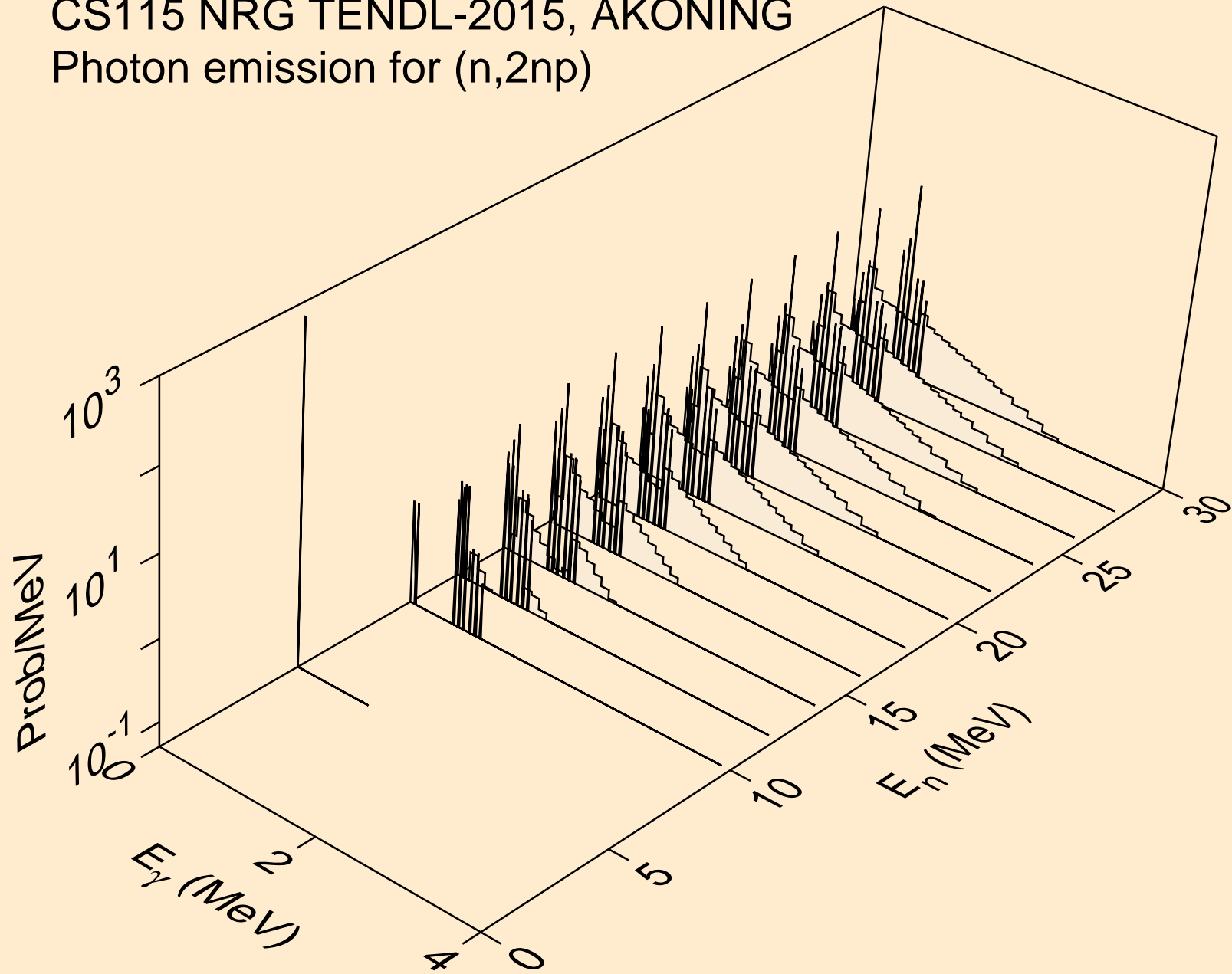

CS115 NRG TENDL-2015, AKONING
Photon emission for (n,npa)

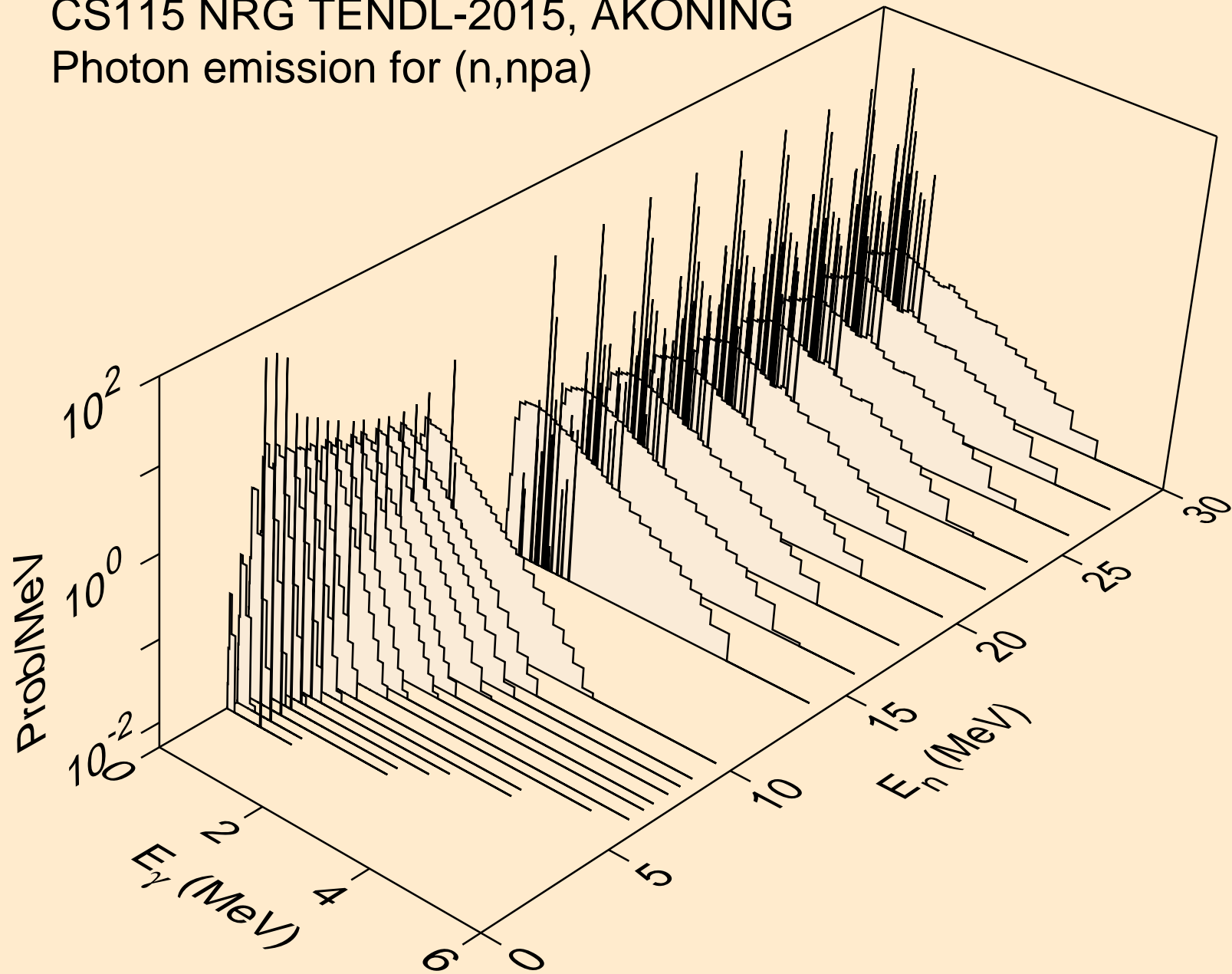

CS115 NRG TENDL-2015, AKONING
Photon emission for (n,n*c)

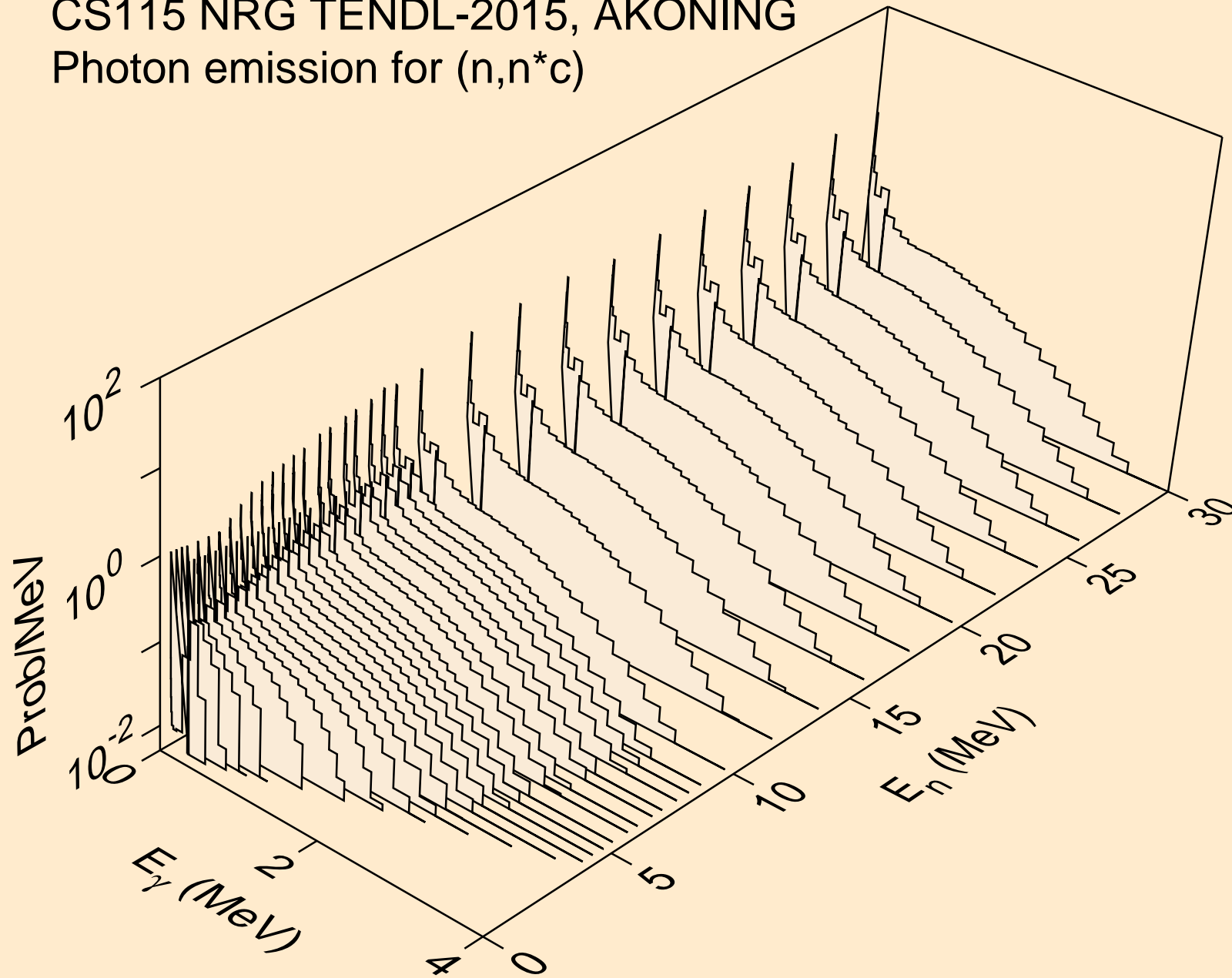

CS115 NRG TENDL-2015, AKONING
Photon emission for (n,gma)

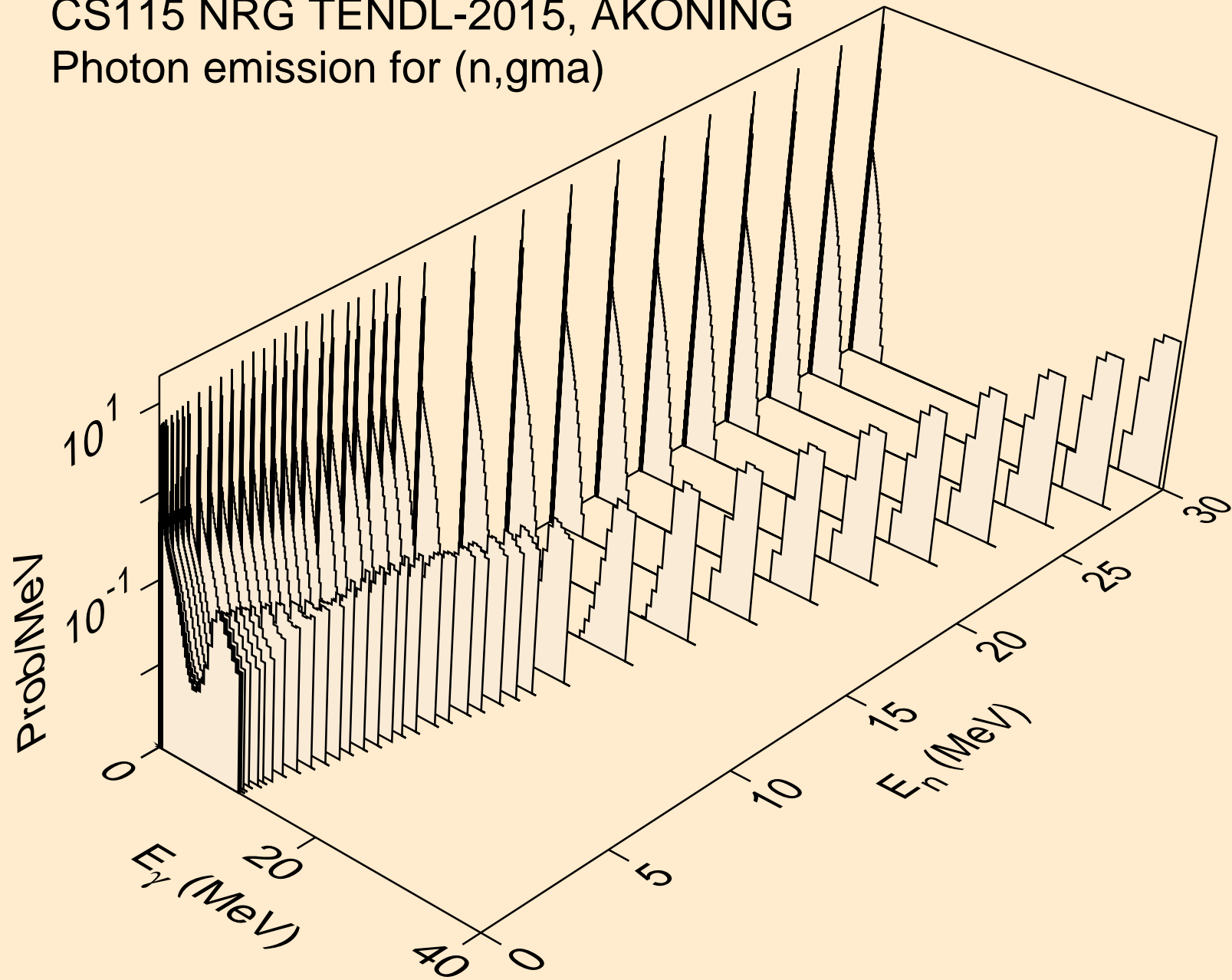

CS115 NRG TENDL-2015, AKONING
Photon emission for (n,p)

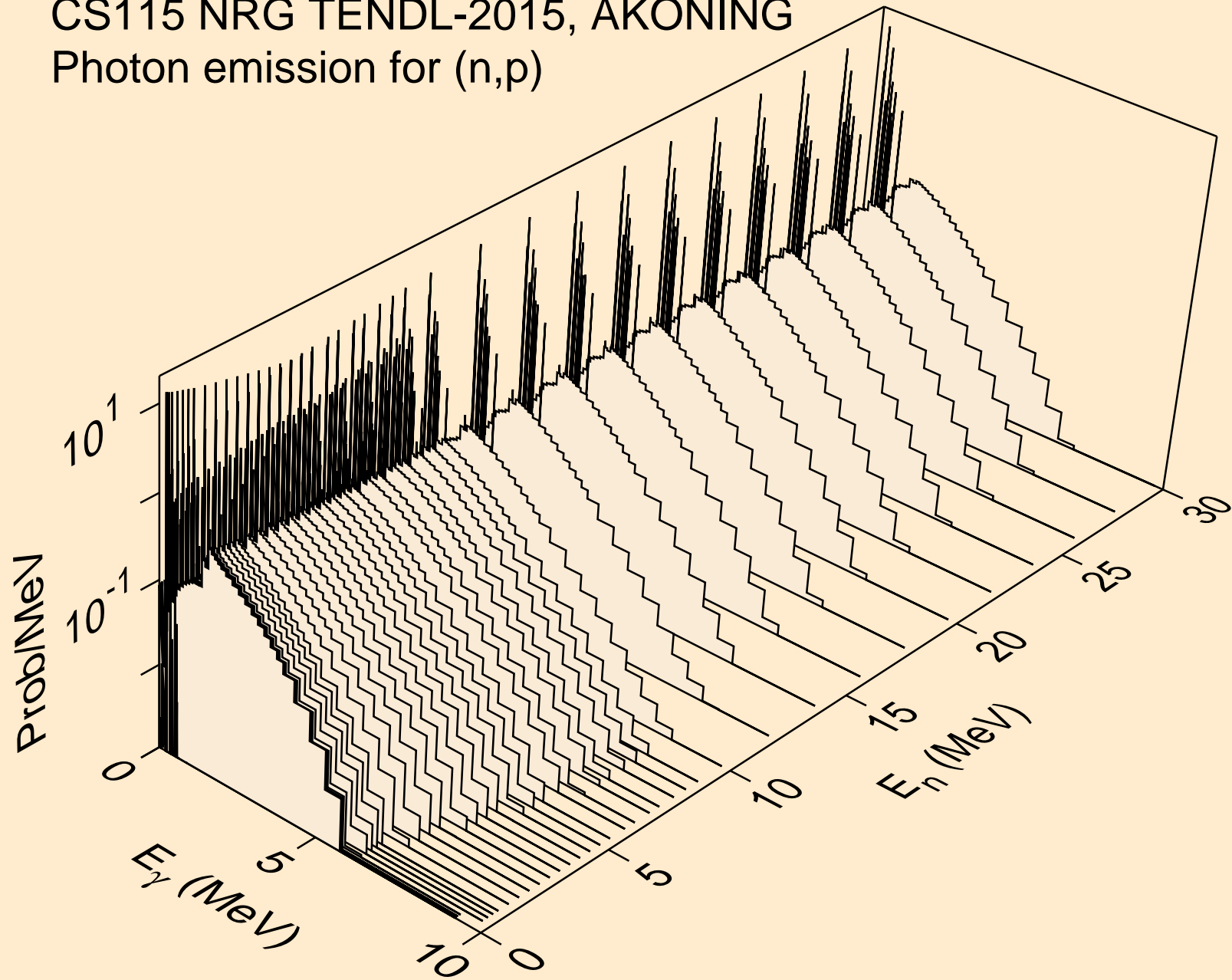

CS115 NRG TENDL-2015, AKONING
Photon emission for (n,d)

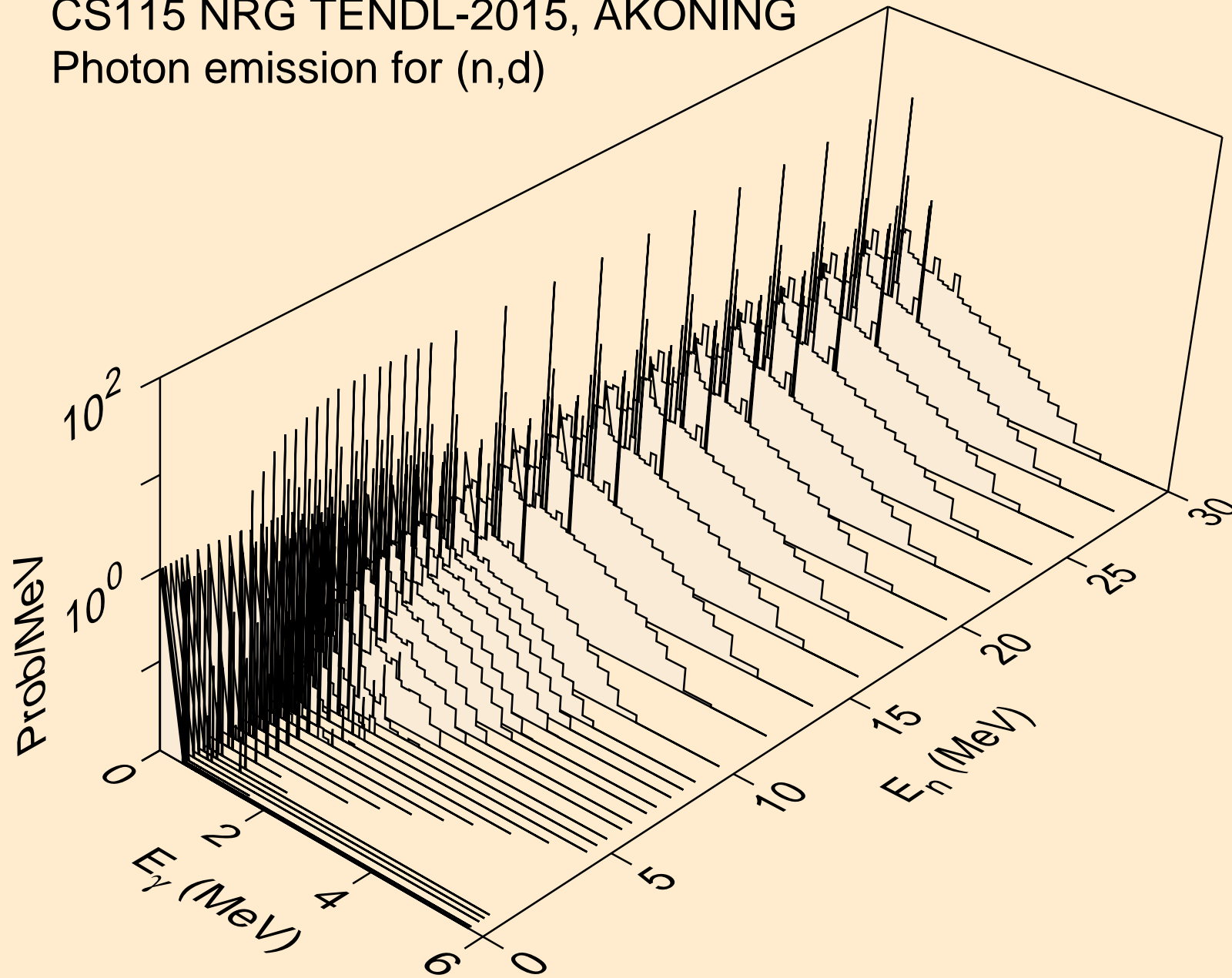

CS115 NRG TENDL-2015, AKONING
Photon emission for (n,t)

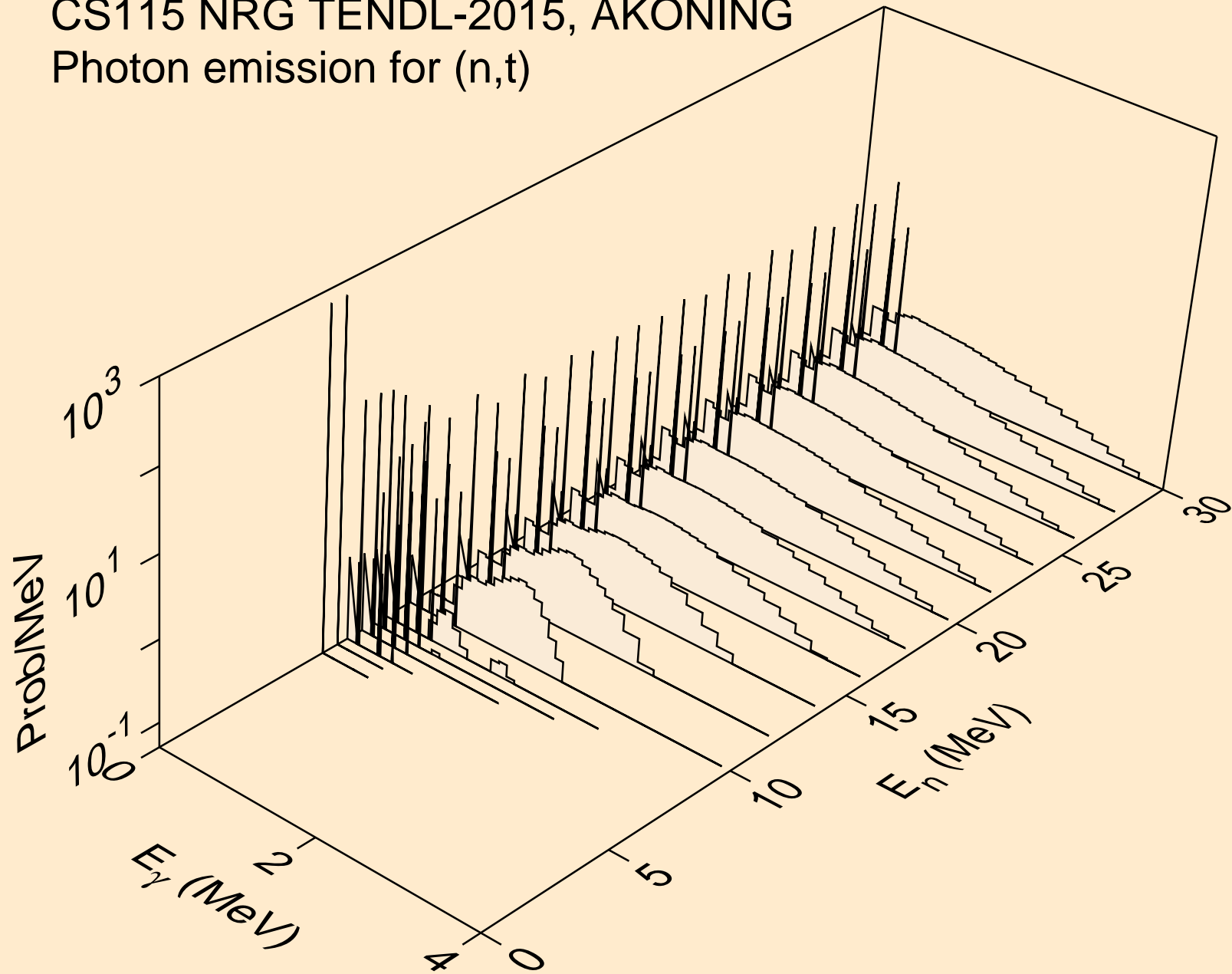

CS115 NRG TENDL-2015, AKONING
Photon emission for (n,he3)

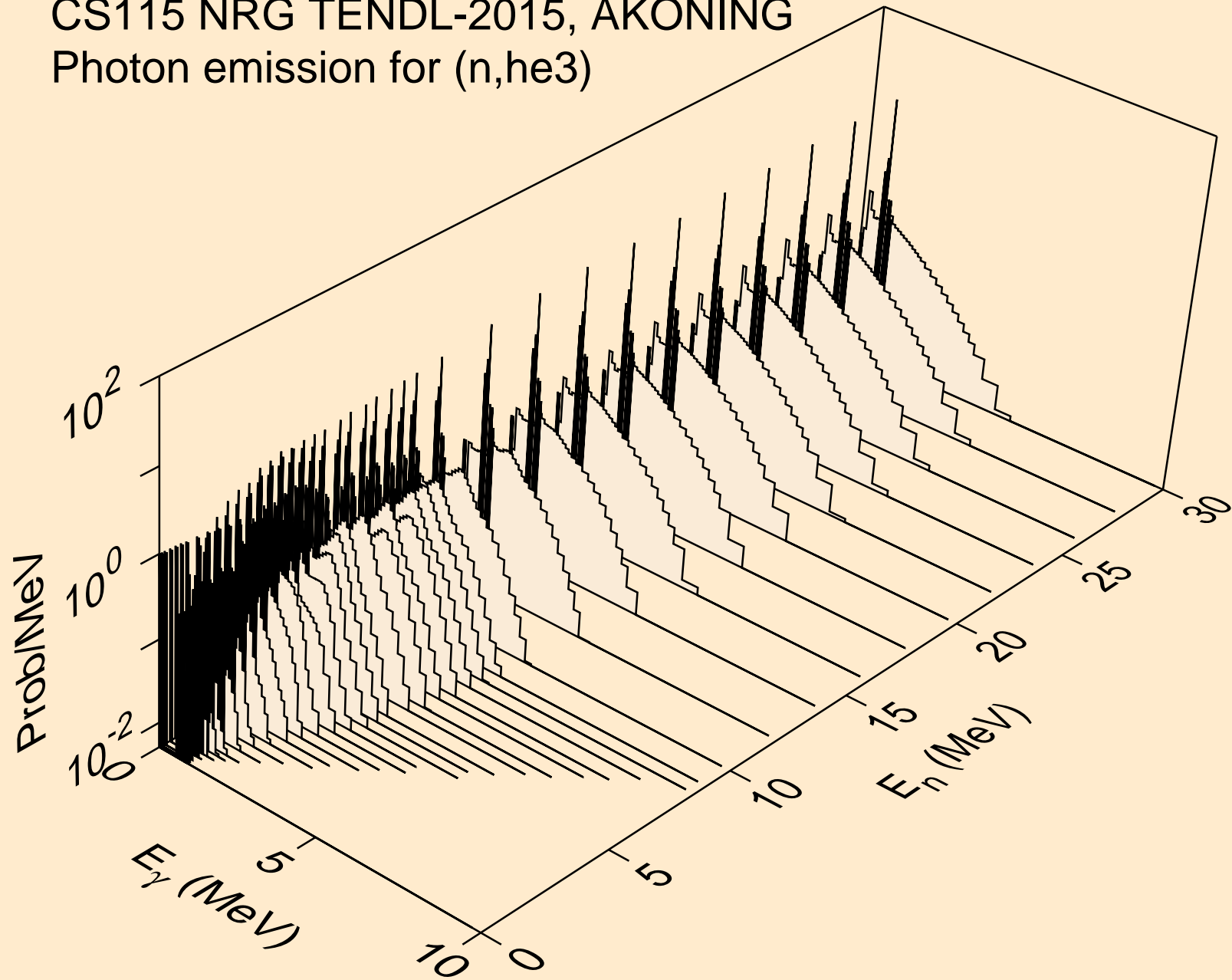

CS115 NRG TENDL-2015, AKONING
Photon emission for (n,a)

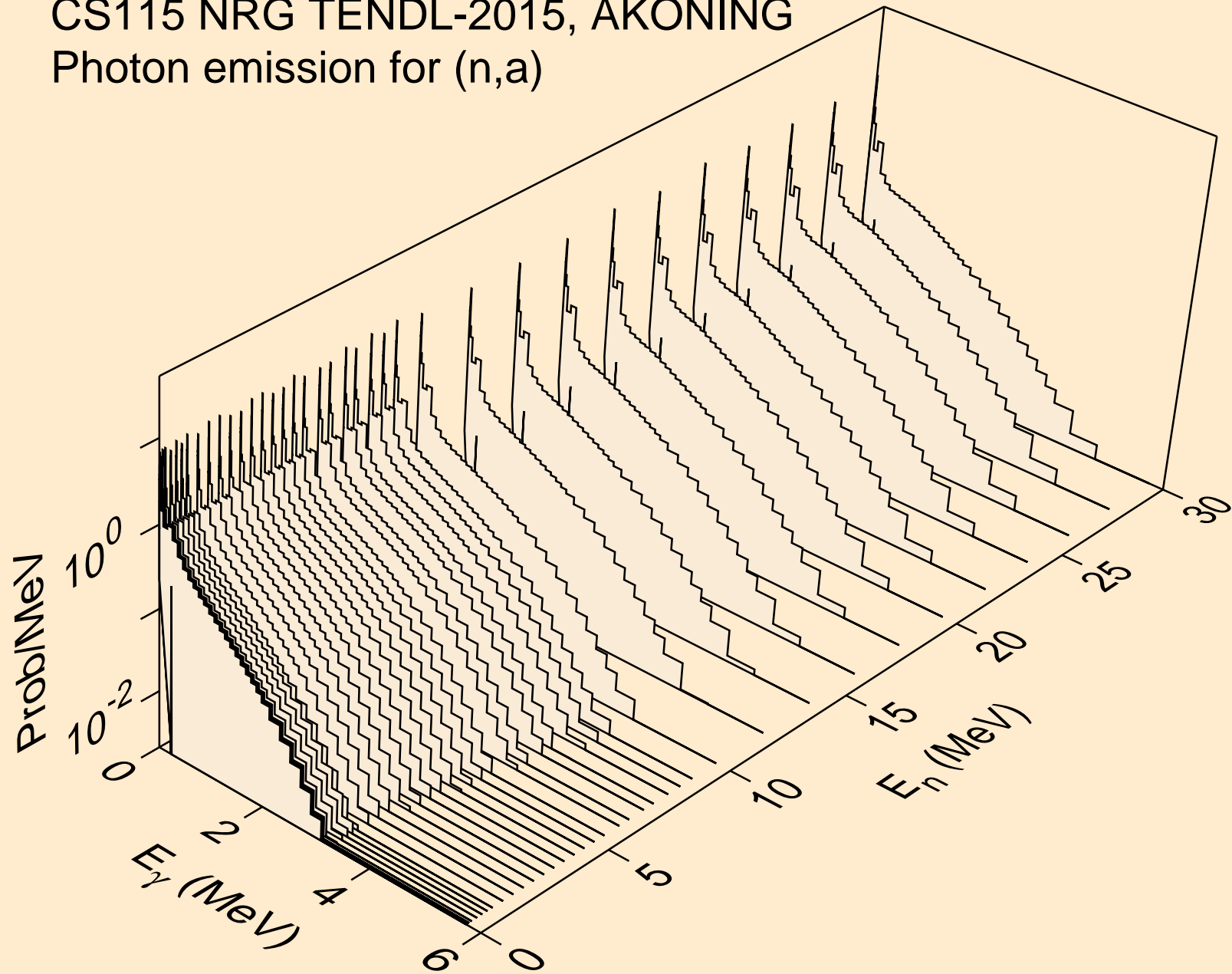

CS115 NRG TENDL-2015, AKONING
Photon emission for (n,2a)

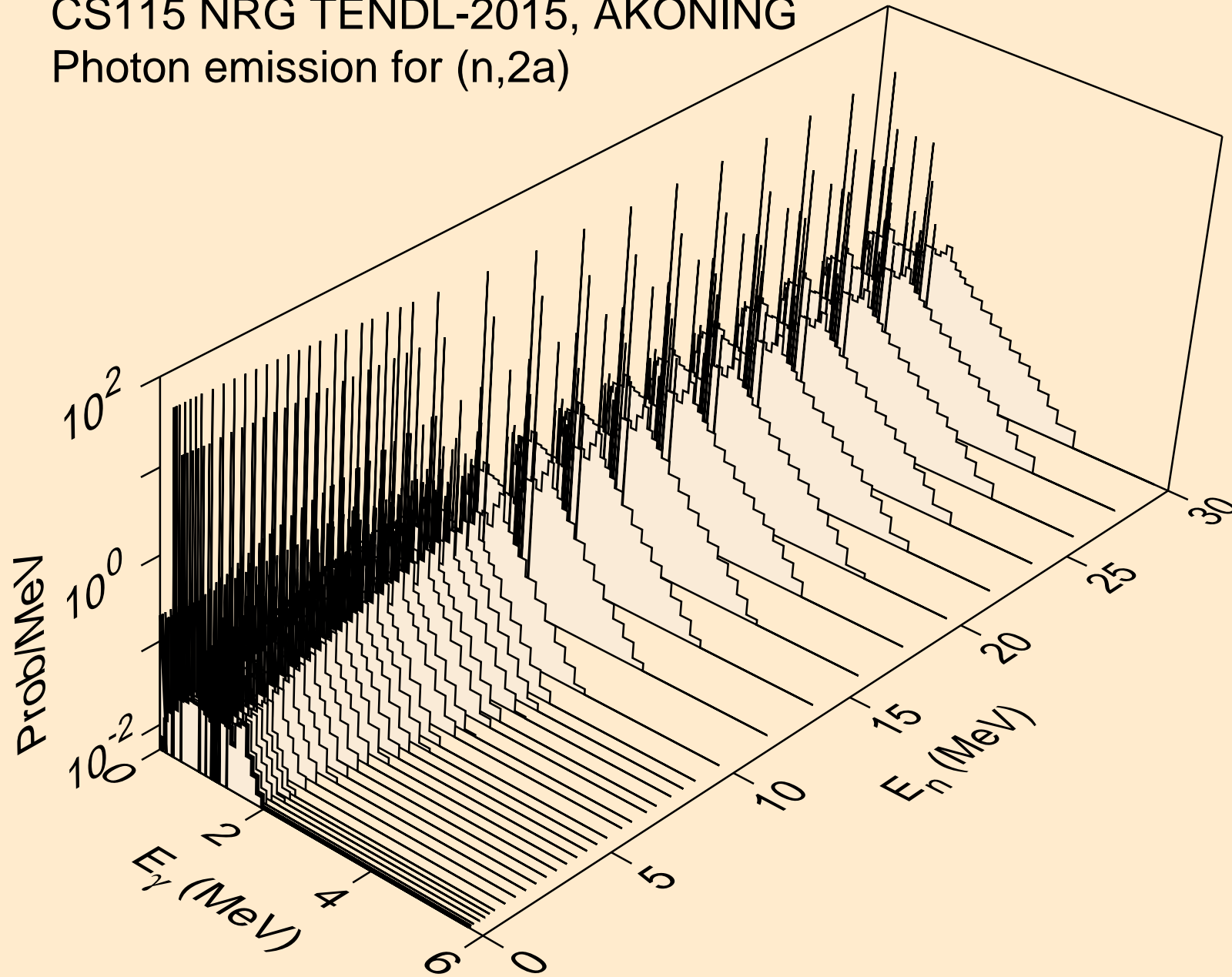

CS115 NRG TENDL-2015, AKONING
Photon emission for (n,3a)

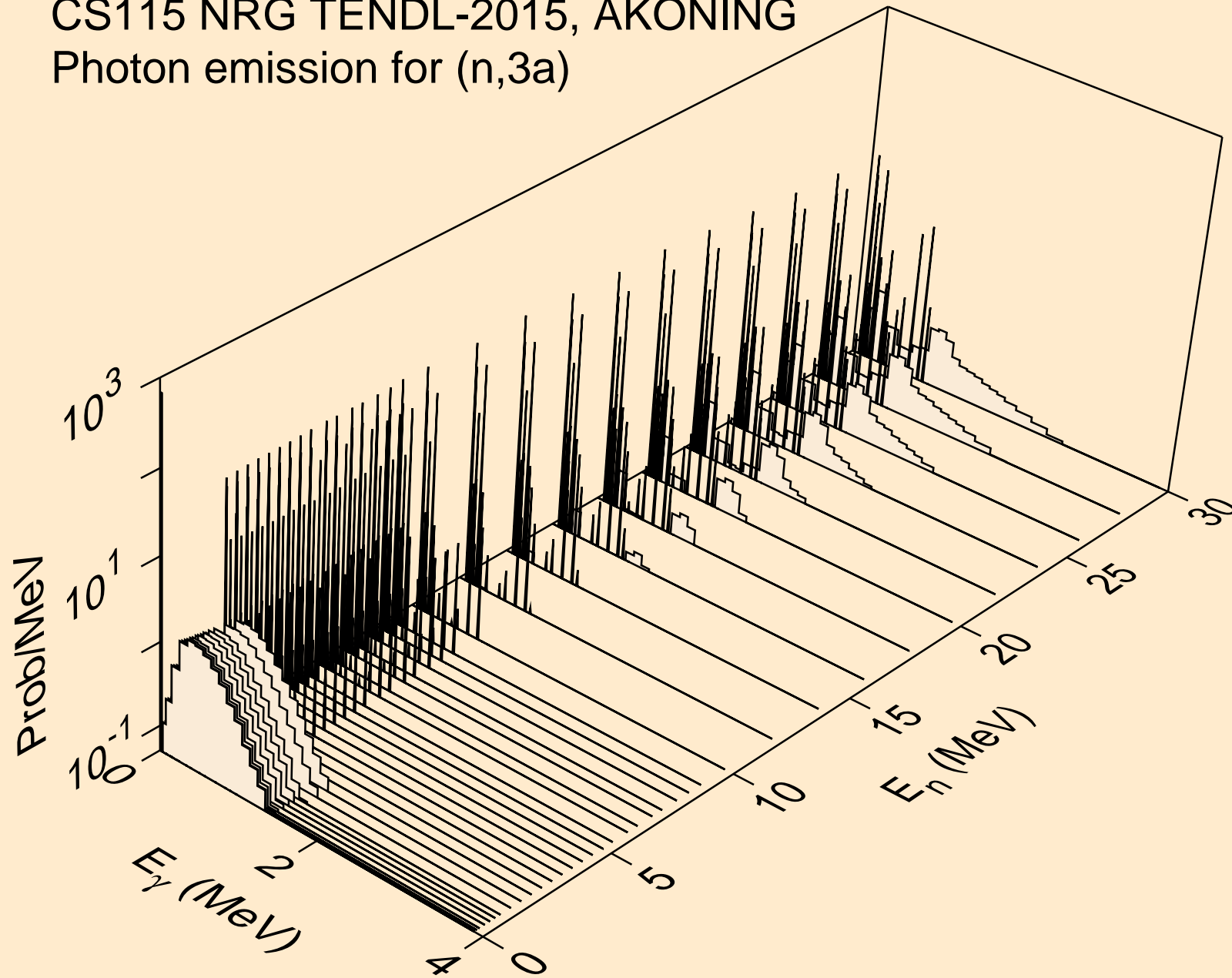

CS115 NRG TENDL-2015, AKONING
Photon emission for (n,2p)

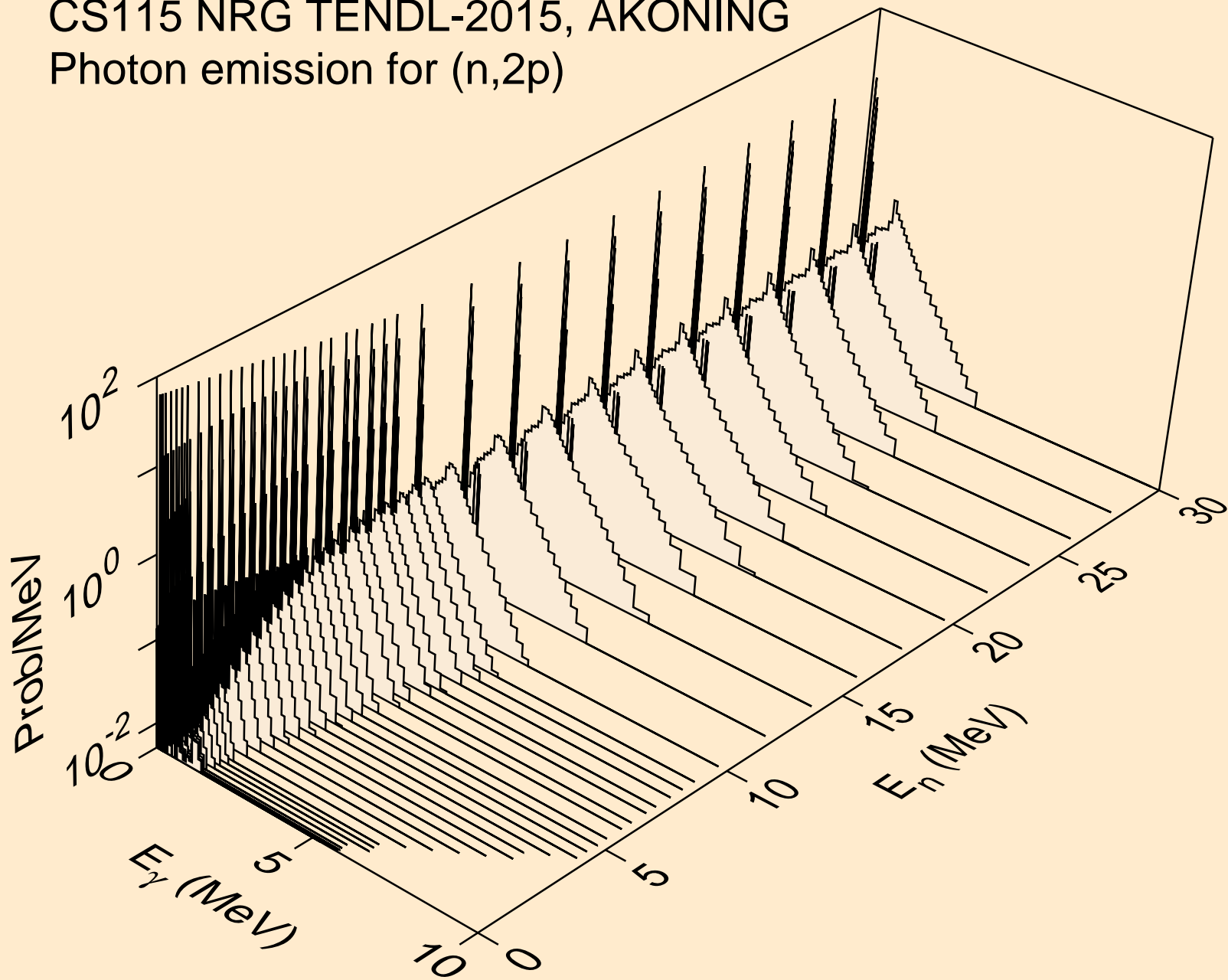

CS115 NRG TENDL-2015, AKONING
Photon emission for (n,p α)

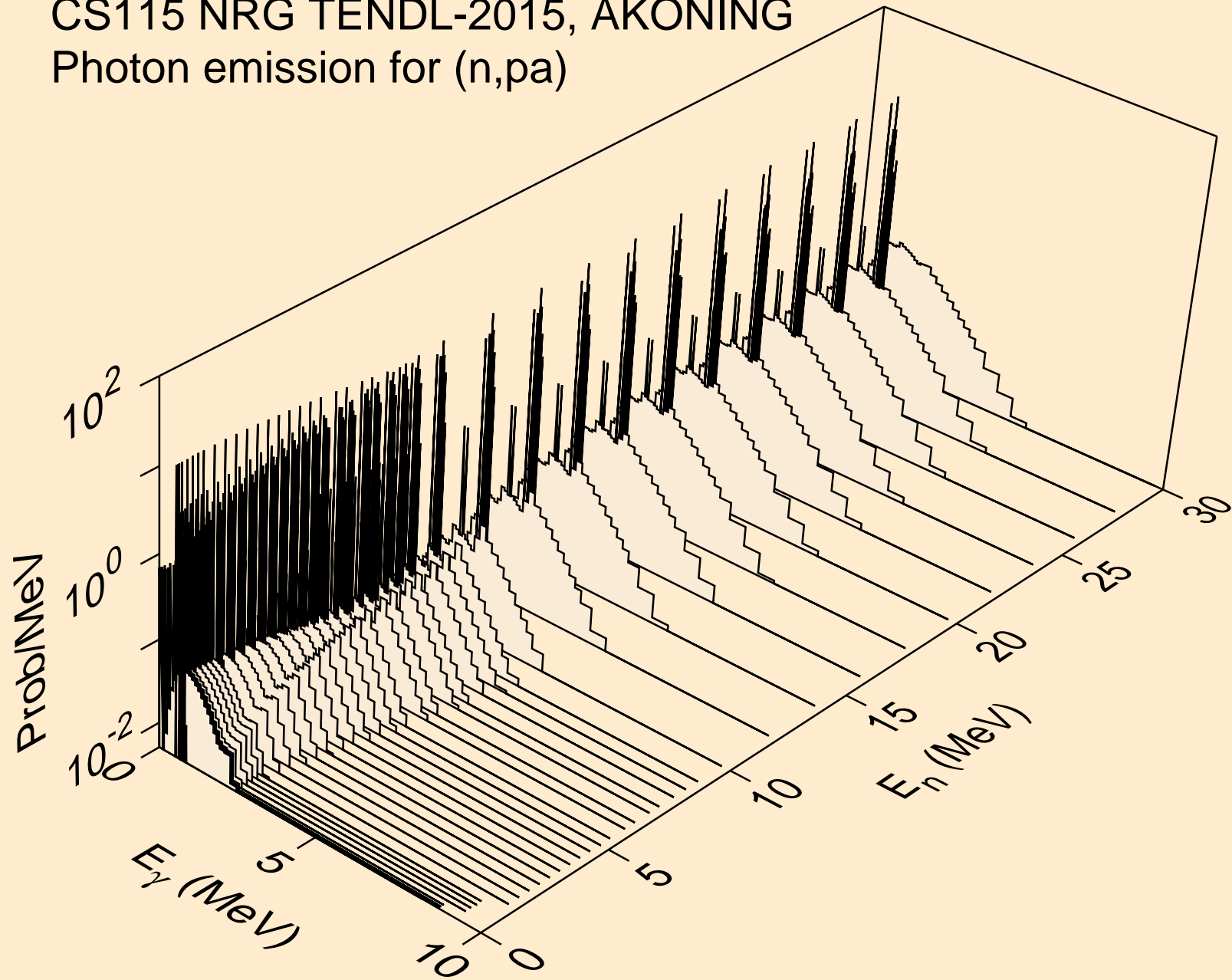

CS115 NRG TENDL-2015, AKONING
Photon emission for (n,t2a)

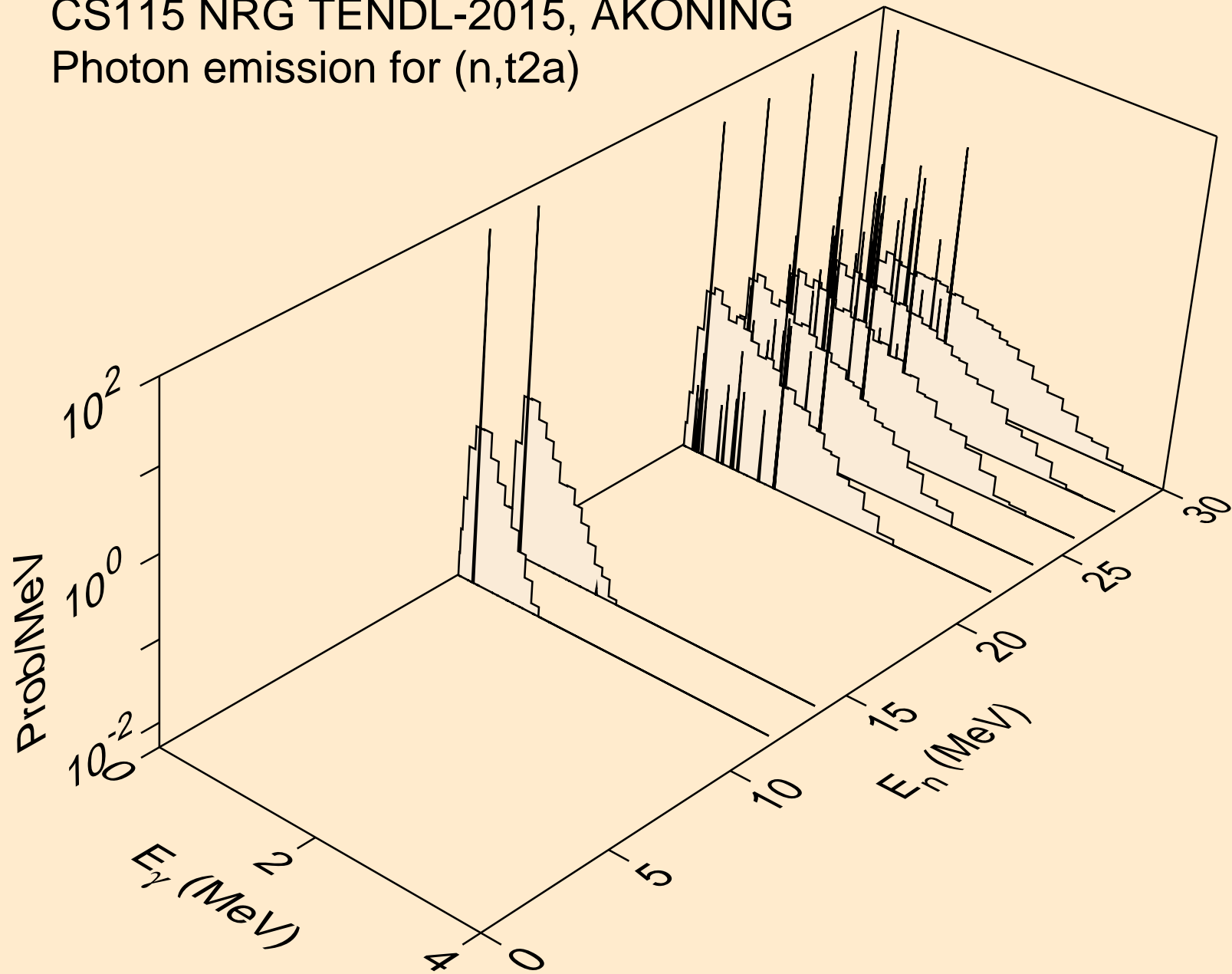

CS115 NRG TENDL-2015, AKONING
Photon emission for (n,d2a)

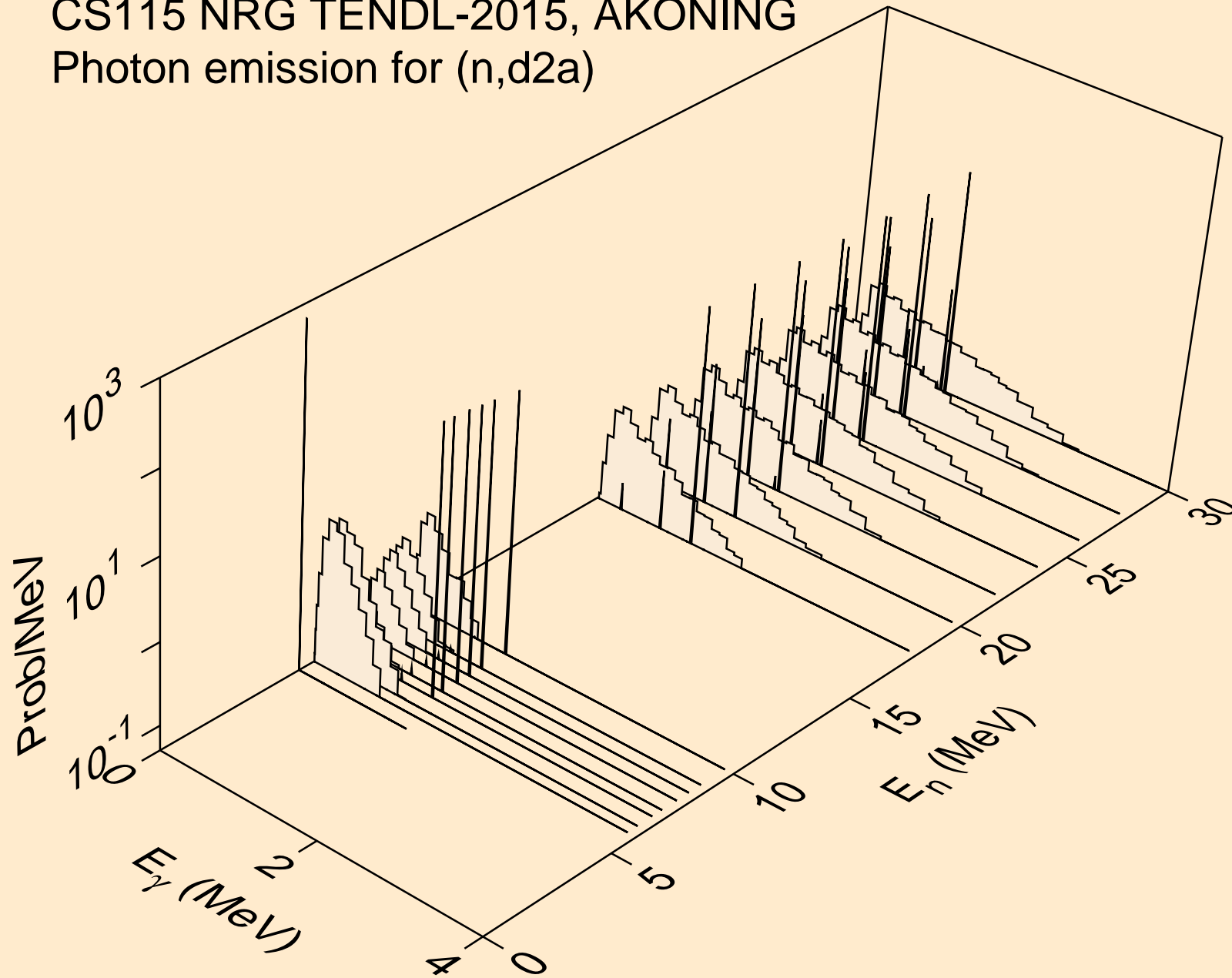

CS115 NRG TENDL-2015, AKONING
Photon emission for (n,pd)

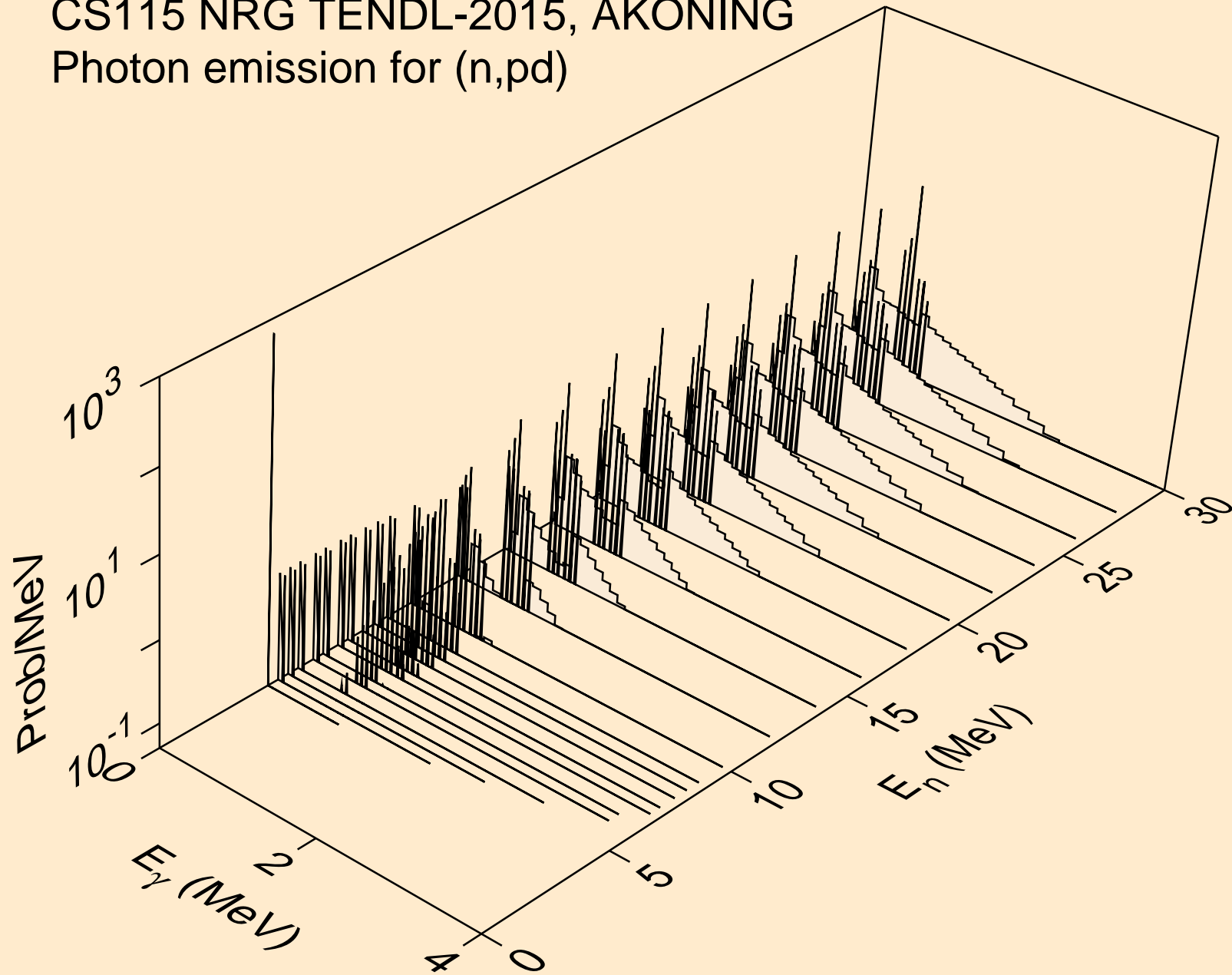

CS115 NRG TENDL-2015, AKONING
Photon emission for (n,pt)

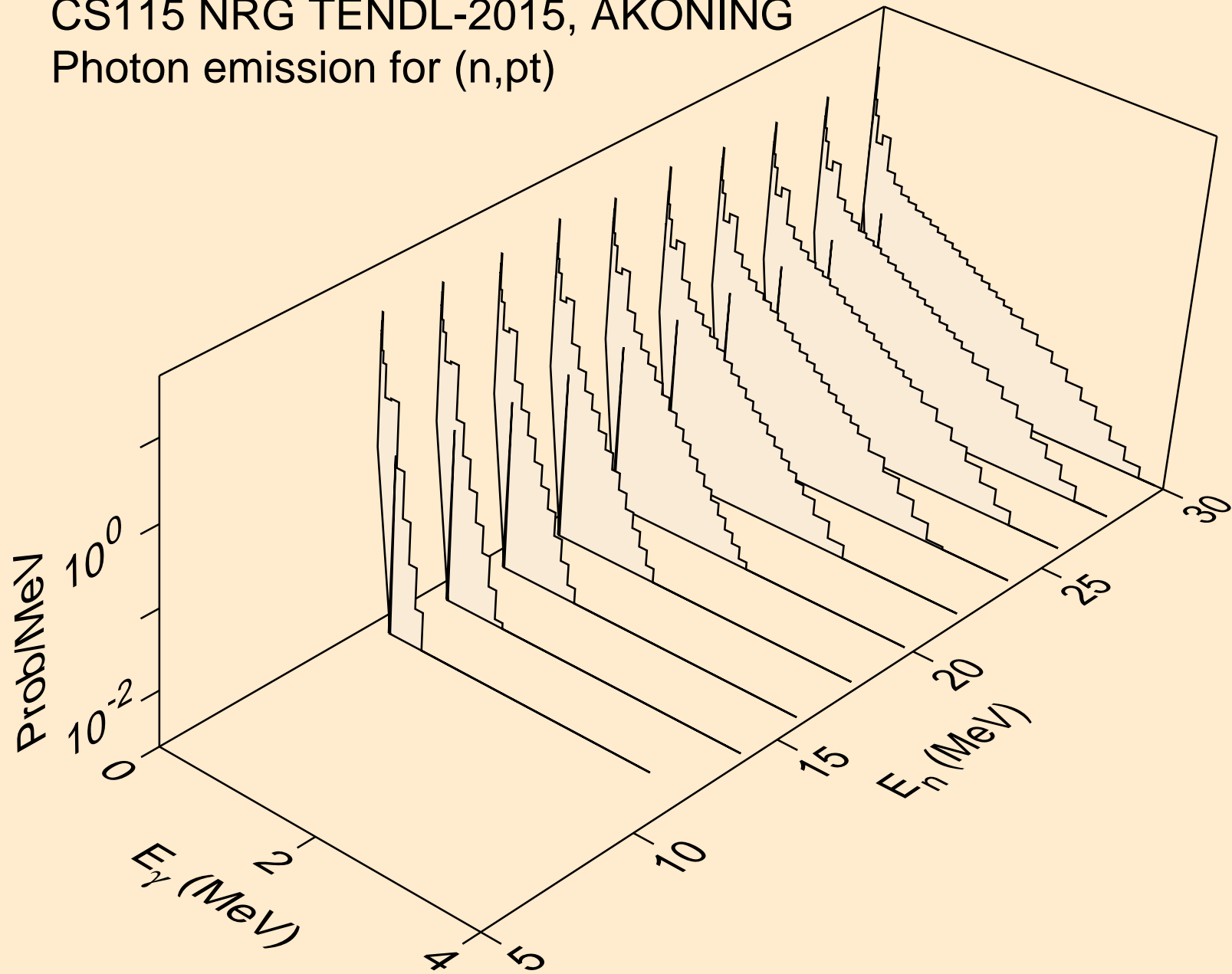

CS115 NRG TENDL-2015, AKONING
Photon emission for (n,da)

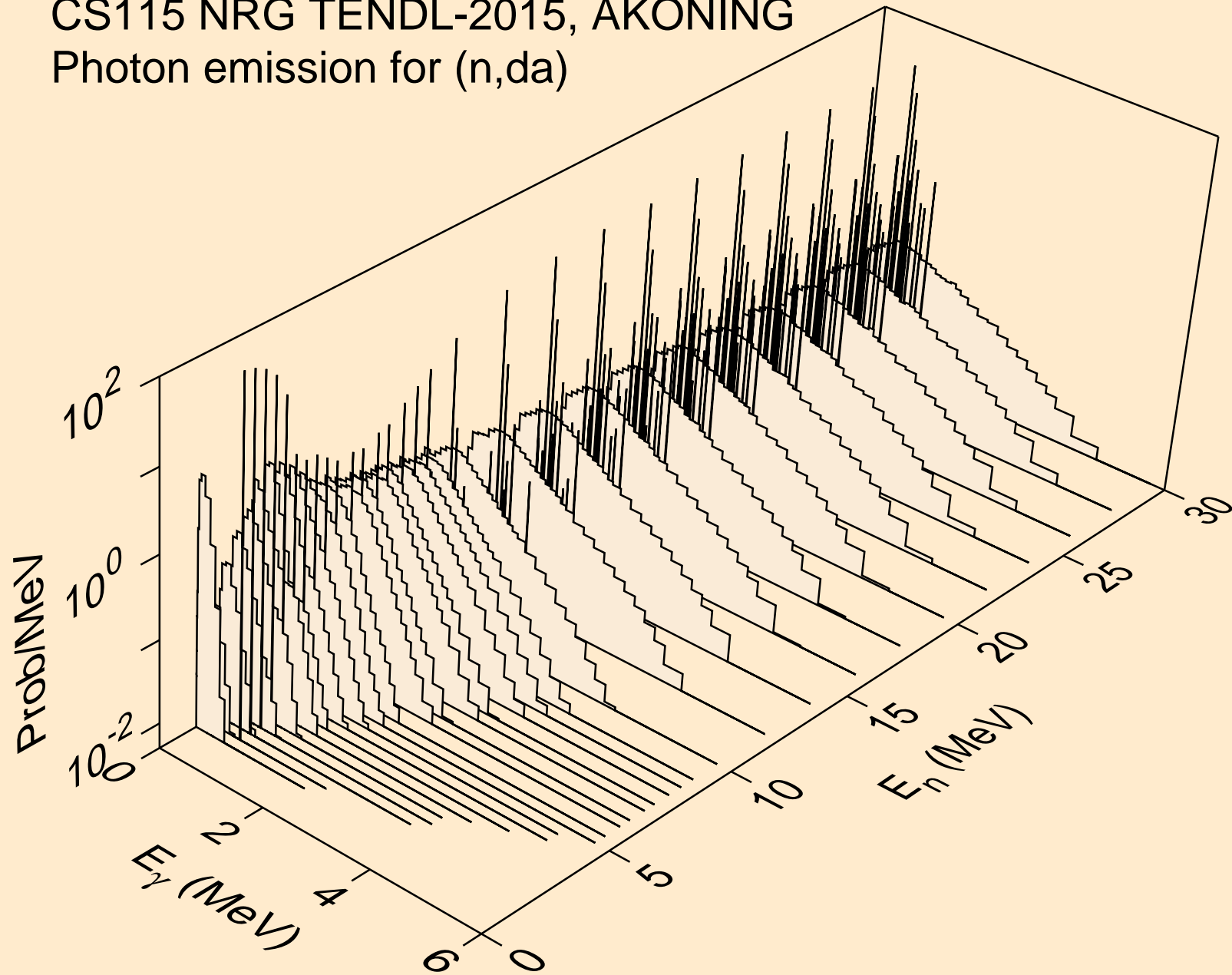

CS115 NRG TENDL-2015, AKONING
thermal capture photon spectrum

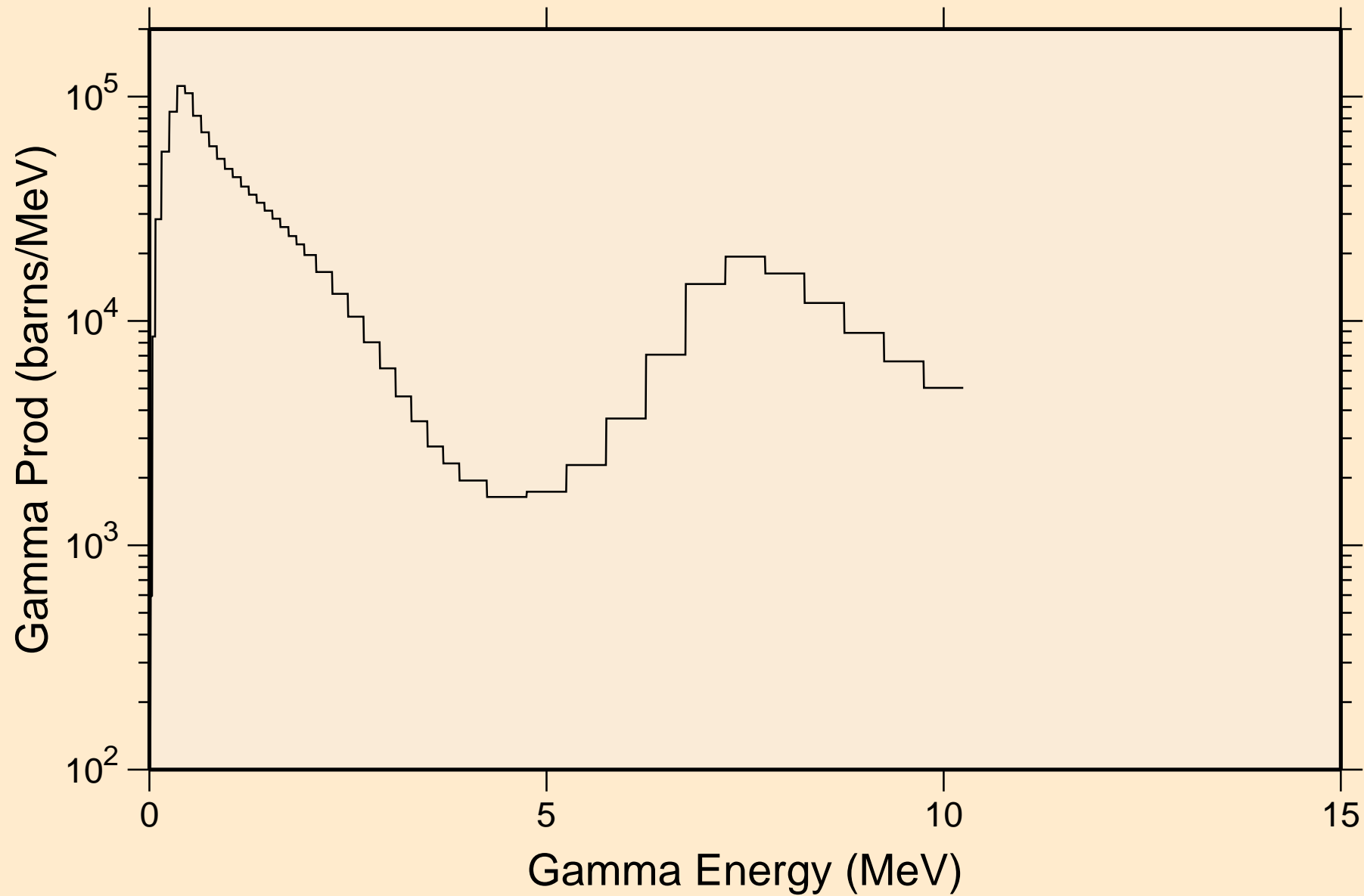

CS115 NRG TENDL-2015, AKONING

14 MeV photon spectrum

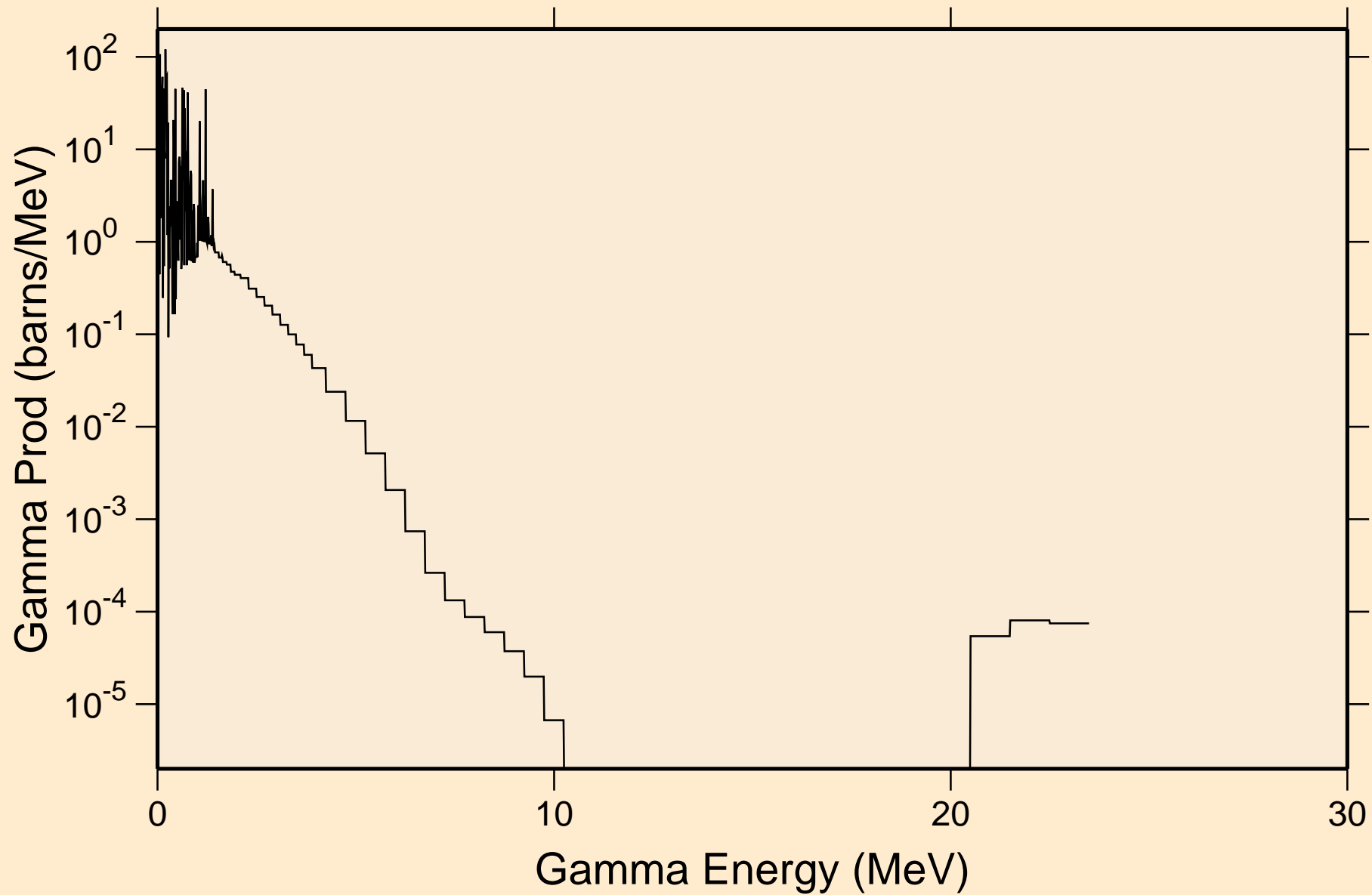

CS115 NRG TENDL-2015, AKONING

Particle heating contributions

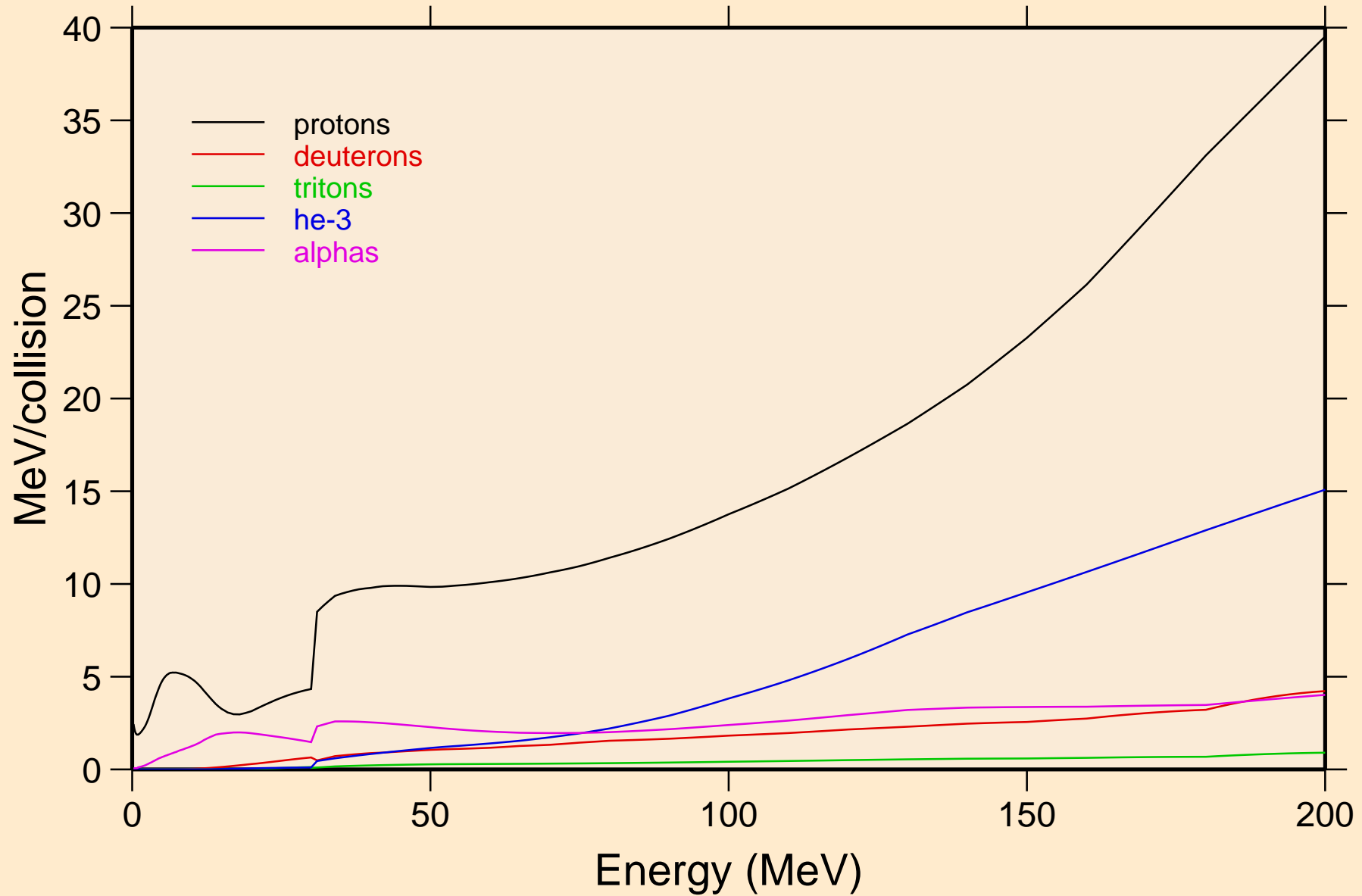

CS115 NRG TENDL-2015, AKONING

Recoil Heating

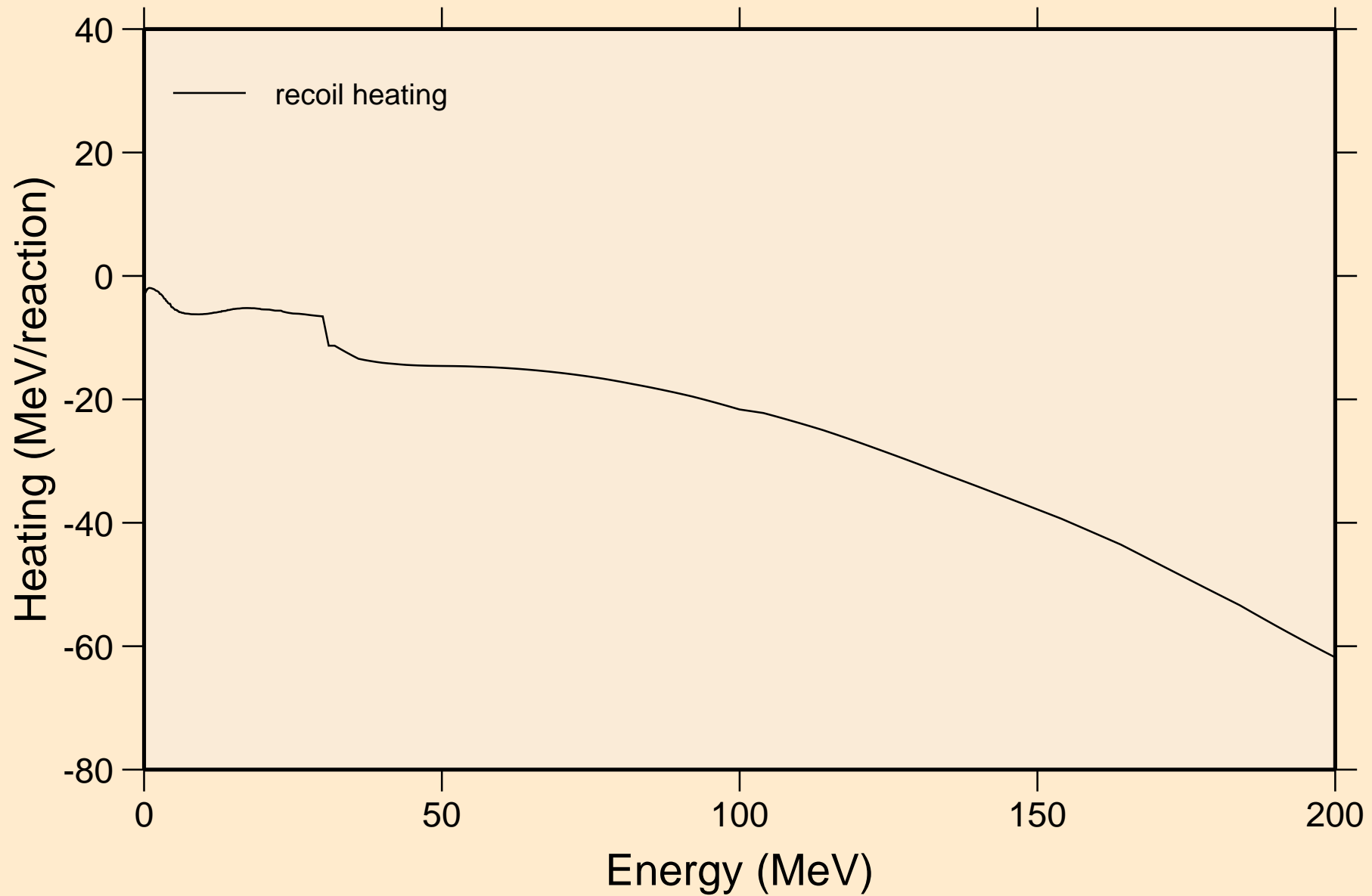

CS115 NRG TENDL-2015, AKONING

Particle production cross sections

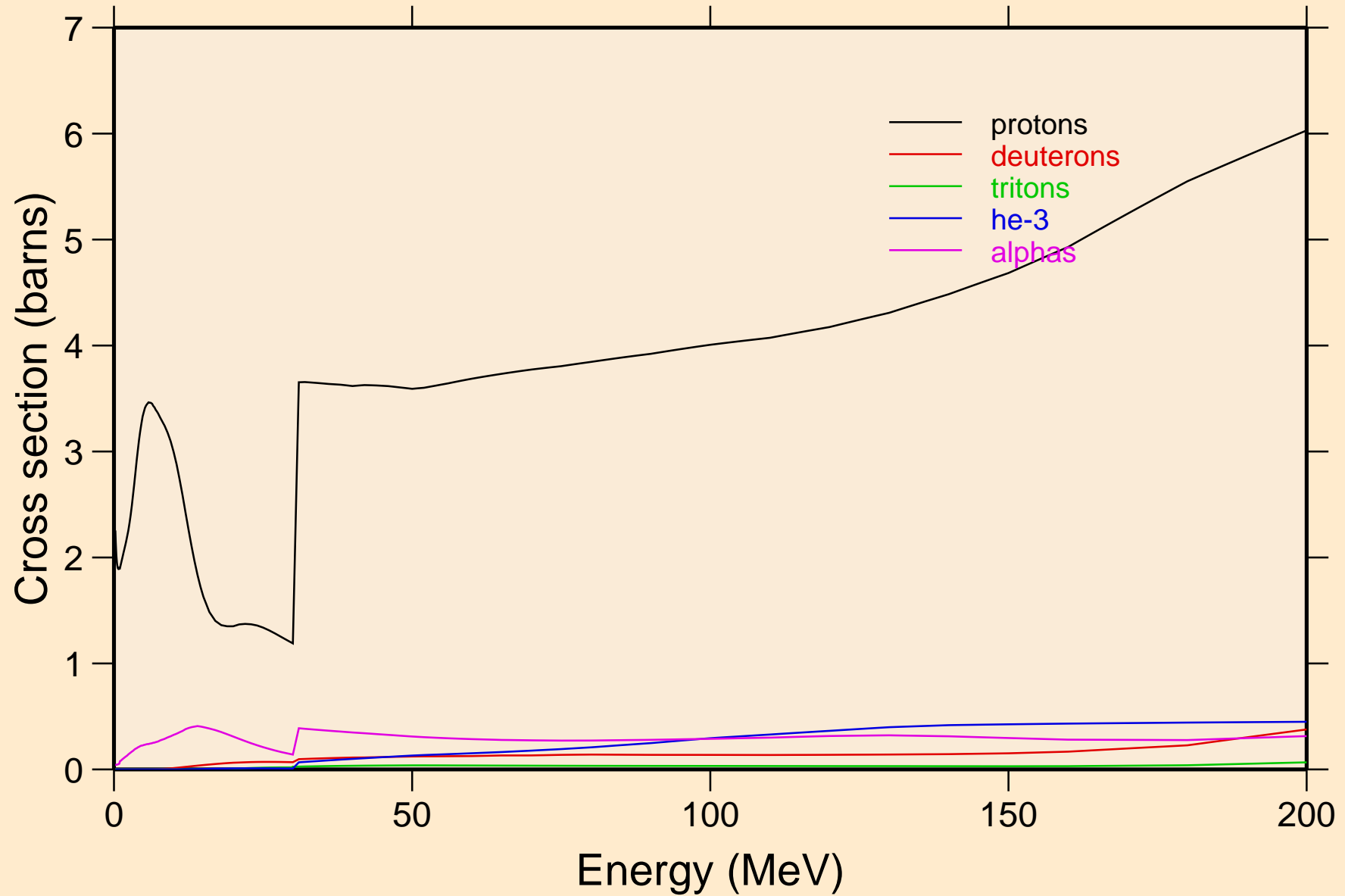

CS115 NRG TENDL-2015, AKONING
protons from (n,x)

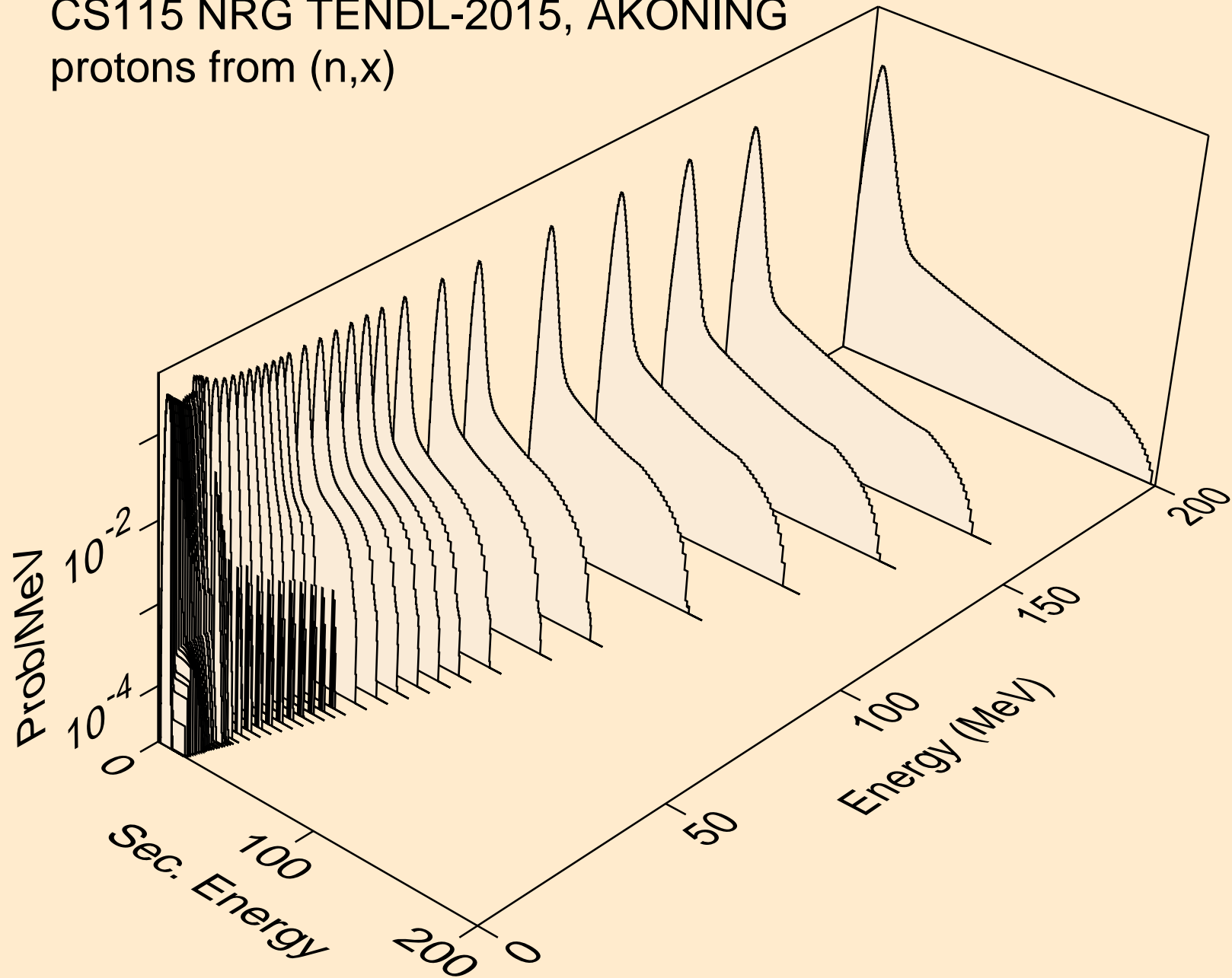

CS115 NRG TENDL-2015, AKONING
protons from (n,n*)p

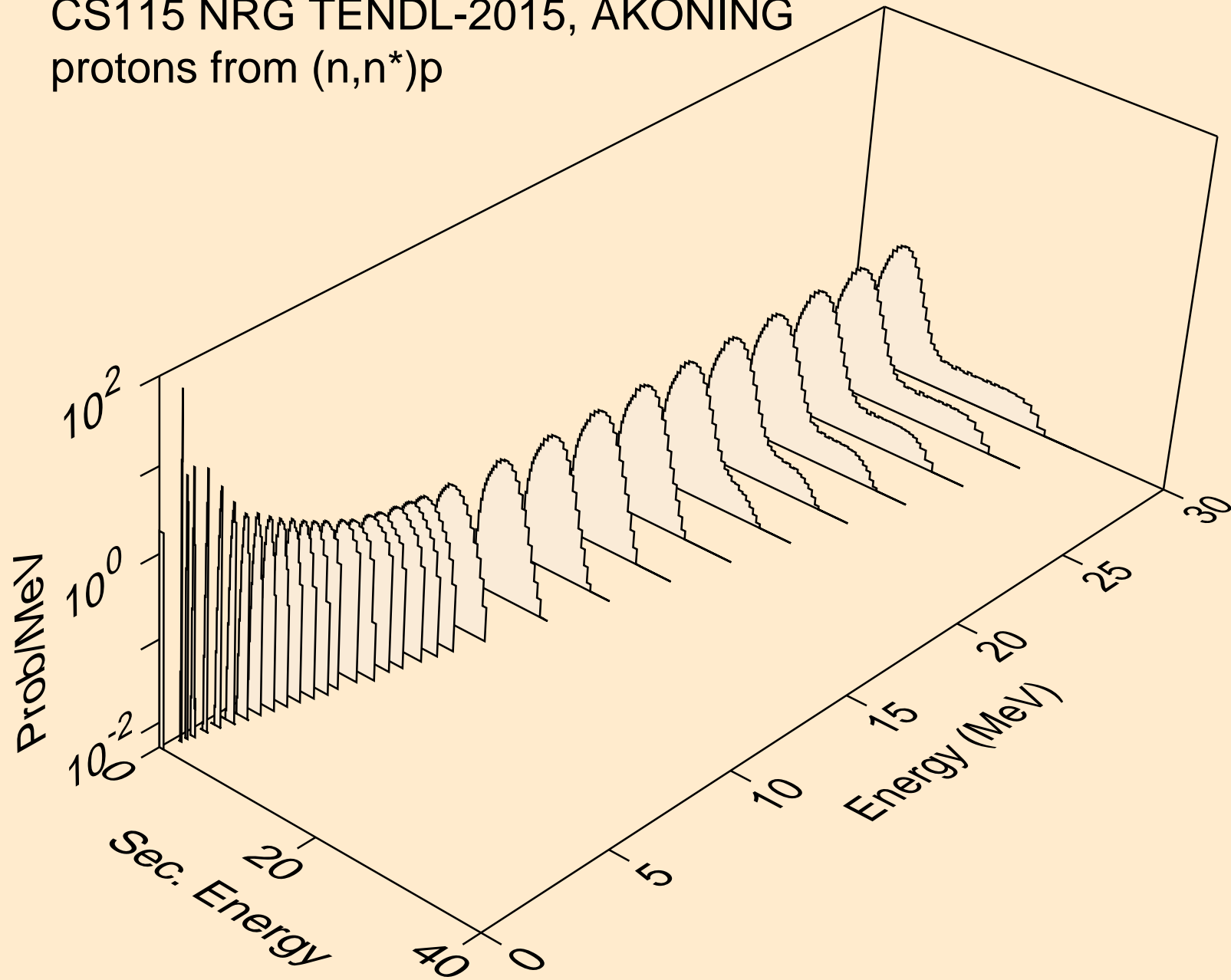

CS115 NRG TENDL-2015, AKONING
protons from (n,2np)

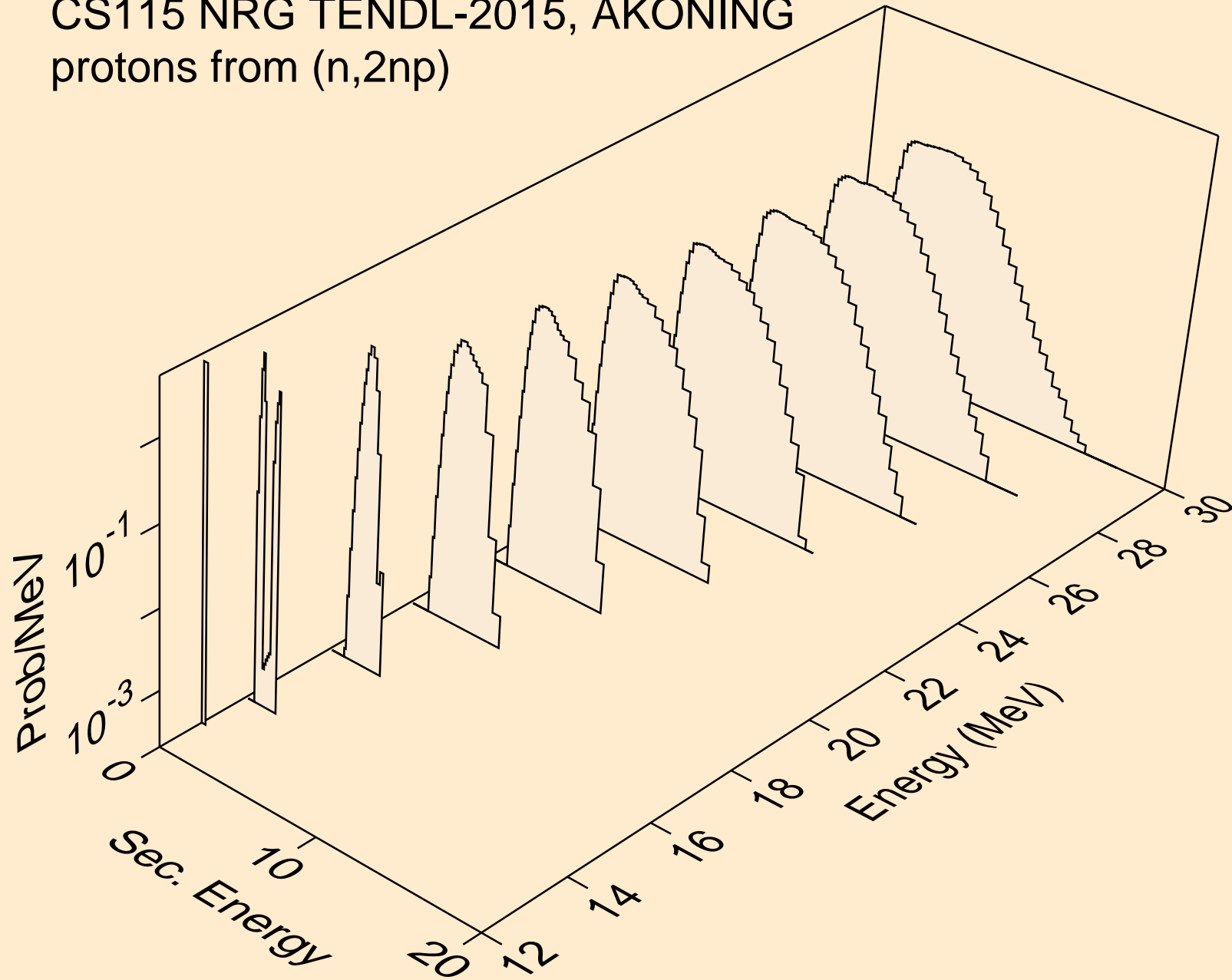

CS115 NRG TENDL-2015, AKONING
protons from (n,3np)

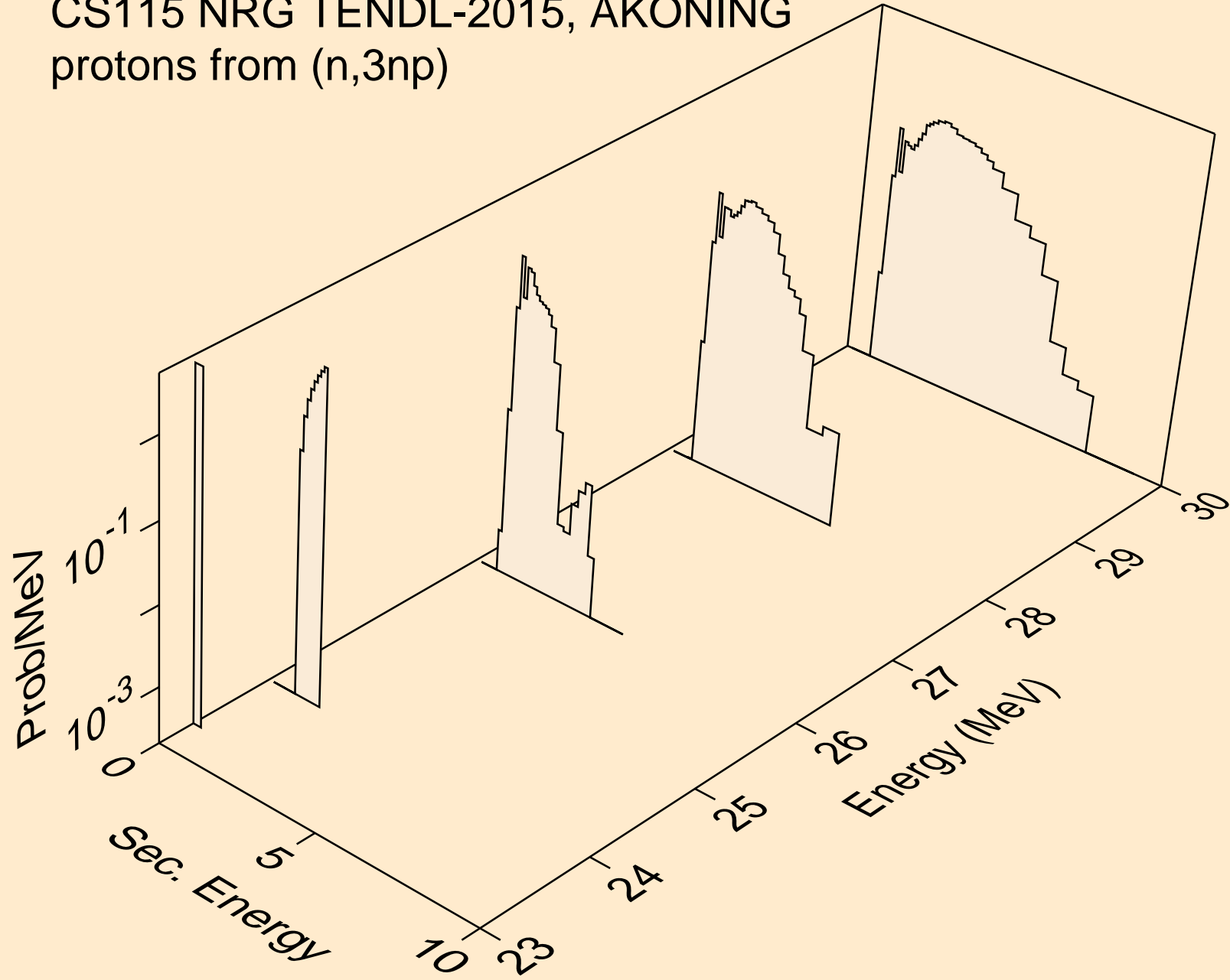

CS115 NRG TENDL-2015, AKONING
protons from (n,2np)

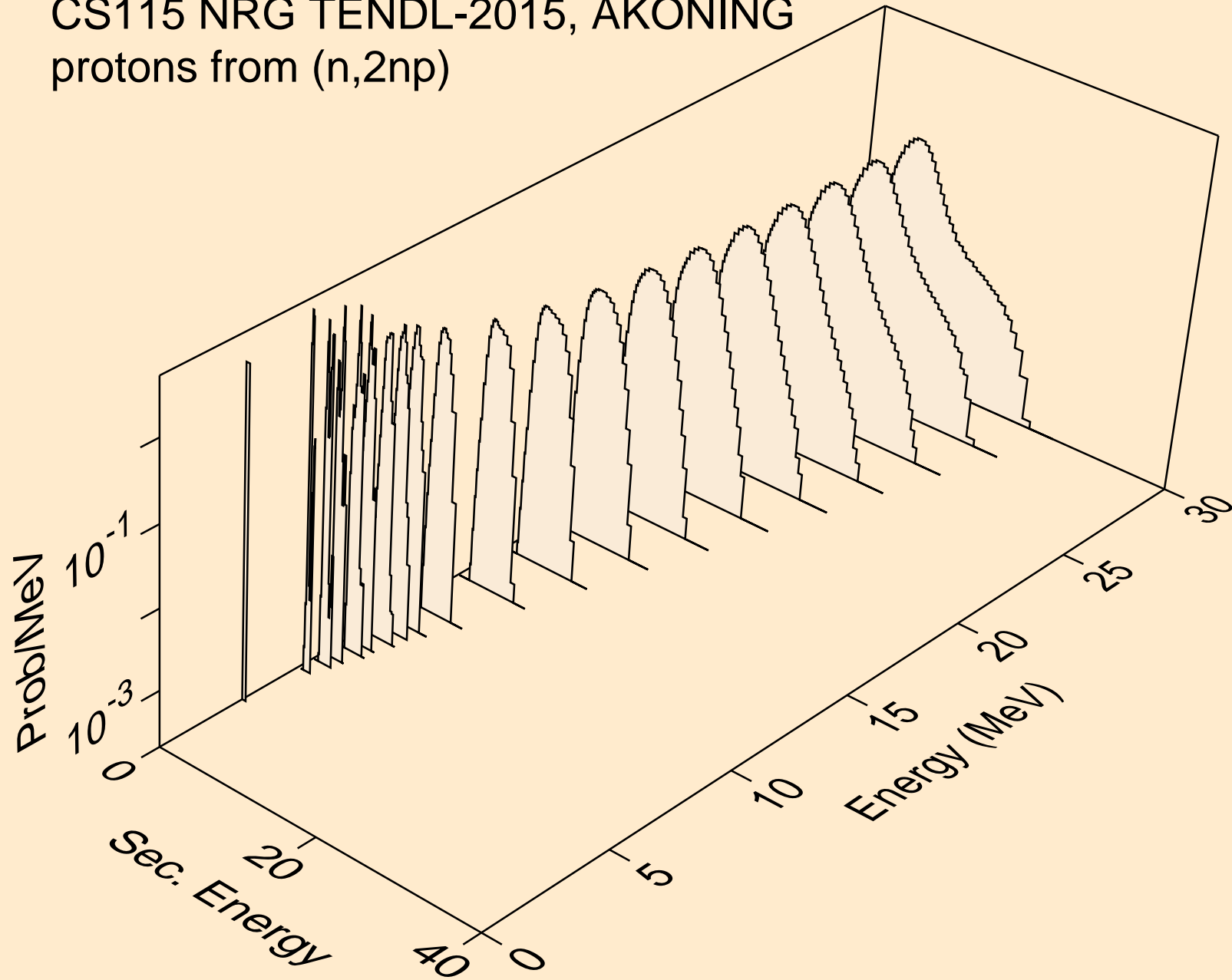

CS115 NRG TENDL-2015, AKONING
protons from (n,npa)

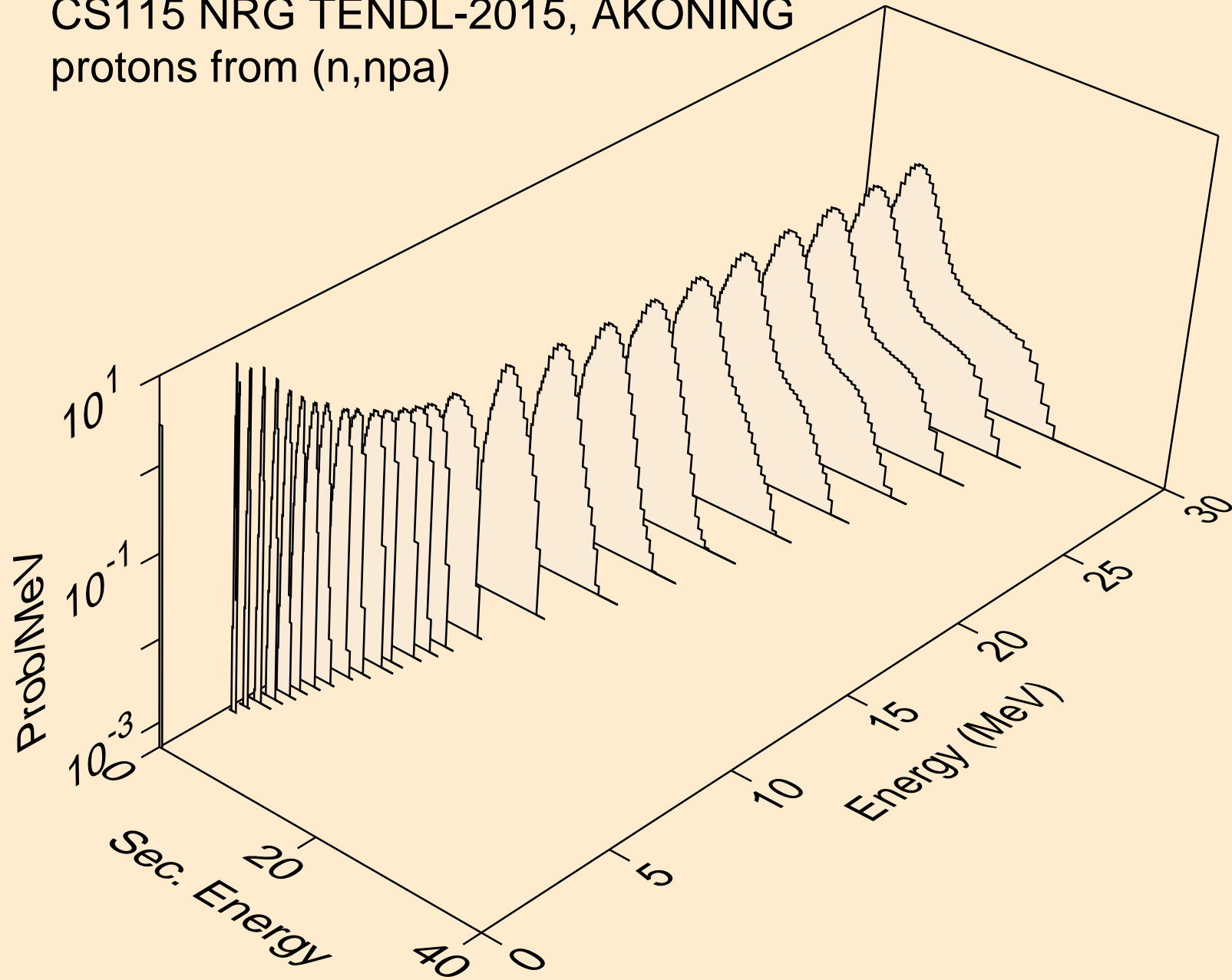

CS115 NRG TENDL-2015, AKONING
protons from (n,p)

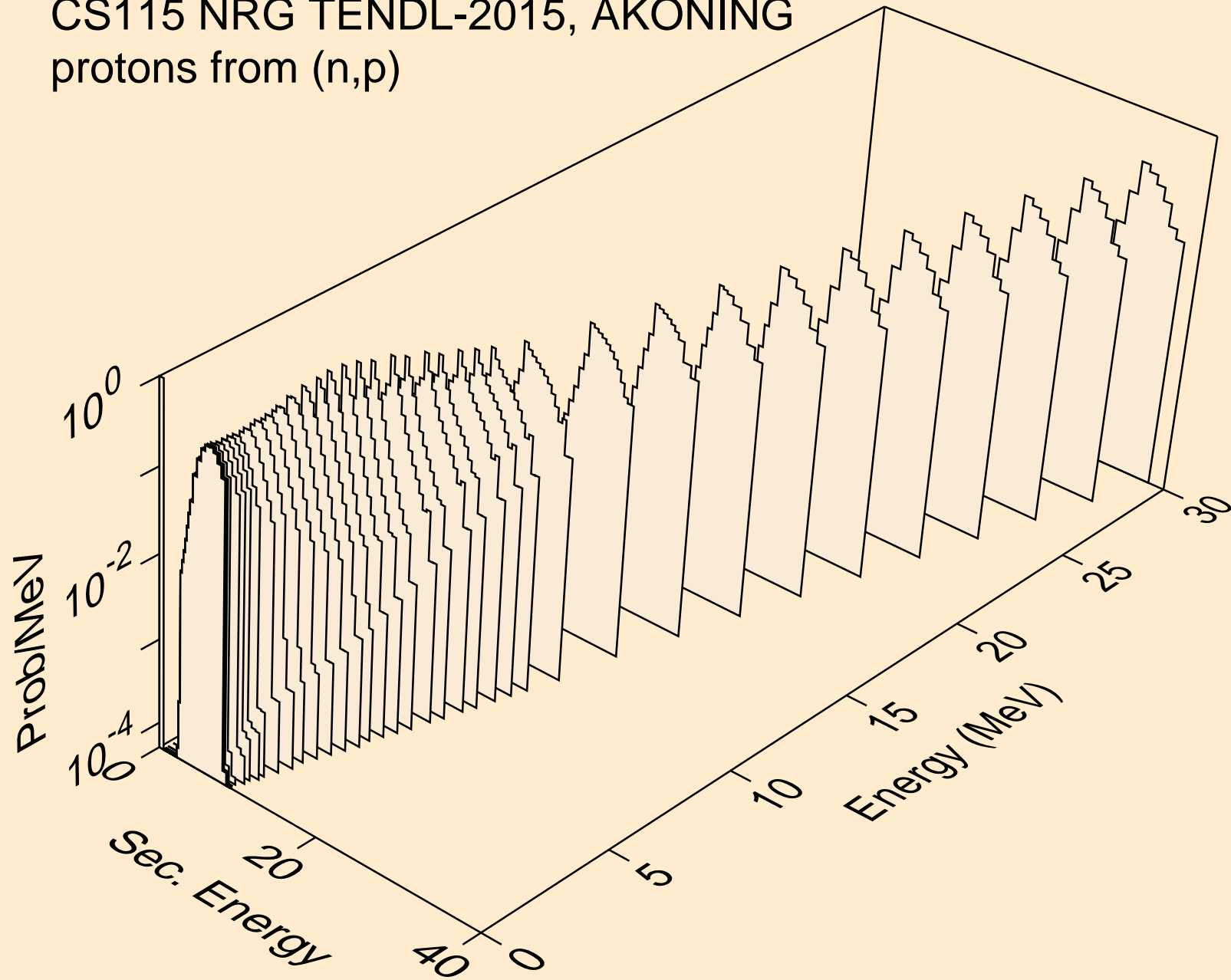

CS115 NRG TENDL-2015, AKONING
protons from (n,2p)

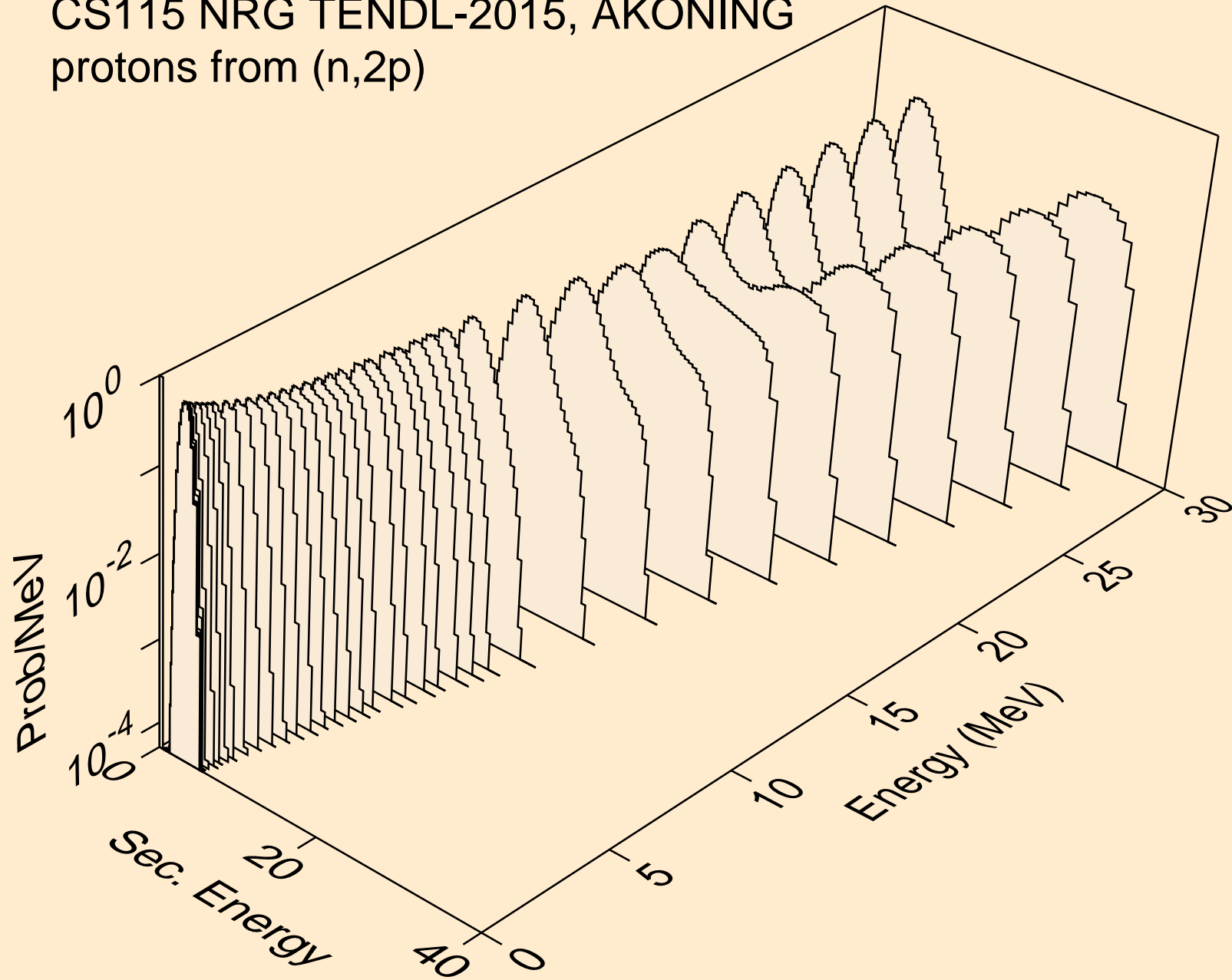

CS115 NRG TENDL-2015, AKONING
protons from (n,pa)

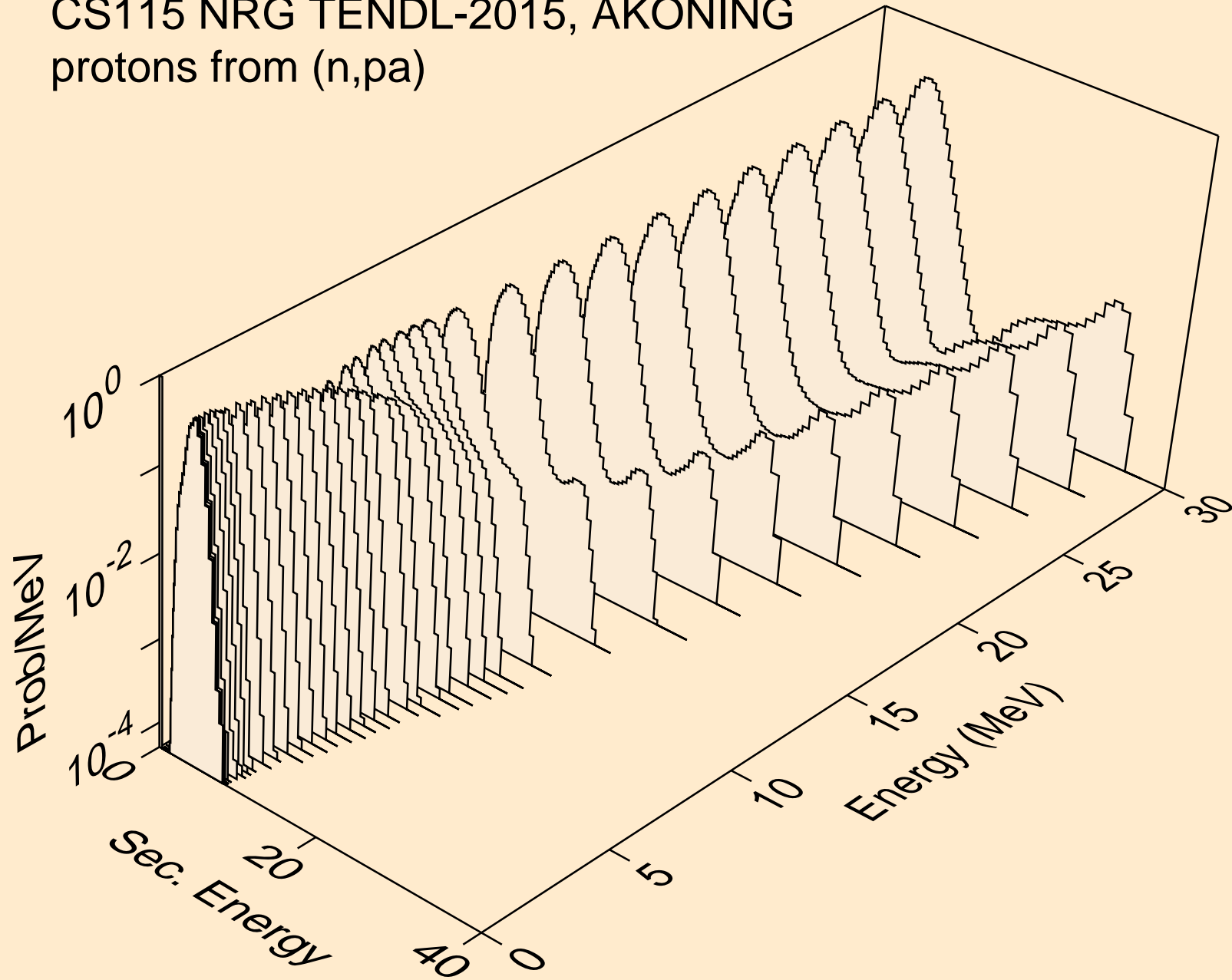

CS115 NRG TENDL-2015, AKONING
protons from (n,pd)

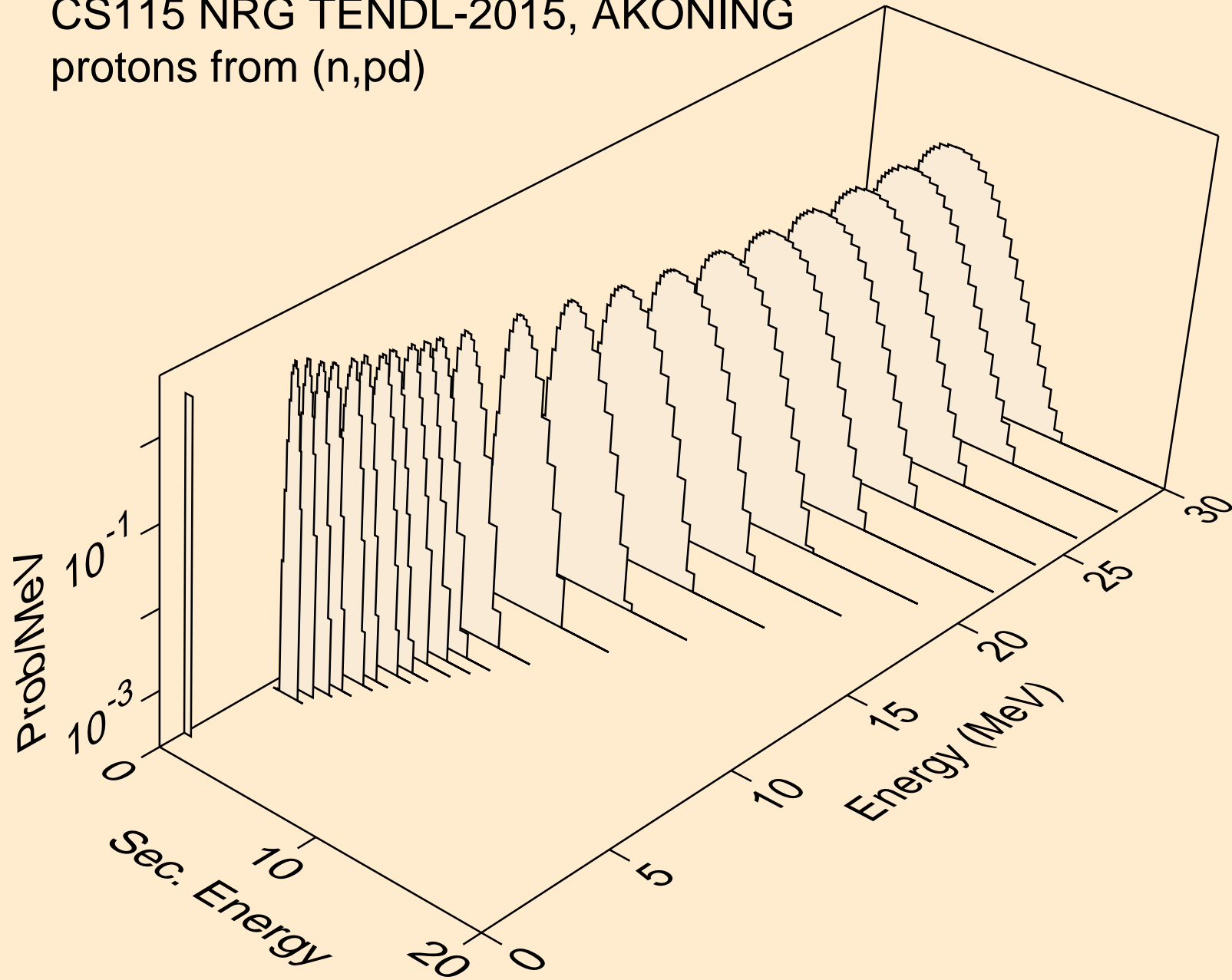

CS115 NRG TENDL-2015, AKONING
protons from (n,pt)

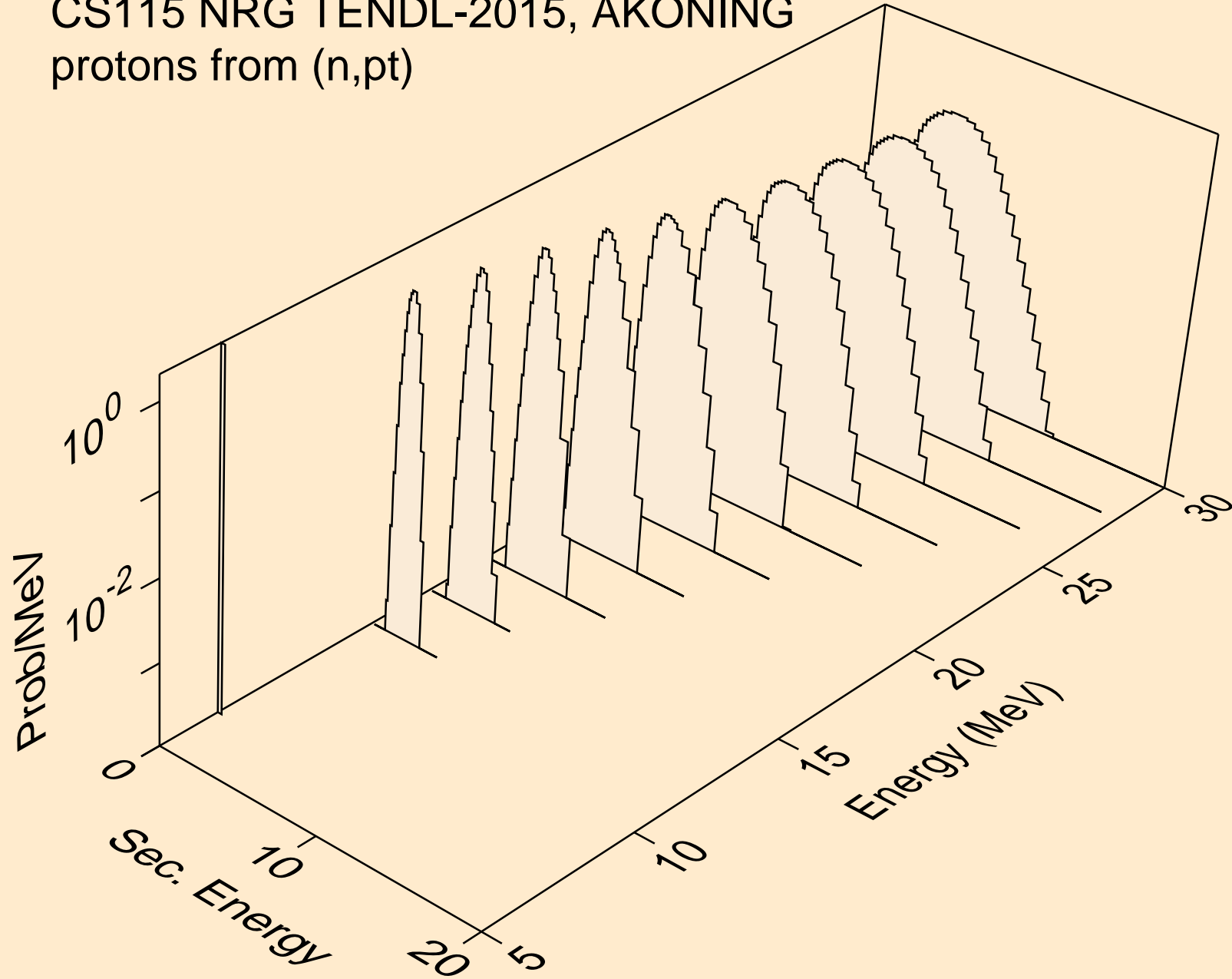

CS115 NRG TENDL-2015, AKONING
deuterons from (n,x)

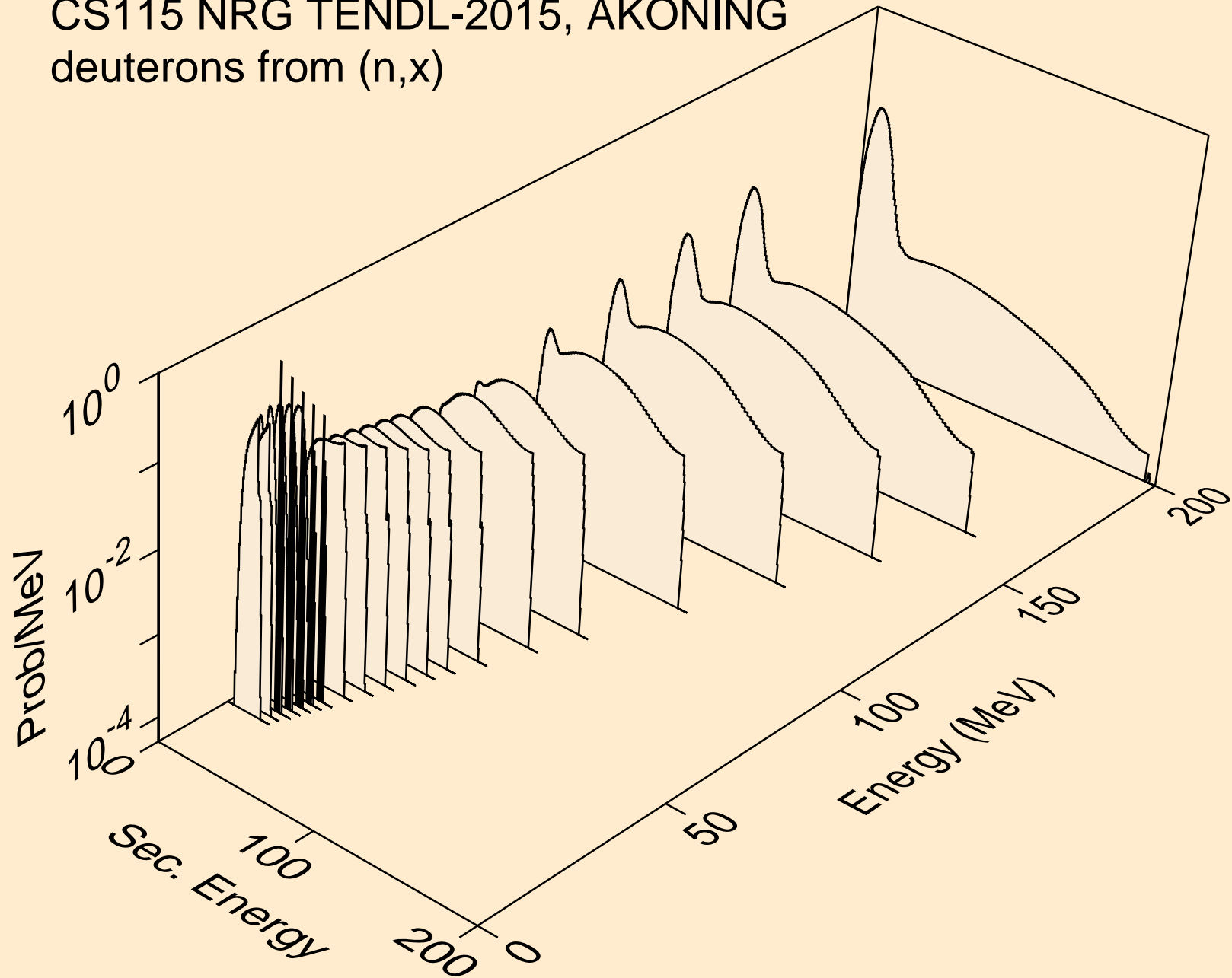

CS115 NRG TENDL-2015, AKONING
deuterons from (n,2nd)

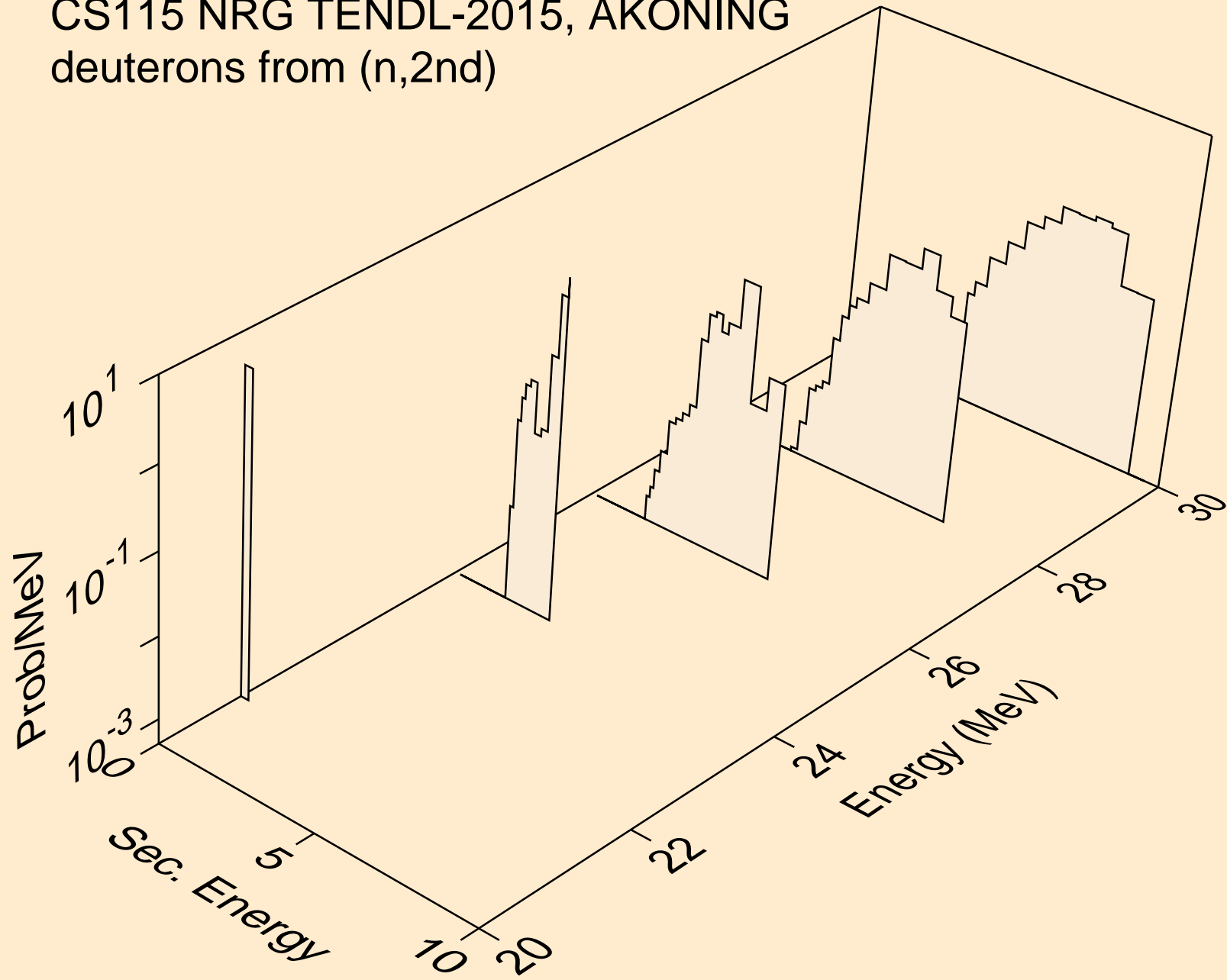

CS115 NRG TENDL-2015, AKONING
deuterons from (n,n*)d

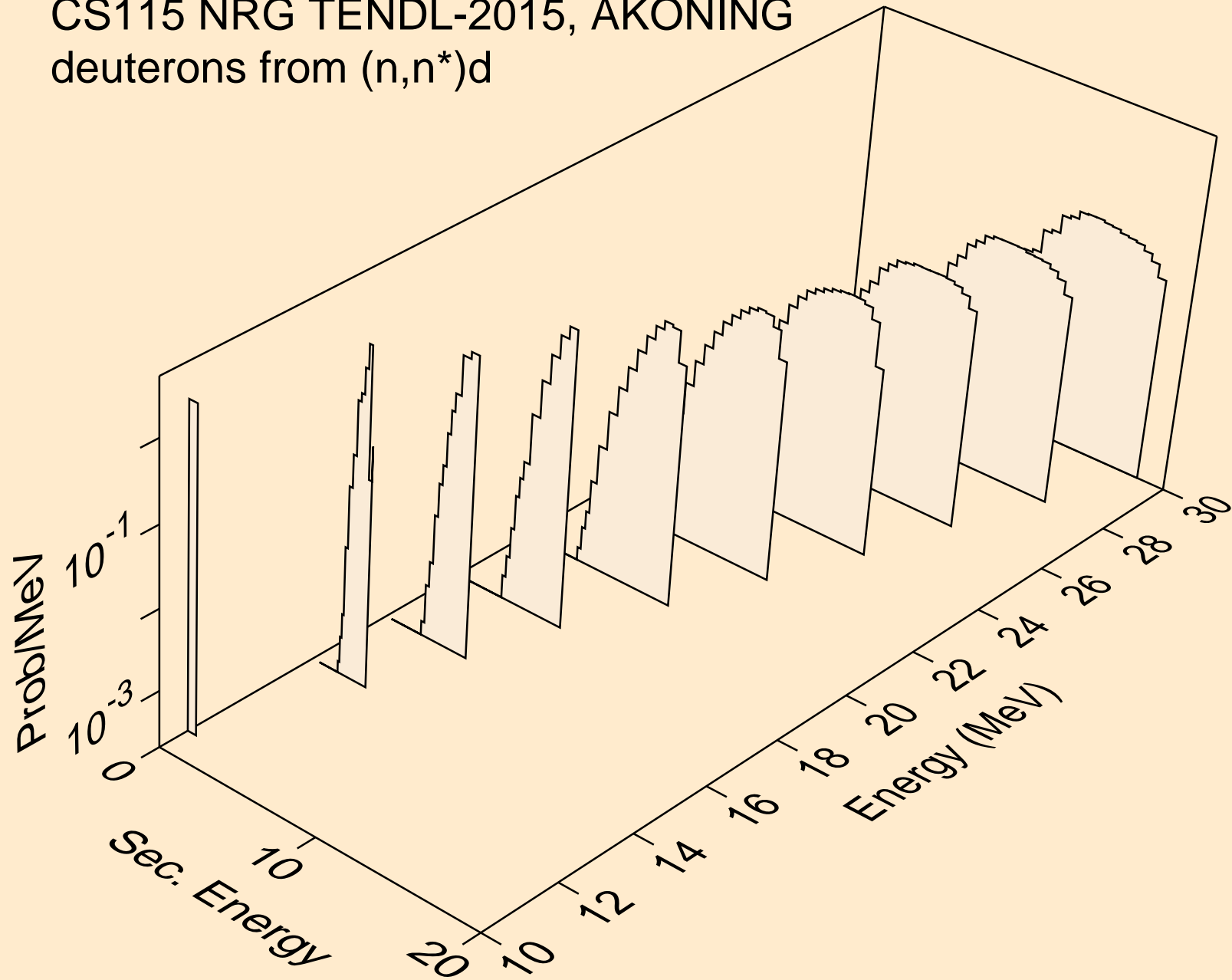

CS115 NRG TENDL-2015, AKONING
deuterons from (n,n*)d2a

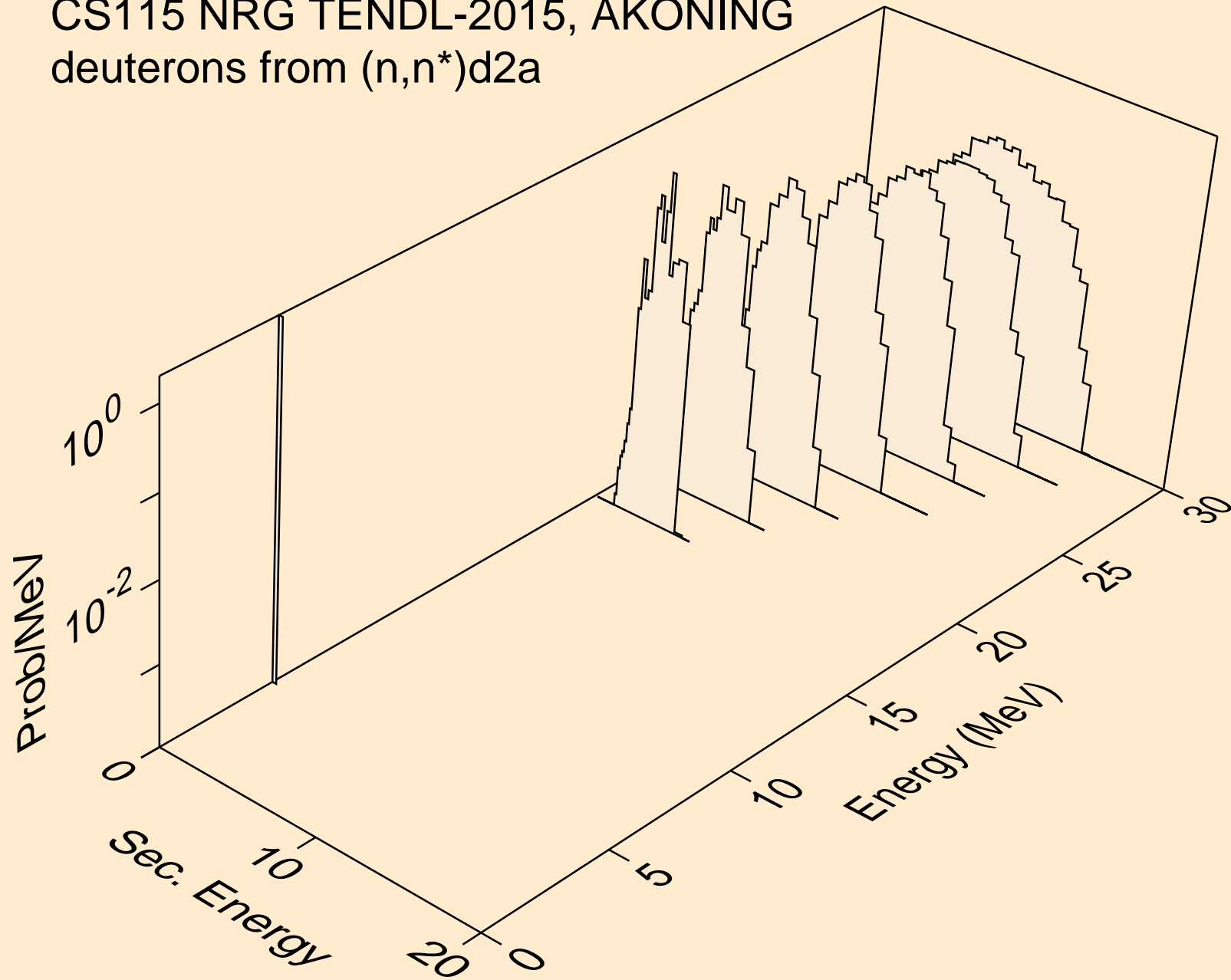

CS115 NRG TENDL-2015, AKONING
deuterons from (n,d)

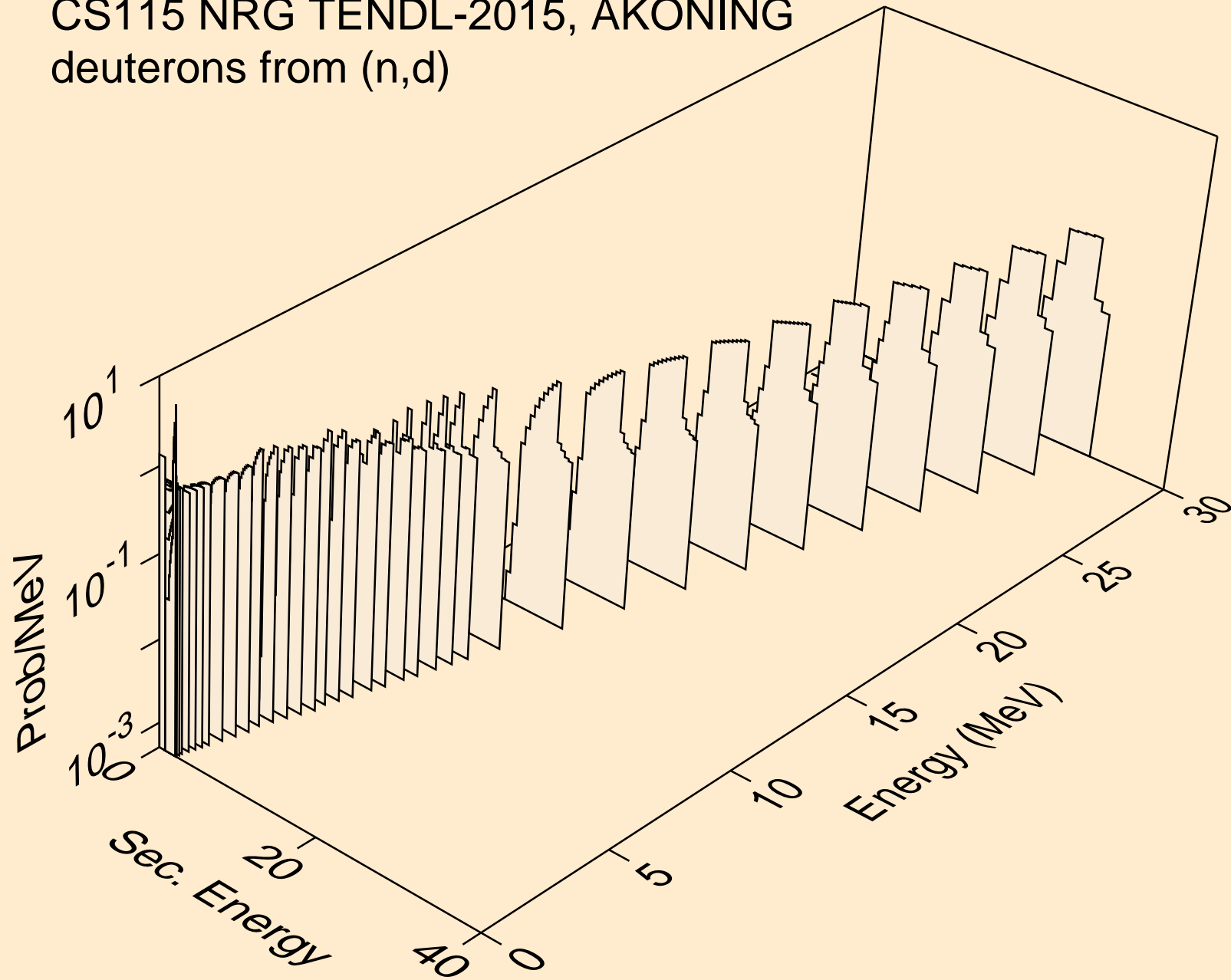

CS115 NRG TENDL-2015, AKONING
deuterons from (n,d2a)

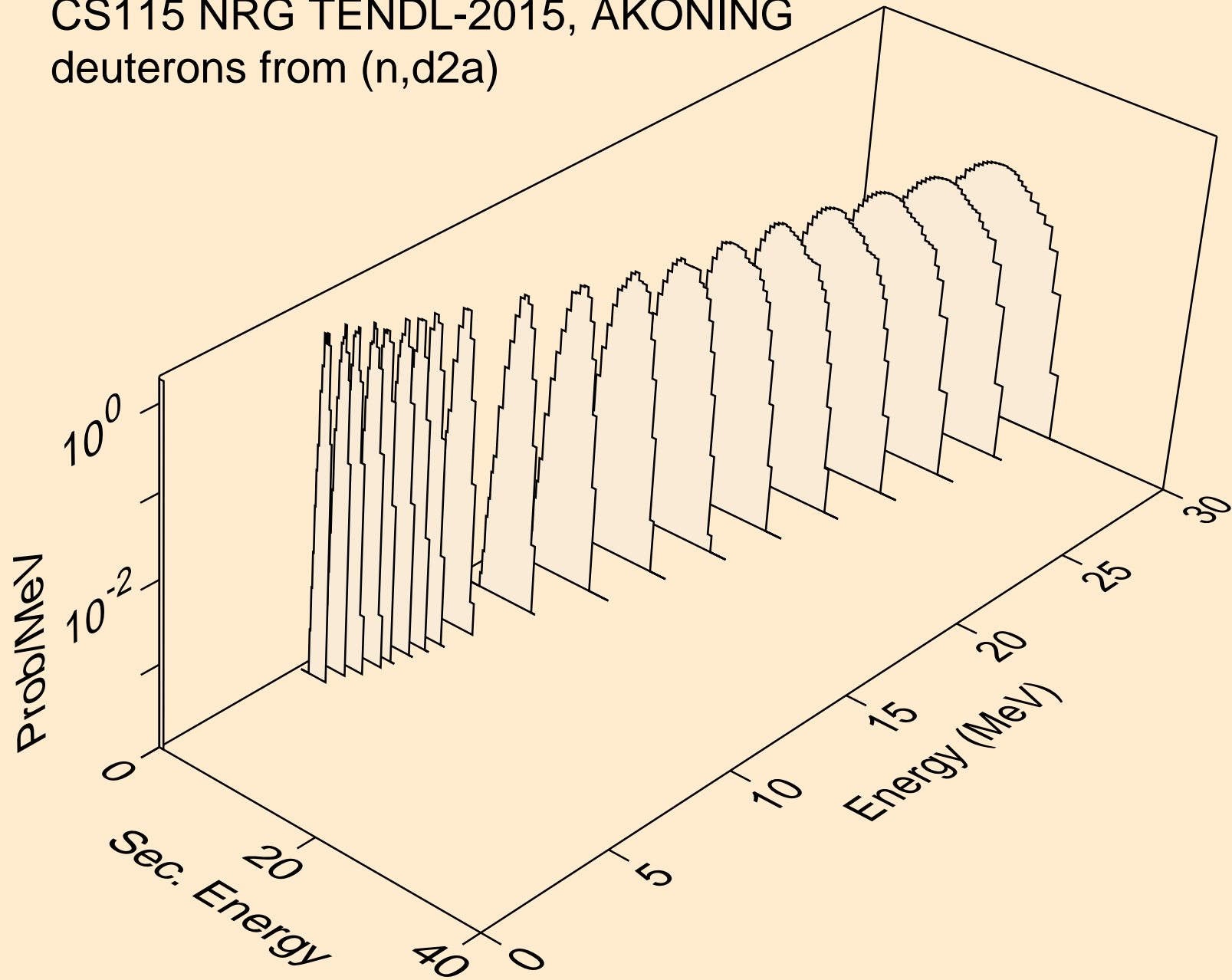

CS115 NRG TENDL-2015, AKONING
deuterons from (n,pd)

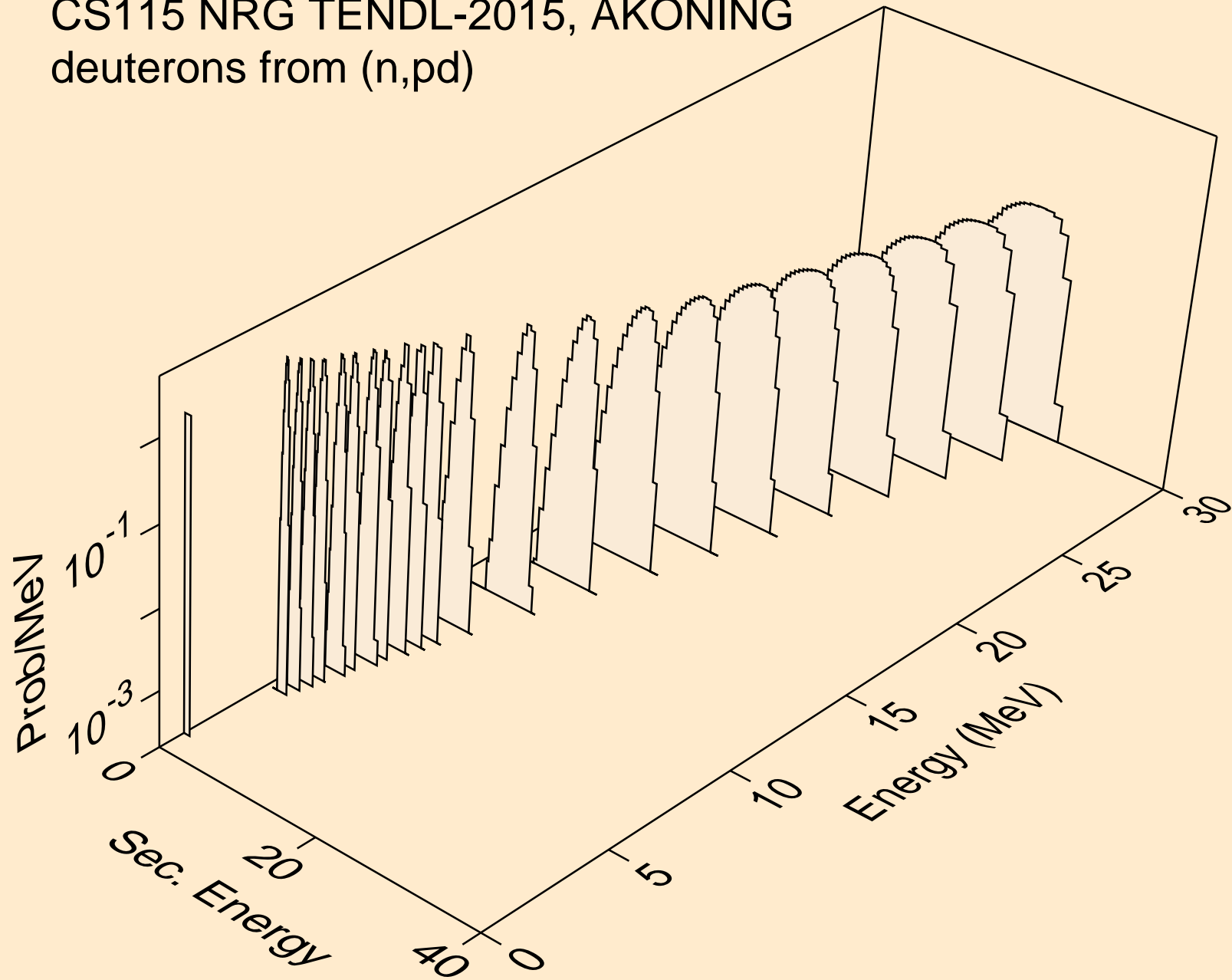

CS115 NRG TENDL-2015, AKONING
deuterons from (n,da)

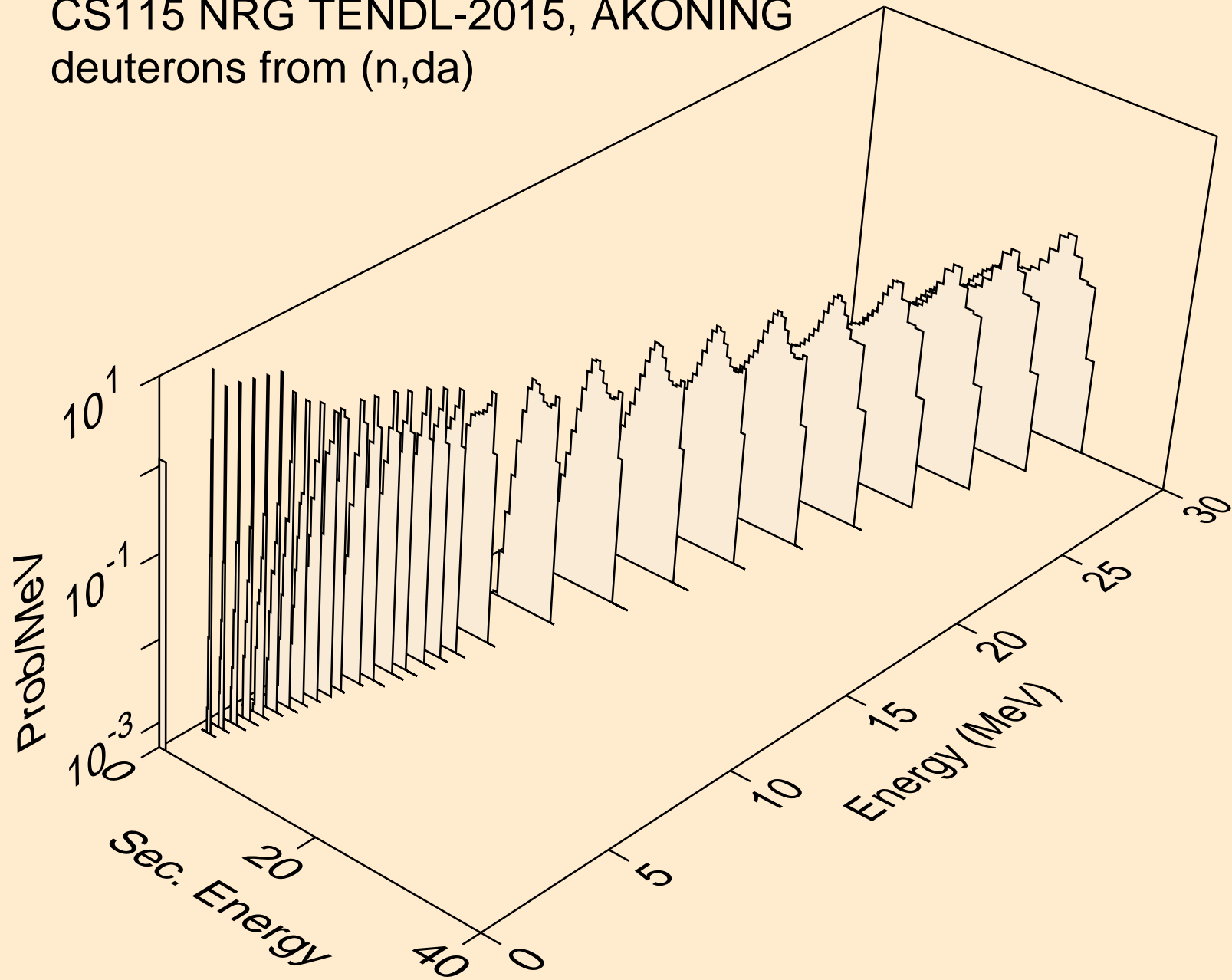

CS115 NRG TENDL-2015, AKONING
tritons from (n,x)

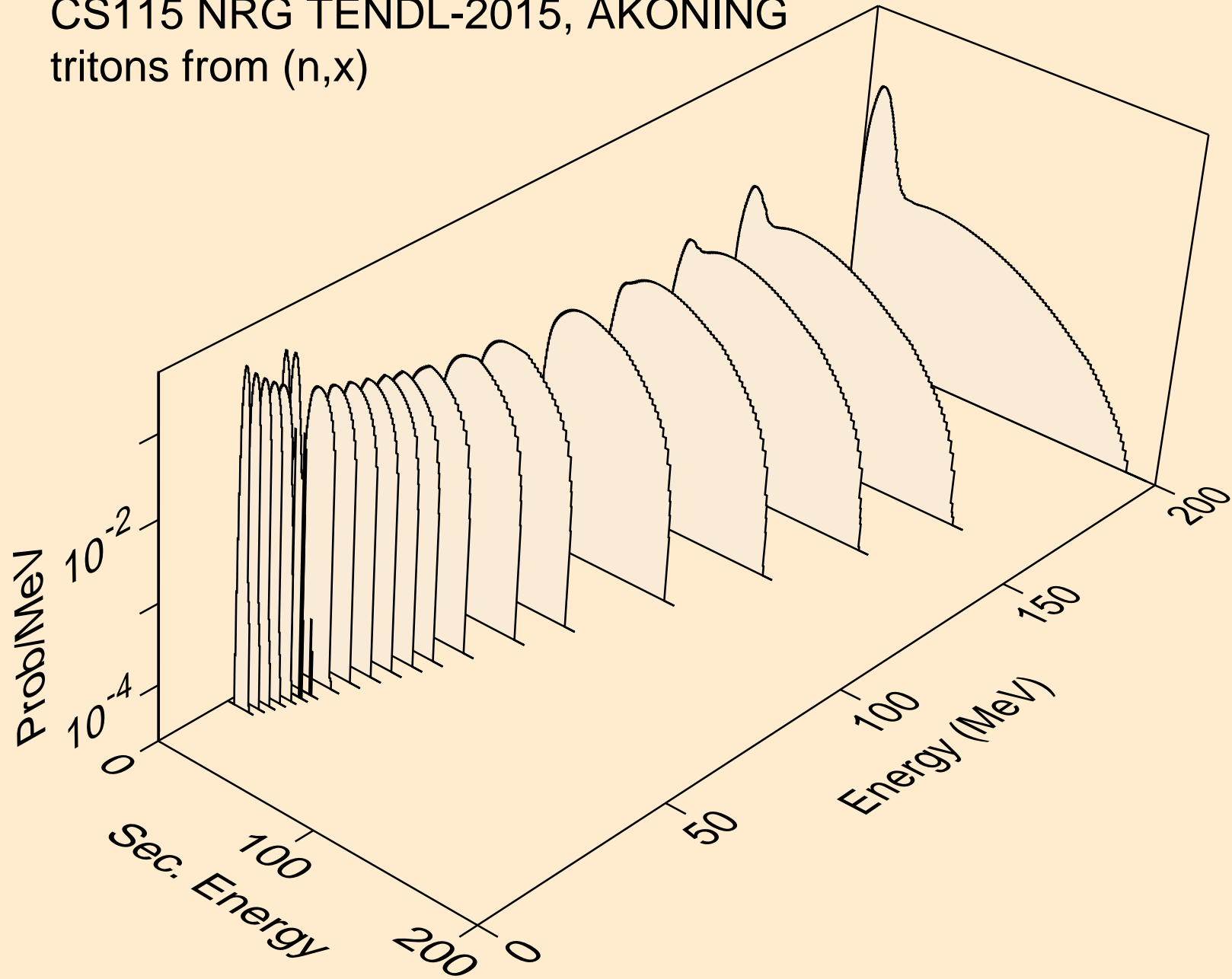

CS115 NRG TENDL-2015, AKONING
tritons from (n,n*)t

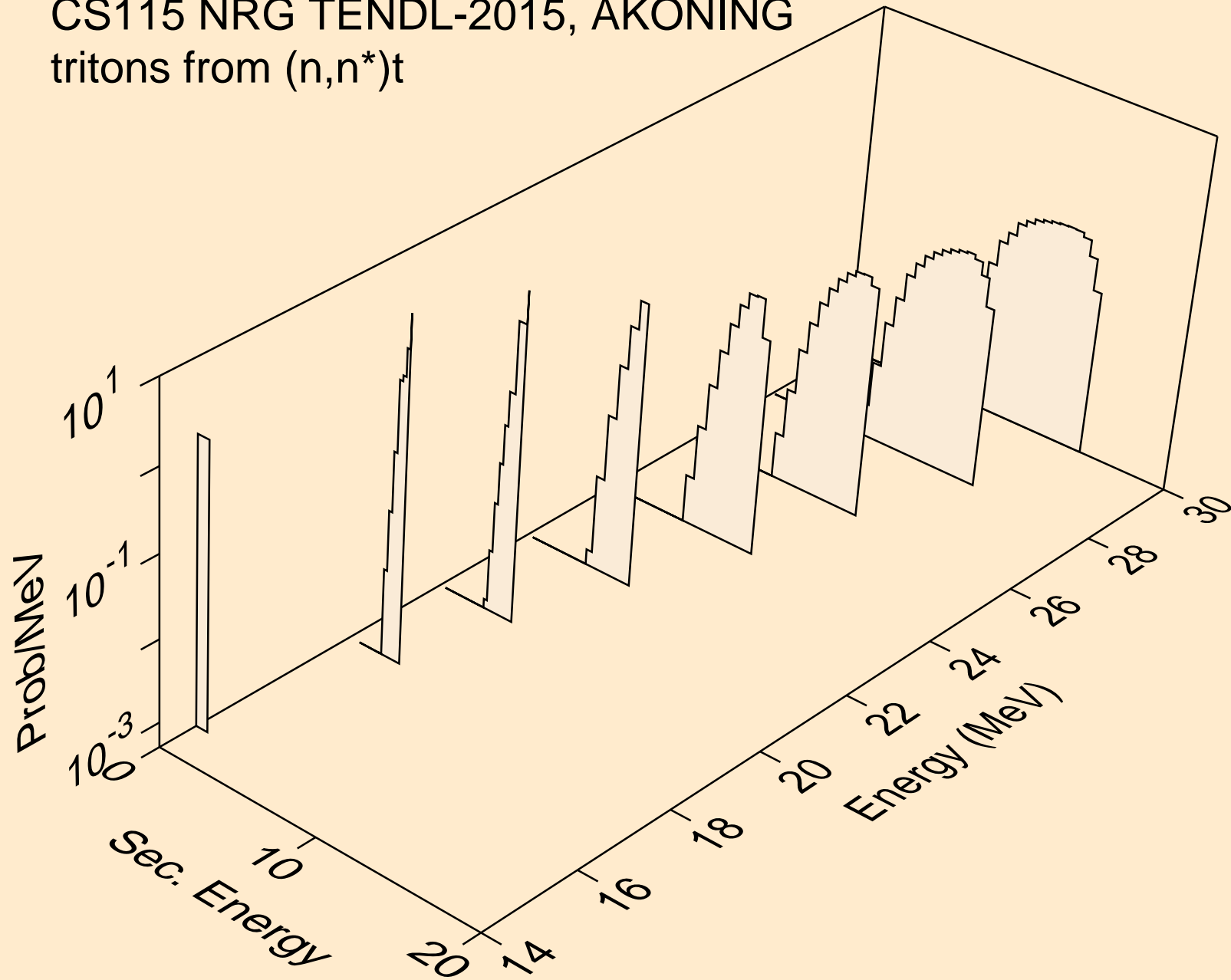

CS115 NRG TENDL-2015, AKONING
tritons from (n,t)

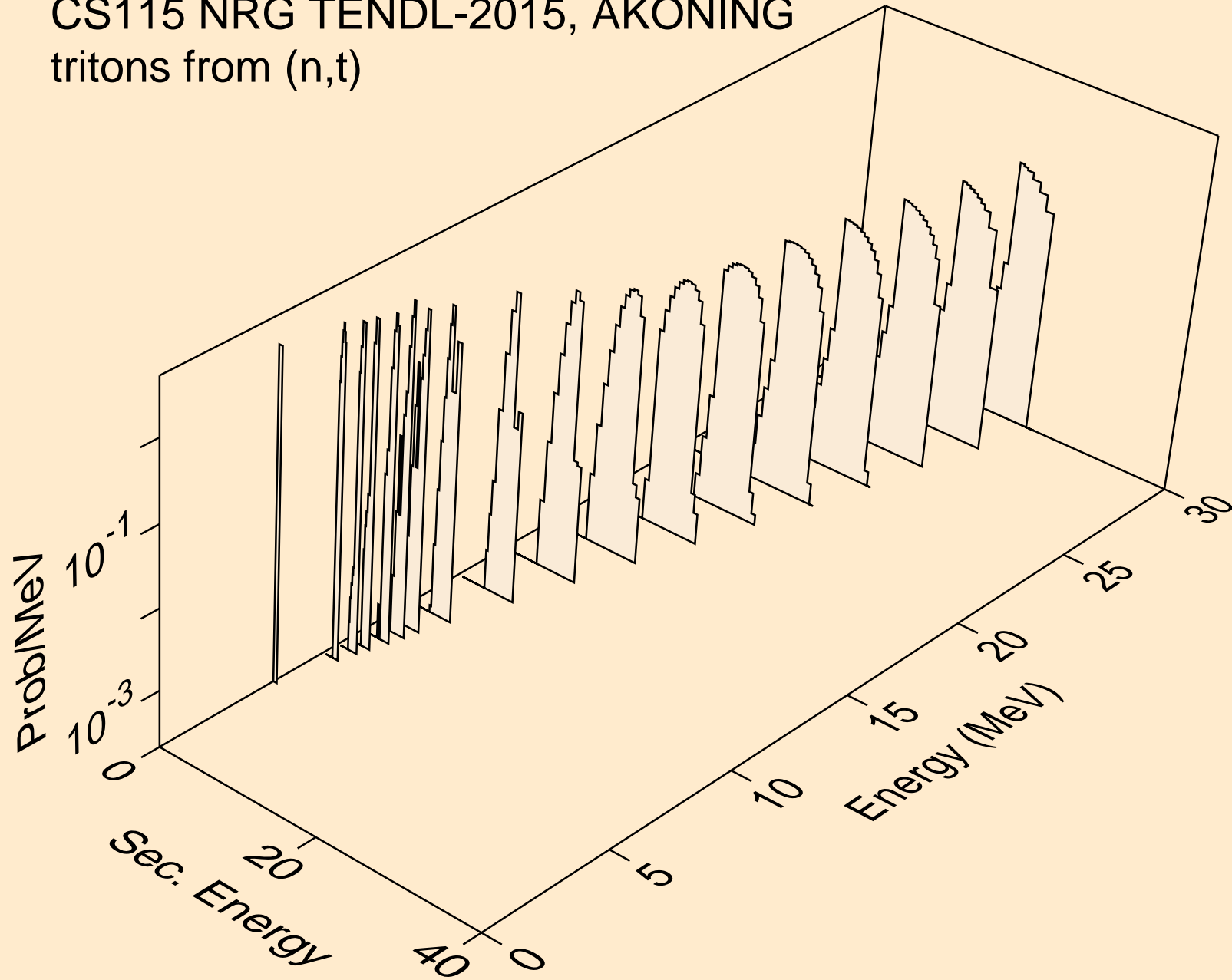

CS115 NRG TENDL-2015, AKONING
tritons from (n,t2a)

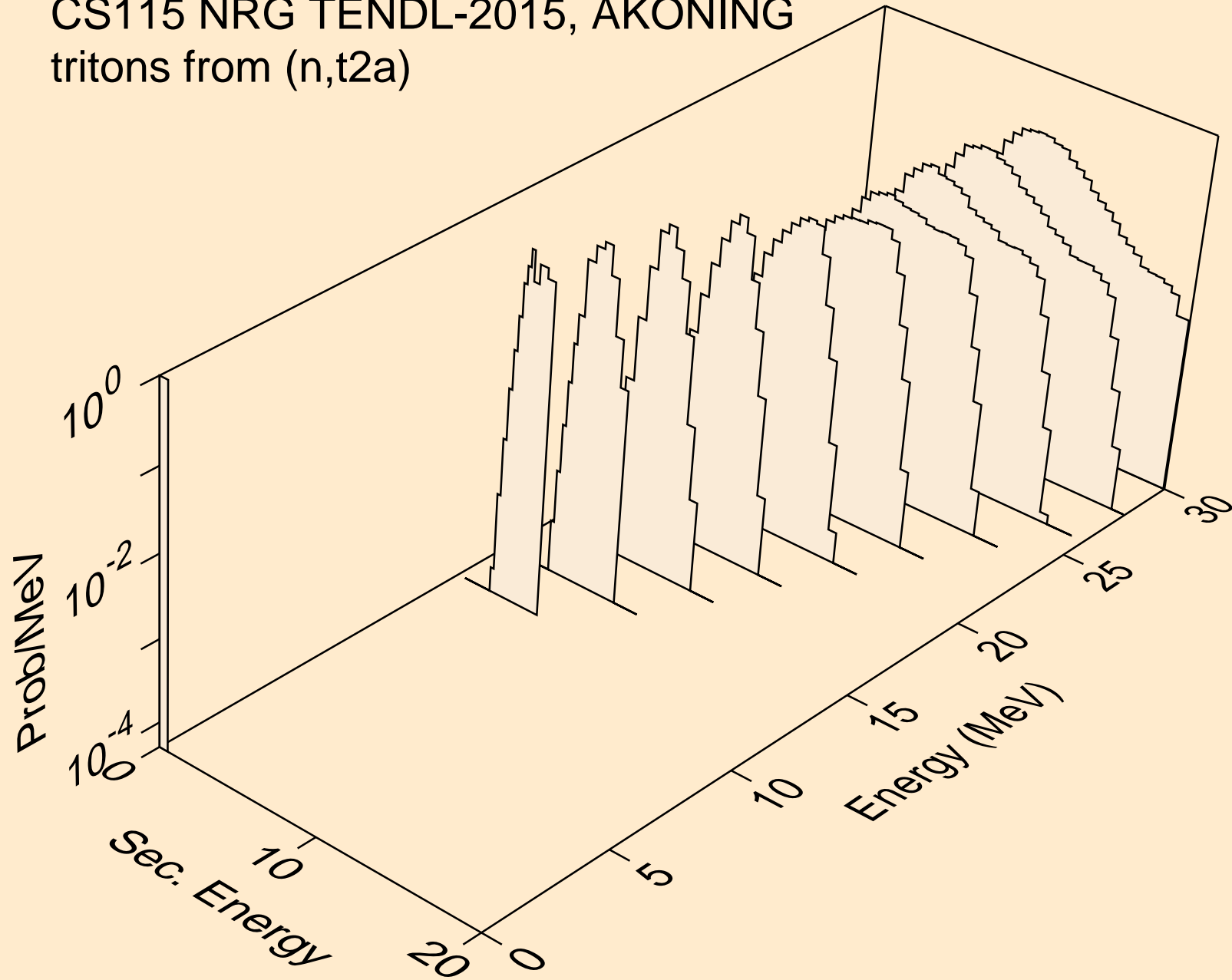

CS115 NRG TENDL-2015, AKONING
tritons from (n,pt)

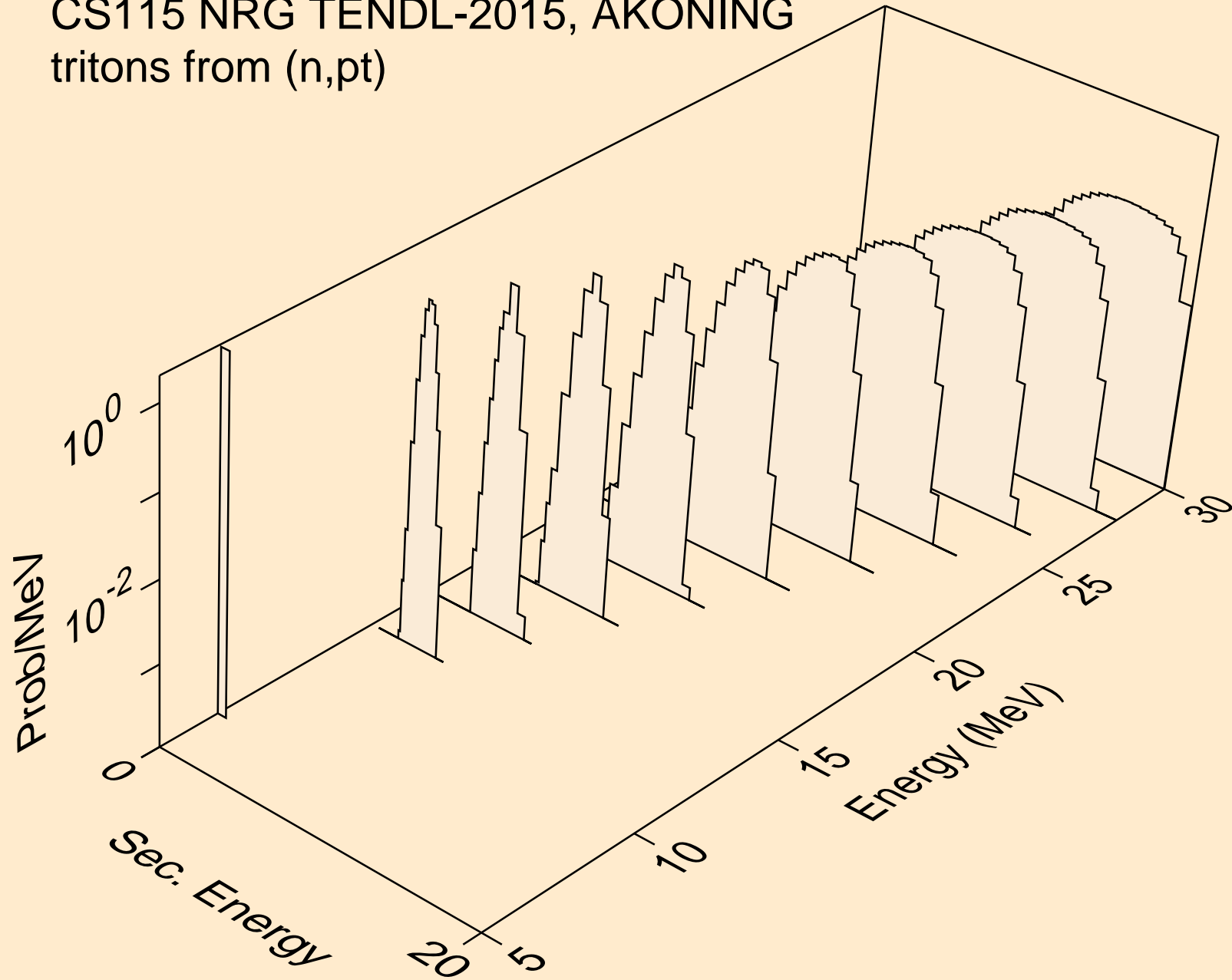

CS115 NRG TENDL-2015, AKONING
he3s from (n,x)

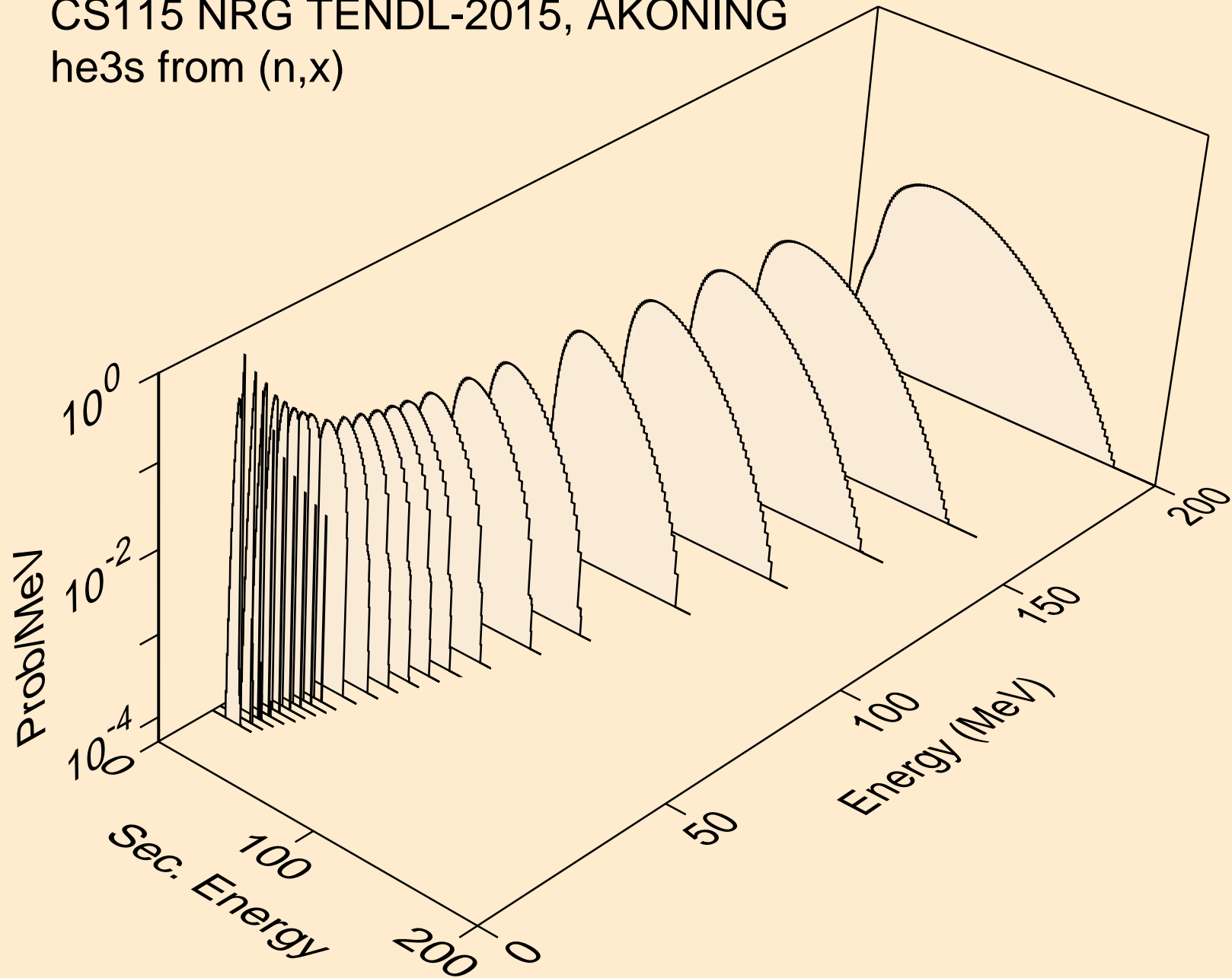

CS115 NRG TENDL-2015, AKONING
he3s from (n,n*)he3

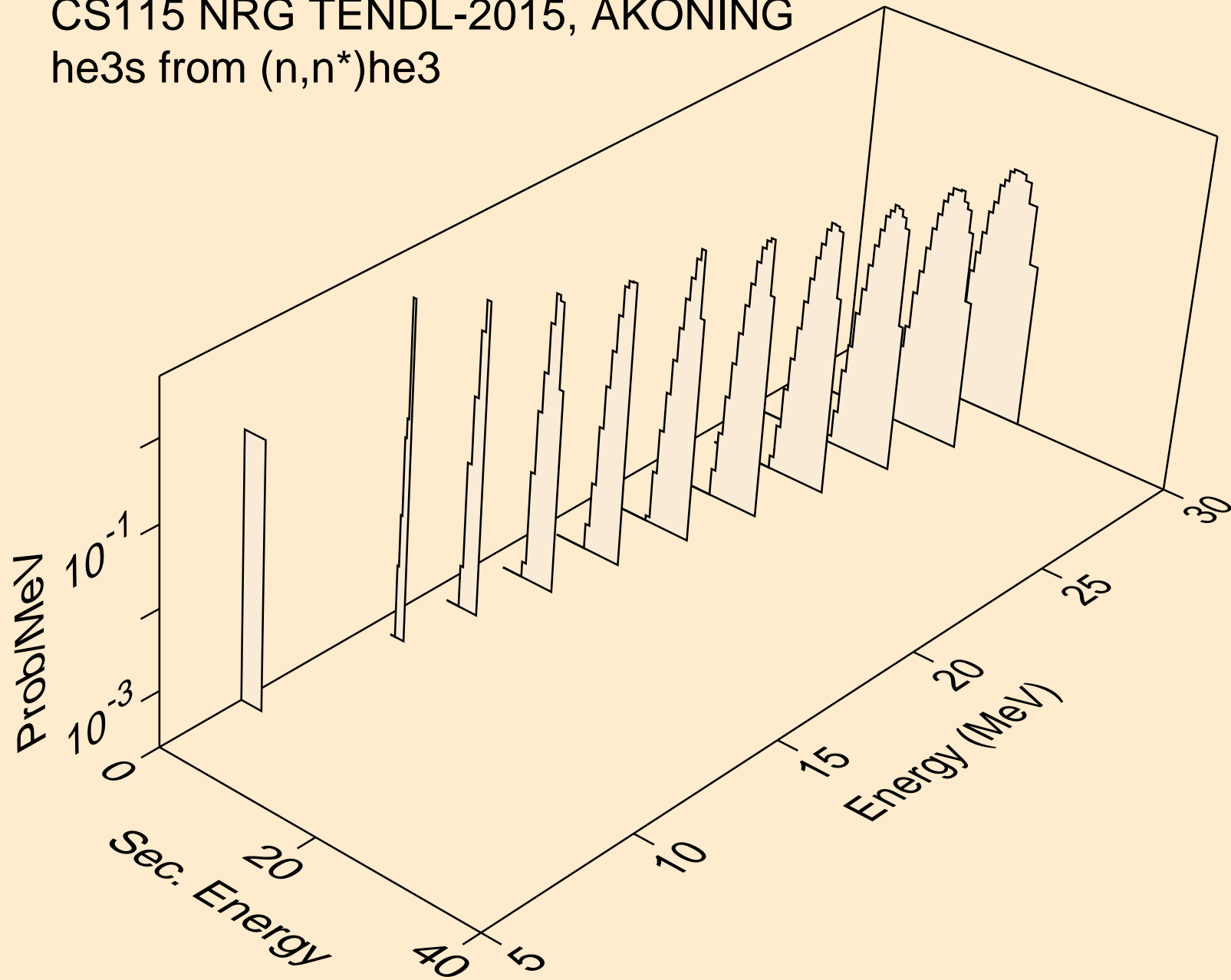

CS115 NRG TENDL-2015, AKONING
he3s from (n,he3)

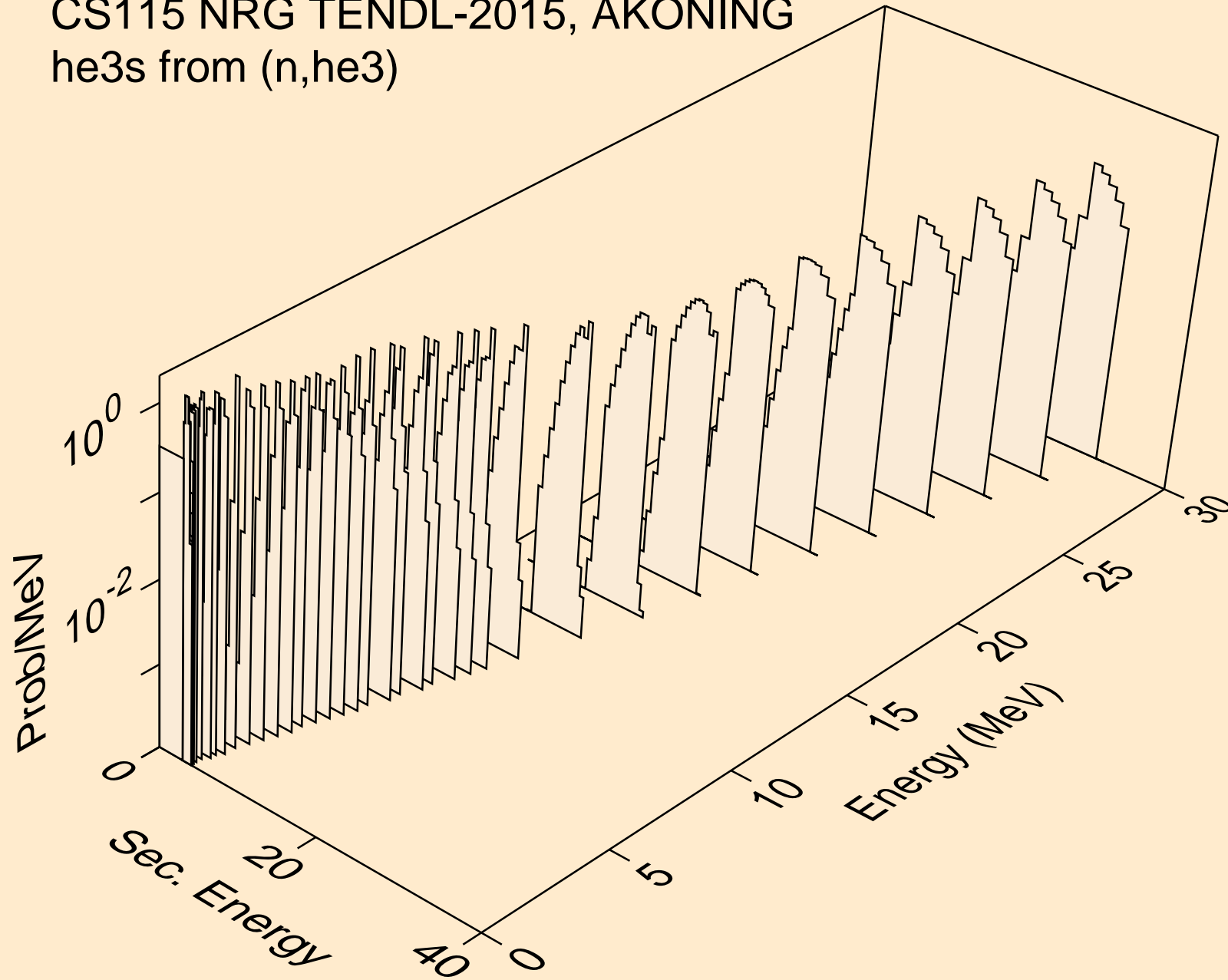

CS115 NRG TENDL-2015, AKONING
alphas from (n,x)

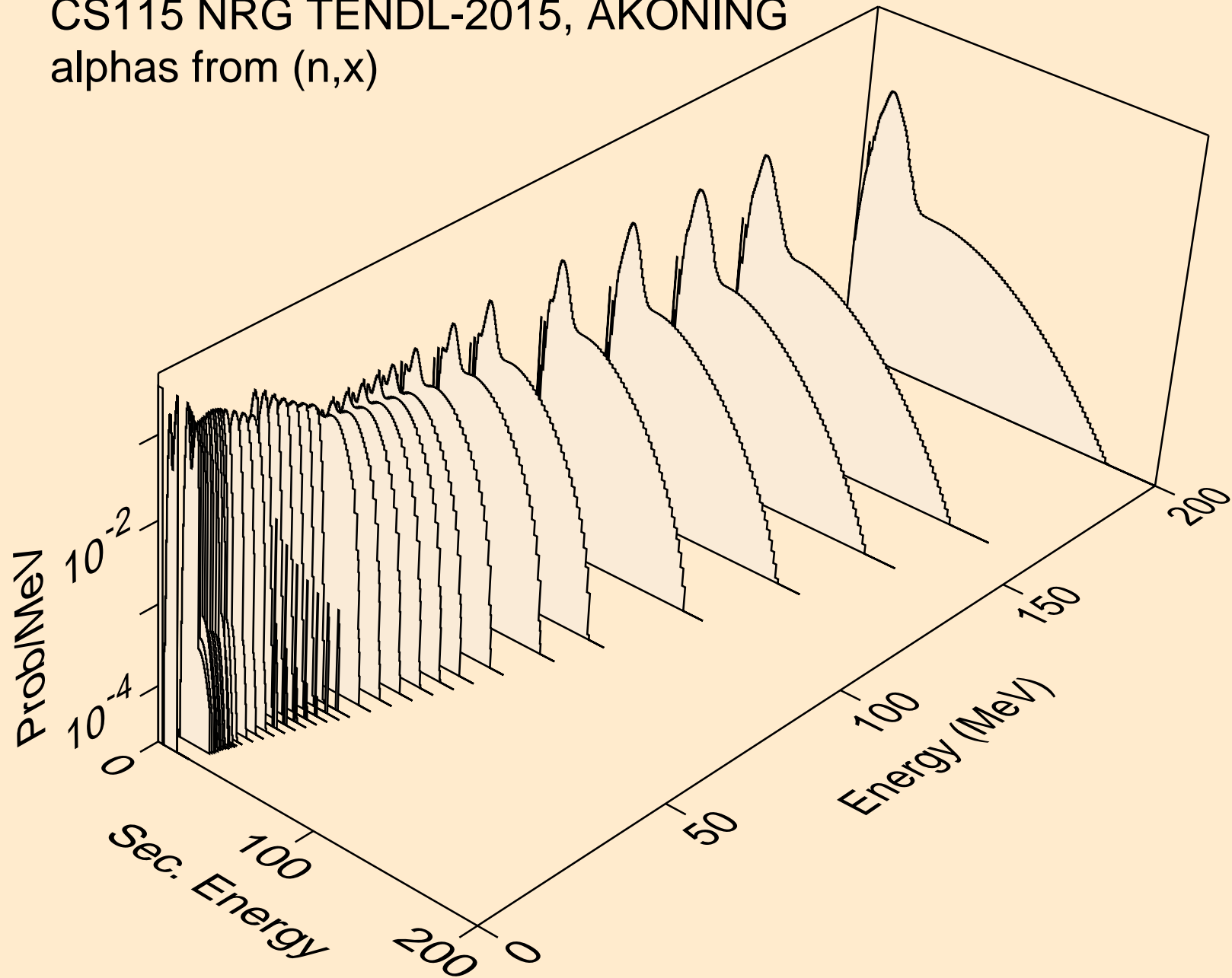

CS115 NRG TENDL-2015, AKONING
alphas from (n,n*)a

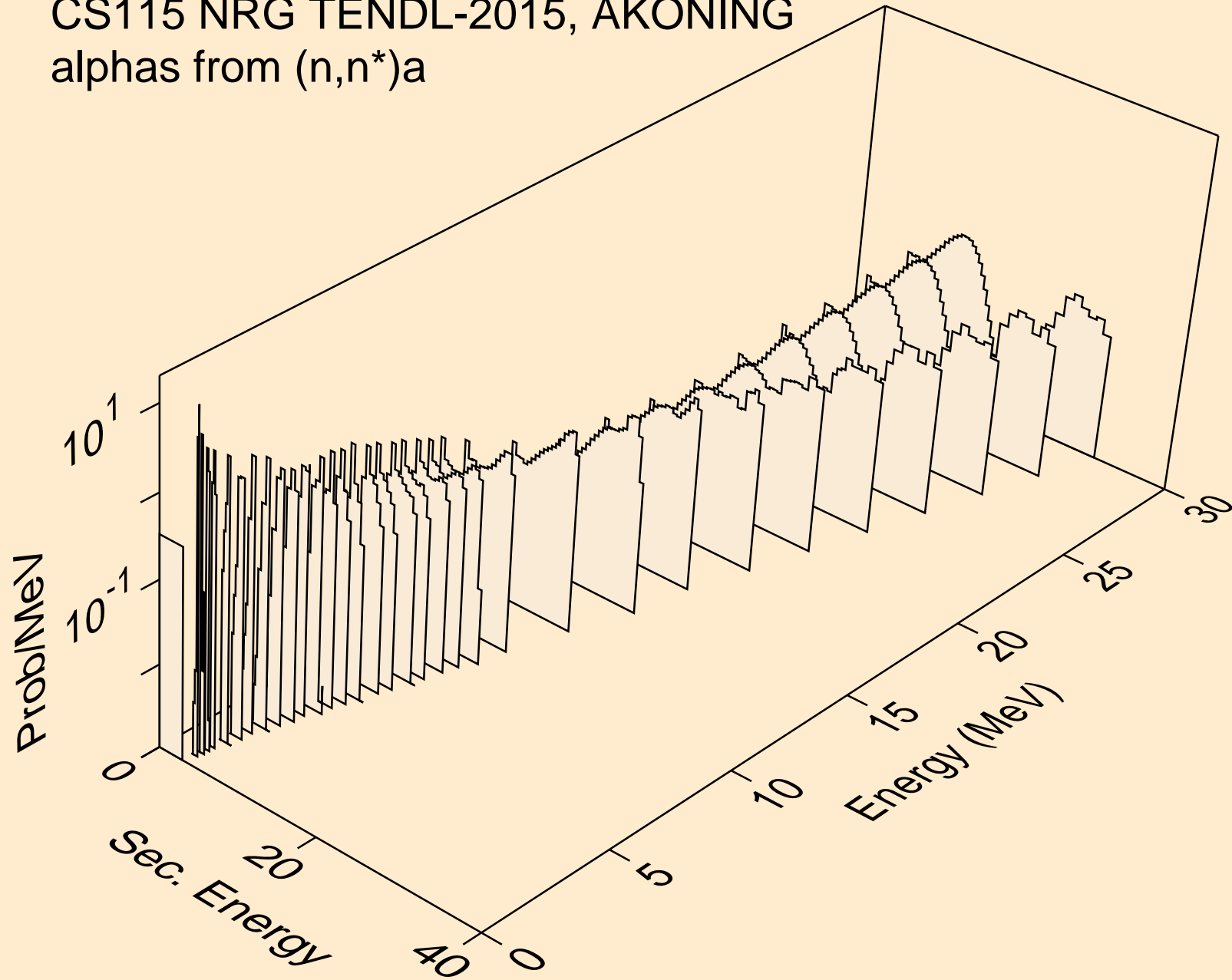

CS115 NRG TENDL-2015, AKONING
alphas from (n,n*)3a

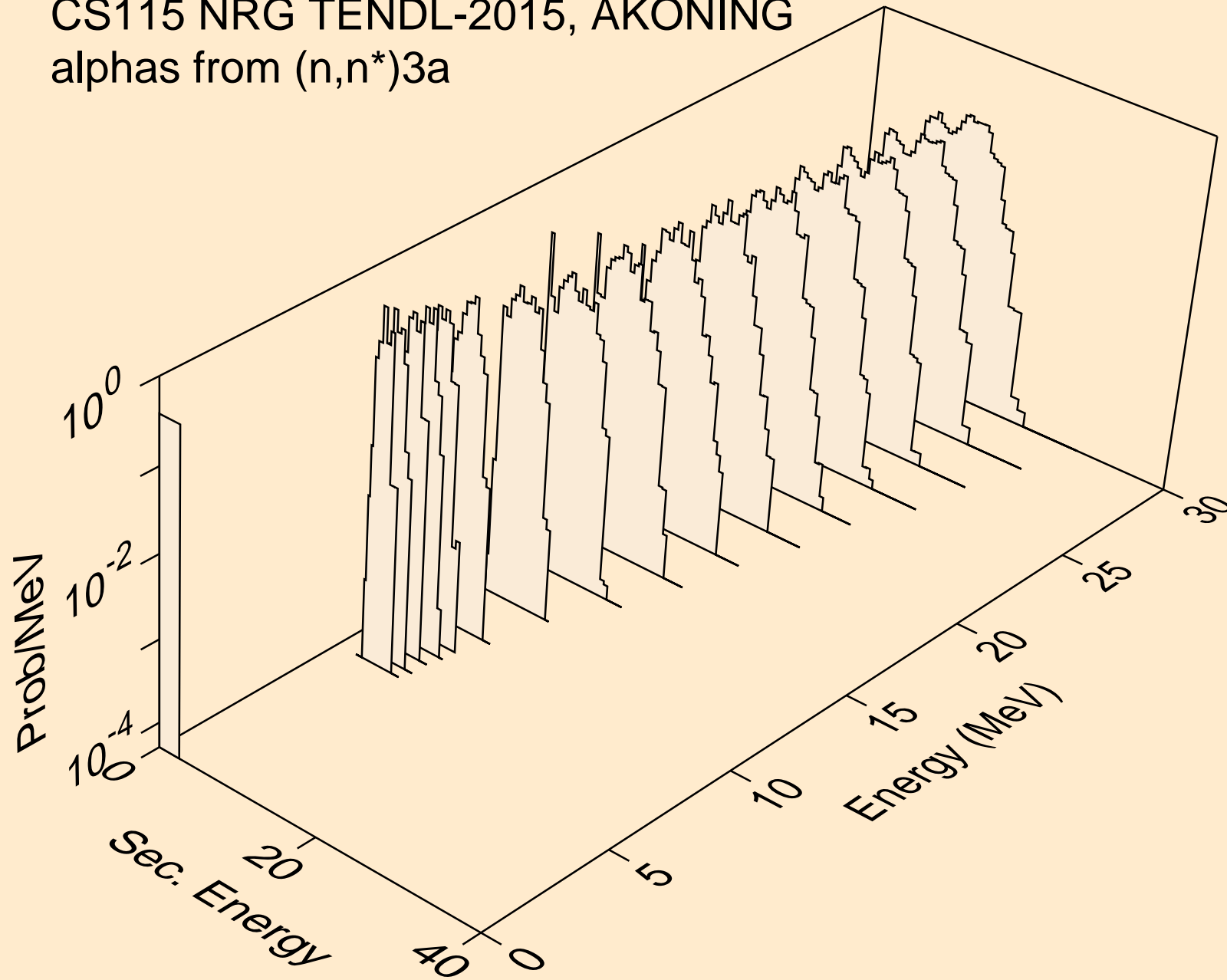

CS115 NRG TENDL-2015, AKONING
alphas from (n,2n)a

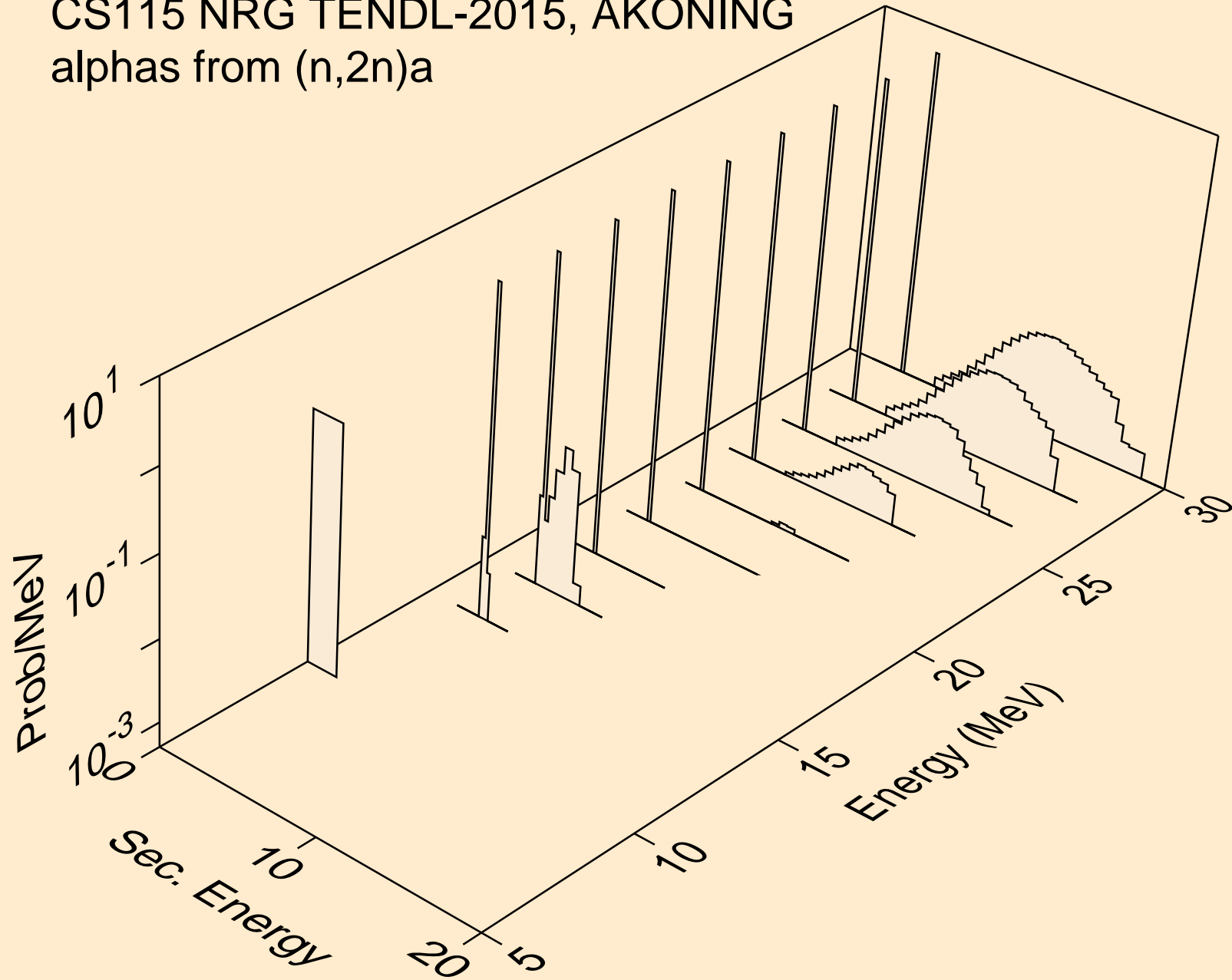

CS115 NRG TENDL-2015, AKONING
alphas from (n,n*)2a

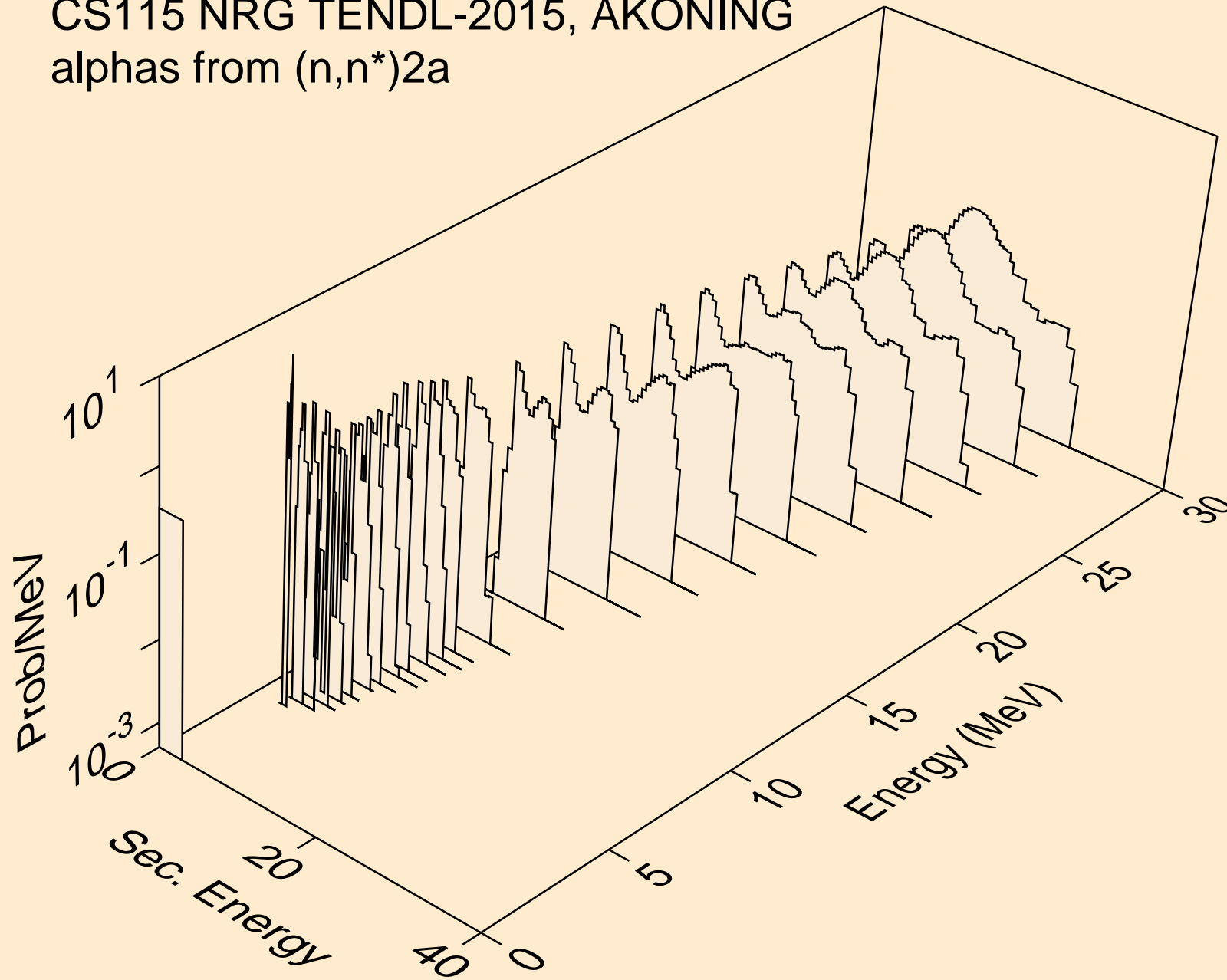

CS115 NRG TENDL-2015, AKONING
alphas from (n,2n)2a

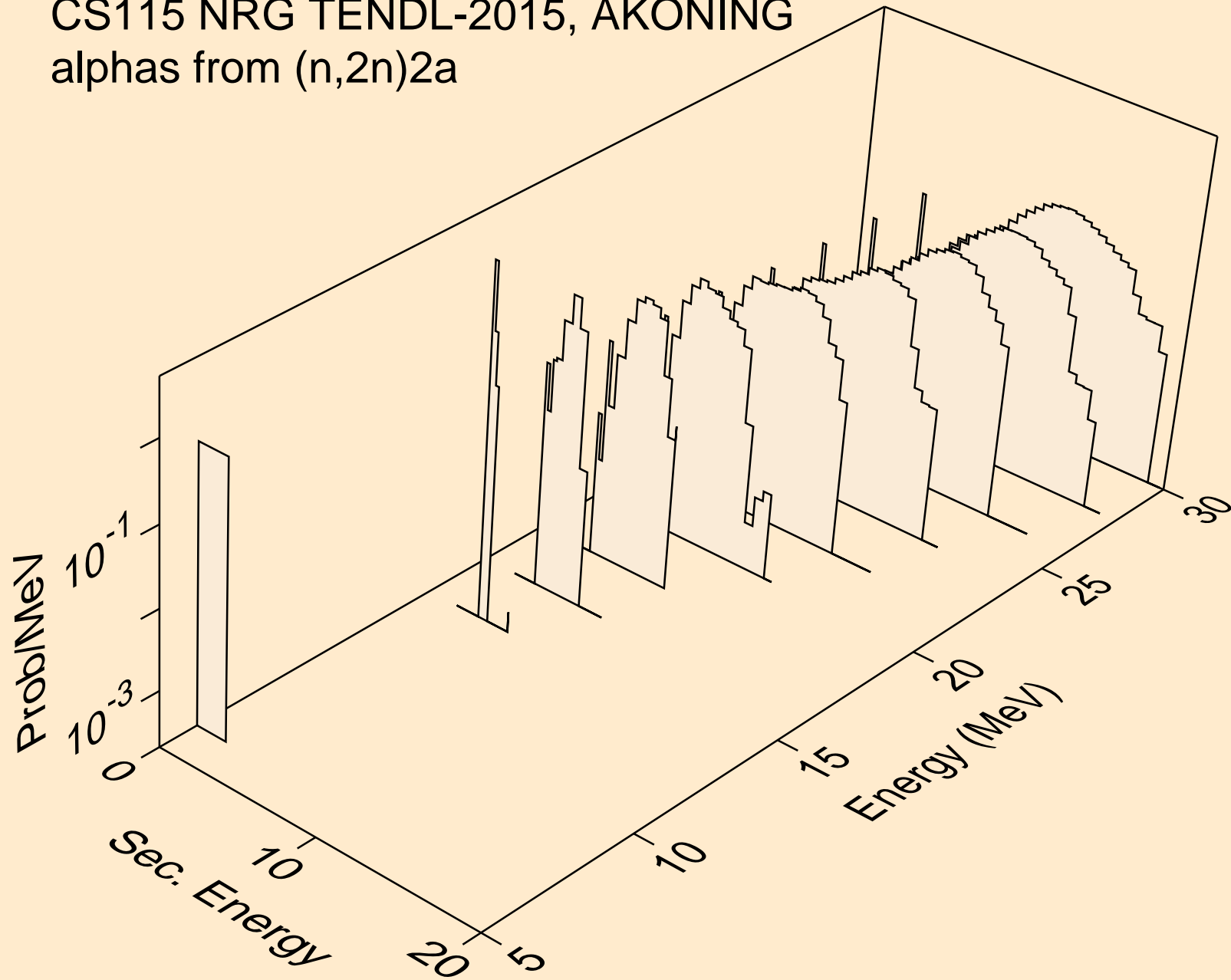

CS115 NRG TENDL-2015, AKONING
alphas from (n,n*)d2a

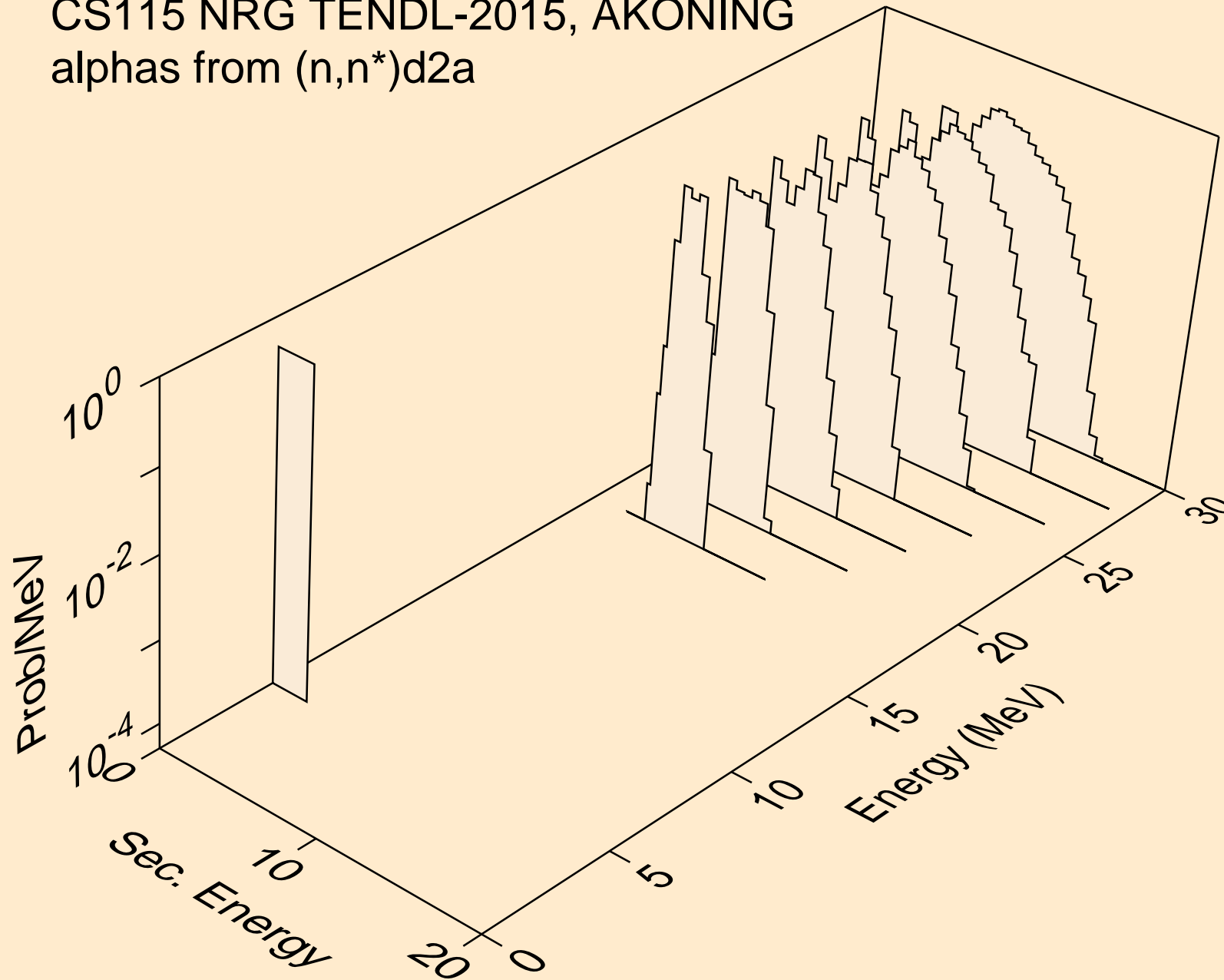

CS115 NRG TENDL-2015, AKONING
alphas from (n,npa)

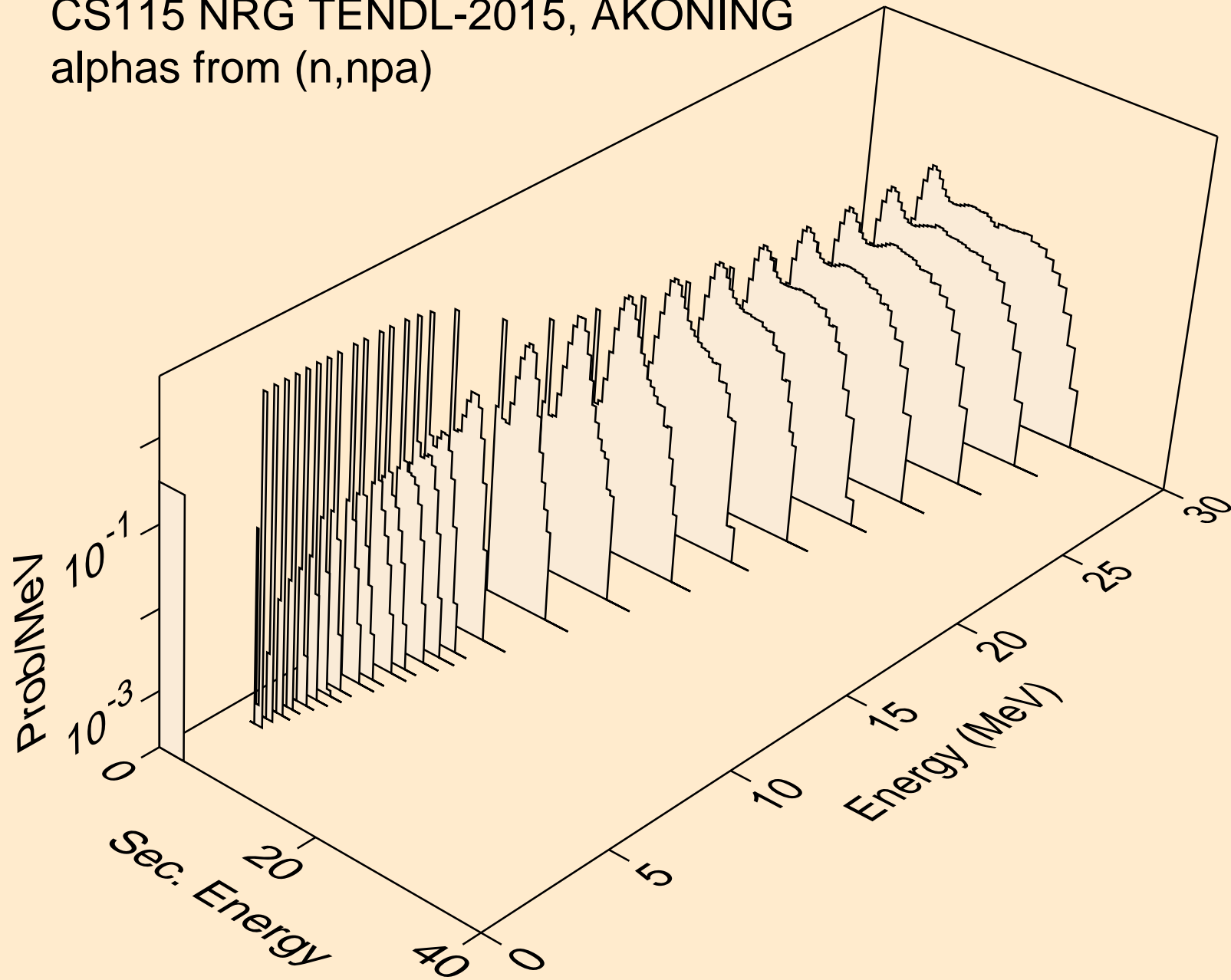

CS115 NRG TENDL-2015, AKONING
alphas from (n,a)

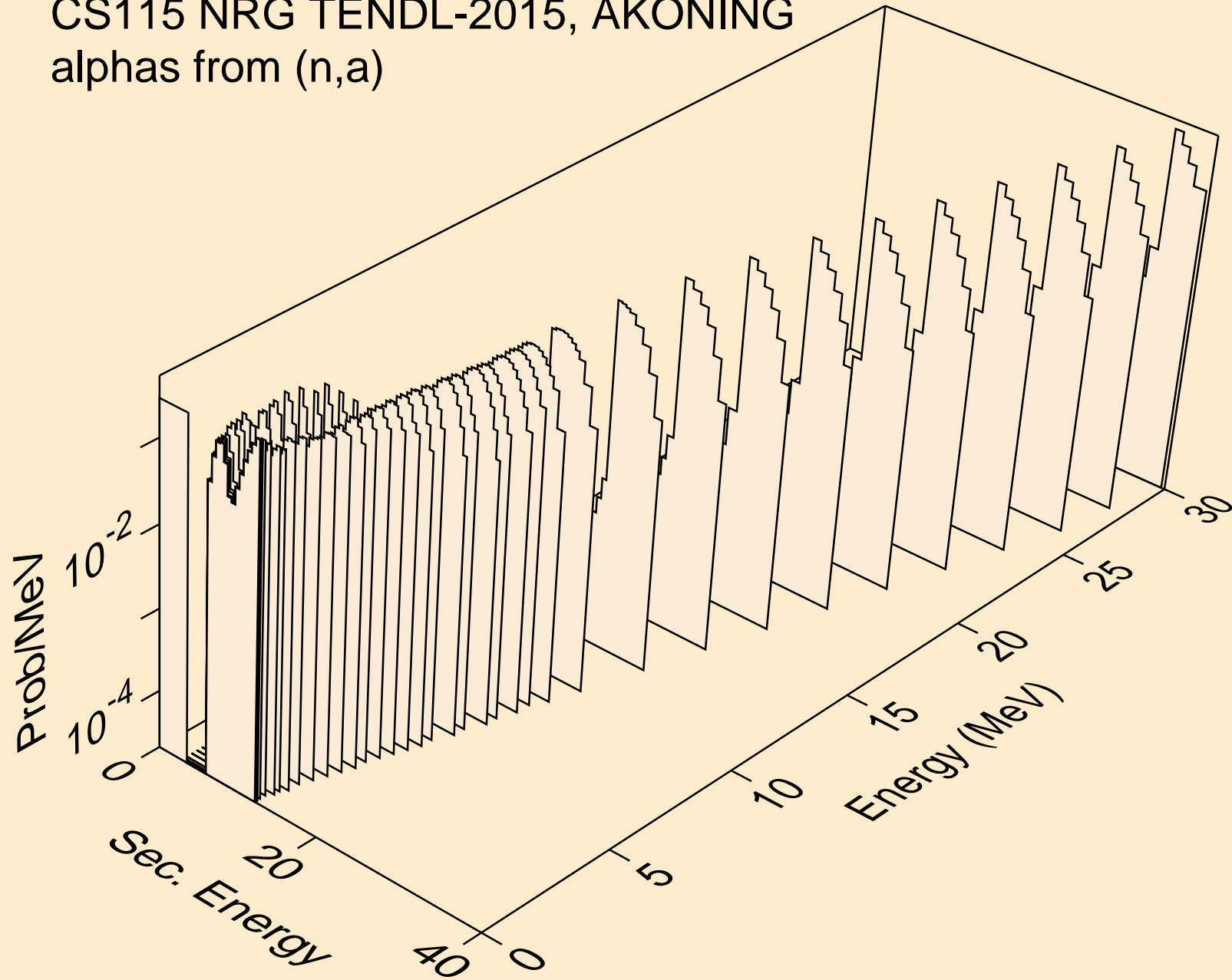

CS115 NRG TENDL-2015, AKONING
alphas from (n,2a)

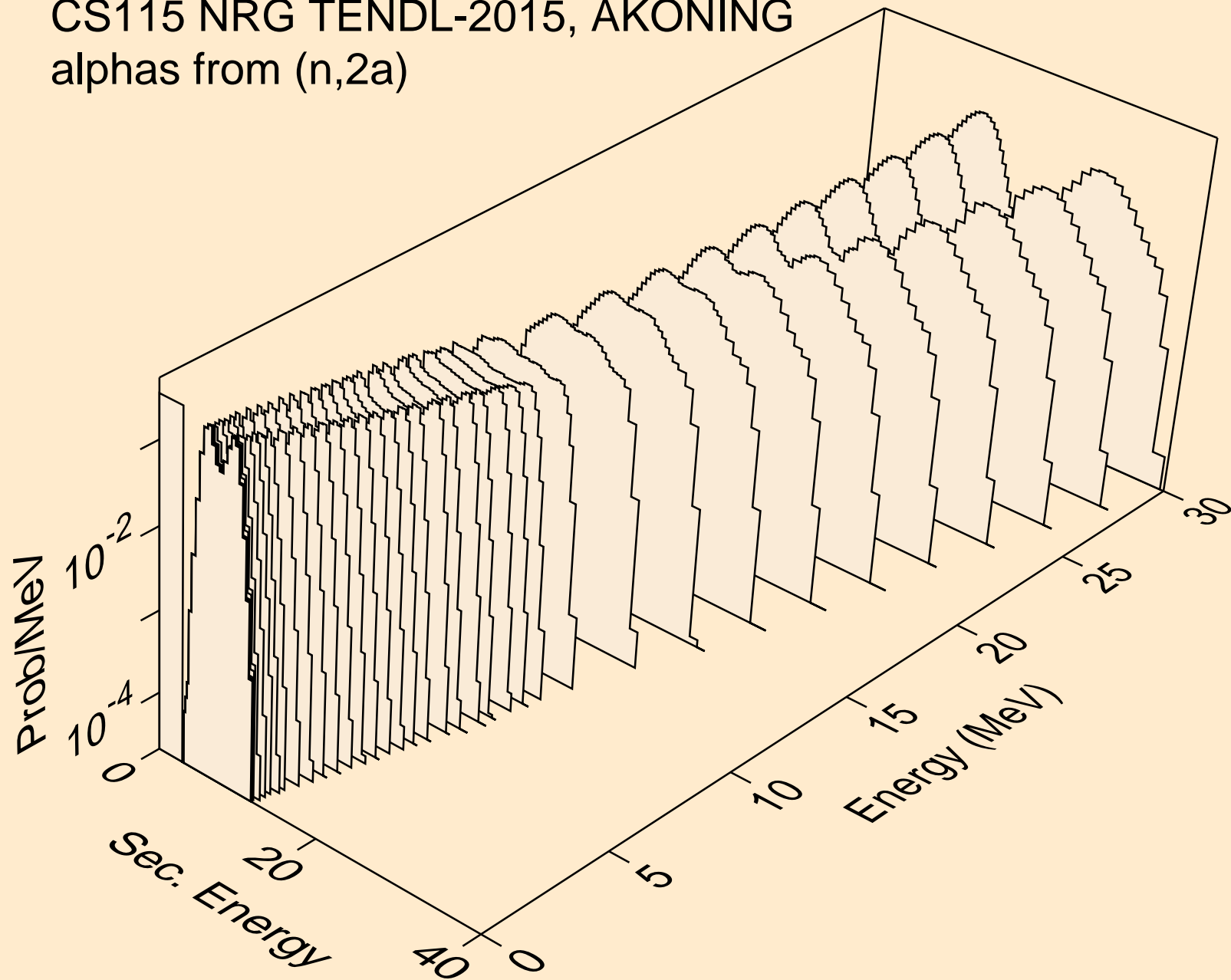

CS115 NRG TENDL-2015, AKONING
alphas from (n,3a)

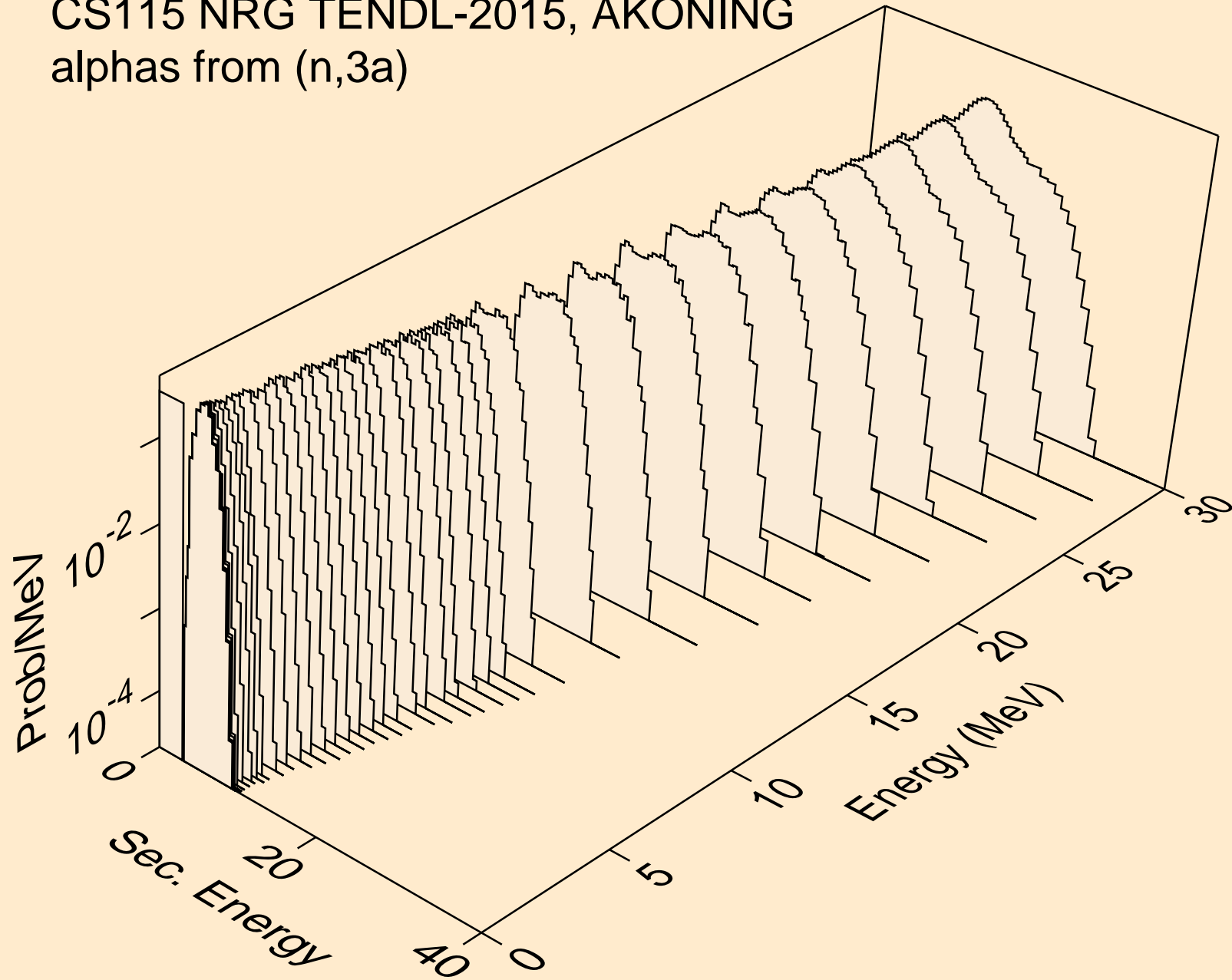

CS115 NRG TENDL-2015, AKONING
alphas from (n,pa)

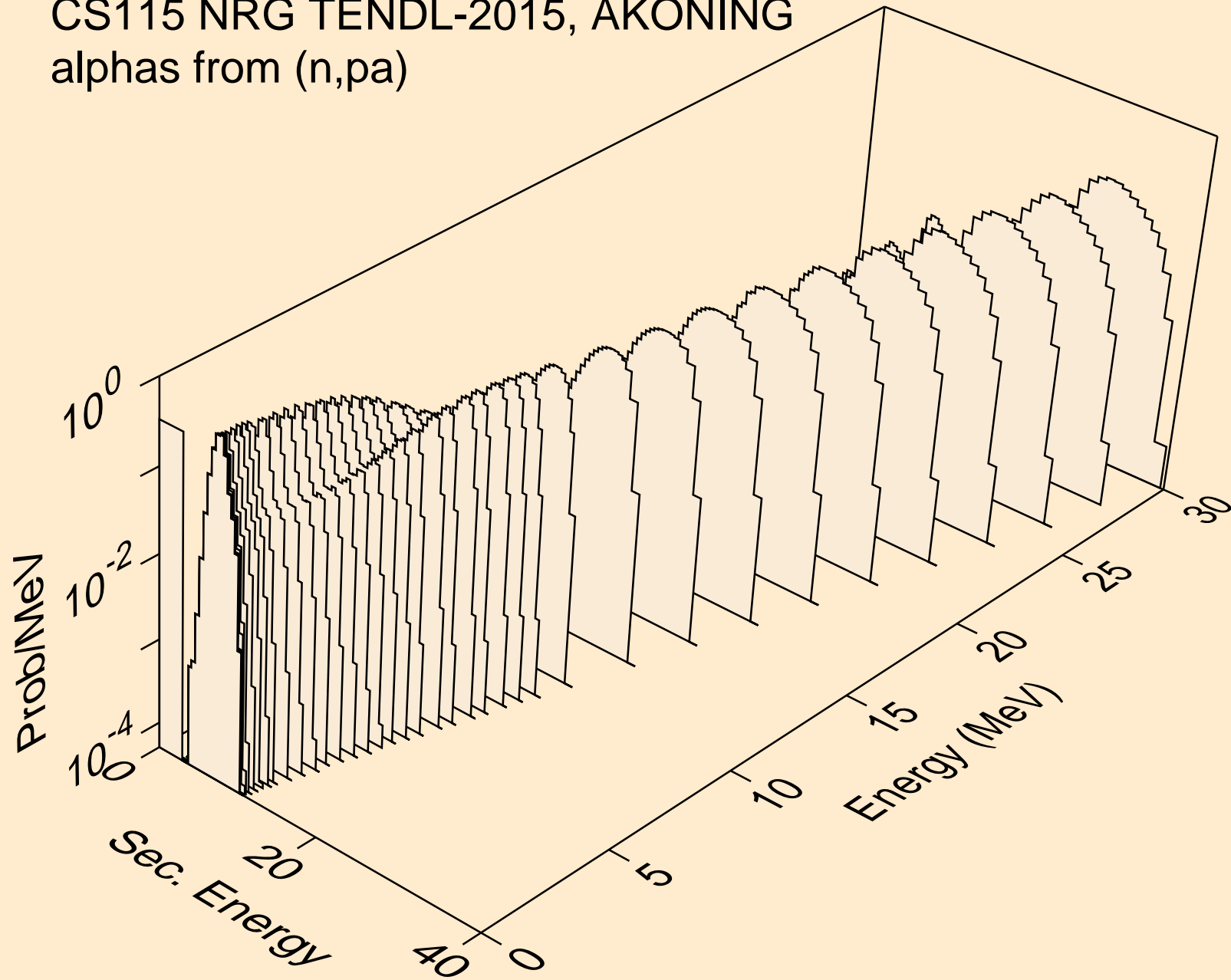

CS115 NRG TENDL-2015, AKONING
alphas from (n,t2a)

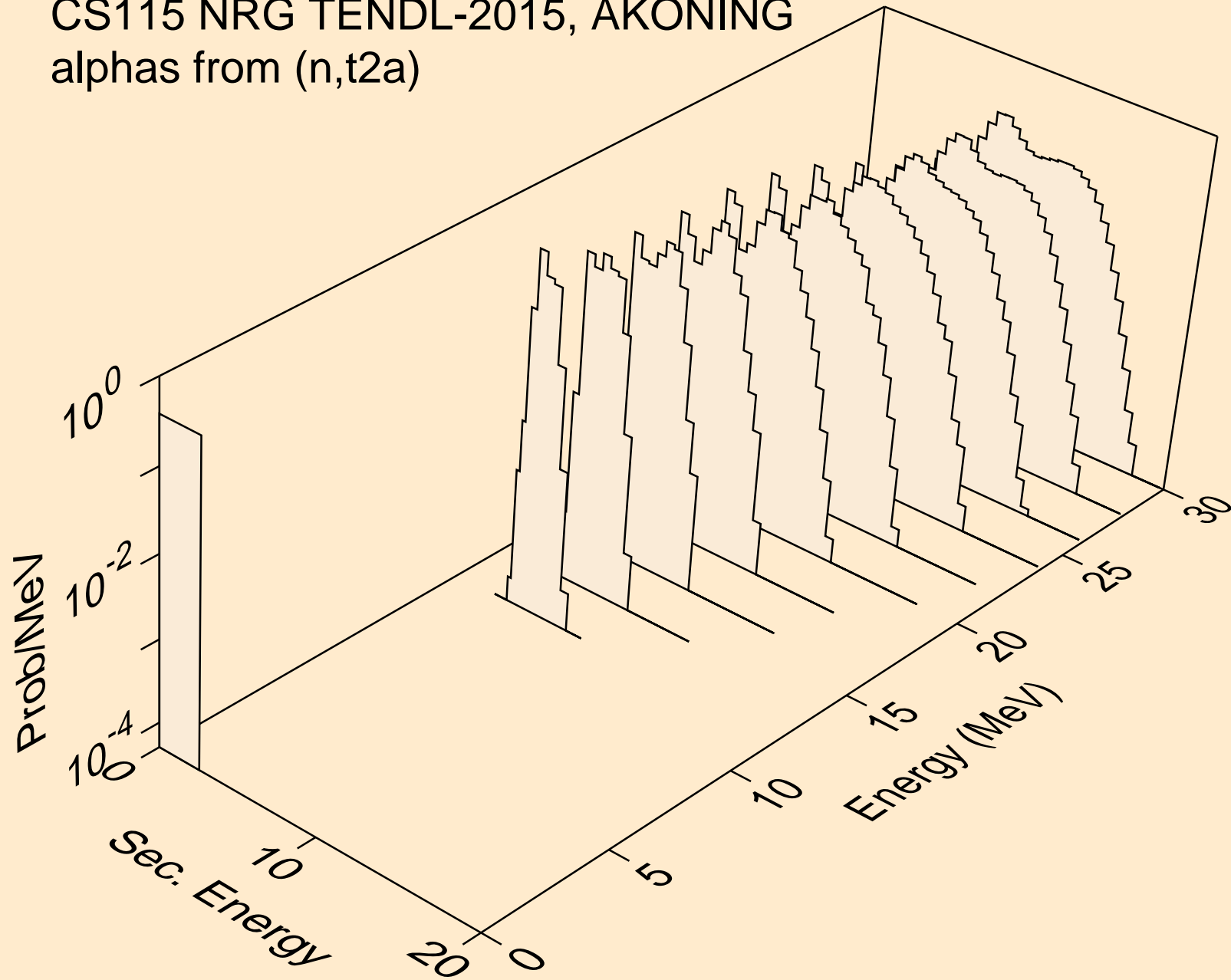

CS115 NRG TENDL-2015, AKONING
alphas from (n,d2a)

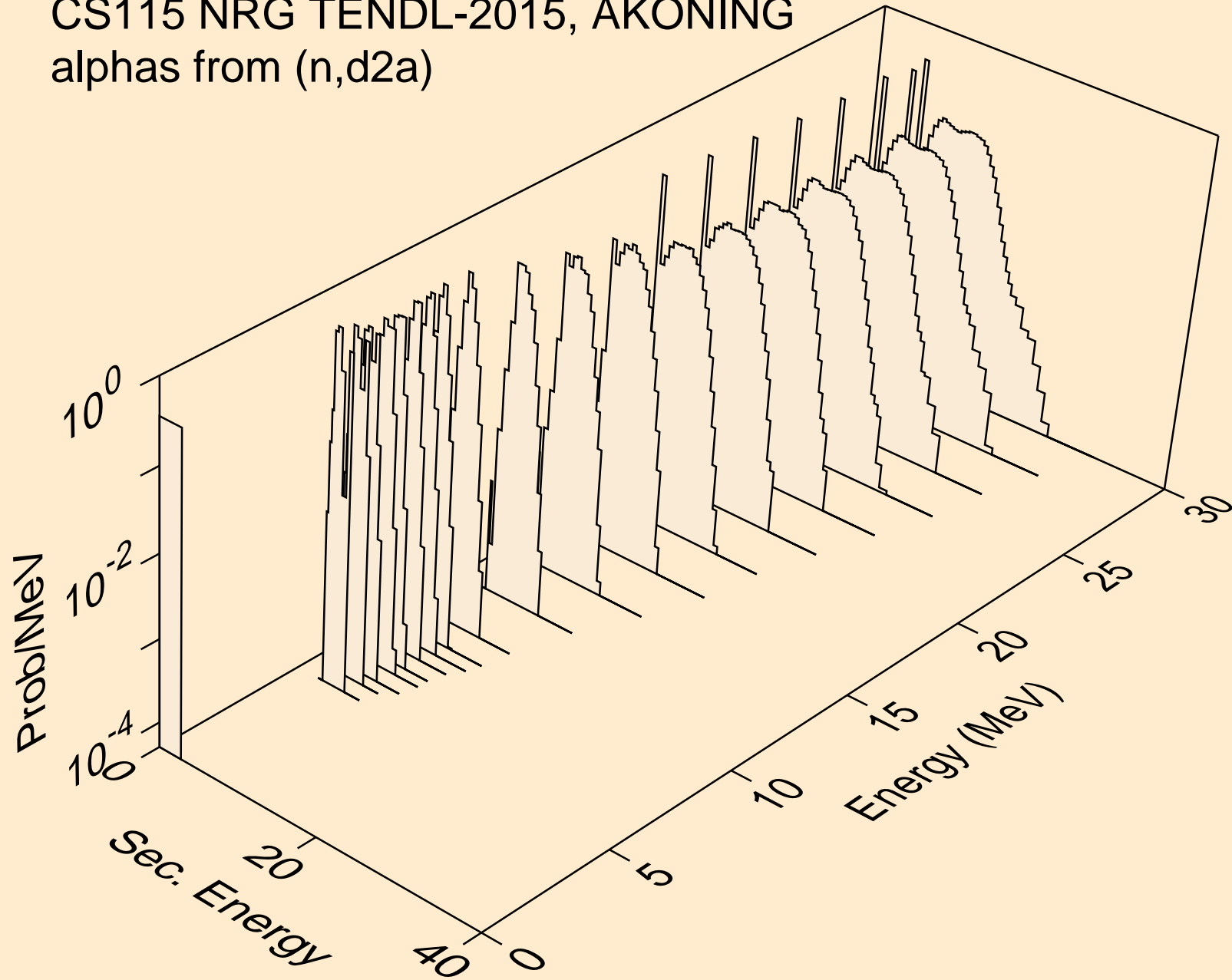

CS115 NRG TENDL-2015, AKONING
alphas from (n,da)

