

# CS117 NRG TENDL-2015, AKONING

## Principal cross sections

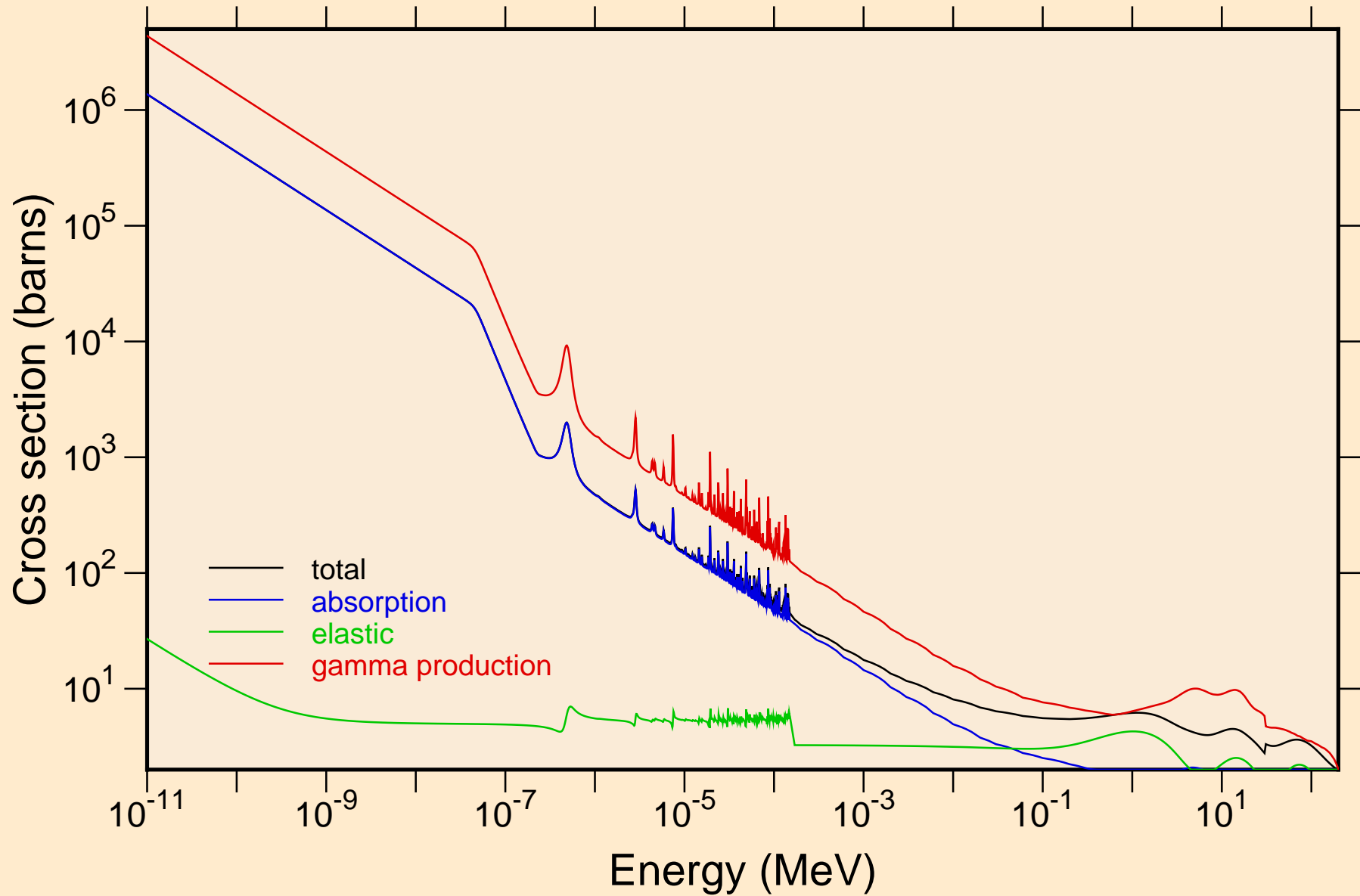

CS117 NRG TENDL-2015, AKONING  
resonance total cross section

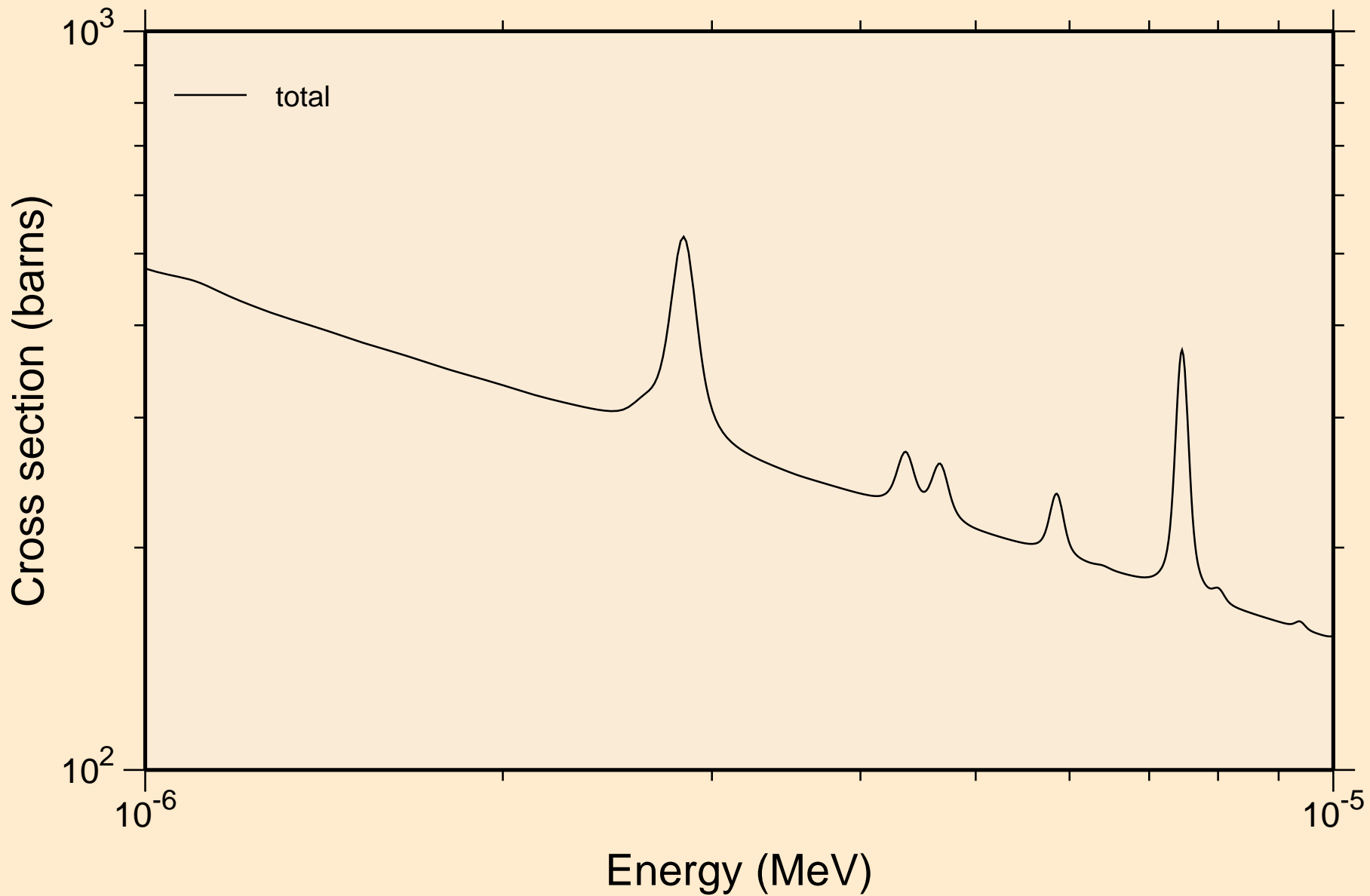

CS117 NRG TENDL-2015, AKONING  
resonance total cross section

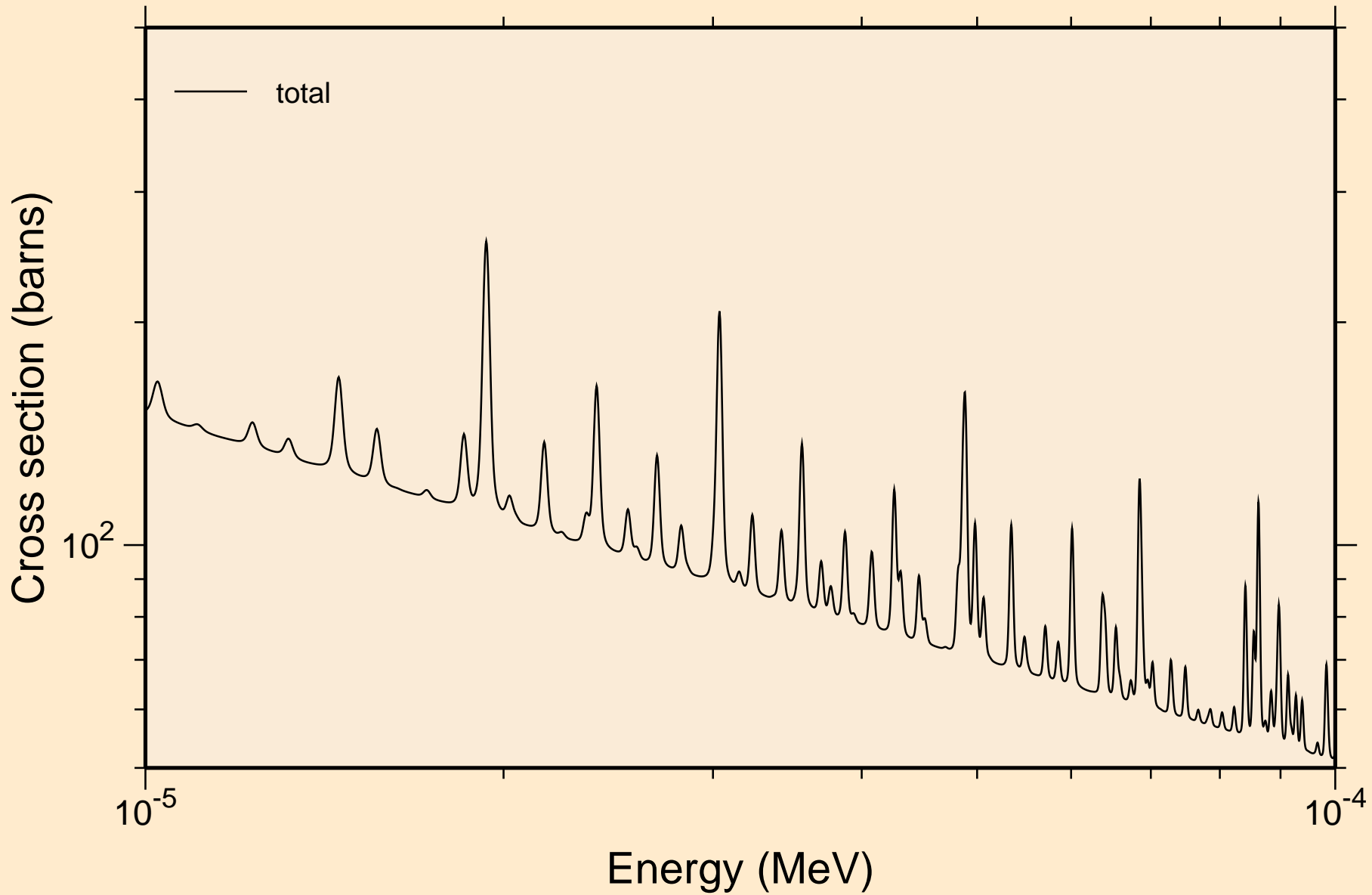

CS117 NRG TENDL-2015, AKONING  
resonance total cross section

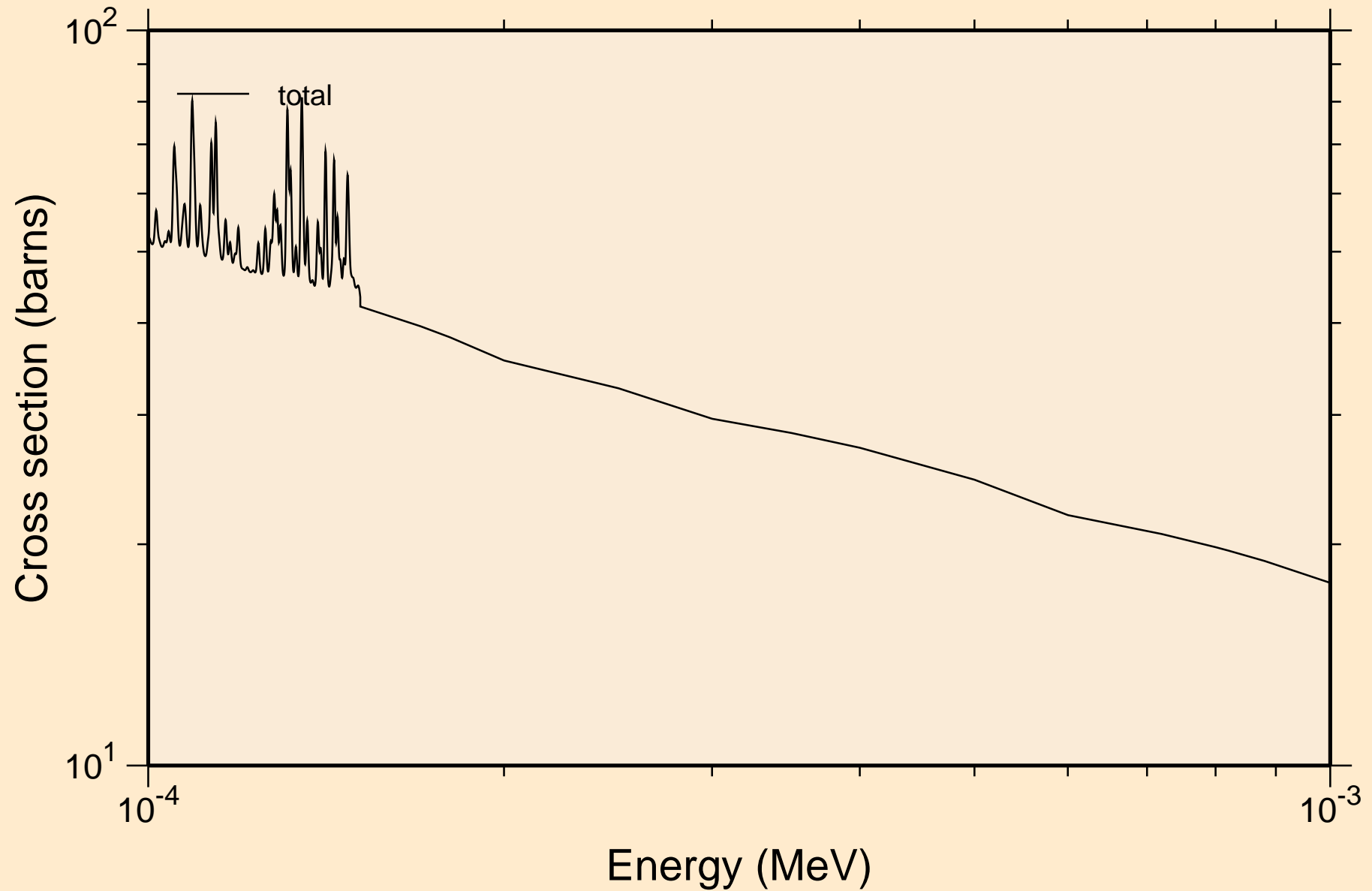

CS117 NRG TENDL-2015, AKONING  
resonance total cross section

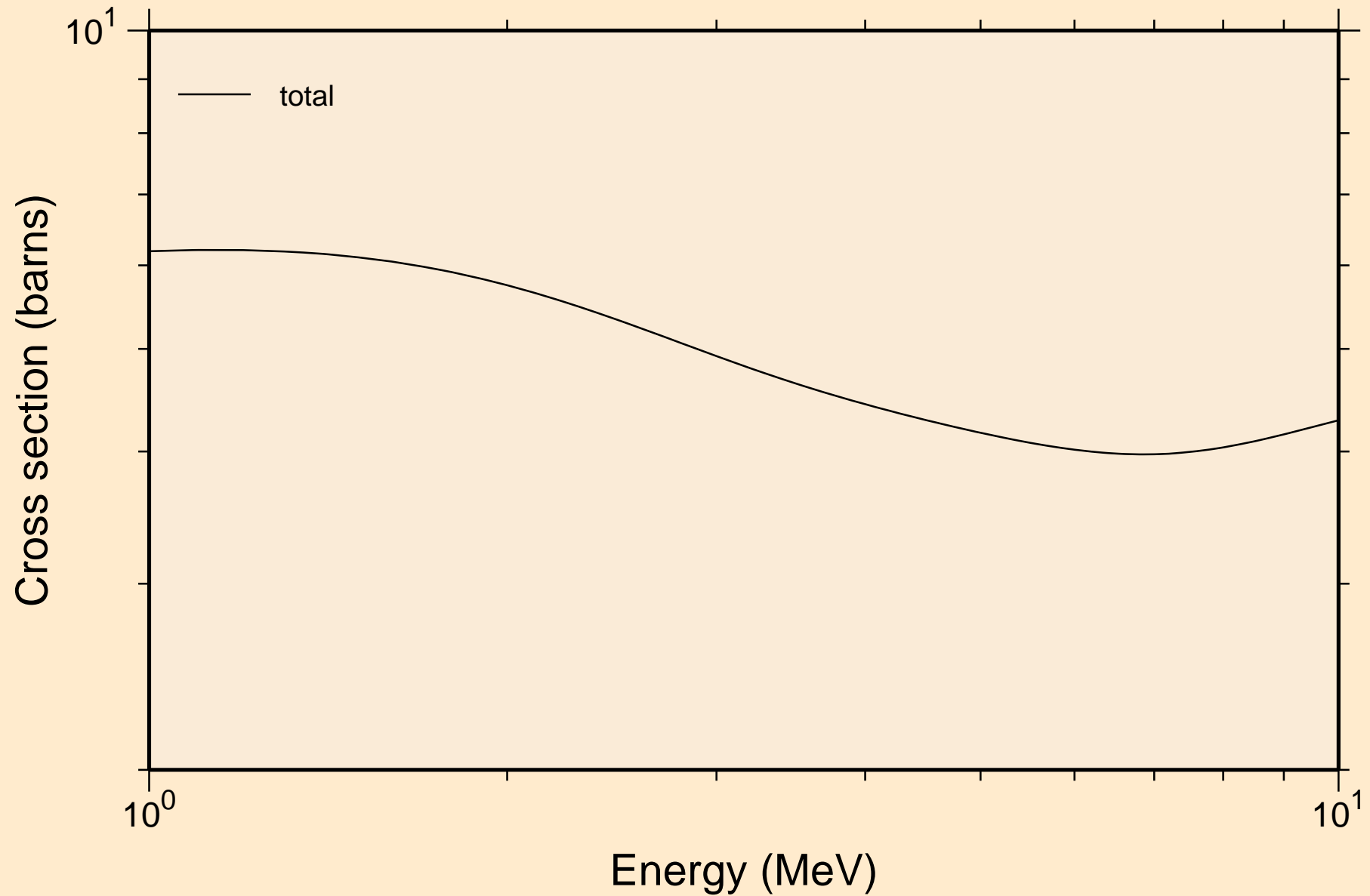

CS117 NRG TENDL-2015, AKONING  
resonance absorption cross sections

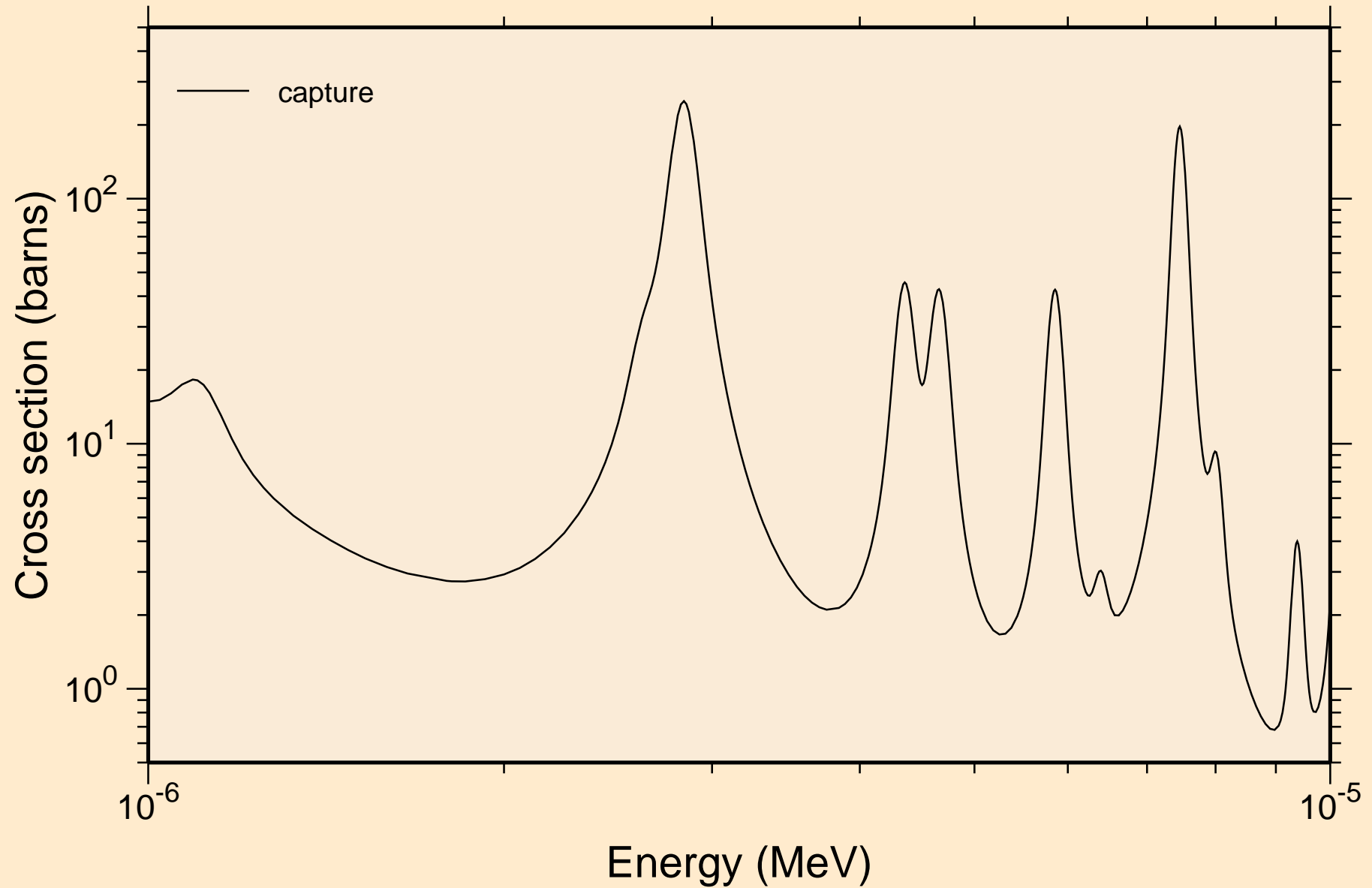

CS117 NRG TENDL-2015, AKONING  
resonance absorption cross sections

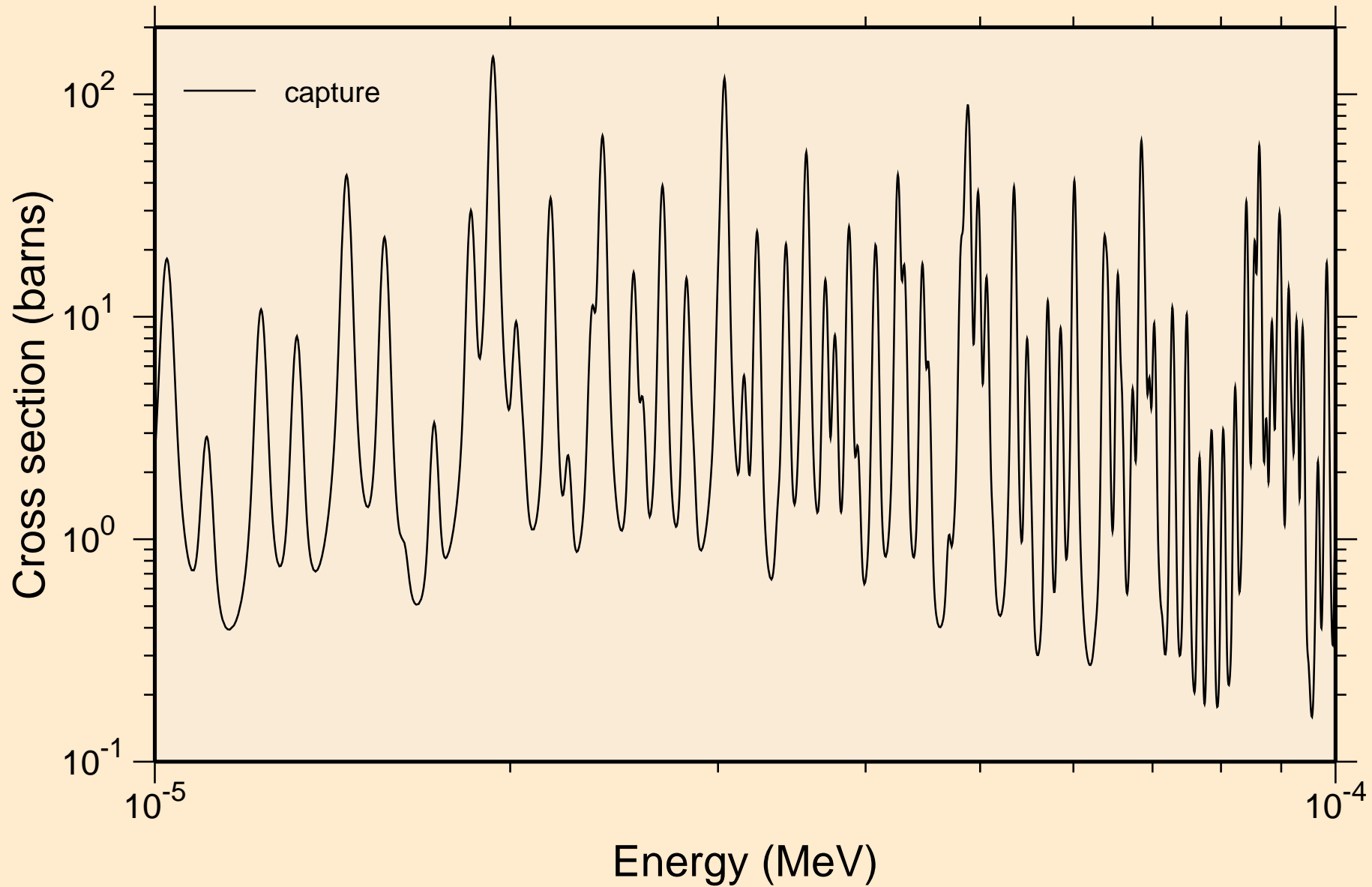

CS117 NRG TENDL-2015, AKONING  
resonance absorption cross sections

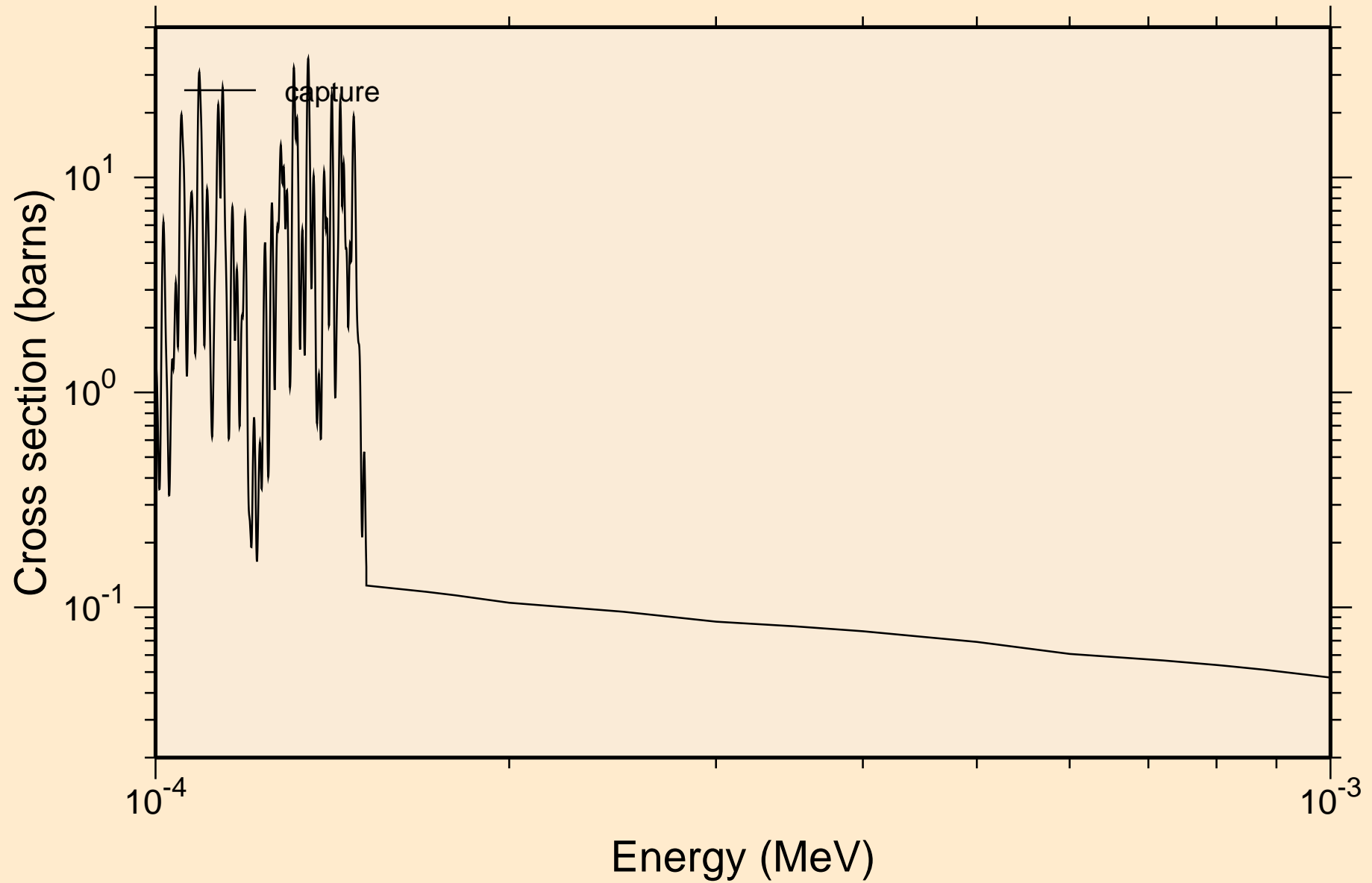



CS117 NRG TENDL-2015, AKONING  
resonance absorption cross sections

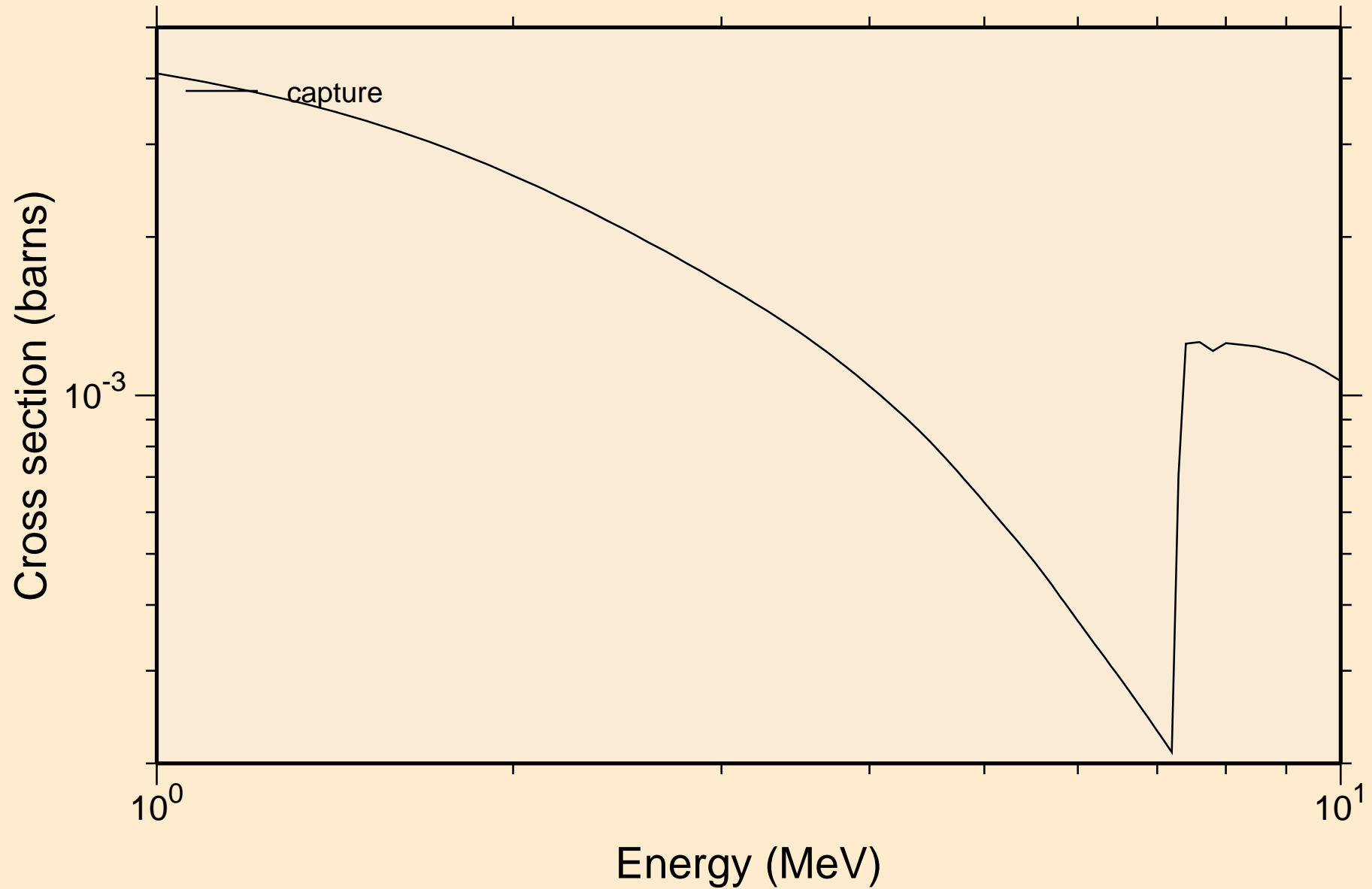

# CS117 NRG TENDL-2015, AKONING

## Non-threshold reactions

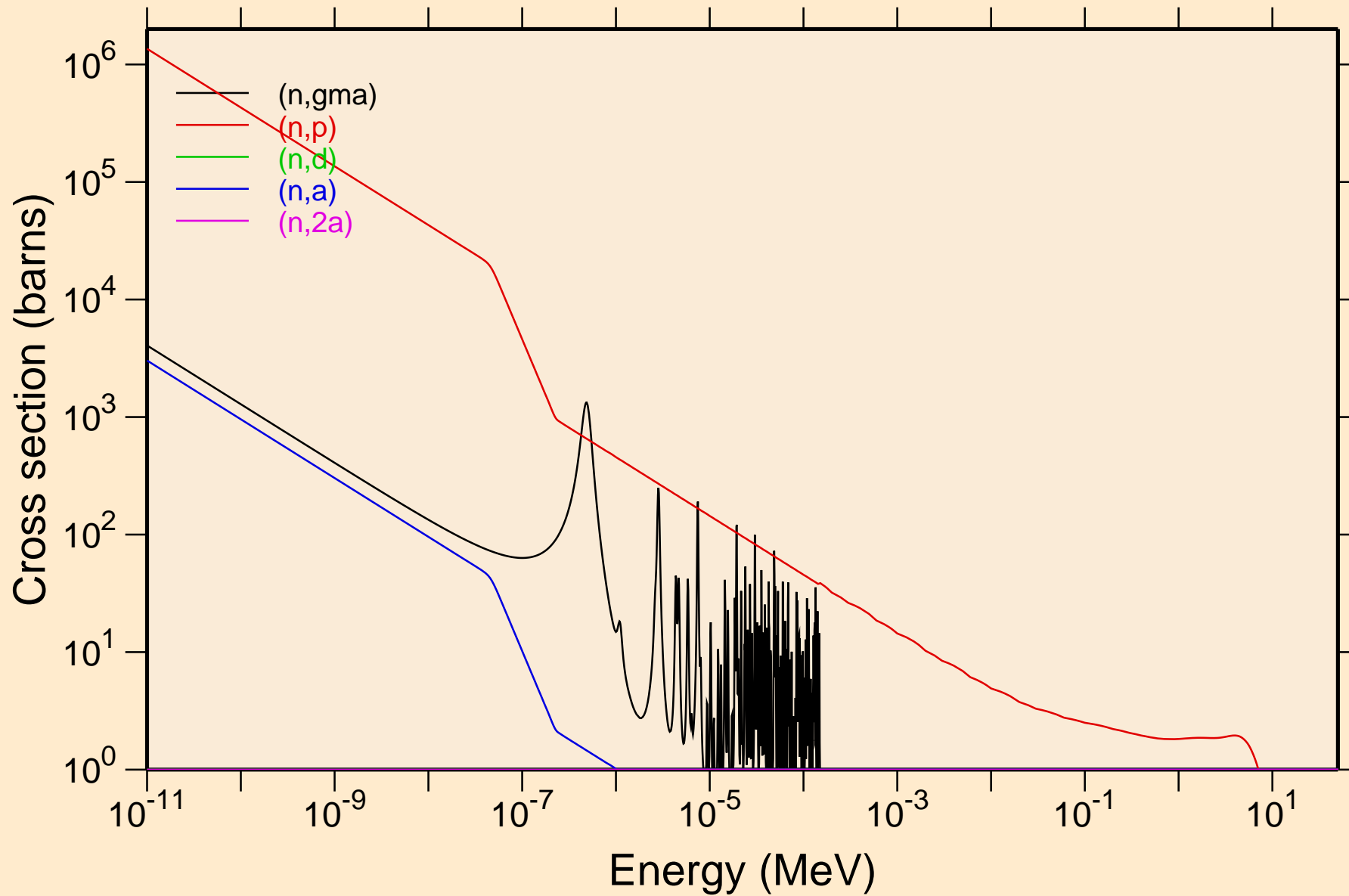

# CS117 NRG TENDL-2015, AKONING

## Non-threshold reactions

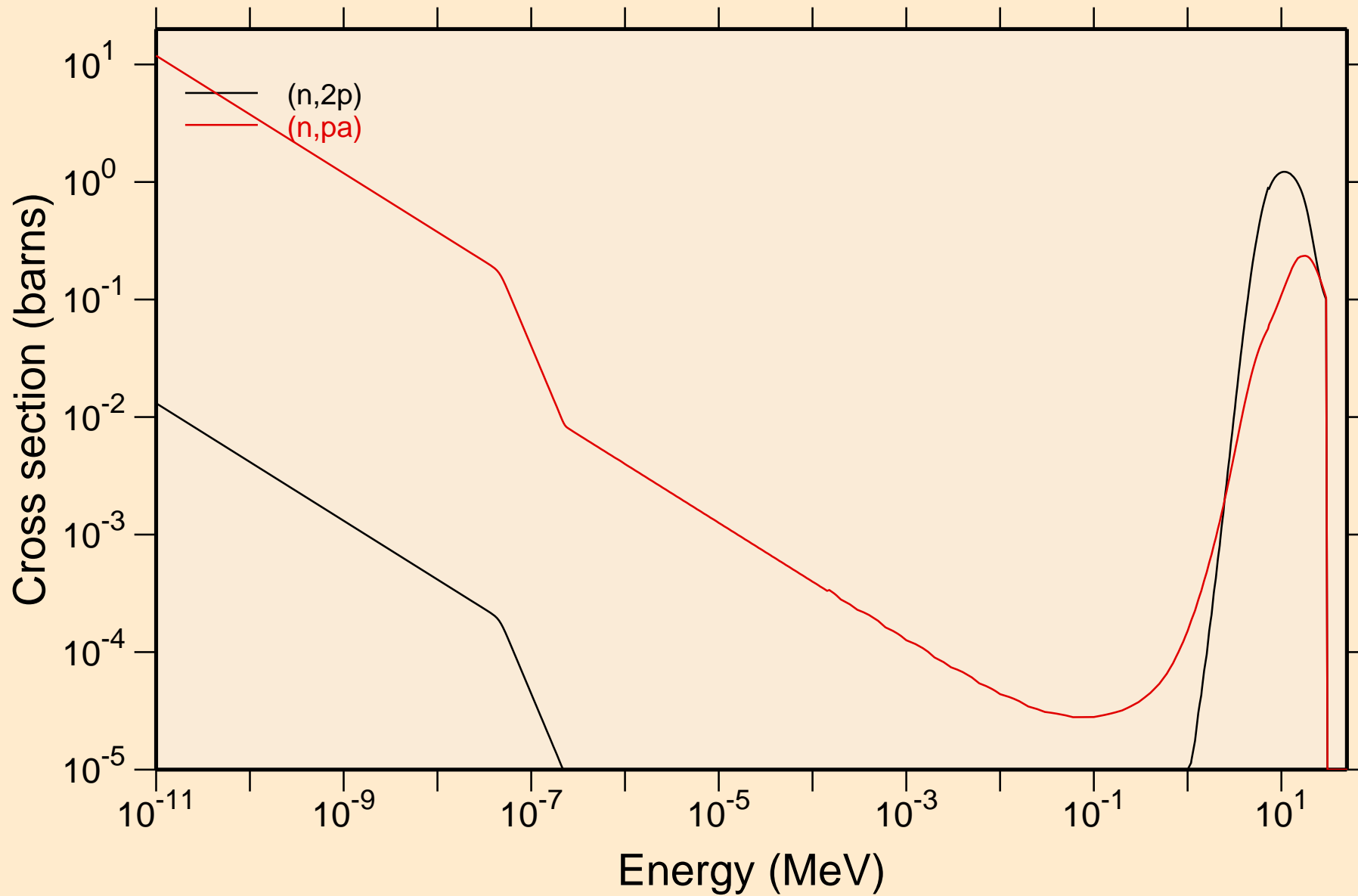

# CS117 NRG TENDL-2015, AKONING

## Principal cross sections

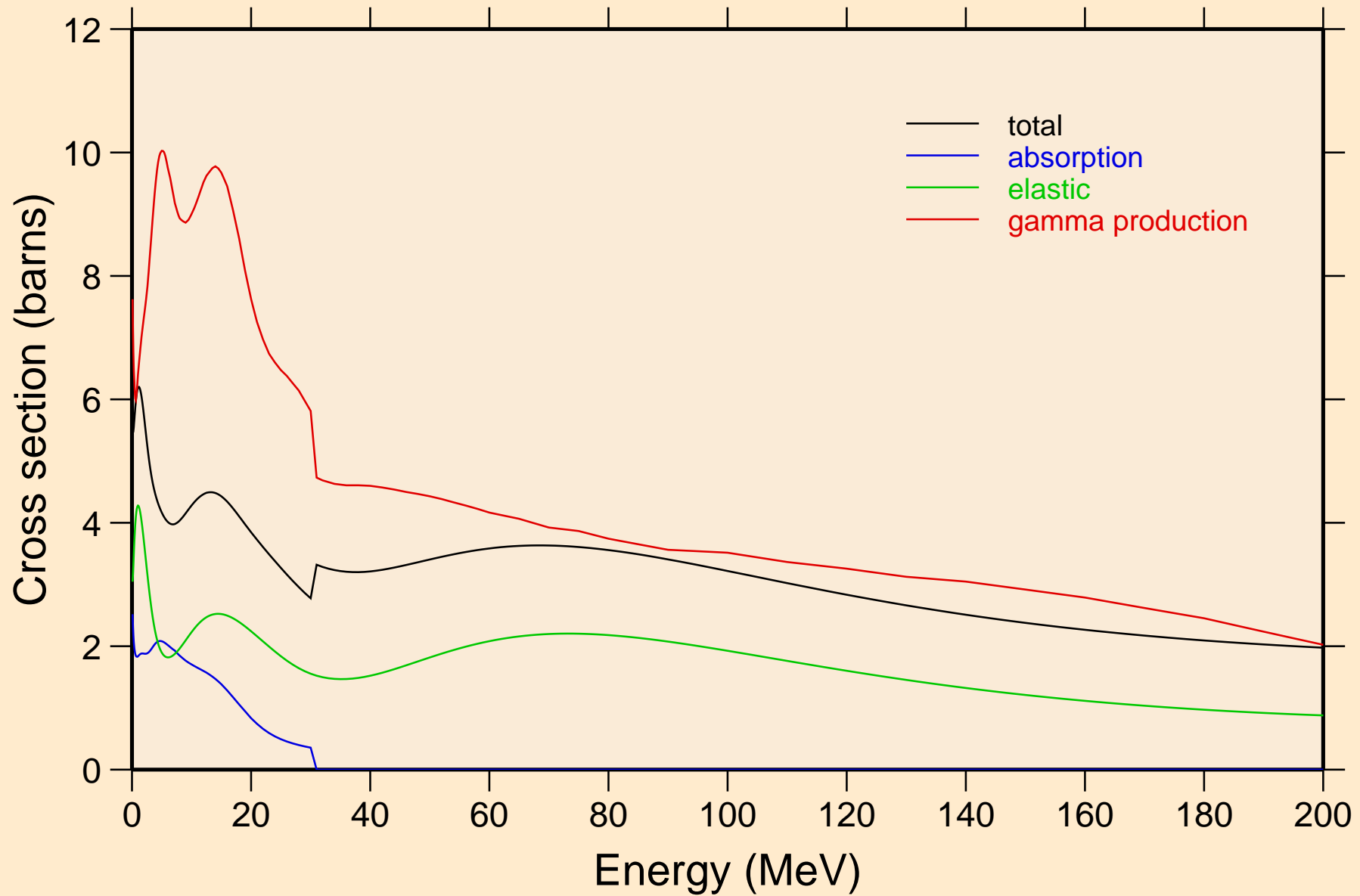

# CS117 NRG TENDL-2015, AKONING

## Non-threshold reactions

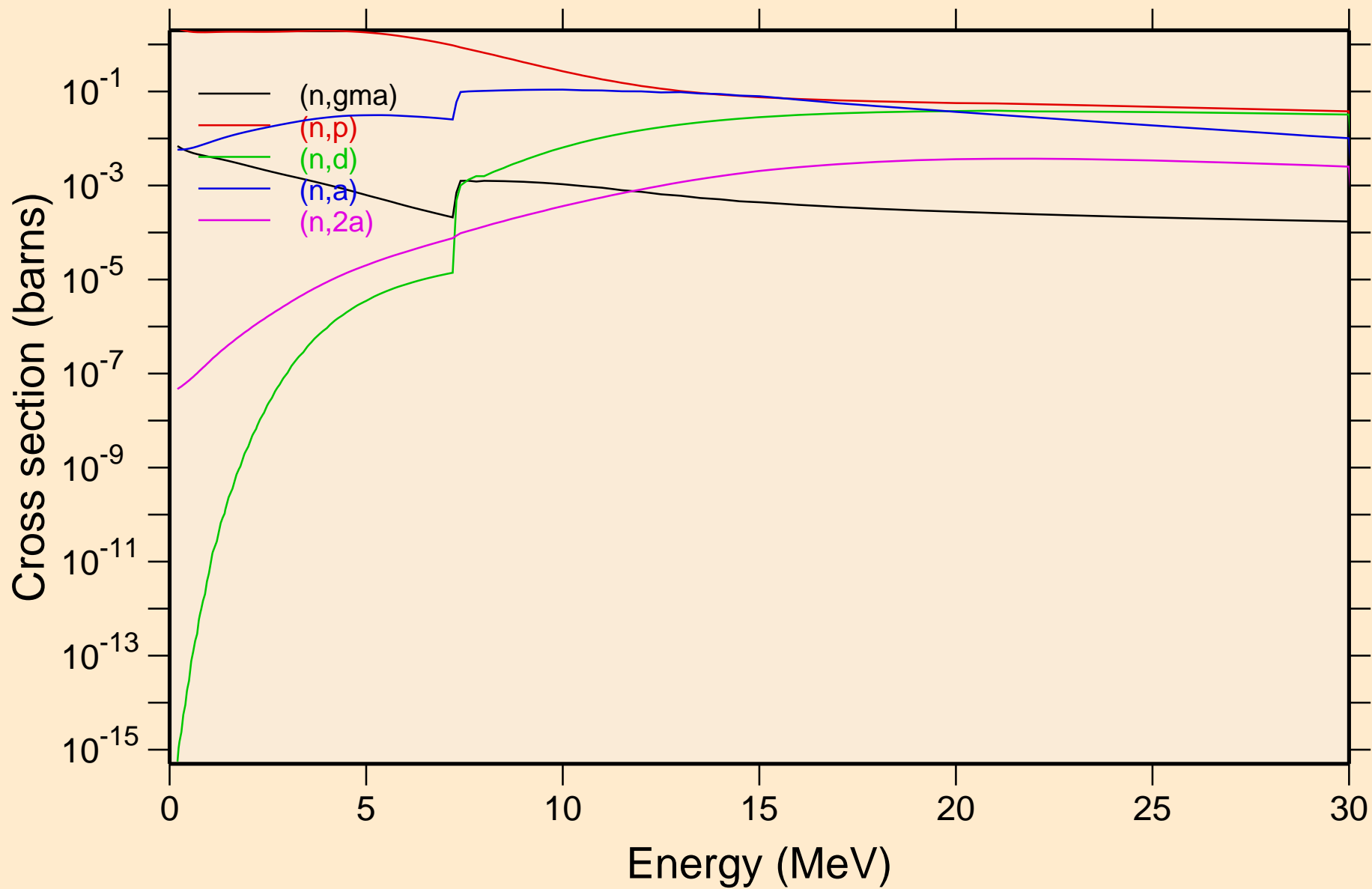

# CS117 NRG TENDL-2015, AKONING

## Non-threshold reactions

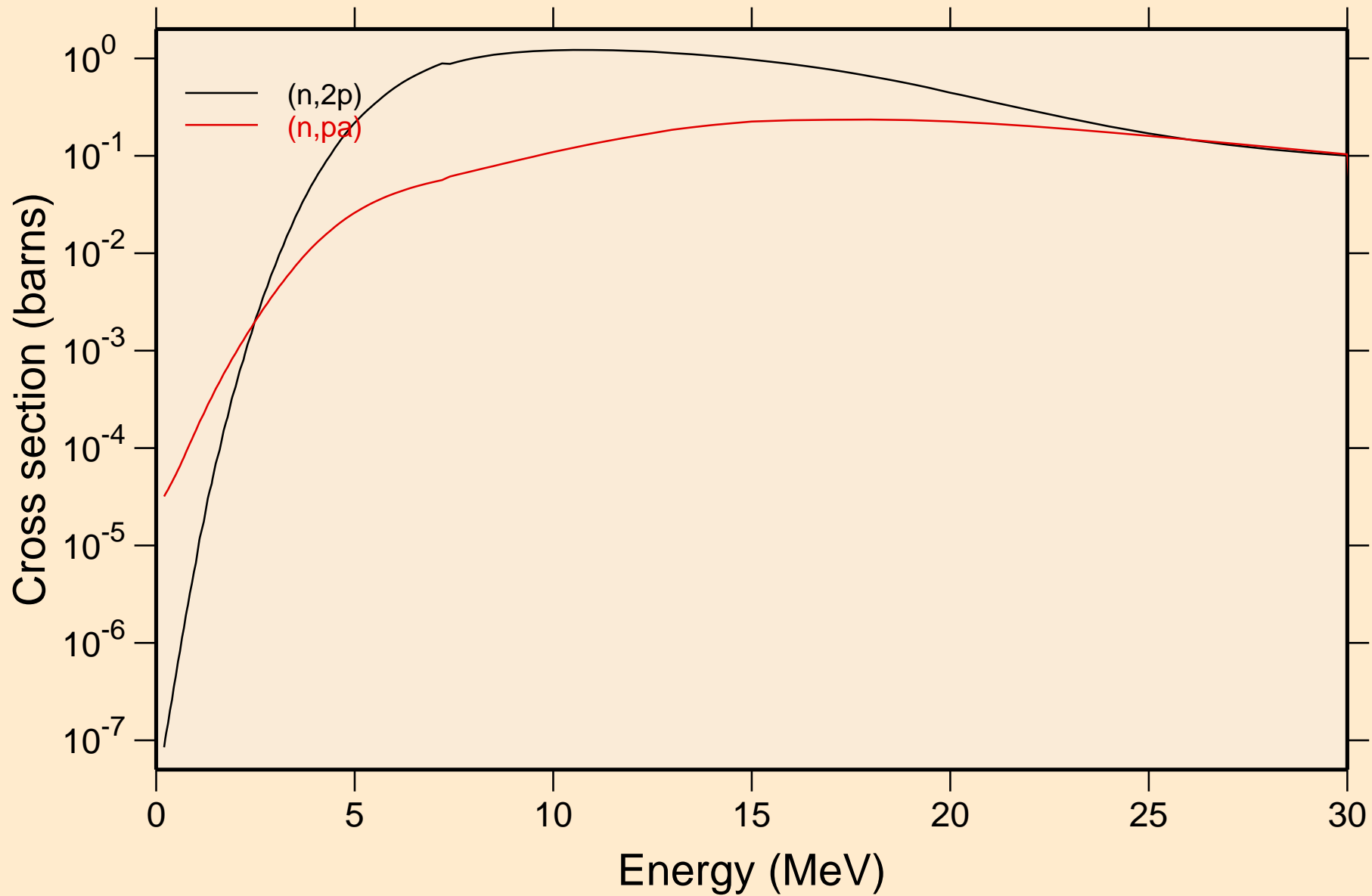

# CS117 NRG TENDL-2015, AKONING

## Inelastic levels

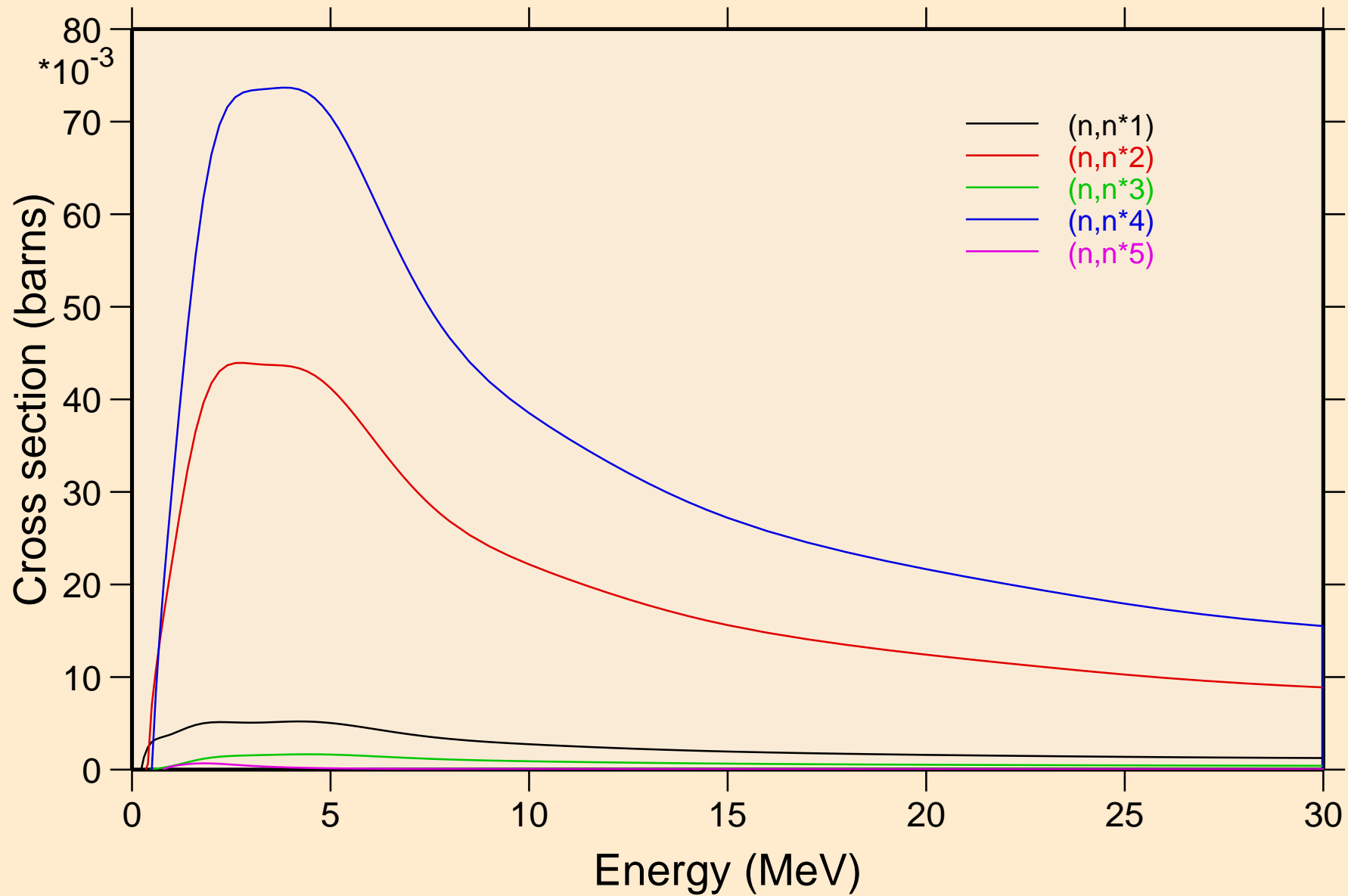

# CS117 NRG TENDL-2015, AKONING

## Inelastic levels

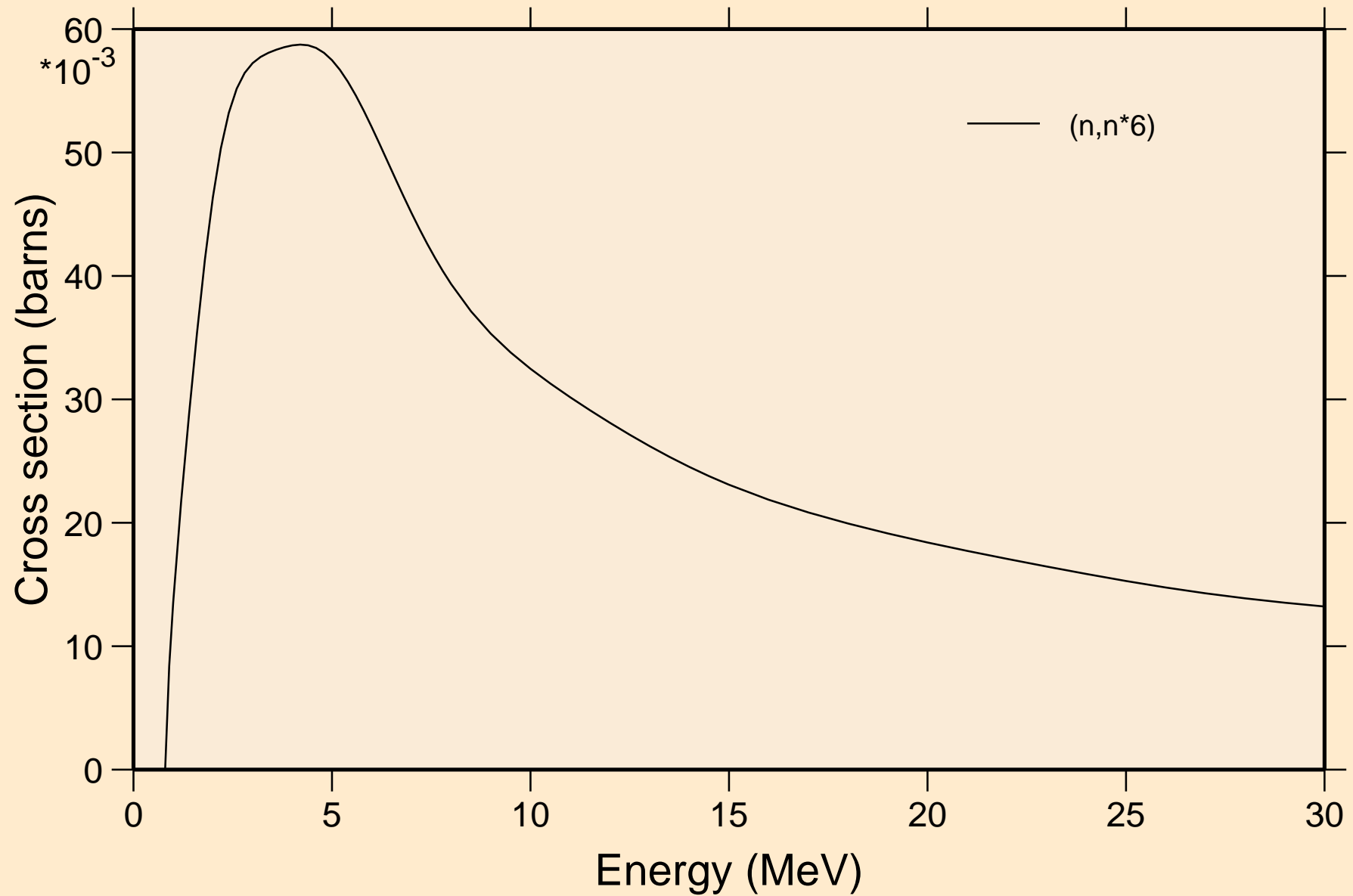



# CS117 NRG TENDL-2015, AKONING

## Threshold reactions

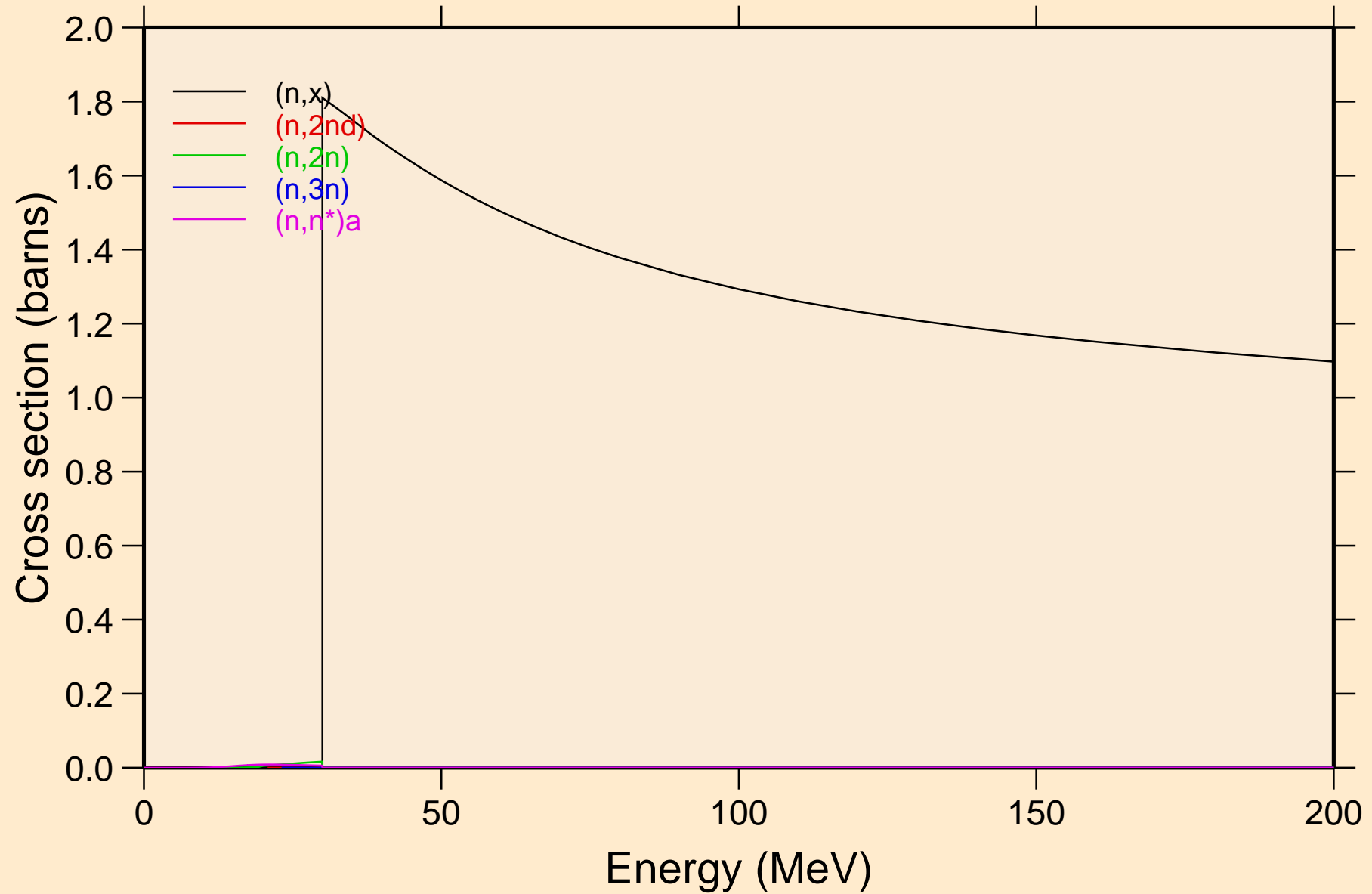

# CS117 NRG TENDL-2015, AKONING

## Threshold reactions

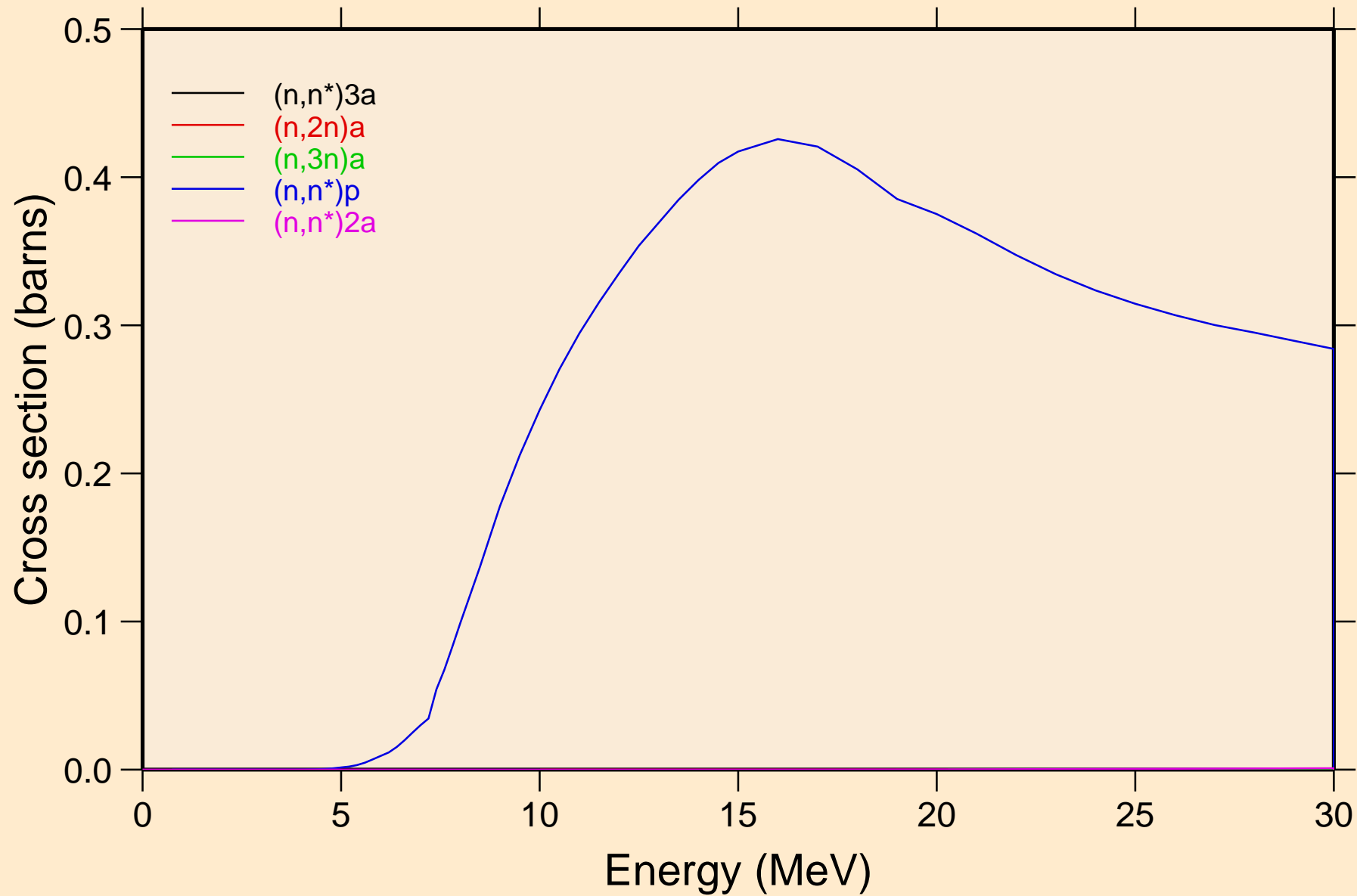

# CS117 NRG TENDL-2015, AKONING

## Threshold reactions

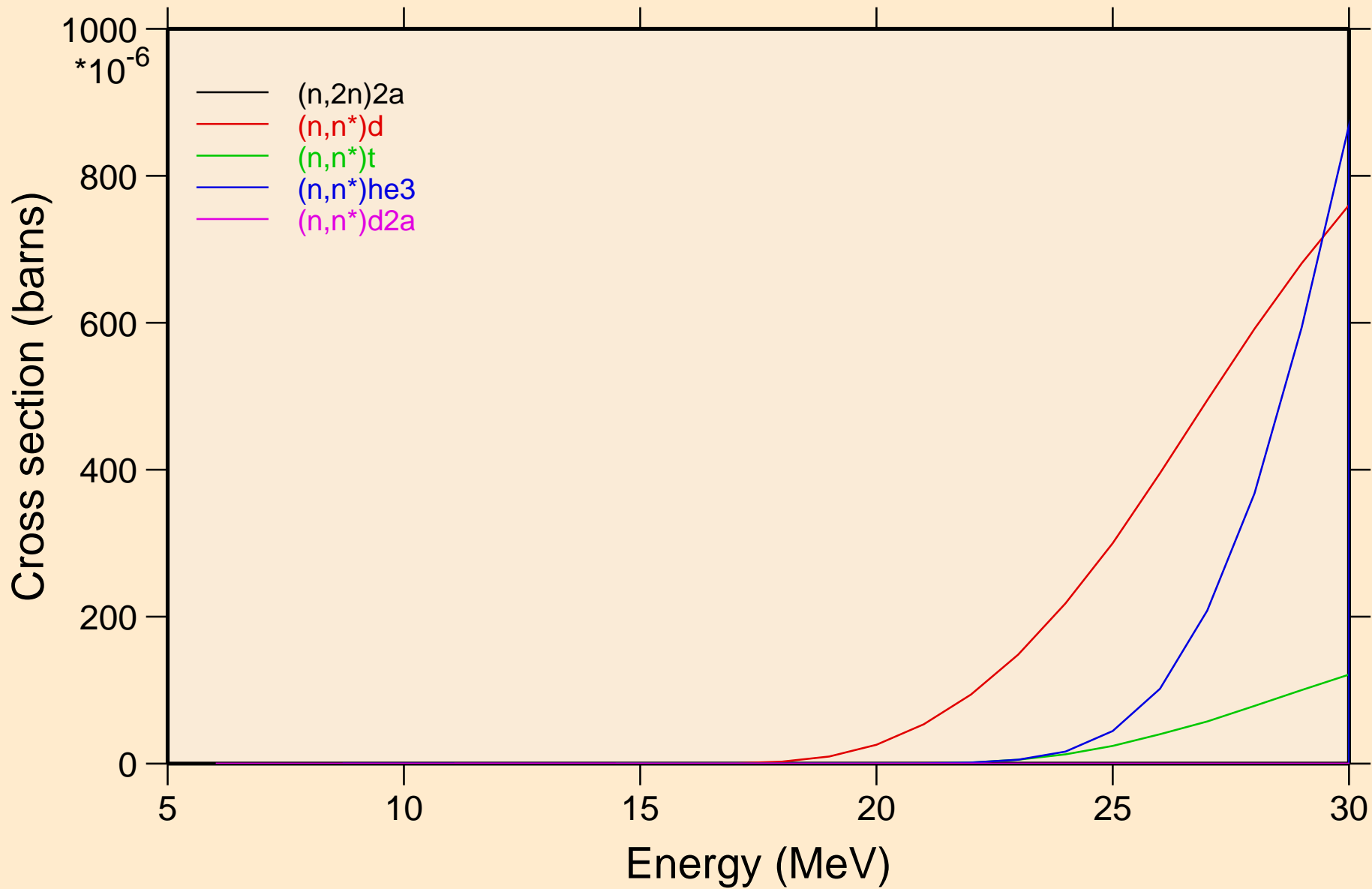

# CS117 NRG TENDL-2015, AKONING

## Threshold reactions

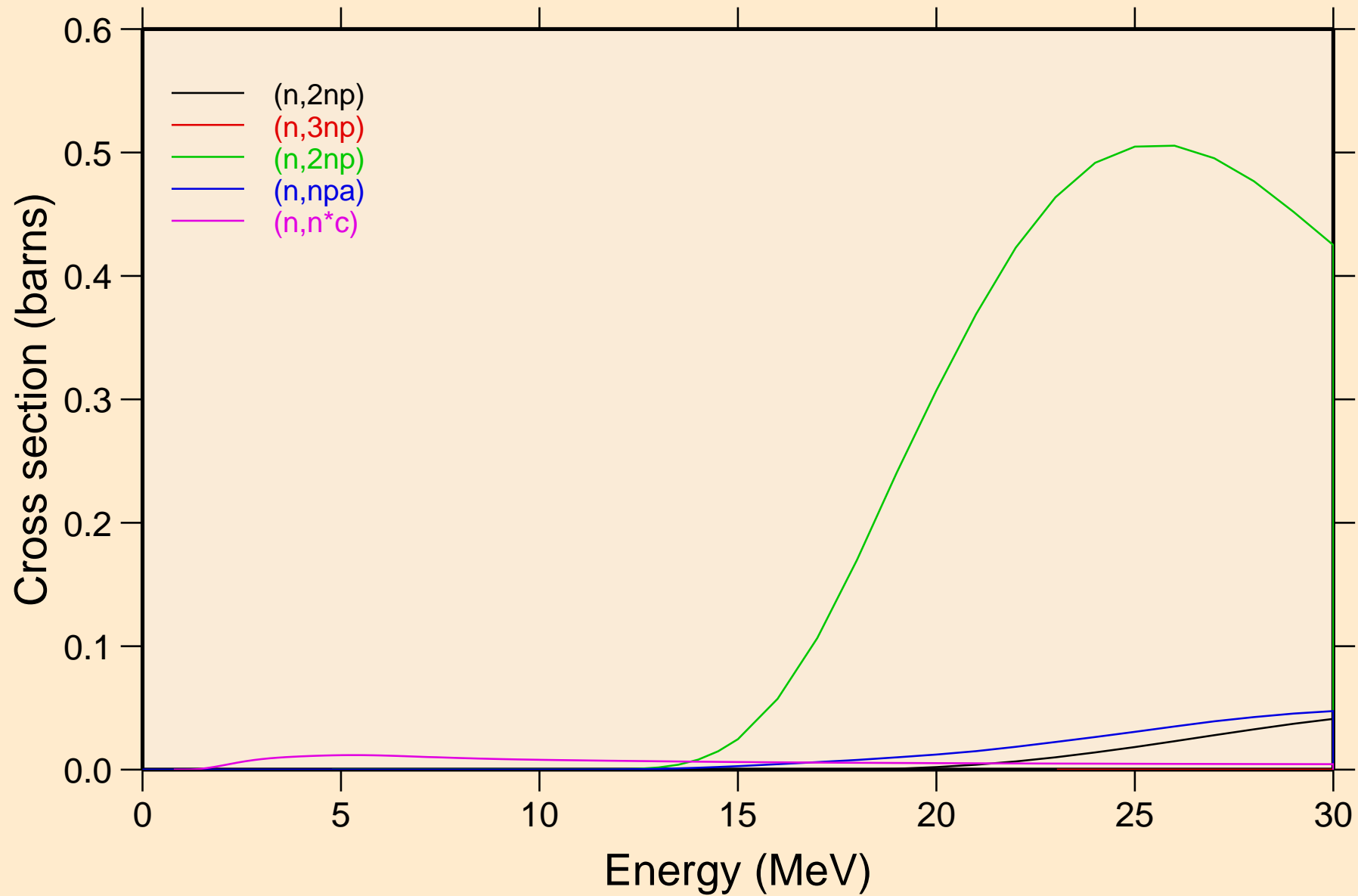

# CS117 NRG TENDL-2015, AKONING

## Threshold reactions

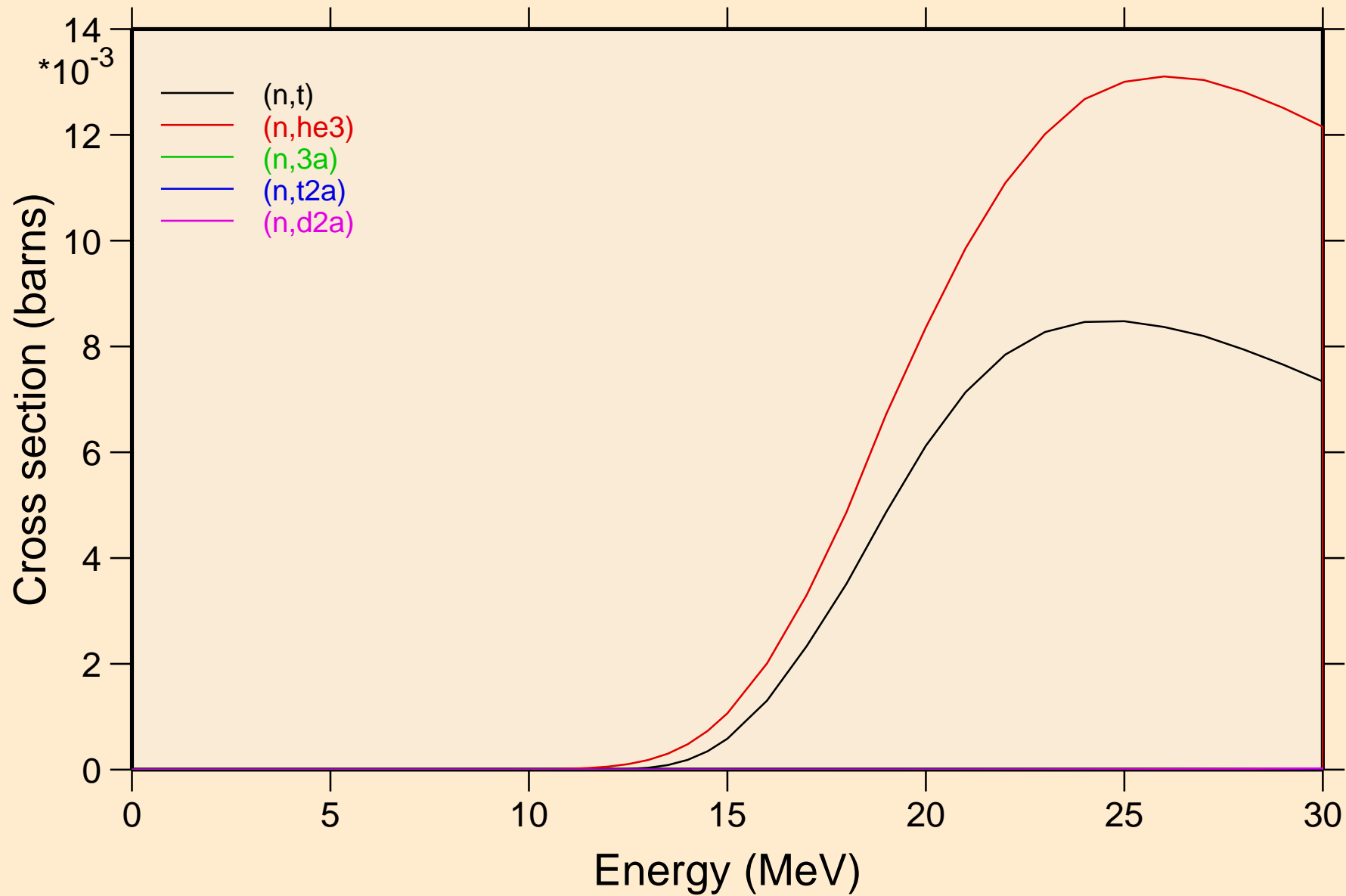

# CS117 NRG TENDL-2015, AKONING

## Threshold reactions

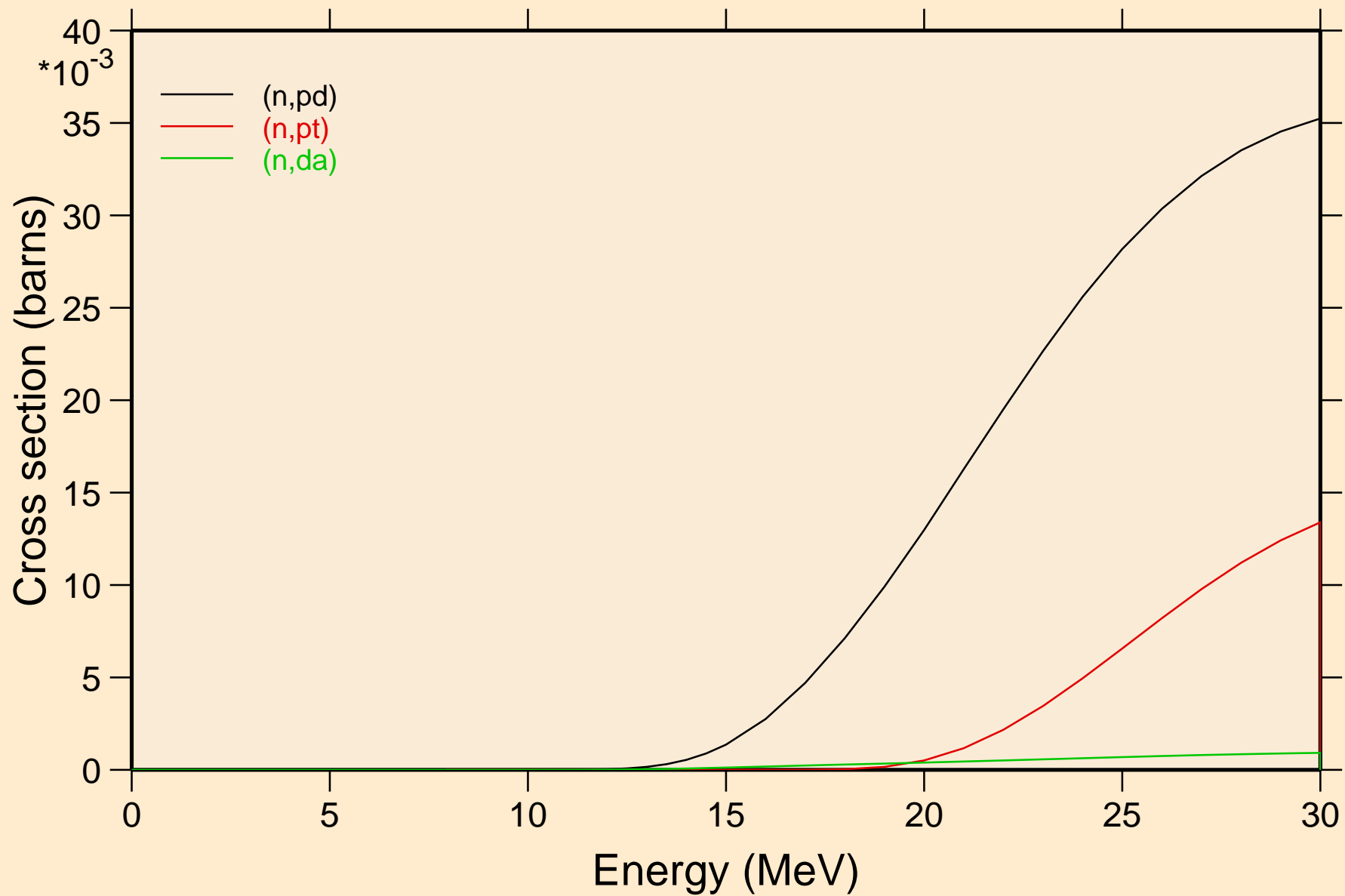

CS117 NRG TENDL-2015, AKONING  
angular distribution for elastic

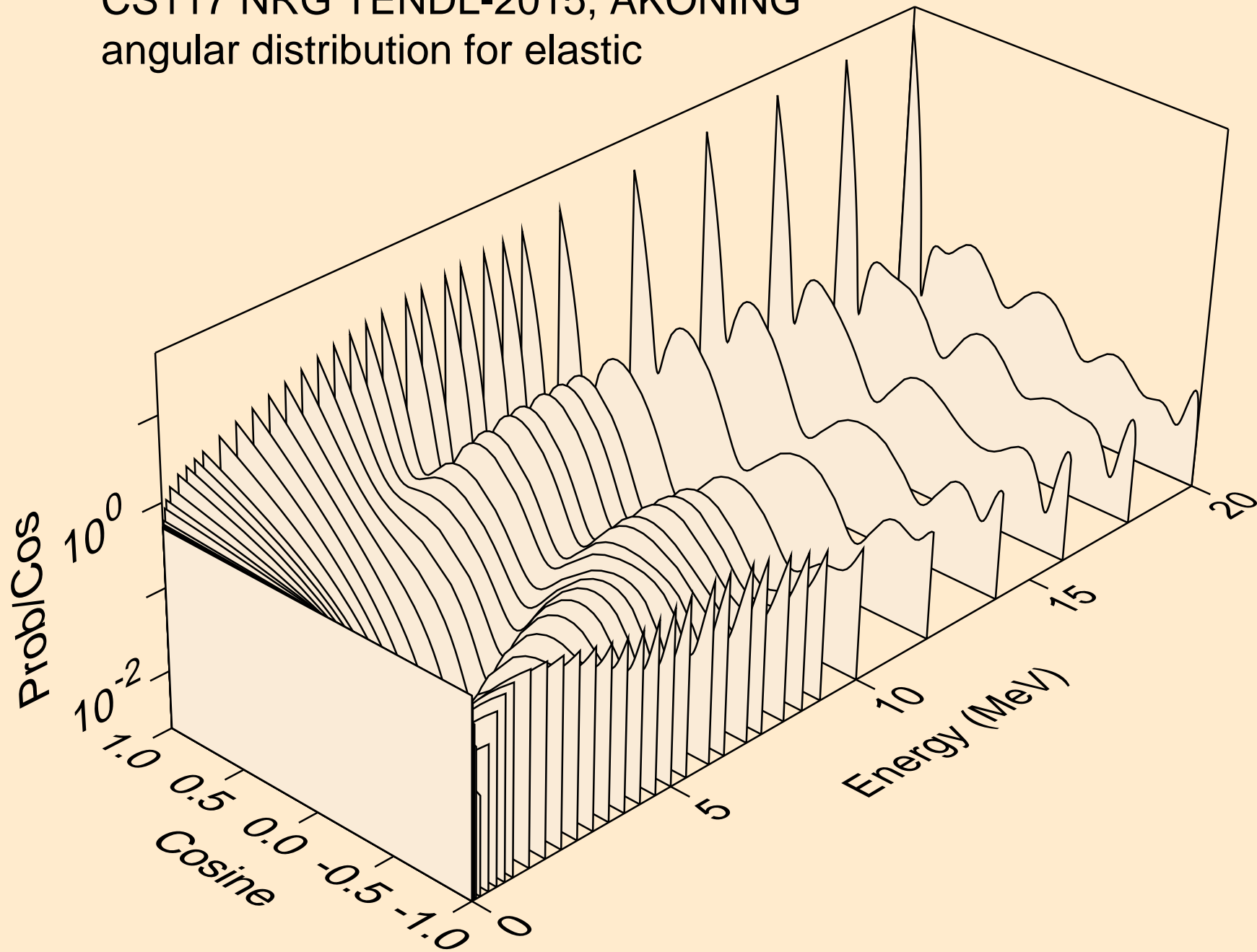

CS117 NRG TENDL-2015, AKONING  
angular distribution for elastic

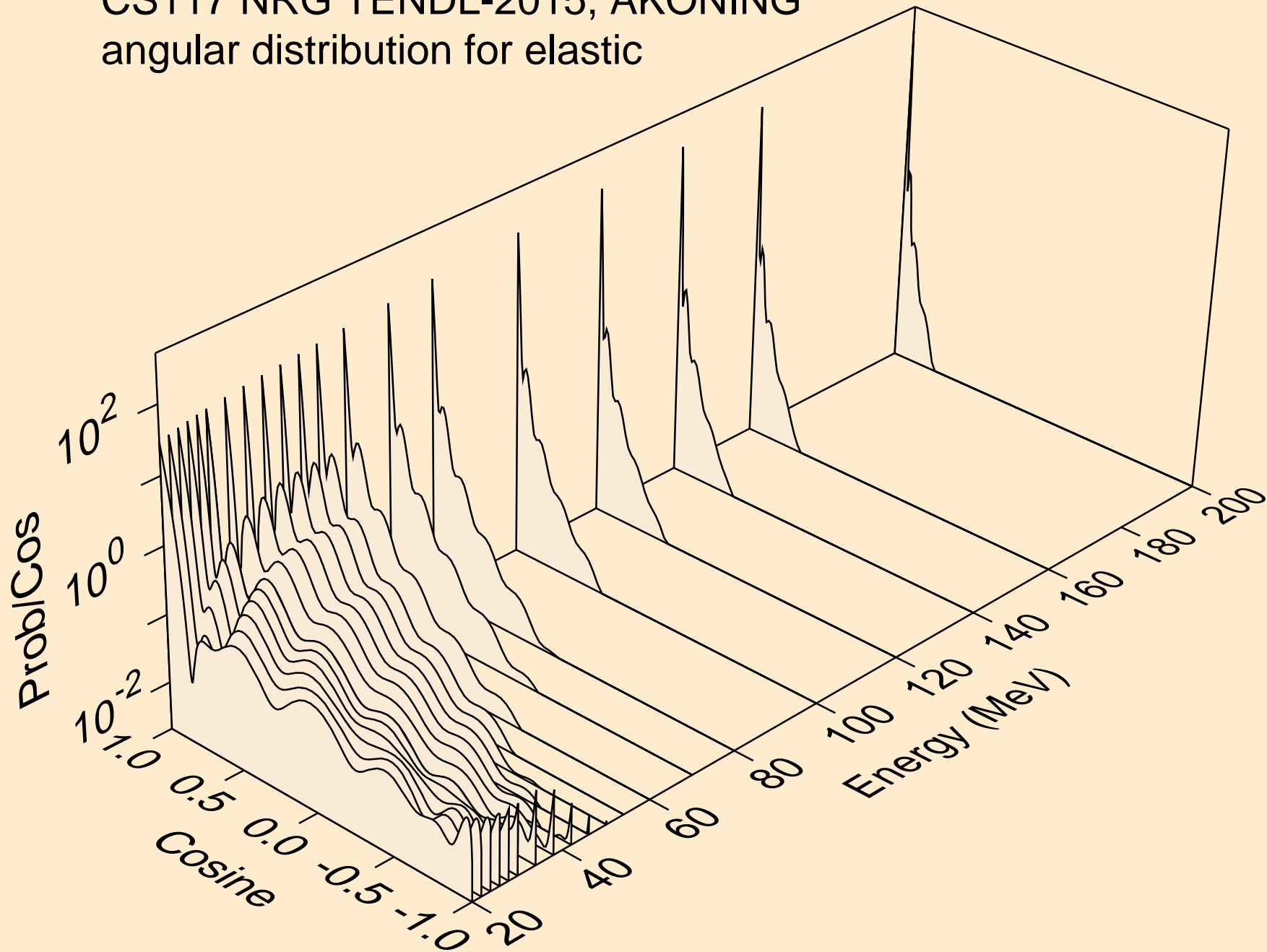



CS117 NRG TENDL-2015, AKONING  
angular distribution for (n,n\*1)

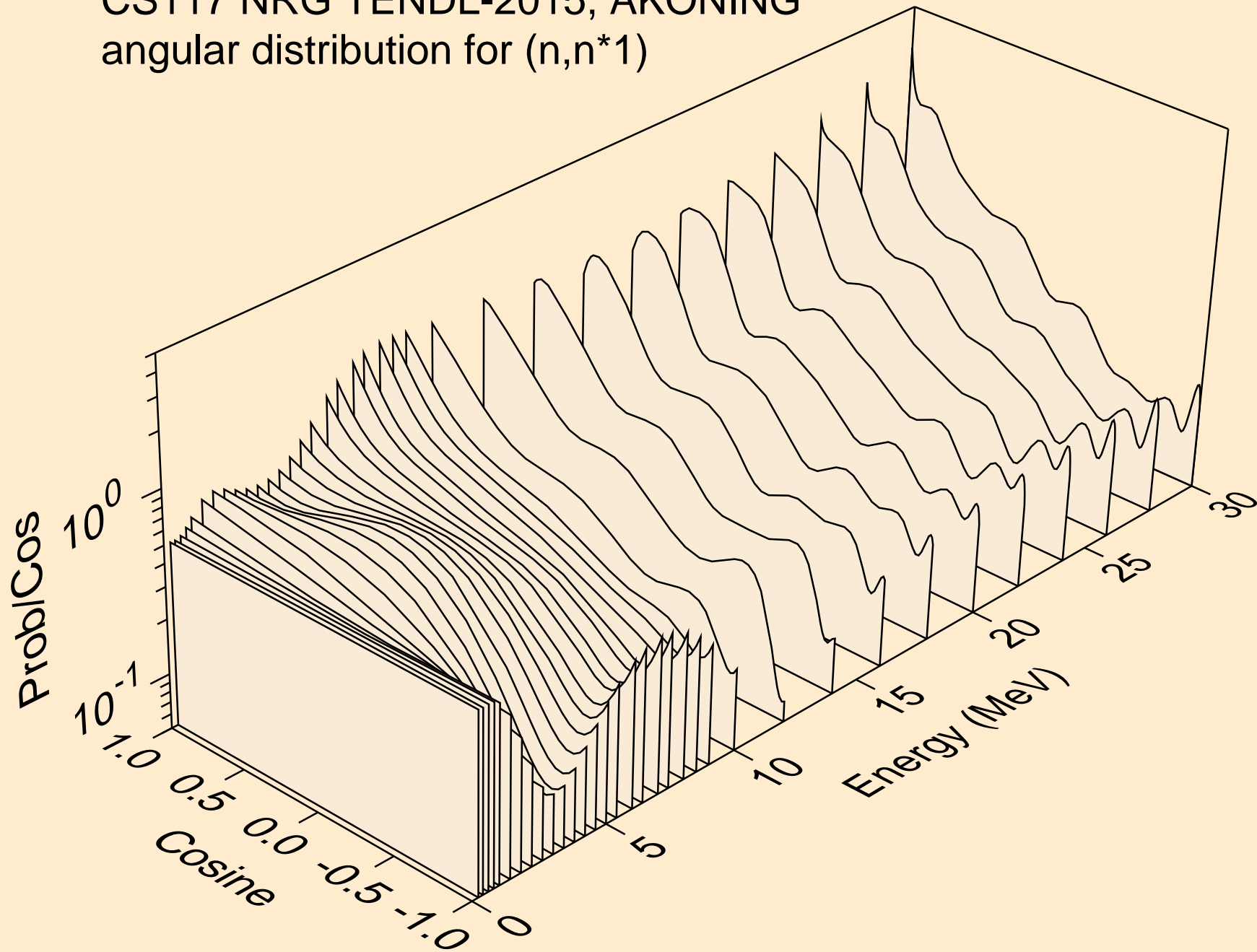

CS117 NRG TENDL-2015, AKONING  
angular distribution for (n,n\*2)

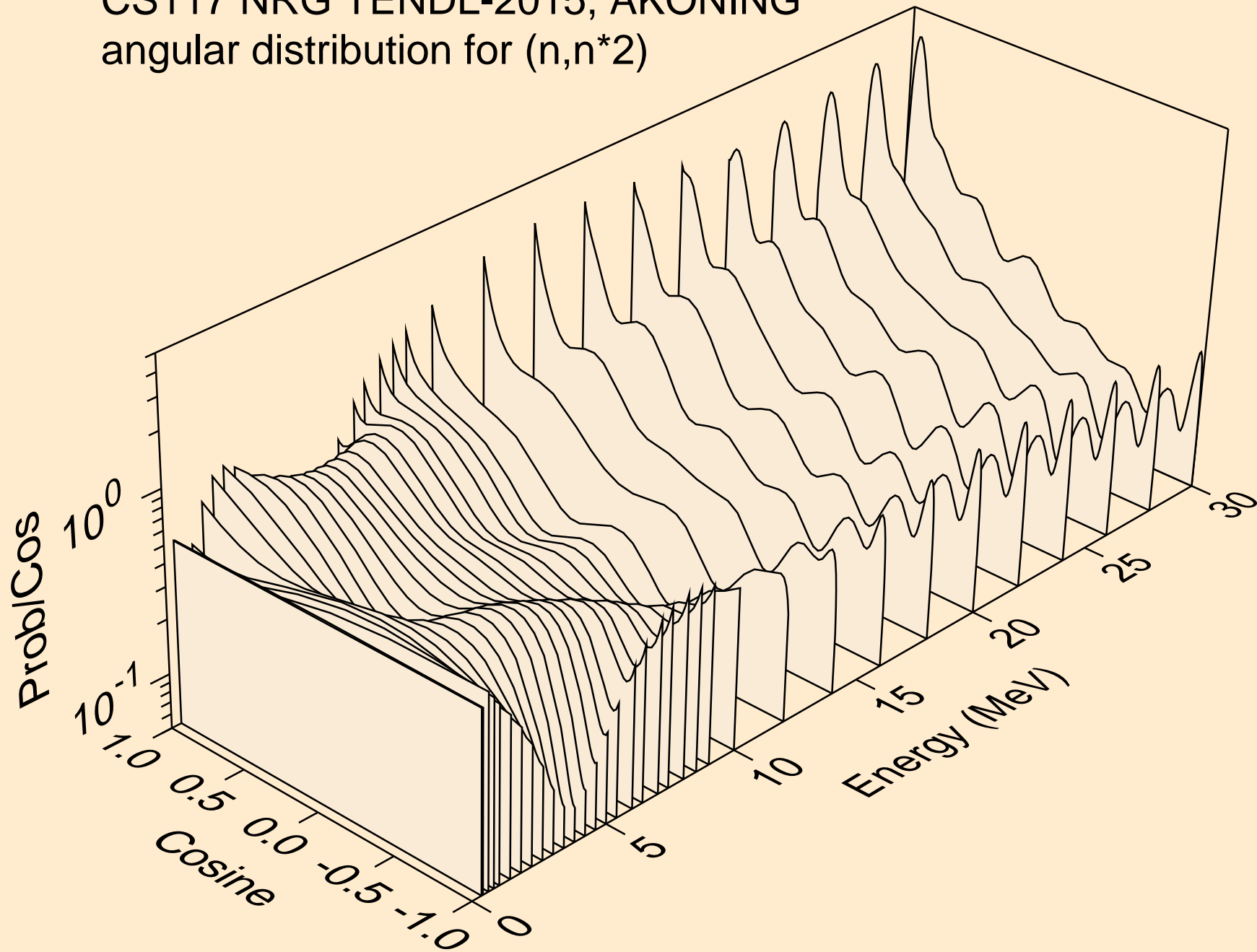

CS117 NRG TENDL-2015, AKONING  
angular distribution for (n,n\*3)

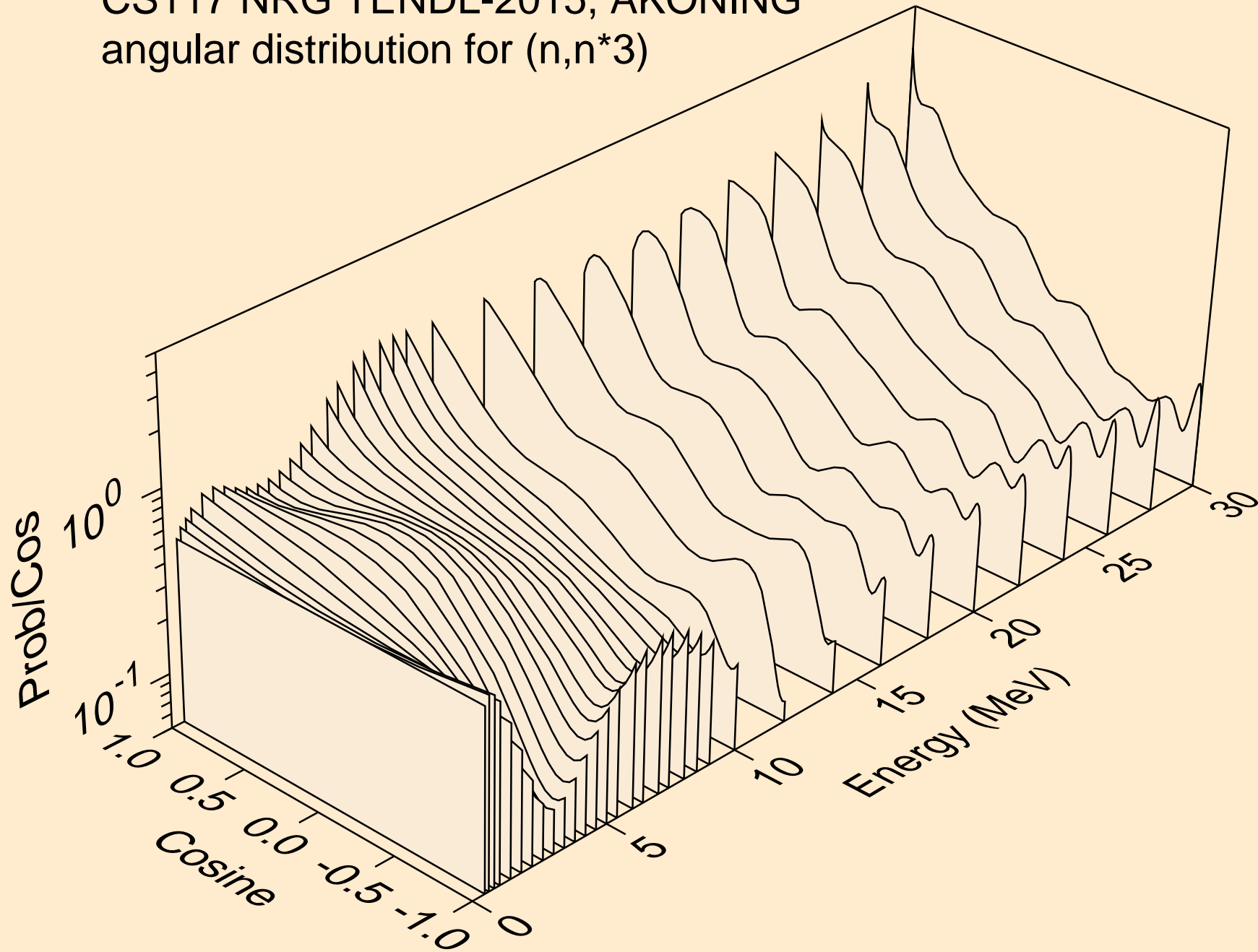

CS117 NRG TENDL-2015, AKONING  
angular distribution for (n,n\*4)

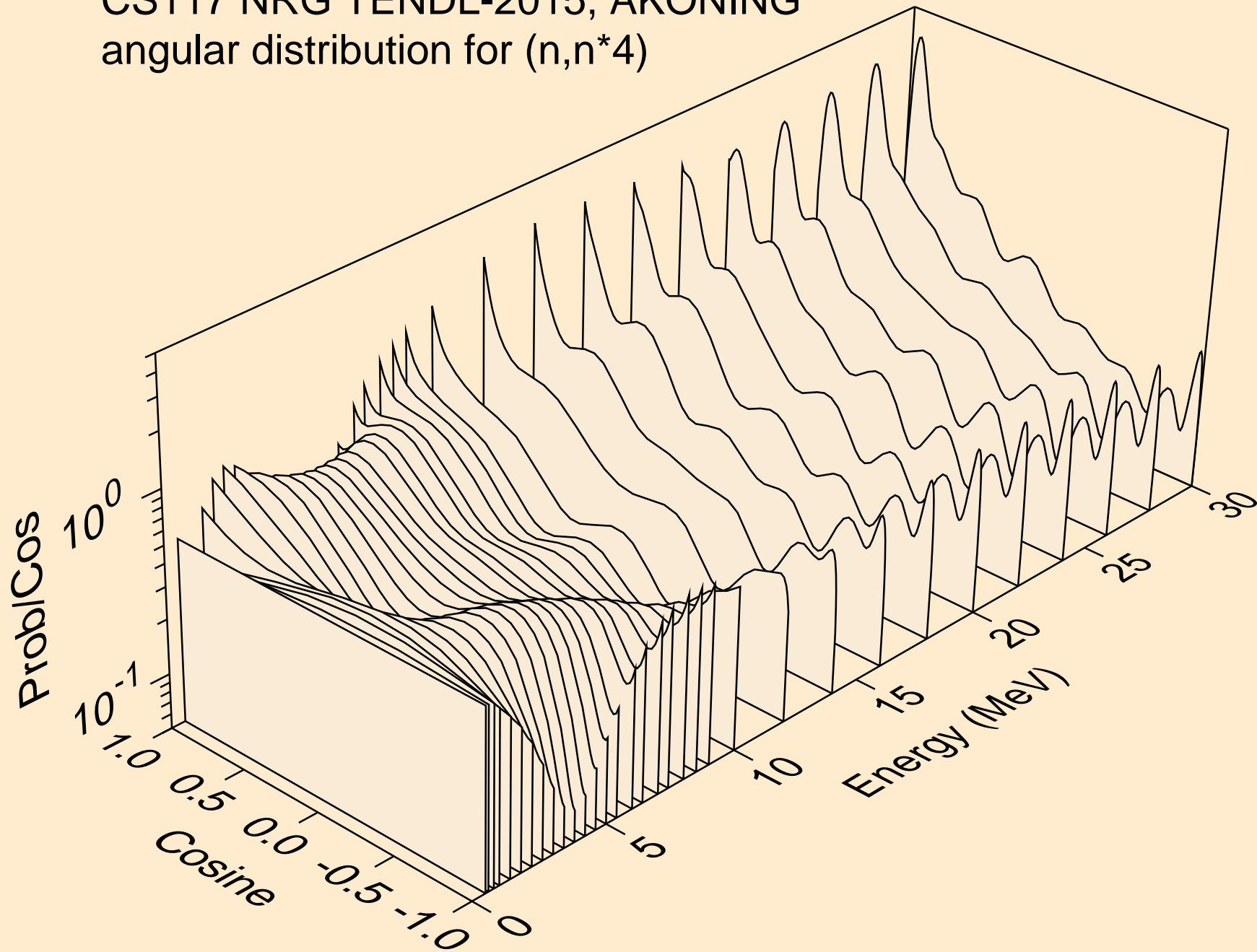

CS117 NRG TENDL-2015, AKONING  
angular distribution for (n,n\*5)

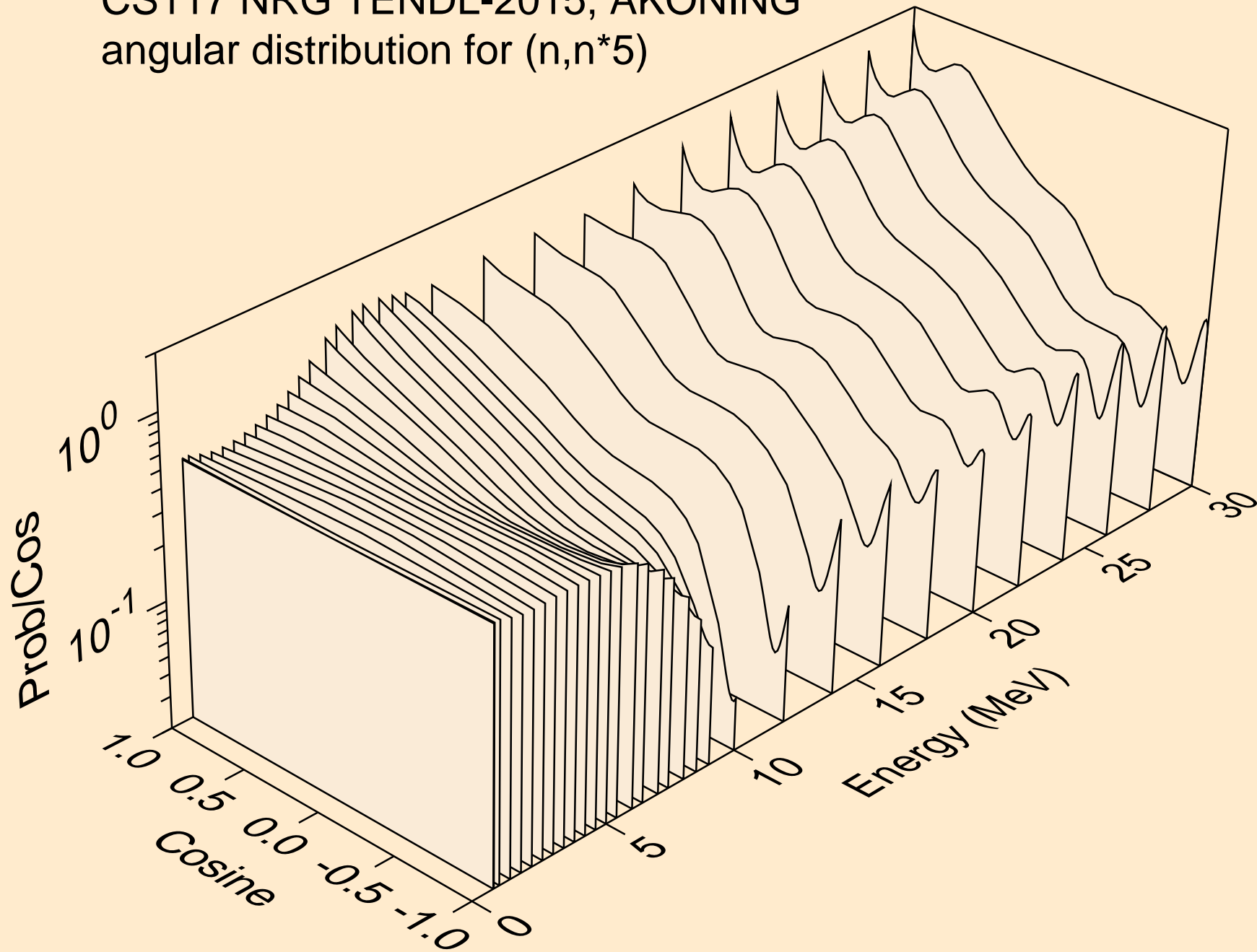

CS117 NRG TENDL-2015, AKONING  
angular distribution for (n,n\*6)

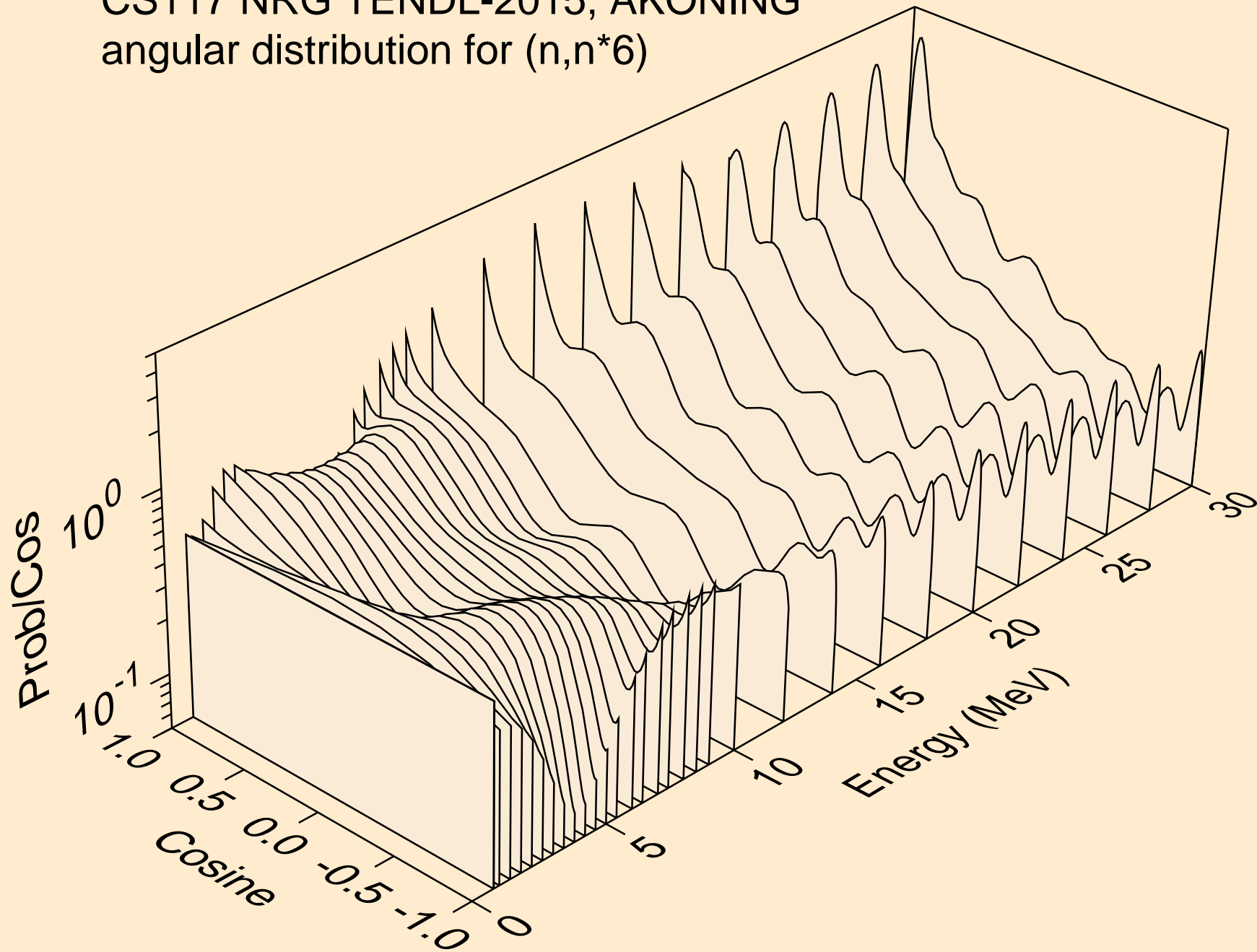

CS117 NRG TENDL-2015, AKONING  
Neutron emission for (n,x)

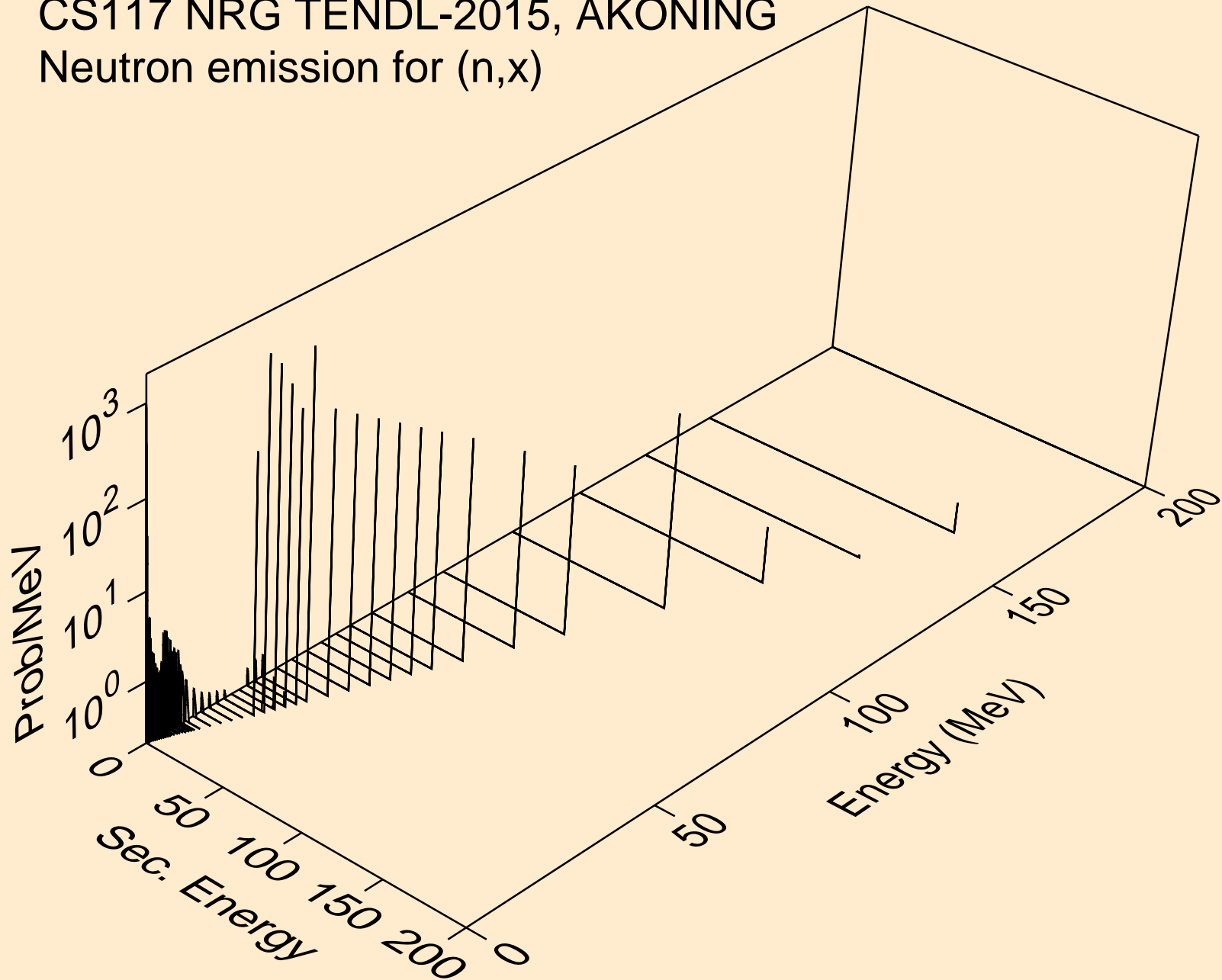

CS117 NRG TENDL-2015, AKONING  
Neutron emission for (n,2nd)

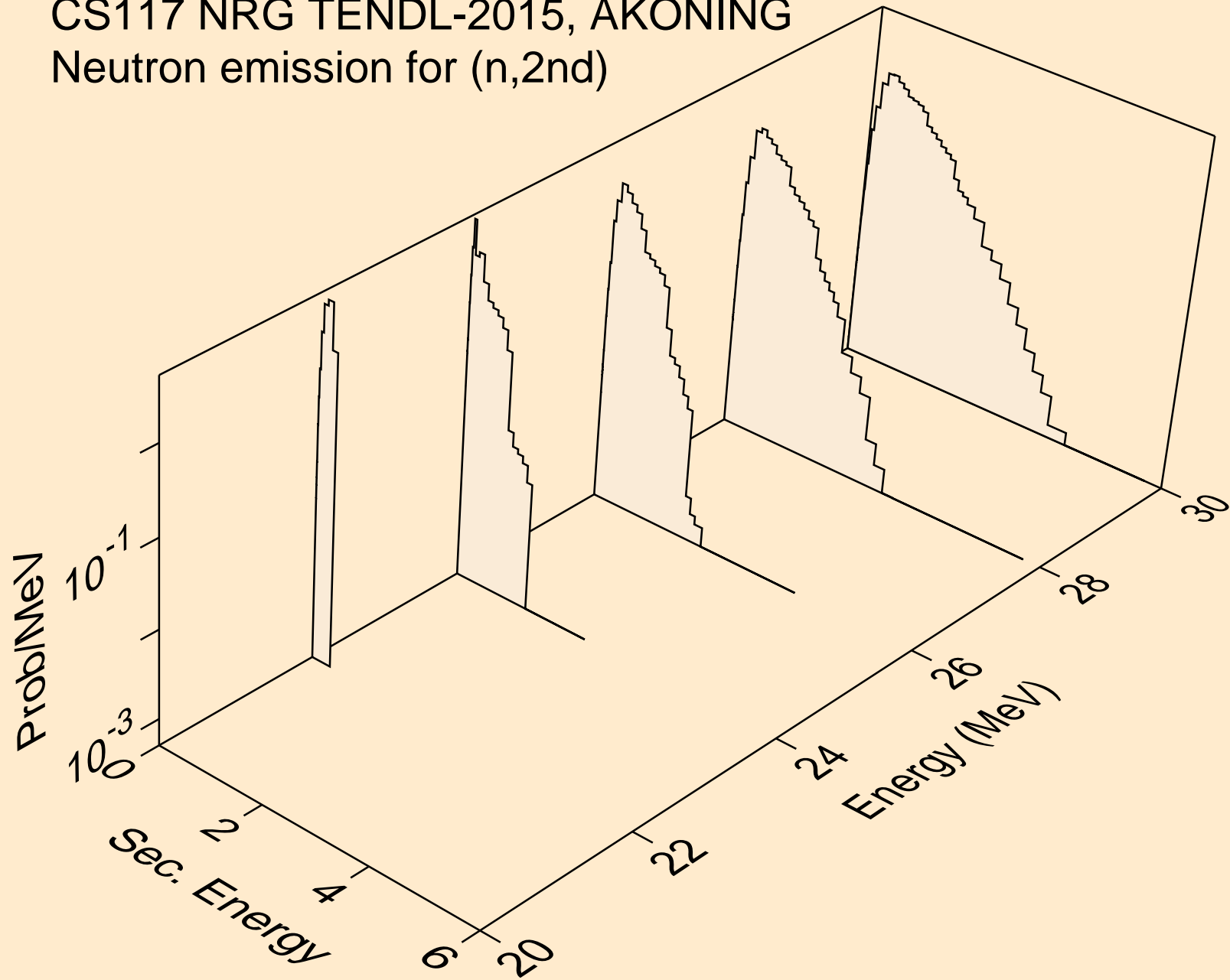



CS117 NRG TENDL-2015, AKONING  
Neutron emission for (n,2n)

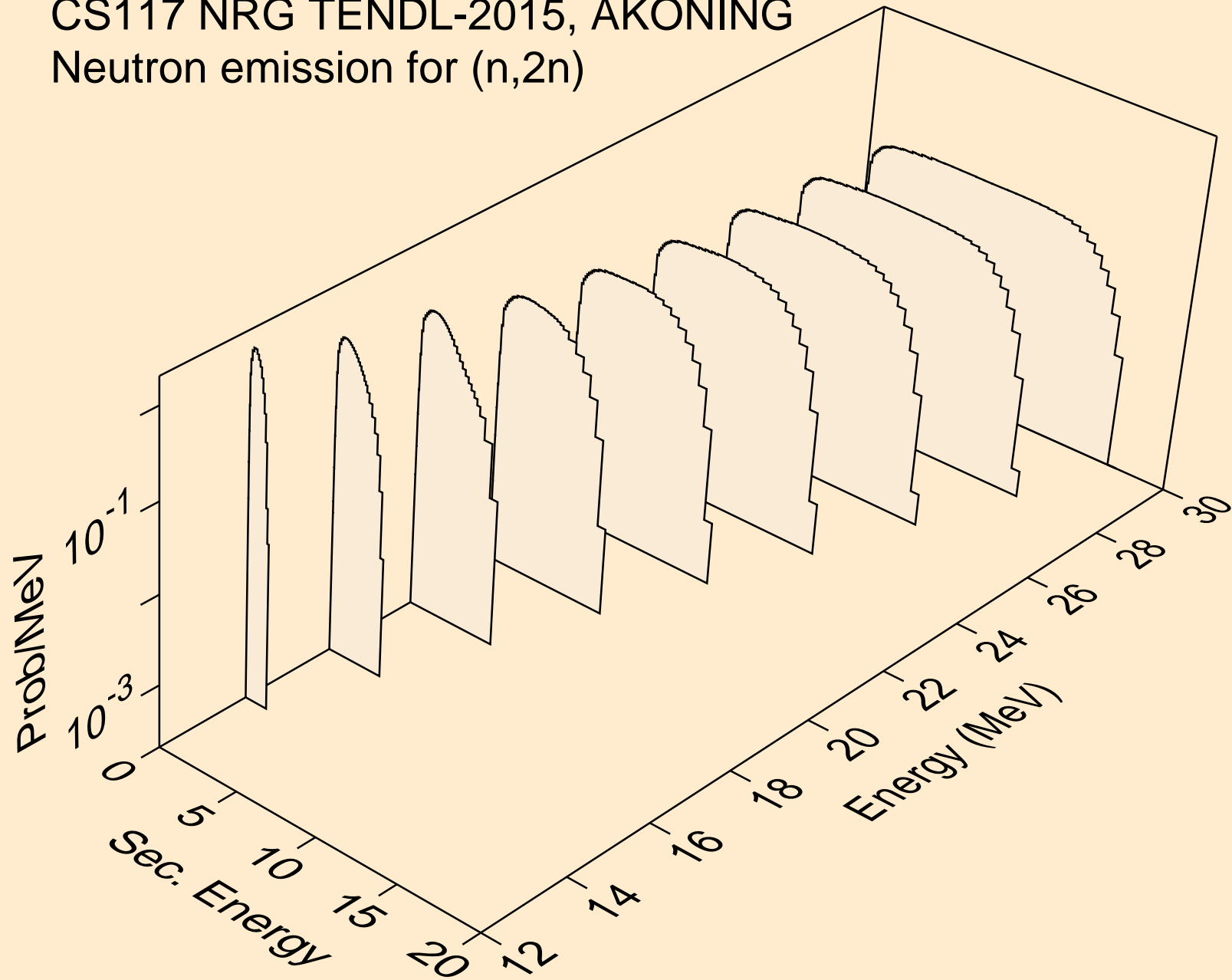

CS117 NRG TENDL-2015, AKONING  
Neutron emission for (n,3n)

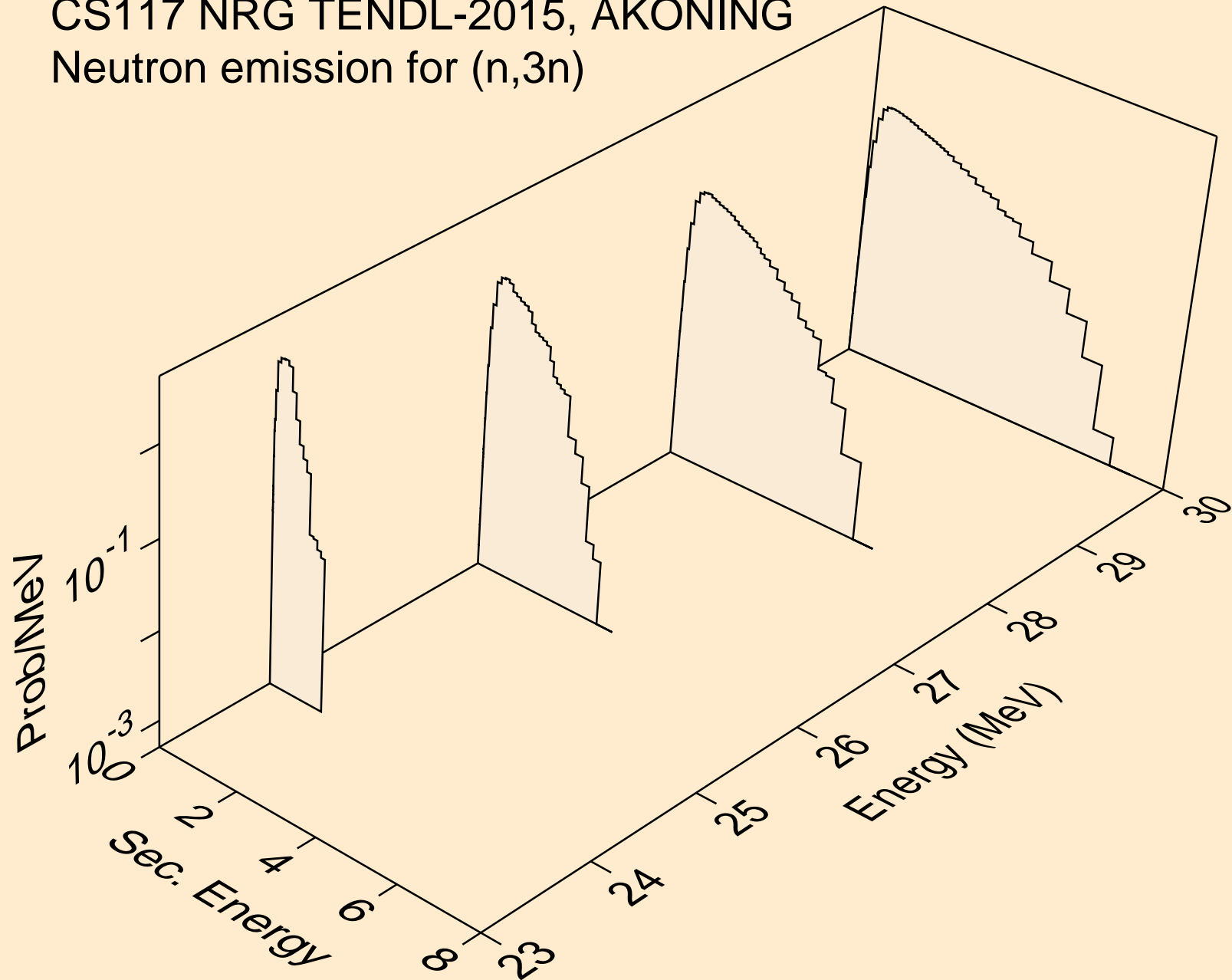

CS117 NRG TENDL-2015, AKONING  
Neutron emission for (n,n\*)a

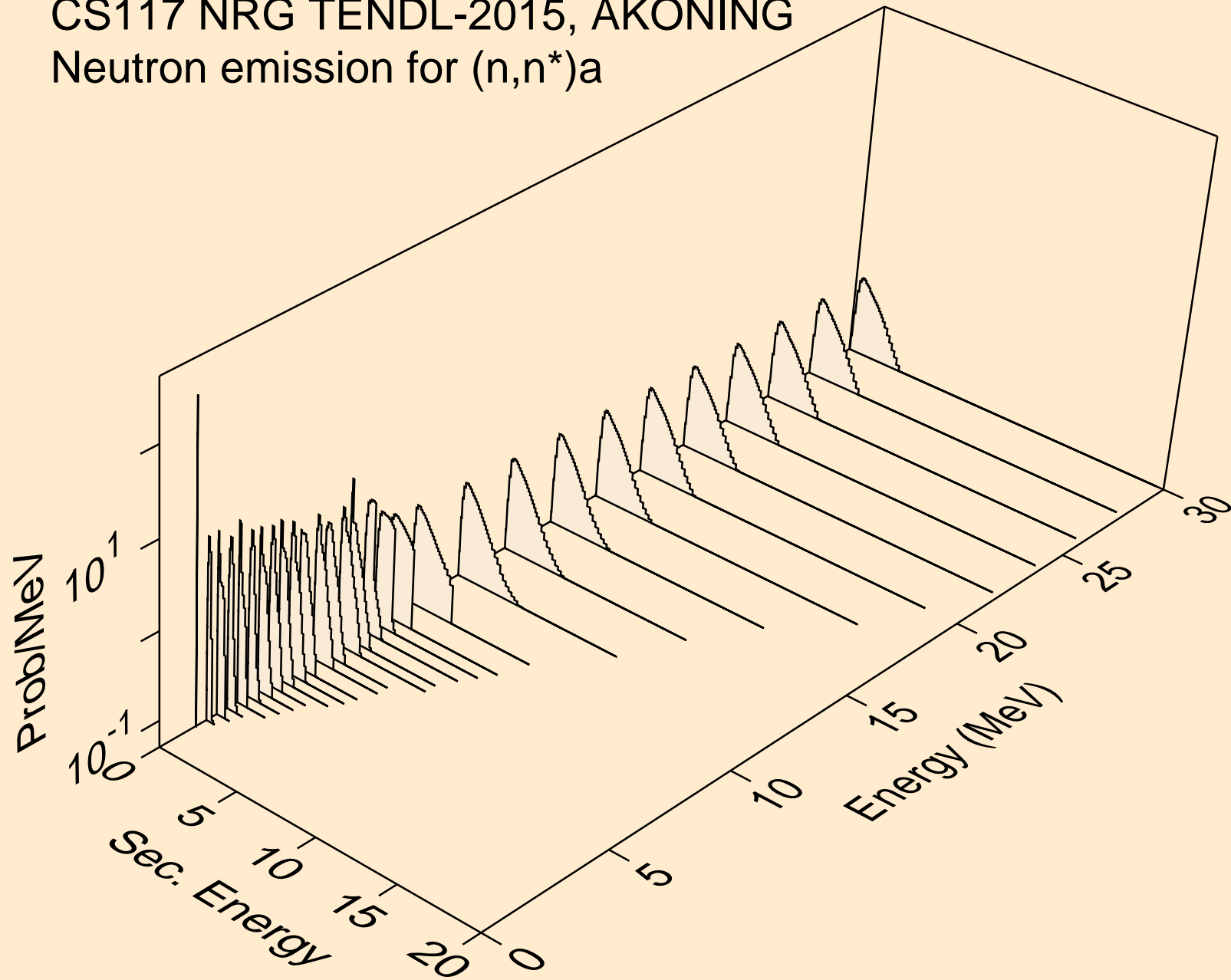

CS117 NRG TENDL-2015, AKONING  
Neutron emission for (n,n\*)3a

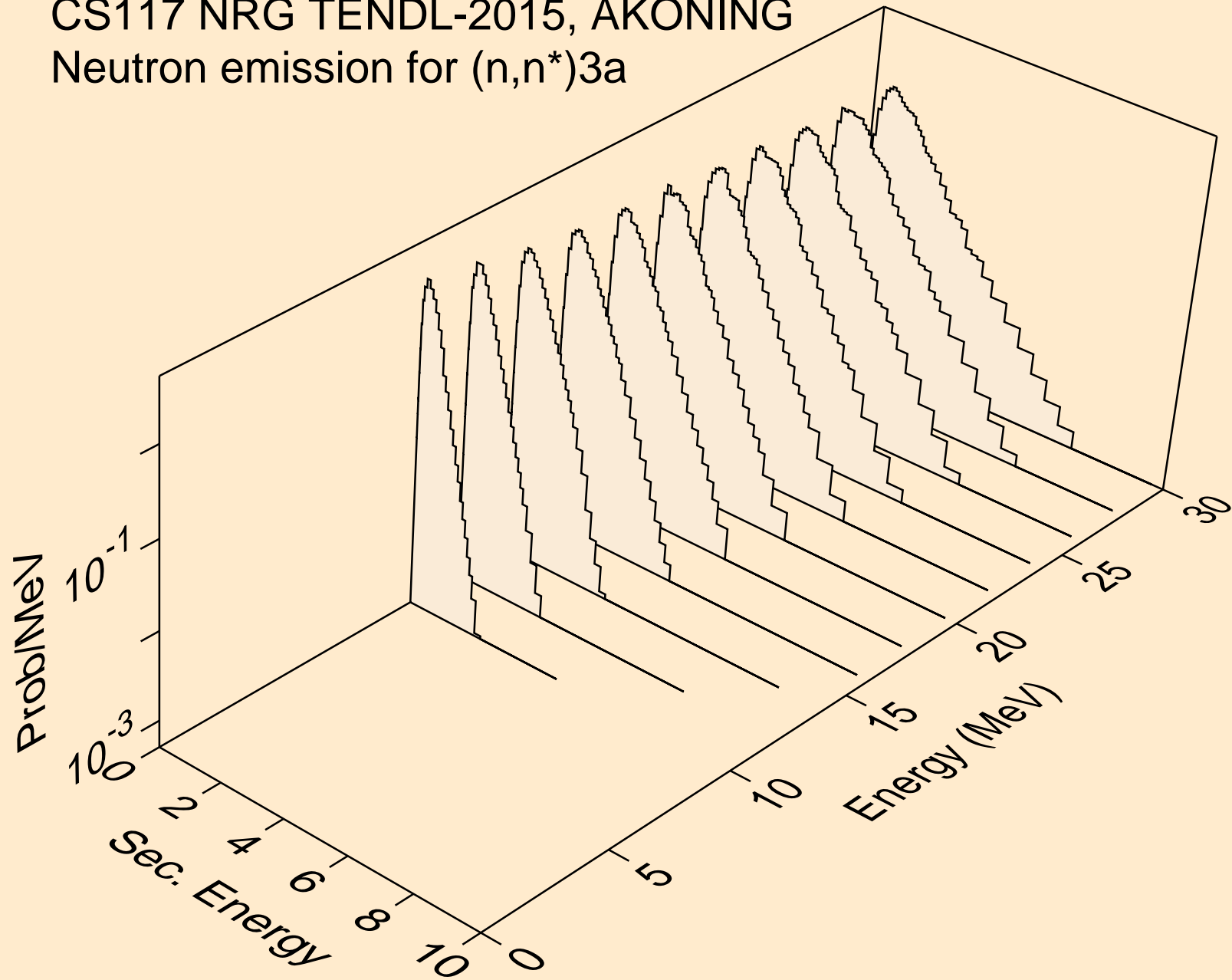

CS117 NRG TENDL-2015, AKONING  
Neutron emission for (n,2n)a

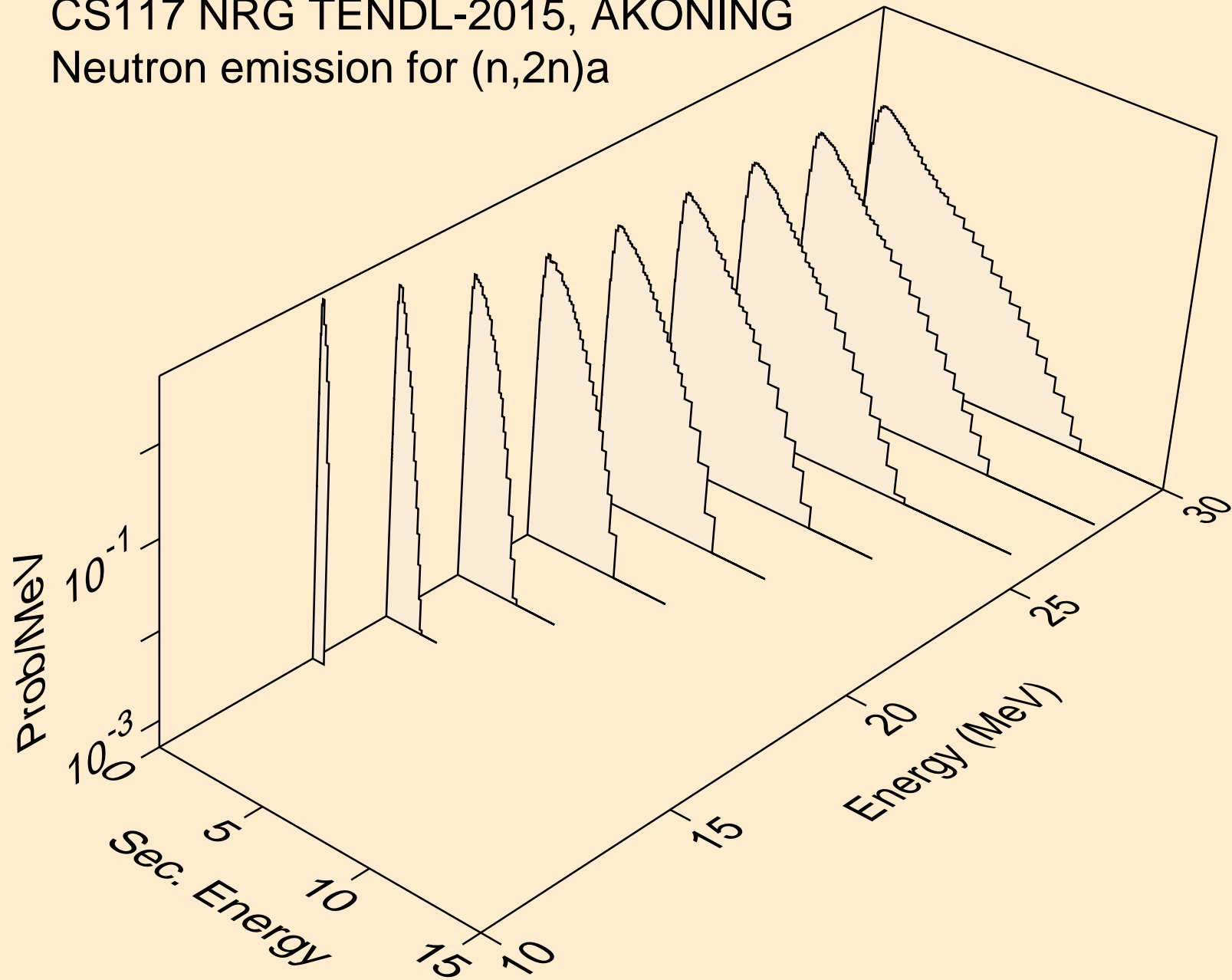

CS117 NRG TENDL-2015, AKONING  
Neutron emission for (n,3n)a

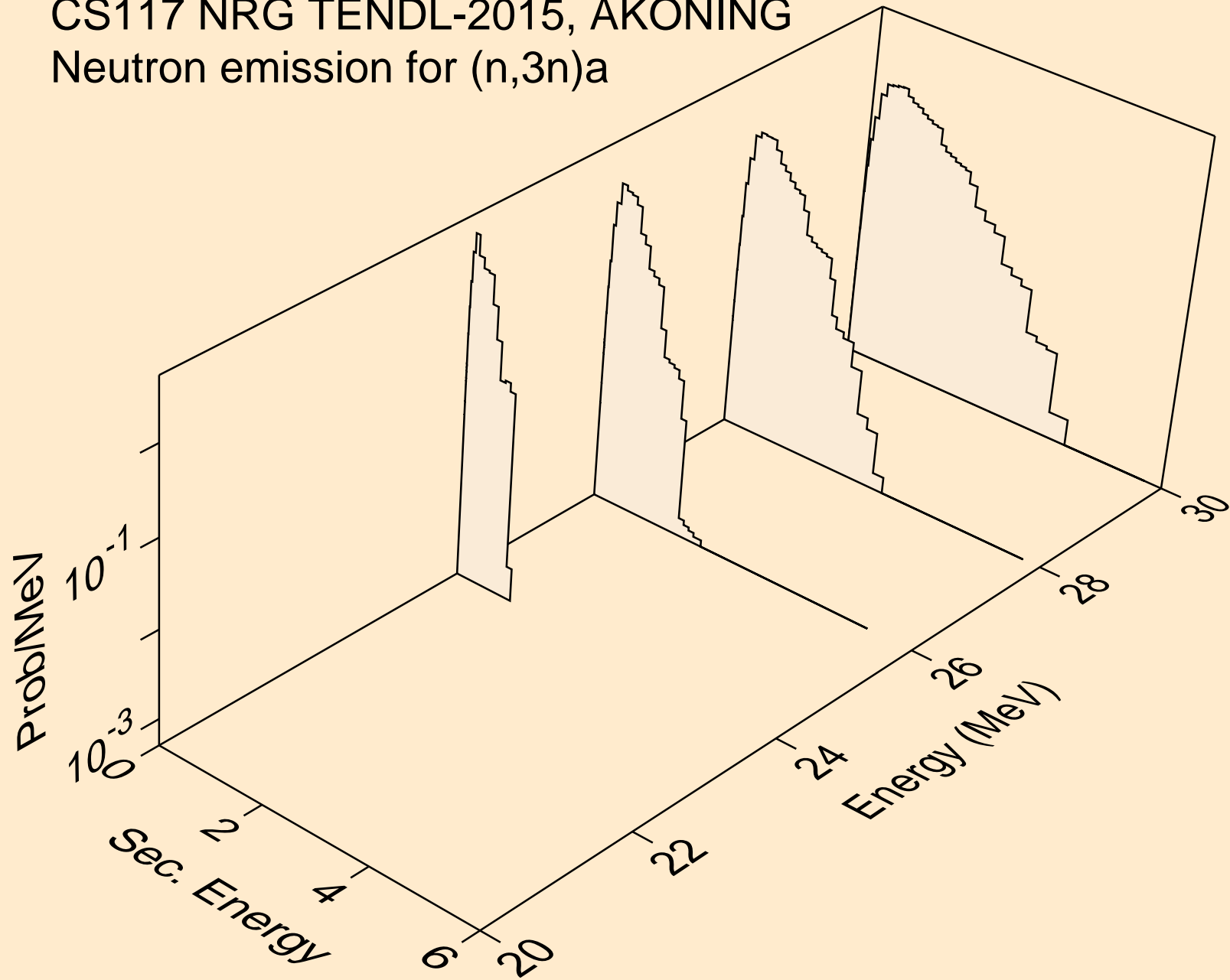

CS117 NRG TENDL-2015, AKONING  
Neutron emission for (n,n\*)p

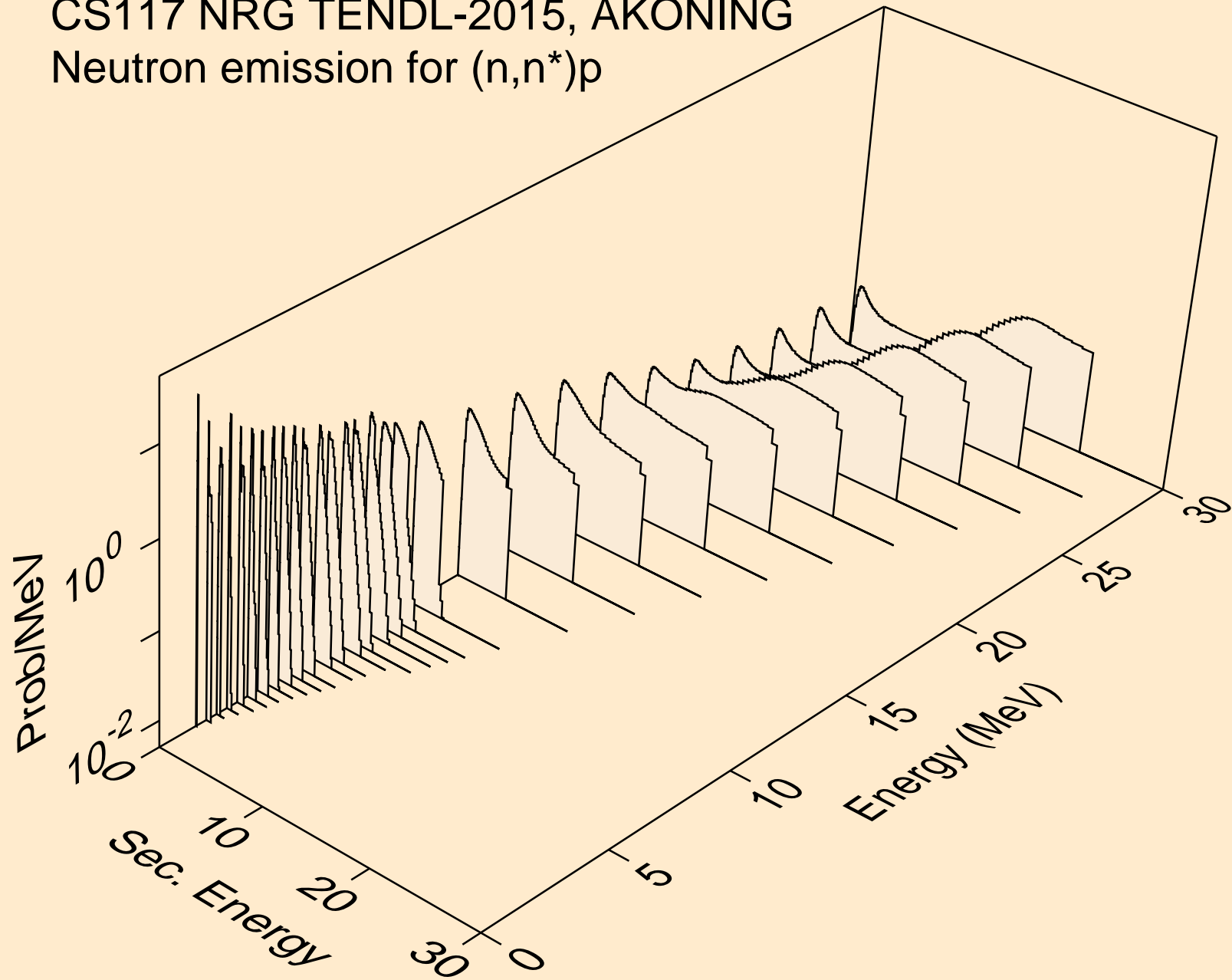

CS117 NRG TENDL-2015, AKONING  
Neutron emission for (n,n\*)2a

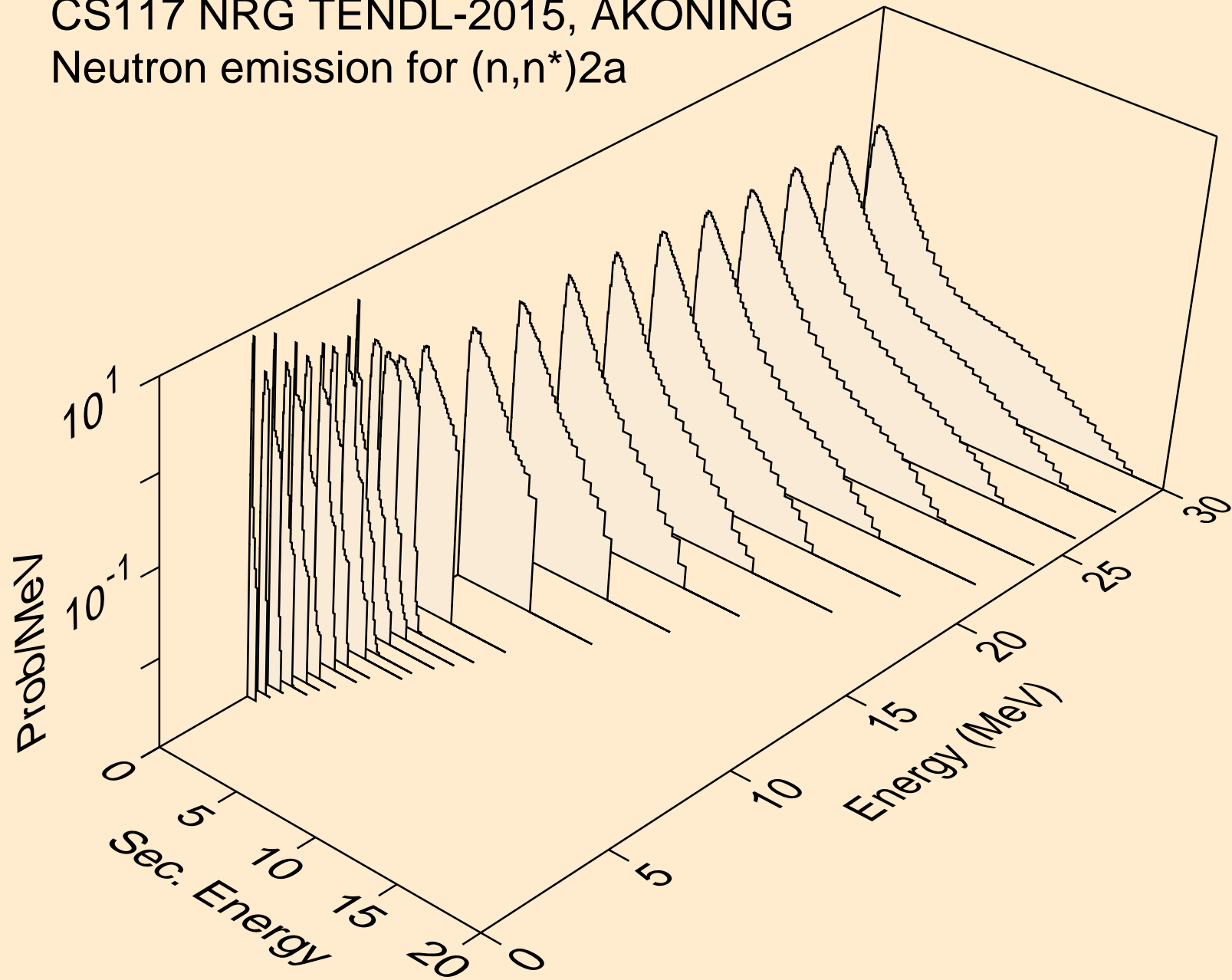



CS117 NRG TENDL-2015, AKONING  
Neutron emission for (n,2n)2a

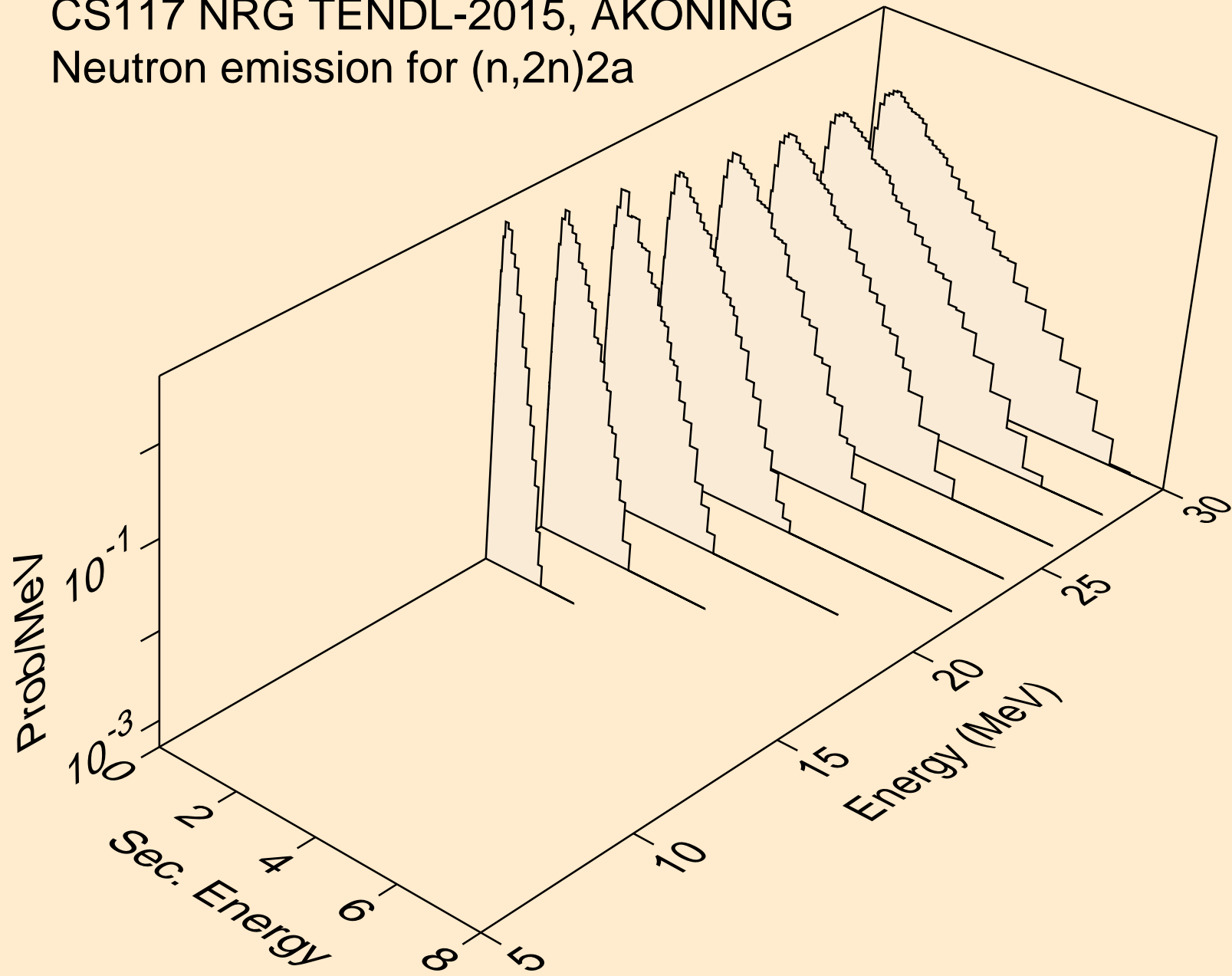

CS117 NRG TENDL-2015, AKONING  
Neutron emission for (n,n\*)d

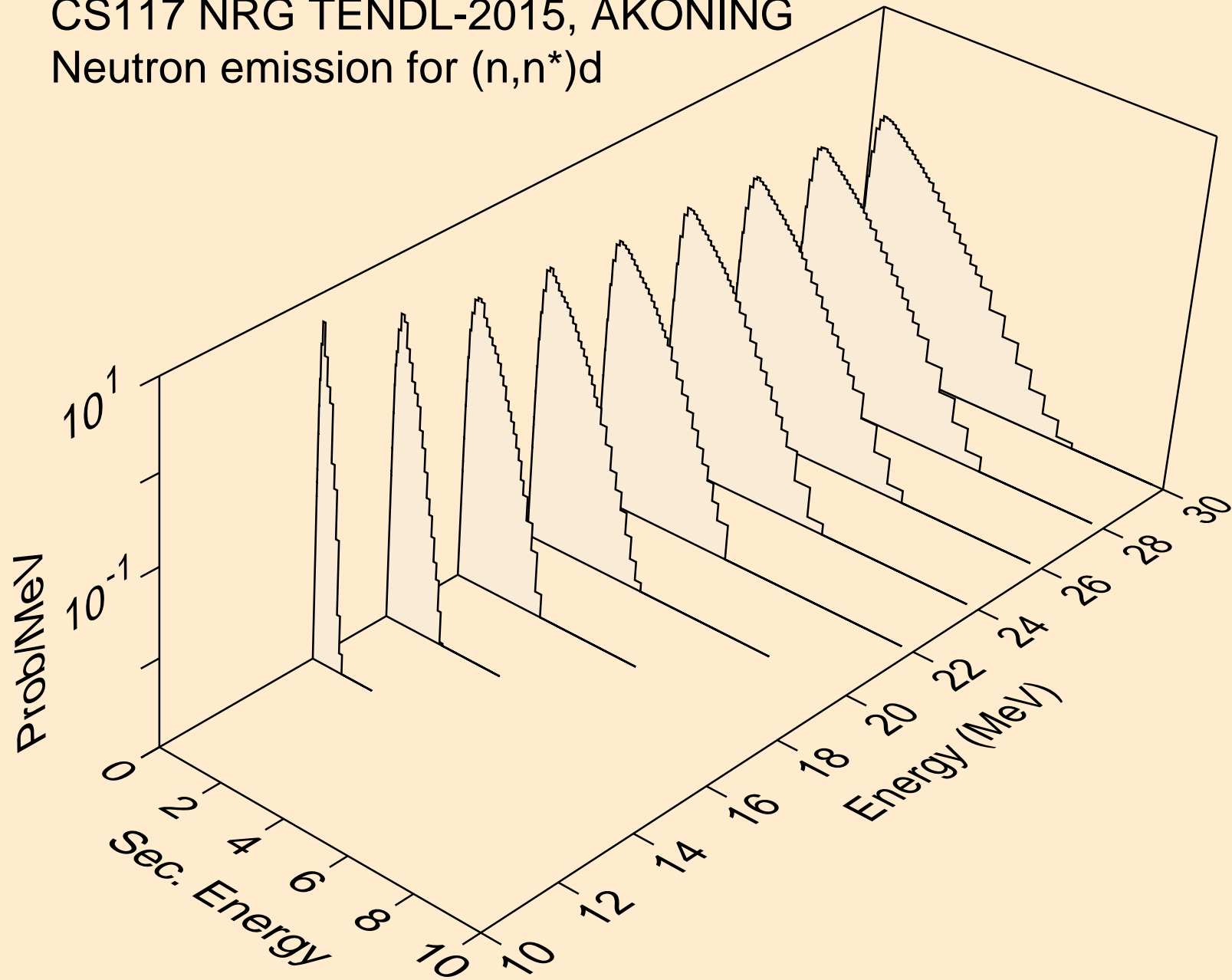

CS117 NRG TENDL-2015, AKONING  
Neutron emission for (n,n\*)t

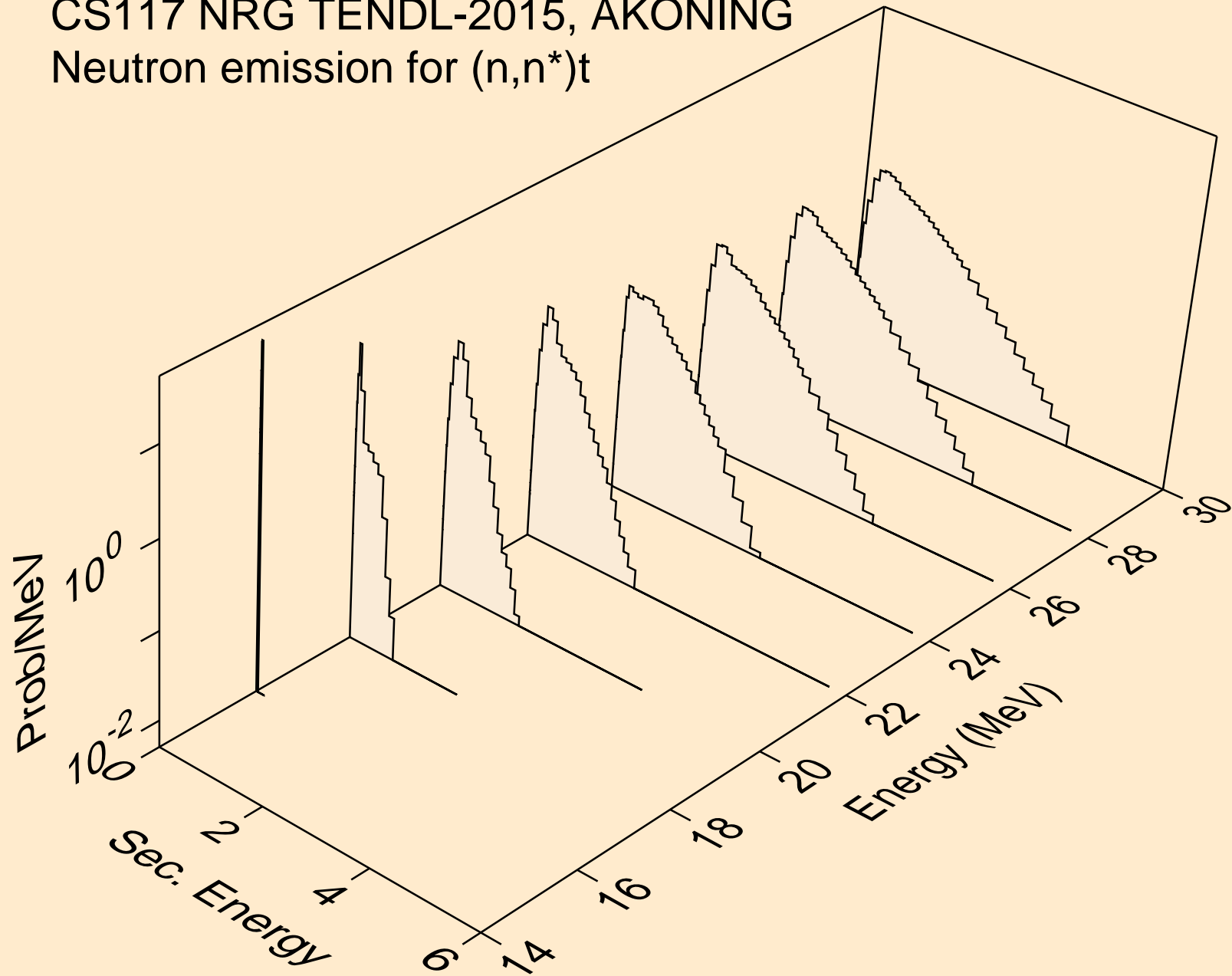

CS117 NRG TENDL-2015, AKONING  
Neutron emission for (n,n\*)he3

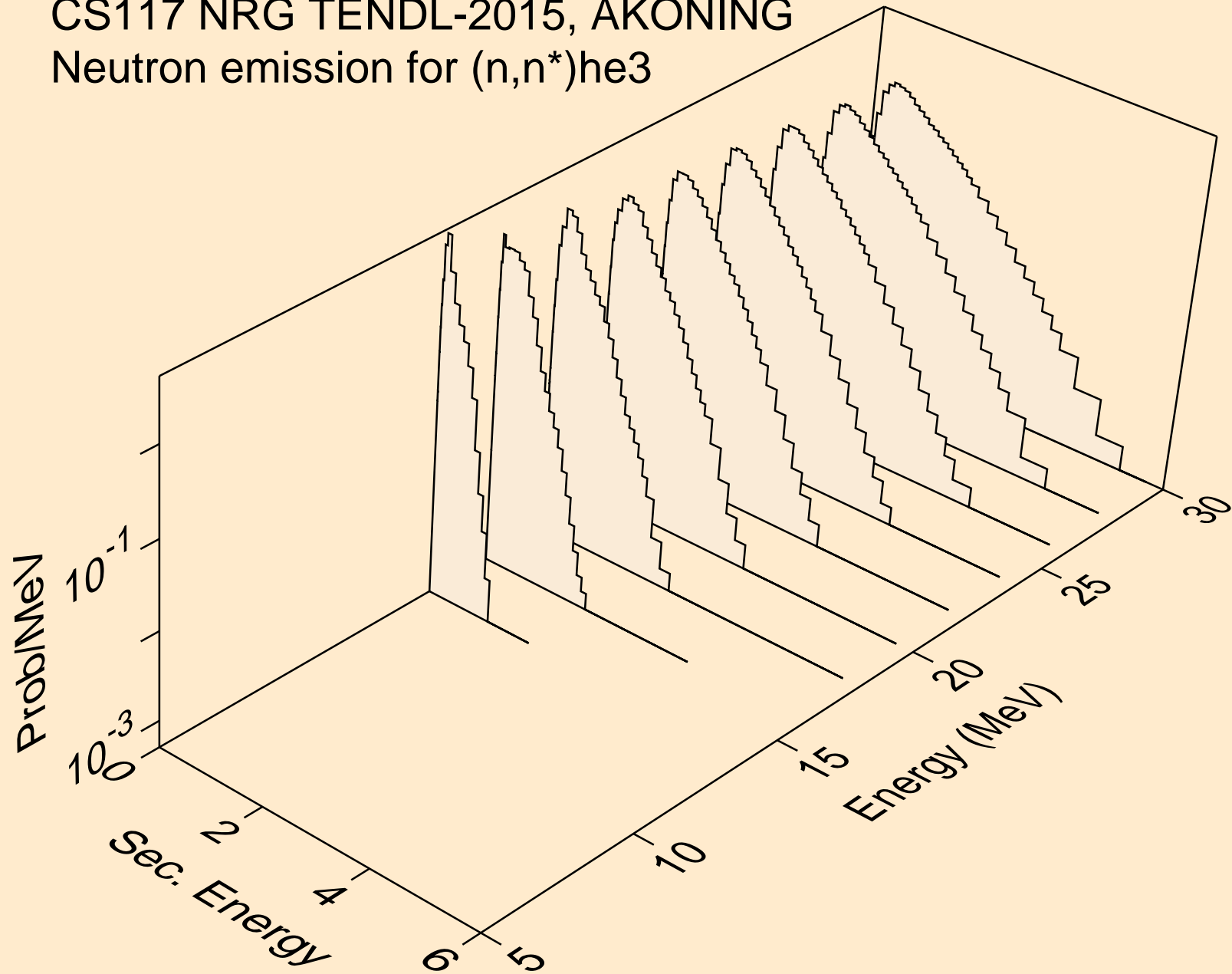

CS117 NRG TENDL-2015, AKONING  
Neutron emission for (n,n\*)d2a

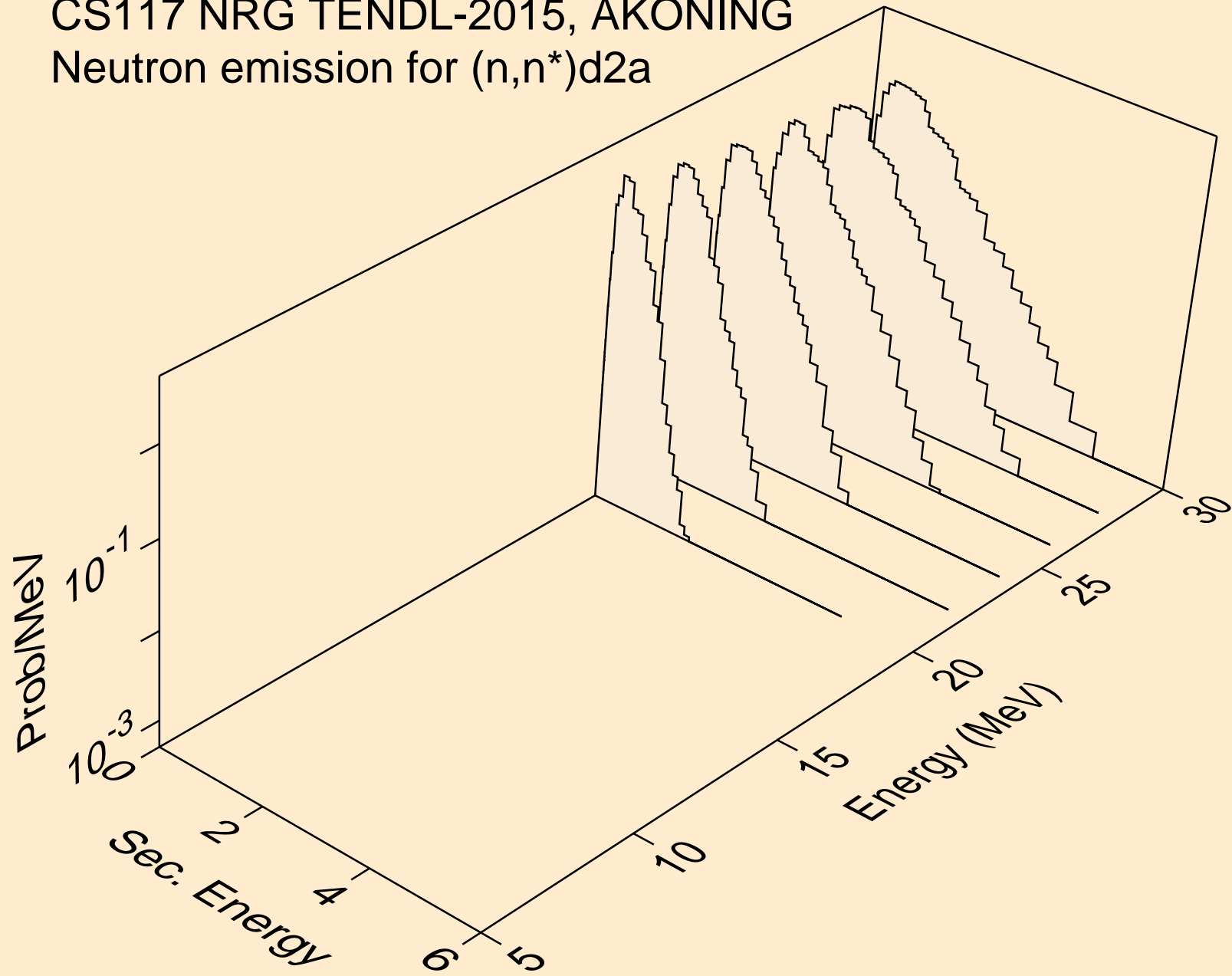

CS117 NRG TENDL-2015, AKONING  
Neutron emission for (n,2np)

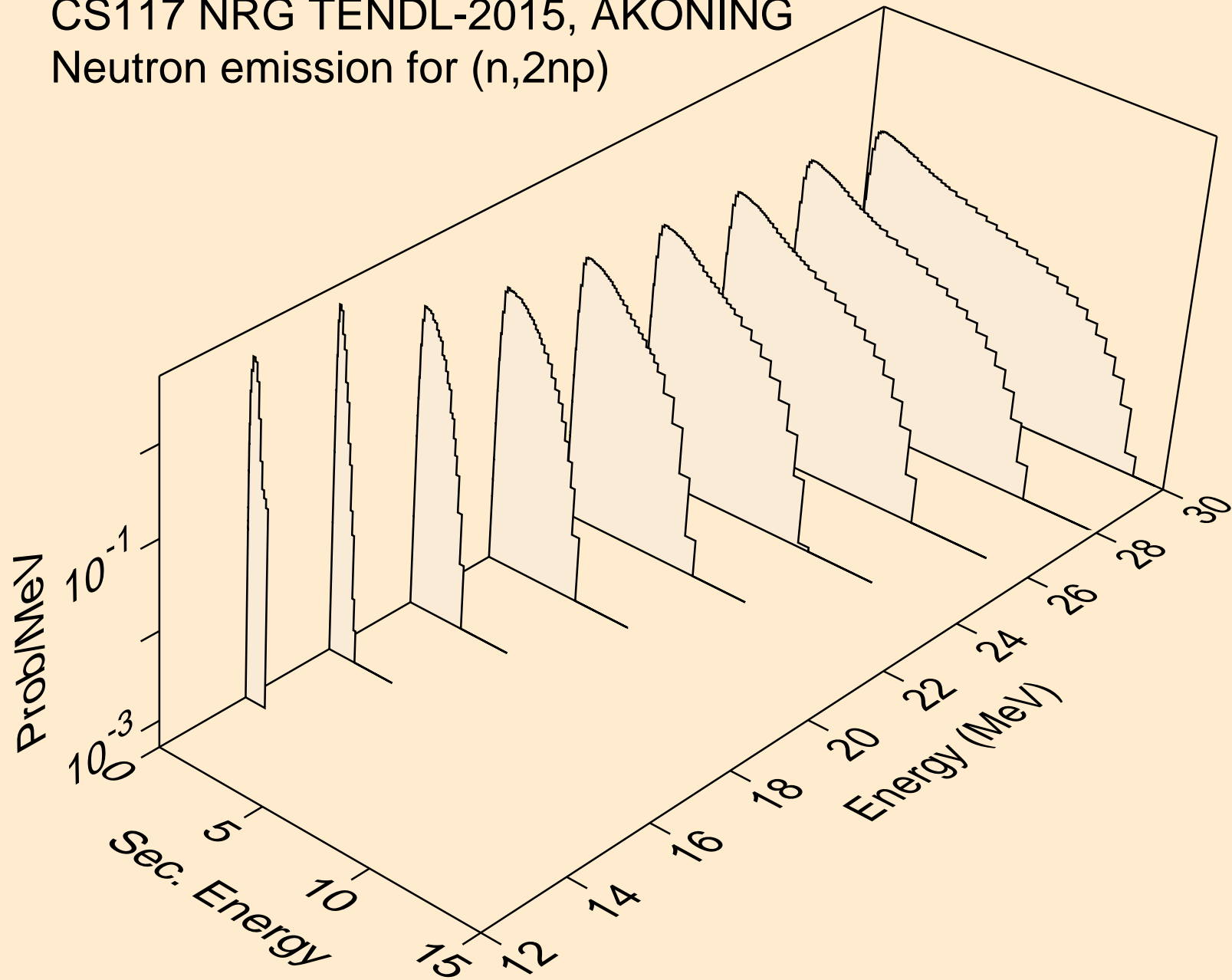

CS117 NRG TENDL-2015, AKONING  
Neutron emission for (n,3np)

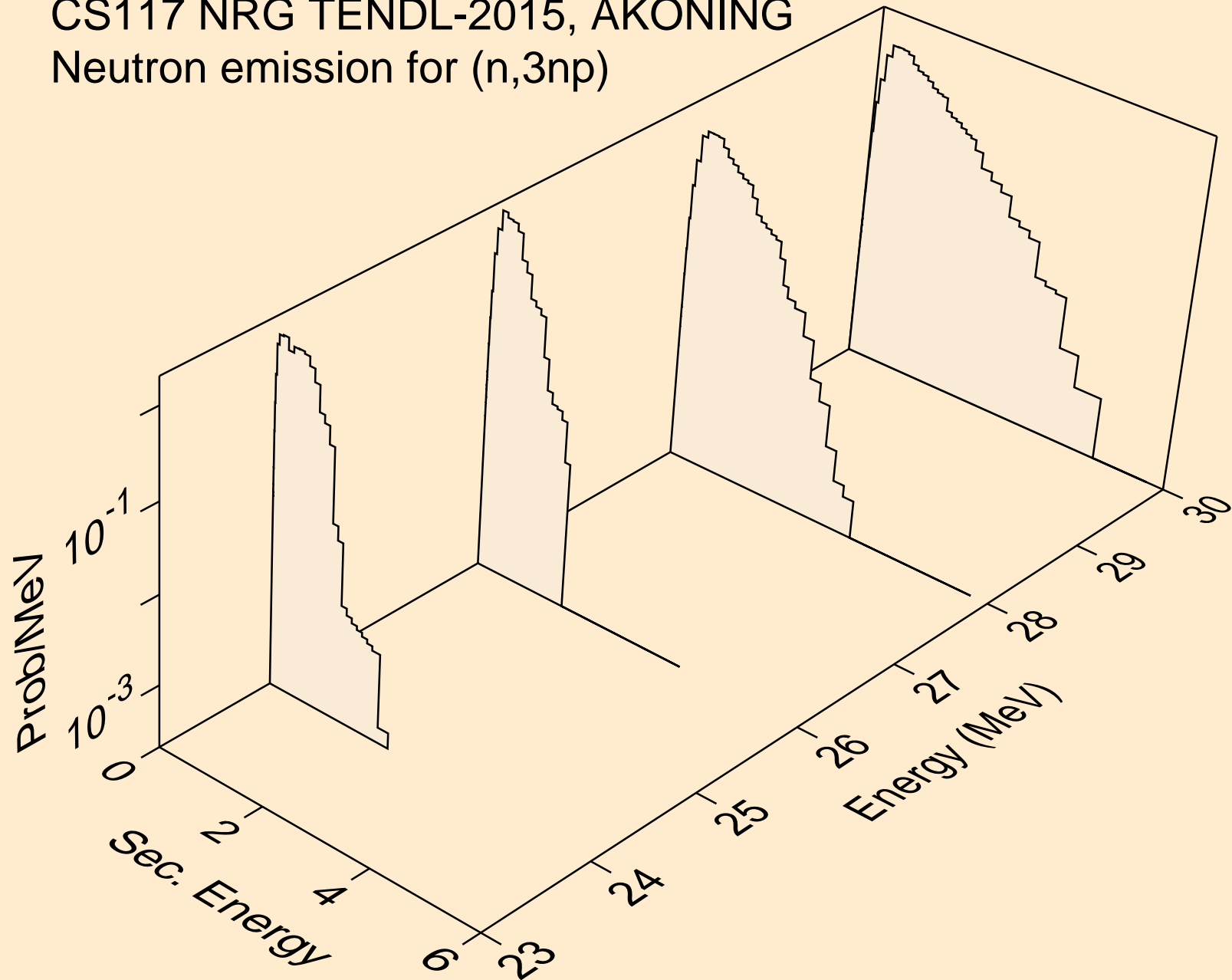

CS117 NRG TENDL-2015, AKONING  
Neutron emission for (n,2np)

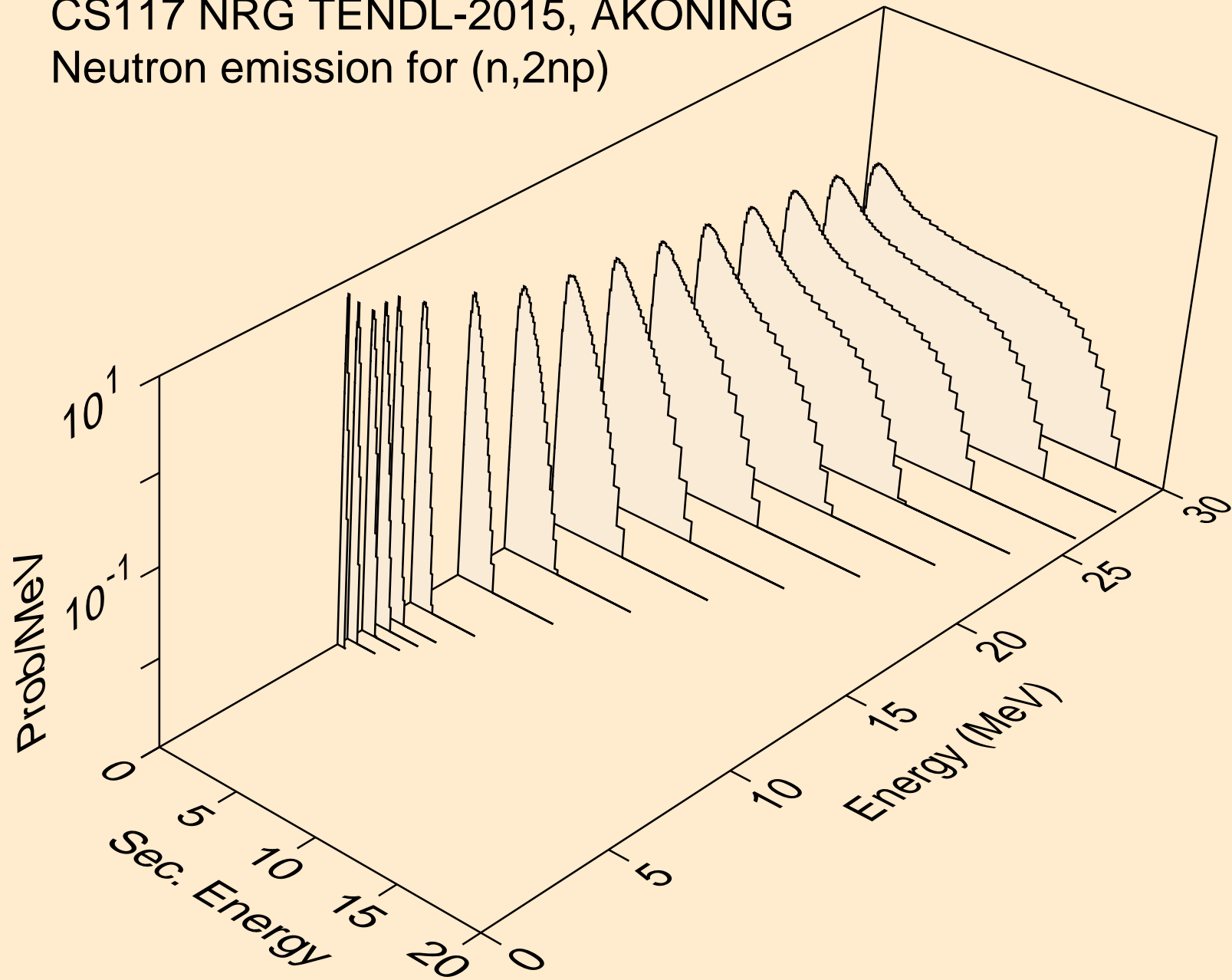



CS117 NRG TENDL-2015, AKONING  
Neutron emission for (n,npa)

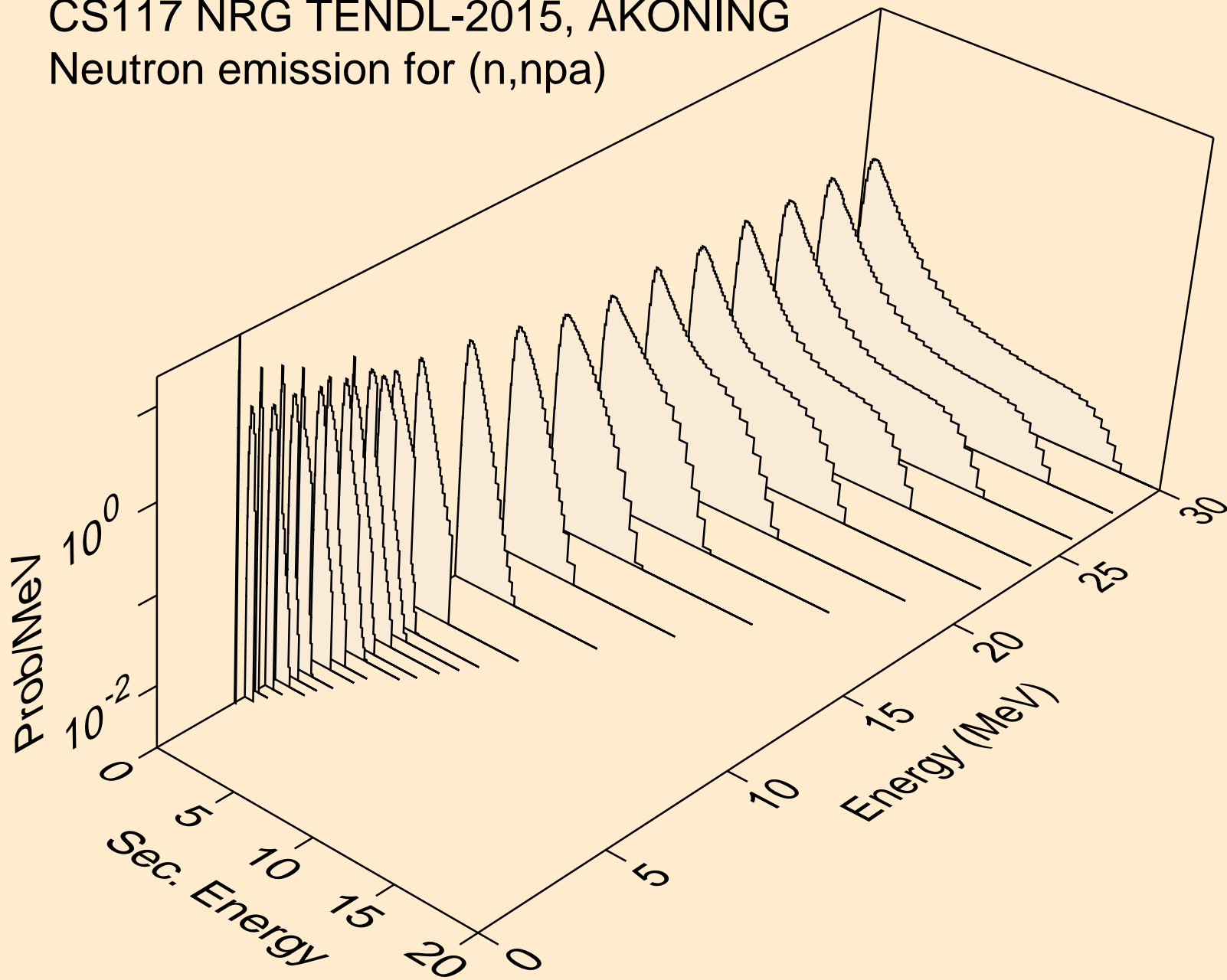

CS117 NRG TENDL-2015, AKONING  
Neutron emission for (n,n\*c)

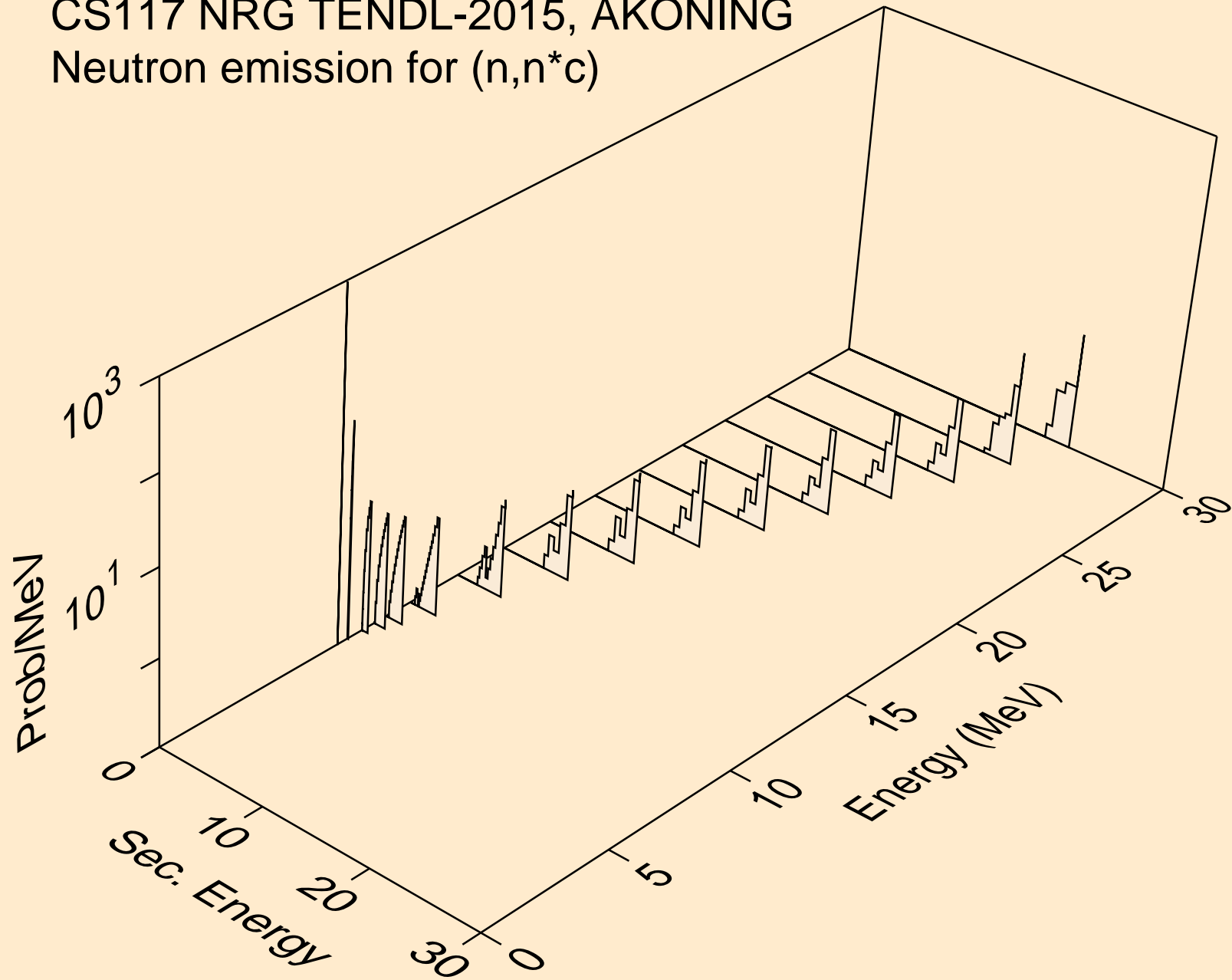

CS117 NRG TENDL-2015, AKONING  
Photon emission for (n,x)

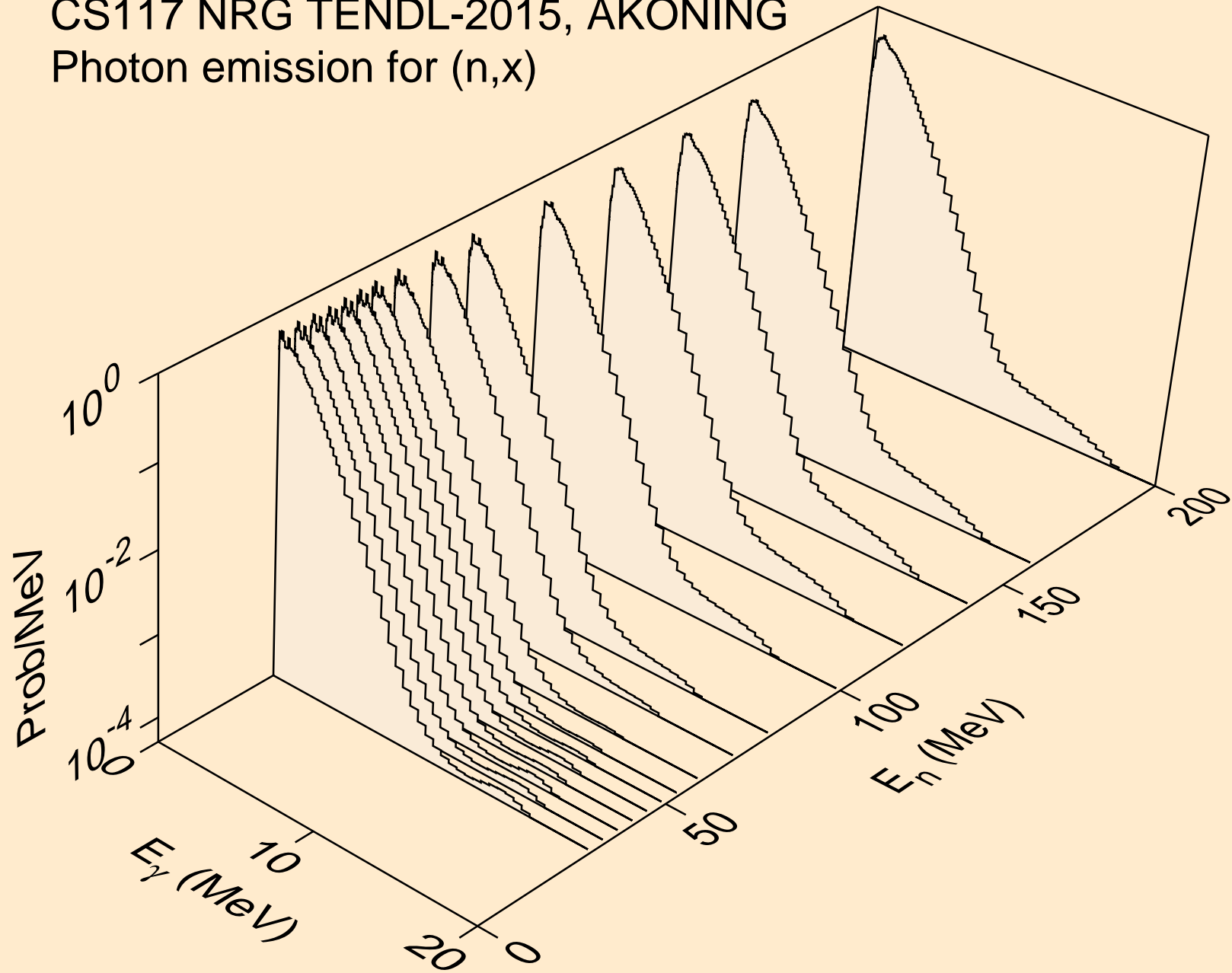

CS117 NRG TENDL-2015, AKONING  
Photon emission for (n,2nd)

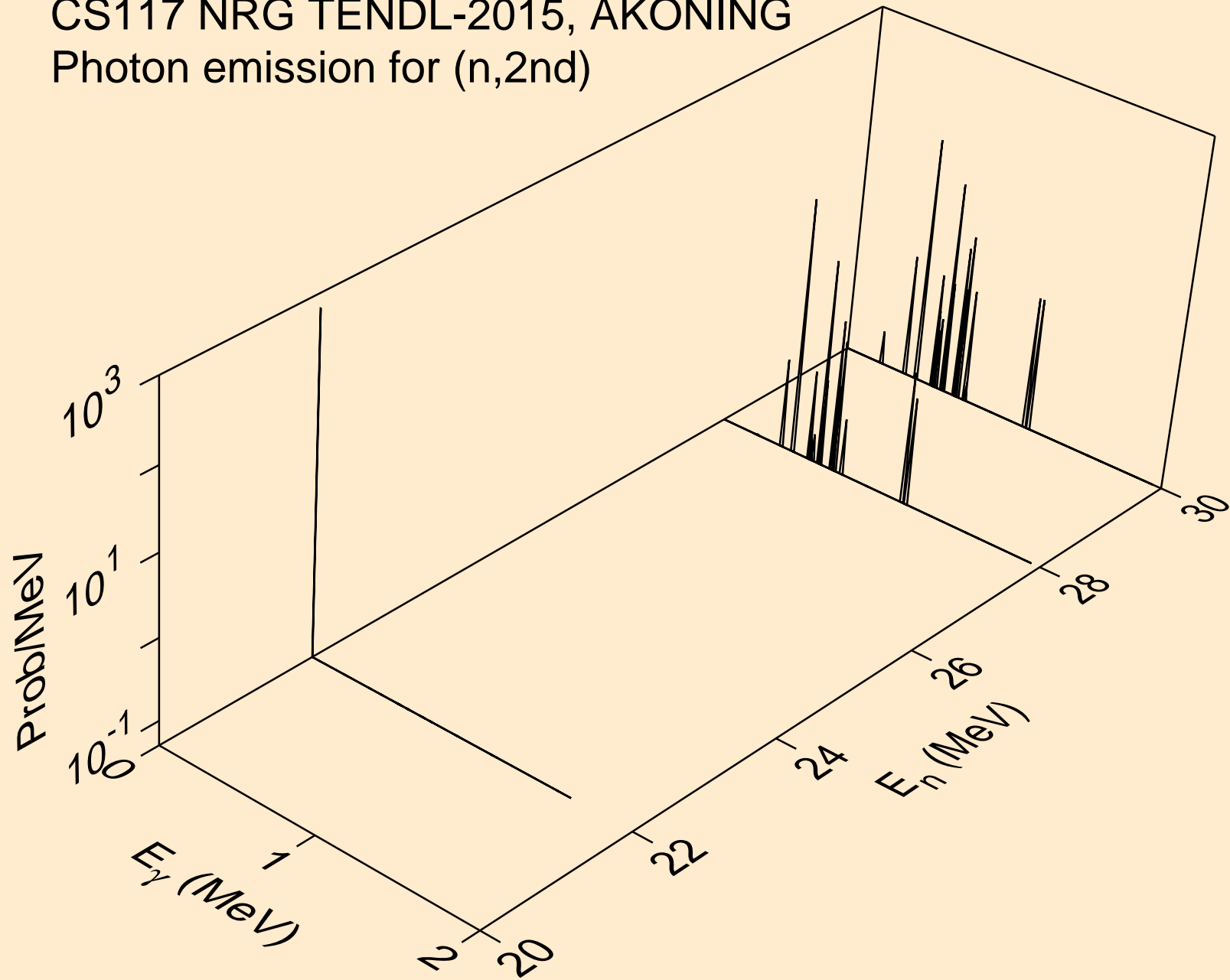

CS117 NRG TENDL-2015, AKONING  
Photon emission for (n,2n)

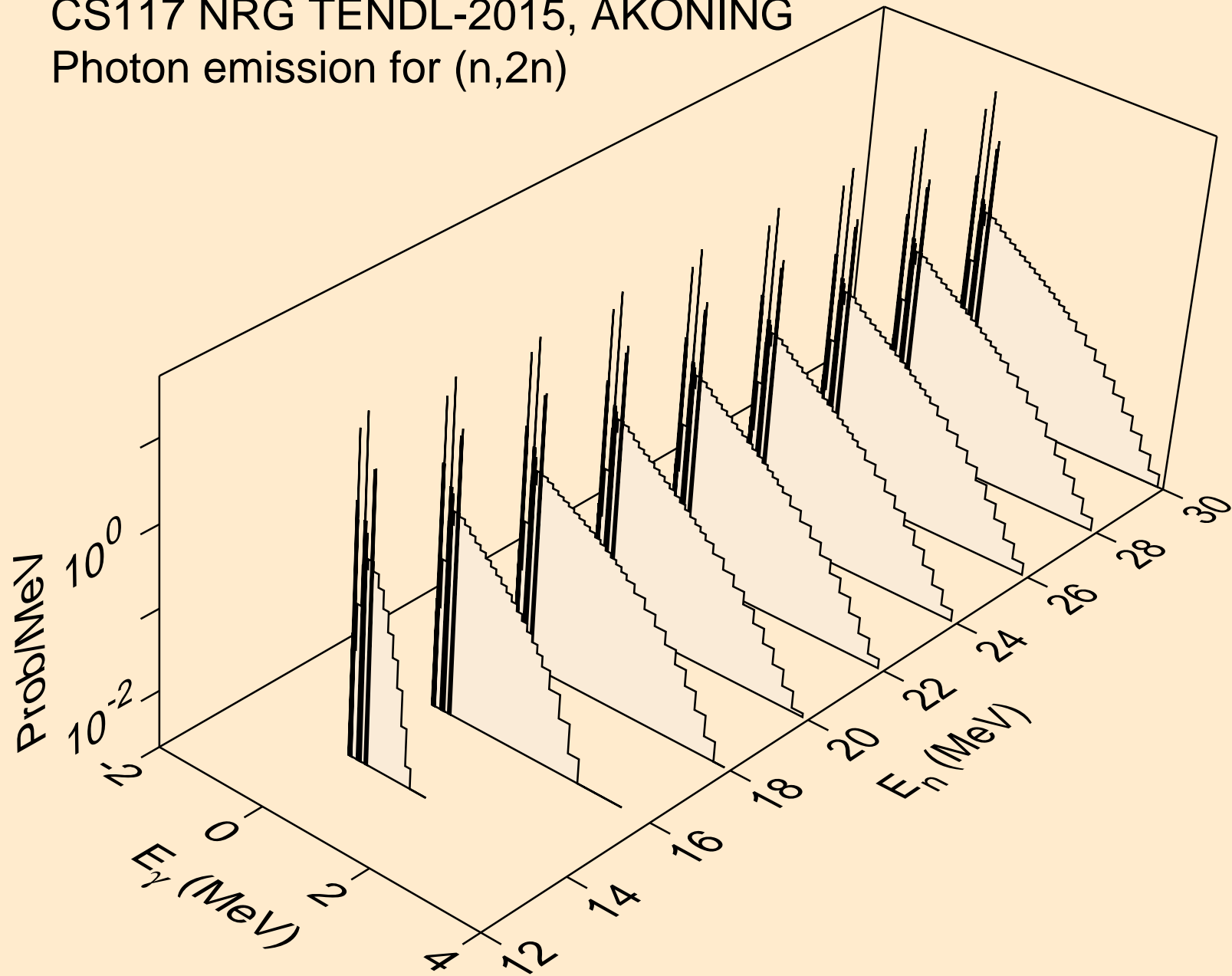

CS117 NRG TENDL-2015, AKONING  
Photon emission for (n,3n)

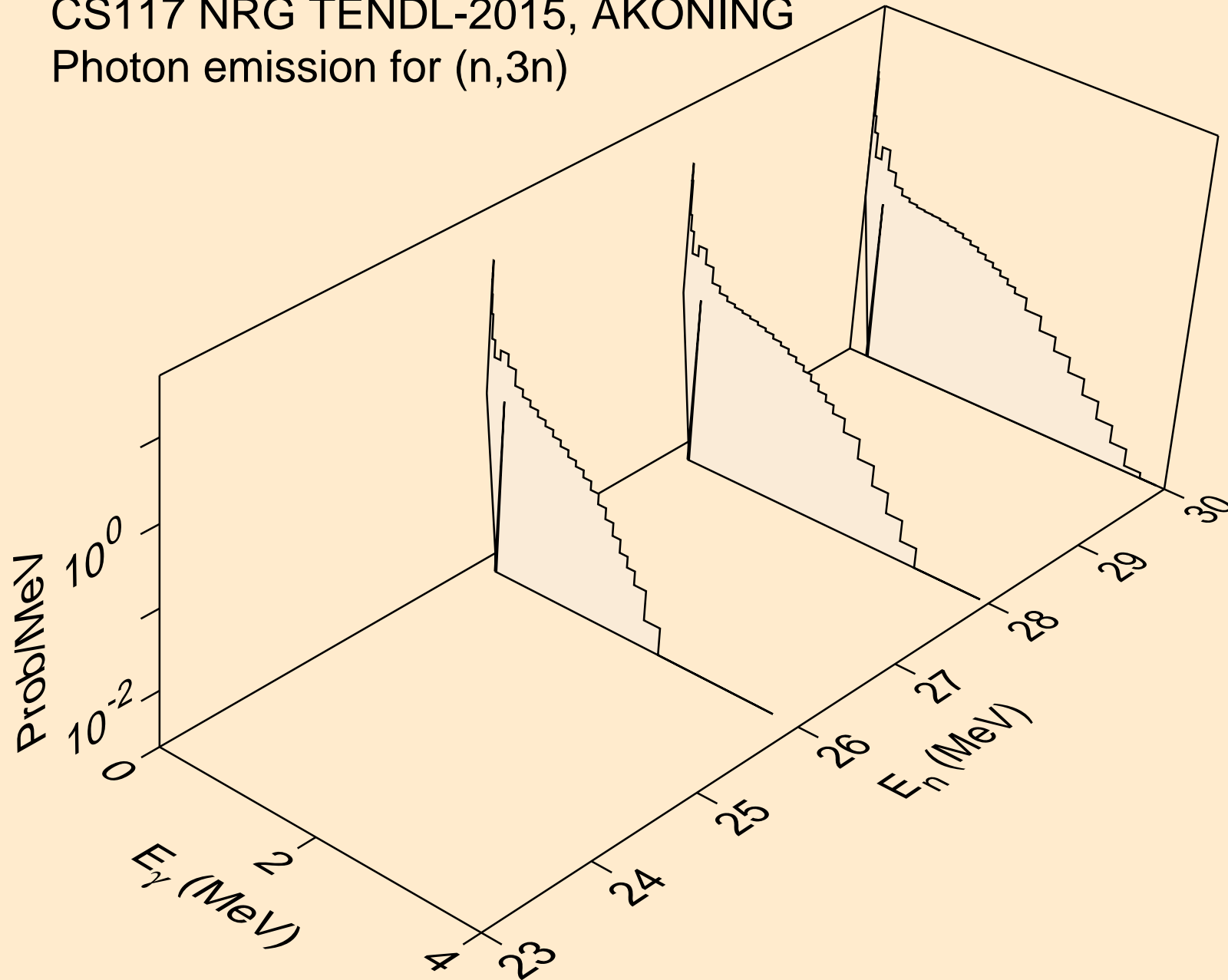

CS117 NRG TENDL-2015, AKONING  
Photon emission for (n,n\*)a

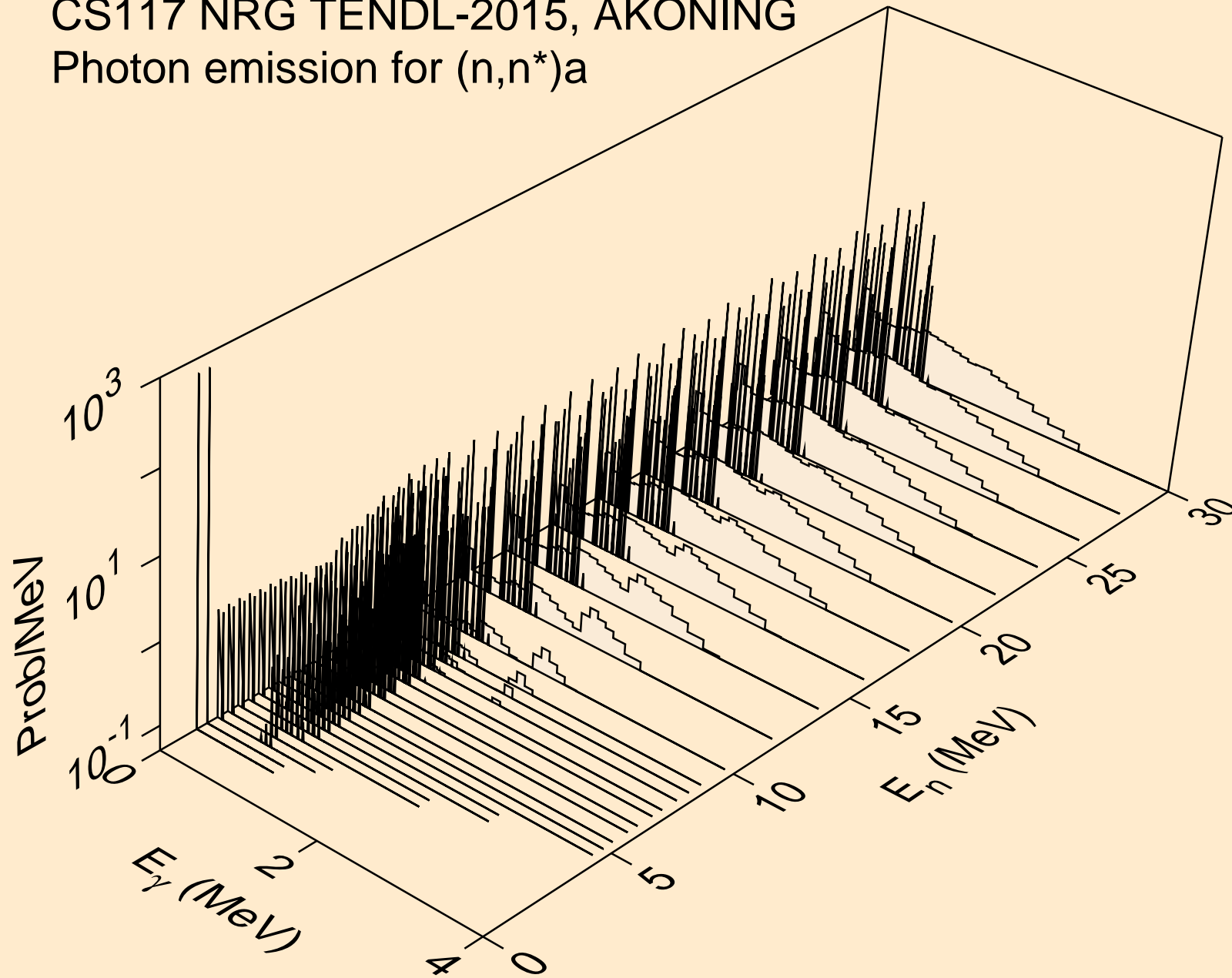

CS117 NRG TENDL-2015, AKONING  
Photon emission for (n,n\*)3a

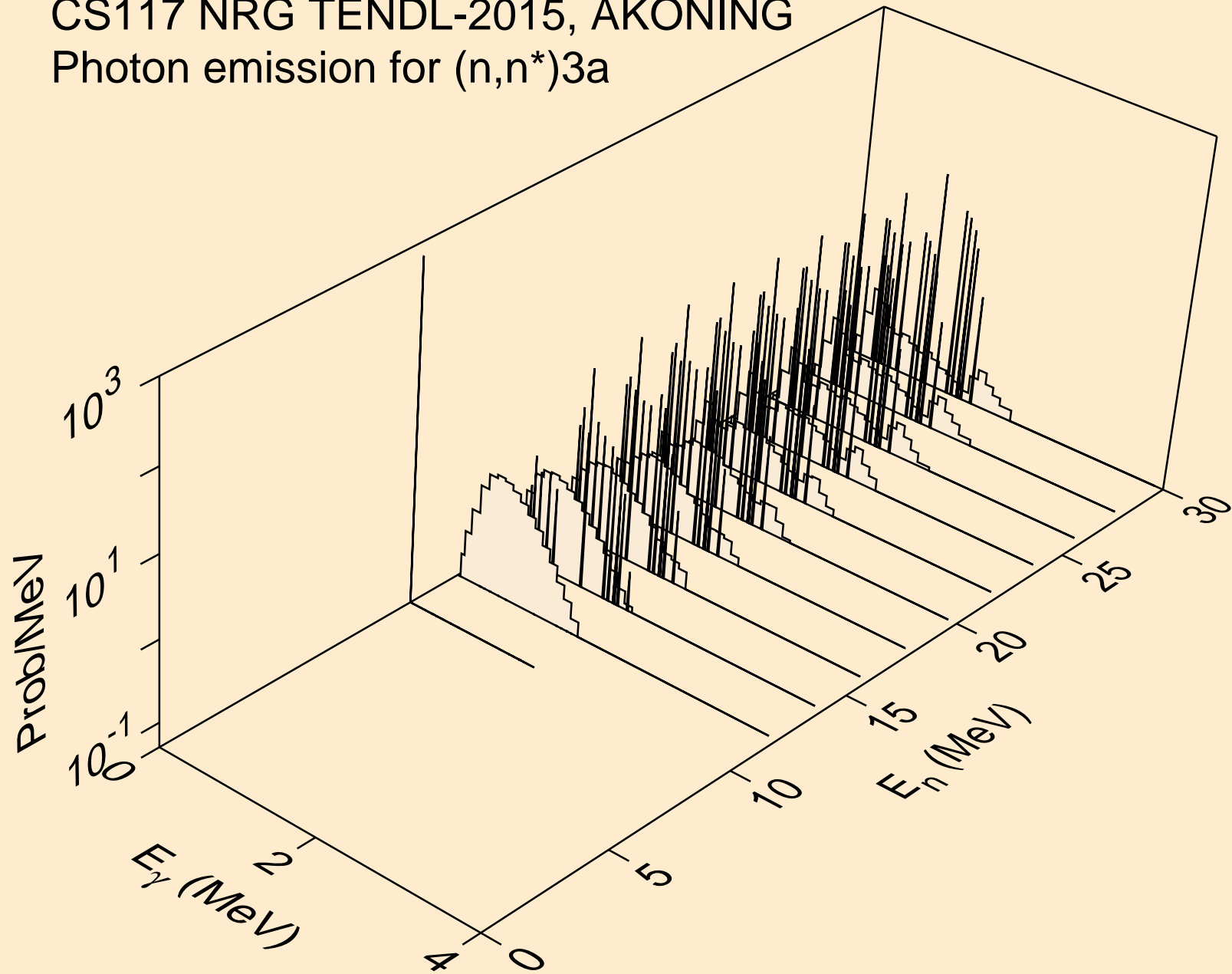



CS117 NRG TENDL-2015, AKONING

Photon emission for (n,2n) $\alpha$

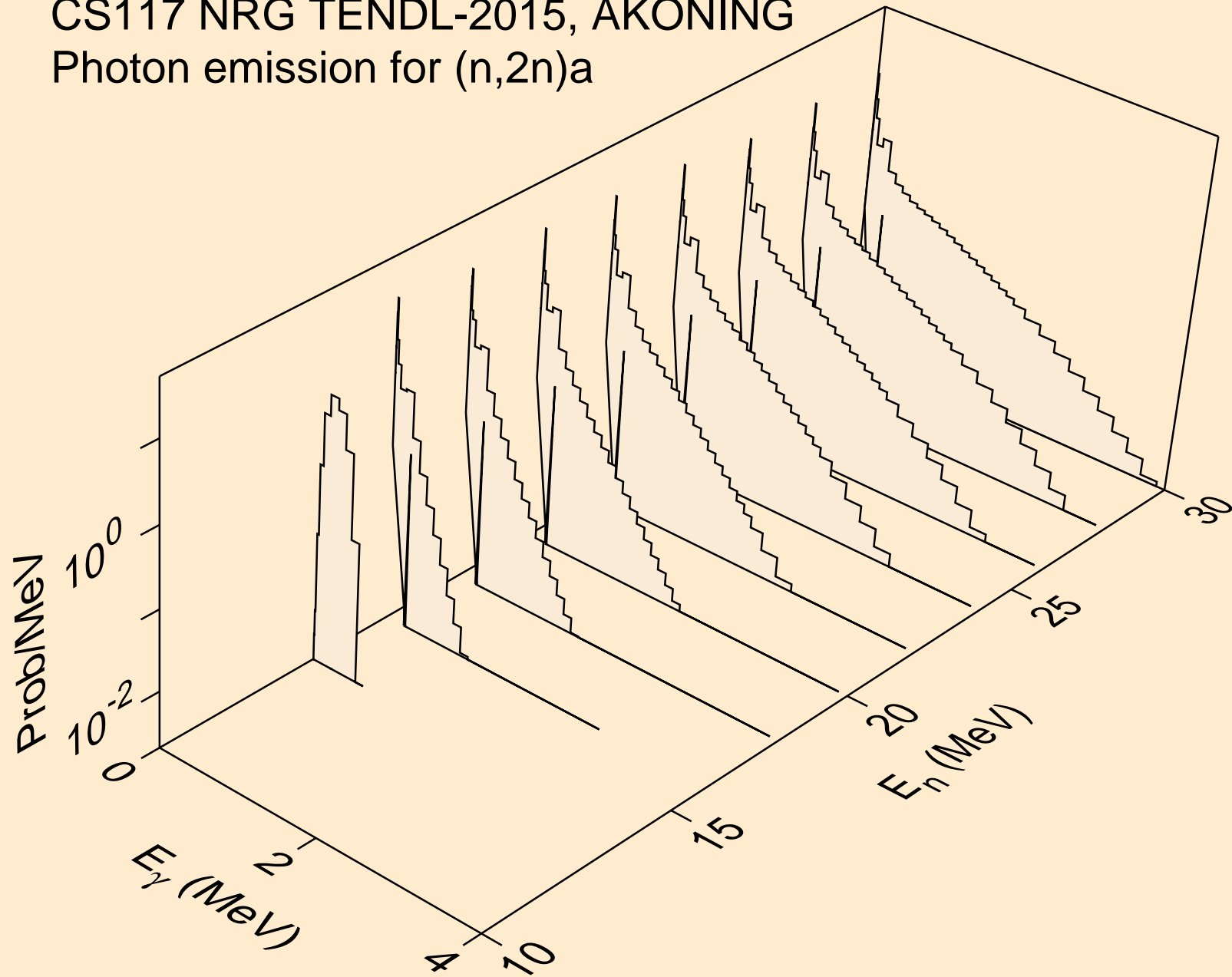

CS117 NRG TENDL-2015, AKONING  
Photon emission for (n,3n)a

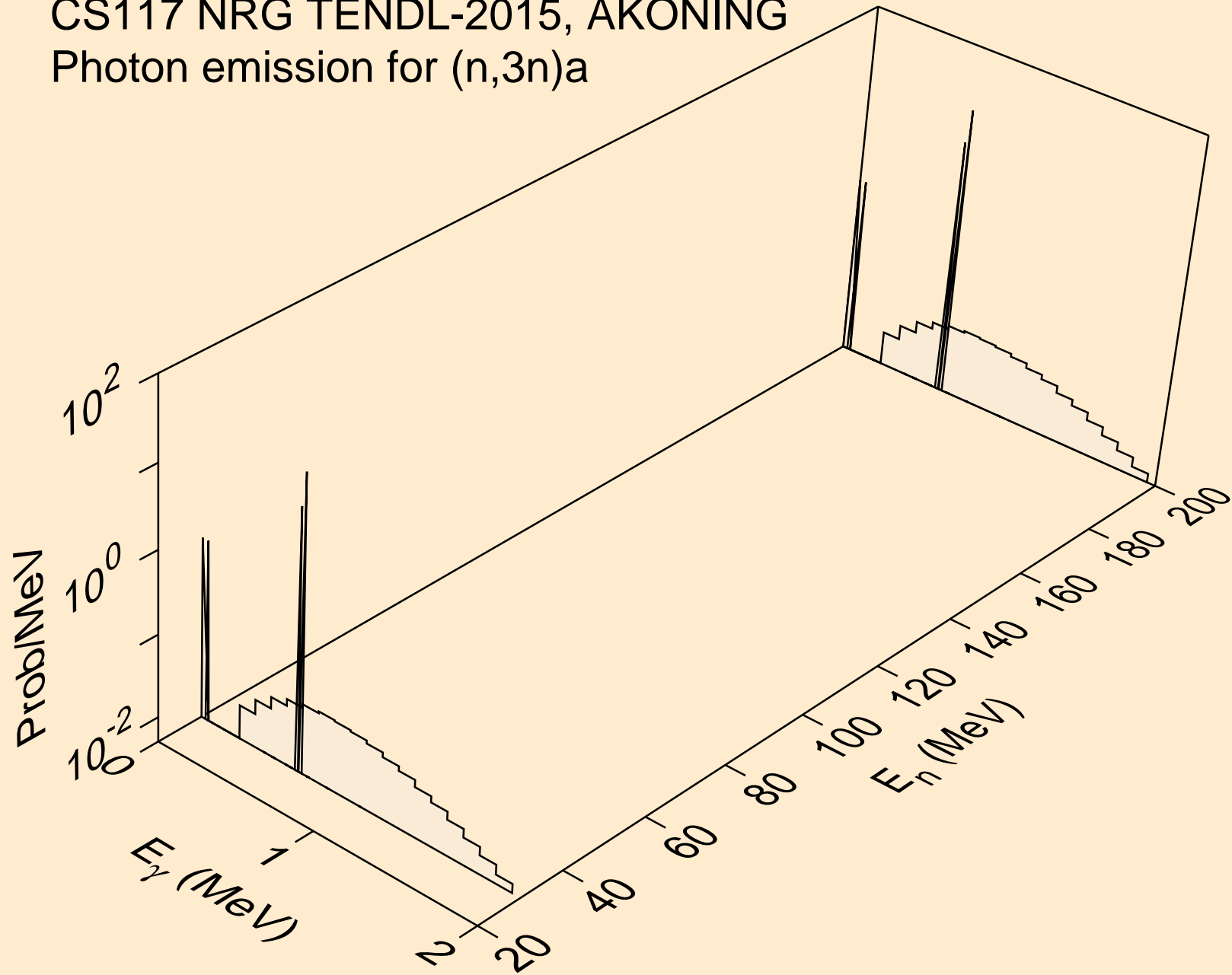

CS117 NRG TENDL-2015, AKONING  
Photon emission for (n,n\*)p

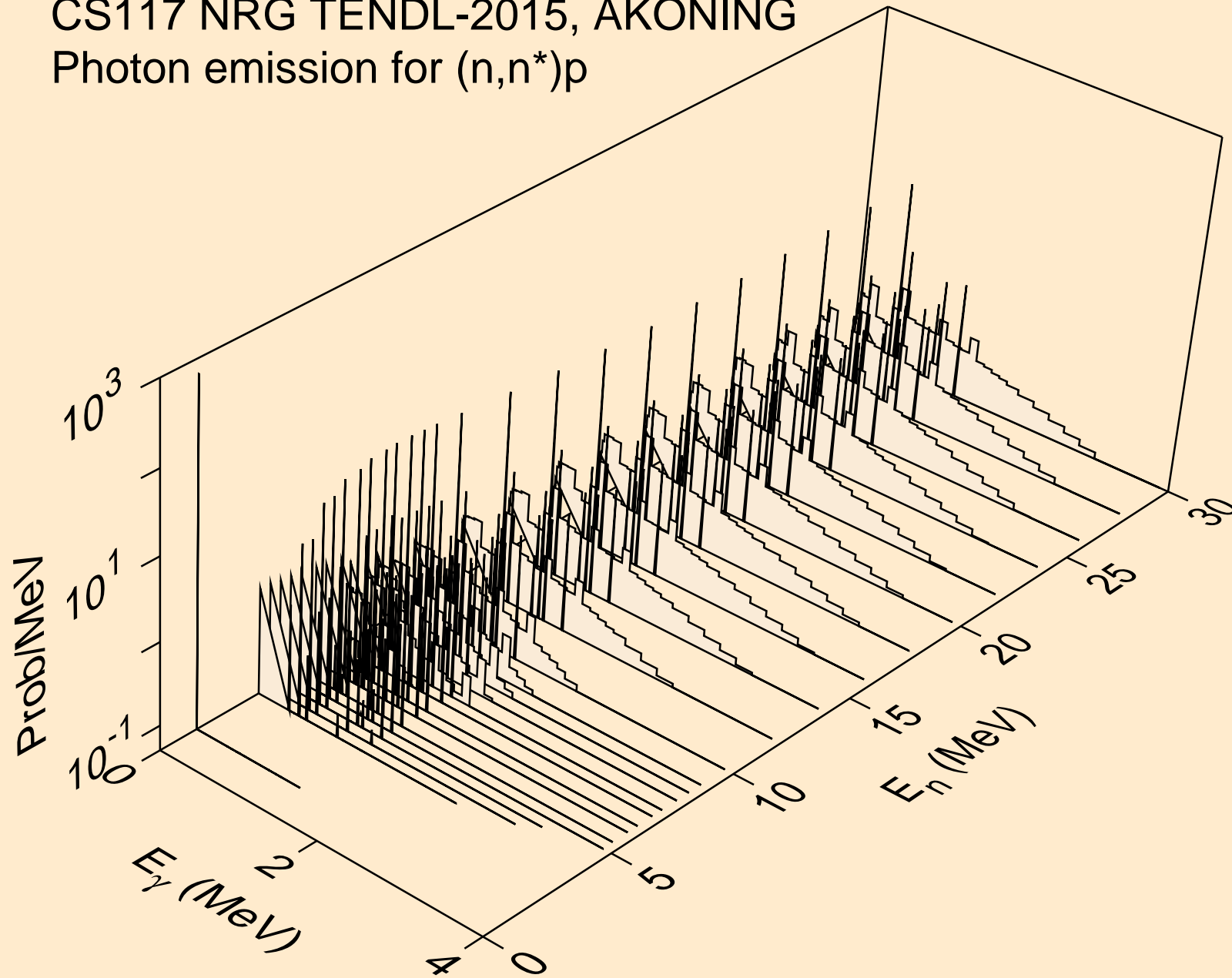

CS117 NRG TENDL-2015, AKONING  
Photon emission for (n,n\*)2a

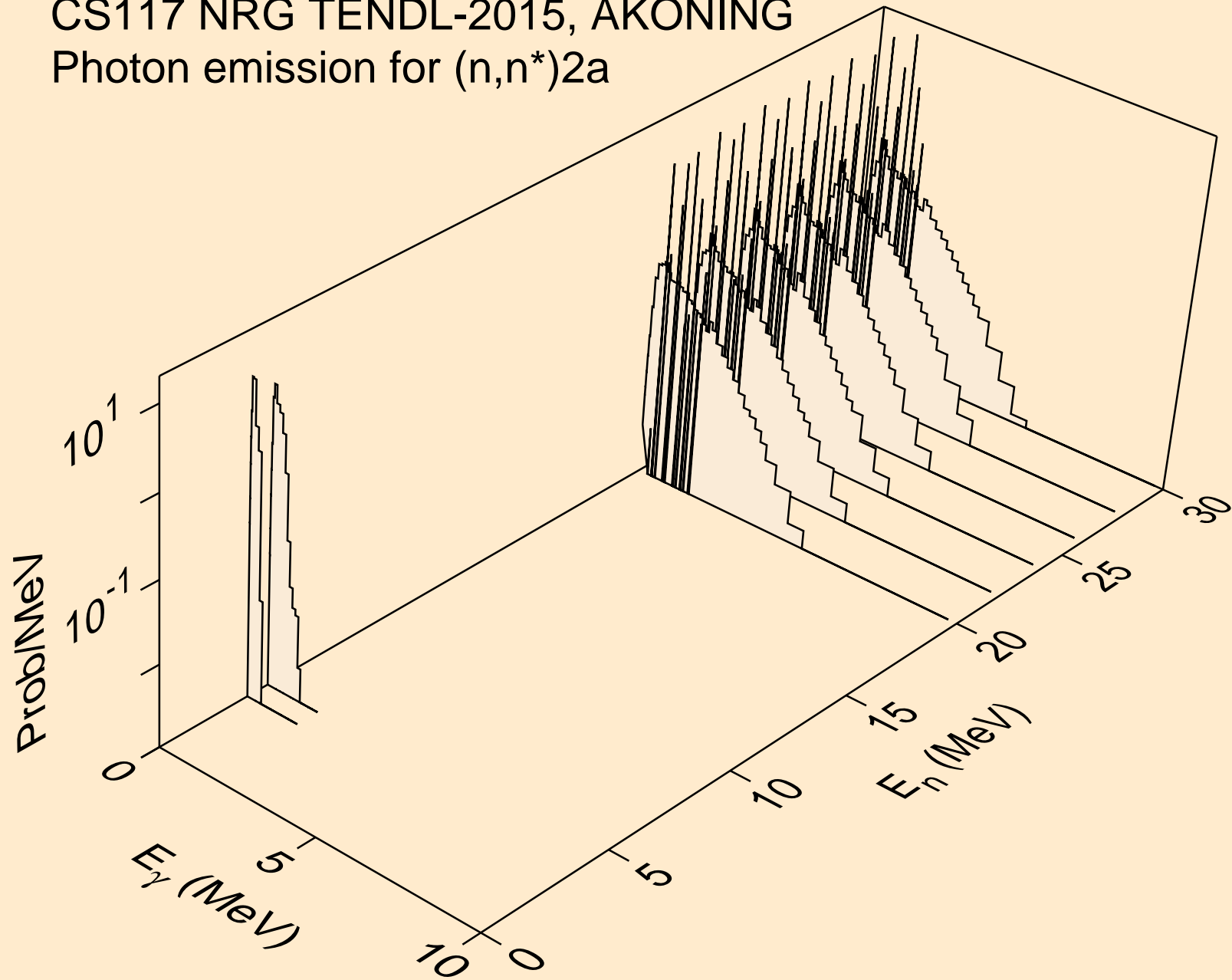

CS117 NRG TENDL-2015, AKONING  
Photon emission for (n,2n)2a

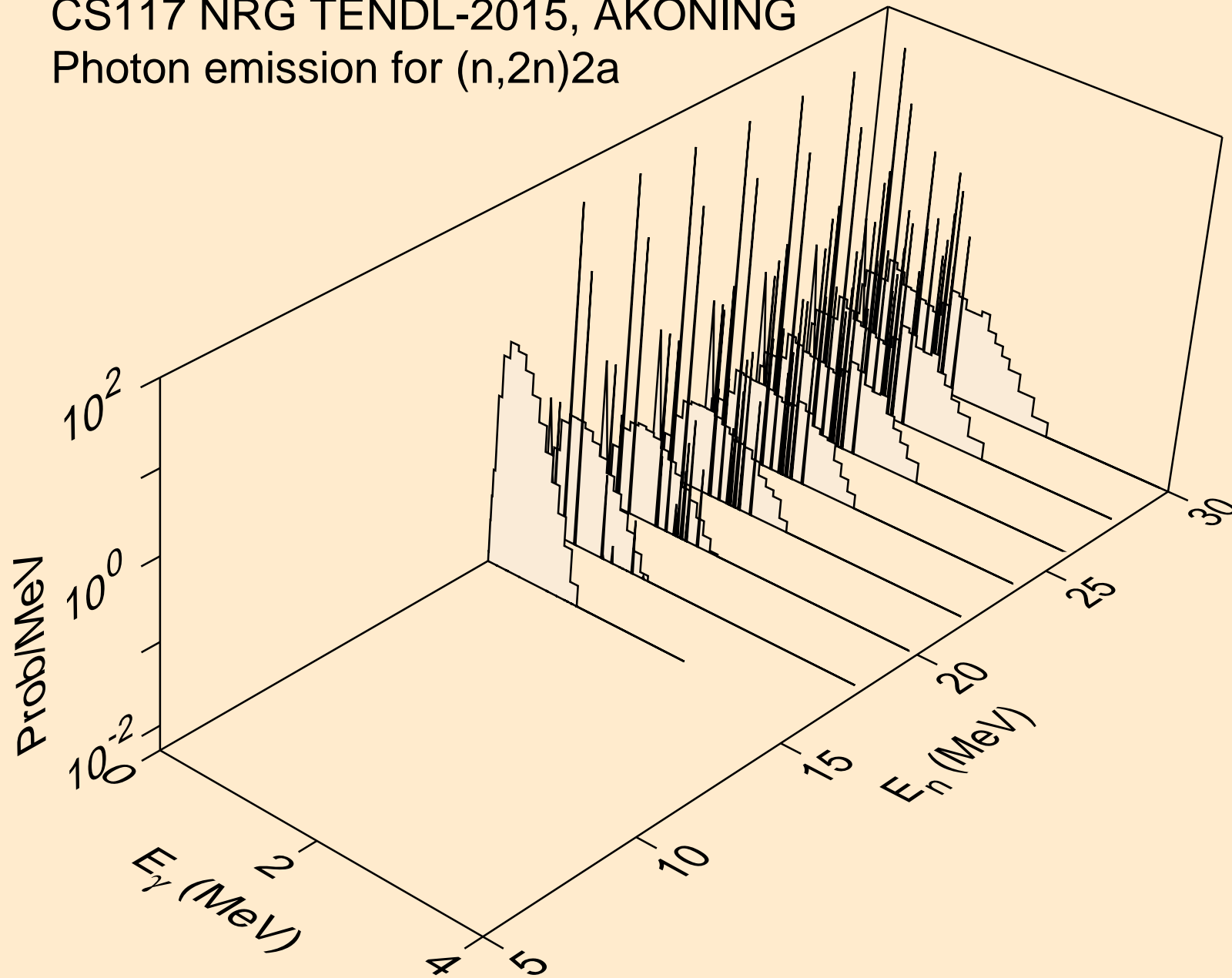

CS117 NRG TENDL-2015, AKONING  
Photon emission for (n,n\*)d

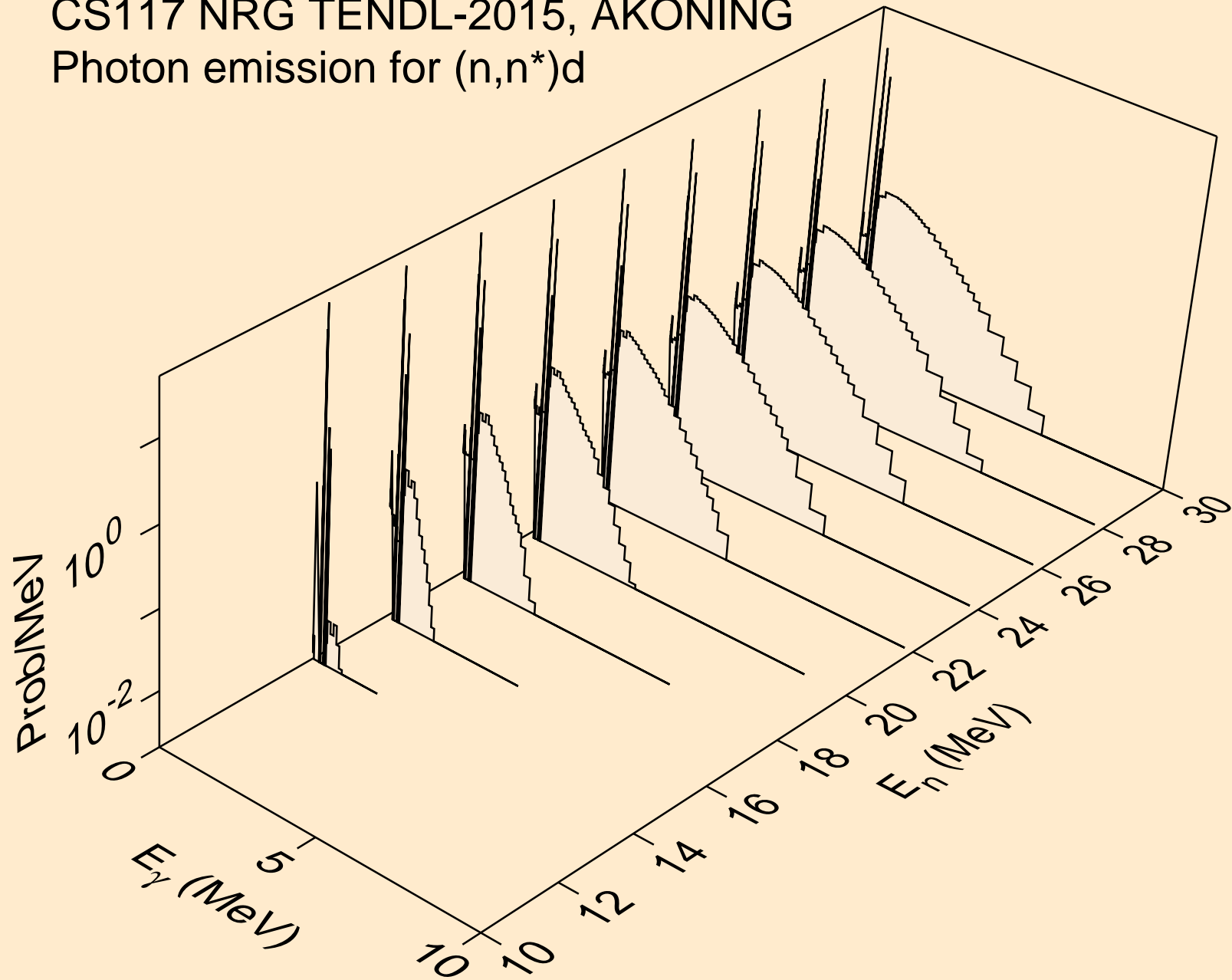

CS117 NRG TENDL-2015, AKONING  
Photon emission for (n,n\*)t

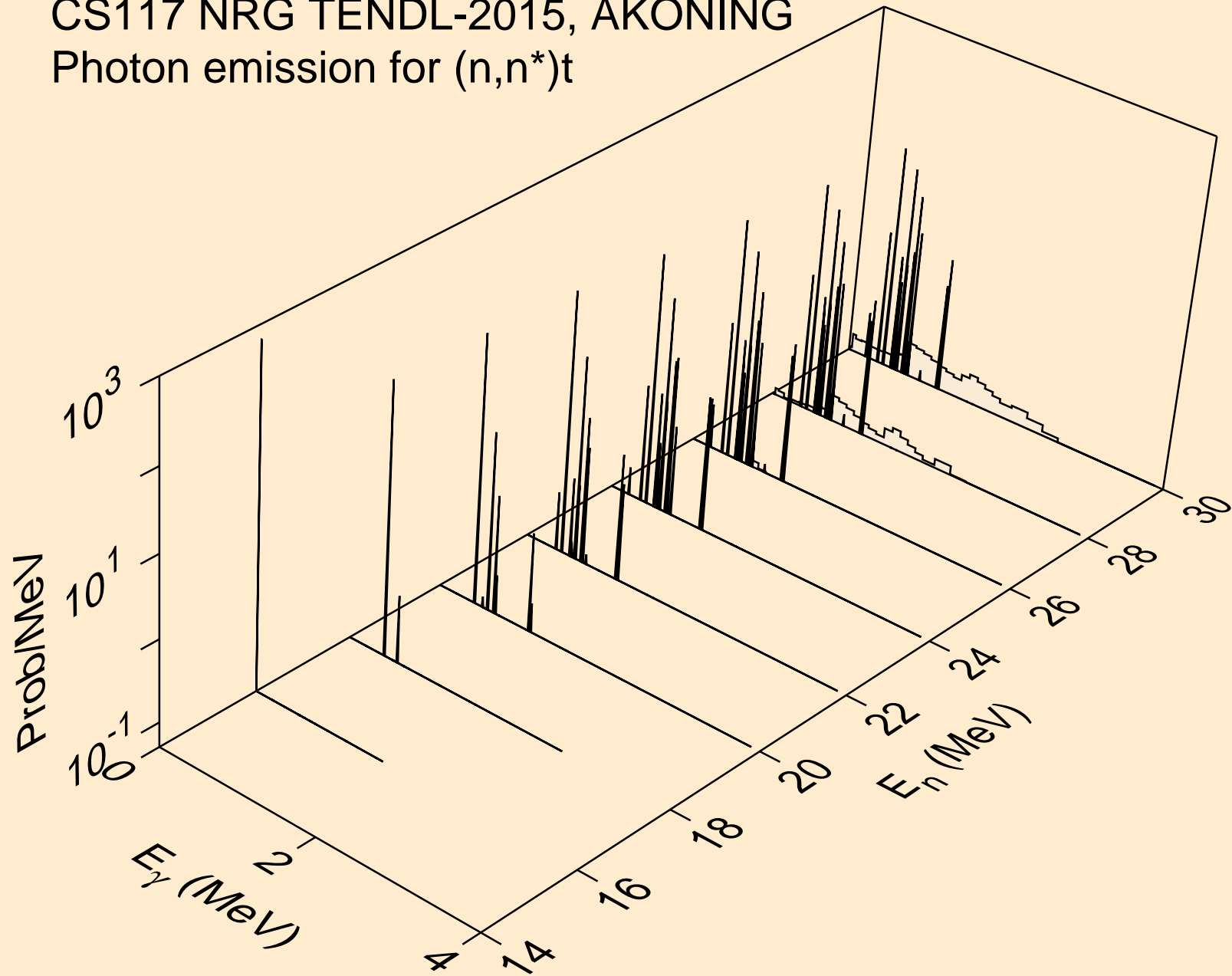

CS117 NRG TENDL-2015, AKONING  
Photon emission for (n,n\*)he3

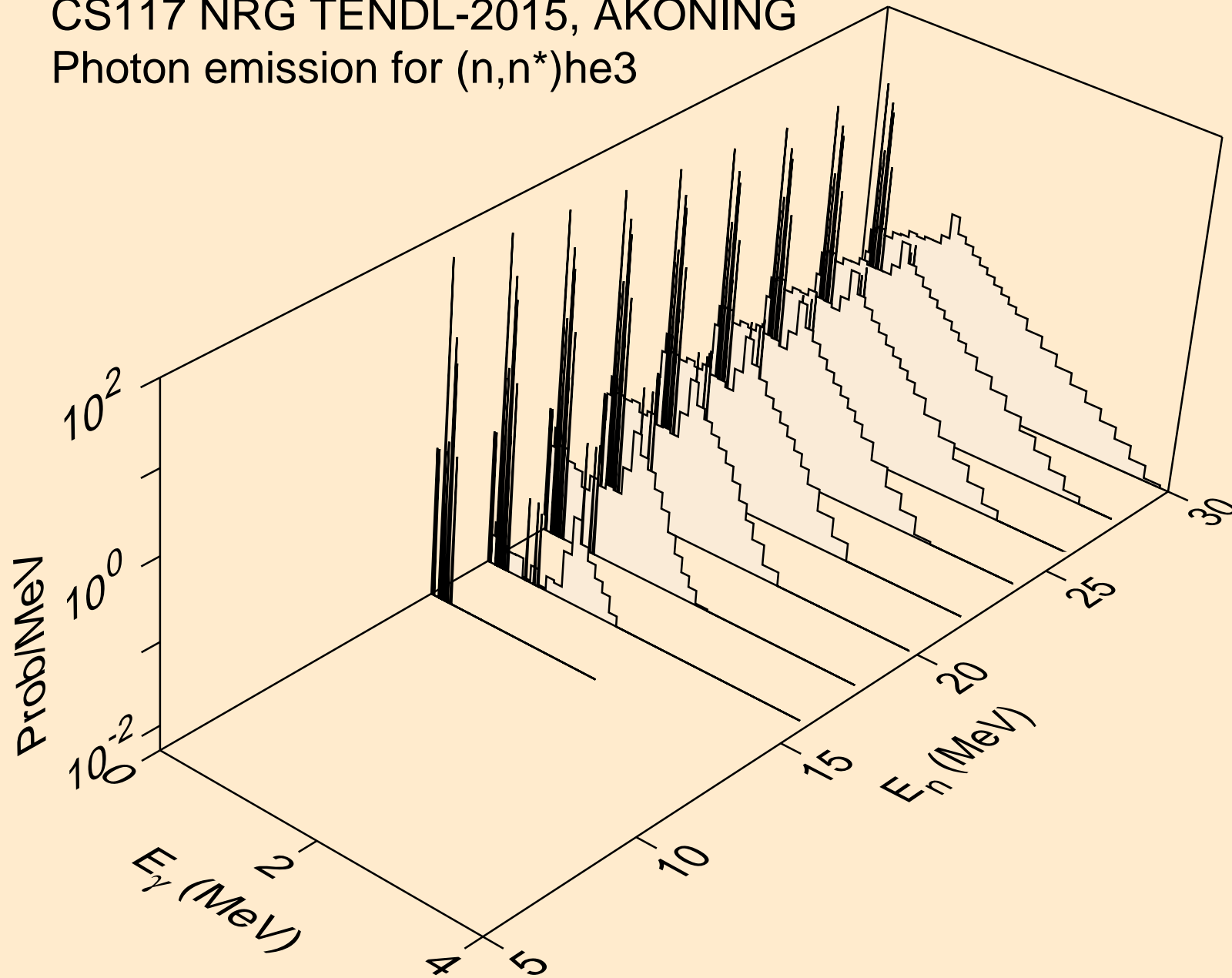



CS117 NRG TENDL-2015, AKONING  
Photon emission for (n,n\*)d2a

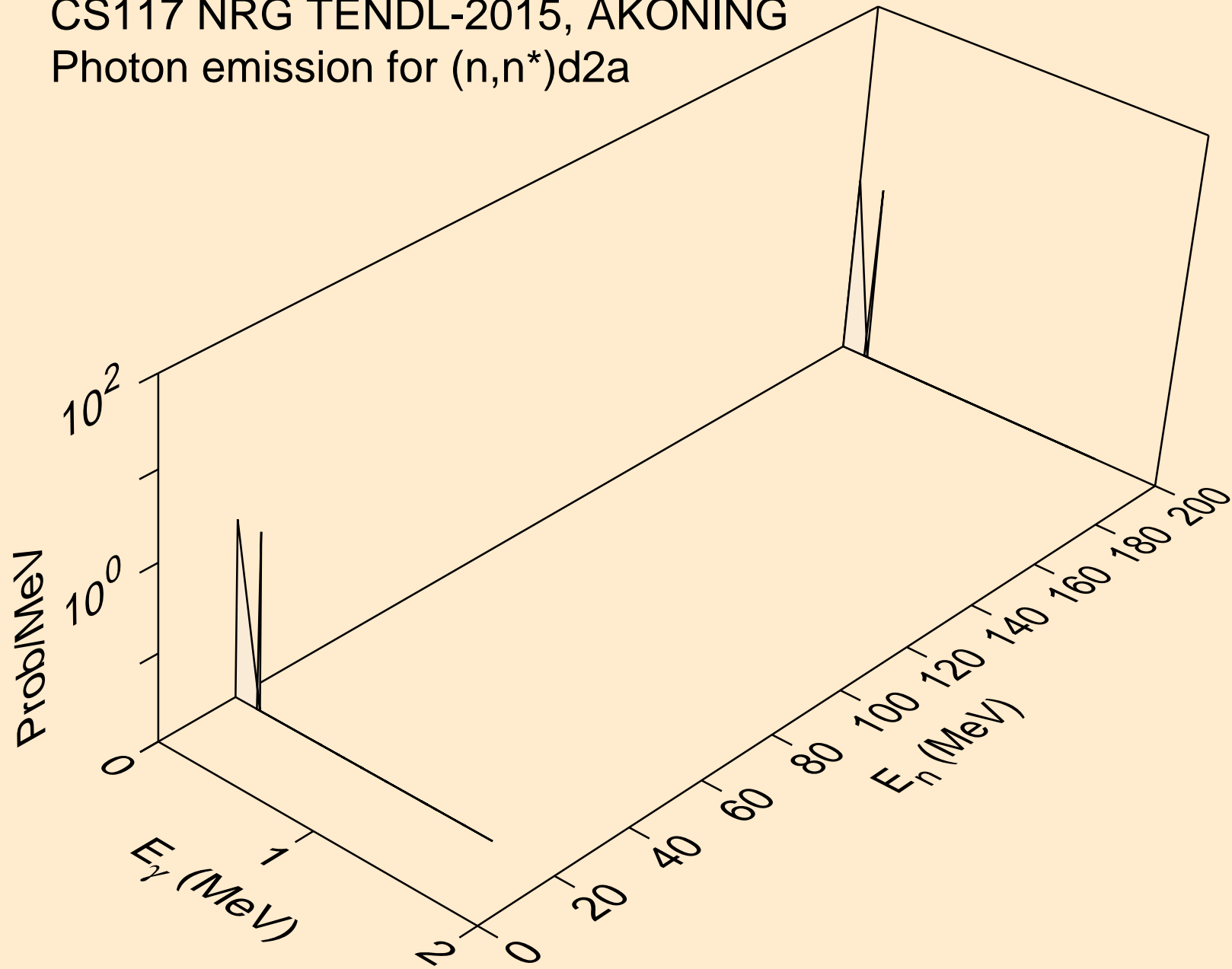

CS117 NRG TENDL-2015, AKONING  
Photon emission for (n,2np)

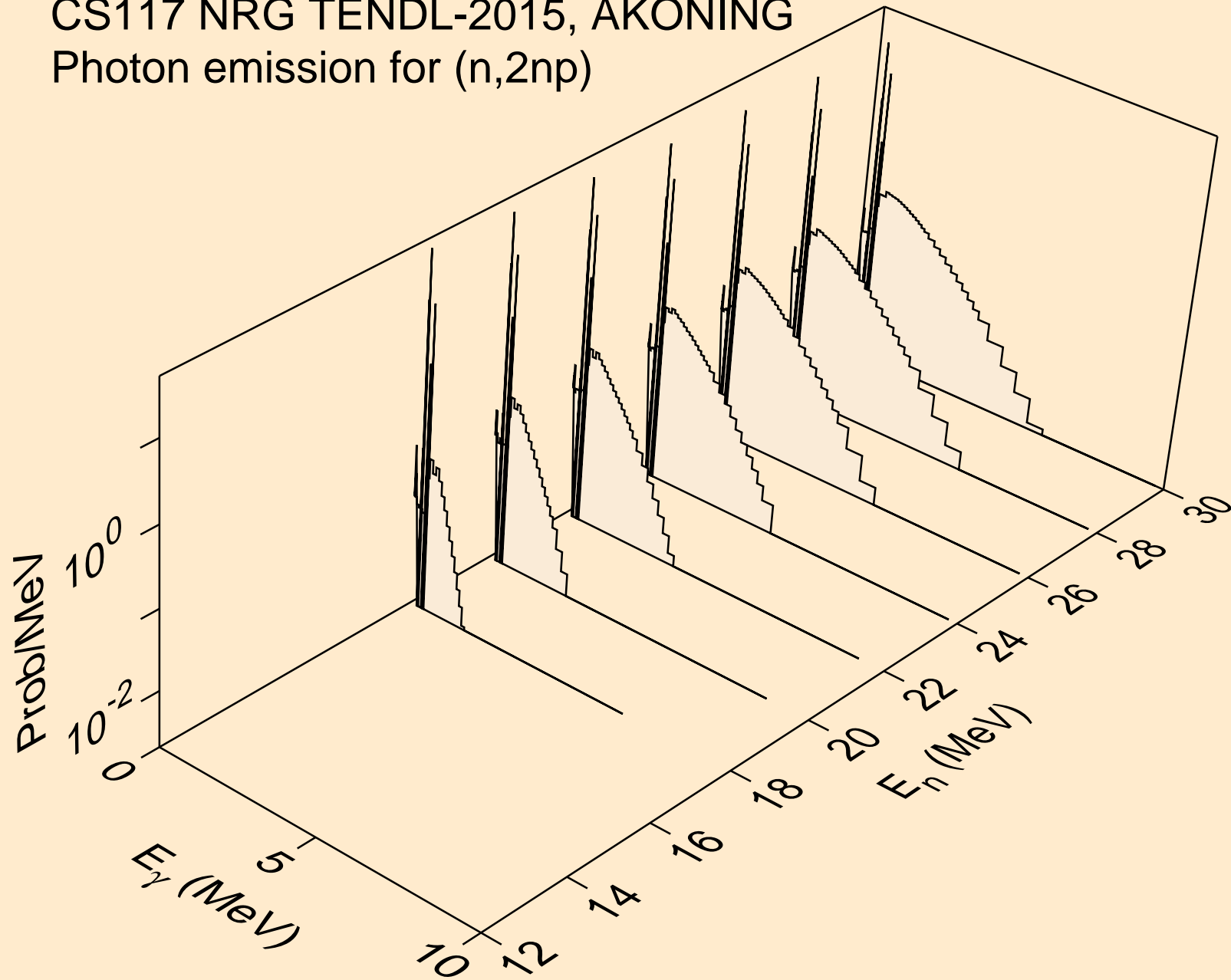

CS117 NRG TENDL-2015, AKONING  
Photon emission for (n,3np)

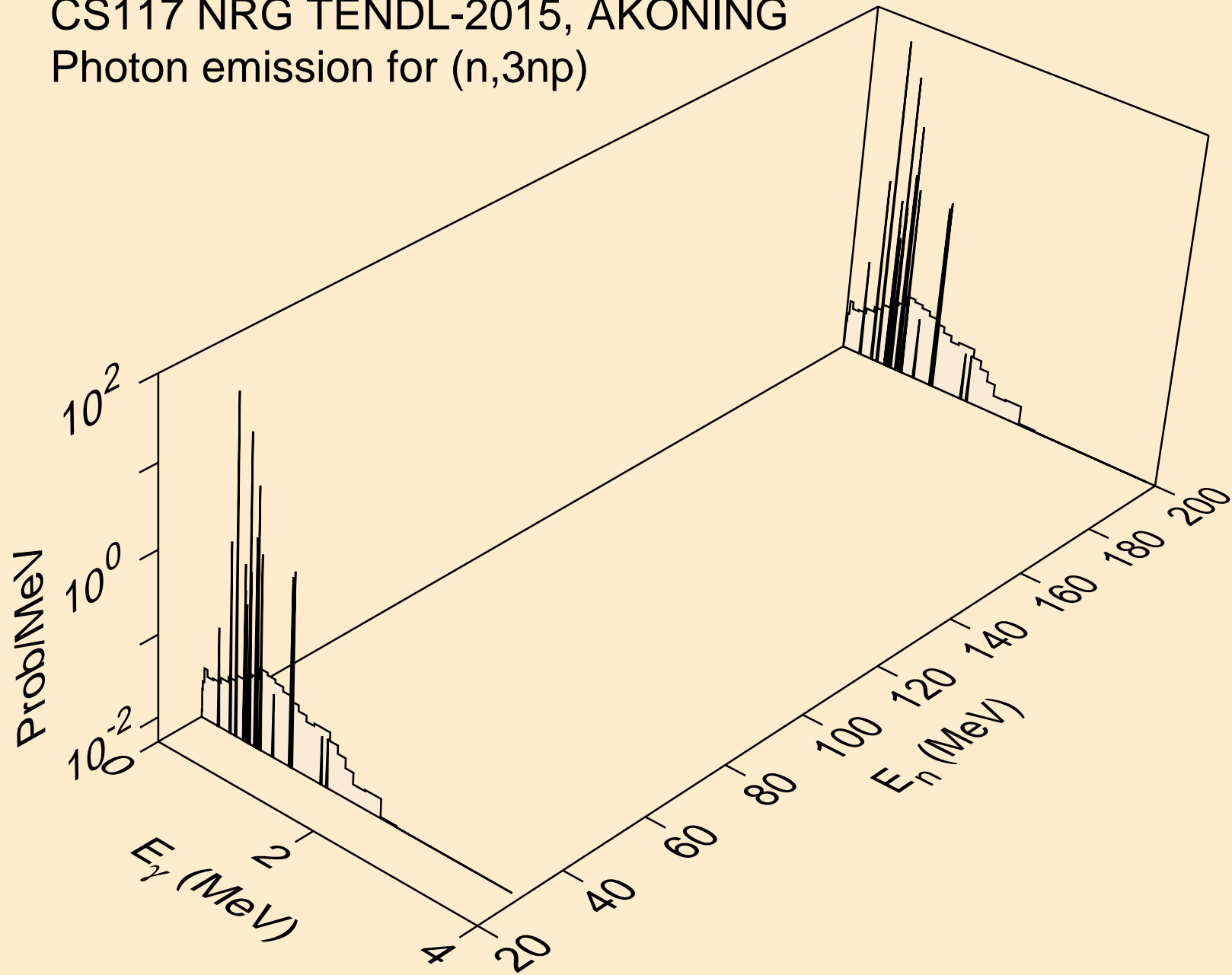

CS117 NRG TENDL-2015, AKONING  
Photon emission for (n,2np)

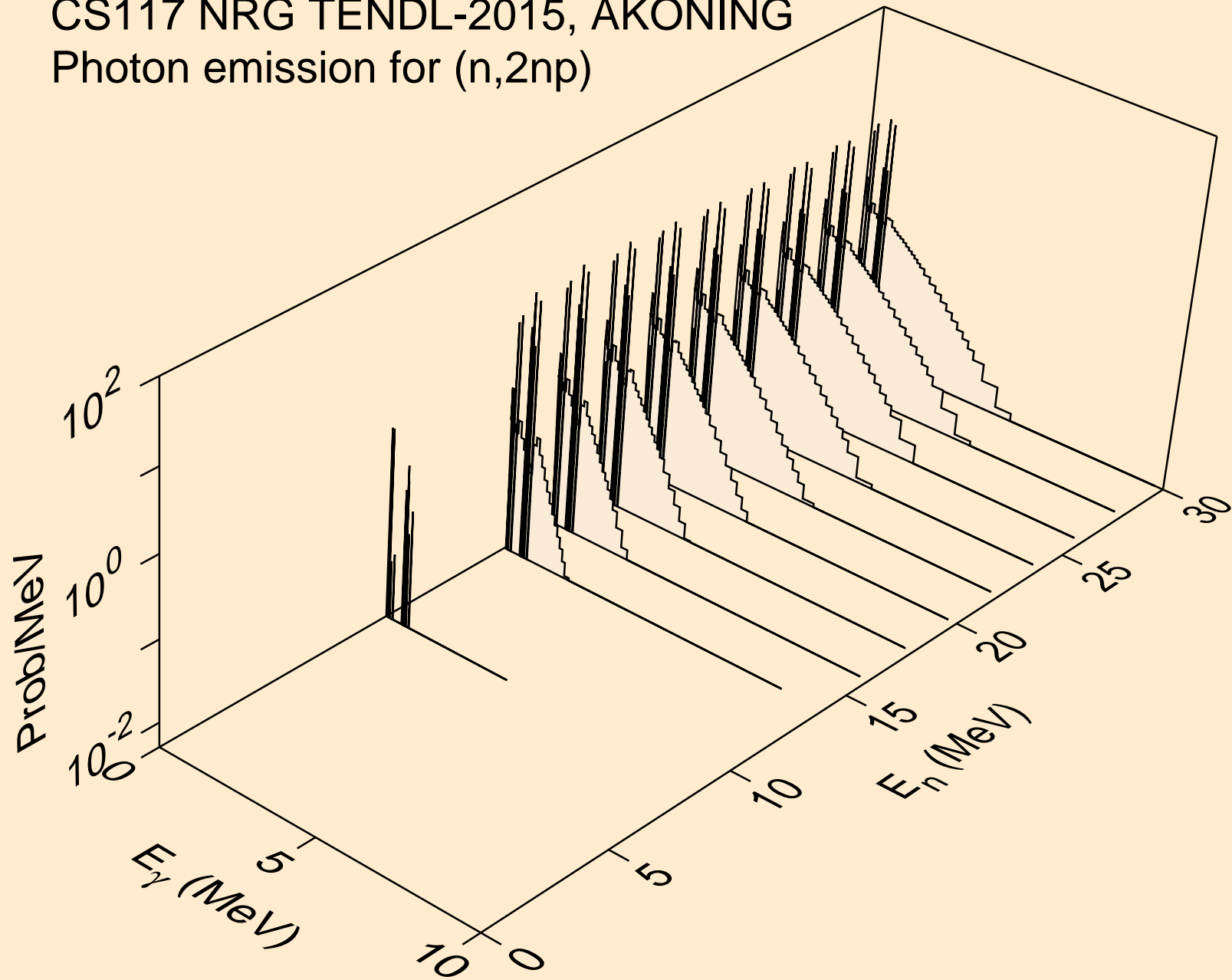

CS117 NRG TENDL-2015, AKONING  
Photon emission for (n,npa)

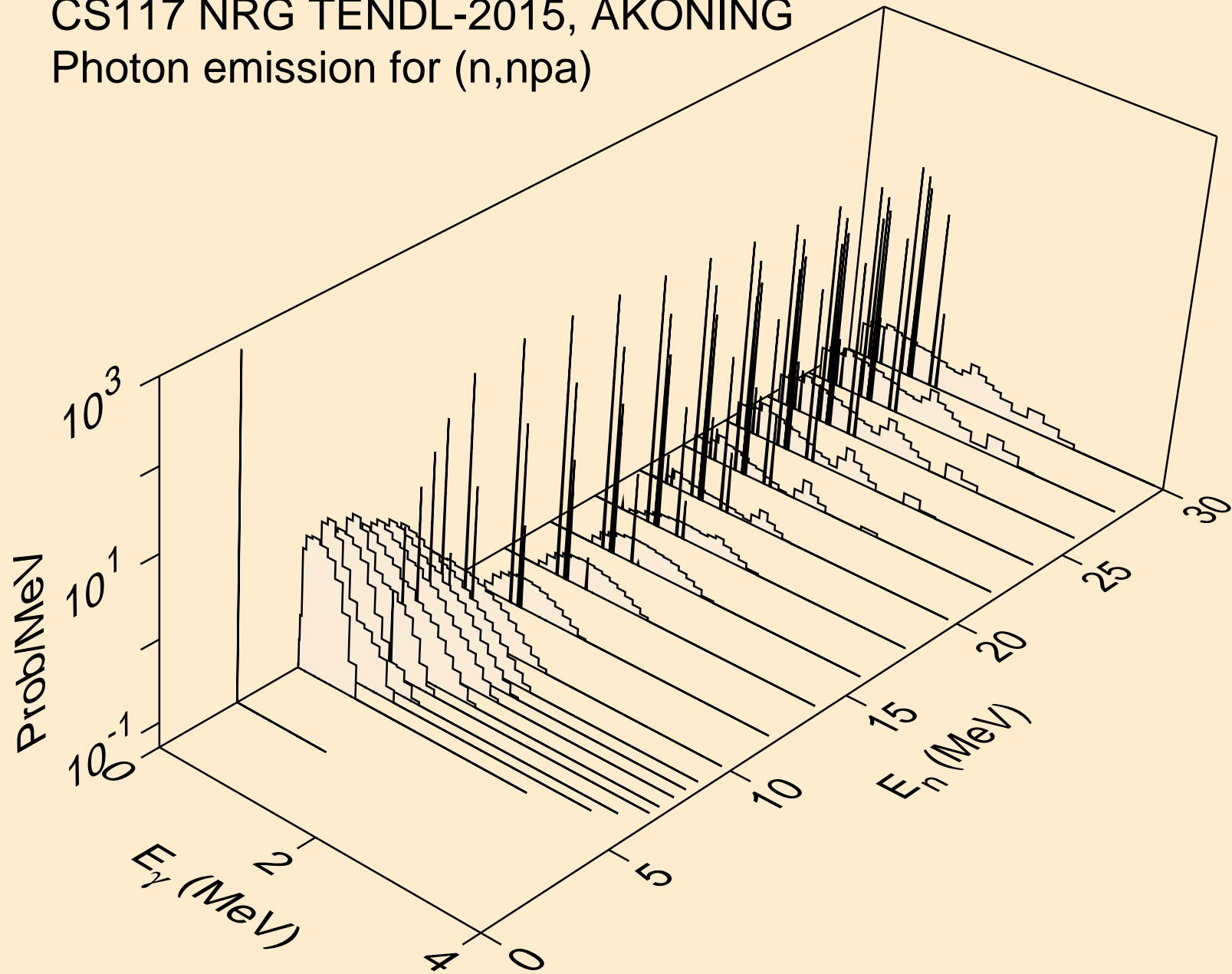

CS117 NRG TENDL-2015, AKONING  
Photon emission for (n,n\*c)

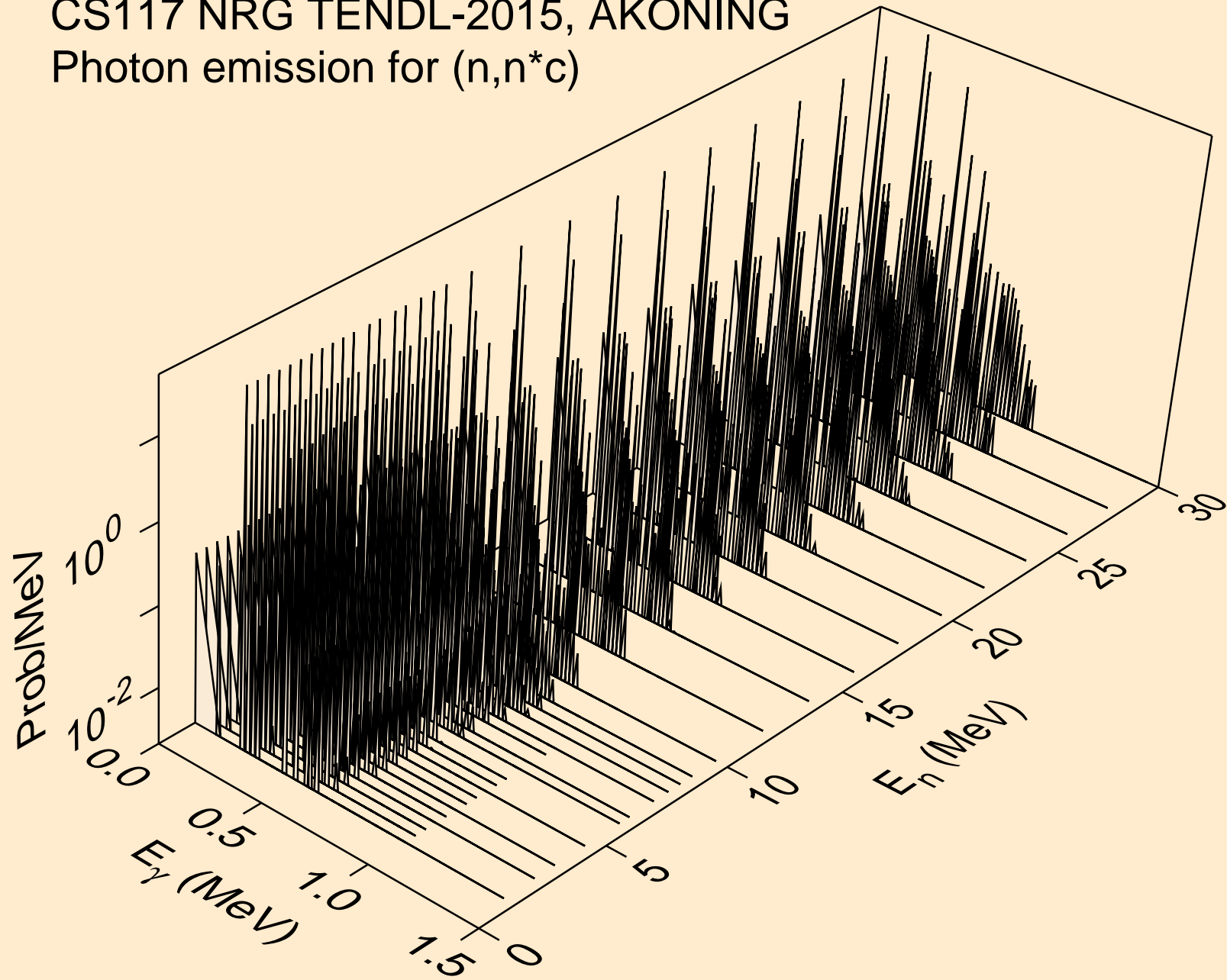

CS117 NRG TENDL-2015, AKONING  
Photon emission for (n,gma)

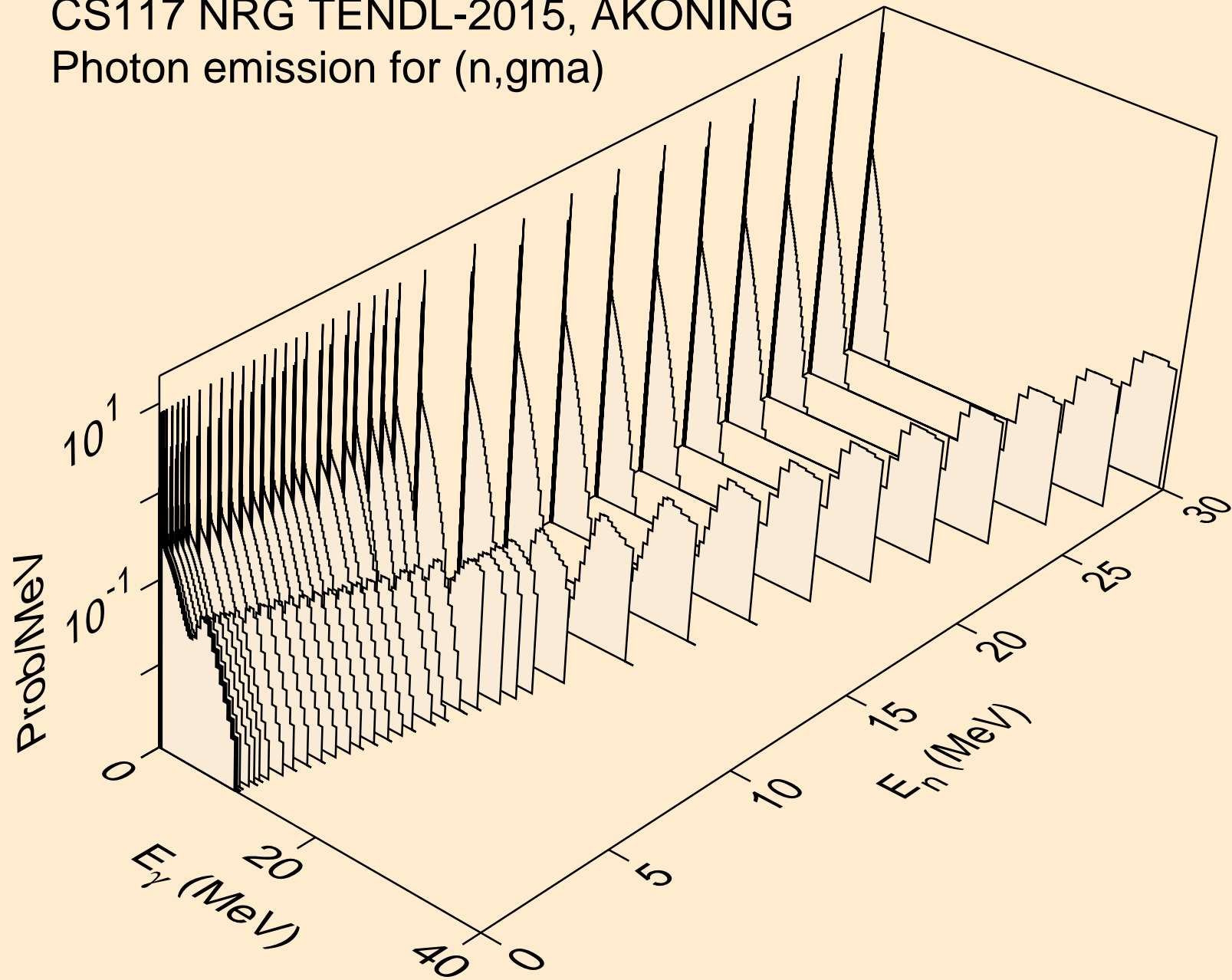

CS117 NRG TENDL-2015, AKONING  
Photon emission for (n,p)

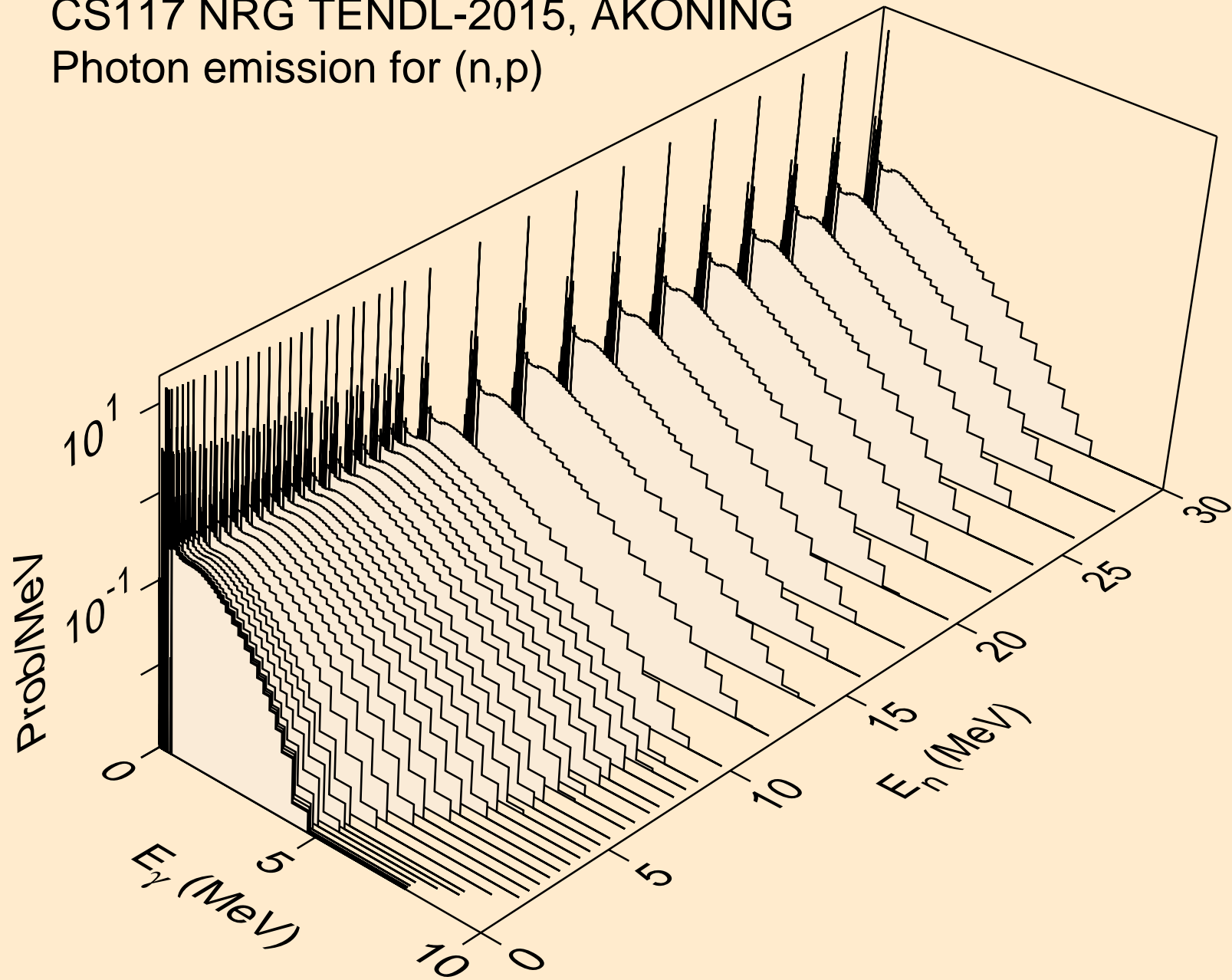



CS117 NRG TENDL-2015, AKONING  
Photon emission for (n,d)

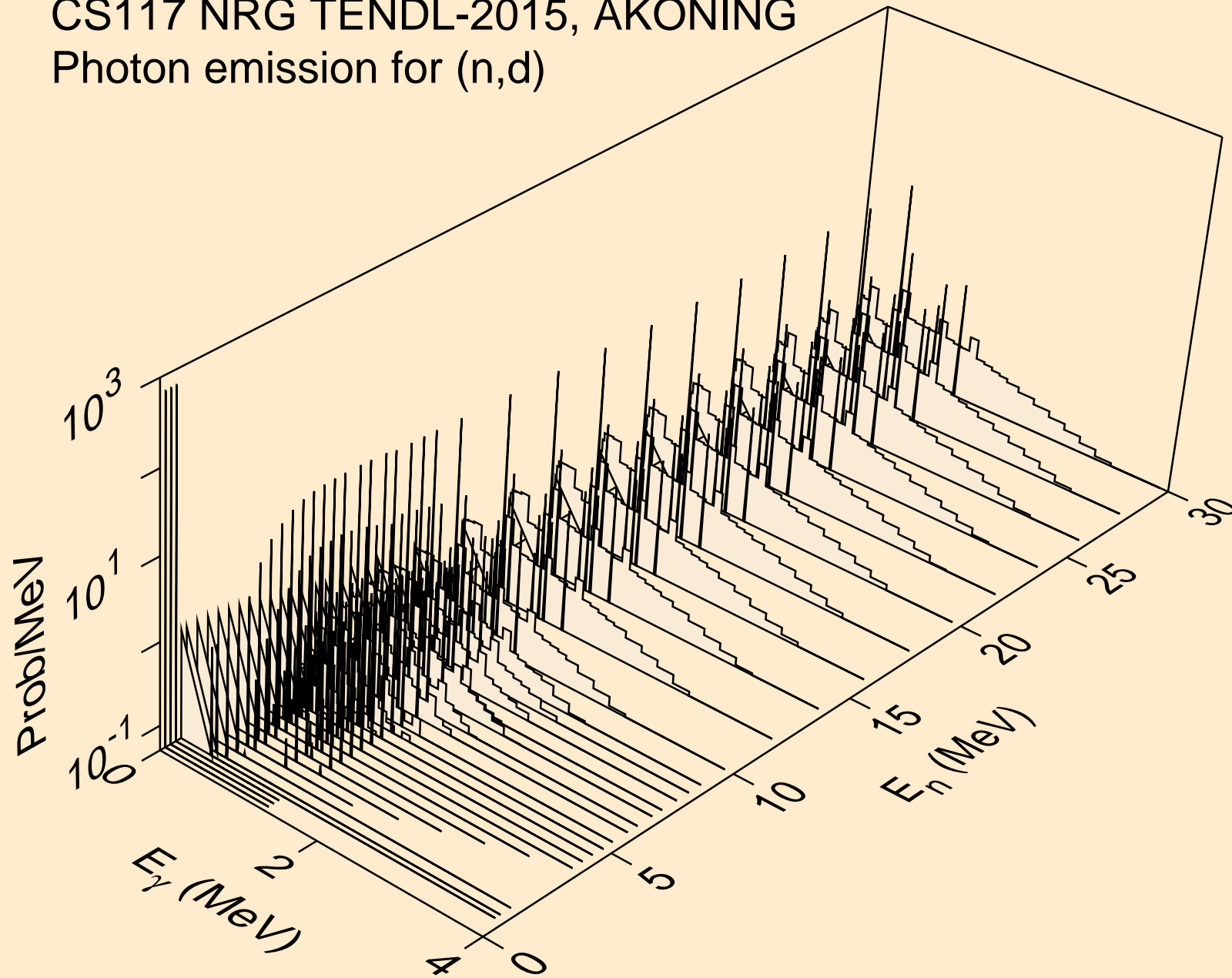

CS117 NRG TENDL-2015, AKONING  
Photon emission for (n,t)

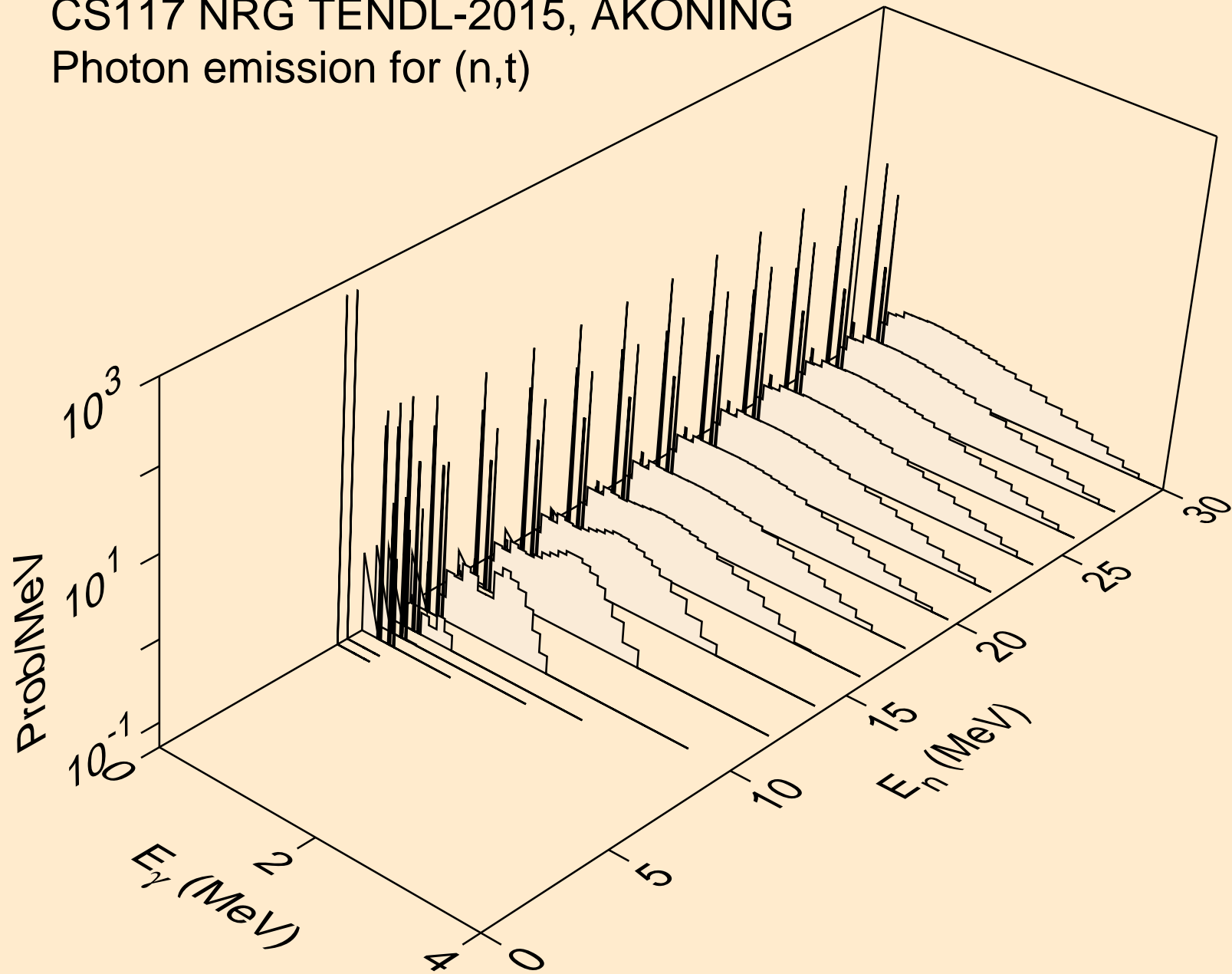

CS117 NRG TENDL-2015, AKONING  
Photon emission for (n,he3)

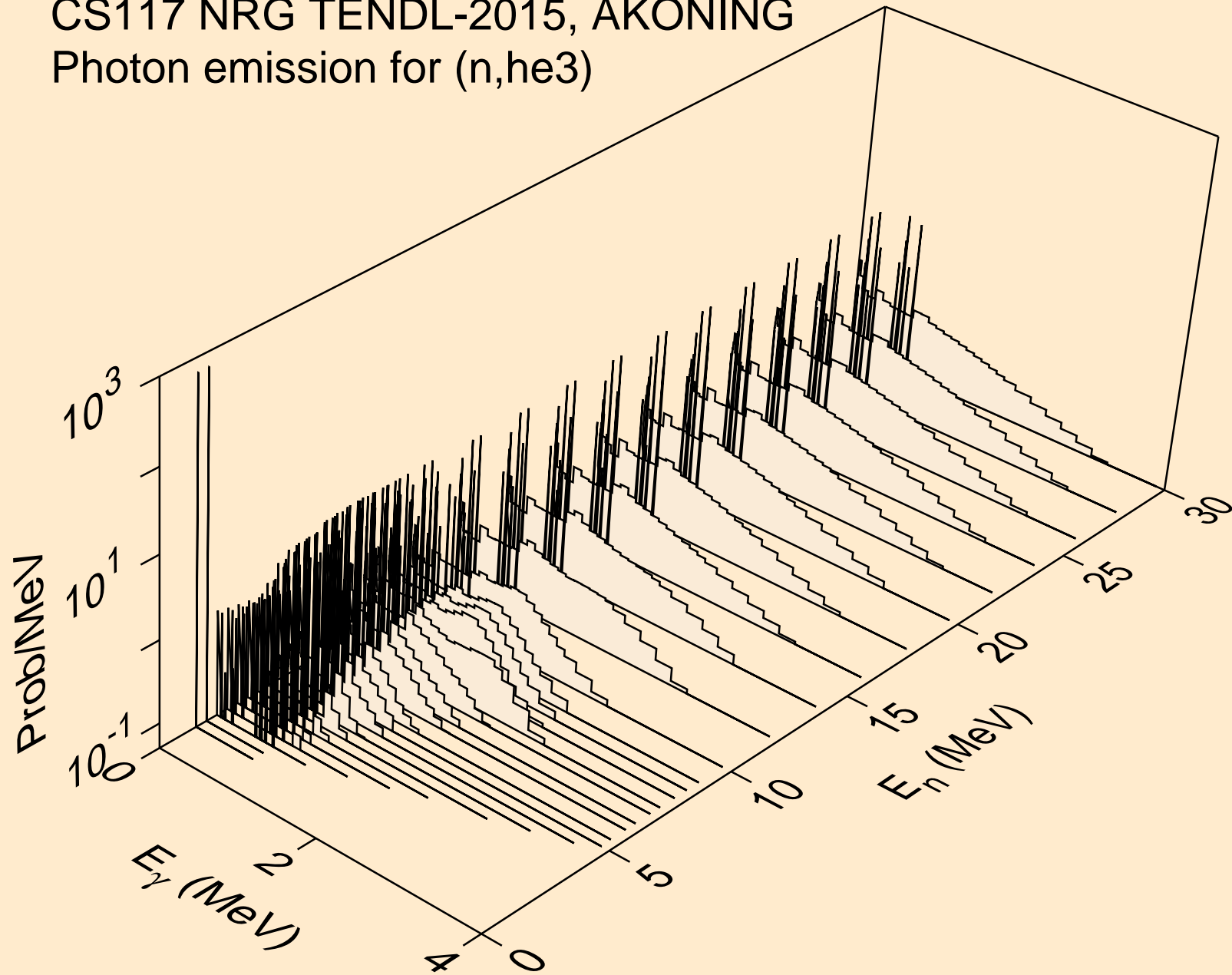

CS117 NRG TENDL-2015, AKONING  
Photon emission for (n,a)

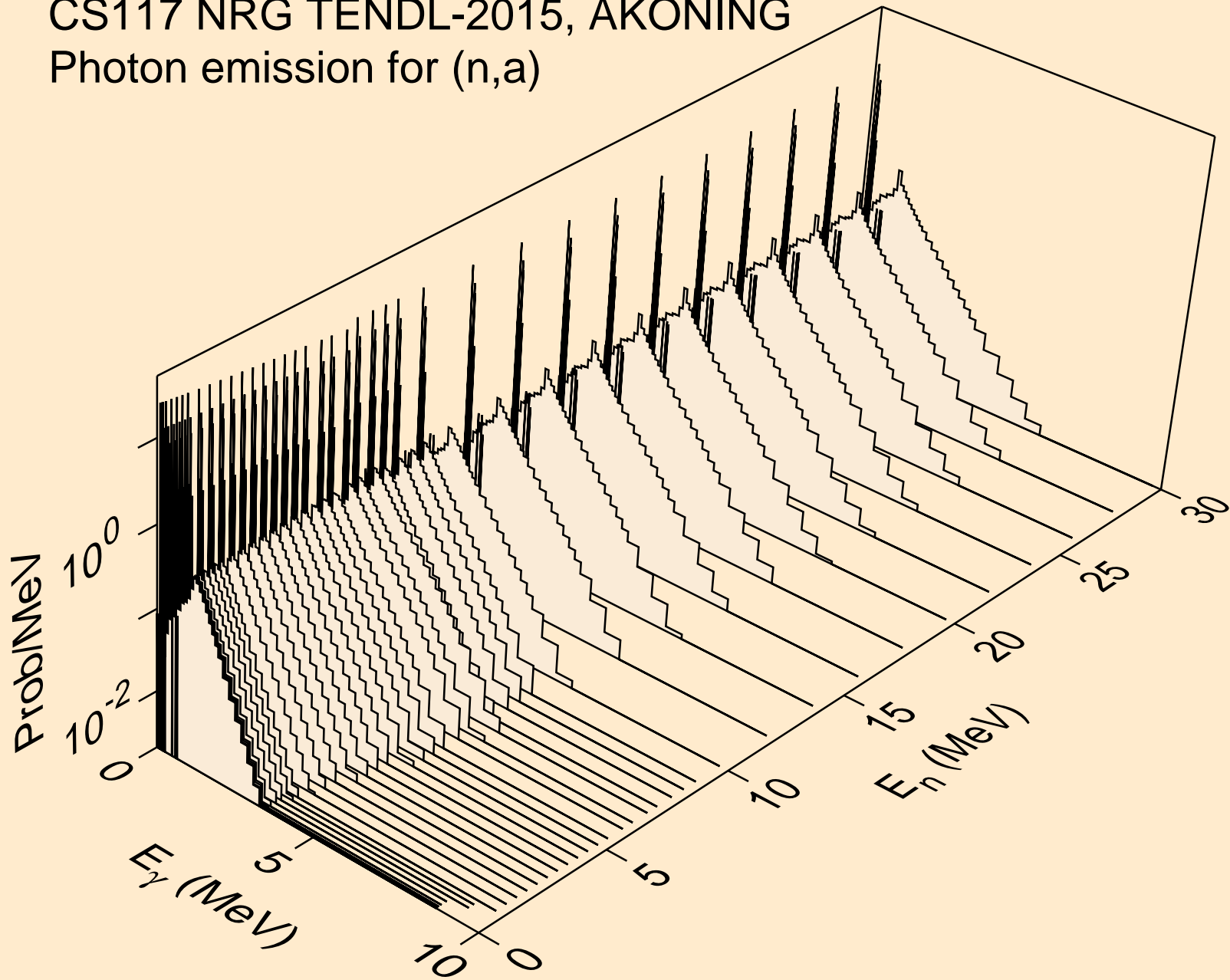

CS117 NRG TENDL-2015, AKONING  
Photon emission for (n,2a)

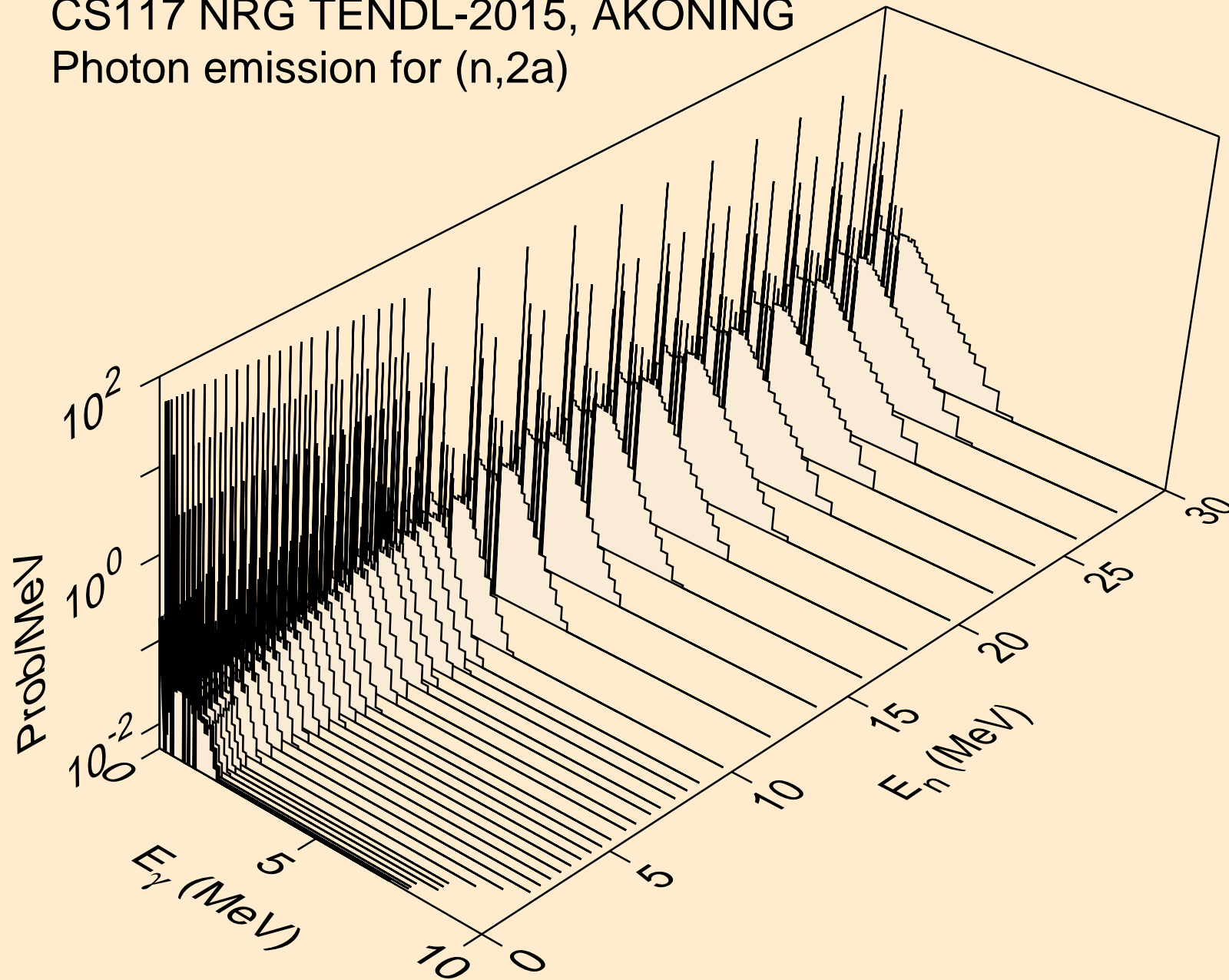

CS117 NRG TENDL-2015, AKONING  
Photon emission for (n,3a)

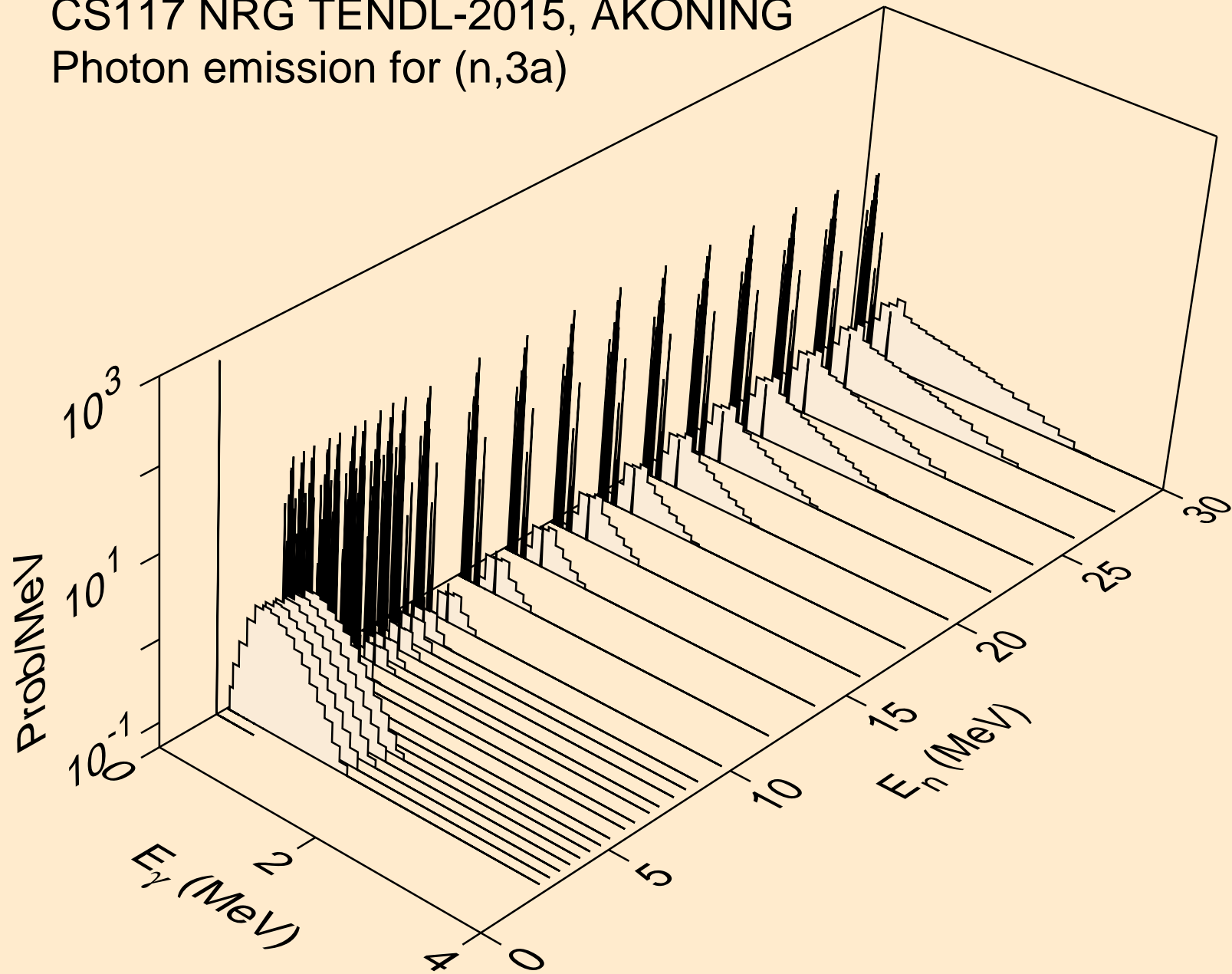

CS117 NRG TENDL-2015, AKONING  
Photon emission for (n,2p)

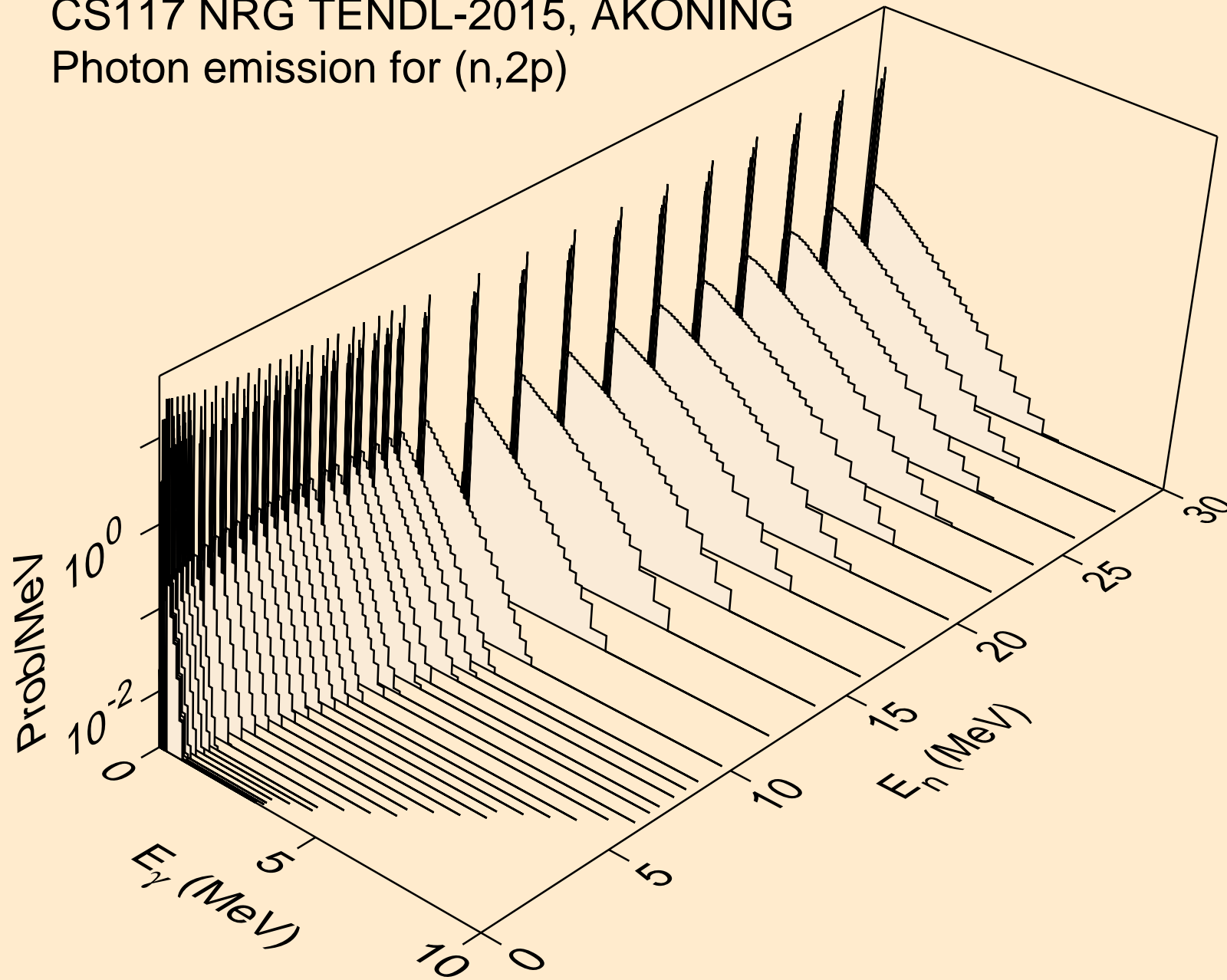

CS117 NRG TENDL-2015, AKONING  
Photon emission for (n,p $\alpha$ )

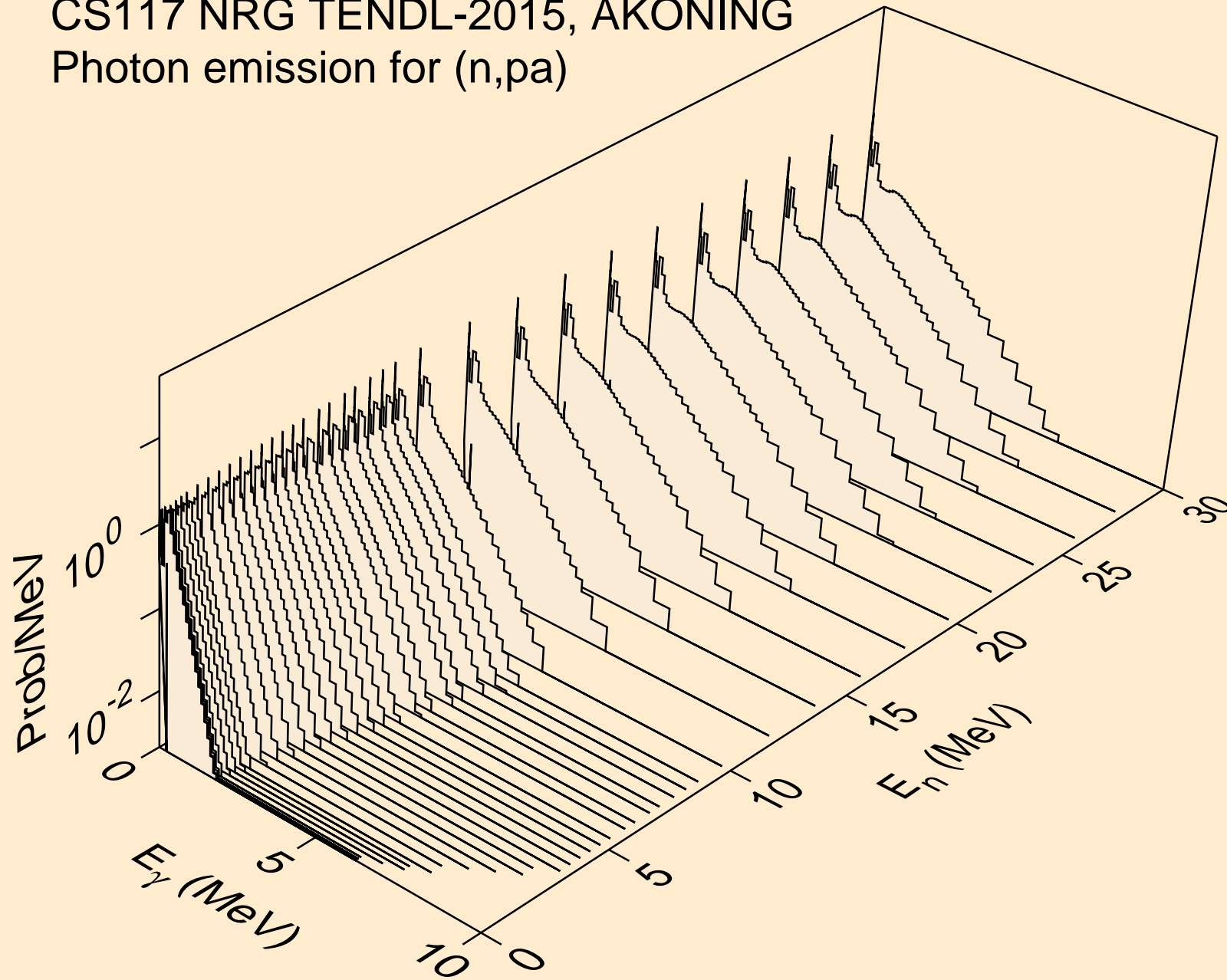



CS117 NRG TENDL-2015, AKONING  
Photon emission for (n,t2a)

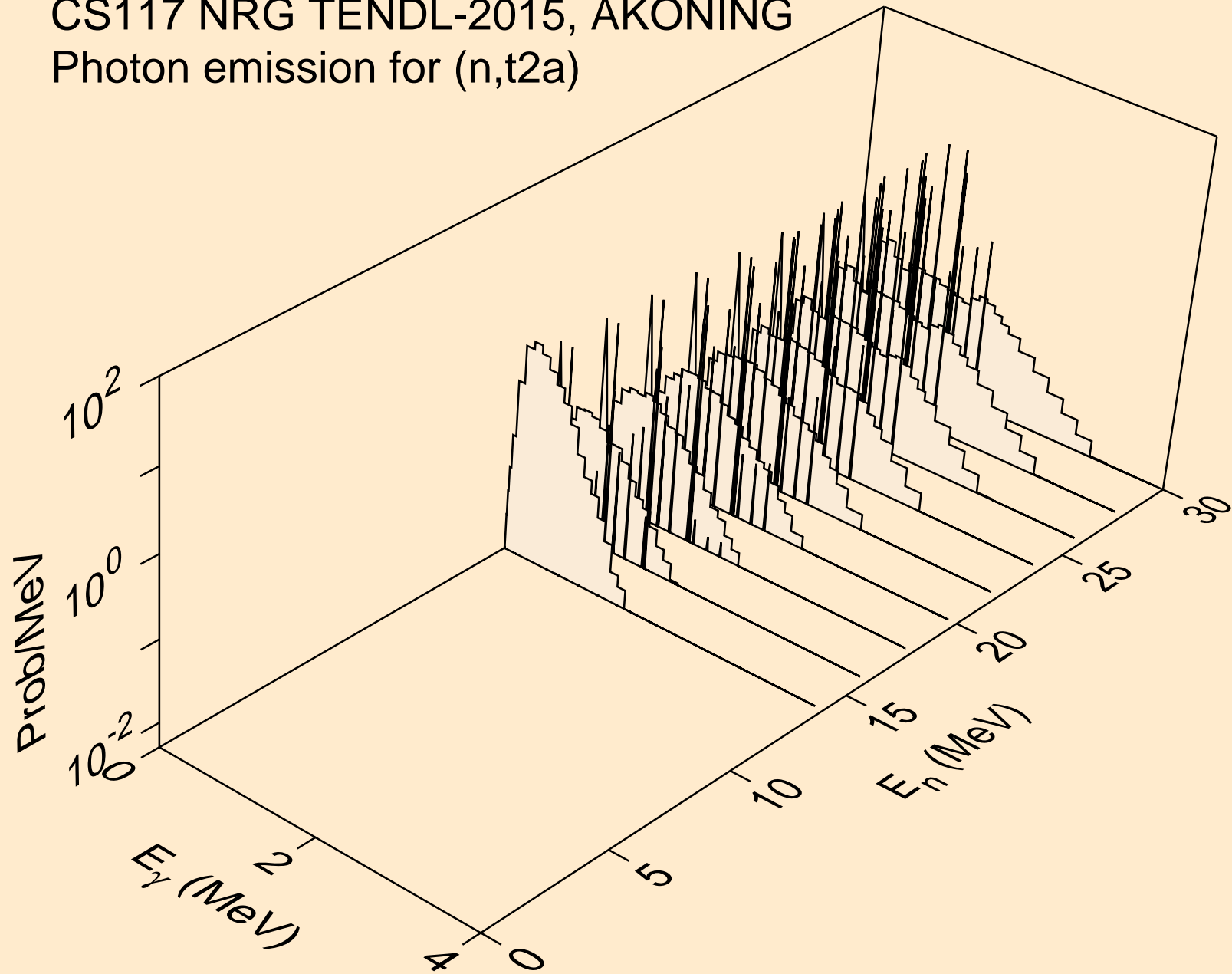

CS117 NRG TENDL-2015, AKONING  
Photon emission for (n,d2a)

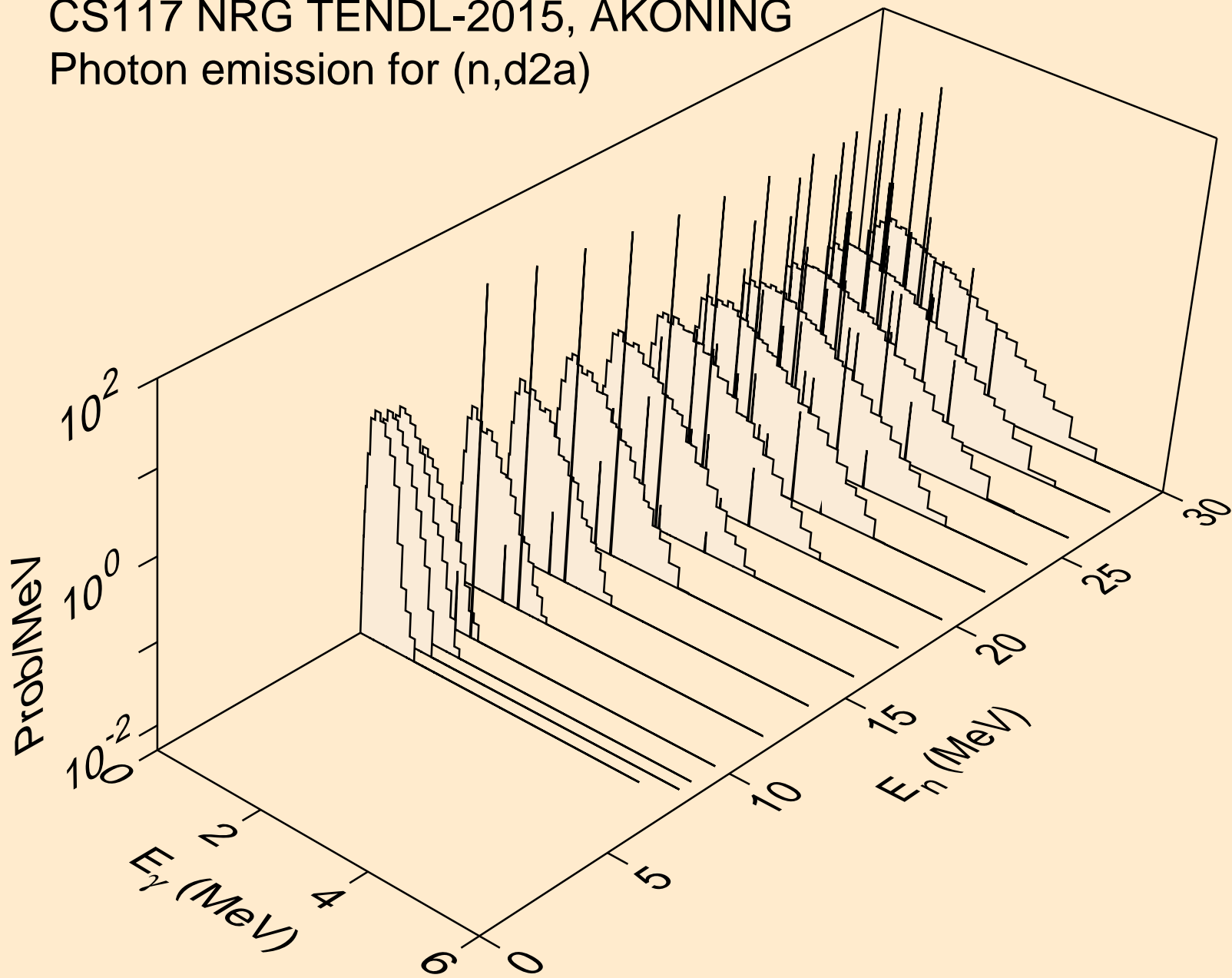

CS117 NRG TENDL-2015, AKONING  
Photon emission for (n,pd)

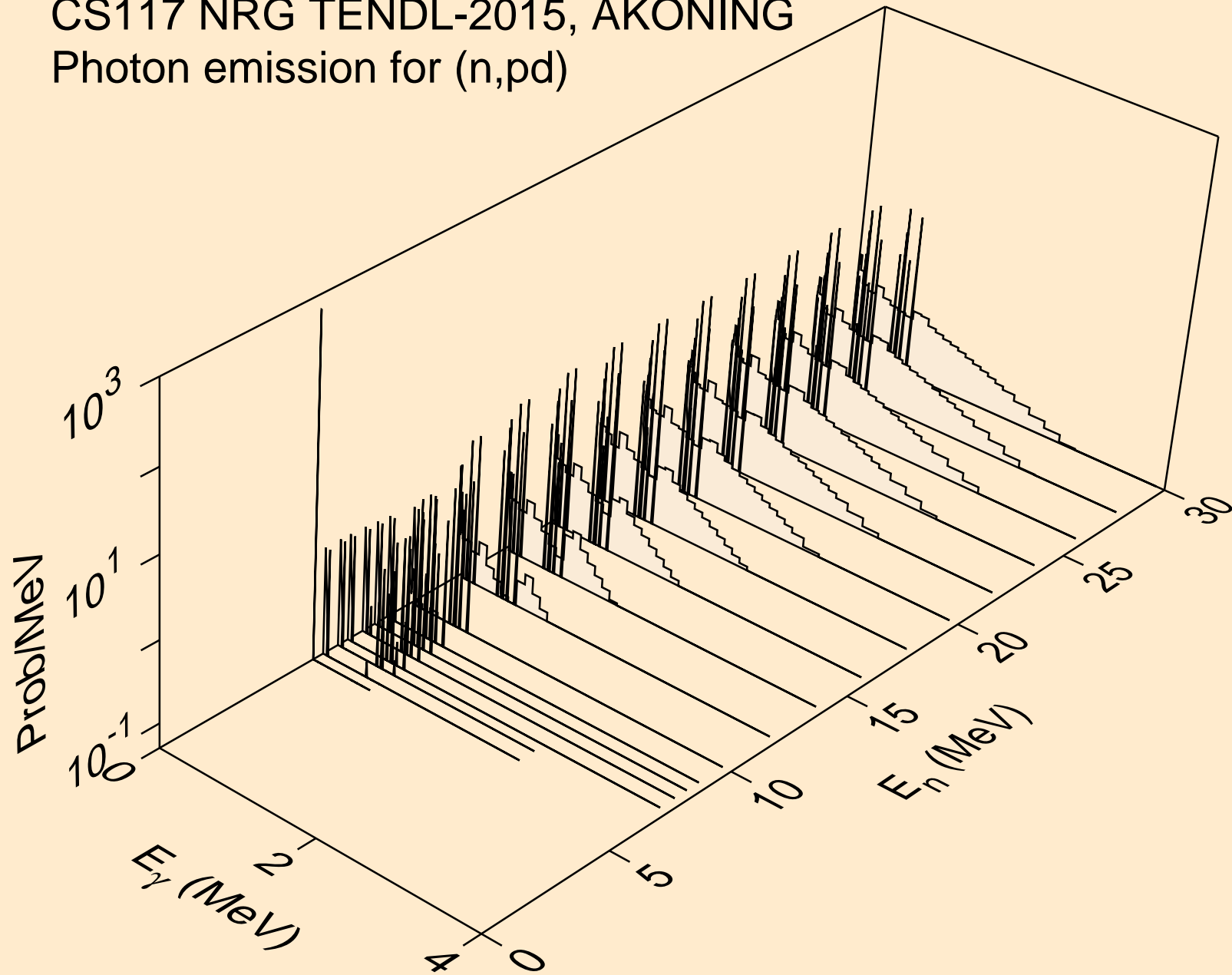

CS117 NRG TENDL-2015, AKONING  
Photon emission for (n,pt)

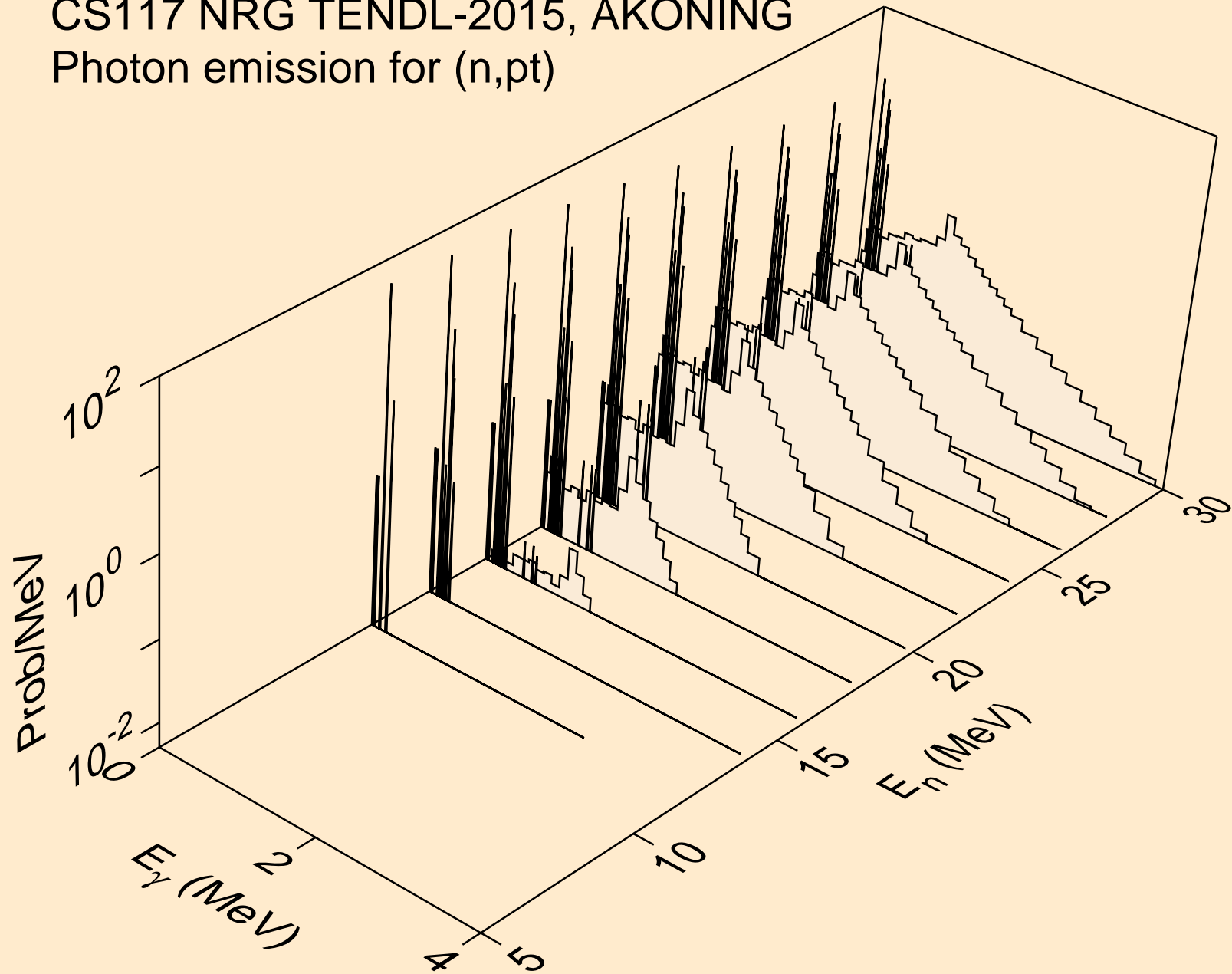

CS117 NRG TENDL-2015, AKONING  
Photon emission for (n,da)

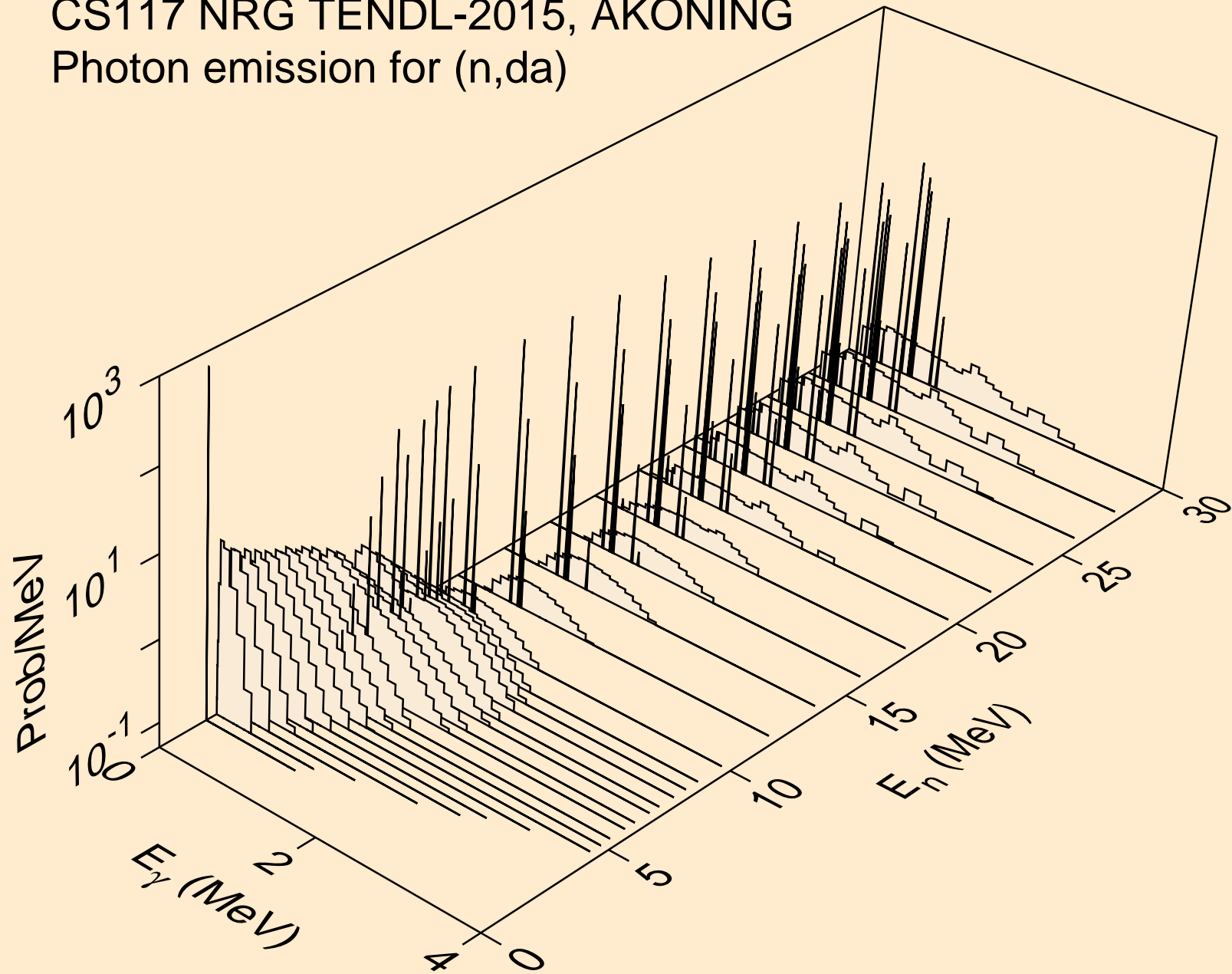

CS117 NRG TENDL-2015, AKONING  
thermal capture photon spectrum

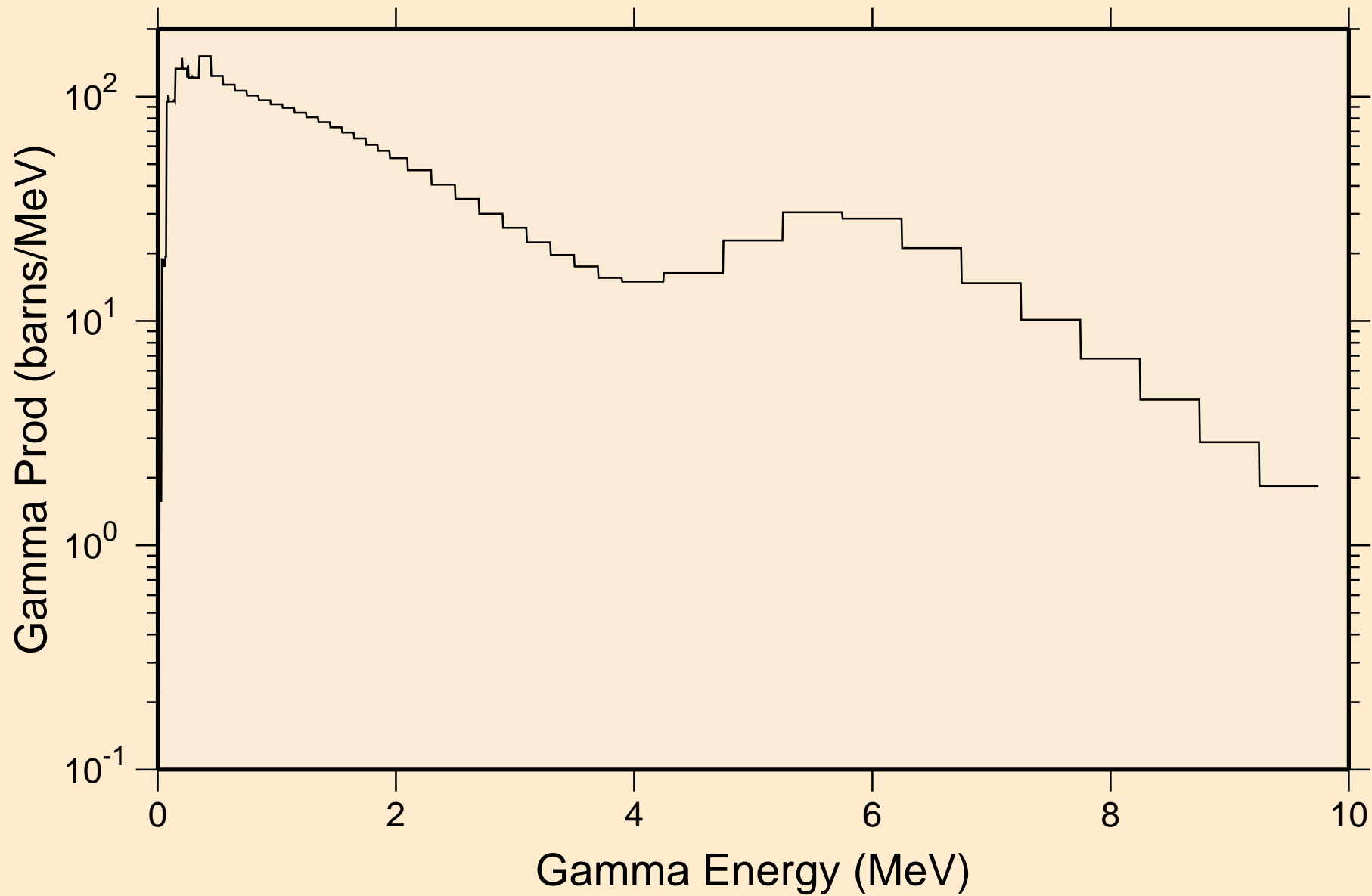

CS117 NRG TENDL-2015, AKONING  
14 MeV photon spectrum

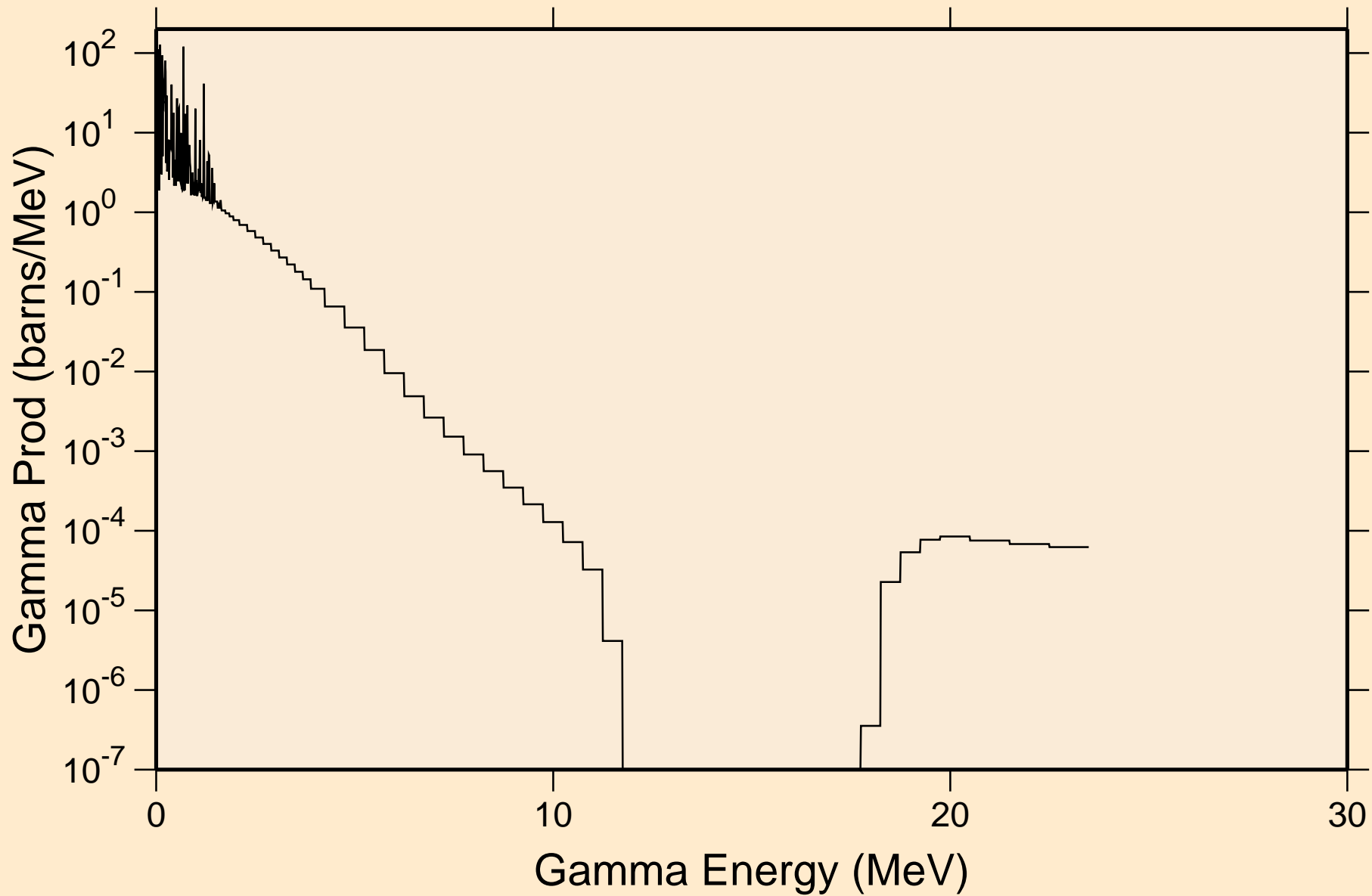

# CS117 NRG TENDL-2015, AKONING

## Particle heating contributions

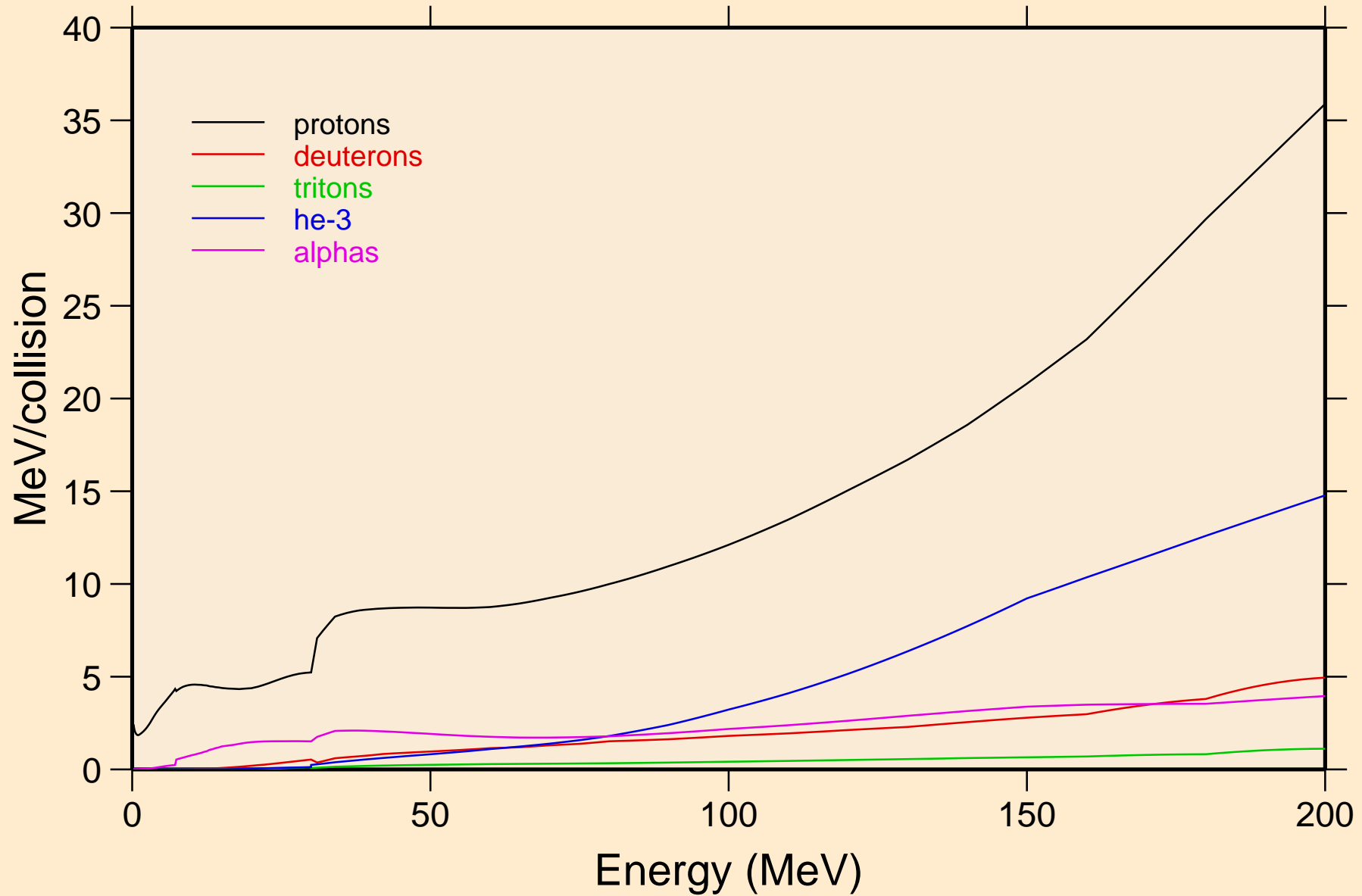



# CS117 NRG TENDL-2015, AKONING

## Recoil Heating

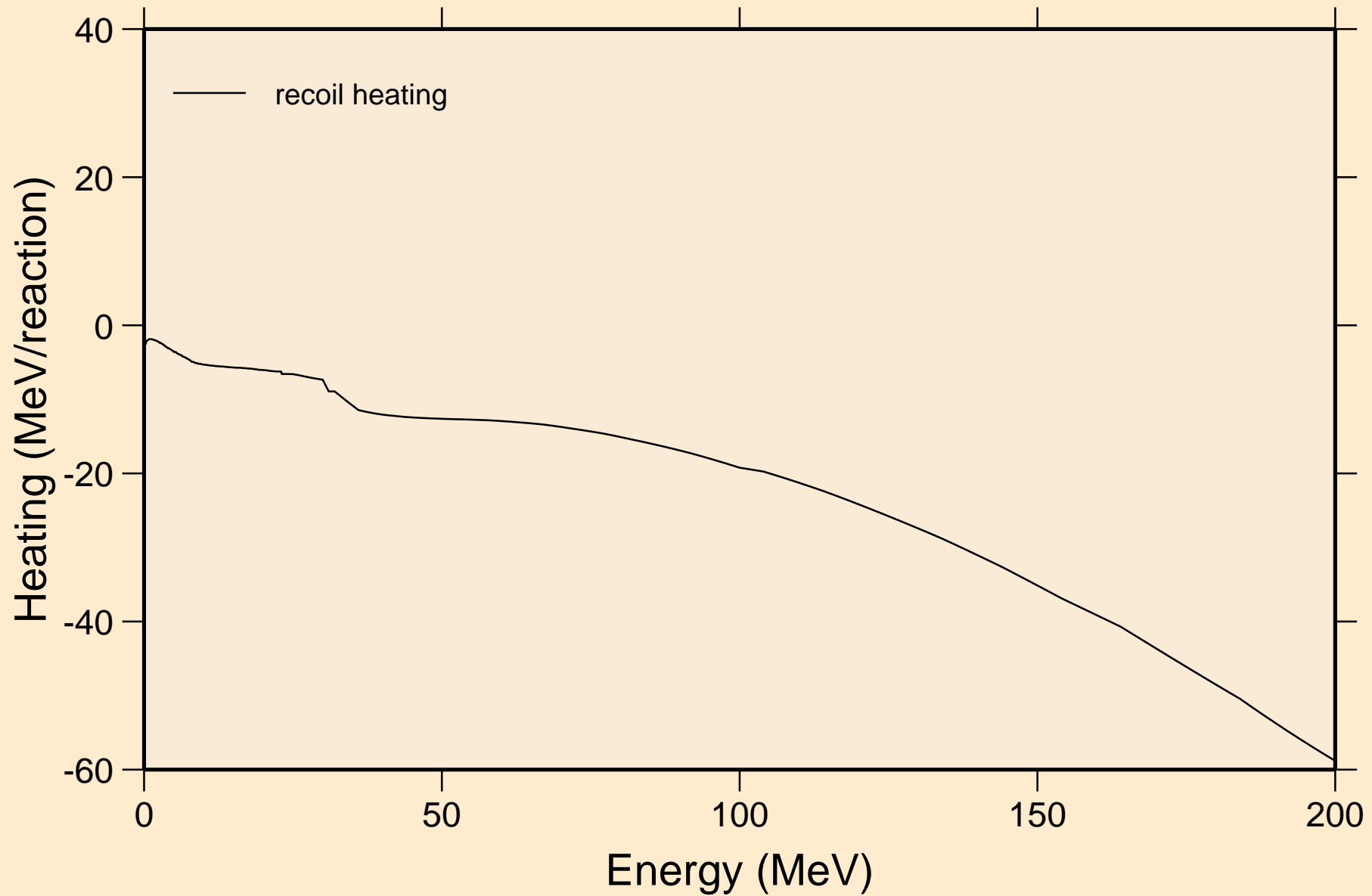

# CS117 NRG TENDL-2015, AKONING

## Particle production cross sections

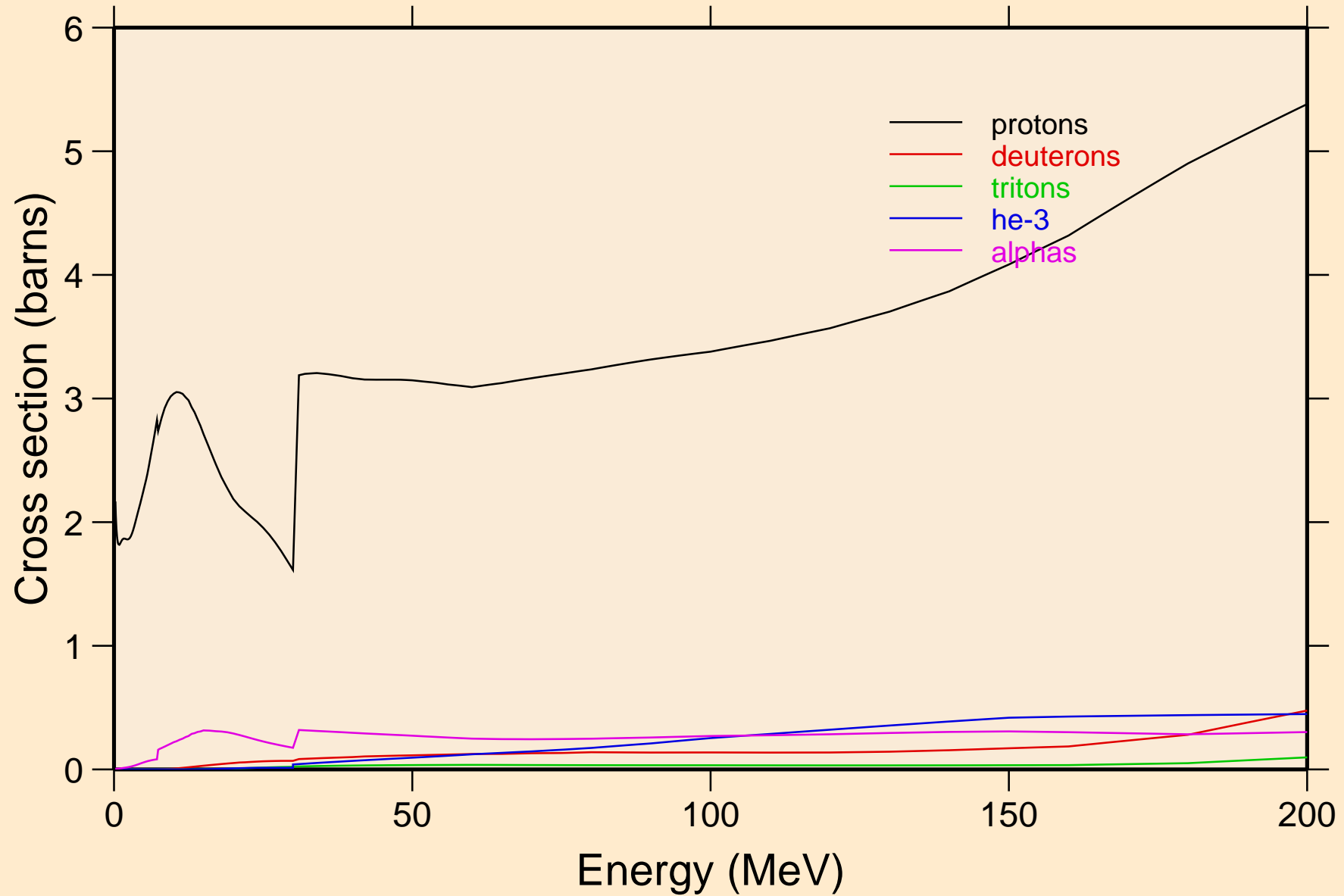

CS117 NRG TENDL-2015, AKONING  
protons from (n,x)

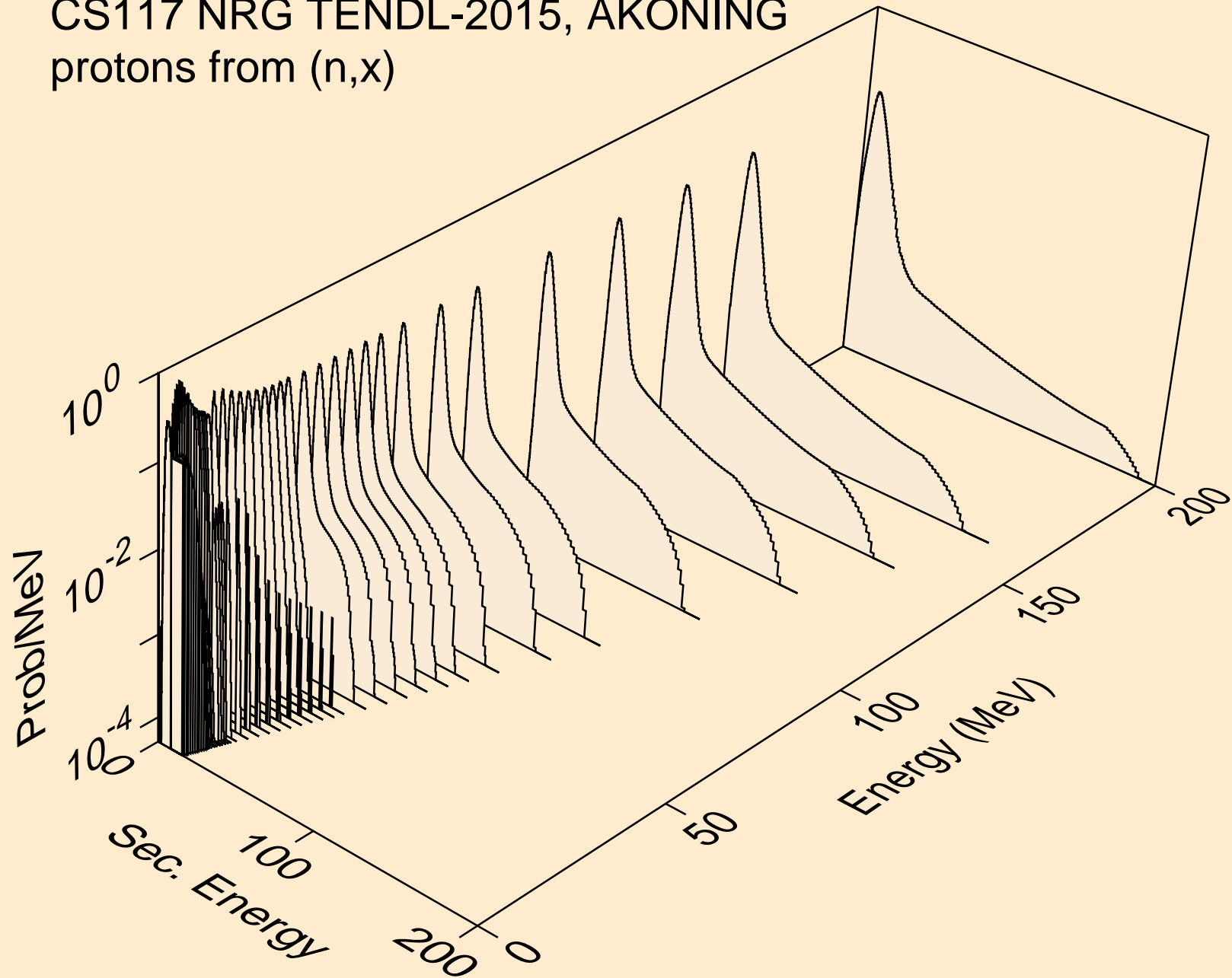

CS117 NRG TENDL-2015, AKONING  
protons from (n,n\*)p

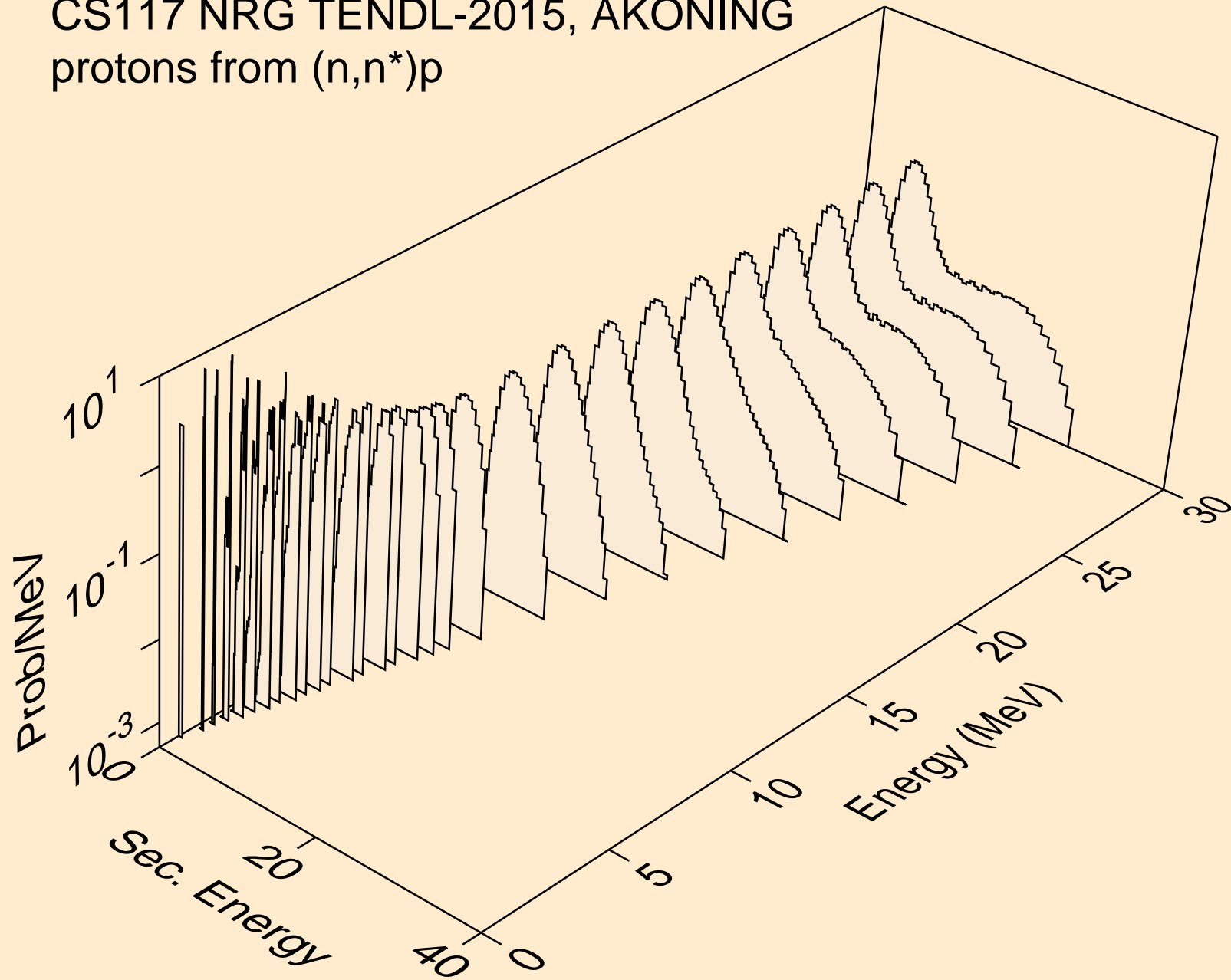

CS117 NRG TENDL-2015, AKONING  
protons from (n,2np)

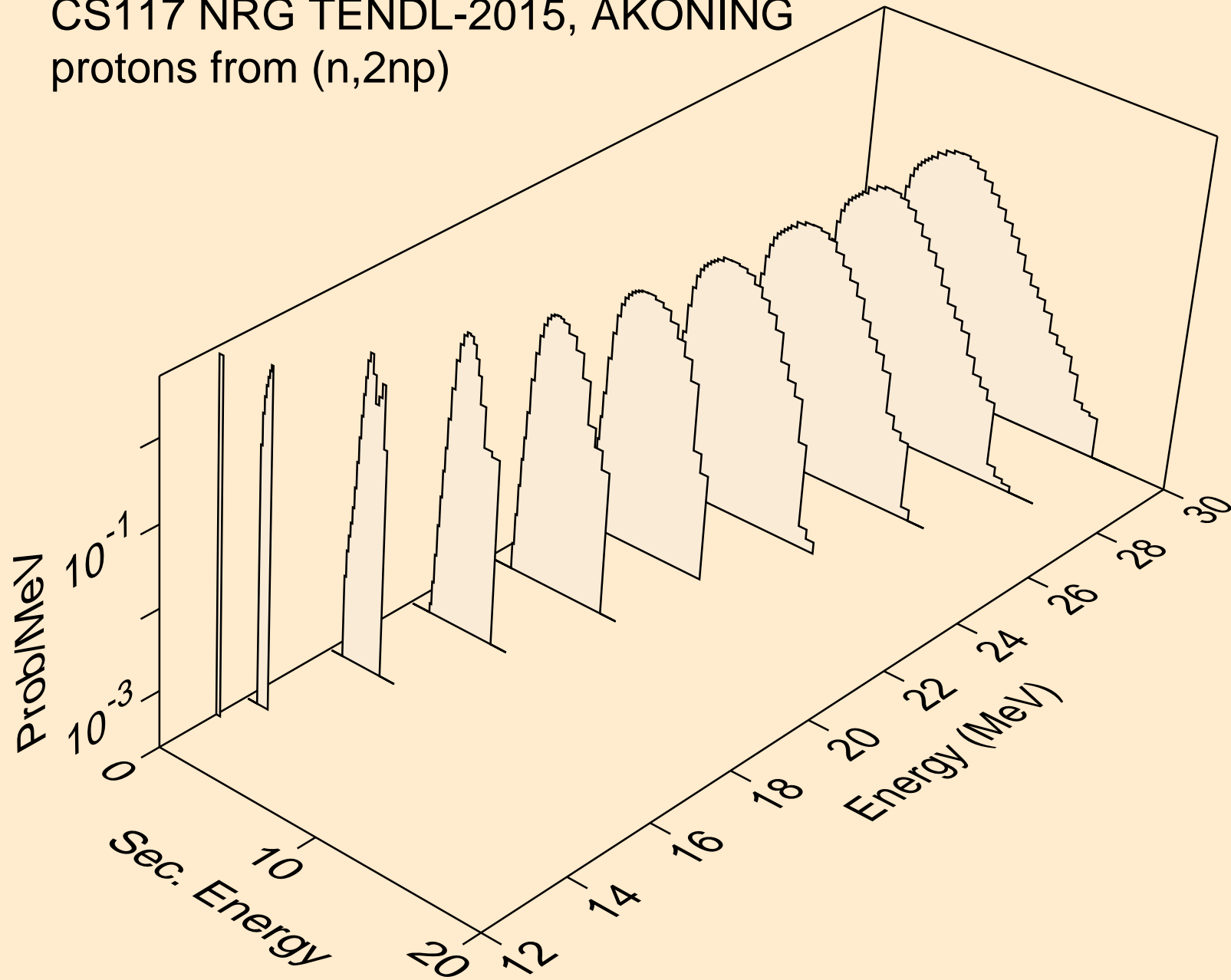

CS117 NRG TENDL-2015, AKONING  
protons from (n,3np)

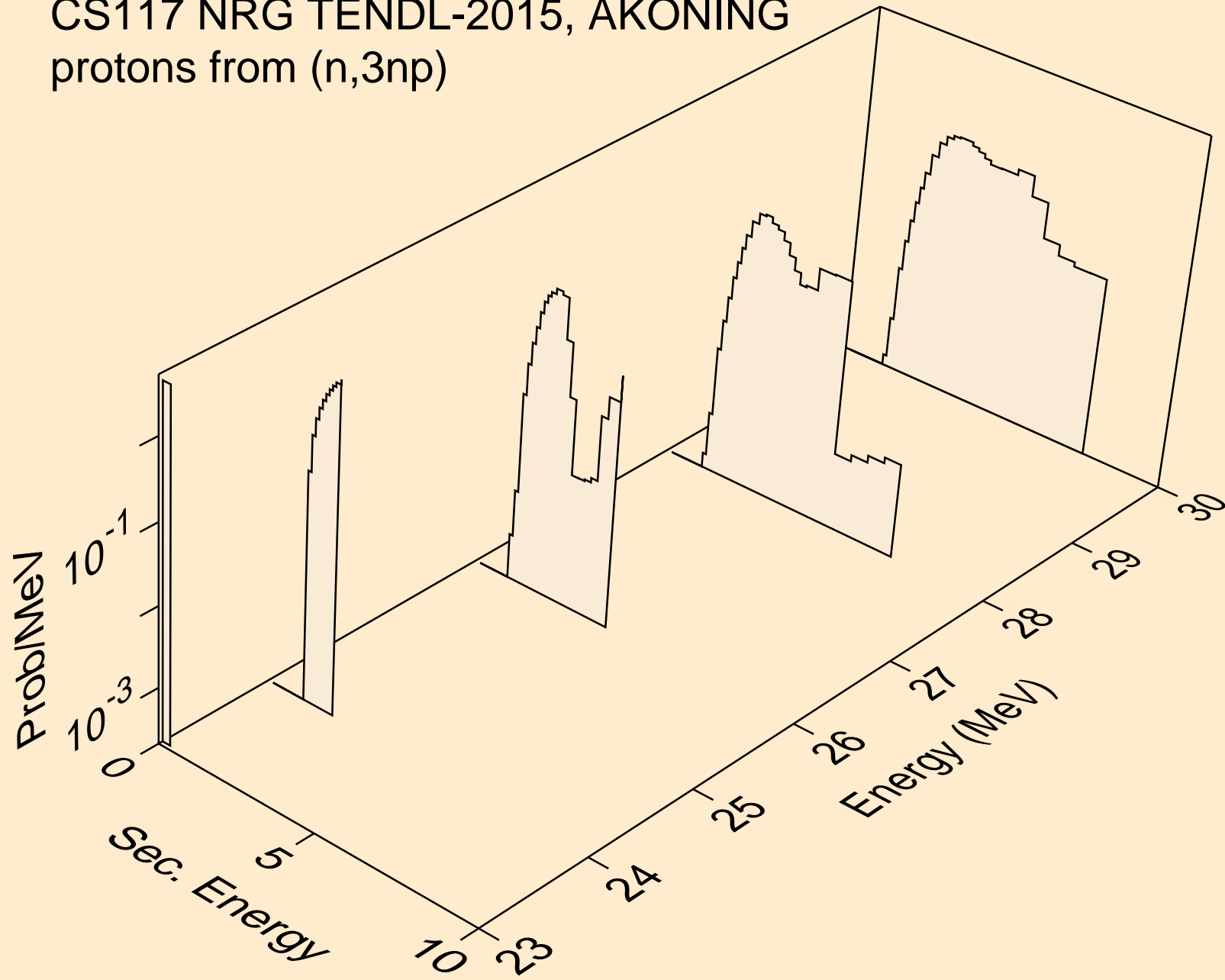

CS117 NRG TENDL-2015, AKONING  
protons from (n,2np)

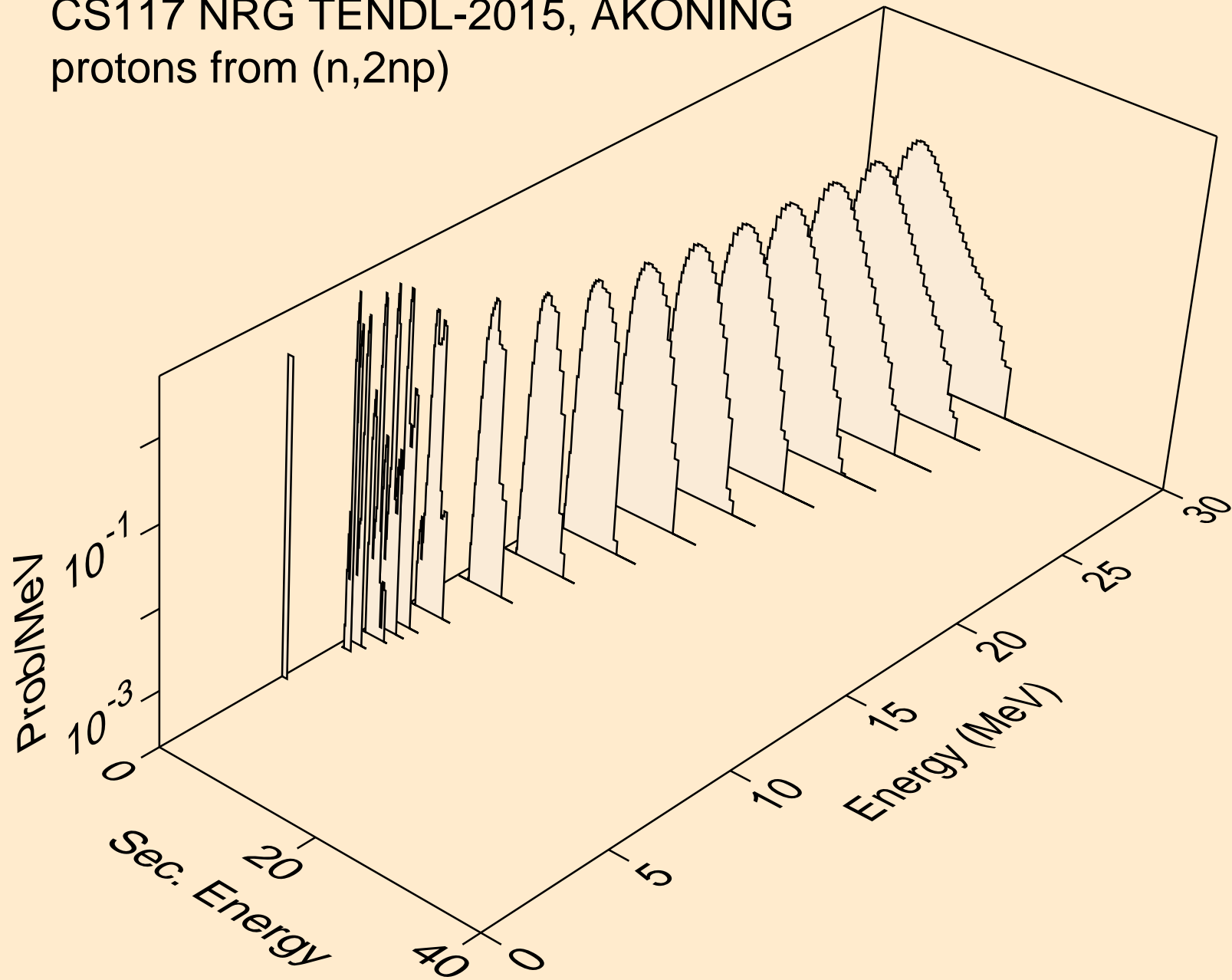

CS117 NRG TENDL-2015, AKONING  
protons from (n,npa)

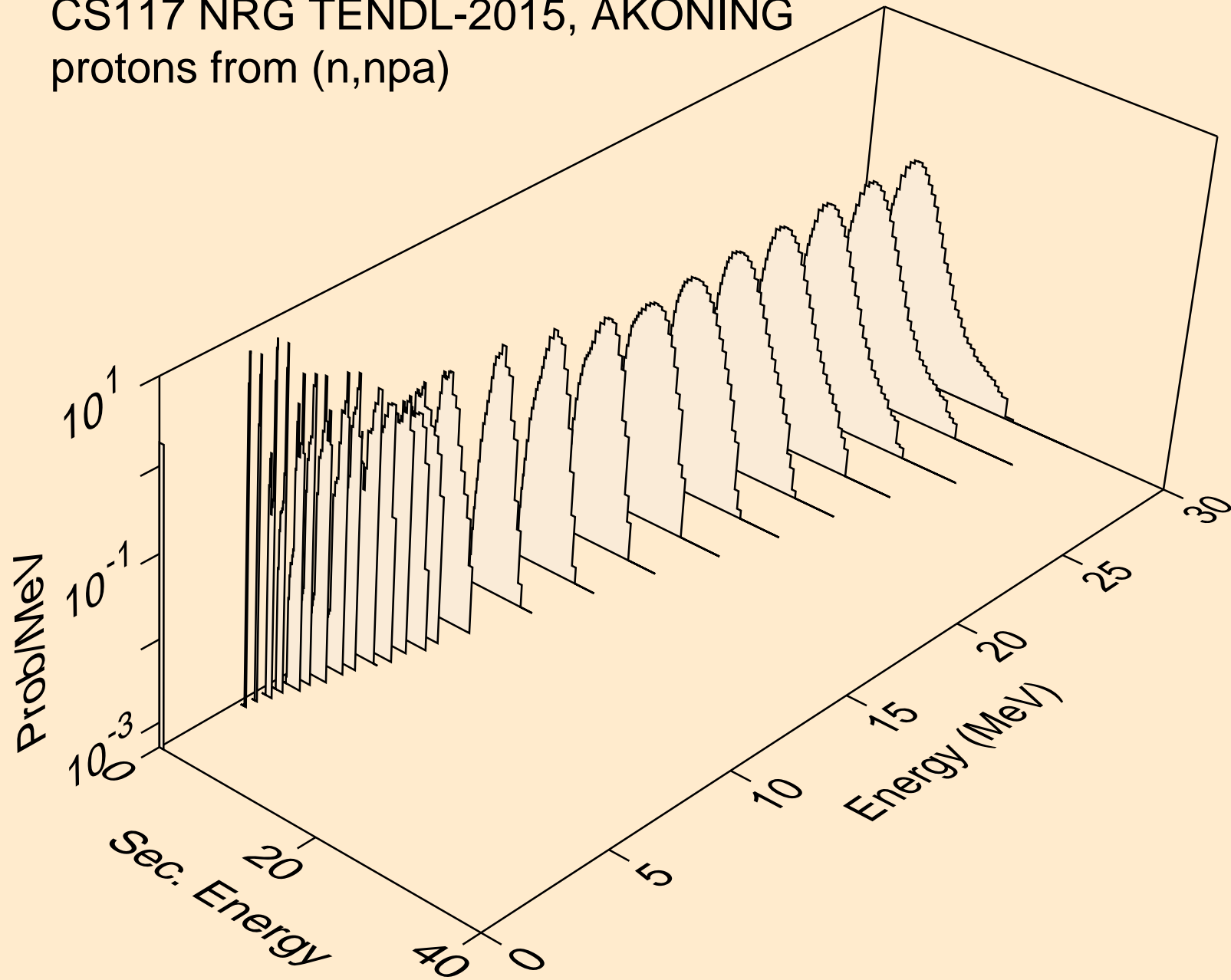



CS117 NRG TENDL-2015, AKONING  
protons from (n,p)

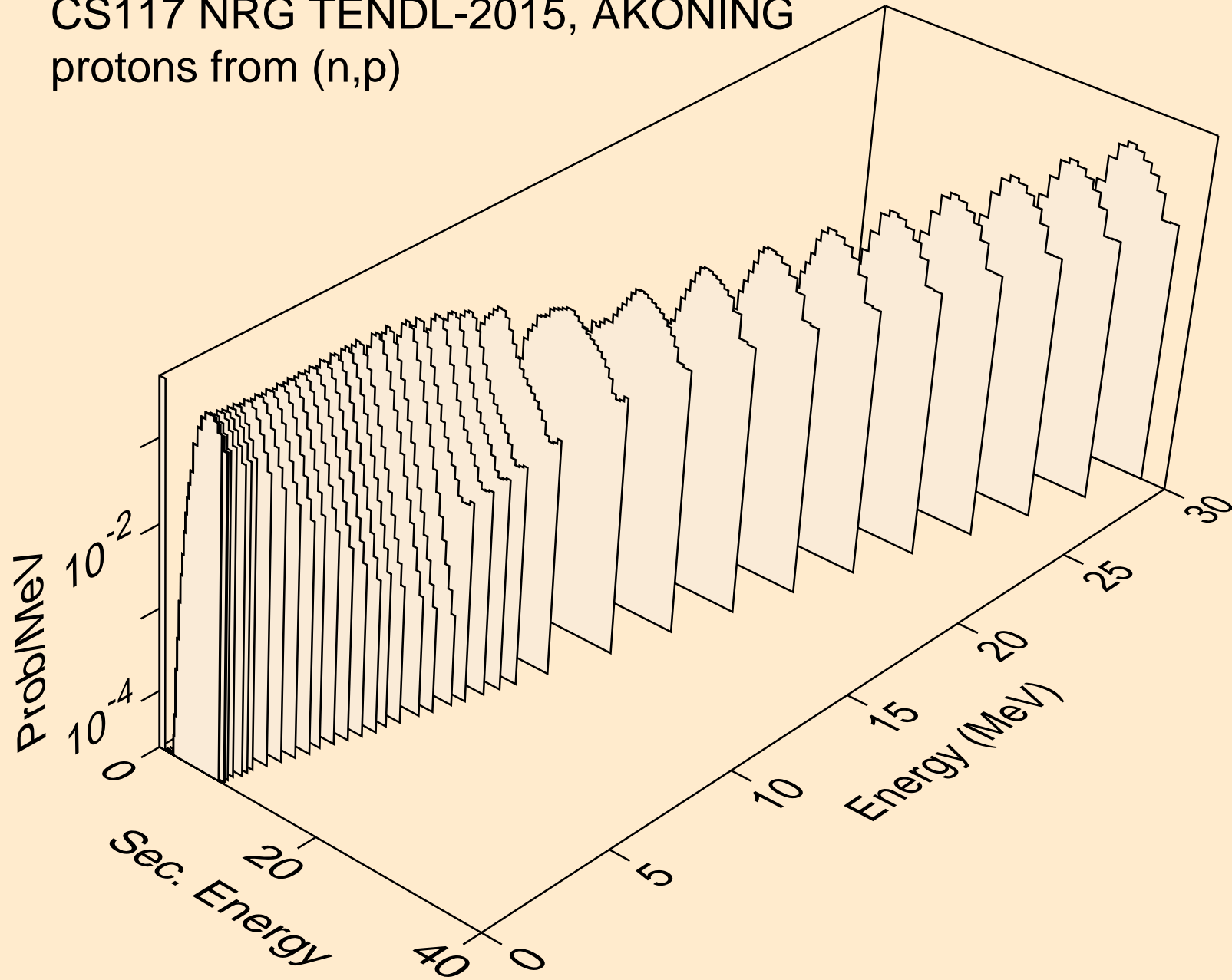

CS117 NRG TENDL-2015, AKONING  
protons from (n,2p)

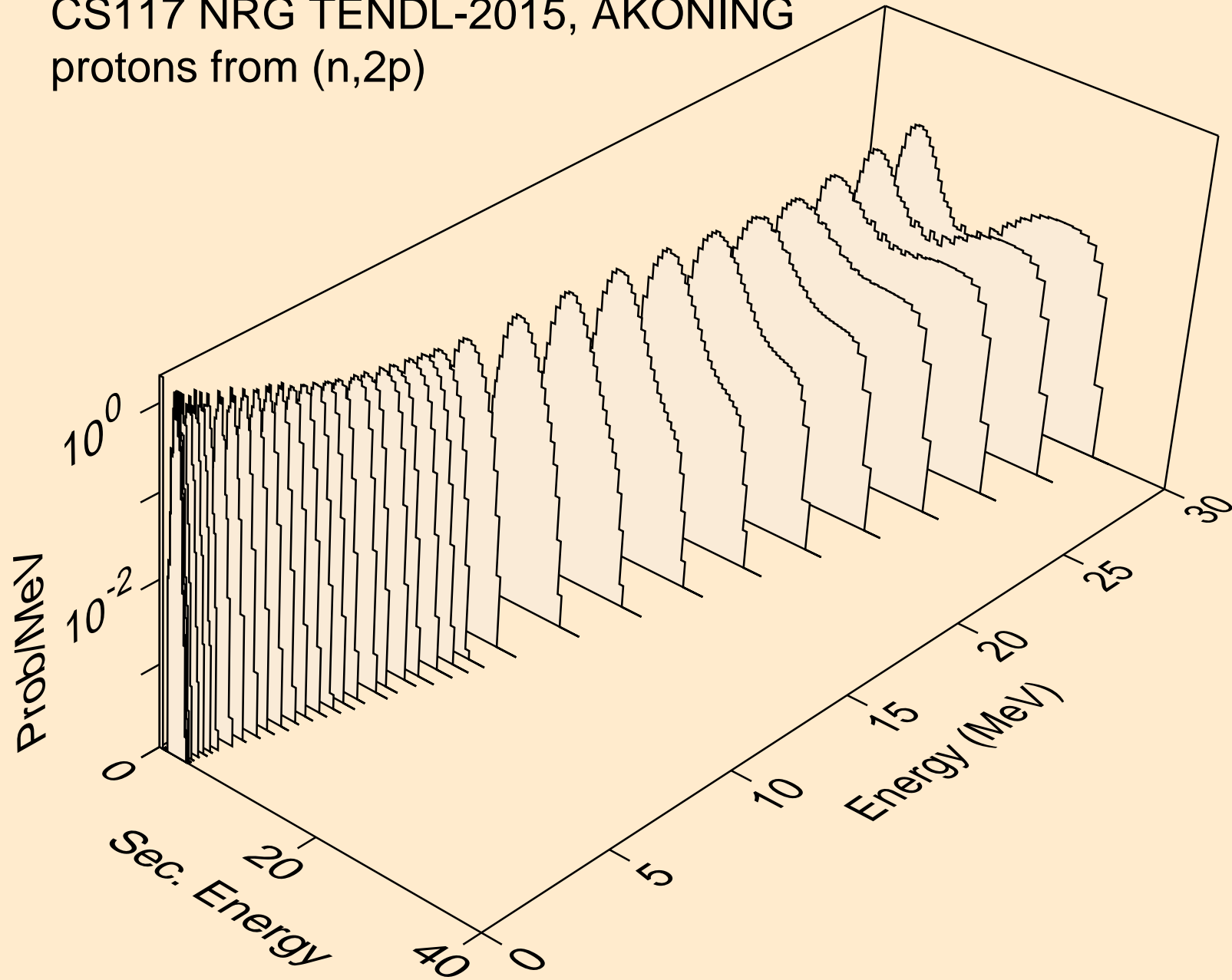

CS117 NRG TENDL-2015, AKONING  
protons from (n,pa)

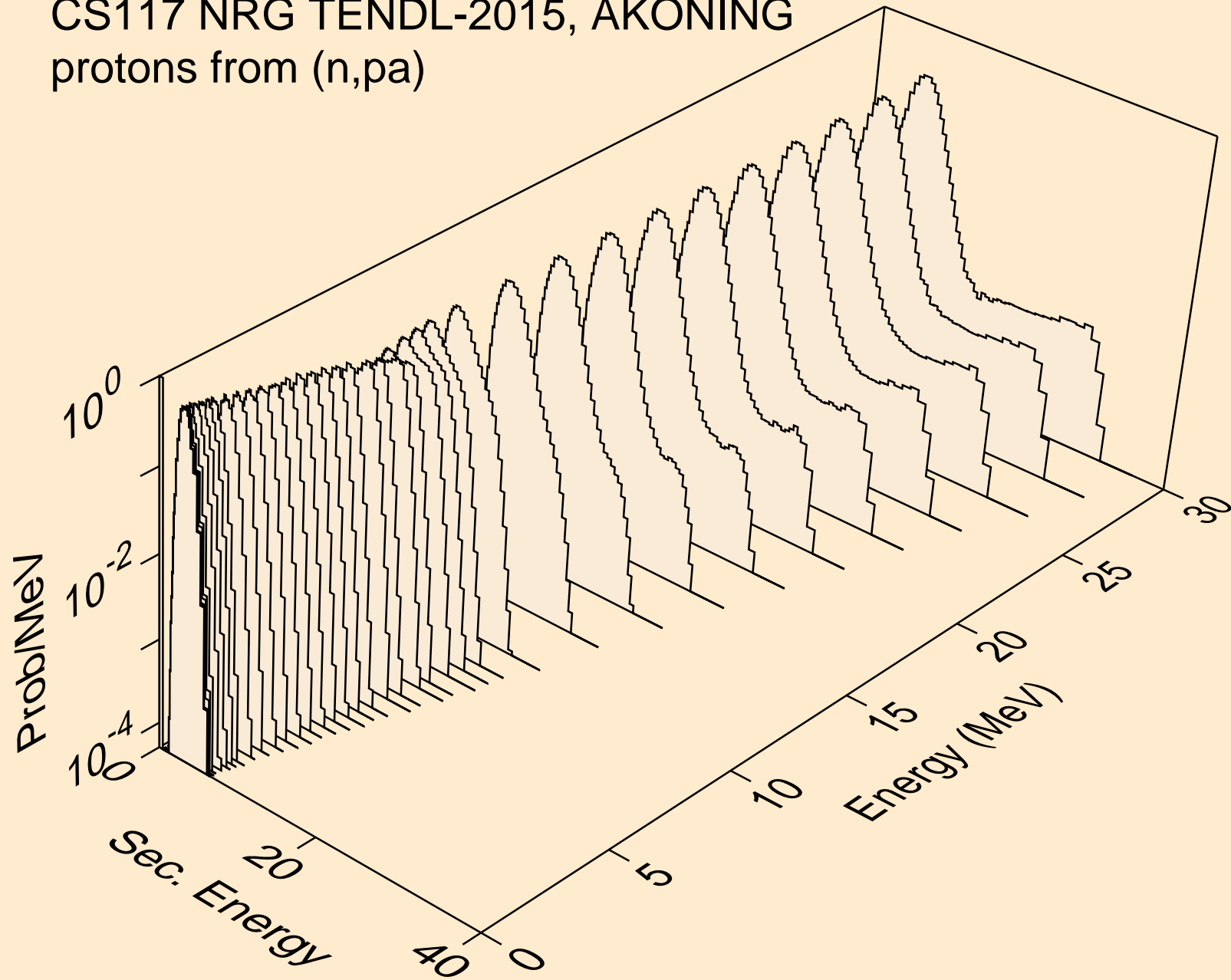

CS117 NRG TENDL-2015, AKONING  
protons from (n,pd)

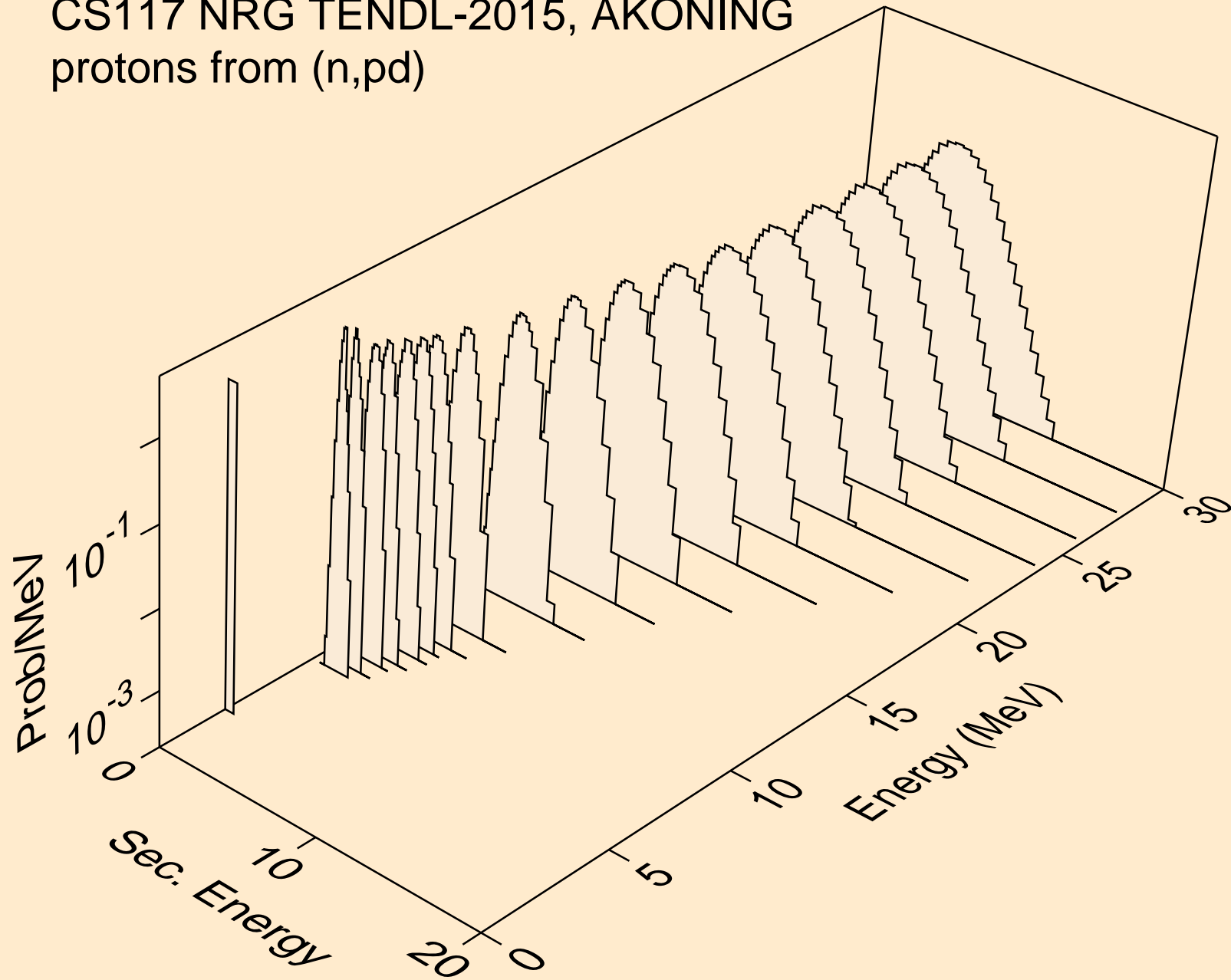

CS117 NRG TENDL-2015, AKONING  
protons from (n,pt)

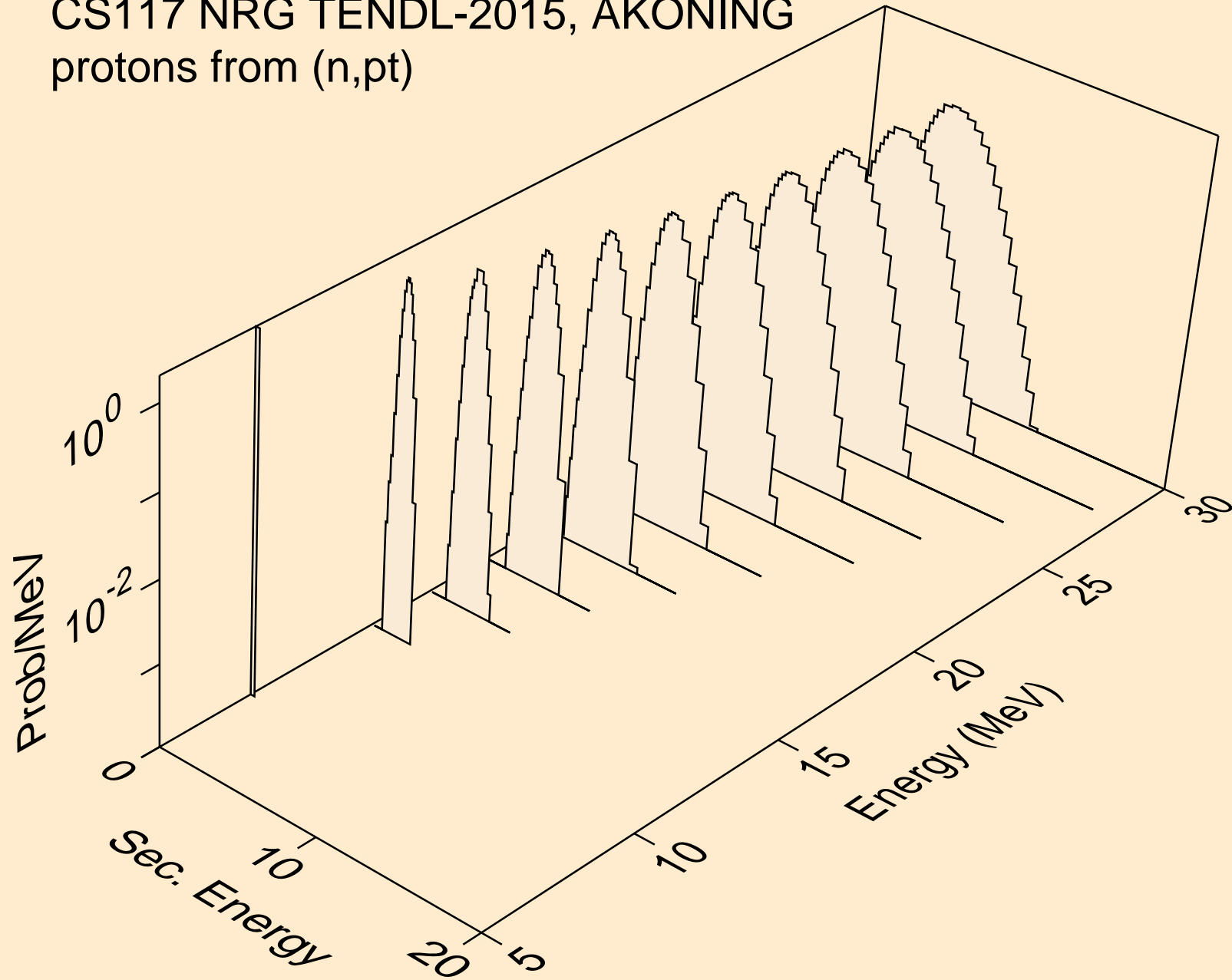

CS117 NRG TENDL-2015, AKONING  
deuterons from (n,x)

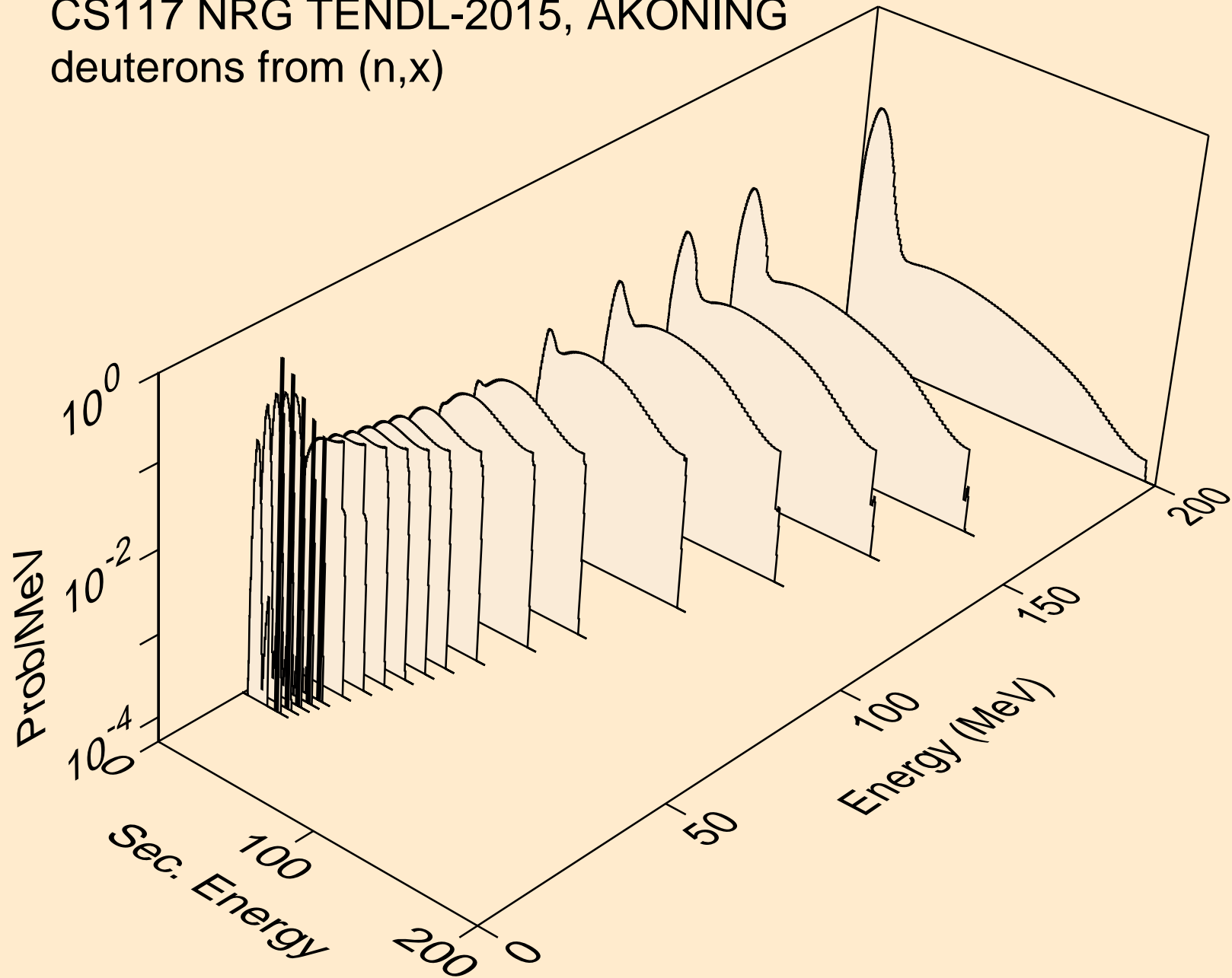

CS117 NRG TENDL-2015, AKONING  
deuterons from (n,2nd)

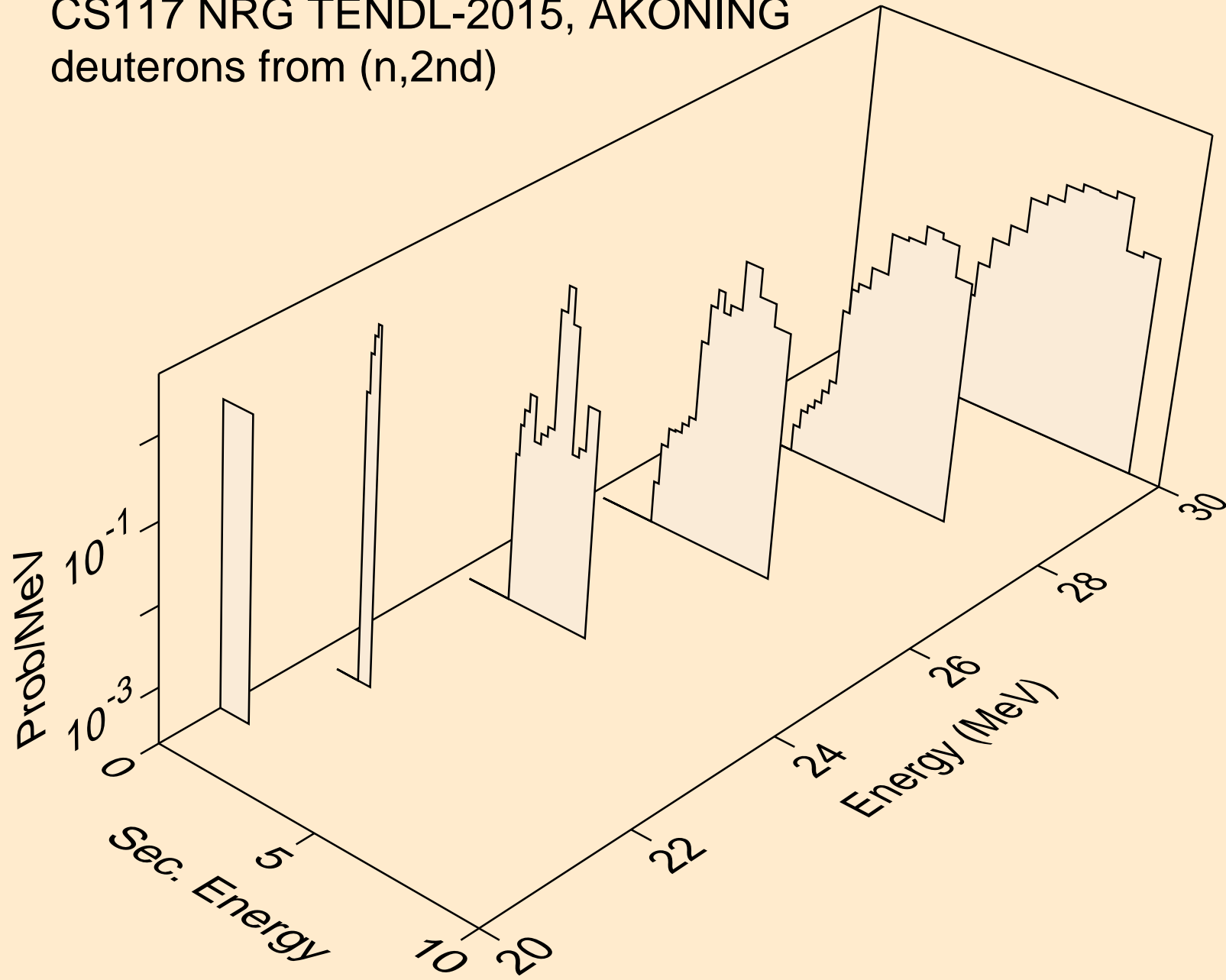

CS117 NRG TENDL-2015, AKONING  
deuterons from (n,n\*)d

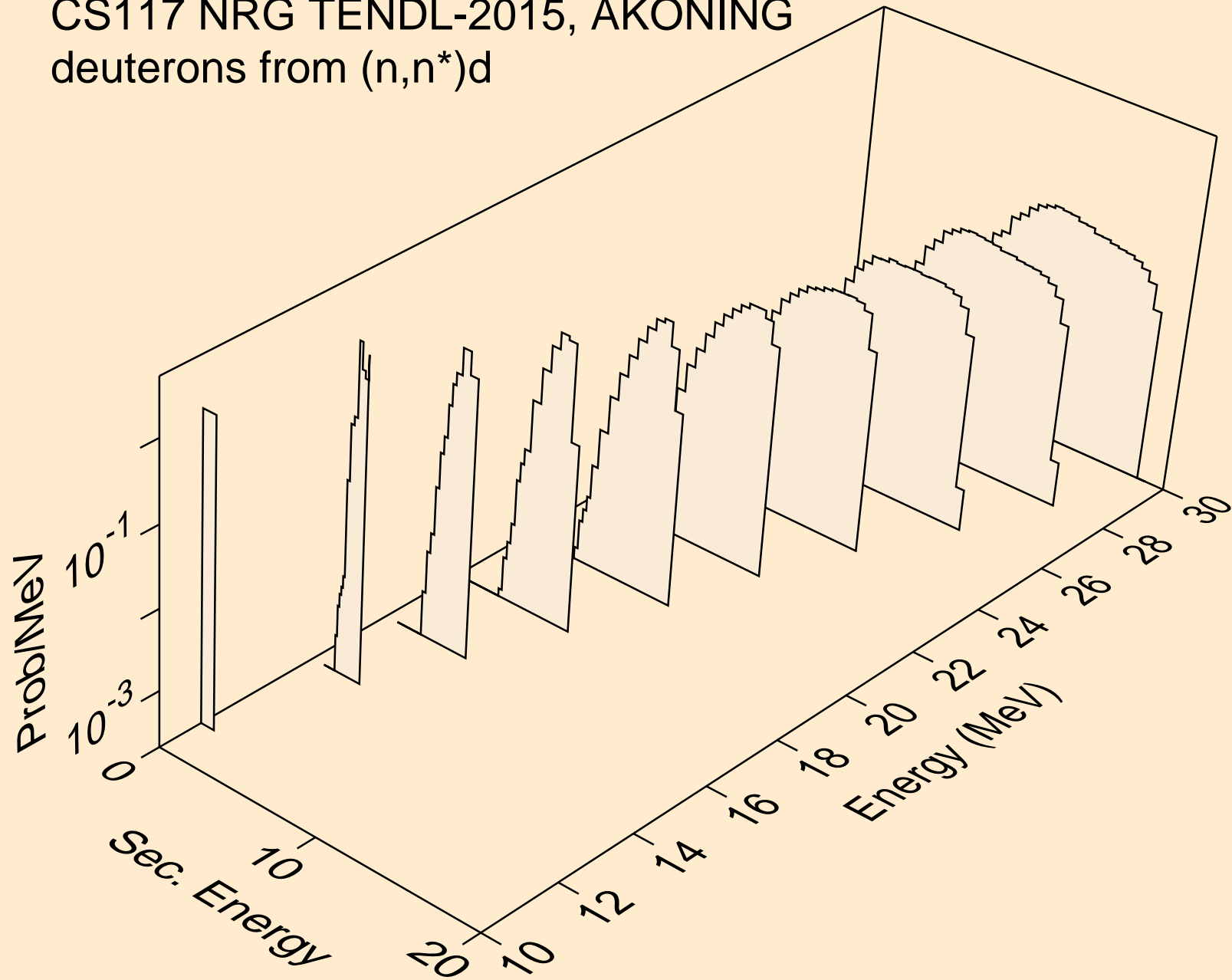



CS117 NRG TENDL-2015, AKONING  
deuterons from (n,n\*)d2a

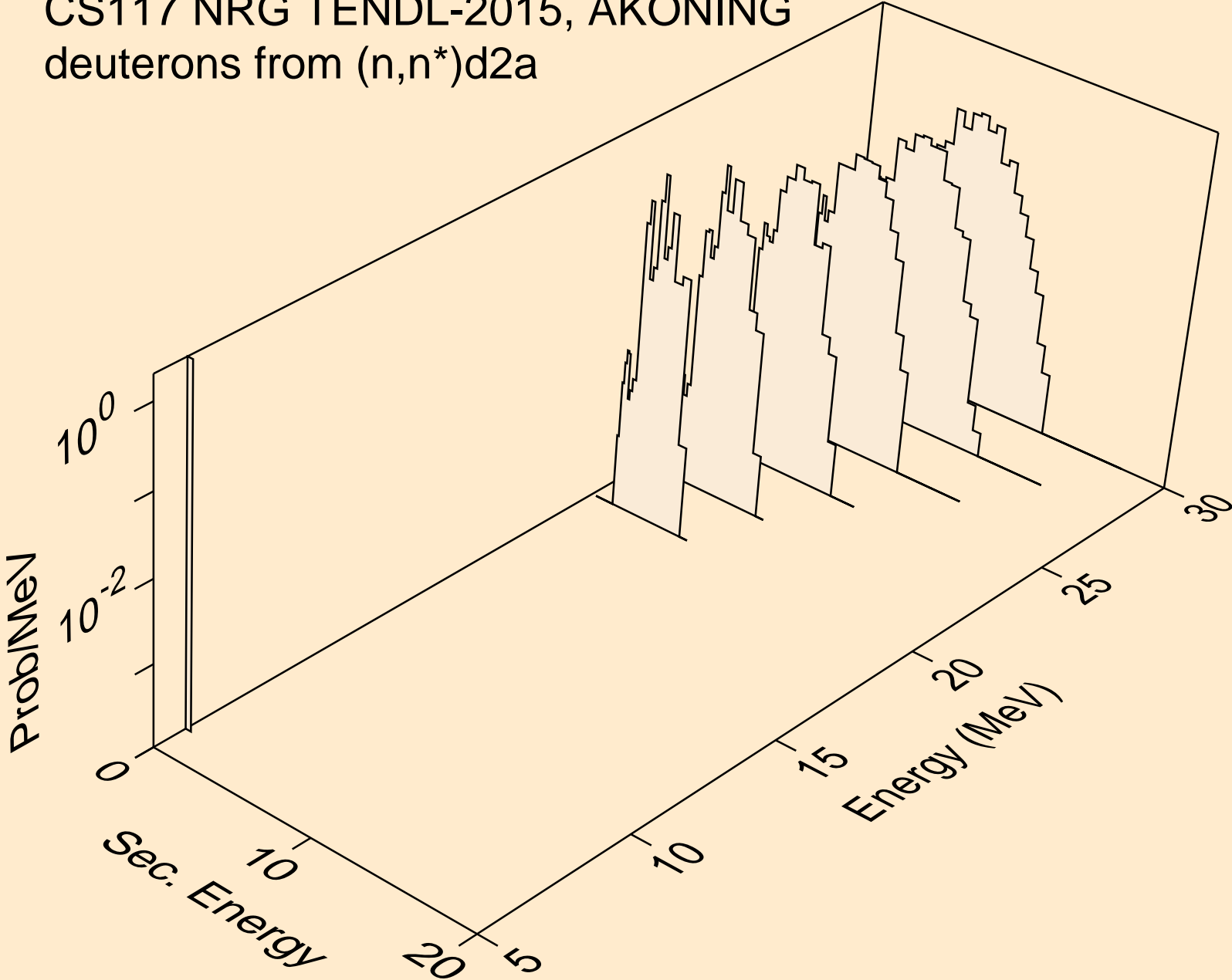

CS117 NRG TENDL-2015, AKONING  
deuterons from (n,d)

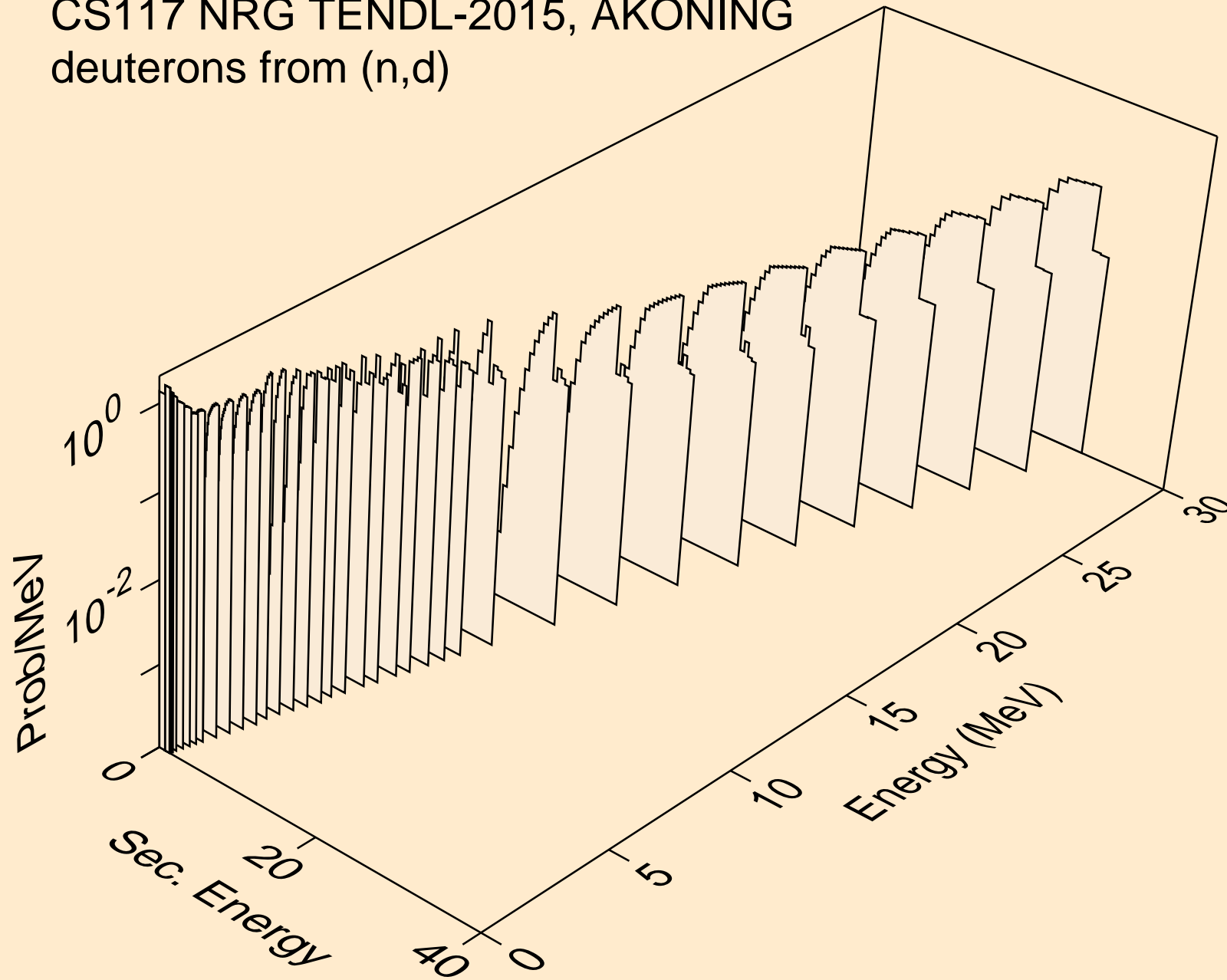

CS117 NRG TENDL-2015, AKONING  
deuterons from (n,d2a)

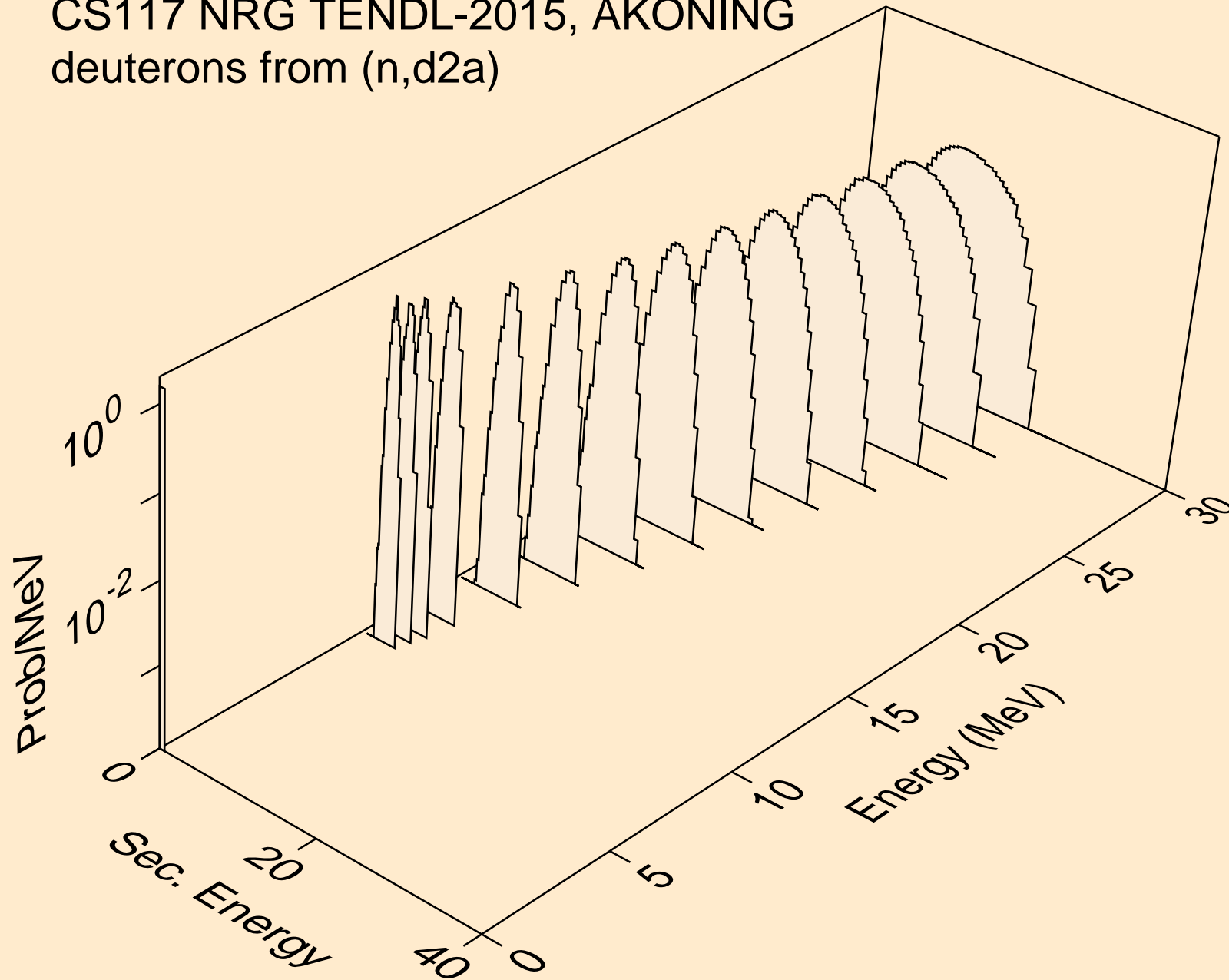

CS117 NRG TENDL-2015, AKONING  
deuterons from (n,pd)

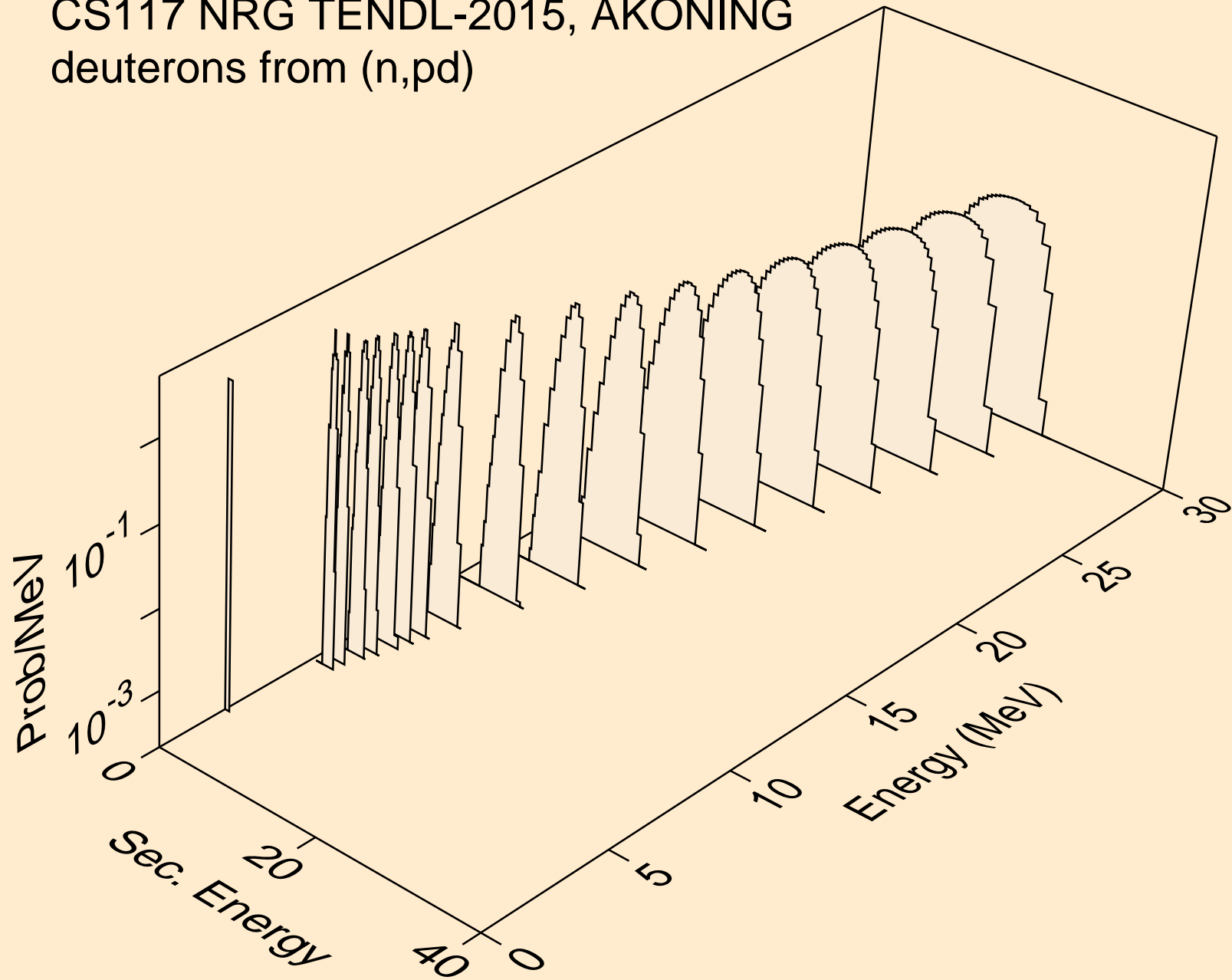

CS117 NRG TENDL-2015, AKONING  
deuterons from (n,da)

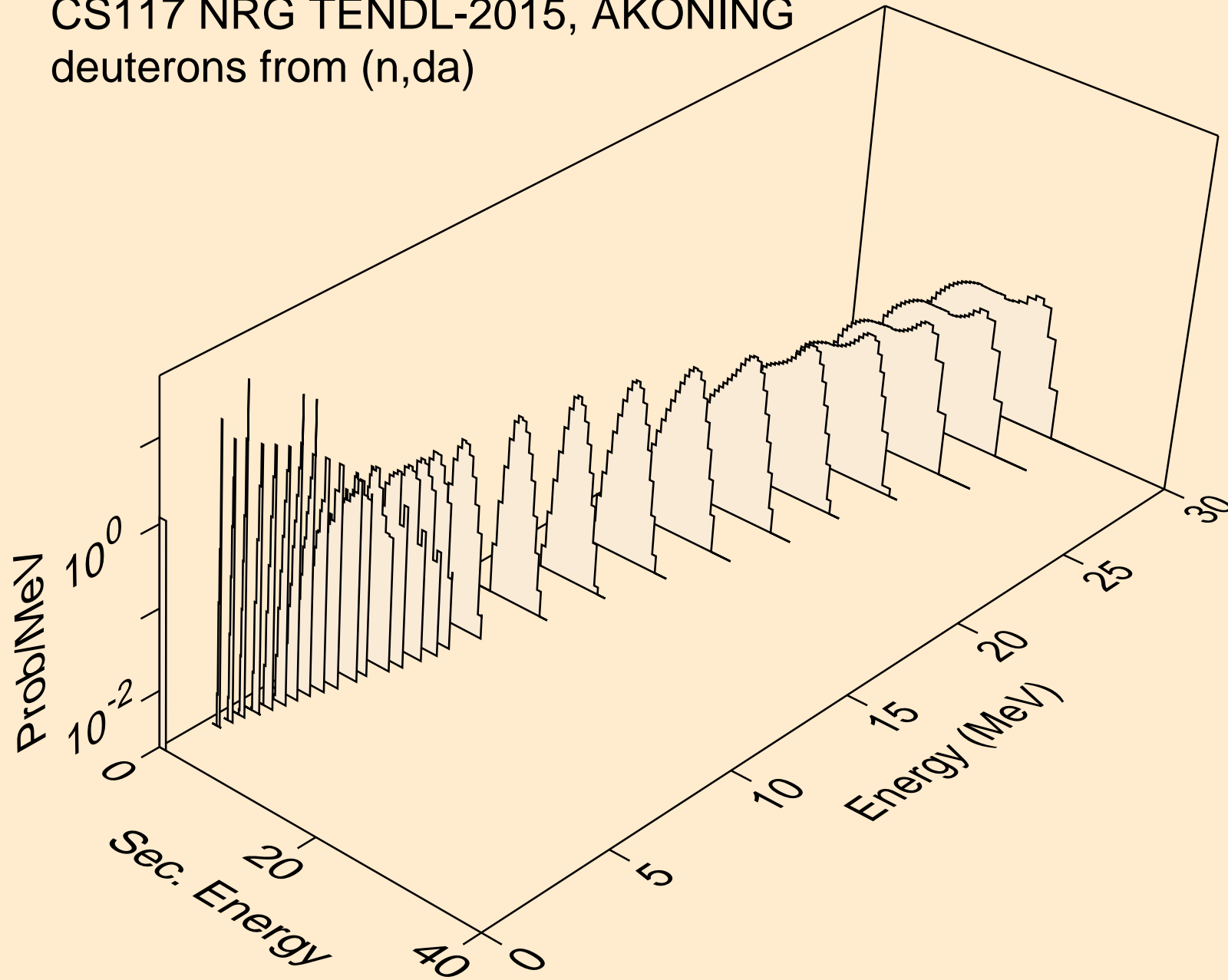

CS117 NRG TENDL-2015, AKONING  
tritons from (n,x)

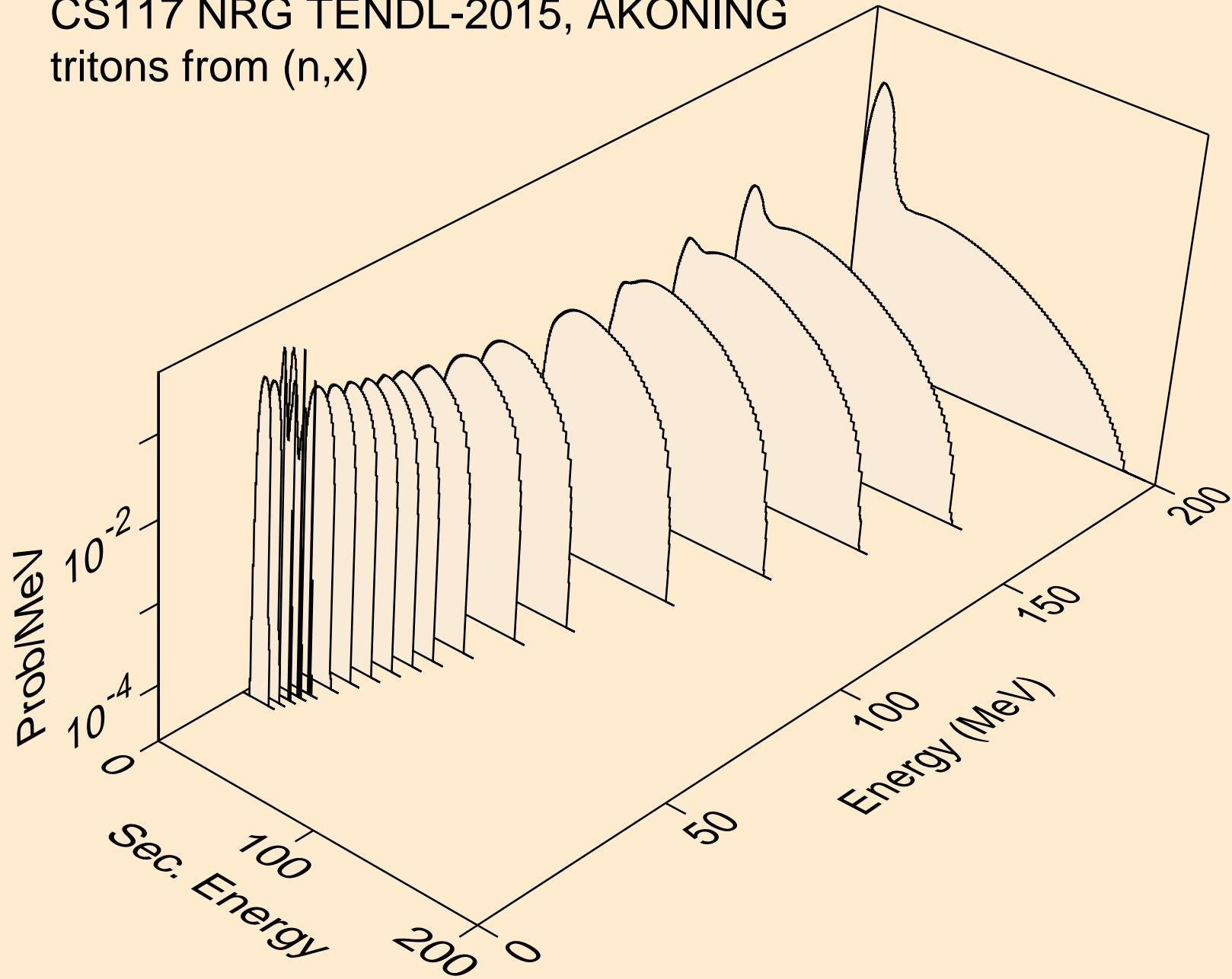

CS117 NRG TENDL-2015, AKONING  
tritons from (n,n\*)t

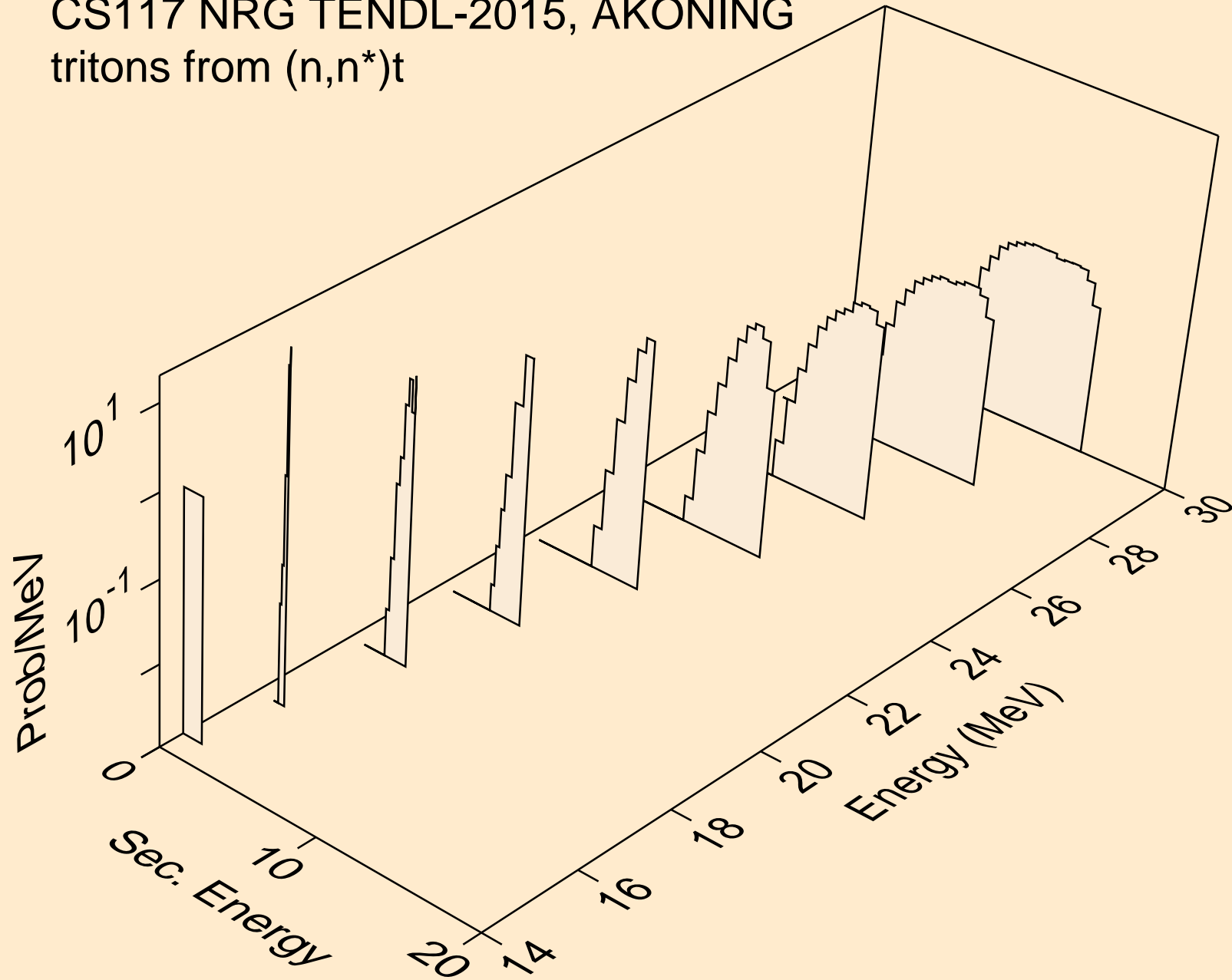

CS117 NRG TENDL-2015, AKONING  
tritons from (n,t)

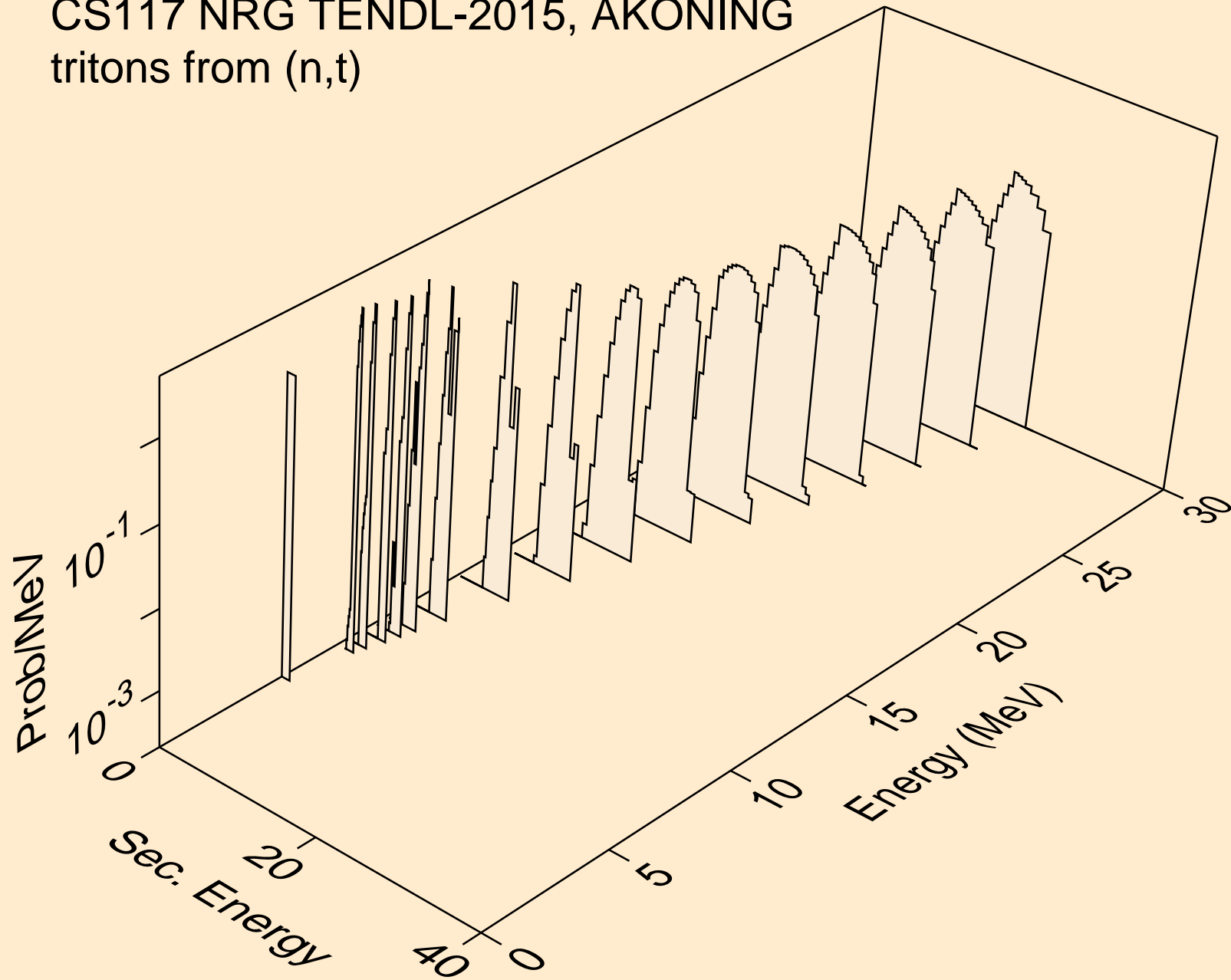



CS117 NRG TENDL-2015, AKONING  
tritons from (n,t2a)

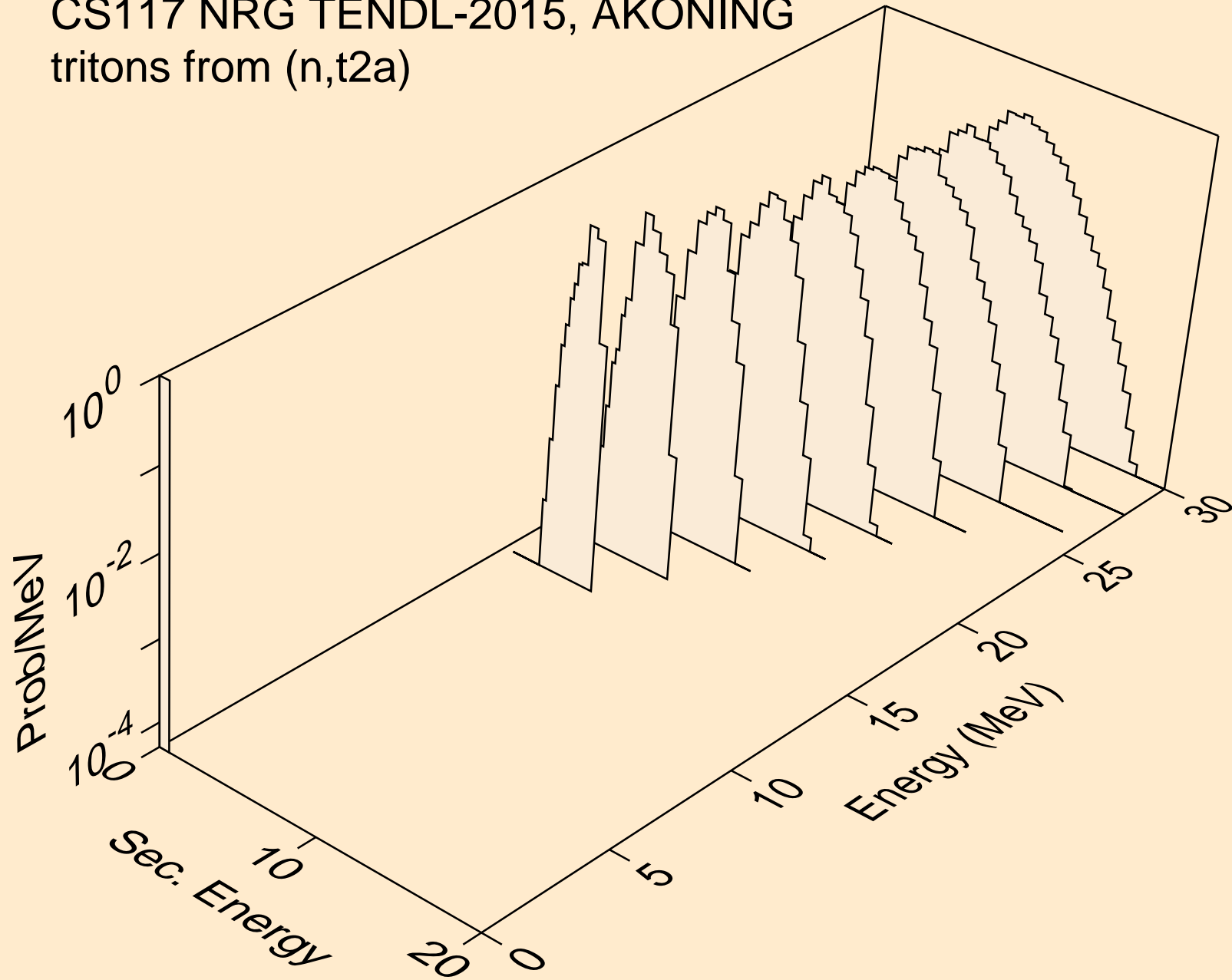

CS117 NRG TENDL-2015, AKONING  
tritons from (n,pt)

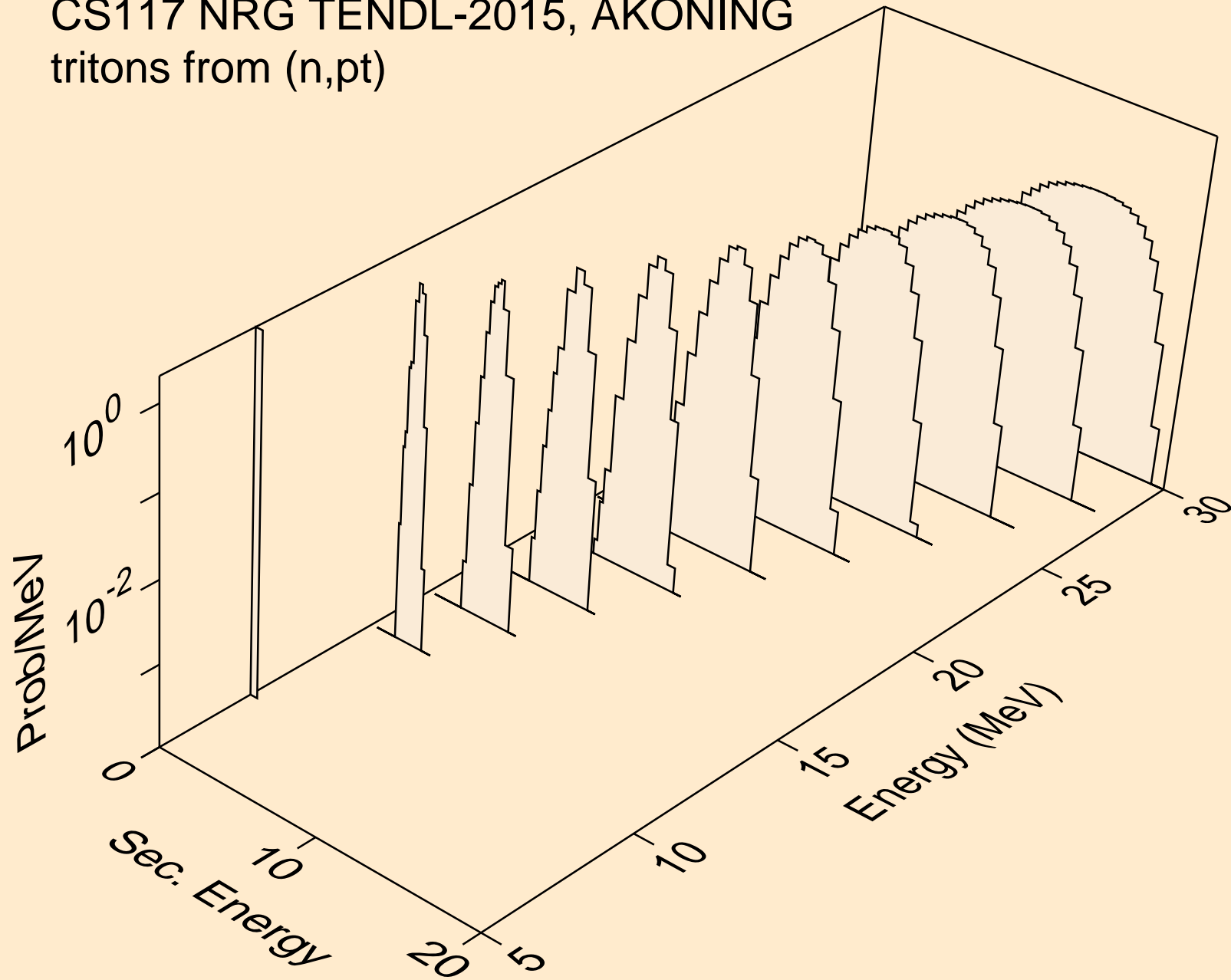

CS117 NRG TENDL-2015, AKONING  
he3s from (n,x)

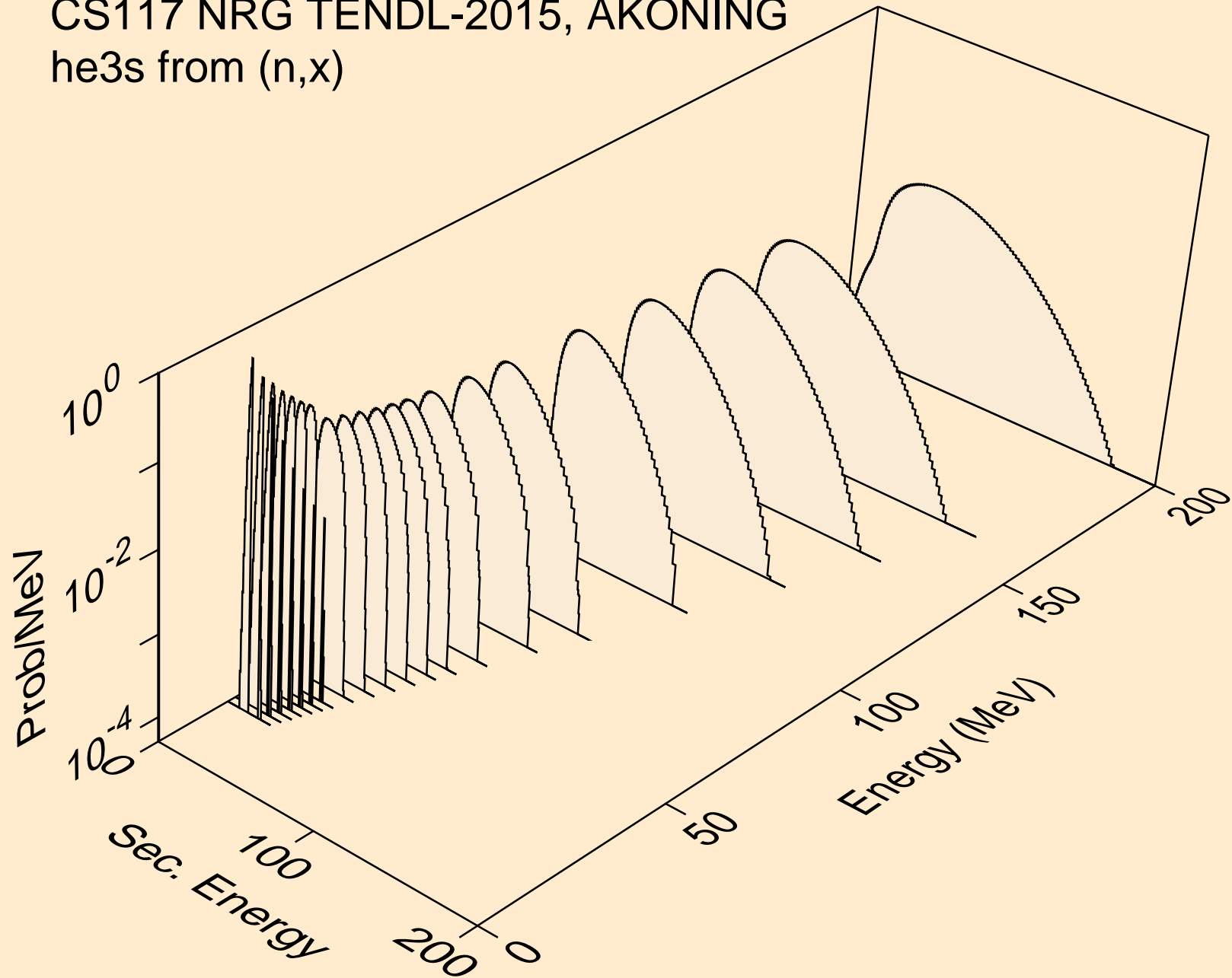

CS117 NRG TENDL-2015, AKONING  
he3s from (n,n\*)he3

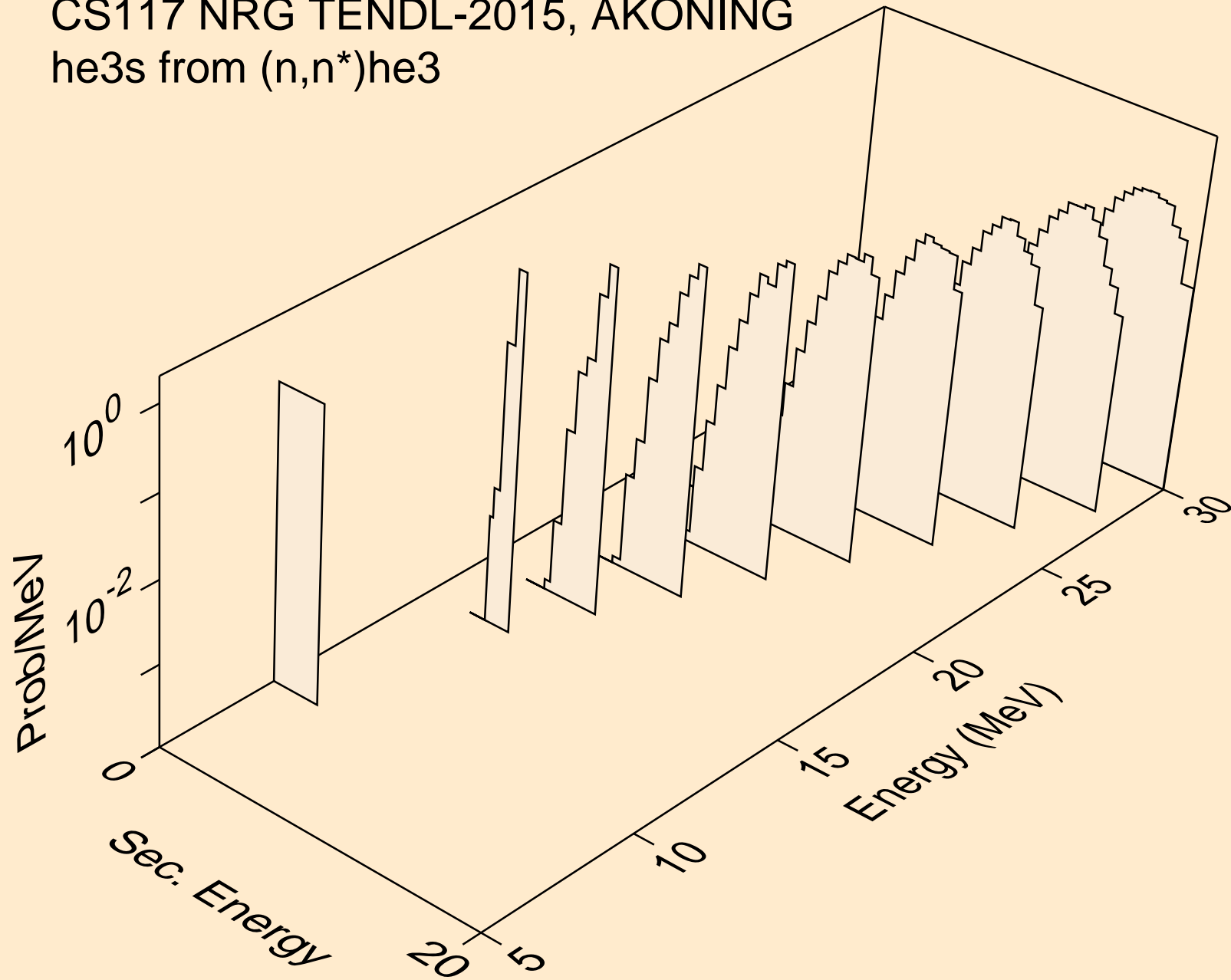

CS117 NRG TENDL-2015, AKONING  
he3s from (n,he3)

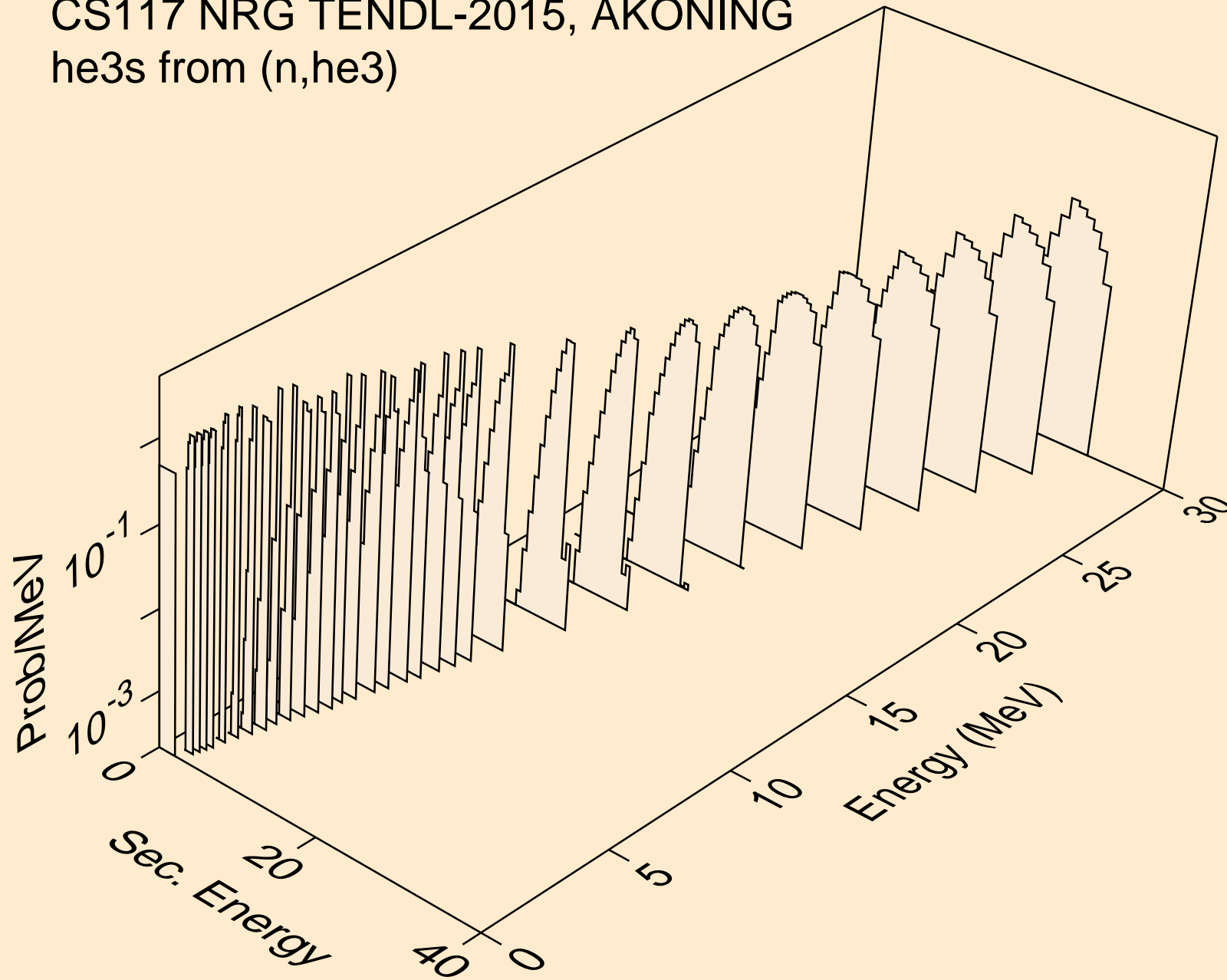

CS117 NRG TENDL-2015, AKONING  
alphas from (n,x)

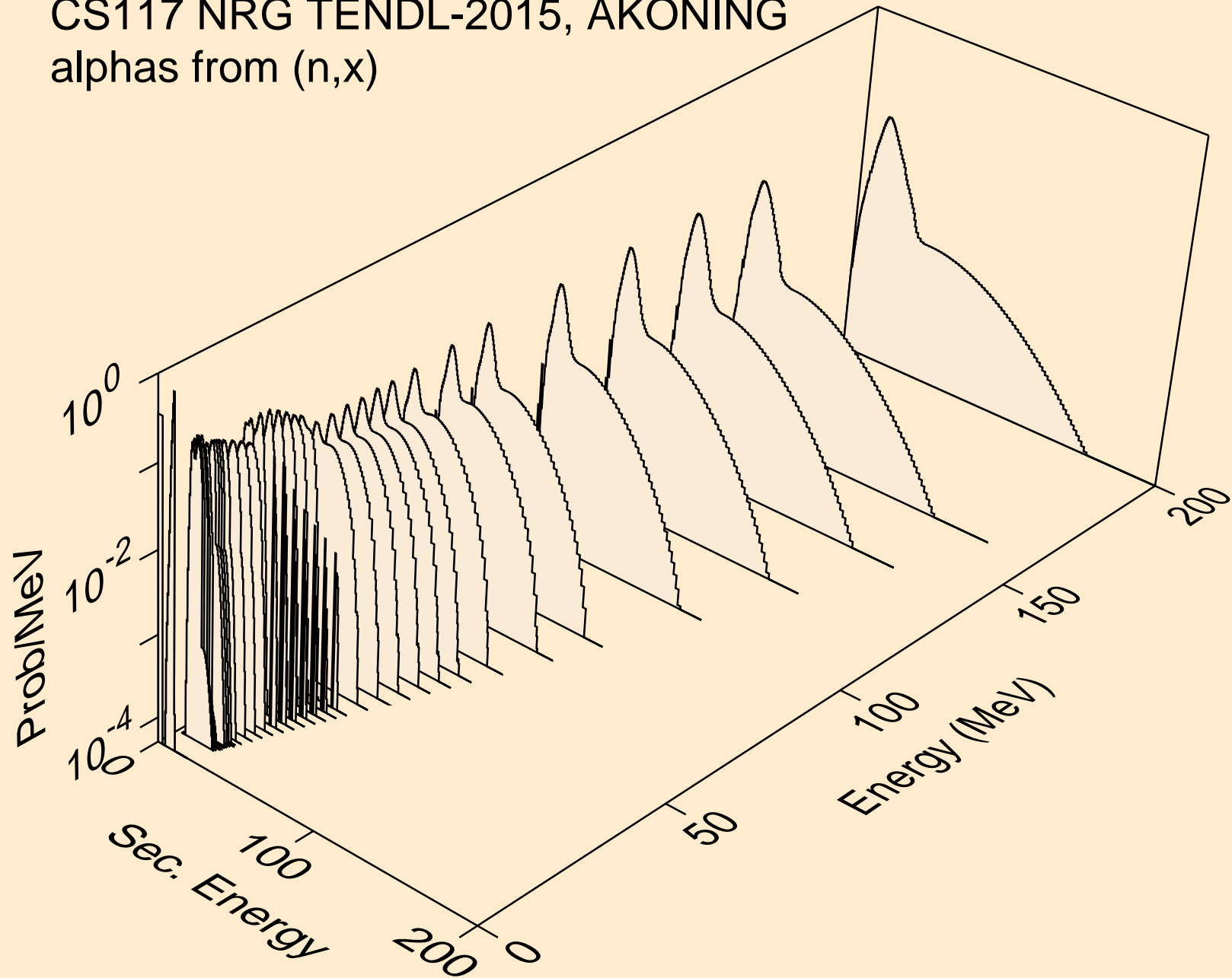

CS117 NRG TENDL-2015, AKONING  
alphas from (n,n\*)a

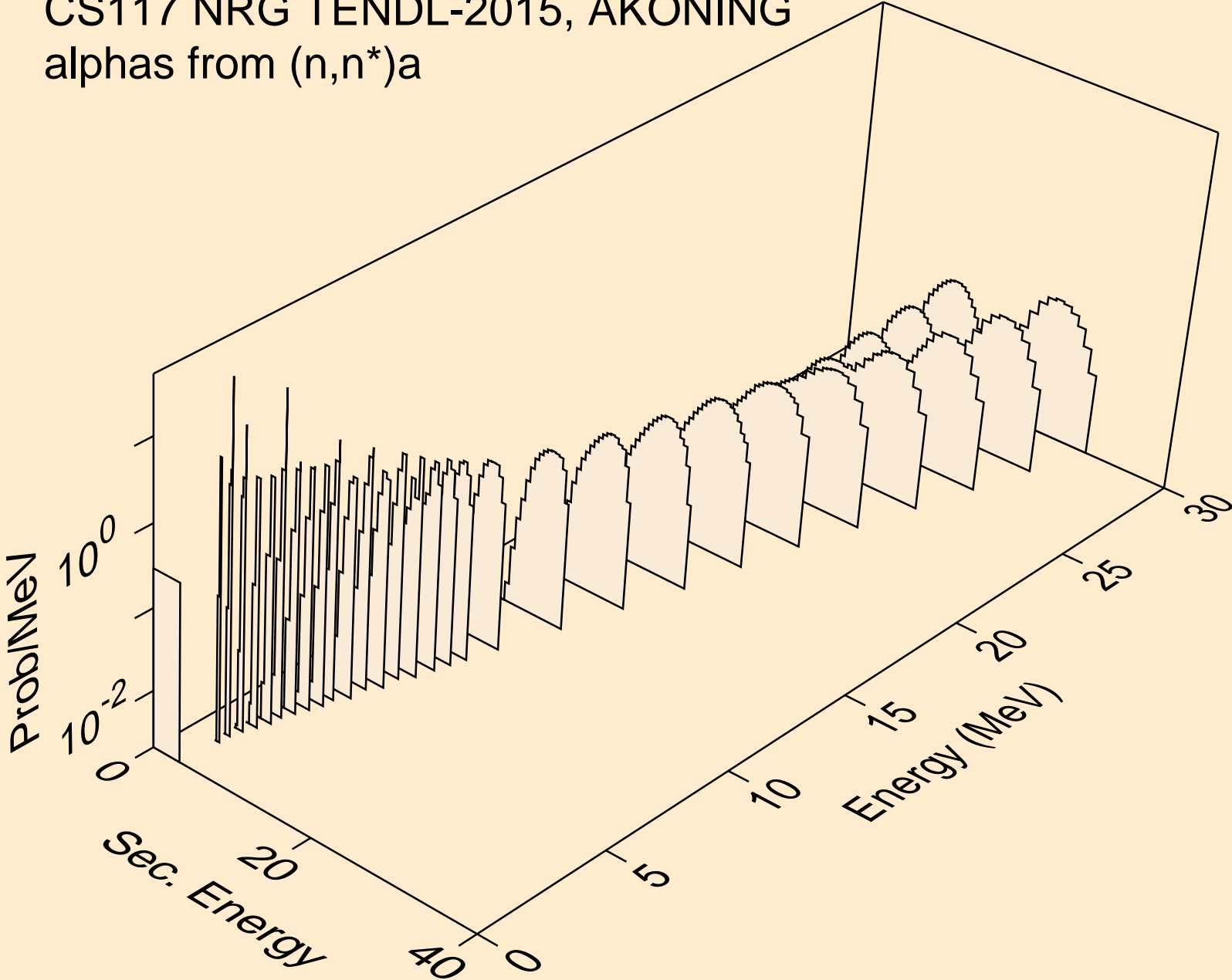

CS117 NRG TENDL-2015, AKONING  
alphas from (n,n\*)3a

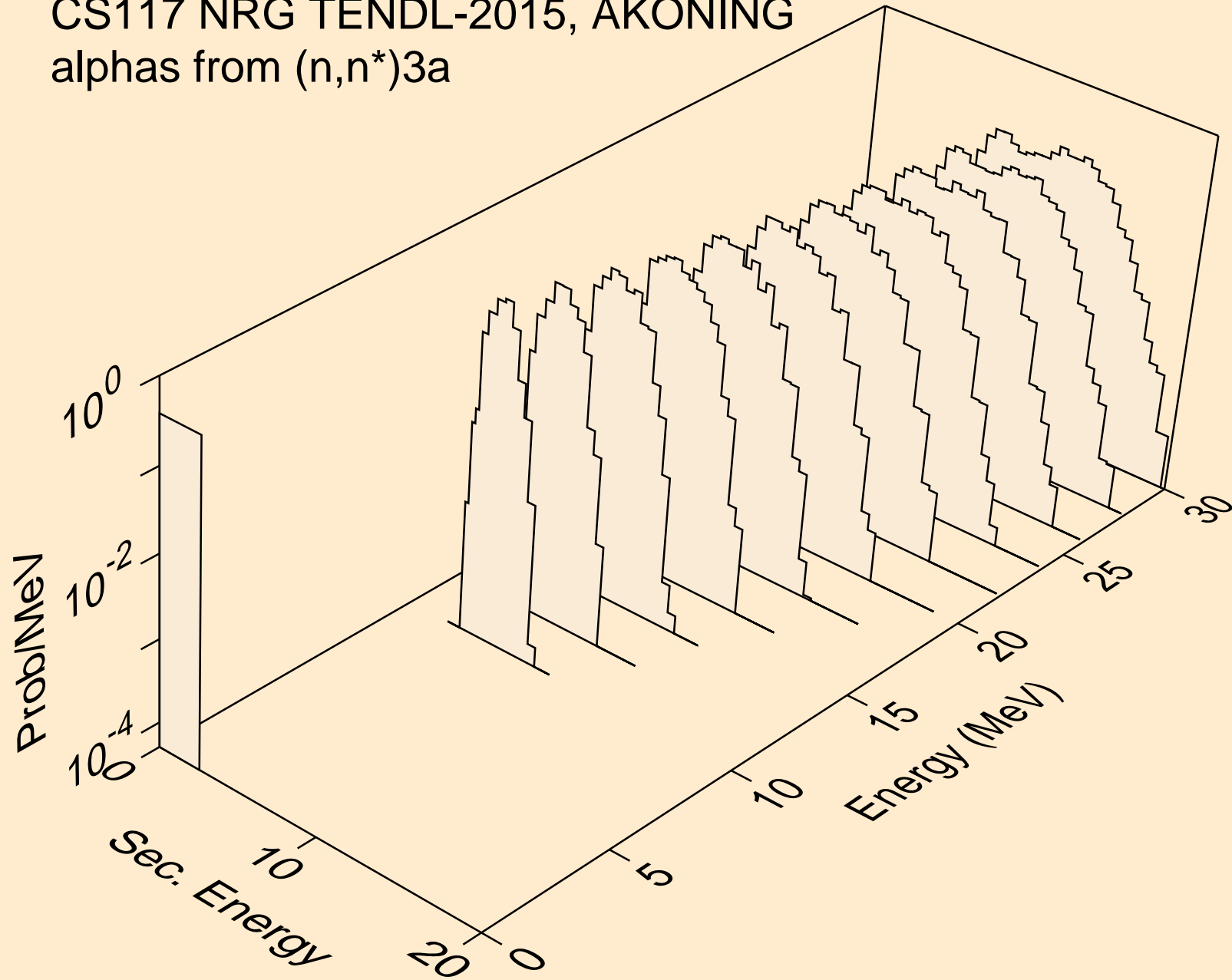



CS117 NRG TENDL-2015, AKONING  
alphas from (n,2n)a

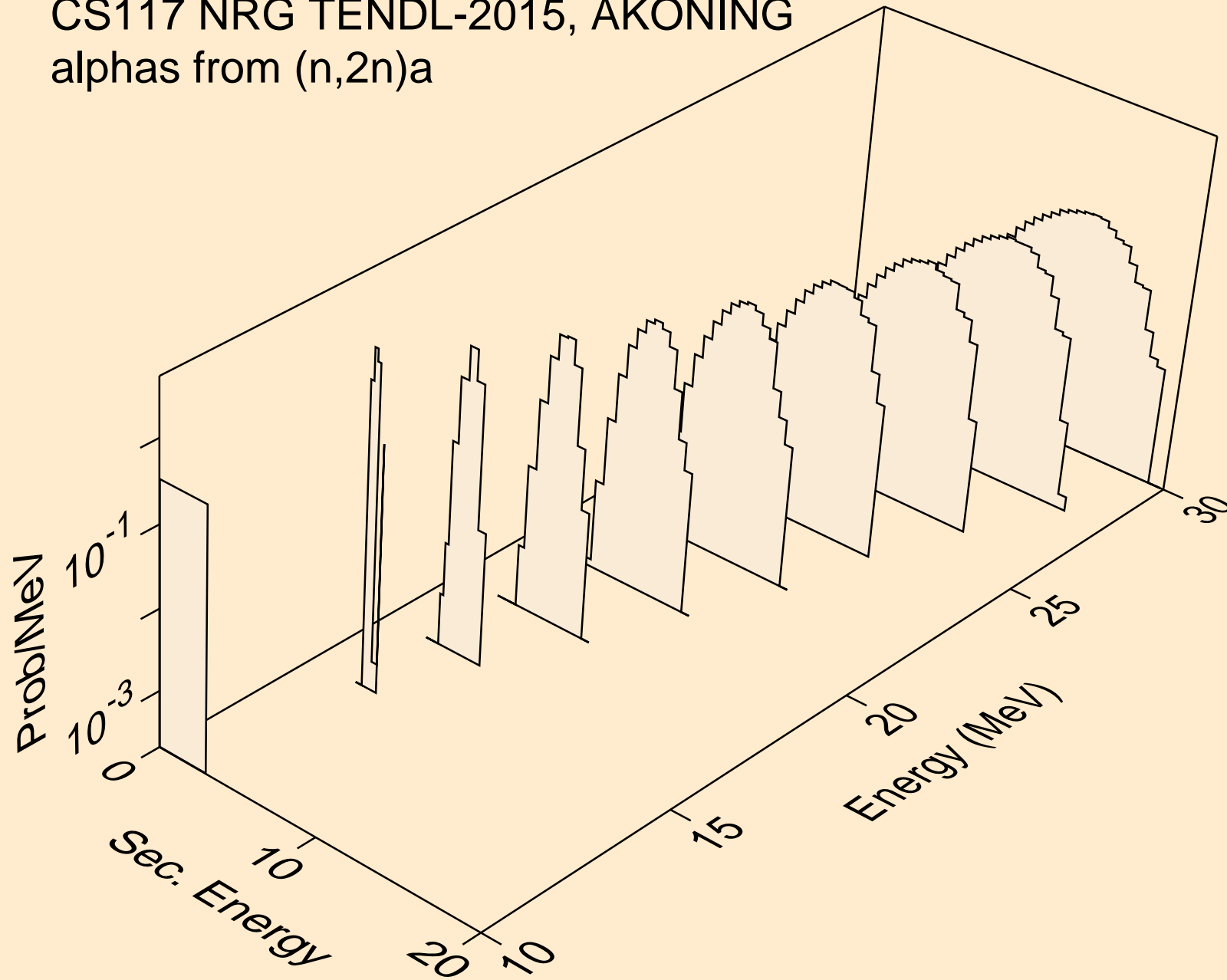

CS117 NRG TENDL-2015, AKONING  
alphas from (n,3n)a

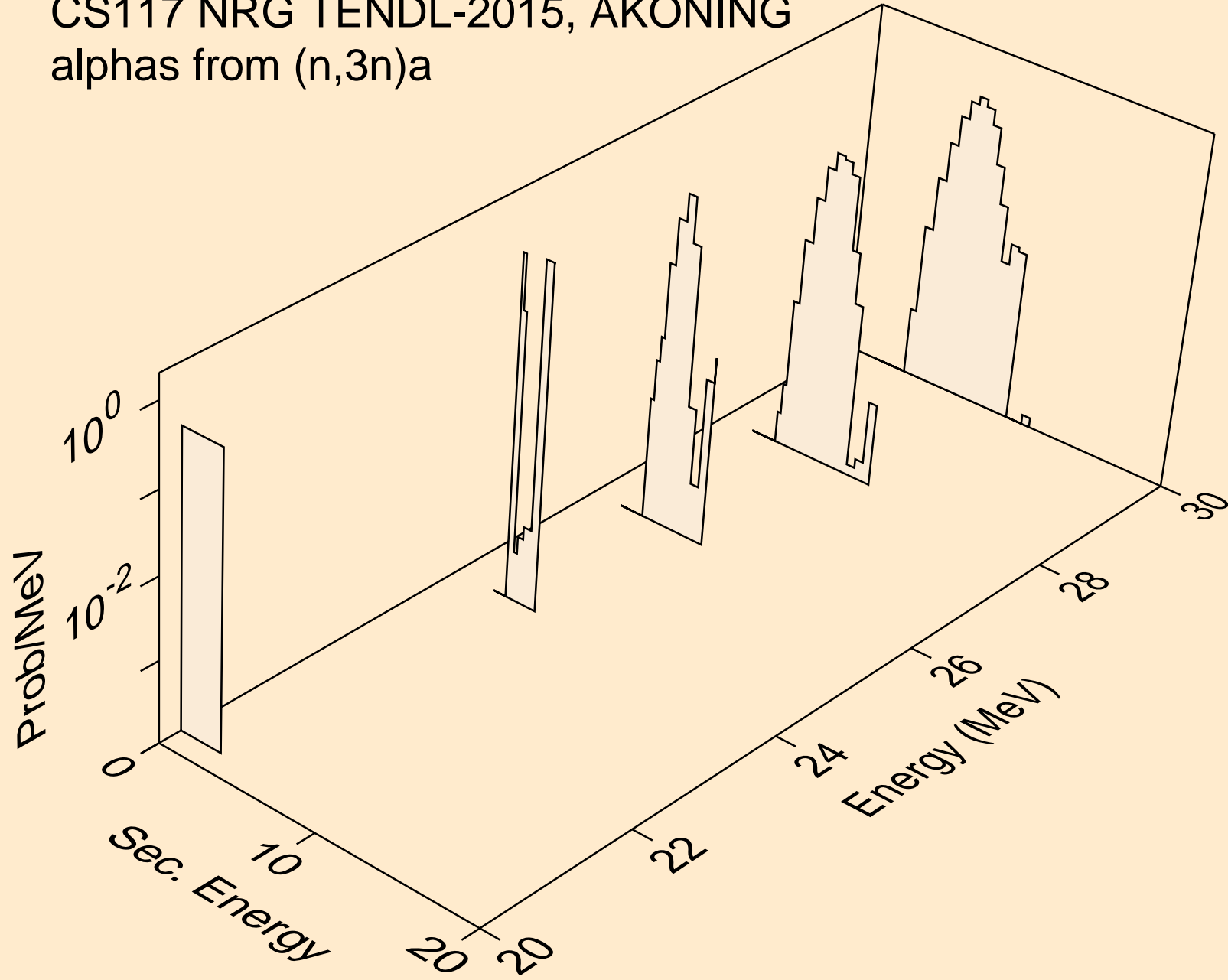

CS117 NRG TENDL-2015, AKONING  
alphas from (n,n\*)2a

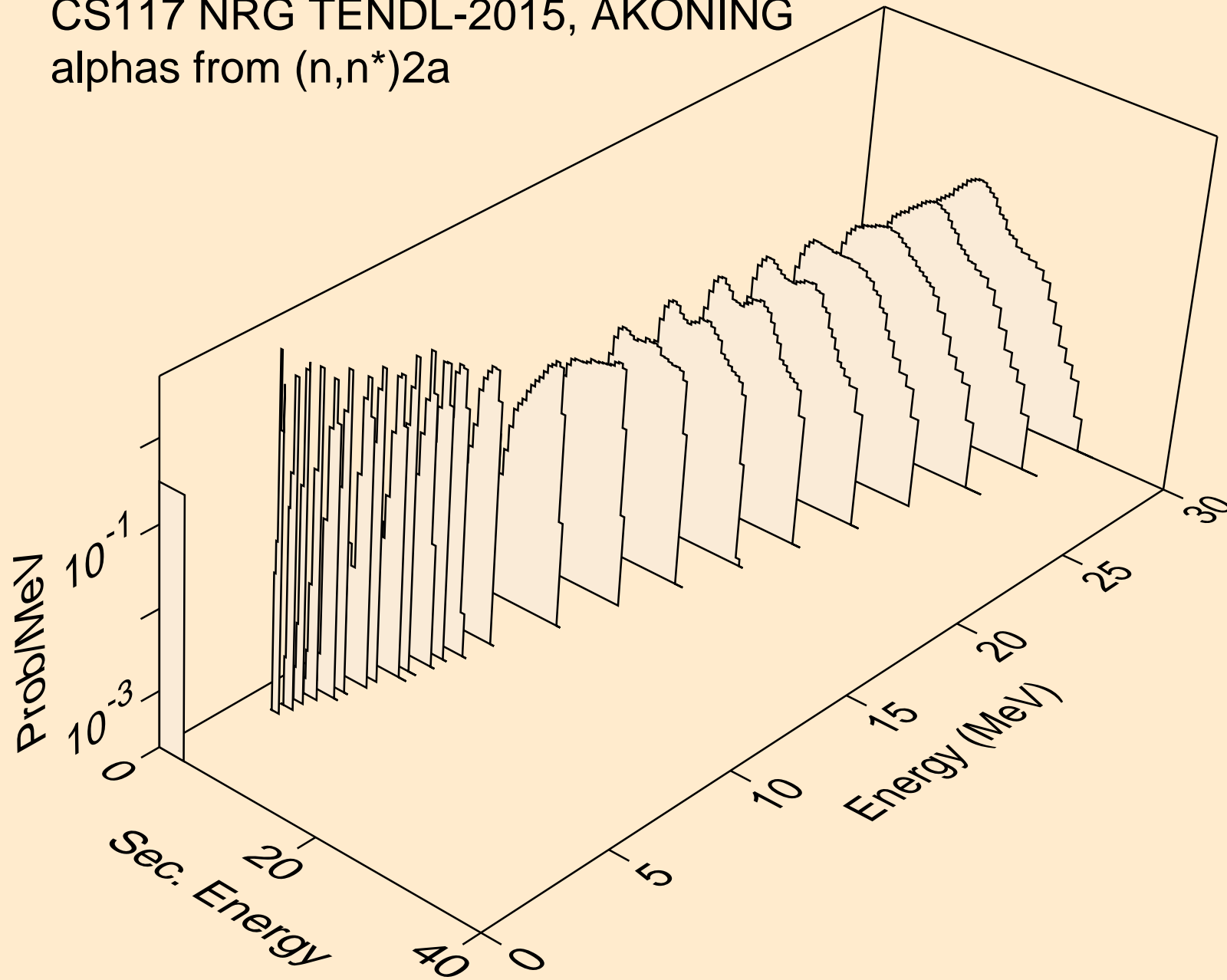

CS117 NRG TENDL-2015, AKONING  
alphas from (n,2n)2a

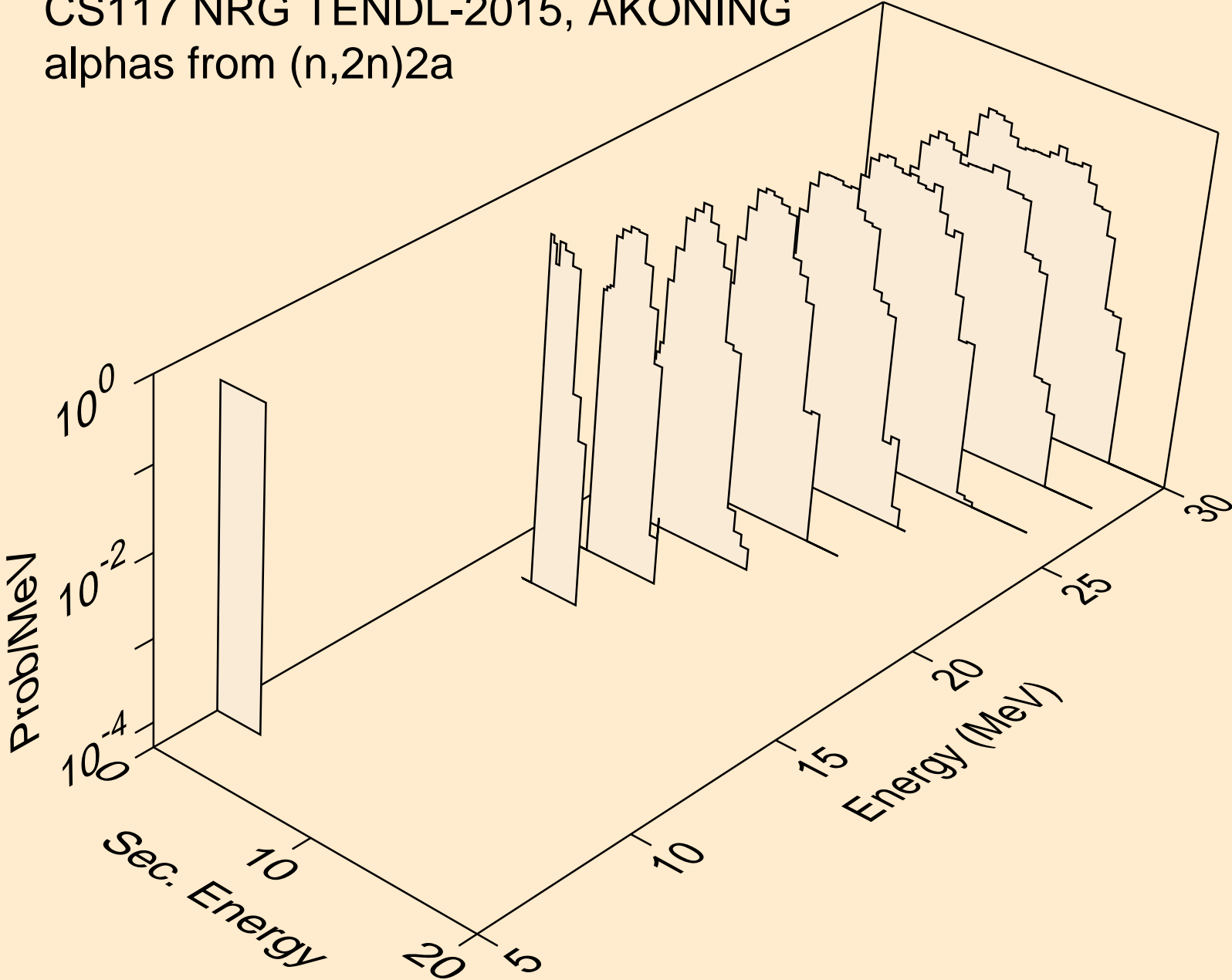

CS117 NRG TENDL-2015, AKONING  
alphas from (n,n\*)d2a

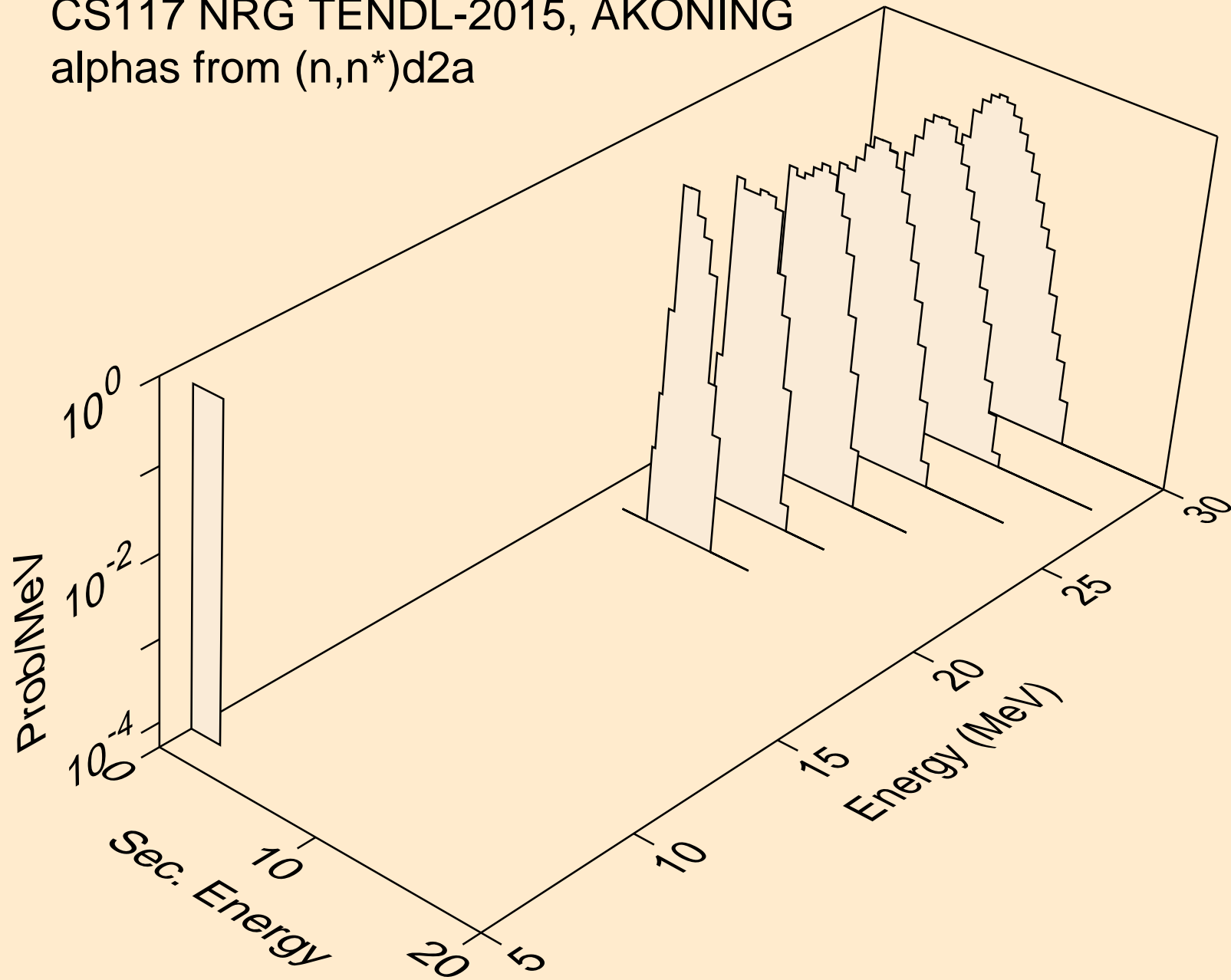

CS117 NRG TENDL-2015, AKONING  
alphas from (n,npa)

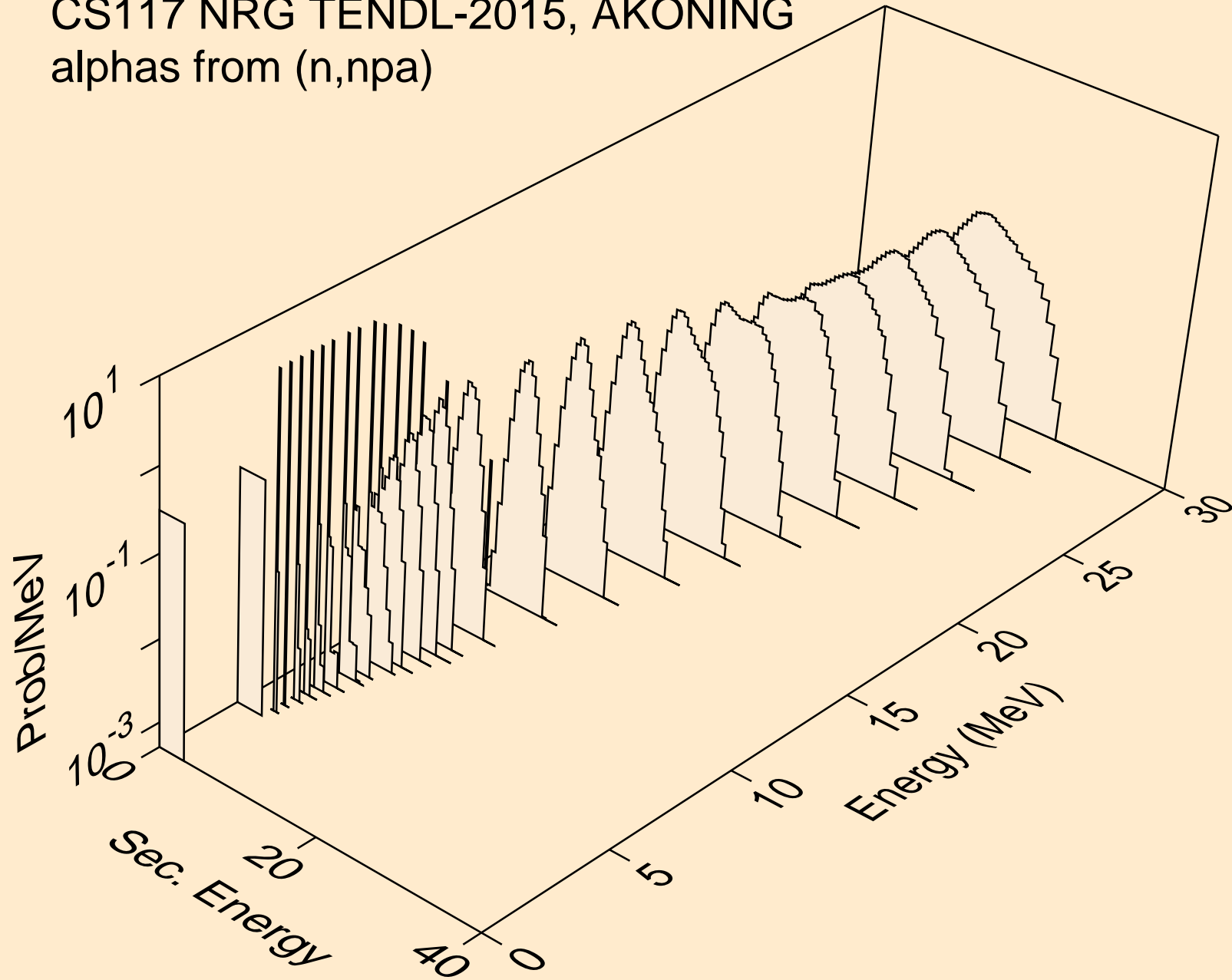

CS117 NRG TENDL-2015, AKONING  
alphas from (n,a)

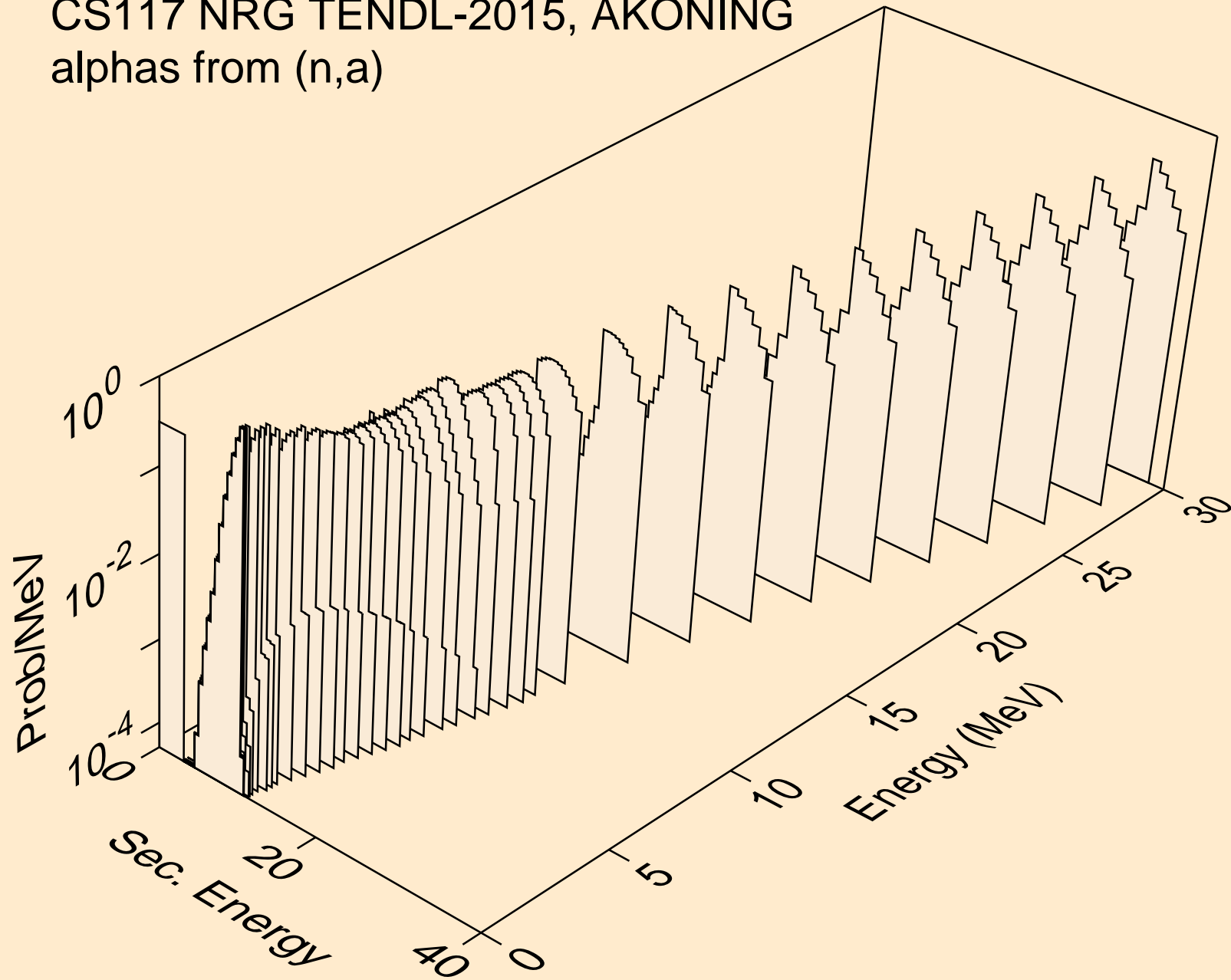

CS117 NRG TENDL-2015, AKONING  
alphas from (n,2a)

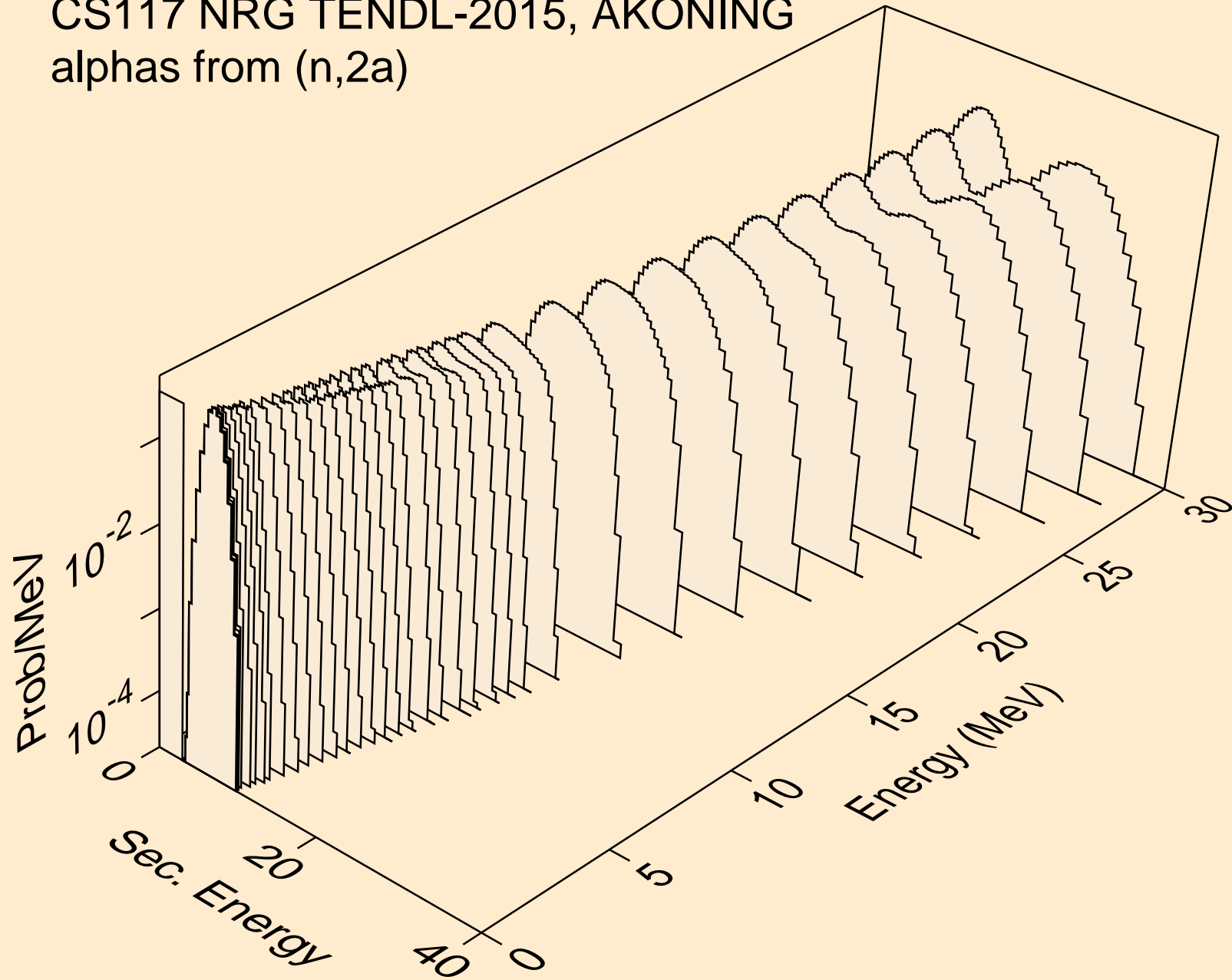



CS117 NRG TENDL-2015, AKONING  
alphas from (n,3a)

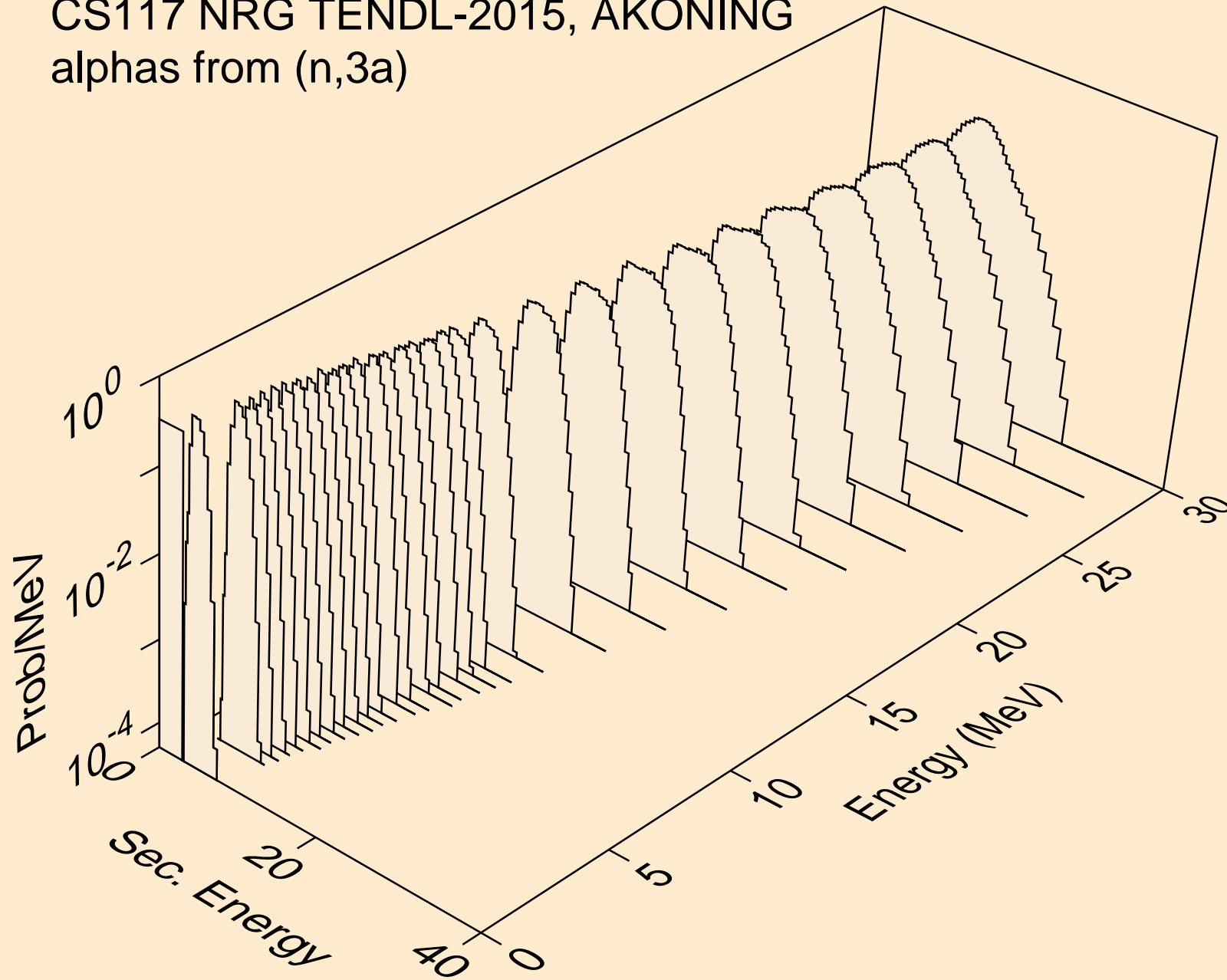

CS117 NRG TENDL-2015, AKONING  
alphas from (n,pa)

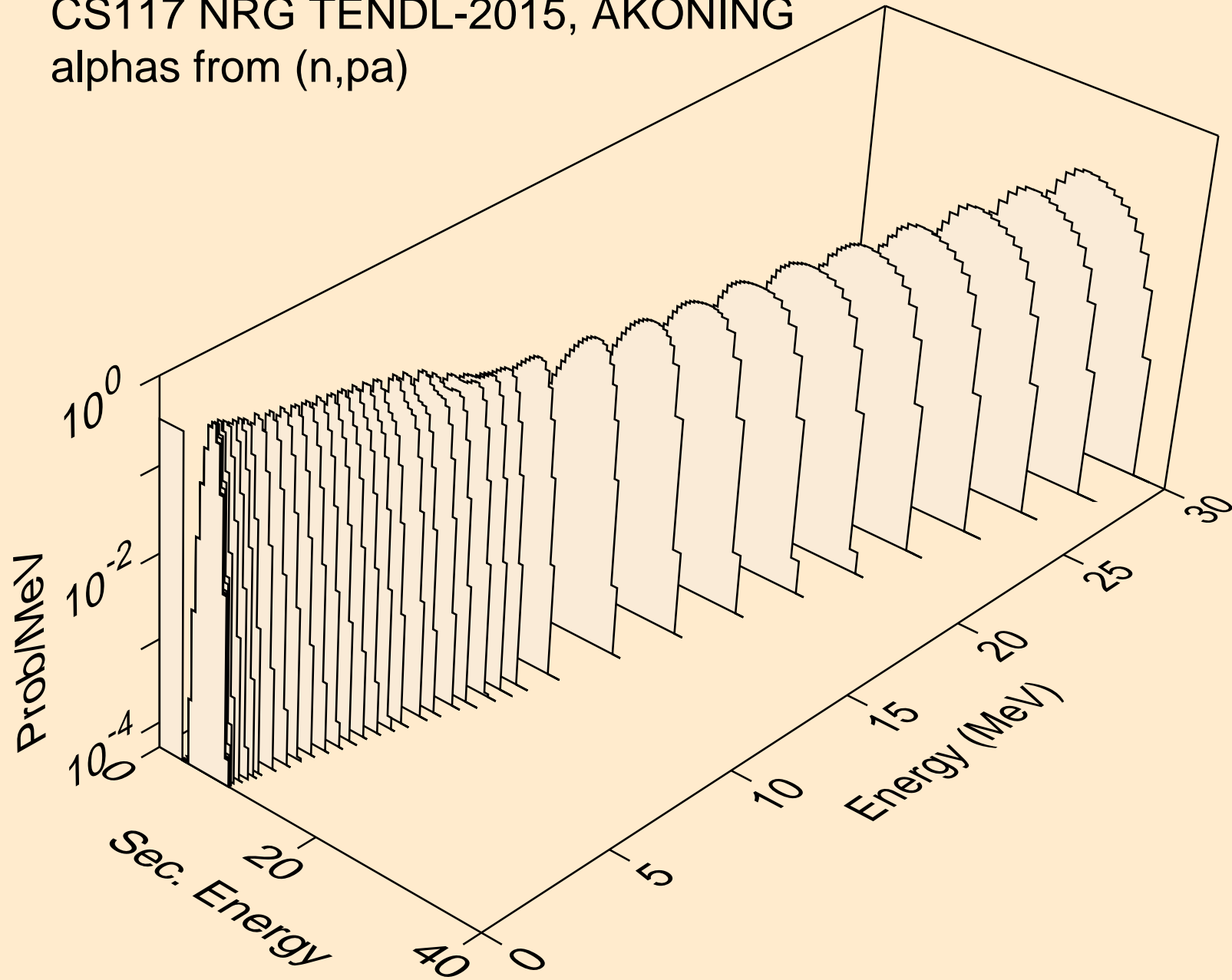

CS117 NRG TENDL-2015, AKONING  
alphas from (n,t2a)

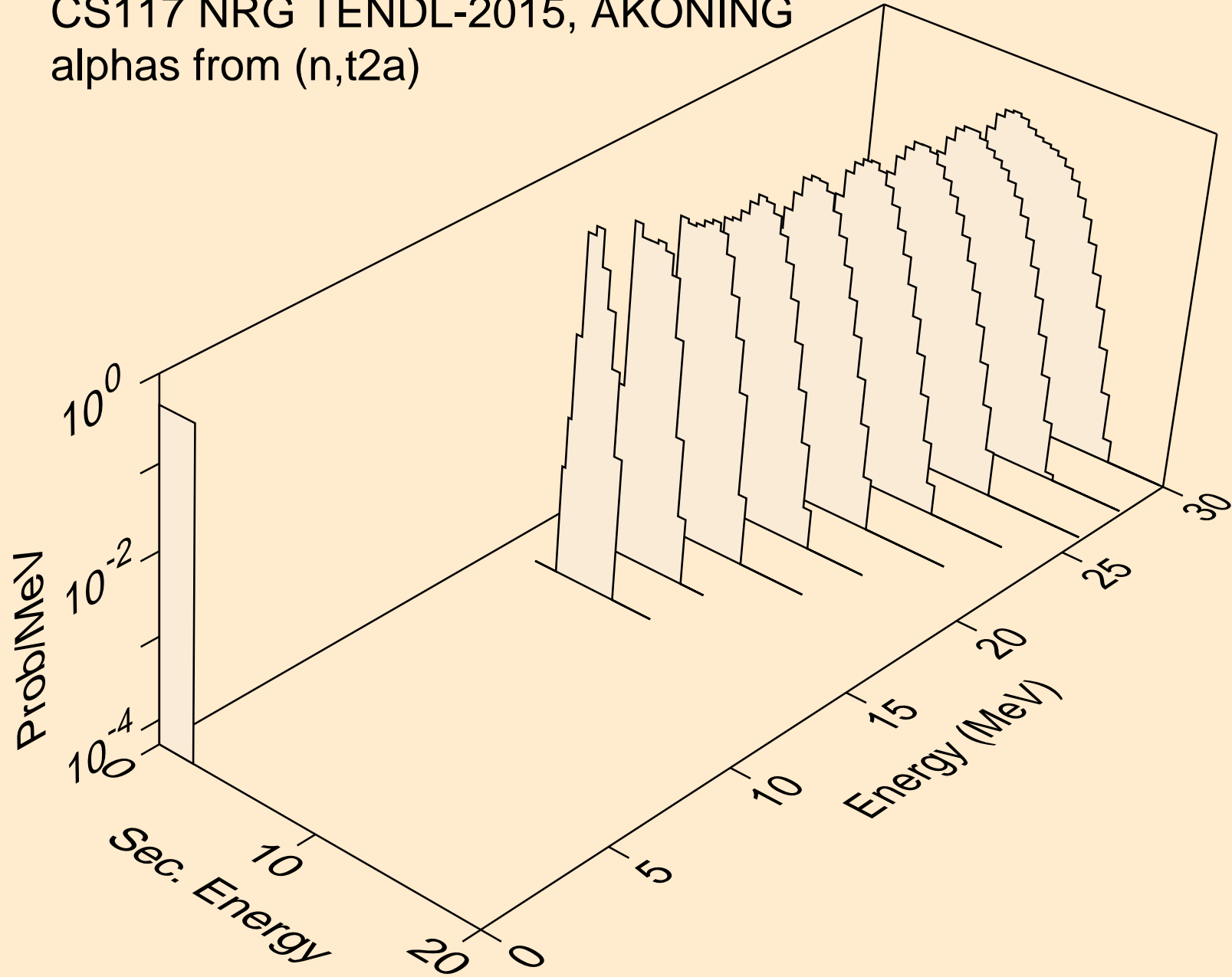

CS117 NRG TENDL-2015, AKONING  
alphas from (n,d2a)

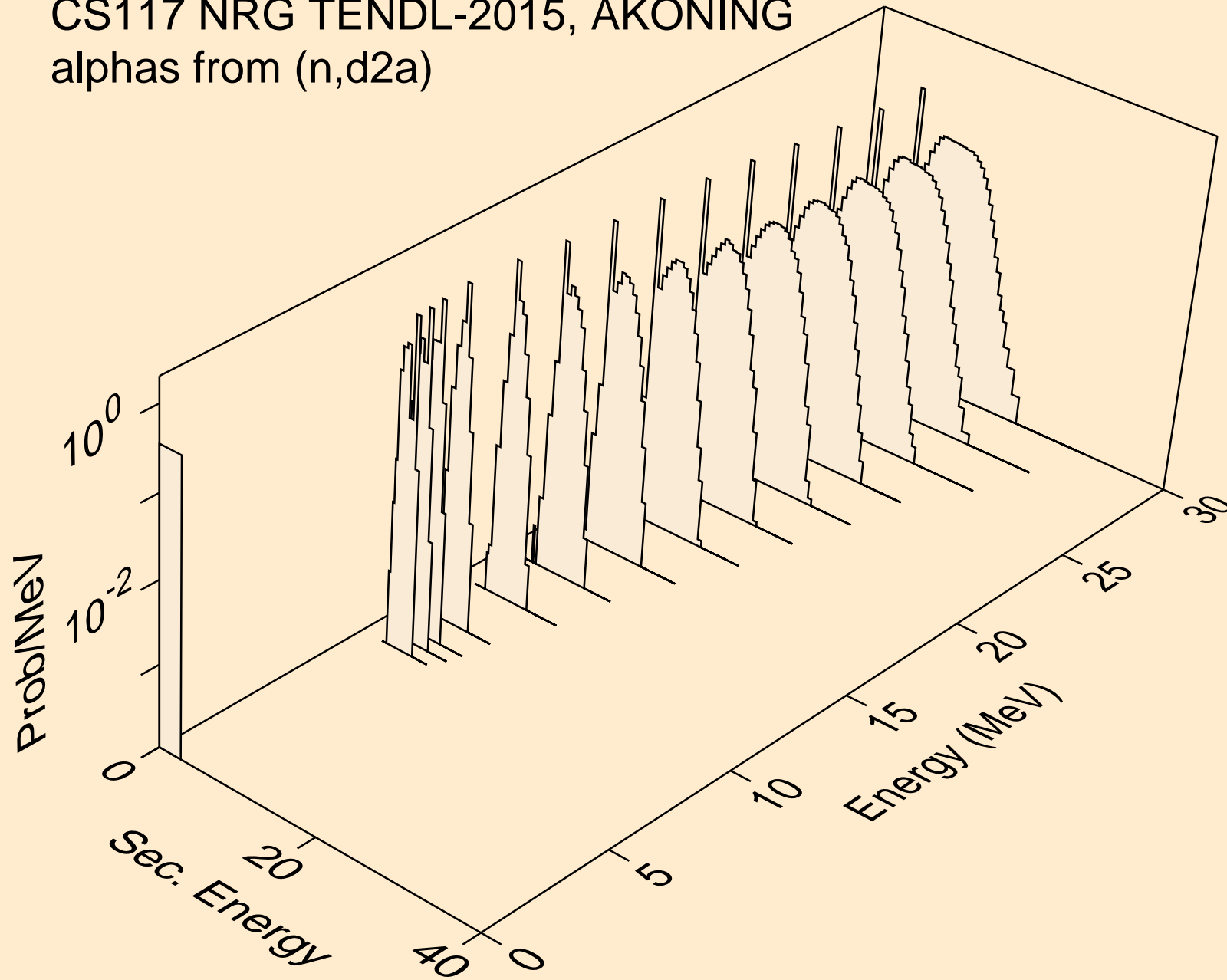

CS117 NRG TENDL-2015, AKONING  
alphas from (n,da)

