

CU075 NRG TENDL-2015, AKONING

Principal cross sections

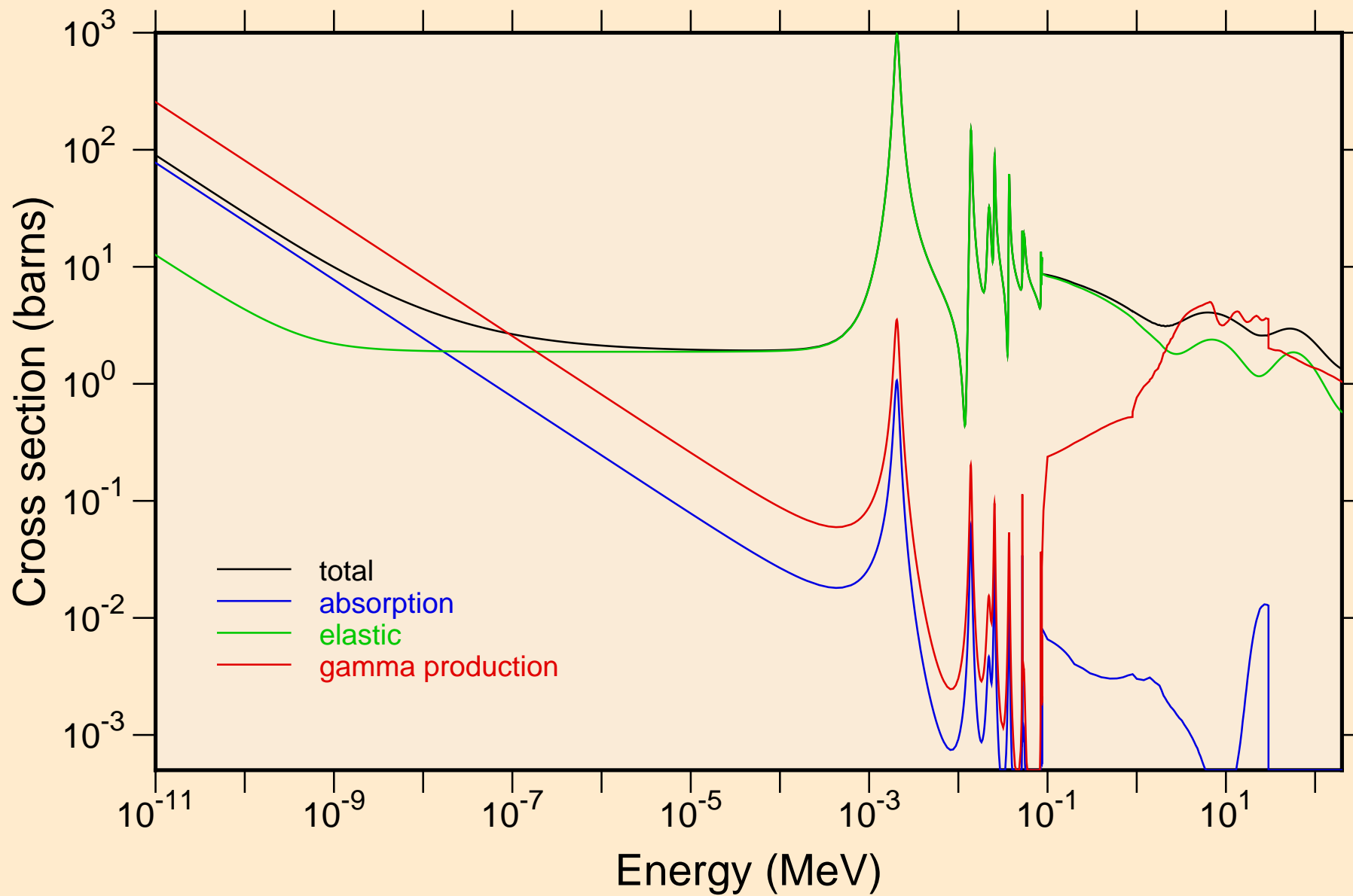

CU075 NRG TENDL-2015, AKONING

Non-threshold reactions

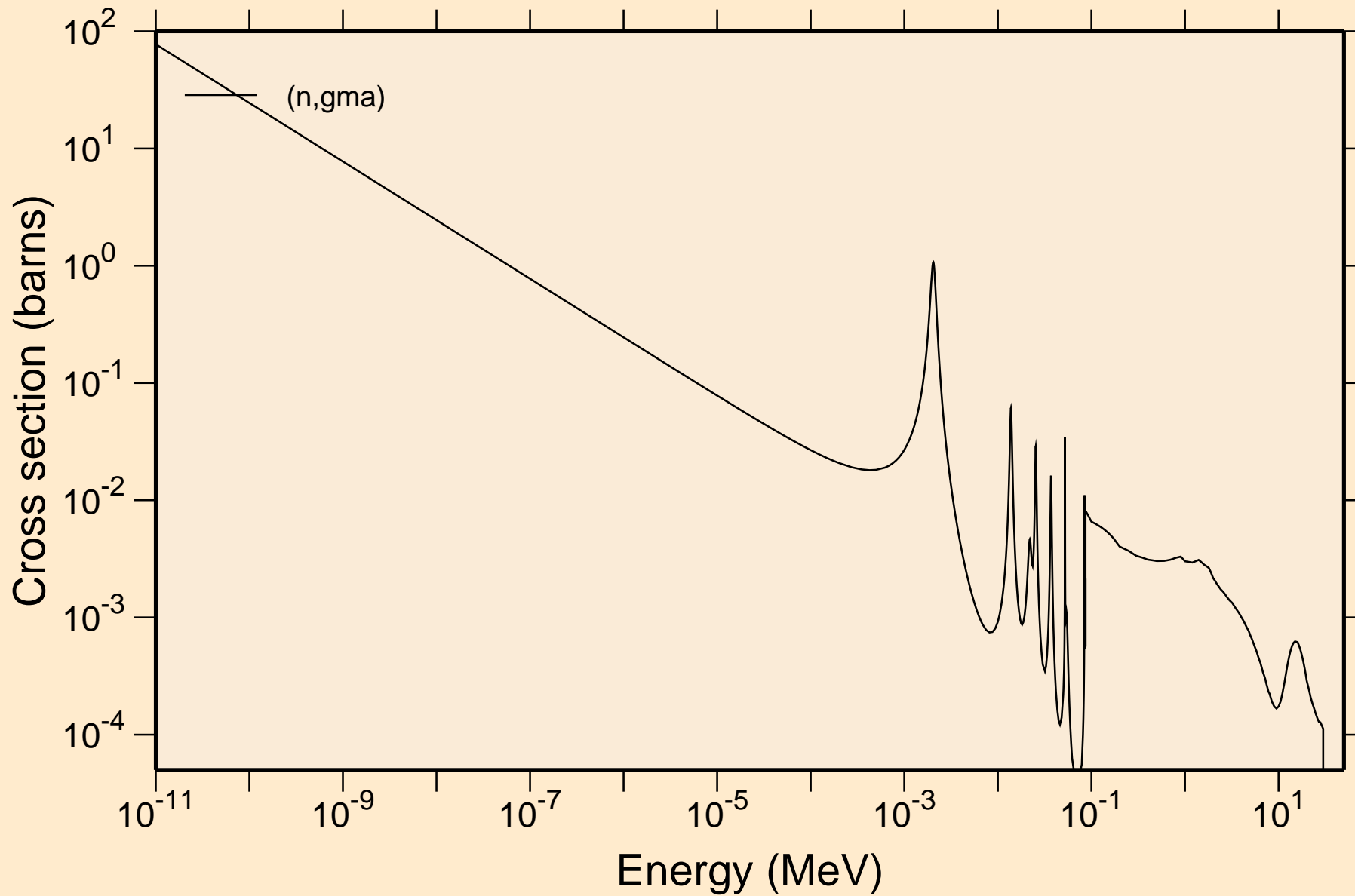

CU075 NRG TENDL-2015, AKONING

Principal cross sections

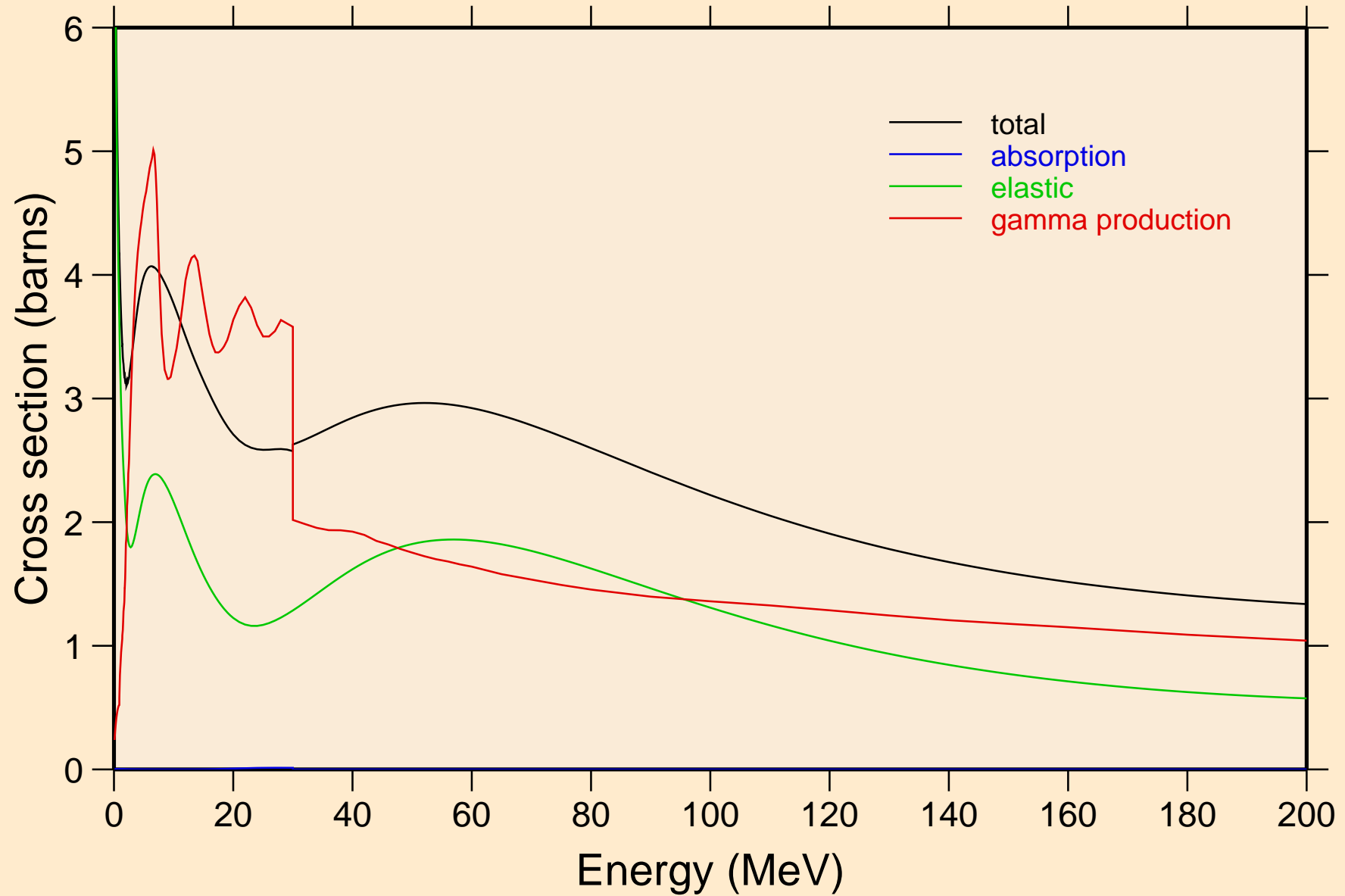

CU075 NRG TENDL-2015, AKONING
Non-threshold reactions

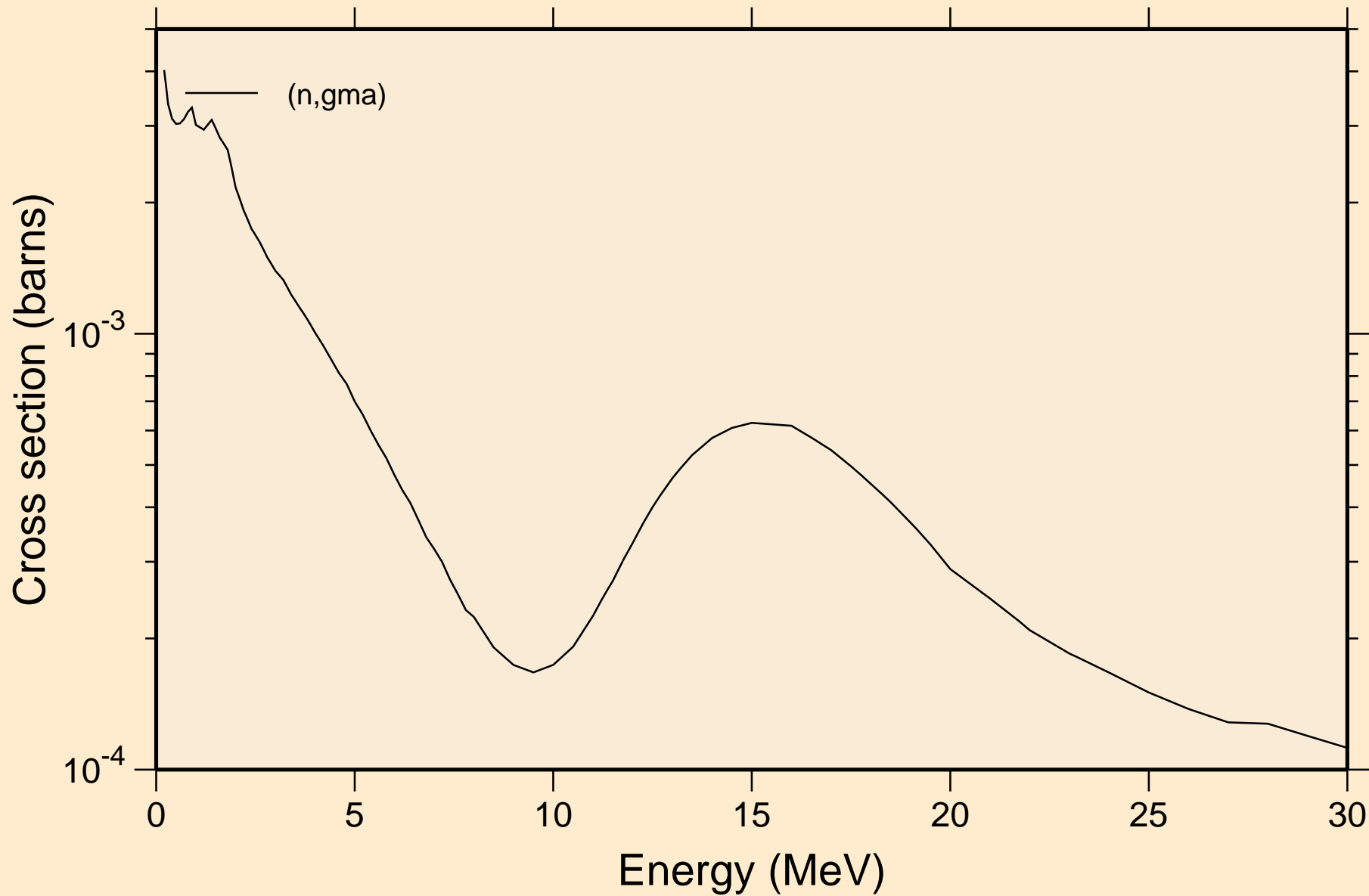

CU075 NRG TENDL-2015, AKONING

Inelastic levels

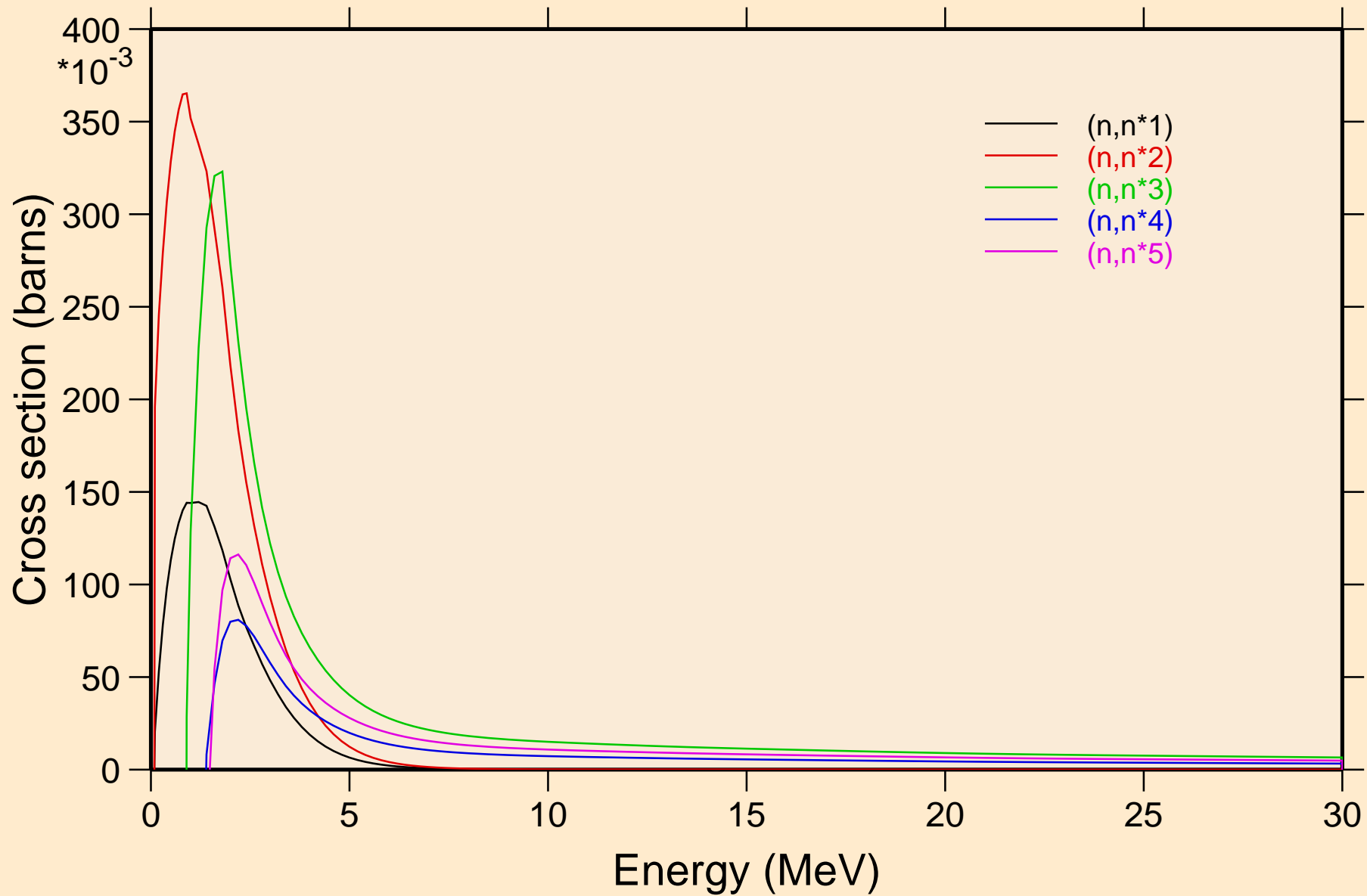

CU075 NRG TENDL-2015, AKONING

Inelastic levels

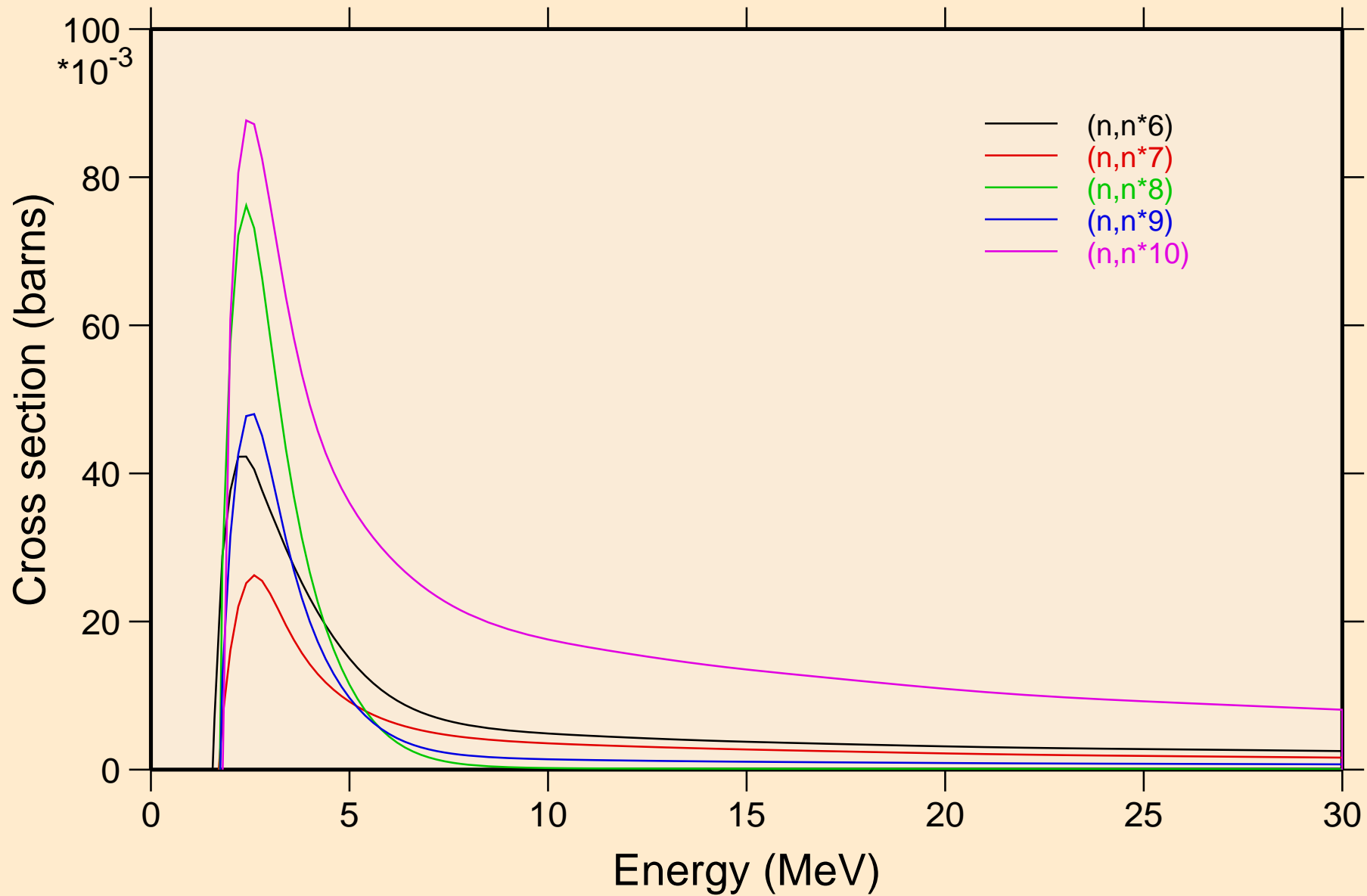

CU075 NRG TENDL-2015, AKONING

Inelastic levels

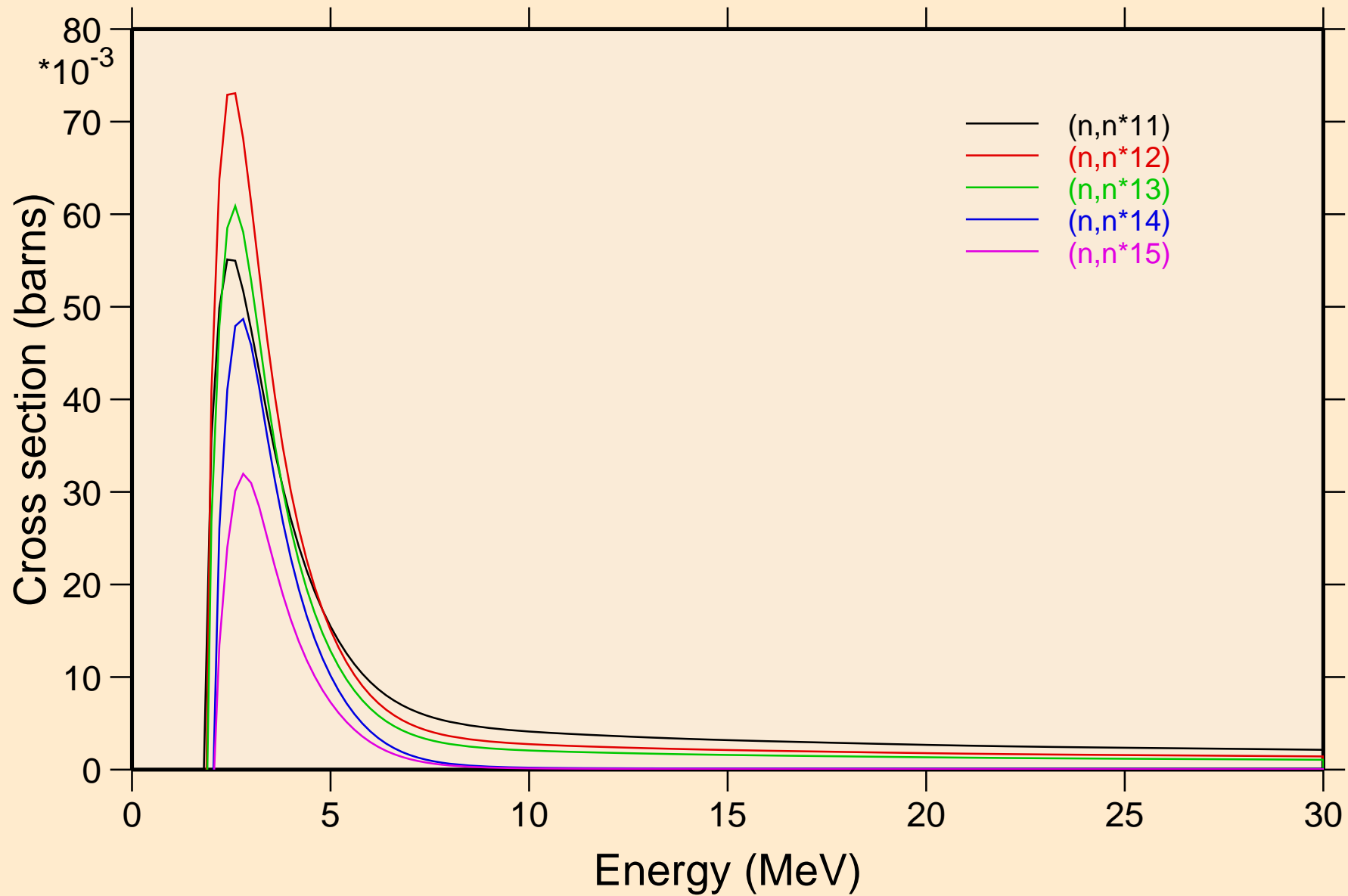

CU075 NRG TENDL-2015, AKONING

Inelastic levels

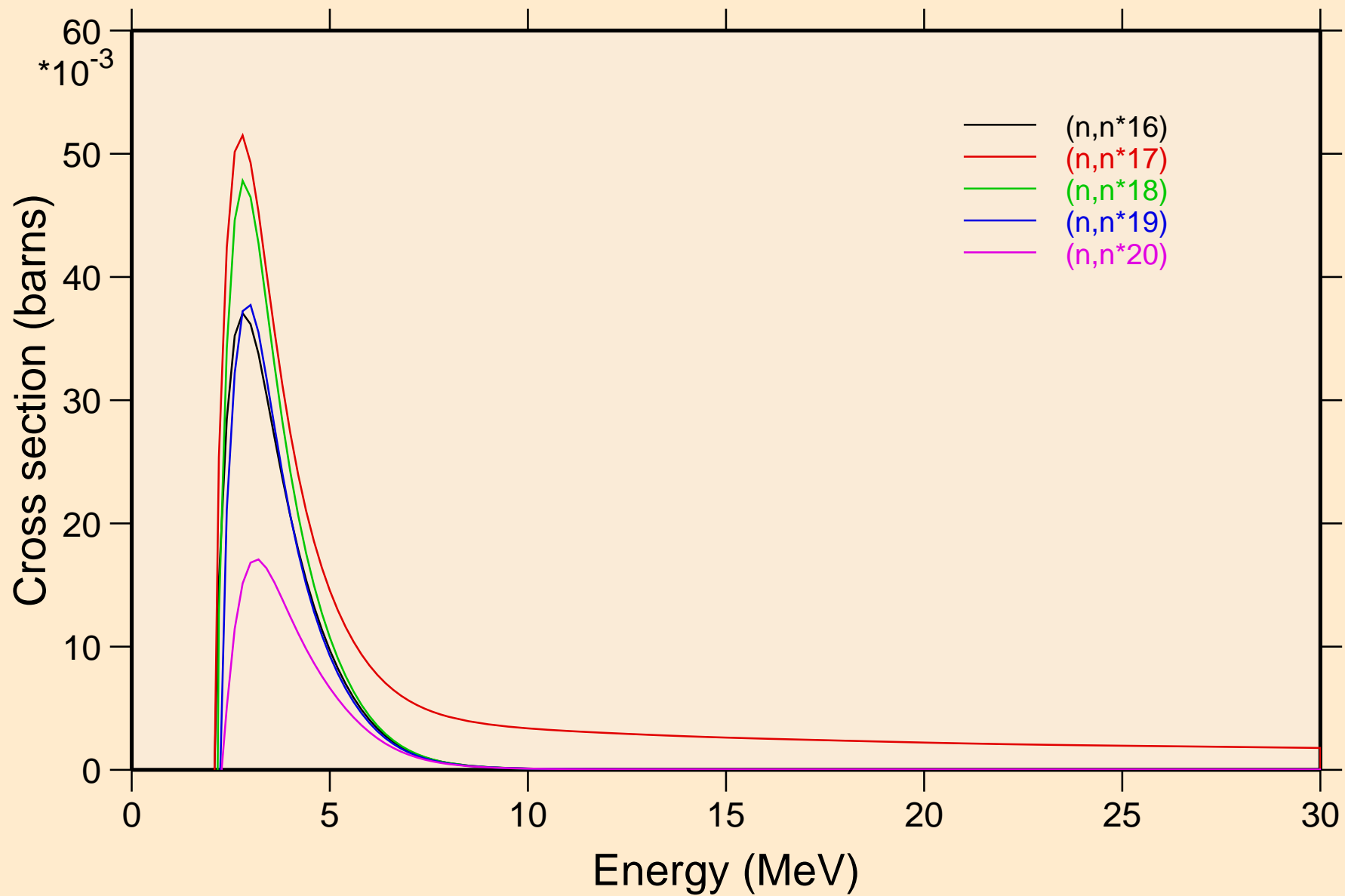

CU075 NRG TENDL-2015, AKONING

Inelastic levels

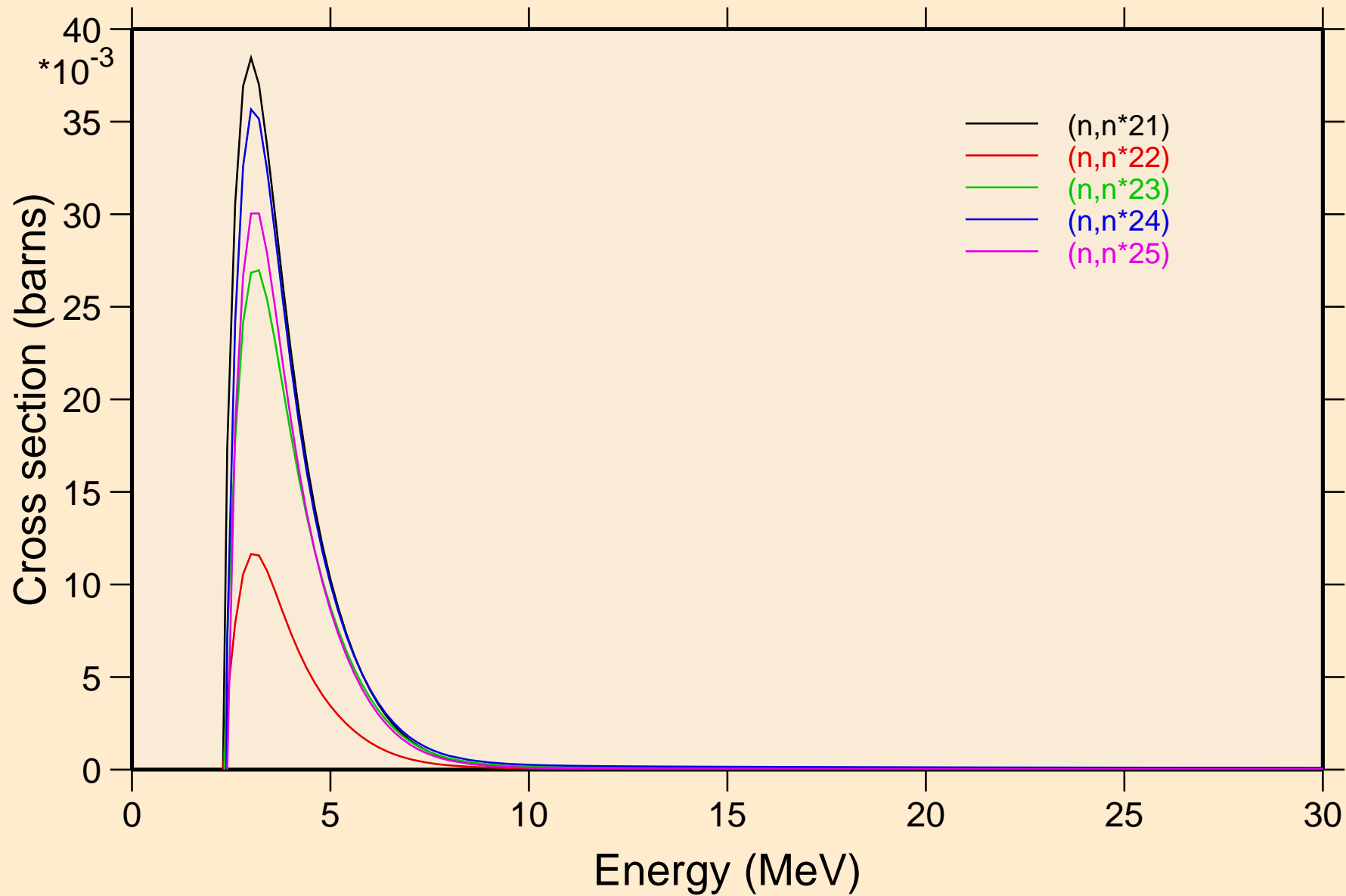

CU075 NRG TENDL-2015, AKONING

Inelastic levels

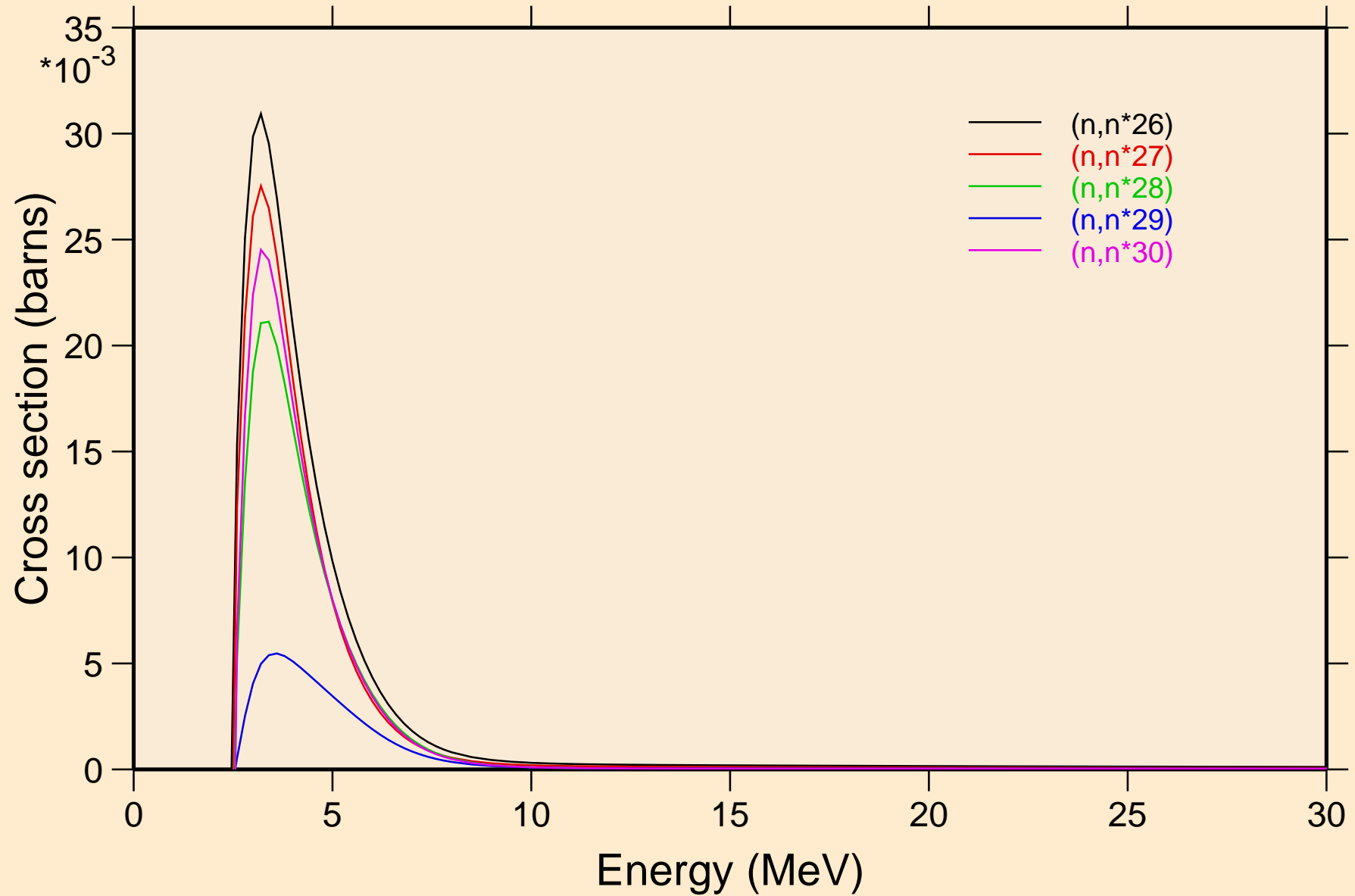

CU075 NRG TENDL-2015, AKONING

Threshold reactions

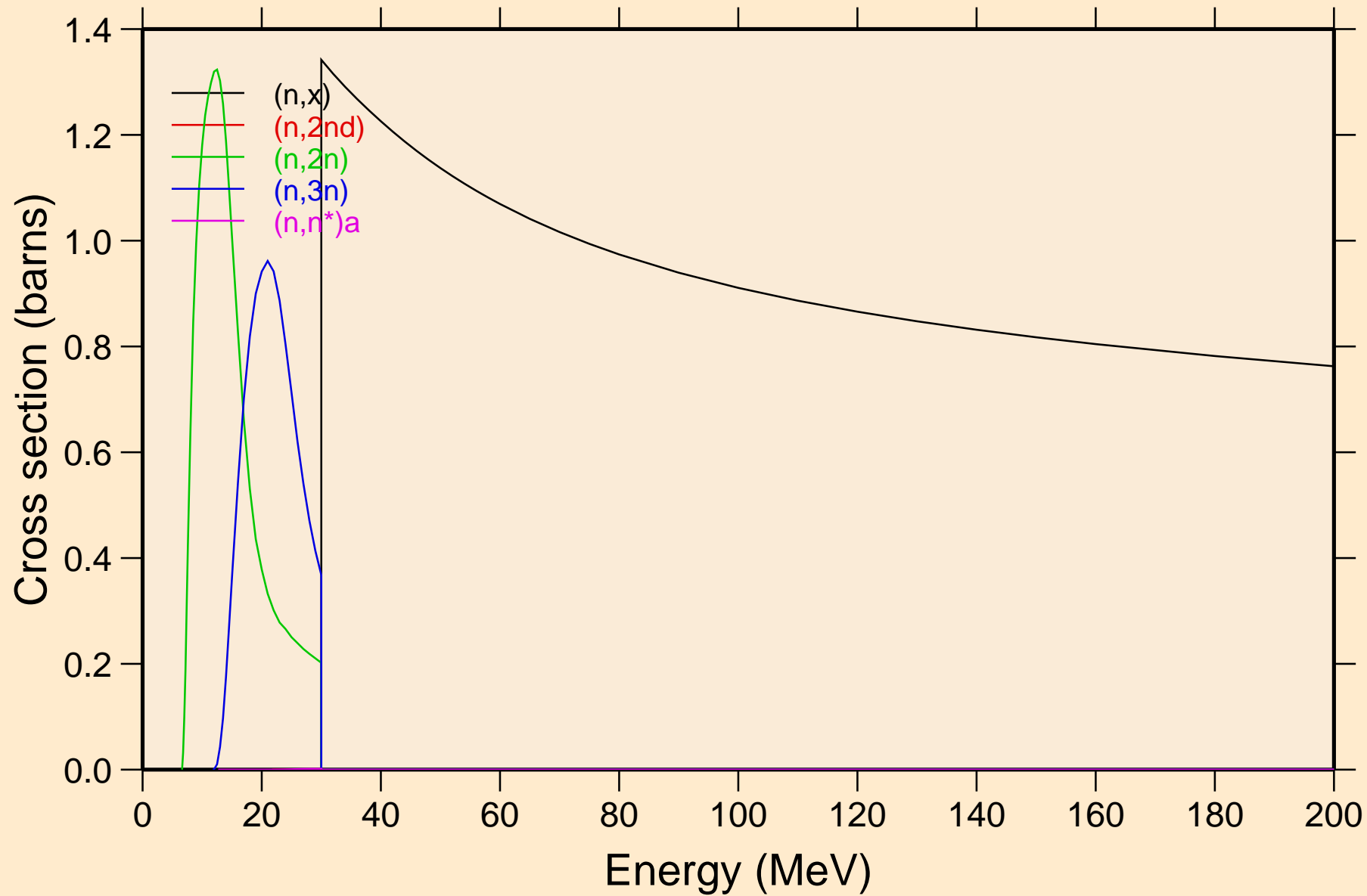

CU075 NRG TENDL-2015, AKONING

Threshold reactions

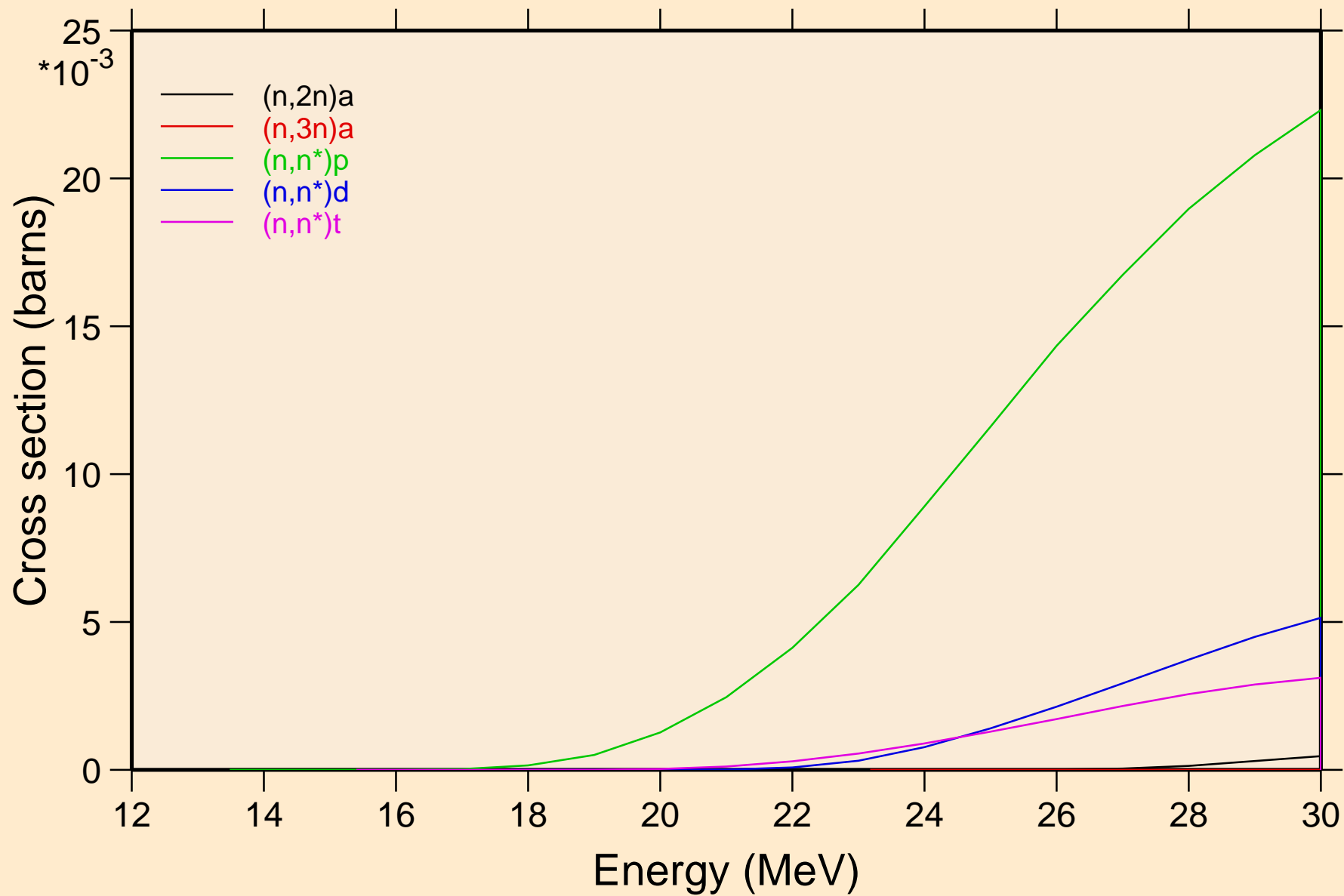

CU075 NRG TENDL-2015, AKONING

Threshold reactions

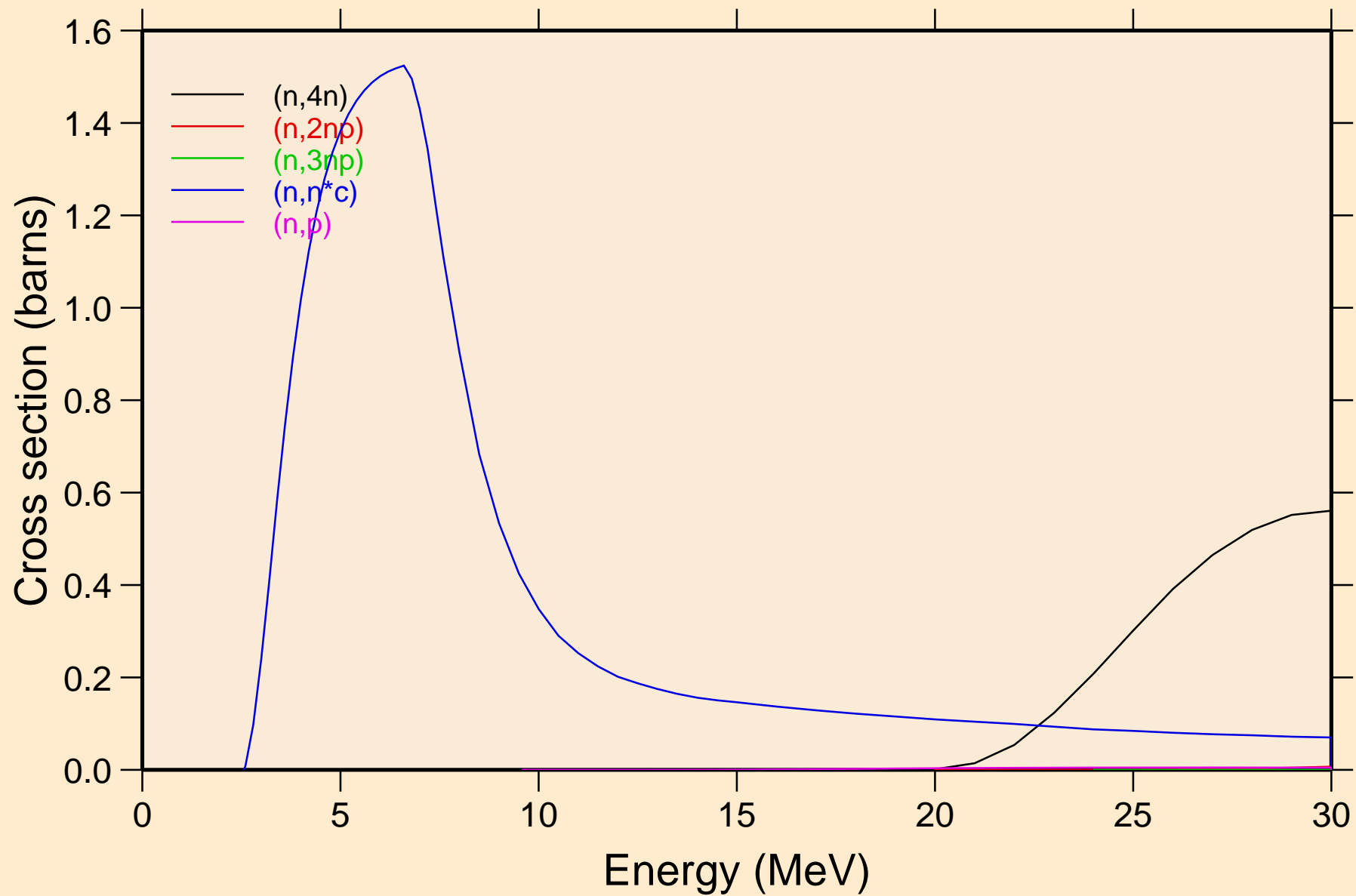

CU075 NRG TENDL-2015, AKONING

Threshold reactions

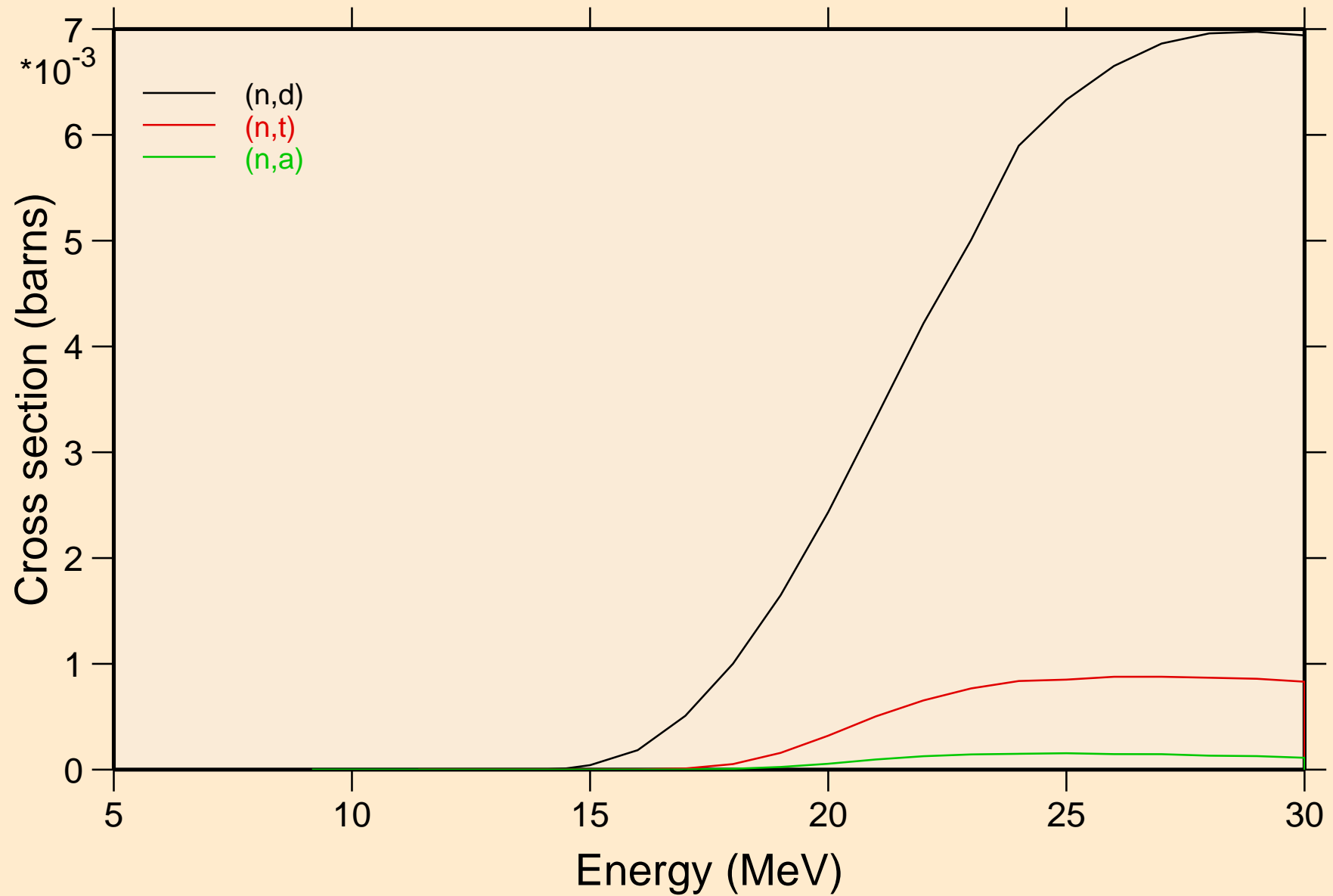

CU075 NRG TENDL-2015, AKONING
angular distribution for elastic

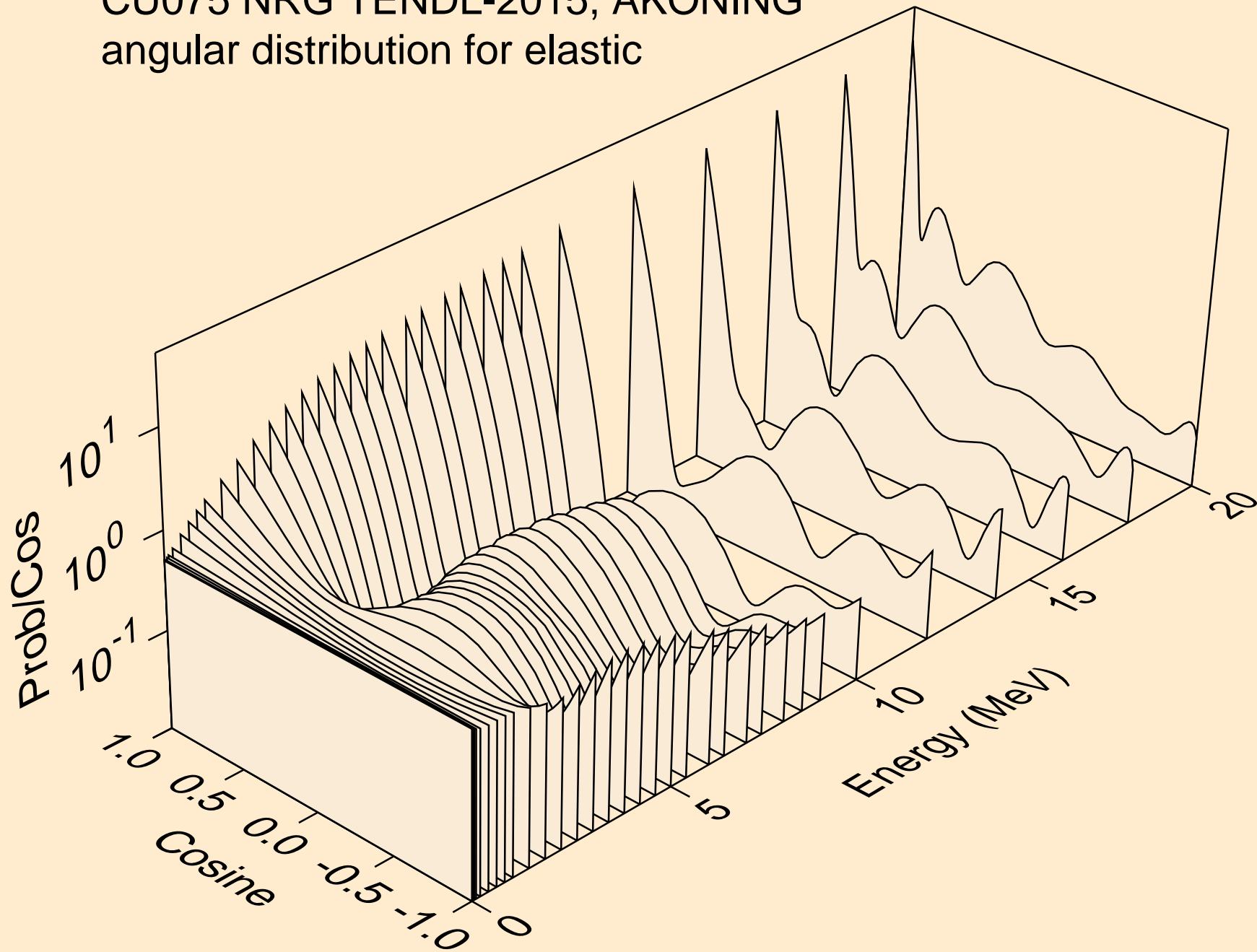

CU075 NRG TENDL-2015, AKONING
angular distribution for elastic

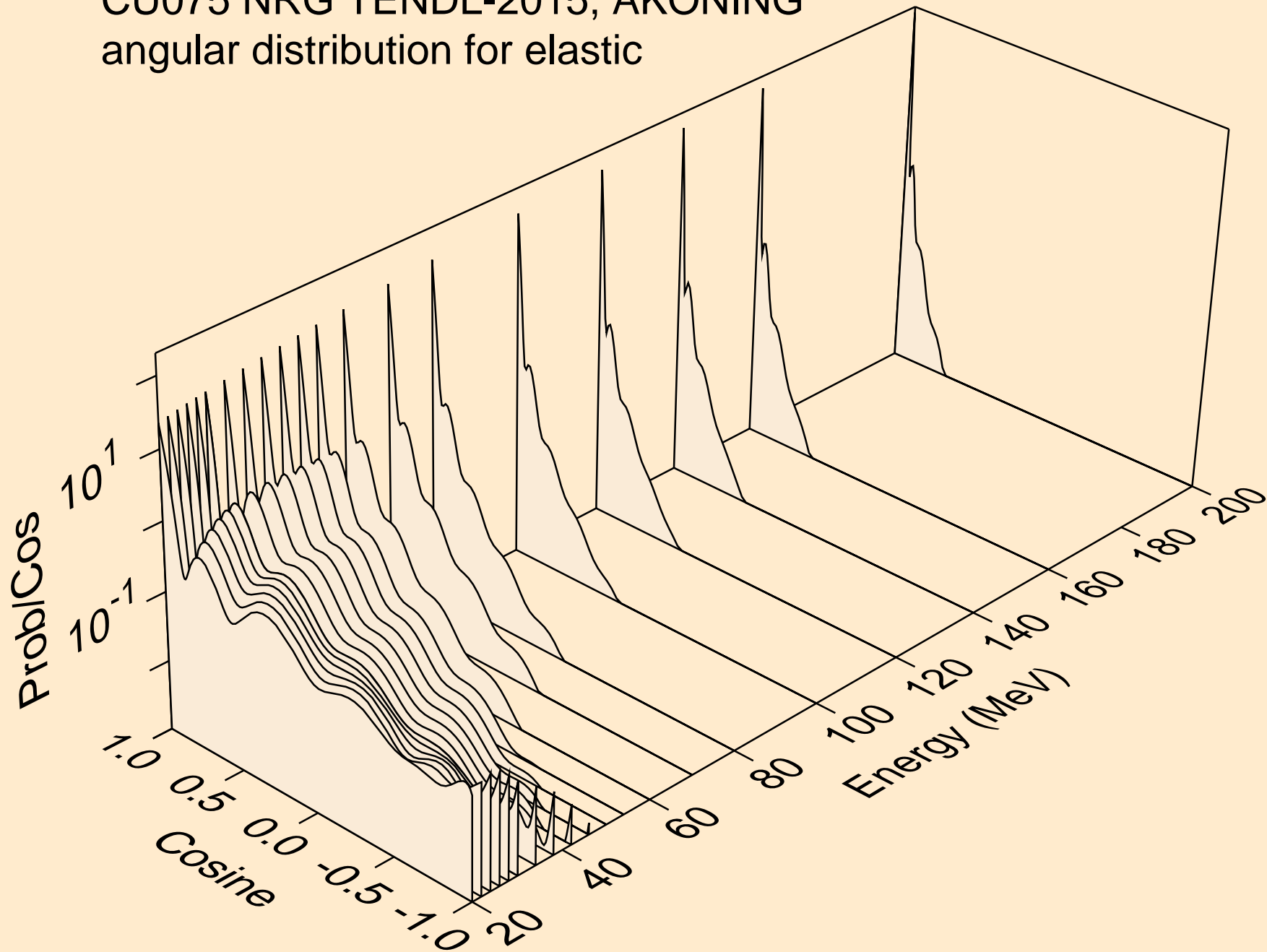

CU075 NRG TENDL-2015, AKONING
angular distribution for (n,n*1)

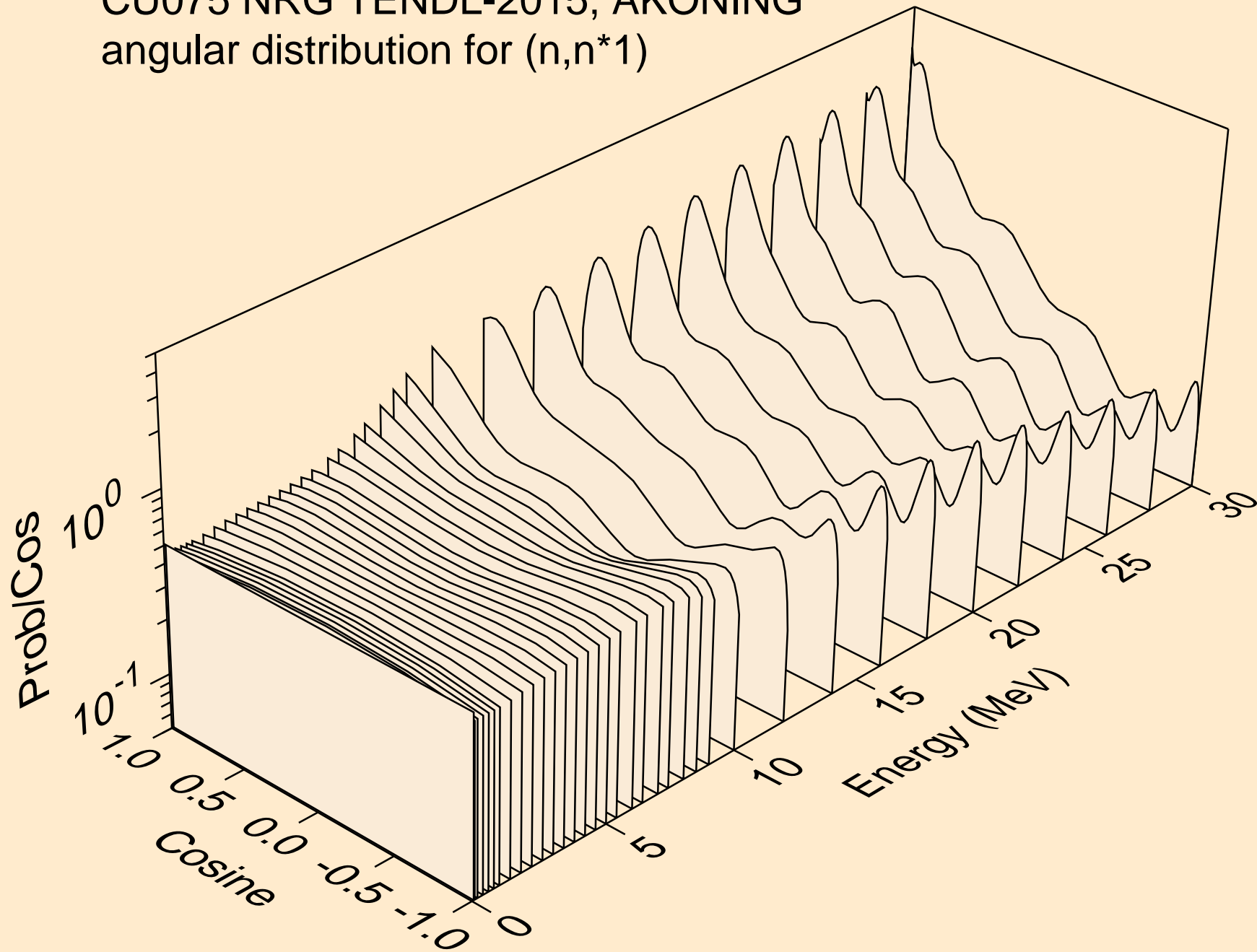

CU075 NRG TENDL-2015, AKONING
angular distribution for (n,n*2)

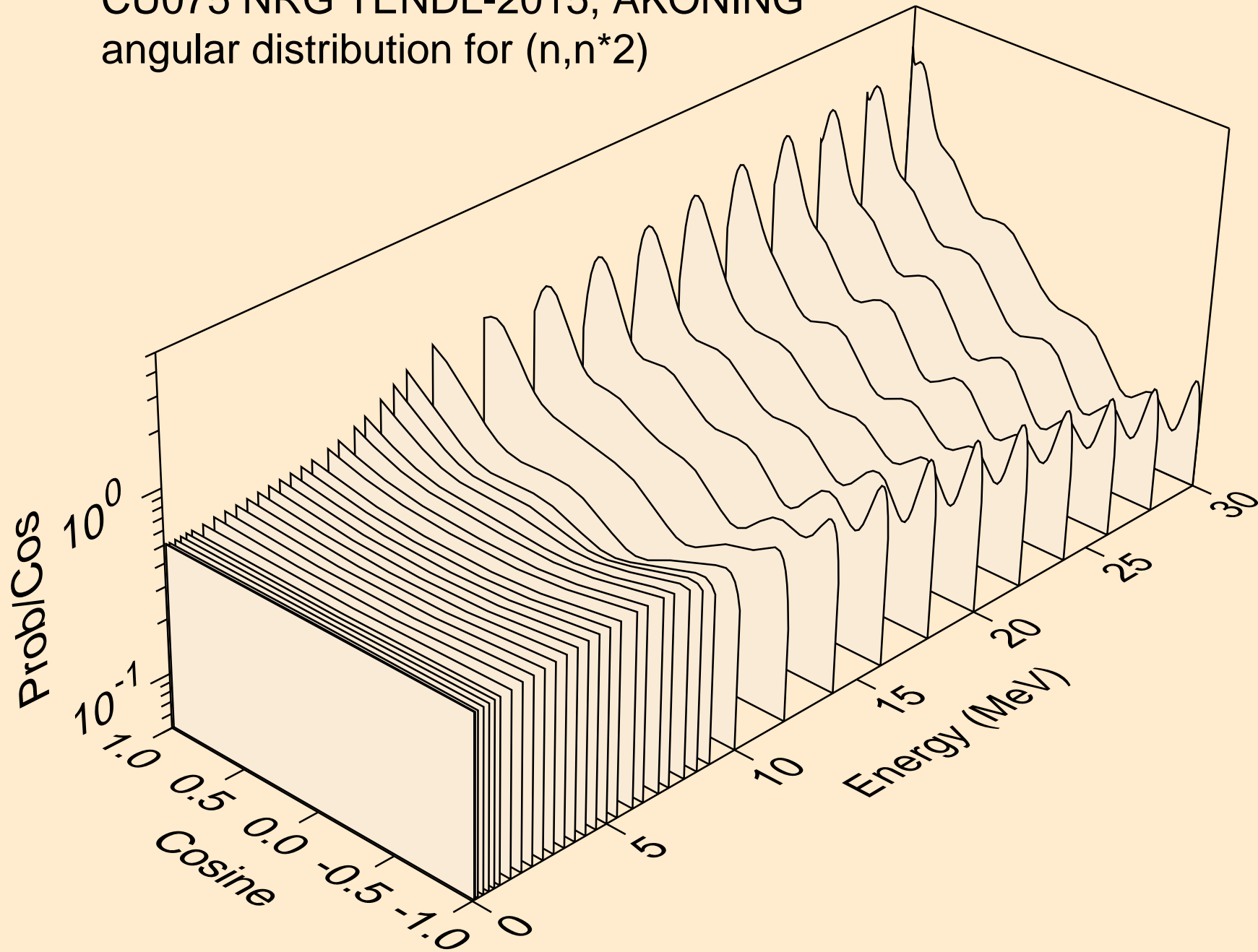

CU075 NRG TENDL-2015, AKONING
angular distribution for (n,n*3)

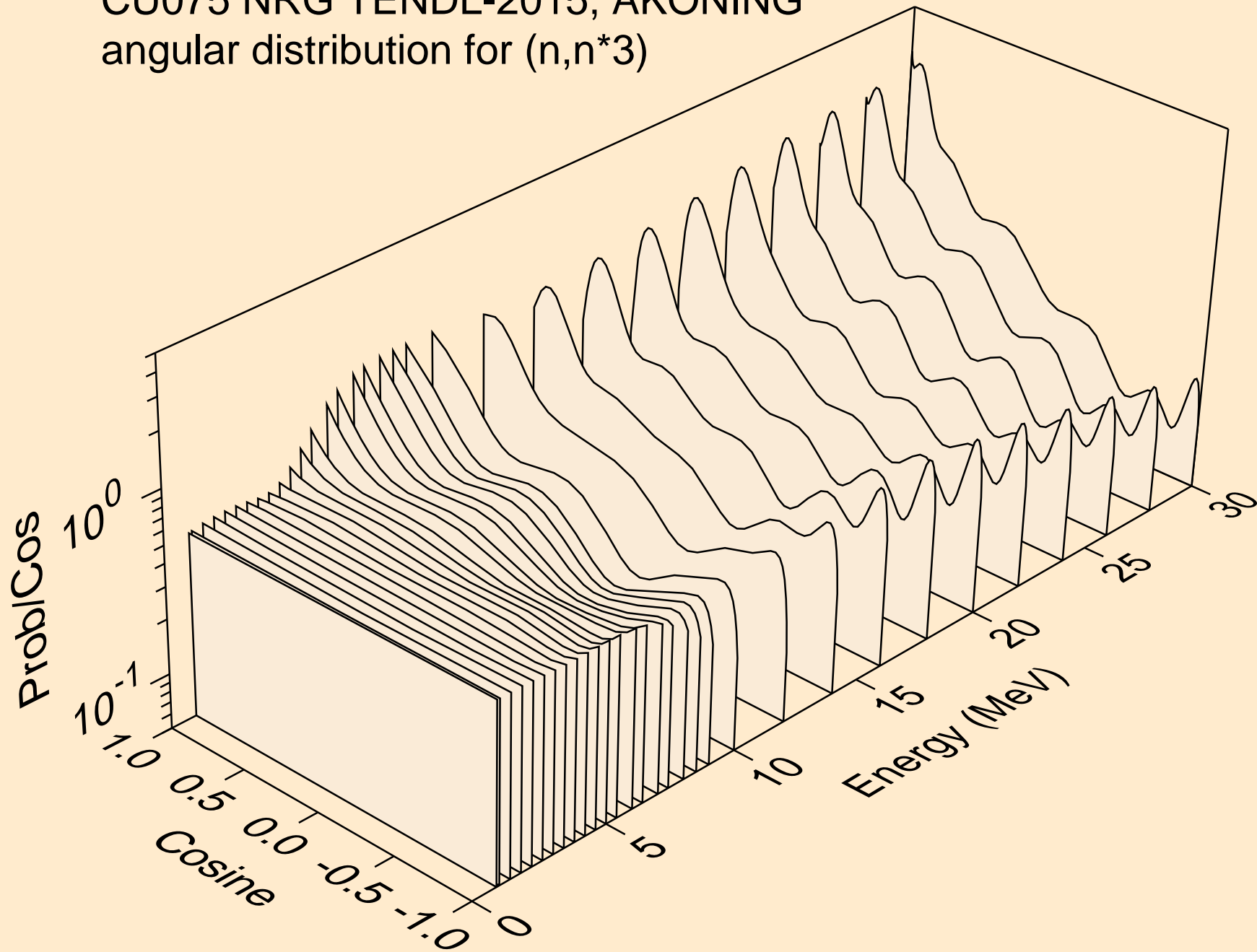

CU075 NRG TENDL-2015, AKONING
angular distribution for (n,n*4)

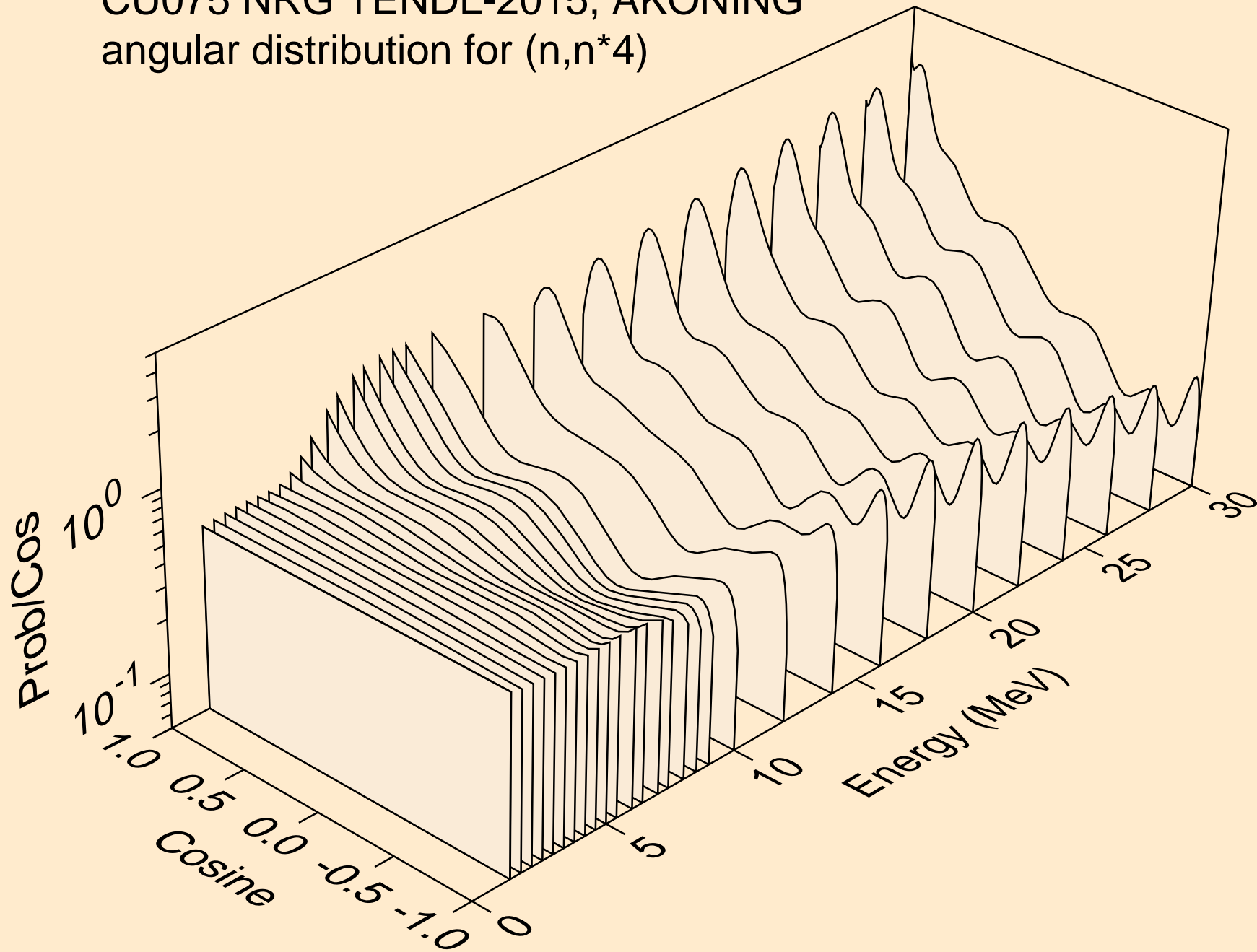

CU075 NRG TENDL-2015, AKONING
angular distribution for (n,n*5)

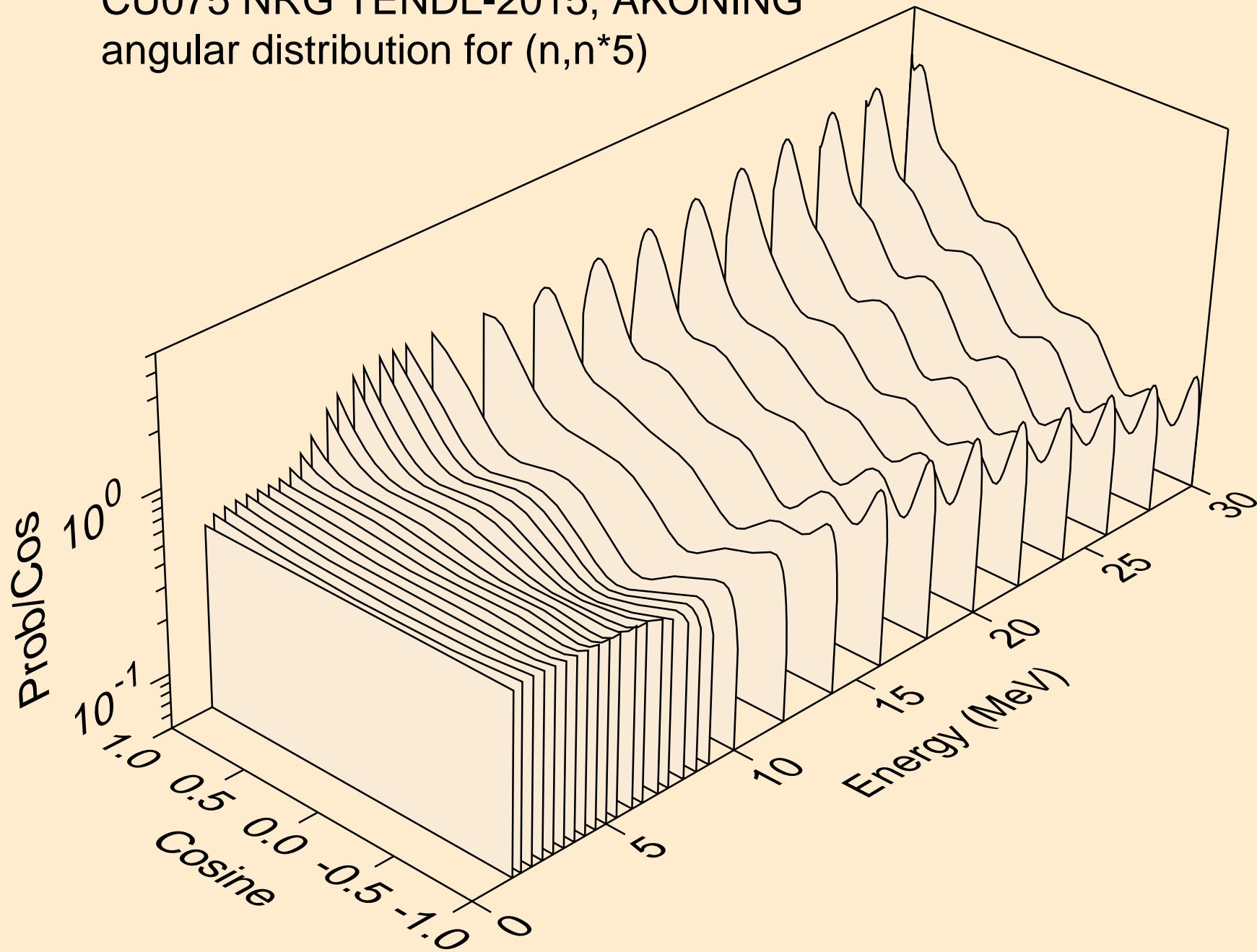

CU075 NRG TENDL-2015, AKONING
angular distribution for (n,n*6)

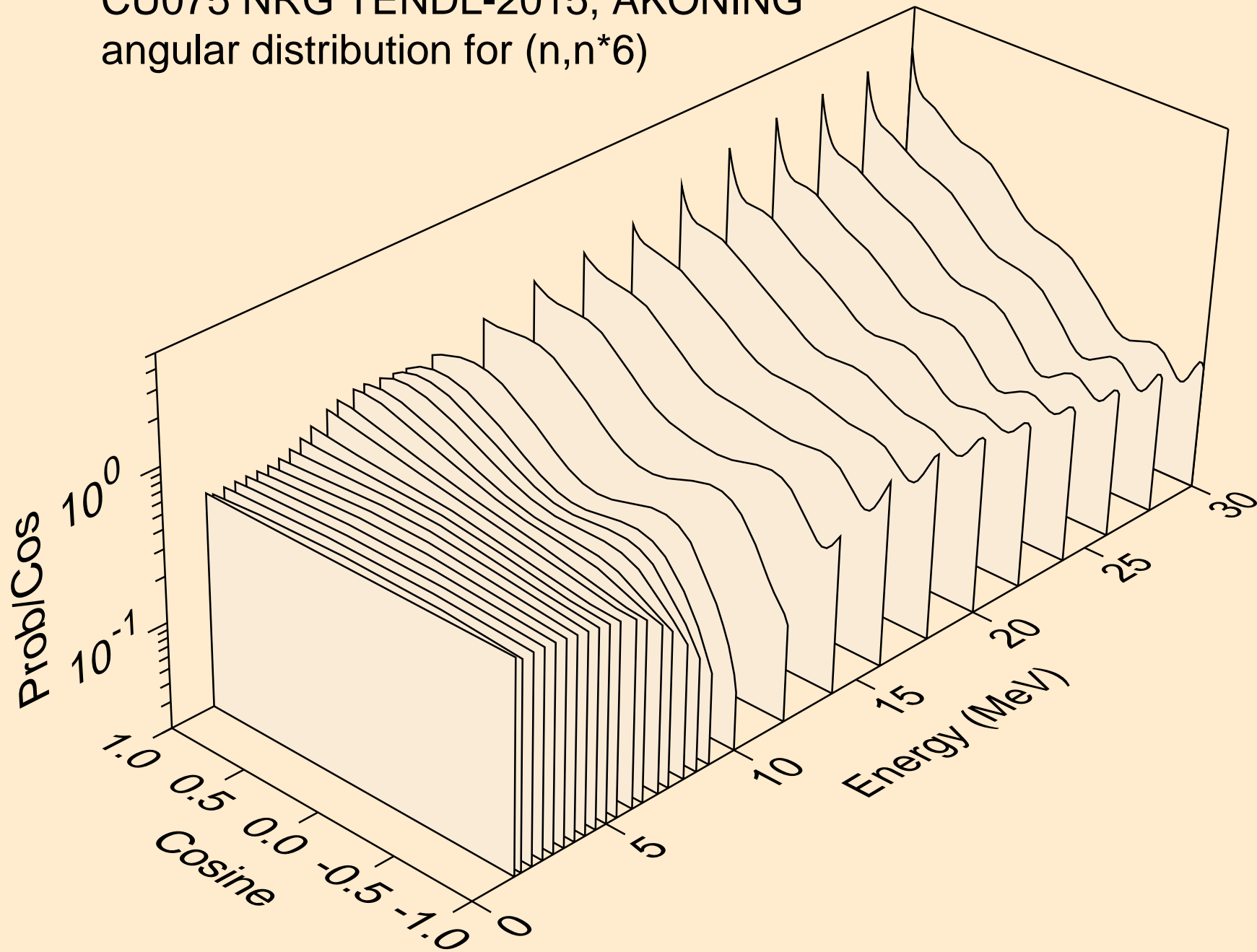

CU075 NRG TENDL-2015, AKONING
angular distribution for (n,n*7)

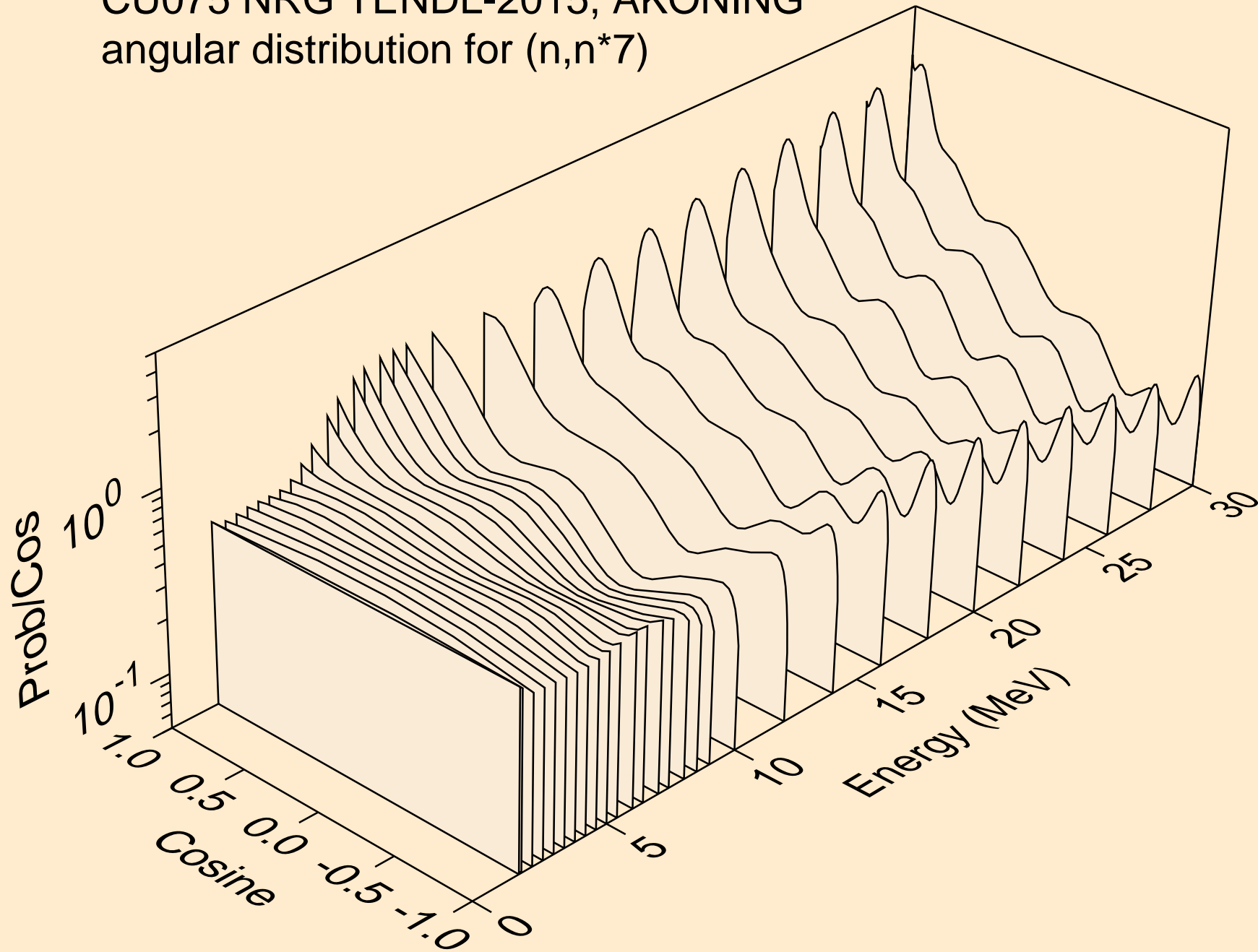

CU075 NRG TENDL-2015, AKONING
angular distribution for (n,n*8)

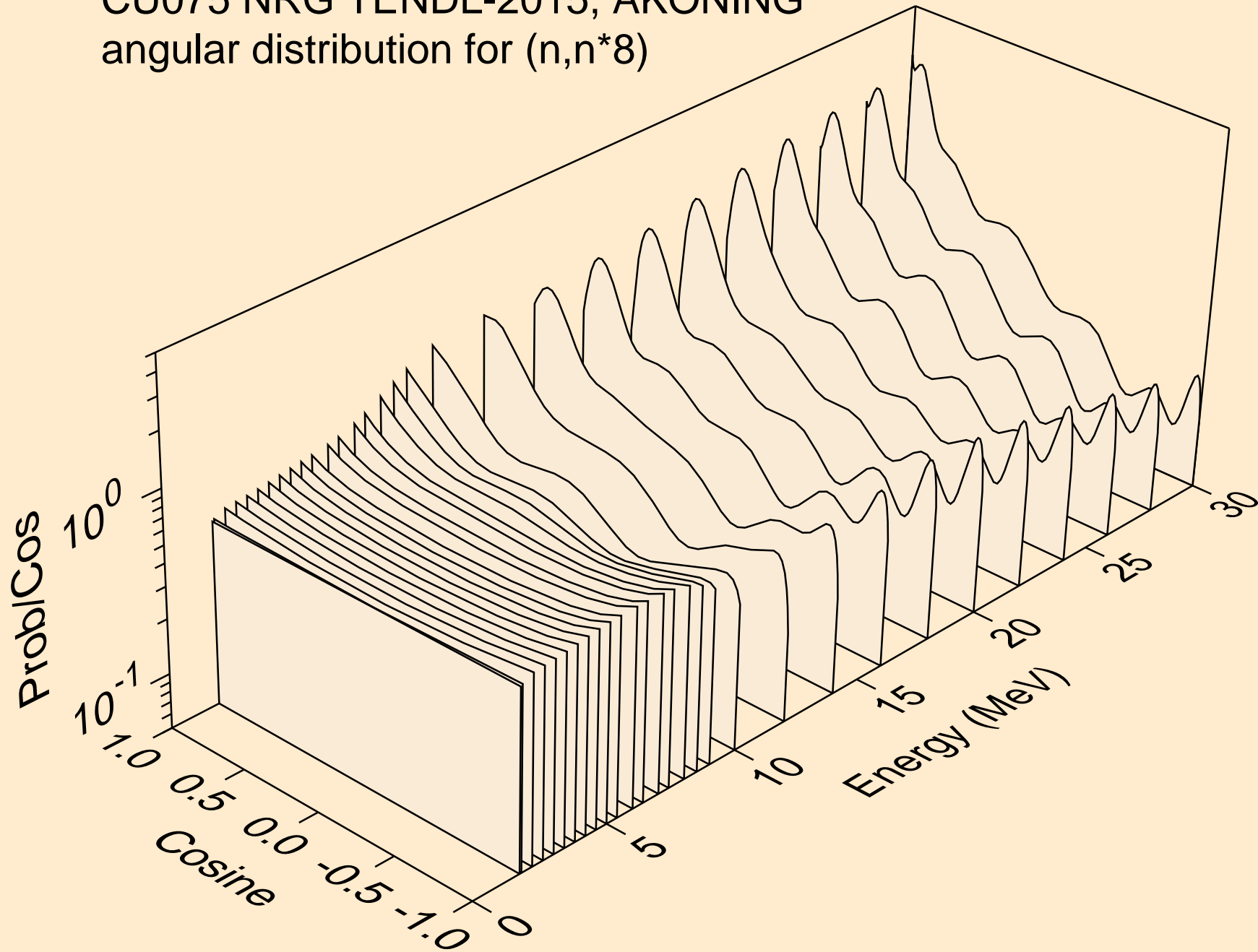

CU075 NRG TENDL-2015, AKONING
angular distribution for (n,n*9)

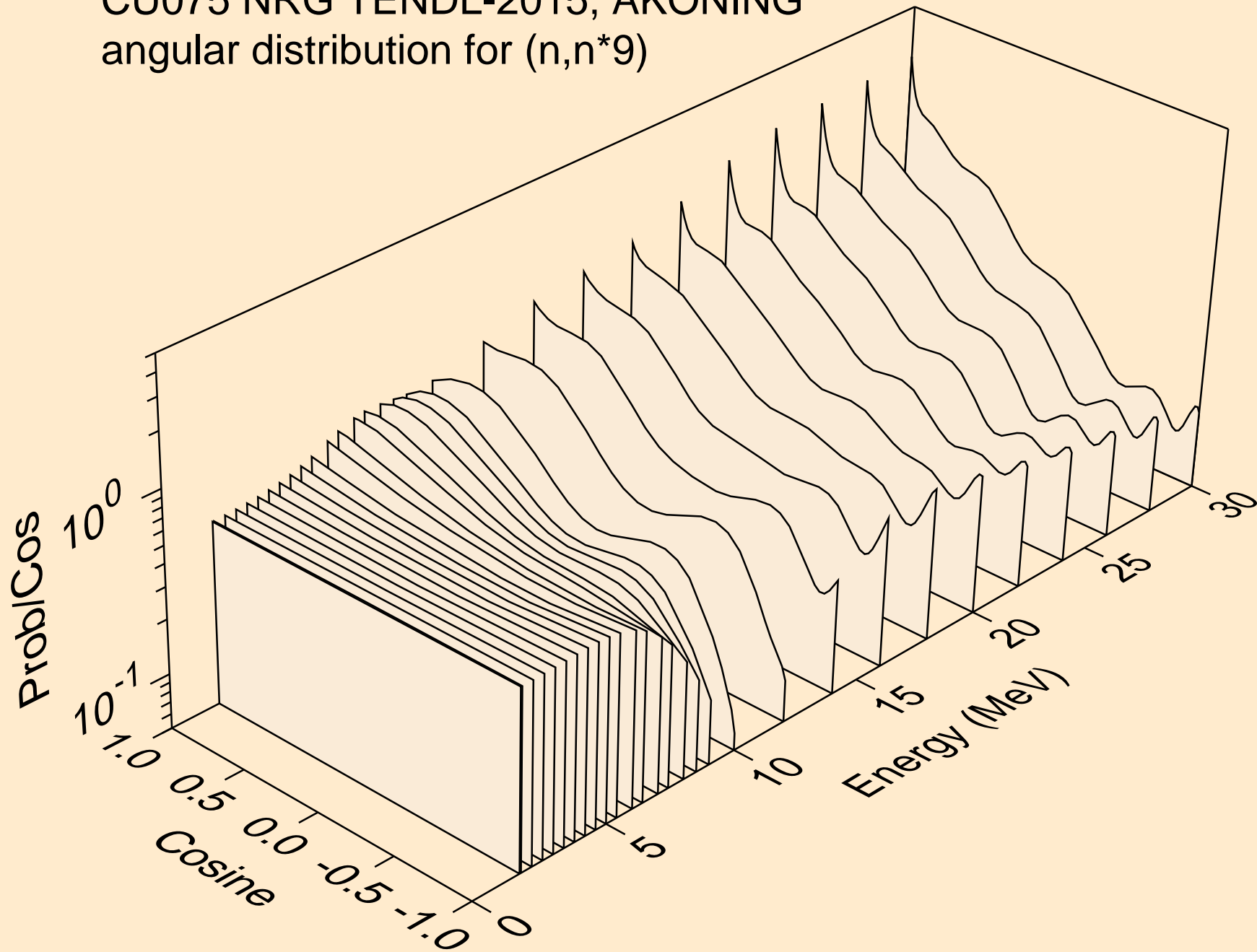

CU075 NRG TENDL-2015, AKONING
angular distribution for (n,n*10)

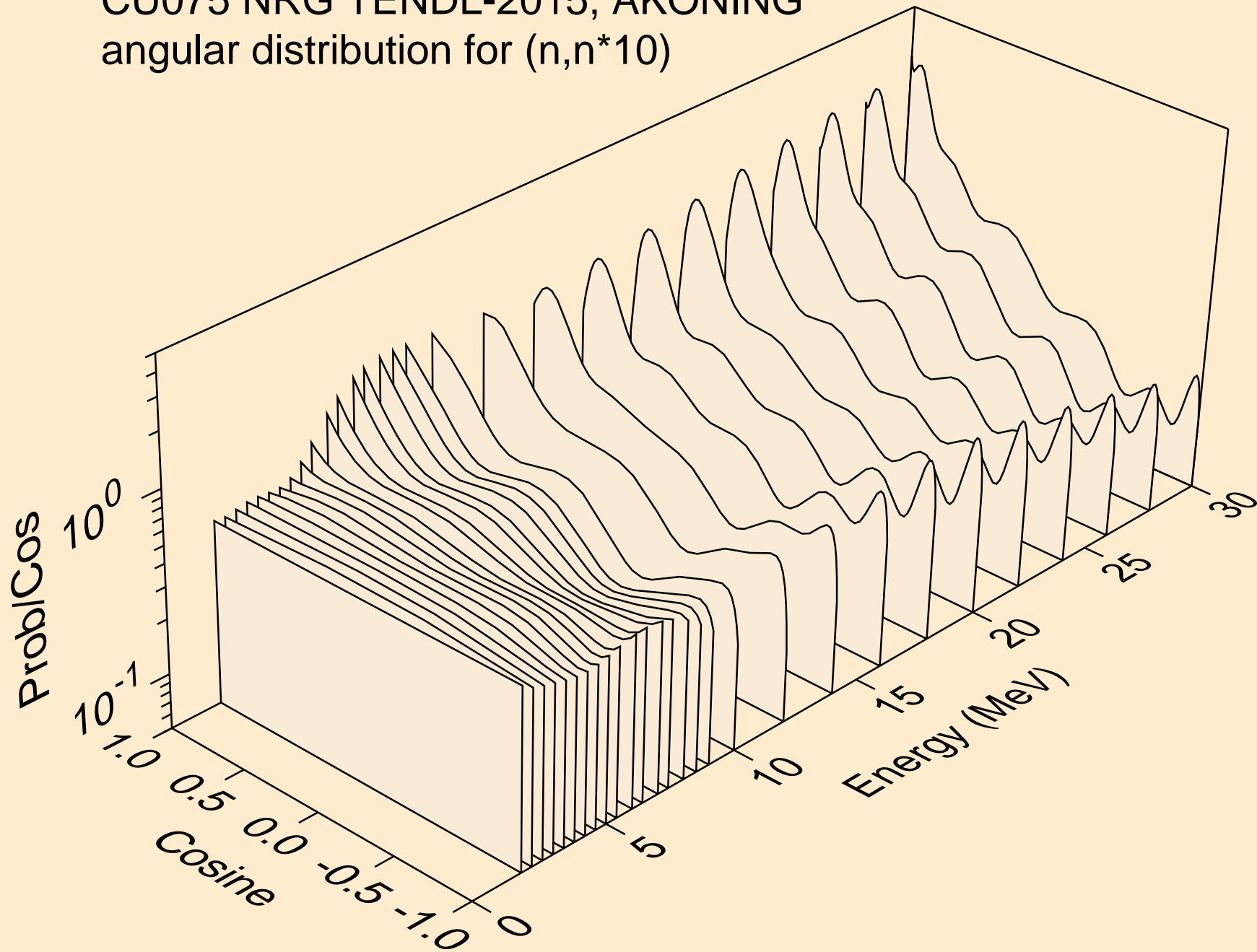

CU075 NRG TENDL-2015, AKONING
angular distribution for (n,n*11)

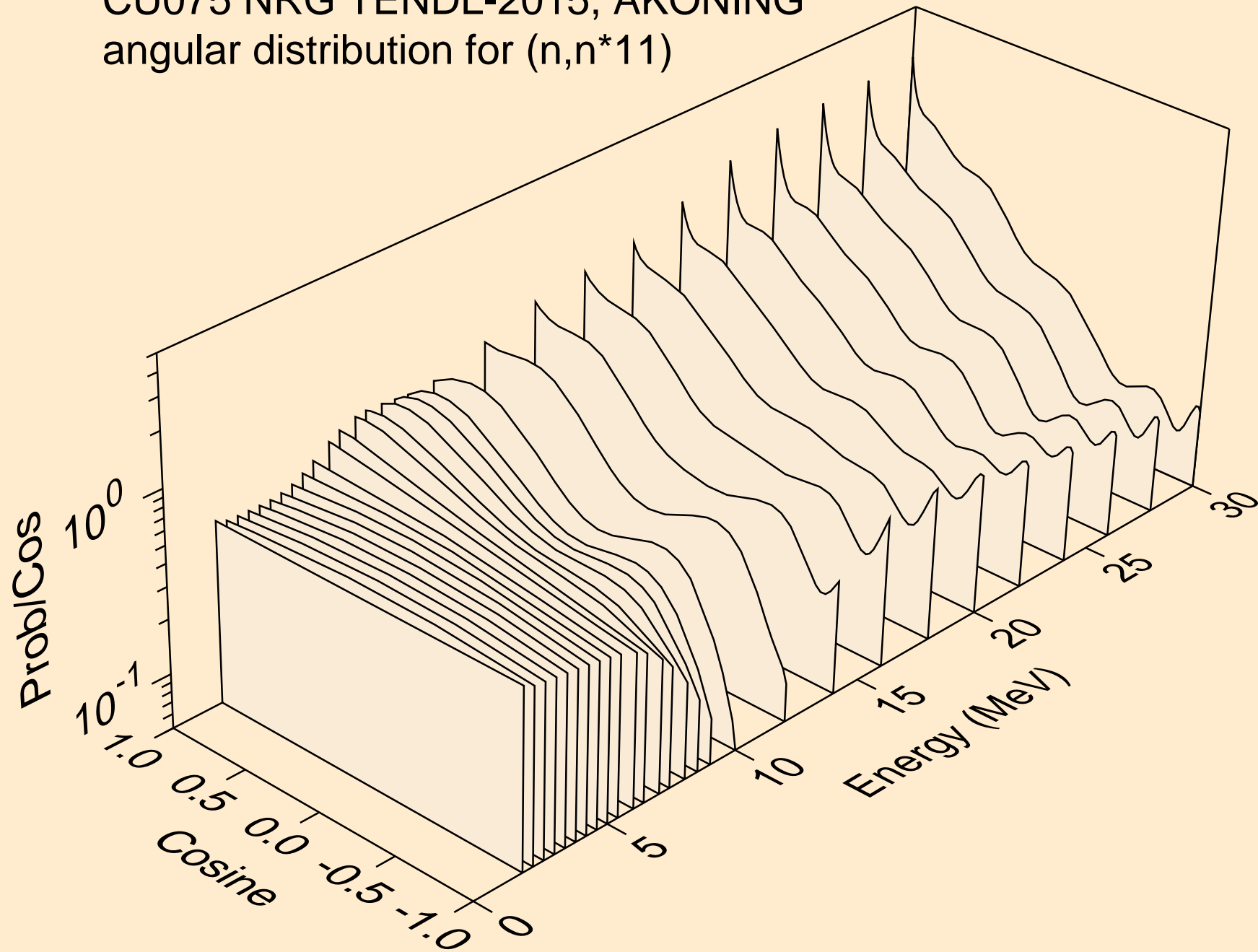

CU075 NRG TENDL-2015, AKONING
angular distribution for (n,n*12)

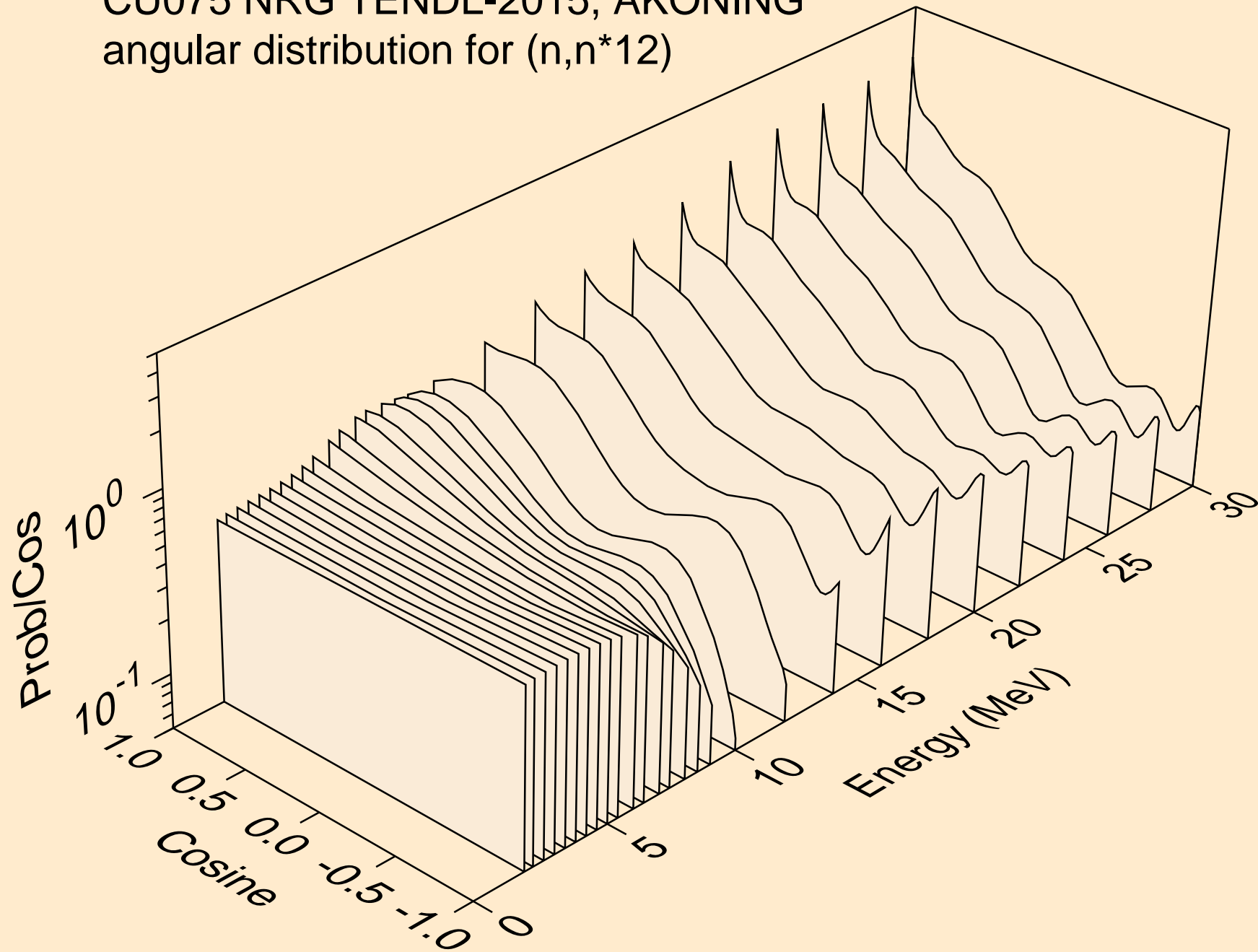

CU075 NRG TENDL-2015, AKONING
angular distribution for (n,n*13)

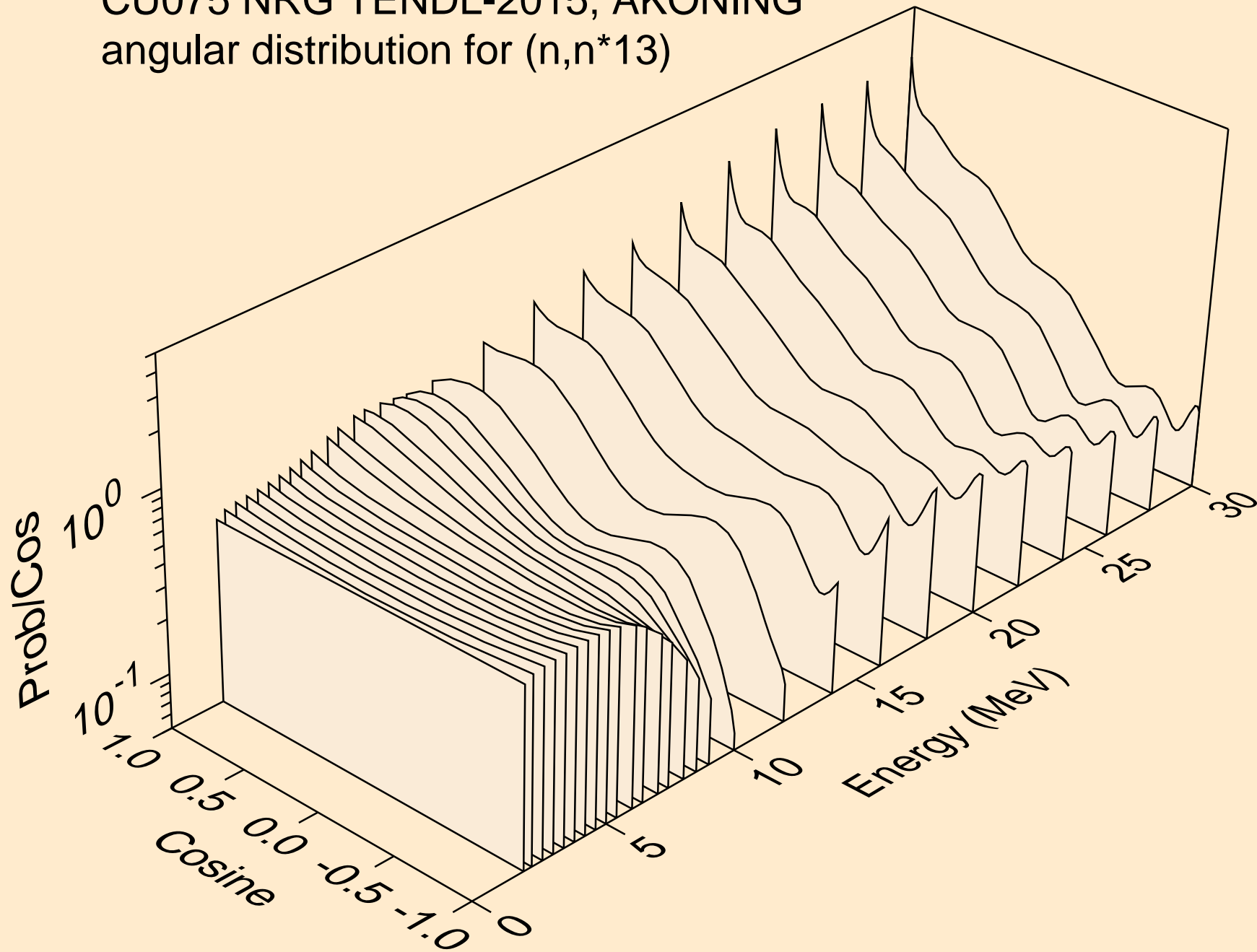

CU075 NRG TENDL-2015, AKONING
angular distribution for (n,n*14)

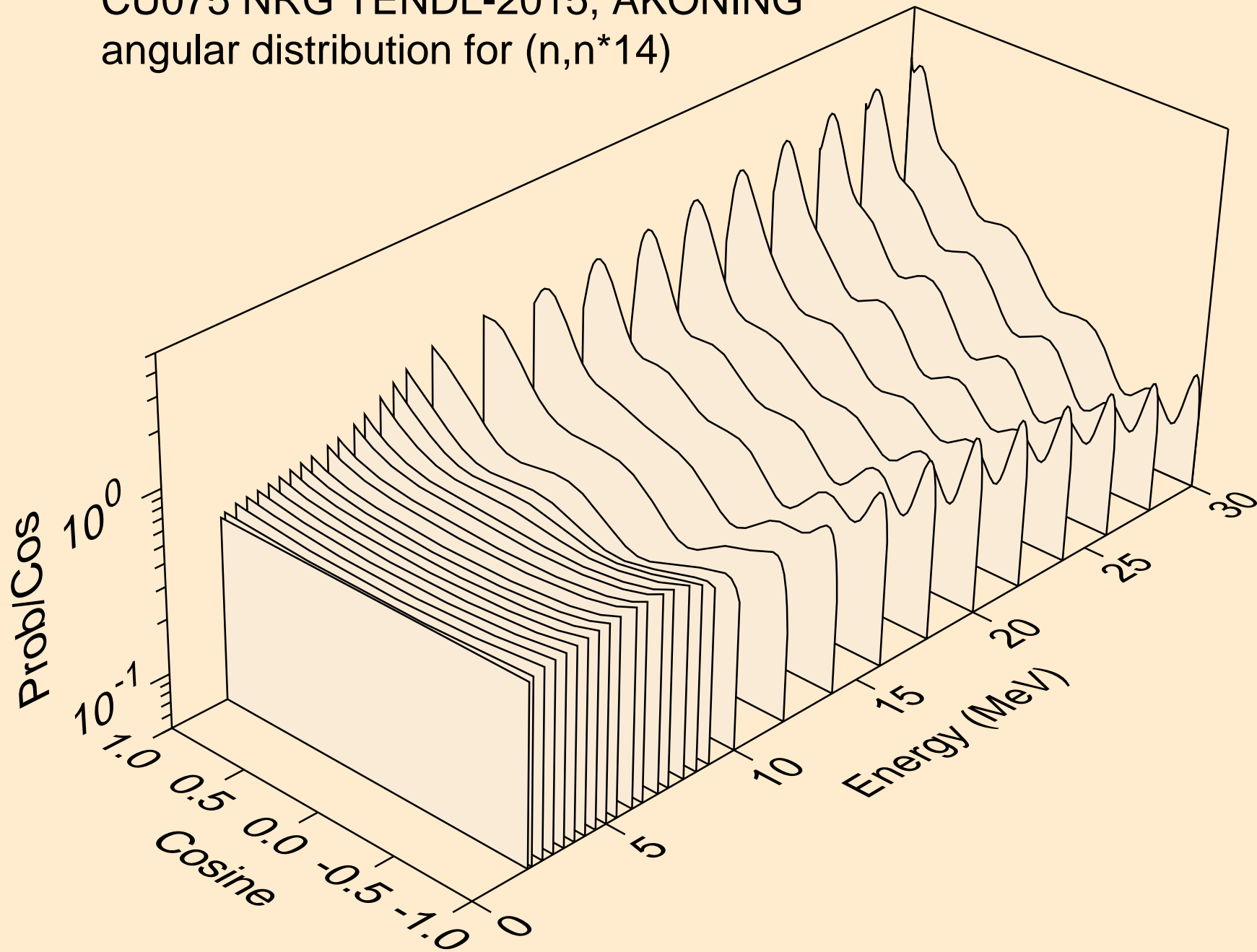

CU075 NRG TENDL-2015, AKONING
angular distribution for (n,n*15)

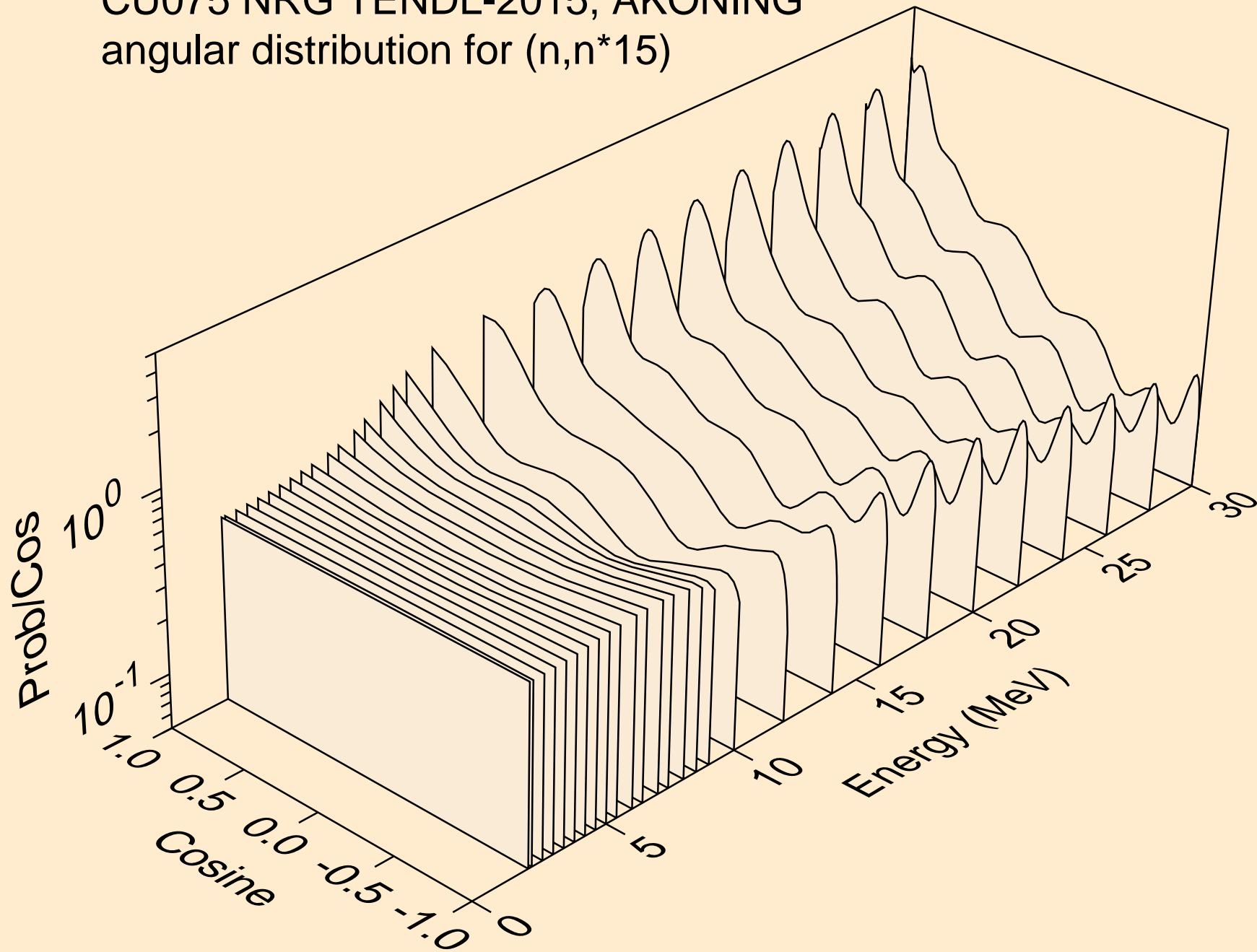

CU075 NRG TENDL-2015, AKONING
angular distribution for (n,n*16)

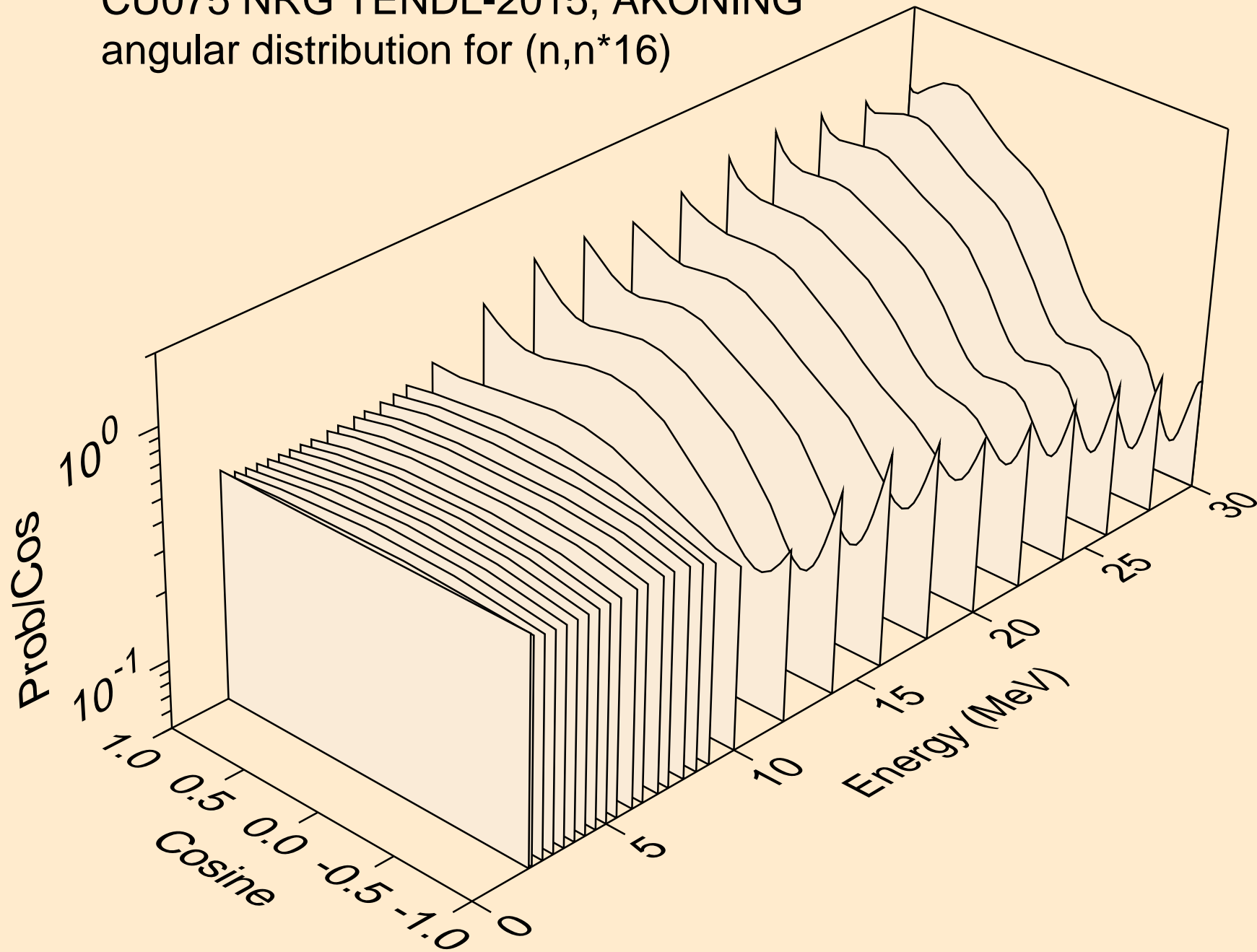

CU075 NRG TENDL-2015, AKONING
angular distribution for (n,n*17)

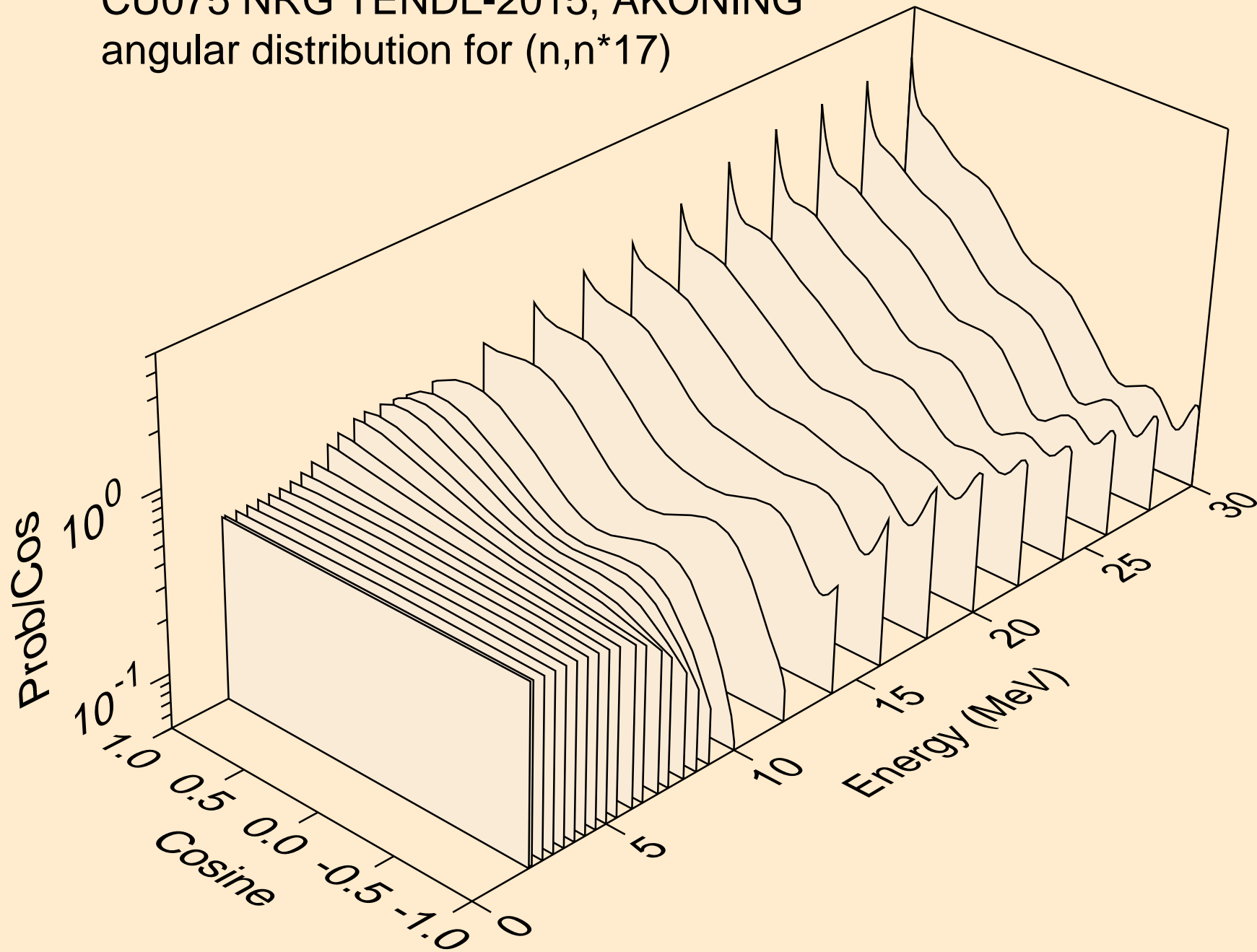

CU075 NRG TENDL-2015, AKONING
angular distribution for (n,n*18)

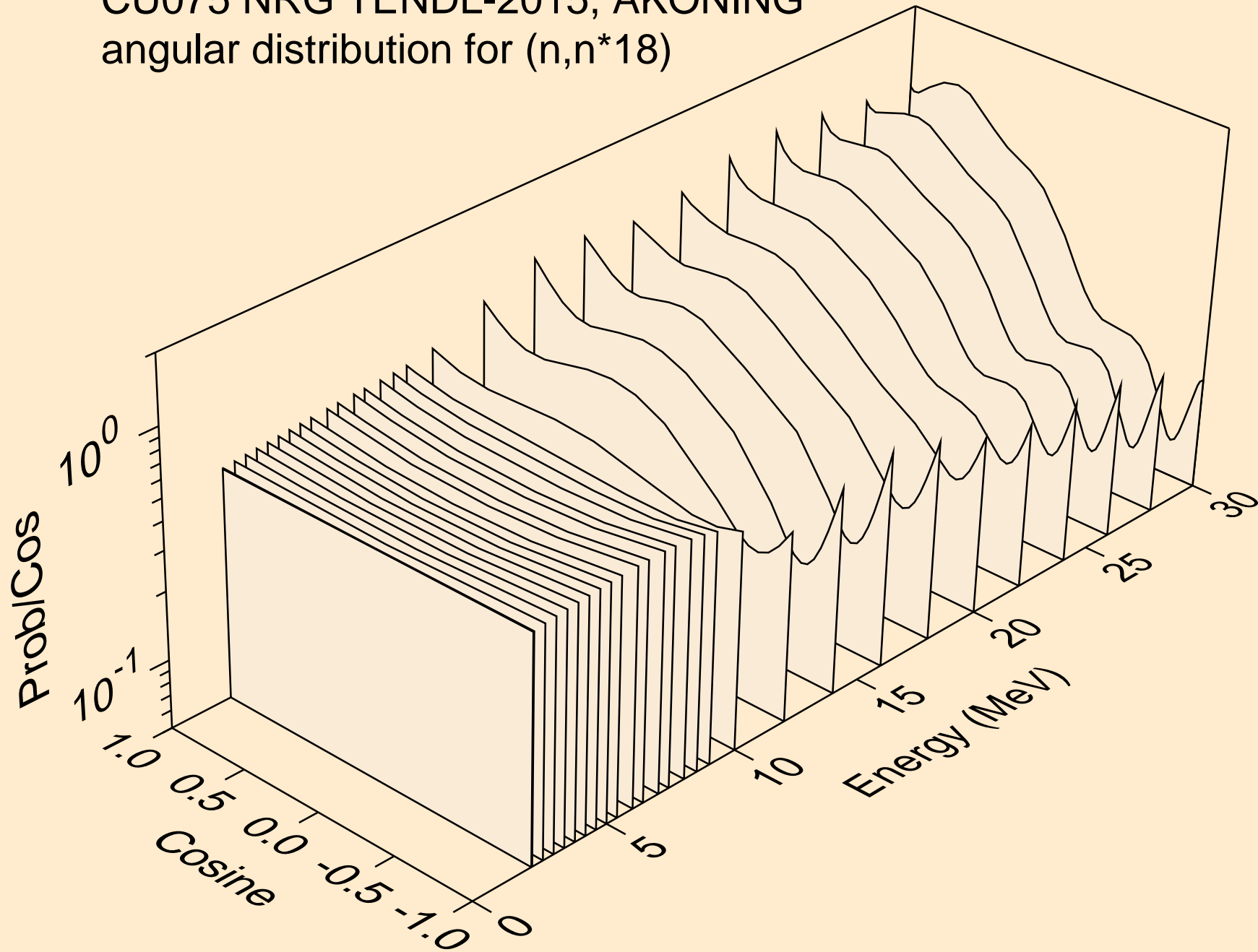

CU075 NRG TENDL-2015, AKONING
angular distribution for (n,n*19)

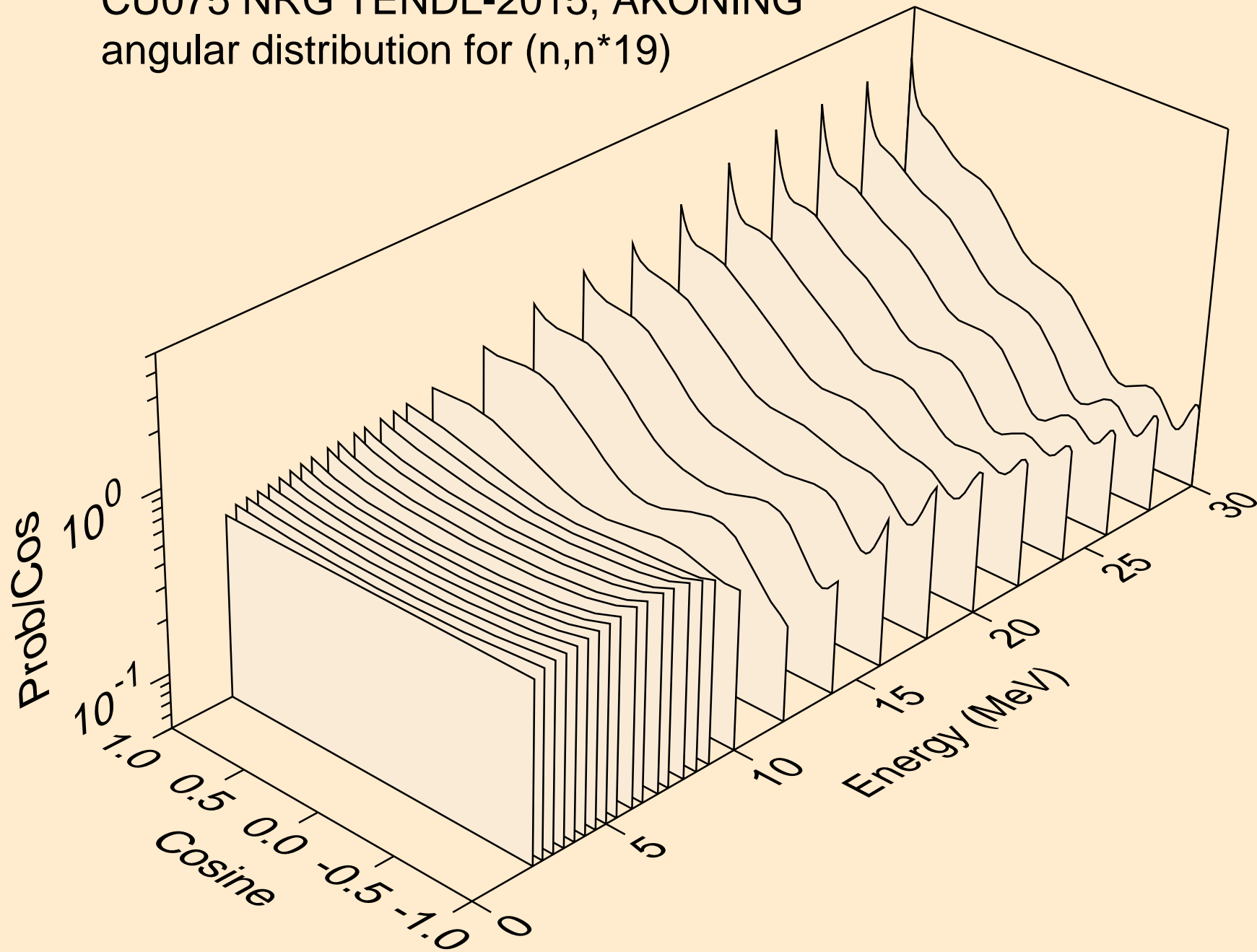

CU075 NRG TENDL-2015, AKONING
angular distribution for (n,n*20)

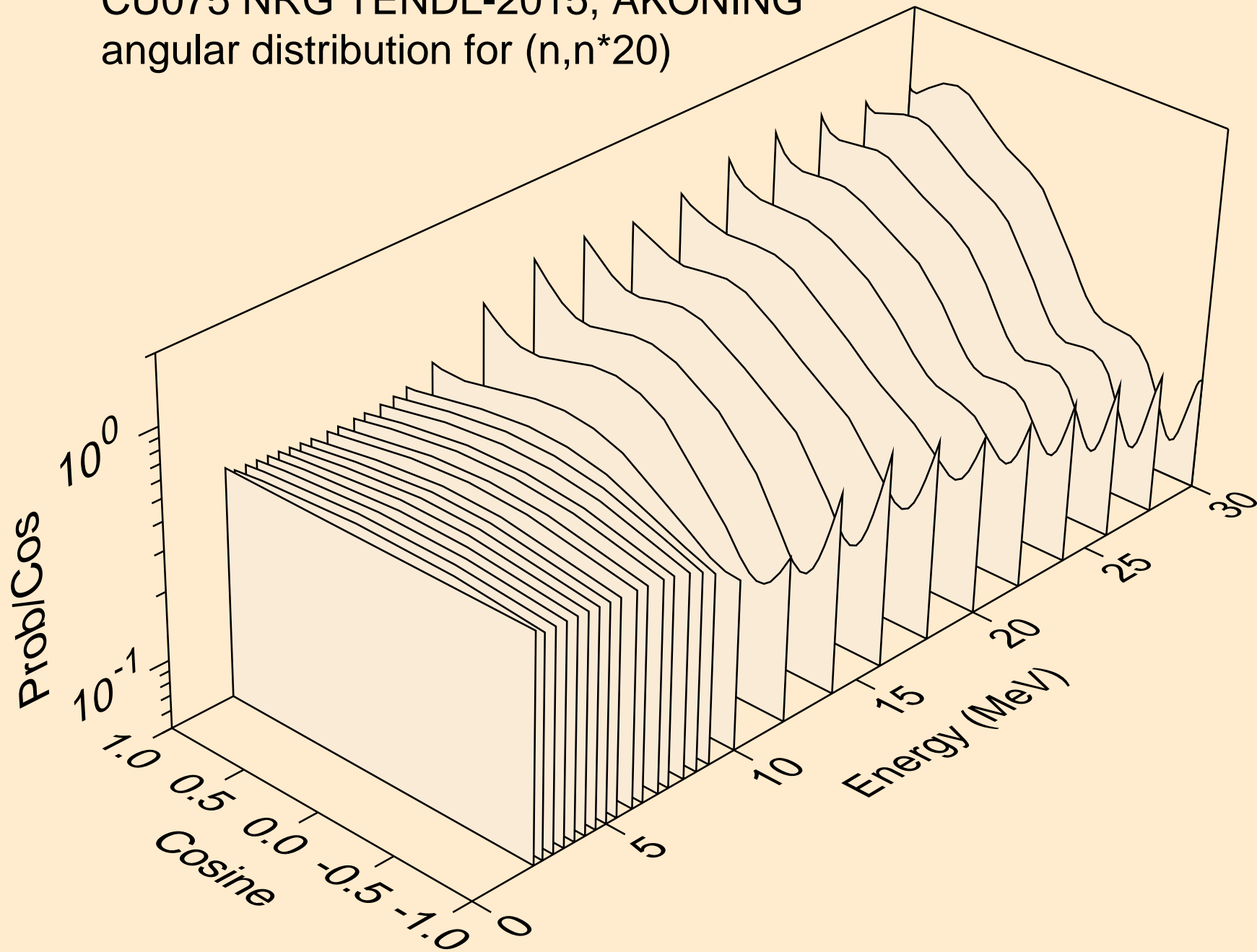

CU075 NRG TENDL-2015, AKONING
angular distribution for (n,n*21)

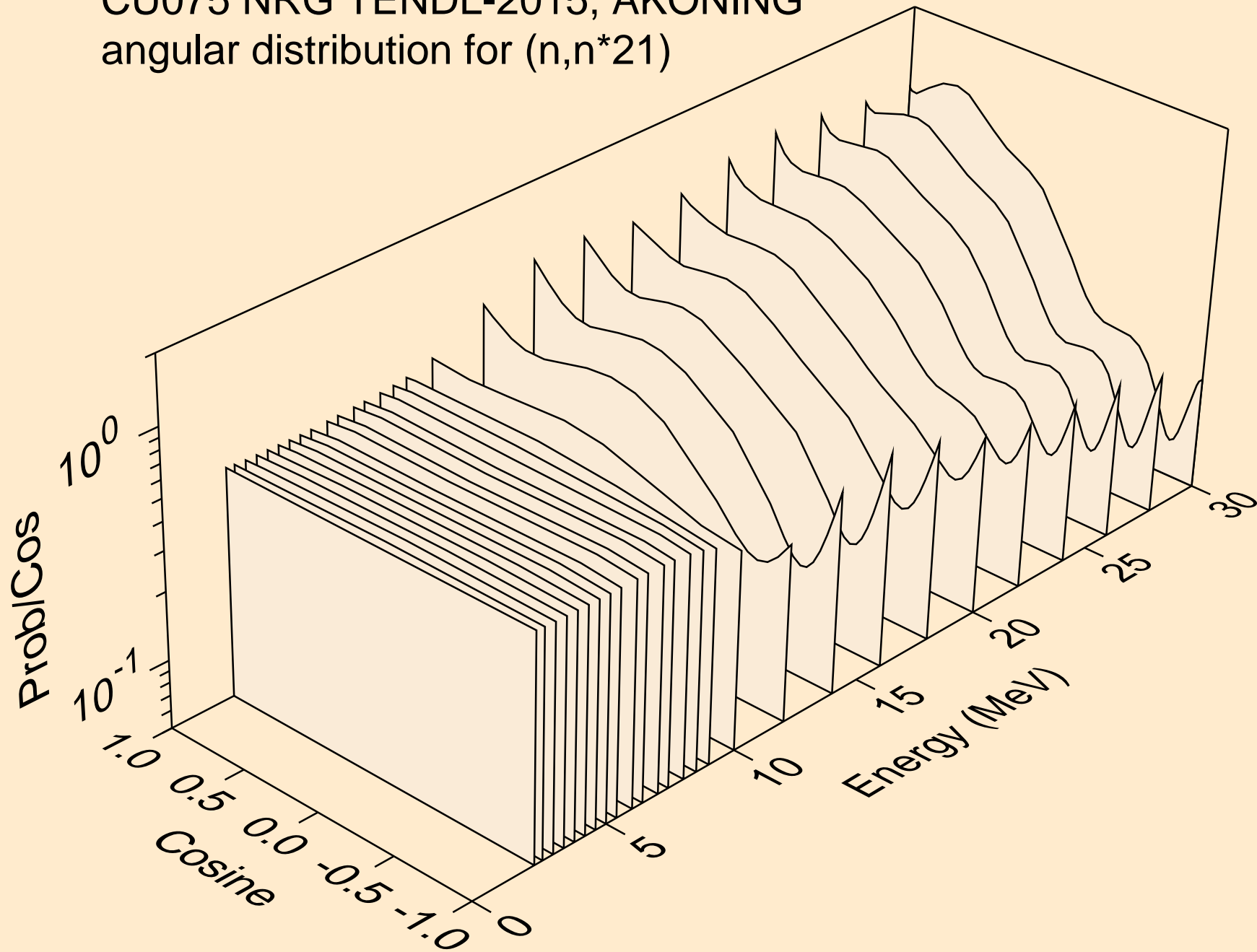

CU075 NRG TENDL-2015, AKONING
angular distribution for (n,n*22)

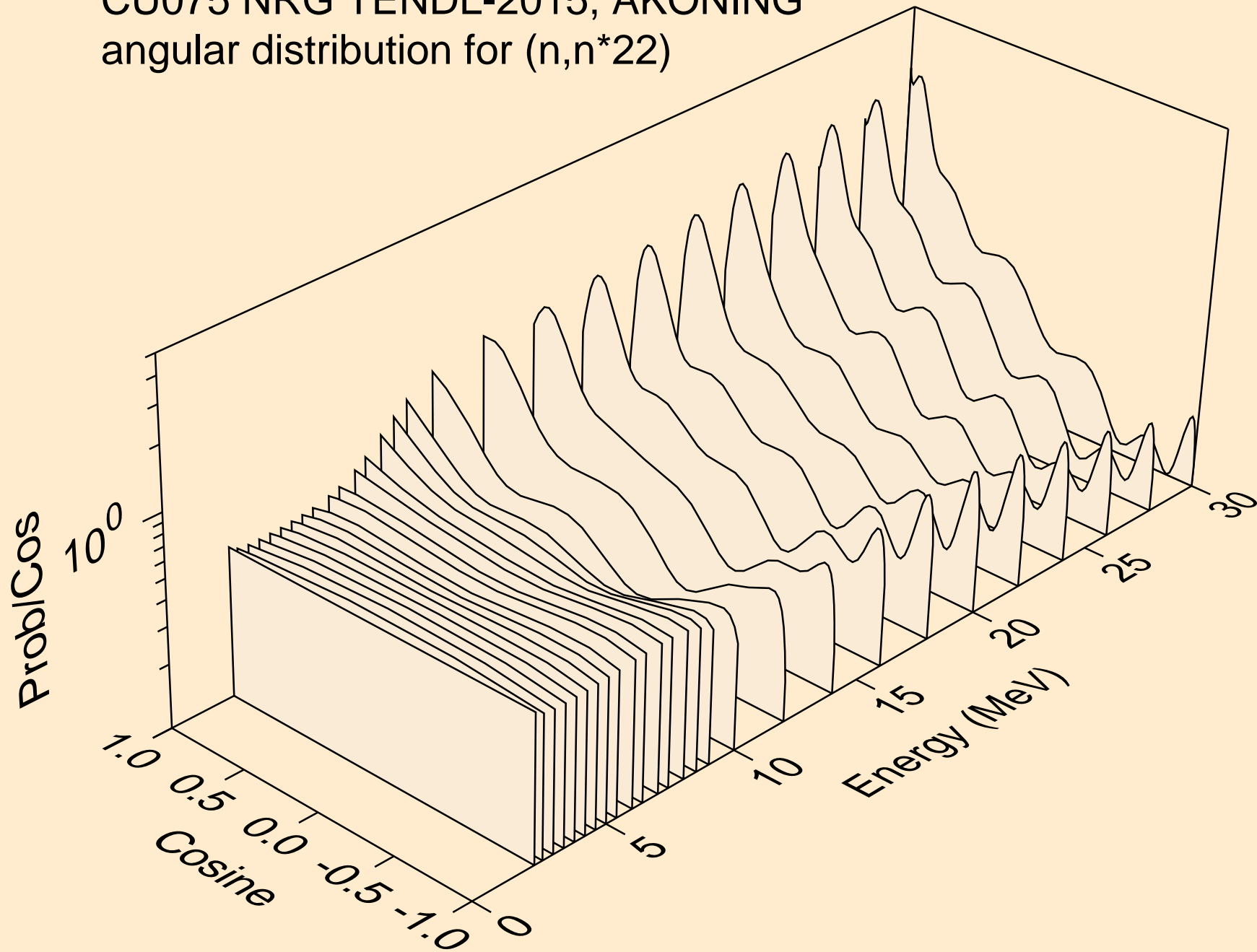

CU075 NRG TENDL-2015, AKONING
angular distribution for (n,n*23)

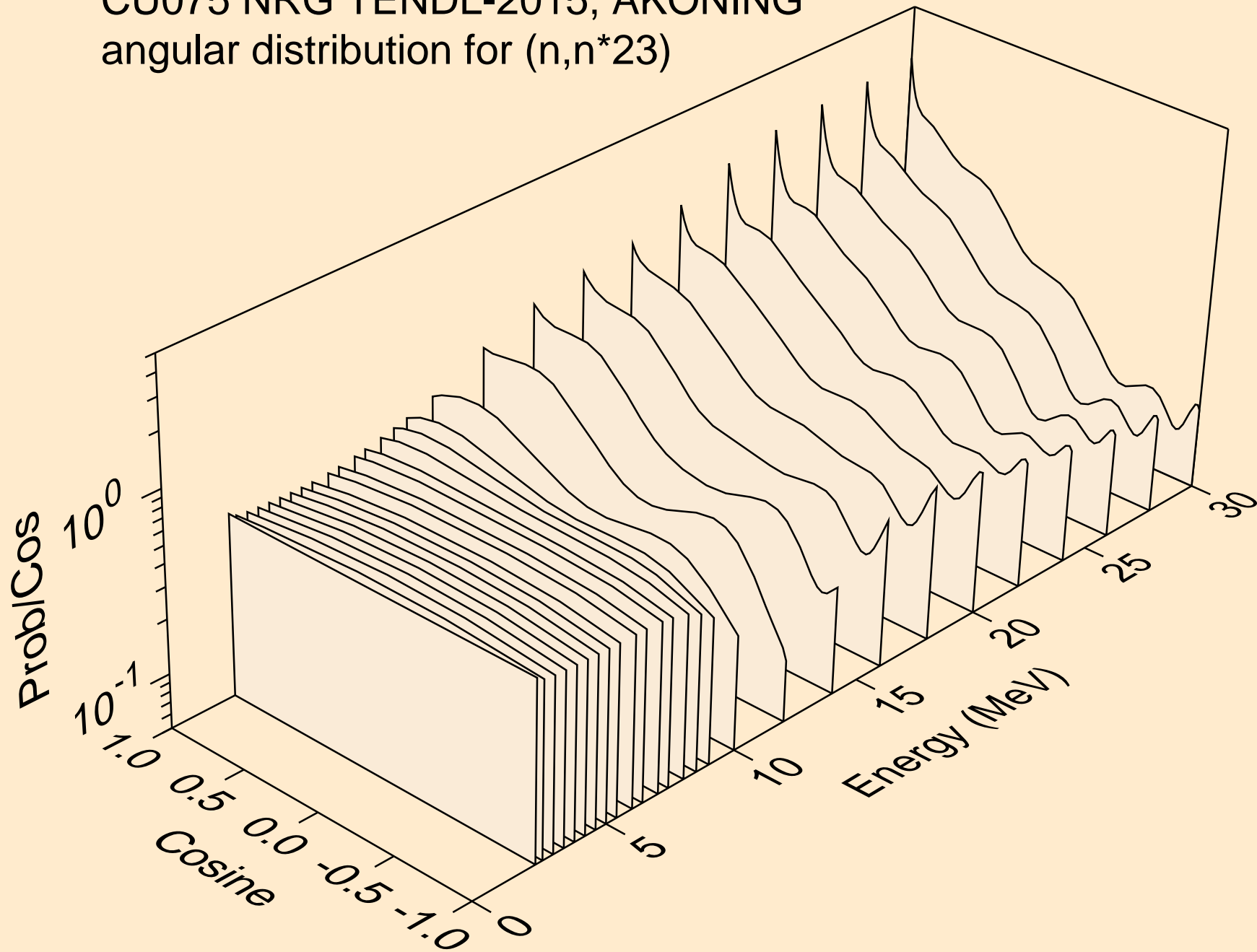

CU075 NRG TENDL-2015, AKONING
angular distribution for (n,n*24)

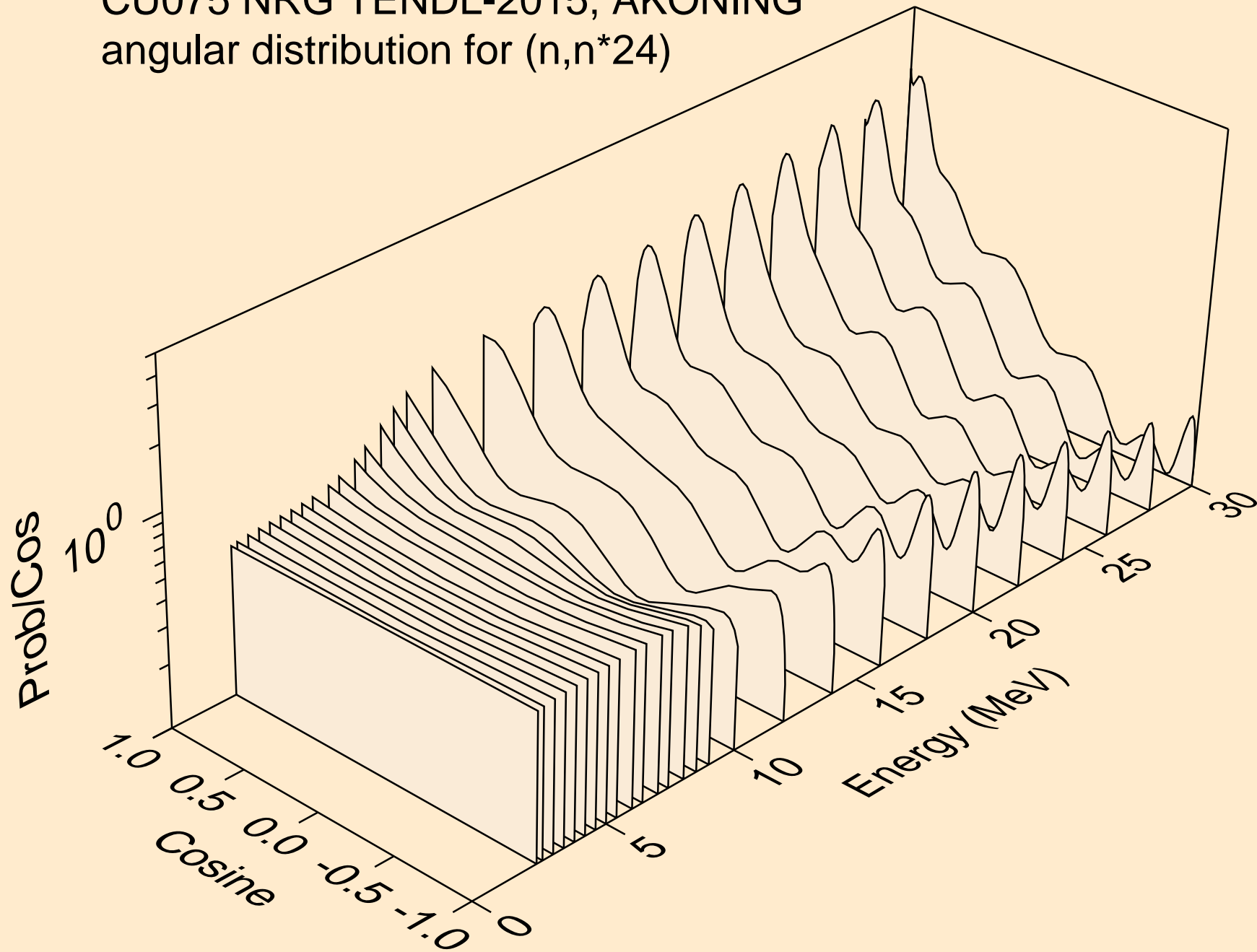

CU075 NRG TENDL-2015, AKONING
angular distribution for (n,n*25)

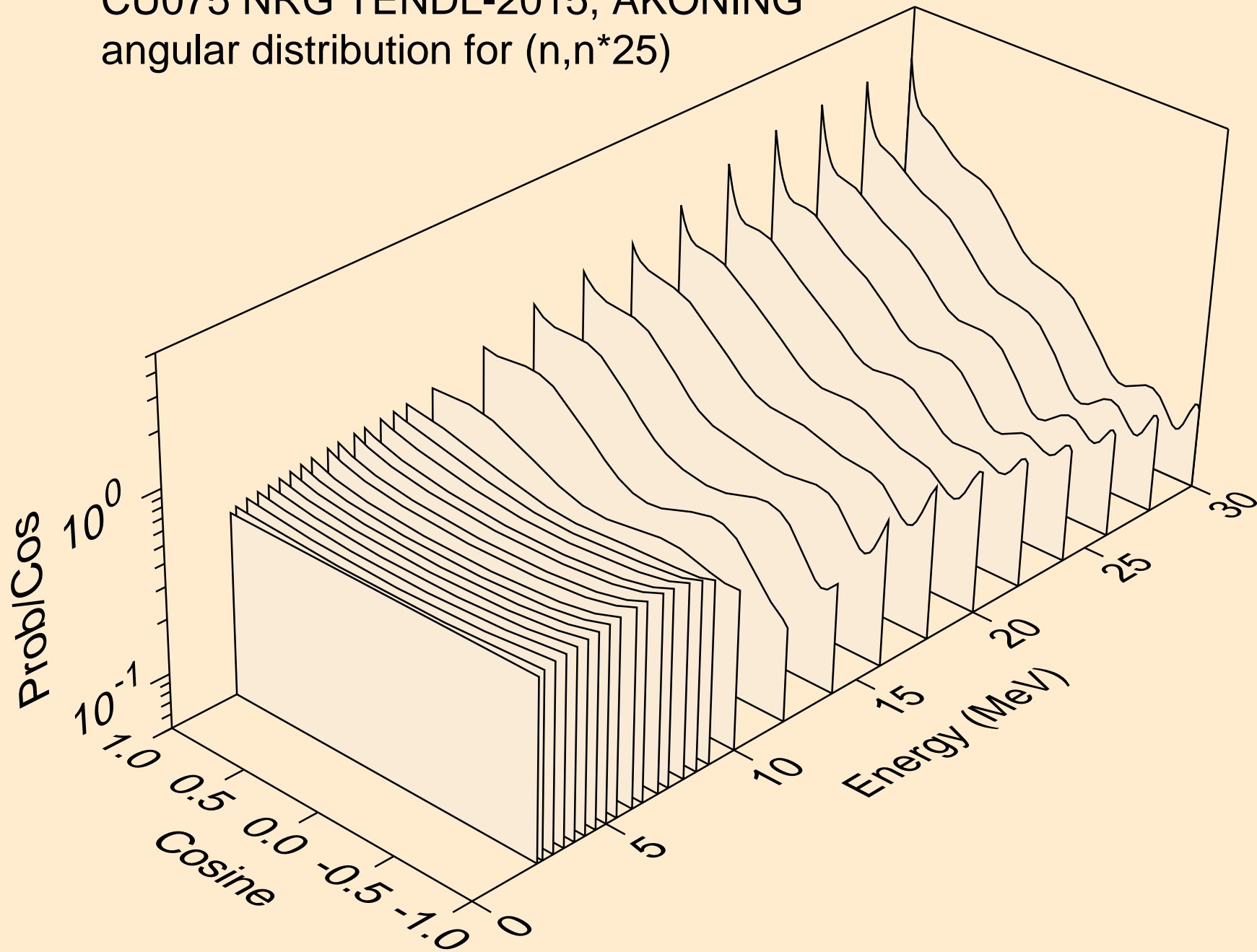

CU075 NRG TENDL-2015, AKONING
angular distribution for (n,n*26)

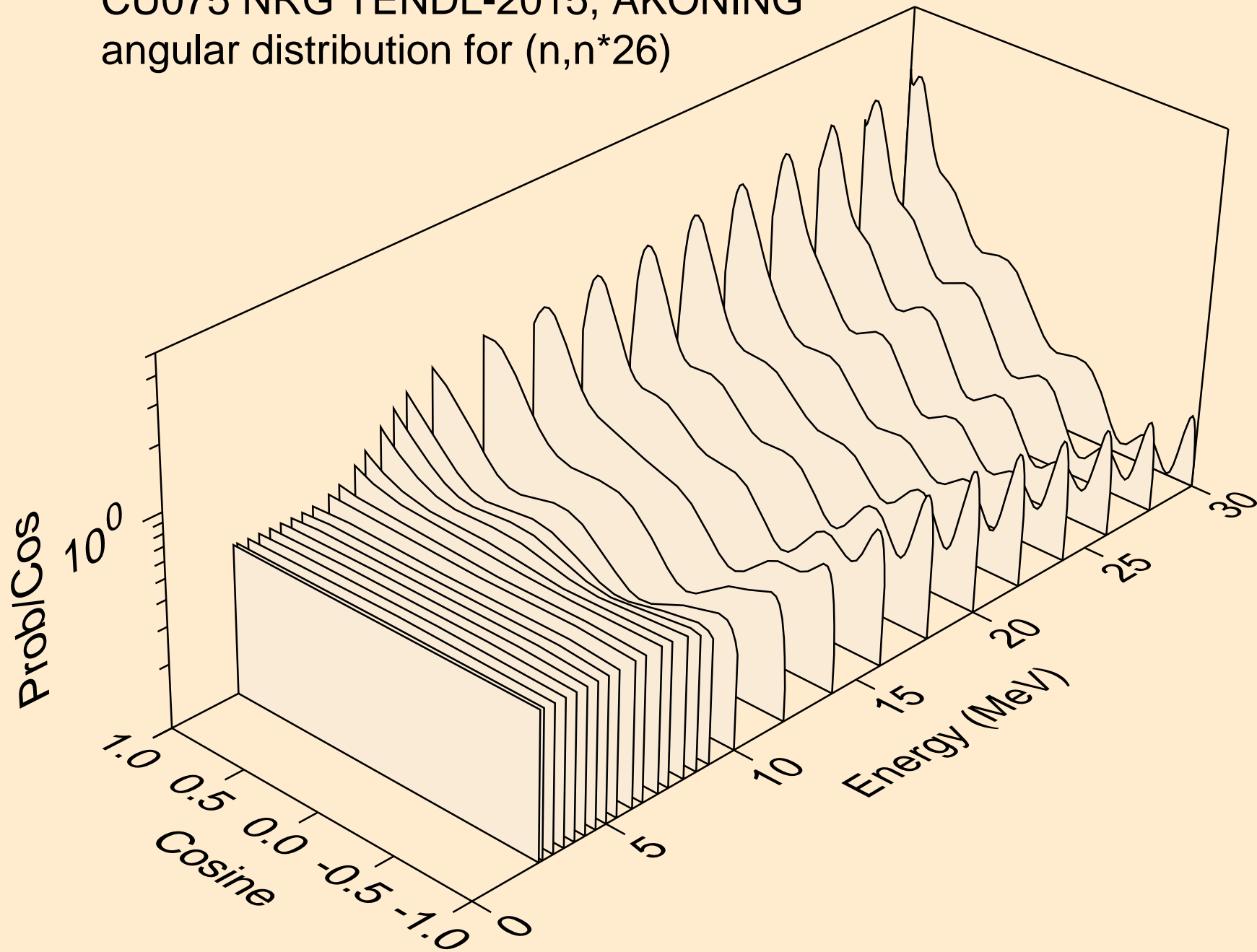

CU075 NRG TENDL-2015, AKONING
angular distribution for (n,n*27)

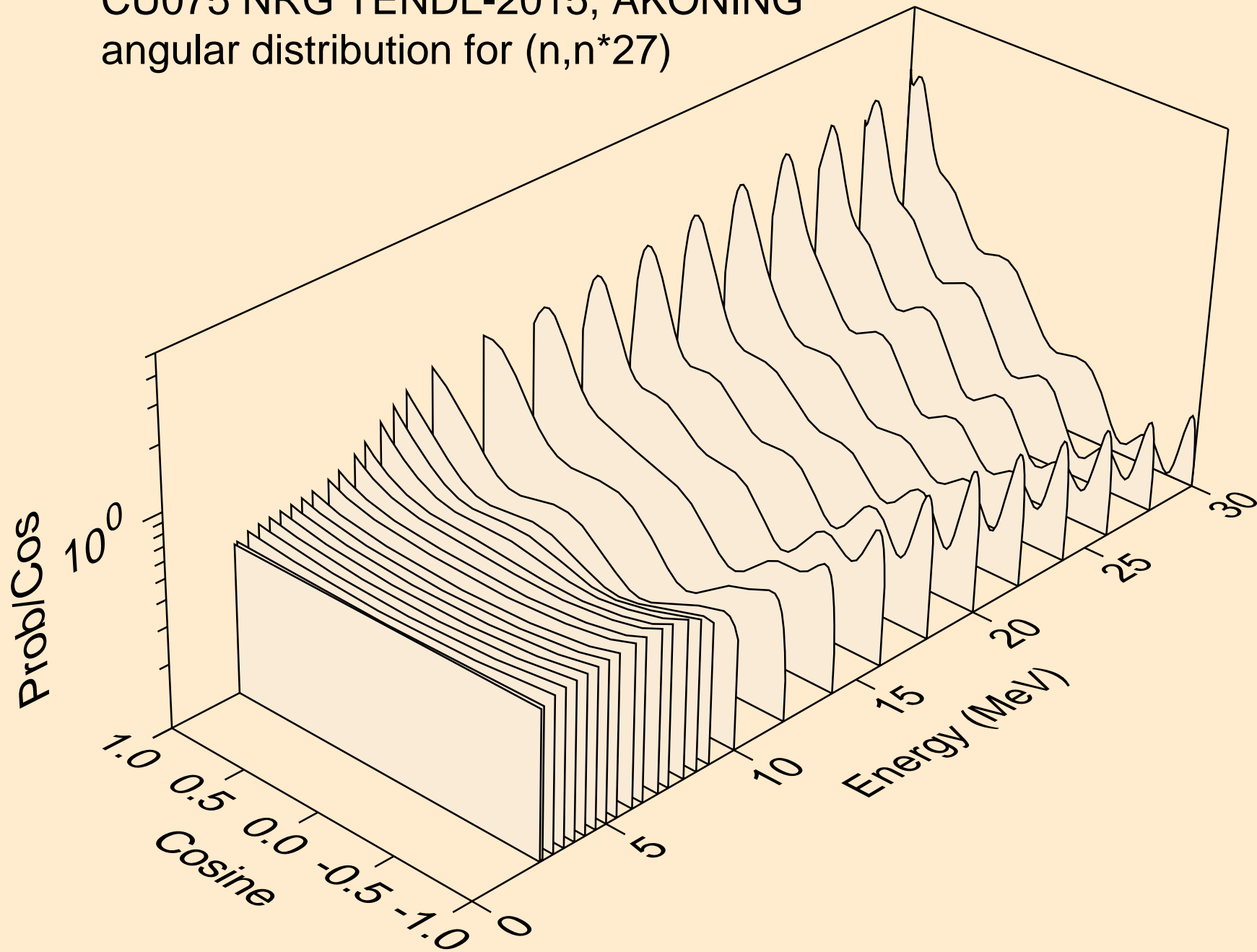

CU075 NRG TENDL-2015, AKONING
angular distribution for (n,n*28)

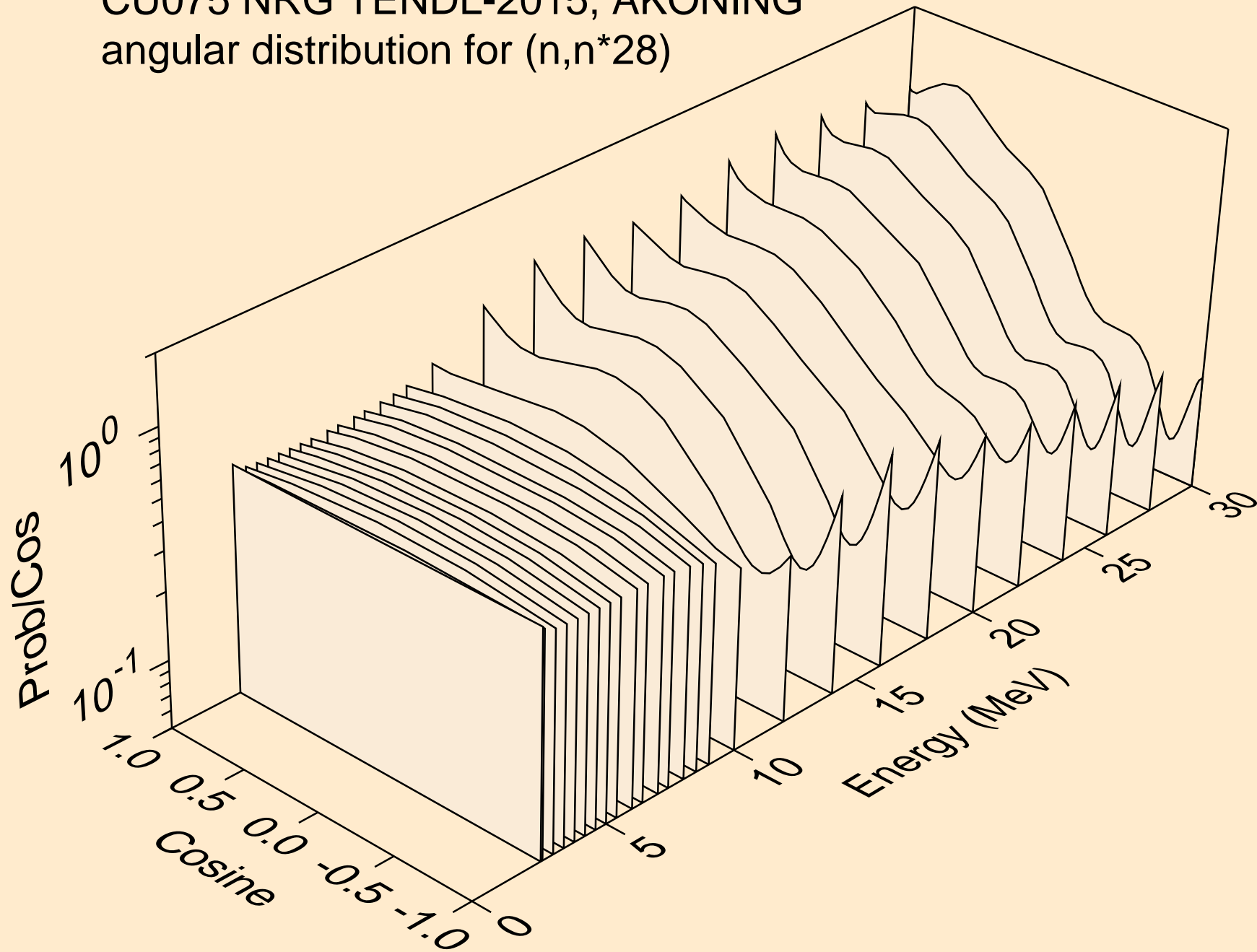

CU075 NRG TENDL-2015, AKONING
angular distribution for (n,n*29)

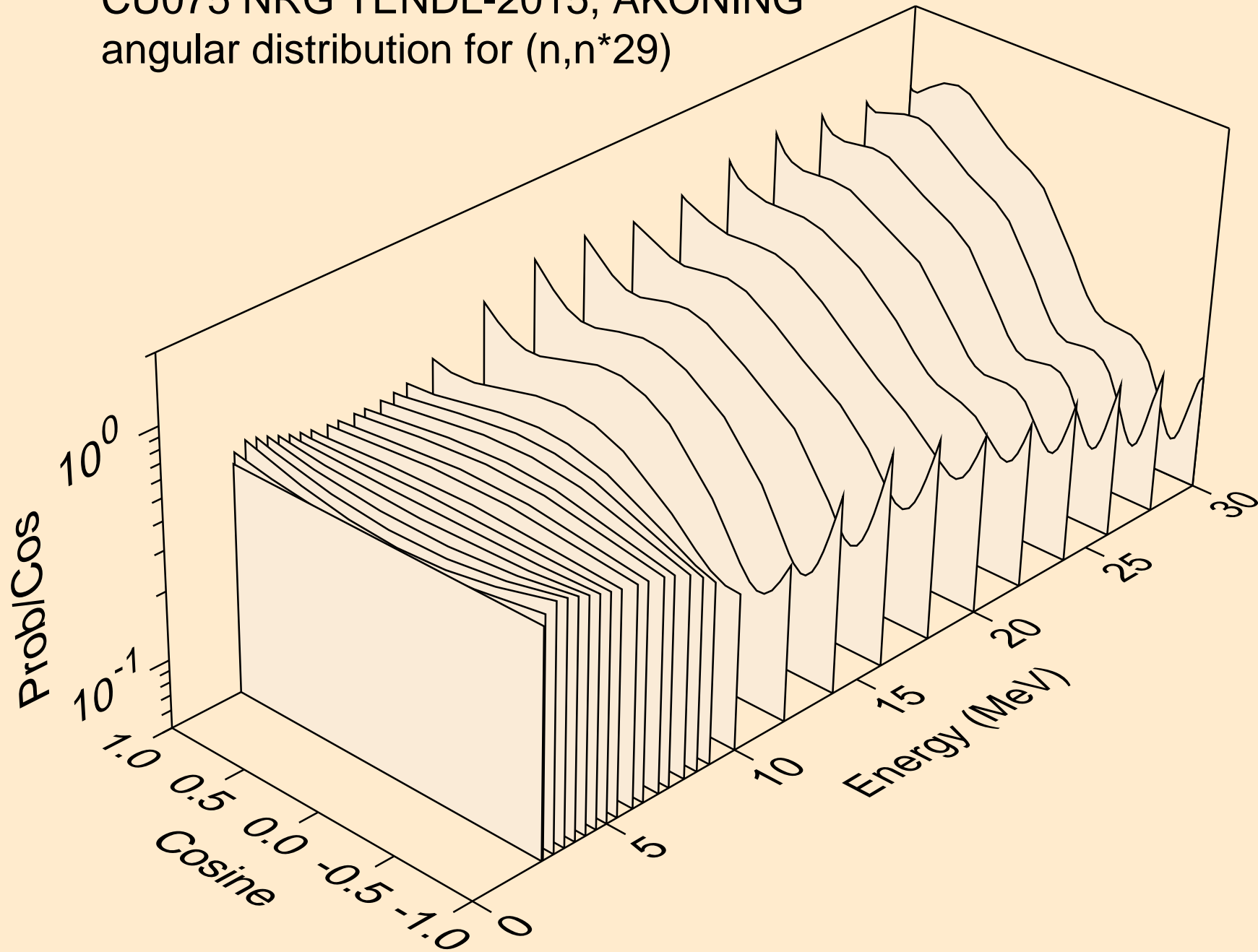

CU075 NRG TENDL-2015, AKONING
angular distribution for (n,n*30)

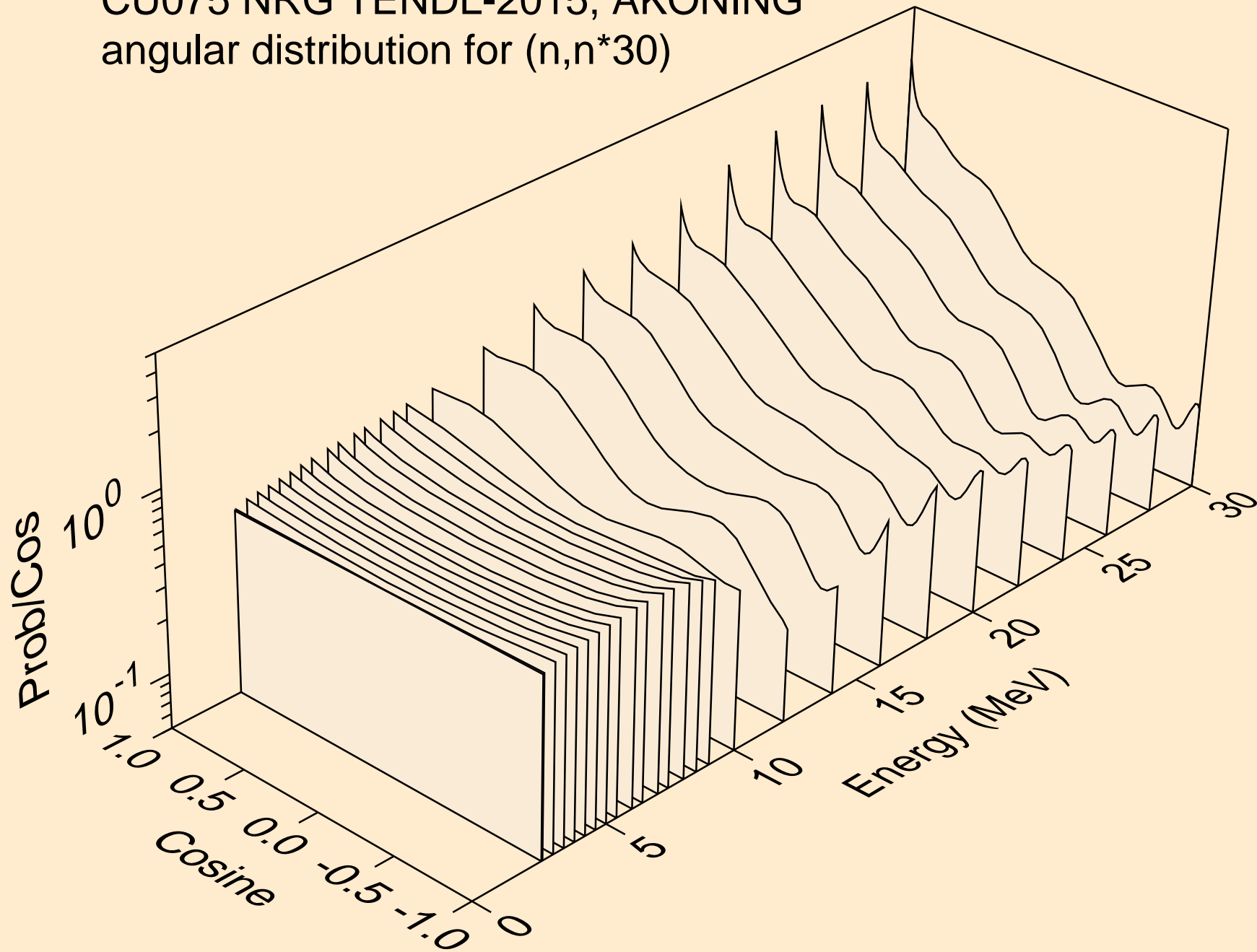

CU075 NRG TENDL-2015, AKONING
Neutron emission for (n,x)

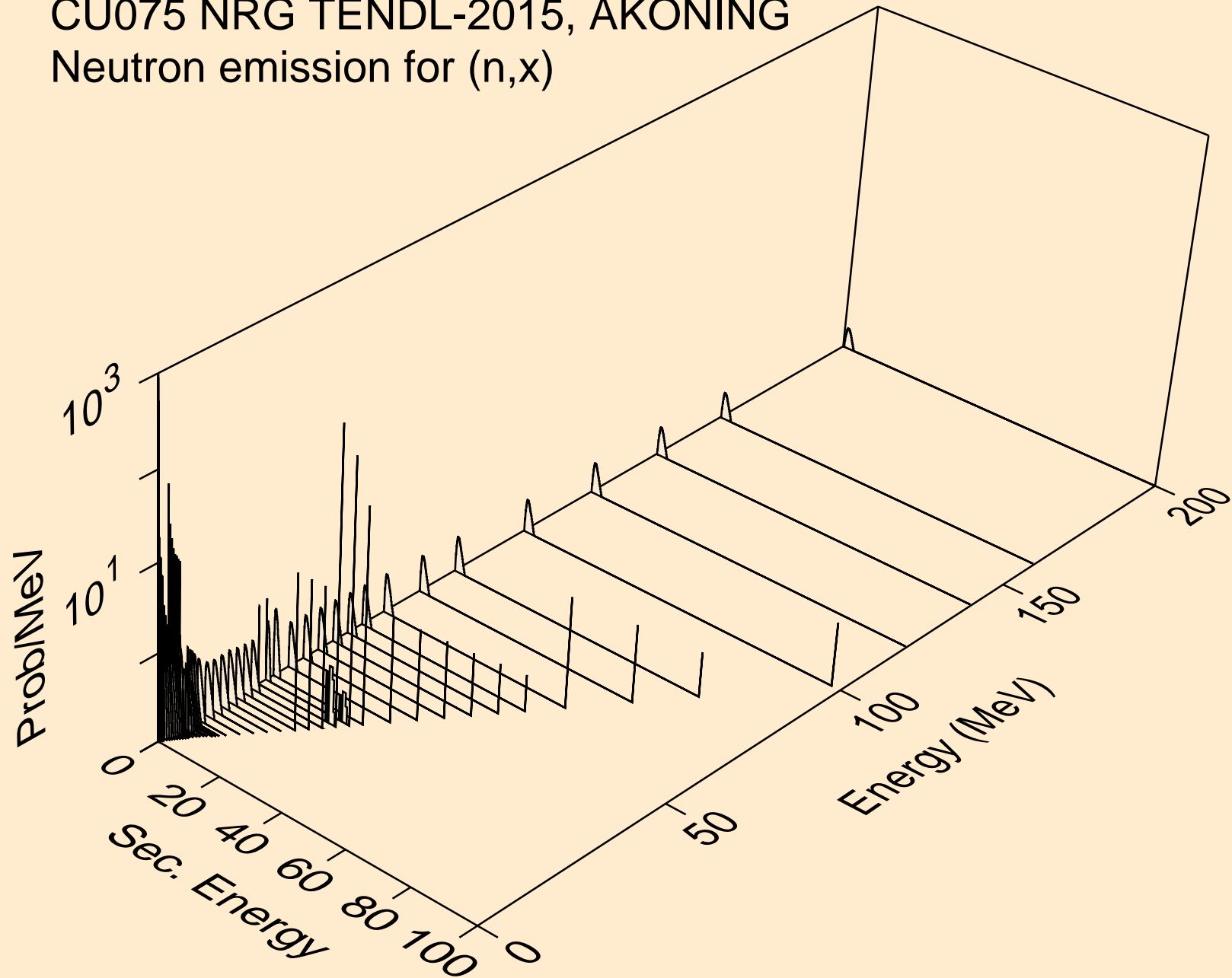

CU075 NRG TENDL-2015, AKONING
Neutron emission for (n,2nd)

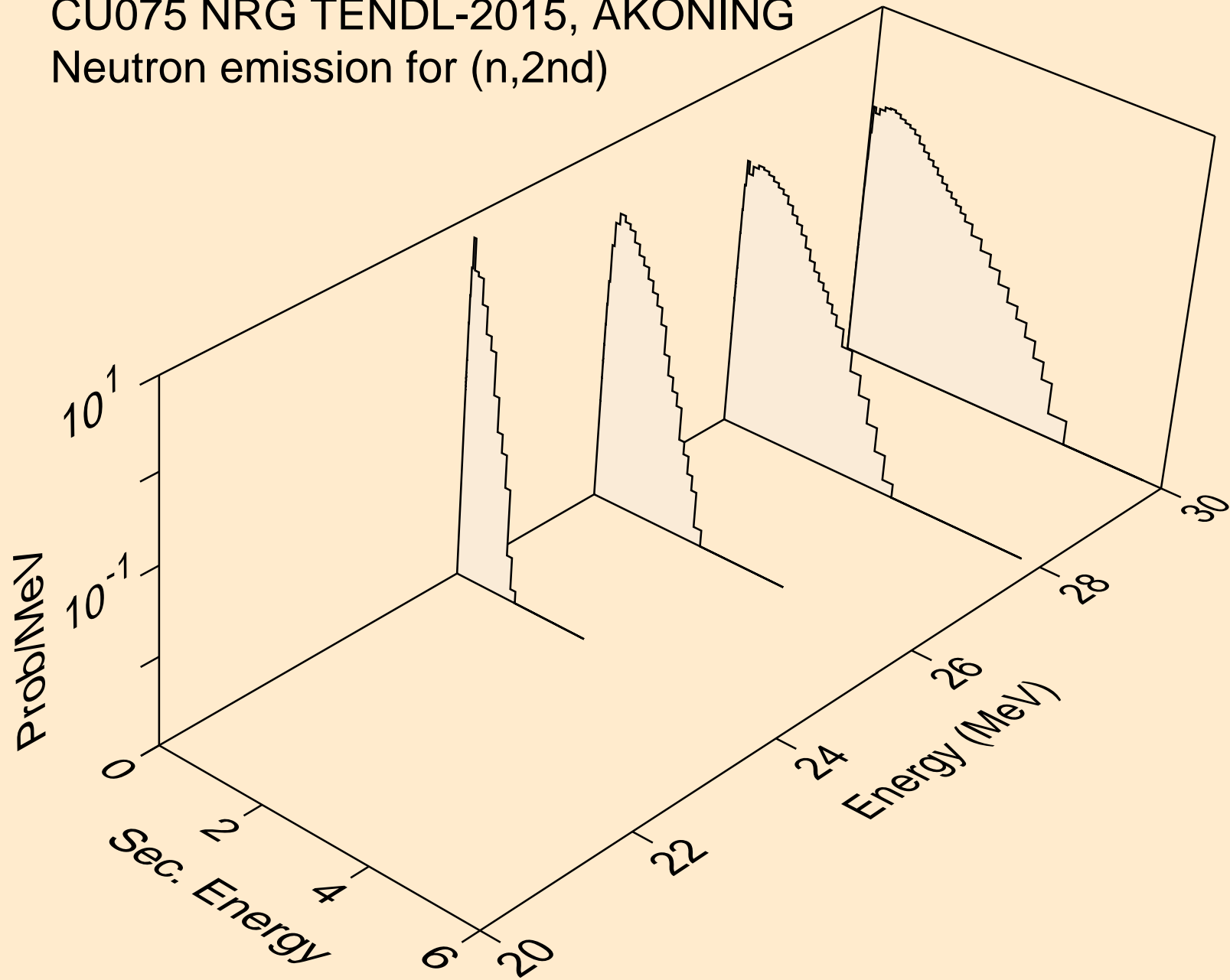

CU075 NRG TENDL-2015, AKONING
Neutron emission for (n,2n)

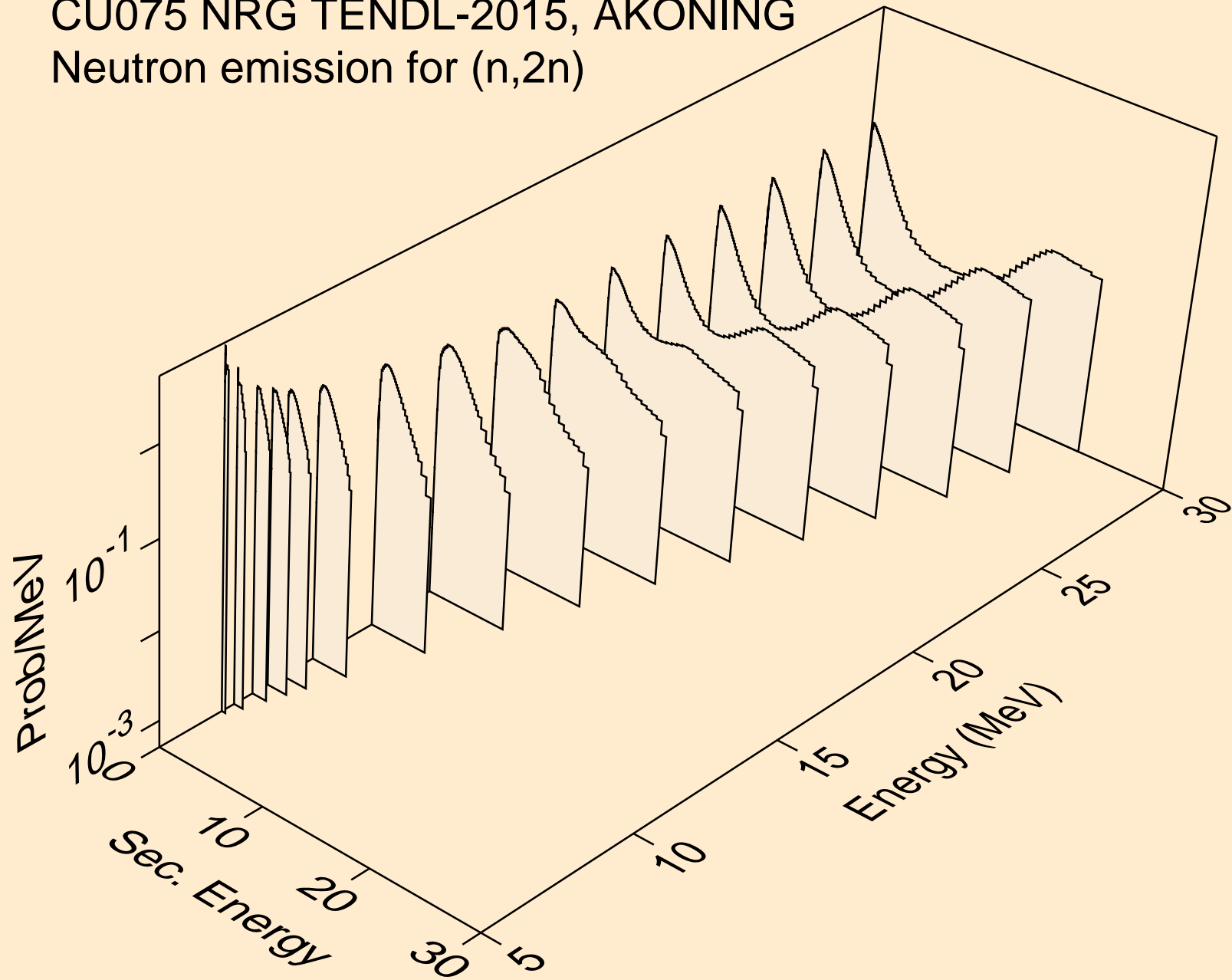

CU075 NRG TENDL-2015, AKONING
Neutron emission for (n,3n)

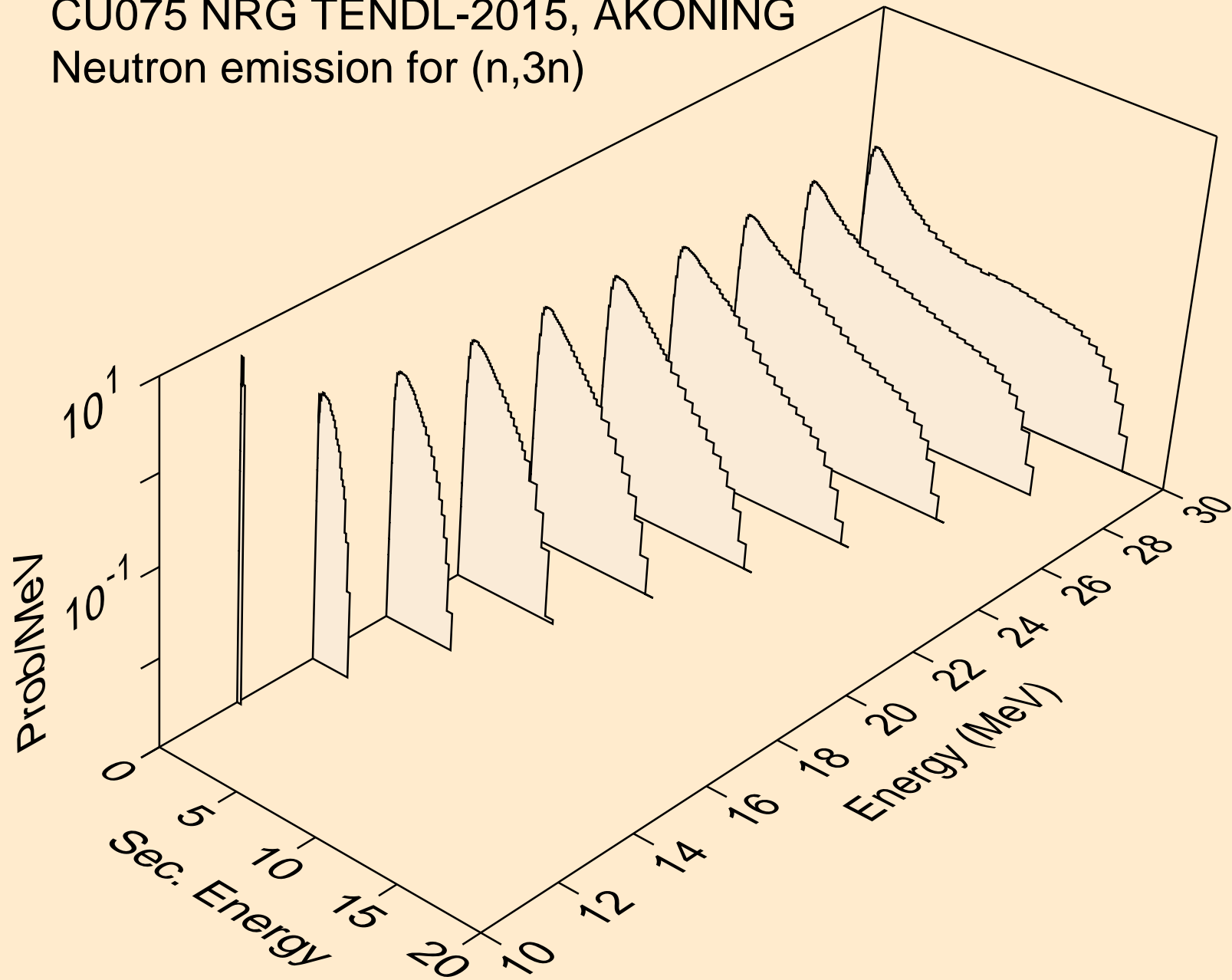

CU075 NRG TENDL-2015, AKONING
Neutron emission for (n,n*)a

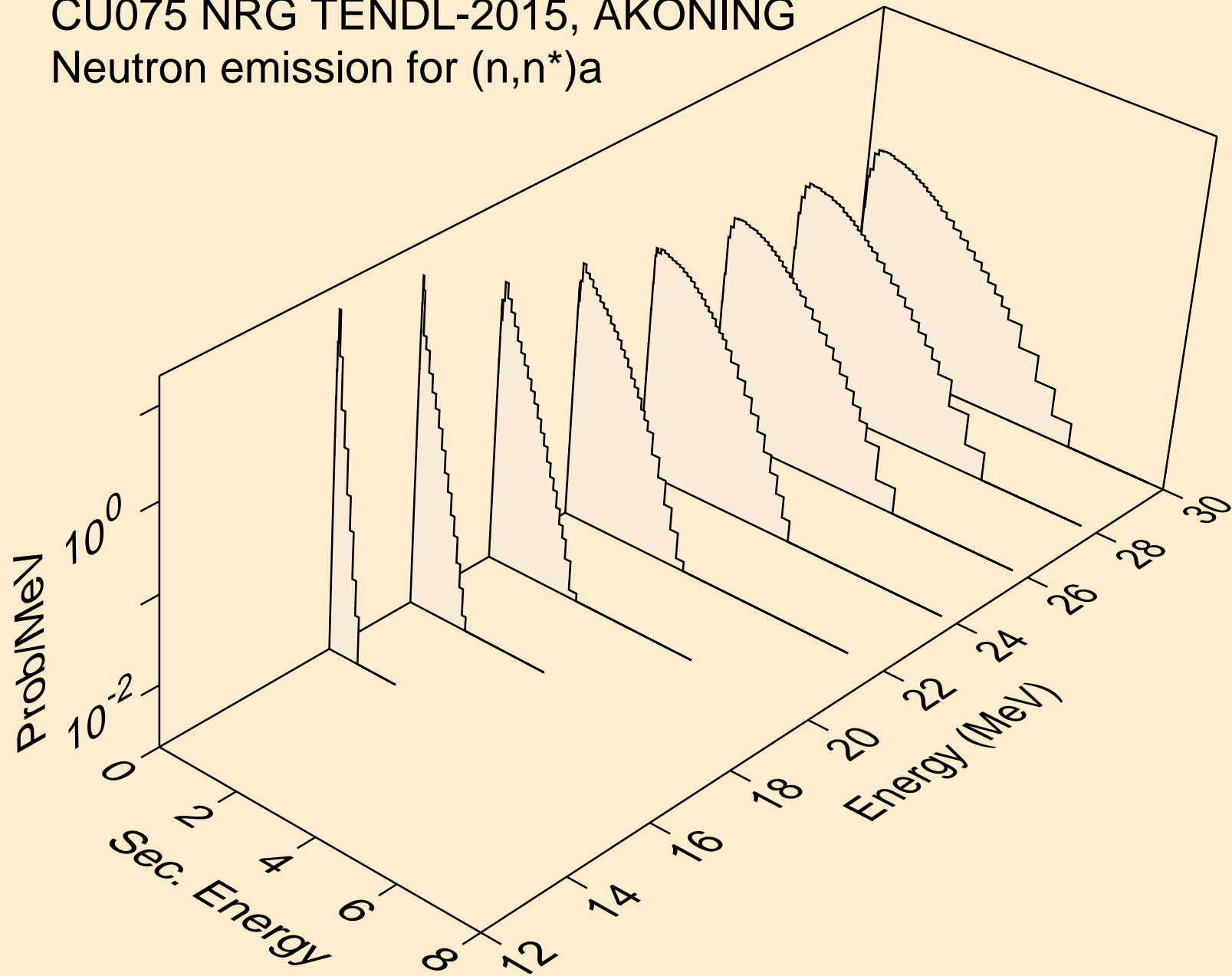

CU075 NRG TENDL-2015, AKONING
Neutron emission for (n,2n)a

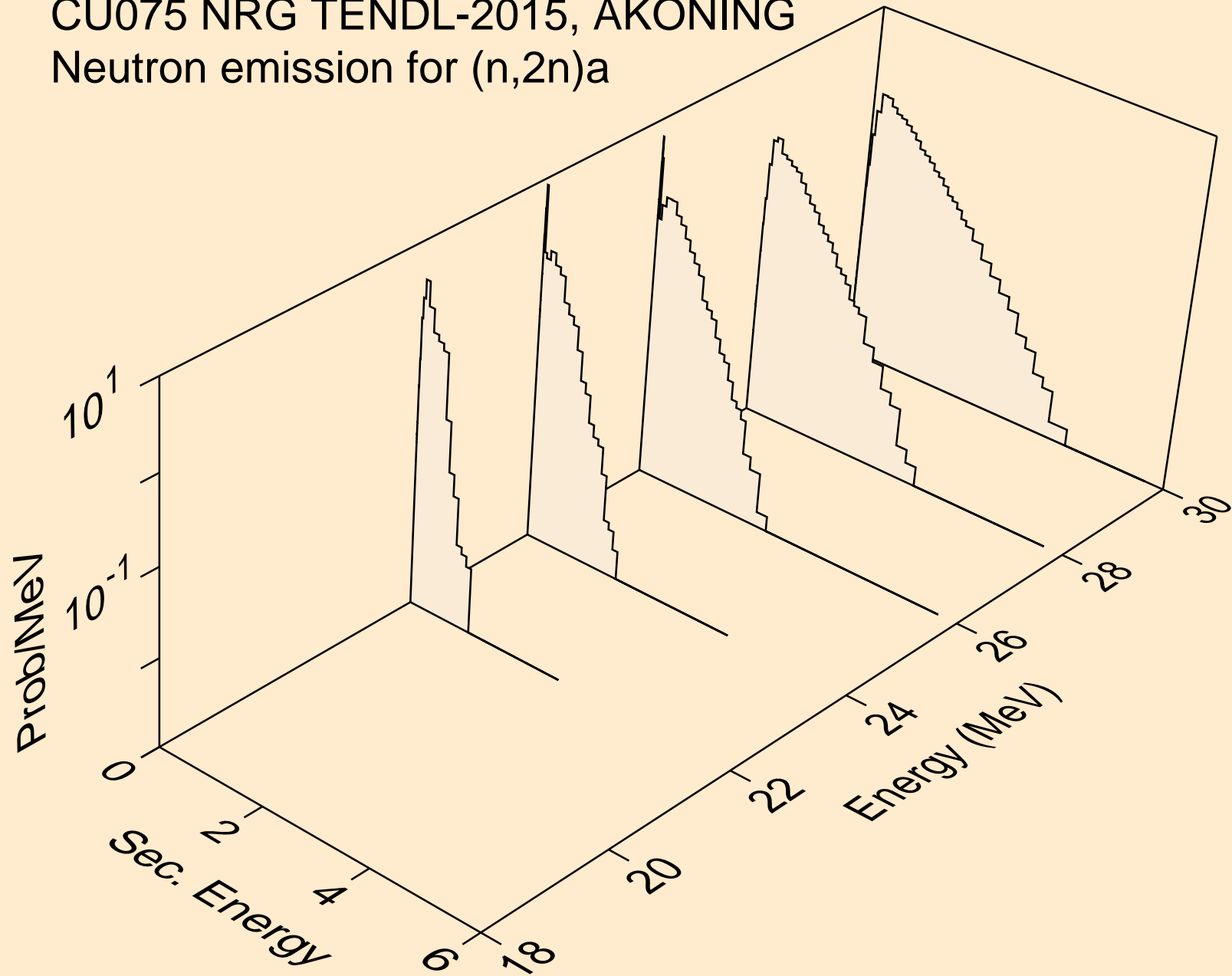

CU075 NRG TENDL-2015, AKONING
Neutron emission for (n,3n)a

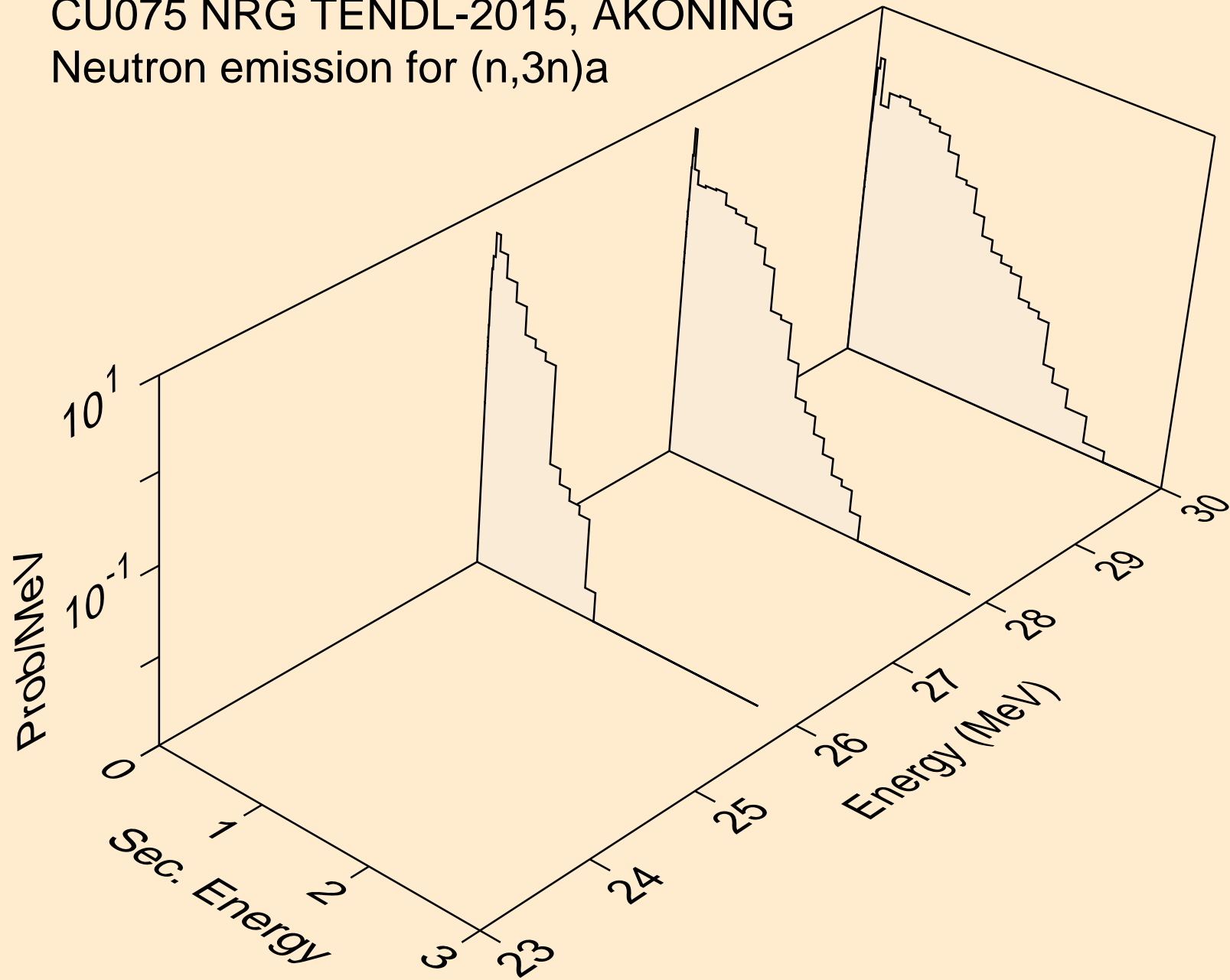

CU075 NRG TENDL-2015, AKONING
Neutron emission for (n,n*)p

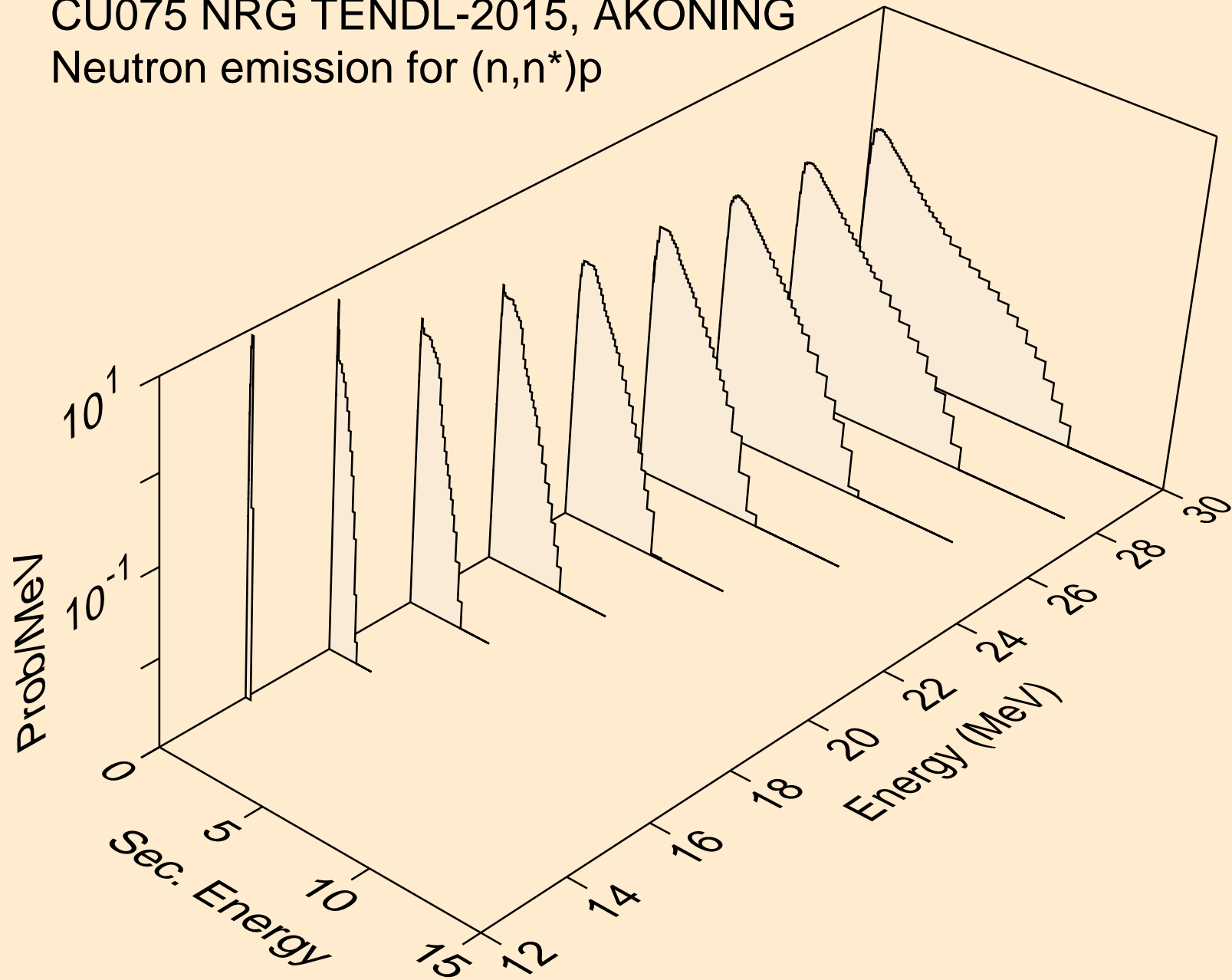

CU075 NRG TENDL-2015, AKONING
Neutron emission for (n,n*)d

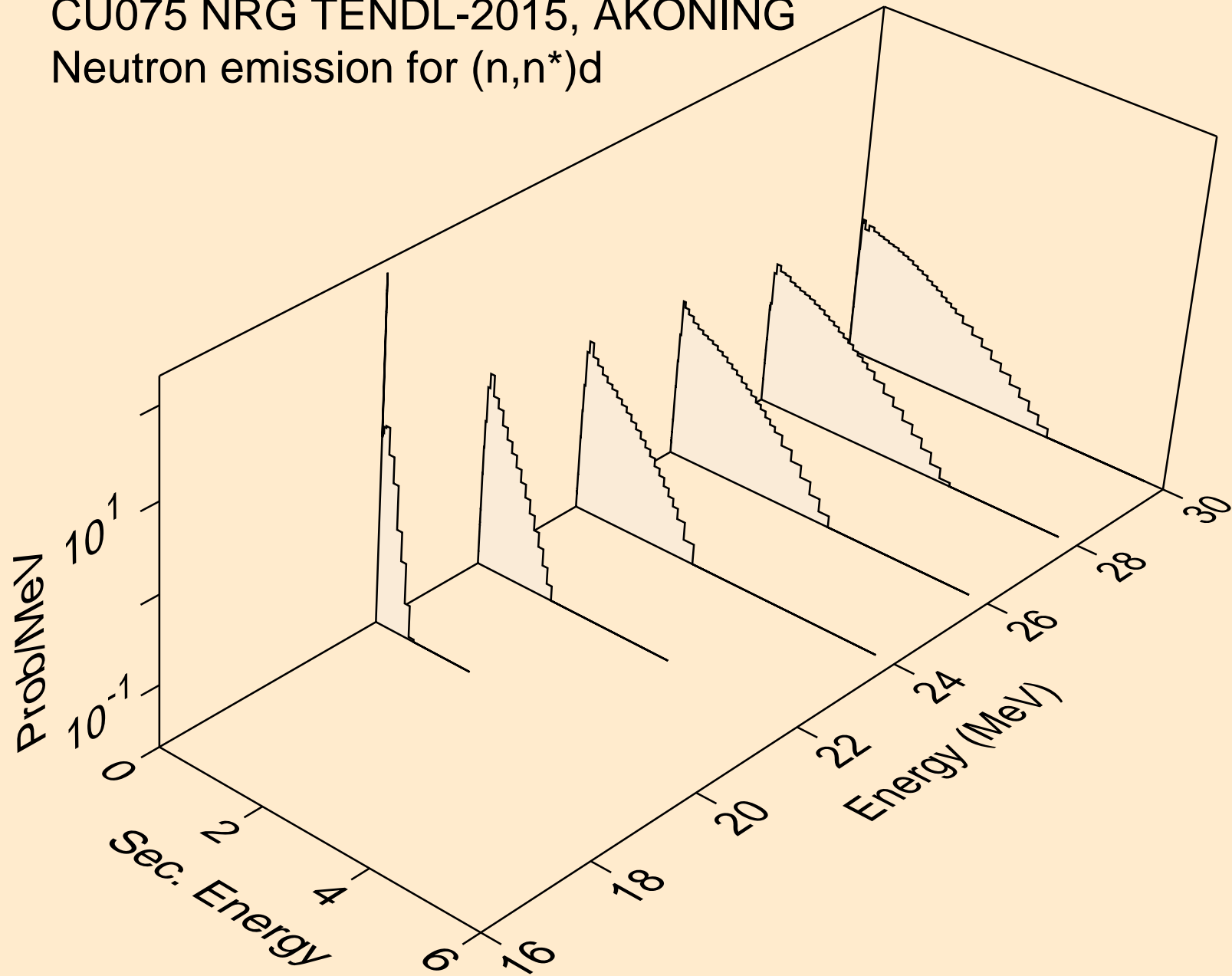

CU075 NRG TENDL-2015, AKONING
Neutron emission for (n,n*)t

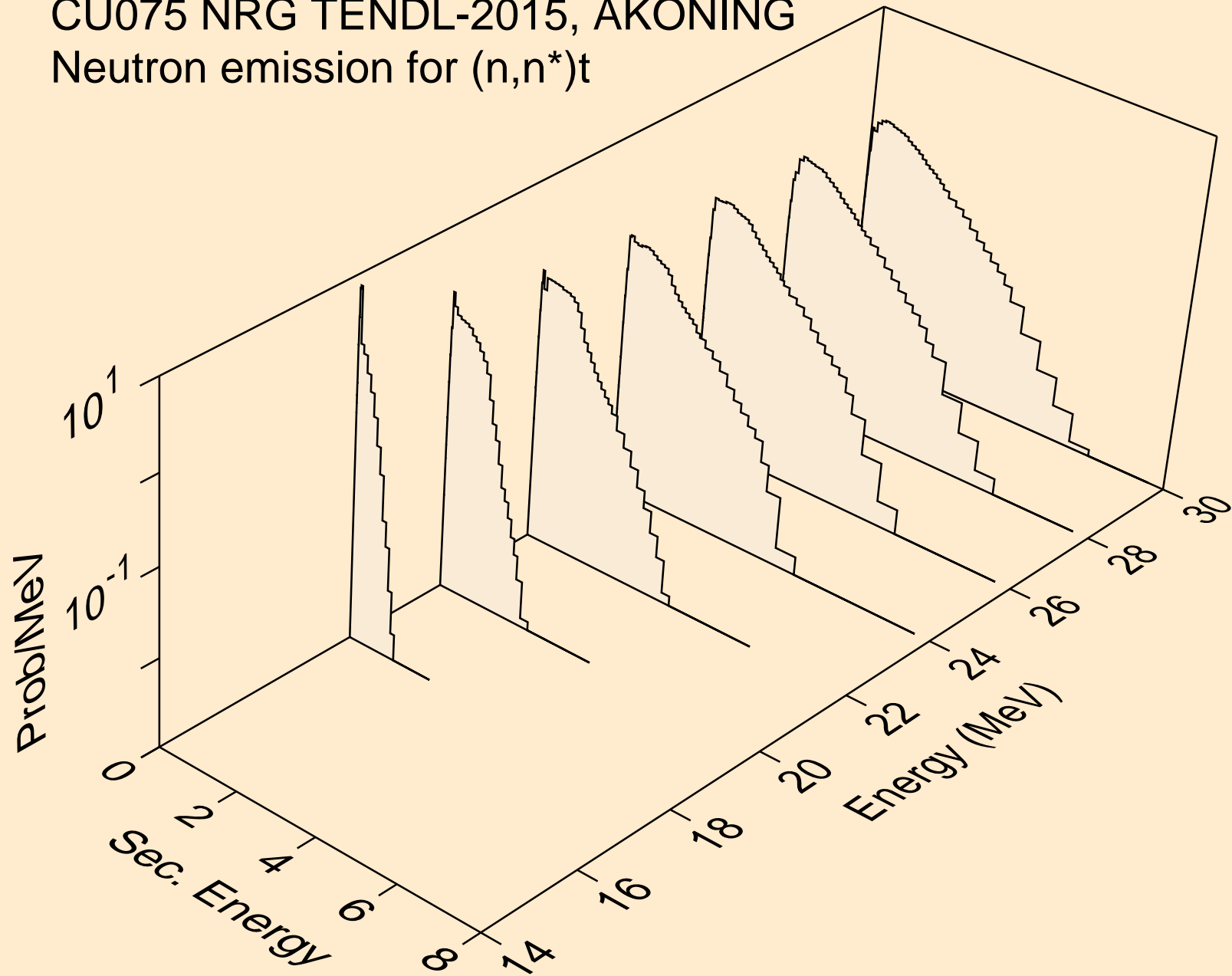

CU075 NRG TENDL-2015, AKONING
Neutron emission for (n,4n)

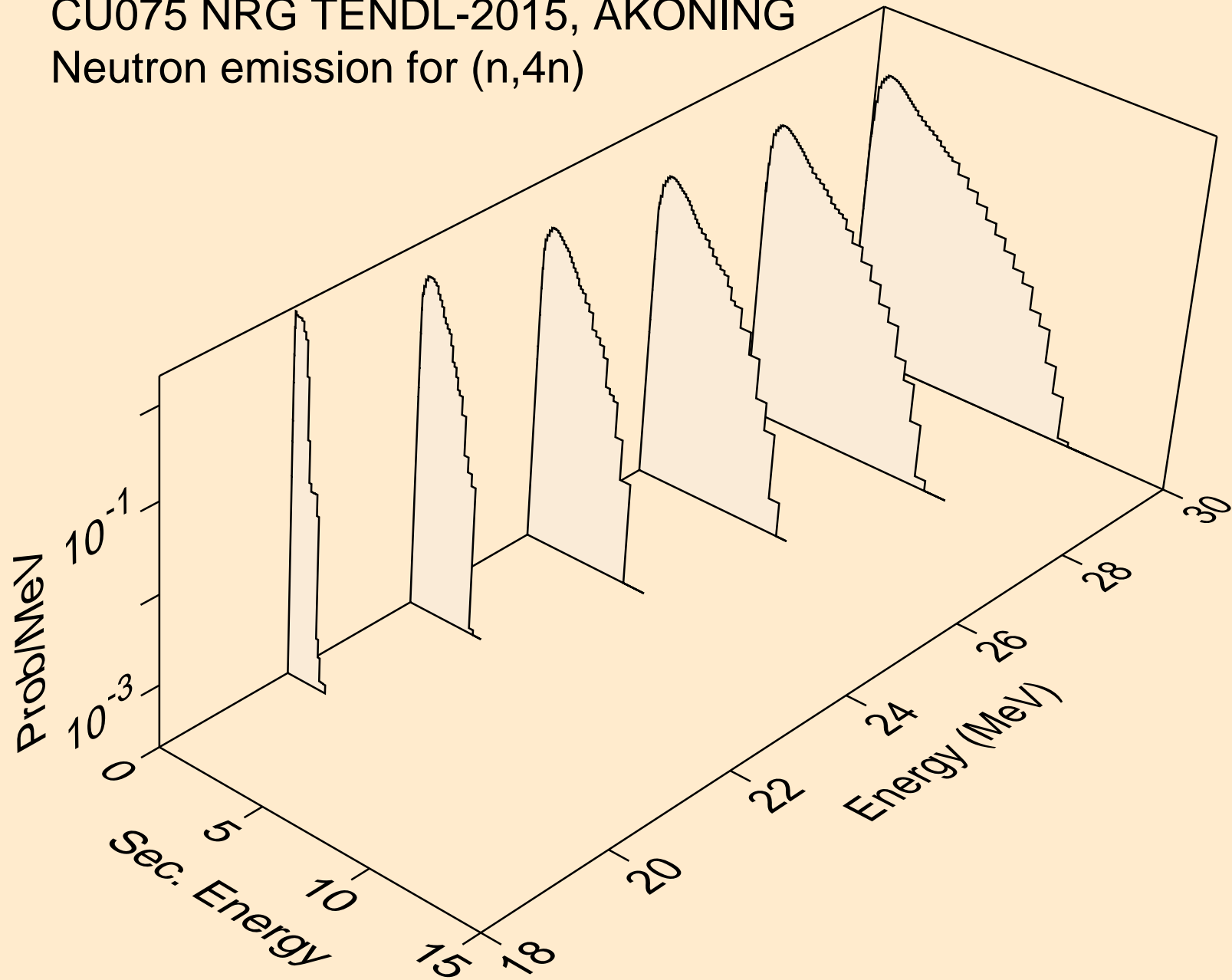

CU075 NRG TENDL-2015, AKONING
Neutron emission for (n,2np)

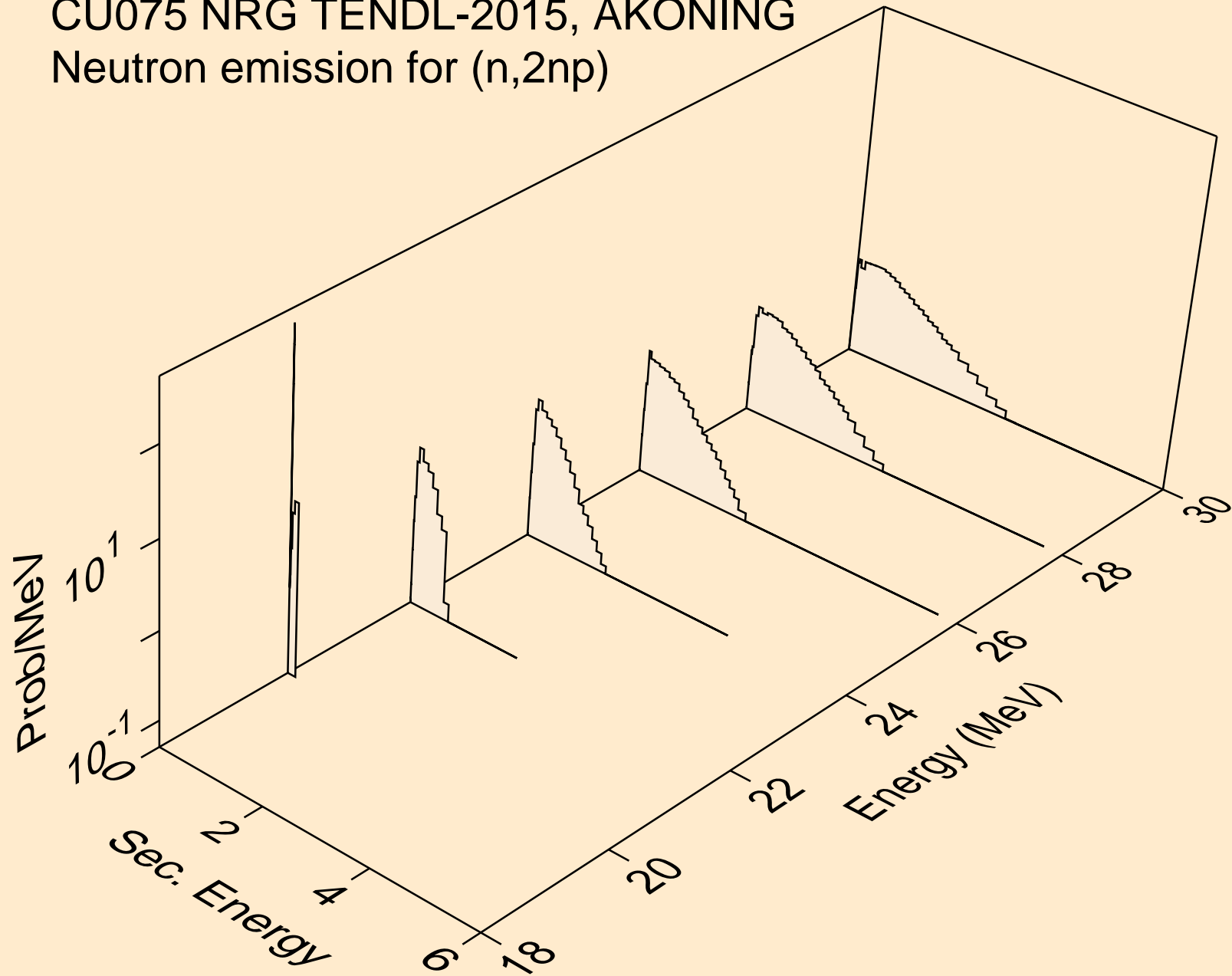

CU075 NRG TENDL-2015, AKONING
Neutron emission for (n,3np)

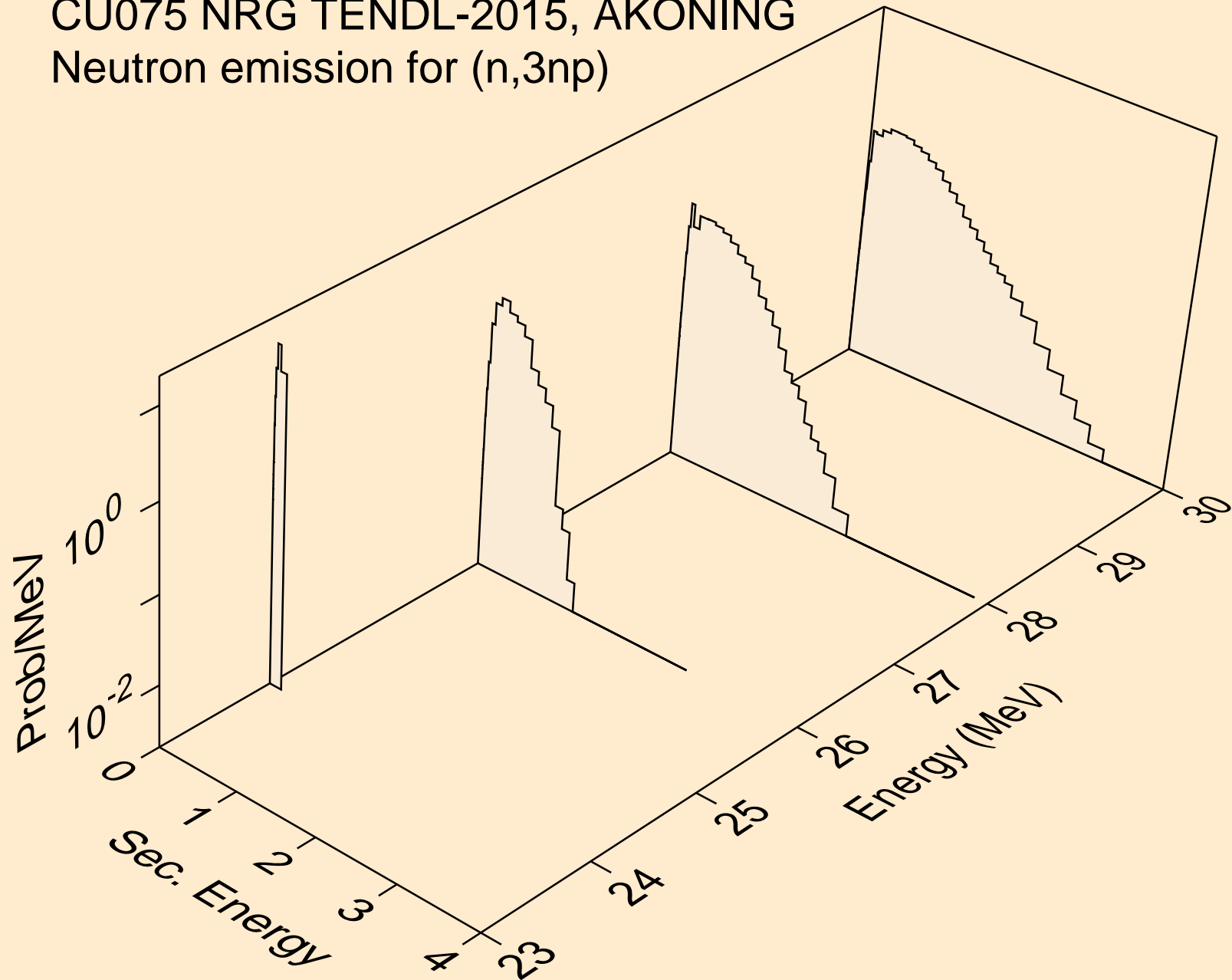

CU075 NRG TENDL-2015, AKONING
Neutron emission for (n,n*c)

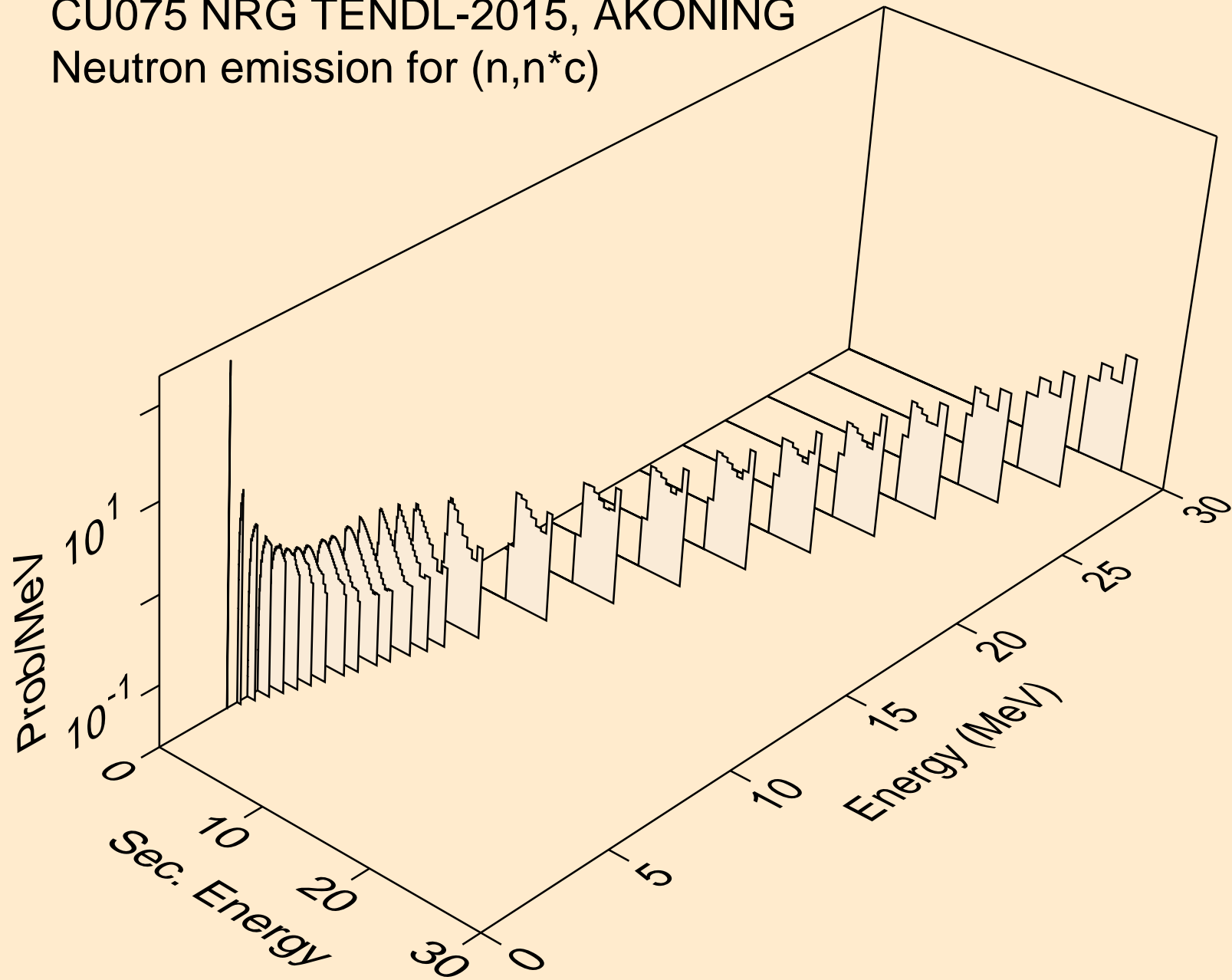

CU075 NRG TENDL-2015, AKONING
Photon emission for (n,x)

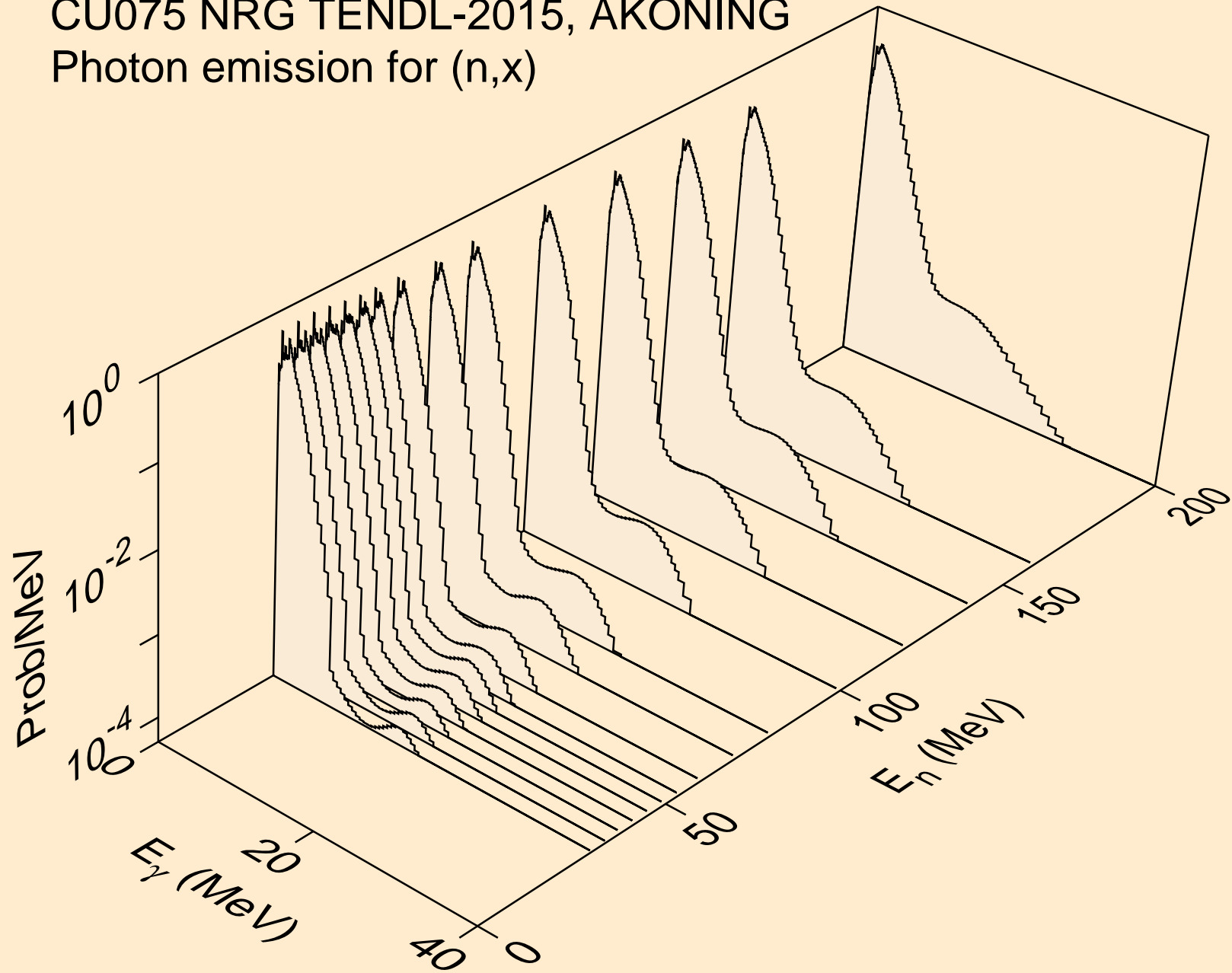

CU075 NRG TENDL-2015, AKONING
Photon emission for (n,2nd)

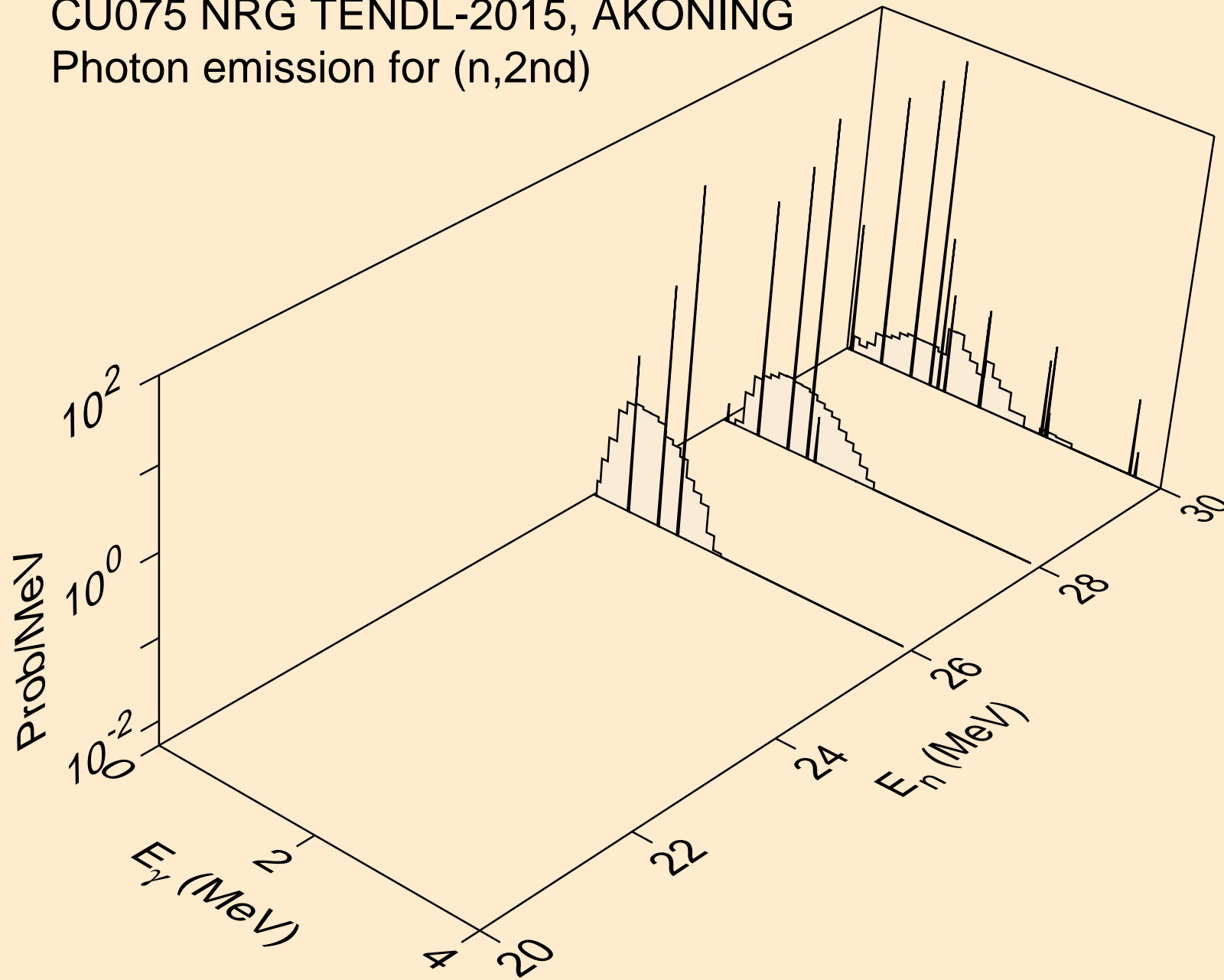

CU075 NRG TENDL-2015, AKONING
Photon emission for (n,2n)

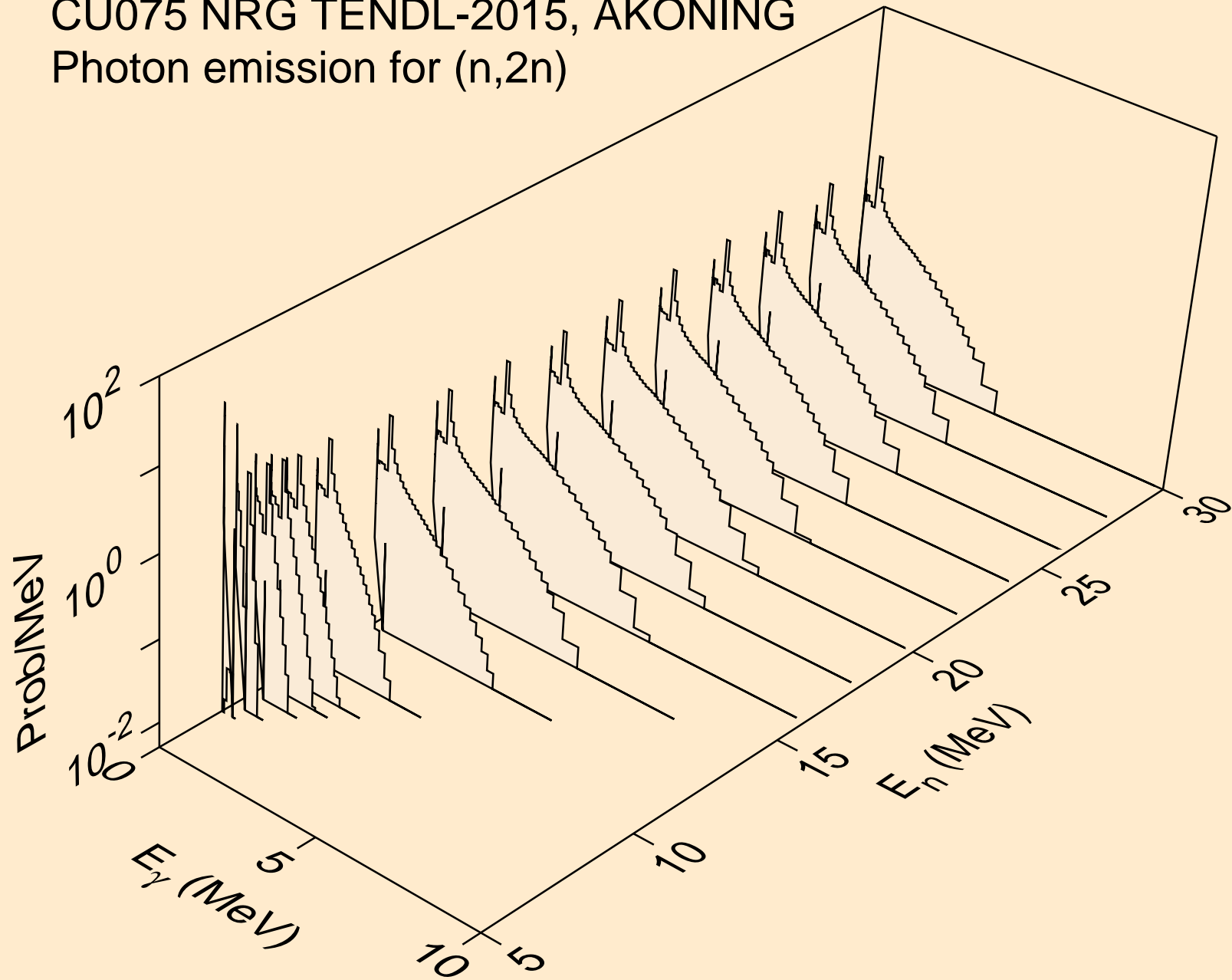

CU075 NRG TENDL-2015, AKONING
Photon emission for (n,3n)

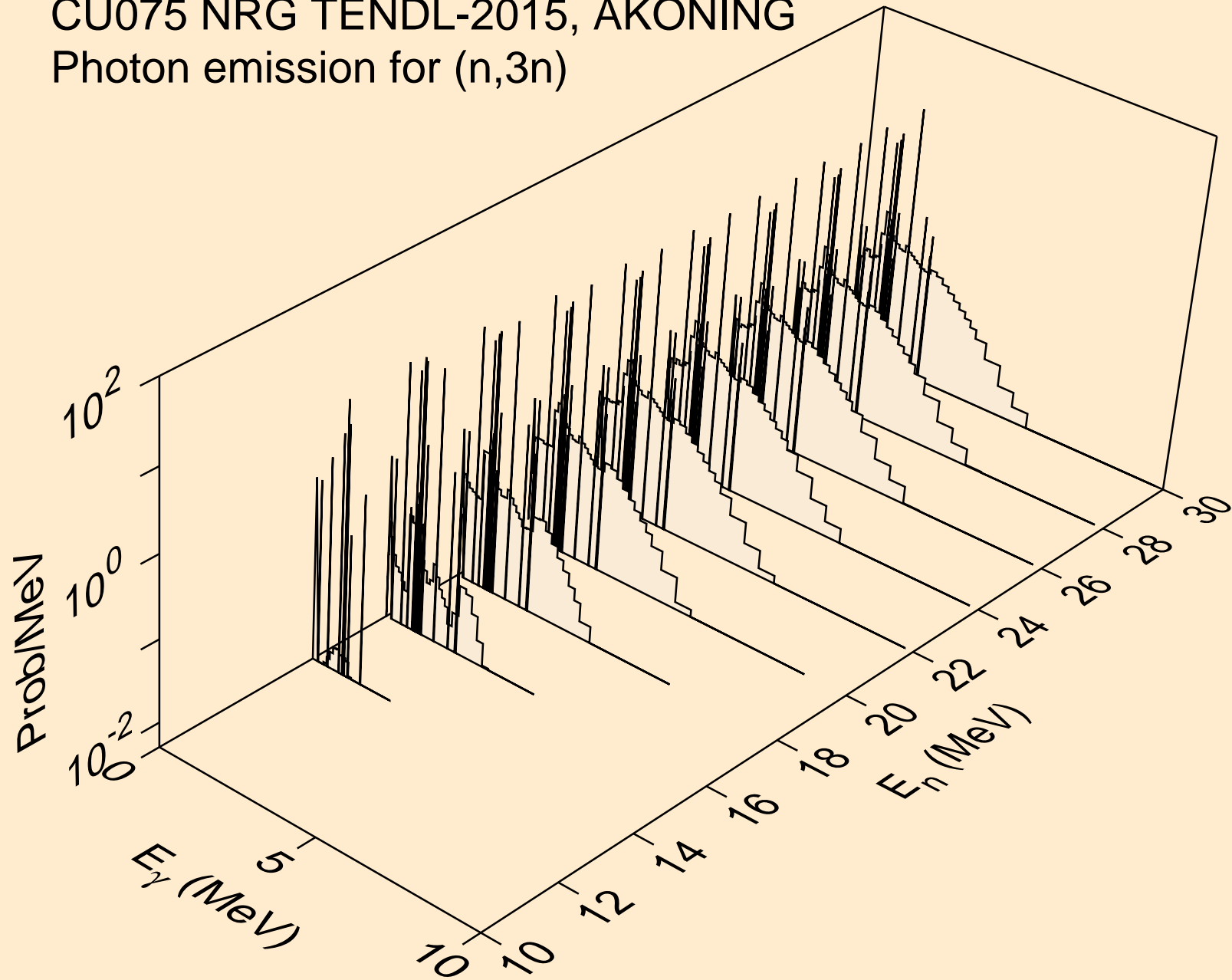

CU075 NRG TENDL-2015, AKONING
Photon emission for (n,n*)a

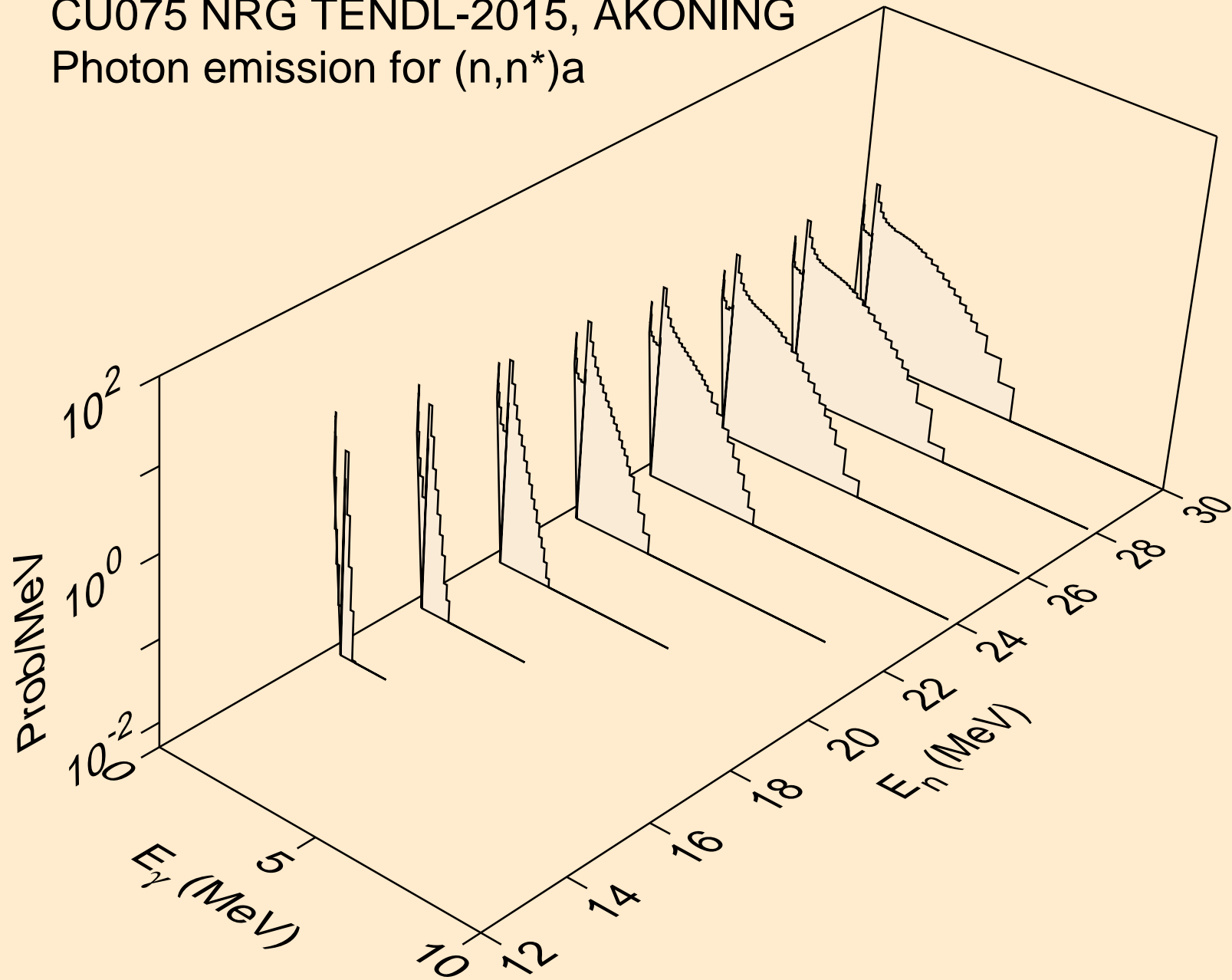

CU075 NRG TENDL-2015, AKONING
Photon emission for (n,2n)a

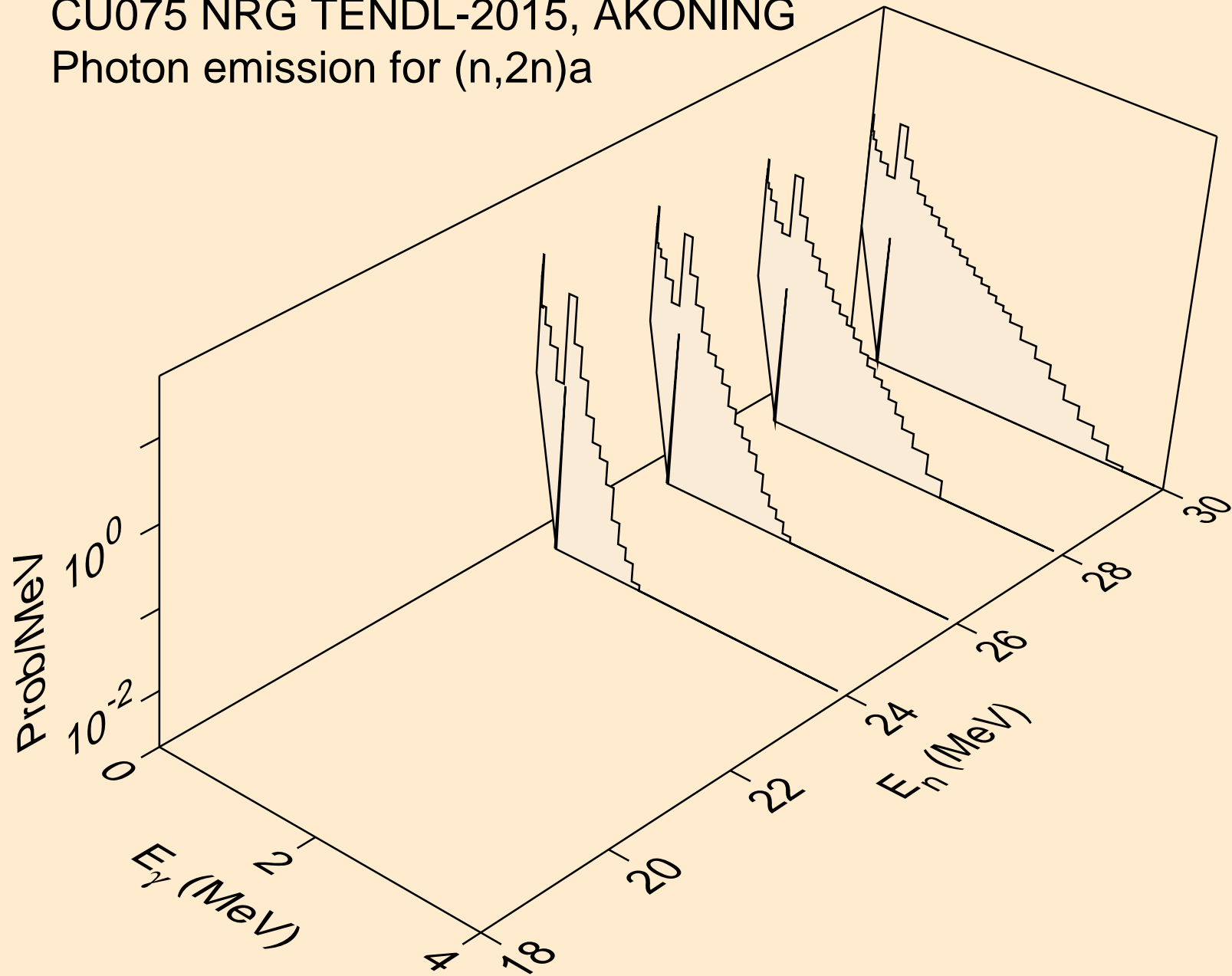

CU075 NRG TENDL-2015, AKONING
Photon emission for (n,3n)a

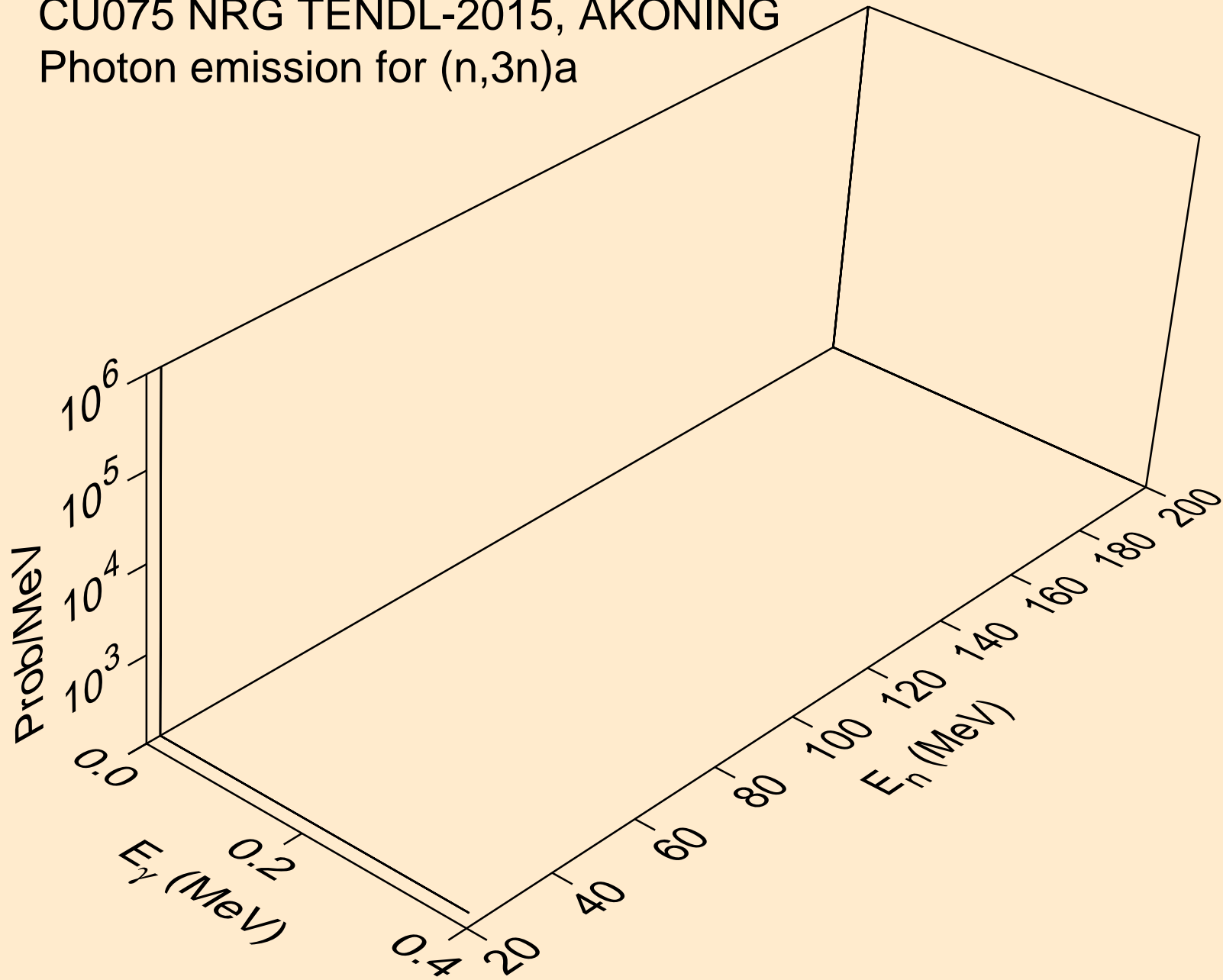

CU075 NRG TENDL-2015, AKONING
Photon emission for (n,n*)p

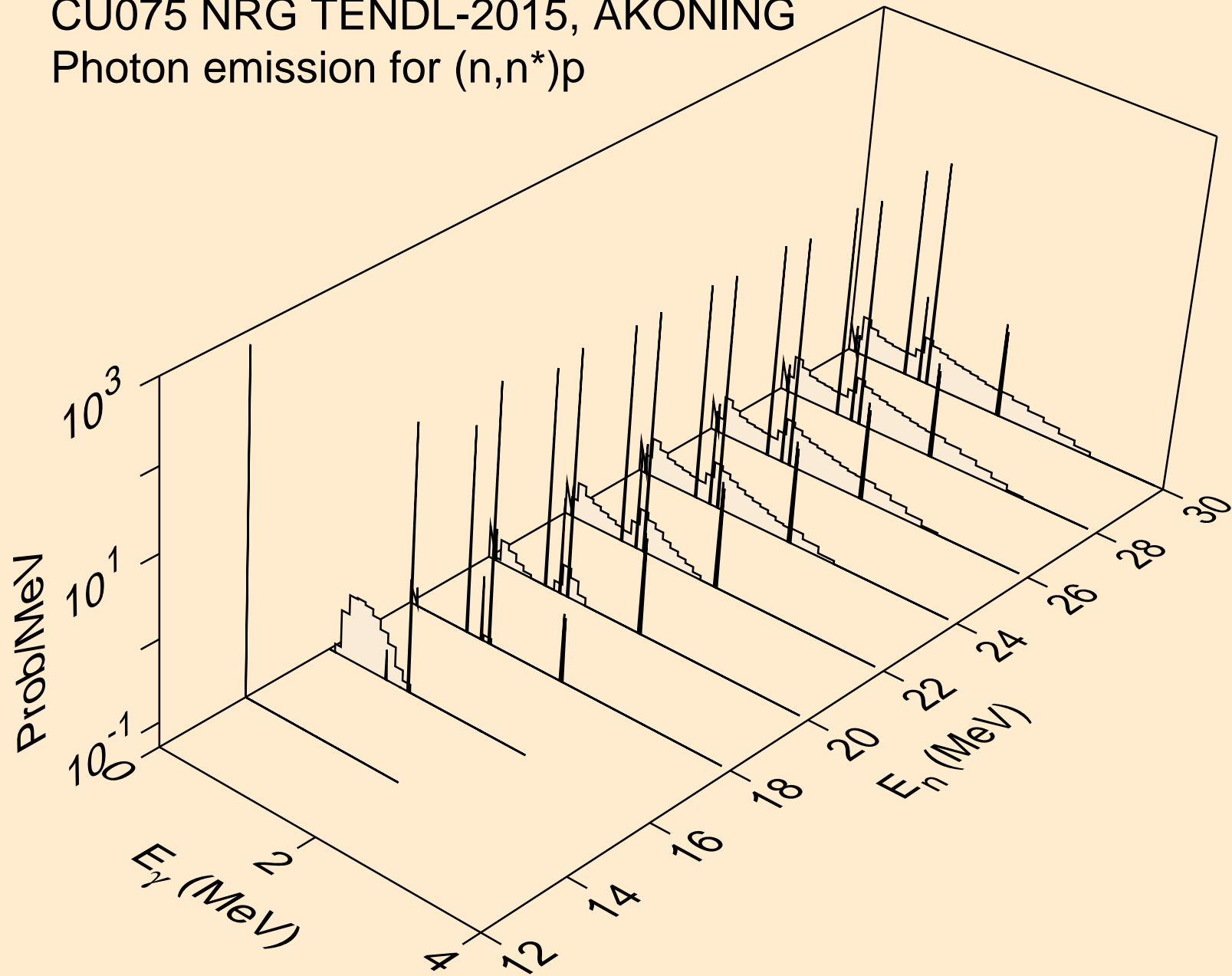

CU075 NRG TENDL-2015, AKONING
Photon emission for (n,n*)d

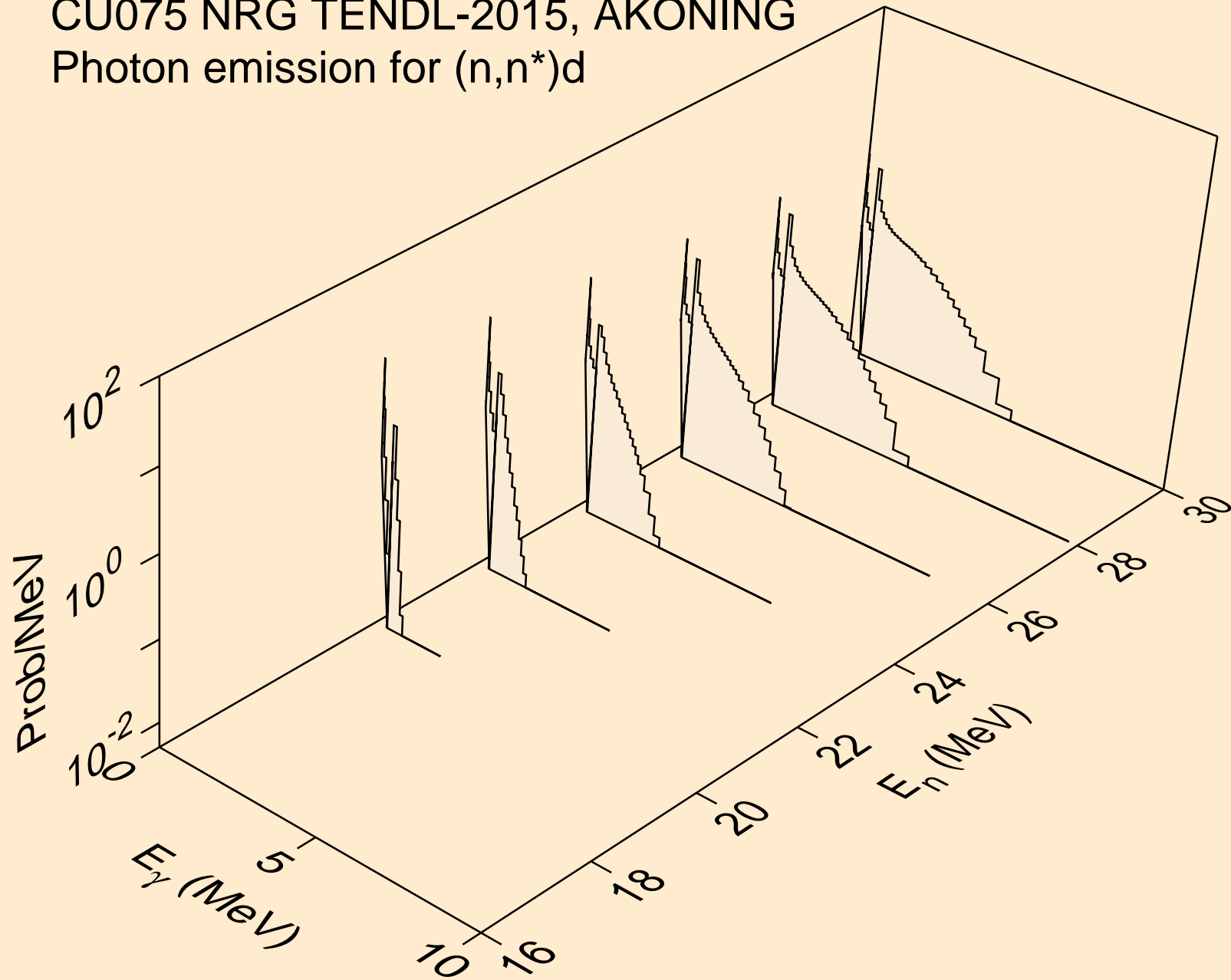

CU075 NRG TENDL-2015, AKONING
Photon emission for (n,n*)t

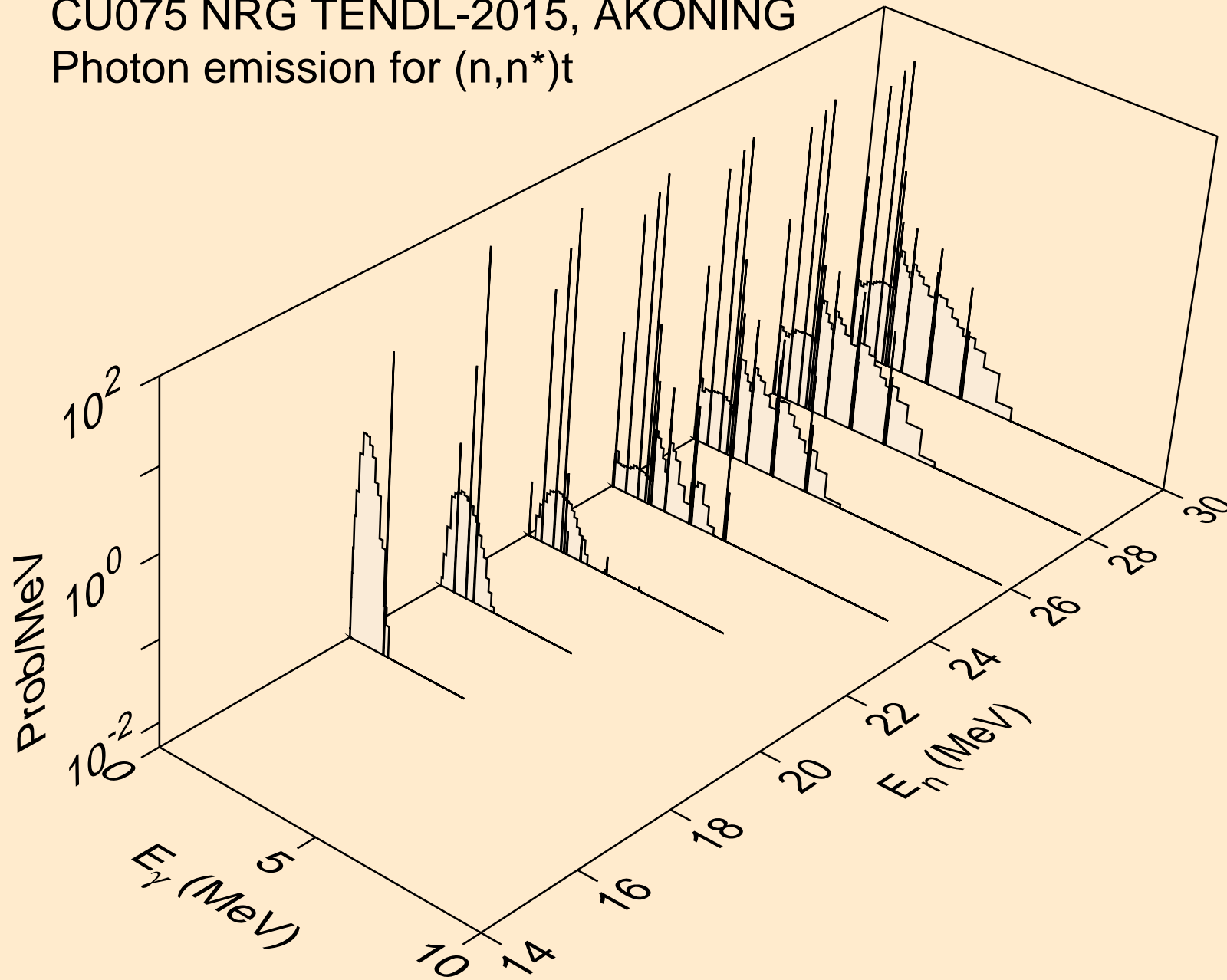

CU075 NRG TENDL-2015, AKONING
Photon emission for (n,4n)

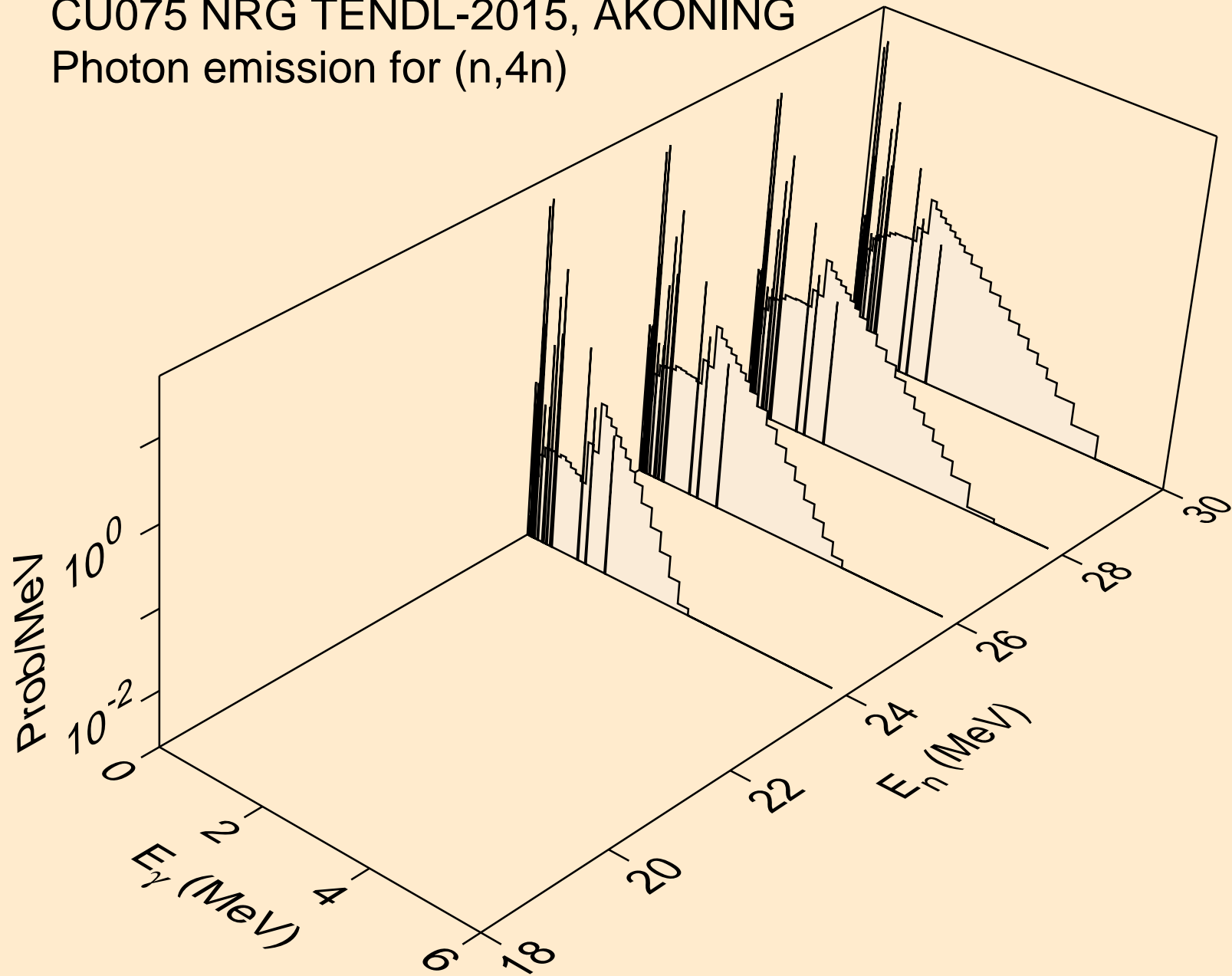

CU075 NRG TENDL-2015, AKONING
Photon emission for (n,2np)

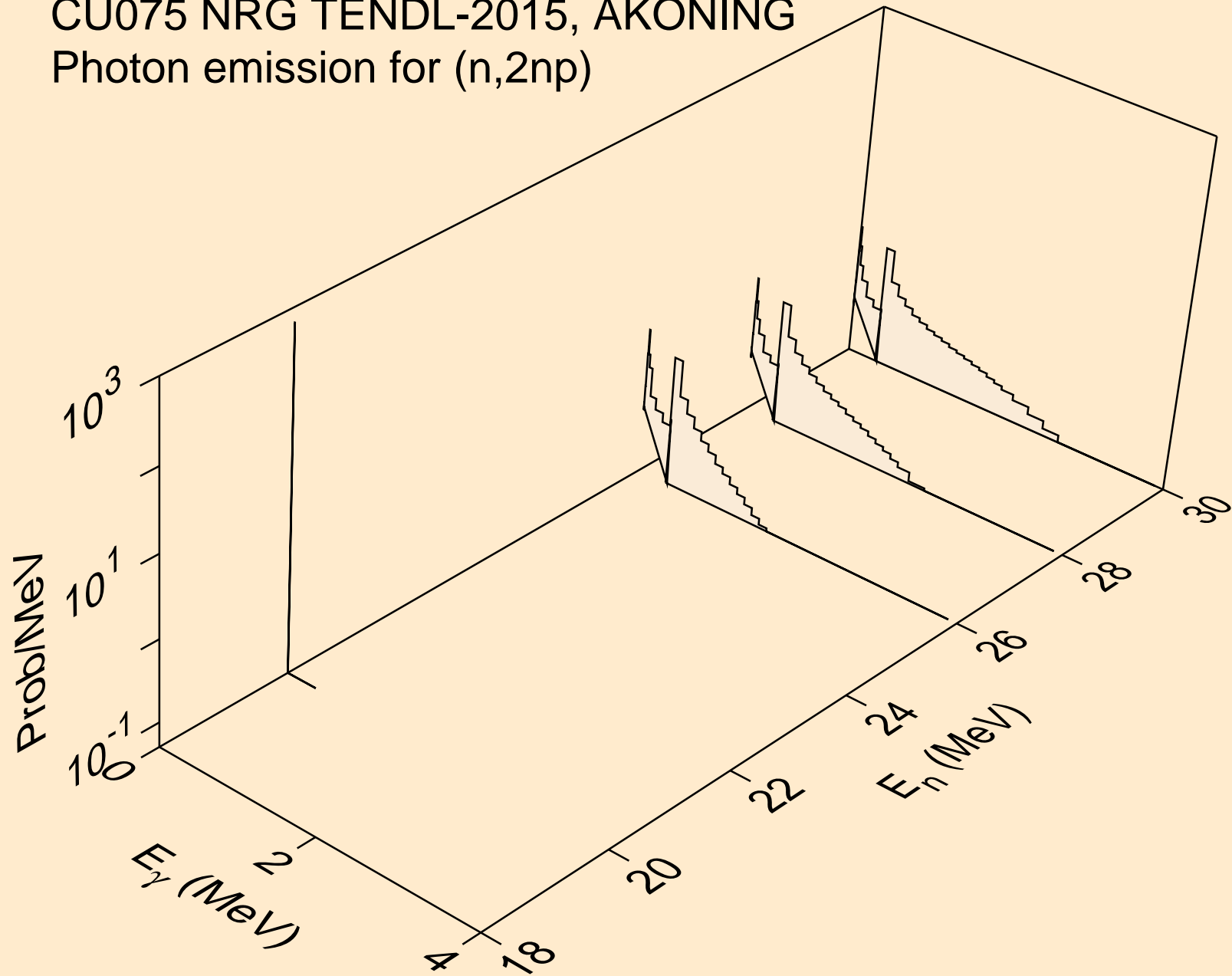

CU075 NRG TENDL-2015, AKONING
Photon emission for (n,3np)

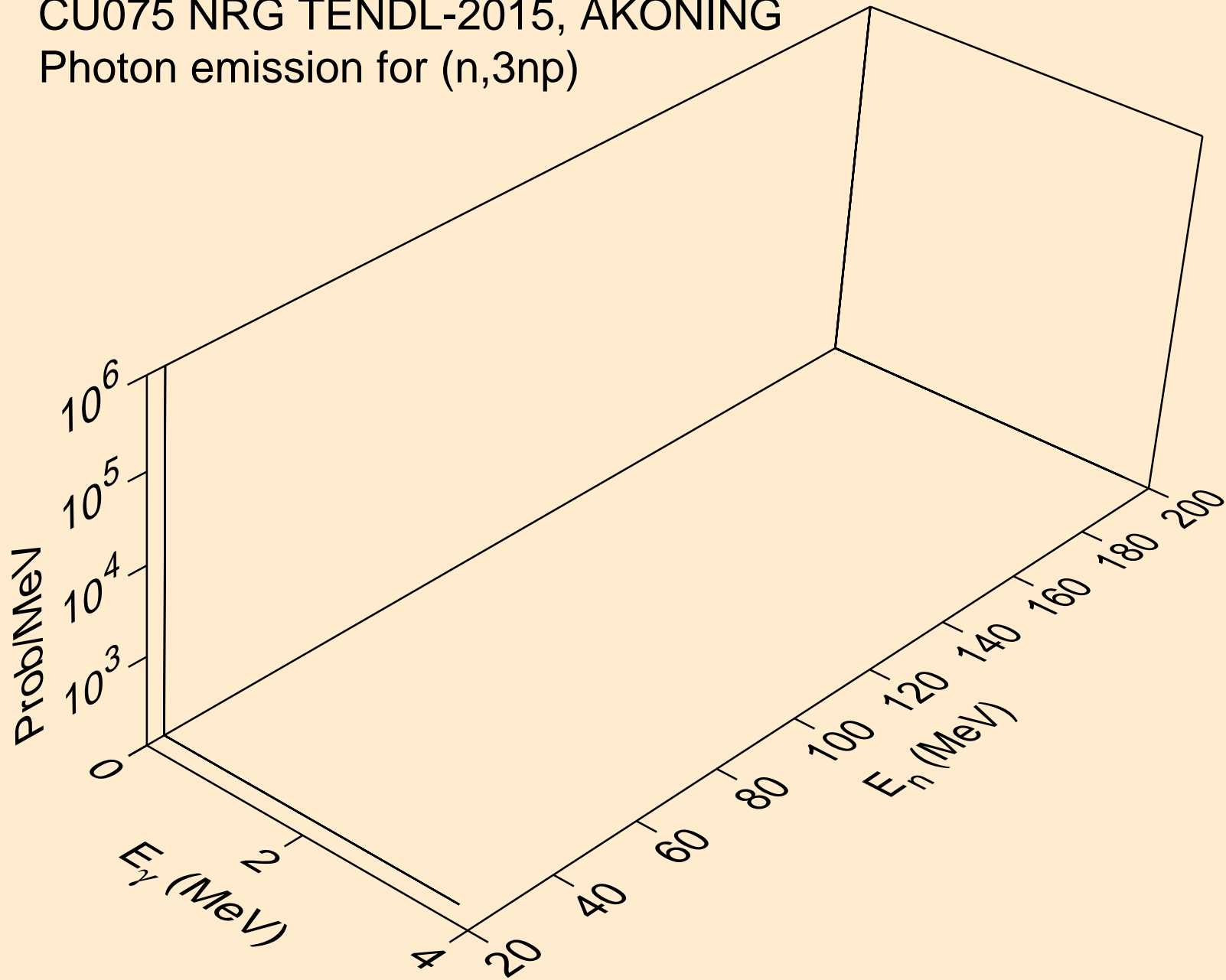

CU075 NRG TENDL-2015, AKONING
Photon emission for (n,n*c)

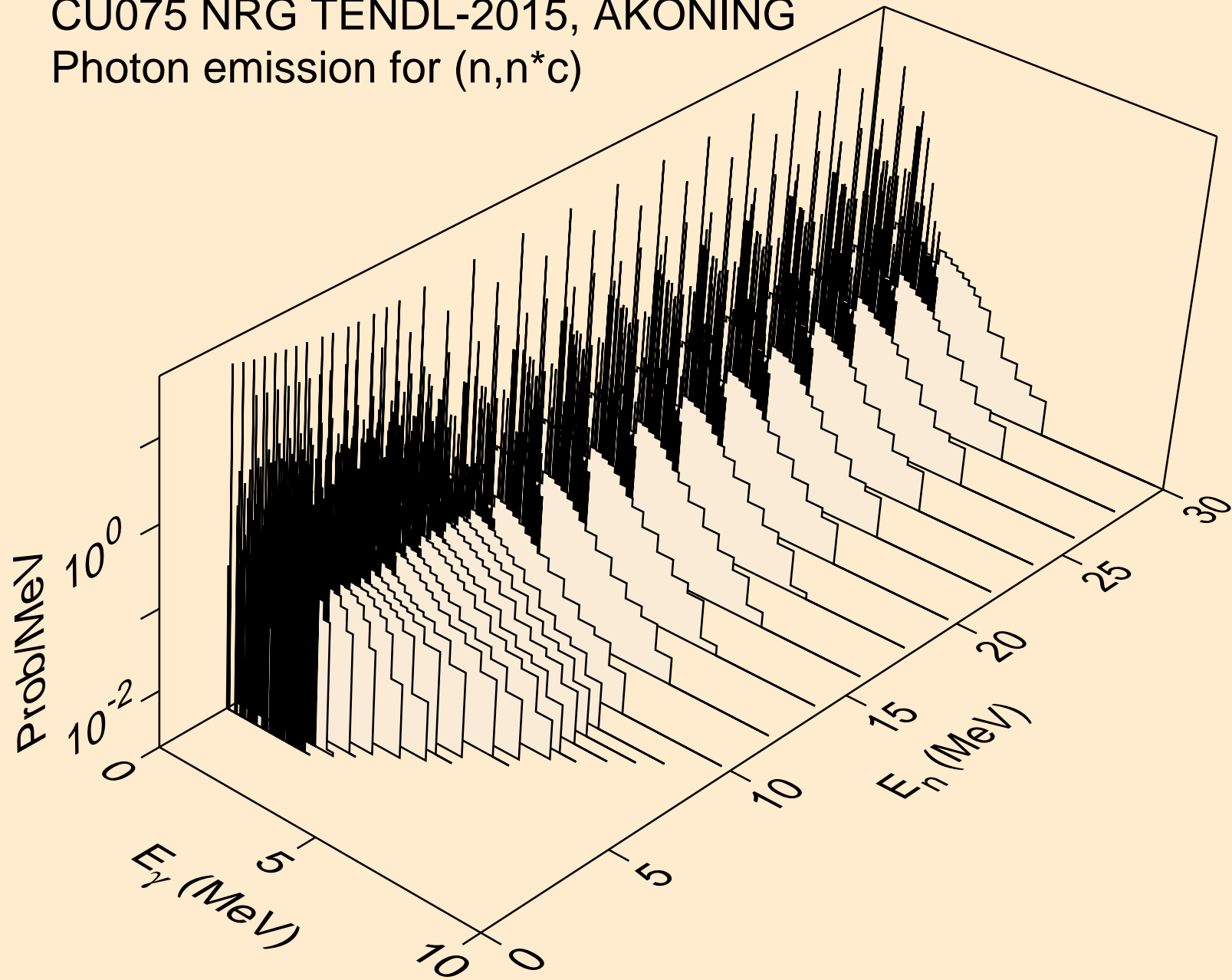

CU075 NRG TENDL-2015, AKONING
Photon emission for (n,gma)

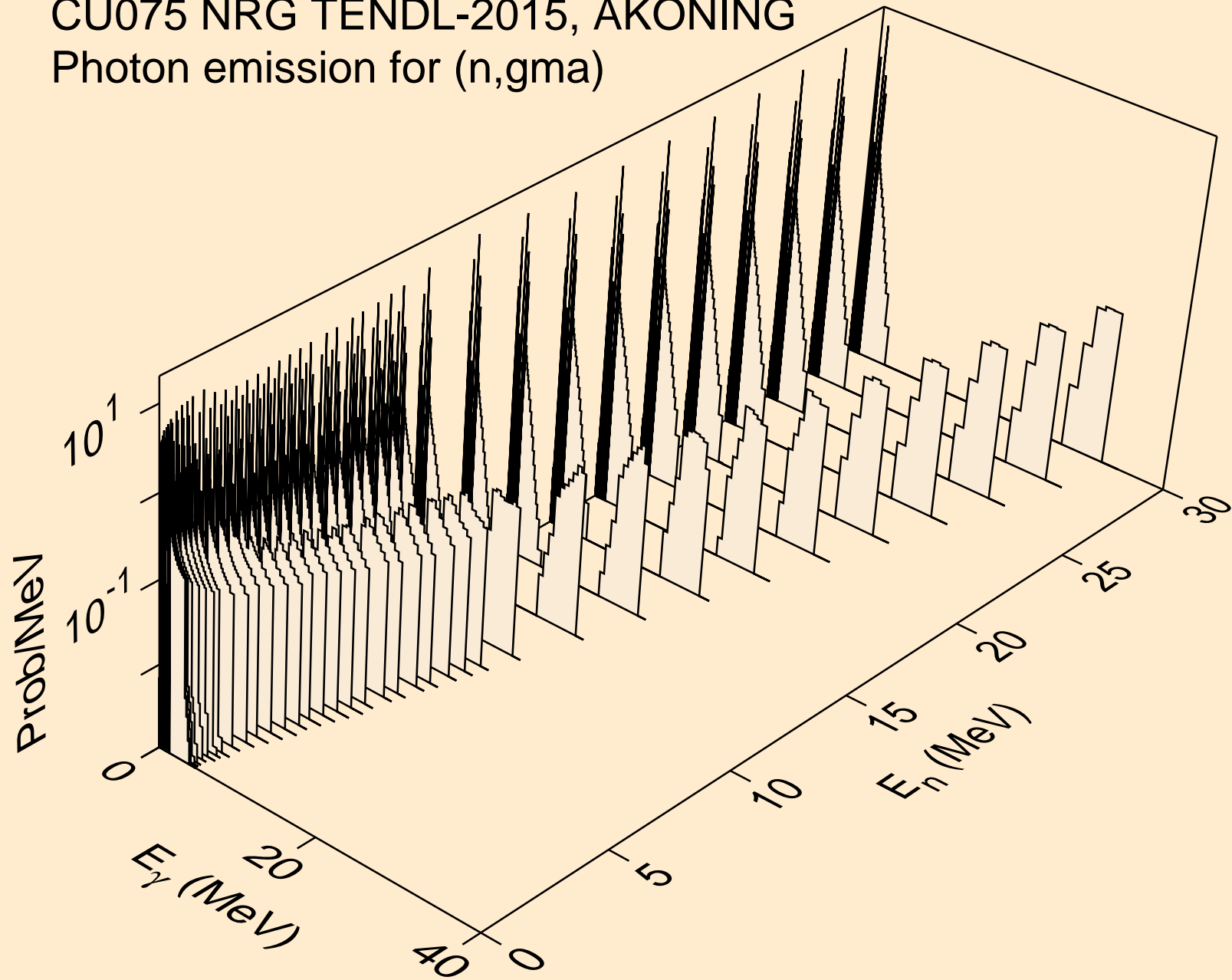

CU075 NRG TENDL-2015, AKONING
Photon emission for (n,p)

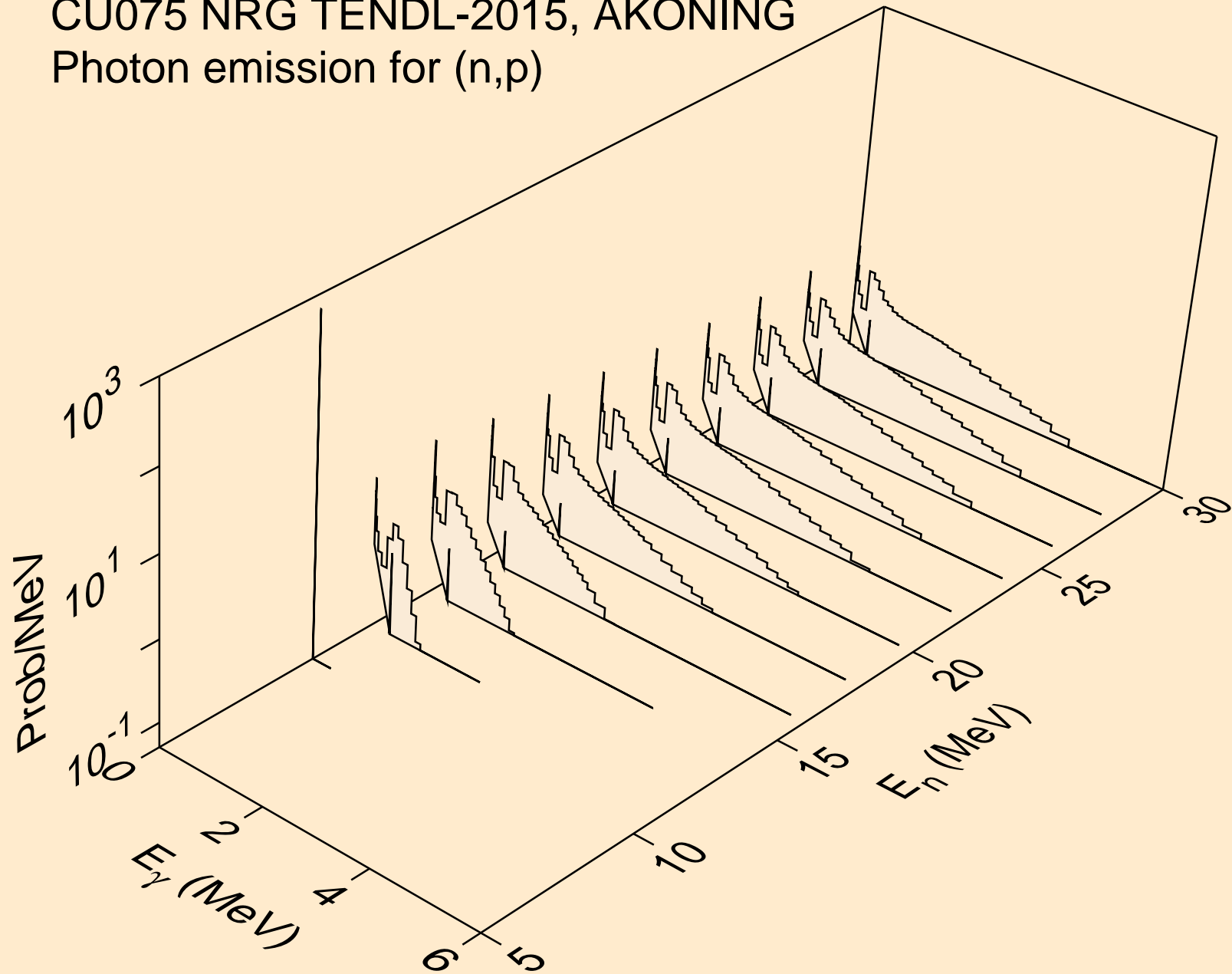

CU075 NRG TENDL-2015, AKONING
Photon emission for (n,d)

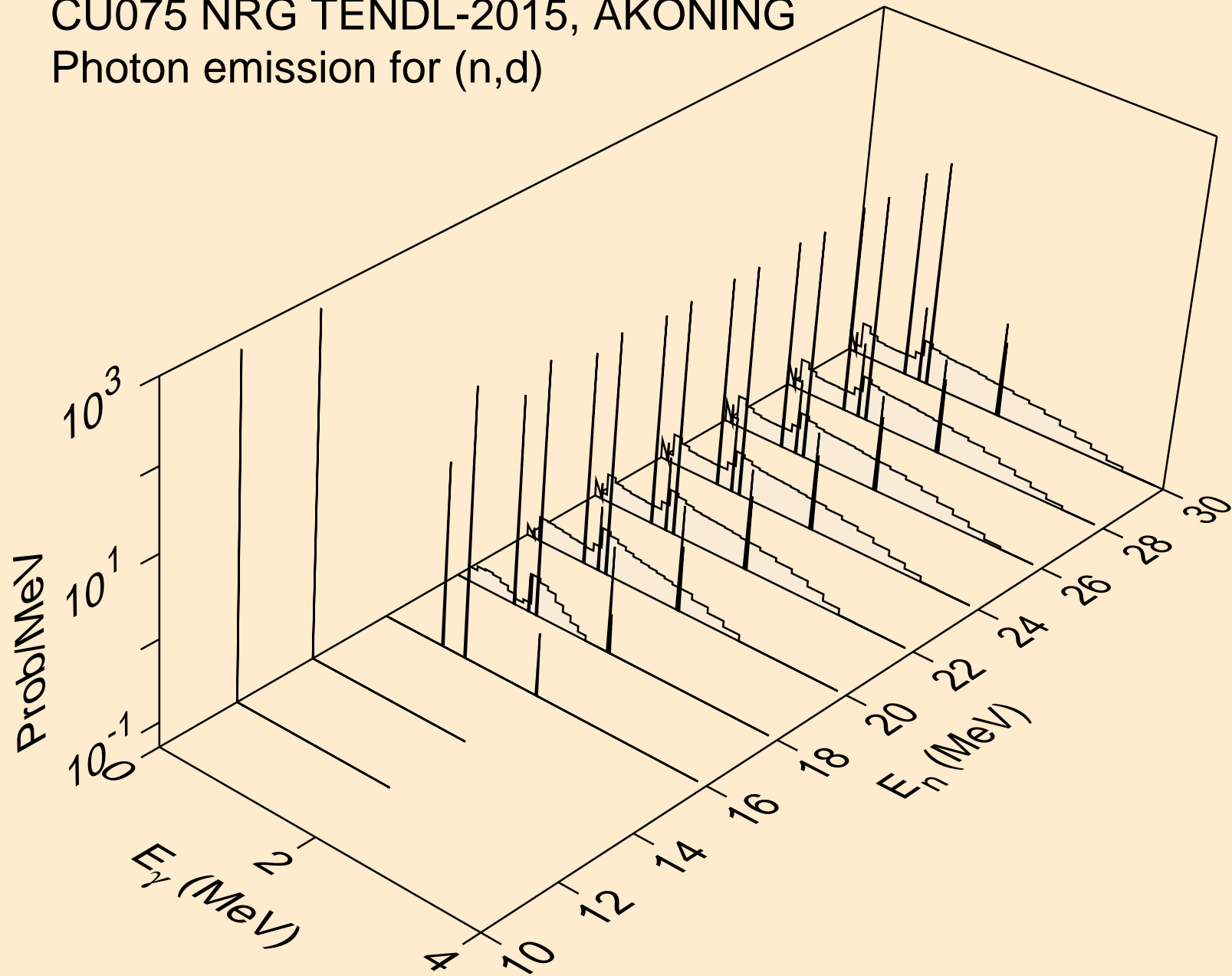

CU075 NRG TENDL-2015, AKONING
Photon emission for (n,t)

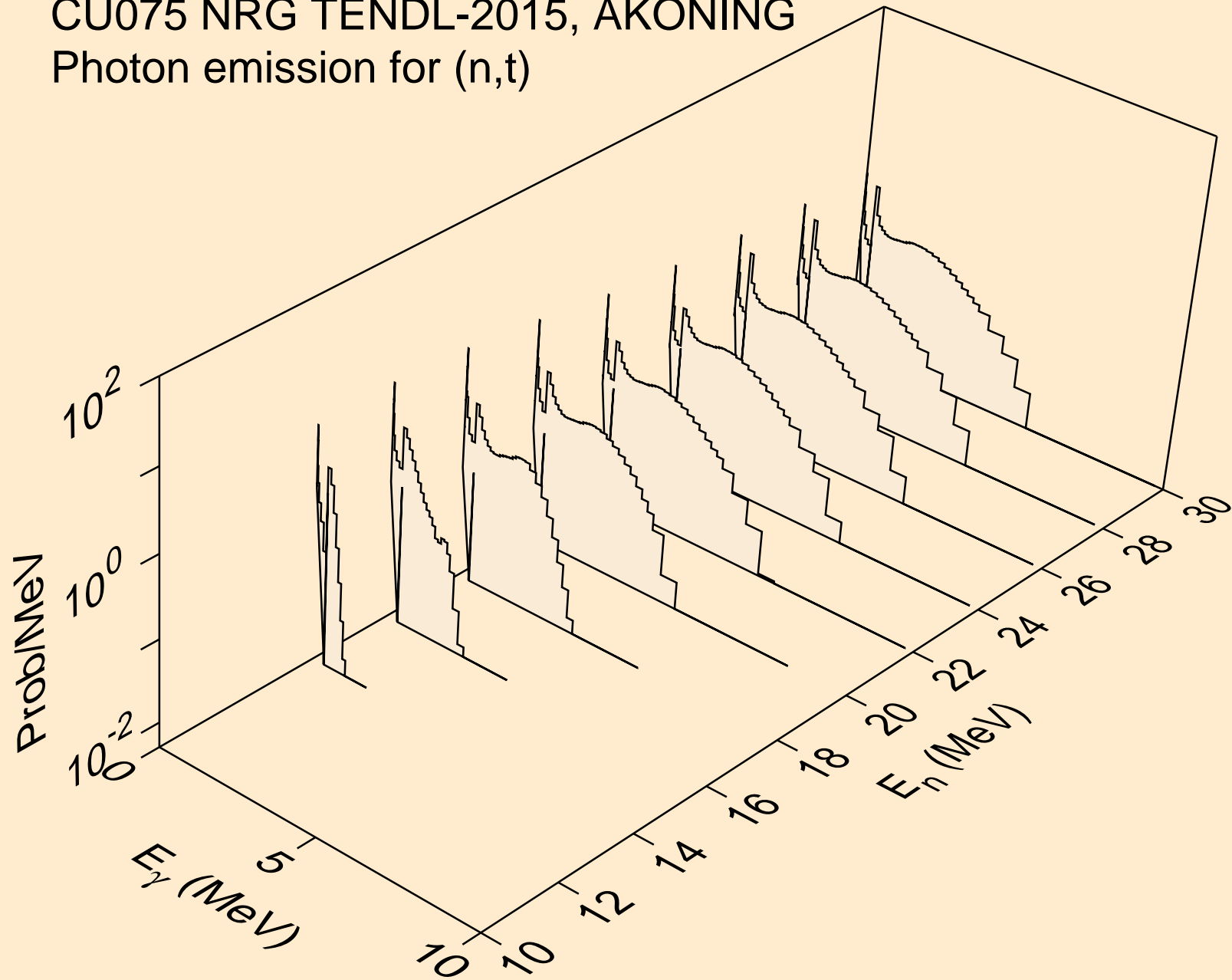

CU075 NRG TENDL-2015, AKONING
Photon emission for (n,a)

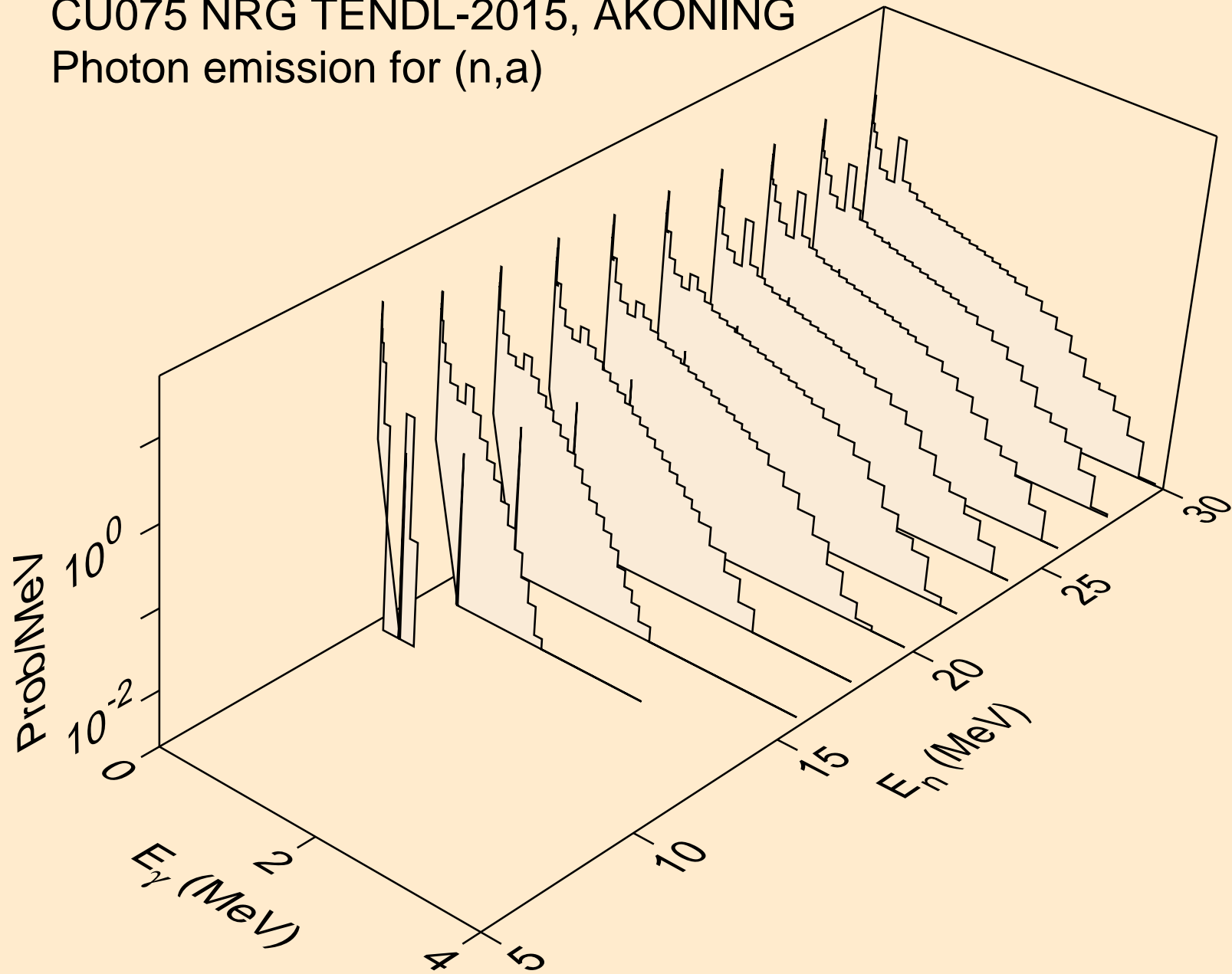

CU075 NRG TENDL-2015, AKONING
thermal capture photon spectrum

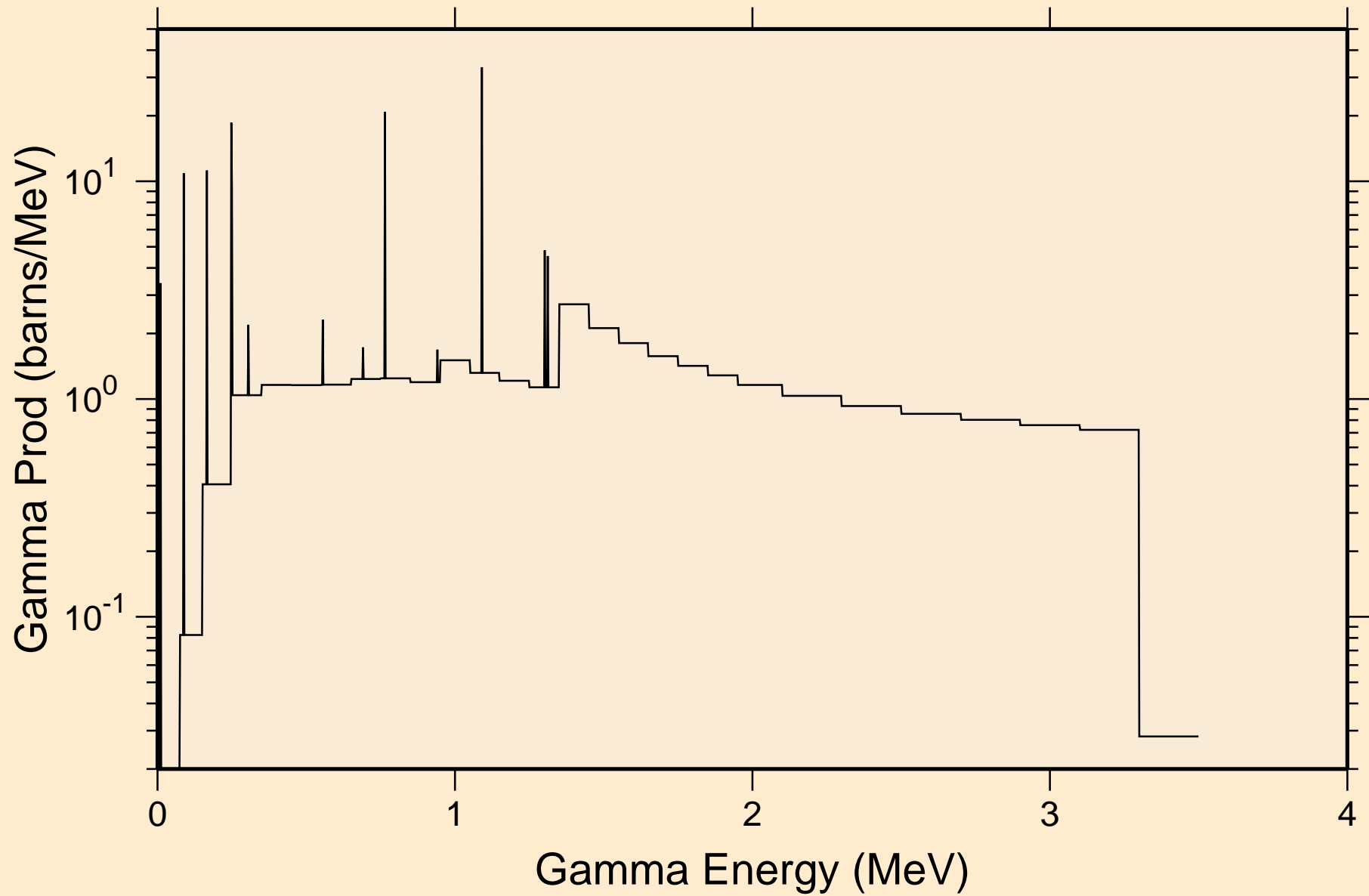

CU075 NRG TENDL-2015, AKONING
14 MeV photon spectrum

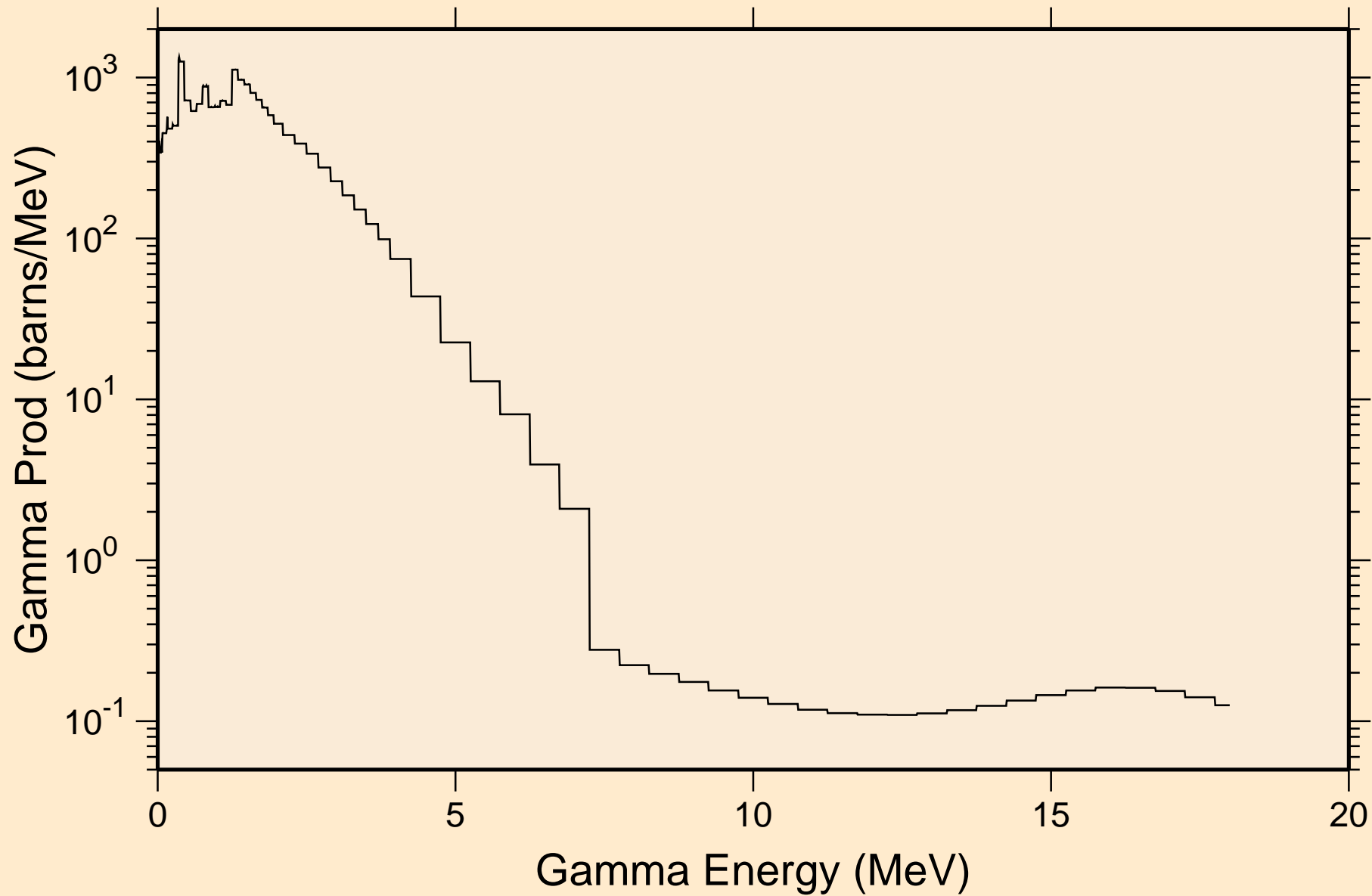

CU075 NRG TENDL-2015, AKONING

Particle heating contributions

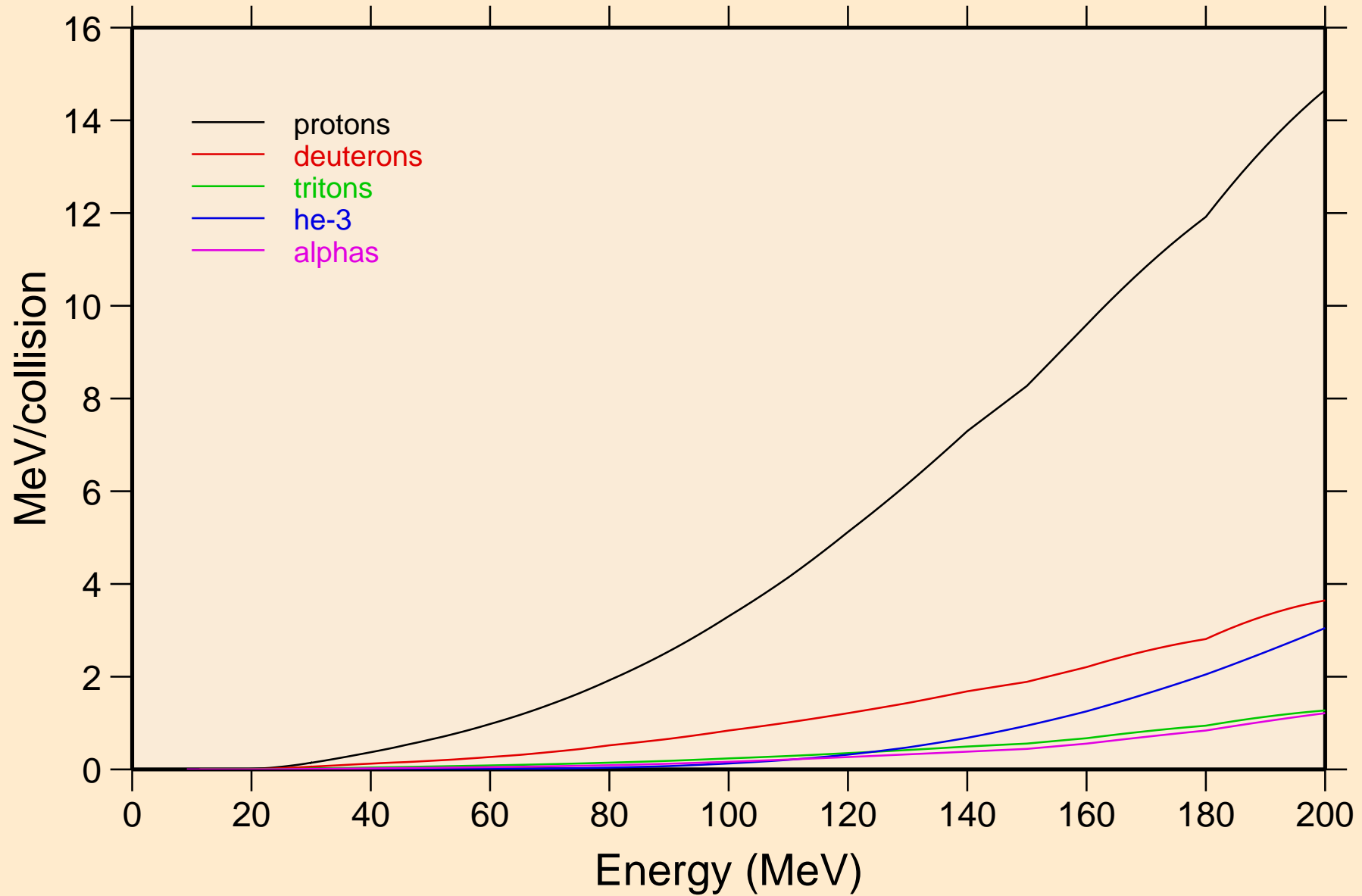

CU075 NRG TENDL-2015, AKONING

Recoil Heating

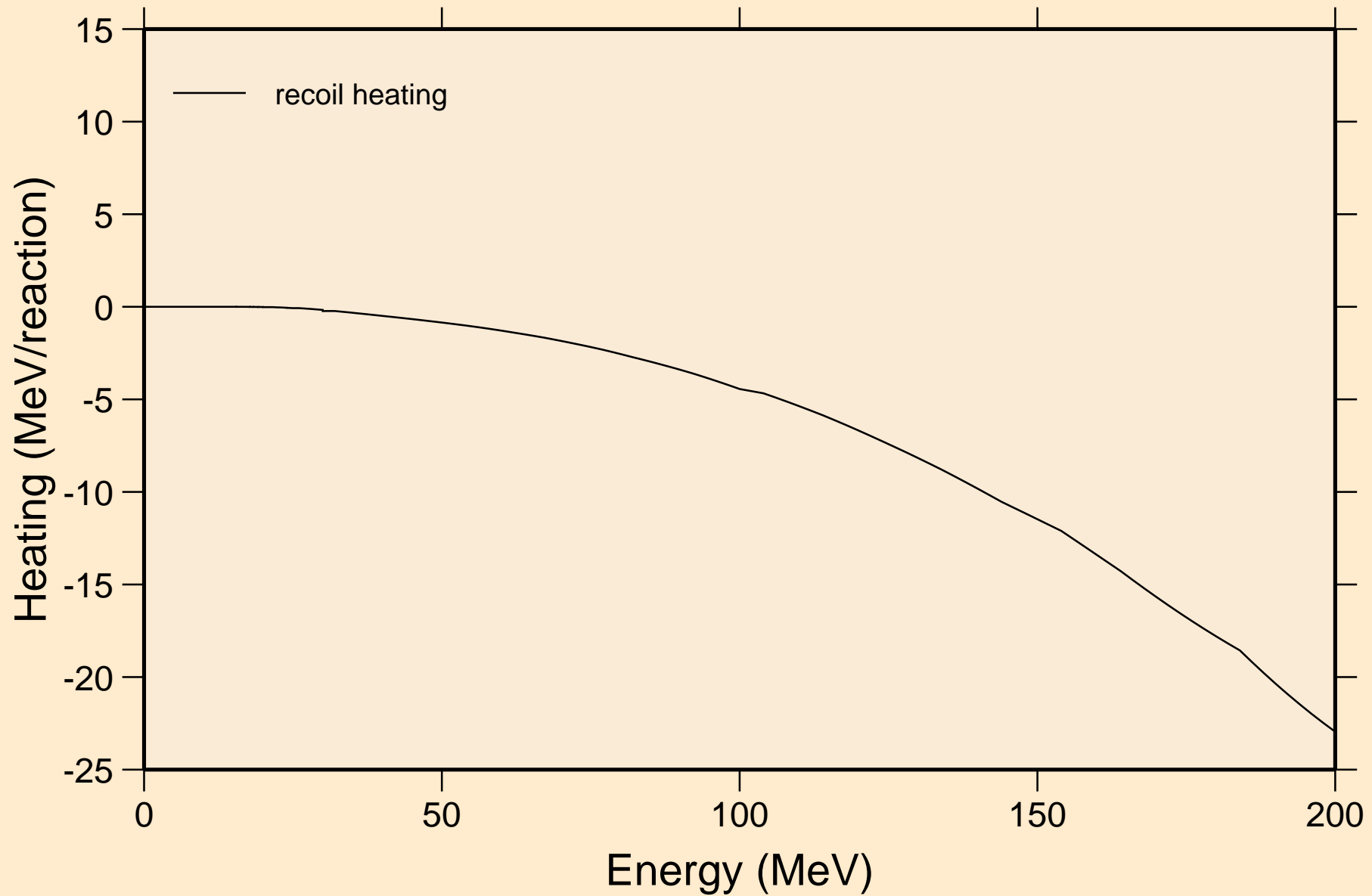

CU075 NRG TENDL-2015, AKONING

Particle production cross sections

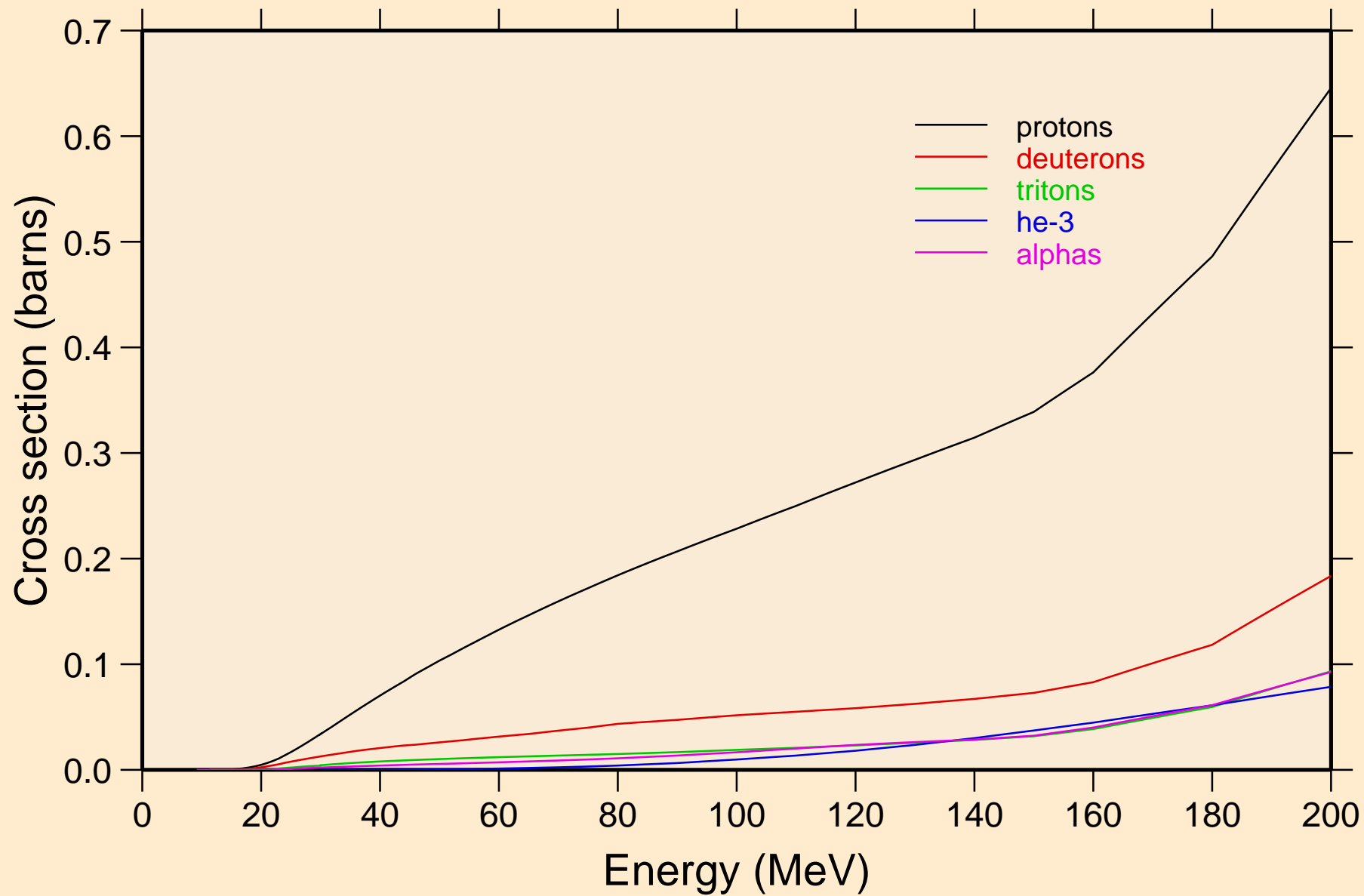

CU075 NRG TENDL-2015, AKONING
protons from (n,x)

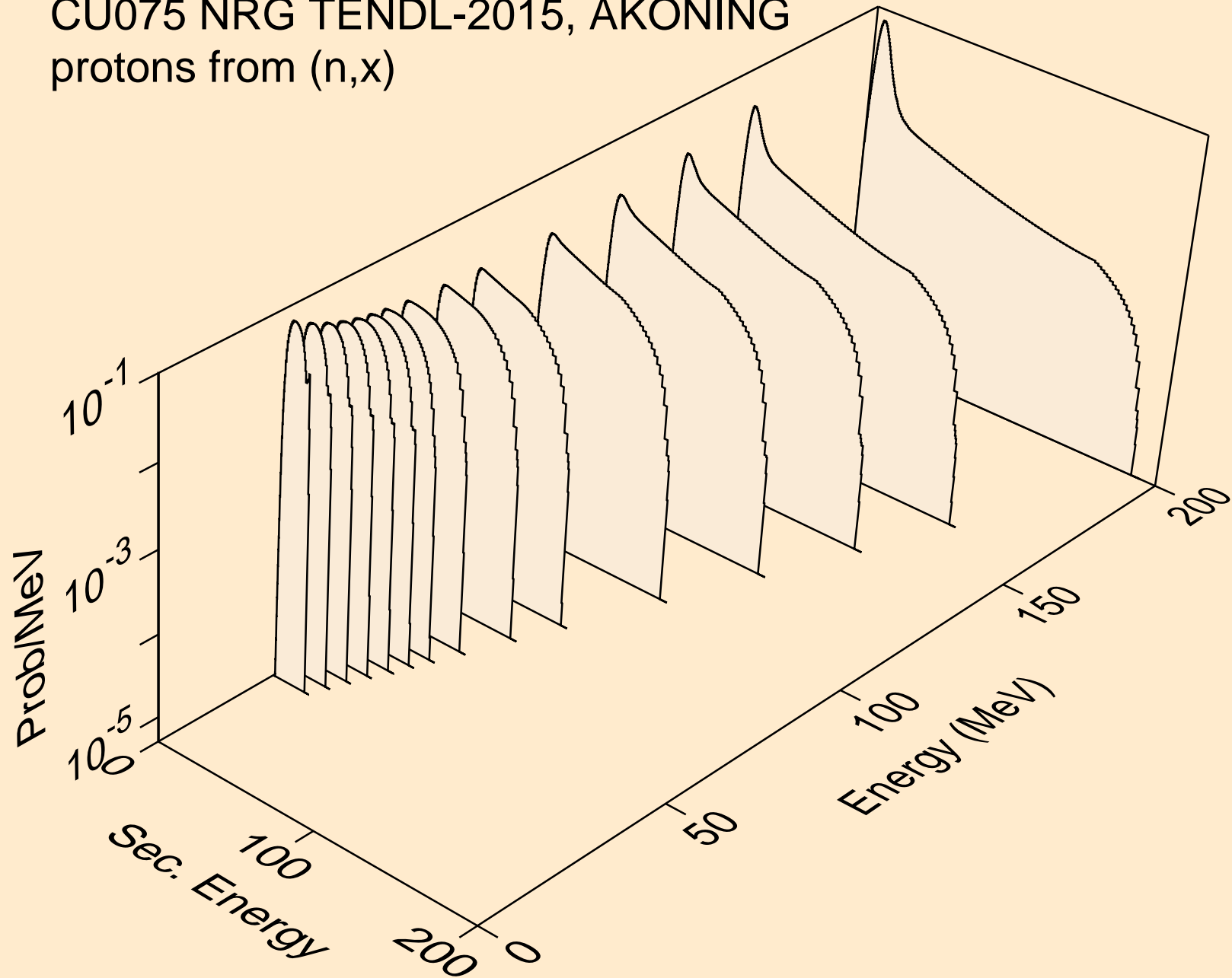

CU075 NRG TENDL-2015, AKONING
protons from (n,n*)p

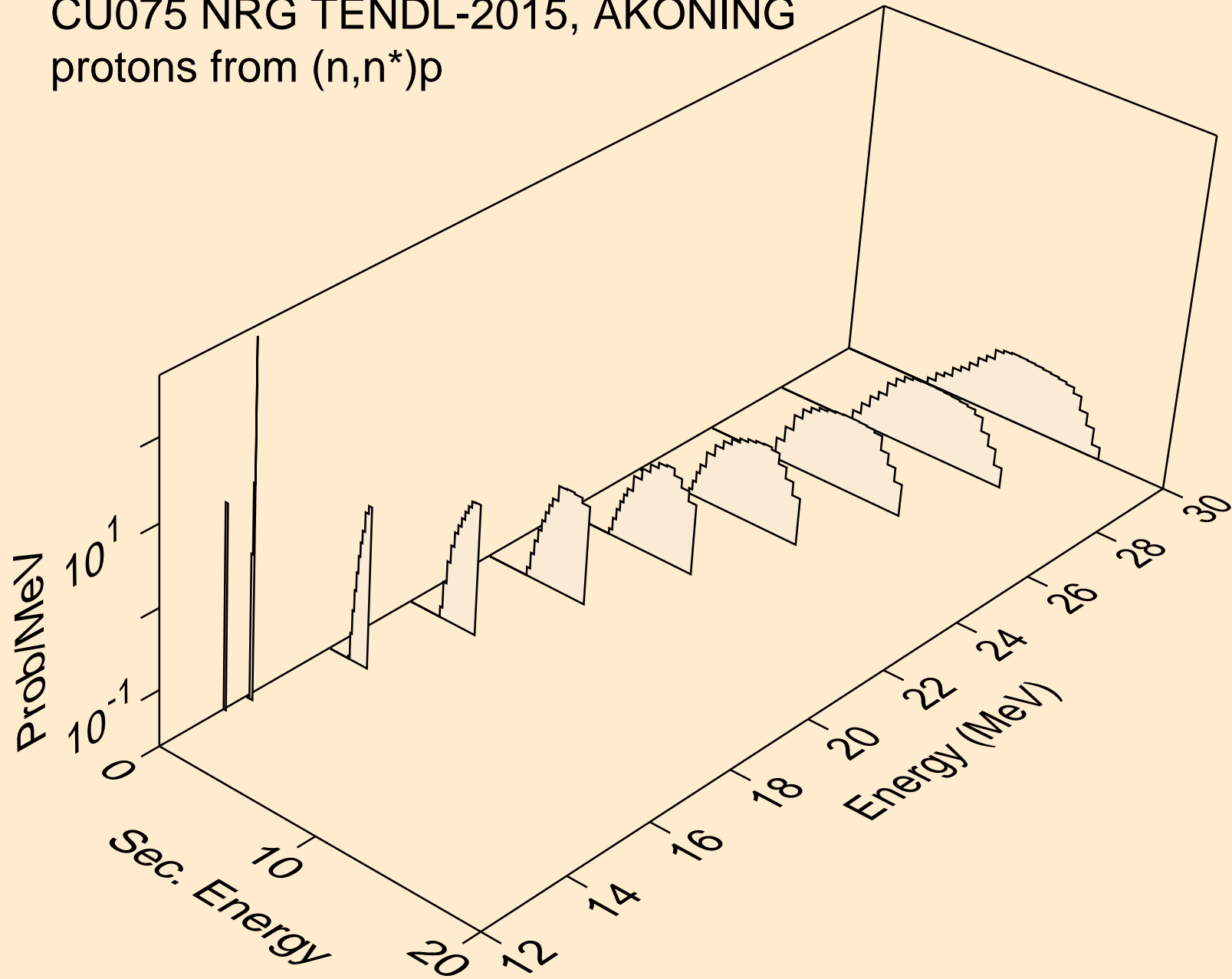

CU075 NRG TENDL-2015, AKONING
protons from (n,2np)

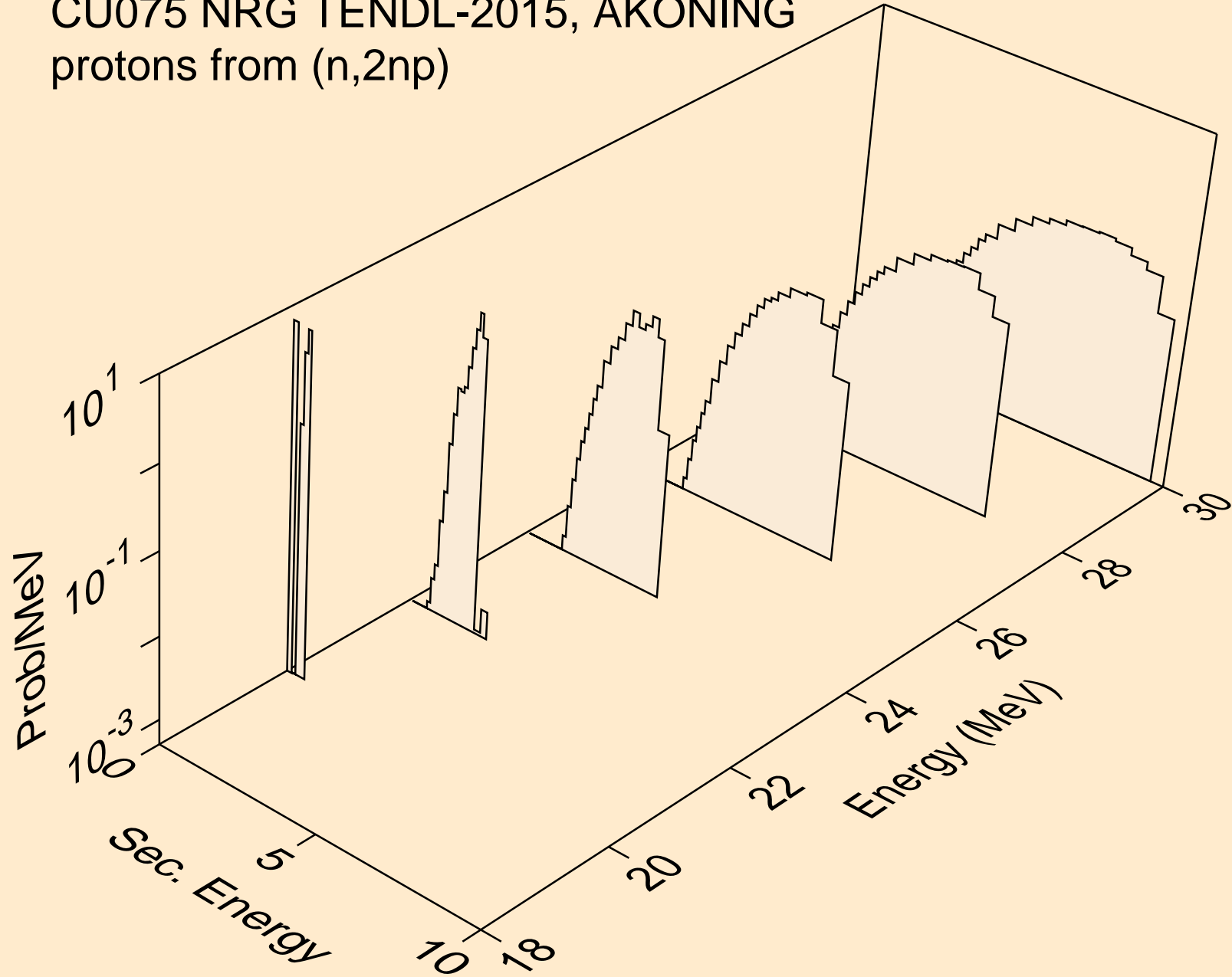

CU075 NRG TENDL-2015, AKONING
protons from (n,3np)

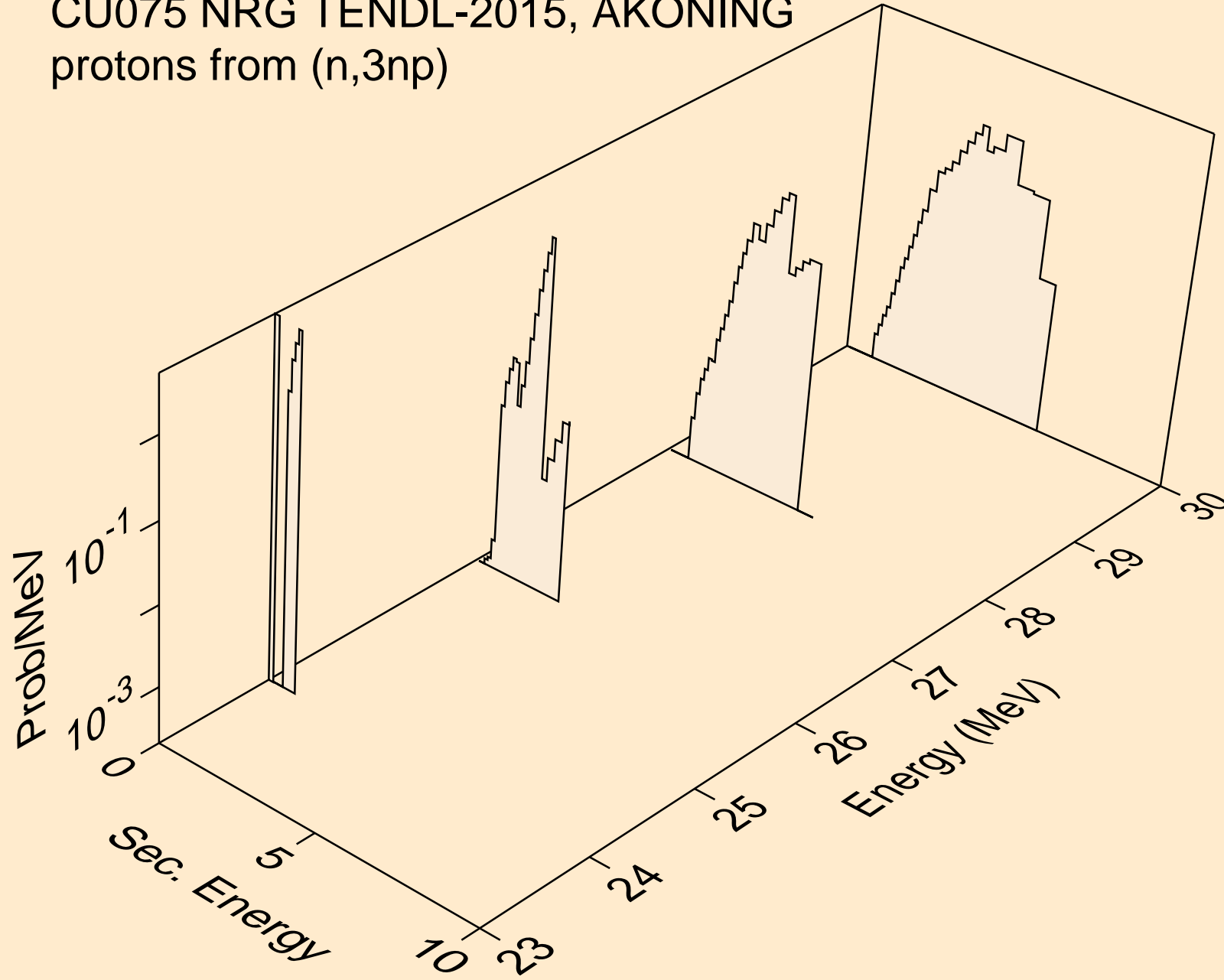

CU075 NRG TENDL-2015, AKONING
protons from (n,p)

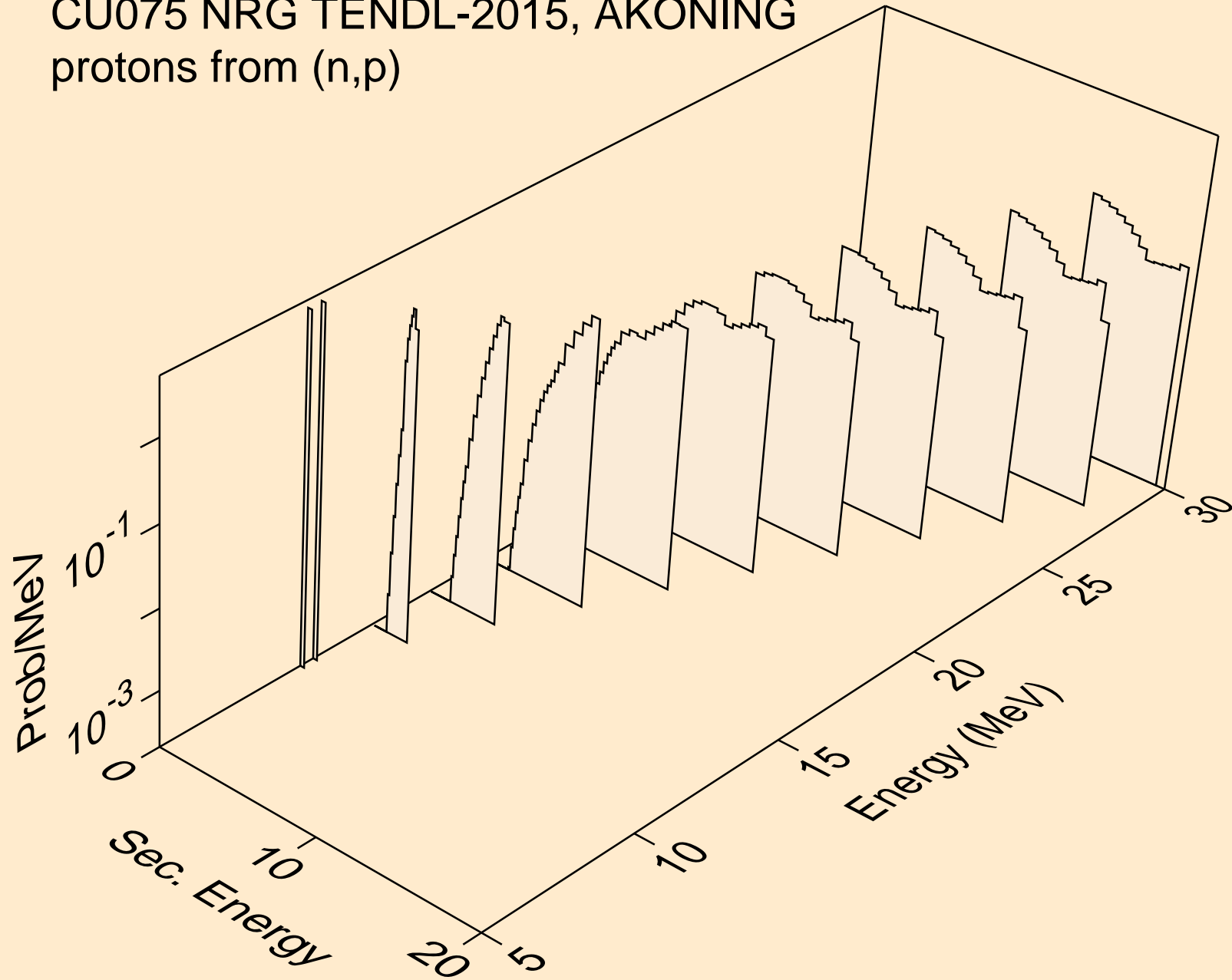

CU075 NRG TENDL-2015, AKONING
deuterons from (n,x)

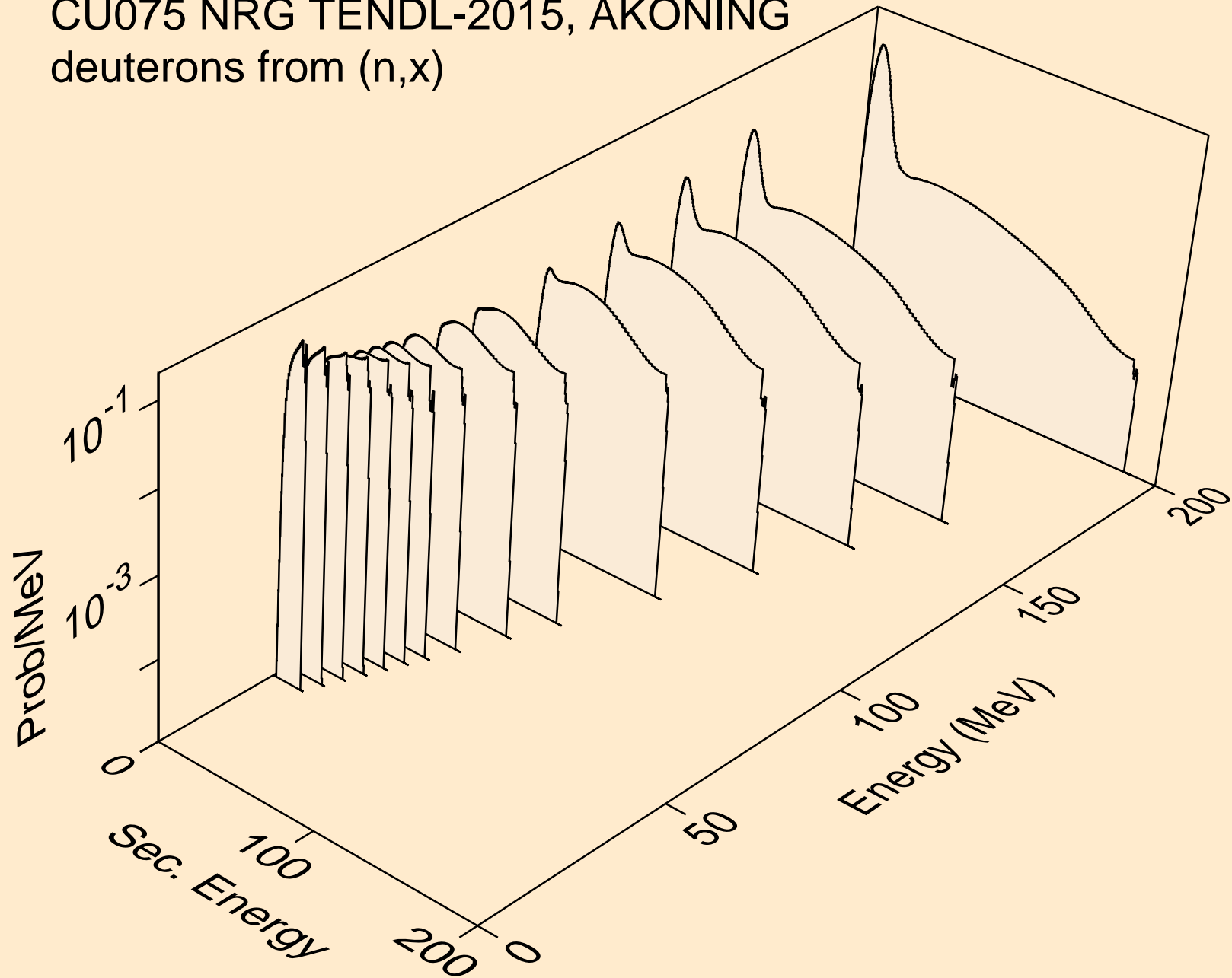

CU075 NRG TENDL-2015, AKONING
deuterons from (n,2nd)

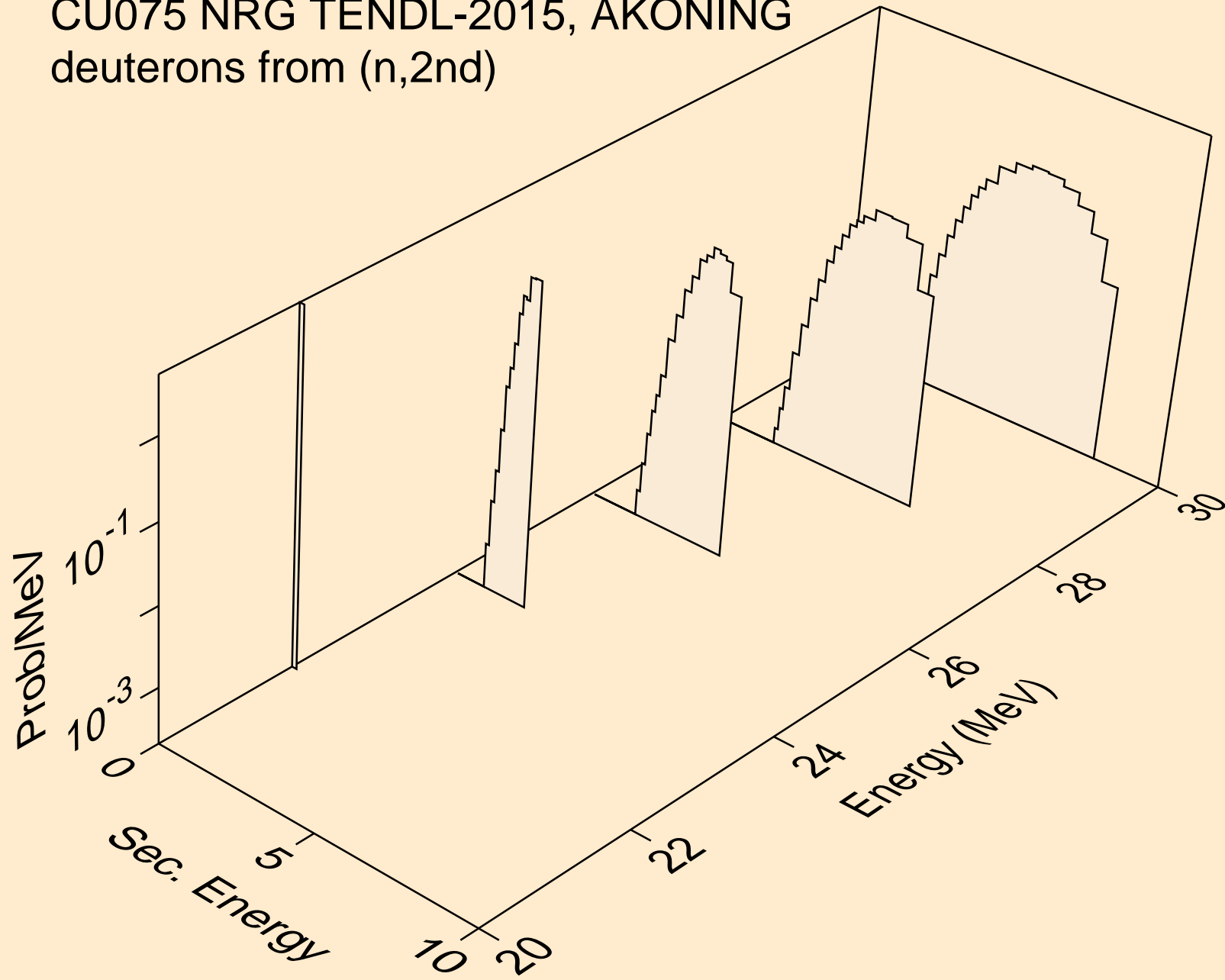

CU075 NRG TENDL-2015, AKONING
deuterons from (n,n*)d

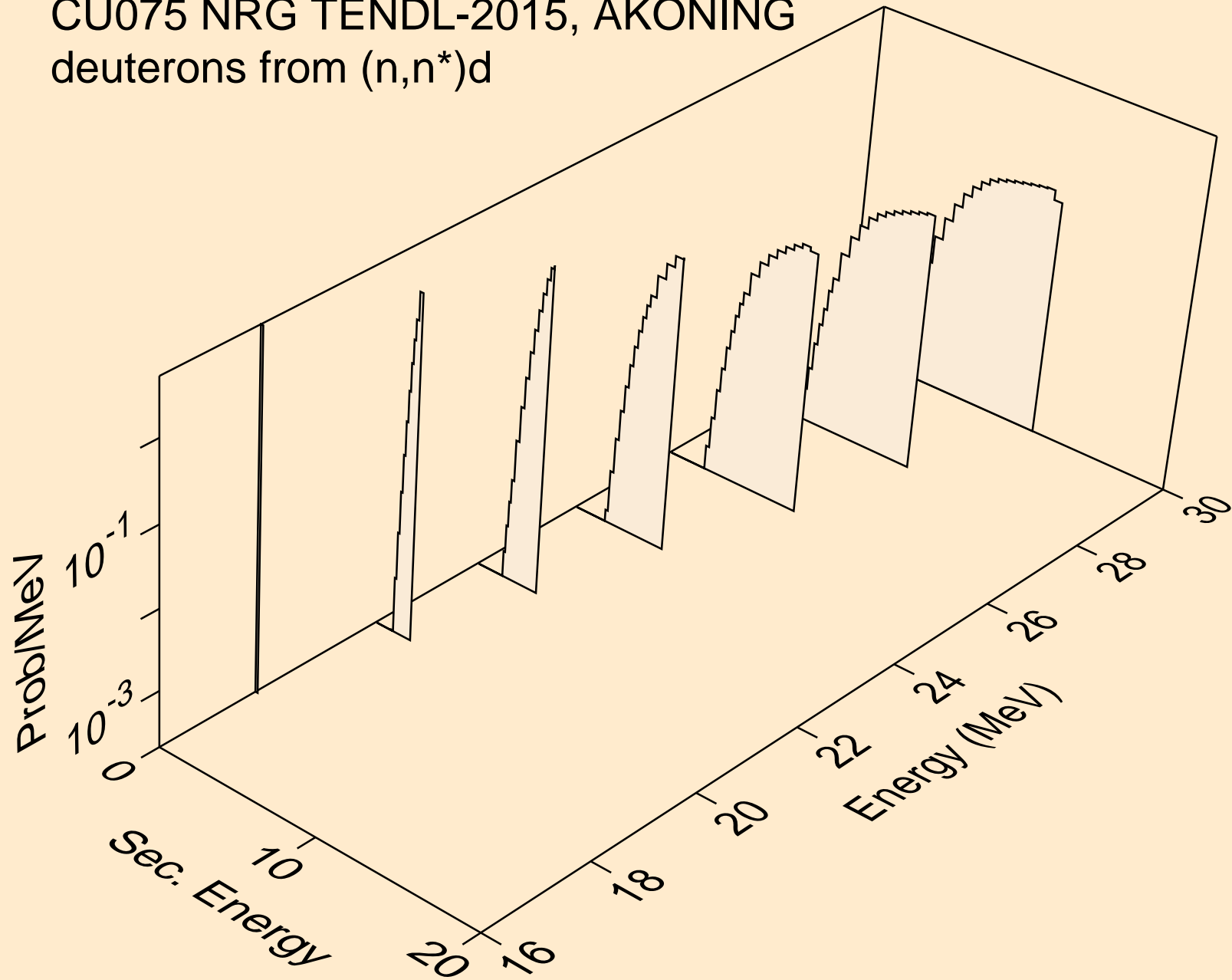

CU075 NRG TENDL-2015, AKONING
deuterons from (n,d)

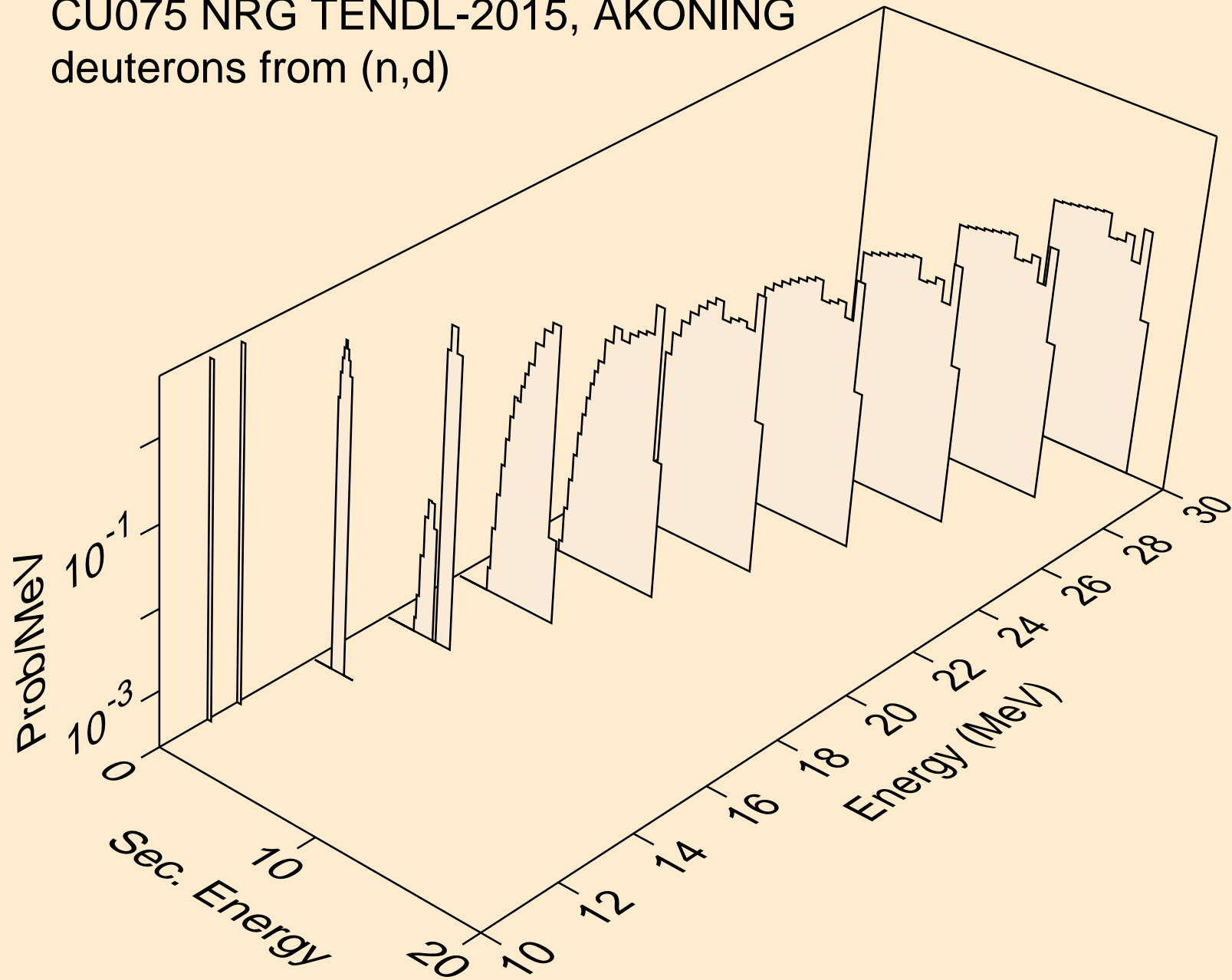

CU075 NRG TENDL-2015, AKONING
tritons from (n,x)

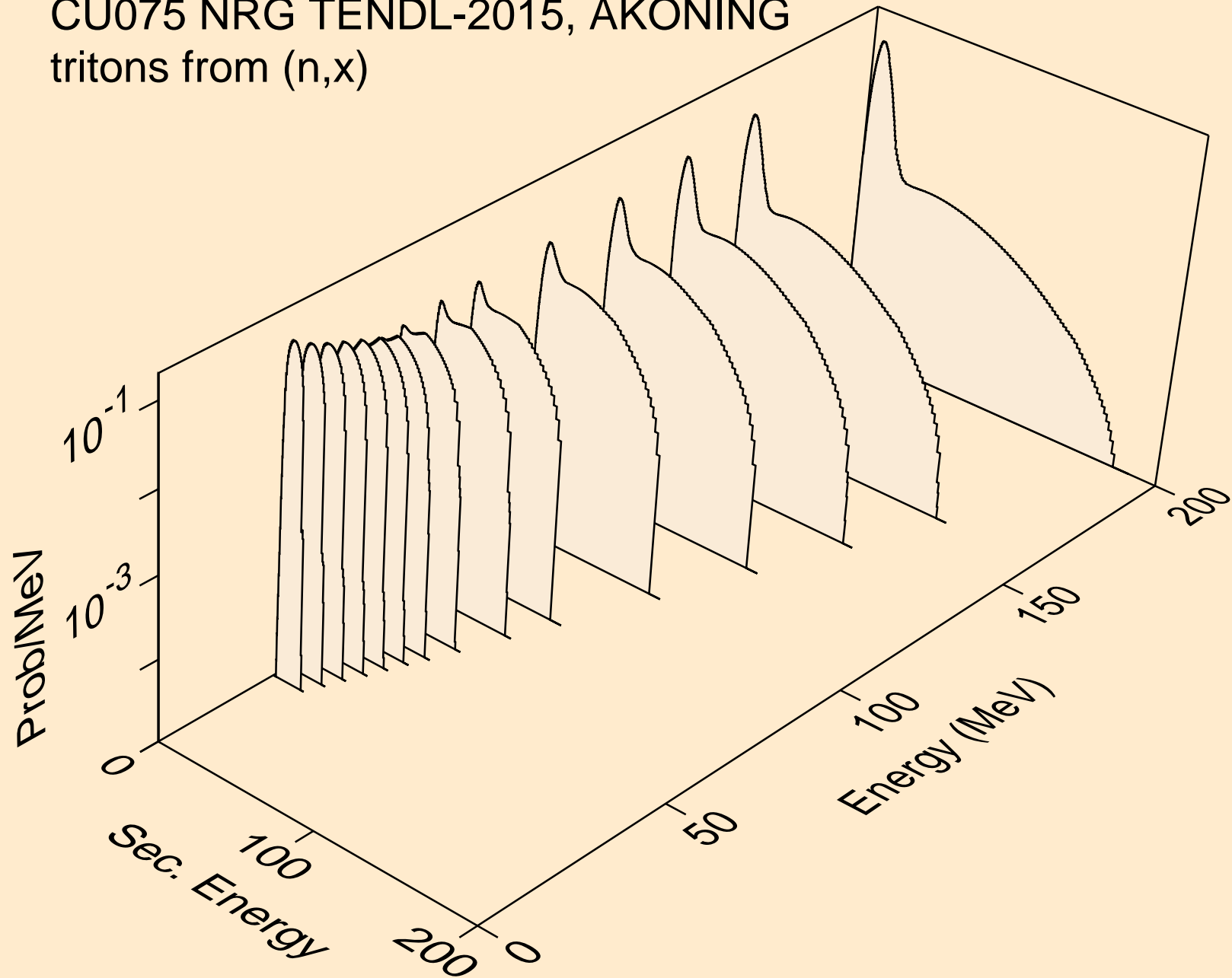

CU075 NRG TENDL-2015, AKONING
tritons from (n,n*)t

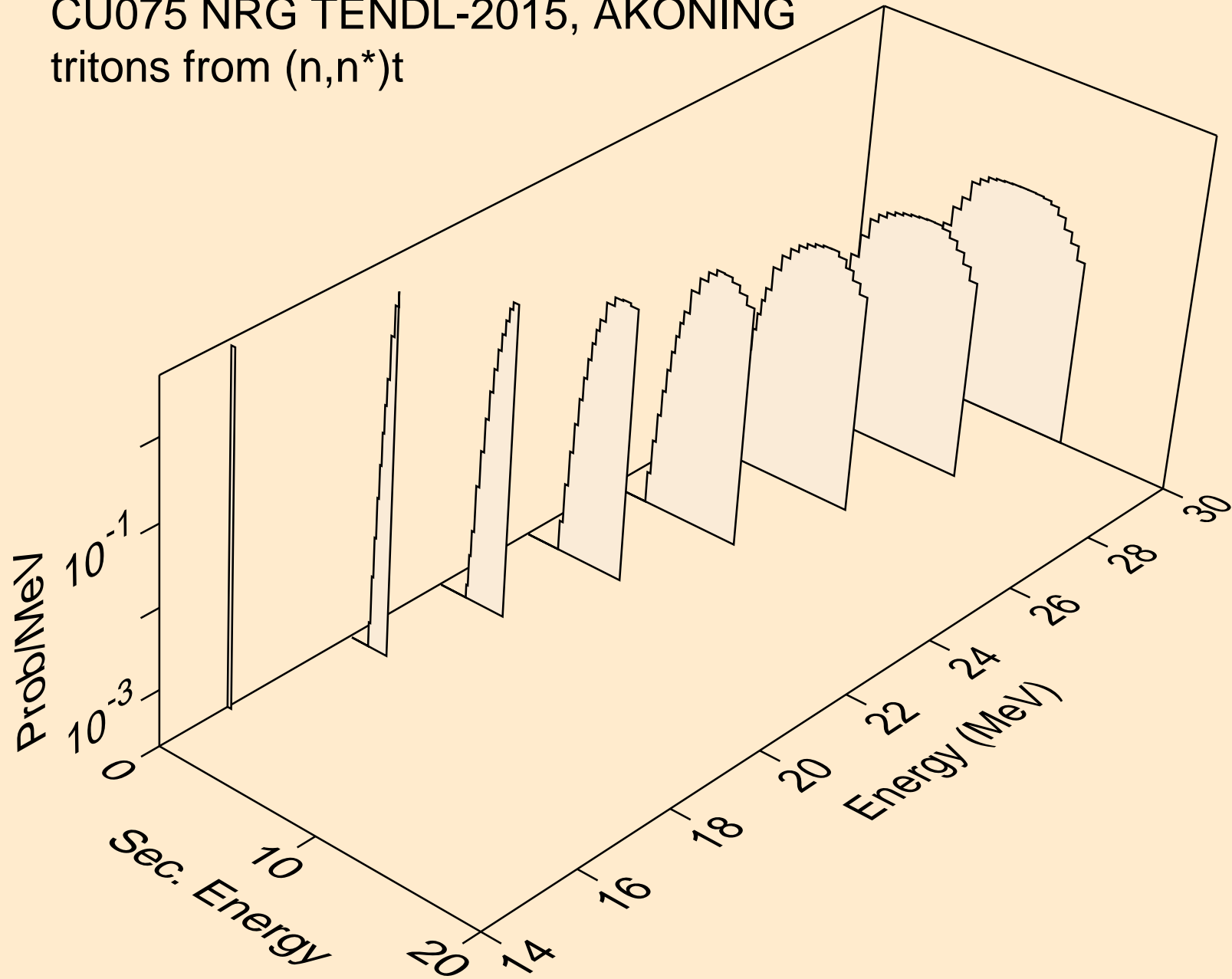

CU075 NRG TENDL-2015, AKONING
tritons from (n,t)

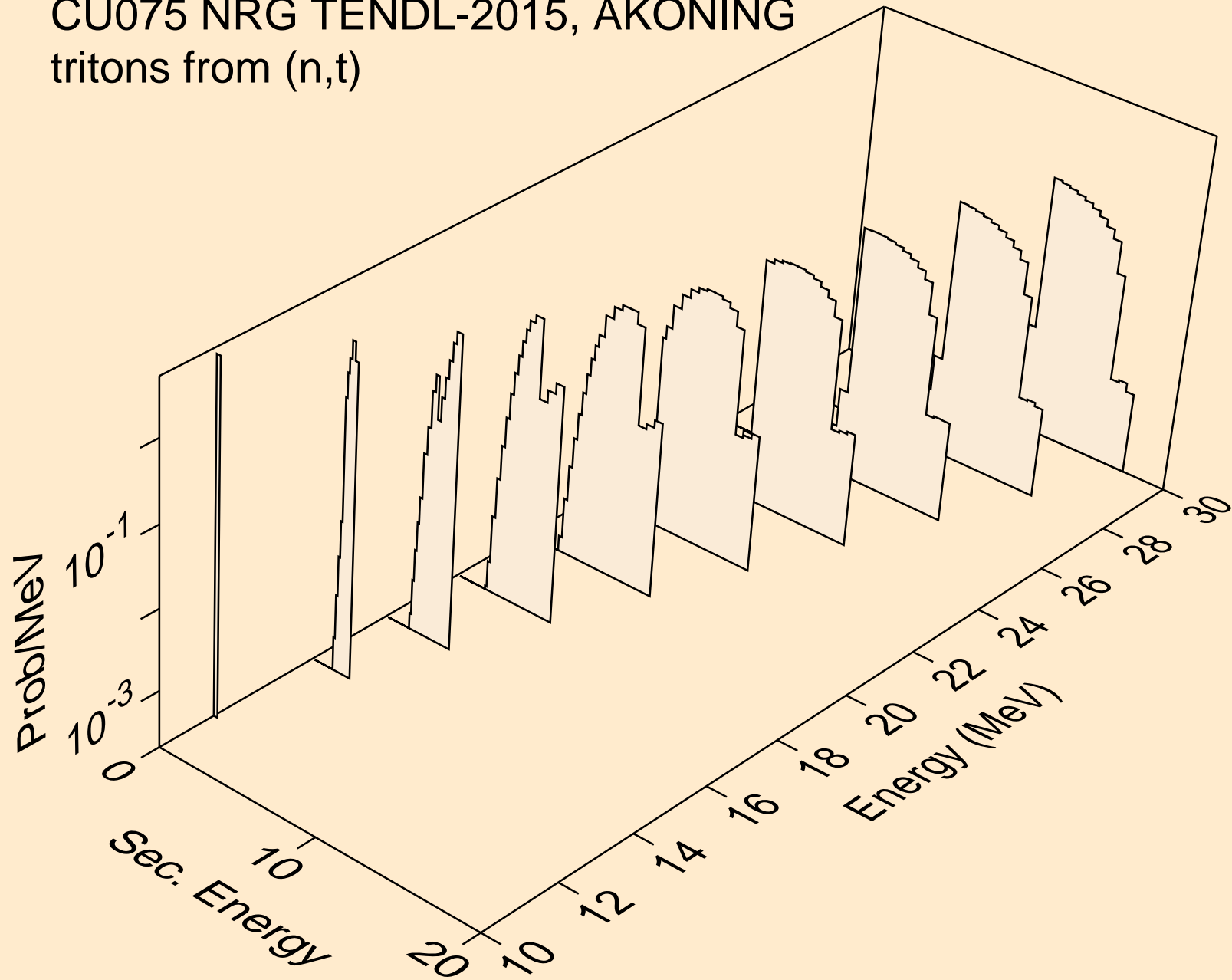

CU075 NRG TENDL-2015, AKONING
he3s from (n,x)

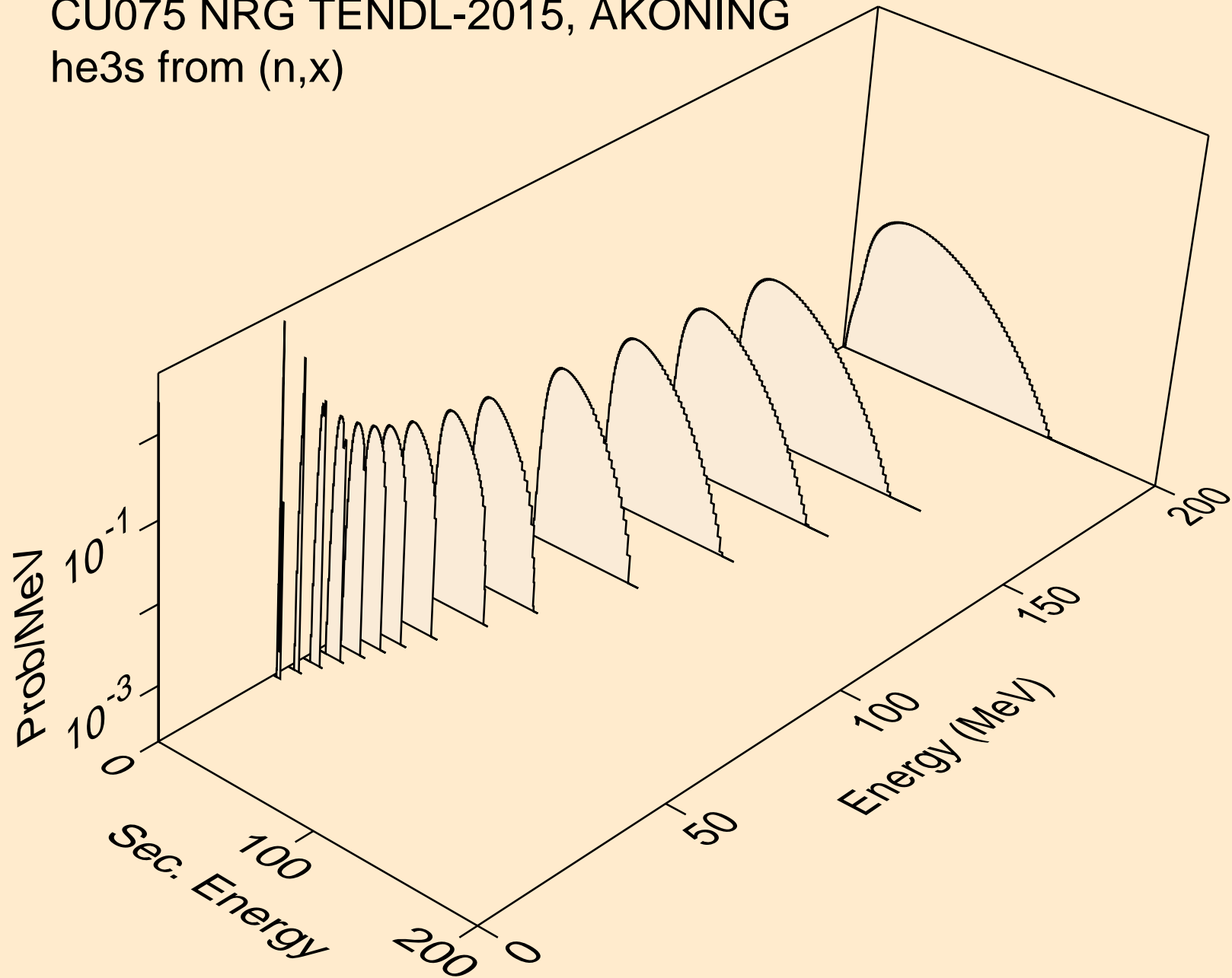

CU075 NRG TENDL-2015, AKONING
alphas from (n,x)

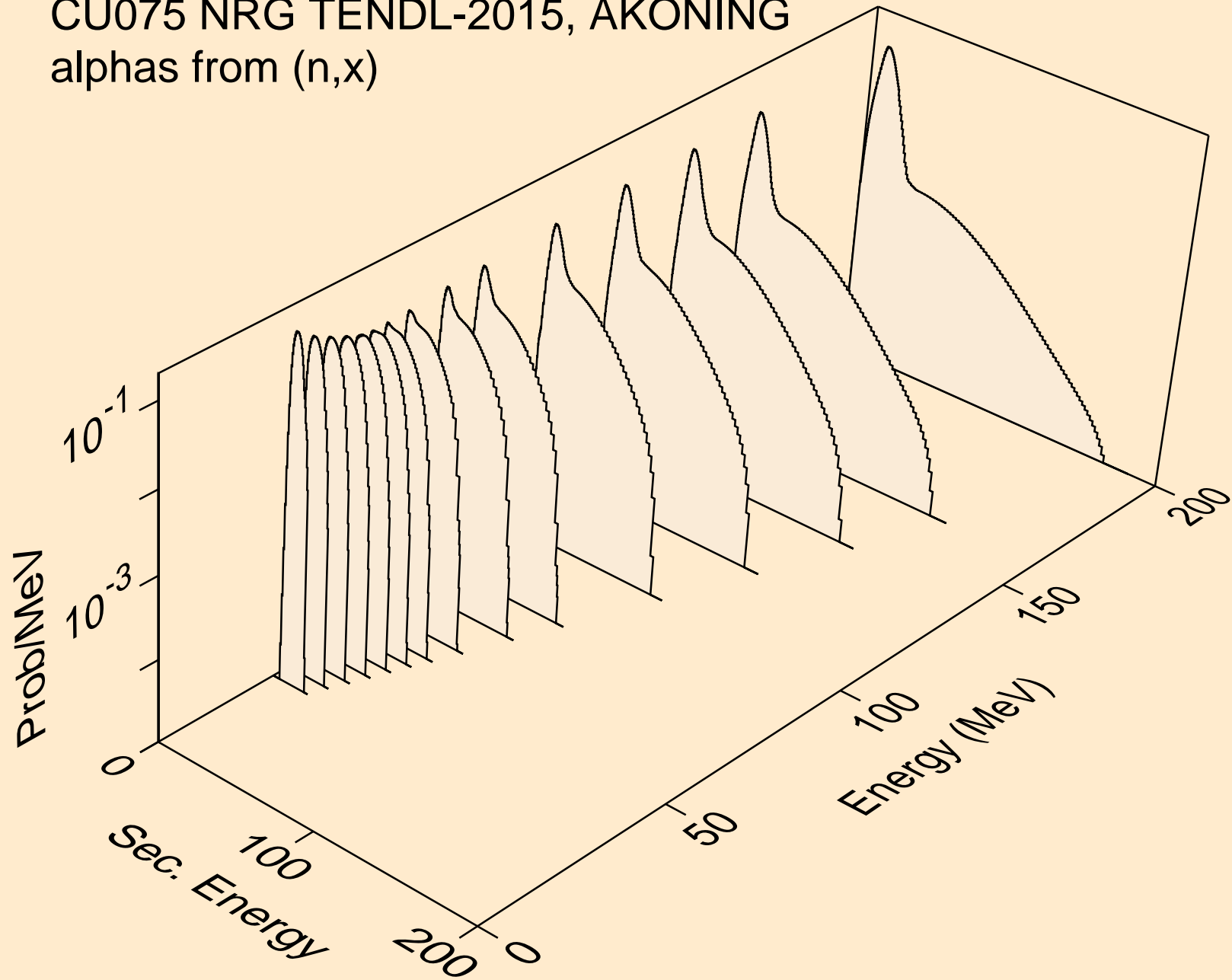

CU075 NRG TENDL-2015, AKONING
alphas from (n,n*)a

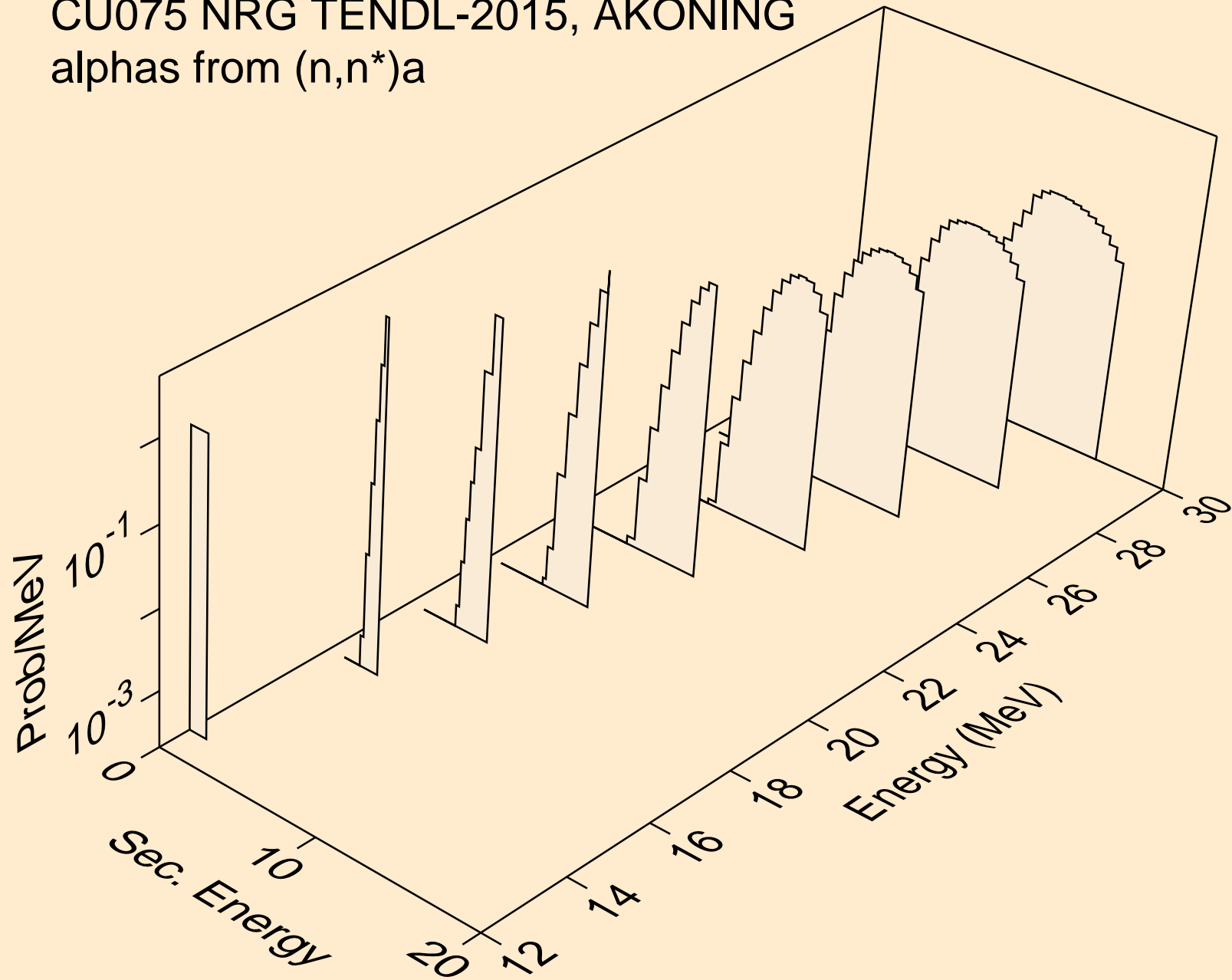

CU075 NRG TENDL-2015, AKONING
alphas from (n,2n)a

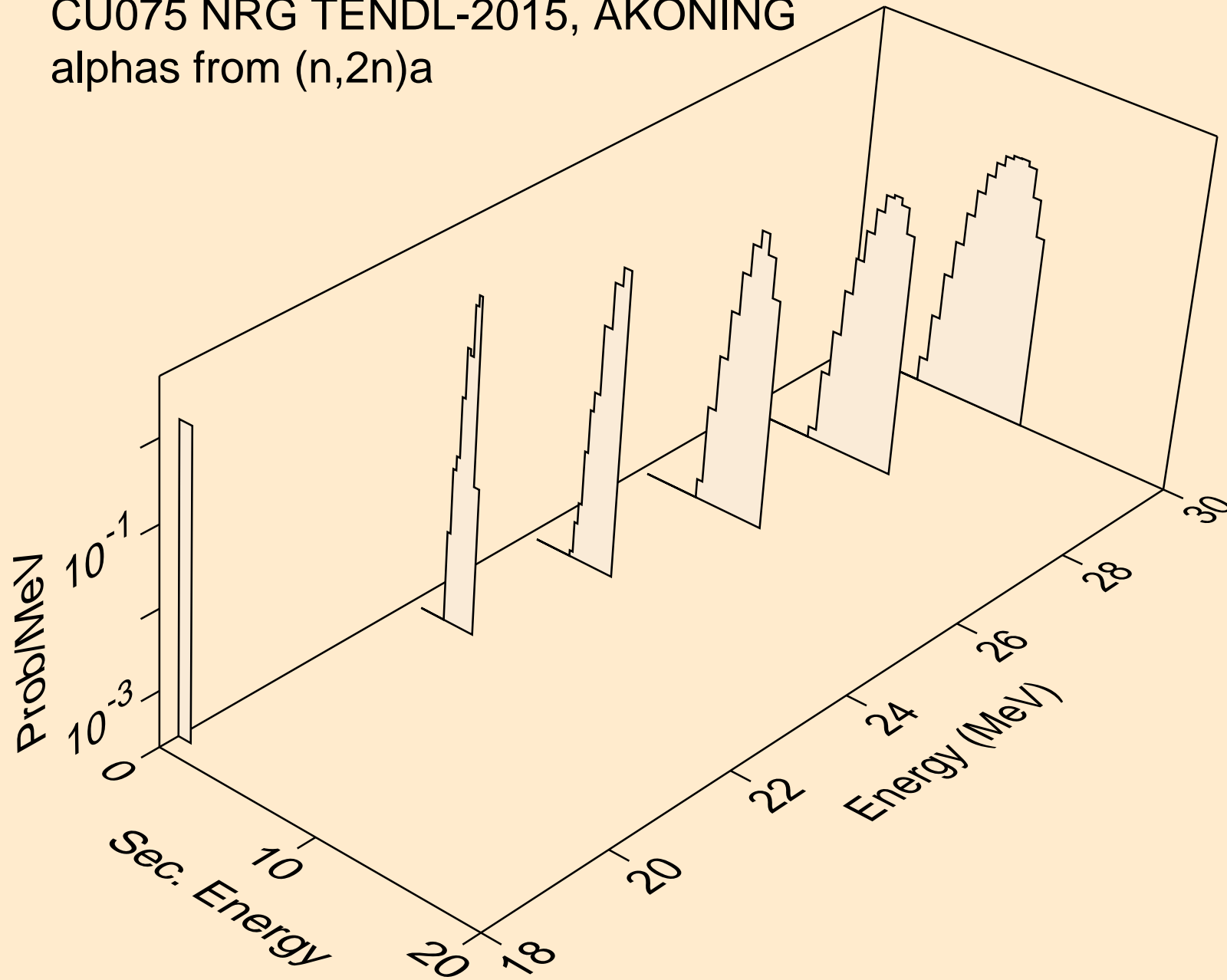

CU075 NRG TENDL-2015, AKONING
alphas from (n,3n)a

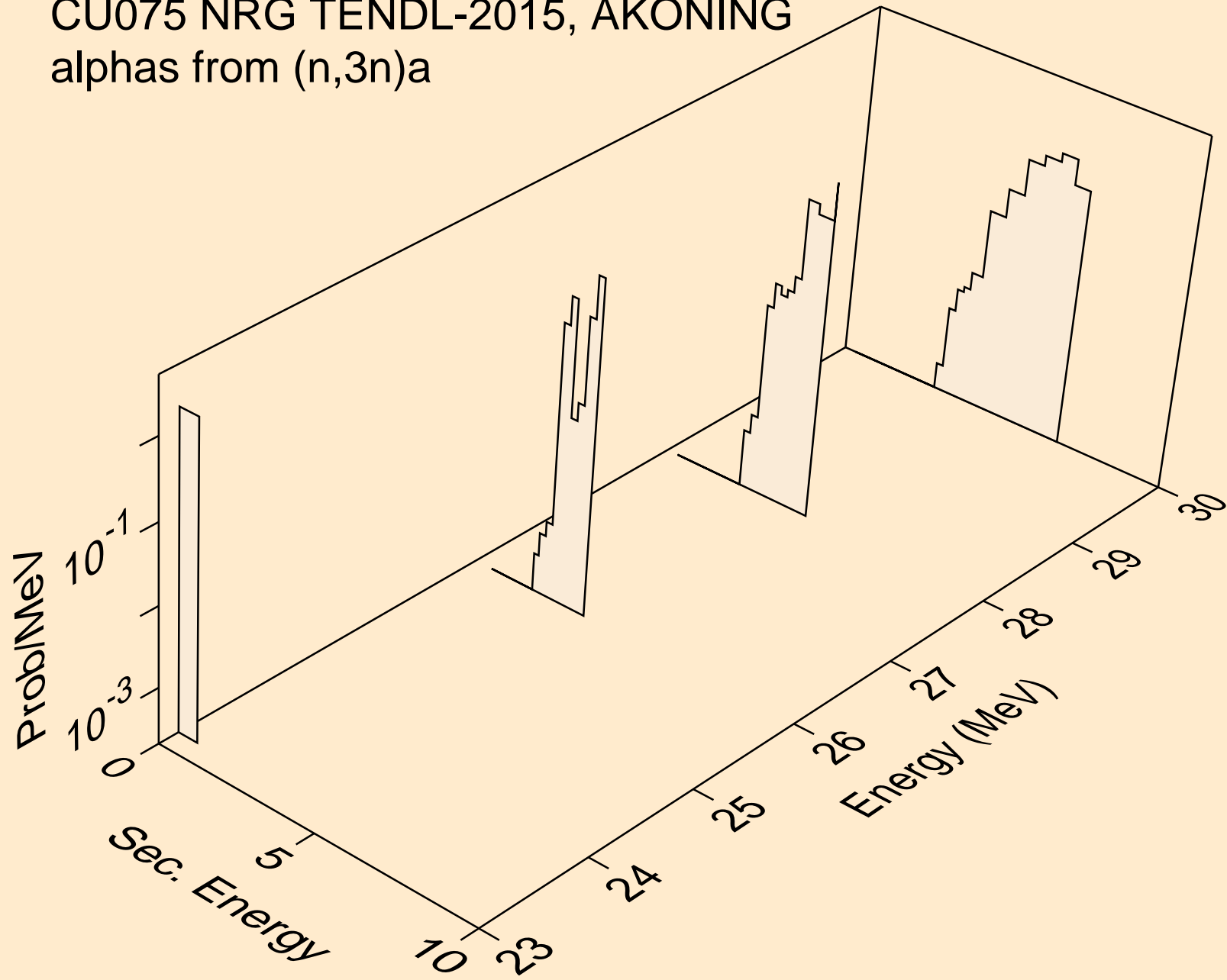

CU075 NRG TENDL-2015, AKONING
alphas from (n,a)

