

DB262 NRG TENDL-2015, AKONING

Principal cross sections

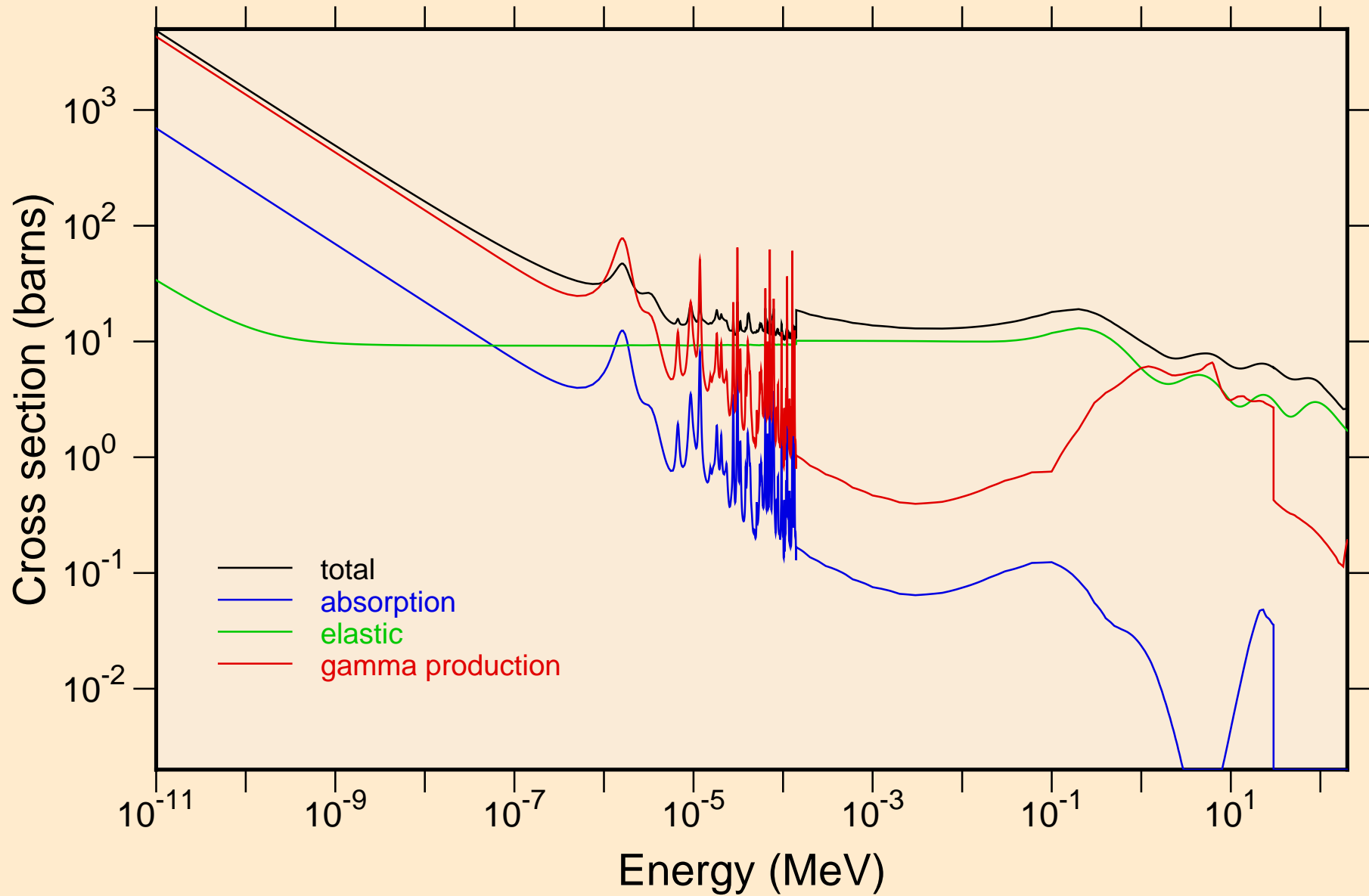

DB262 NRG TENDL-2015, AKONING
resonance total cross section

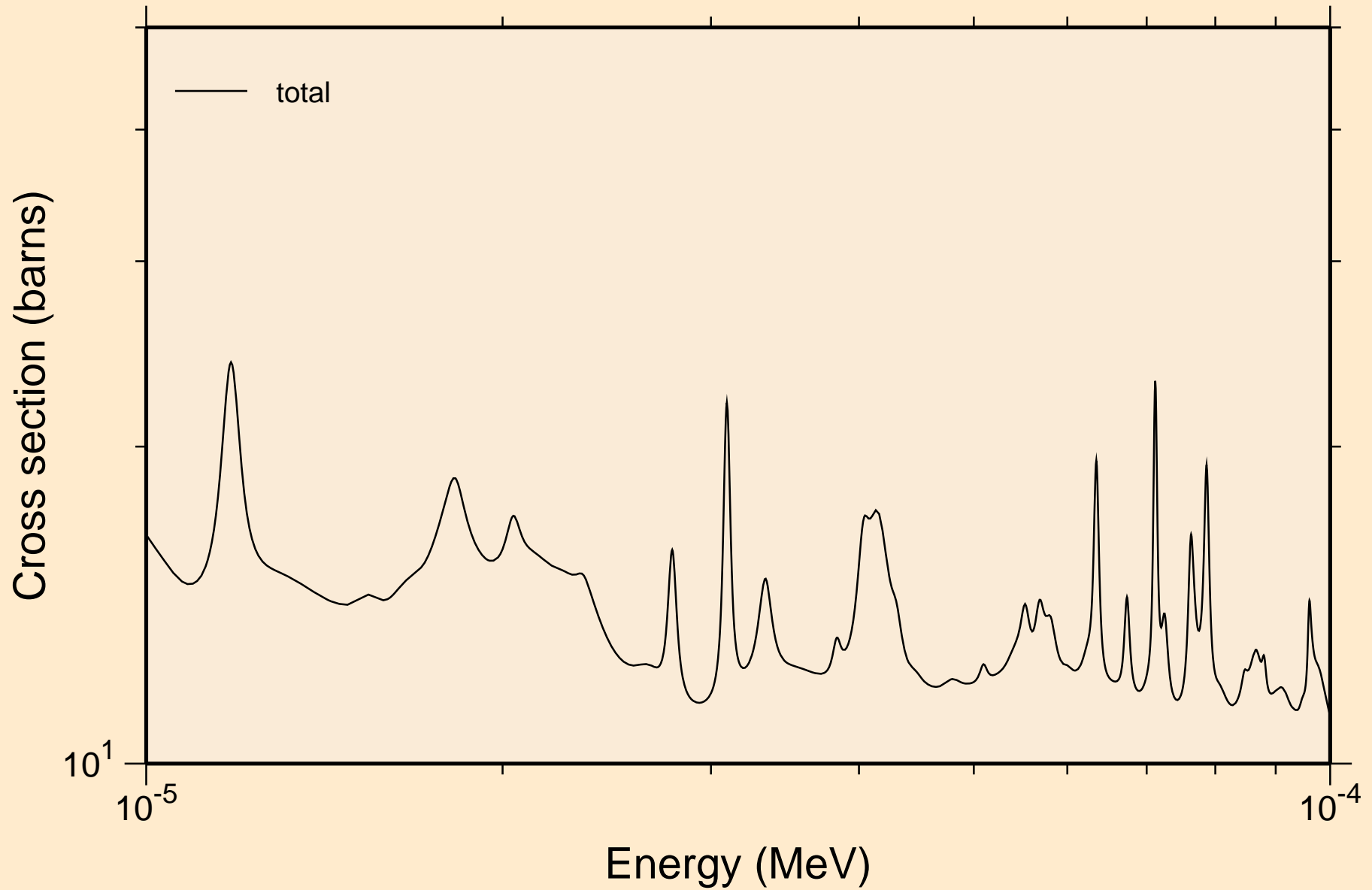

DB262 NRG TENDL-2015, AKONING
resonance total cross section

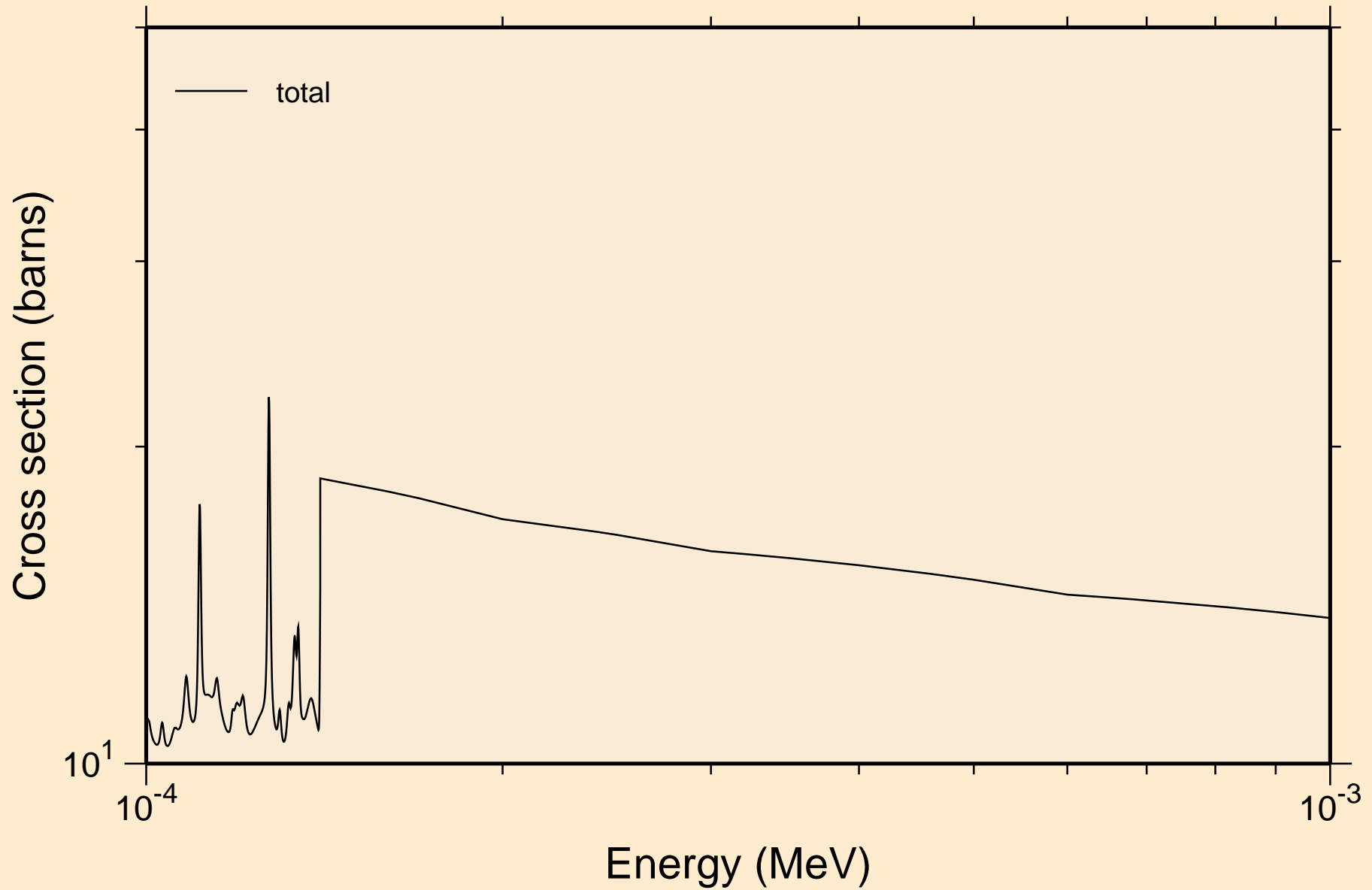

DB262 NRG TENDL-2015, AKONING
resonance total cross section

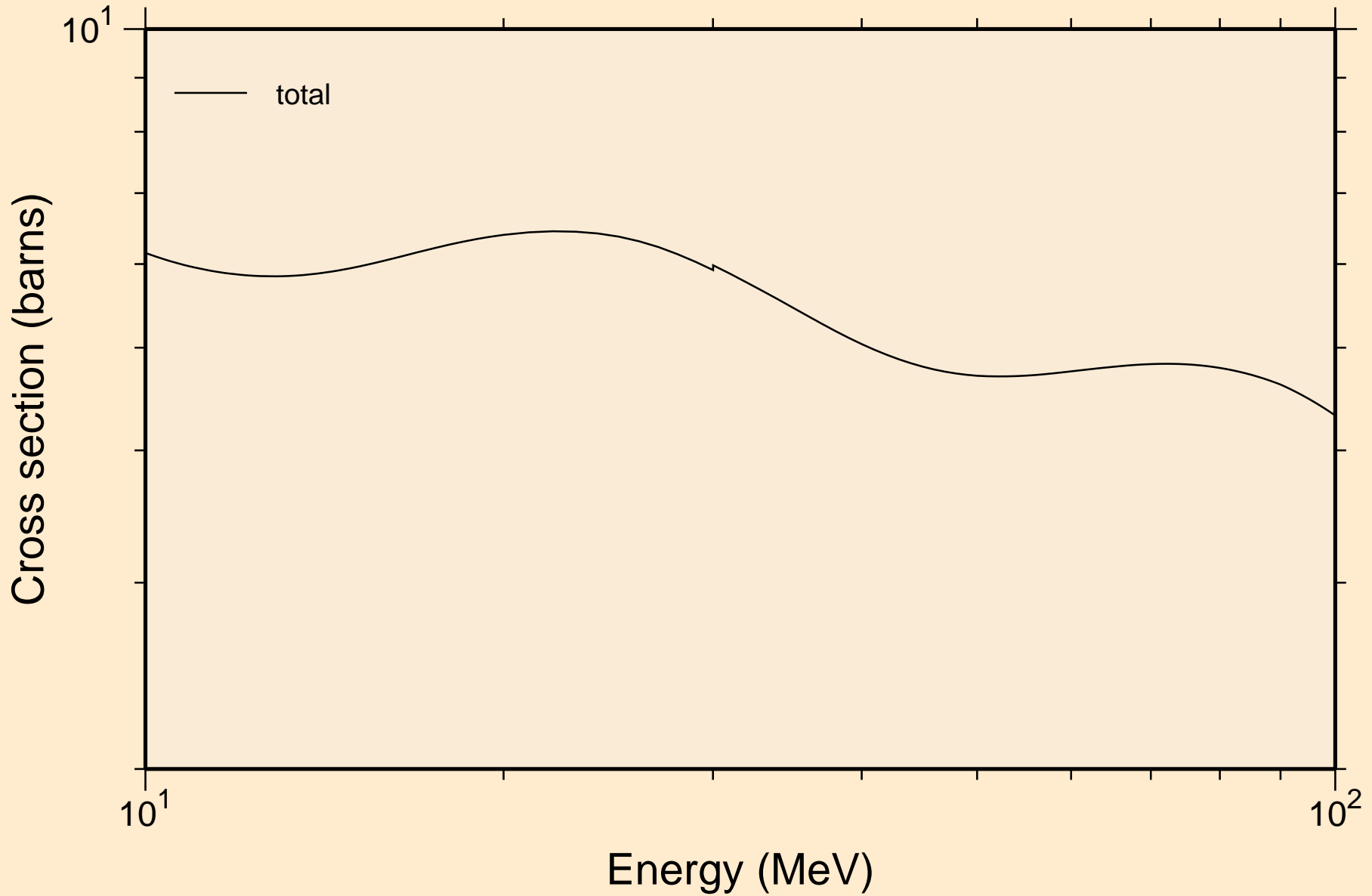

DB262 NRG TENDL-2015, AKONING
resonance absorption cross sections

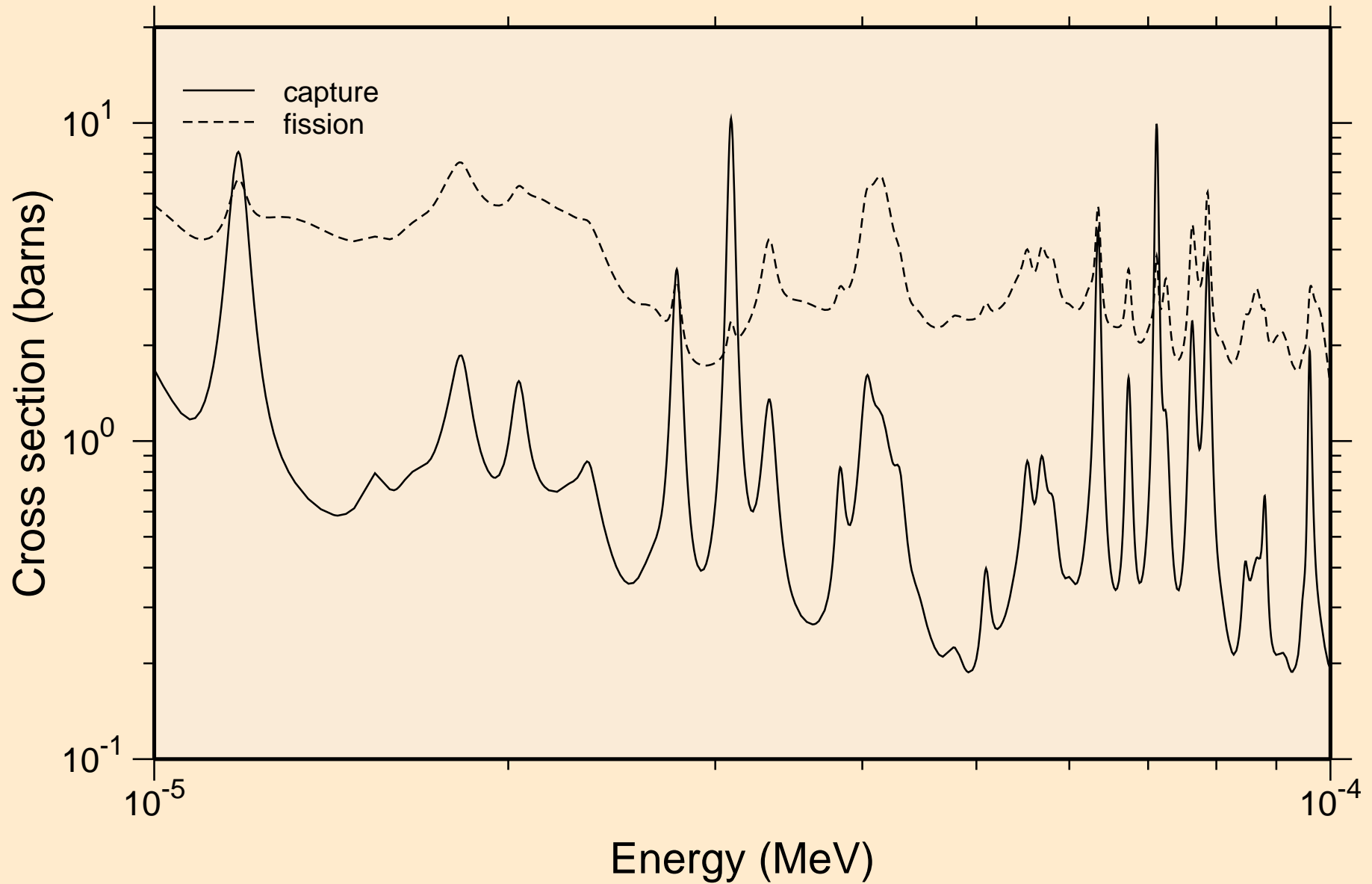

DB262 NRG TENDL-2015, AKONING
resonance absorption cross sections

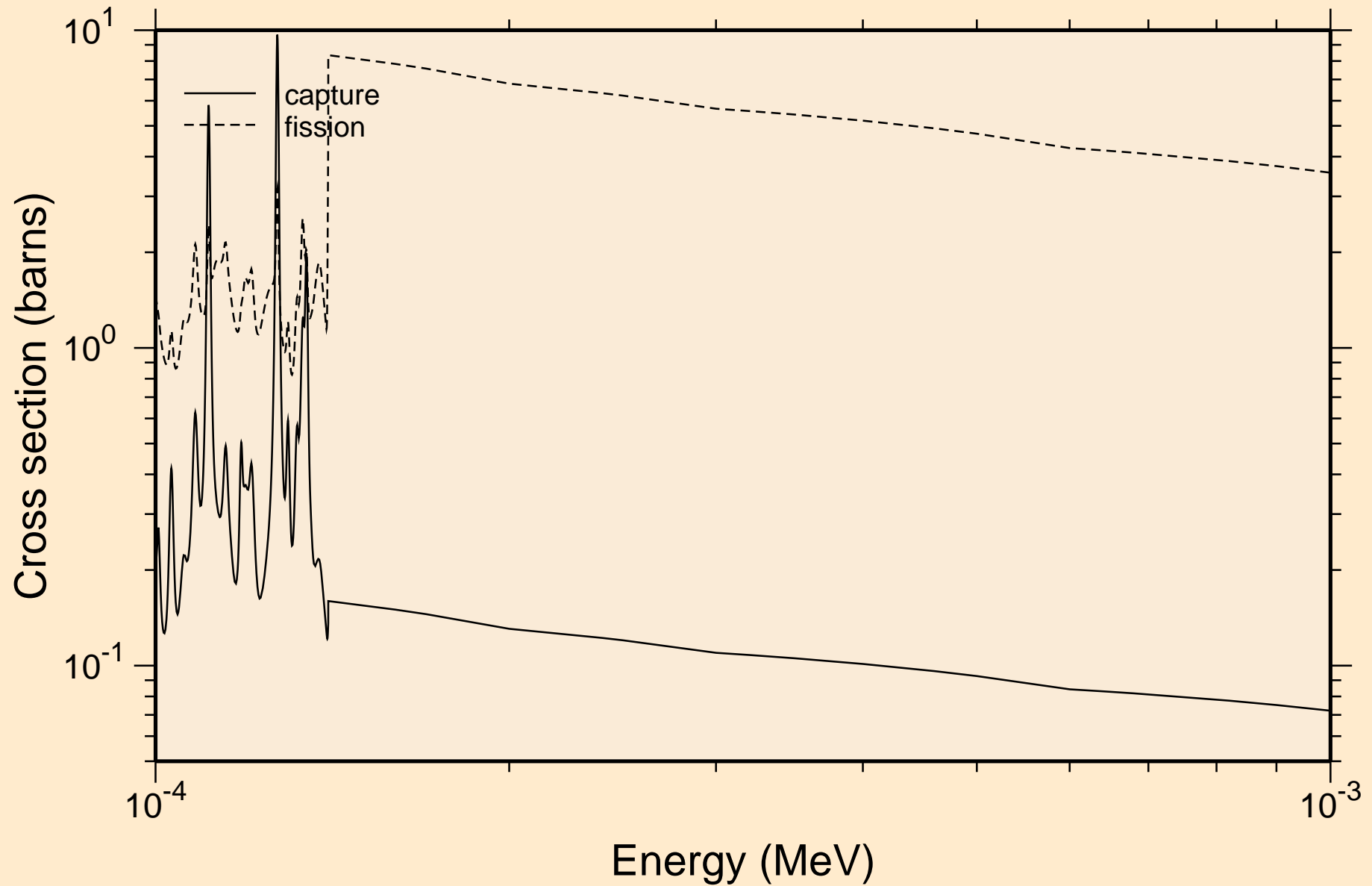

DB262 NRG TENDL-2015, AKONING
resonance absorption cross sections

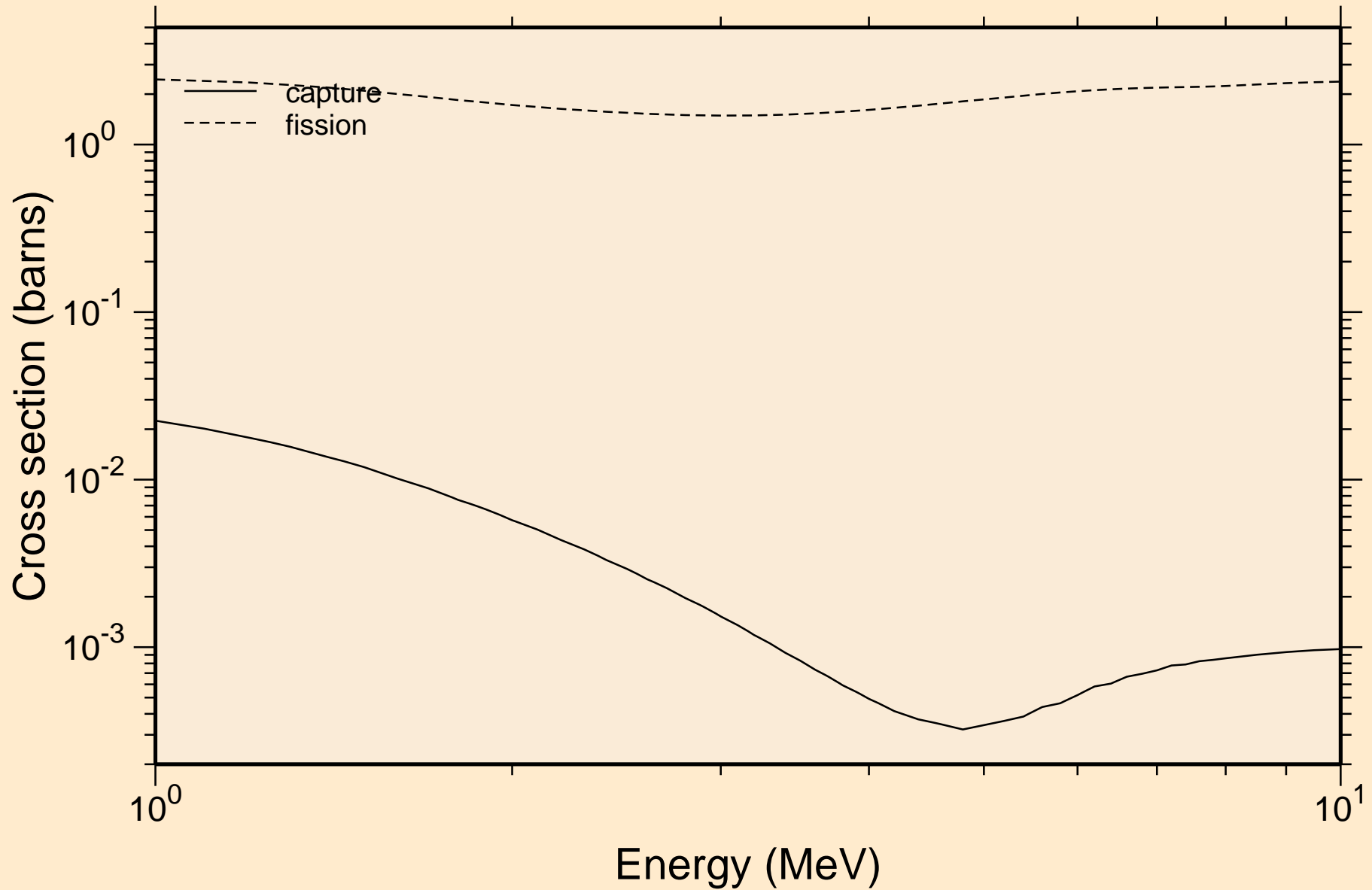

DB262 NRG TENDL-2015, AKONING

Non-threshold reactions

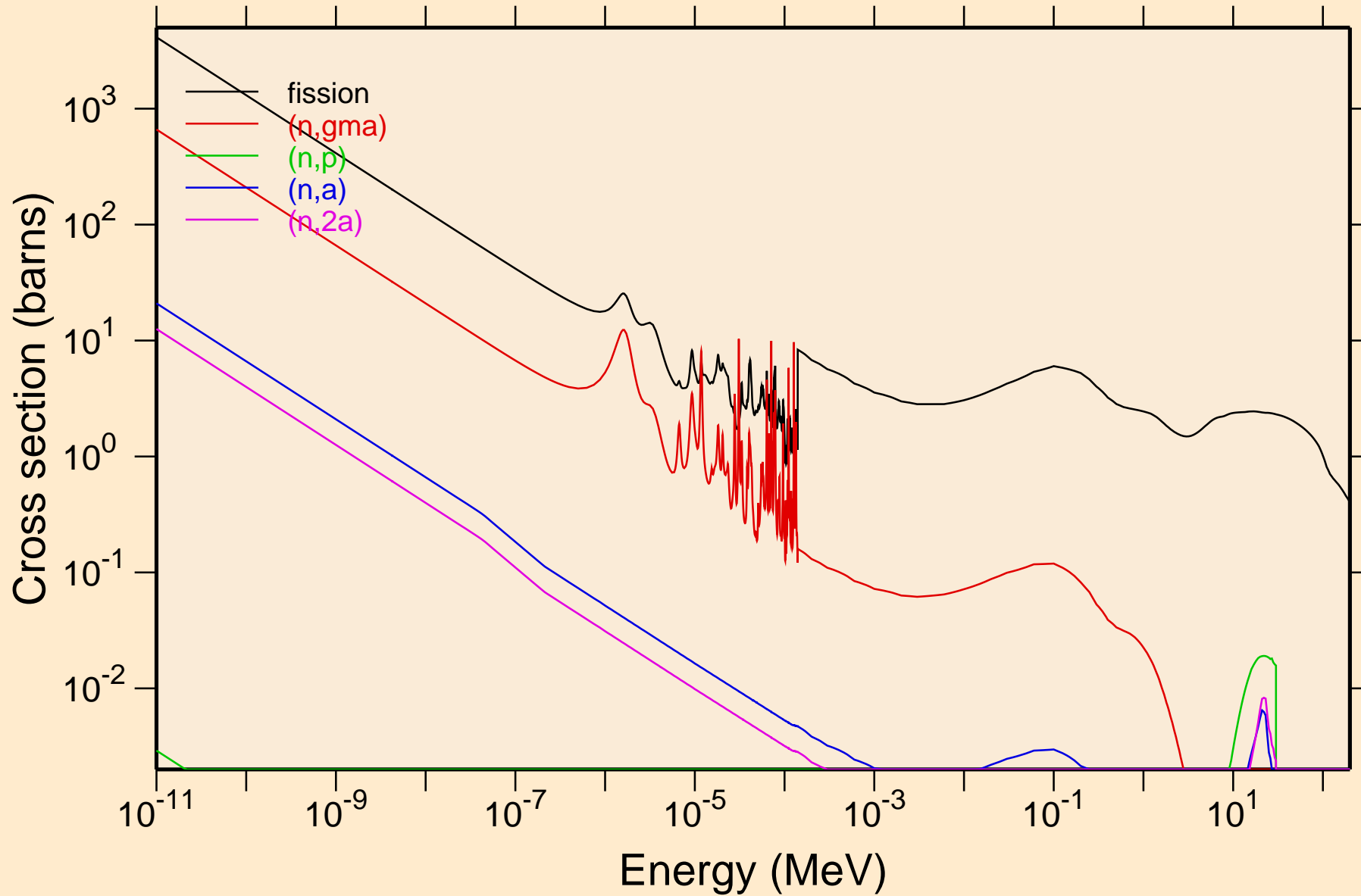

DB262 NRG TENDL-2015, AKONING

Non-threshold reactions

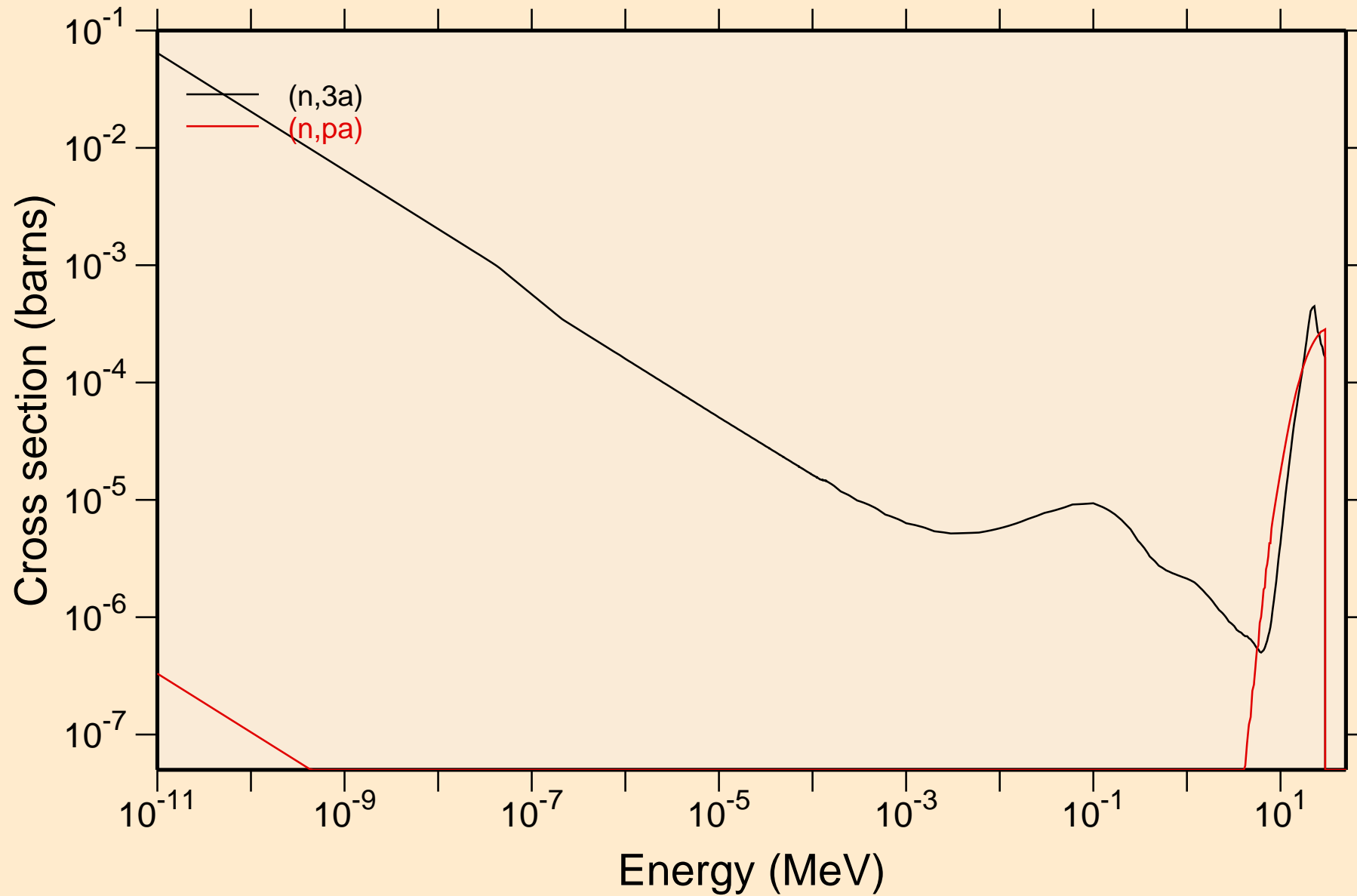

DB262 NRG TENDL-2015, AKONING

Principal cross sections

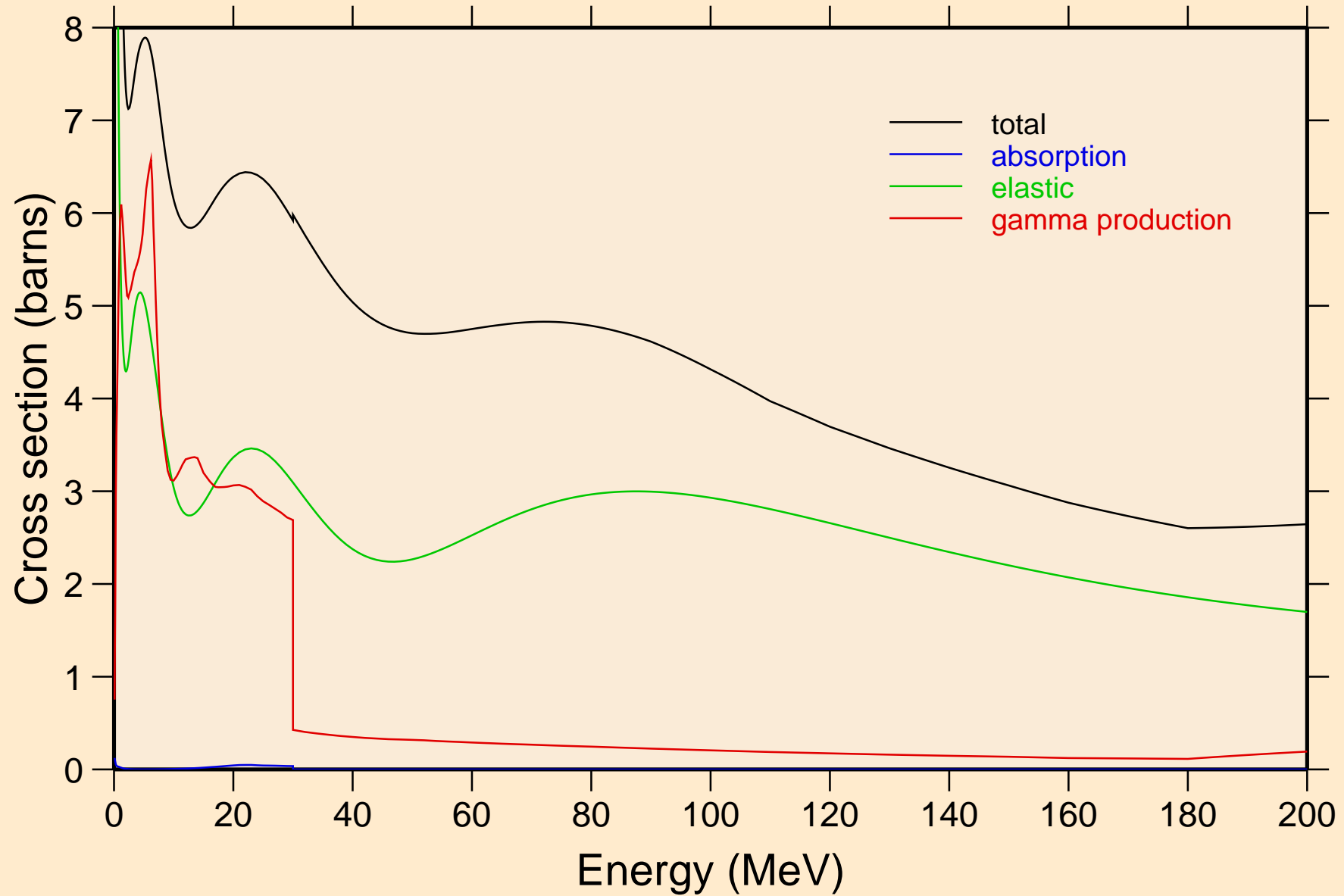

DB262 NRG TENDL-2015, AKONING

Non-threshold reactions

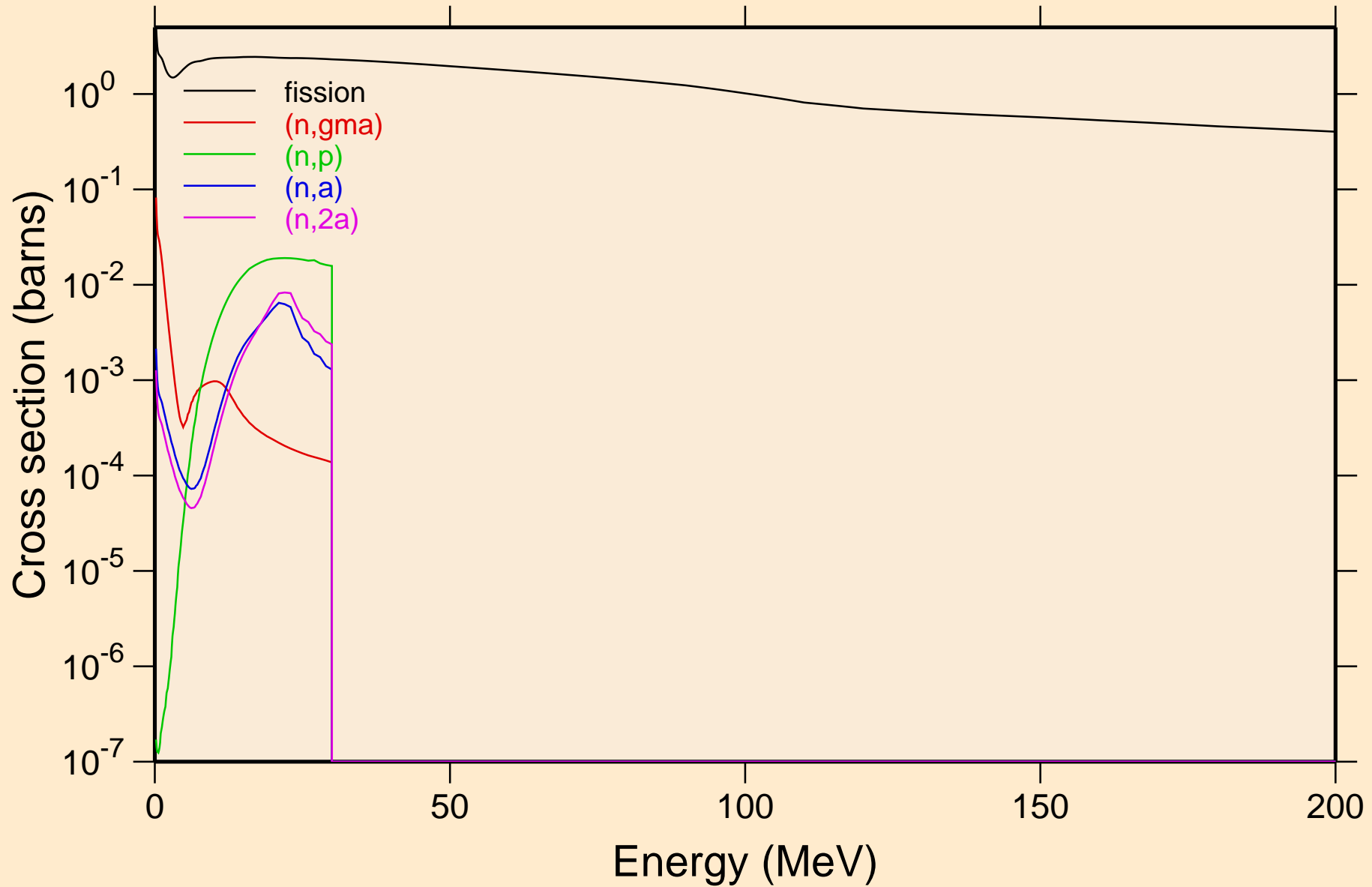

DB262 NRG TENDL-2015, AKONING

Non-threshold reactions

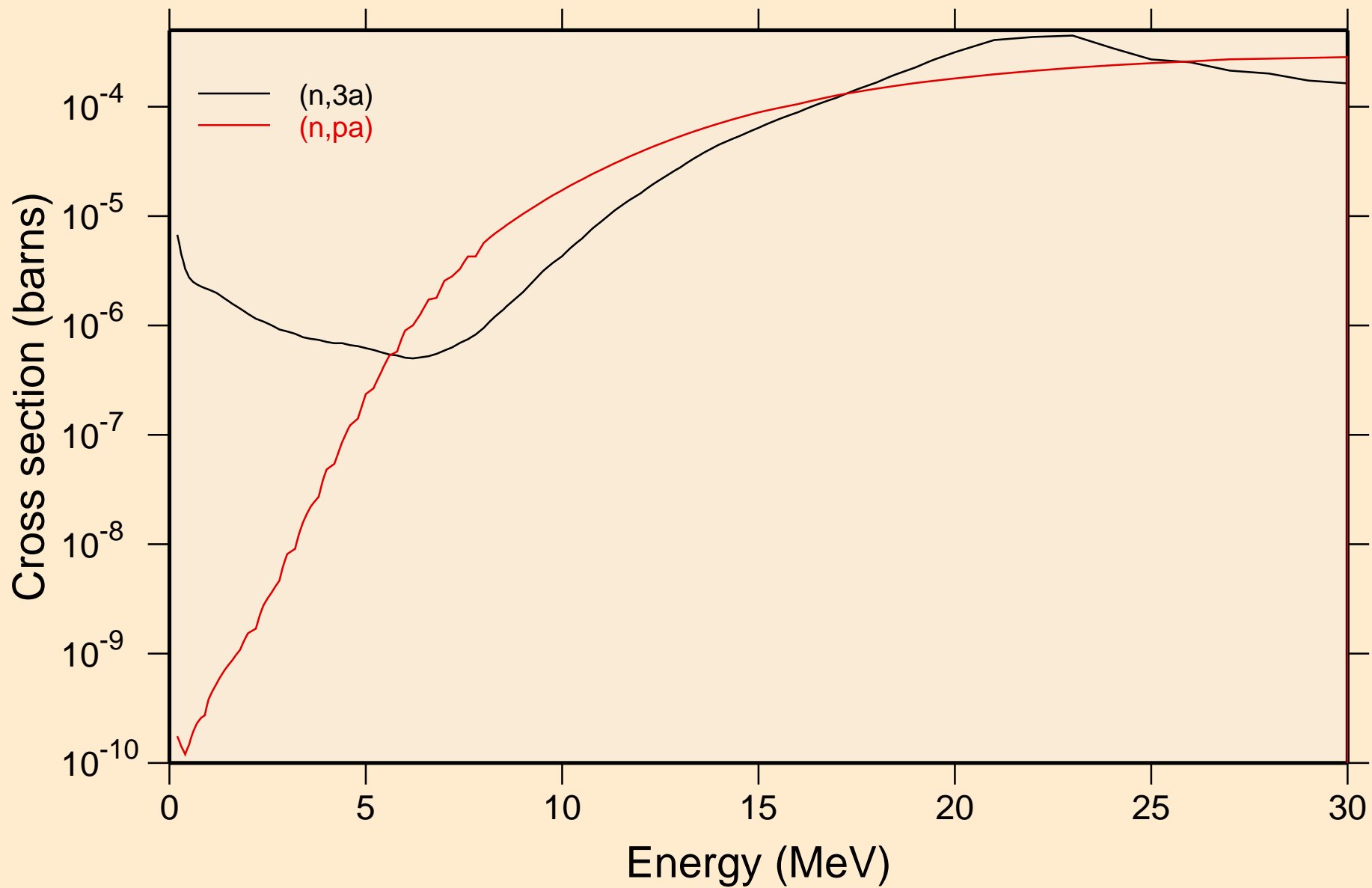

DB262 NRG TENDL-2015, AKONING
Inelastic levels

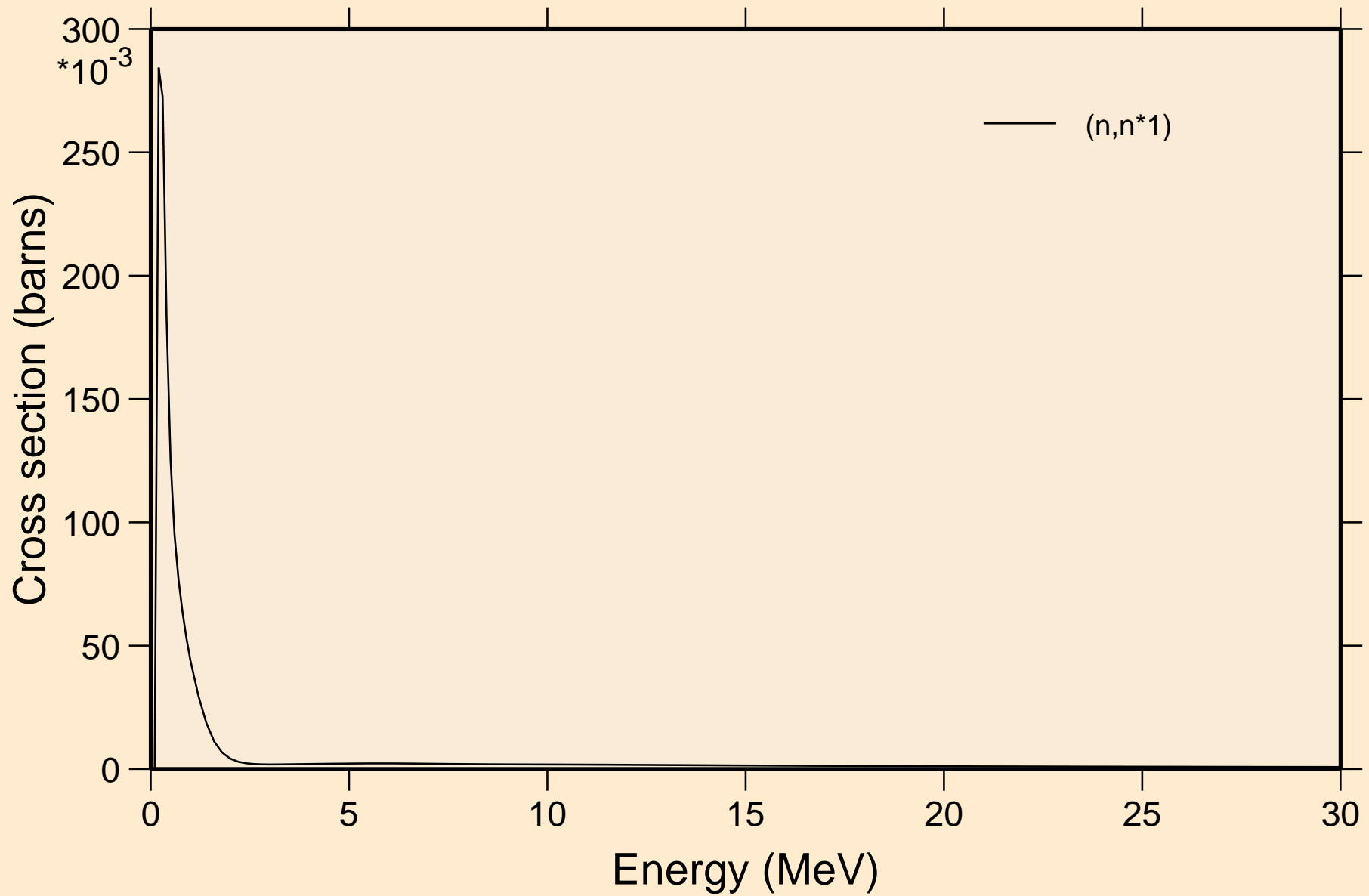

DB262 NRG TENDL-2015, AKONING

Threshold reactions

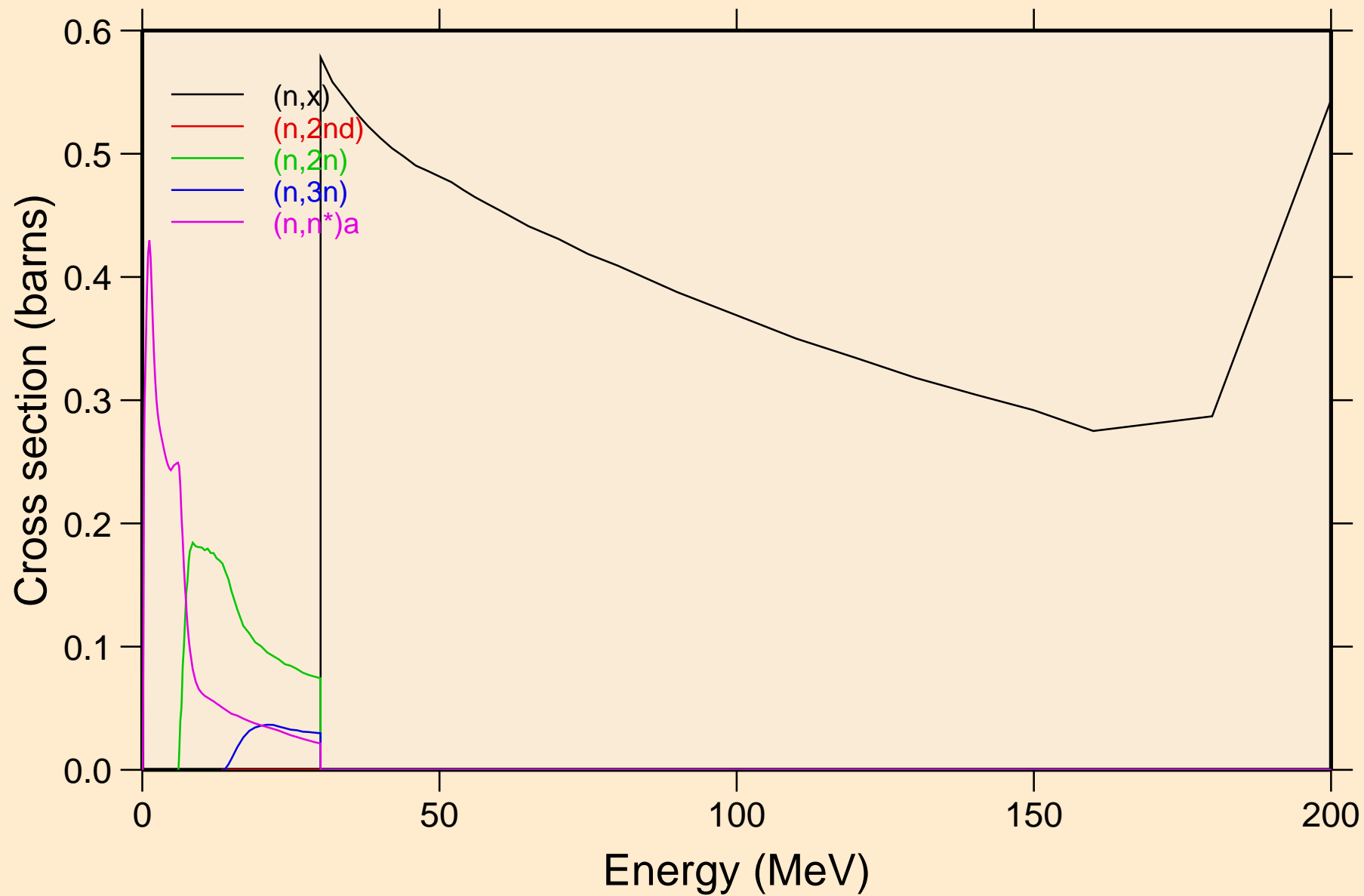

DB262 NRG TENDL-2015, AKONING

Threshold reactions

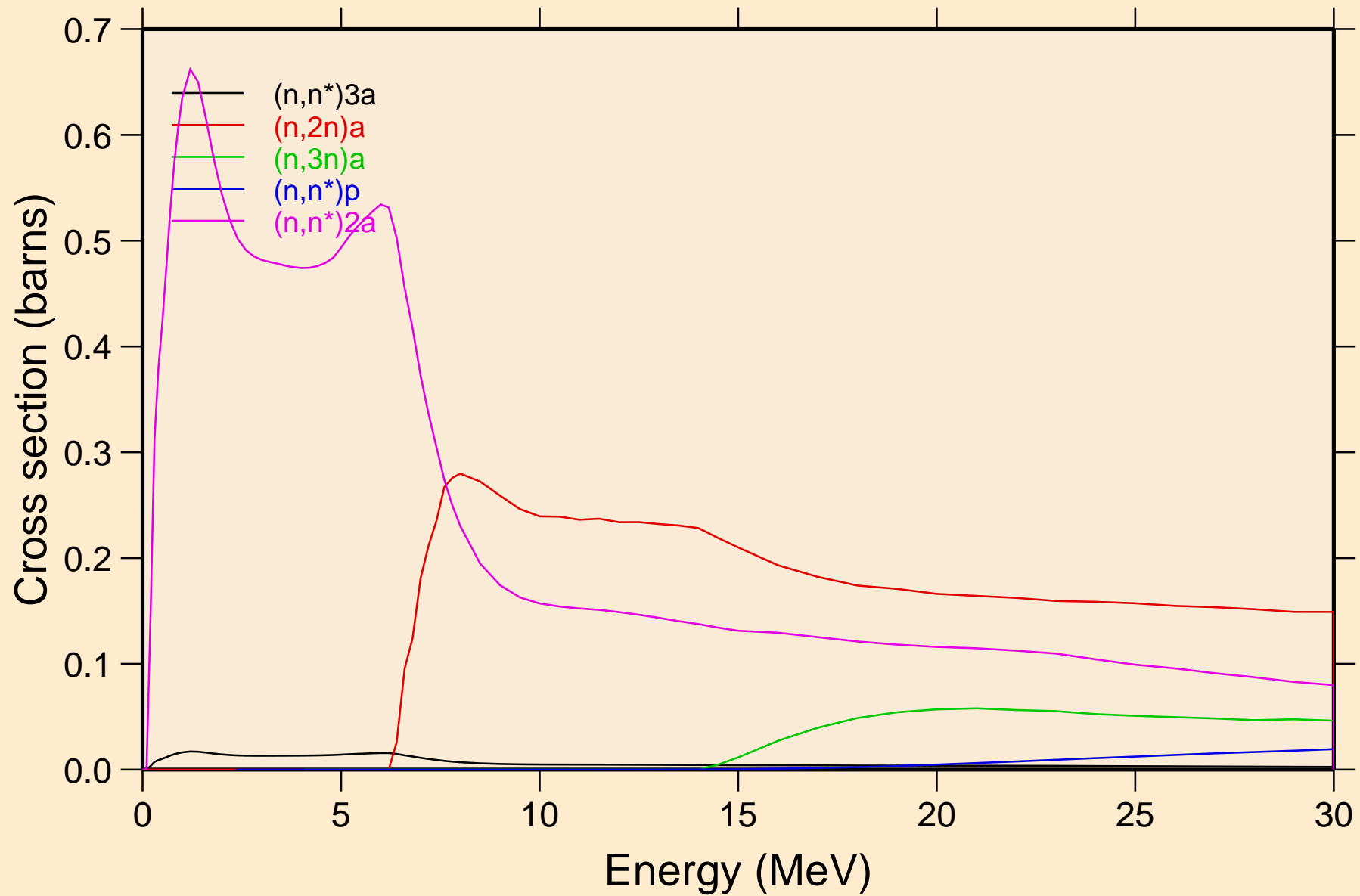

DB262 NRG TENDL-2015, AKONING

Threshold reactions

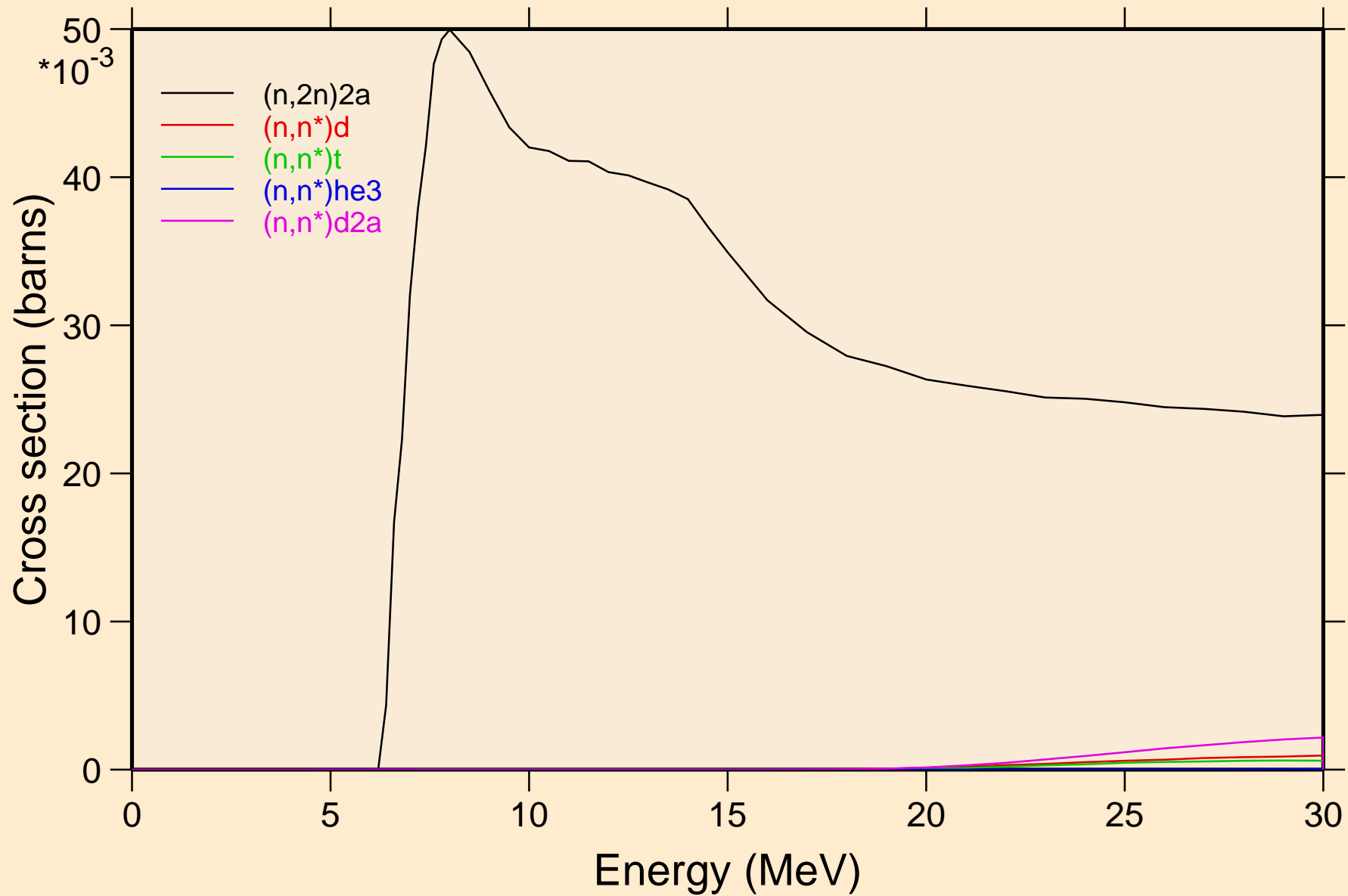

DB262 NRG TENDL-2015, AKONING

Threshold reactions

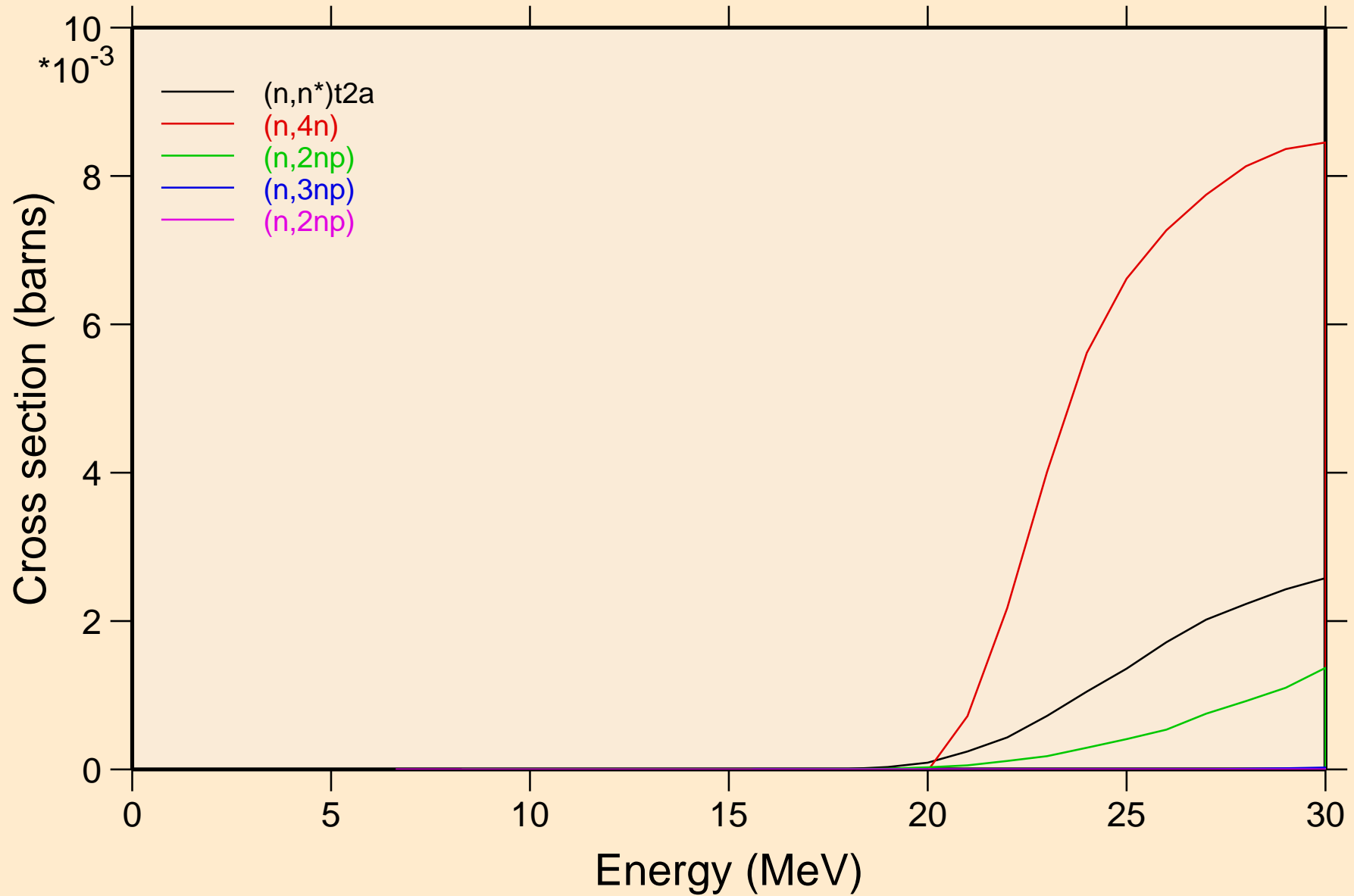

DB262 NRG TENDL-2015, AKONING

Threshold reactions

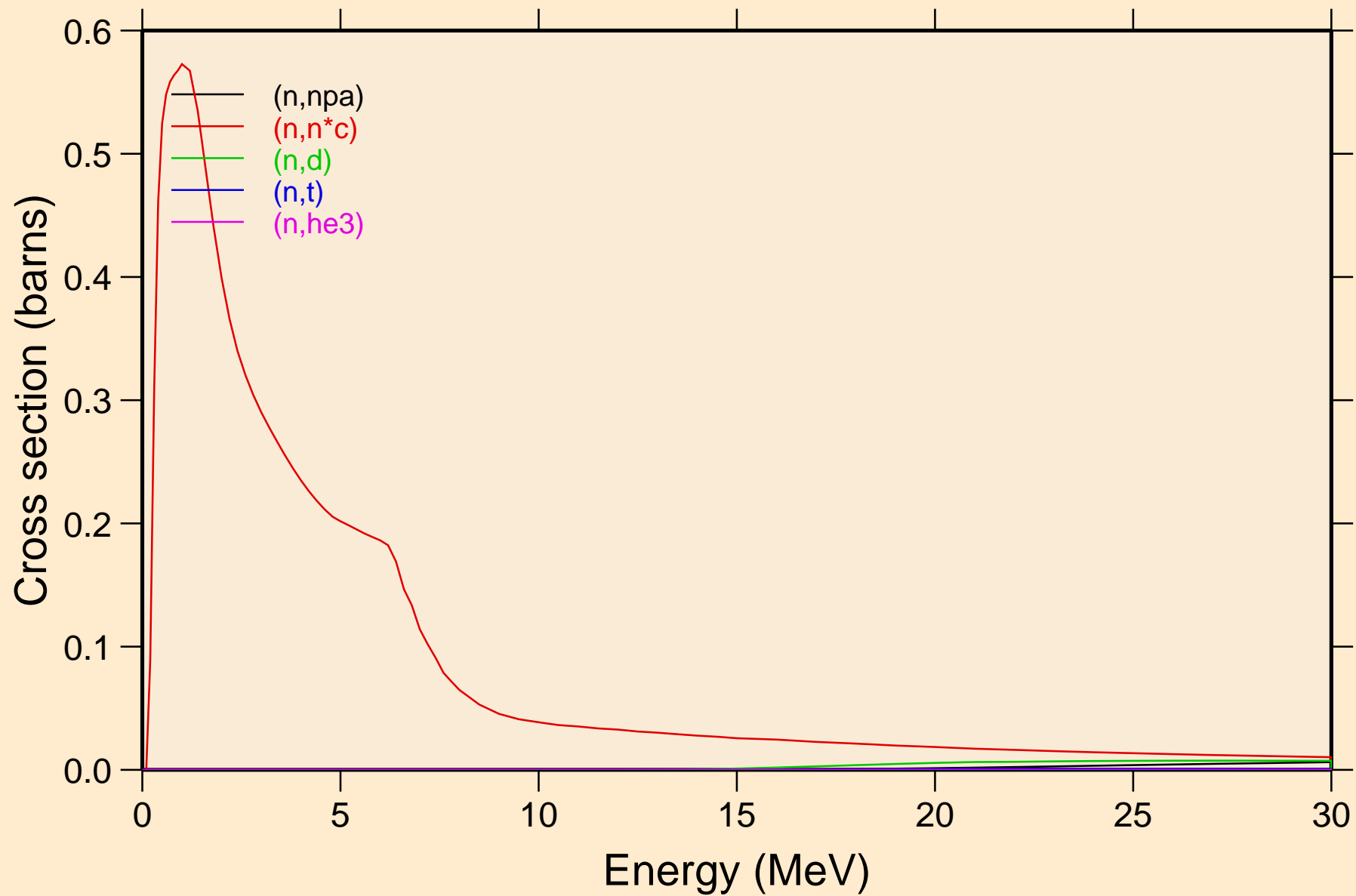

DB262 NRG TENDL-2015, AKONING

Threshold reactions

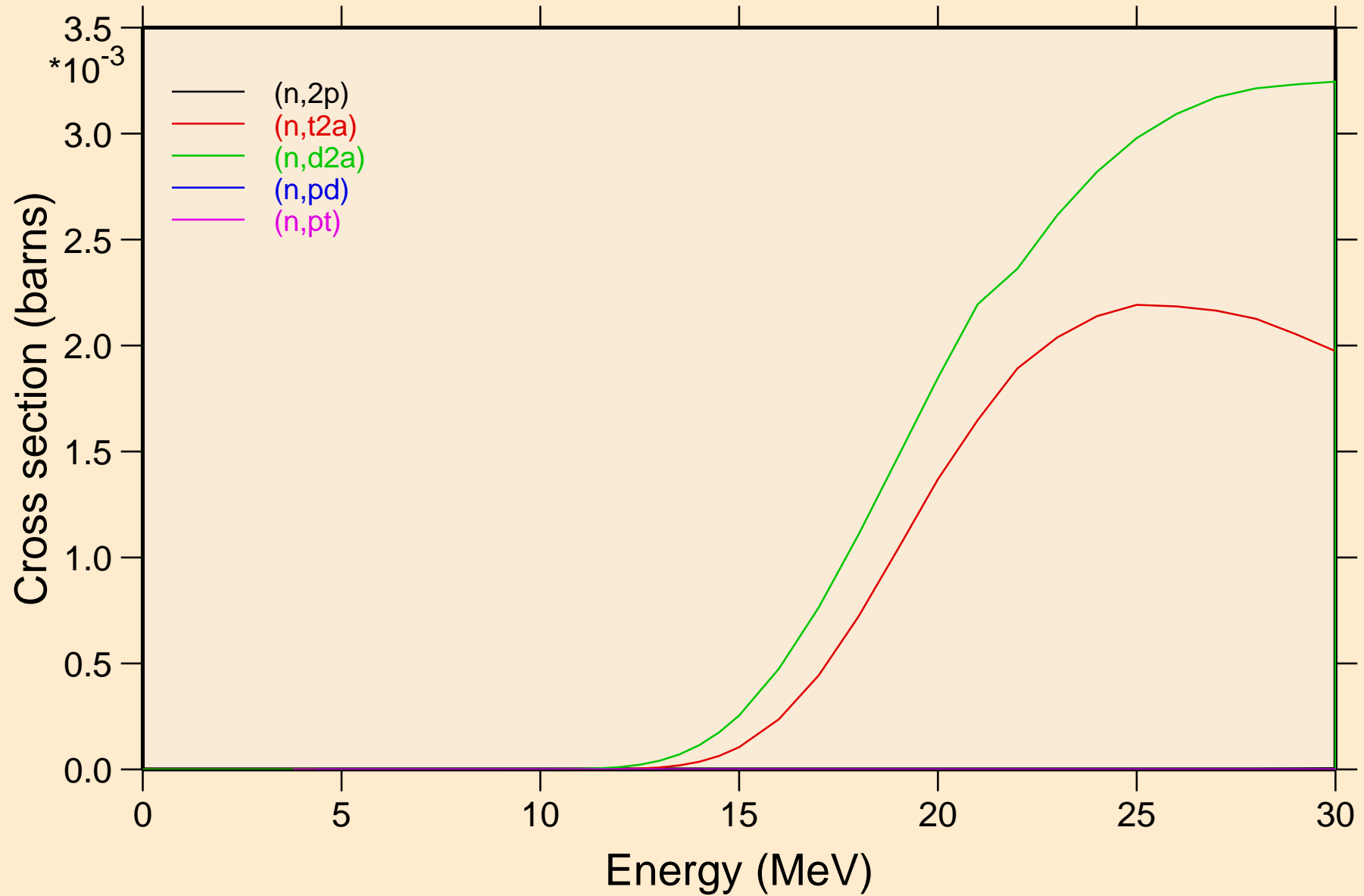

DB262 NRG TENDL-2015, AKONING
Threshold reactions

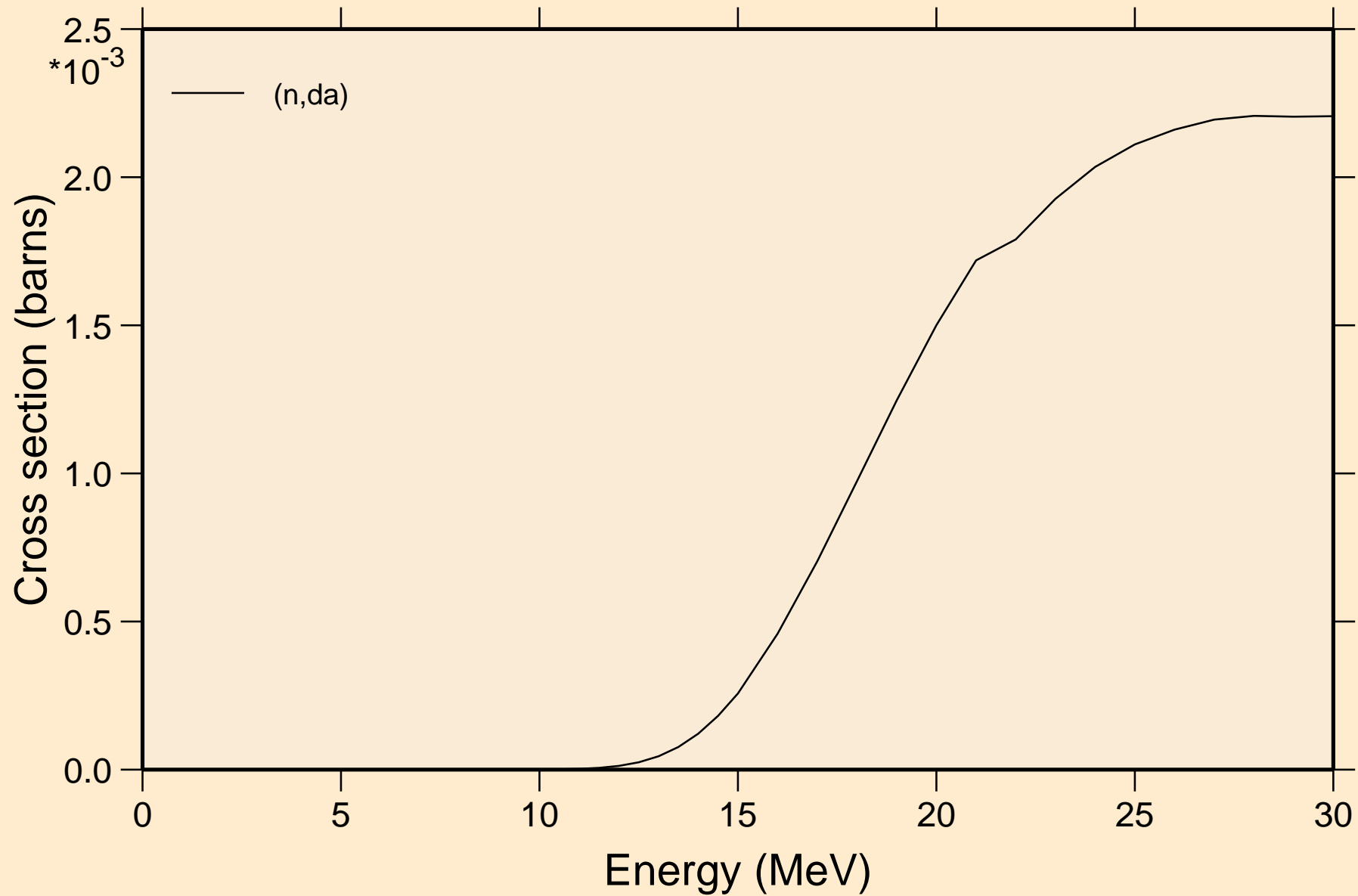

DB262 NRG TENDL-2015, AKONING
angular distribution for elastic

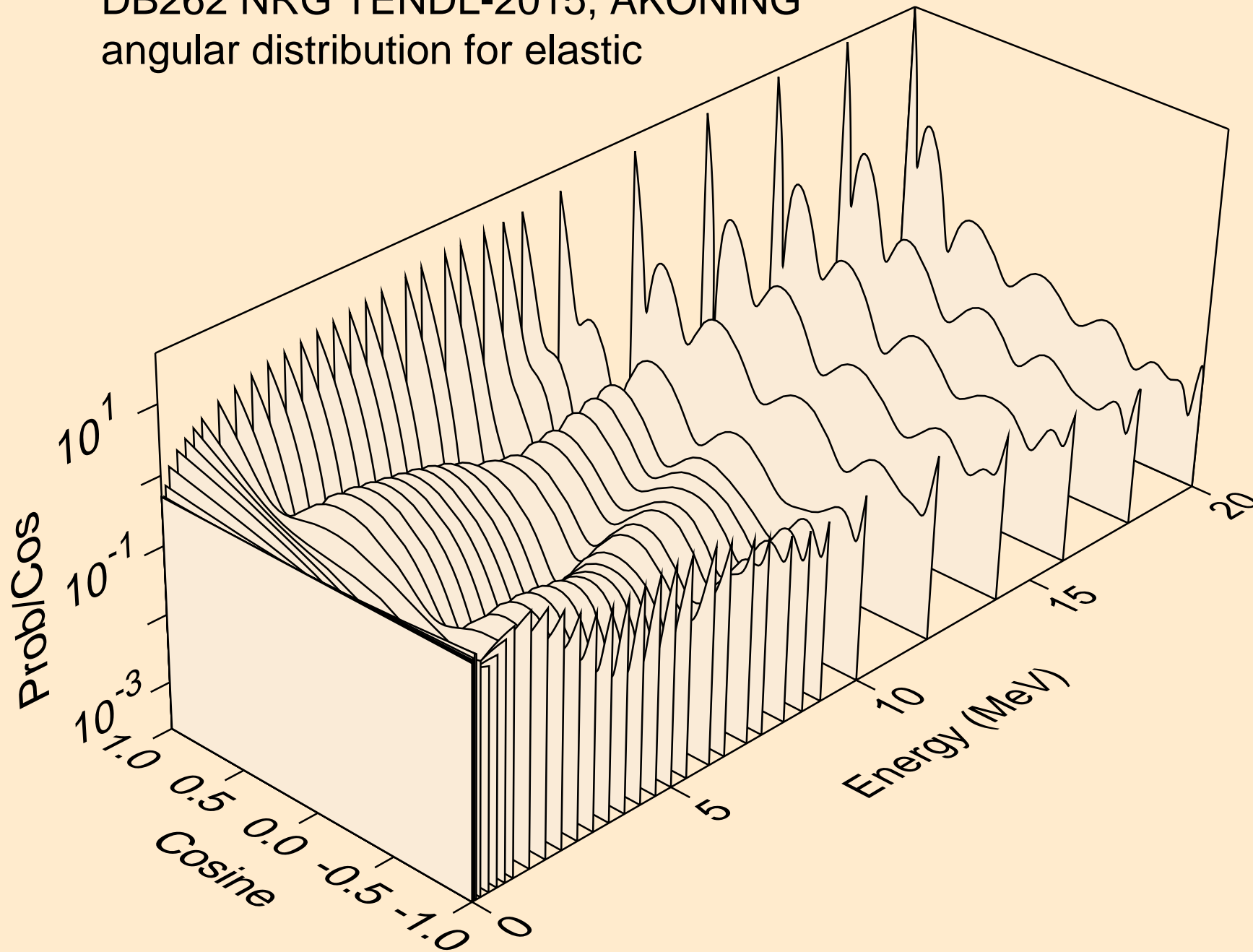

DB262 NRG TENDL-2015, AKONING
angular distribution for elastic

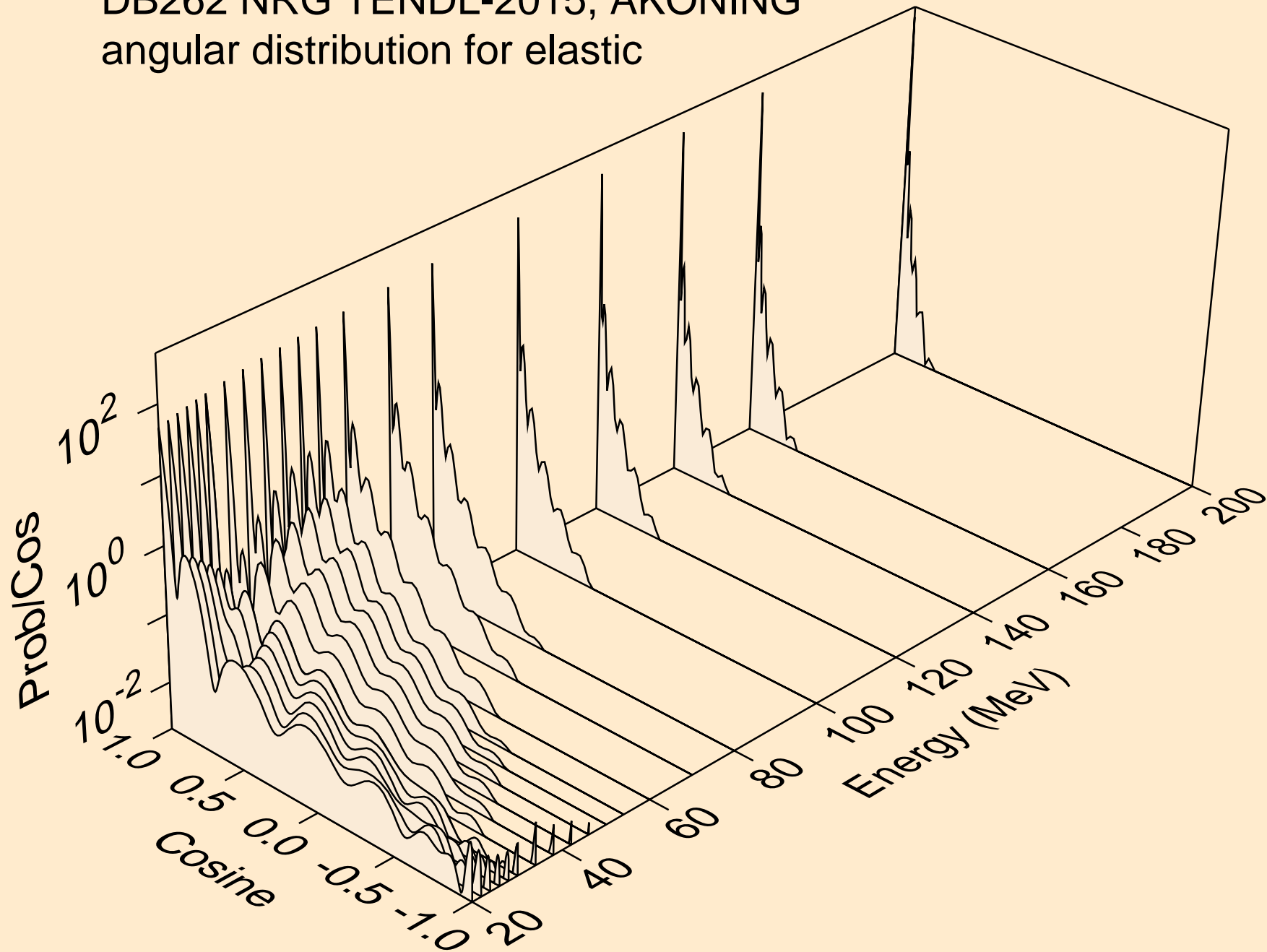

DB262 NRG TENDL-2015, AKONING
angular distribution for (n,n*1)

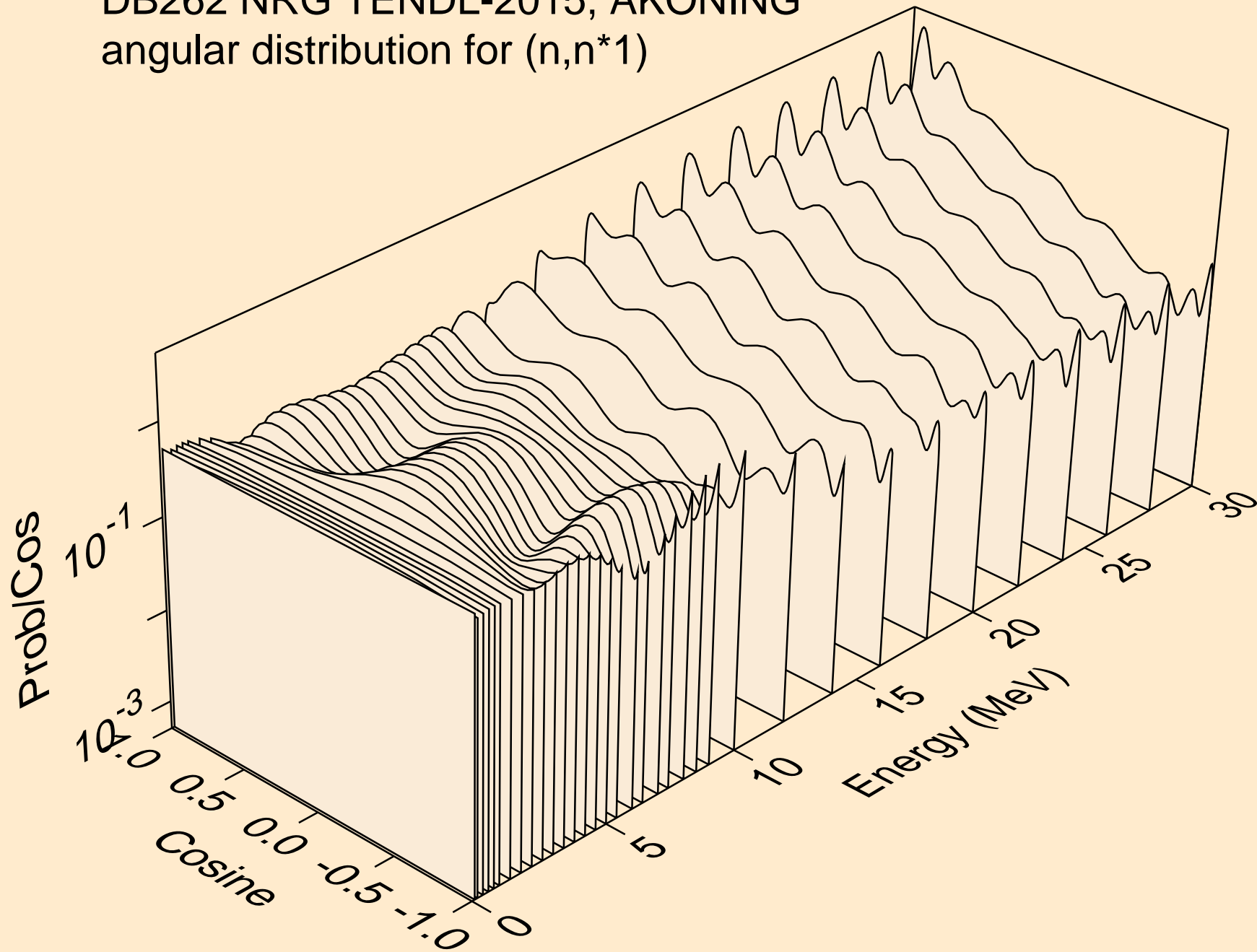

DB262 NRG TENDL-2015, AKONING

Total fission nubar

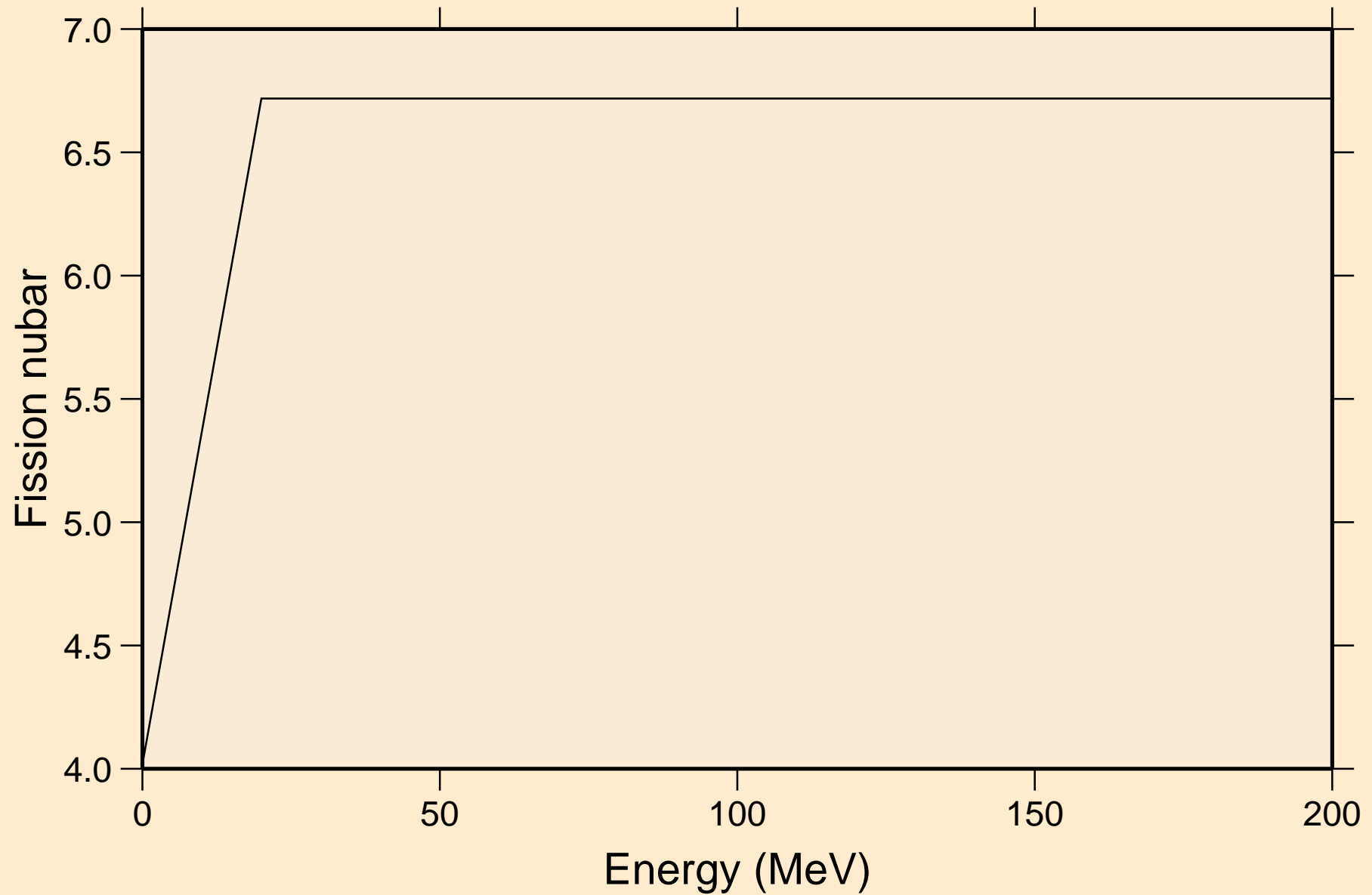

DB262 NRG TENDL-2015, AKONING
Neutron emission for (n,x)

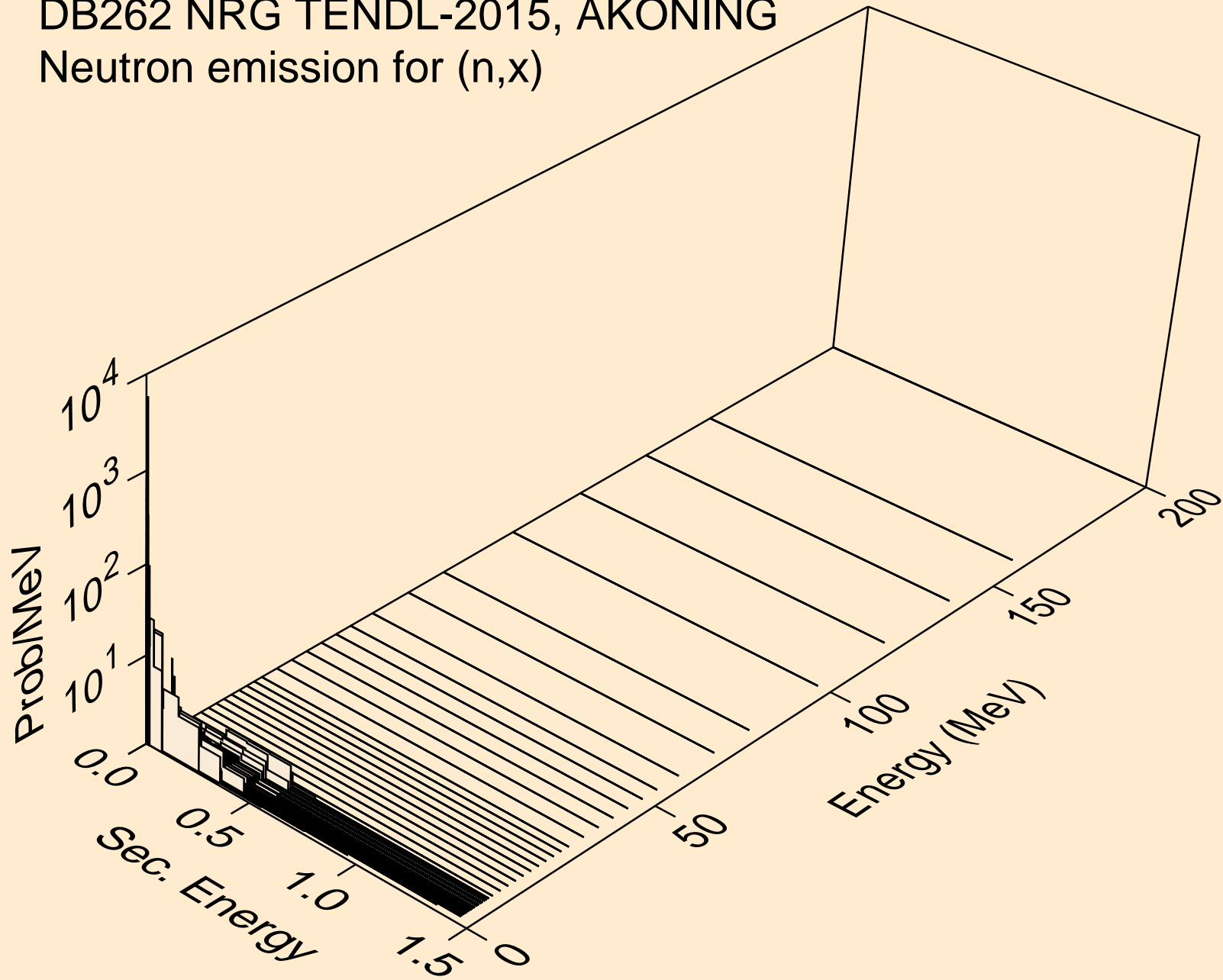

DB262 NRG TENDL-2015, AKONING
Neutron emission for (n,2nd)

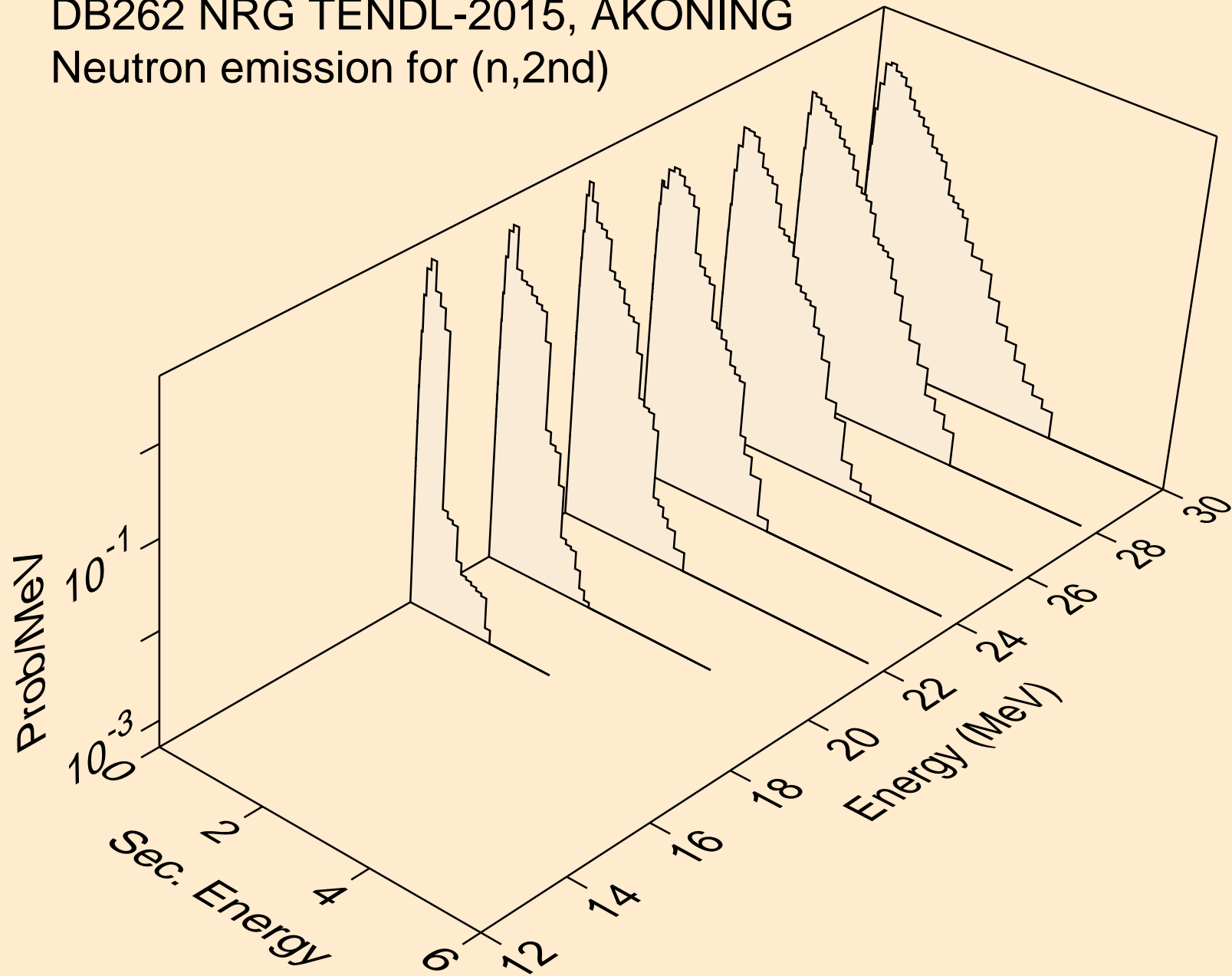

DB262 NRG TENDL-2015, AKONING
Neutron emission for (n,2n)

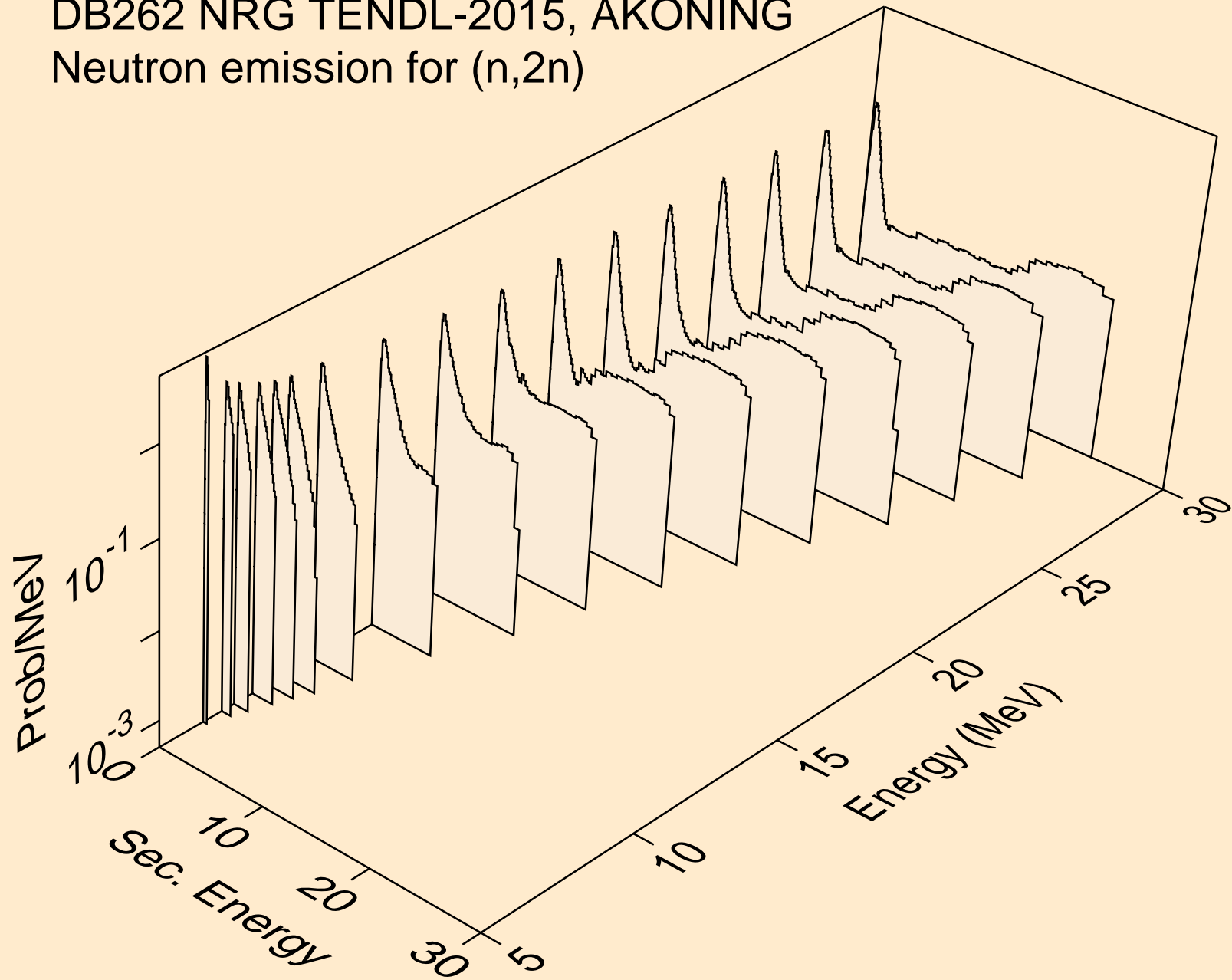

DB262 NRG TENDL-2015, AKONING
Neutron emission for (n,3n)

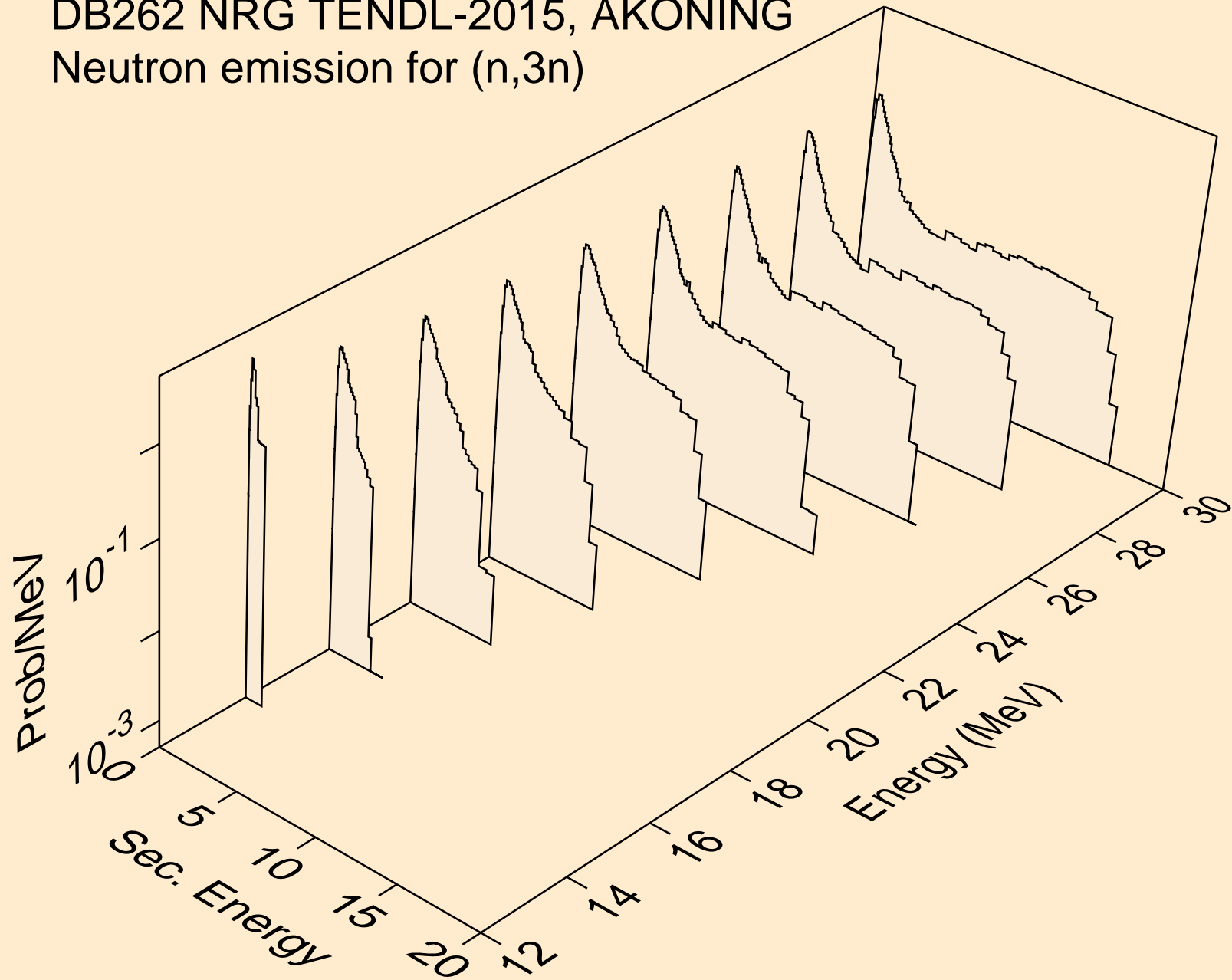

DB262 NRG TENDL-2015, AKONING
Neutron emission for fission

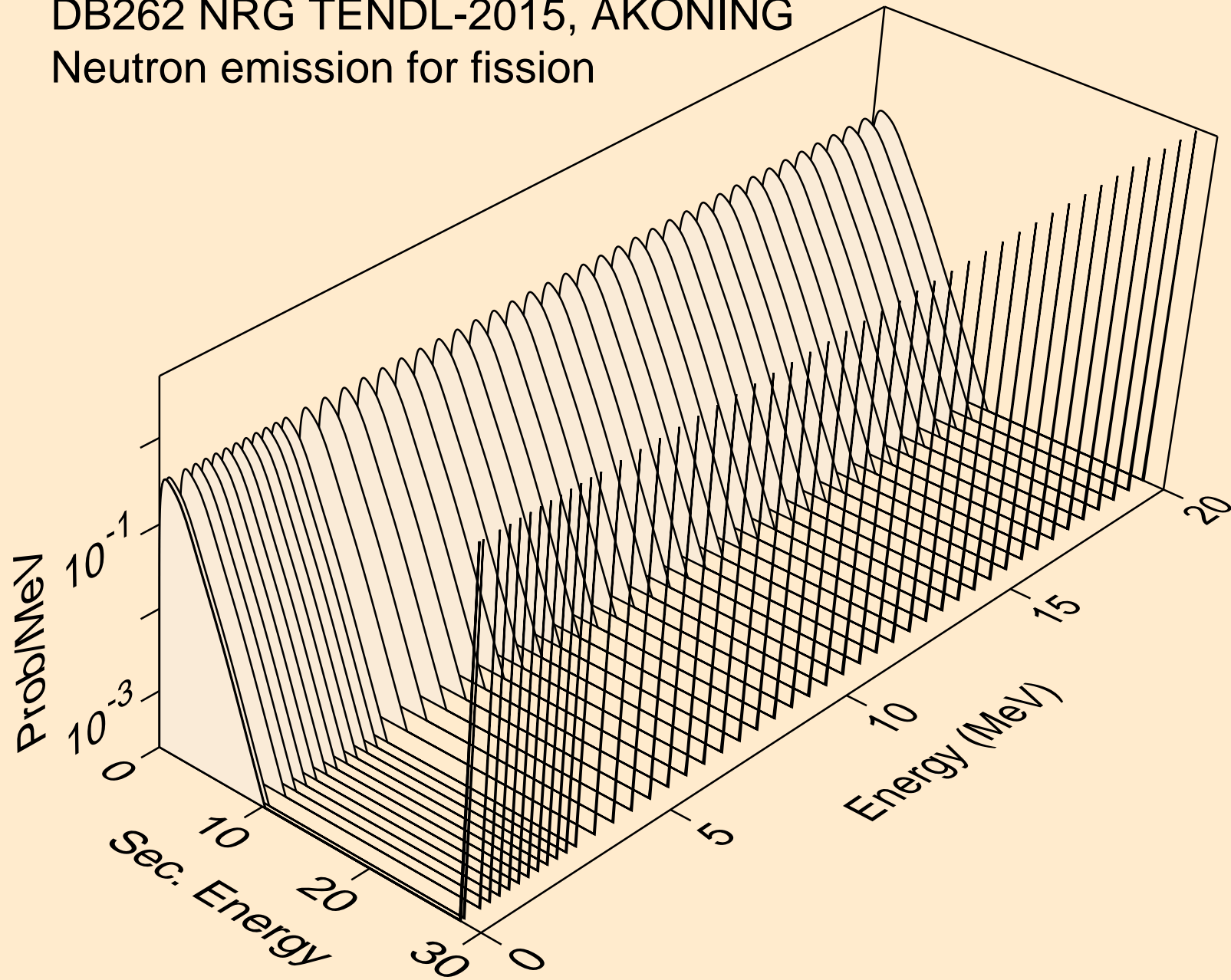

DB262 NRG TENDL-2015, AKONING
Neutron emission for (n,n*)a

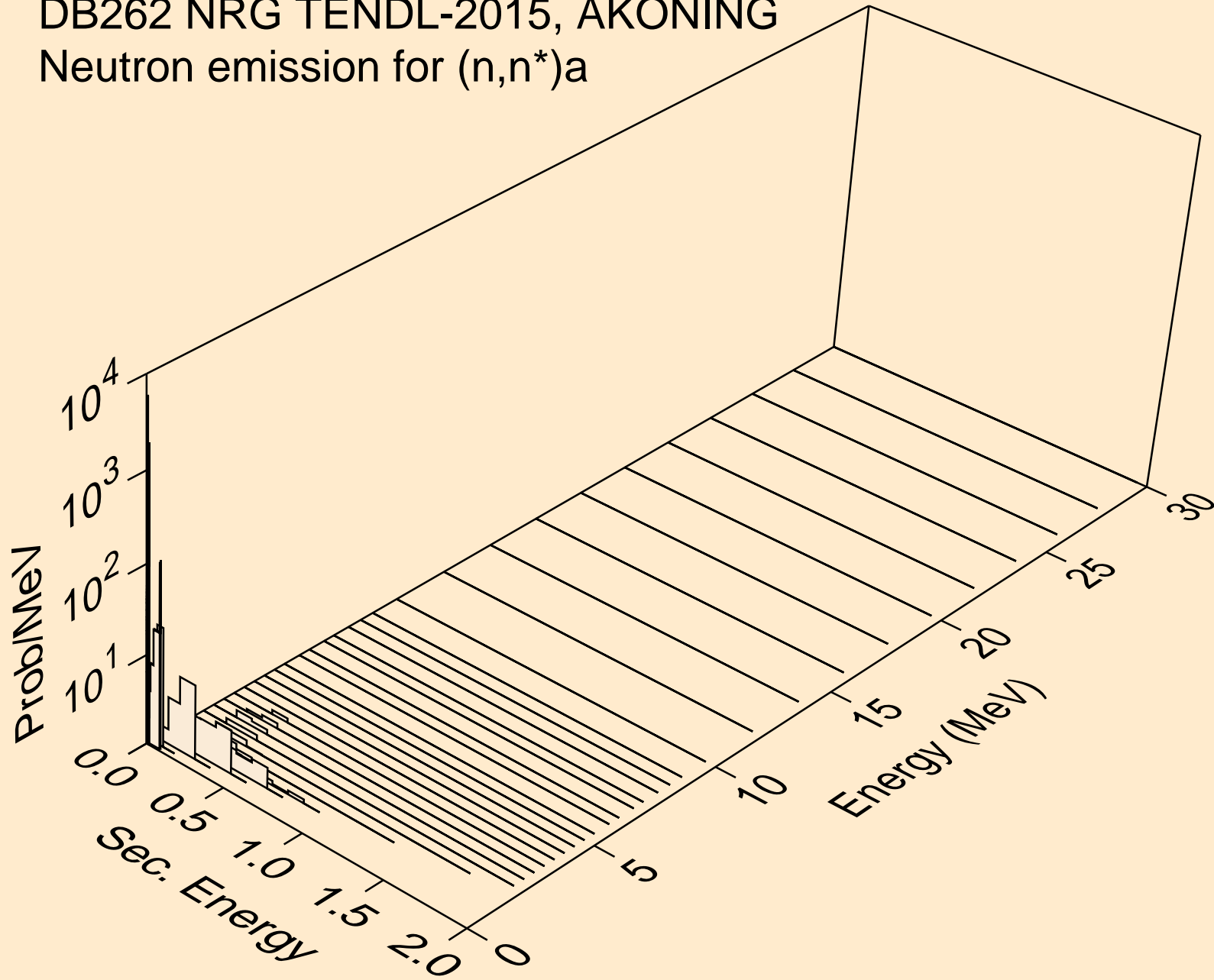

DB262 NRG TENDL-2015, AKONING
Neutron emission for (n,n*)3a

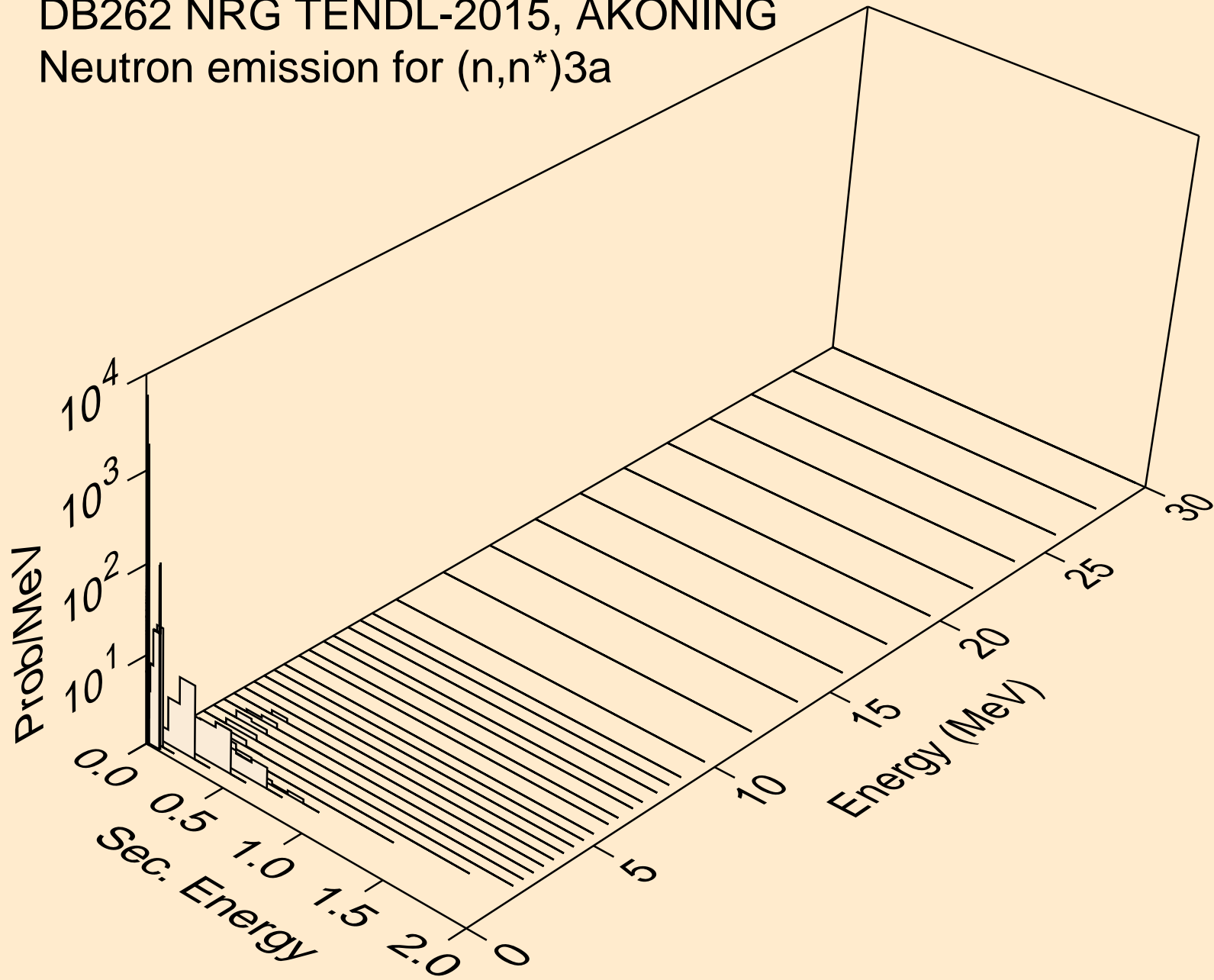

DB262 NRG TENDL-2015, AKONING
Neutron emission for (n,2n)a

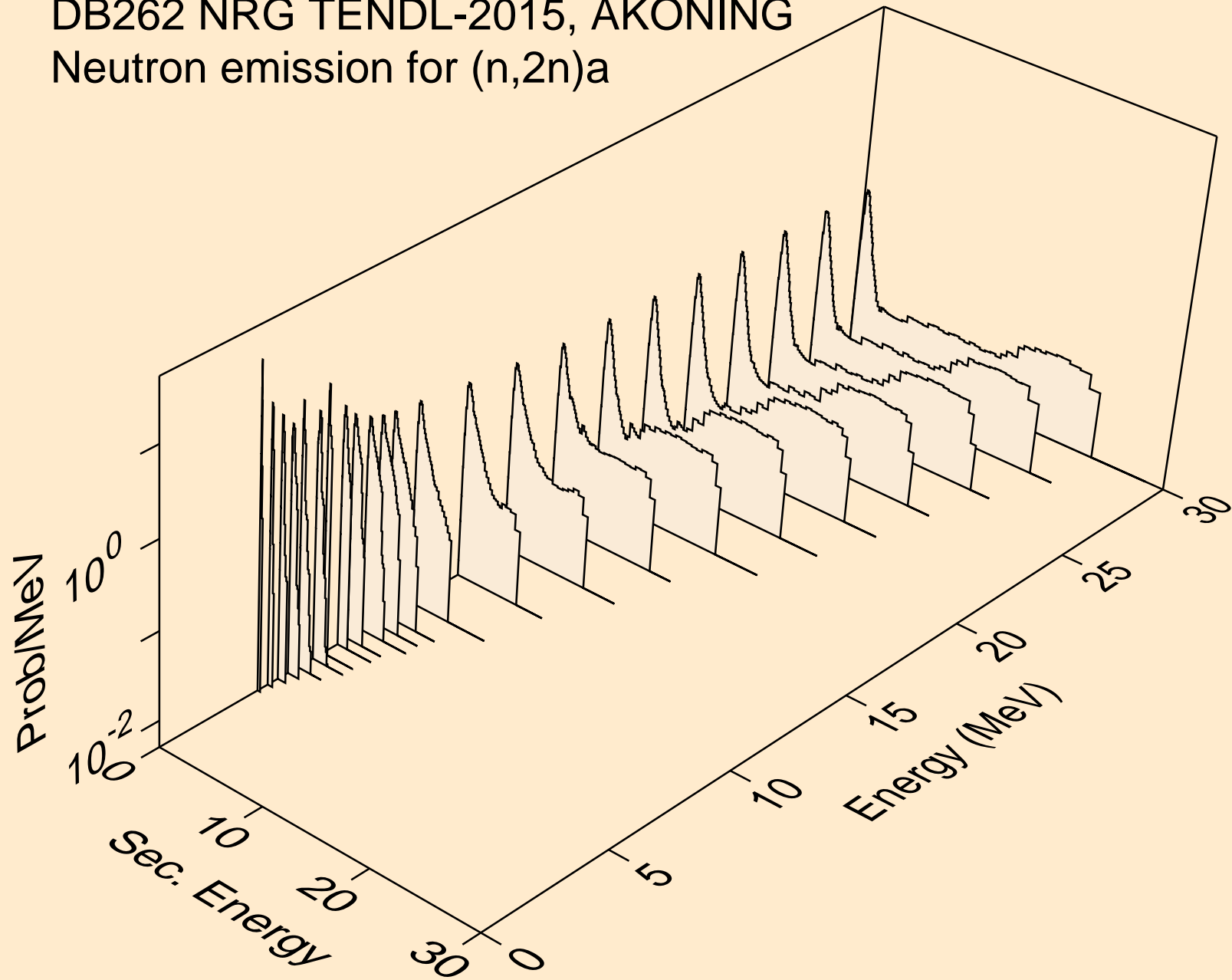

DB262 NRG TENDL-2015, AKONING
Neutron emission for (n,3n)a

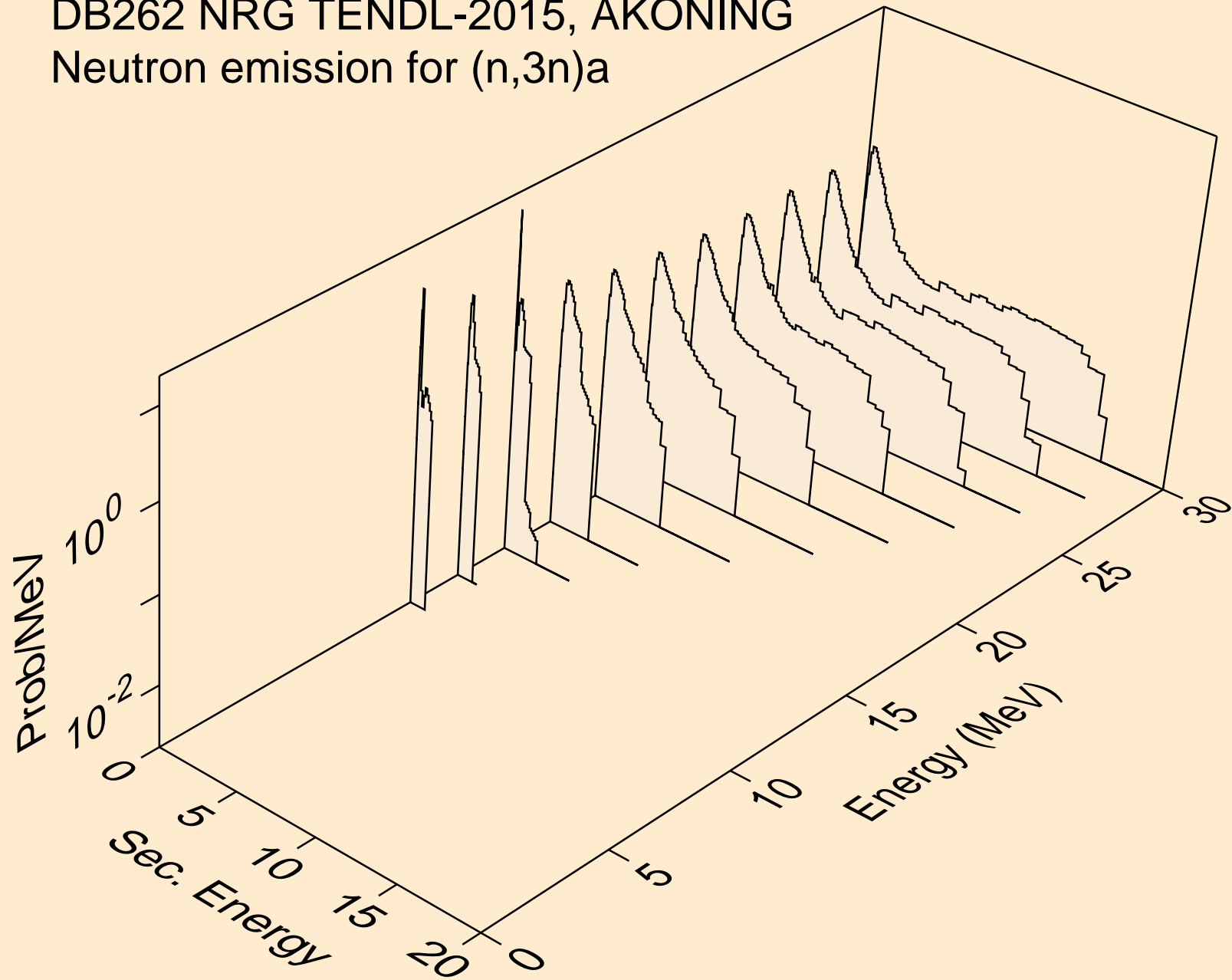

DB262 NRG TENDL-2015, AKONING

Neutron emission for (n,n*)p

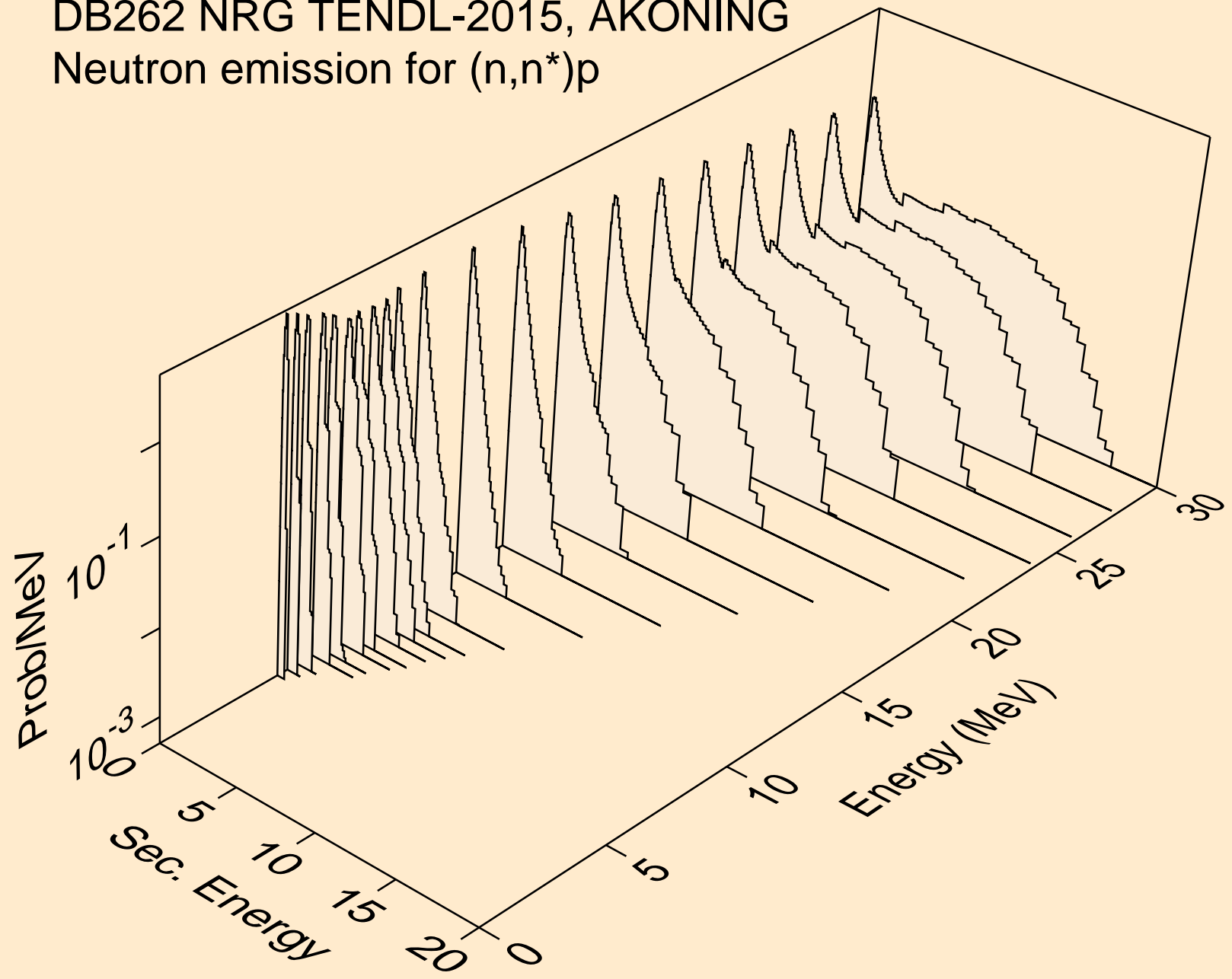

DB262 NRG TENDL-2015, AKONING
Neutron emission for (n,n*)2a

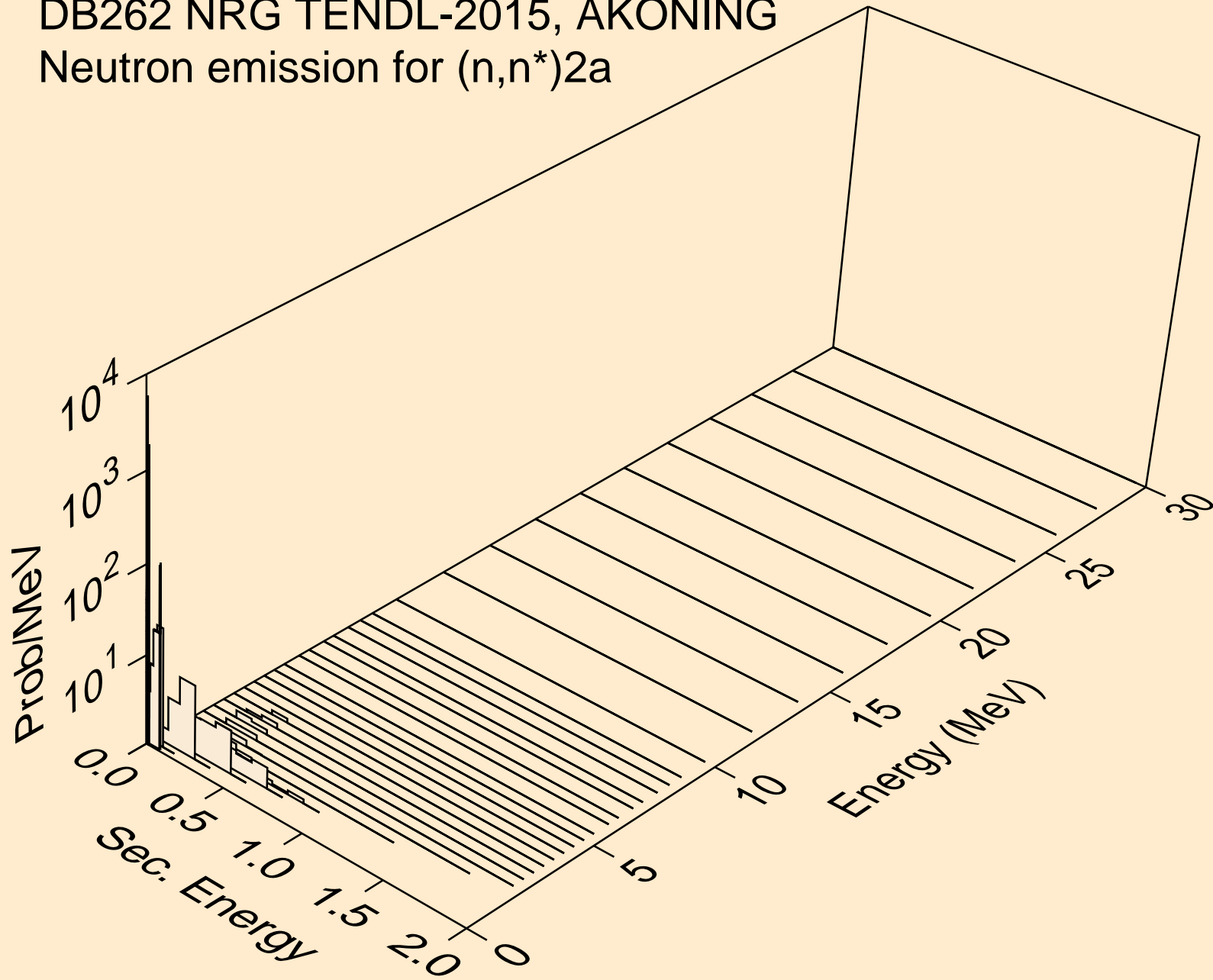

DB262 NRG TENDL-2015, AKONING
Neutron emission for (n,2n)2a

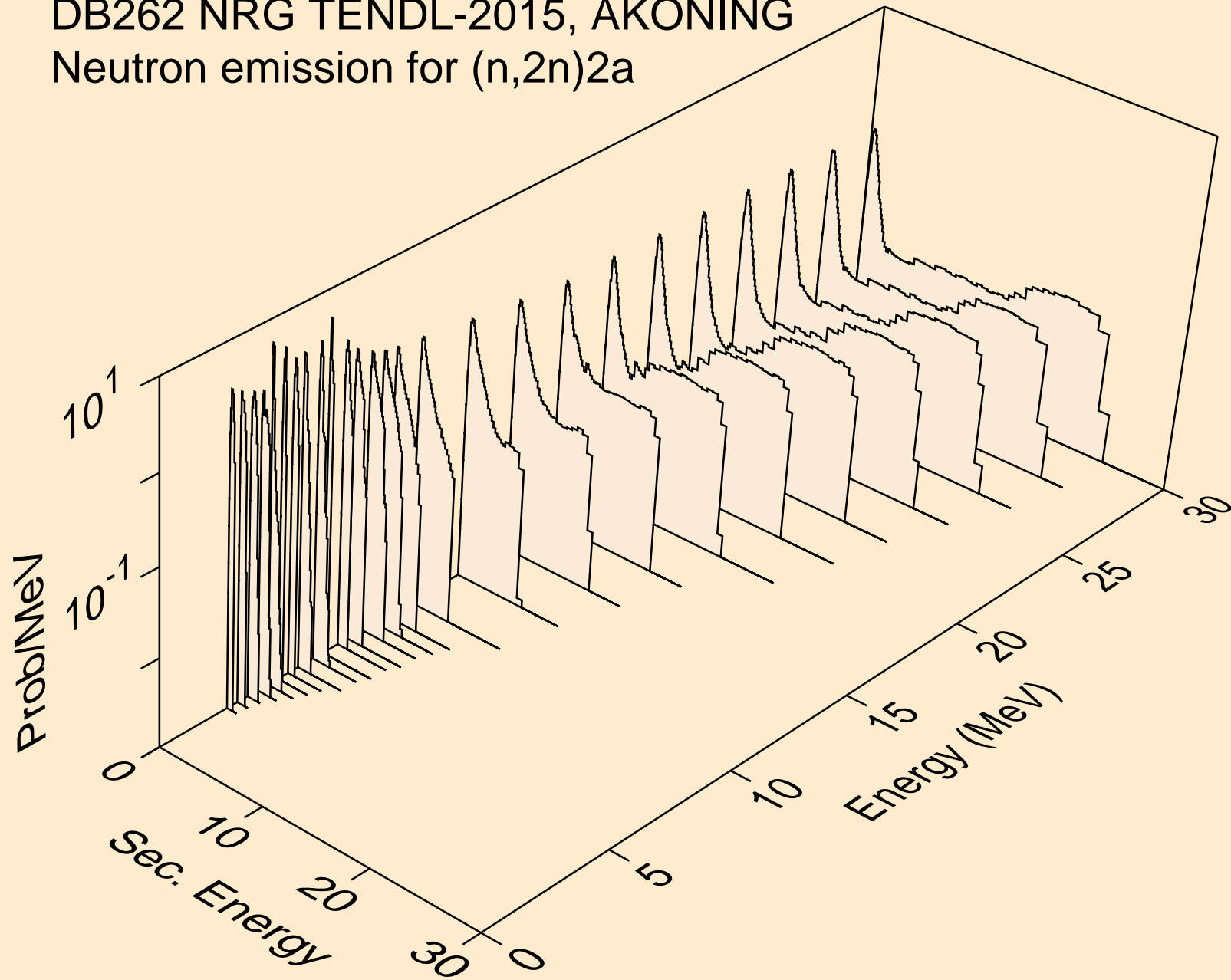

DB262 NRG TENDL-2015, AKONING
Neutron emission for (n,n*)d

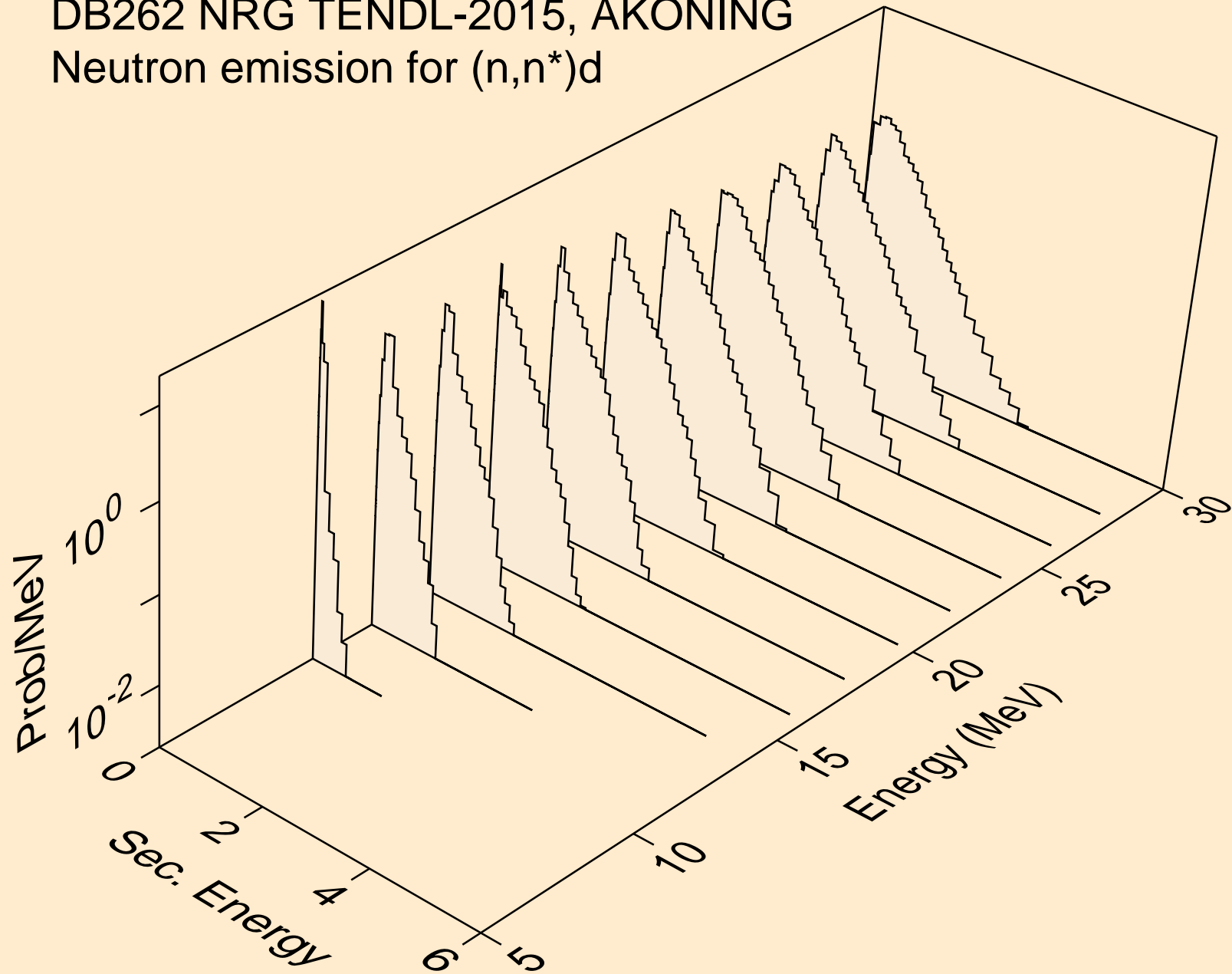

DB262 NRG TENDL-2015, AKONING
Neutron emission for (n,n*)t

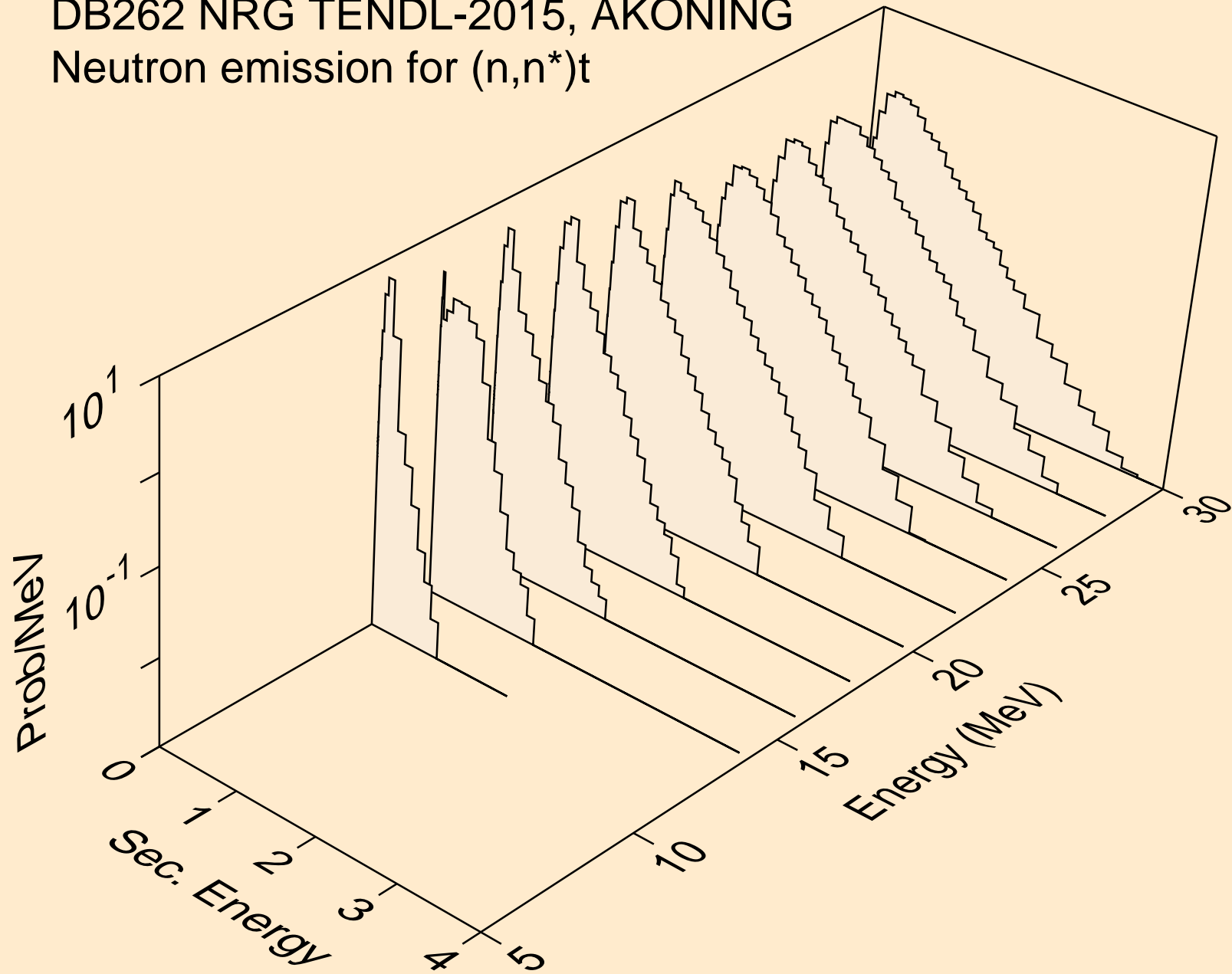

DB262 NRG TENDL-2015, AKONING
Neutron emission for (n,n*)he3

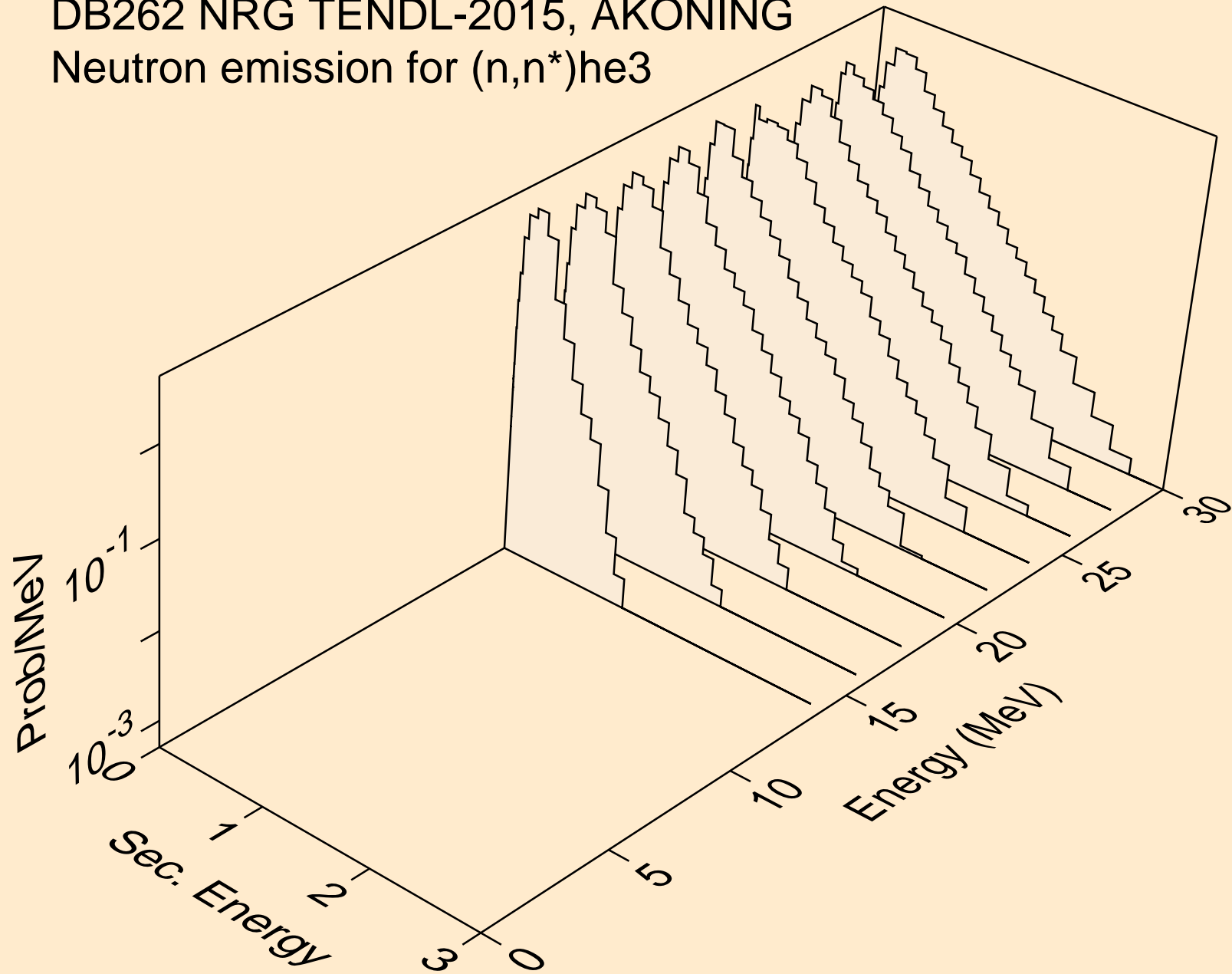

DB262 NRG TENDL-2015, AKONING
Neutron emission for (n,n*)d2a

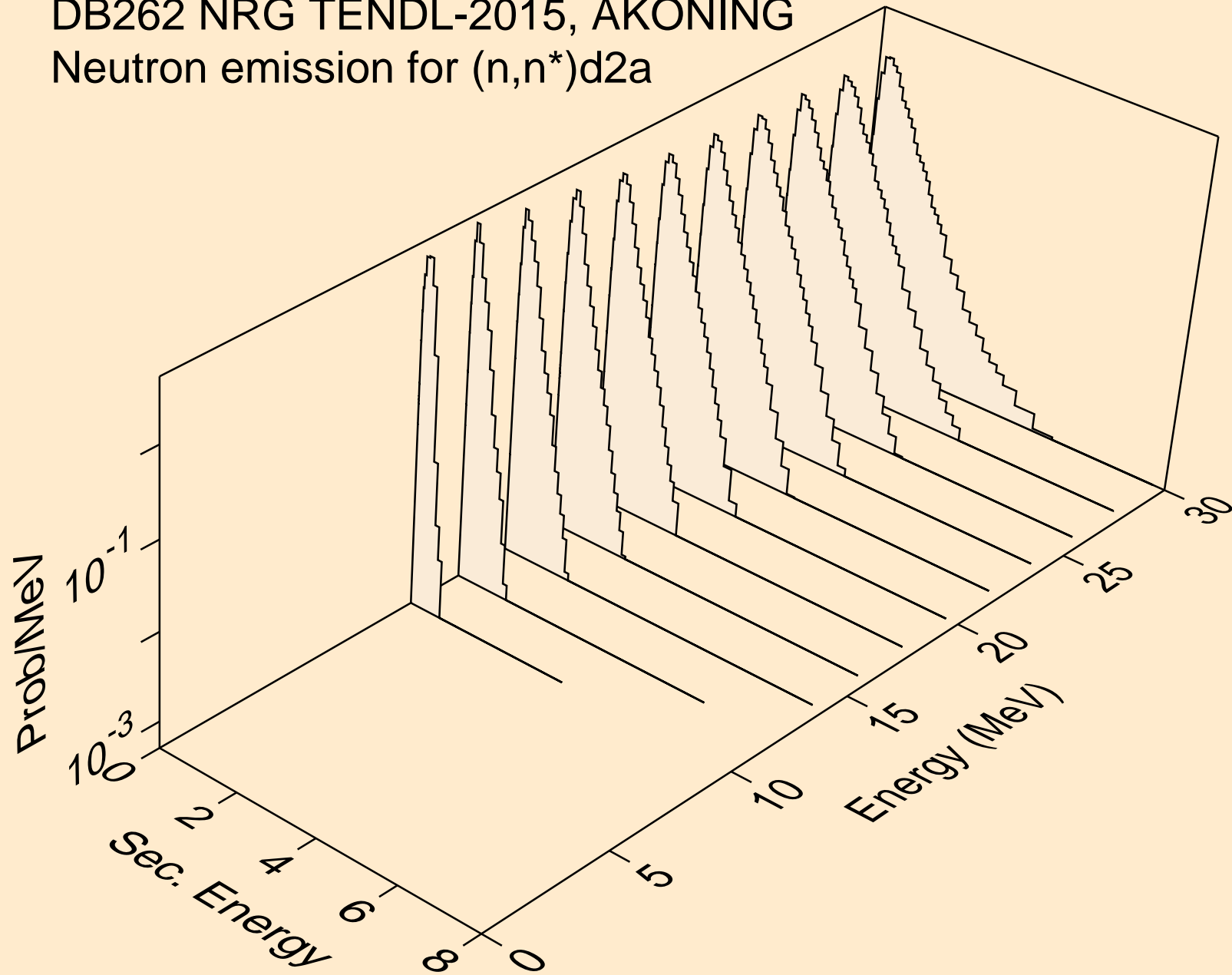

DB262 NRG TENDL-2015, AKONING
Neutron emission for (n,n*)t2a

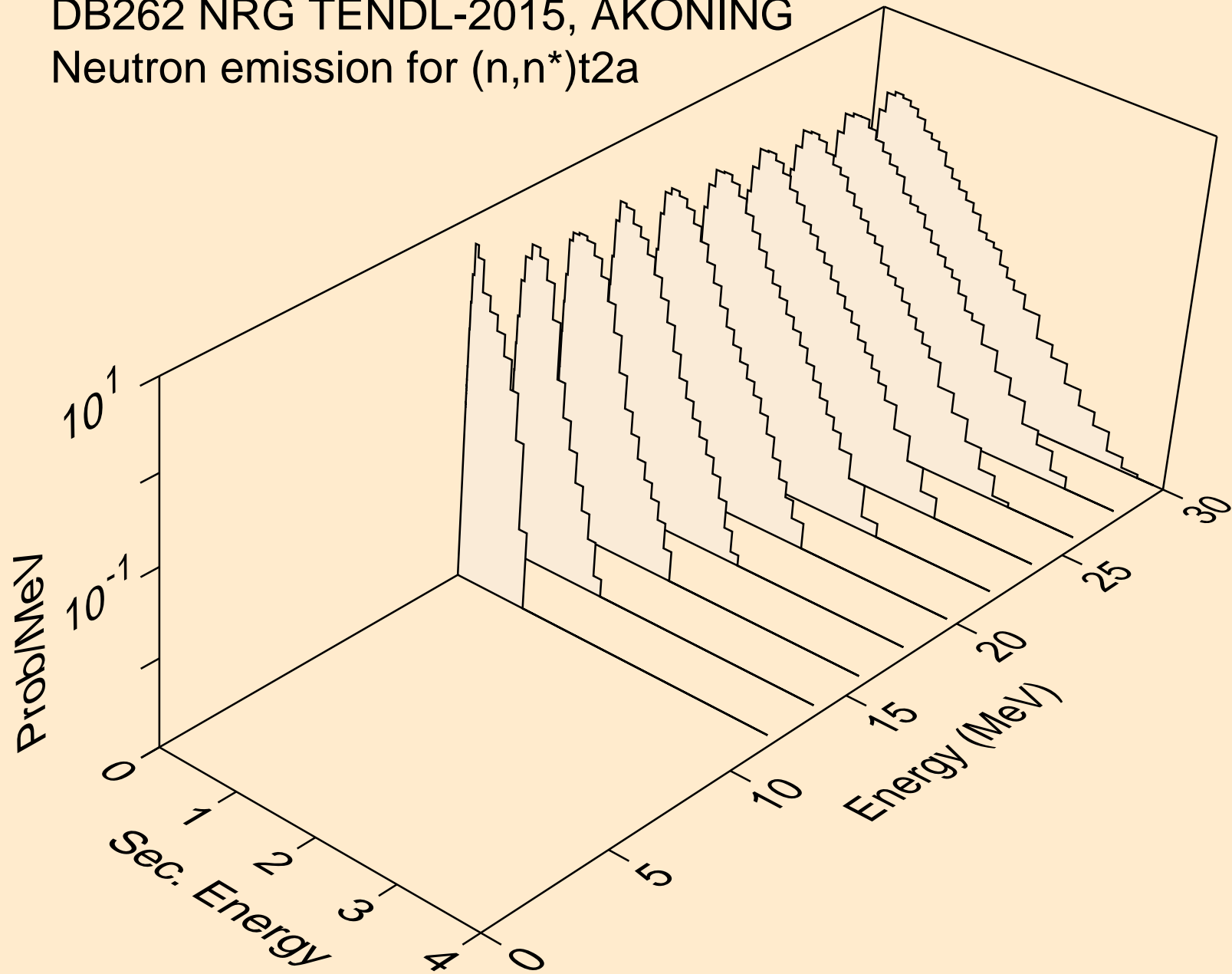

DB262 NRG TENDL-2015, AKONING
Neutron emission for (n,4n)

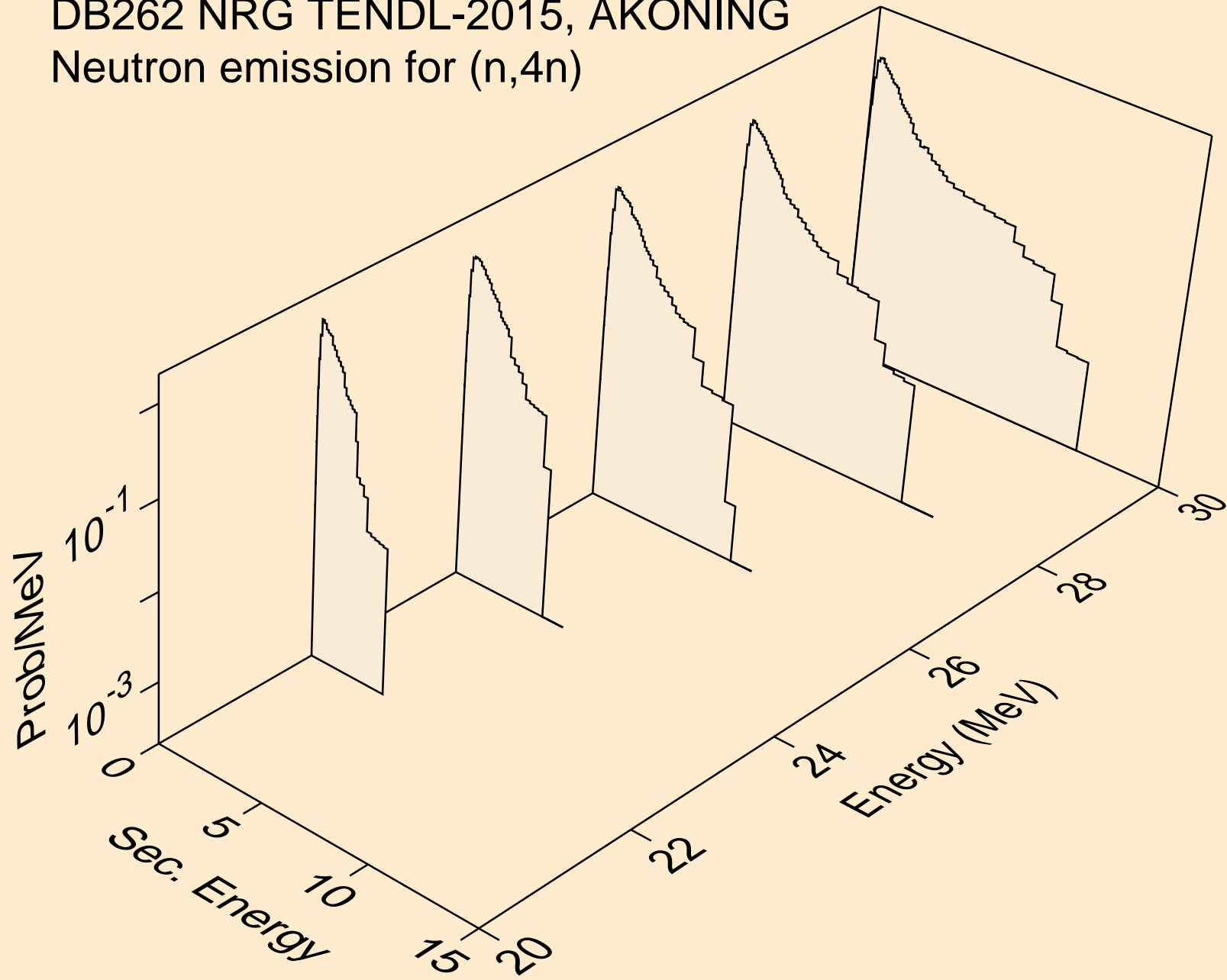

DB262 NRG TENDL-2015, AKONING
Neutron emission for (n,2np)

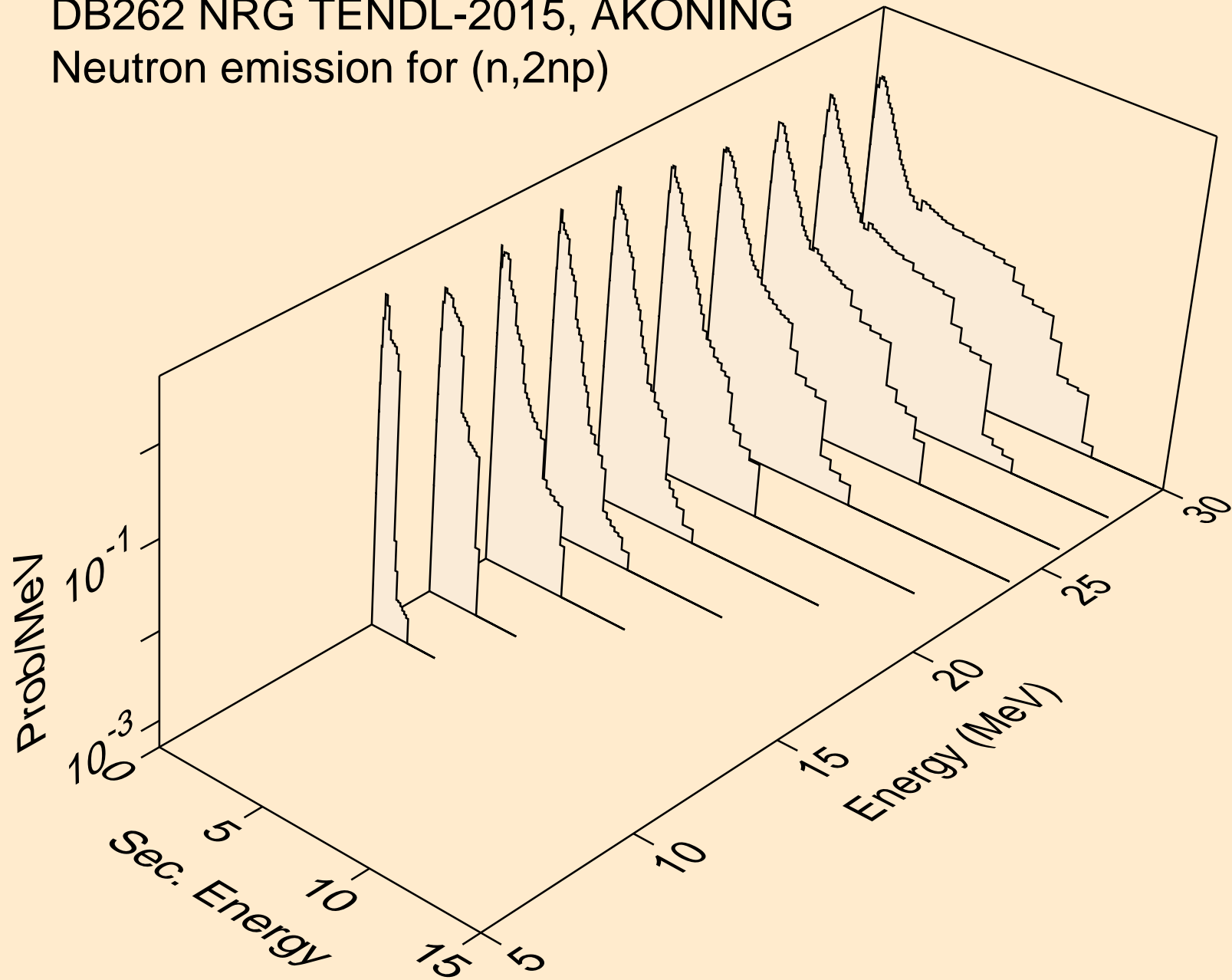

DB262 NRG TENDL-2015, AKONING
Neutron emission for (n,3np)

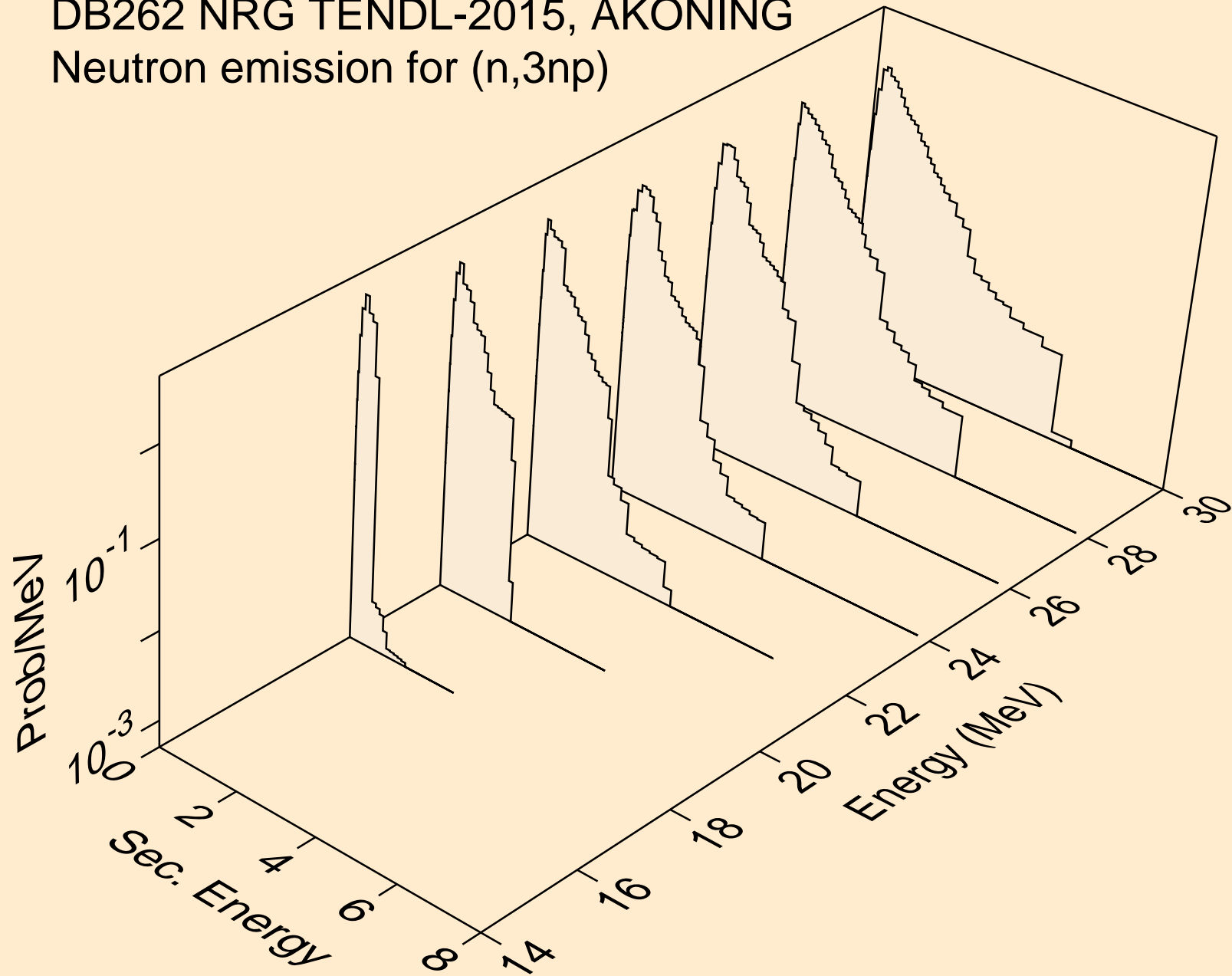

DB262 NRG TENDL-2015, AKONING
Neutron emission for (n,2np)

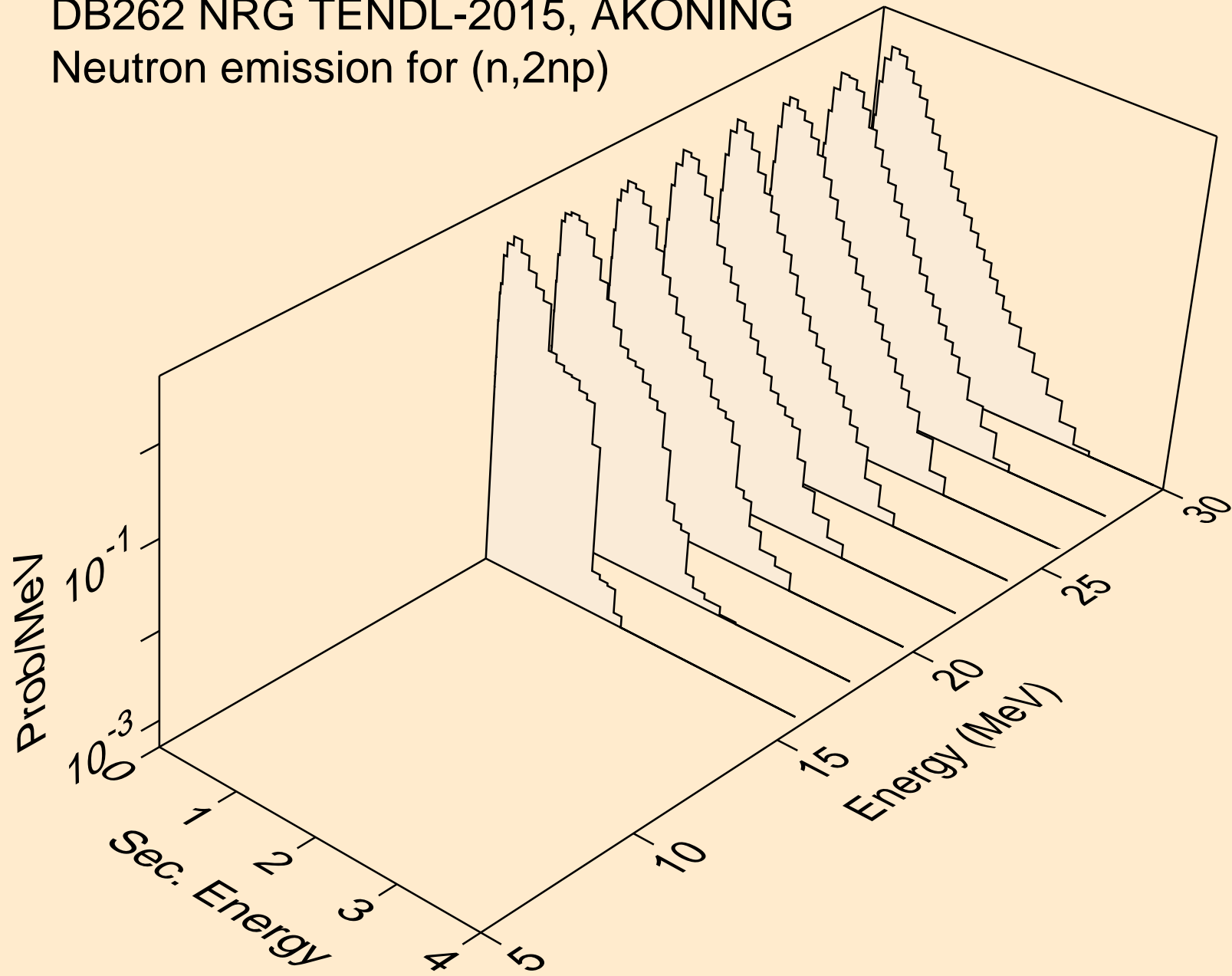

DB262 NRG TENDL-2015, AKONING
Neutron emission for (n,npa)

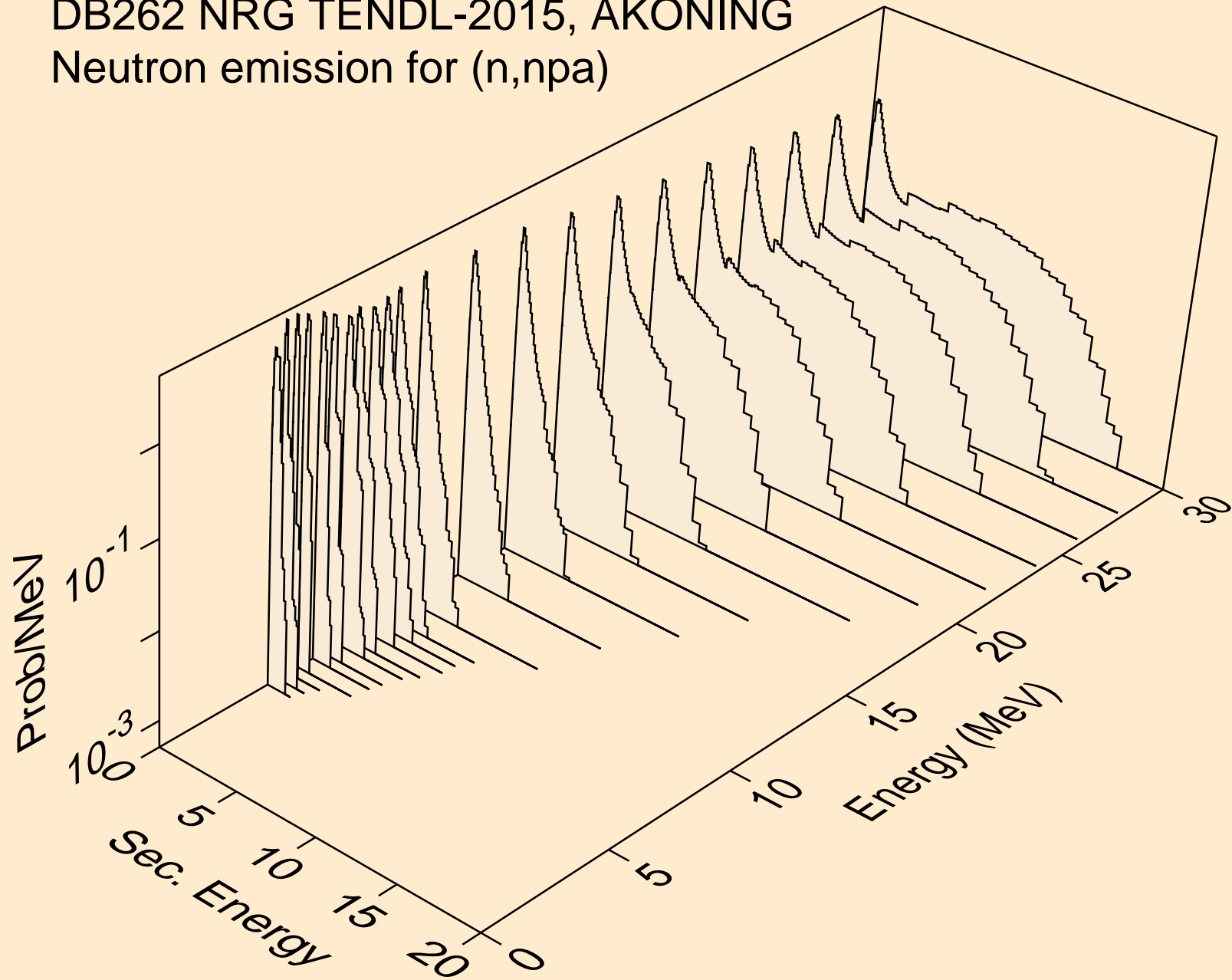

DB262 NRG TENDL-2015, AKONING
Neutron emission for (n,n*c)

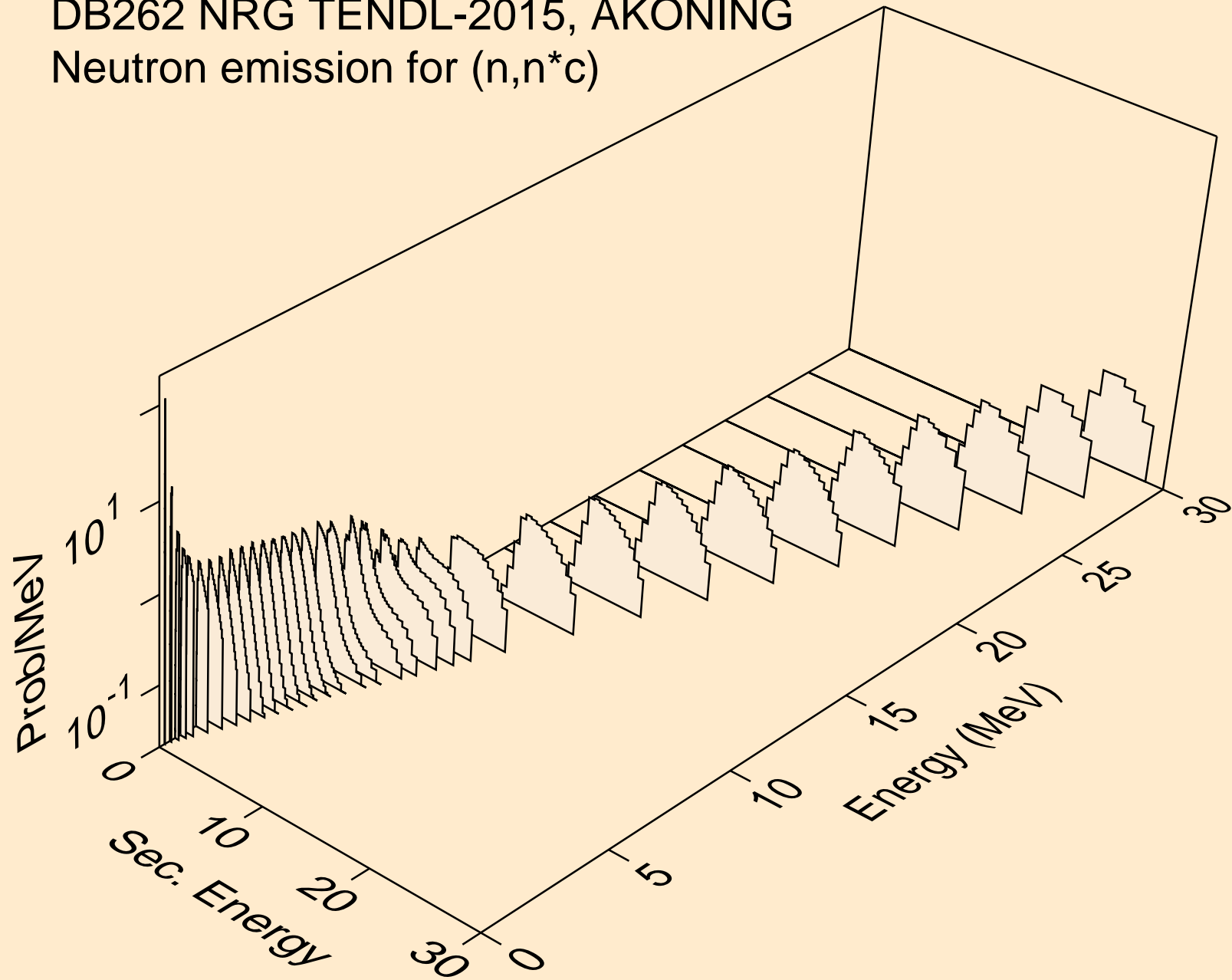

DB262 NRG TENDL-2015, AKONING

Delayed nubar

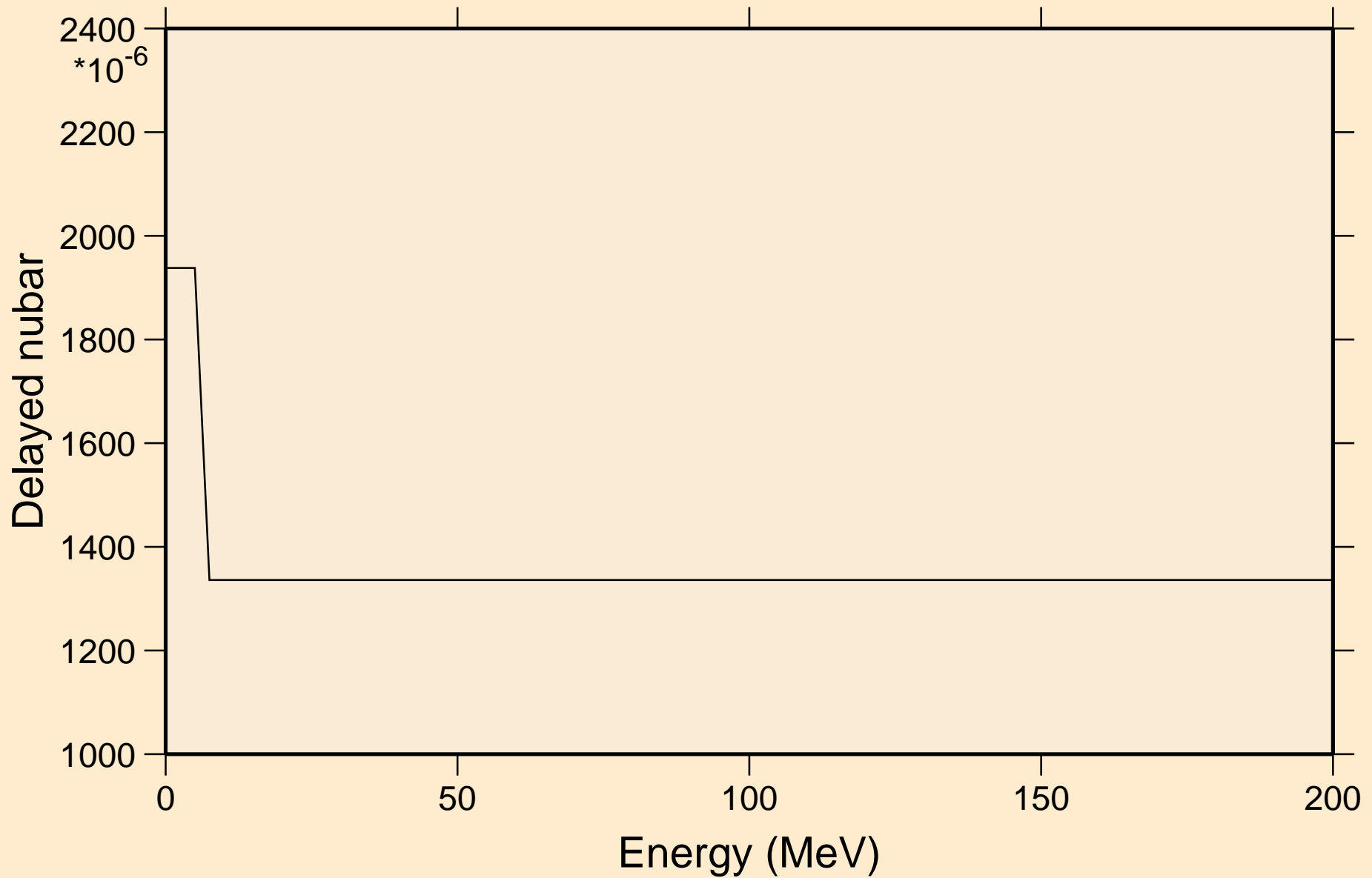

DB262 NRG TENDL-2015, AKONING

Delayed neutron spectra

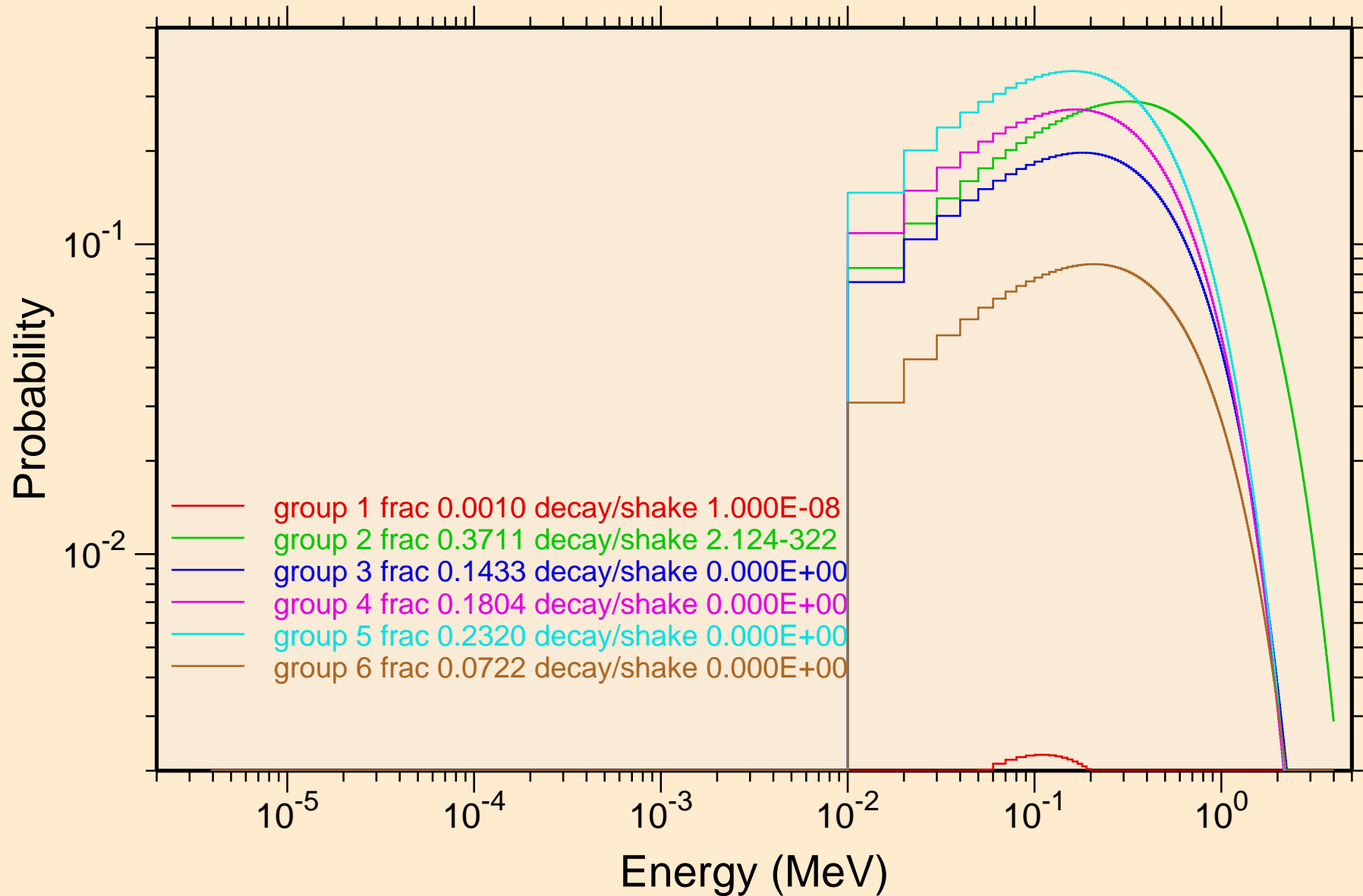

DB262 NRG TENDL-2015, AKONING
Photon emission for (n,x)

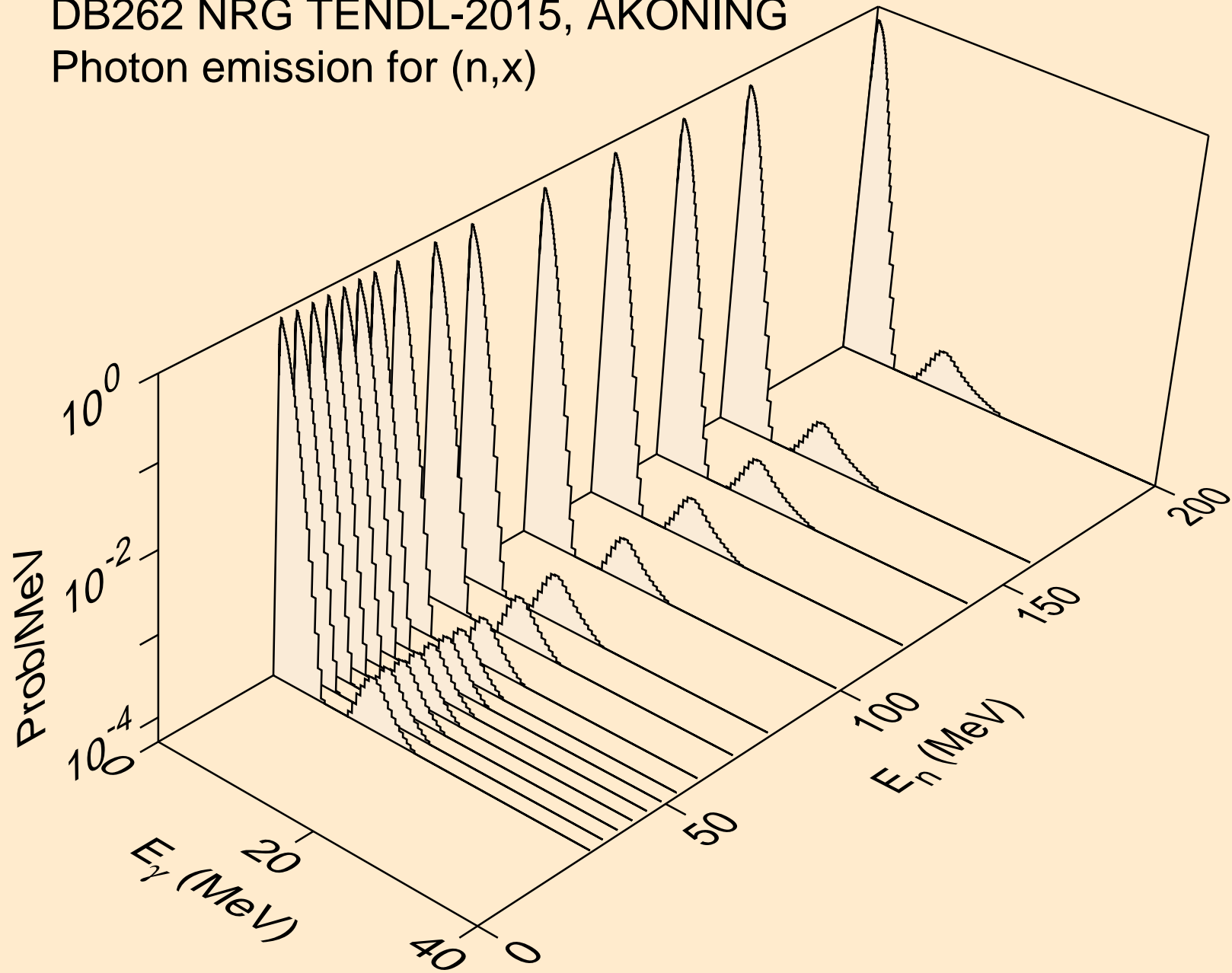

DB262 NRG TENDL-2015, AKONING
Photon emission for (n,2nd)

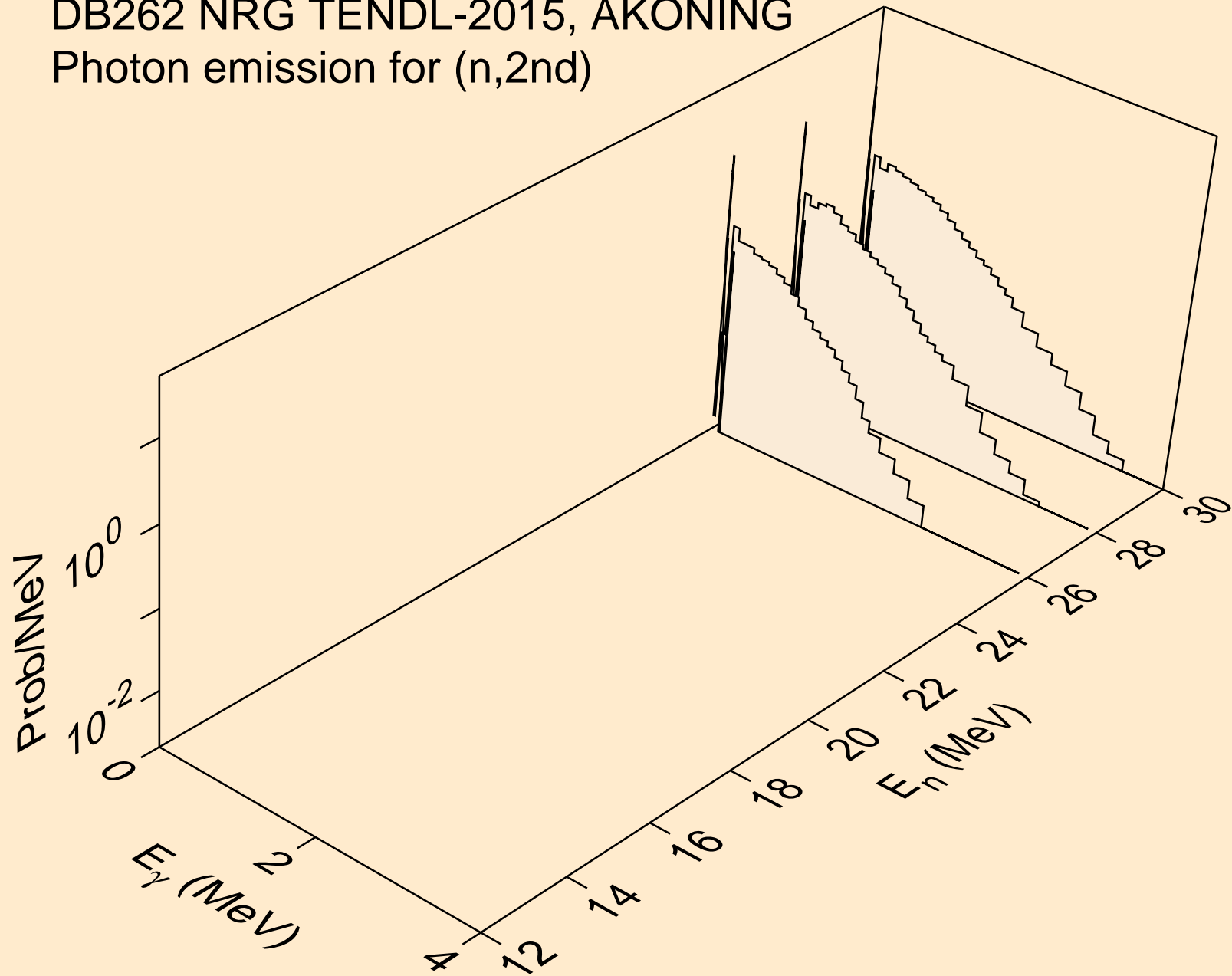

DB262 NRG TENDL-2015, AKONING
Photon emission for (n,2n)

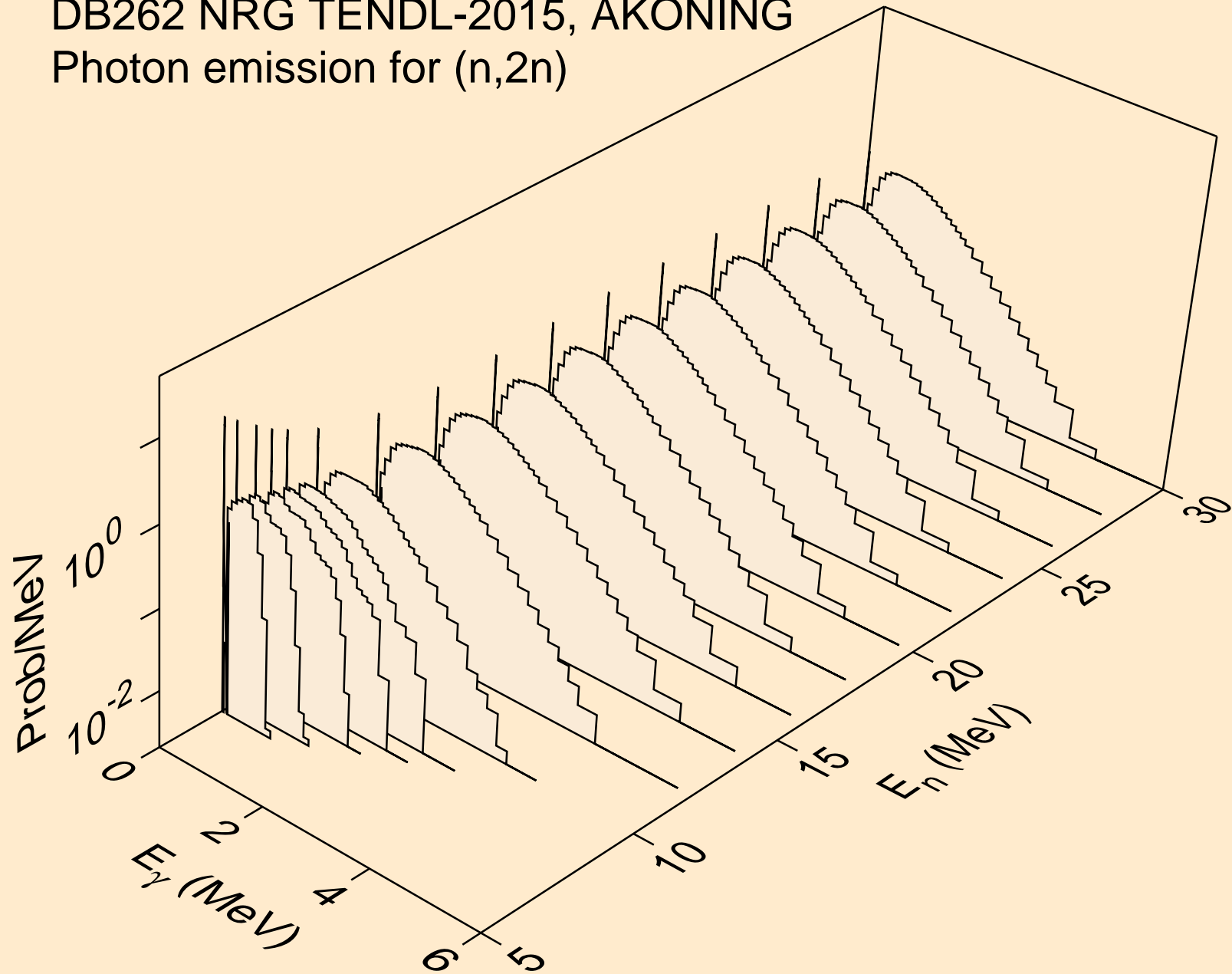

DB262 NRG TENDL-2015, AKONING
Photon emission for (n,3n)

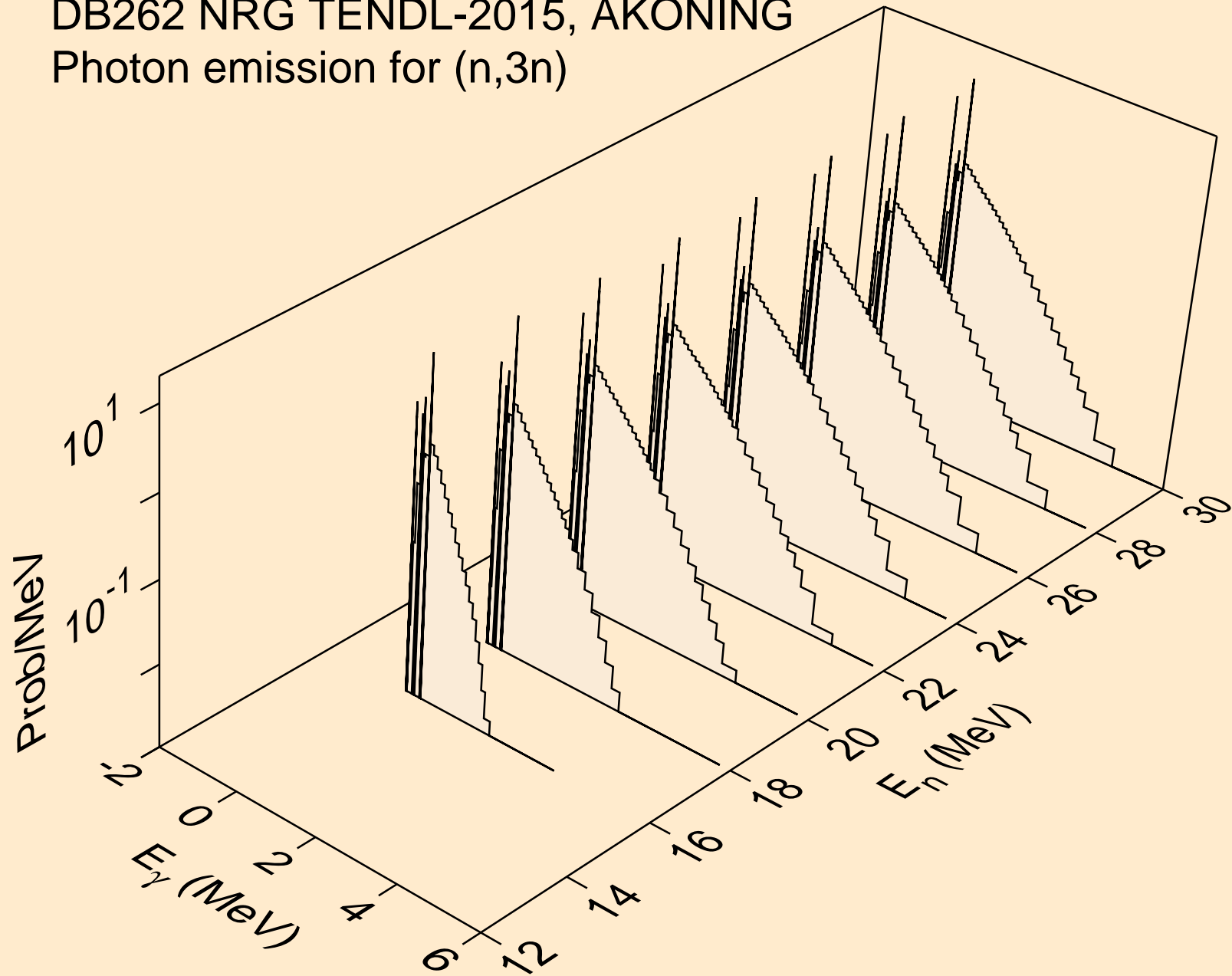

DB262 NRG TENDL-2015, AKONING
Photon emission for (n,n*)a

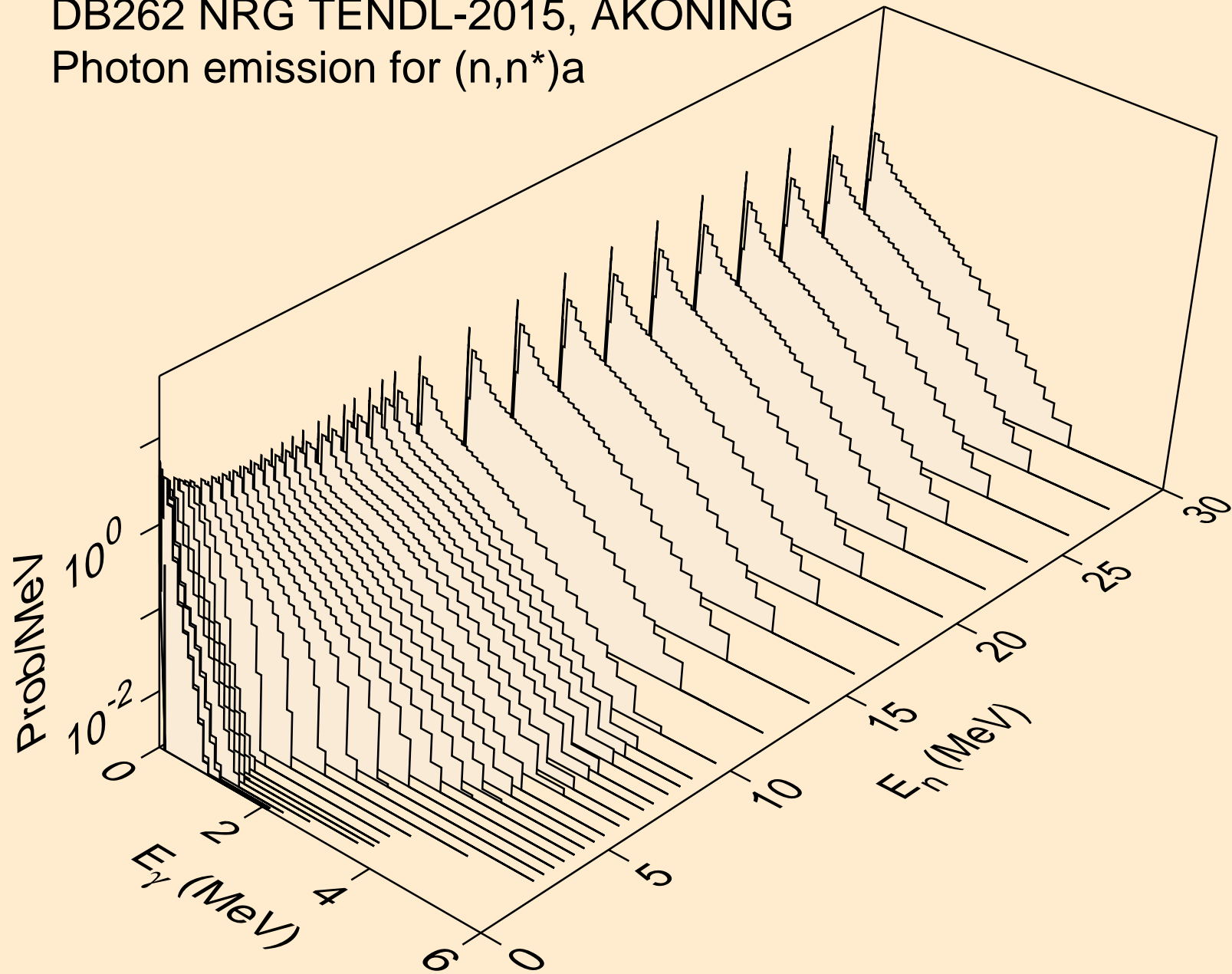

DB262 NRG TENDL-2015, AKONING
Photon emission for (n,n*)3a

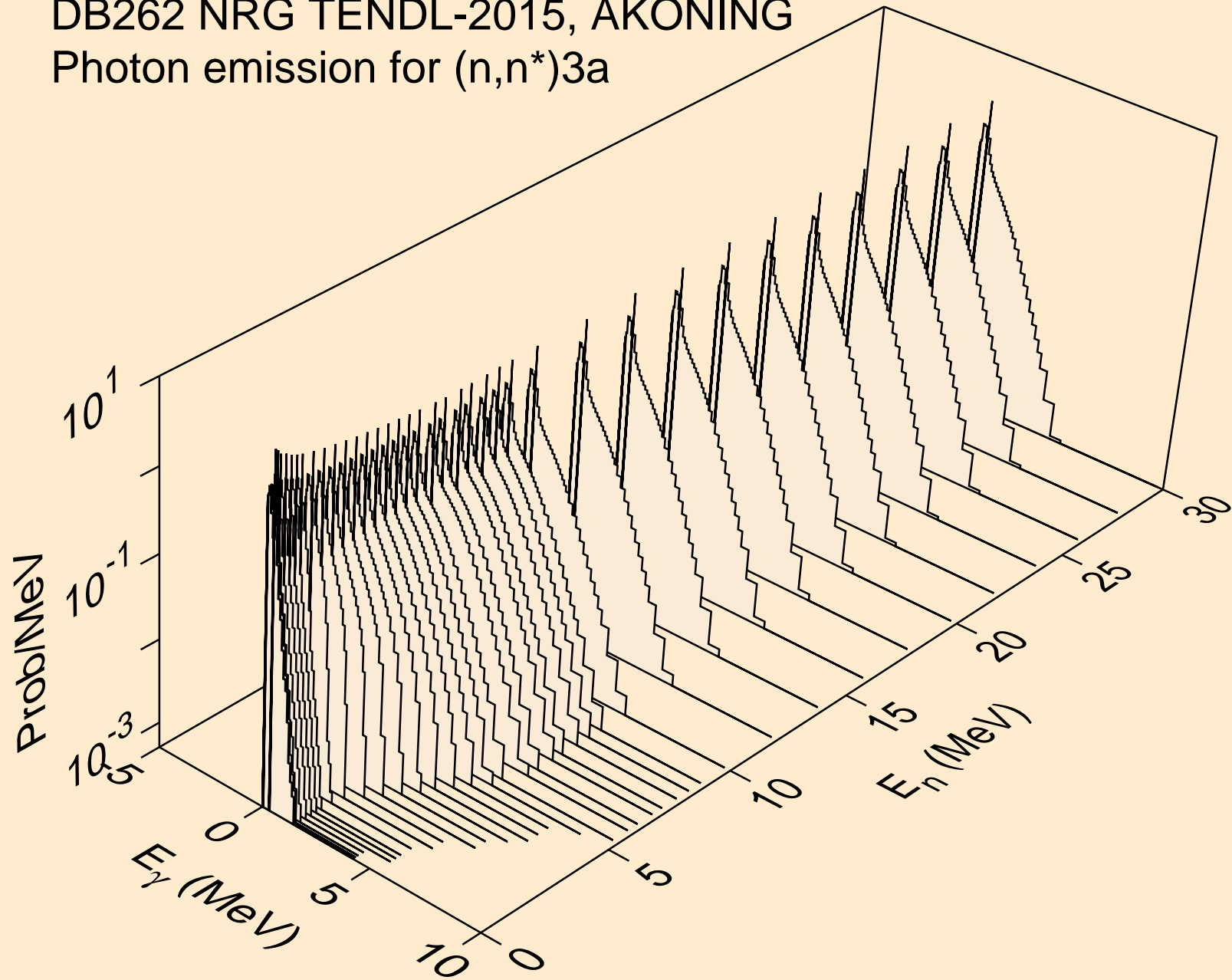

DB262 NRG TENDL-2015, AKONING
Photon emission for (n,2n)a

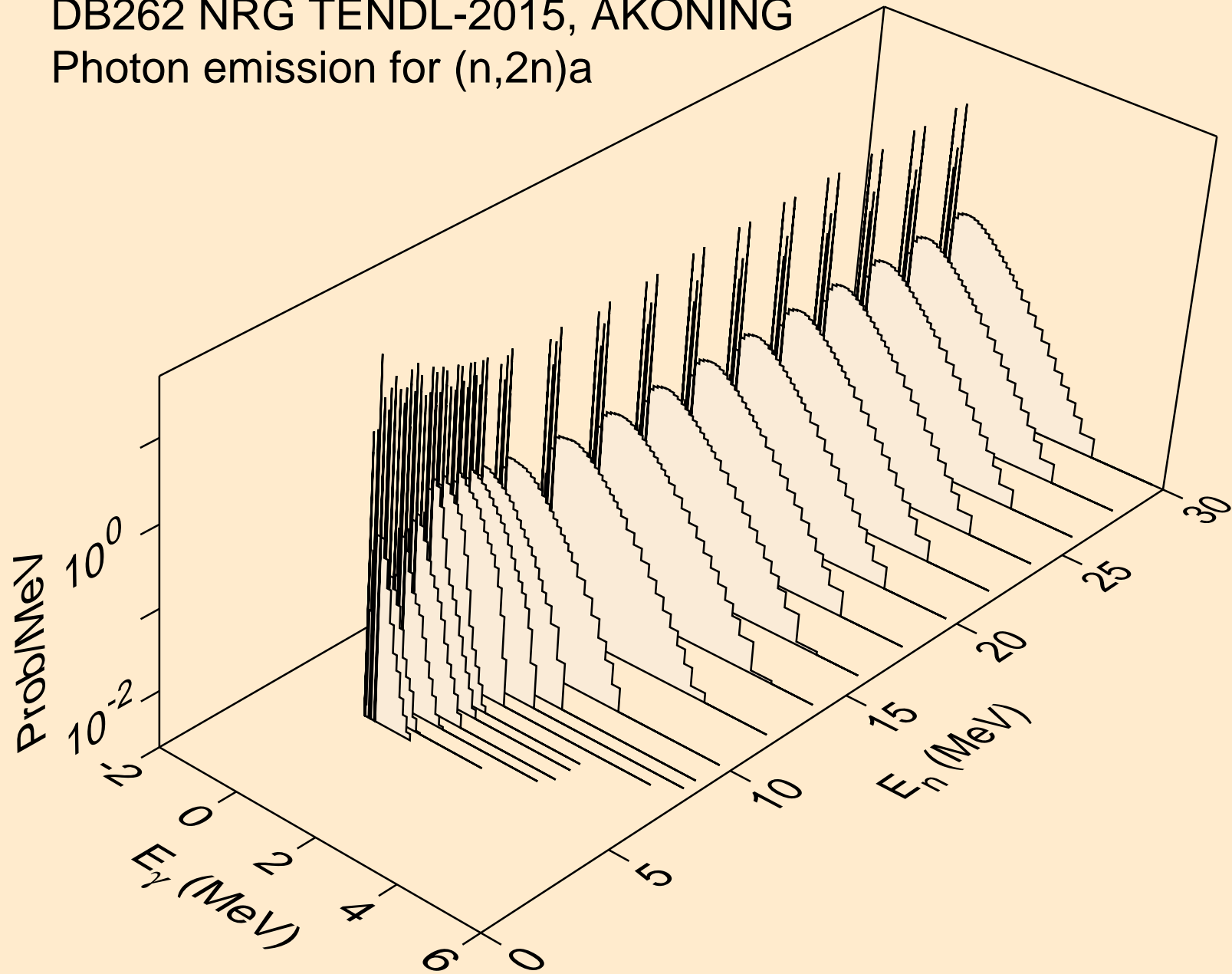

DB262 NRG TENDL-2015, AKONING
Photon emission for (n,3n)a

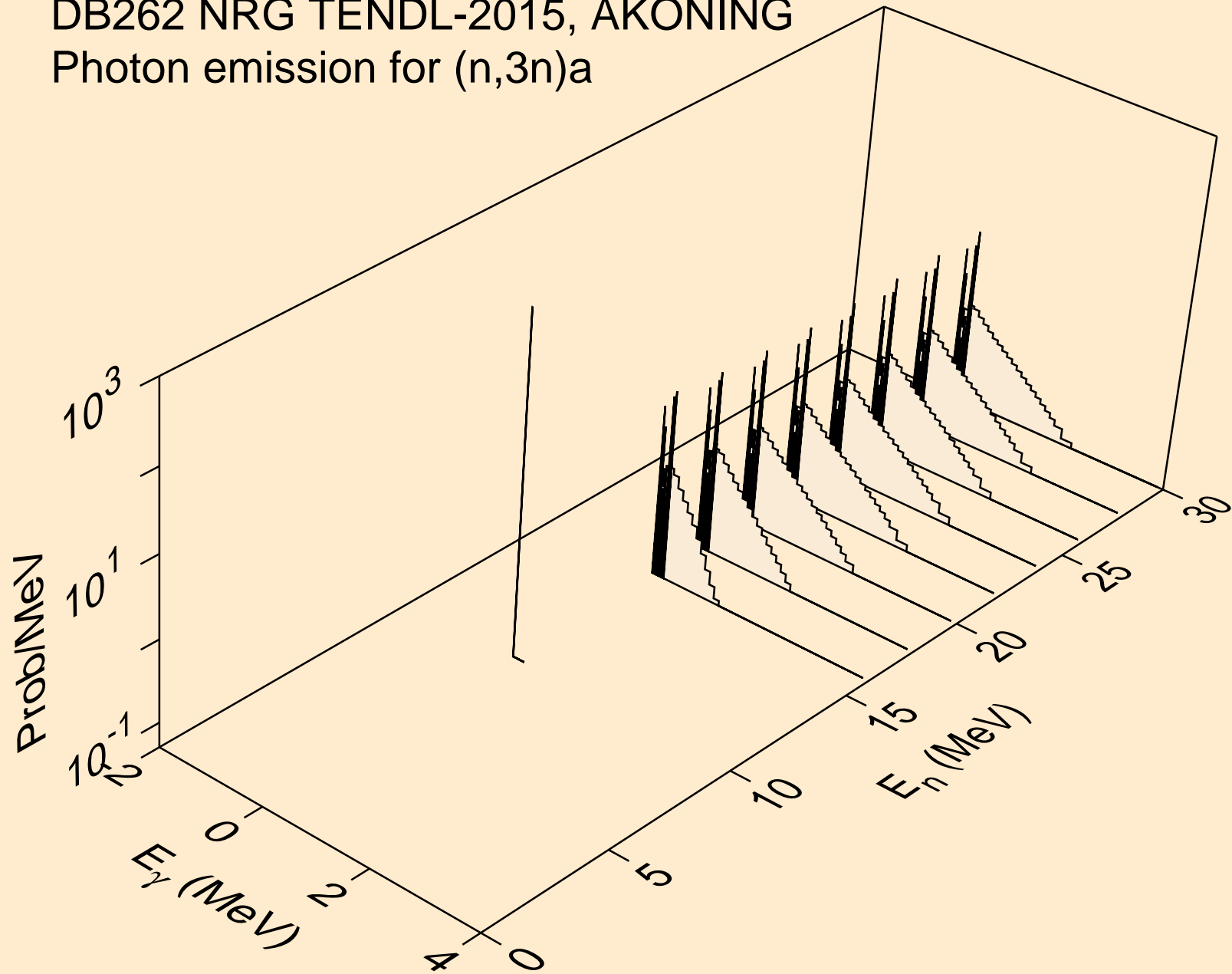

DB262 NRG TENDL-2015, AKONING

Photon emission for (n,n*)p

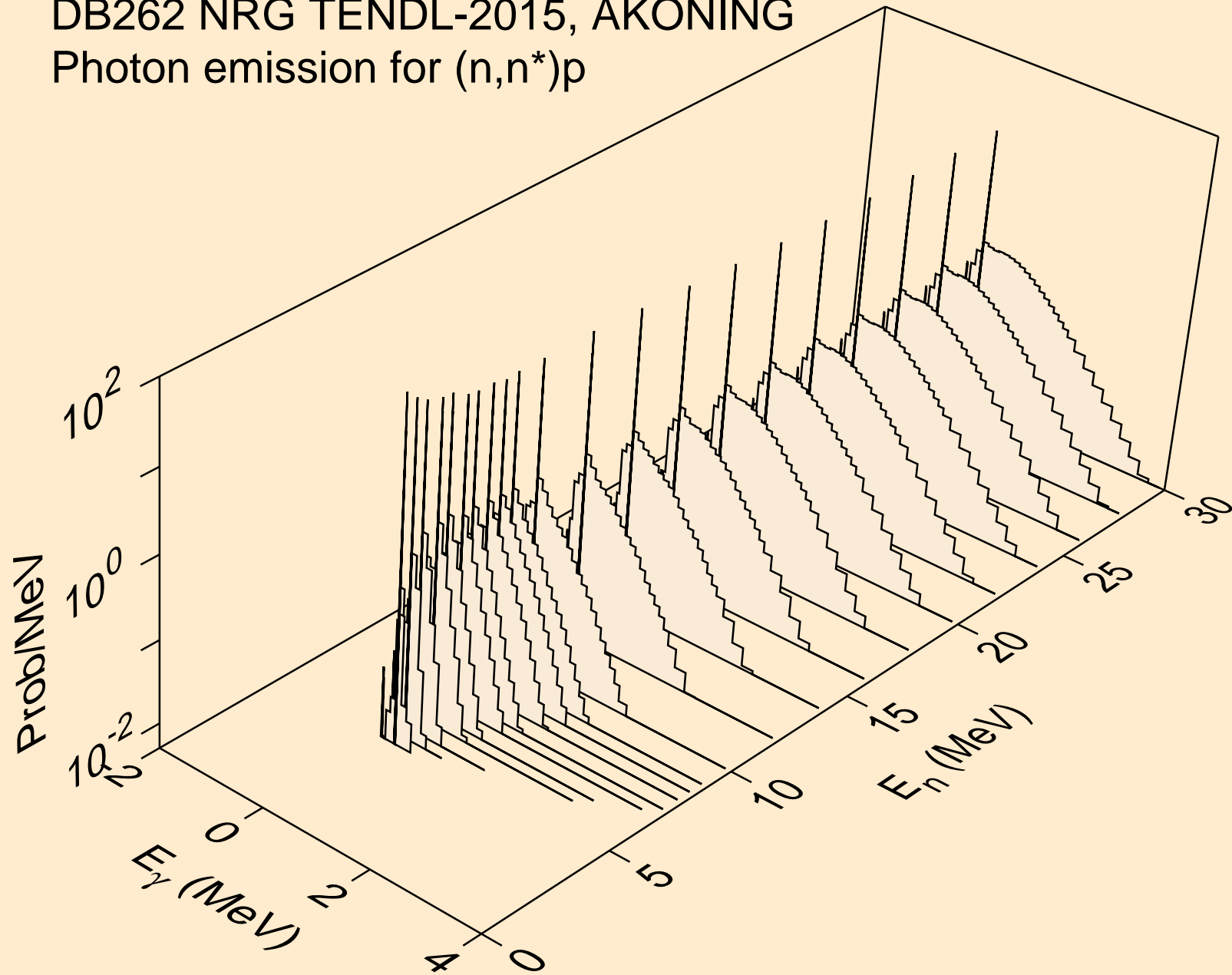

DB262 NRG TENDL-2015, AKONING
Photon emission for (n,n*)2a

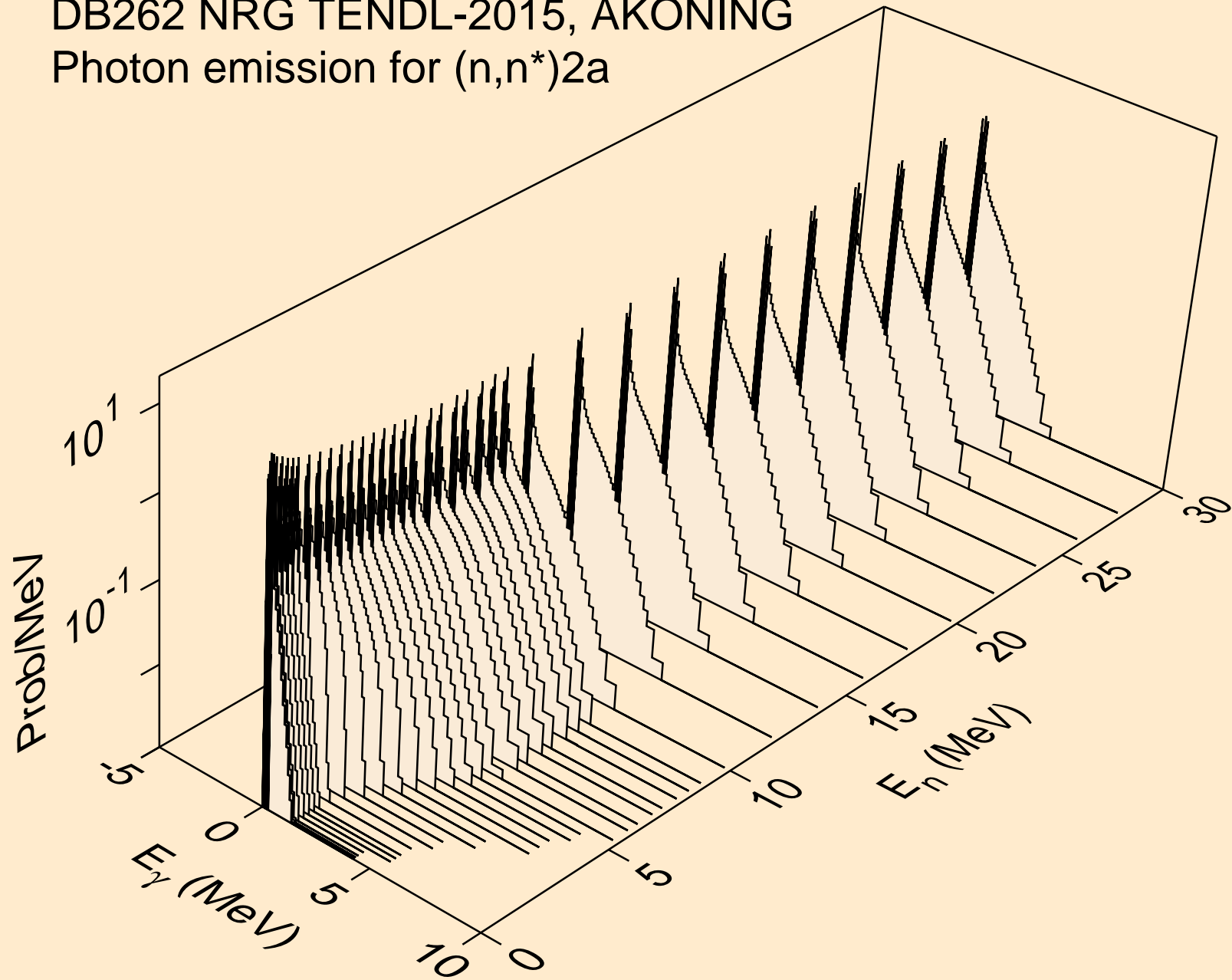

DB262 NRG TENDL-2015, AKONING
Photon emission for (n,2n)2a

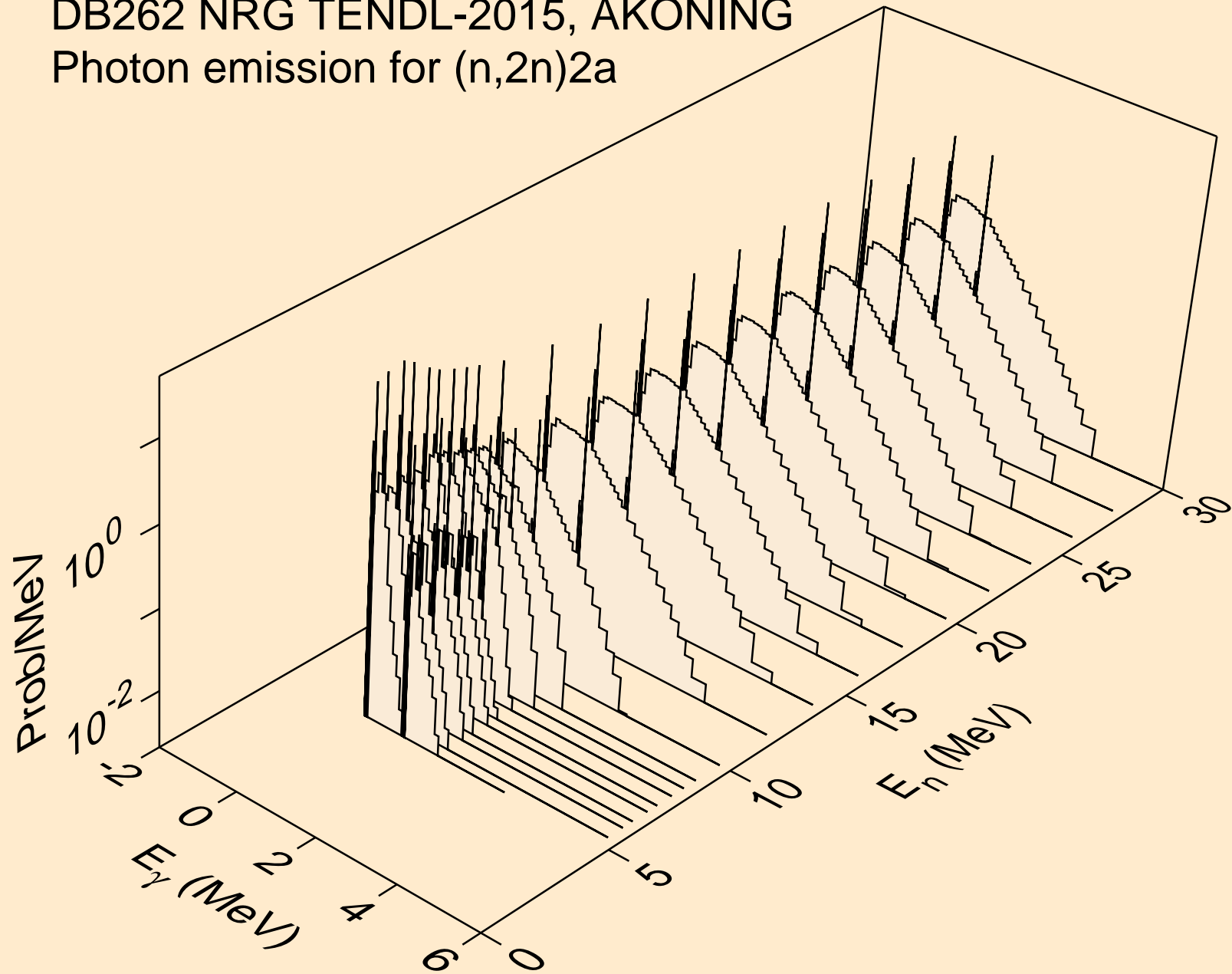

DB262 NRG TENDL-2015, AKONING
Photon emission for (n,n*)d

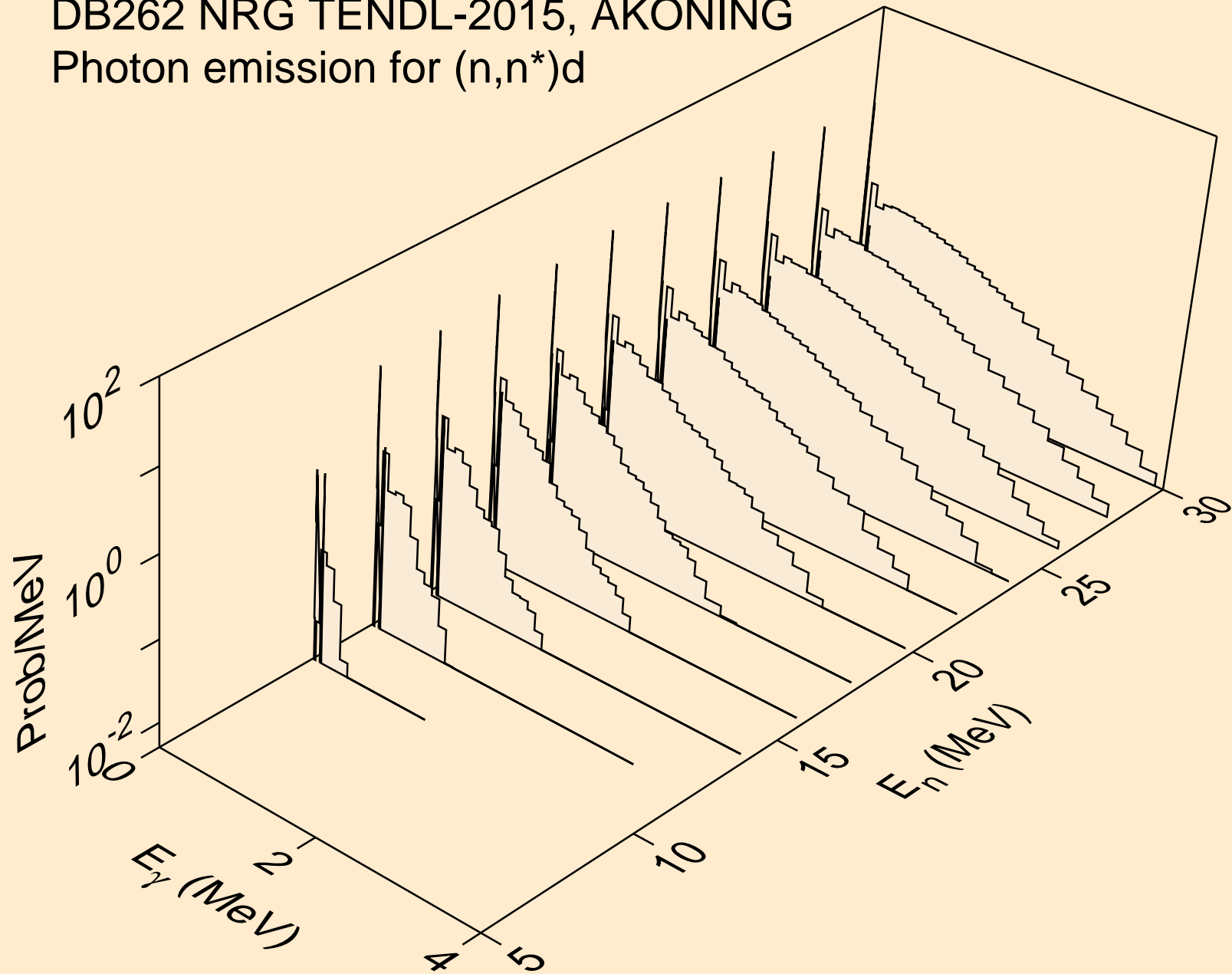

DB262 NRG TENDL-2015, AKONING
Photon emission for (n,n*)t

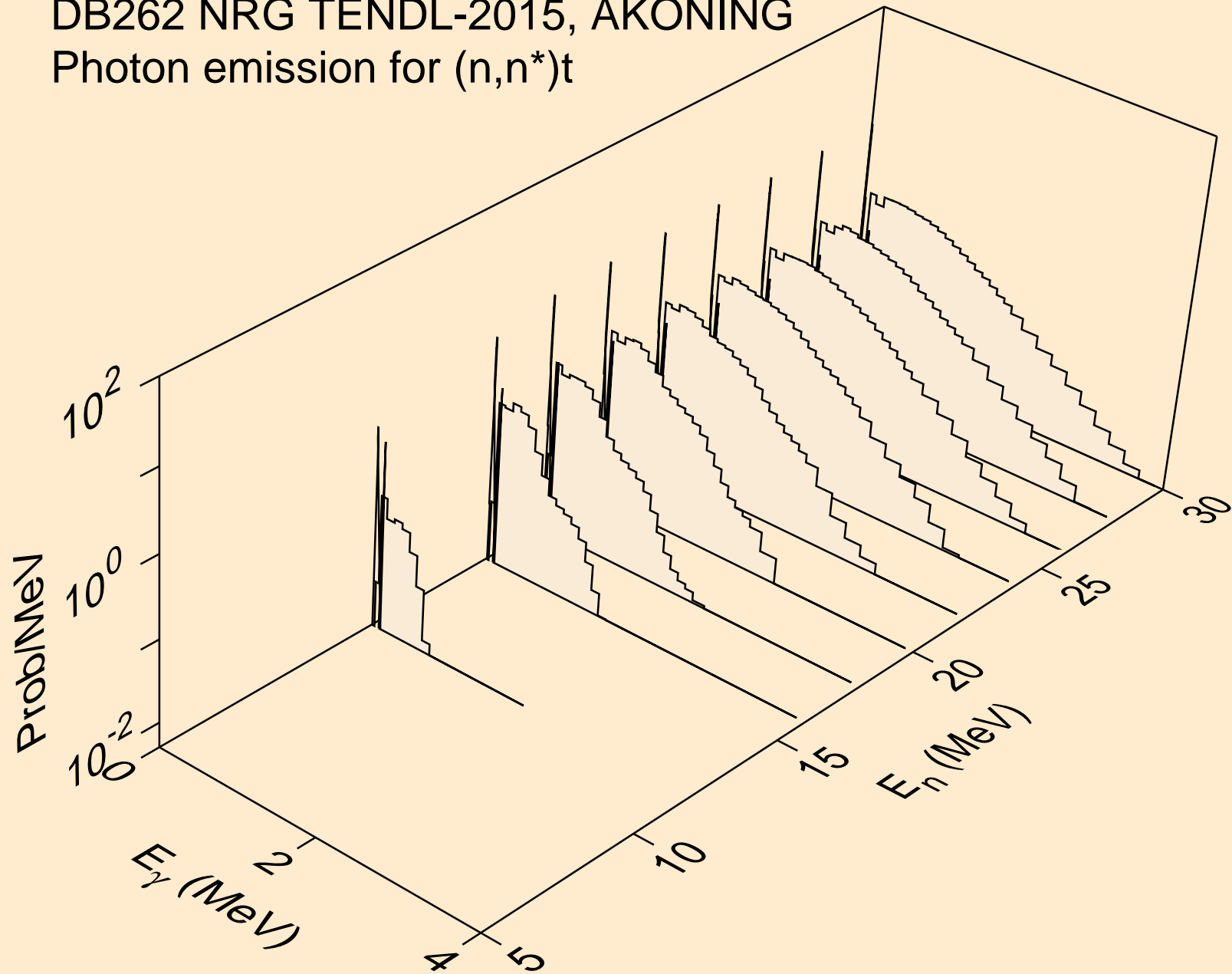

DB262 NRG TENDL-2015, AKONING
Photon emission for (n,n*)he3

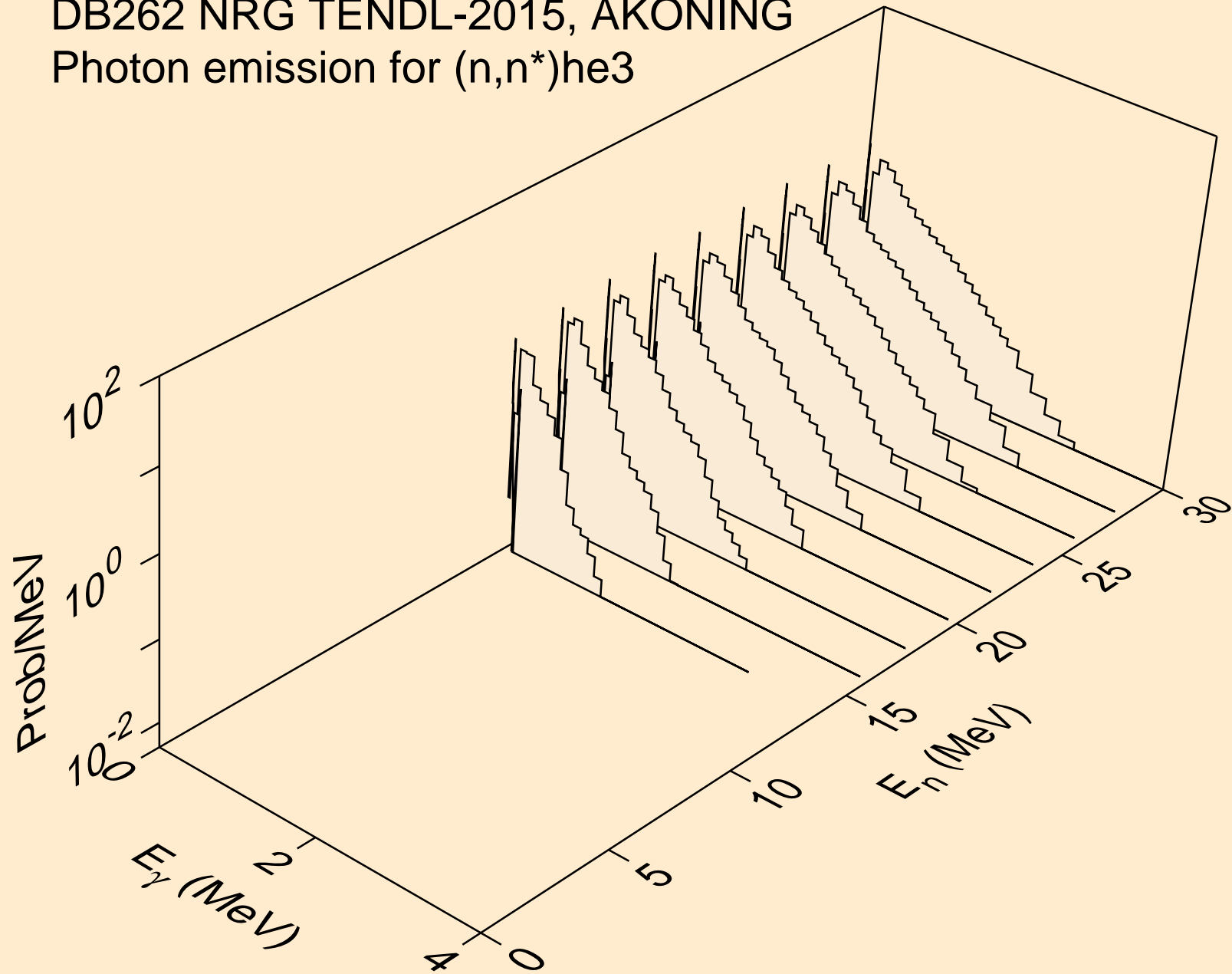

DB262 NRG TENDL-2015, AKONING
Photon emission for (n,n*)d2a

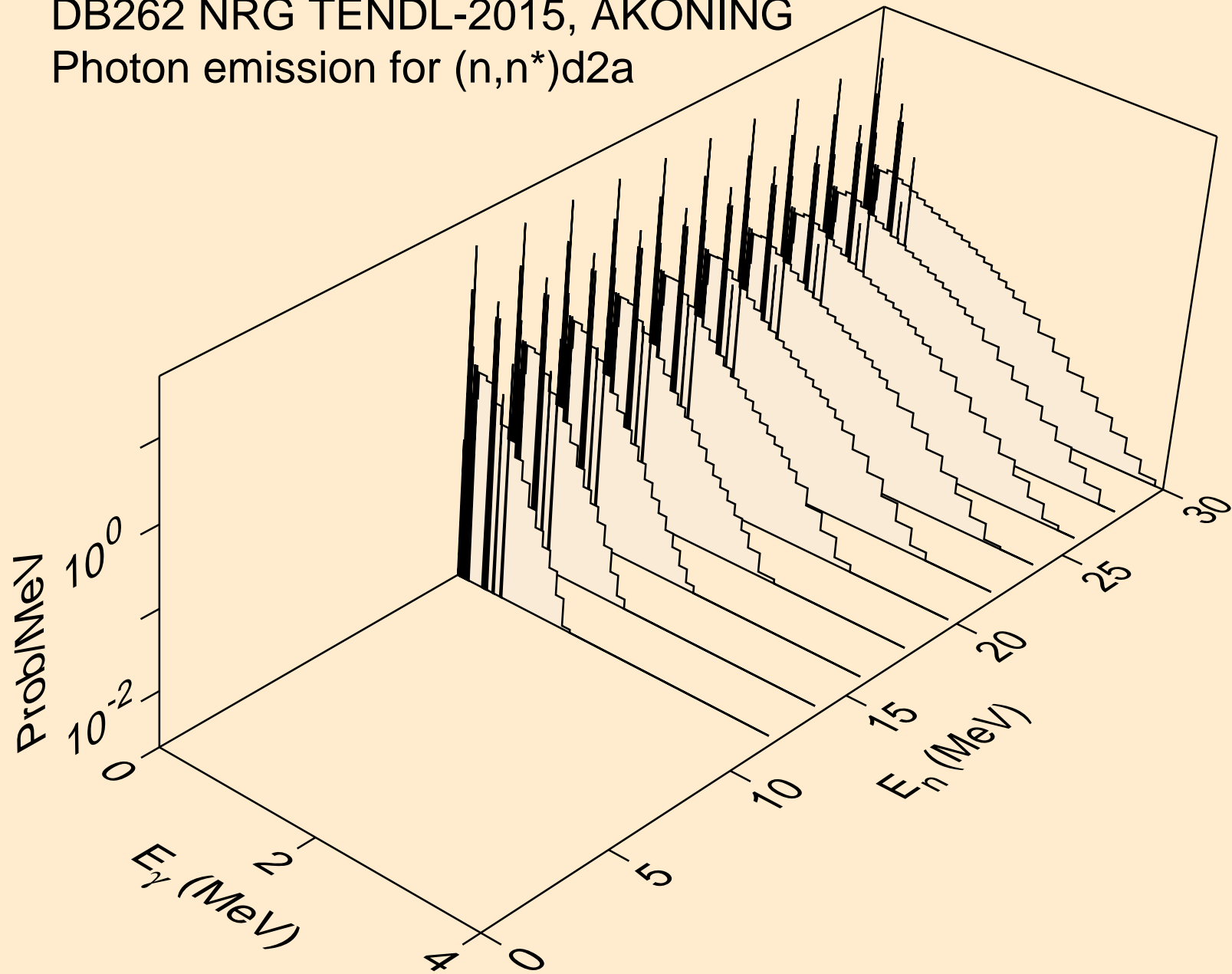

DB262 NRG TENDL-2015, AKONING
Photon emission for (n,n*)t2a

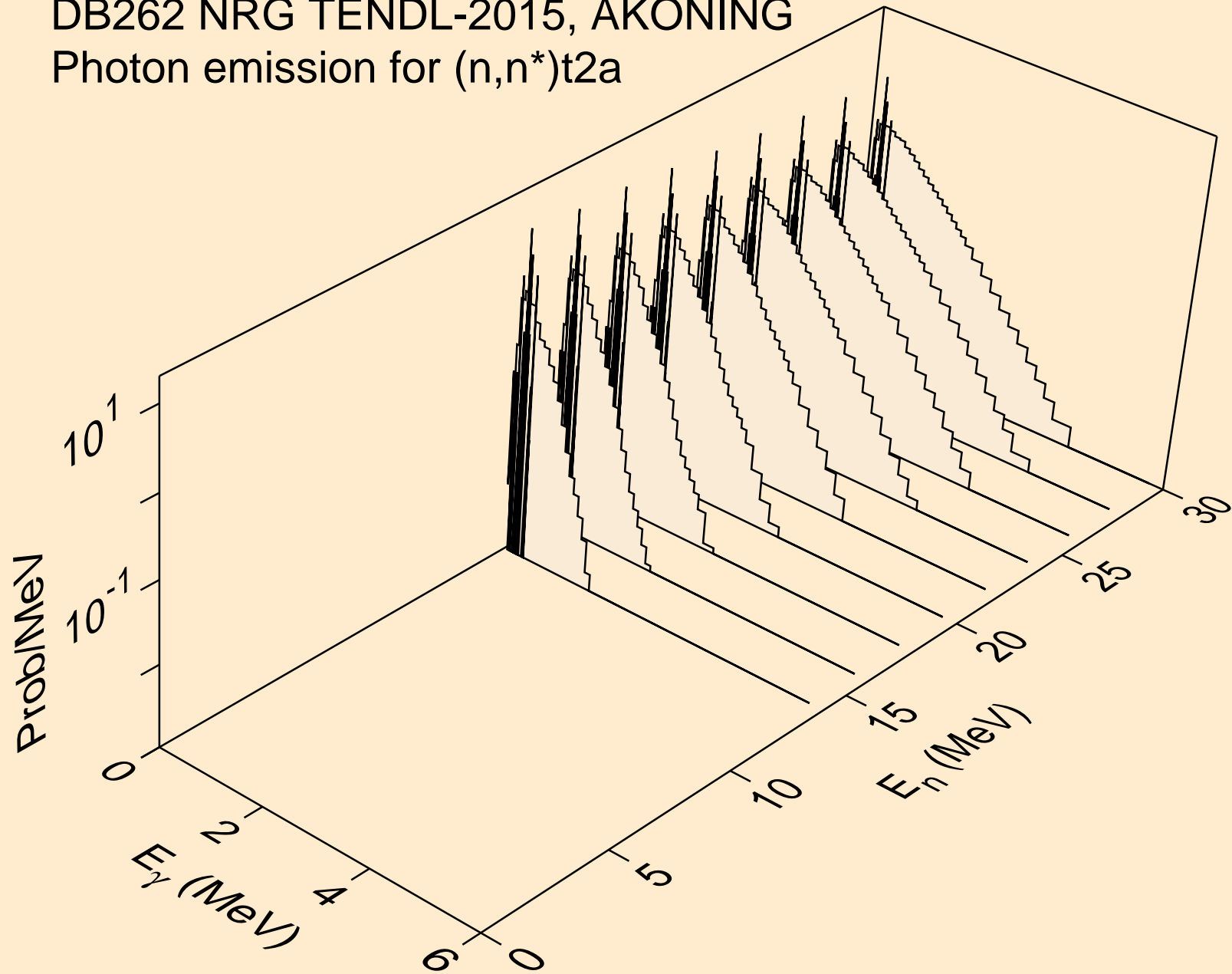

DB262 NRG TENDL-2015, AKONING
Photon emission for (n,4n)

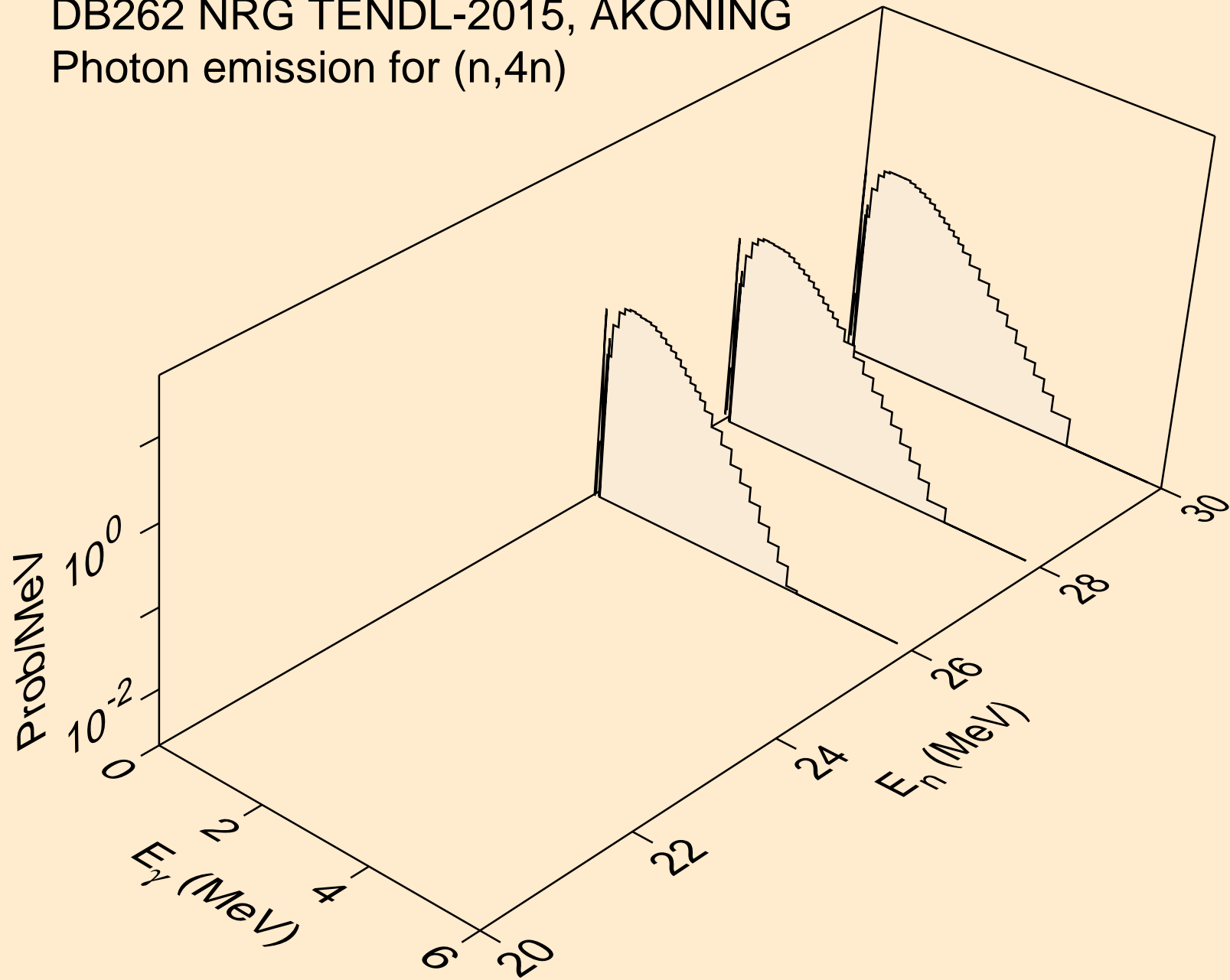

DB262 NRG TENDL-2015, AKONING
Photon emission for (n,2np)

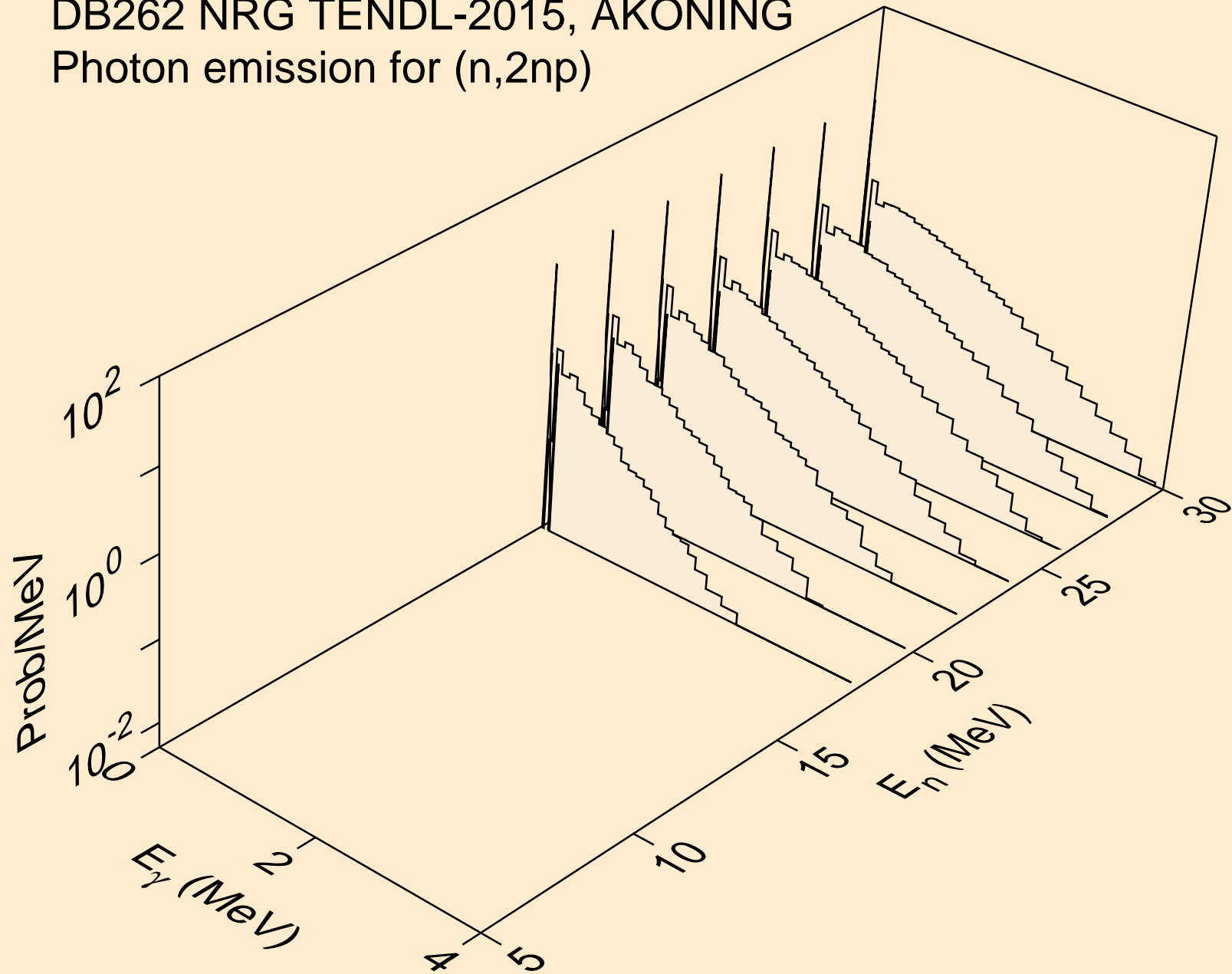

DB262 NRG TENDL-2015, AKONING
Photon emission for (n,3np)

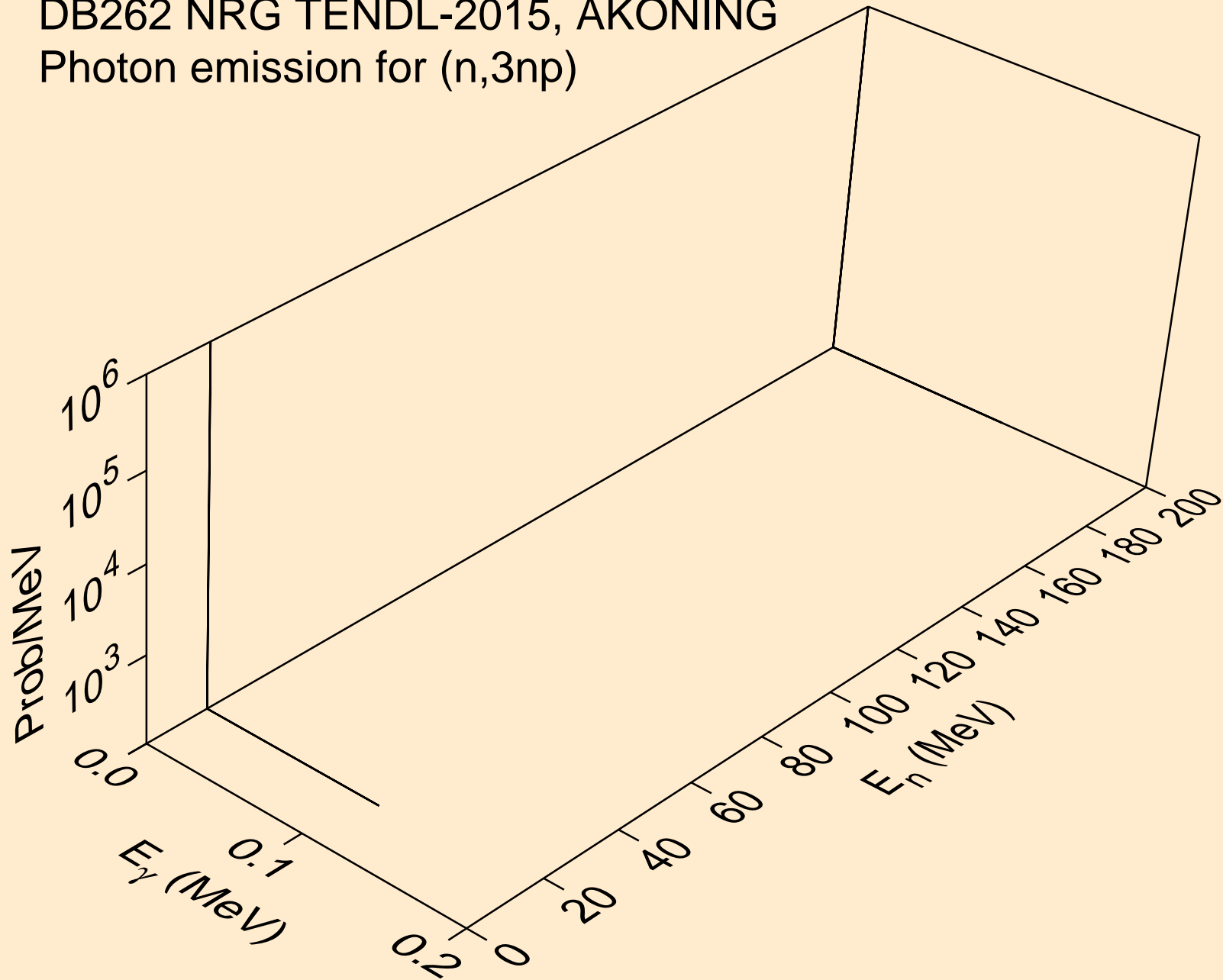

DB262 NRG TENDL-2015, AKONING
Photon emission for (n,2np)

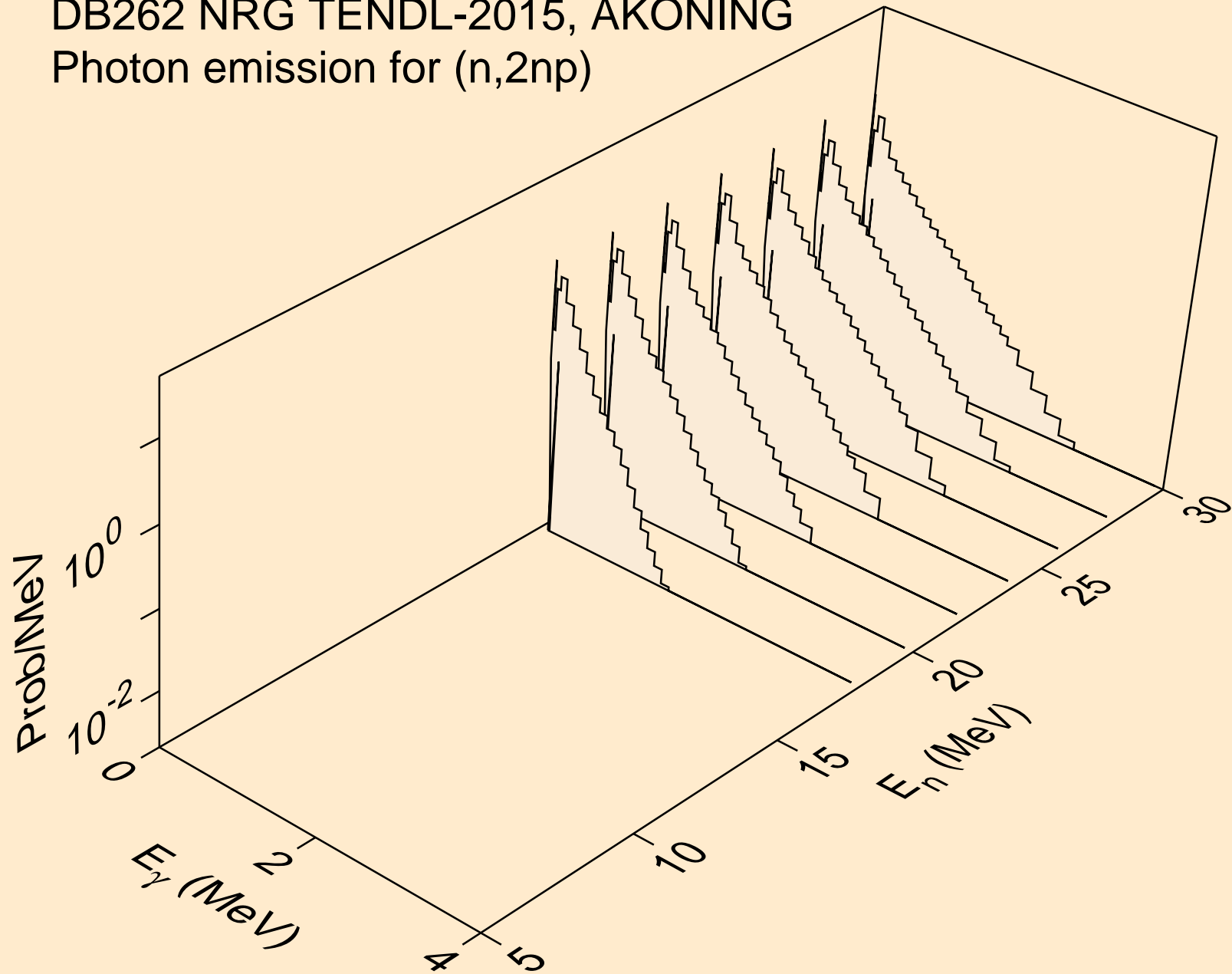

DB262 NRG TENDL-2015, AKONING
Photon emission for (n,npa)

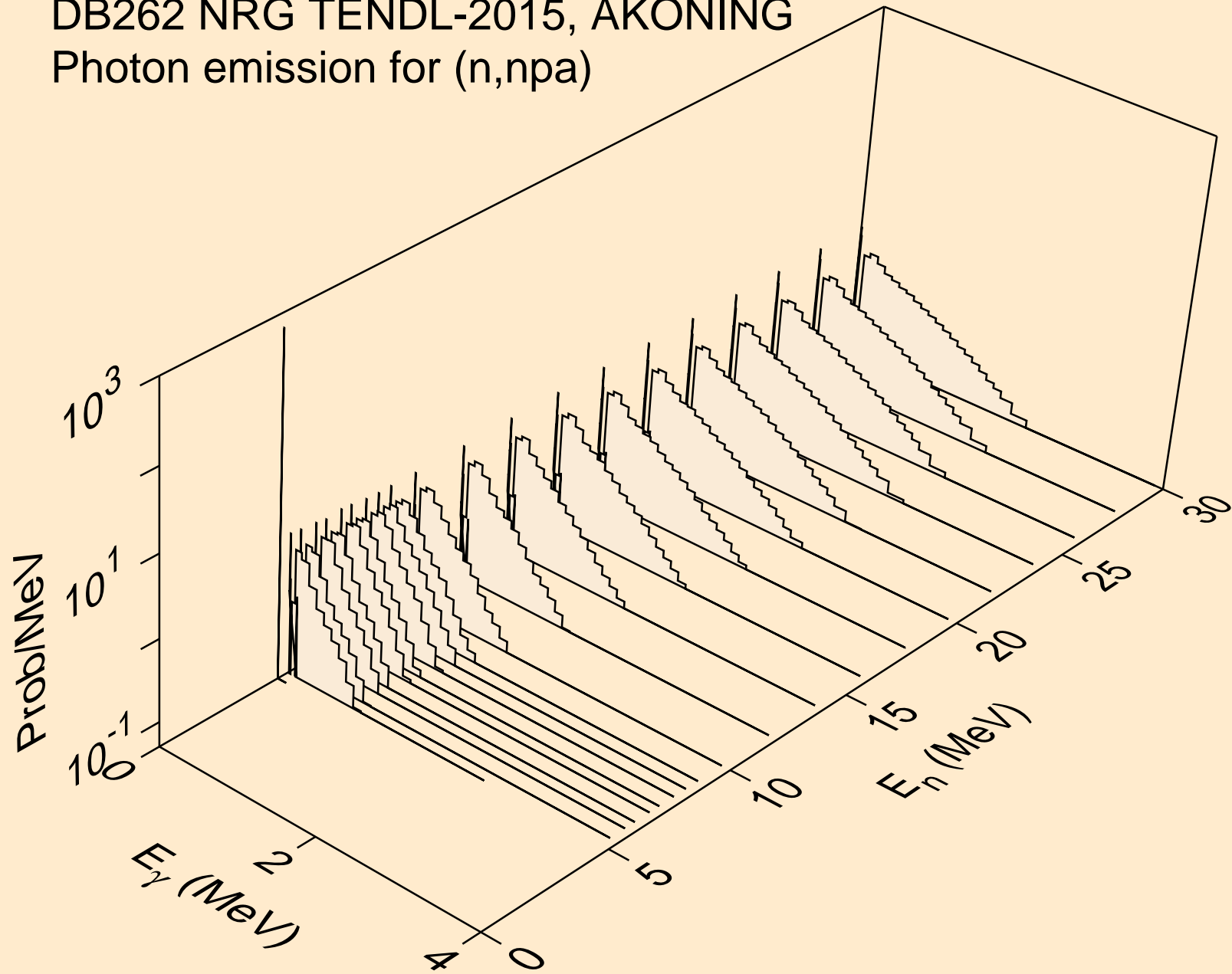

DB262 NRG TENDL-2015, AKONING
Photon emission for (n,n*c)

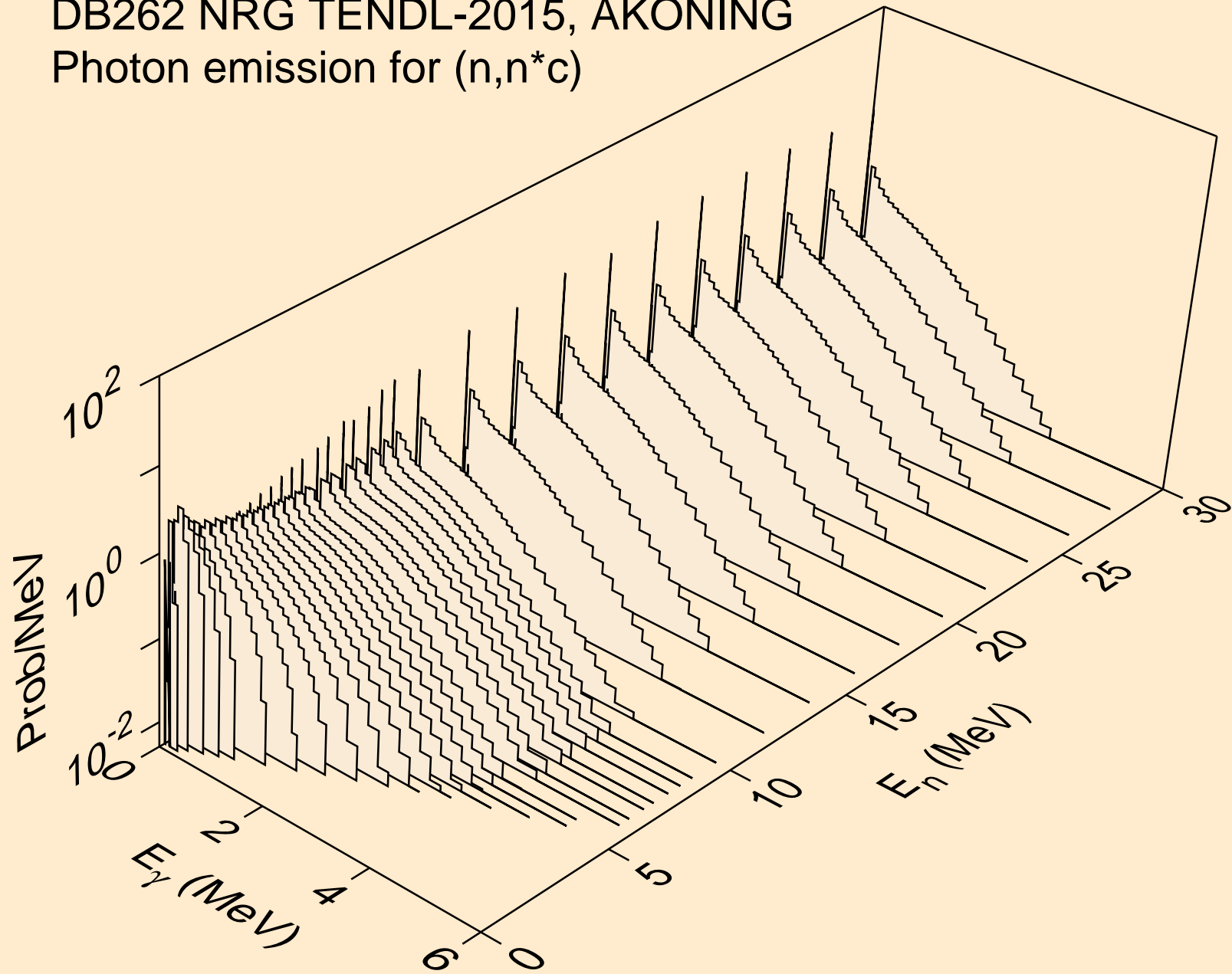

DB262 NRG TENDL-2015, AKONING
Photon emission for (n,gma)

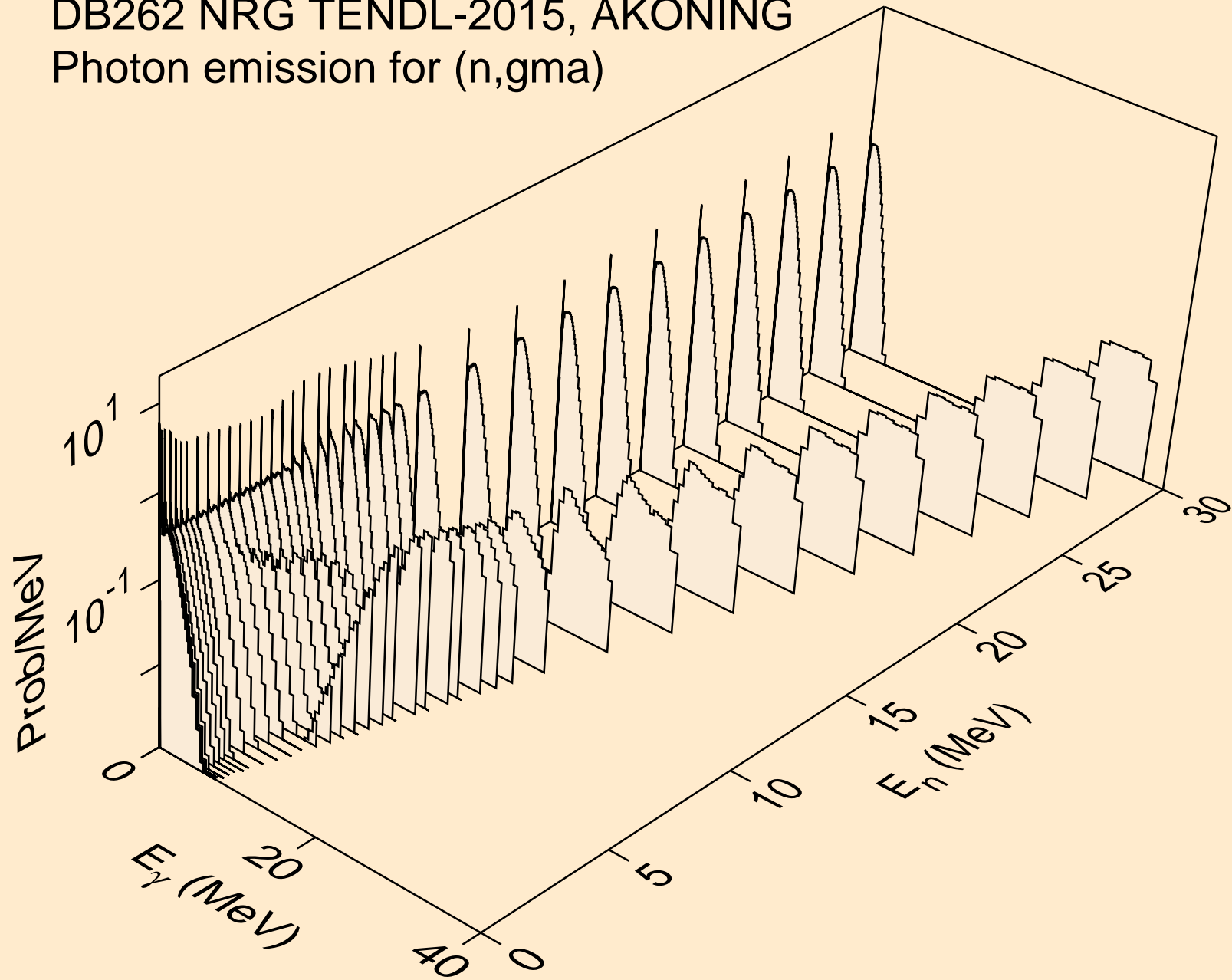

DB262 NRG TENDL-2015, AKONING
Photon emission for (n,p)

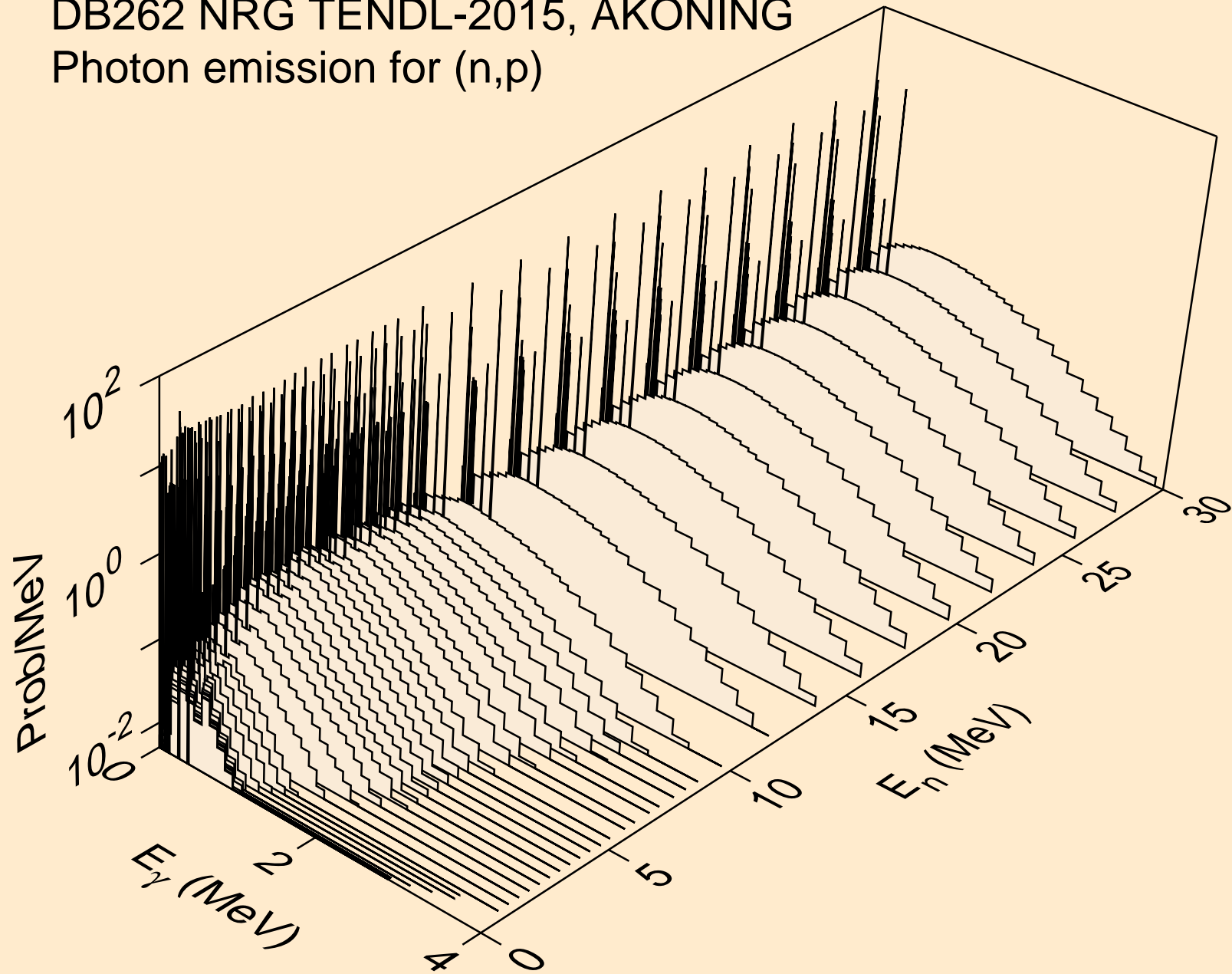

DB262 NRG TENDL-2015, AKONING
Photon emission for (n,d)

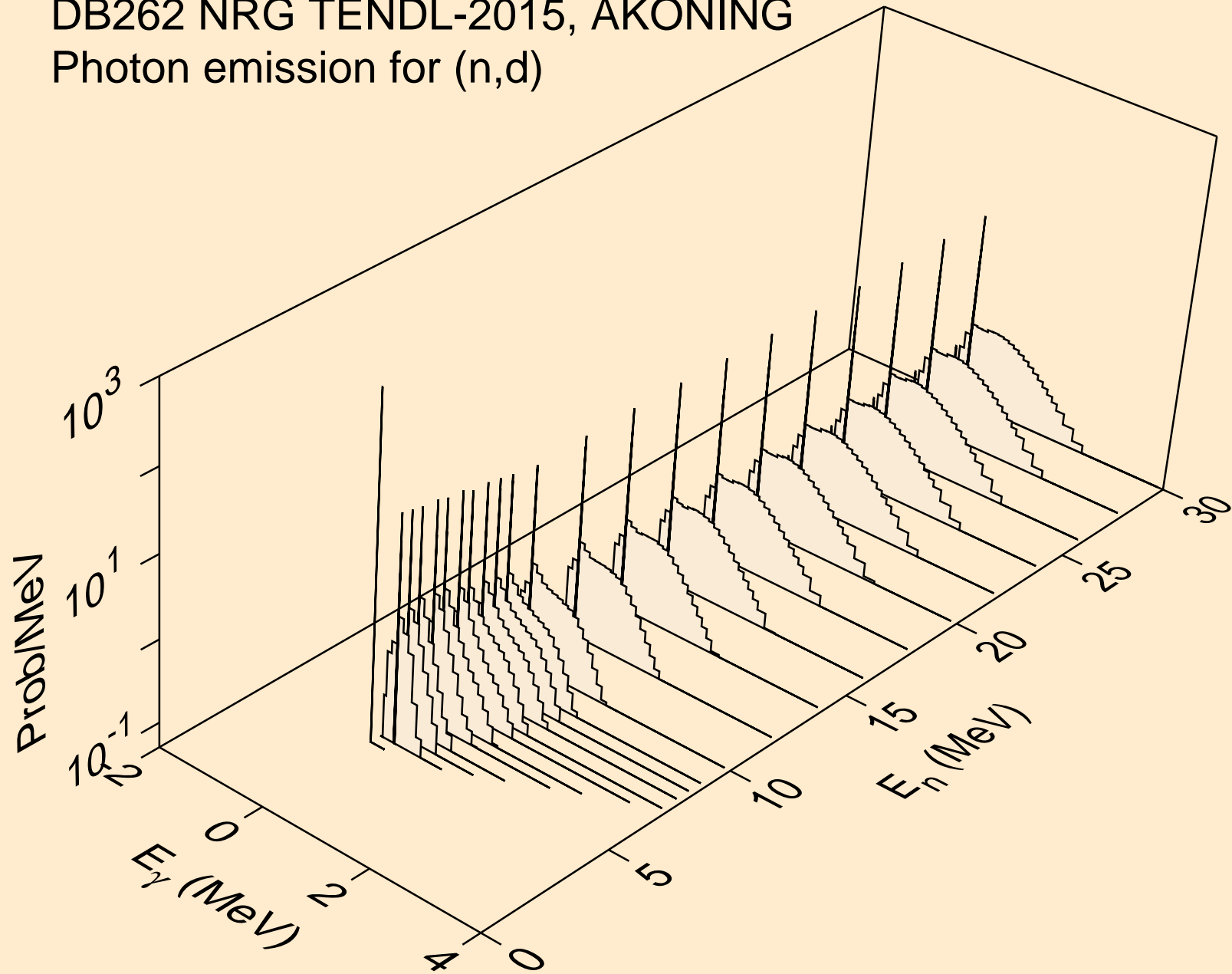

DB262 NRG TENDL-2015, AKONING
Photon emission for (n,t)

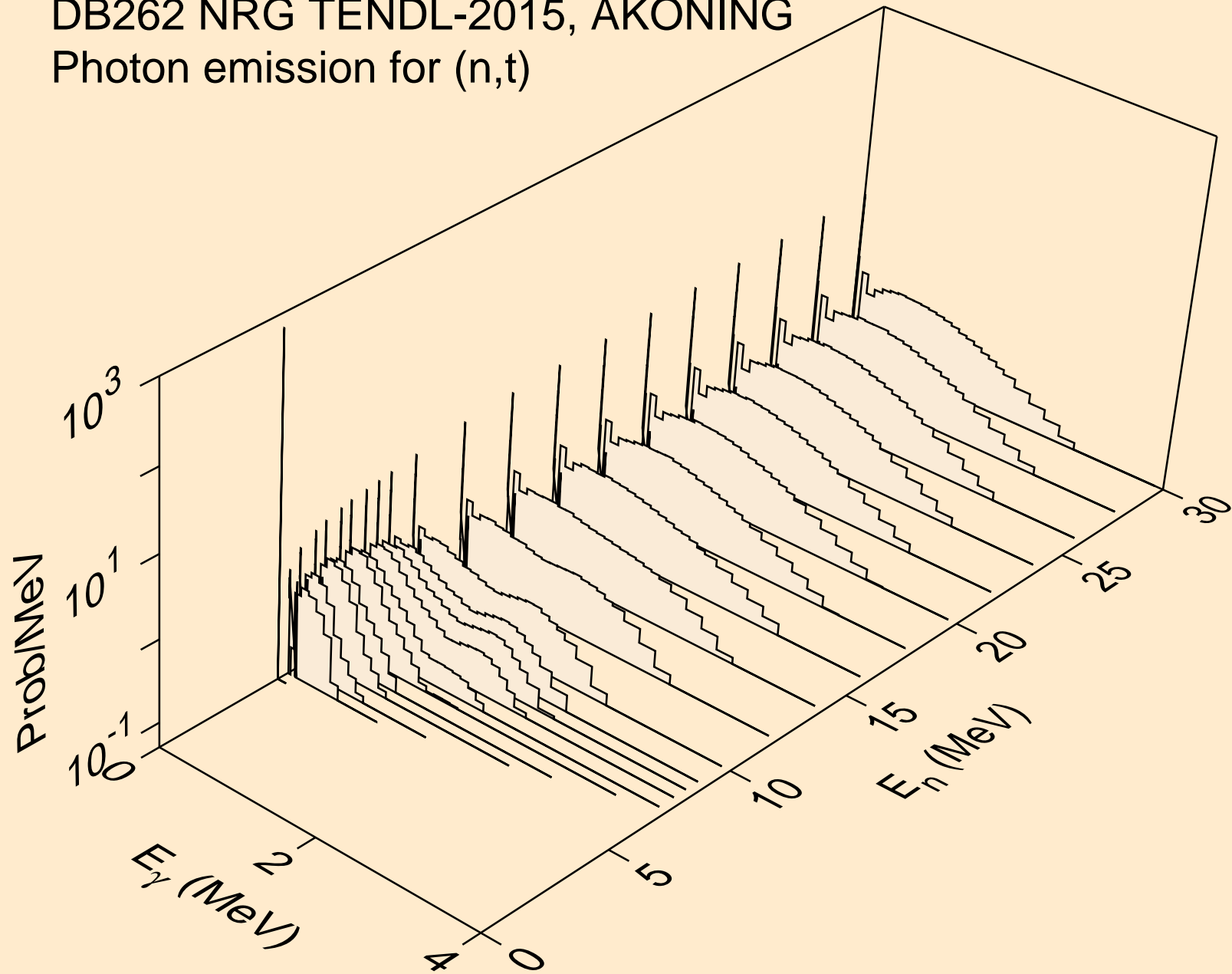

DB262 NRG TENDL-2015, AKONING
Photon emission for (n,he3)

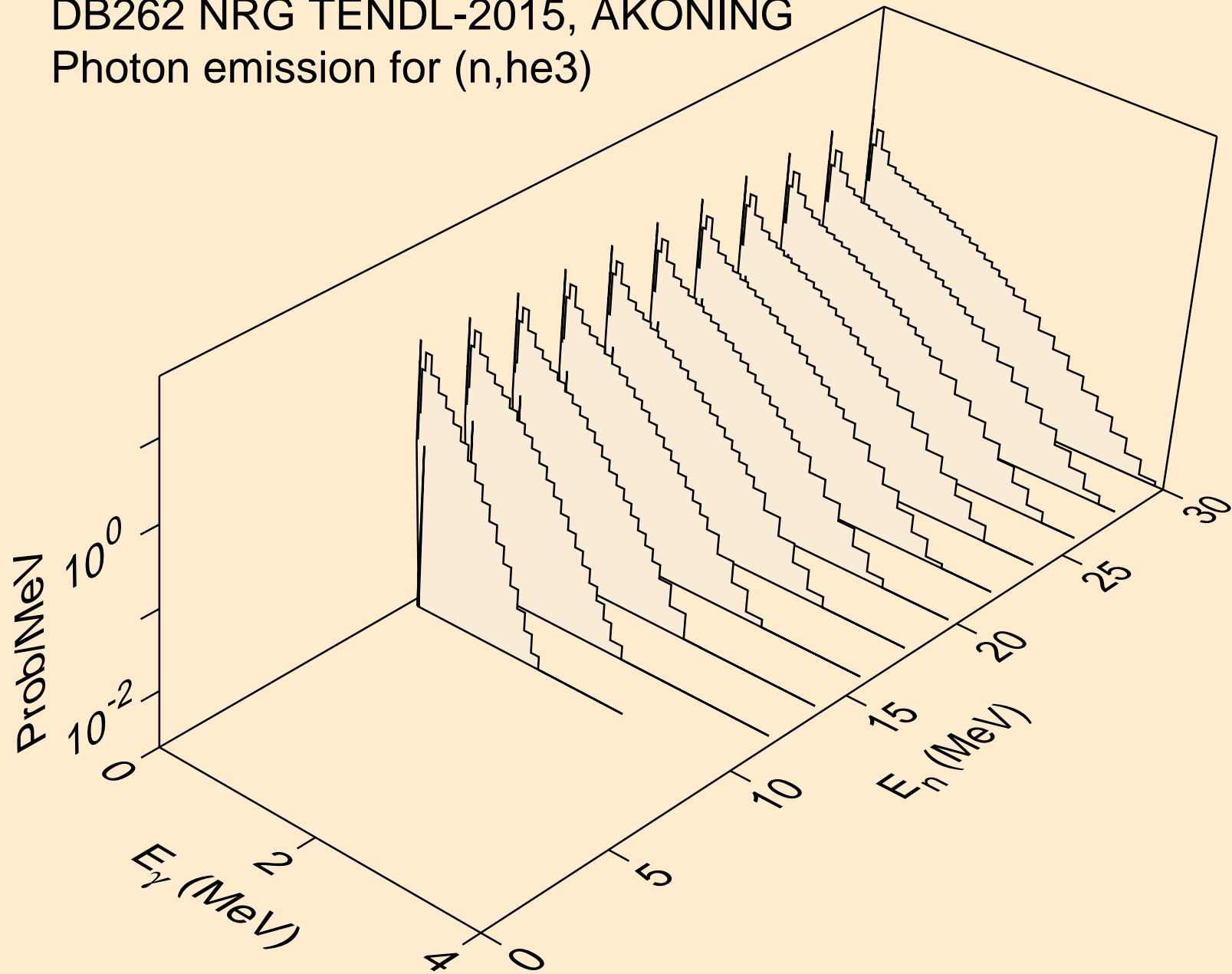

DB262 NRG TENDL-2015, AKONING
Photon emission for (n,a)

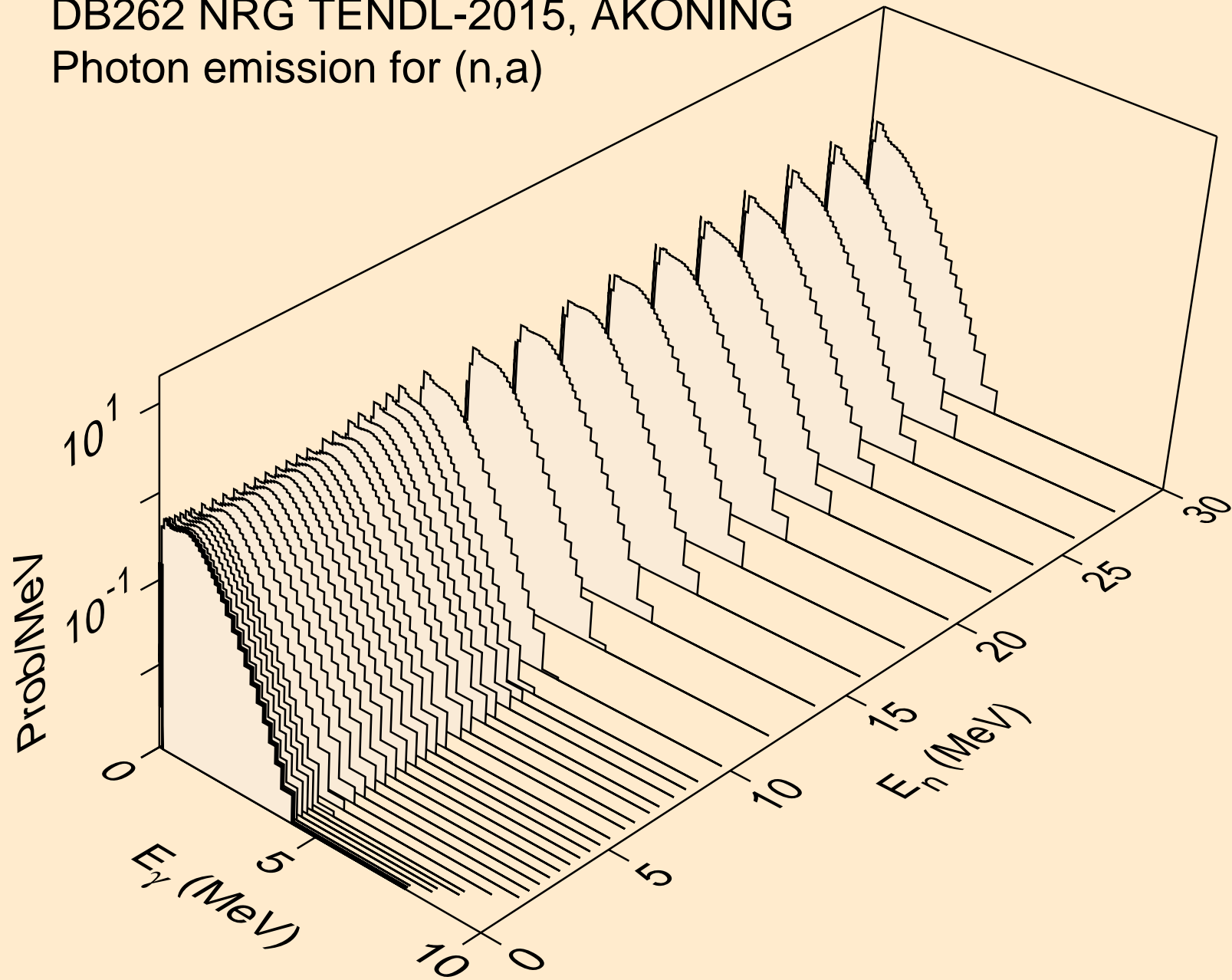

DB262 NRG TENDL-2015, AKONING
Photon emission for (n,2a)

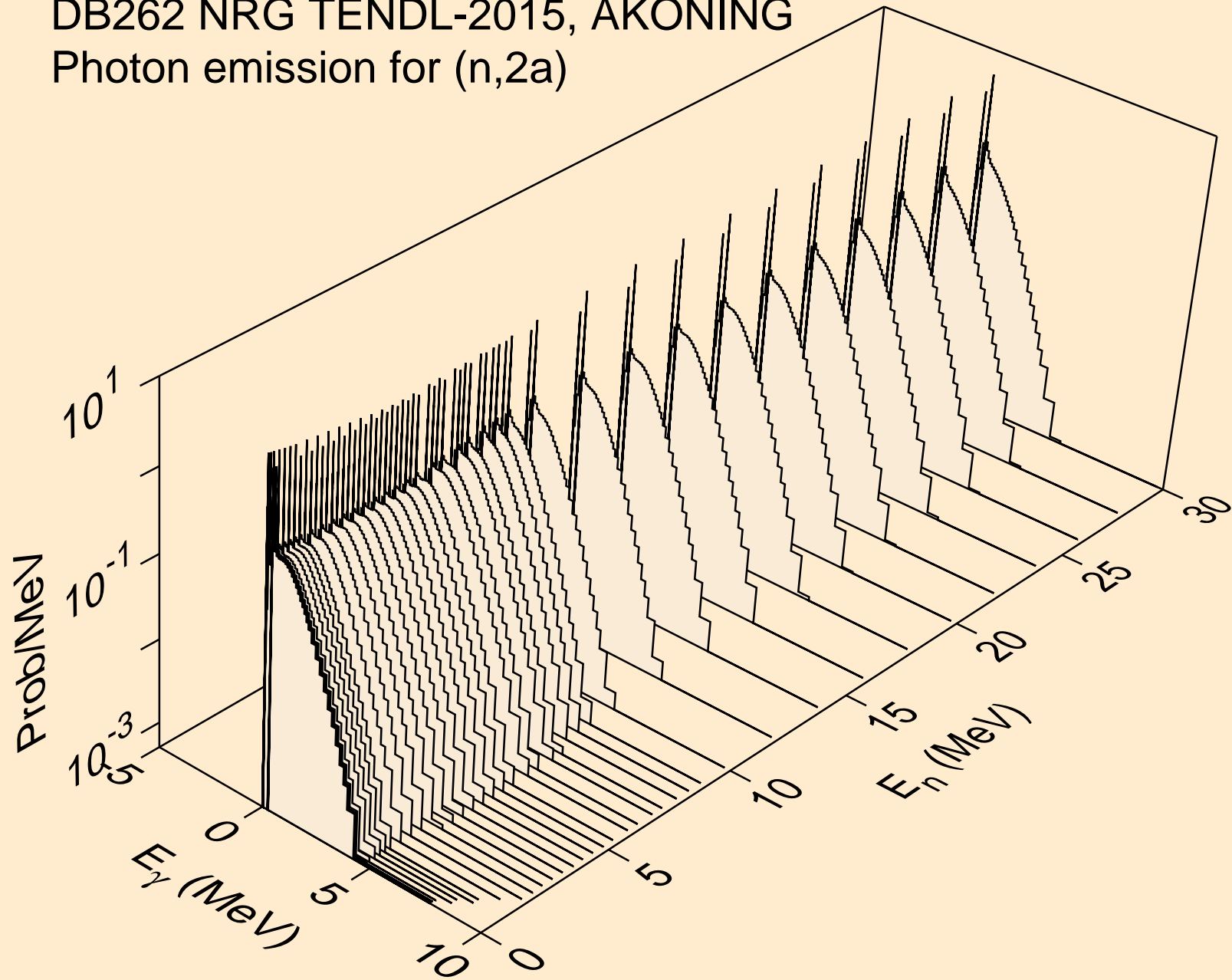

DB262 NRG TENDL-2015, AKONING
Photon emission for (n,3a)

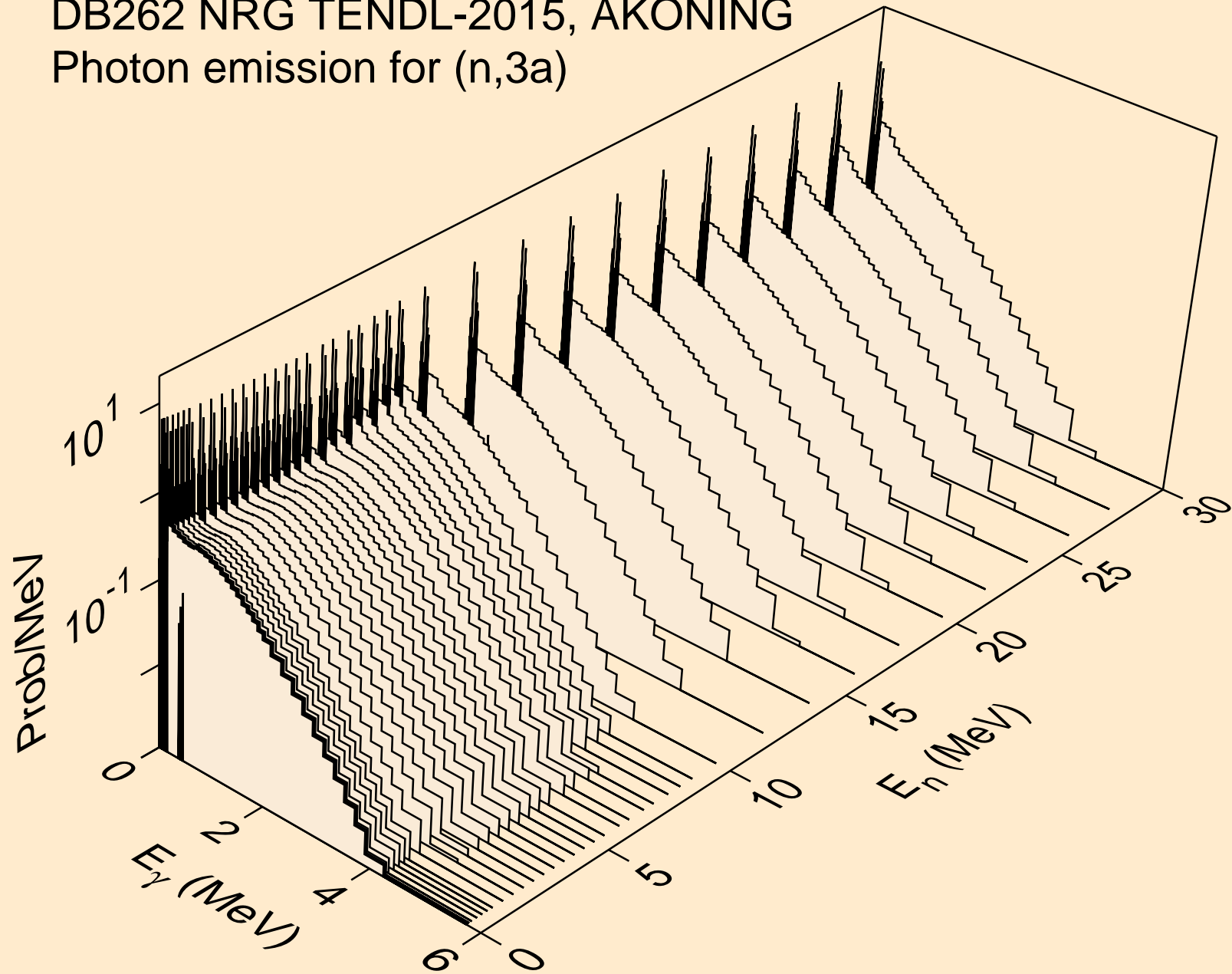

DB262 NRG TENDL-2015, AKONING
Photon emission for (n,2p)

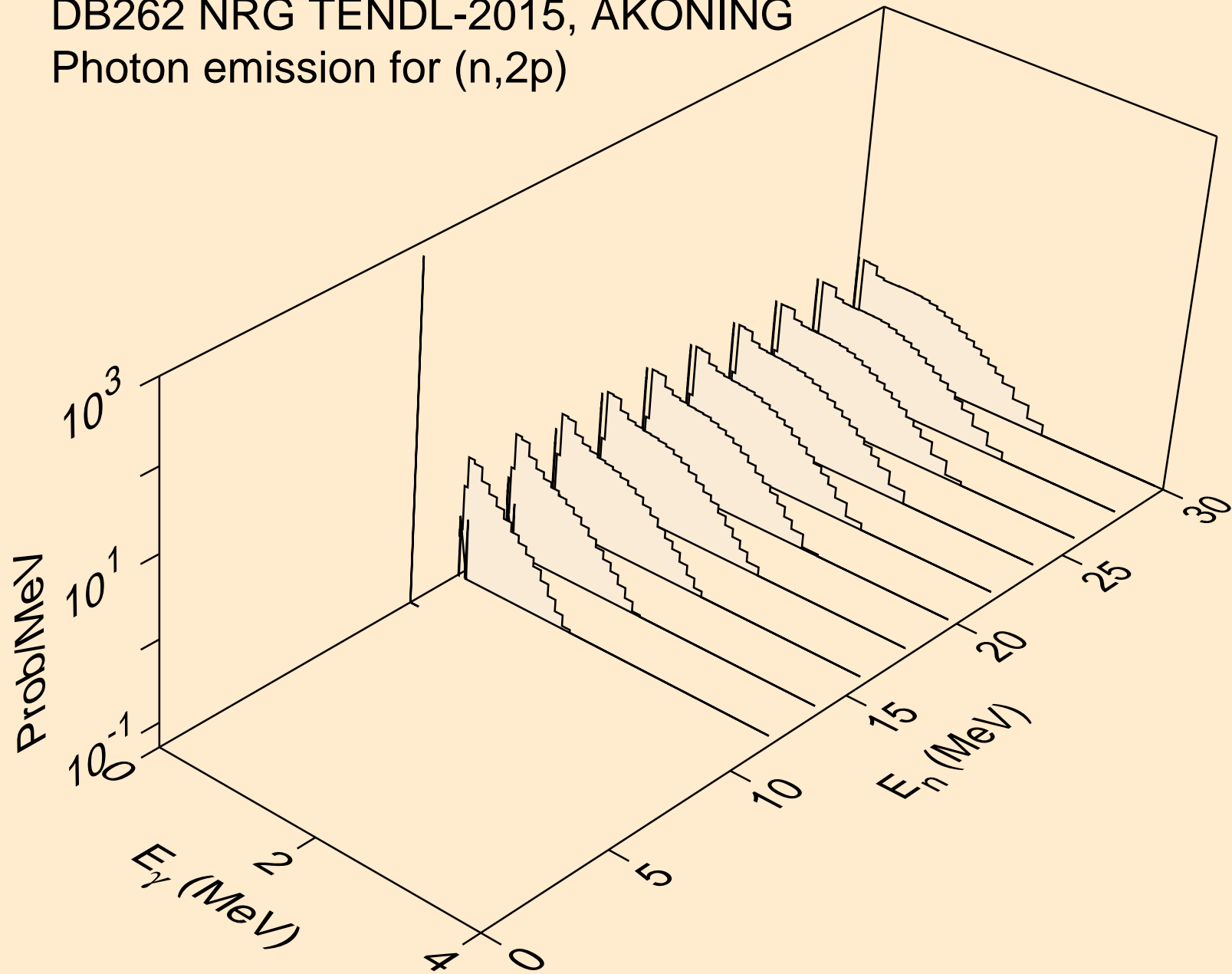

DB262 NRG TENDL-2015, AKONING
Photon emission for (n,p α)

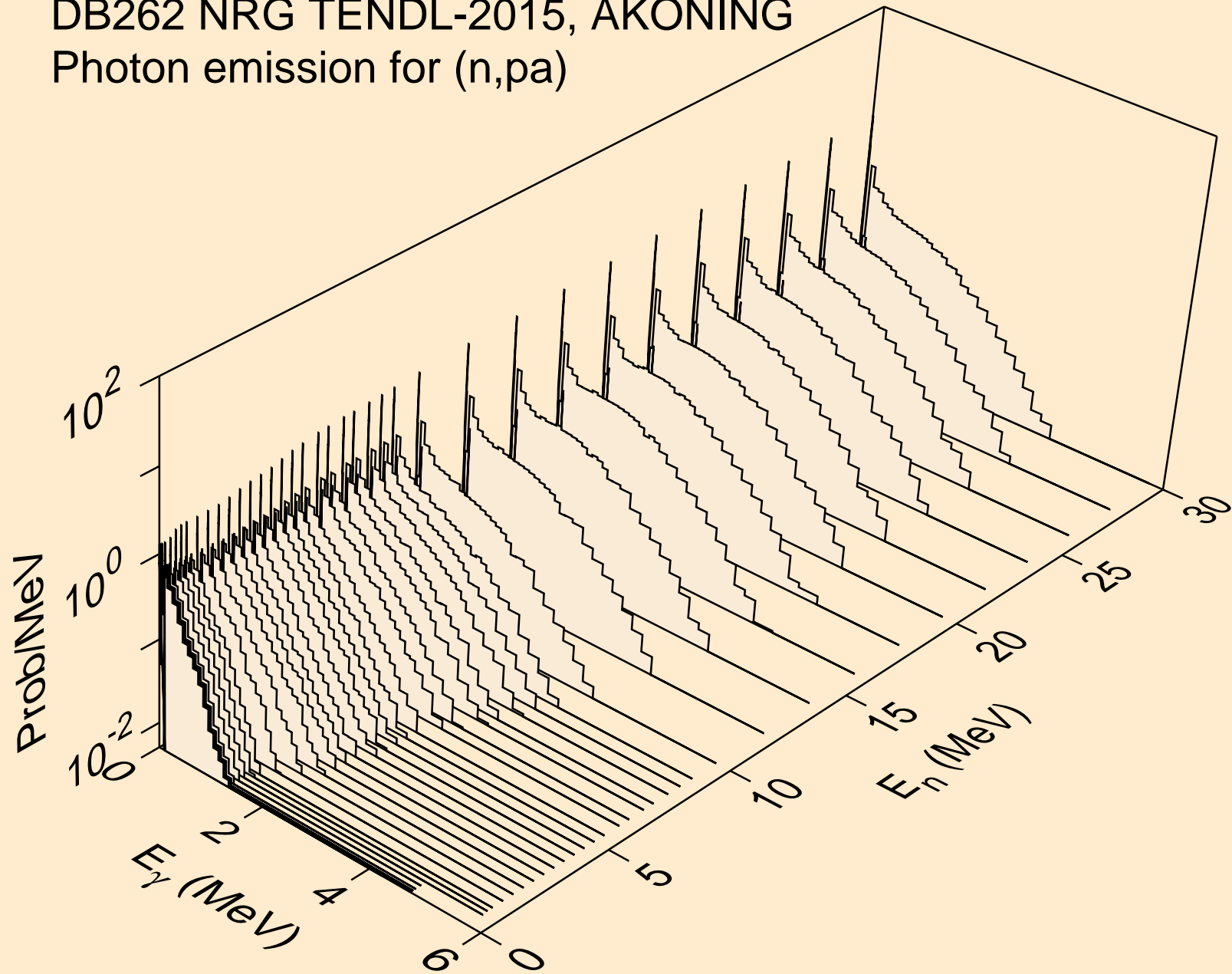

DB262 NRG TENDL-2015, AKONING
Photon emission for (n,t2a)

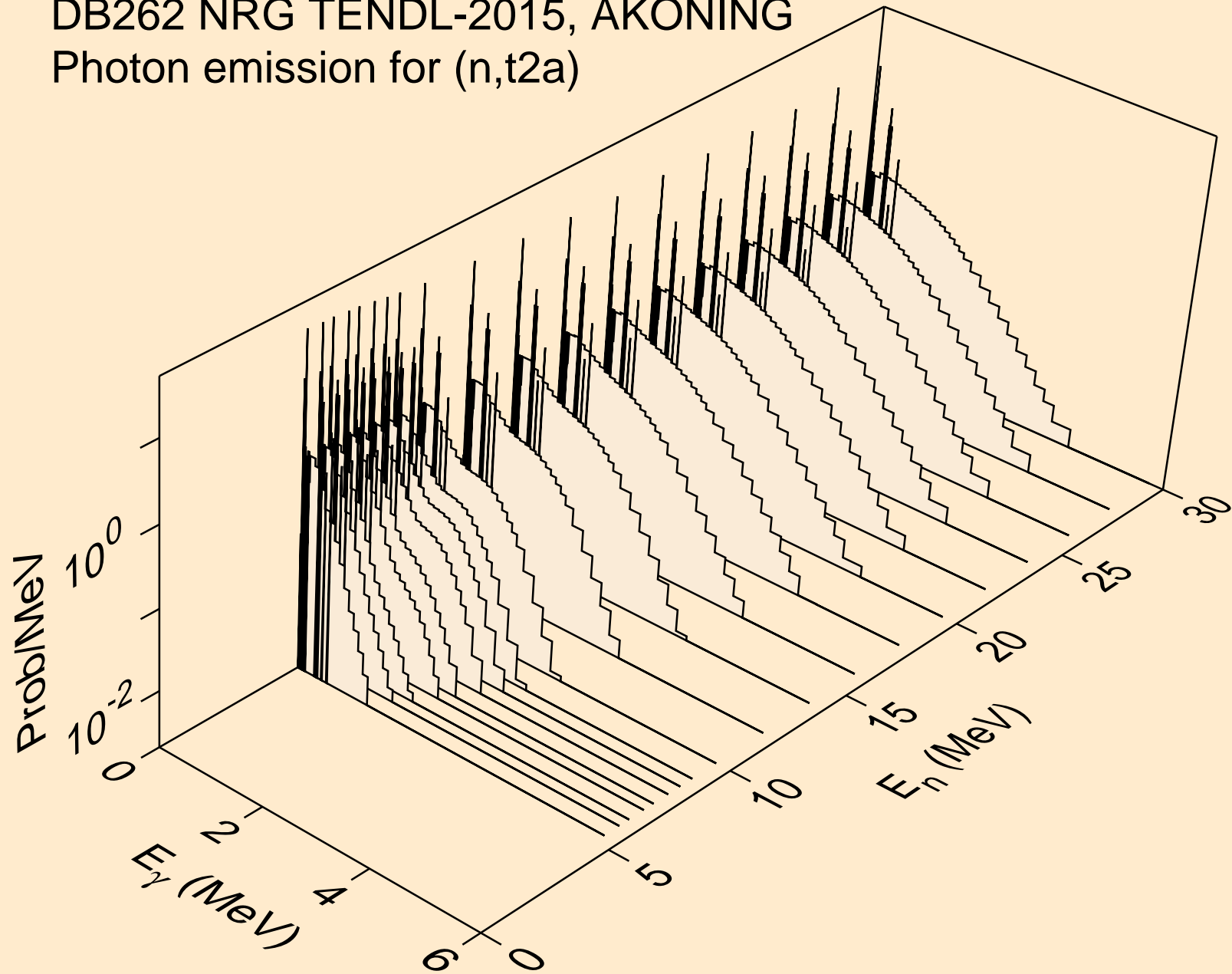

DB262 NRG TENDL-2015, AKONING
Photon emission for (n,d2a)

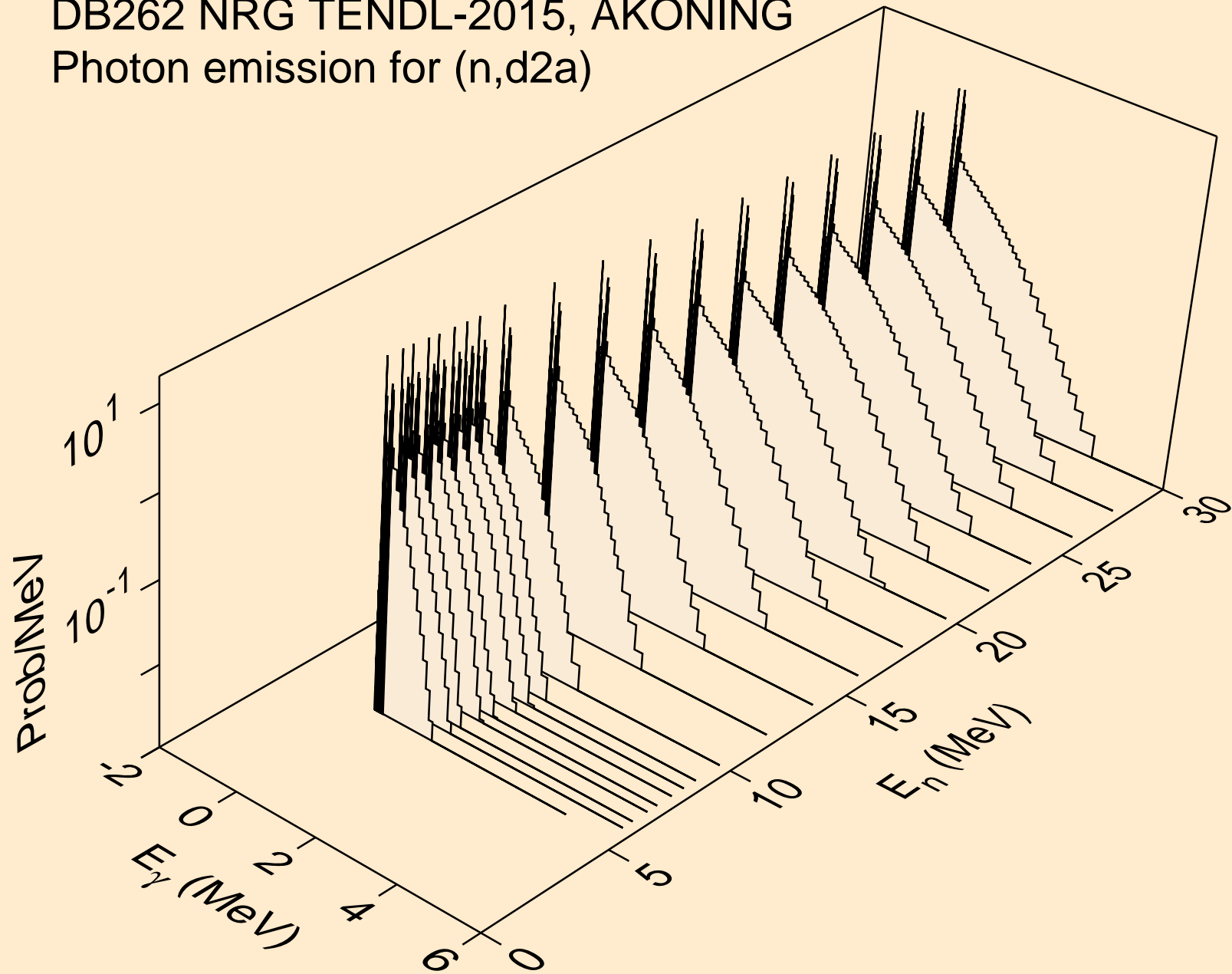

DB262 NRG TENDL-2015, AKONING
Photon emission for (n,pd)

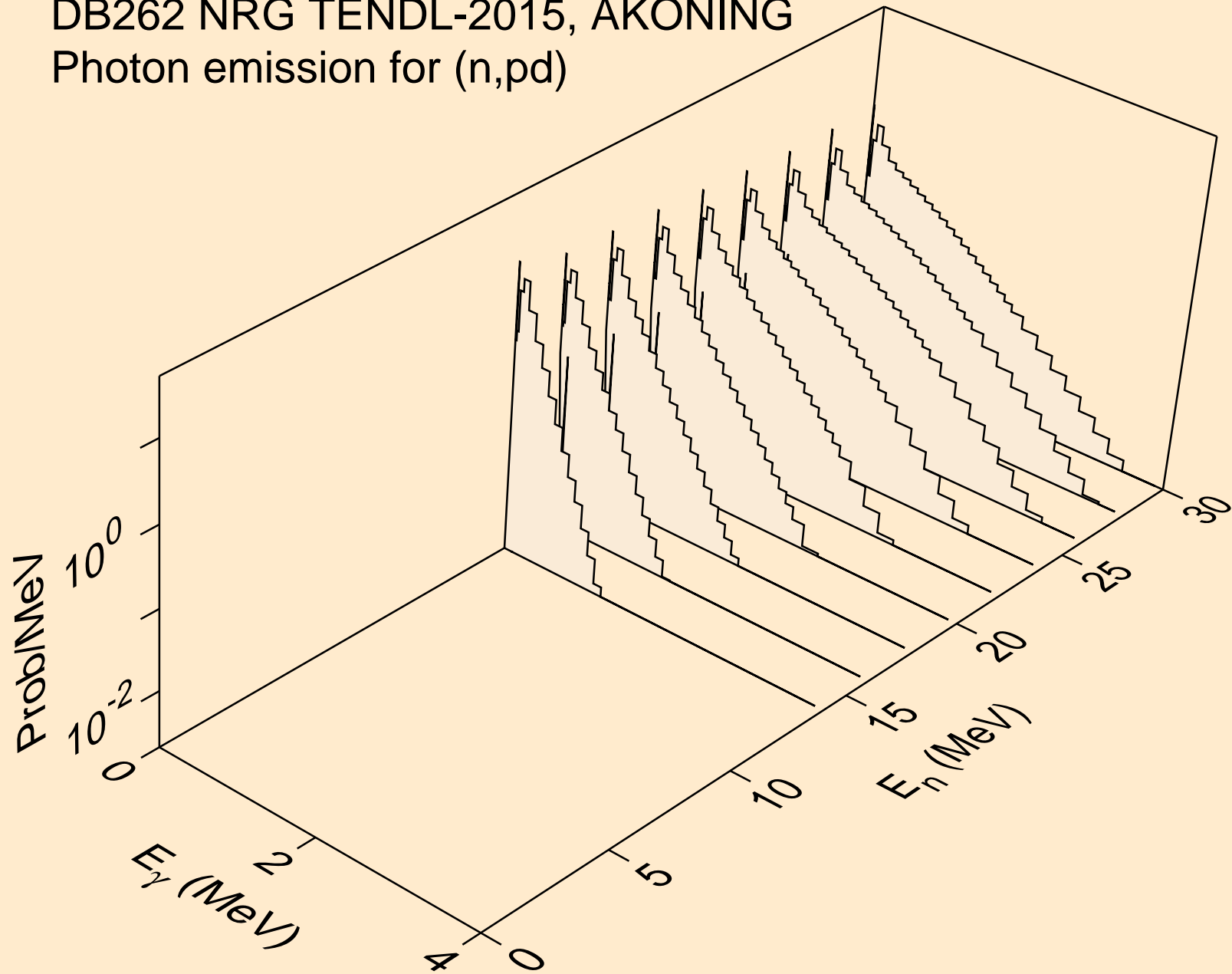

DB262 NRG TENDL-2015, AKONING

Photon emission for (n,pt)

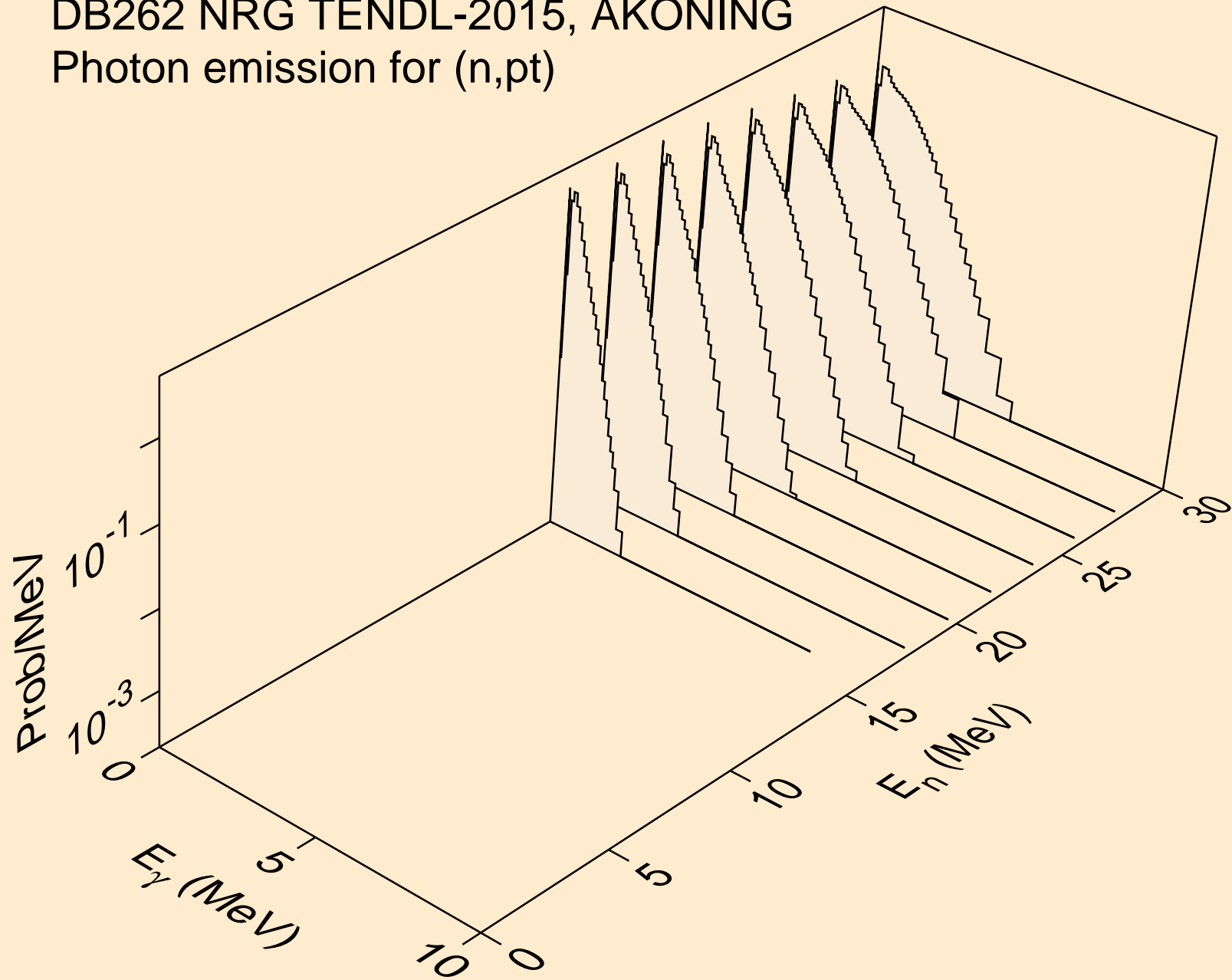

DB262 NRG TENDL-2015, AKONING
Photon emission for (n,da)

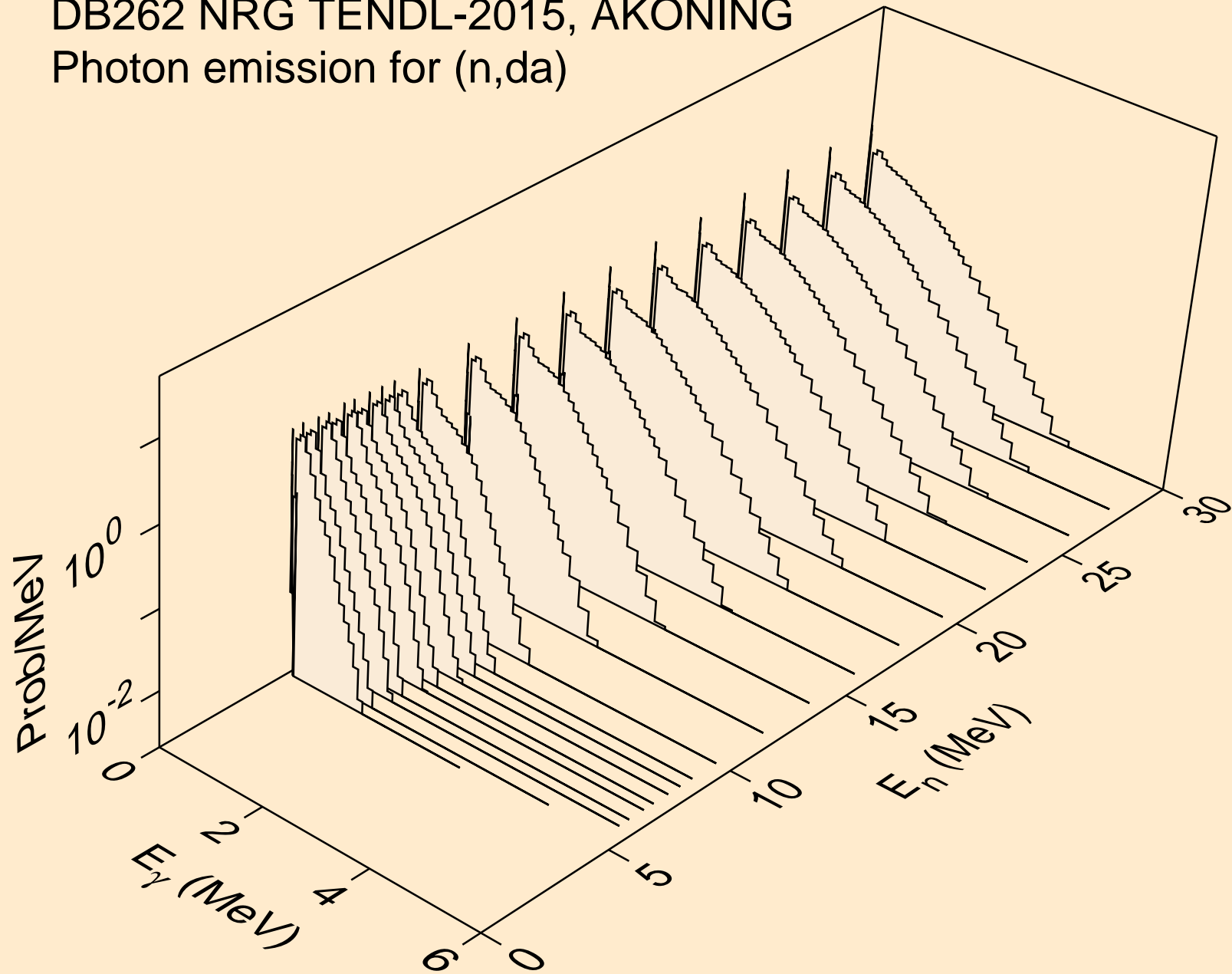

DB262 NRG TENDL-2015, AKONING
thermal capture photon spectrum

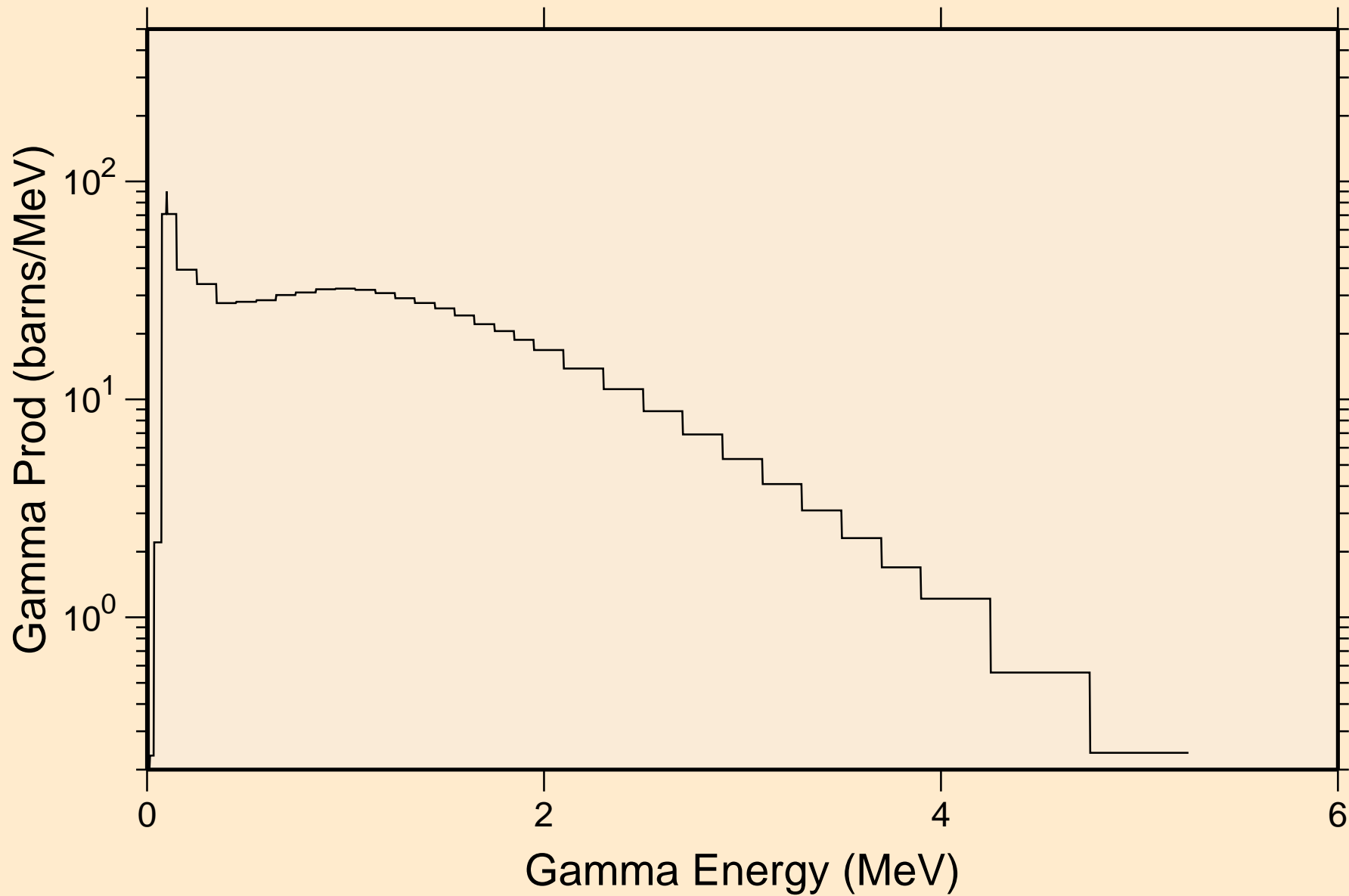

DB262 NRG TENDL-2015, AKONING
14 MeV photon spectrum

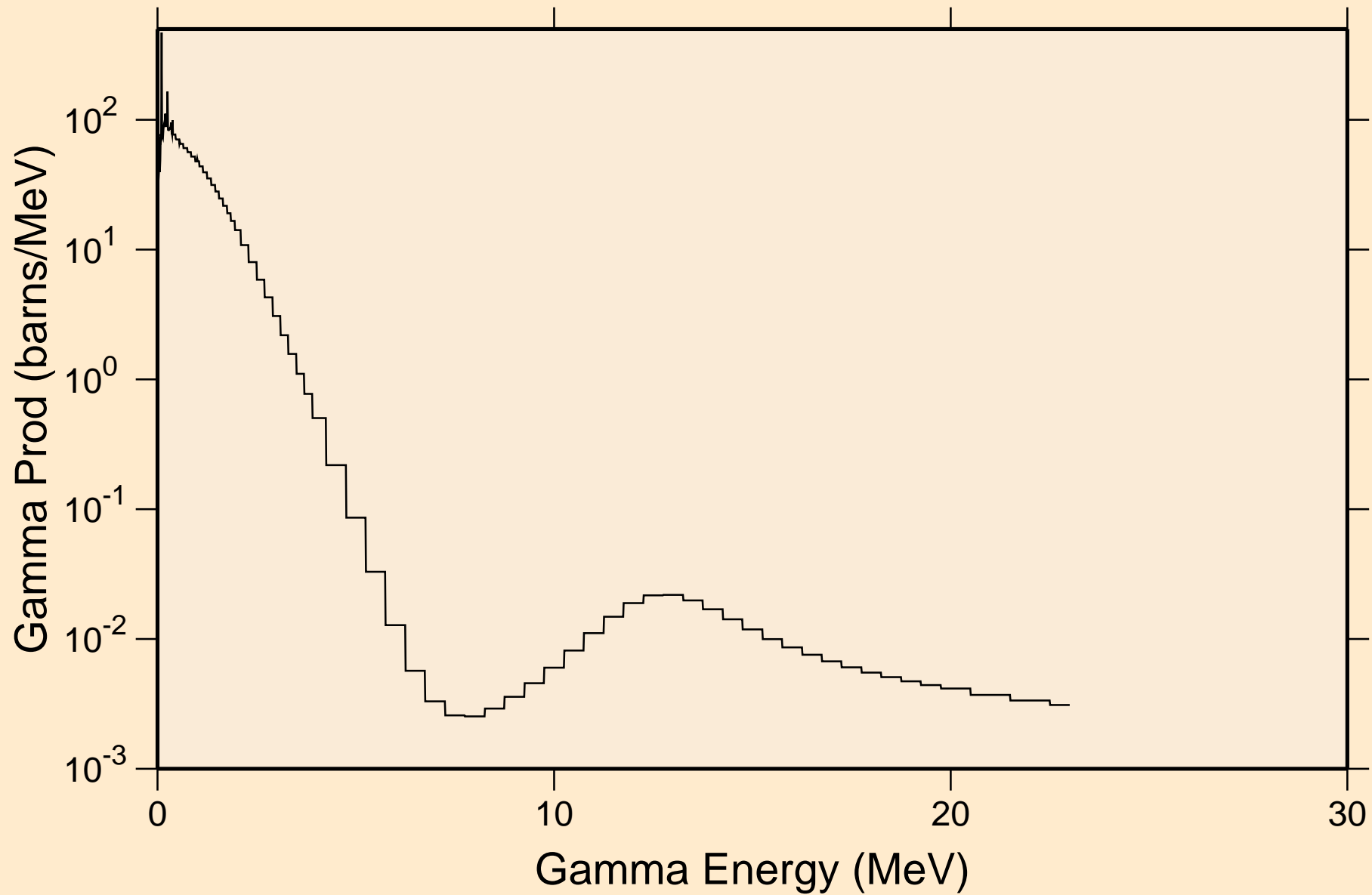

DB262 NRG TENDL-2015, AKONING

Particle heating contributions

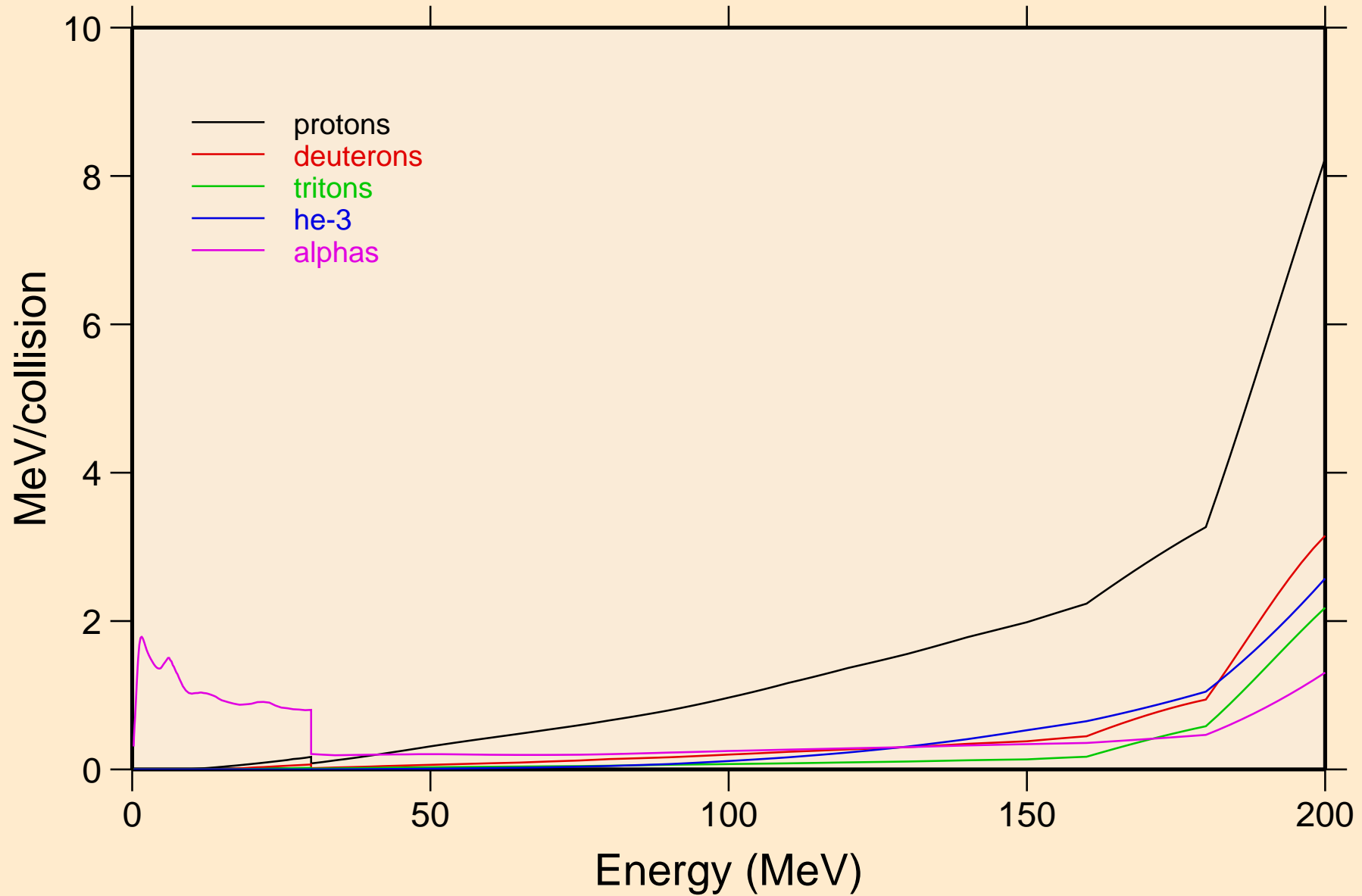

DB262 NRG TENDL-2015, AKONING

Recoil Heating

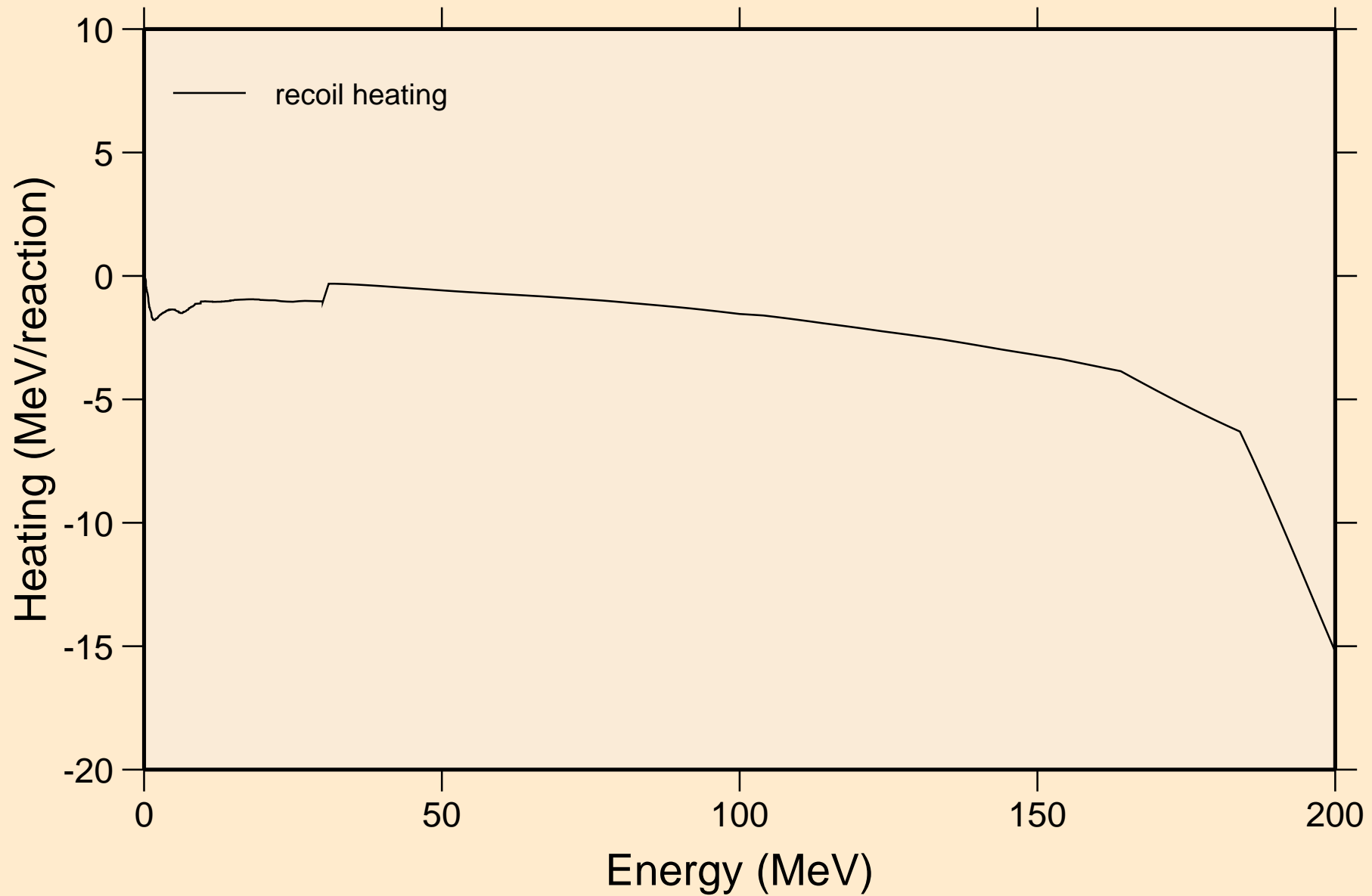

DB262 NRG TENDL-2015, AKONING

Particle production cross sections

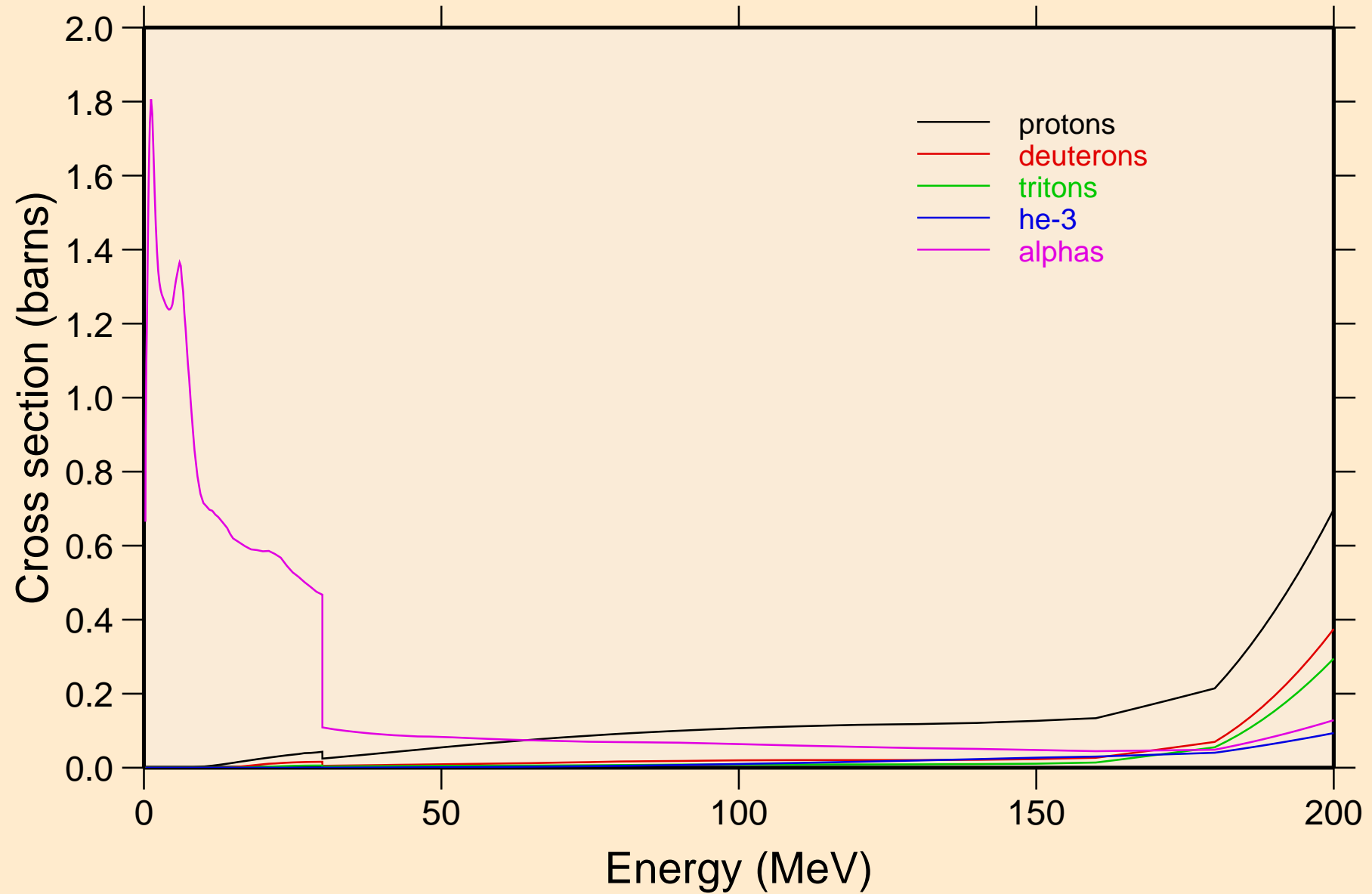

DB262 NRG TENDL-2015, AKONING
protons from (n,x)

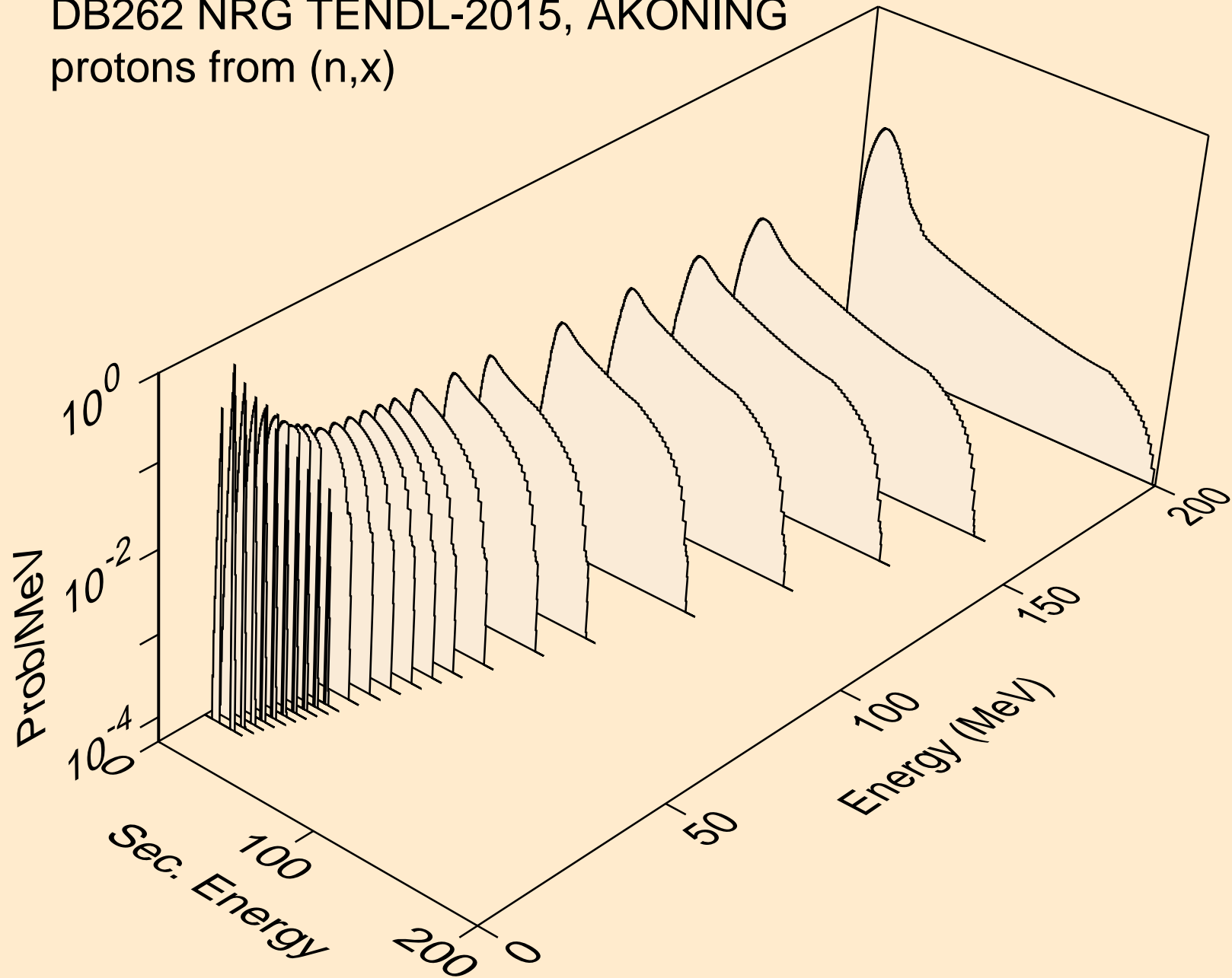

DB262 NRG TENDL-2015, AKONING
protons from (n,n*)p

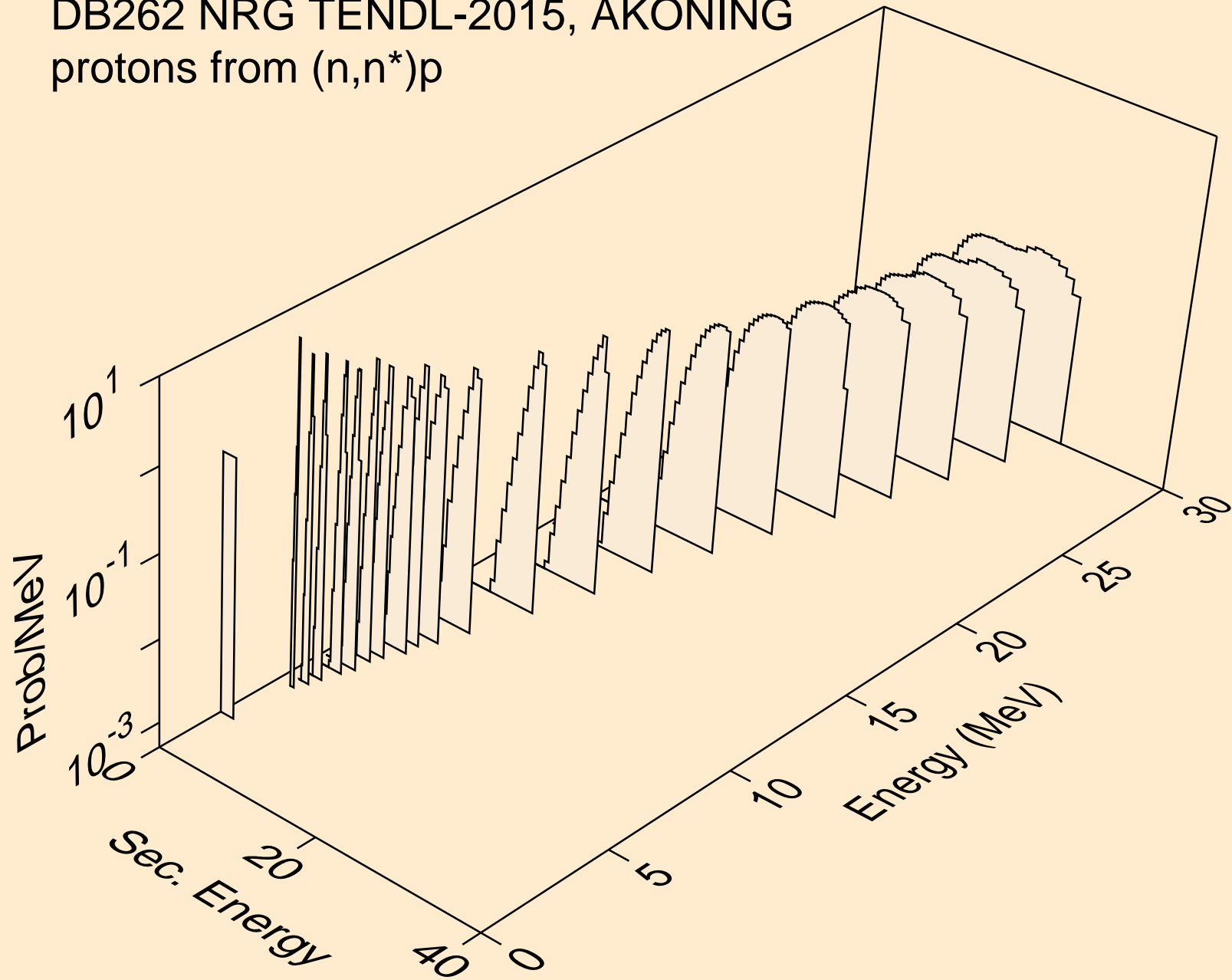

DB262 NRG TENDL-2015, AKONING
protons from (n,2np)

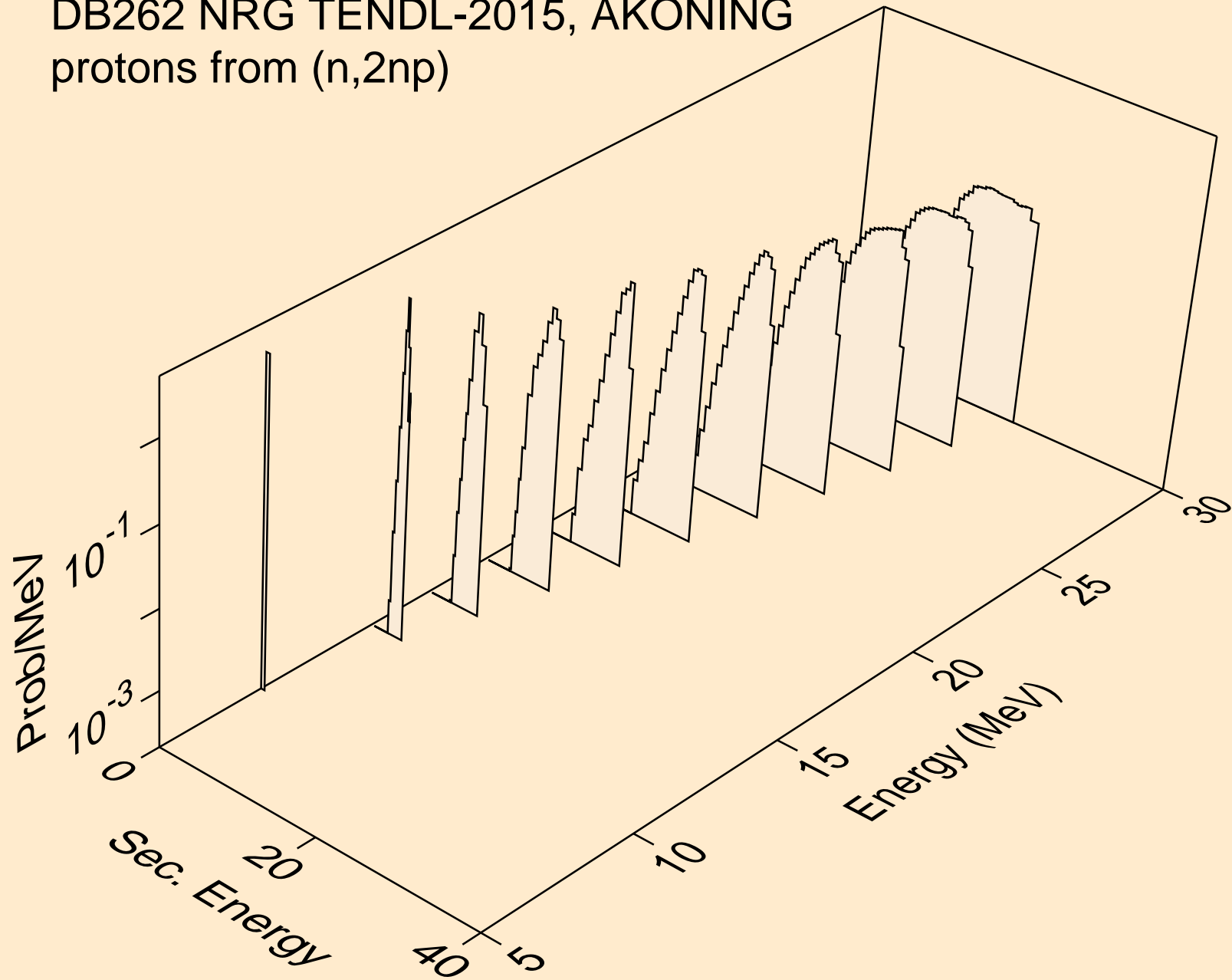

DB262 NRG TENDL-2015, AKONING
protons from (n,3np)

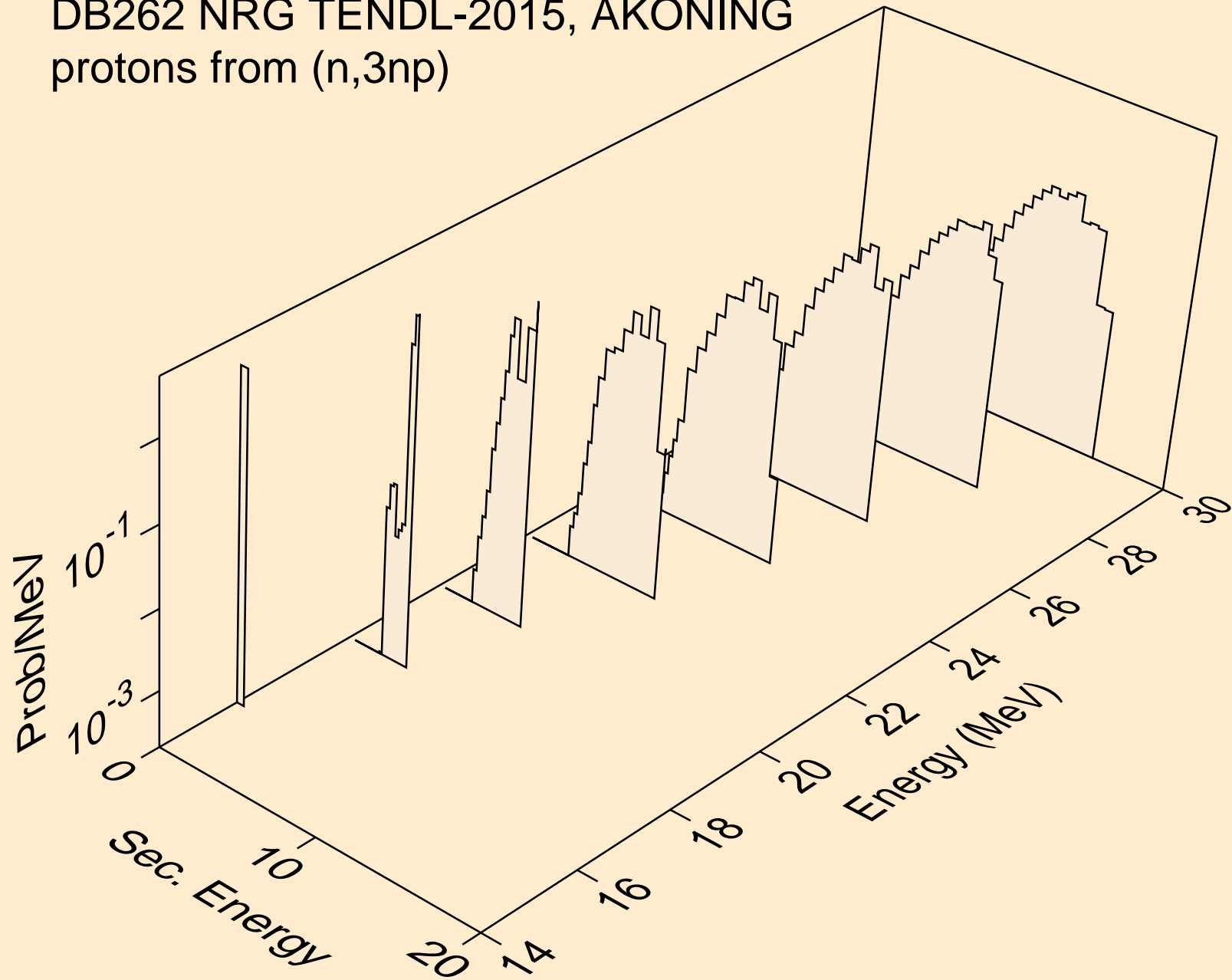

DB262 NRG TENDL-2015, AKONING
protons from (n,2np)

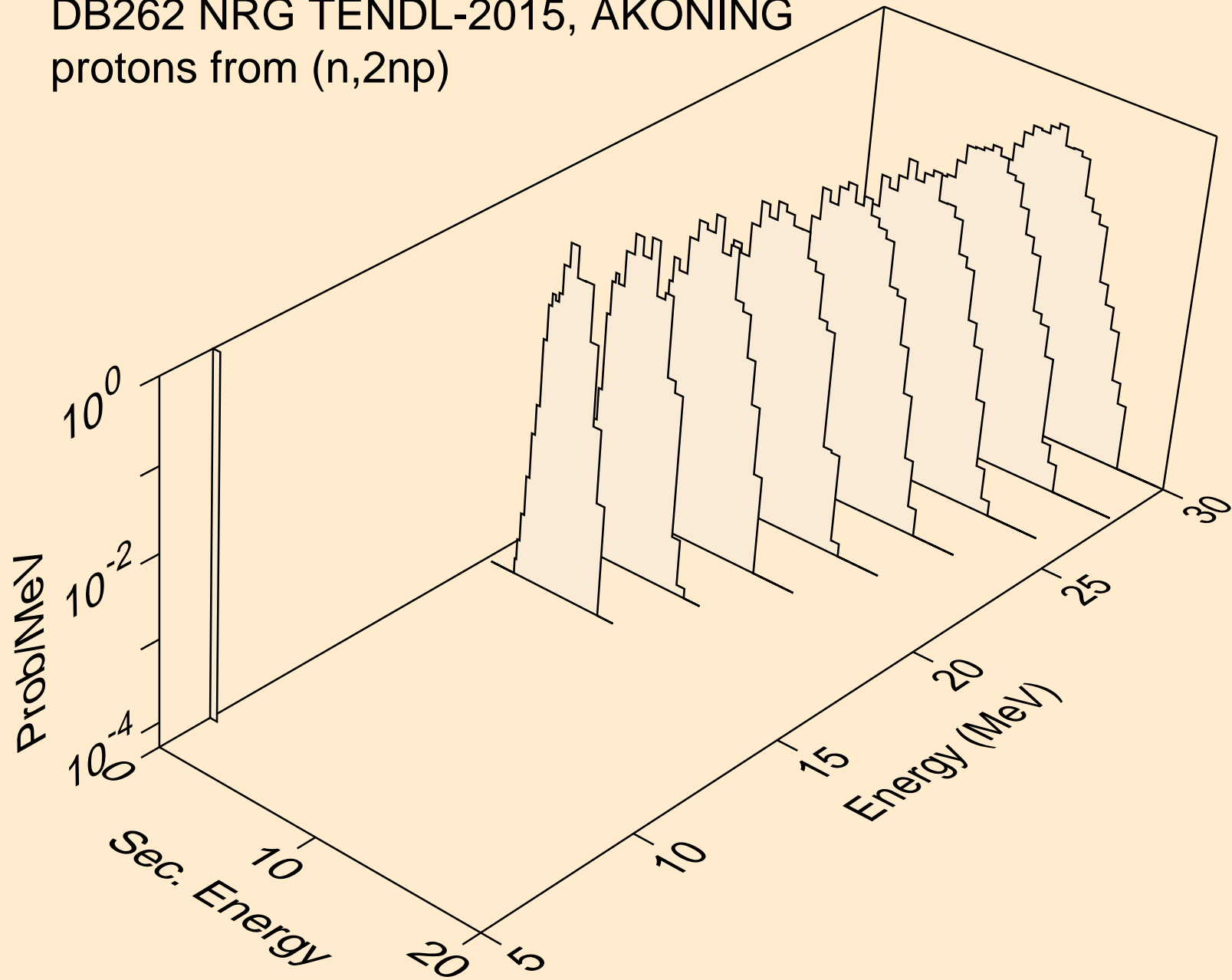

DB262 NRG TENDL-2015, AKONING
protons from (n,npa)

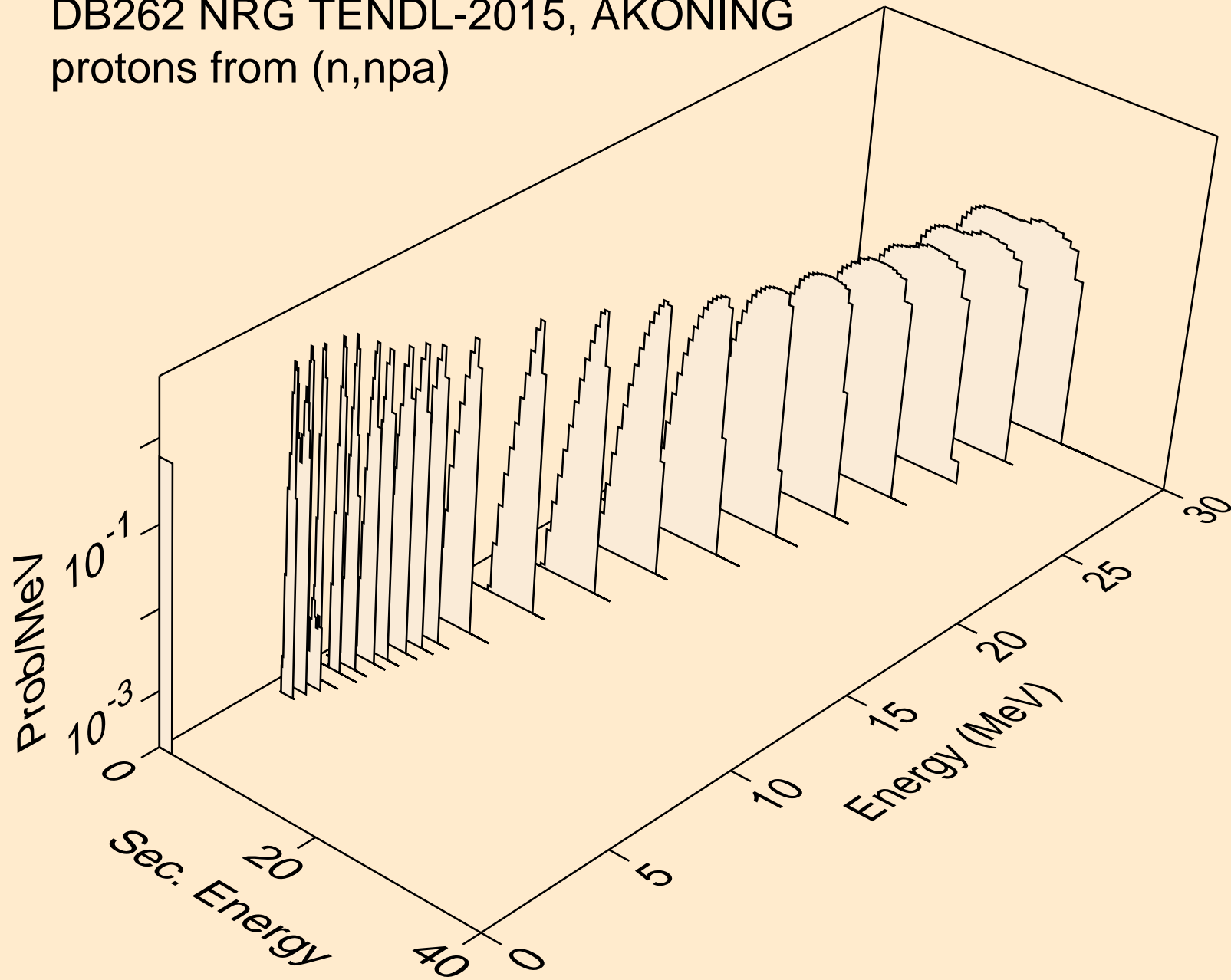

DB262 NRG TENDL-2015, AKONING
protons from (n,p)

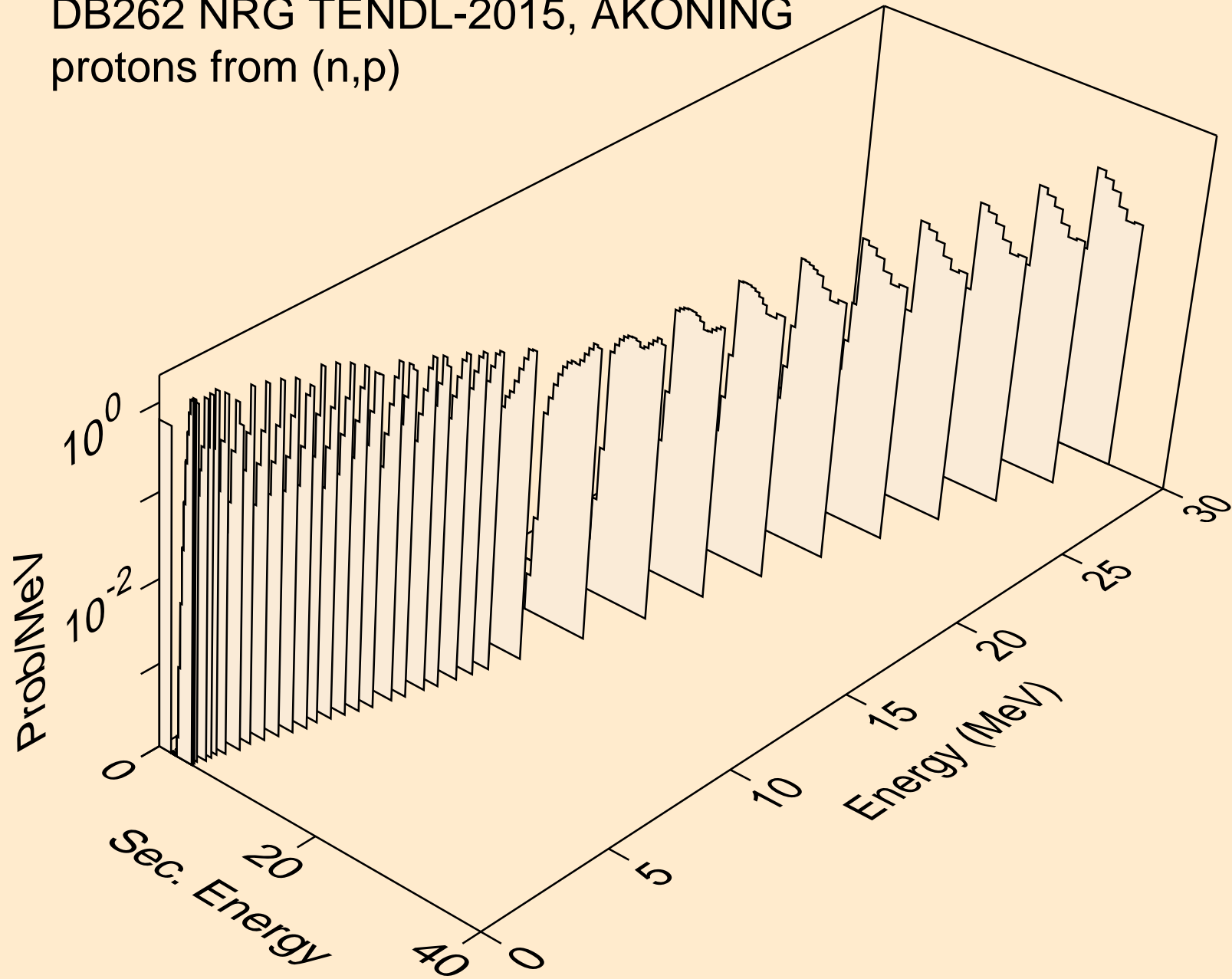

DB262 NRG TENDL-2015, AKONING
protons from (n,2p)

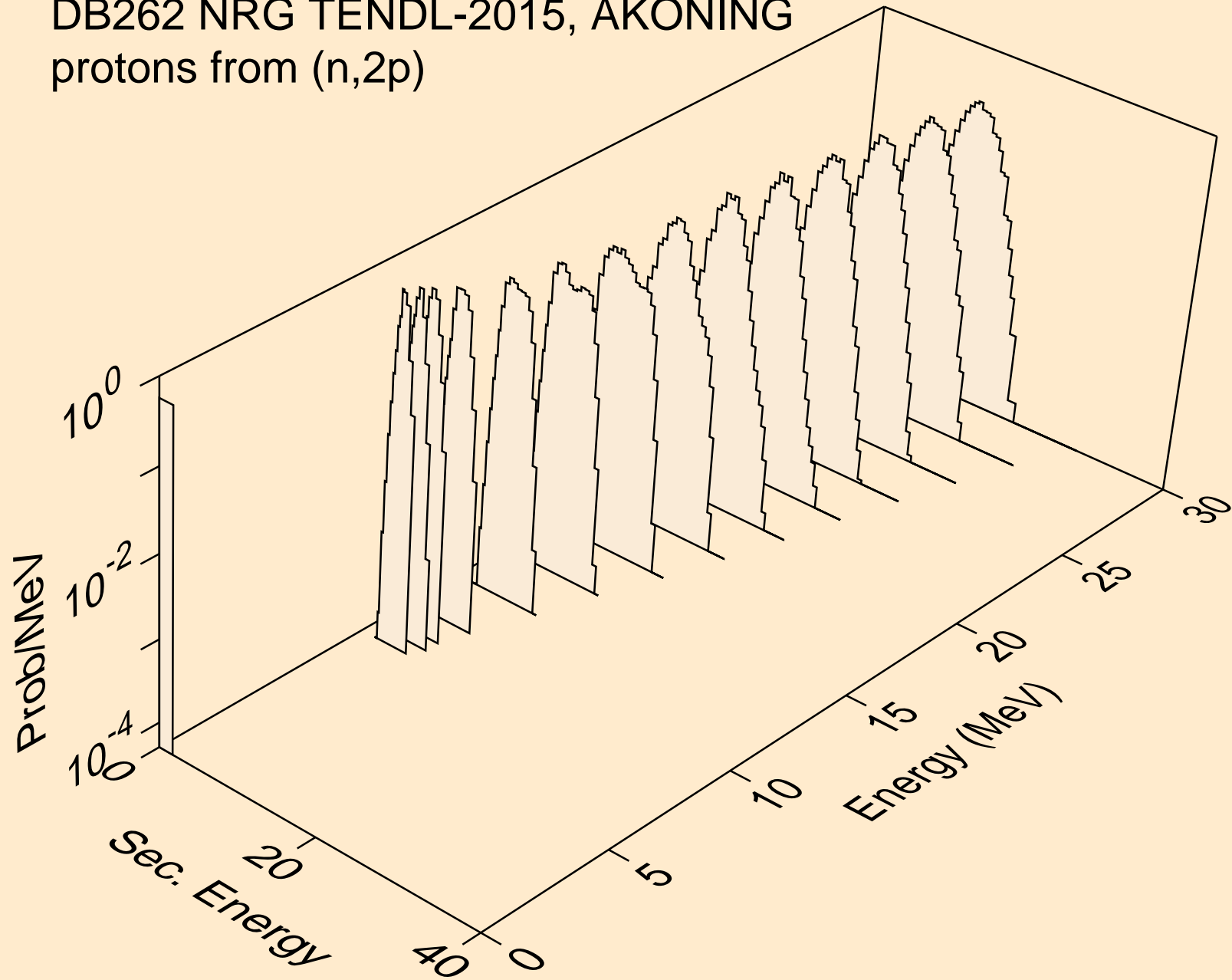

DB262 NRG TENDL-2015, AKONING
protons from (n,pa)

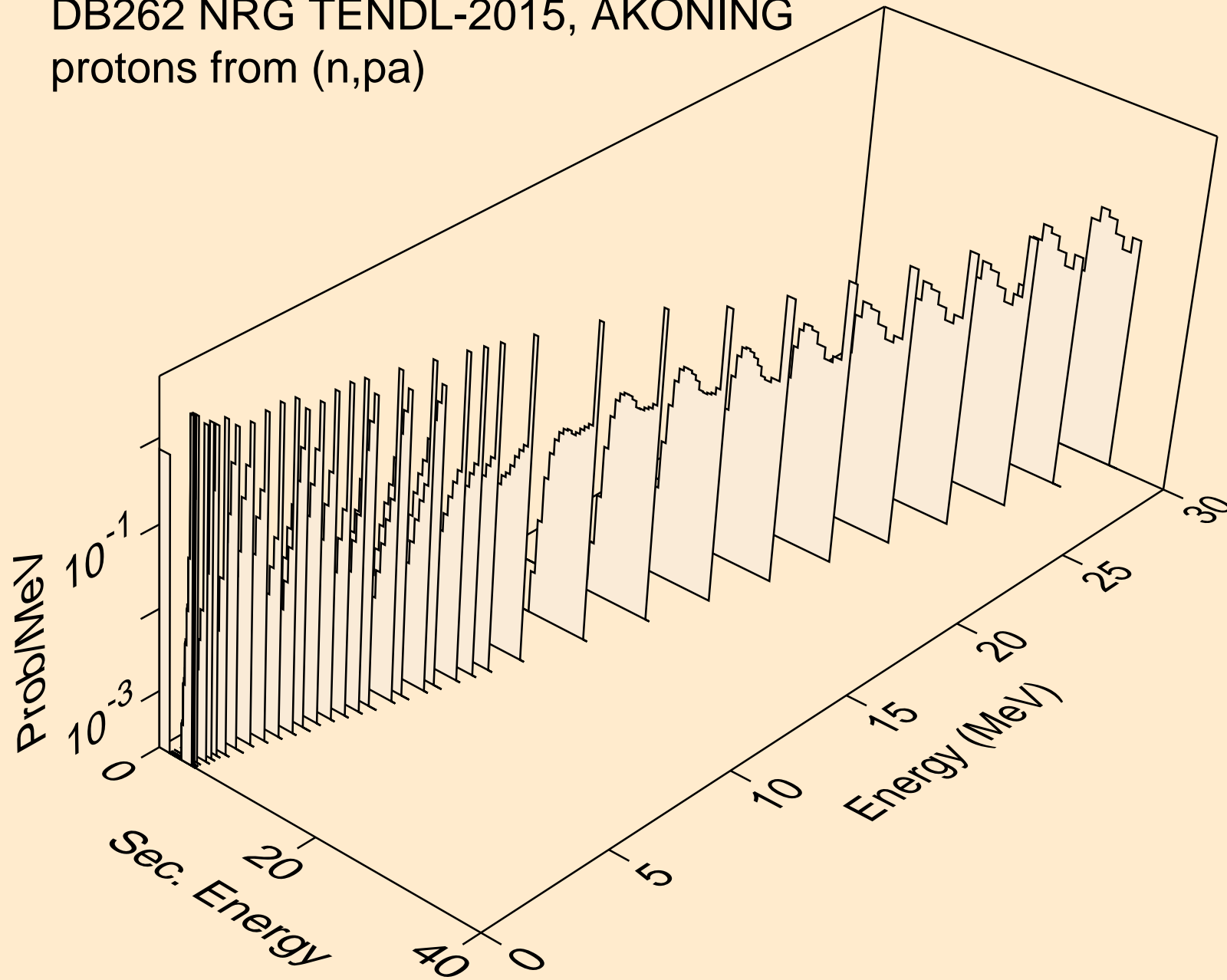

DB262 NRG TENDL-2015, AKONING
protons from (n,pd)

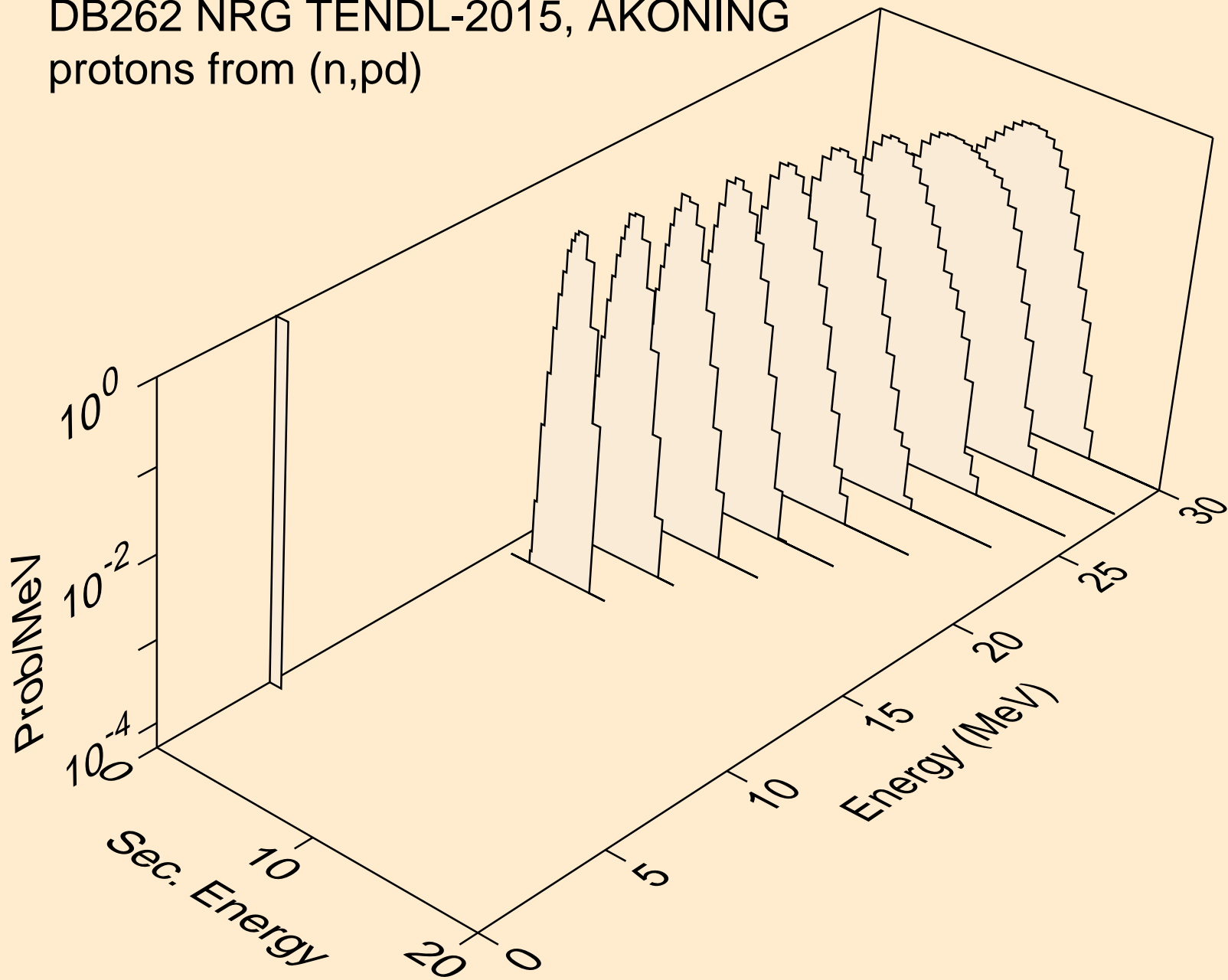

DB262 NRG TENDL-2015, AKONING
protons from (n,pt)

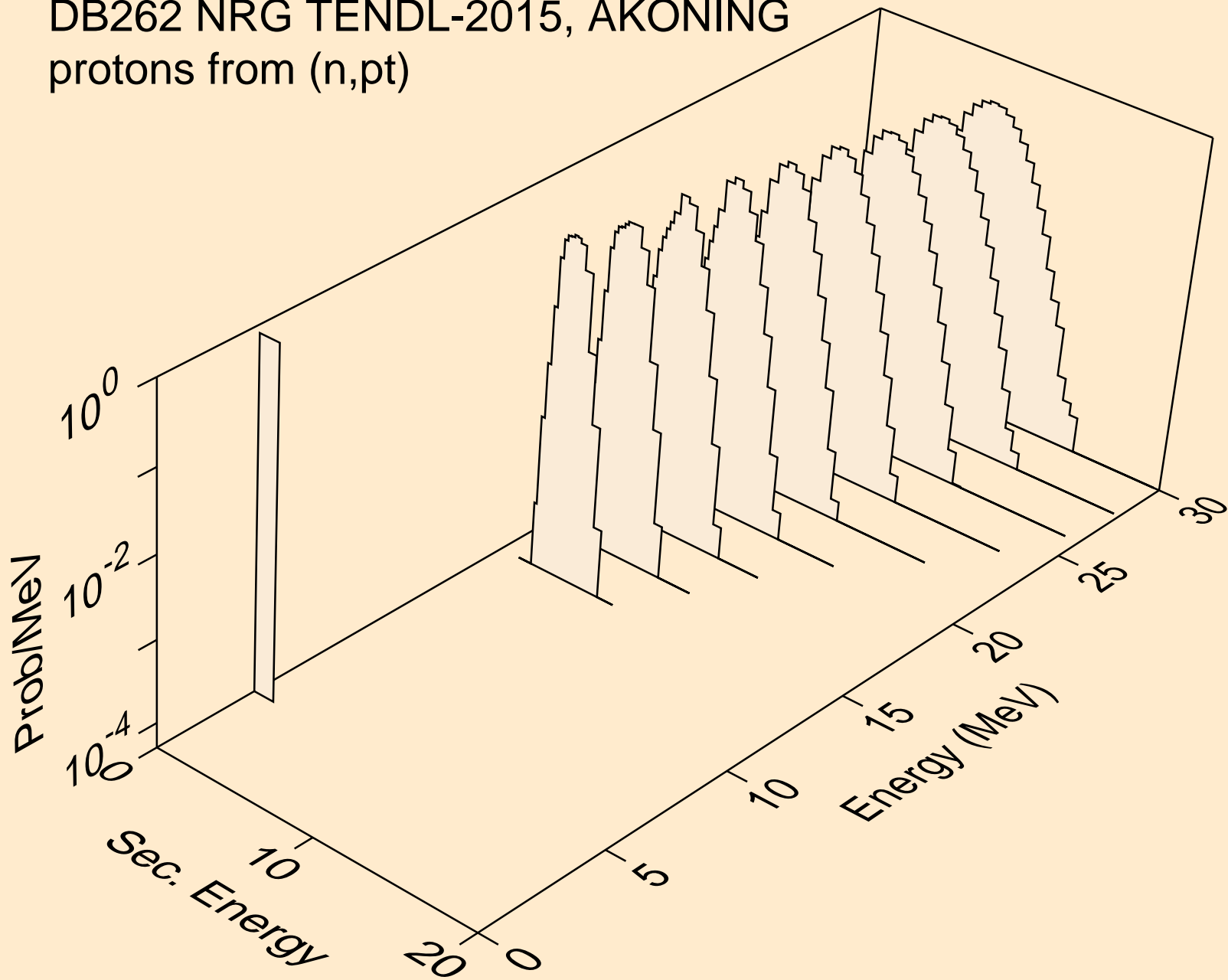

DB262 NRG TENDL-2015, AKONING
deuterons from (n,x)

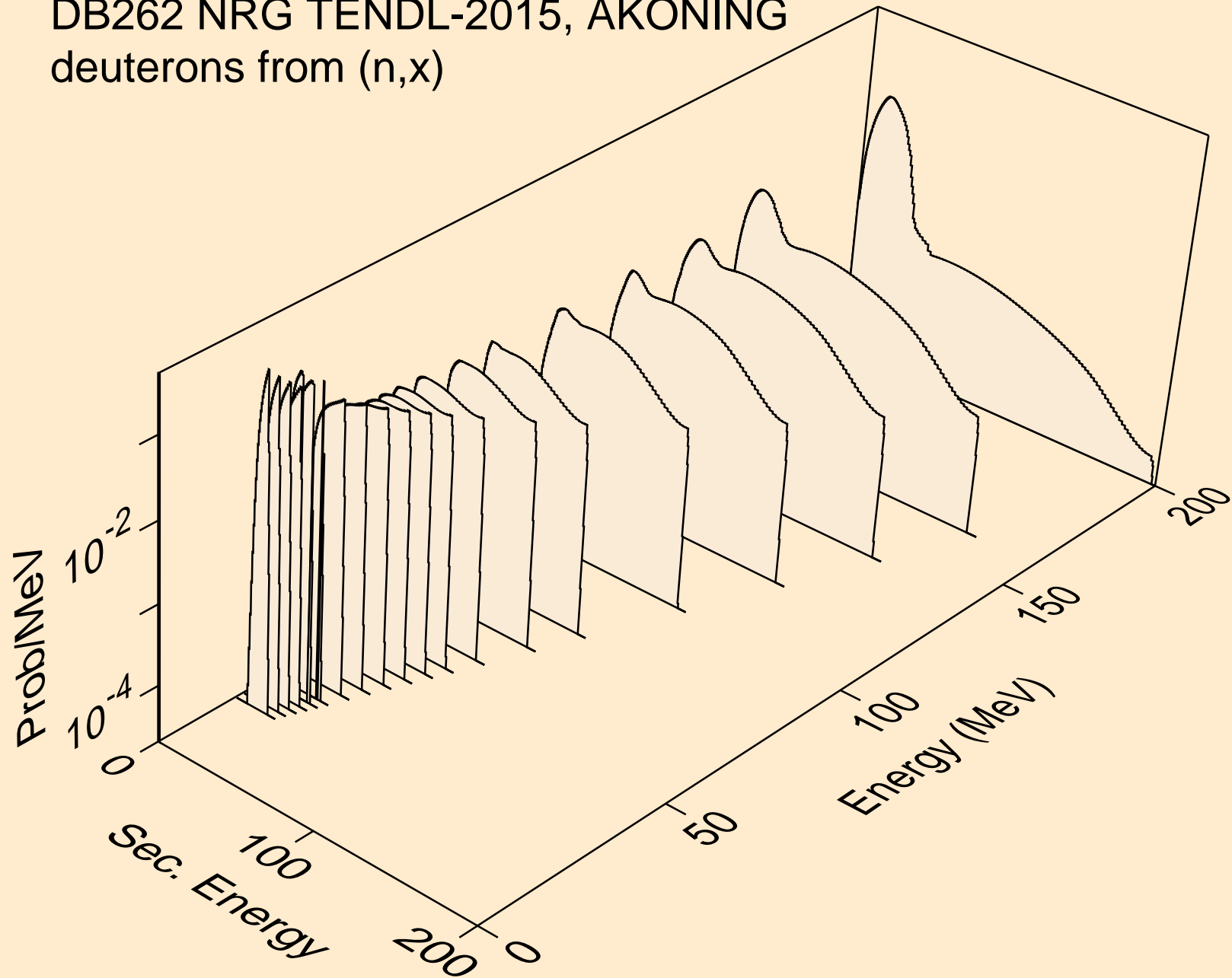

DB262 NRG TENDL-2015, AKONING
deuterons from (n,2nd)

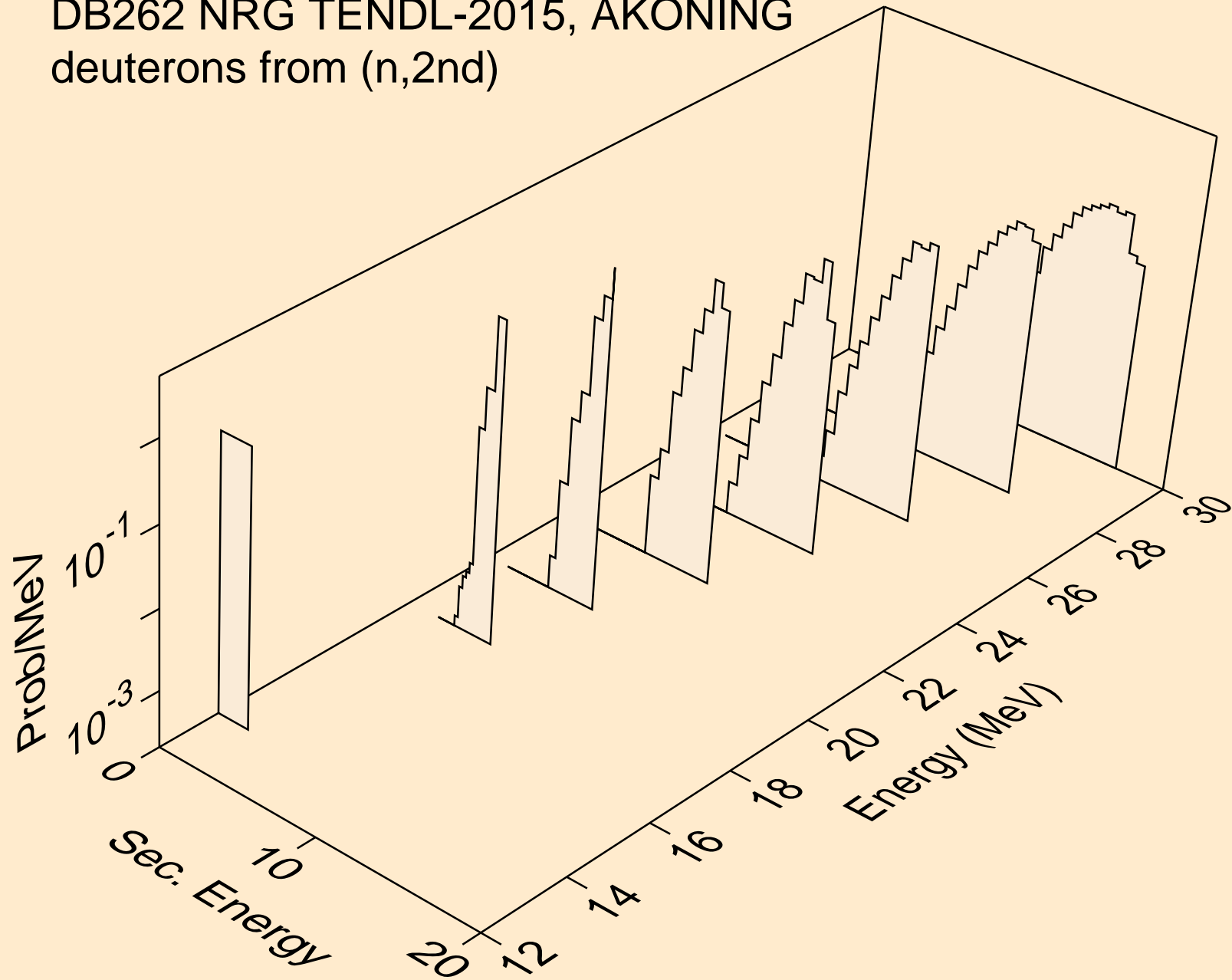

DB262 NRG TENDL-2015, AKONING
deuterons from (n,n*)d

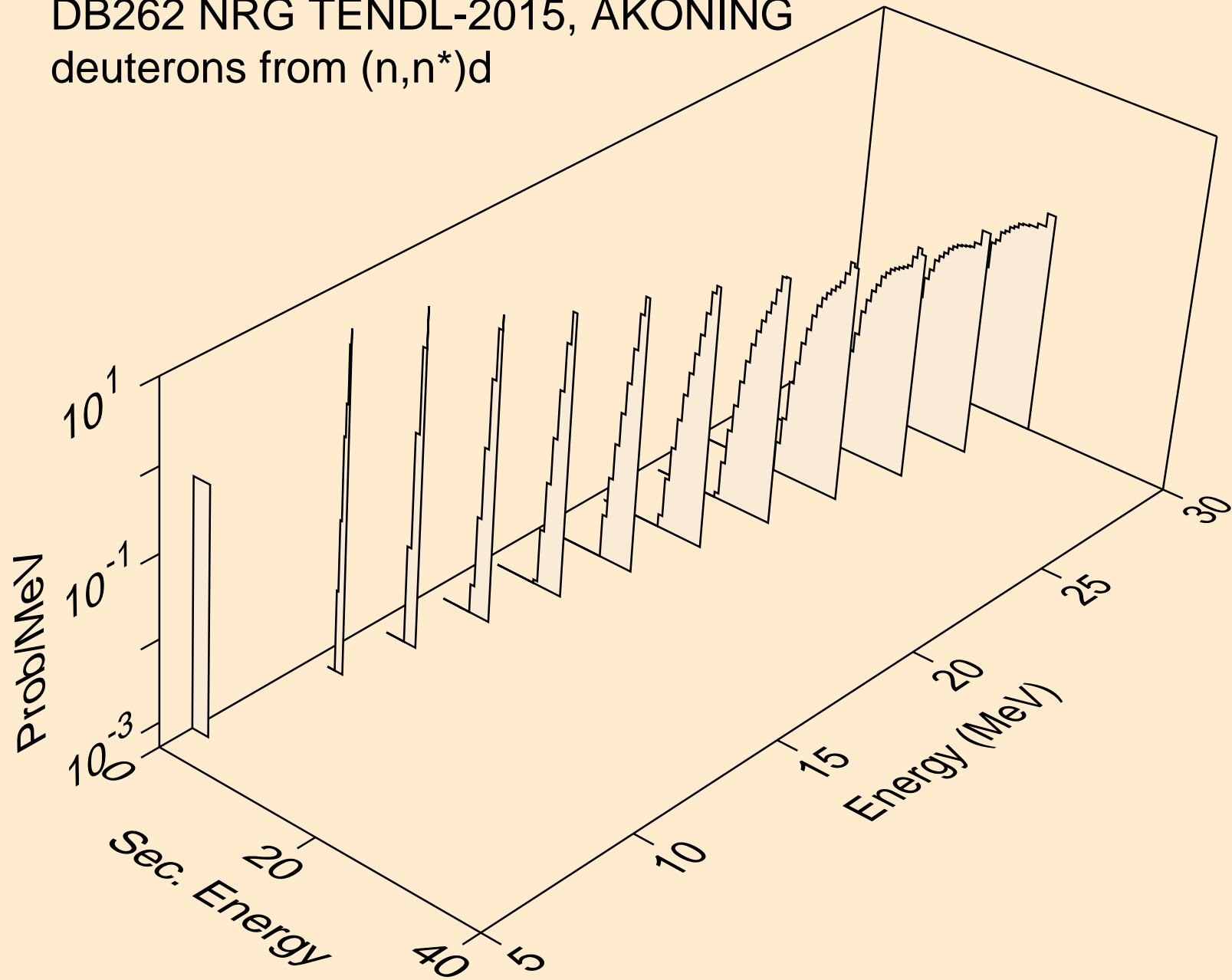

DB262 NRG TENDL-2015, AKONING
deuterons from (n,n*)d2a

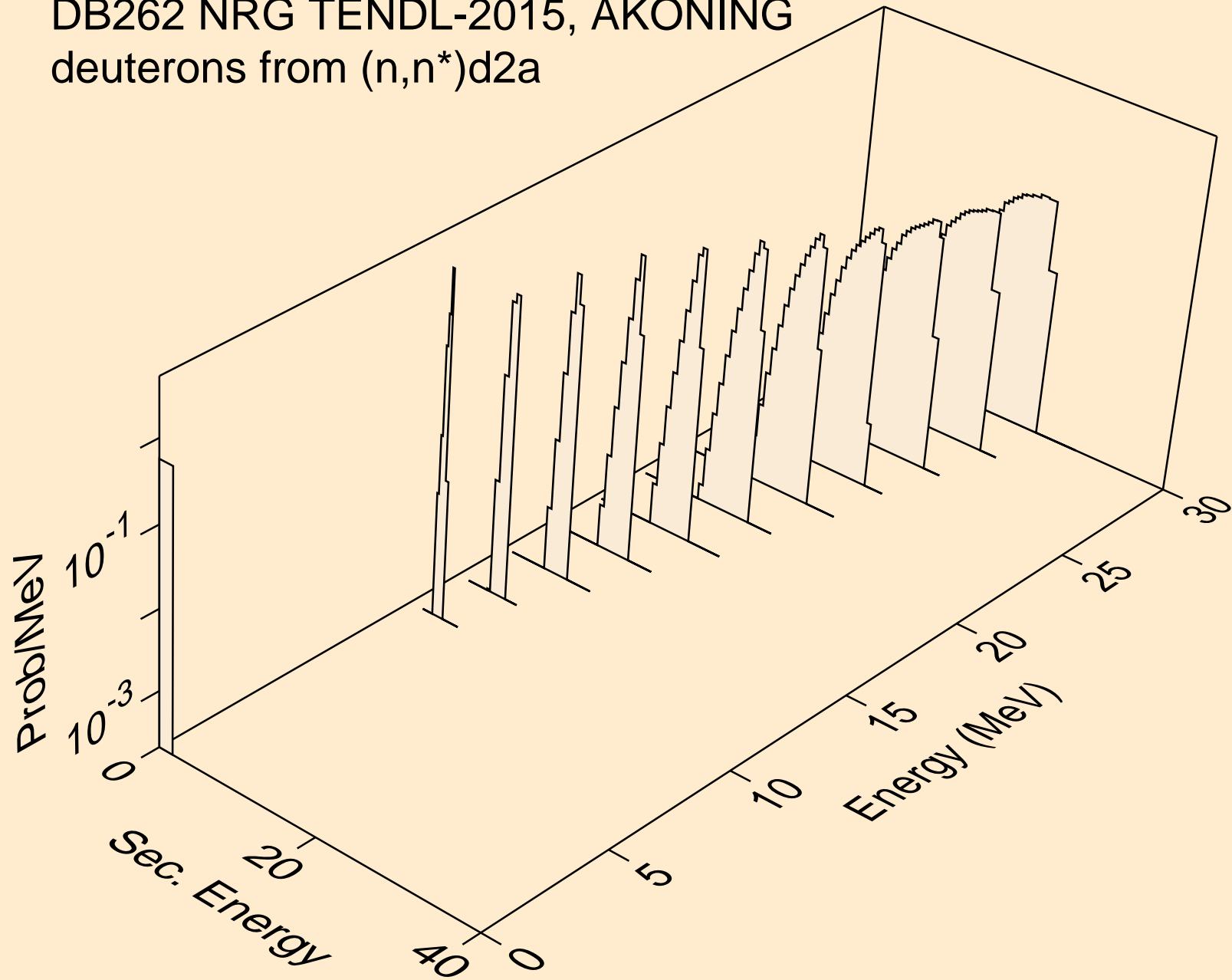

DB262 NRG TENDL-2015, AKONING
deuterons from (n,d)

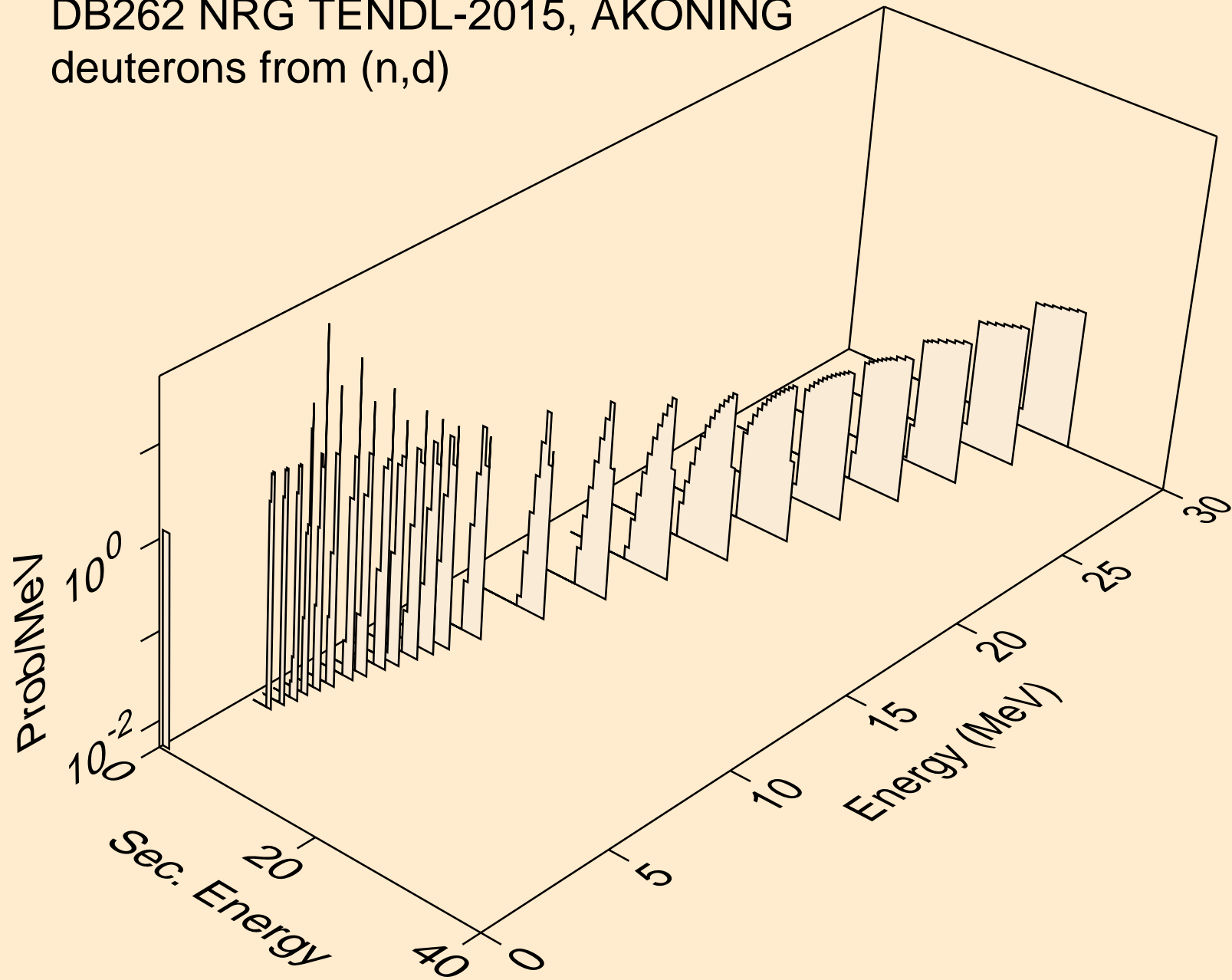

DB262 NRG TENDL-2015, AKONING
deuterons from (n,d2a)

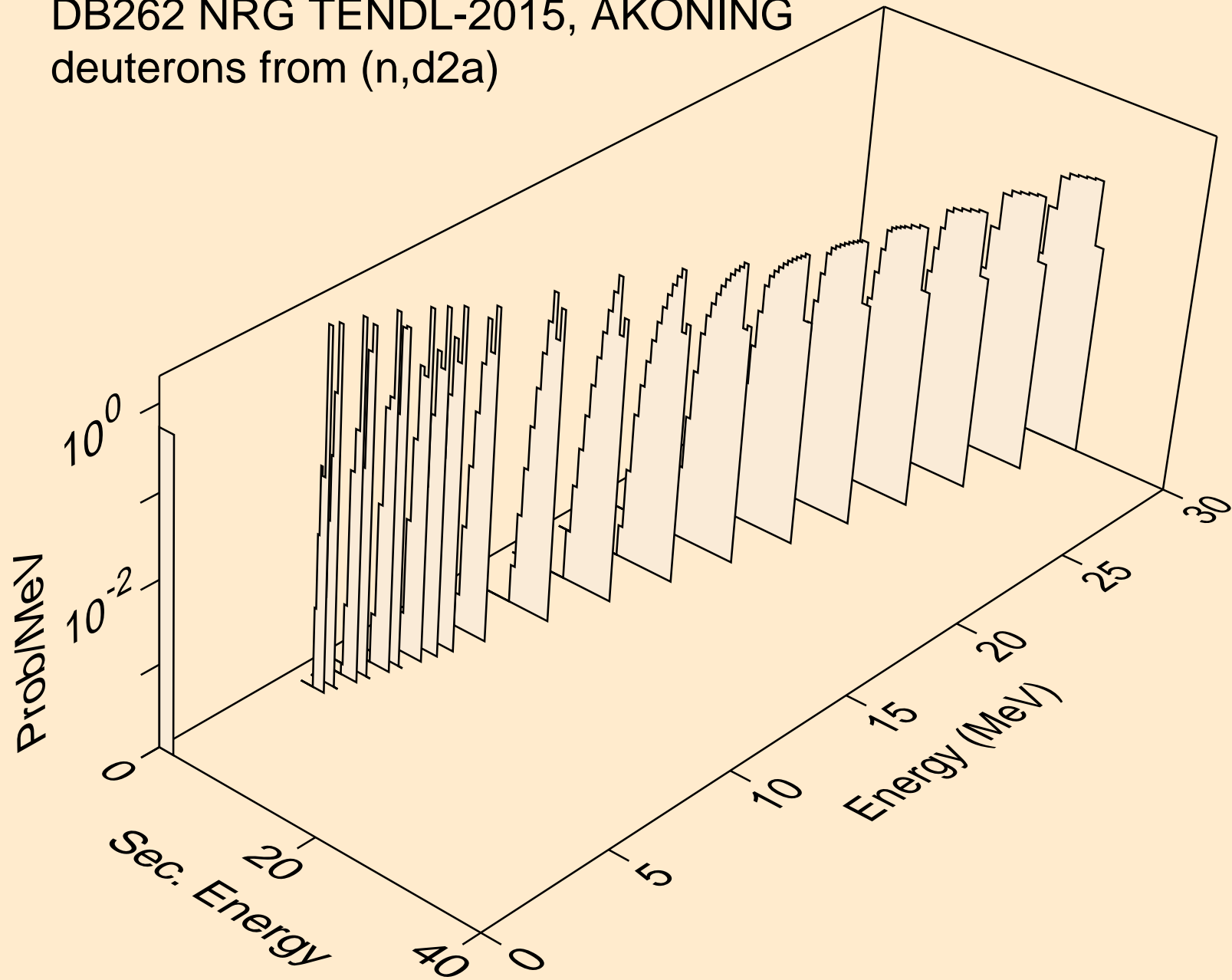

DB262 NRG TENDL-2015, AKONING
deuterons from (n,pd)

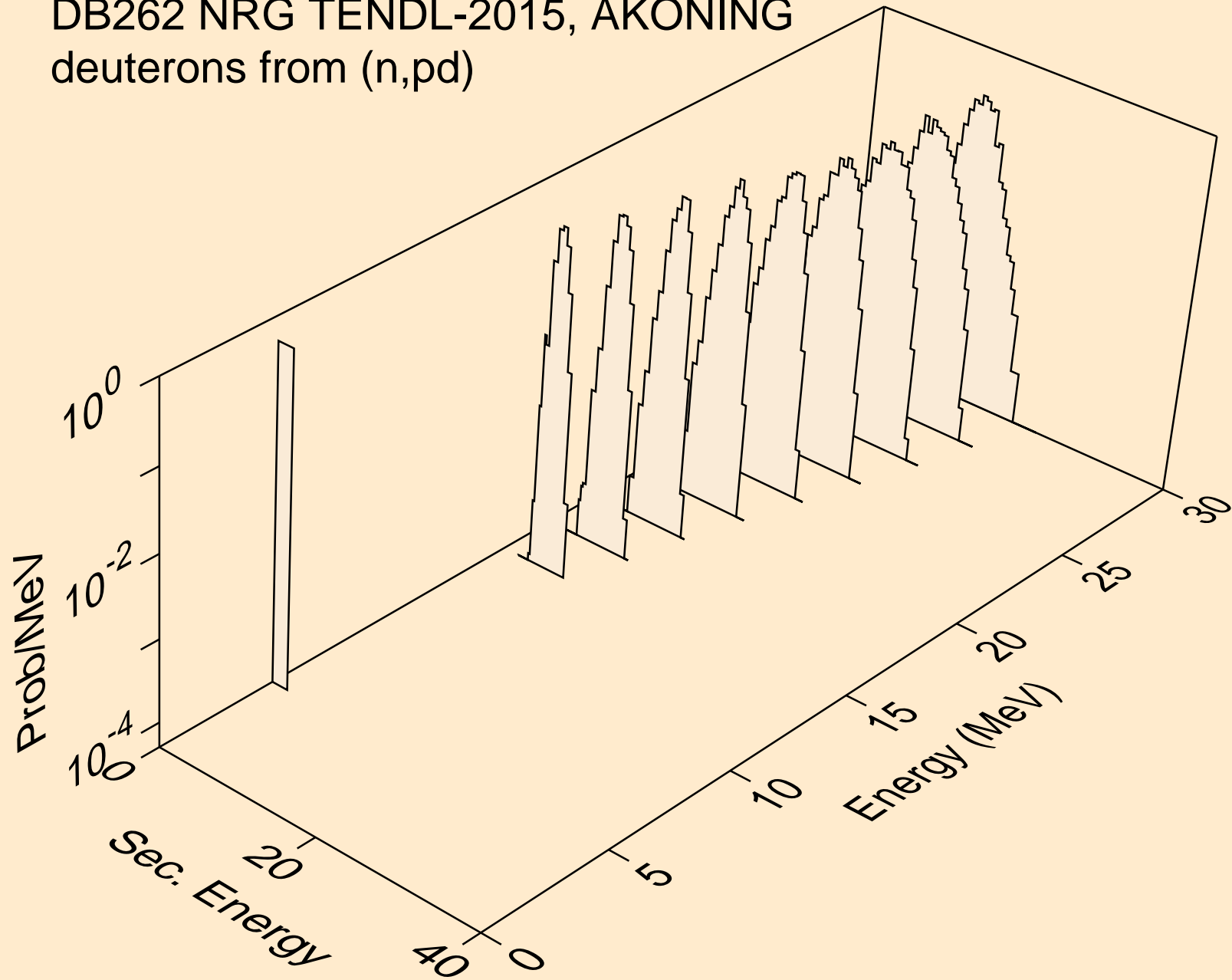

DB262 NRG TENDL-2015, AKONING
deuterons from (n,da)

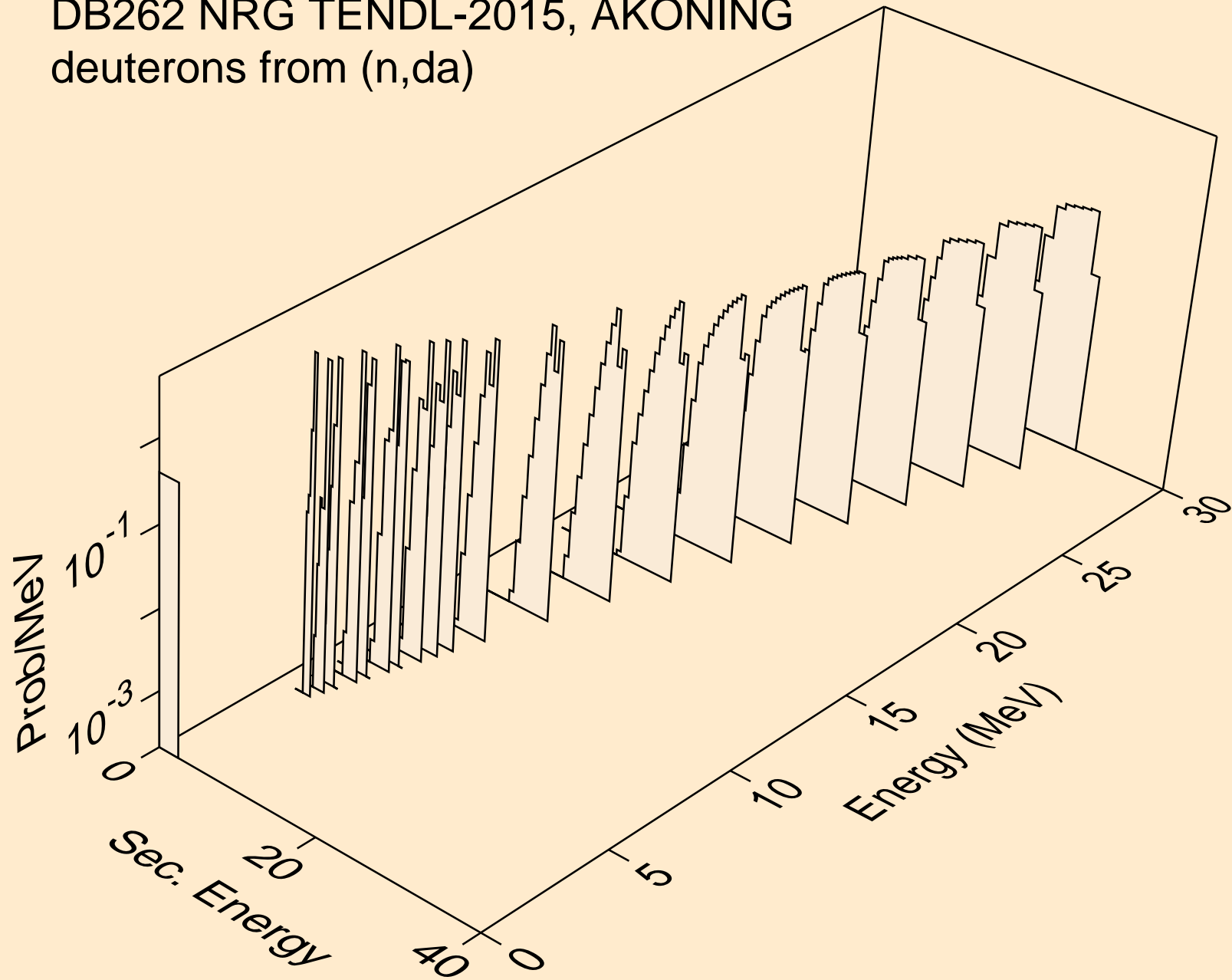

DB262 NRG TENDL-2015, AKONING
tritons from (n,x)

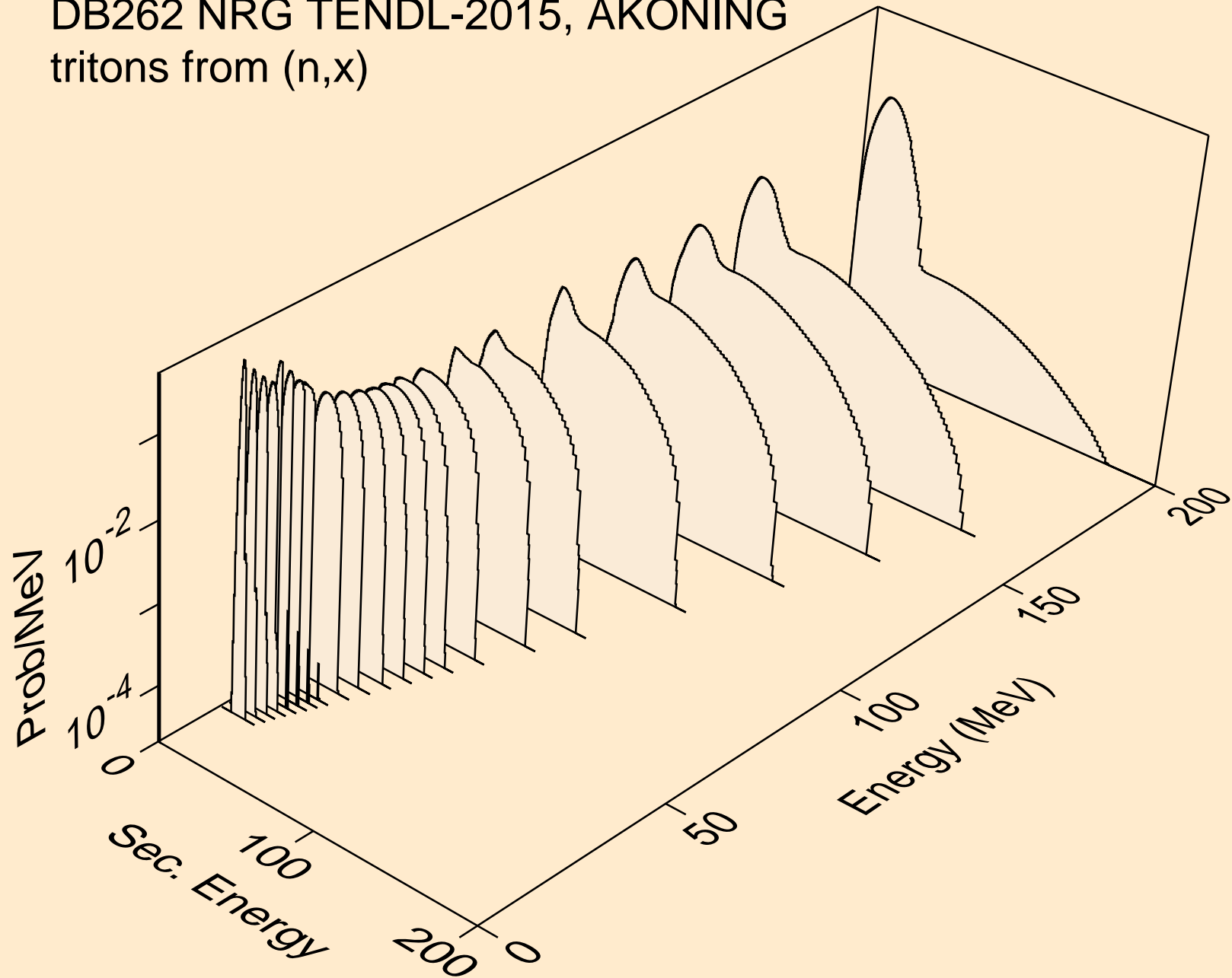

DB262 NRG TENDL-2015, AKONING
tritons from (n,n*)t

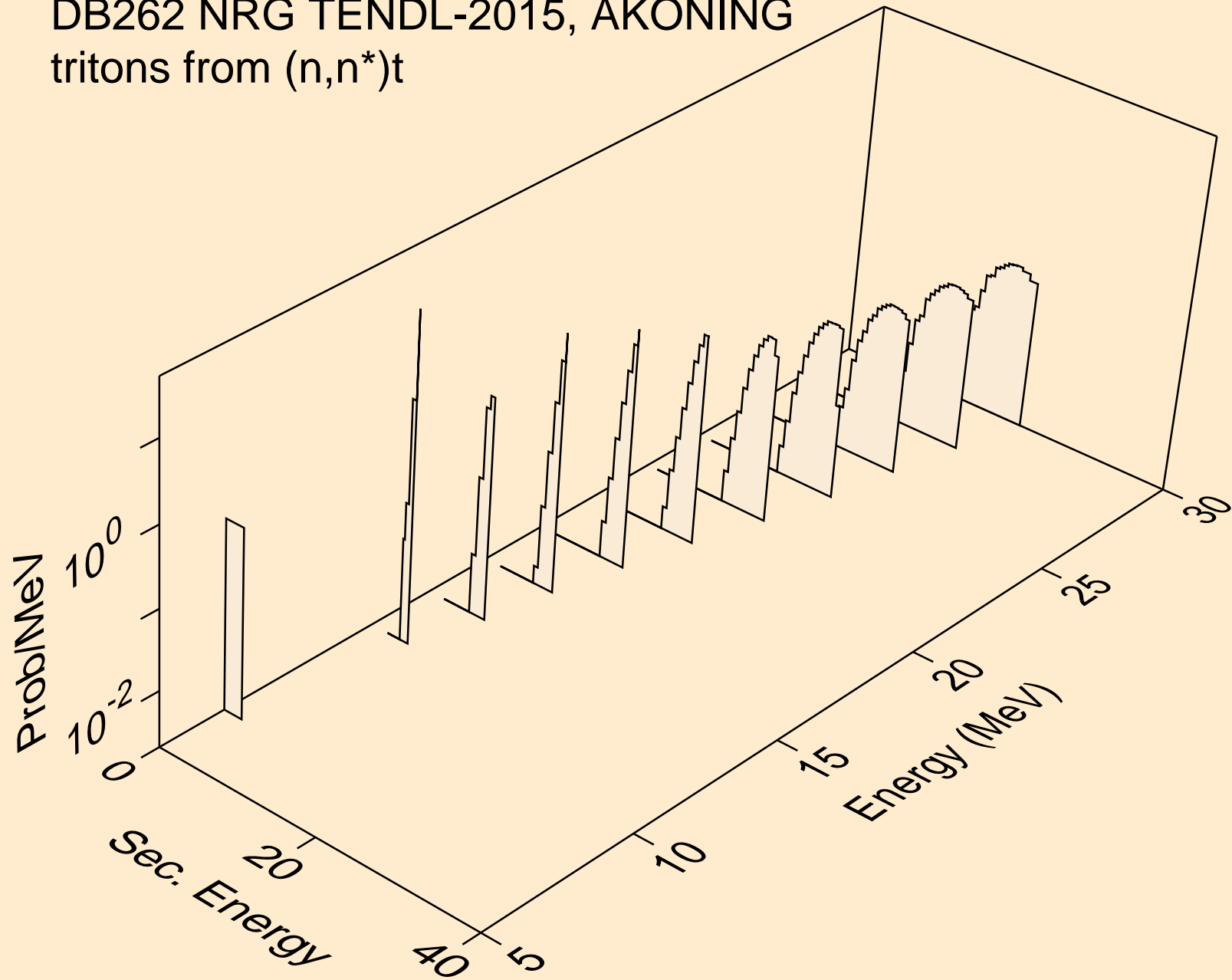

DB262 NRG TENDL-2015, AKONING
tritons from (n,n*)t2a

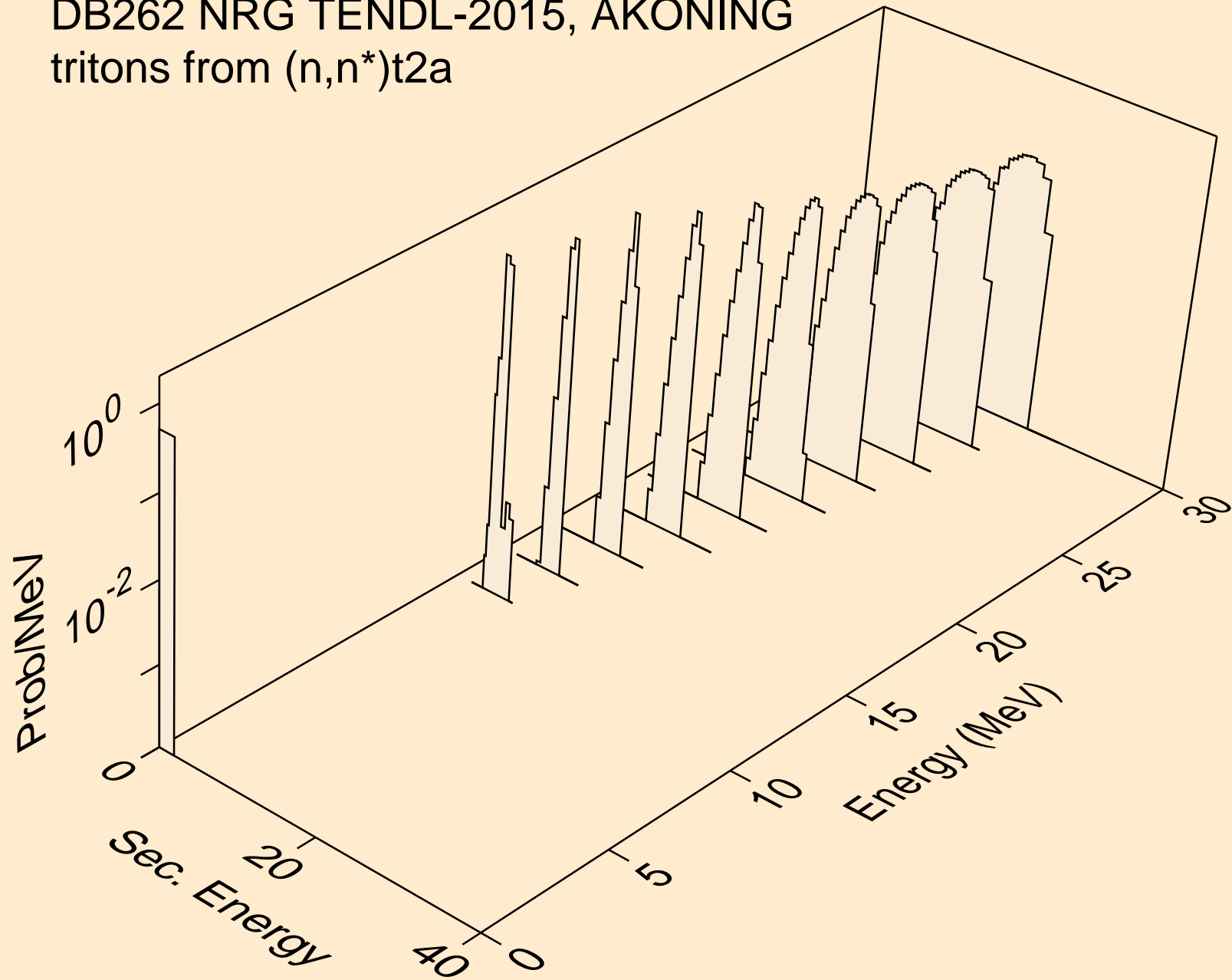

DB262 NRG TENDL-2015, AKONING
tritons from (n,t)

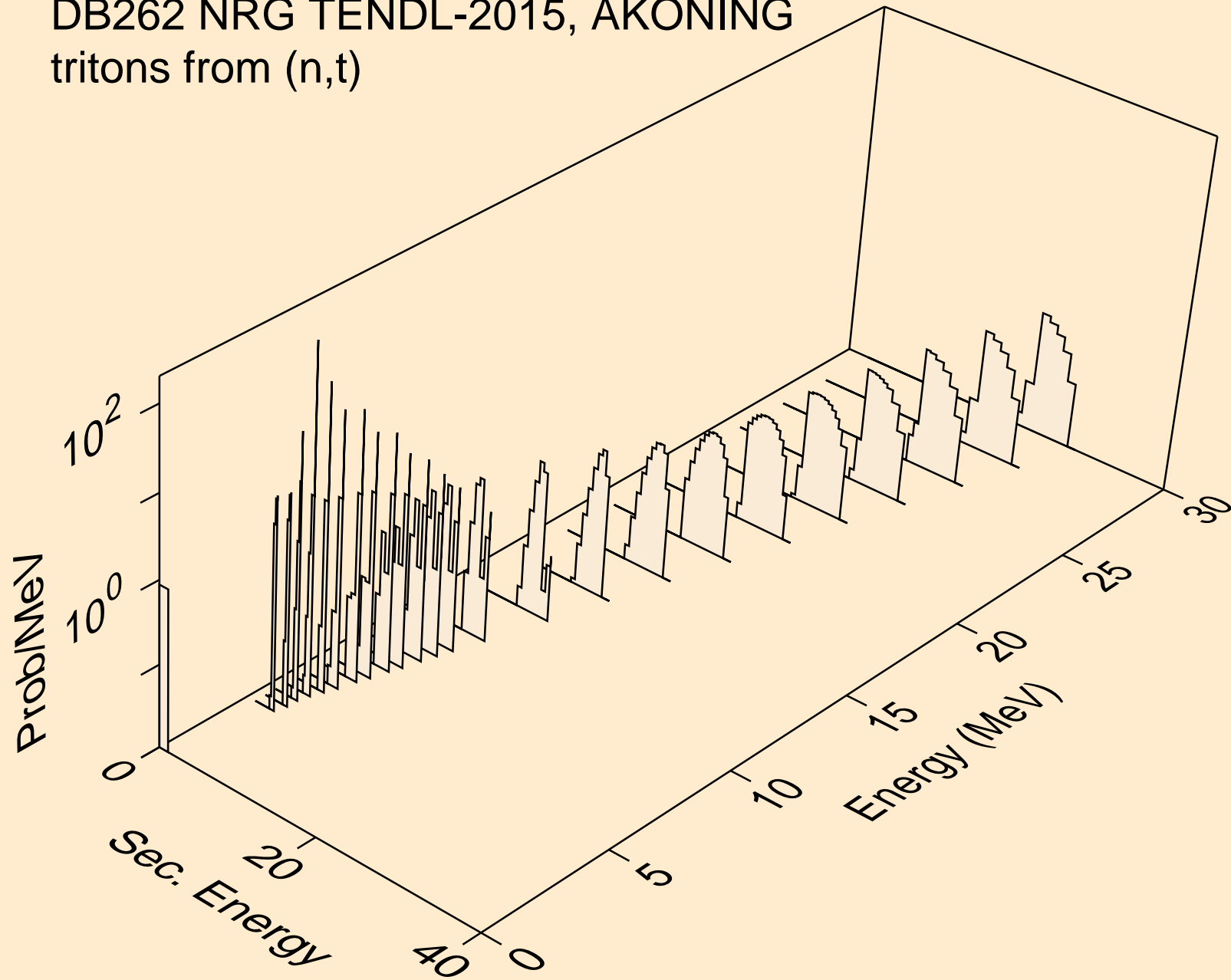

DB262 NRG TENDL-2015, AKONING
tritons from (n,t2a)

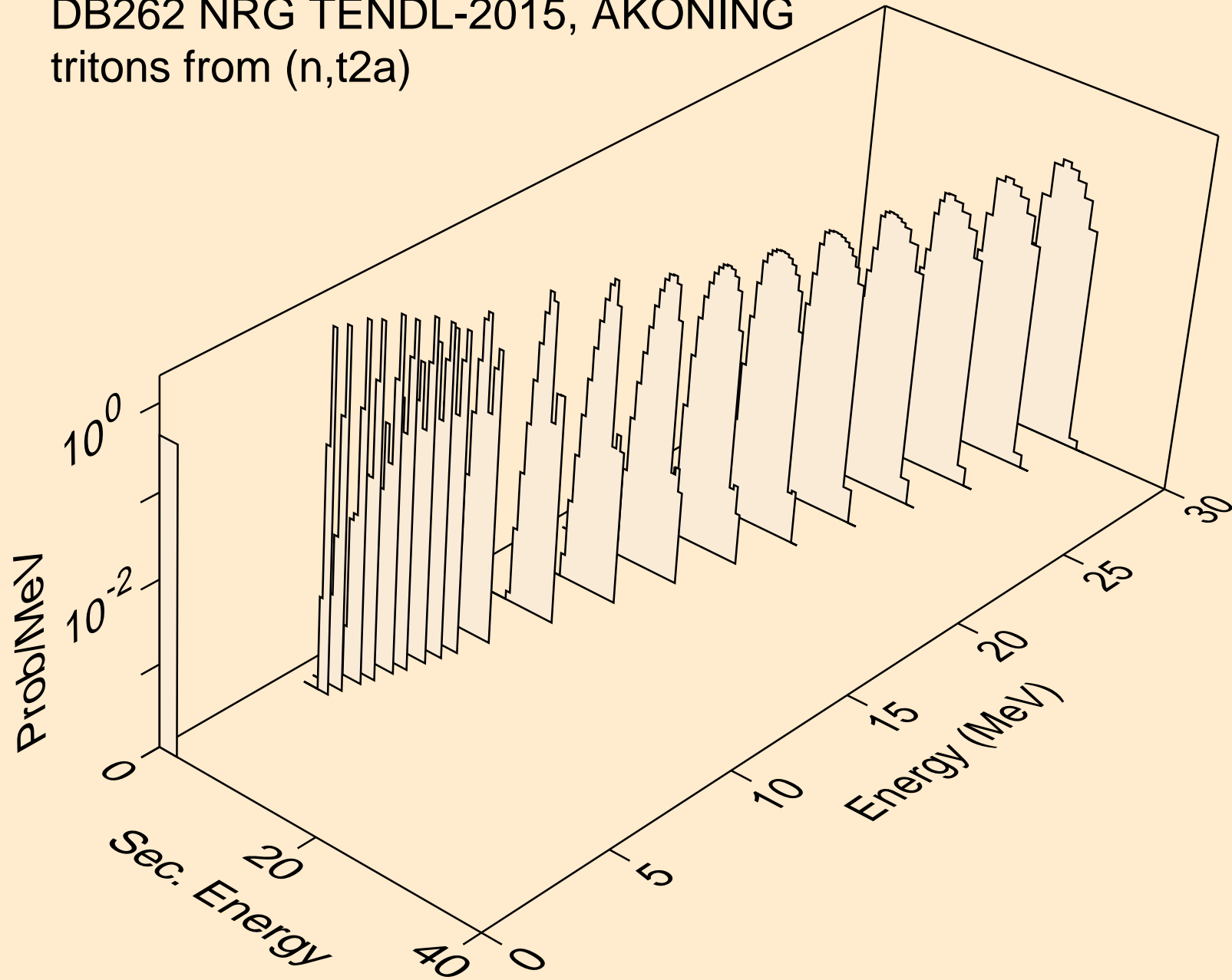

DB262 NRG TENDL-2015, AKONING
tritons from (n,pt)

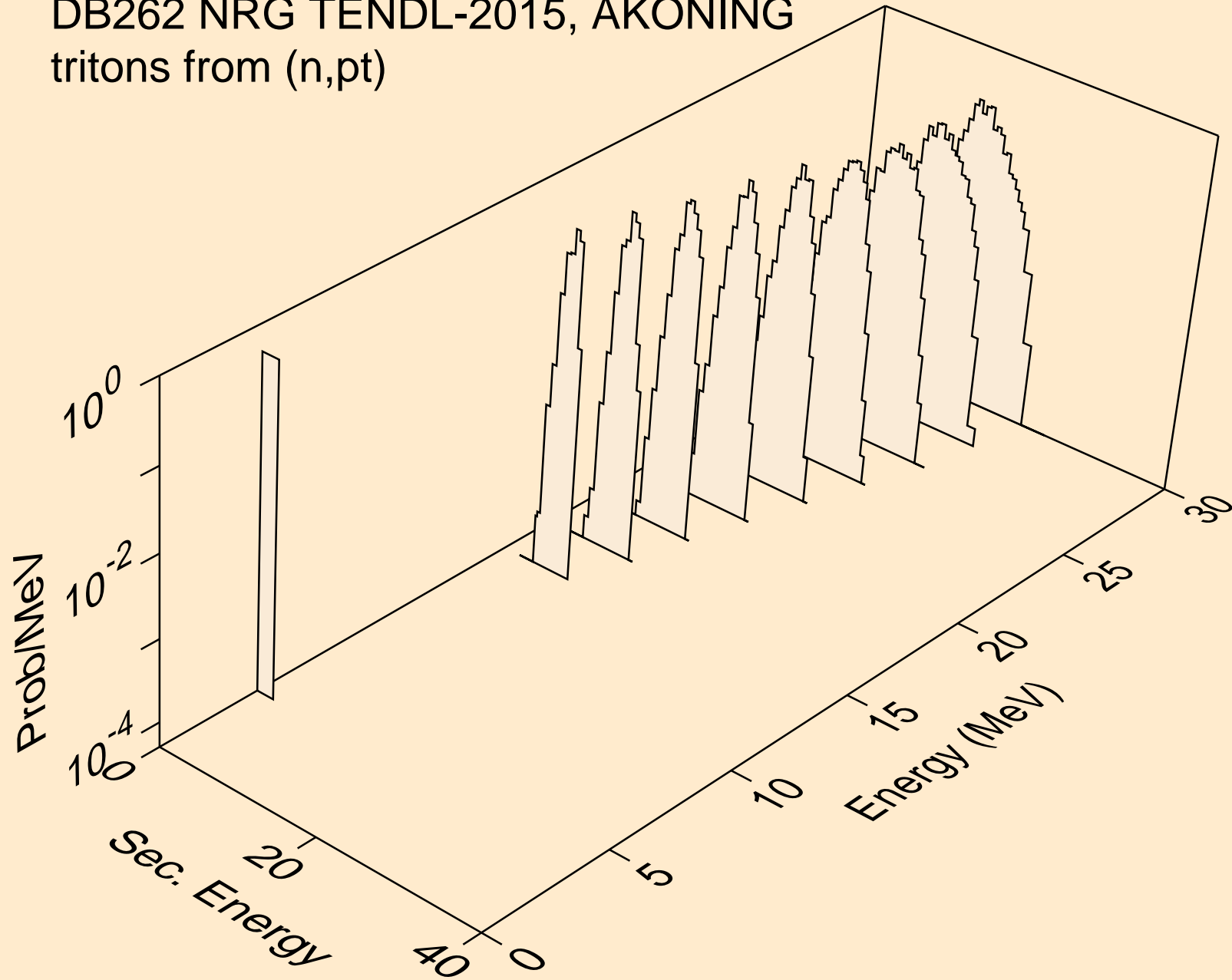

DB262 NRG TENDL-2015, AKONING
he3s from (n,x)

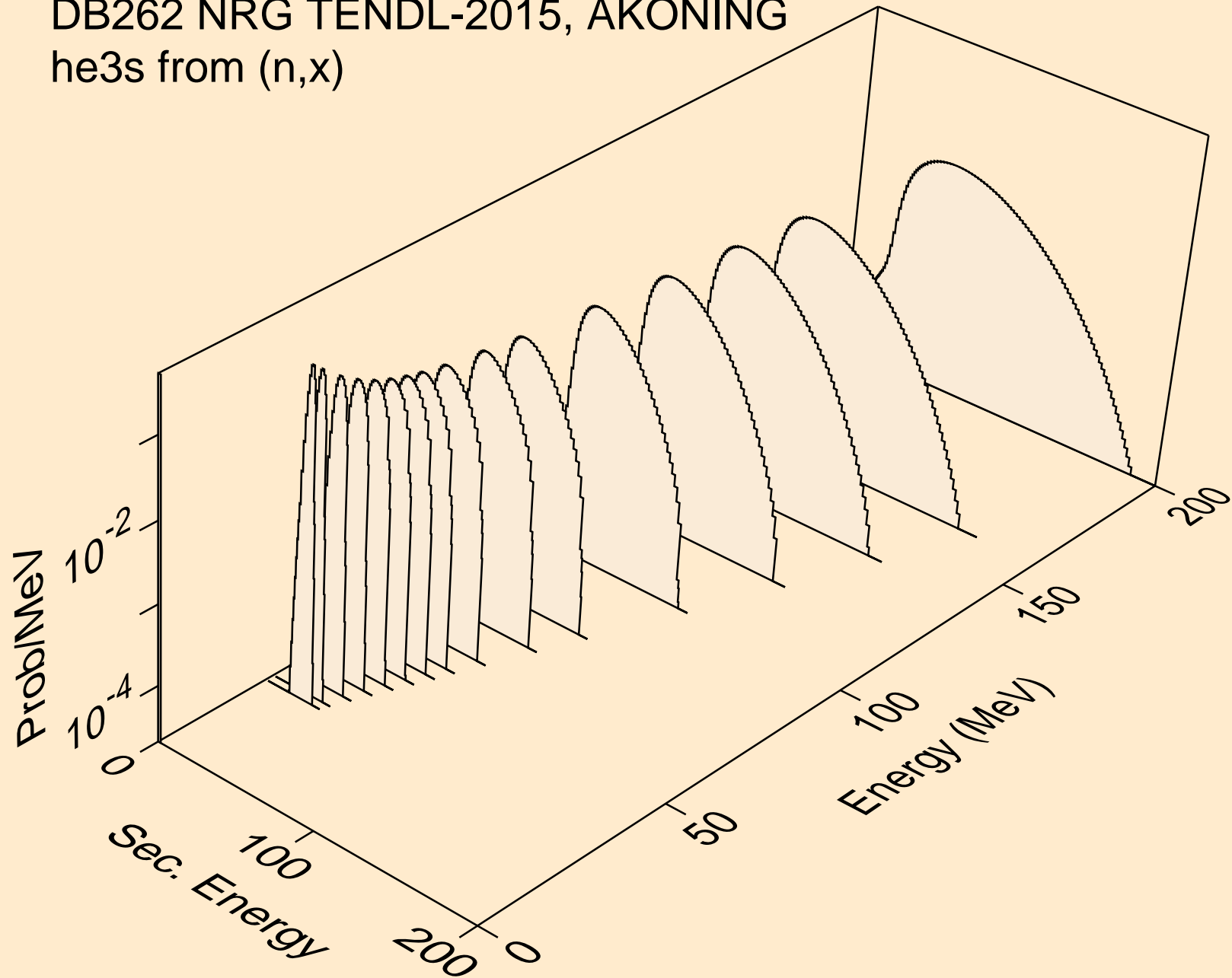

DB262 NRG TENDL-2015, AKONING
he3s from (n,n*)he3

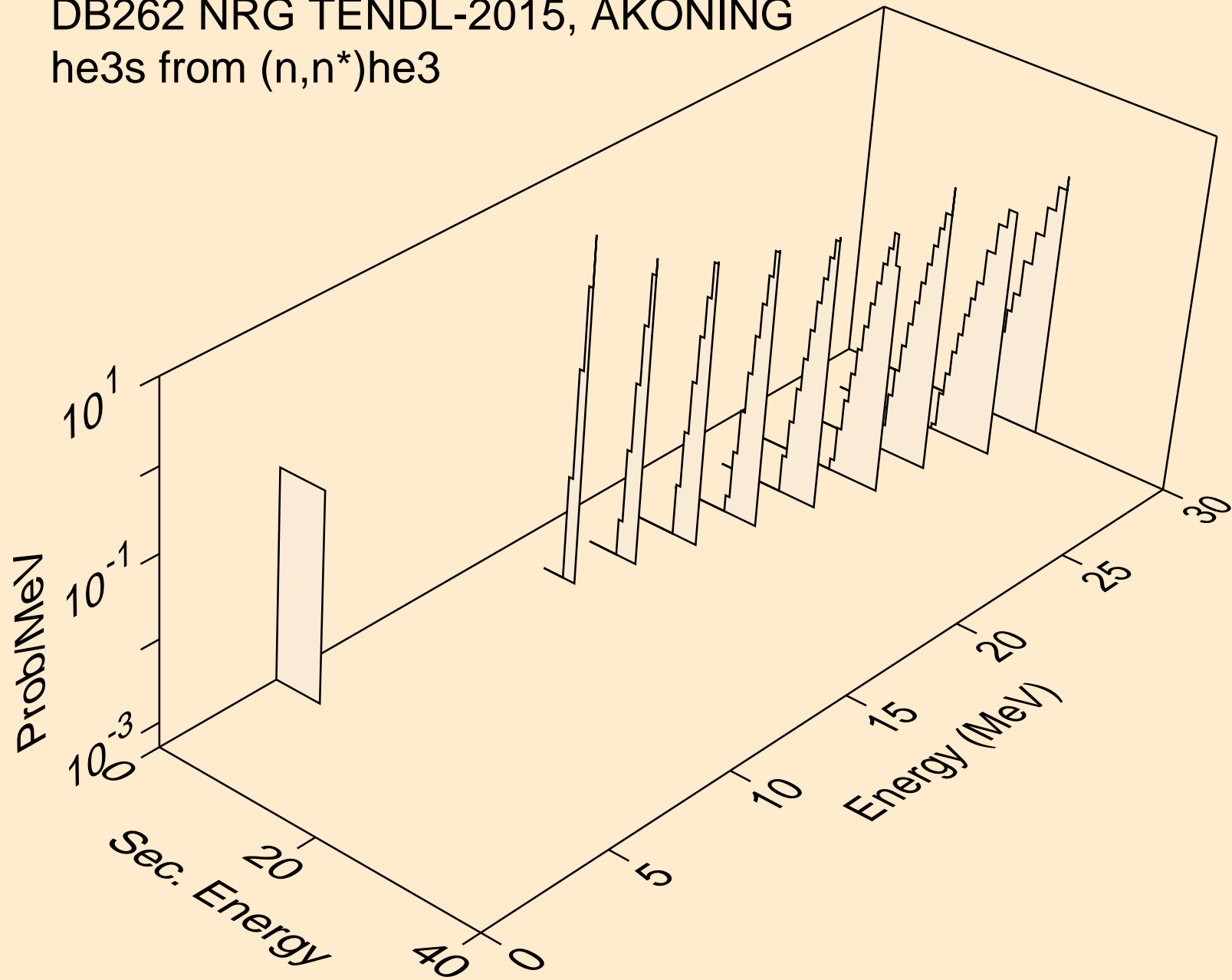

DB262 NRG TENDL-2015, AKONING
he3s from (n,he3)

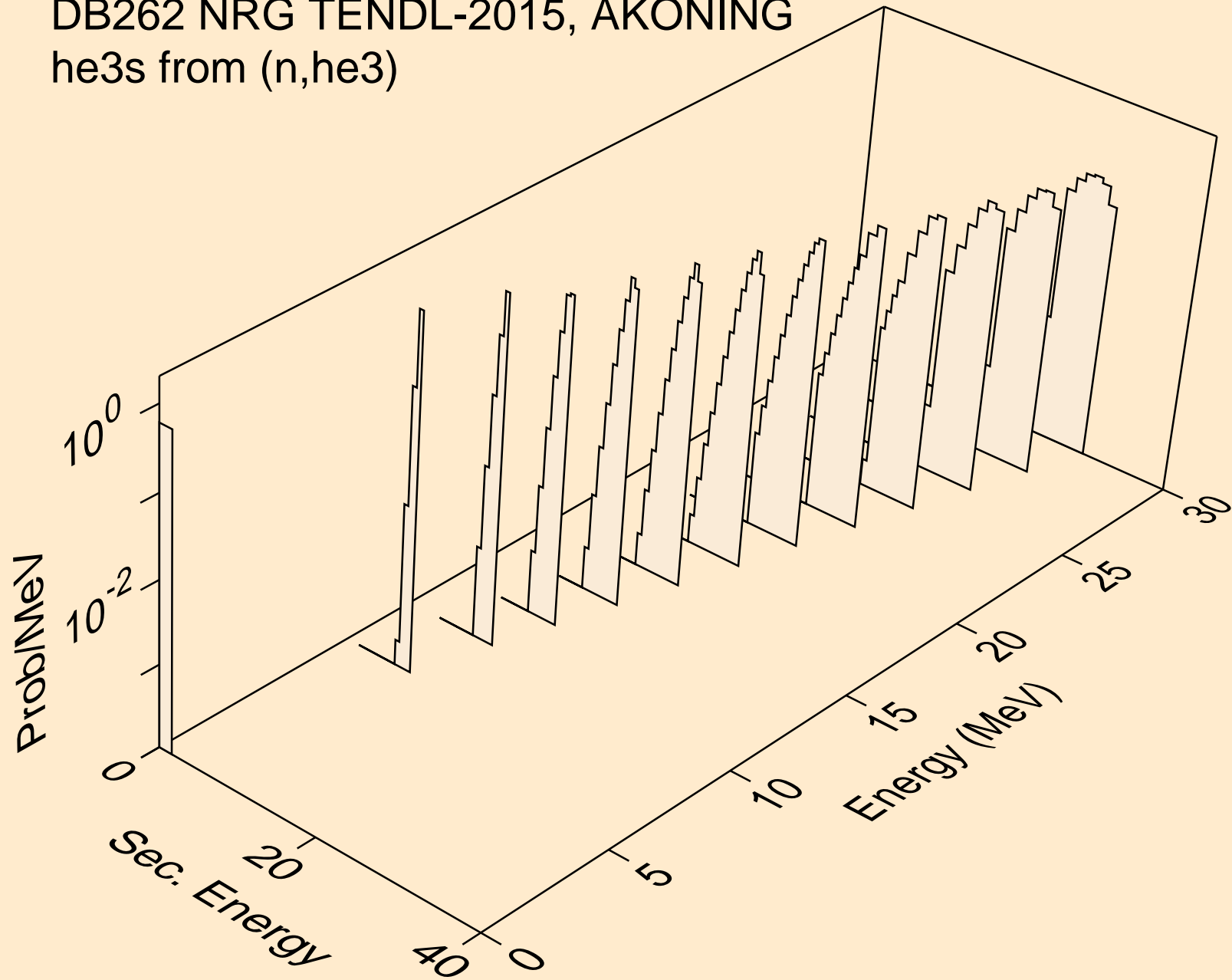

DB262 NRG TENDL-2015, AKONING
alphas from (n,x)

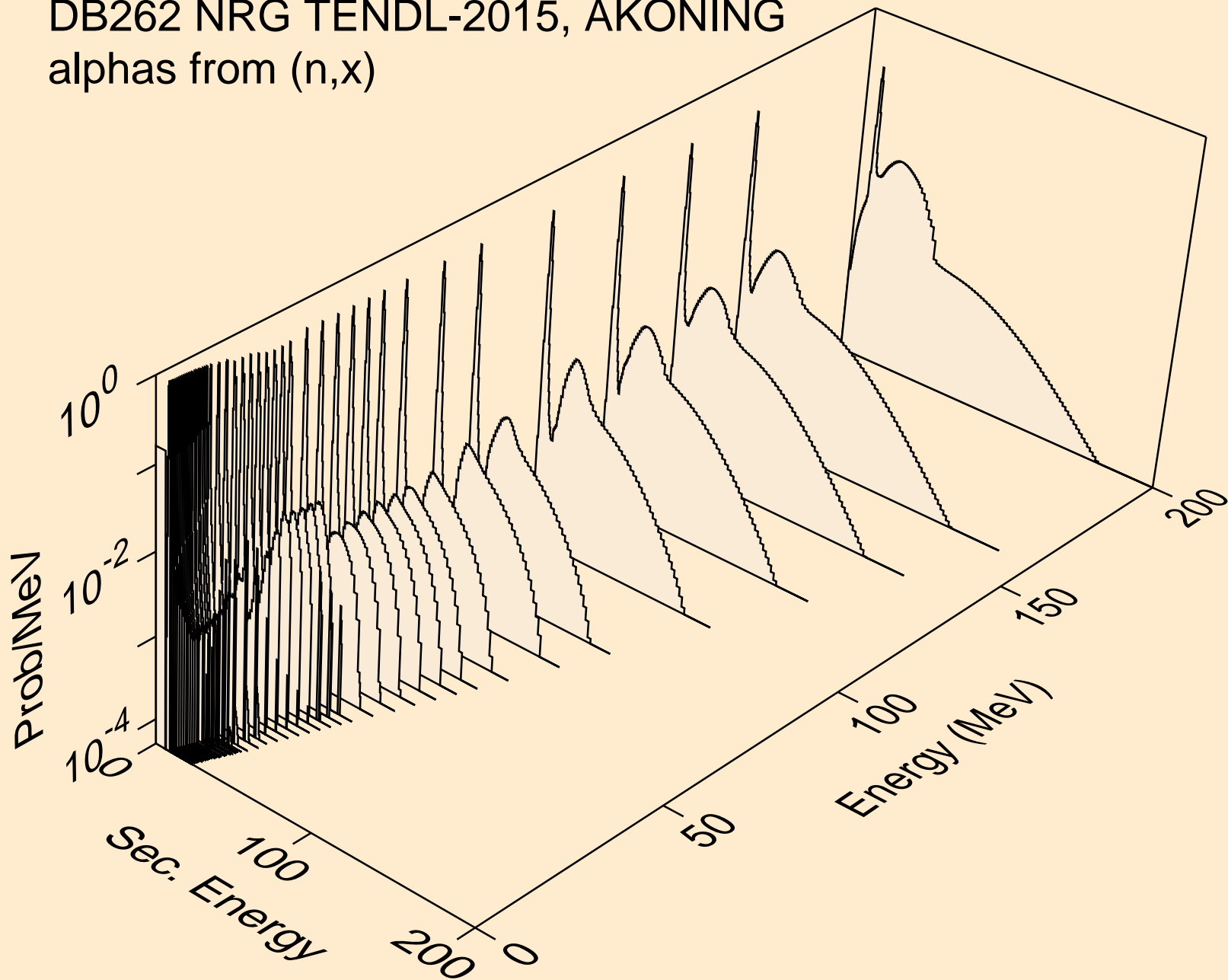

DB262 NRG TENDL-2015, AKONING
alphas from (n,n*)a

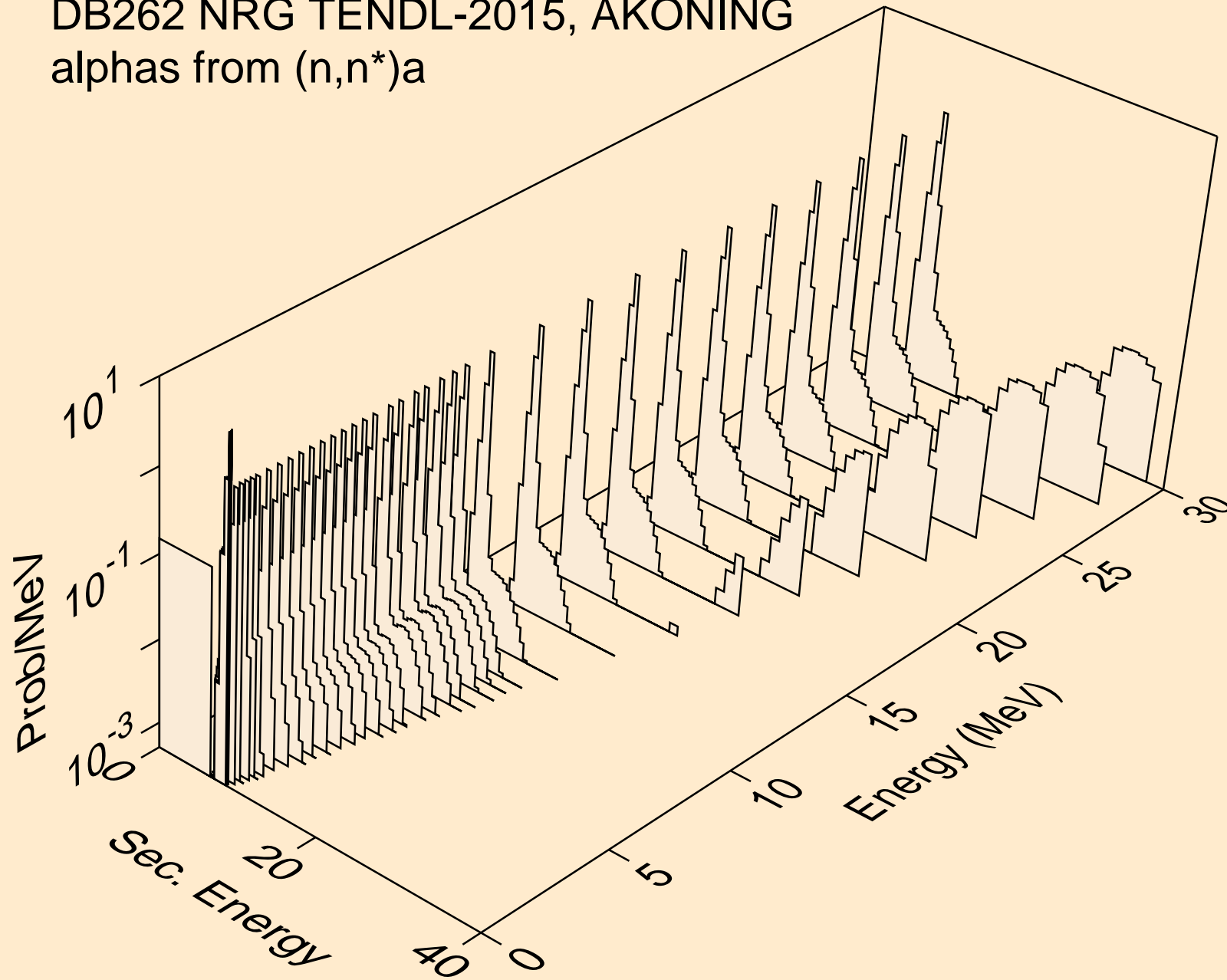

DB262 NRG TENDL-2015, AKONING
alphas from (n,n*)3a

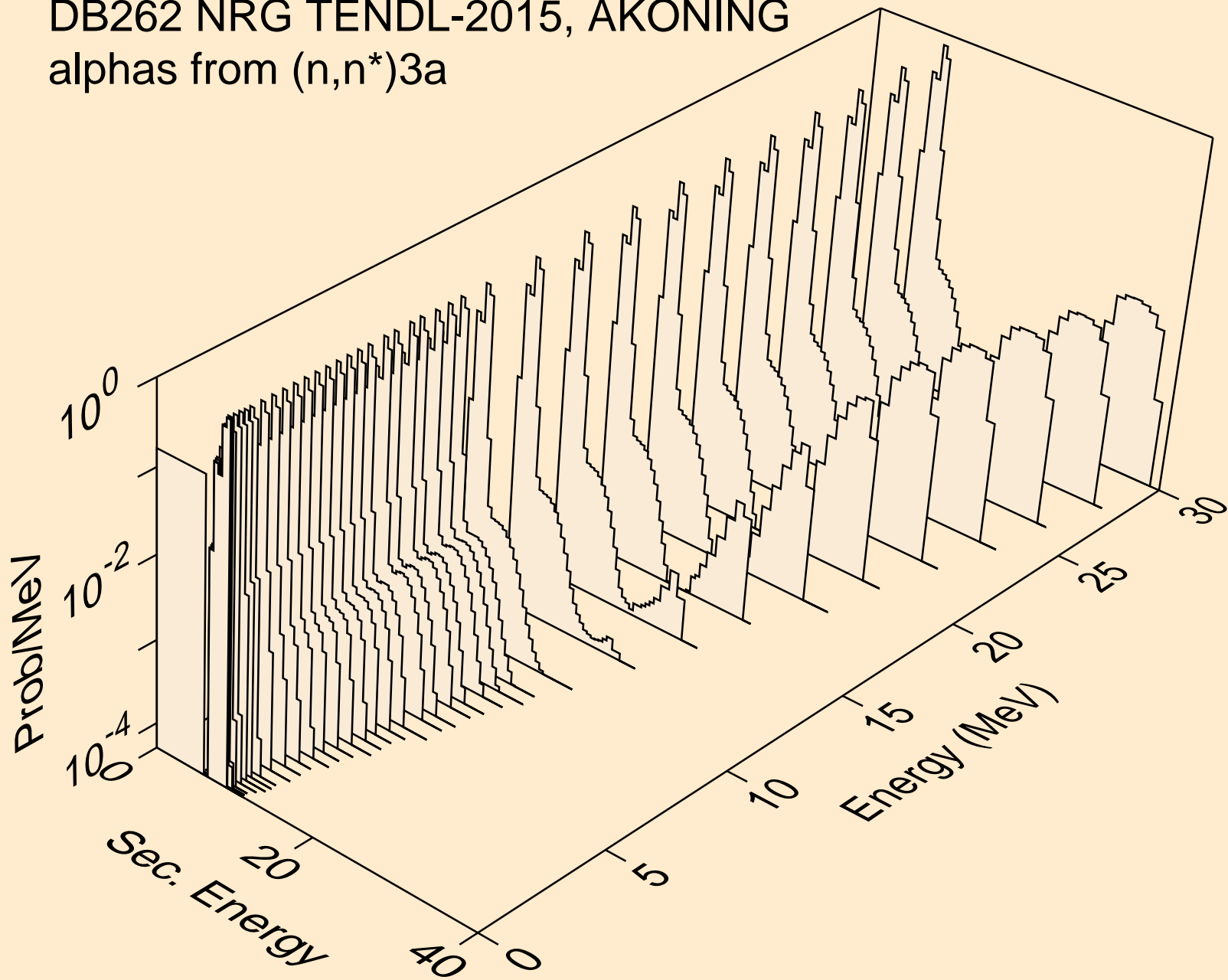

DB262 NRG TENDL-2015, AKONING
alphas from (n,2n)a

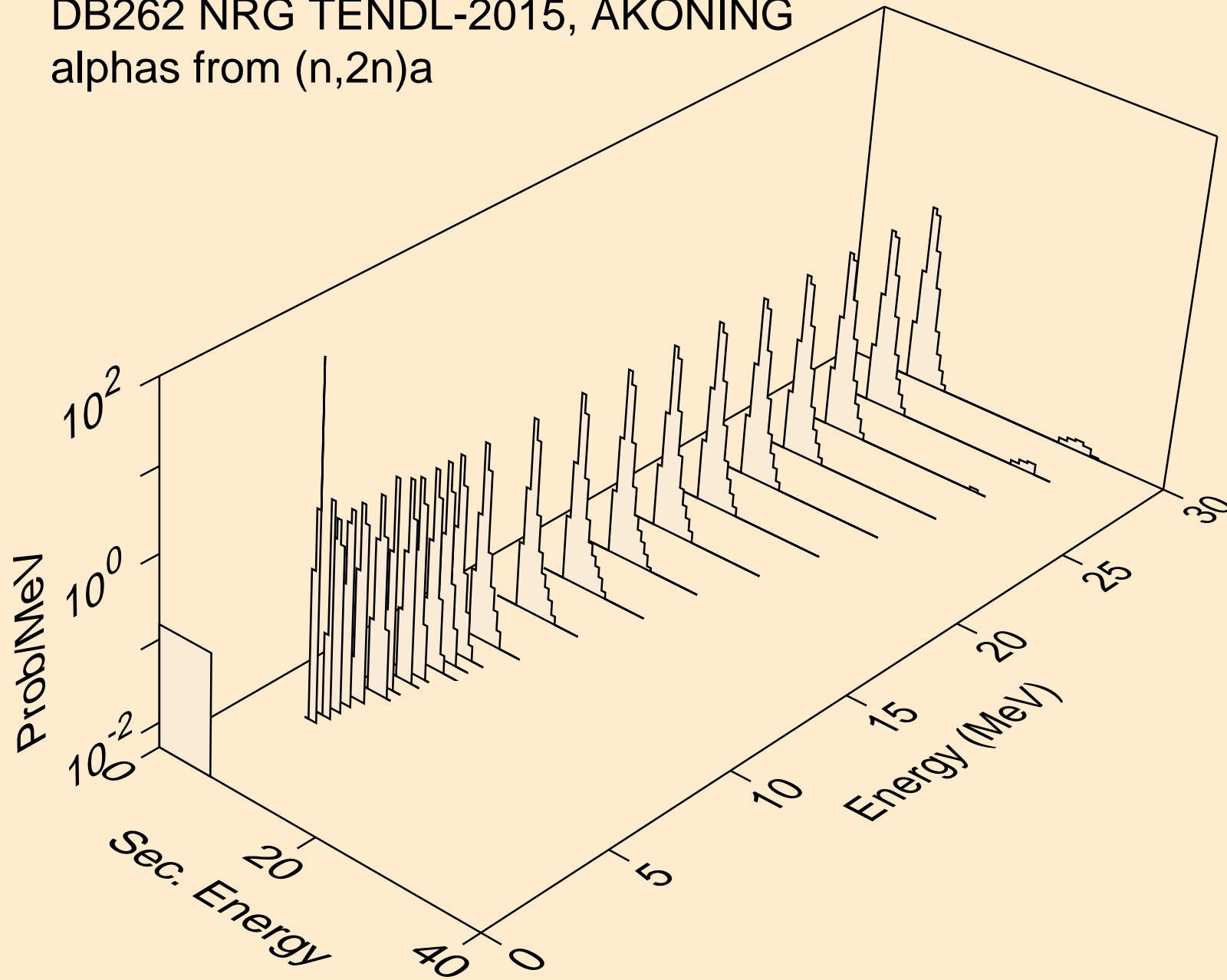

DB262 NRG TENDL-2015, AKONING
alphas from (n,3n)a

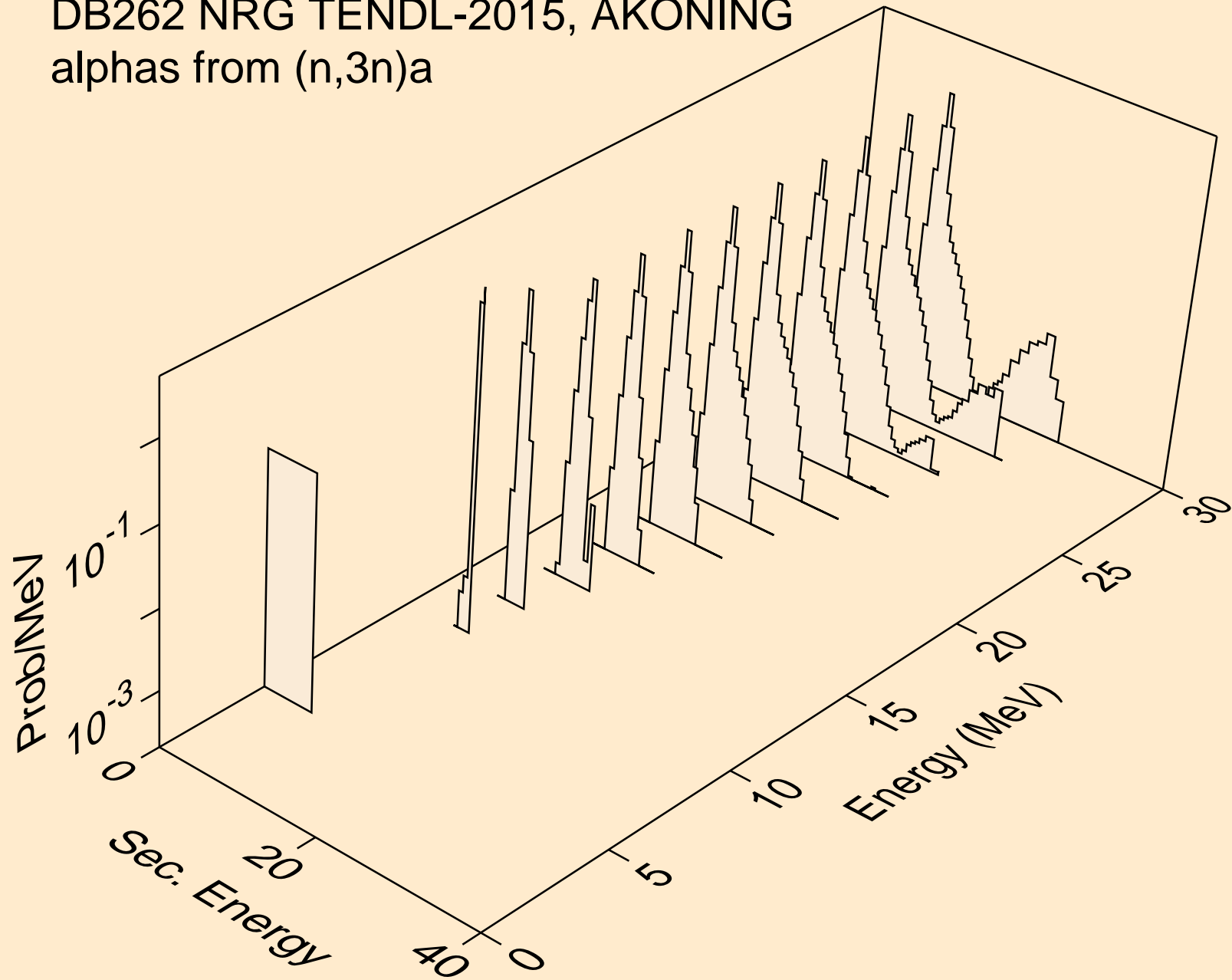

DB262 NRG TENDL-2015, AKONING
alphas from (n,n*)2a

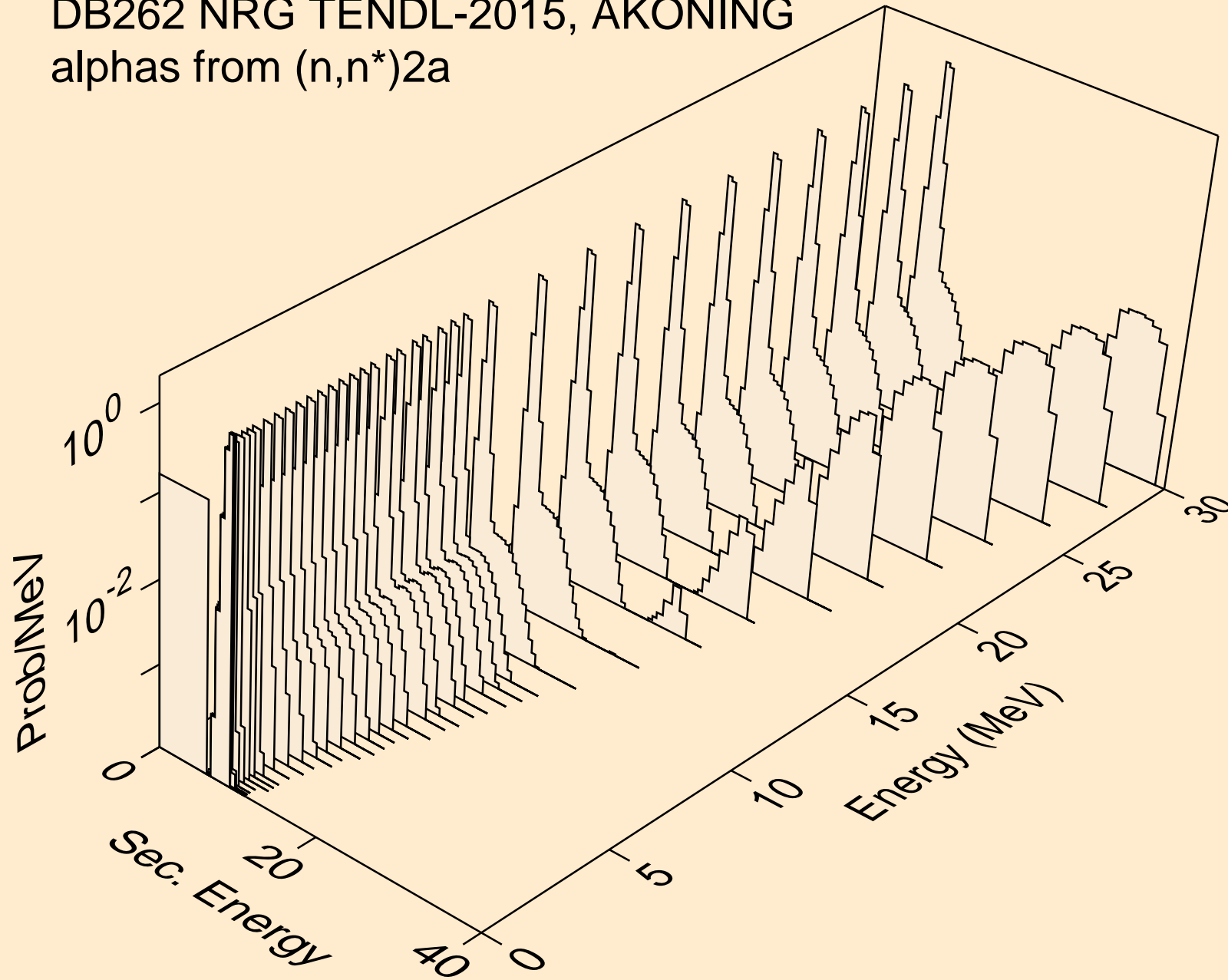

DB262 NRG TENDL-2015, AKONING
alphas from (n,2n)2a

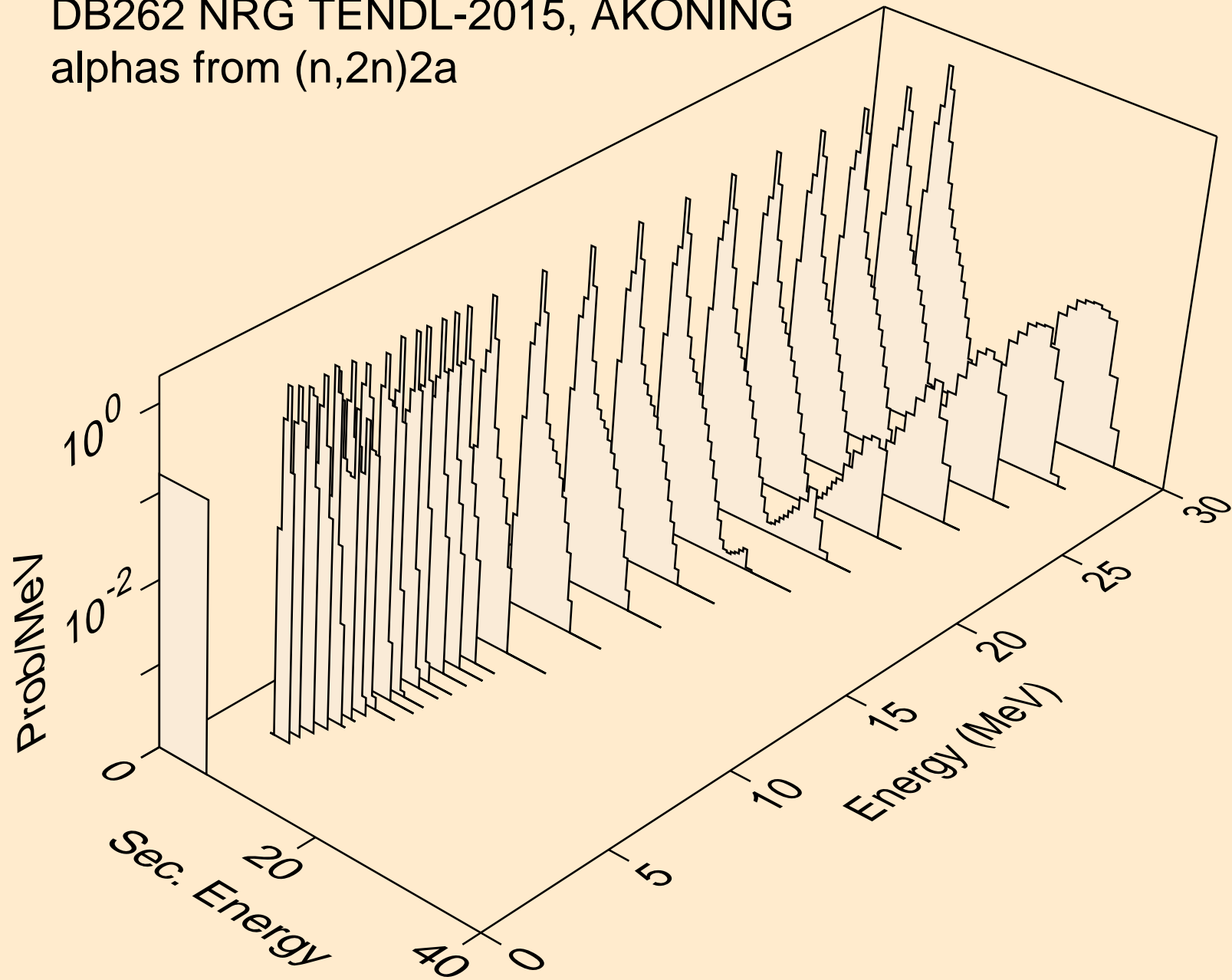

DB262 NRG TENDL-2015, AKONING
alphas from (n,n*)d2a

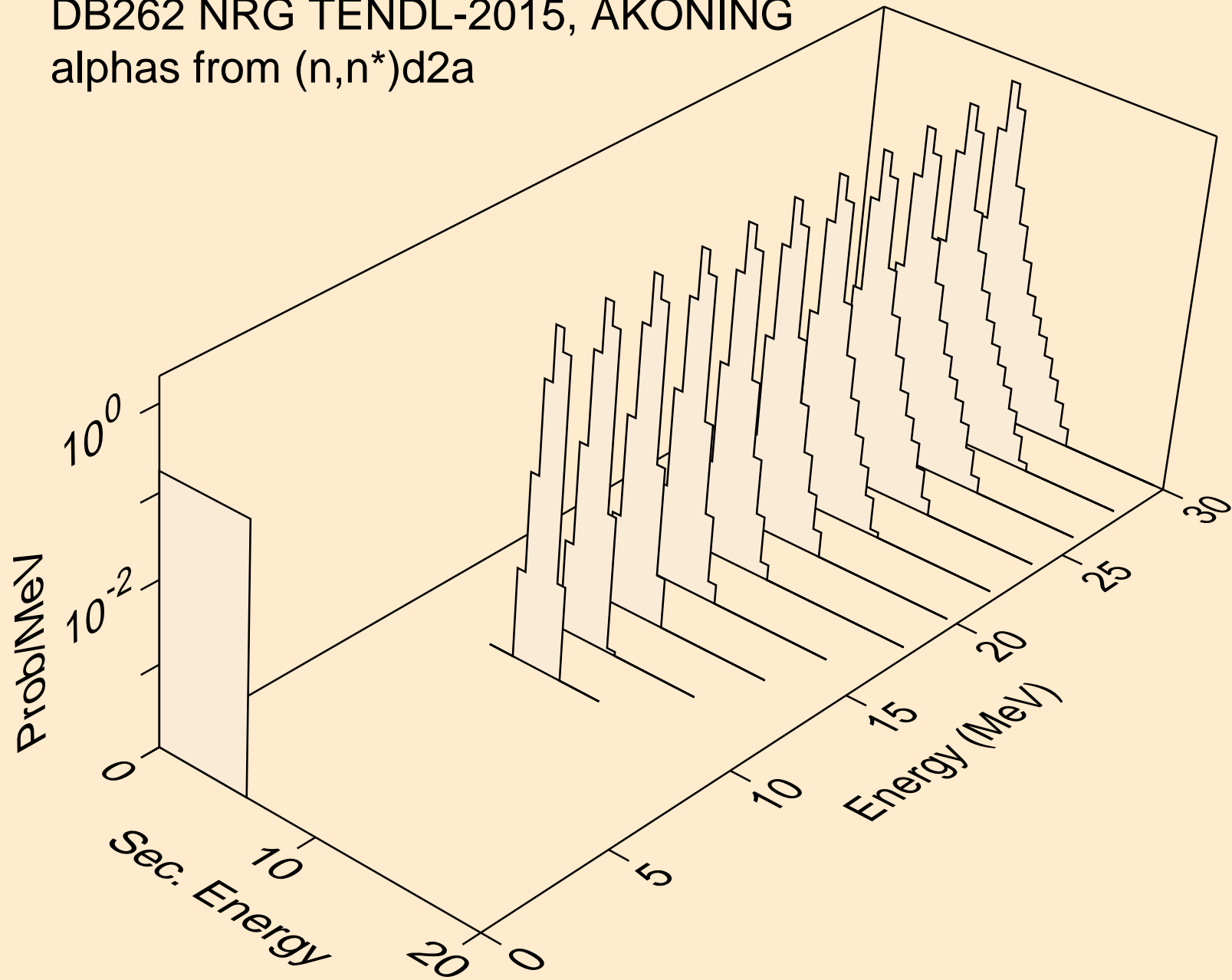

DB262 NRG TENDL-2015, AKONING
alphas from (n,n*)t2a

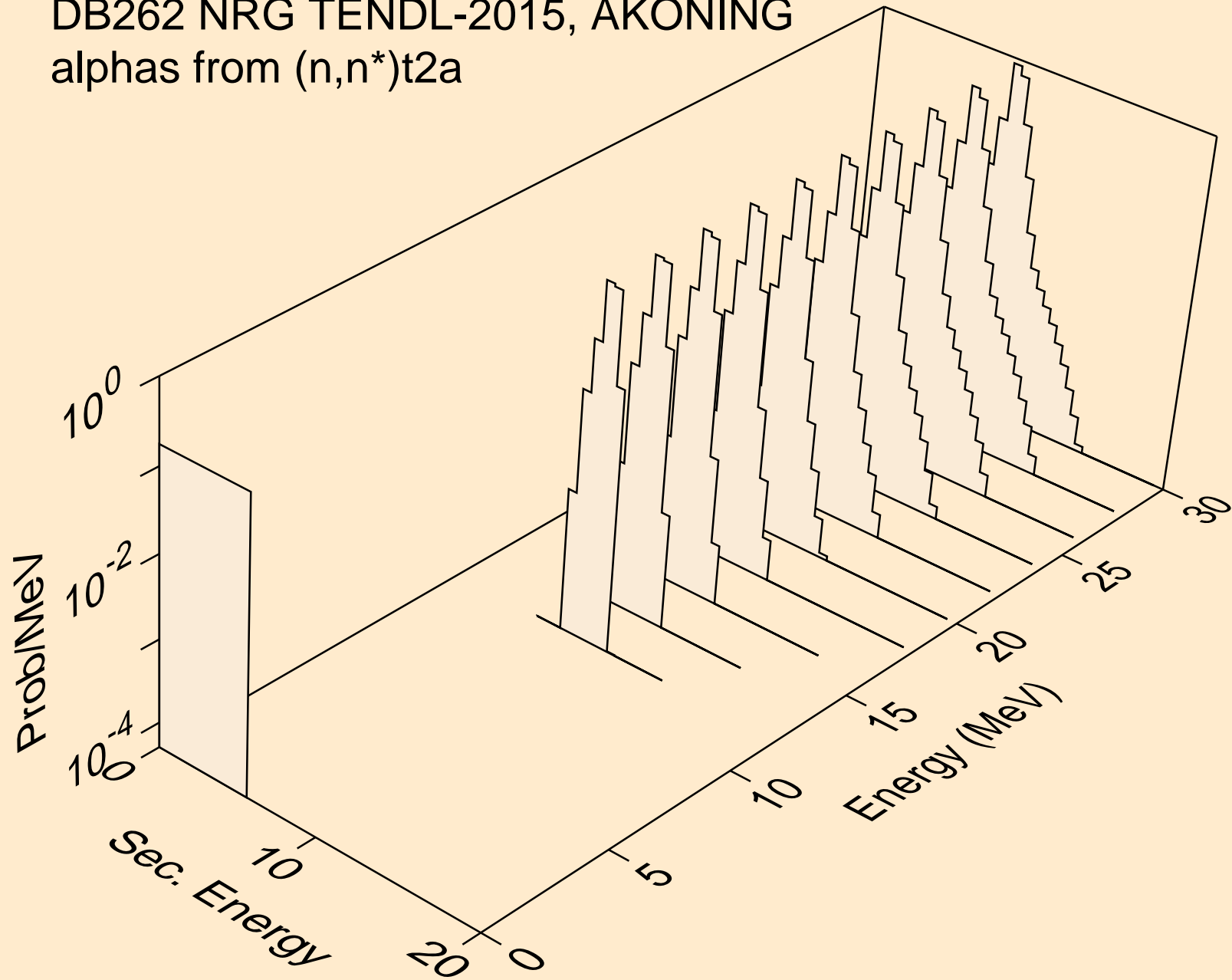

DB262 NRG TENDL-2015, AKONING
alphas from (n,npa)

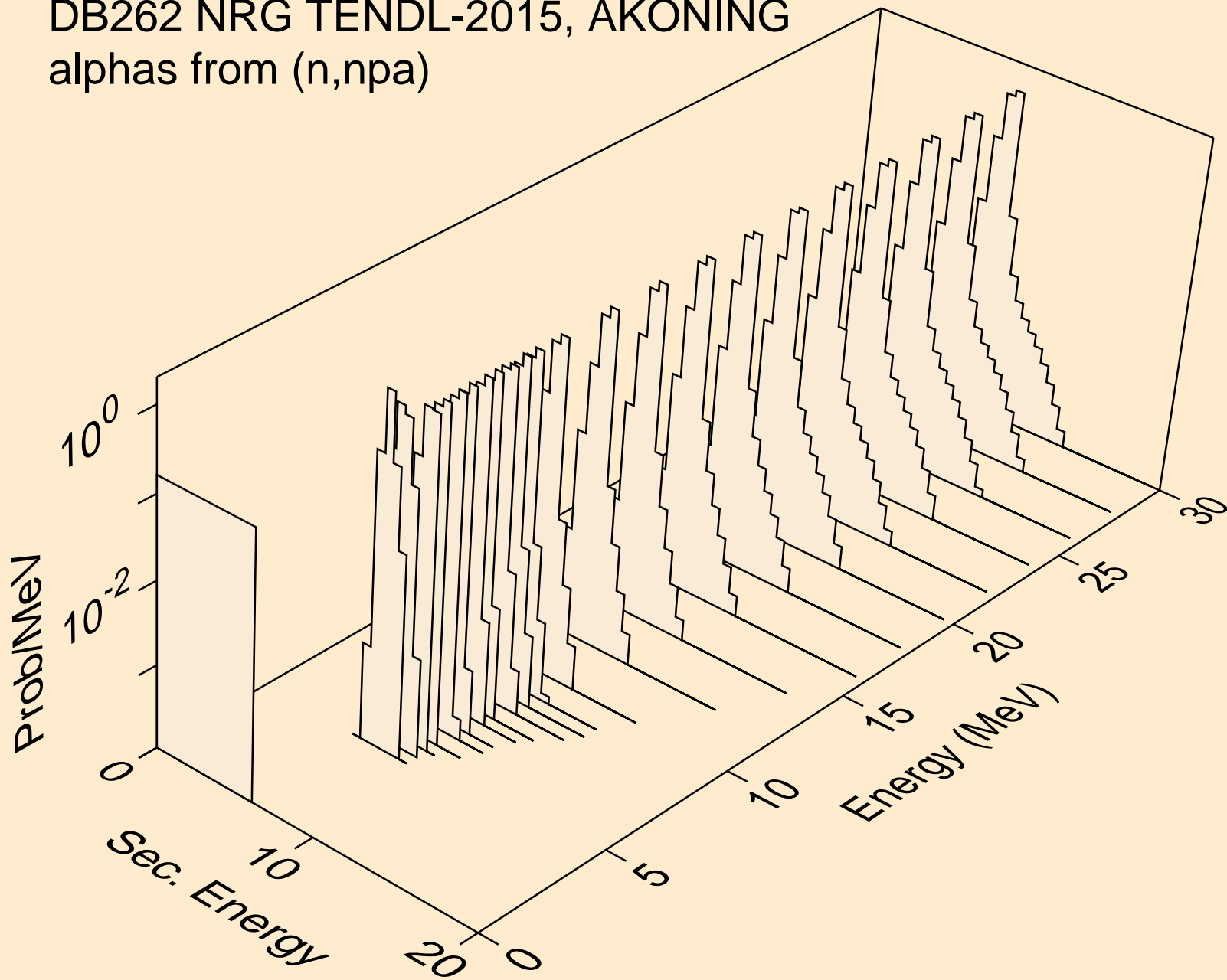

DB262 NRG TENDL-2015, AKONING
alphas from (n,a)

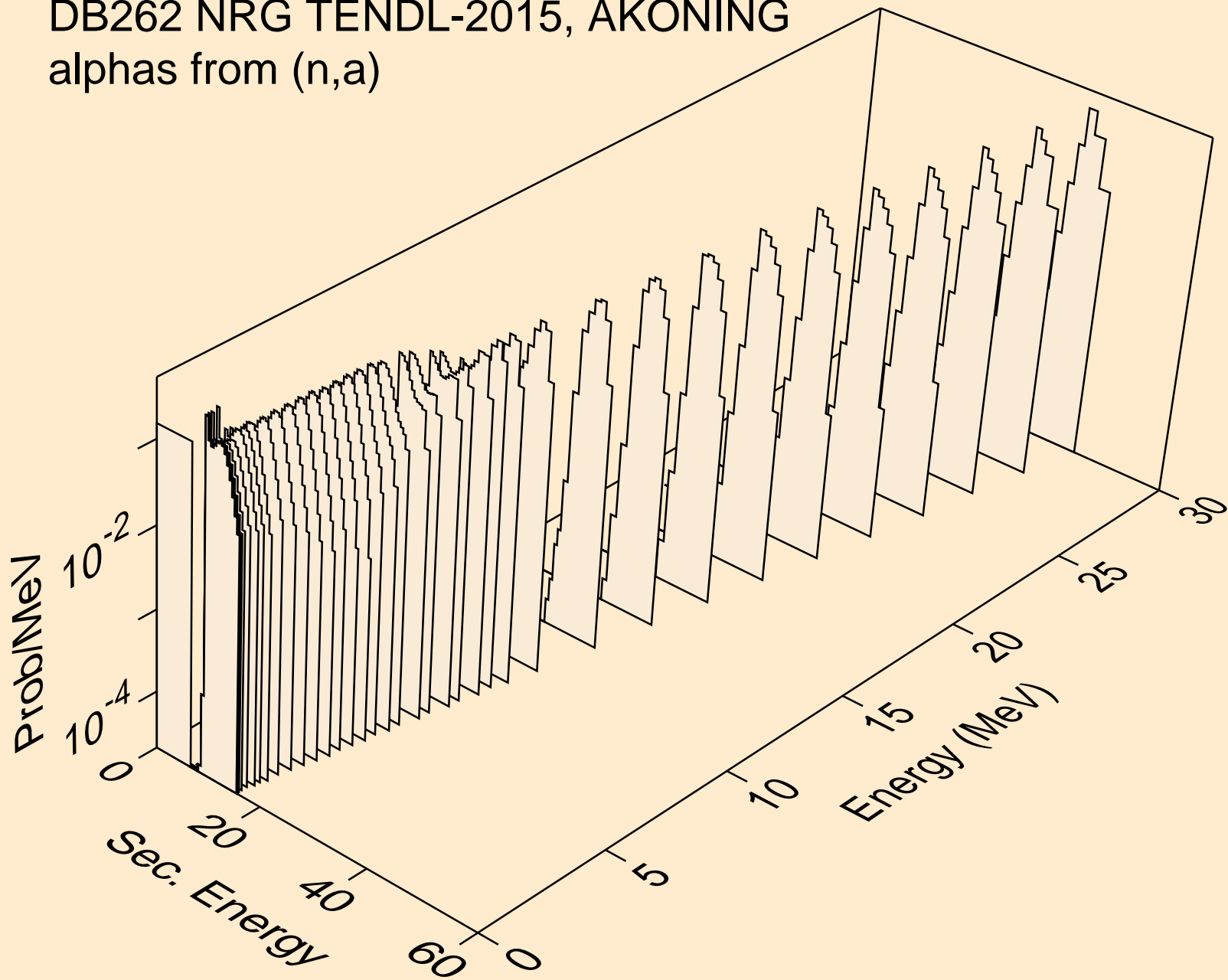

DB262 NRG TENDL-2015, AKONING
alphas from (n,2a)

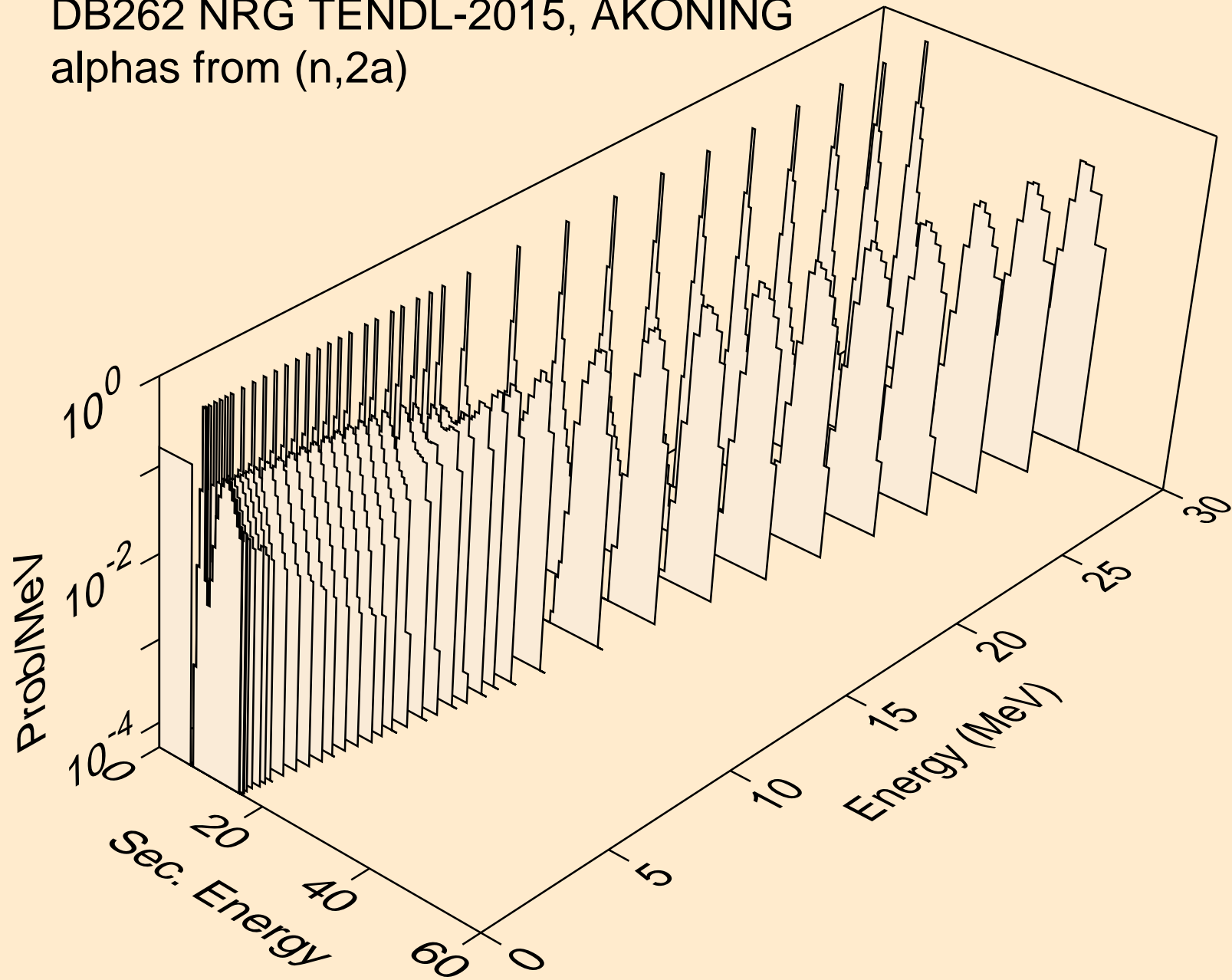

DB262 NRG TENDL-2015, AKONING
alphas from (n,3a)

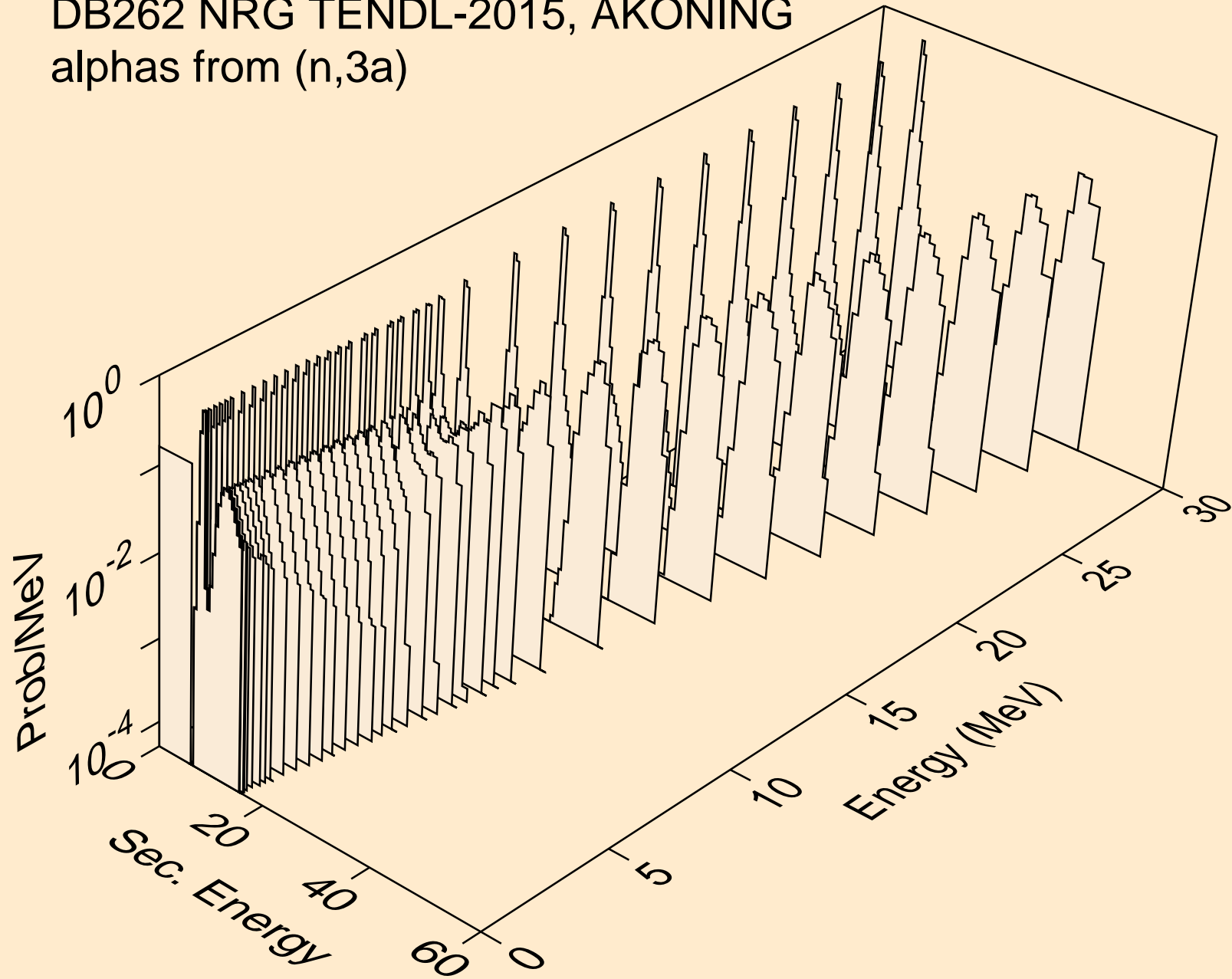

DB262 NRG TENDL-2015, AKONING
alphas from (n,pa)

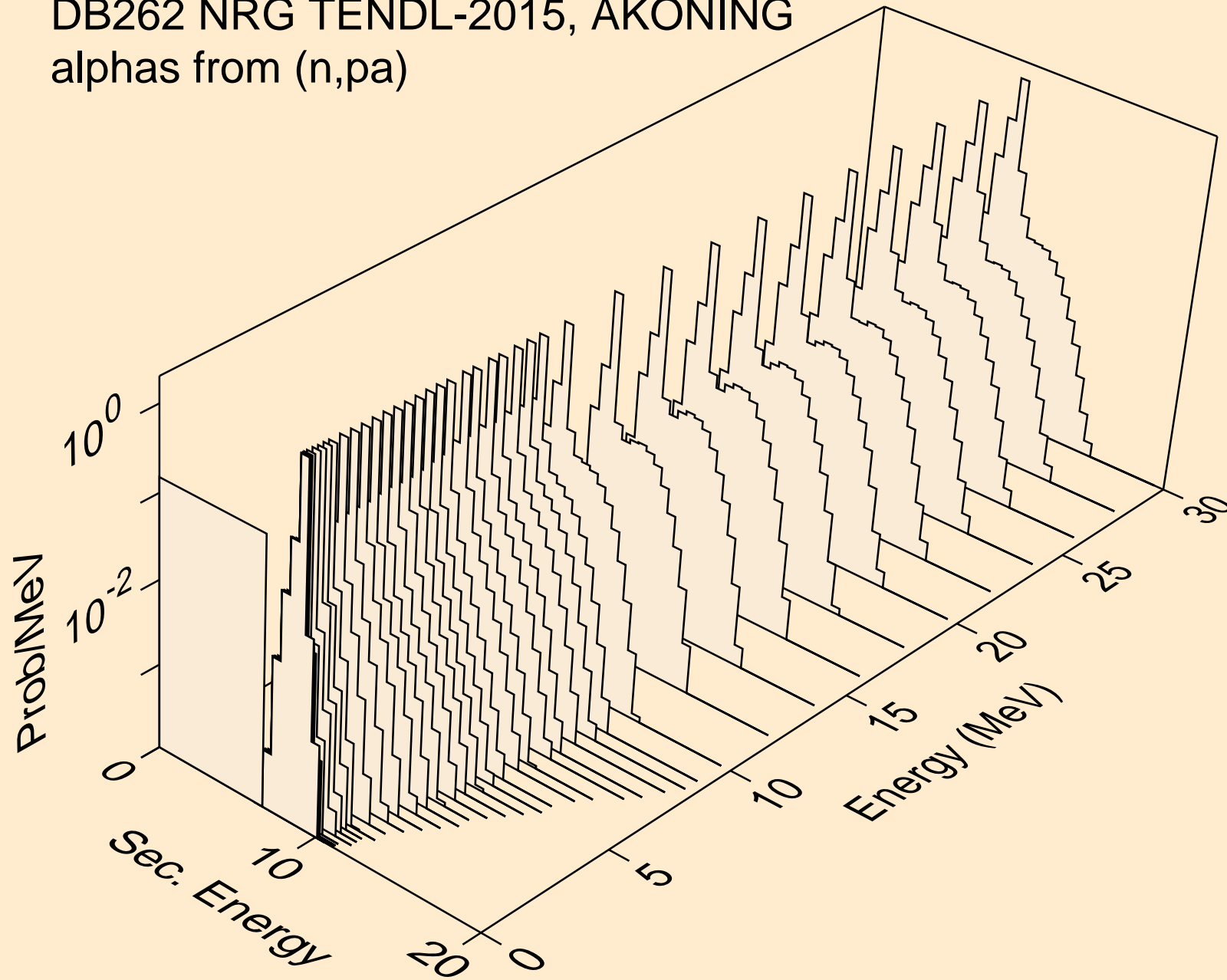

DB262 NRG TENDL-2015, AKONING
alphas from (n,t2a)

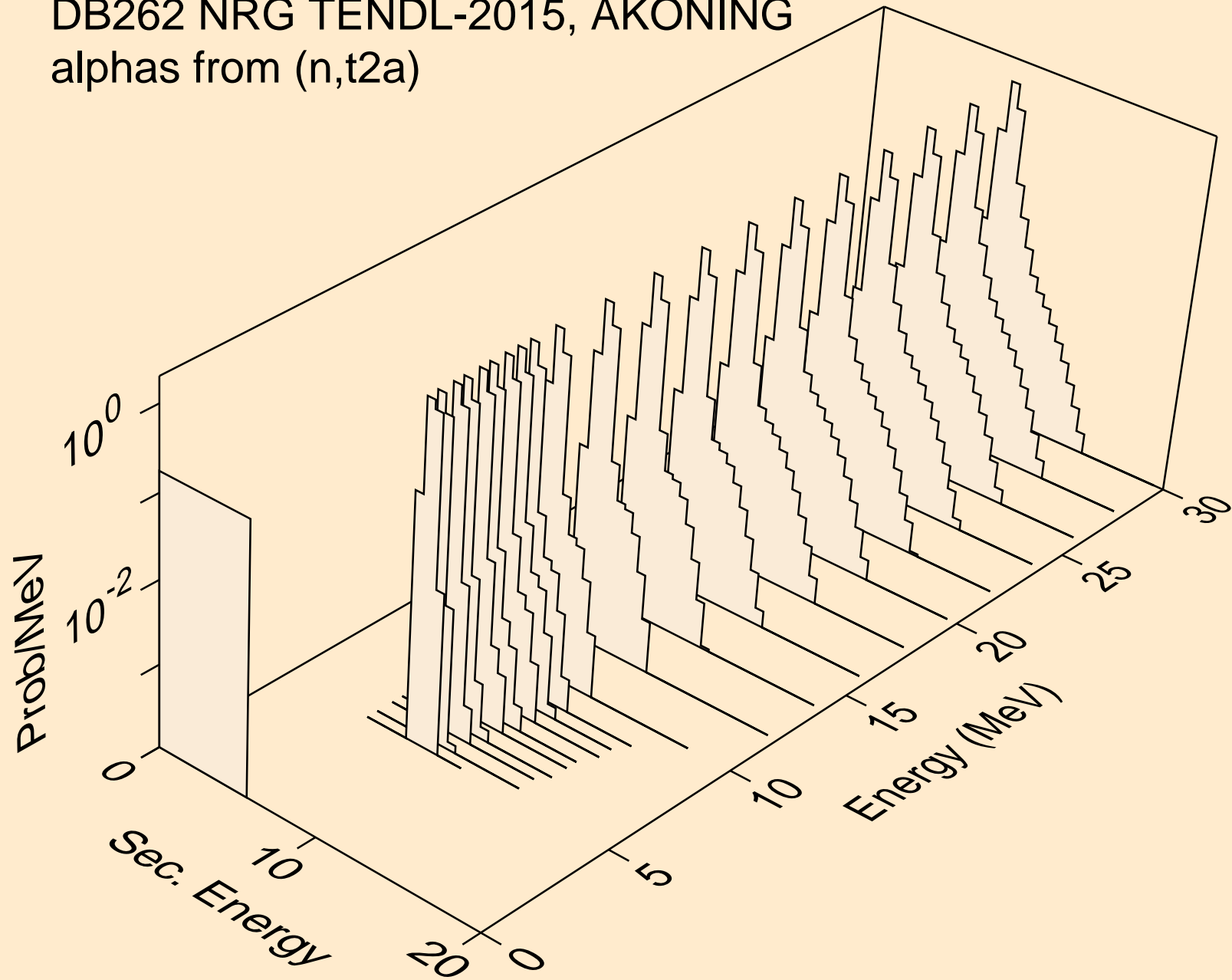

DB262 NRG TENDL-2015, AKONING
alphas from (n,d2a)

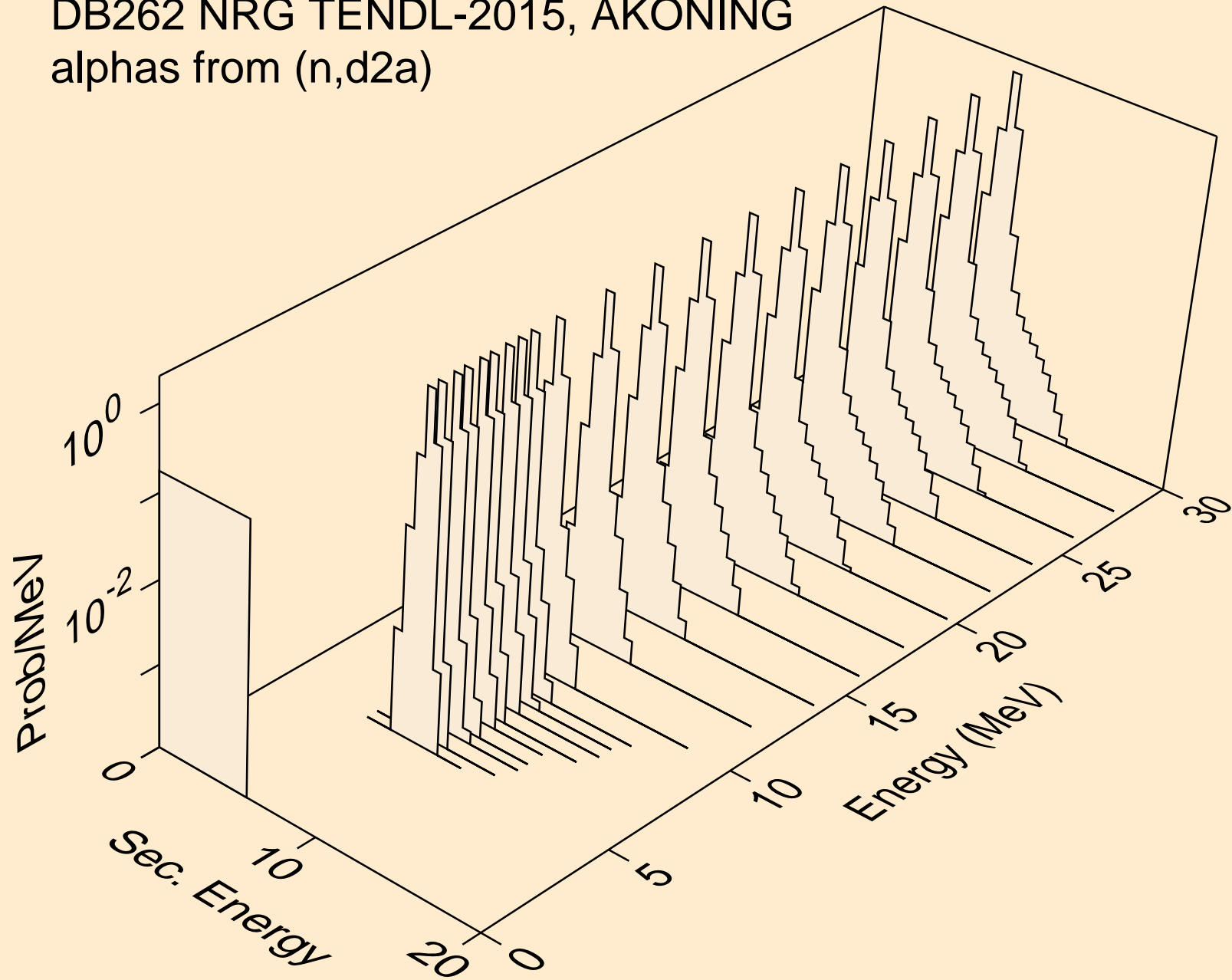

DB262 NRG TENDL-2015, AKONING
alphas from (n,da)

