

# DY171 NRG TENDL-2015, AKONING

## Principal cross sections

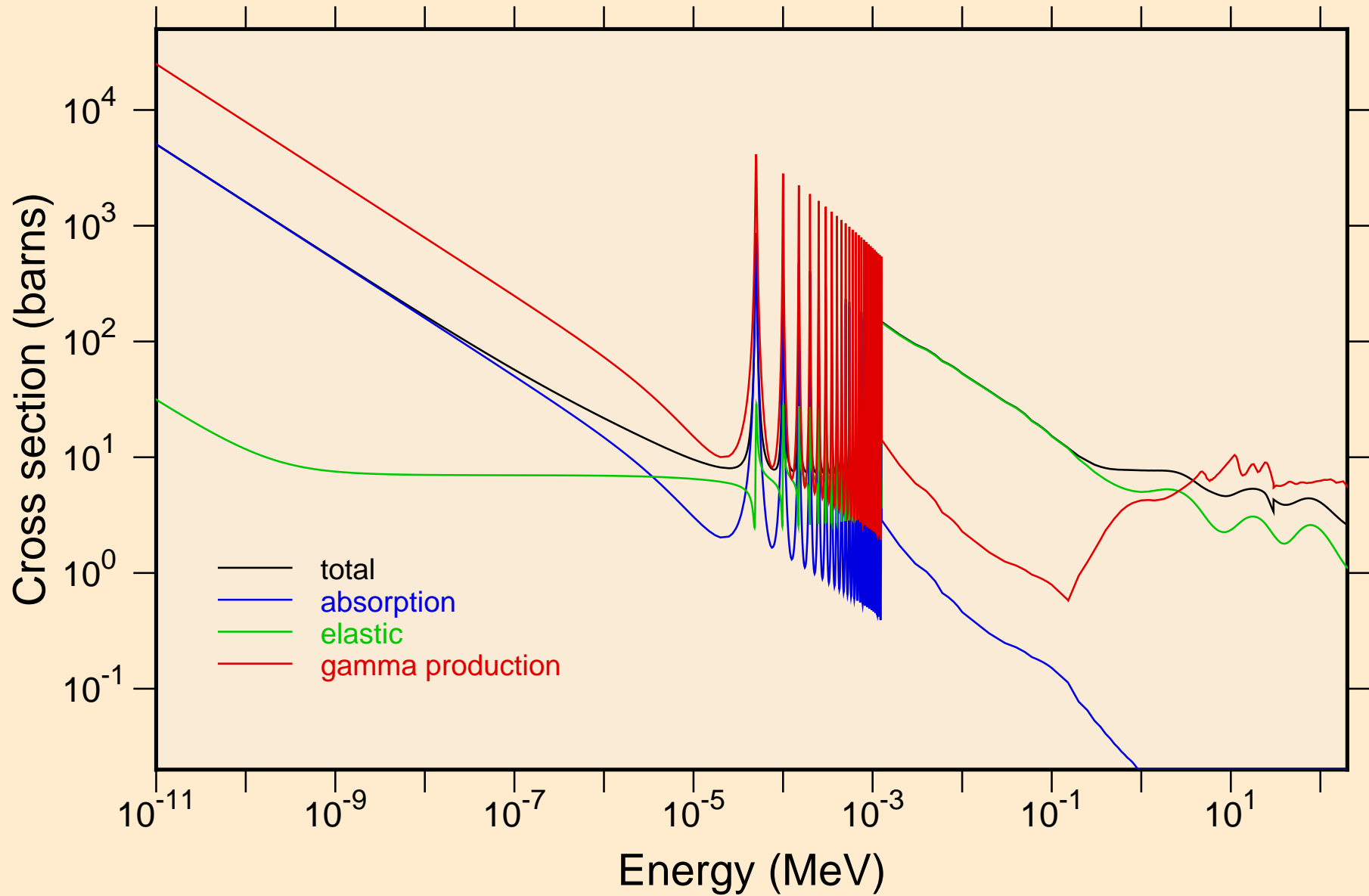

DY171 NRG TENDL-2015, AKONING  
resonance total cross section

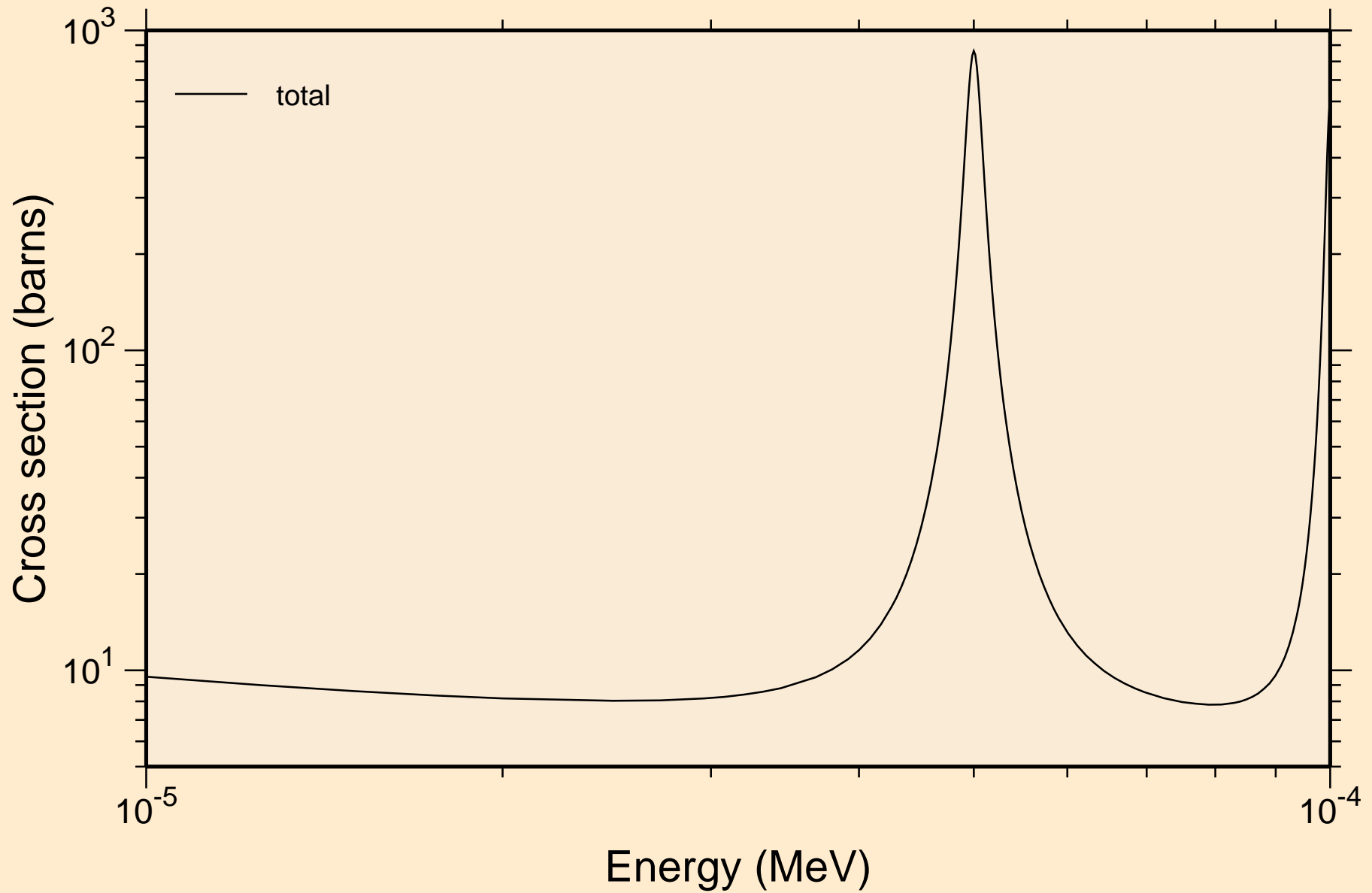

DY171 NRG TENDL-2015, AKONING  
resonance total cross section

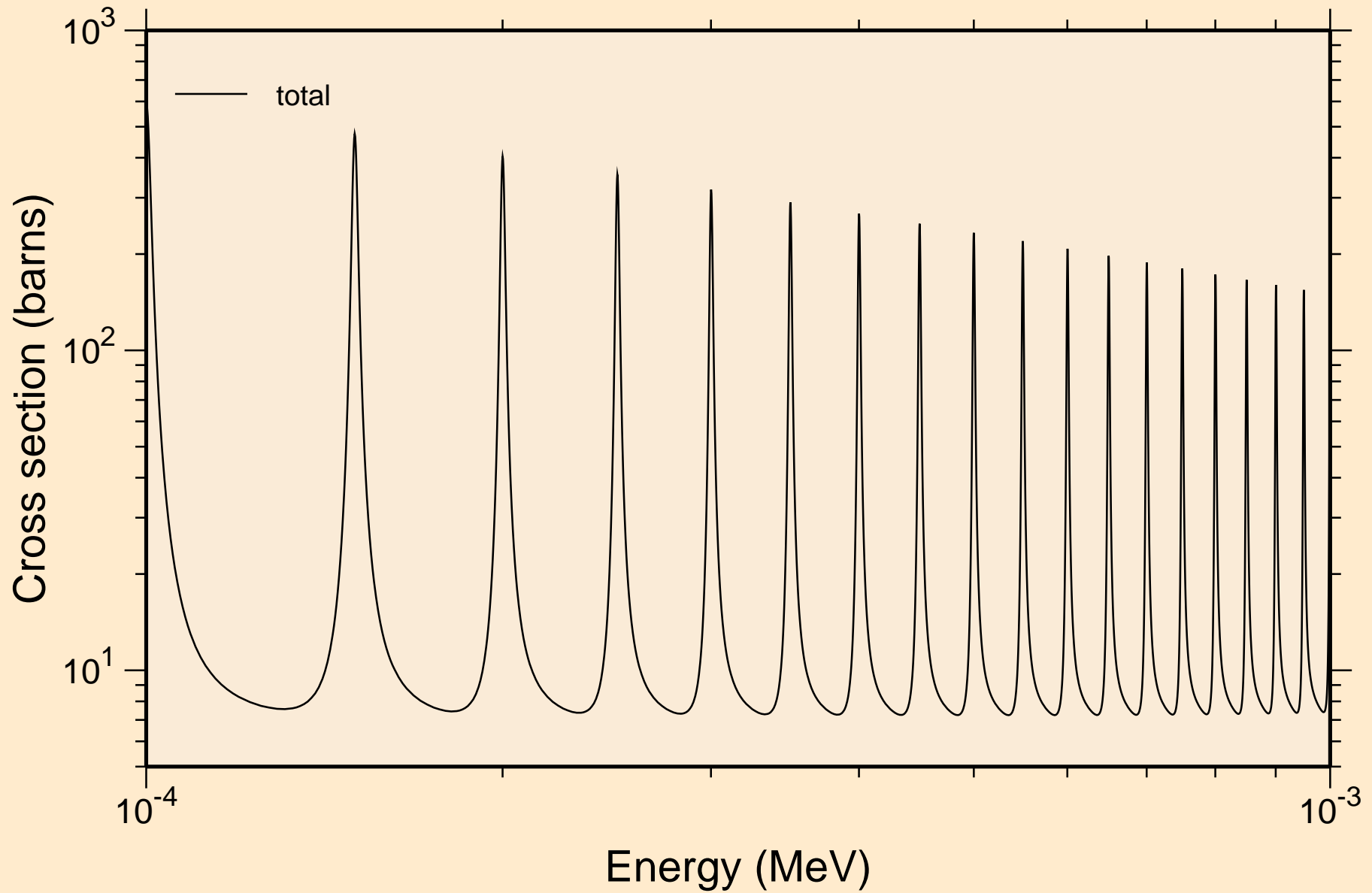

DY171 NRG TENDL-2015, AKONING  
resonance total cross section

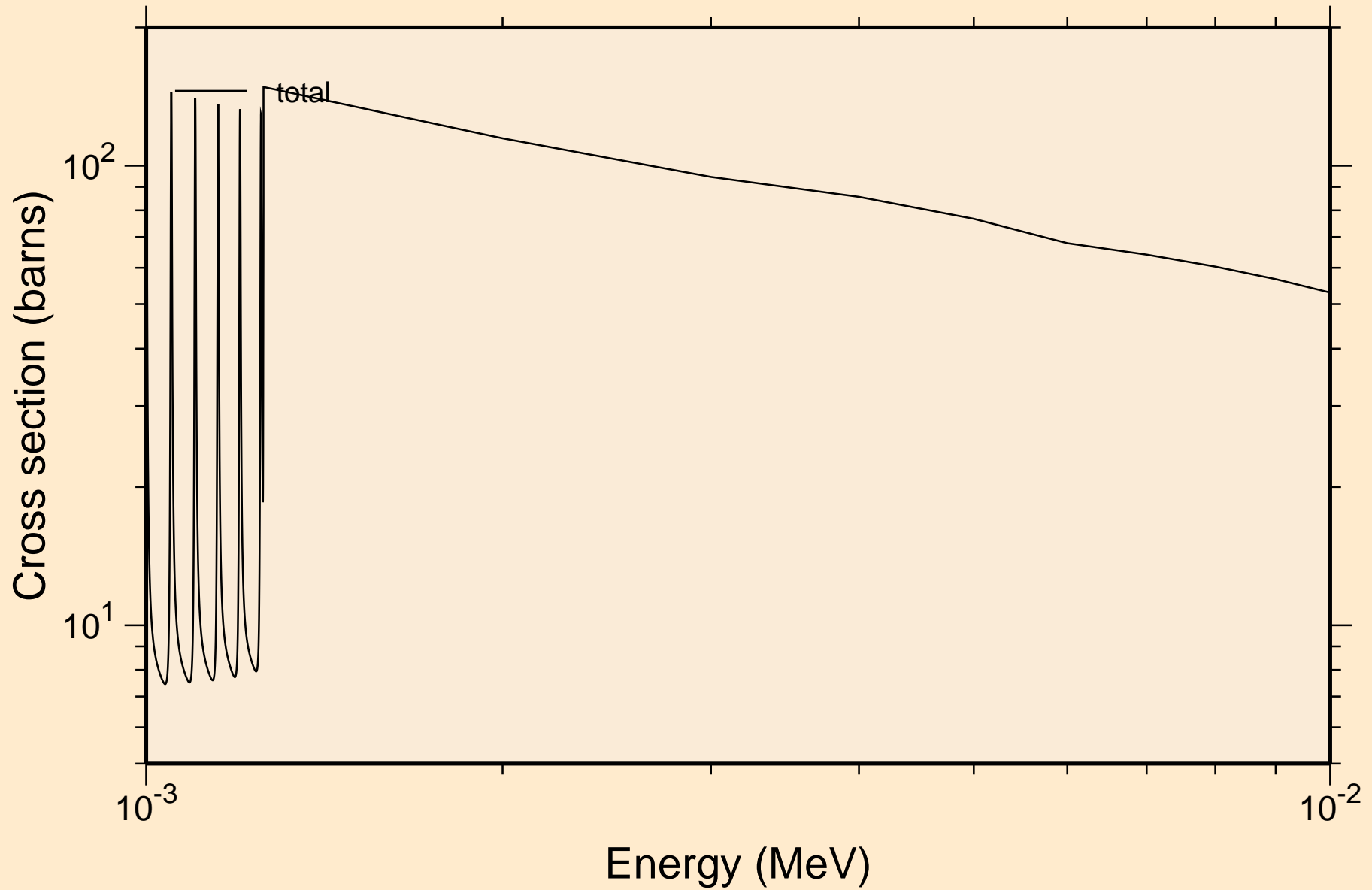

DY171 NRG TENDL-2015, AKONING  
resonance total cross section

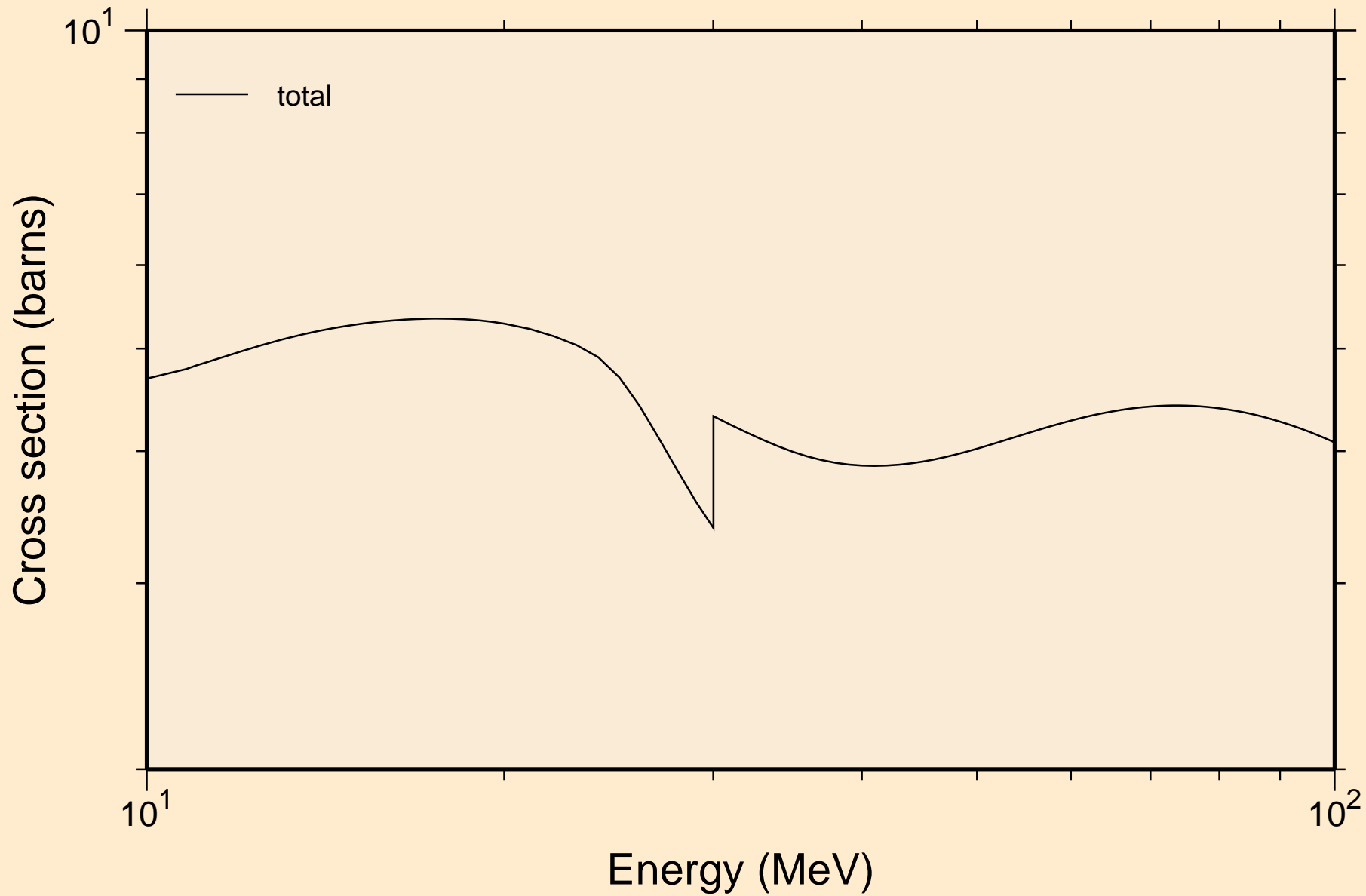

DY171 NRG TENDL-2015, AKONING  
resonance absorption cross sections

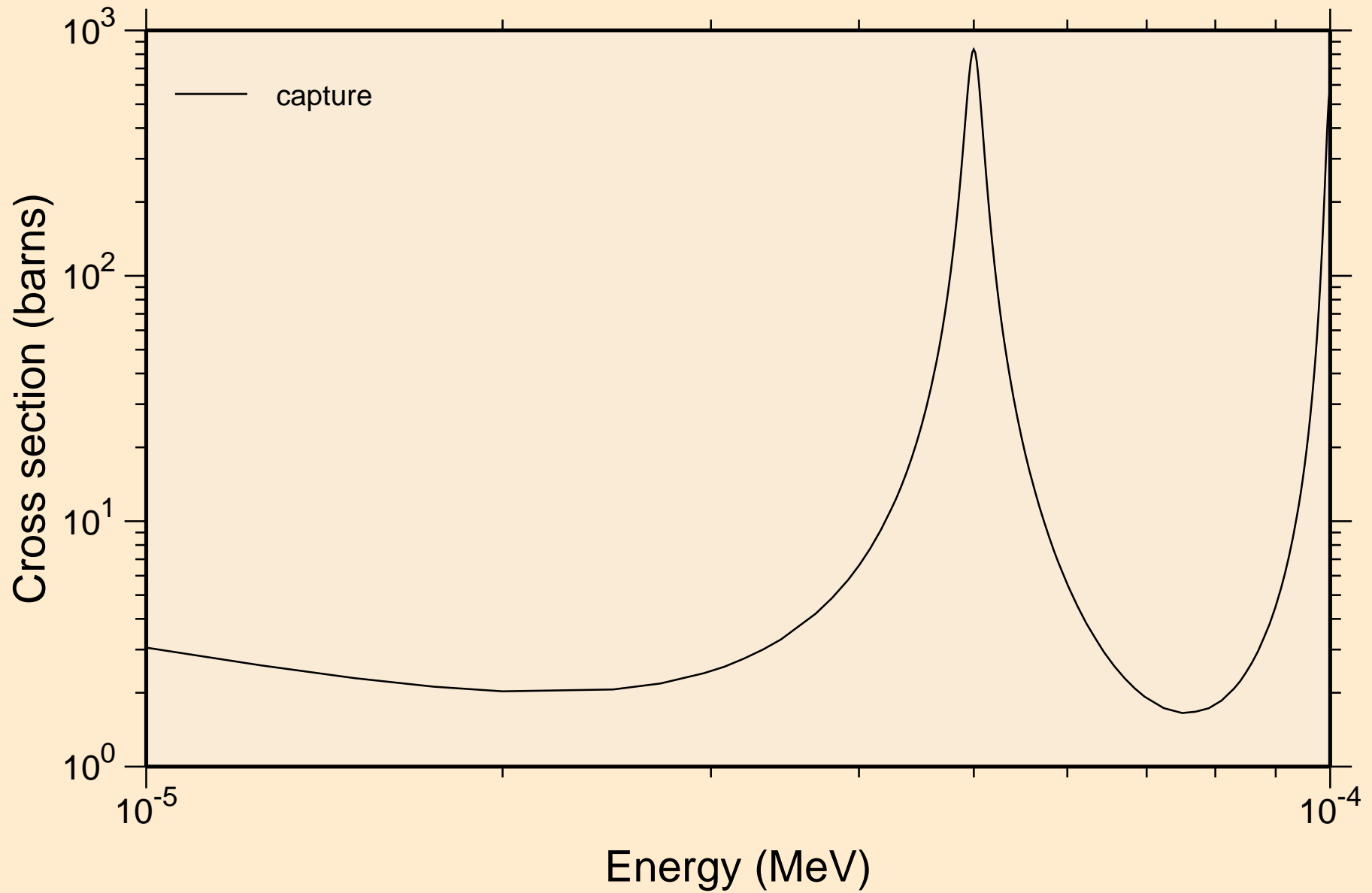

# DY171 NRG TENDL-2015, AKONING

## resonance absorption cross sections

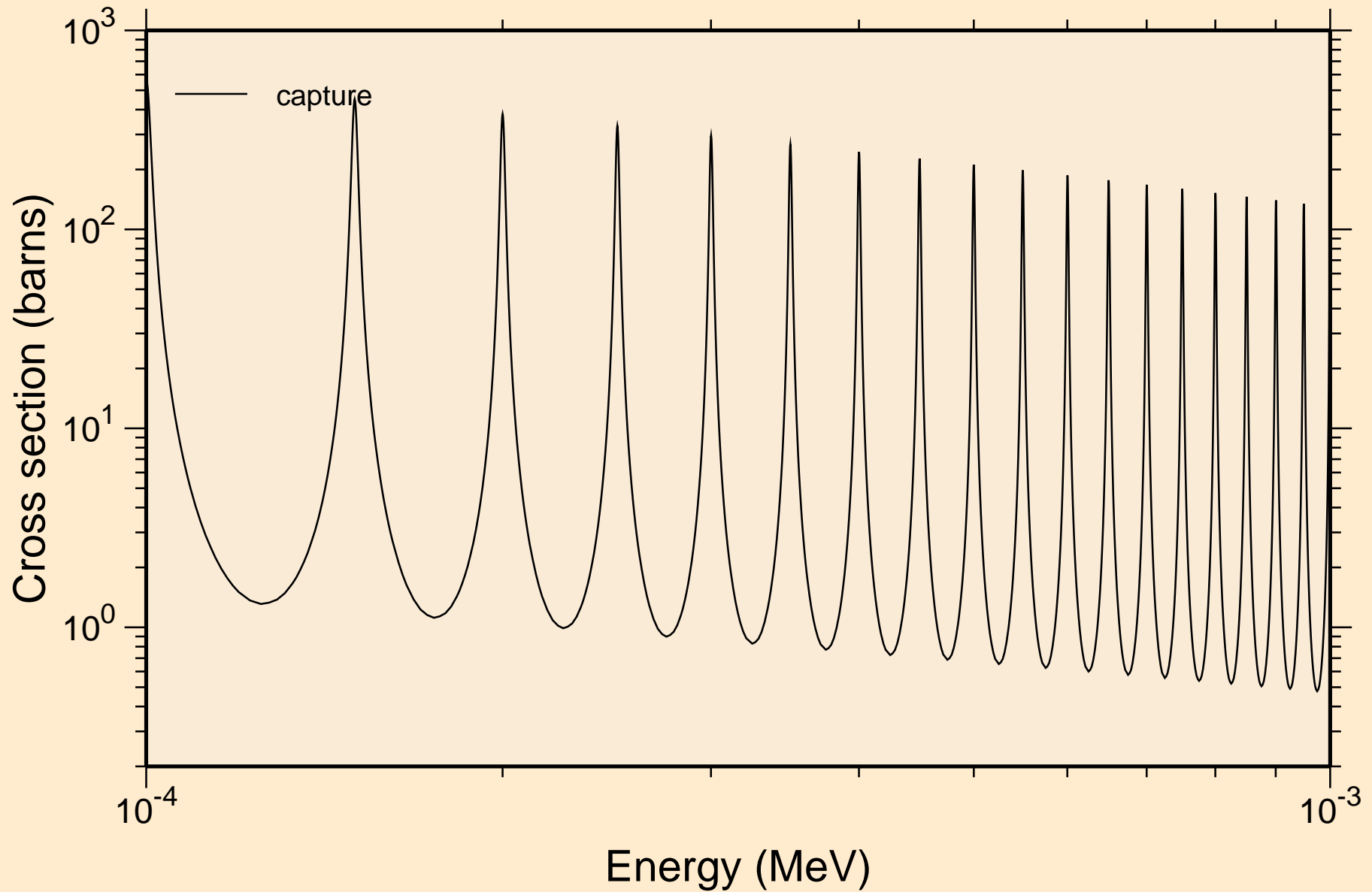

DY171 NRG TENDL-2015, AKONING  
resonance absorption cross sections

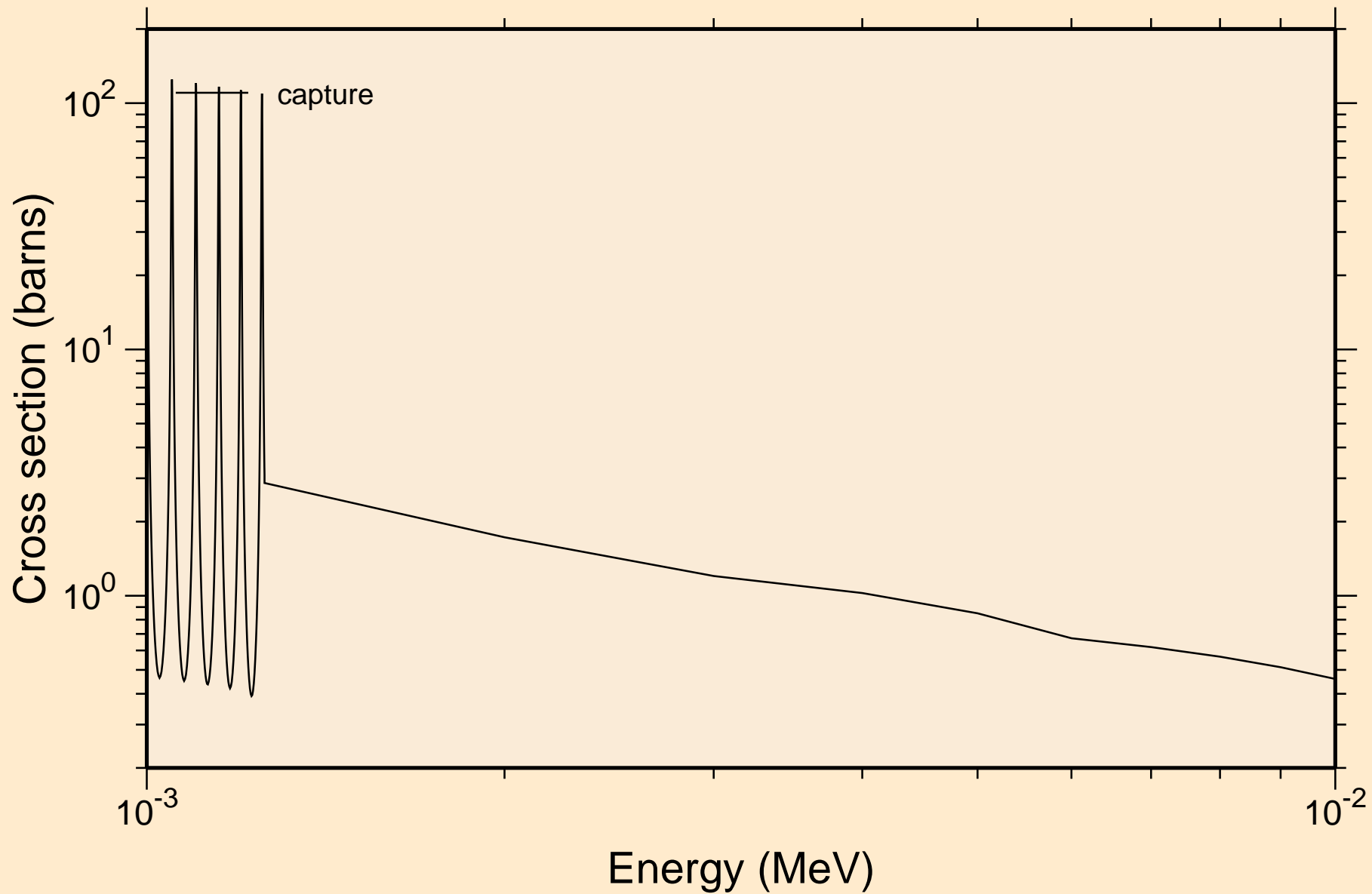



DY171 NRG TENDL-2015, AKONING  
resonance absorption cross sections

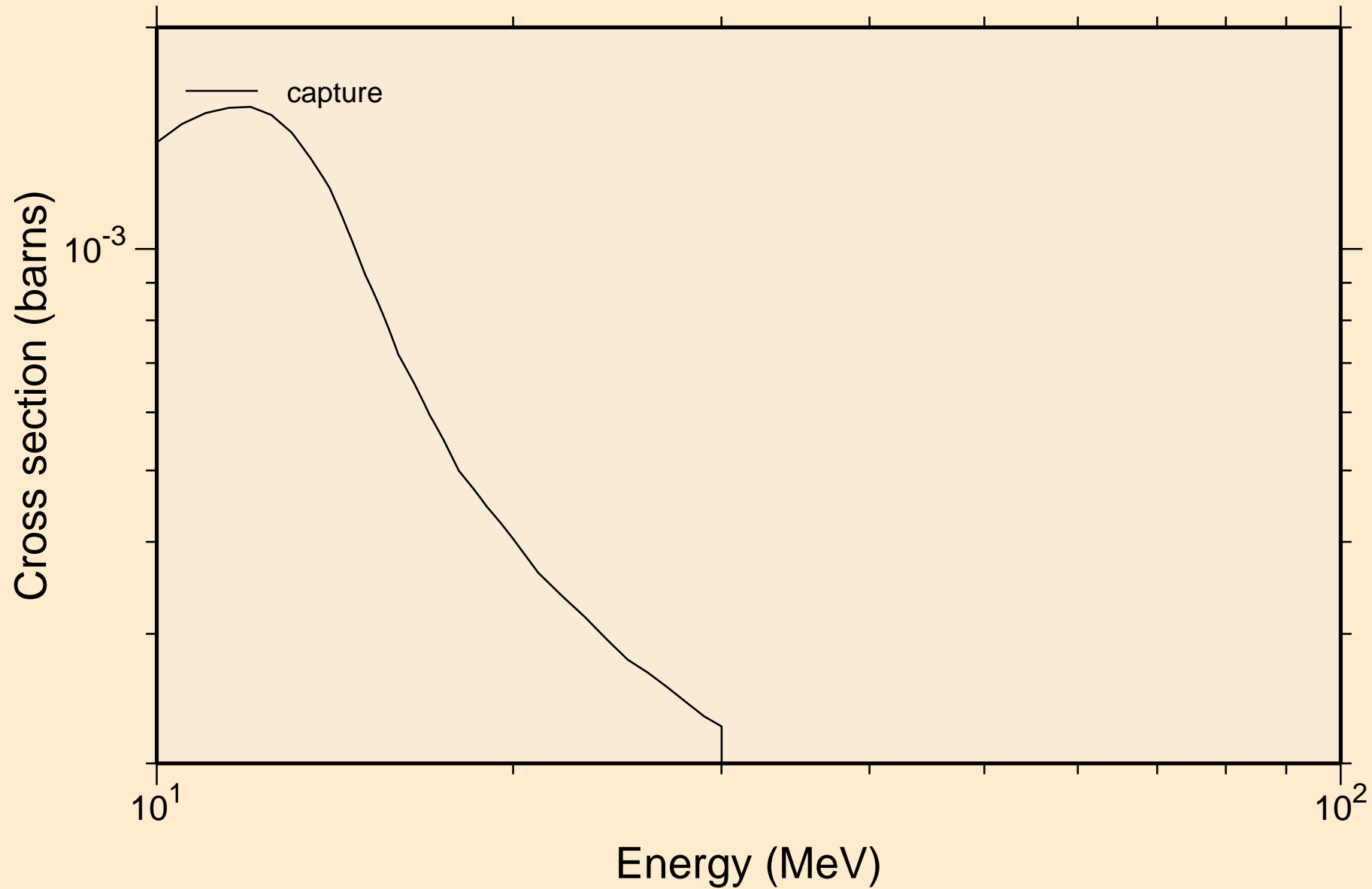

DY171 NRG TENDL-2015, AKONING  
Non-threshold reactions

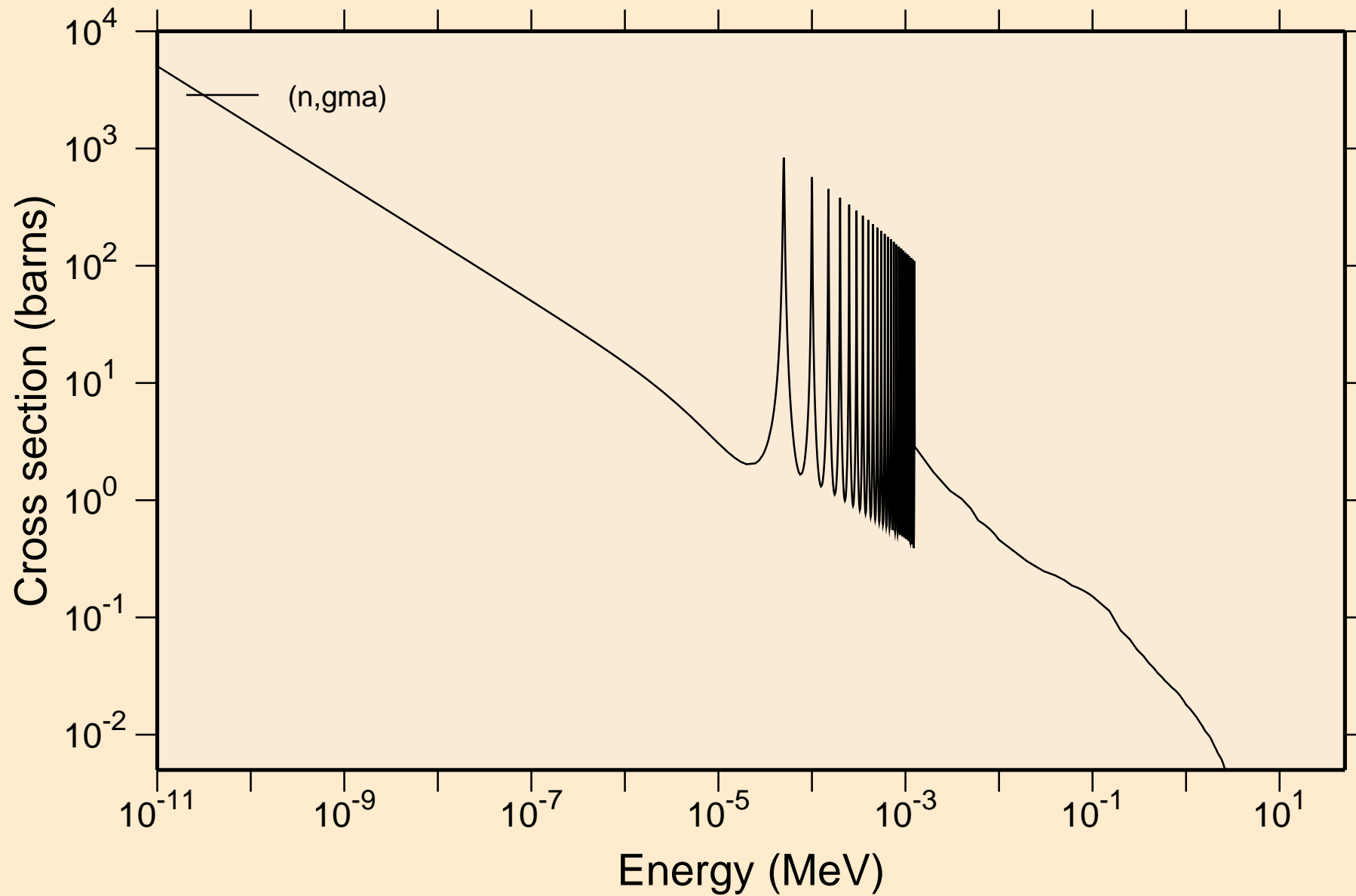

# DY171 NRG TENDL-2015, AKONING

## Principal cross sections

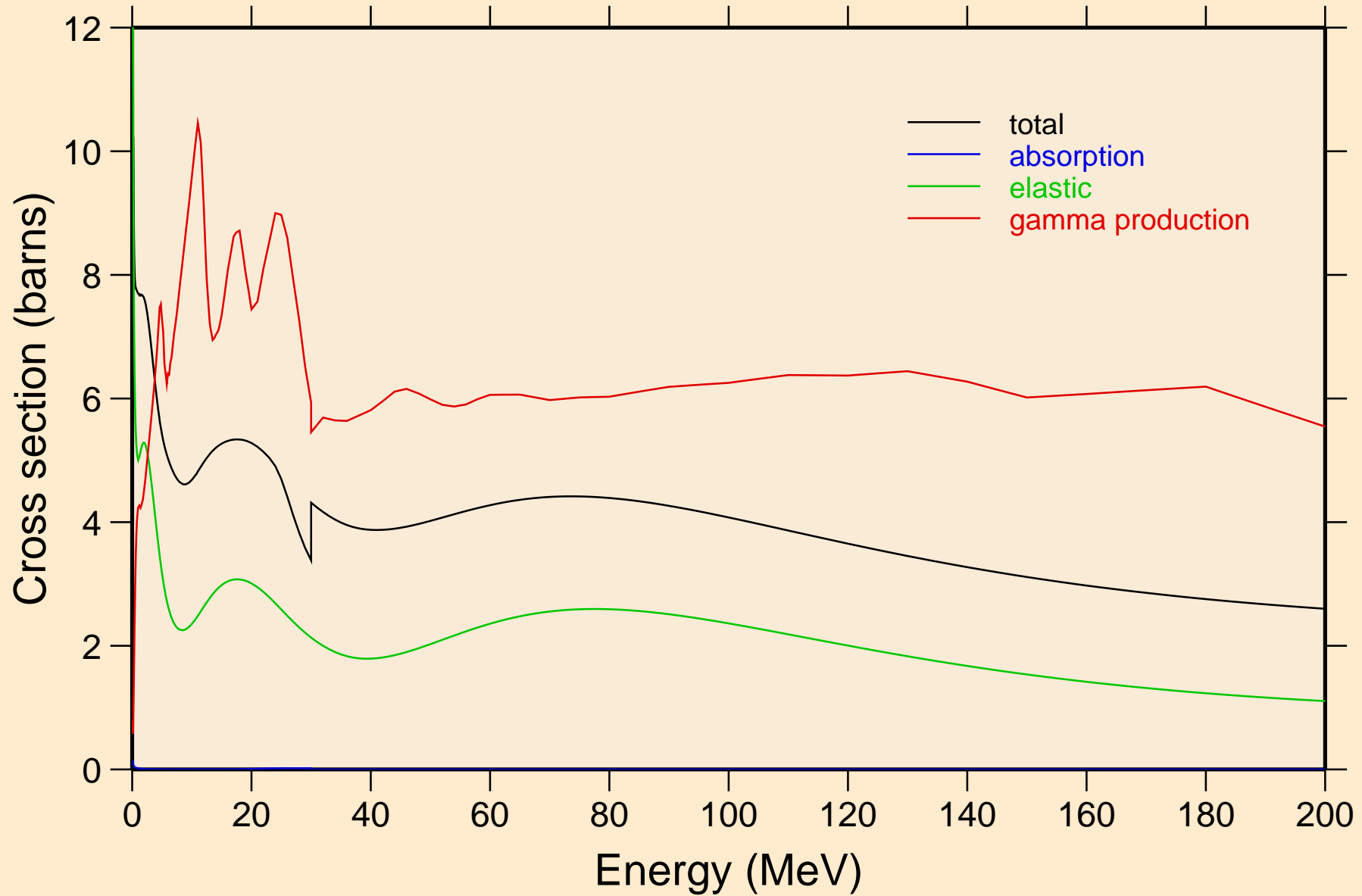

DY171 NRG TENDL-2015, AKONING  
Non-threshold reactions

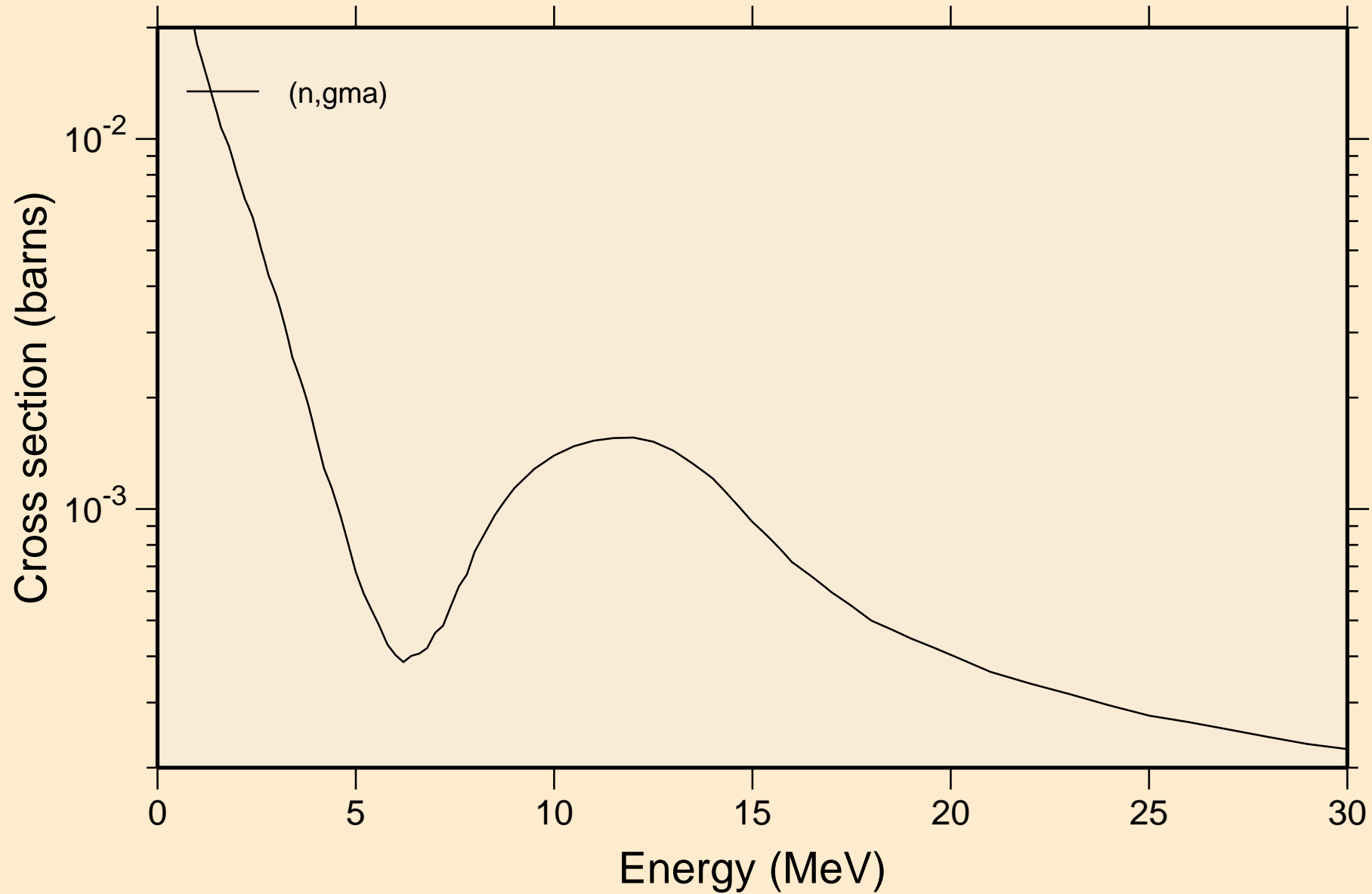

DY171 NRG TENDL-2015, AKONING  
Inelastic levels

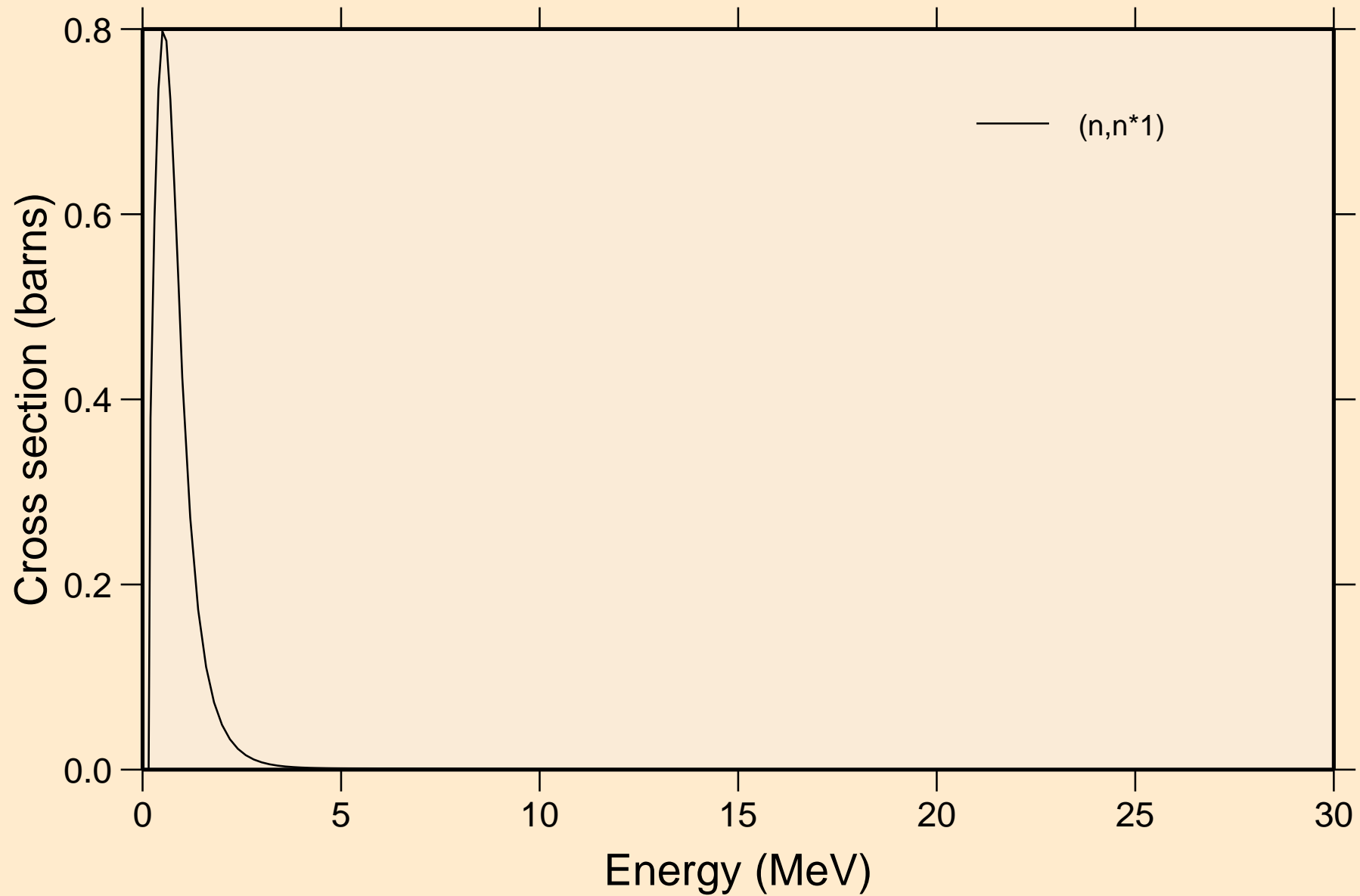

# DY171 NRG TENDL-2015, AKONING

## Threshold reactions

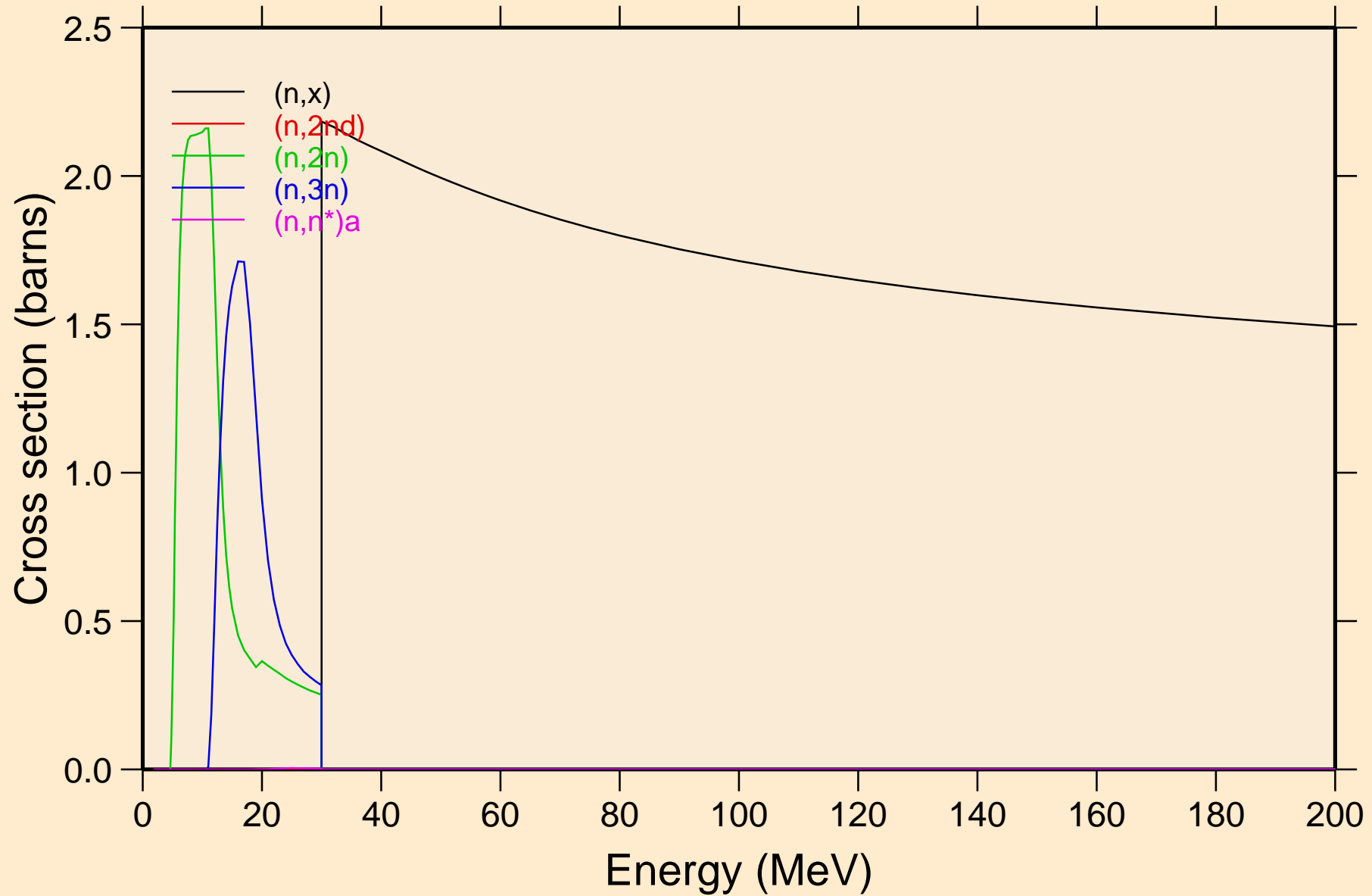

# DY171 NRG TENDL-2015, AKONING

## Threshold reactions

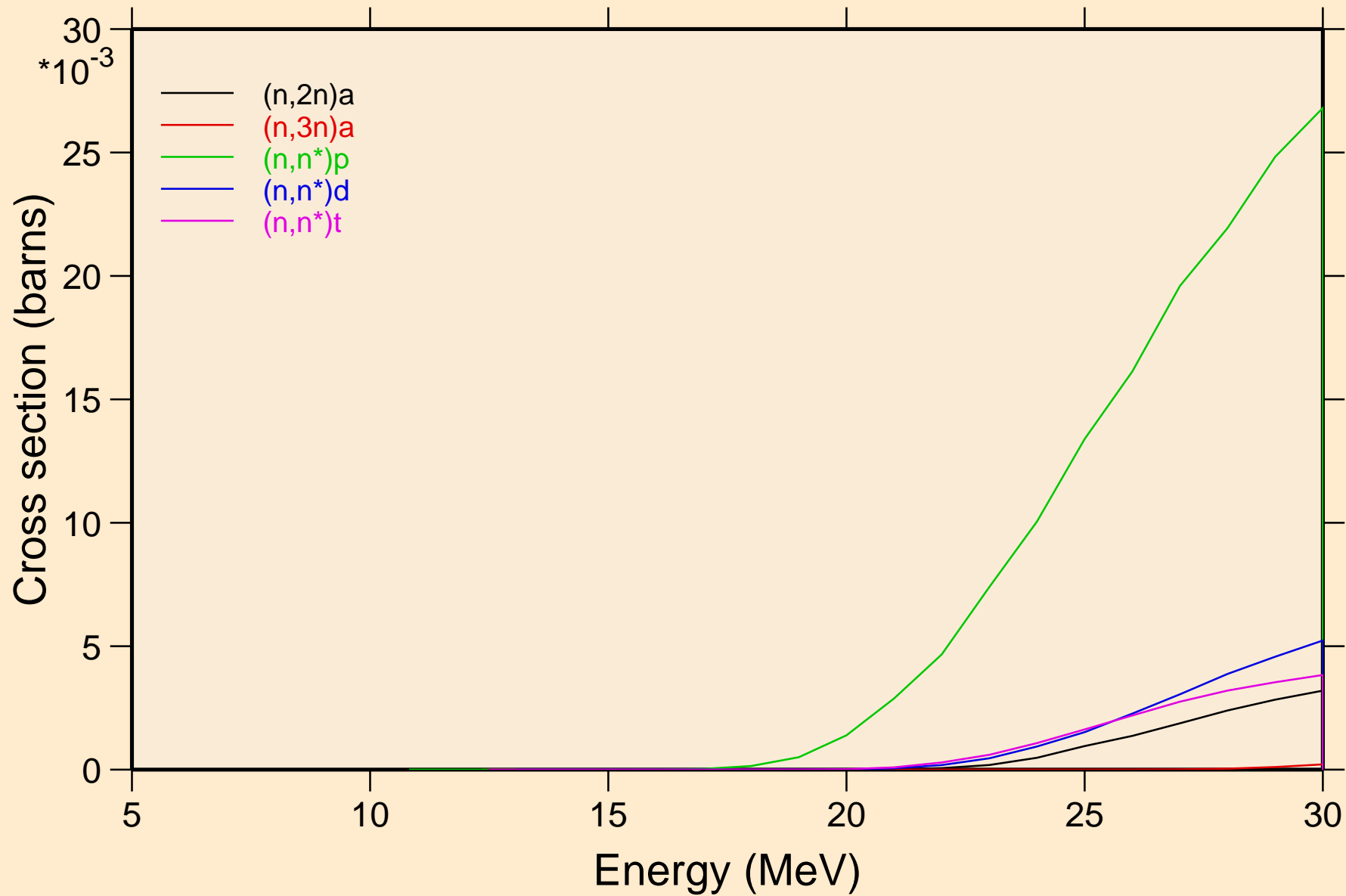

# DY171 NRG TENDL-2015, AKONING

## Threshold reactions

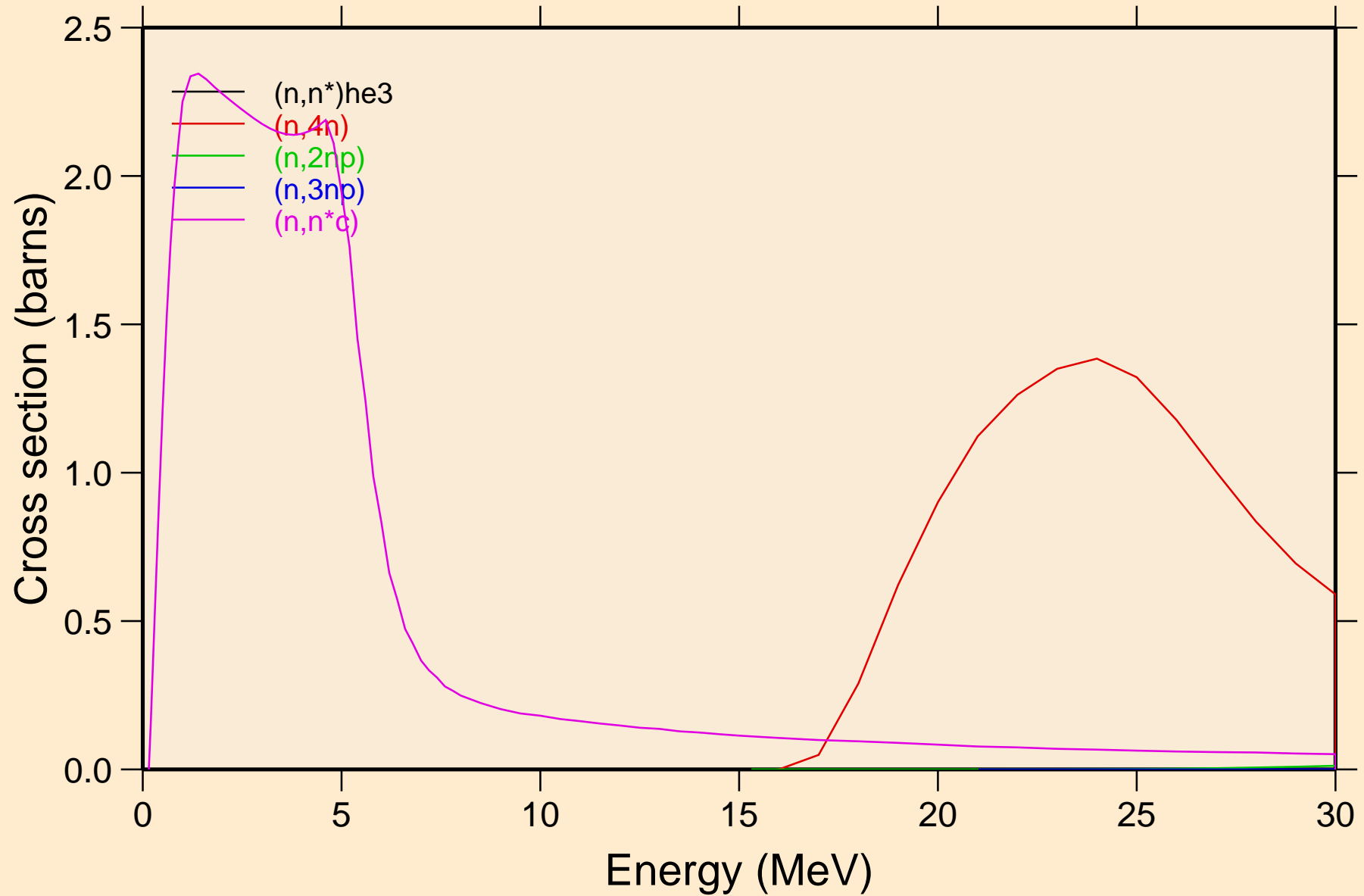



# DY171 NRG TENDL-2015, AKONING

## Threshold reactions

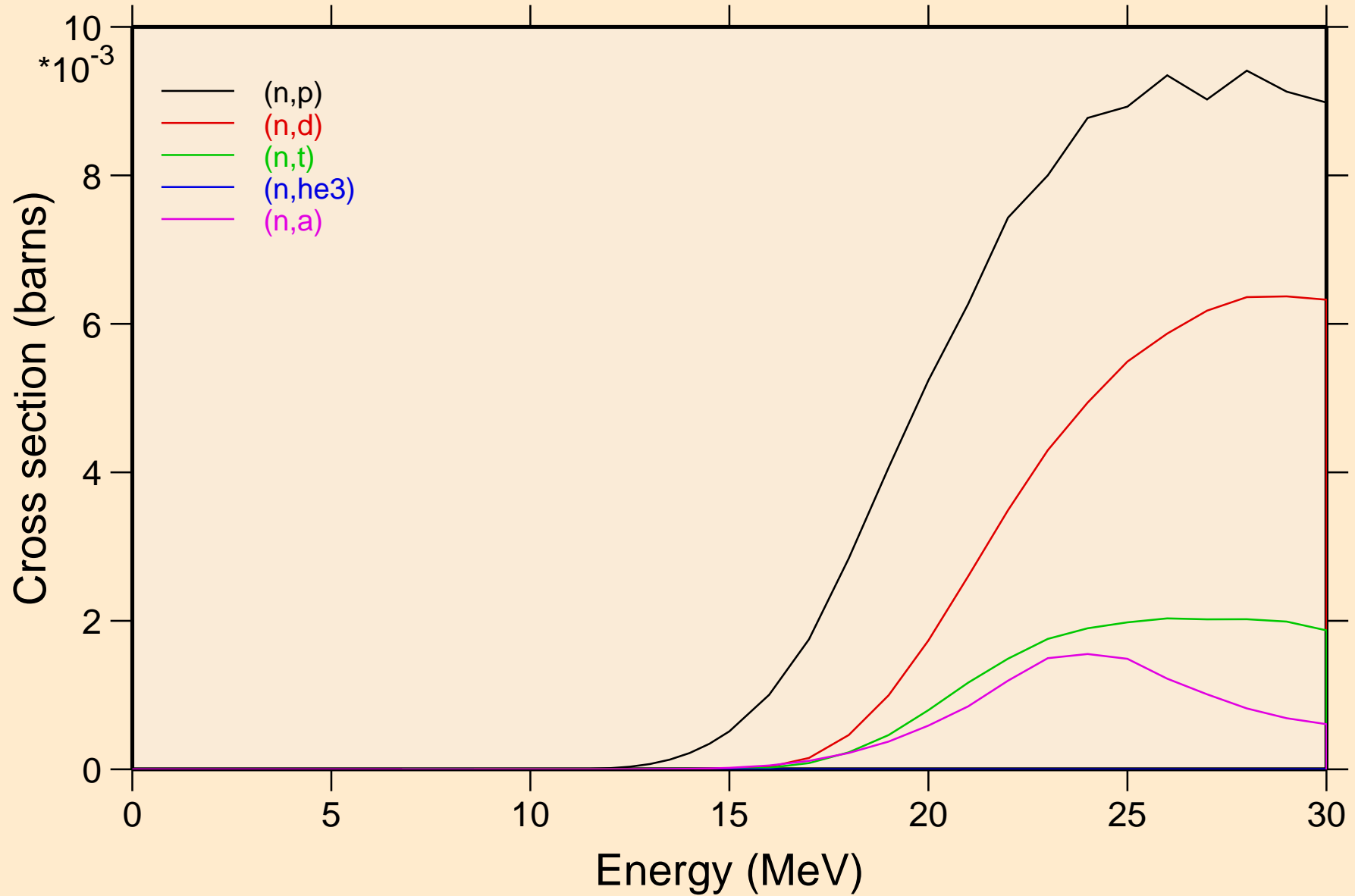

# DY171 NRG TENDL-2015, AKONING

## Threshold reactions

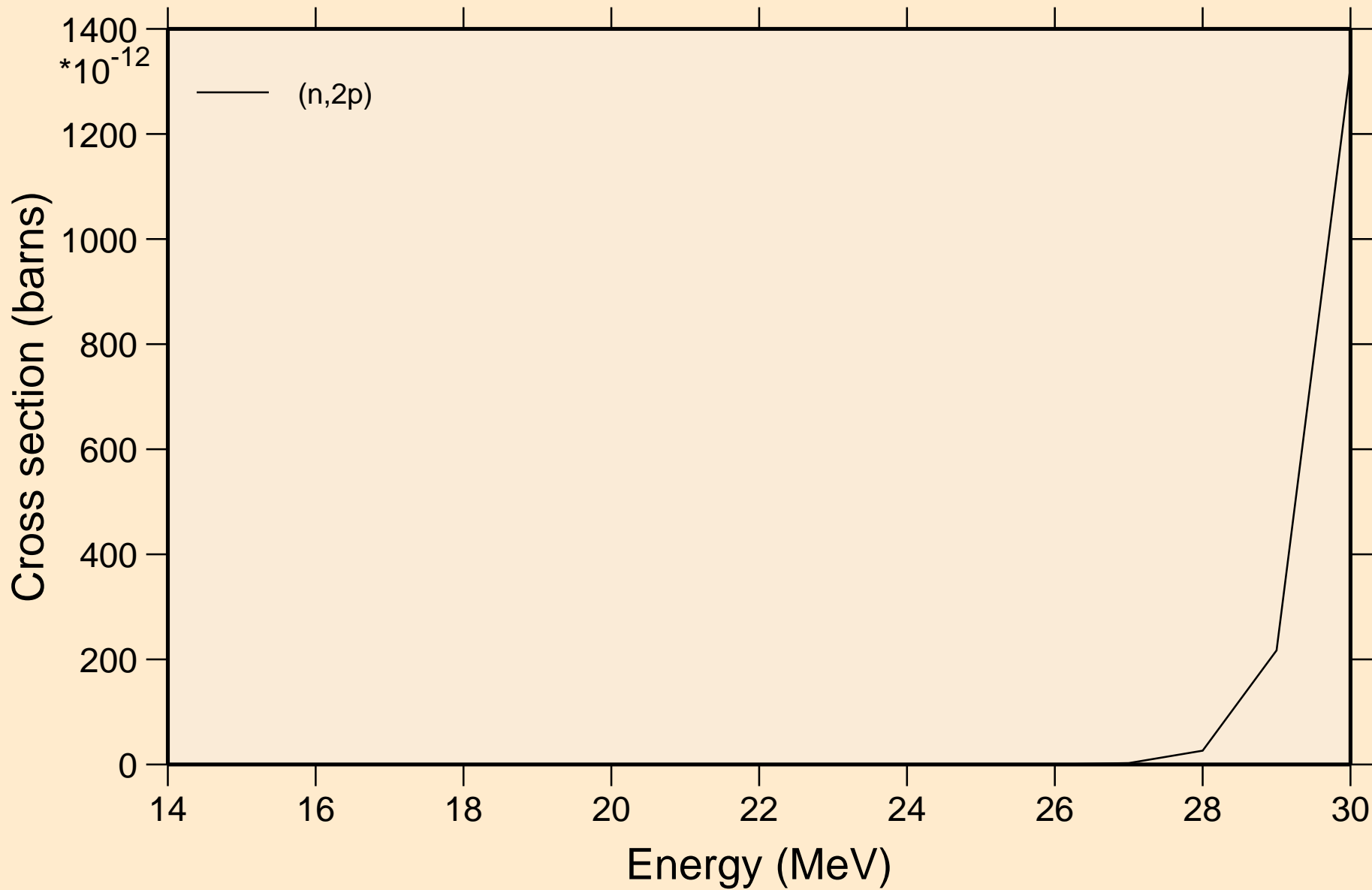

DY171 NRG TENDL-2015, AKONING  
angular distribution for elastic

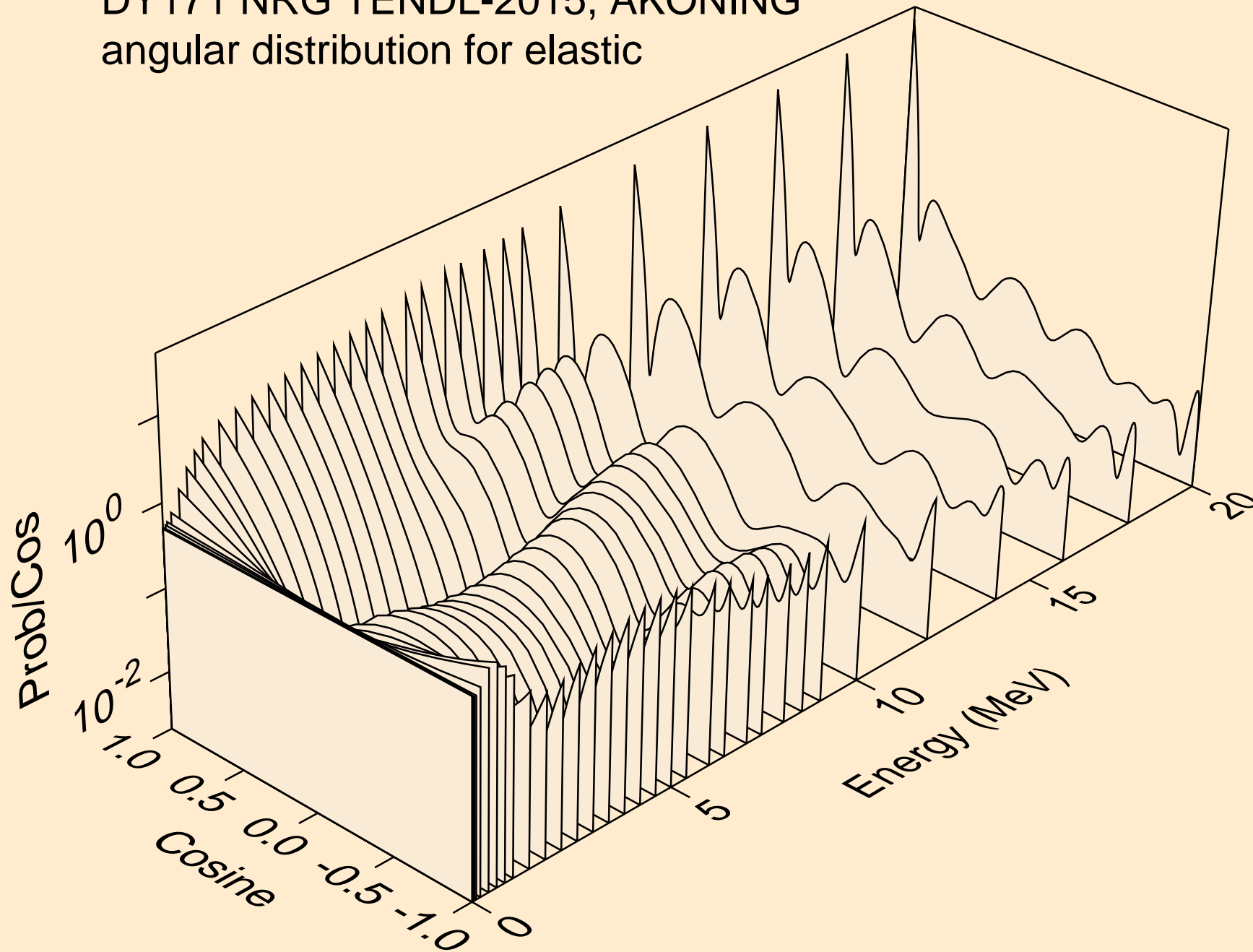

DY171 NRG TENDL-2015, AKONING  
angular distribution for elastic

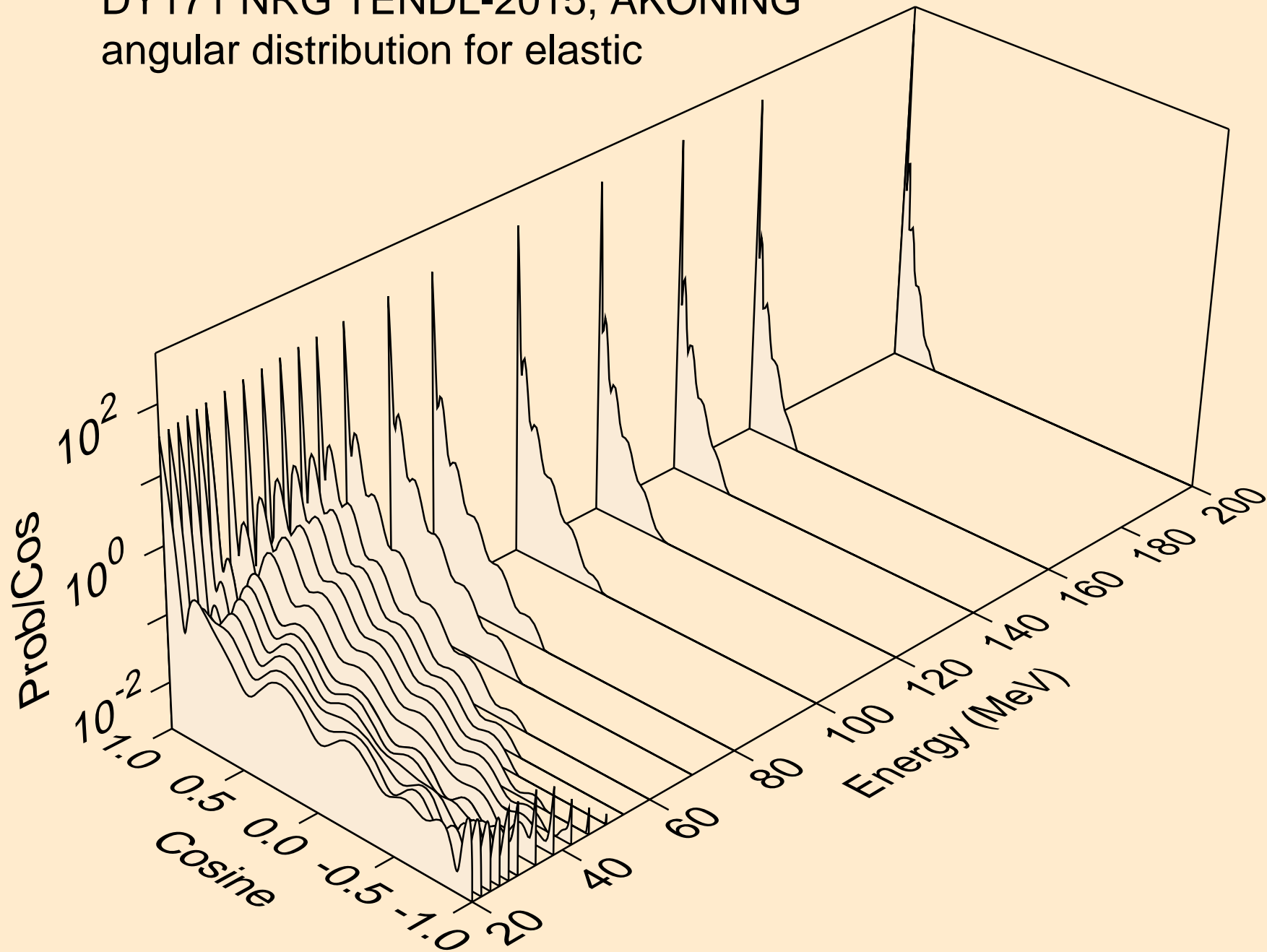

DY171 NRG TENDL-2015, AKONING  
angular distribution for (n,n\*1)

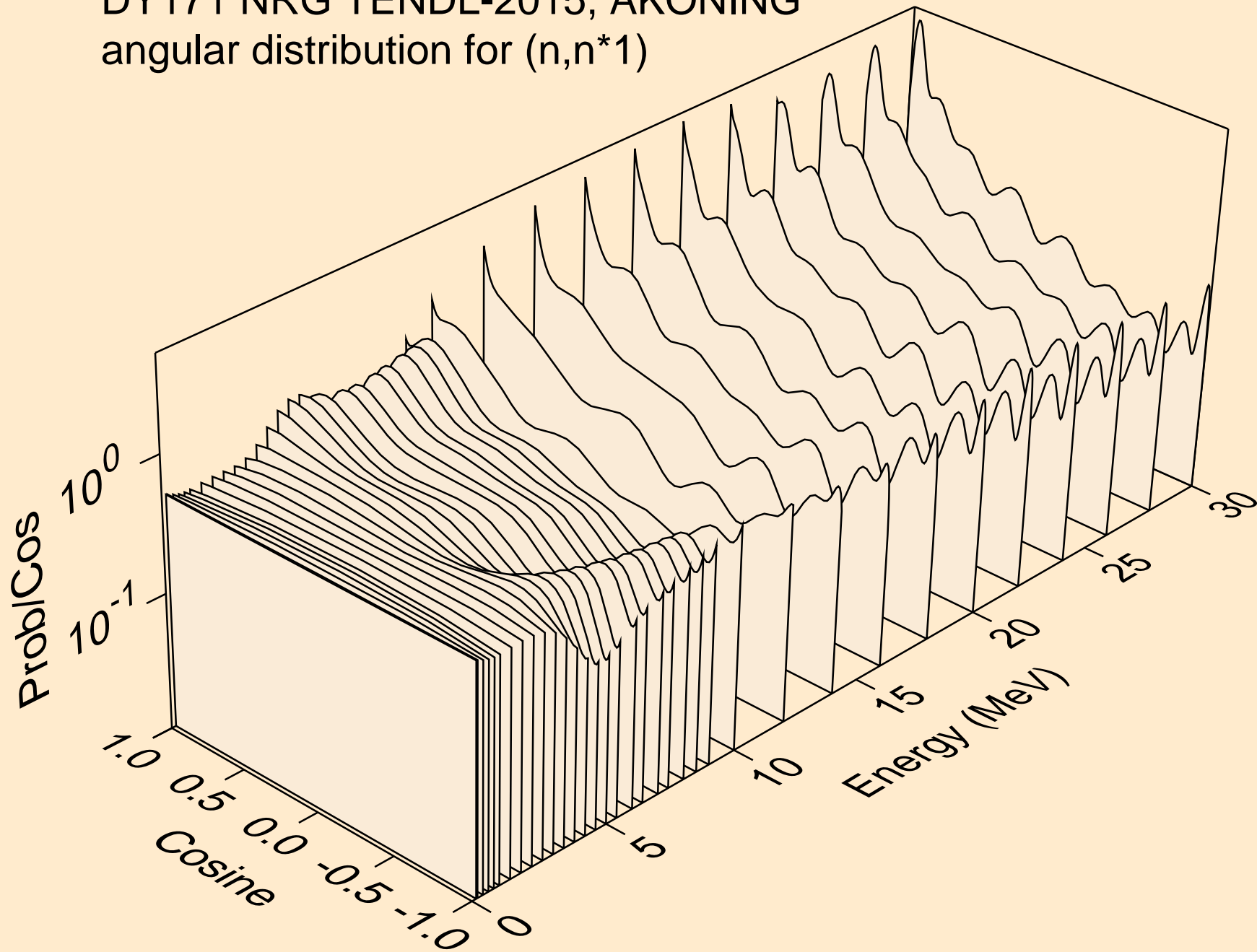

DY171 NRG TENDL-2015, AKONING  
Neutron emission for (n,x)

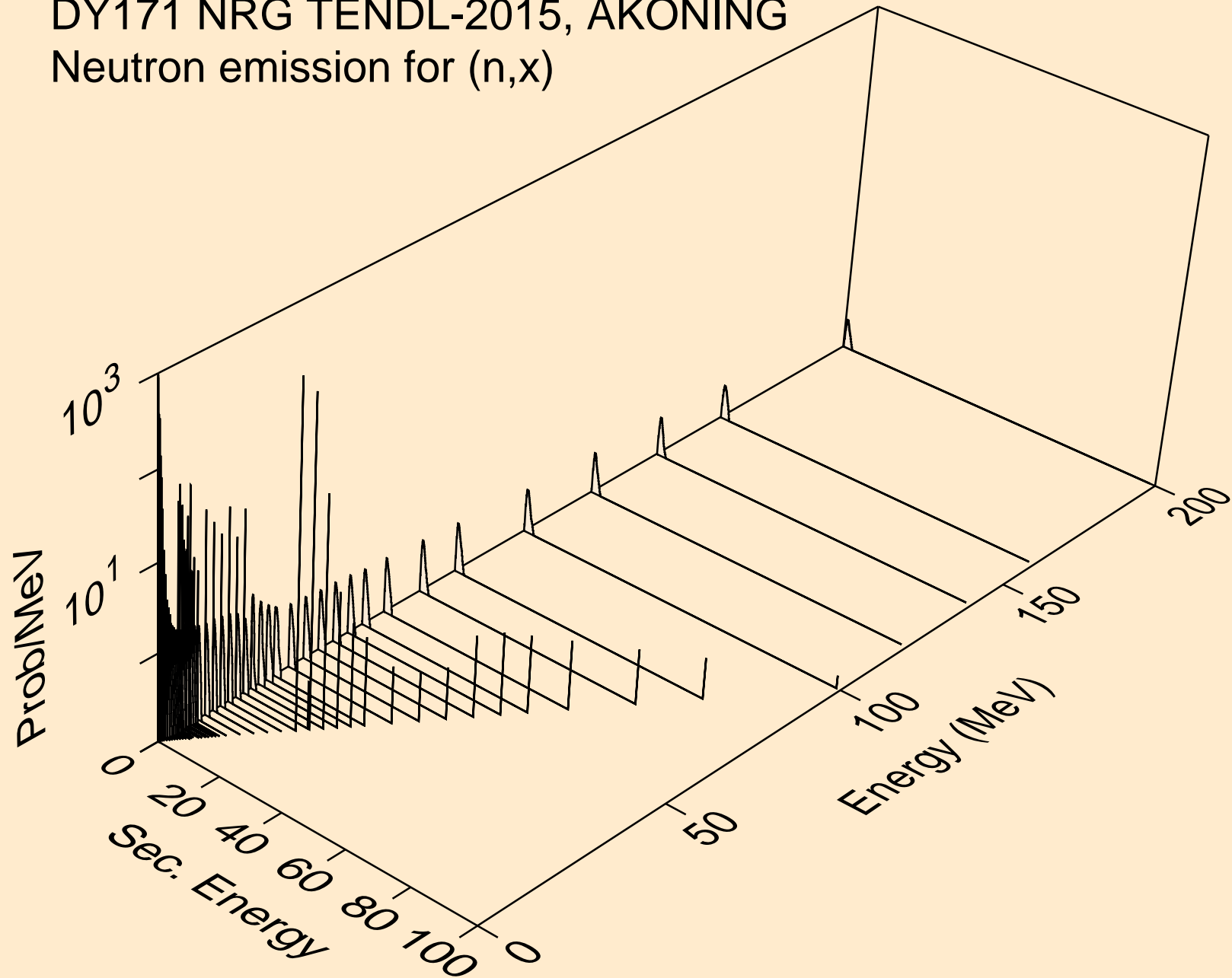

DY171 NRG TENDL-2015, AKONING  
Neutron emission for (n,2nd)

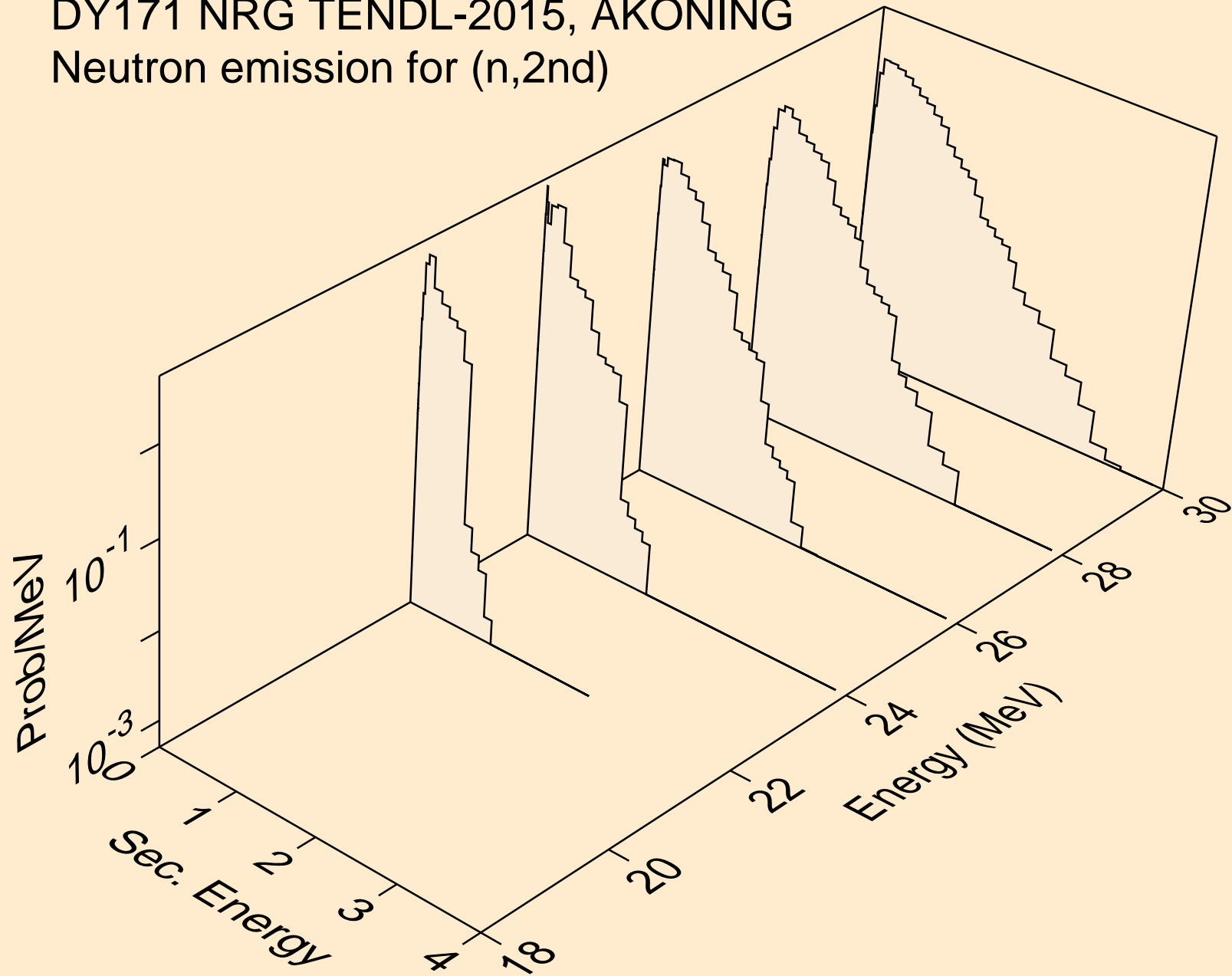

DY171 NRG TENDL-2015, AKONING  
Neutron emission for (n,2n)

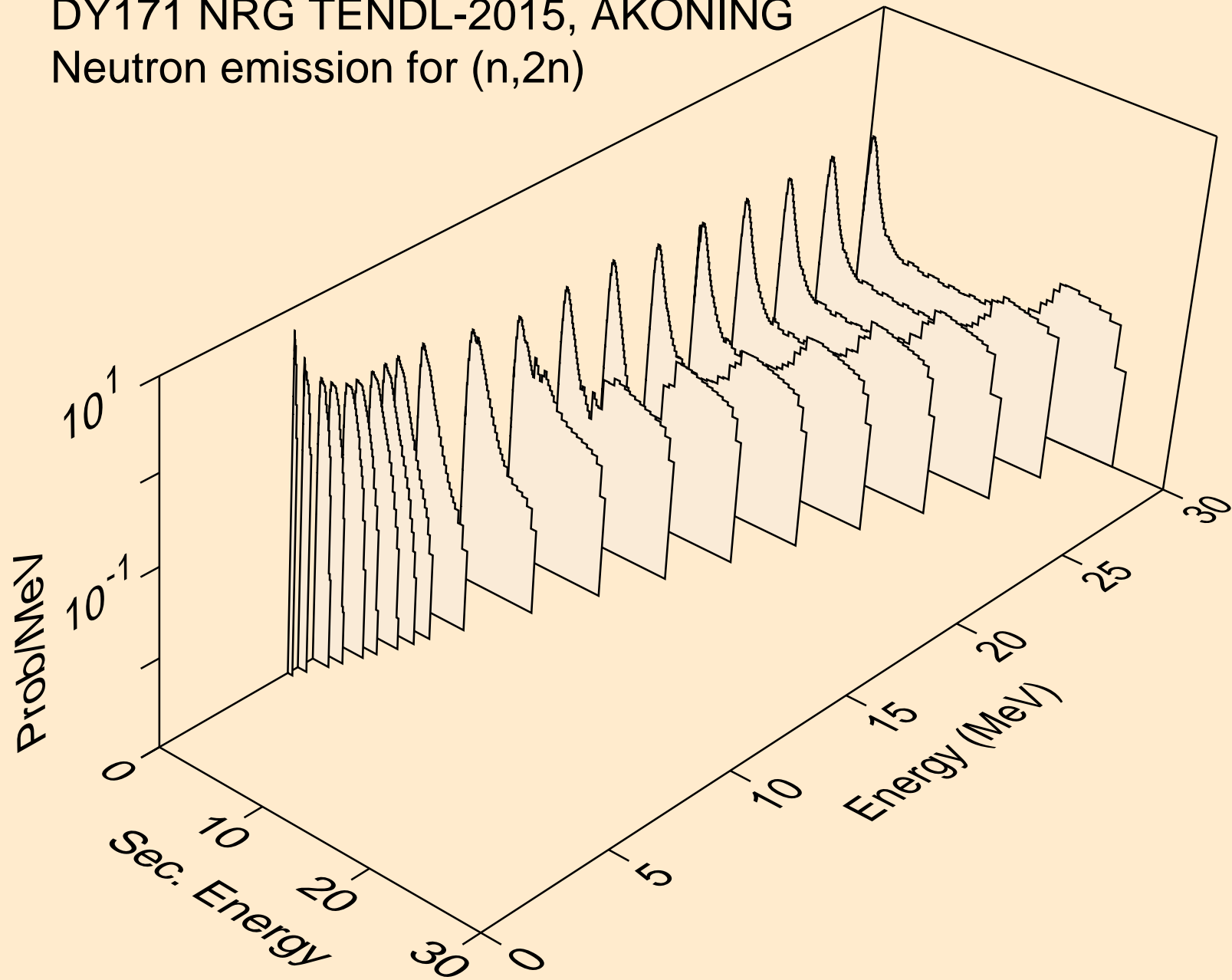



DY171 NRG TENDL-2015, AKONING  
Neutron emission for (n,3n)

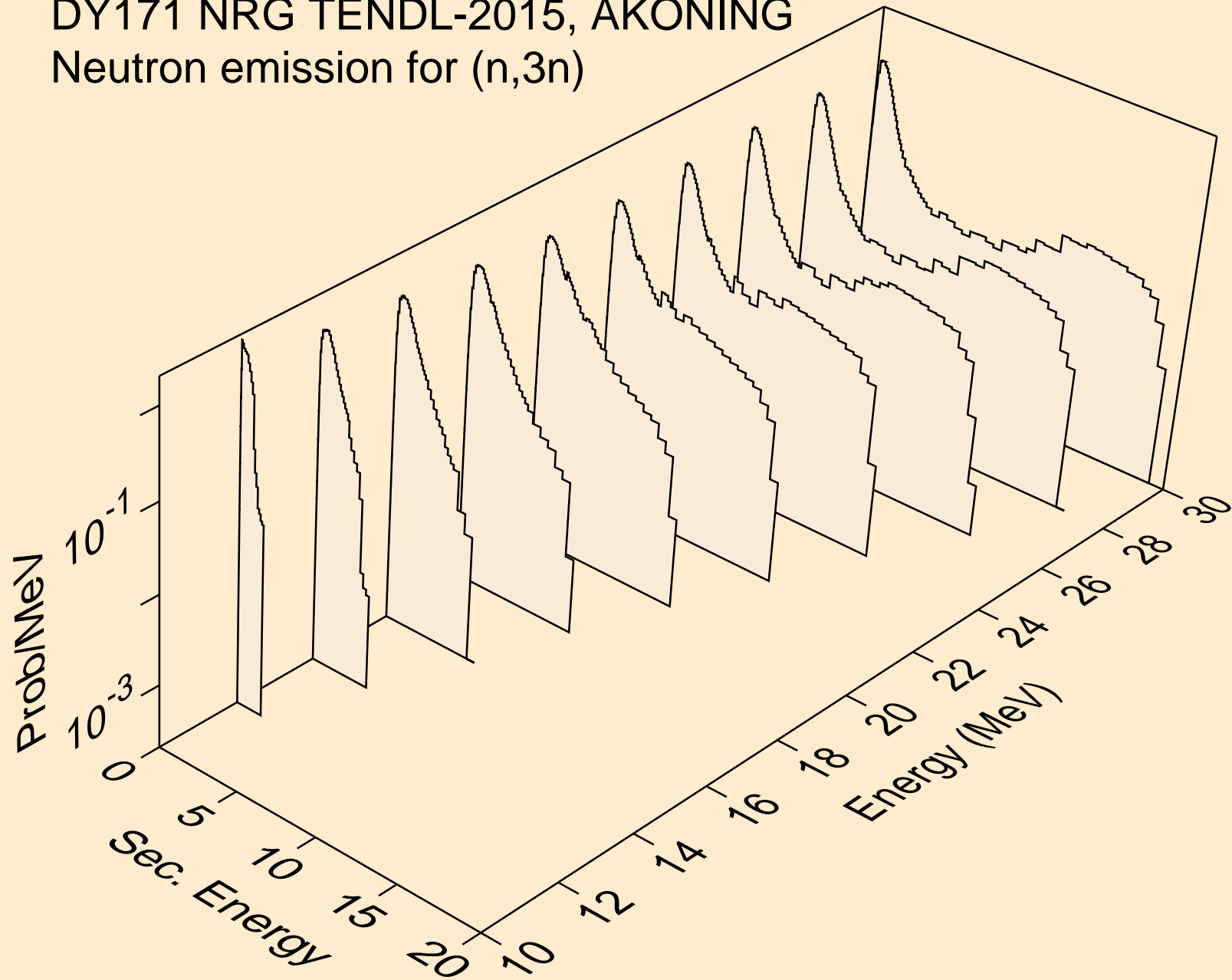

DY171 NRG TENDL-2015, AKONING  
Neutron emission for (n,n\*)a

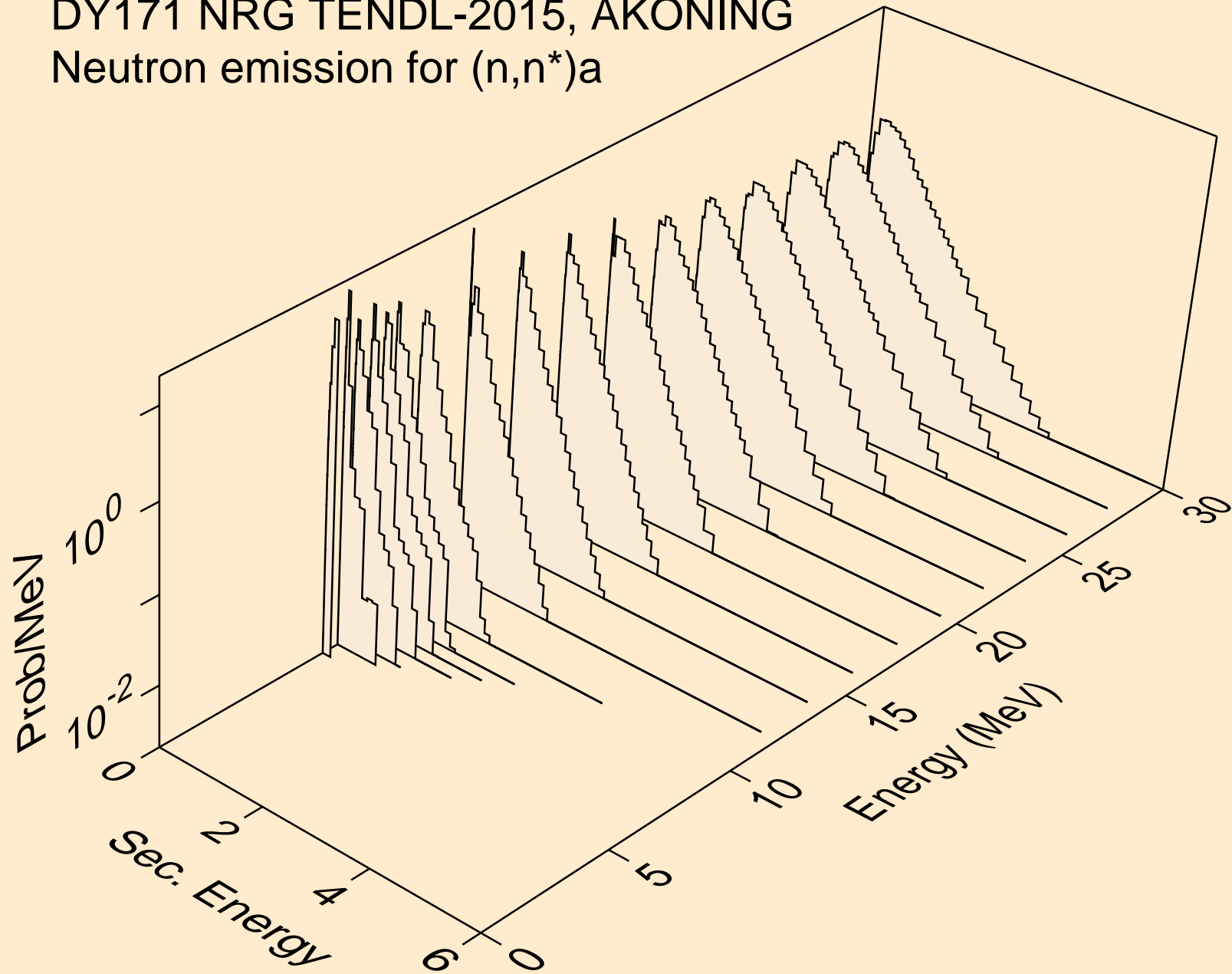

DY171 NRG TENDL-2015, AKONING  
Neutron emission for (n,2n)a

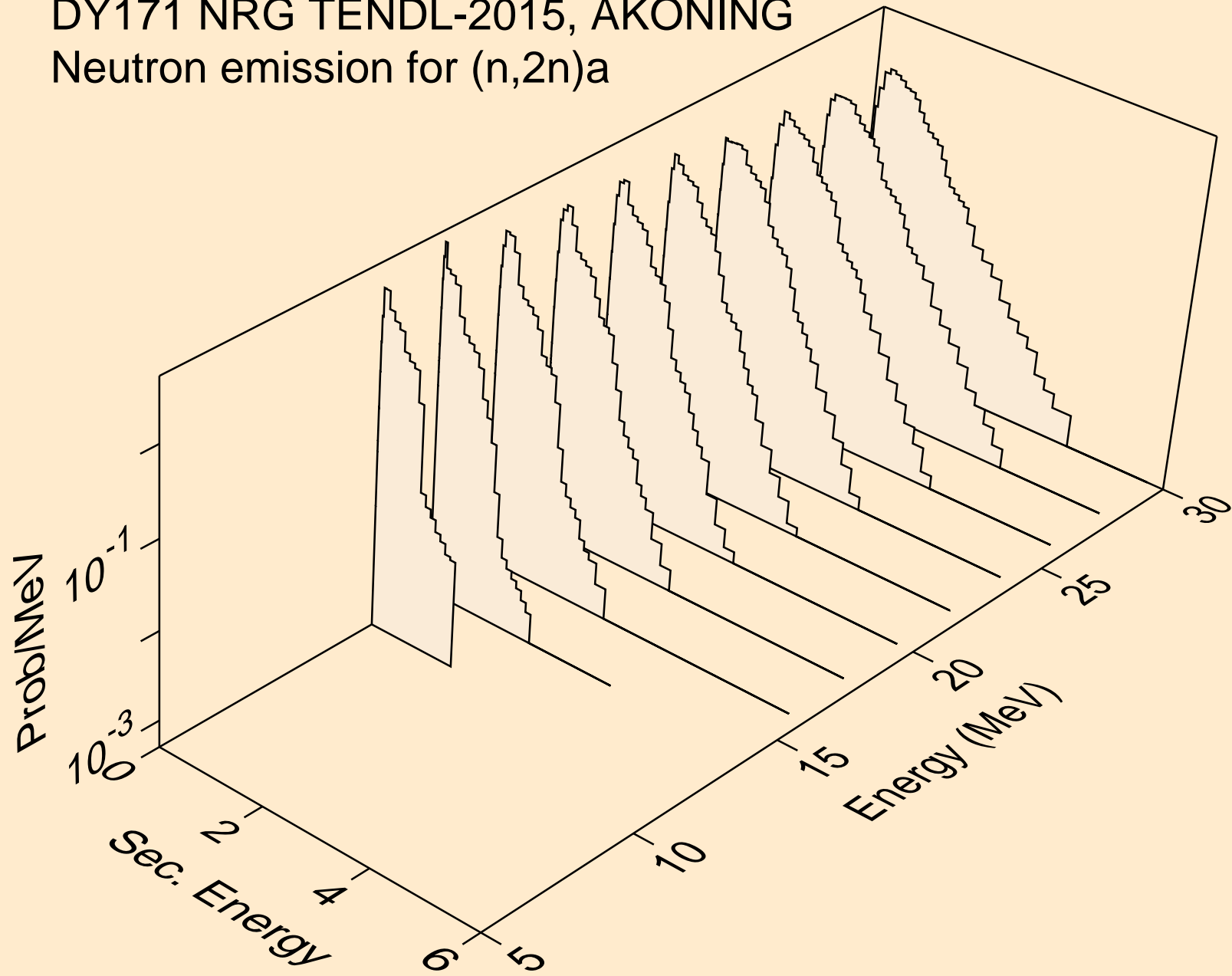

DY171 NRG TENDL-2015, AKONING  
Neutron emission for (n,3n)a

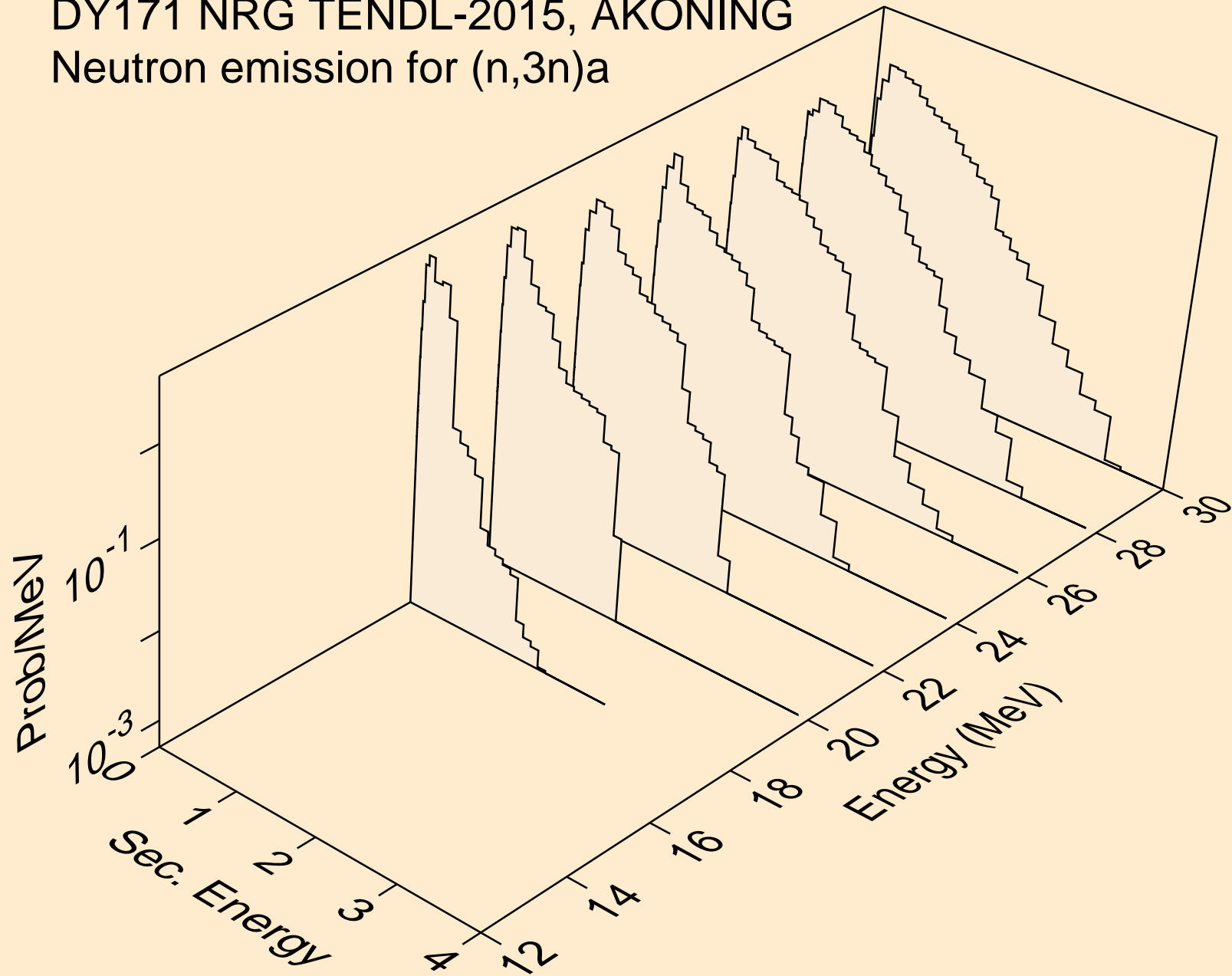

DY171 NRG TENDL-2015, AKONING  
Neutron emission for (n,n\*)p

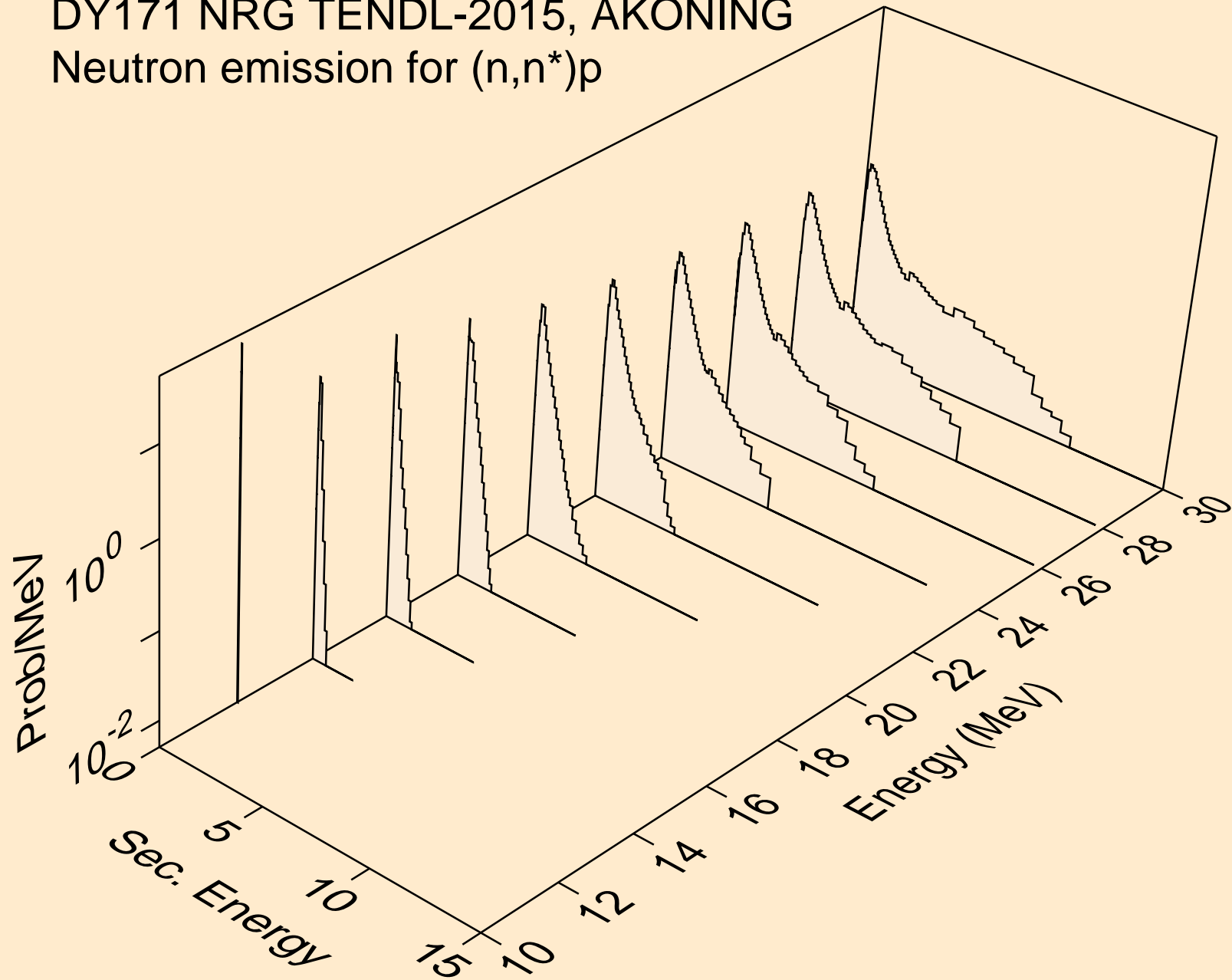

DY171 NRG TENDL-2015, AKONING  
Neutron emission for (n,n\*)d

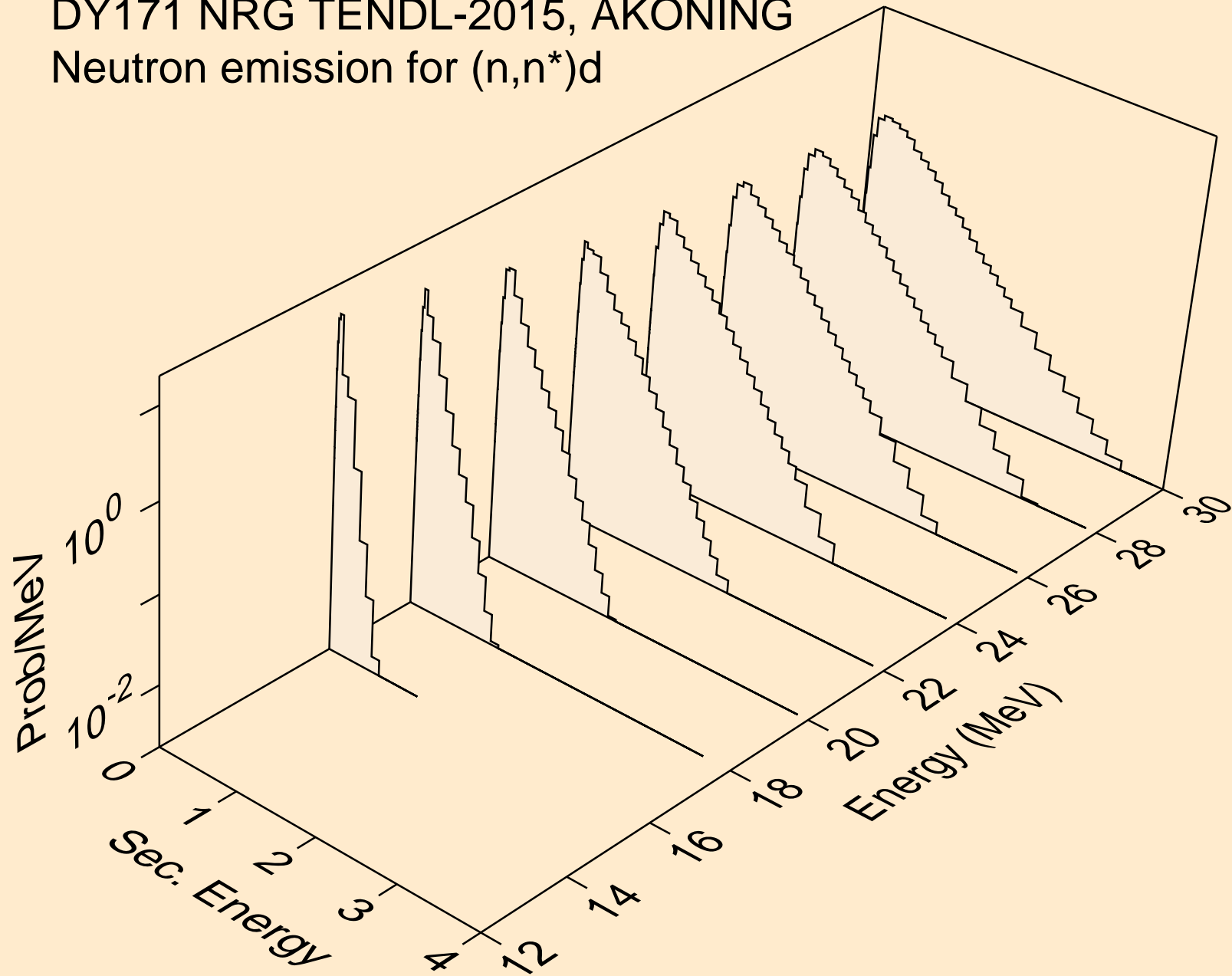

DY171 NRG TENDL-2015, AKONING  
Neutron emission for (n,n\*)t

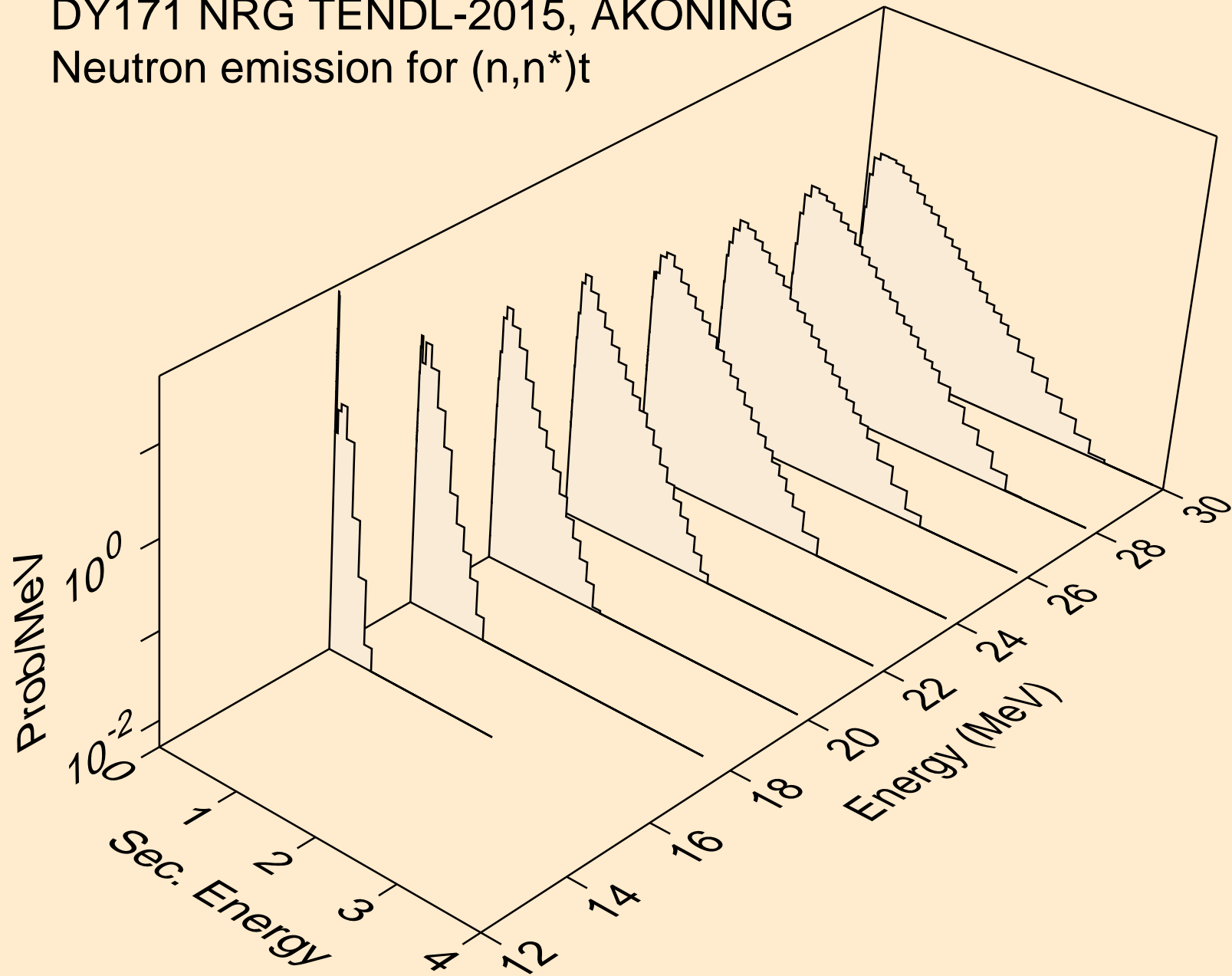

DY171 NRG TENDL-2015, AKONING  
Neutron emission for (n,n\*)he3

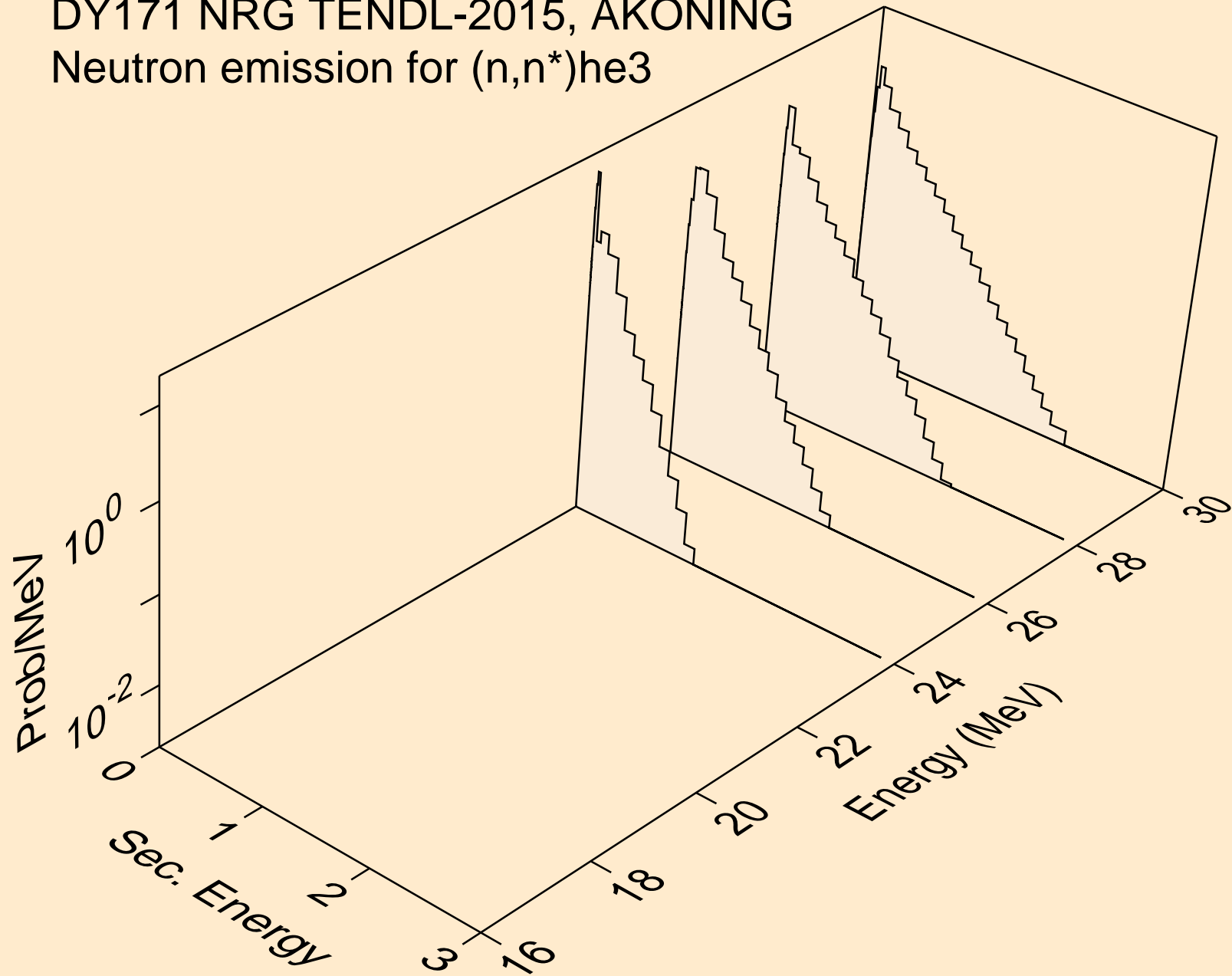



DY171 NRG TENDL-2015, AKONING  
Neutron emission for (n,4n)

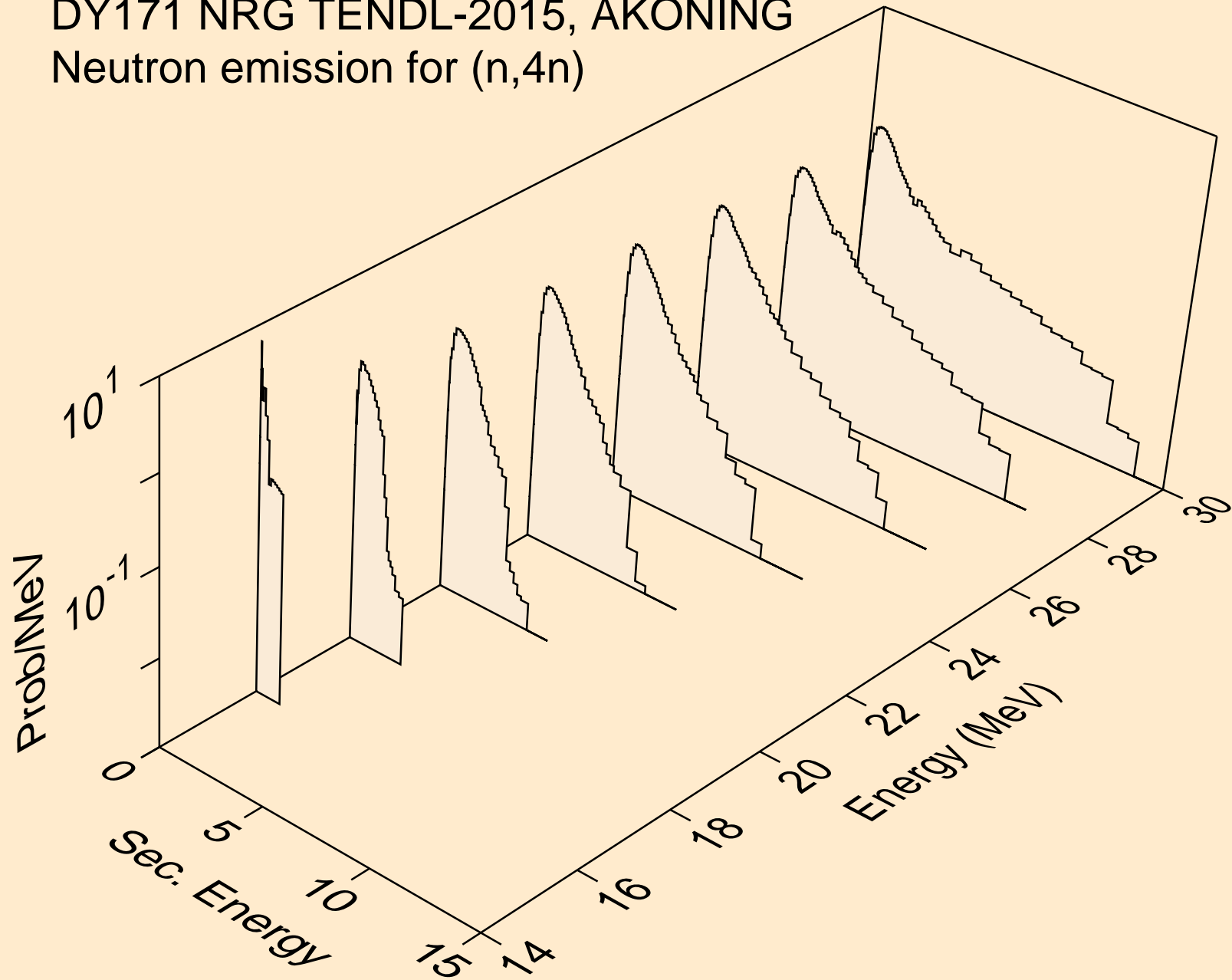

DY171 NRG TENDL-2015, AKONING  
Neutron emission for (n,2np)

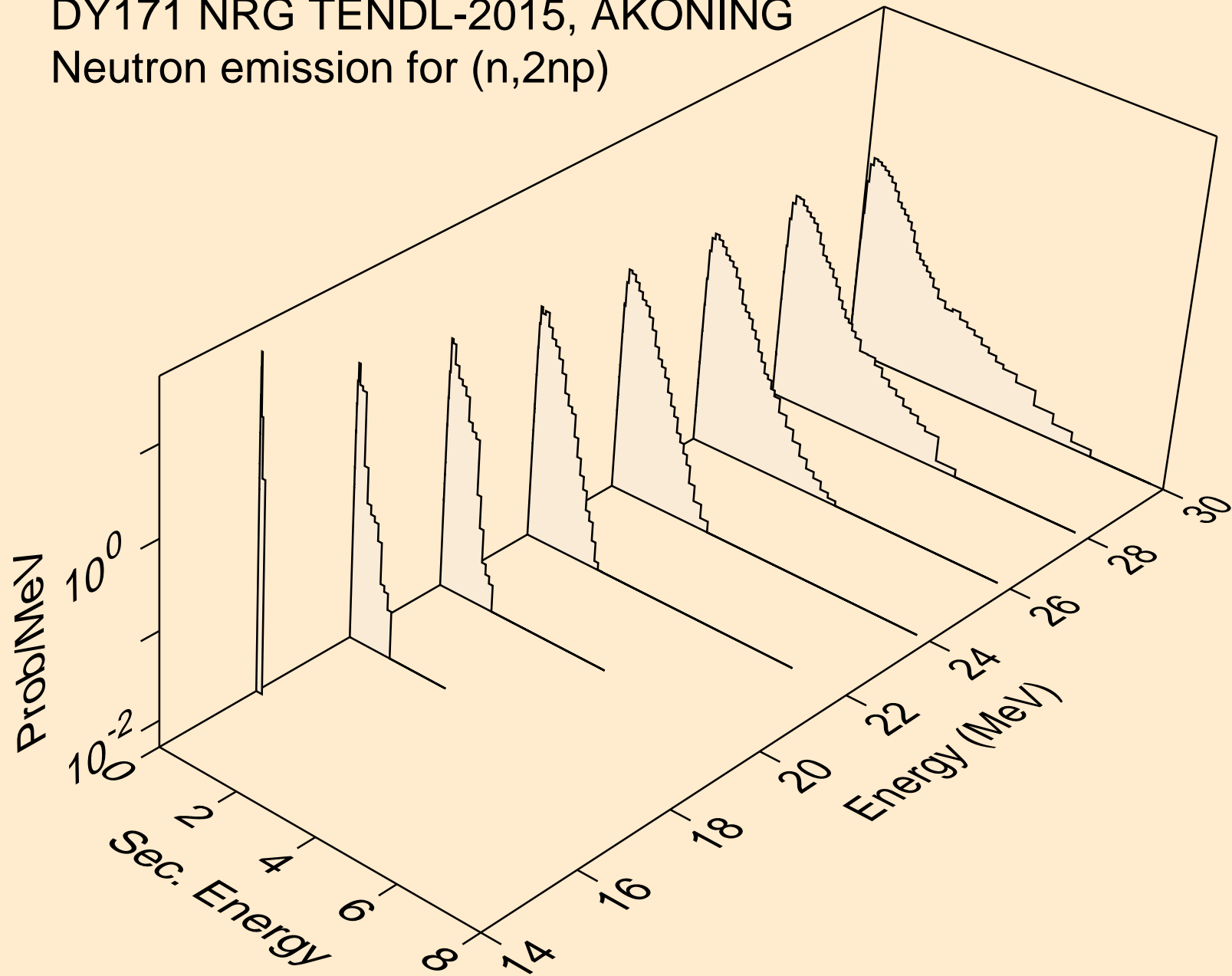

DY171 NRG TENDL-2015, AKONING  
Neutron emission for (n,3np)

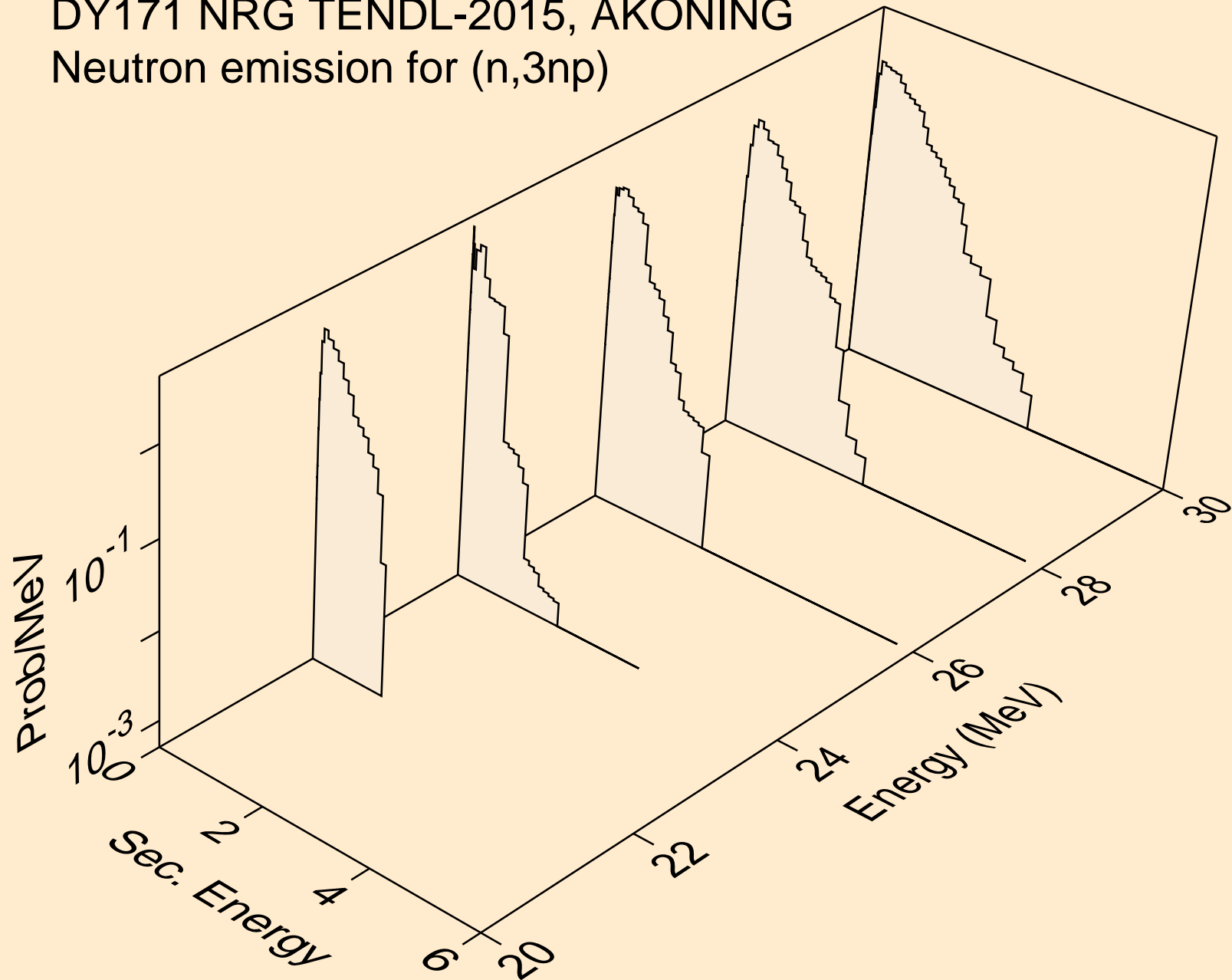

DY171 NRG TENDL-2015, AKONING  
Neutron emission for (n,n\*c)

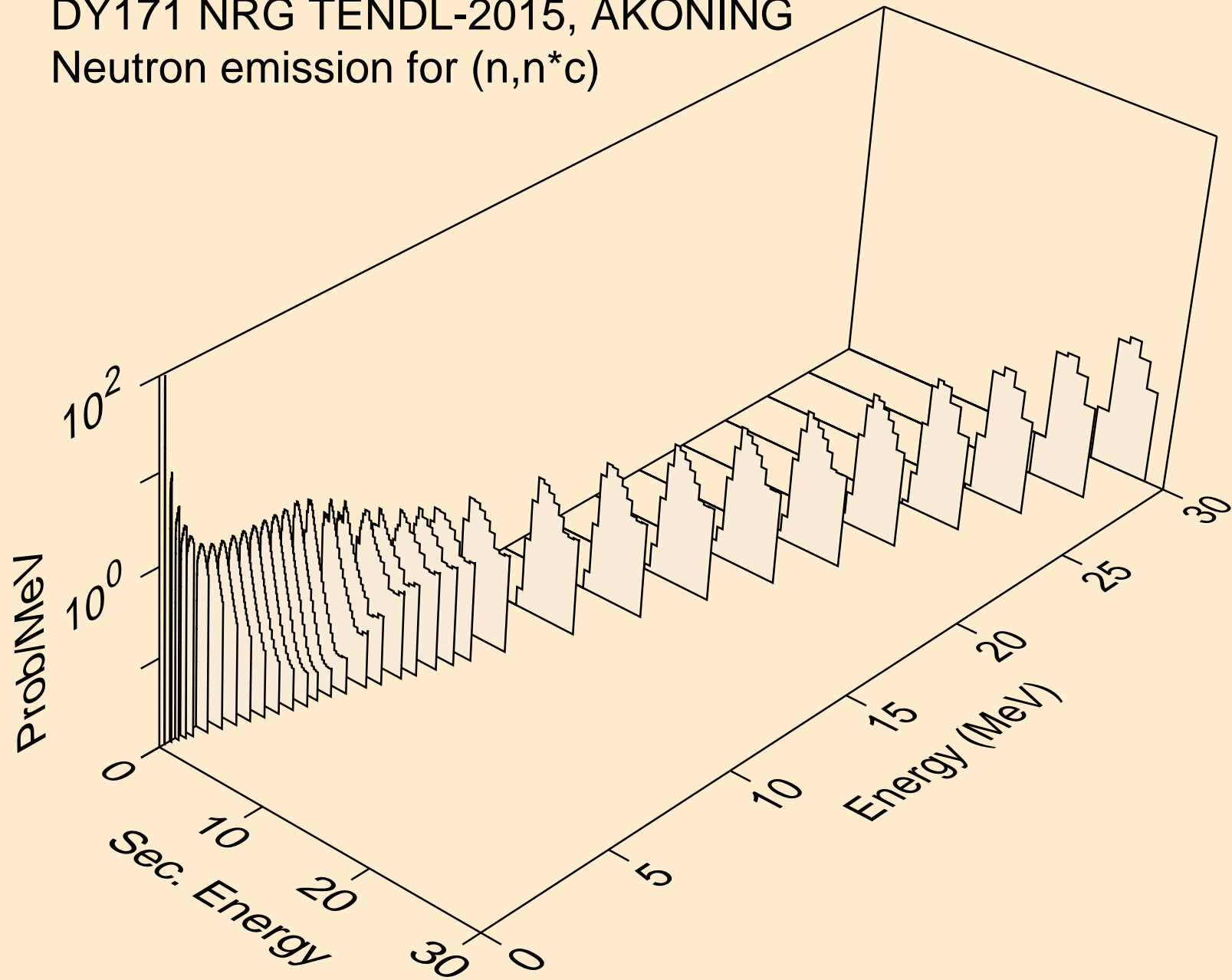

DY171 NRG TENDL-2015, AKONING  
Photon emission for (n,x)

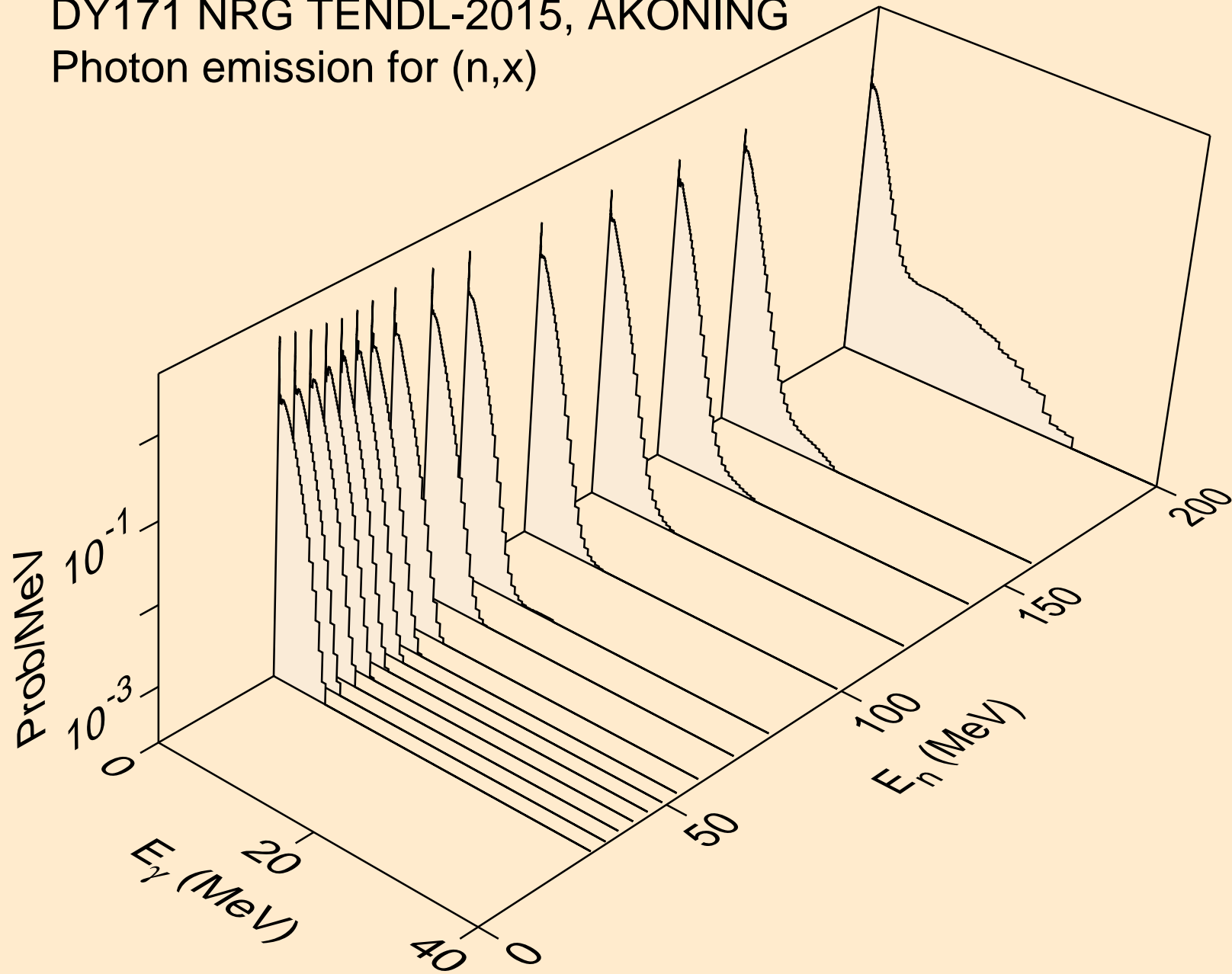

DY171 NRG TENDL-2015, AKONING  
Photon emission for (n,2nd)

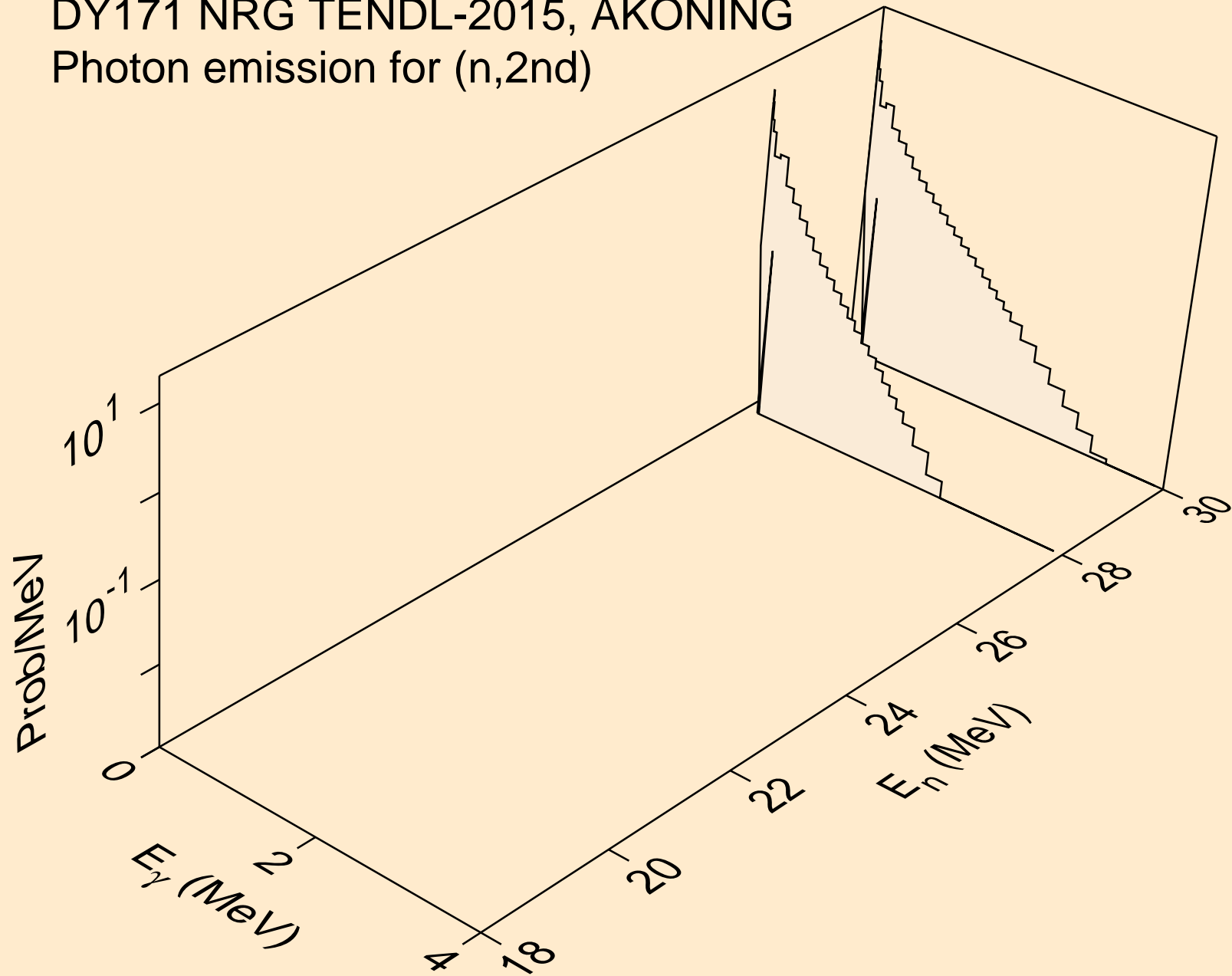

DY171 NRG TENDL-2015, AKONING  
Photon emission for (n,2n)

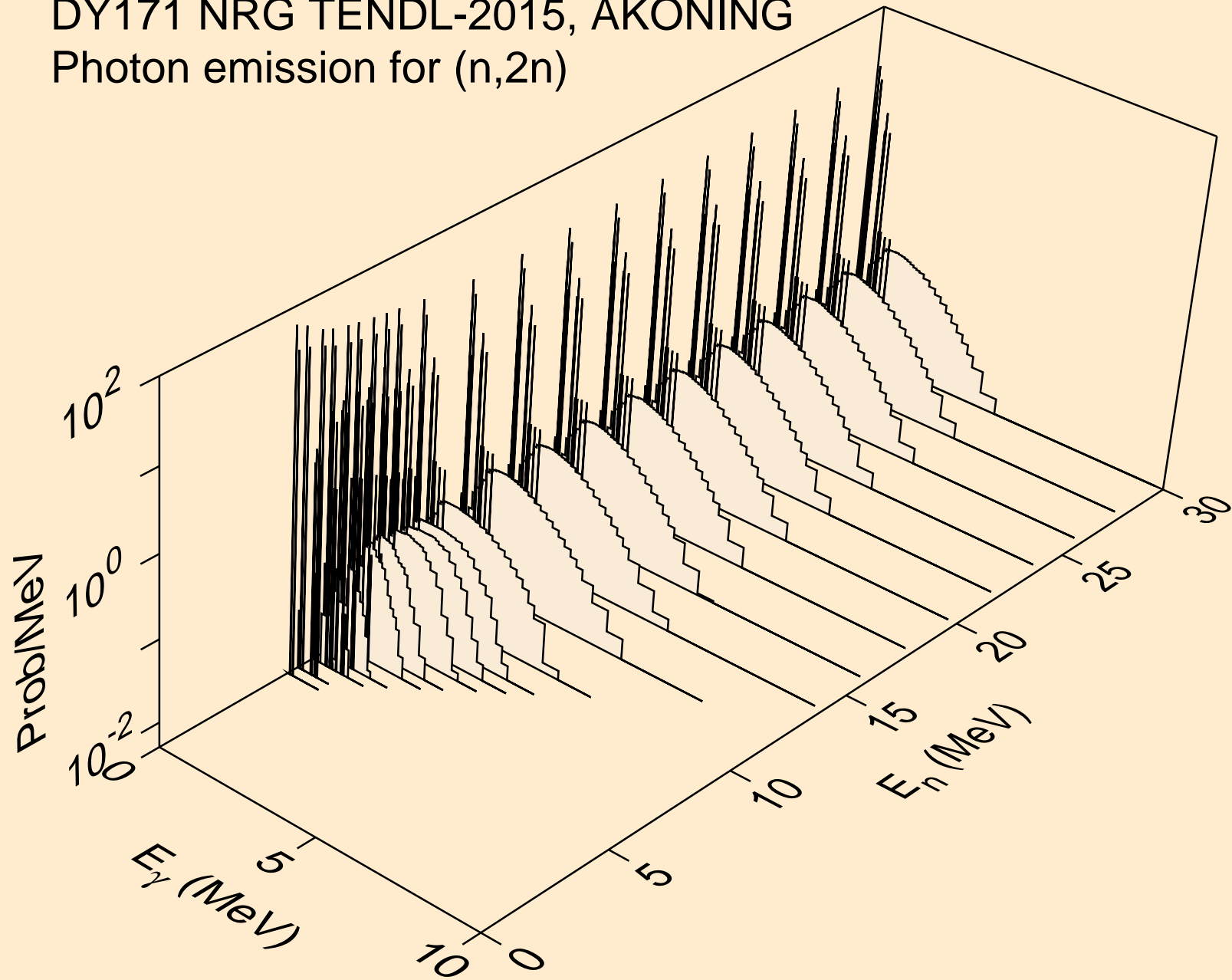

DY171 NRG TENDL-2015, AKONING  
Photon emission for (n,3n)

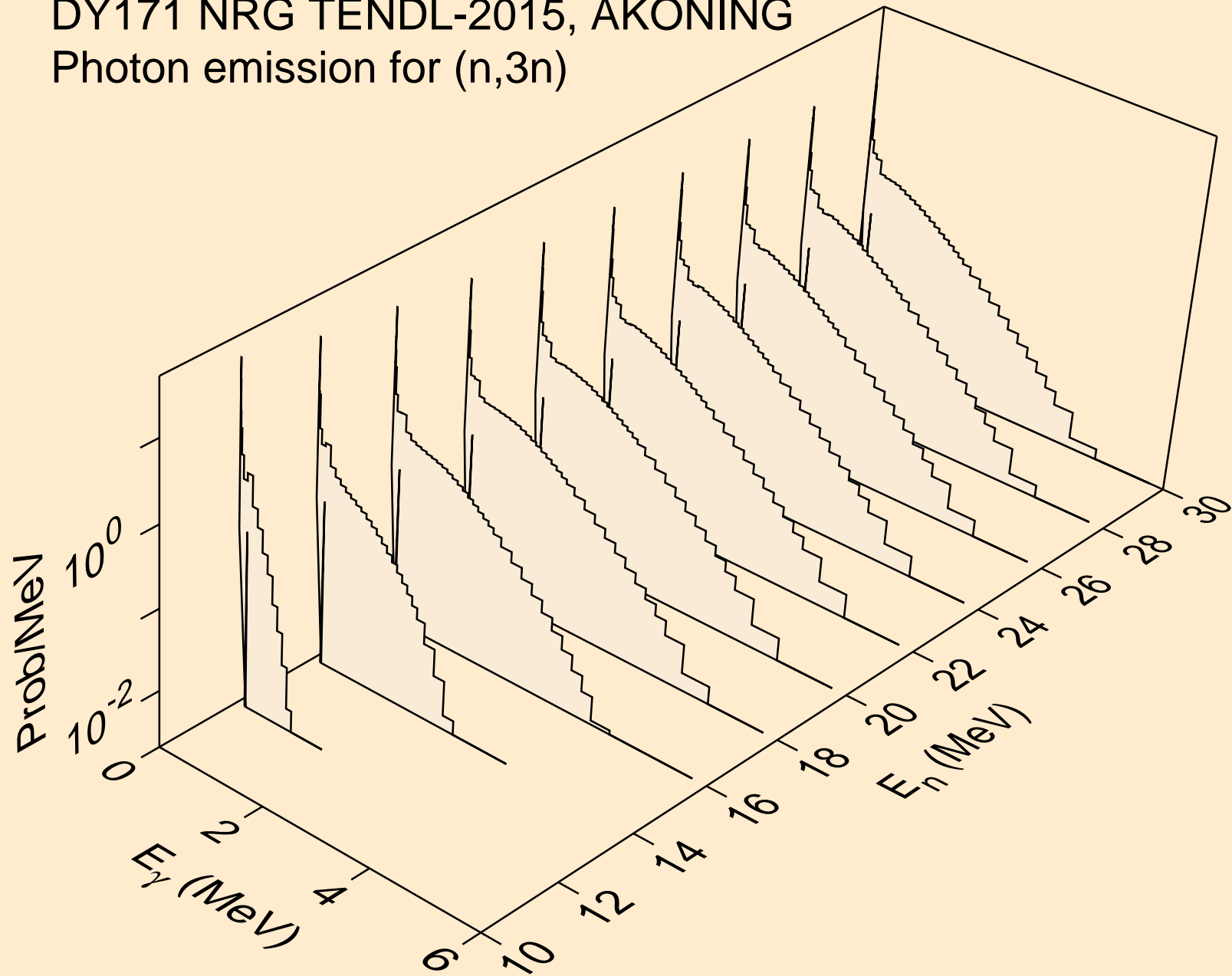



DY171 NRG TENDL-2015, AKONING  
Photon emission for (n,n\*)a

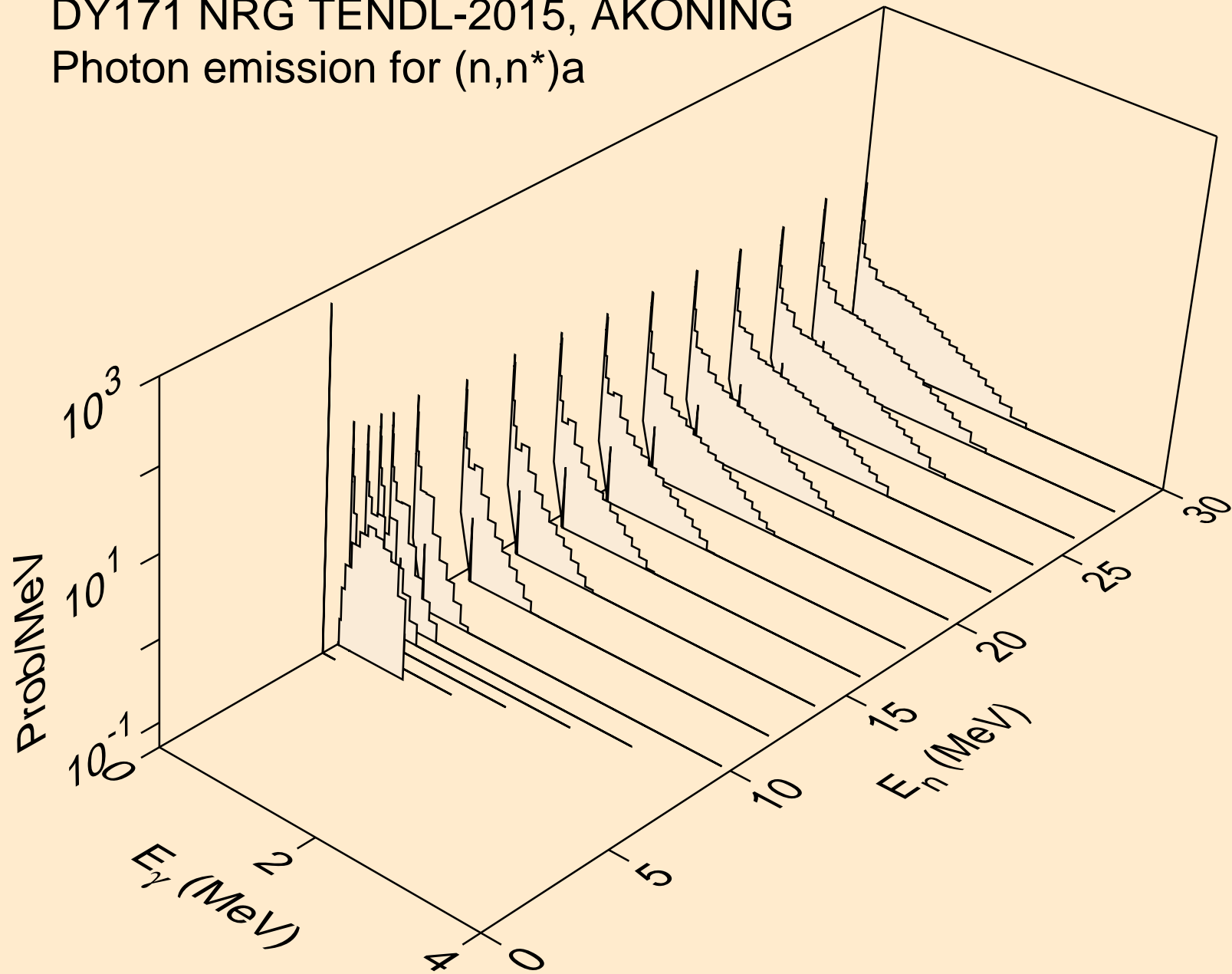

DY171 NRG TENDL-2015, AKONING  
Photon emission for (n,2n)a

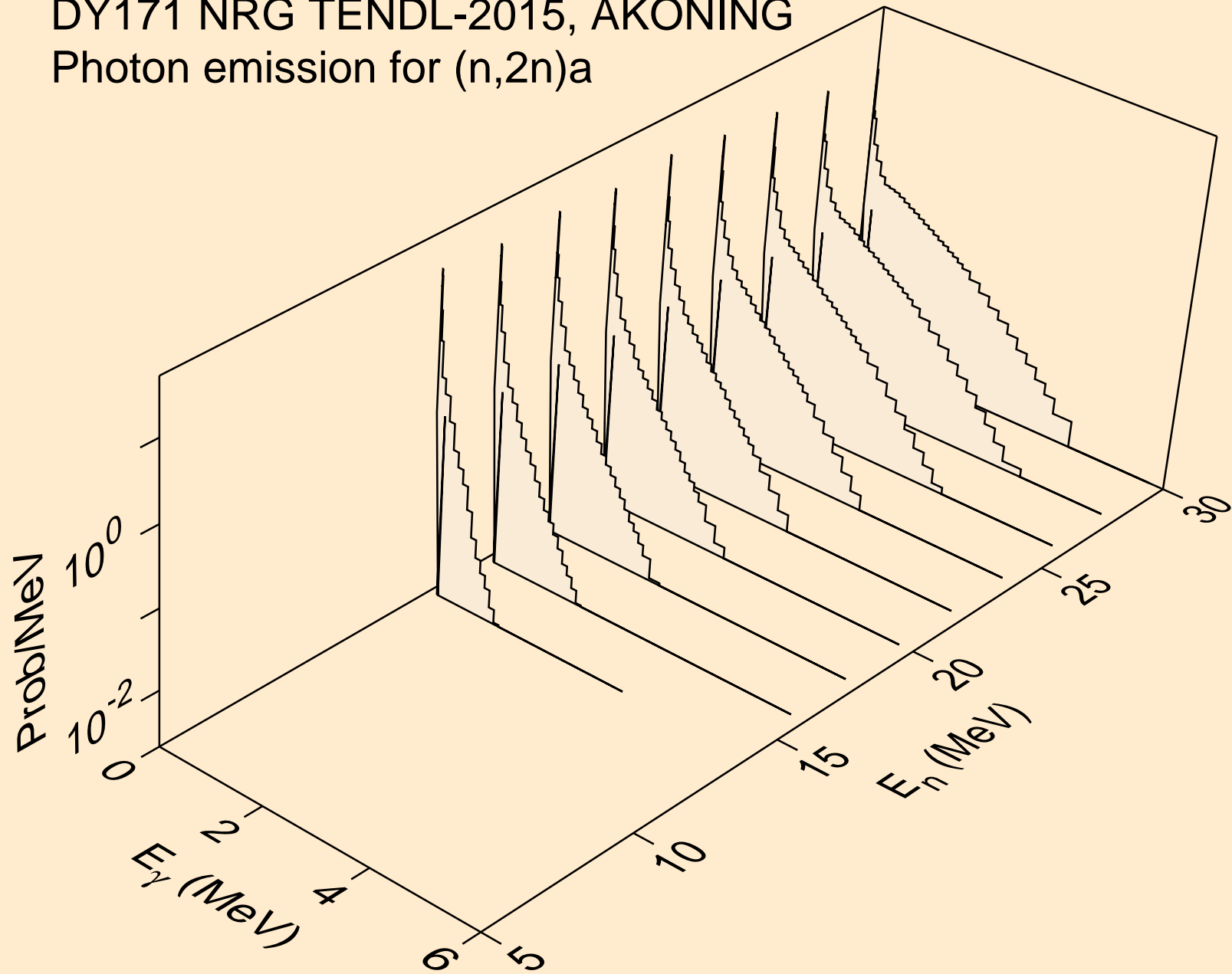

DY171 NRG TENDL-2015, AKONING  
Photon emission for (n,3n)a

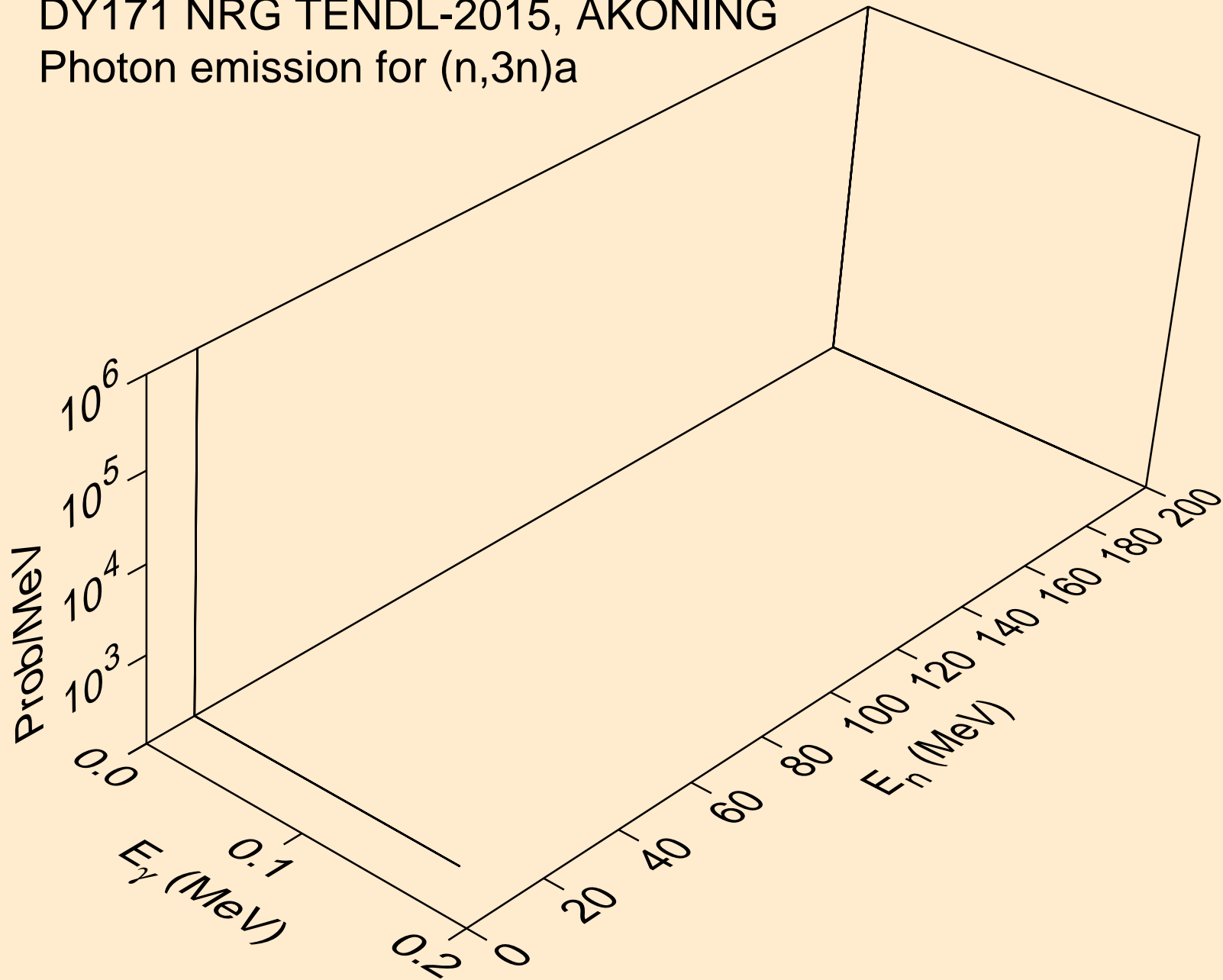

DY171 NRG TENDL-2015, AKONING  
Photon emission for (n,n\*)p

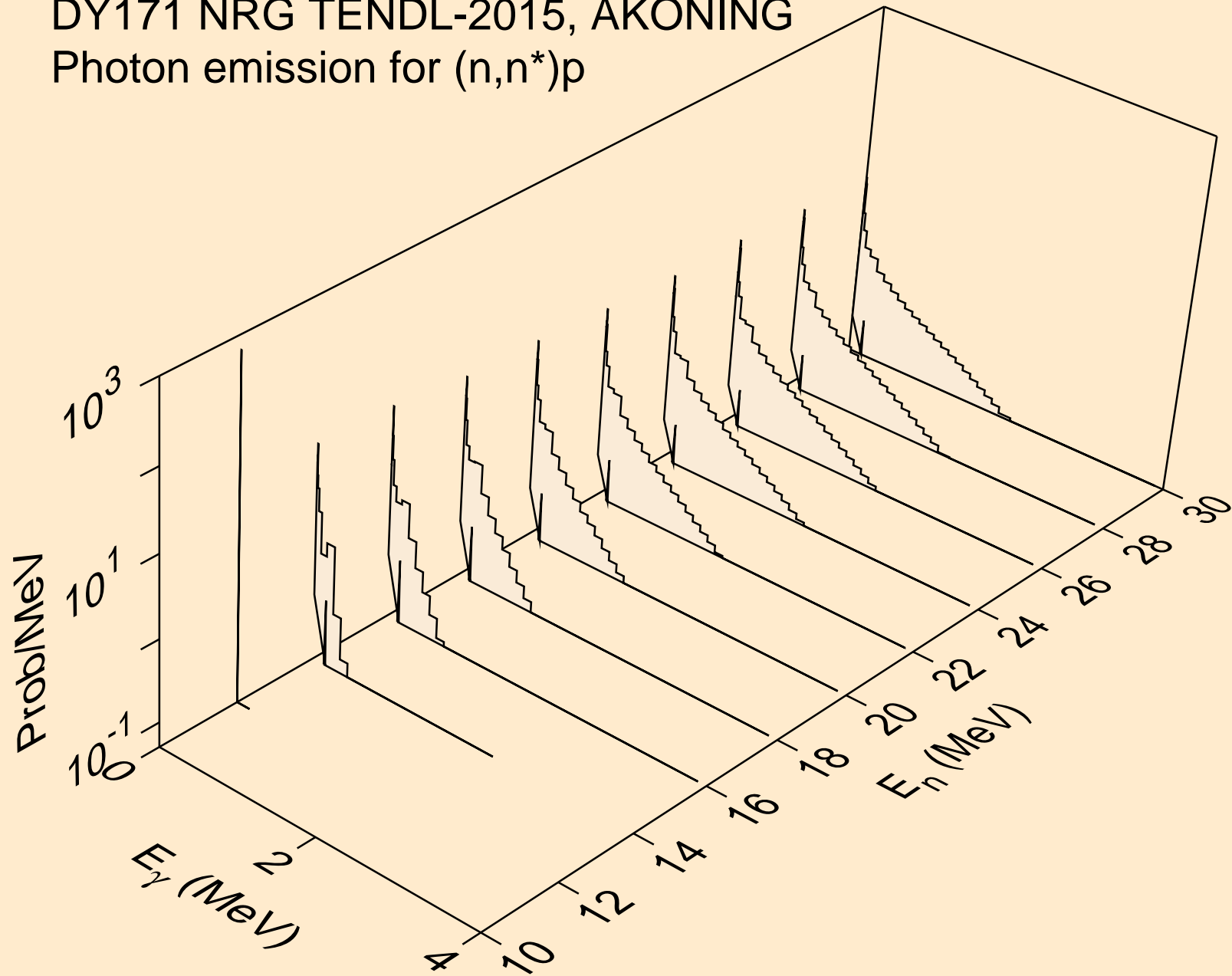

DY171 NRG TENDL-2015, AKONING  
Photon emission for (n,n\*)d

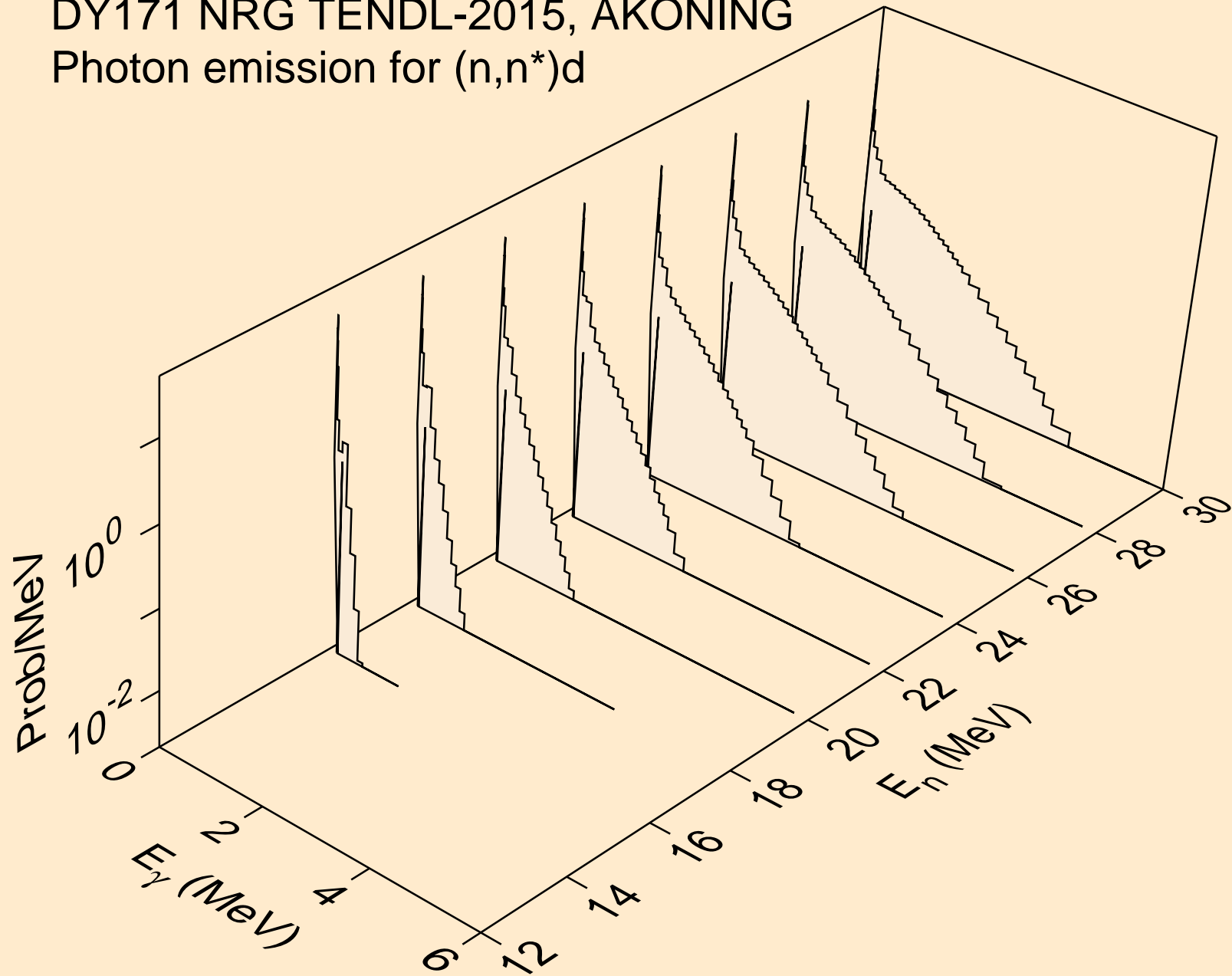

DY171 NRG TENDL-2015, AKONING  
Photon emission for (n,n\*)t

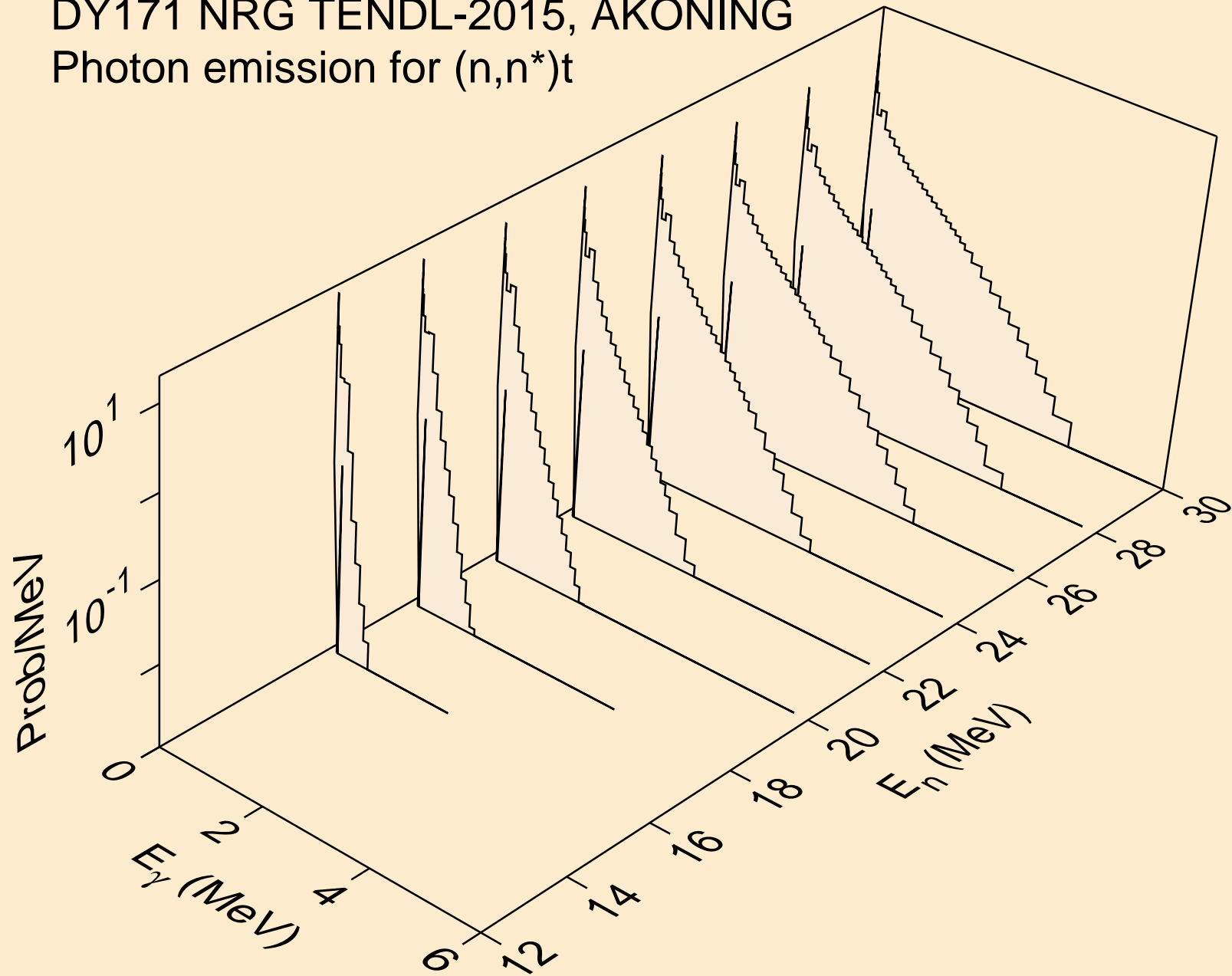

DY171 NRG TENDL-2015, AKONING  
Photon emission for (n,n\*)he3

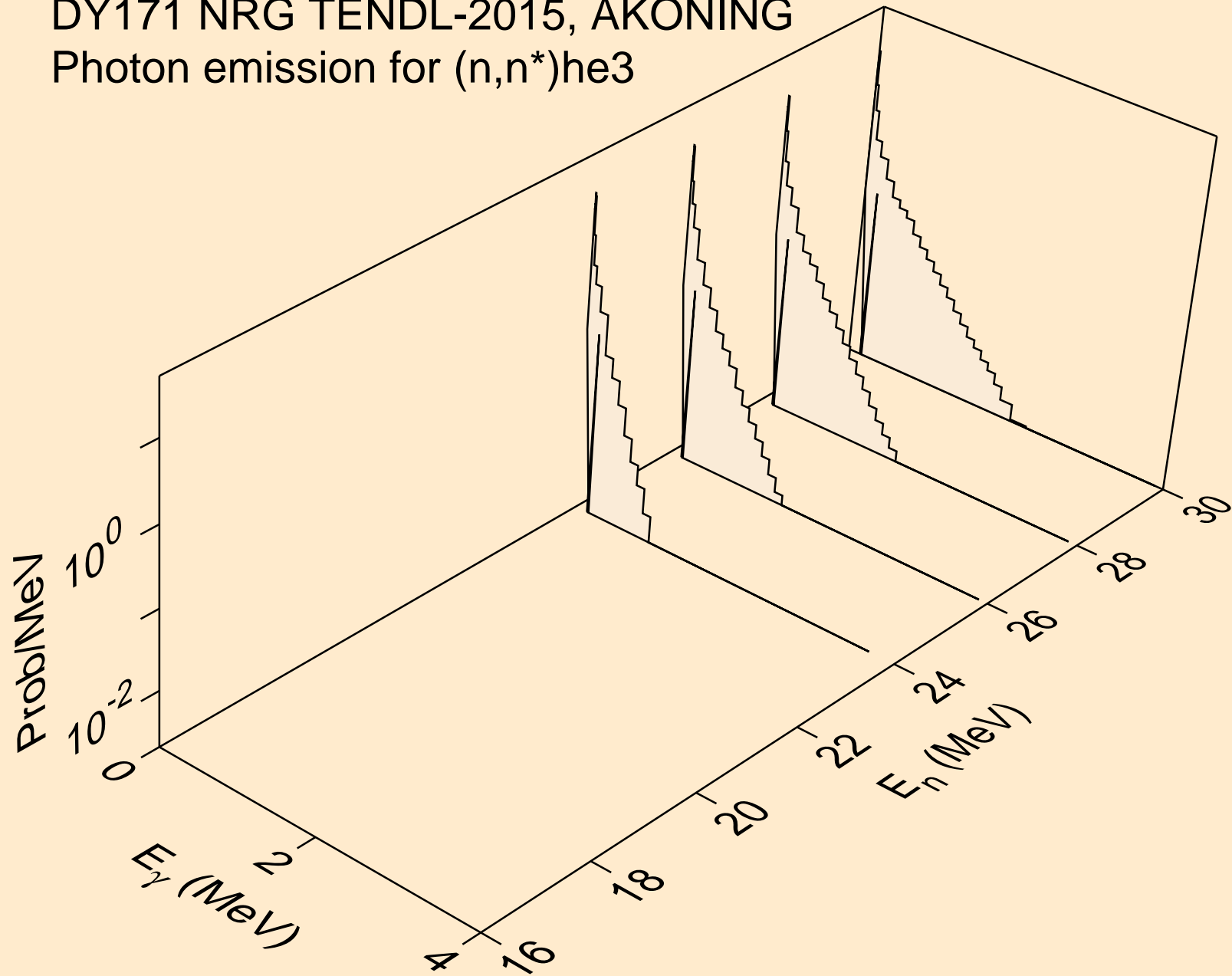

DY171 NRG TENDL-2015, AKONING  
Photon emission for (n,4n)

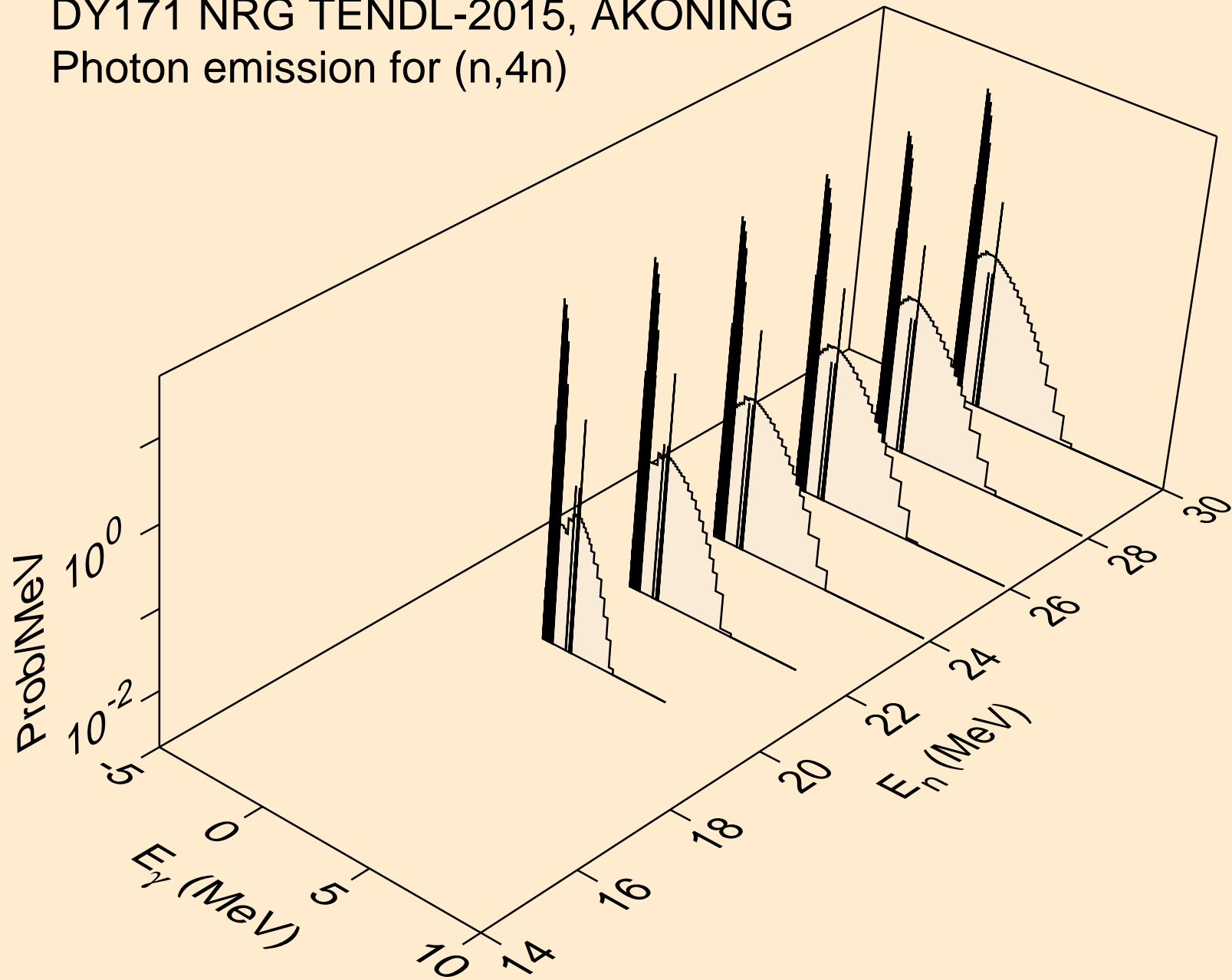



DY171 NRG TENDL-2015, AKONING  
Photon emission for (n,2np)

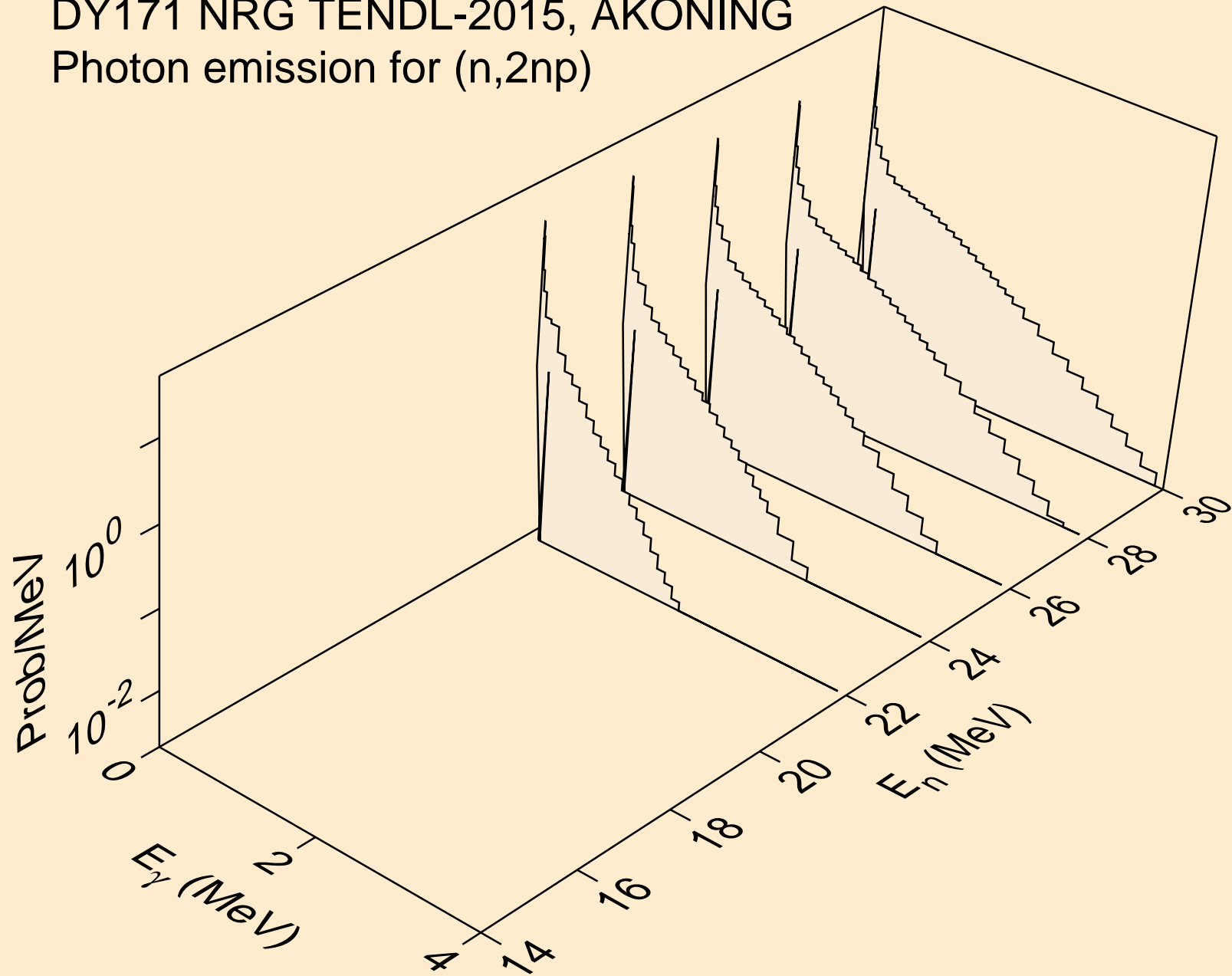

DY171 NRG TENDL-2015, AKONING  
Photon emission for (n,3np)

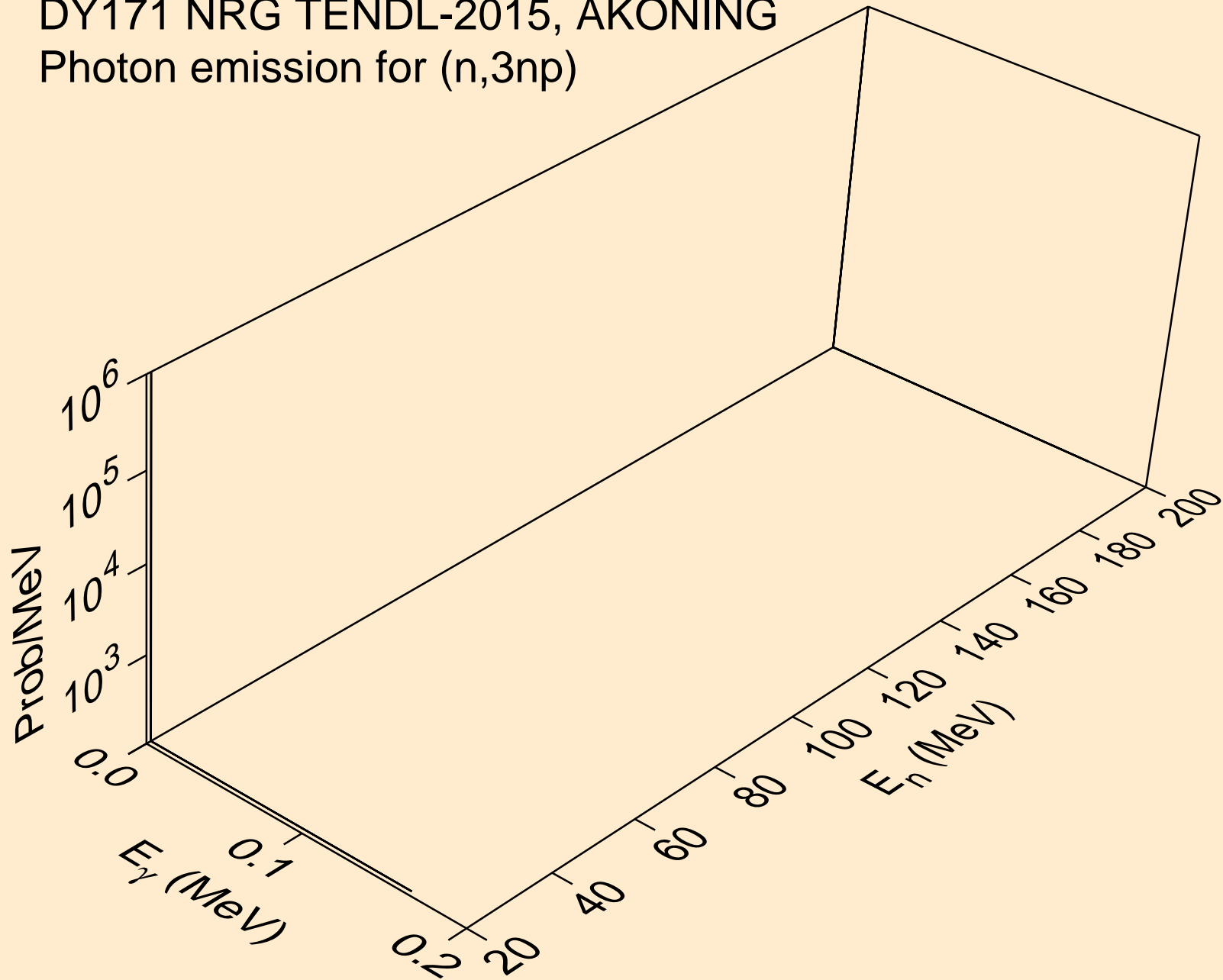

DY171 NRG TENDL-2015, AKONING  
Photon emission for (n,n\*c)

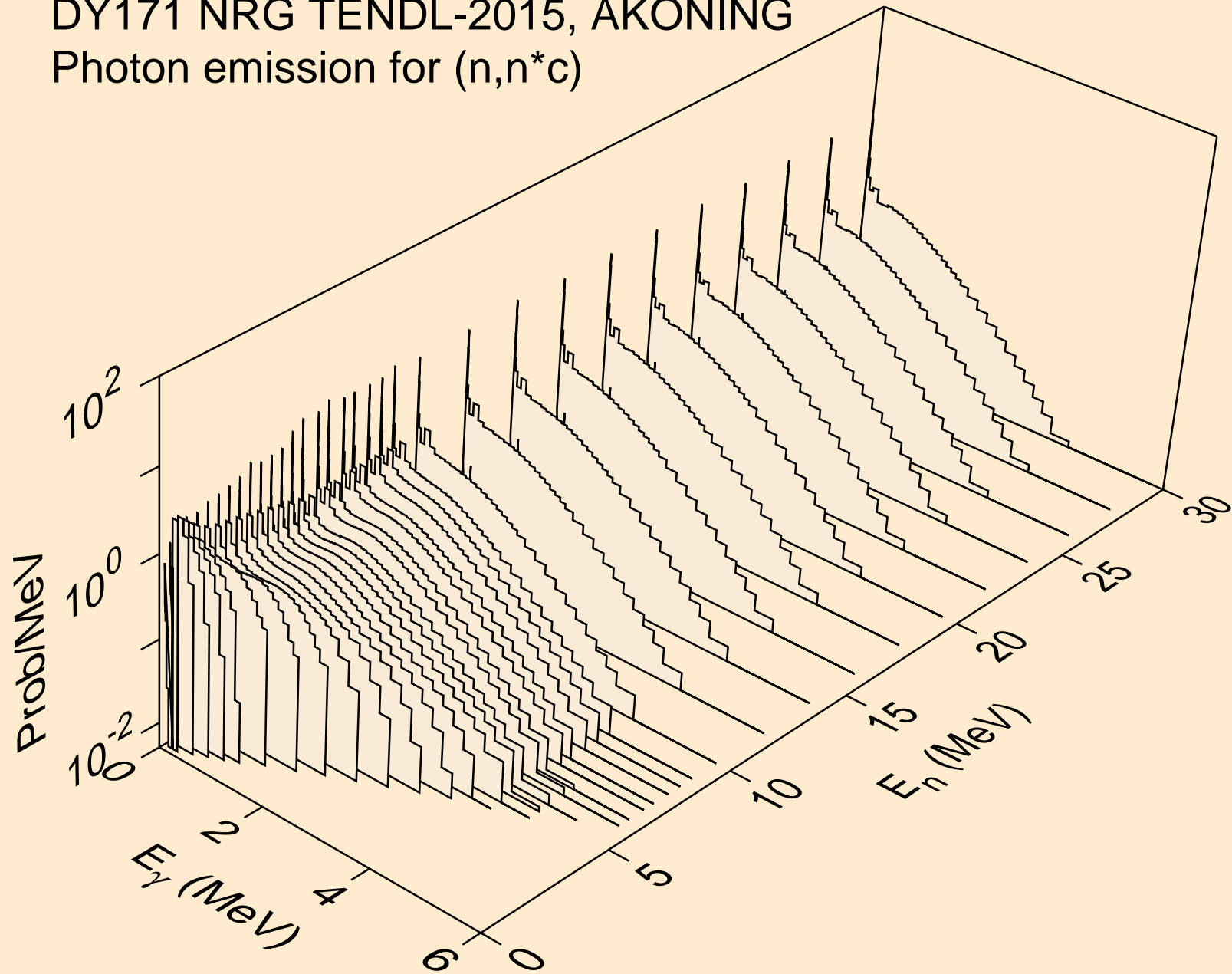

DY171 NRG TENDL-2015, AKONING  
Photon emission for (n,gma)

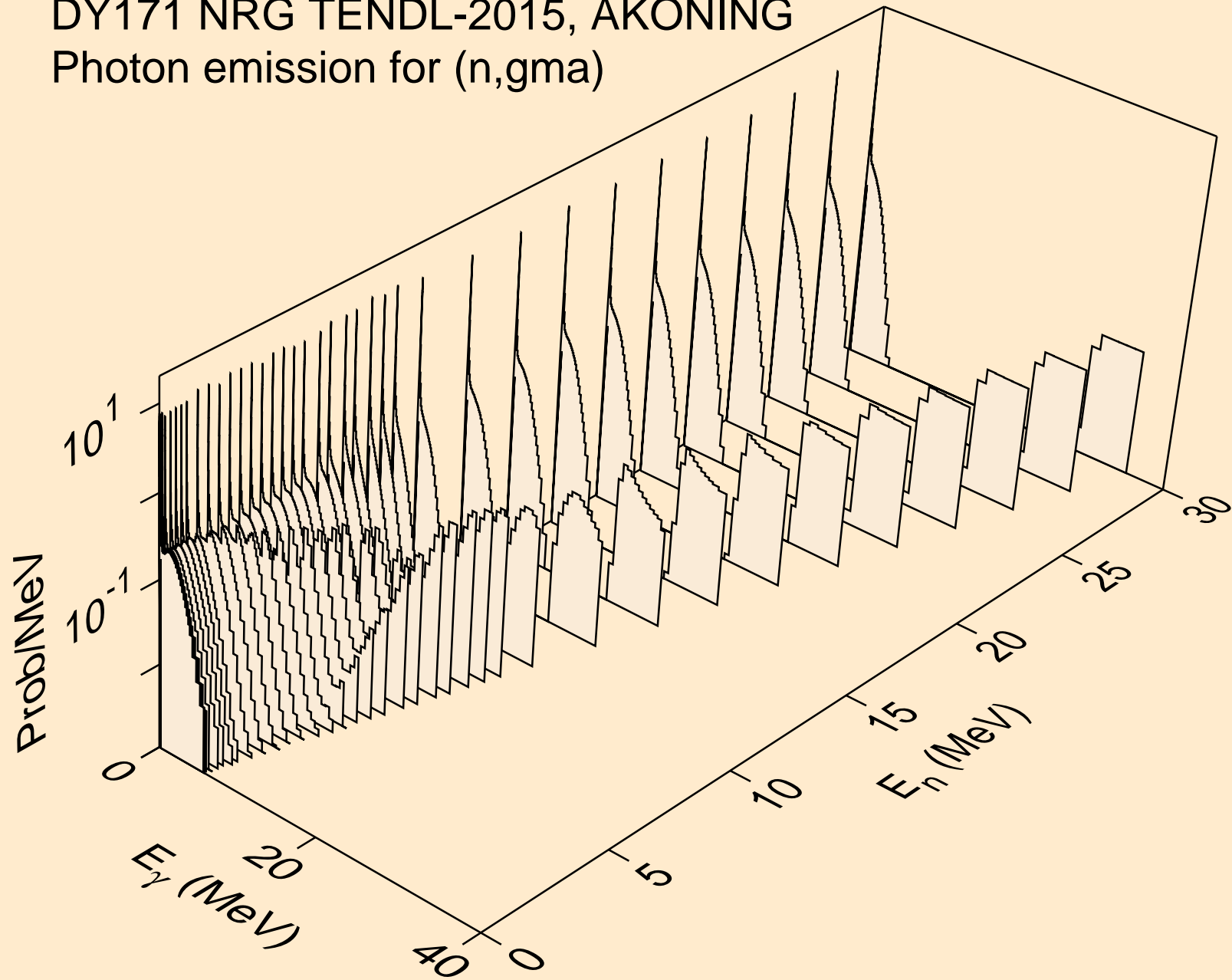

DY171 NRG TENDL-2015, AKONING  
Photon emission for (n,p)

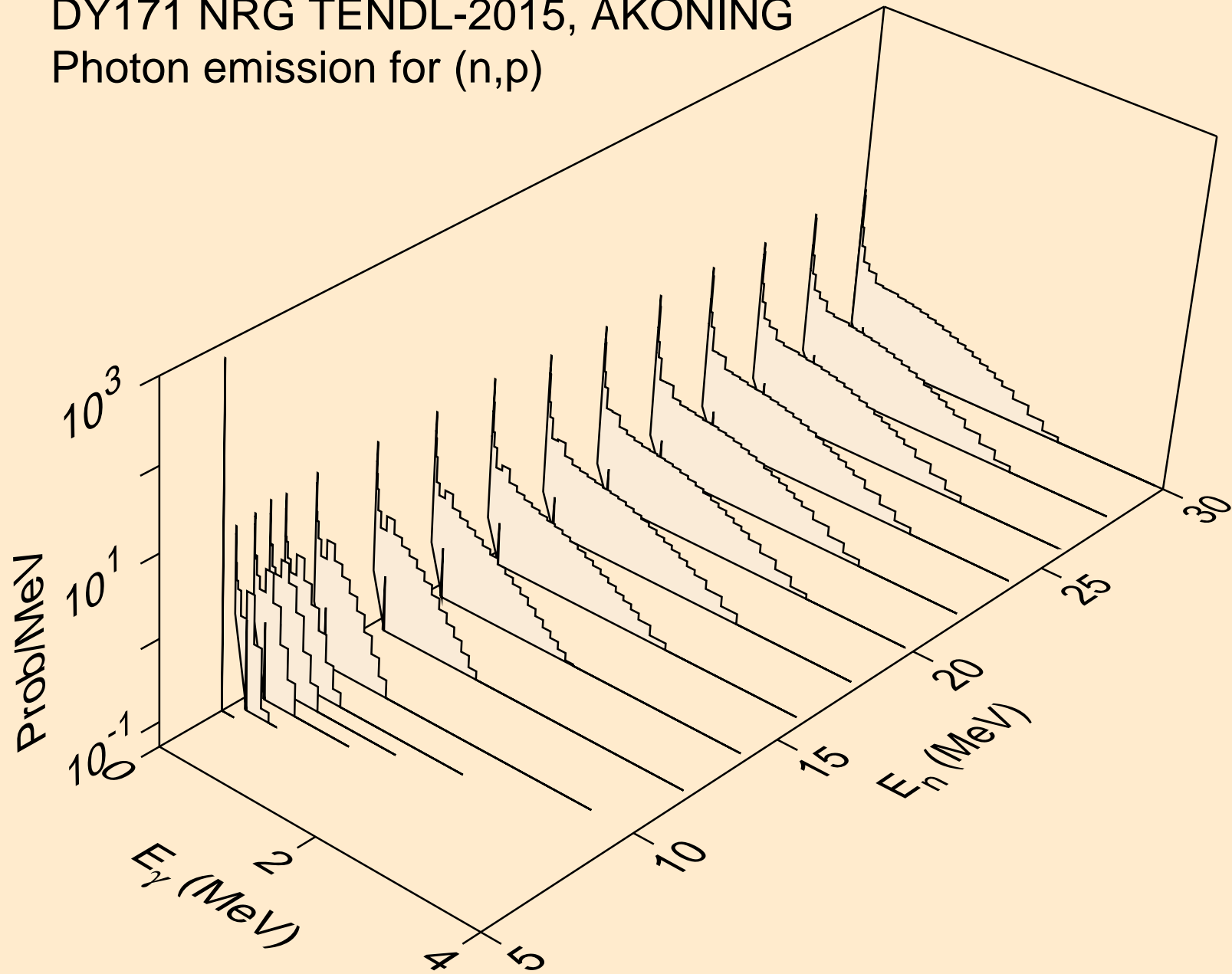

DY171 NRG TENDL-2015, AKONING  
Photon emission for (n,d)

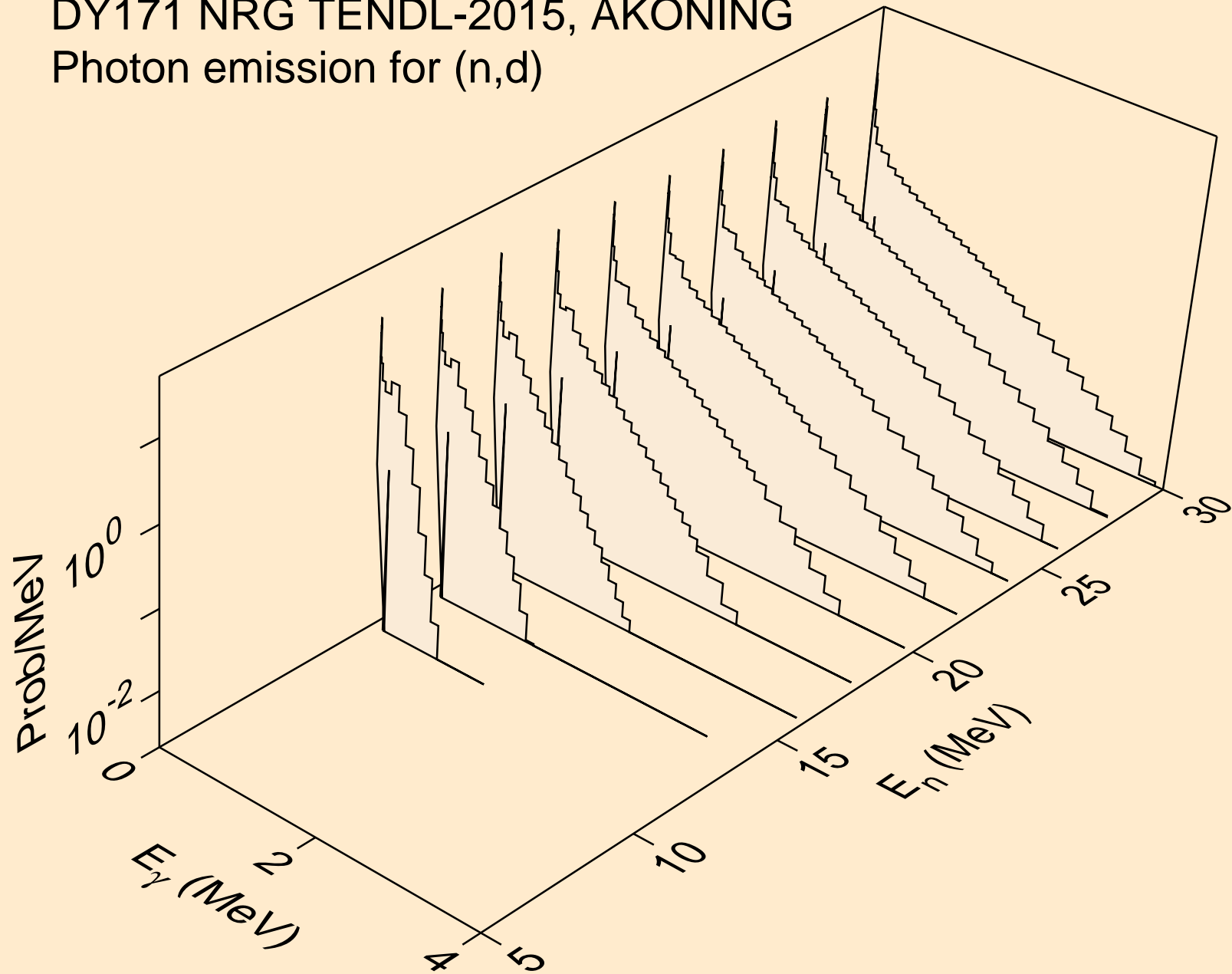

DY171 NRG TENDL-2015, AKONING  
Photon emission for (n,t)

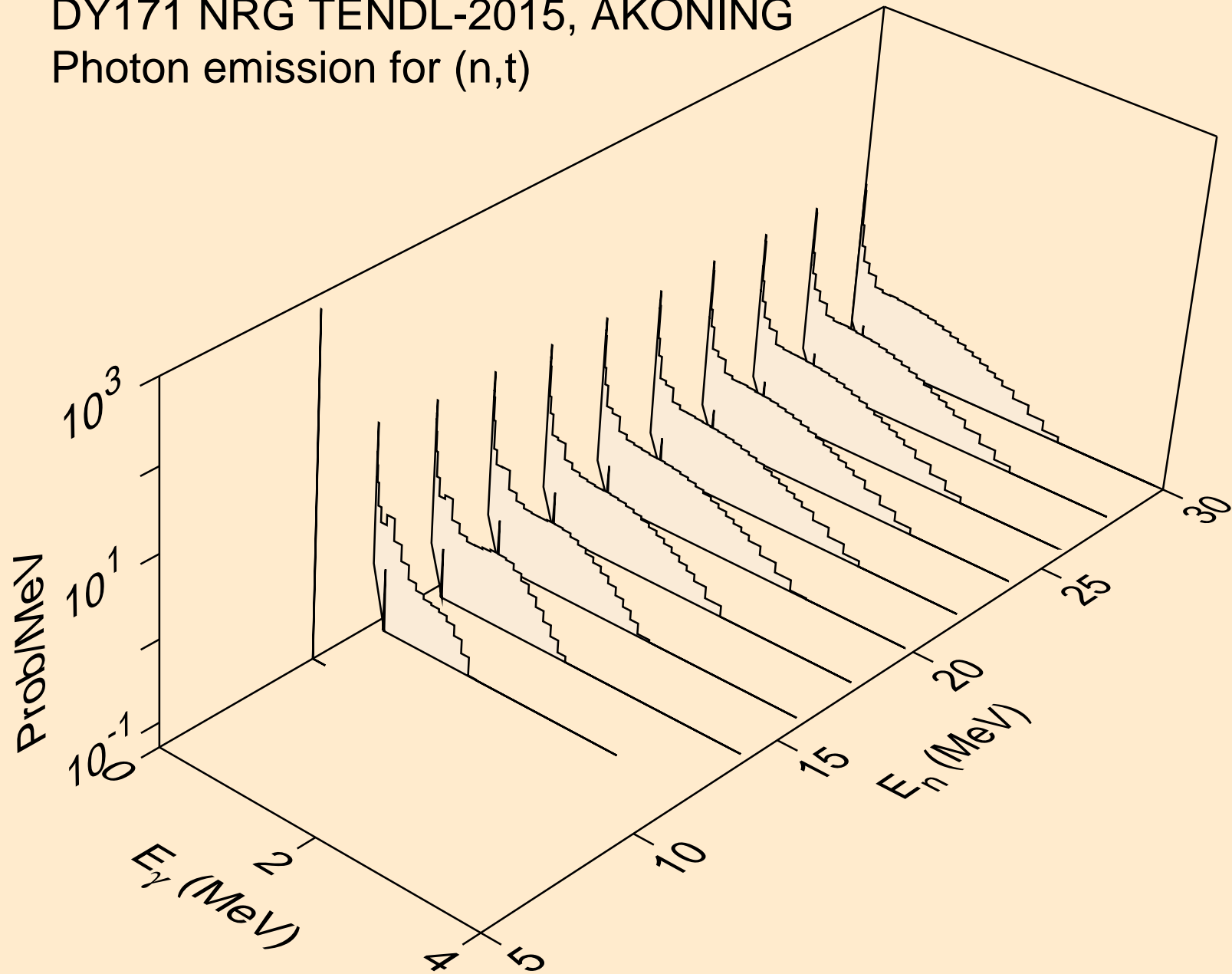

DY171 NRG TENDL-2015, AKONING  
Photon emission for (n,he3)

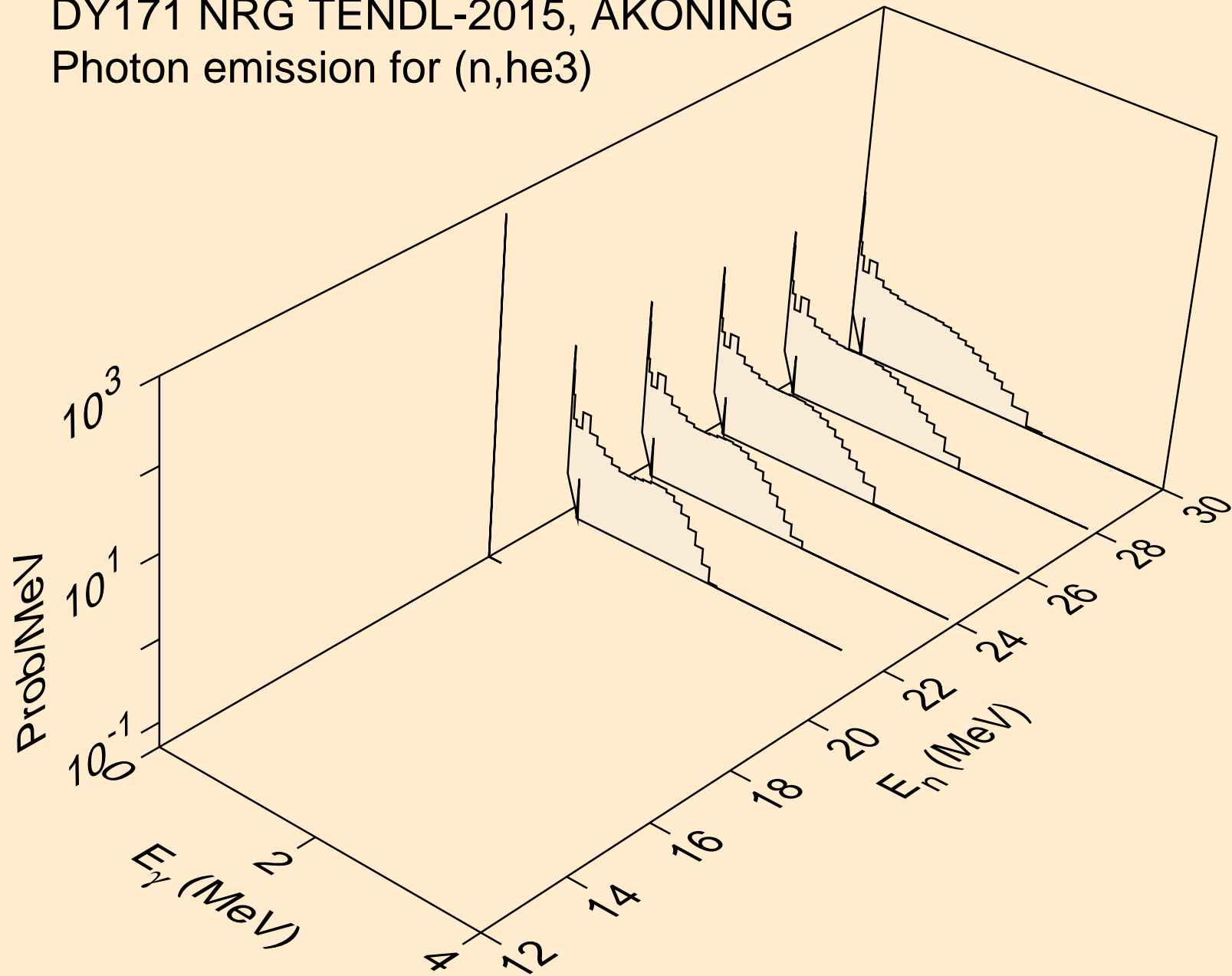



DY171 NRG TENDL-2015, AKONING  
Photon emission for (n,a)

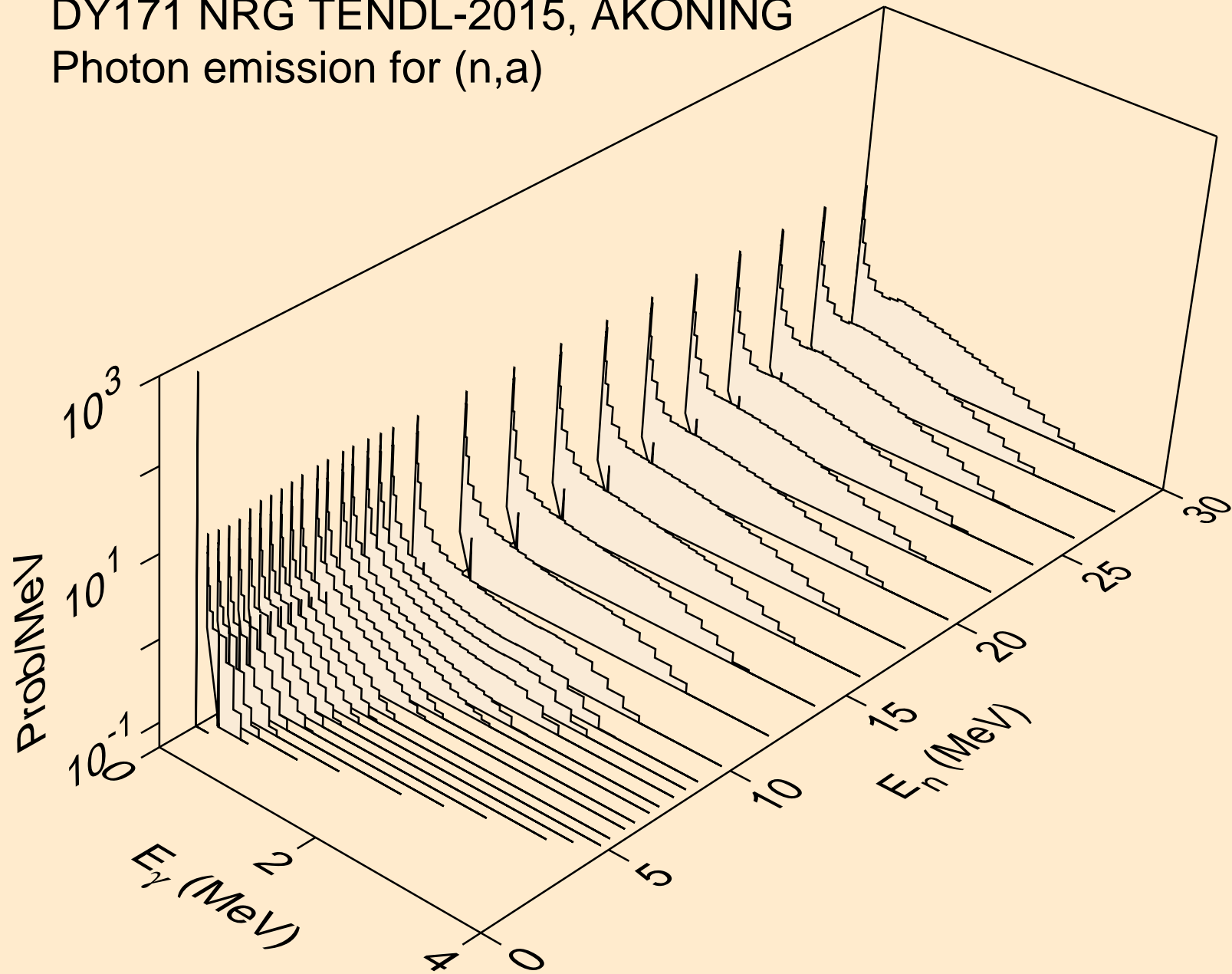

DY171 NRG TENDL-2015, AKONING  
Photon emission for (n,2p)

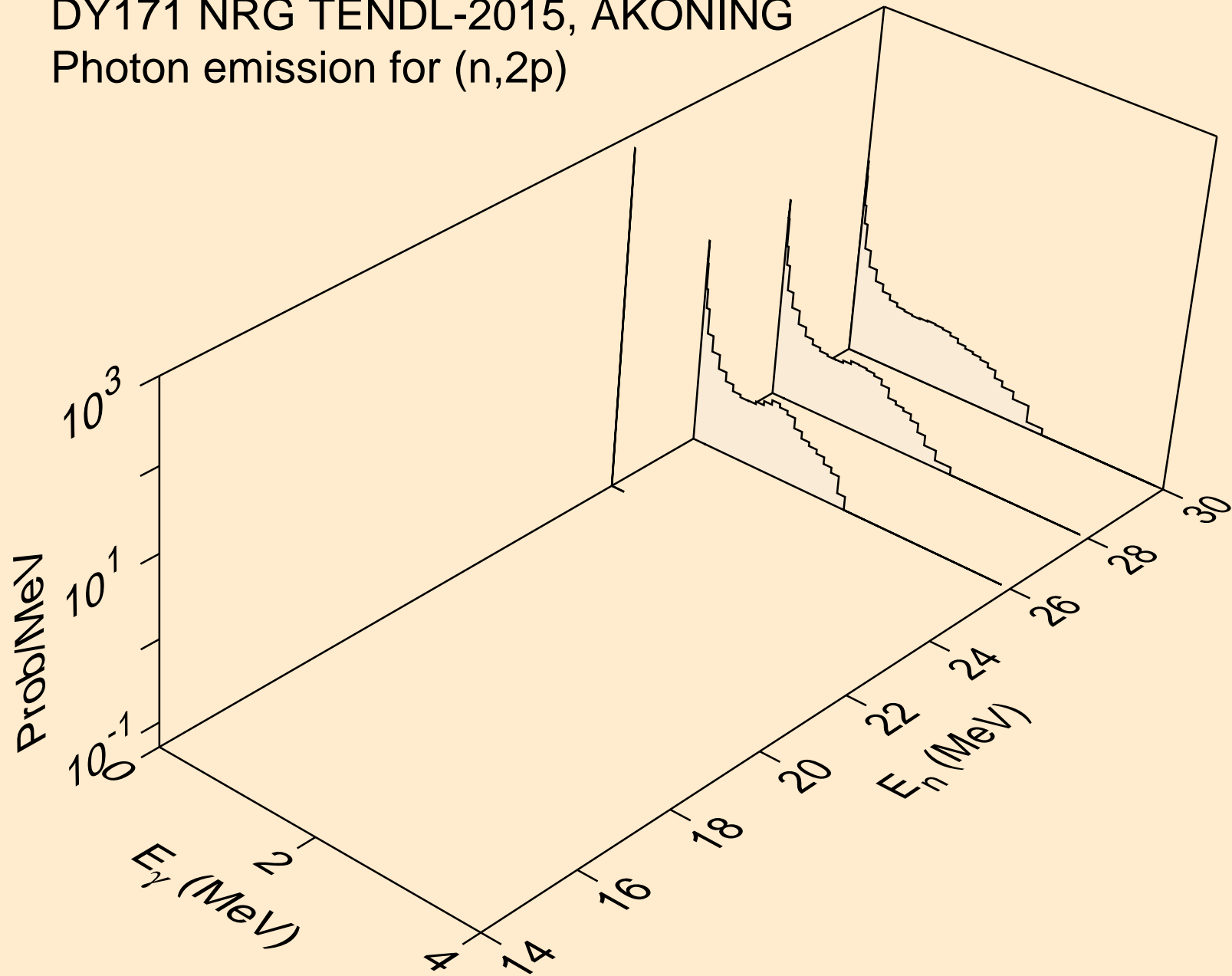

DY171 NRG TENDL-2015, AKONING  
thermal capture photon spectrum

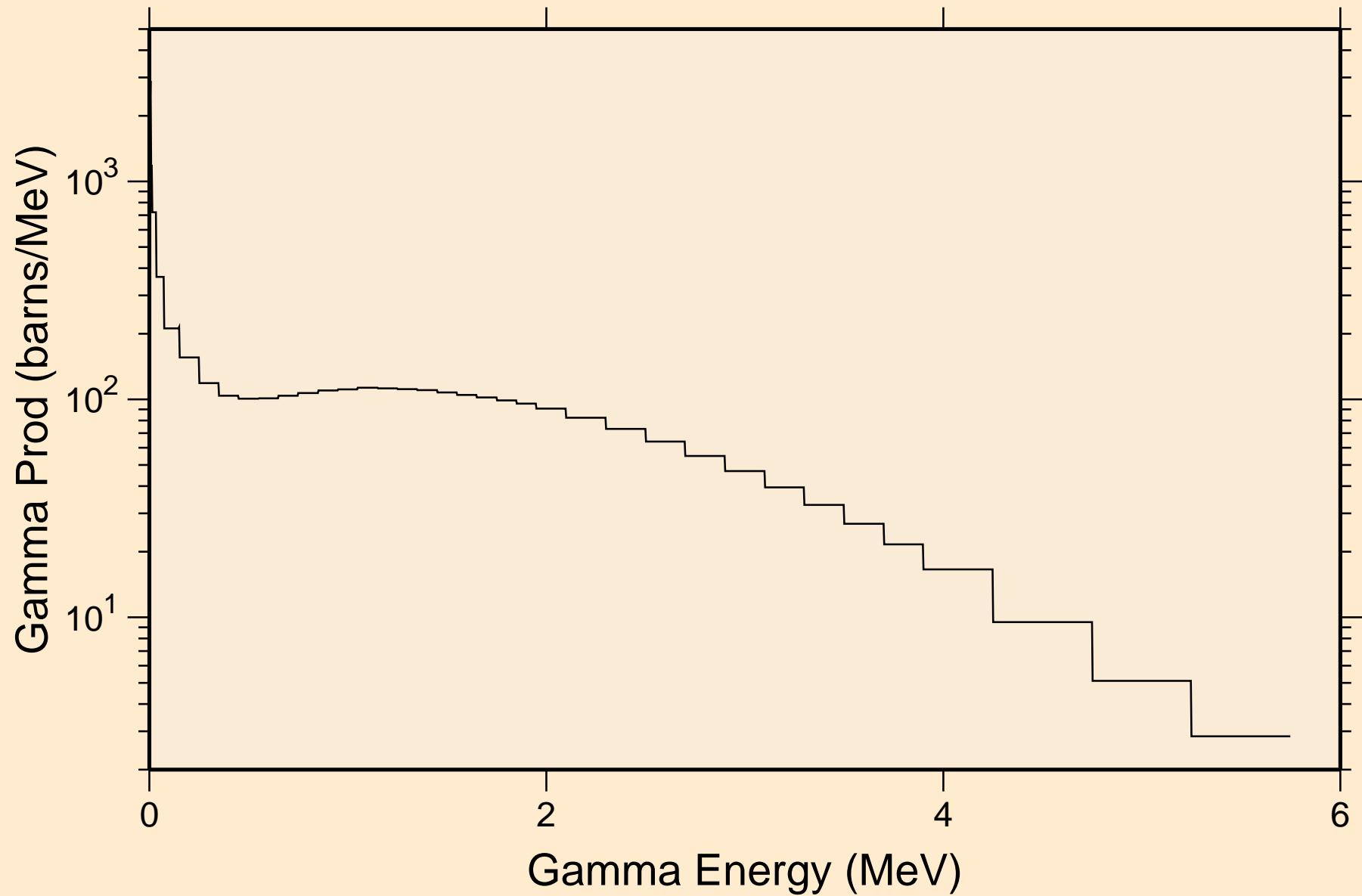

DY171 NRG TENDL-2015, AKONING  
14 MeV photon spectrum

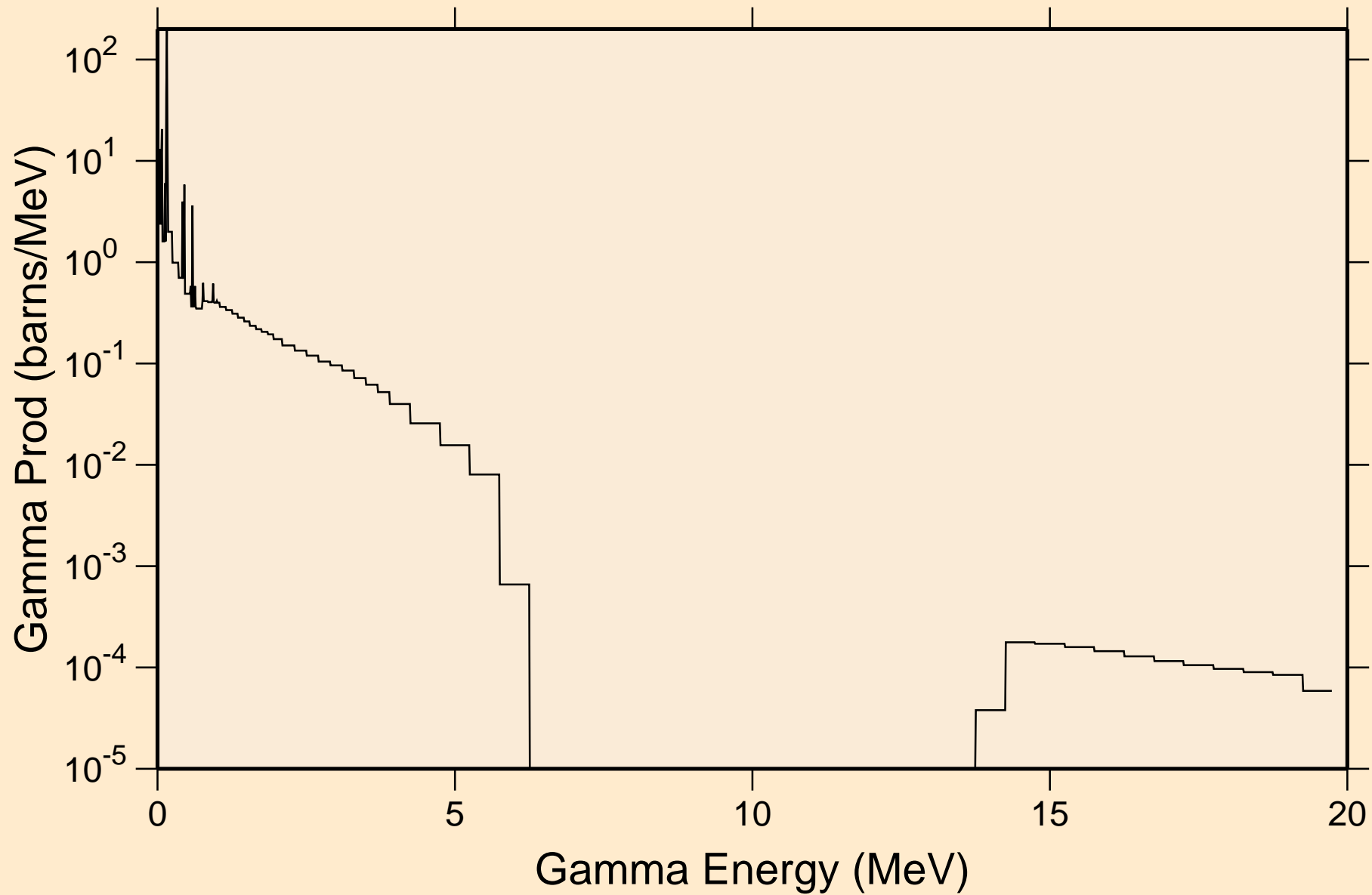

# DY171 NRG TENDL-2015, AKONING

## Particle heating contributions

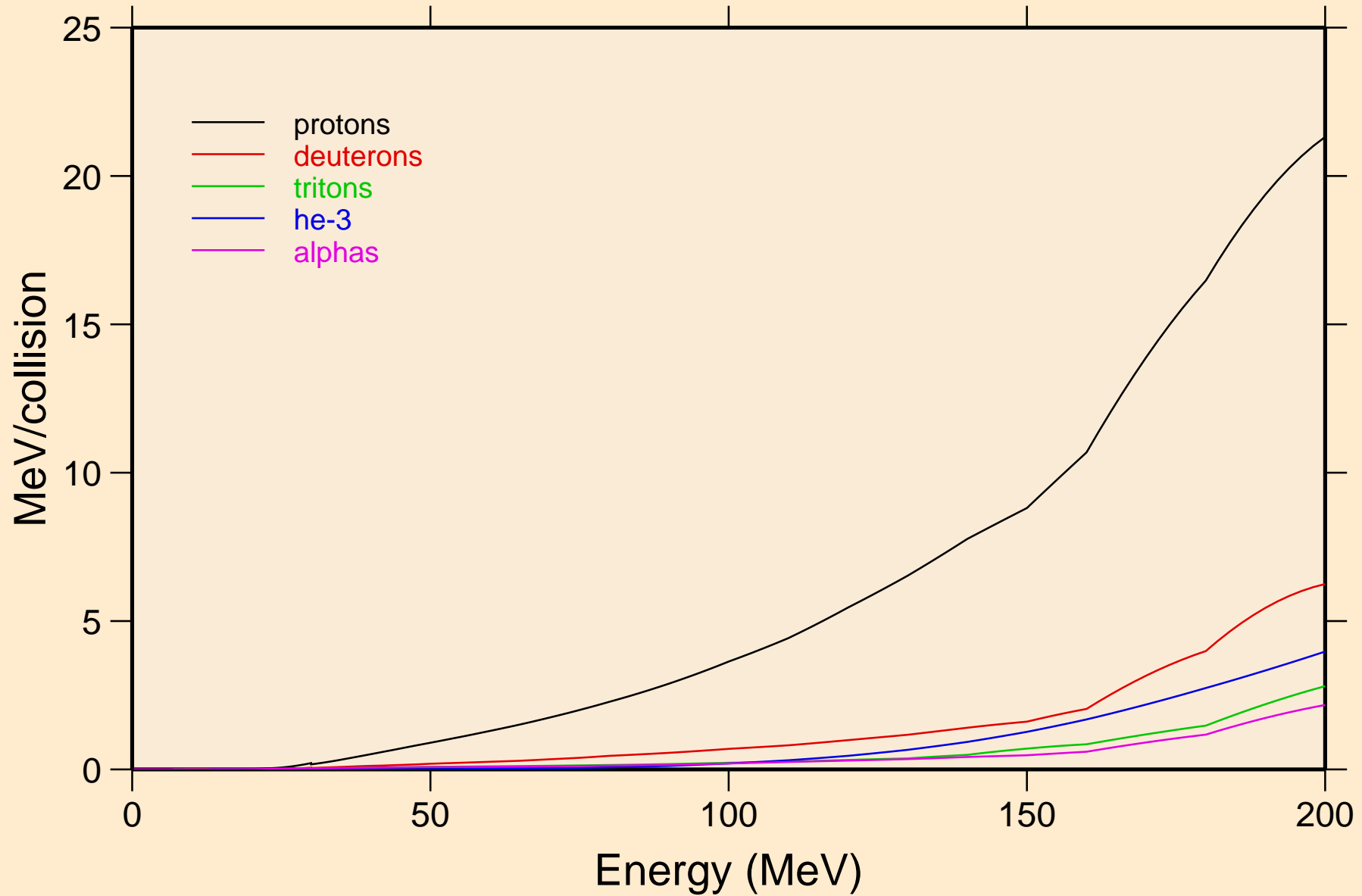

# DY171 NRG TENDL-2015, AKONING

## Recoil Heating

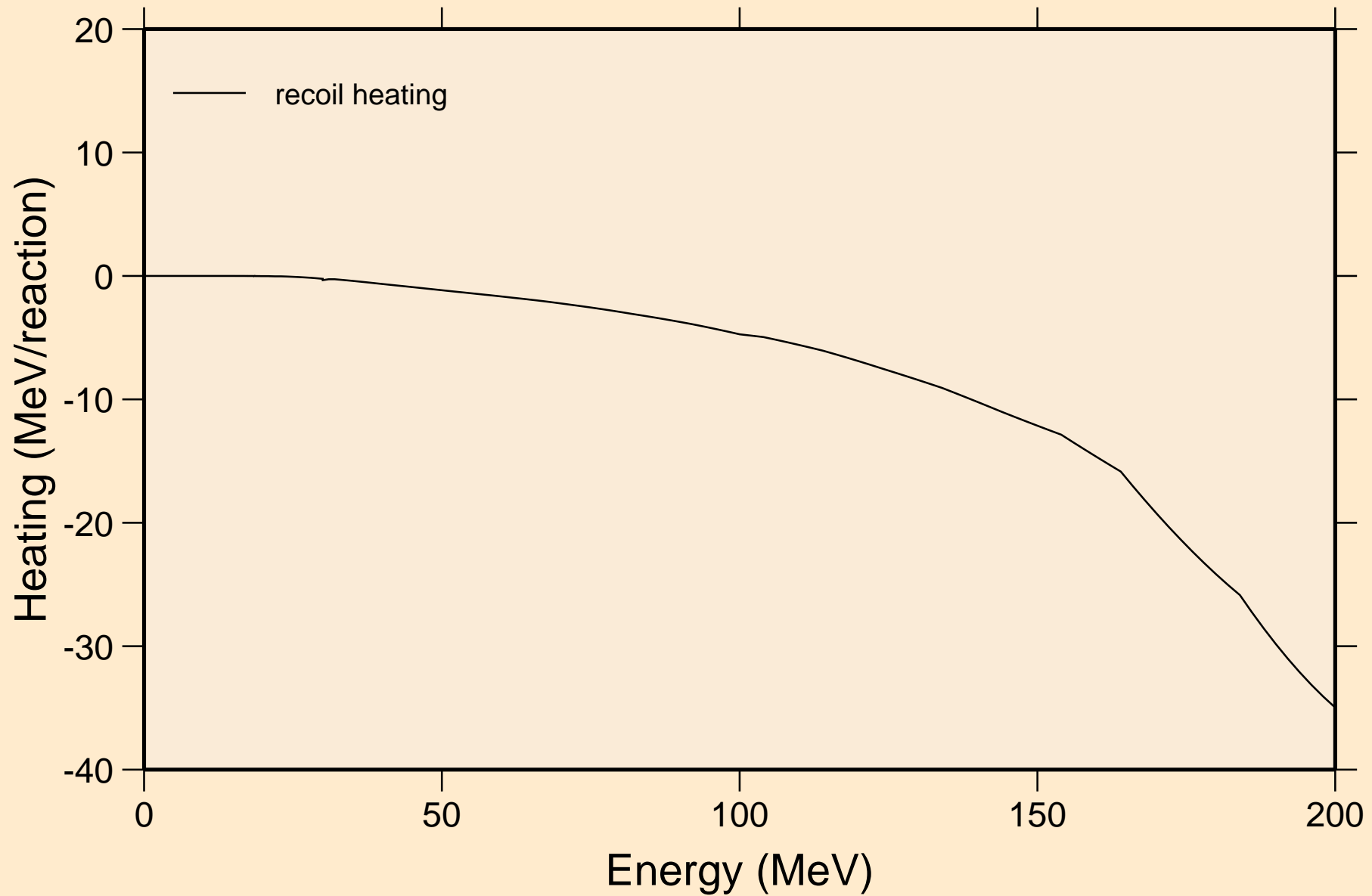

# DY171 NRG TENDL-2015, AKONING

## Particle production cross sections

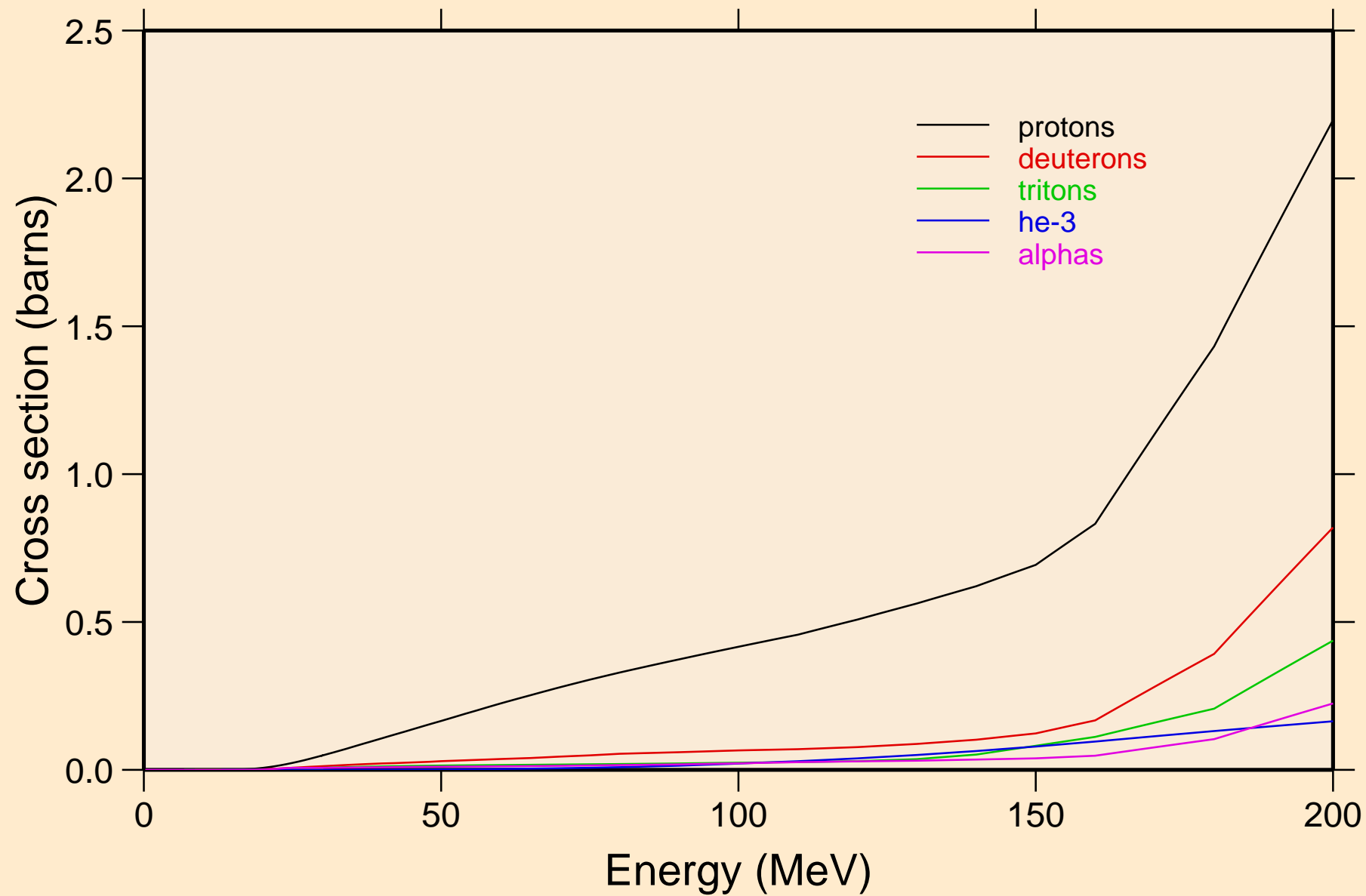

DY171 NRG TENDL-2015, AKONING  
protons from (n,x)

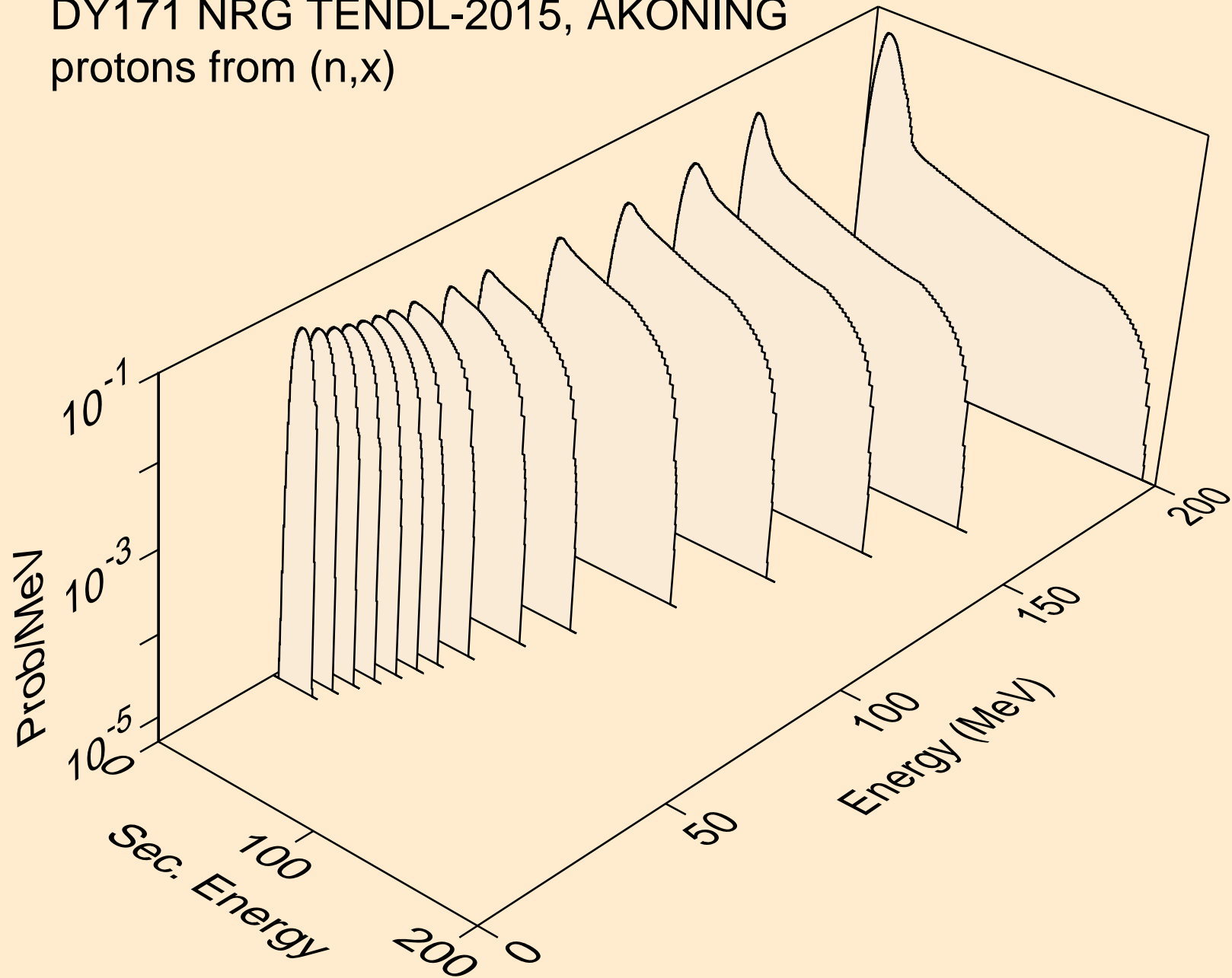



DY171 NRG TENDL-2015, AKONING  
protons from (n,n\*)p

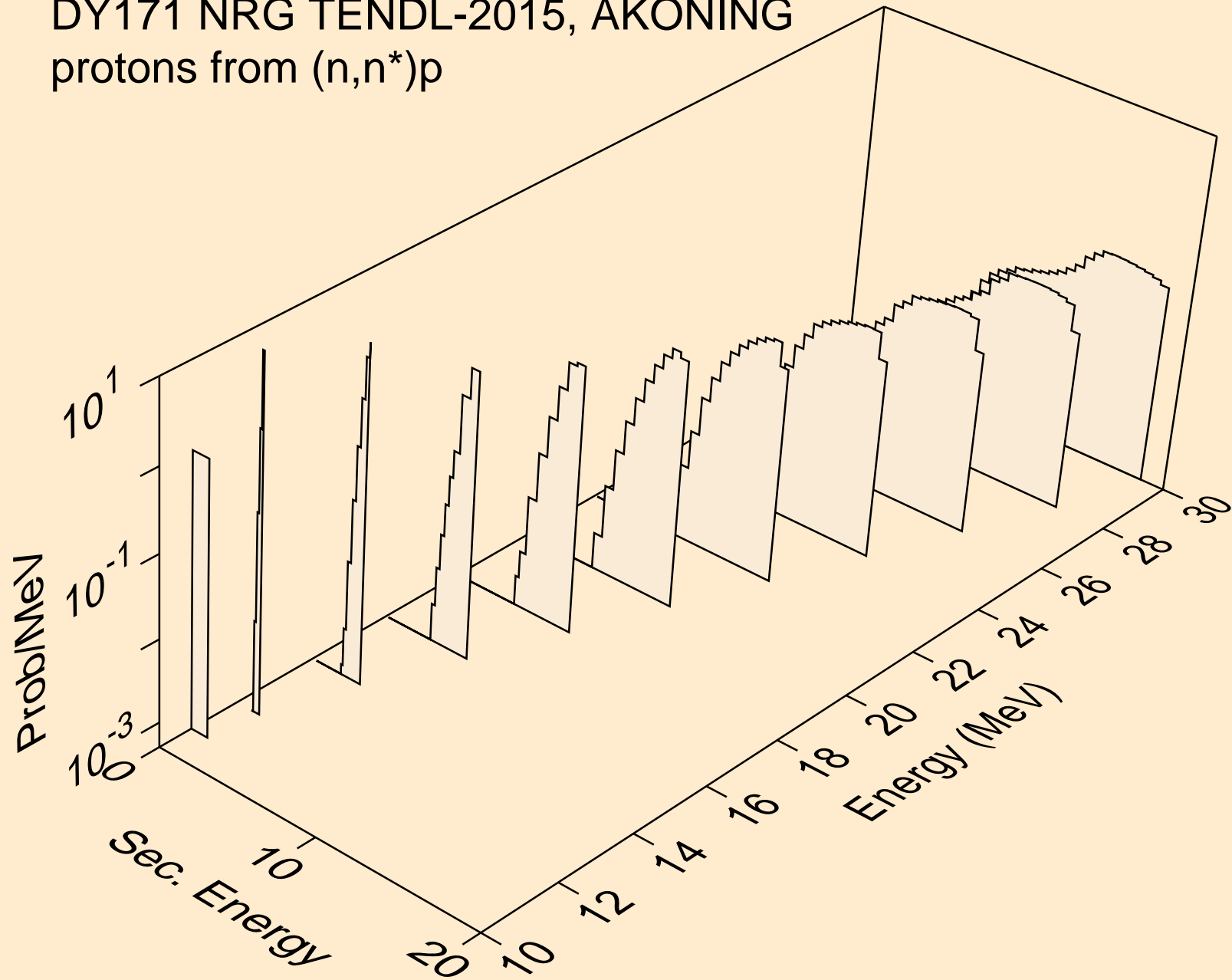

DY171 NRG TENDL-2015, AKONING  
protons from (n,2np)

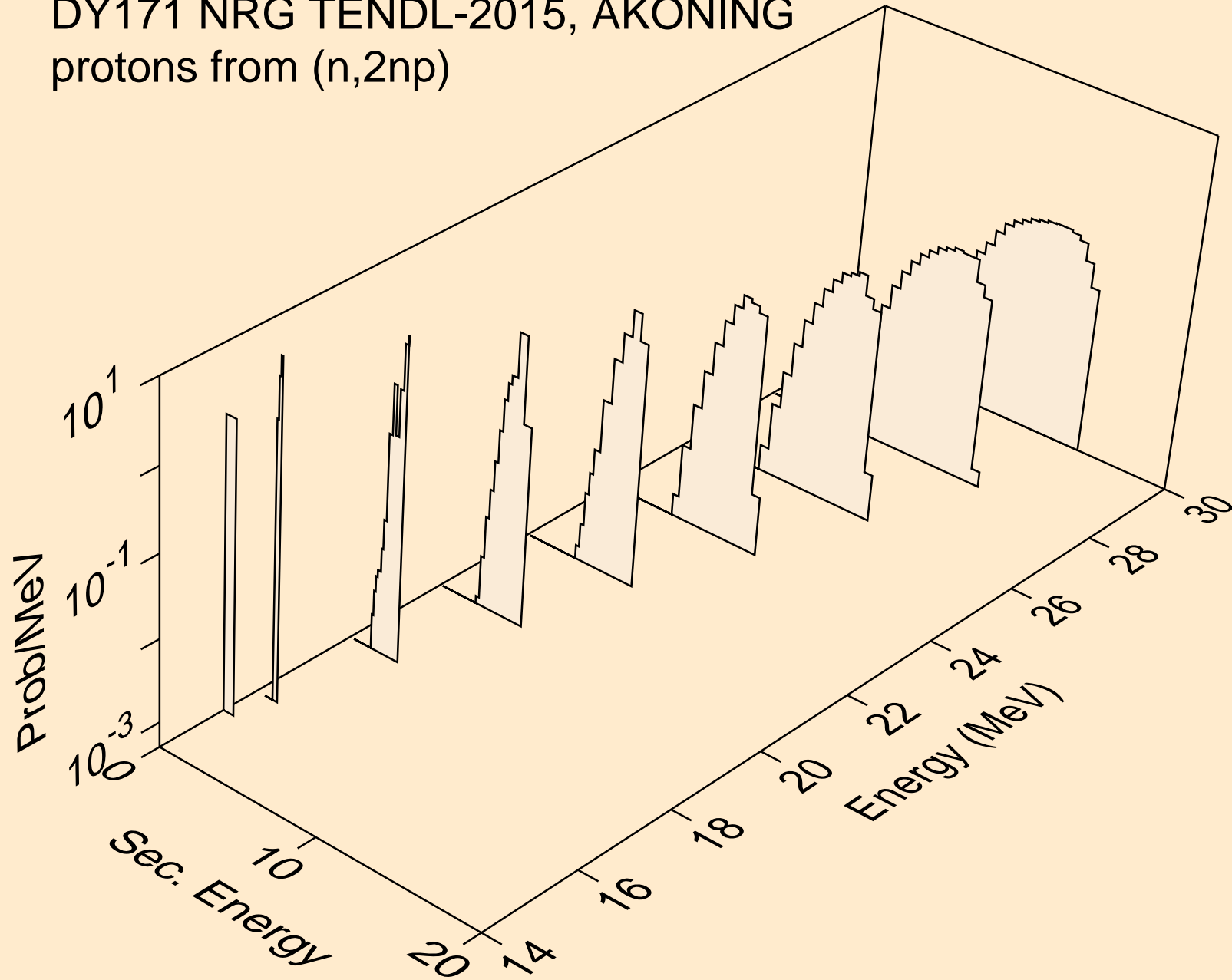

DY171 NRG TENDL-2015, AKONING  
protons from (n,3np)

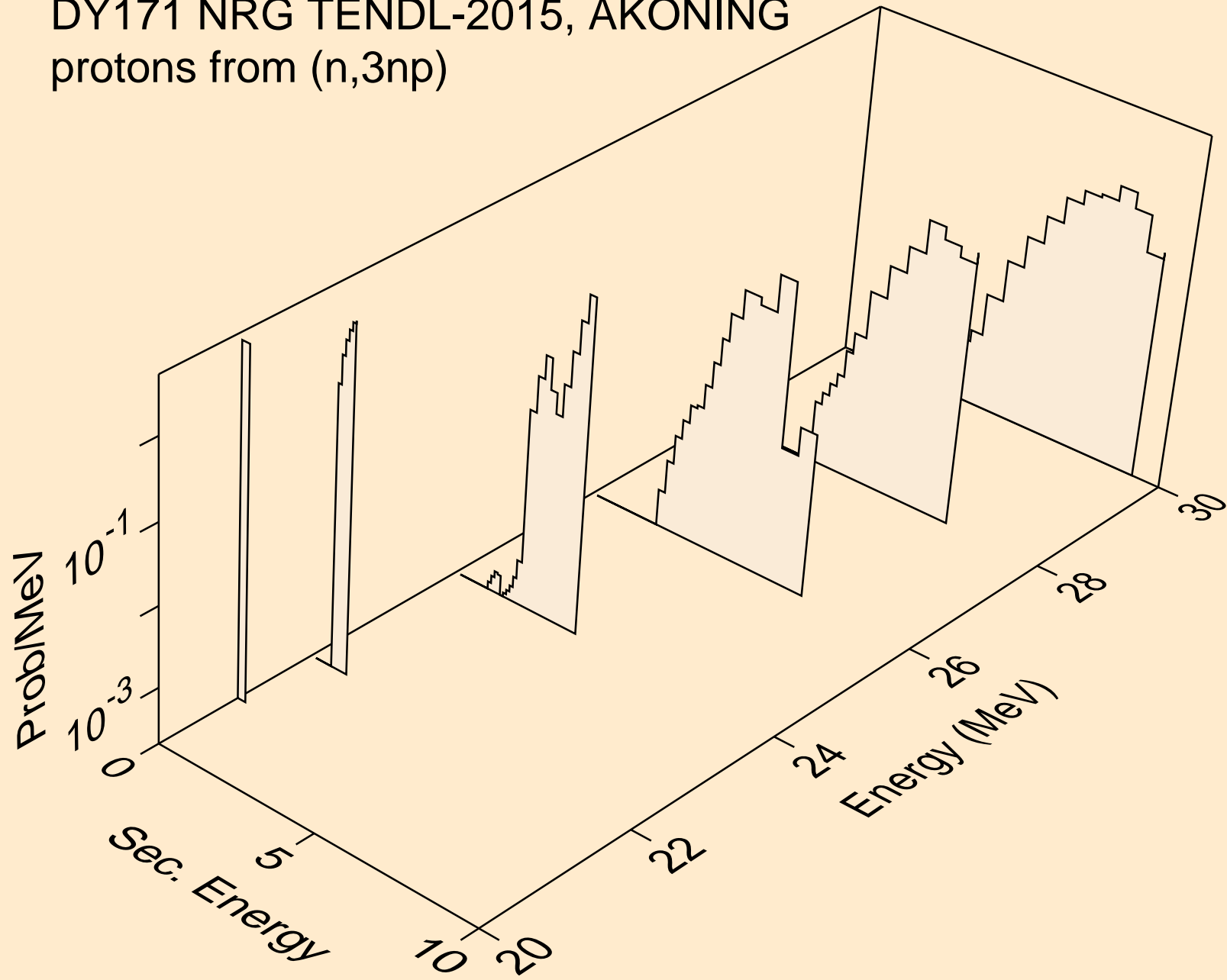

DY171 NRG TENDL-2015, AKONING  
protons from (n,p)

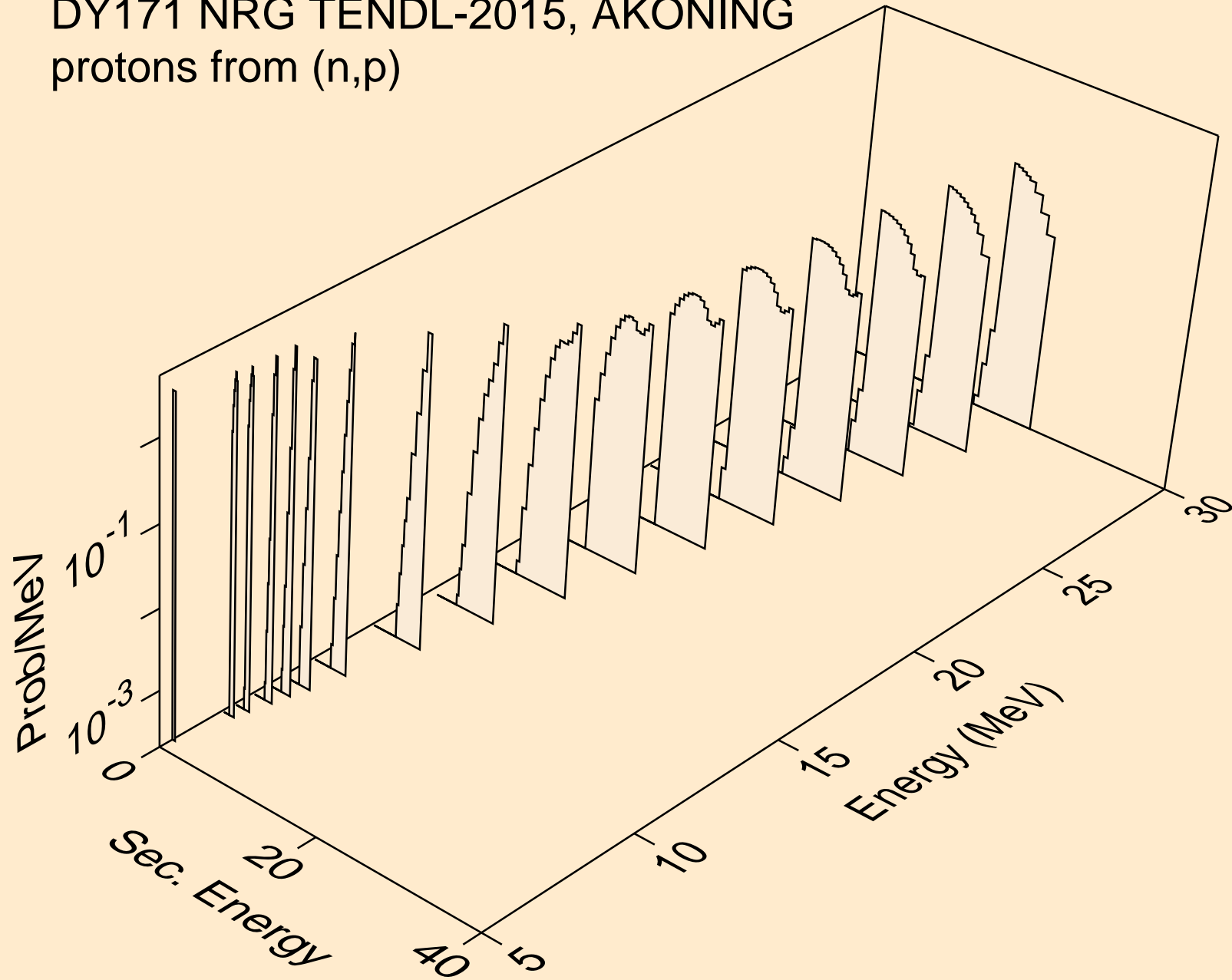

DY171 NRG TENDL-2015, AKONING  
protons from (n,2p)

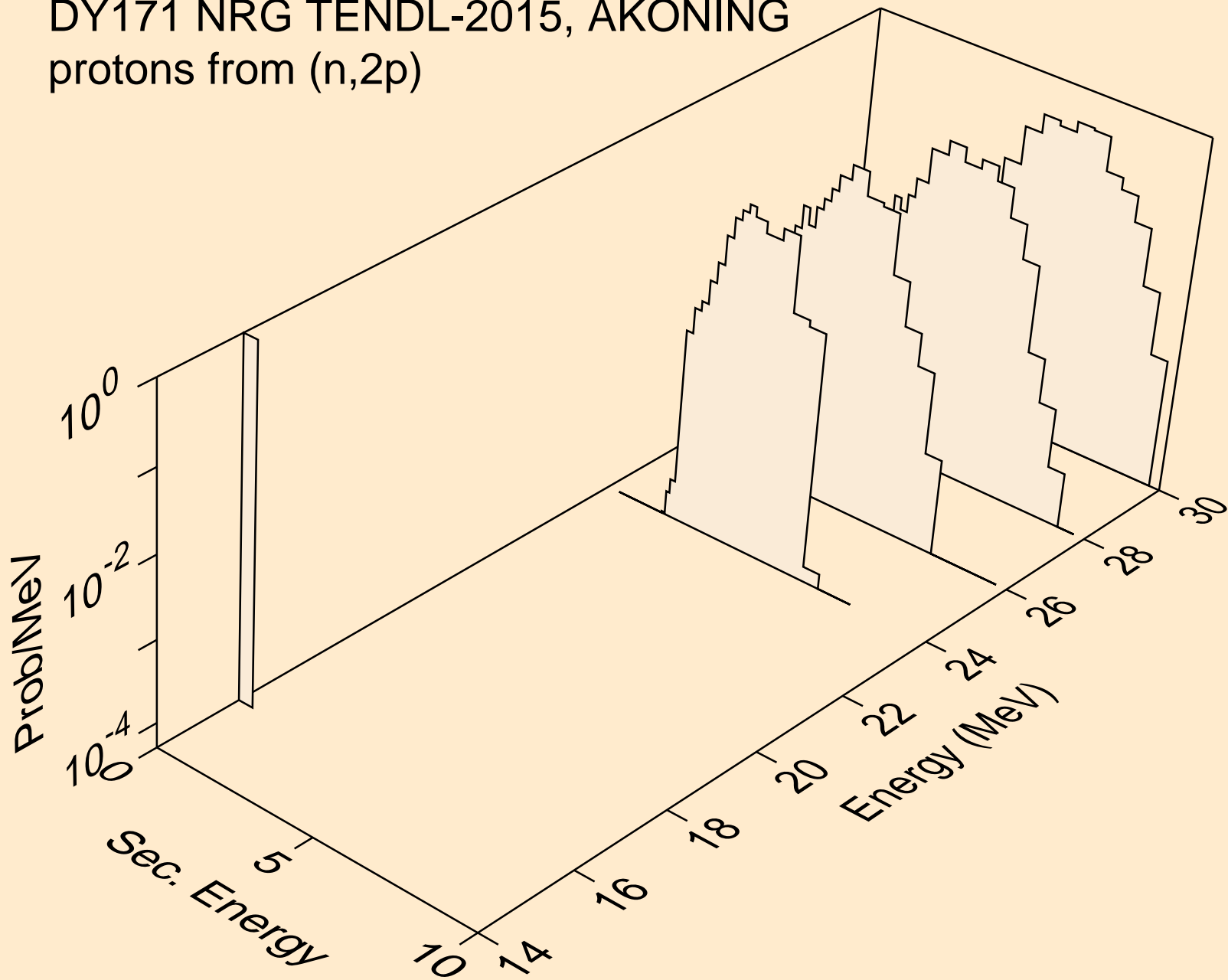

DY171 NRG TENDL-2015, AKONING  
deuterons from (n,x)

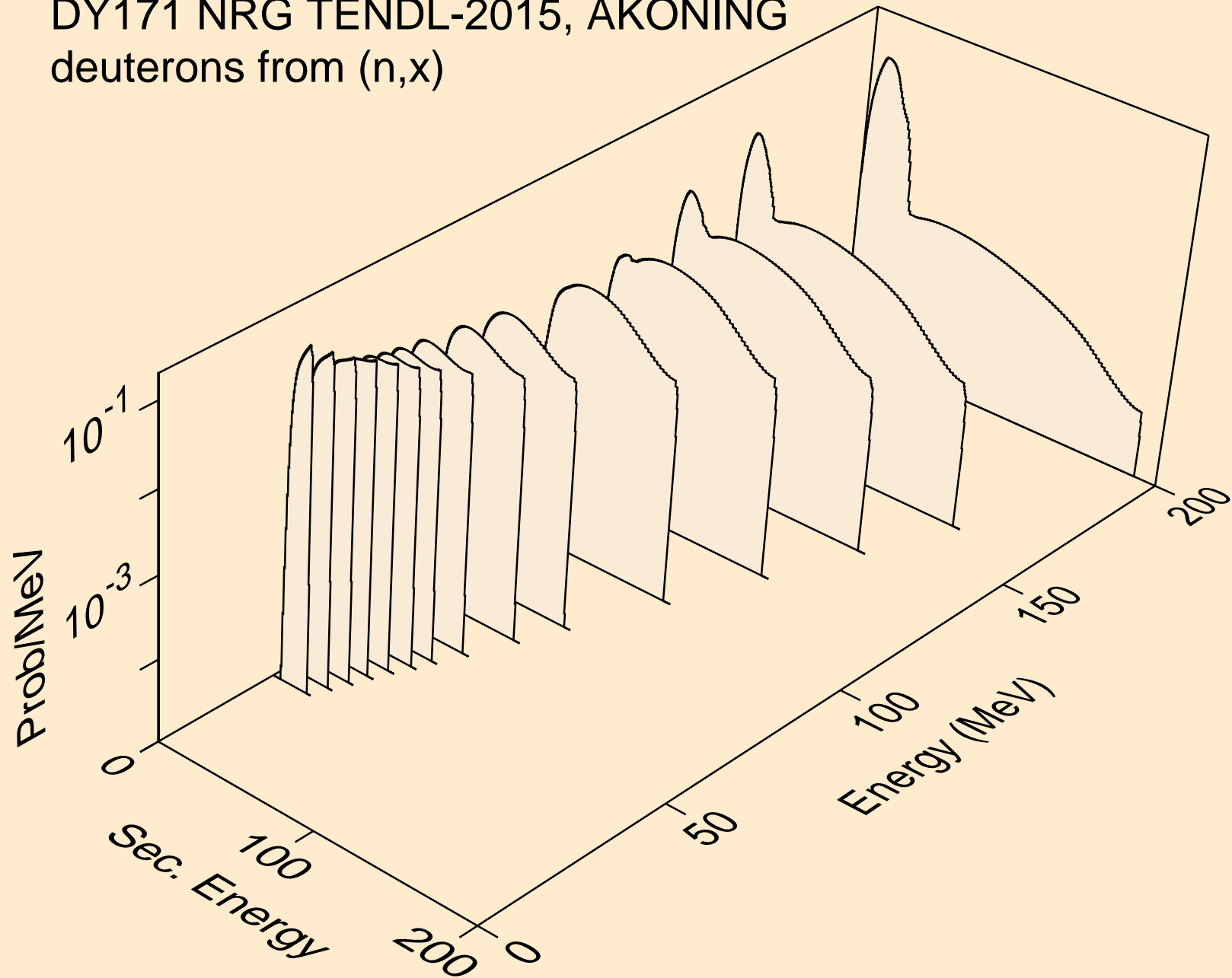

DY171 NRG TENDL-2015, AKONING  
deuterons from (n,2nd)

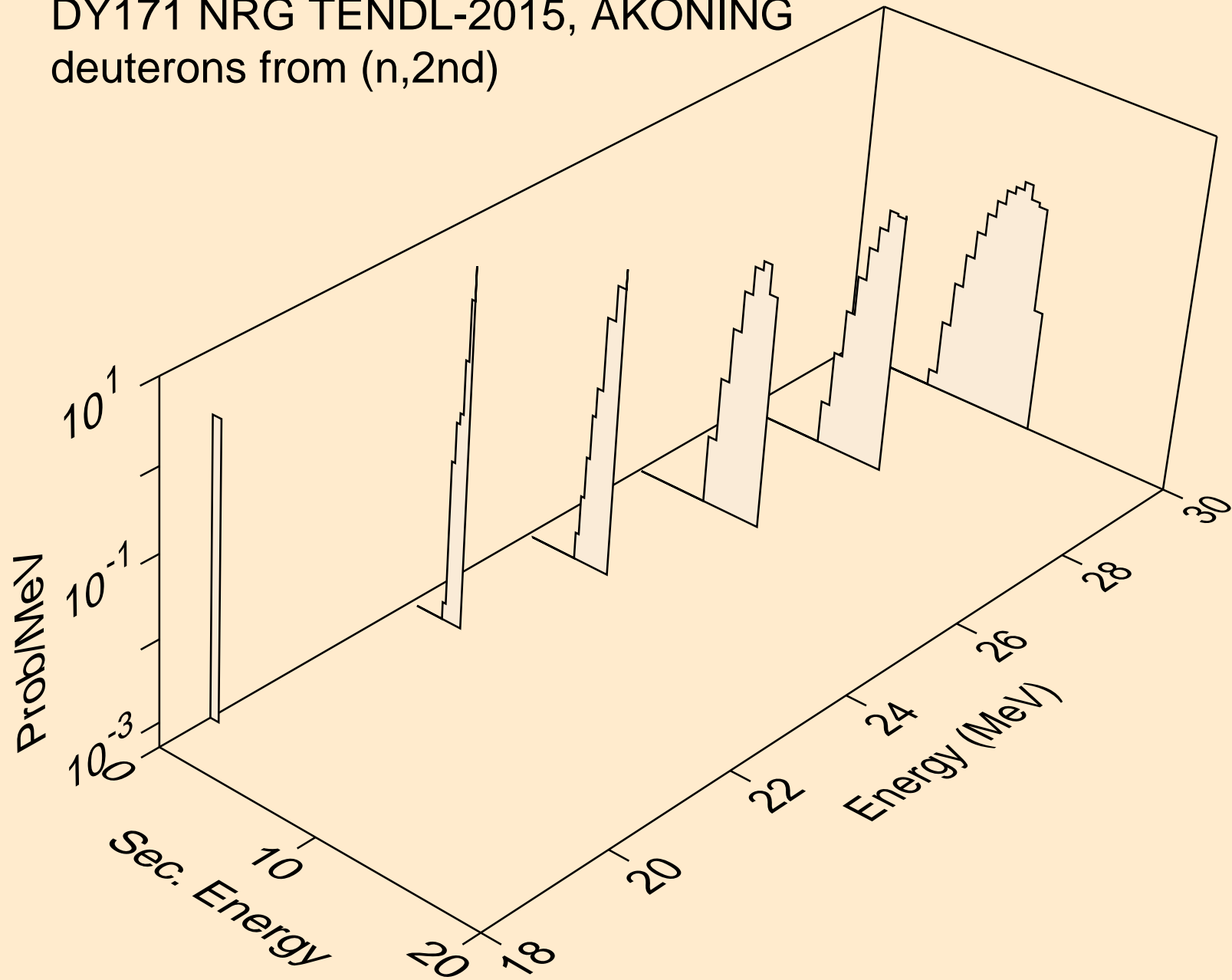

DY171 NRG TENDL-2015, AKONING  
deuterons from (n,n\*)d

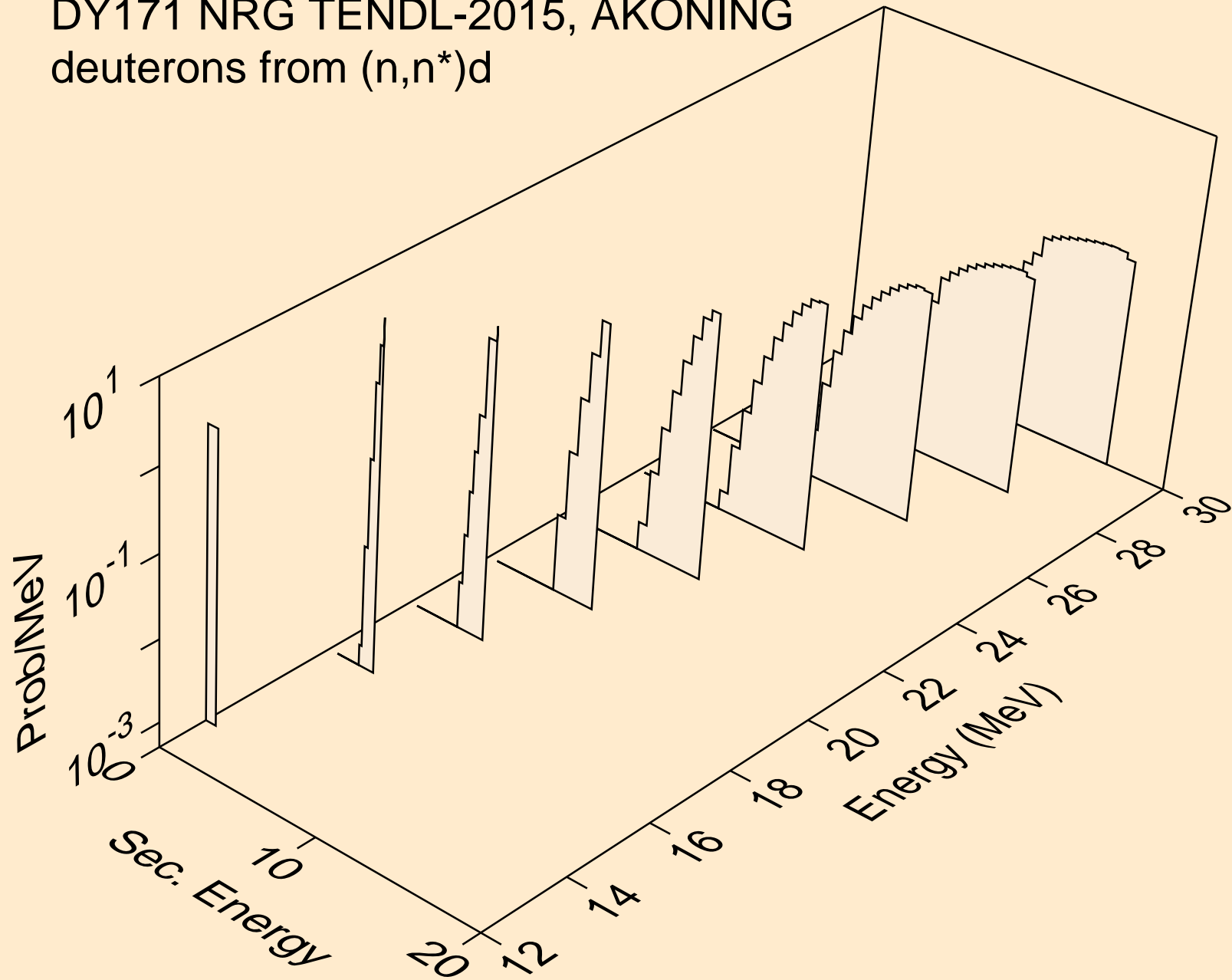



DY171 NRG TENDL-2015, AKONING  
deuterons from (n,d)

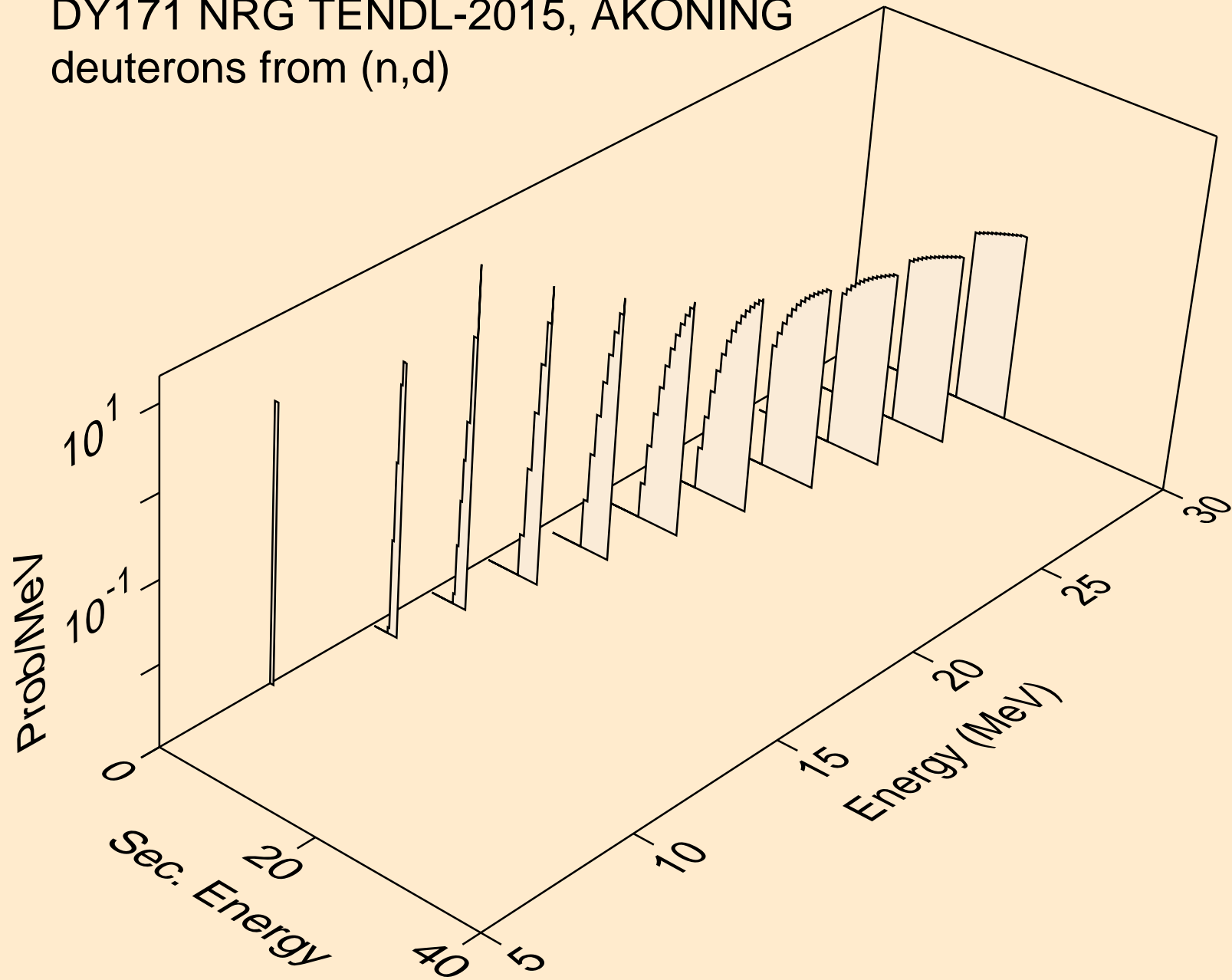

DY171 NRG TENDL-2015, AKONING  
tritons from (n,x)

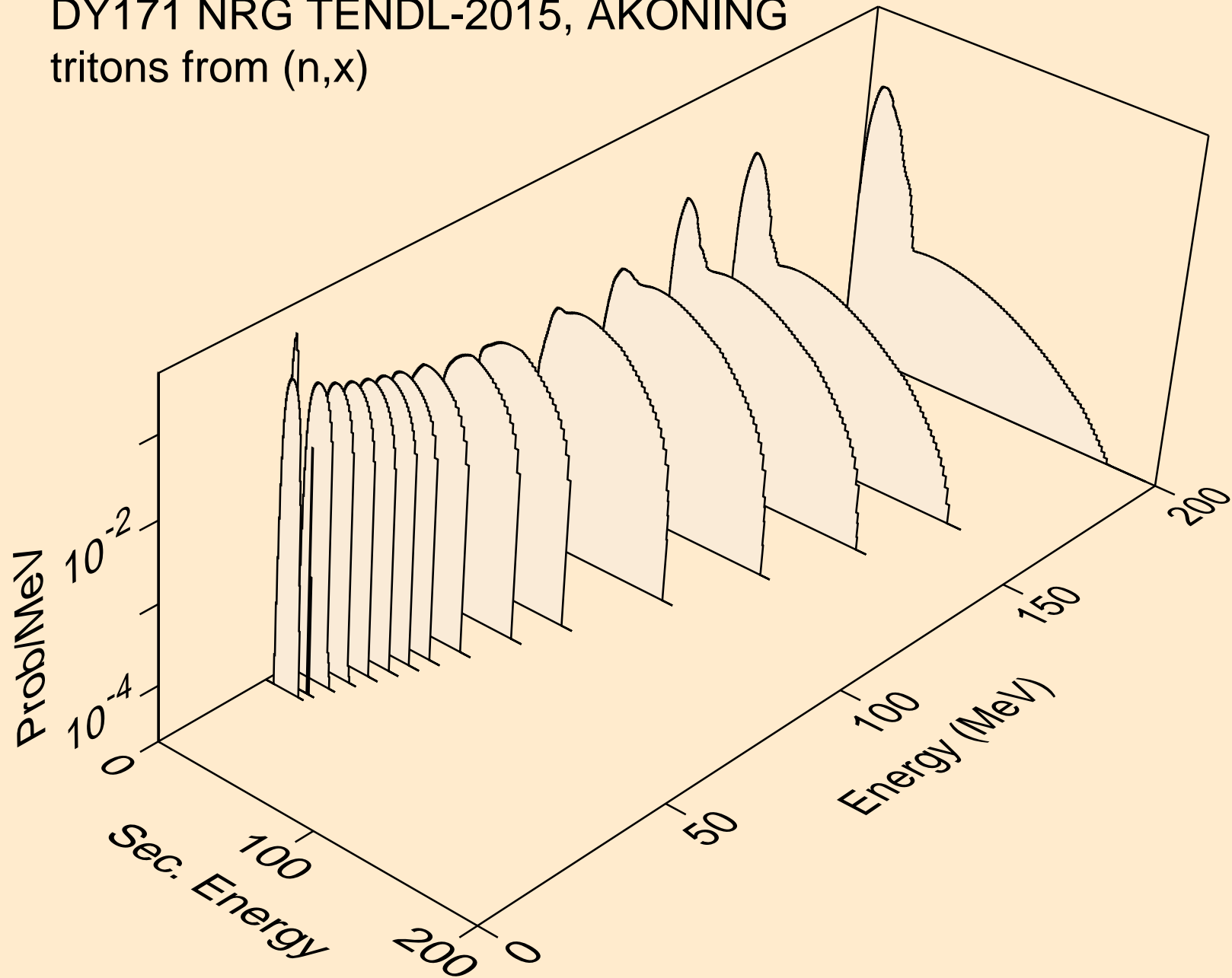

DY171 NRG TENDL-2015, AKONING  
tritons from (n,n\*)t

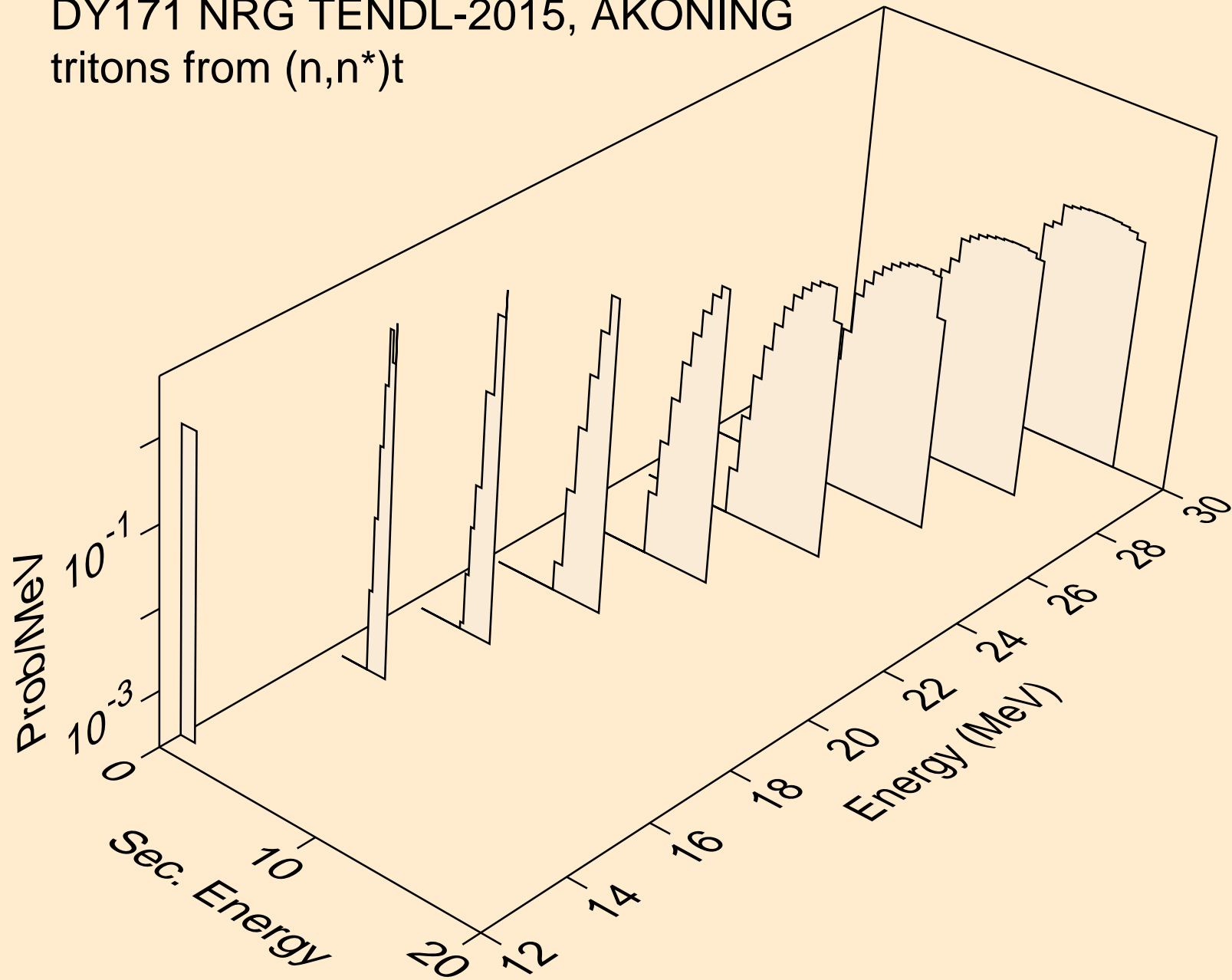

DY171 NRG TENDL-2015, AKONING  
tritons from (n,t)

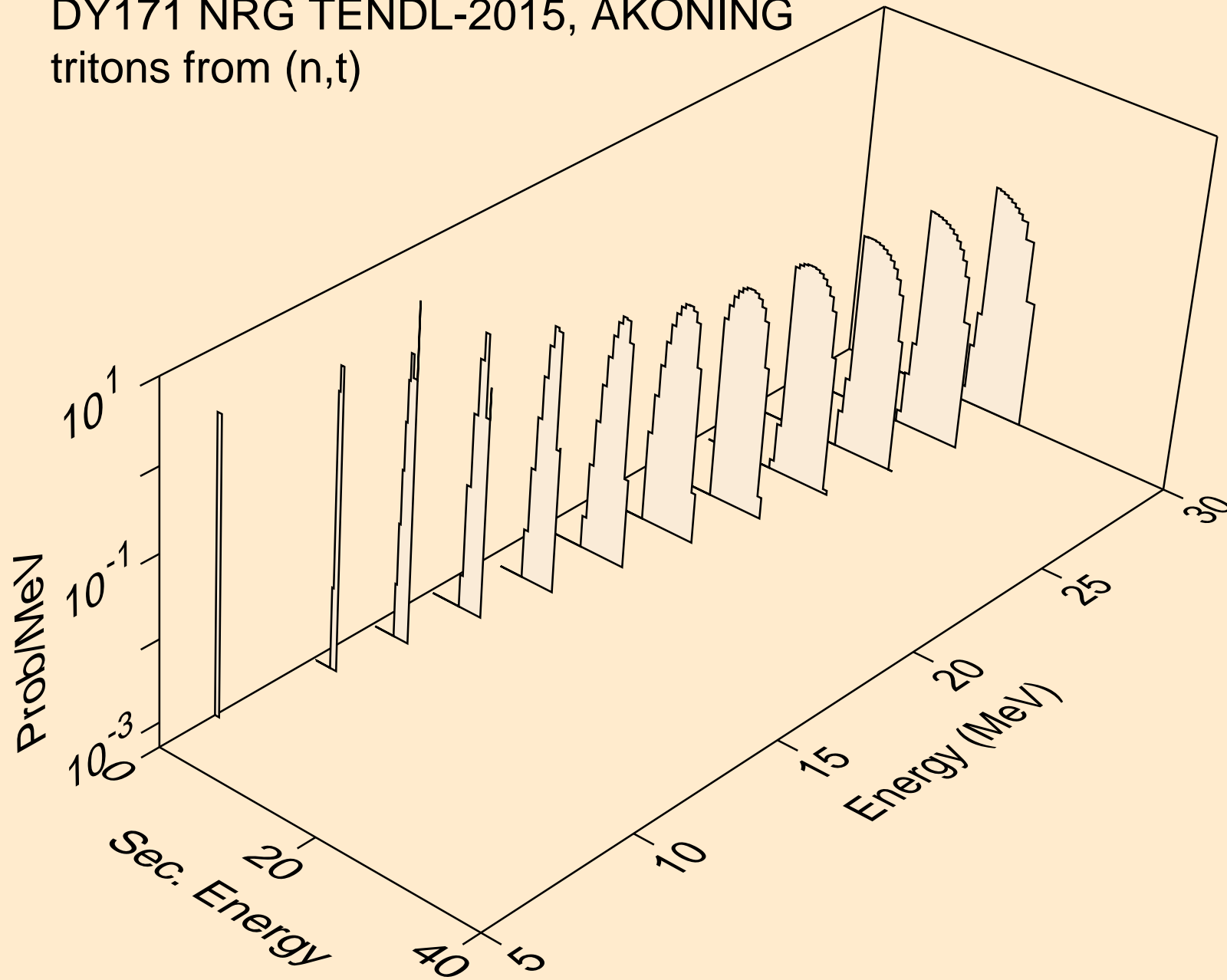

DY171 NRG TENDL-2015, AKONING  
he3s from (n,x)

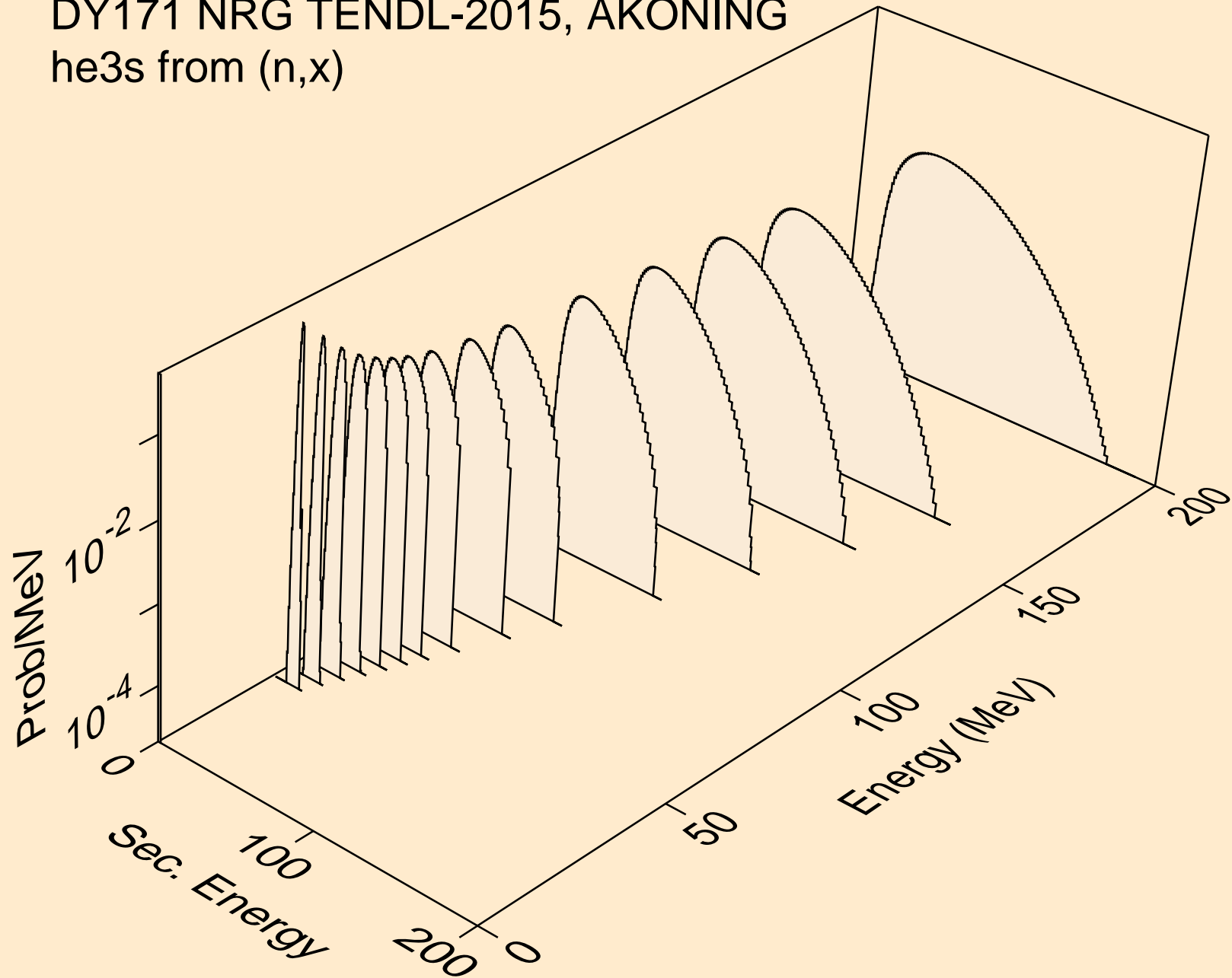

DY171 NRG TENDL-2015, AKONING  
he3s from (n,n\*)he3

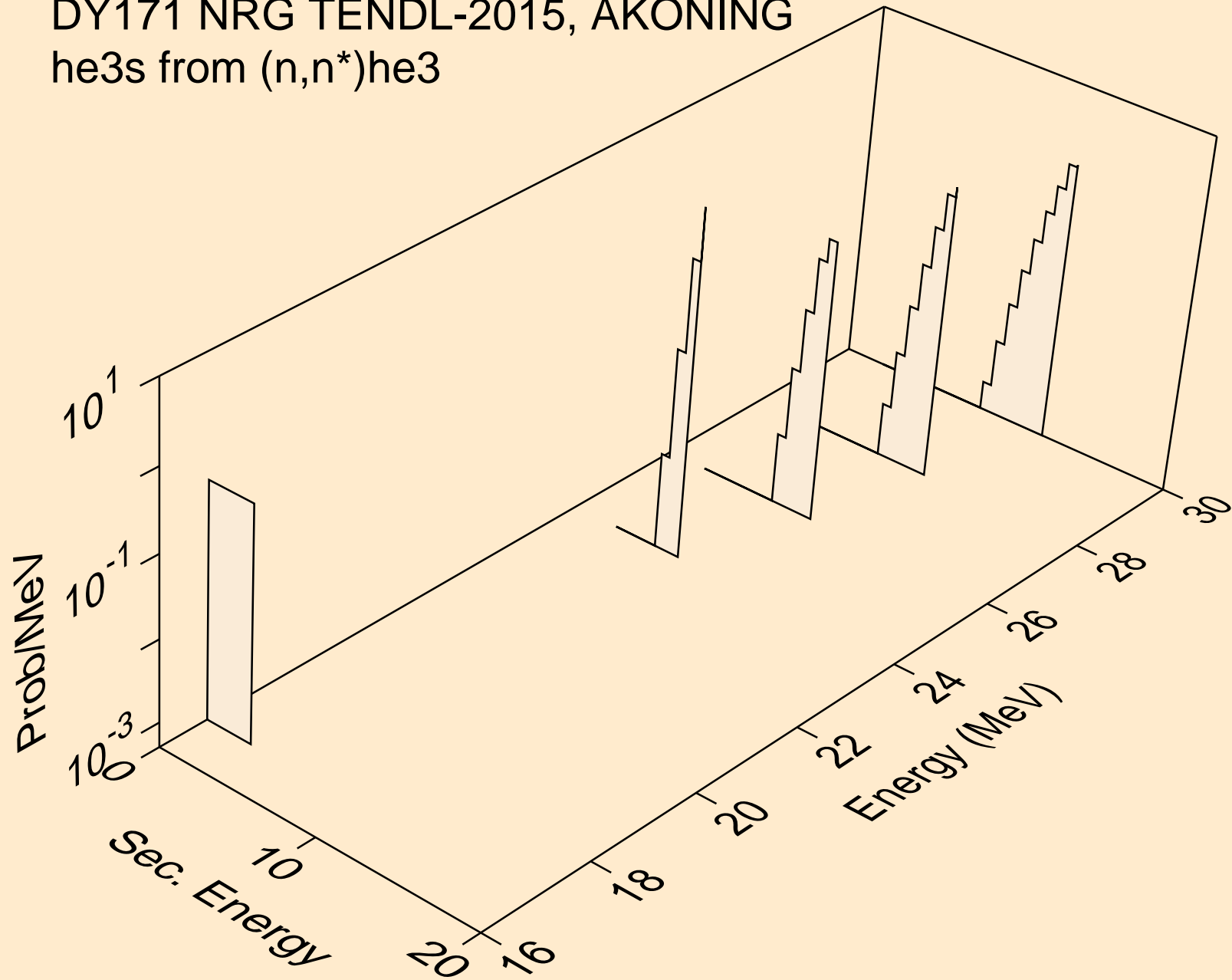

DY171 NRG TENDL-2015, AKONING  
he3s from (n,he3)

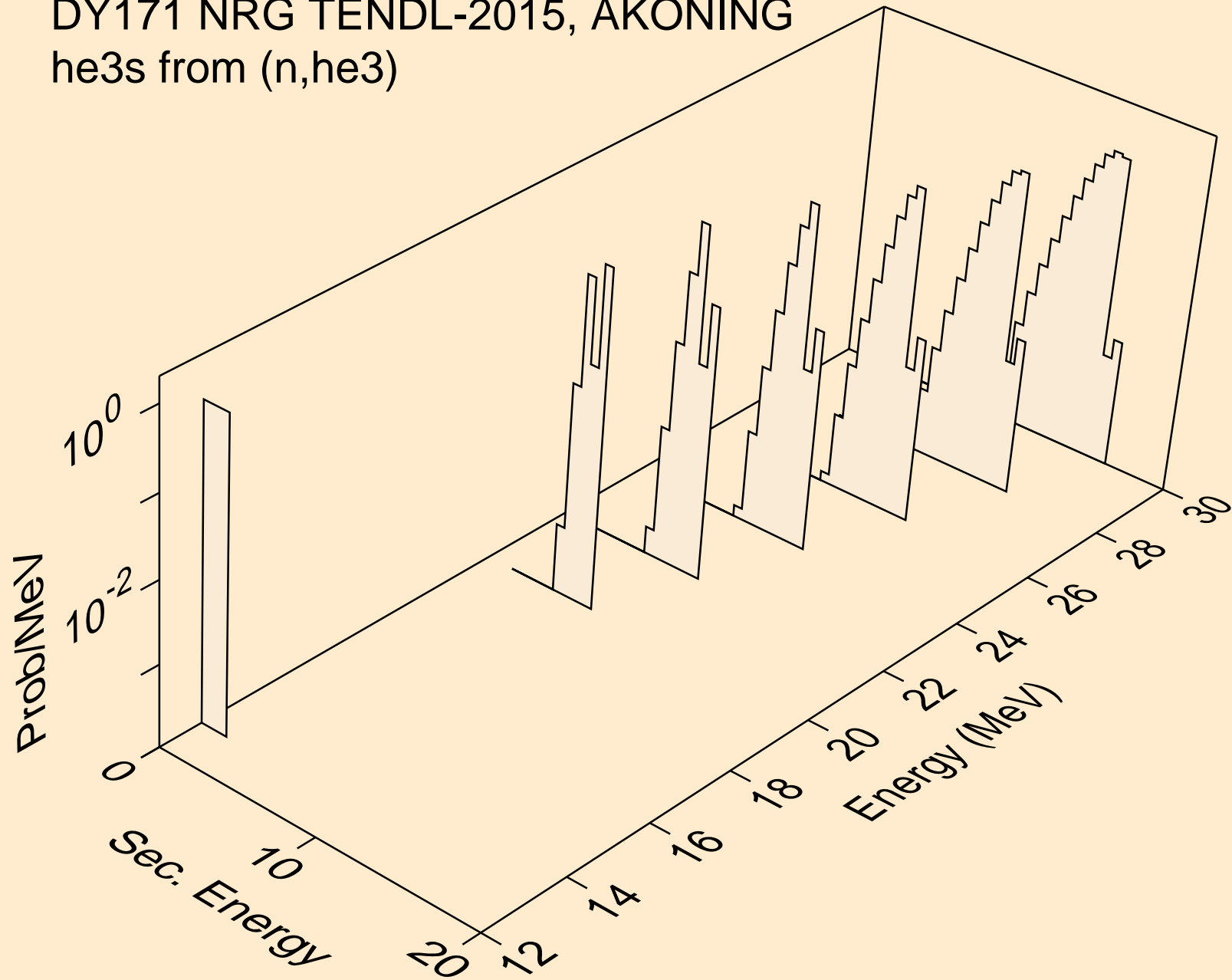

DY171 NRG TENDL-2015, AKONING  
alphas from (n,x)

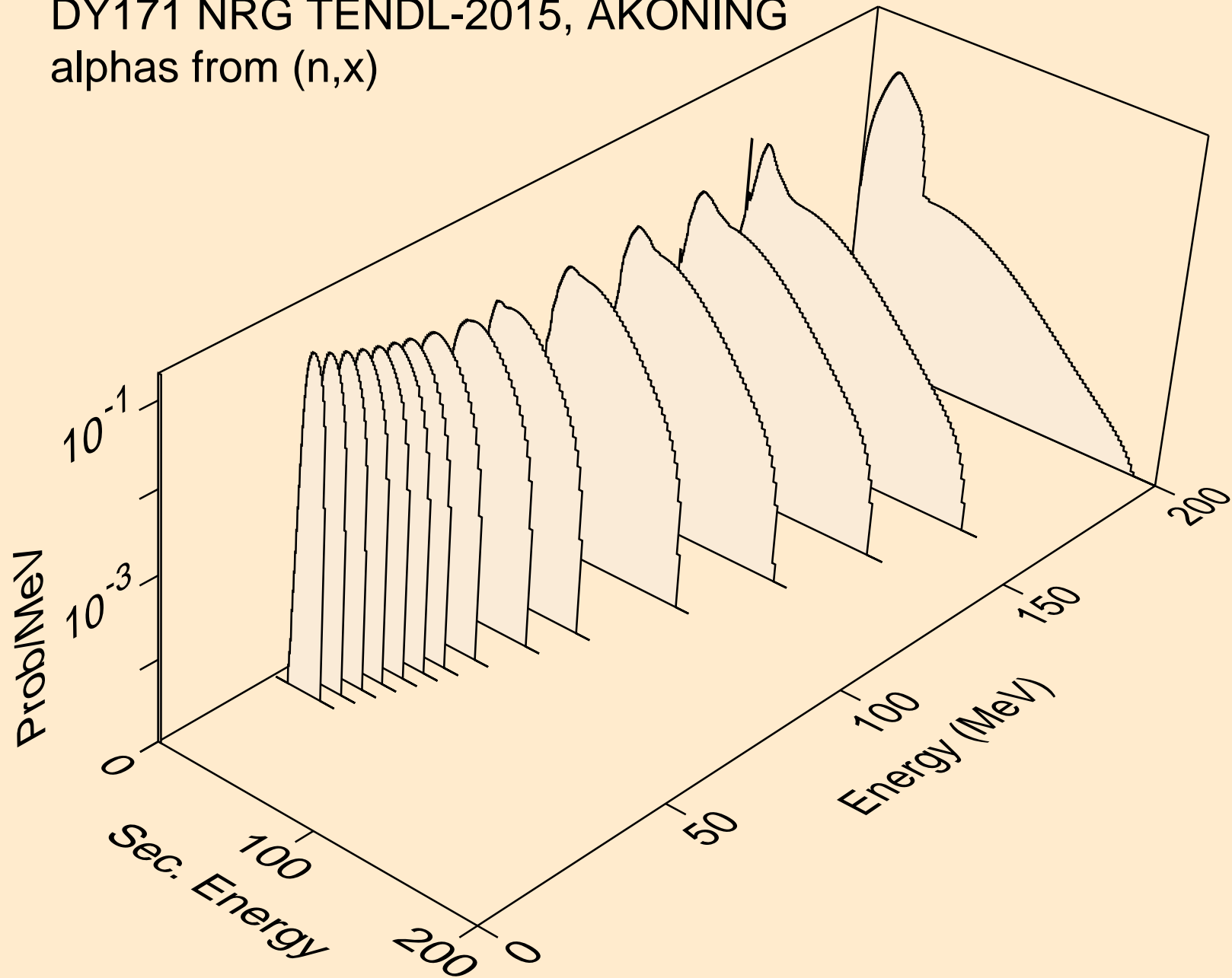



DY171 NRG TENDL-2015, AKONING  
alphas from (n,n\*)a

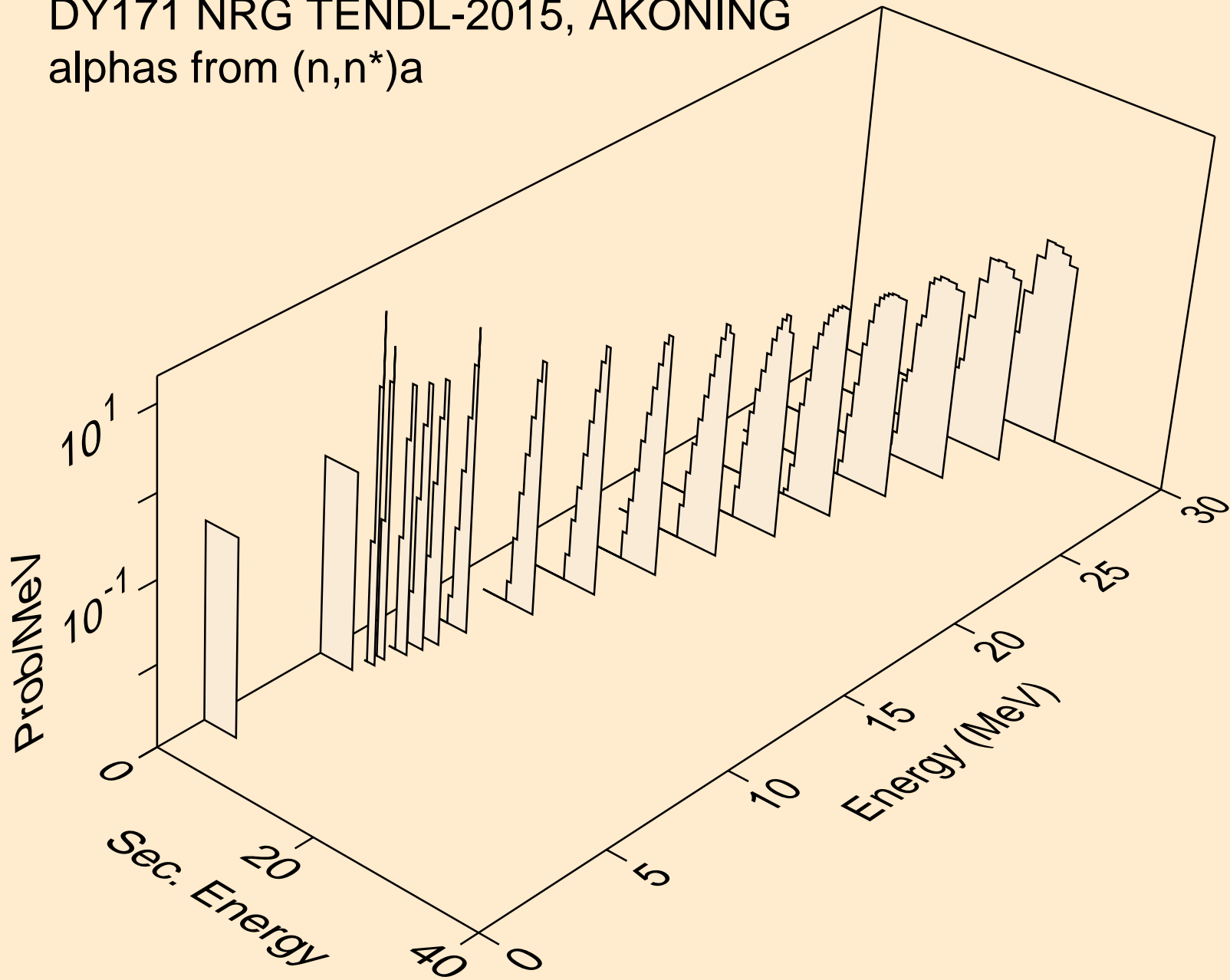

DY171 NRG TENDL-2015, AKONING  
alphas from (n,2n)a

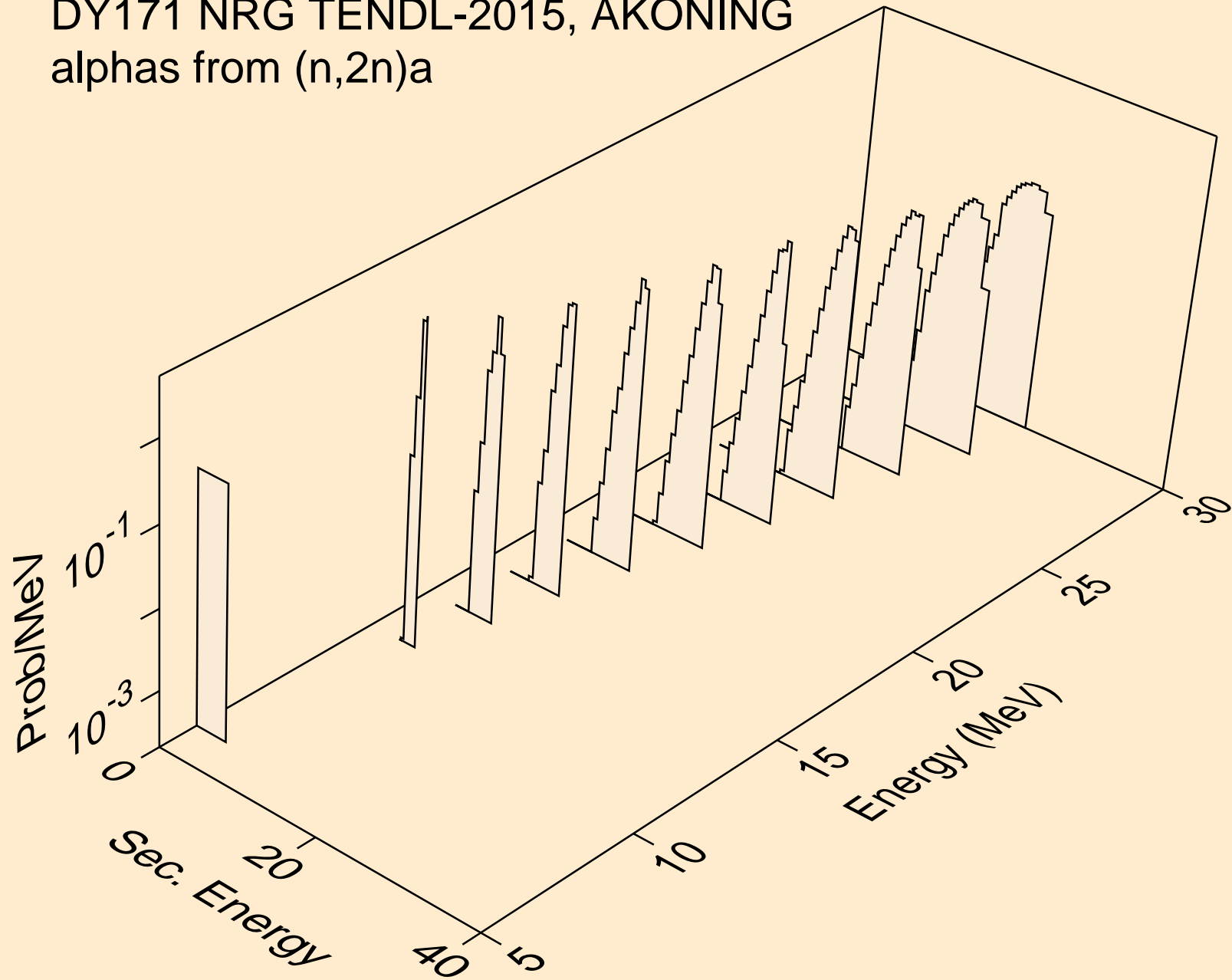

DY171 NRG TENDL-2015, AKONING  
alphas from (n,3n)a

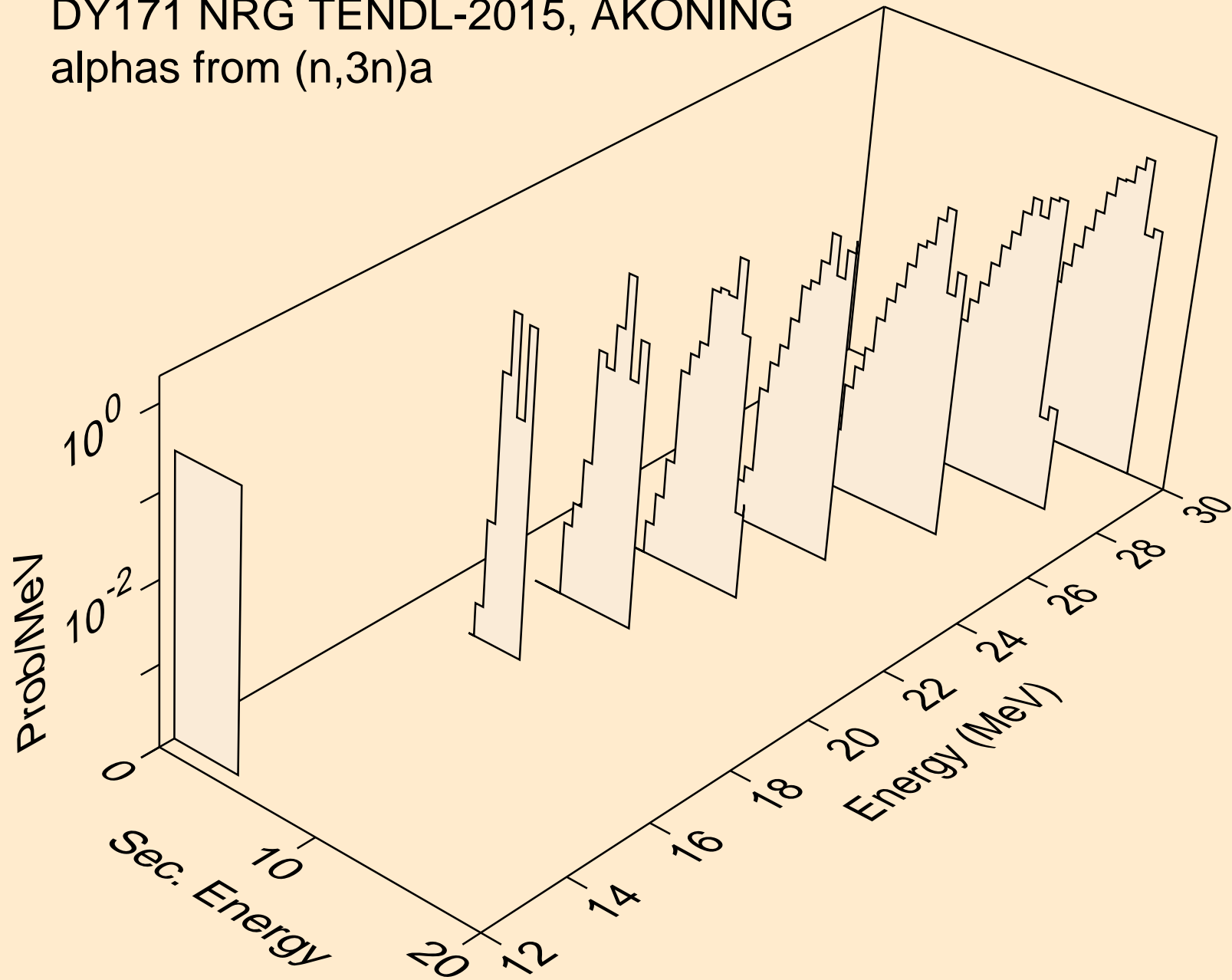

DY171 NRG TENDL-2015, AKONING  
alphas from (n,a)

