

DY172 NRG TENDL-2015, AKONING

Principal cross sections

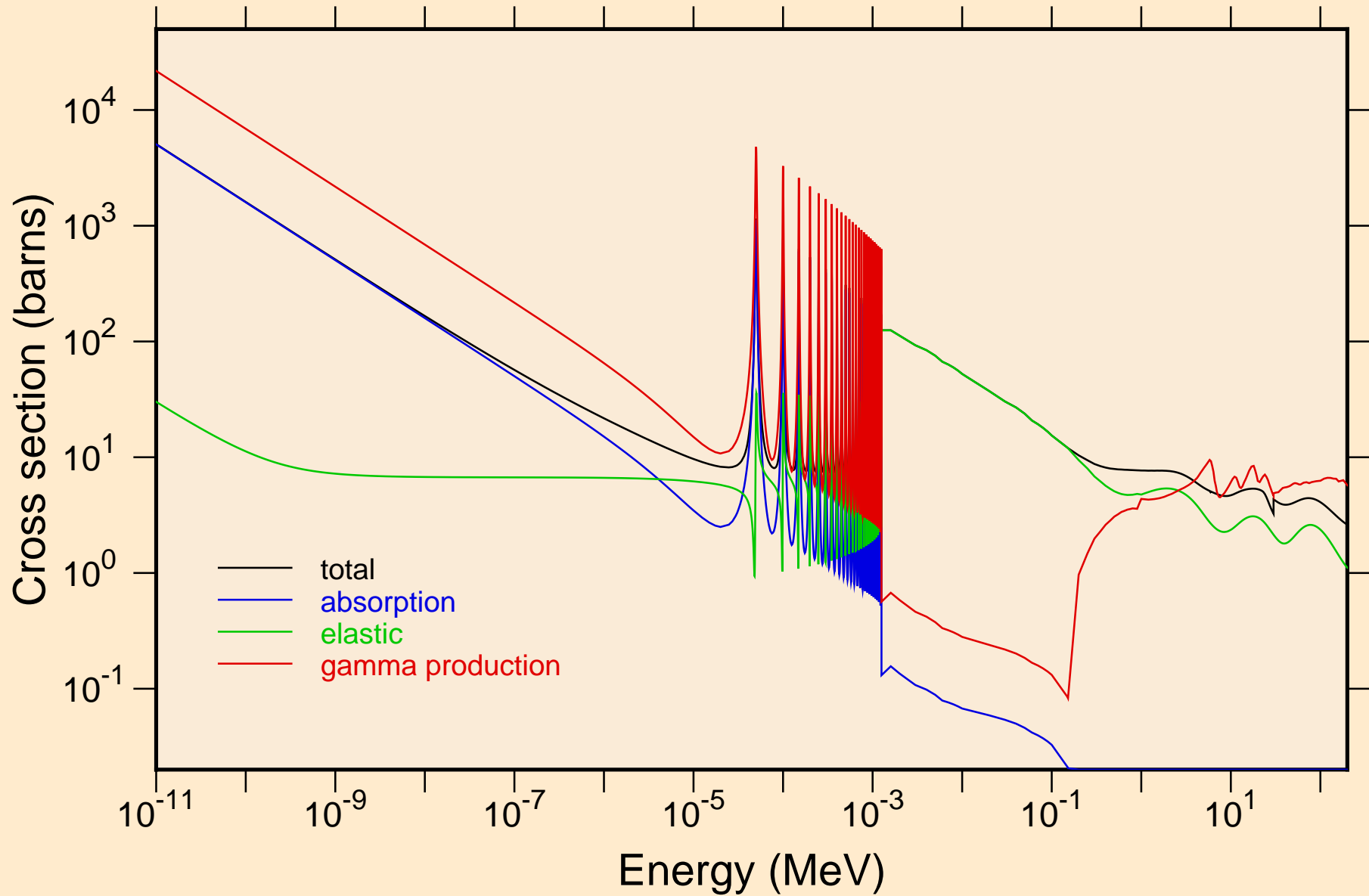

DY172 NRG TENDL-2015, AKONING
resonance total cross section

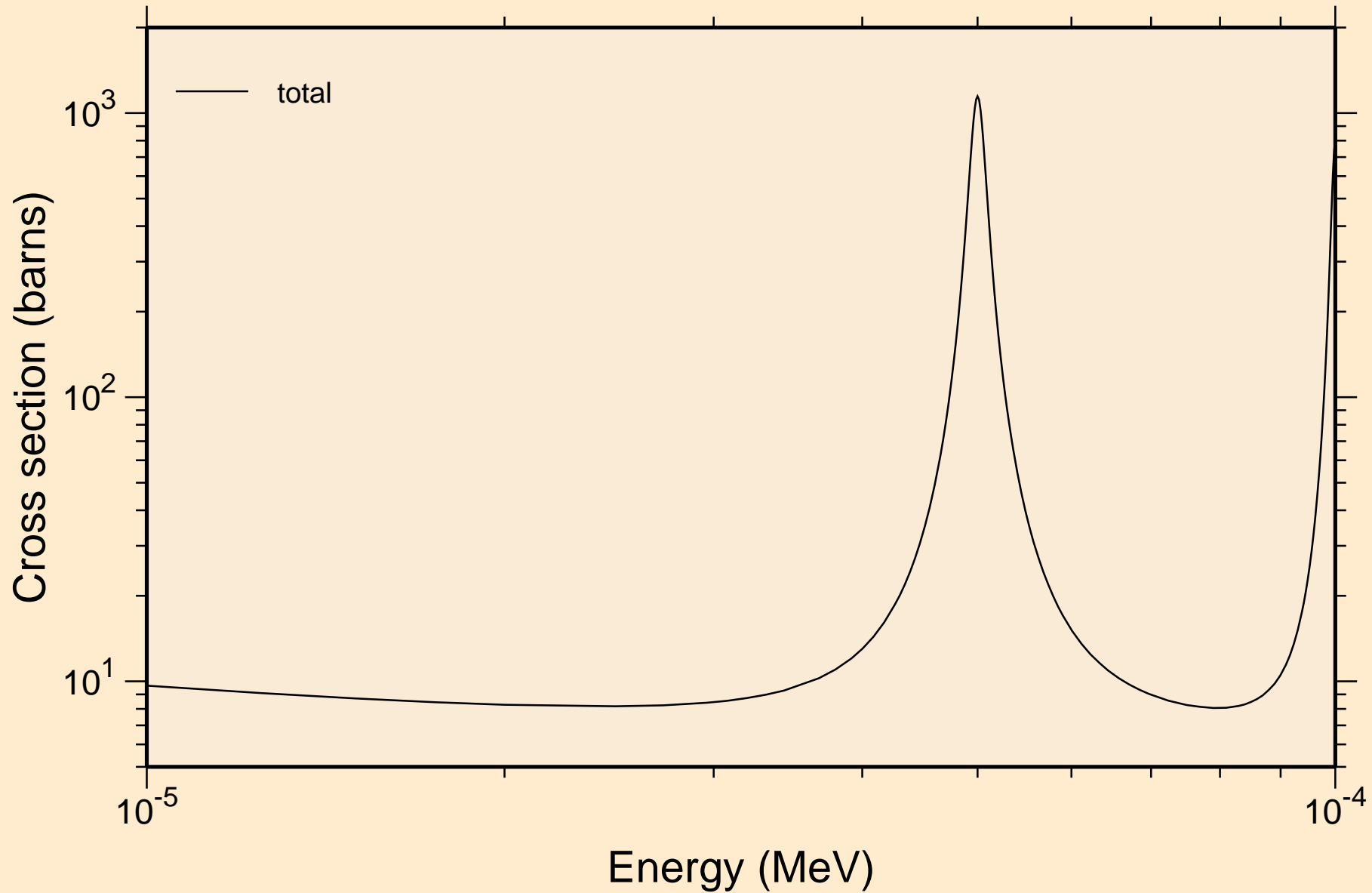

DY172 NRG TENDL-2015, AKONING
resonance total cross section

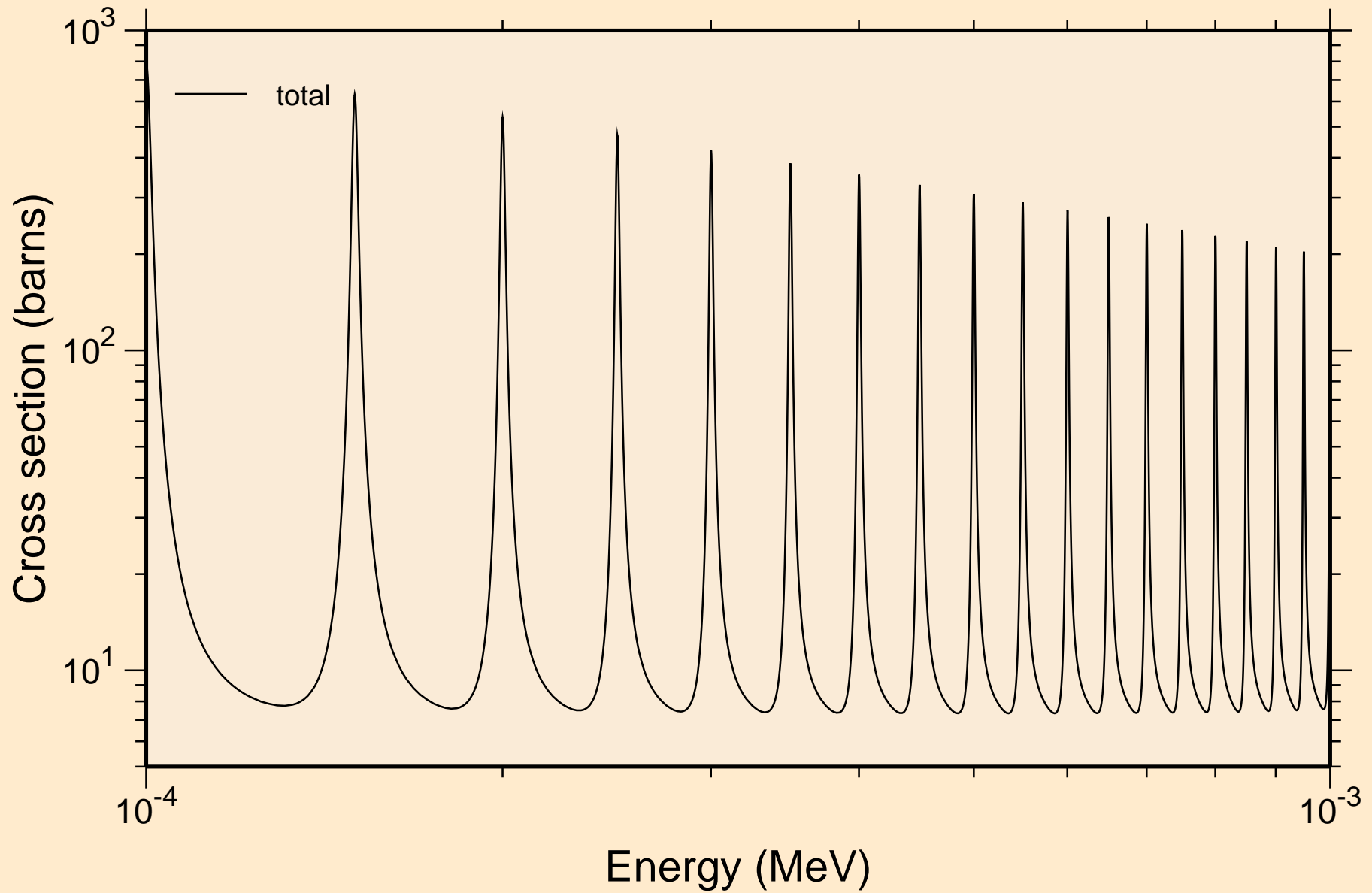

DY172 NRG TENDL-2015, AKONING
resonance total cross section

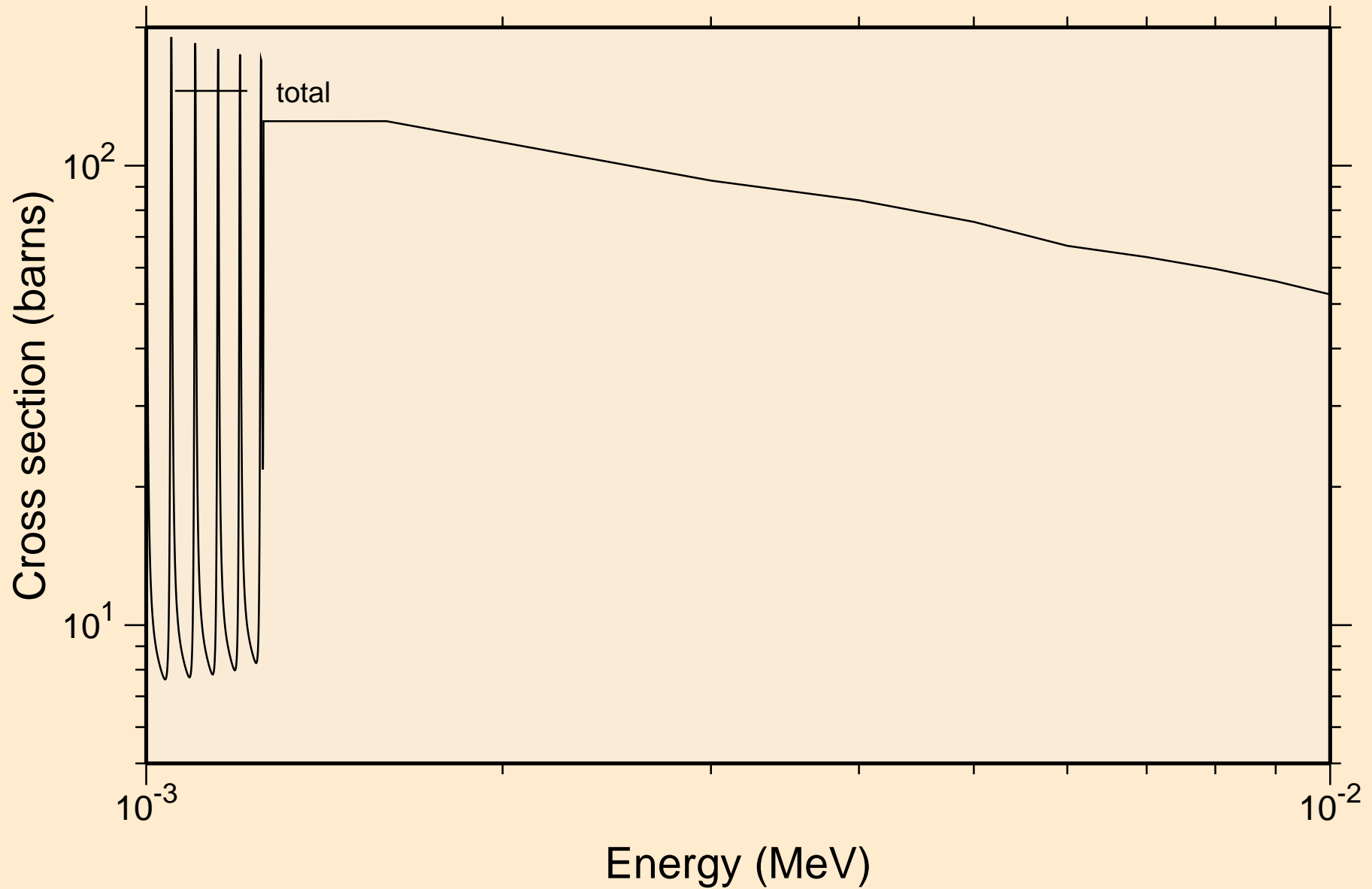

DY172 NRG TENDL-2015, AKONING
resonance total cross section

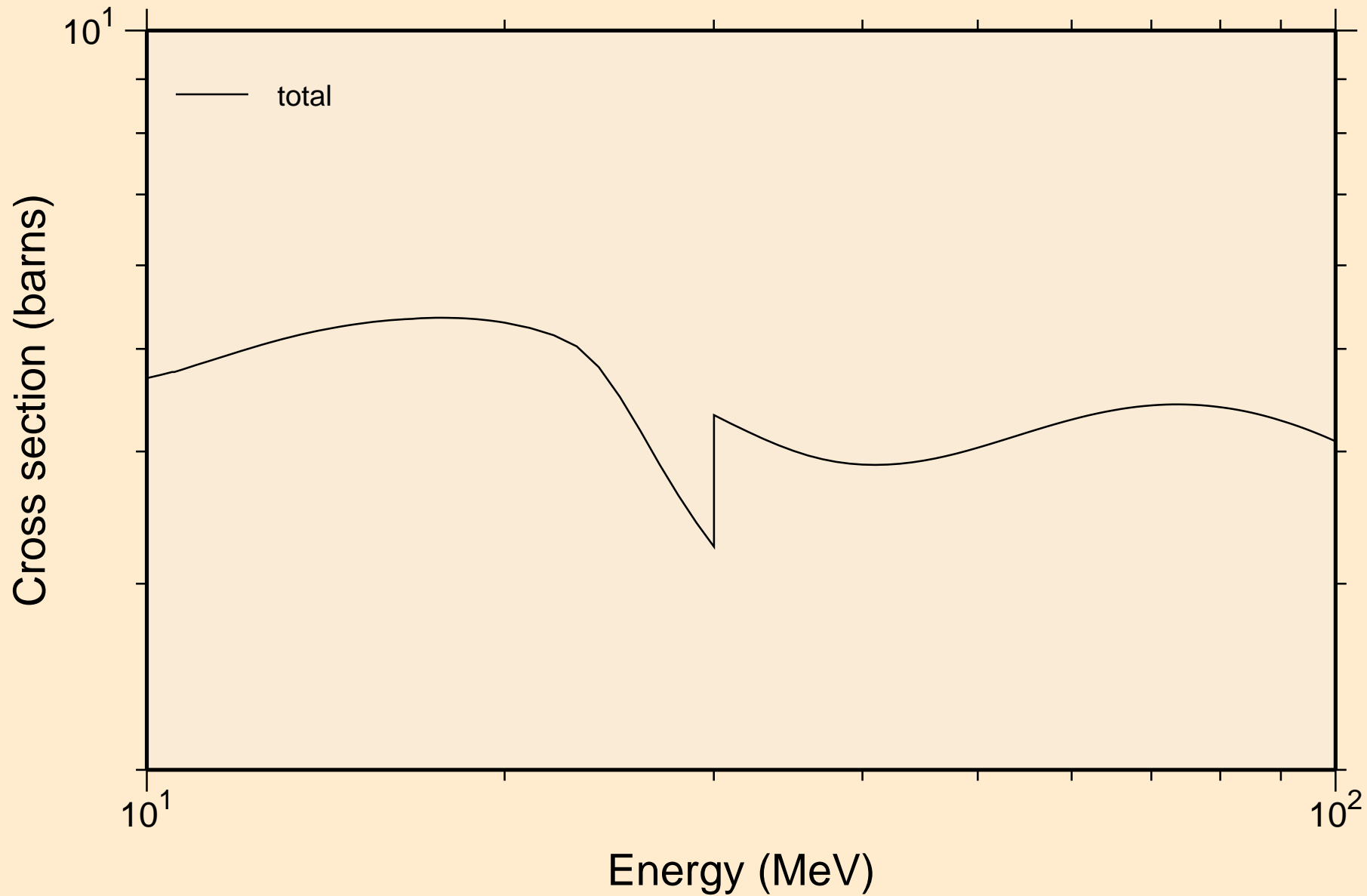

DY172 NRG TENDL-2015, AKONING
resonance absorption cross sections

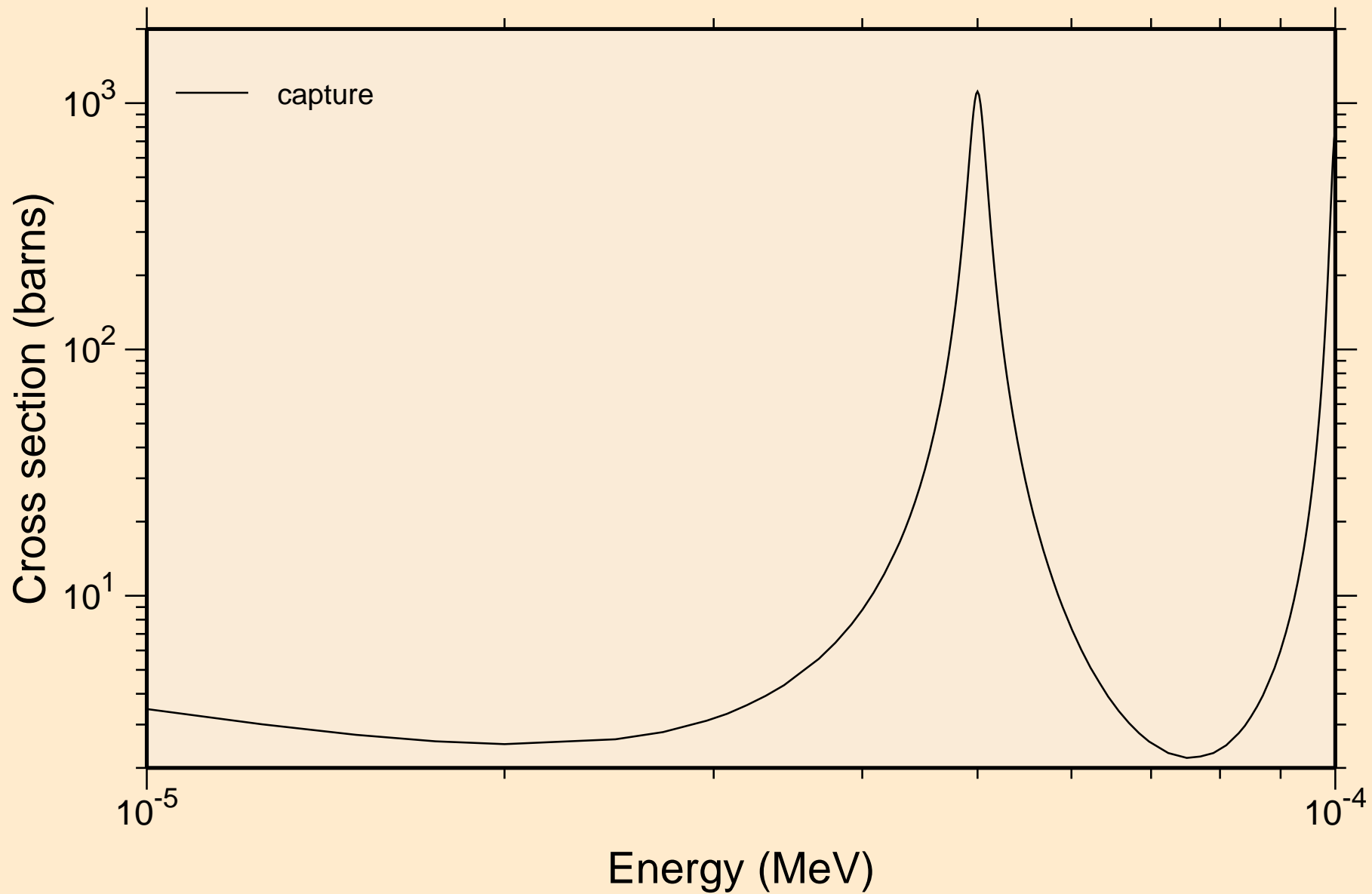

DY172 NRG TENDL-2015, AKONING
resonance absorption cross sections

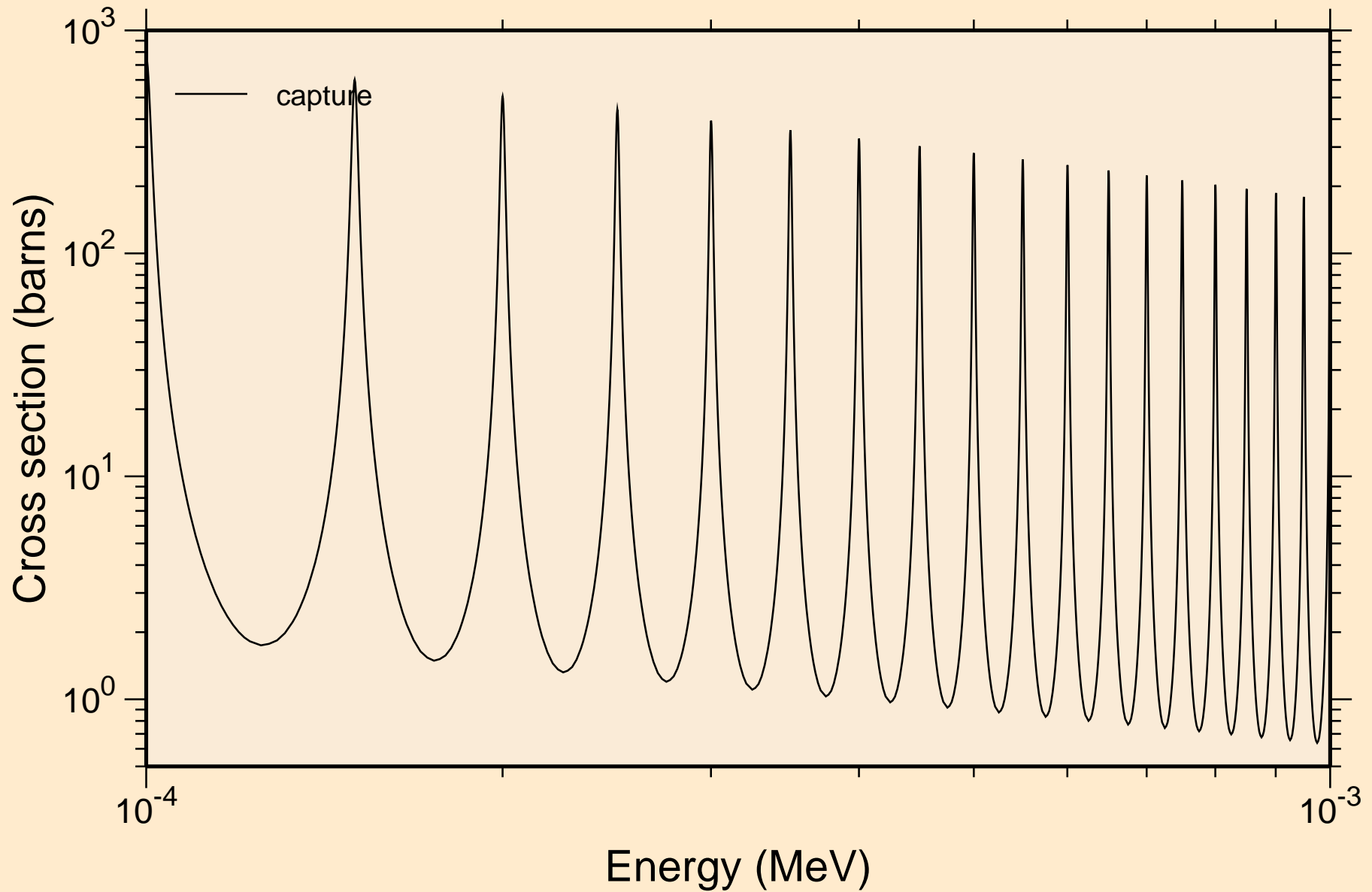

DY172 NRG TENDL-2015, AKONING

resonance absorption cross sections

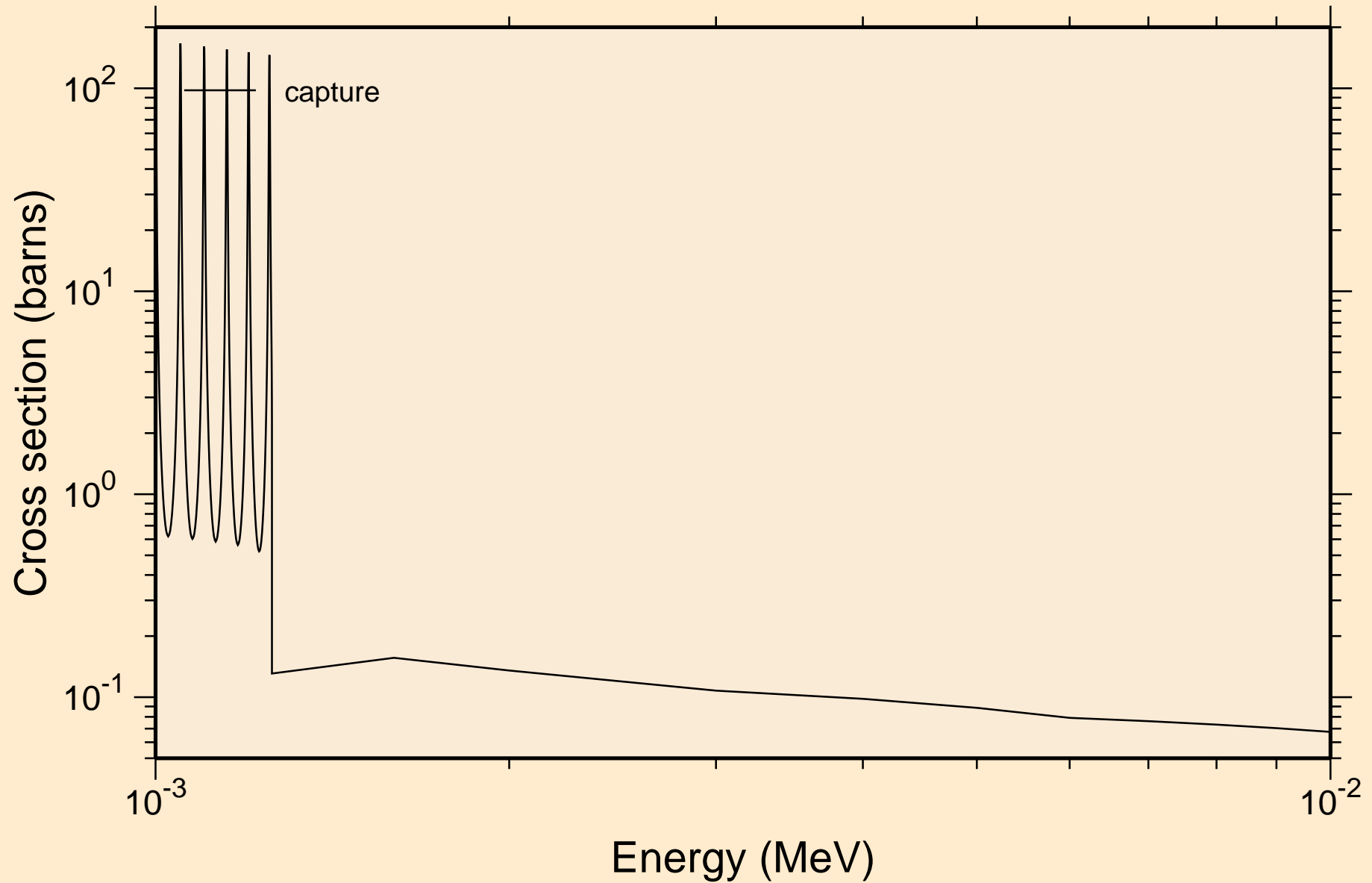

DY172 NRG TENDL-2015, AKONING
resonance absorption cross sections

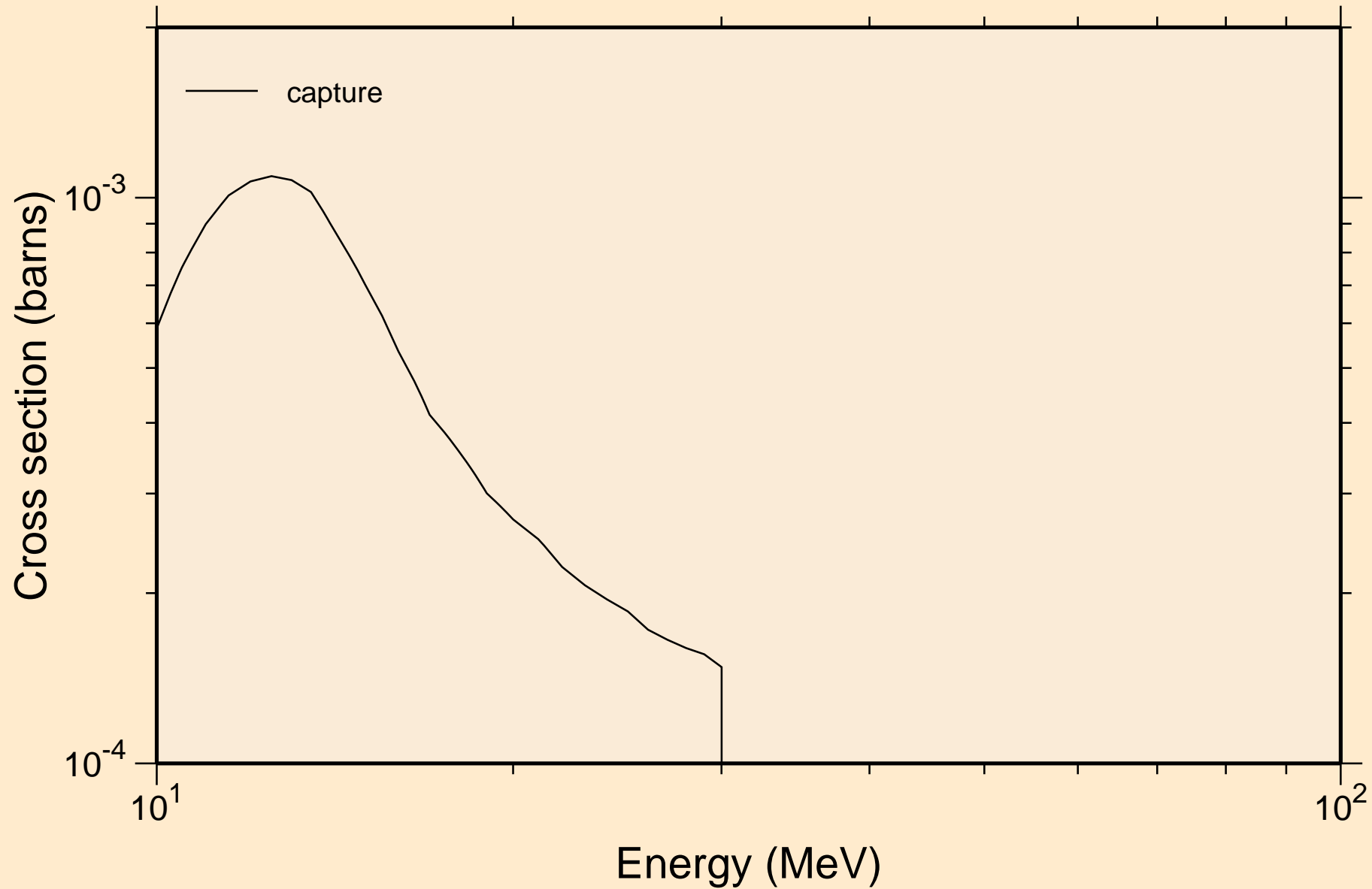

DY172 NRG TENDL-2015, AKONING
Non-threshold reactions

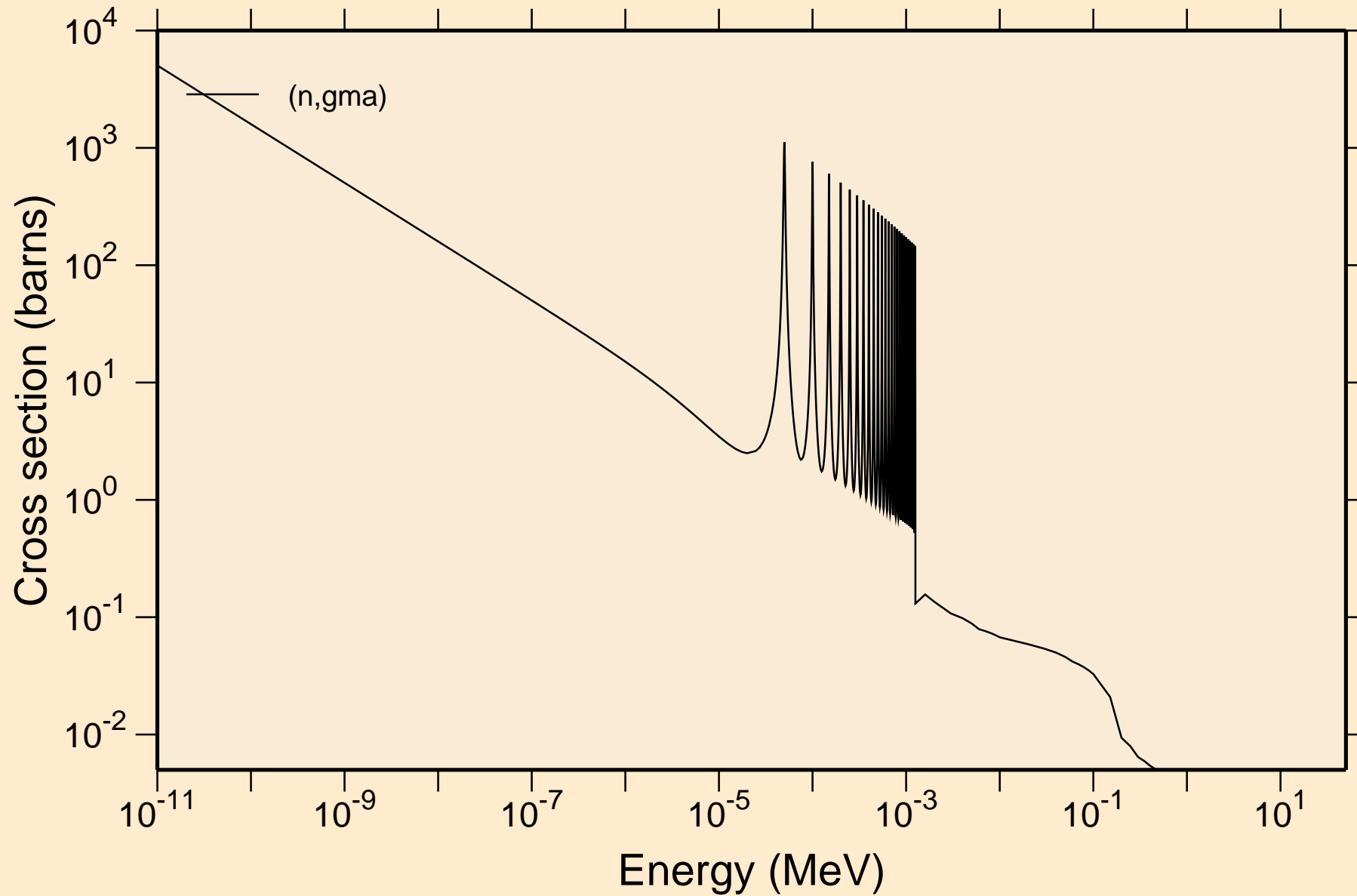

DY172 NRG TENDL-2015, AKONING

Principal cross sections

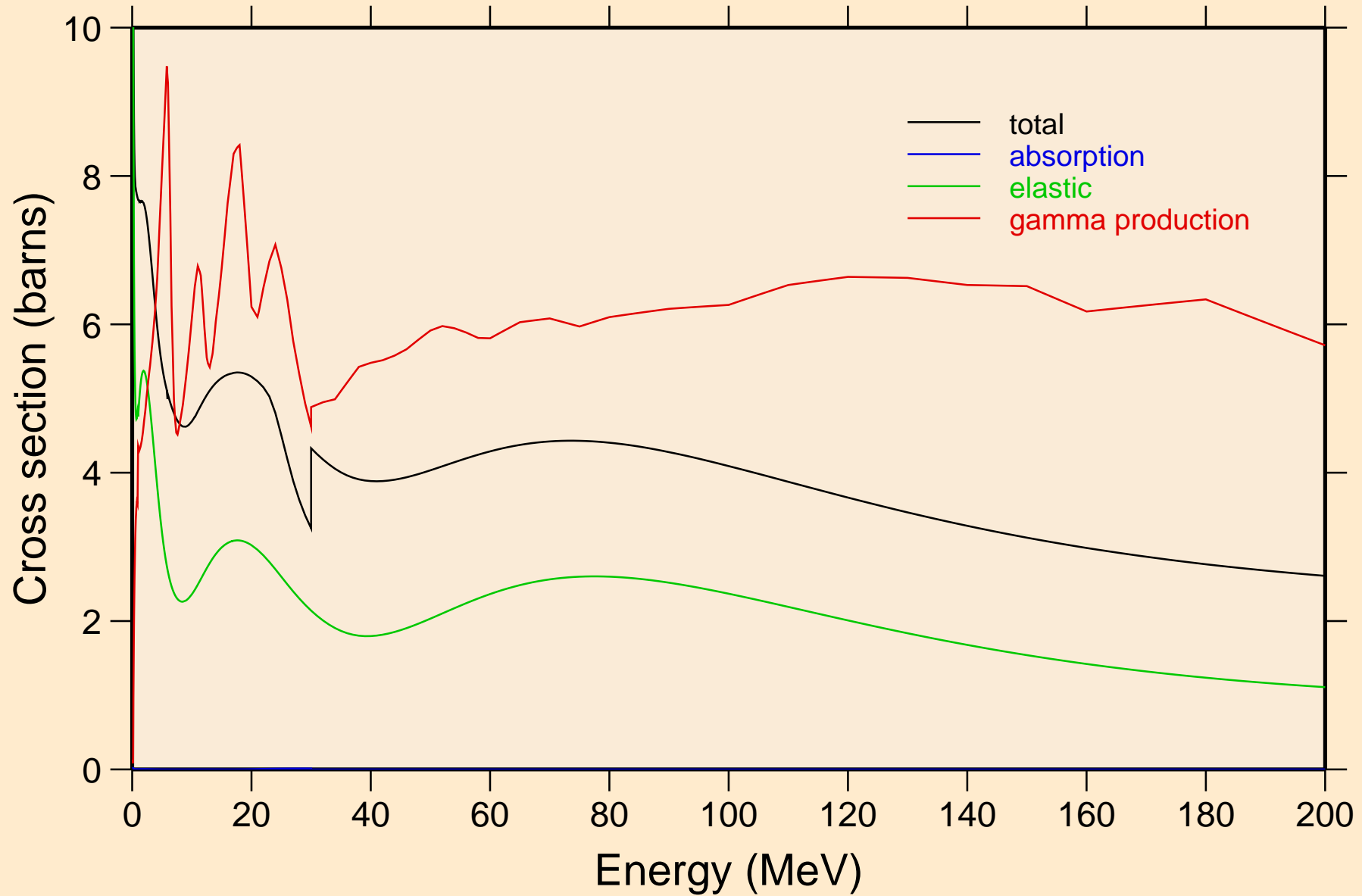

DY172 NRG TENDL-2015, AKONING
Non-threshold reactions

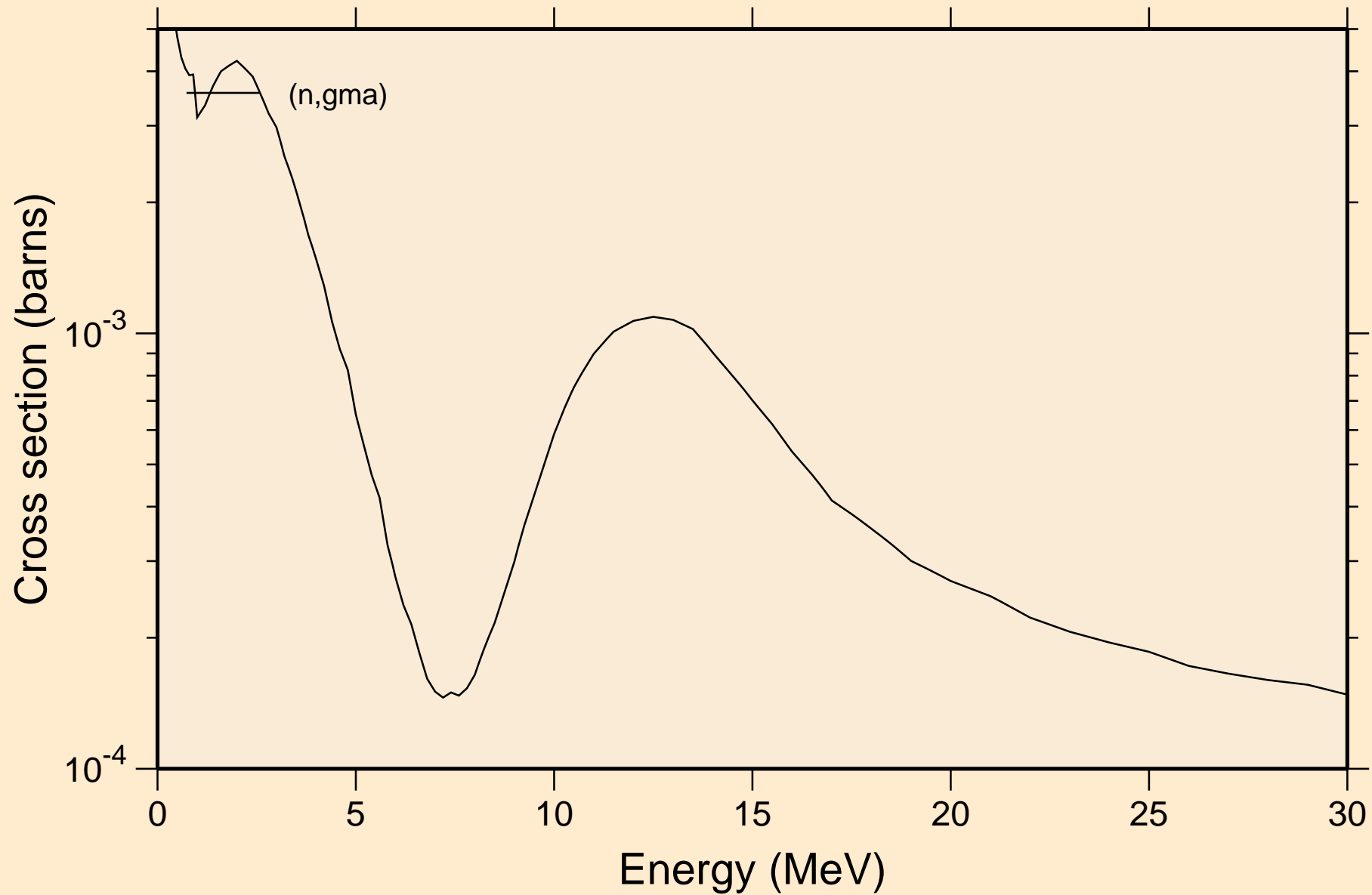

DY172 NRG TENDL-2015, AKONING
Inelastic levels

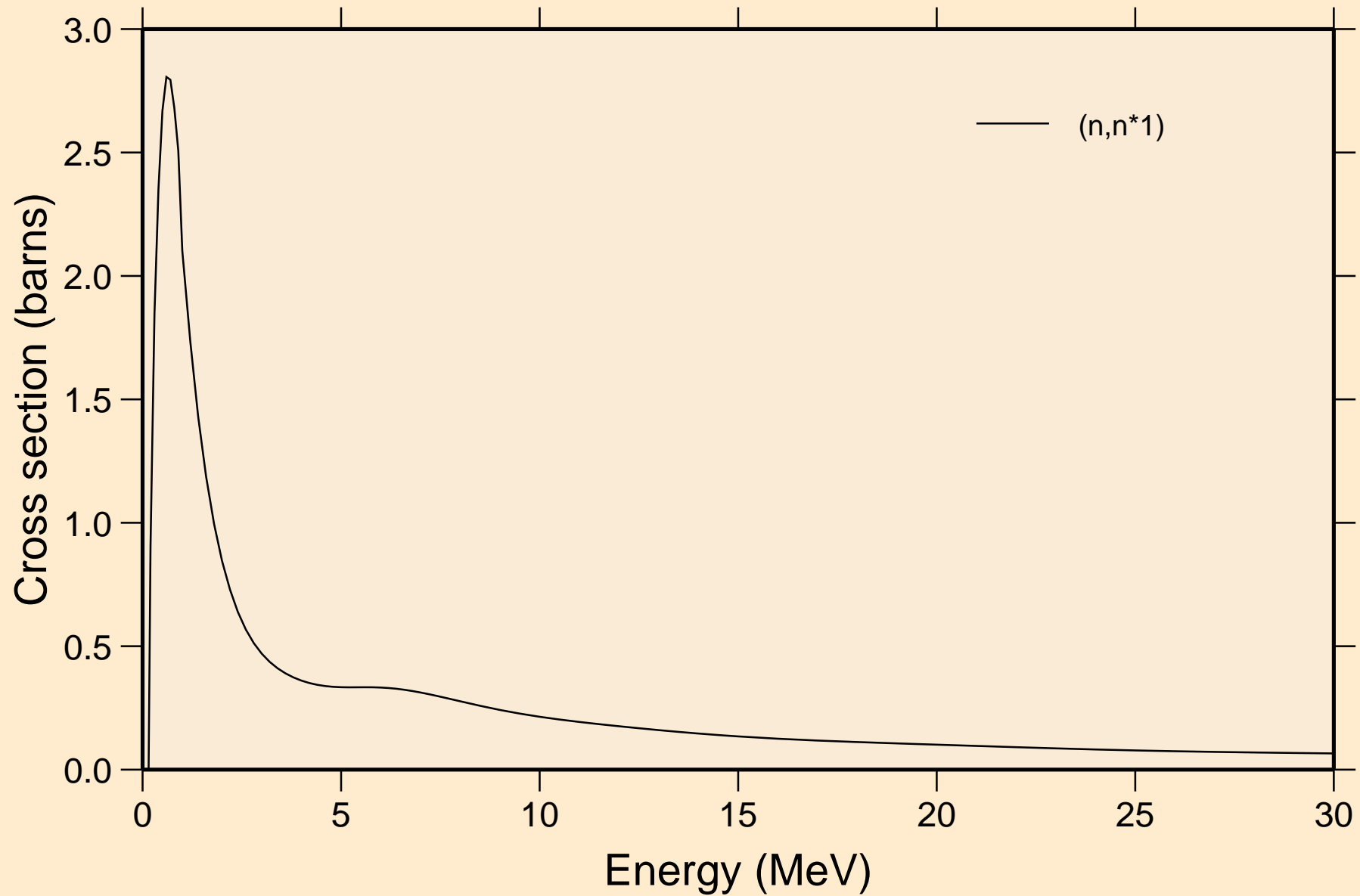

DY172 NRG TENDL-2015, AKONING

Threshold reactions

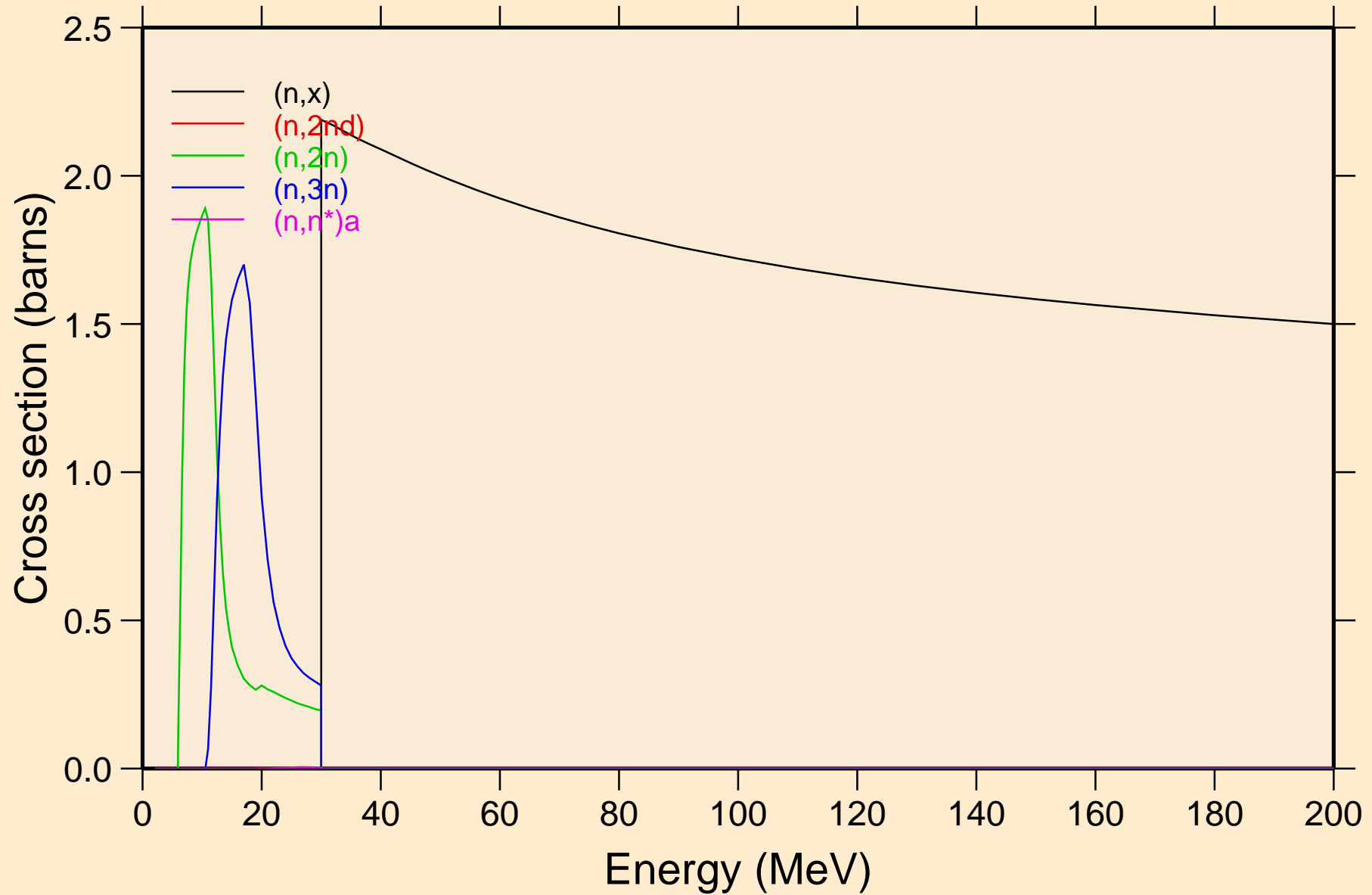

DY172 NRG TENDL-2015, AKONING

Threshold reactions

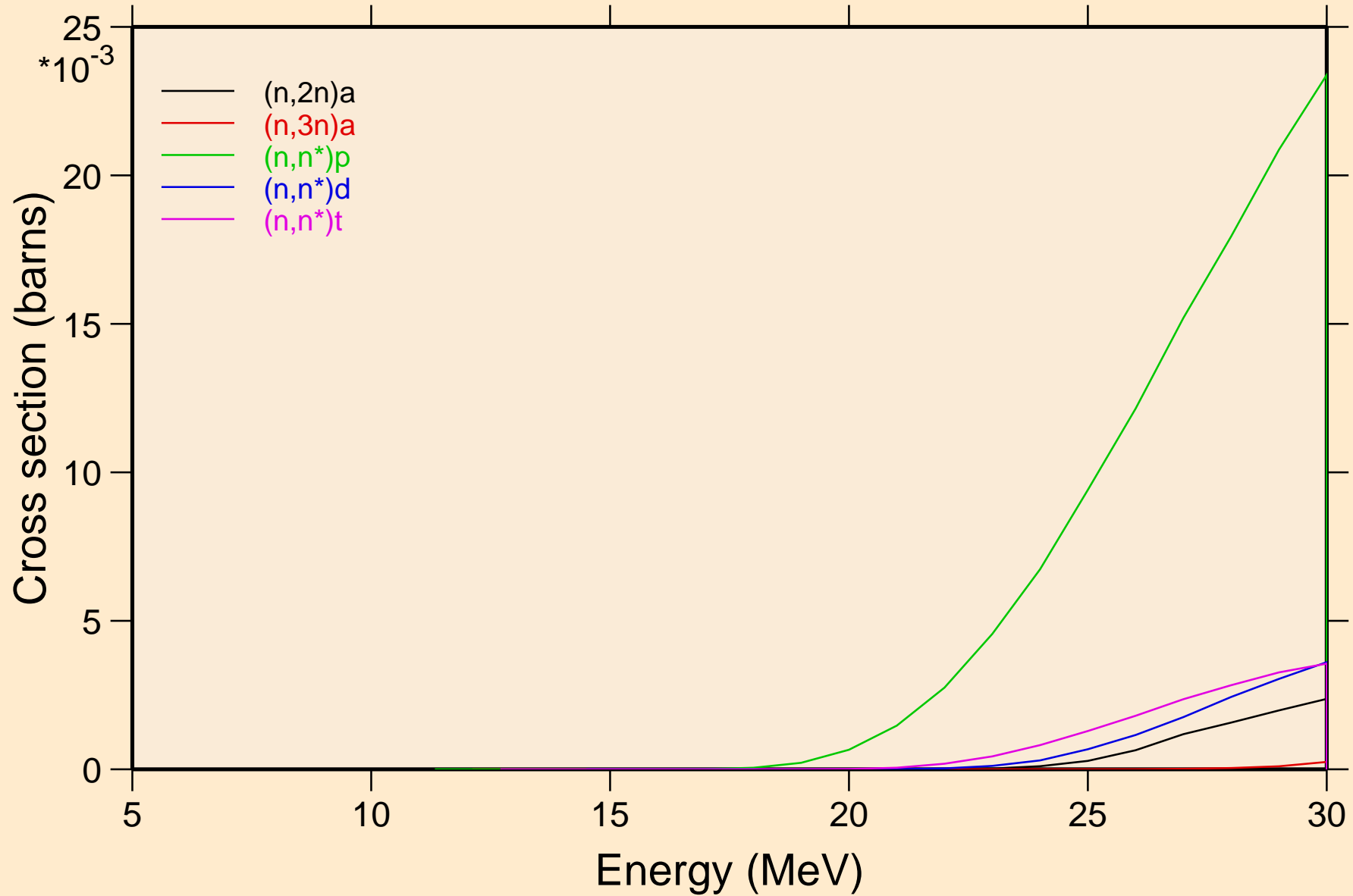

DY172 NRG TENDL-2015, AKONING

Threshold reactions

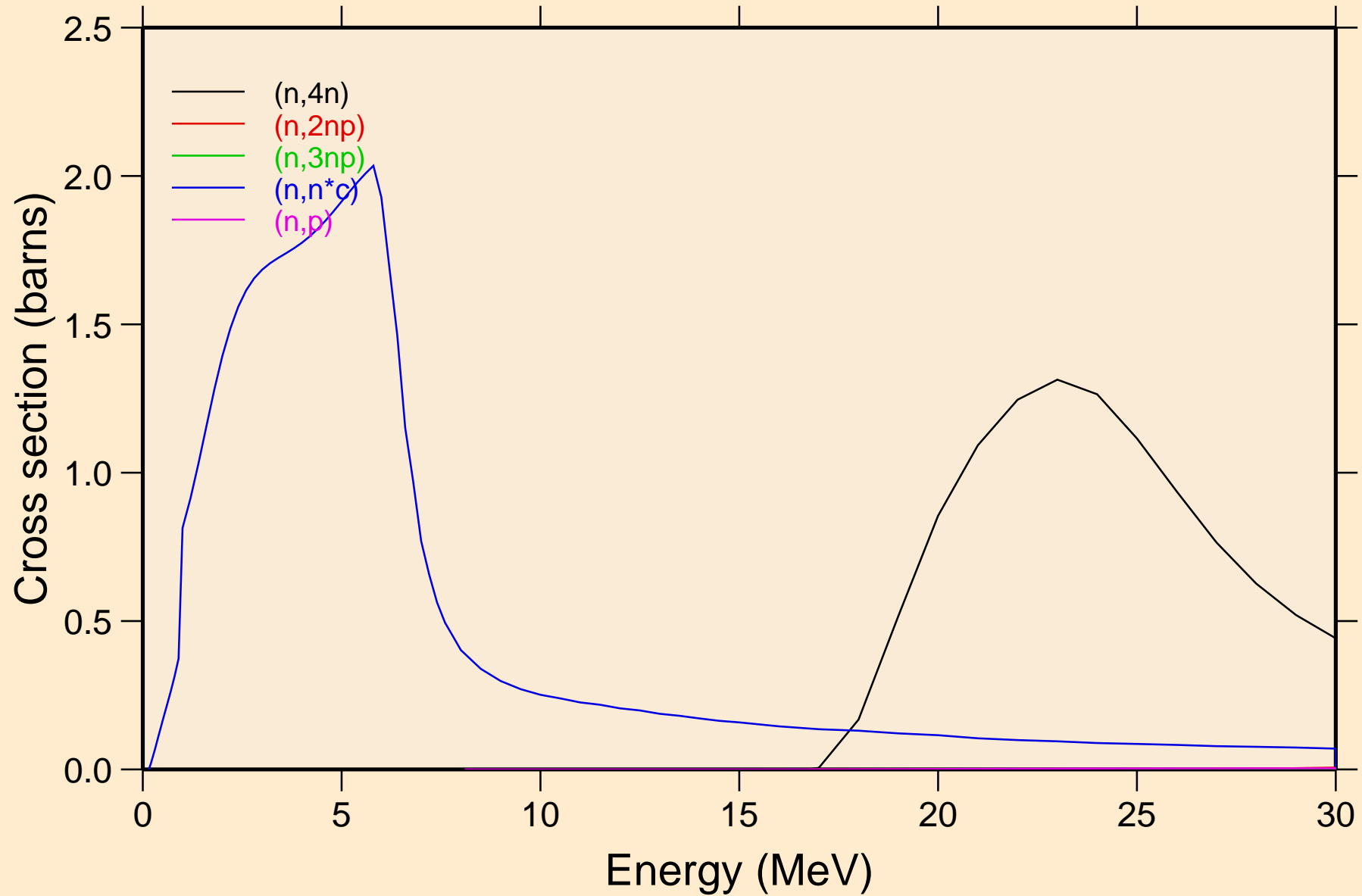

DY172 NRG TENDL-2015, AKONING

Threshold reactions

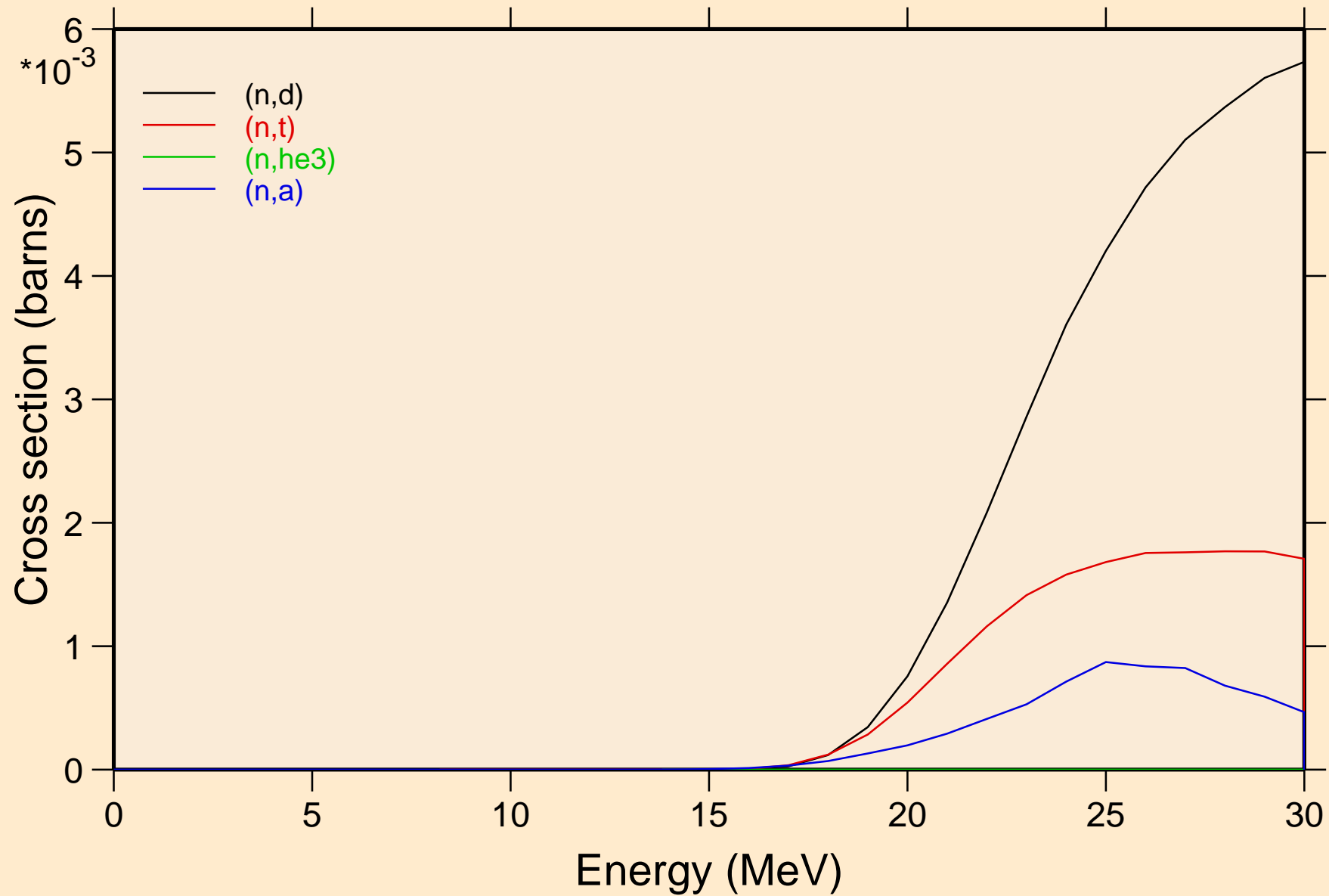

DY172 NRG TENDL-2015, AKONING
angular distribution for elastic

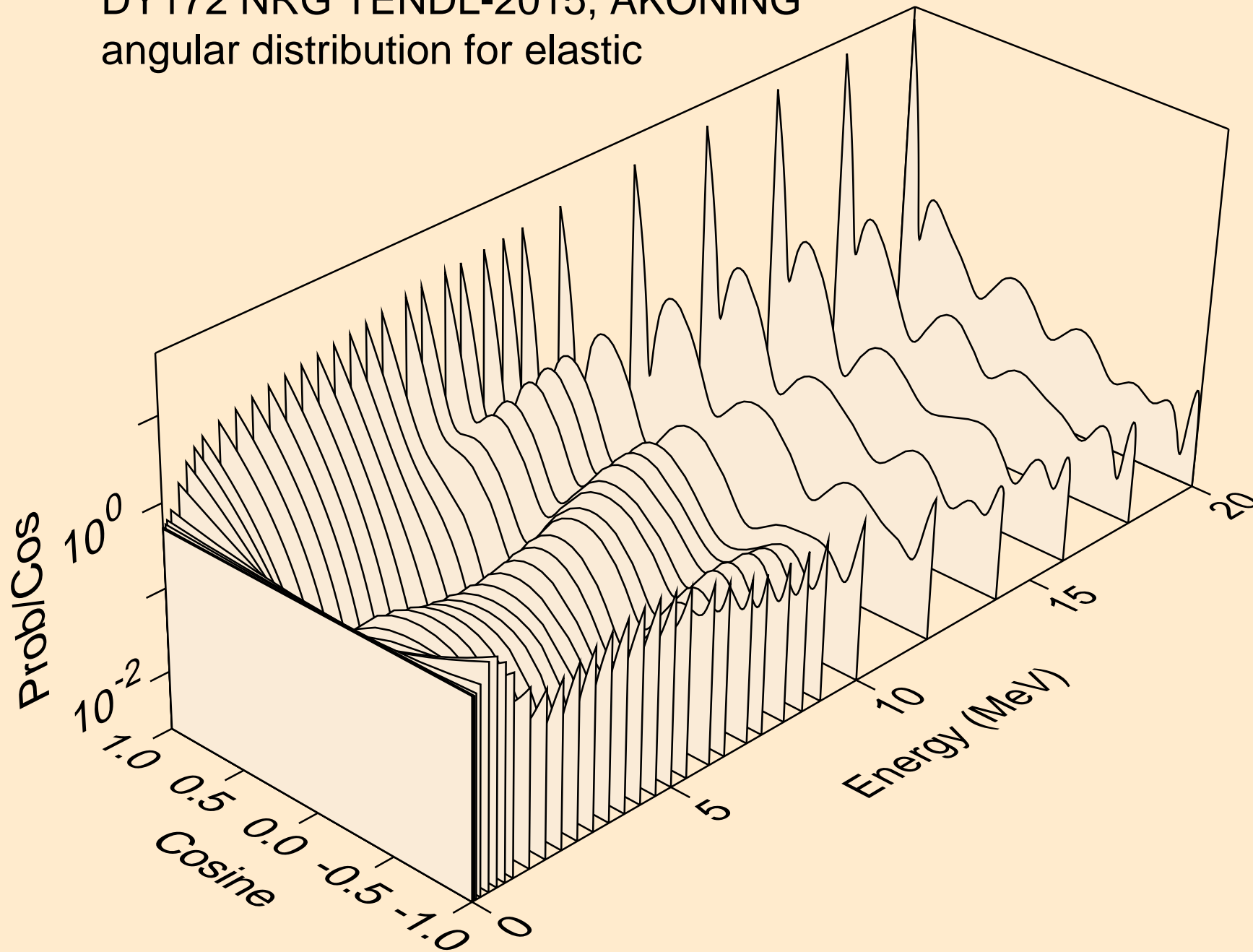

DY172 NRG TENDL-2015, AKONING
angular distribution for elastic

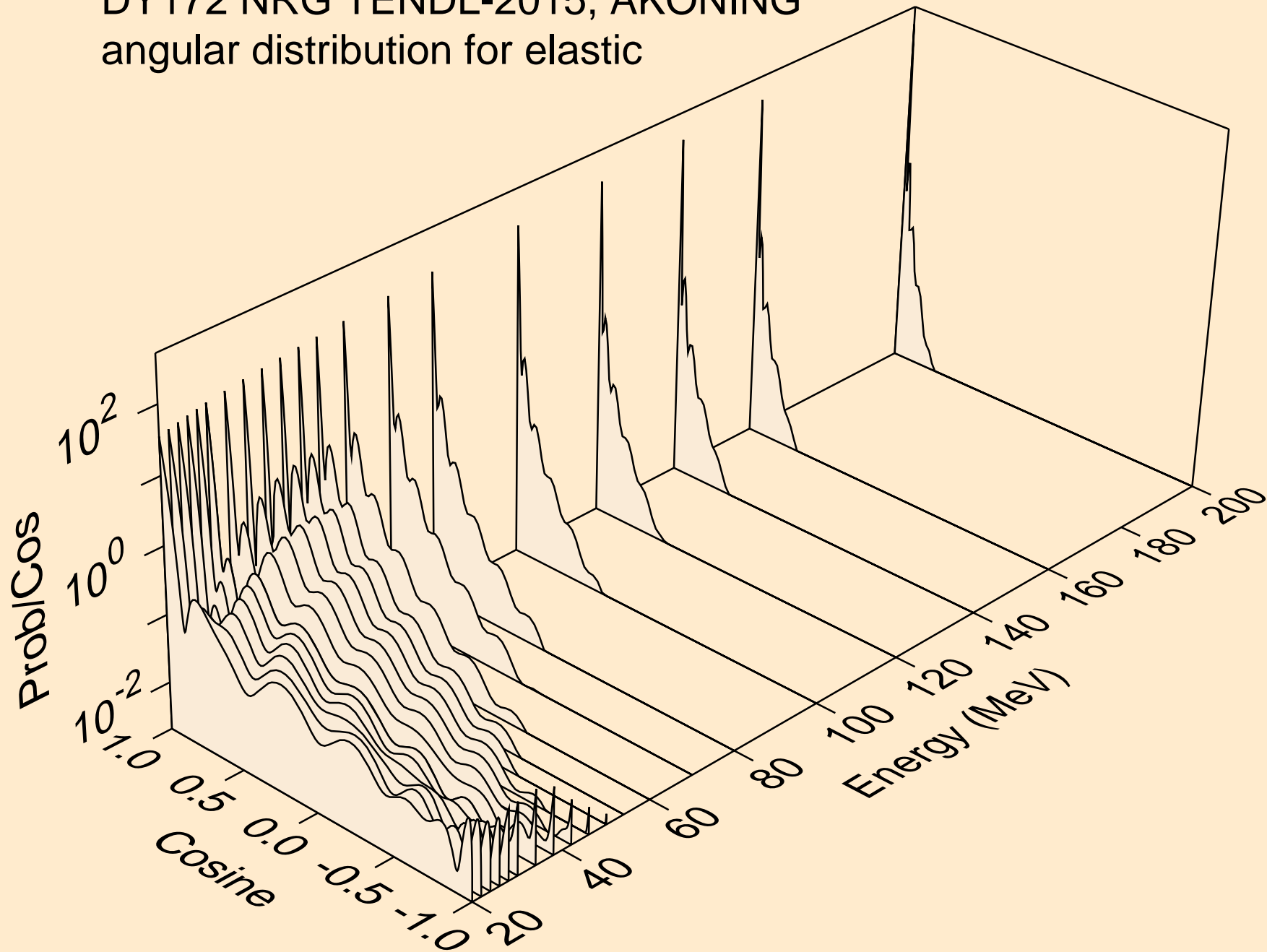

DY172 NRG TENDL-2015, AKONING
angular distribution for (n,n*1)

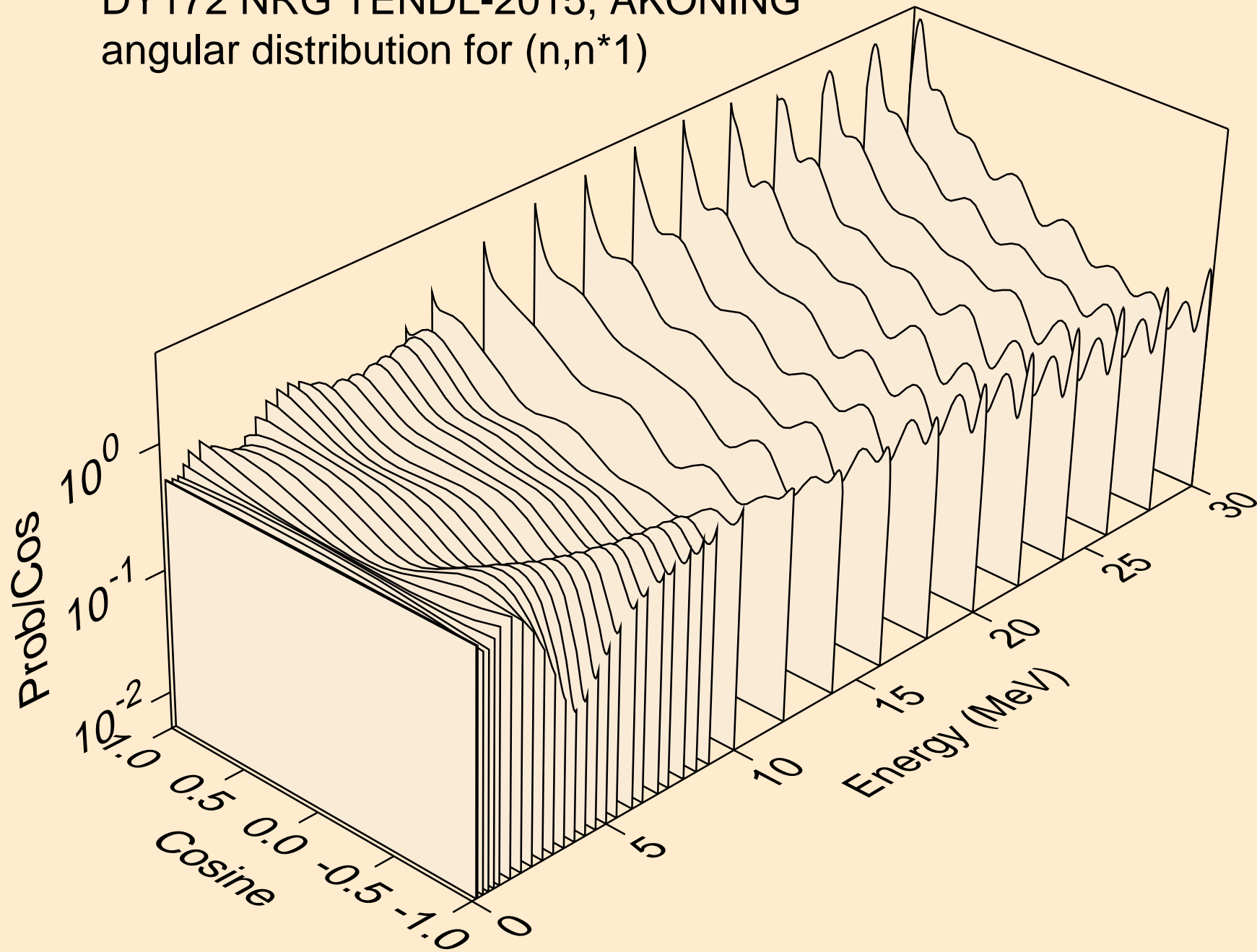

DY172 NRG TENDL-2015, AKONING
Neutron emission for (n,x)

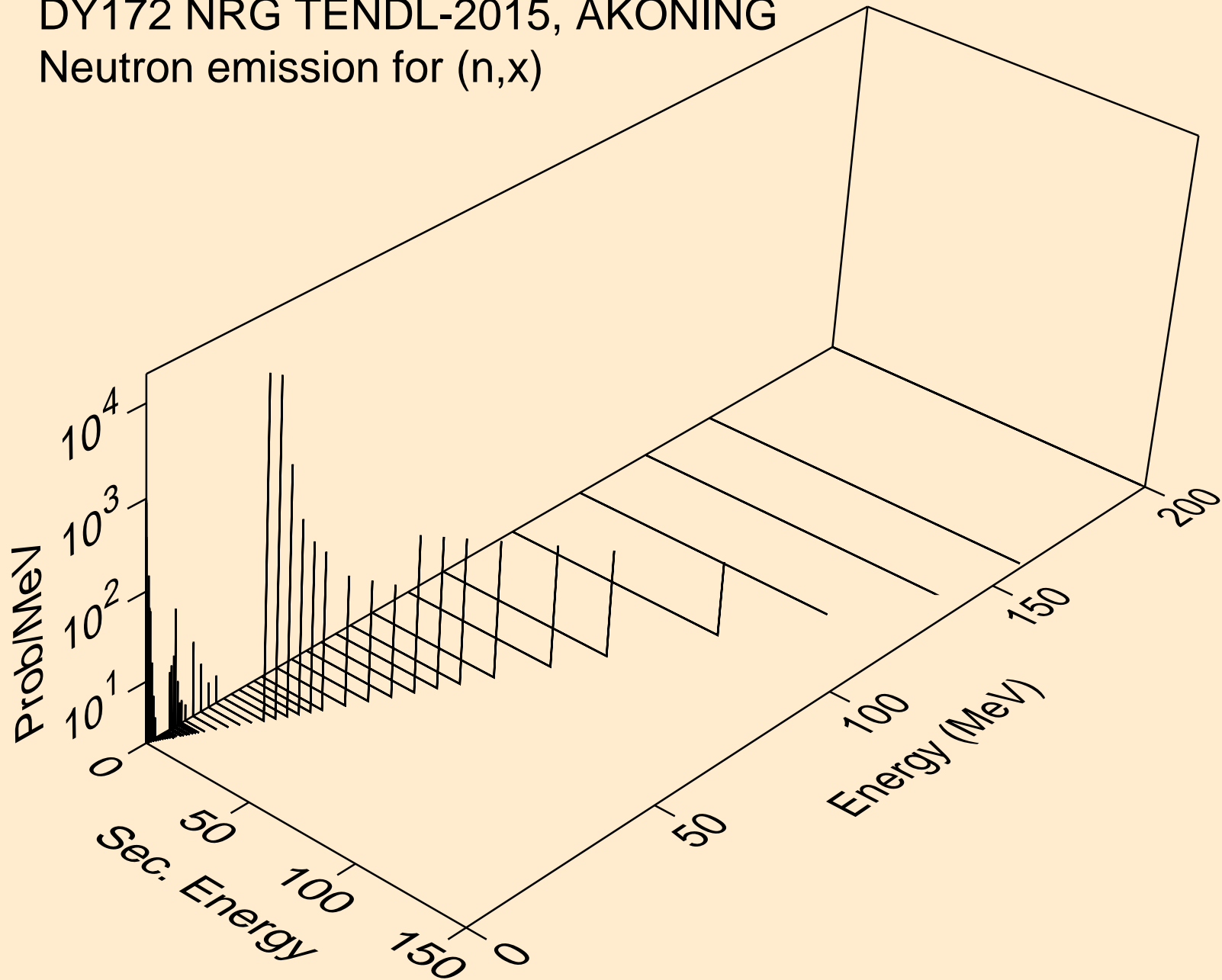

DY172 NRG TENDL-2015, AKONING
Neutron emission for (n,2nd)

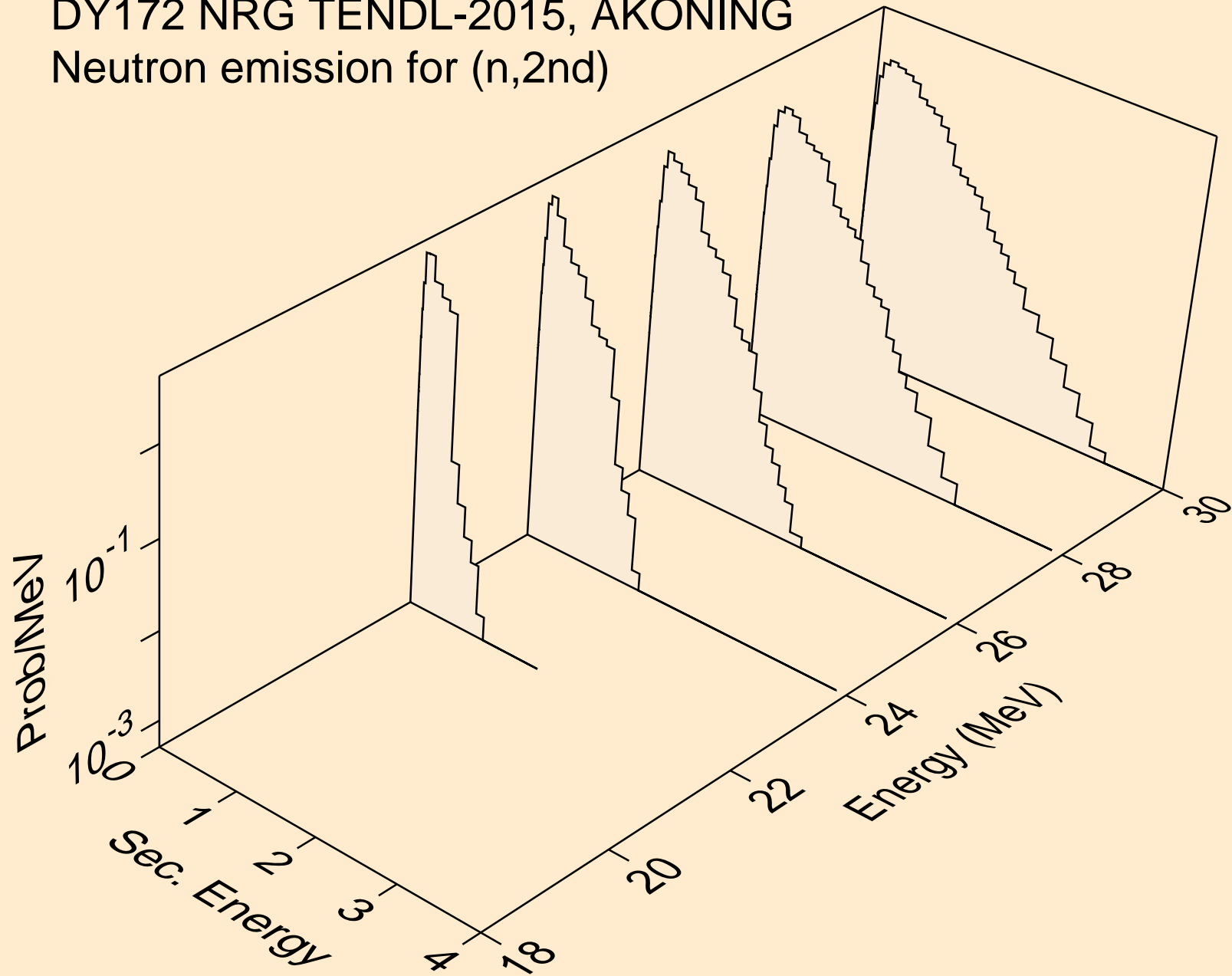

DY172 NRG TENDL-2015, AKONING
Neutron emission for (n,2n)

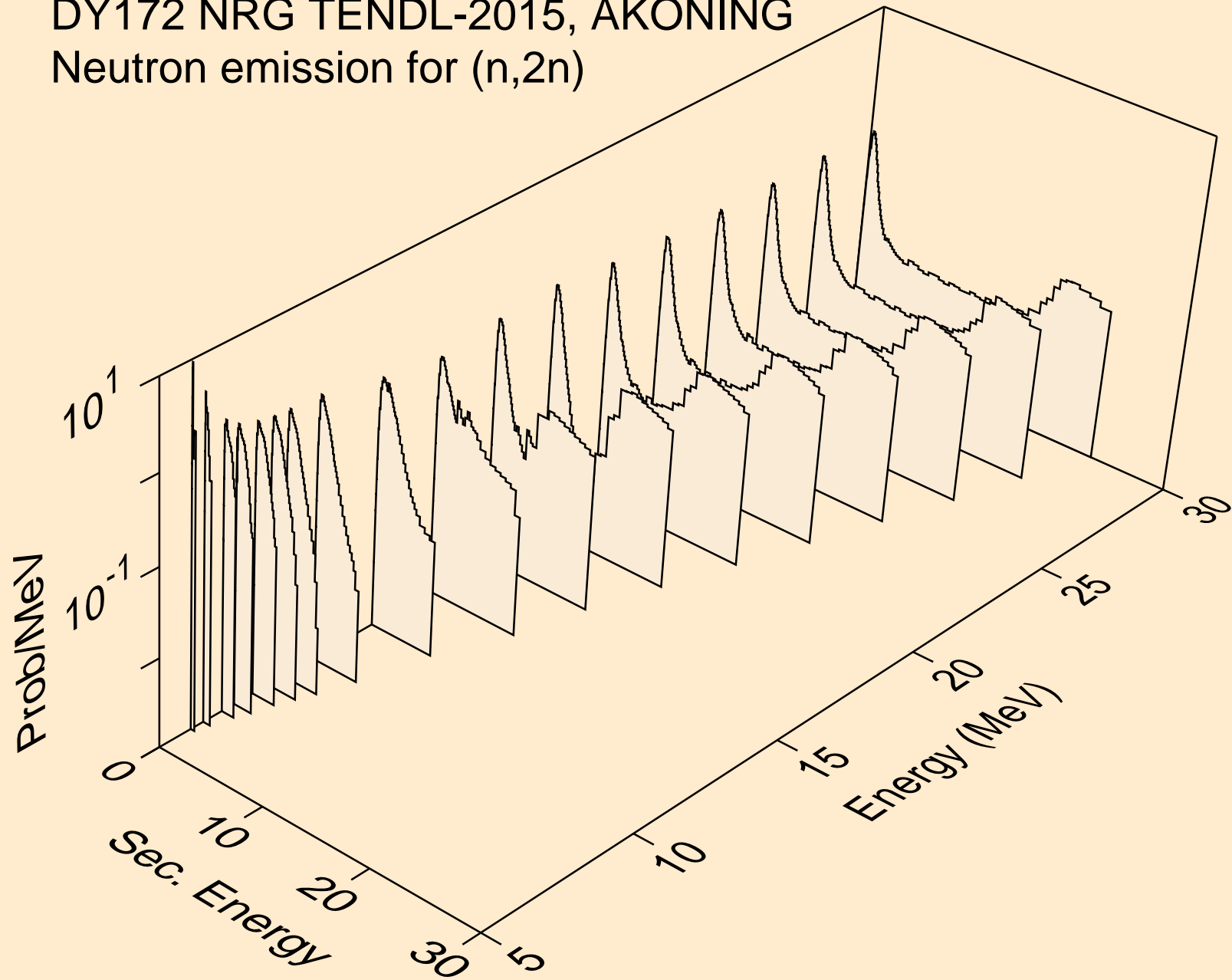

DY172 NRG TENDL-2015, AKONING
Neutron emission for (n,3n)

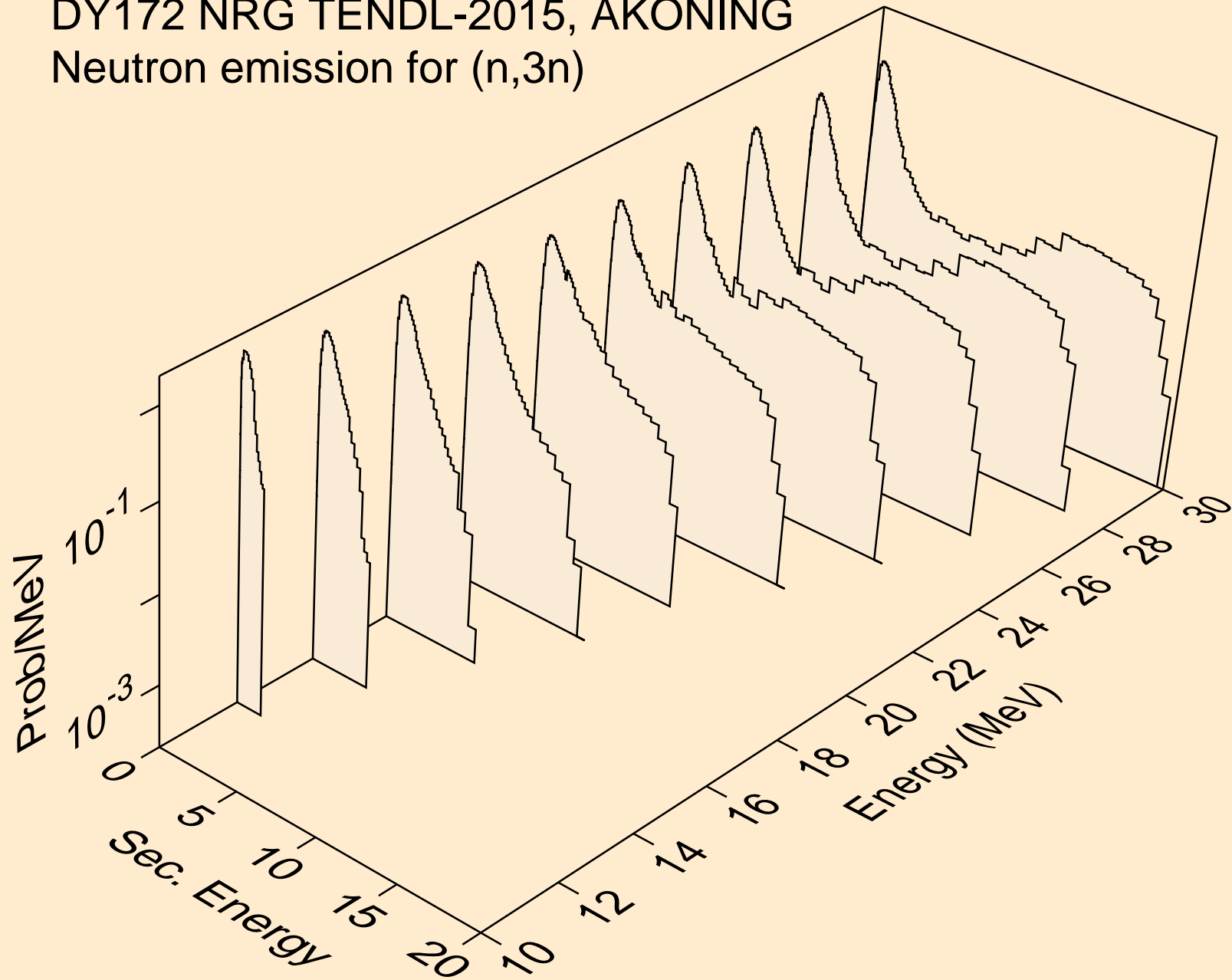

DY172 NRG TENDL-2015, AKONING
Neutron emission for (n,n*)a

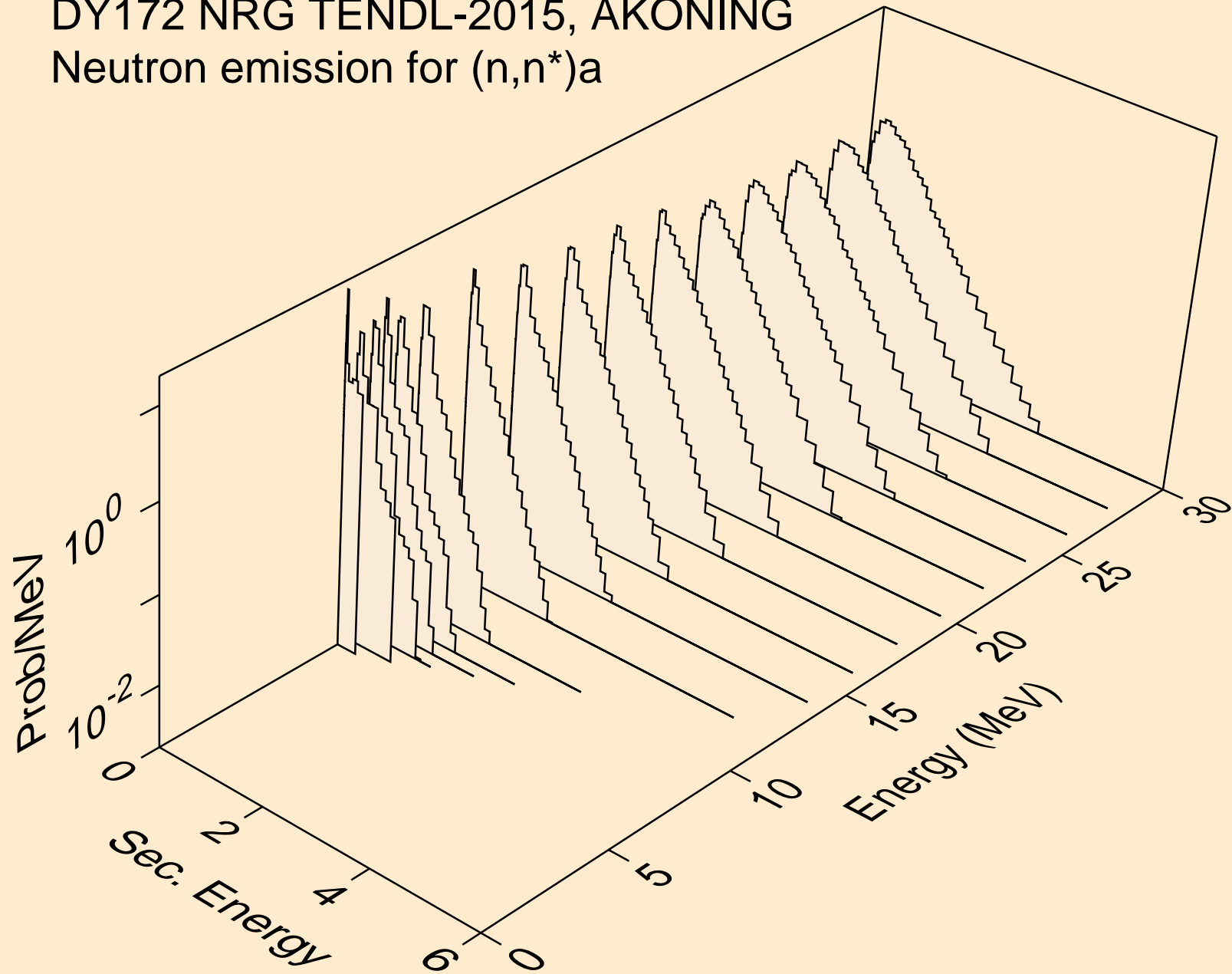

DY172 NRG TENDL-2015, AKONING
Neutron emission for (n,2n)a

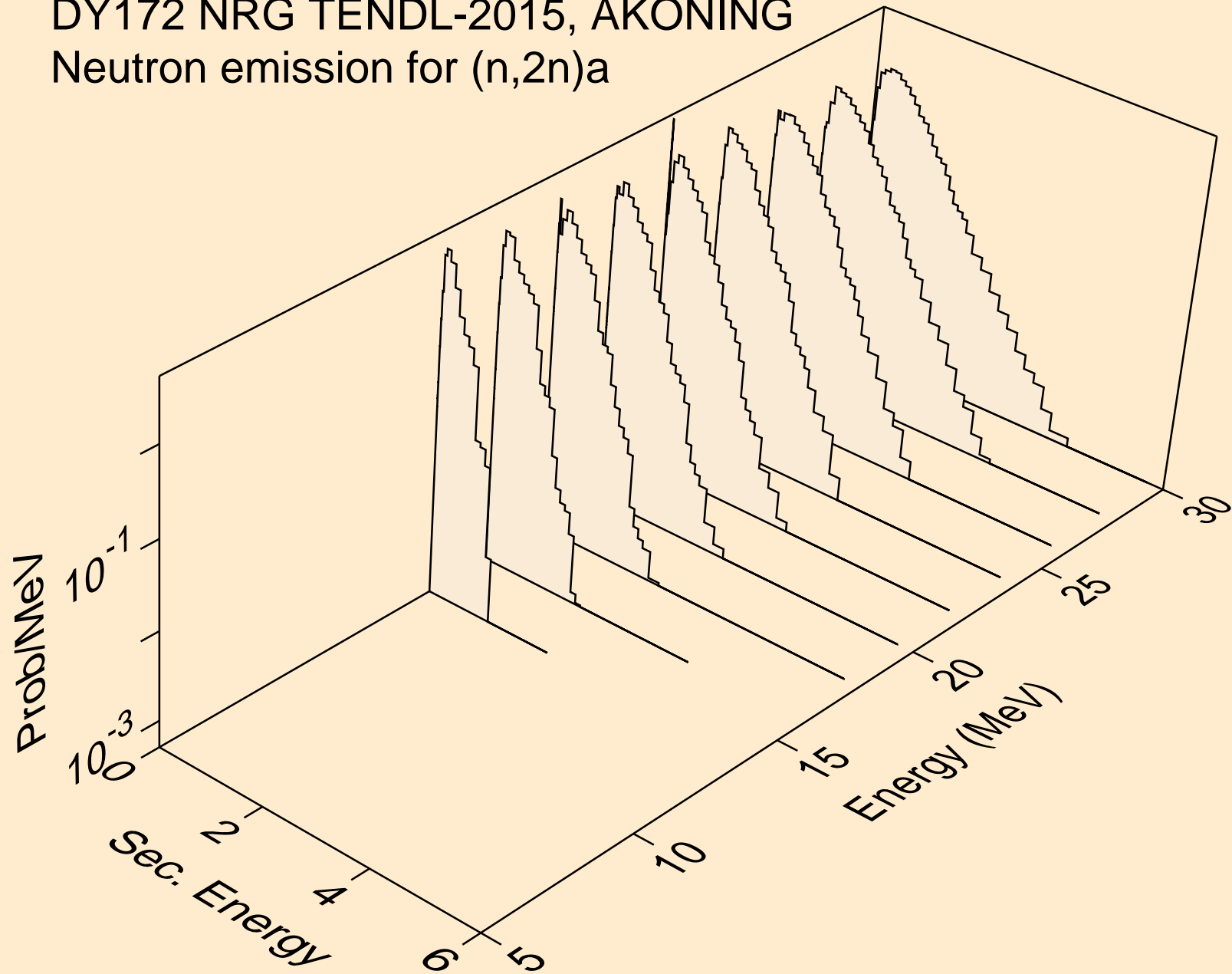

DY172 NRG TENDL-2015, AKONING
Neutron emission for (n,3n)a

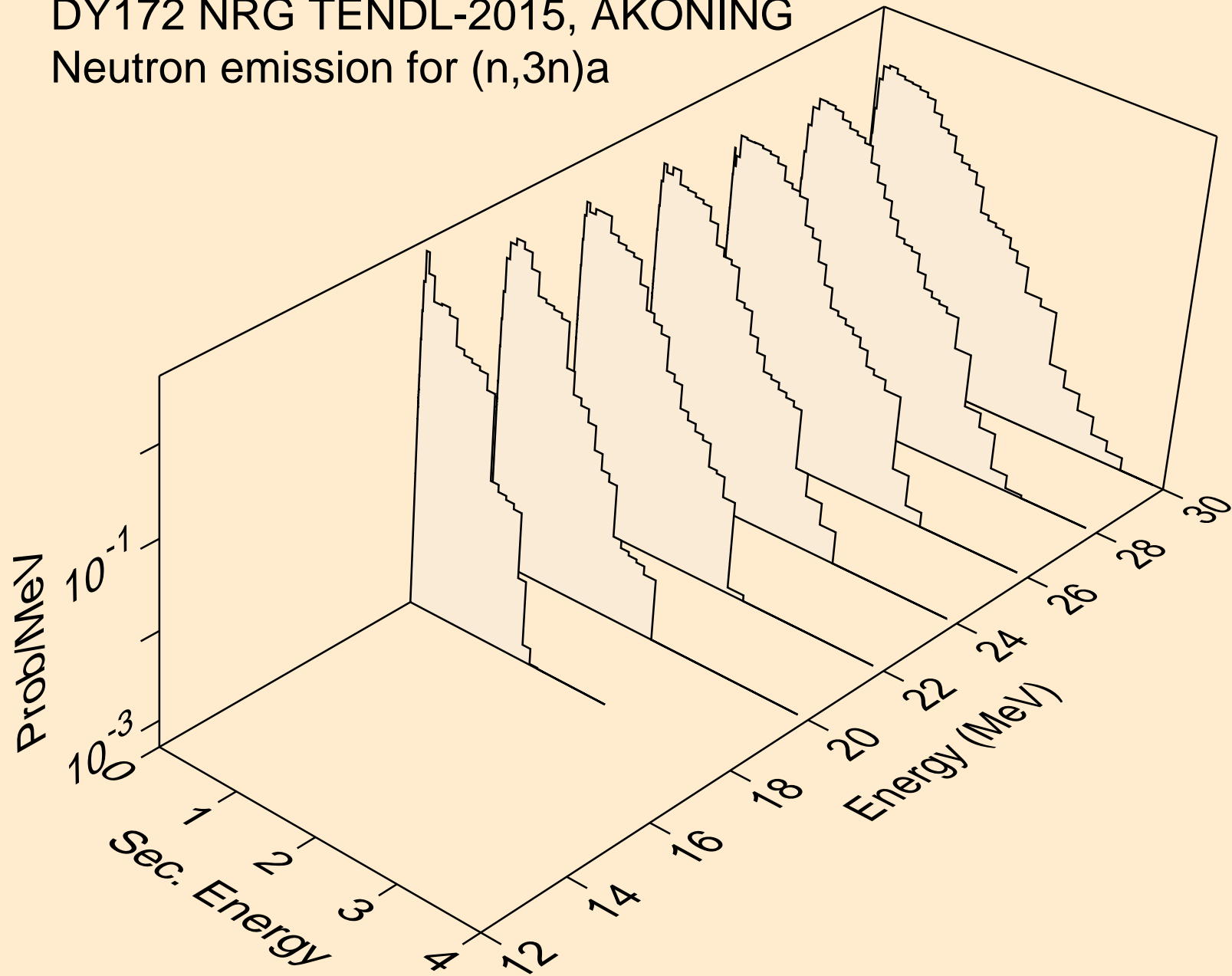

DY172 NRG TENDL-2015, AKONING
Neutron emission for (n,n*)p

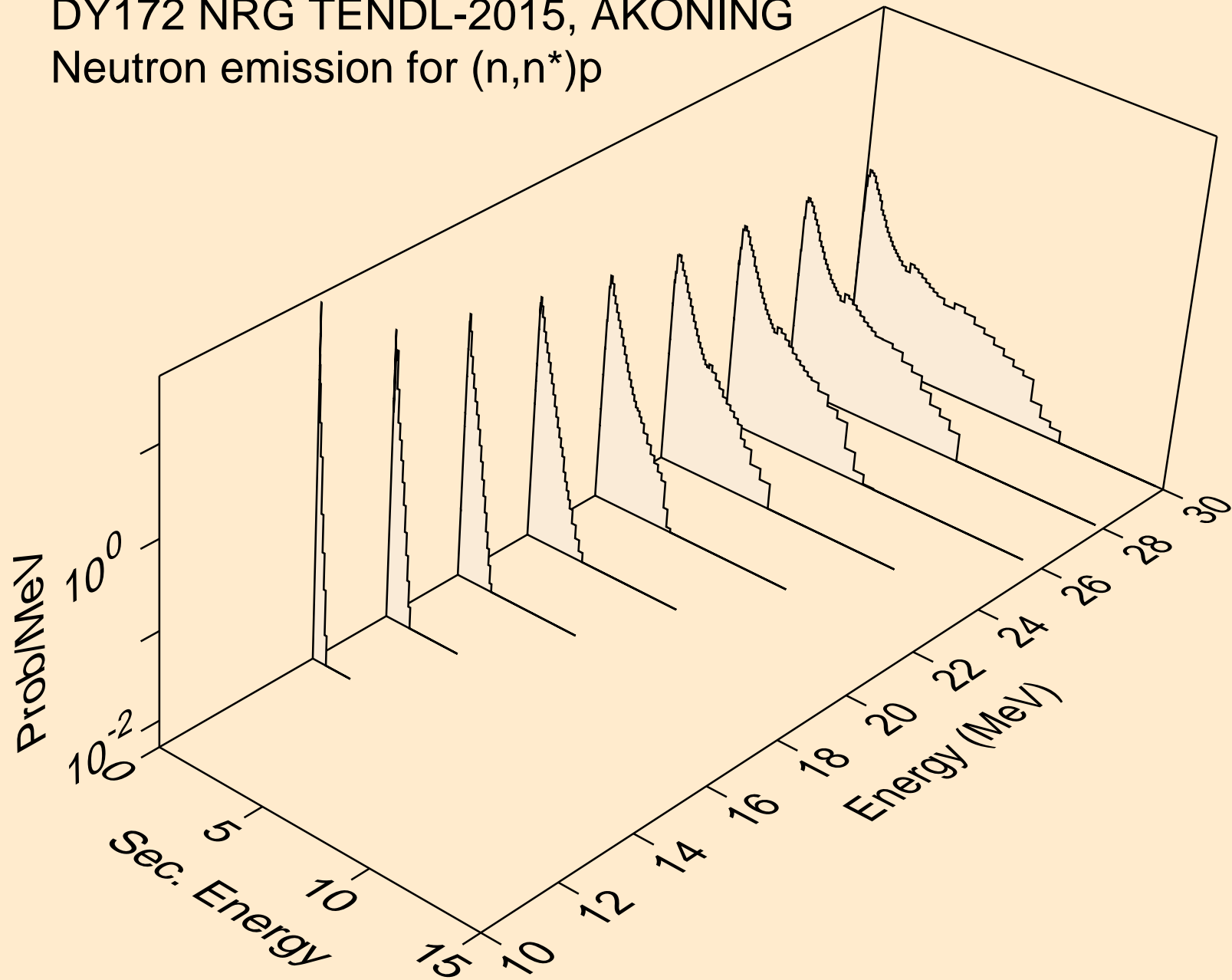

DY172 NRG TENDL-2015, AKONING
Neutron emission for (n,n*)d

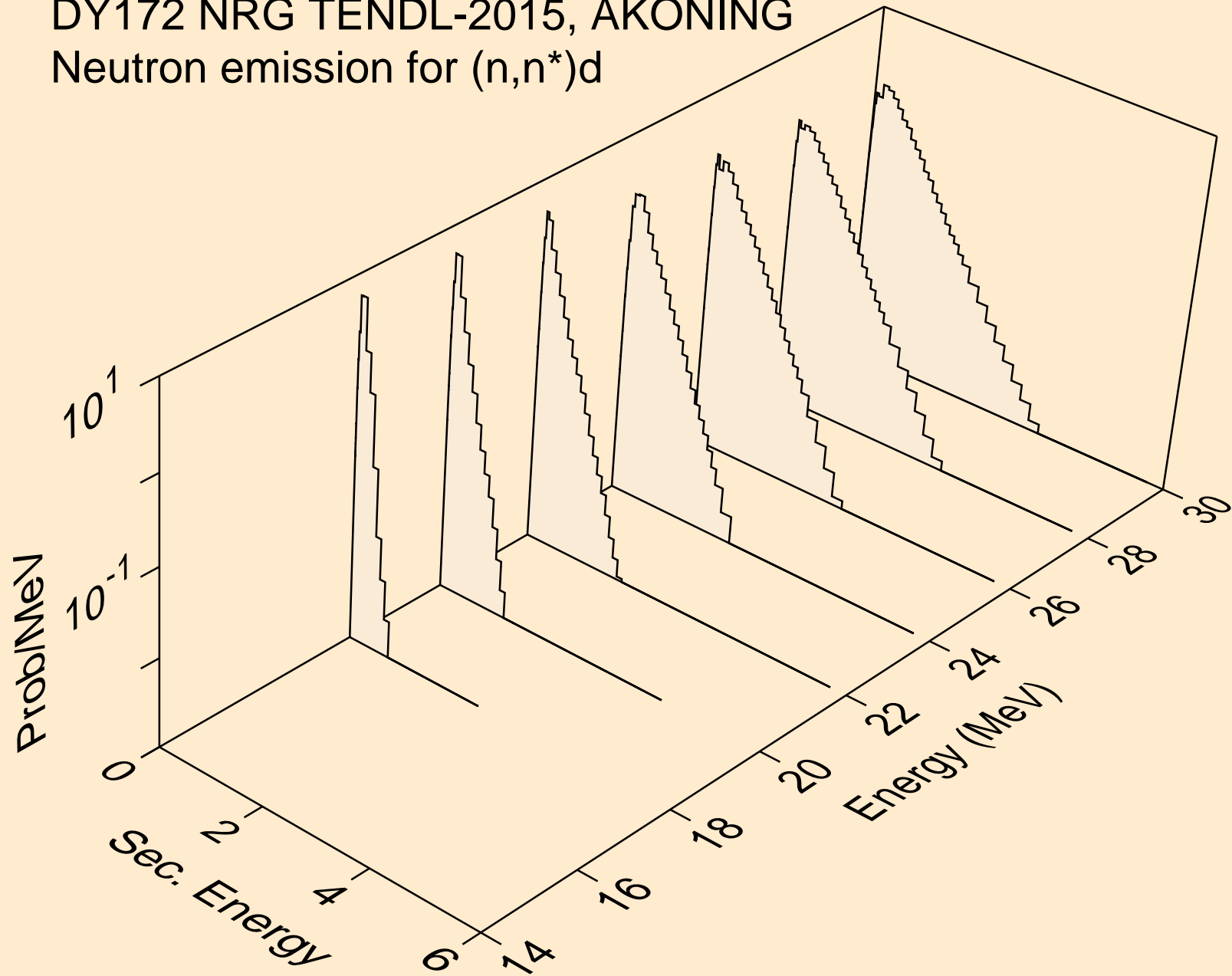

DY172 NRG TENDL-2015, AKONING
Neutron emission for (n,n*)t

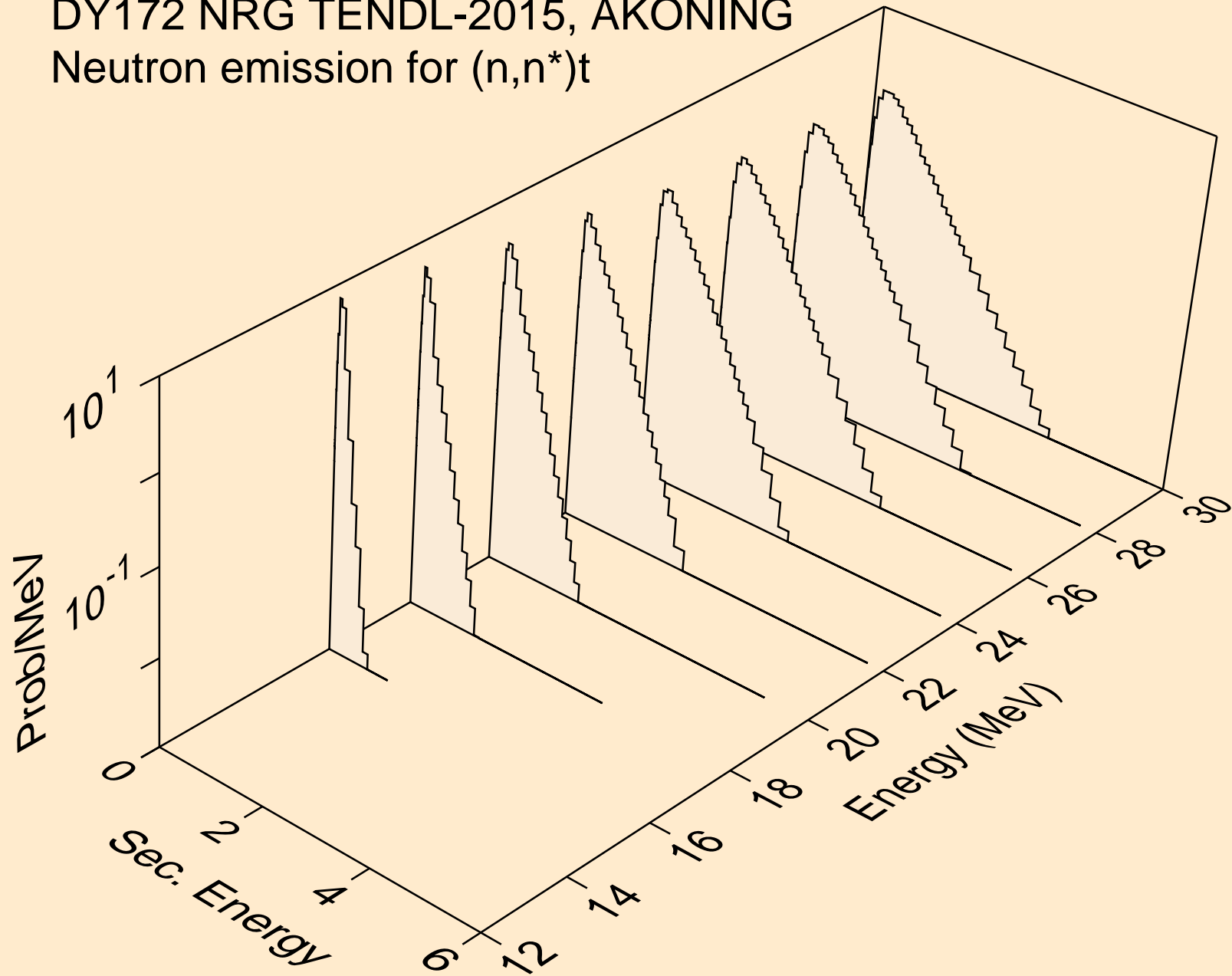

DY172 NRG TENDL-2015, AKONING
Neutron emission for (n,4n)

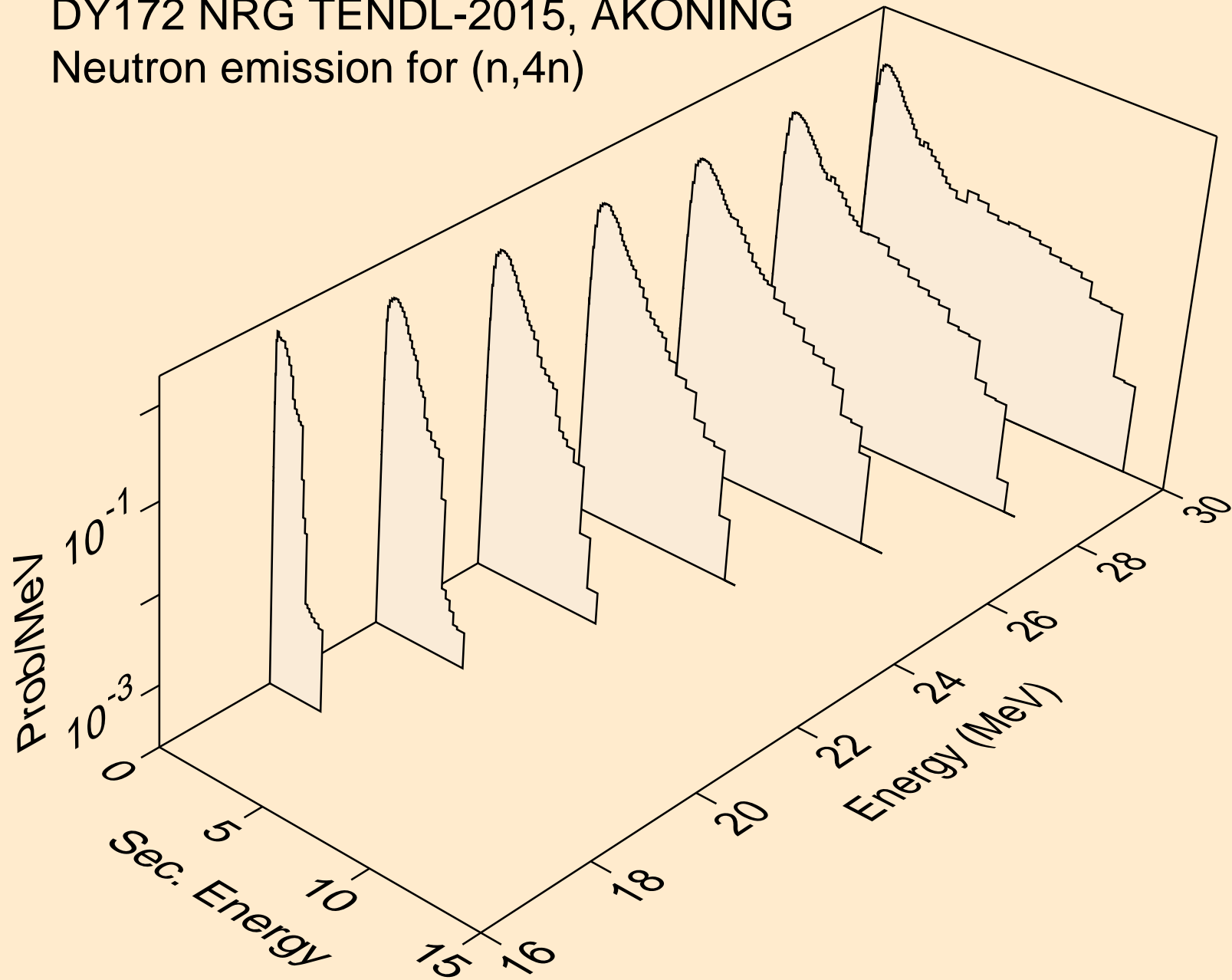

DY172 NRG TENDL-2015, AKONING
Neutron emission for (n,2np)

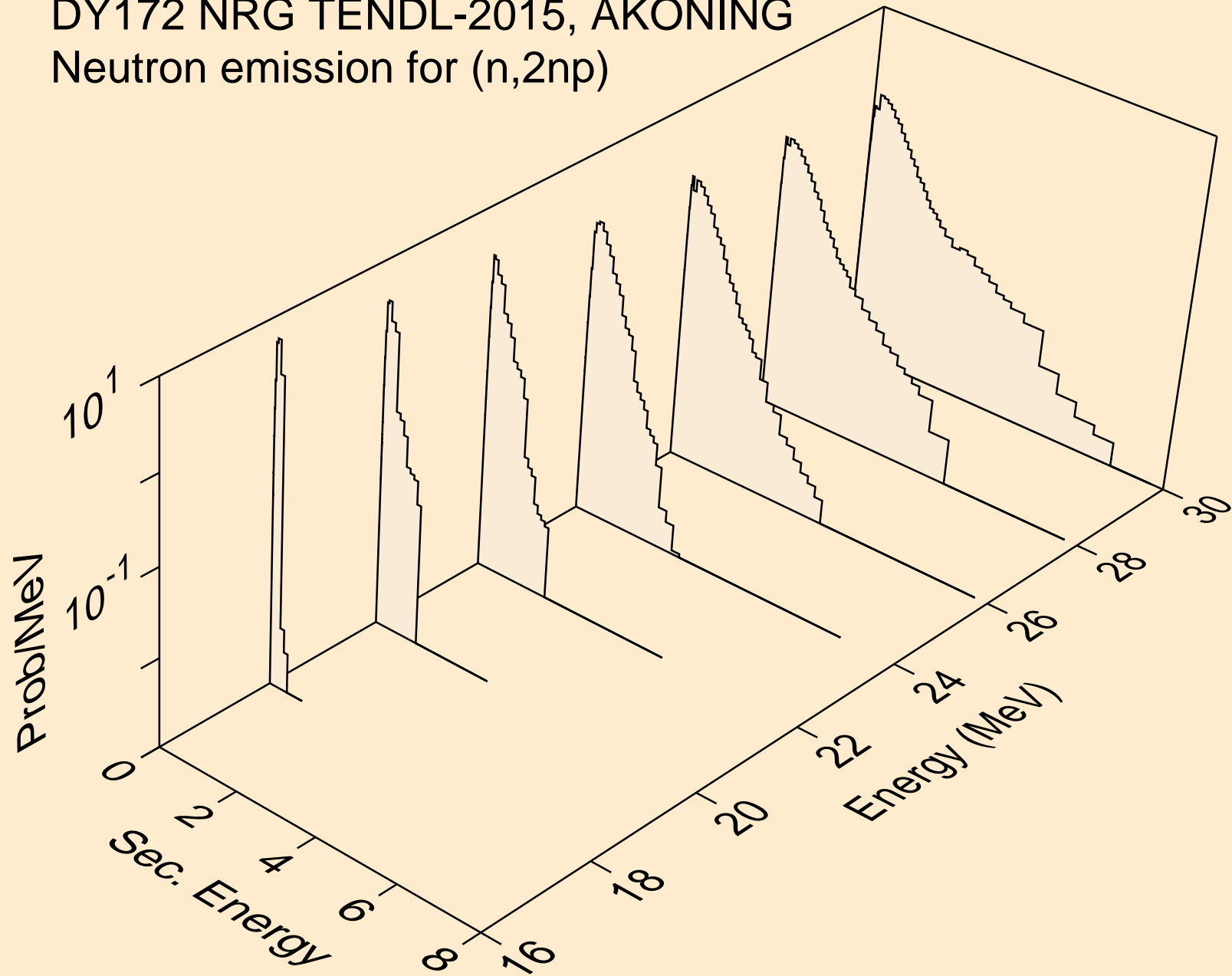

DY172 NRG TENDL-2015, AKONING
Neutron emission for (n,3np)

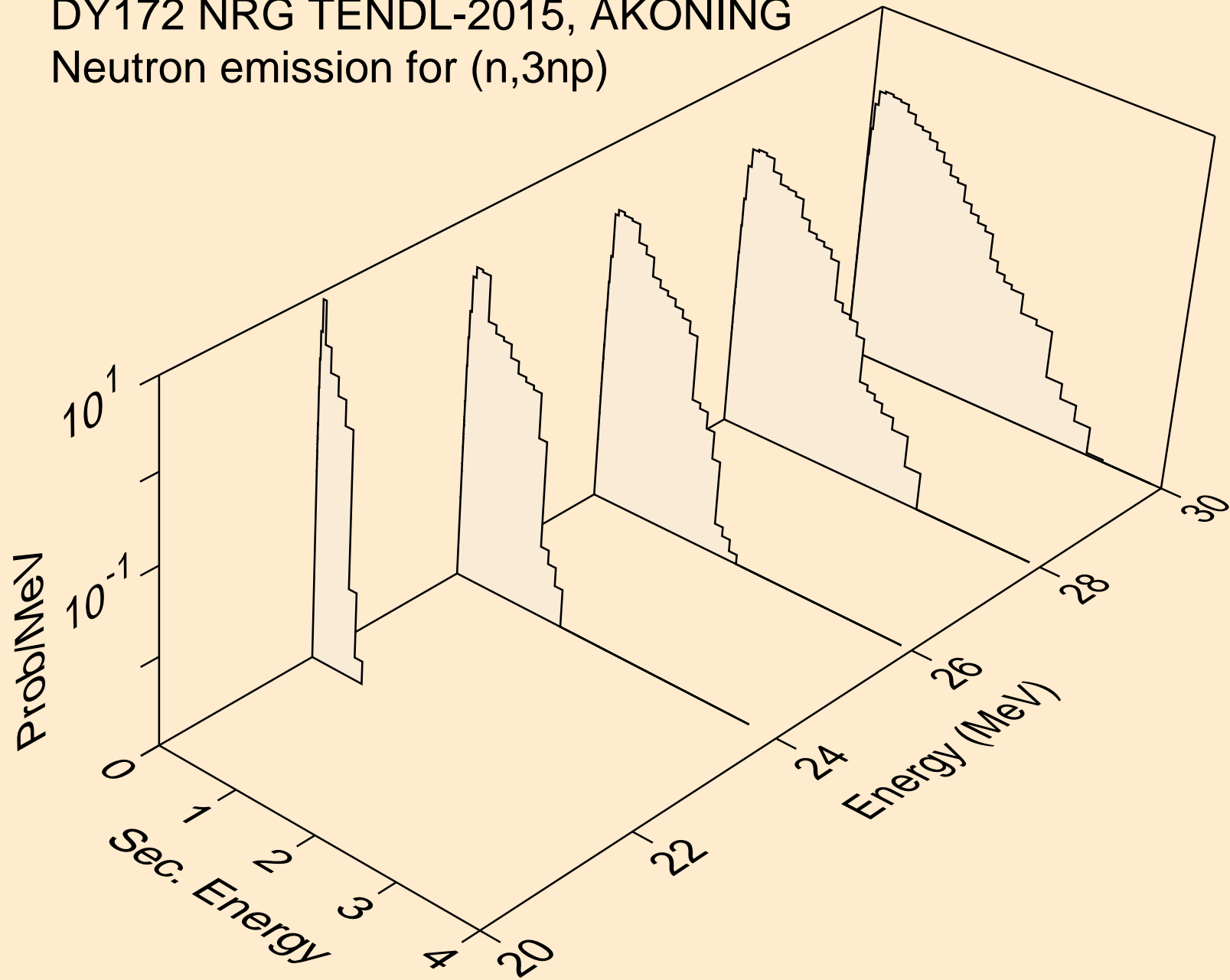

DY172 NRG TENDL-2015, AKONING
Neutron emission for (n,n*c)

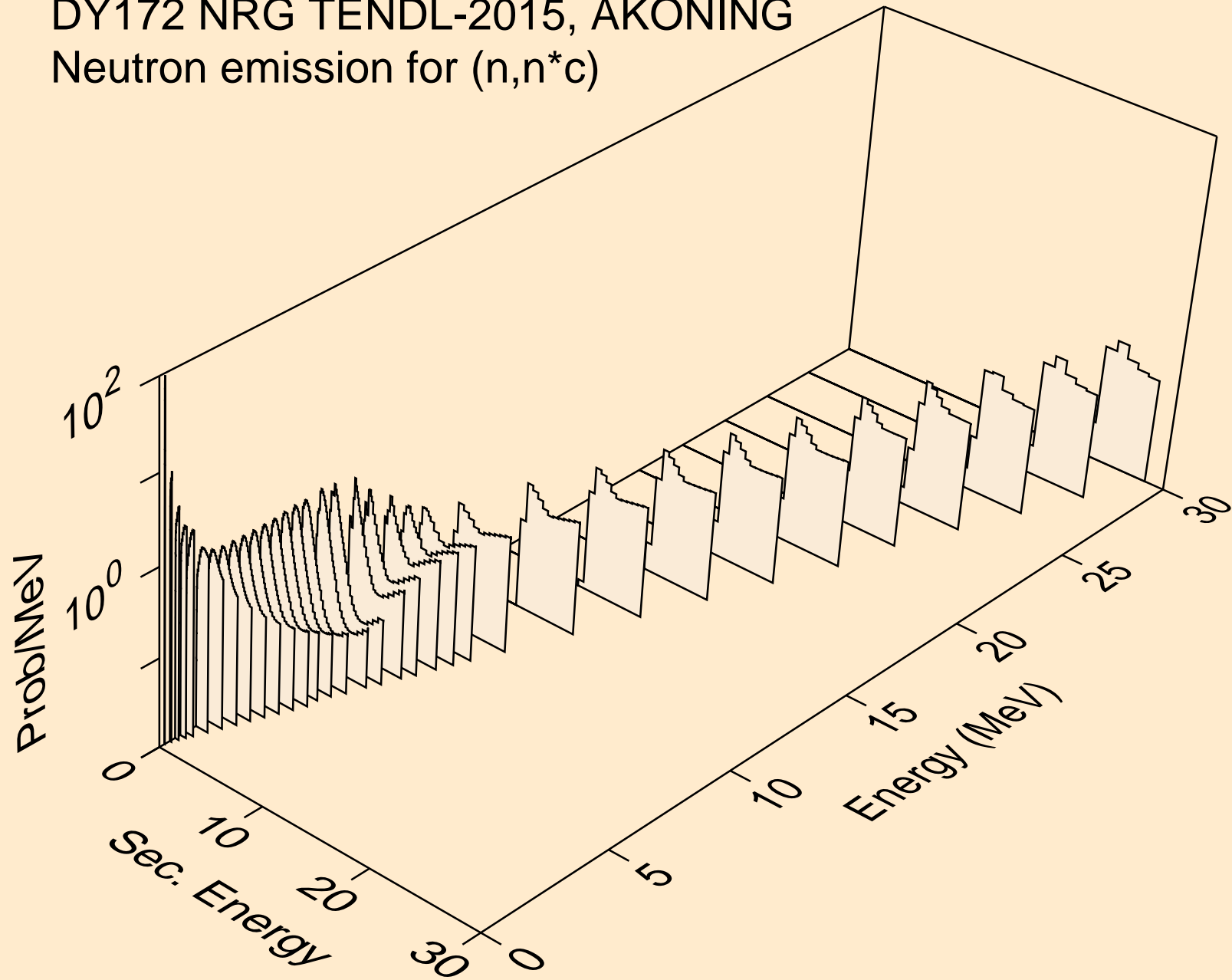

DY172 NRG TENDL-2015, AKONING
Photon emission for (n,x)

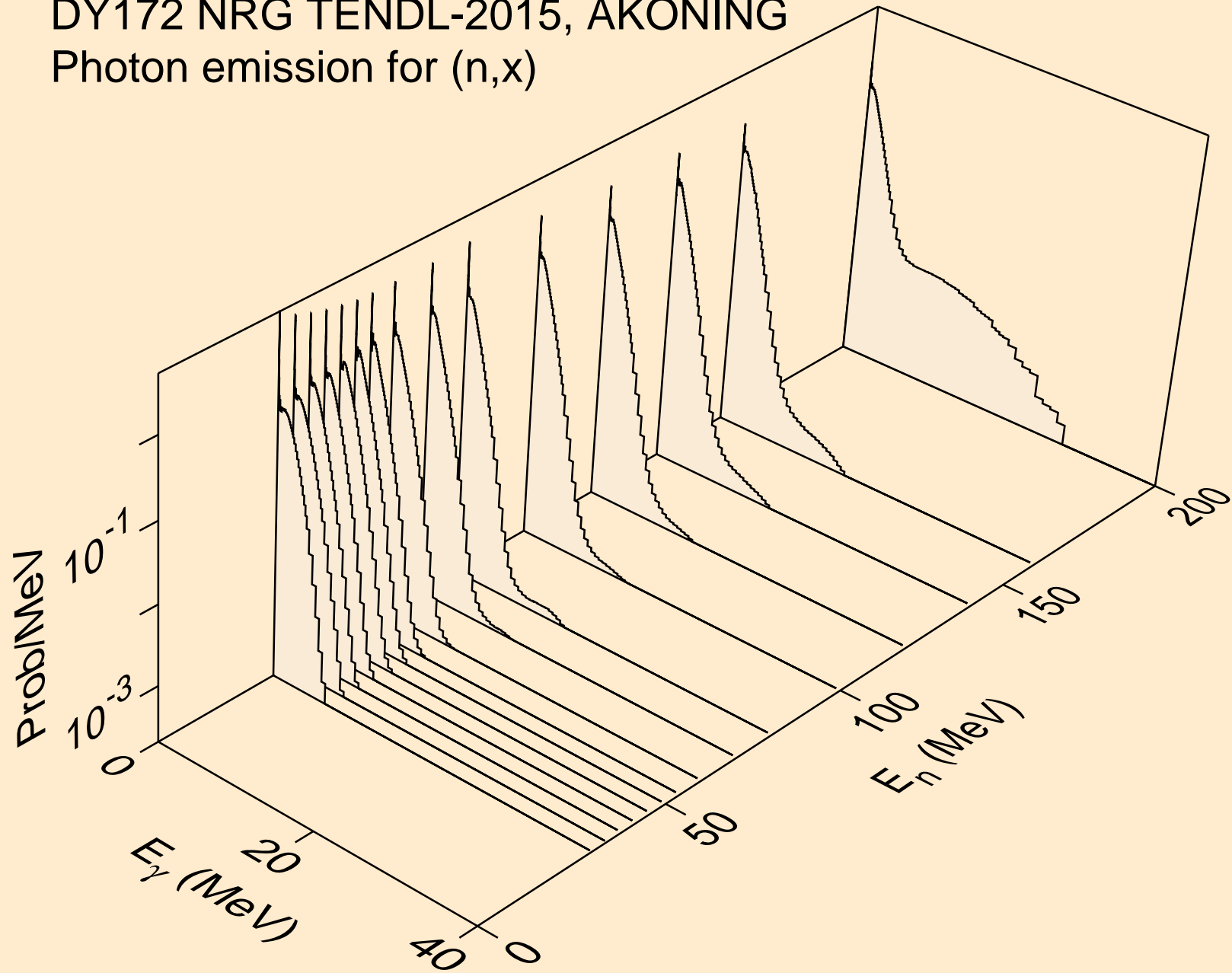

DY172 NRG TENDL-2015, AKONING
Photon emission for (n,2nd)

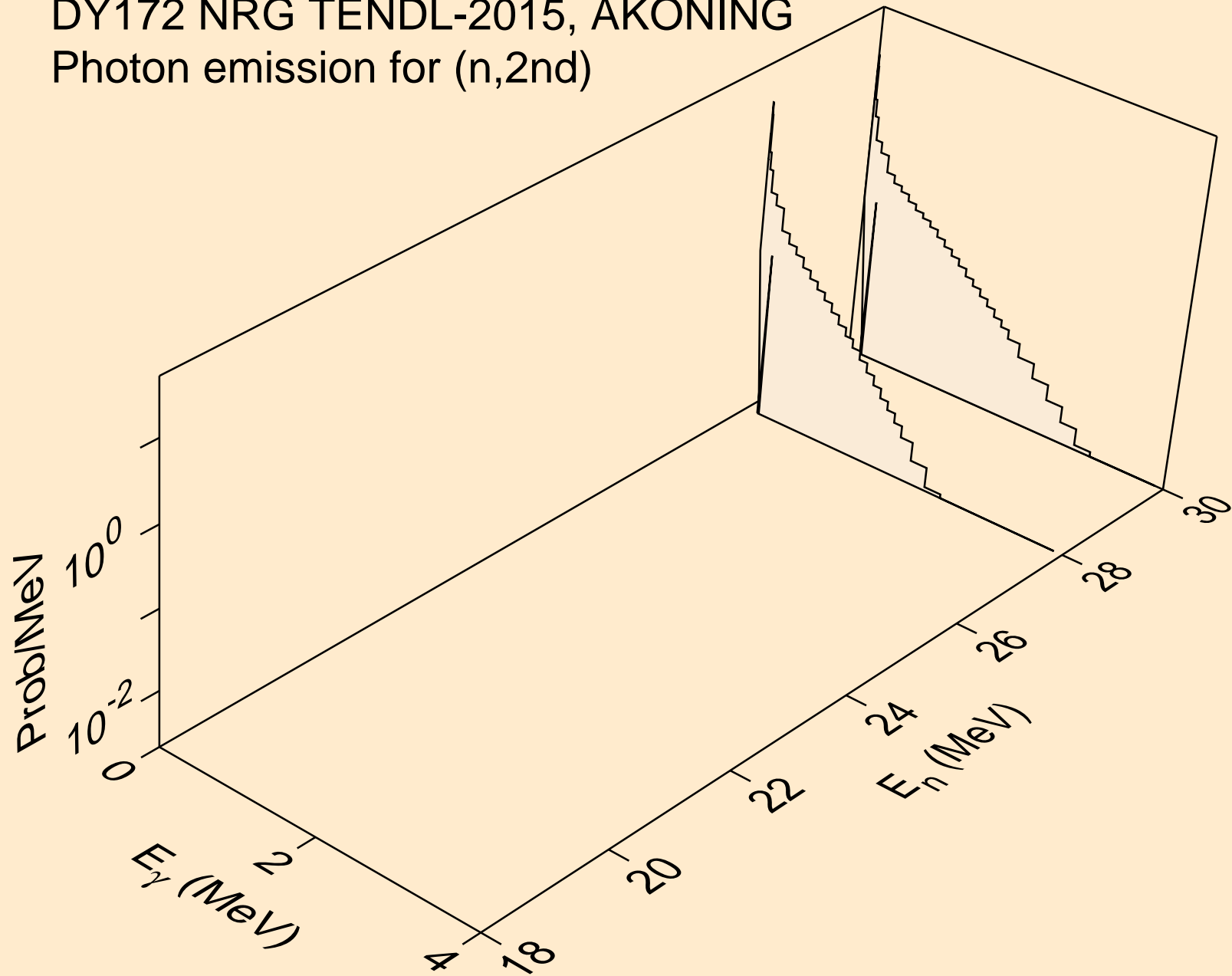

DY172 NRG TENDL-2015, AKONING
Photon emission for (n,2n)

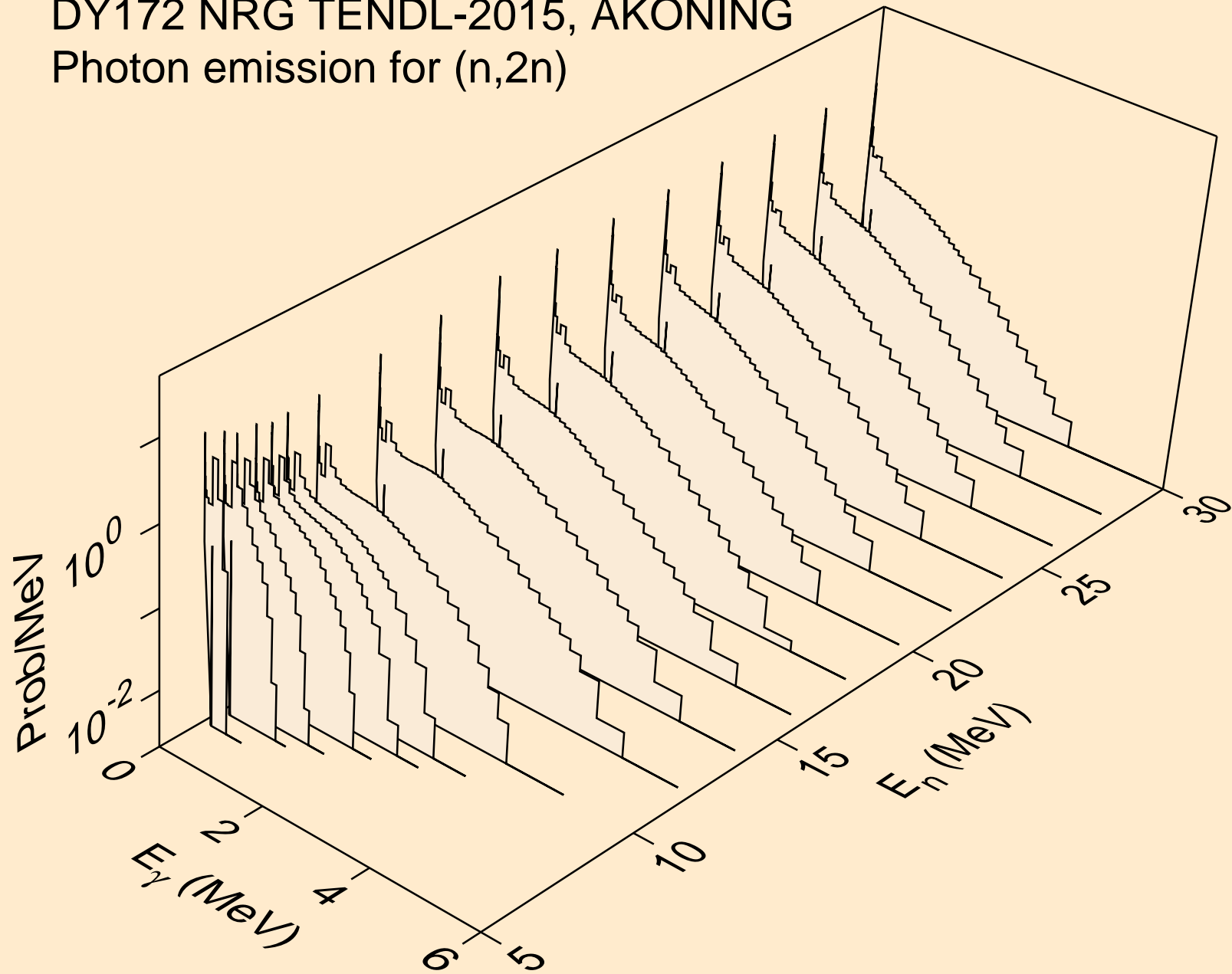

DY172 NRG TENDL-2015, AKONING
Photon emission for (n,3n)

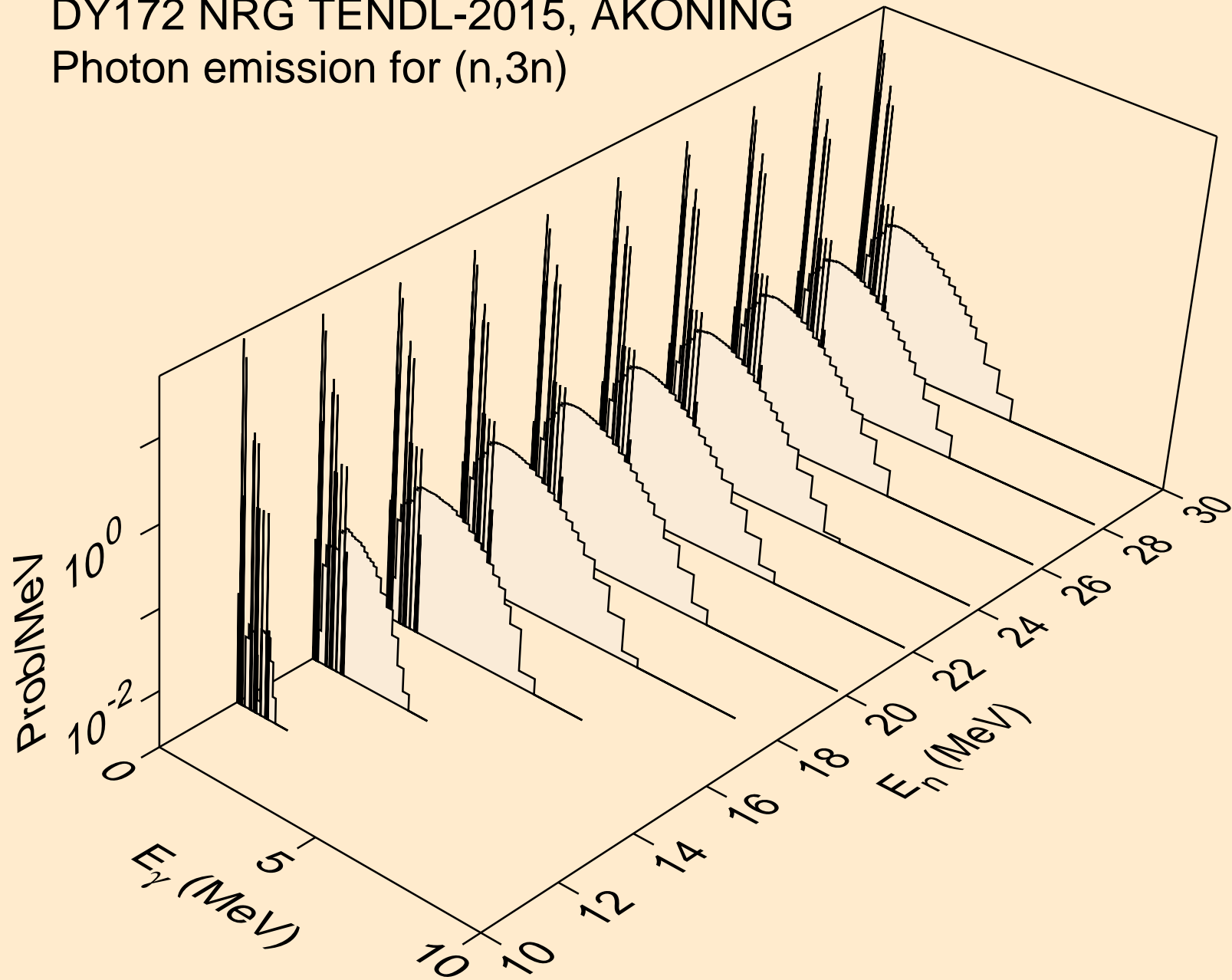

DY172 NRG TENDL-2015, AKONING
Photon emission for (n,n*)a

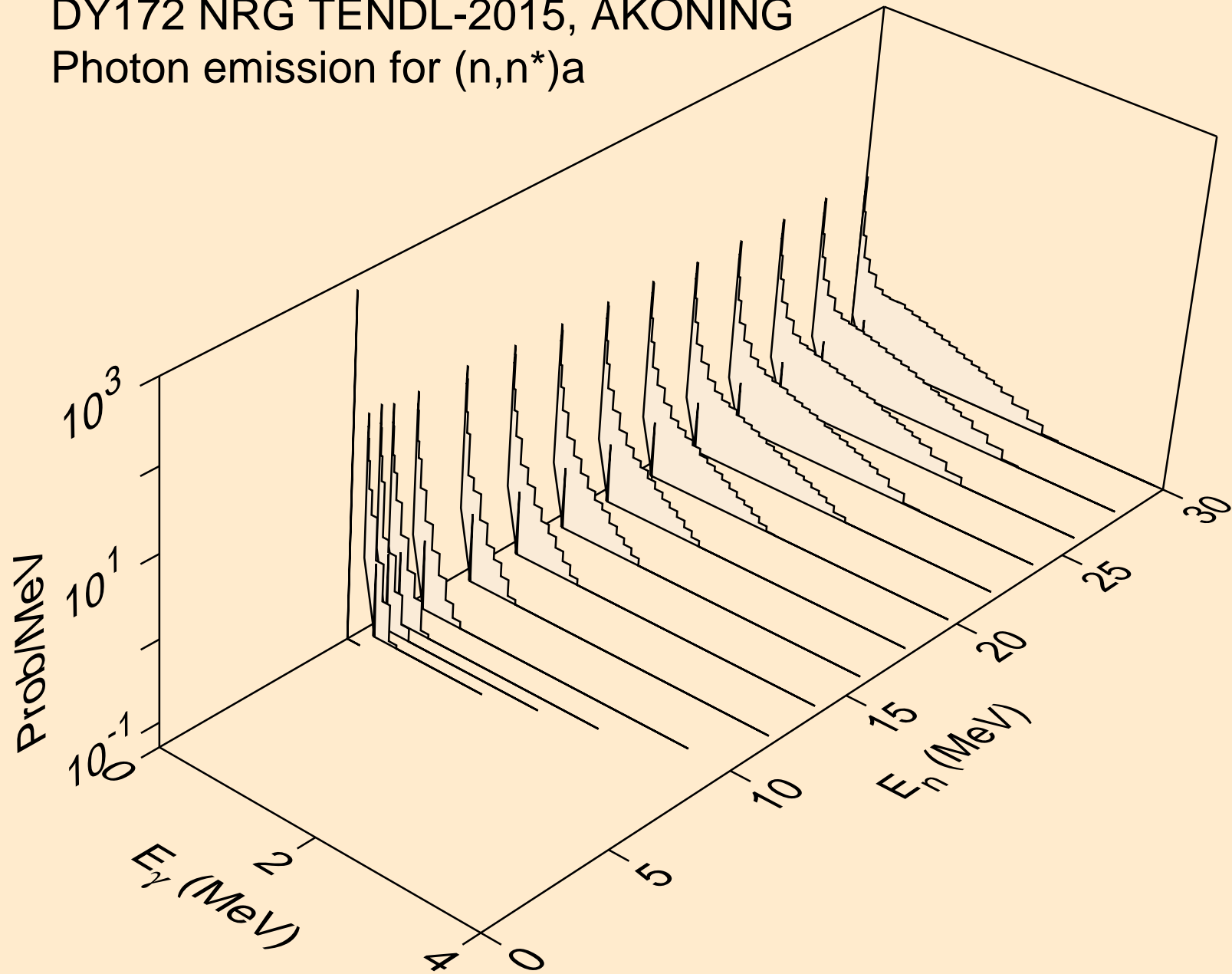

DY172 NRG TENDL-2015, AKONING
Photon emission for (n,2n)a

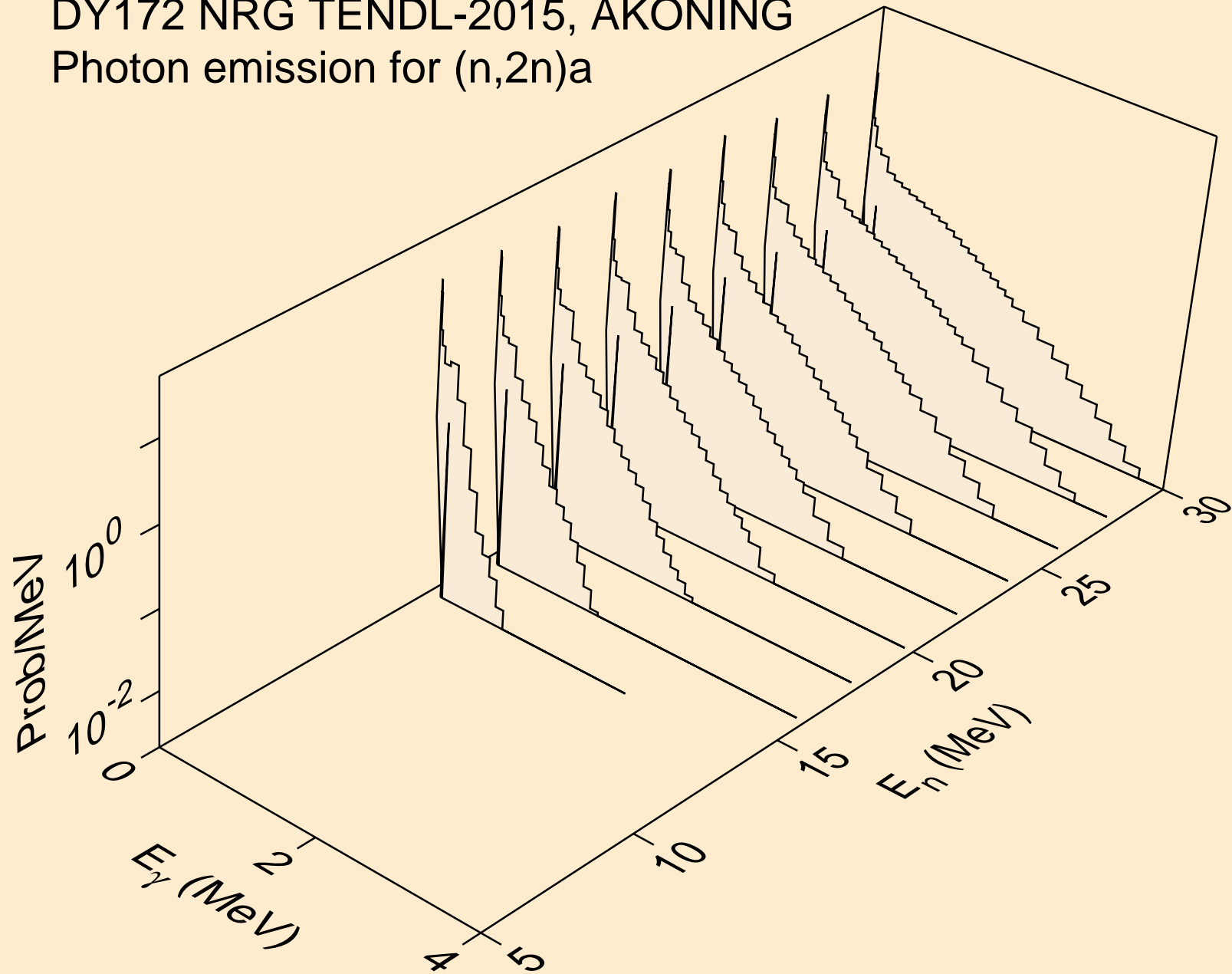

DY172 NRG TENDL-2015, AKONING
Photon emission for (n,3n)a

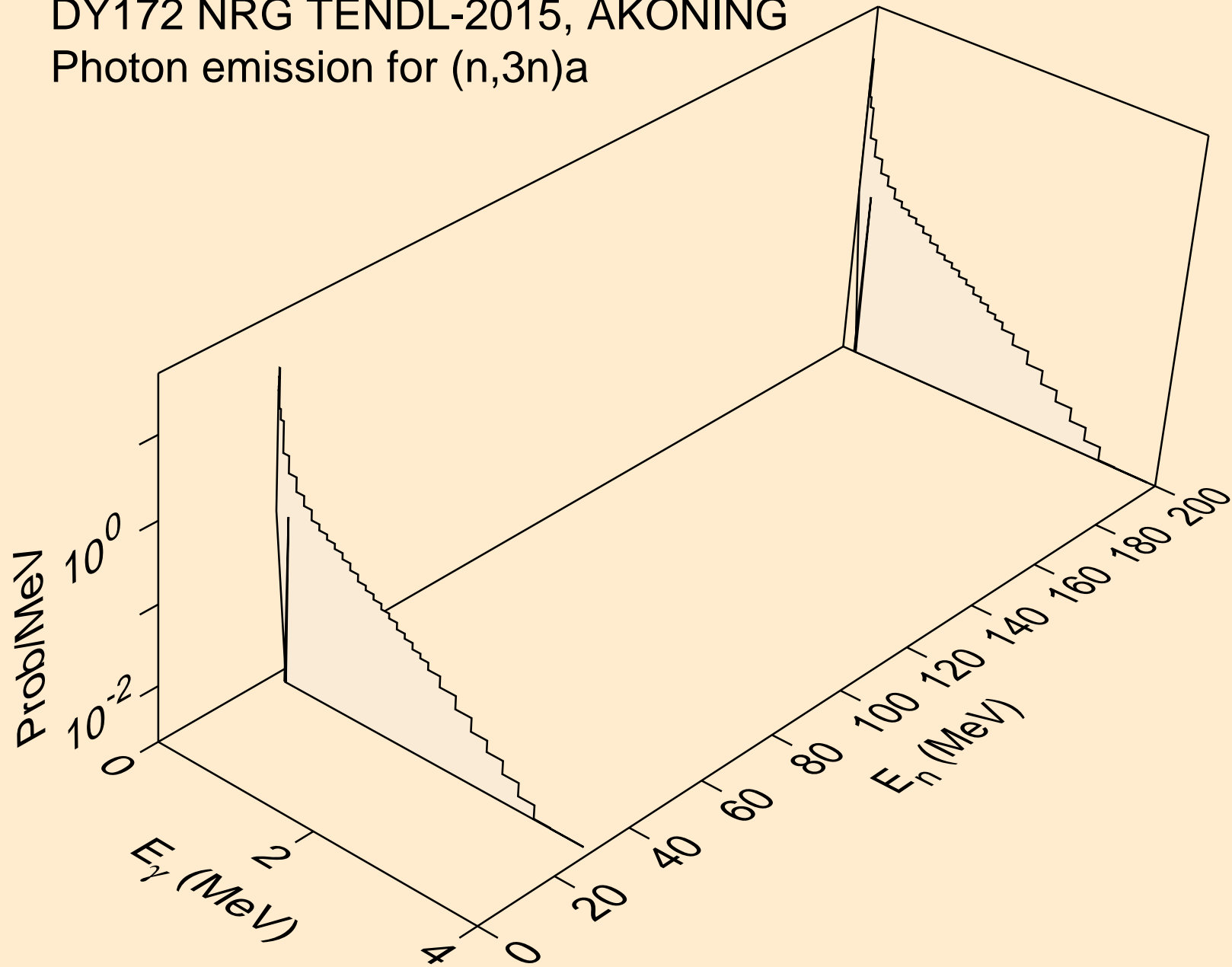

DY172 NRG TENDL-2015, AKONING

Photon emission for (n,n*)p

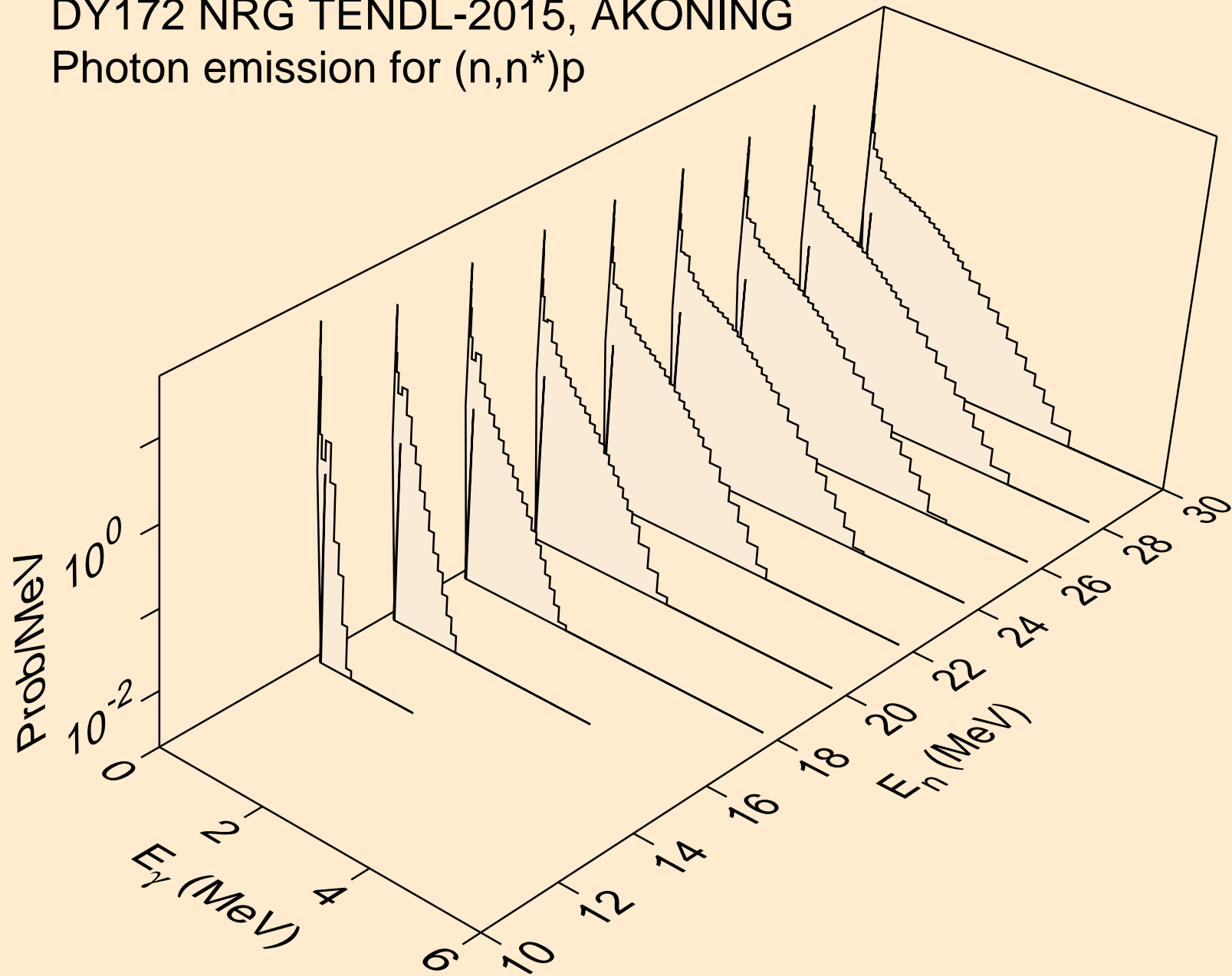

DY172 NRG TENDL-2015, AKONING
Photon emission for (n,n*)d

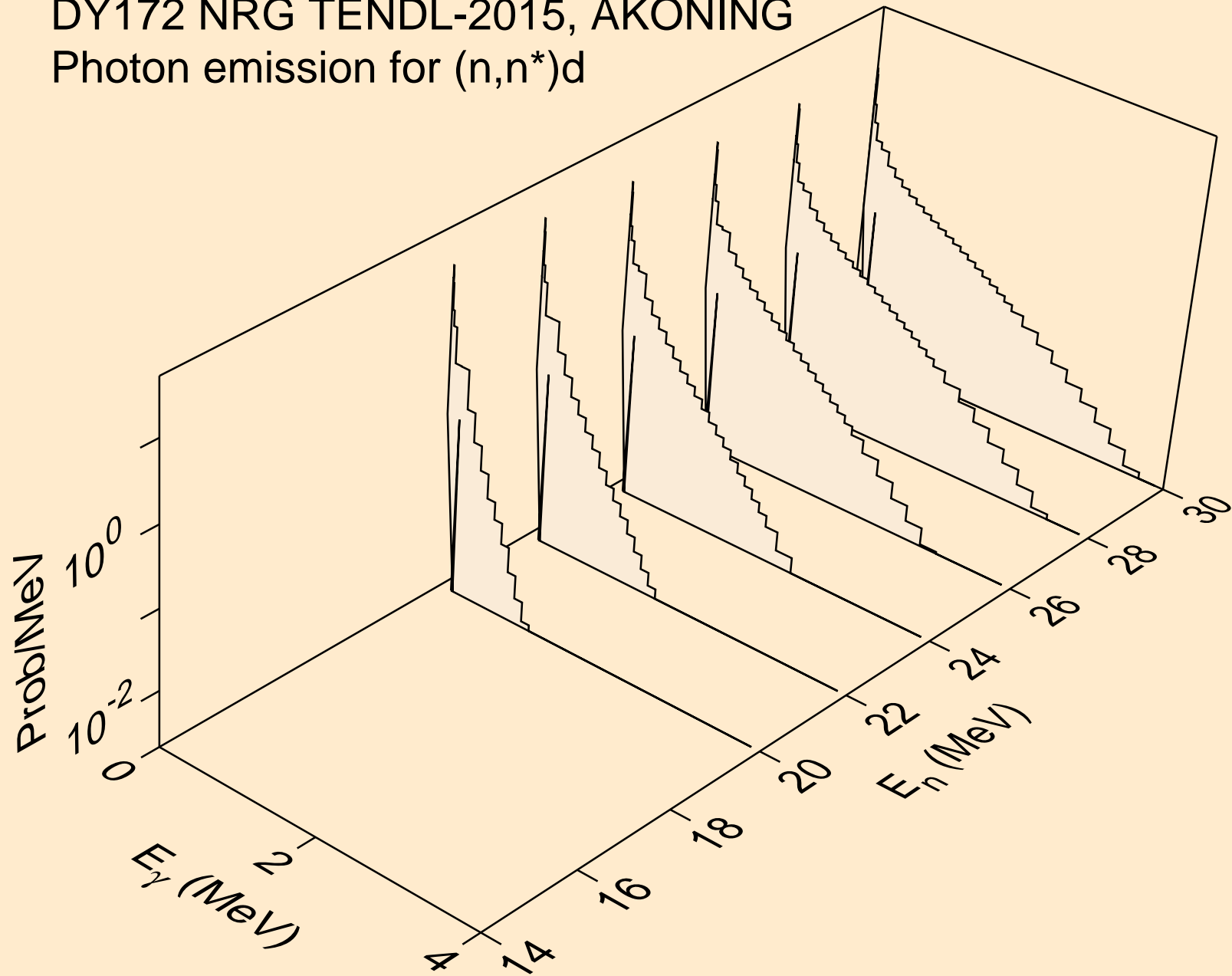

DY172 NRG TENDL-2015, AKONING
Photon emission for (n,n*)t

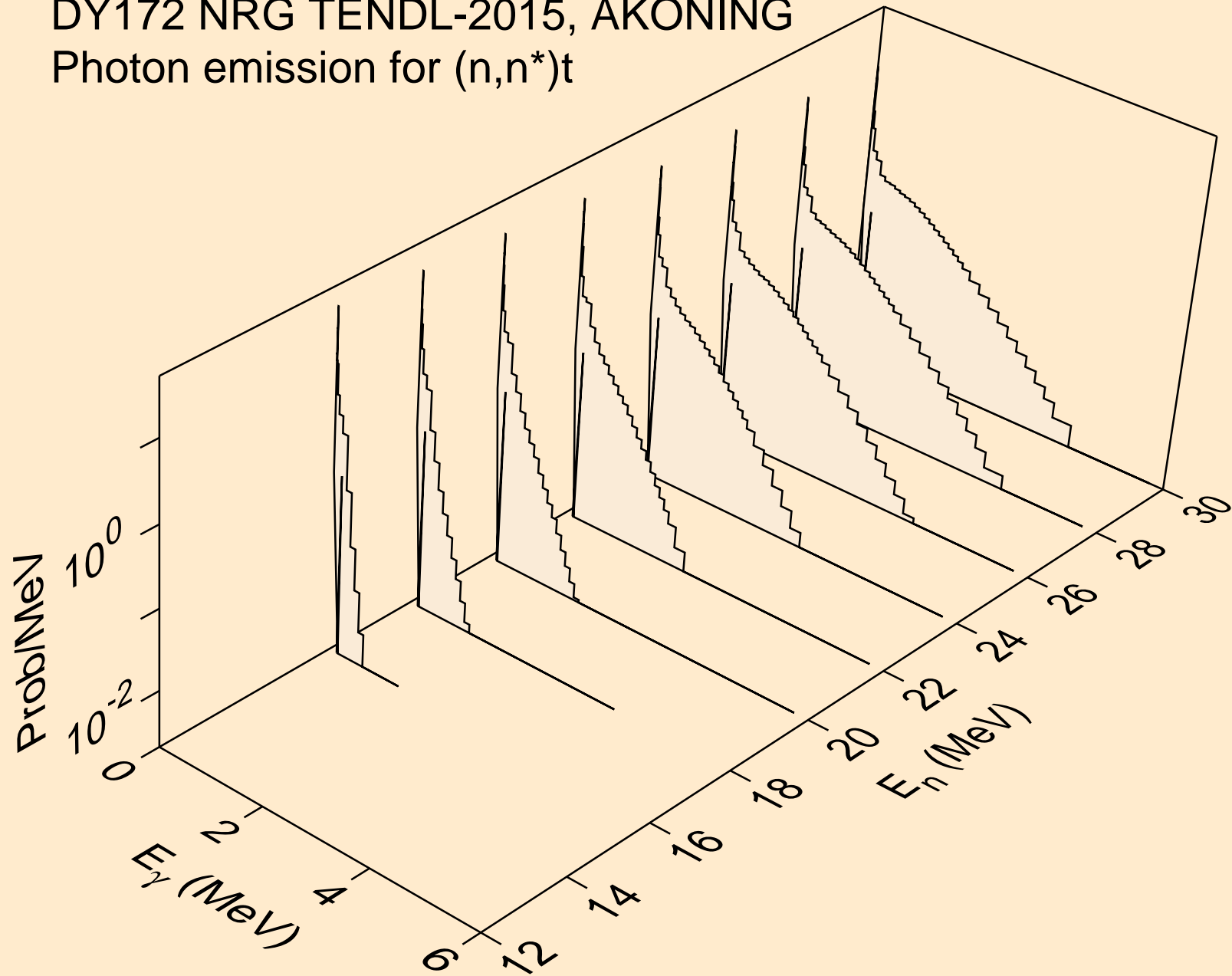

DY172 NRG TENDL-2015, AKONING
Photon emission for (n,4n)

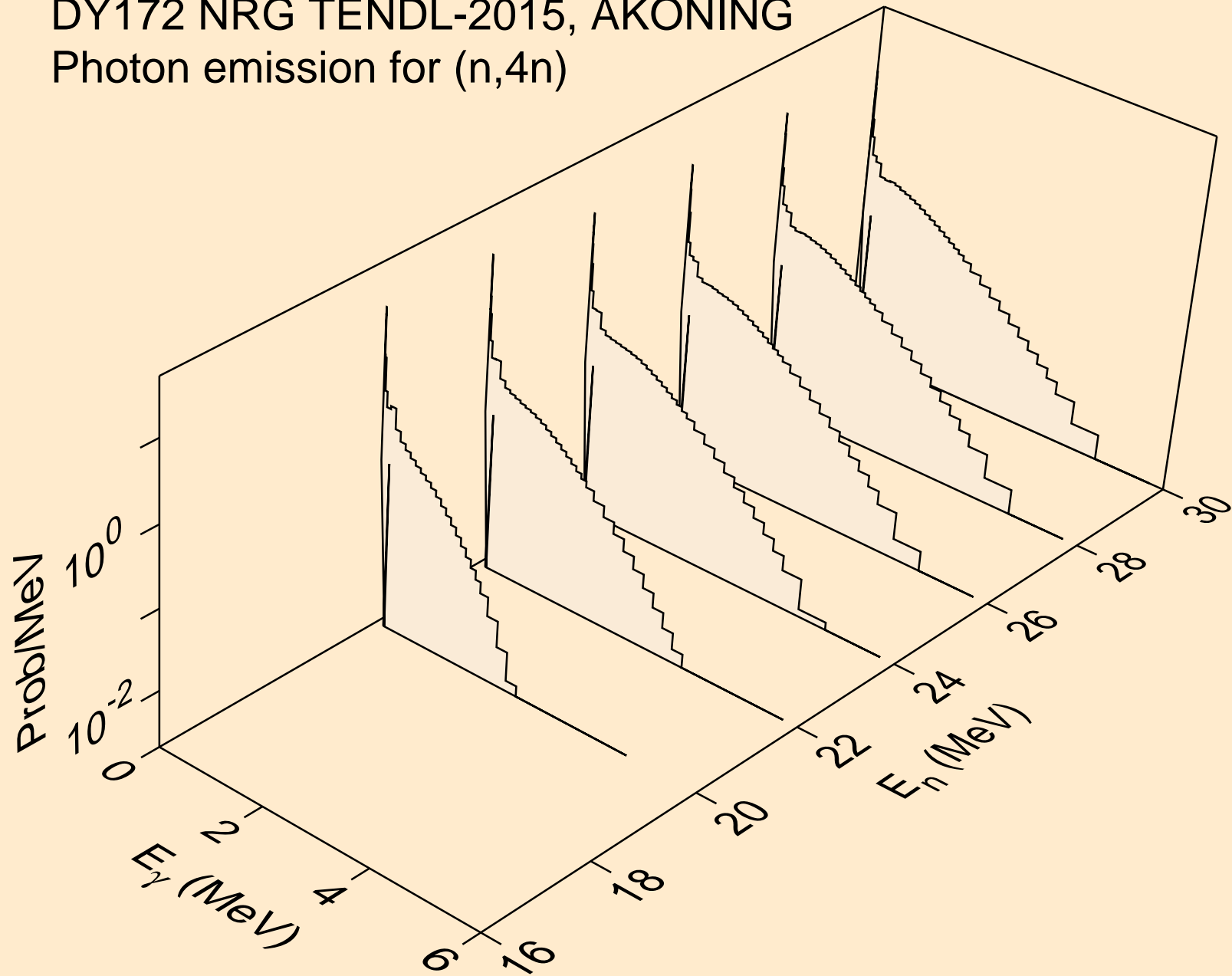

DY172 NRG TENDL-2015, AKONING
Photon emission for (n,2np)

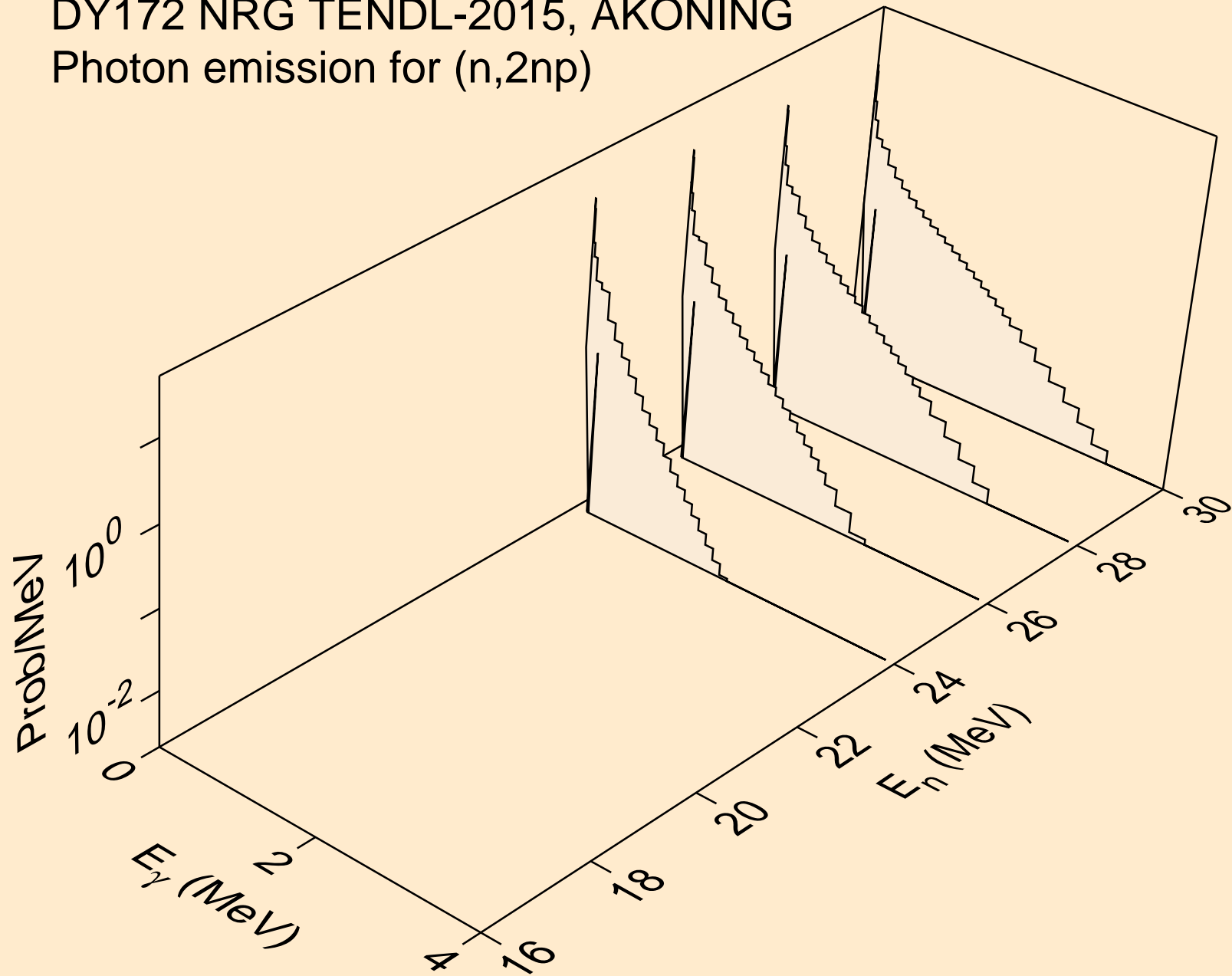

DY172 NRG TENDL-2015, AKONING
Photon emission for (n,3np)

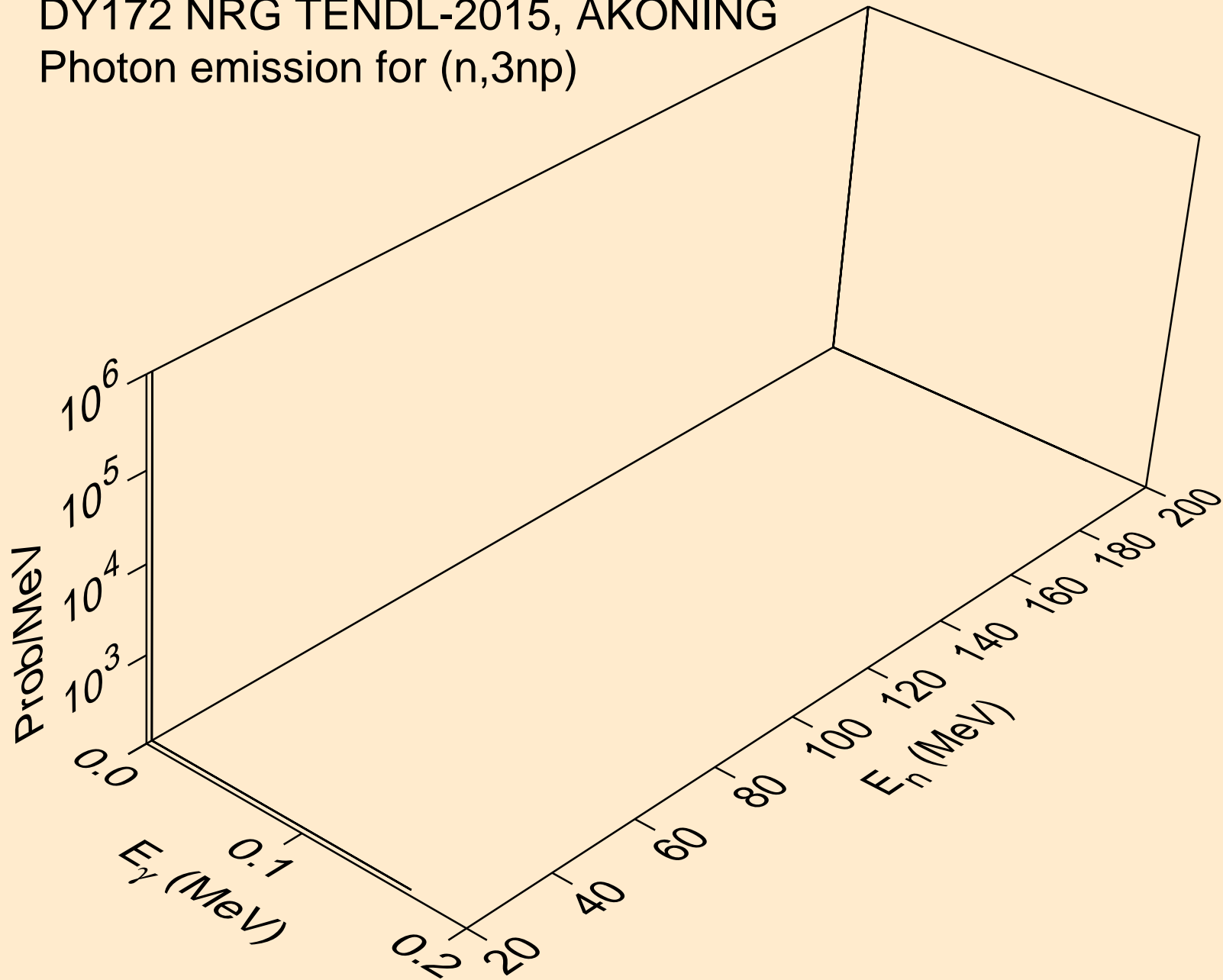

DY172 NRG TENDL-2015, AKONING
Photon emission for (n,n*c)

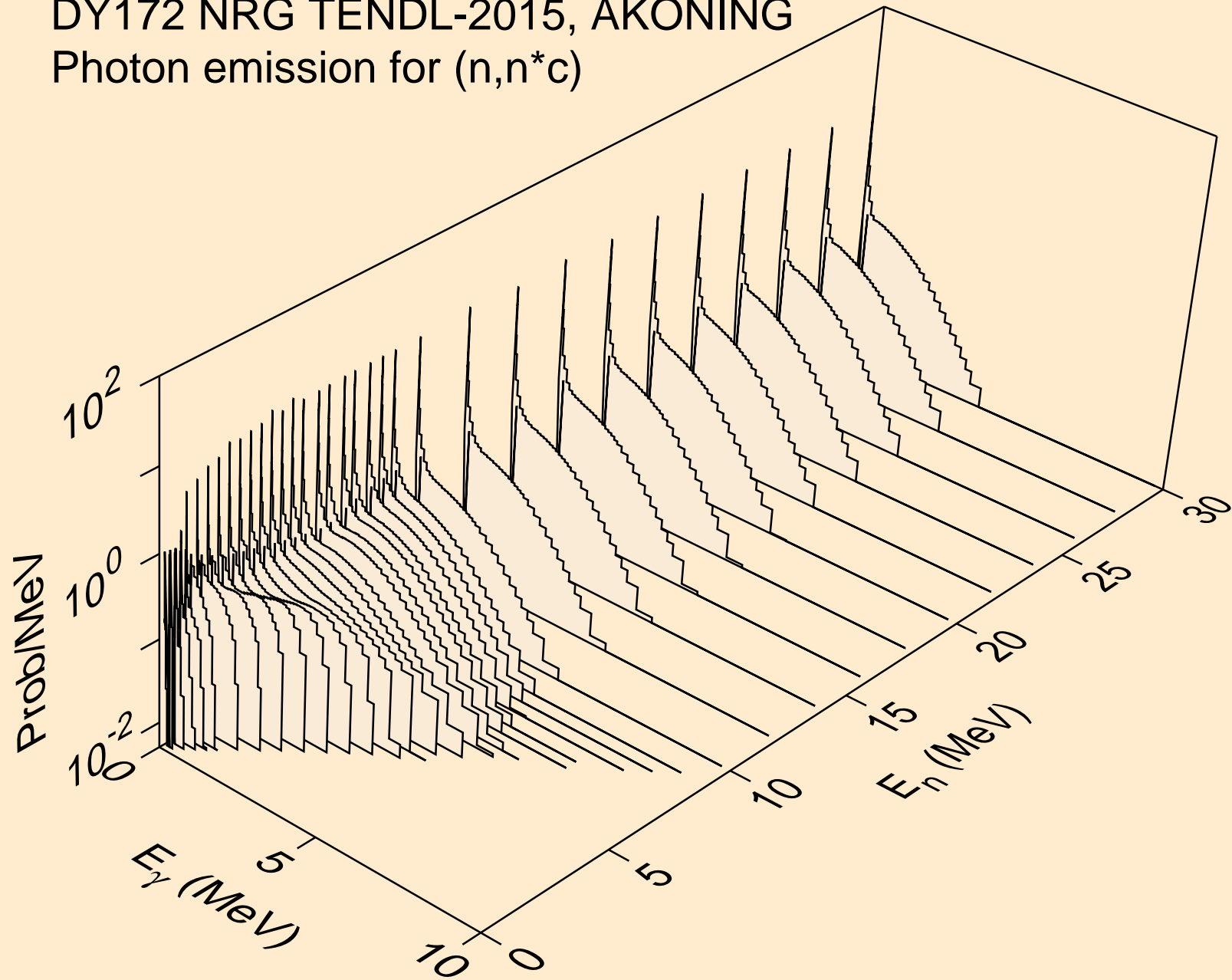

DY172 NRG TENDL-2015, AKONING
Photon emission for (n,gma)

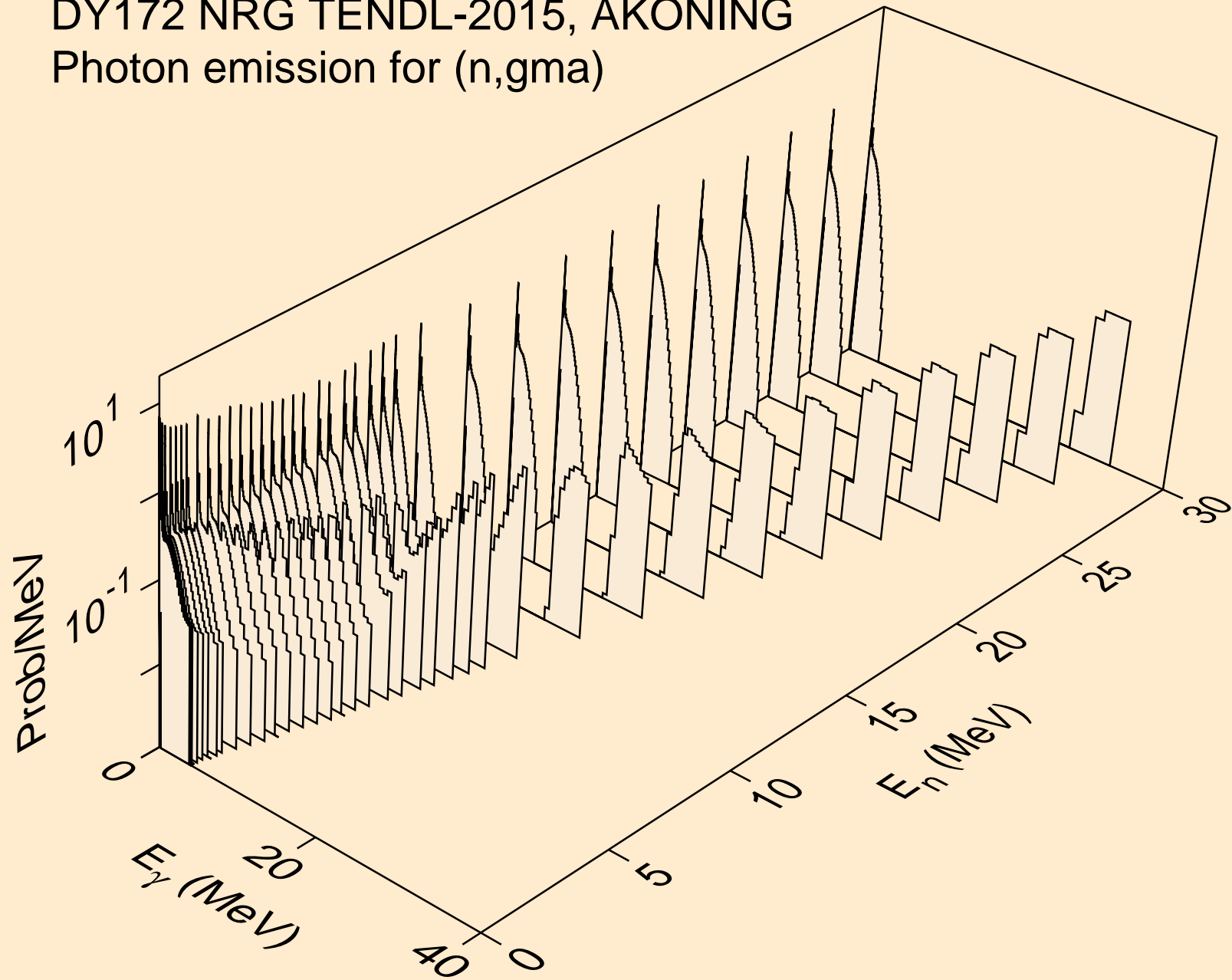

DY172 NRG TENDL-2015, AKONING
Photon emission for (n,p)

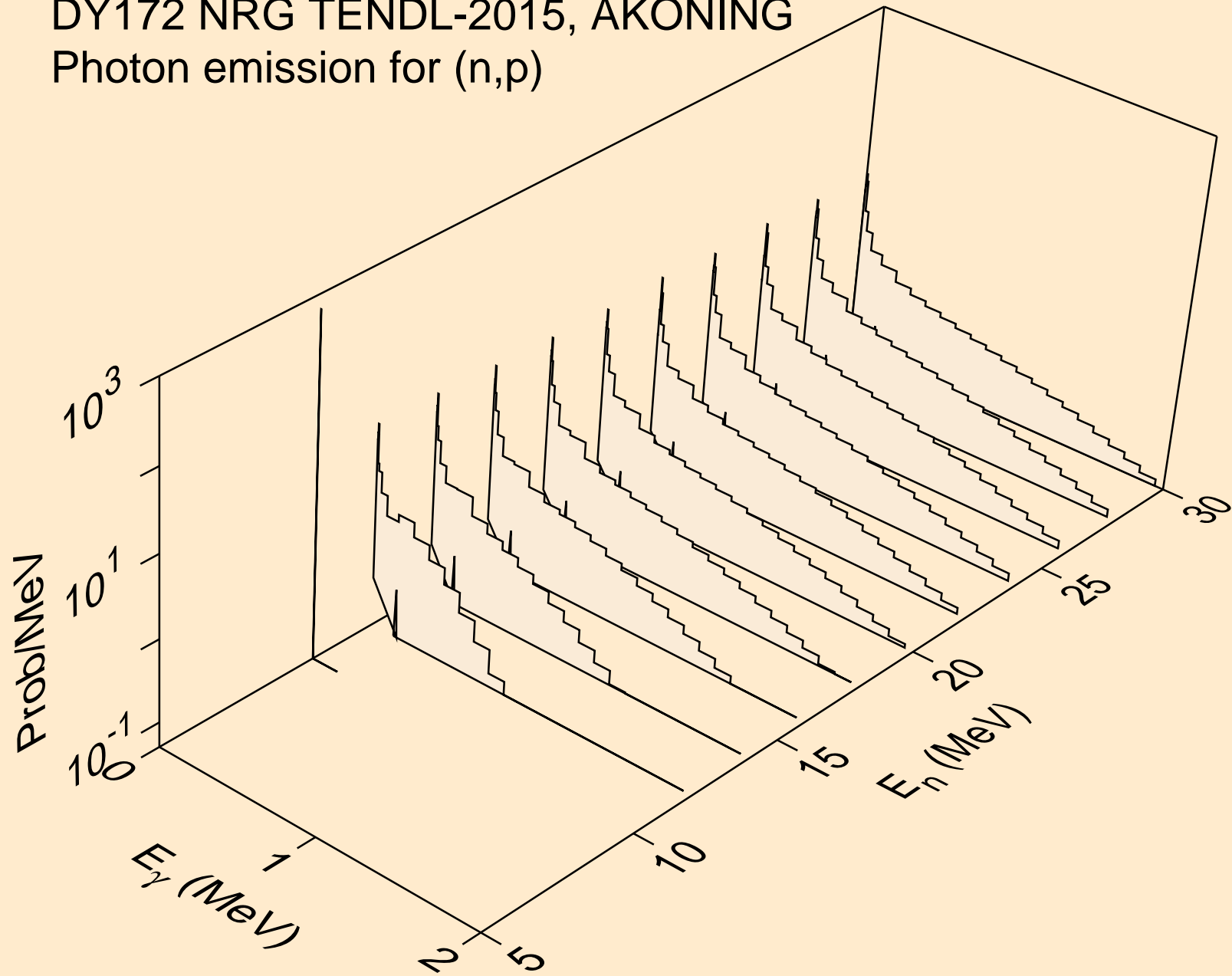

DY172 NRG TENDL-2015, AKONING
Photon emission for (n,d)

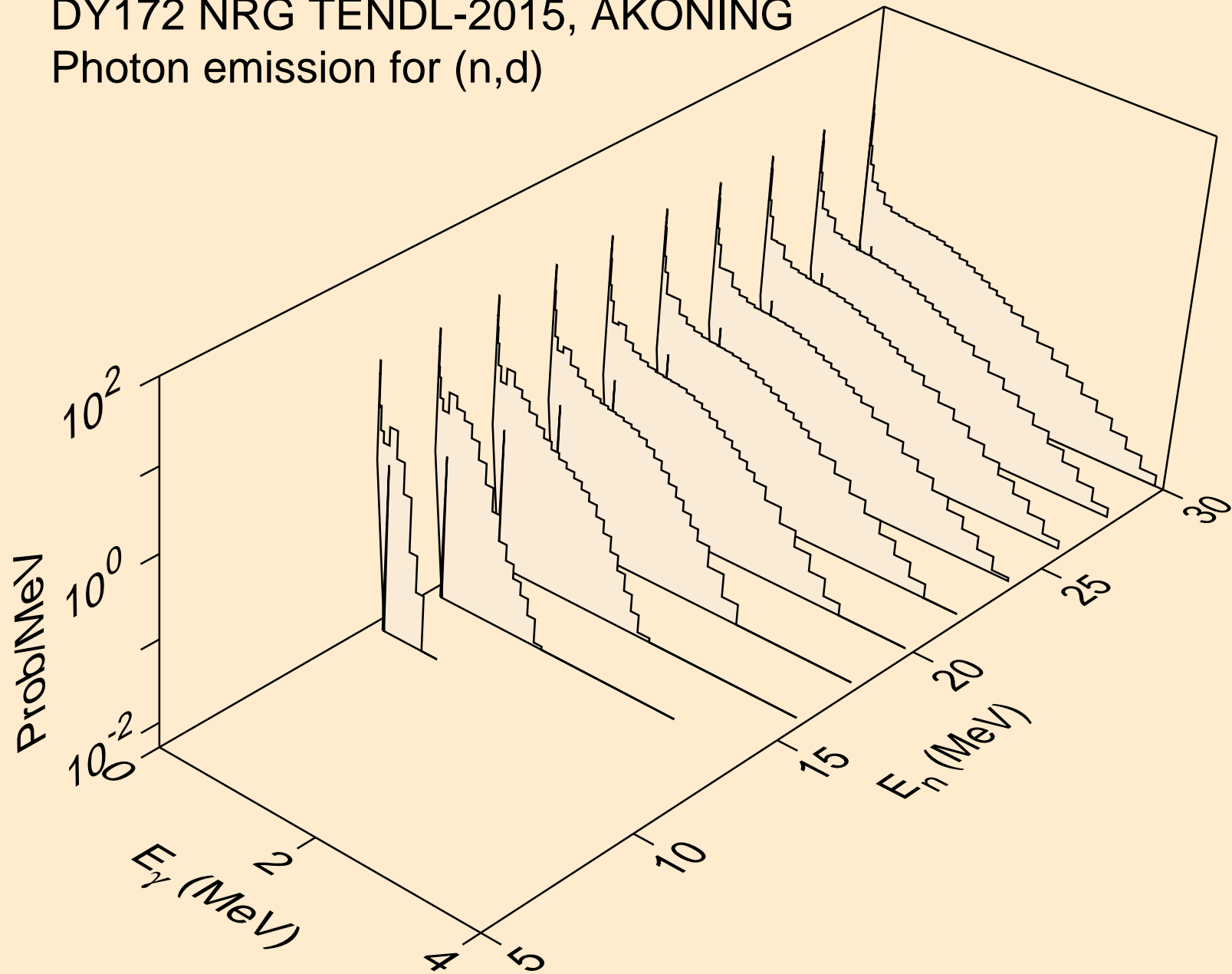

DY172 NRG TENDL-2015, AKONING
Photon emission for (n,t)

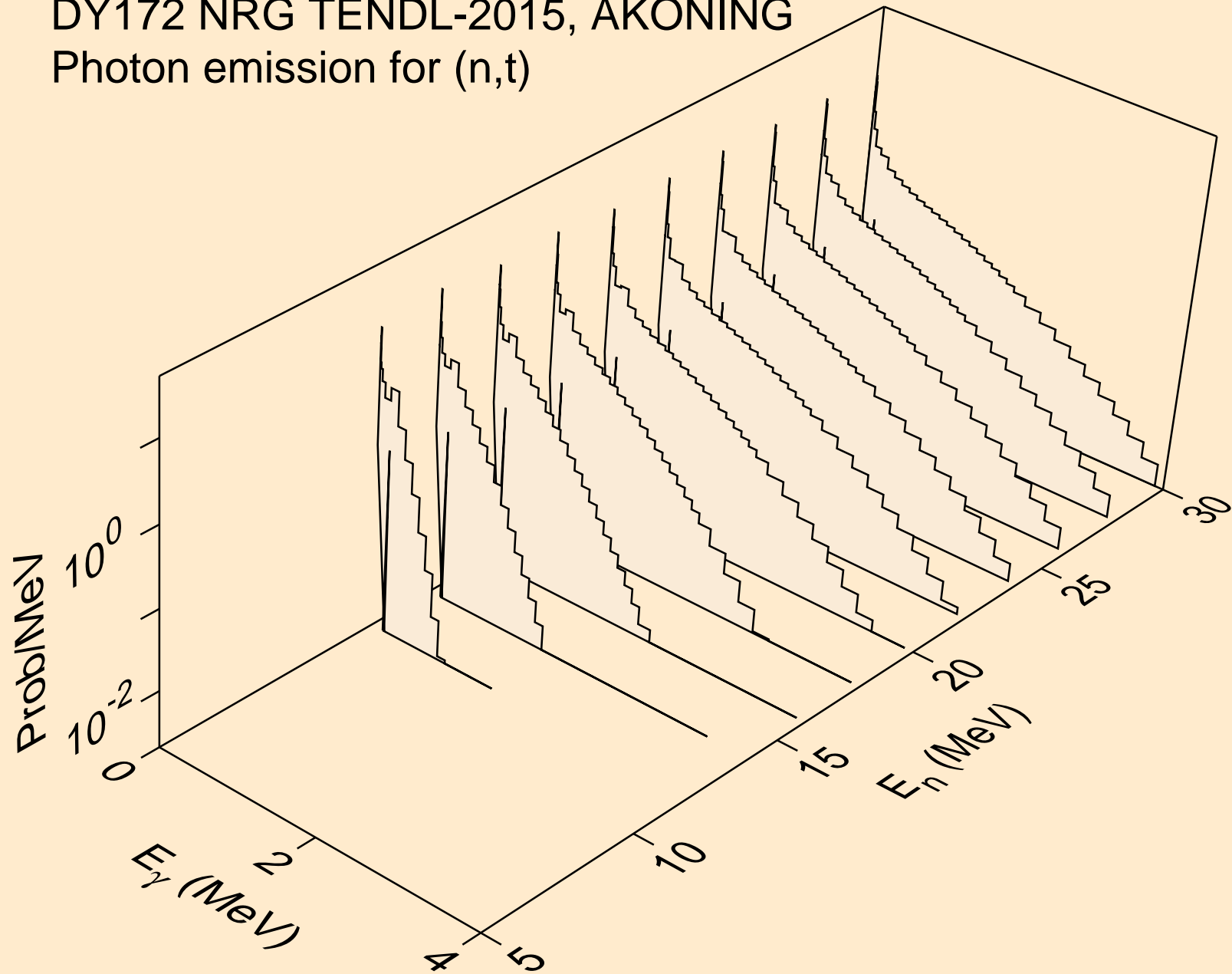

DY172 NRG TENDL-2015, AKONING
Photon emission for (n,he3)

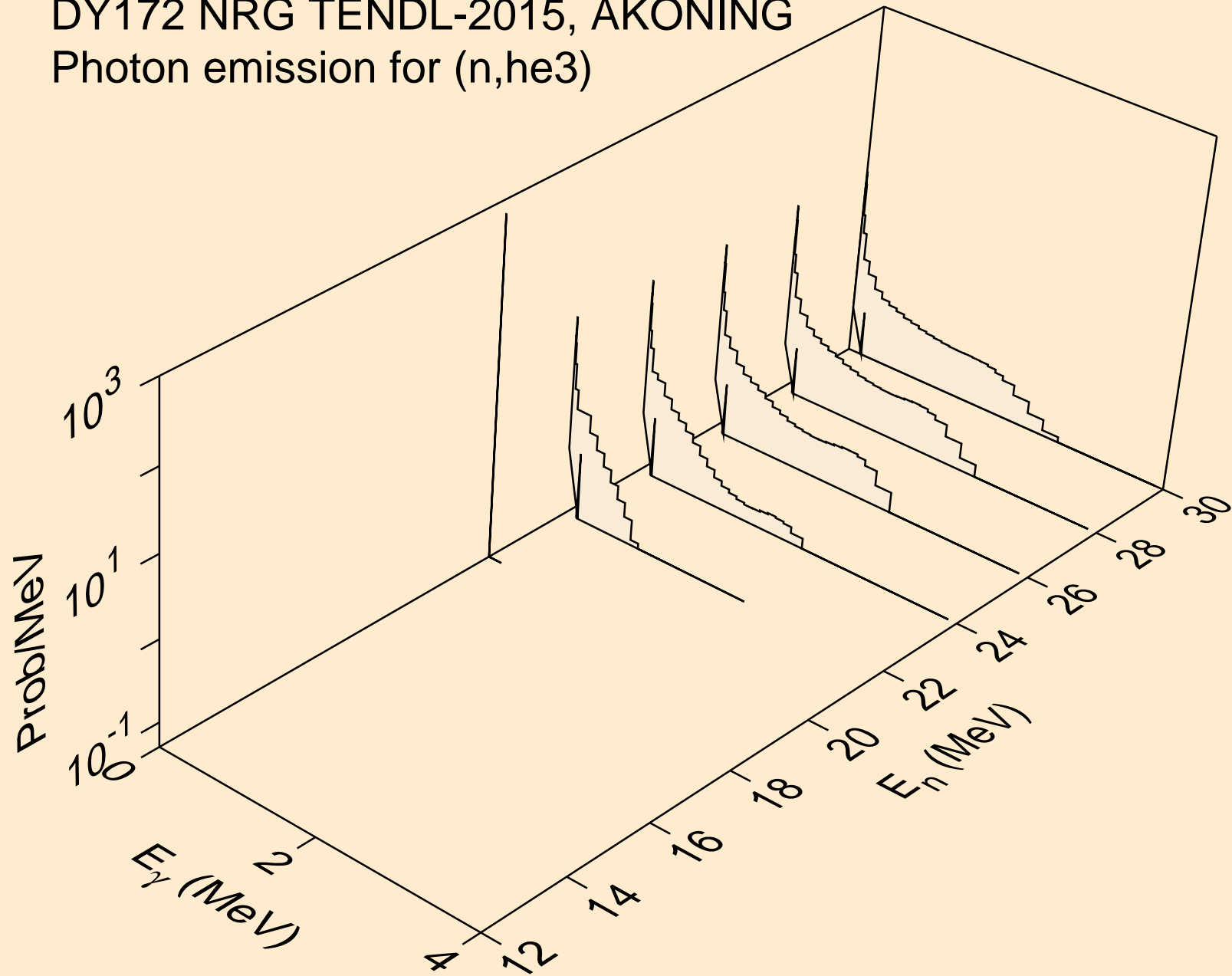

DY172 NRG TENDL-2015, AKONING
Photon emission for (n,a)

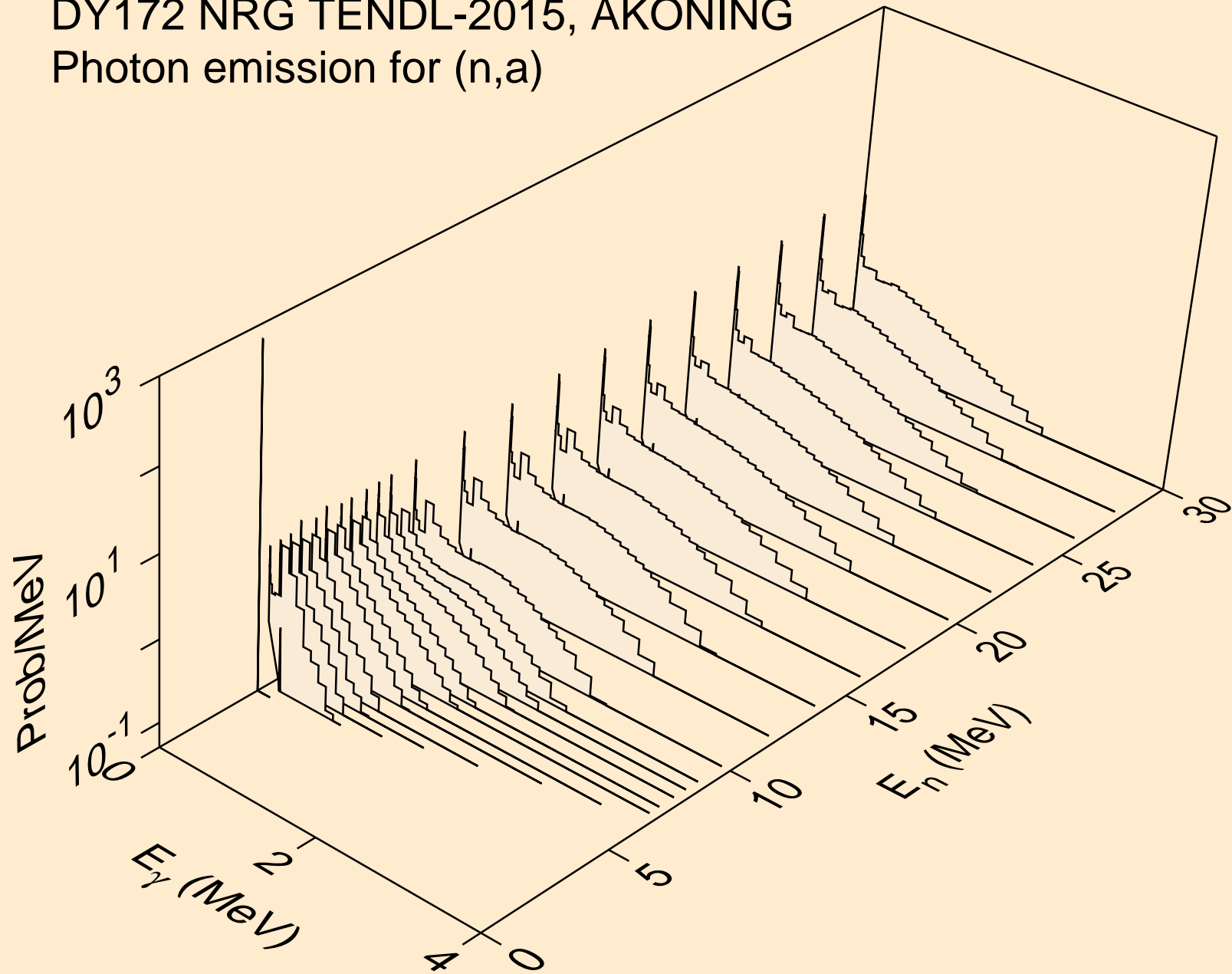

DY172 NRG TENDL-2015, AKONING
thermal capture photon spectrum

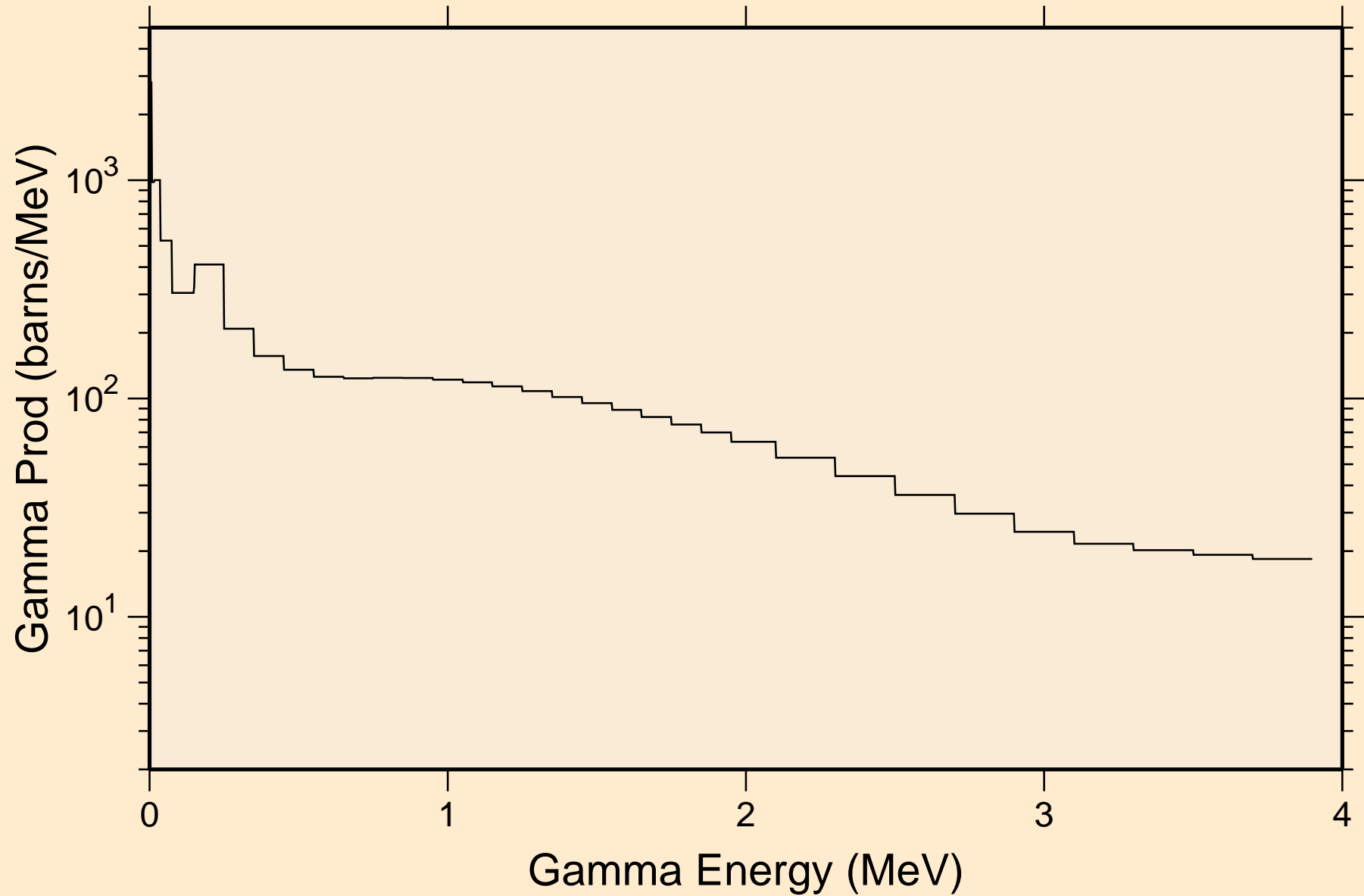

DY172 NRG TENDL-2015, AKONING
14 MeV photon spectrum

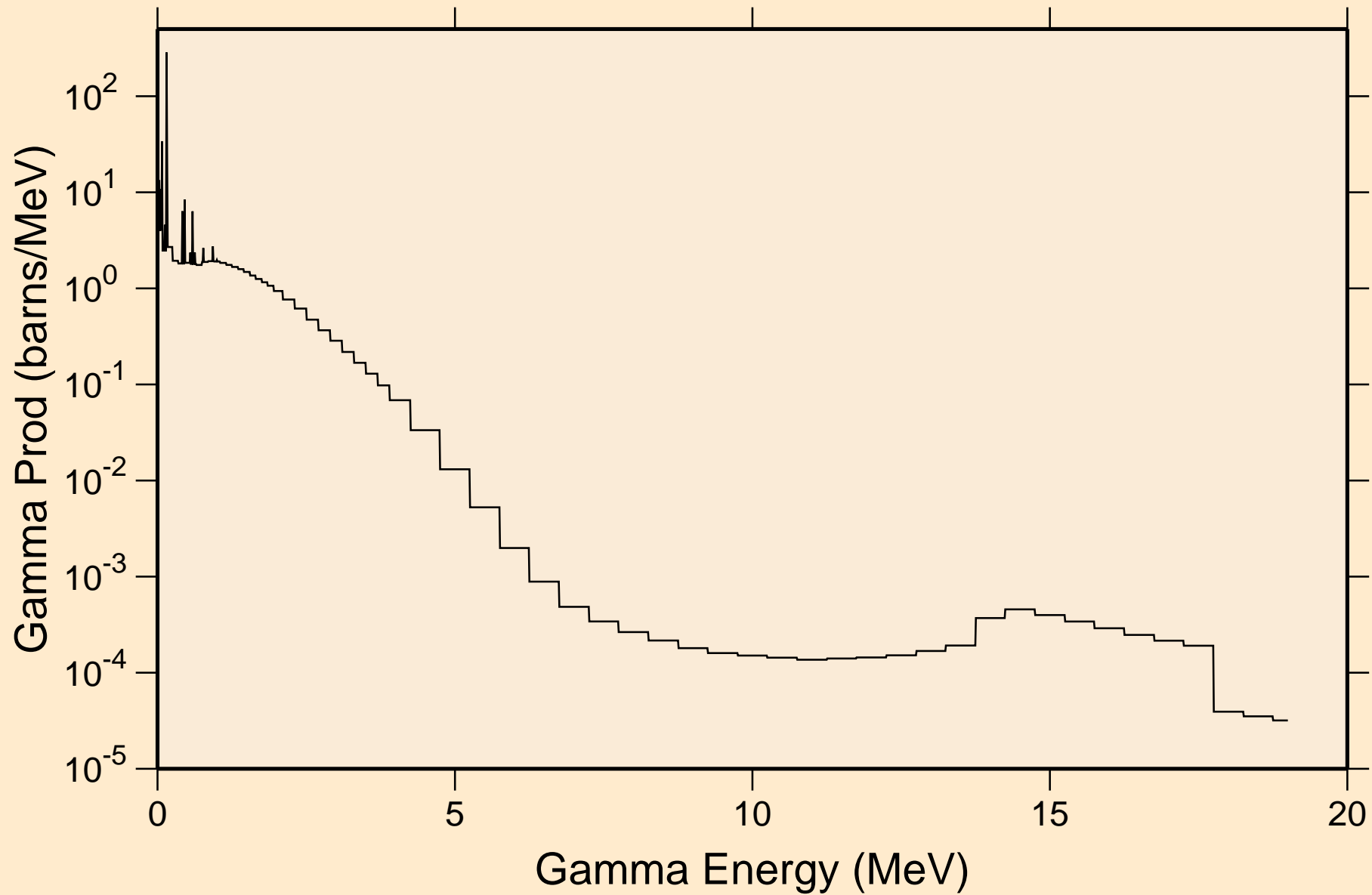

DY172 NRG TENDL-2015, AKONING

Particle heating contributions

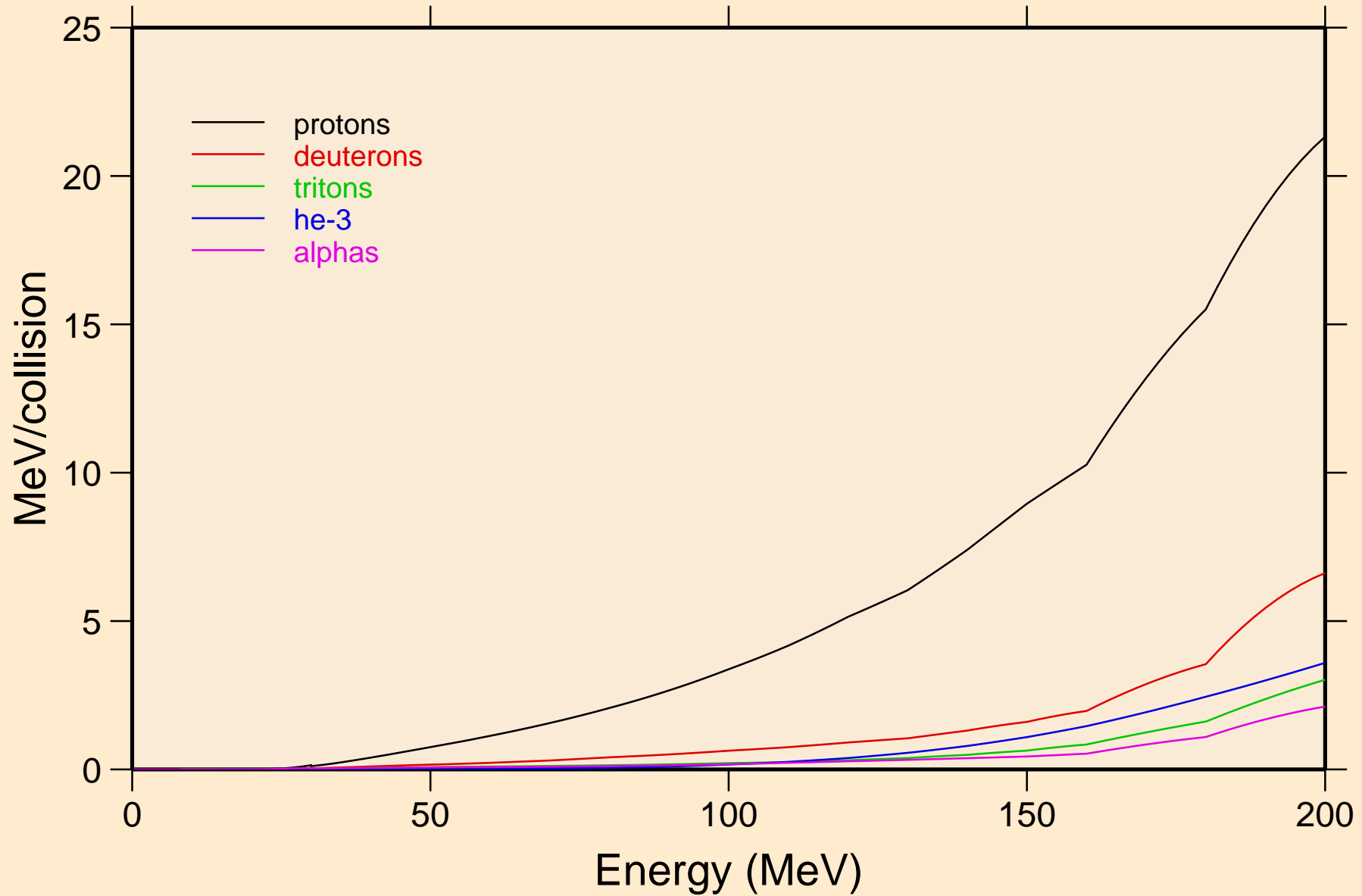

DY172 NRG TENDL-2015, AKONING

Recoil Heating

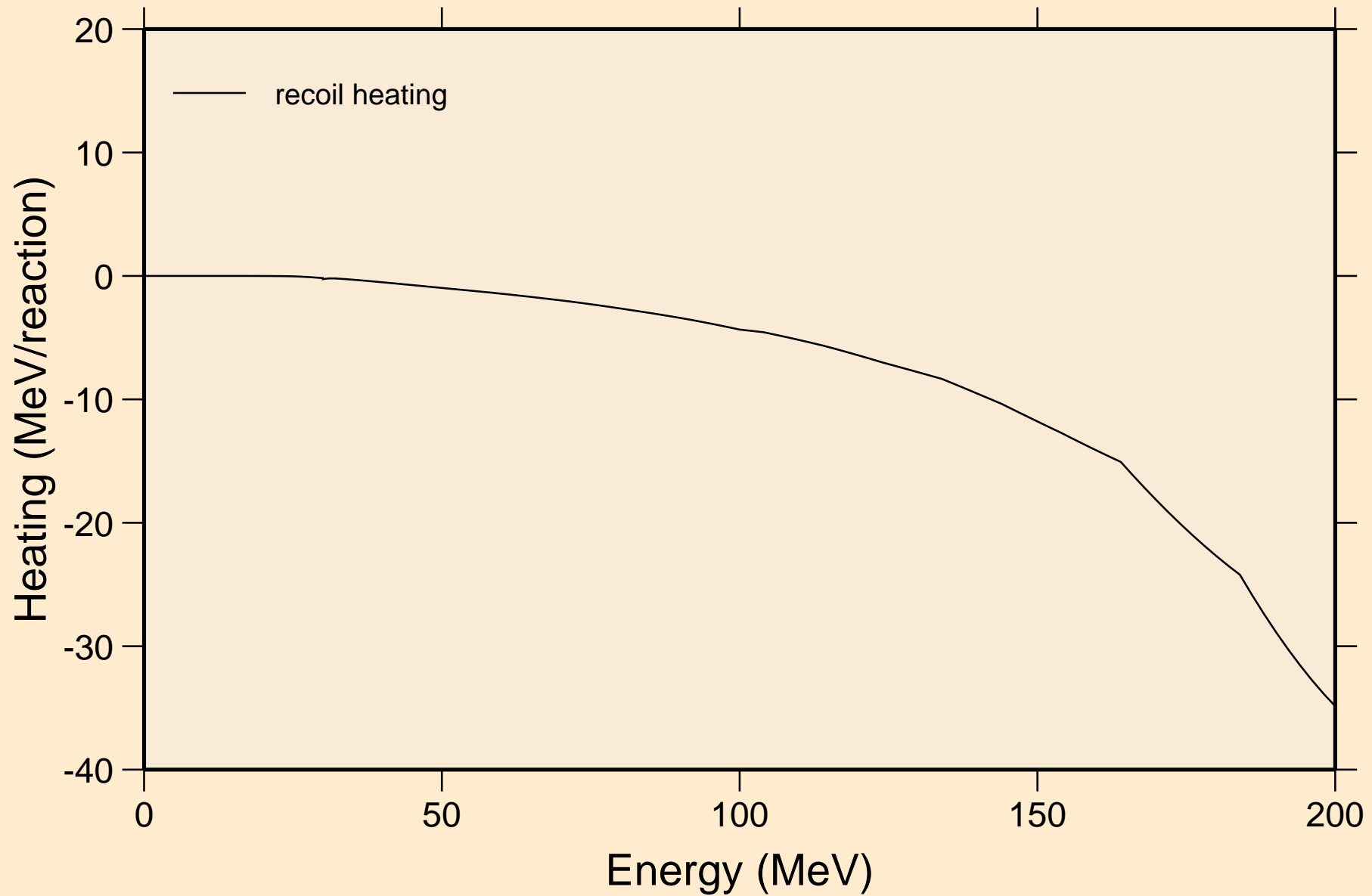

DY172 NRG TENDL-2015, AKONING

Particle production cross sections

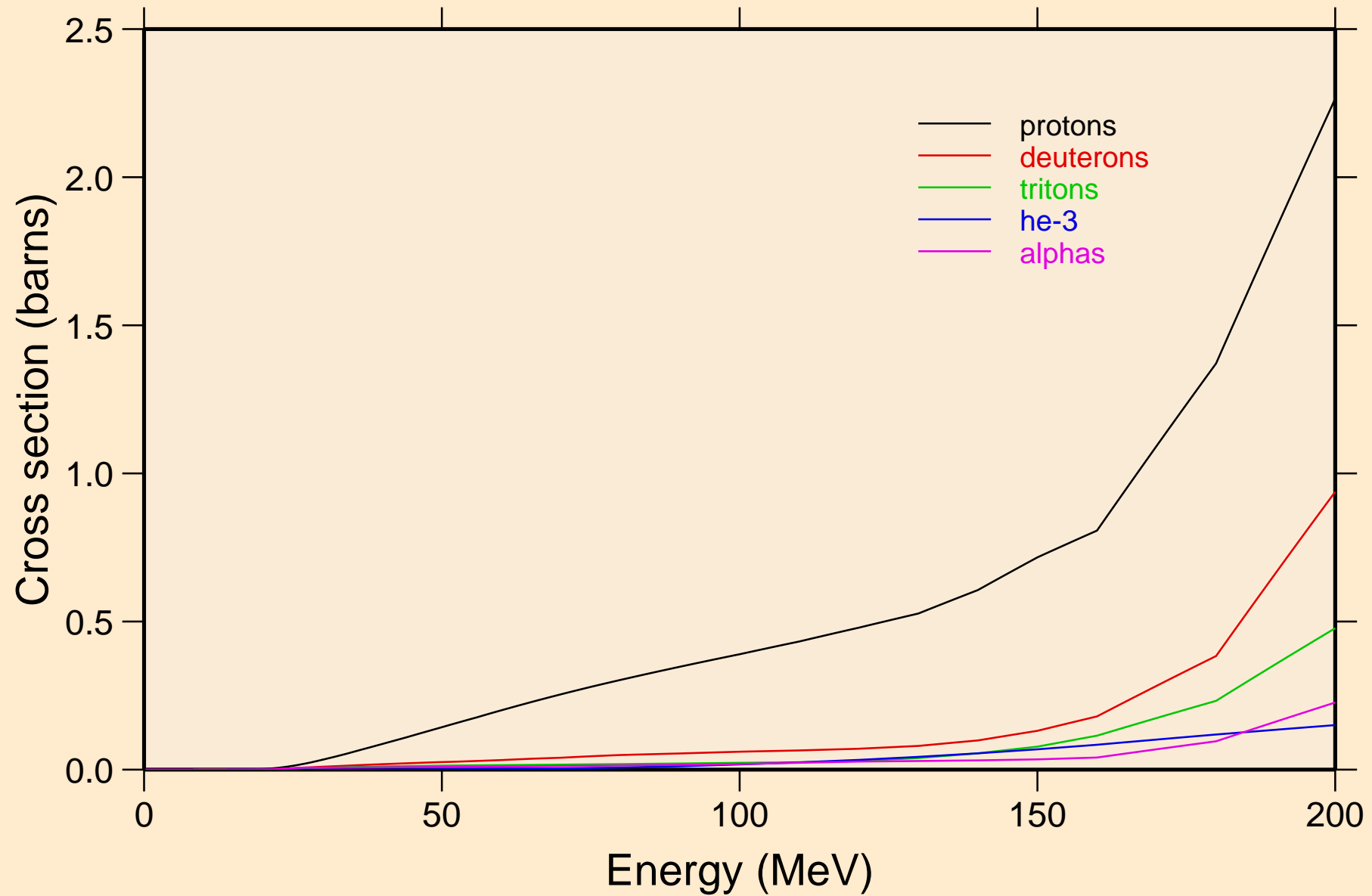

DY172 NRG TENDL-2015, AKONING
protons from (n,x)

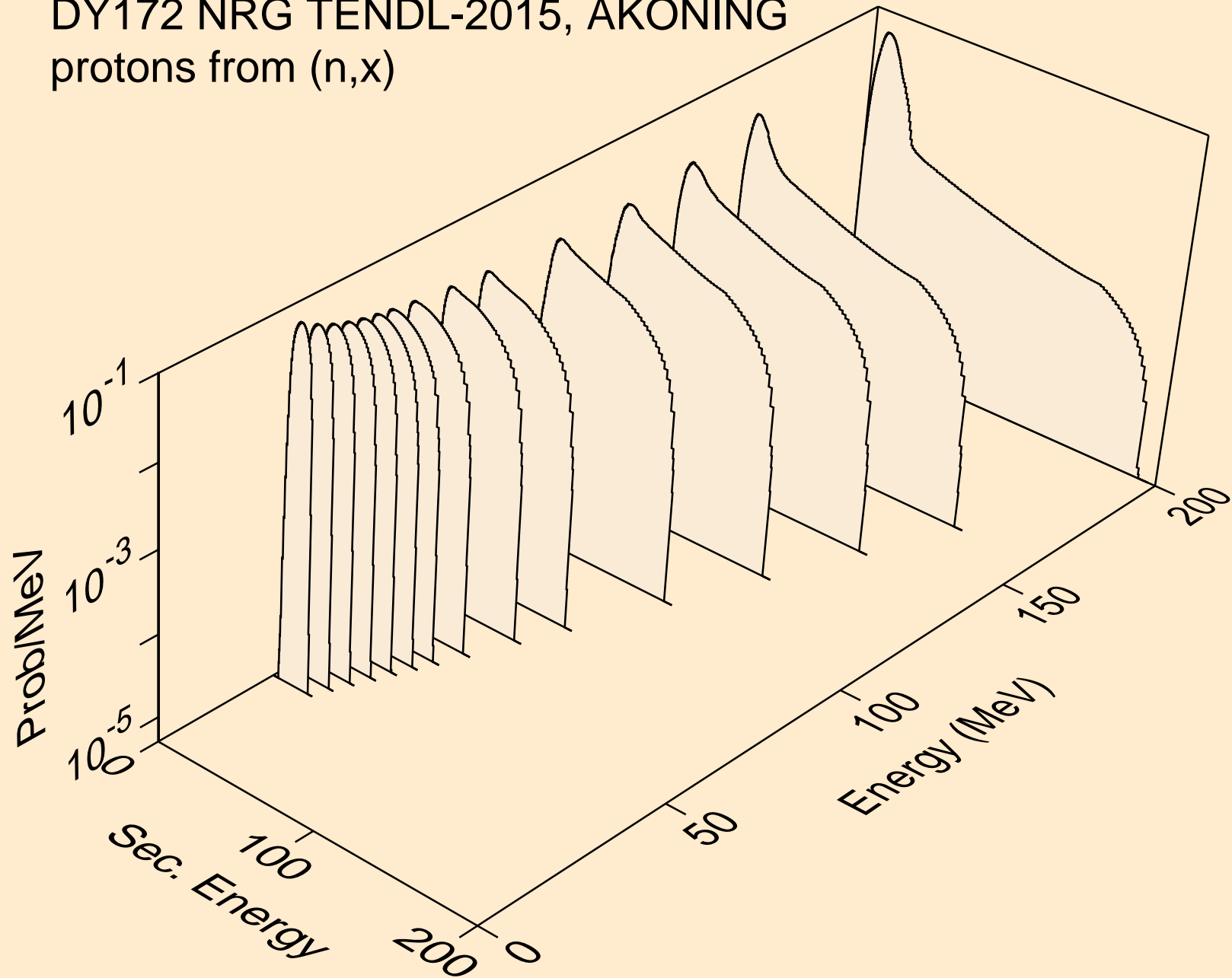

DY172 NRG TENDL-2015, AKONING
protons from (n,n*)p

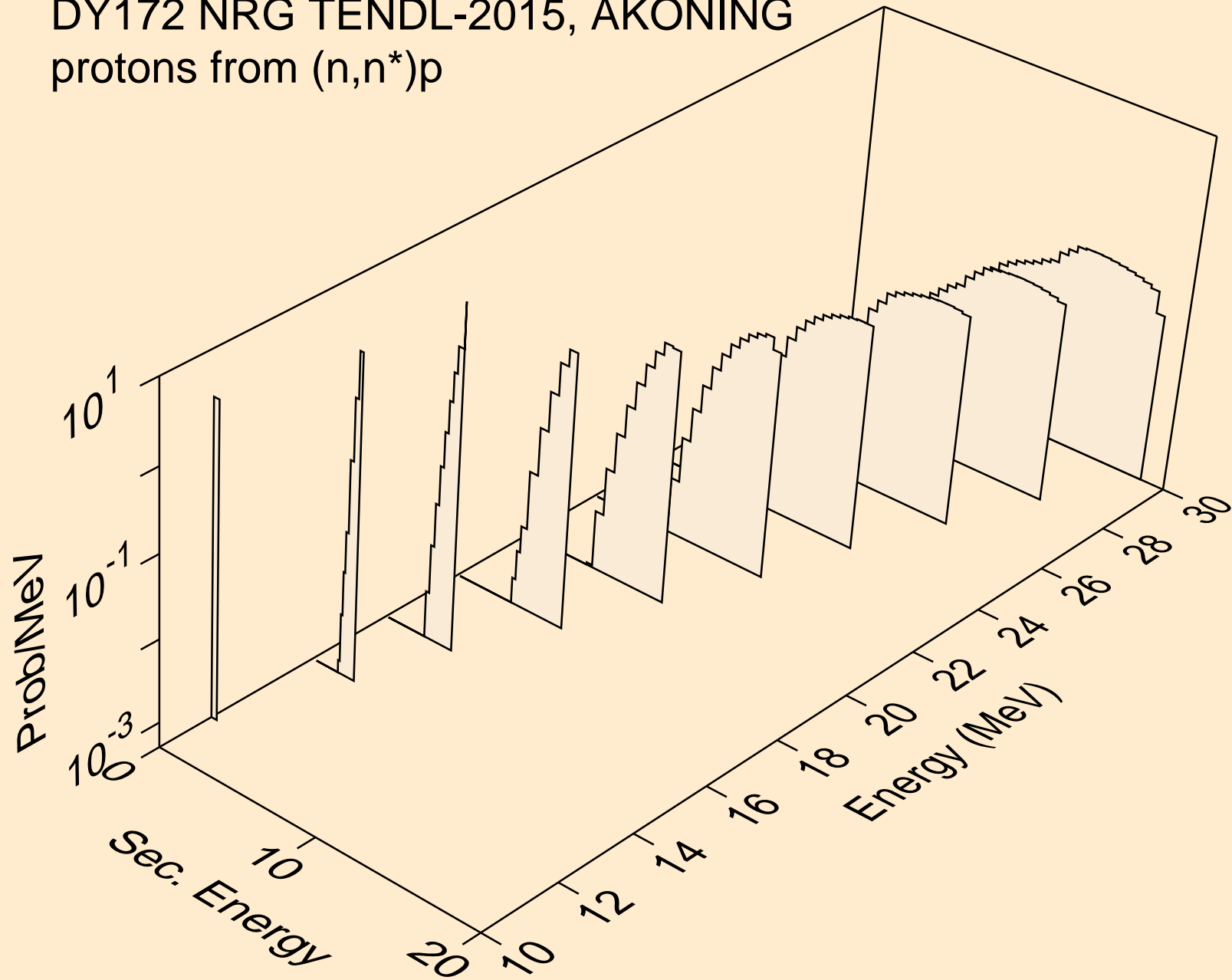

DY172 NRG TENDL-2015, AKONING
protons from (n,2np)

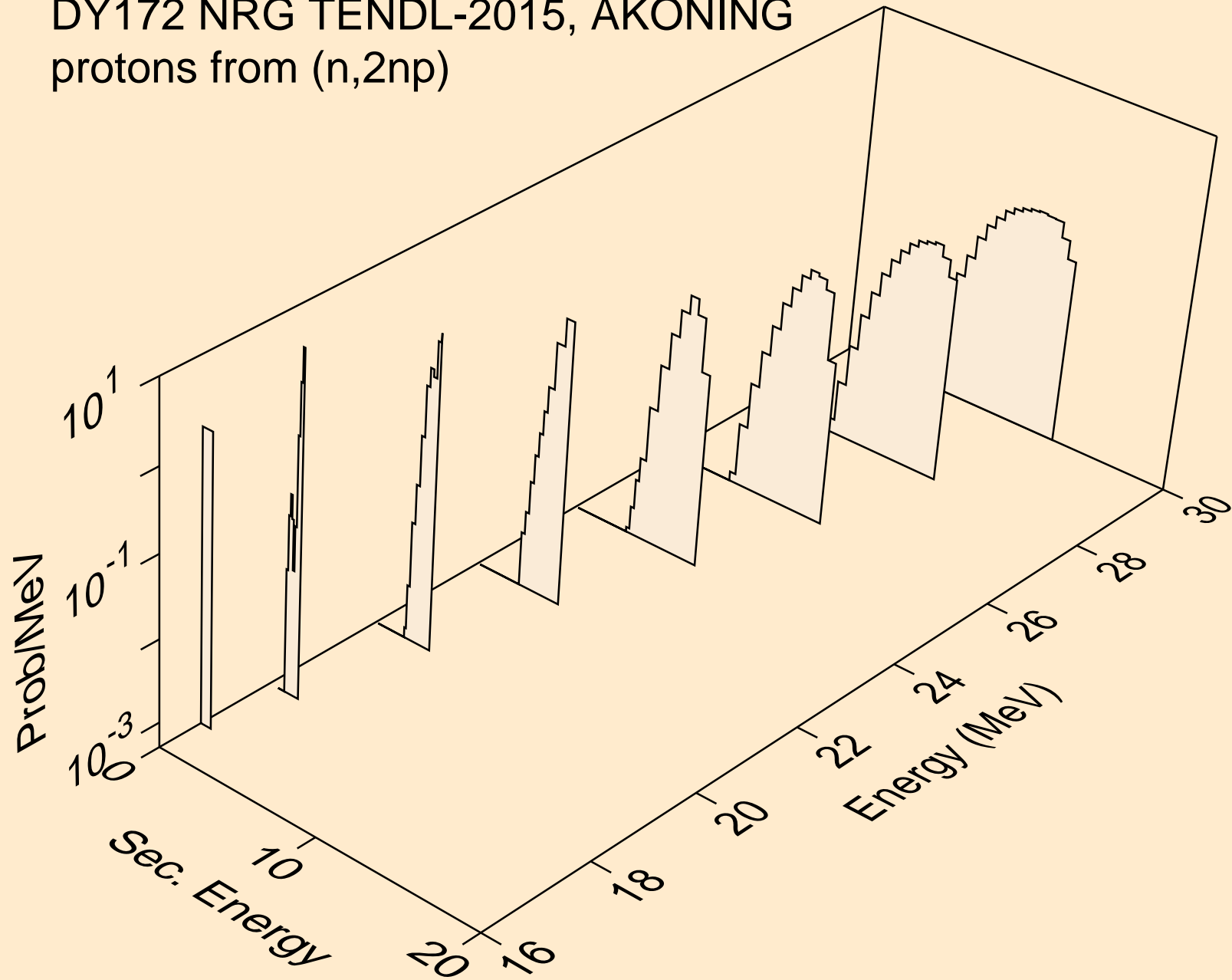

DY172 NRG TENDL-2015, AKONING
protons from (n,3np)

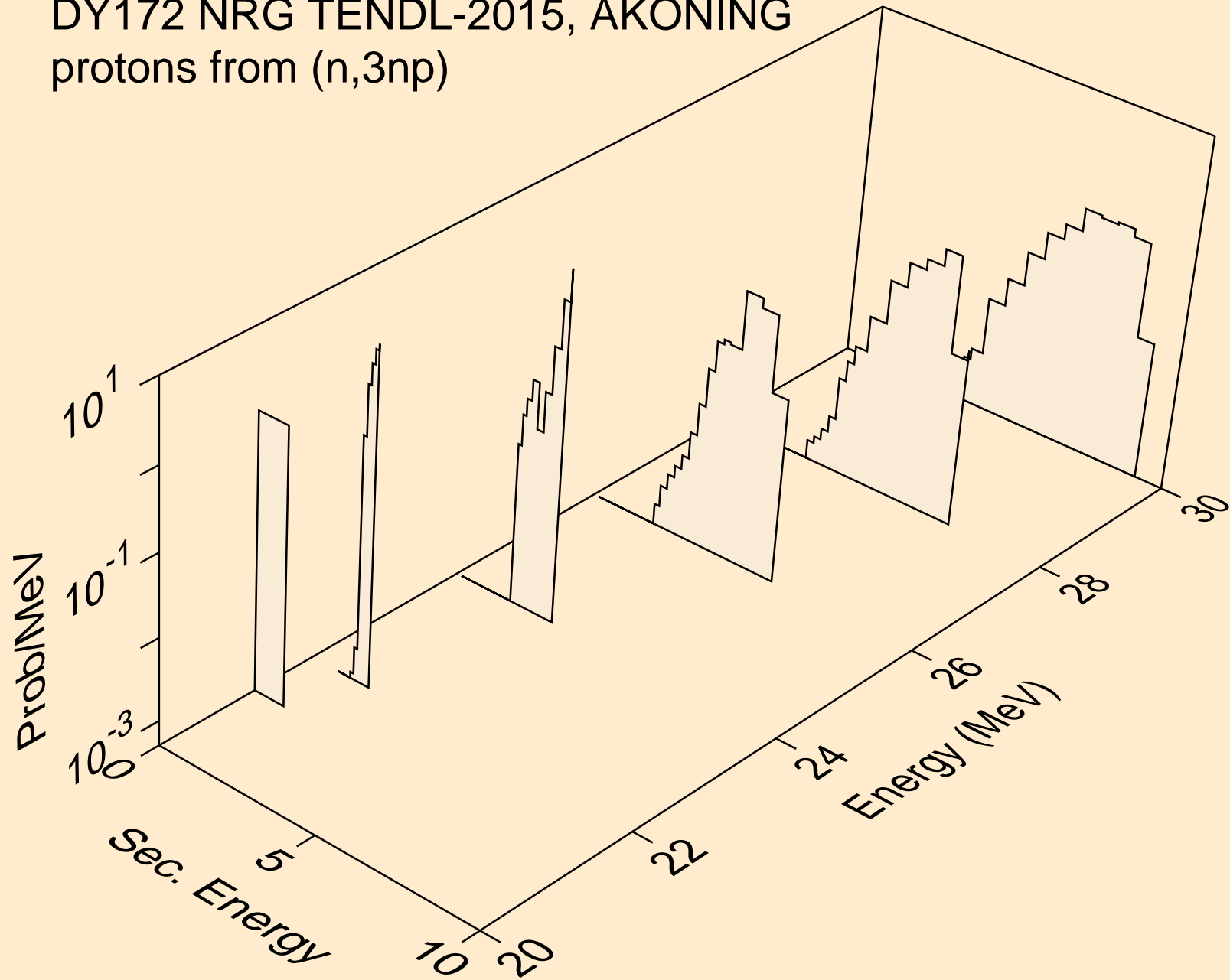

DY172 NRG TENDL-2015, AKONING
protons from (n,p)

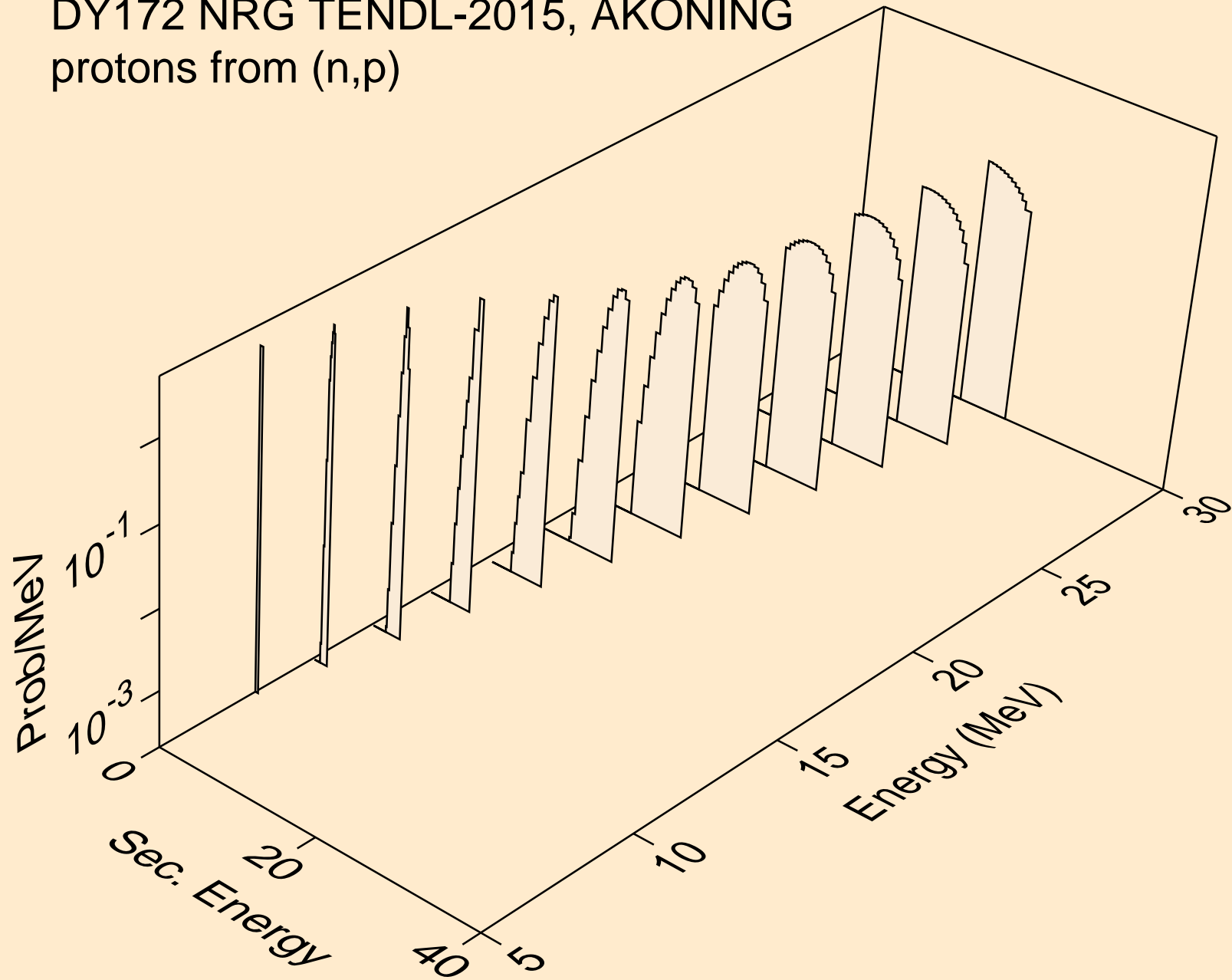

DY172 NRG TENDL-2015, AKONING
deuterons from (n,x)

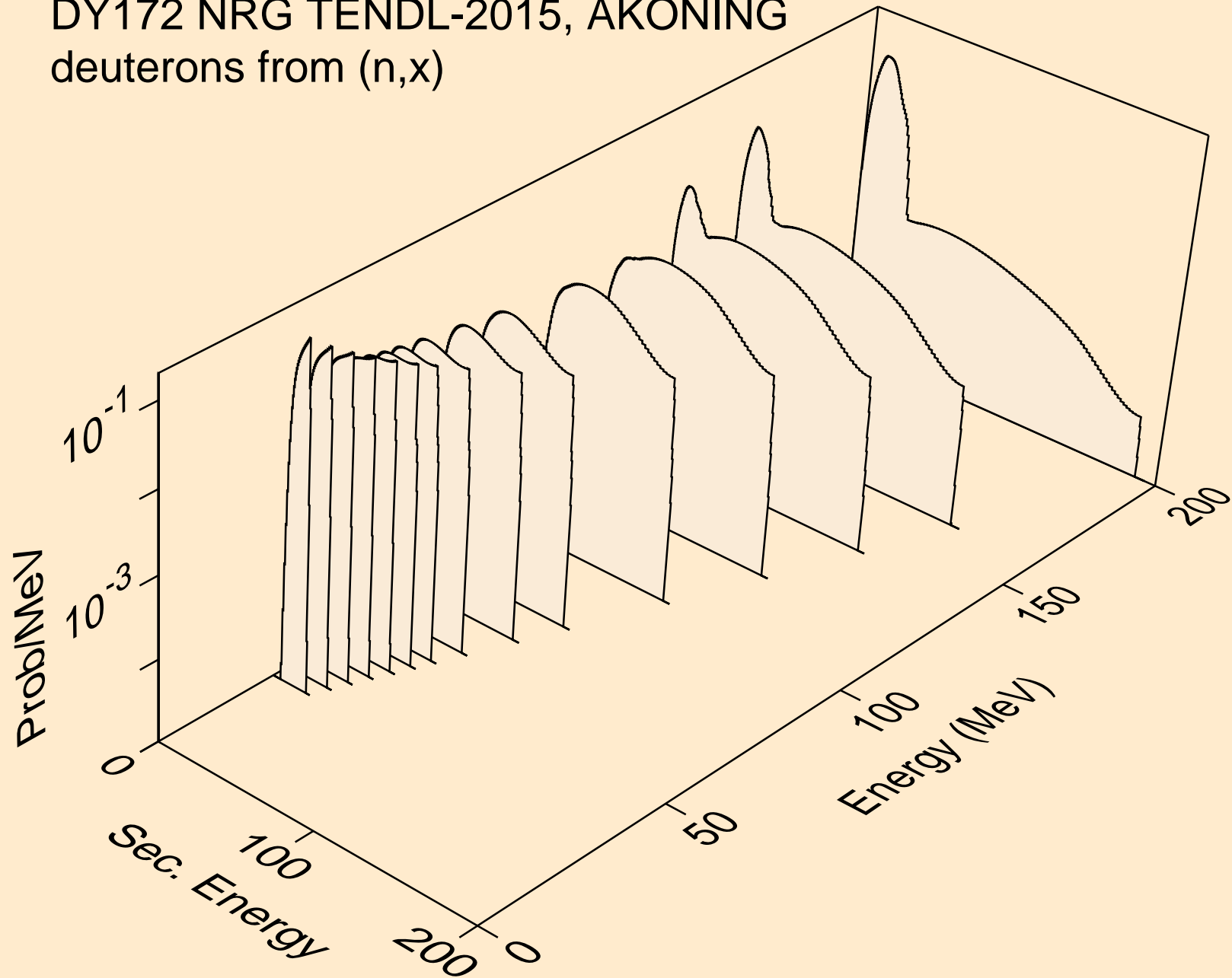

DY172 NRG TENDL-2015, AKONING
deuterons from (n,2nd)

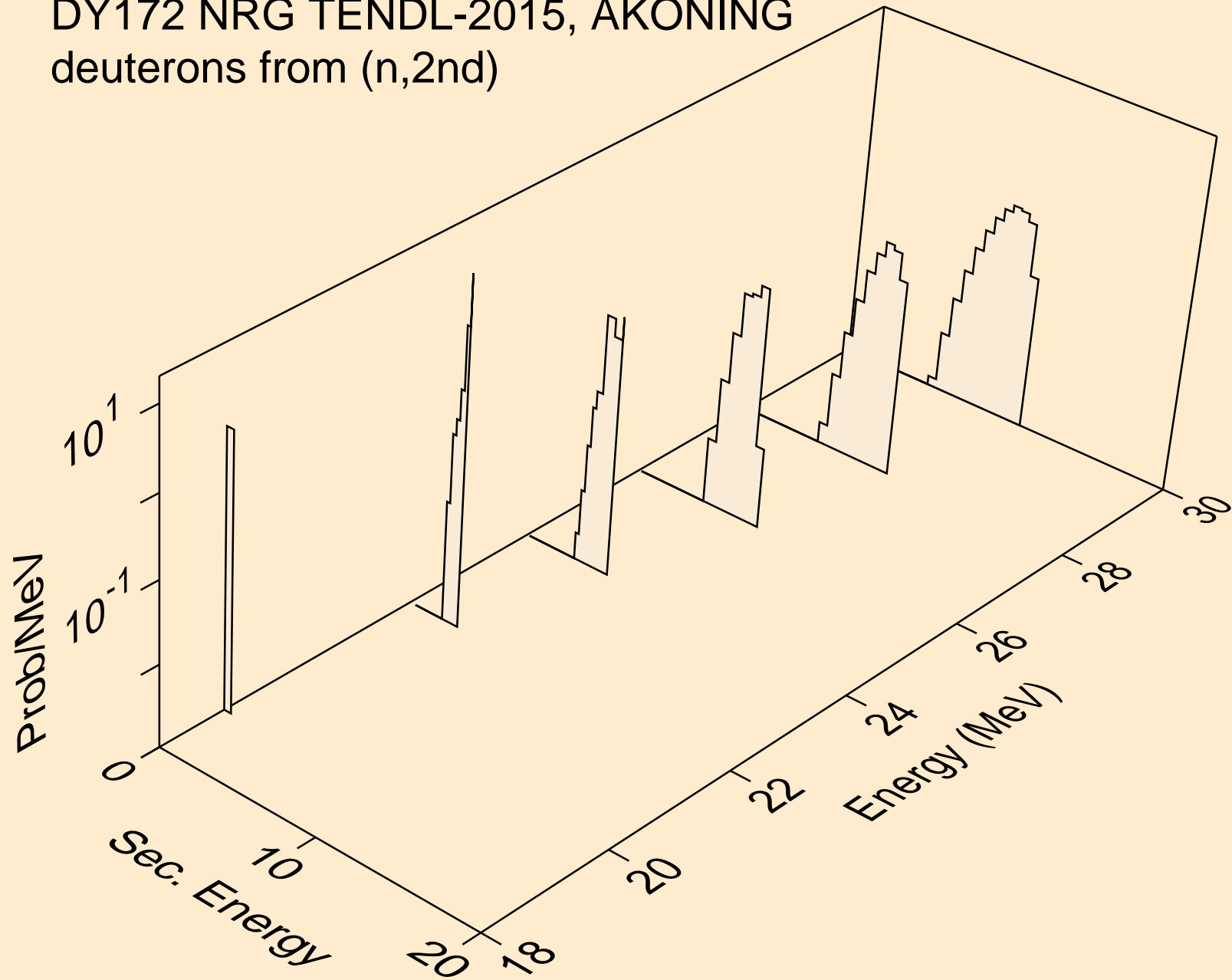

DY172 NRG TENDL-2015, AKONING
deuterons from (n,n*)d

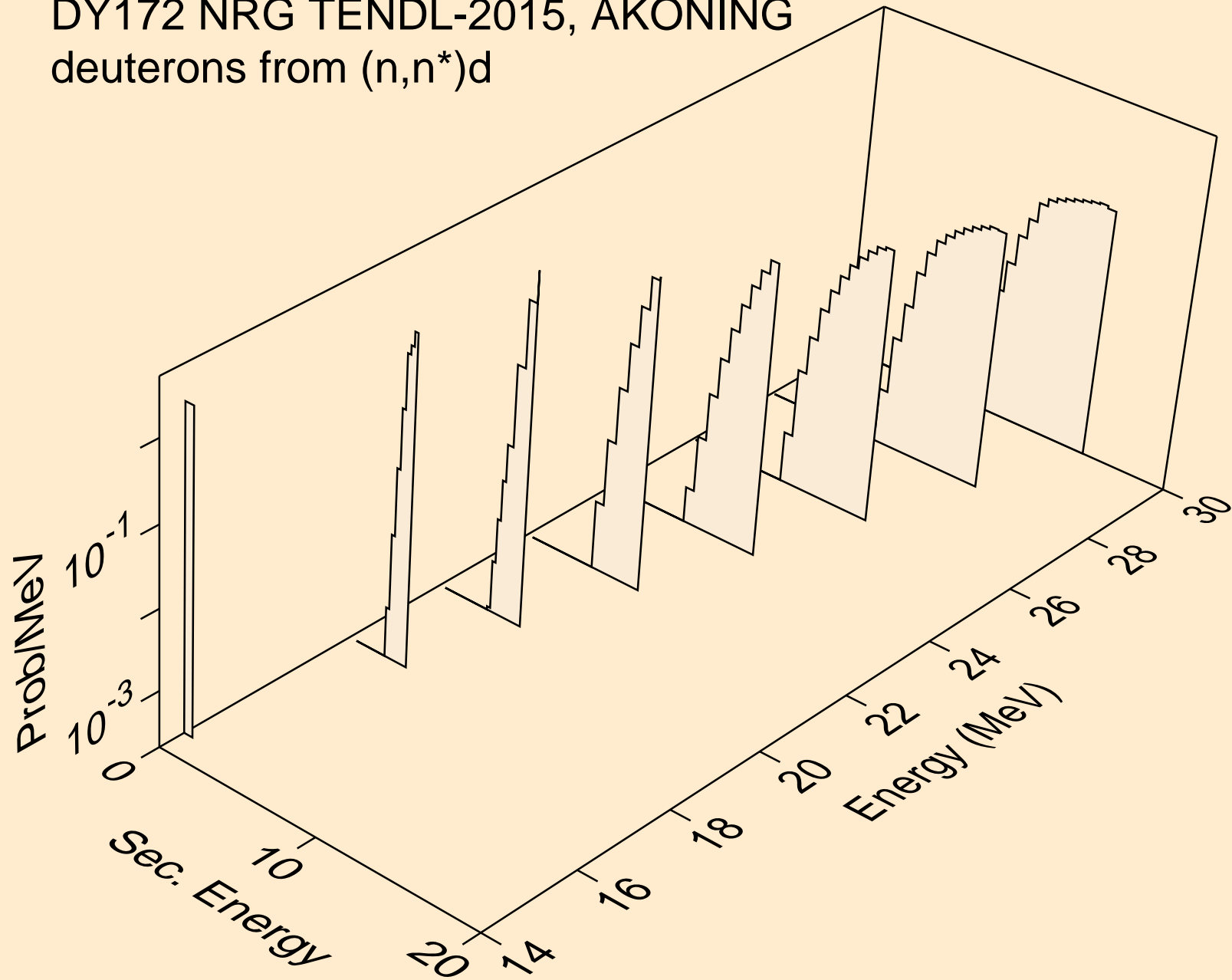

DY172 NRG TENDL-2015, AKONING
deuterons from (n,d)

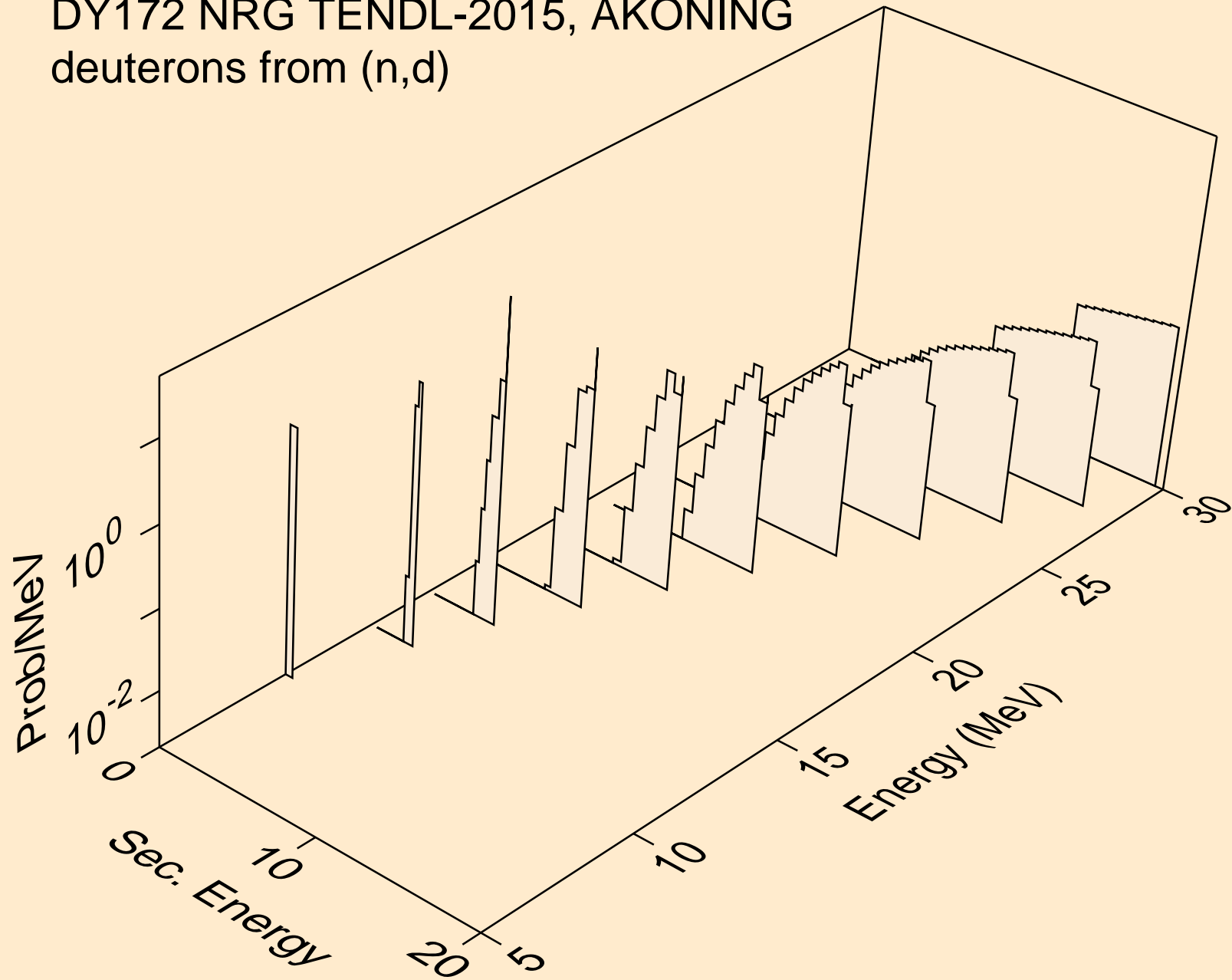

DY172 NRG TENDL-2015, AKONING
tritons from (n,x)

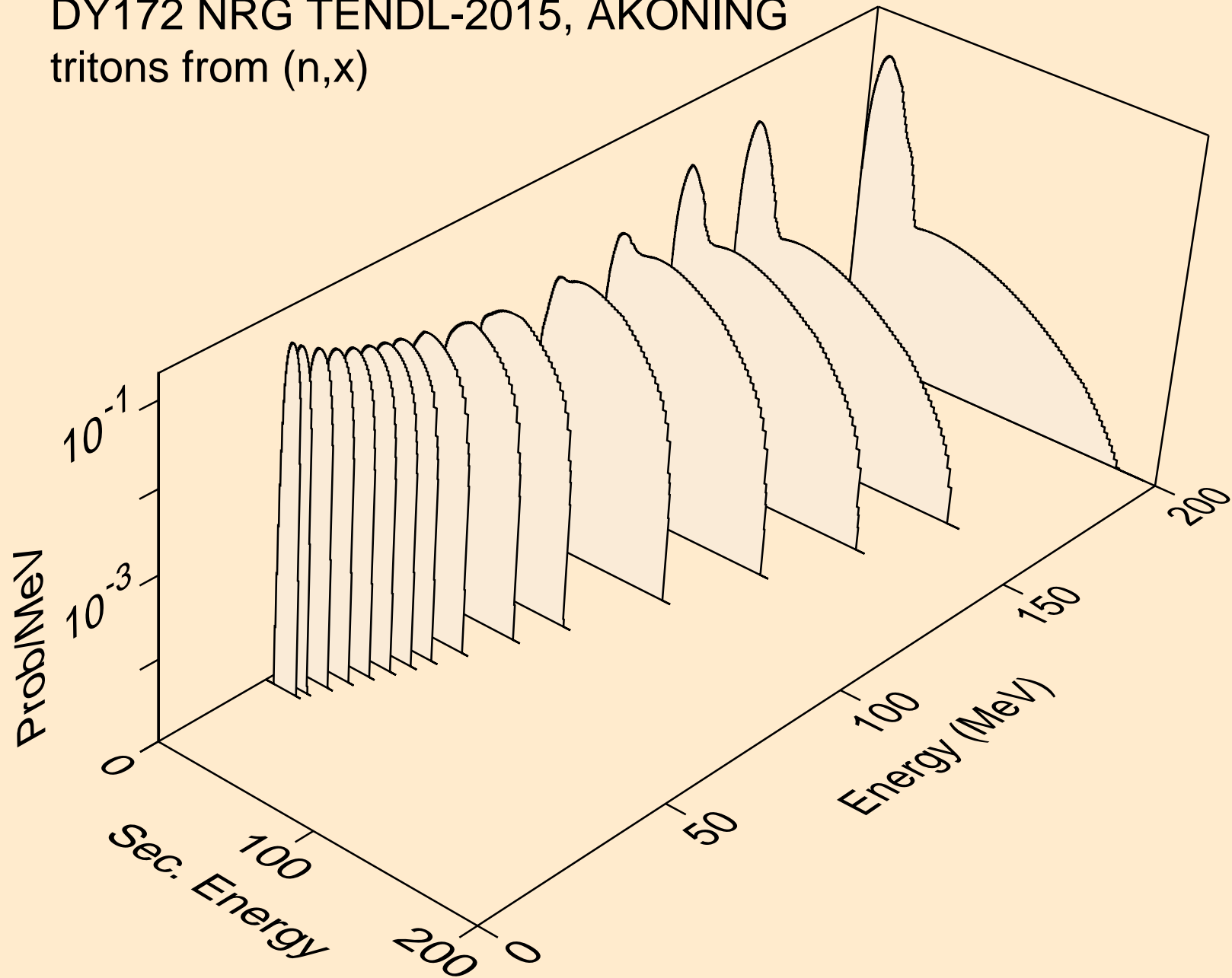

DY172 NRG TENDL-2015, AKONING
tritons from (n,n*)t

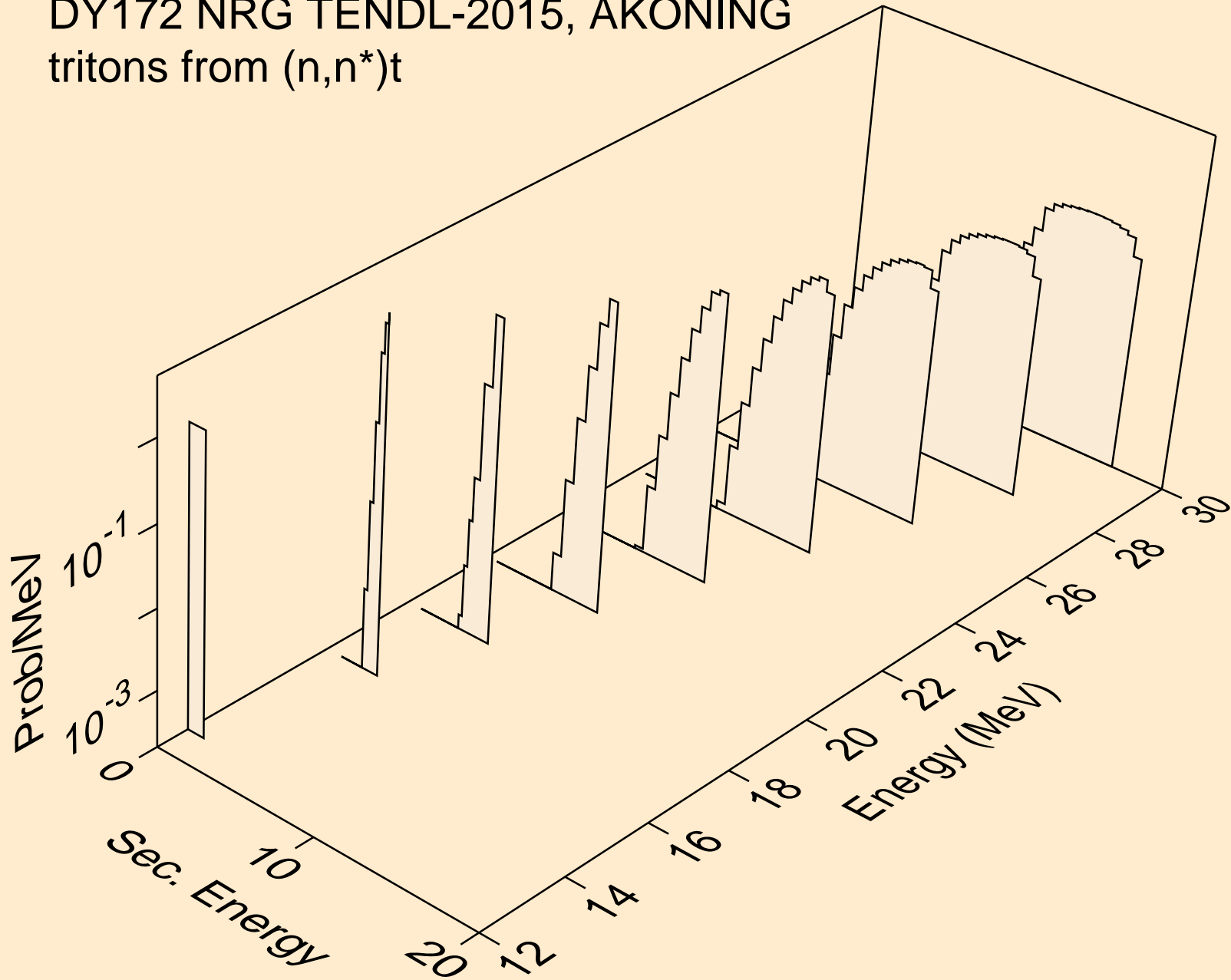

DY172 NRG TENDL-2015, AKONING
tritons from (n,t)

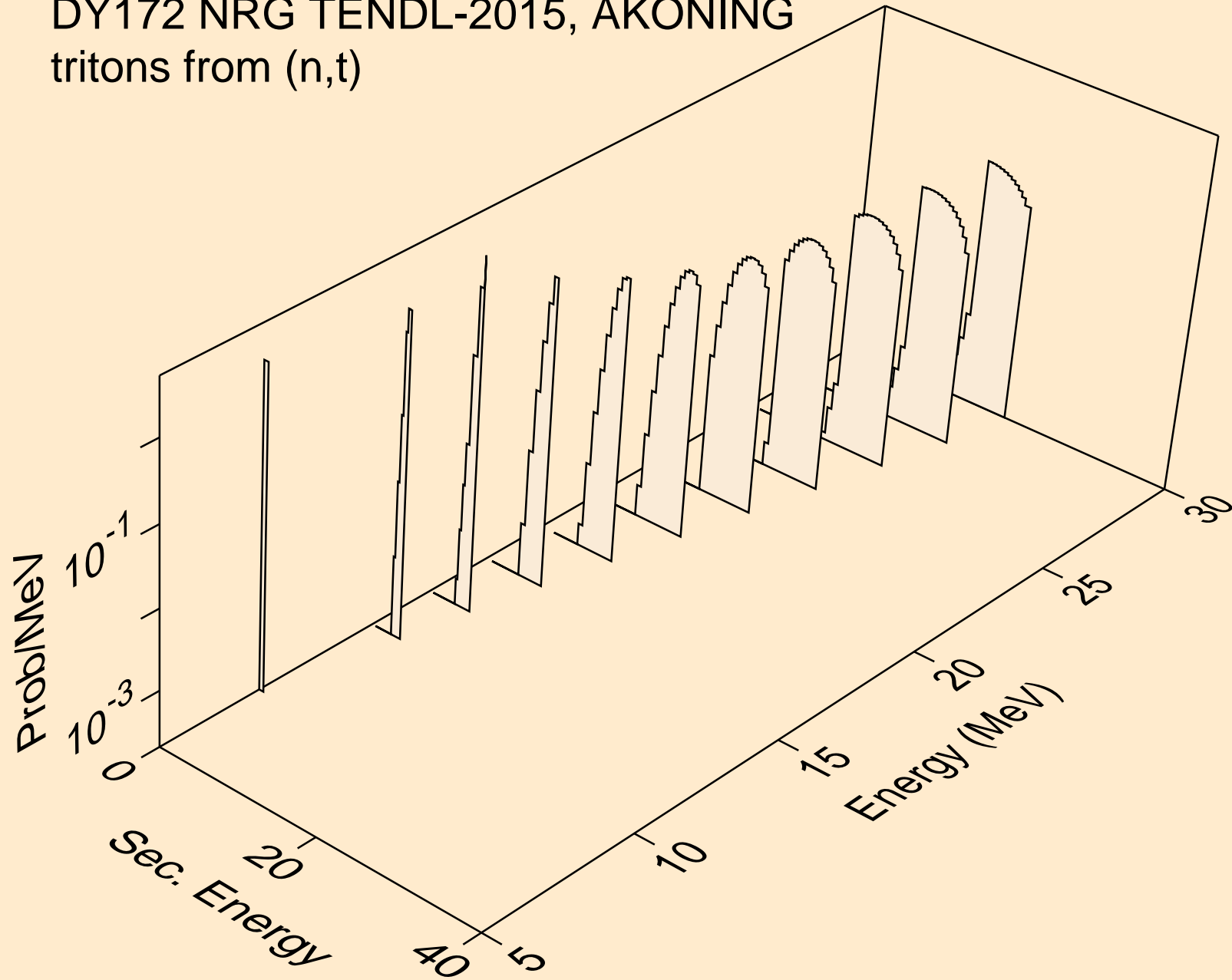

DY172 NRG TENDL-2015, AKONING
he3s from (n,x)

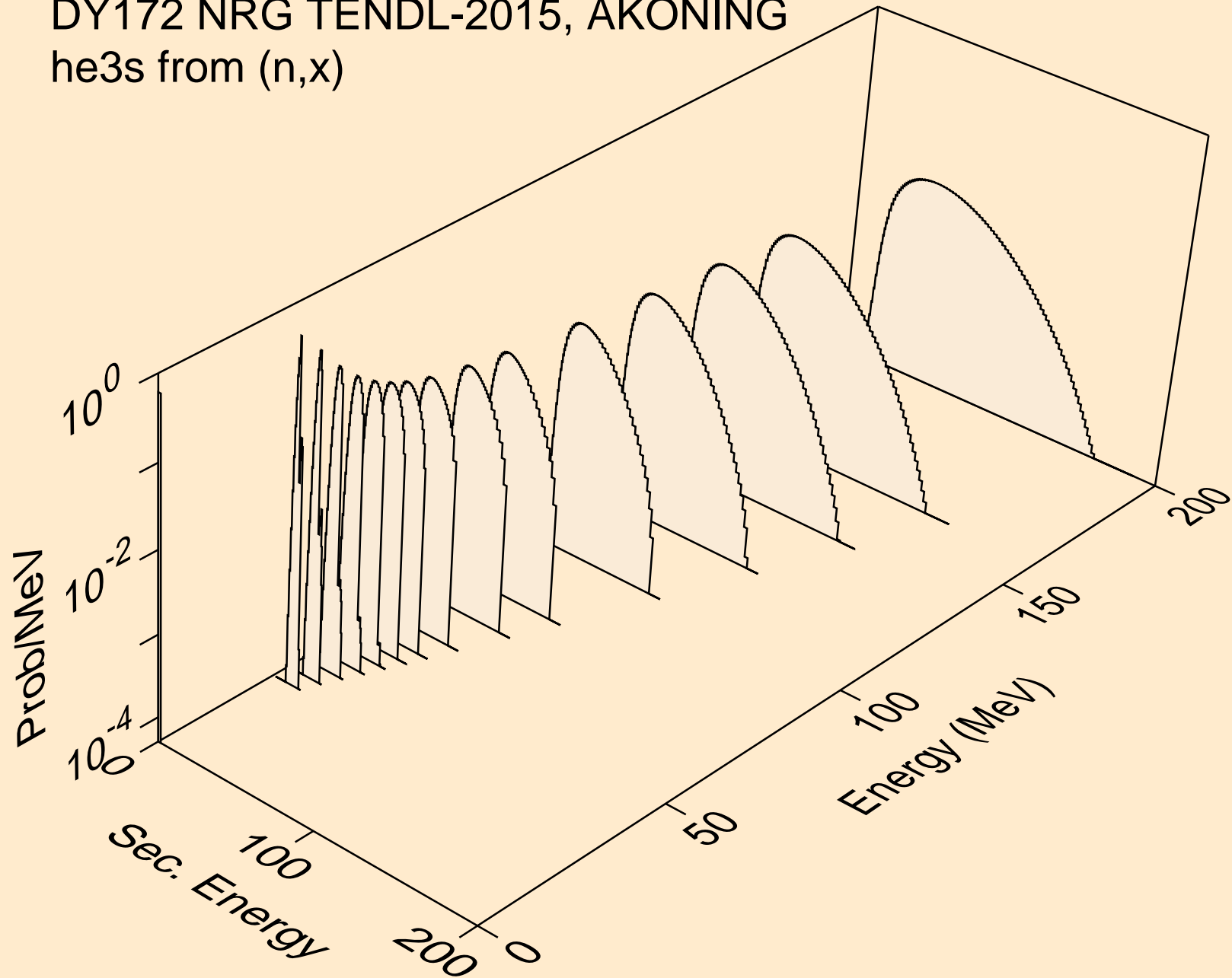

DY172 NRG TENDL-2015, AKONING
he3s from (n,he3)

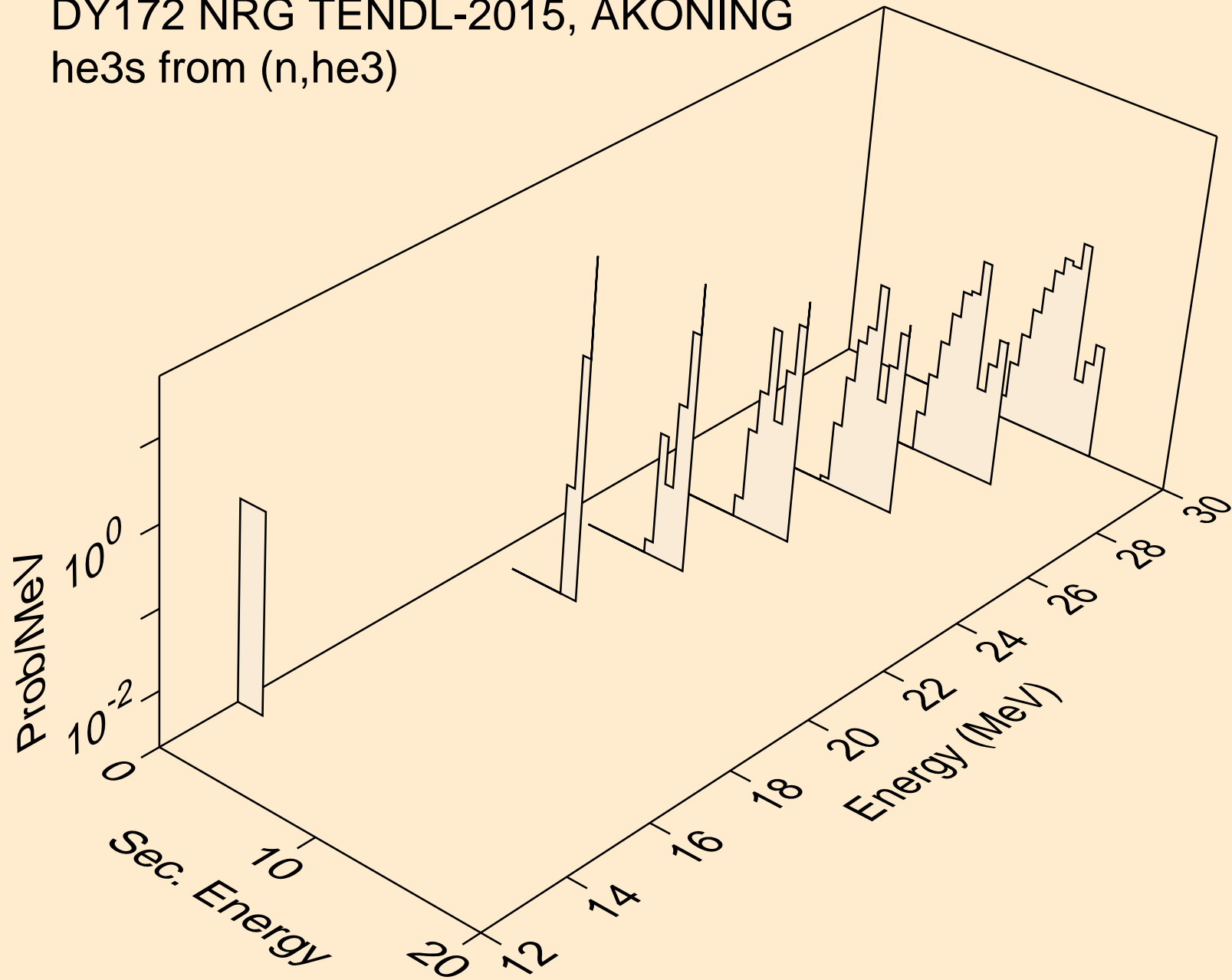

DY172 NRG TENDL-2015, AKONING
alphas from (n,x)

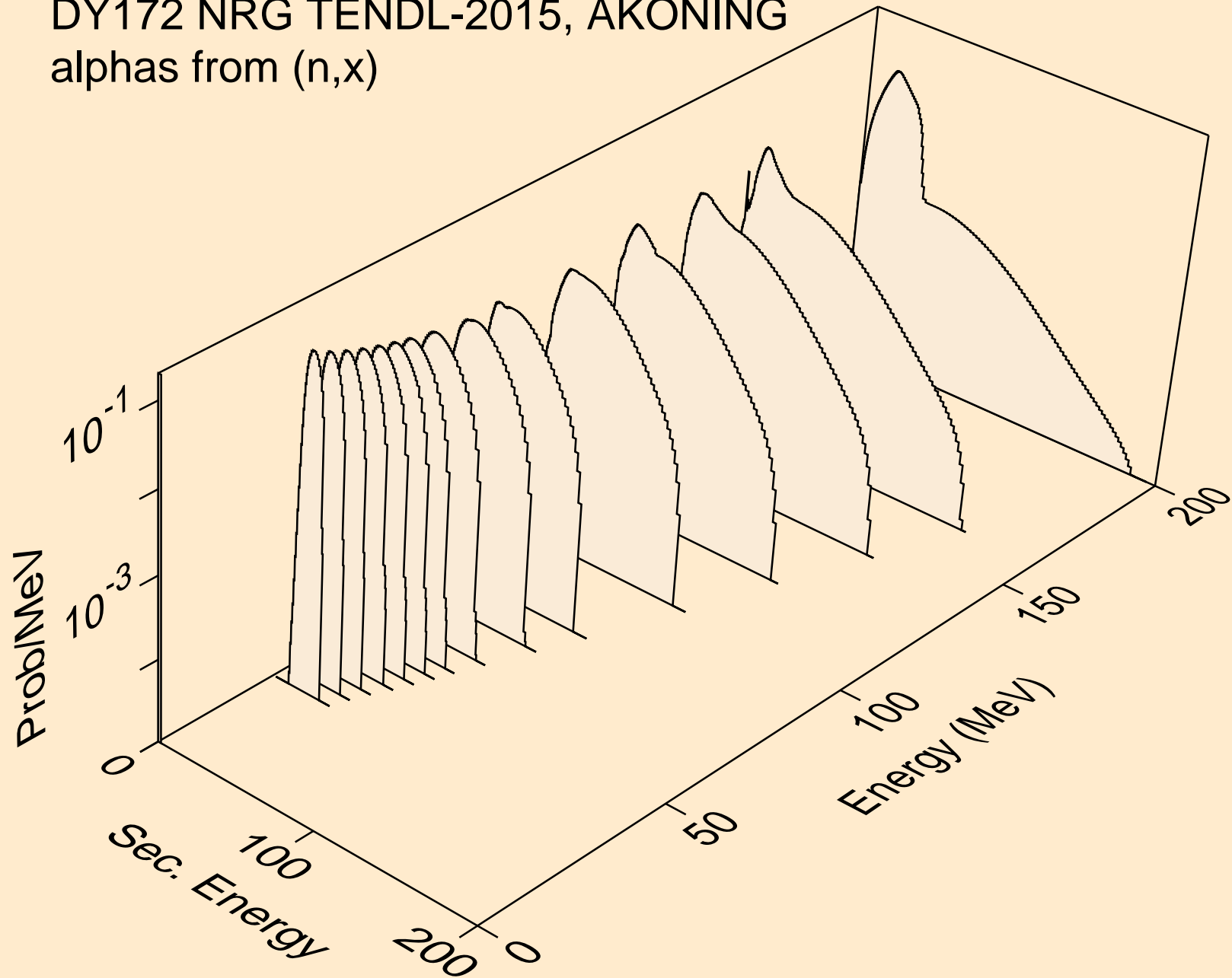

DY172 NRG TENDL-2015, AKONING
alphas from (n,n*)a

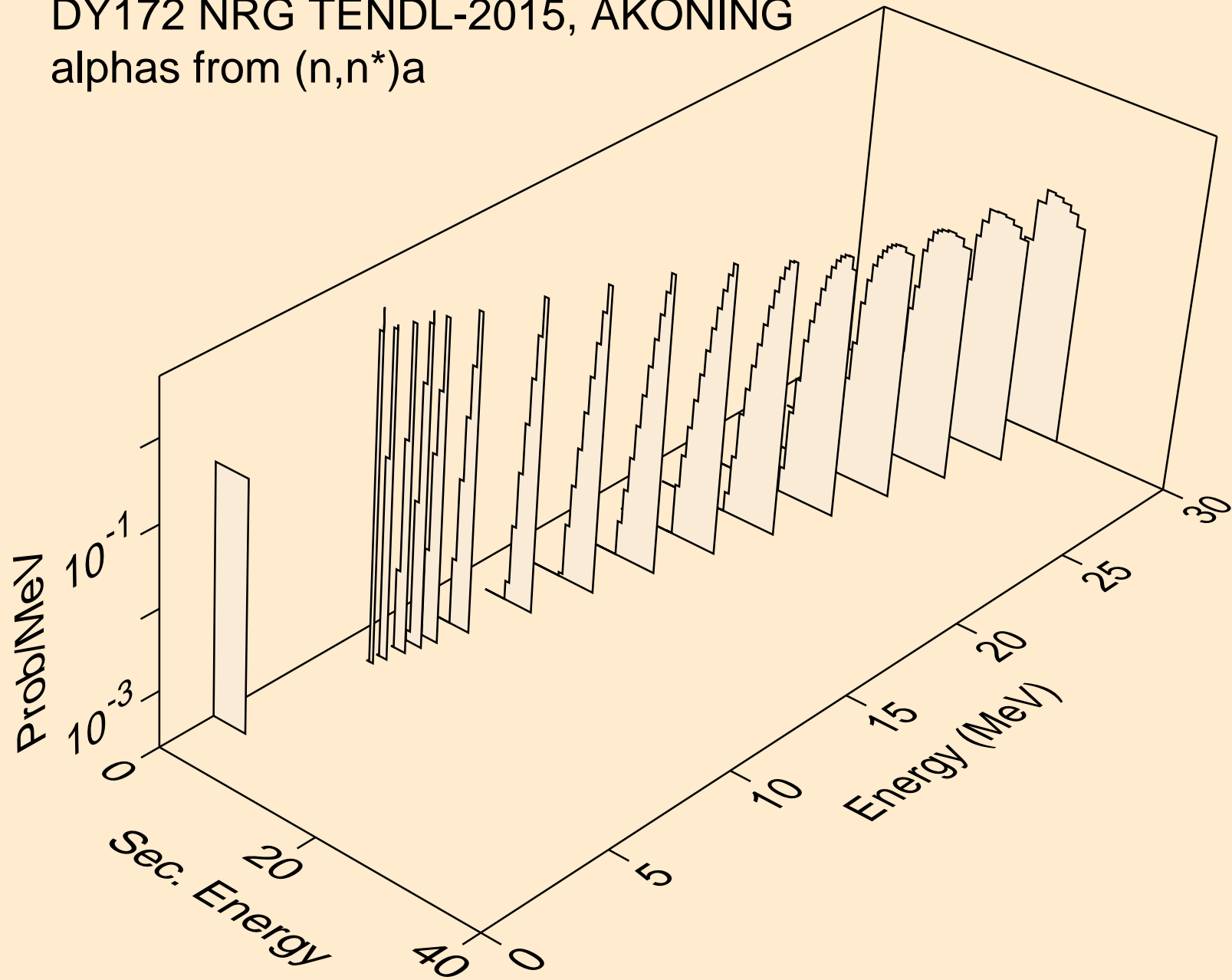

DY172 NRG TENDL-2015, AKONING
alphas from (n,2n)a

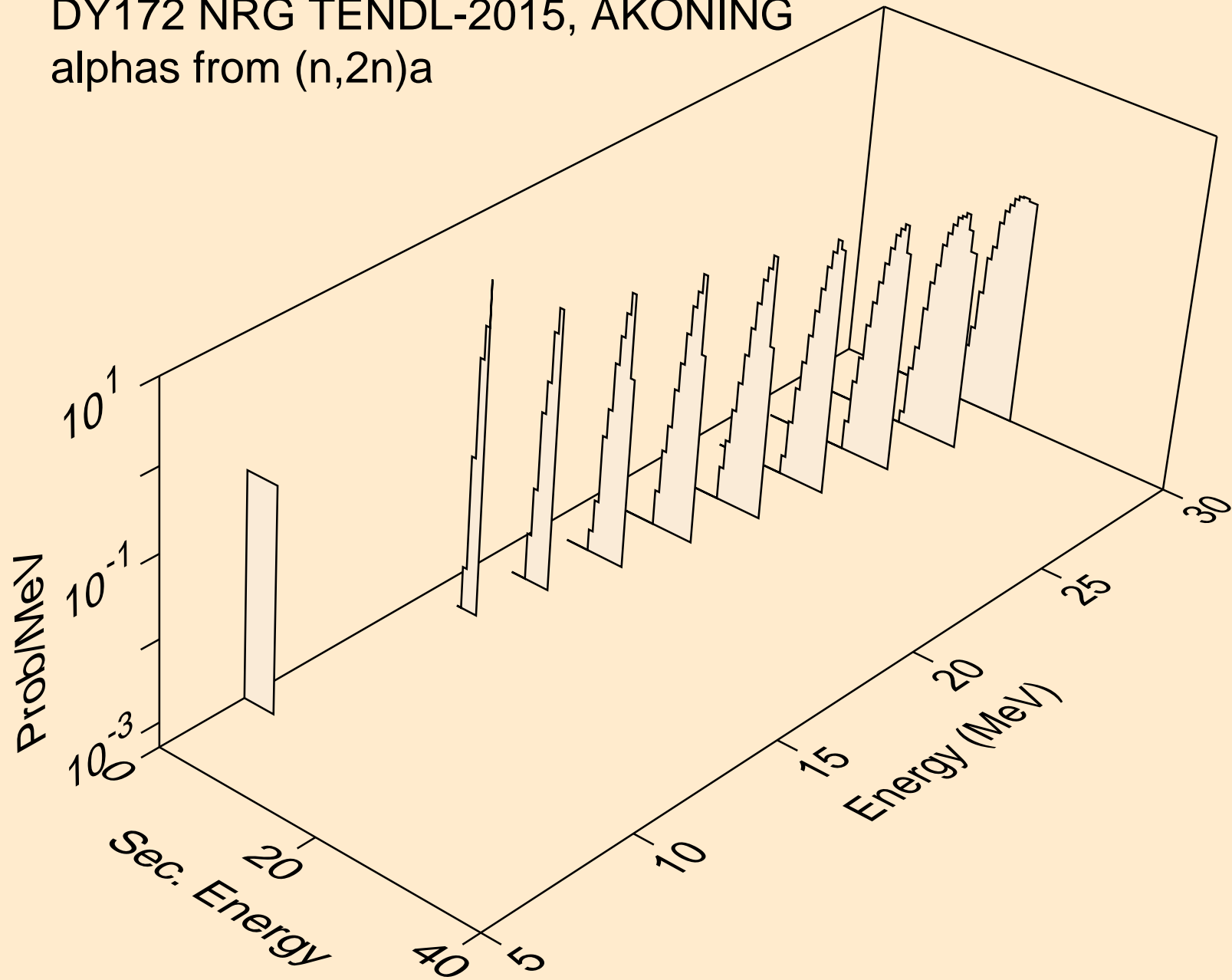

DY172 NRG TENDL-2015, AKONING
alphas from (n,3n)a

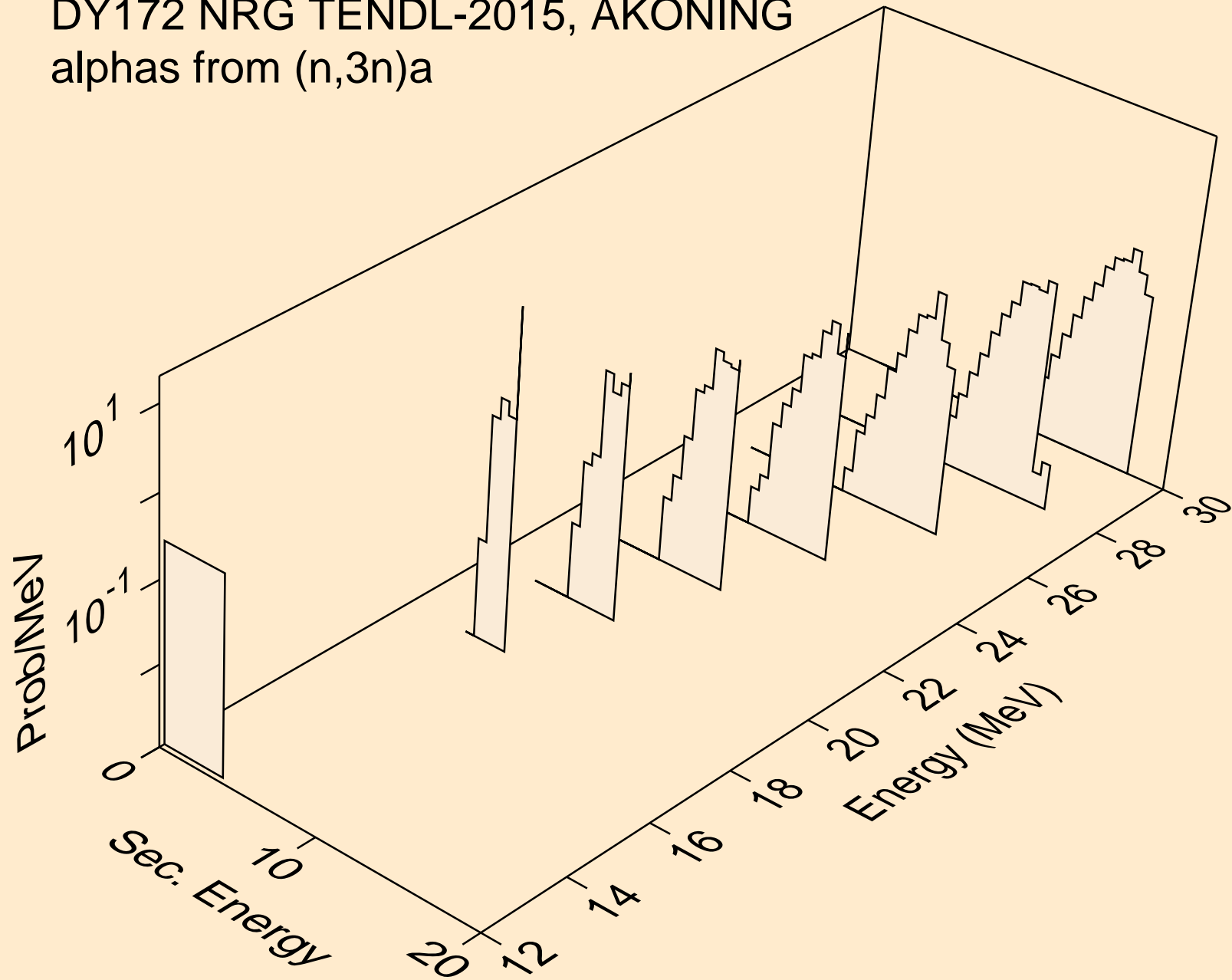

DY172 NRG TENDL-2015, AKONING
alphas from (n,a)

