

# ER147 NRG TENDL-2015, AKONING

## Principal cross sections

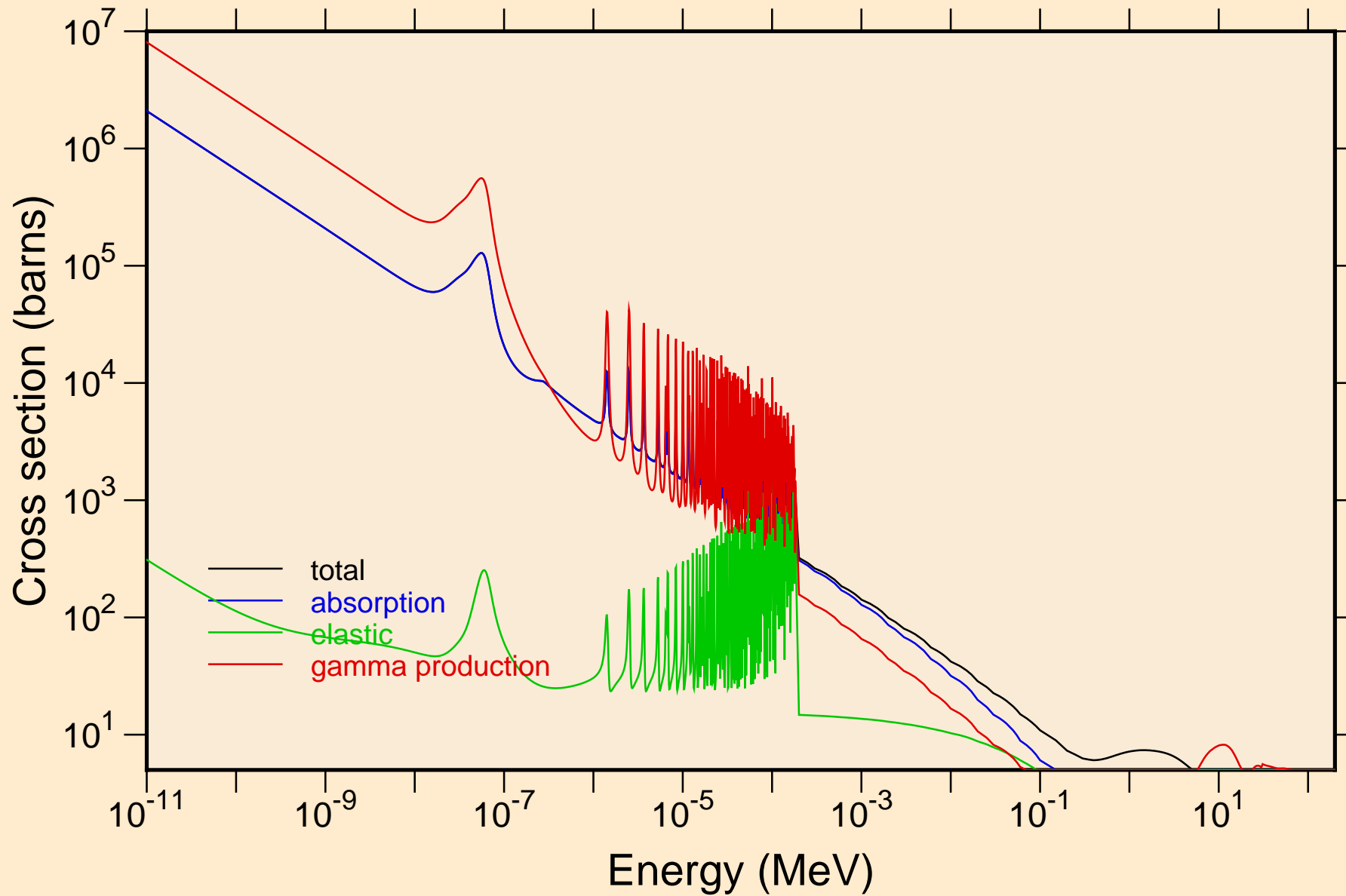

ER147 NRG TENDL-2015, AKONING  
resonance total cross section

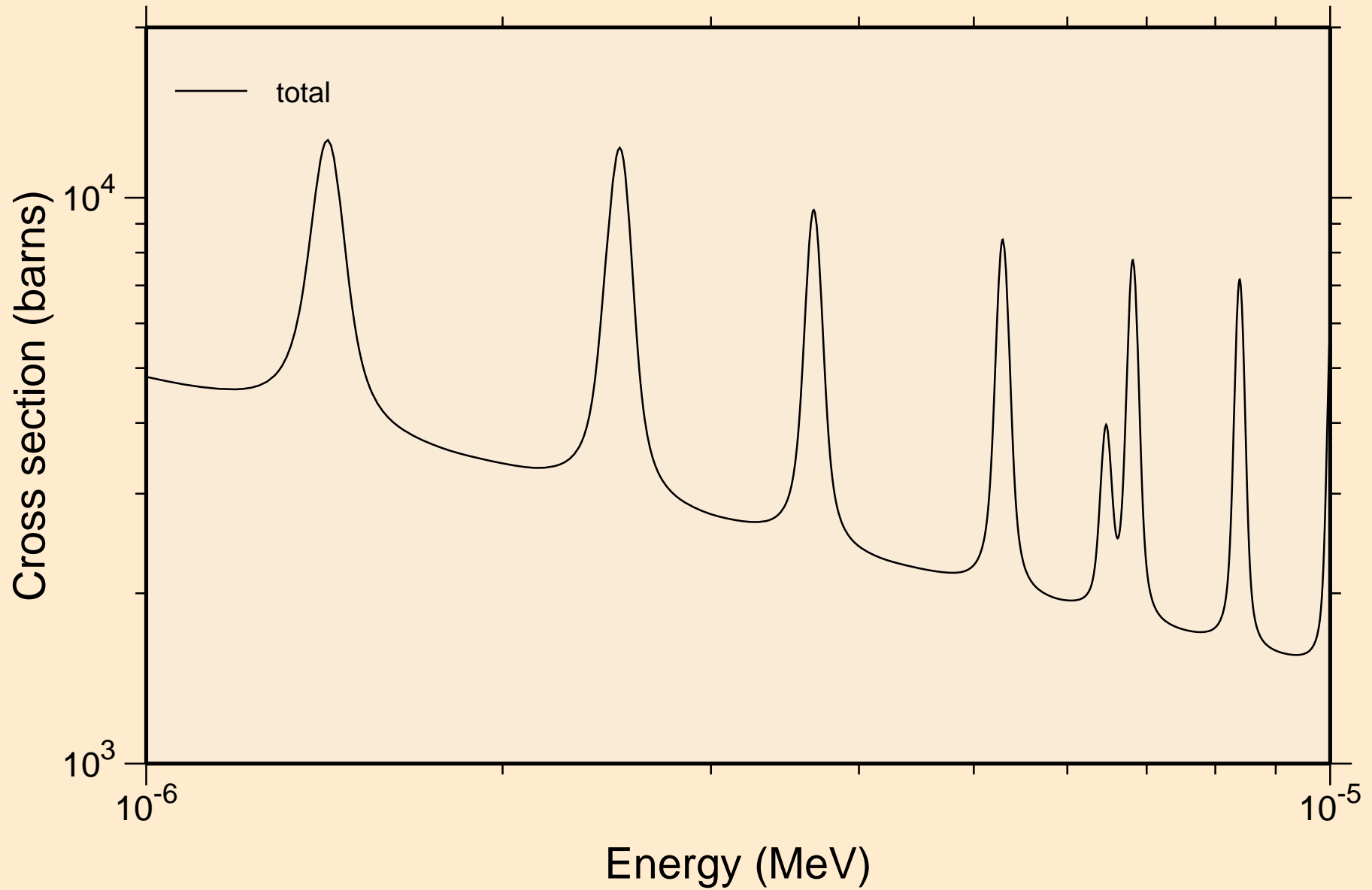

ER147 NRG TENDL-2015, AKONING  
resonance total cross section

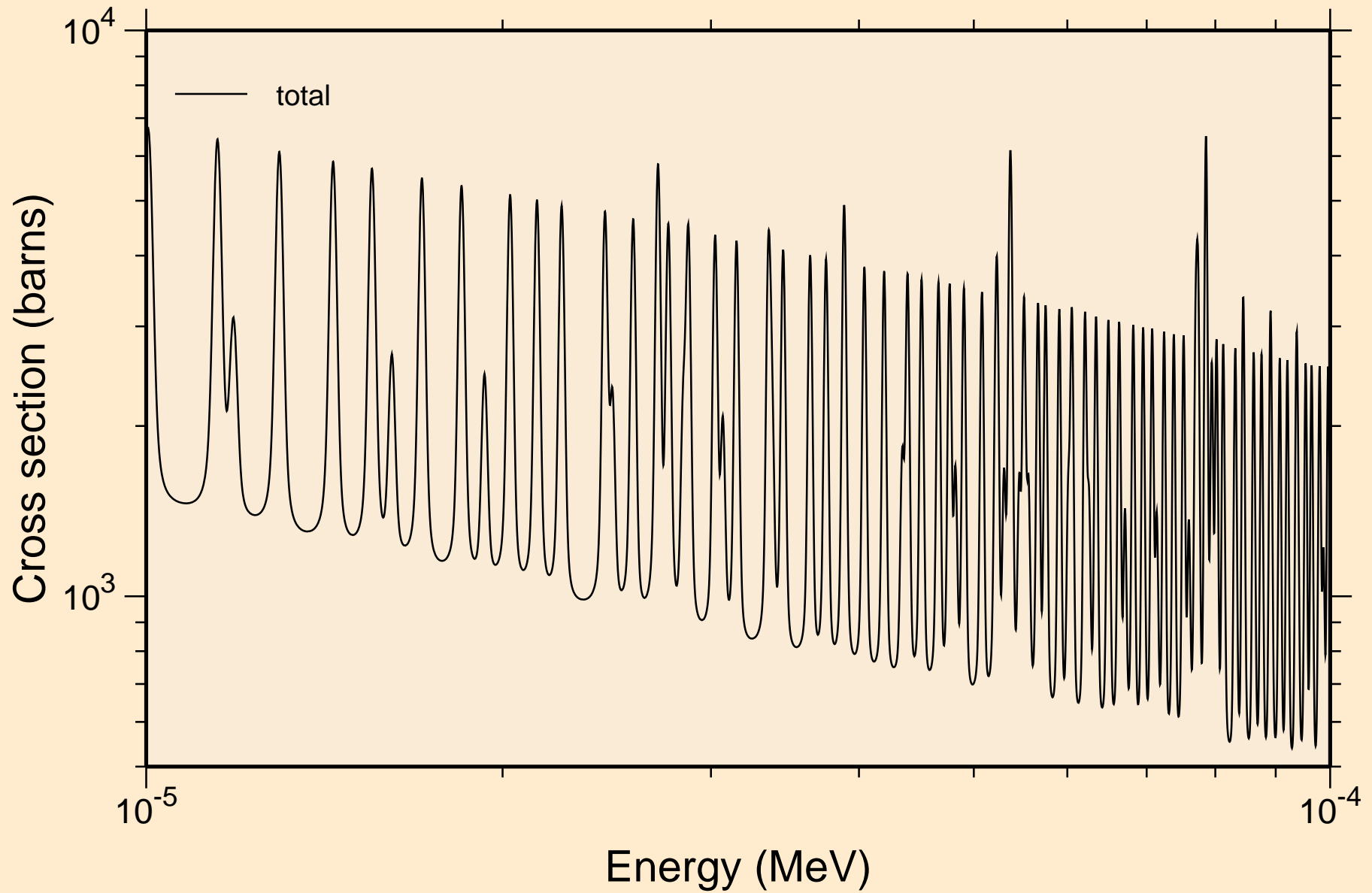

ER147 NRG TENDL-2015, AKONING  
resonance total cross section

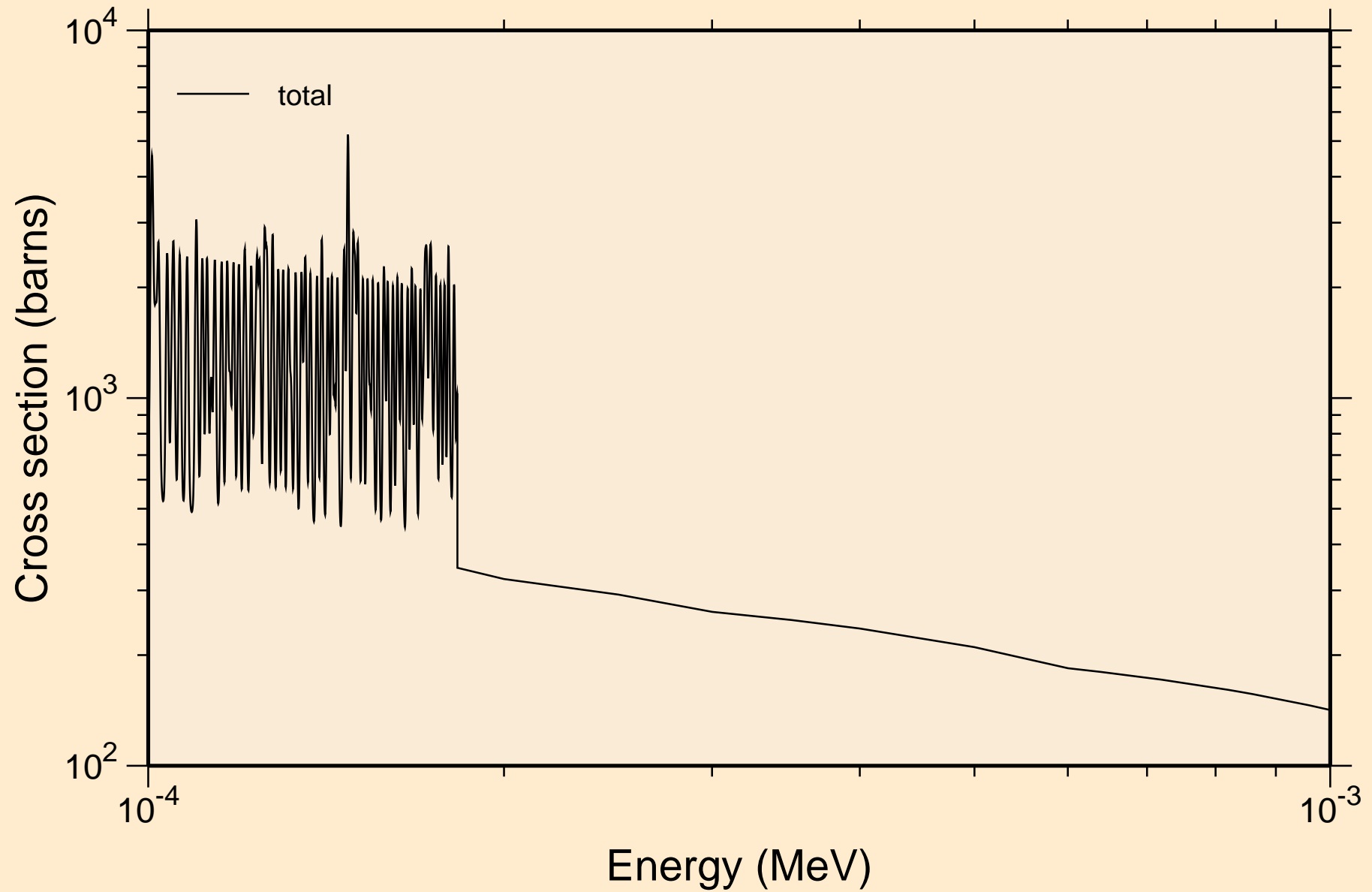

ER147 NRG TENDL-2015, AKONING  
resonance total cross section

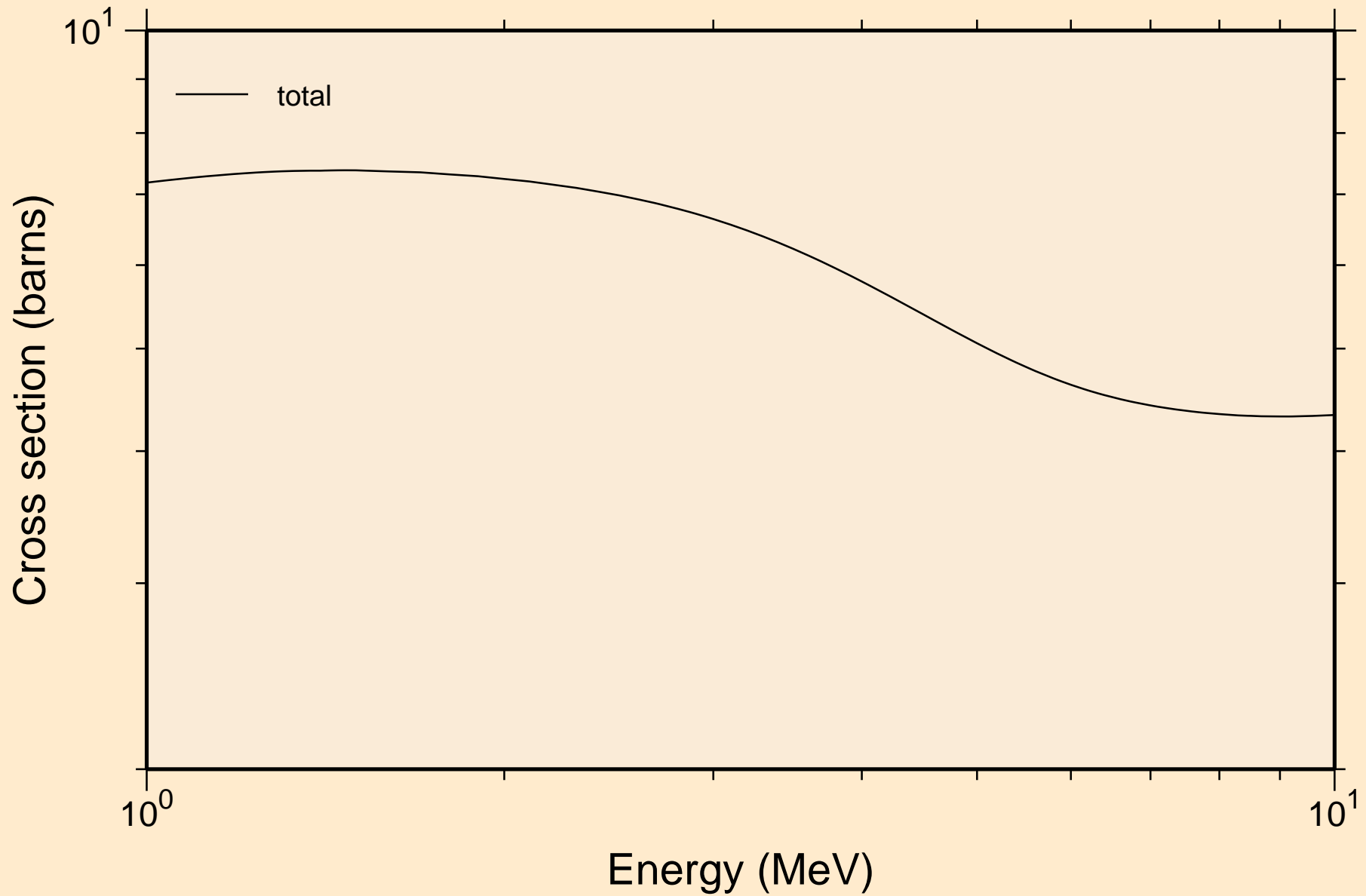

ER147 NRG TENDL-2015, AKONING  
resonance absorption cross sections

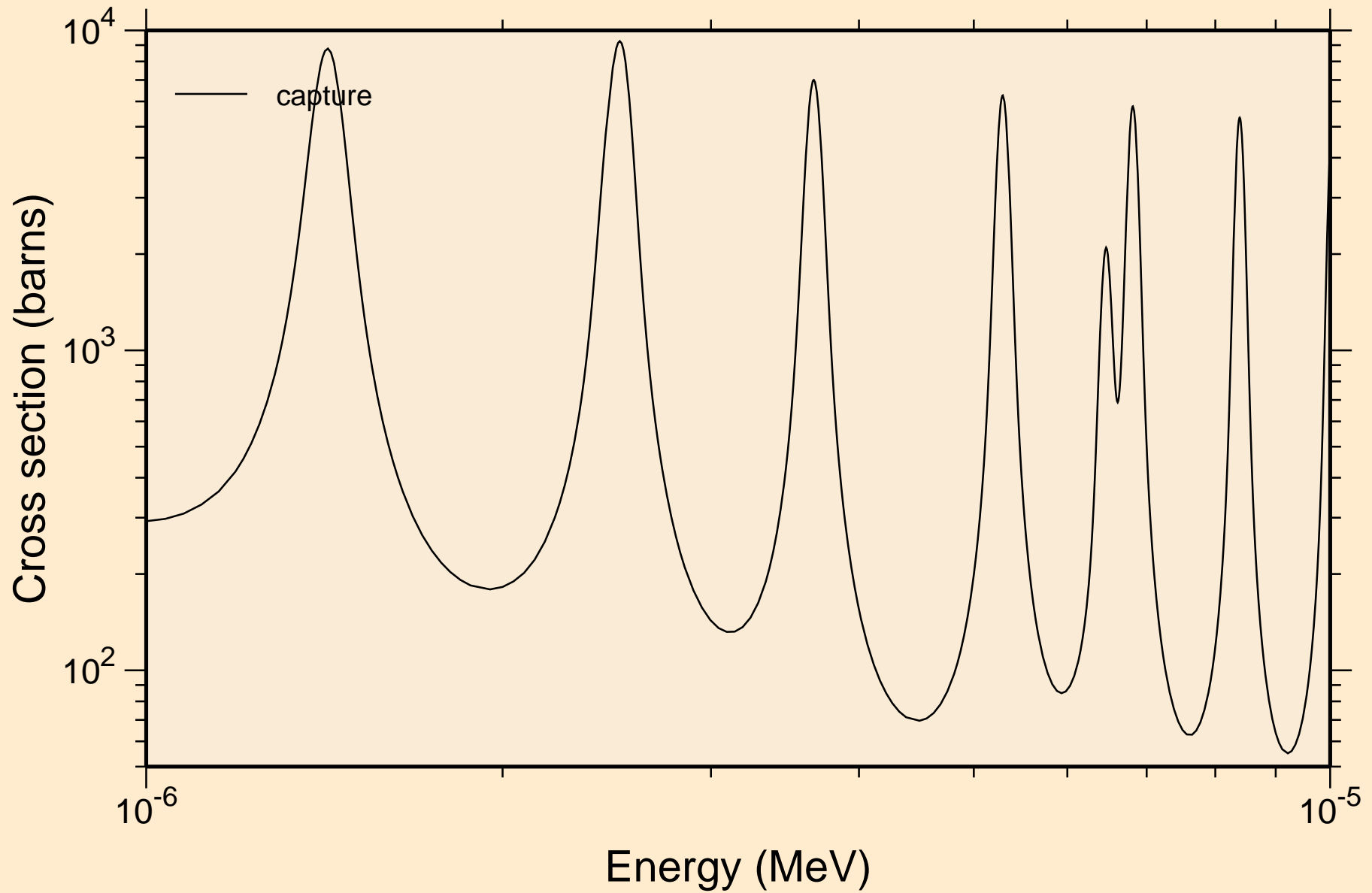

ER147 NRG TENDL-2015, AKONING  
resonance absorption cross sections

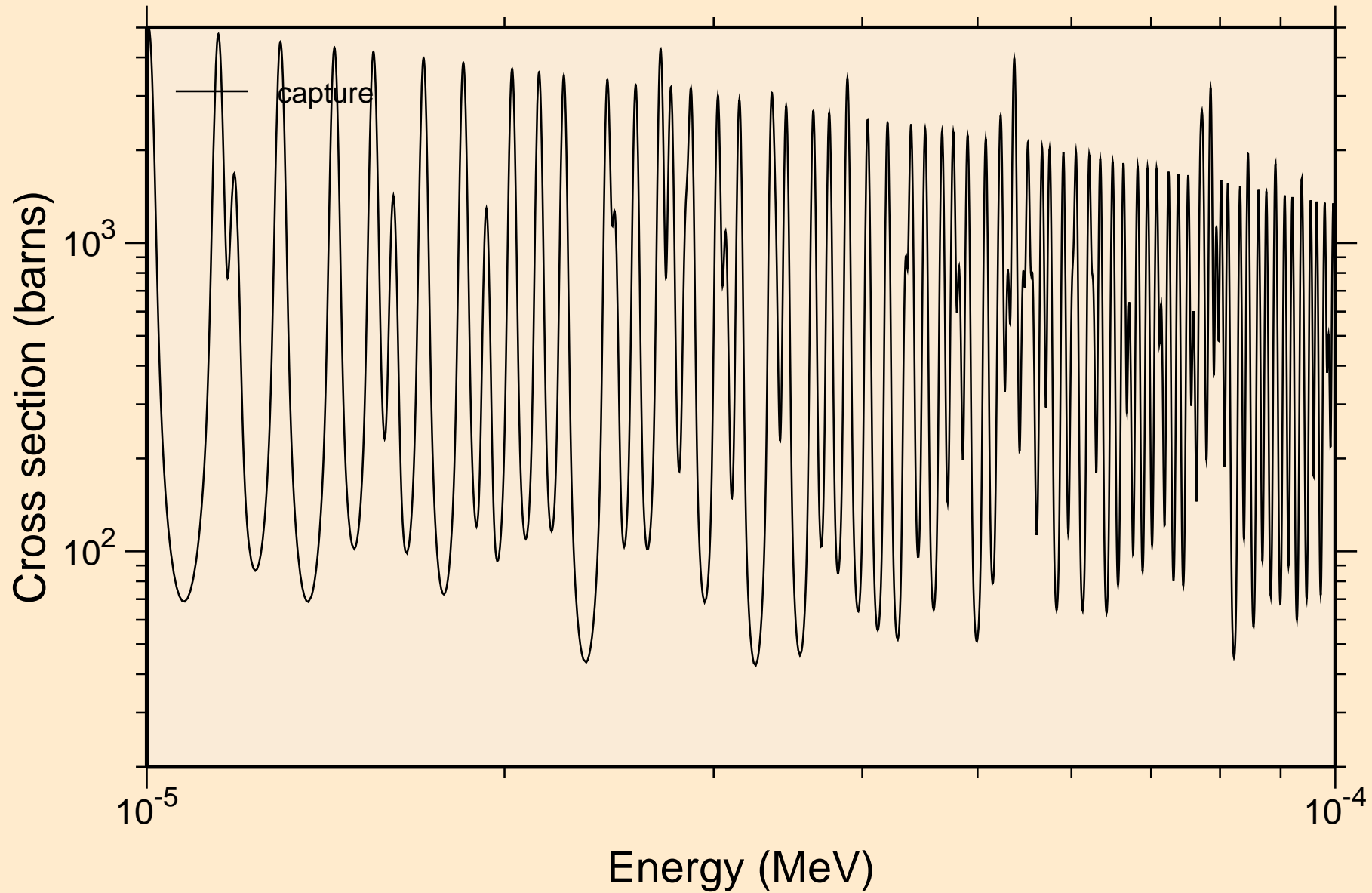

ER147 NRG TENDL-2015, AKONING  
resonance absorption cross sections

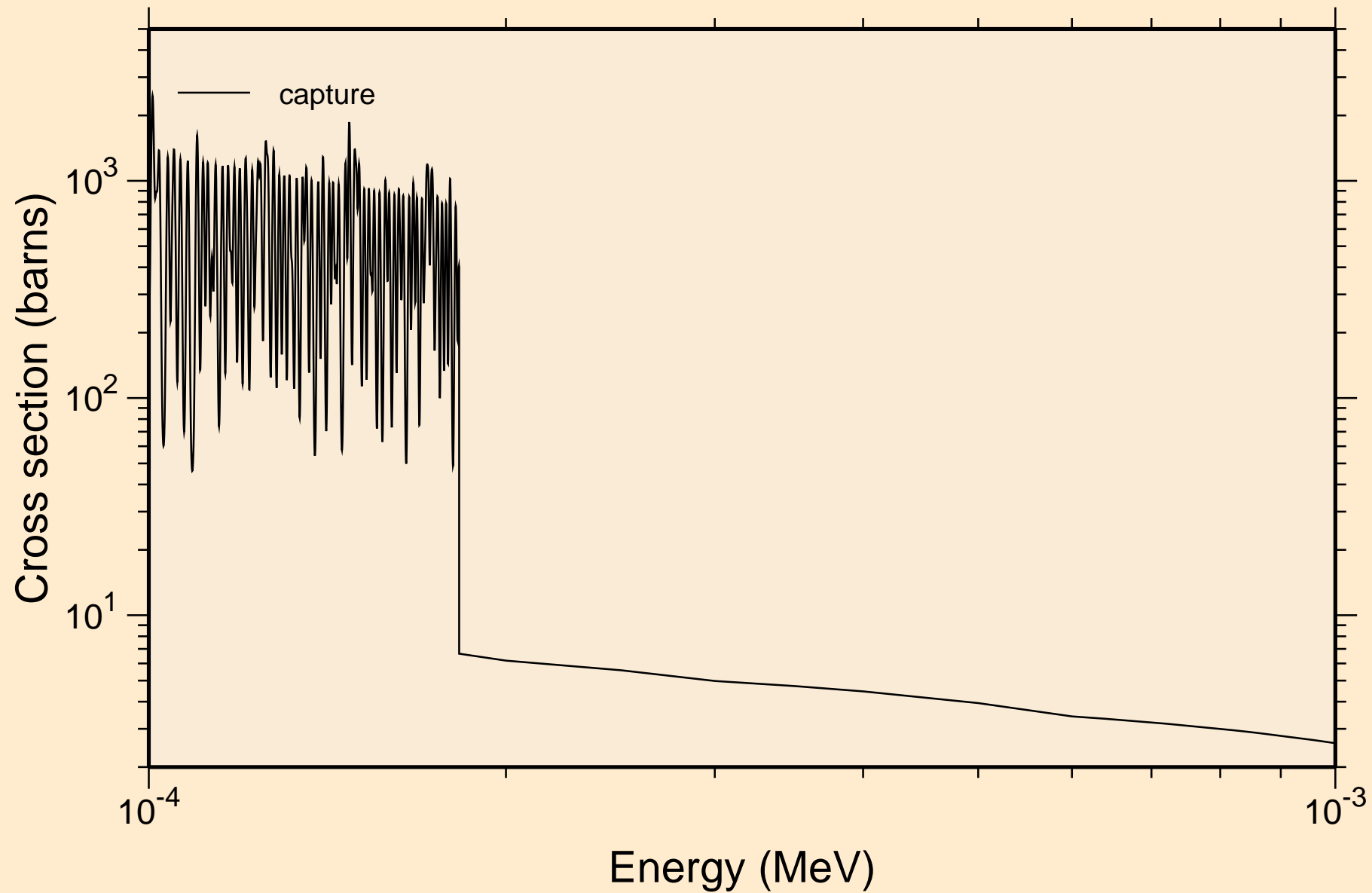



ER147 NRG TENDL-2015, AKONING  
resonance absorption cross sections

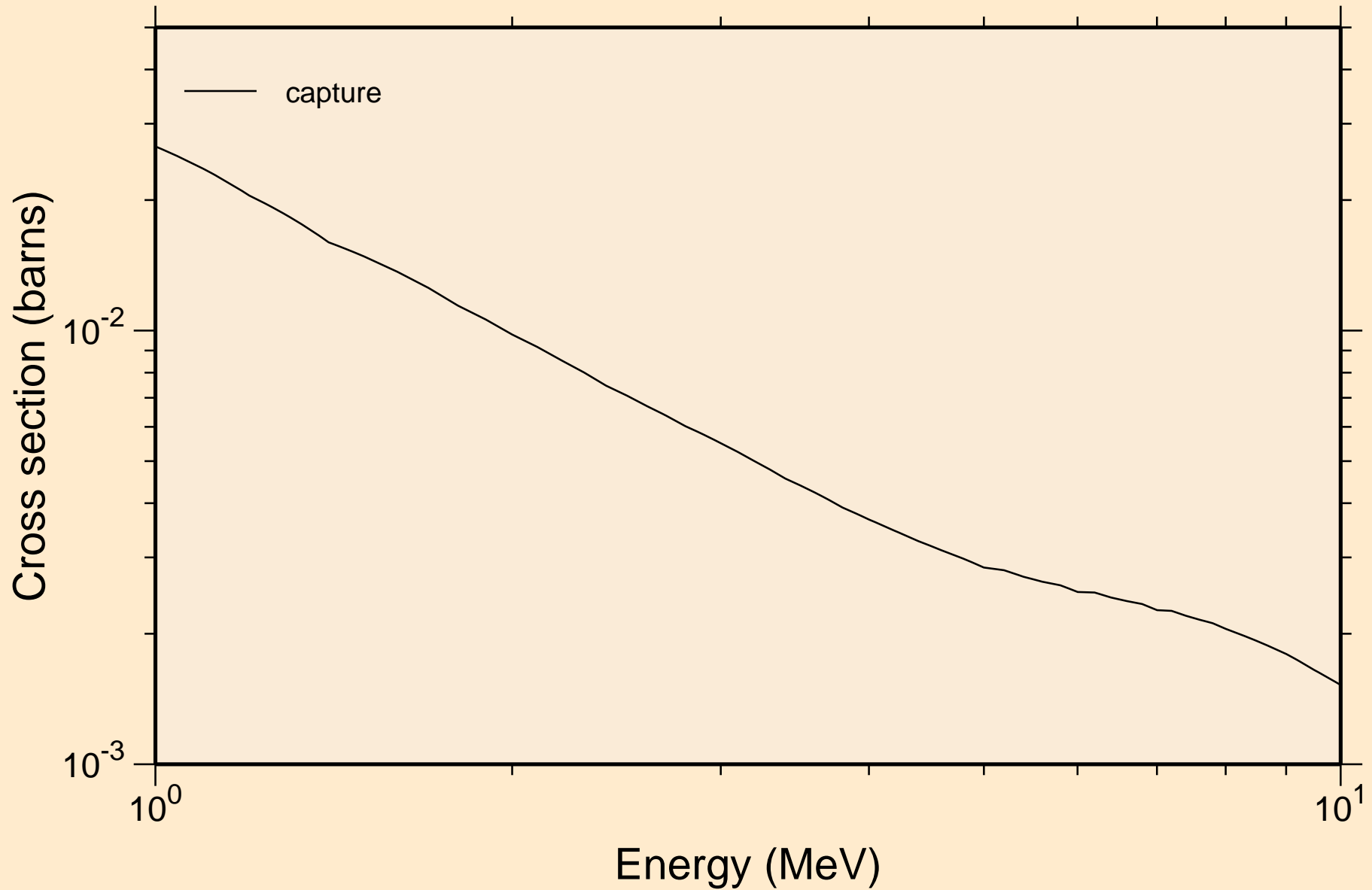

# ER147 NRG TENDL-2015, AKONING

## Non-threshold reactions

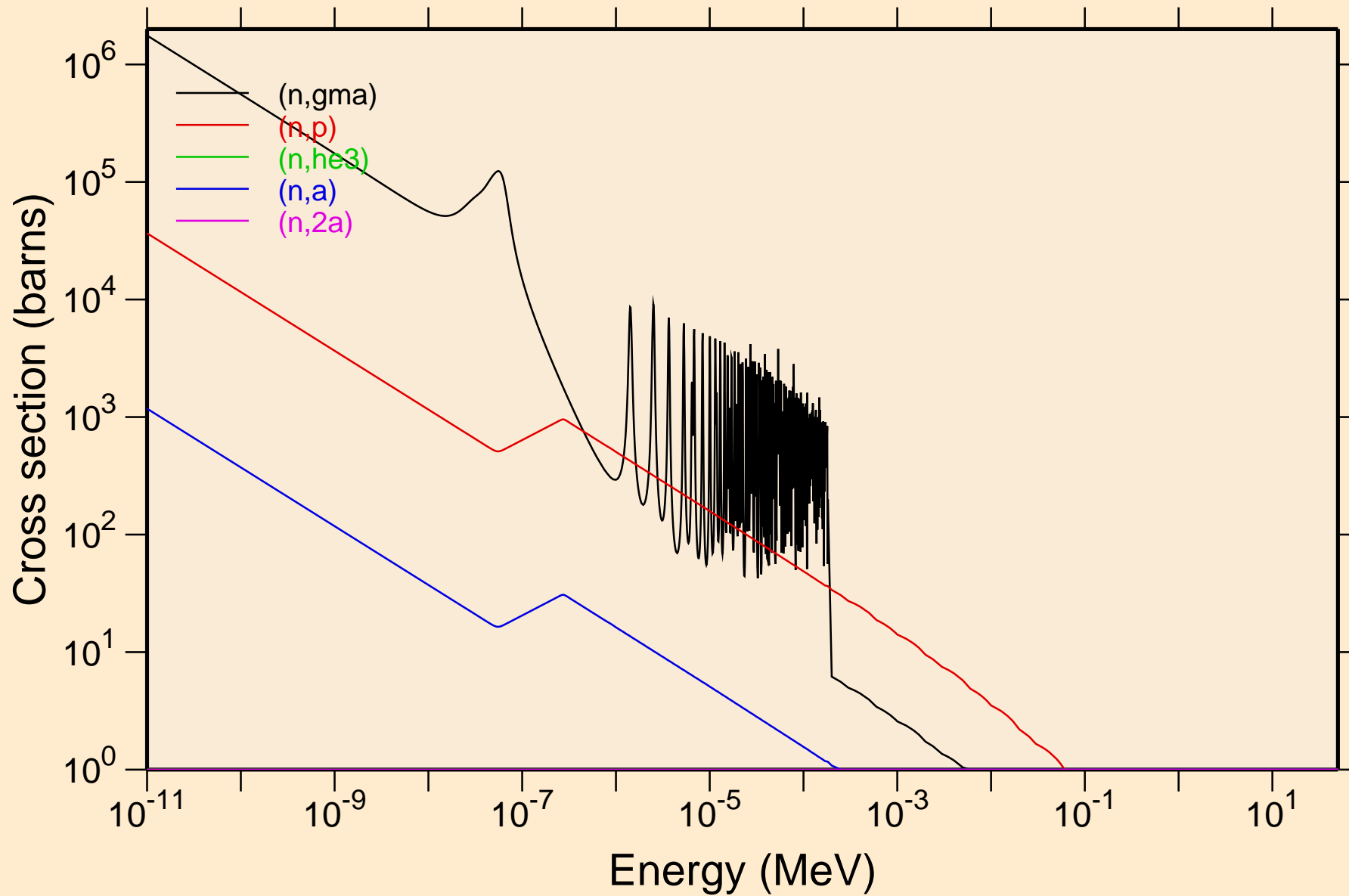

# ER147 NRG TENDL-2015, AKONING

## Non-threshold reactions

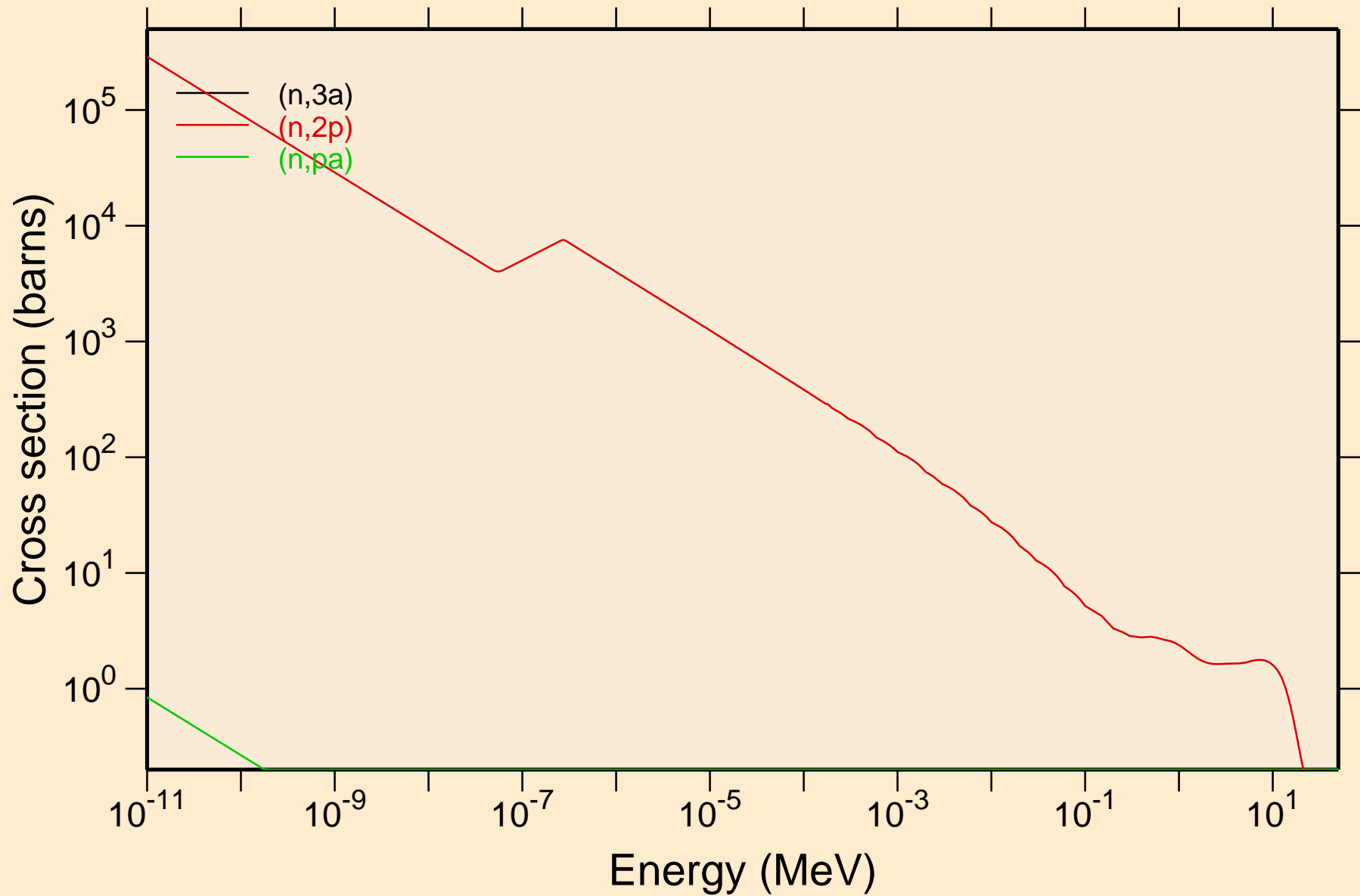

# ER147 NRG TENDL-2015, AKONING

## Principal cross sections

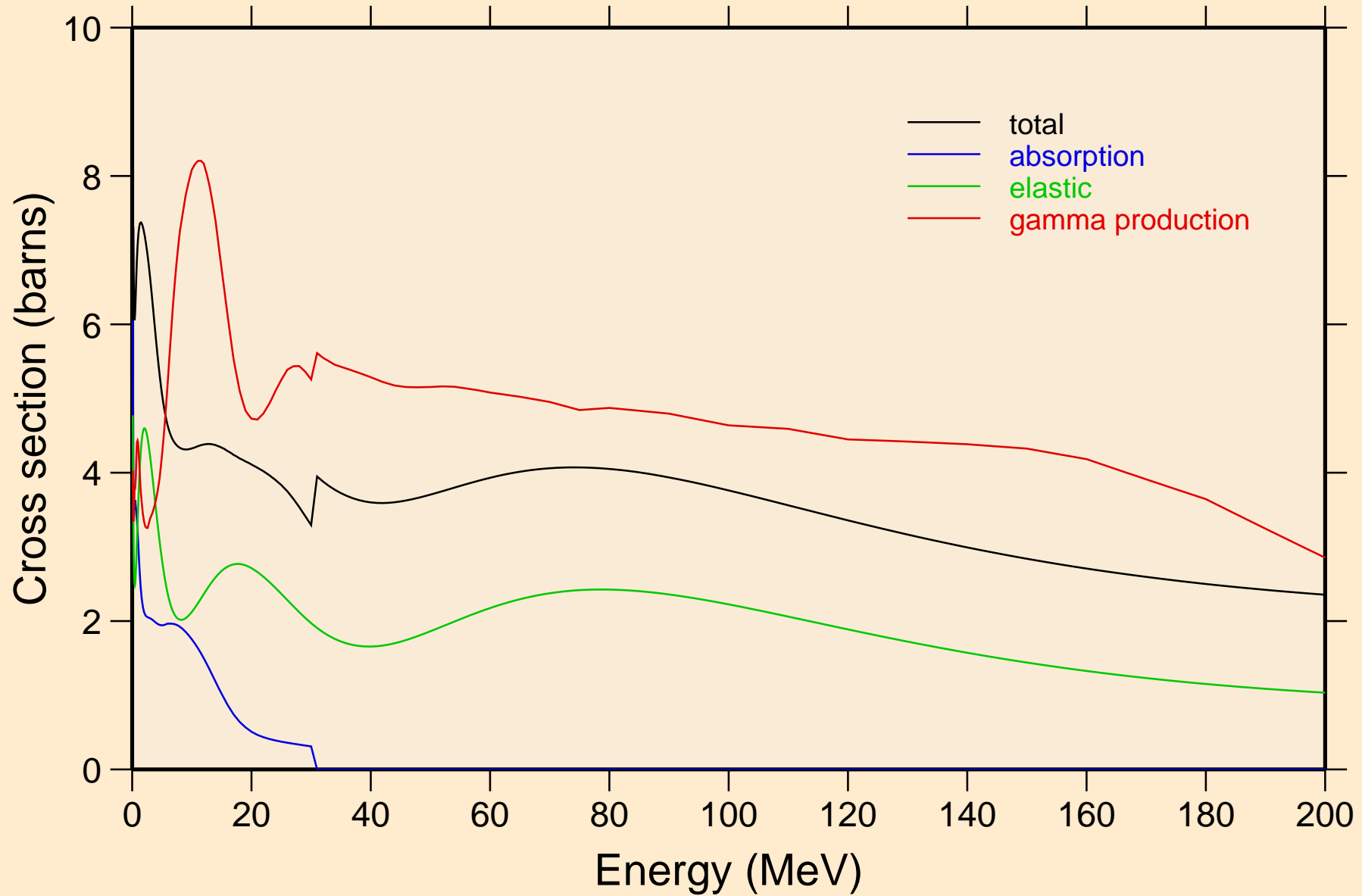

# ER147 NRG TENDL-2015, AKONING

## Non-threshold reactions

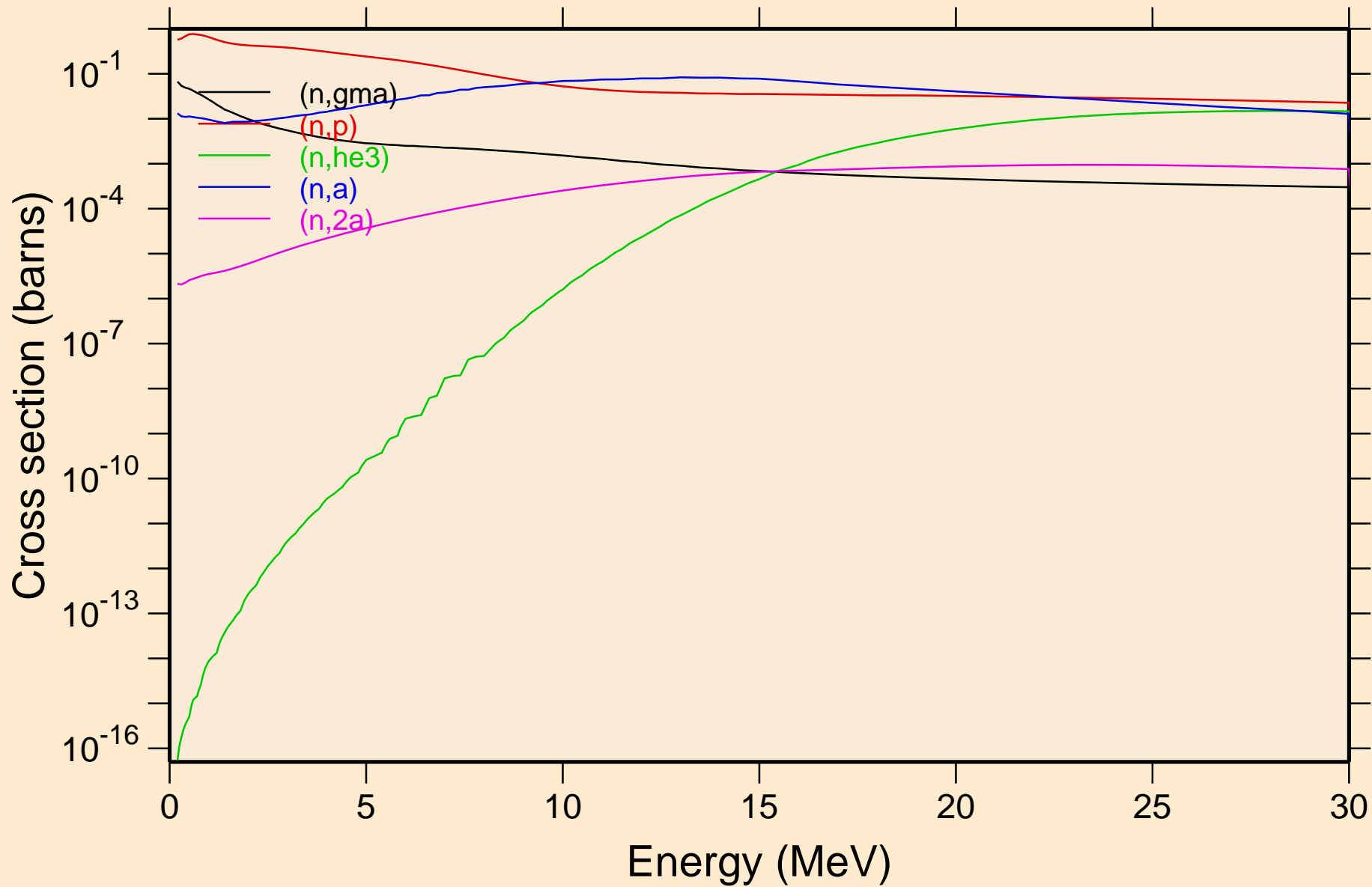

# ER147 NRG TENDL-2015, AKONING

## Non-threshold reactions

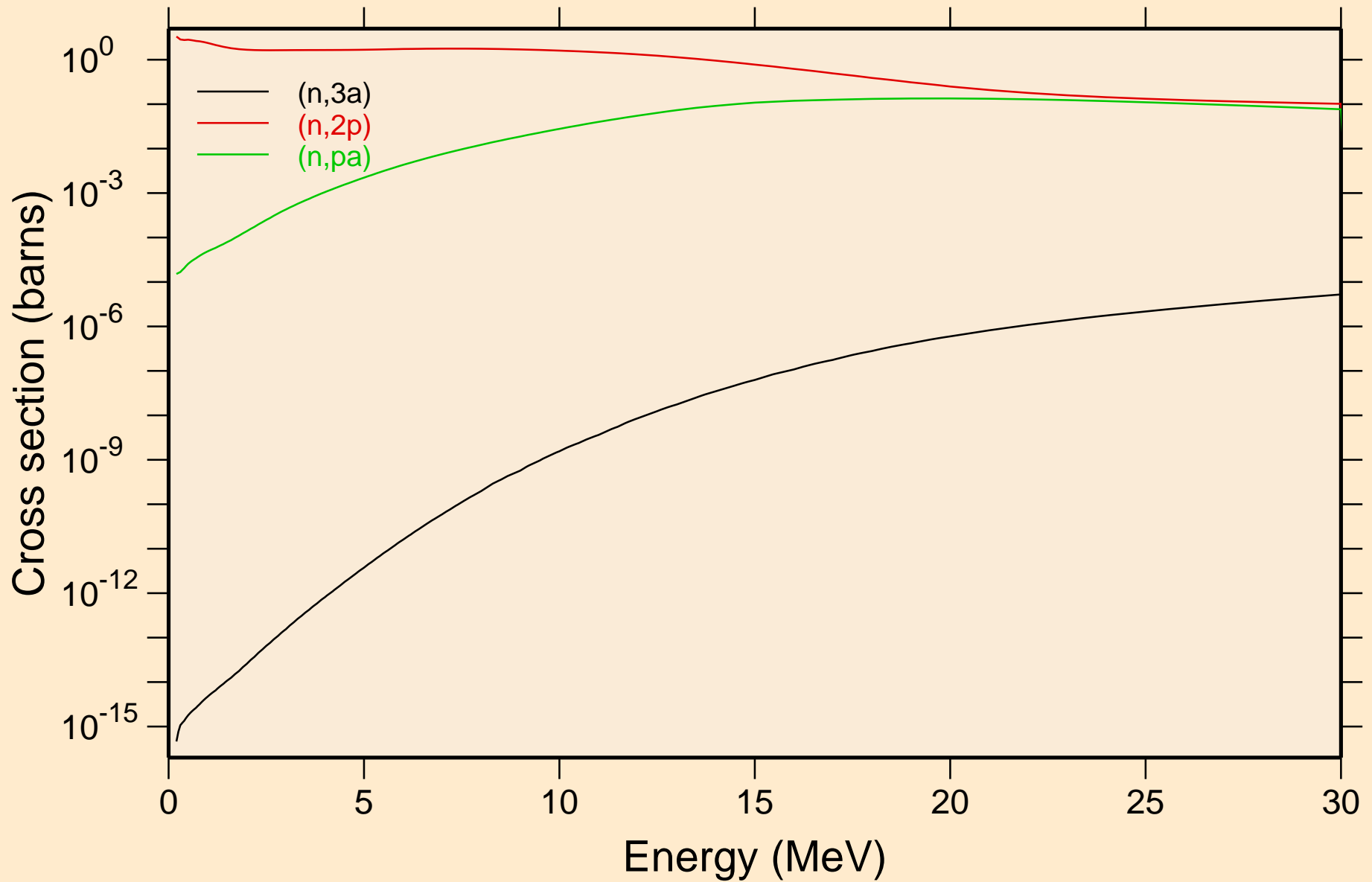

# ER147 NRG TENDL-2015, AKONING

## Inelastic levels

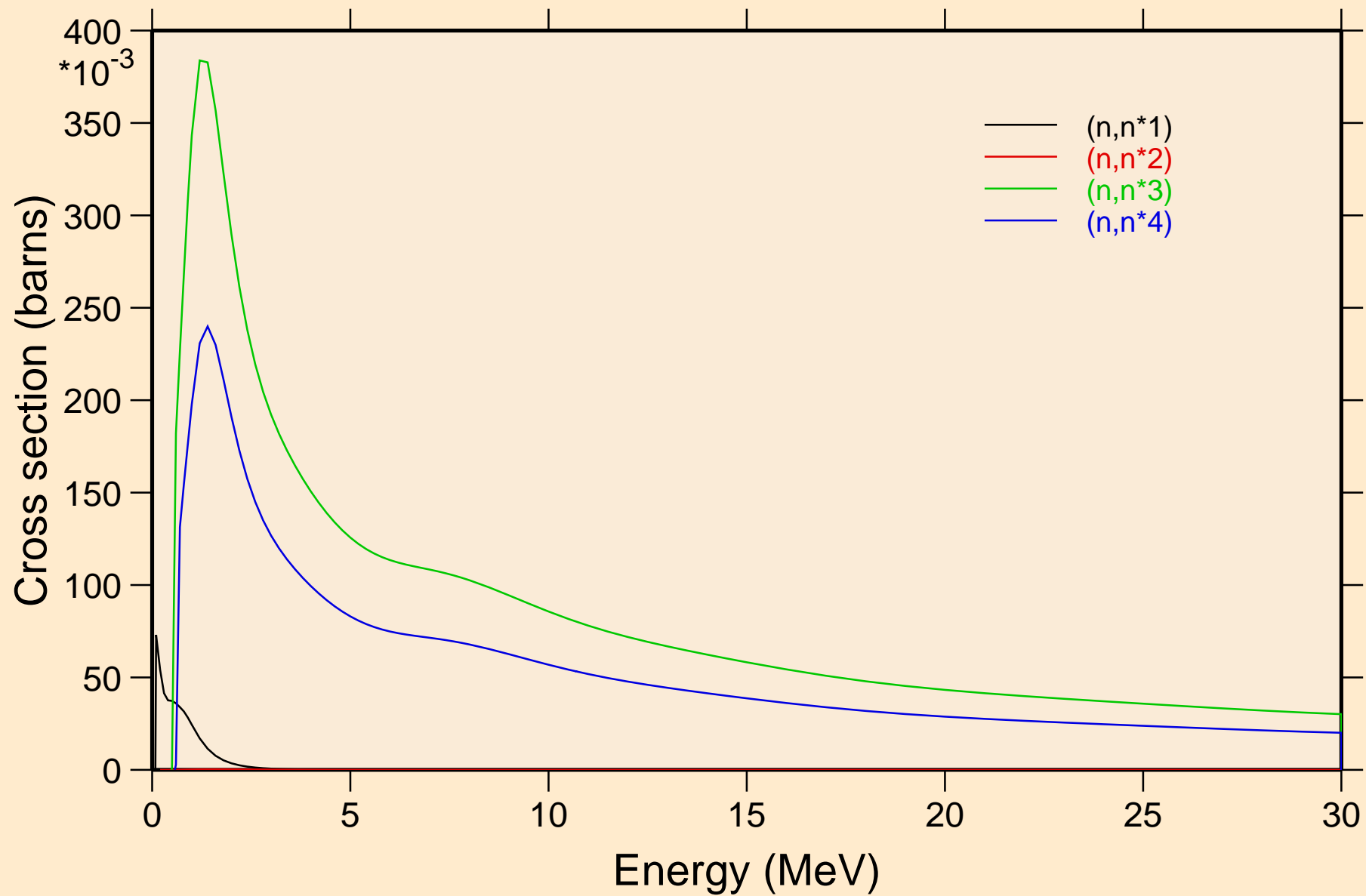

# ER147 NRG TENDL-2015, AKONING

## Threshold reactions

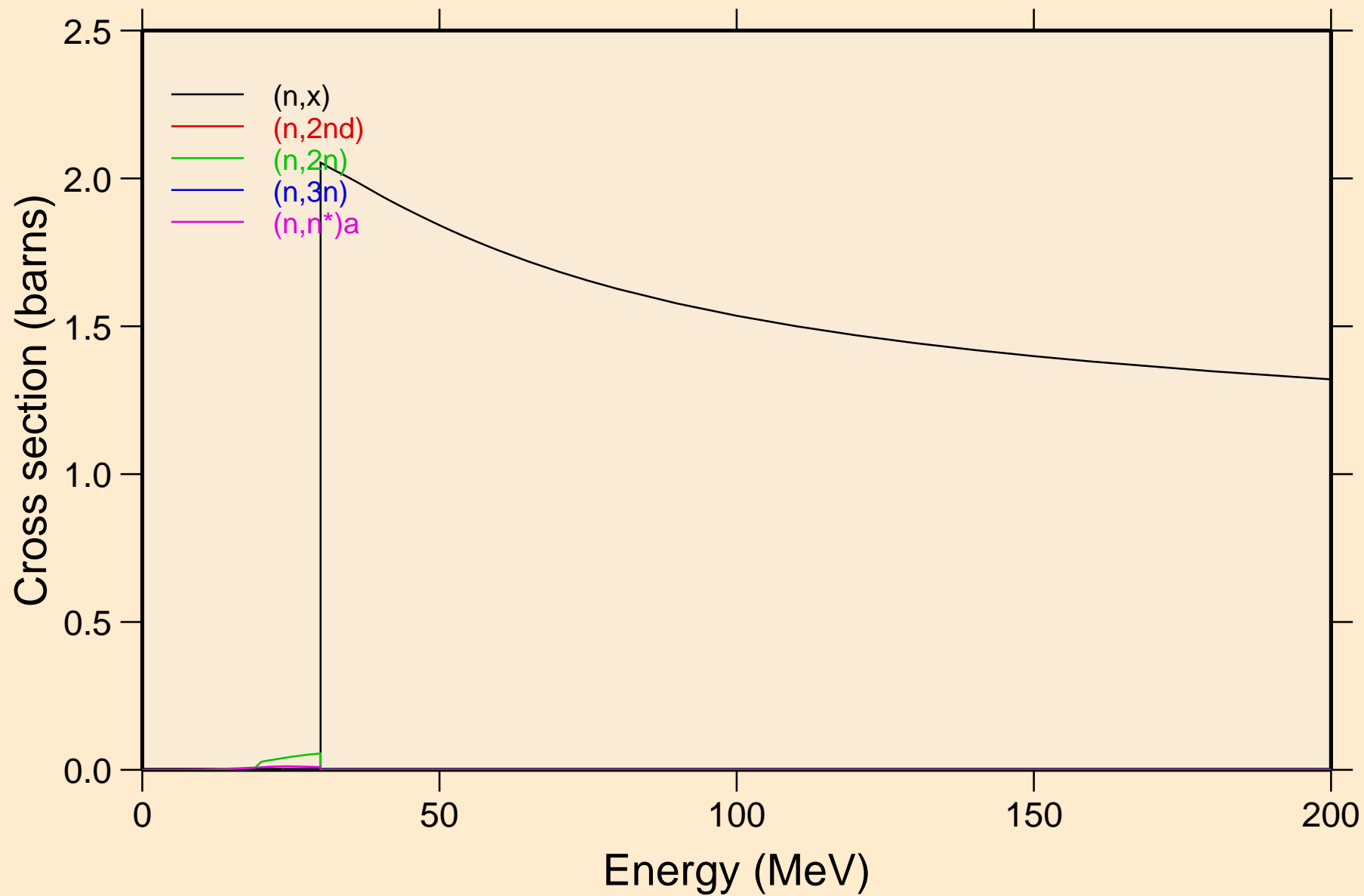



# ER147 NRG TENDL-2015, AKONING

## Threshold reactions

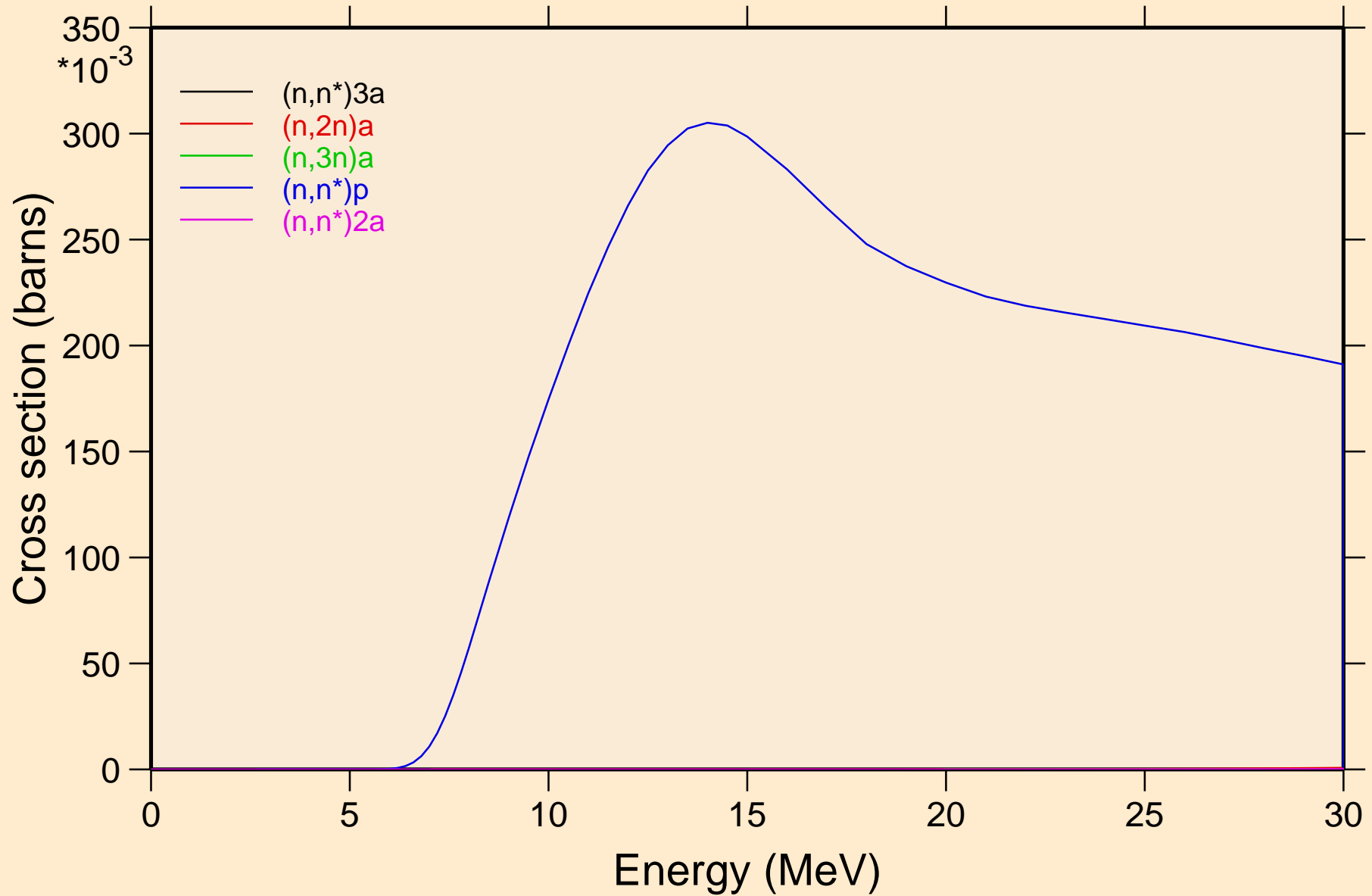

# ER147 NRG TENDL-2015, AKONING

## Threshold reactions

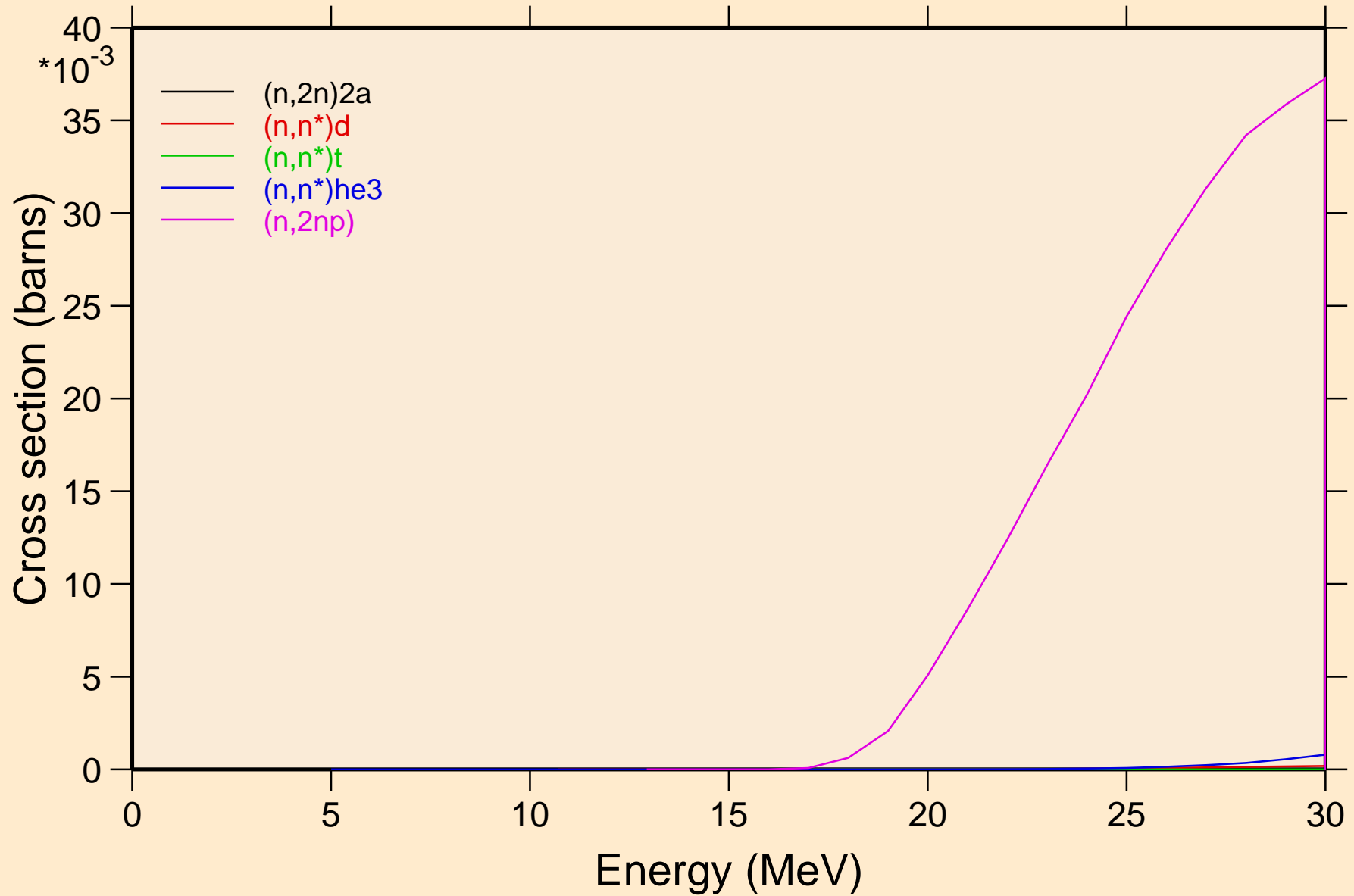

# ER147 NRG TENDL-2015, AKONING

## Threshold reactions

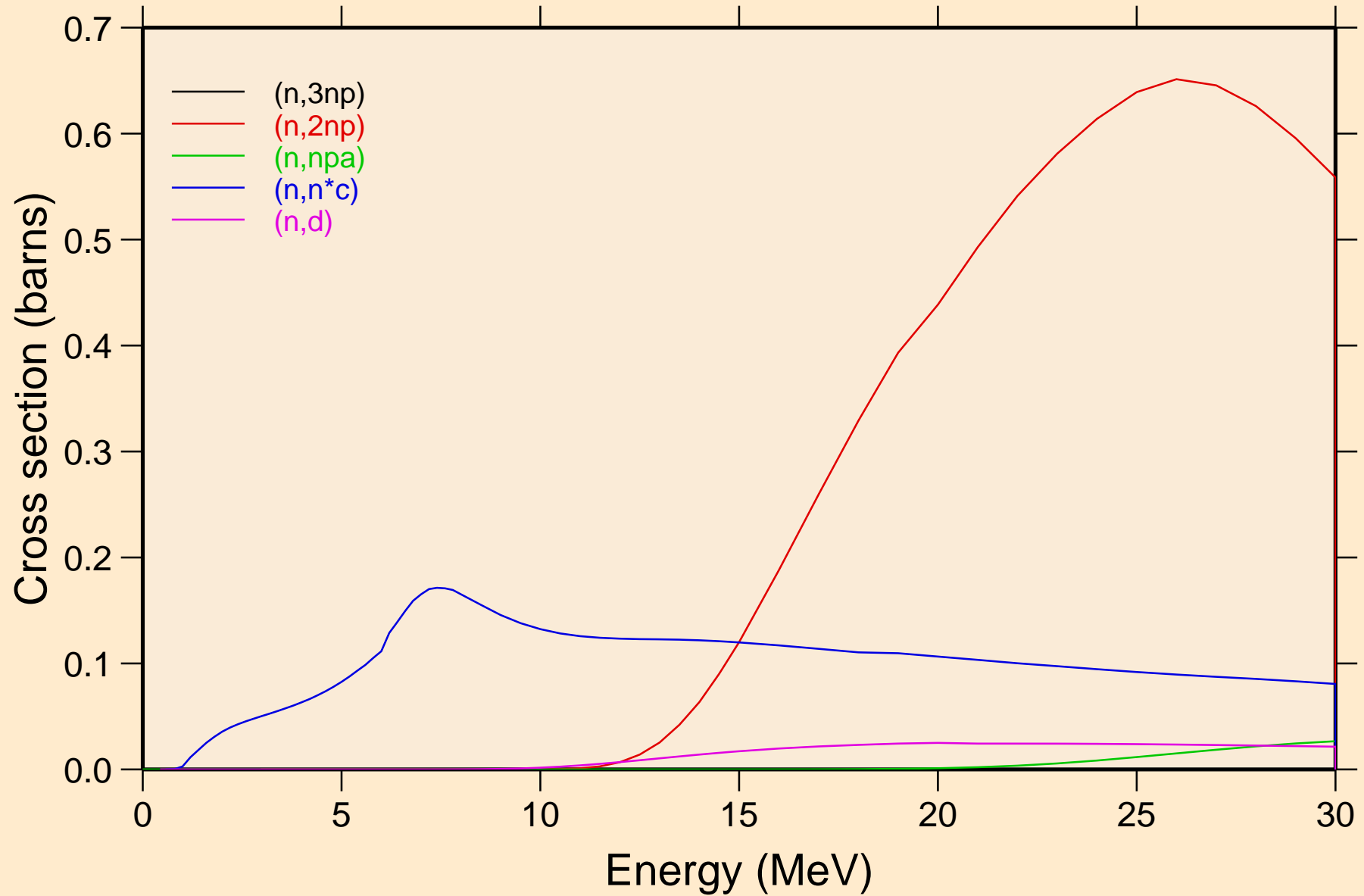

# ER147 NRG TENDL-2015, AKONING

## Threshold reactions

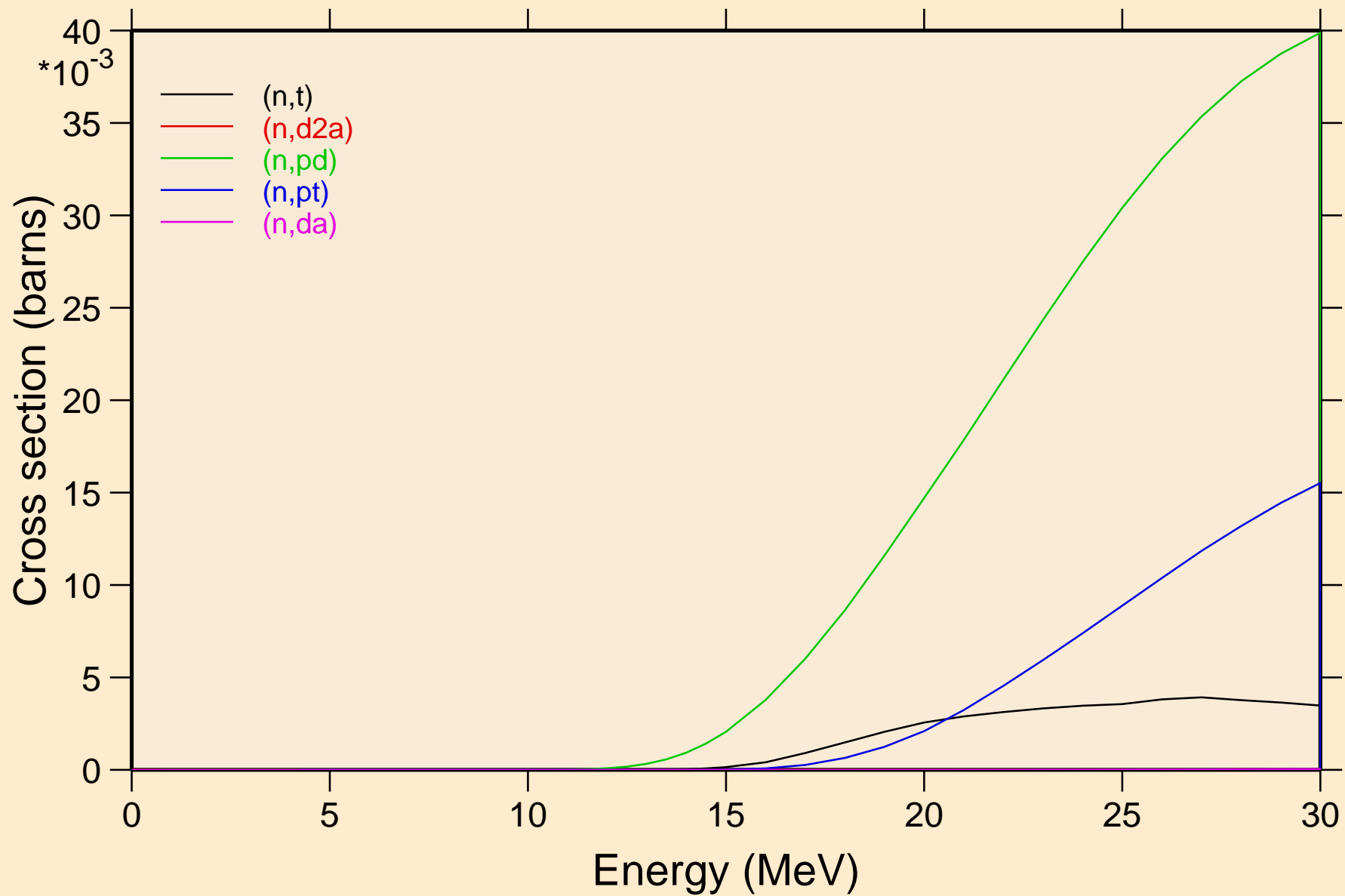

ER147 NRG TENDL-2015, AKONING  
angular distribution for elastic

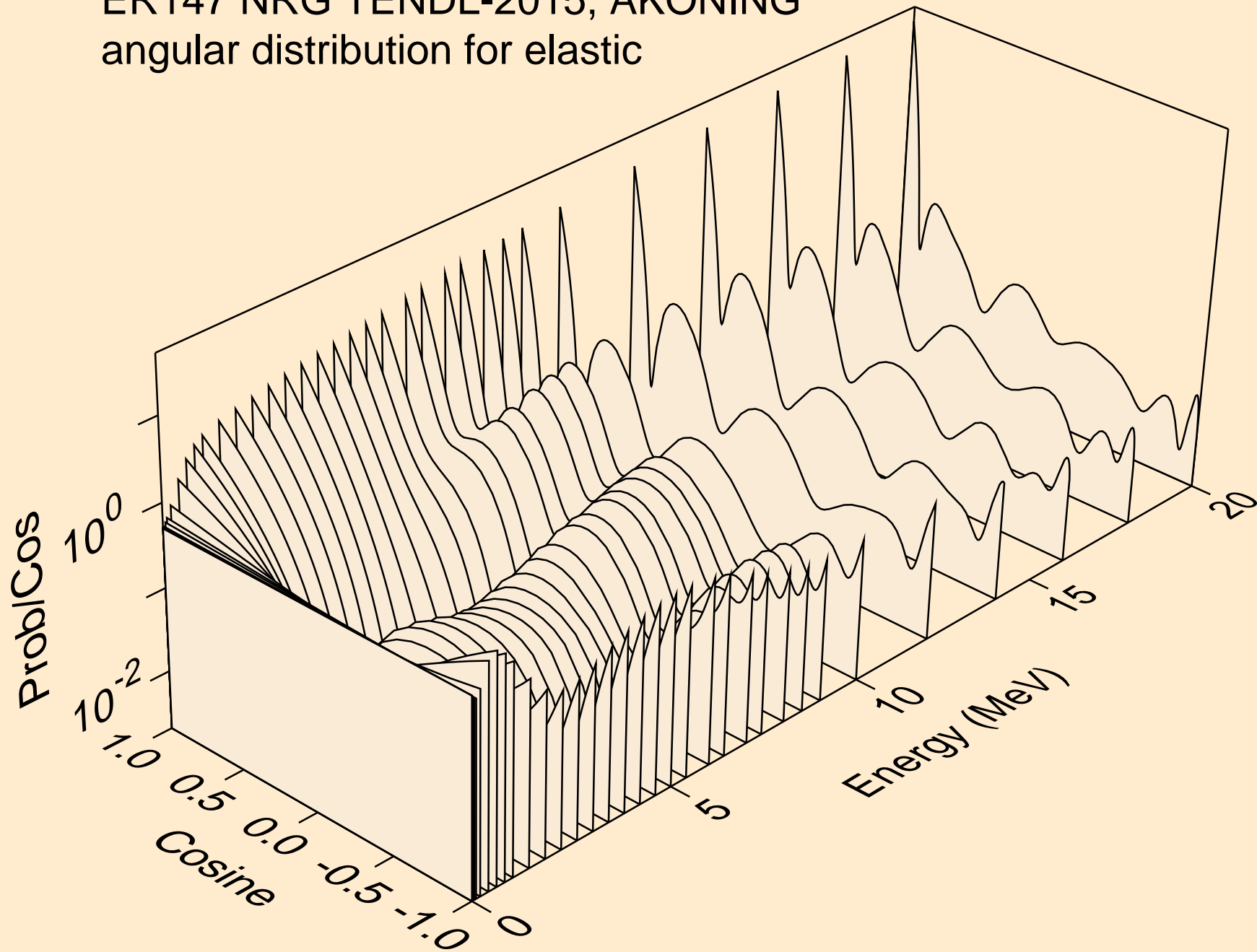

ER147 NRG TENDL-2015, AKONING  
angular distribution for elastic

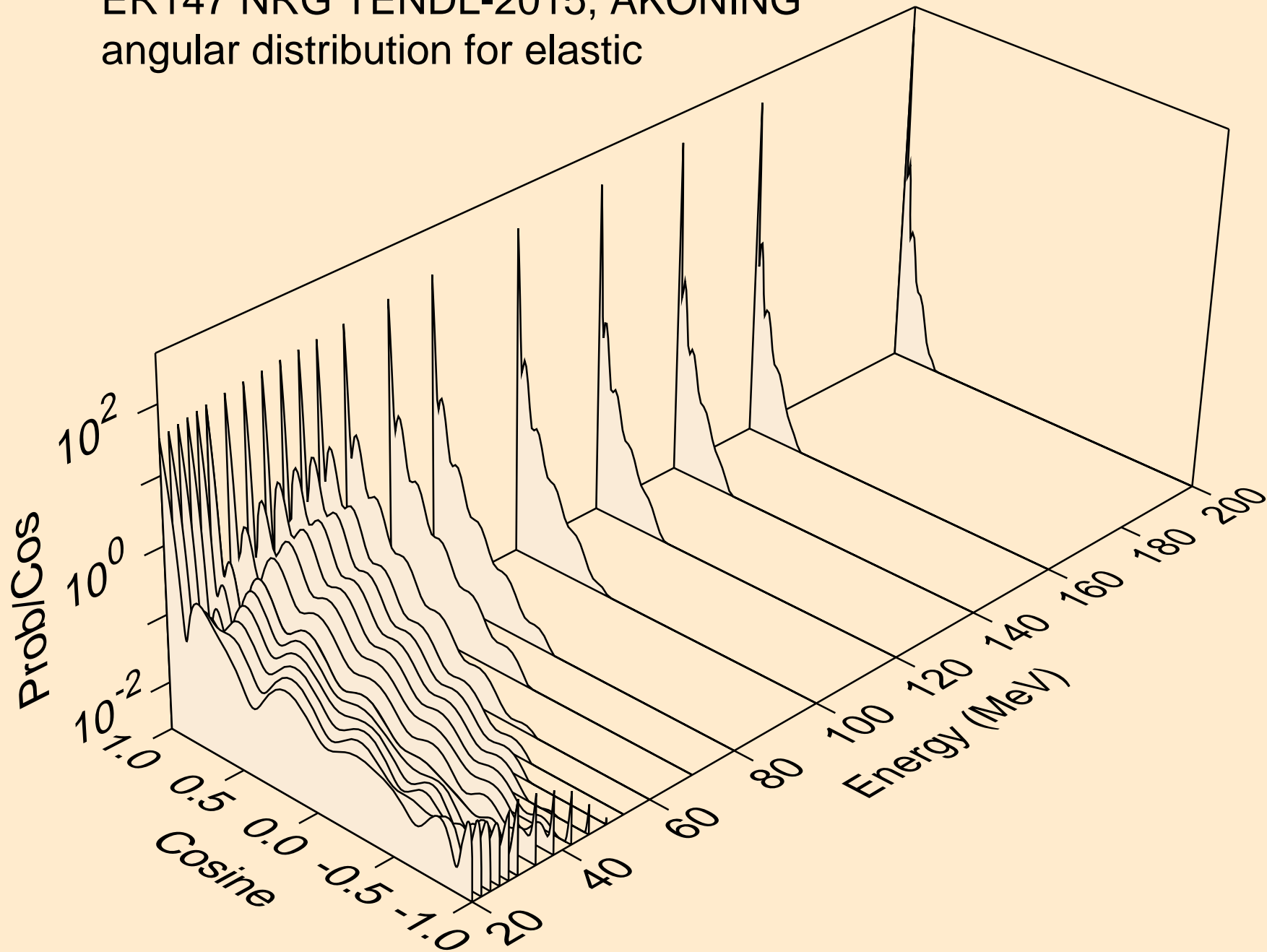

ER147 NRG TENDL-2015, AKONING  
angular distribution for (n,n\*1)

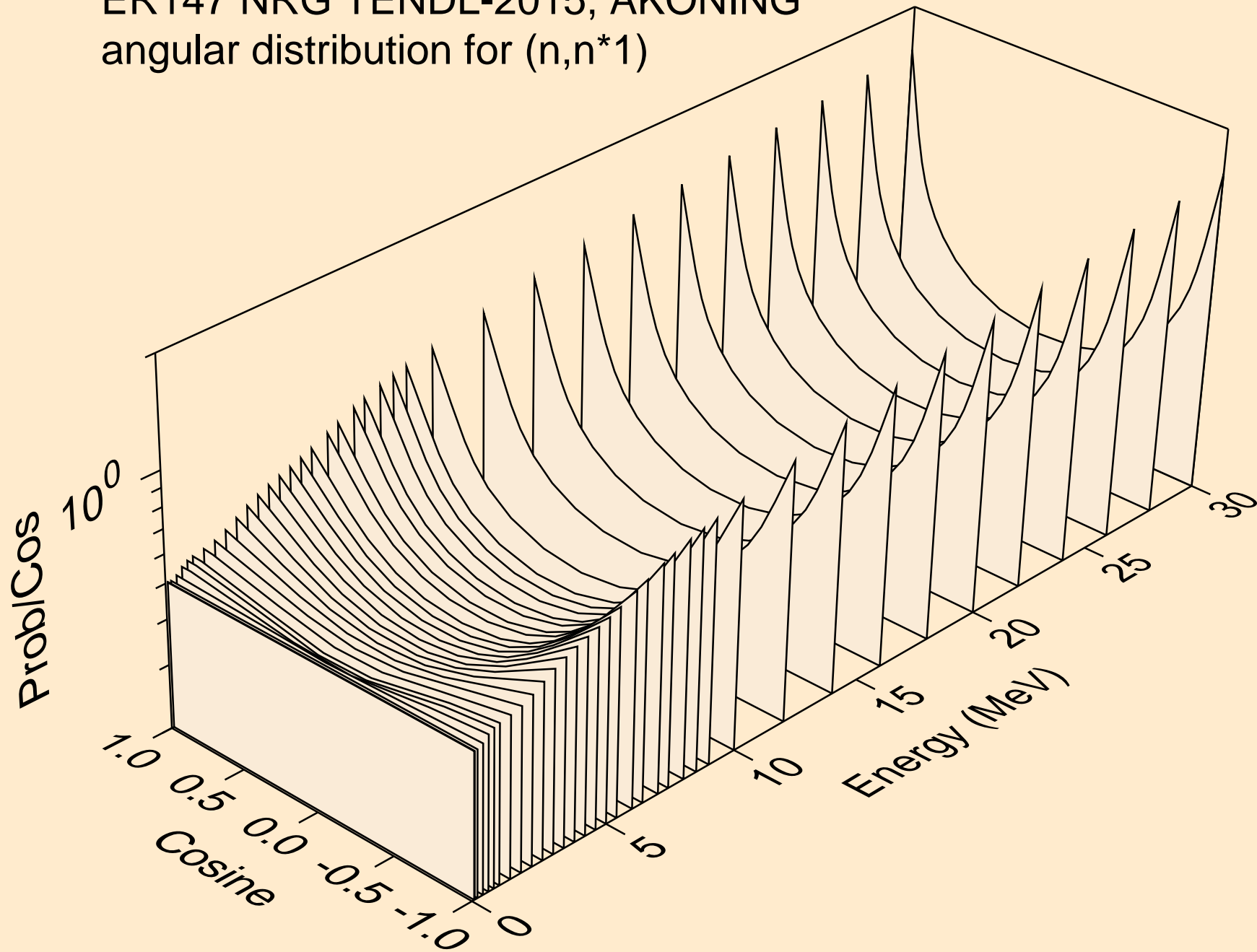

ER147 NRG TENDL-2015, AKONING  
angular distribution for (n,n\*2)

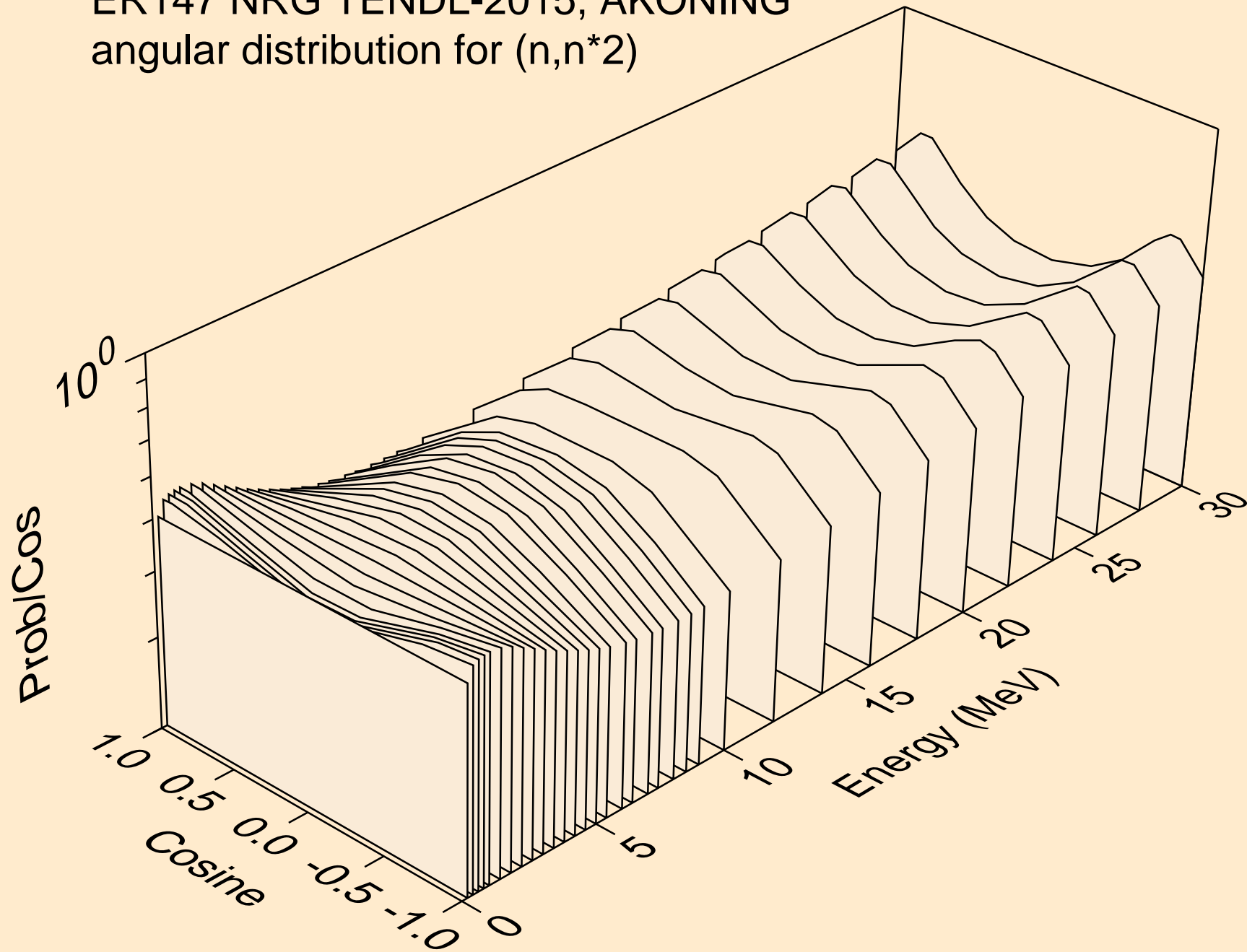



ER147 NRG TENDL-2015, AKONING  
angular distribution for (n,n\*3)

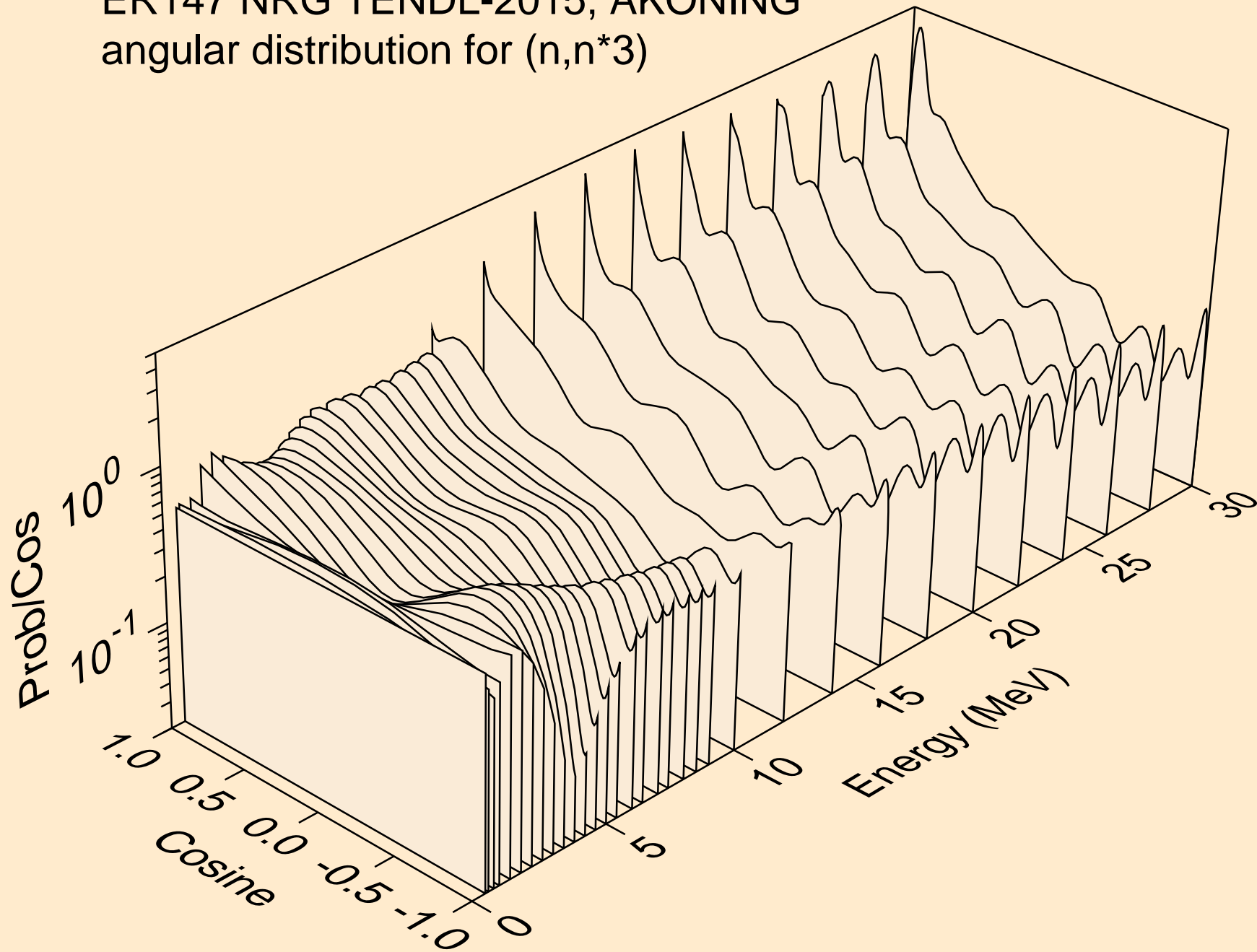

ER147 NRG TENDL-2015, AKONING  
angular distribution for (n,n\*4)

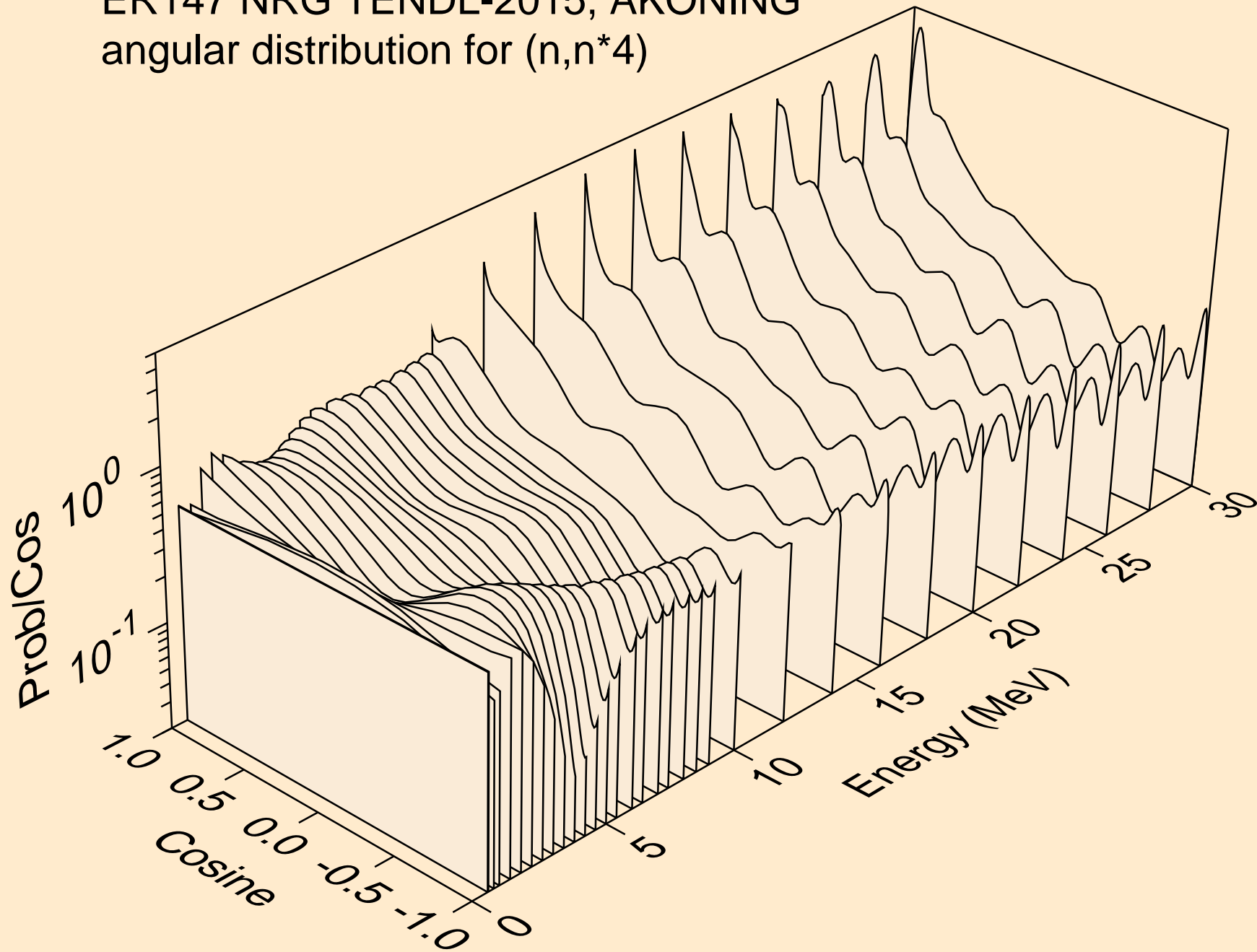

ER147 NRG TENDL-2015, AKONING  
Neutron emission for (n,x)

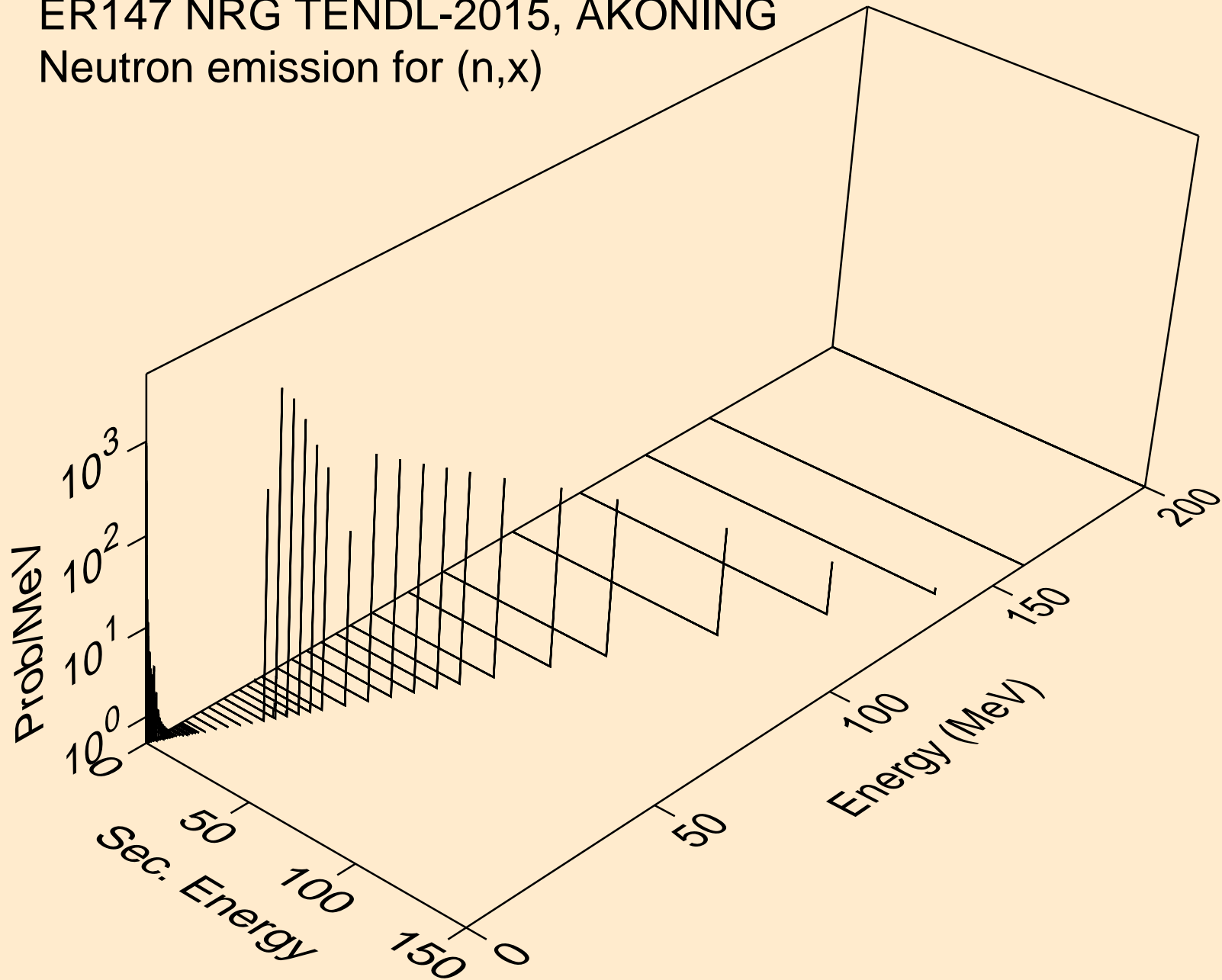

ER147 NRG TENDL-2015, AKONING  
Neutron emission for (n,2nd)

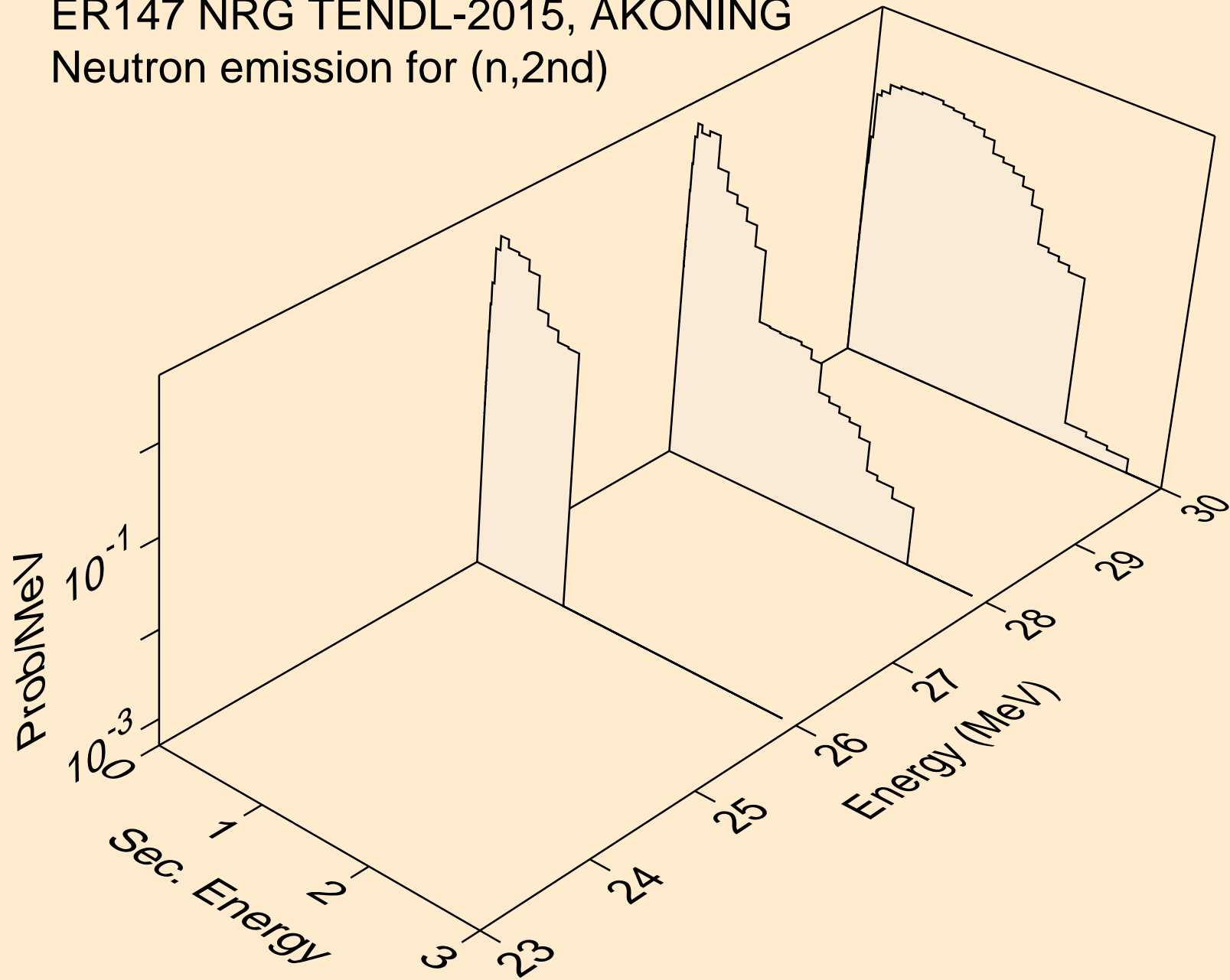

ER147 NRG TENDL-2015, AKONING  
Neutron emission for (n,2n)

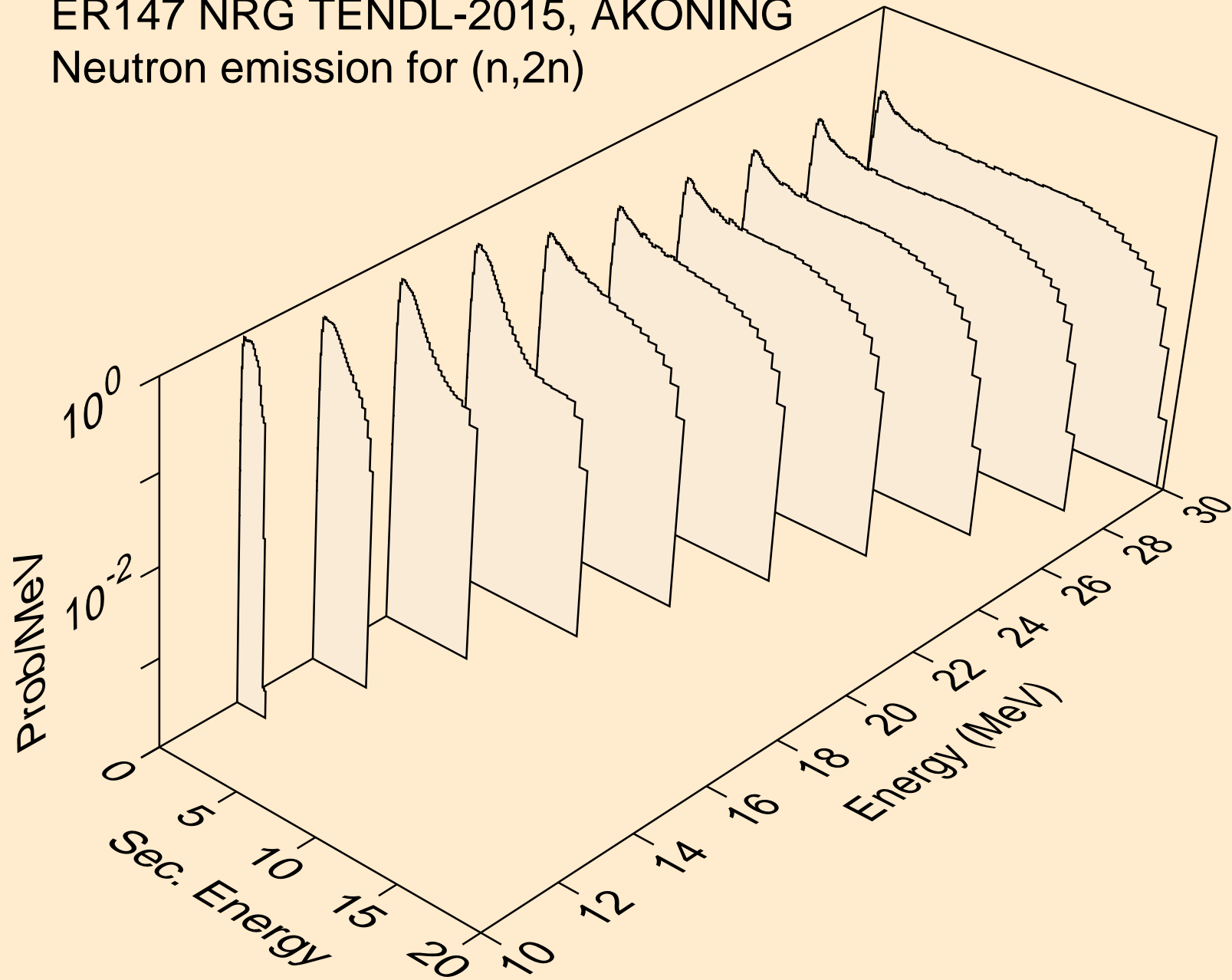

ER147 NRG TENDL-2015, AKONING  
Neutron emission for (n,3n)

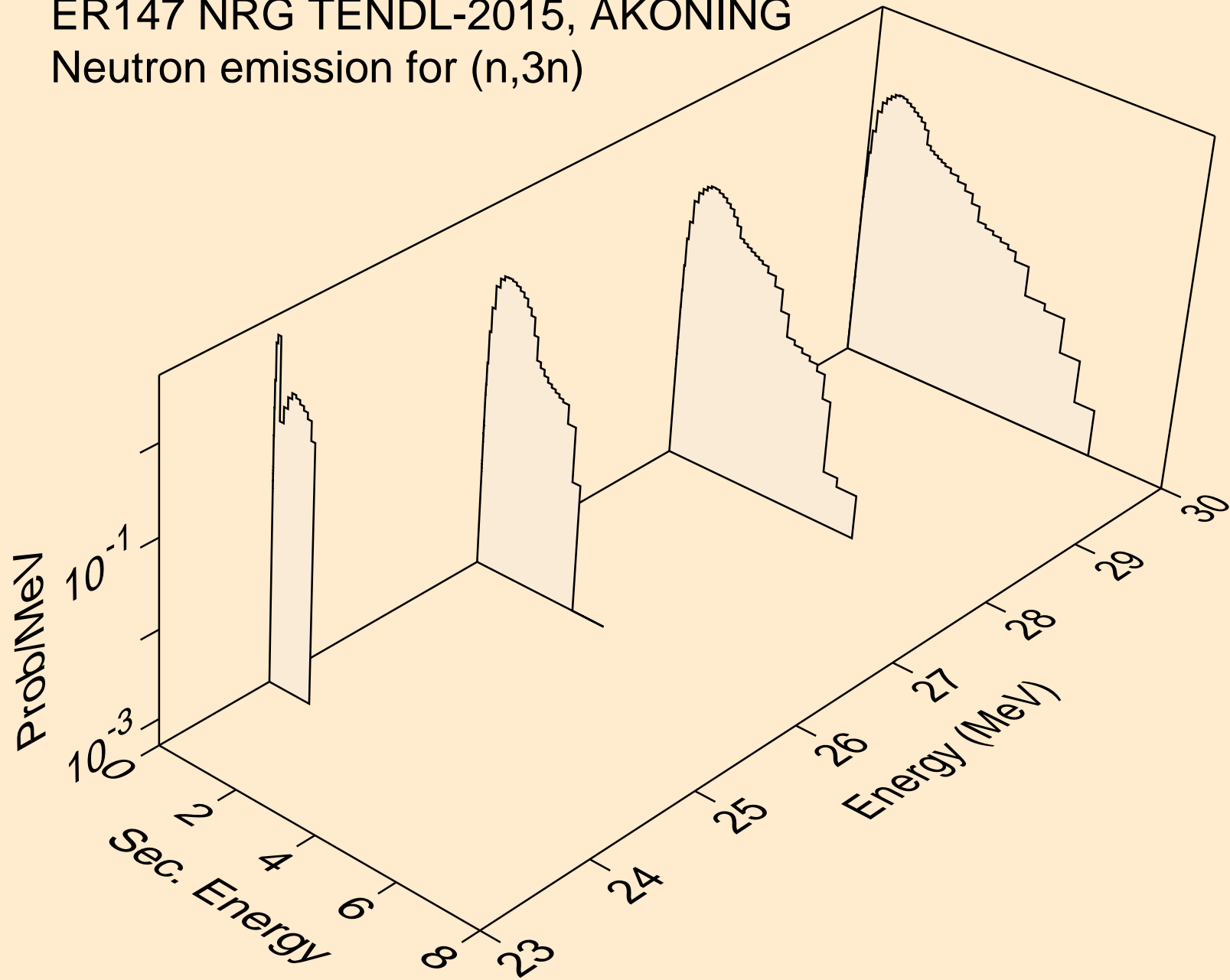

ER147 NRG TENDL-2015, AKONING  
Neutron emission for (n,n\*)a

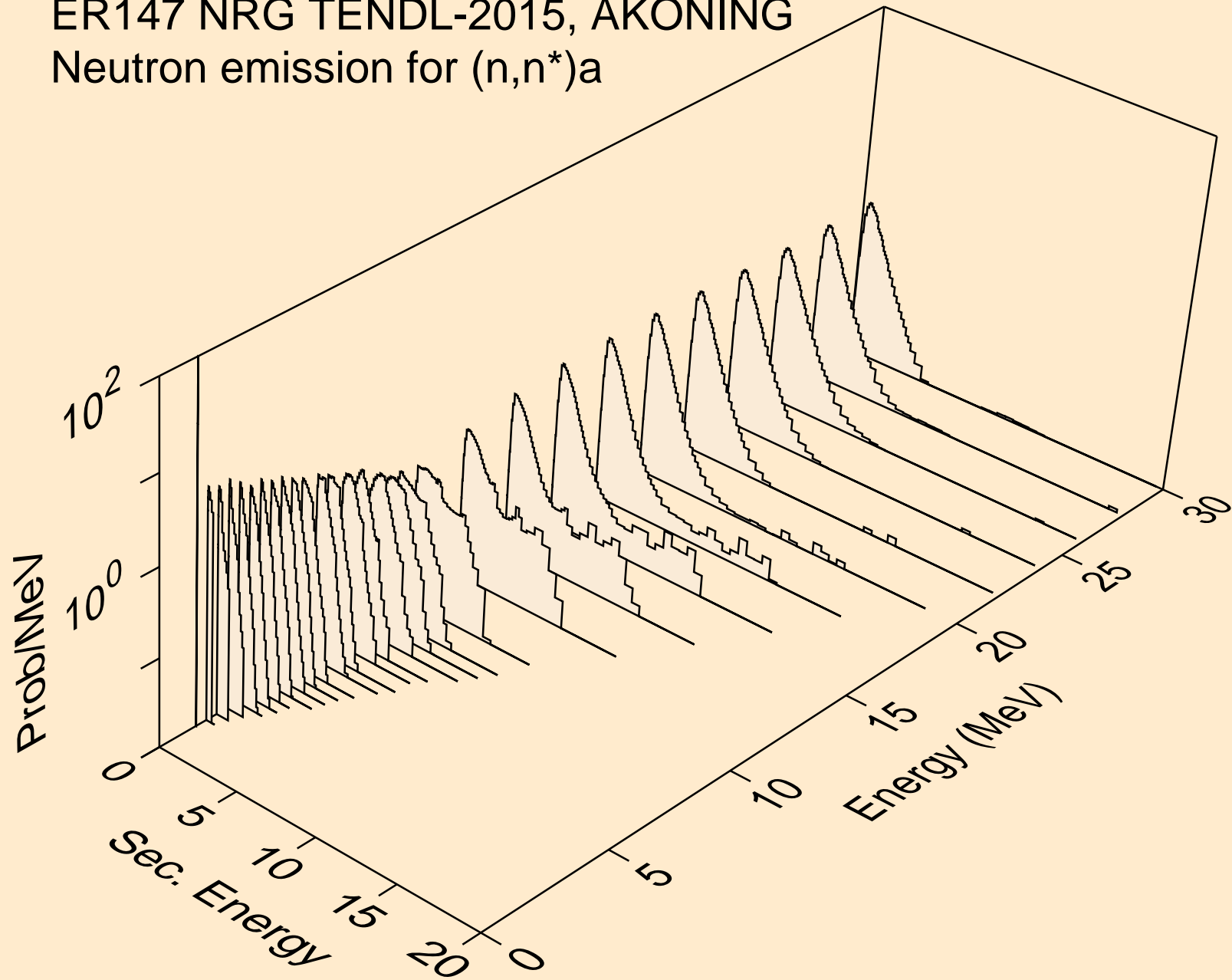

ER147 NRG TENDL-2015, AKONING  
Neutron emission for (n,n\*)3a

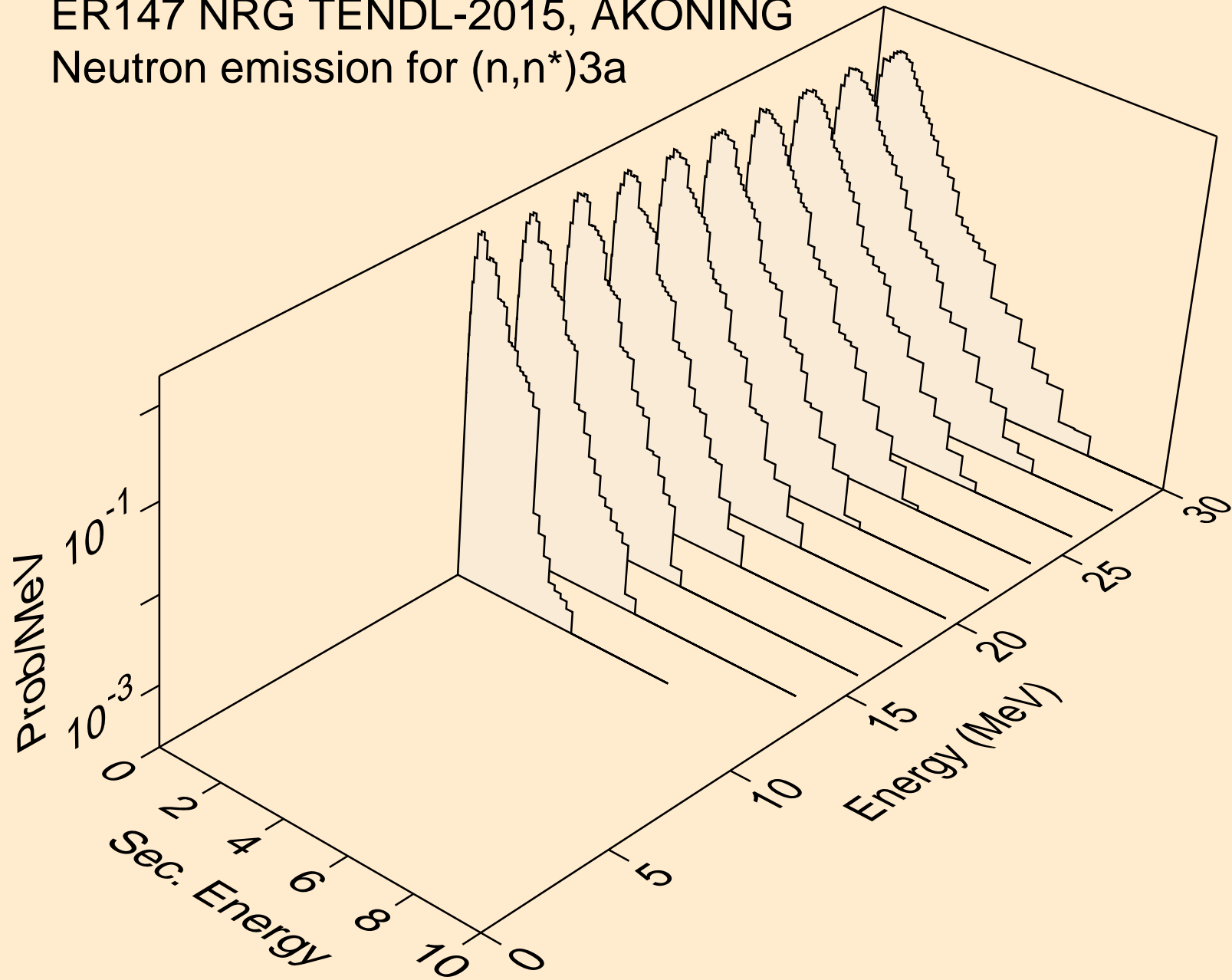



ER147 NRG TENDL-2015, AKONING  
Neutron emission for (n,2n)a

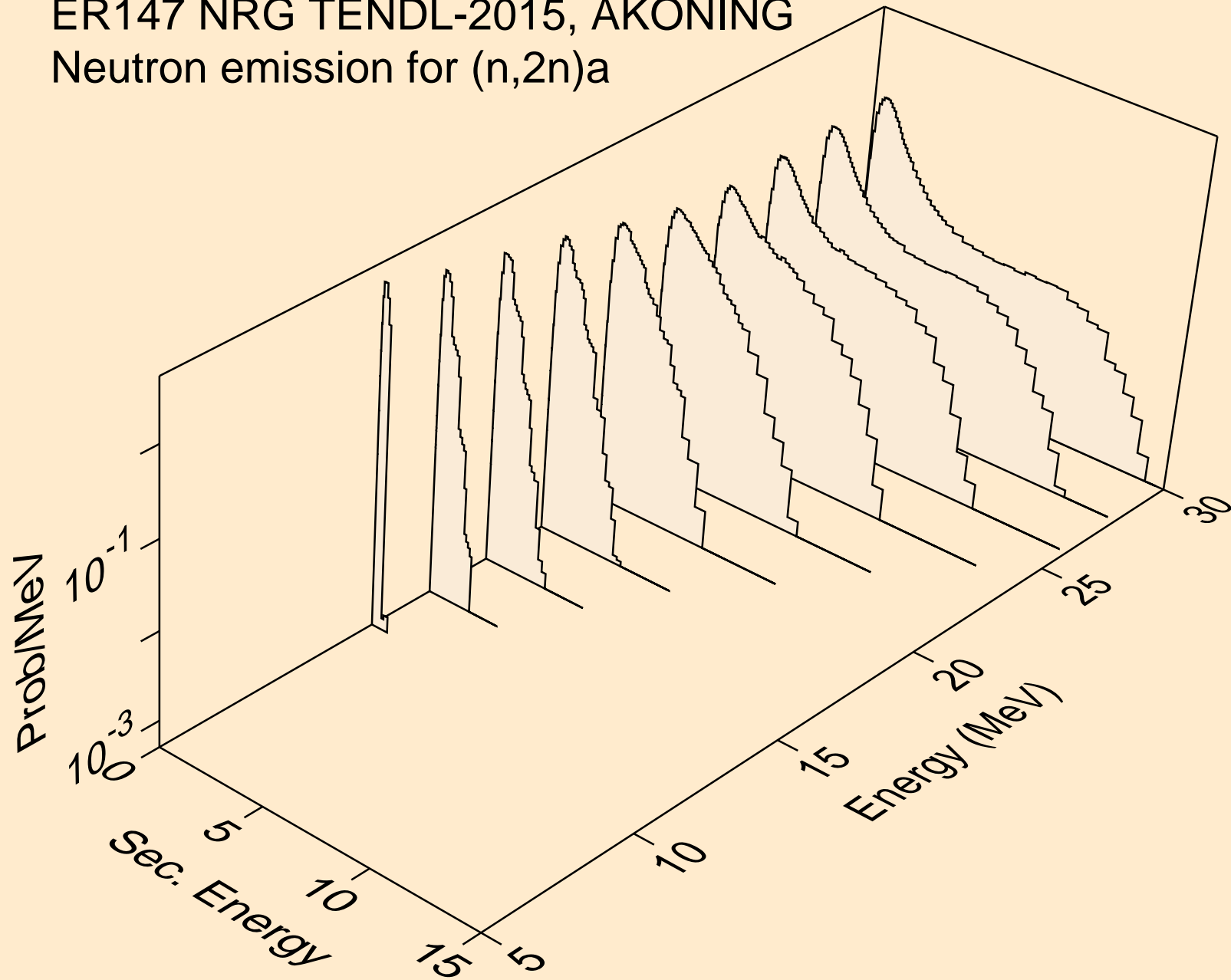

ER147 NRG TENDL-2015, AKONING  
Neutron emission for (n,3n)a

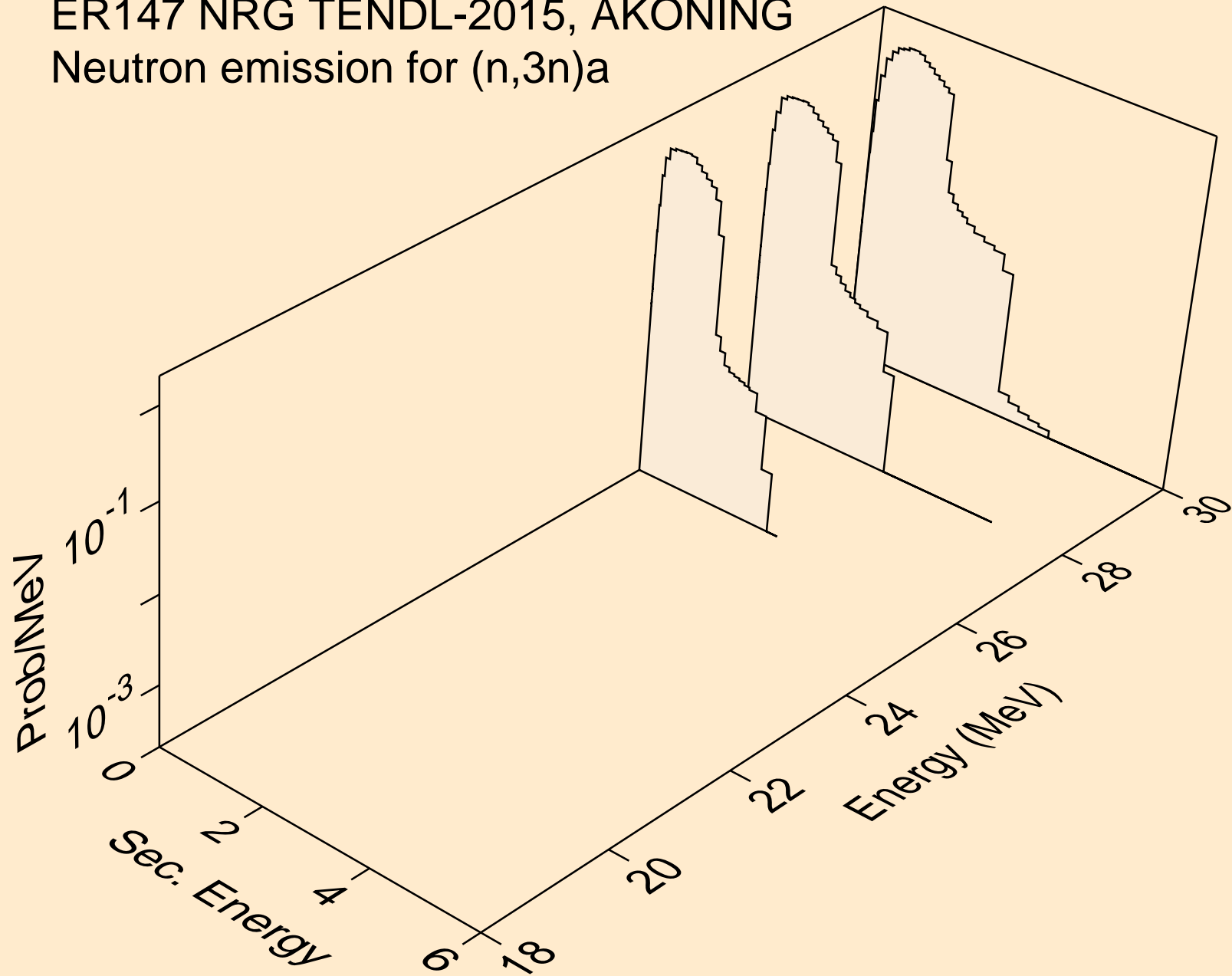

ER147 NRG TENDL-2015, AKONING  
Neutron emission for (n,n\*)p

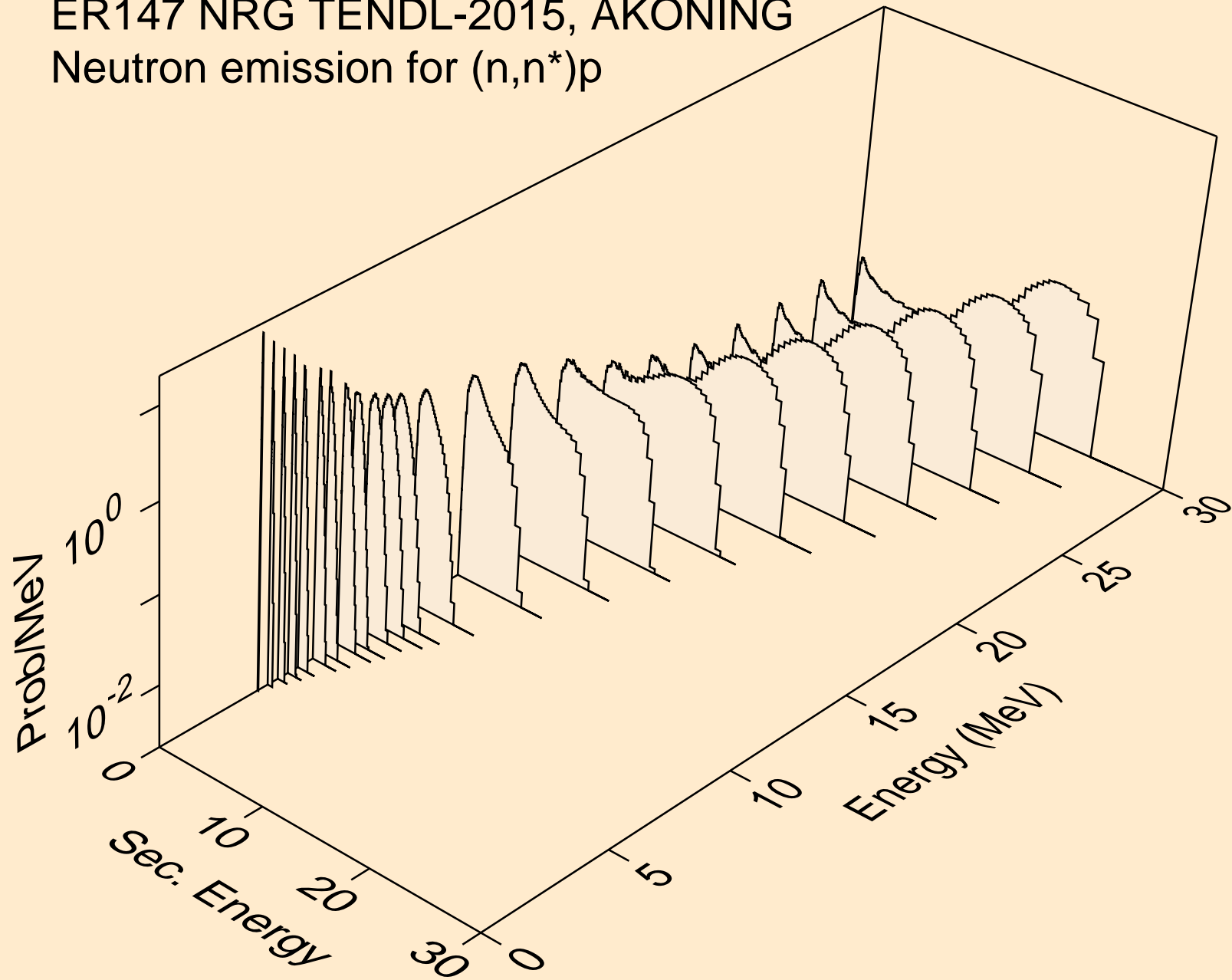

ER147 NRG TENDL-2015, AKONING  
Neutron emission for (n,n\*)2a

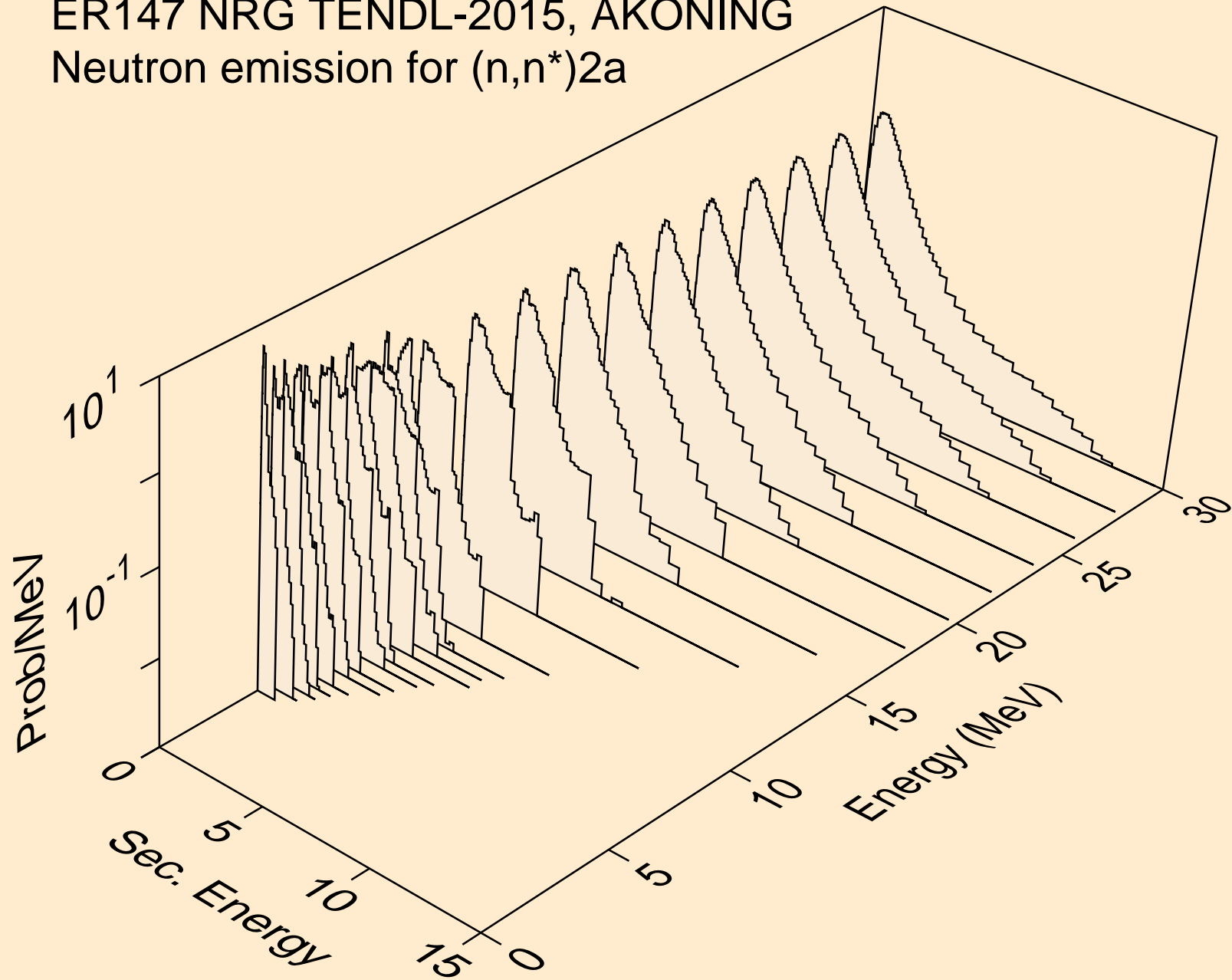

ER147 NRG TENDL-2015, AKONING  
Neutron emission for (n,2n)2a

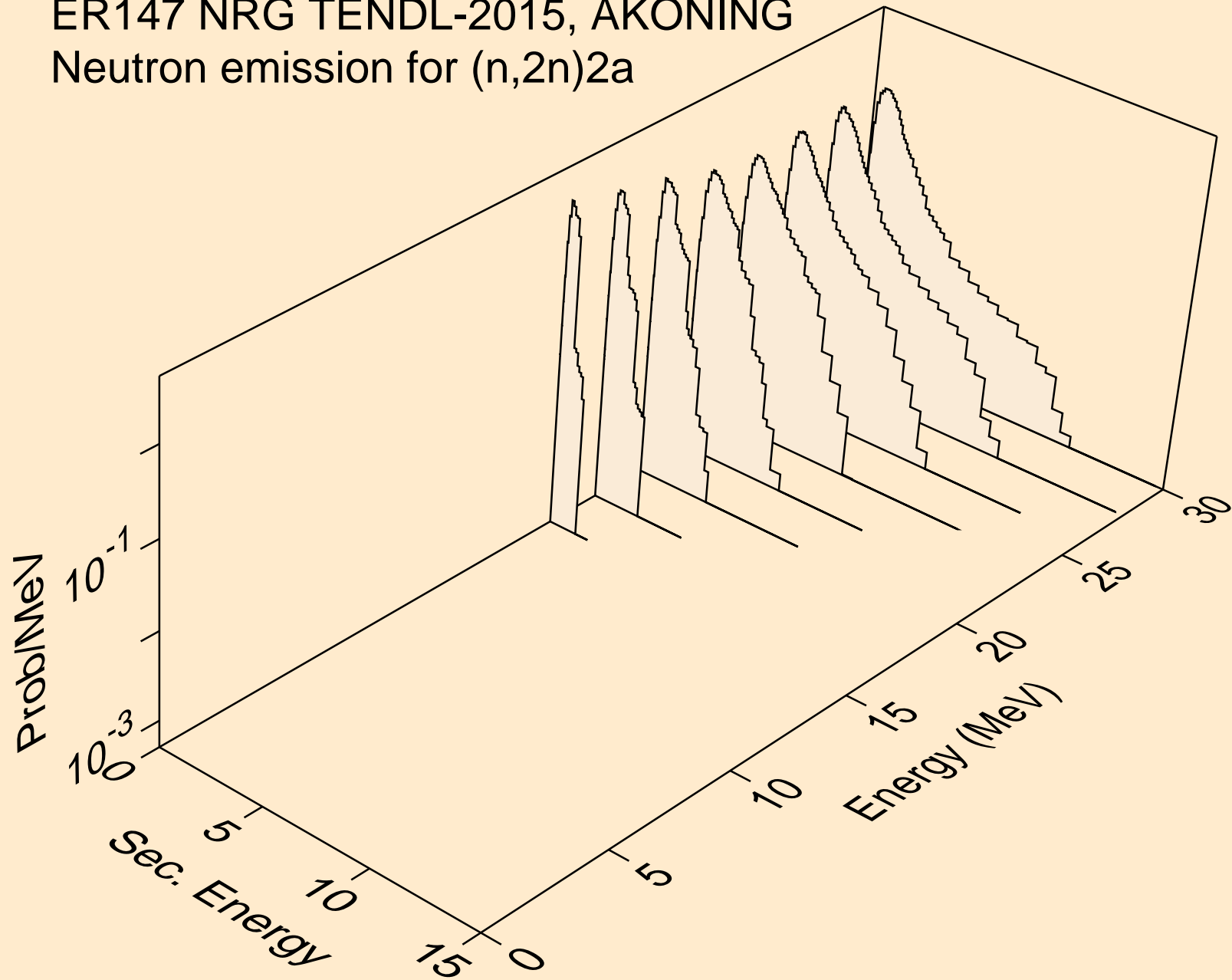

ER147 NRG TENDL-2015, AKONING  
Neutron emission for (n,n\*)d

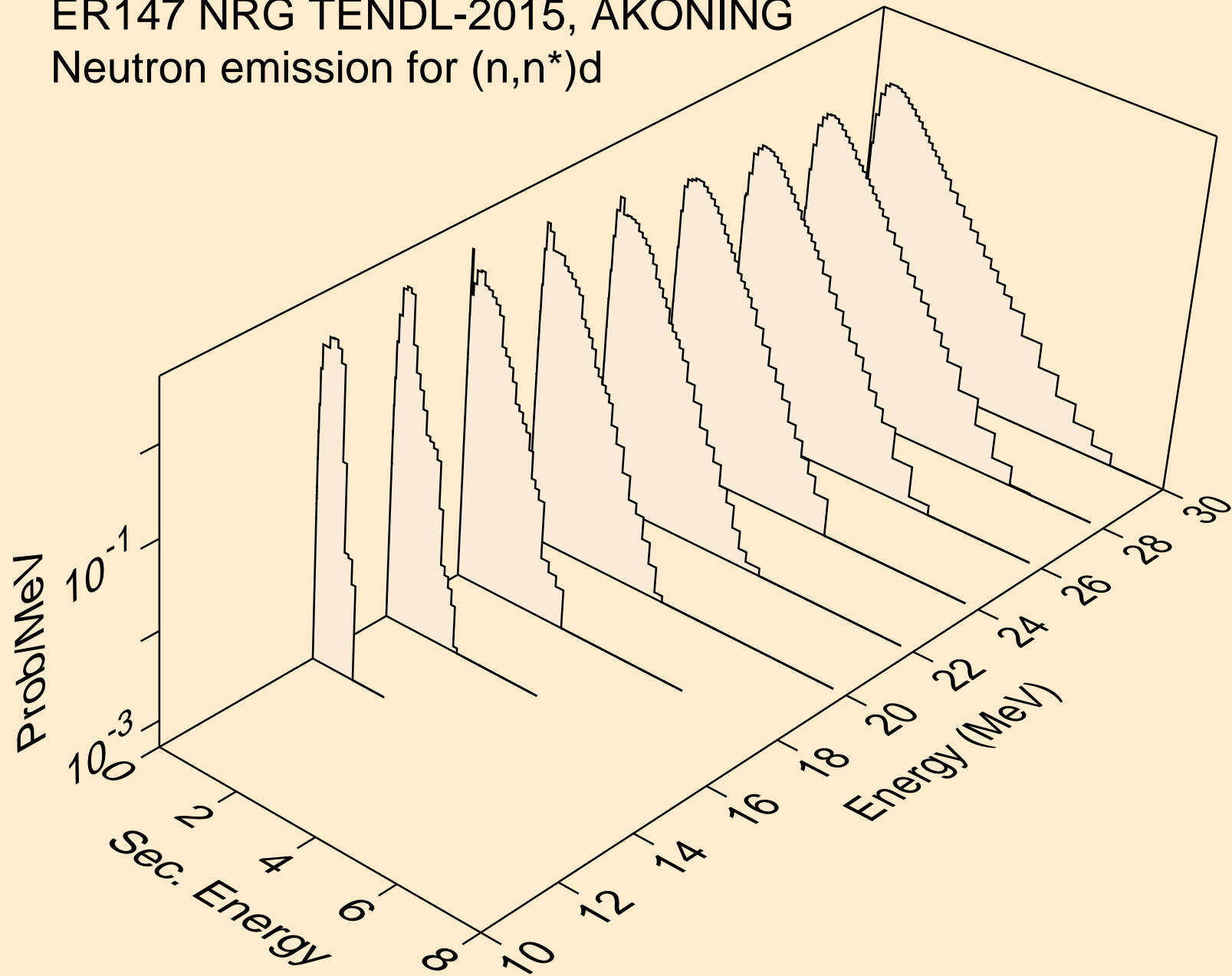

ER147 NRG TENDL-2015, AKONING  
Neutron emission for (n,n\*)t

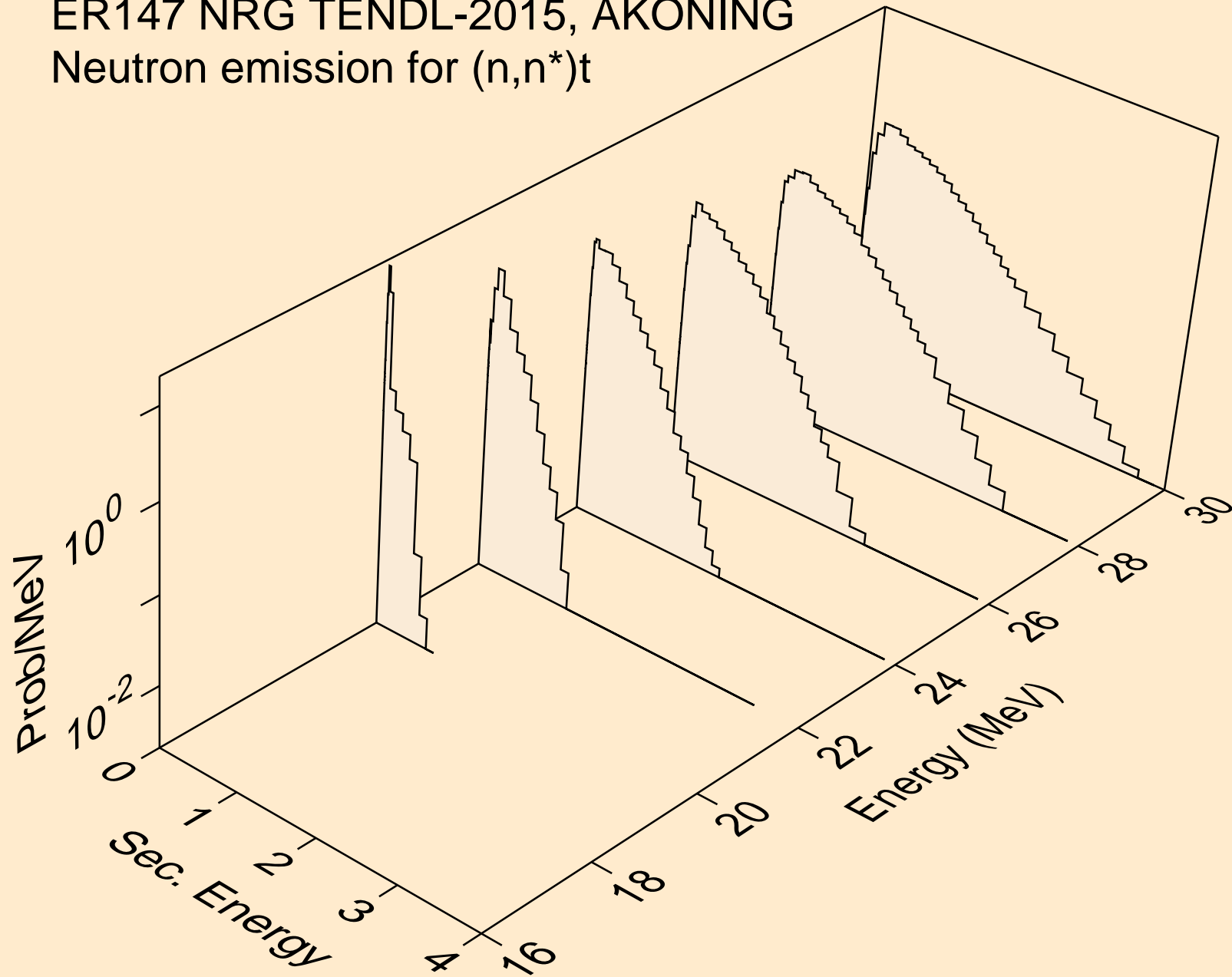

ER147 NRG TENDL-2015, AKONING  
Neutron emission for (n,n\*)he3

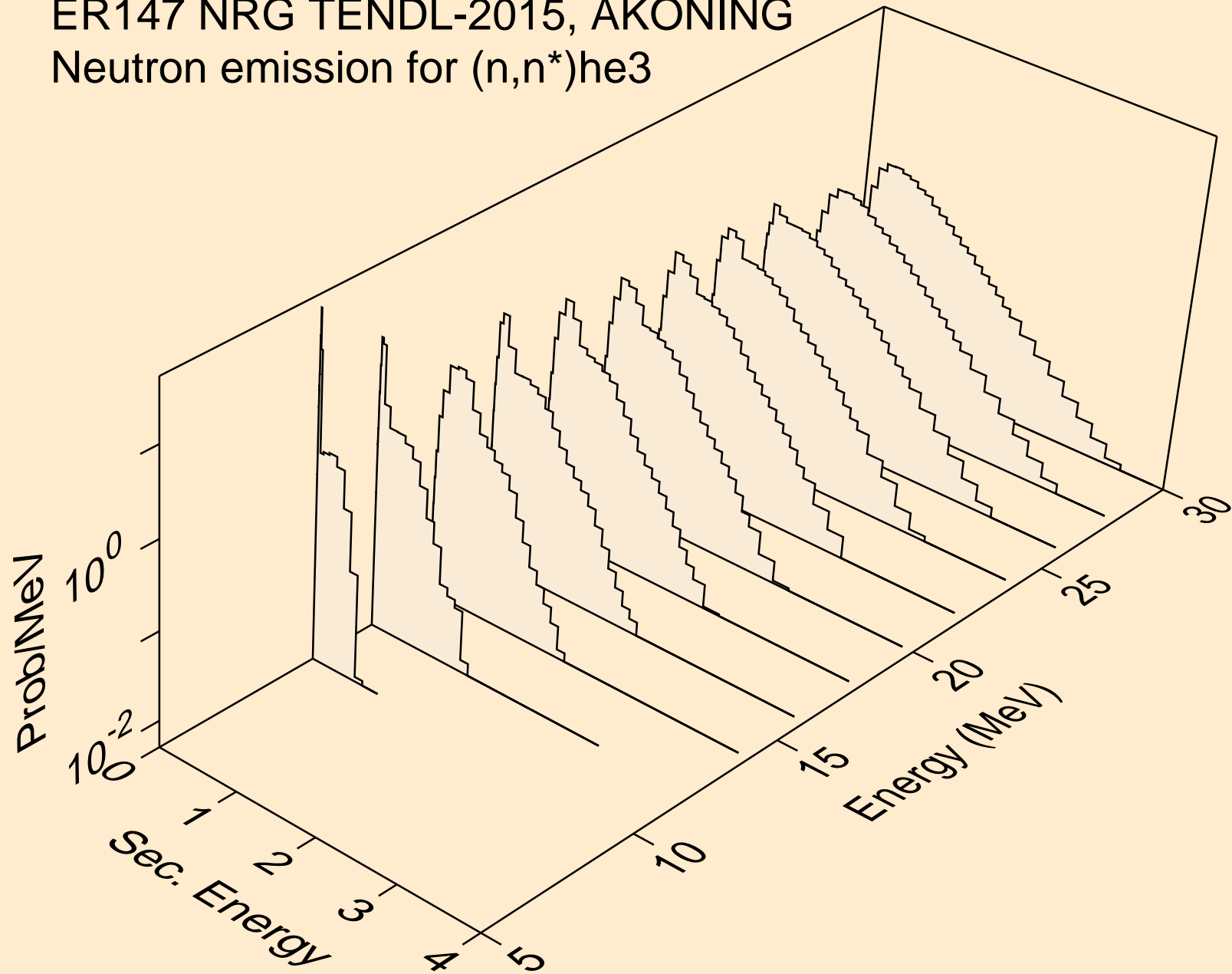



ER147 NRG TENDL-2015, AKONING  
Neutron emission for (n,2np)

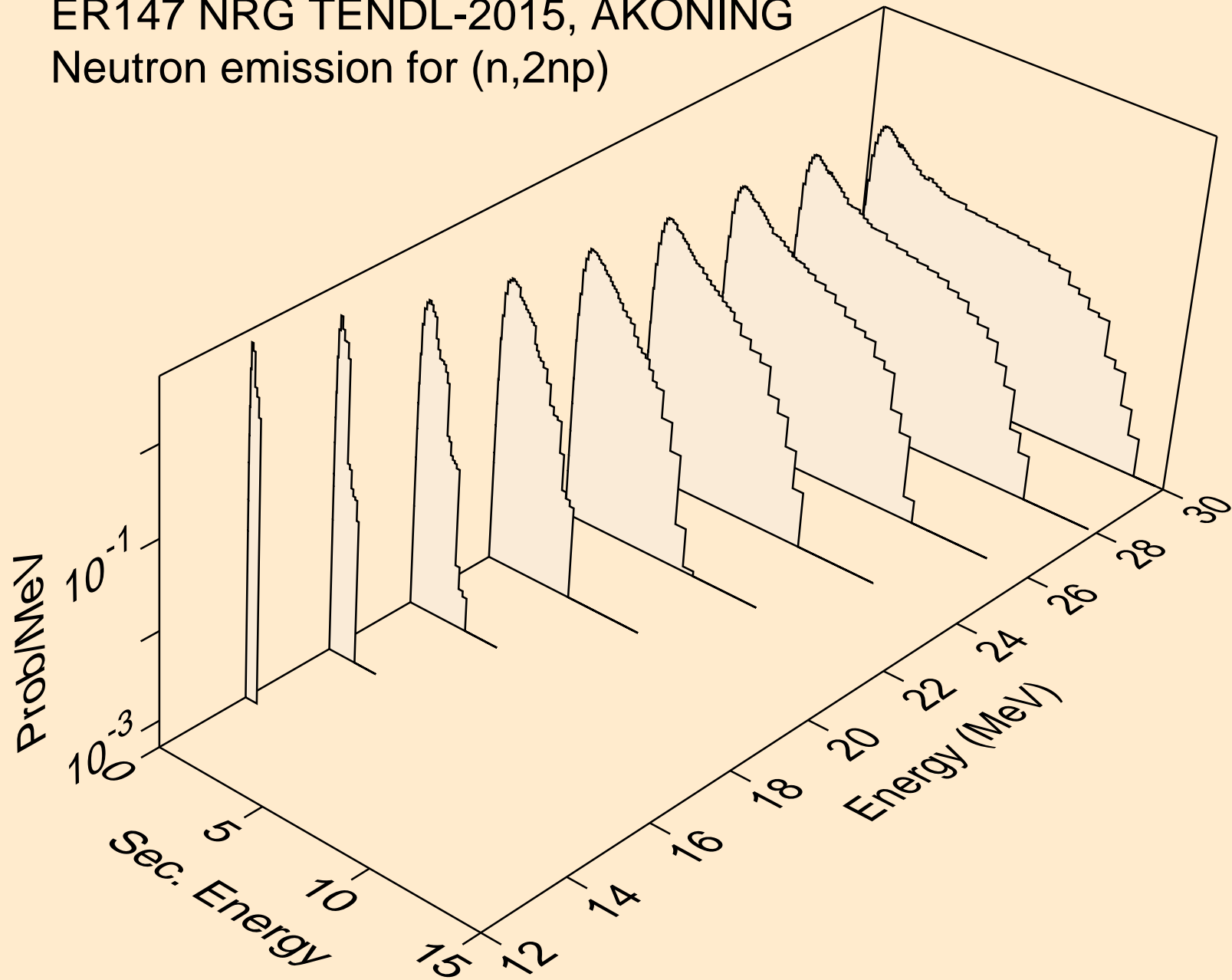

ER147 NRG TENDL-2015, AKONING  
Neutron emission for (n,3np)

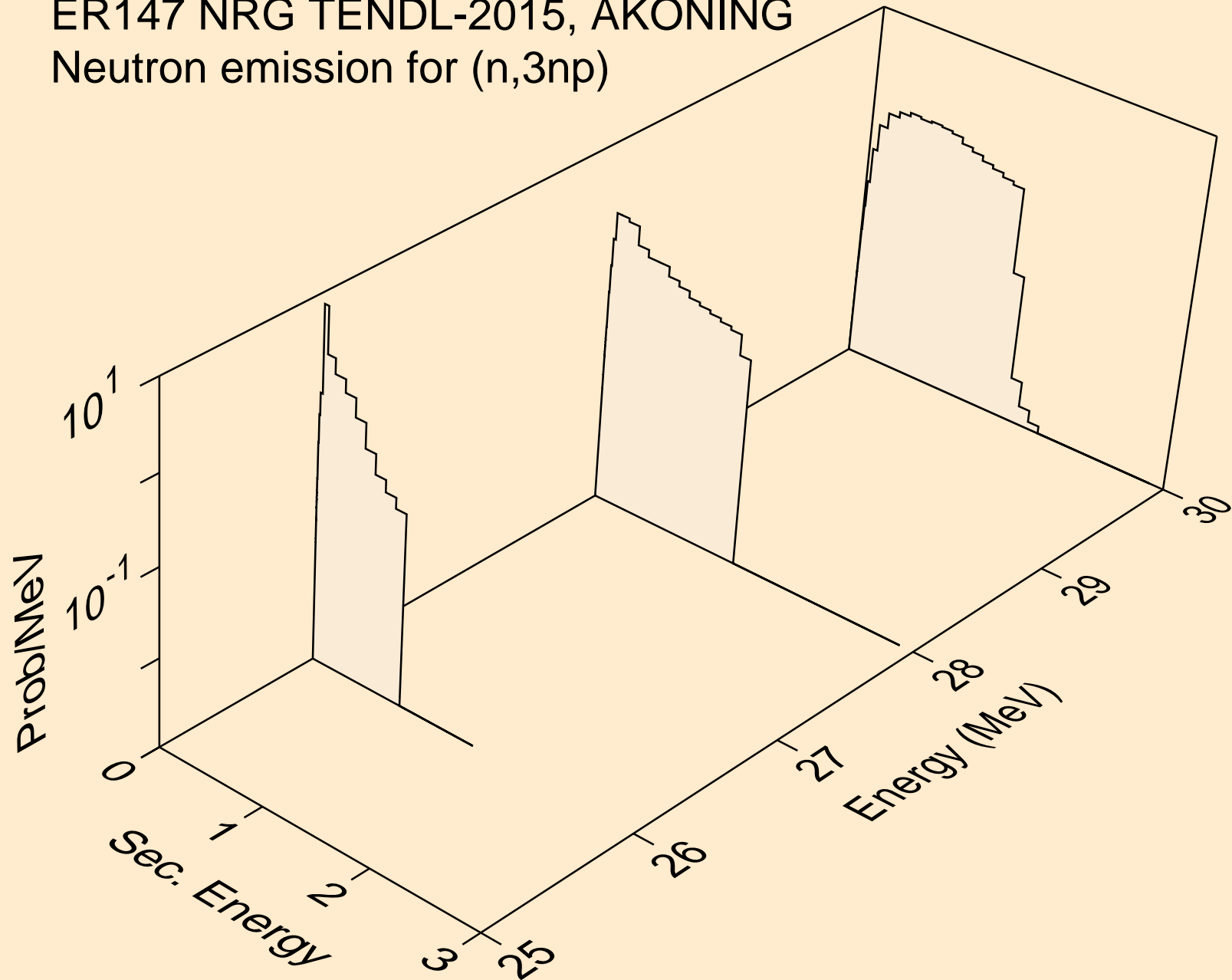

ER147 NRG TENDL-2015, AKONING  
Neutron emission for (n,2np)

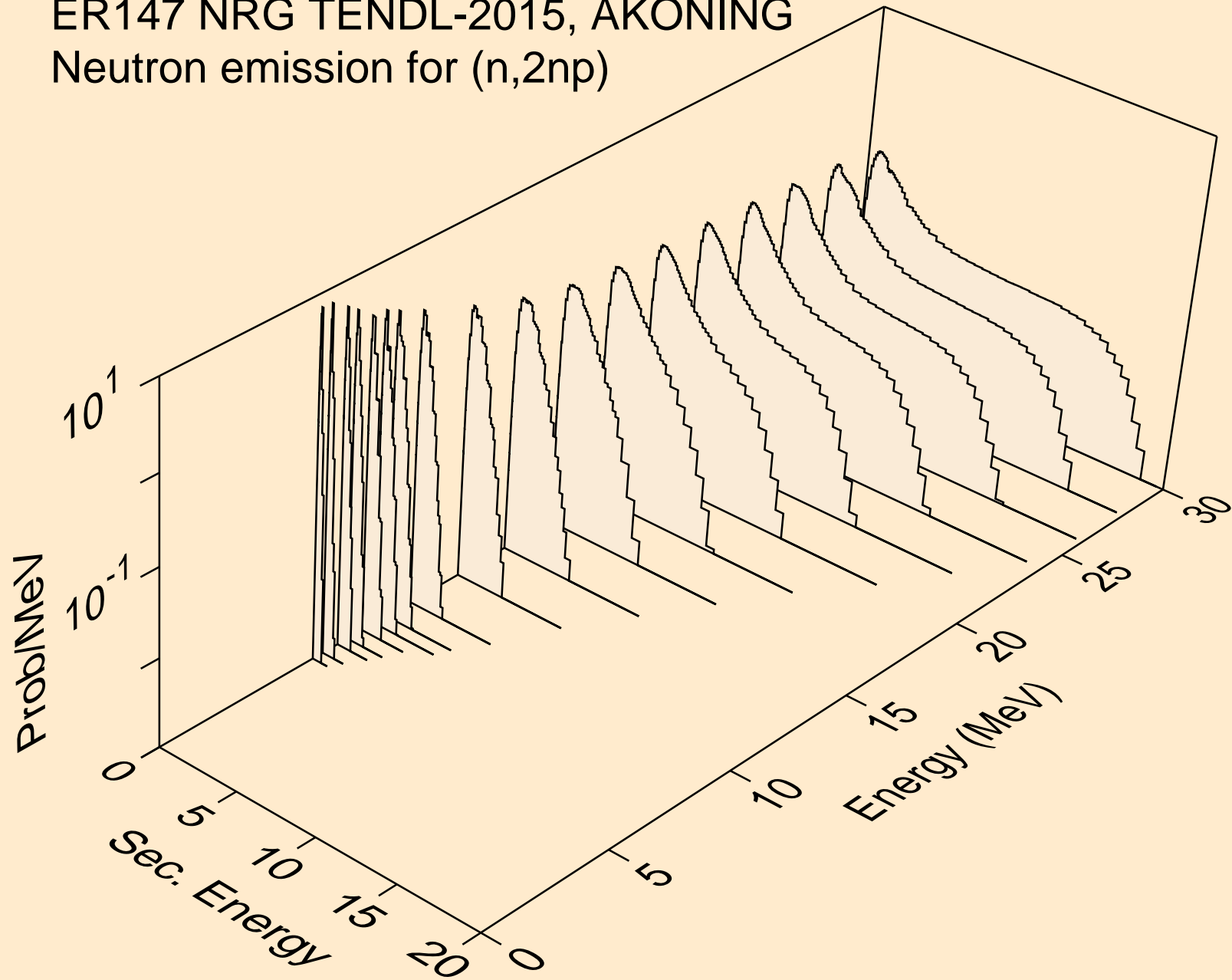

ER147 NRG TENDL-2015, AKONING  
Neutron emission for (n,npa)

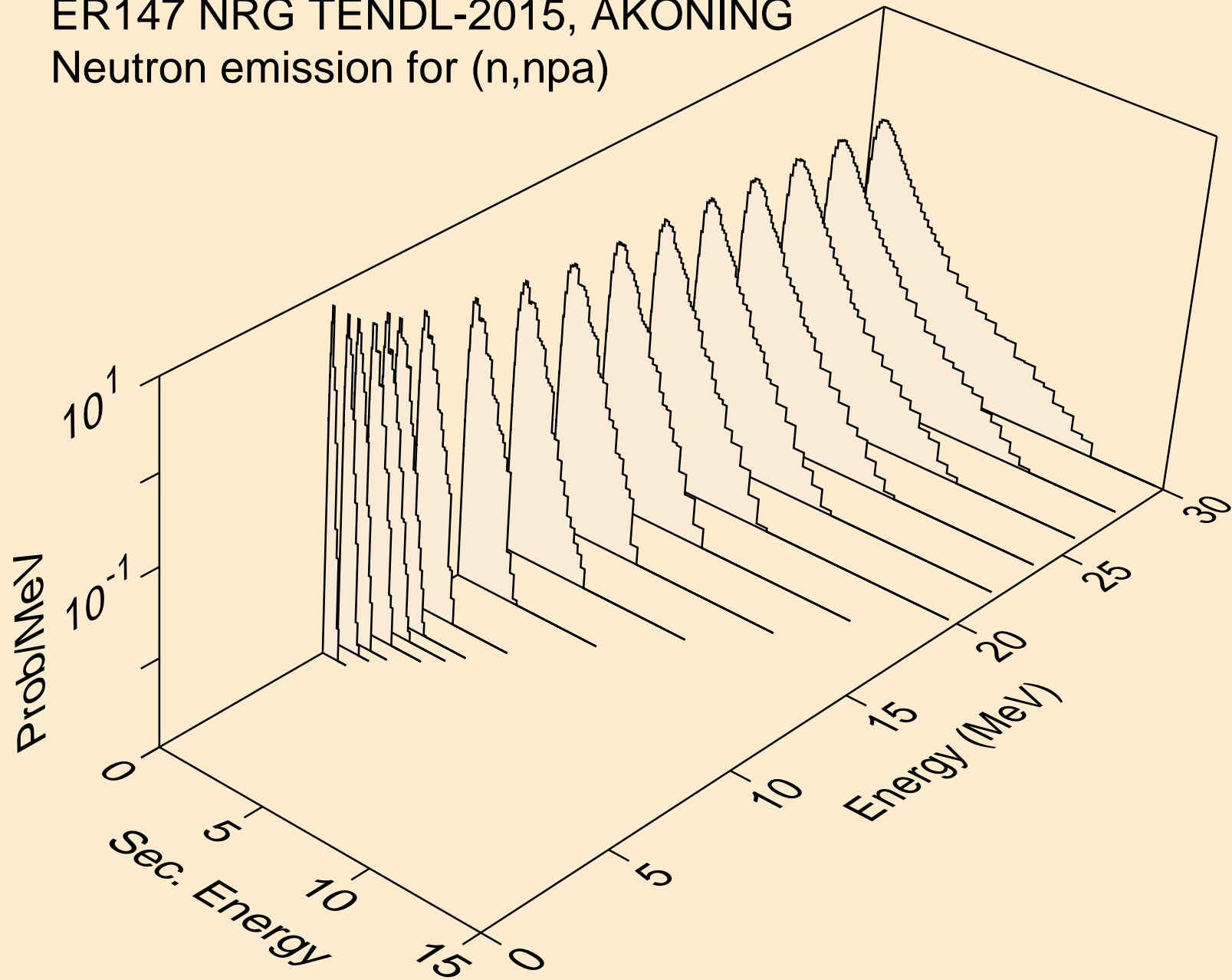

ER147 NRG TENDL-2015, AKONING  
Neutron emission for (n,n\*c)

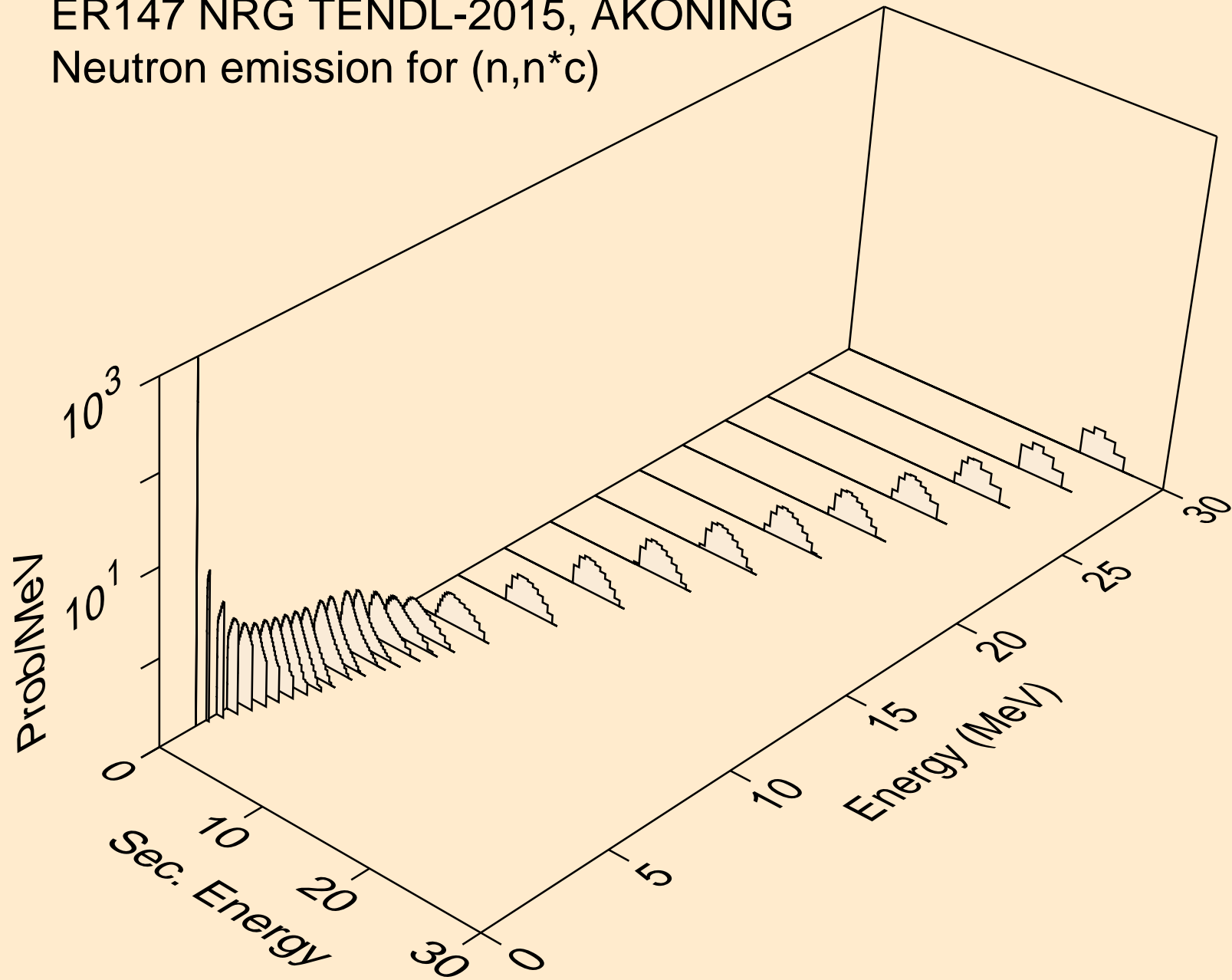

ER147 NRG TENDL-2015, AKONING  
Photon emission for (n,x)

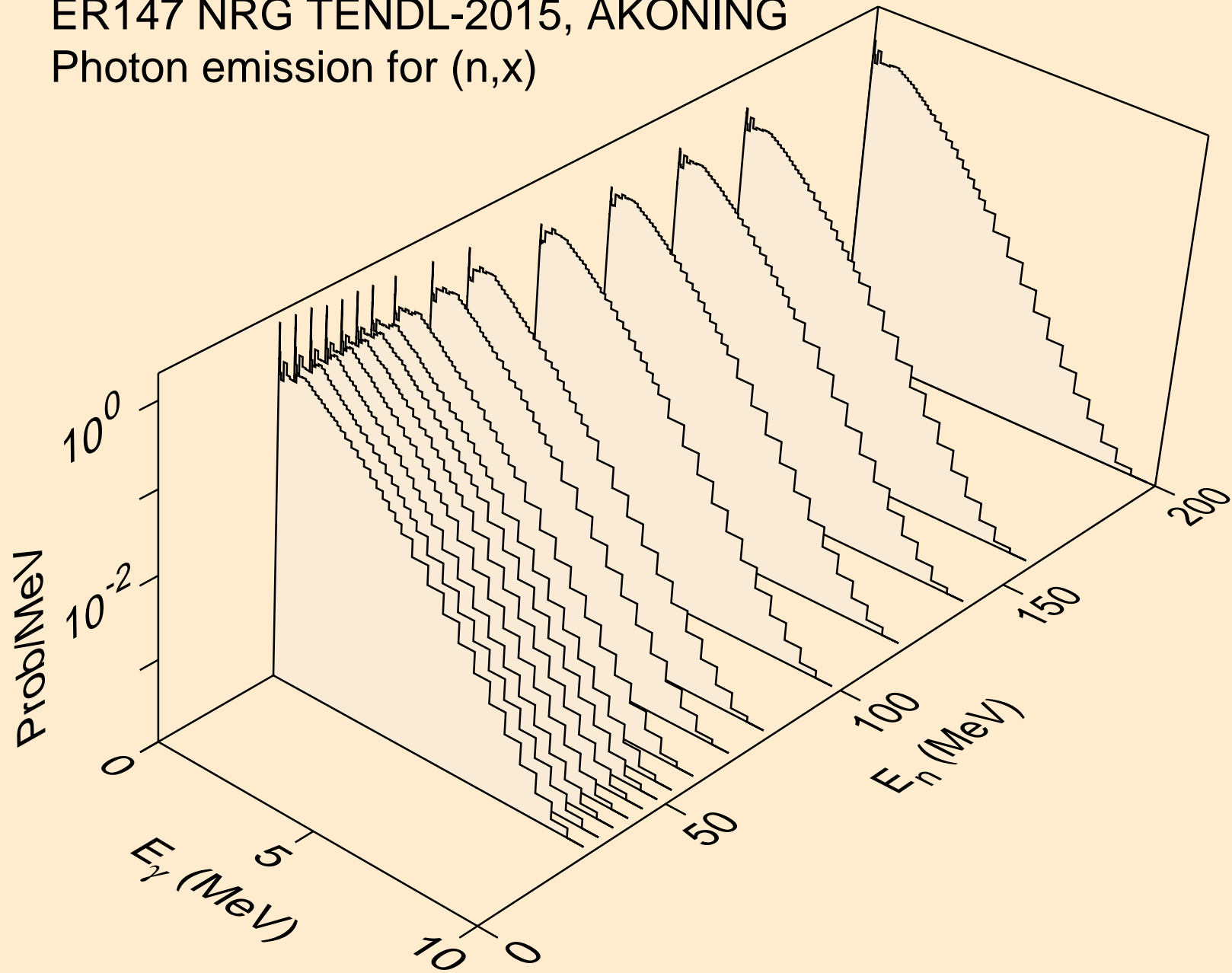

ER147 NRG TENDL-2015, AKONING  
Photon emission for (n,2nd)

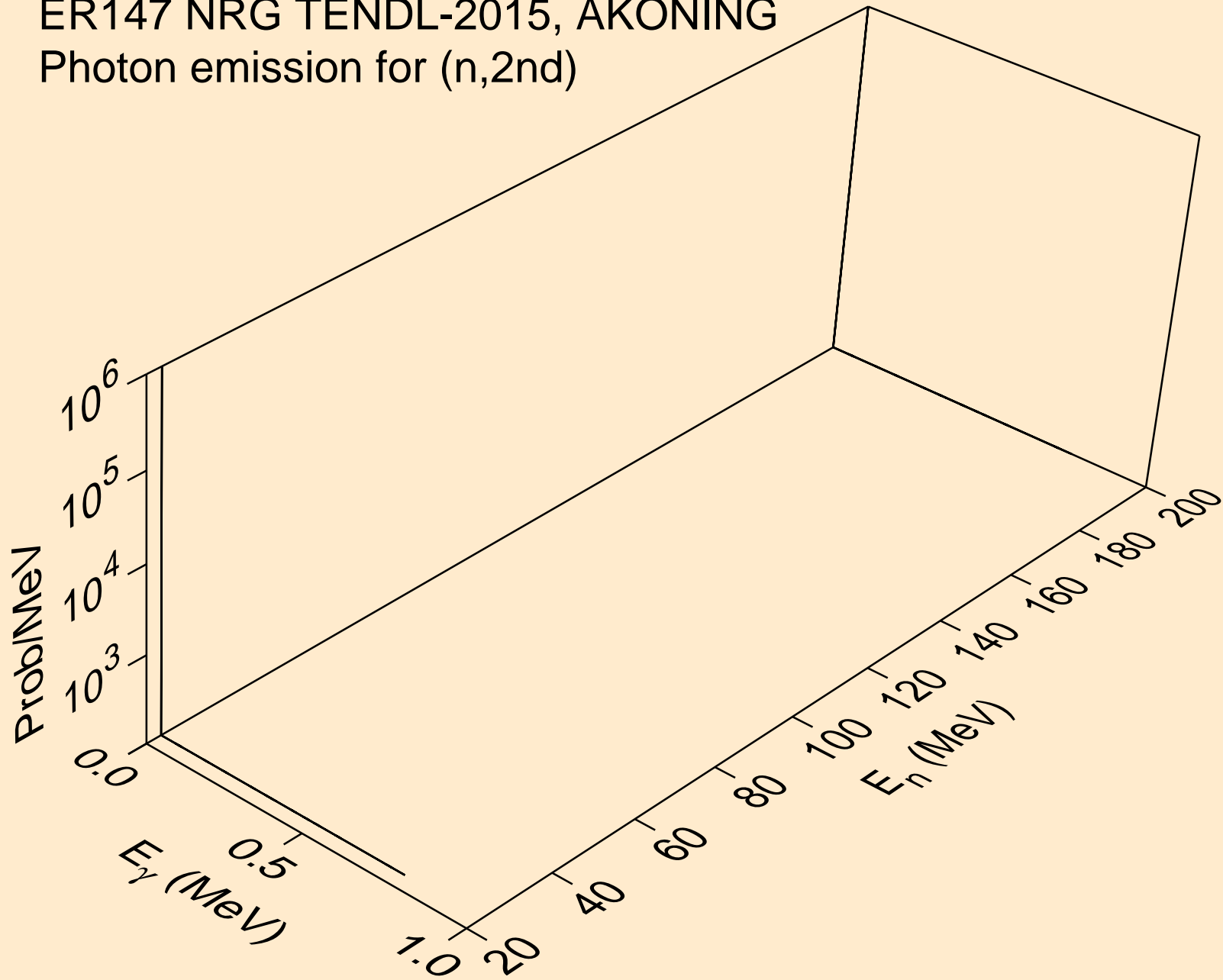

ER147 NRG TENDL-2015, AKONING  
Photon emission for (n,2n)

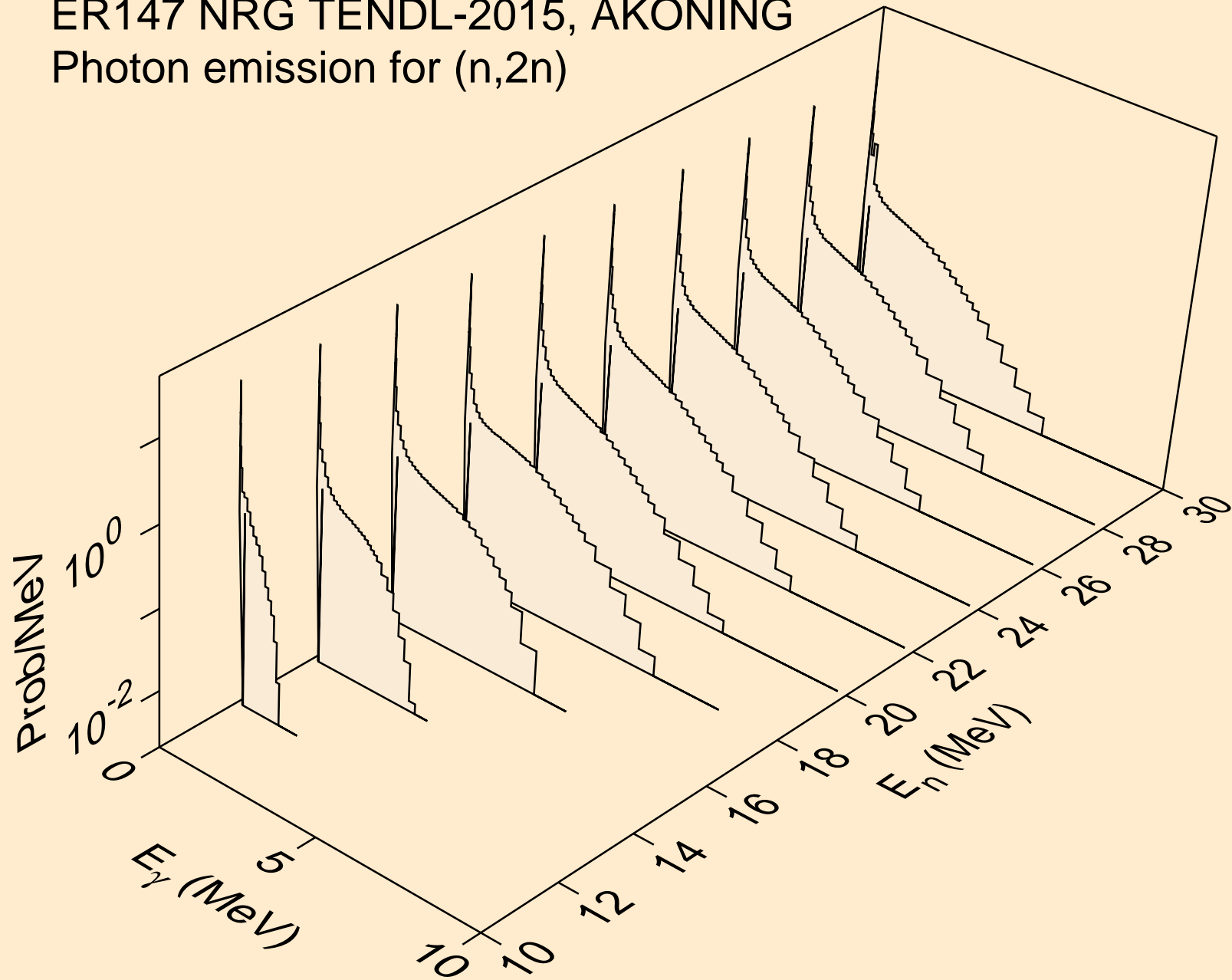



ER147 NRG TENDL-2015, AKONING  
Photon emission for (n,3n)

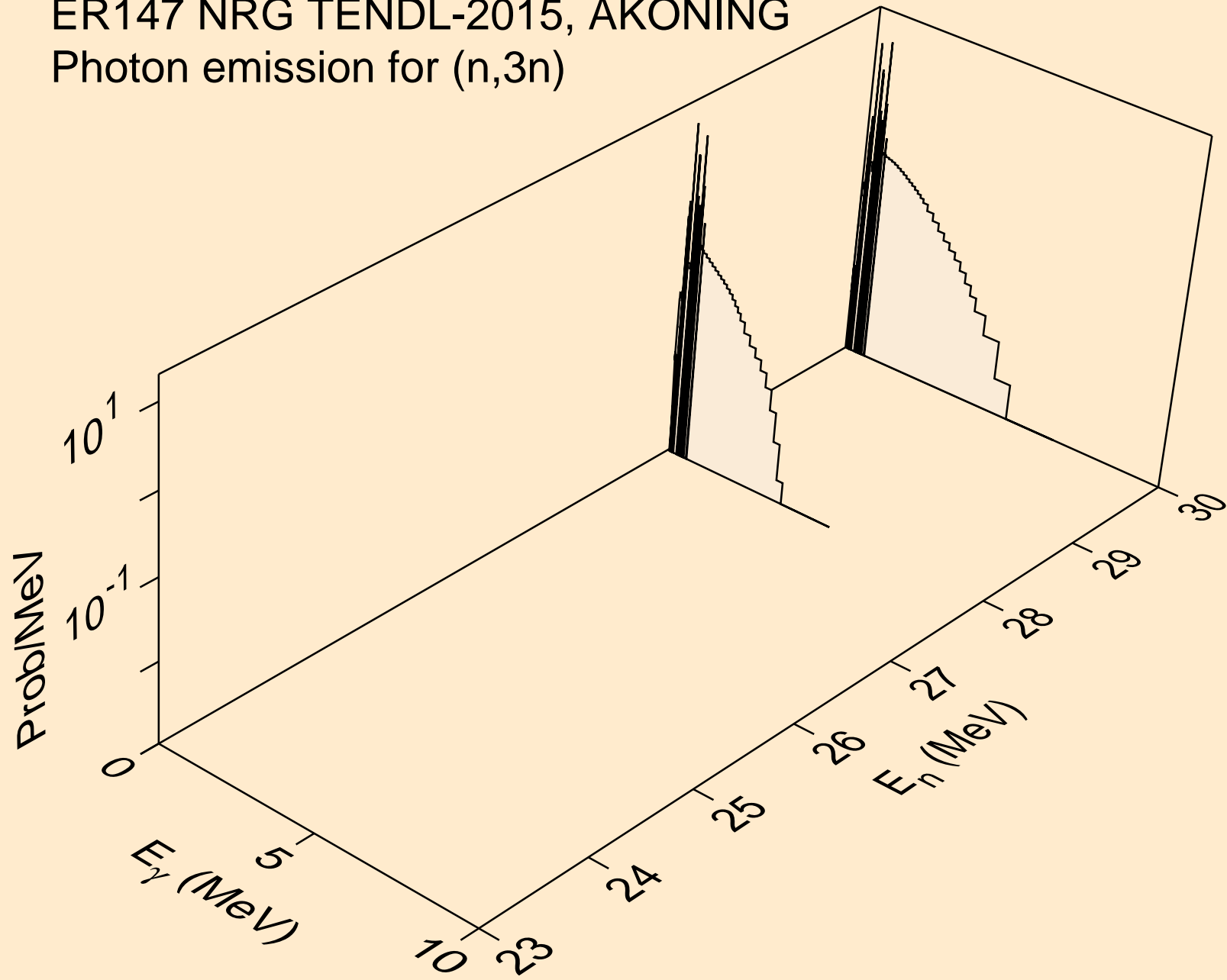

ER147 NRG TENDL-2015, AKONING  
Photon emission for (n,n\*)a

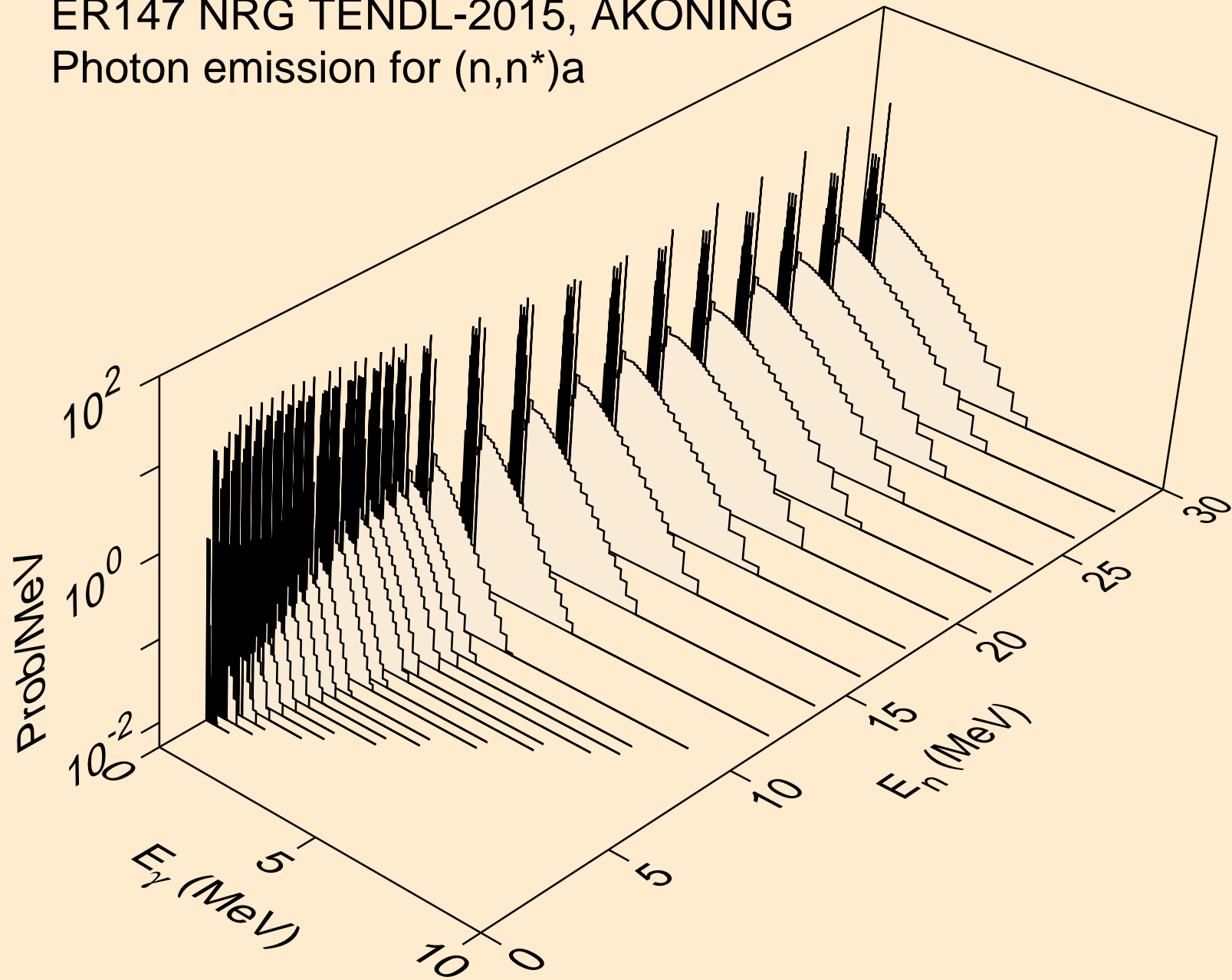

ER147 NRG TENDL-2015, AKONING  
Photon emission for (n,n\*)3a

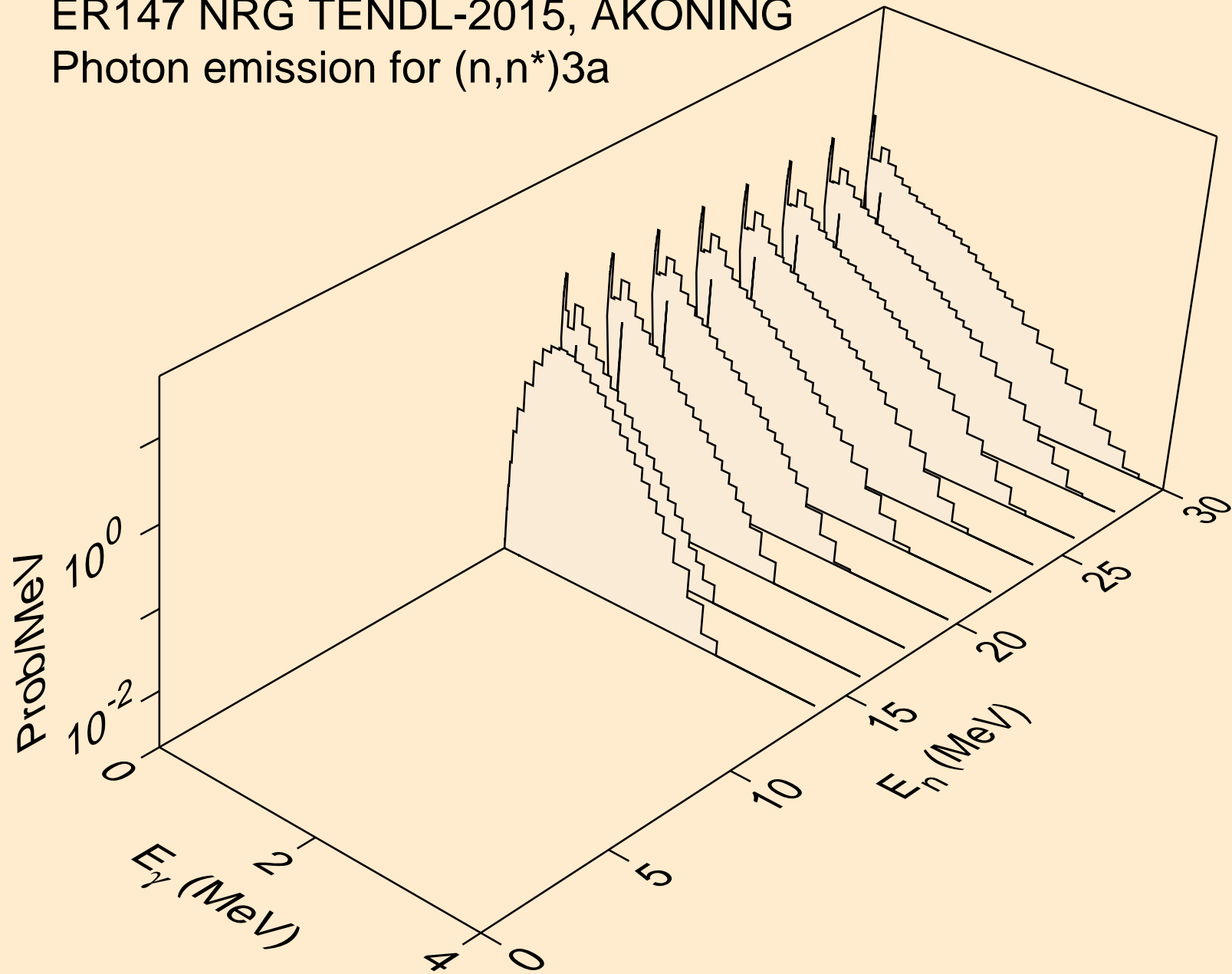

ER147 NRG TENDL-2015, AKONING  
Photon emission for (n,2n)a

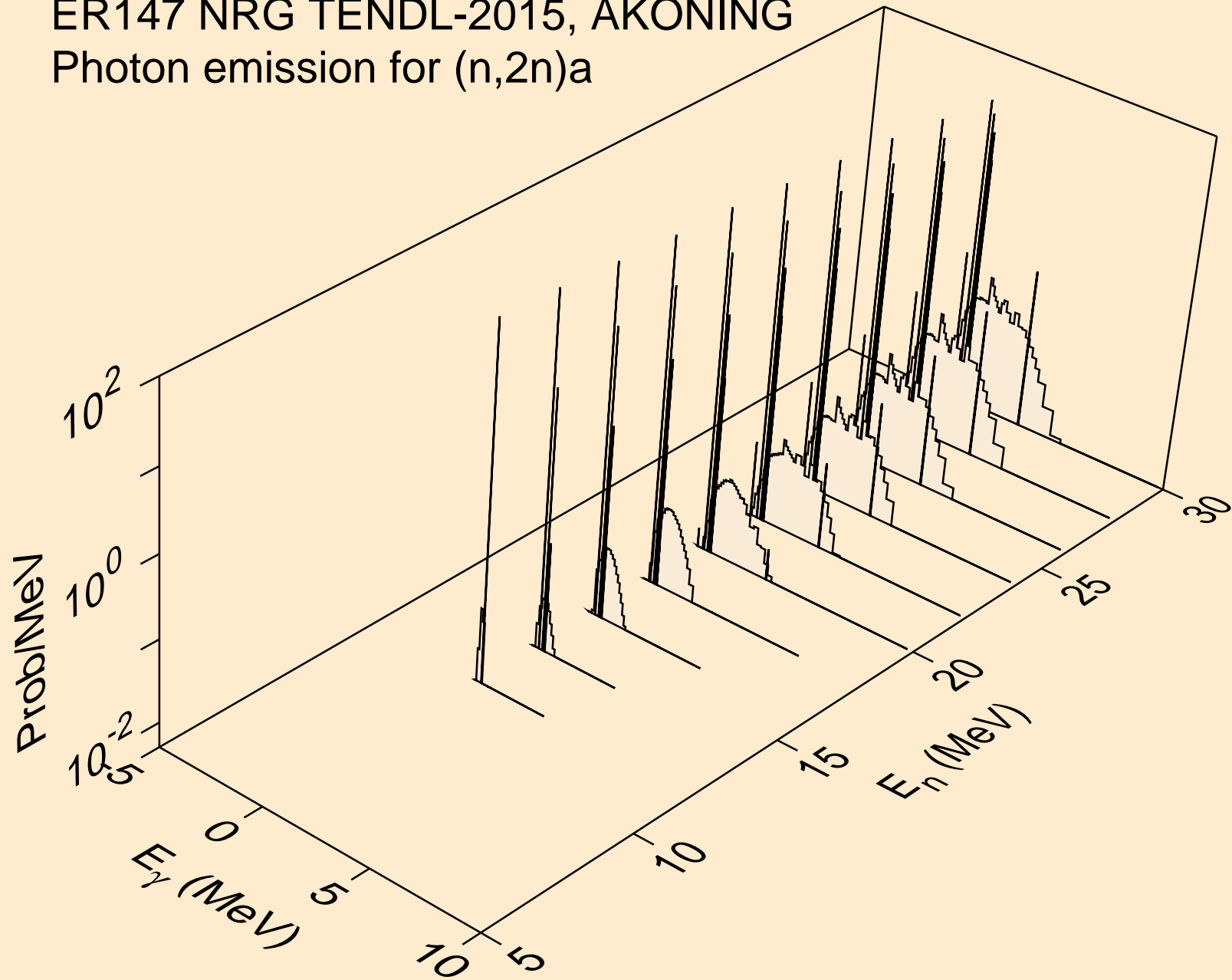

ER147 NRG TENDL-2015, AKONING  
Photon emission for (n,3n)a

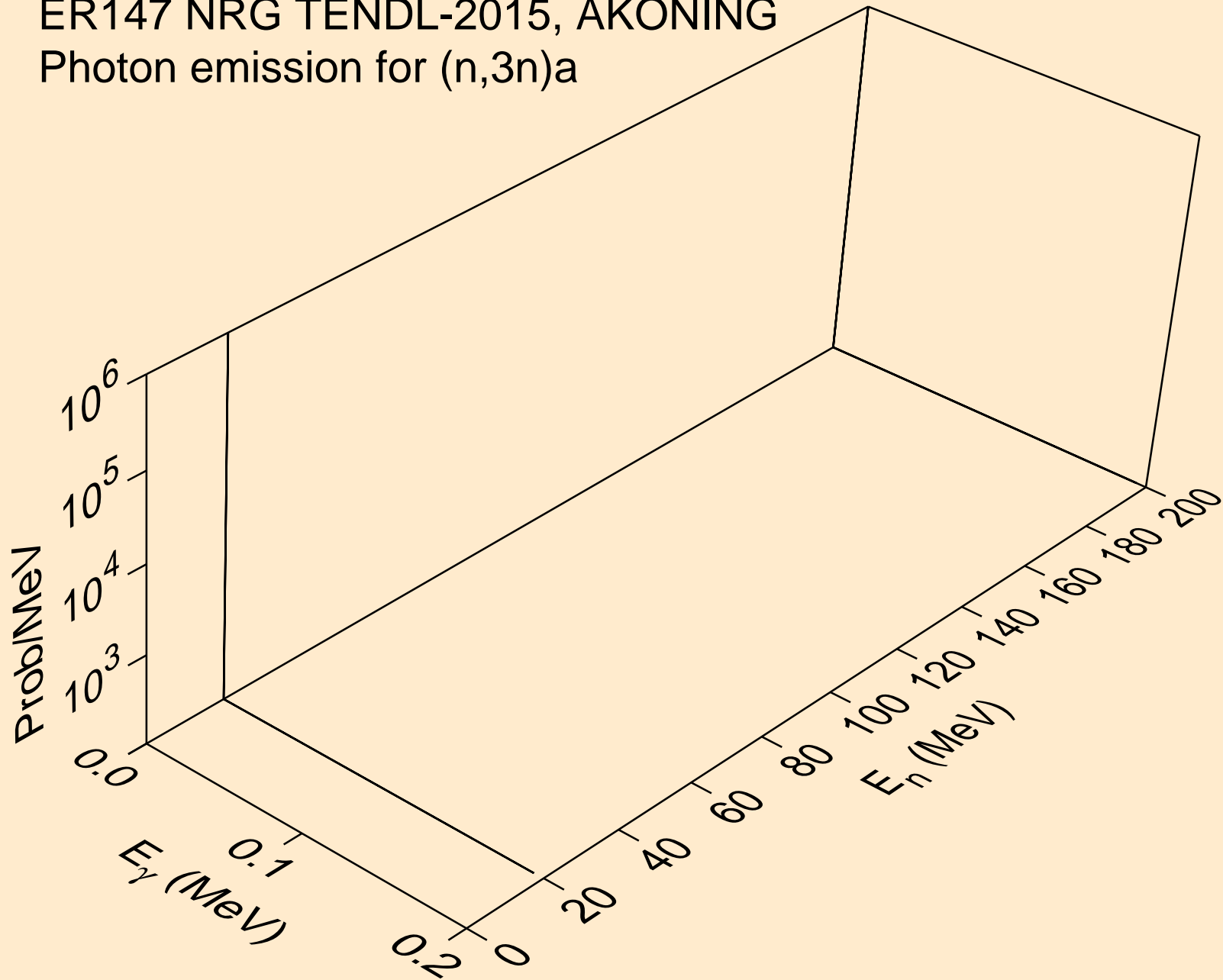

# ER147 NRG TENDL-2015, AKONING

Photon emission for (n,n\*)p

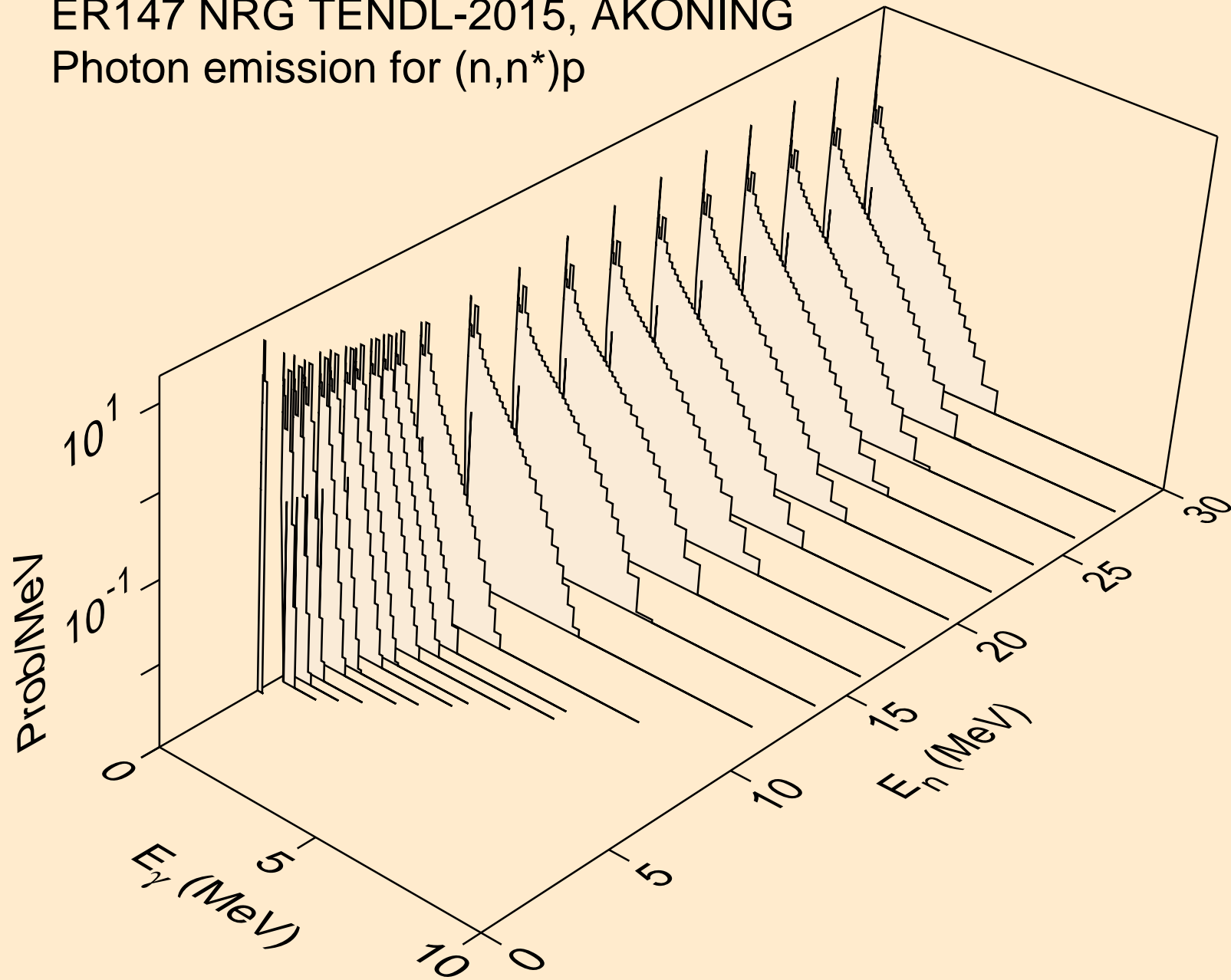

ER147 NRG TENDL-2015, AKONING  
Photon emission for (n,n\*)2a

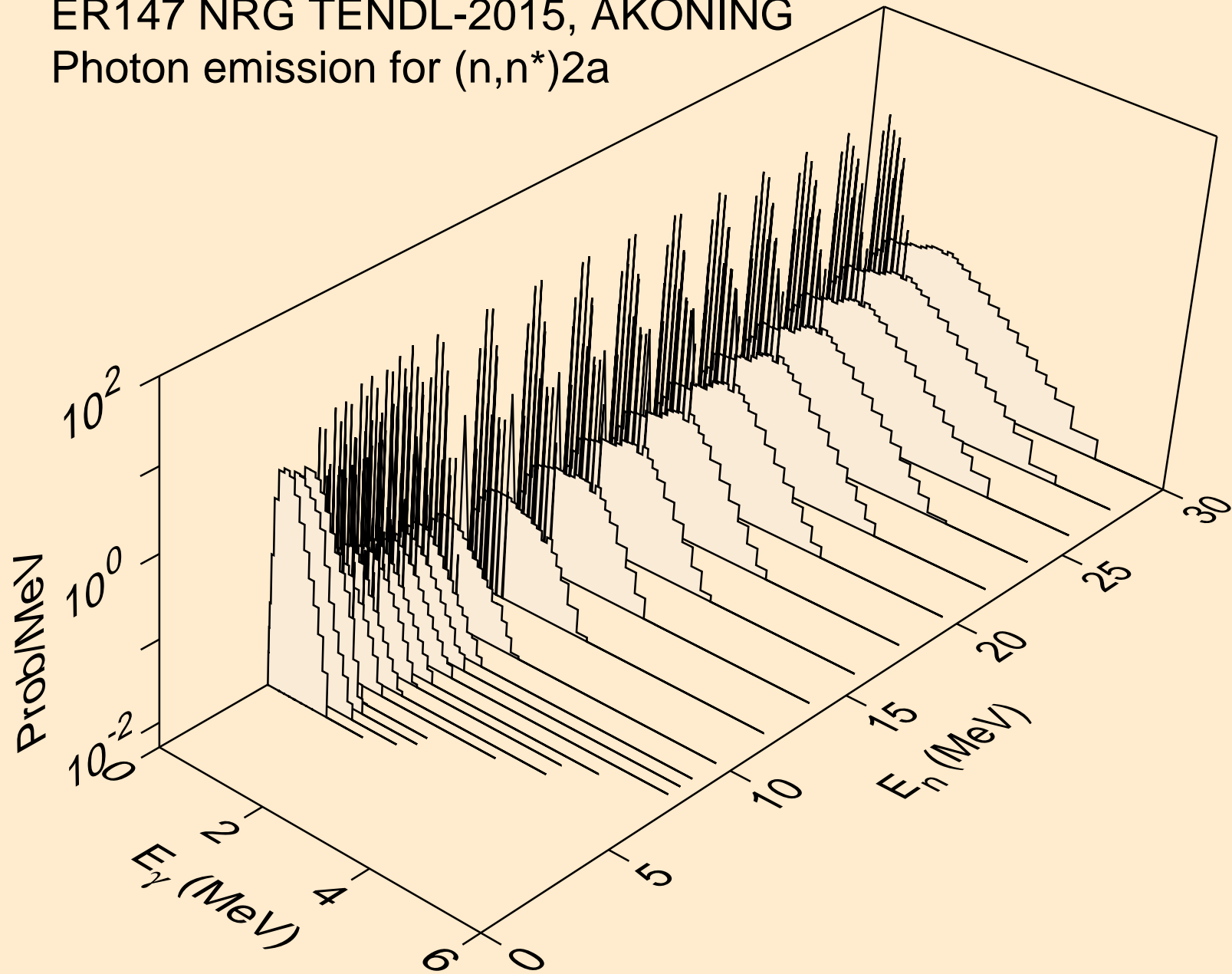

ER147 NRG TENDL-2015, AKONING  
Photon emission for (n,2n)2a

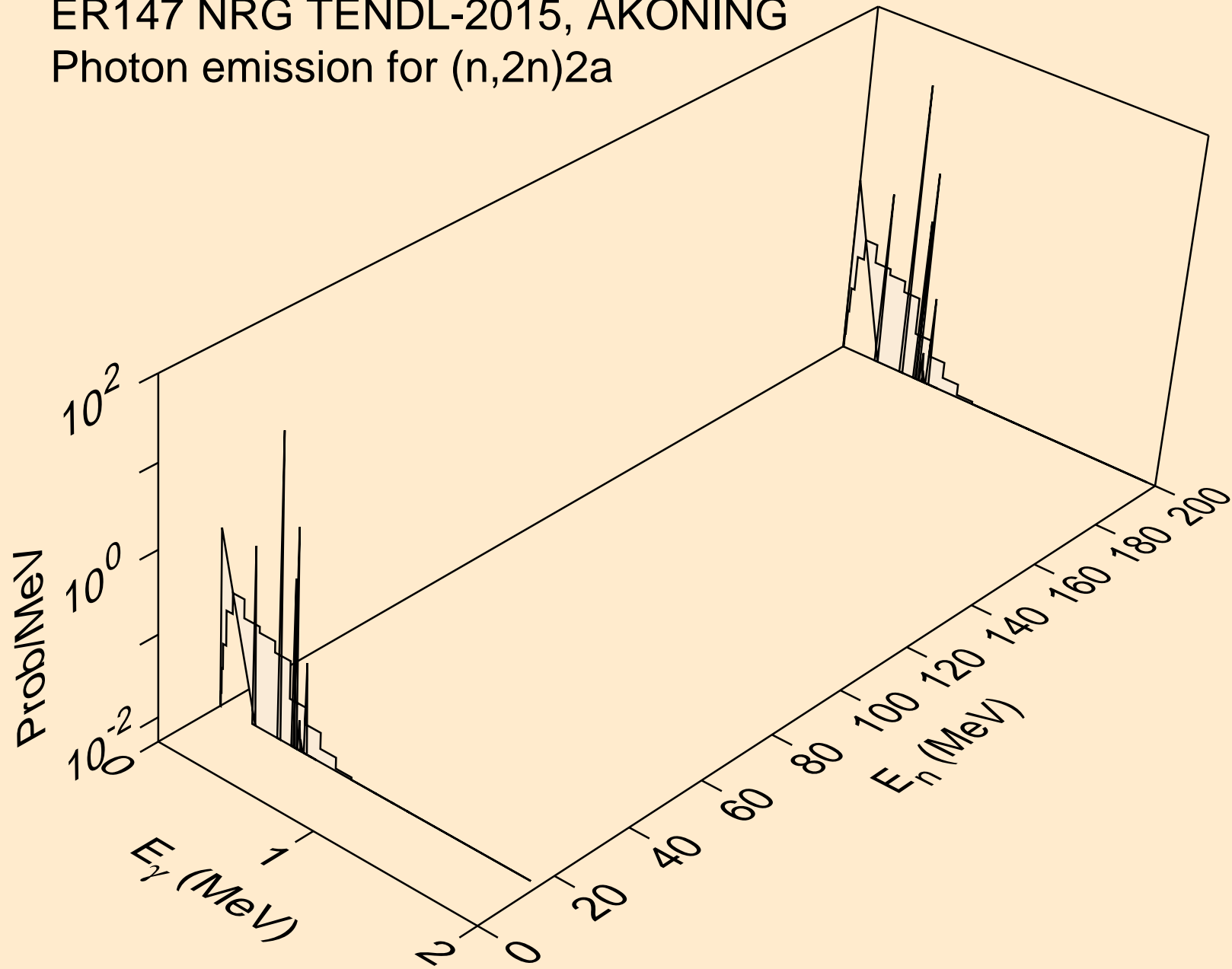



ER147 NRG TENDL-2015, AKONING  
Photon emission for (n,n\*)d

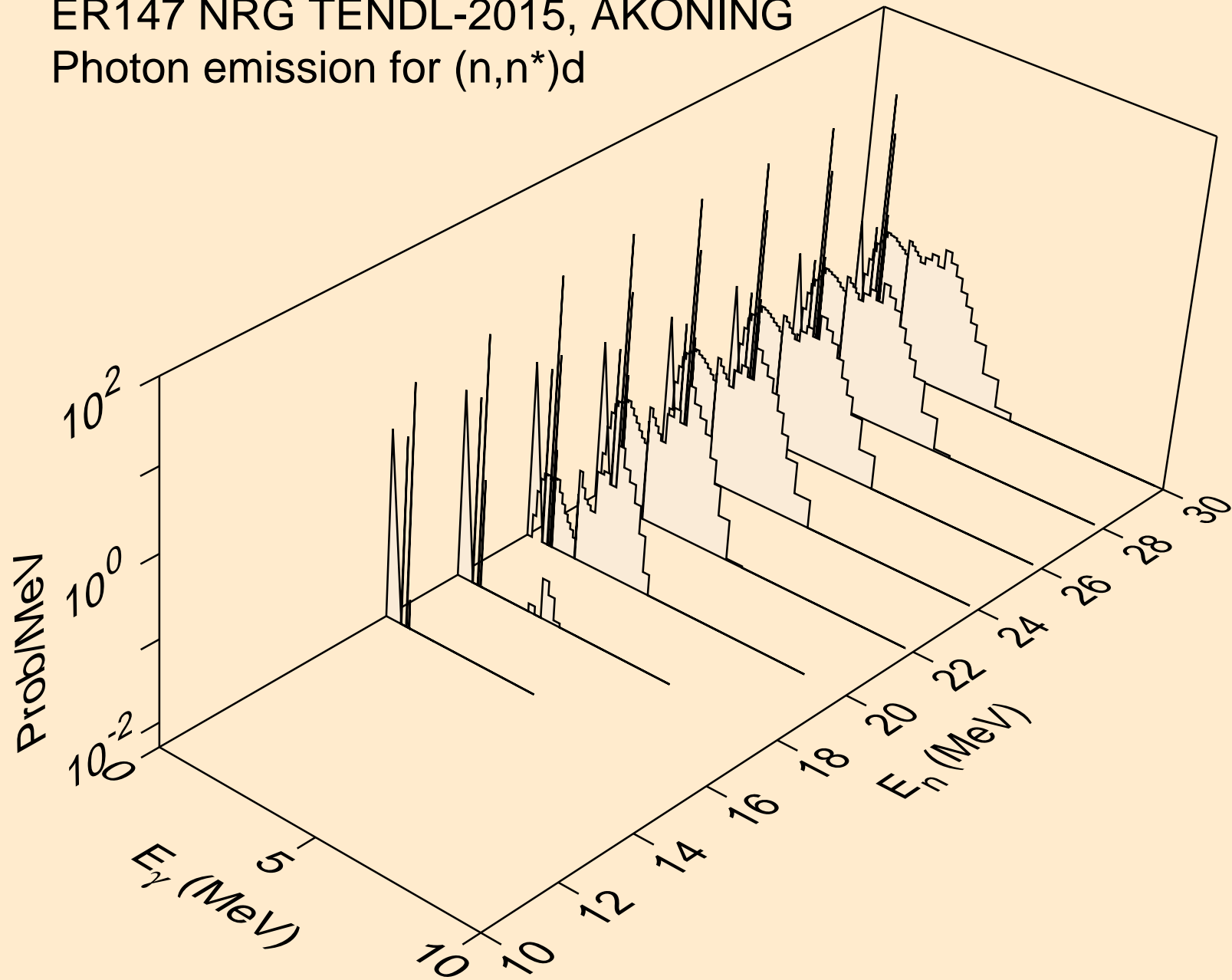

ER147 NRG TENDL-2015, AKONING  
Photon emission for (n,n\*)t

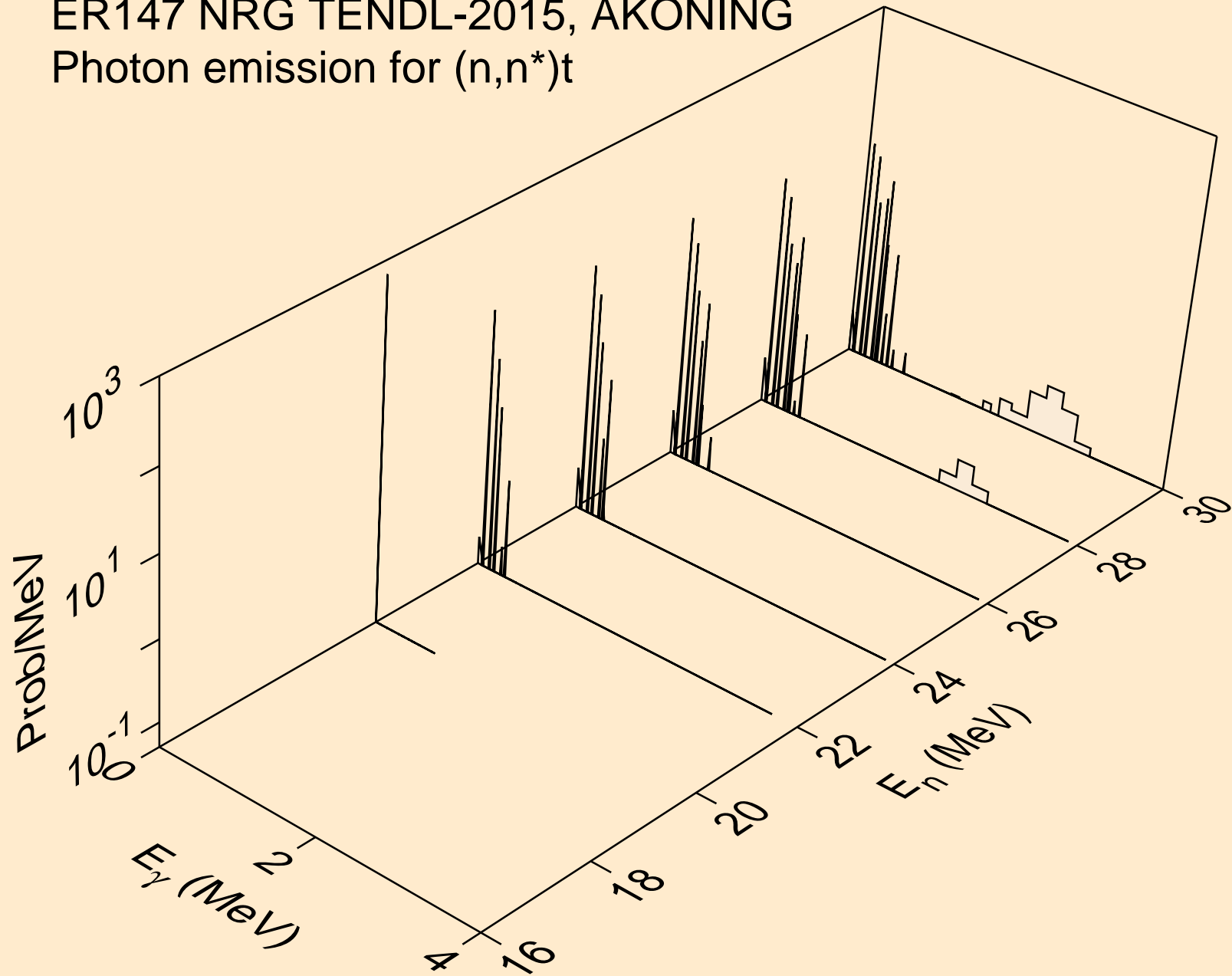

ER147 NRG TENDL-2015, AKONING  
Photon emission for (n,n\*)he3

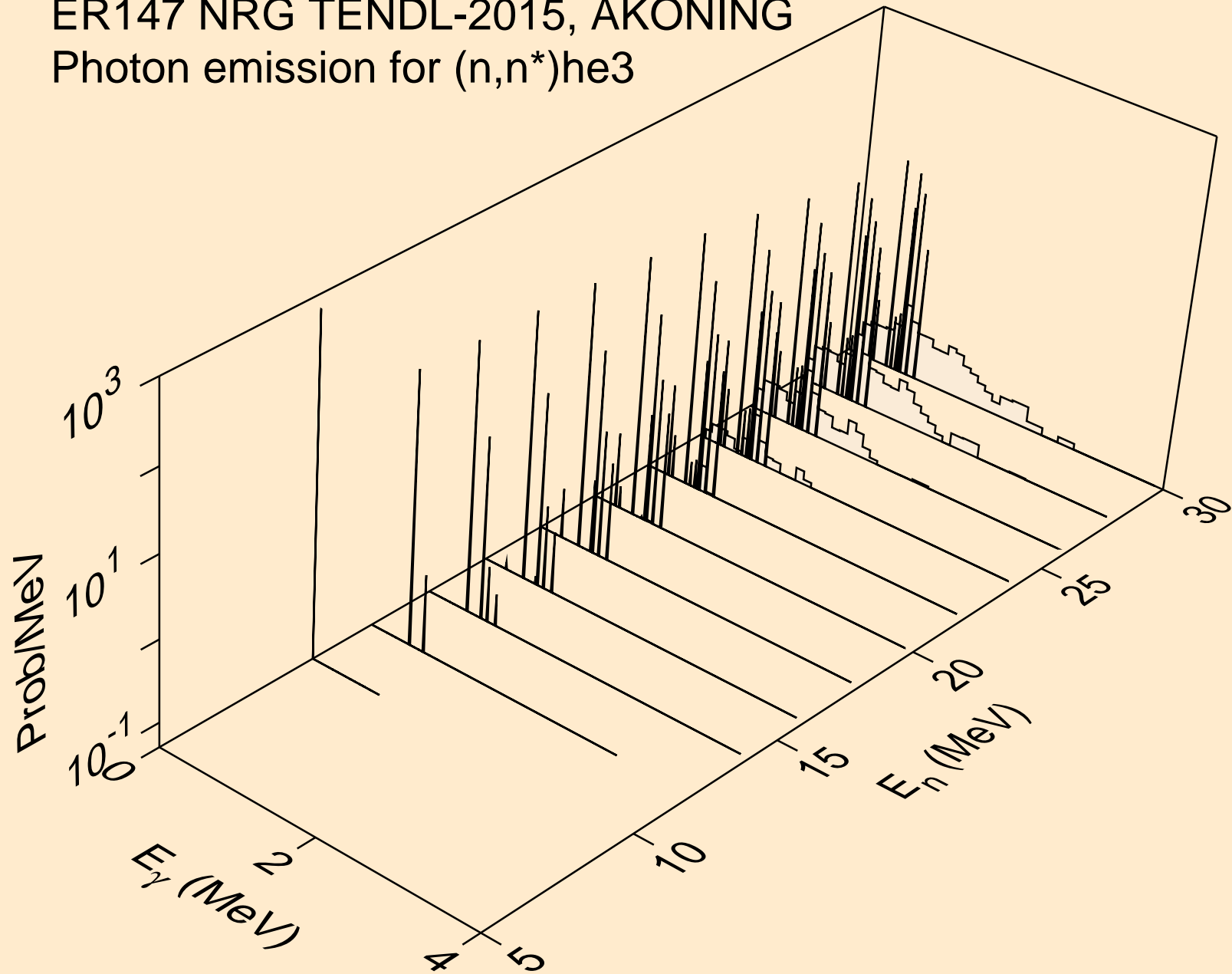

ER147 NRG TENDL-2015, AKONING  
Photon emission for (n,2np)

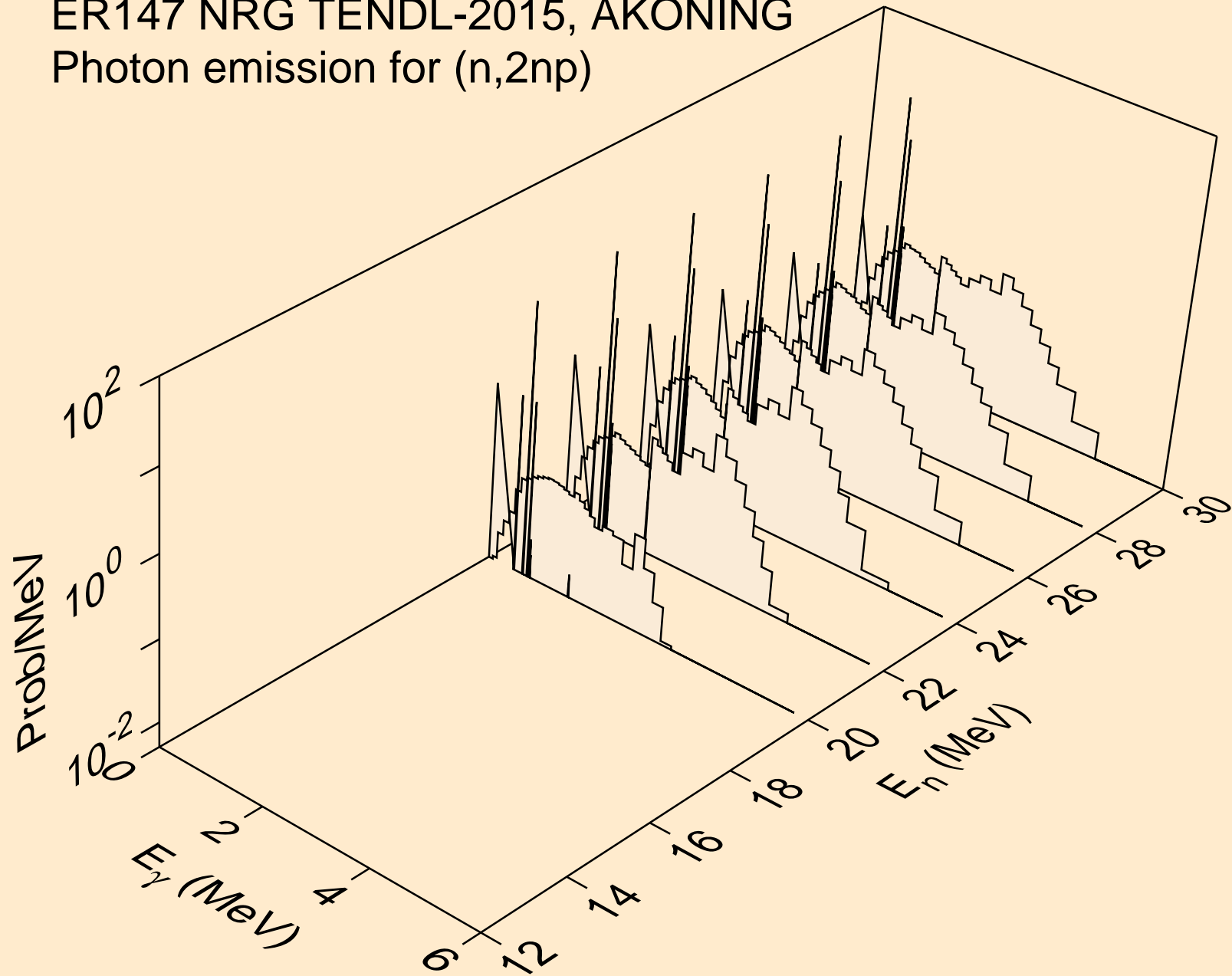

ER147 NRG TENDL-2015, AKONING  
Photon emission for (n,3np)

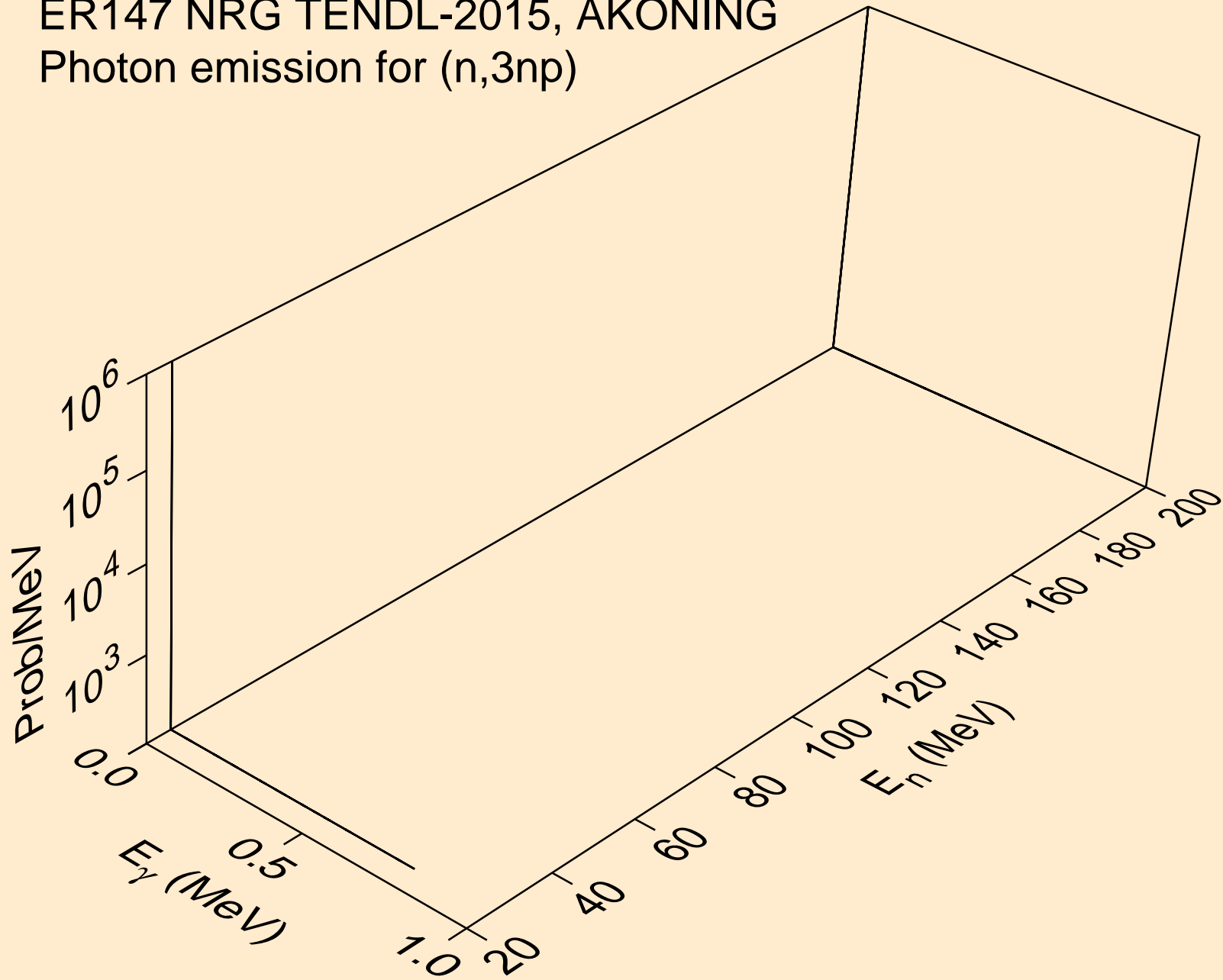

ER147 NRG TENDL-2015, AKONING  
Photon emission for (n,2np)

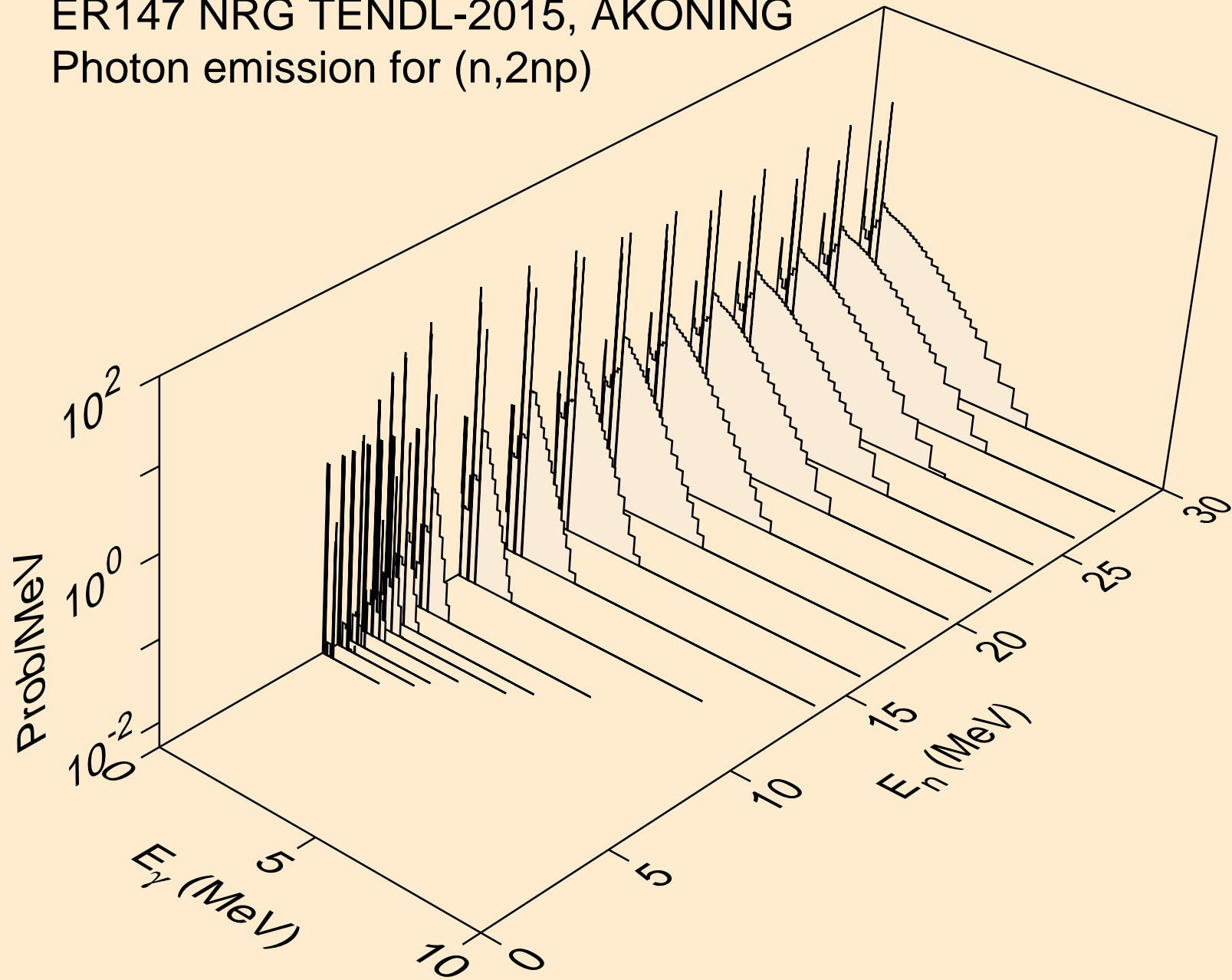

ER147 NRG TENDL-2015, AKONING  
Photon emission for (n,npa)

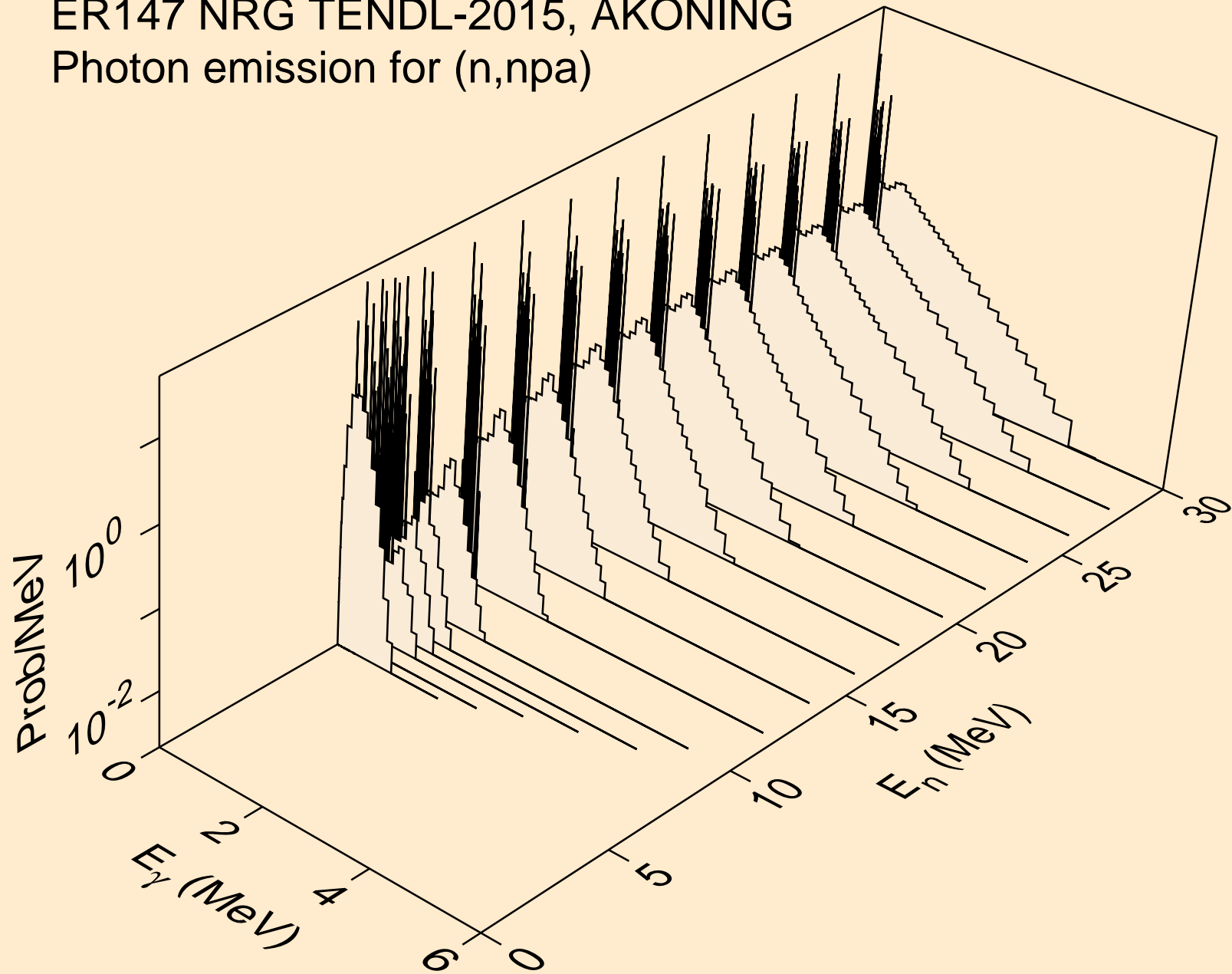

ER147 NRG TENDL-2015, AKONING  
Photon emission for (n,n\*c)

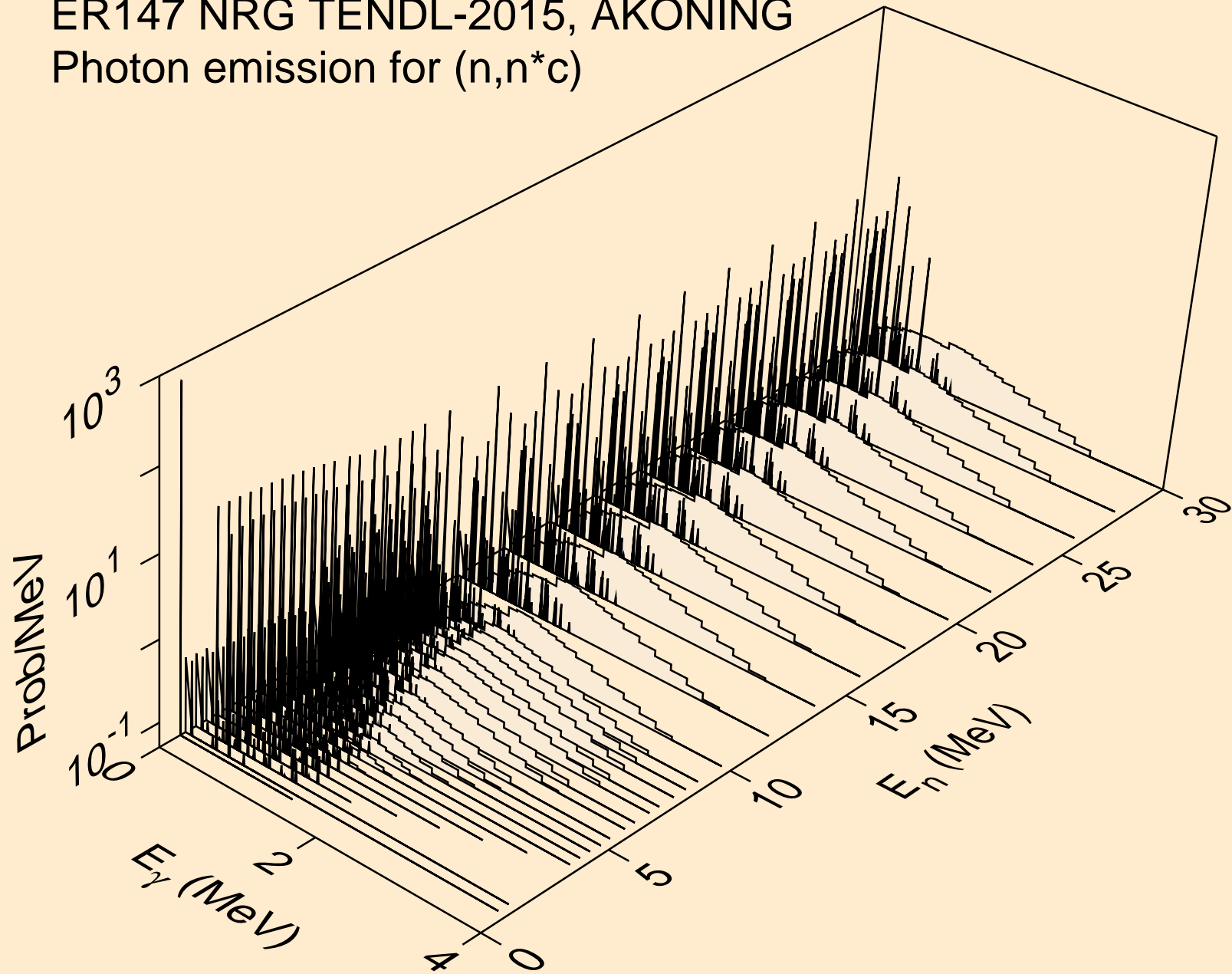



ER147 NRG TENDL-2015, AKONING  
Photon emission for (n,gma)

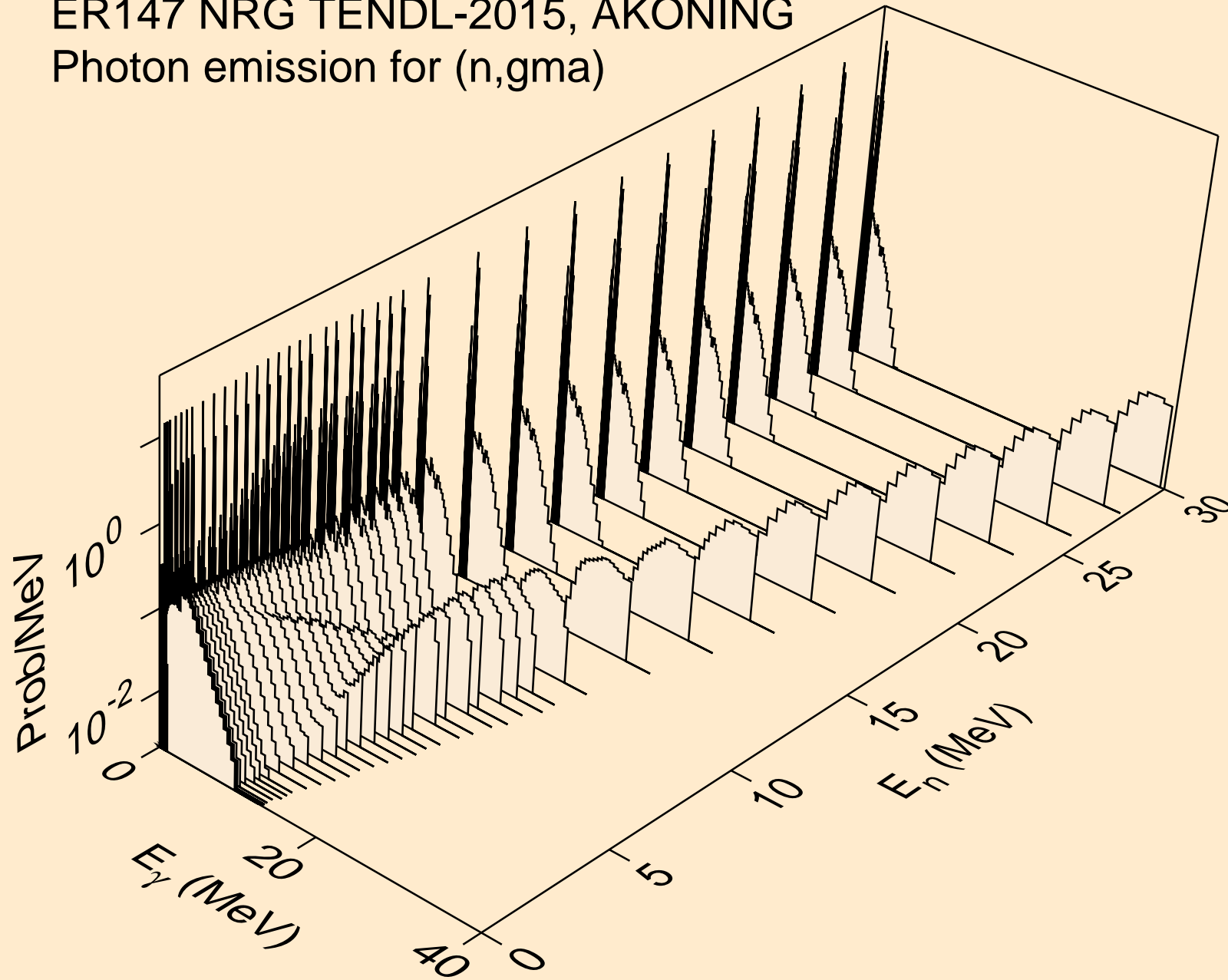

ER147 NRG TENDL-2015, AKONING  
Photon emission for (n,p)

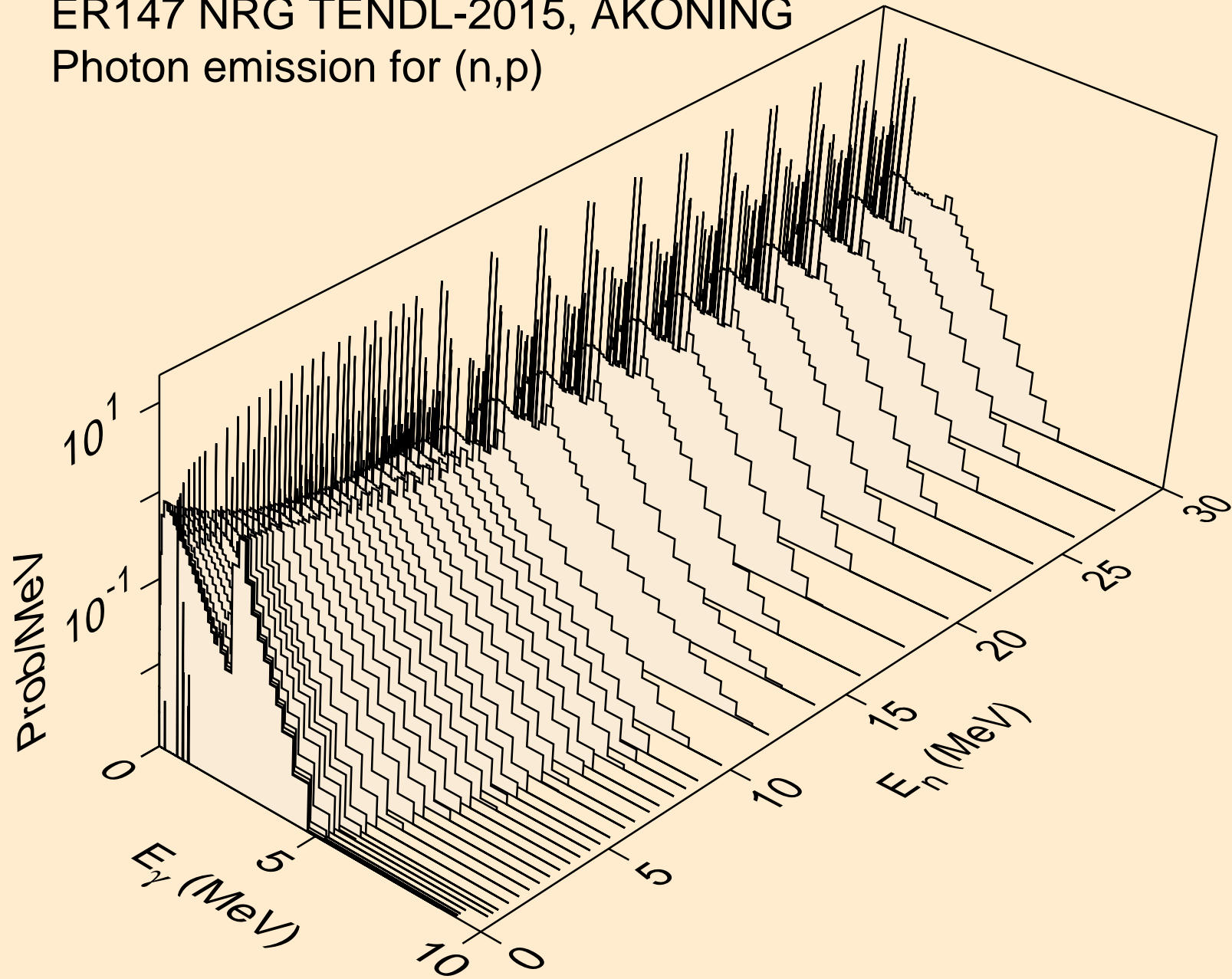

ER147 NRG TENDL-2015, AKONING  
Photon emission for (n,d)

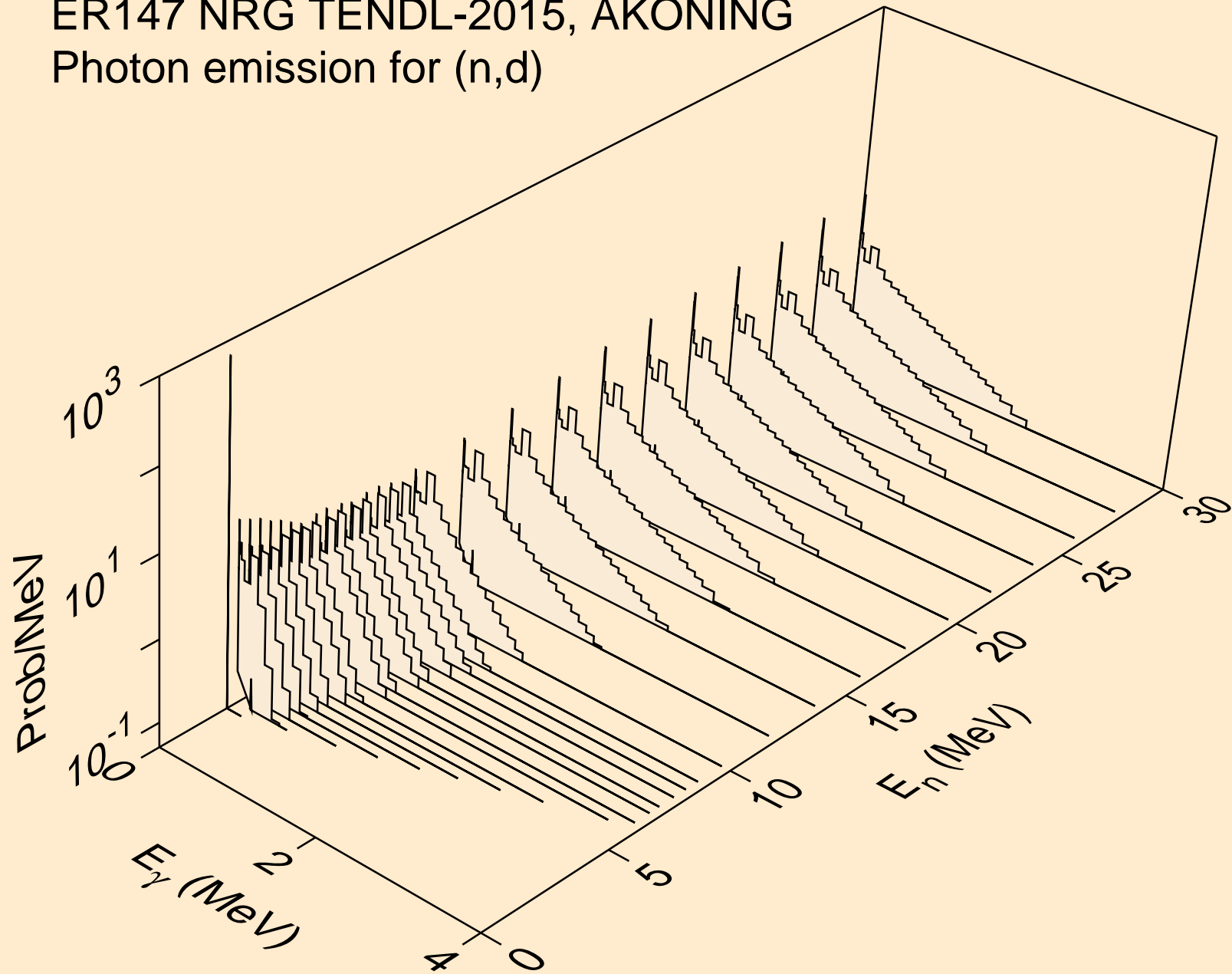

ER147 NRG TENDL-2015, AKONING  
Photon emission for (n,t)

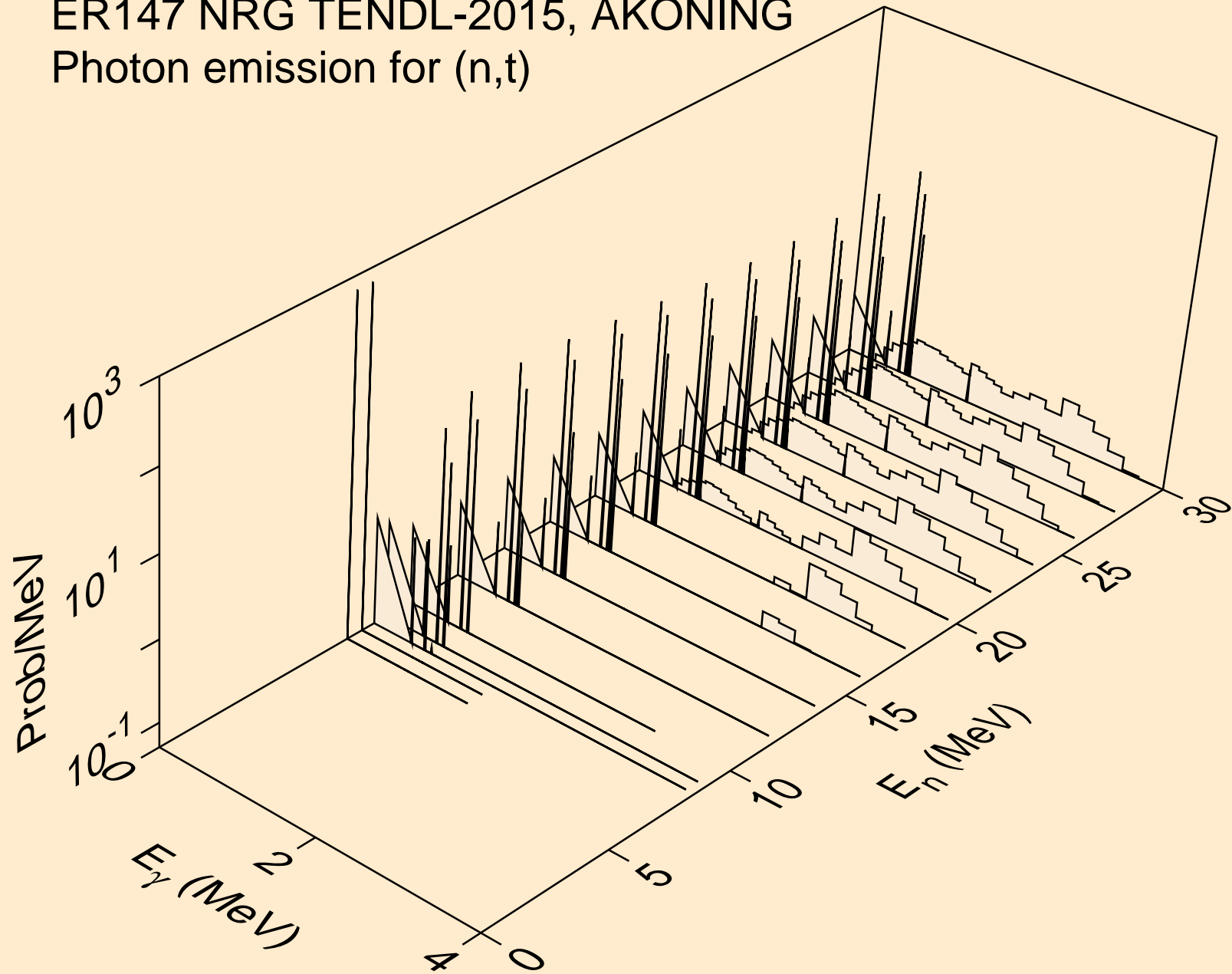

ER147 NRG TENDL-2015, AKONING  
Photon emission for (n,he3)

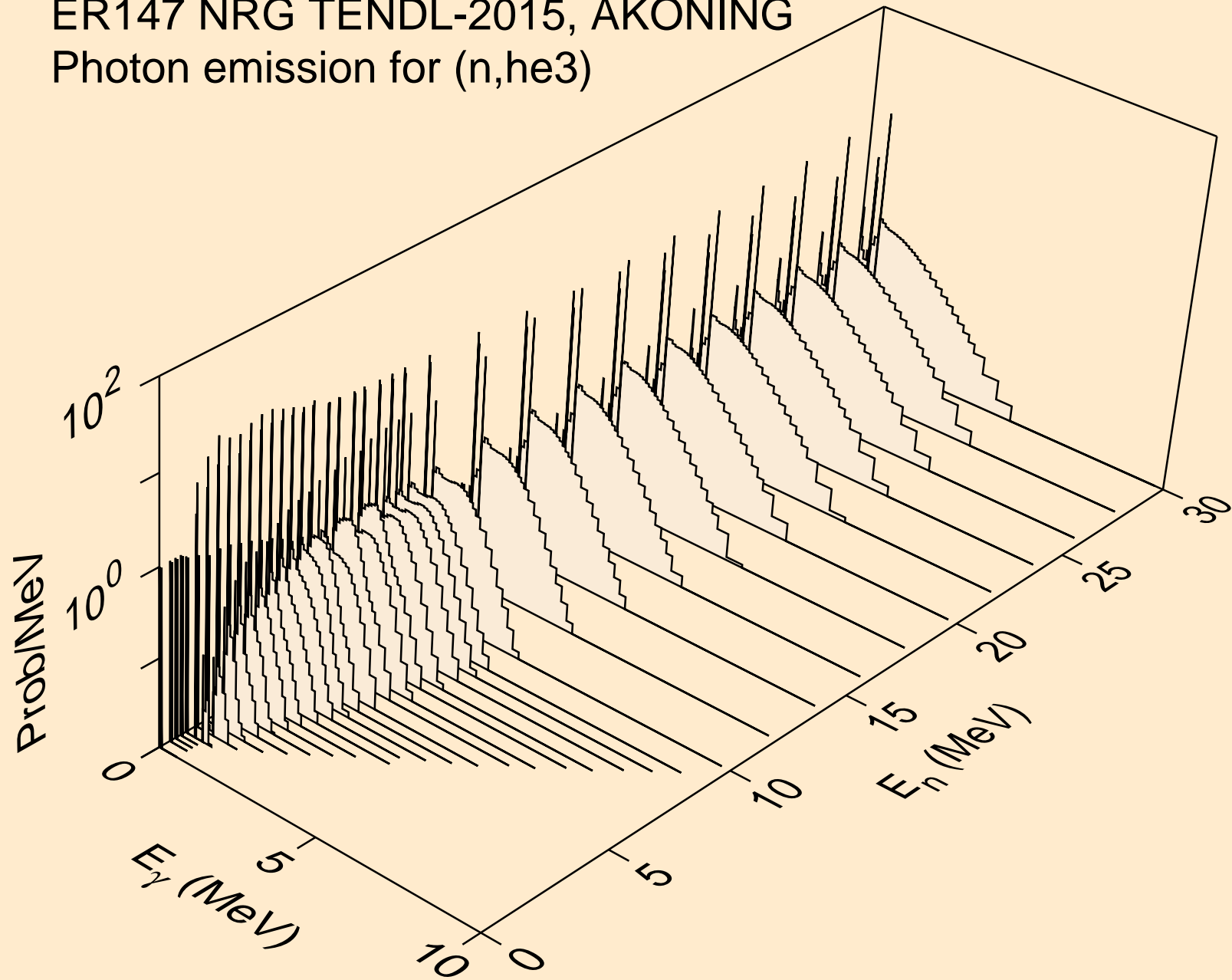

ER147 NRG TENDL-2015, AKONING  
Photon emission for (n,a)

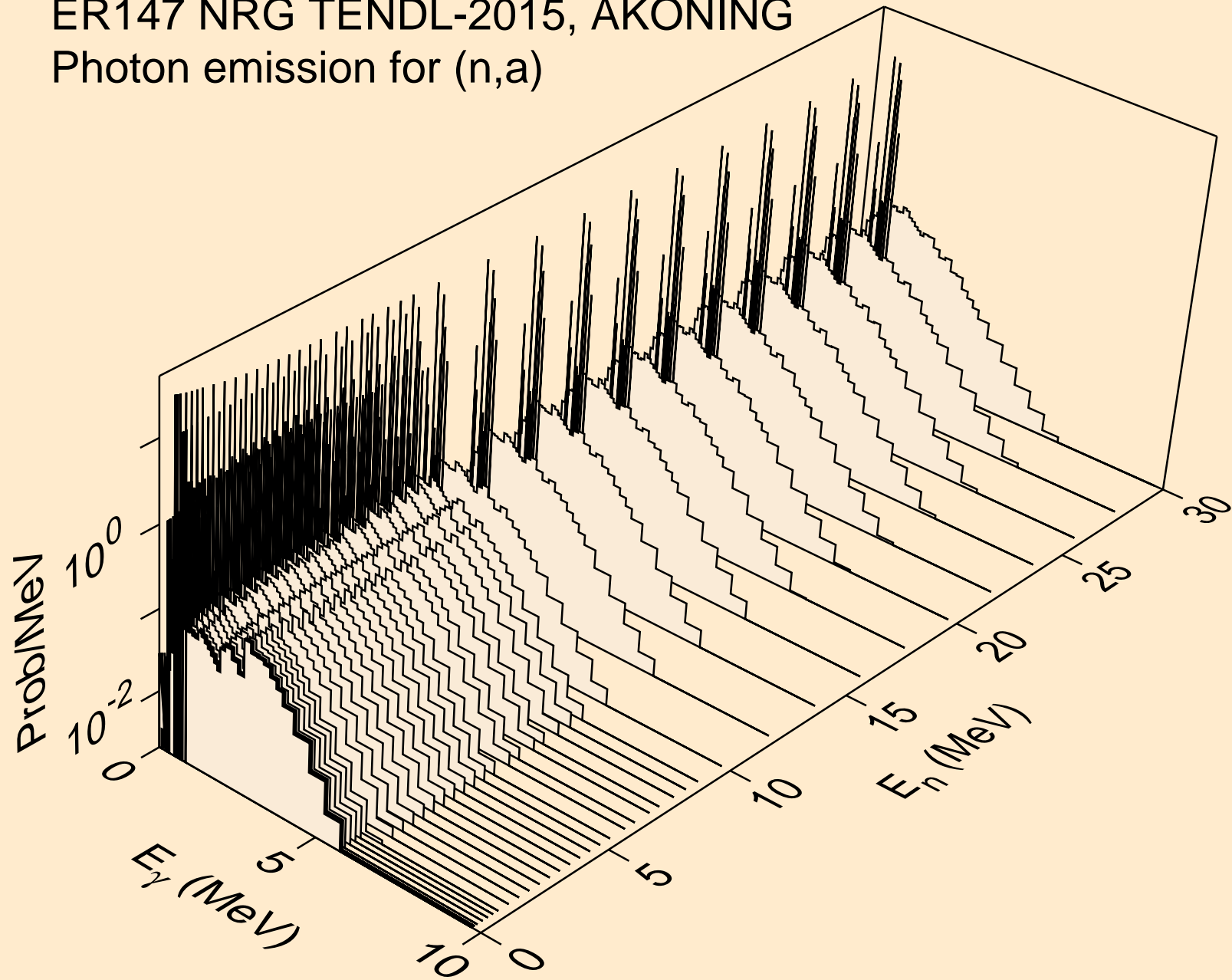

ER147 NRG TENDL-2015, AKONING  
Photon emission for (n,2a)

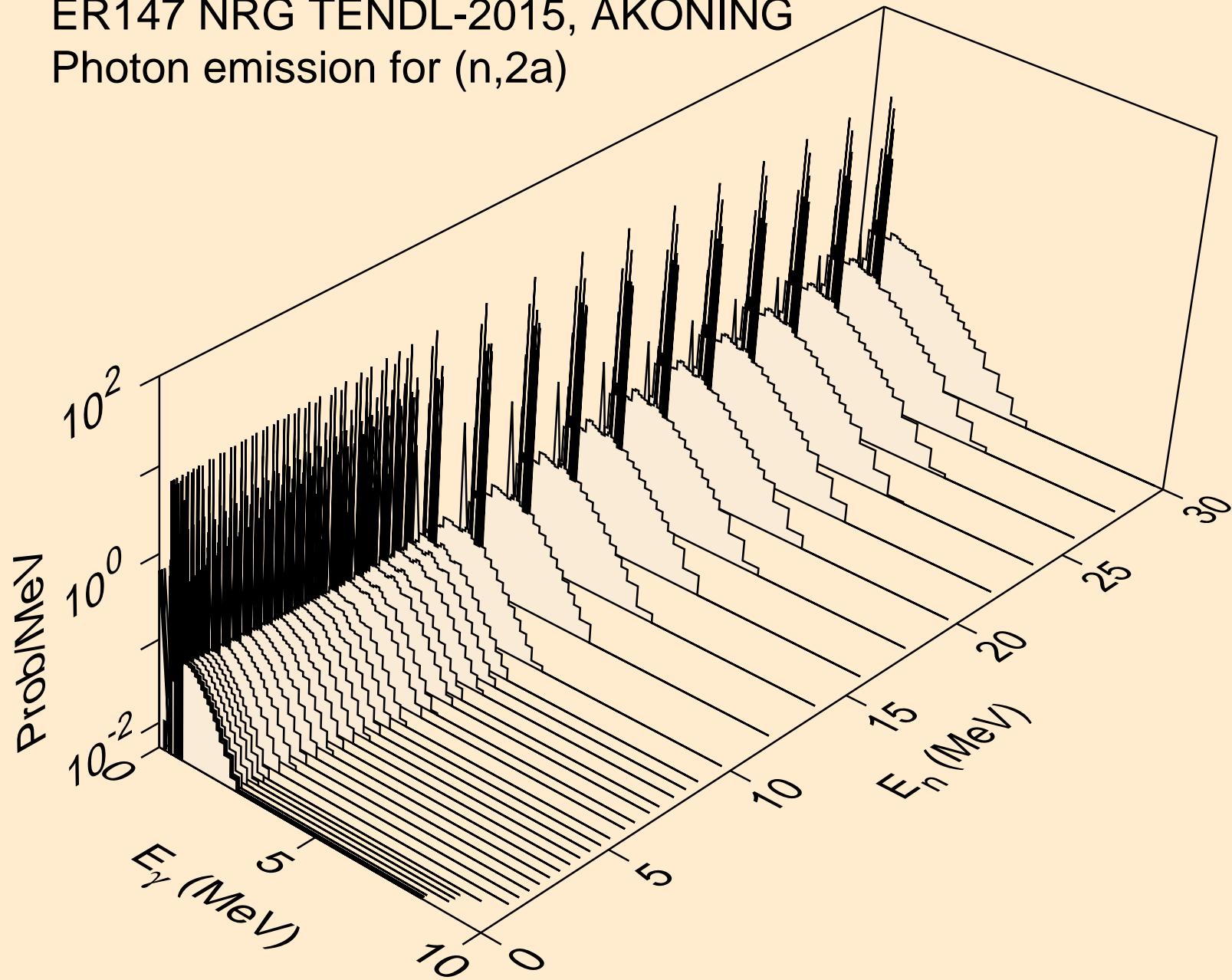

ER147 NRG TENDL-2015, AKONING  
Photon emission for (n,3a)

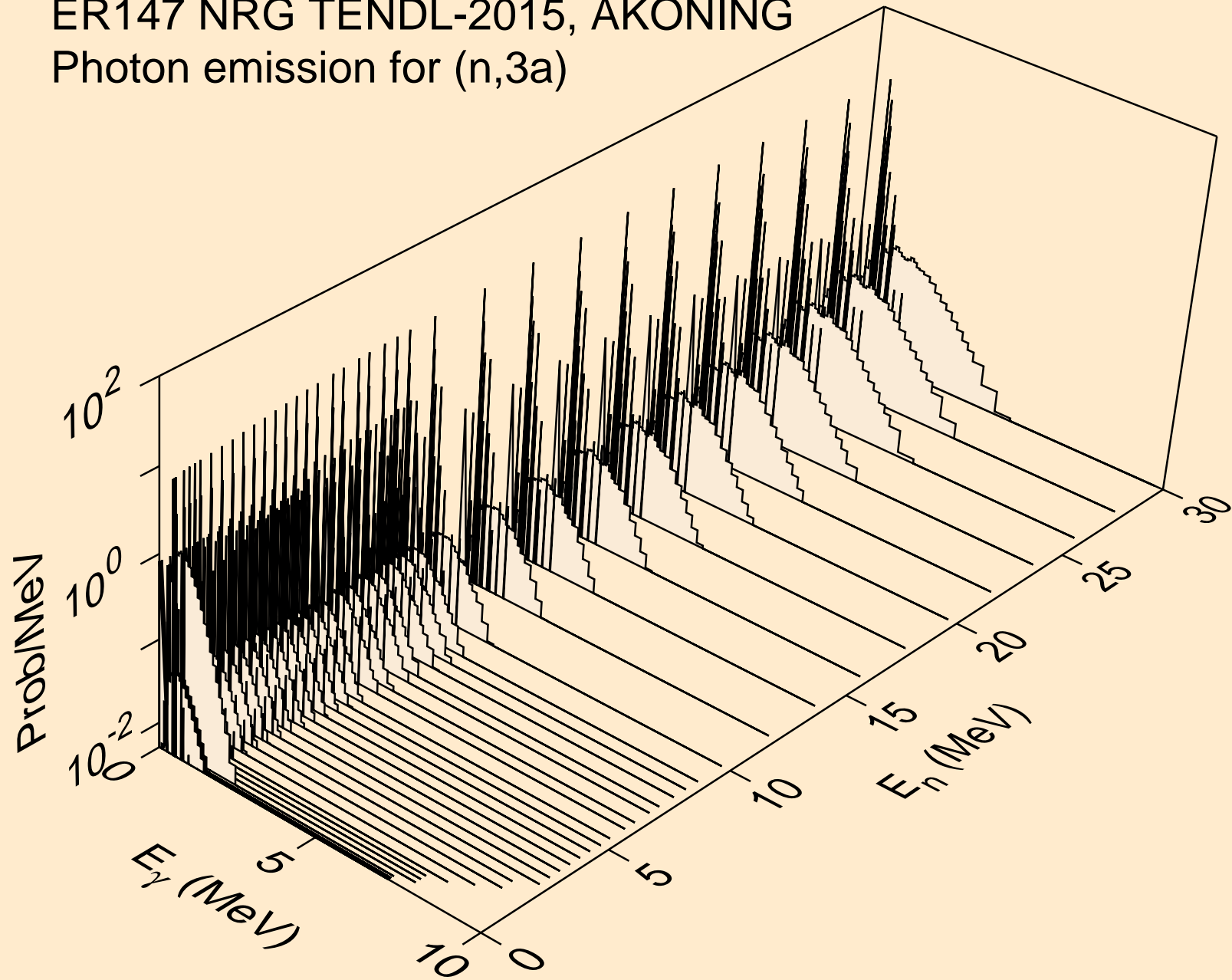



ER147 NRG TENDL-2015, AKONING  
Photon emission for (n,2p)

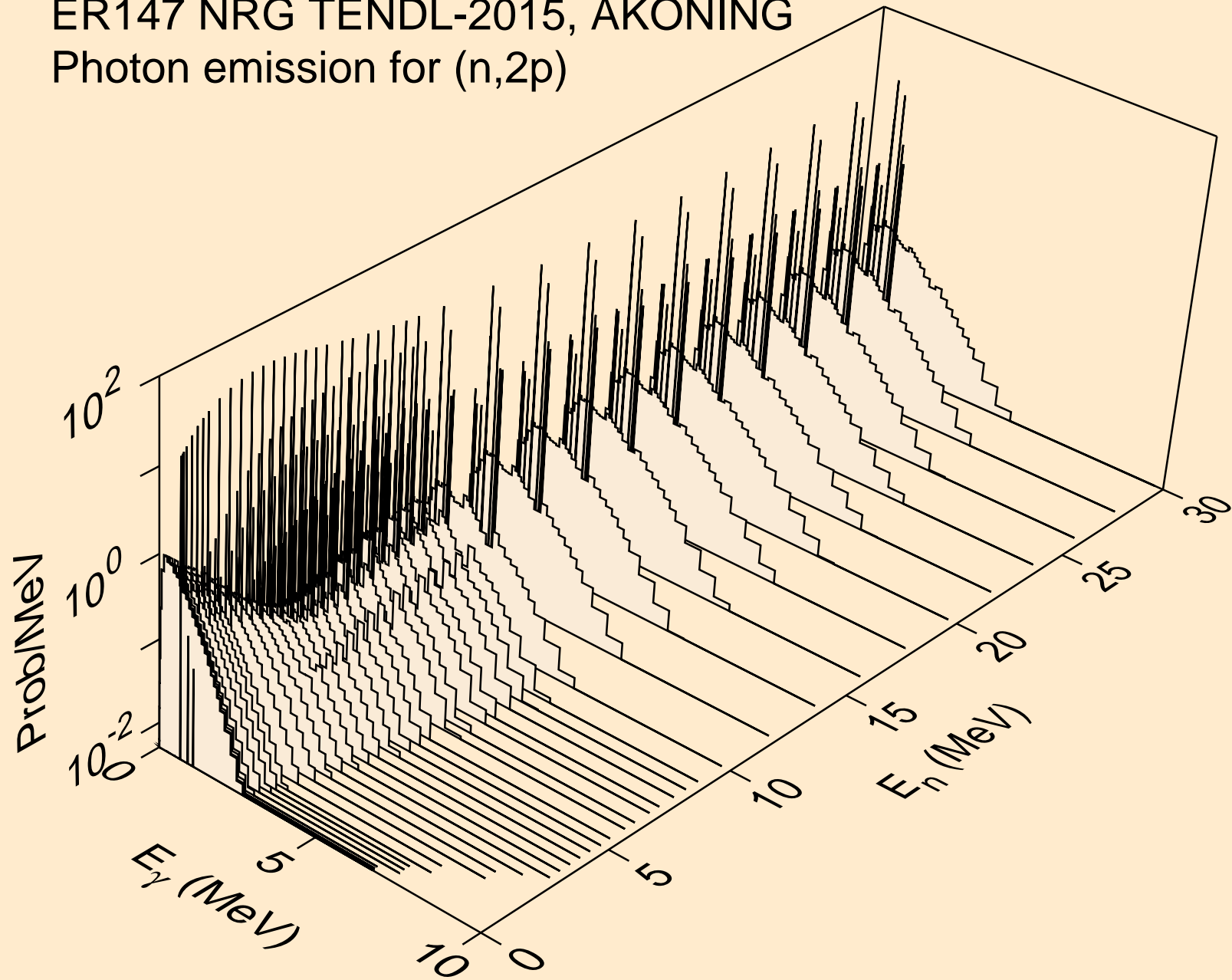

ER147 NRG TENDL-2015, AKONING  
Photon emission for (n,p $\alpha$ )

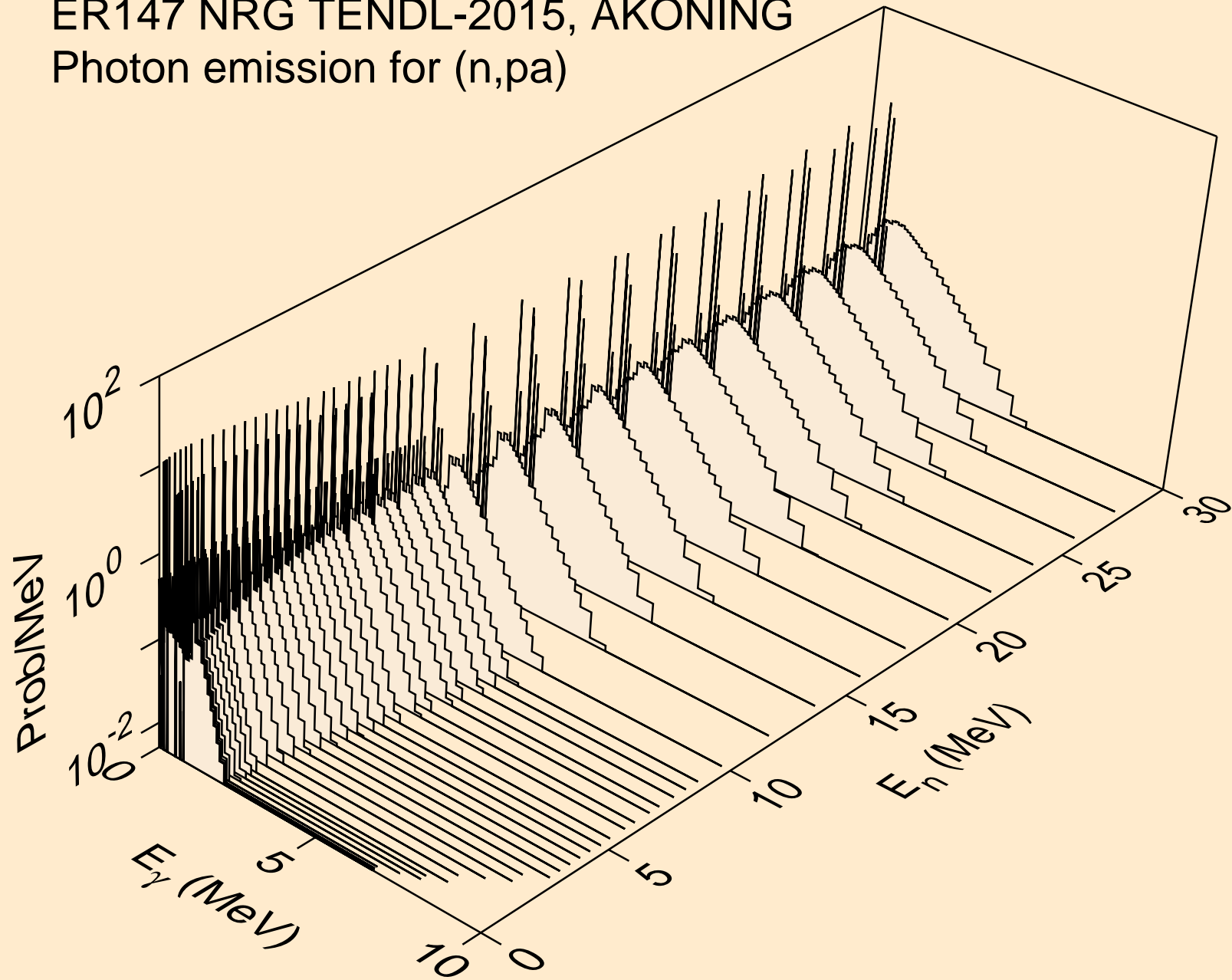

ER147 NRG TENDL-2015, AKONING  
Photon emission for (n,d2a)

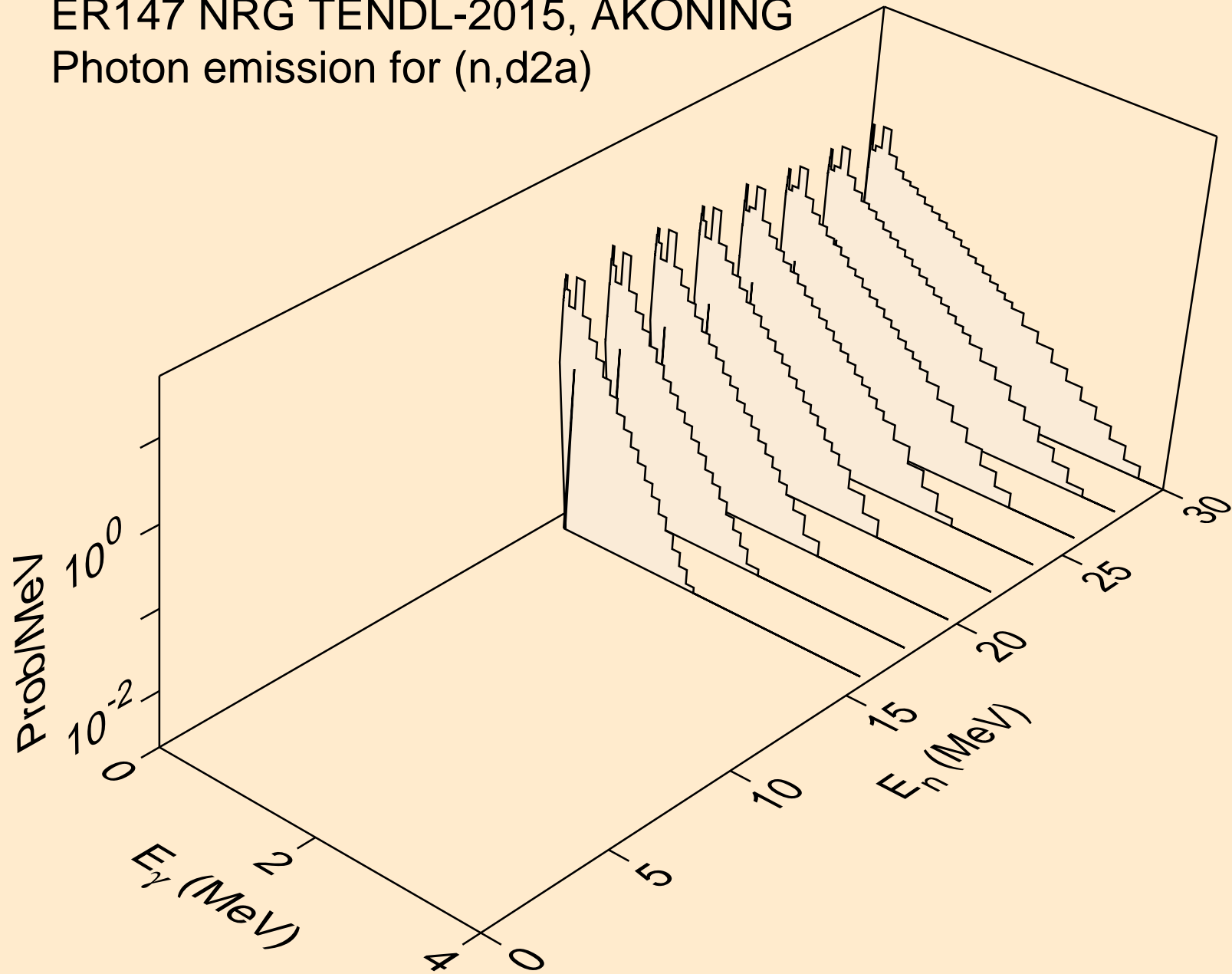

ER147 NRG TENDL-2015, AKONING  
Photon emission for (n,pd)

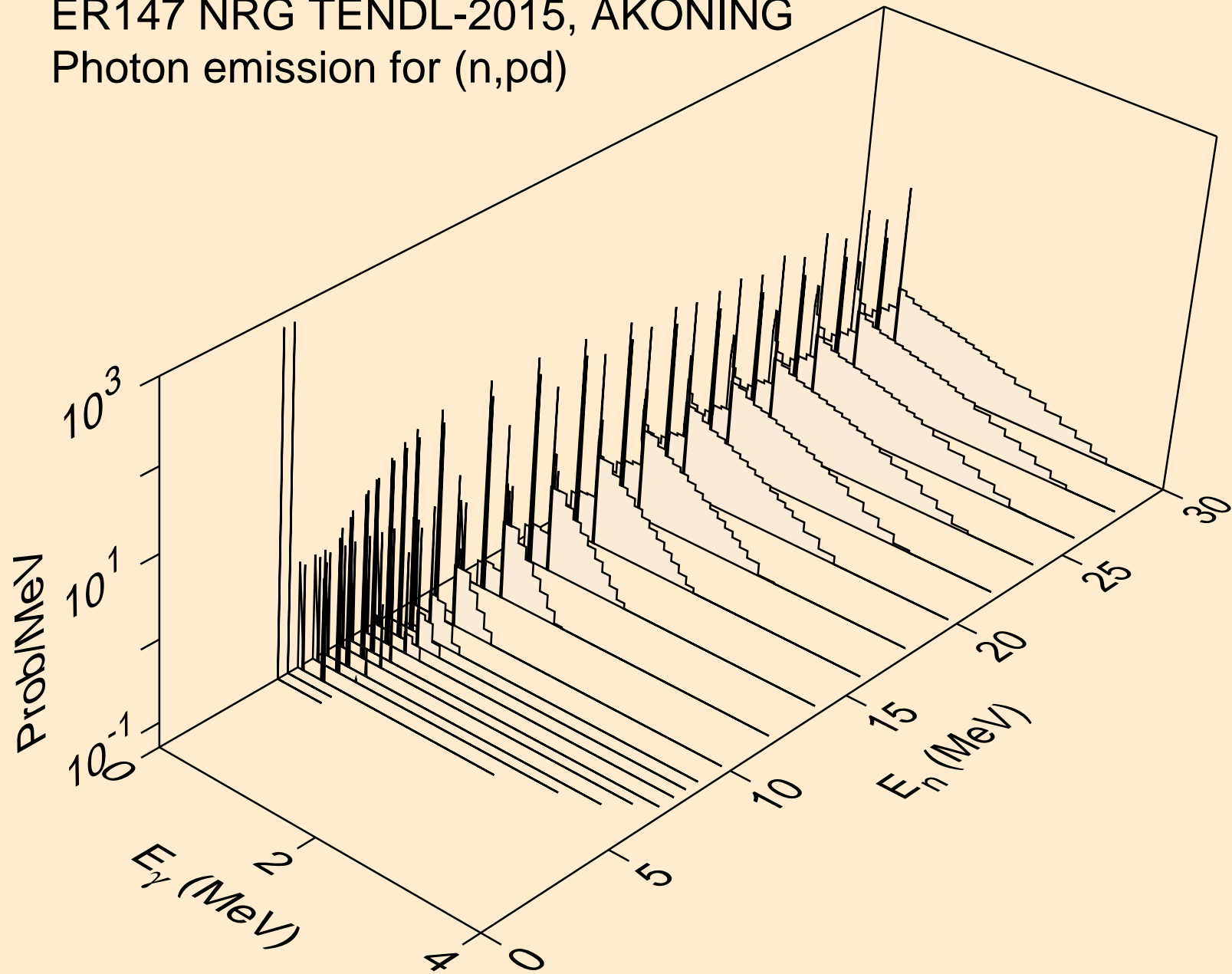

# ER147 NRG TENDL-2015, AKONING

Photon emission for (n,pt)

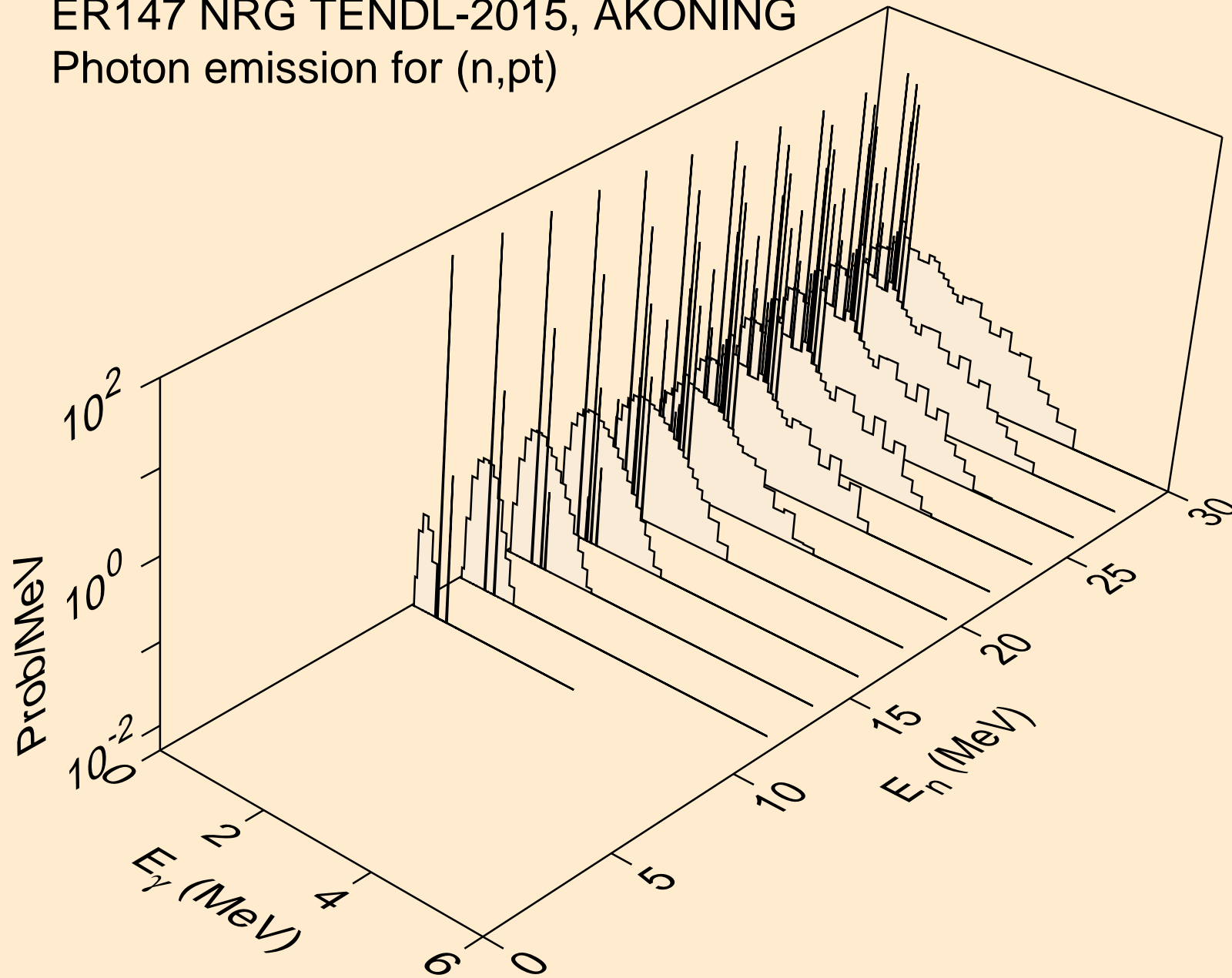

ER147 NRG TENDL-2015, AKONING  
Photon emission for (n,da)

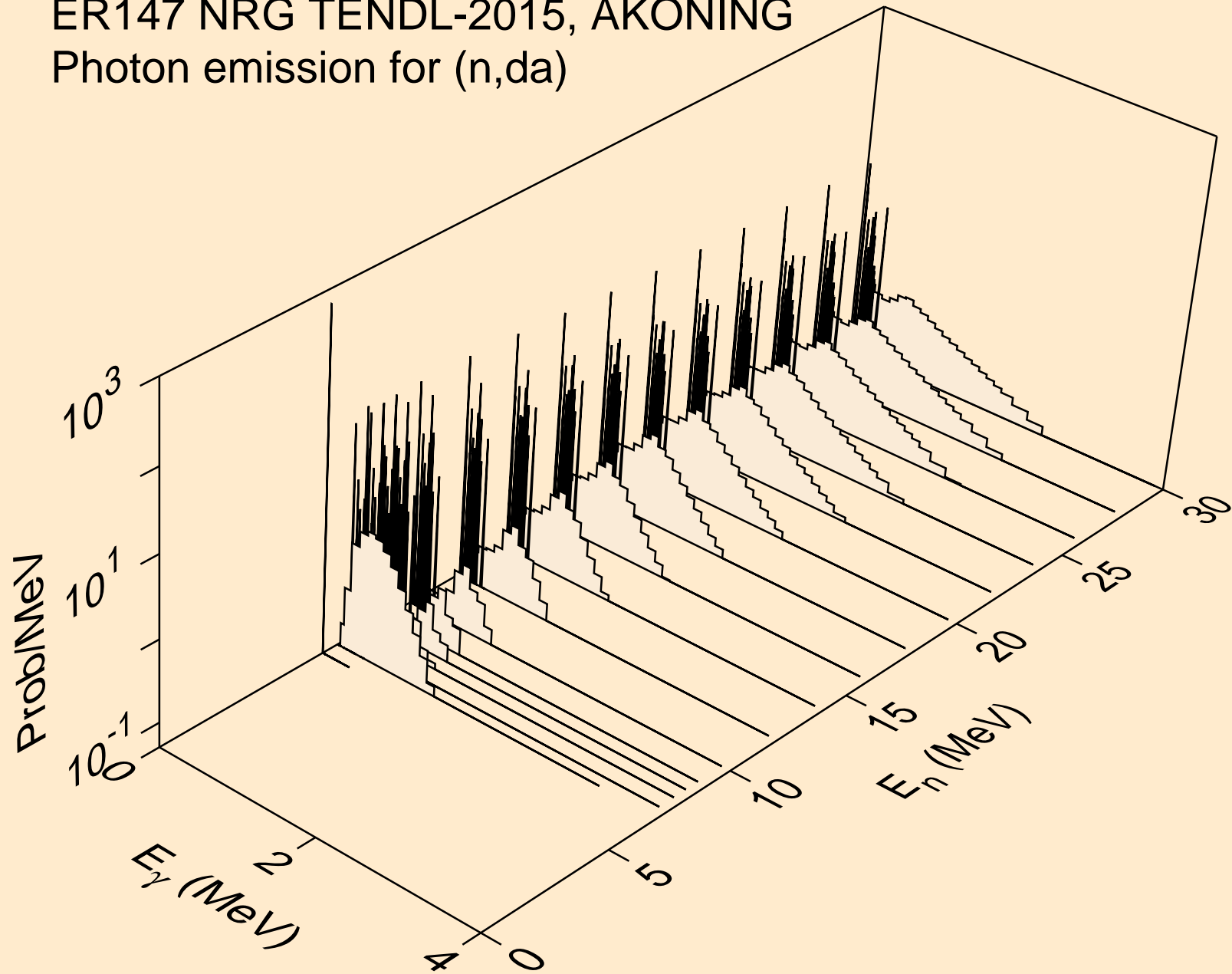

ER147 NRG TENDL-2015, AKONING  
thermal capture photon spectrum

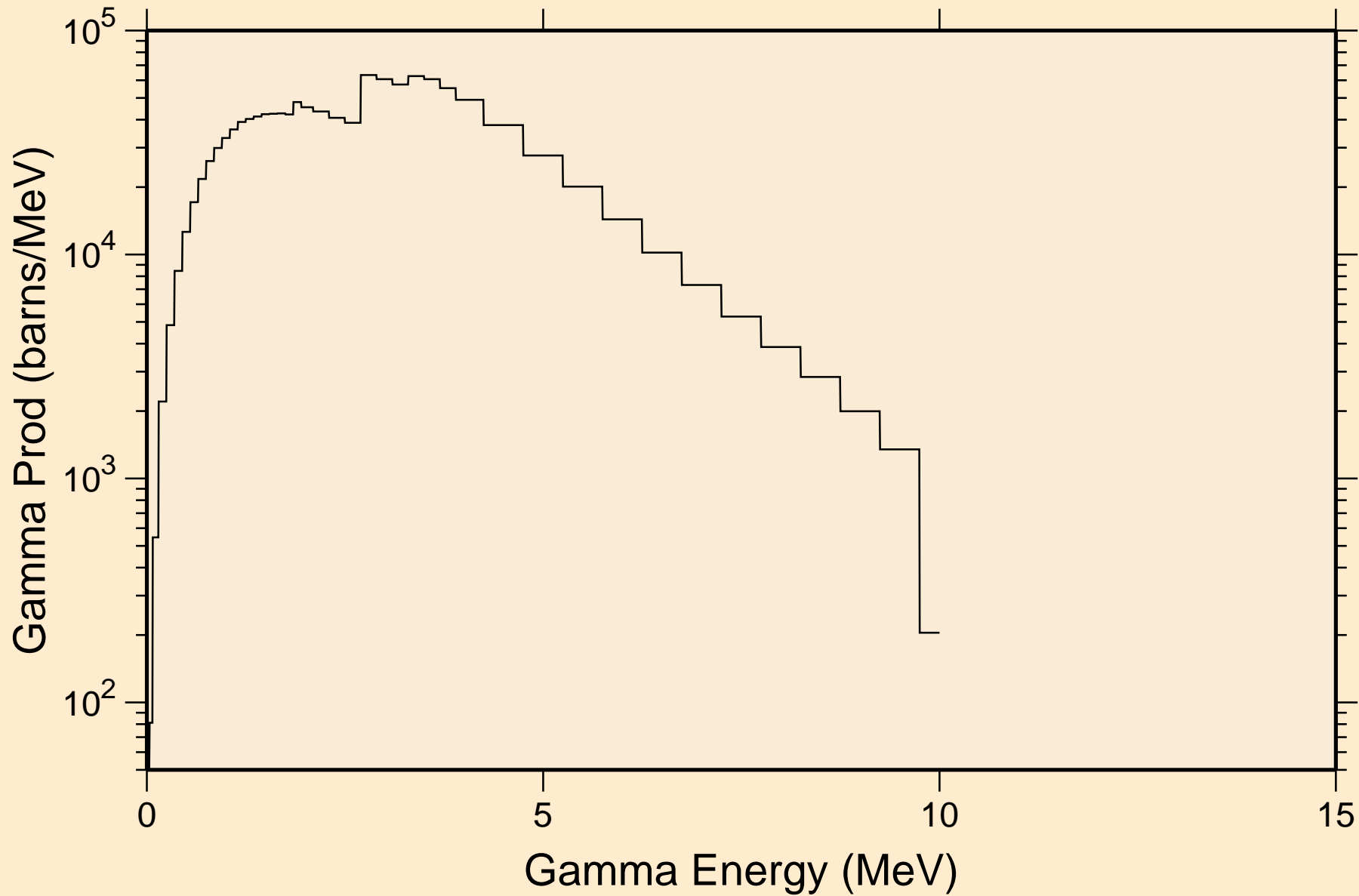

ER147 NRG TENDL-2015, AKONING  
14 MeV photon spectrum

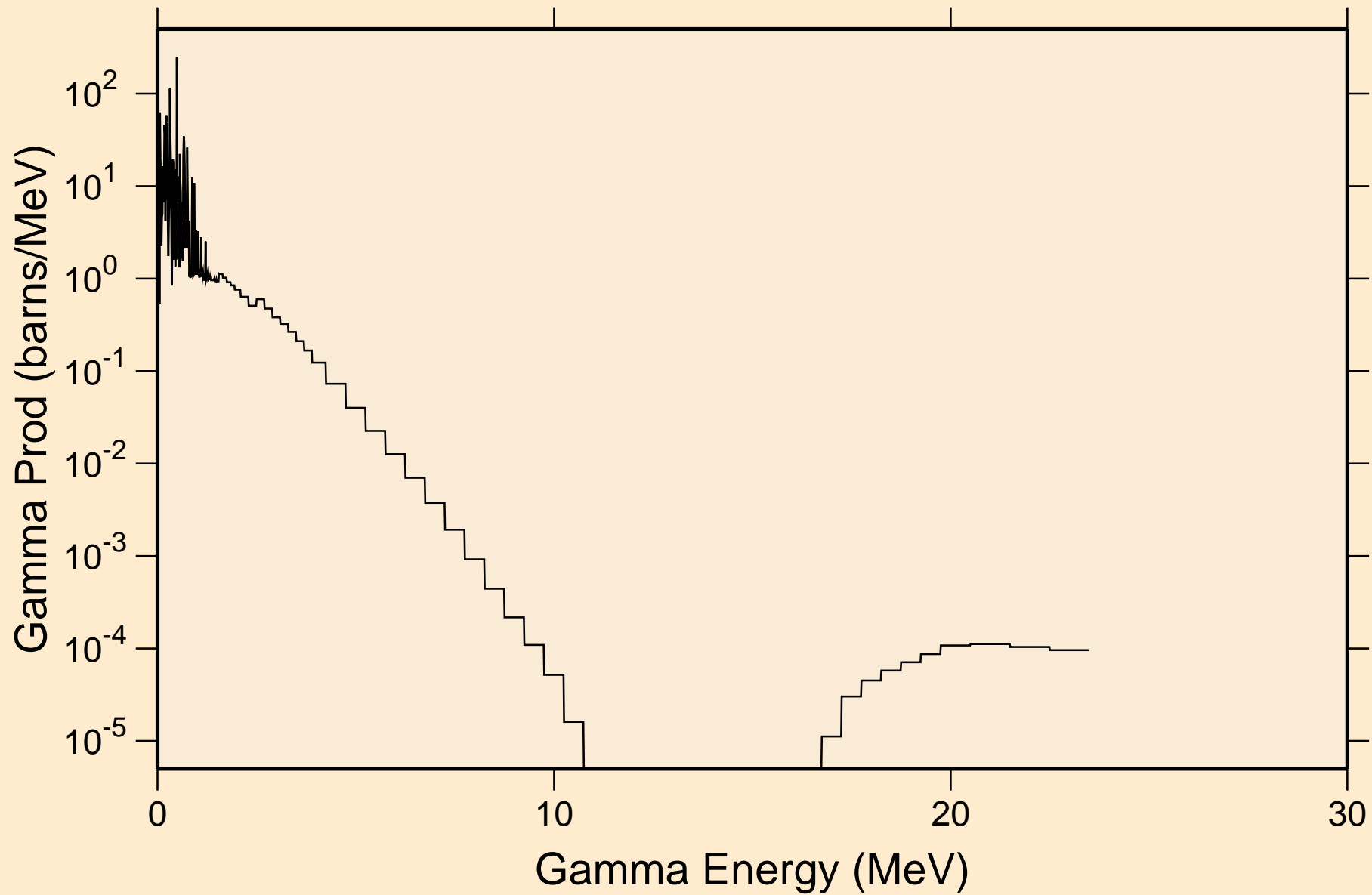



# ER147 NRG TENDL-2015, AKONING

## Particle heating contributions

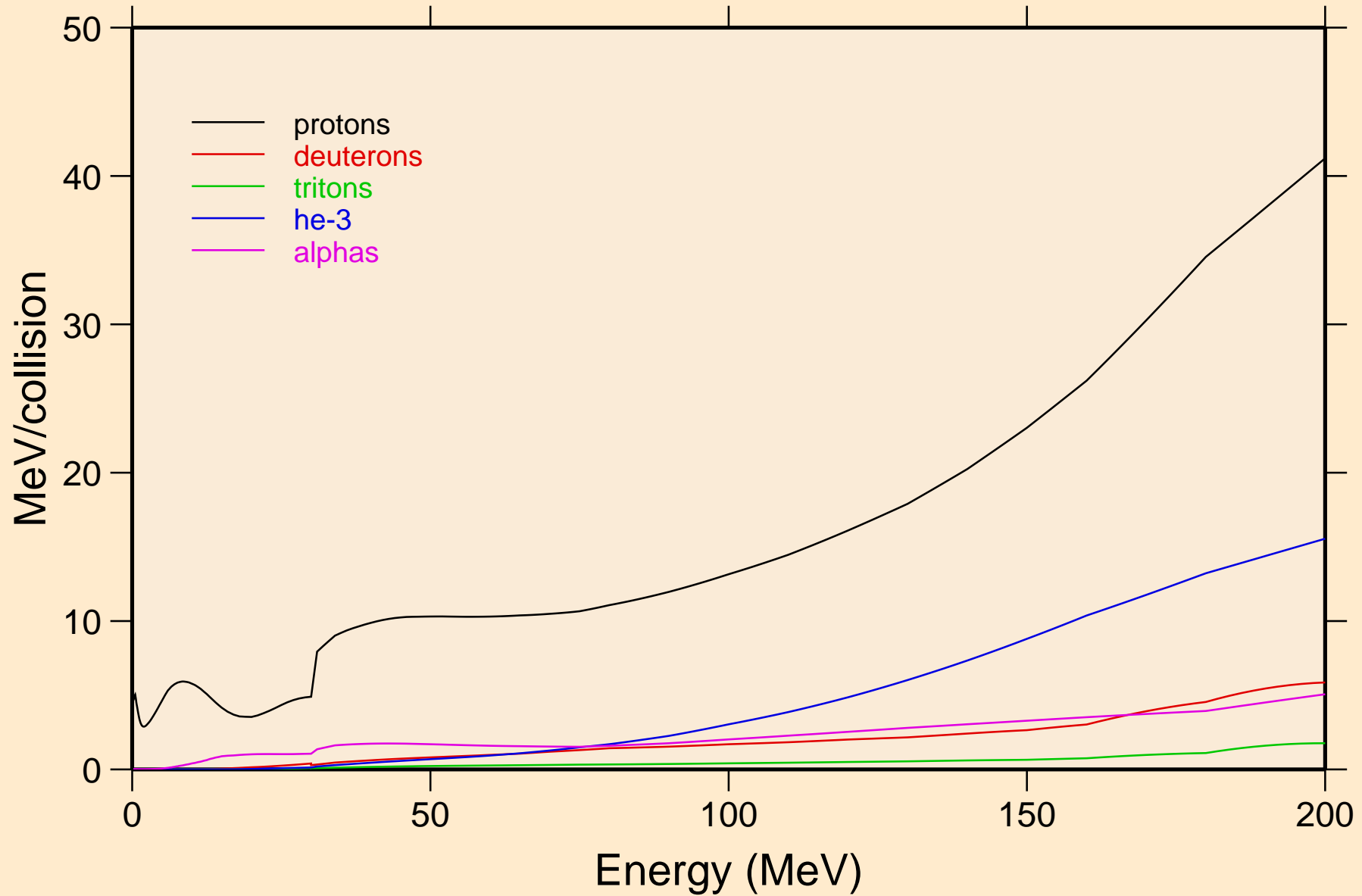

# ER147 NRG TENDL-2015, AKONING

## Recoil Heating

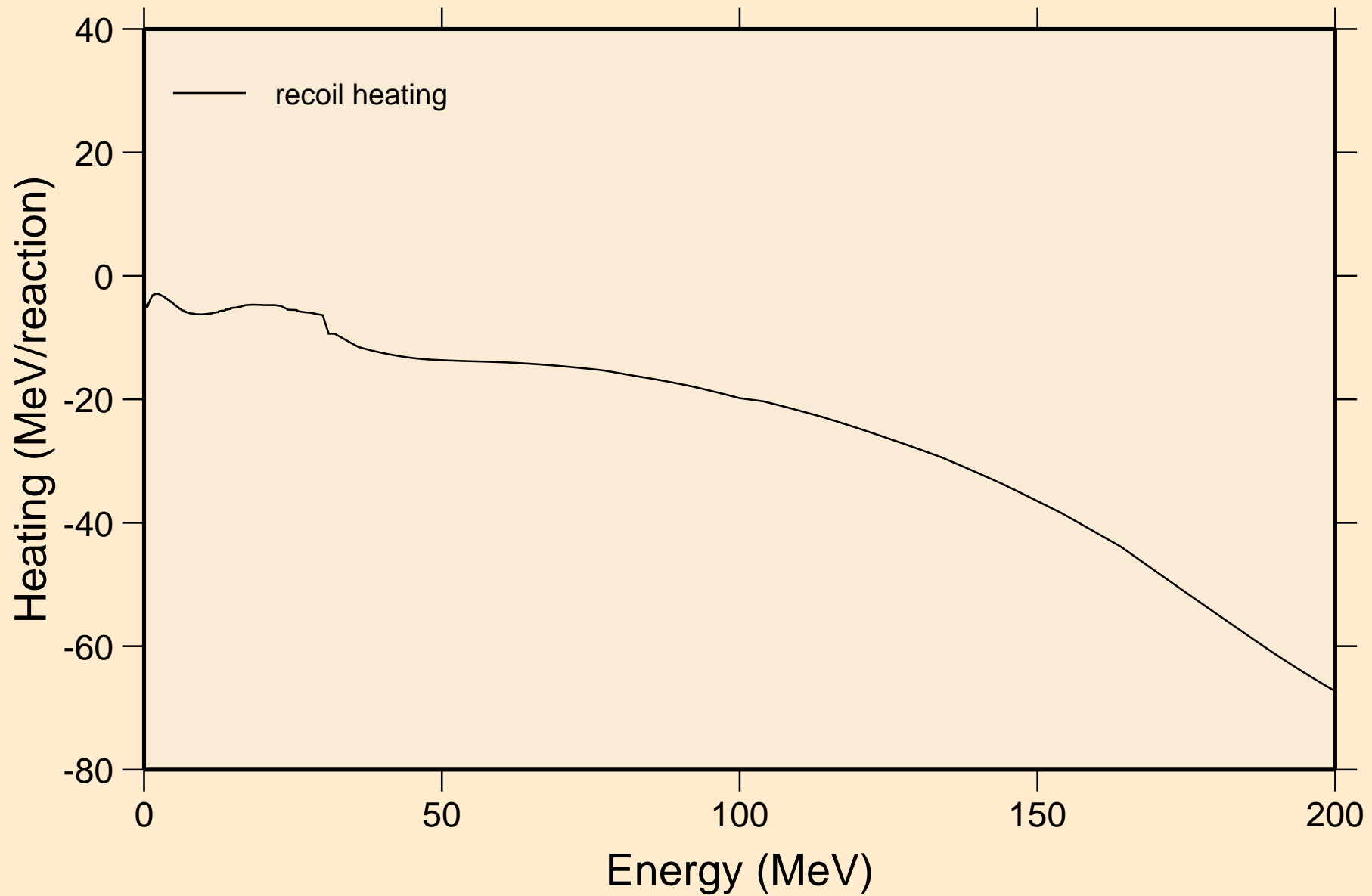

# ER147 NRG TENDL-2015, AKONING

## Particle production cross sections

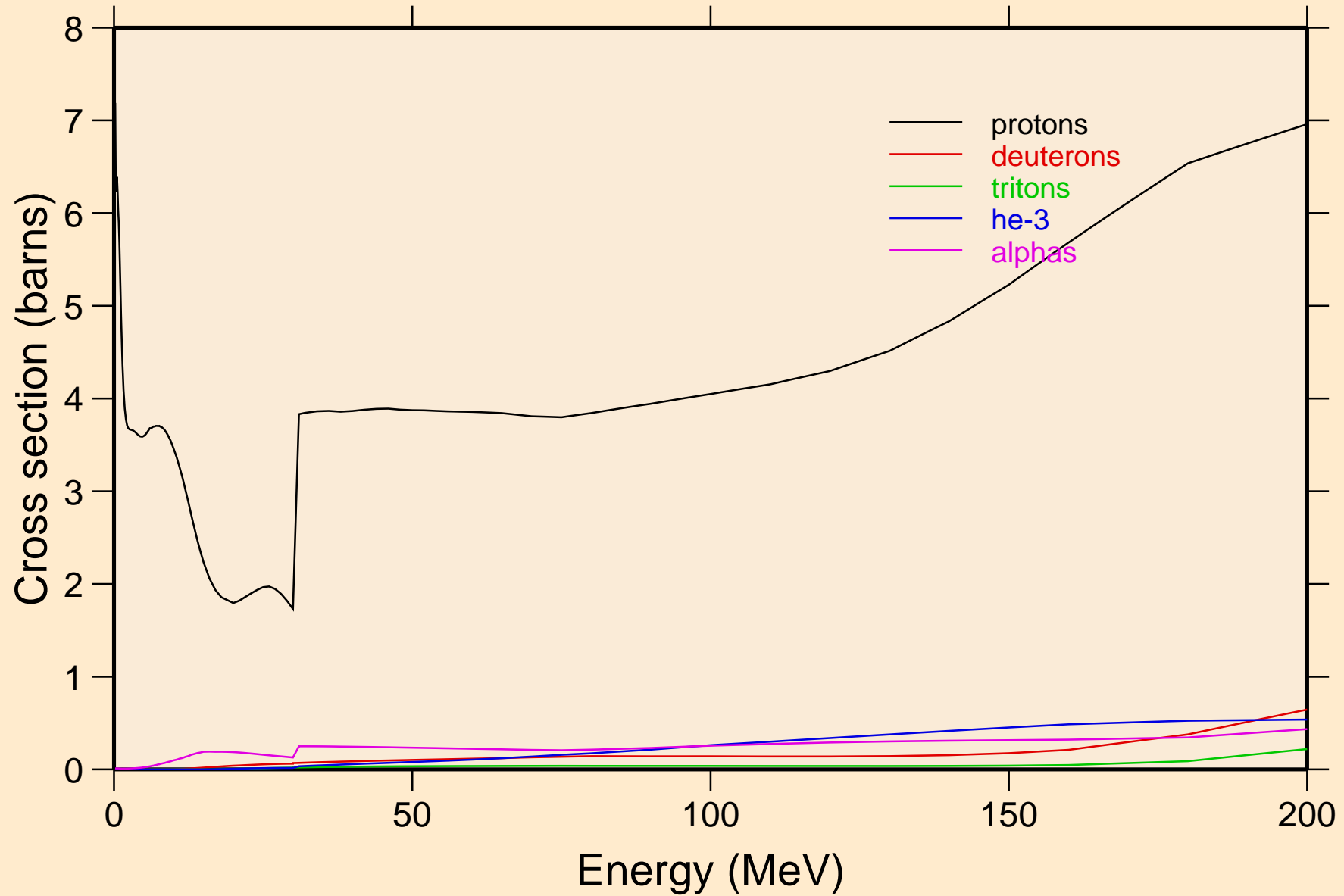

ER147 NRG TENDL-2015, AKONING  
protons from (n,x)

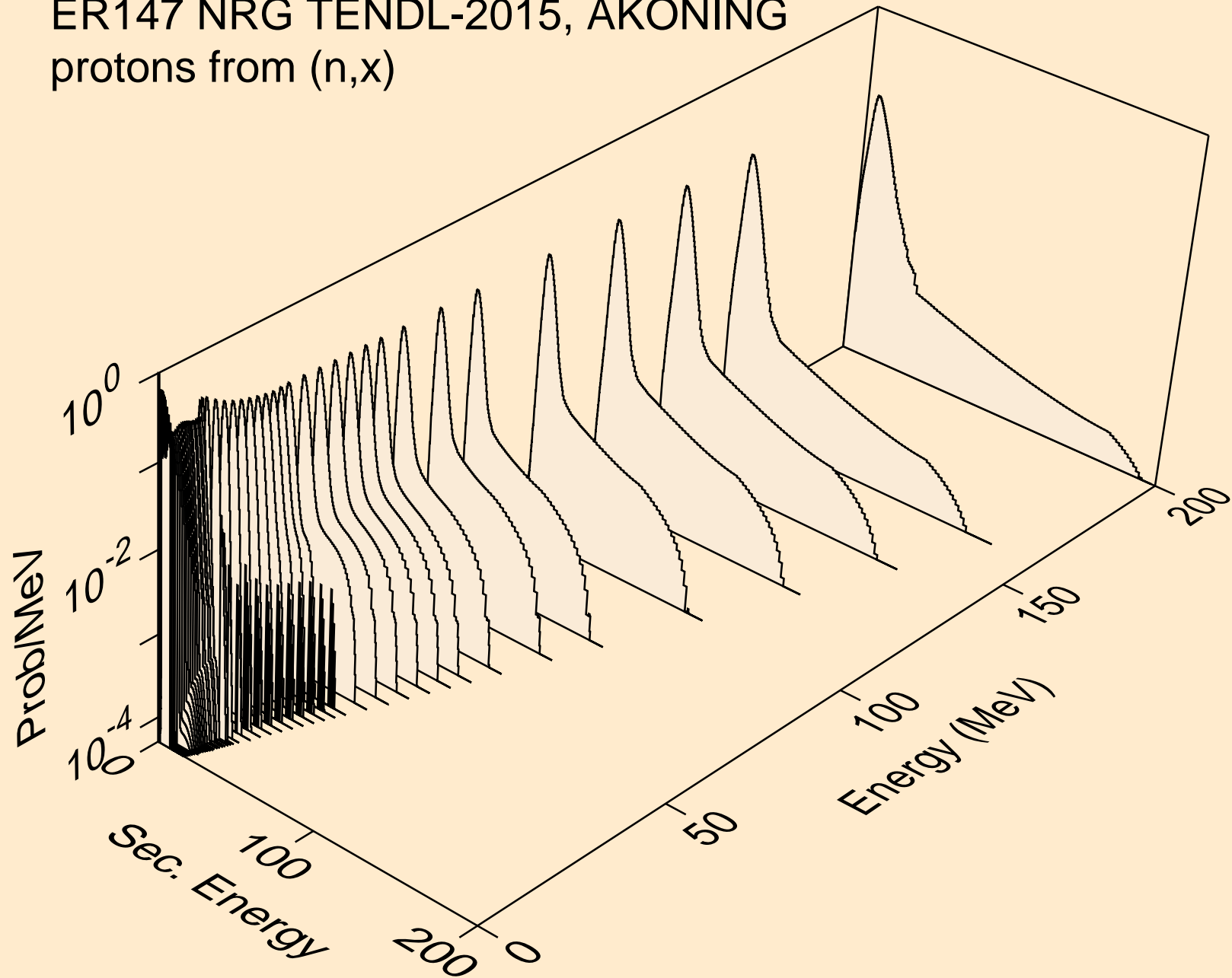

ER147 NRG TENDL-2015, AKONING  
protons from (n,n\*)p

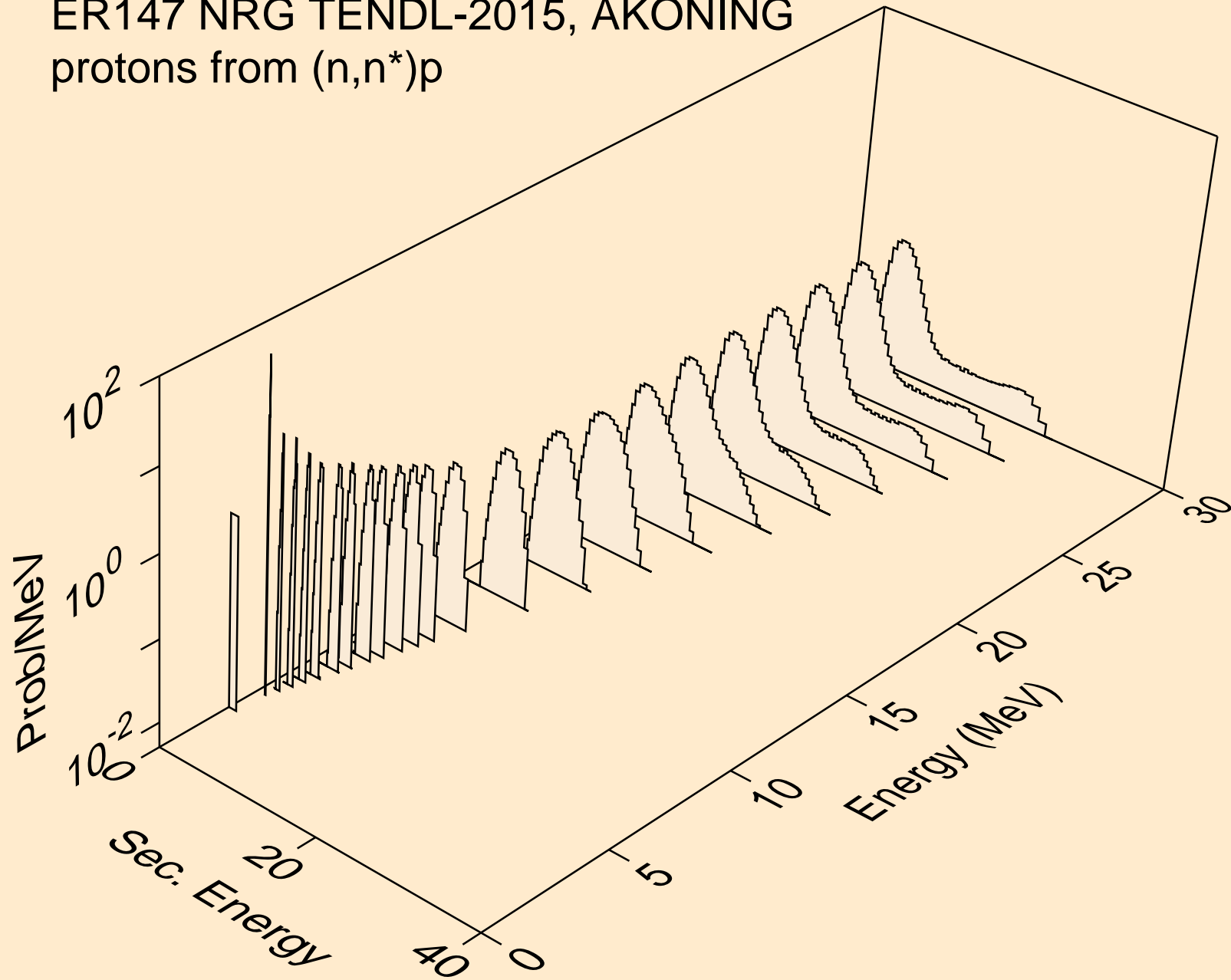

ER147 NRG TENDL-2015, AKONING  
protons from (n,2np)

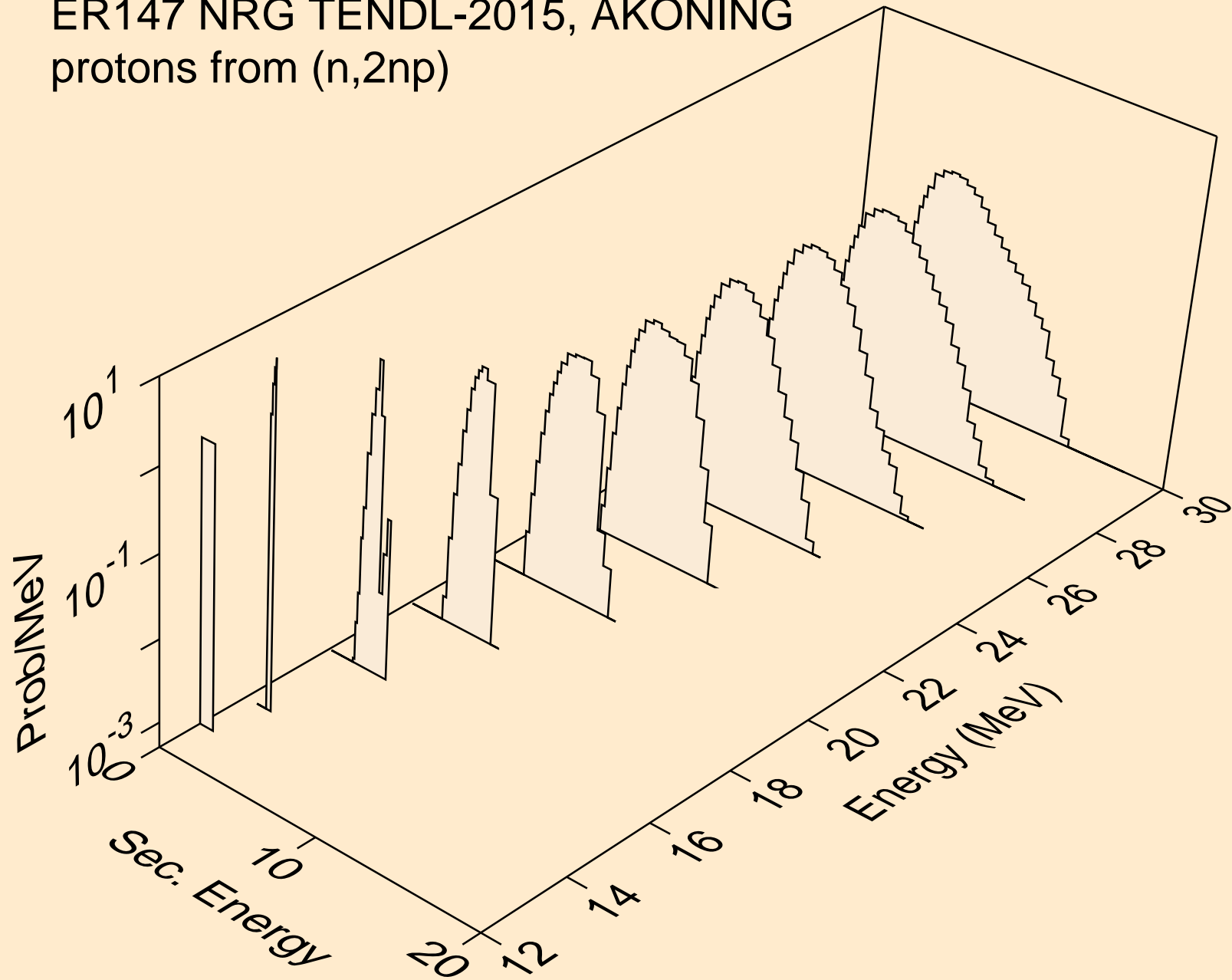

ER147 NRG TENDL-2015, AKONING  
protons from (n,3np)

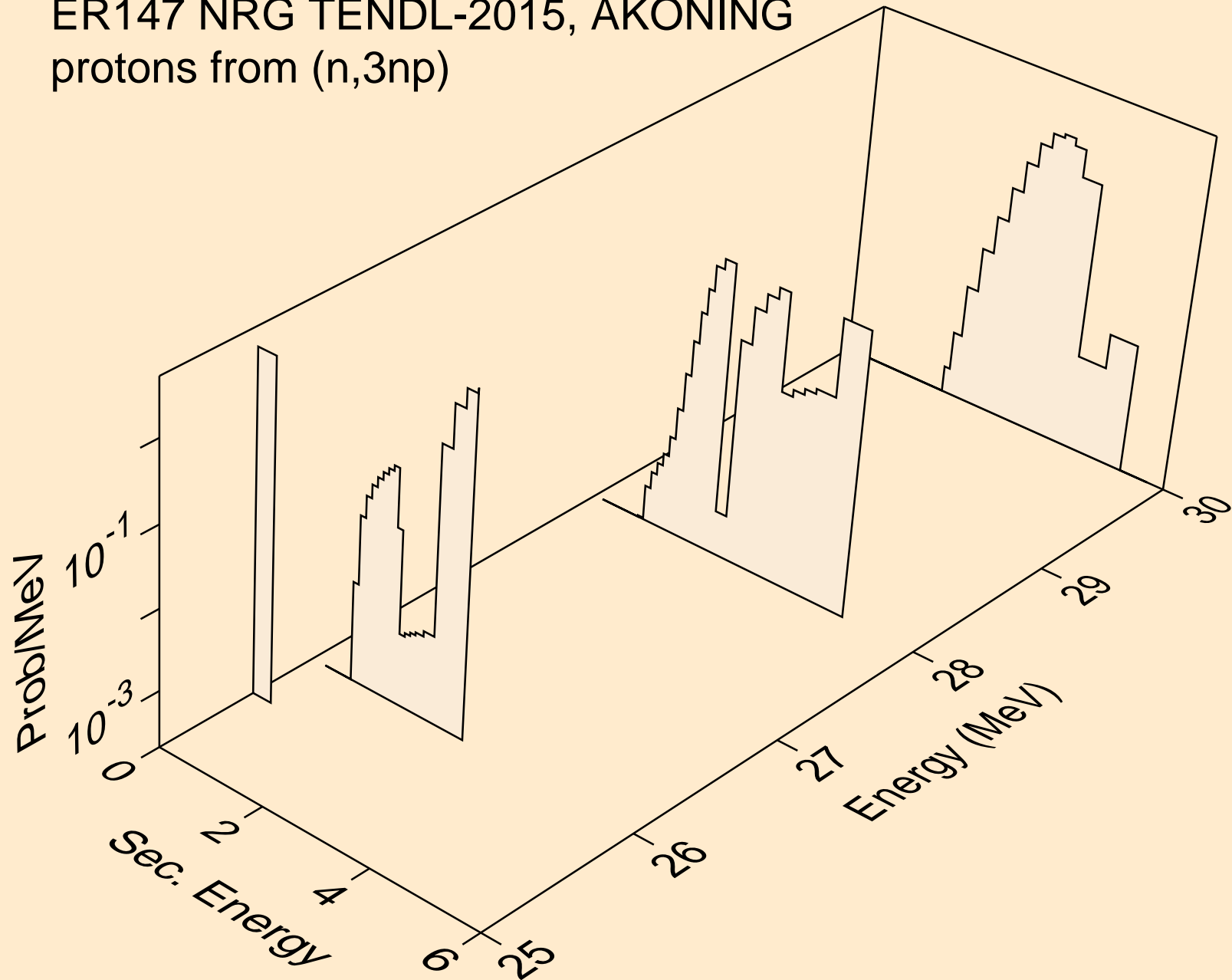

ER147 NRG TENDL-2015, AKONING  
protons from (n,2np)

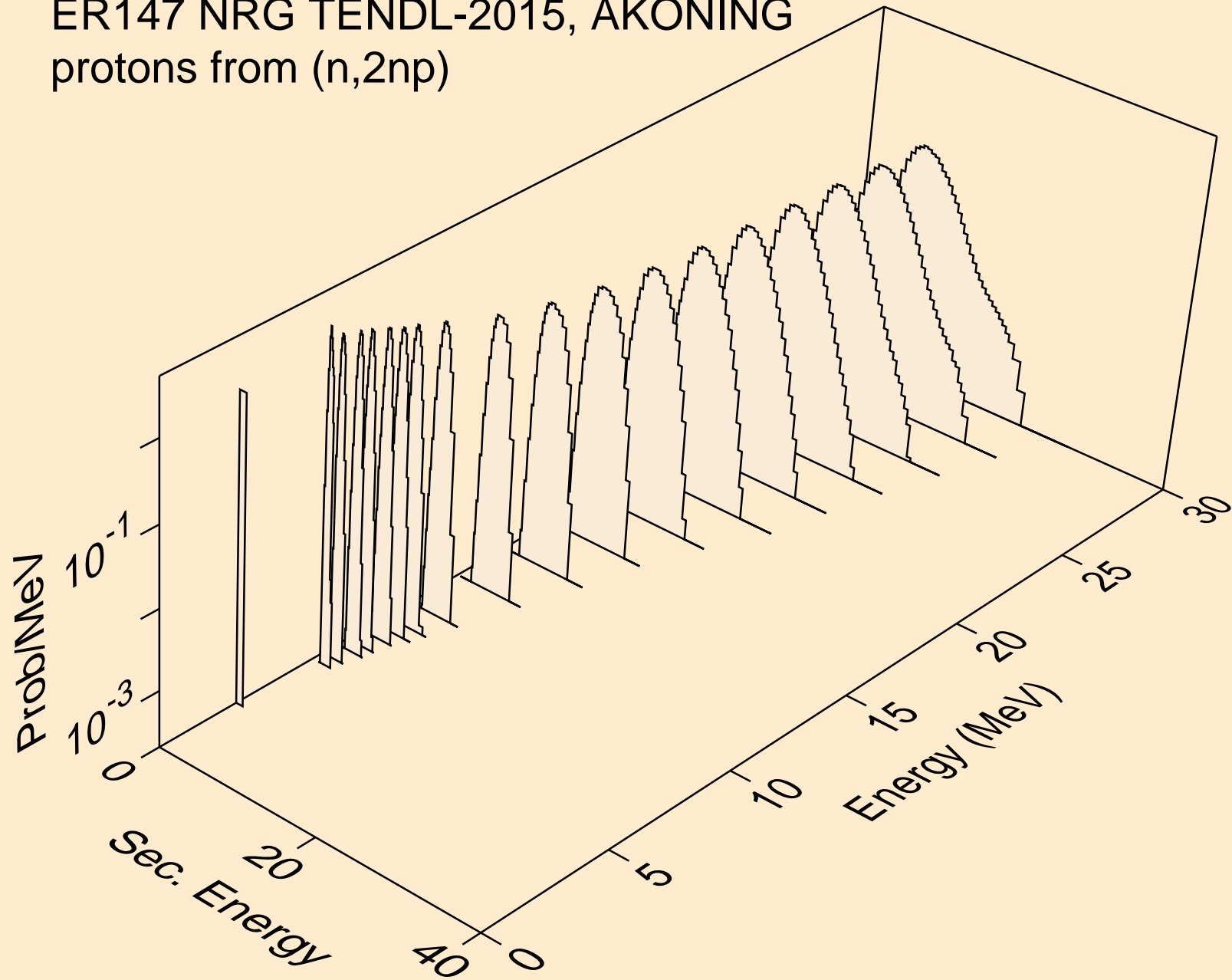



ER147 NRG TENDL-2015, AKONING  
protons from (n,npa)

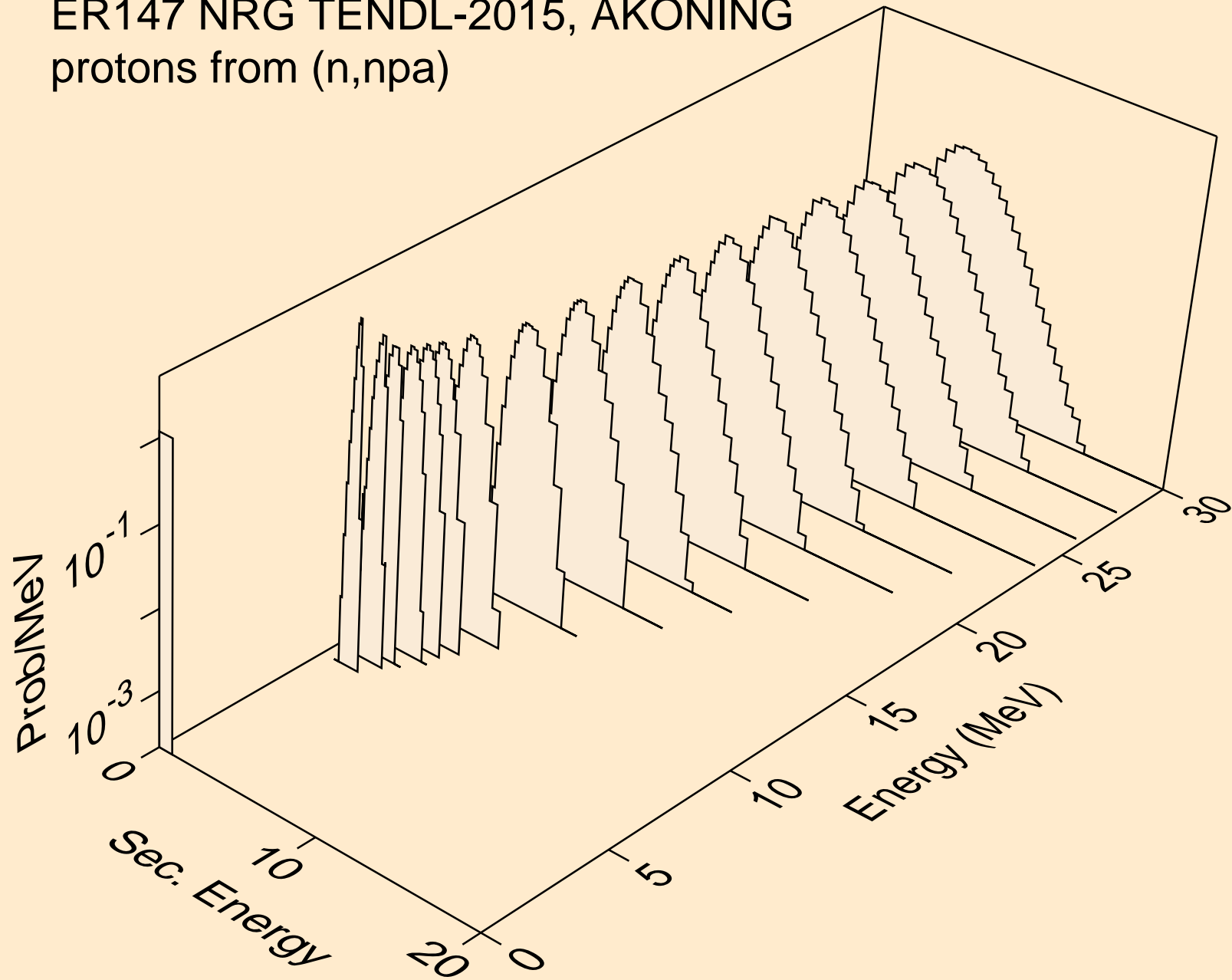

ER147 NRG TENDL-2015, AKONING  
protons from (n,p)

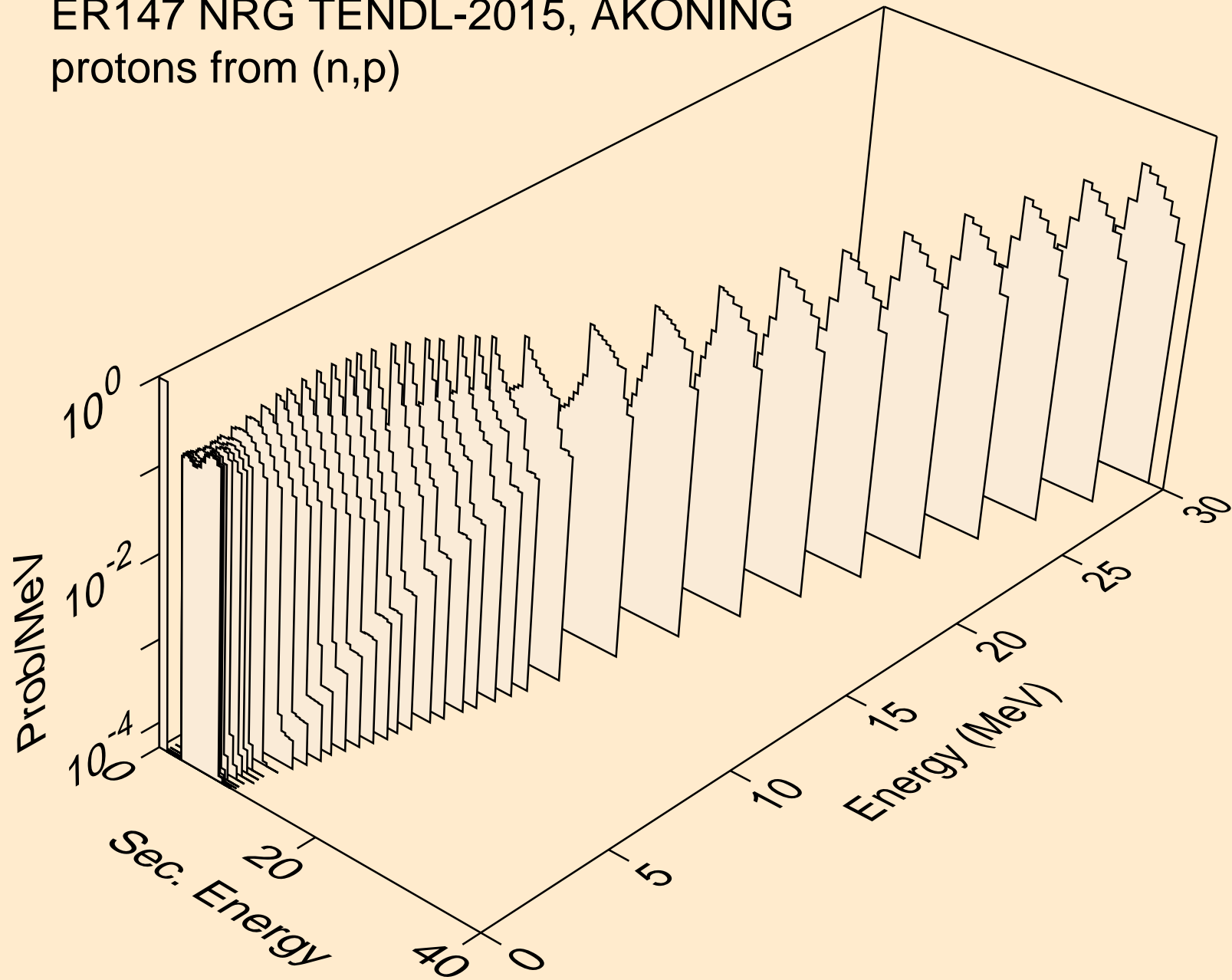

ER147 NRG TENDL-2015, AKONING  
protons from (n,2p)

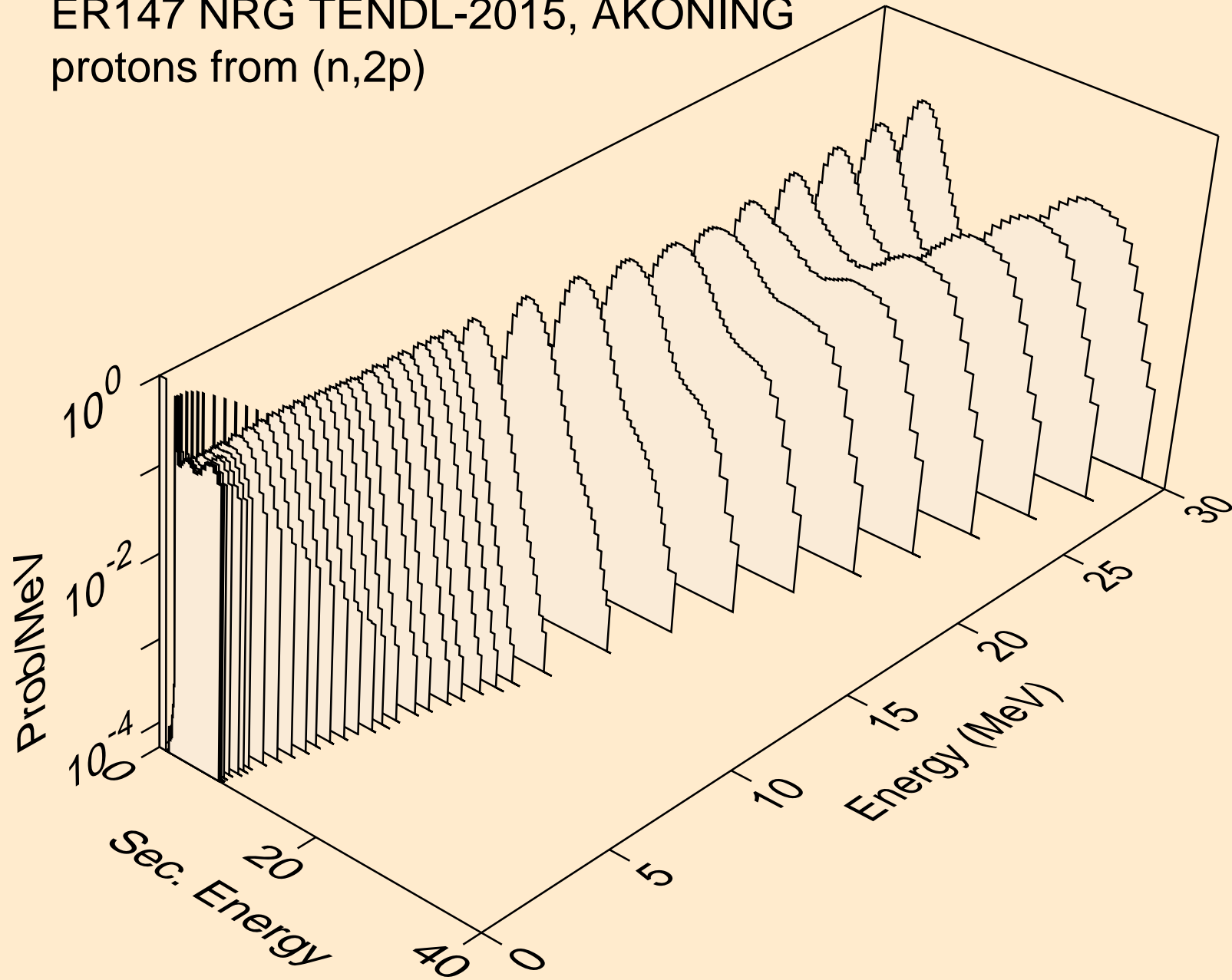

ER147 NRG TENDL-2015, AKONING  
protons from (n,pa)

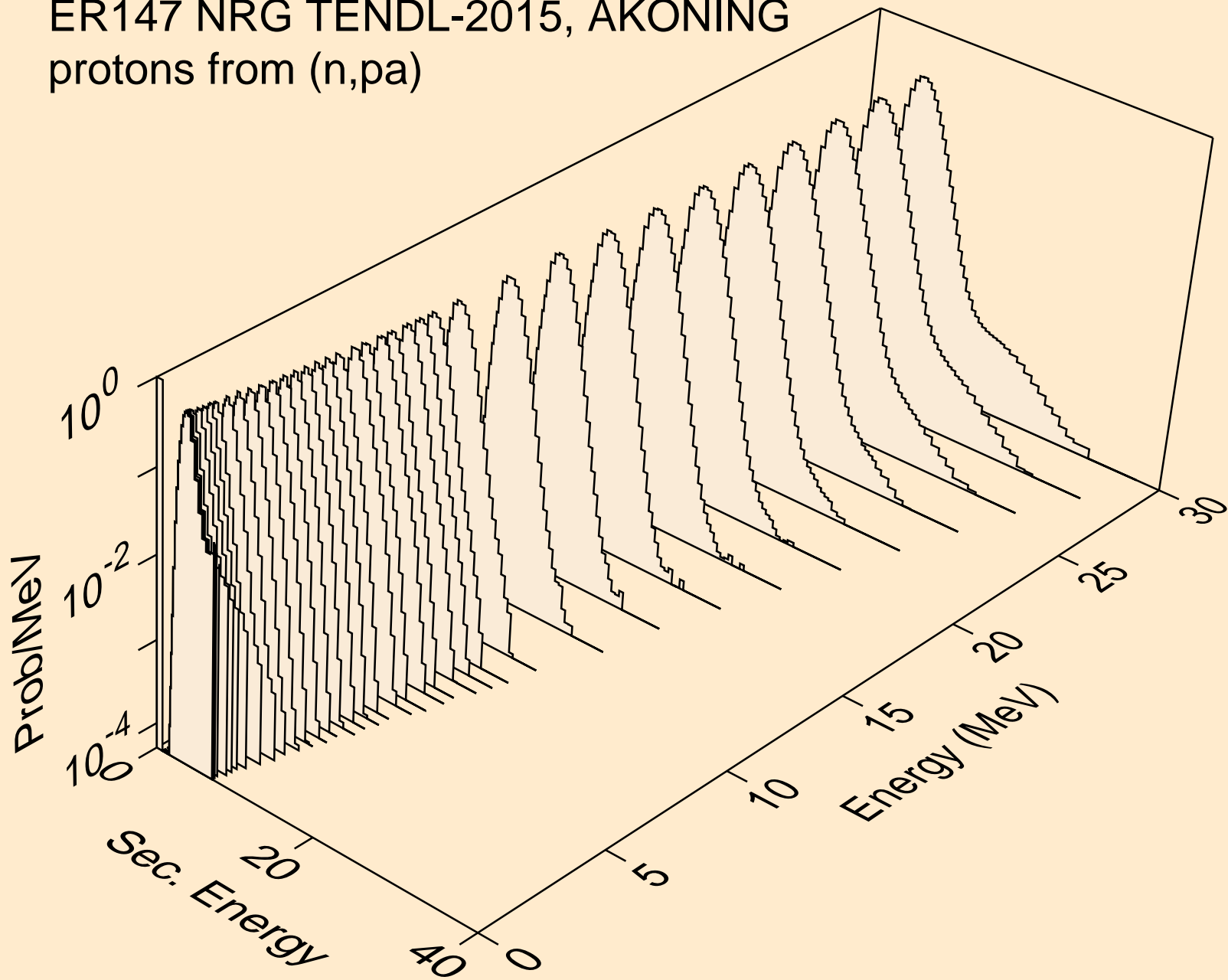

ER147 NRG TENDL-2015, AKONING  
protons from (n,pd)

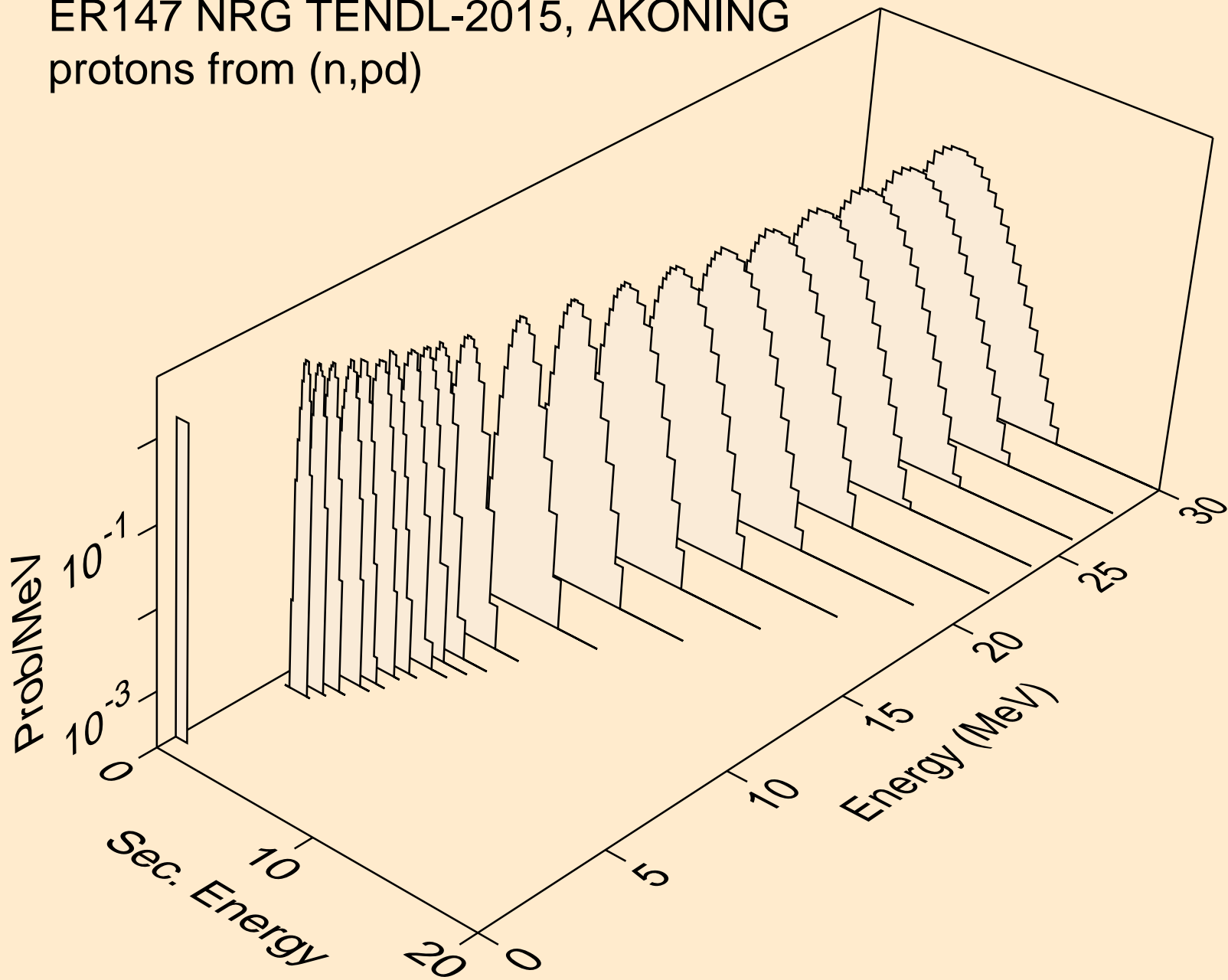

ER147 NRG TENDL-2015, AKONING  
protons from (n,pt)

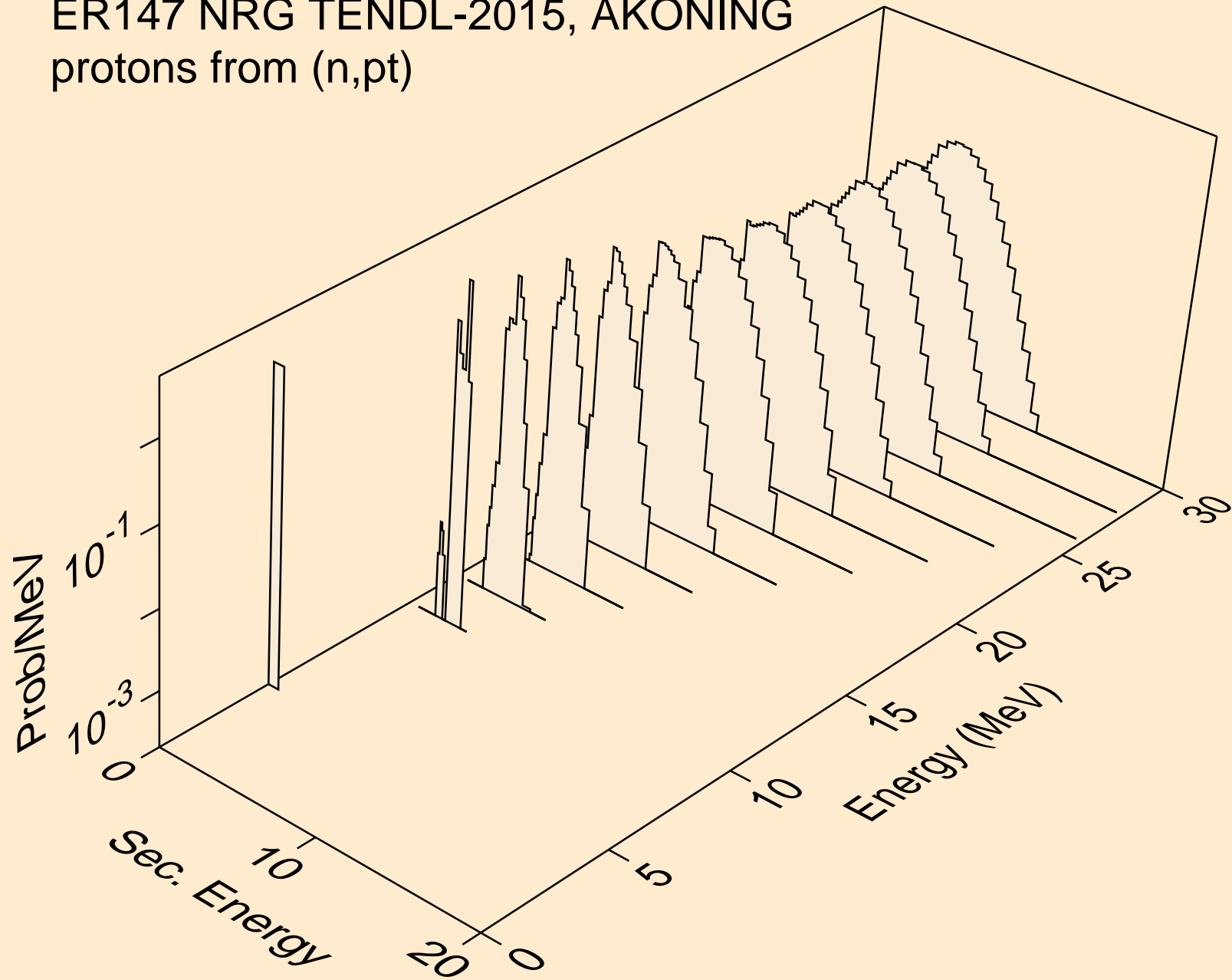

ER147 NRG TENDL-2015, AKONING  
deuterons from (n,x)

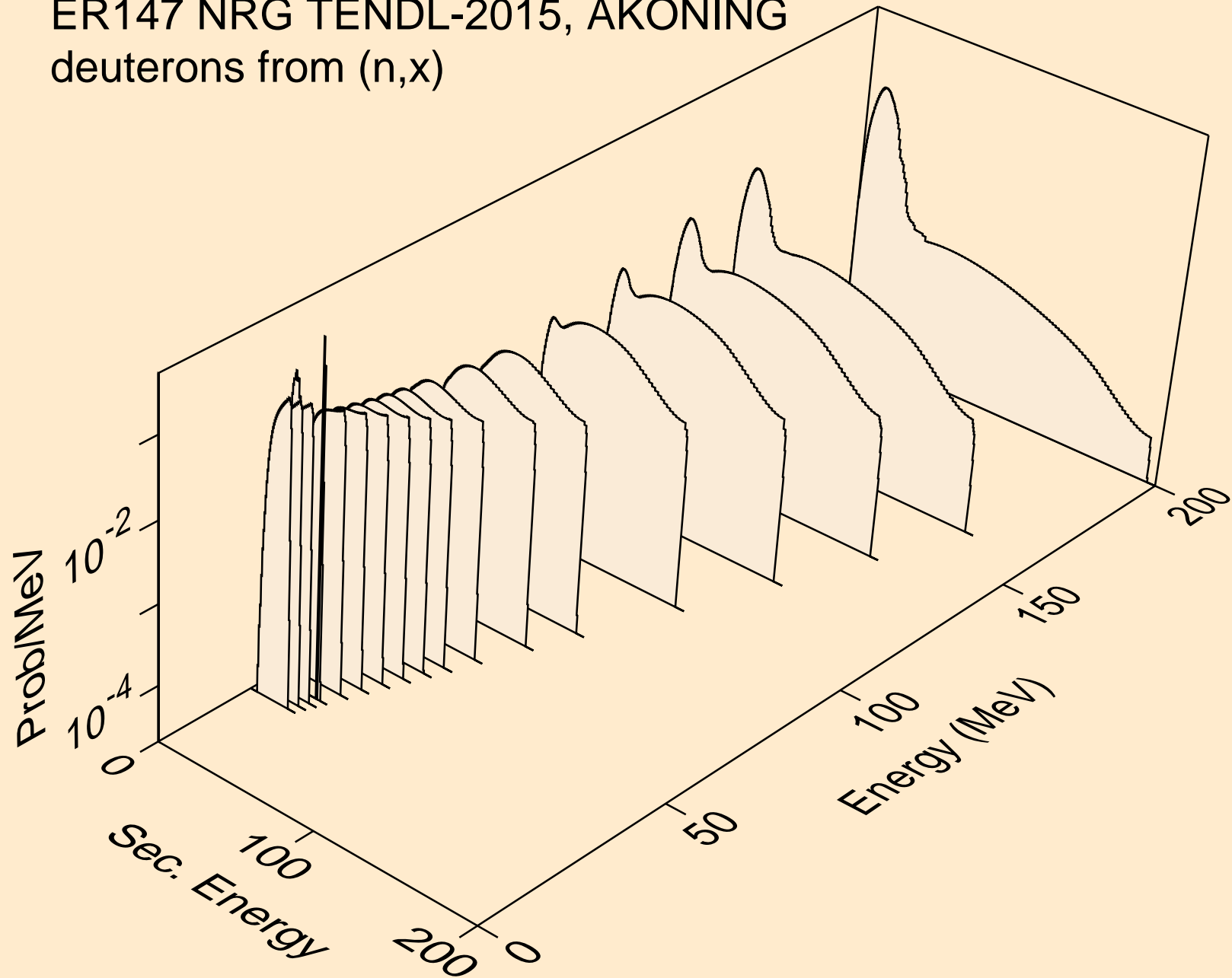

ER147 NRG TENDL-2015, AKONING  
deuterons from (n,2nd)

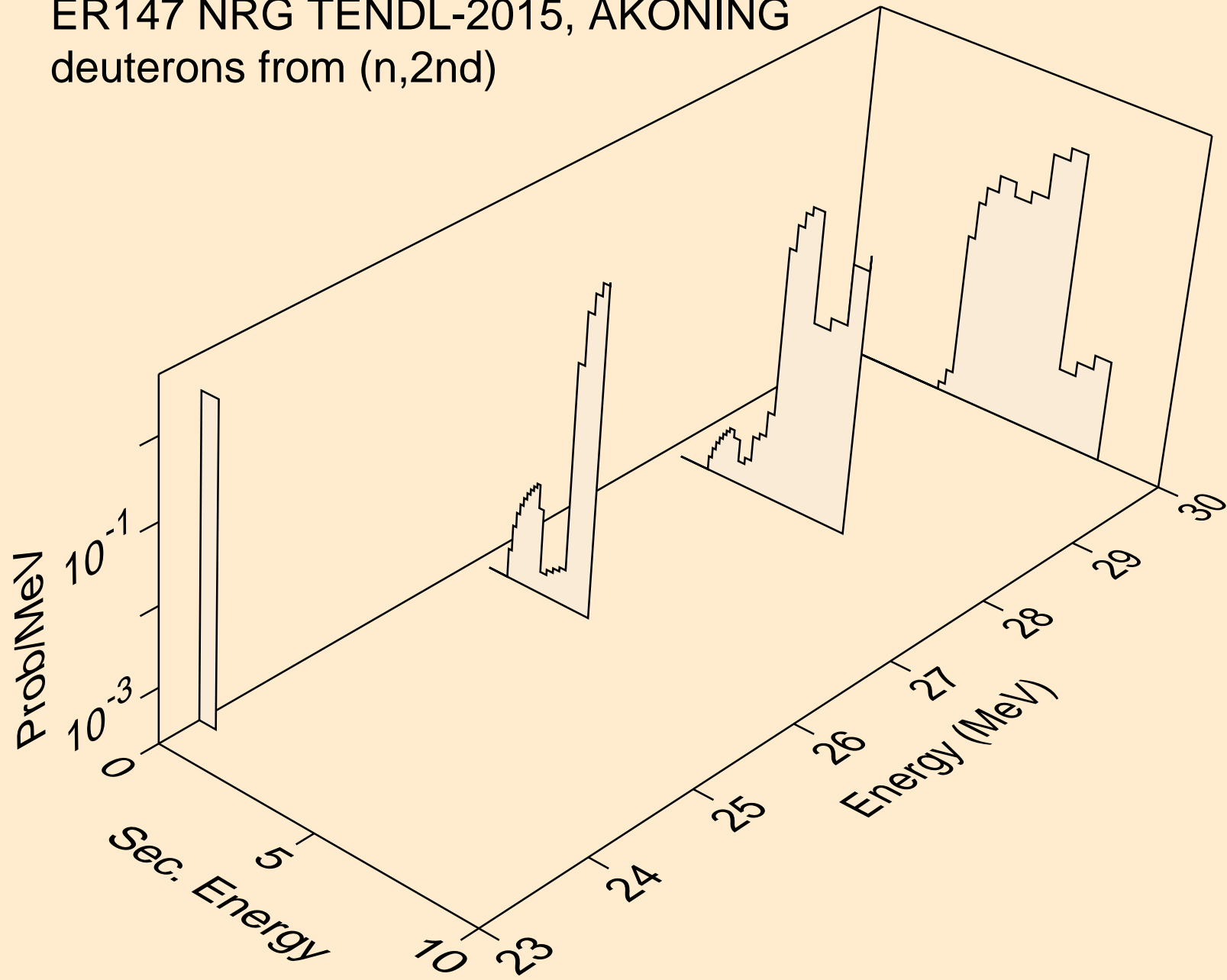



ER147 NRG TENDL-2015, AKONING  
deuterons from (n,n\*)d

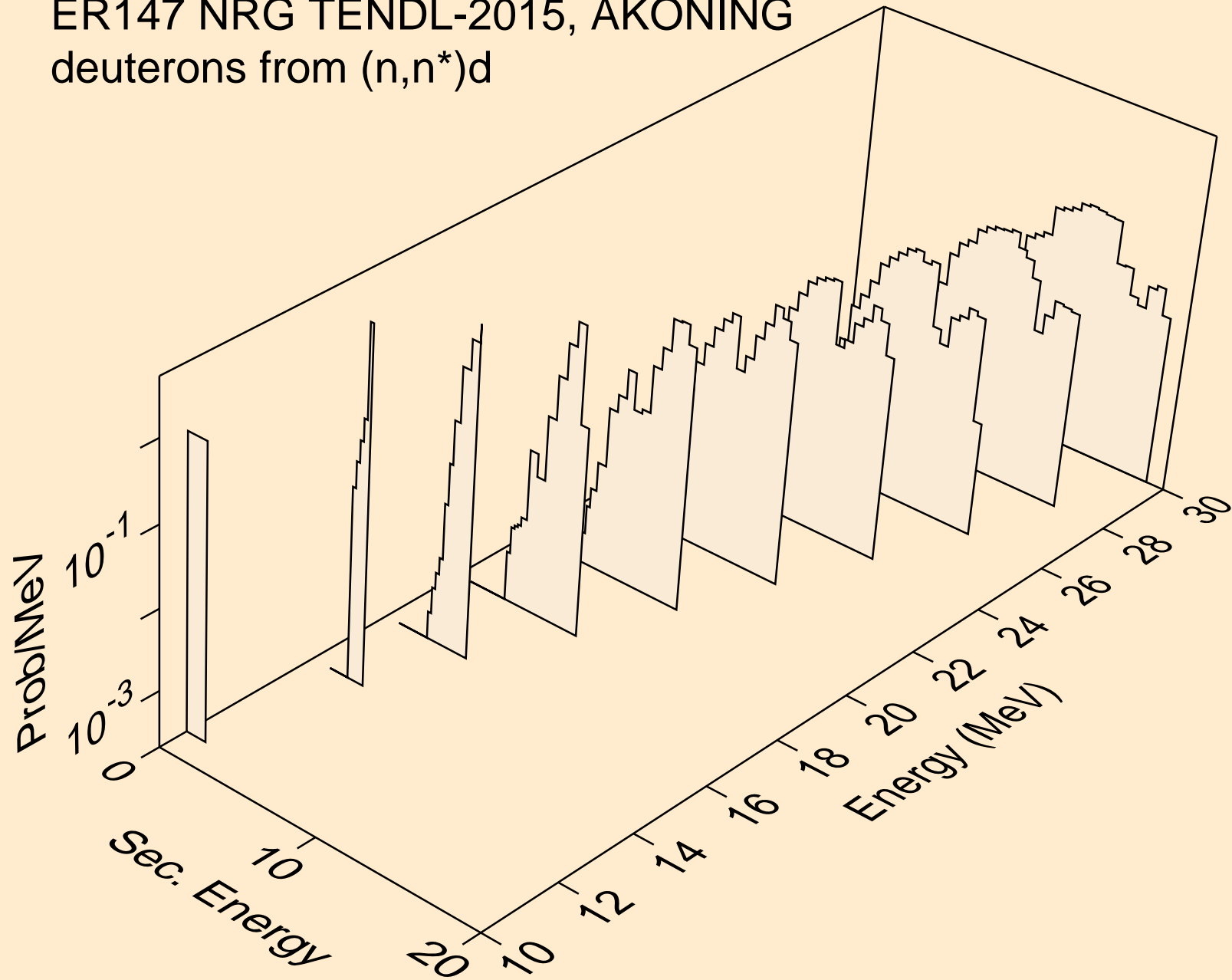

ER147 NRG TENDL-2015, AKONING  
deuterons from (n,d)

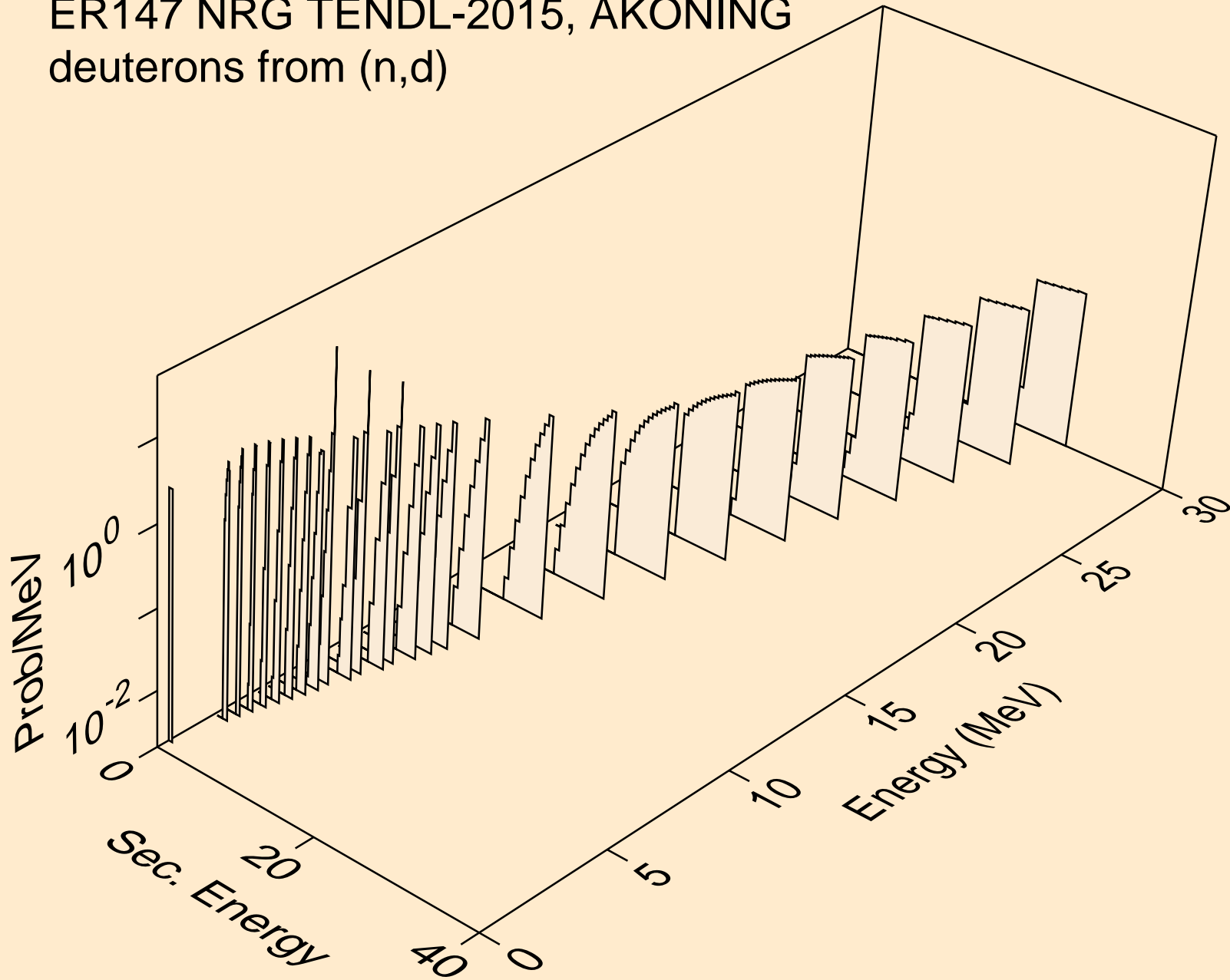

ER147 NRG TENDL-2015, AKONING  
deuterons from (n,d2a)

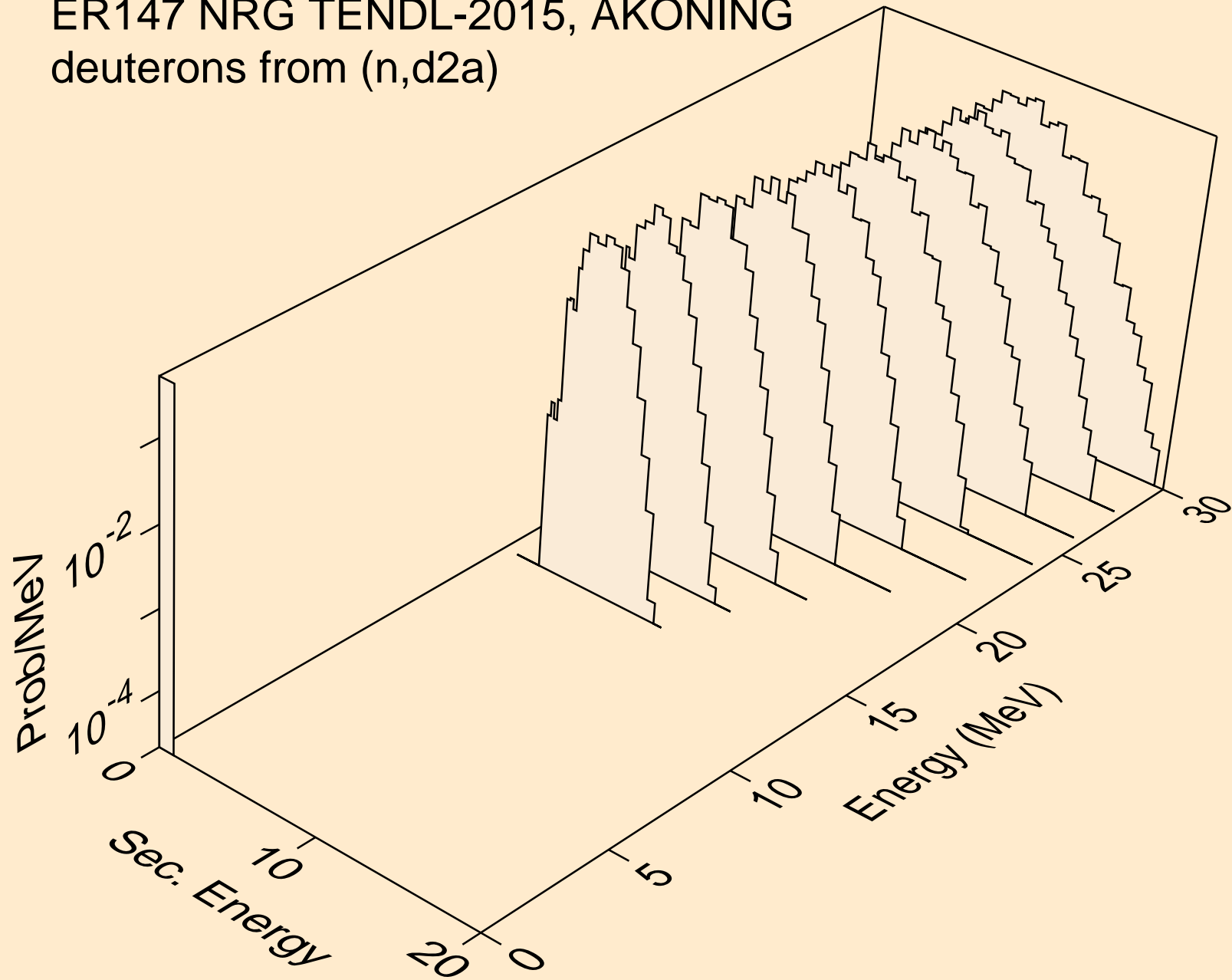

ER147 NRG TENDL-2015, AKONING  
deuterons from (n,pd)

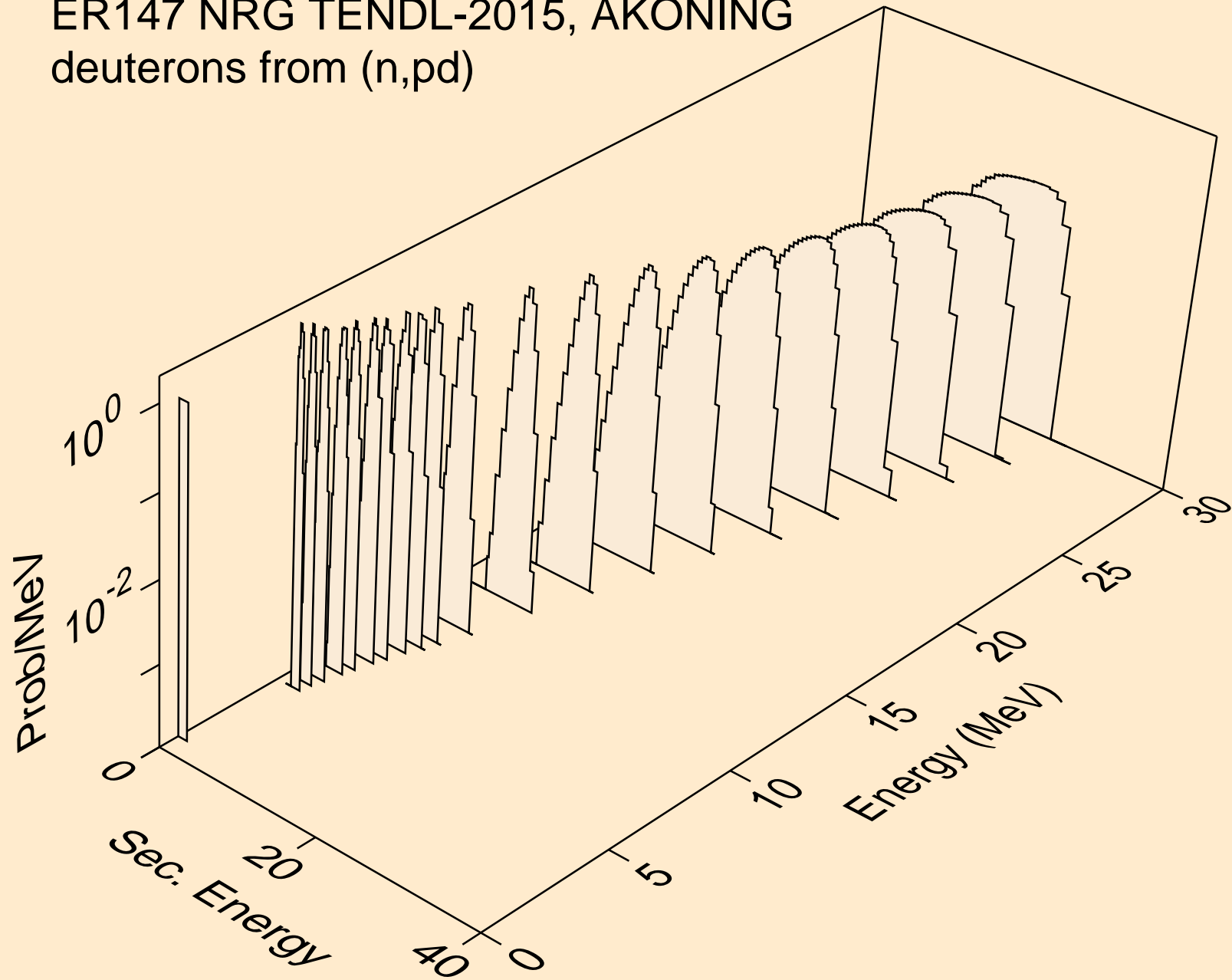

ER147 NRG TENDL-2015, AKONING  
deuterons from (n,da)

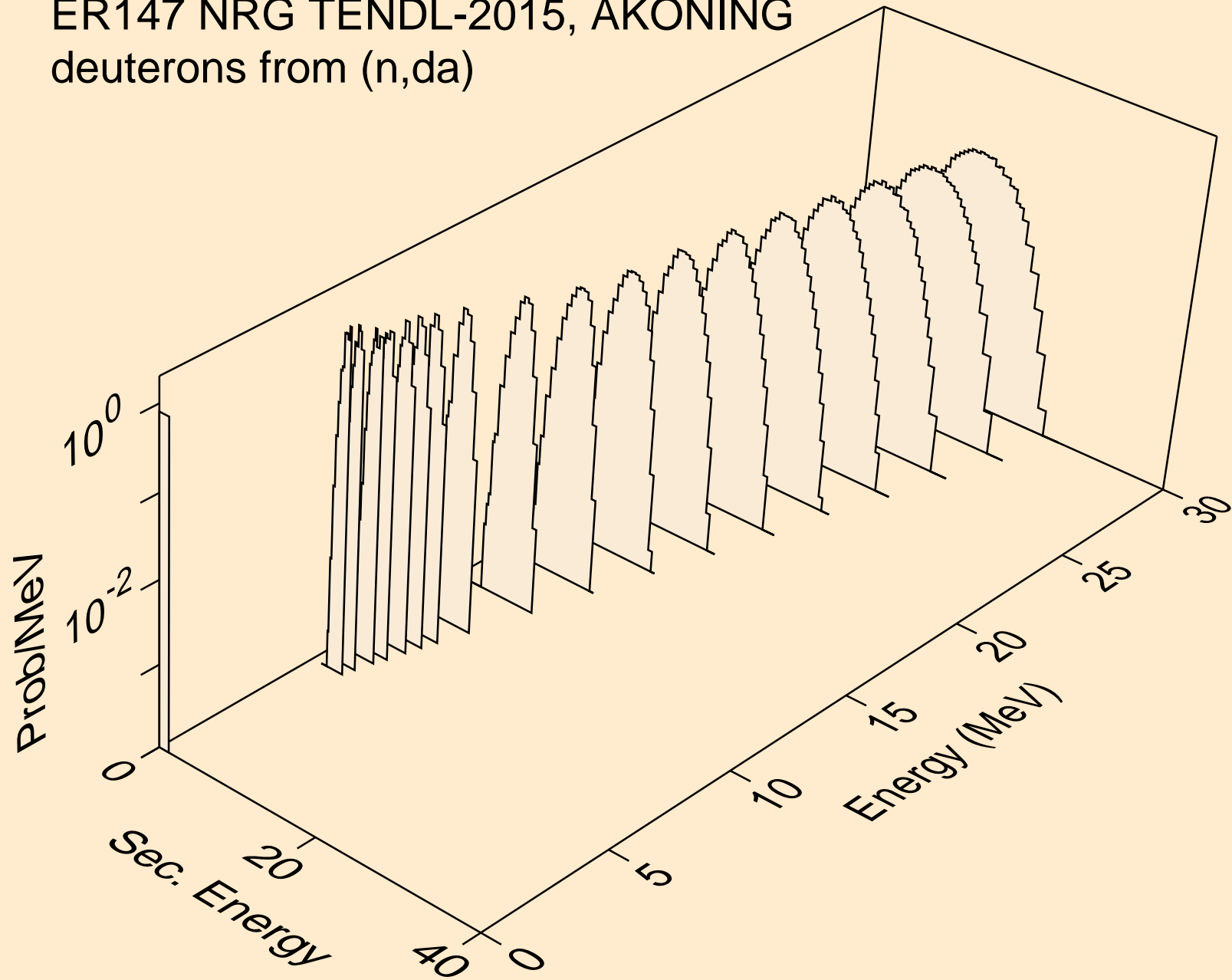

ER147 NRG TENDL-2015, AKONING  
tritons from (n,x)

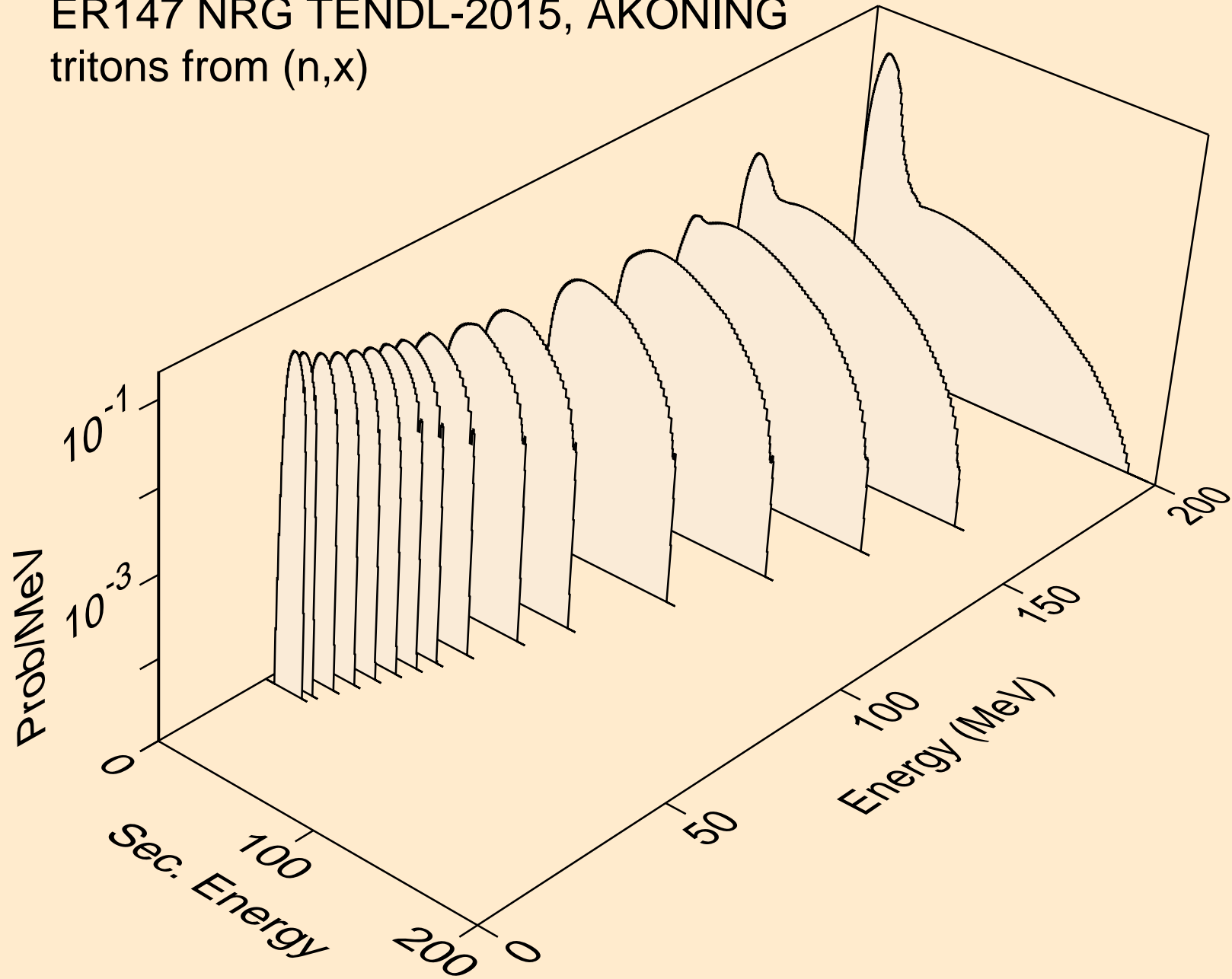

ER147 NRG TENDL-2015, AKONING  
tritons from (n,n\*)t

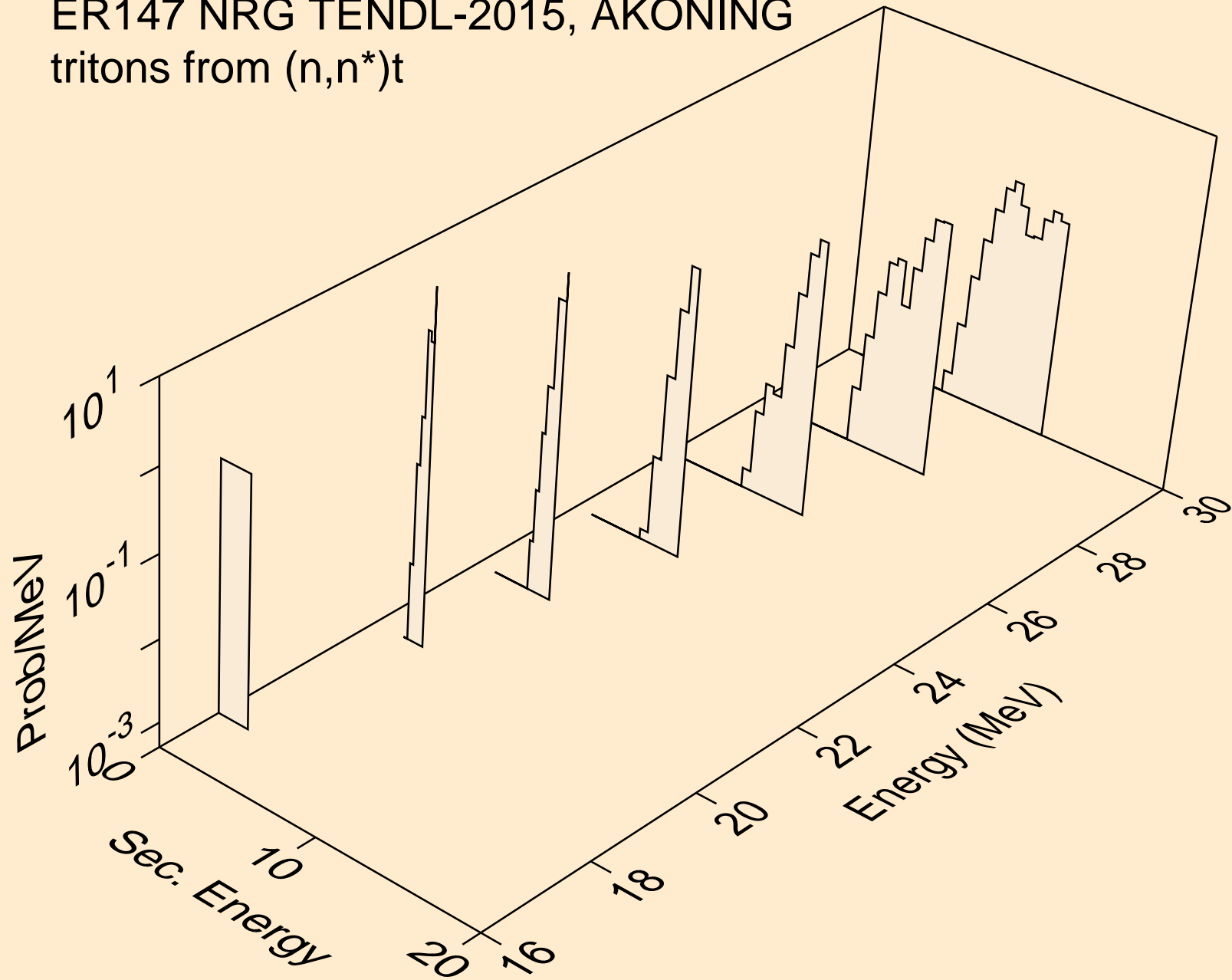

ER147 NRG TENDL-2015, AKONING  
tritons from (n,t)

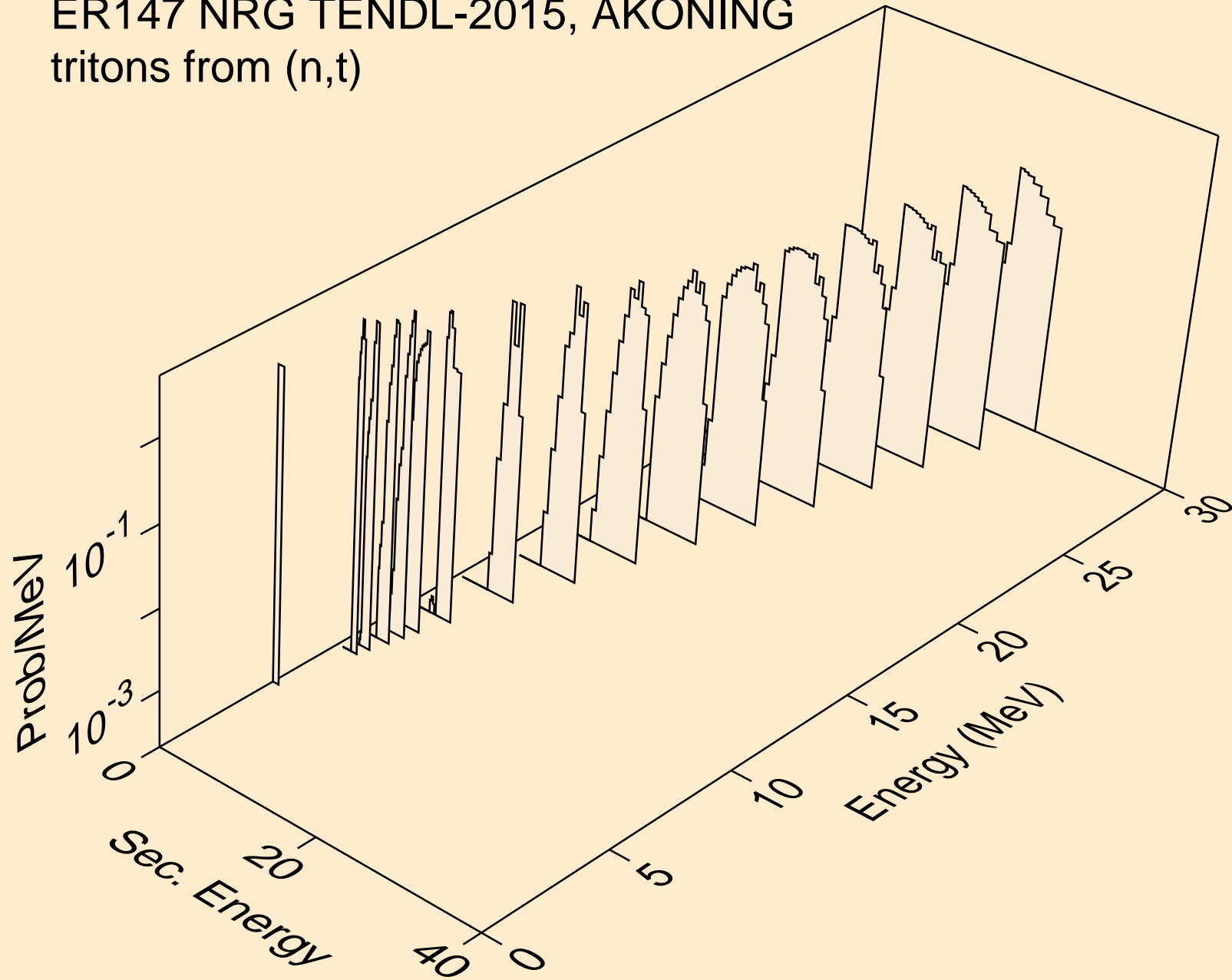



ER147 NRG TENDL-2015, AKONING  
tritons from (n,pt)

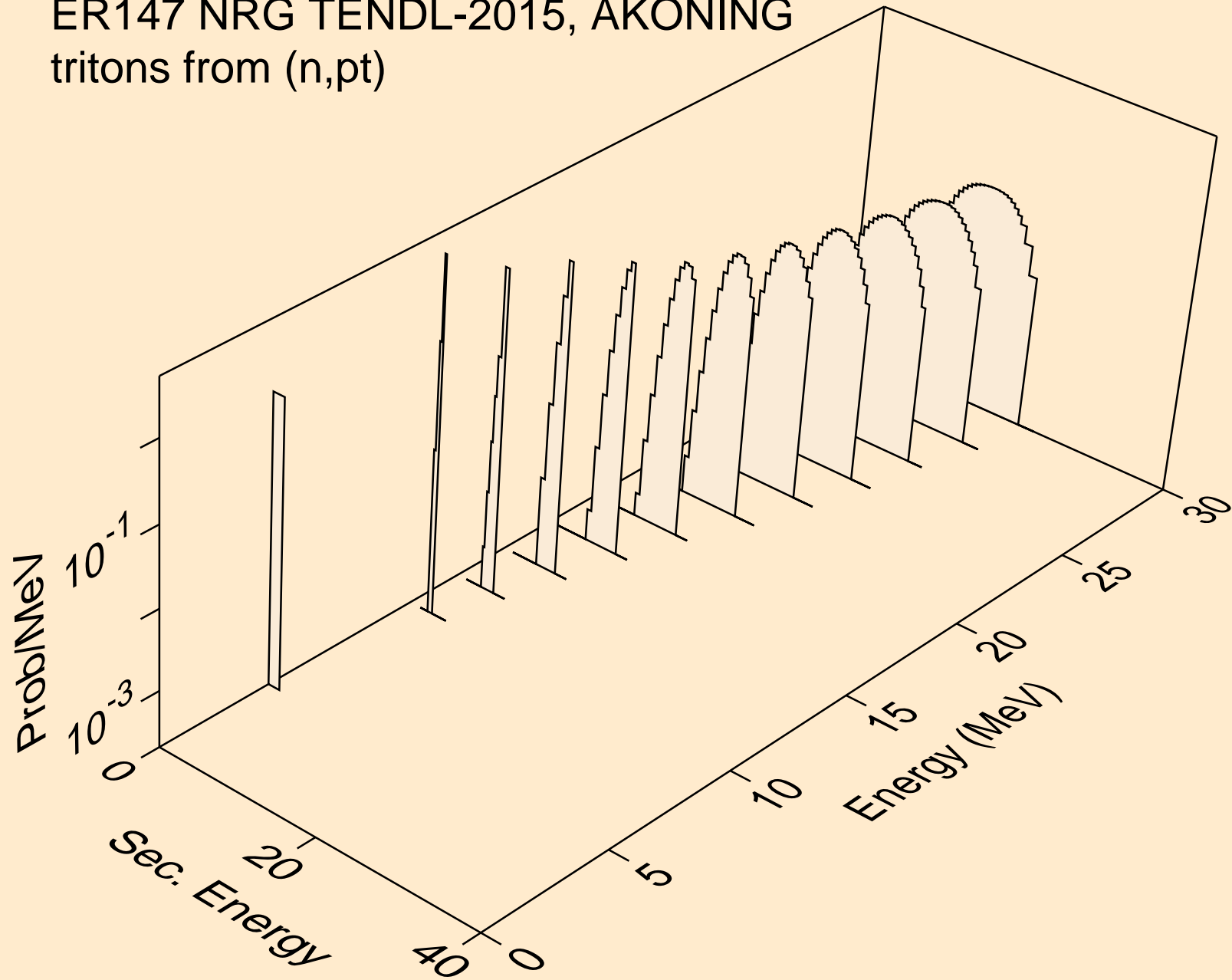

ER147 NRG TENDL-2015, AKONING  
he3s from (n,x)

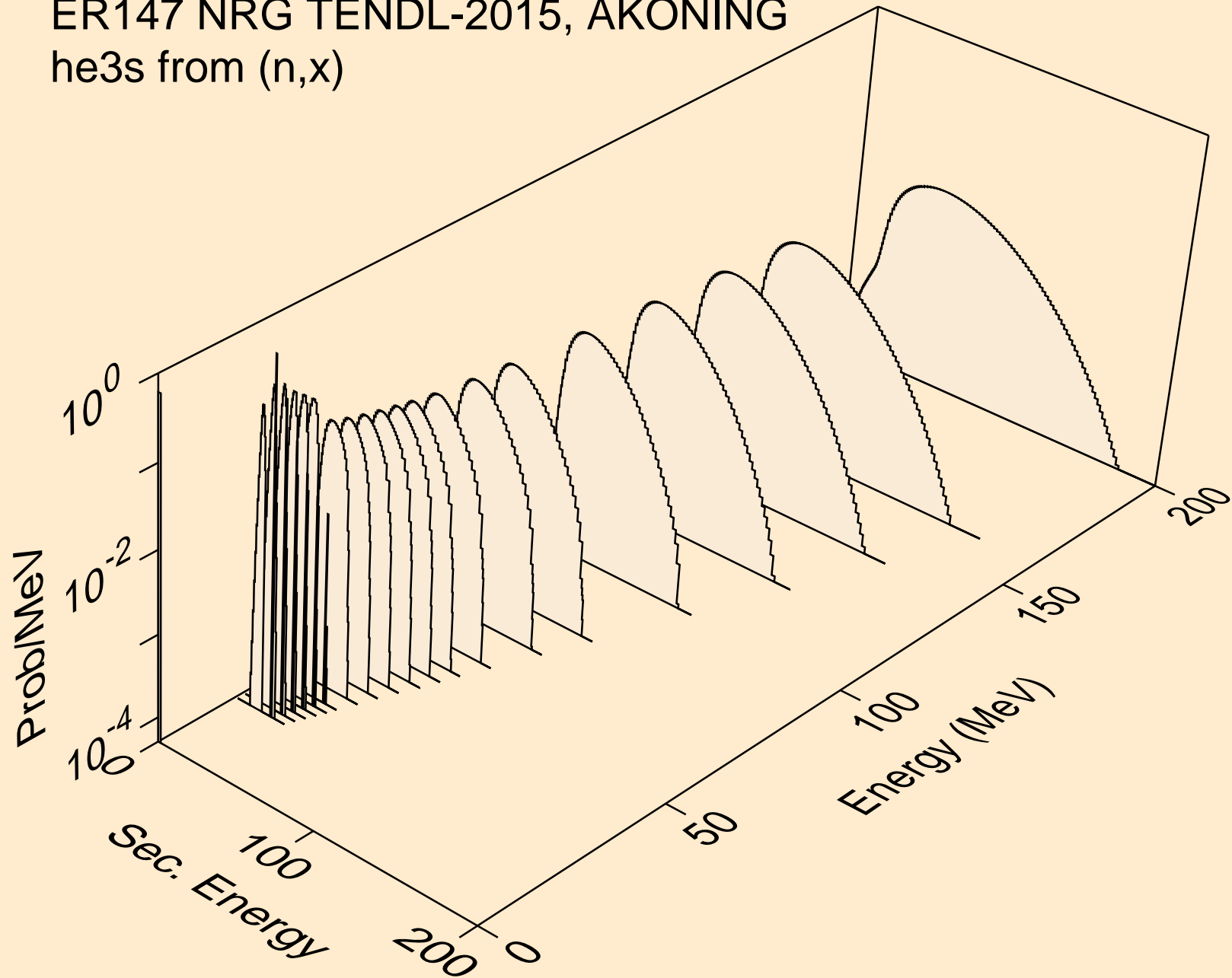

ER147 NRG TENDL-2015, AKONING  
he3s from (n,n\*)he3

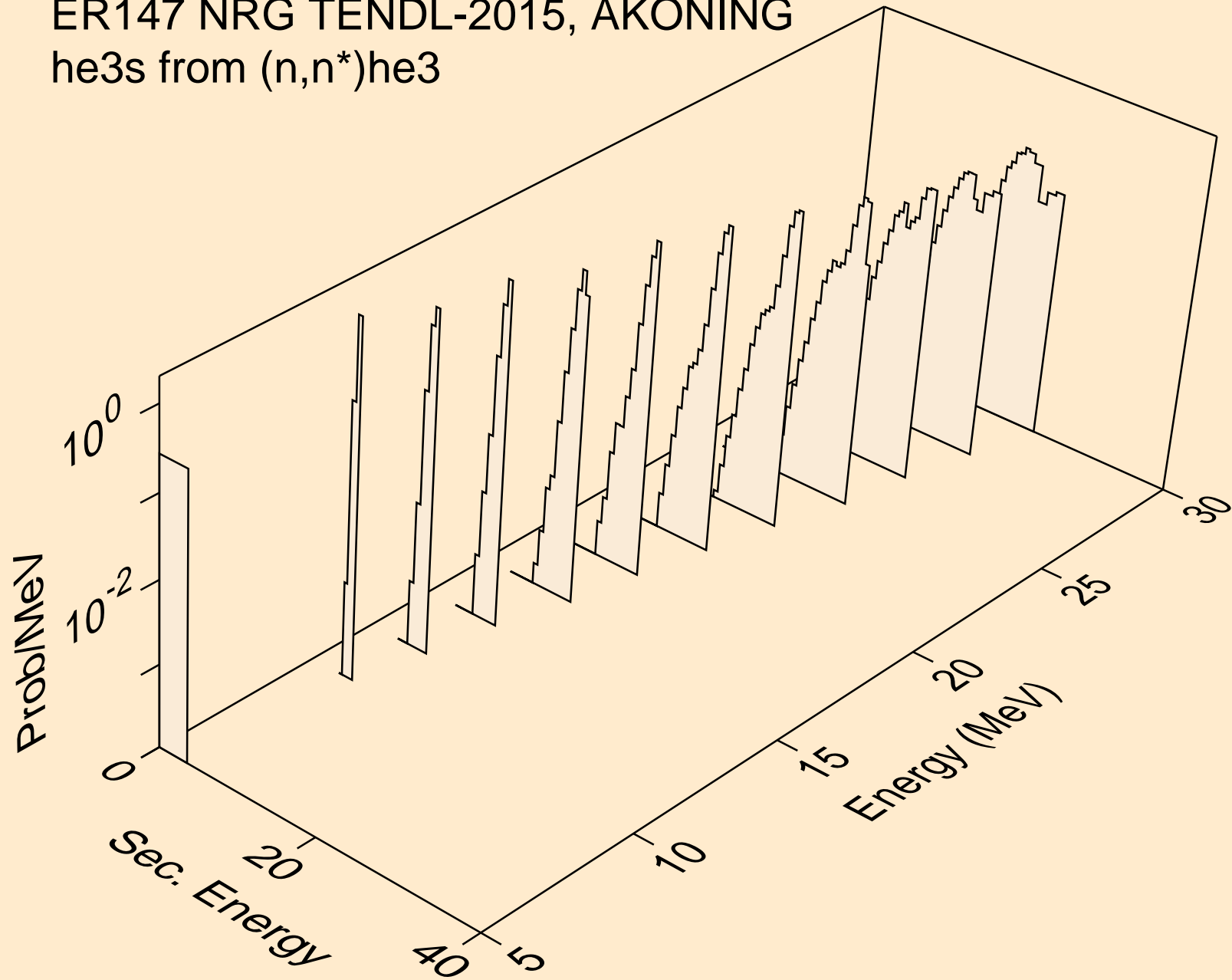

ER147 NRG TENDL-2015, AKONING  
he3s from (n,he3)

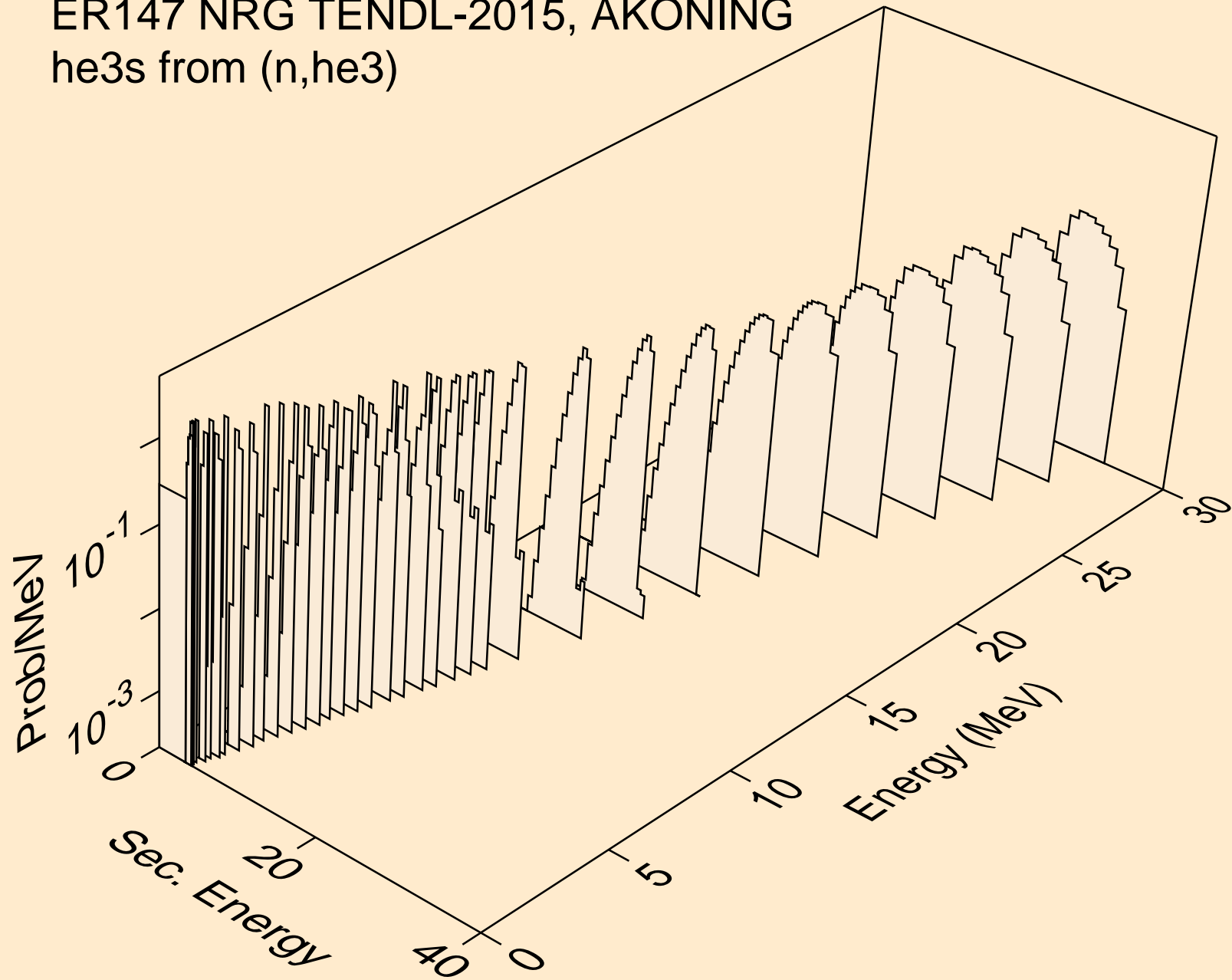

ER147 NRG TENDL-2015, AKONING  
alphas from (n,x)

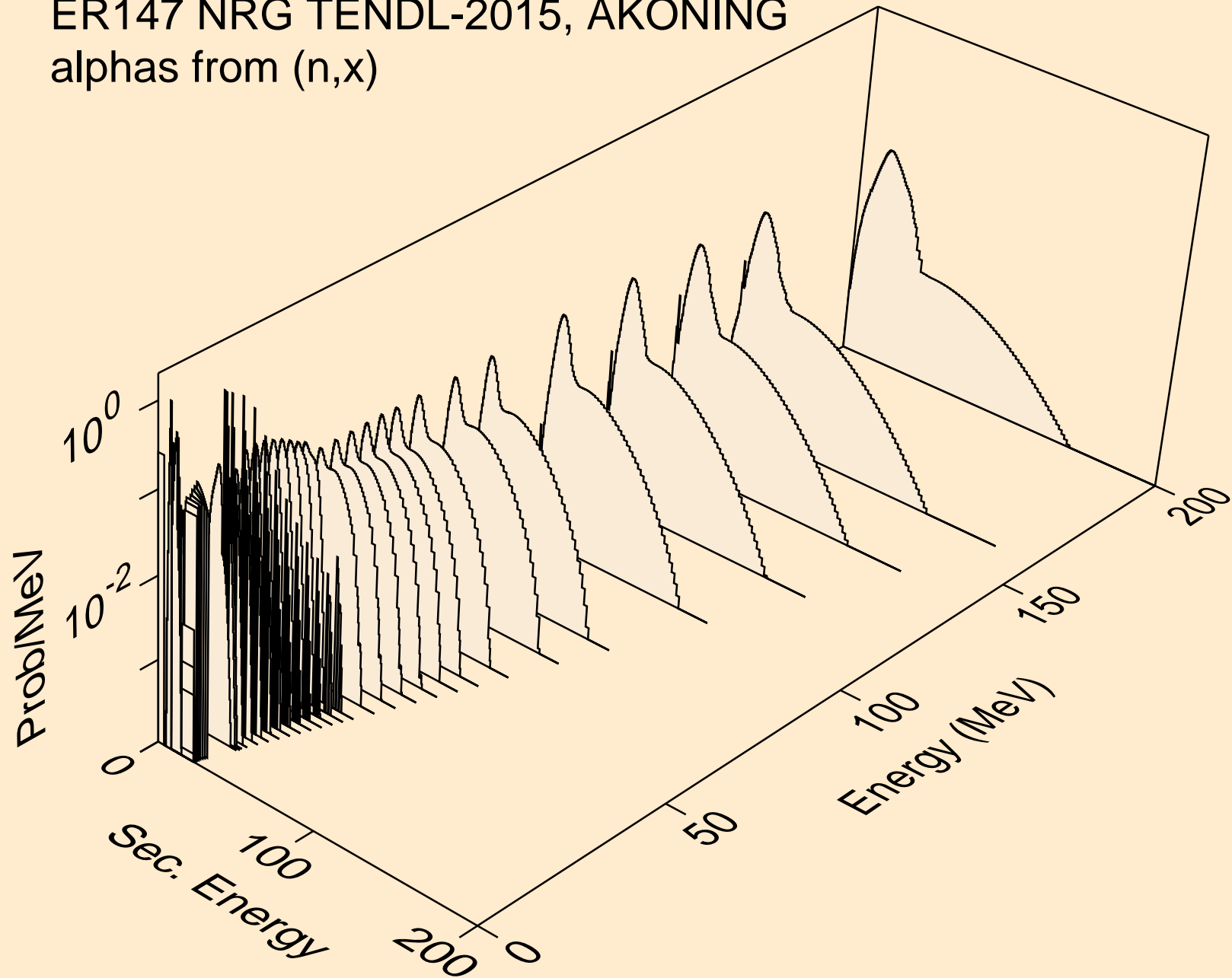

ER147 NRG TENDL-2015, AKONING  
alphas from (n,n\*)a

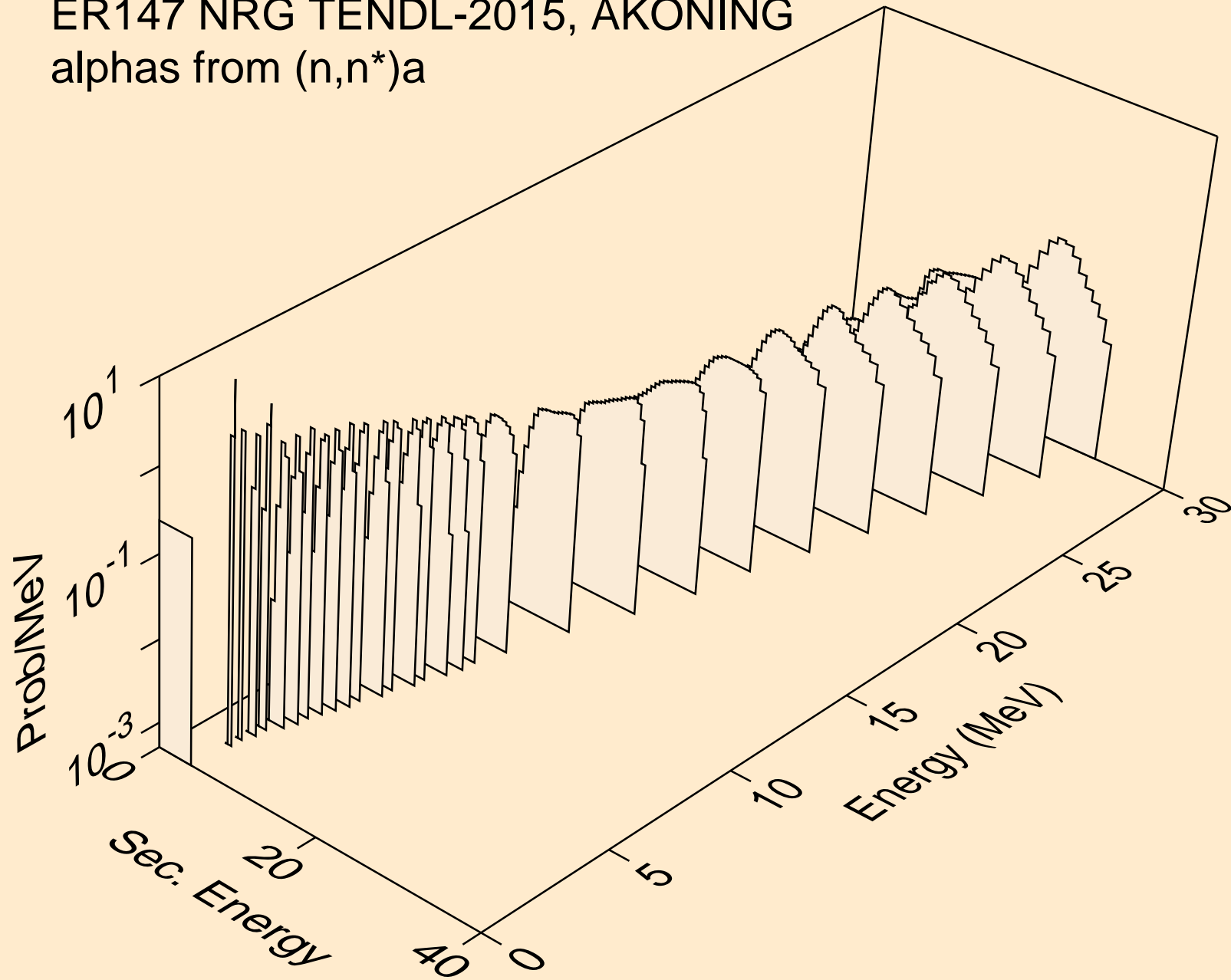

ER147 NRG TENDL-2015, AKONING  
alphas from (n,n\*)3a

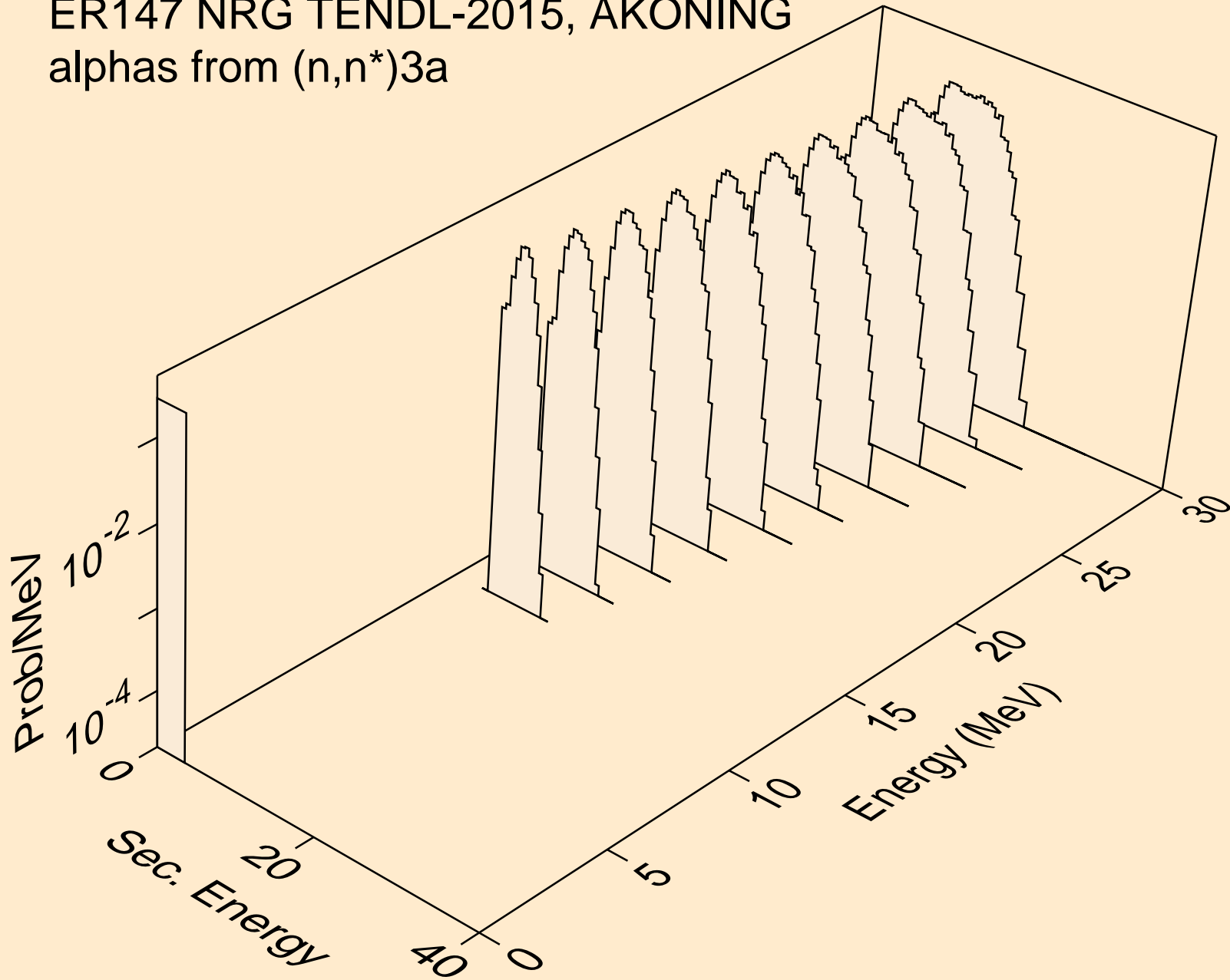

ER147 NRG TENDL-2015, AKONING  
alphas from (n,2n)a

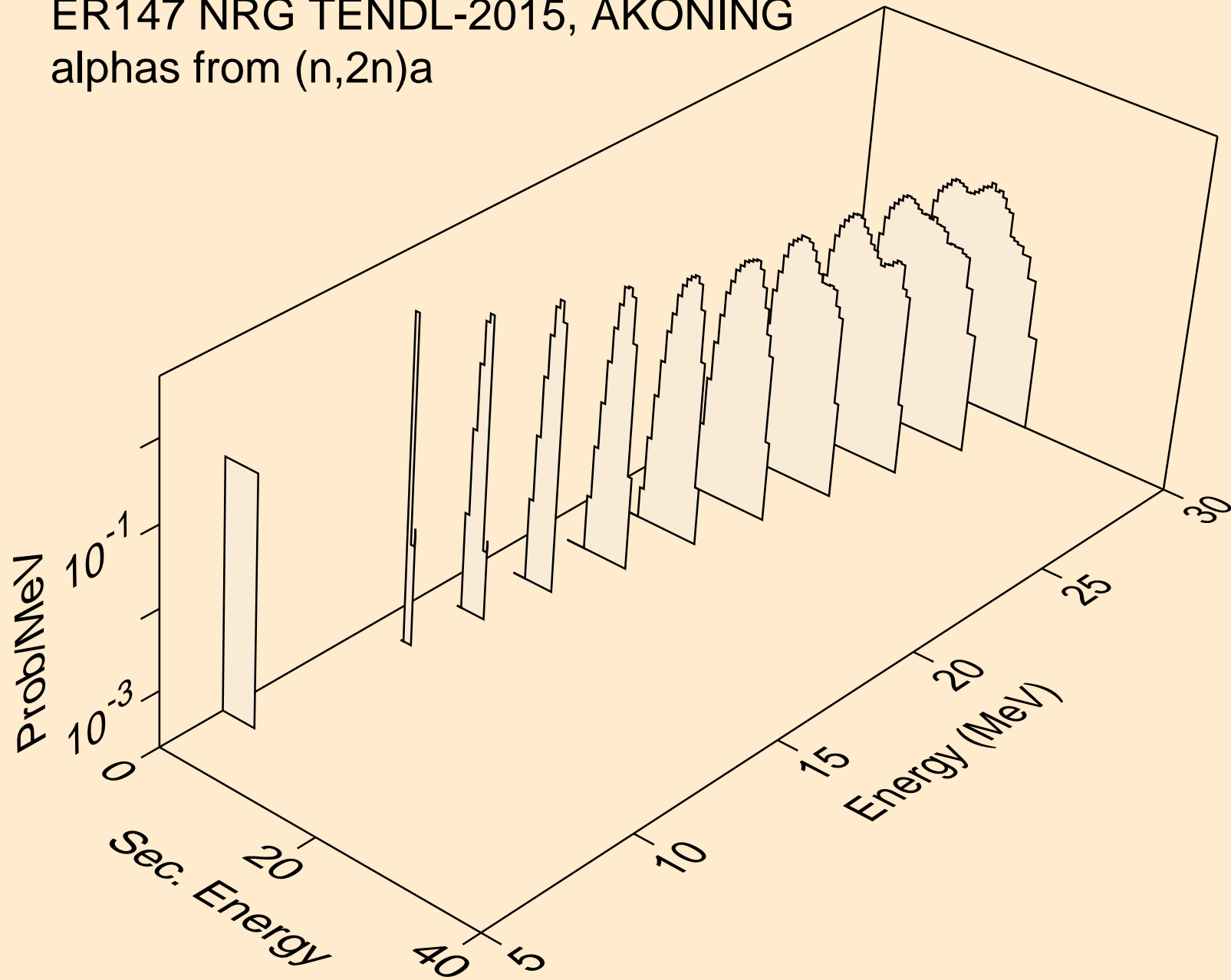



ER147 NRG TENDL-2015, AKONING  
alphas from (n,3n)a

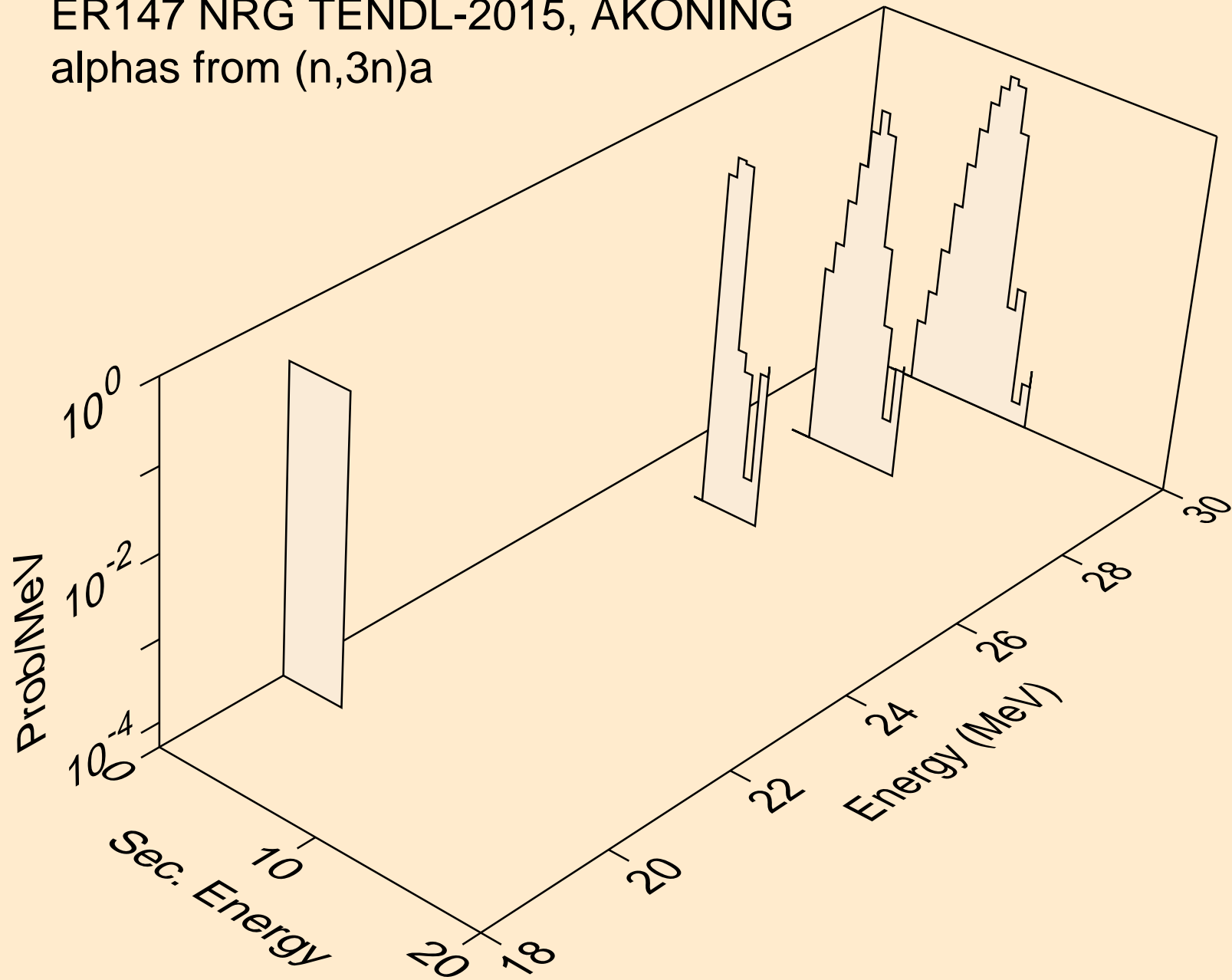

ER147 NRG TENDL-2015, AKONING  
alphas from (n,n\*)2a

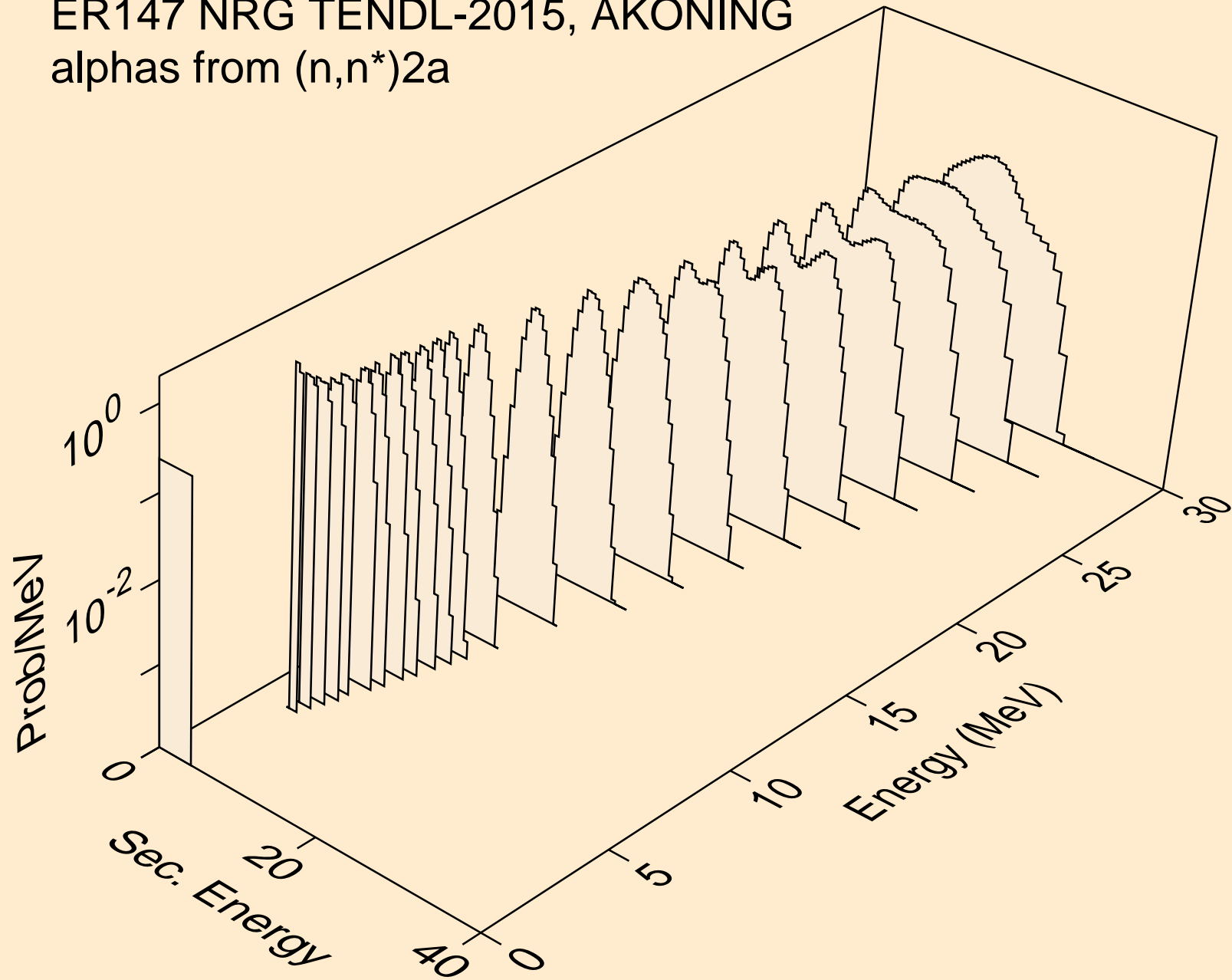

ER147 NRG TENDL-2015, AKONING  
alphas from (n,2n)2a

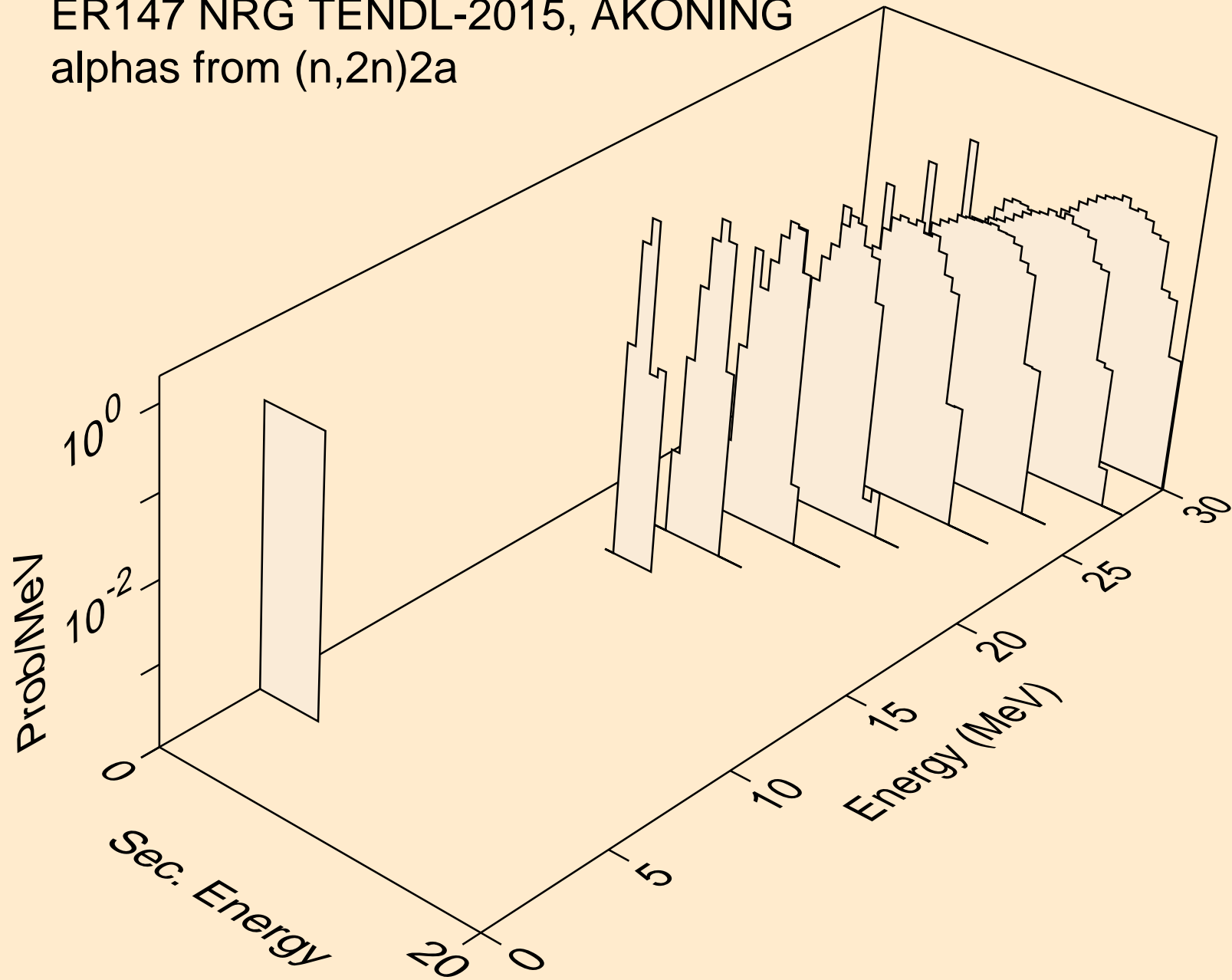

ER147 NRG TENDL-2015, AKONING  
alphas from (n,npa)

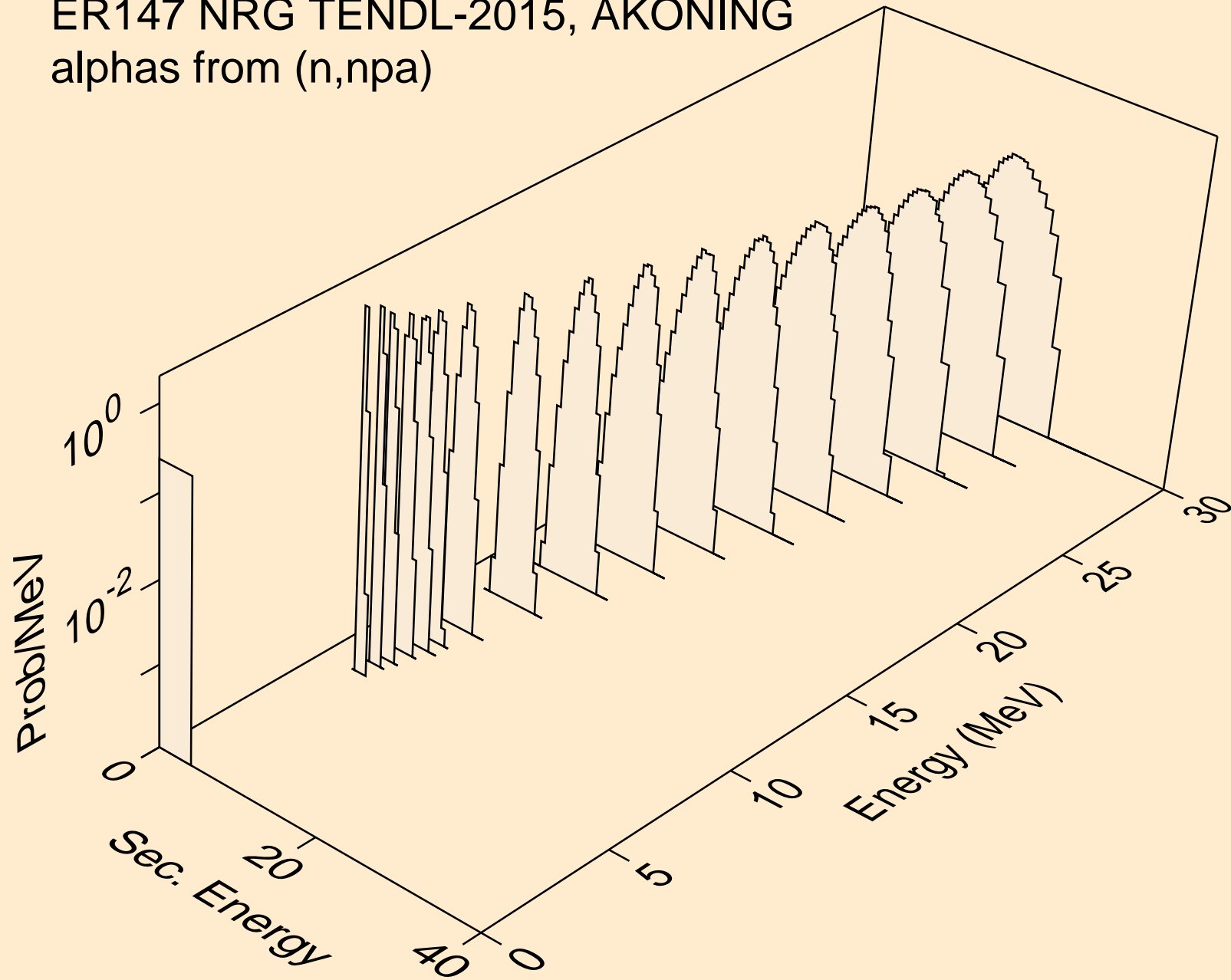

ER147 NRG TENDL-2015, AKONING  
alphas from (n,a)

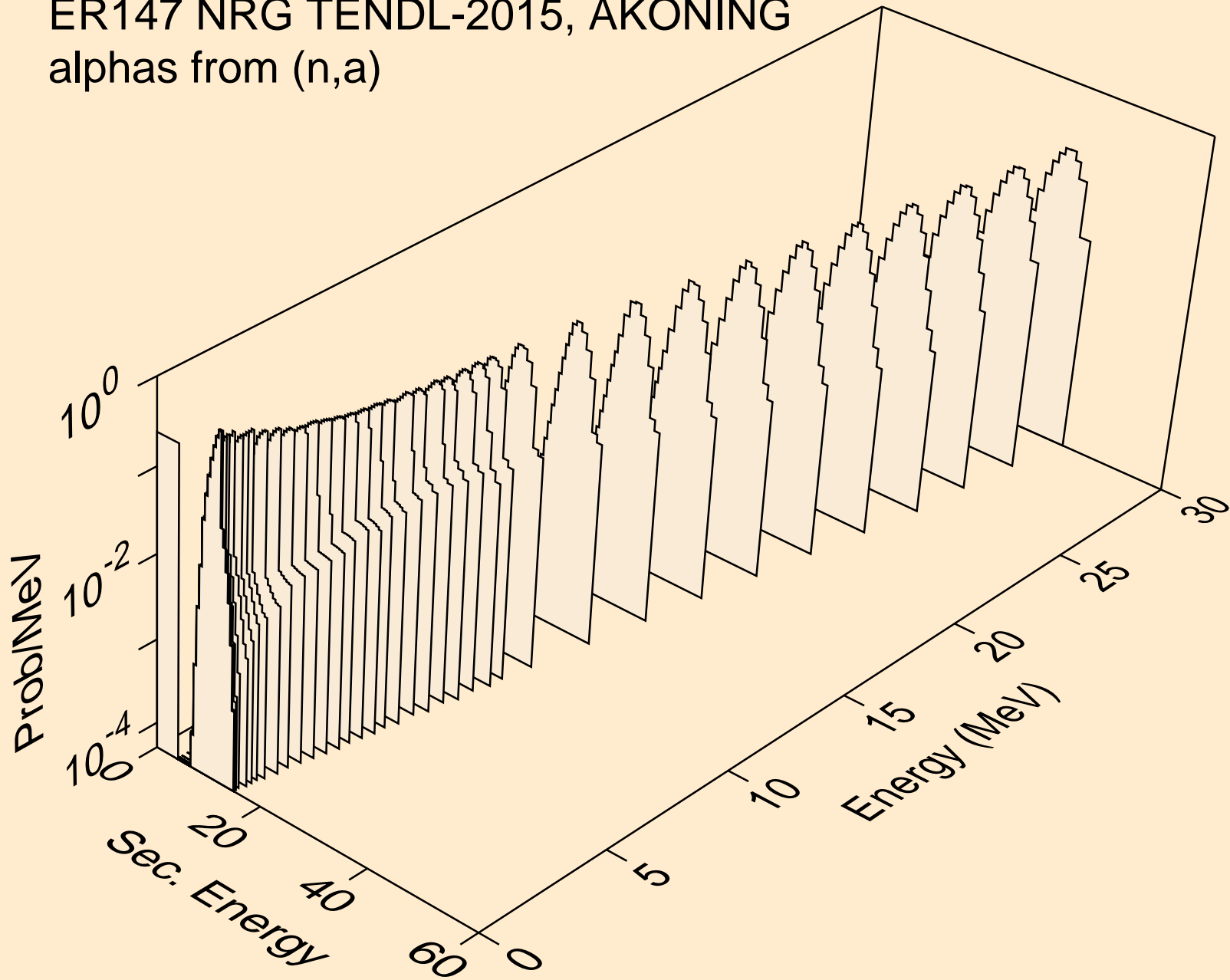

ER147 NRG TENDL-2015, AKONING  
alphas from (n,2a)

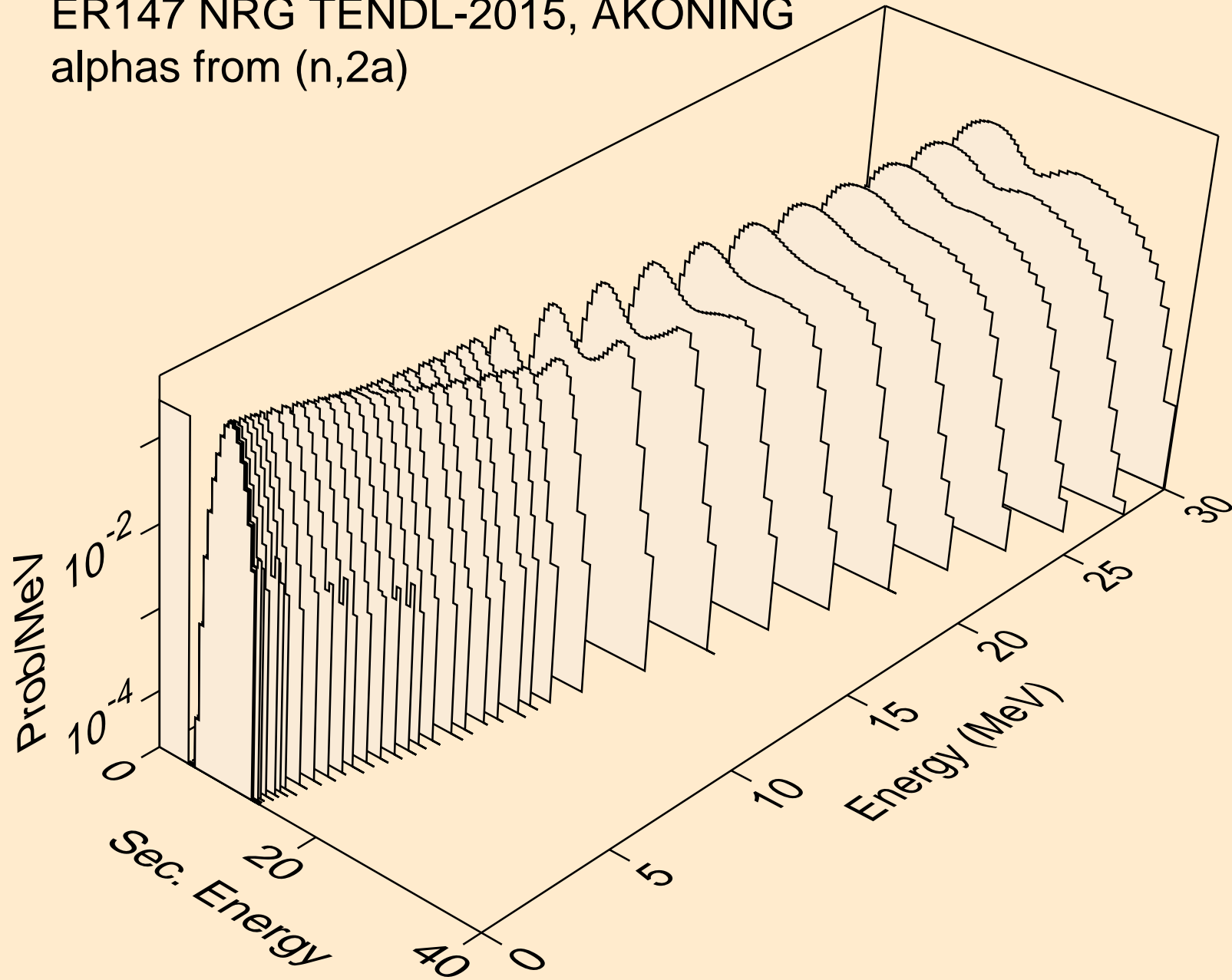

ER147 NRG TENDL-2015, AKONING  
alphas from (n,3a)

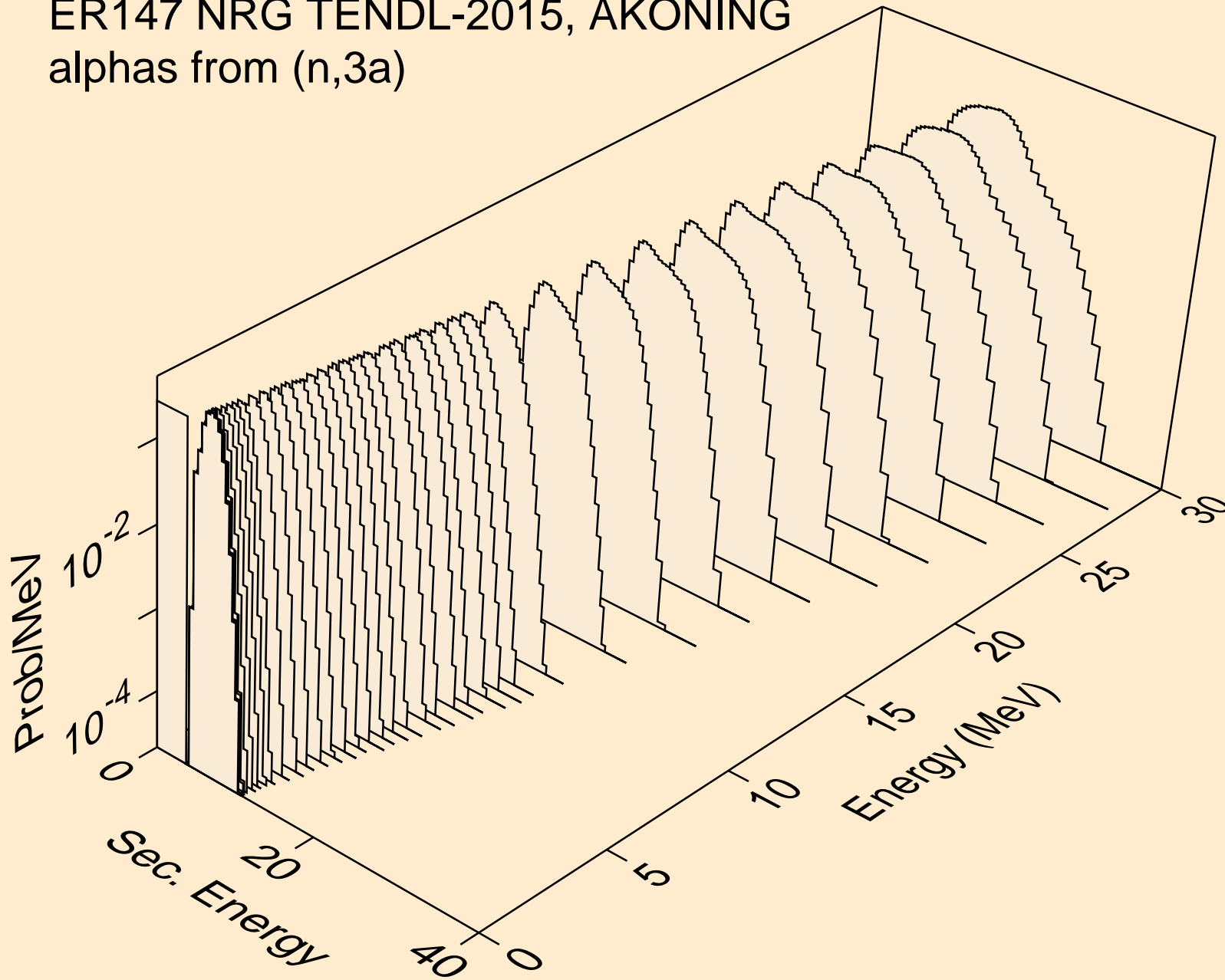

ER147 NRG TENDL-2015, AKONING  
alphas from (n,pa)

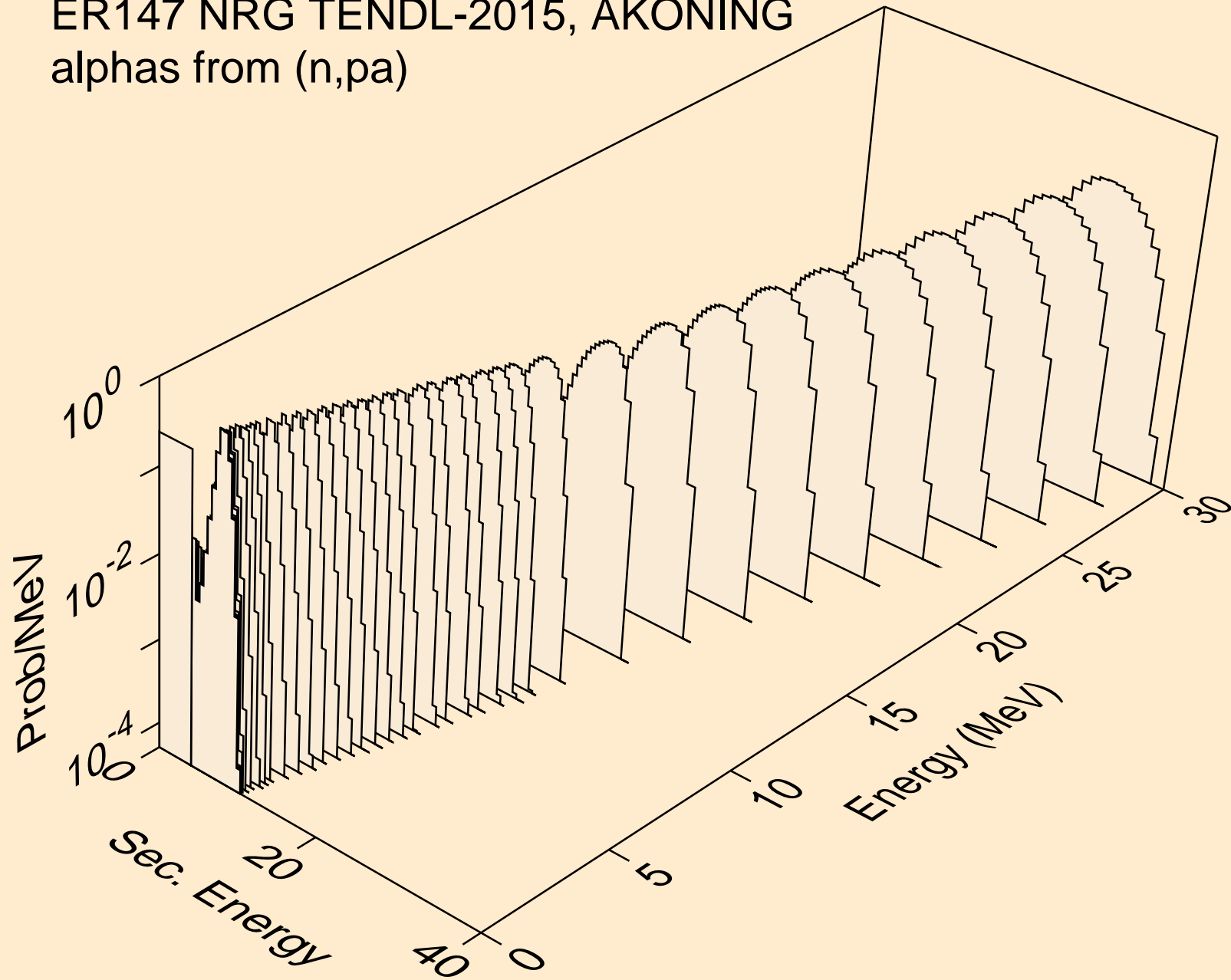



ER147 NRG TENDL-2015, AKONING  
alphas from (n,d2a)

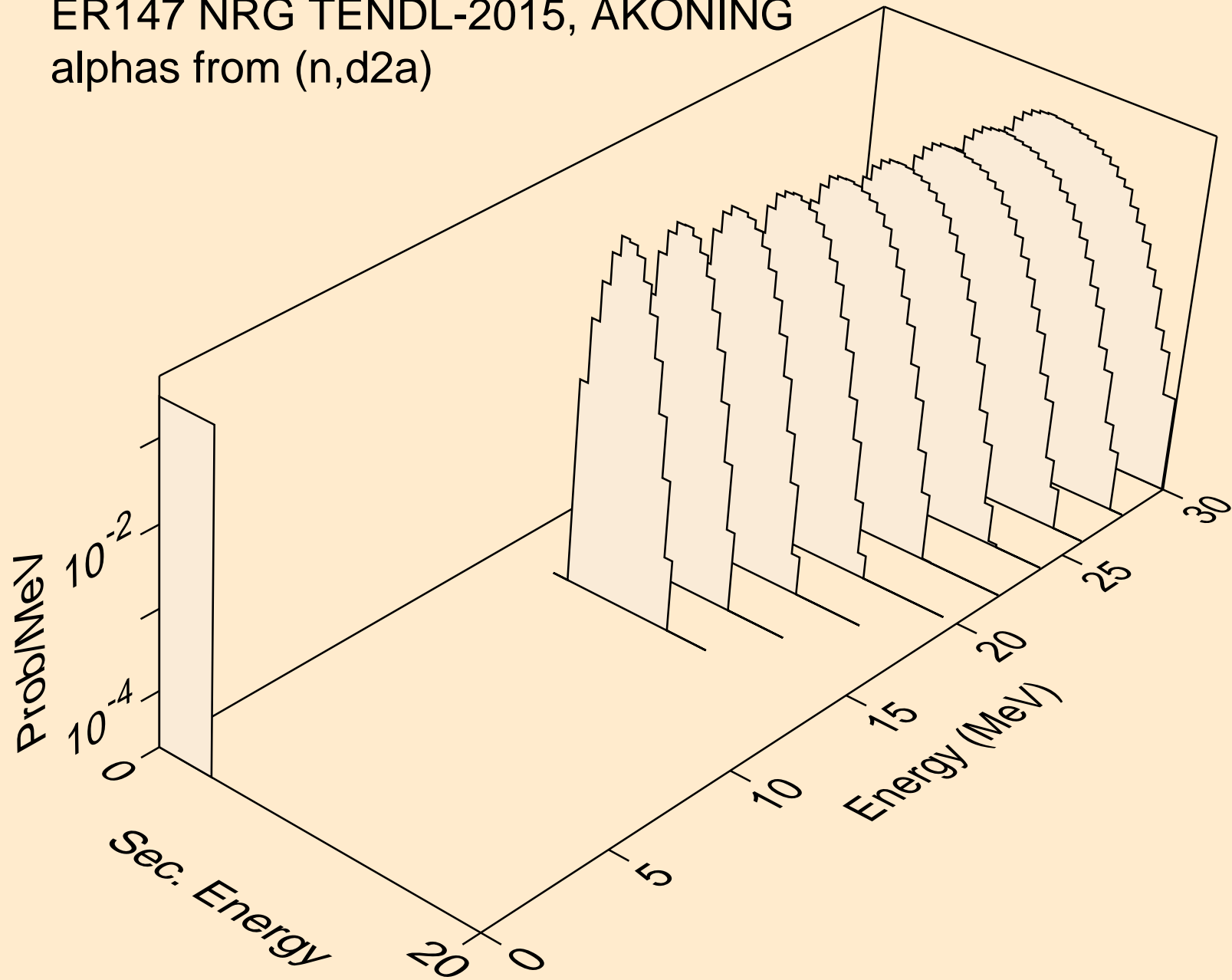

ER147 NRG TENDL-2015, AKONING  
alphas from (n,da)

