

ES239 NRG TENDL-2016, AKONING

Principal cross sections

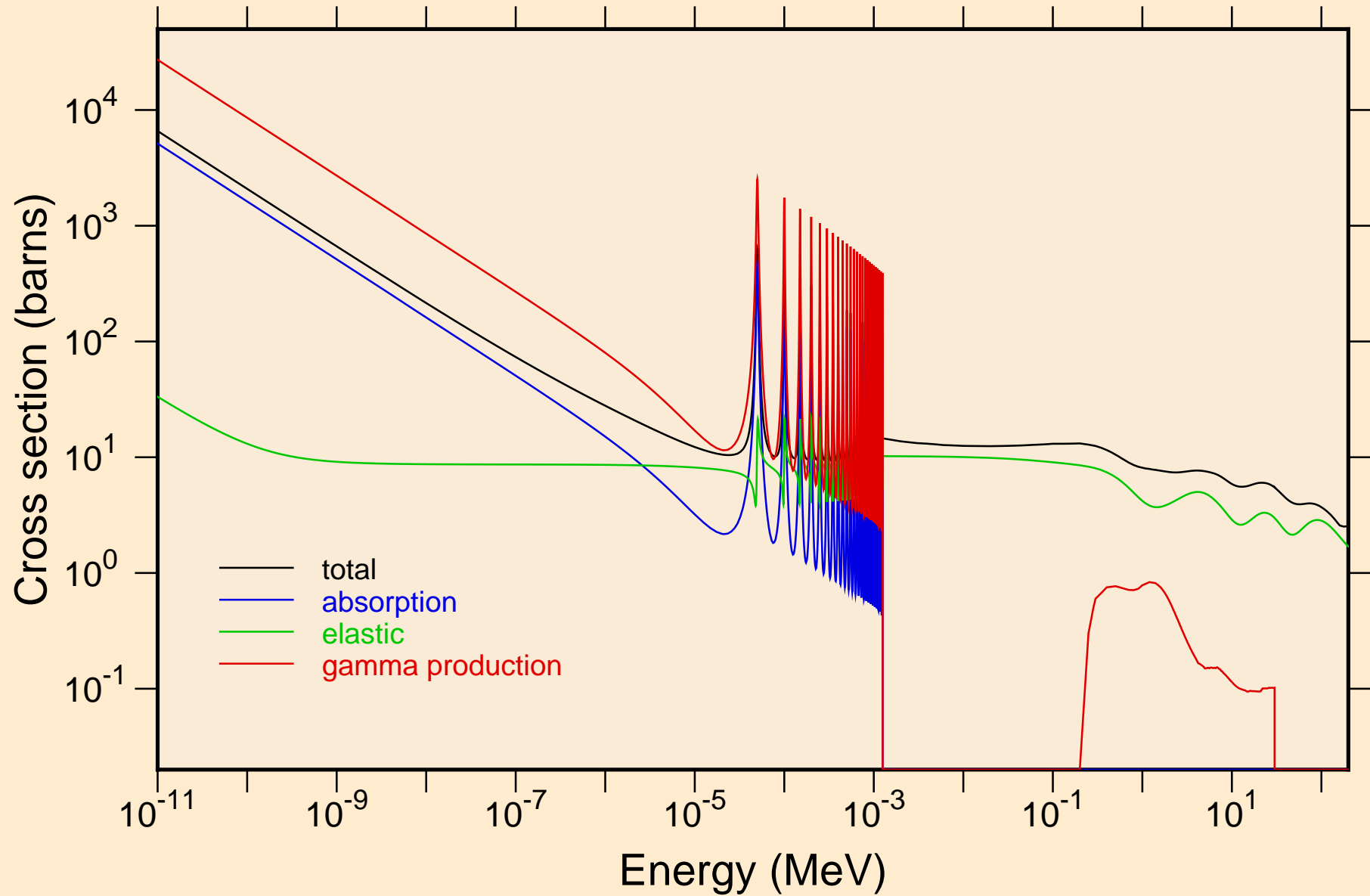

ES239 NRG TENDL-2016, AKONING
resonance total cross section

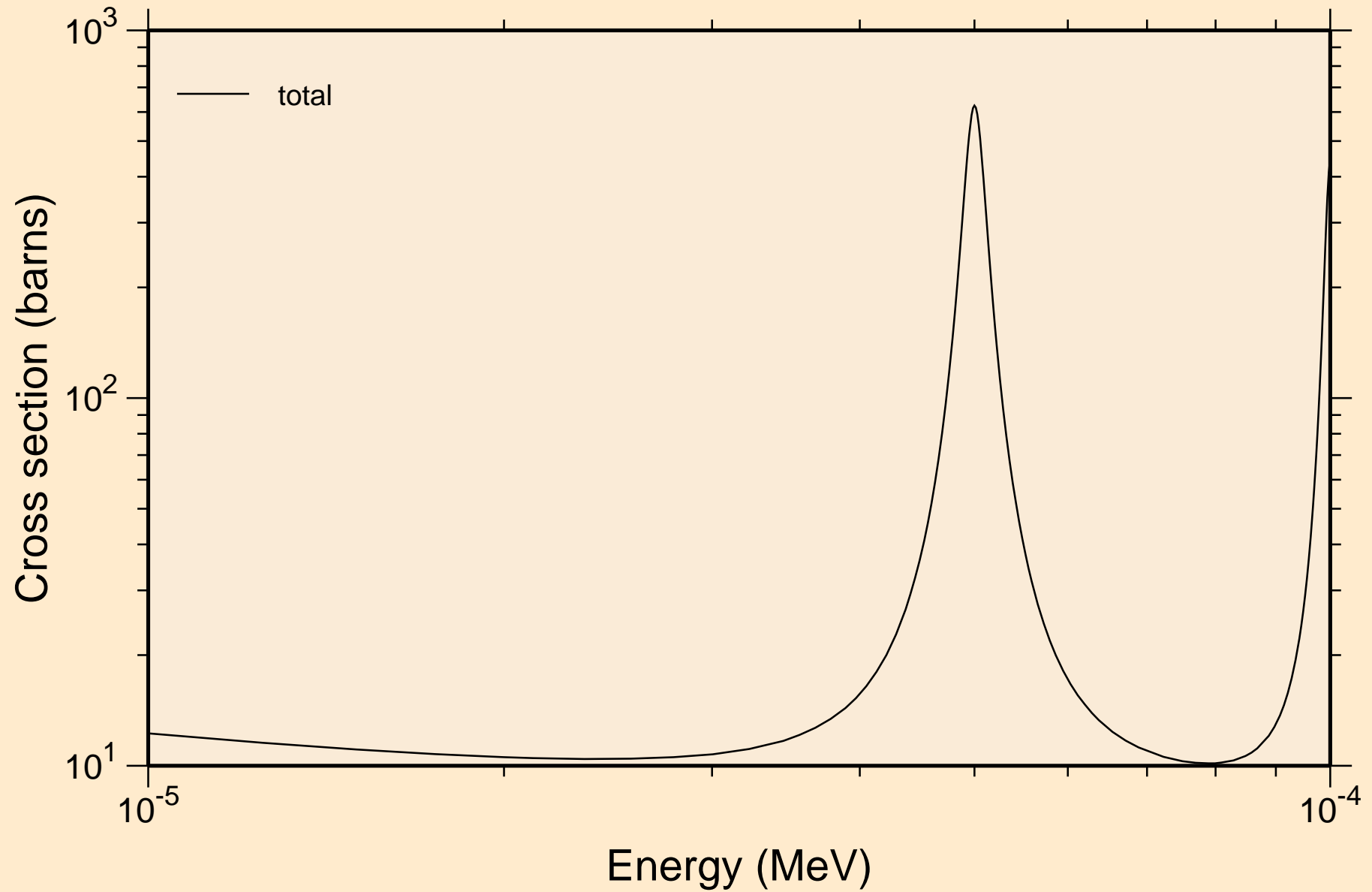

ES239 NRG TENDL-2016, AKONING
resonance total cross section

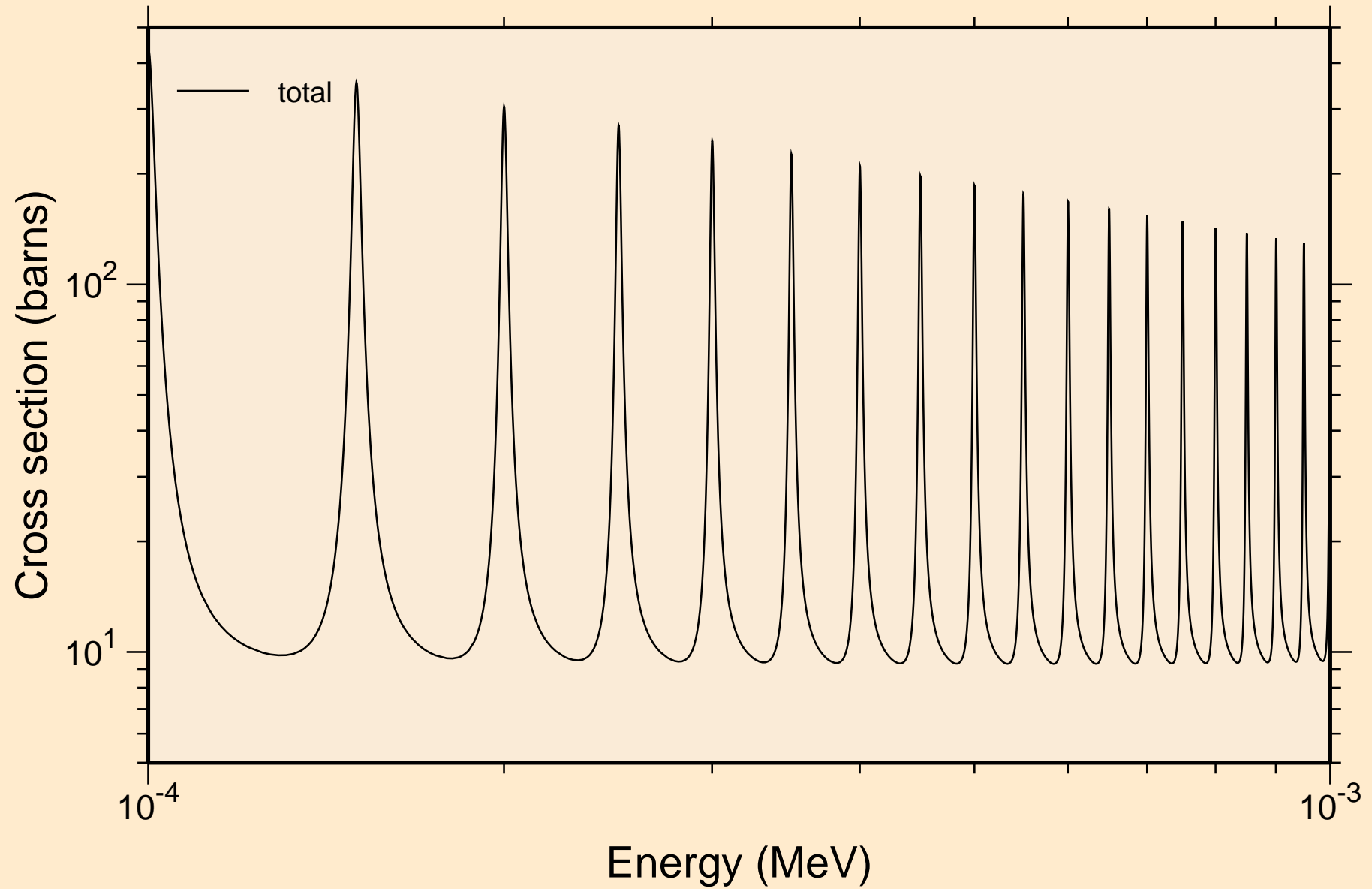

ES239 NRG TENDL-2016, AKONING
resonance total cross section

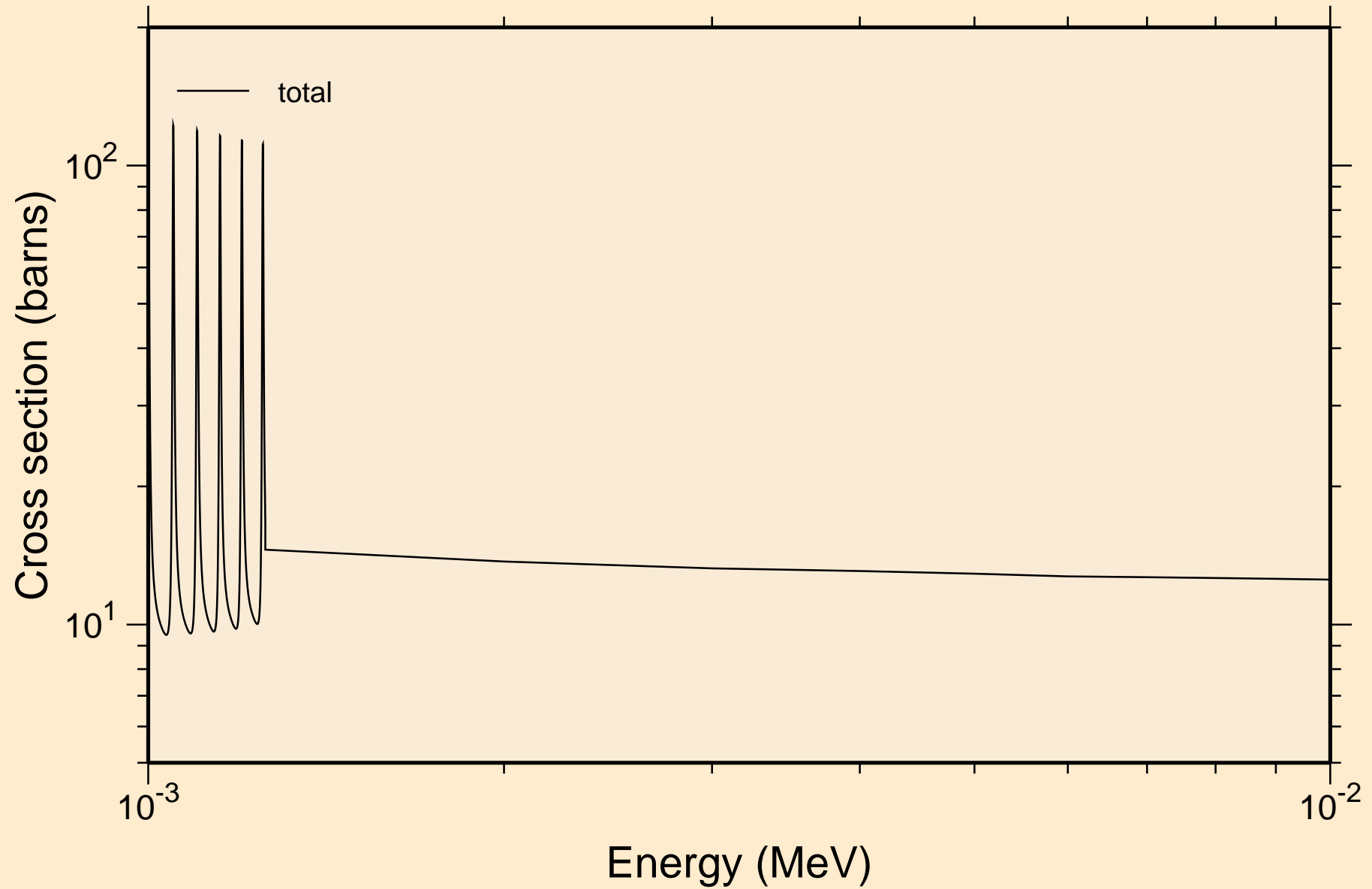

ES239 NRG TENDL-2016, AKONING
resonance total cross section

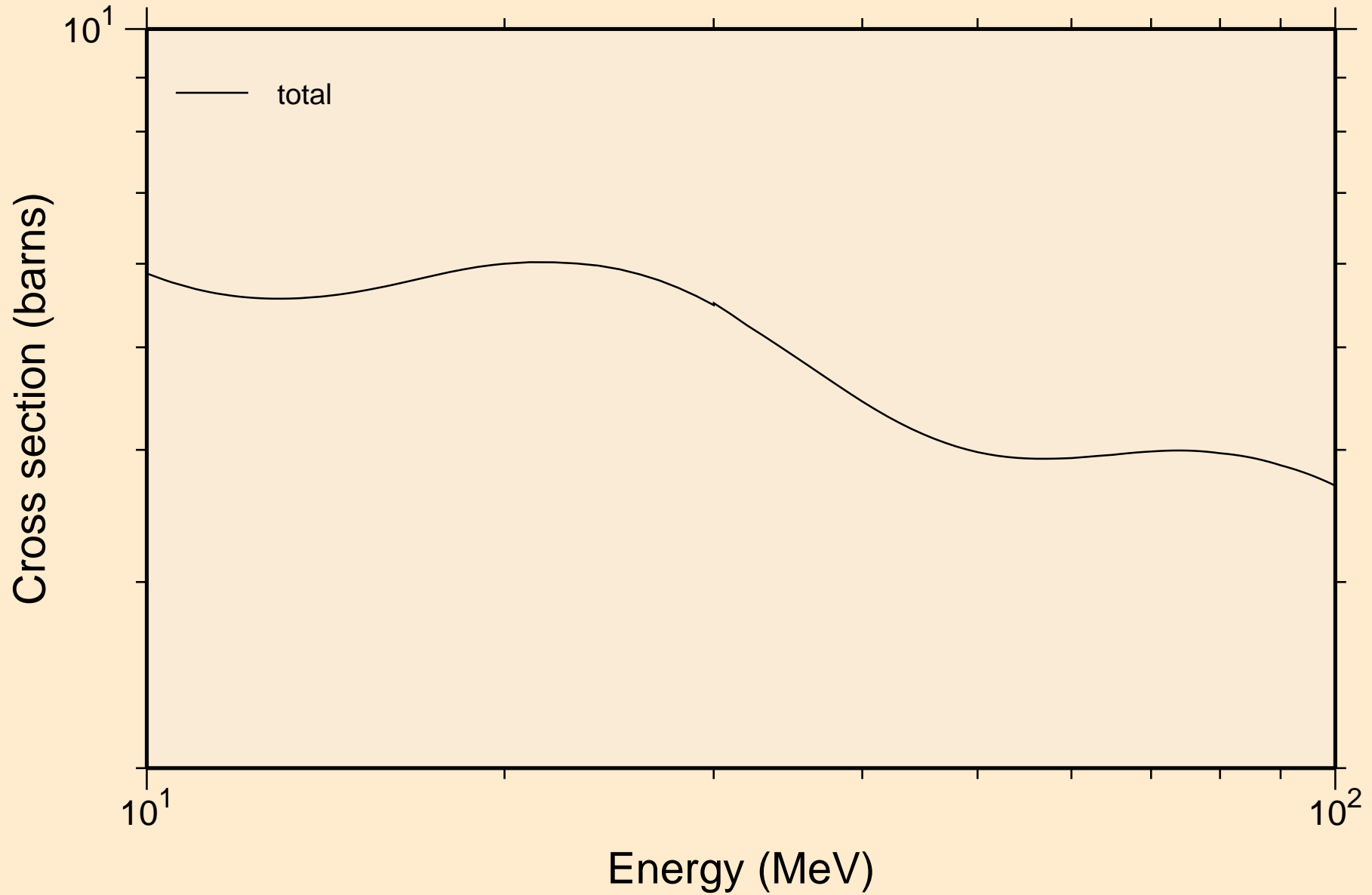

ES239 NRG TENDL-2016, AKONING

resonance absorption cross sections

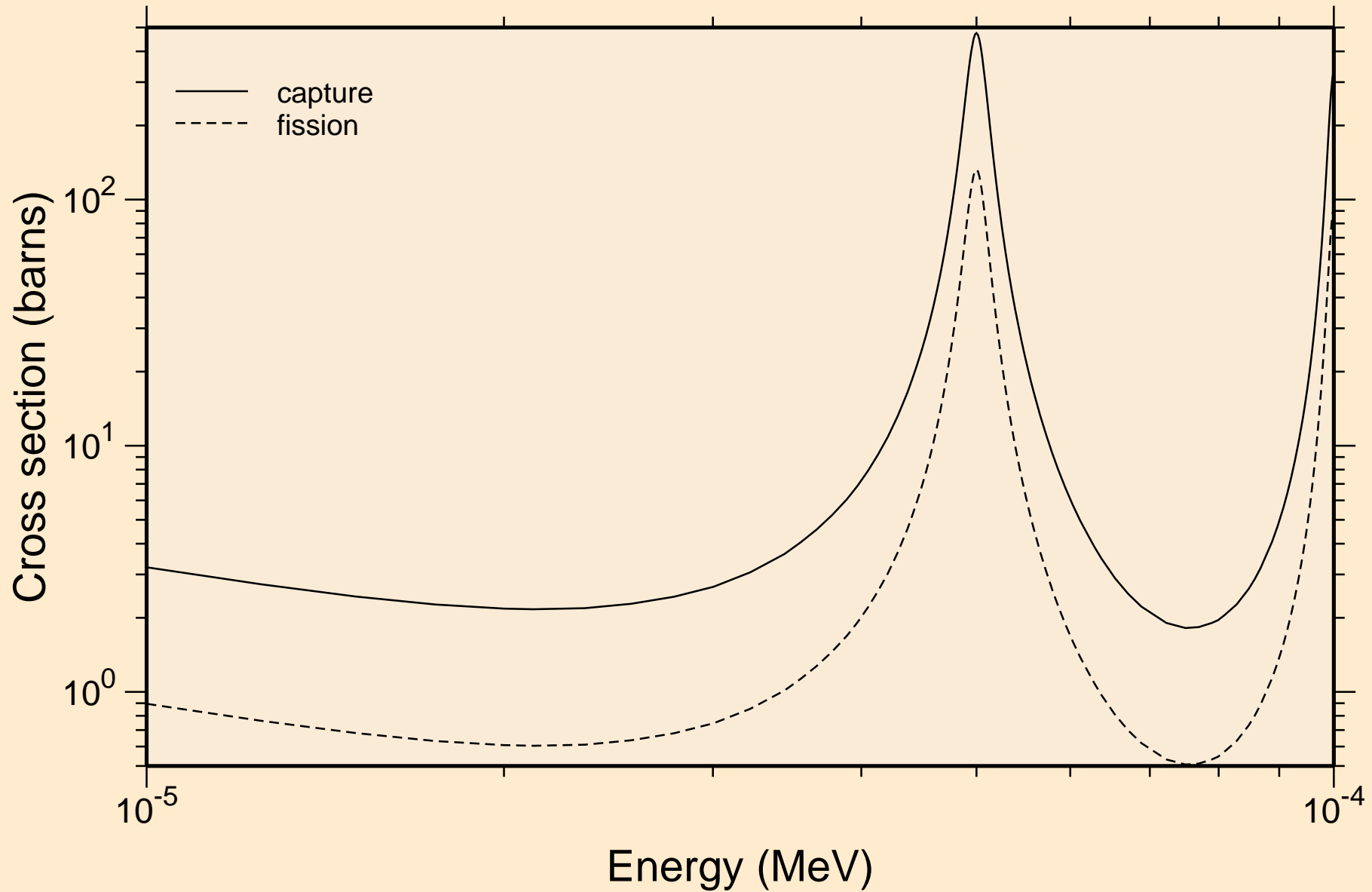

ES239 NRG TENDL-2016, AKONING

resonance absorption cross sections

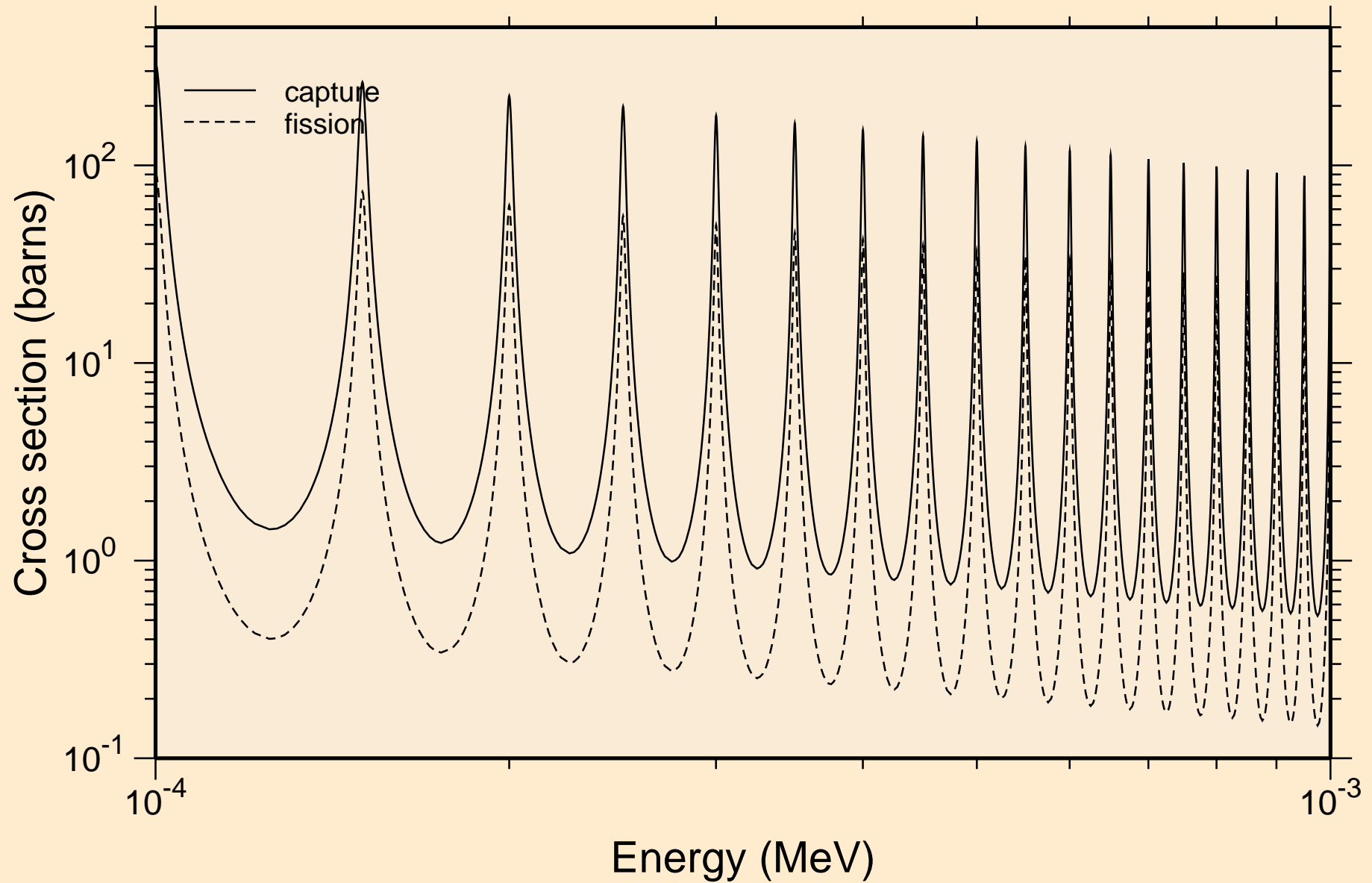

ES239 NRG TENDL-2016, AKONING resonance absorption cross sections

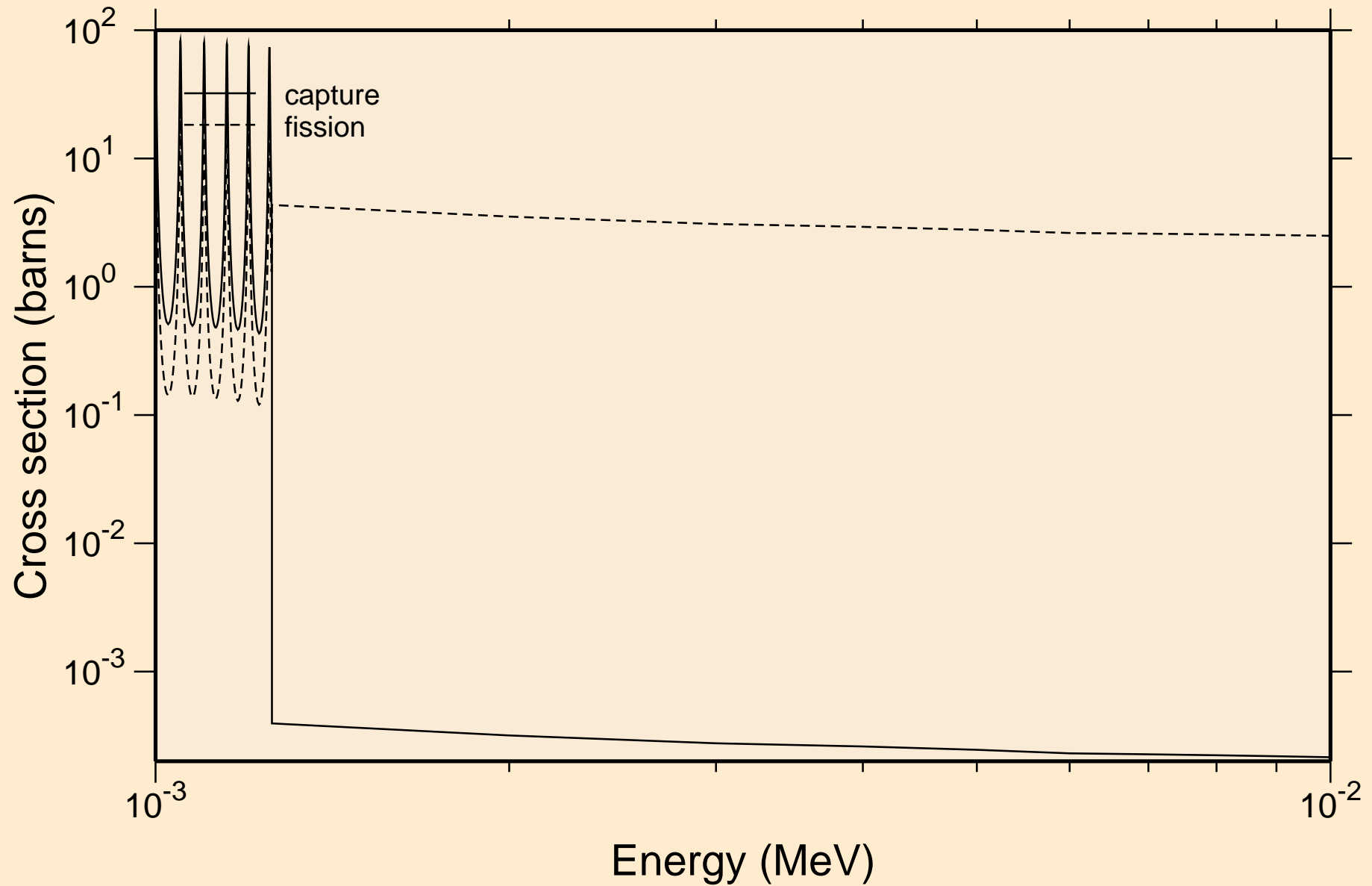

ES239 NRG TENDL-2016, AKONING

resonance absorption cross sections

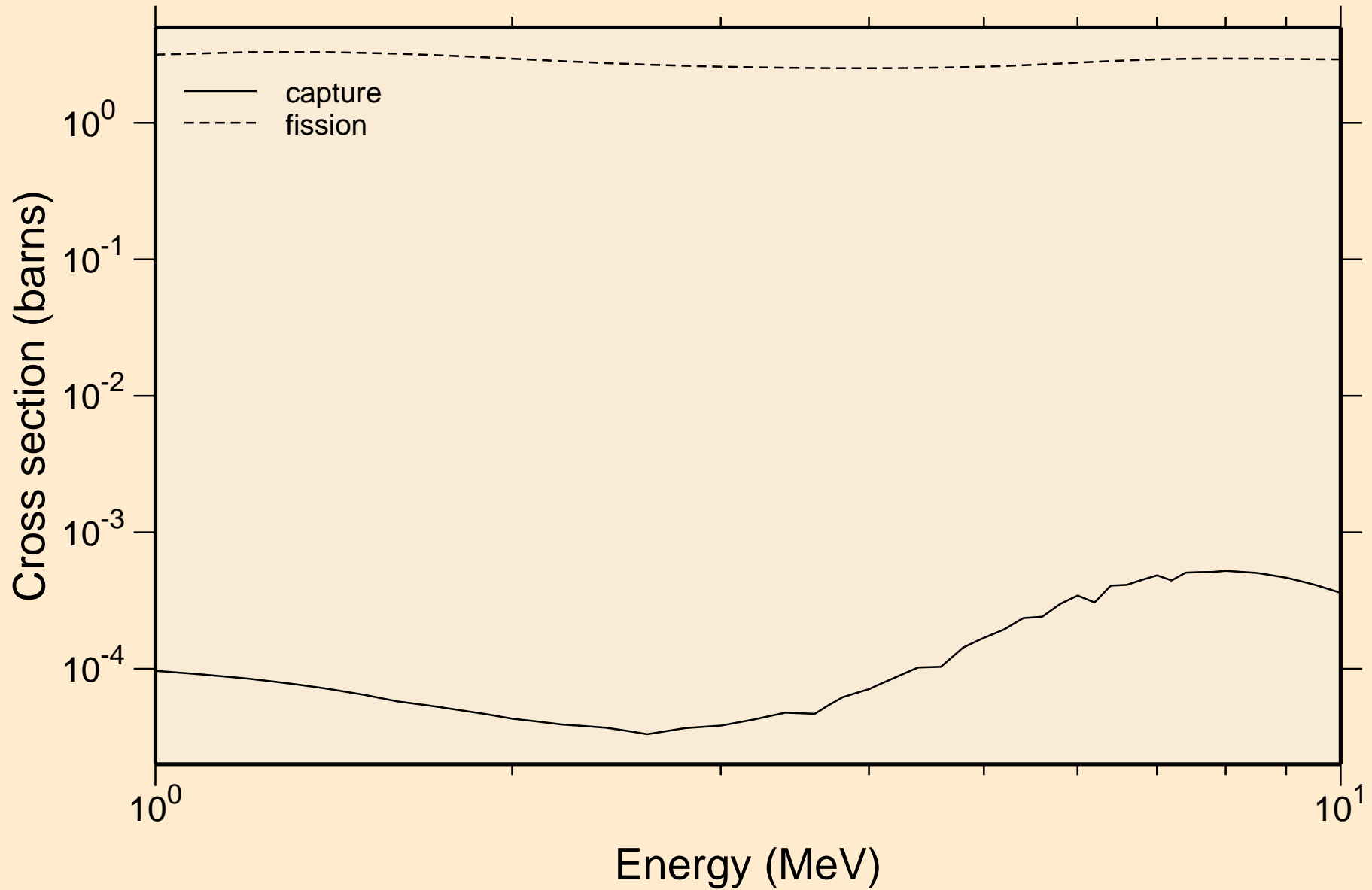

ES239 NRG TENDL-2016, AKONING

Non-threshold reactions

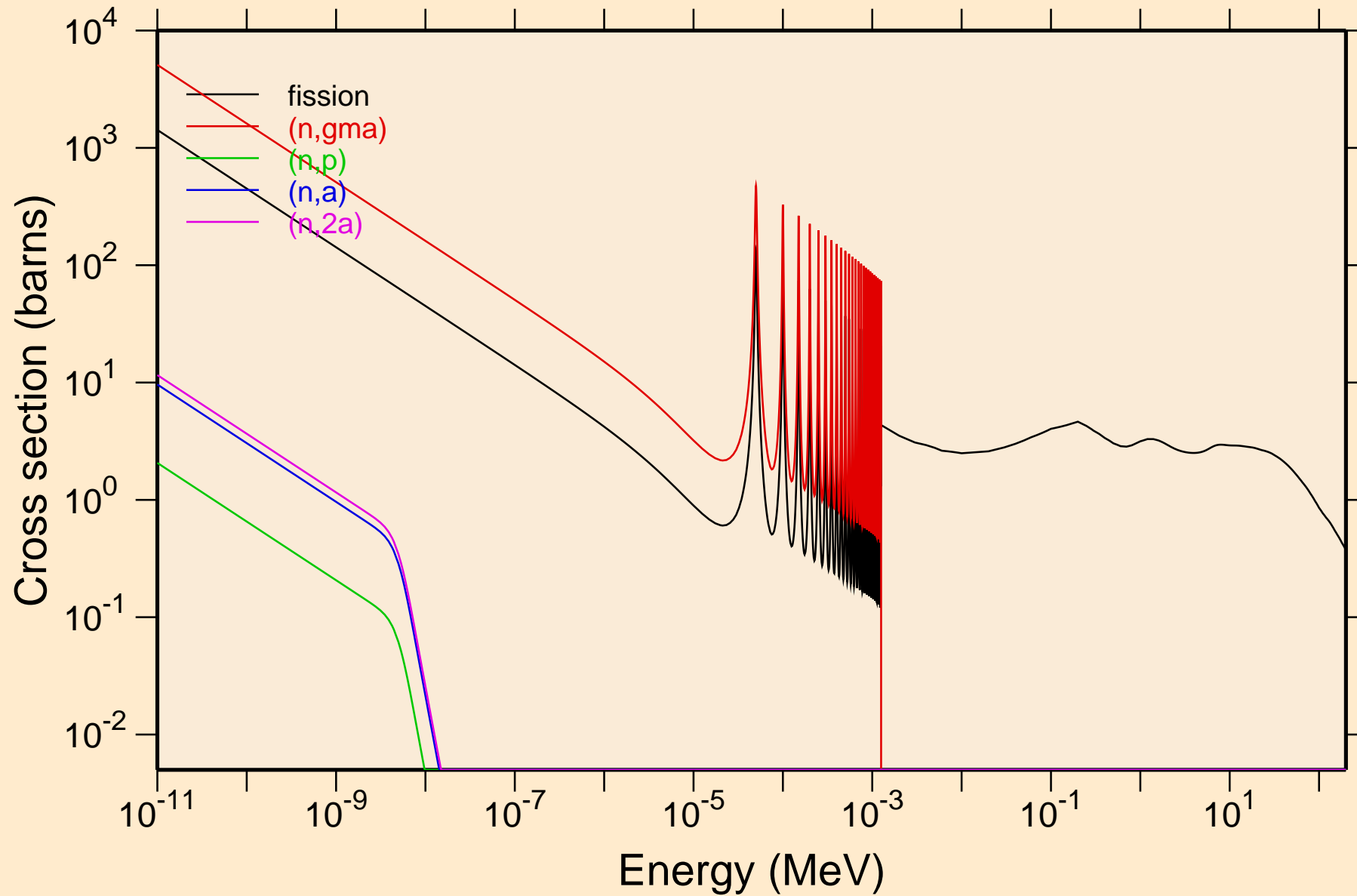

ES239 NRG TENDL-2016, AKONING

Non-threshold reactions

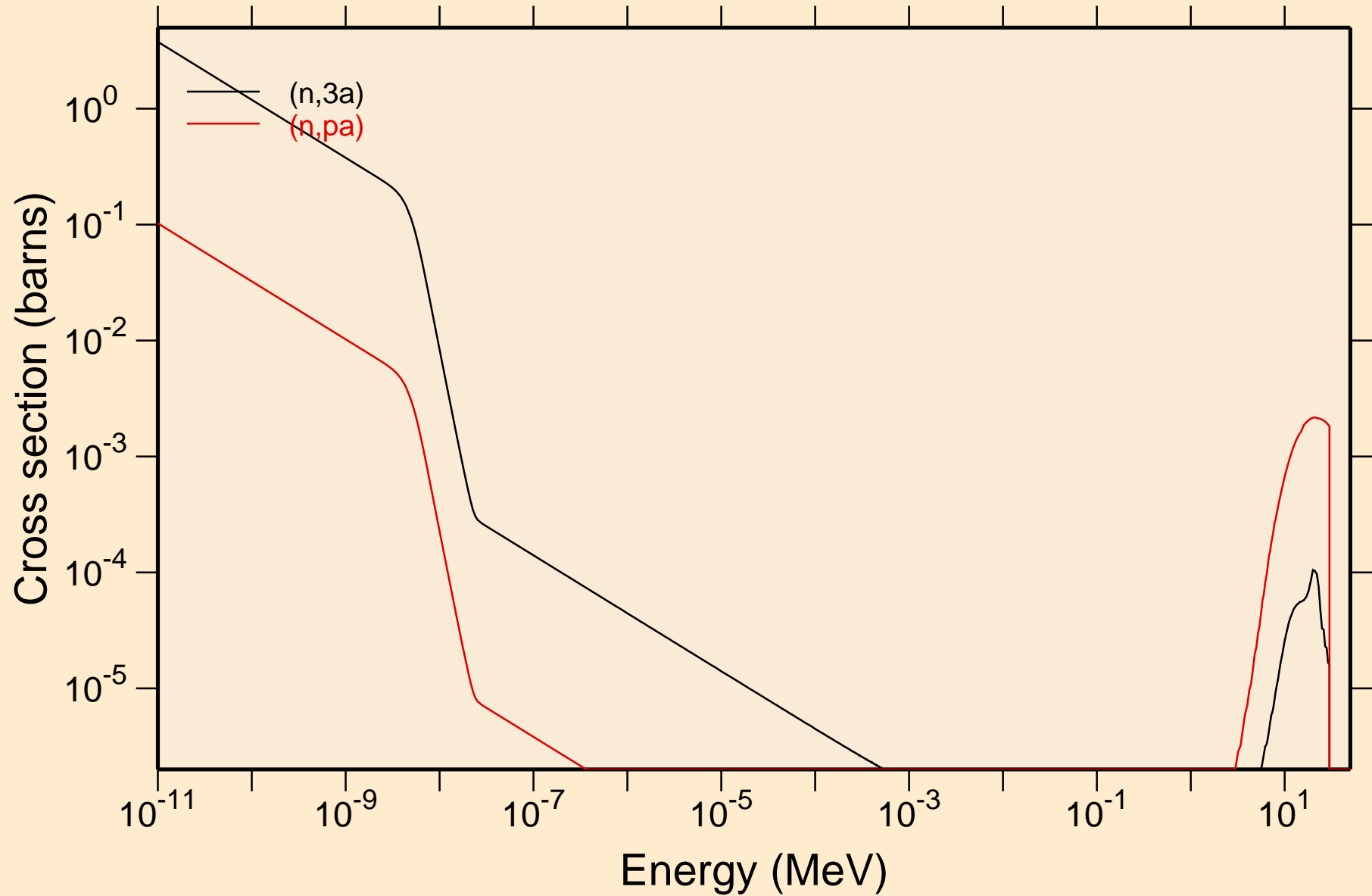

ES239 NRG TENDL-2016, AKONING

Principal cross sections

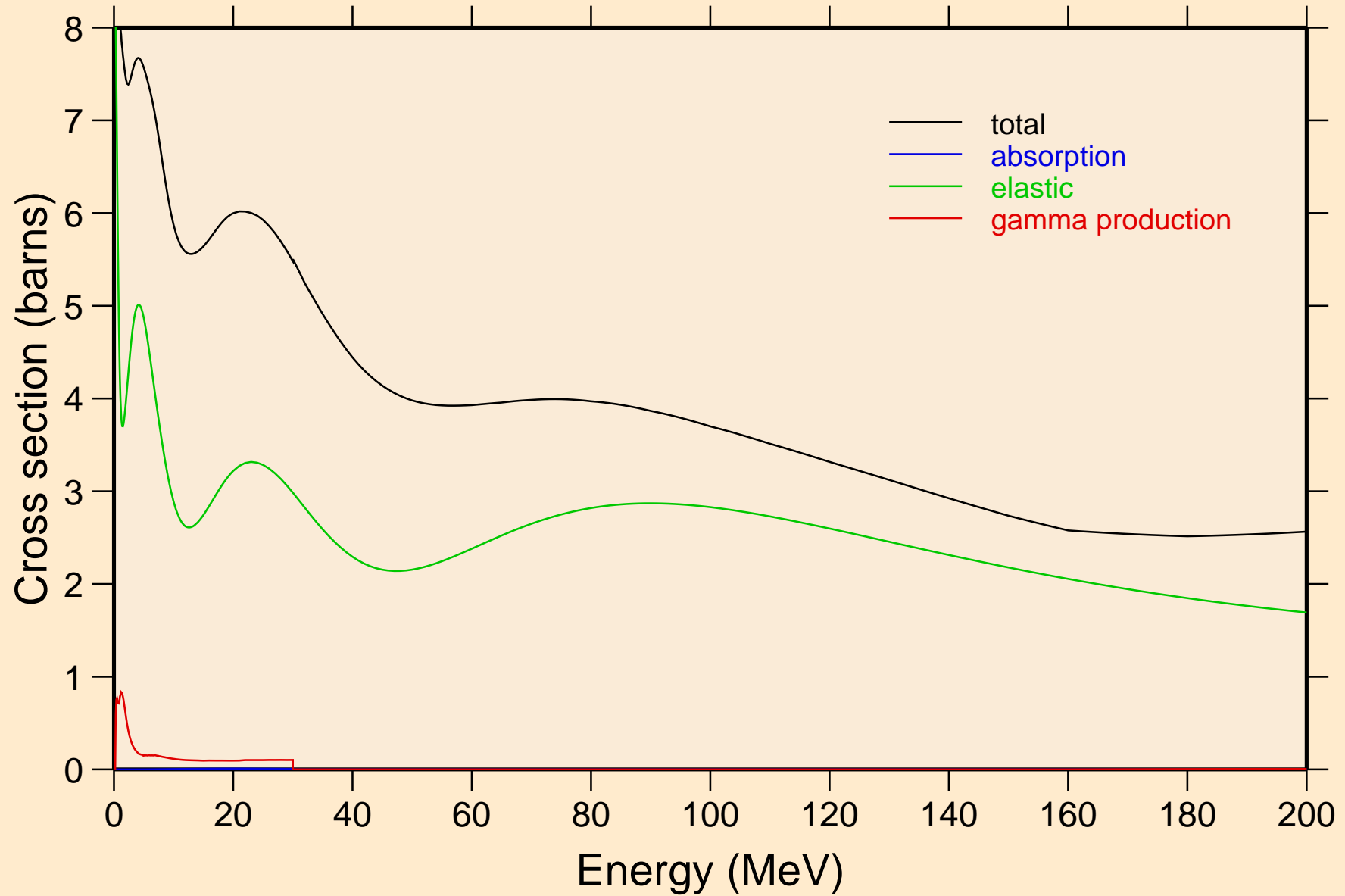

ES239 NRG TENDL-2016, AKONING

Non-threshold reactions

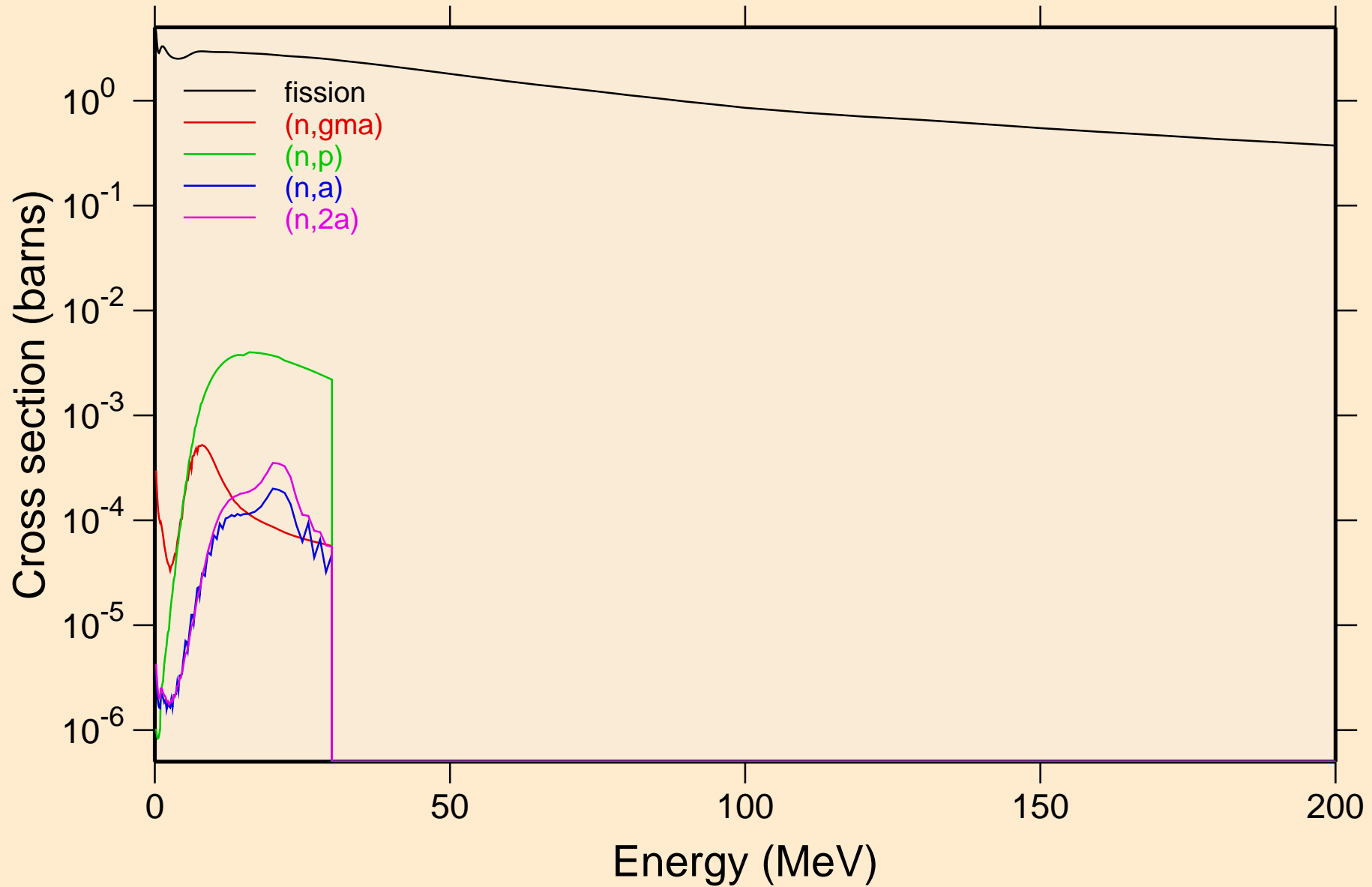

ES239 NRG TENDL-2016, AKONING

Non-threshold reactions

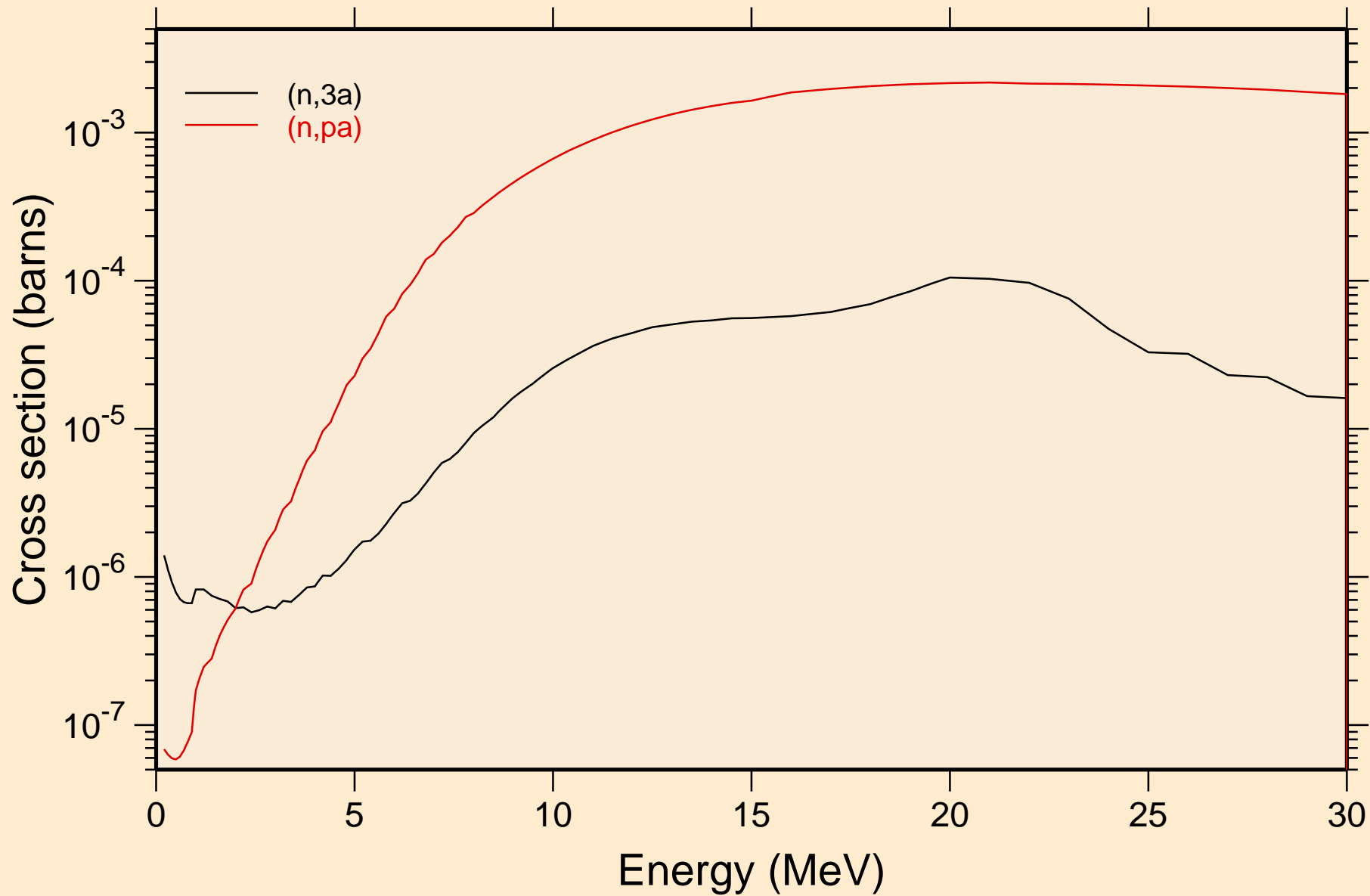

ES239 NRG TENDL-2016, AKONING
Inelastic levels

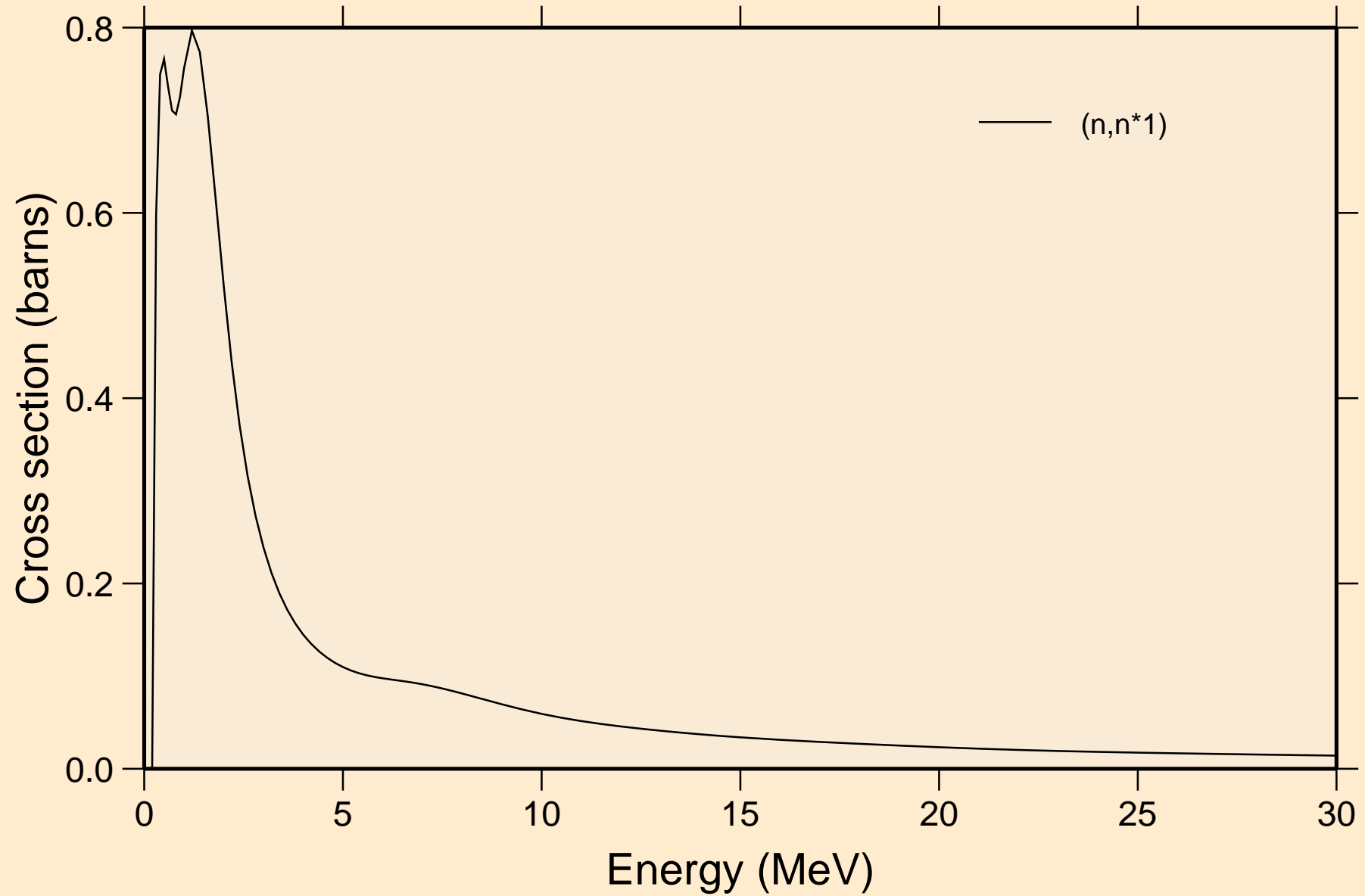

ES239 NRG TENDL-2016, AKONING

Threshold reactions

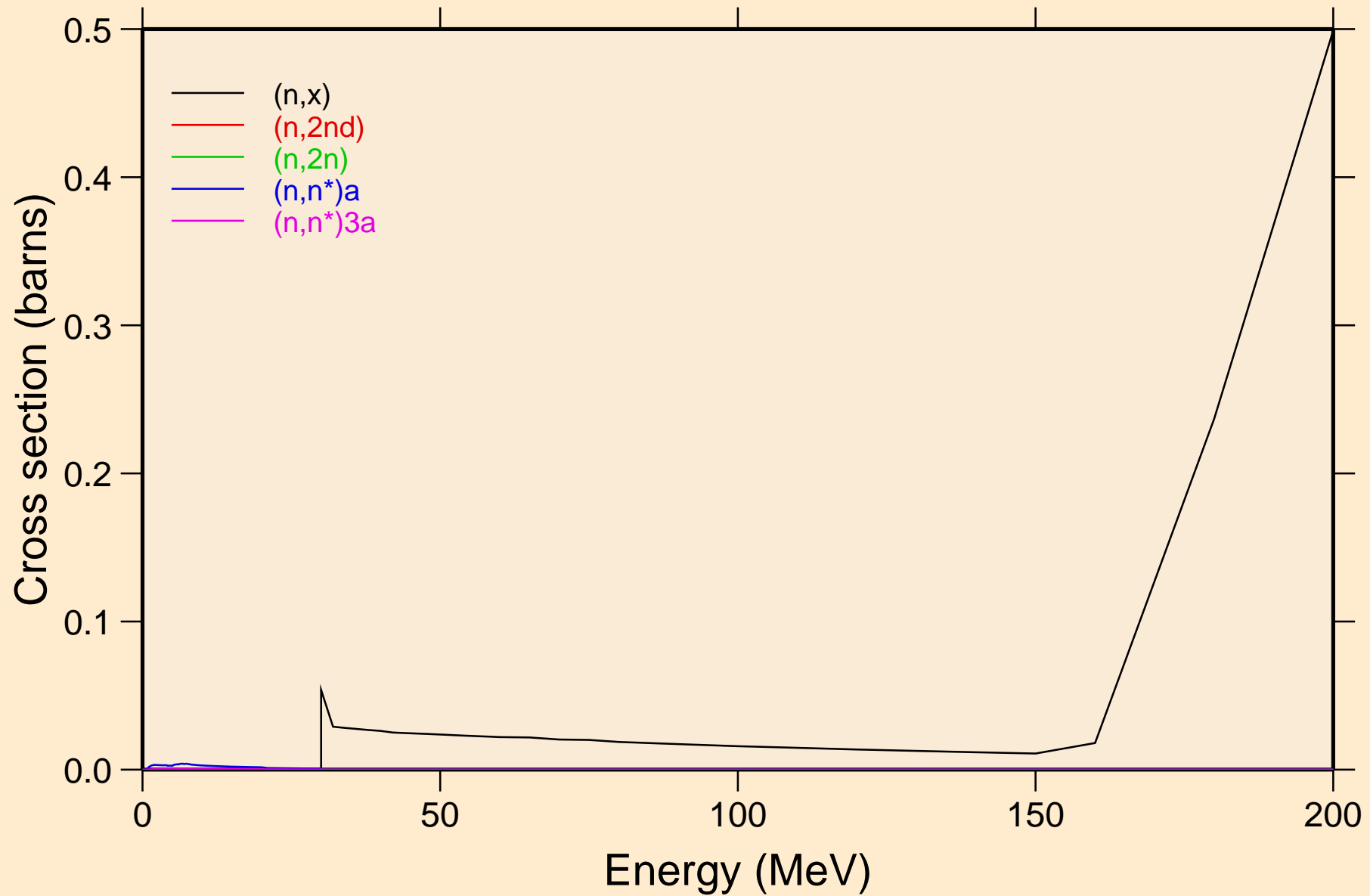

ES239 NRG TENDL-2016, AKONING

Threshold reactions

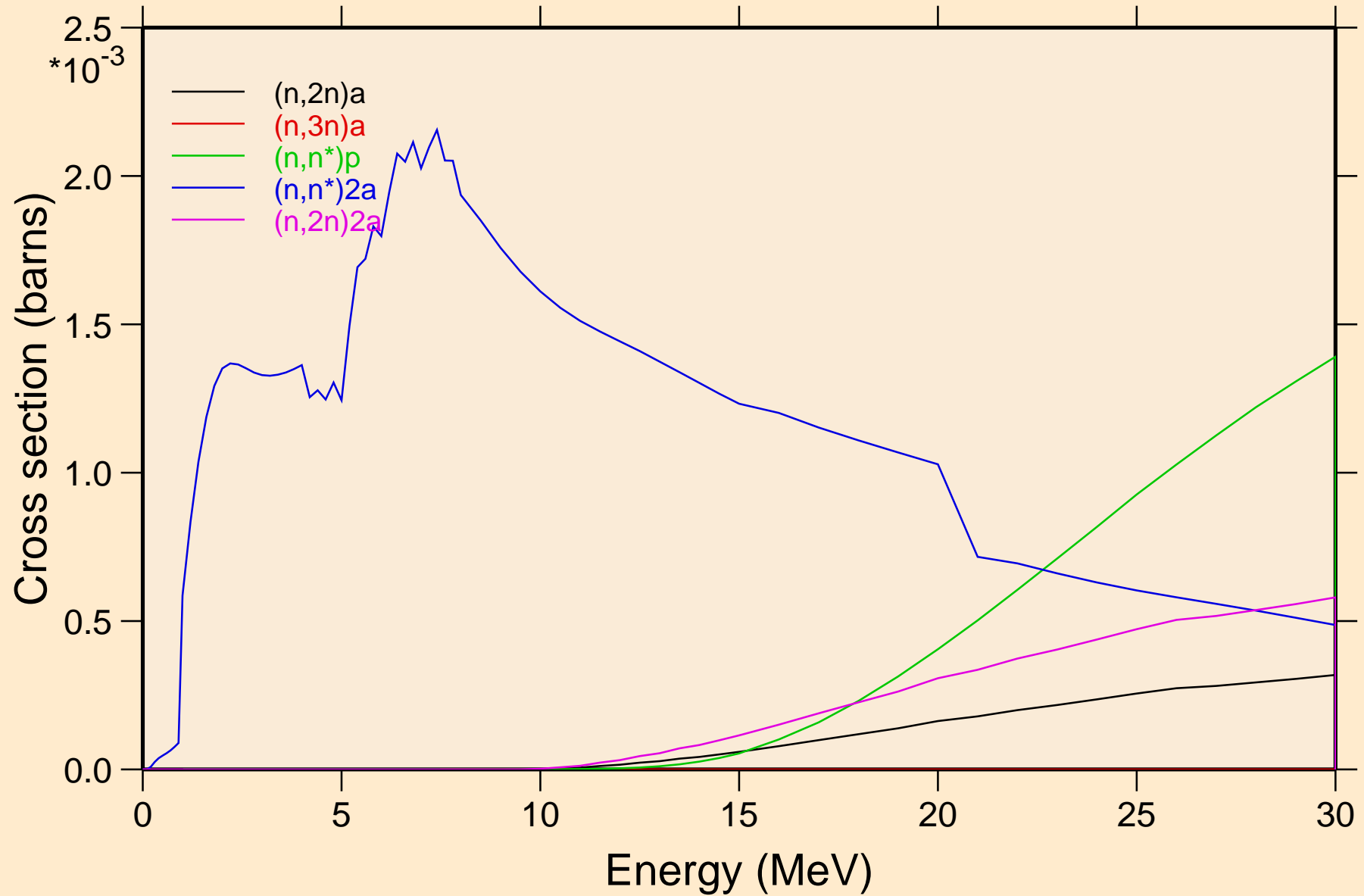

ES239 NRG TENDL-2016, AKONING

Threshold reactions

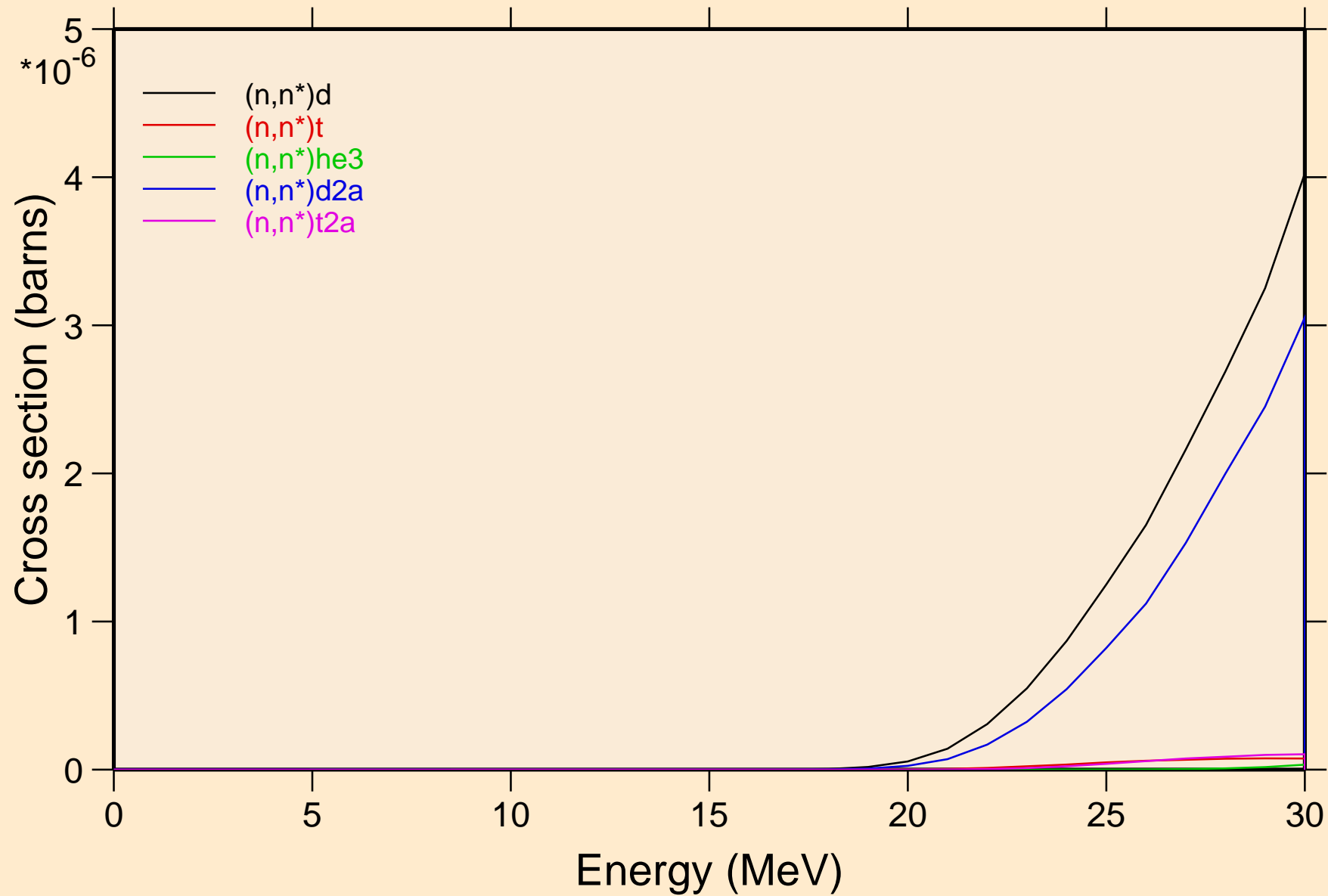

ES239 NRG TENDL-2016, AKONING

Threshold reactions

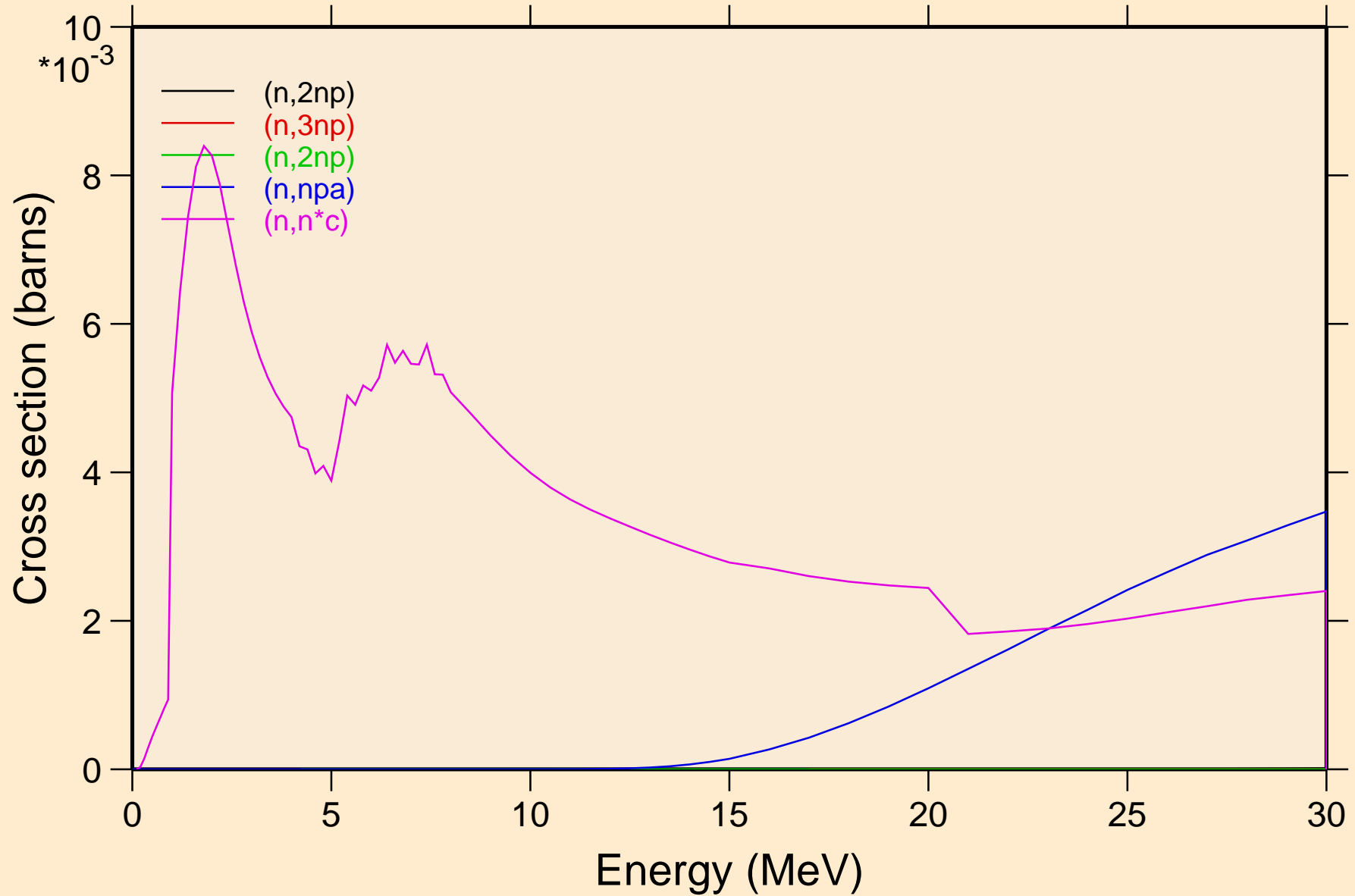

ES239 NRG TENDL-2016, AKONING

Threshold reactions

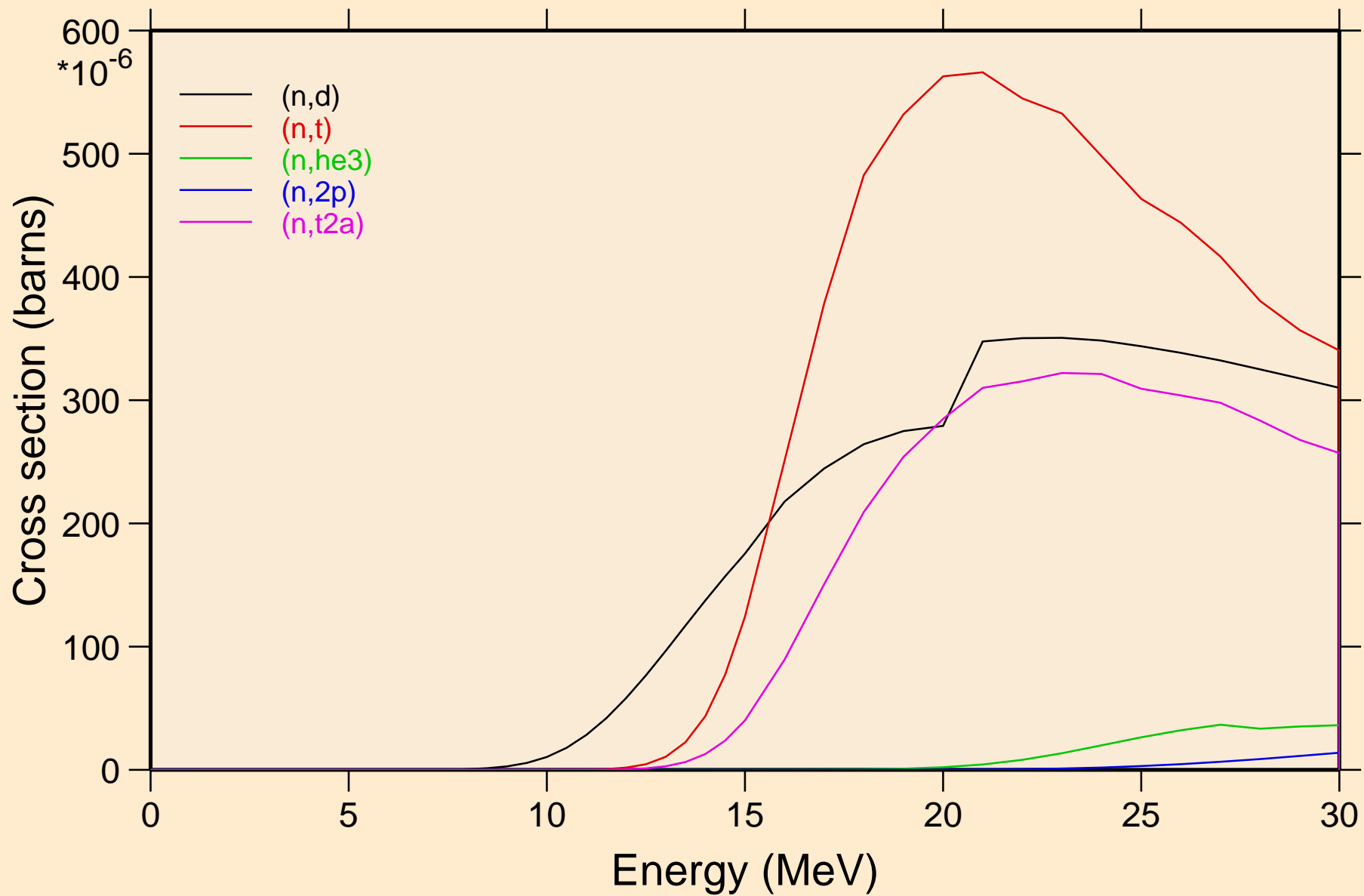

ES239 NRG TENDL-2016, AKONING

Threshold reactions

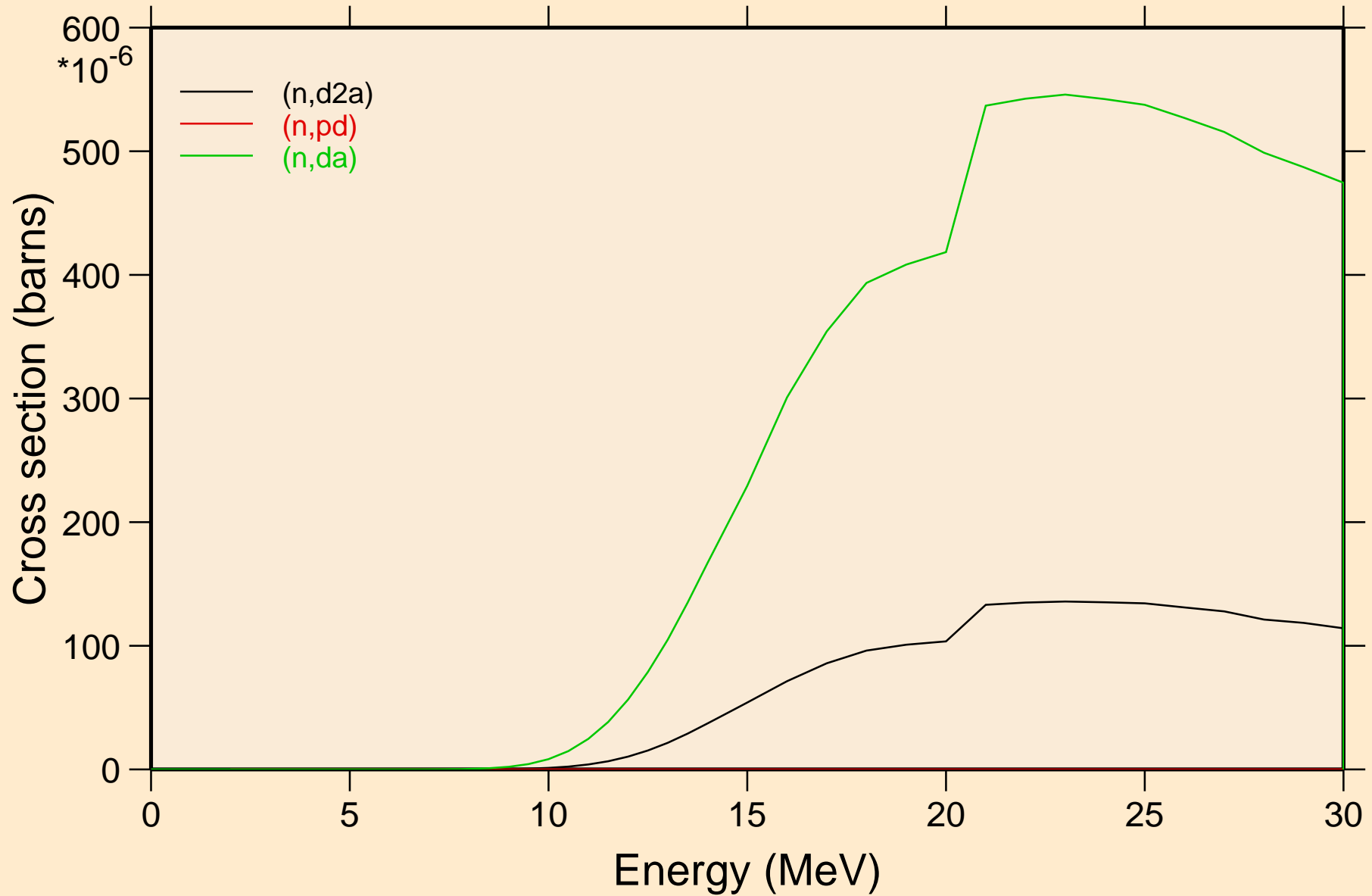

ES239 NRG TENDL-2016, AKONING
angular distribution for elastic

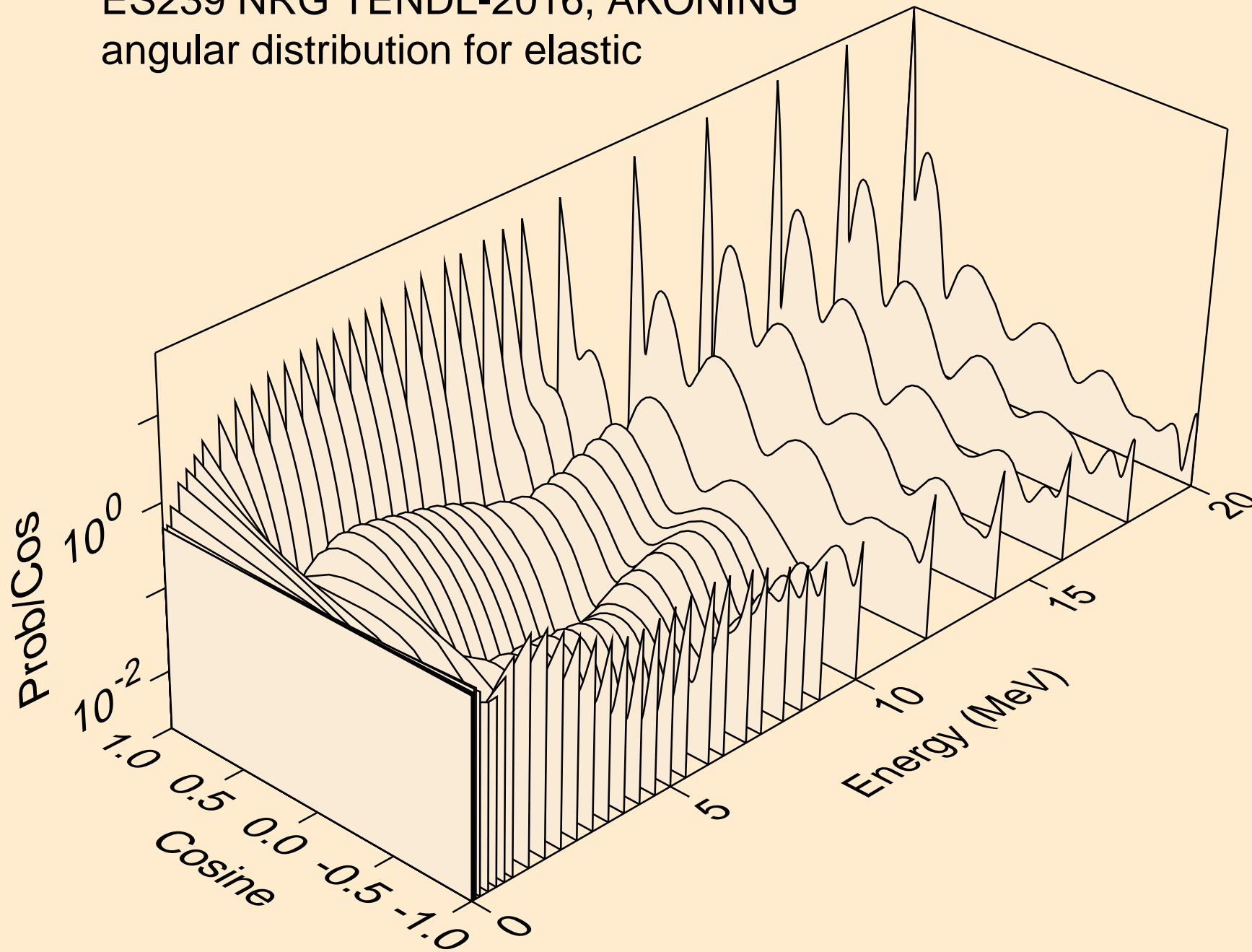

ES239 NRG TENDL-2016, AKONING
angular distribution for elastic

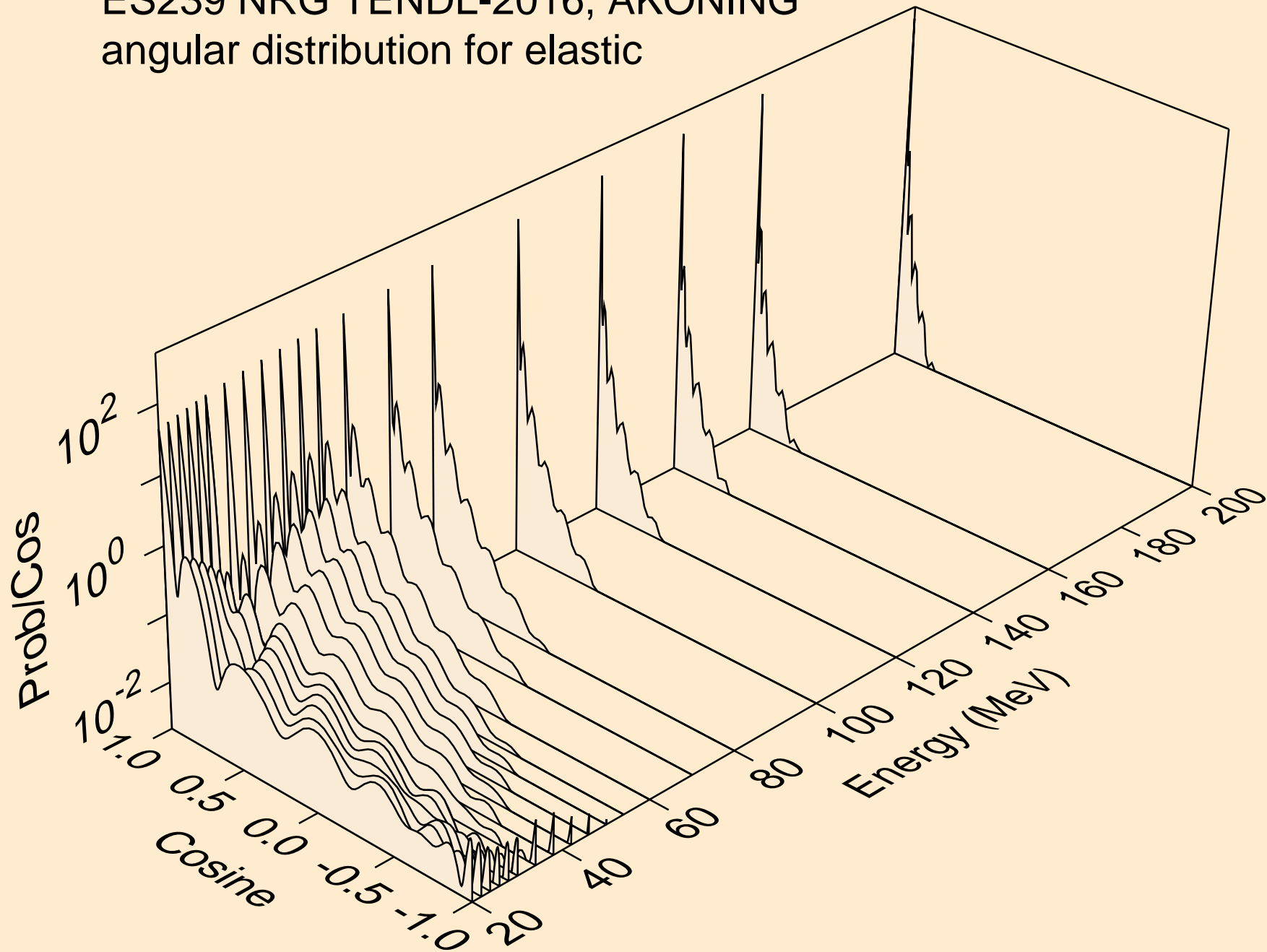

ES239 NRG TENDL-2016, AKONING
angular distribution for (n,n*1)

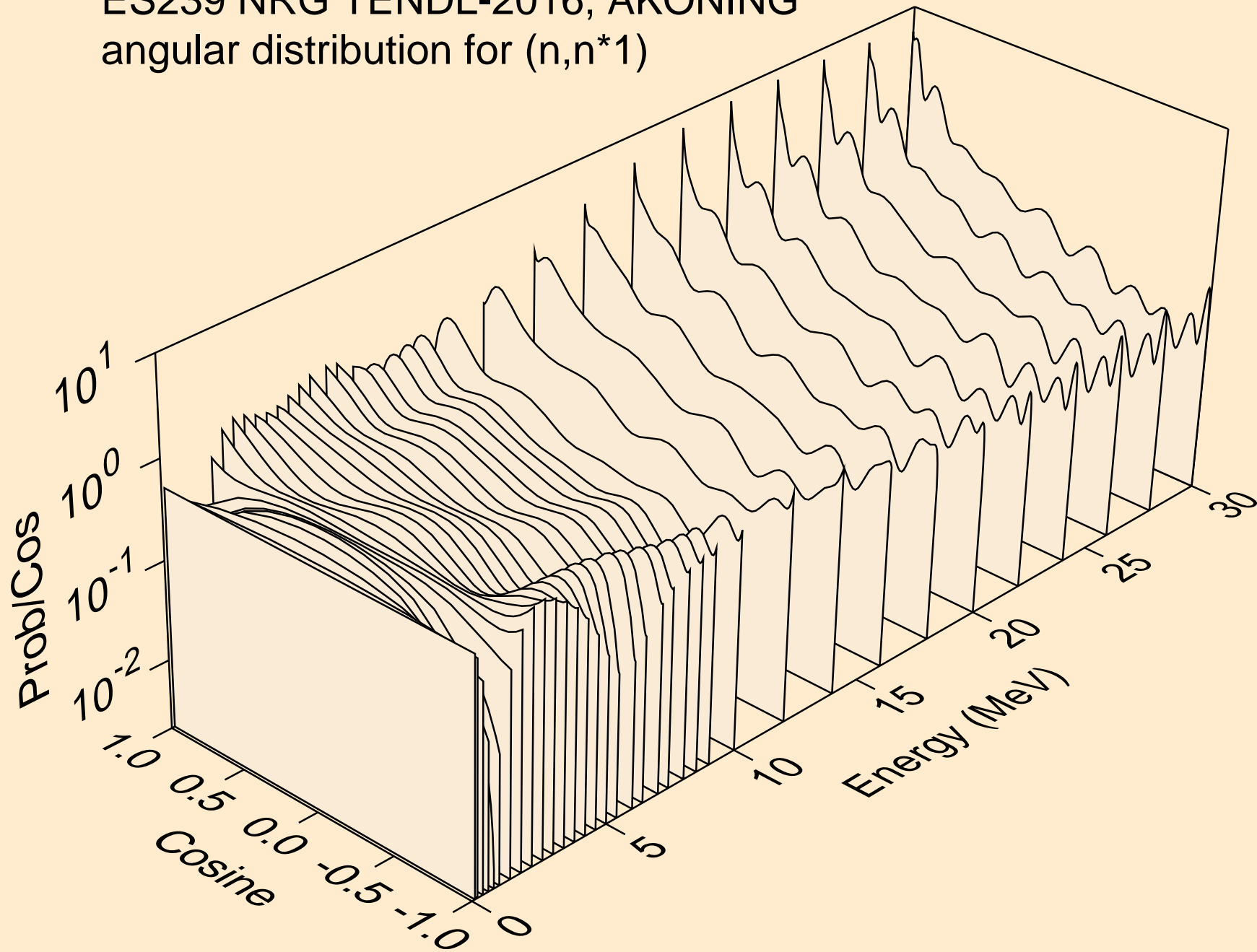

ES239 NRG TENDL-2016, AKONING

Total fission nubar

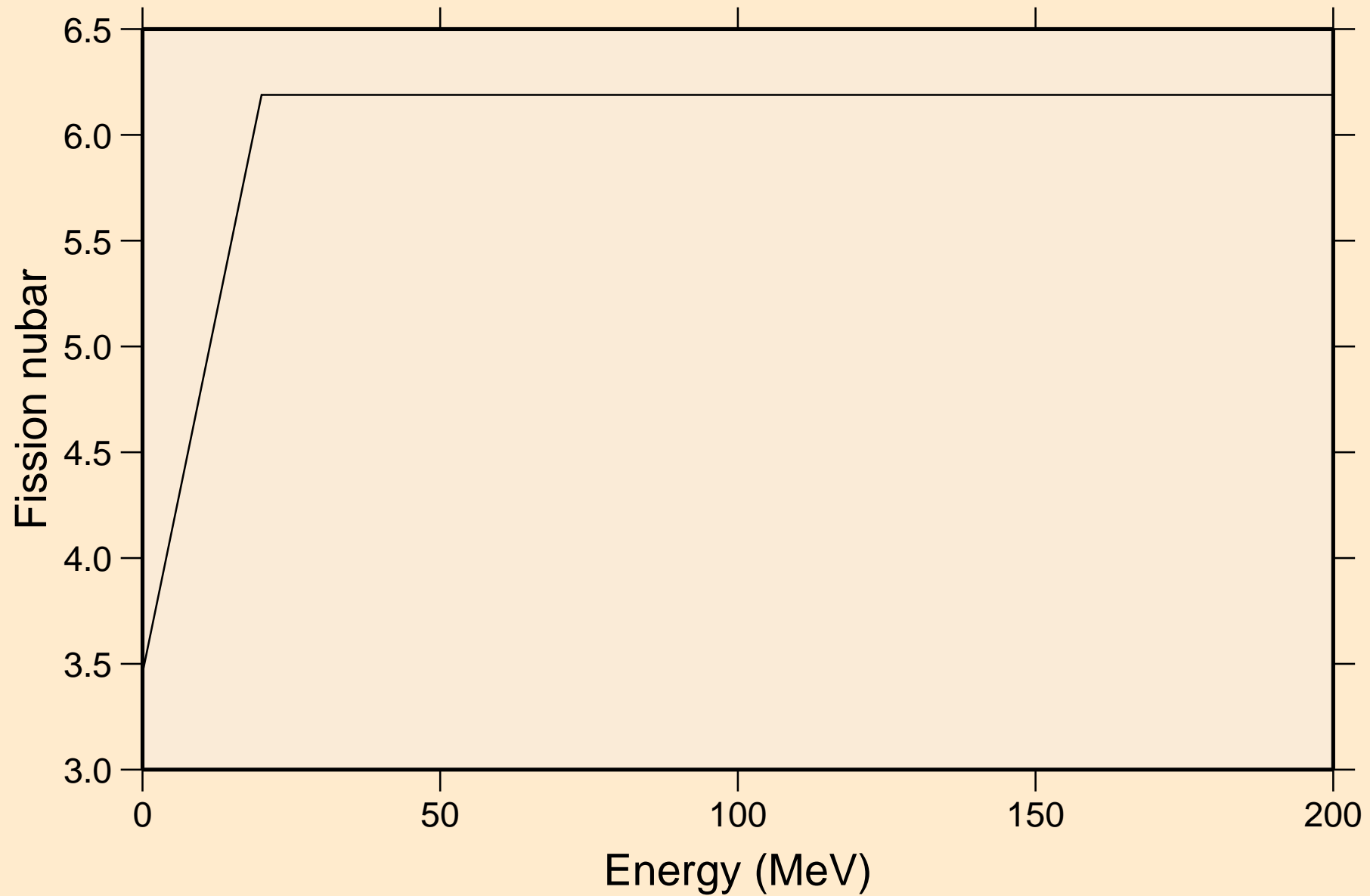

ES239 NRG TENDL-2016, AKONING
Neutron emission for (n,x)

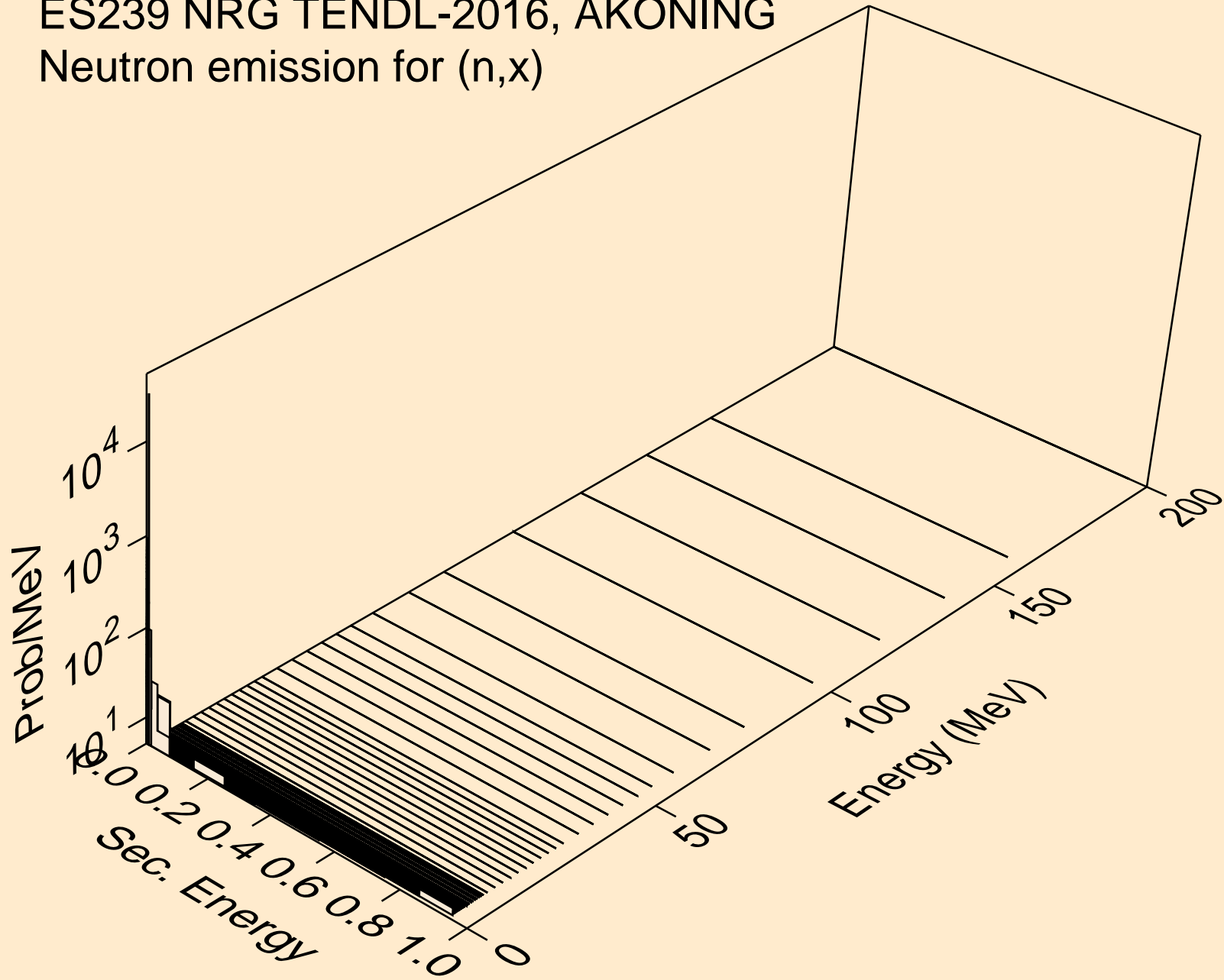

ES239 NRG TENDL-2016, AKONING
Neutron emission for (n,2nd)

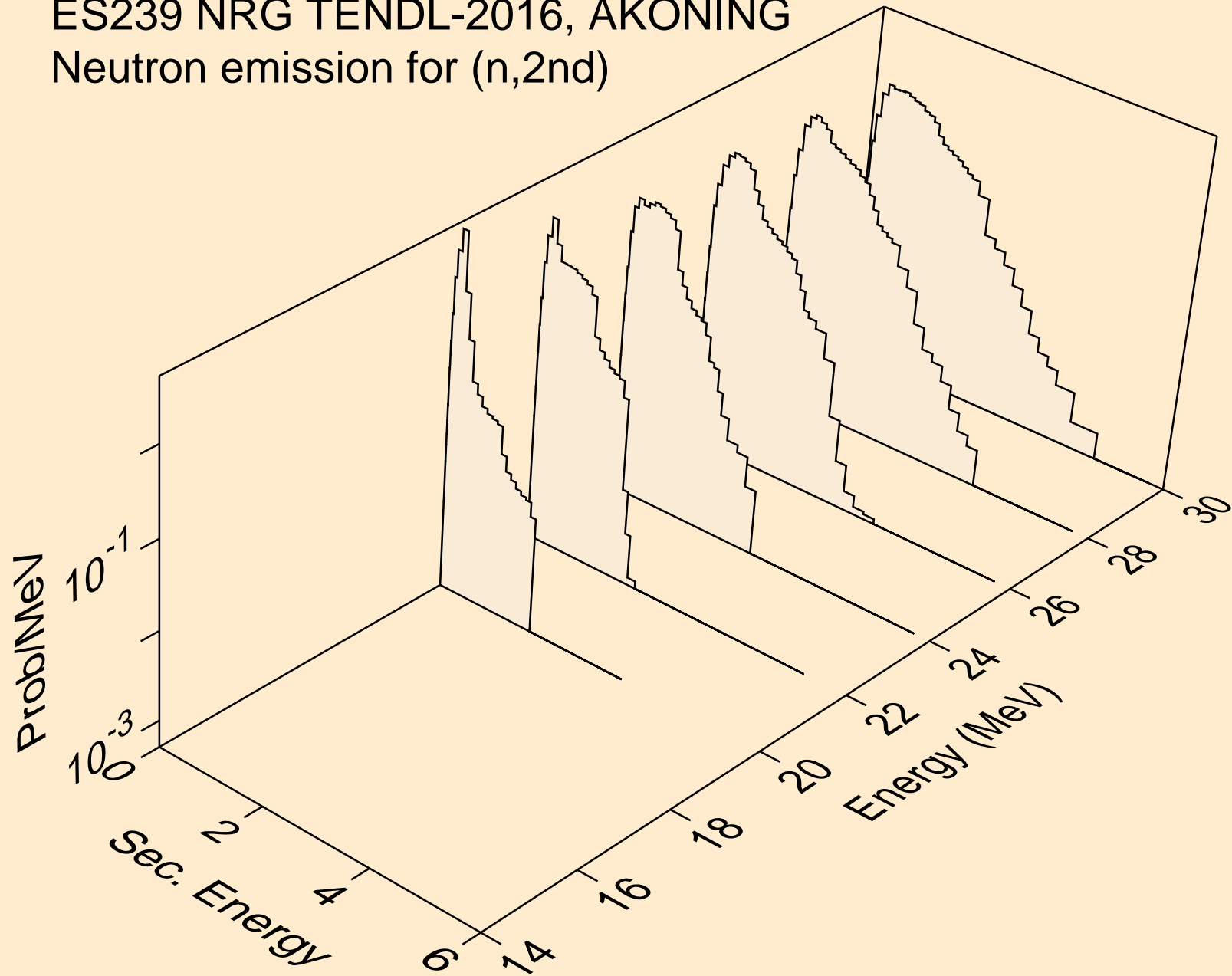

ES239 NRG TENDL-2016, AKONING
Neutron emission for (n,2n)

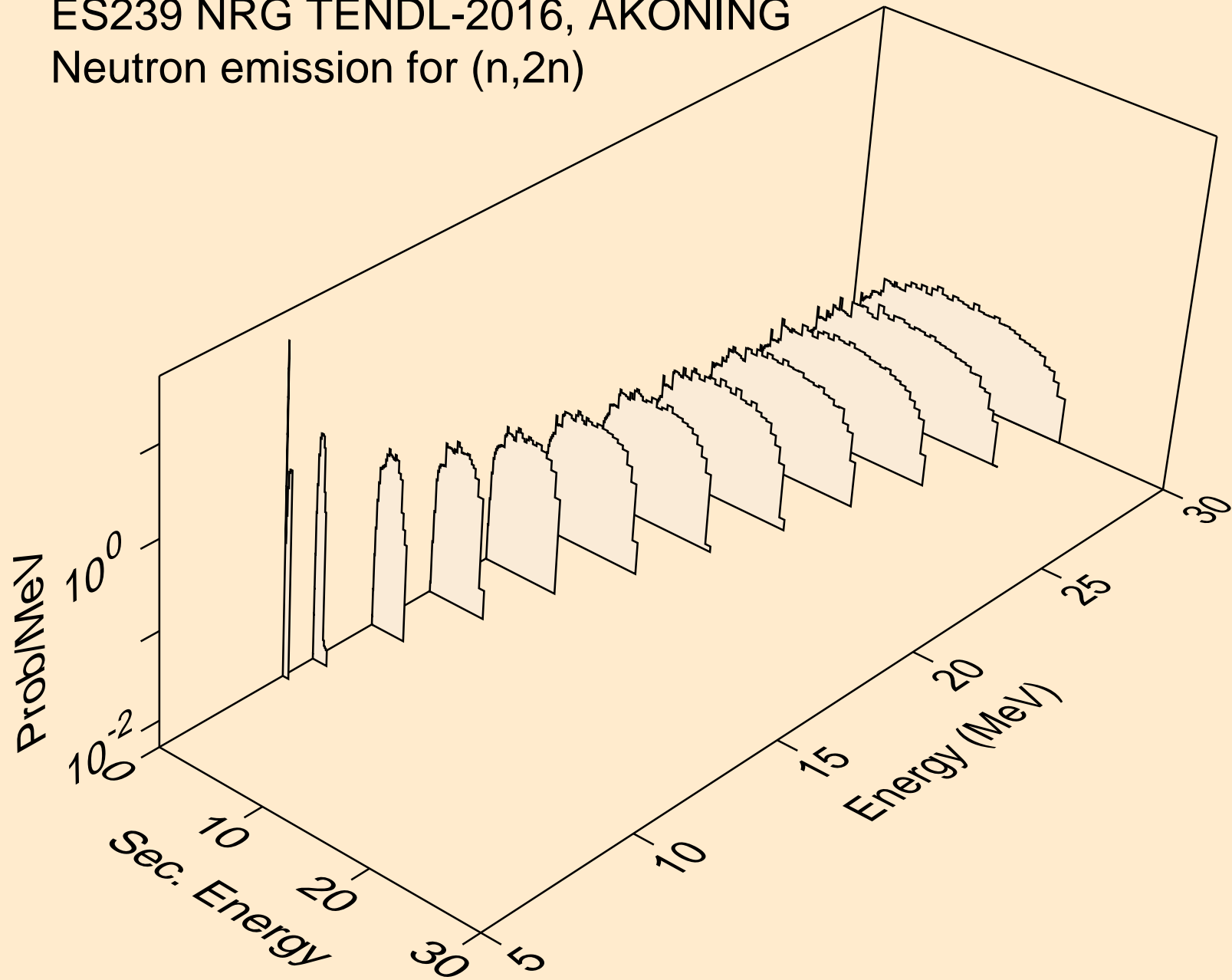

ES239 NRG TENDL-2016, AKONING
Neutron emission for fission

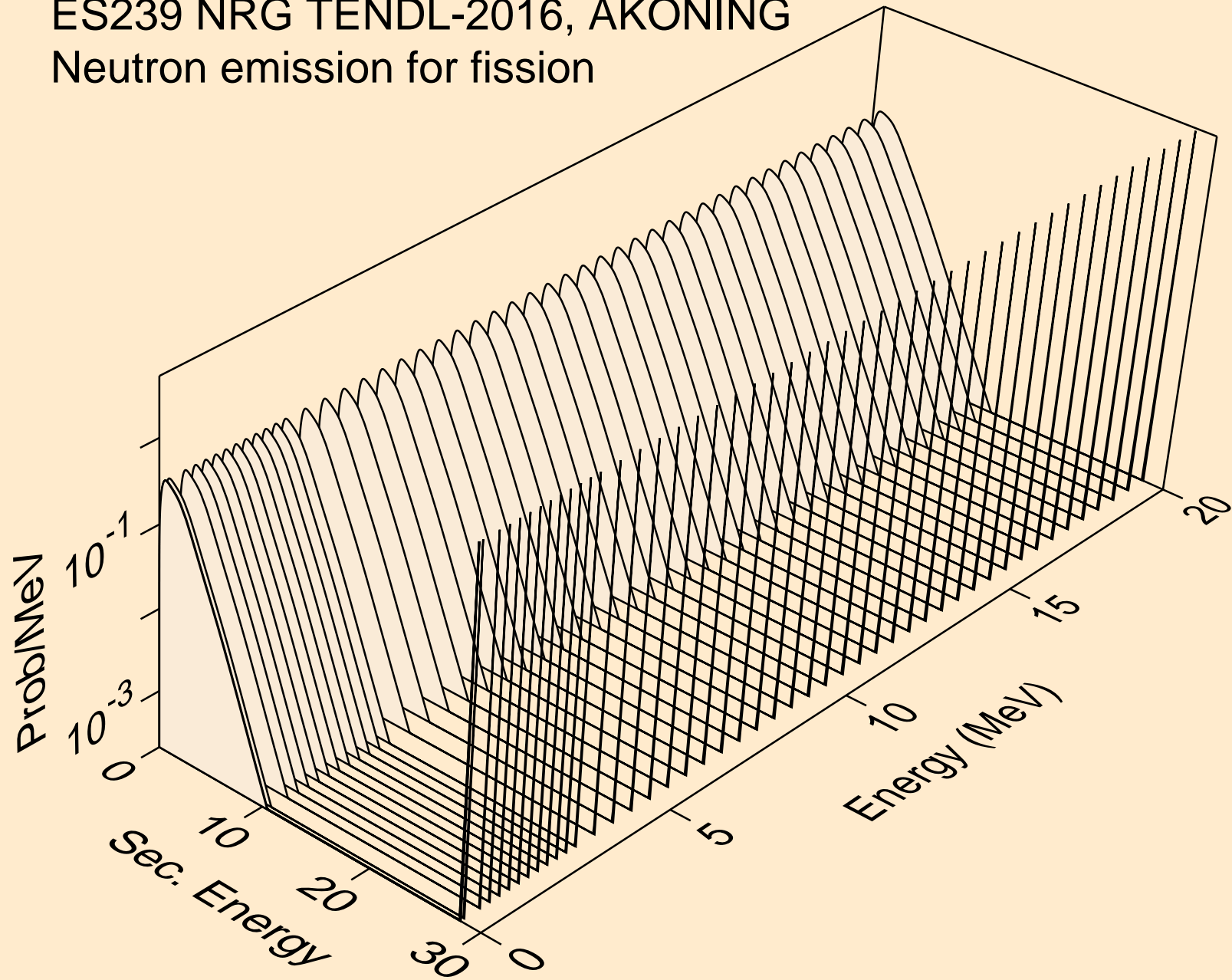

ES239 NRG TENDL-2016, AKONING
Neutron emission for (n,n*)a

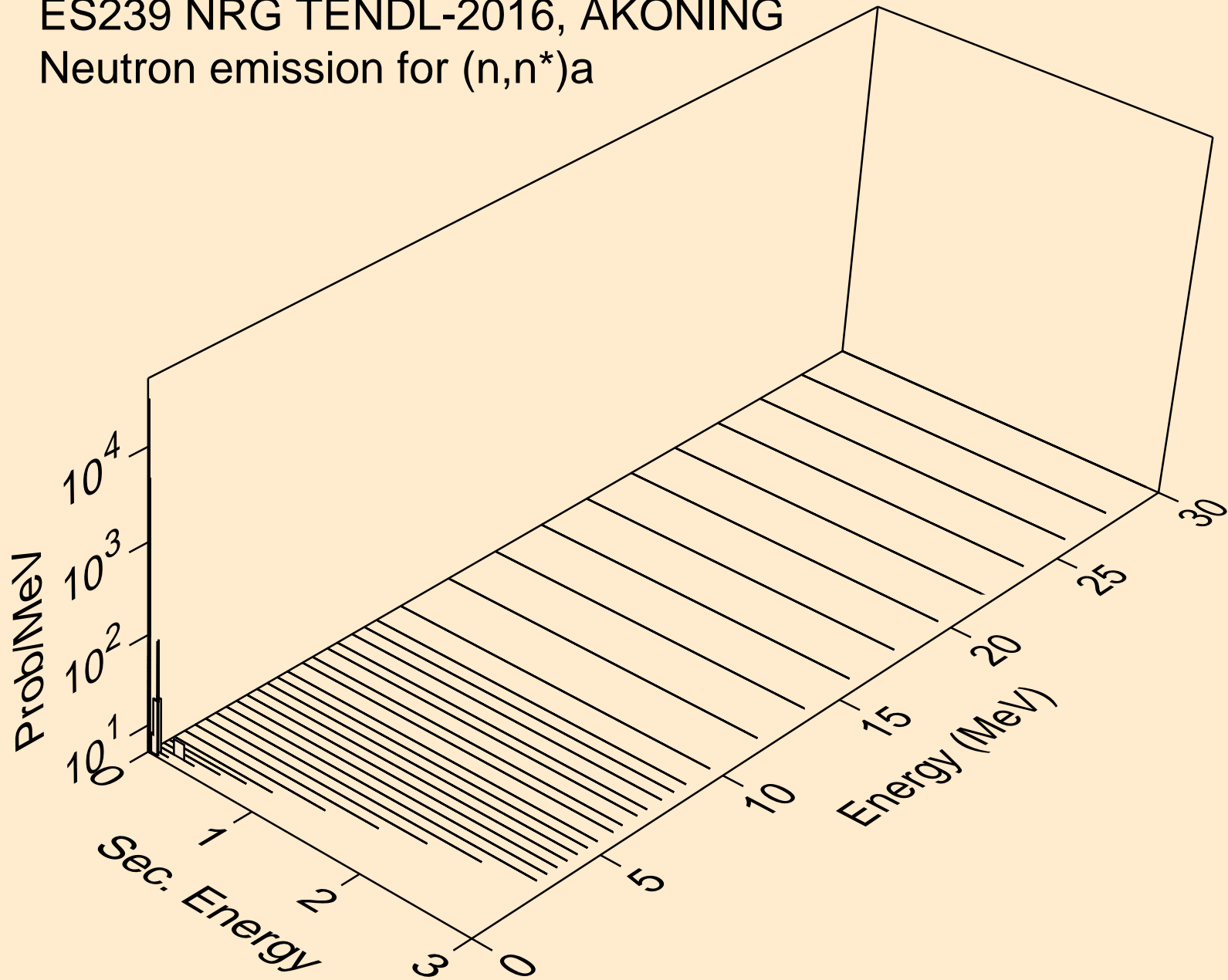

ES239 NRG TENDL-2016, AKONING
Neutron emission for (n,n*)3a

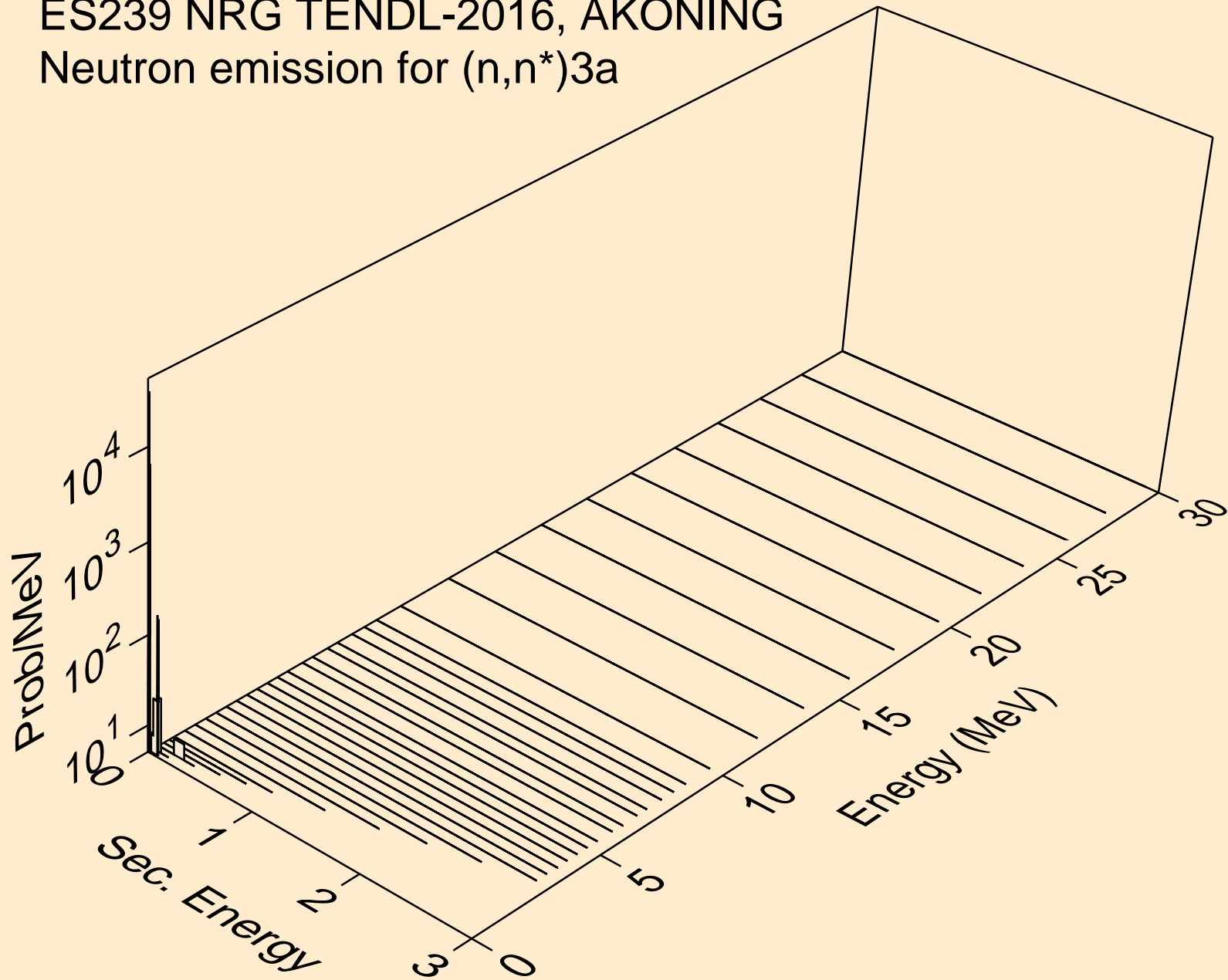

ES239 NRG TENDL-2016, AKONING
Neutron emission for (n,2n)a

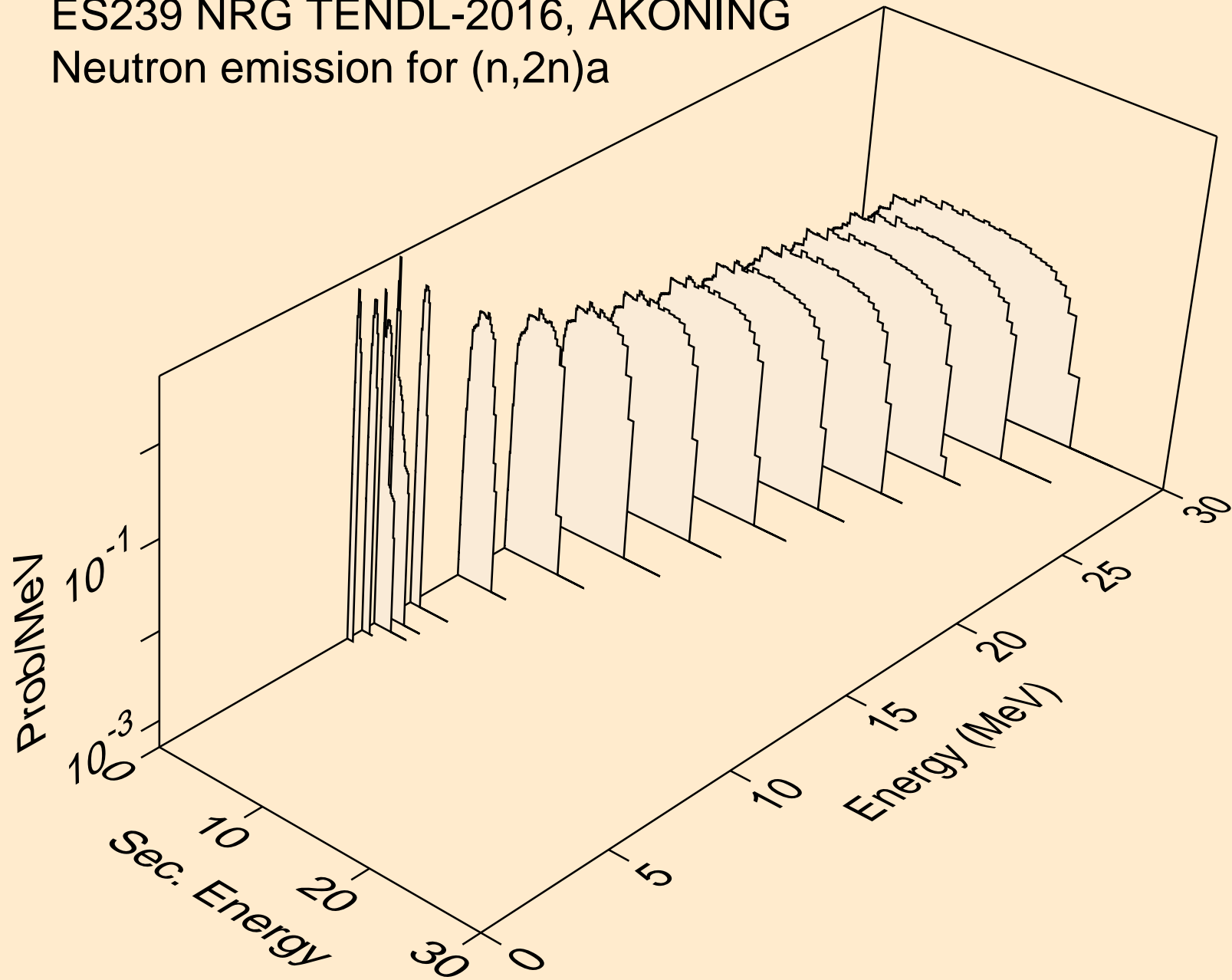

ES239 NRG TENDL-2016, AKONING
Neutron emission for (n,3n)a

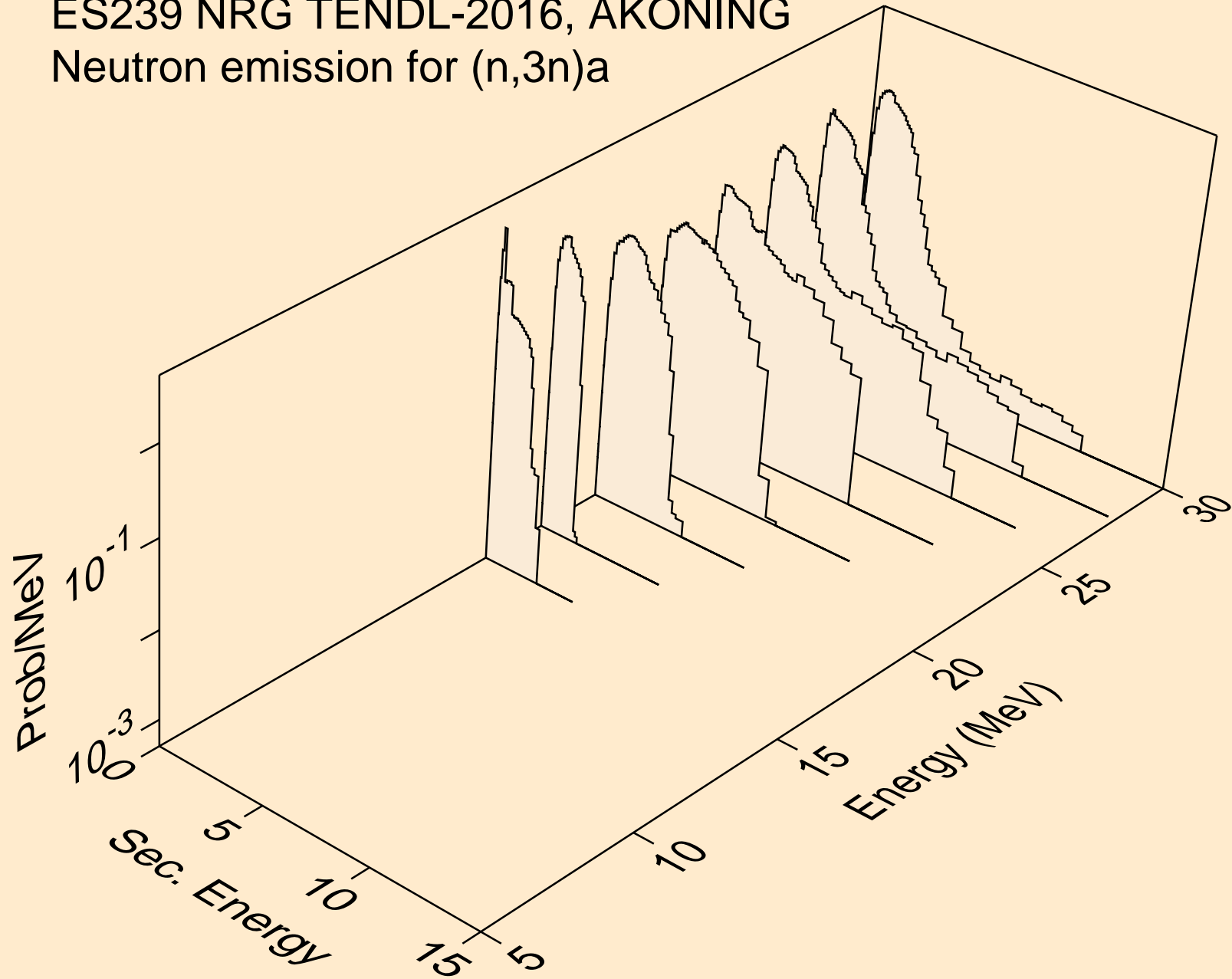

ES239 NRG TENDL-2016, AKONING
Neutron emission for (n,n*)p

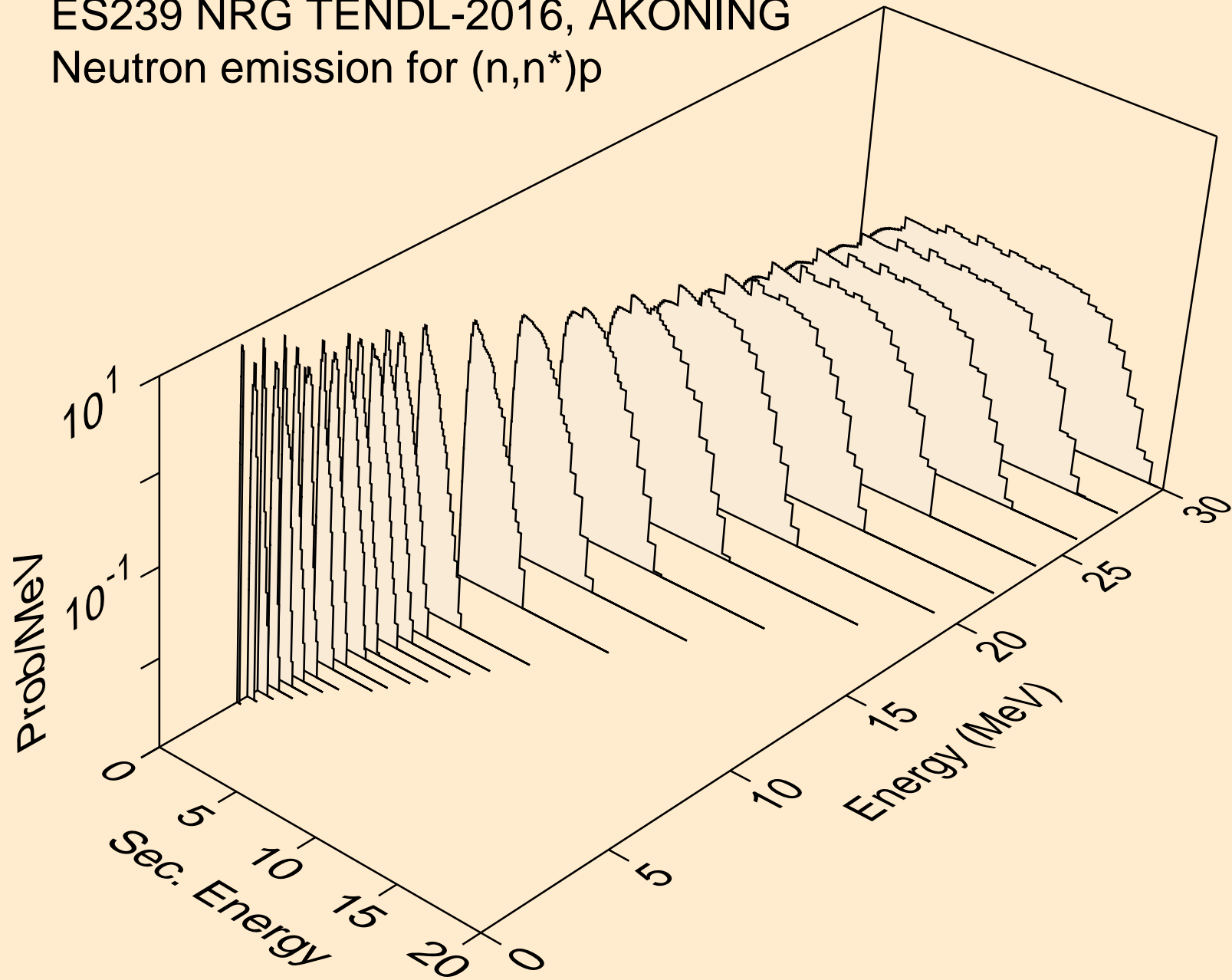

ES239 NRG TENDL-2016, AKONING
Neutron emission for (n,n*)2a

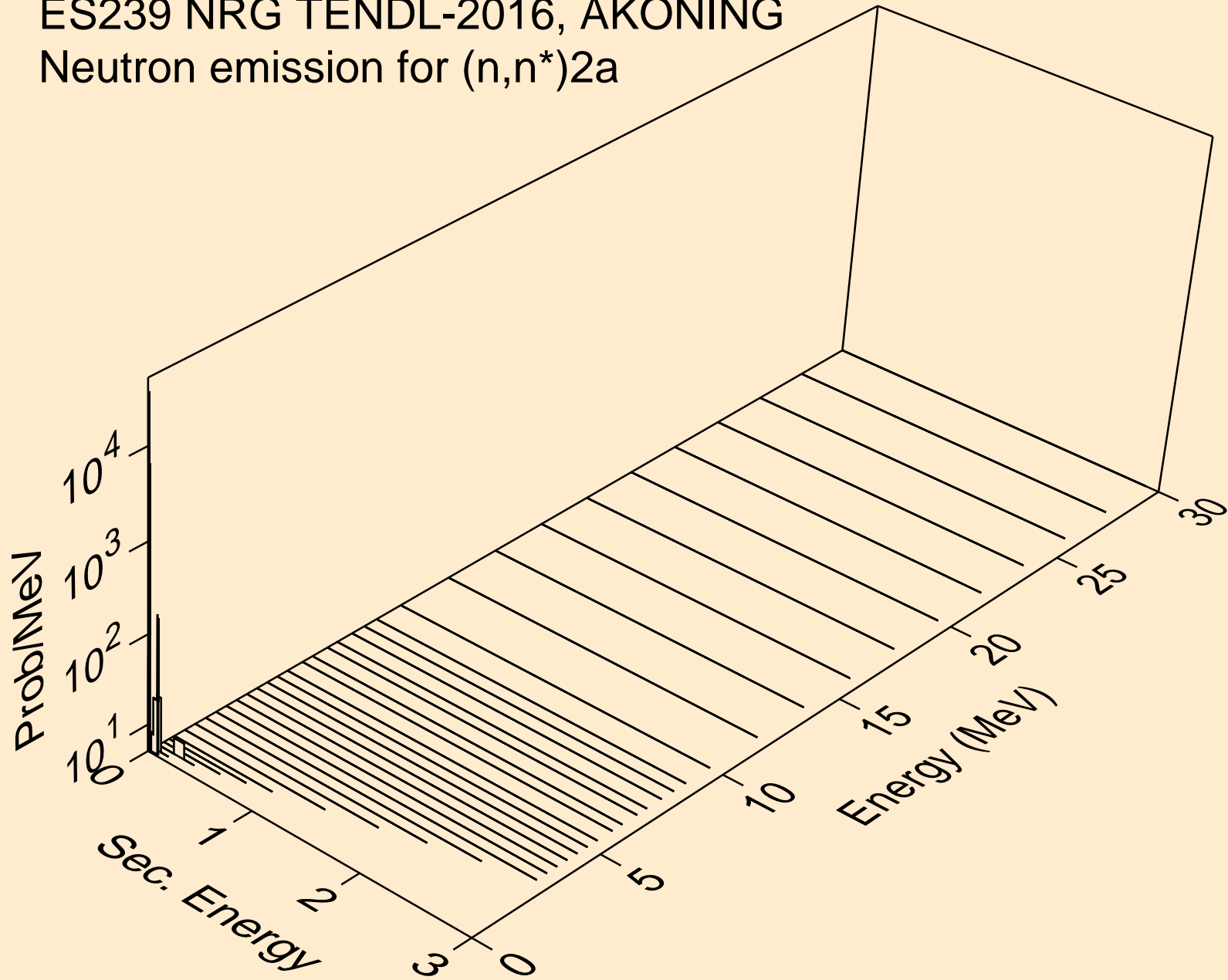

ES239 NRG TENDL-2016, AKONING
Neutron emission for (n,2n)2a

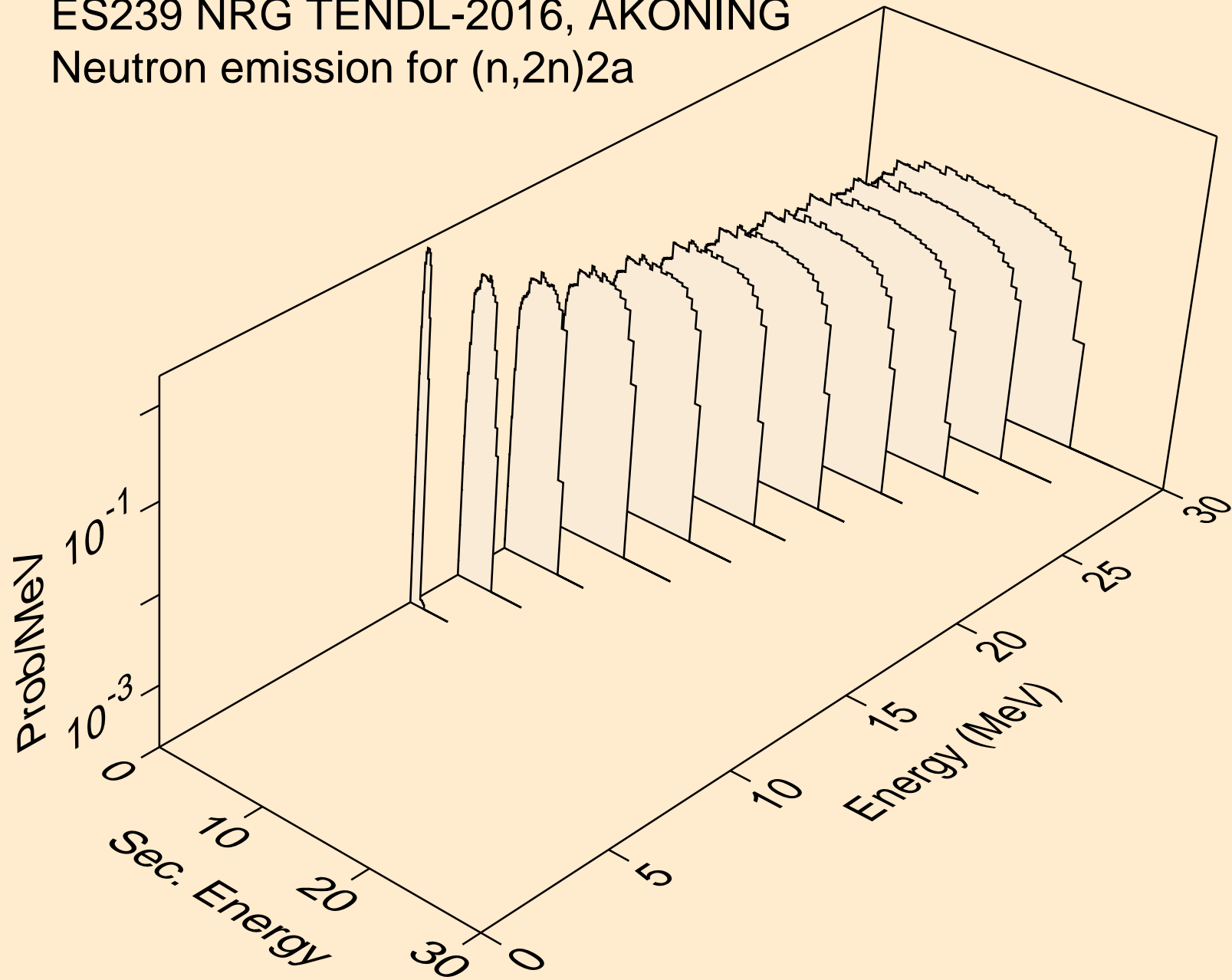

ES239 NRG TENDL-2016, AKONING
Neutron emission for (n,n*)d

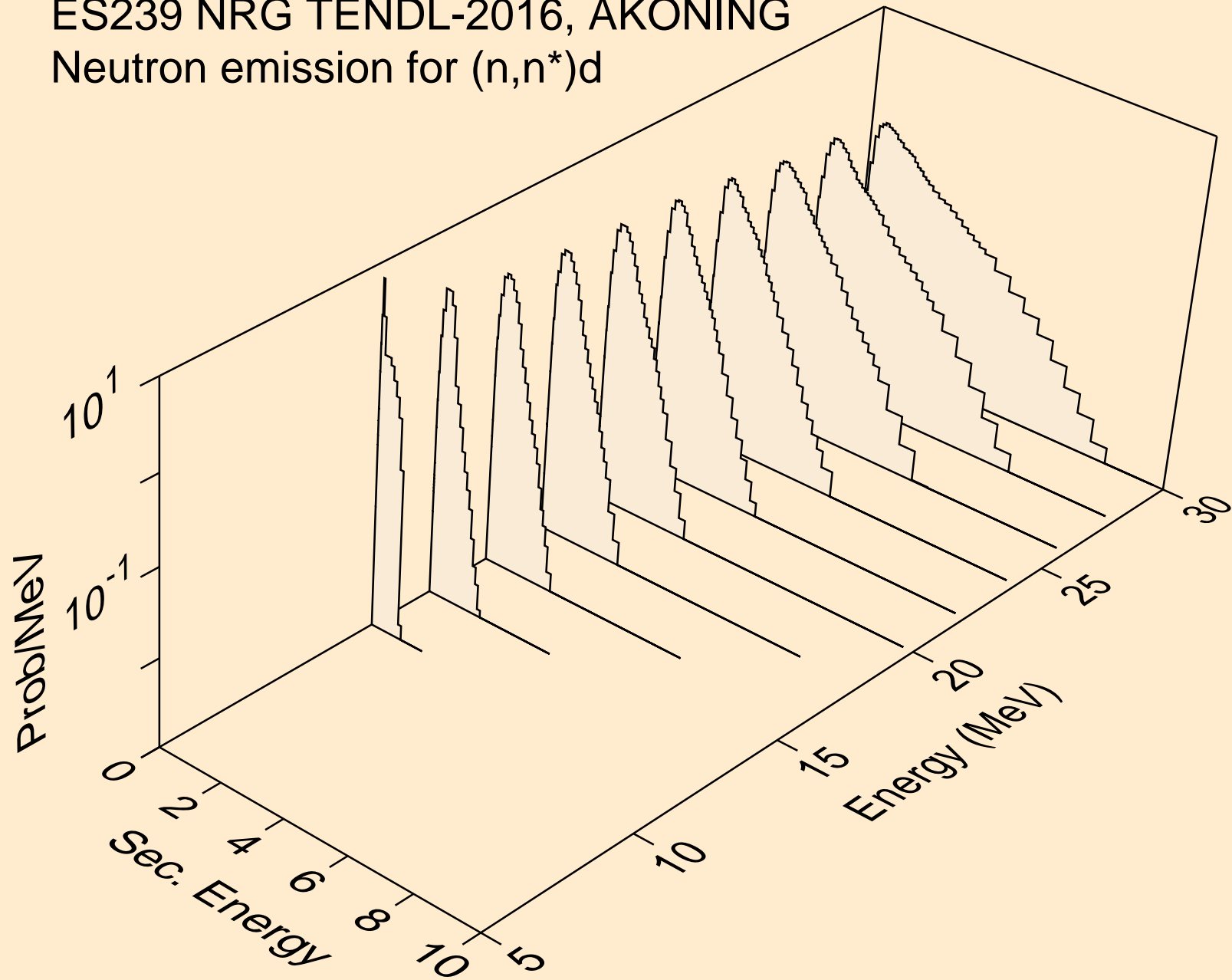

ES239 NRG TENDL-2016, AKONING
Neutron emission for (n,n*)t

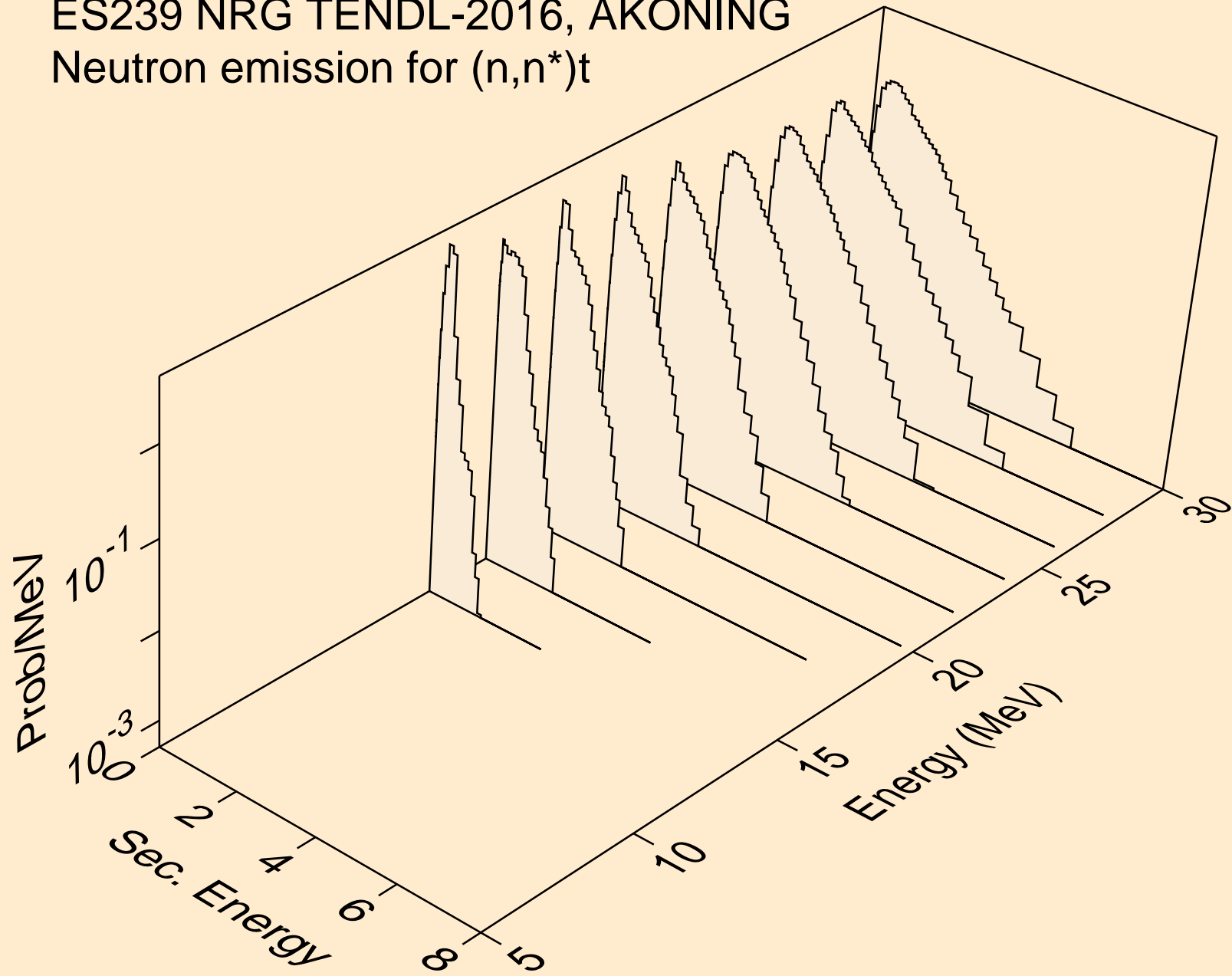

ES239 NRG TENDL-2016, AKONING
Neutron emission for (n,n*)he3

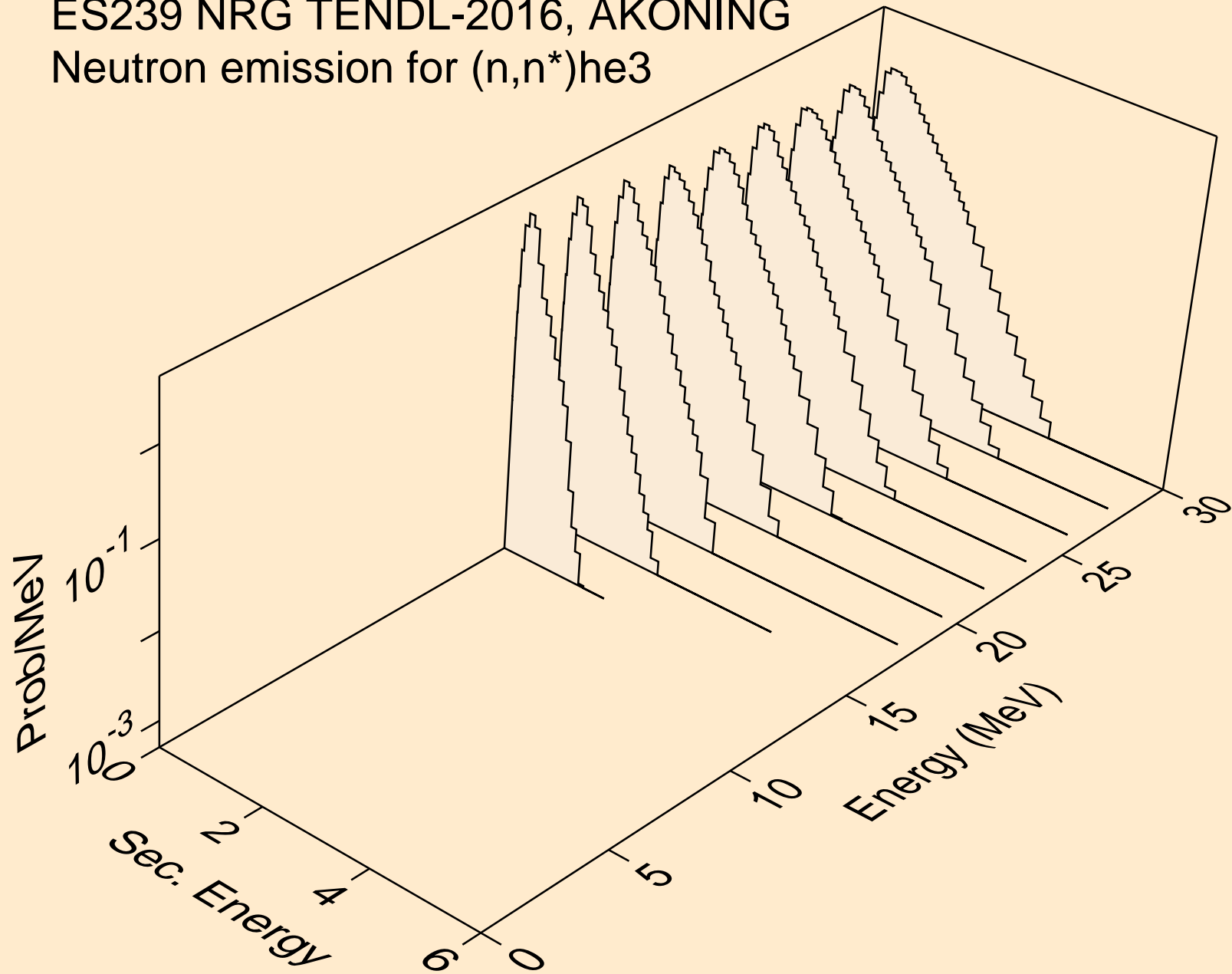

ES239 NRG TENDL-2016, AKONING
Neutron emission for (n,n*)d2a

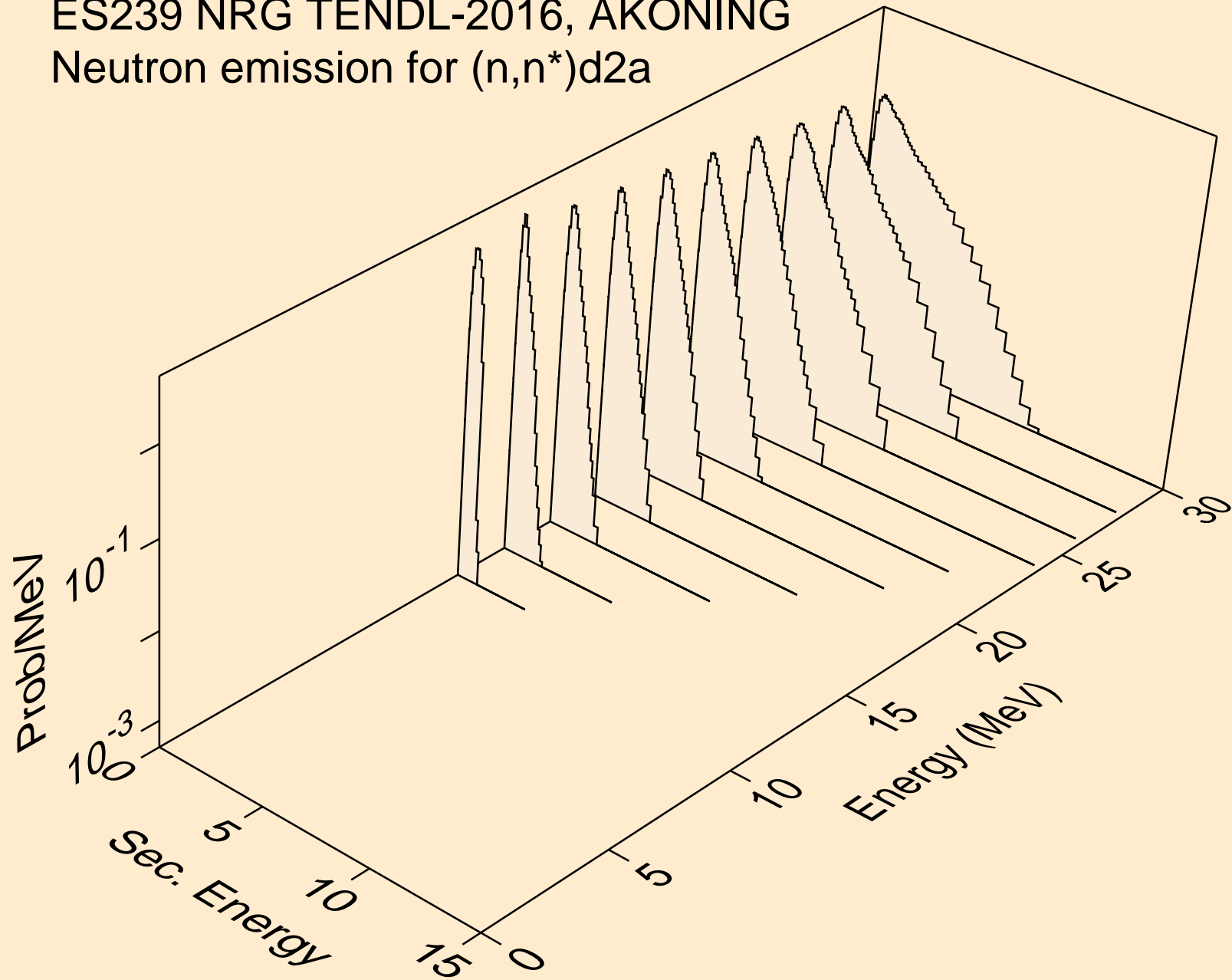

ES239 NRG TENDL-2016, AKONING
Neutron emission for (n,n*)t2a

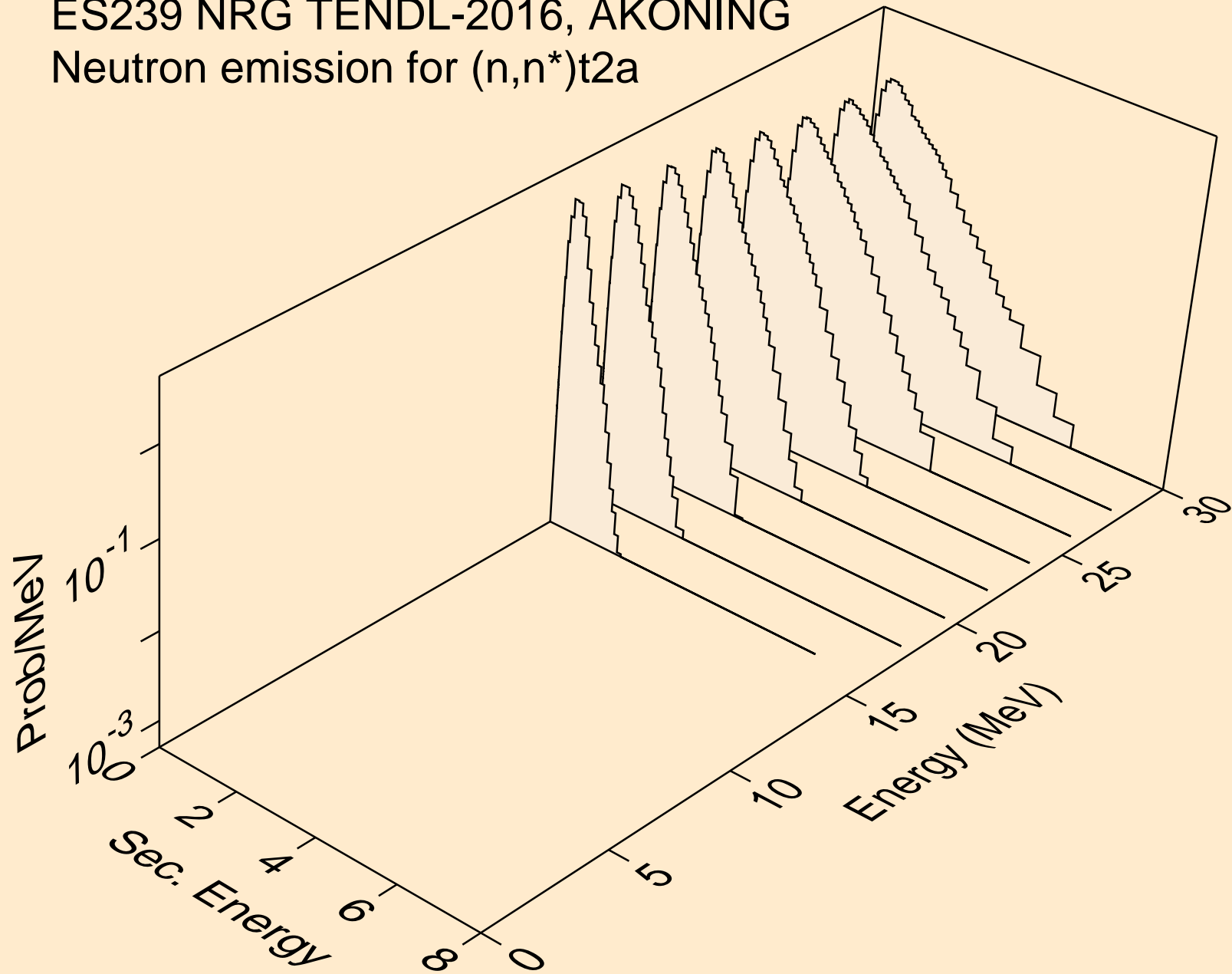

ES239 NRG TENDL-2016, AKONING
Neutron emission for (n,2np)

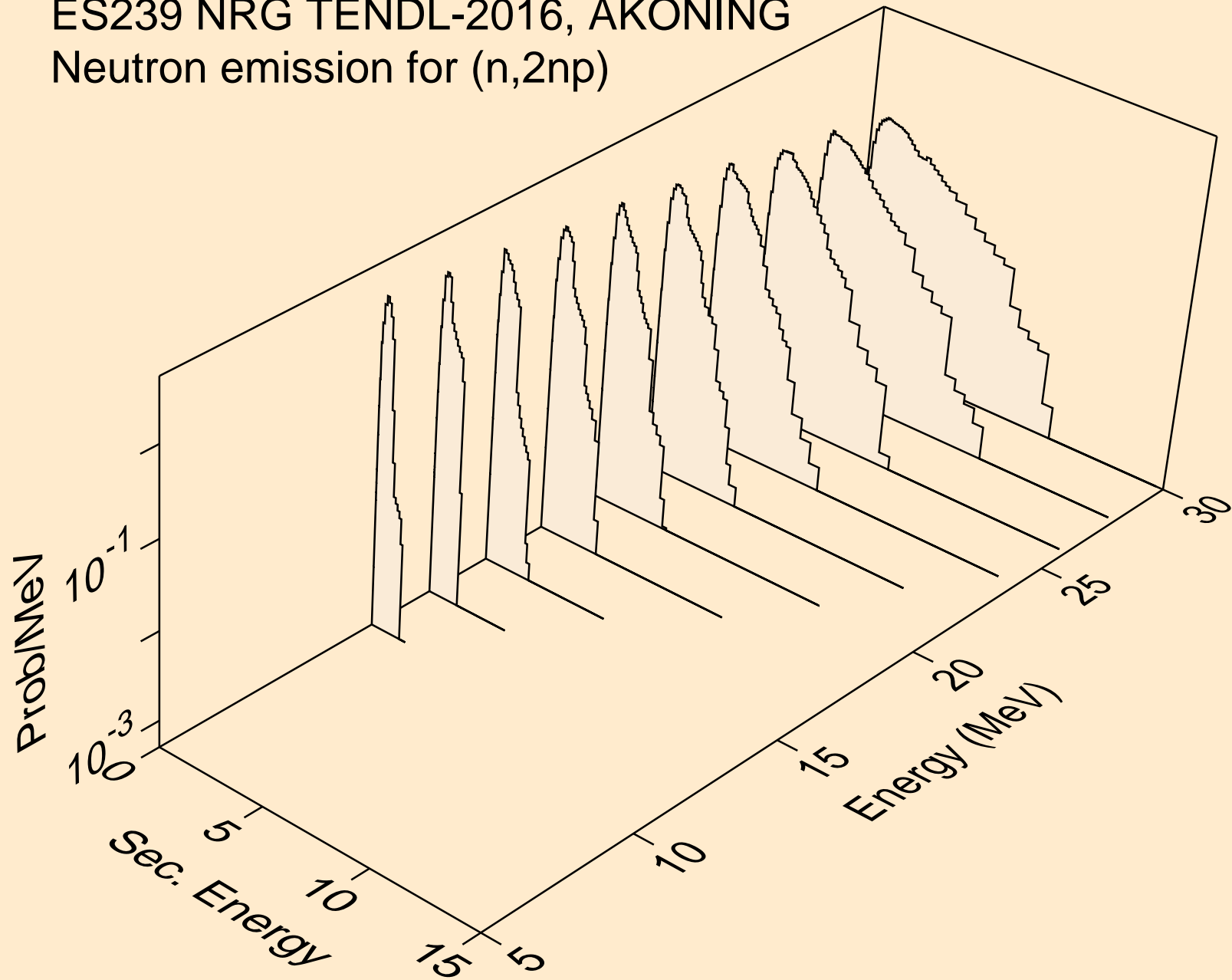

ES239 NRG TENDL-2016, AKONING
Neutron emission for (n,3np)

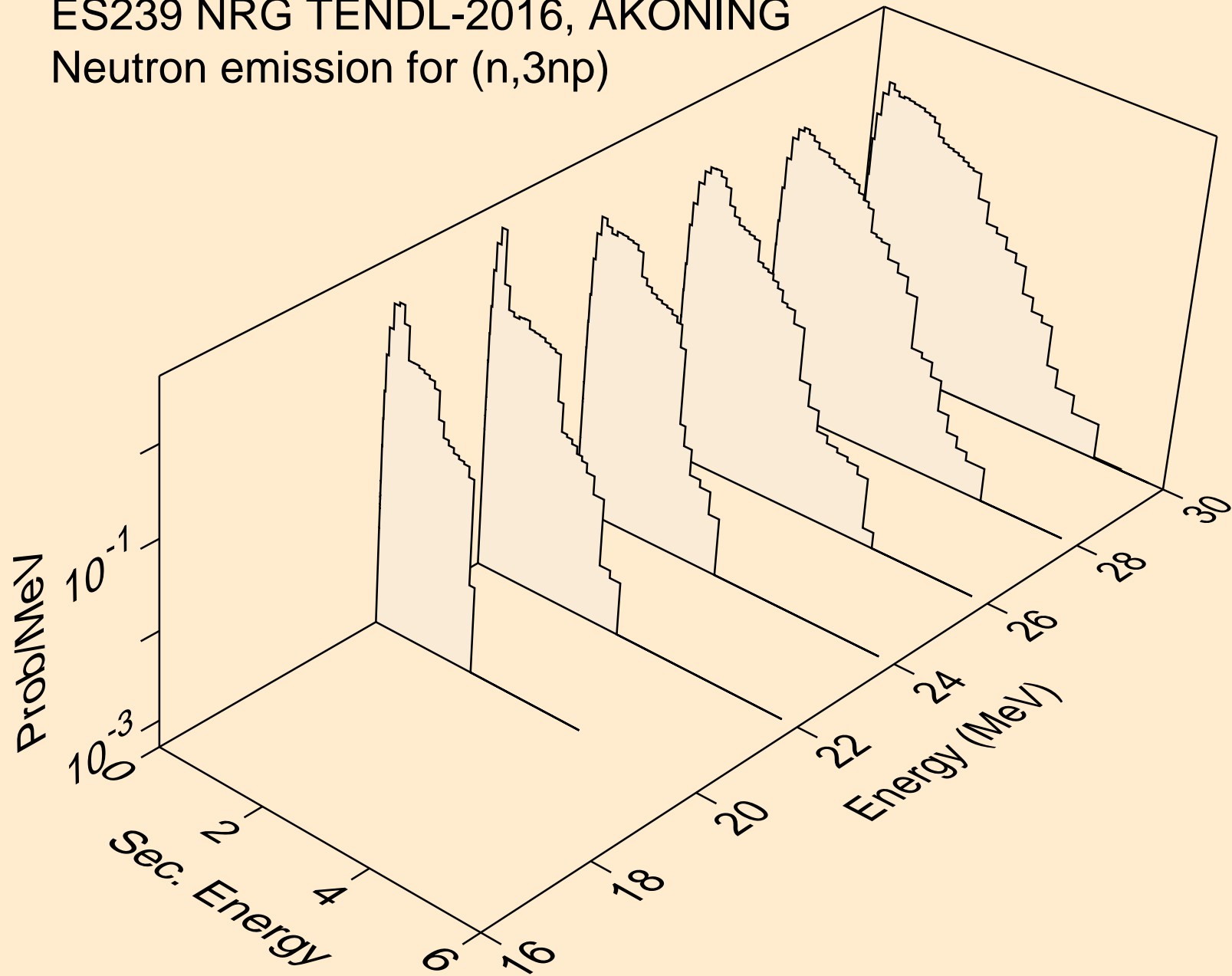

ES239 NRG TENDL-2016, AKONING
Neutron emission for (n,2np)

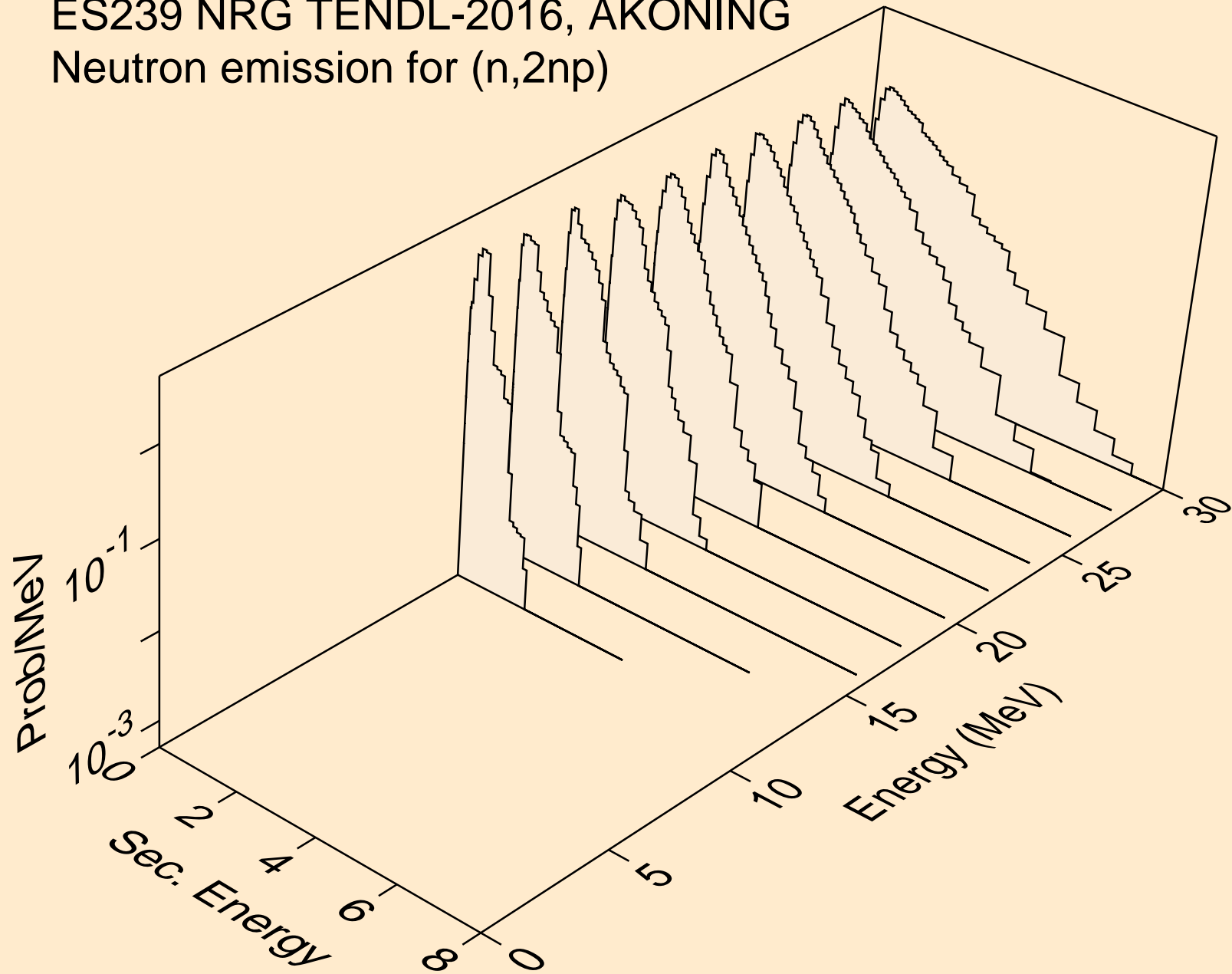

ES239 NRG TENDL-2016, AKONING
Neutron emission for (n,npa)

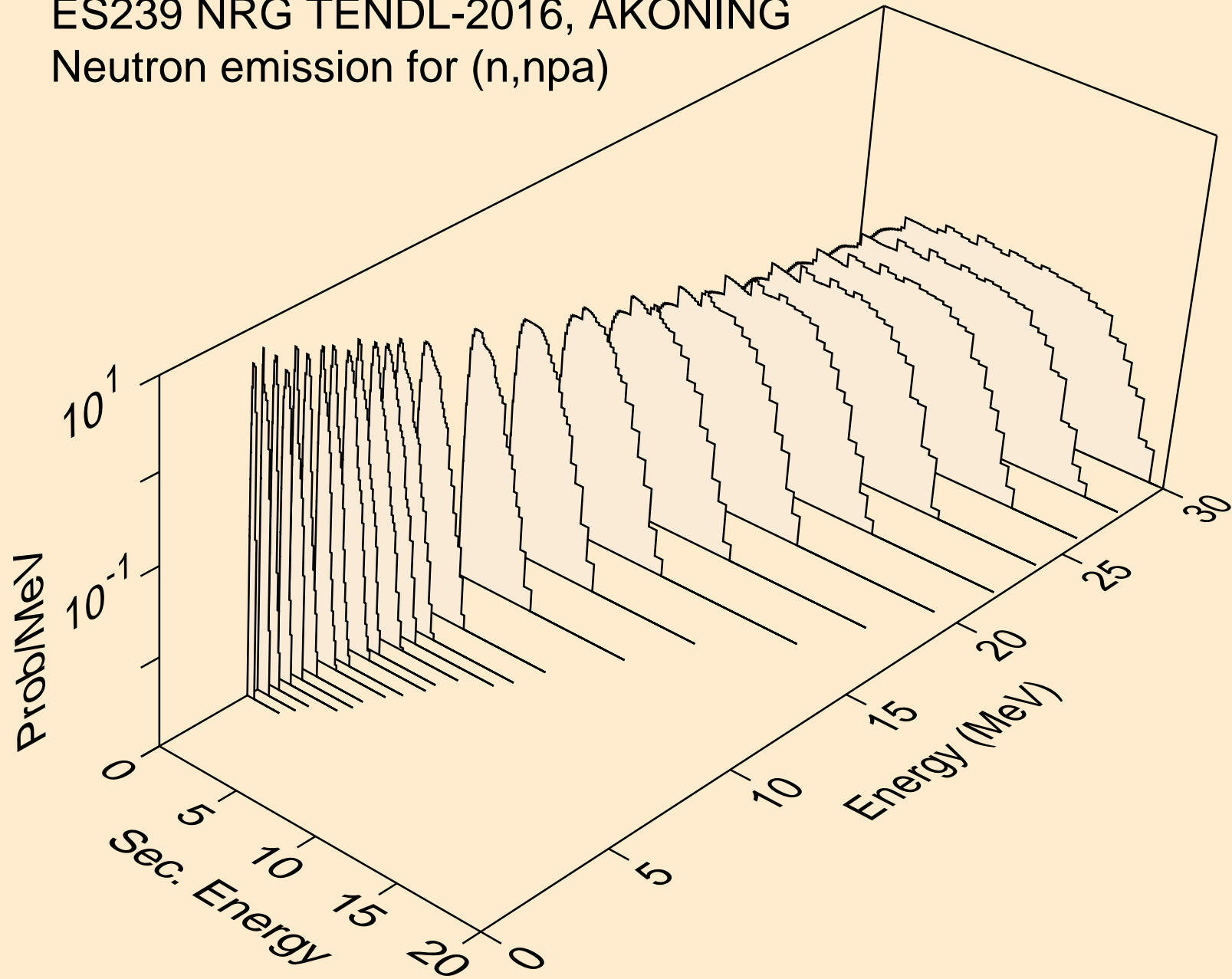

ES239 NRG TENDL-2016, AKONING
Neutron emission for (n,n*c)

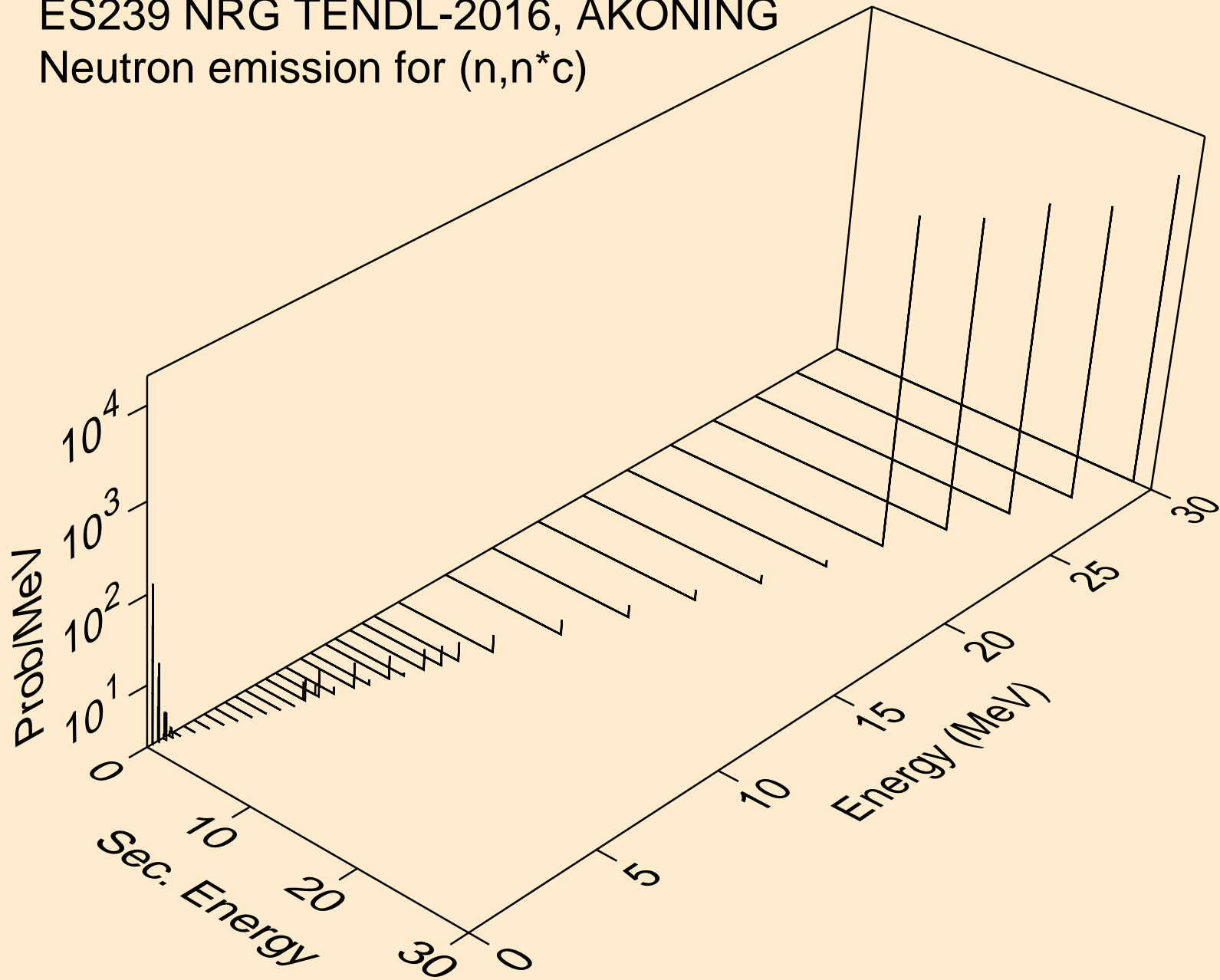

ES239 NRG TENDL-2016, AKONING

Delayed nubar

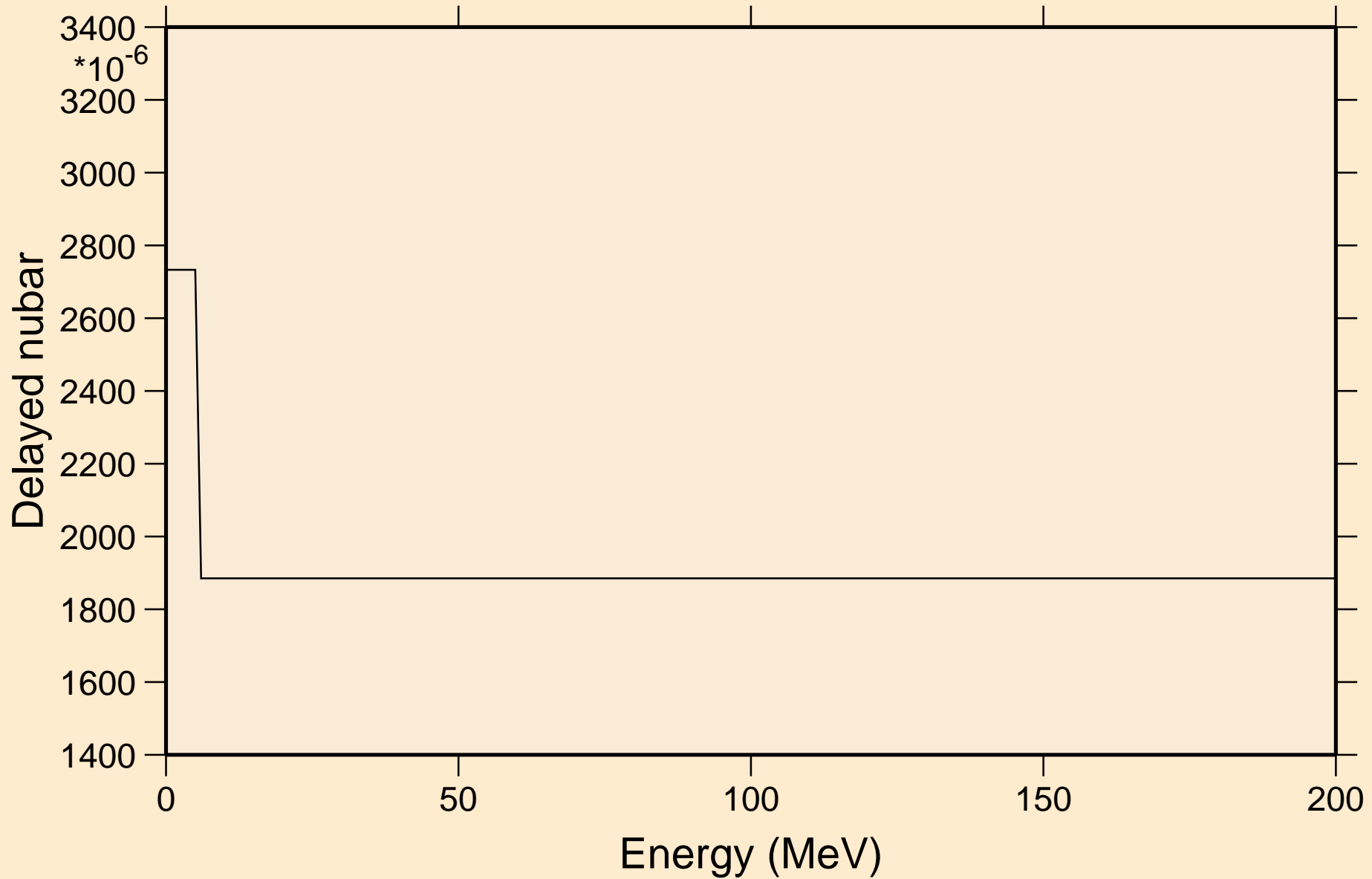

ES239 NRG TENDL-2016, AKONING

Delayed neutron spectra

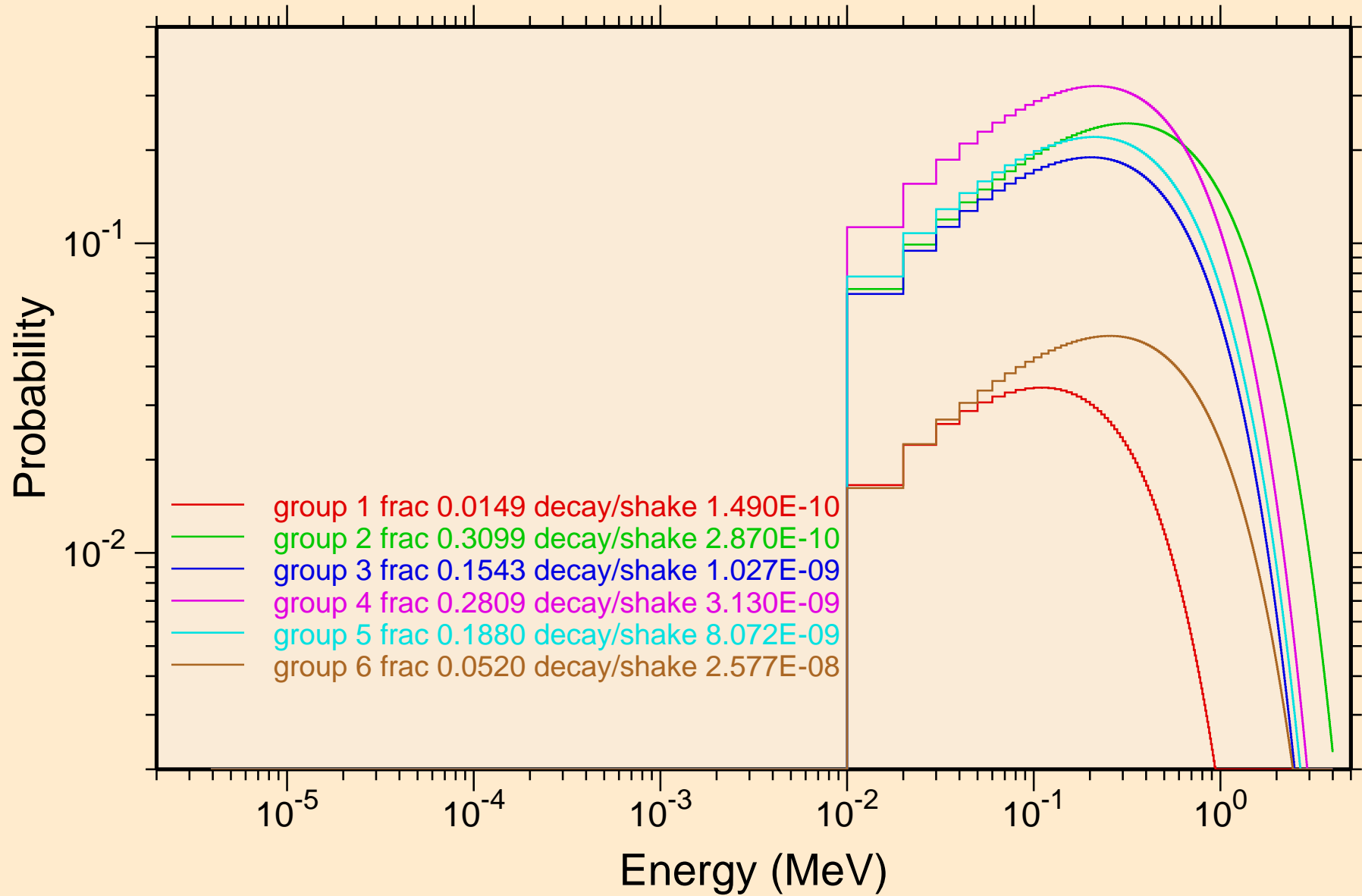

ES239 NRG TENDL-2016, AKONING
Photon emission for (n,x)

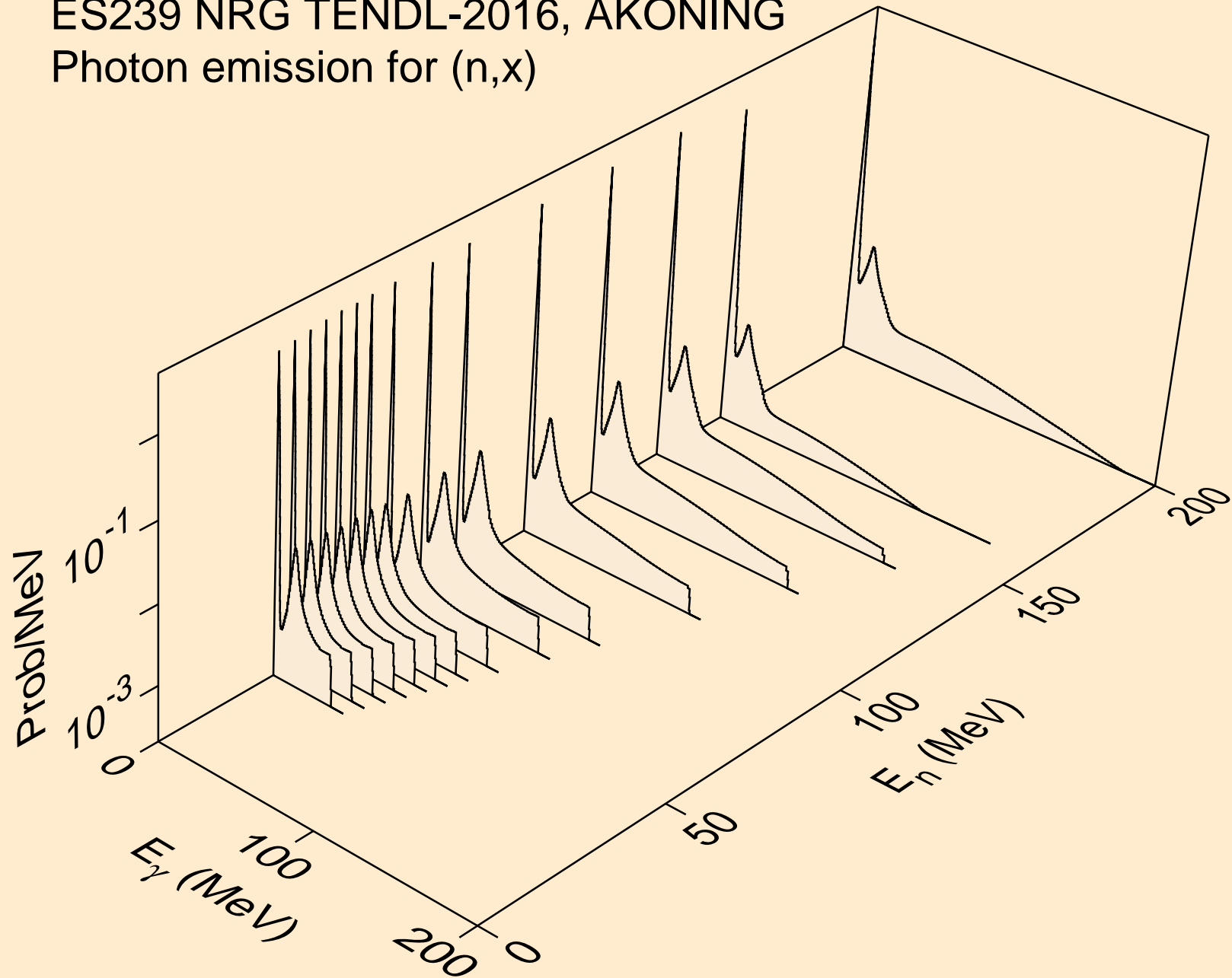

ES239 NRG TENDL-2016, AKONING
Photon emission for (n,2nd)

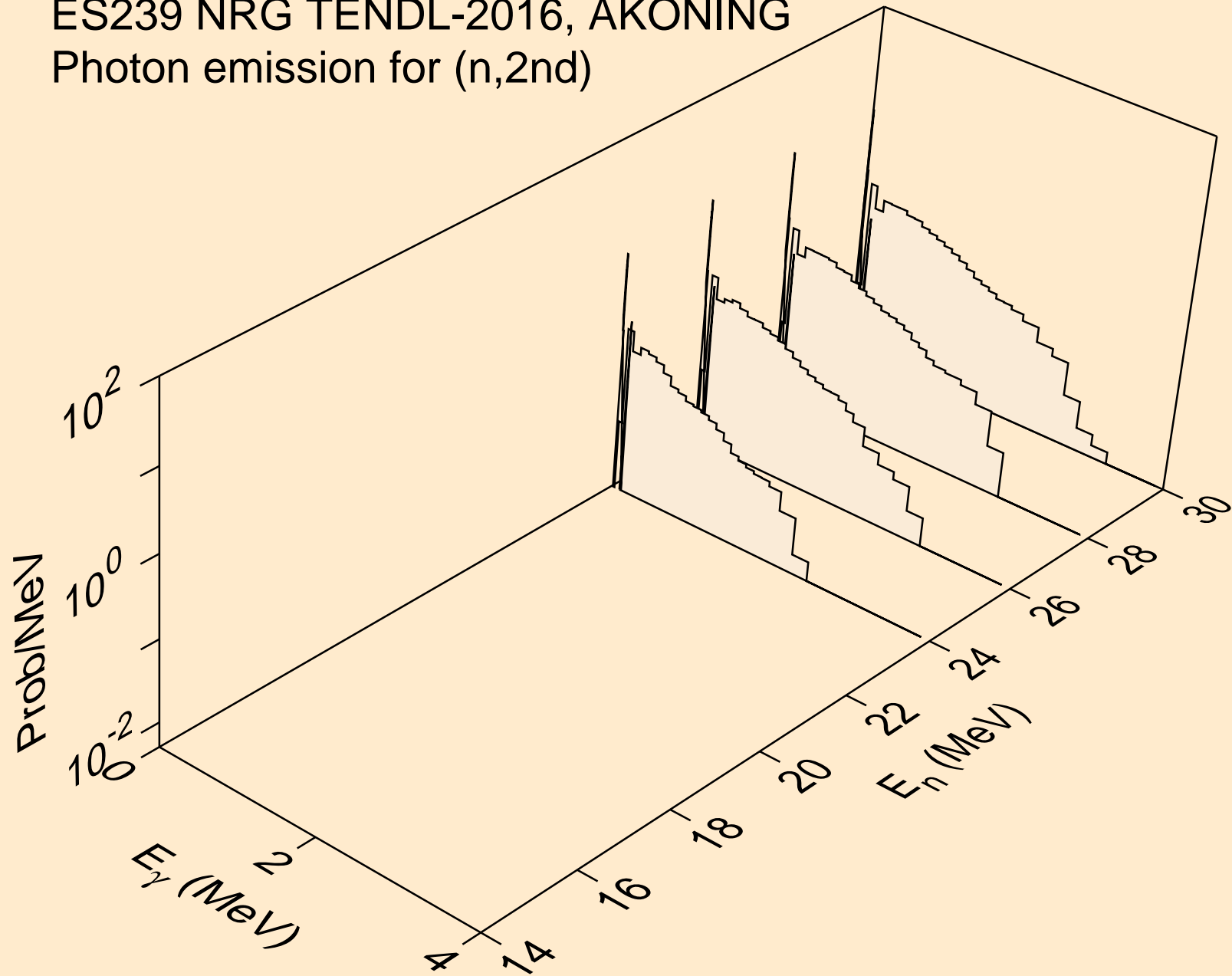

ES239 NRG TENDL-2016, AKONING
Photon emission for (n,2n)

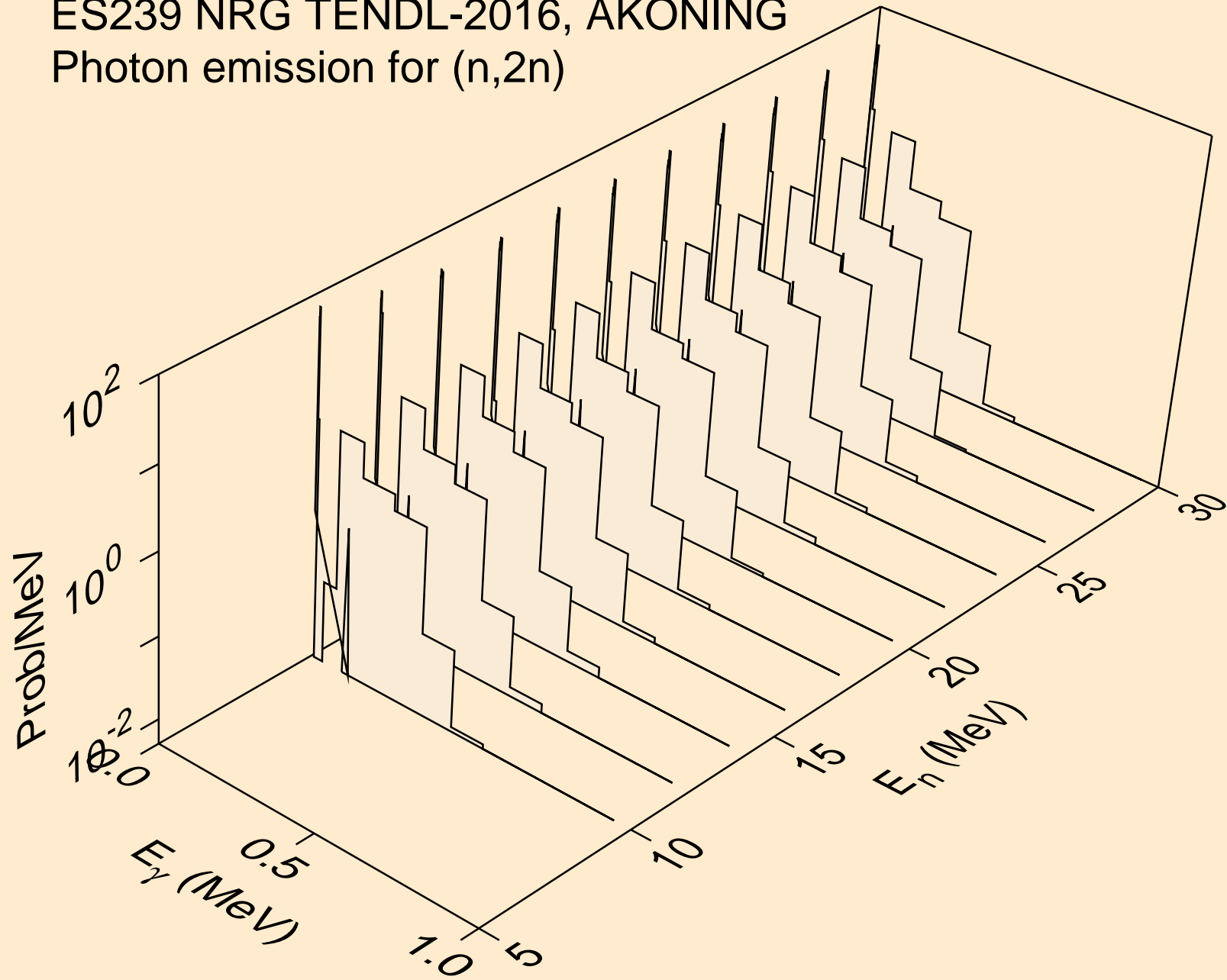

ES239 NRG TENDL-2016, AKONING
Photon emission for (n,n*)a

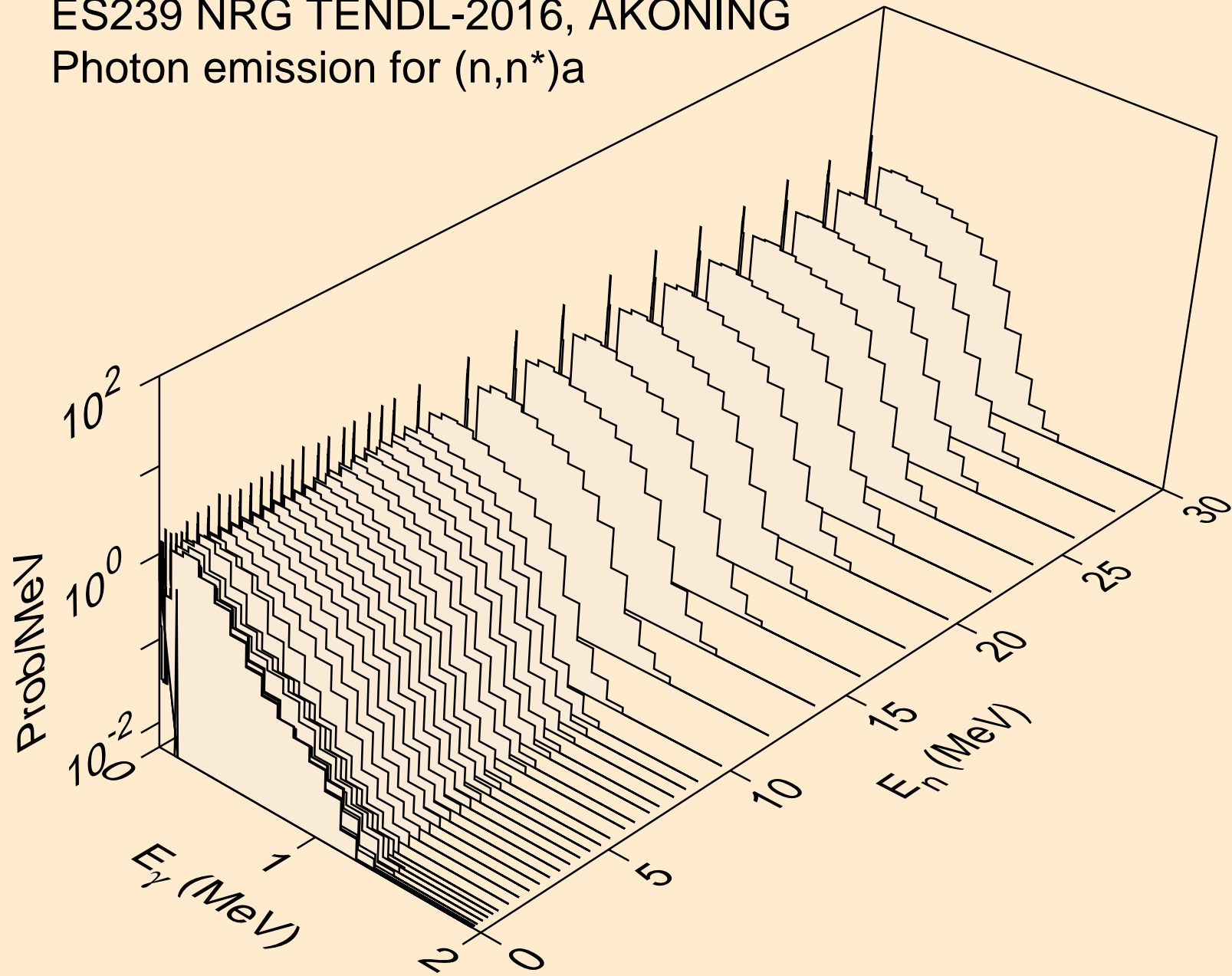

ES239 NRG TENDL-2016, AKONING
Photon emission for (n,n*)3a

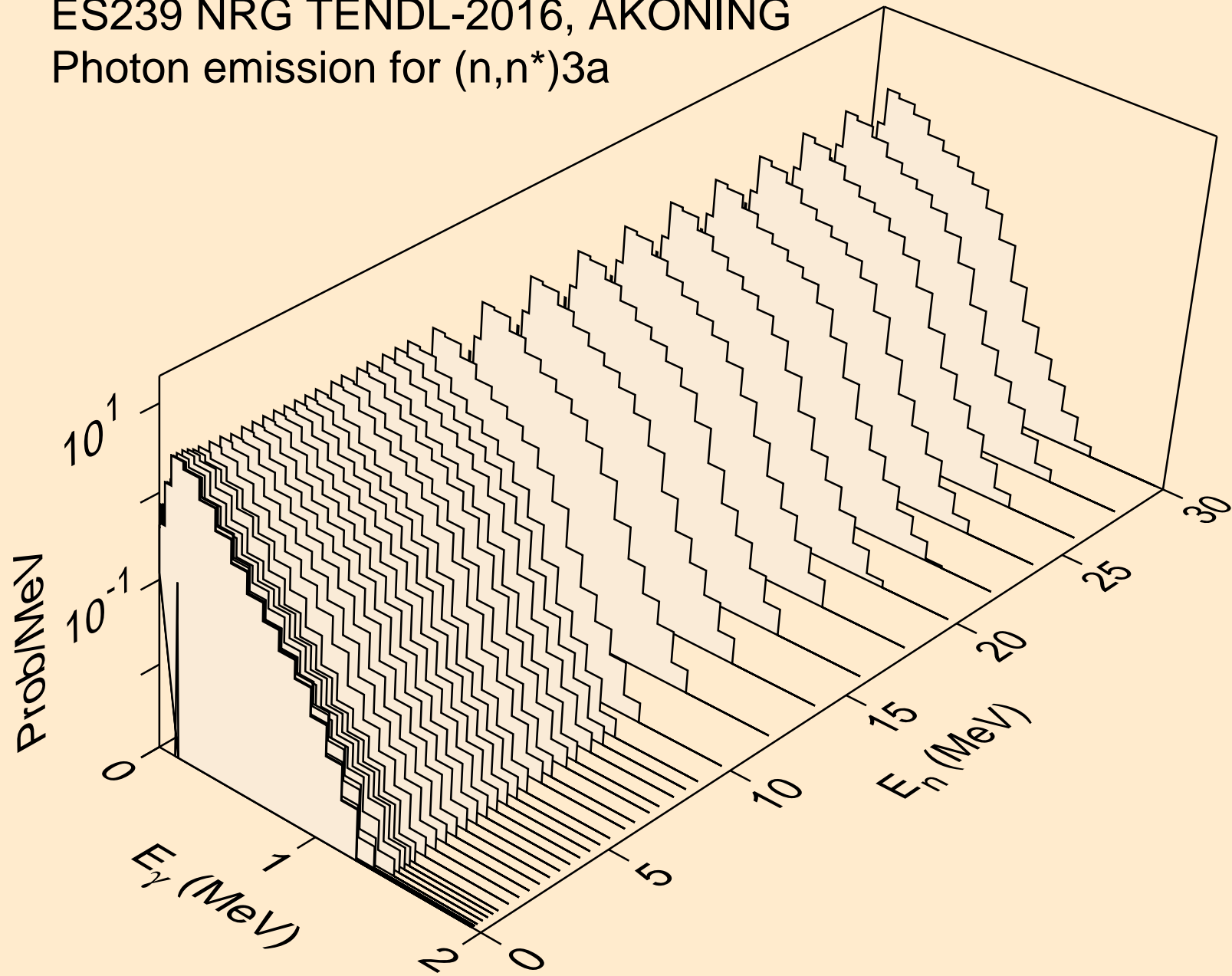

ES239 NRG TENDL-2016, AKONING
Photon emission for (n,2n)a

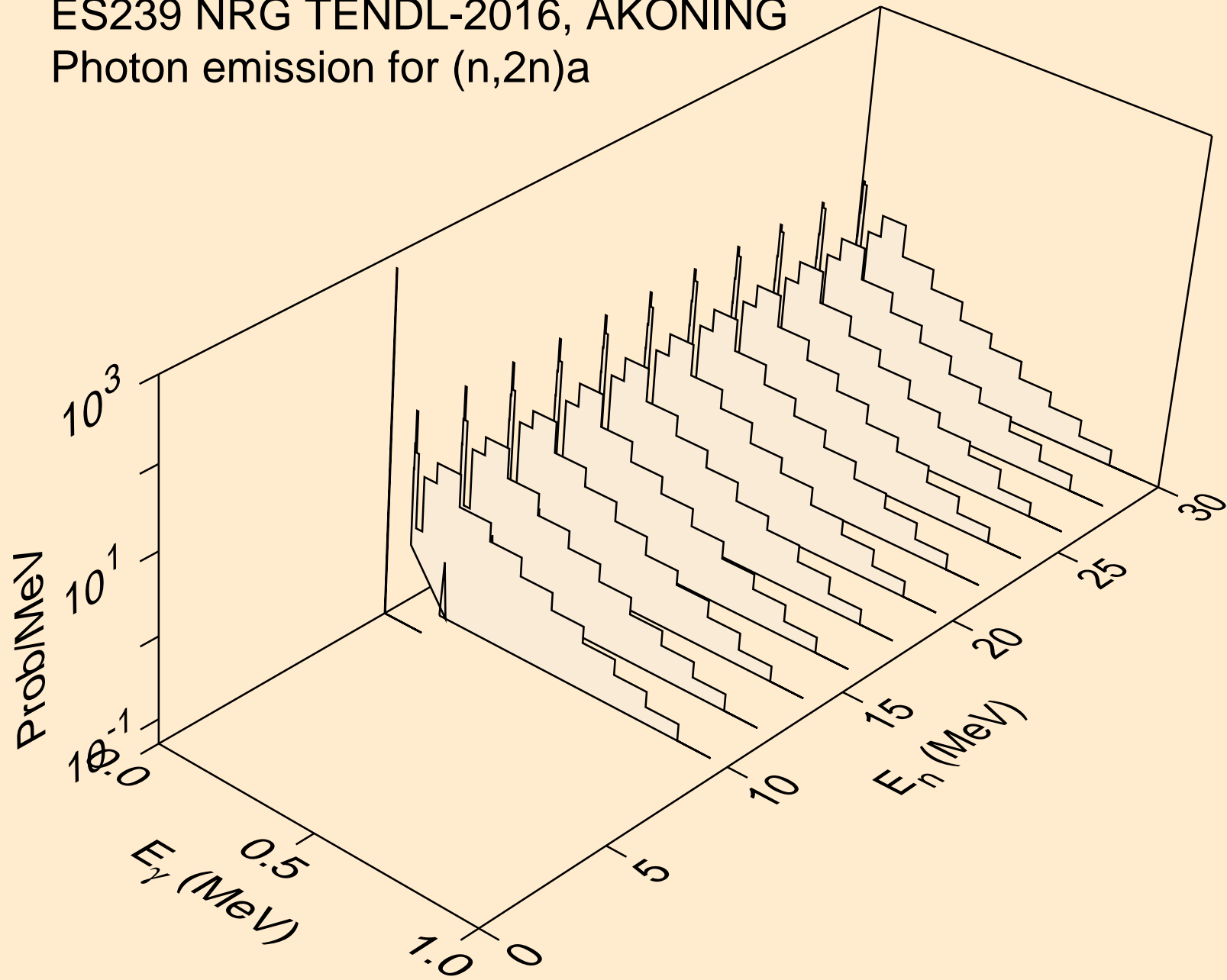

ES239 NRG TENDL-2016, AKONING
Photon emission for (n,3n)a

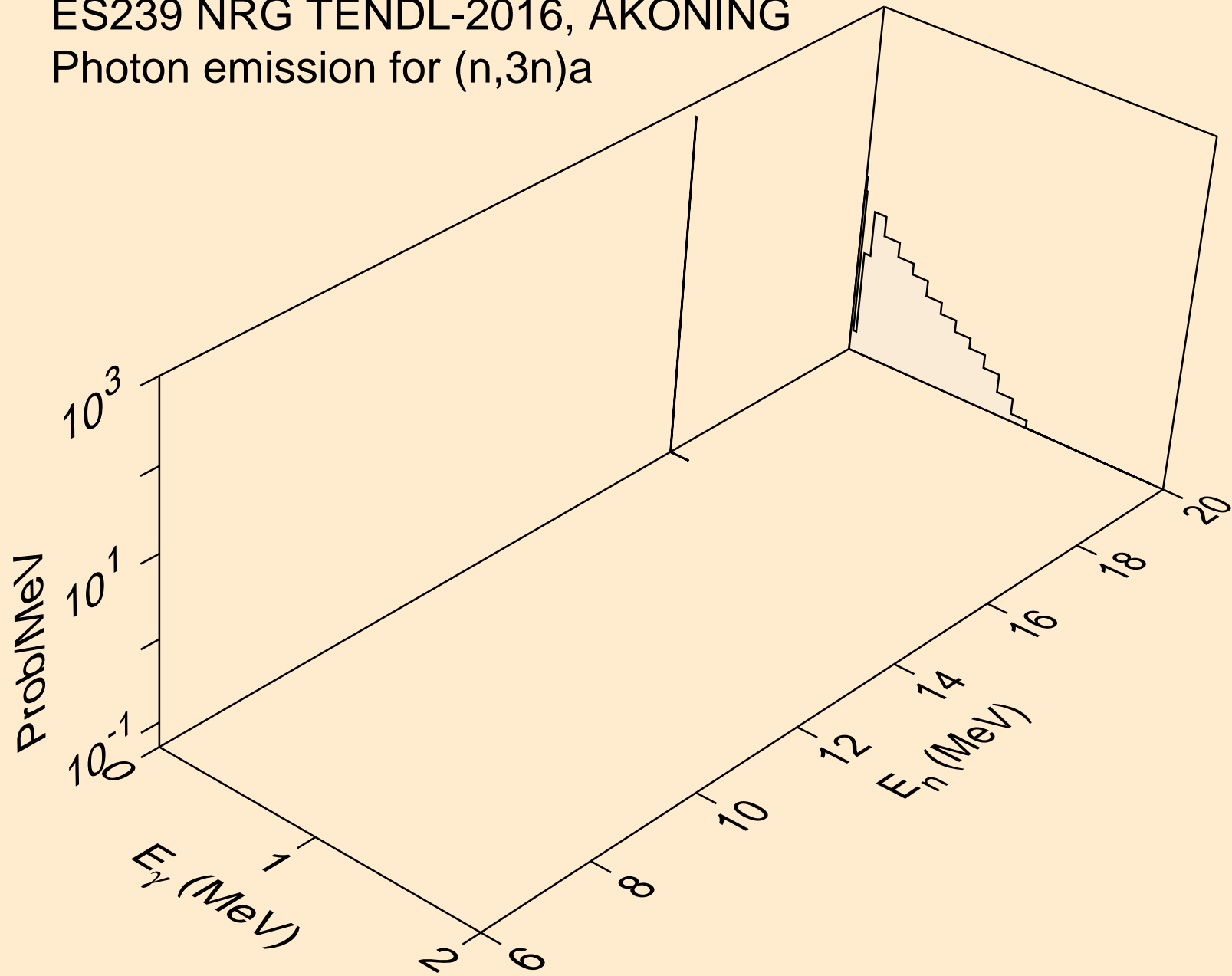

ES239 NRG TENDL-2016, AKONING
Photon emission for (n,n*)p

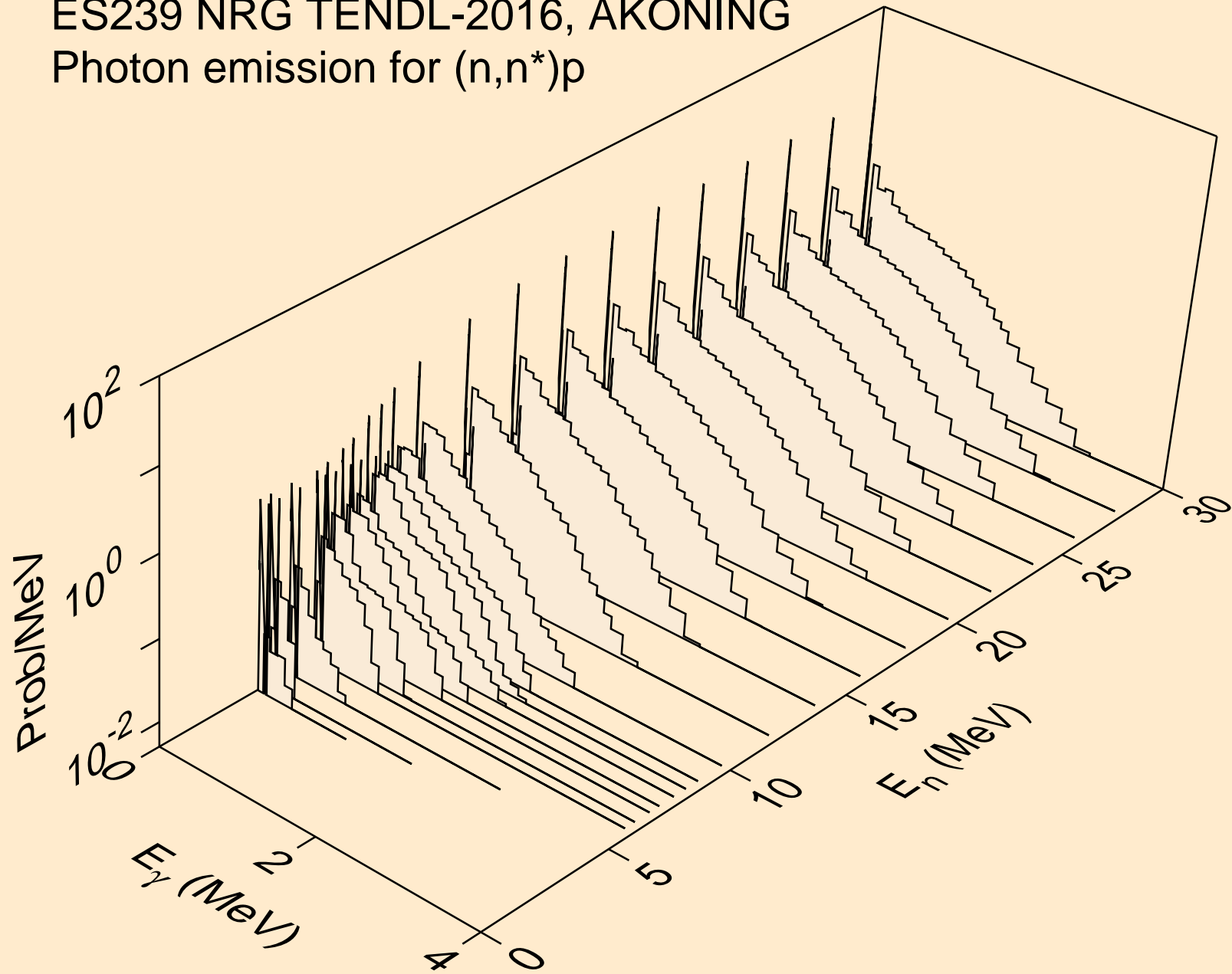

ES239 NRG TENDL-2016, AKONING
Photon emission for (n,n*)2a

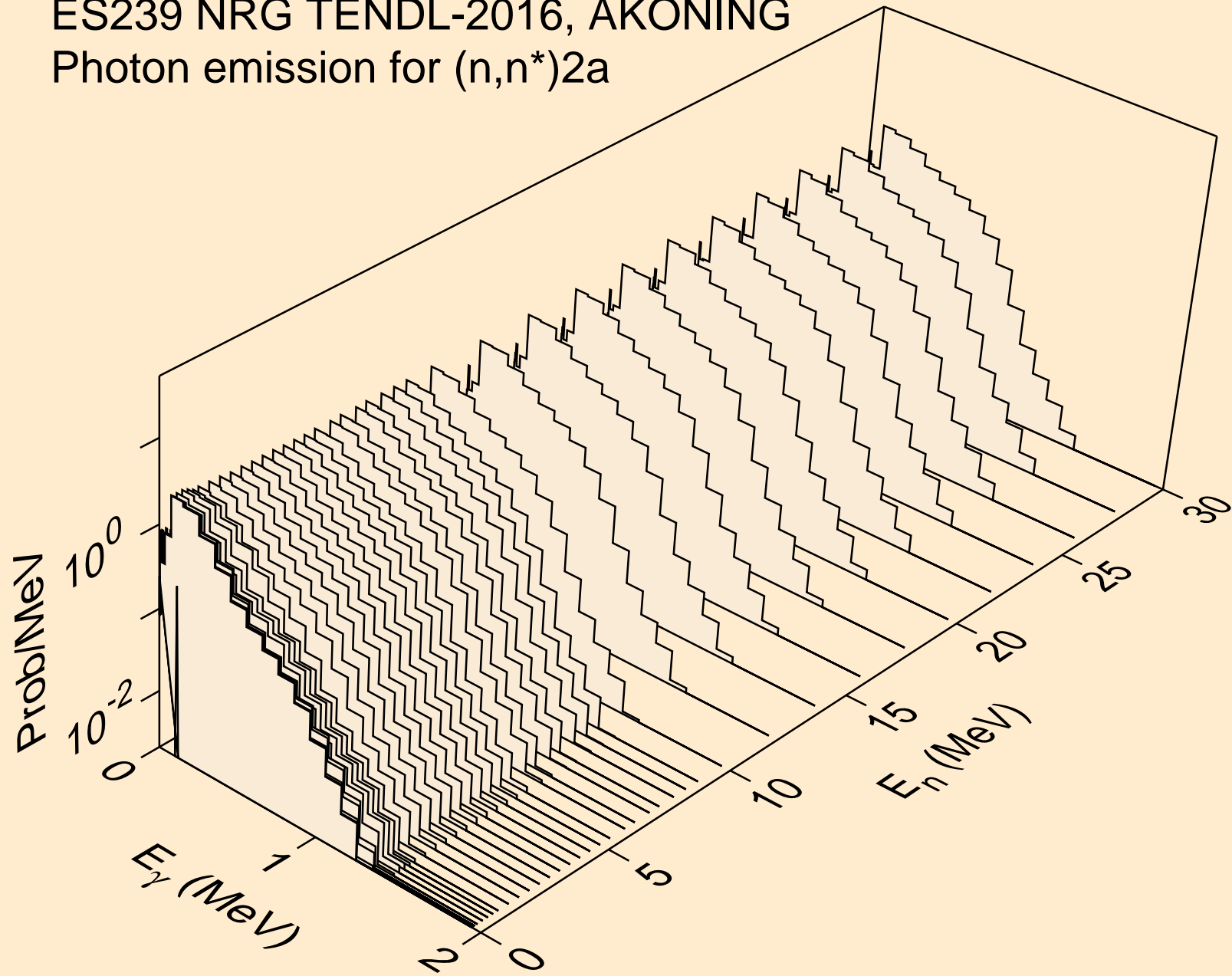

ES239 NRG TENDL-2016, AKONING
Photon emission for (n,2n)2a

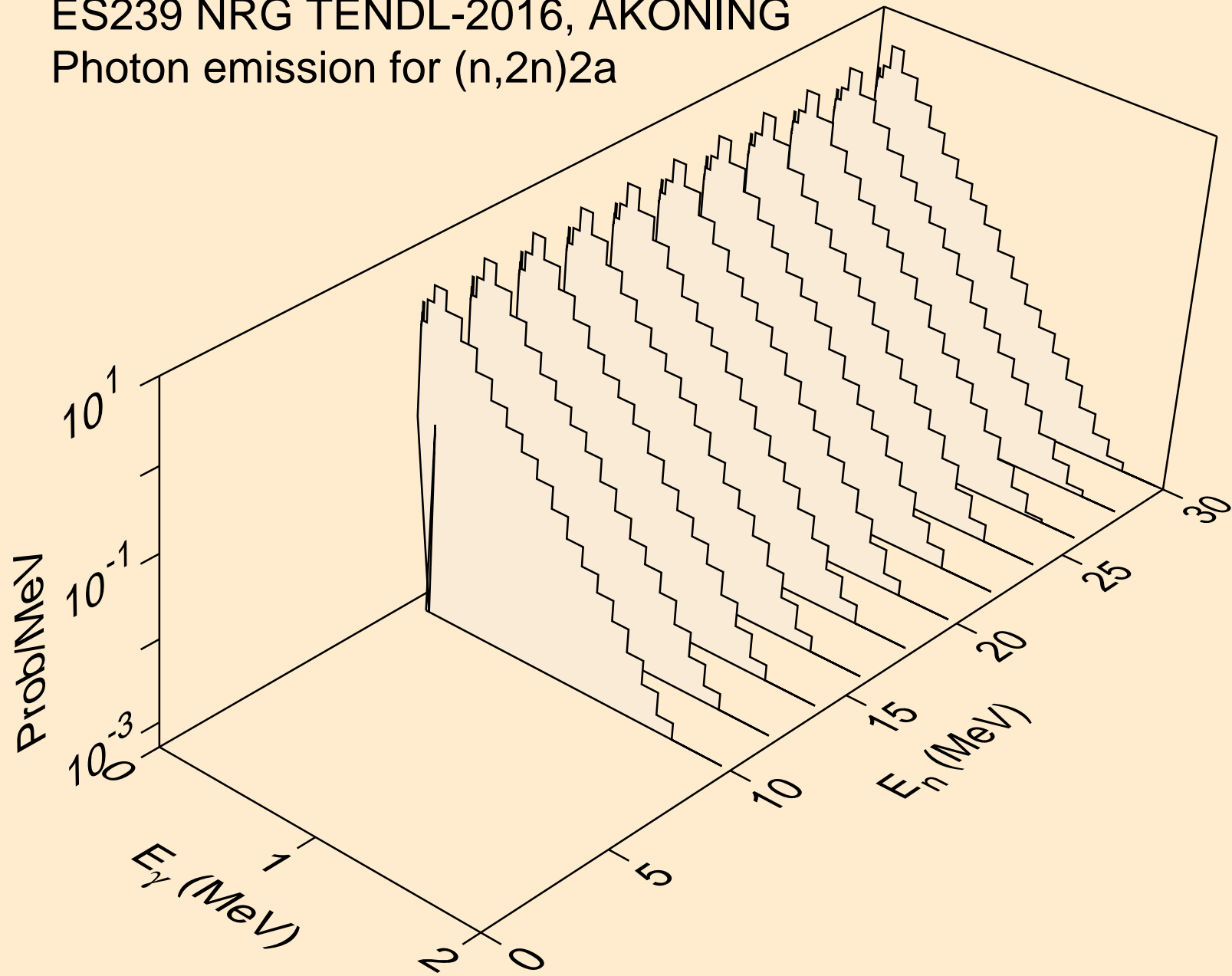

ES239 NRG TENDL-2016, AKONING
Photon emission for (n,n*)d

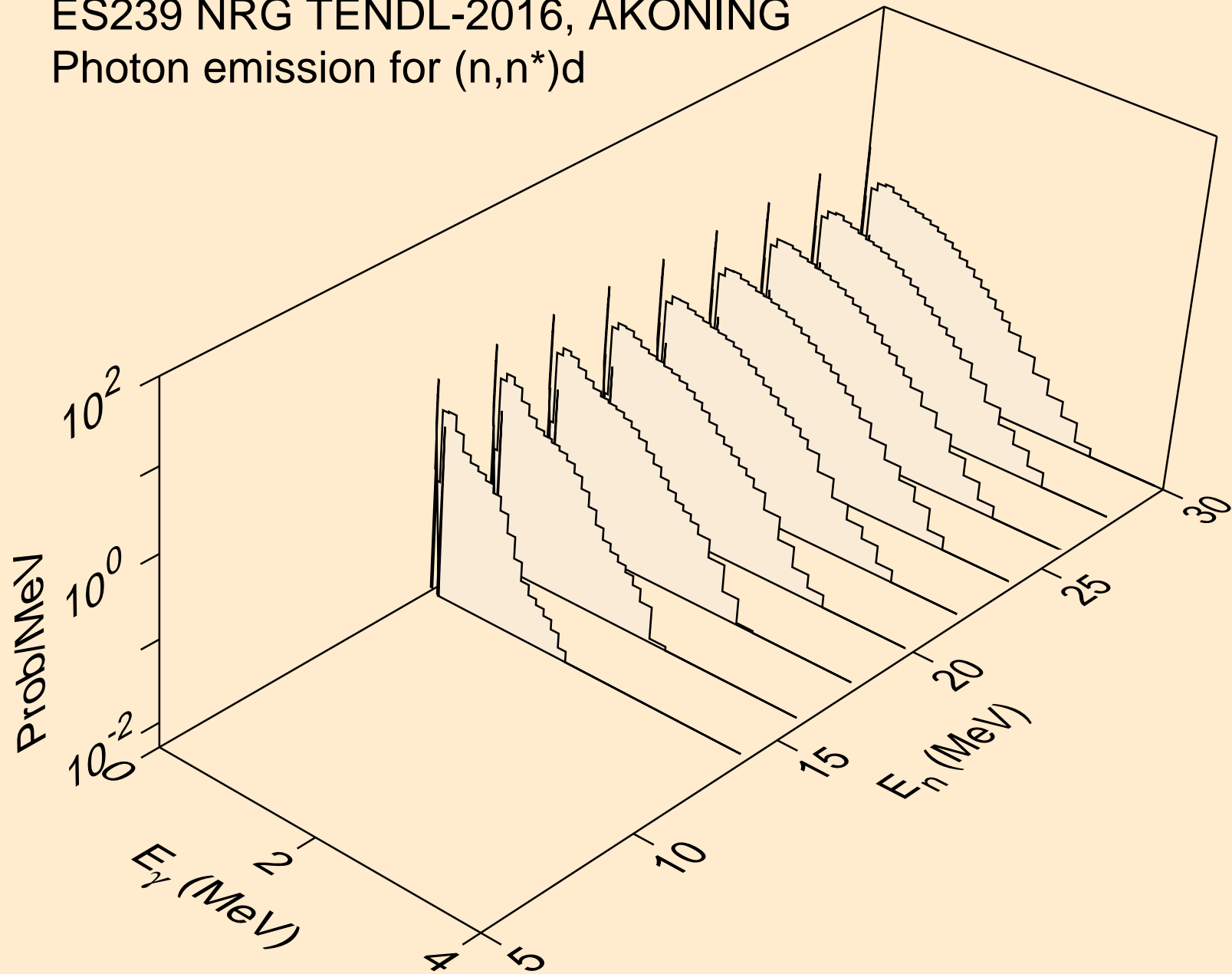

ES239 NRG TENDL-2016, AKONING
Photon emission for (n,n*)t

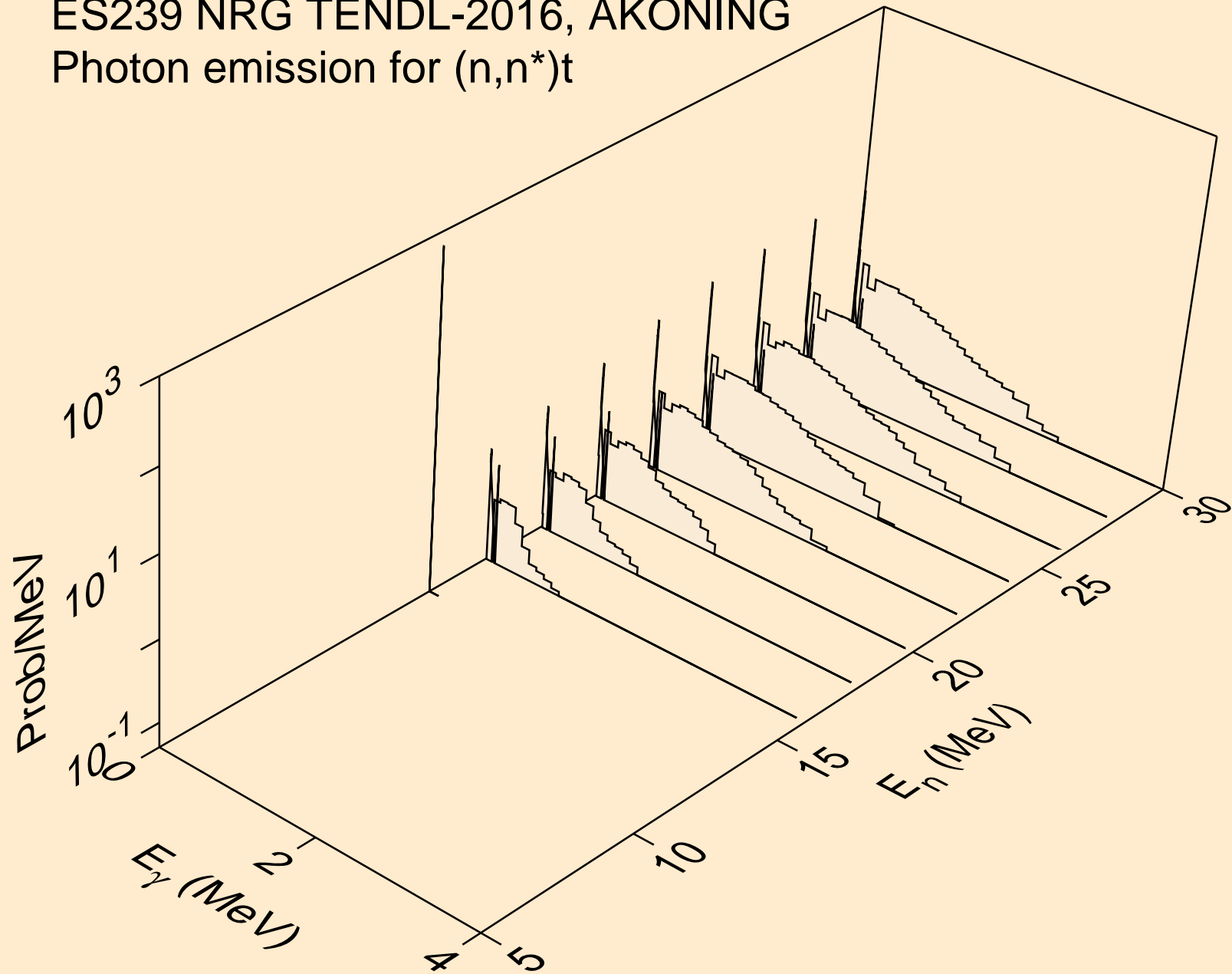

ES239 NRG TENDL-2016, AKONING
Photon emission for (n,n*)he3

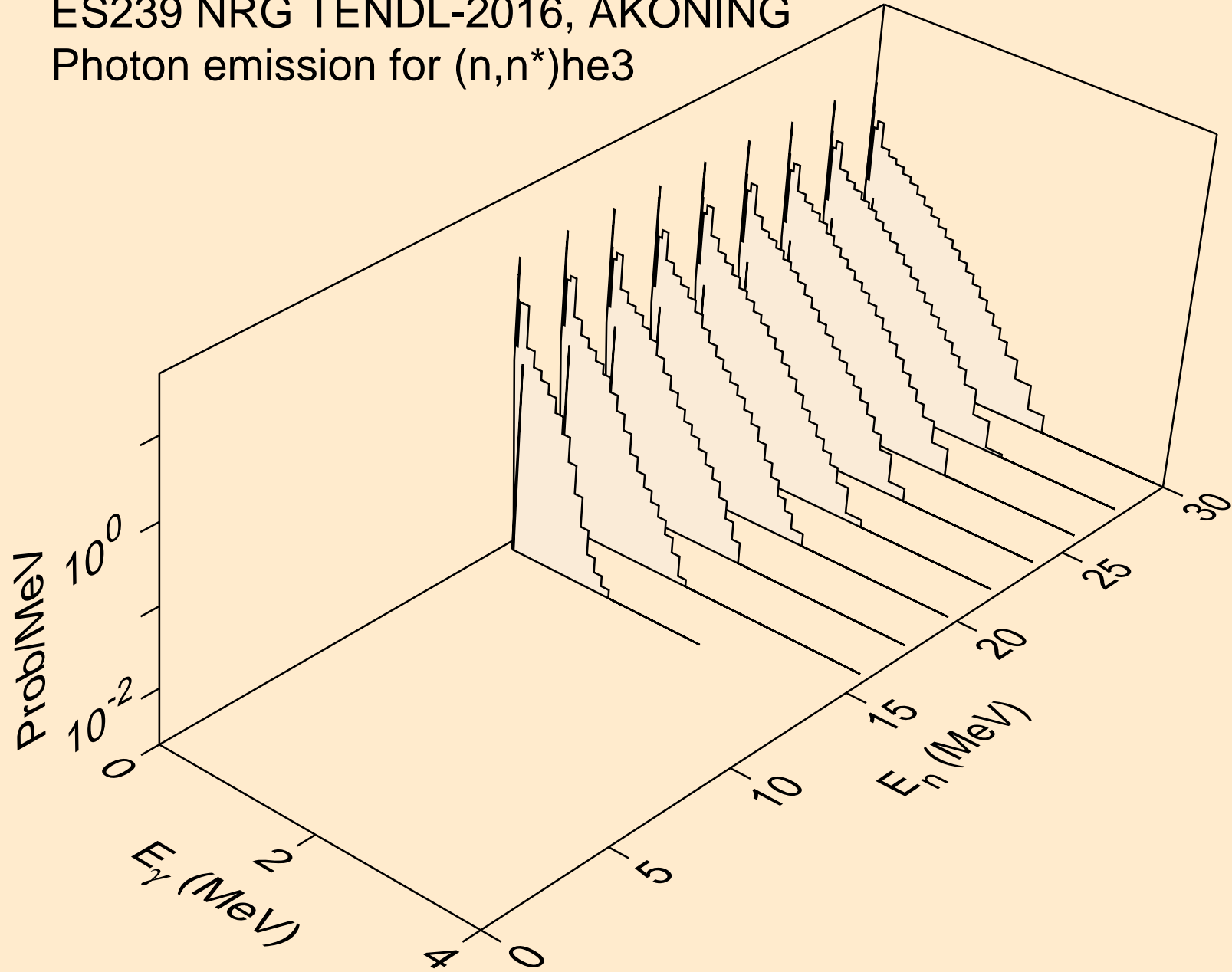

ES239 NRG TENDL-2016, AKONING
Photon emission for (n,n*)d2a

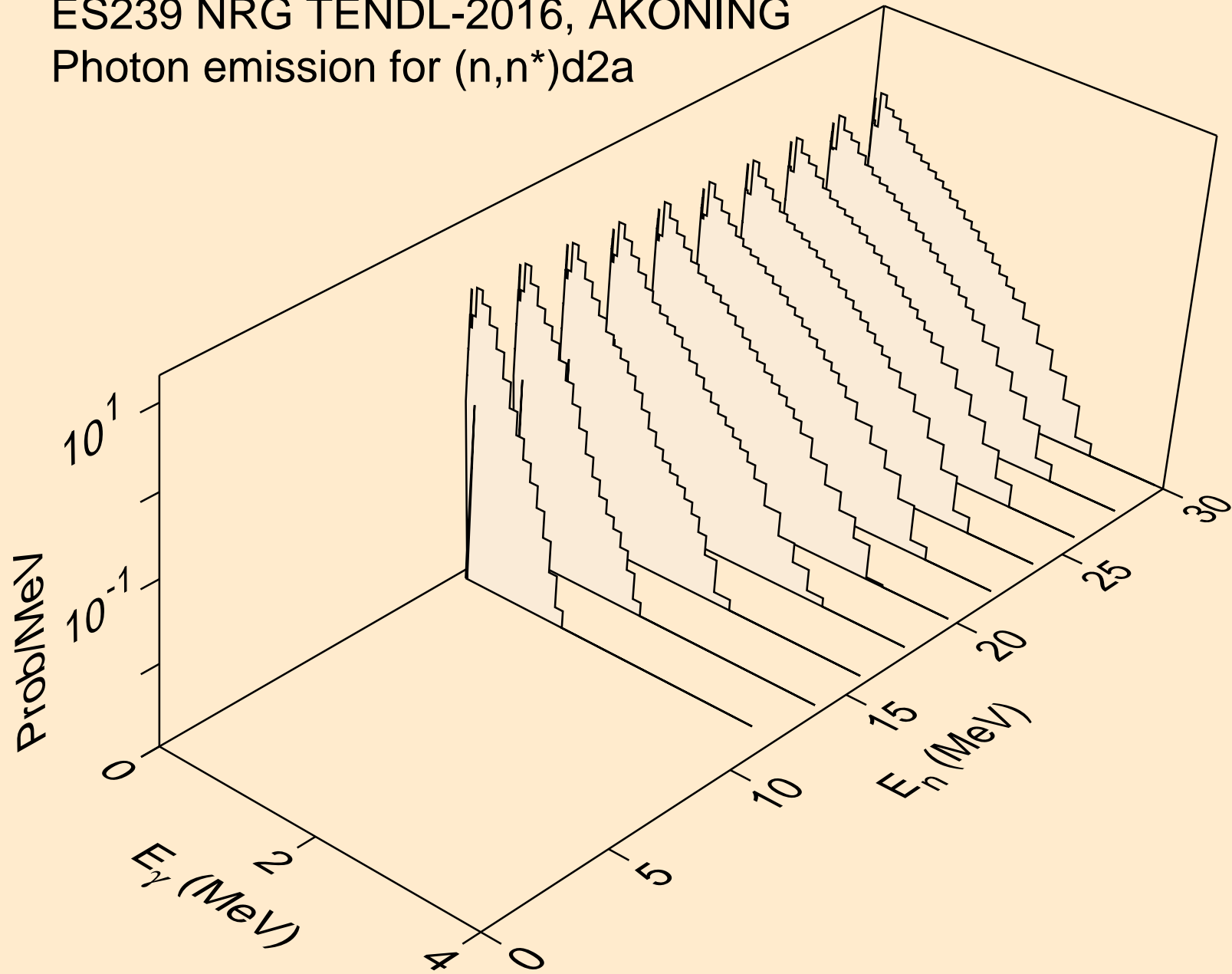

ES239 NRG TENDL-2016, AKONING
Photon emission for (n,n*)t2a

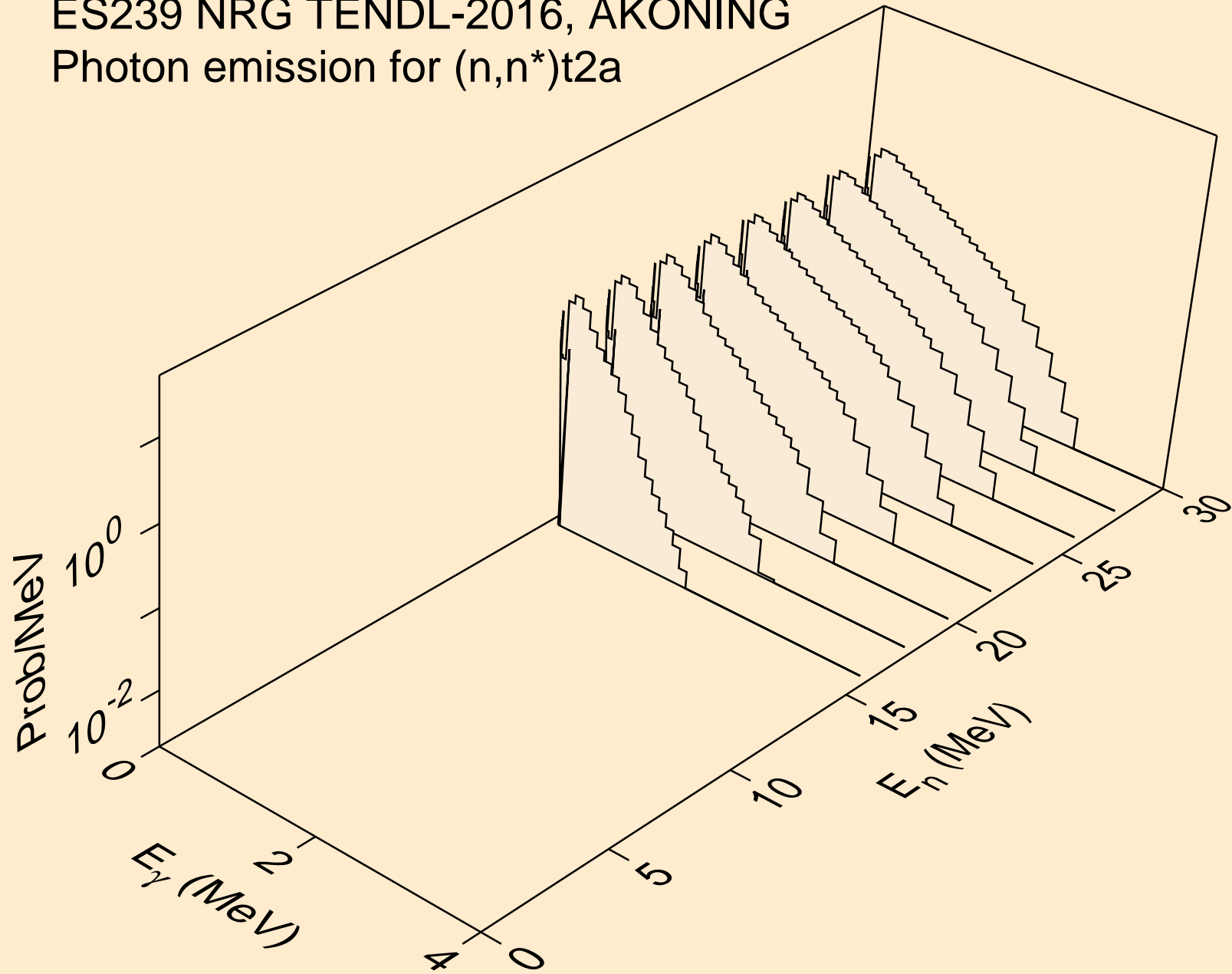

ES239 NRG TENDL-2016, AKONING
Photon emission for (n,2np)

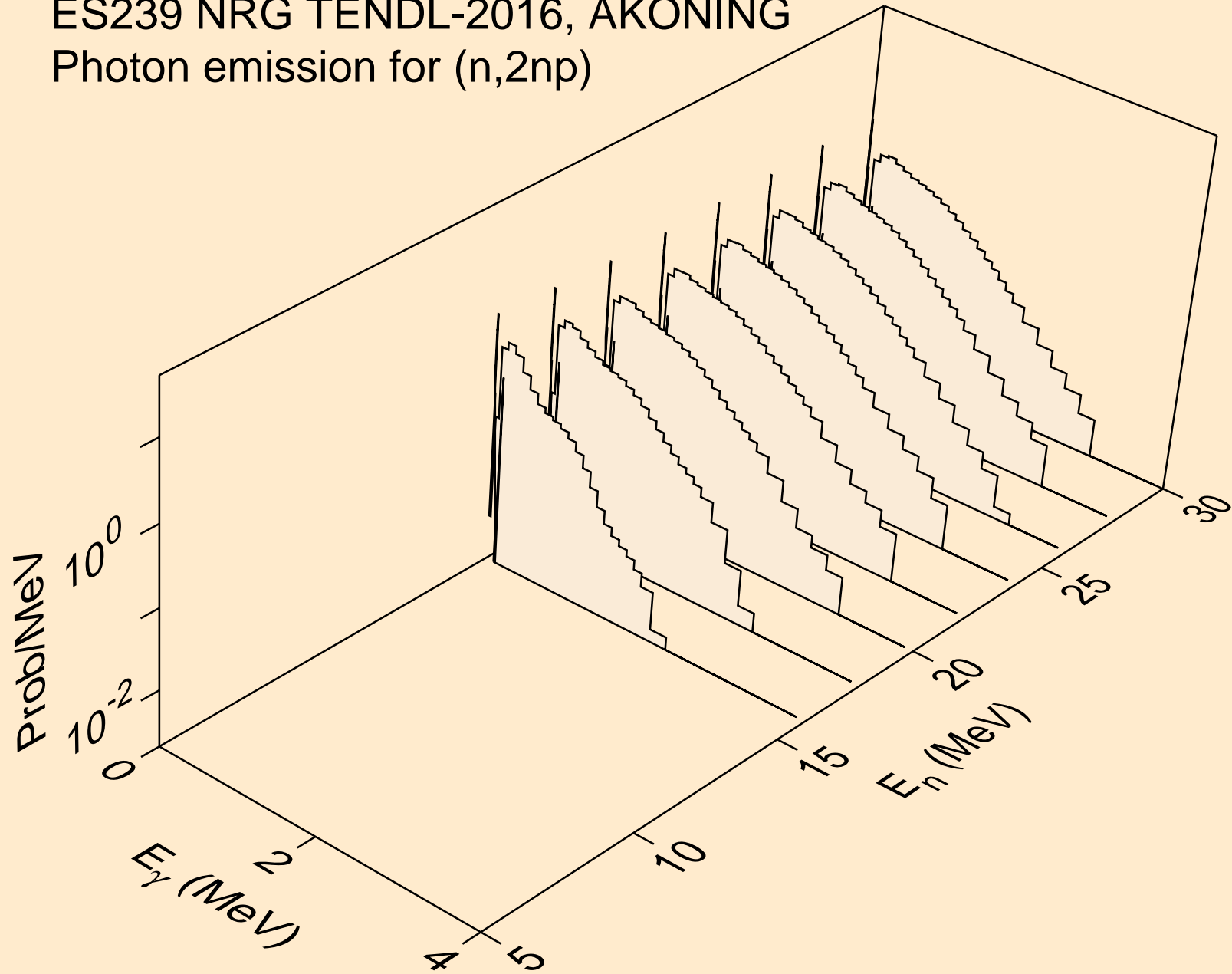

ES239 NRG TENDL-2016, AKONING
Photon emission for (n,3np)

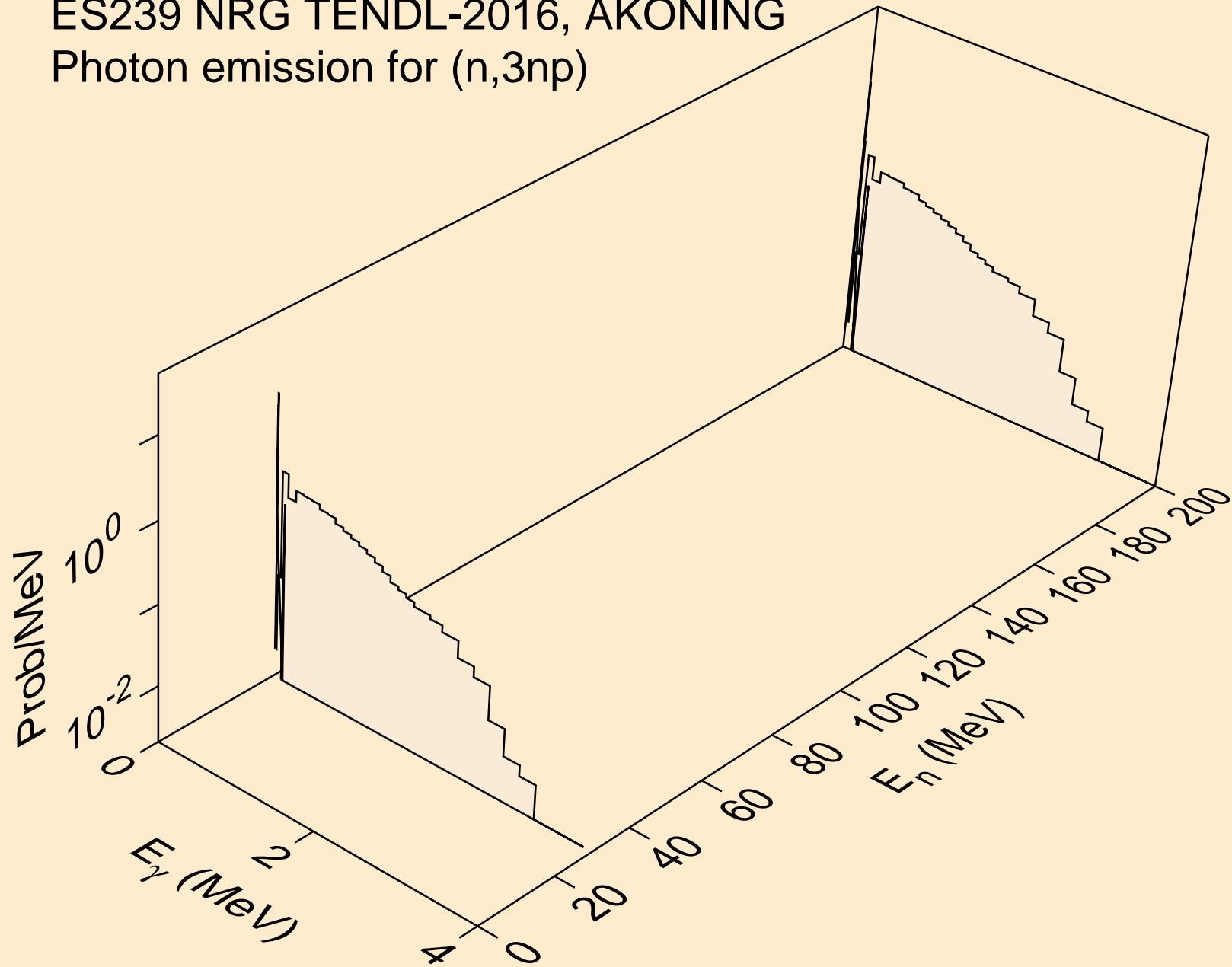

ES239 NRG TENDL-2016, AKONING
Photon emission for (n,2np)

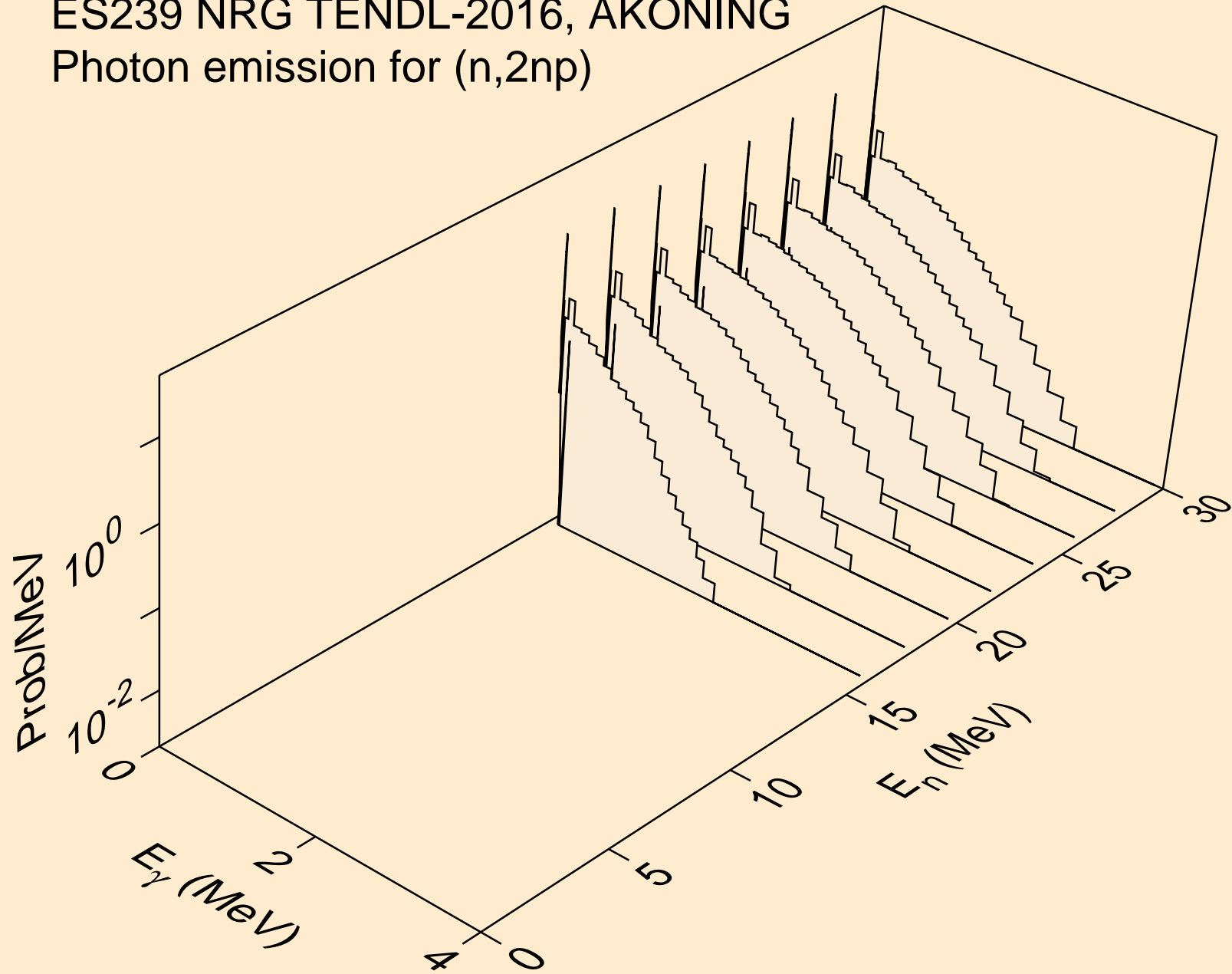

ES239 NRG TENDL-2016, AKONING
Photon emission for (n,npa)

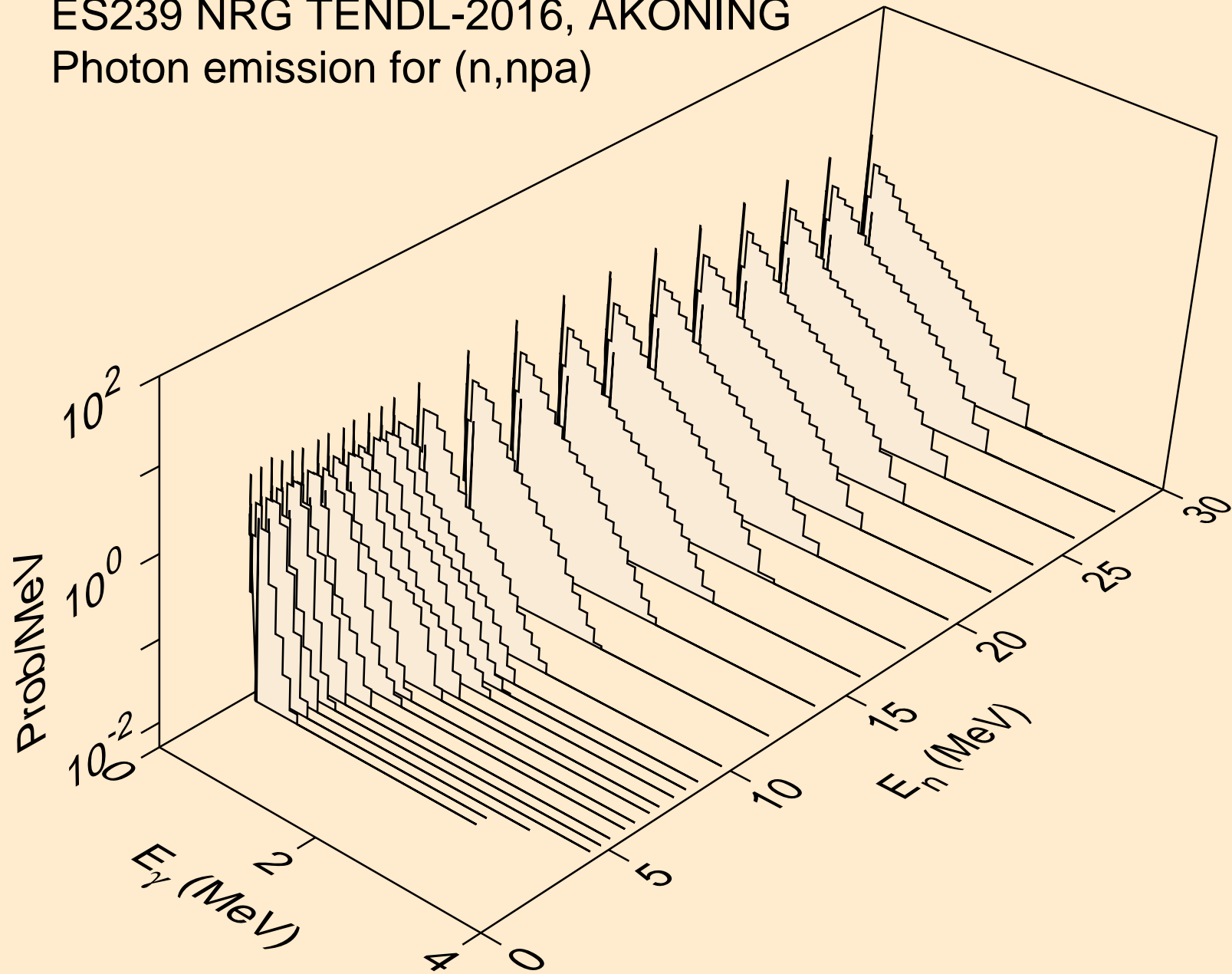

ES239 NRG TENDL-2016, AKONING
Photon emission for (n,n*c)

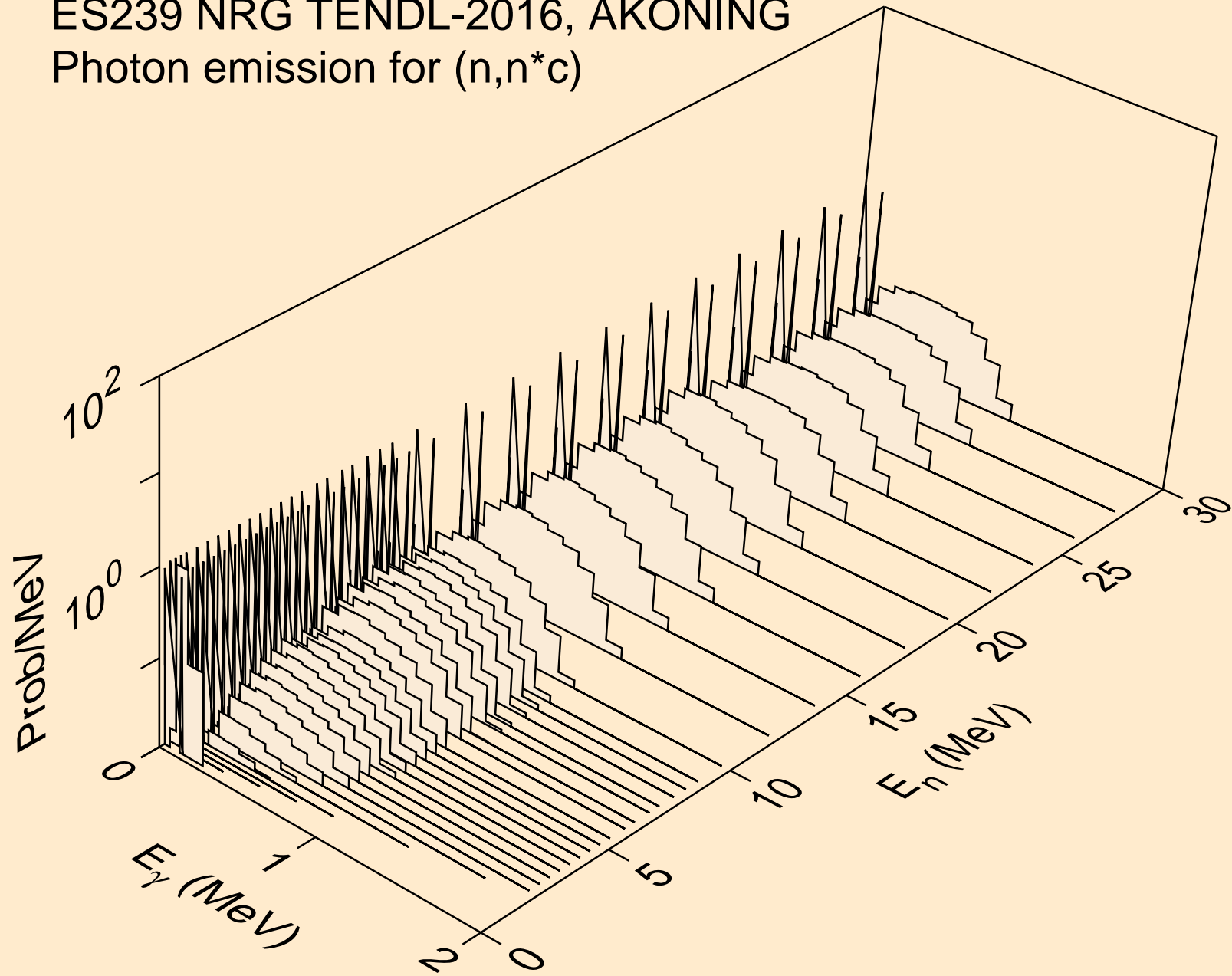

ES239 NRG TENDL-2016, AKONING
Photon emission for (n,gma)

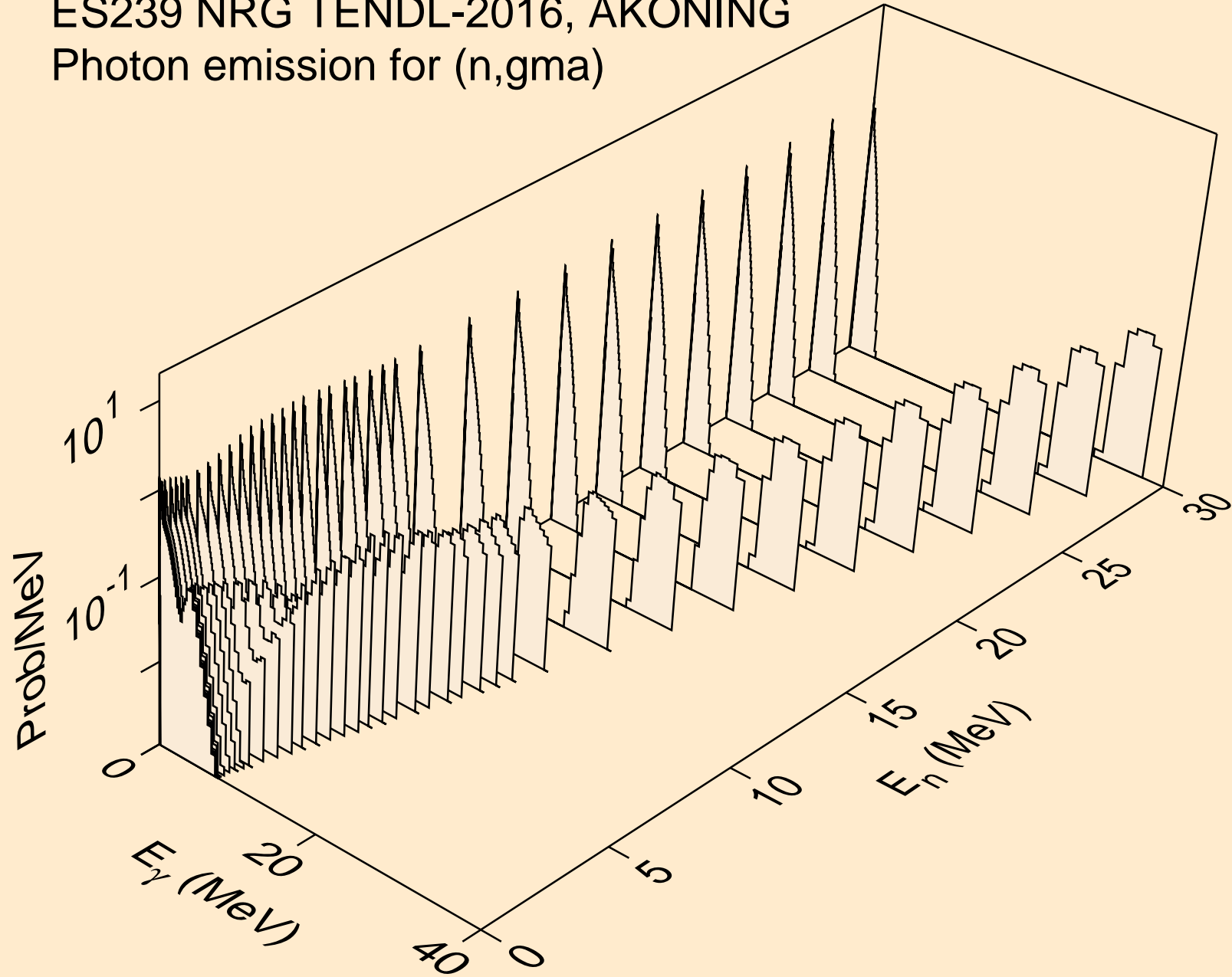

ES239 NRG TENDL-2016, AKONING
Photon emission for (n,p)

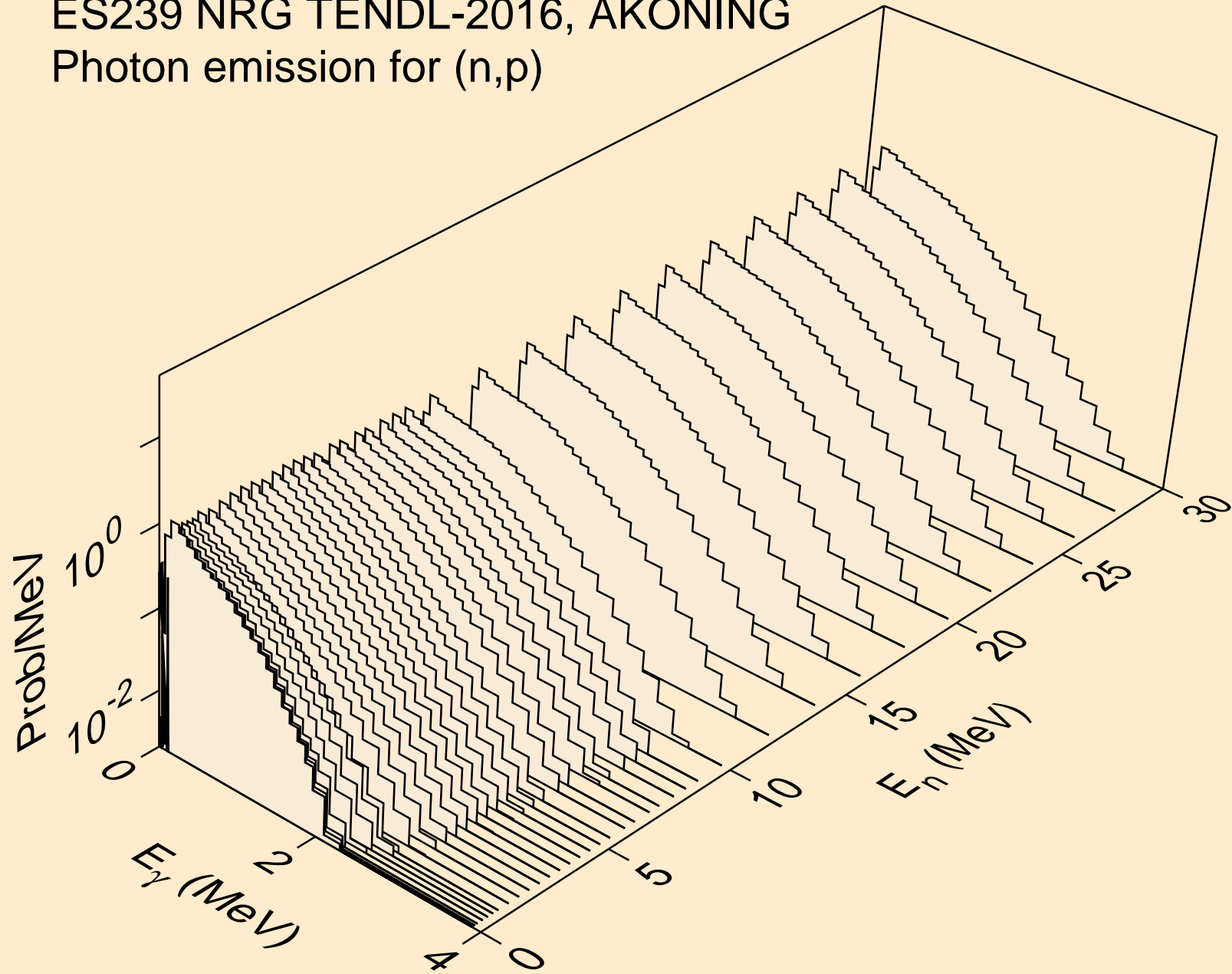

ES239 NRG TENDL-2016, AKONING
Photon emission for (n,d)

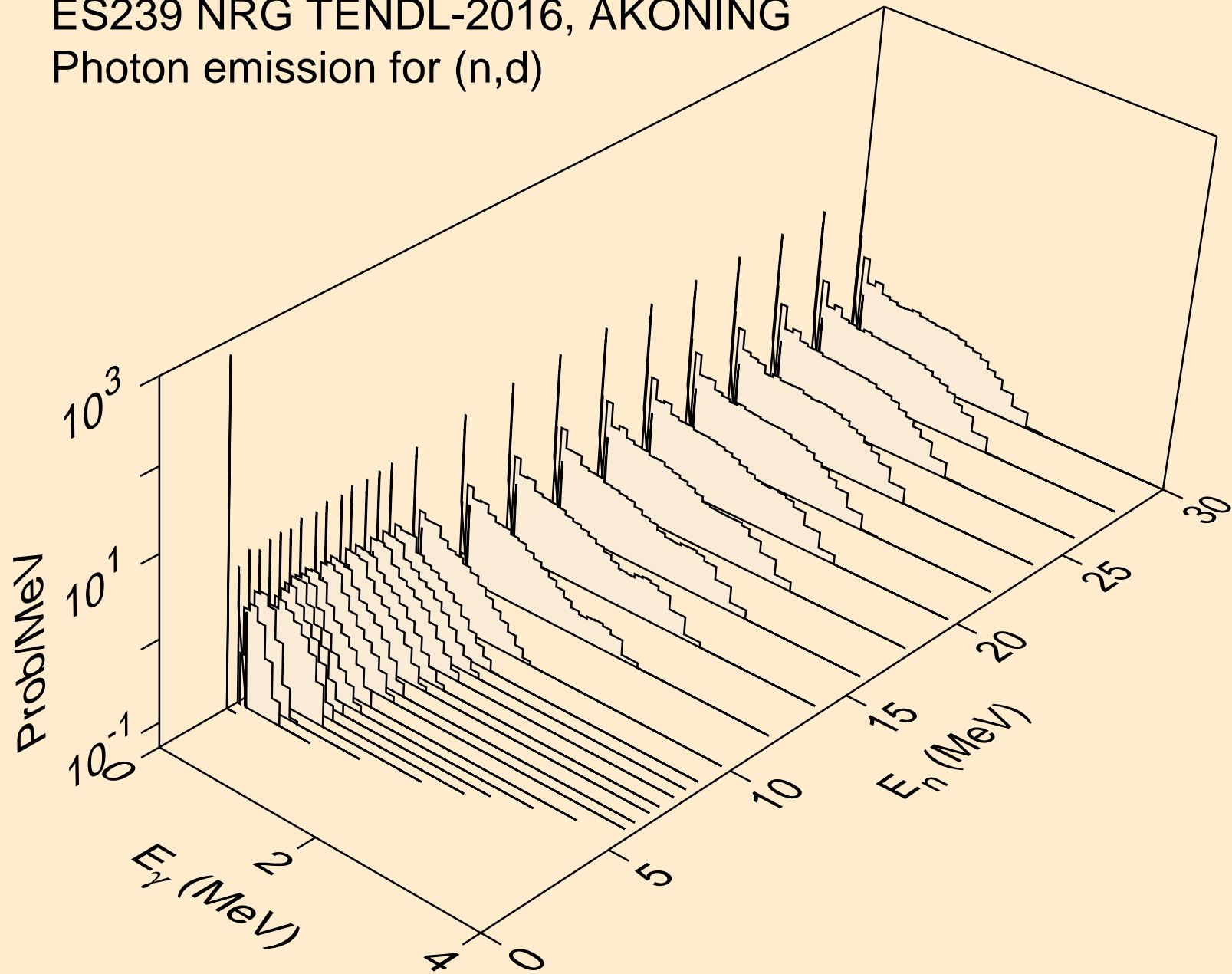

ES239 NRG TENDL-2016, AKONING
Photon emission for (n,t)

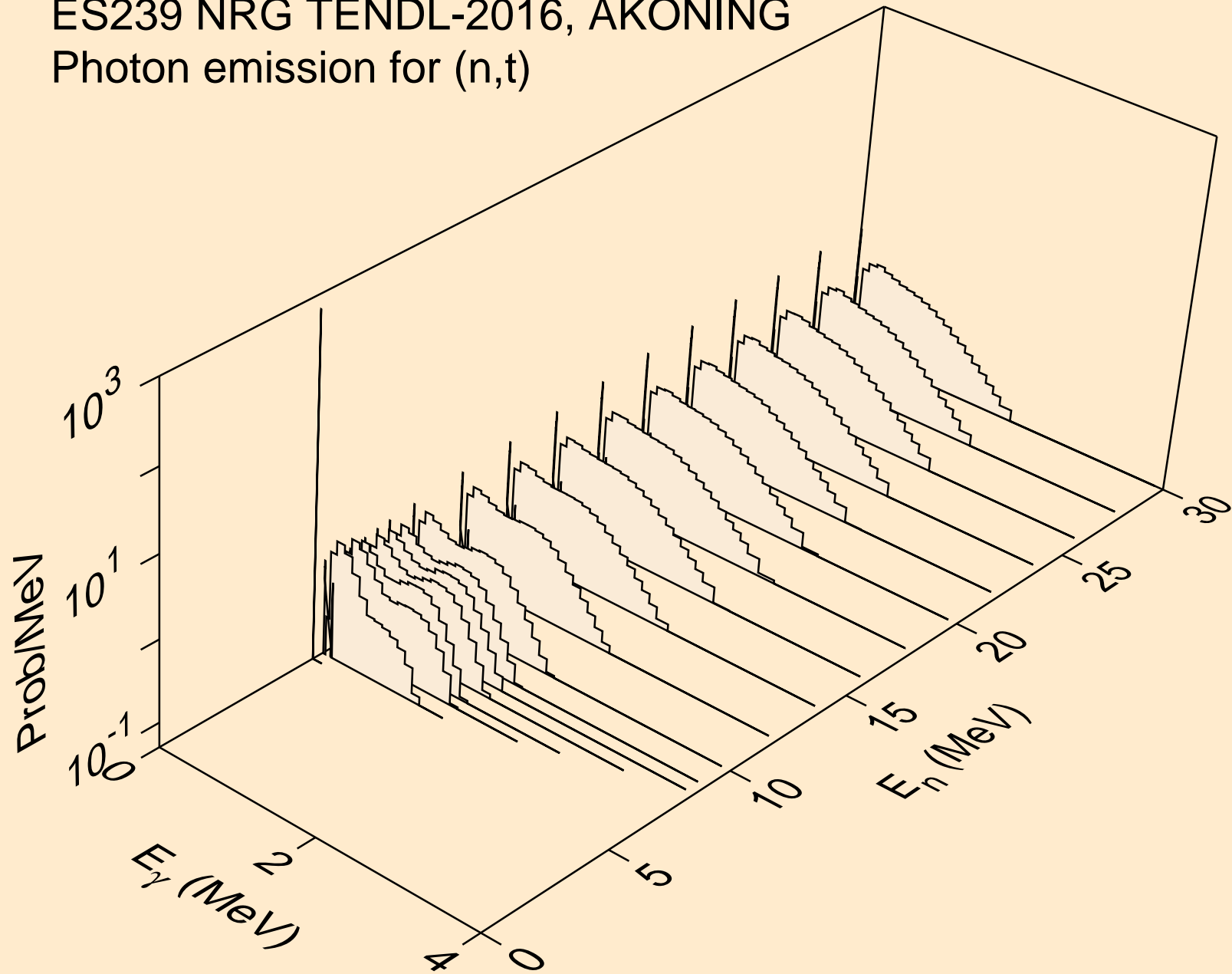

ES239 NRG TENDL-2016, AKONING
Photon emission for (n,he3)

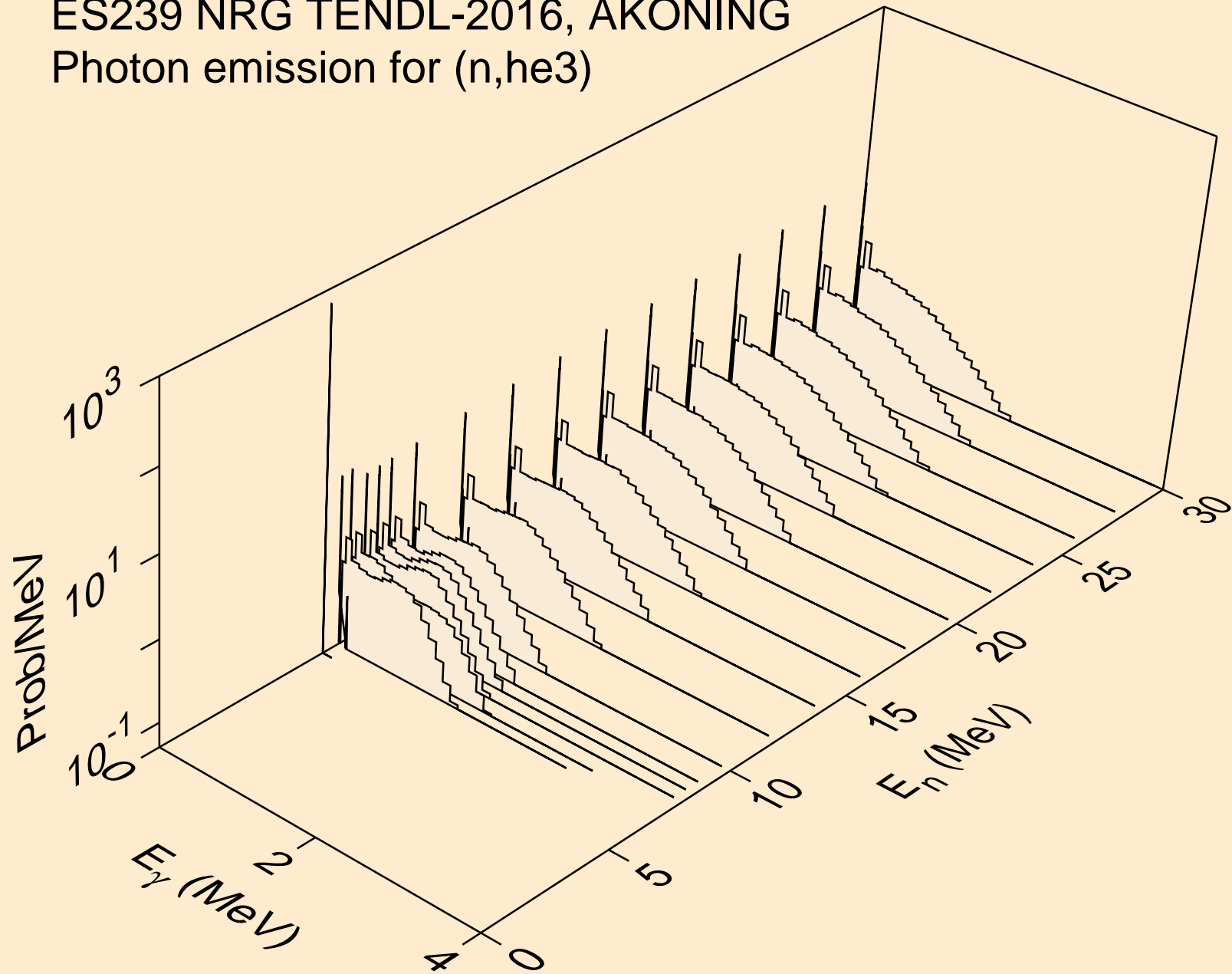

ES239 NRG TENDL-2016, AKONING
Photon emission for (n,a)

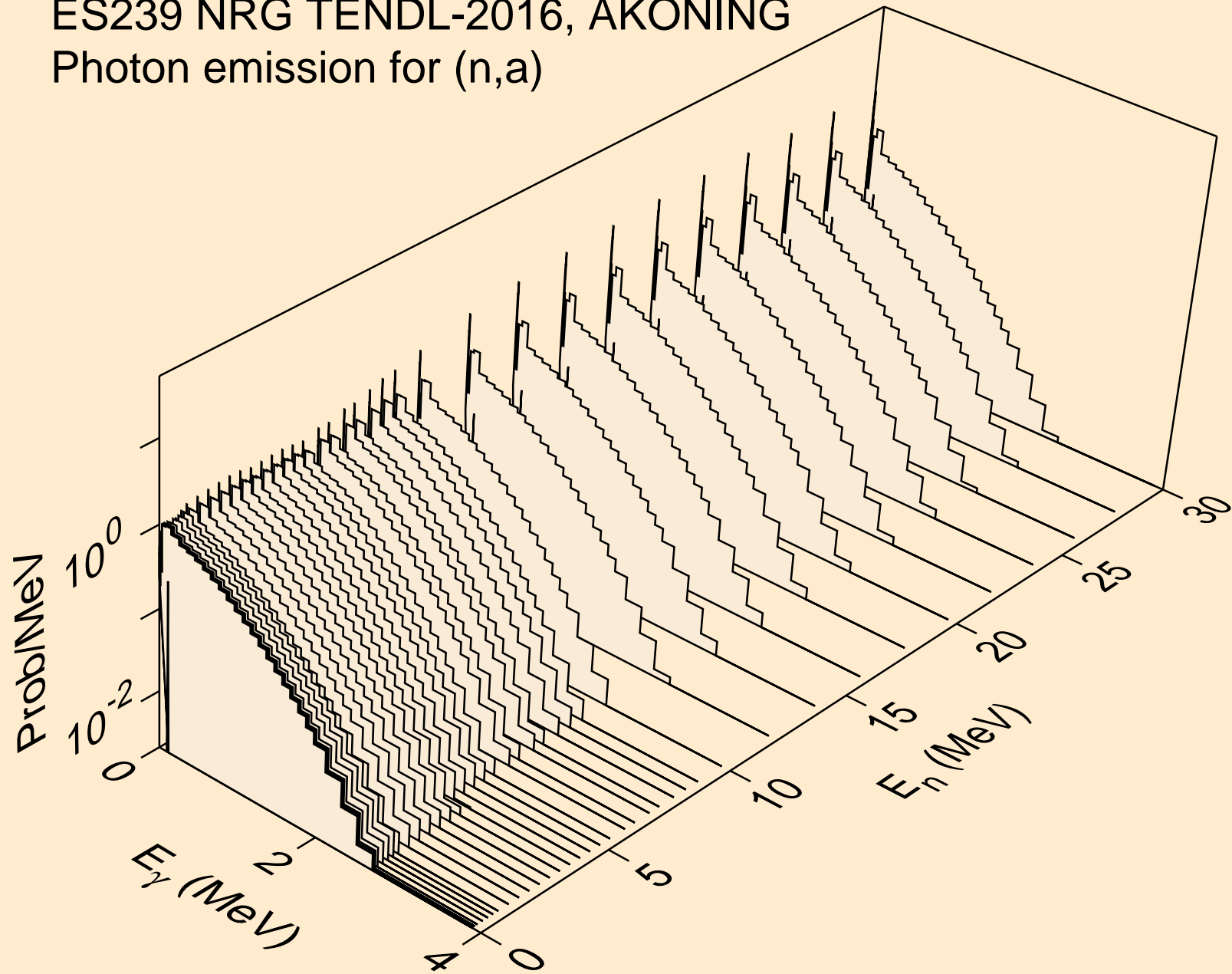

ES239 NRG TENDL-2016, AKONING
Photon emission for (n,2a)

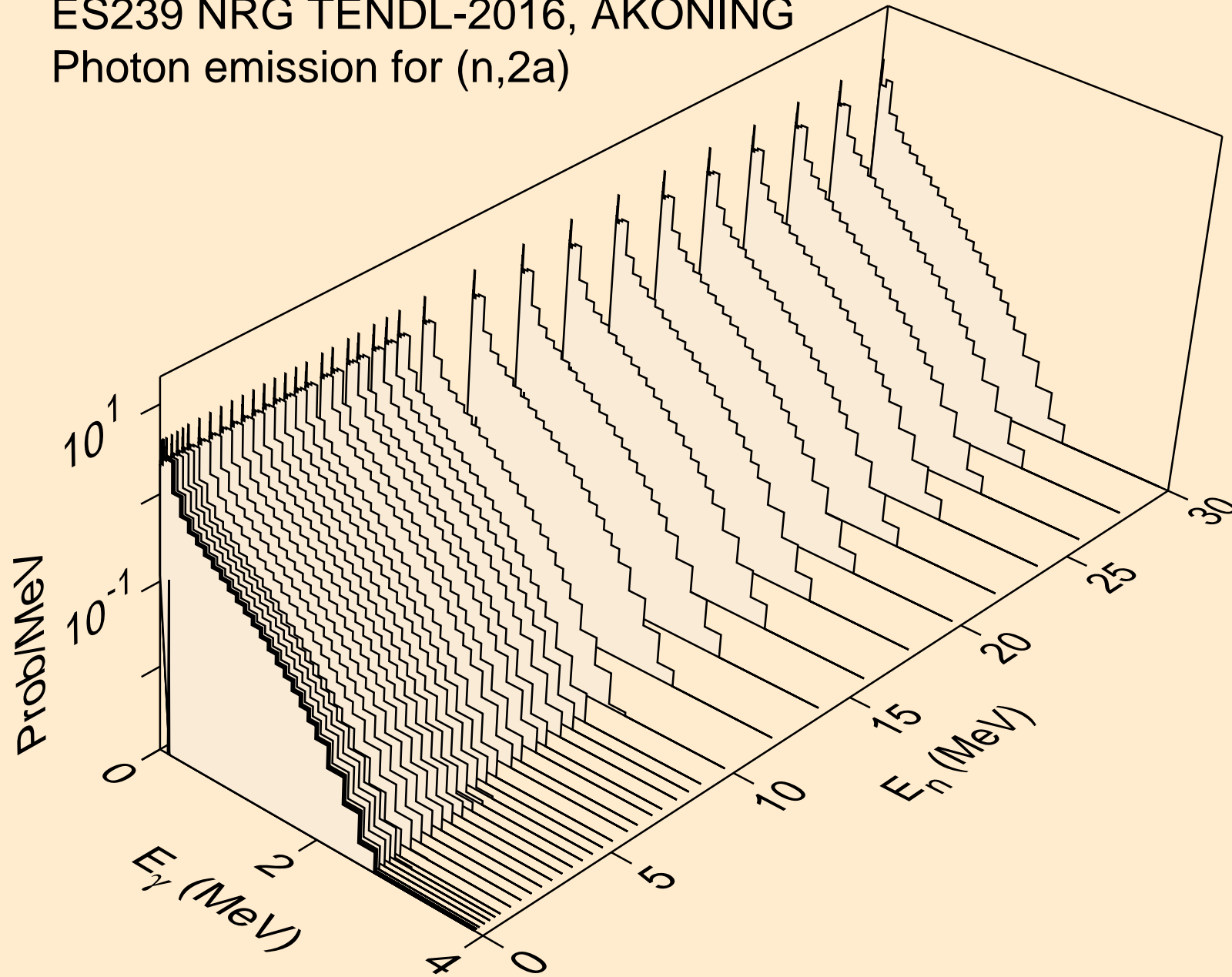

ES239 NRG TENDL-2016, AKONING
Photon emission for (n,3a)

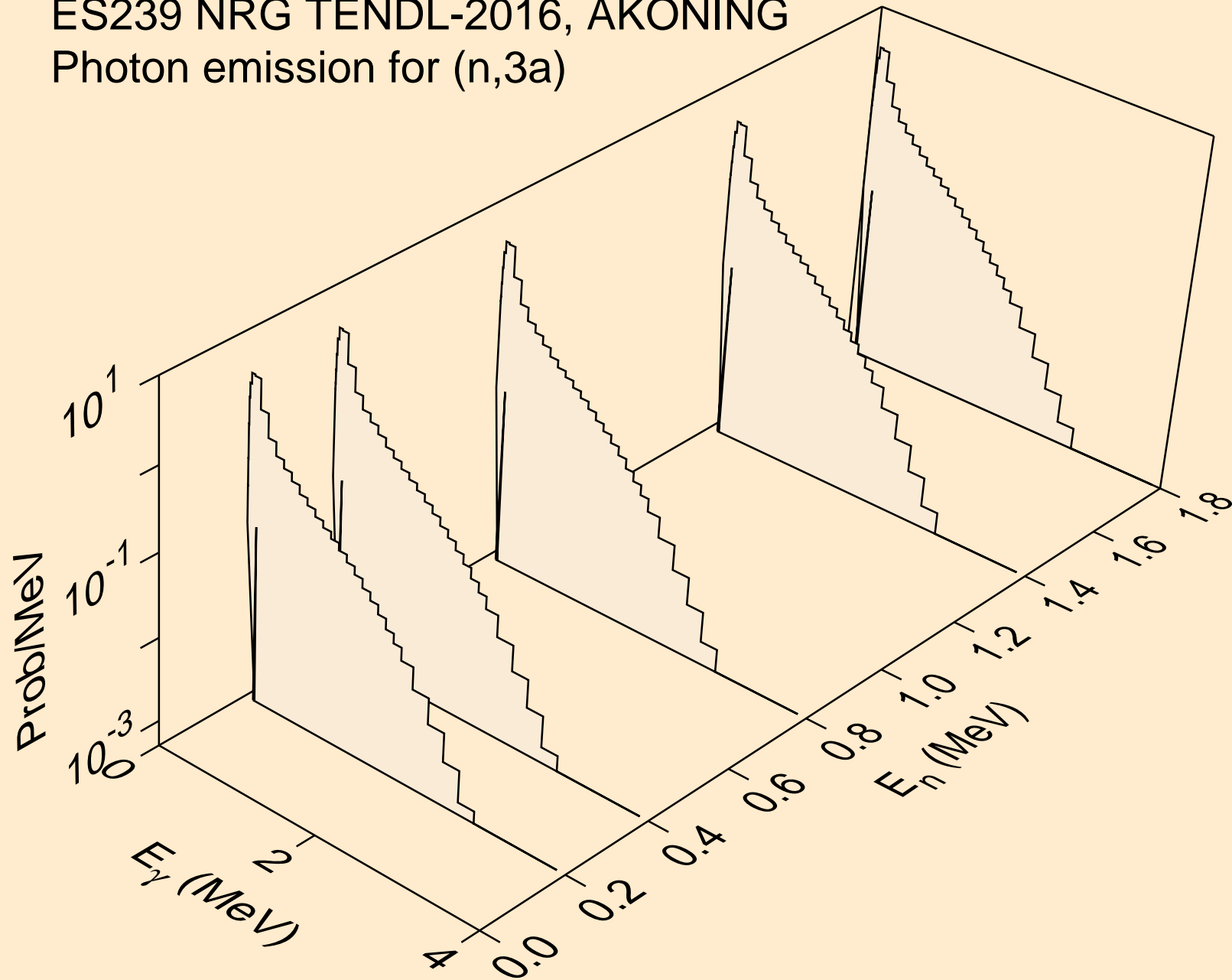

ES239 NRG TENDL-2016, AKONING
Photon emission for (n,2p)

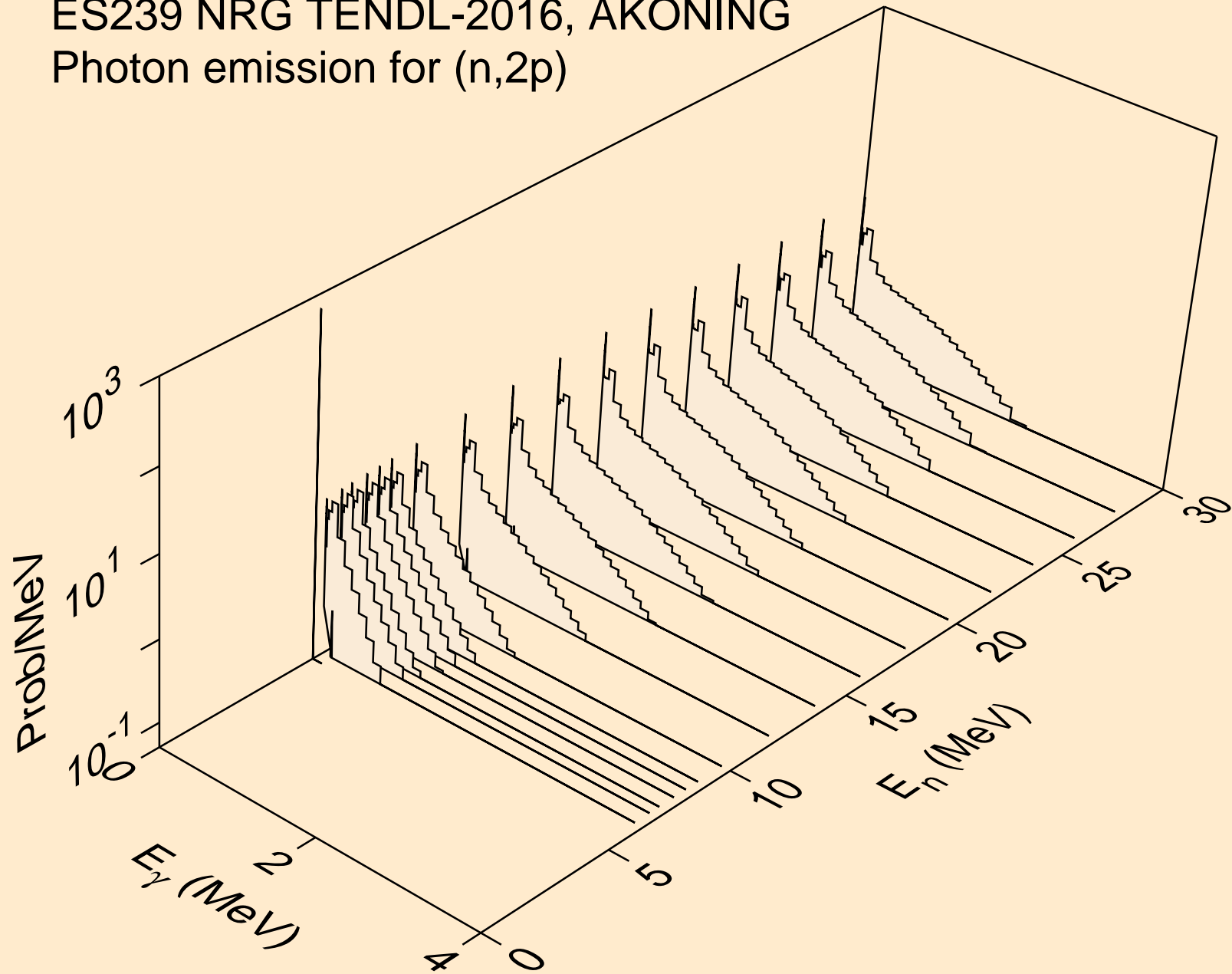

ES239 NRG TENDL-2016, AKONING
Photon emission for (n,p α)

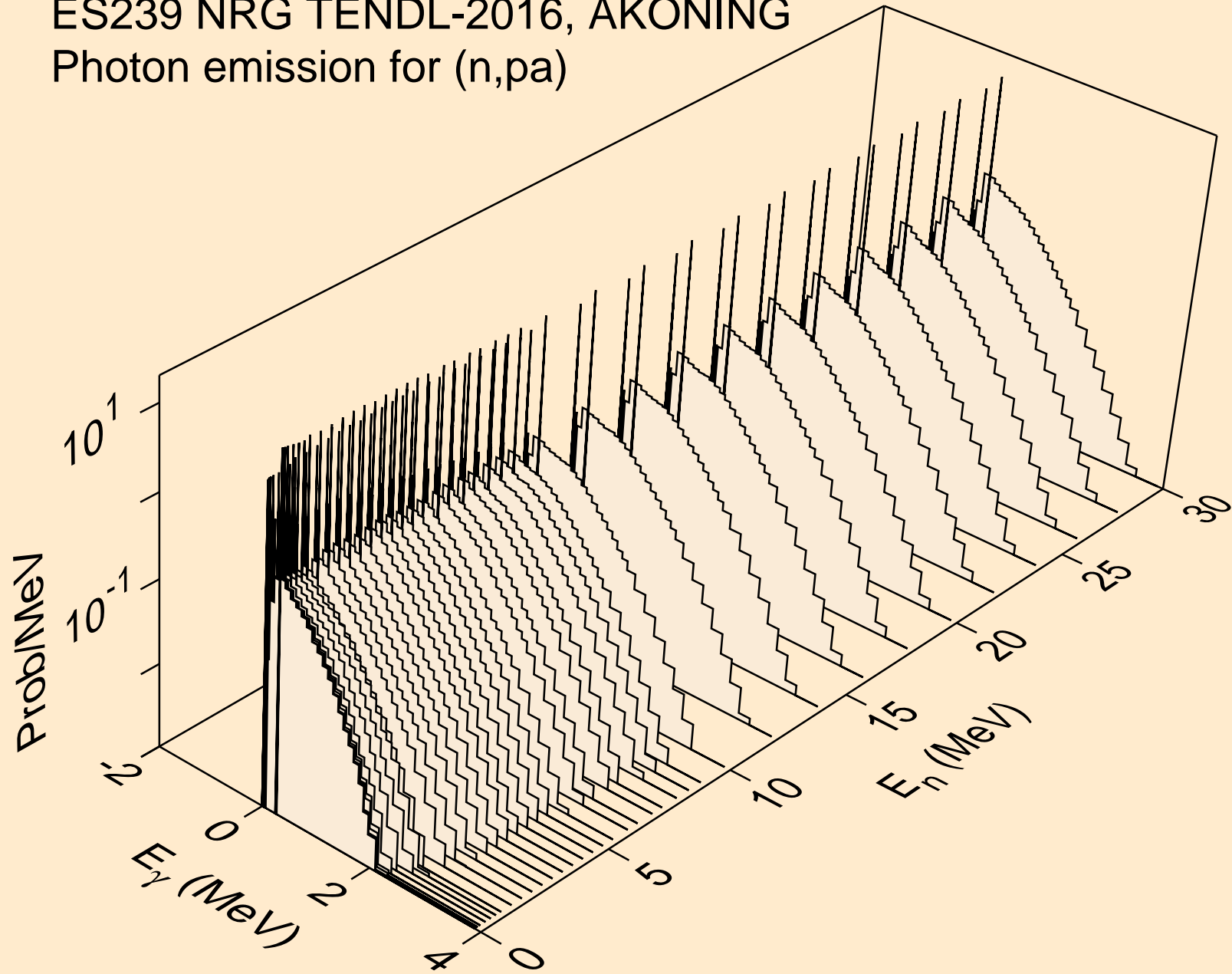

ES239 NRG TENDL-2016, AKONING
Photon emission for (n,t2a)

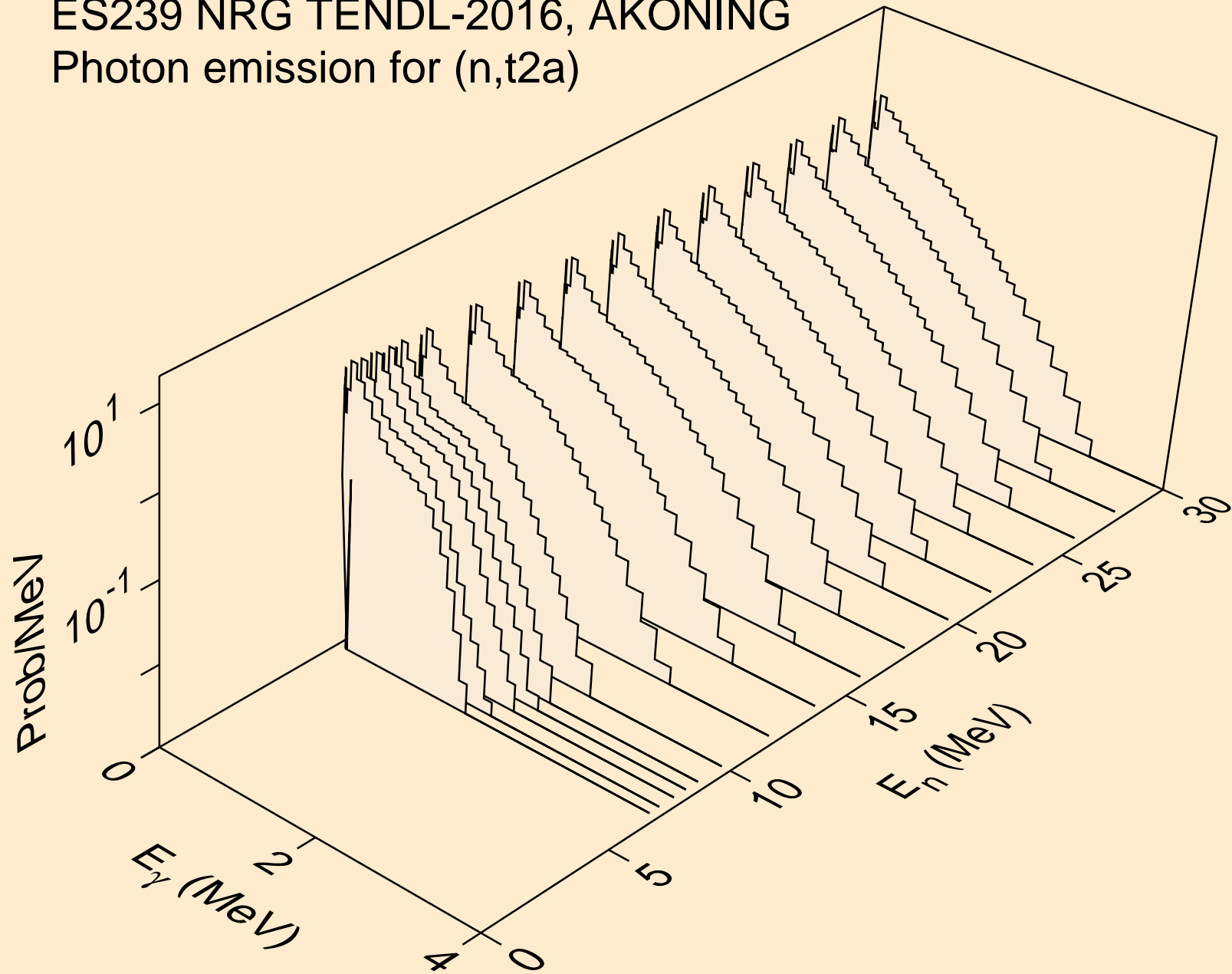

ES239 NRG TENDL-2016, AKONING
Photon emission for (n,d2a)

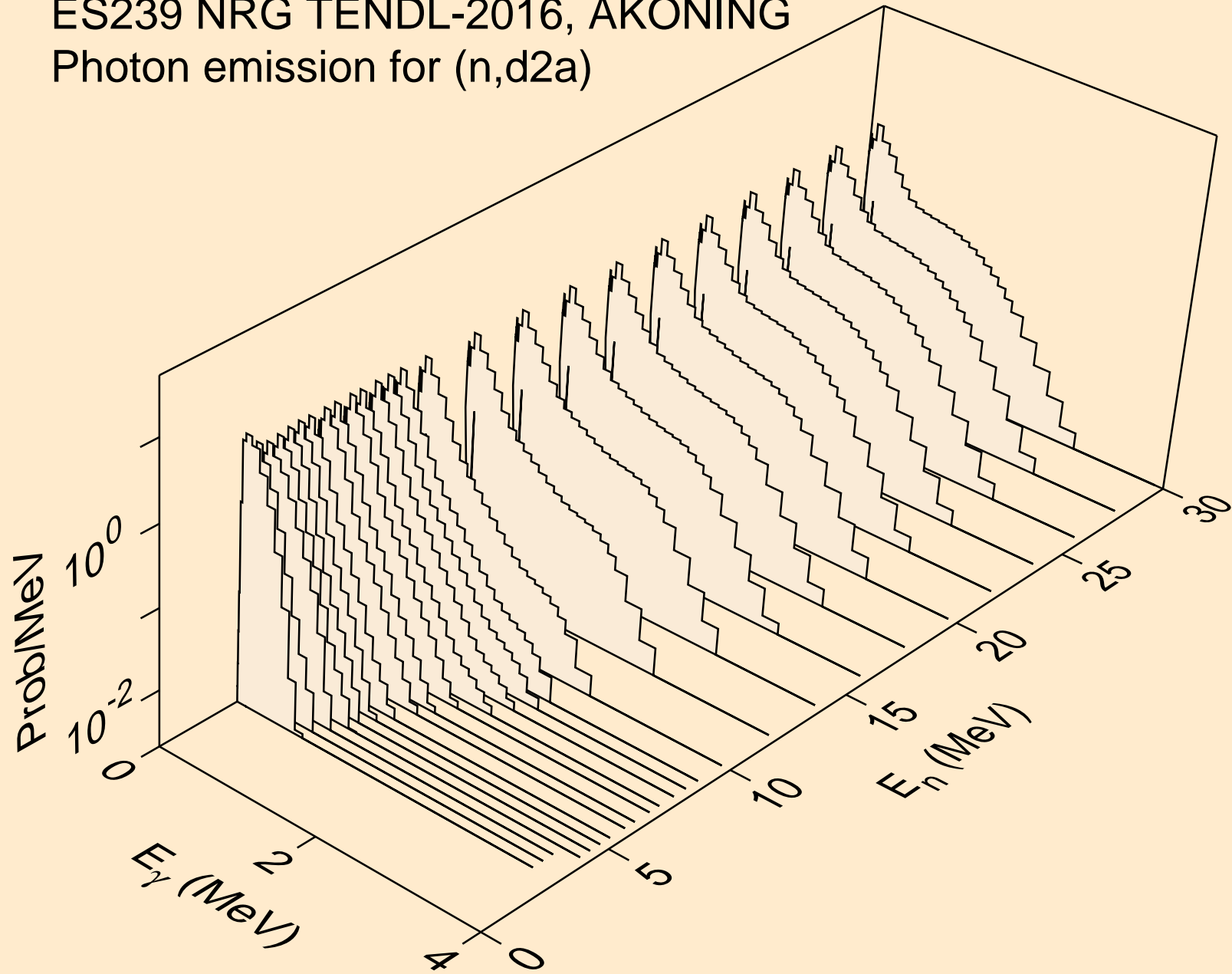

ES239 NRG TENDL-2016, AKONING
Photon emission for (n,pd)

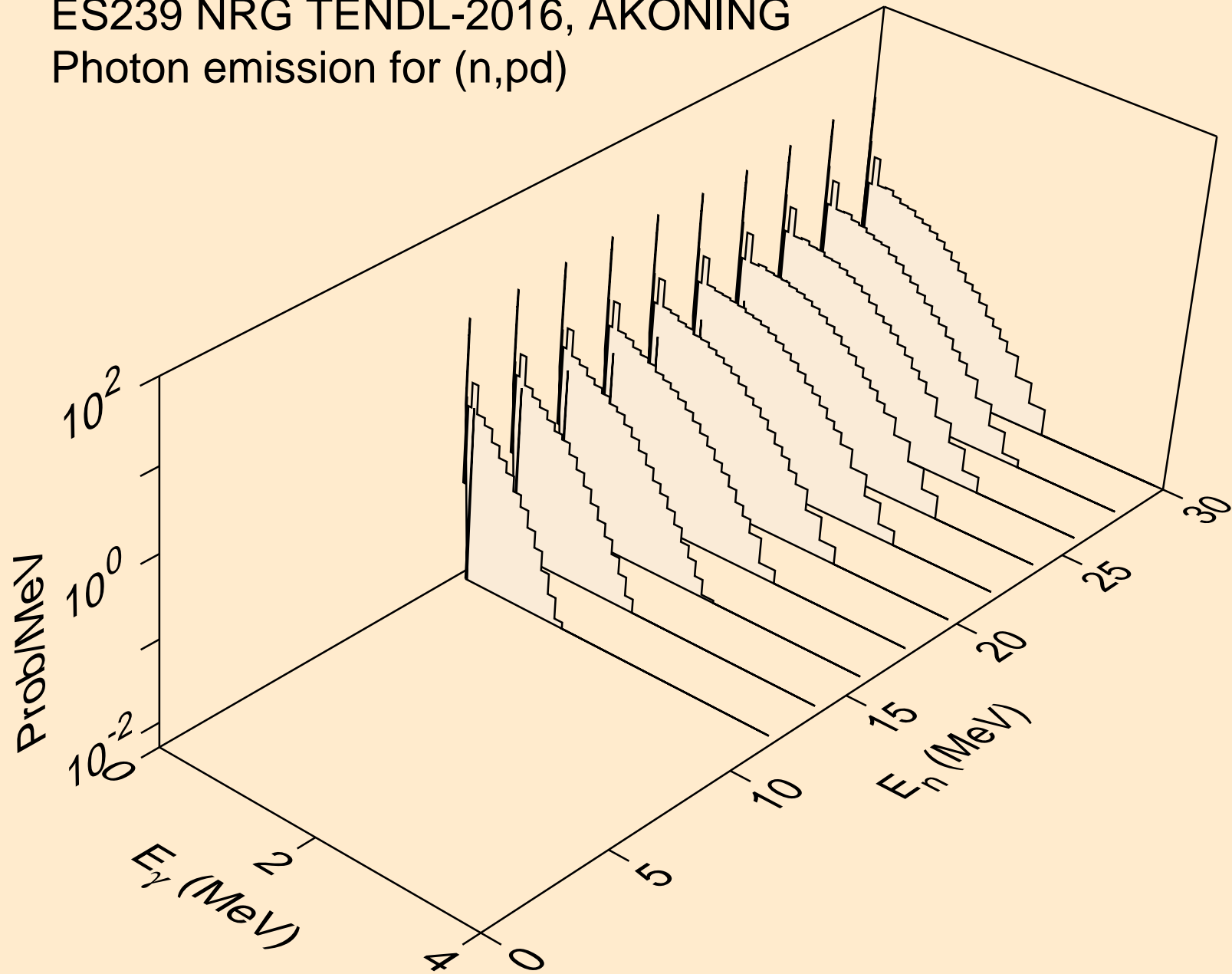

ES239 NRG TENDL-2016, AKONING
Photon emission for (n,da)

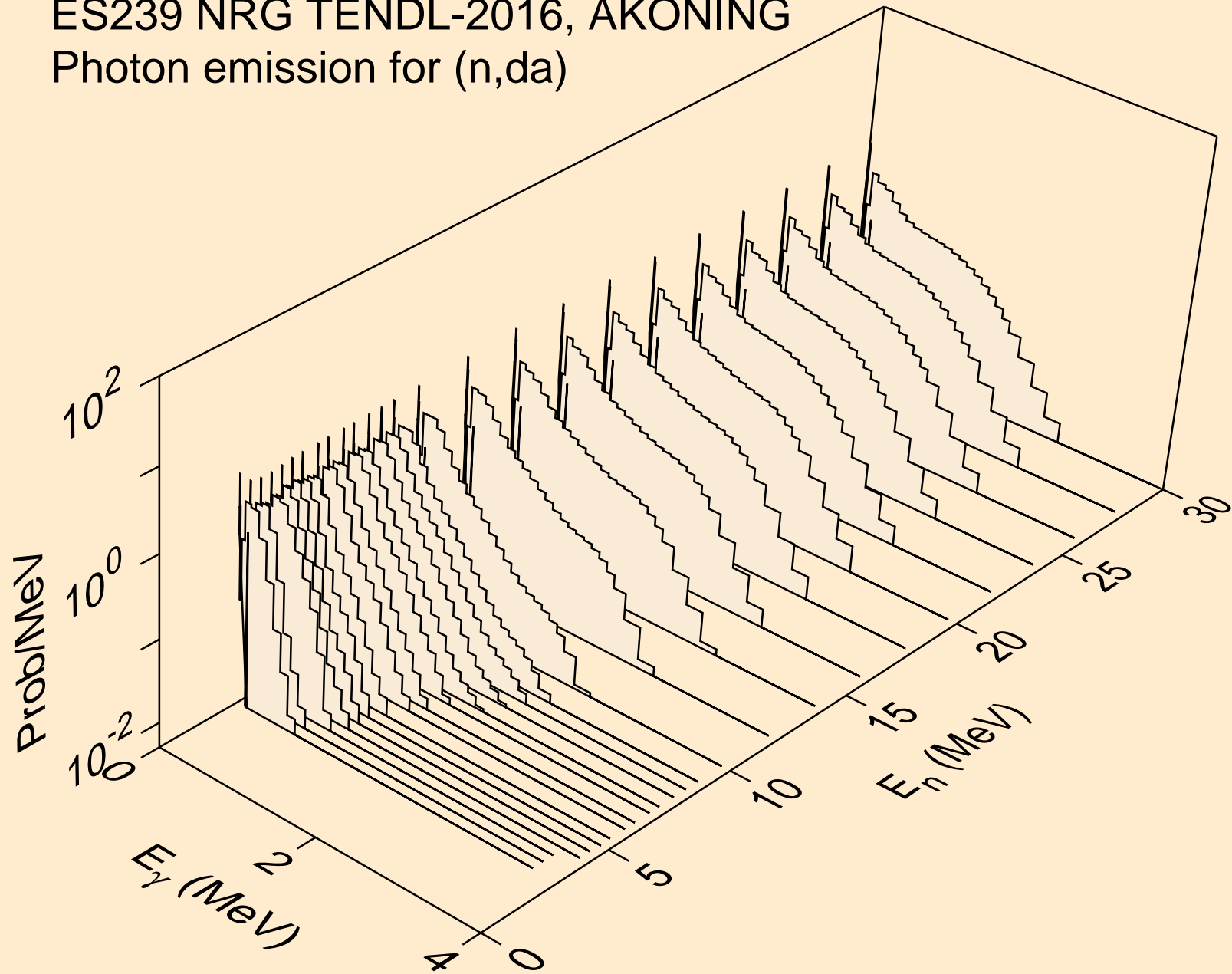

ES239 NRG TENDL-2016, AKONING
thermal capture photon spectrum

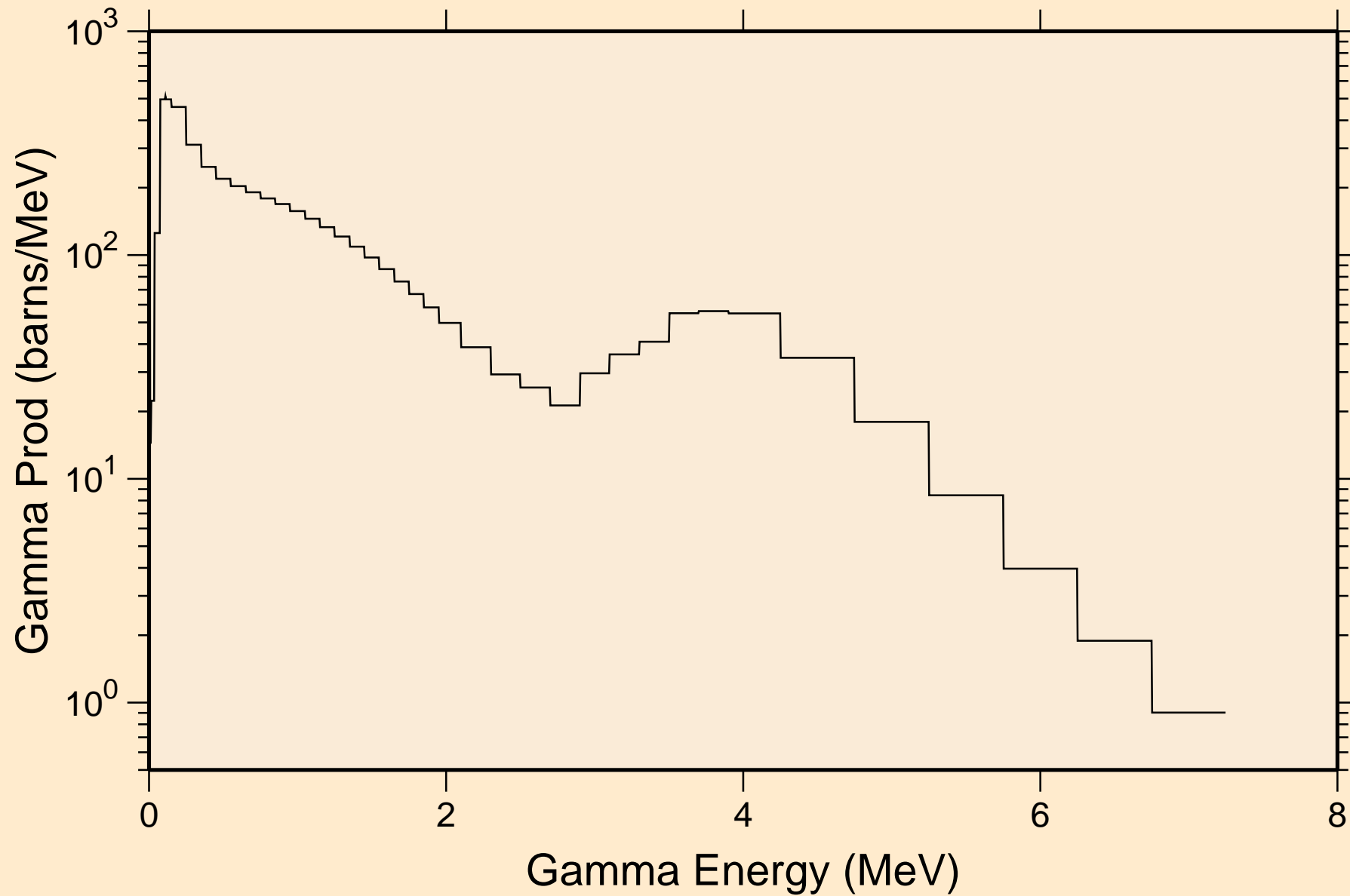

ES239 NRG TENDL-2016, AKONING
14 MeV photon spectrum

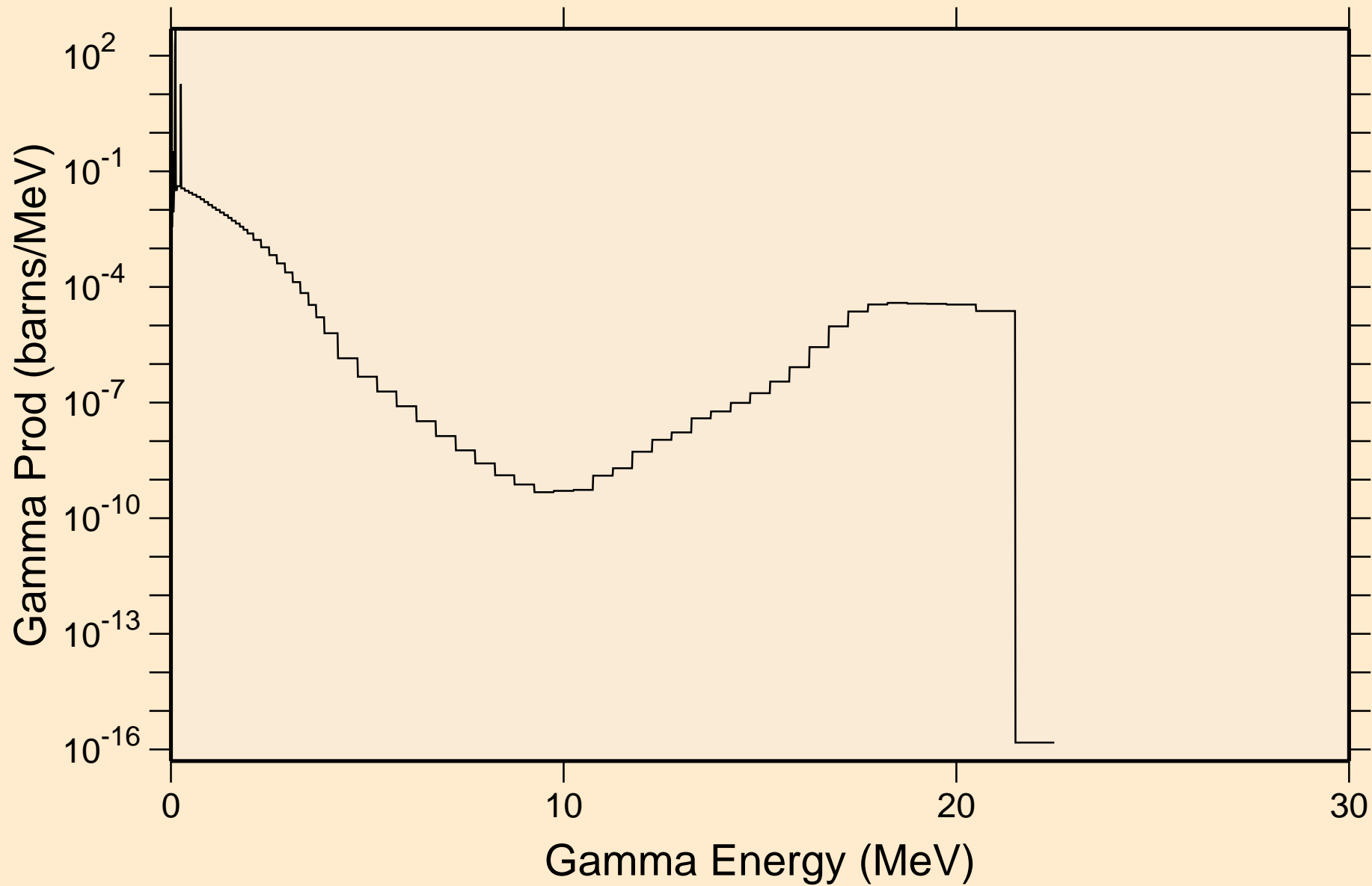

ES239 NRG TENDL-2016, AKONING

Particle heating contributions

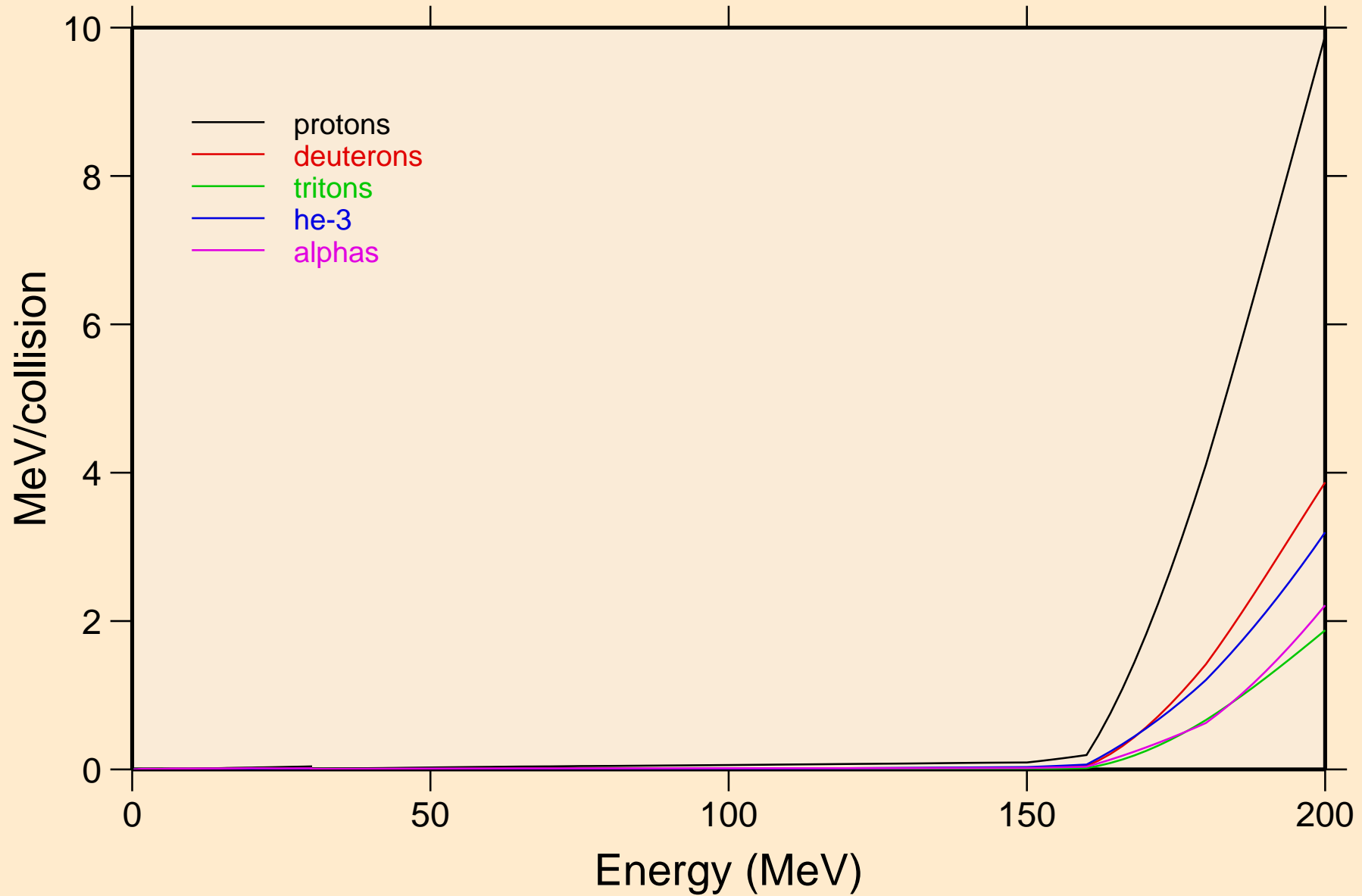

ES239 NRG TENDL-2016, AKONING

Recoil Heating

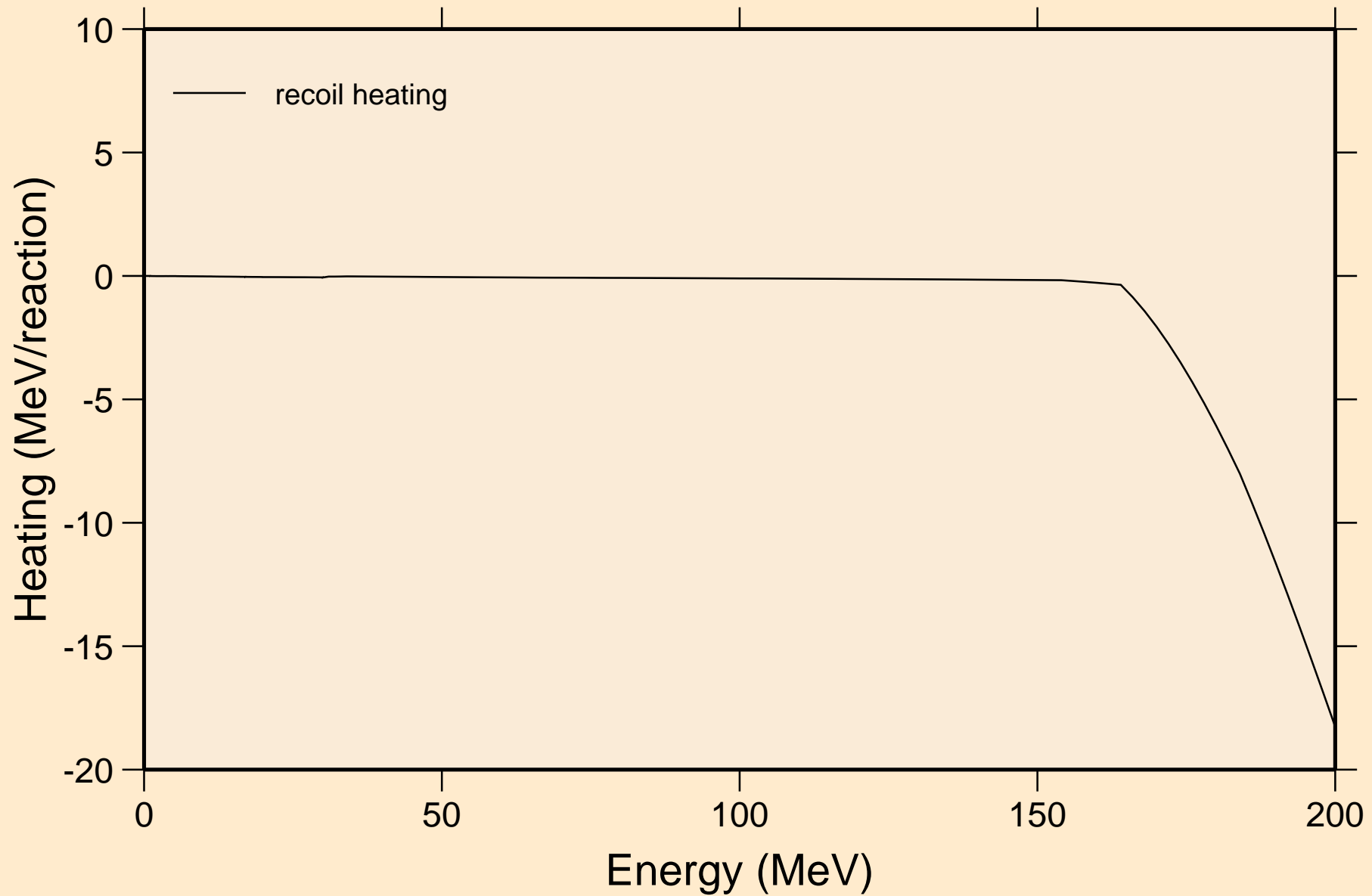

ES239 NRG TENDL-2016, AKONING

Particle production cross sections

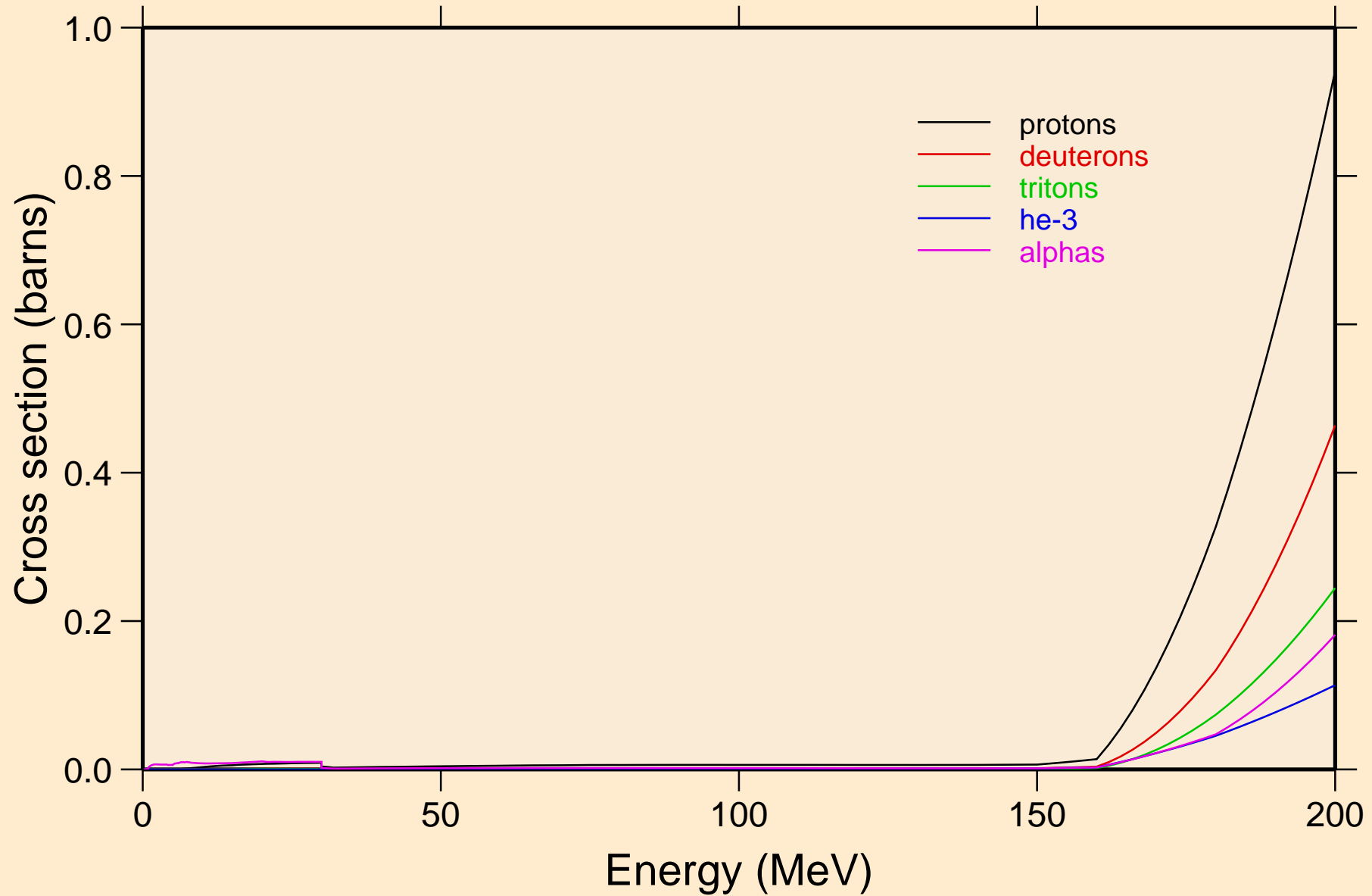

ES239 NRG TENDL-2016, AKONING
protons from (n,x)

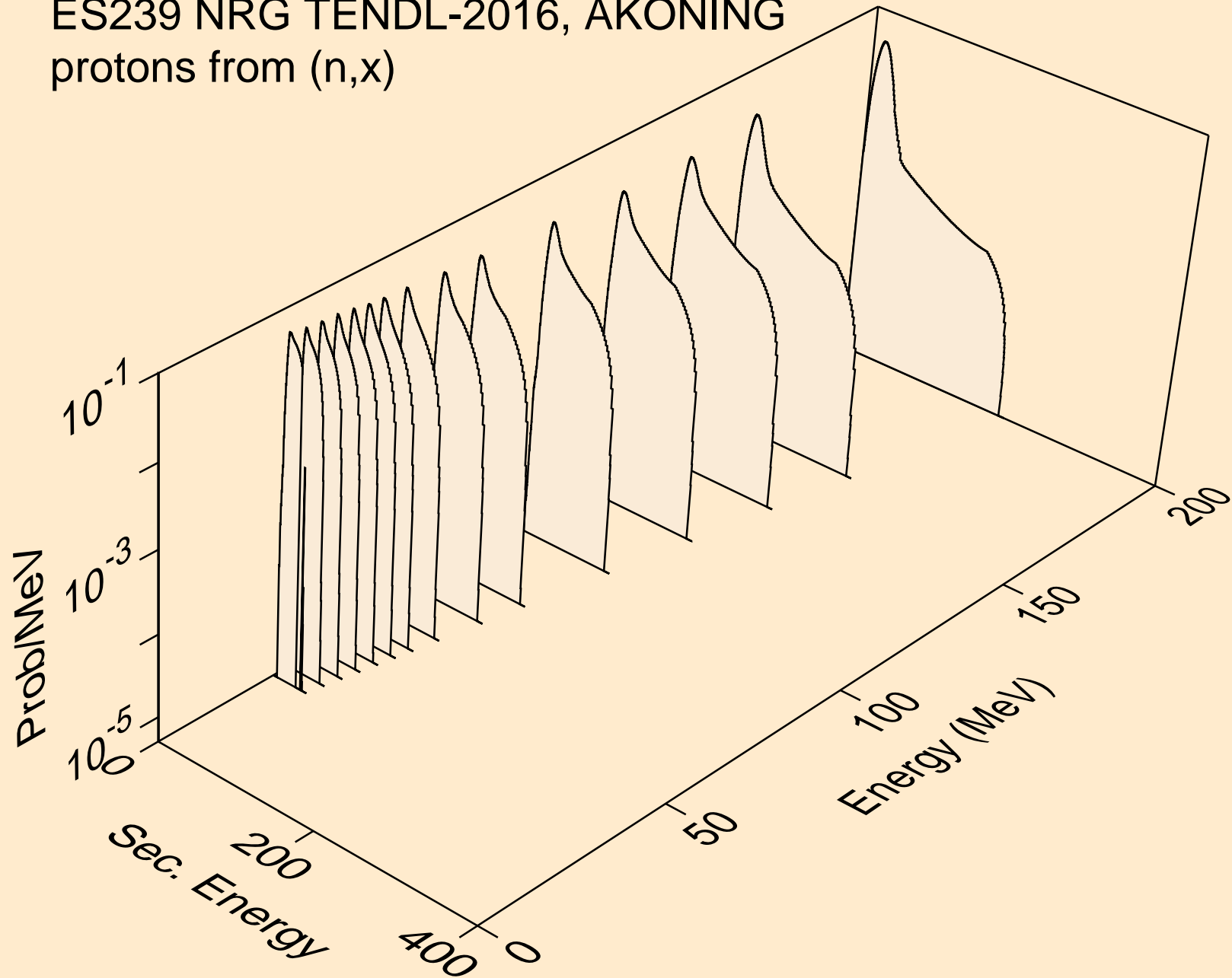

ES239 NRG TENDL-2016, AKONING
protons from (n,n*)p

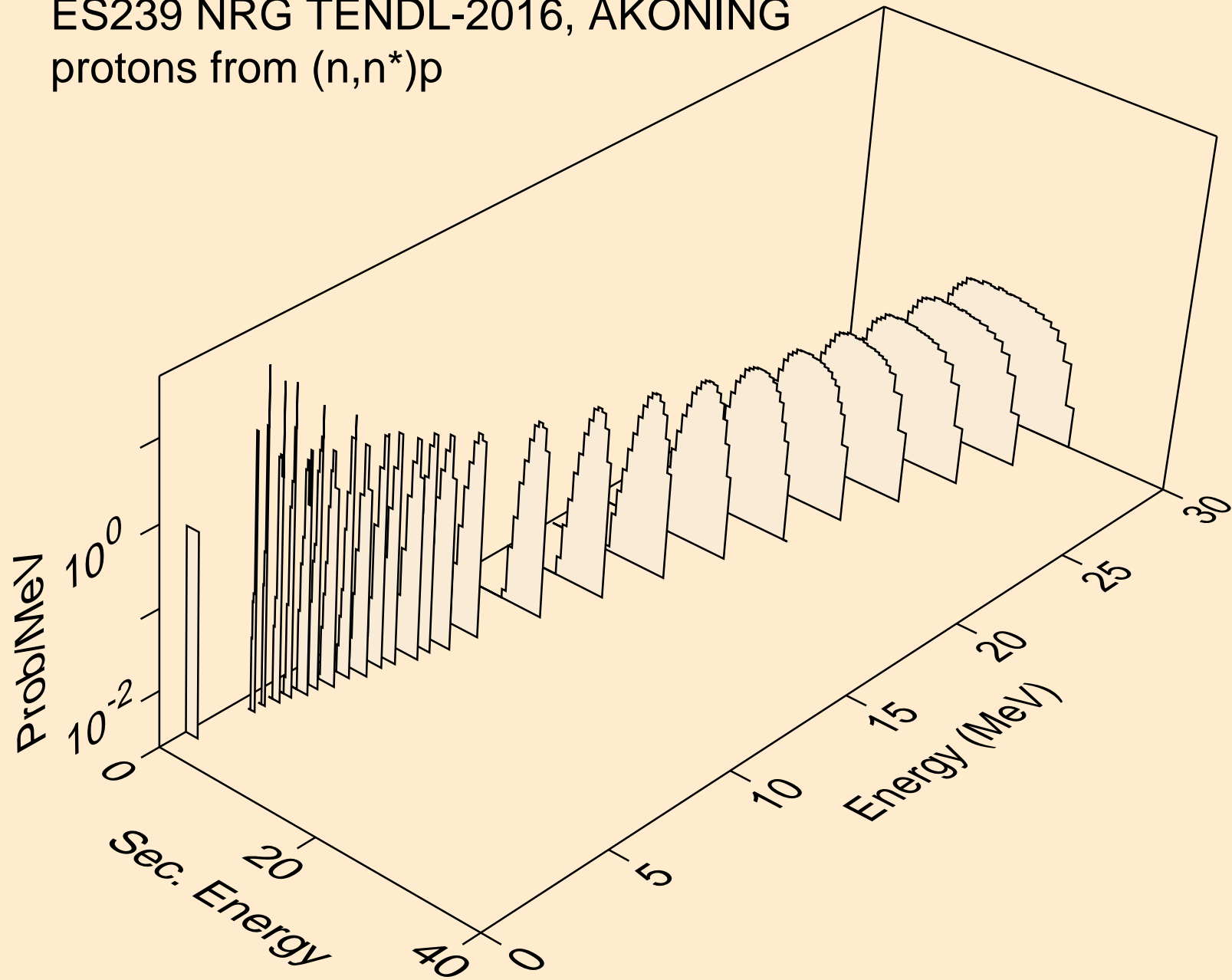

ES239 NRG TENDL-2016, AKONING
protons from (n,2np)

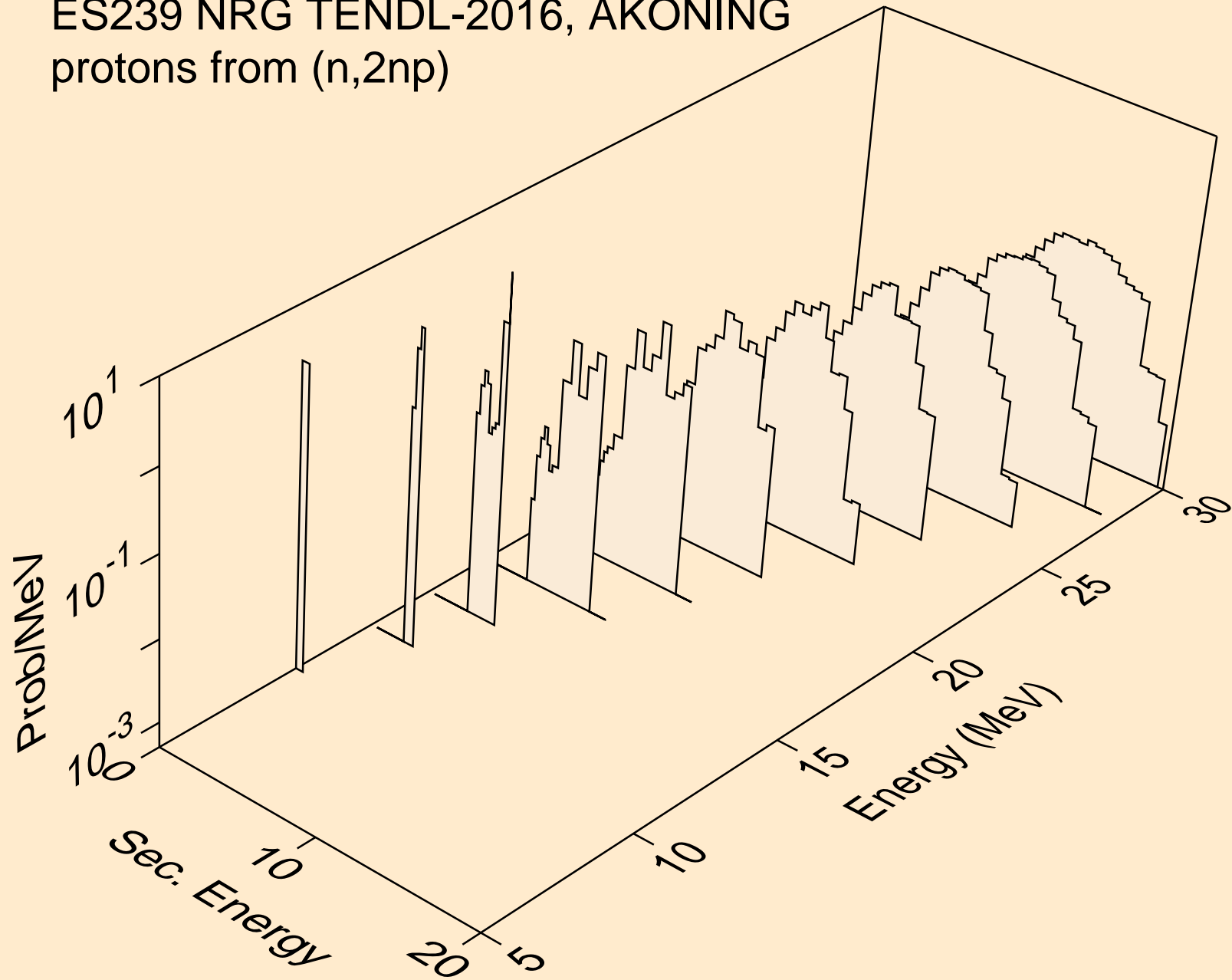

ES239 NRG TENDL-2016, AKONING
protons from (n,3np)

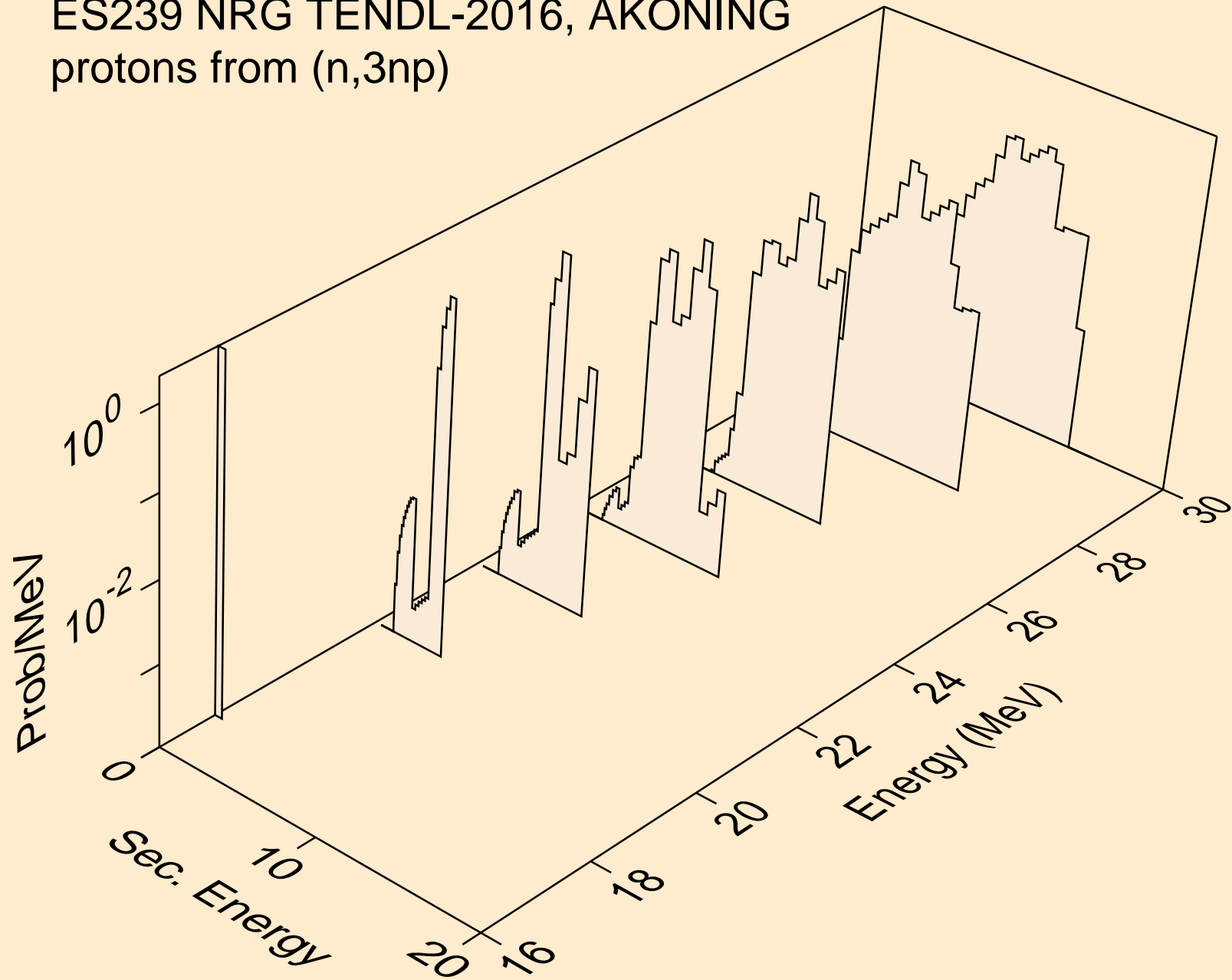

ES239 NRG TENDL-2016, AKONING
protons from (n,2np)

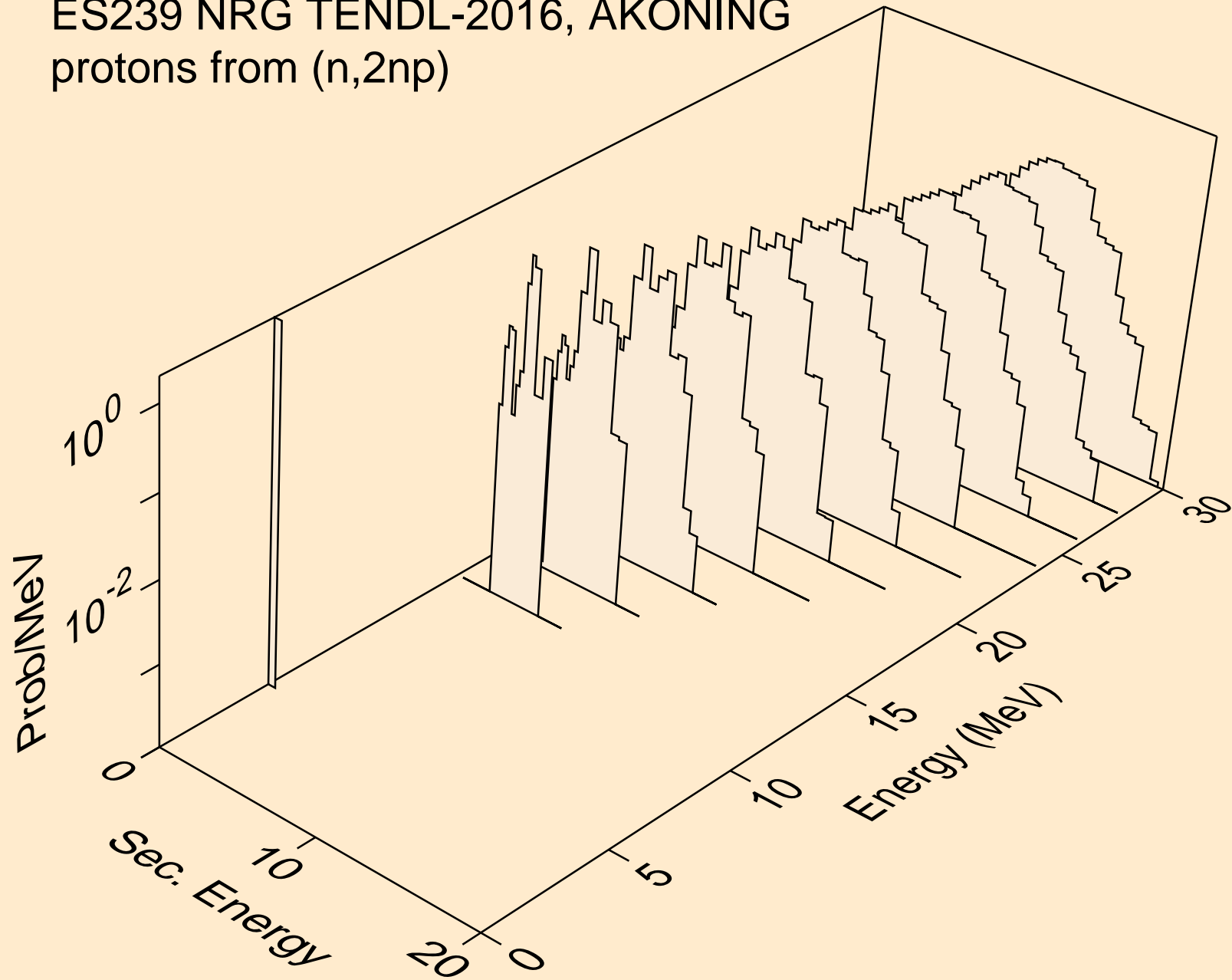

ES239 NRG TENDL-2016, AKONING
protons from (n,npa)

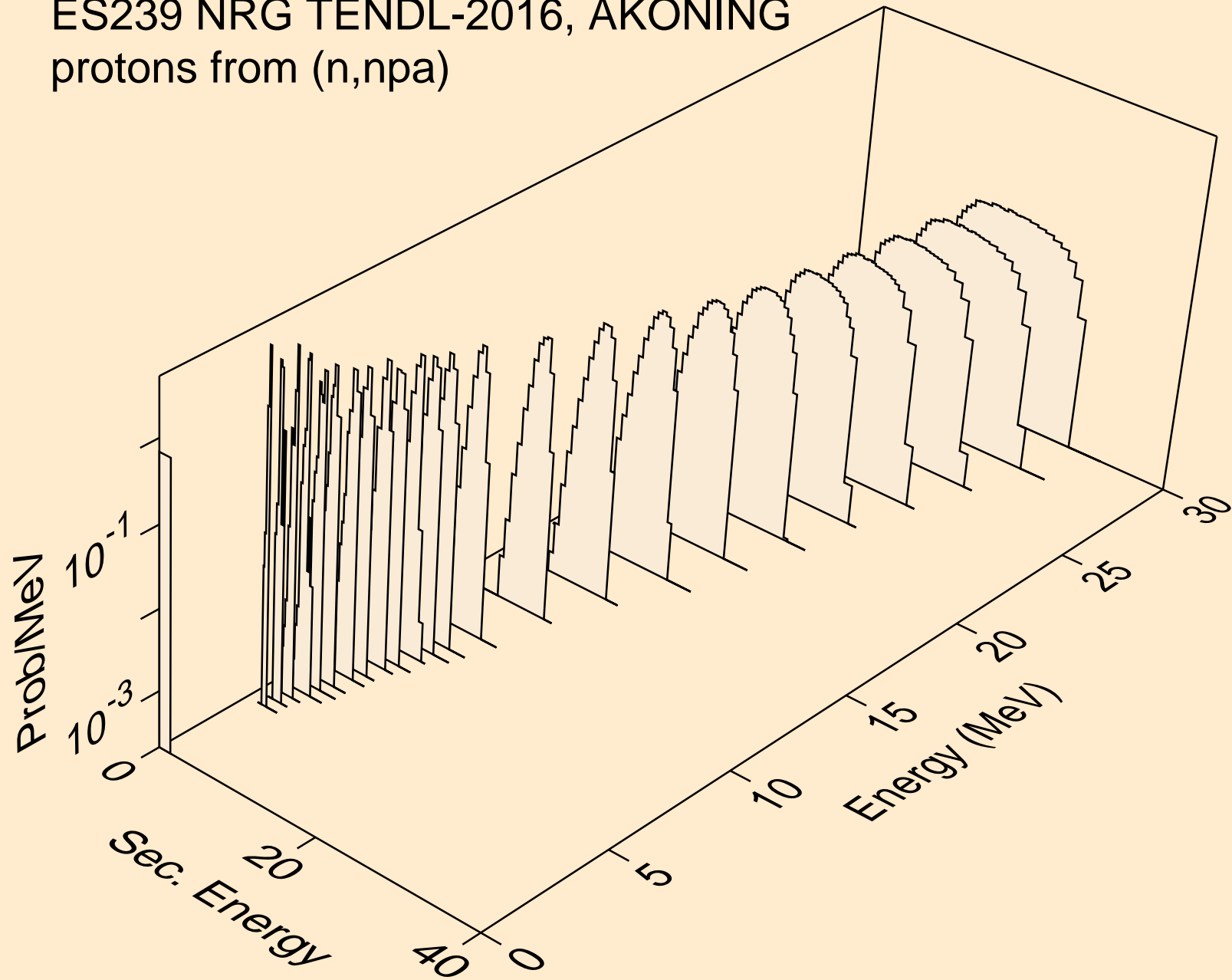

ES239 NRG TENDL-2016, AKONING
protons from (n,p)

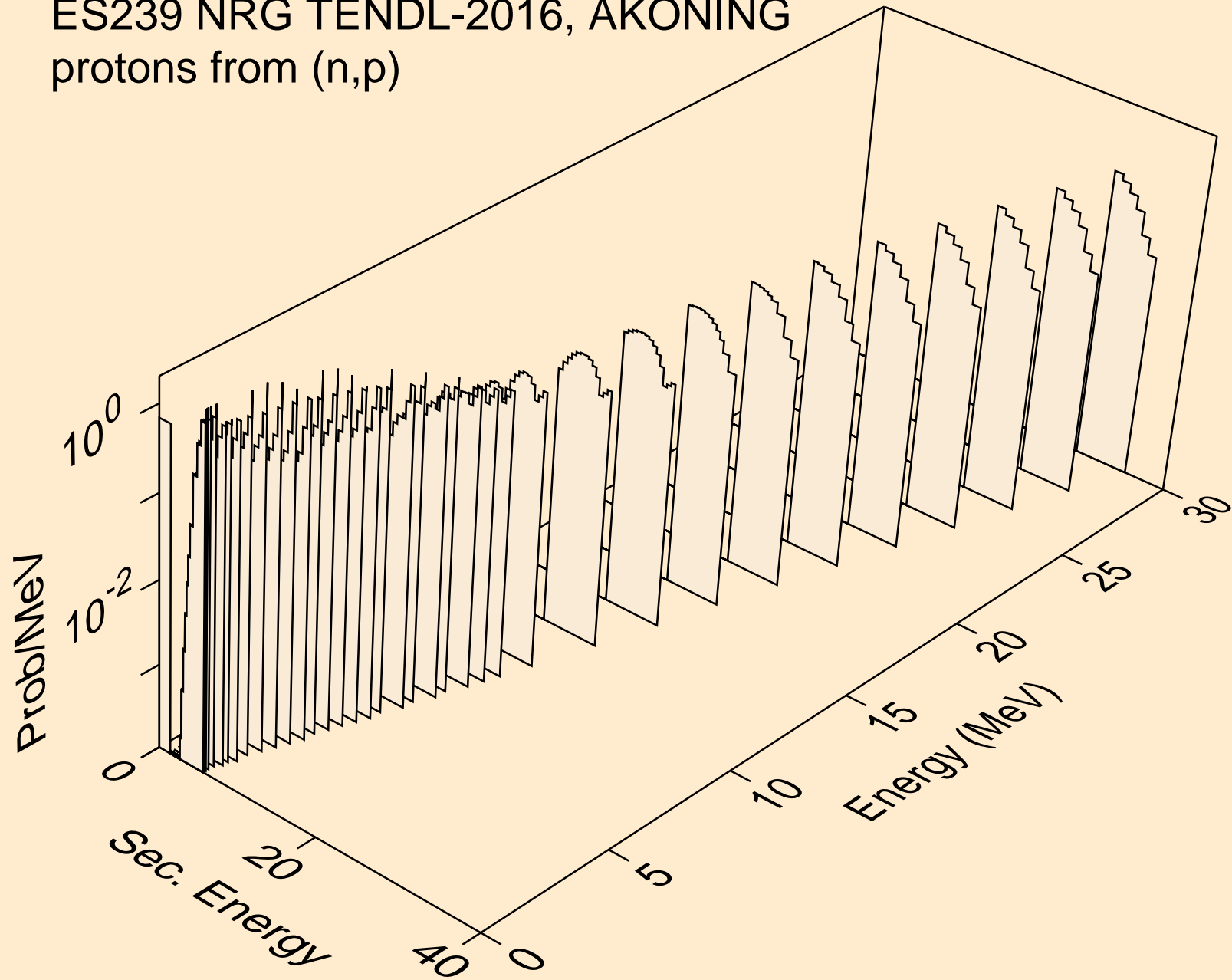

ES239 NRG TENDL-2016, AKONING
protons from (n,2p)

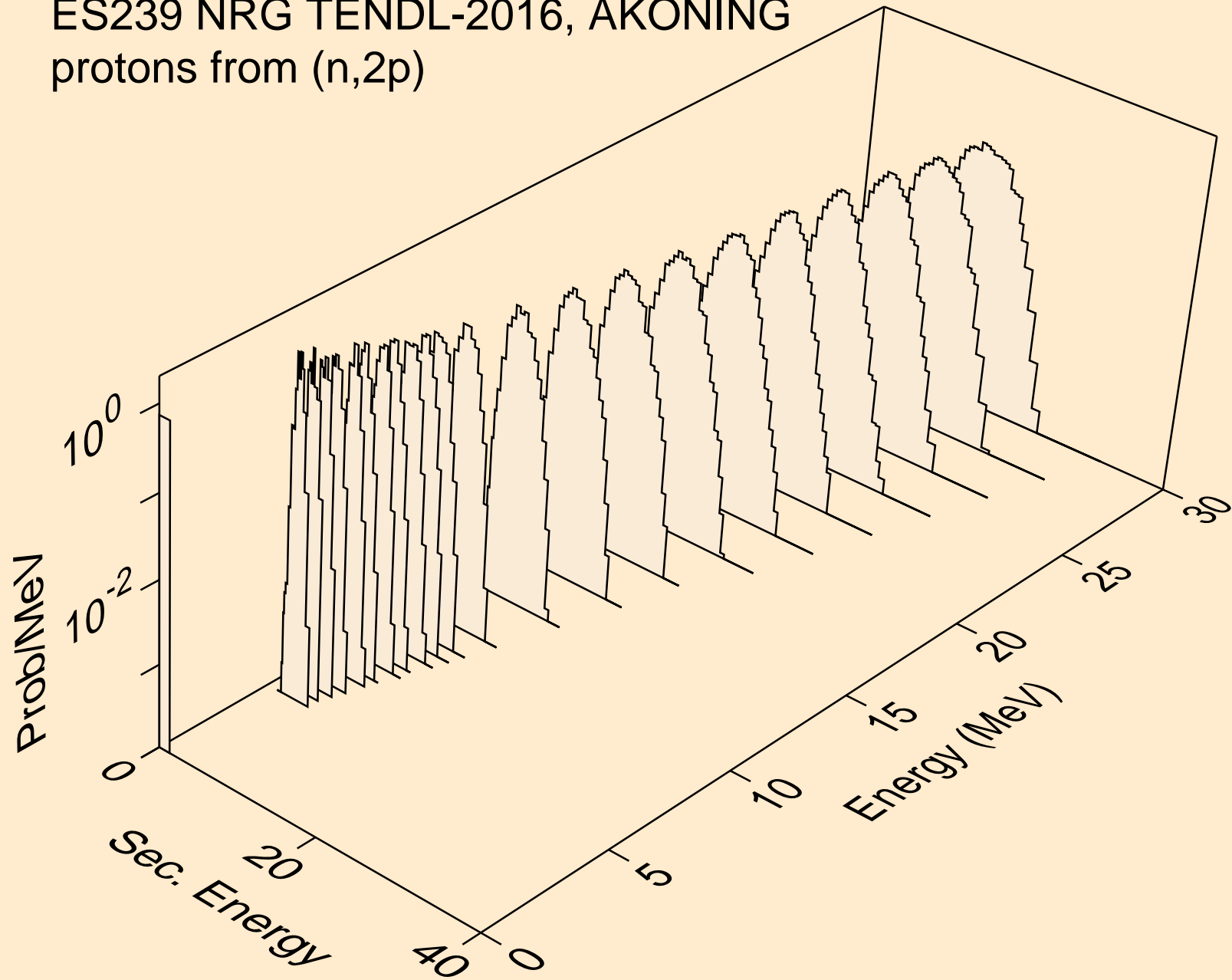

ES239 NRG TENDL-2016, AKONING
protons from (n,pa)

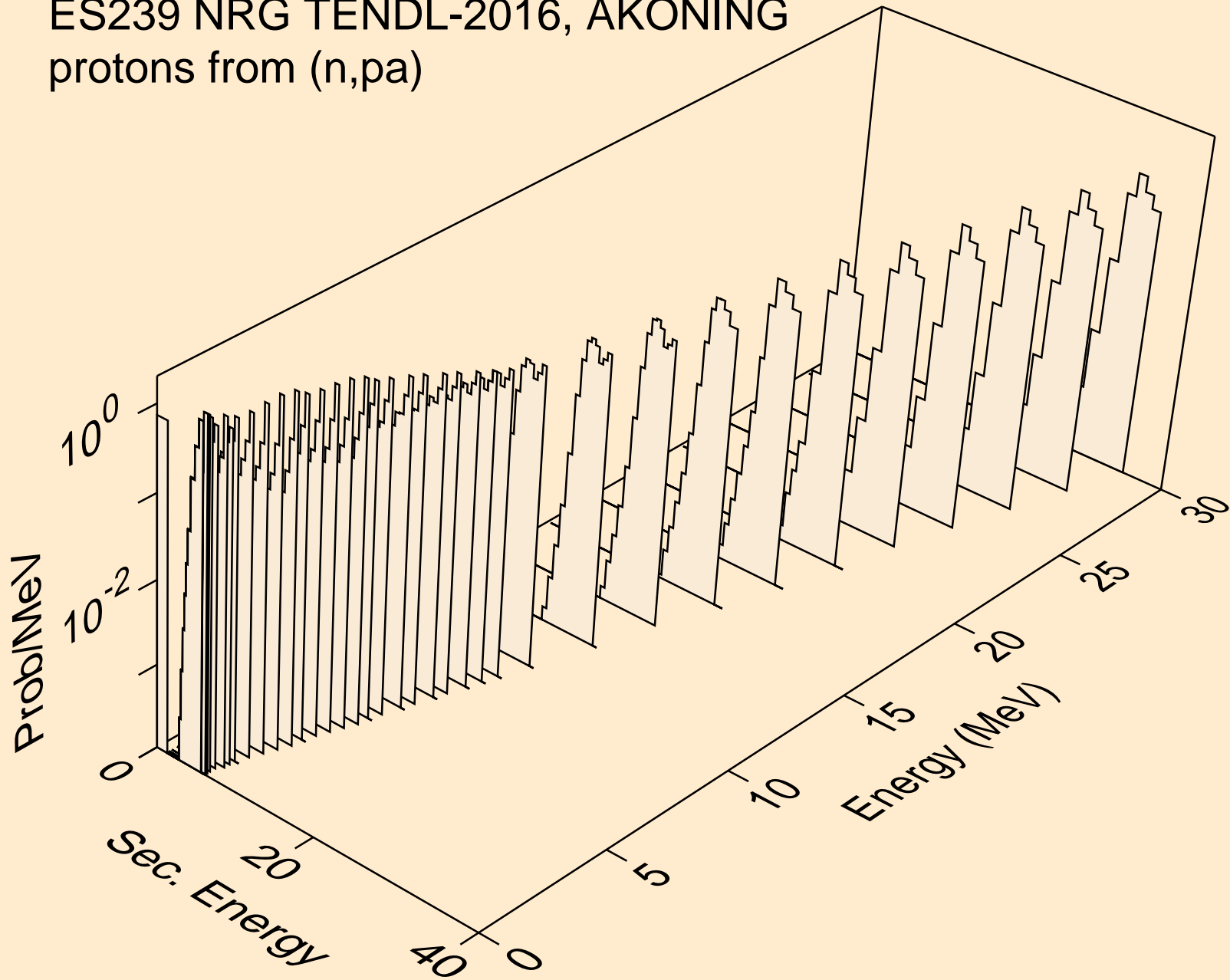

ES239 NRG TENDL-2016, AKONING
protons from (n,pd)

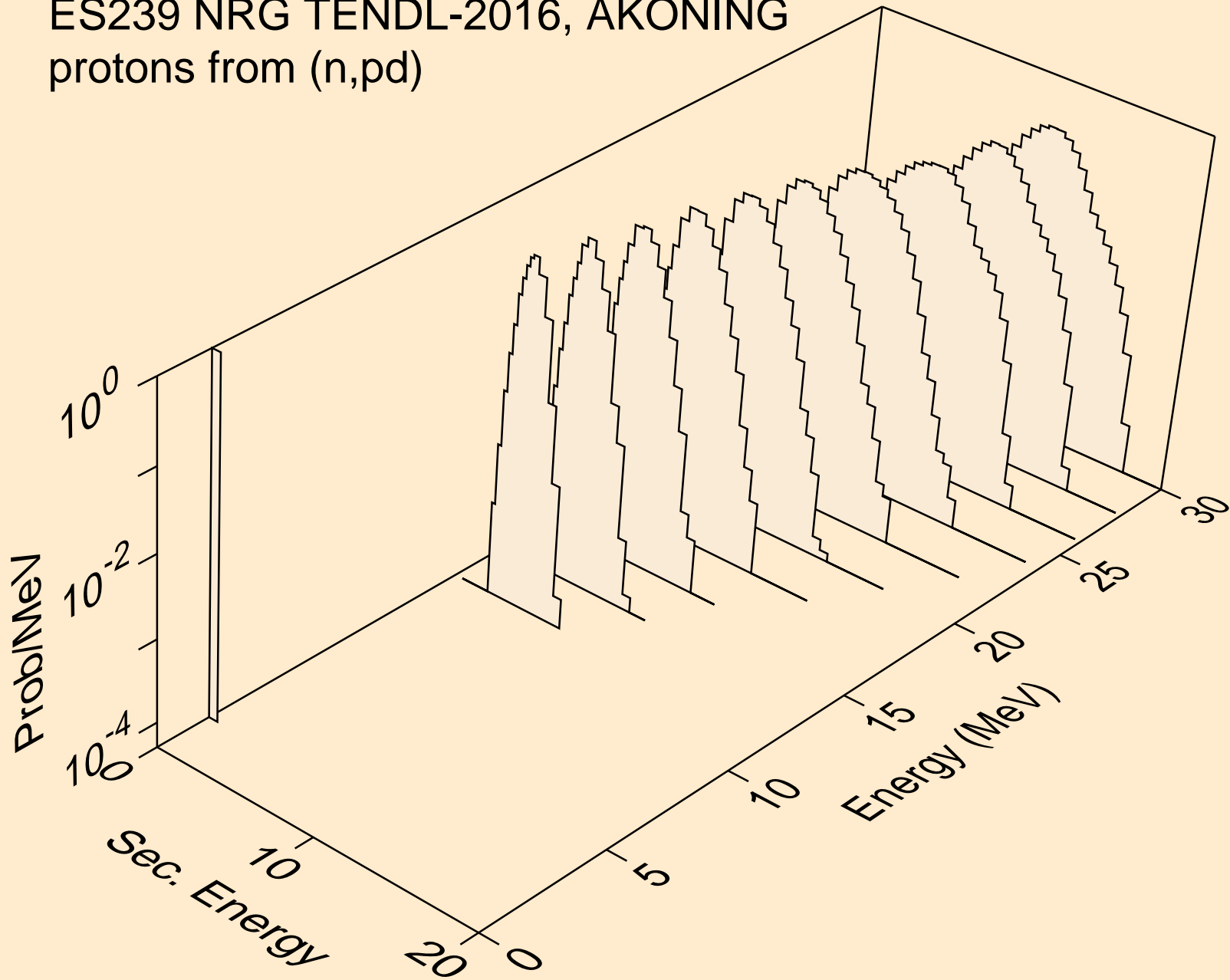

ES239 NRG TENDL-2016, AKONING
deuterons from (n,x)

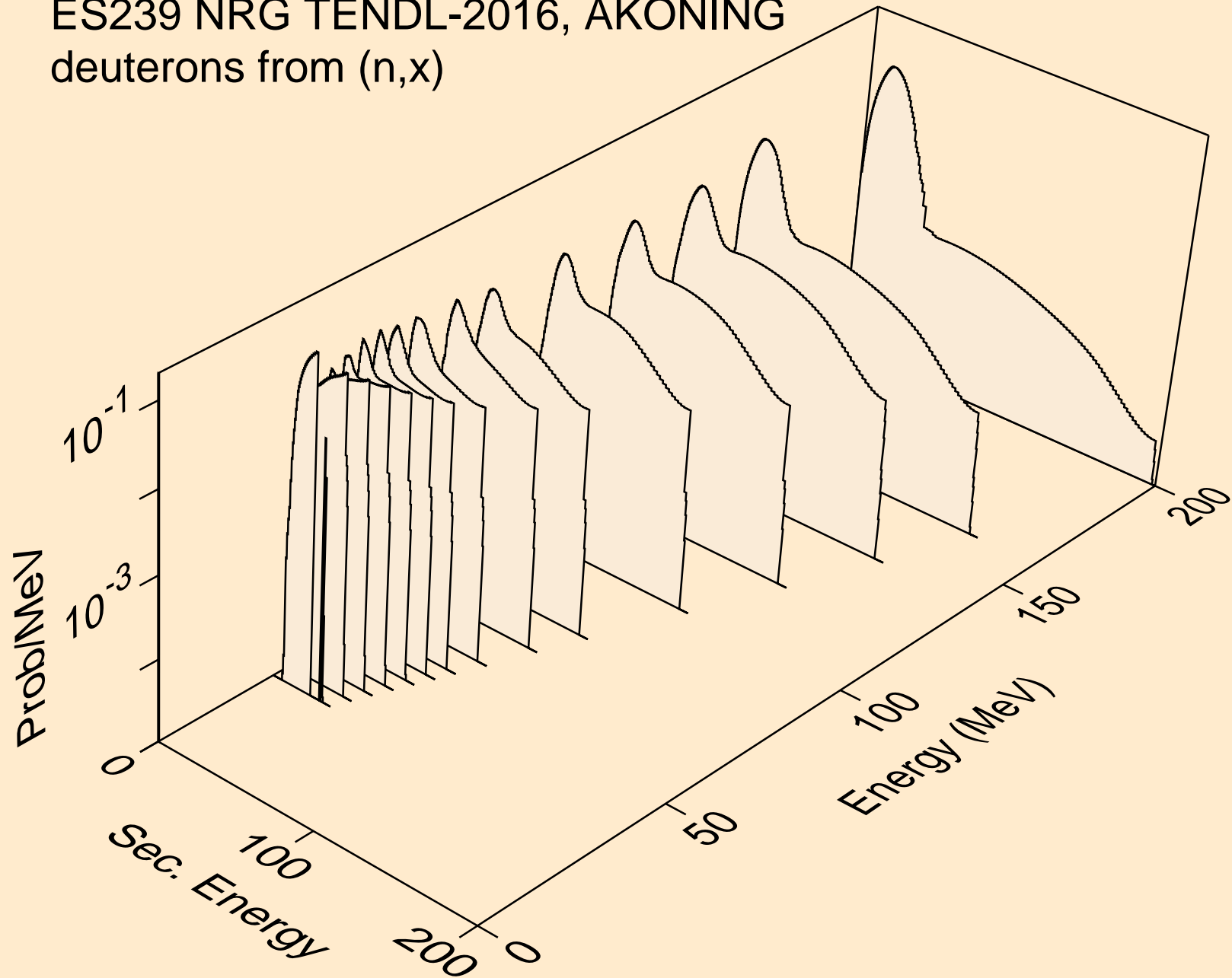

ES239 NRG TENDL-2016, AKONING
deuterons from (n,2nd)

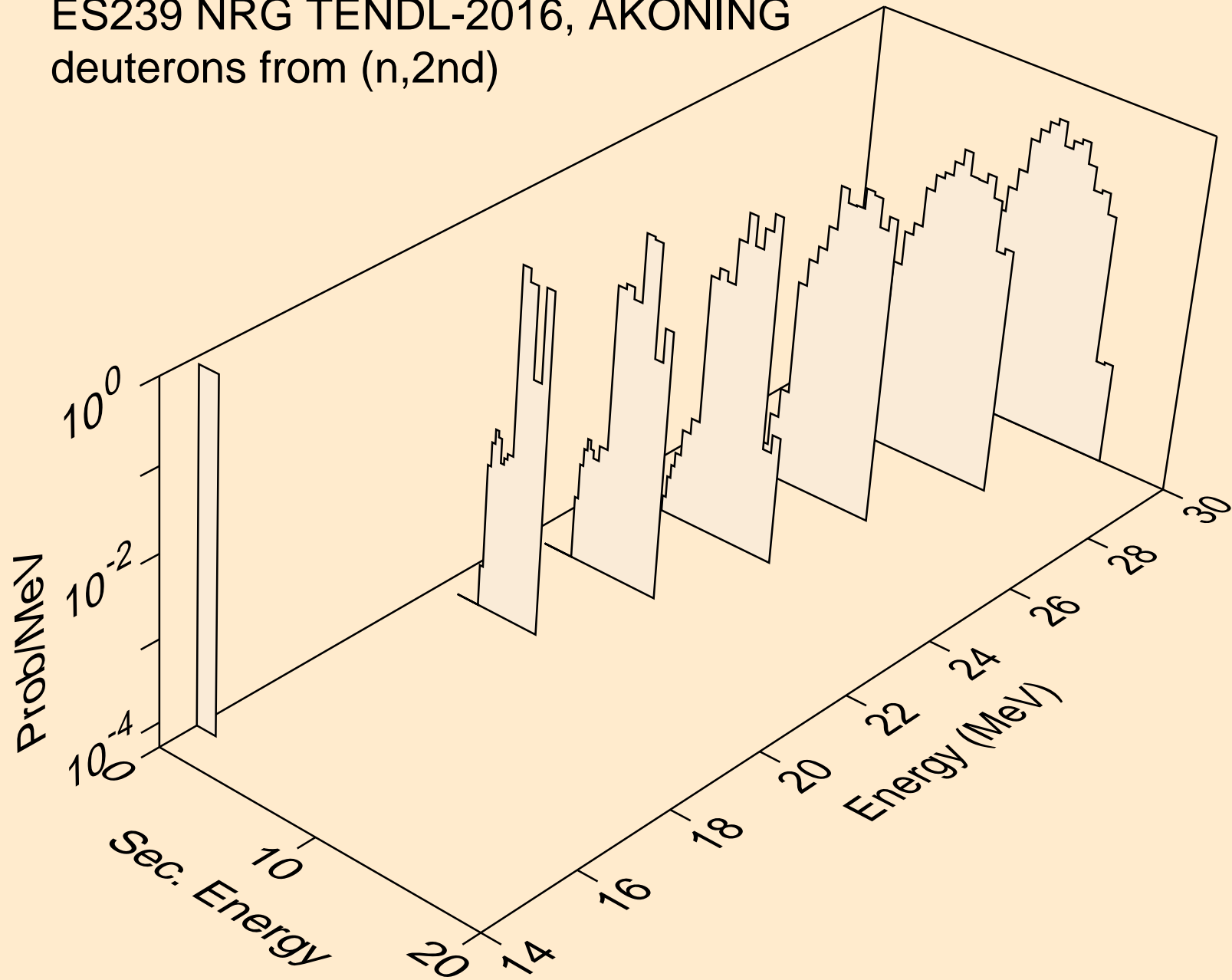

ES239 NRG TENDL-2016, AKONING
deuterons from (n,n*)d

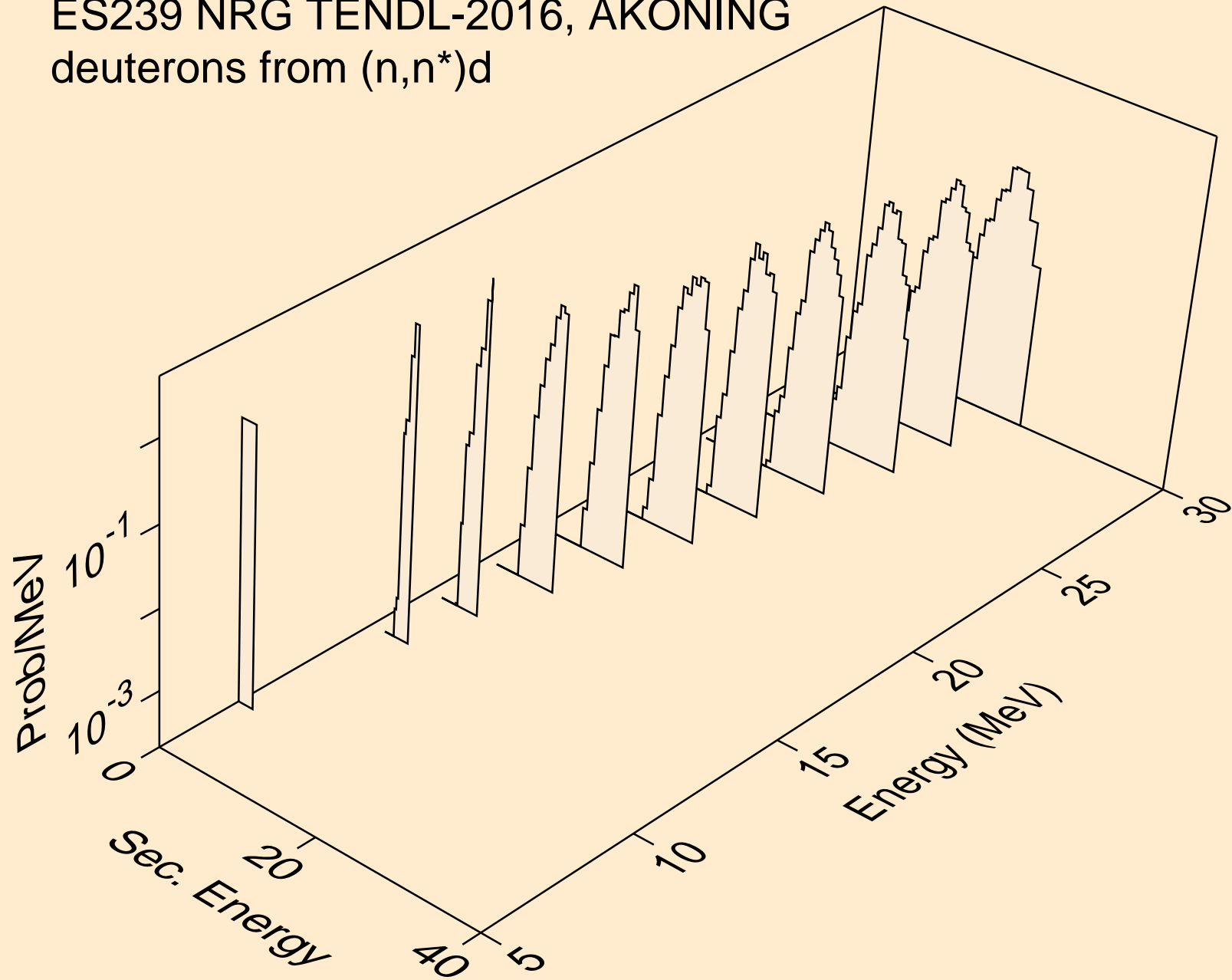

ES239 NRG TENDL-2016, AKONING
deuterons from (n,n*)d2a

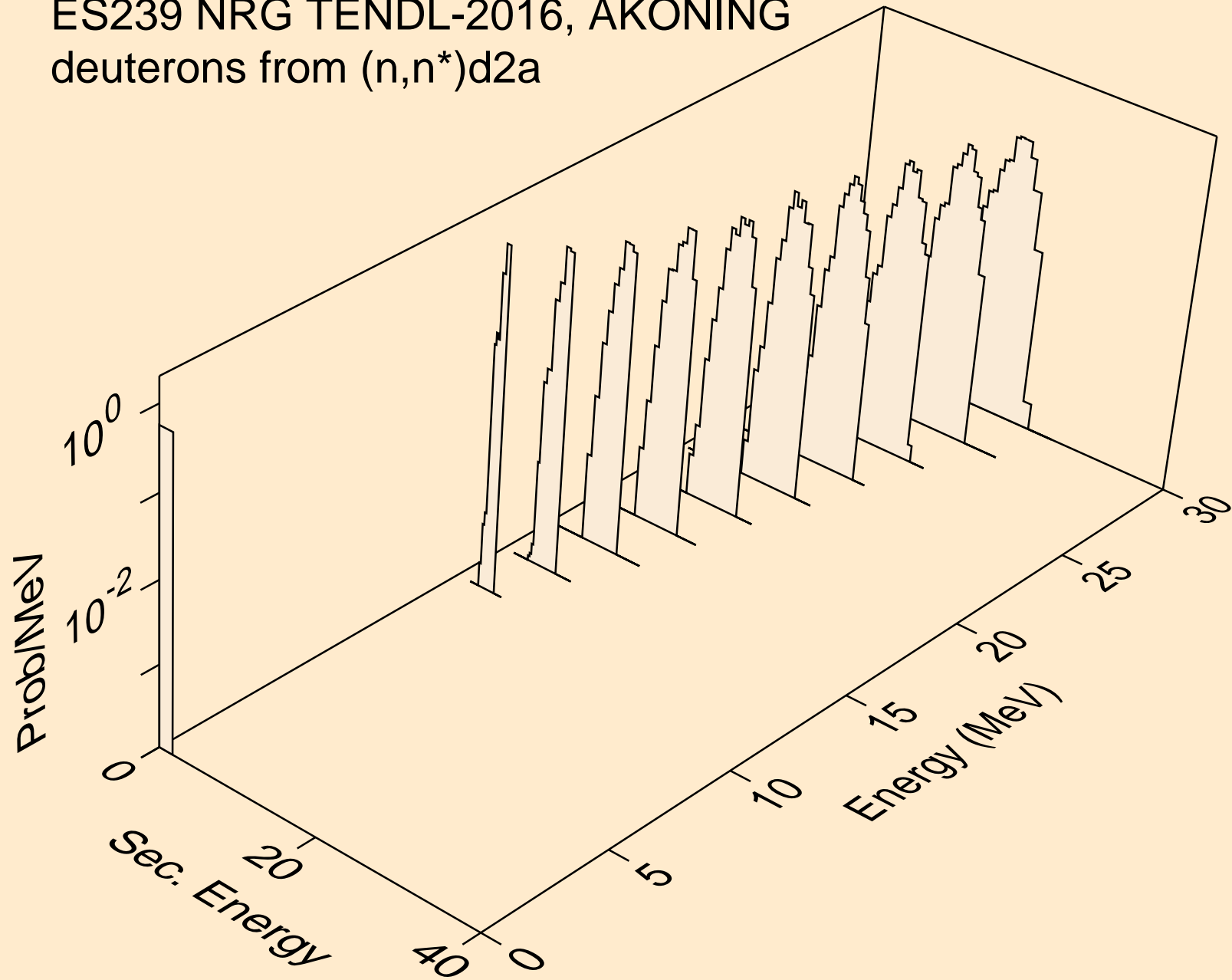

ES239 NRG TENDL-2016, AKONING
deuterons from (n,d)

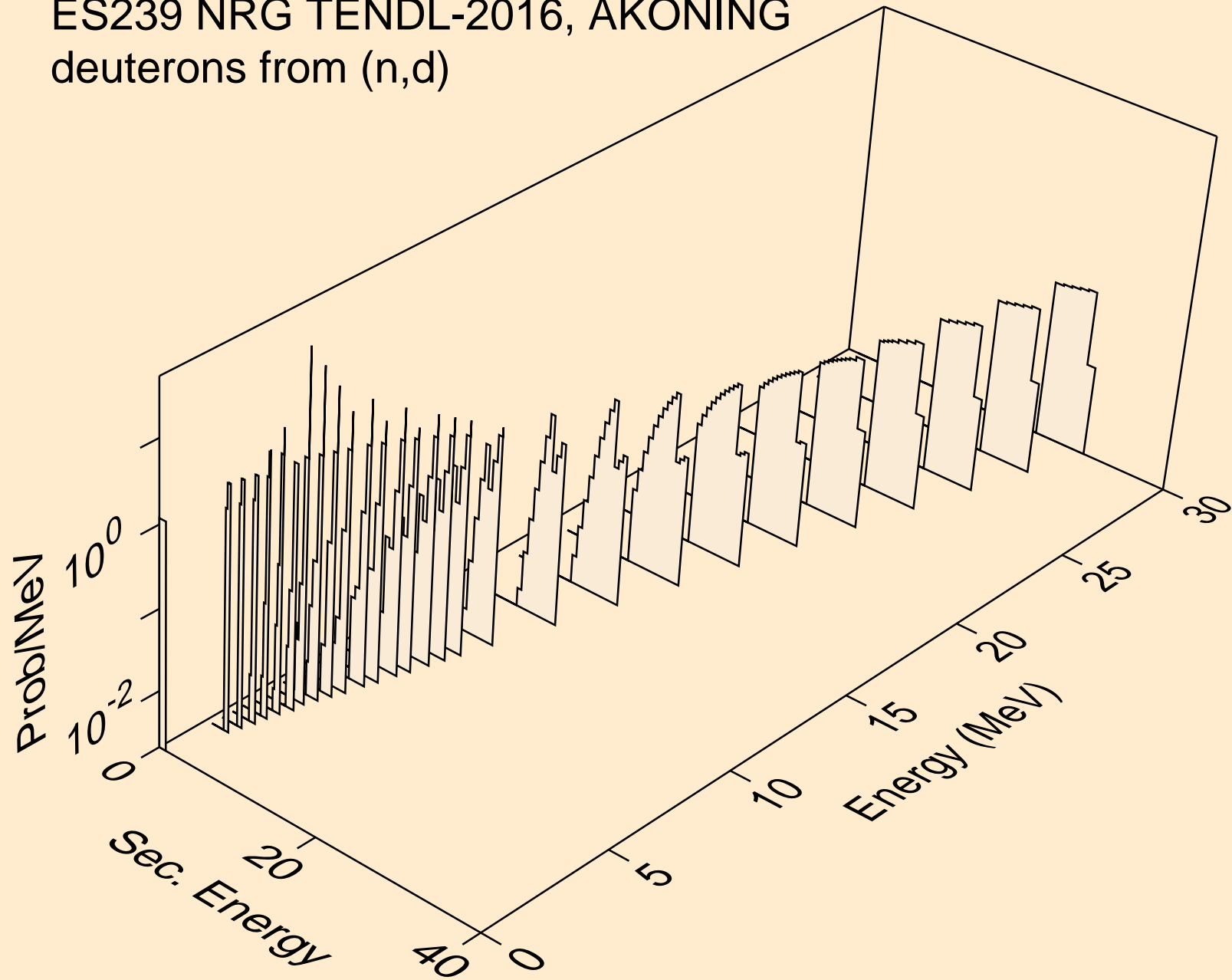

ES239 NRG TENDL-2016, AKONING
deuterons from (n,d2a)

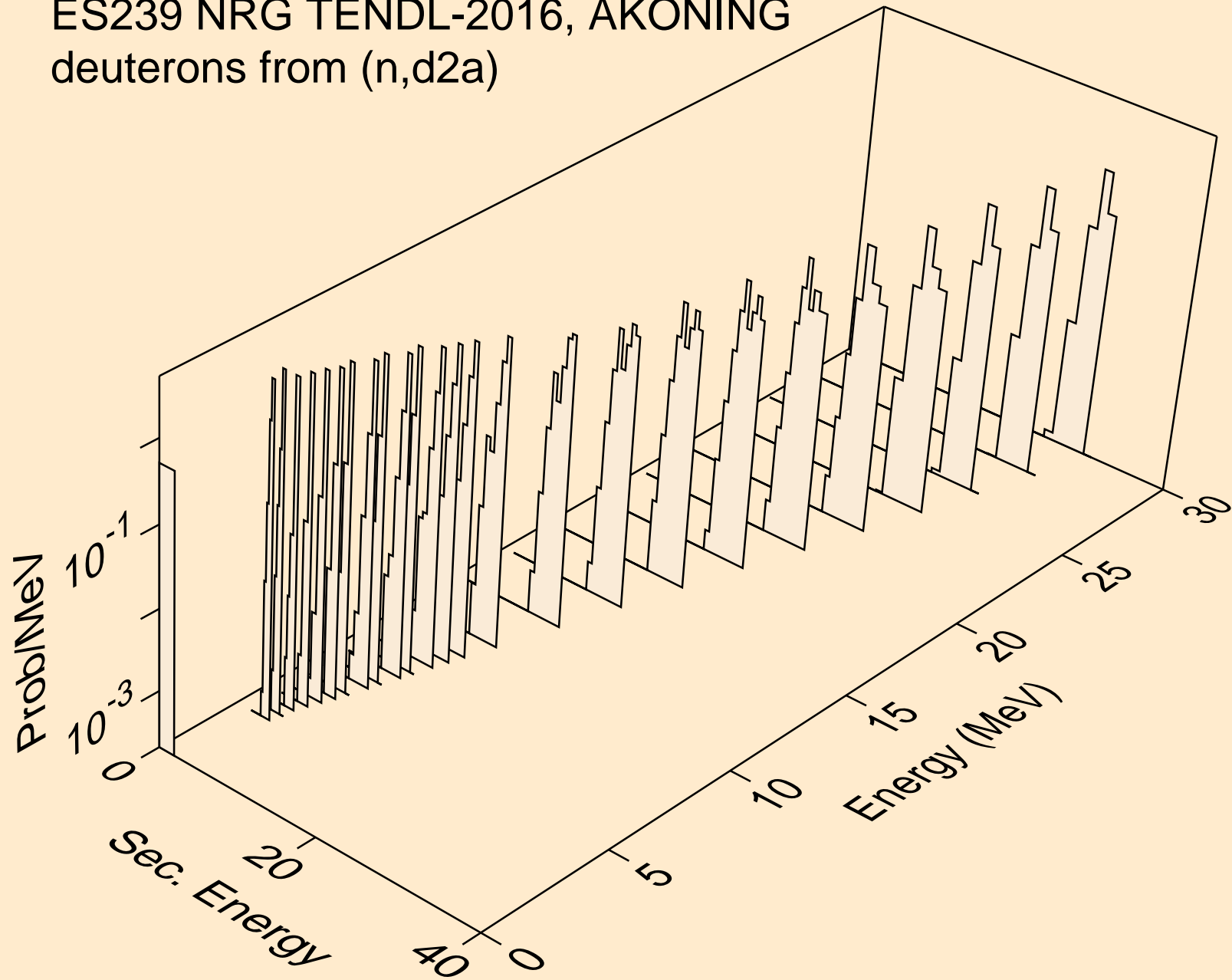

ES239 NRG TENDL-2016, AKONING
deuterons from (n,pd)

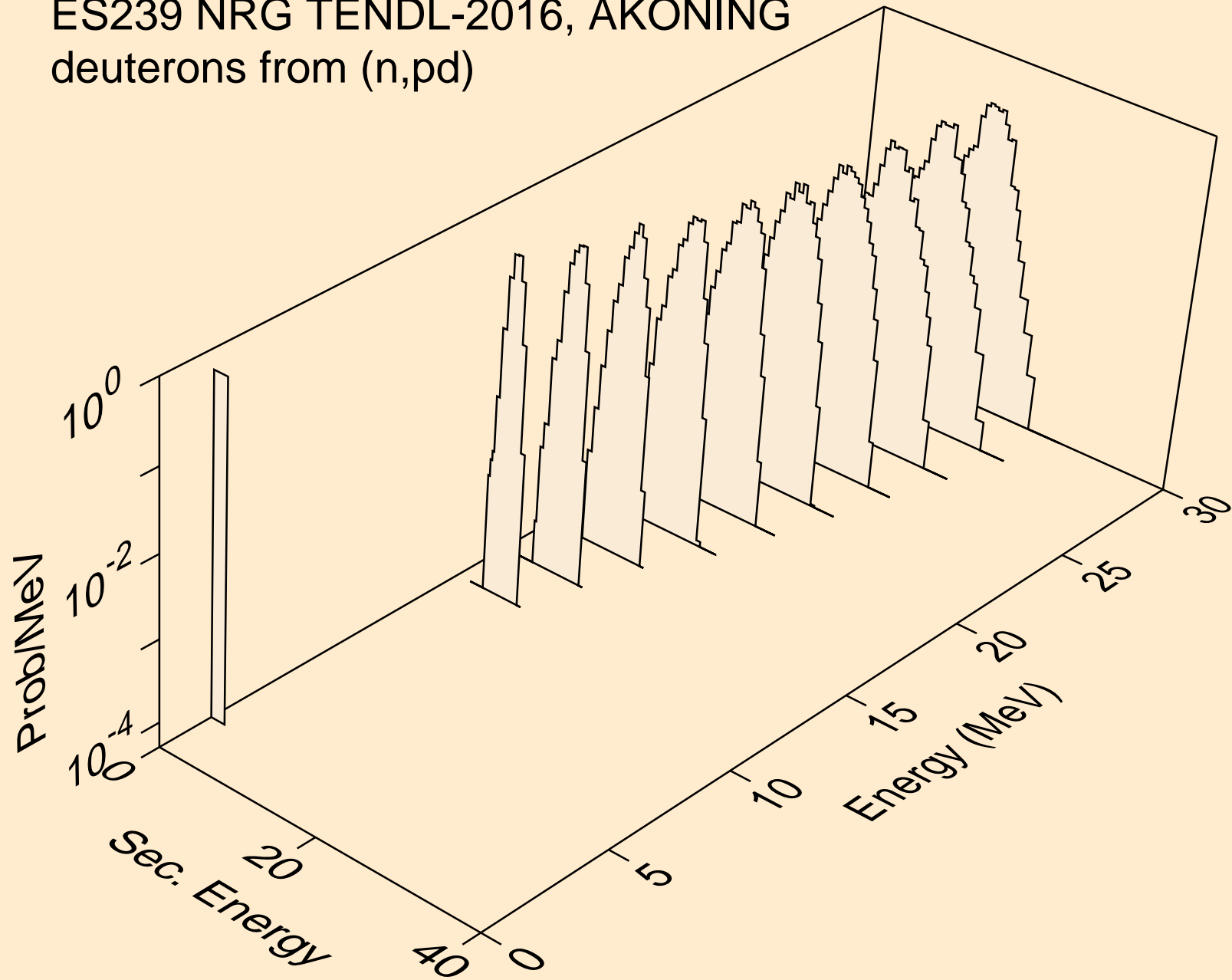

ES239 NRG TENDL-2016, AKONING
deuterons from (n,da)

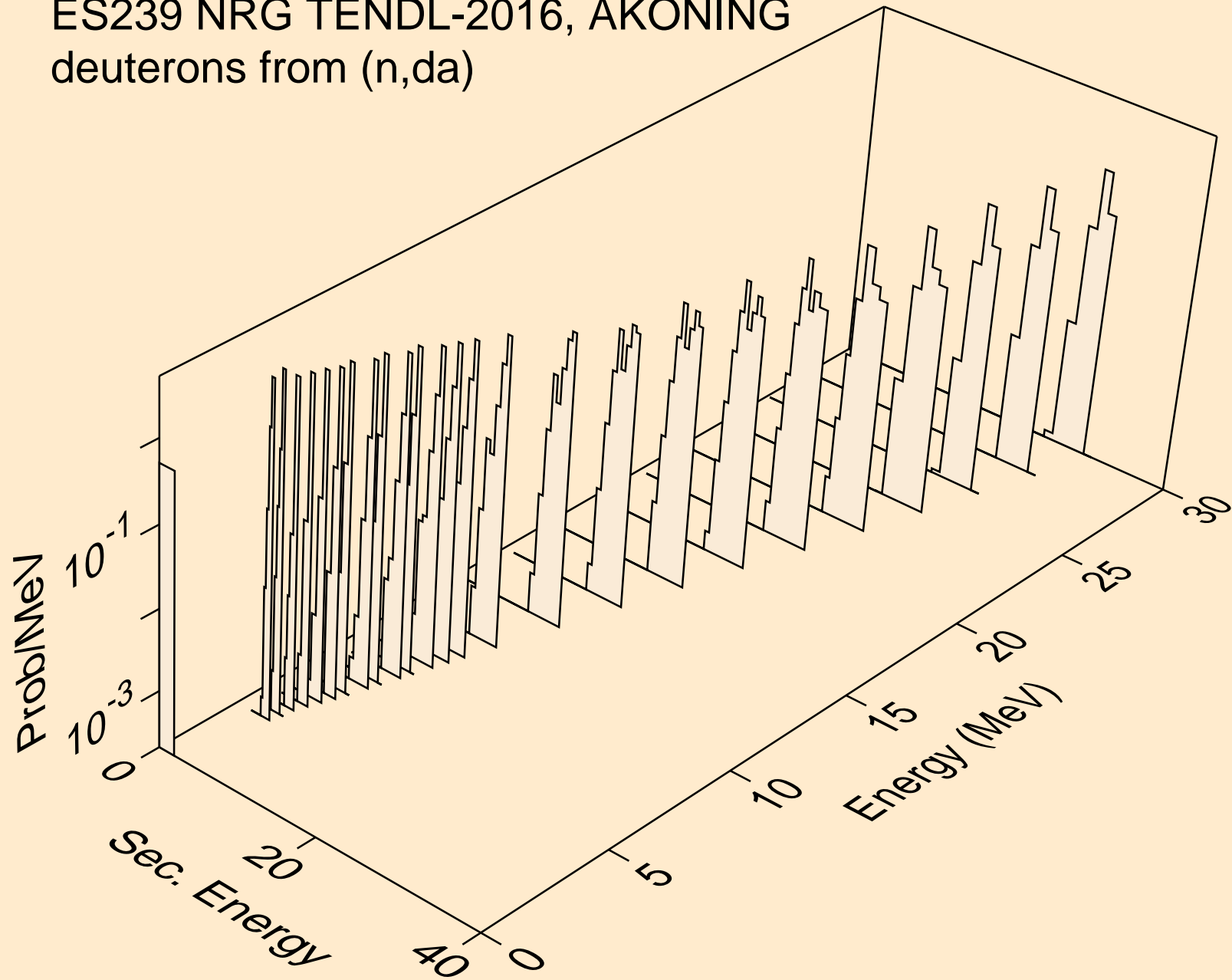

ES239 NRG TENDL-2016, AKONING
tritons from (n,x)

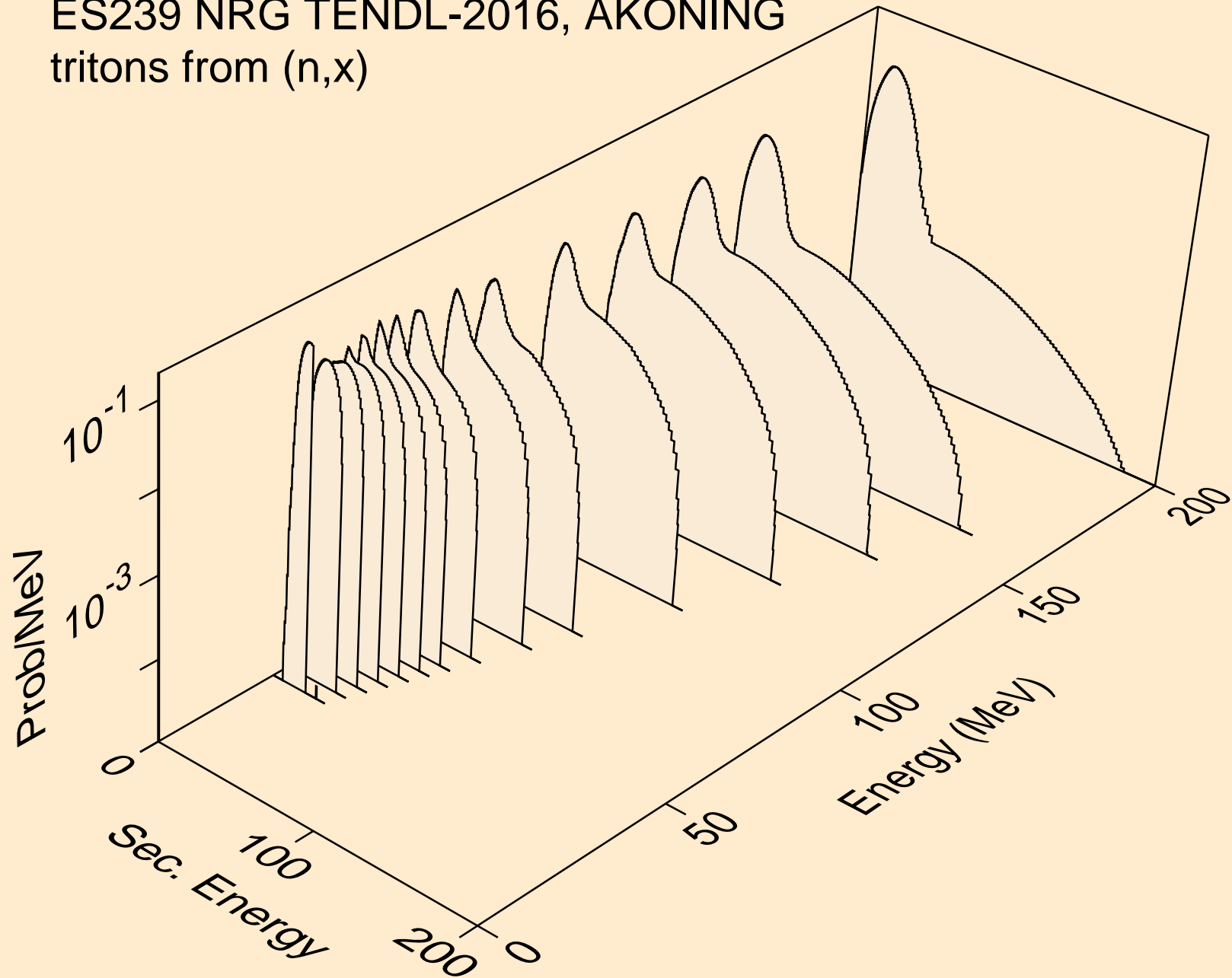

ES239 NRG TENDL-2016, AKONING
tritons from (n,n*)t

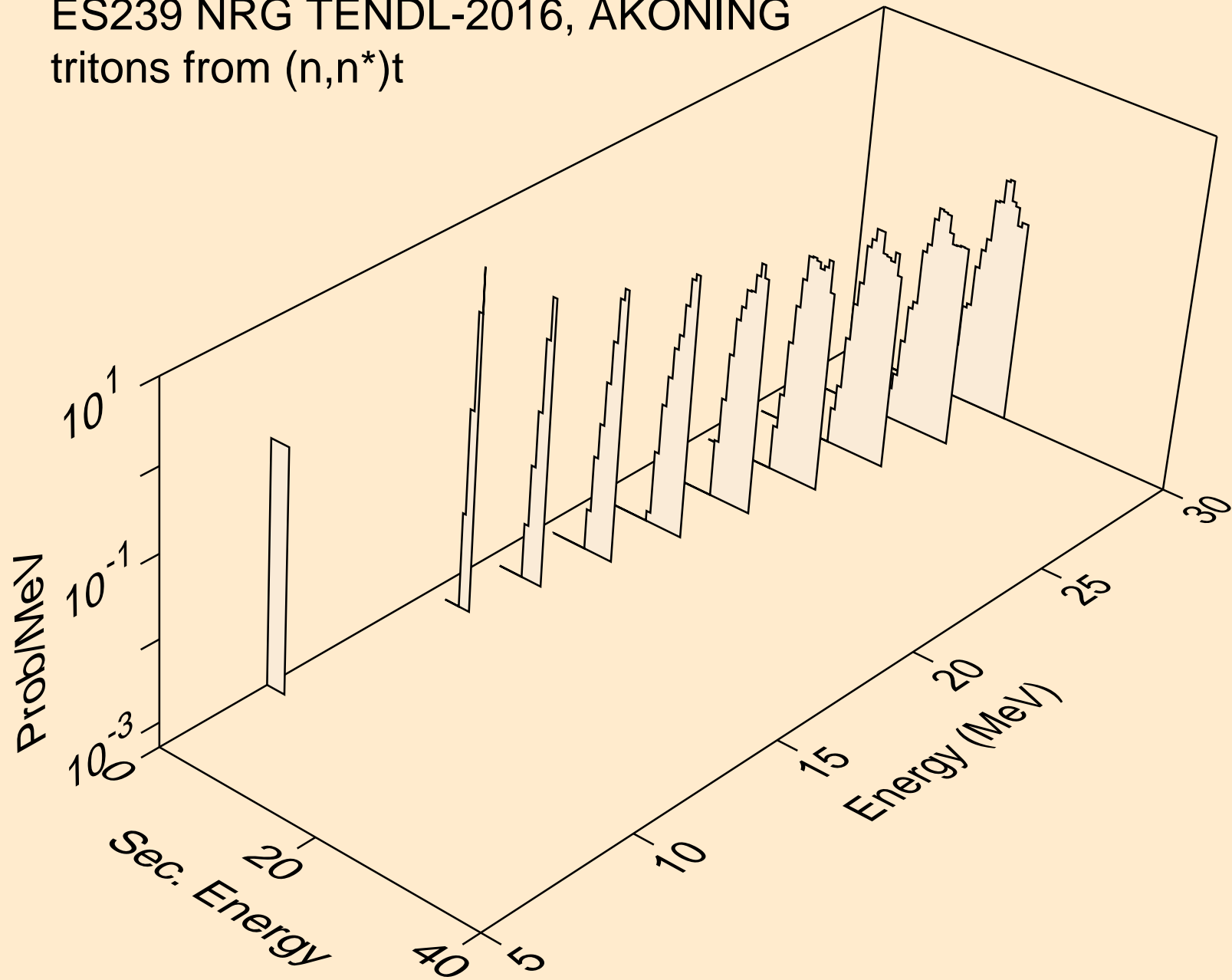

ES239 NRG TENDL-2016, AKONING
tritons from (n,n*)t2a

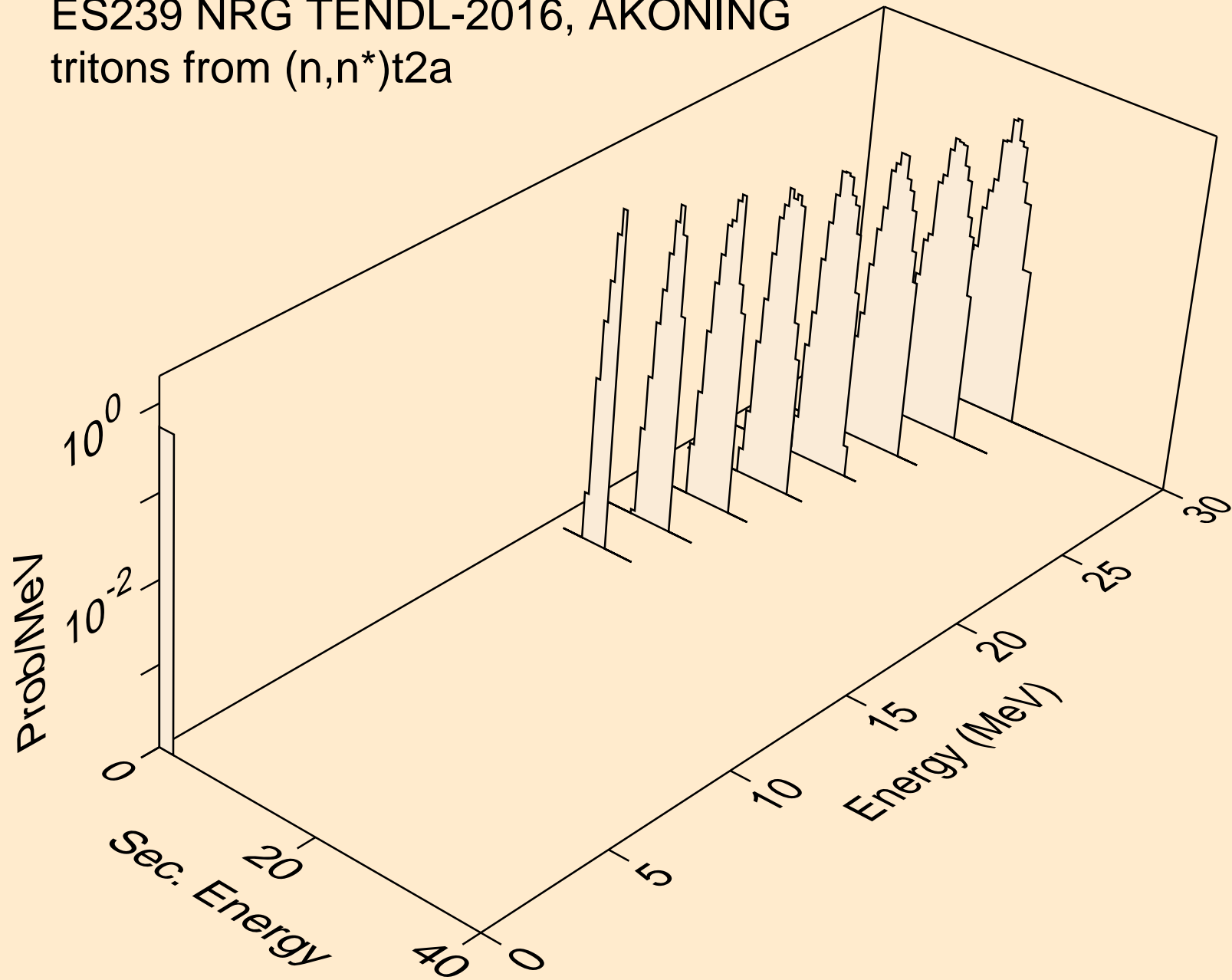

ES239 NRG TENDL-2016, AKONING
tritons from (n,t)

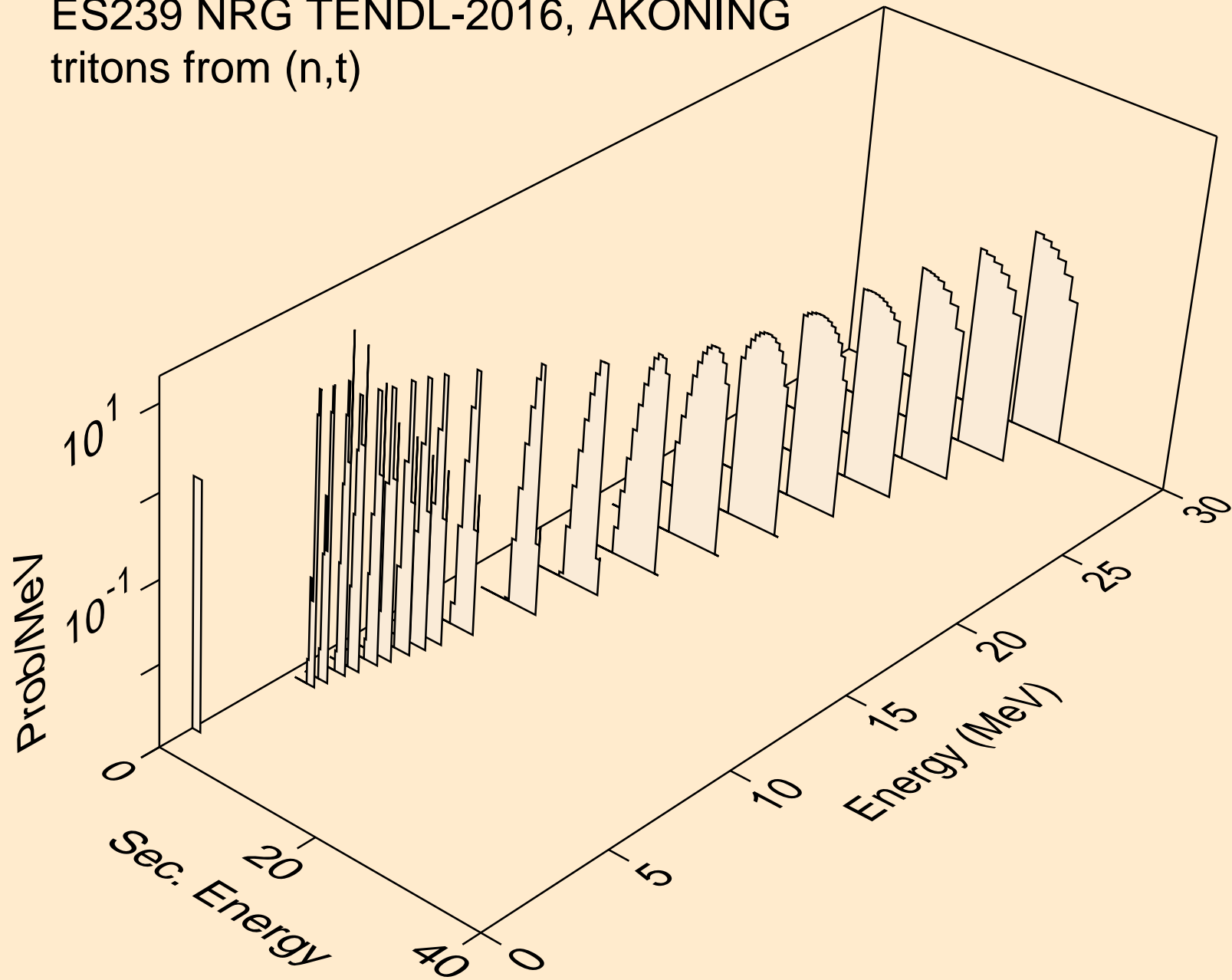

ES239 NRG TENDL-2016, AKONING
tritons from (n,t2a)

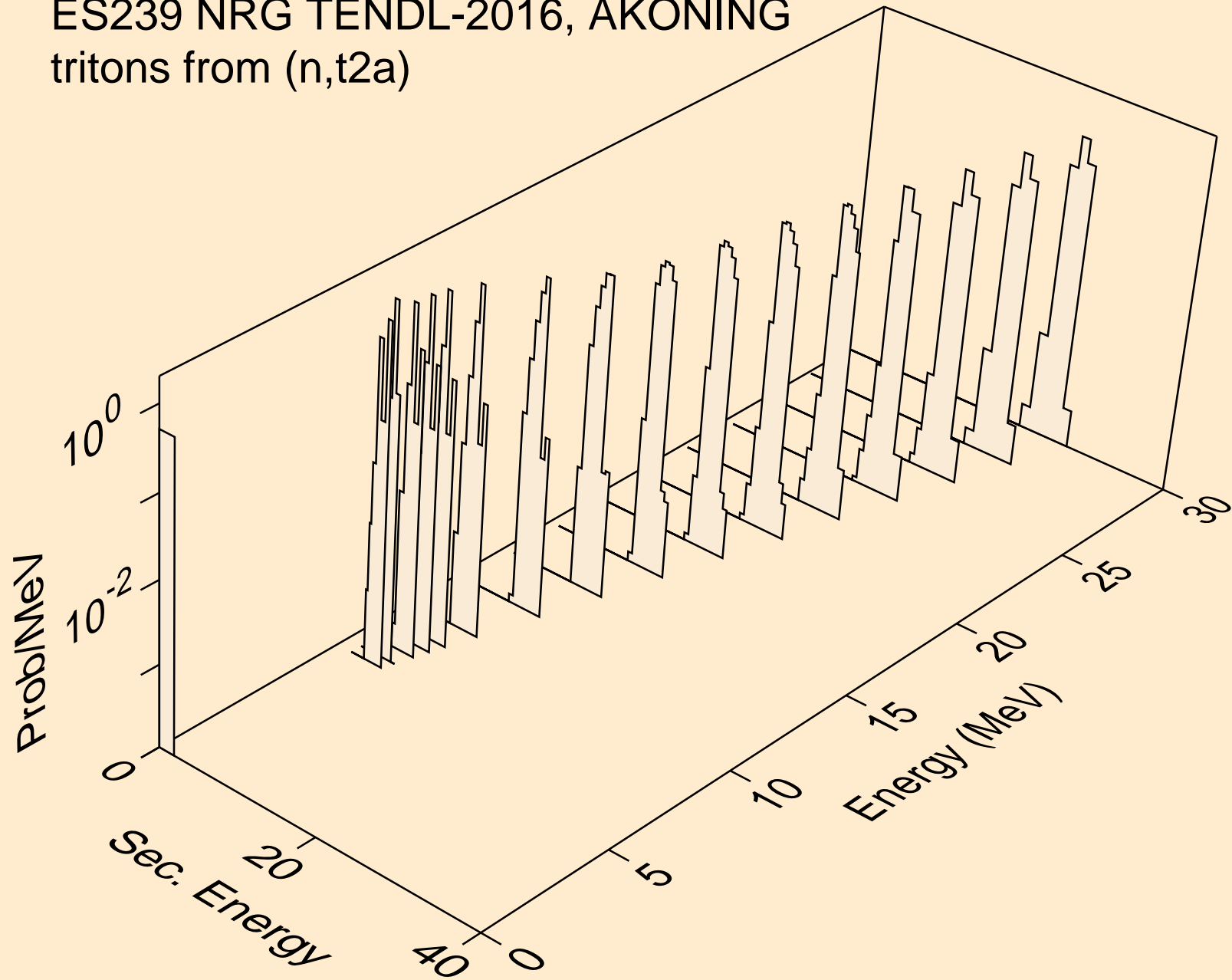

ES239 NRG TENDL-2016, AKONING
he3s from (n,x)

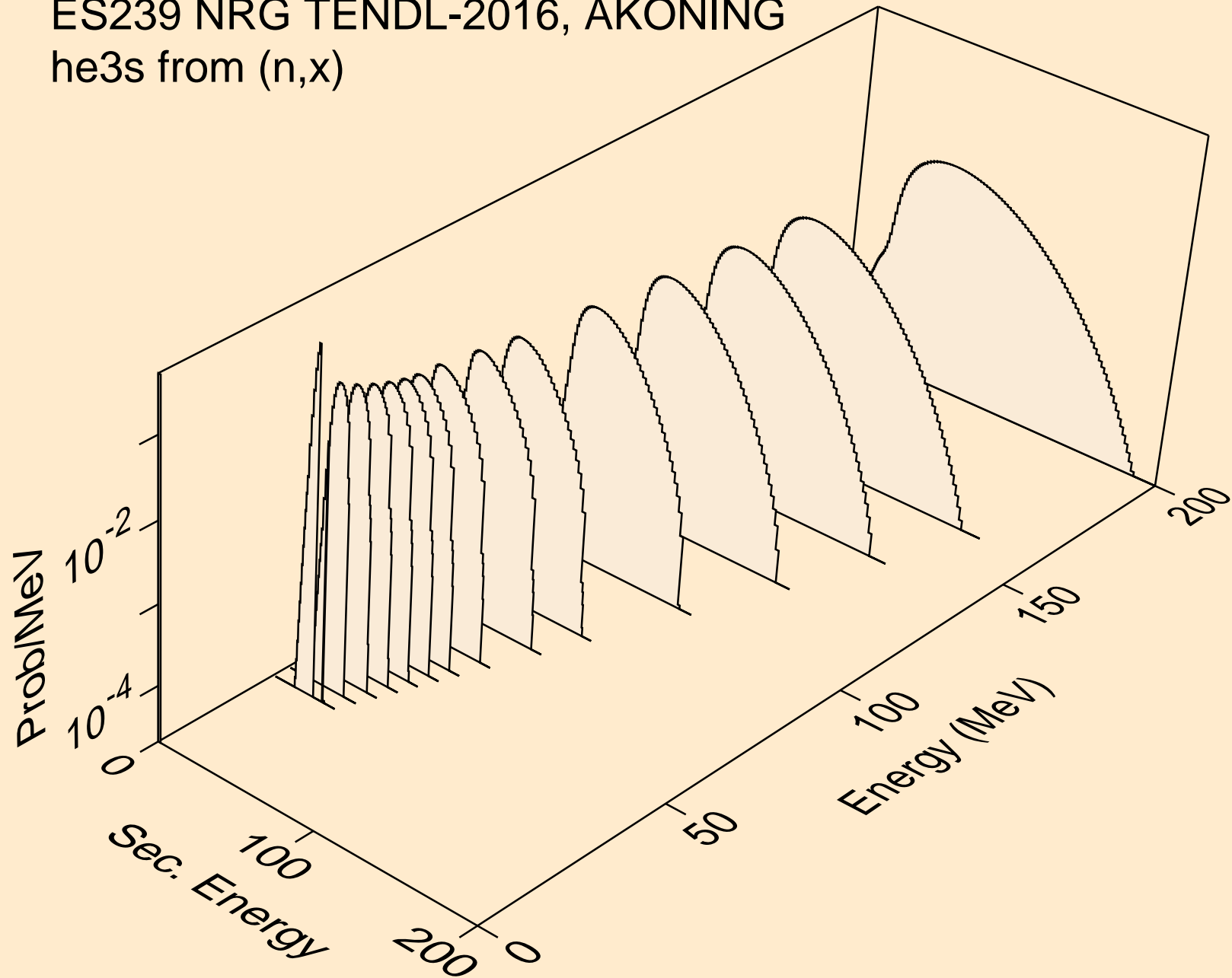

ES239 NRG TENDL-2016, AKONING
he3s from (n,n*)he3

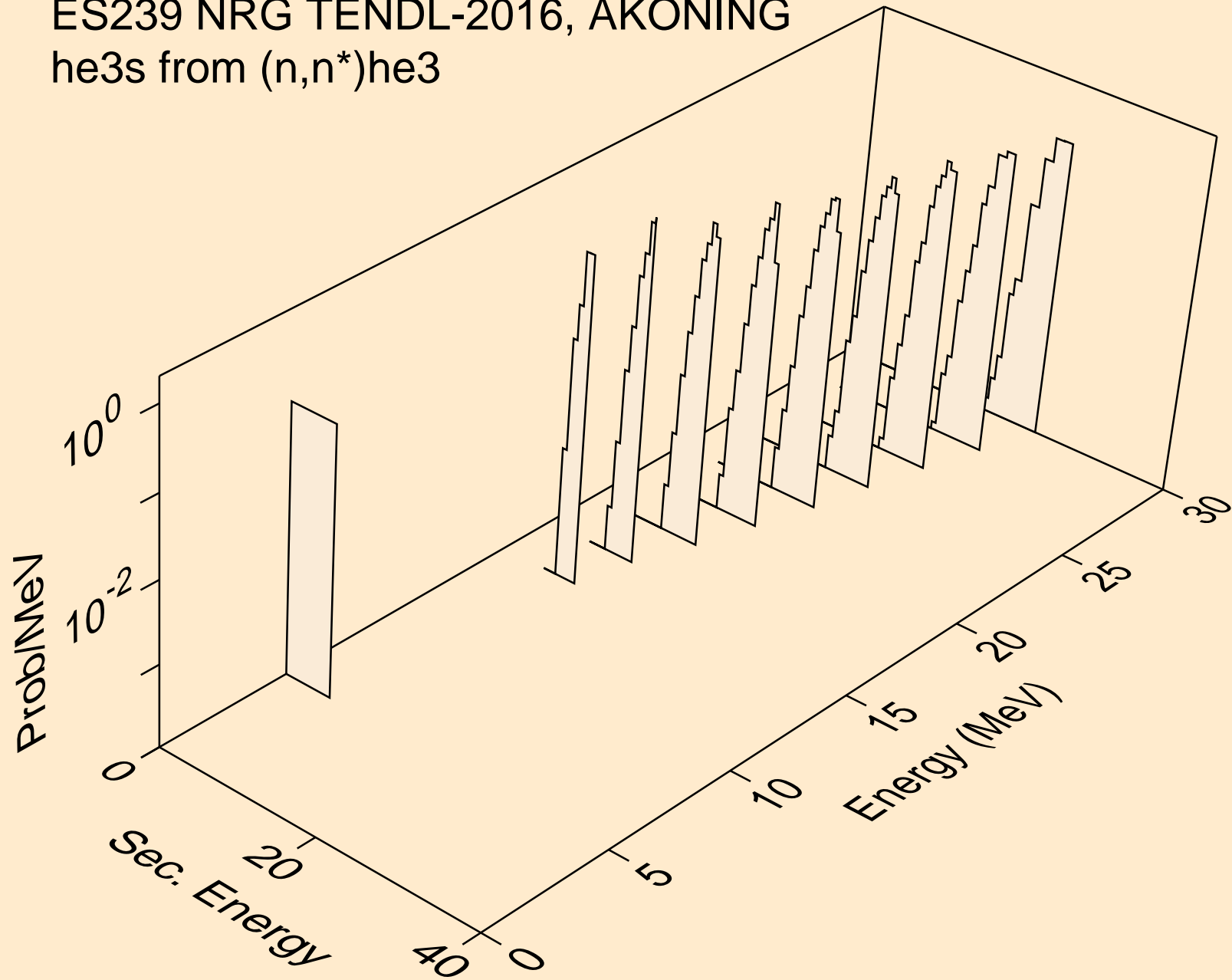

ES239 NRG TENDL-2016, AKONING
he3s from (n,he3)

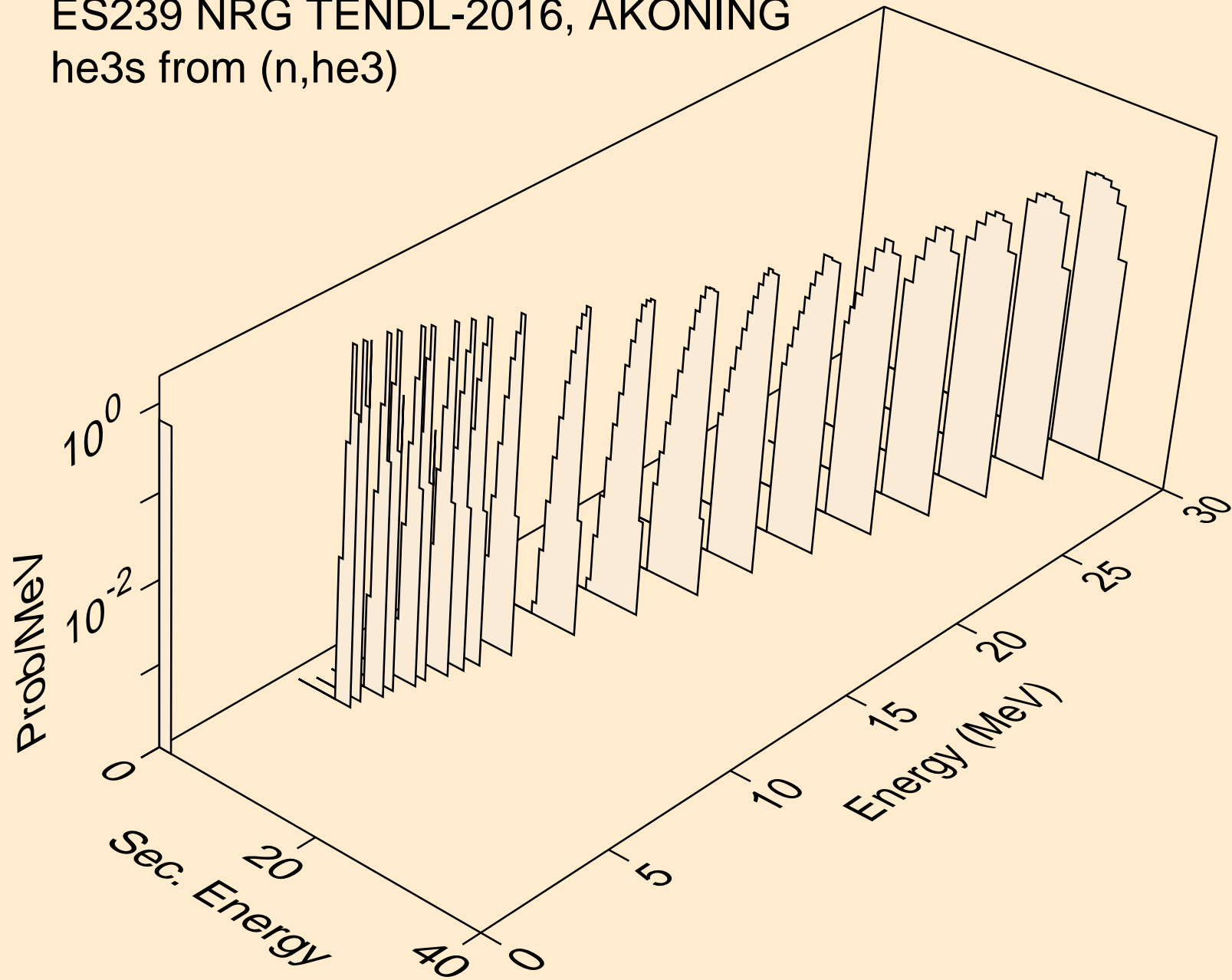

ES239 NRG TENDL-2016, AKONING
alphas from (n,x)

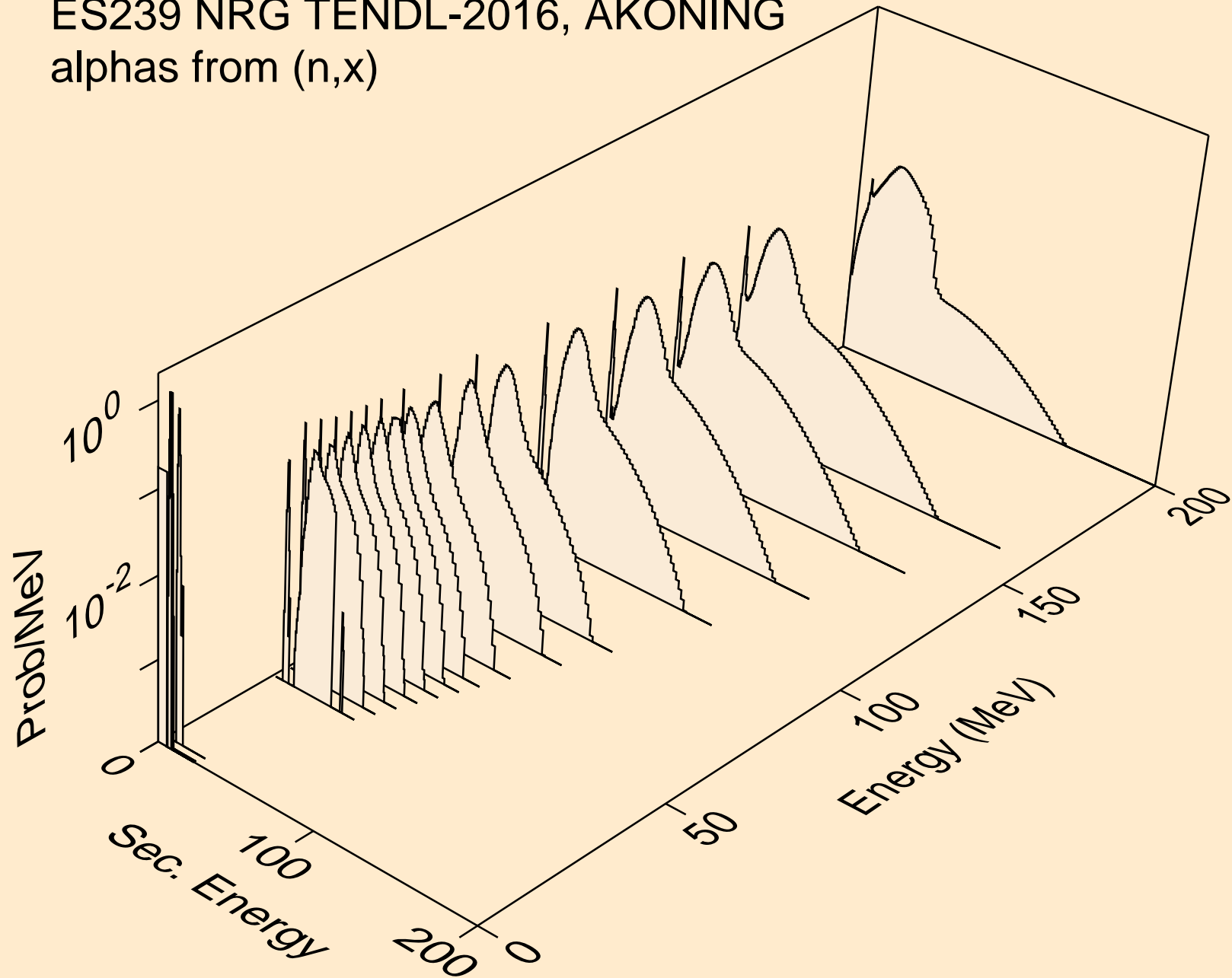

ES239 NRG TENDL-2016, AKONING
alphas from (n,n*)a

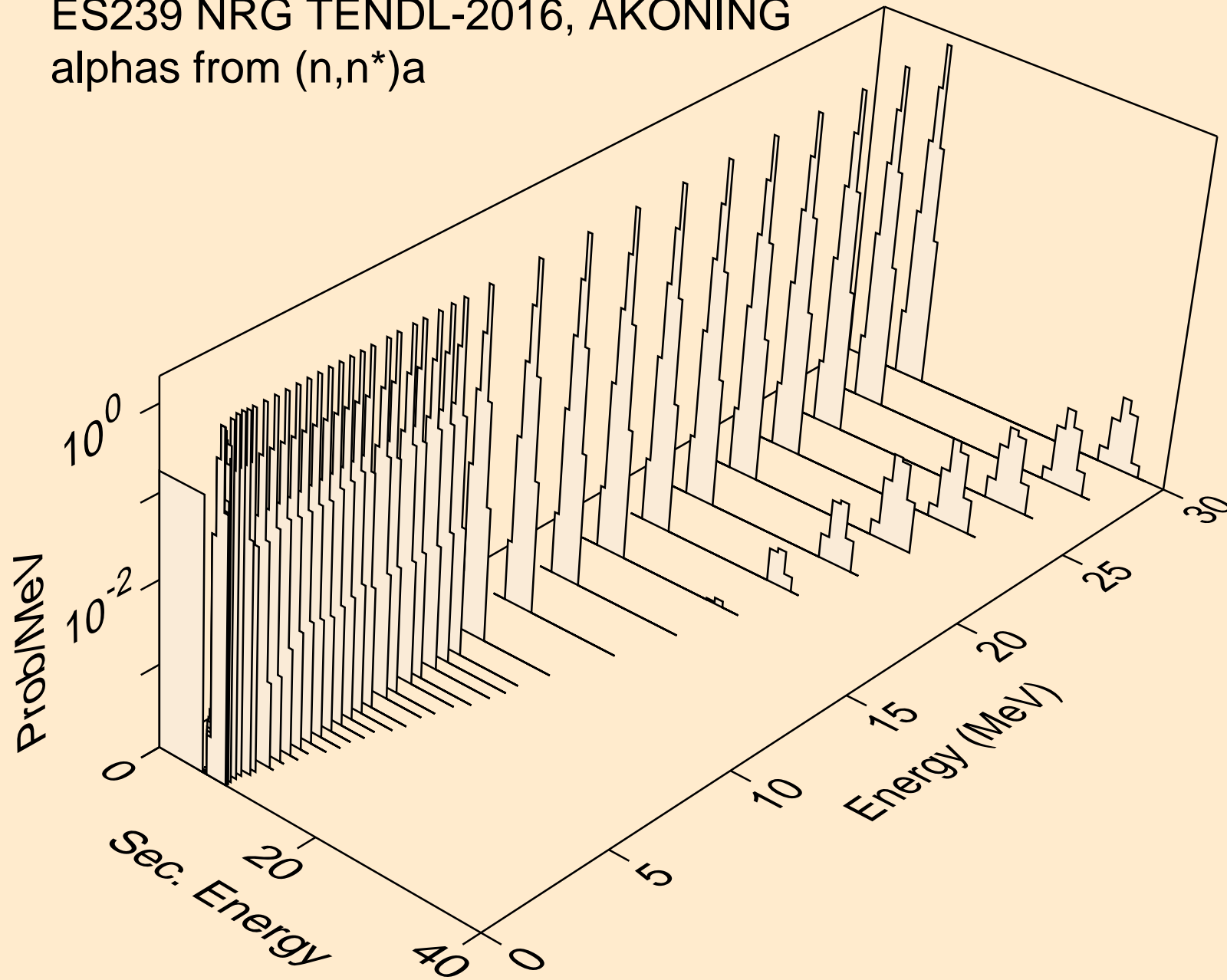

ES239 NRG TENDL-2016, AKONING
alphas from (n,n*)3a

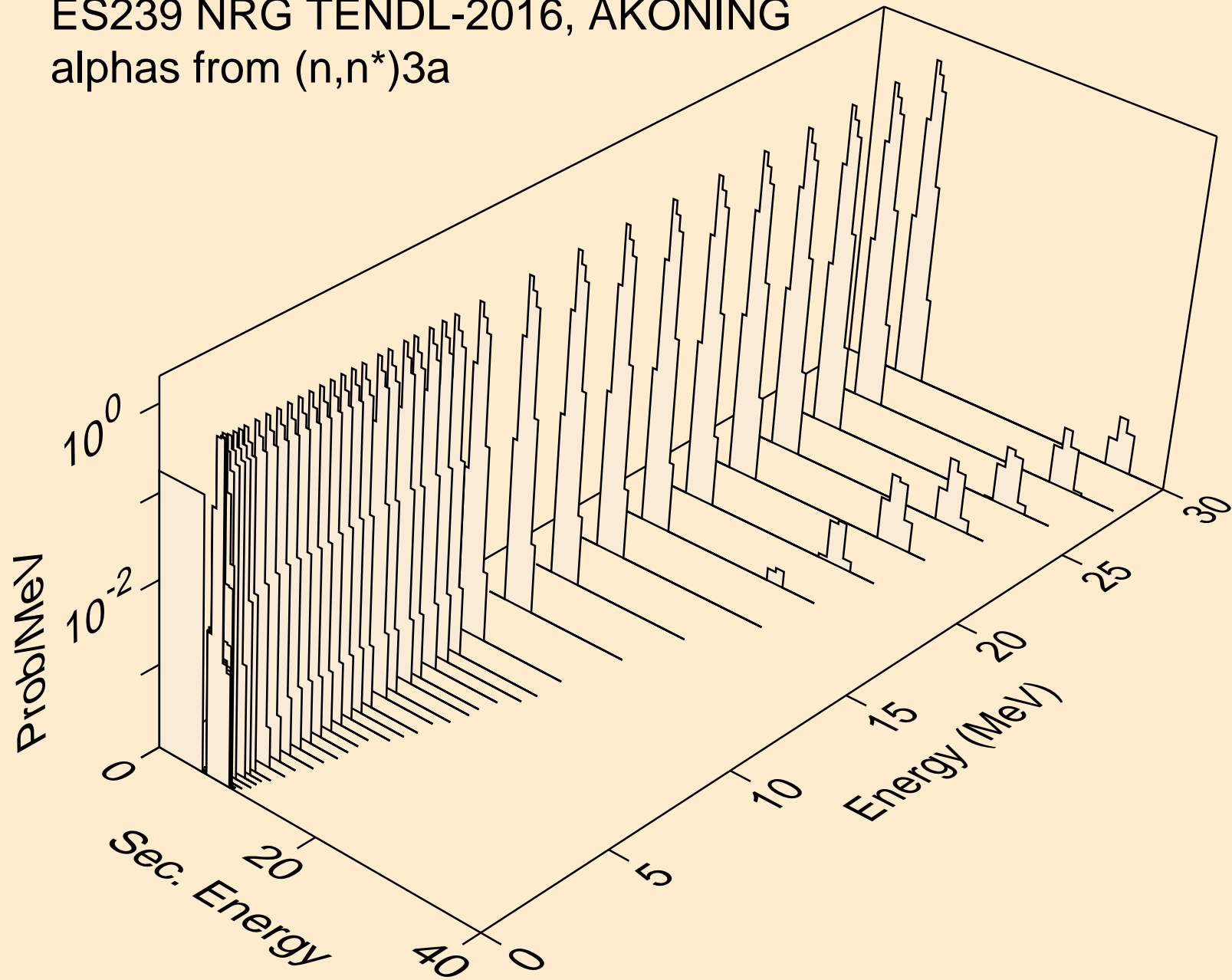

ES239 NRG TENDL-2016, AKONING
alphas from (n,2n)a

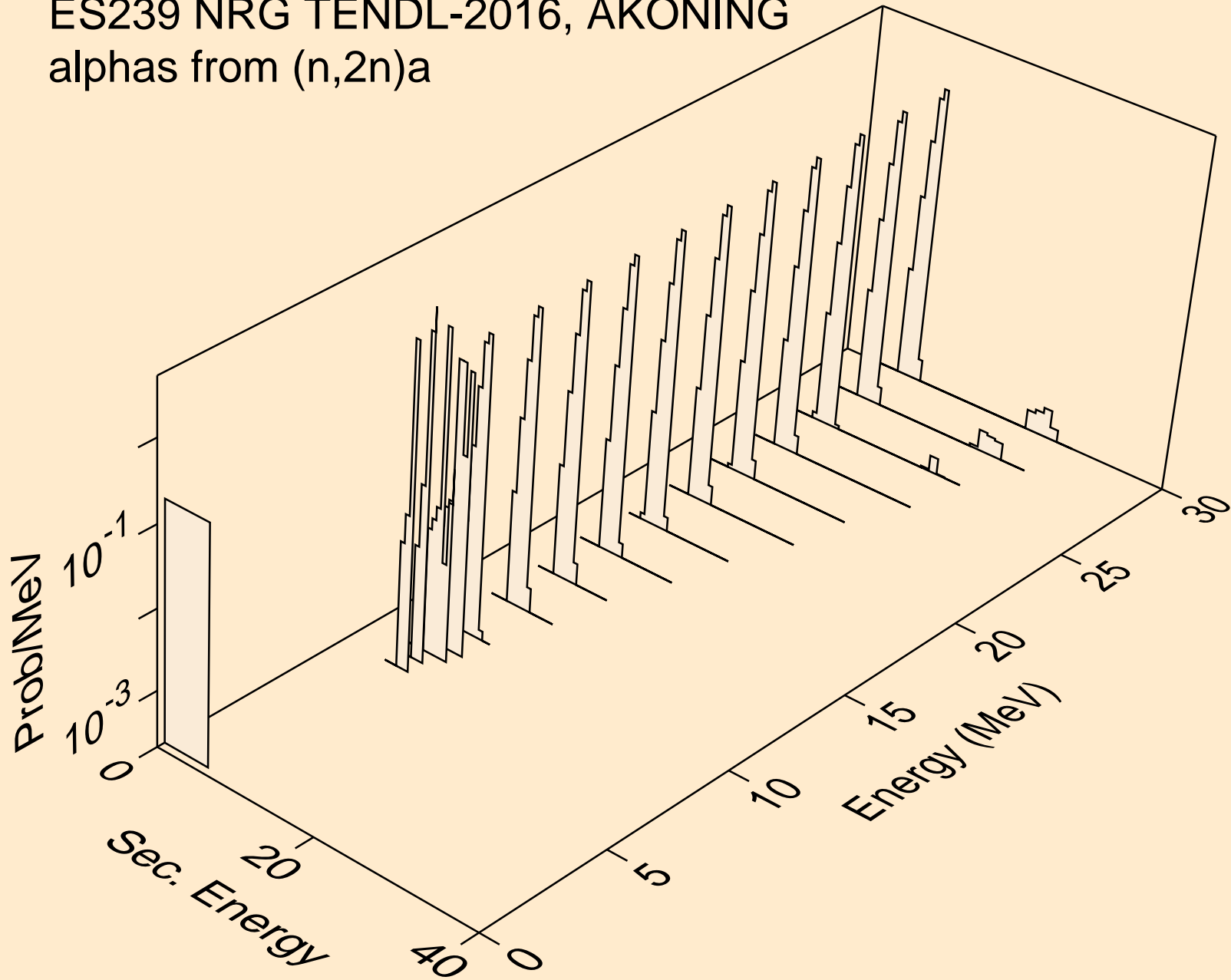

ES239 NRG TENDL-2016, AKONING
alphas from (n,3n)a

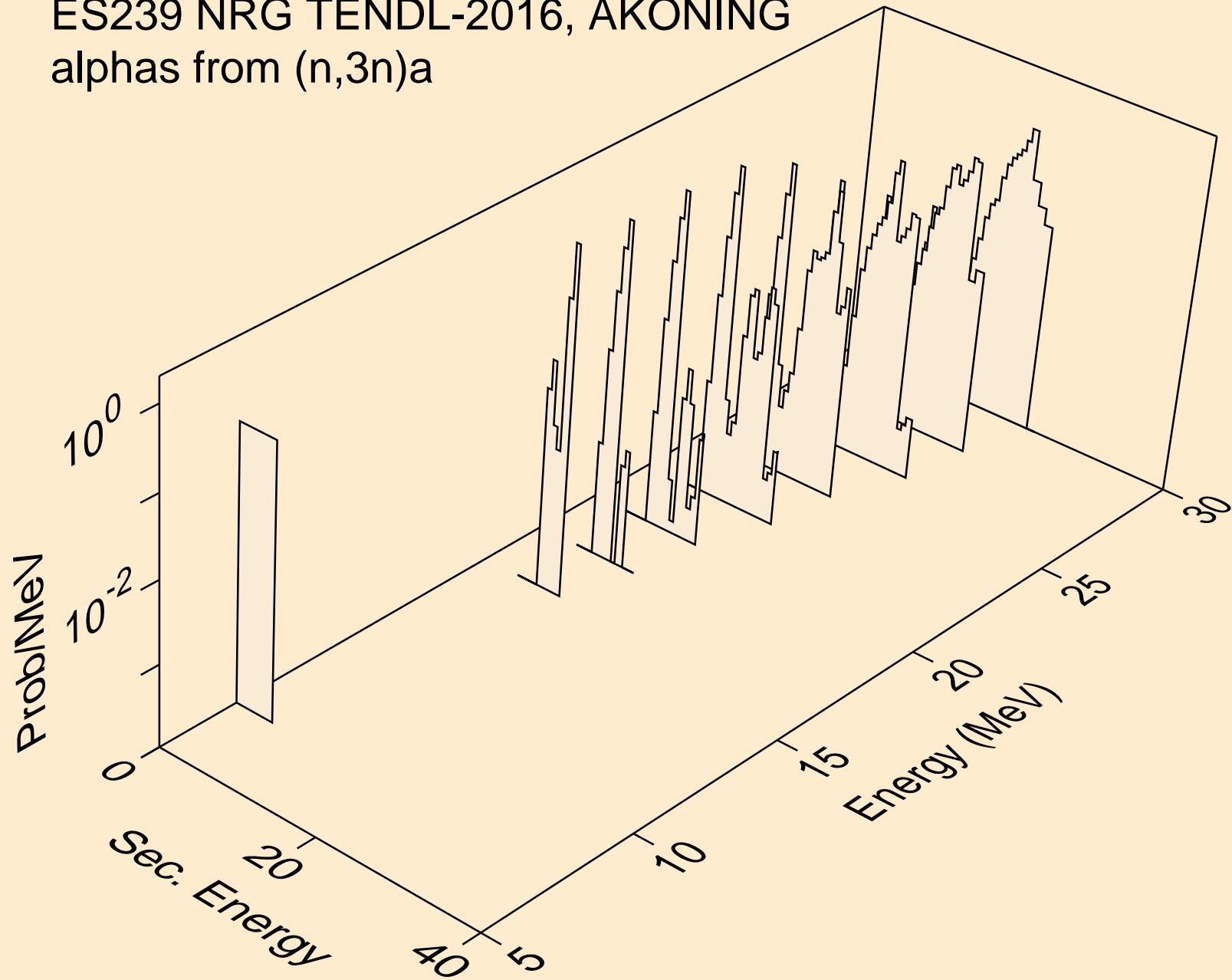

ES239 NRG TENDL-2016, AKONING
alphas from (n,n*)2a

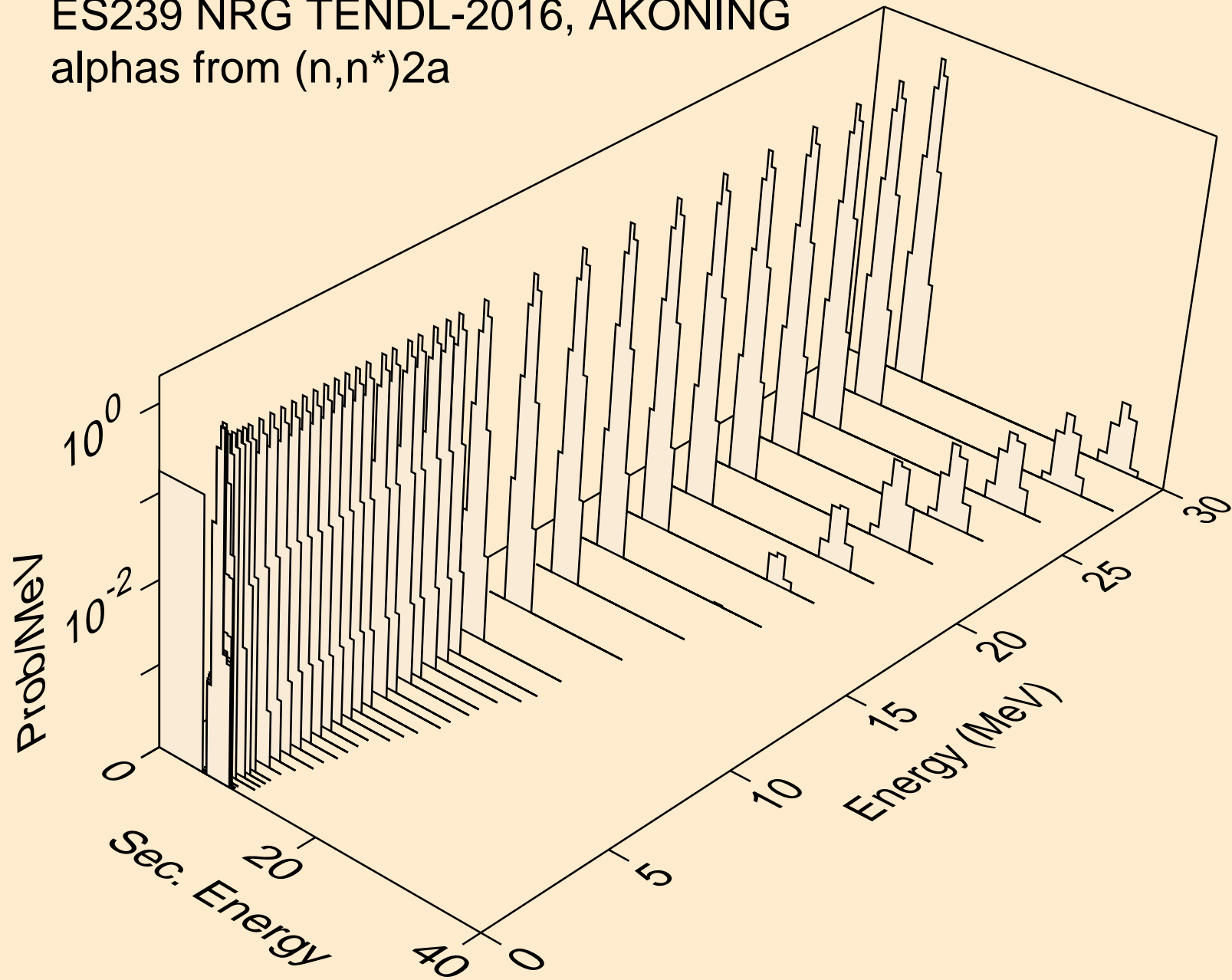

ES239 NRG TENDL-2016, AKONING
alphas from (n,2n)2a

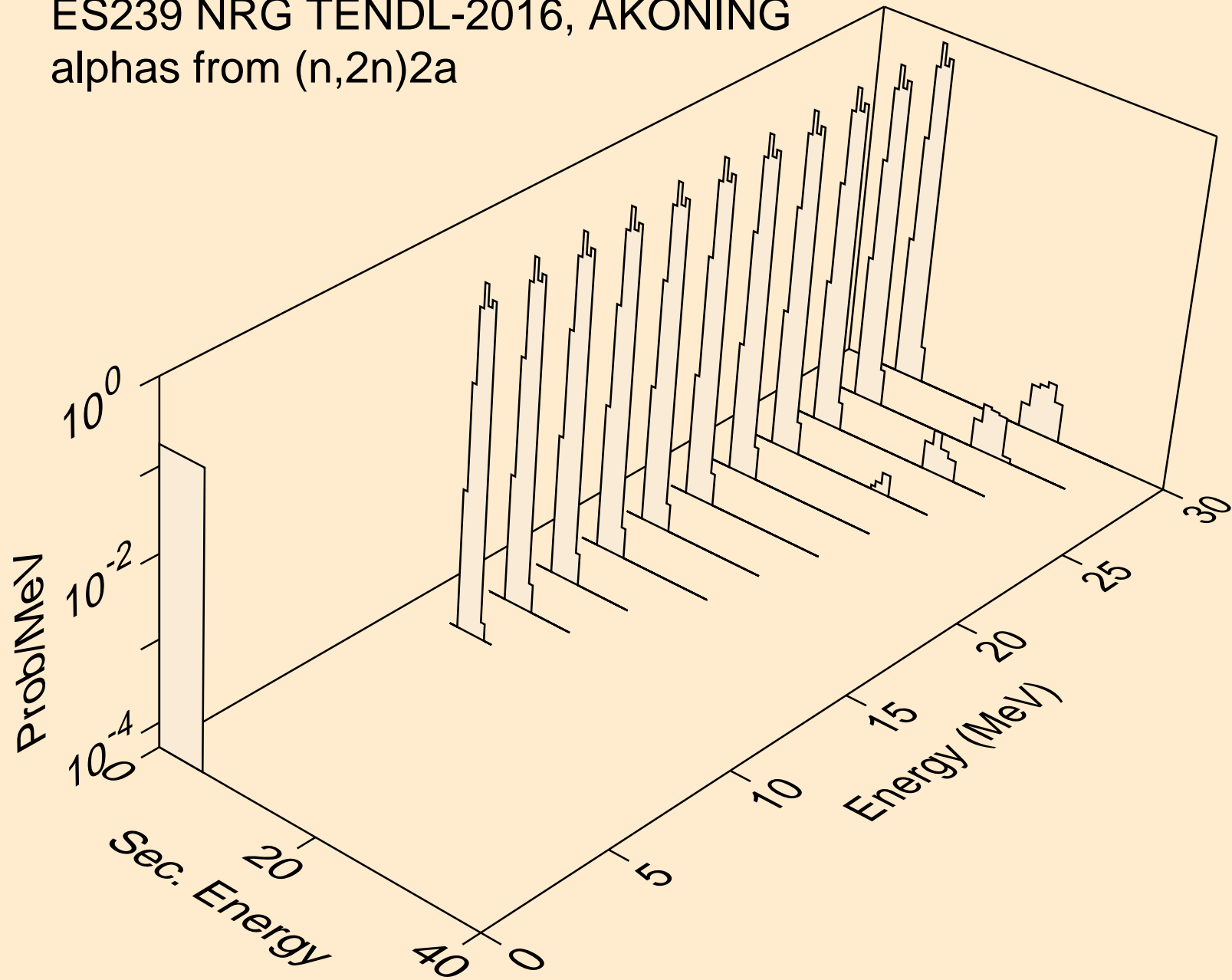

ES239 NRG TENDL-2016, AKONING
alphas from (n,n*)d2a

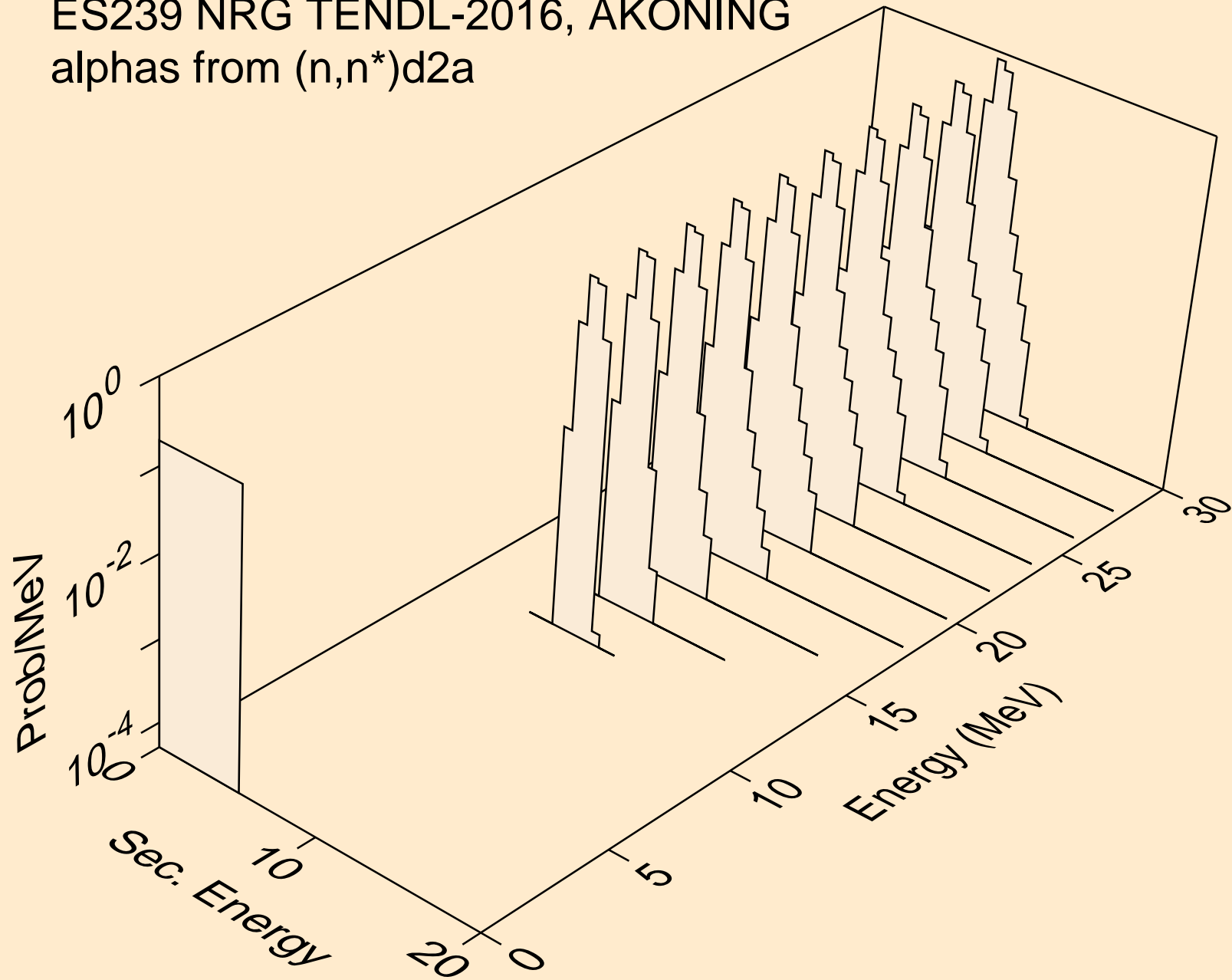

ES239 NRG TENDL-2016, AKONING
alphas from (n,n*)t2a

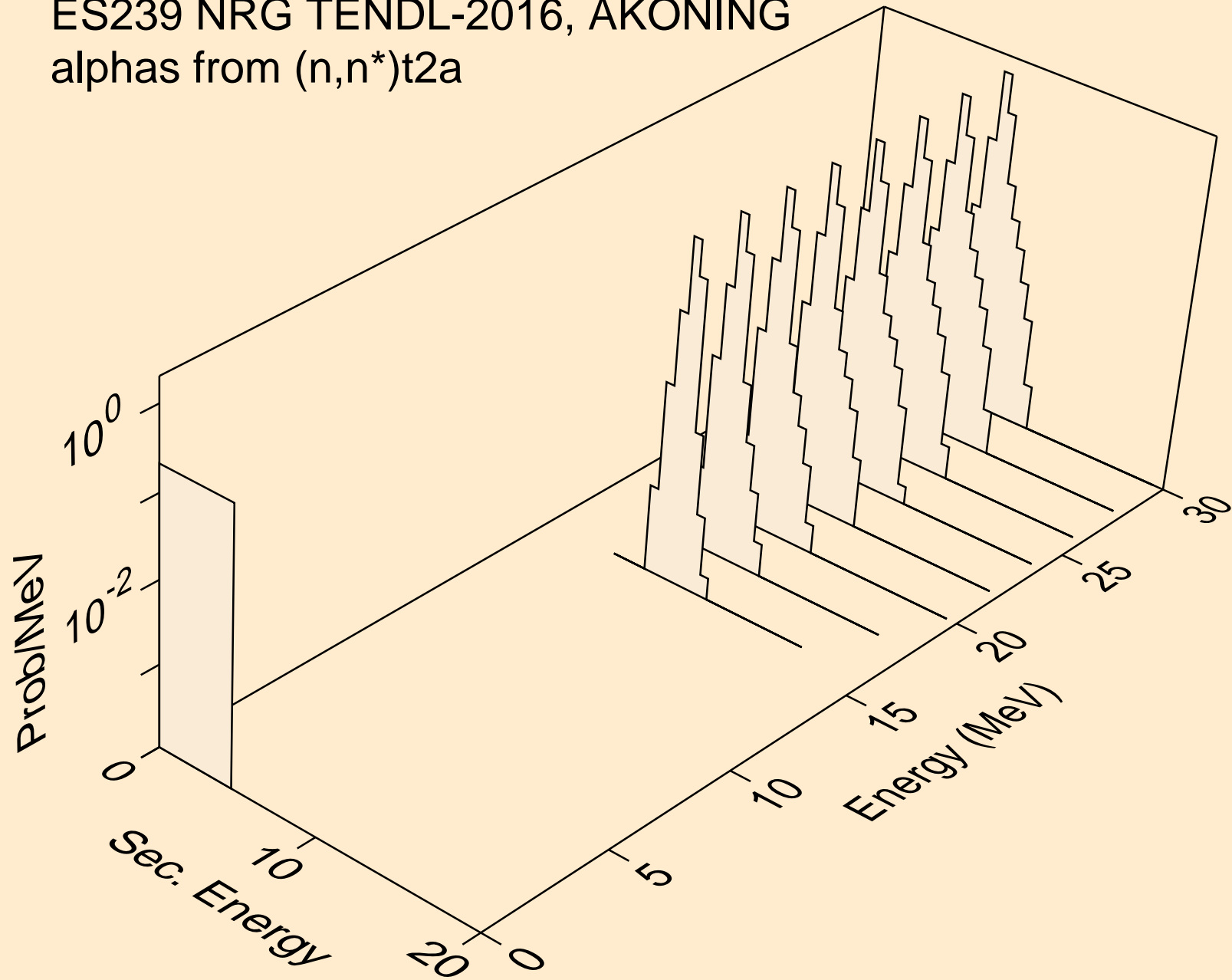

ES239 NRG TENDL-2016, AKONING
alphas from (n,npa)

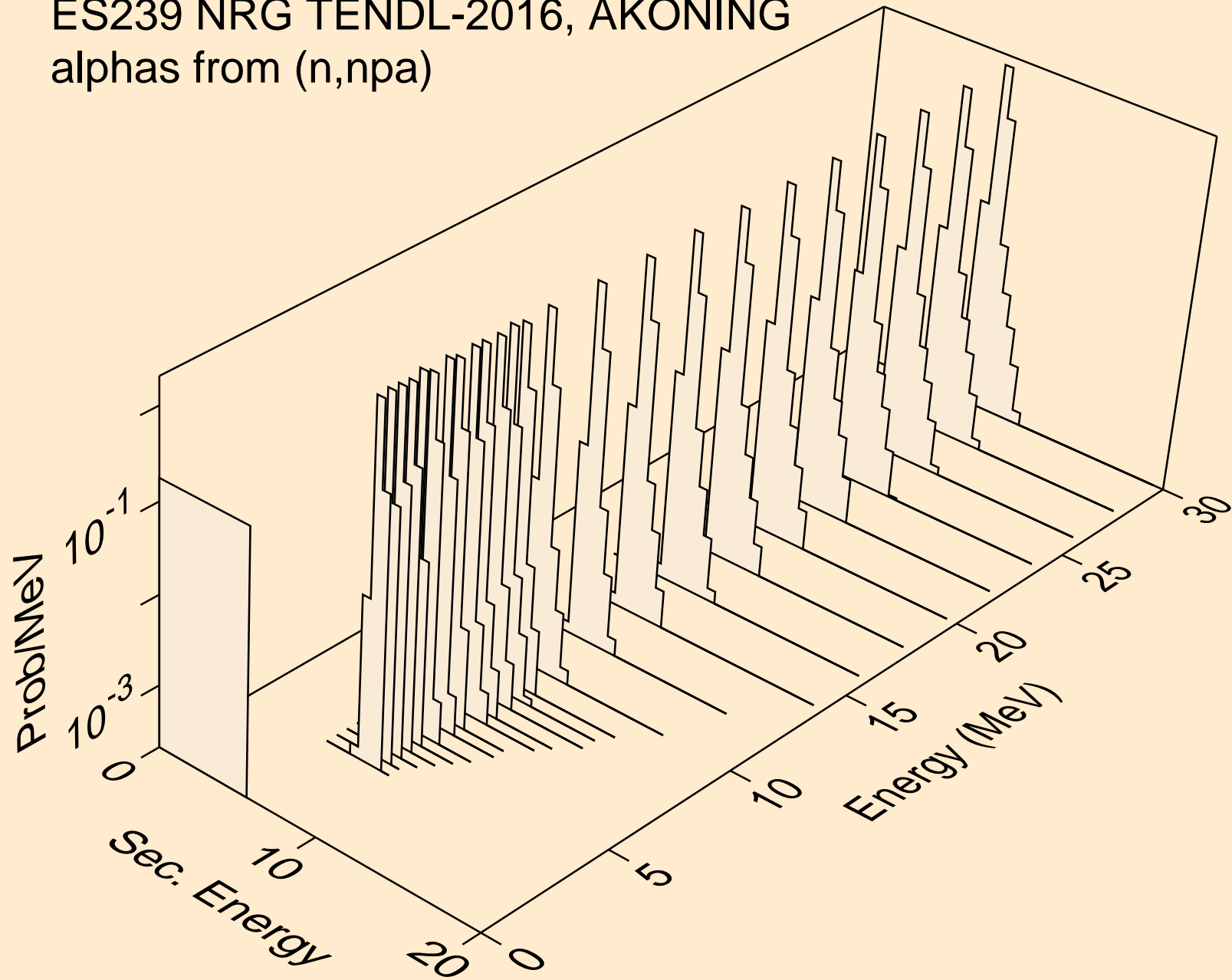

ES239 NRG TENDL-2016, AKONING
alphas from (n,a)

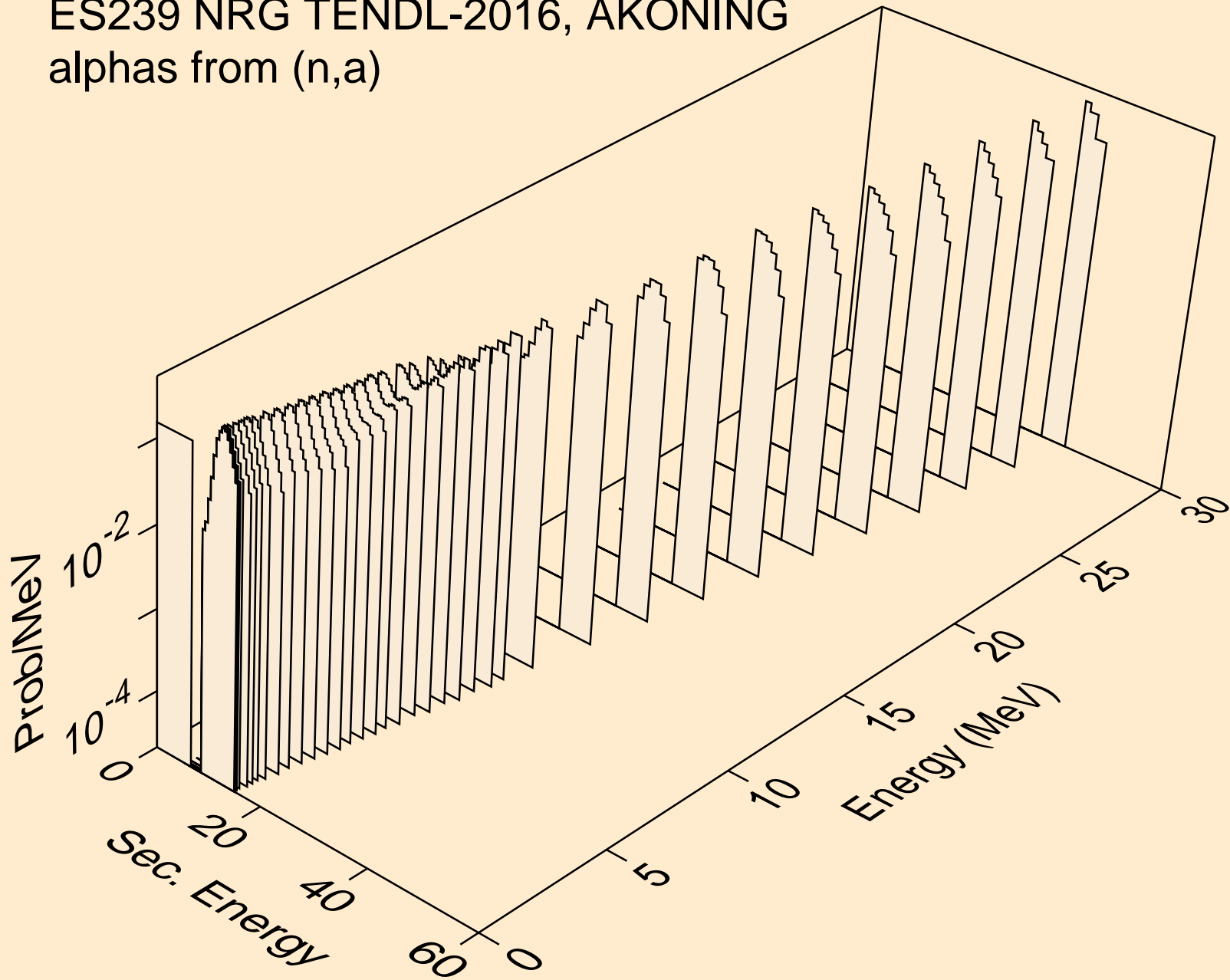

ES239 NRG TENDL-2016, AKONING
alphas from (n,2a)

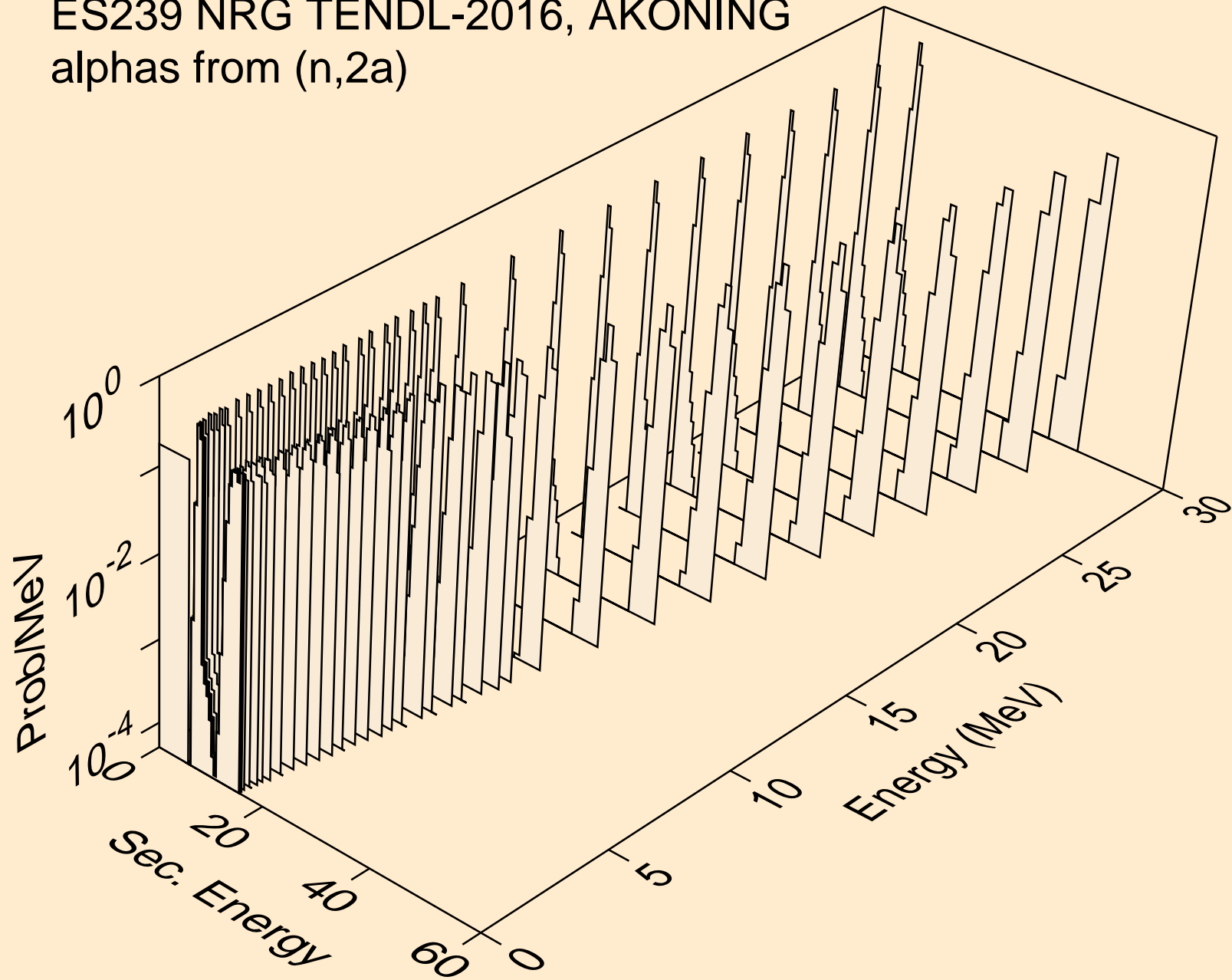

ES239 NRG TENDL-2016, AKONING
alphas from (n,3a)

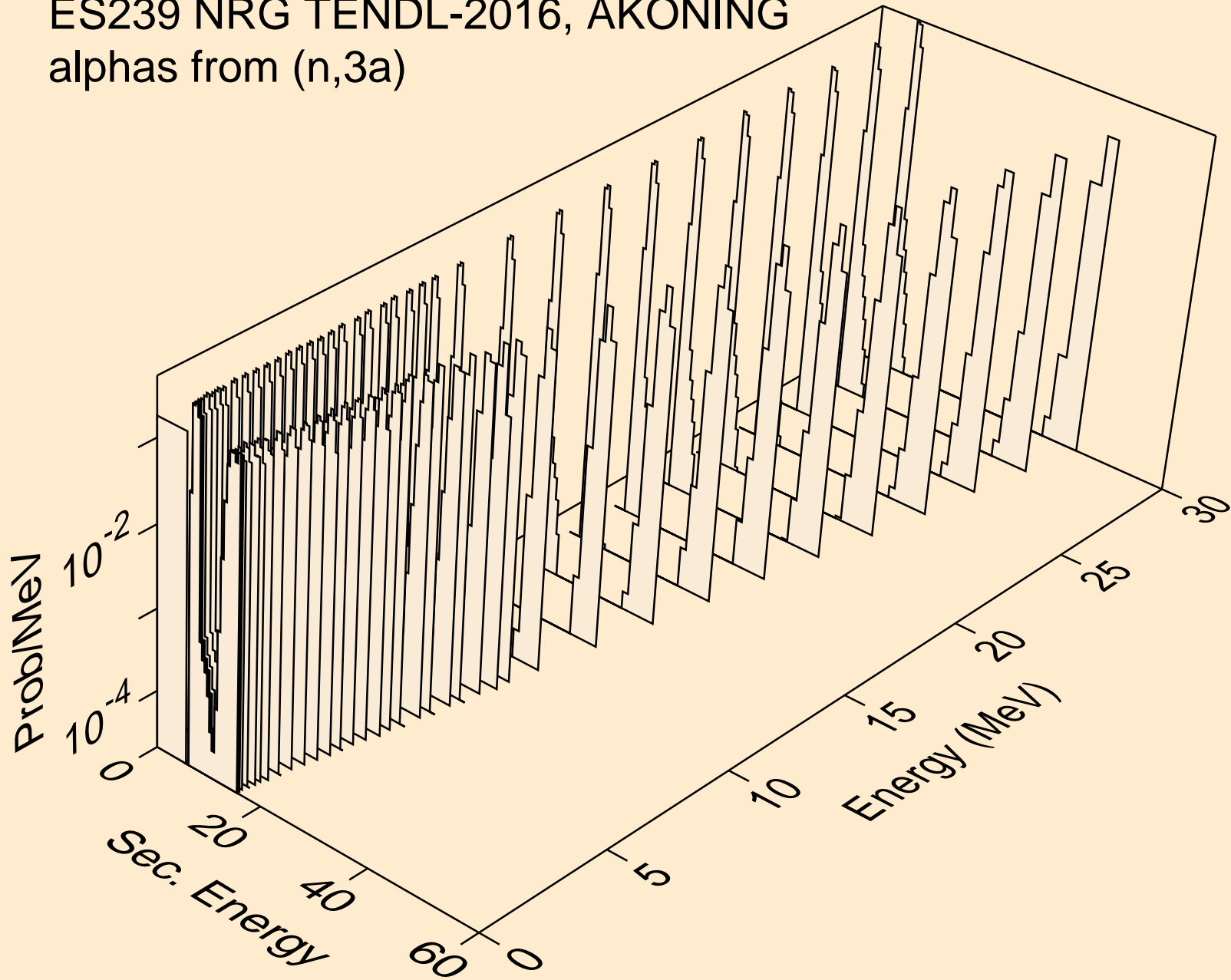

ES239 NRG TENDL-2016, AKONING
alphas from (n,pa)

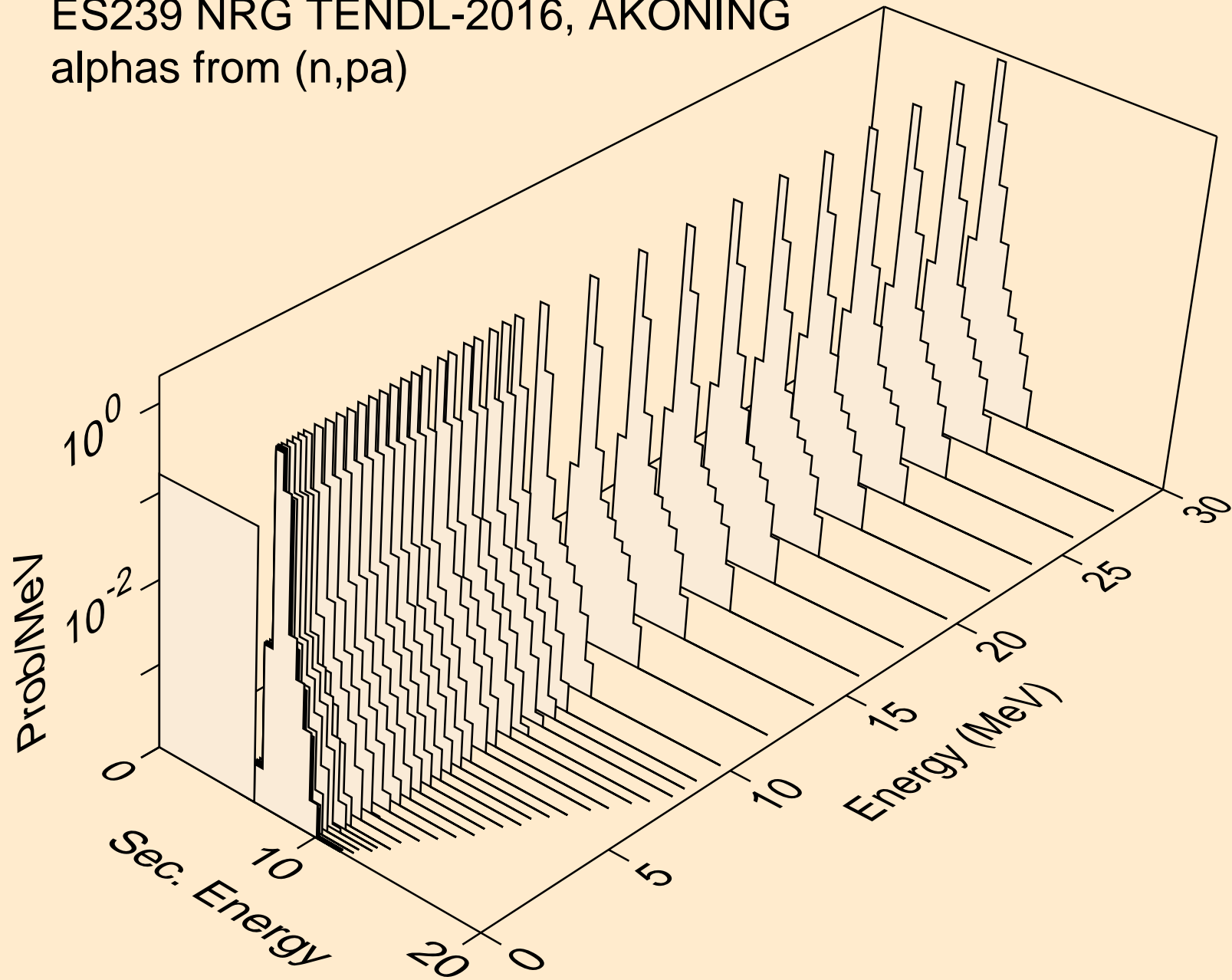

ES239 NRG TENDL-2016, AKONING
alphas from (n,t2a)

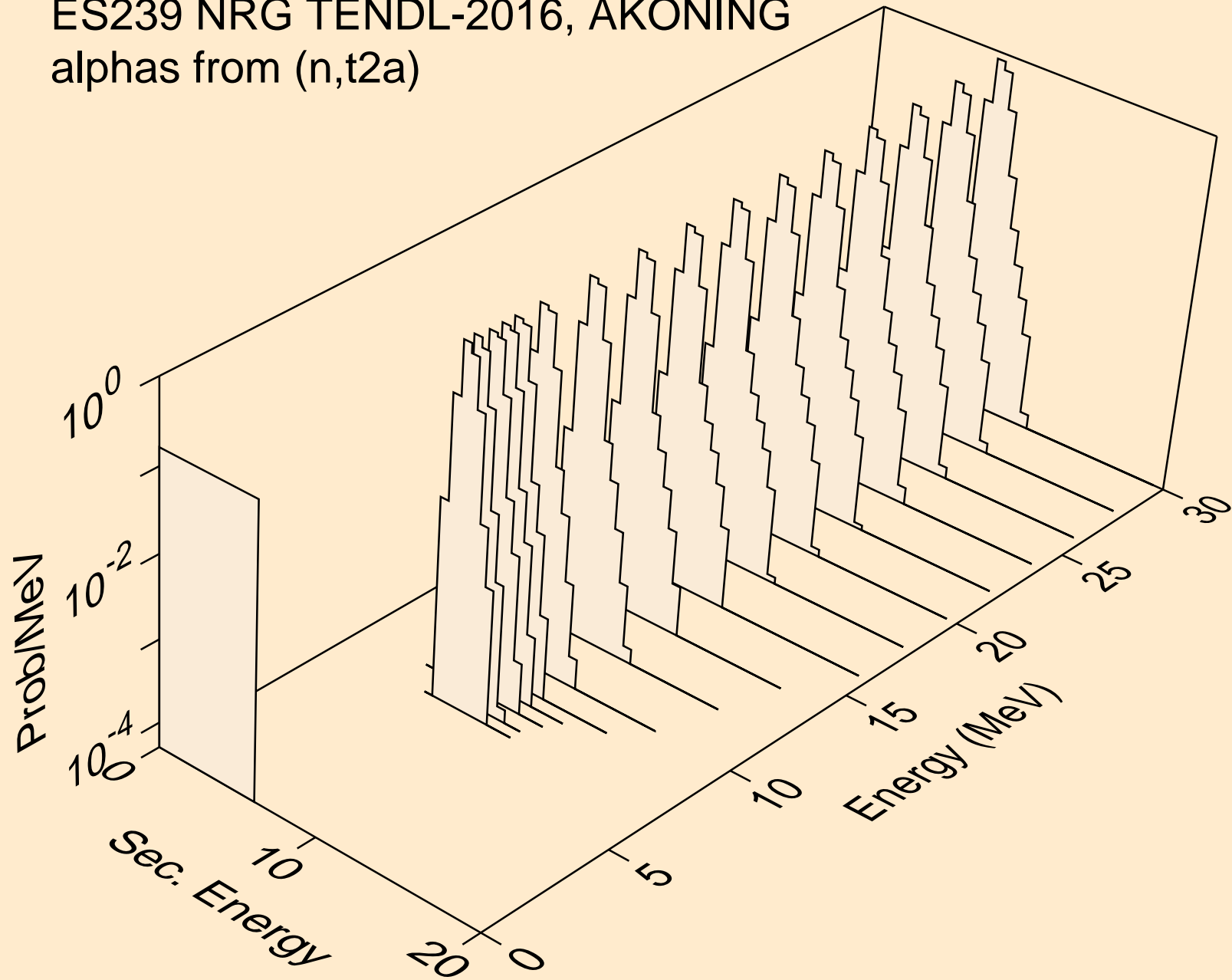

ES239 NRG TENDL-2016, AKONING
alphas from (n,d2a)

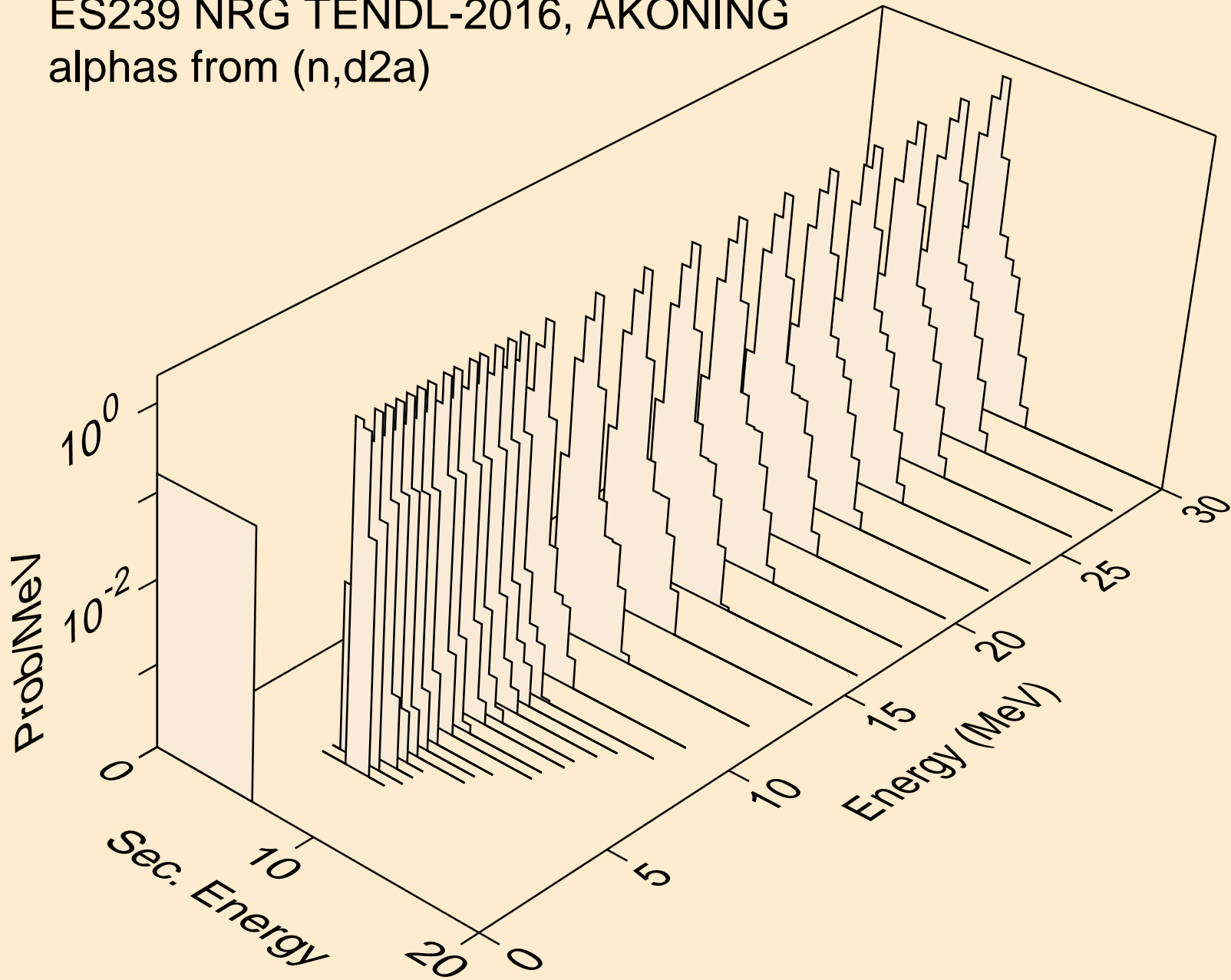

ES239 NRG TENDL-2016, AKONING
alphas from (n,da)

