

# ES240 NRG TENDL-2015, AKONING

## Principal cross sections

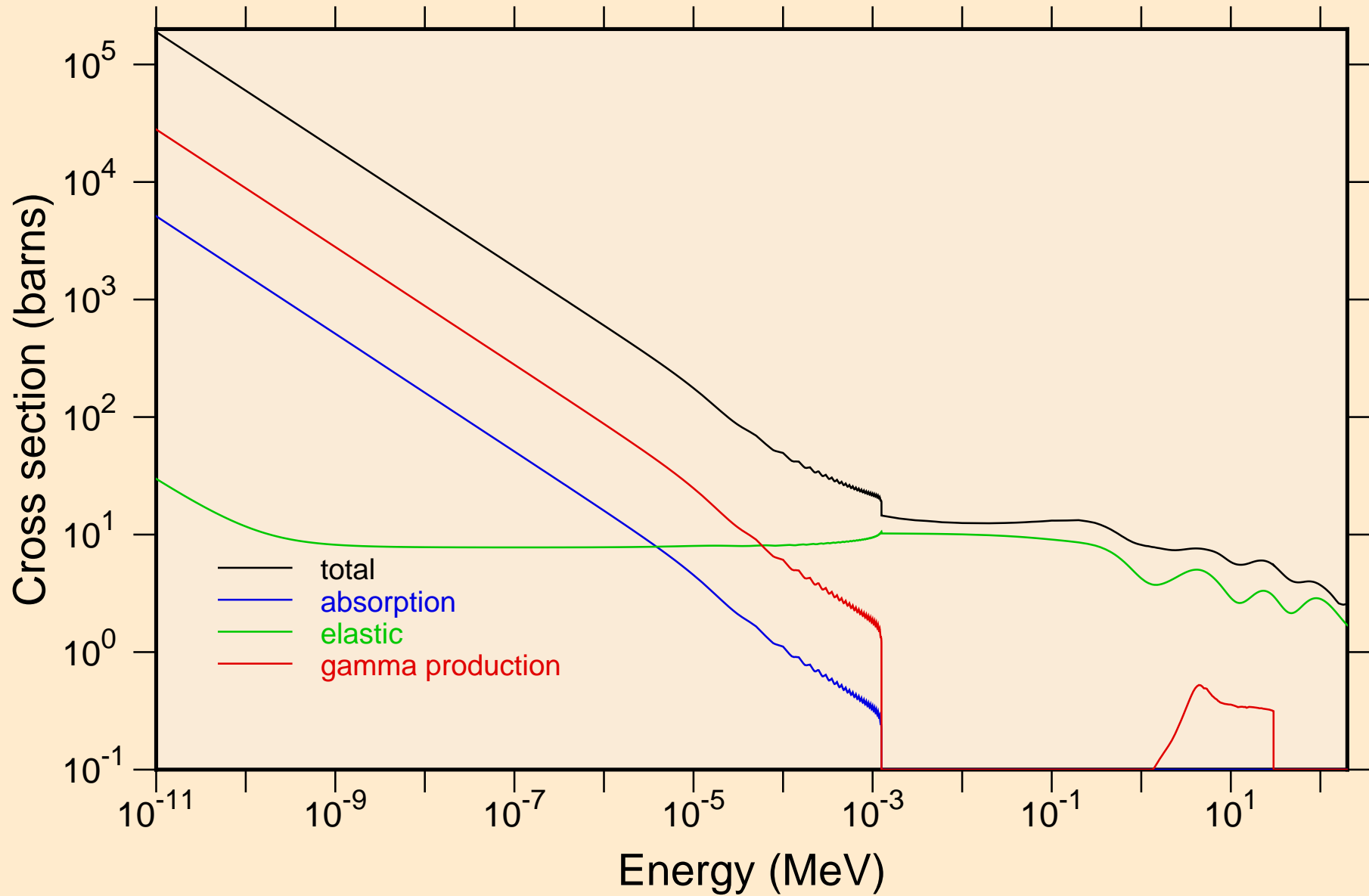

# ES240 NRG TENDL-2015, AKONING

## Non-threshold reactions

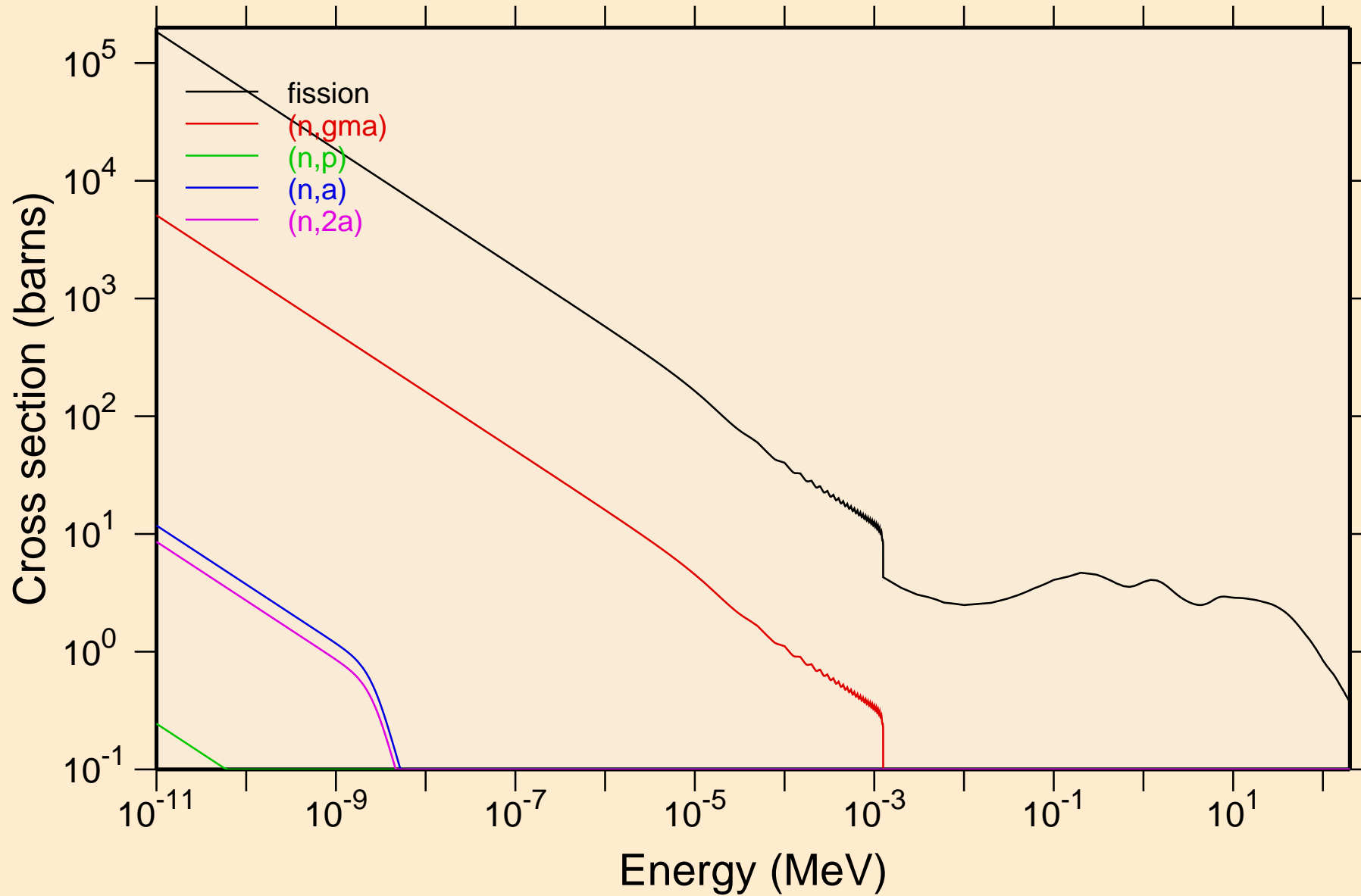

# ES240 NRG TENDL-2015, AKONING

## Non-threshold reactions

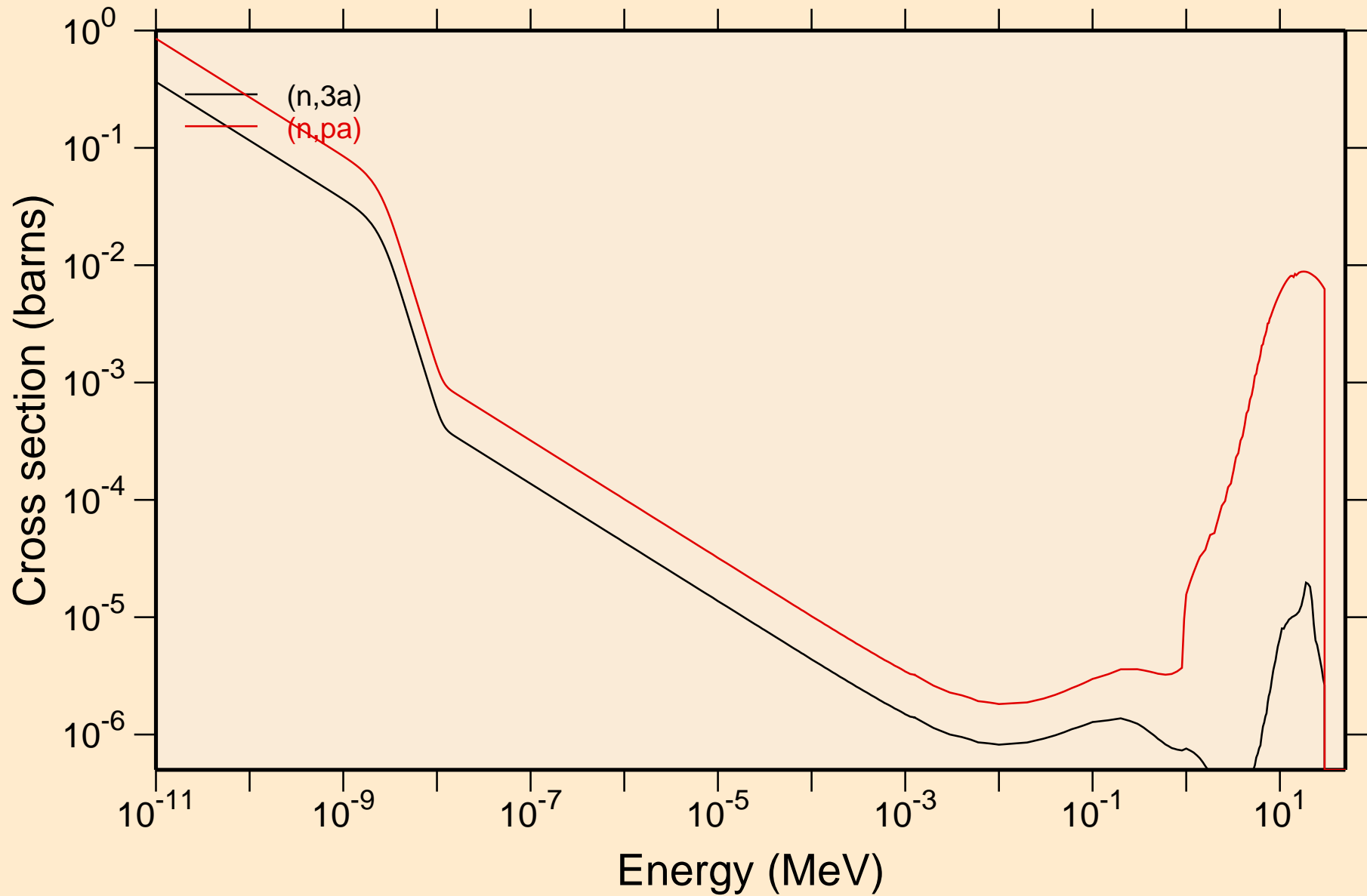

# ES240 NRG TENDL-2015, AKONING

## Principal cross sections

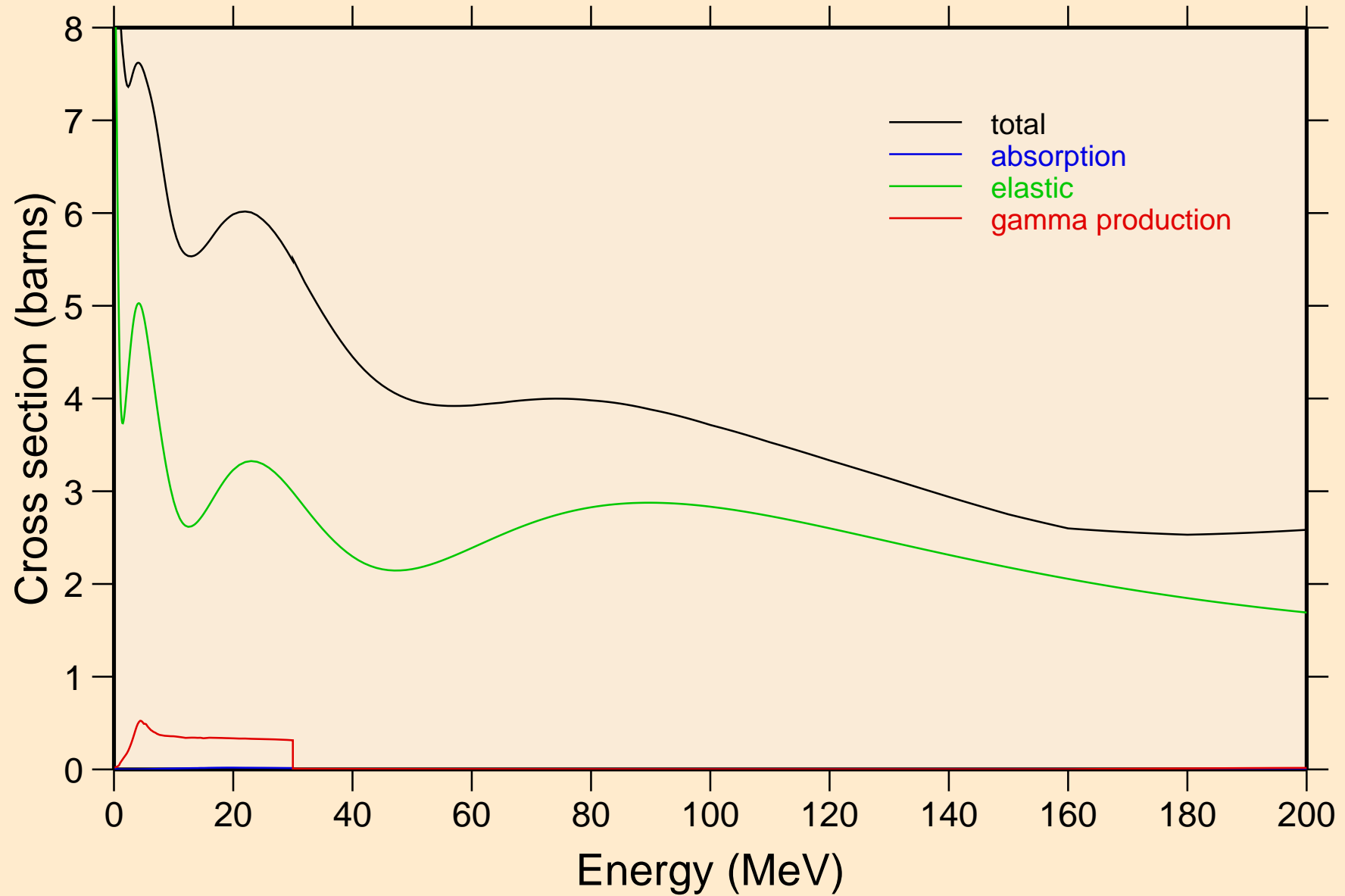

# ES240 NRG TENDL-2015, AKONING

## Non-threshold reactions

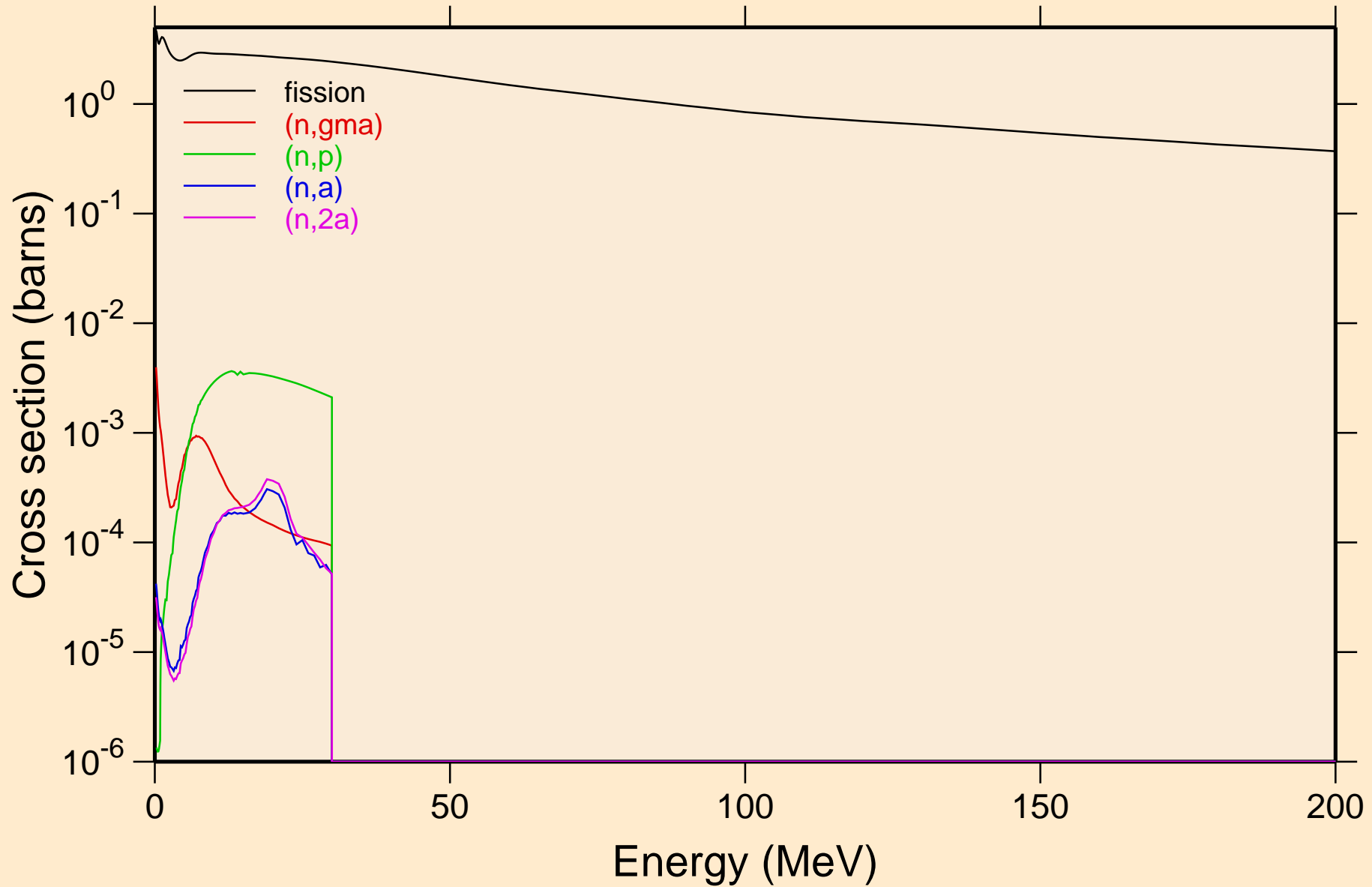

# ES240 NRG TENDL-2015, AKONING

## Non-threshold reactions

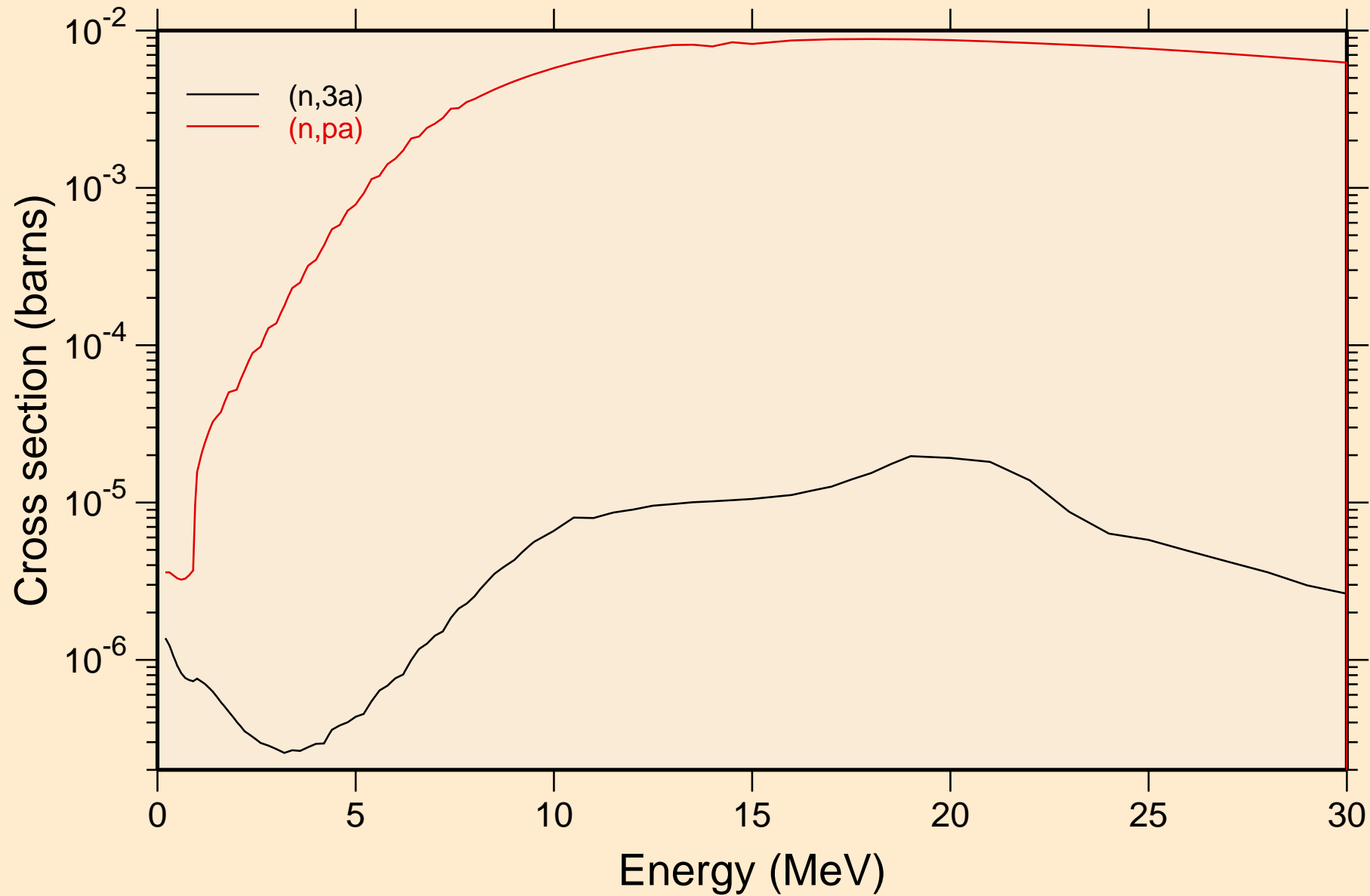

# ES240 NRG TENDL-2015, AKONING

## Inelastic levels

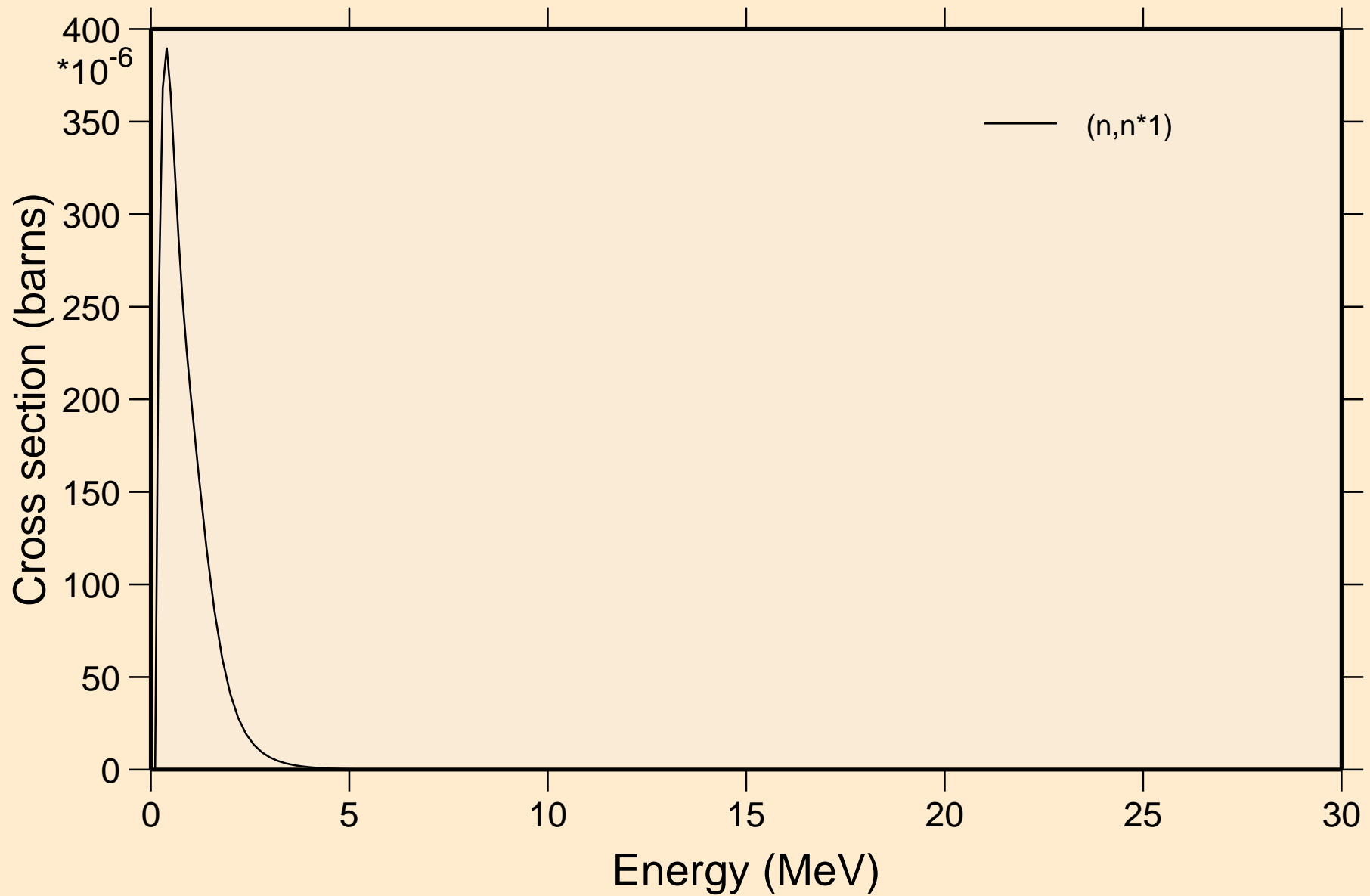

# ES240 NRG TENDL-2015, AKONING

## Threshold reactions

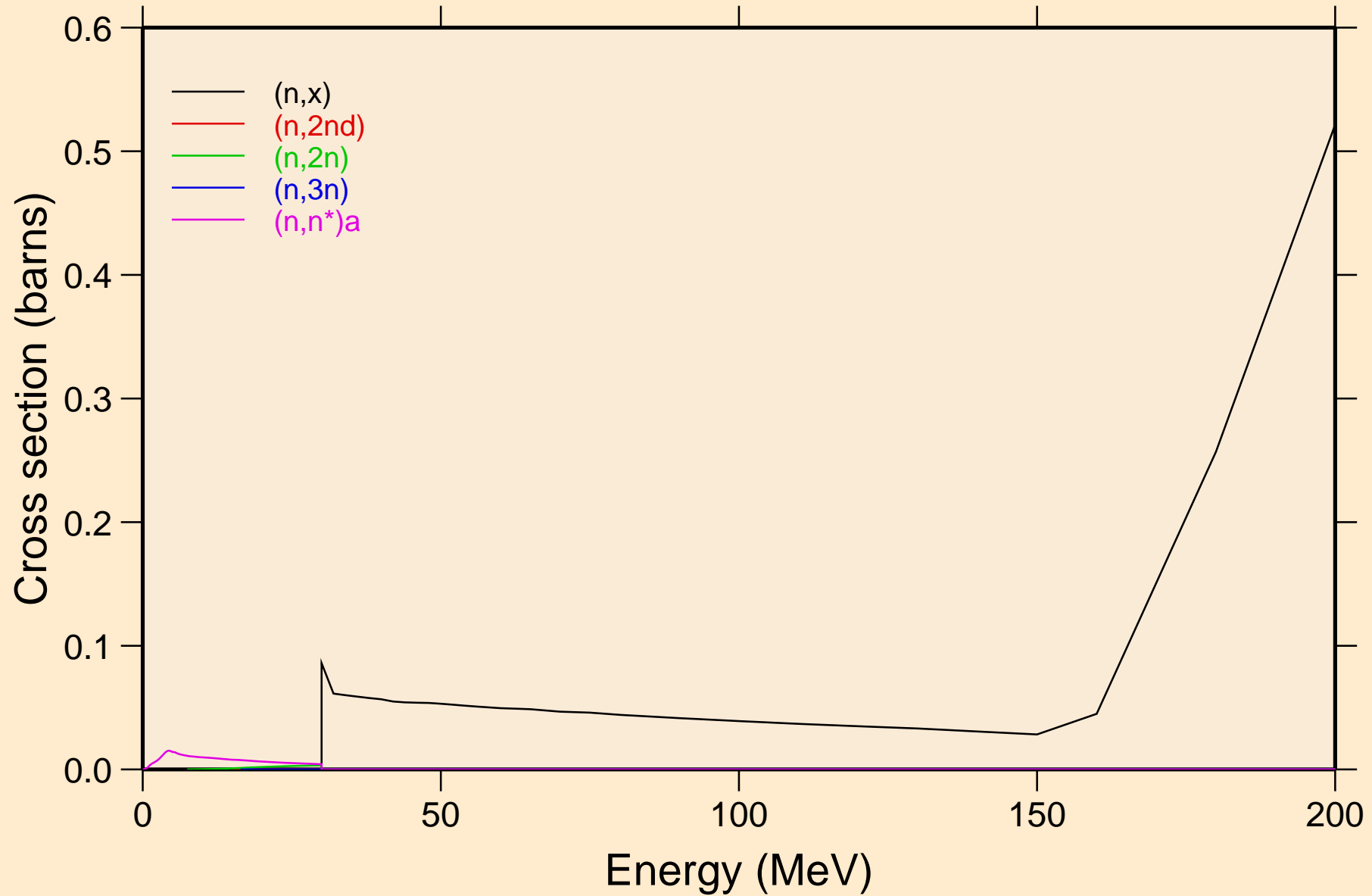



# ES240 NRG TENDL-2015, AKONING

## Threshold reactions

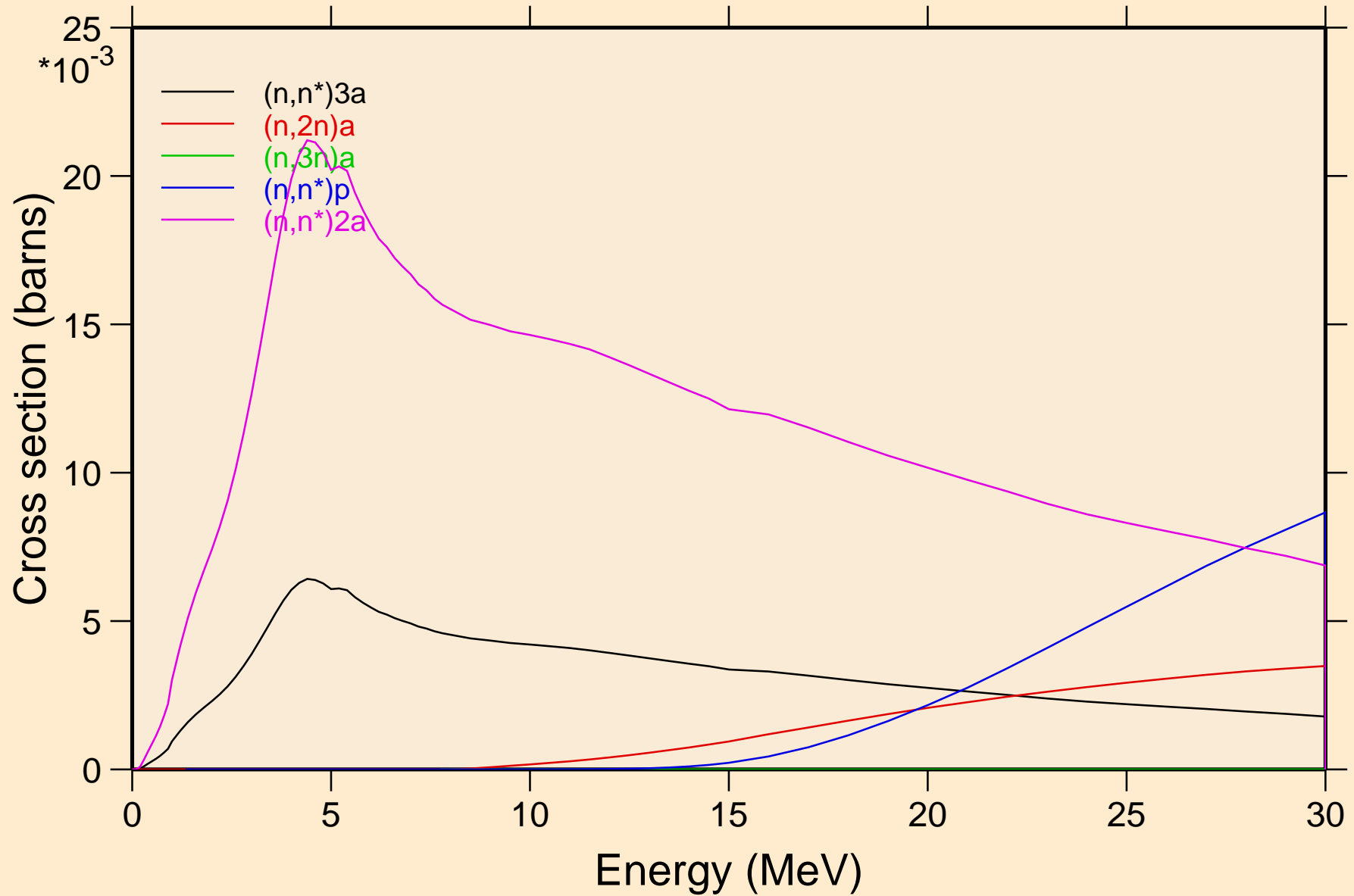

# ES240 NRG TENDL-2015, AKONING

## Threshold reactions

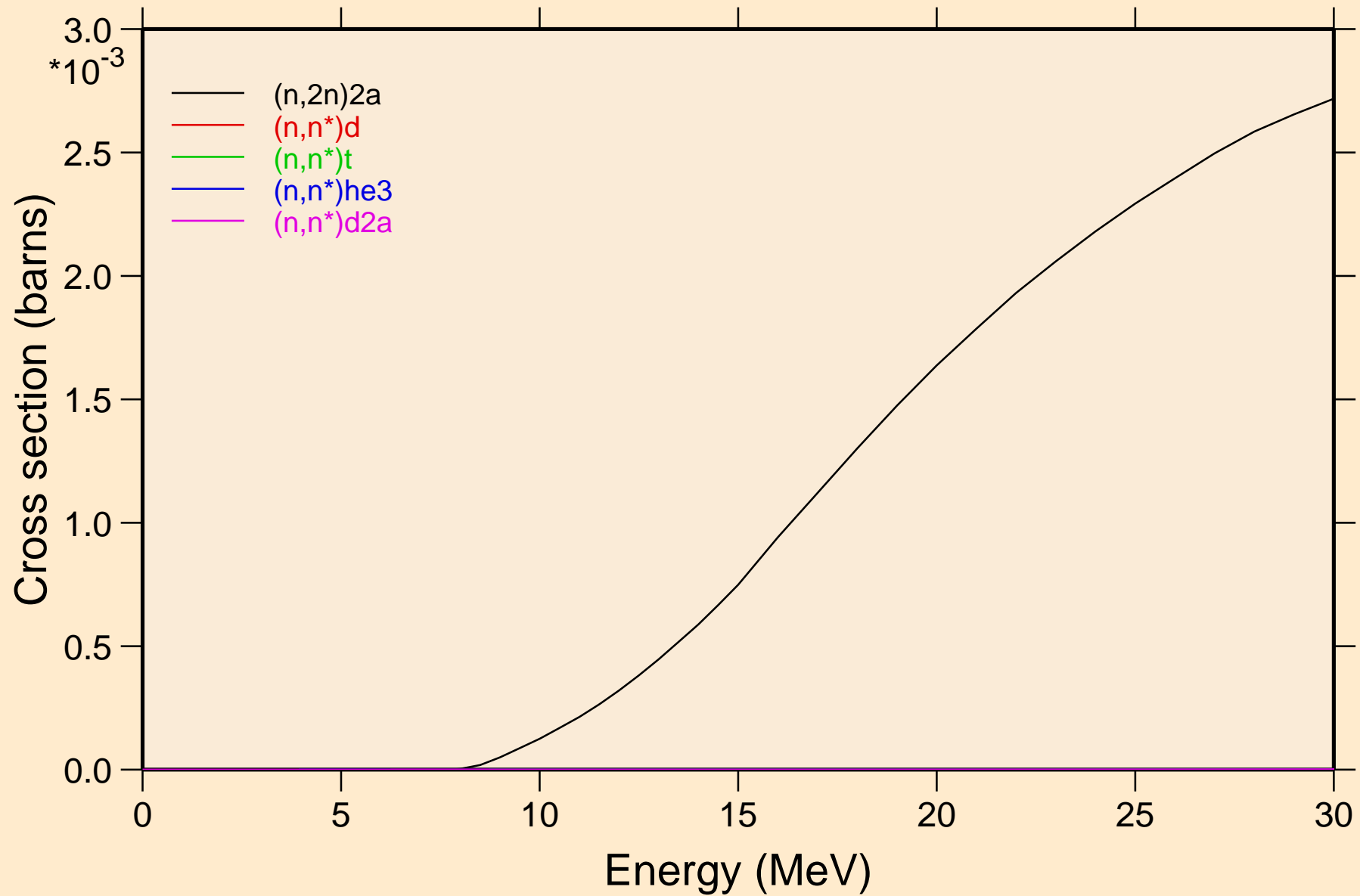

# ES240 NRG TENDL-2015, AKONING

## Threshold reactions

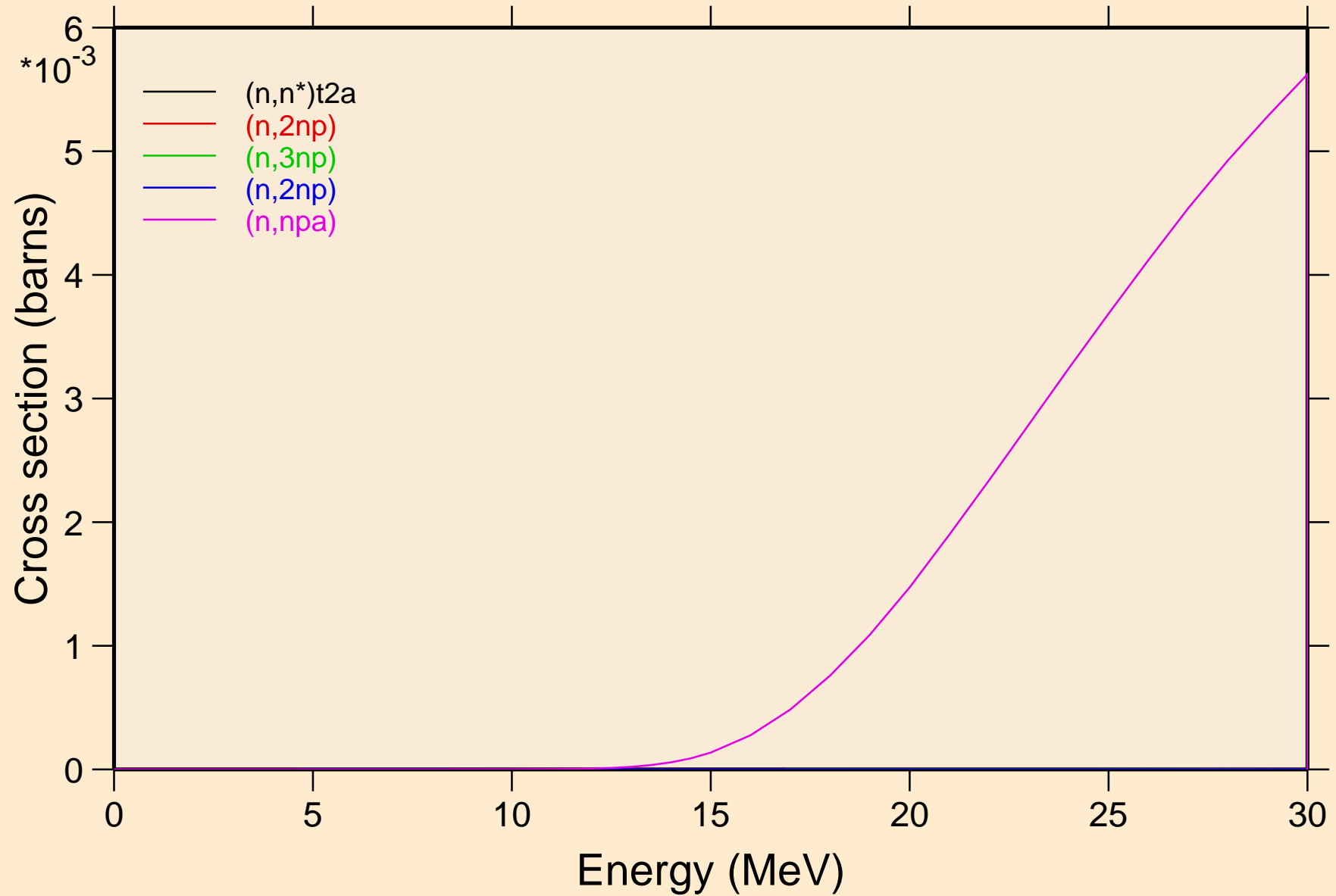

# ES240 NRG TENDL-2015, AKONING

## Threshold reactions

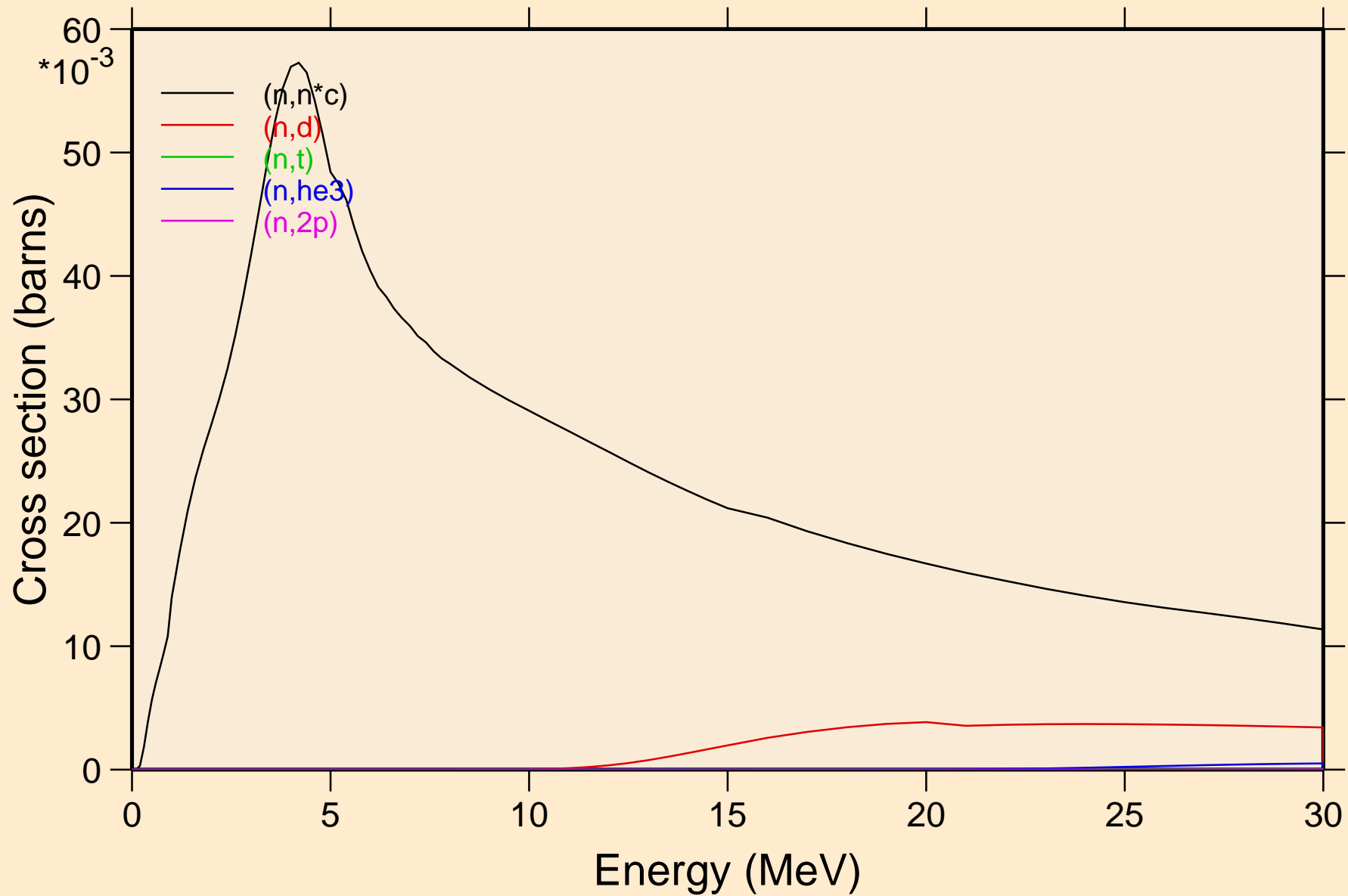

# ES240 NRG TENDL-2015, AKONING

## Threshold reactions

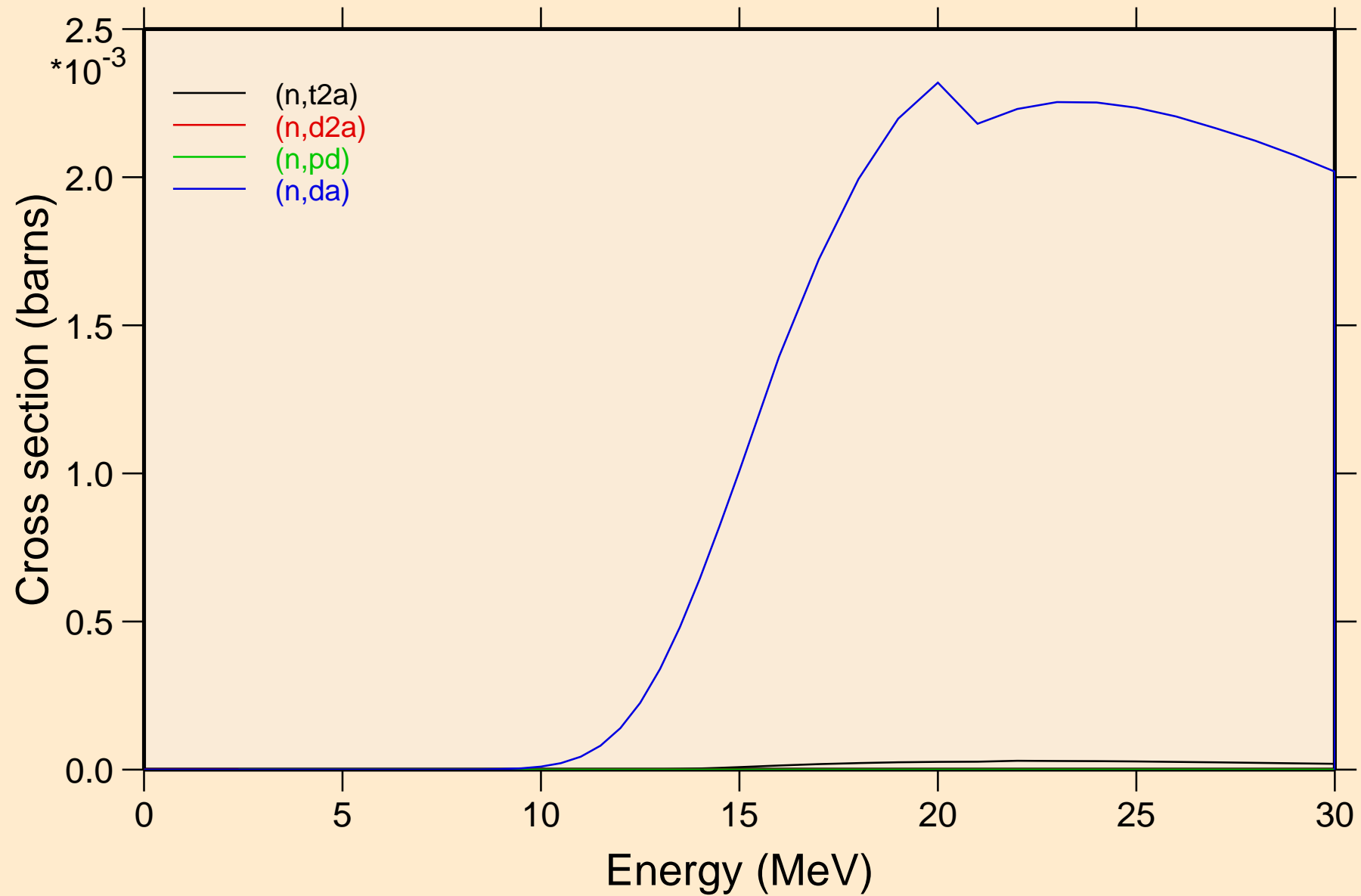

ES240 NRG TENDL-2015, AKONING  
angular distribution for elastic

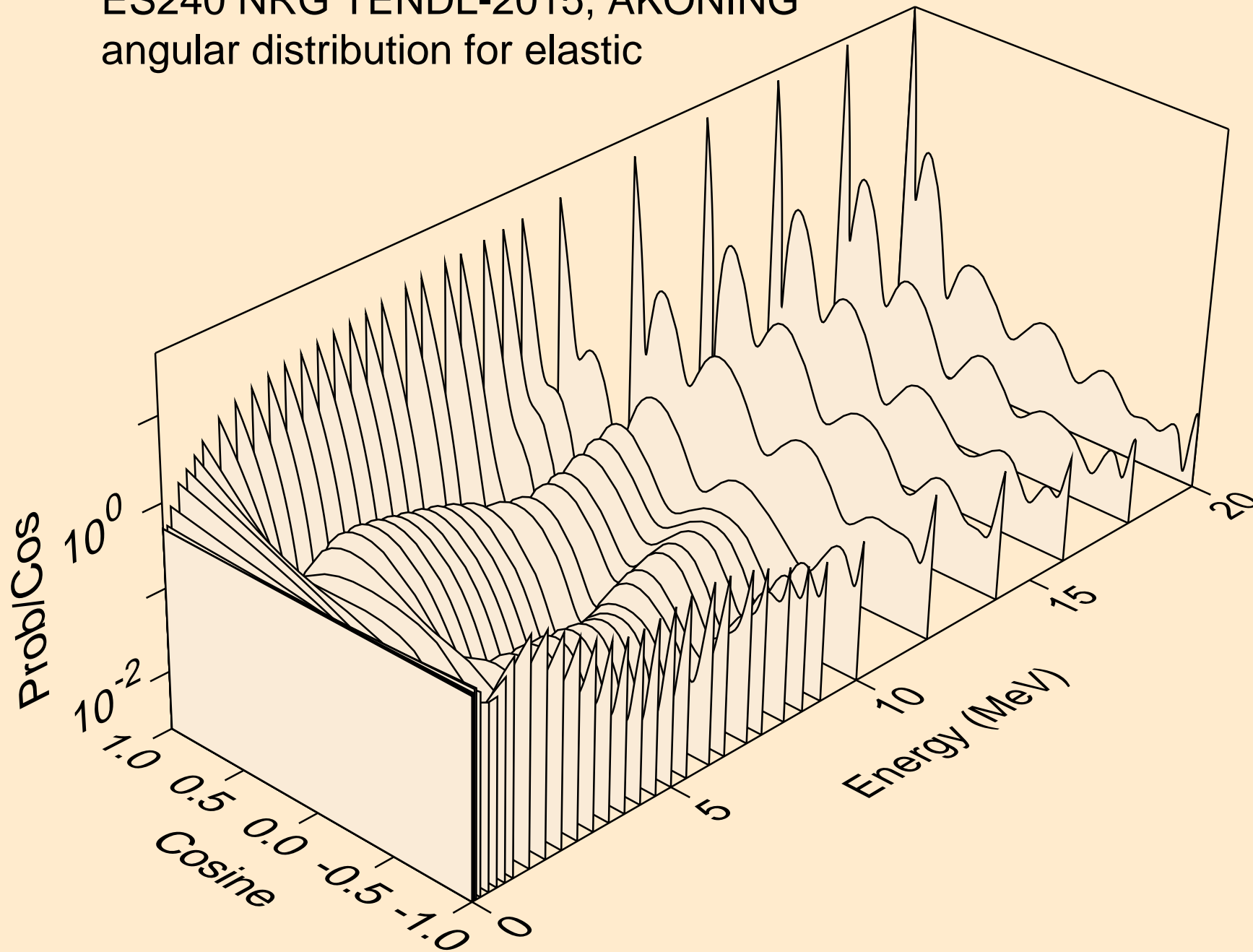

ES240 NRG TENDL-2015, AKONING  
angular distribution for elastic

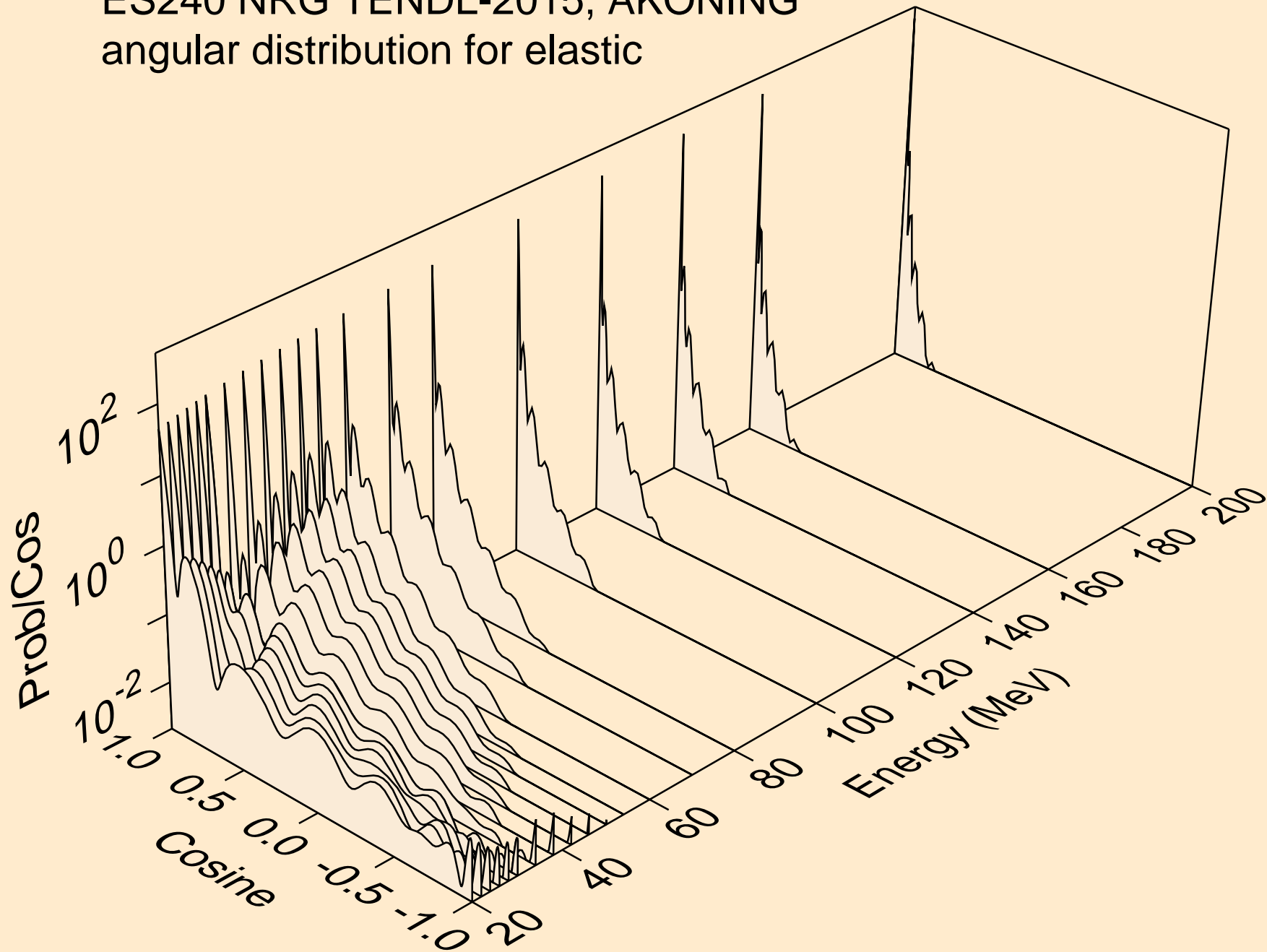

ES240 NRG TENDL-2015, AKONING  
angular distribution for (n,n\*1)

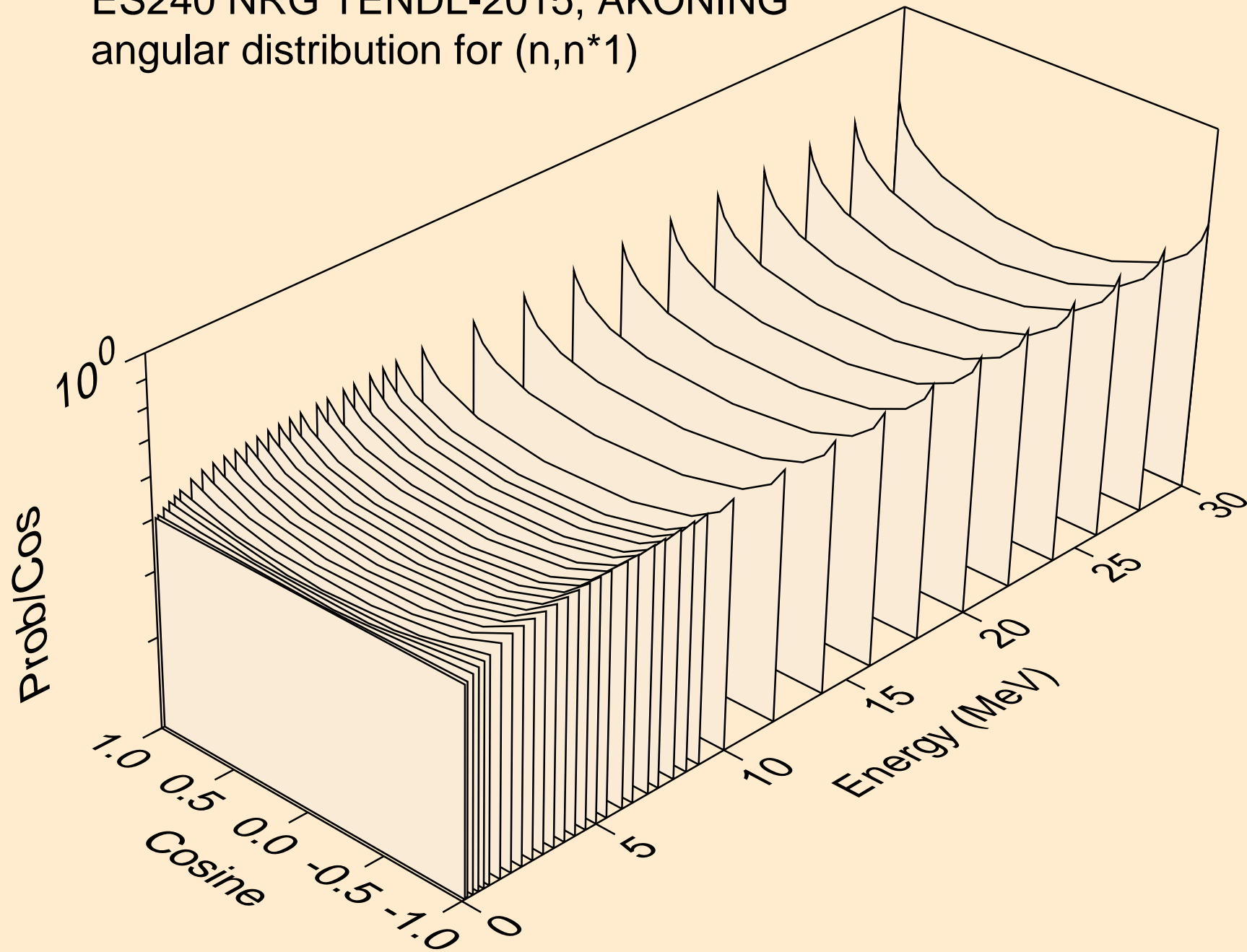



# ES240 NRG TENDL-2015, AKONING

Total fission nubar

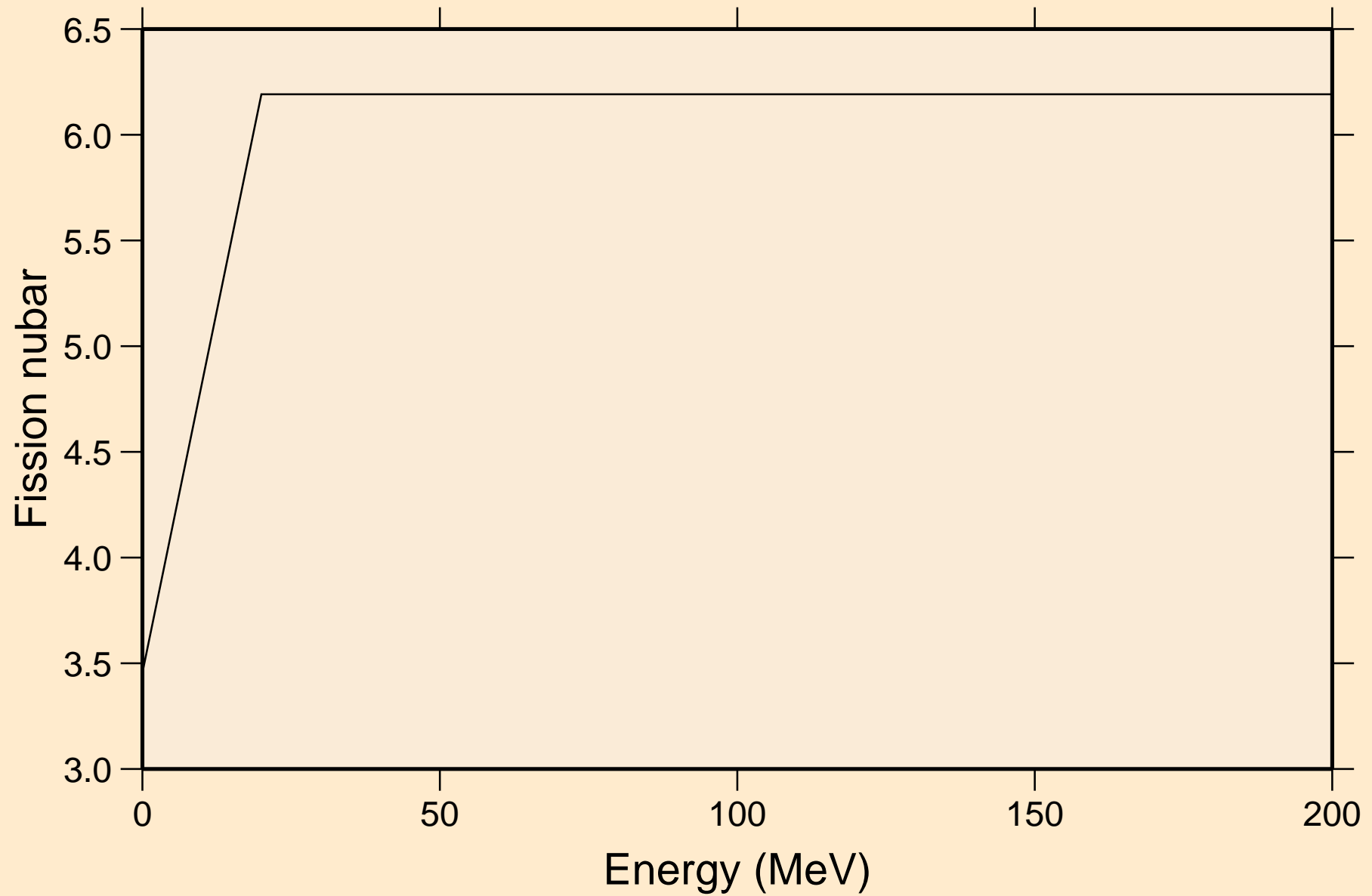

ES240 NRG TENDL-2015, AKONING  
Neutron emission for (n,x)

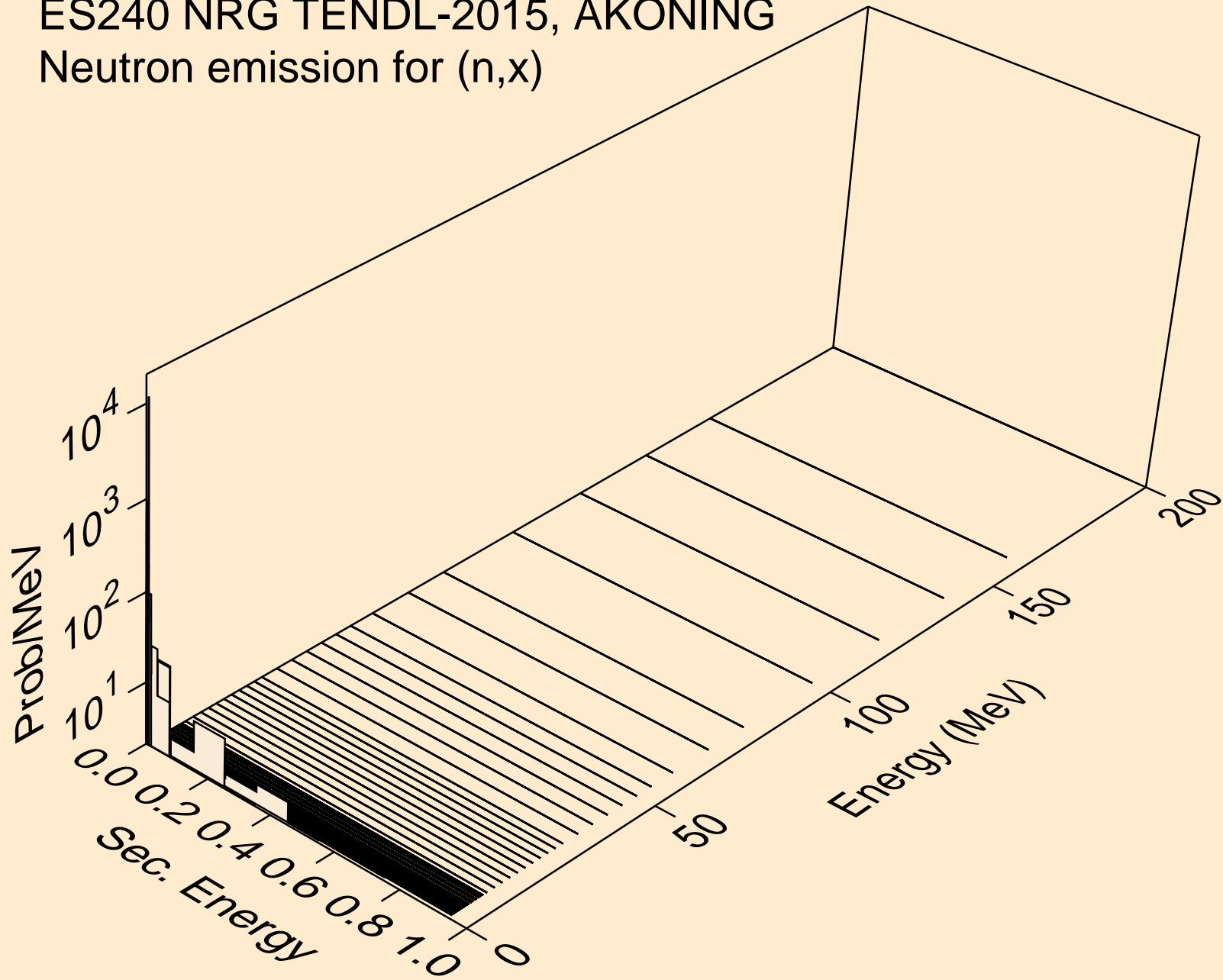

ES240 NRG TENDL-2015, AKONING  
Neutron emission for (n,2nd)

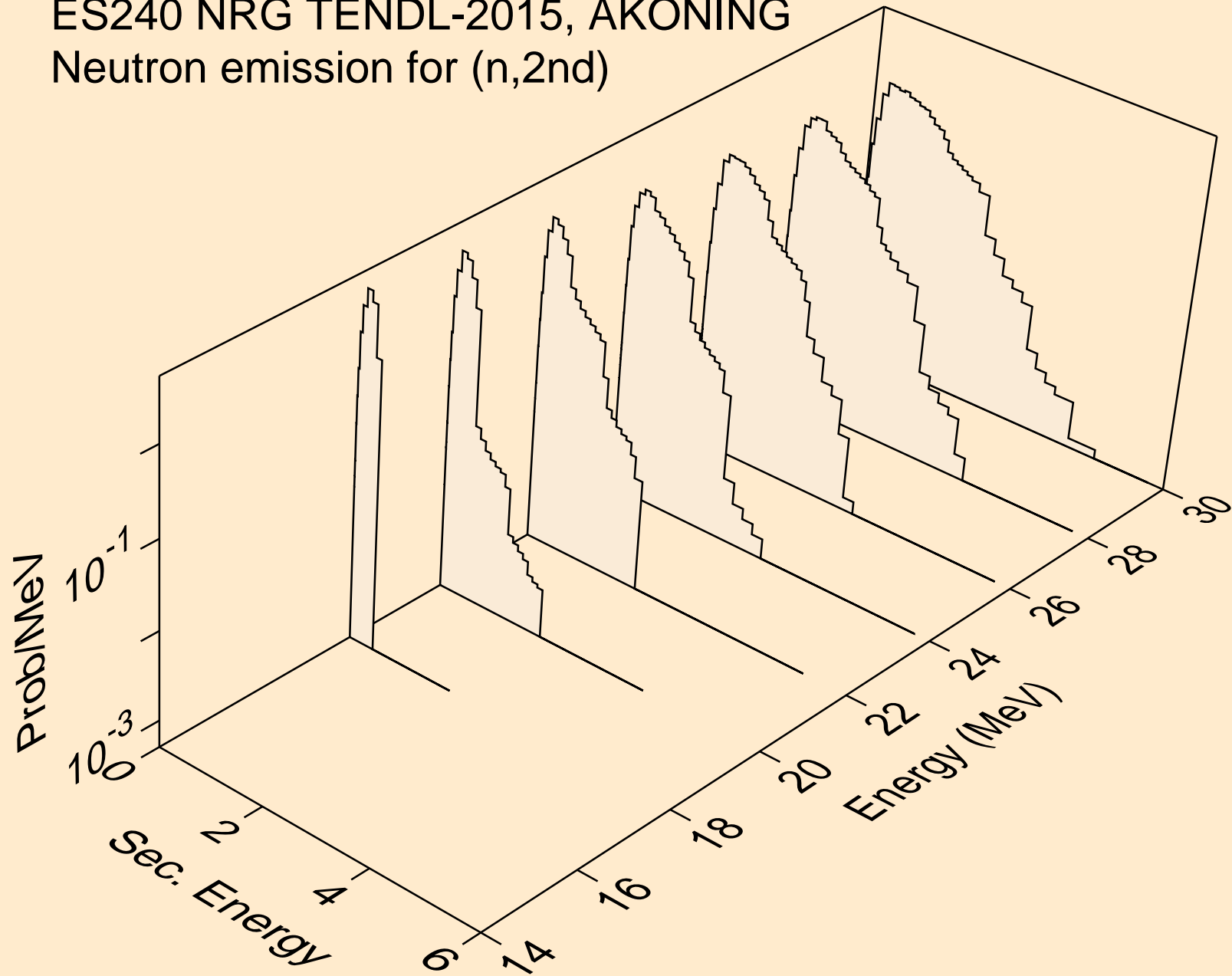

ES240 NRG TENDL-2015, AKONING  
Neutron emission for (n,2n)

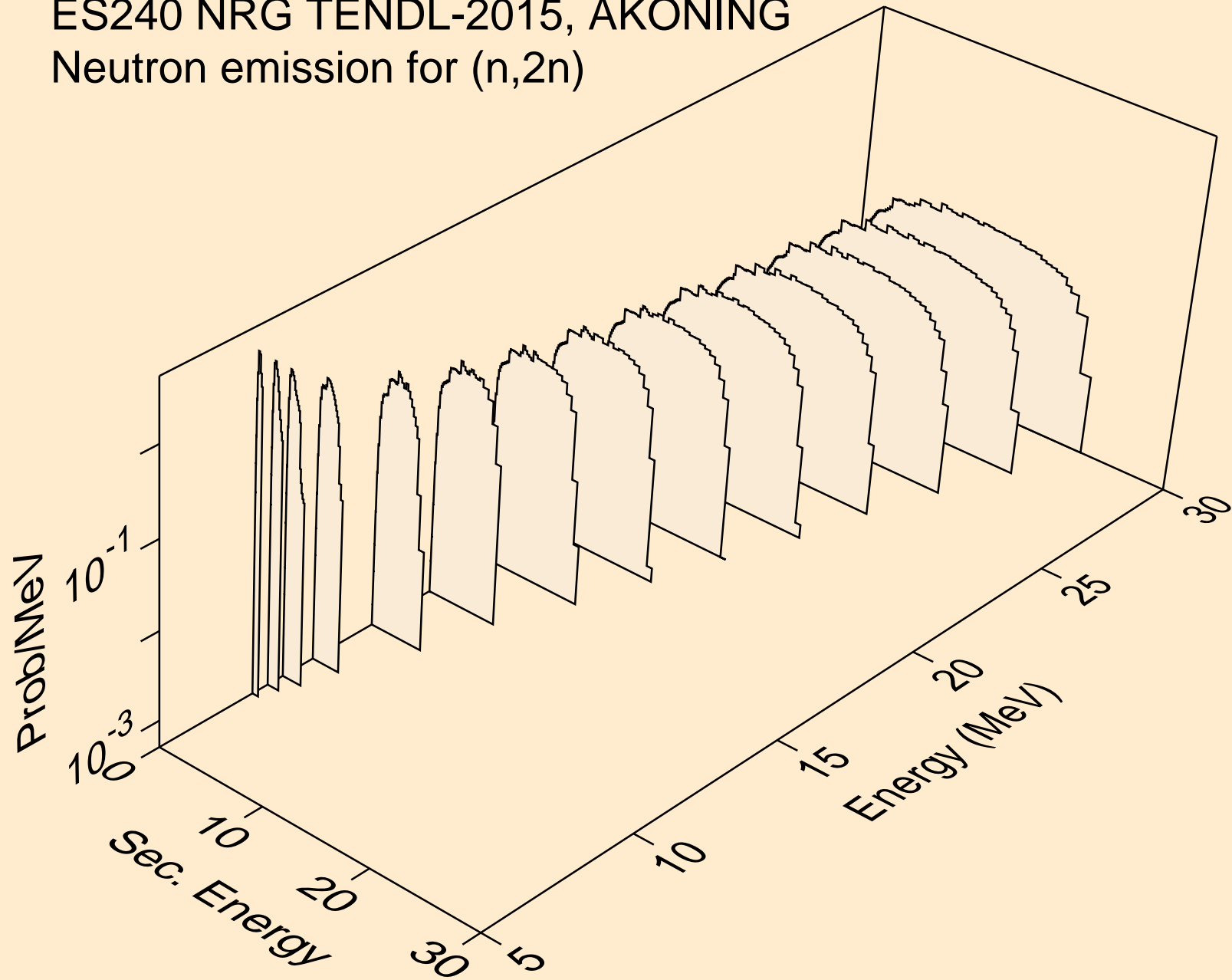

ES240 NRG TENDL-2015, AKONING  
Neutron emission for (n,3n)

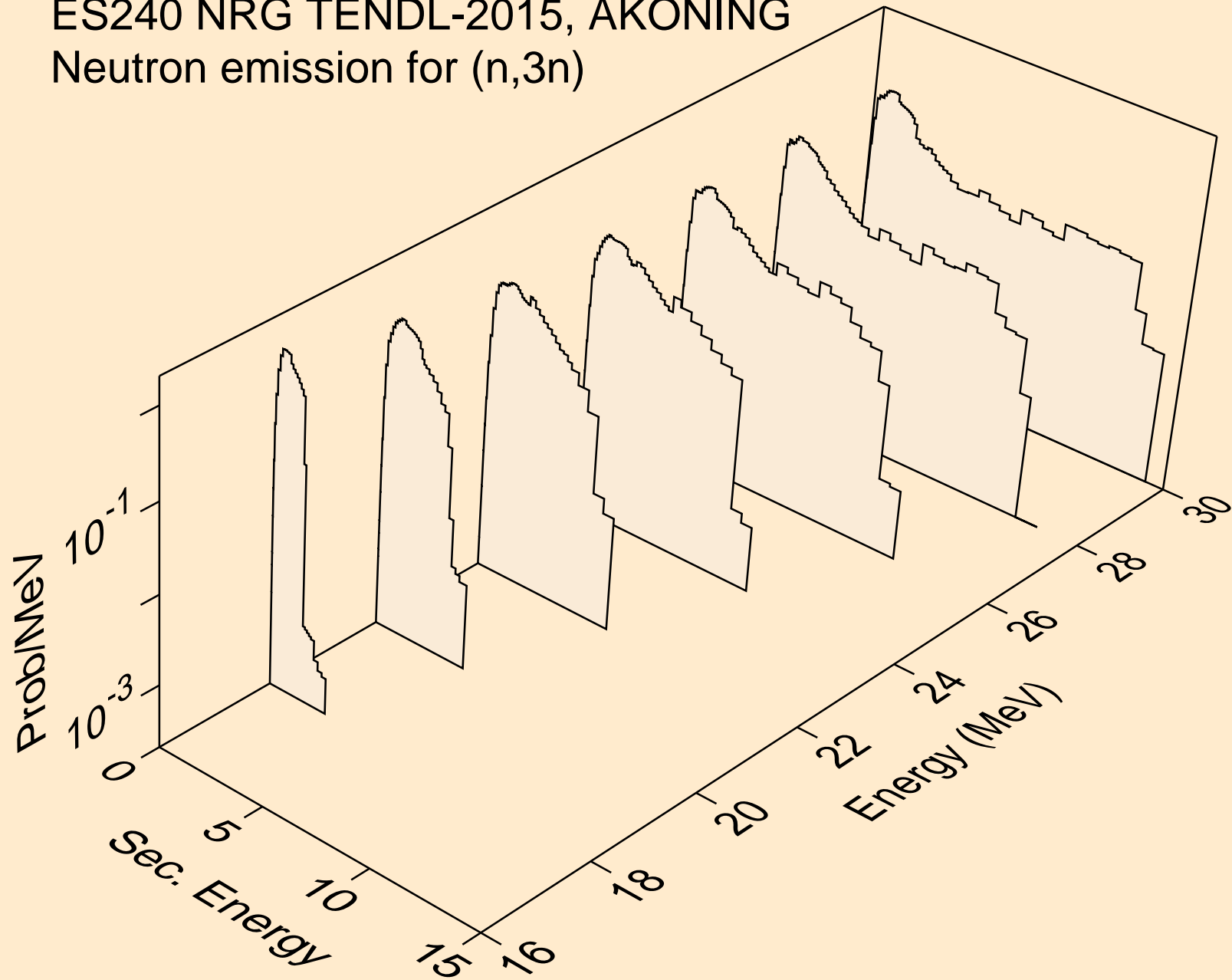

ES240 NRG TENDL-2015, AKONING  
Neutron emission for fission

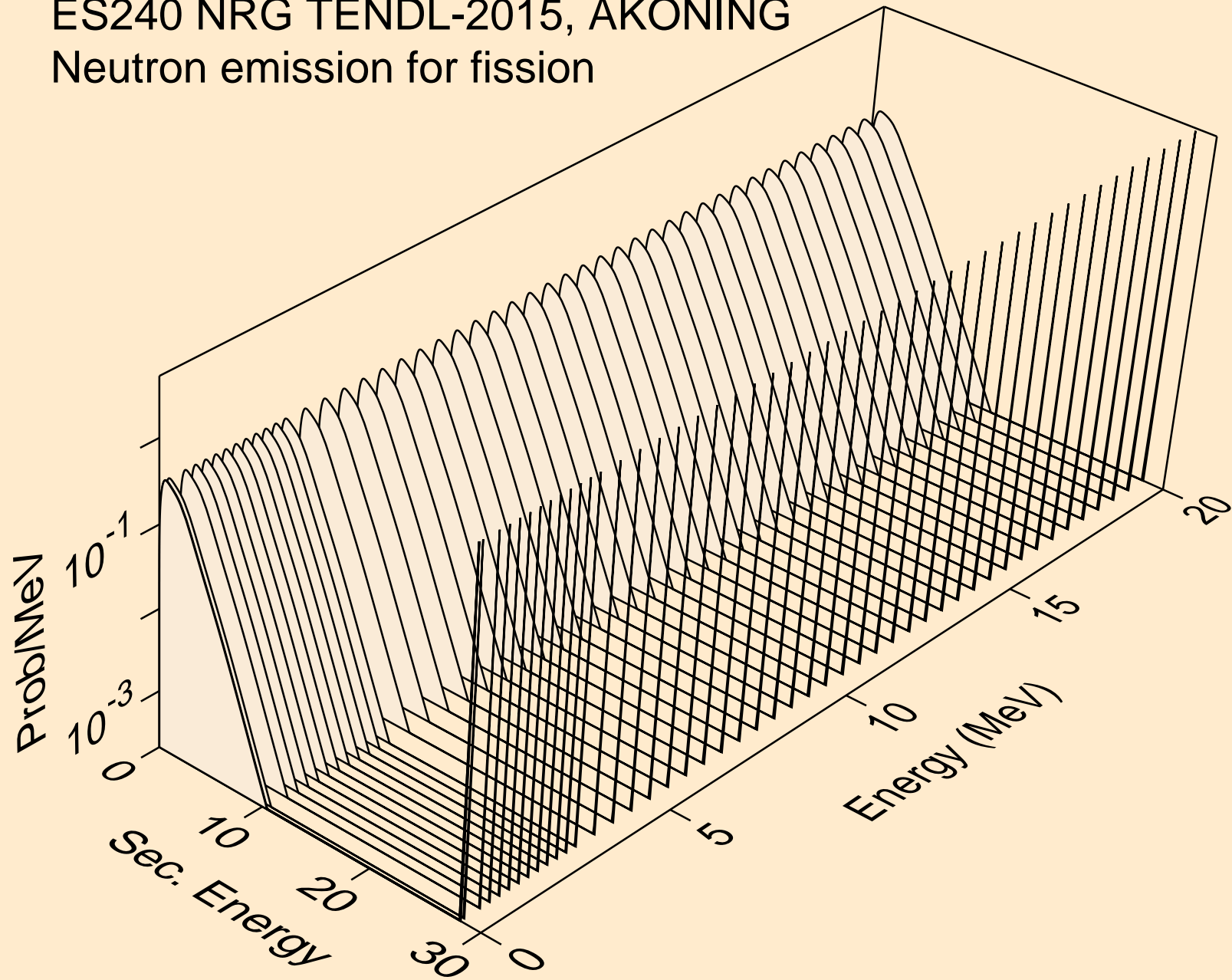

ES240 NRG TENDL-2015, AKONING  
Neutron emission for (n,n\*)a

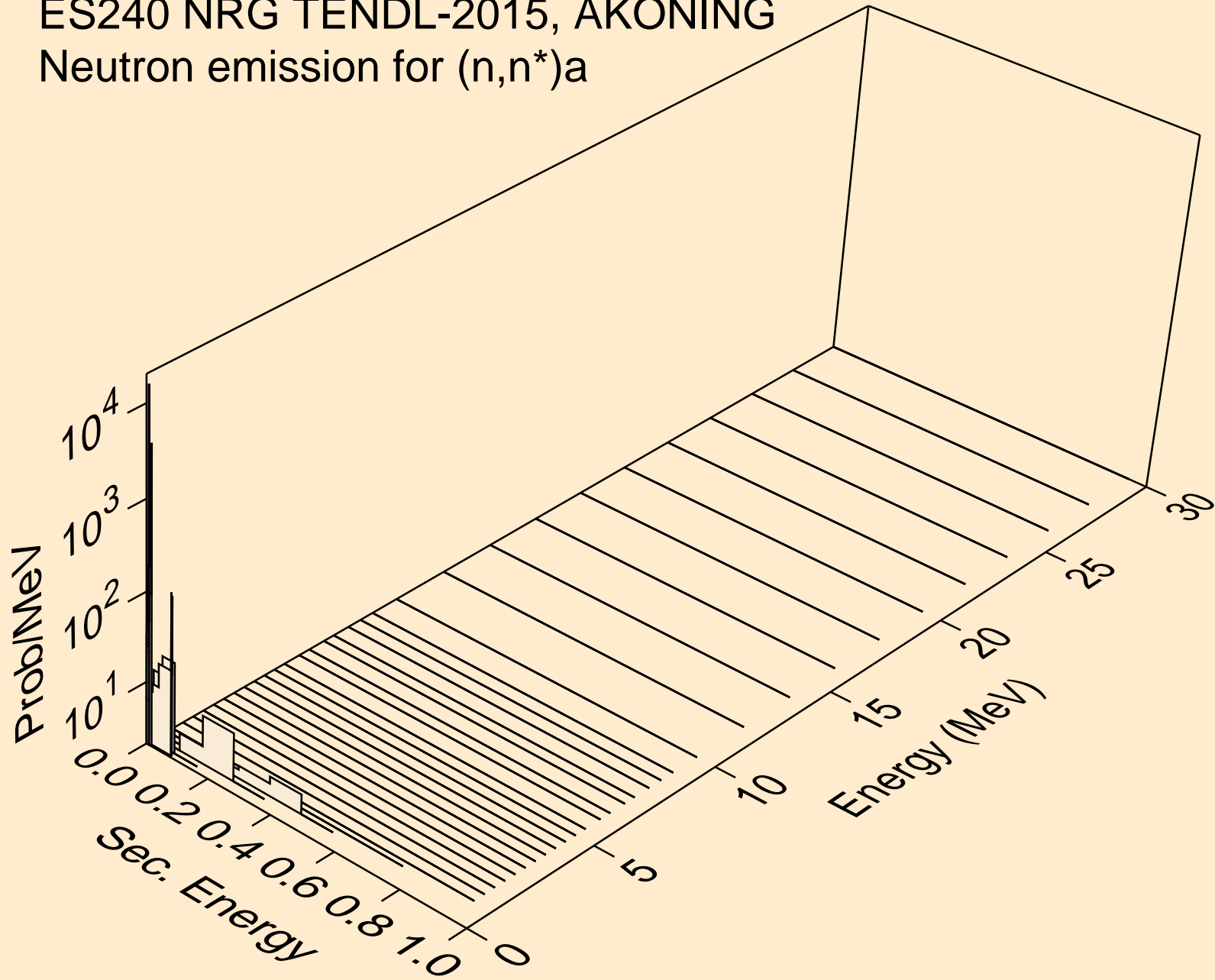

ES240 NRG TENDL-2015, AKONING  
Neutron emission for (n,n\*)3a

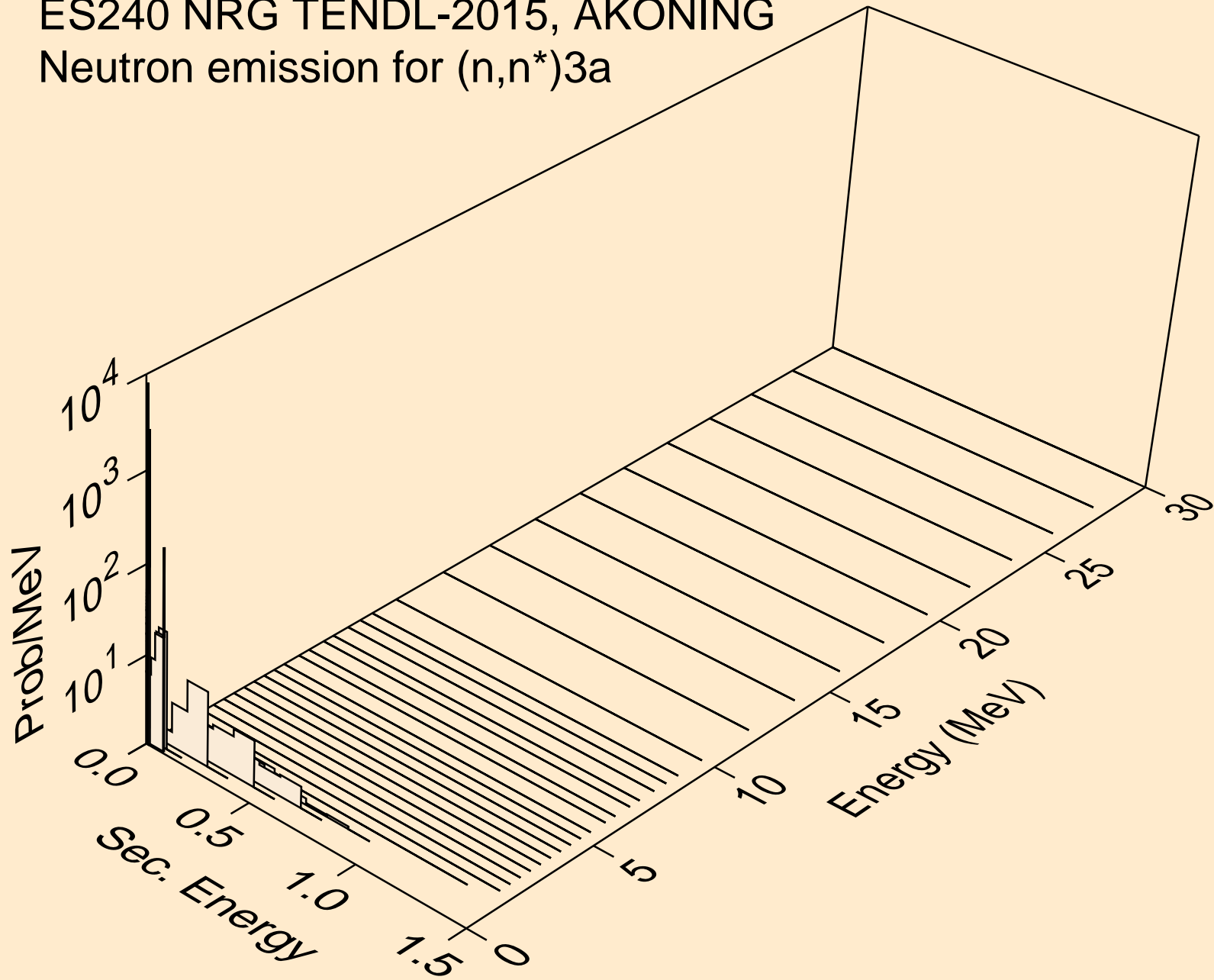



ES240 NRG TENDL-2015, AKONING  
Neutron emission for (n,2n)a

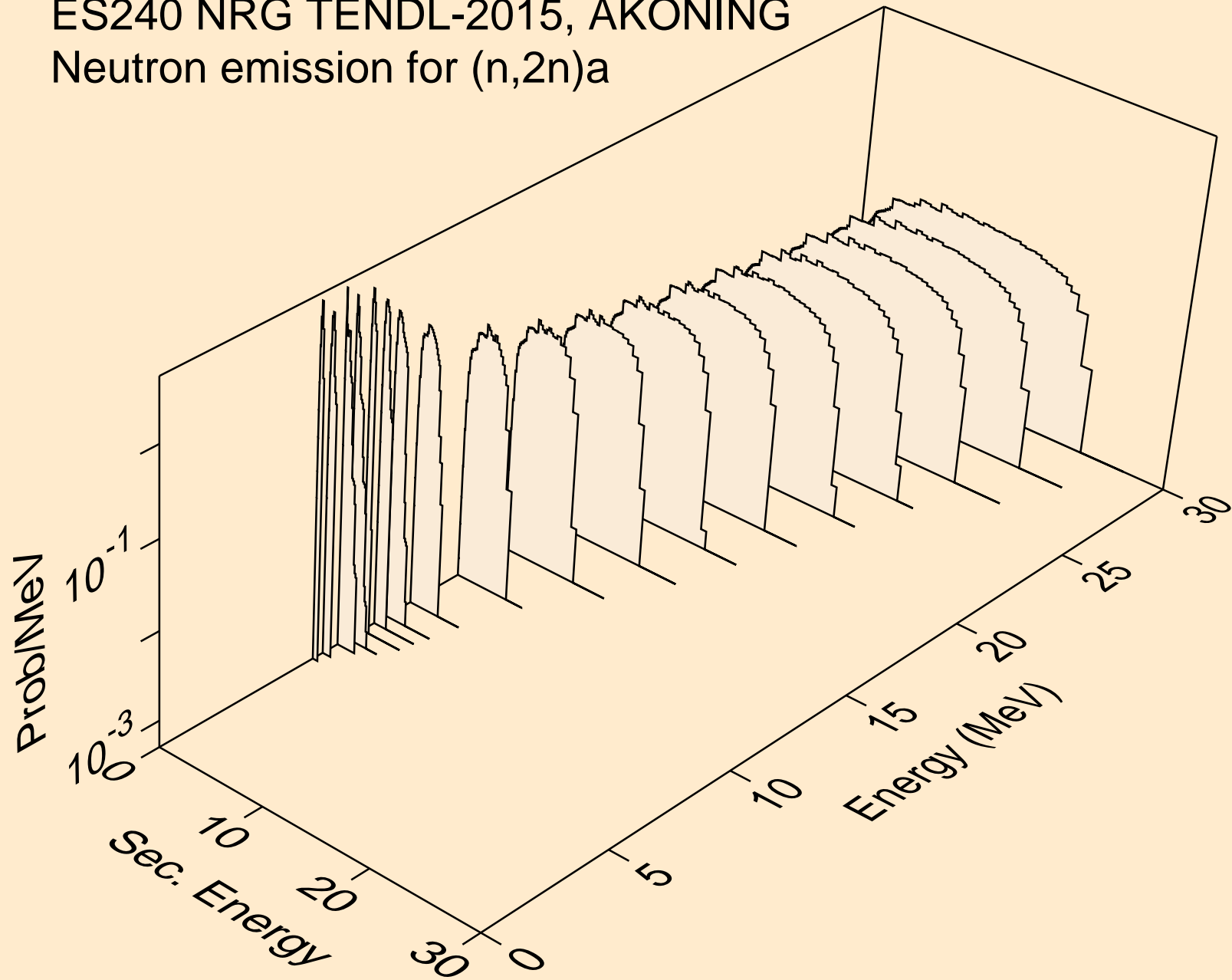

ES240 NRG TENDL-2015, AKONING  
Neutron emission for (n,3n)a

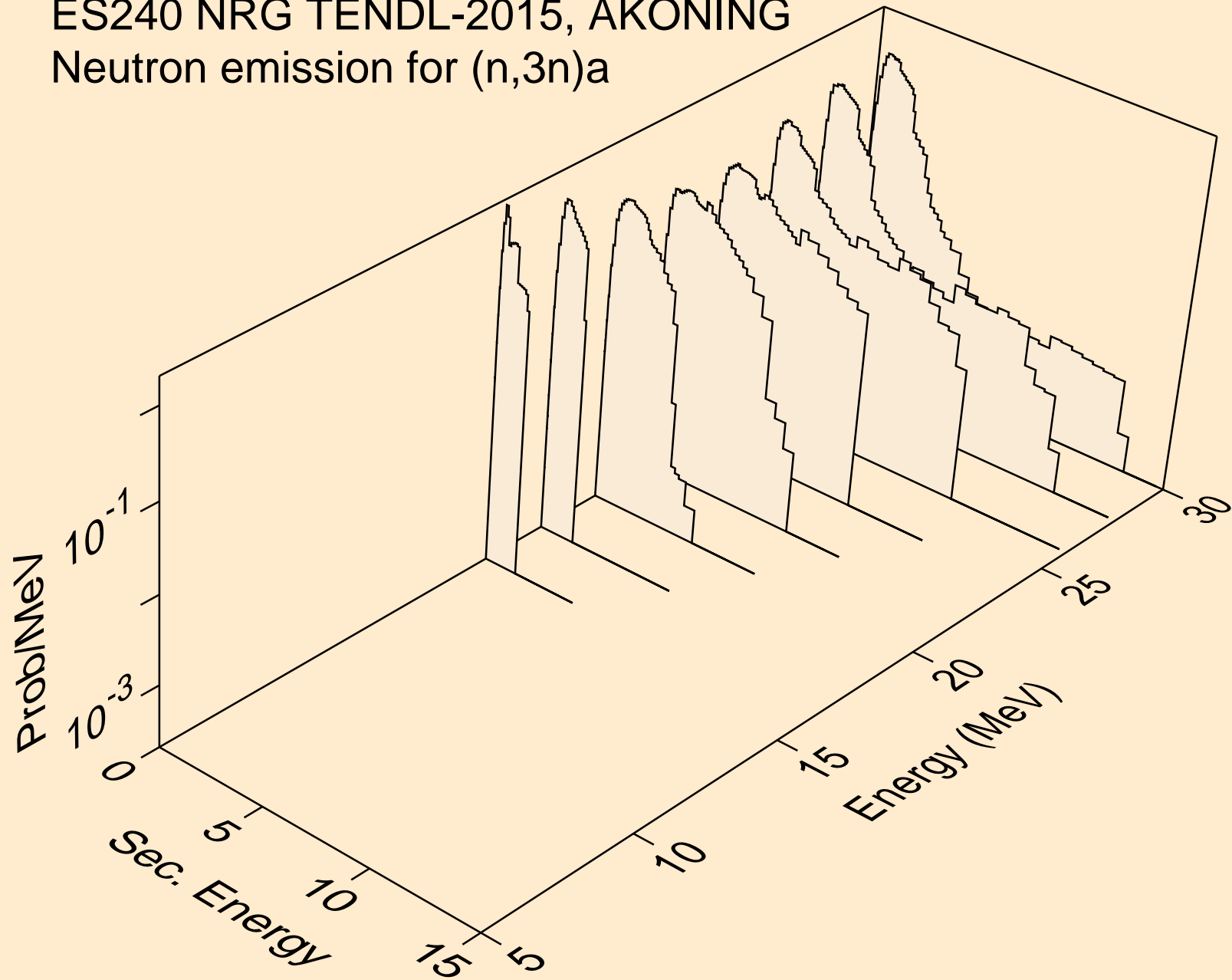

ES240 NRG TENDL-2015, AKONING  
Neutron emission for (n,n\*)p

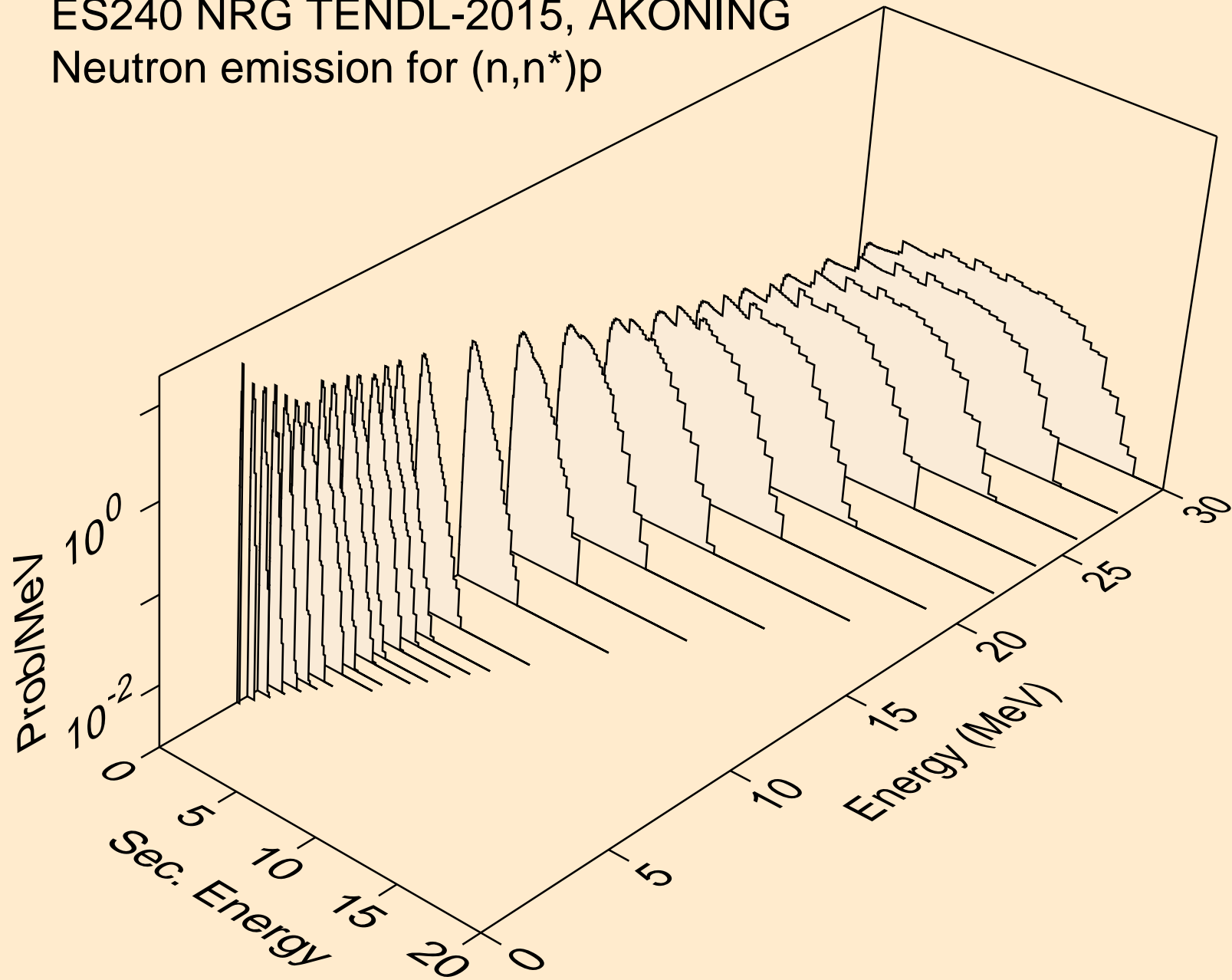

ES240 NRG TENDL-2015, AKONING  
Neutron emission for (n,n\*)2a

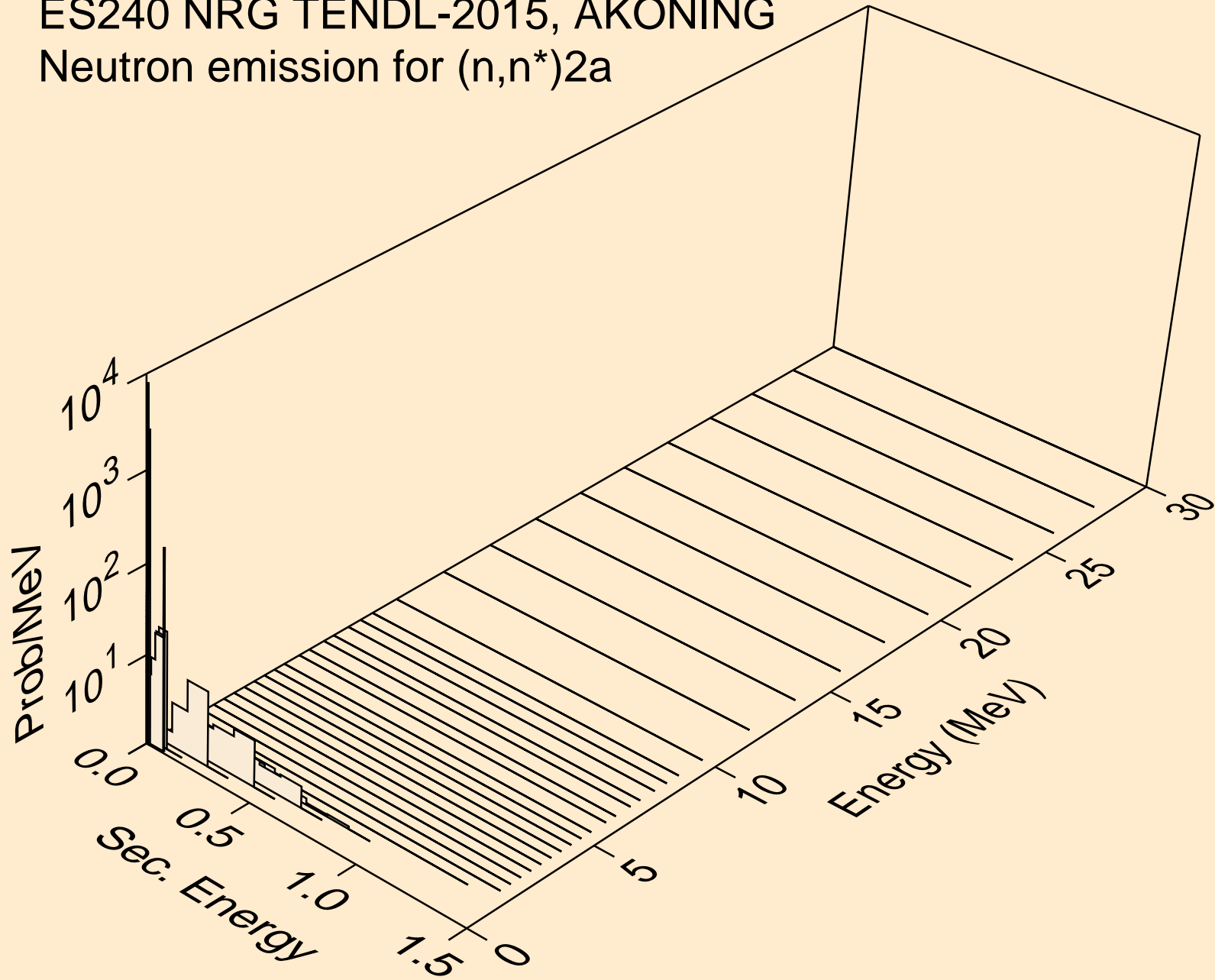

ES240 NRG TENDL-2015, AKONING  
Neutron emission for (n,2n)<sub>2a</sub>

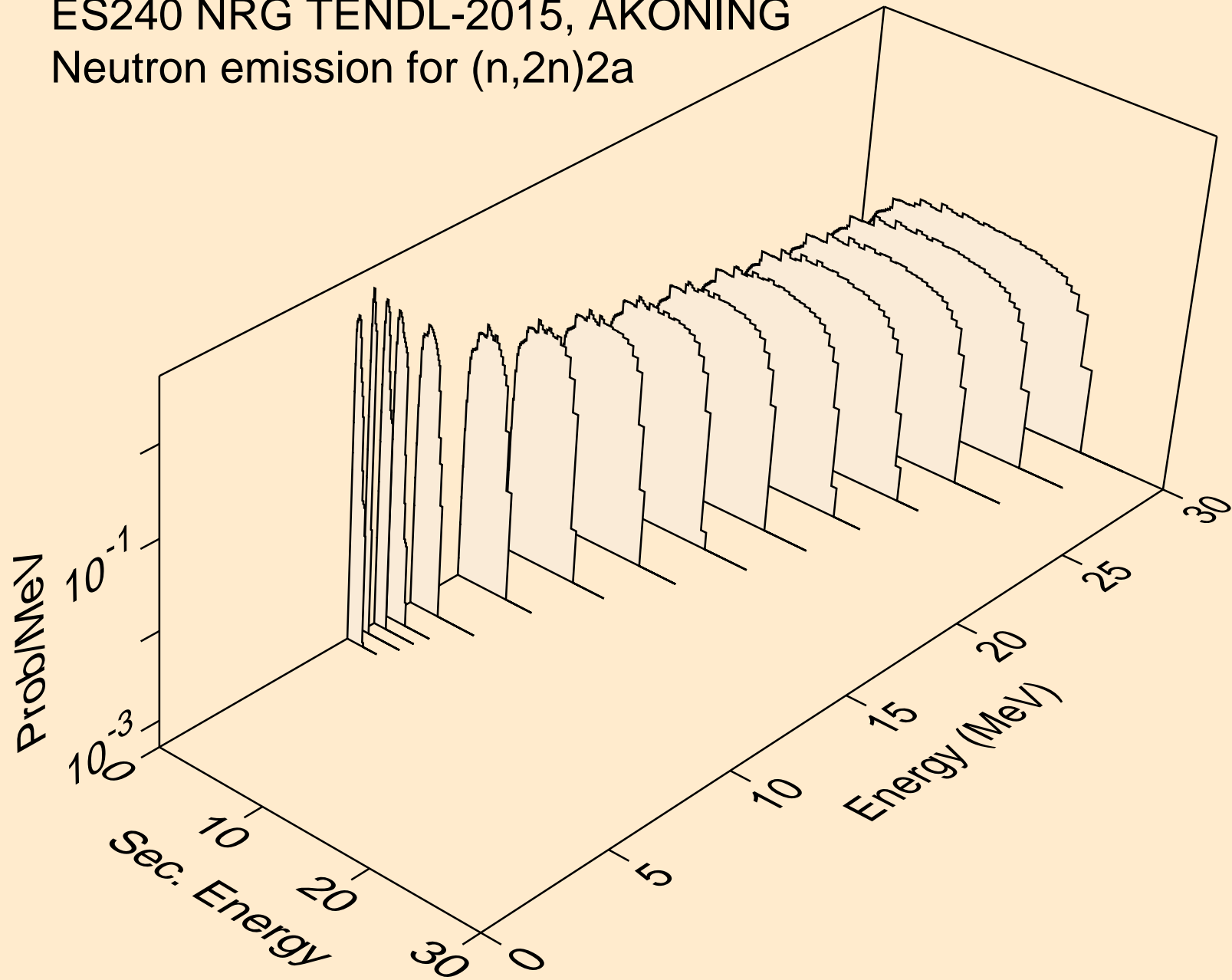

ES240 NRG TENDL-2015, AKONING  
Neutron emission for (n,n\*)d

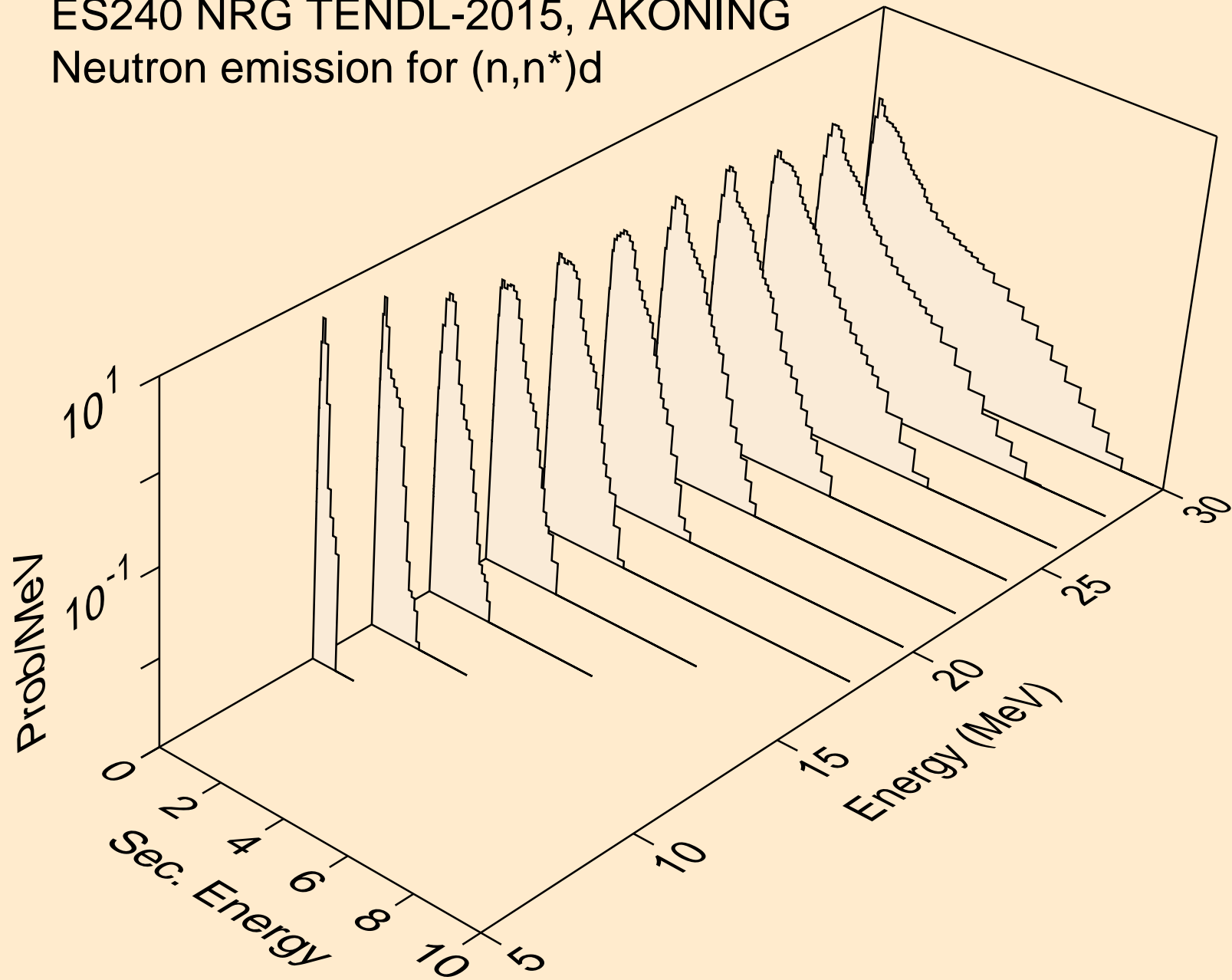

ES240 NRG TENDL-2015, AKONING  
Neutron emission for (n,n\*)t

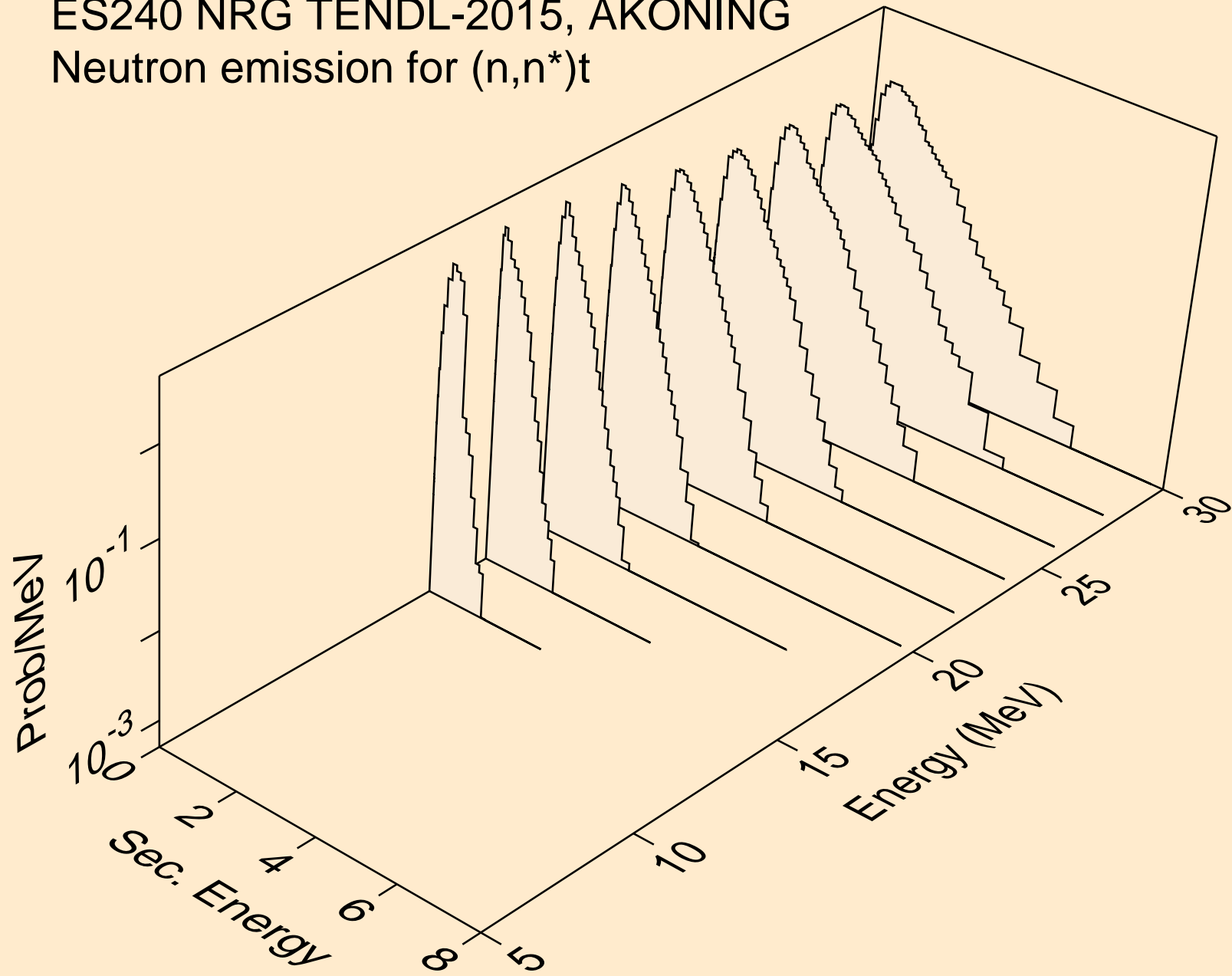

ES240 NRG TENDL-2015, AKONING  
Neutron emission for (n,n\*)he3

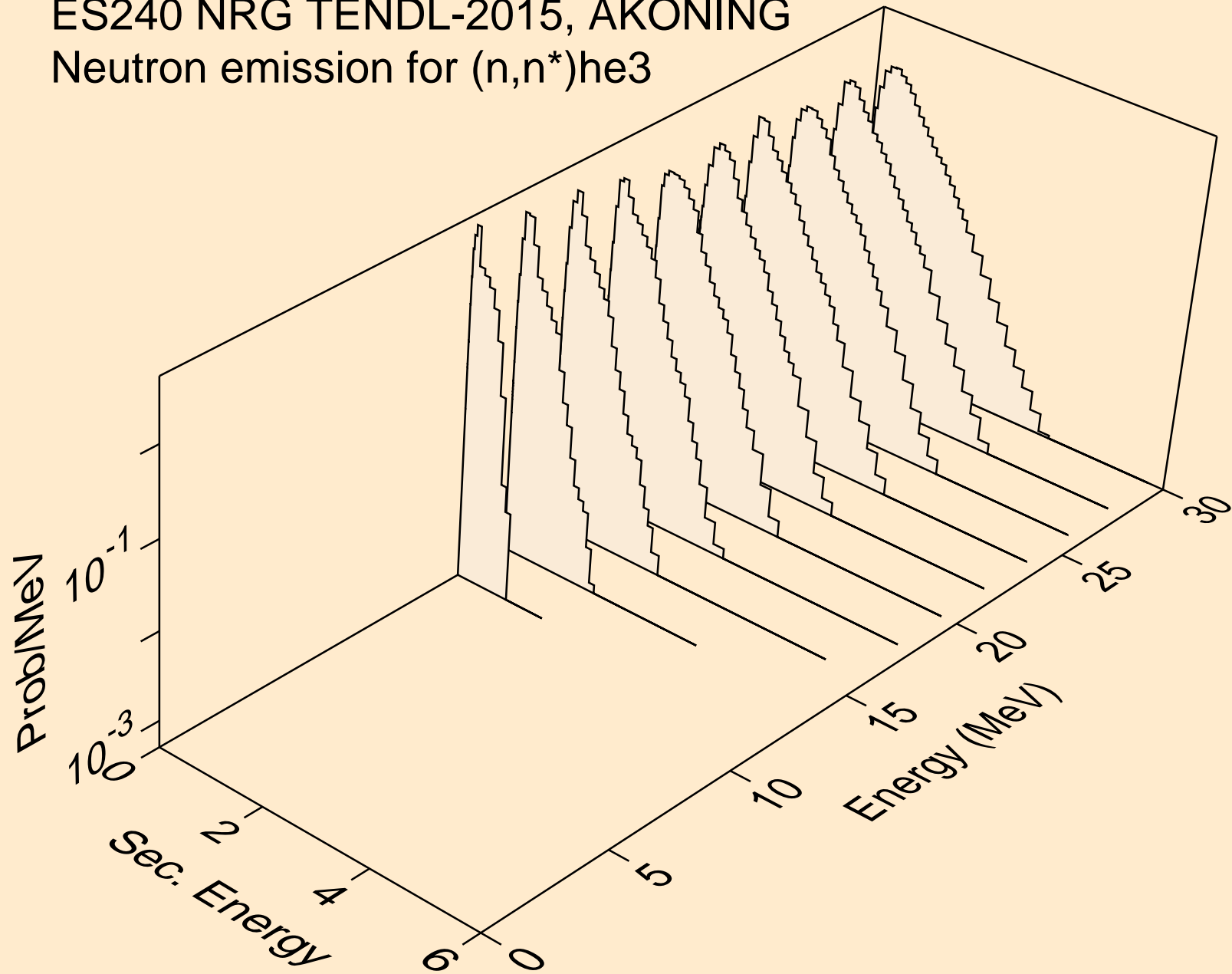



ES240 NRG TENDL-2015, AKONING  
Neutron emission for (n,n\*)d2a

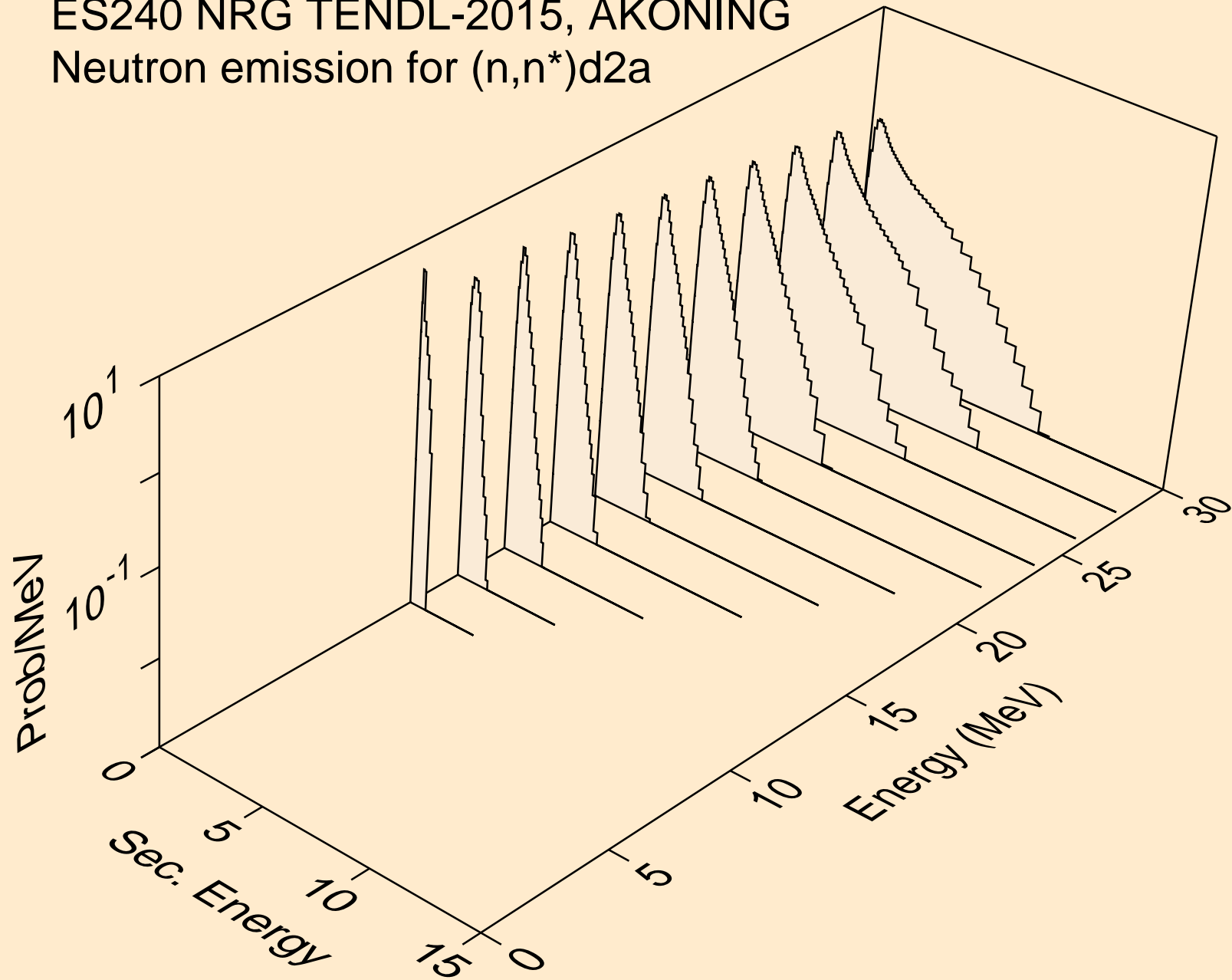

ES240 NRG TENDL-2015, AKONING  
Neutron emission for (n,n\*)t2a

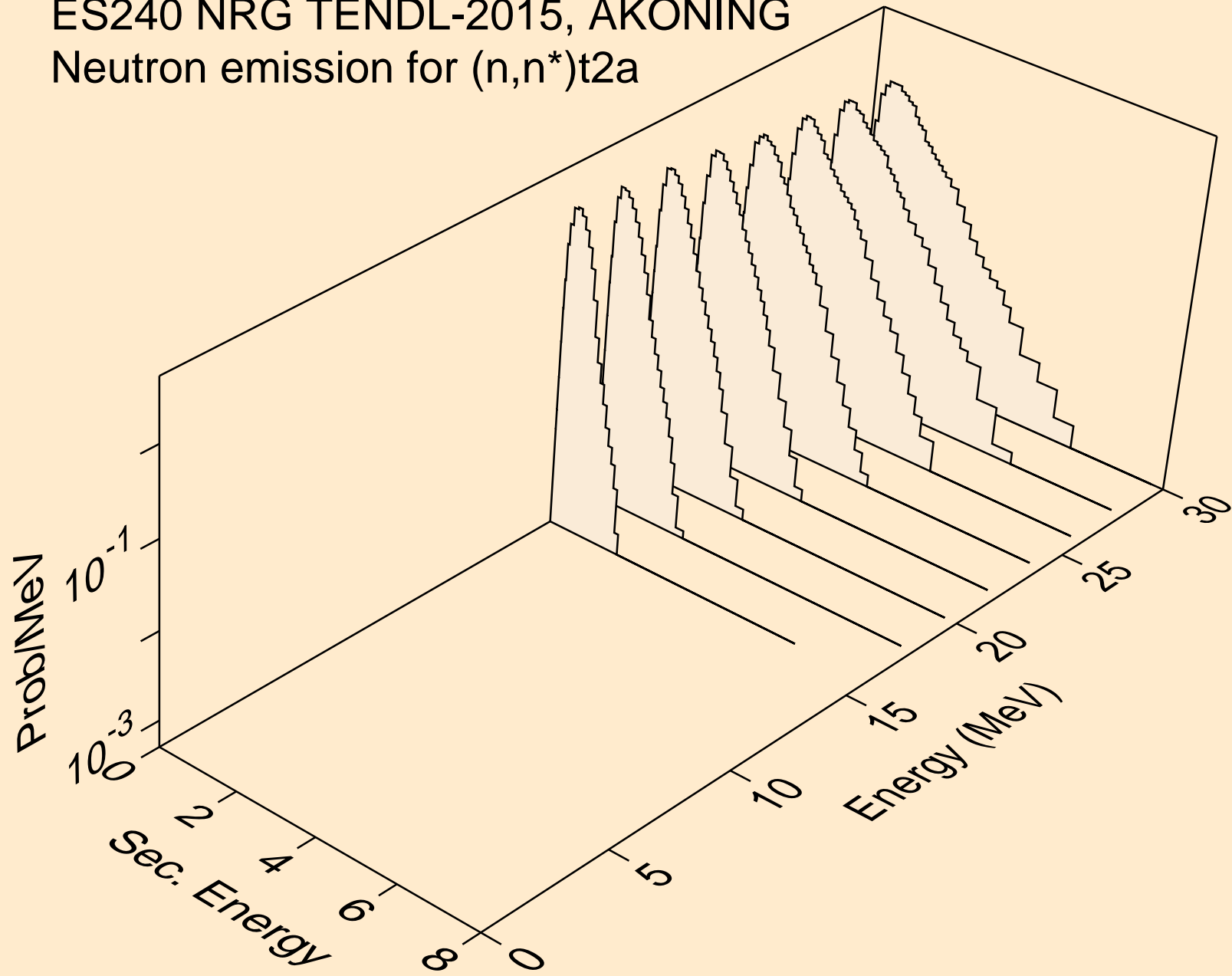

ES240 NRG TENDL-2015, AKONING  
Neutron emission for (n,2np)

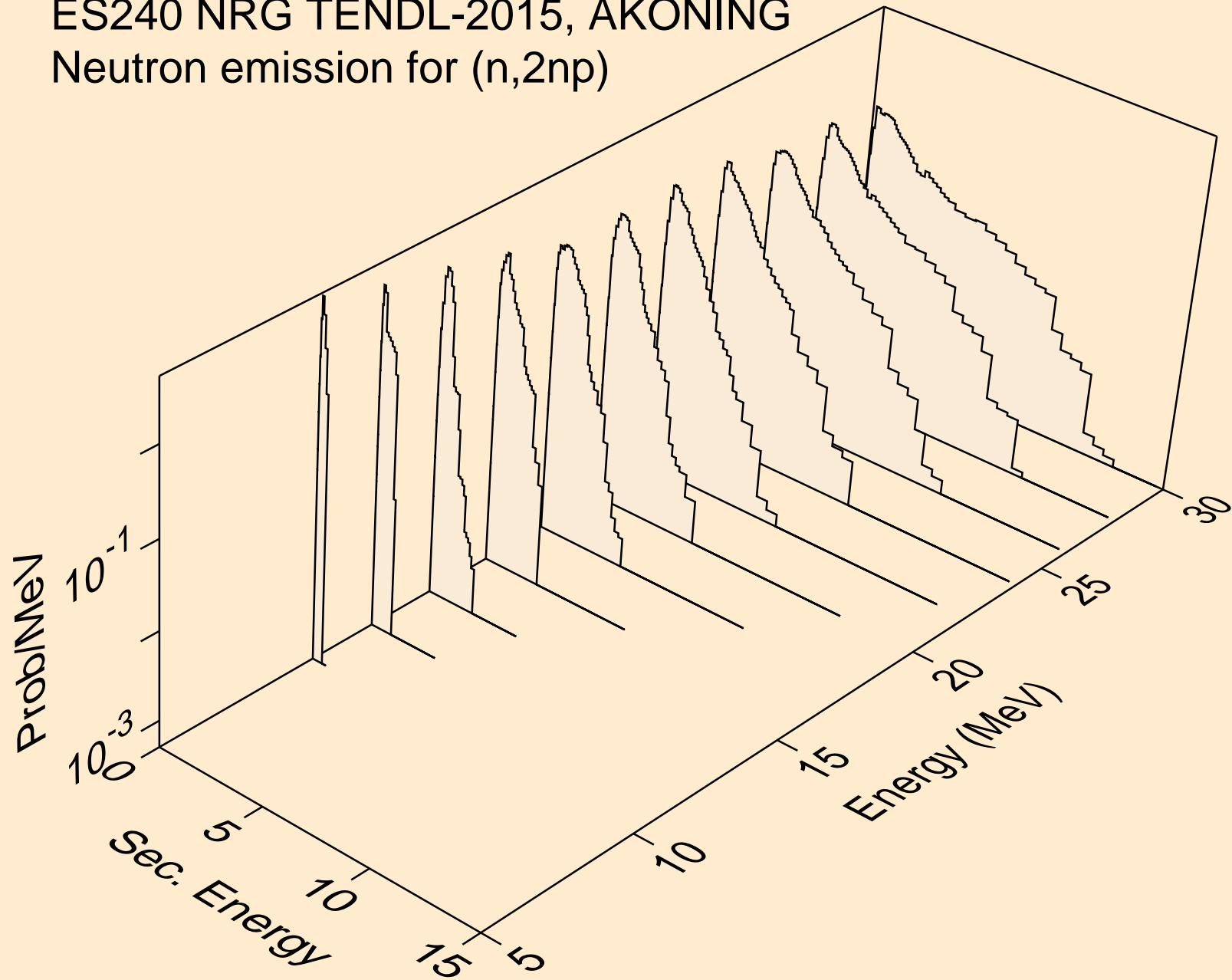

ES240 NRG TENDL-2015, AKONING  
Neutron emission for (n,3np)

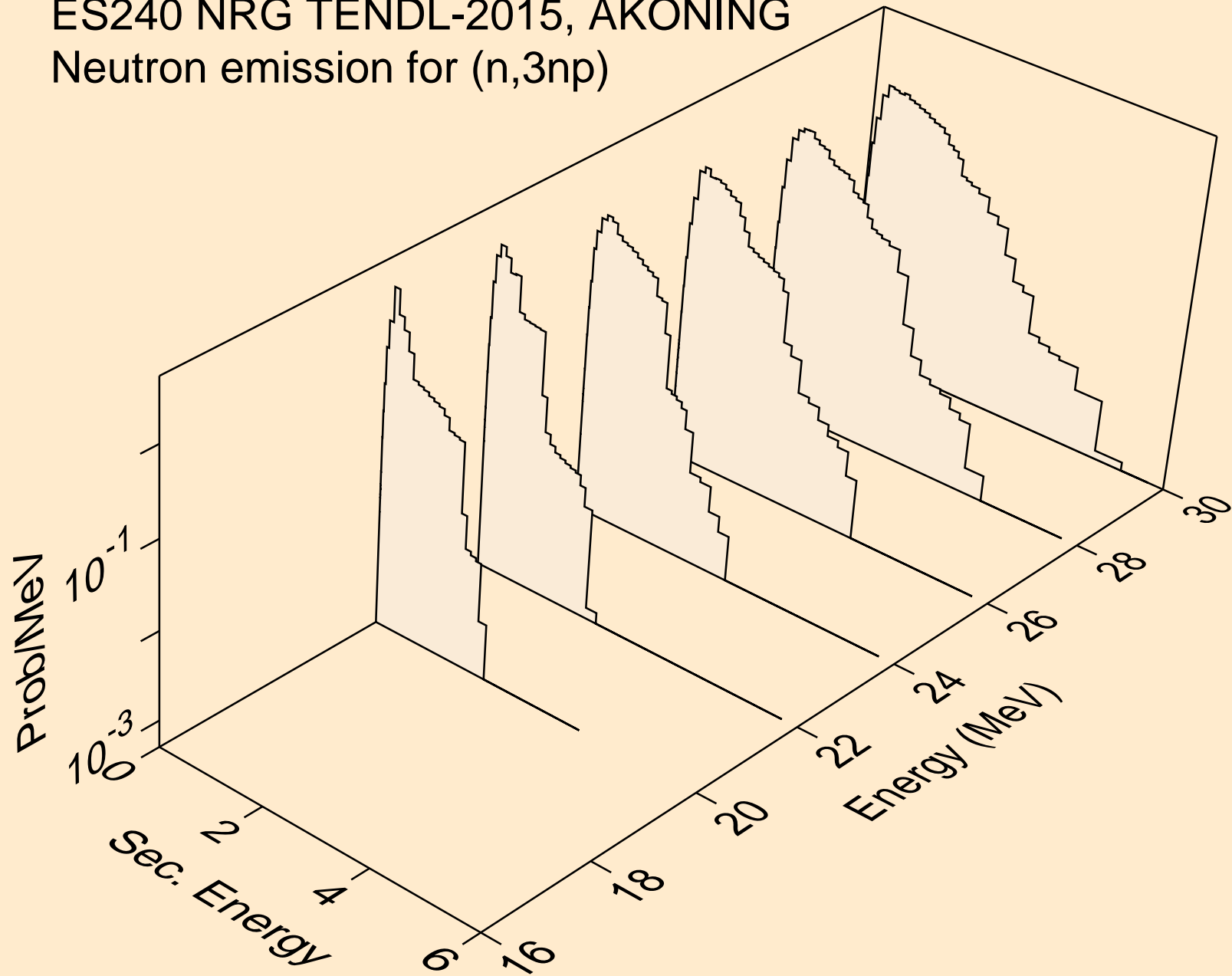

ES240 NRG TENDL-2015, AKONING  
Neutron emission for (n,2np)

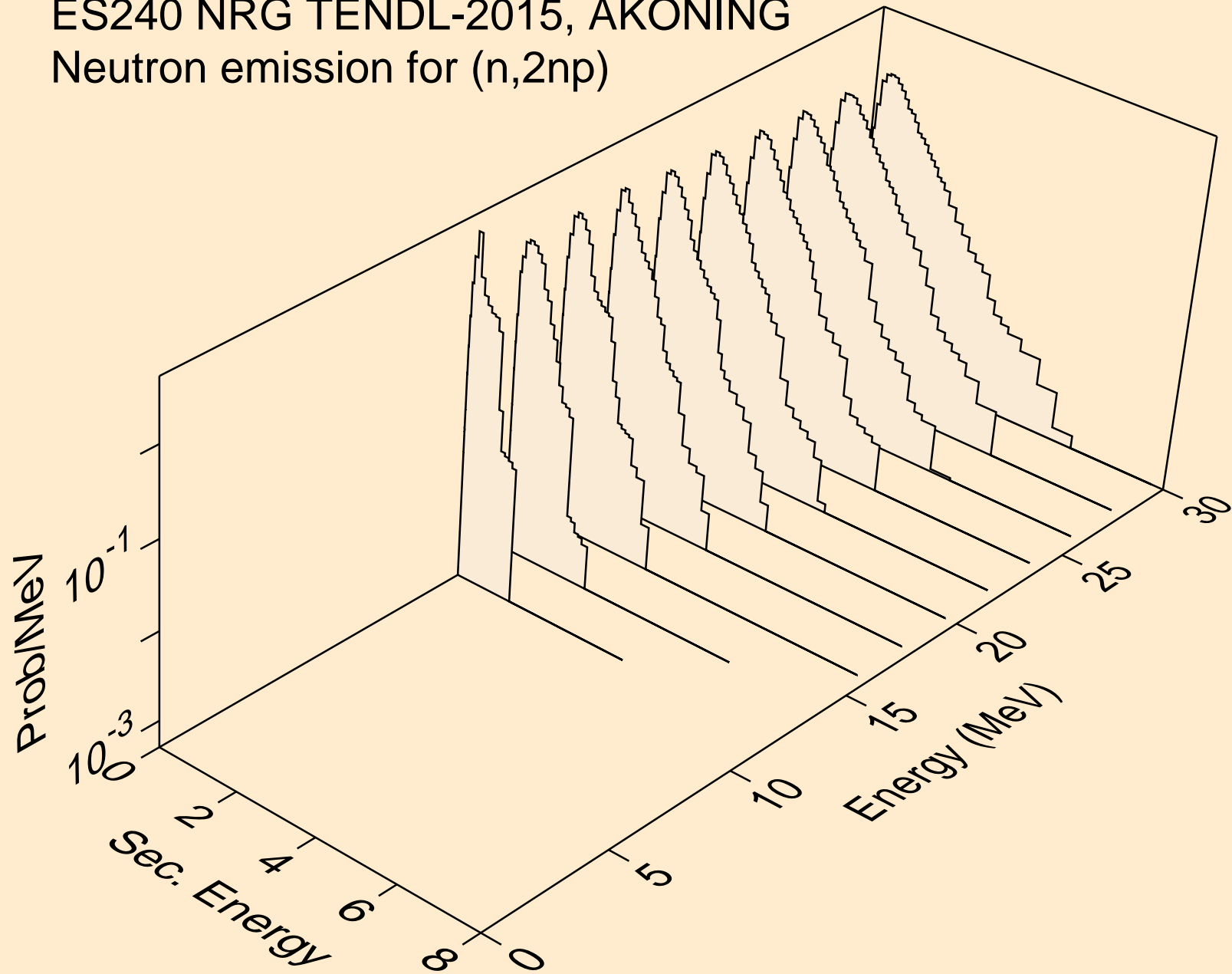

ES240 NRG TENDL-2015, AKONING  
Neutron emission for (n,npa)

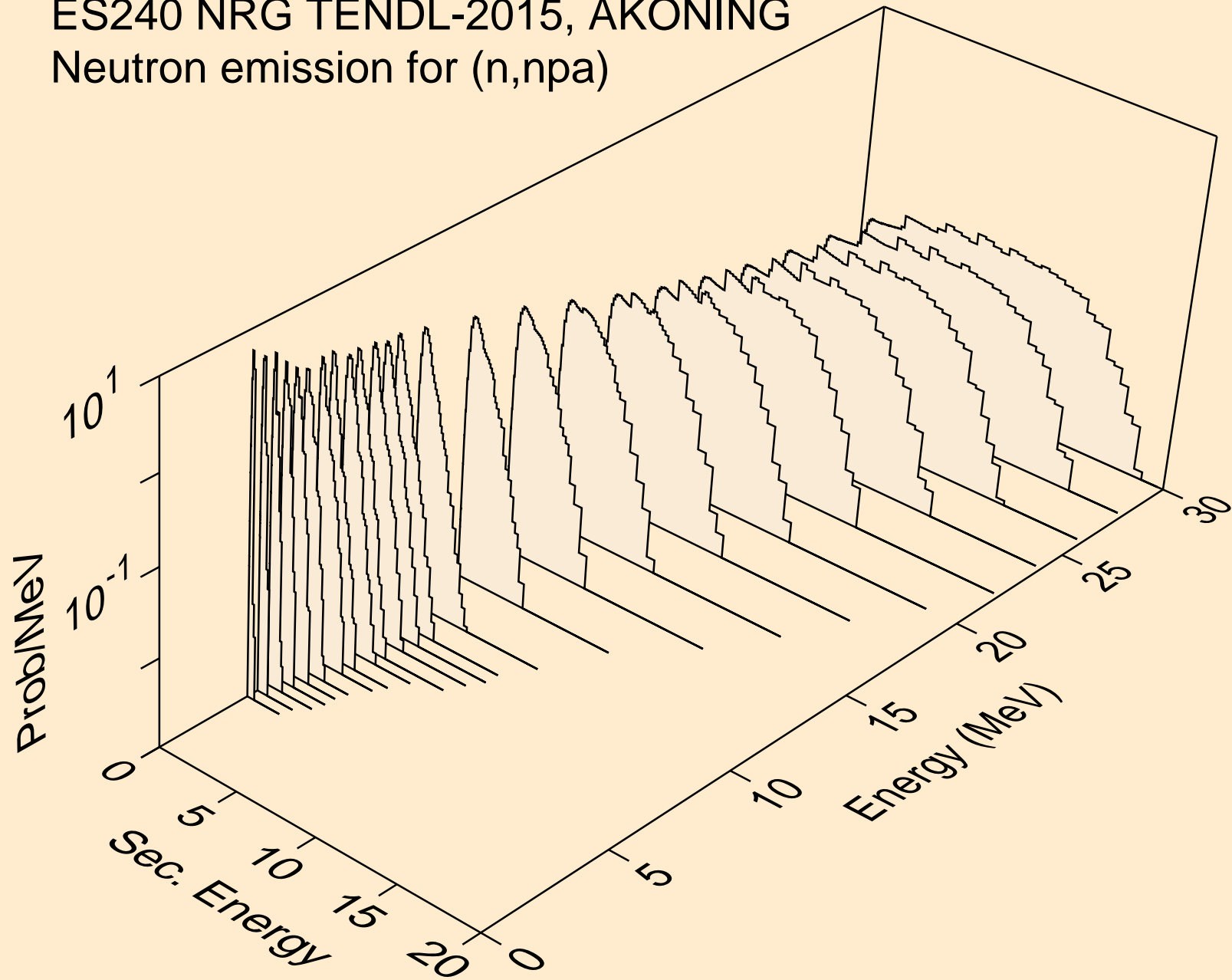

ES240 NRG TENDL-2015, AKONING  
Neutron emission for (n,n\*c)

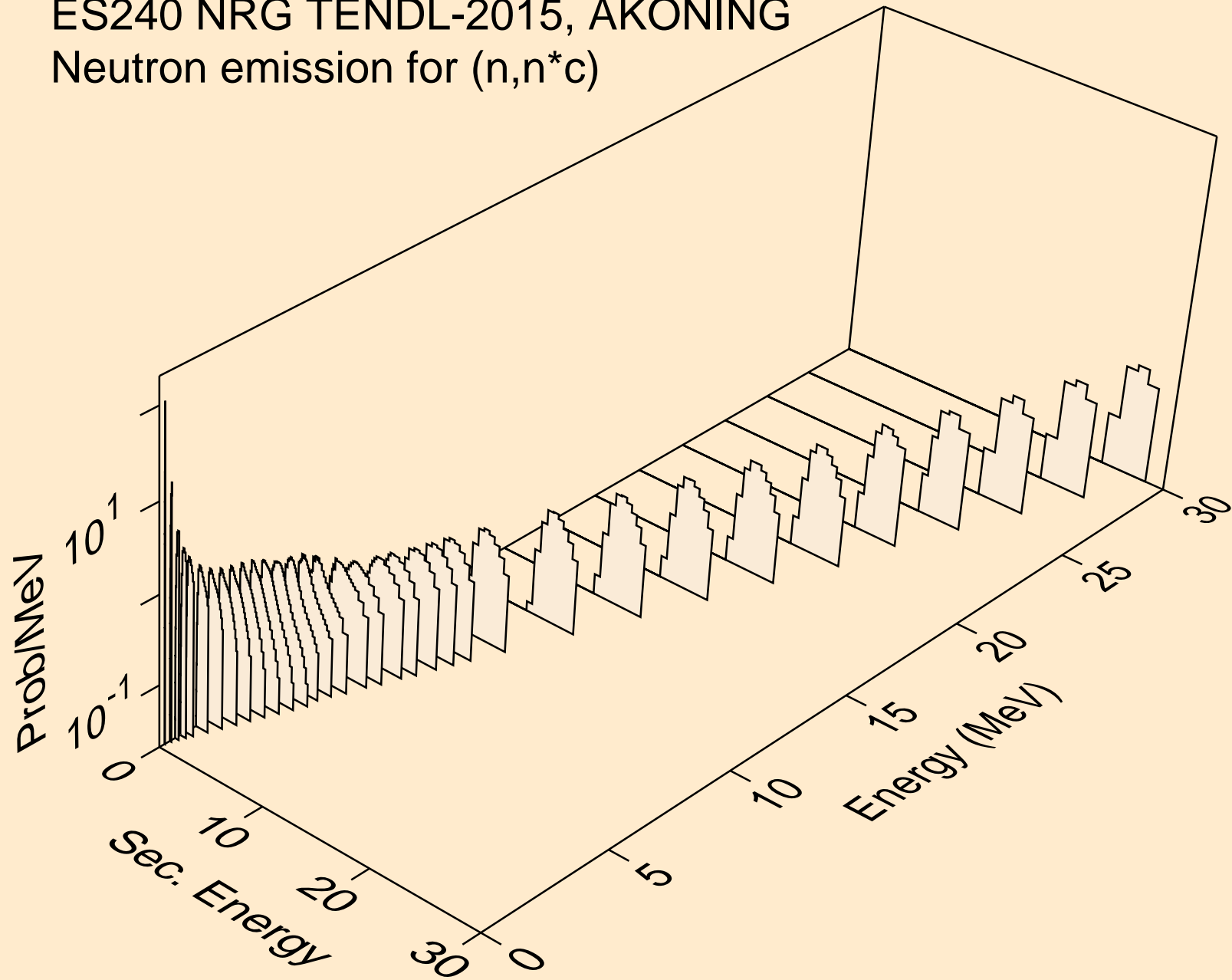

# ES240 NRG TENDL-2015, AKONING

Delayed nubar

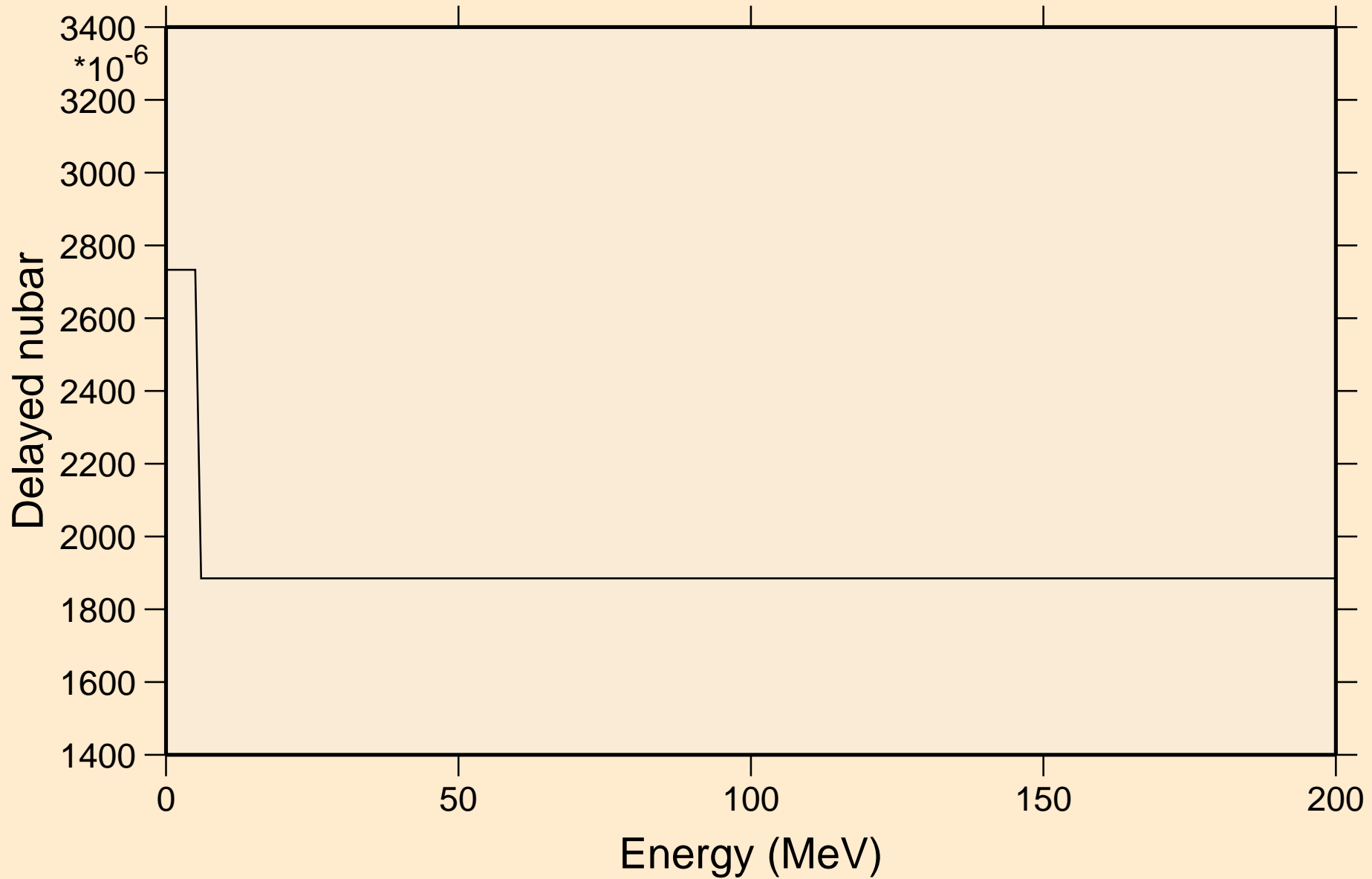



# ES240 NRG TENDL-2015, AKONING

## Delayed neutron spectra

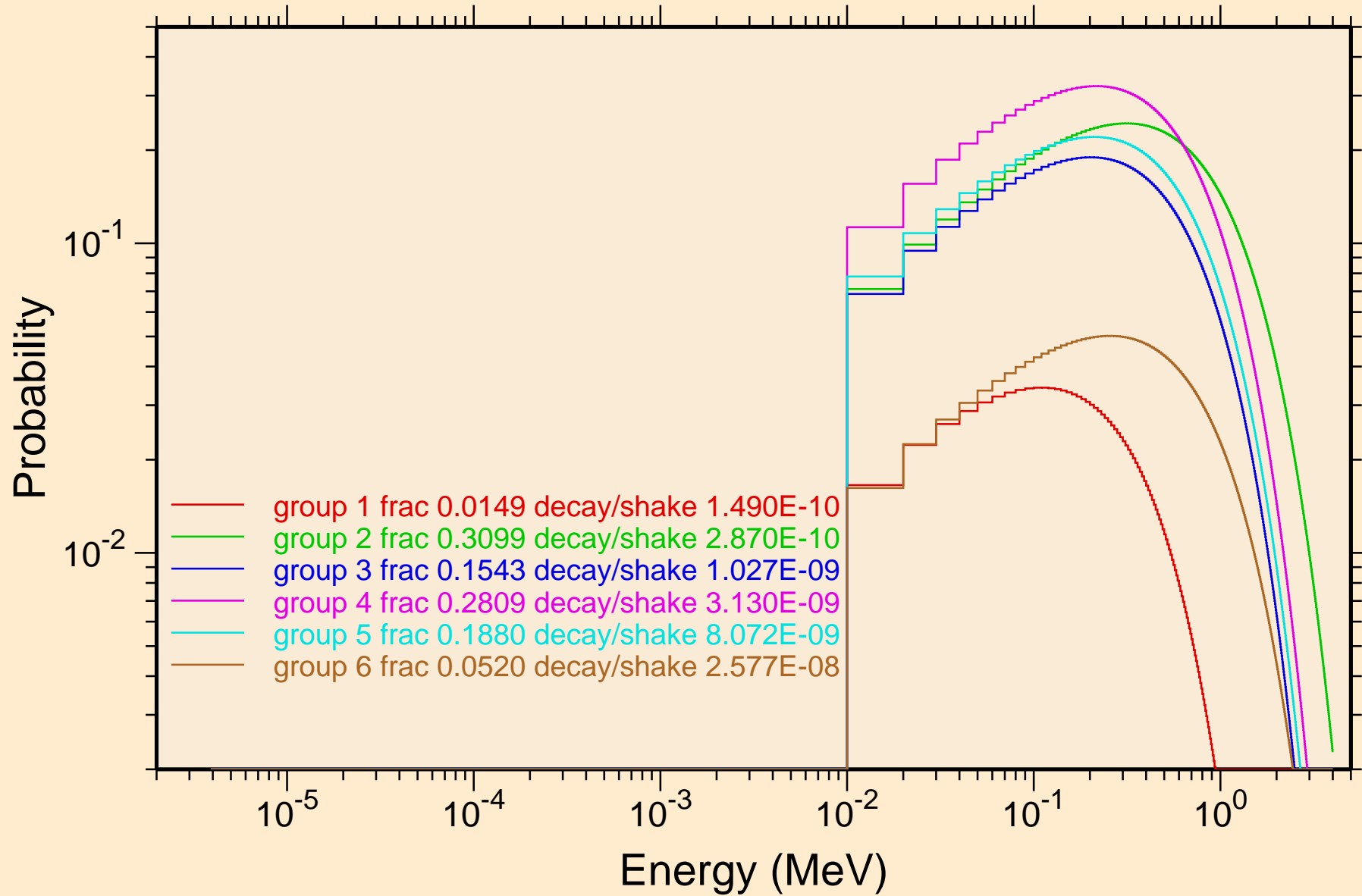

ES240 NRG TENDL-2015, AKONING  
Photon emission for (n,x)

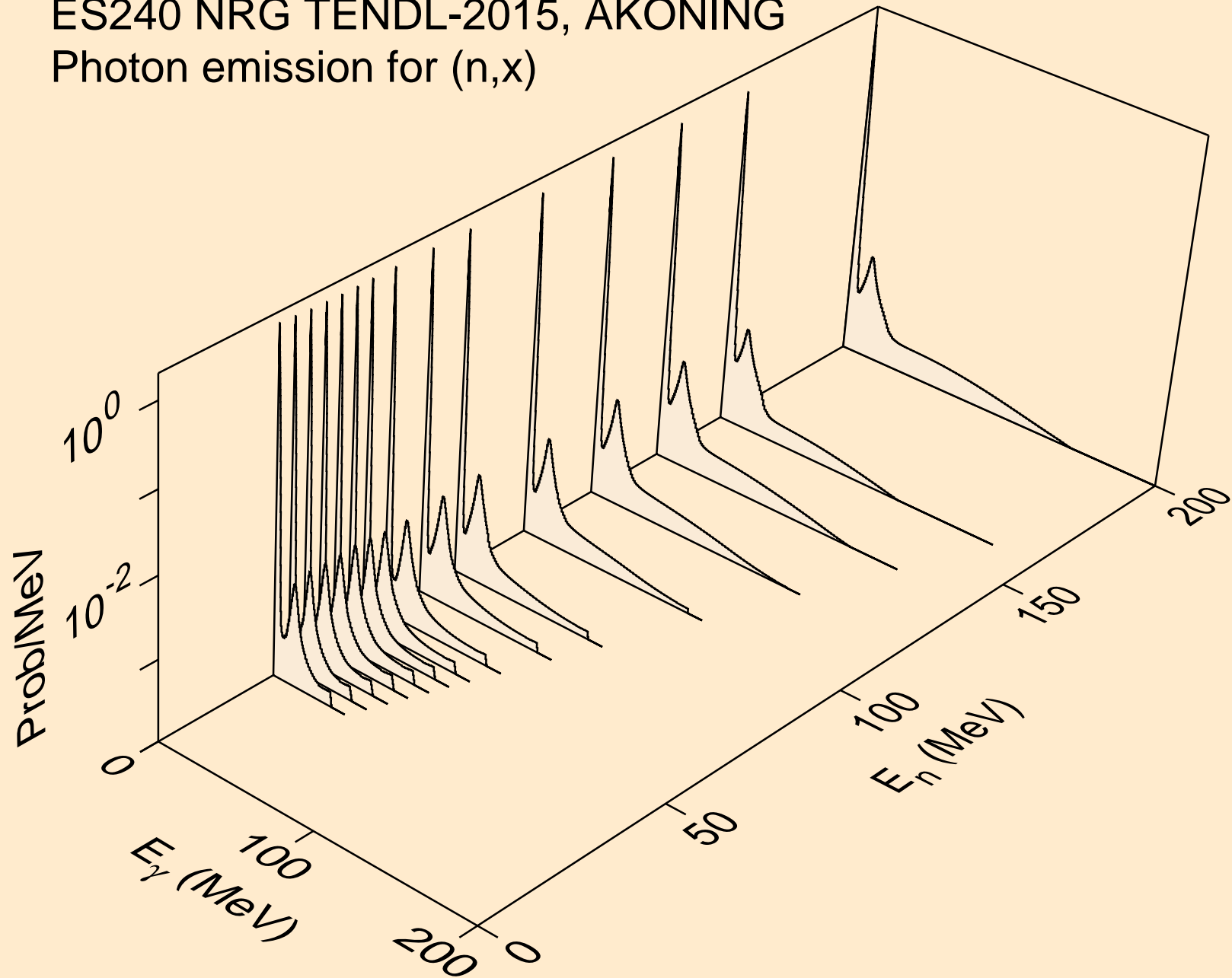

ES240 NRG TENDL-2015, AKONING  
Photon emission for (n,2nd)

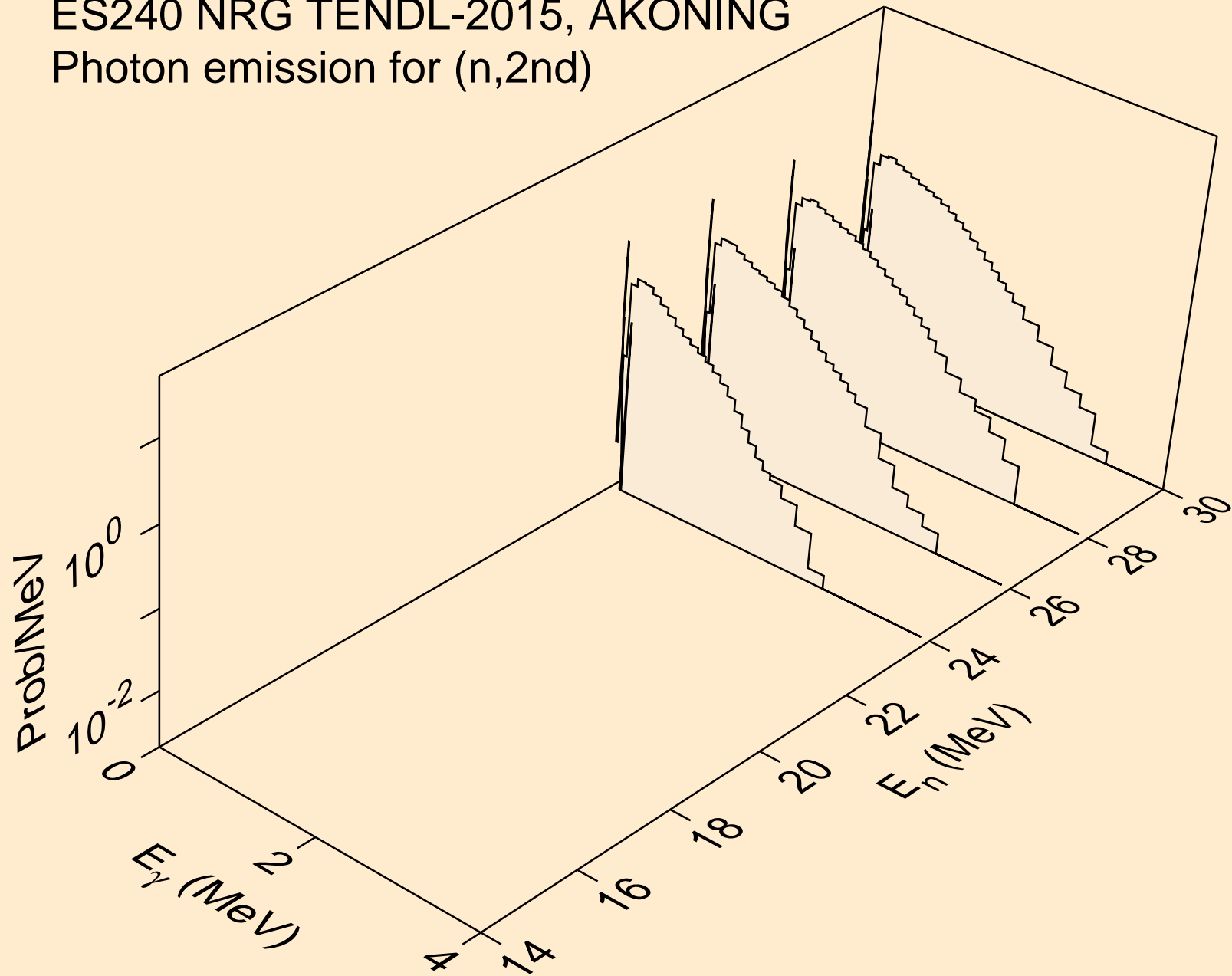

ES240 NRG TENDL-2015, AKONING  
Photon emission for (n,2n)

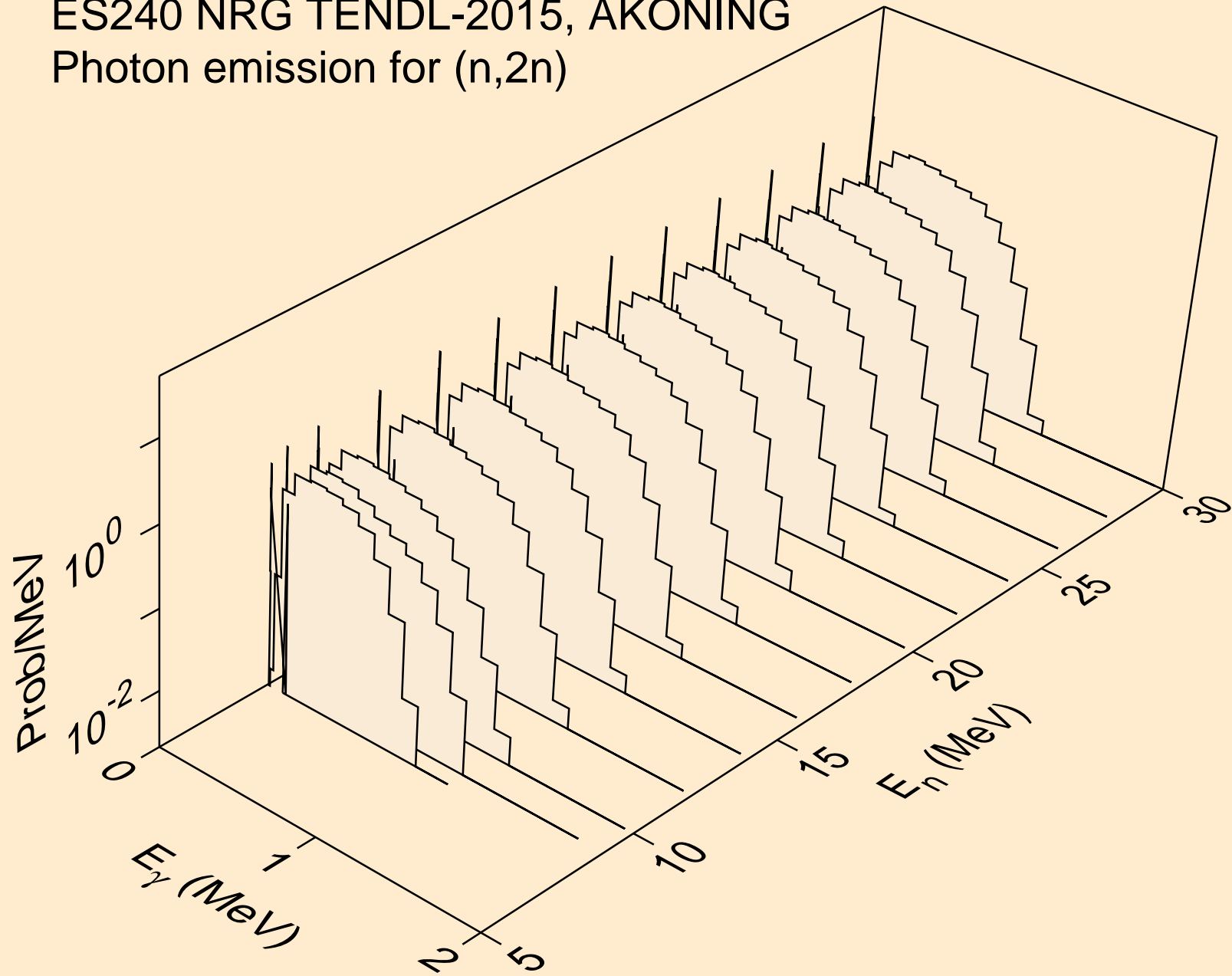

ES240 NRG TENDL-2015, AKONING  
Photon emission for (n,3n)

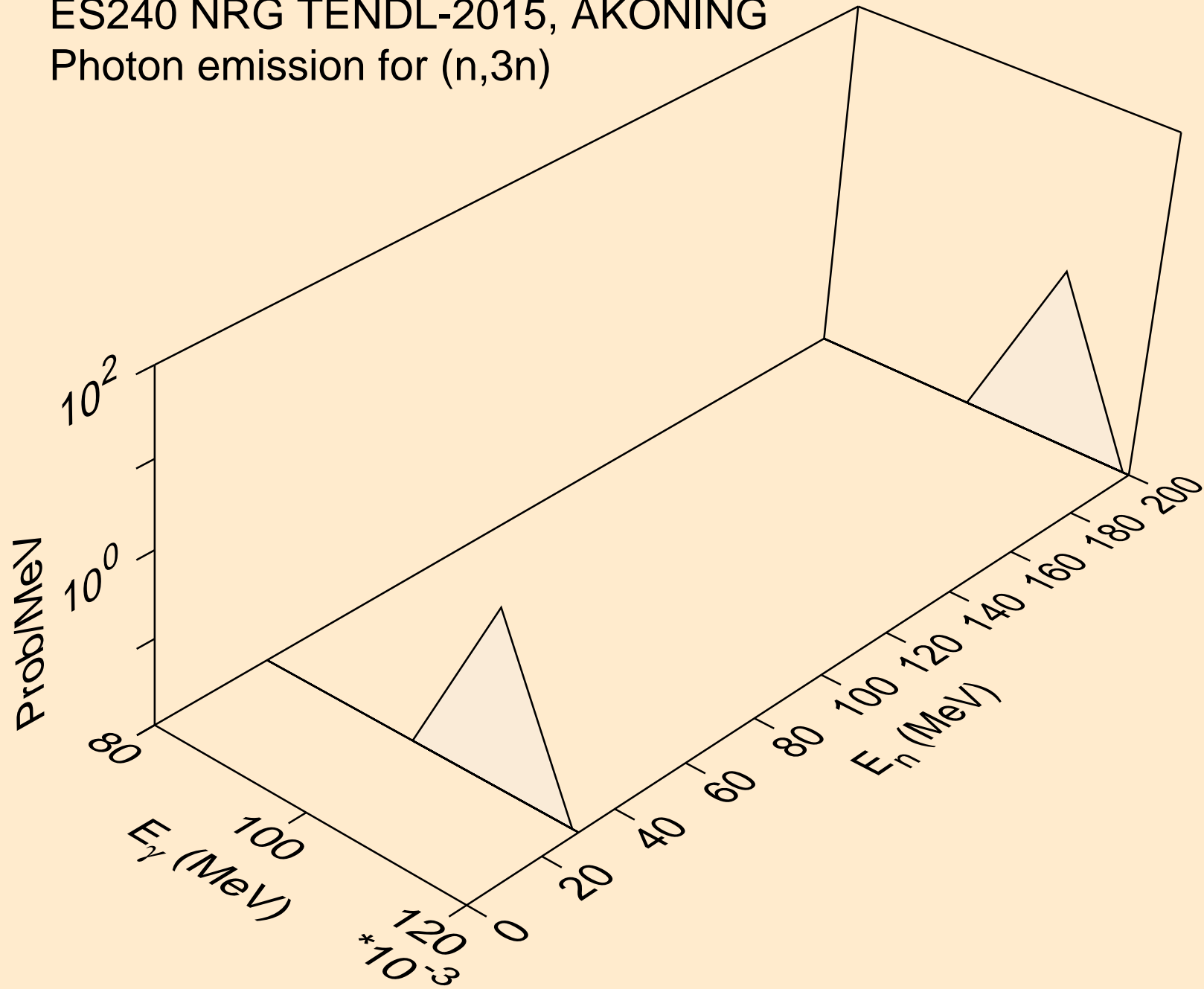

ES240 NRG TENDL-2015, AKONING  
Photon emission for (n,n\*)a

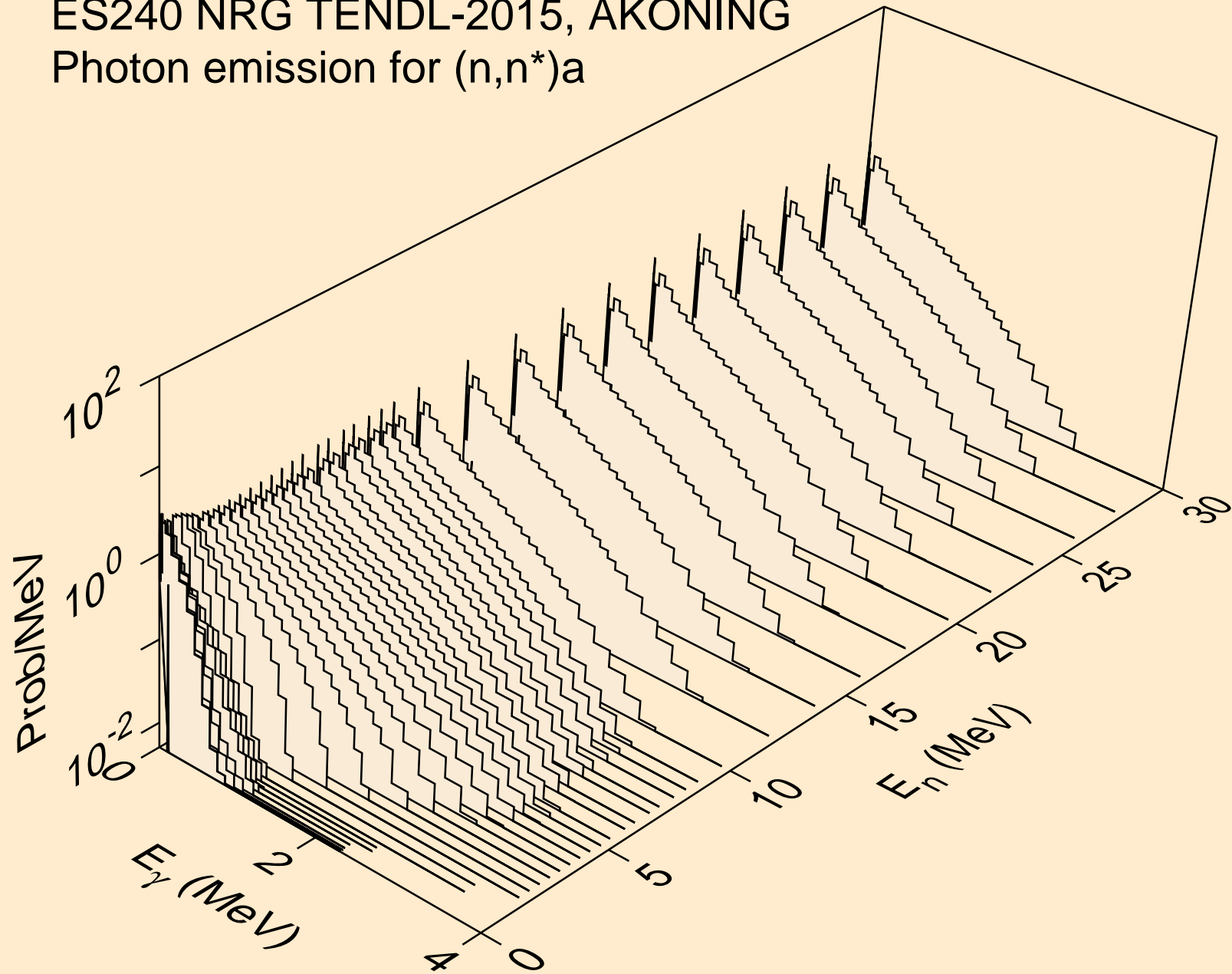

ES240 NRG TENDL-2015, AKONING  
Photon emission for (n,n\*)3a

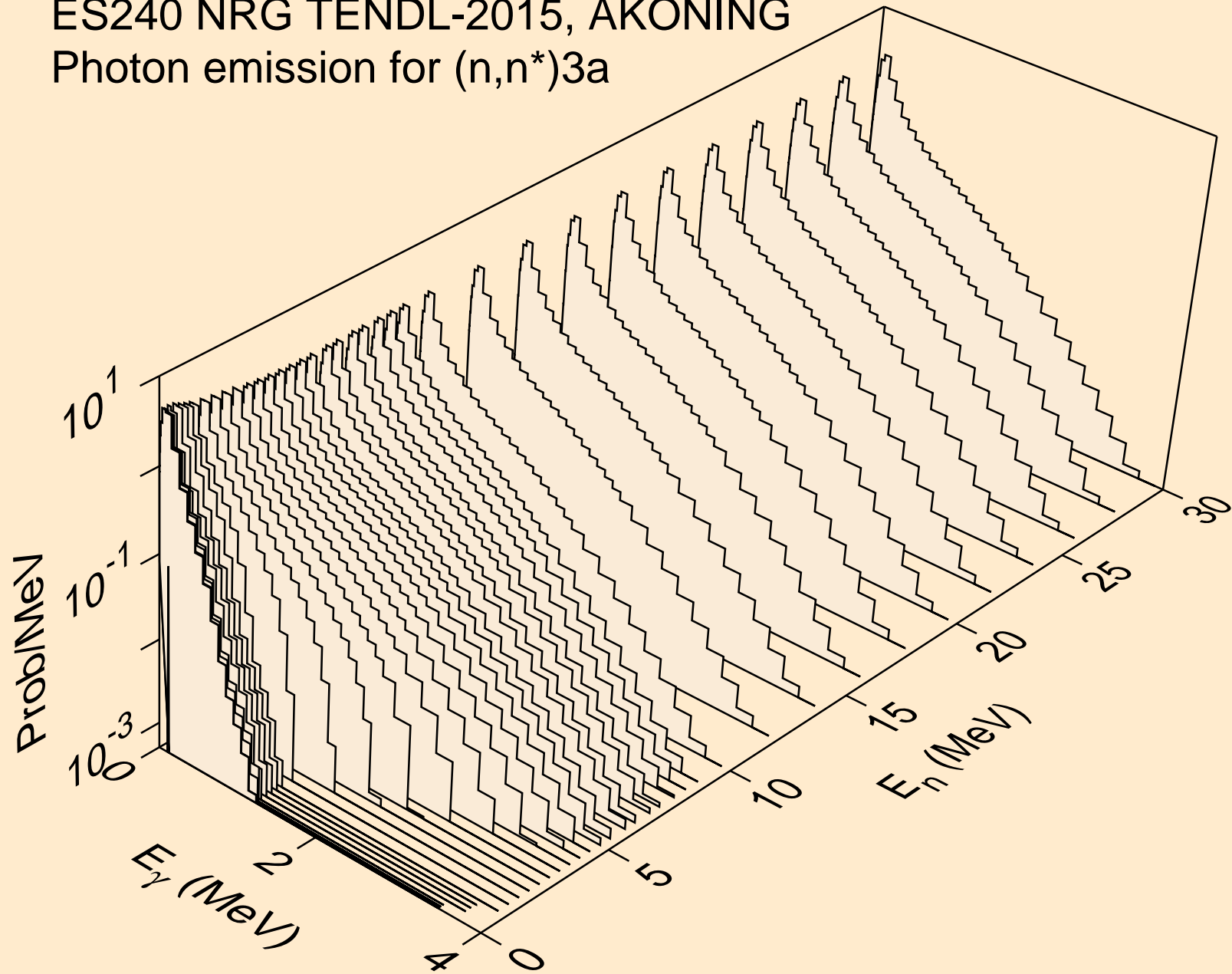

ES240 NRG TENDL-2015, AKONING  
Photon emission for (n,2n)a

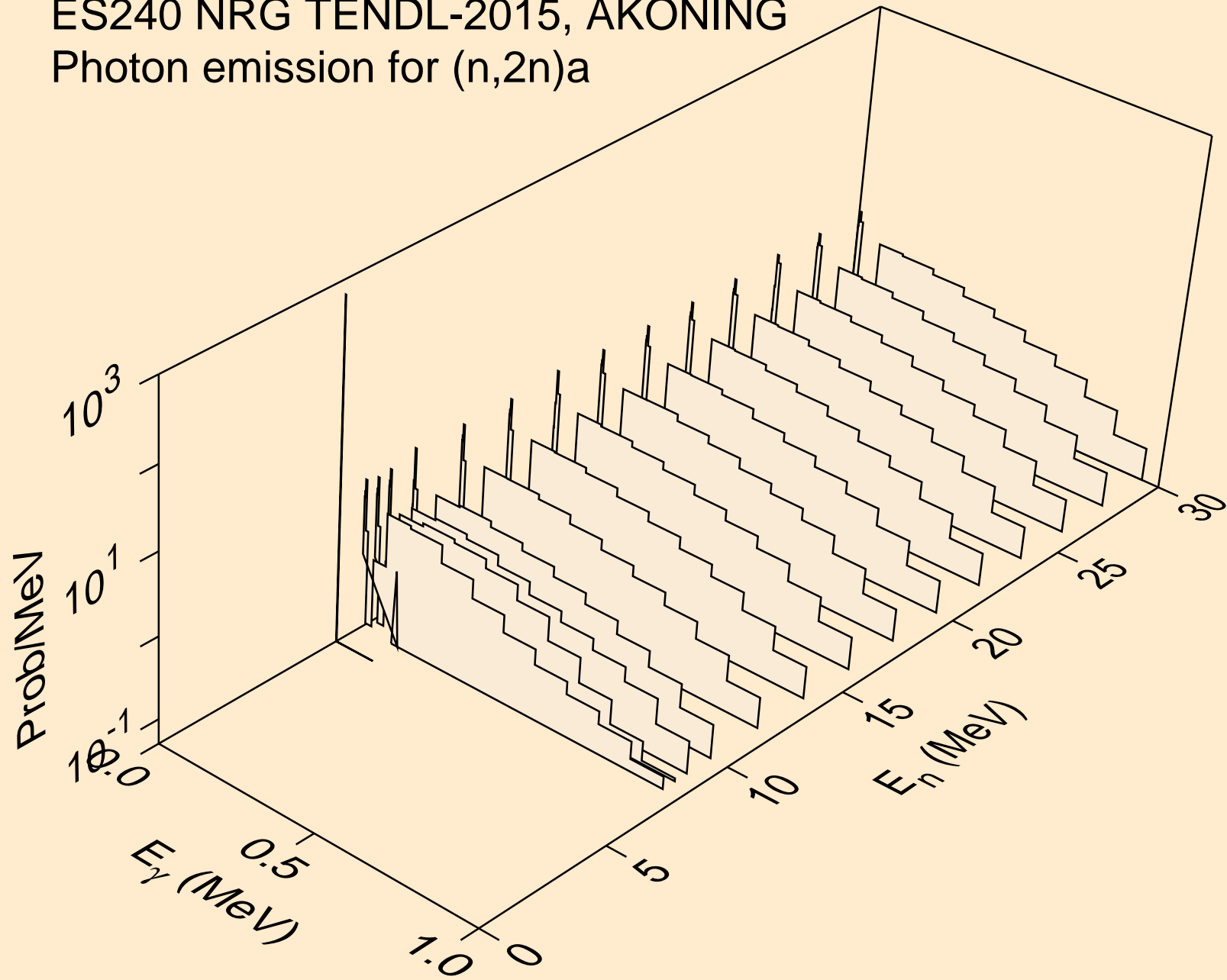



ES240 NRG TENDL-2015, AKONING  
Photon emission for (n,3n)a

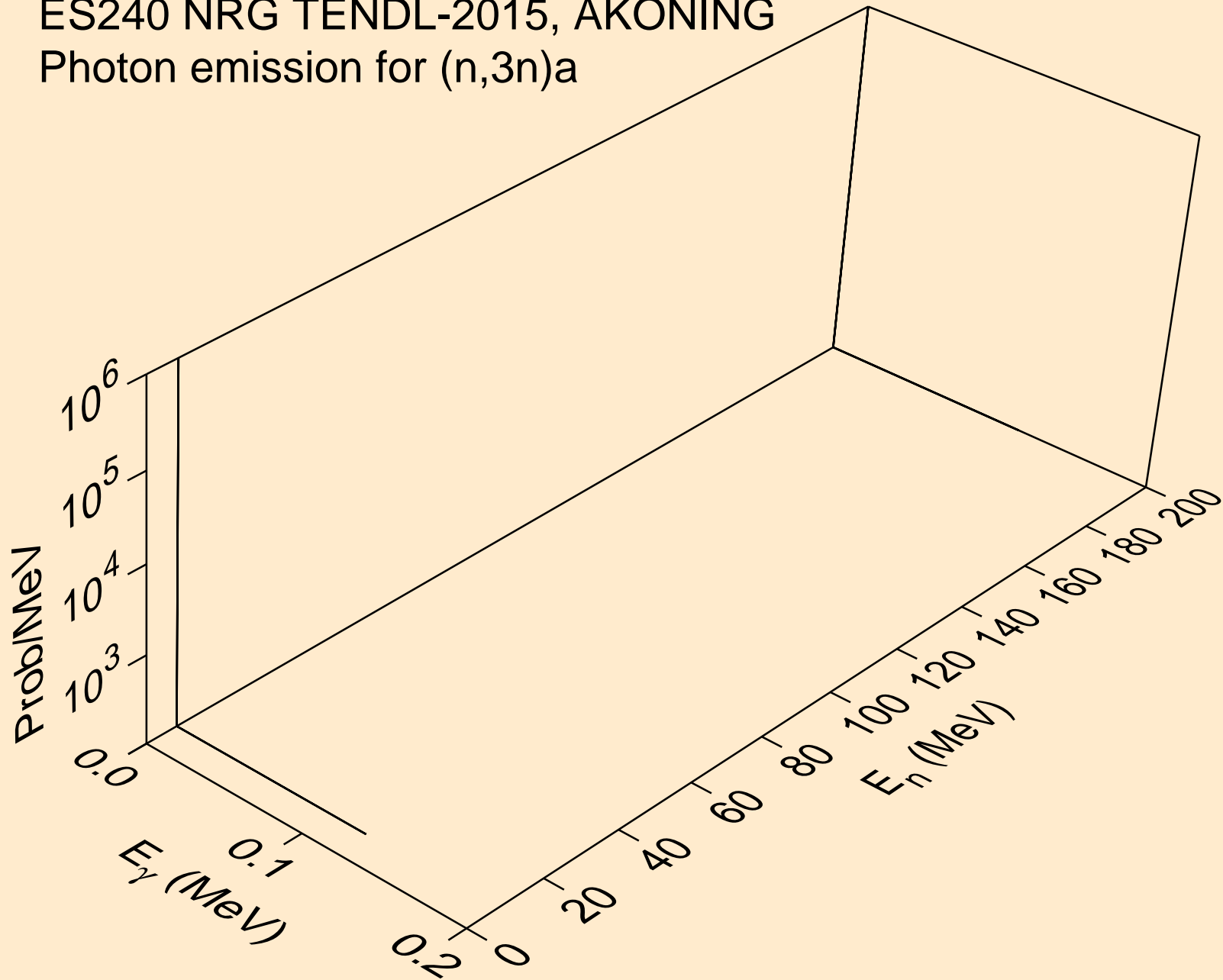

ES240 NRG TENDL-2015, AKONING  
Photon emission for (n,n\*)p

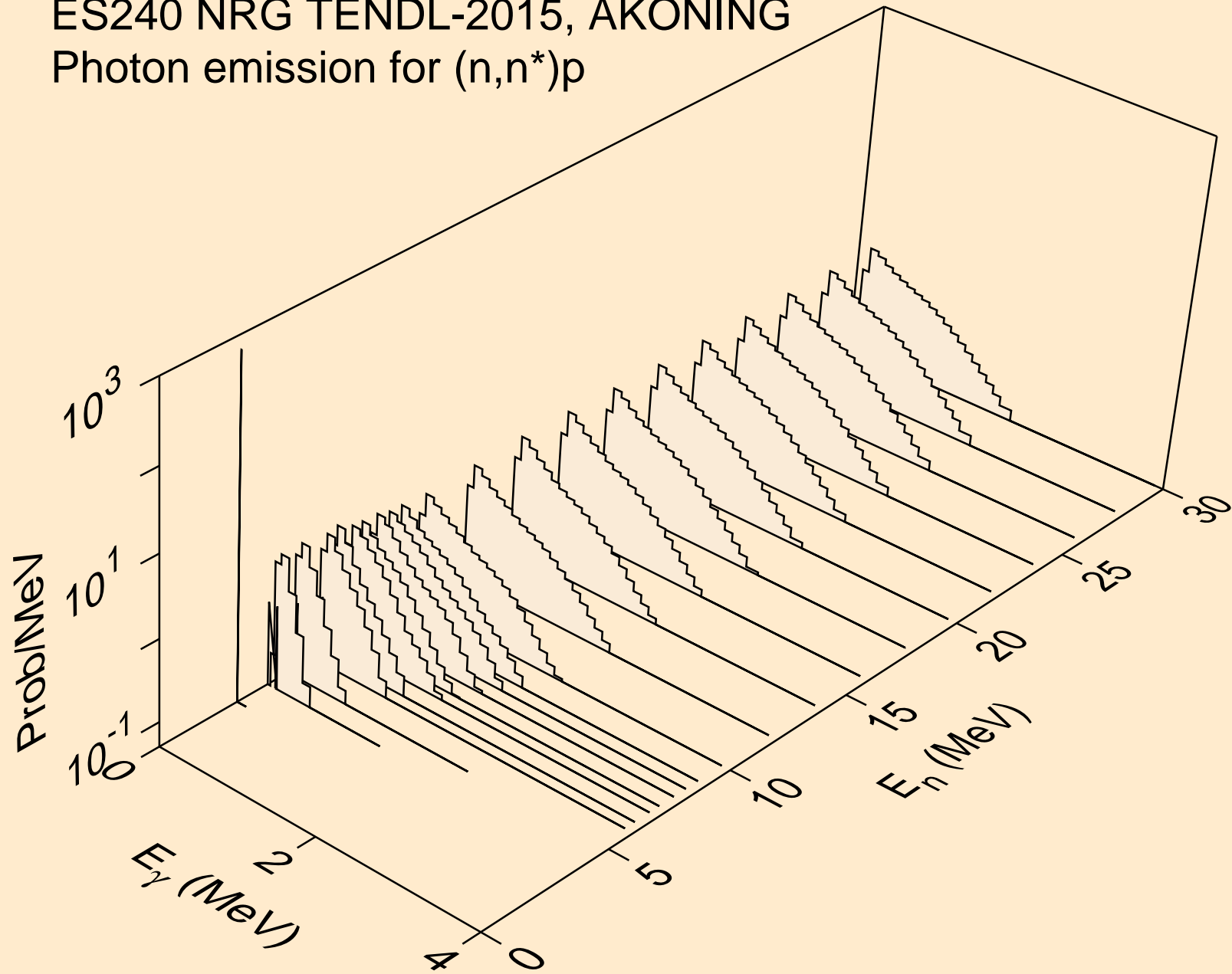

ES240 NRG TENDL-2015, AKONING  
Photon emission for (n,n\*)2a

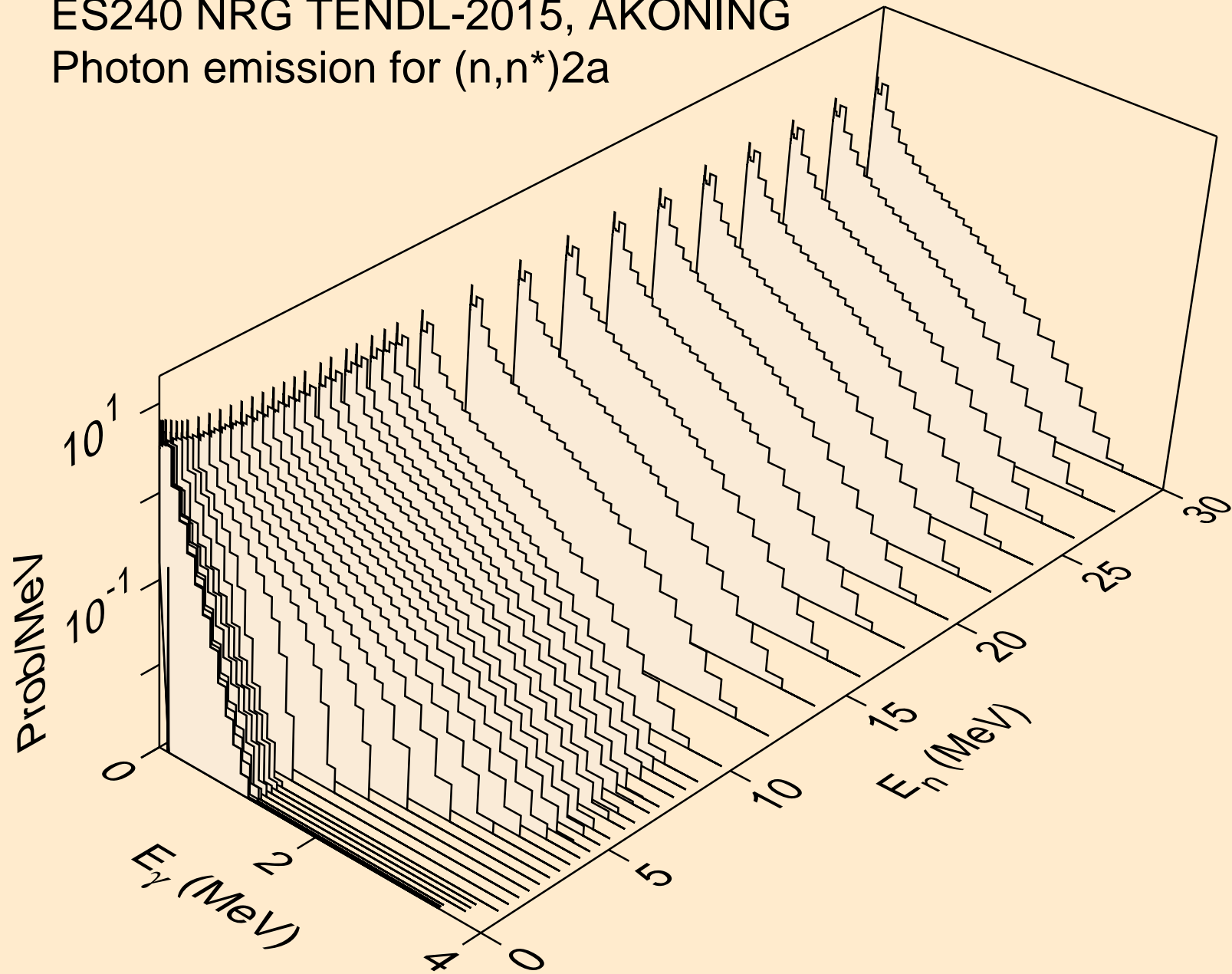

ES240 NRG TENDL-2015, AKONING  
Photon emission for (n,2n)2a

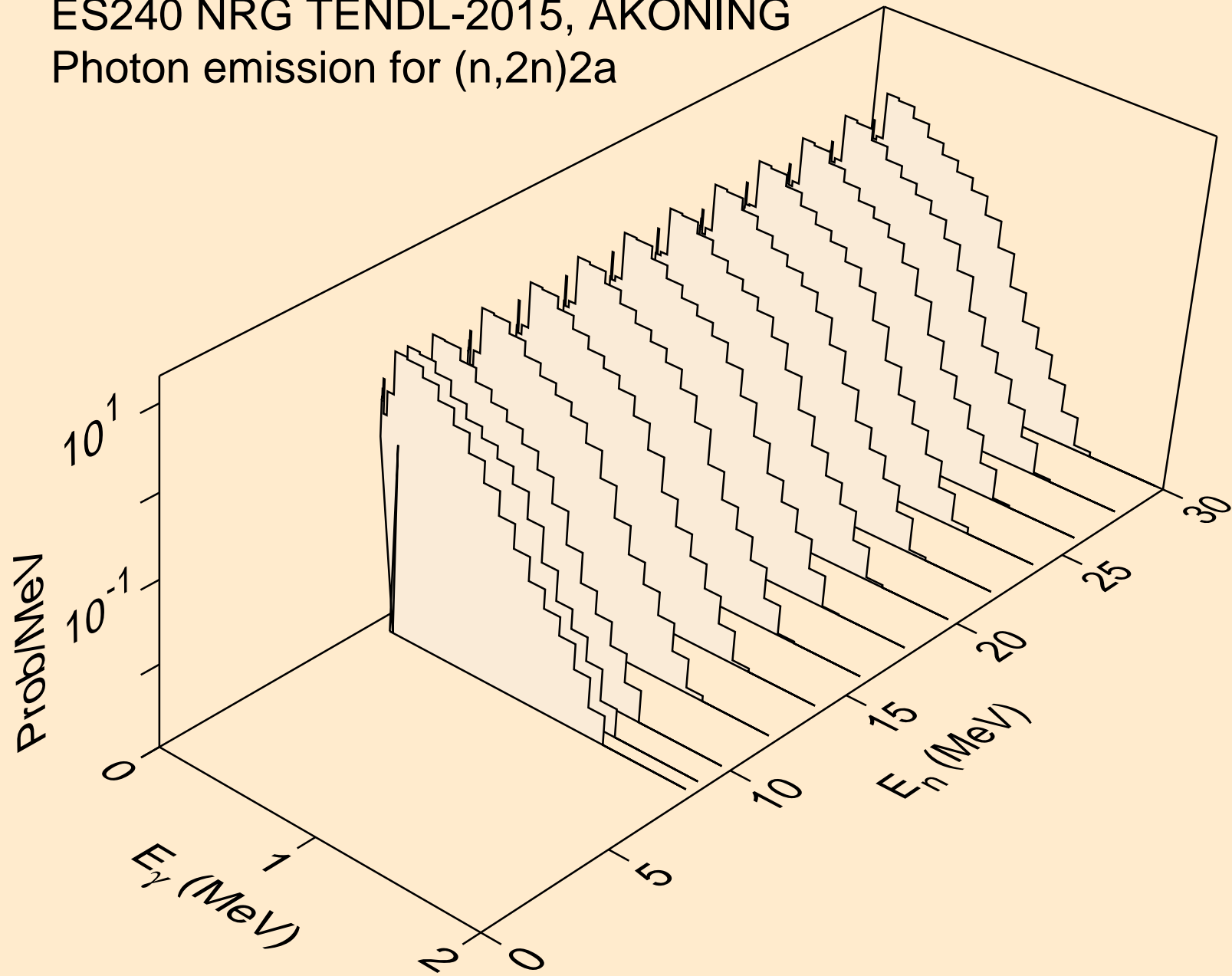

ES240 NRG TENDL-2015, AKONING  
Photon emission for (n,n\*)d

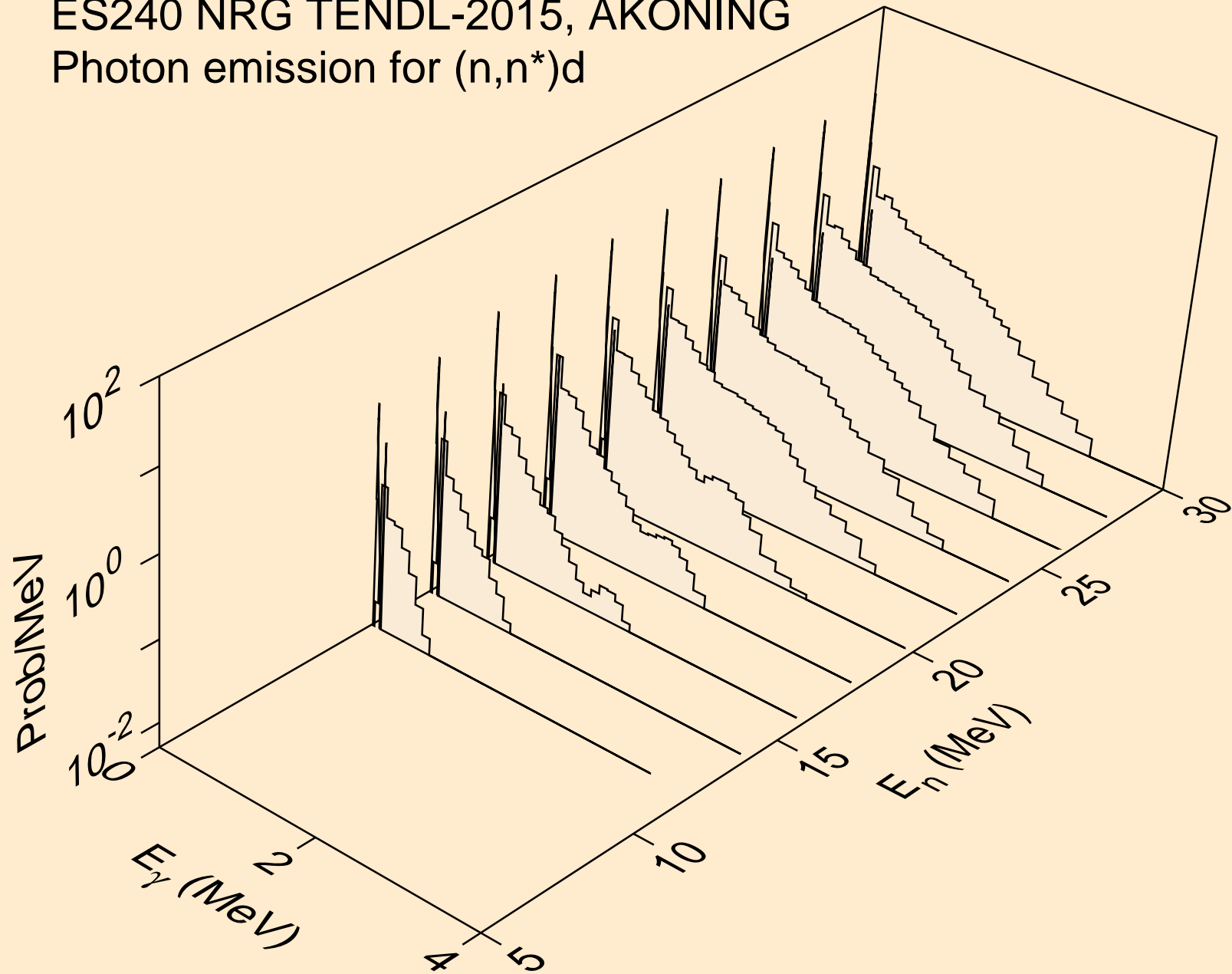

ES240 NRG TENDL-2015, AKONING  
Photon emission for (n,n\*)t

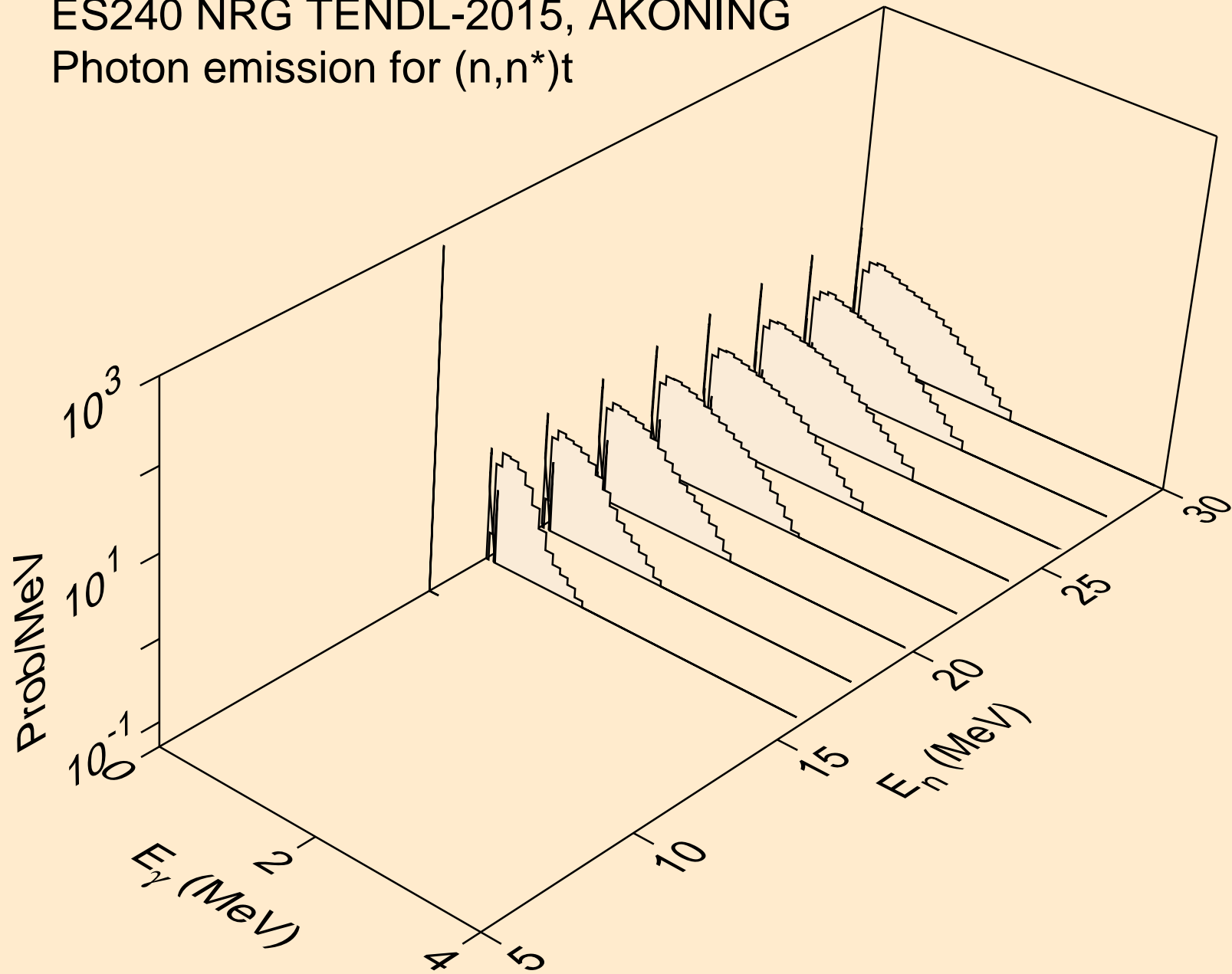

ES240 NRG TENDL-2015, AKONING  
Photon emission for (n,n\*)he3

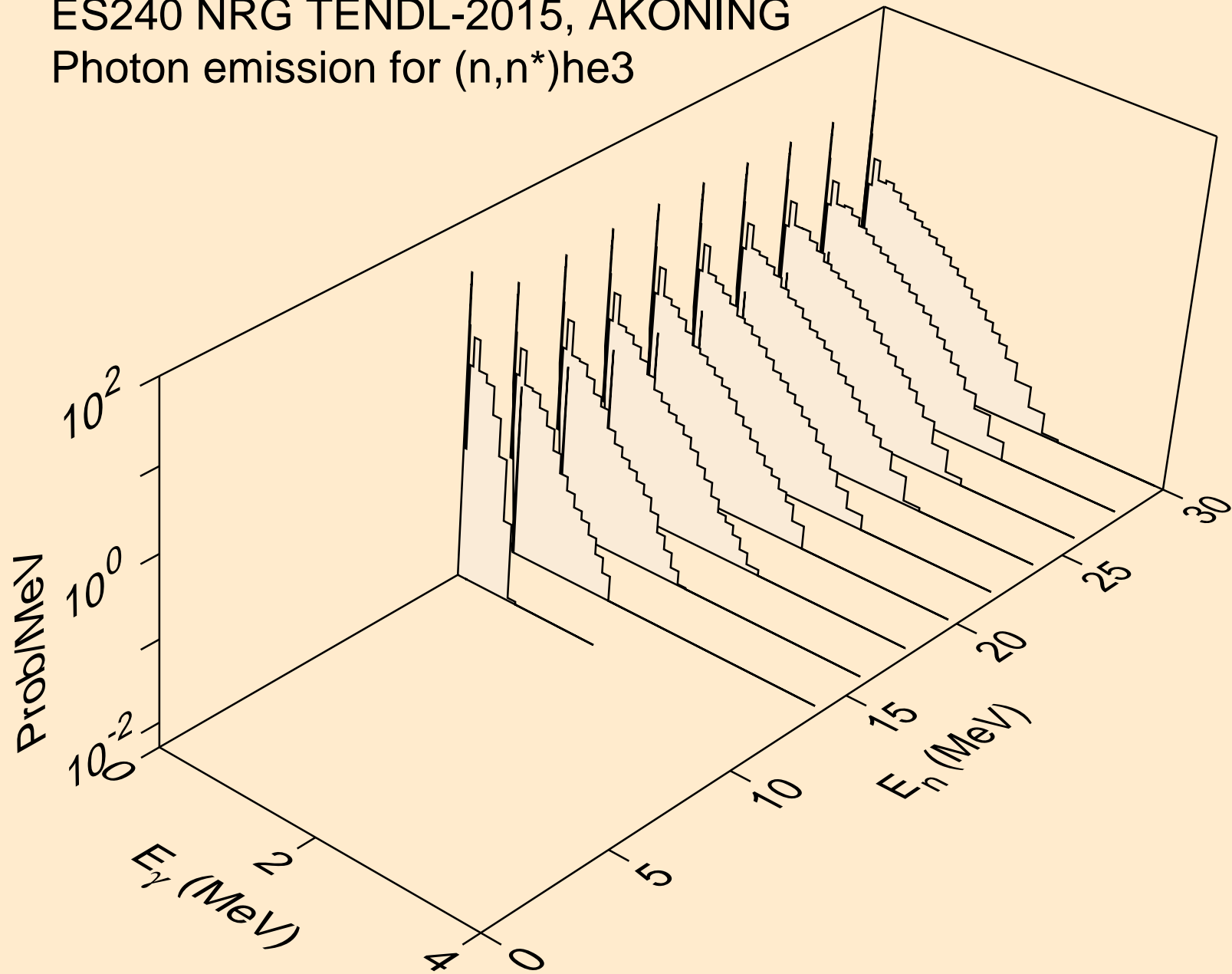

ES240 NRG TENDL-2015, AKONING  
Photon emission for (n,n\*)d2a

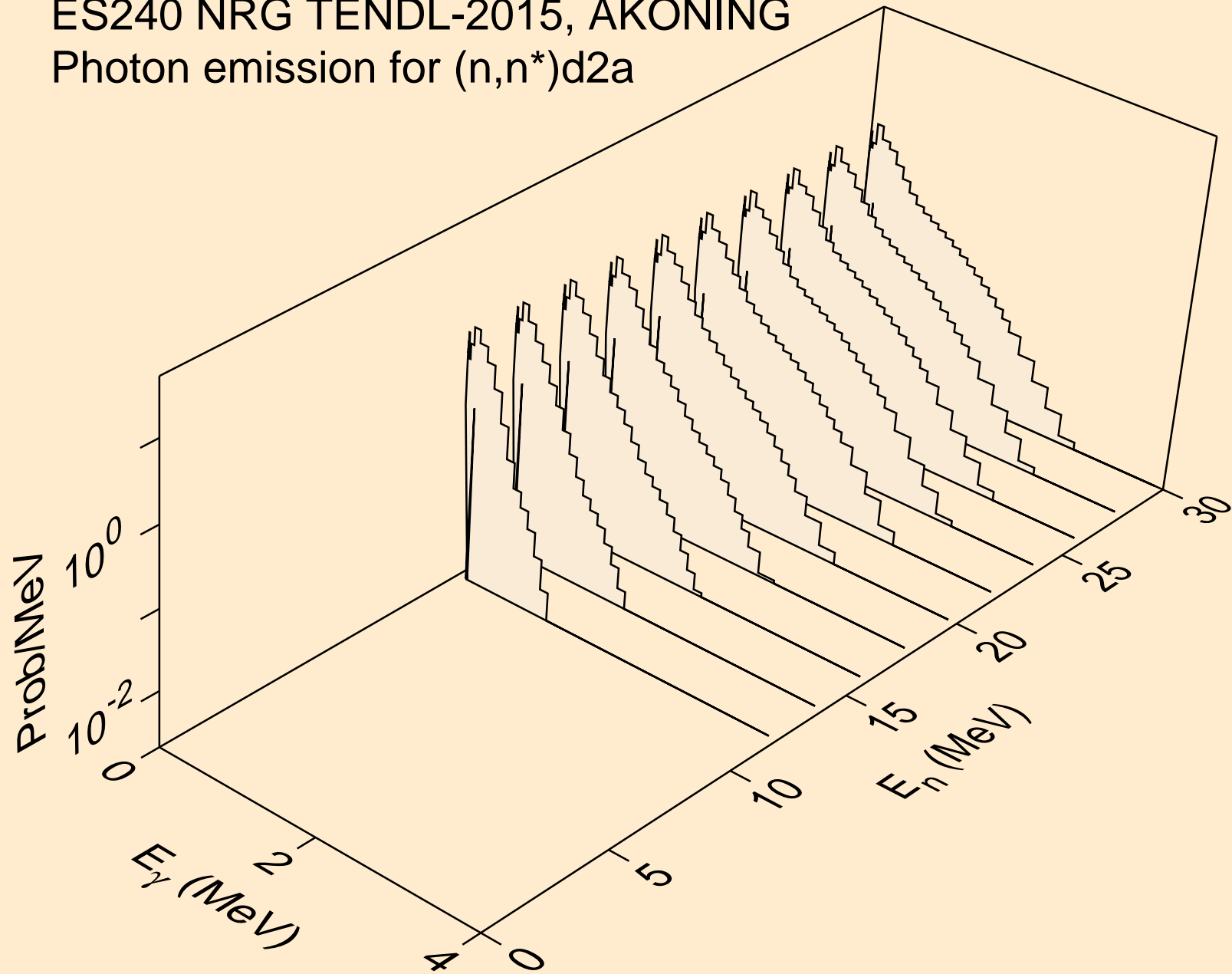



ES240 NRG TENDL-2015, AKONING  
Photon emission for (n,n\*)t2a

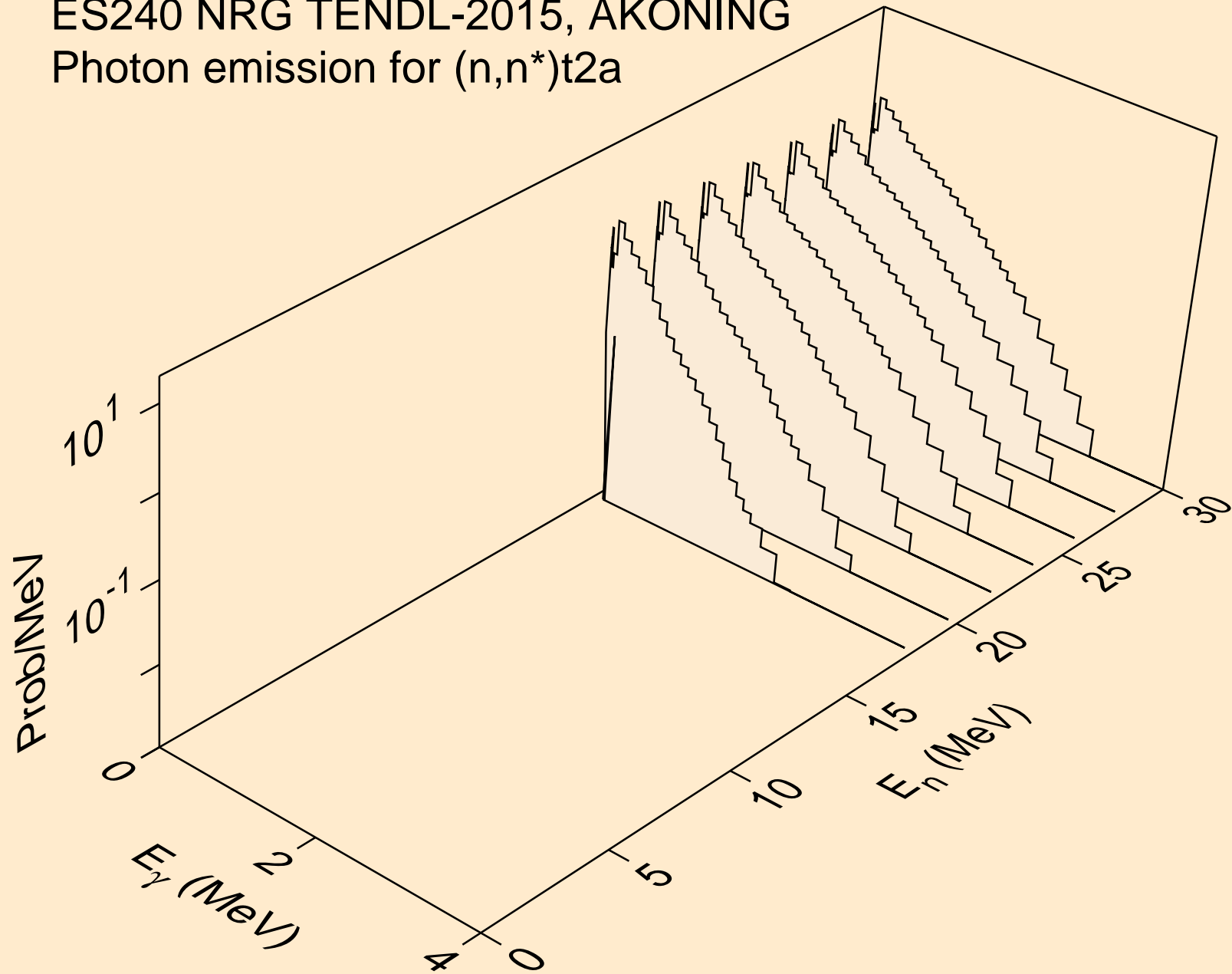

ES240 NRG TENDL-2015, AKONING  
Photon emission for (n,2np)

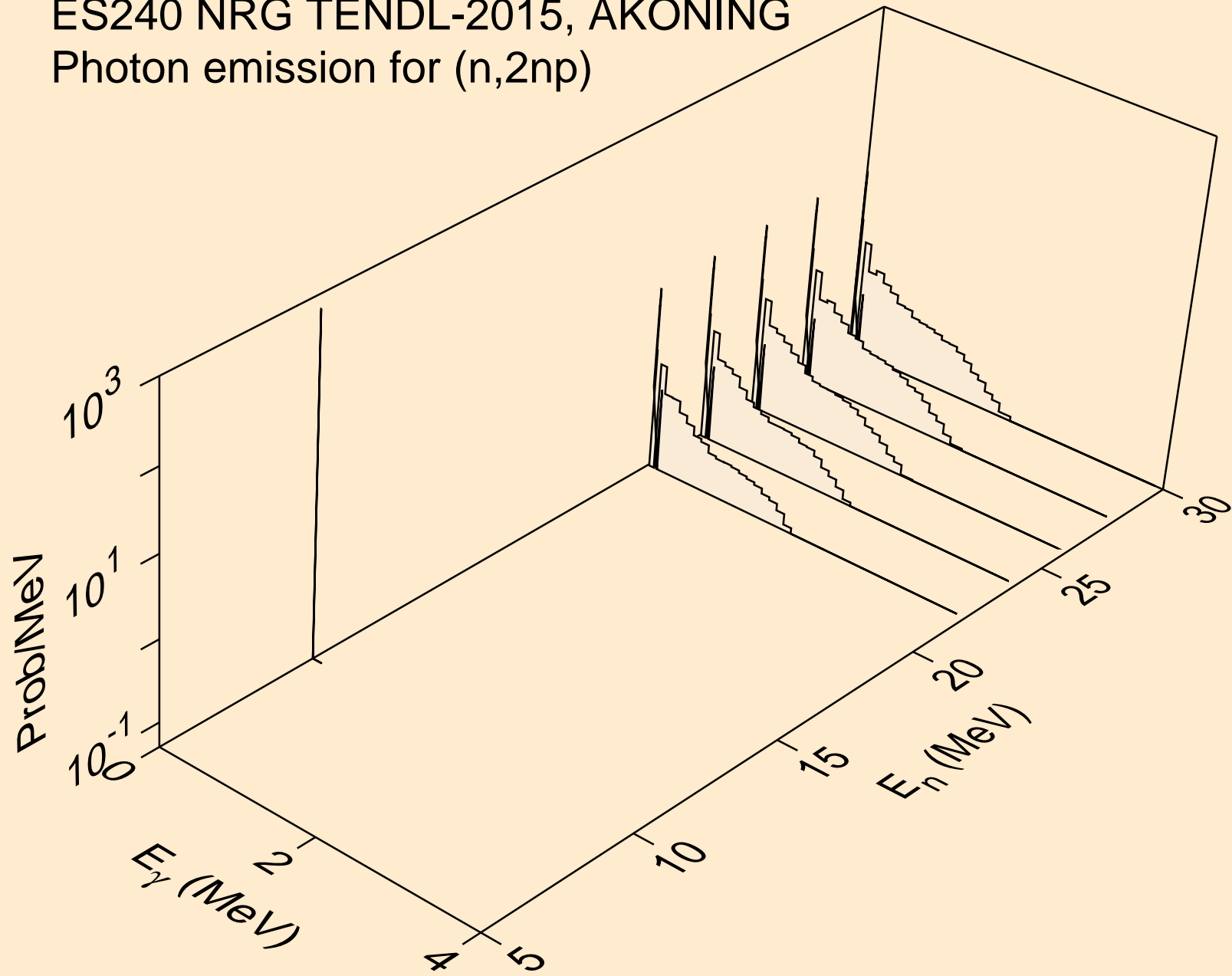

ES240 NRG TENDL-2015, AKONING  
Photon emission for (n,3np)

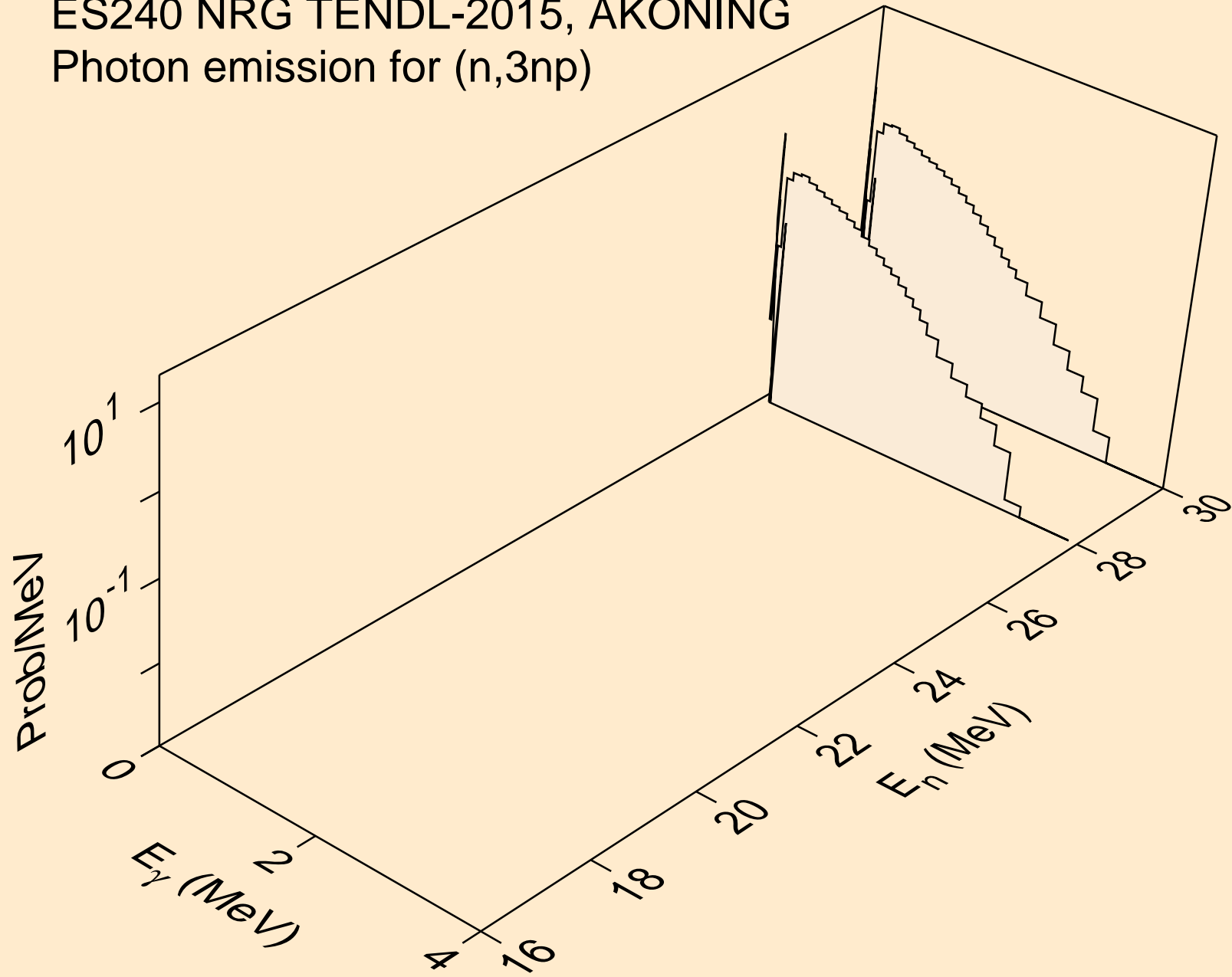

ES240 NRG TENDL-2015, AKONING  
Photon emission for (n,2np)

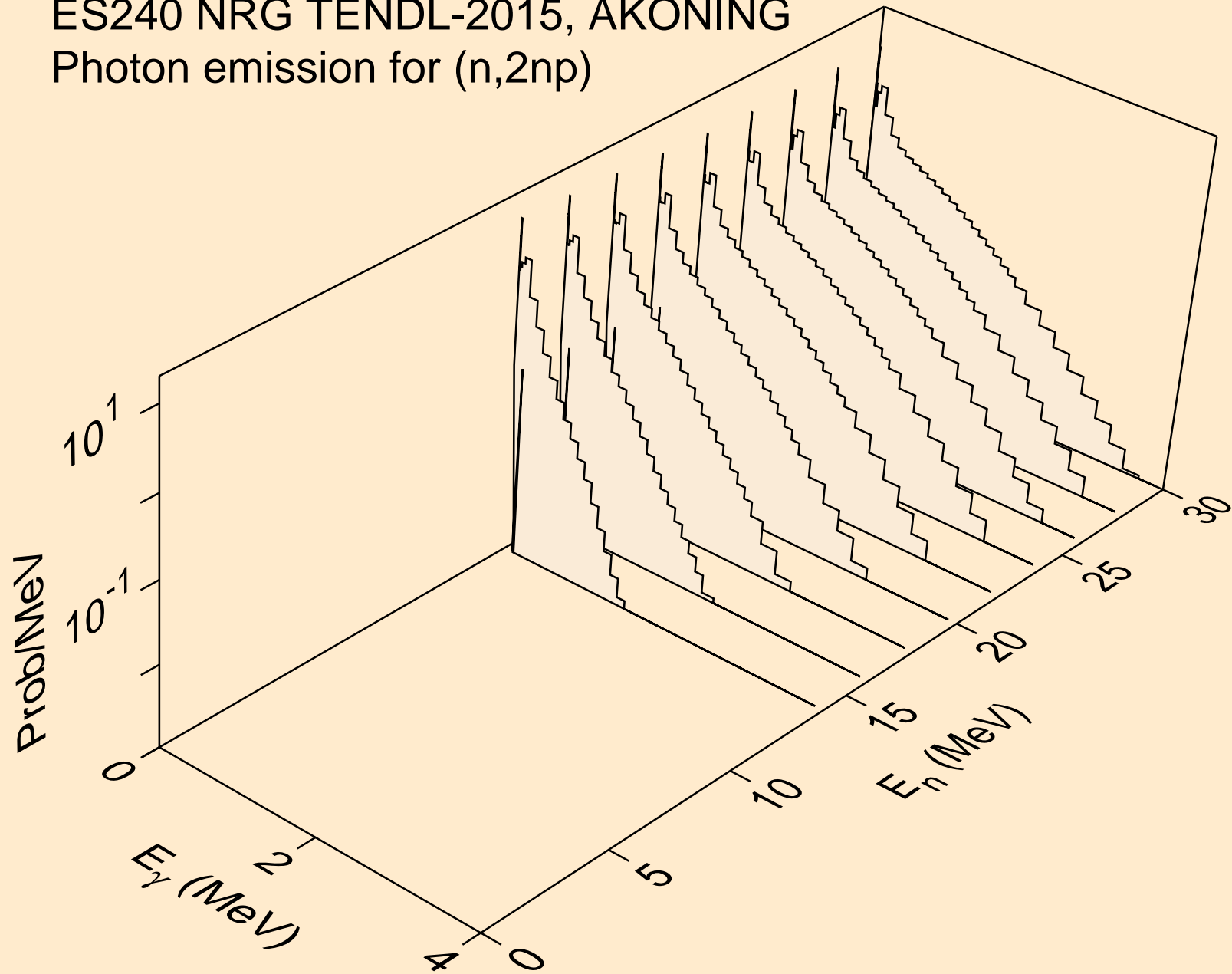

ES240 NRG TENDL-2015, AKONING  
Photon emission for (n,npa)

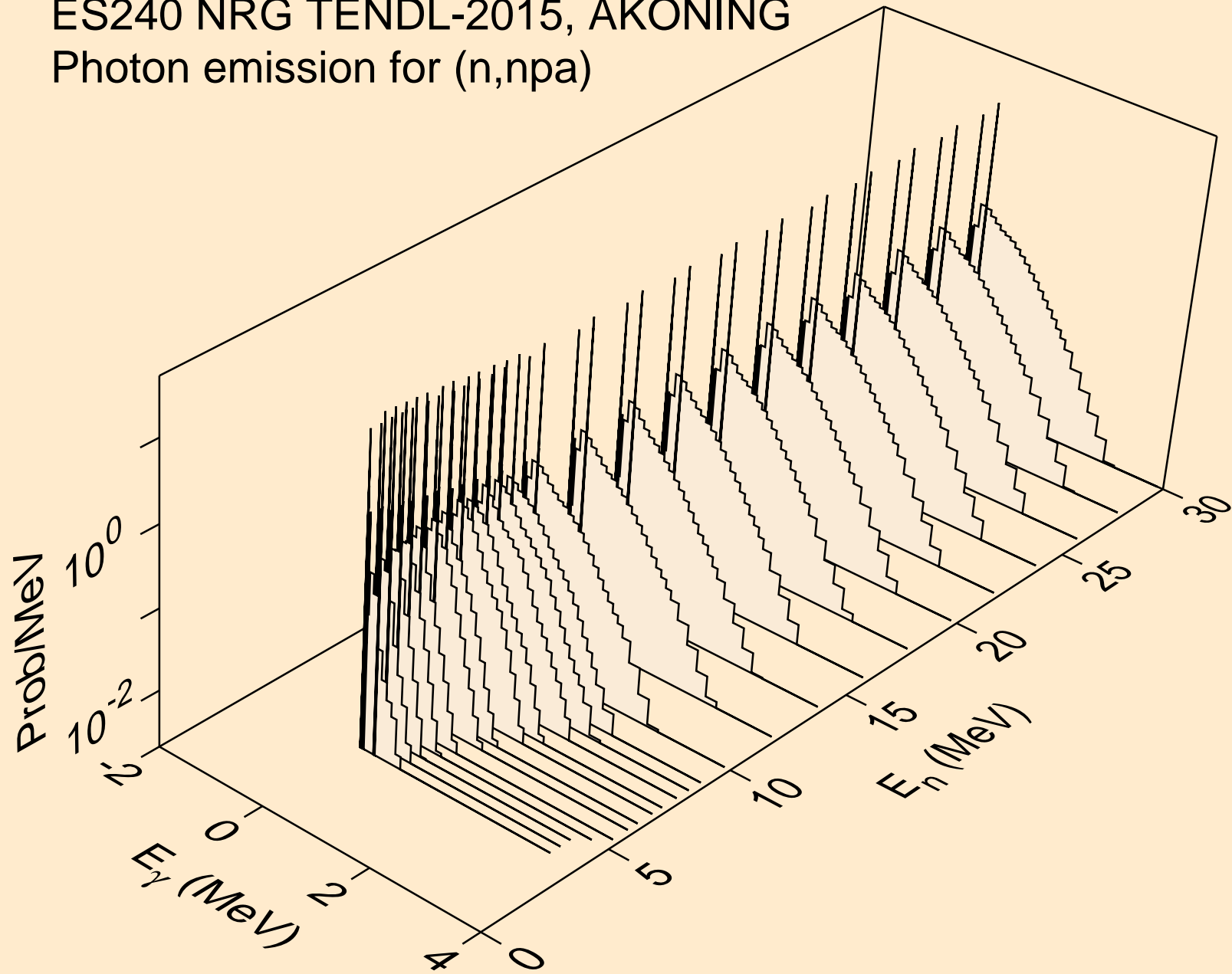

ES240 NRG TENDL-2015, AKONING  
Photon emission for (n,n\*c)

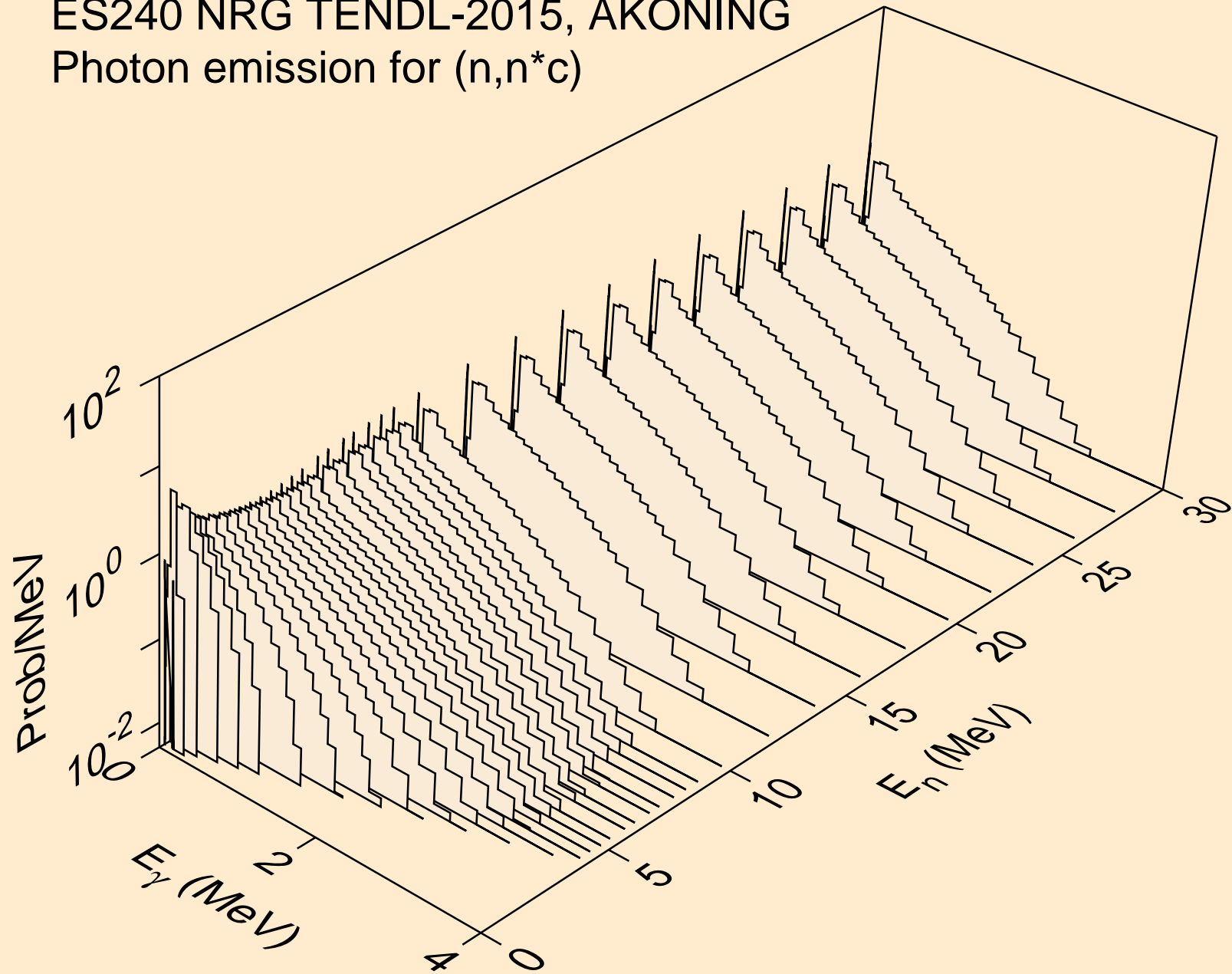

ES240 NRG TENDL-2015, AKONING  
Photon emission for (n,gma)

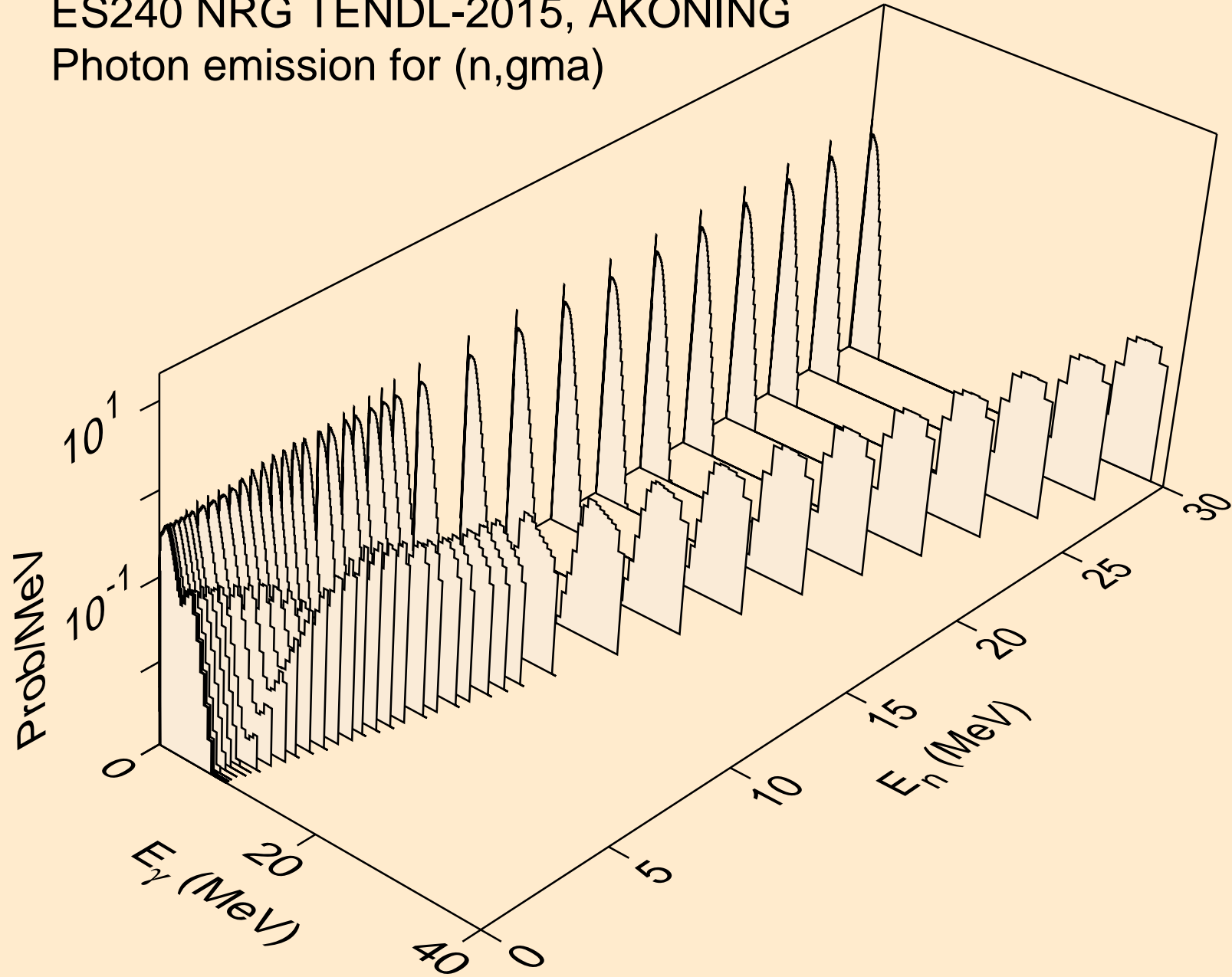

ES240 NRG TENDL-2015, AKONING  
Photon emission for (n,p)

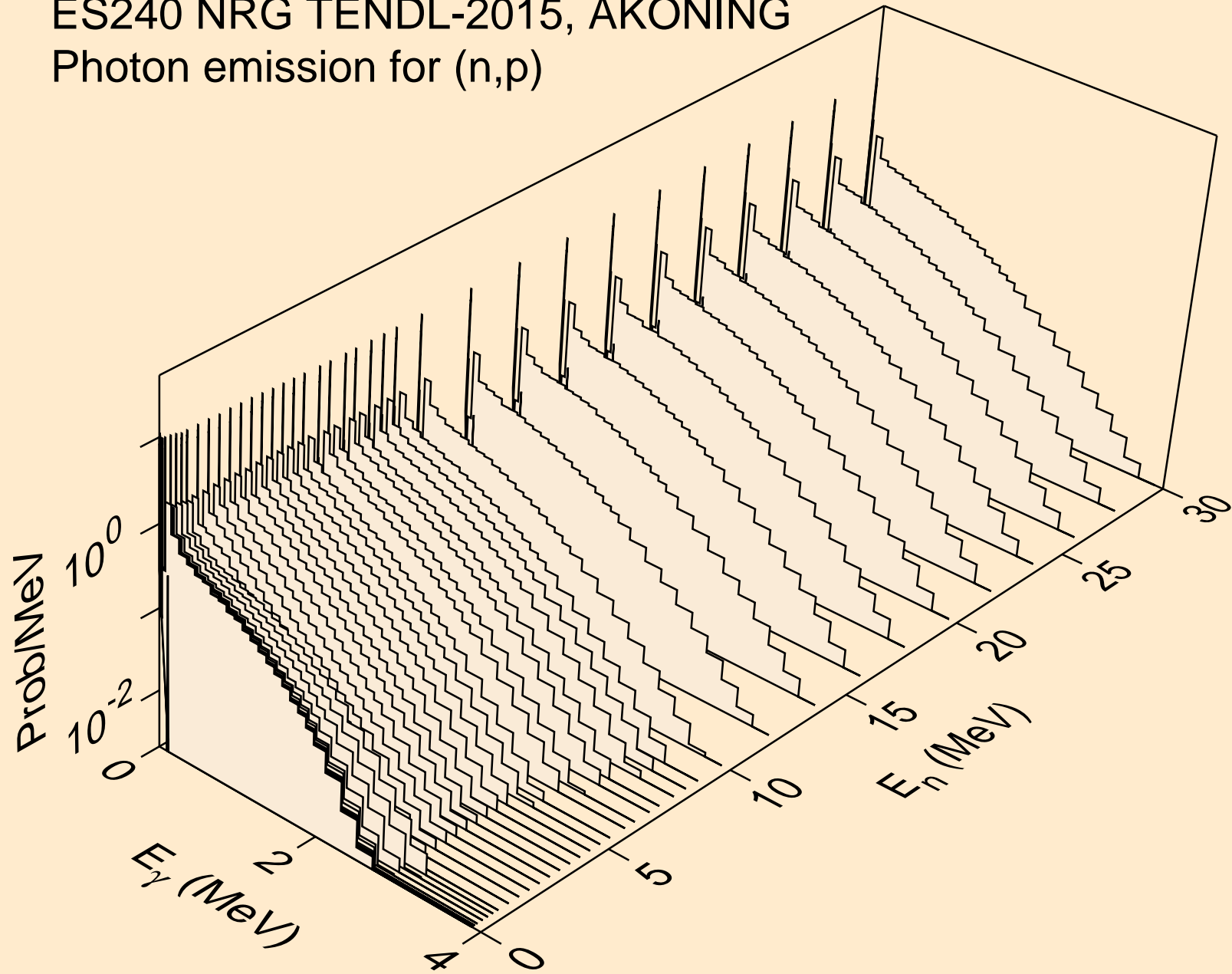



ES240 NRG TENDL-2015, AKONING  
Photon emission for (n,d)

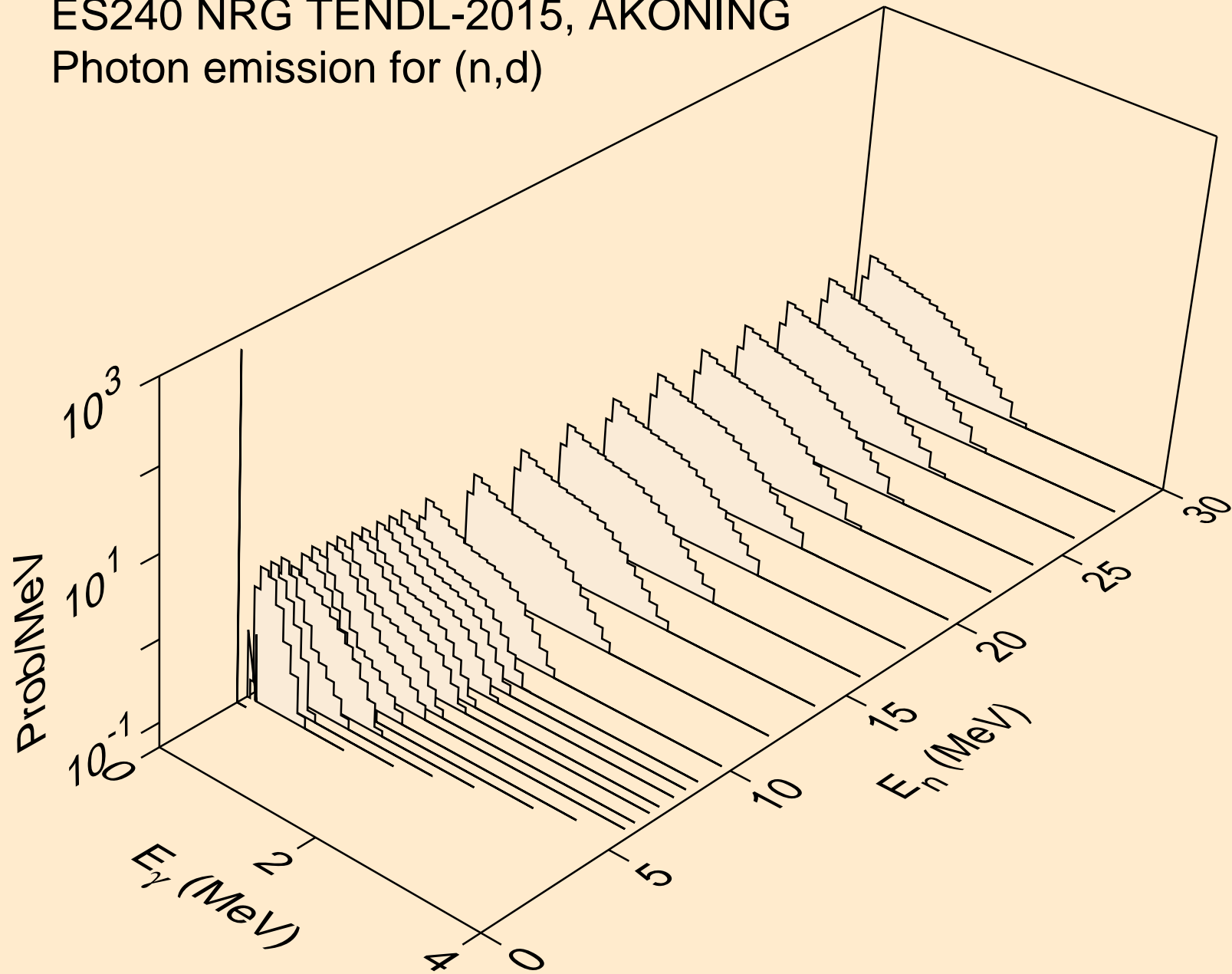

ES240 NRG TENDL-2015, AKONING  
Photon emission for (n,t)

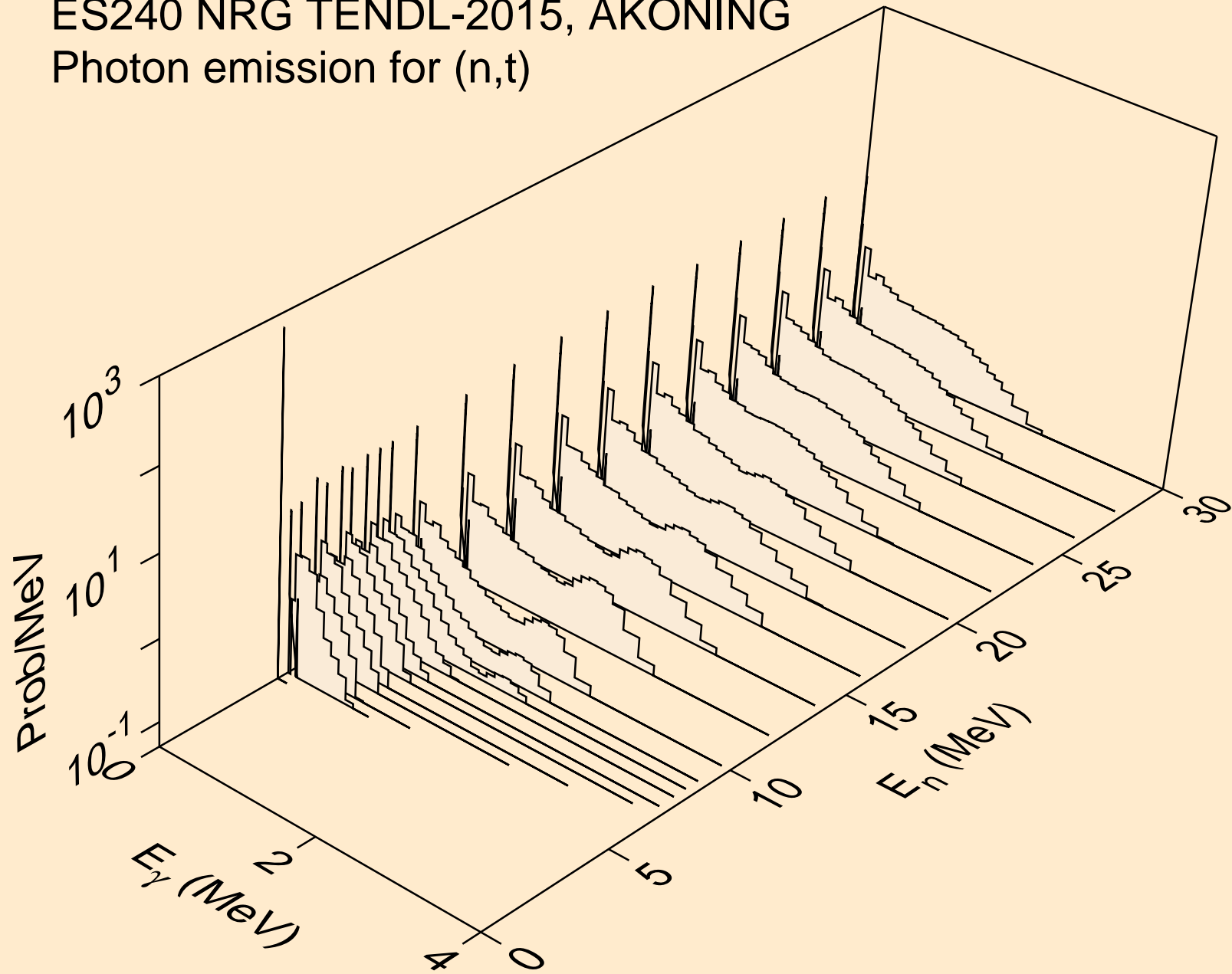

ES240 NRG TENDL-2015, AKONING  
Photon emission for (n,he3)

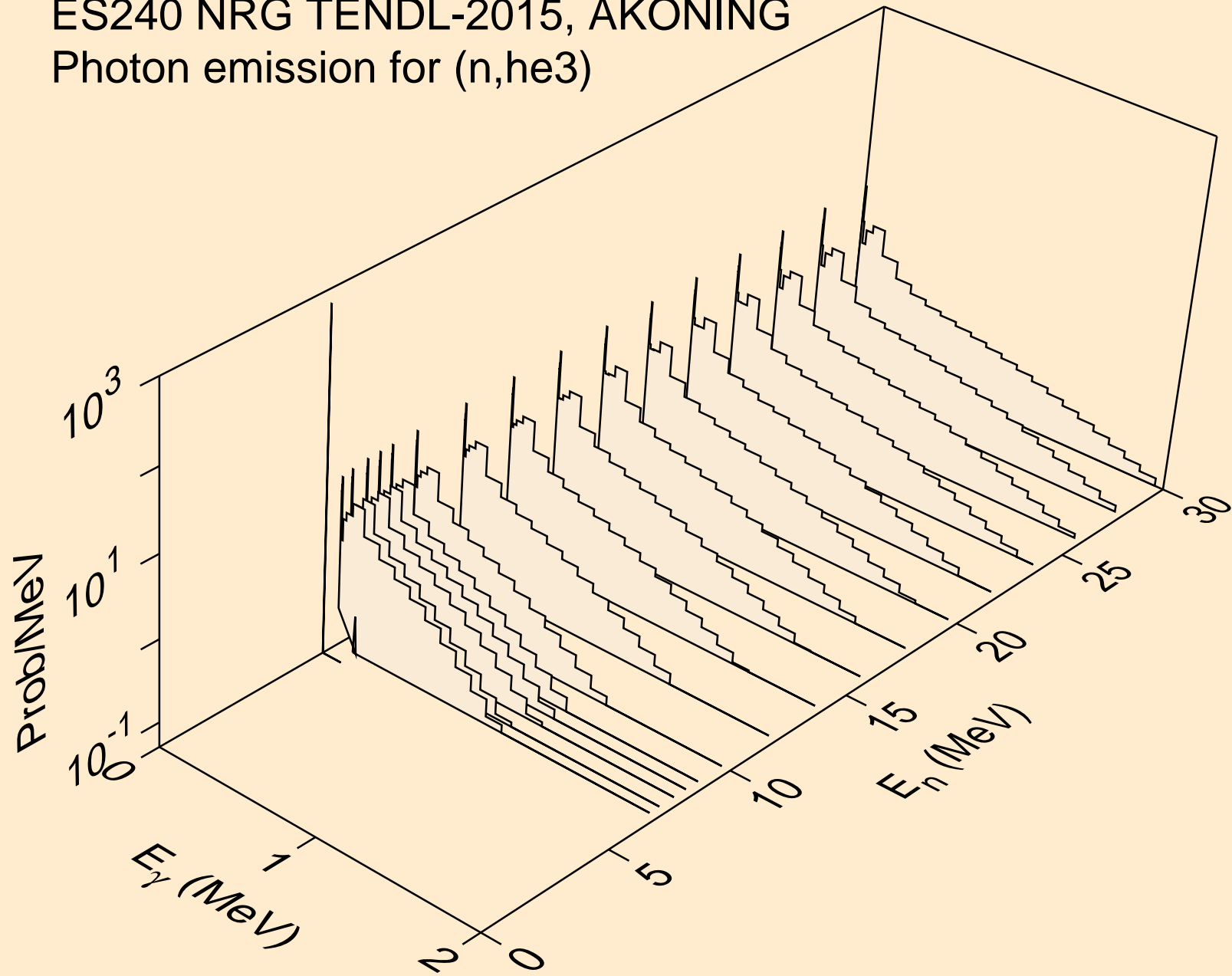

ES240 NRG TENDL-2015, AKONING  
Photon emission for (n,a)

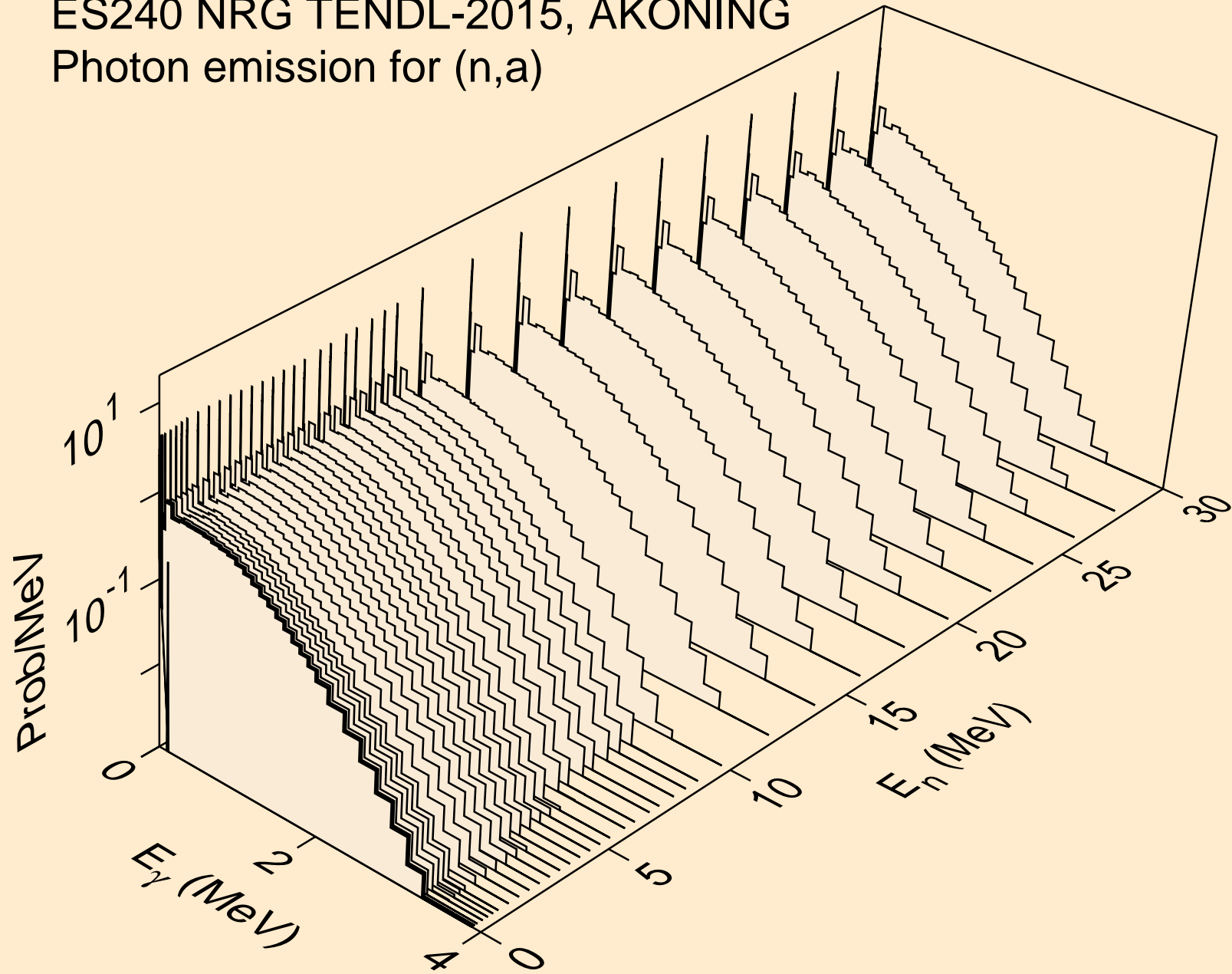

ES240 NRG TENDL-2015, AKONING  
Photon emission for (n,2a)

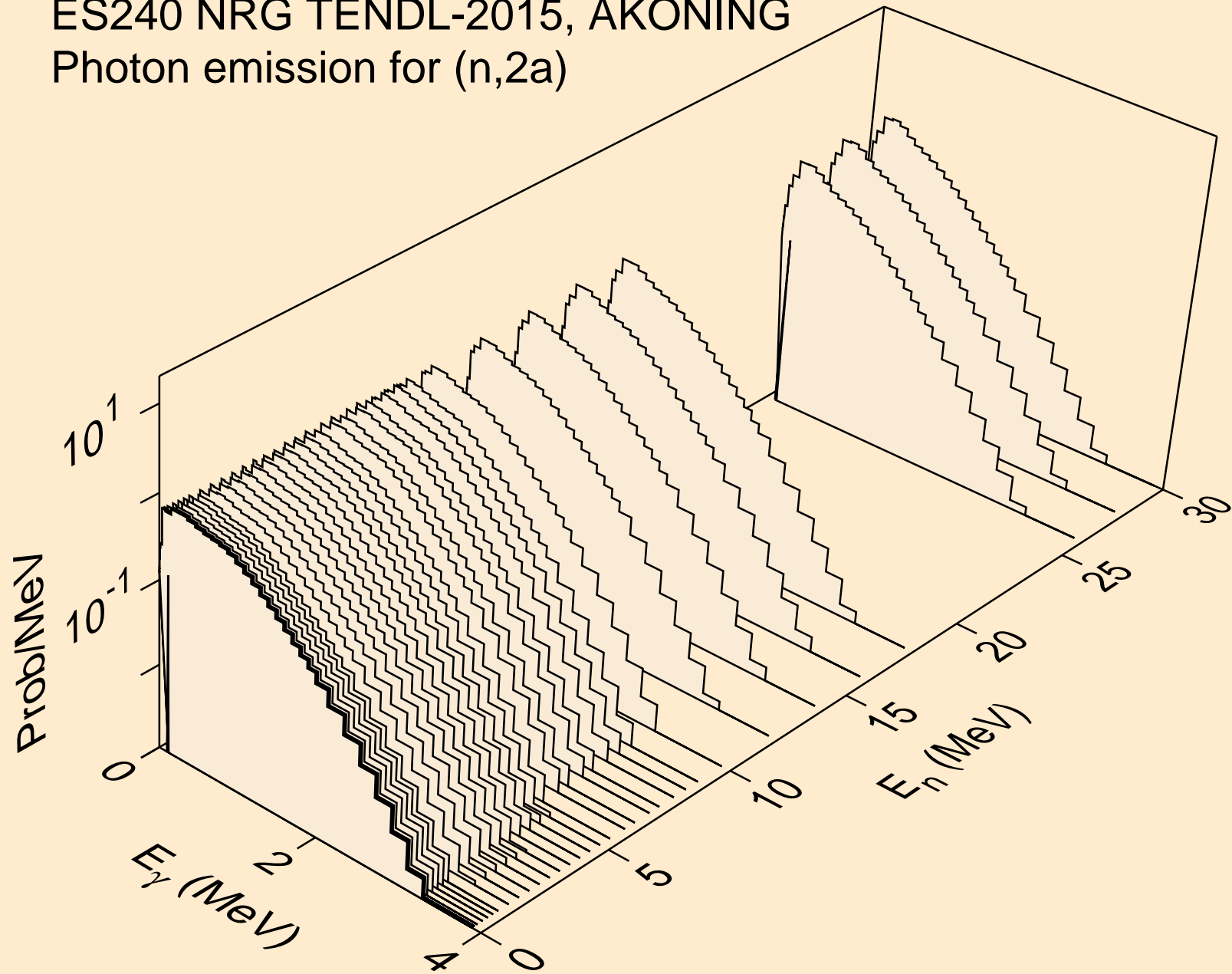

ES240 NRG TENDL-2015, AKONING  
Photon emission for (n,3a)

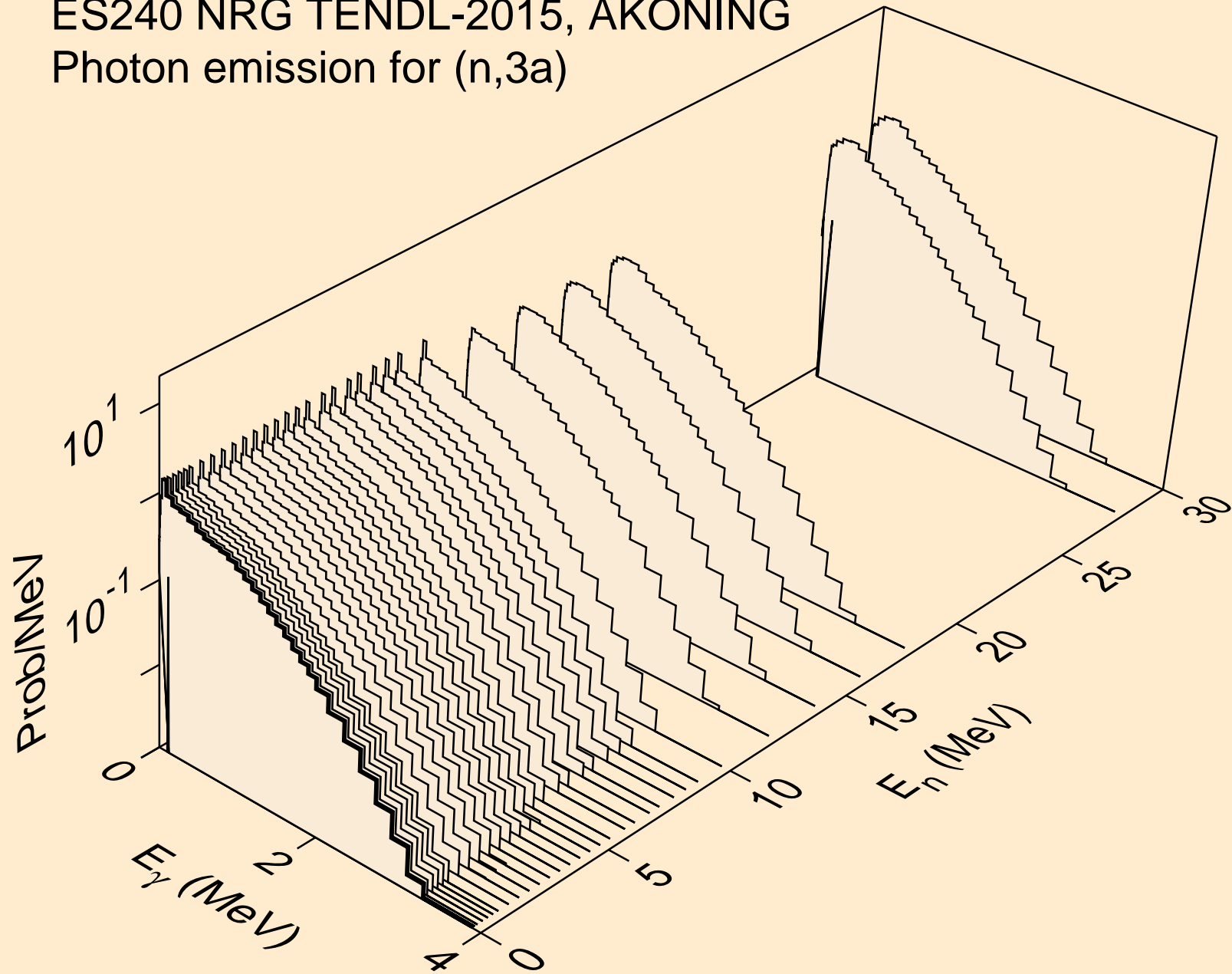

ES240 NRG TENDL-2015, AKONING  
Photon emission for (n,2p)

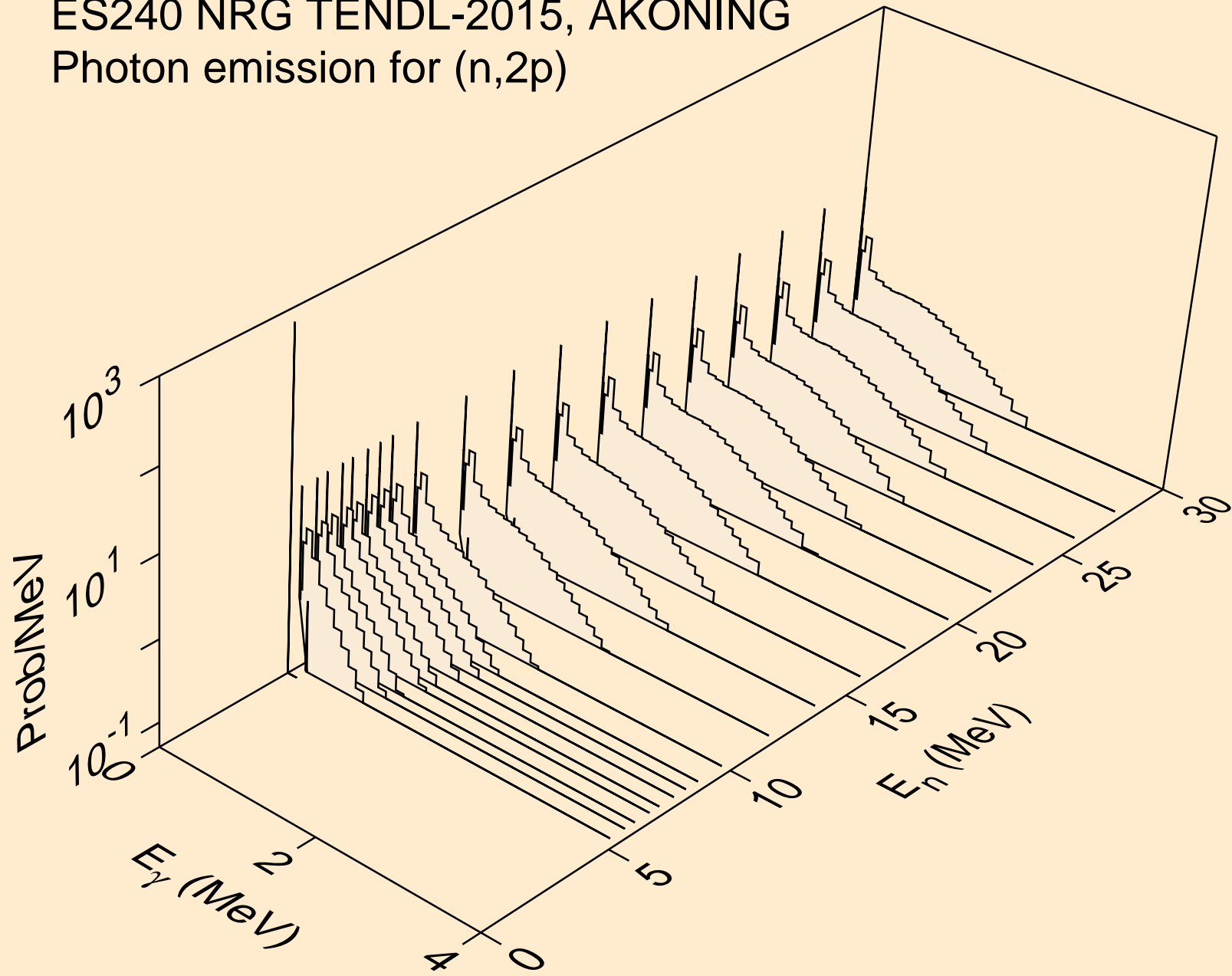

ES240 NRG TENDL-2015, AKONING  
Photon emission for (n,p $\alpha$ )

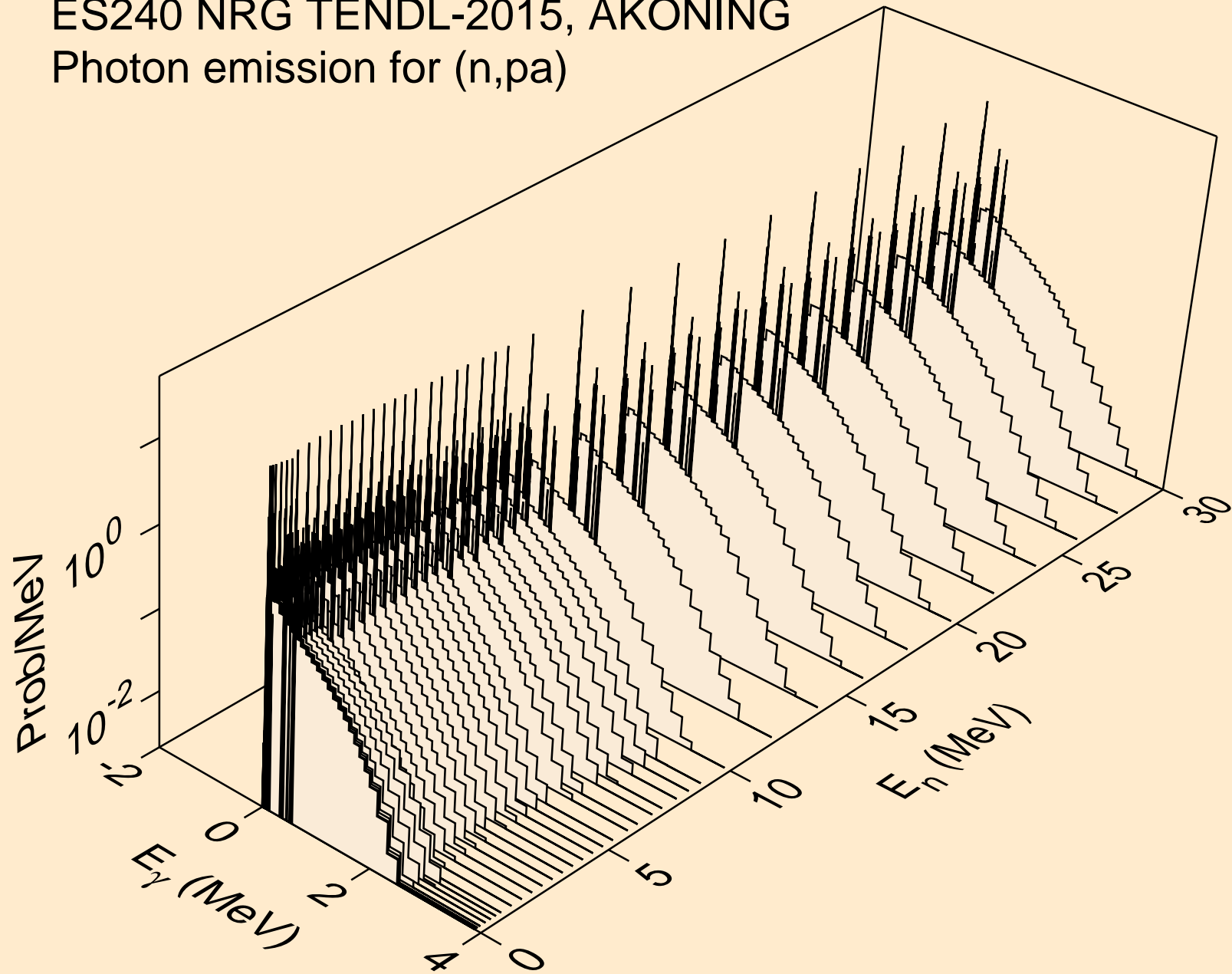



ES240 NRG TENDL-2015, AKONING  
Photon emission for (n,t2a)

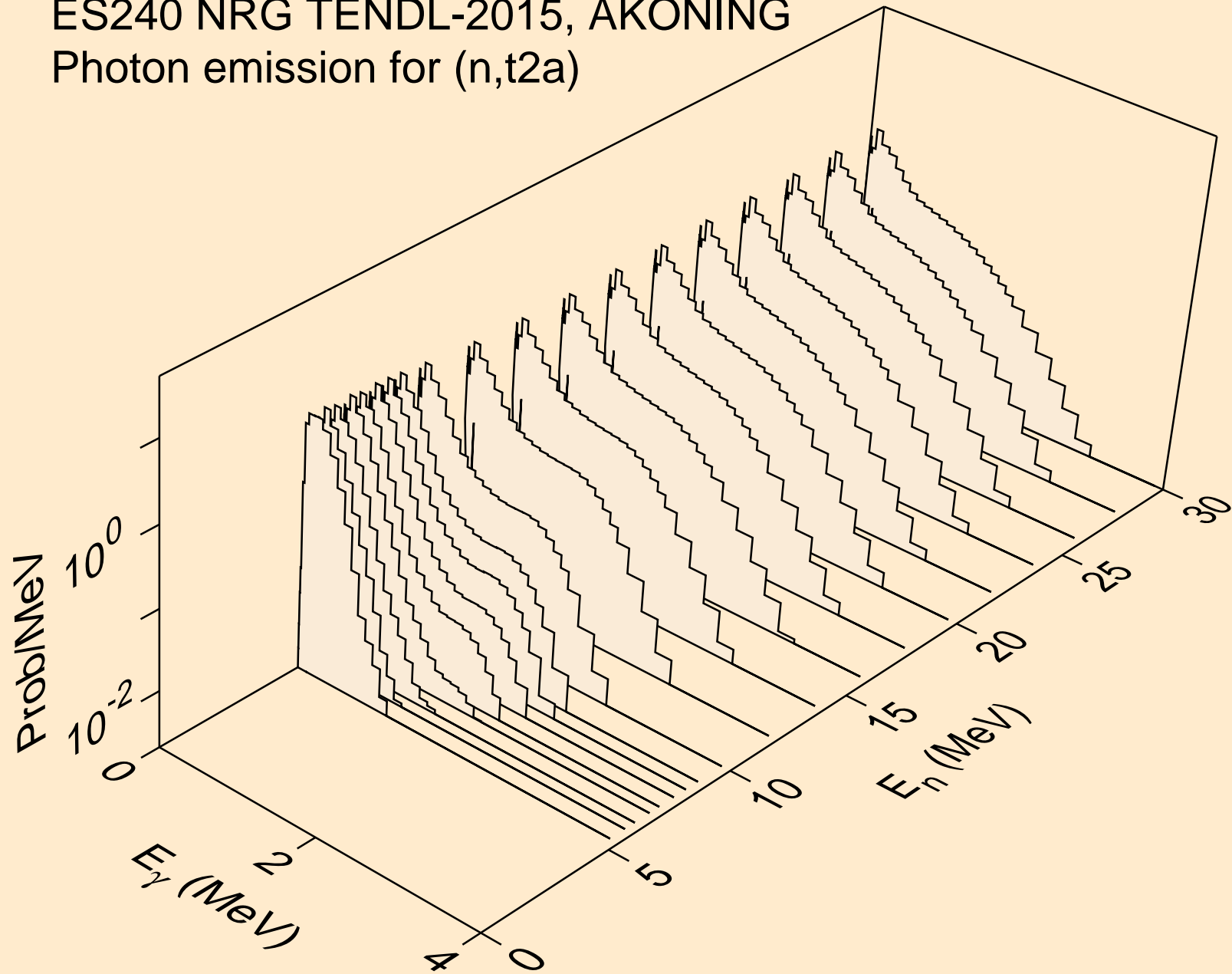

ES240 NRG TENDL-2015, AKONING  
Photon emission for (n,d2a)

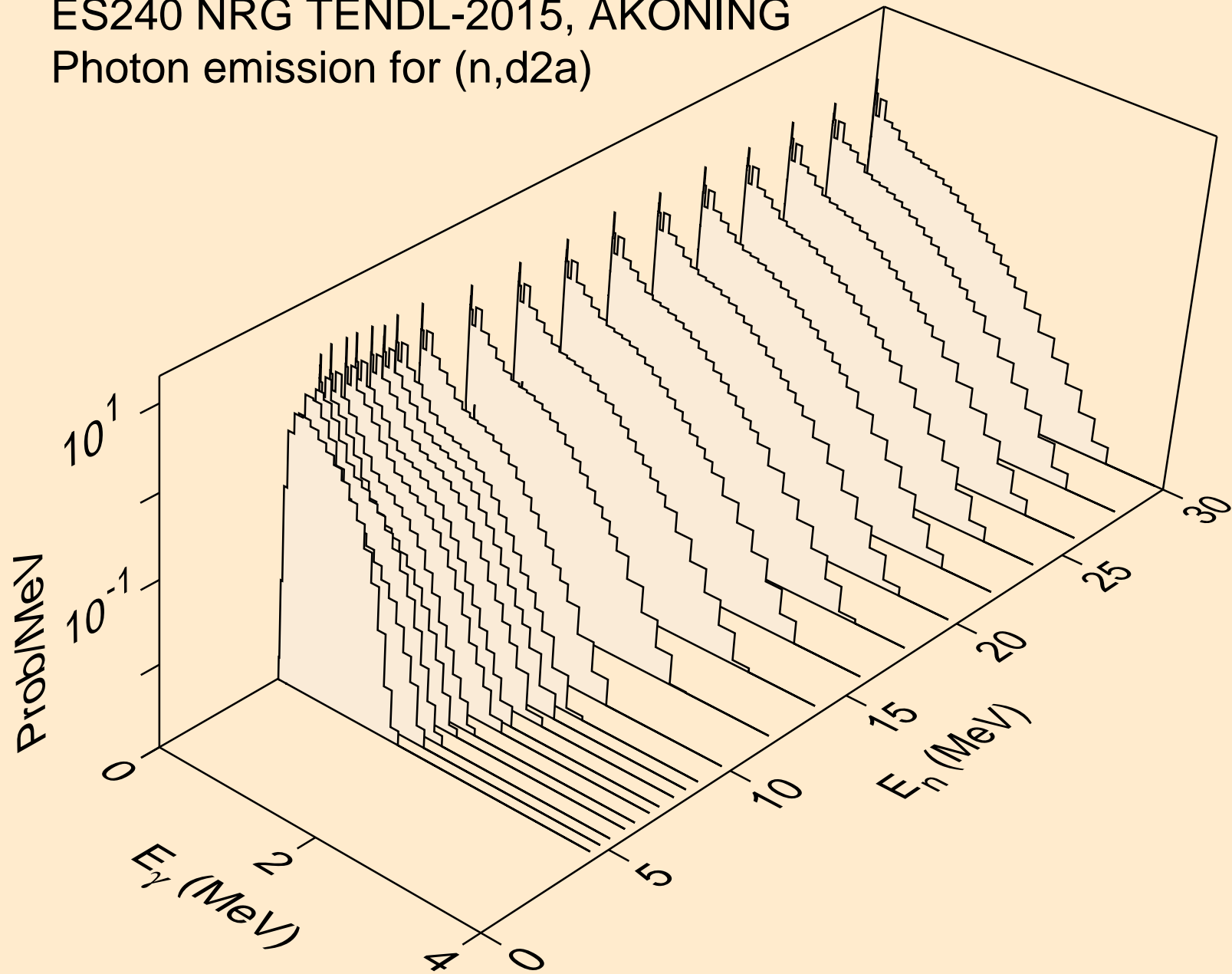

ES240 NRG TENDL-2015, AKONING  
Photon emission for (n,pd)

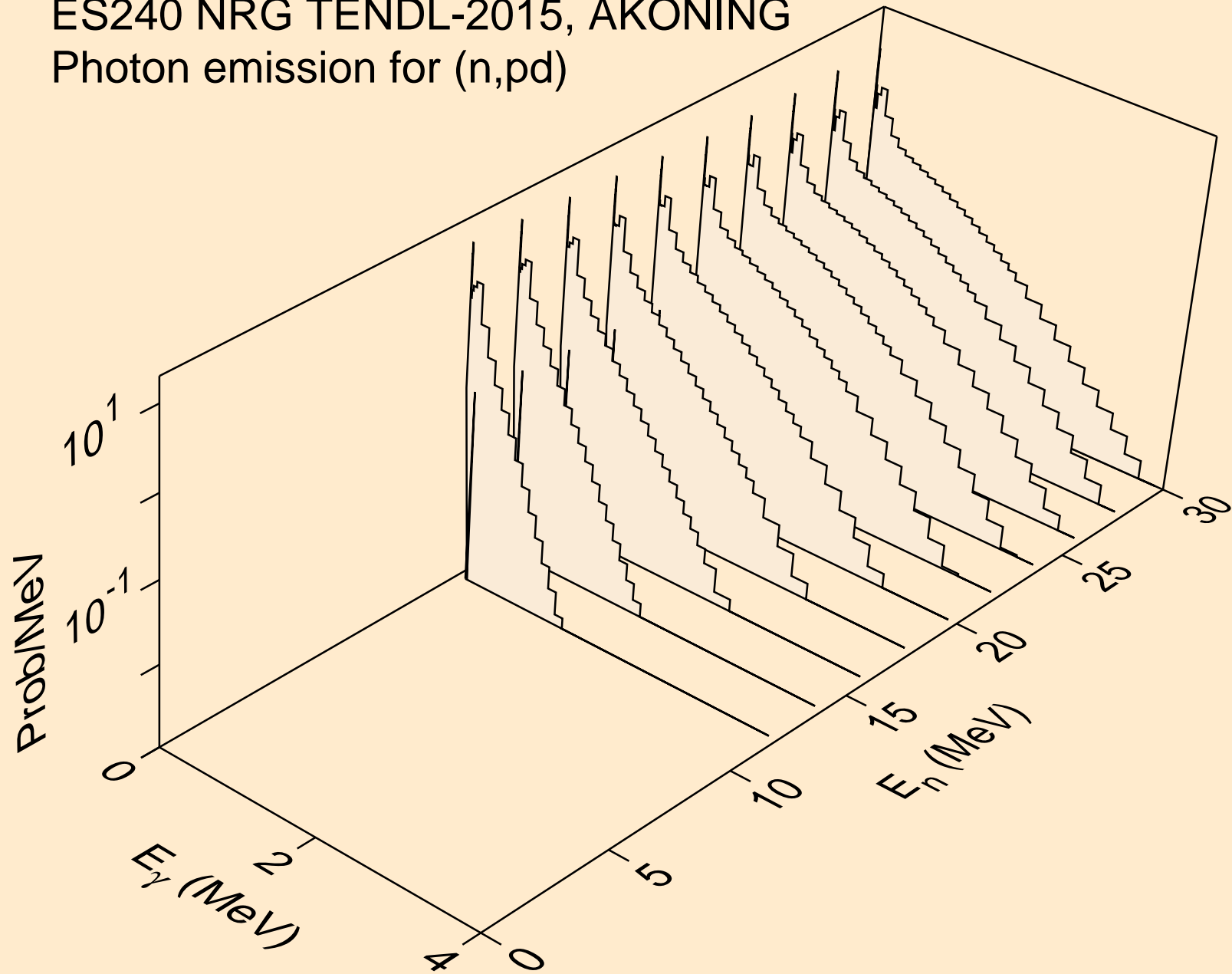

ES240 NRG TENDL-2015, AKONING  
Photon emission for (n,da)

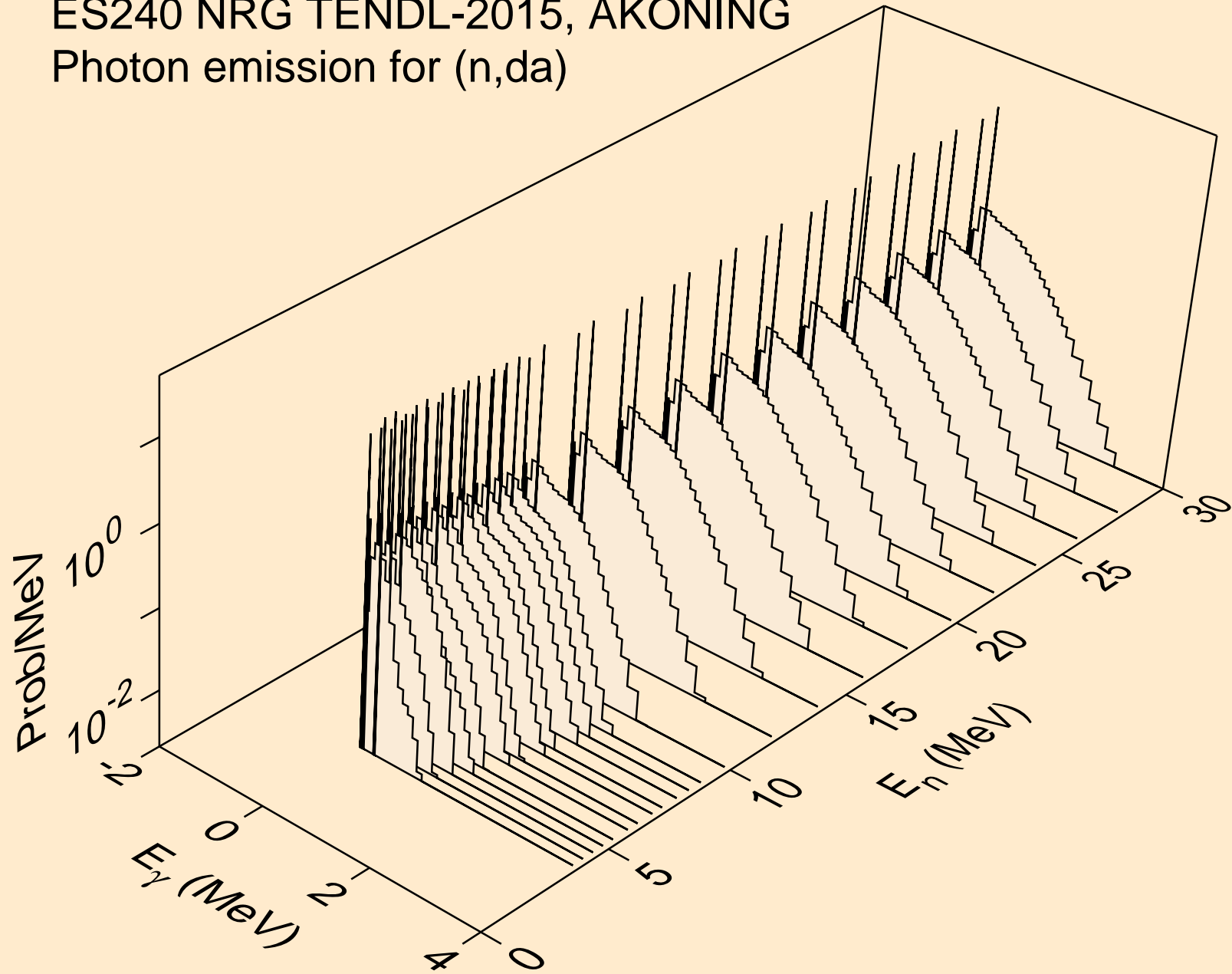

ES240 NRG TENDL-2015, AKONING  
thermal capture photon spectrum

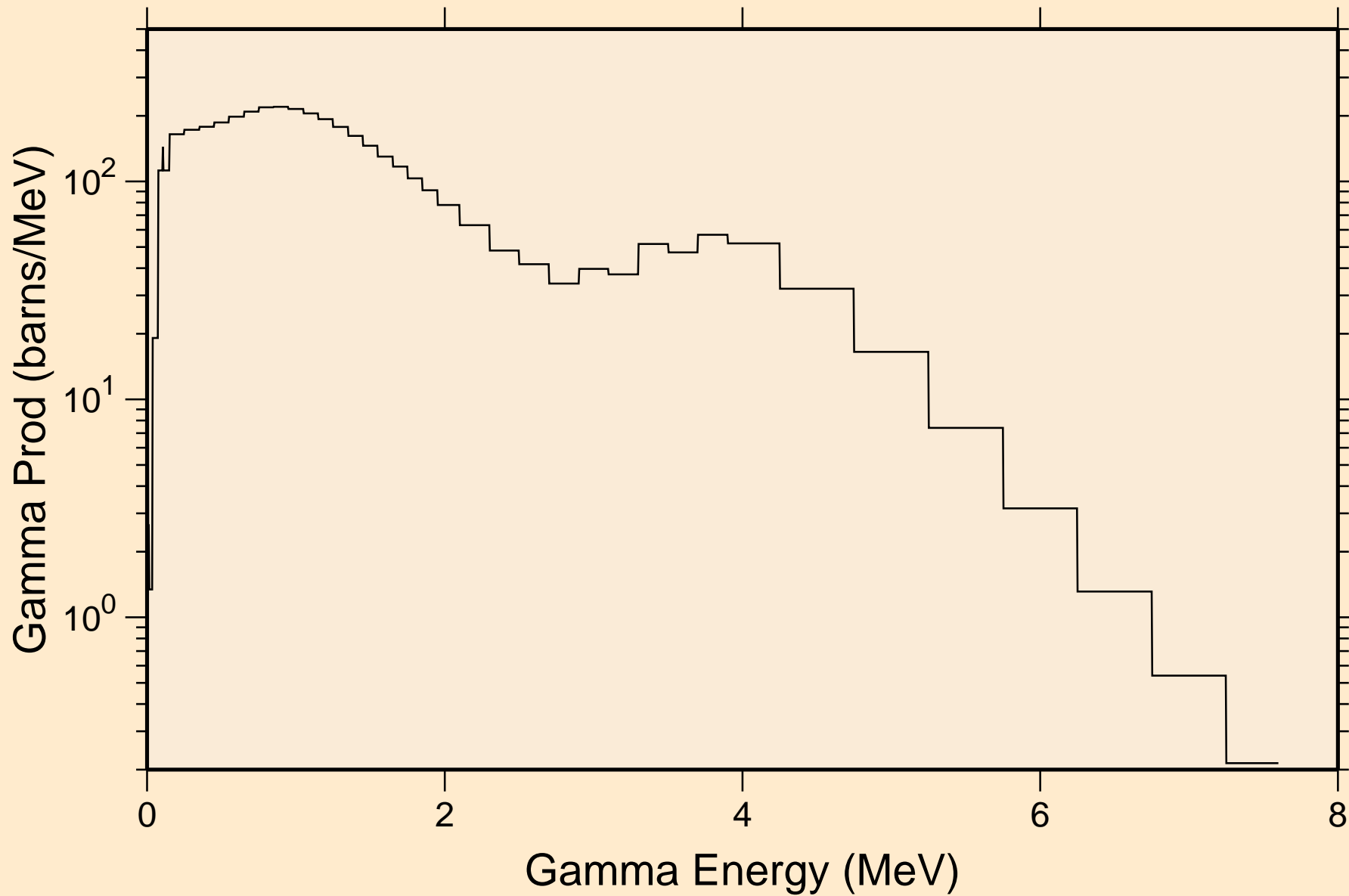

ES240 NRG TENDL-2015, AKONING  
14 MeV photon spectrum

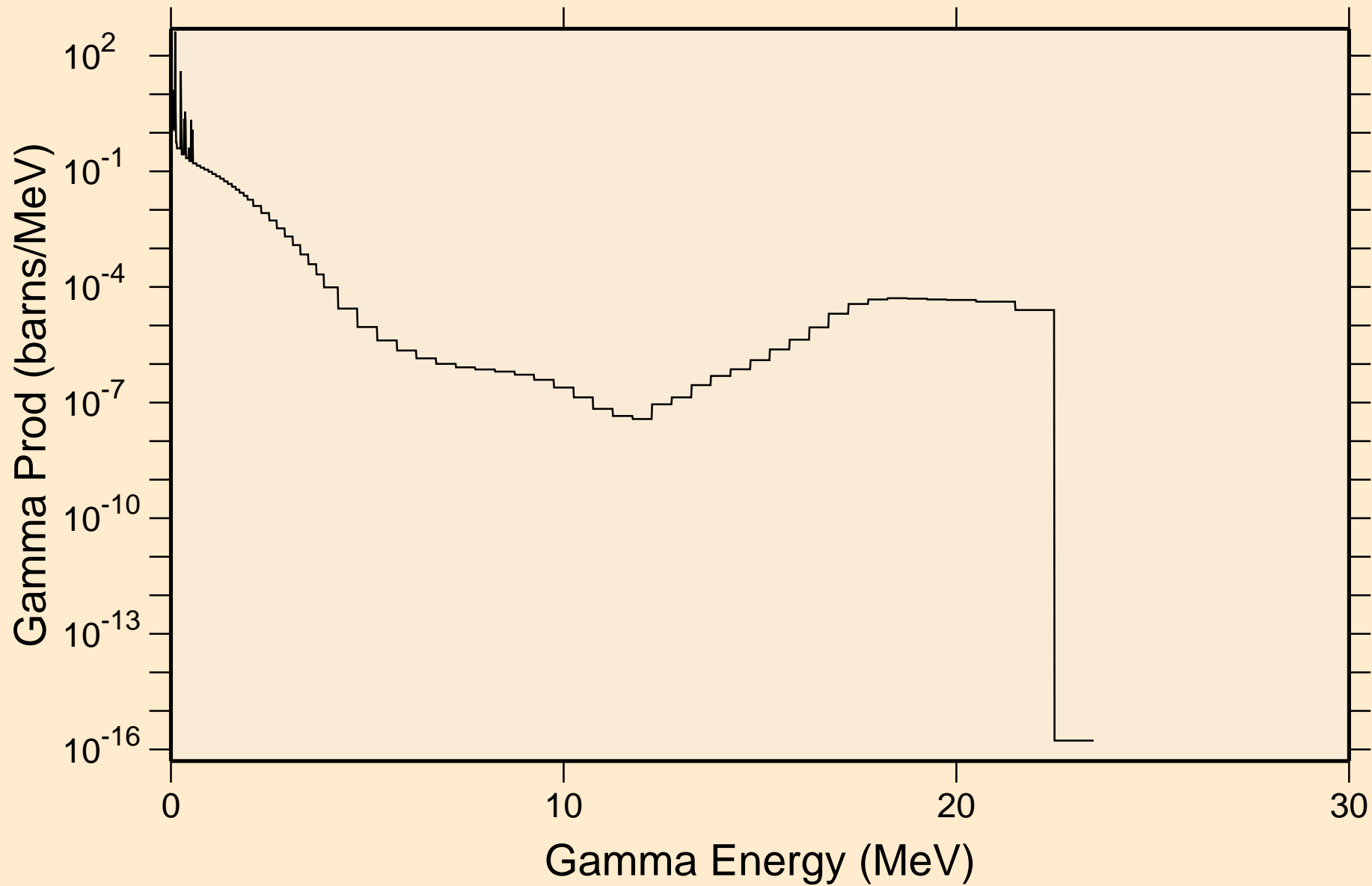

# ES240 NRG TENDL-2015, AKONING

## Particle heating contributions

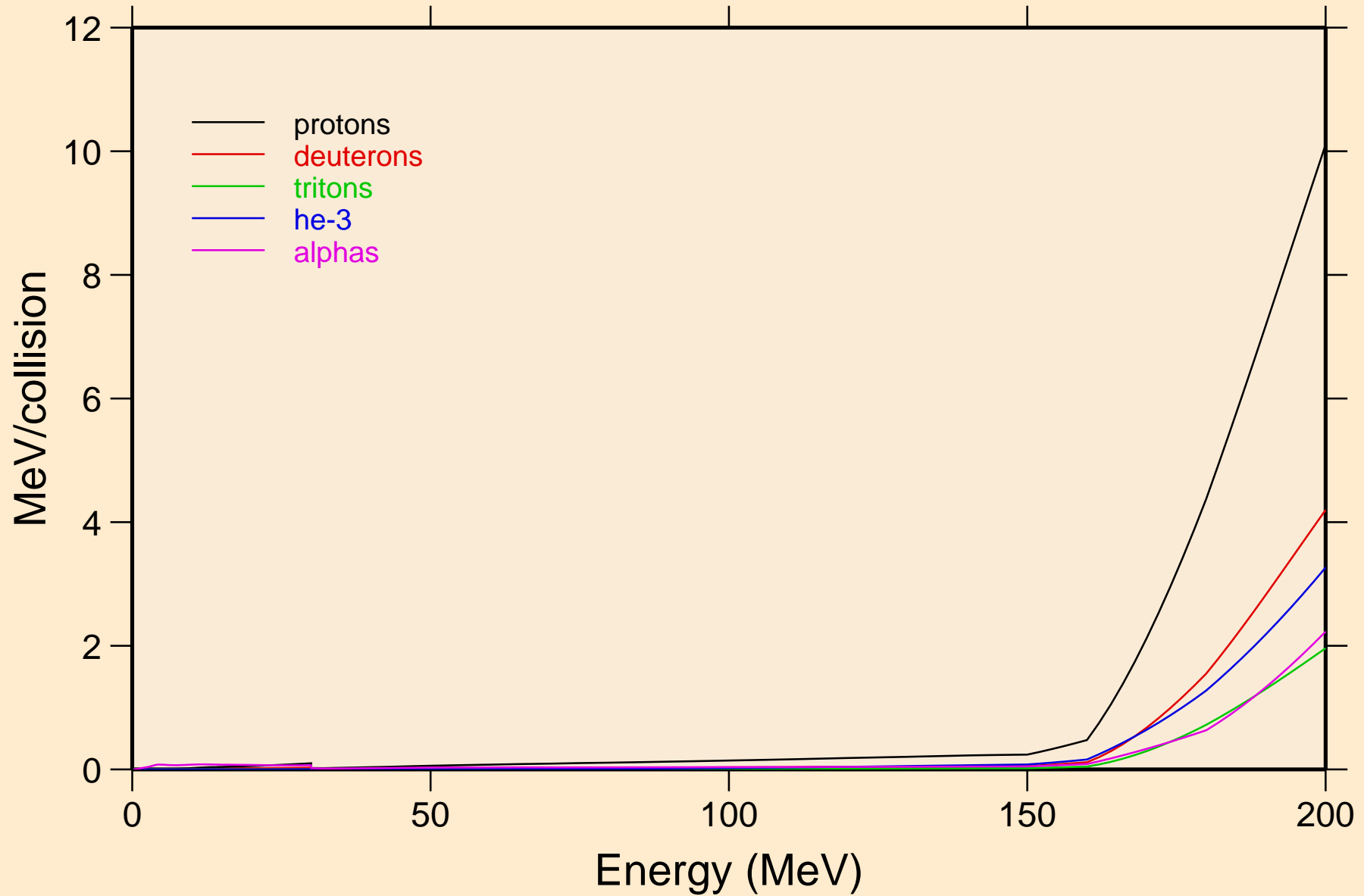

# ES240 NRG TENDL-2015, AKONING

## Recoil Heating

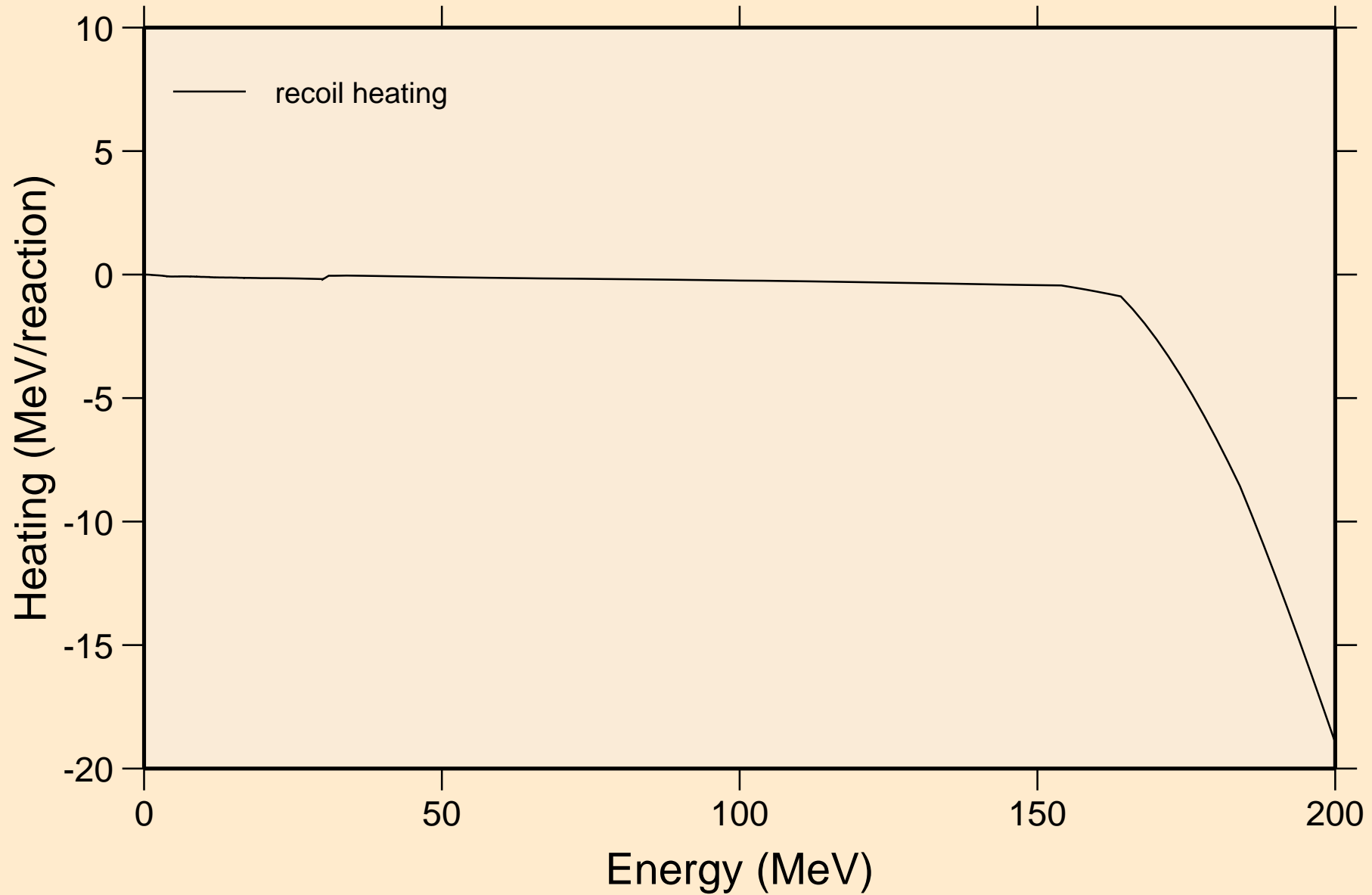



# ES240 NRG TENDL-2015, AKONING

## Particle production cross sections

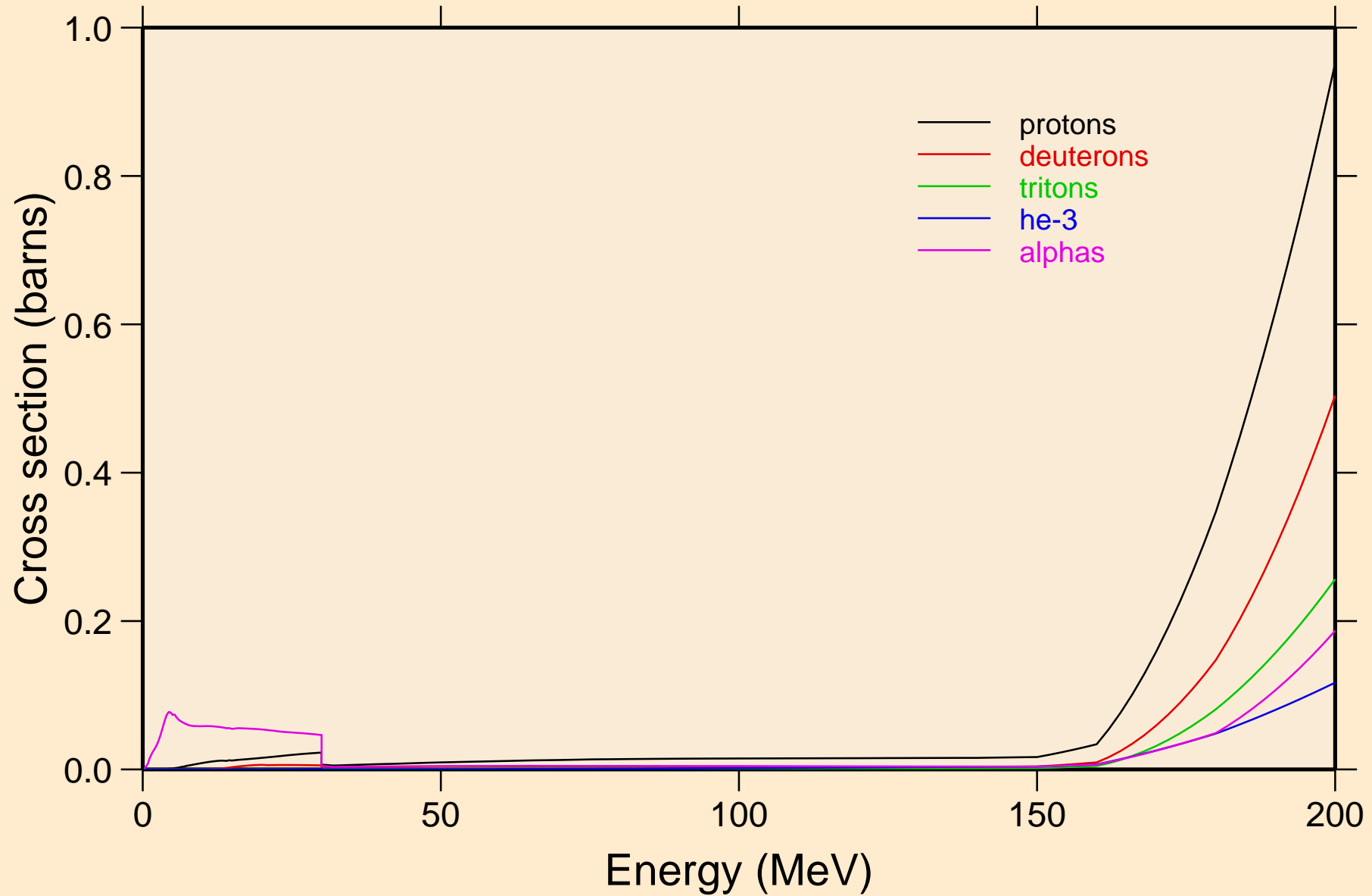

ES240 NRG TENDL-2015, AKONING  
protons from (n,x)

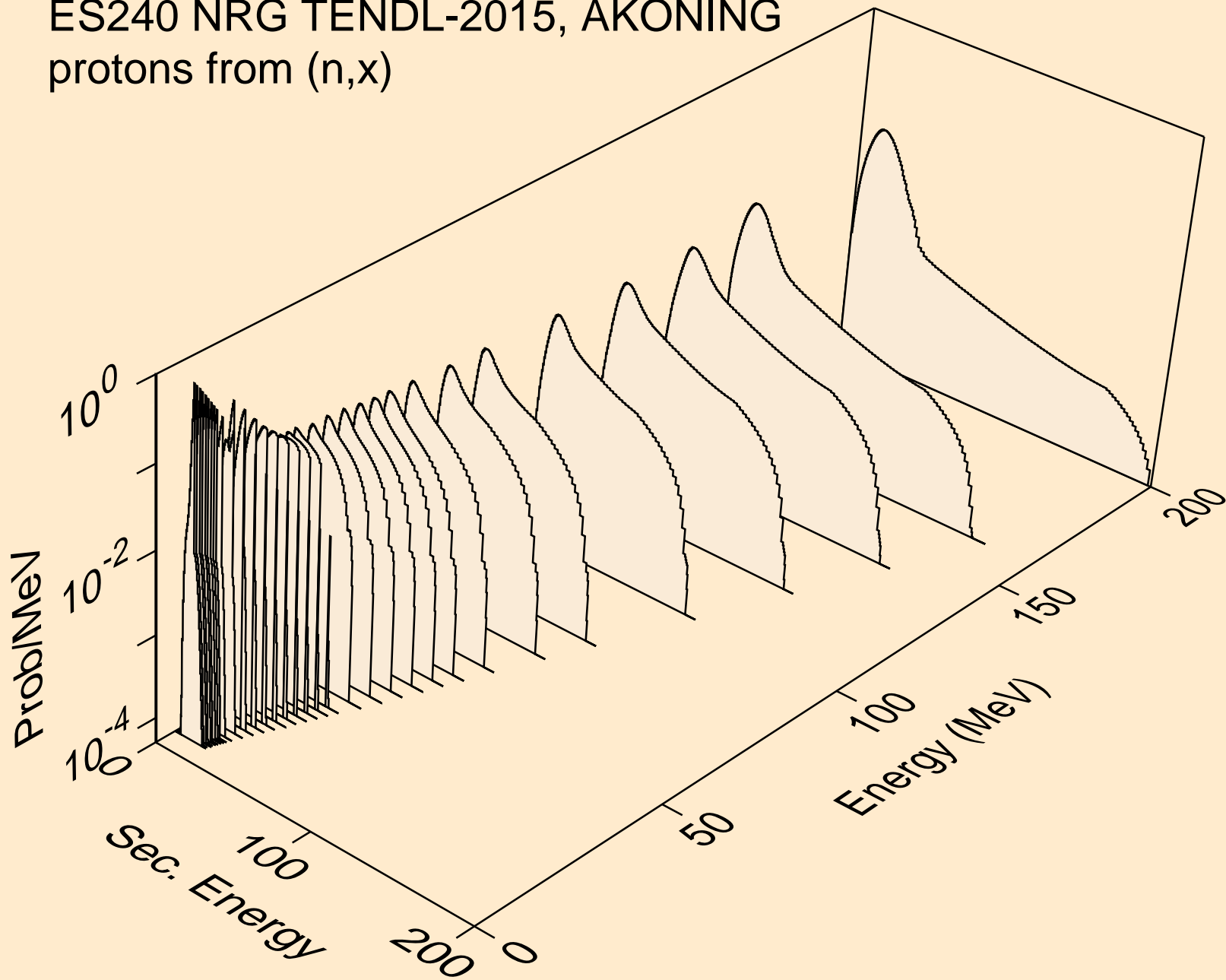

ES240 NRG TENDL-2015, AKONING  
protons from (n,n\*)p

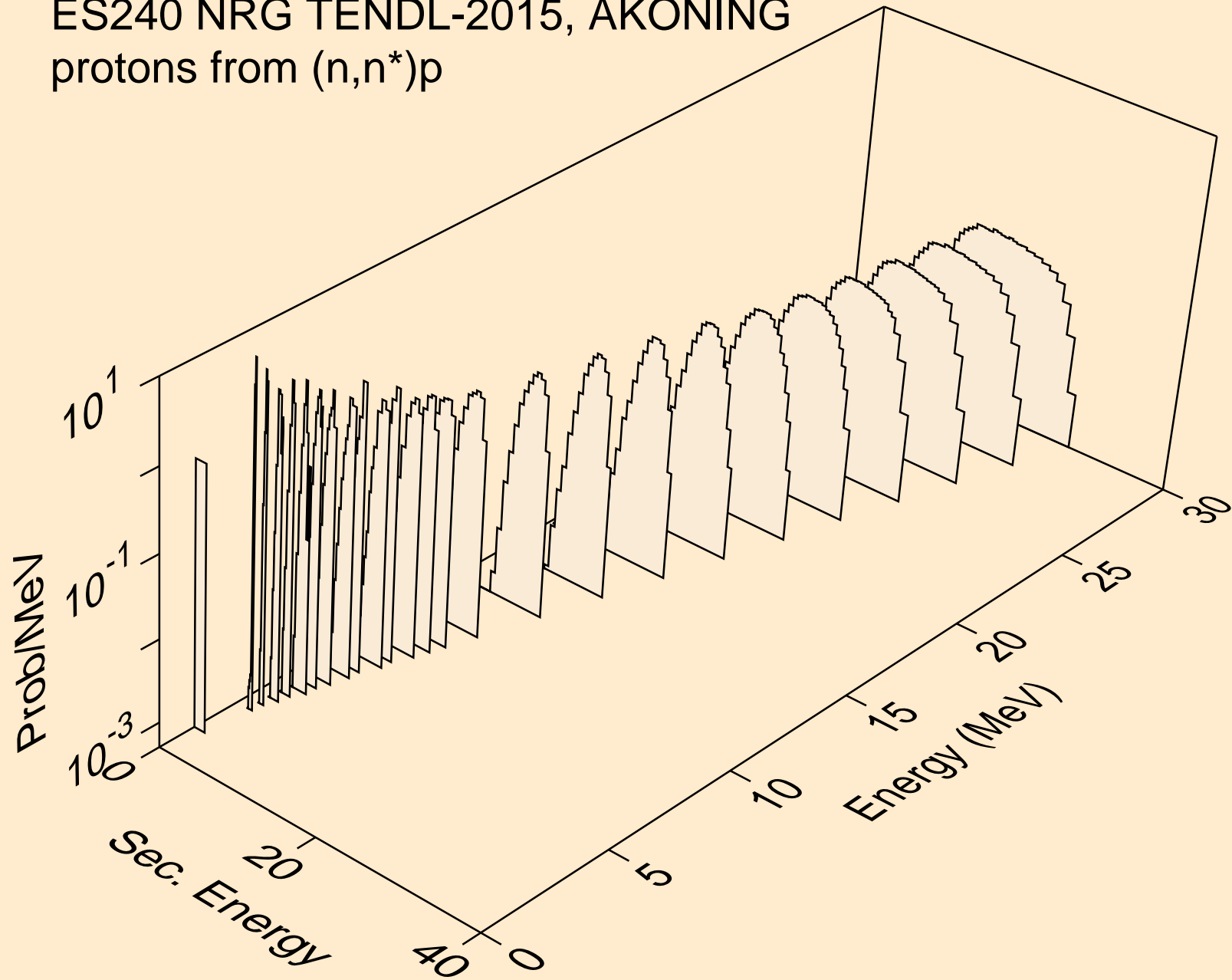

ES240 NRG TENDL-2015, AKONING  
protons from (n,2np)

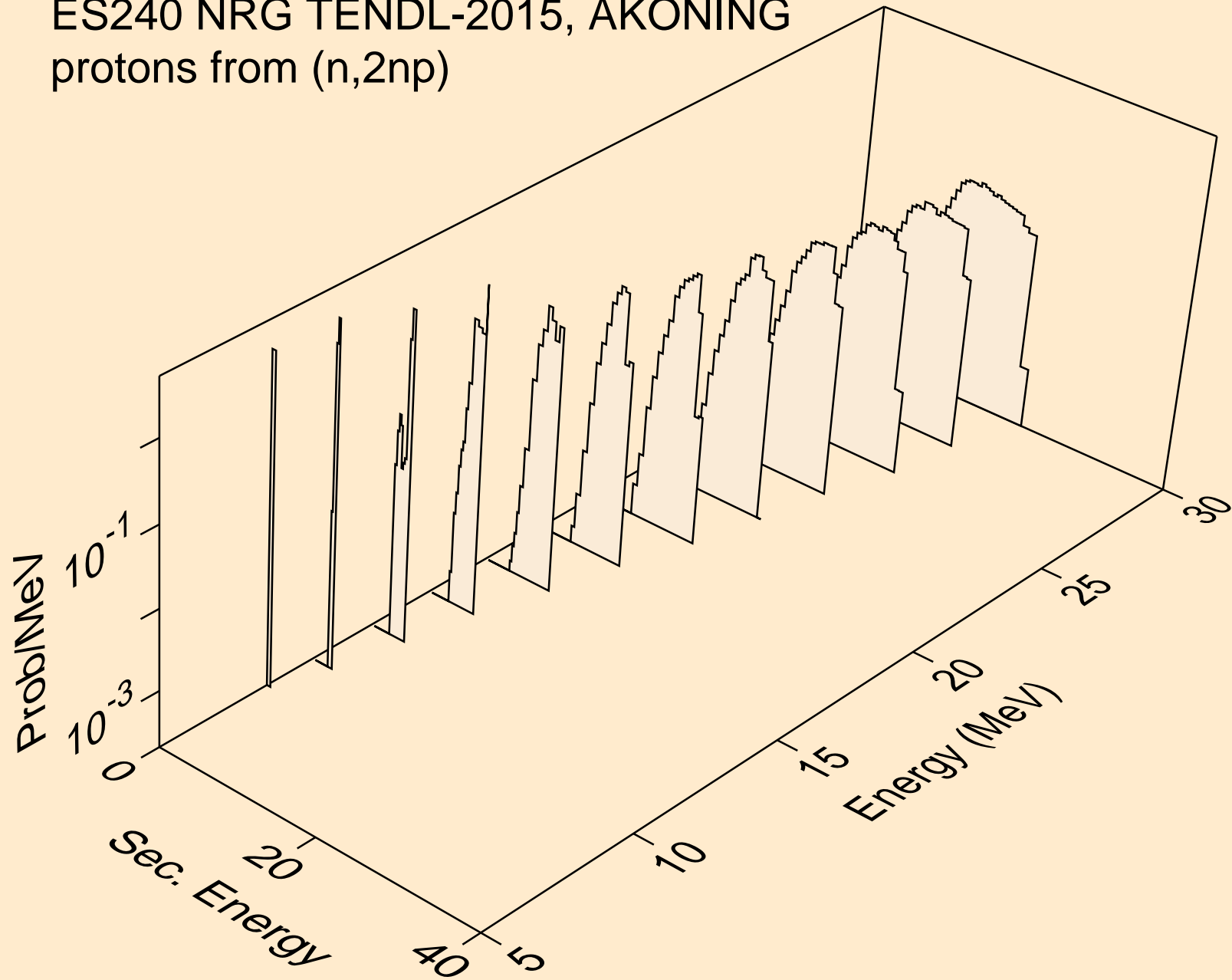

ES240 NRG TENDL-2015, AKONING  
protons from (n,3np)

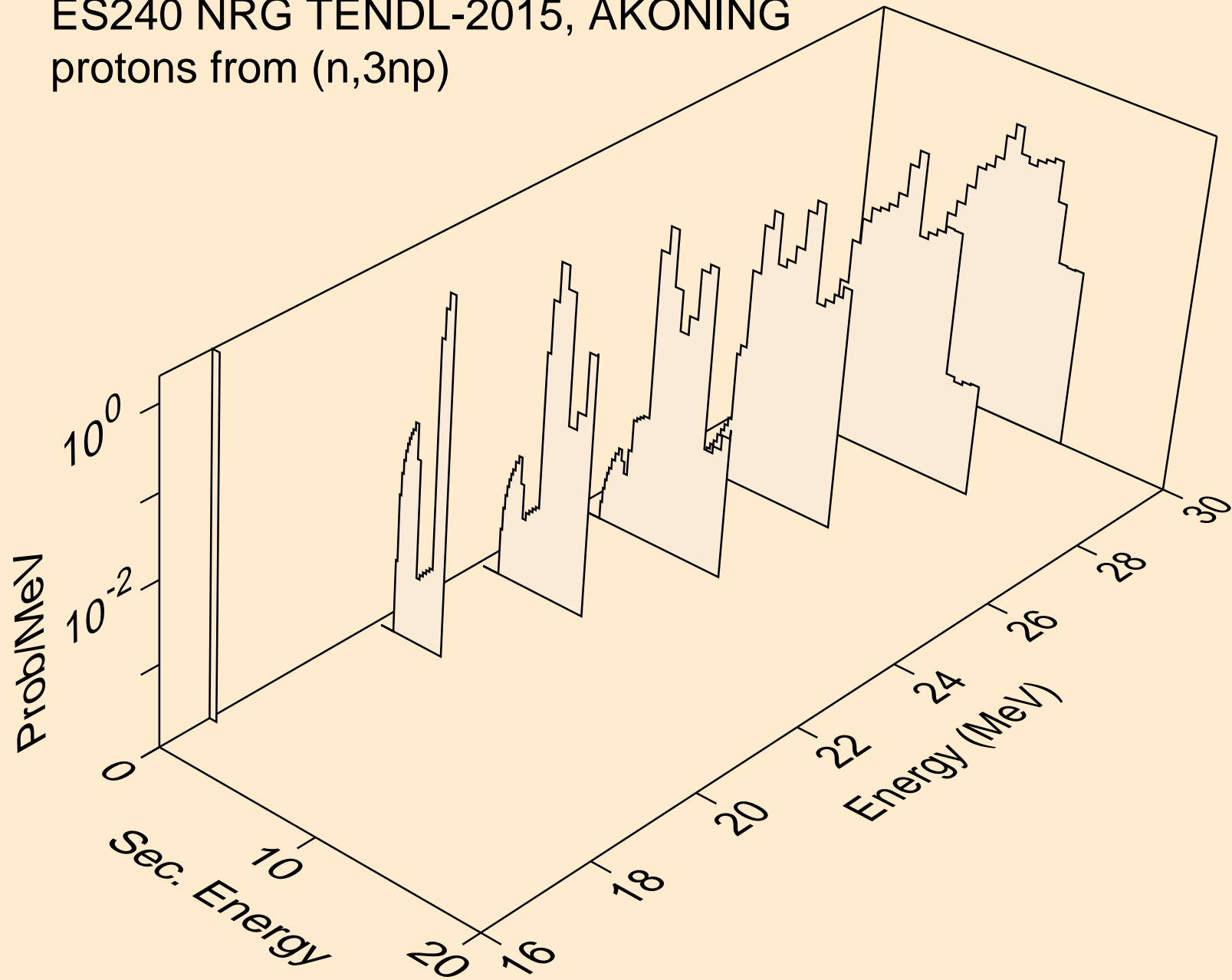

ES240 NRG TENDL-2015, AKONING  
protons from (n,2np)

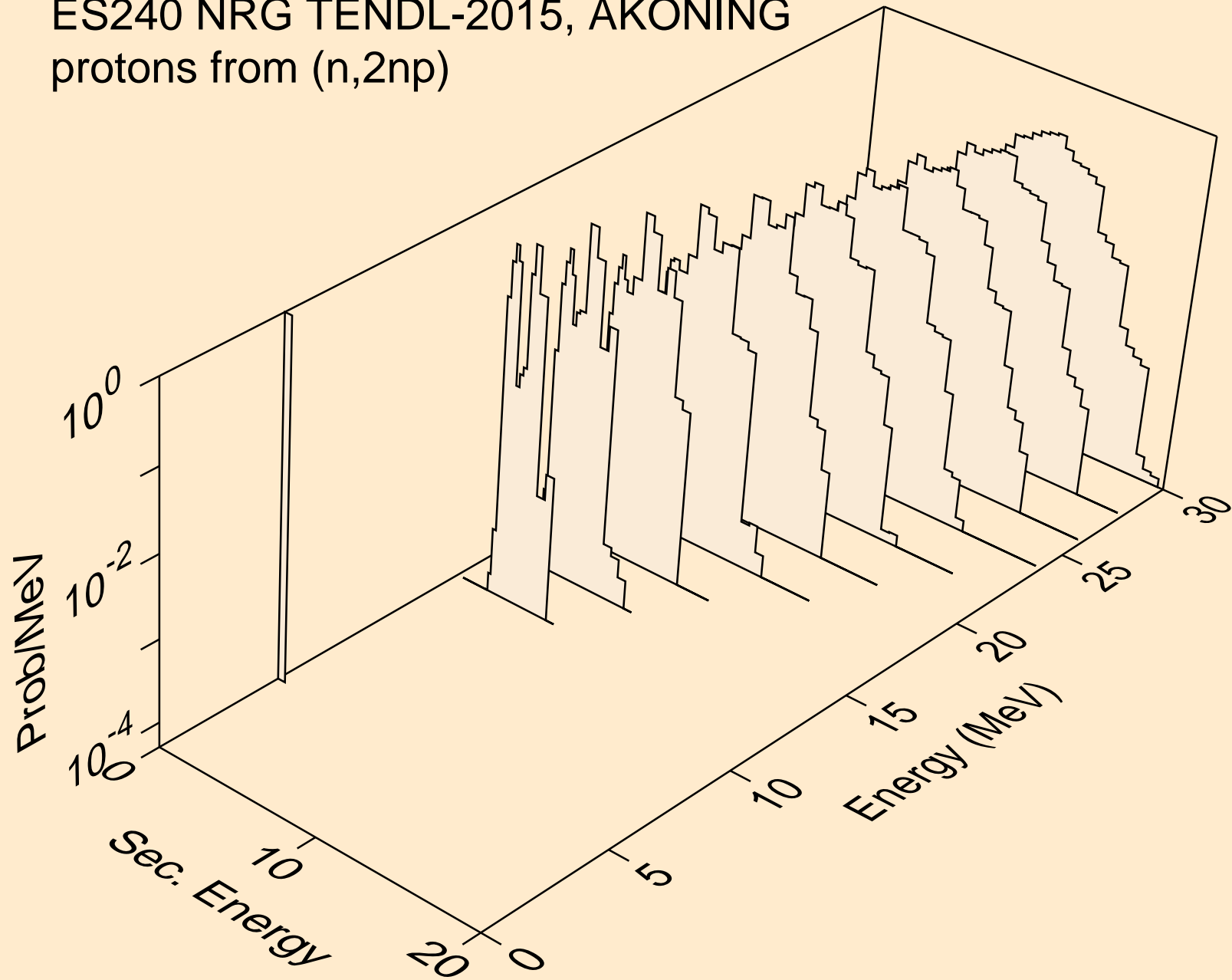

ES240 NRG TENDL-2015, AKONING  
protons from (n,npa)

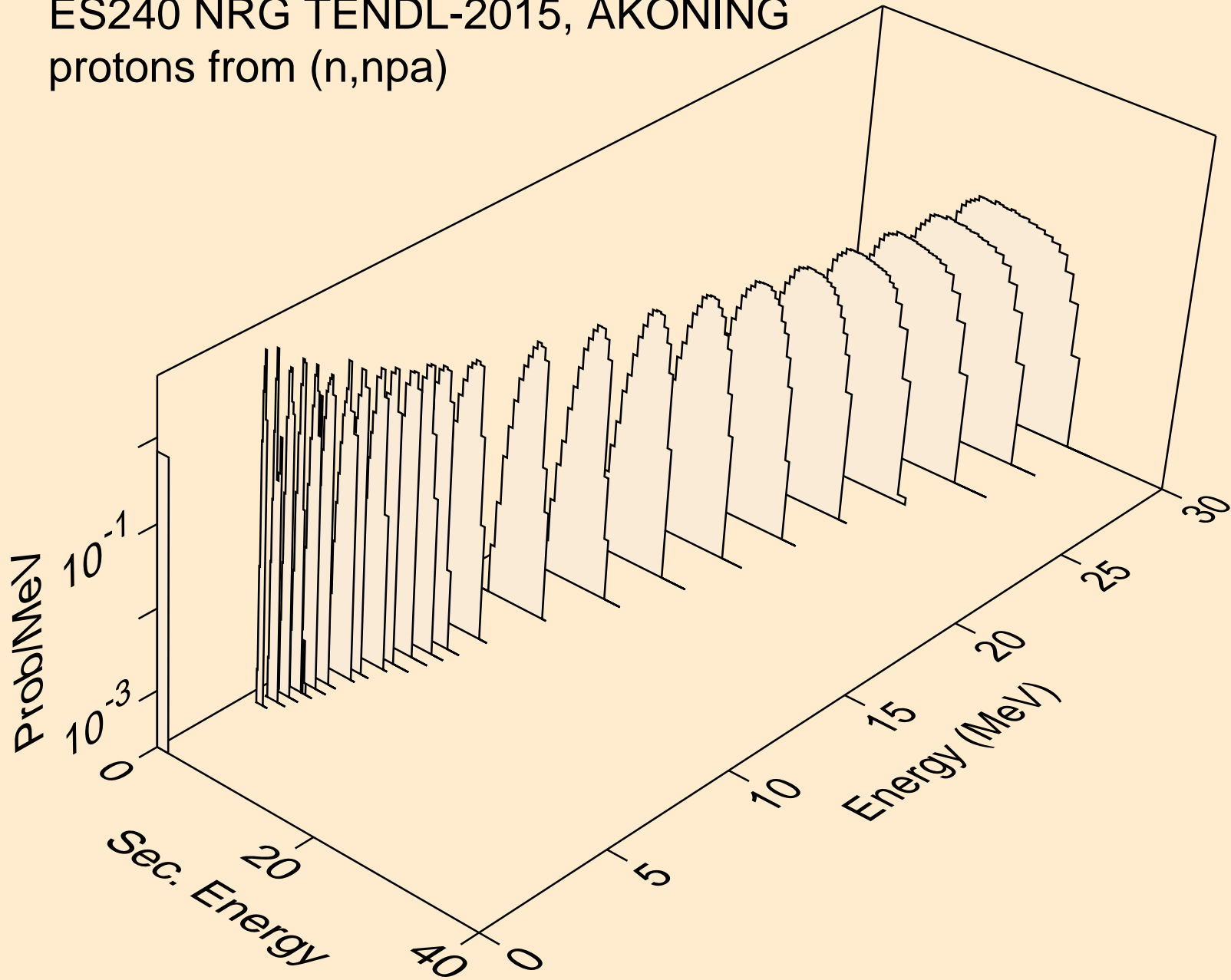

ES240 NRG TENDL-2015, AKONING  
protons from (n,p)

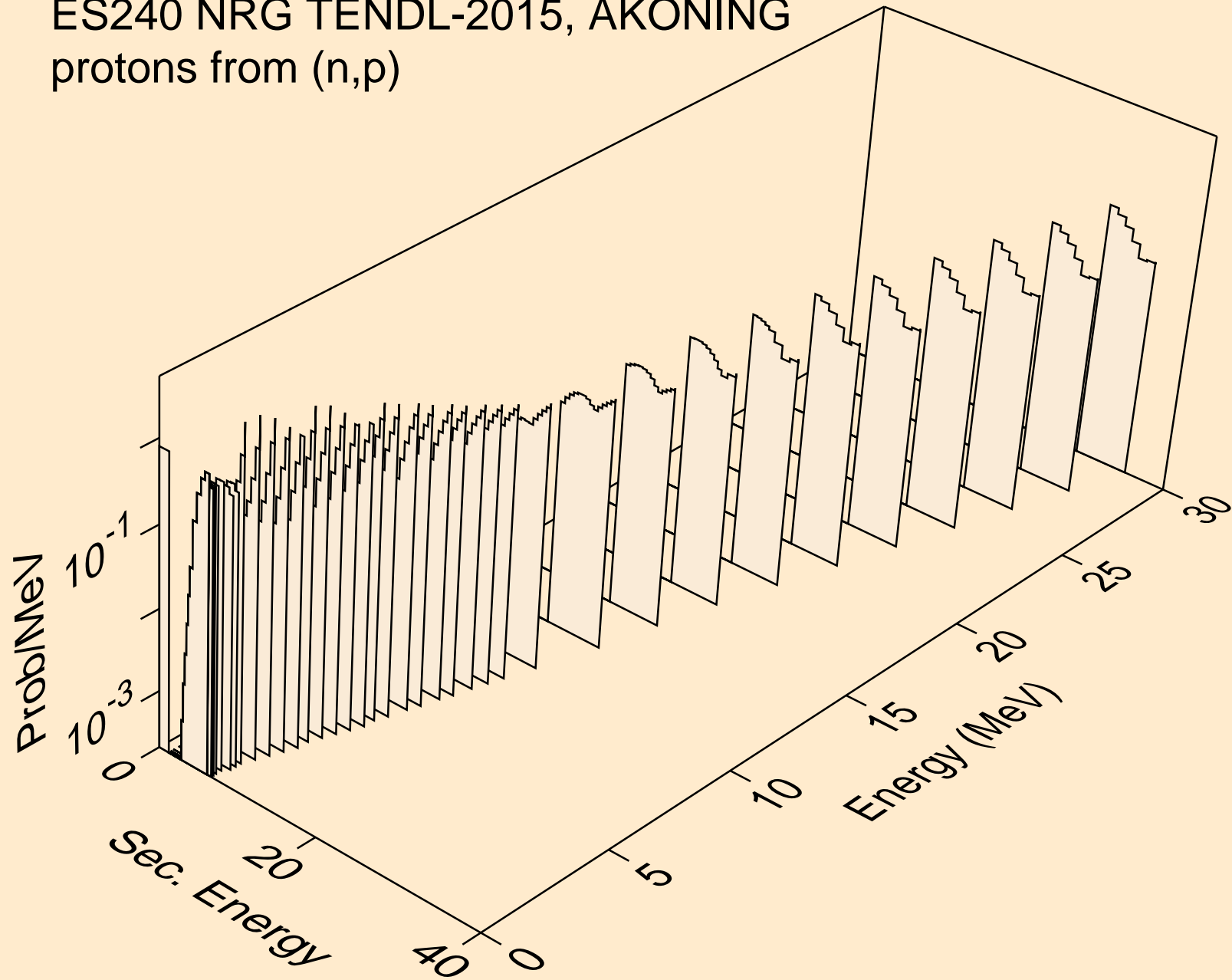



ES240 NRG TENDL-2015, AKONING  
protons from (n,2p)

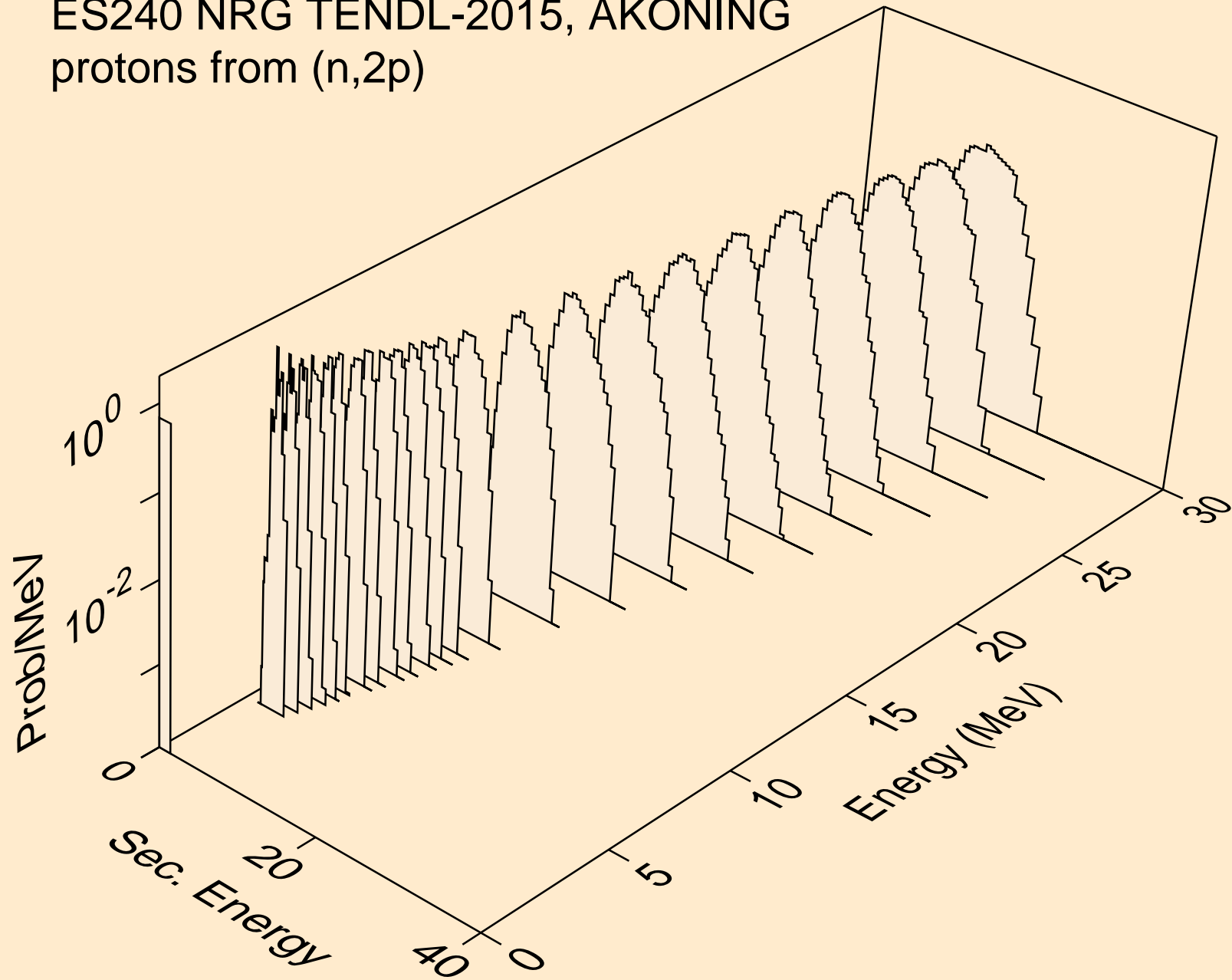

ES240 NRG TENDL-2015, AKONING  
protons from (n,pa)

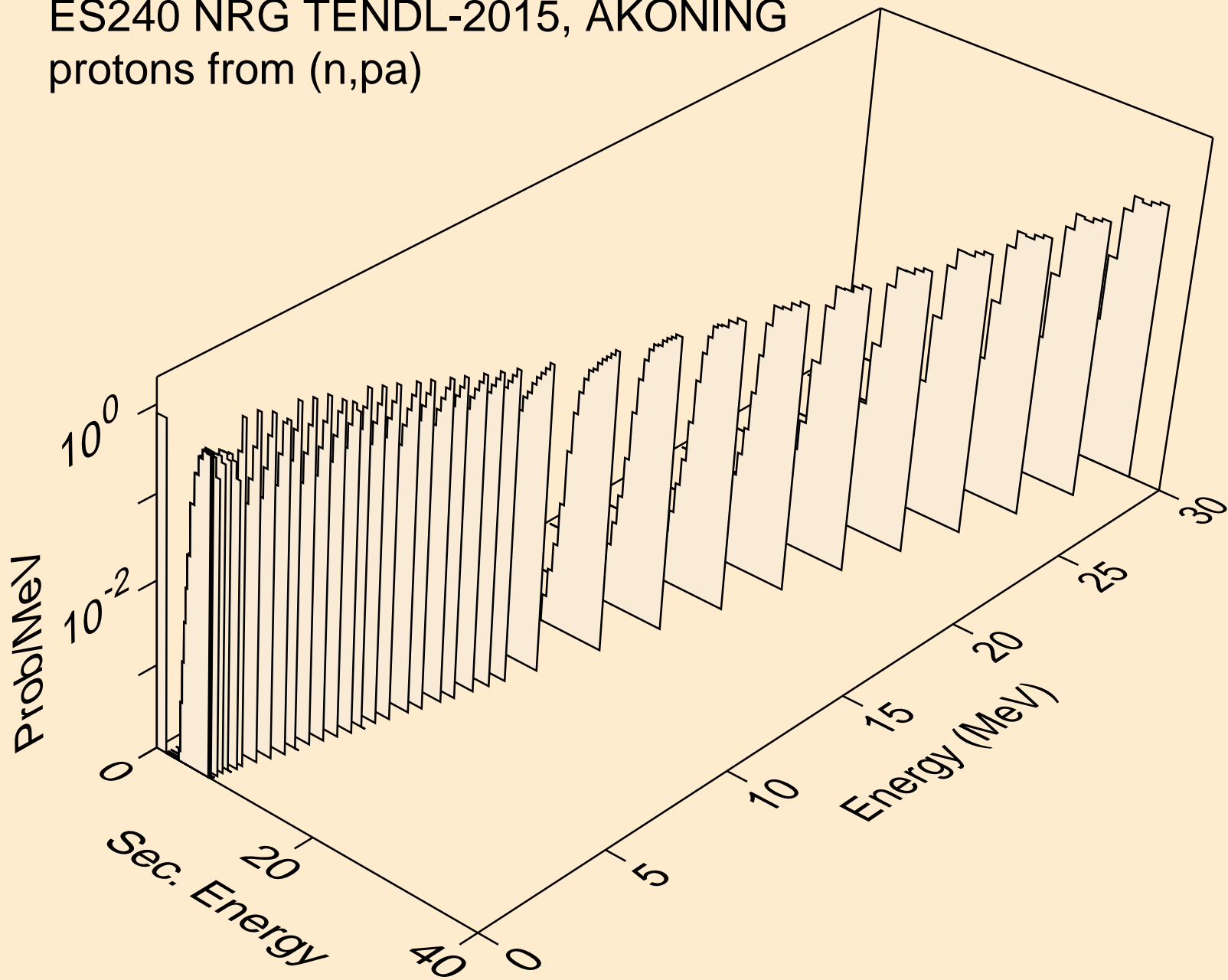

ES240 NRG TENDL-2015, AKONING  
protons from (n,pd)

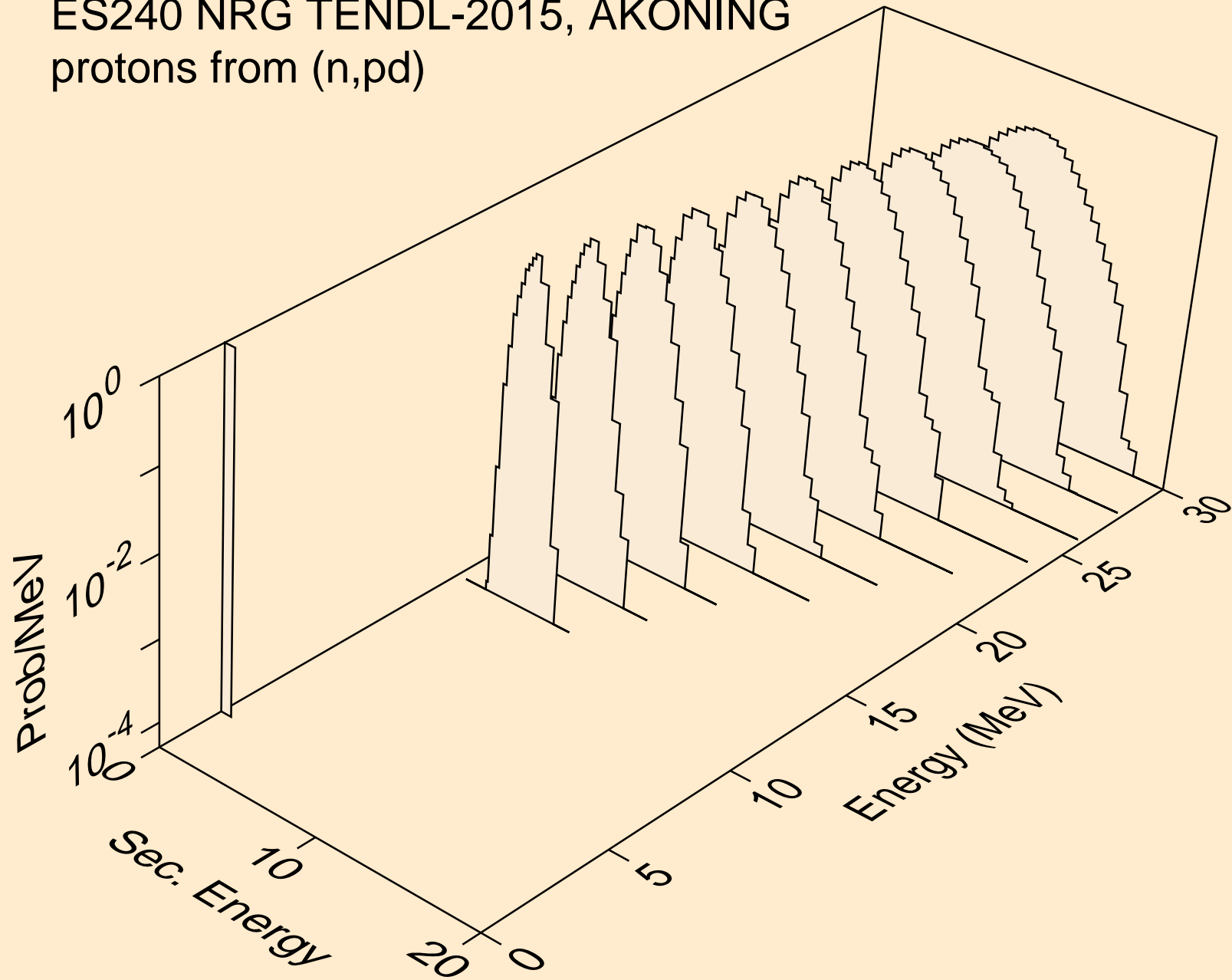

ES240 NRG TENDL-2015, AKONING  
deuterons from (n,x)

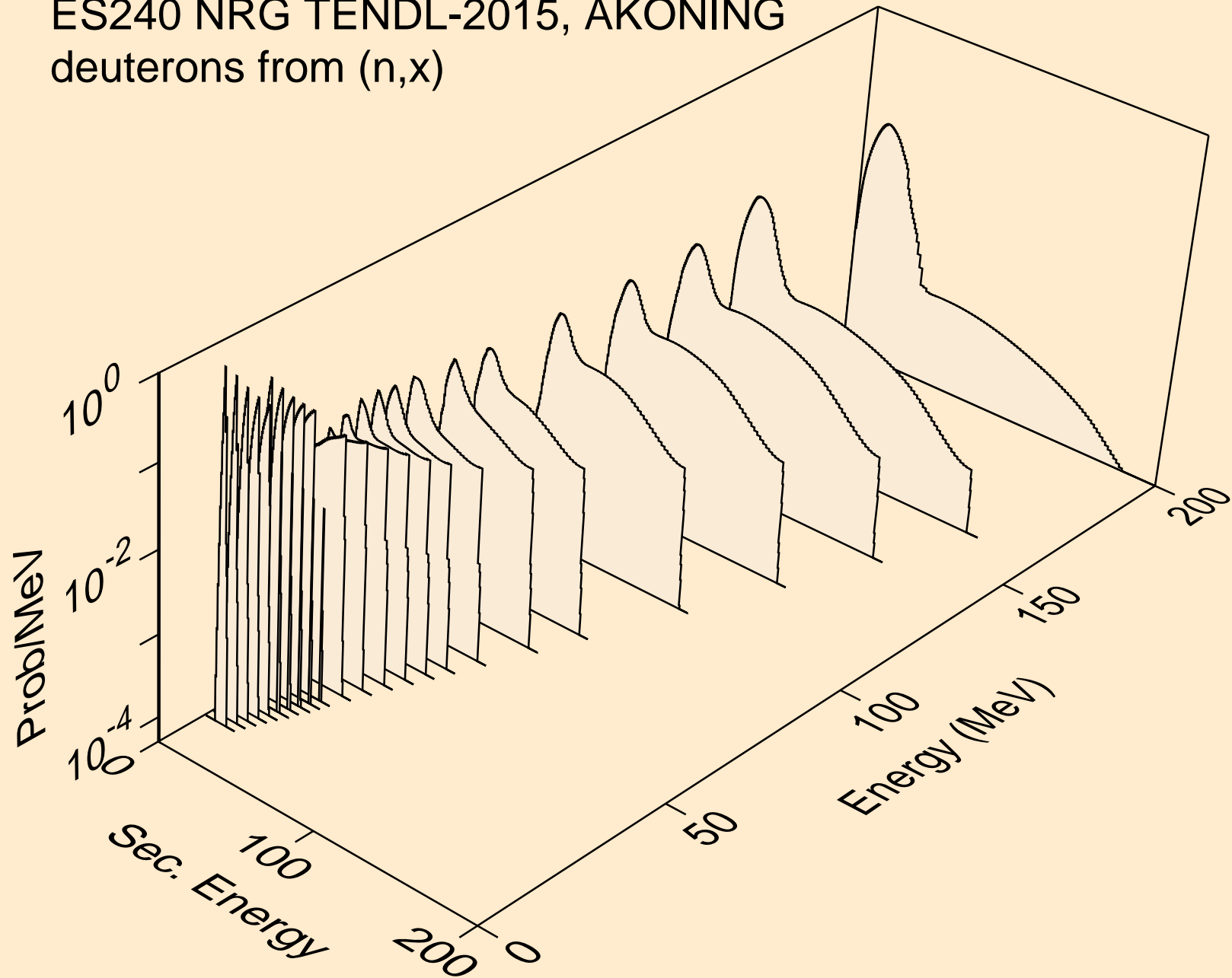

ES240 NRG TENDL-2015, AKONING  
deuterons from (n,2nd)

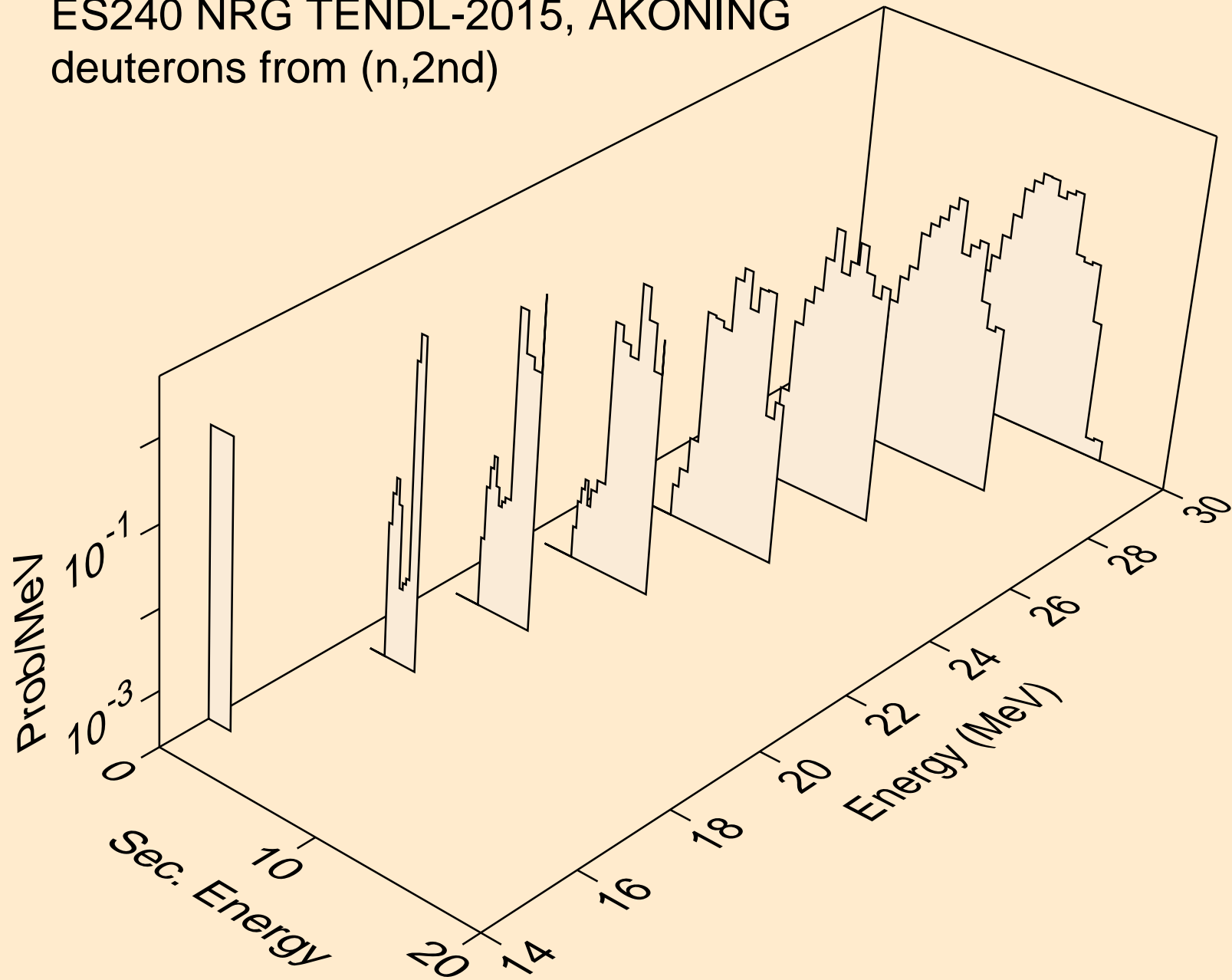

ES240 NRG TENDL-2015, AKONING  
deuterons from (n,n\*)d

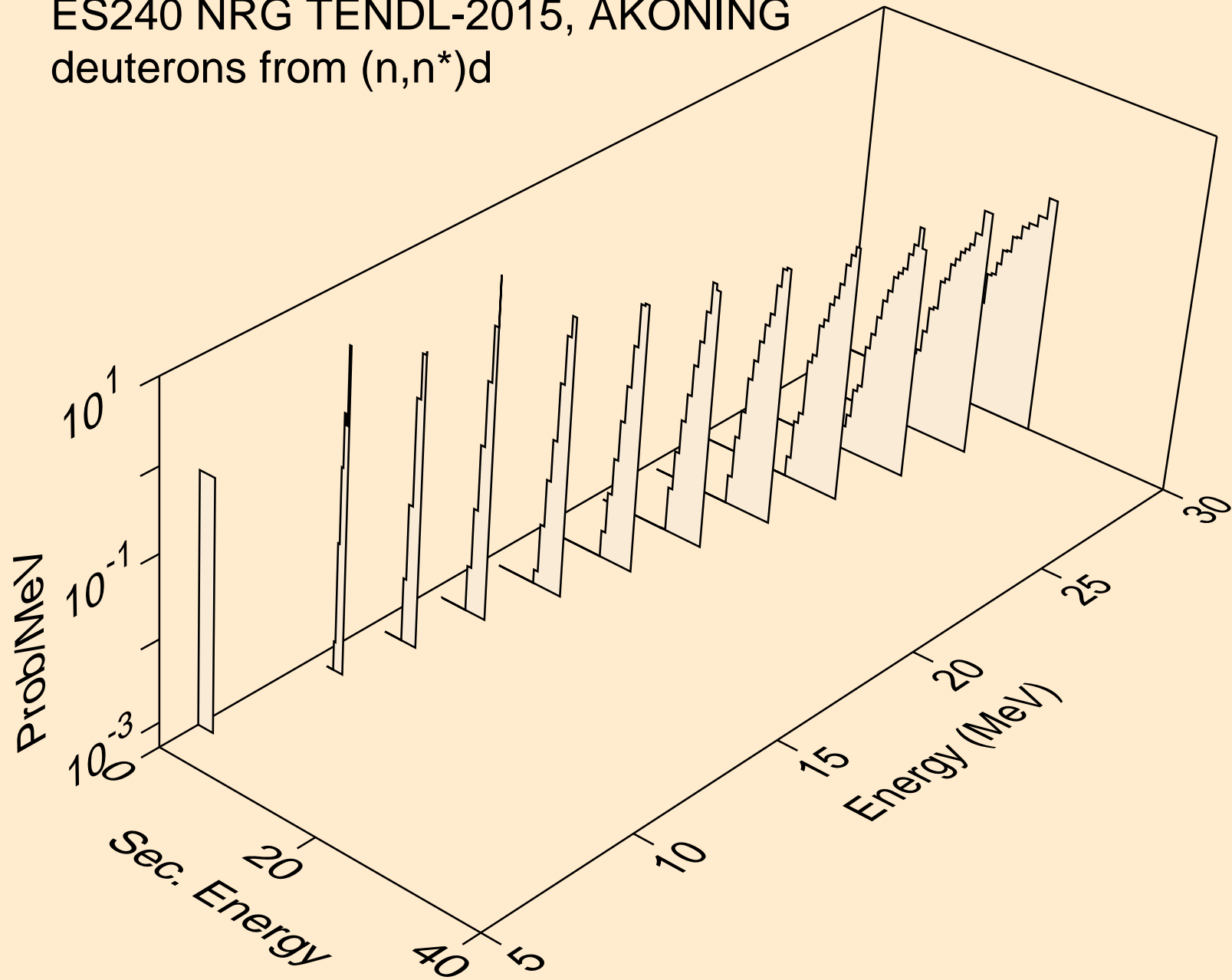

ES240 NRG TENDL-2015, AKONING  
deuterons from (n,n\*)d2a

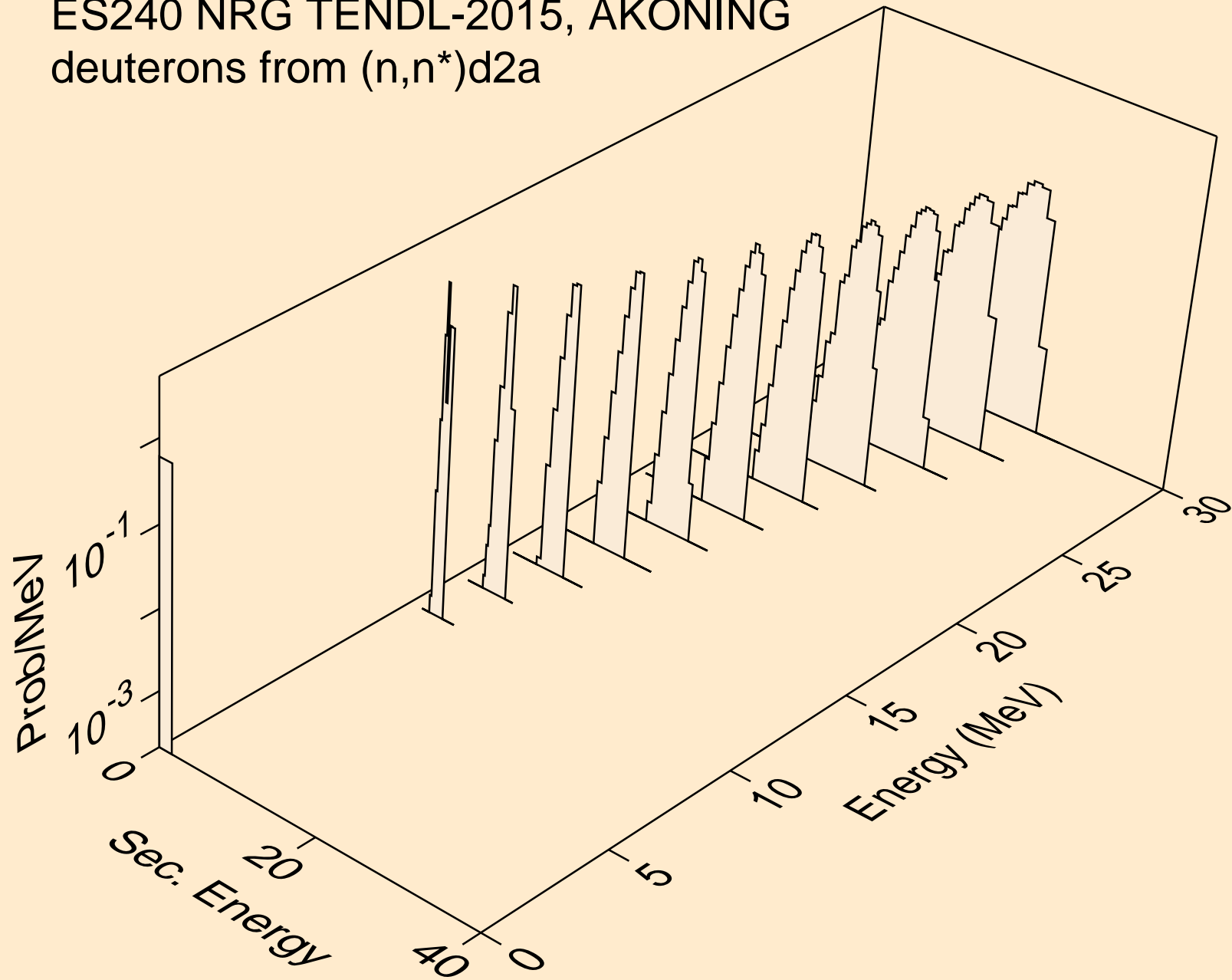

ES240 NRG TENDL-2015, AKONING  
deuterons from (n,d)

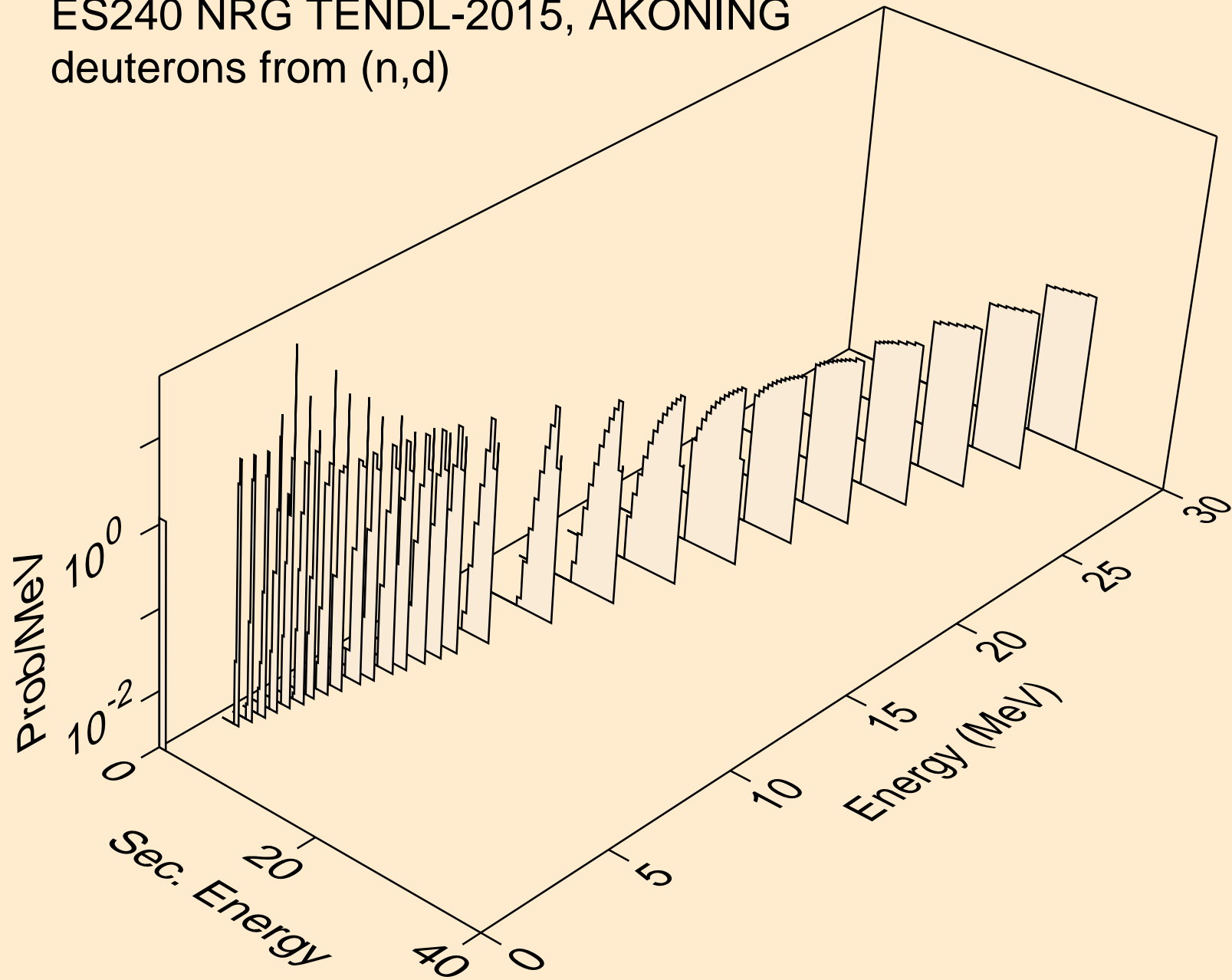



ES240 NRG TENDL-2015, AKONING  
deuterons from (n,d2a)

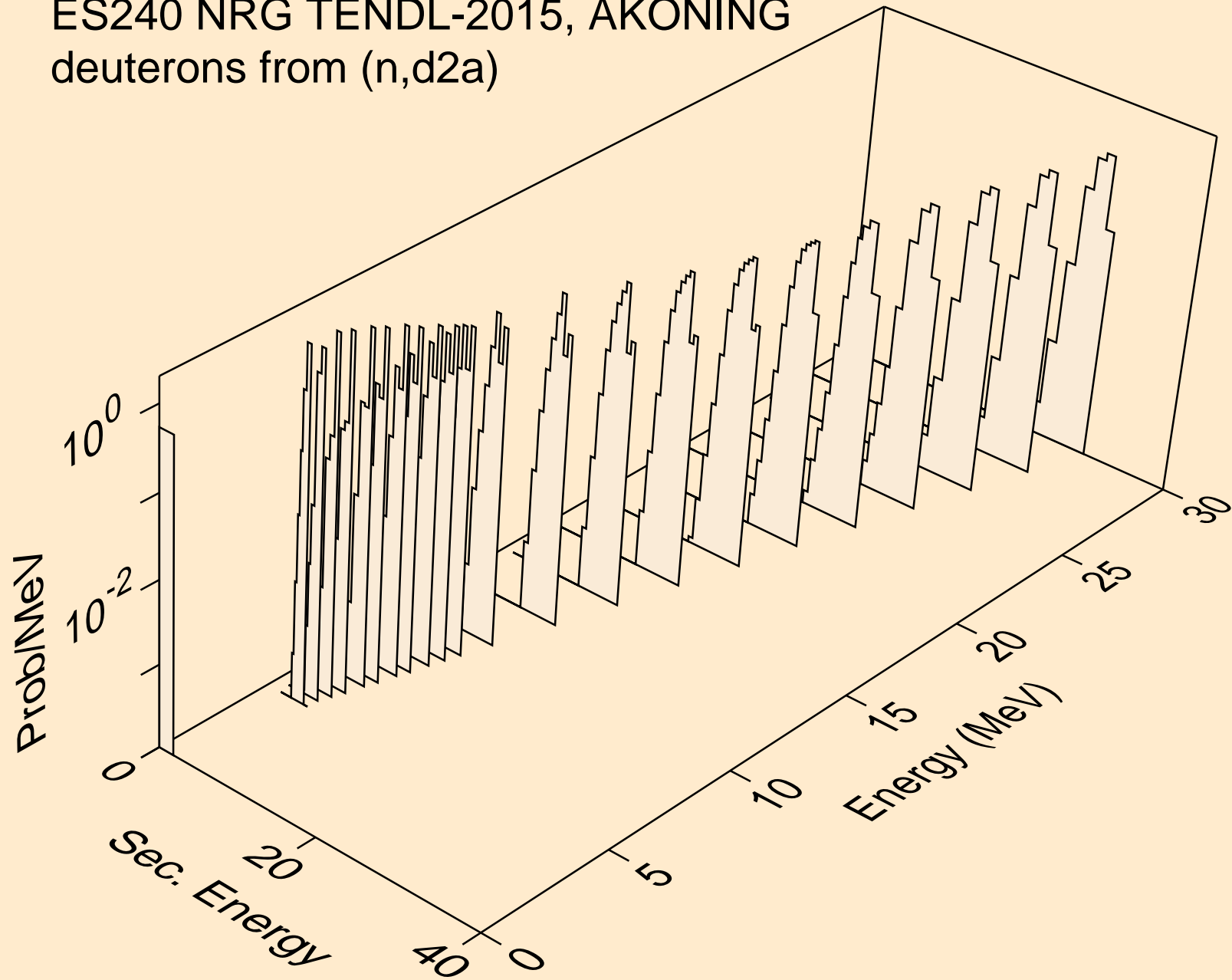

ES240 NRG TENDL-2015, AKONING  
deuterons from (n,pd)

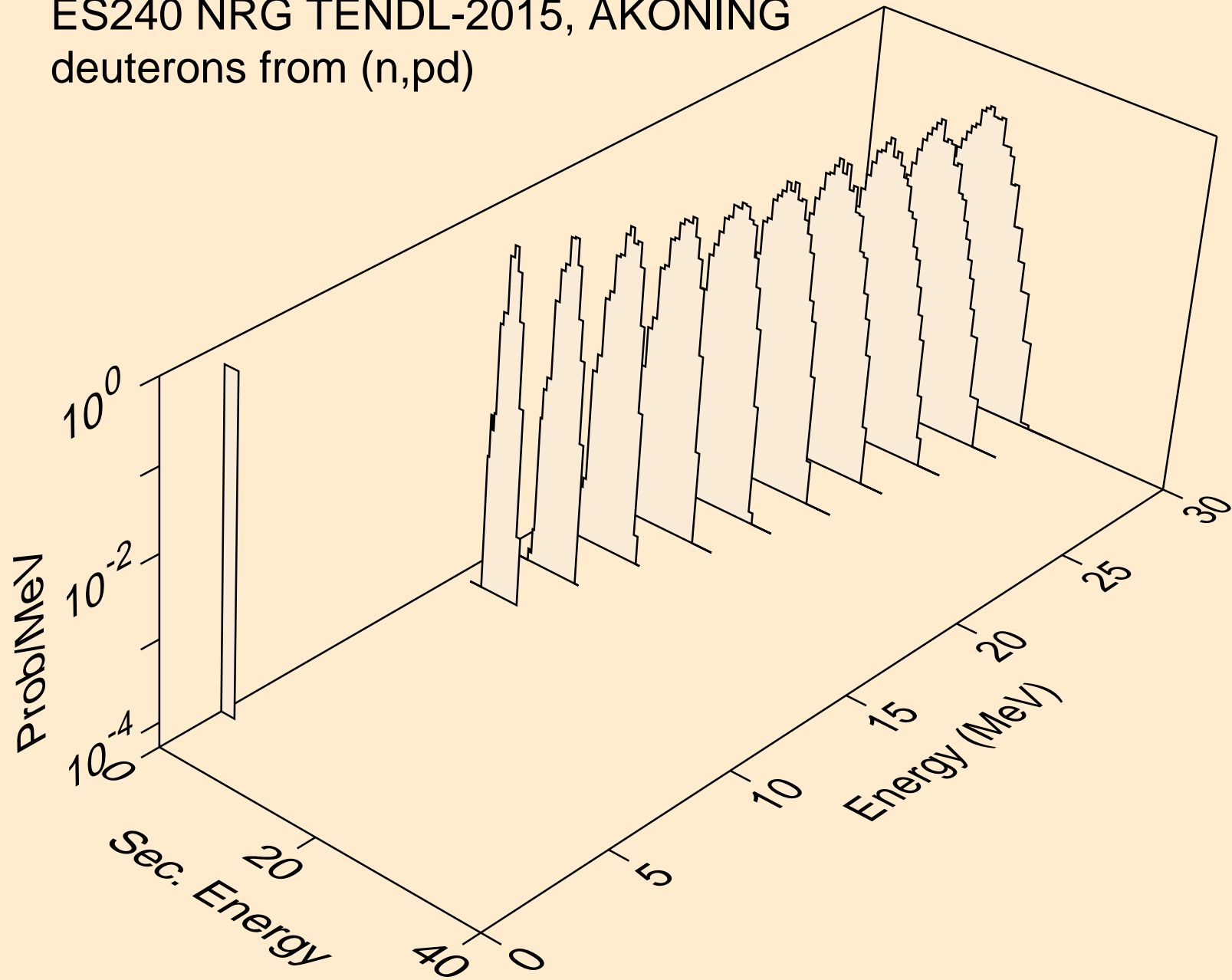

ES240 NRG TENDL-2015, AKONING  
deuterons from (n,da)

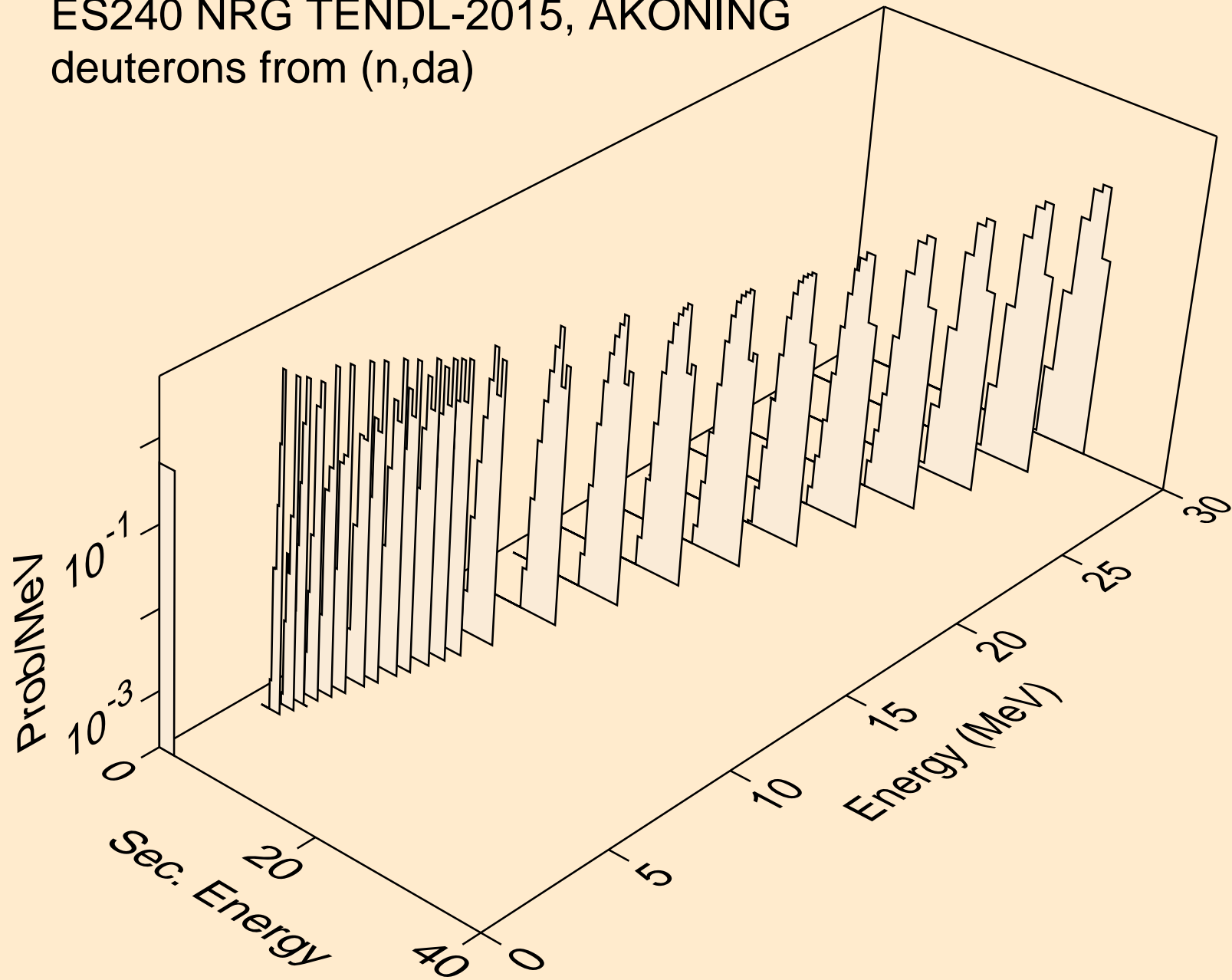

ES240 NRG TENDL-2015, AKONING  
tritons from (n,x)

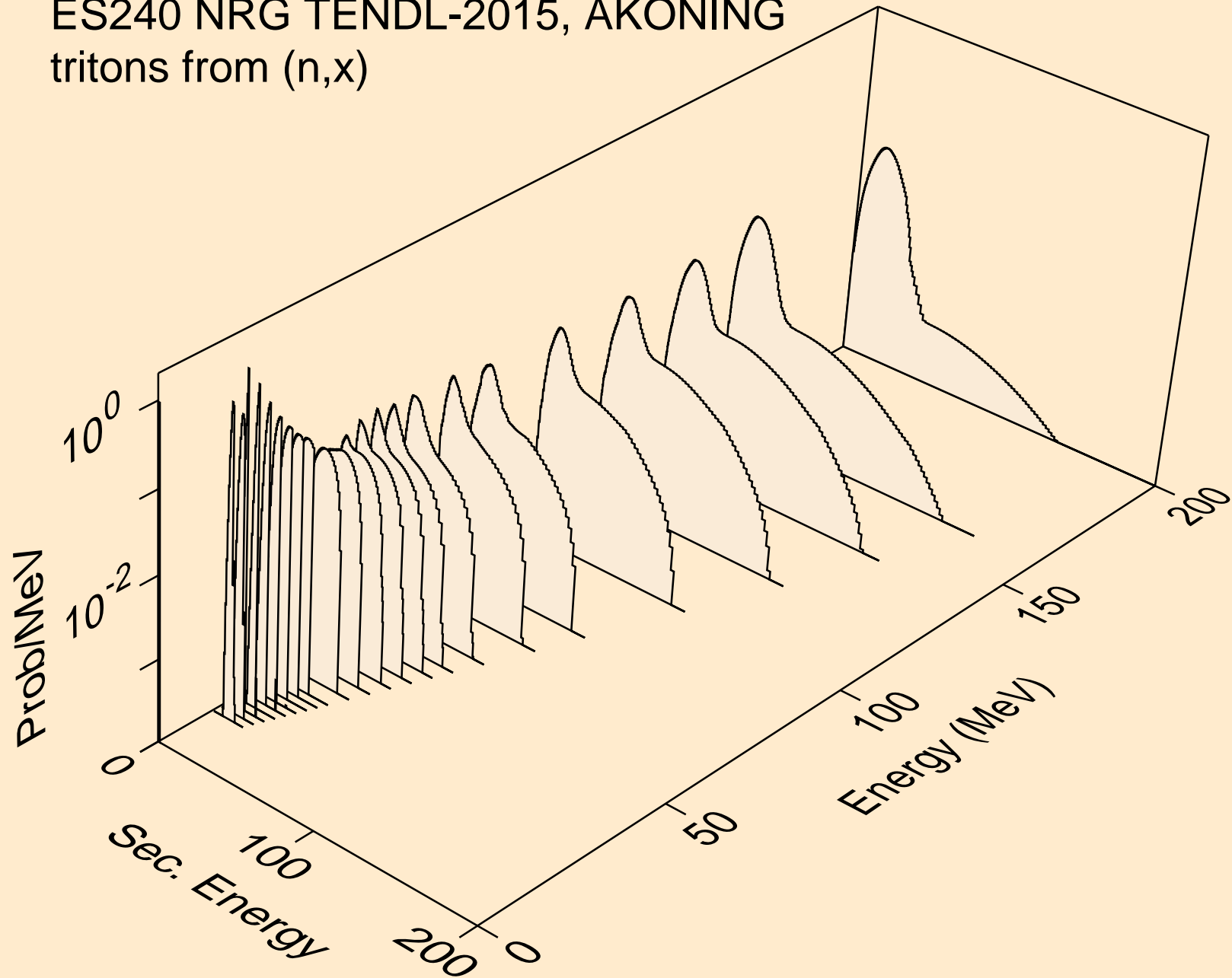

ES240 NRG TENDL-2015, AKONING  
tritons from (n,n\*)t

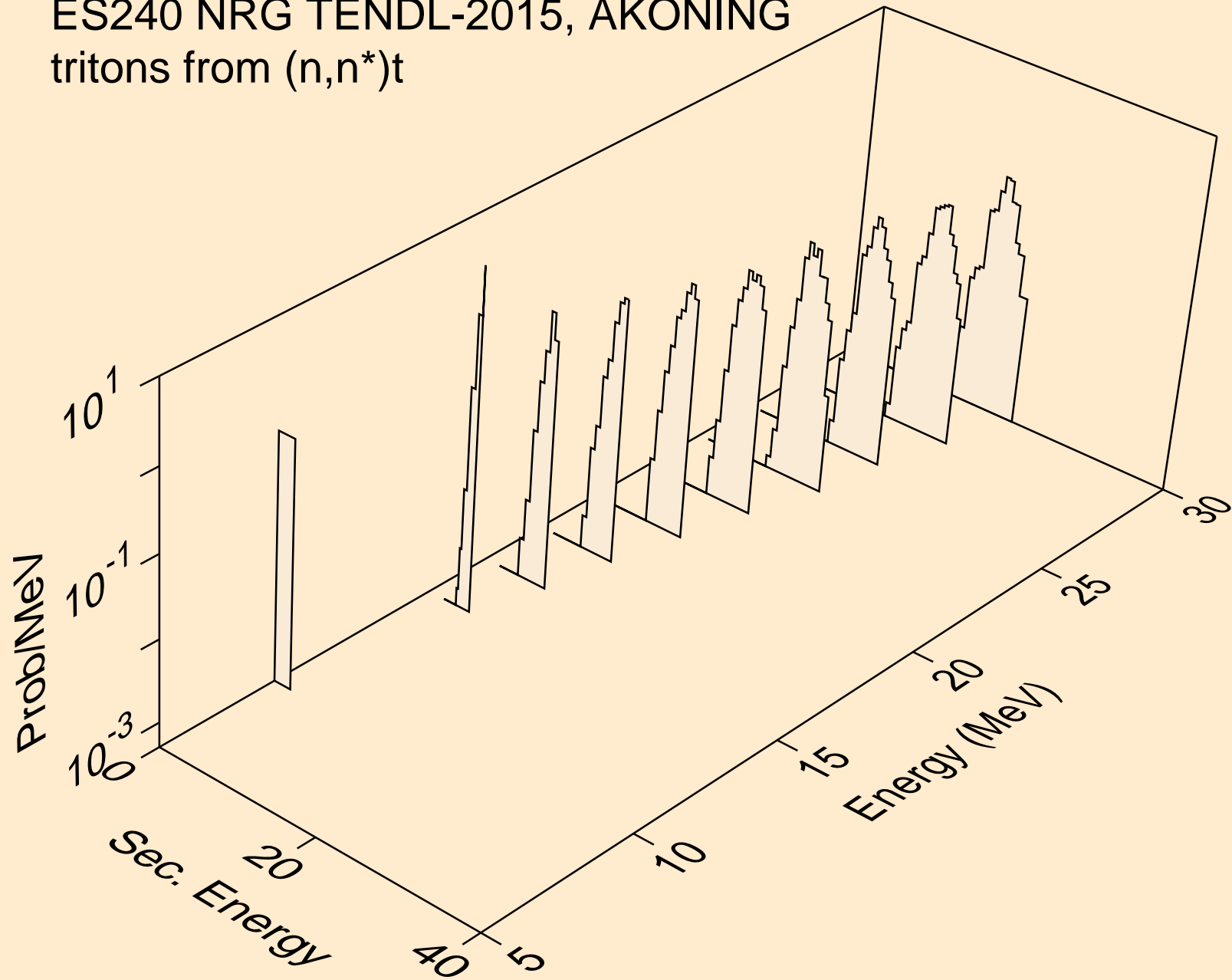

ES240 NRG TENDL-2015, AKONING  
tritons from (n,n\*)t2a

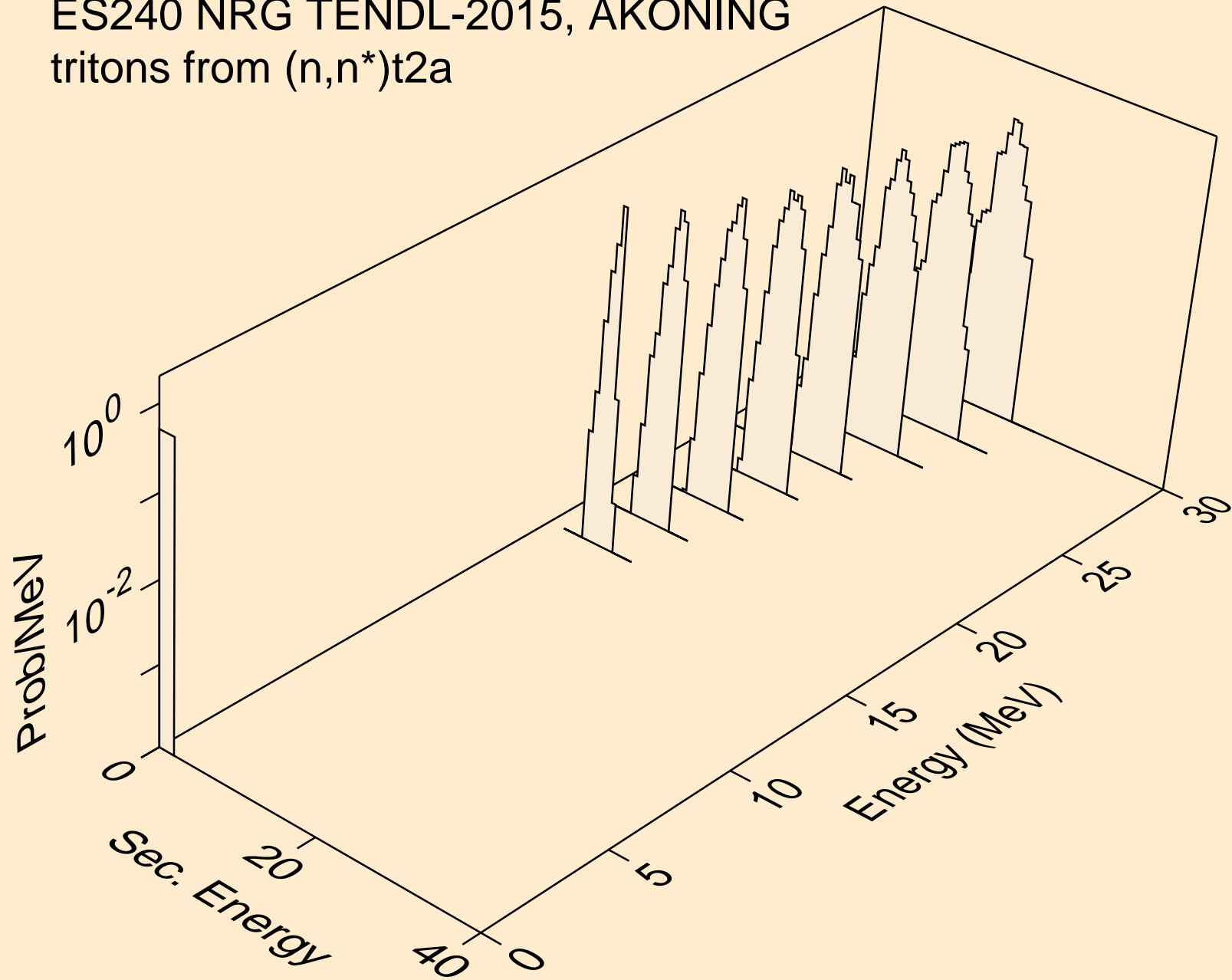

ES240 NRG TENDL-2015, AKONING  
tritons from (n,t)

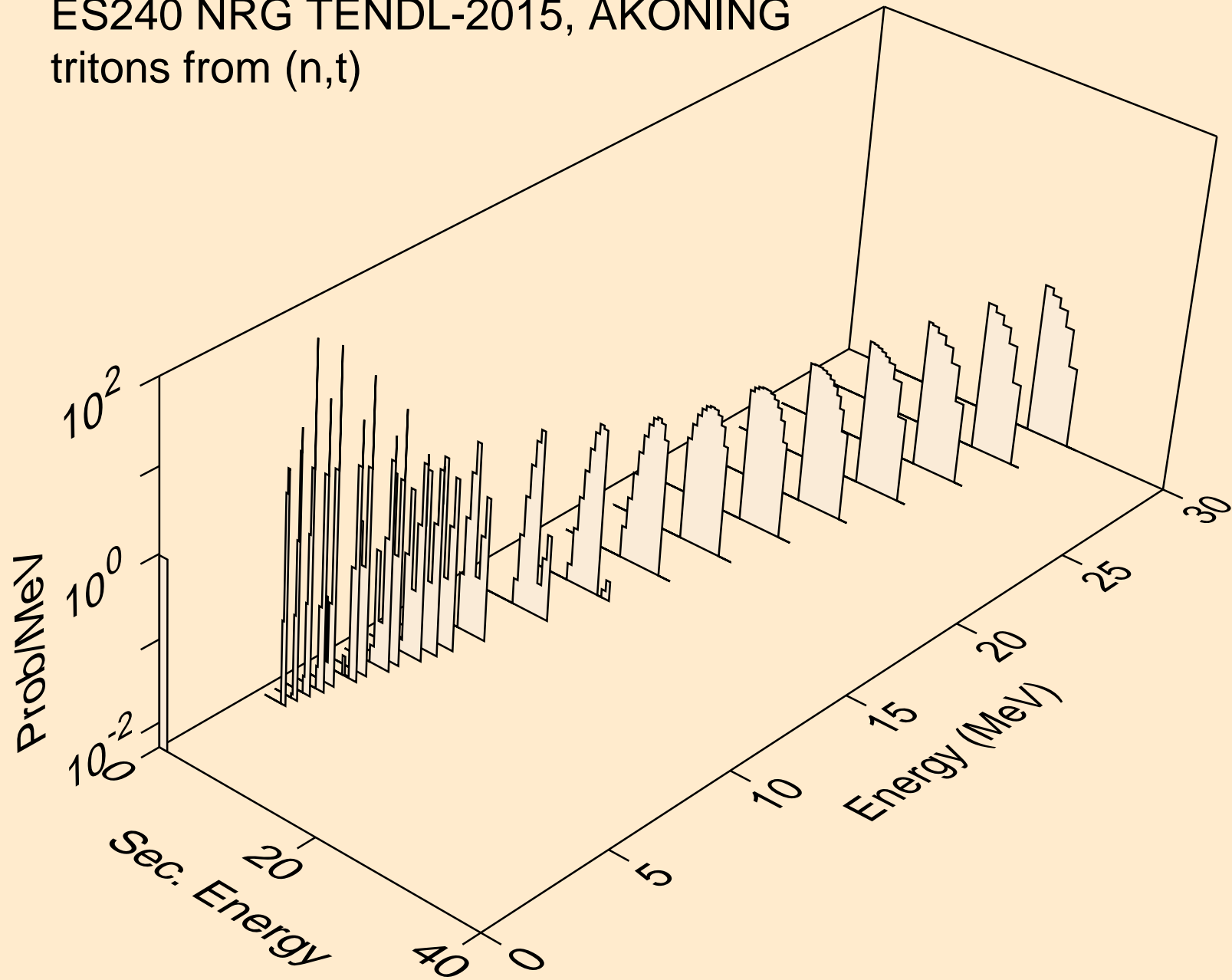

ES240 NRG TENDL-2015, AKONING  
tritons from (n,t2a)

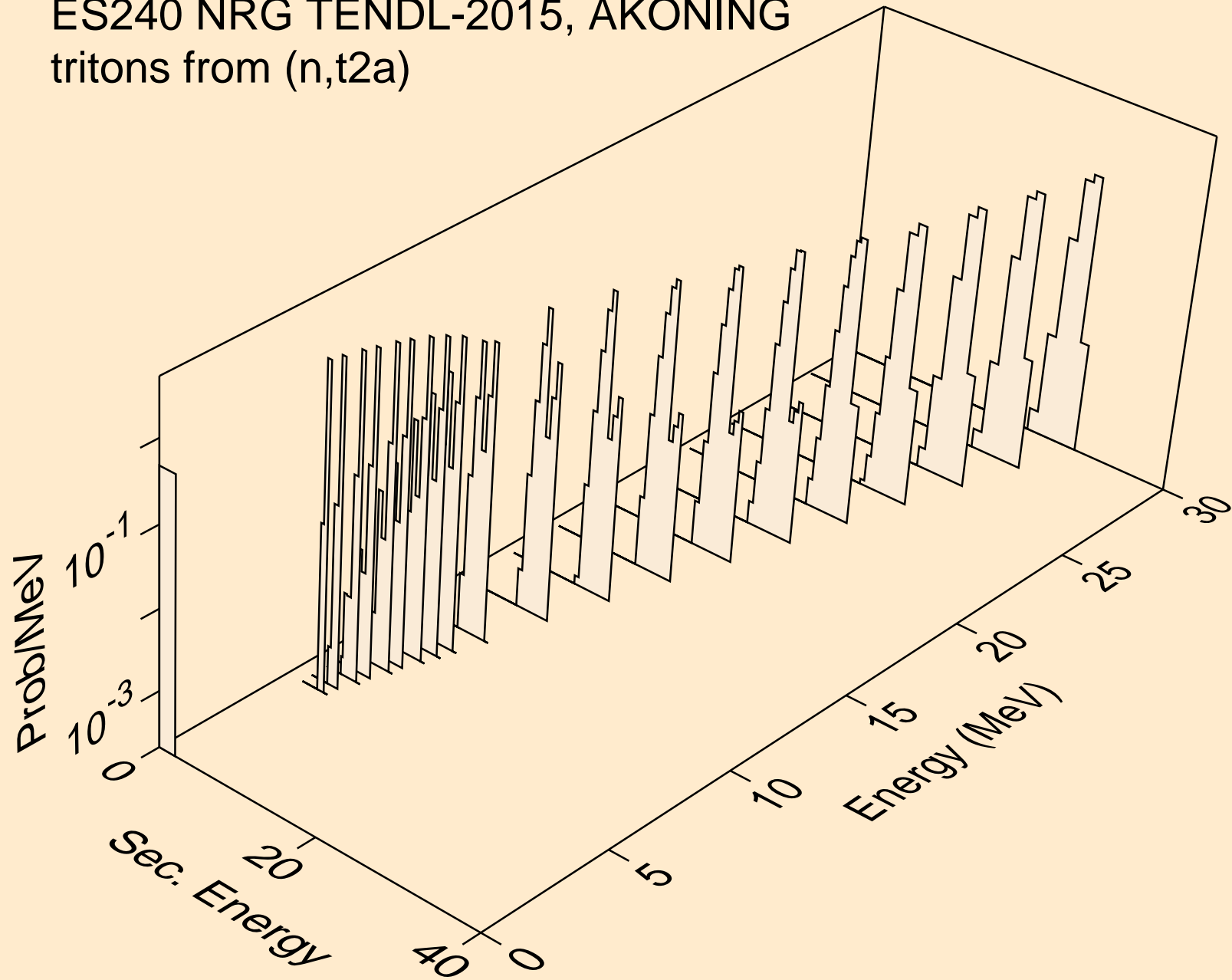



ES240 NRG TENDL-2015, AKONING  
he3s from (n,x)

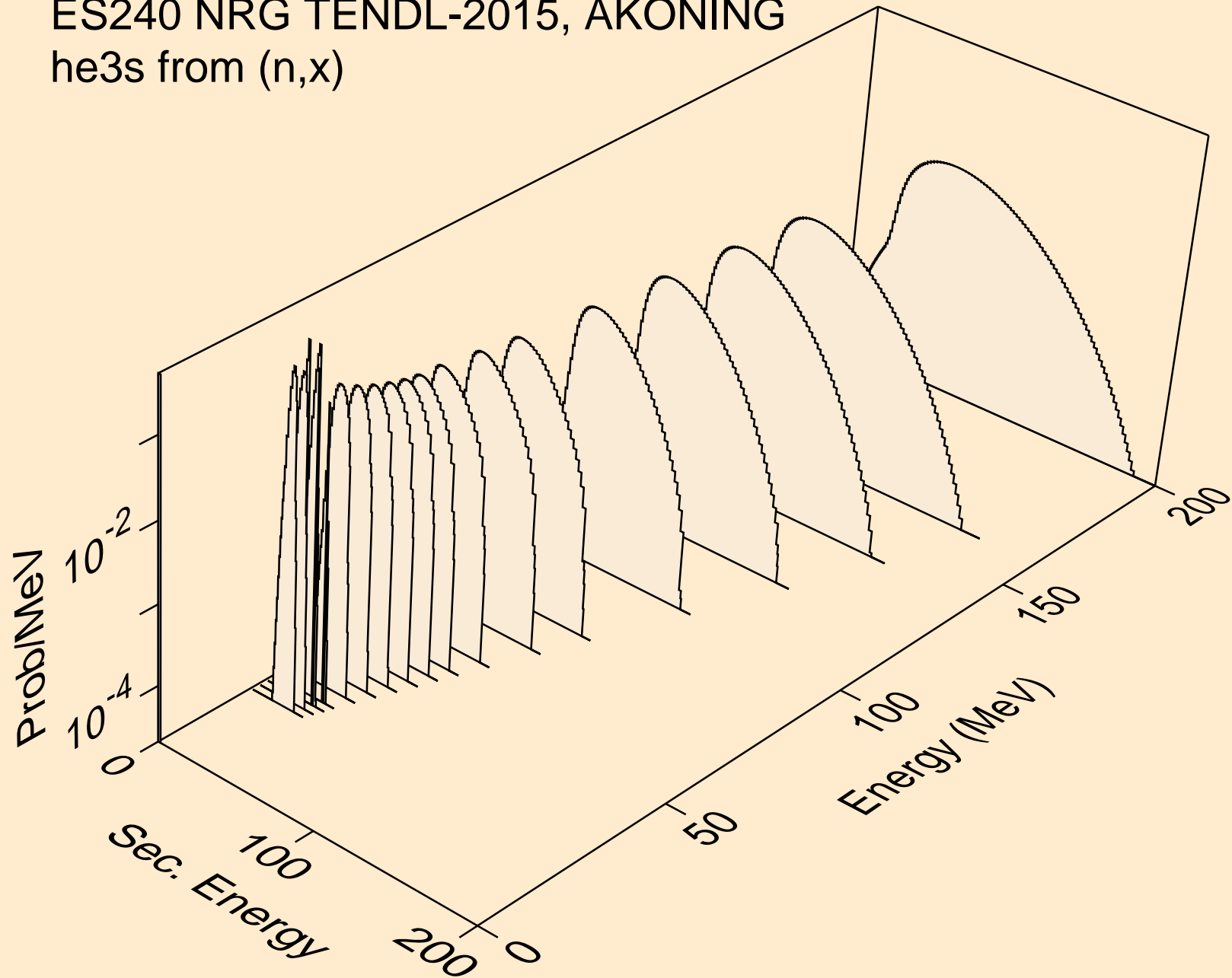

ES240 NRG TENDL-2015, AKONING  
he3s from (n,n\*)he3

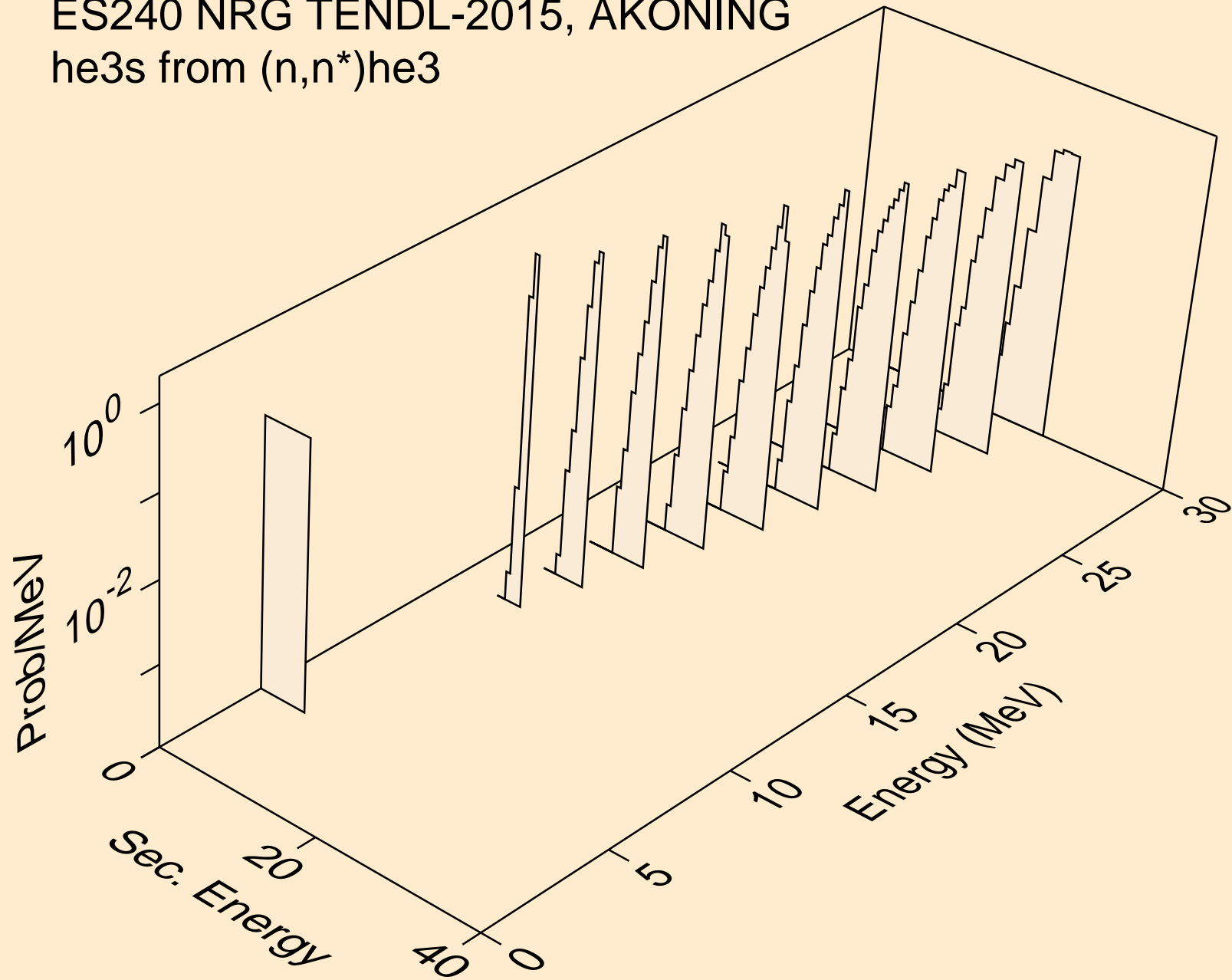

ES240 NRG TENDL-2015, AKONING  
he3s from (n,he3)

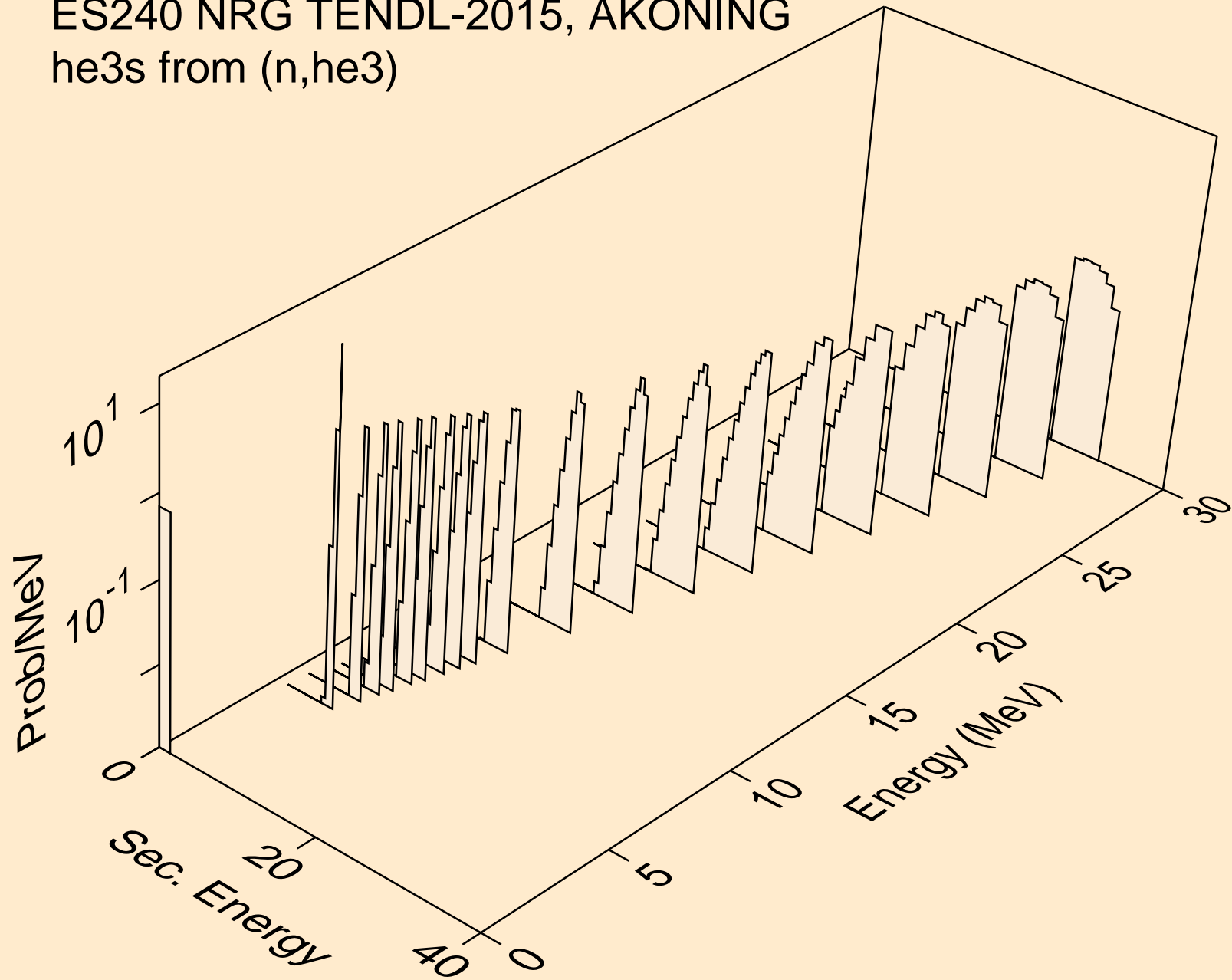

ES240 NRG TENDL-2015, AKONING  
alphas from (n,x)

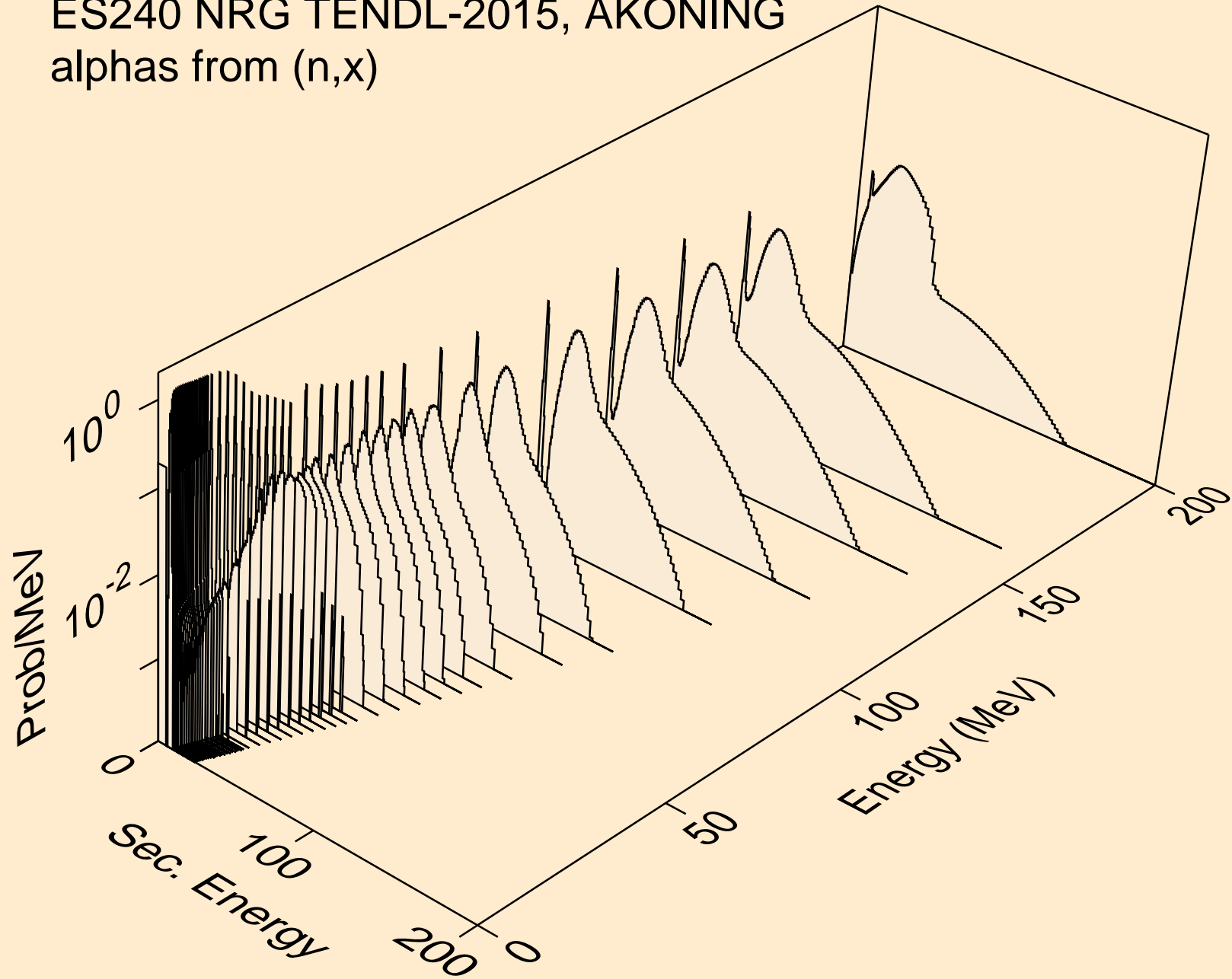

ES240 NRG TENDL-2015, AKONING  
alphas from (n,n\*)a

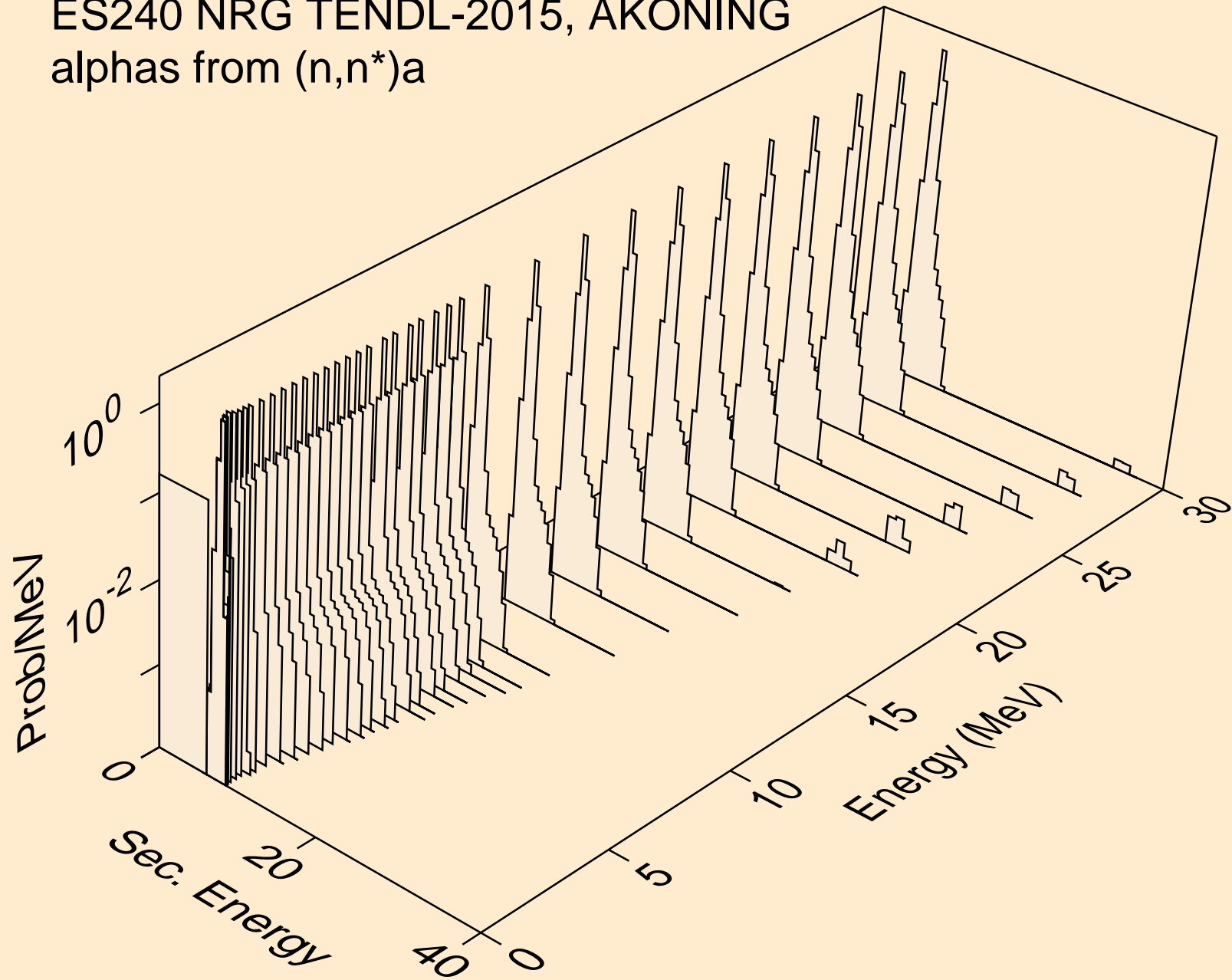

ES240 NRG TENDL-2015, AKONING  
alphas from (n,n\*)3a

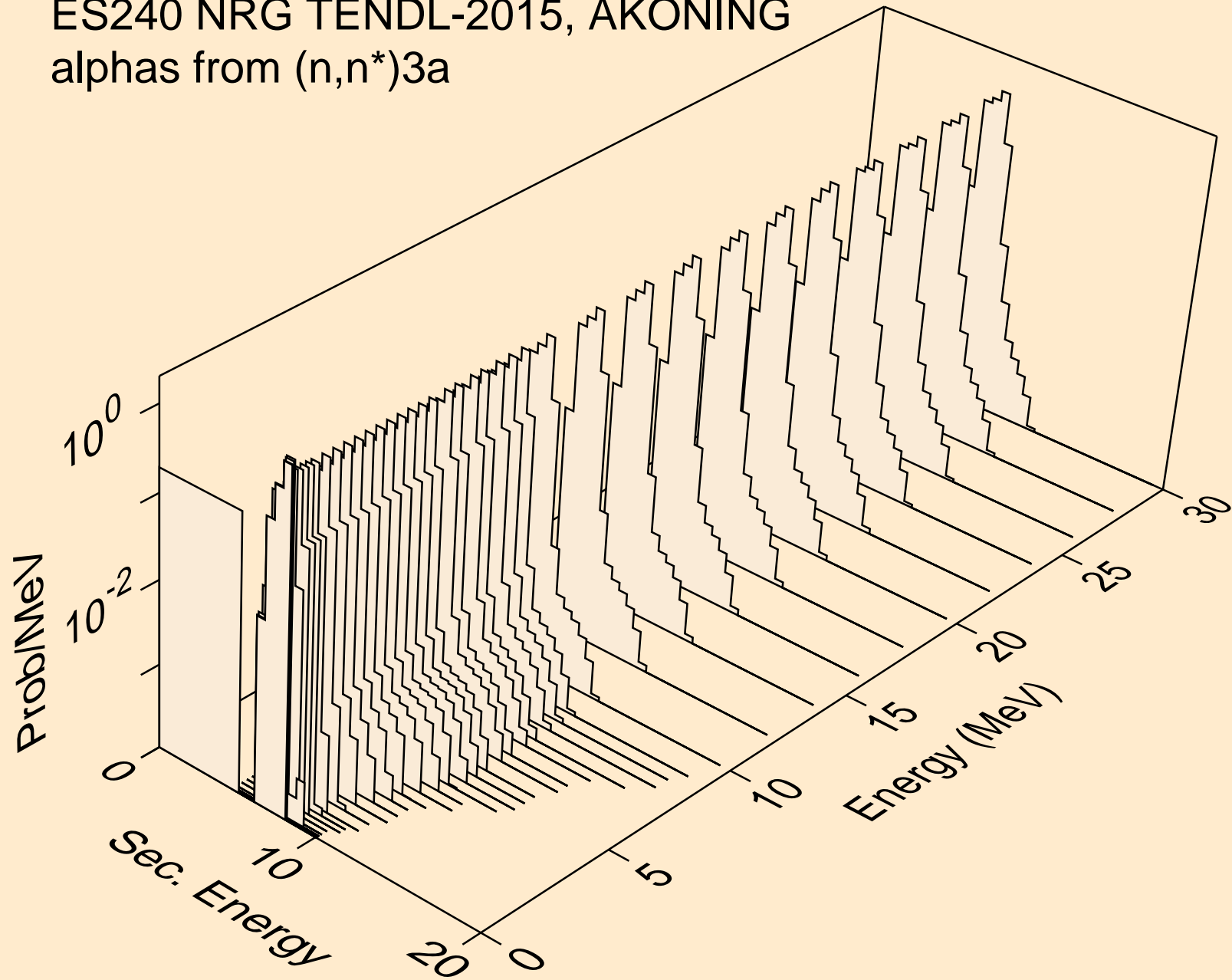

ES240 NRG TENDL-2015, AKONING  
alphas from (n,2n)a

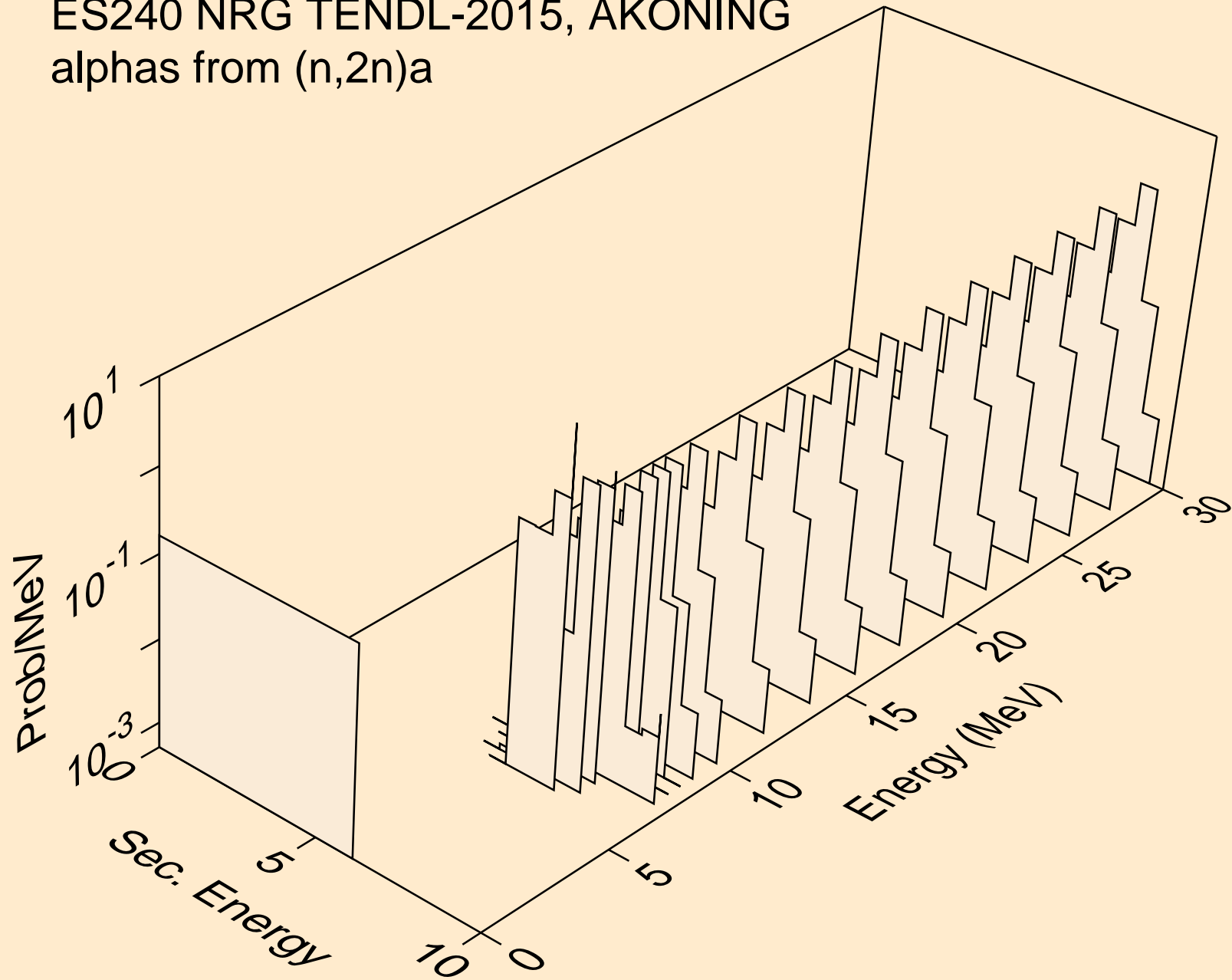

ES240 NRG TENDL-2015, AKONING  
alphas from (n,3n)a

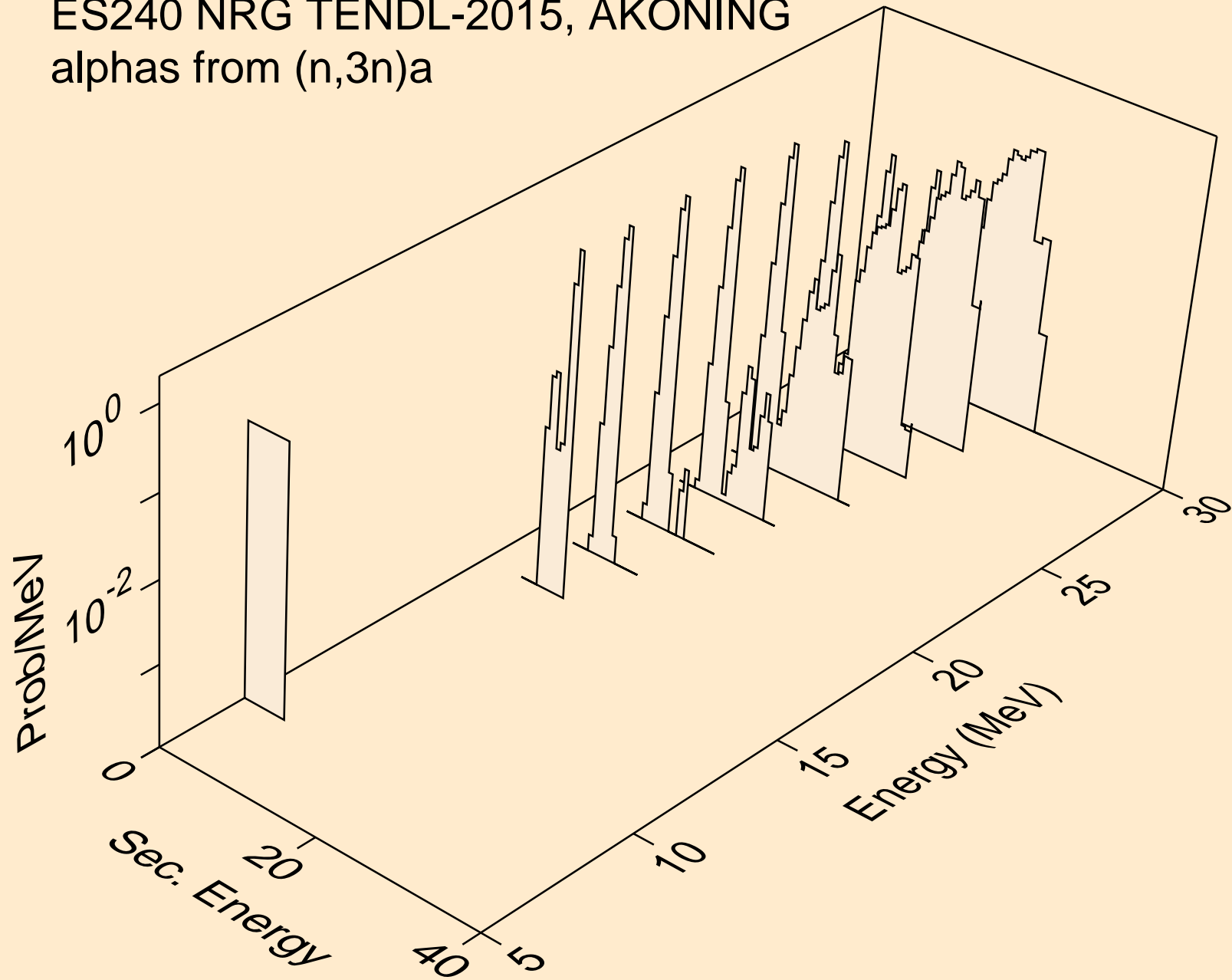



ES240 NRG TENDL-2015, AKONING  
alphas from (n,n\*)2a

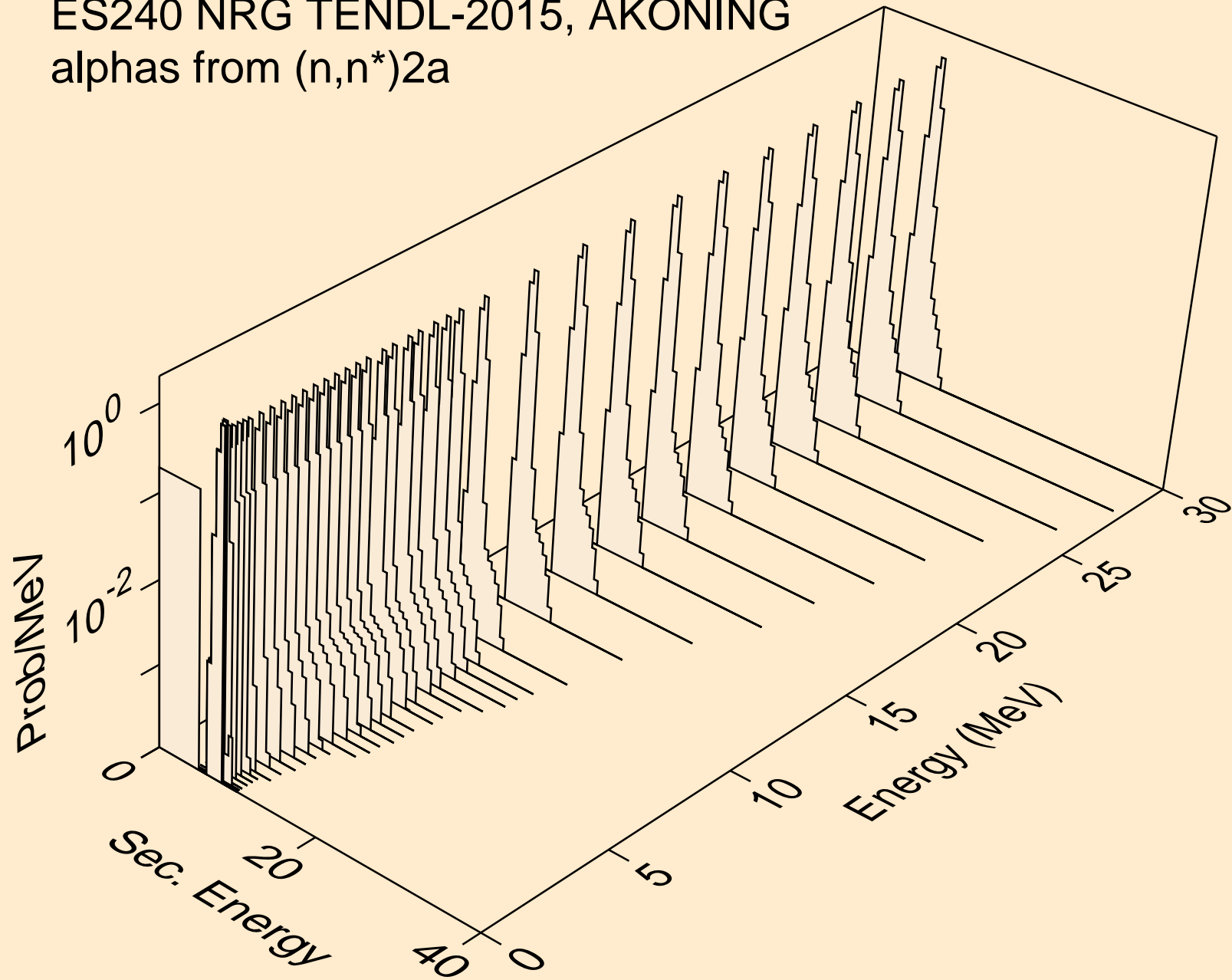

ES240 NRG TENDL-2015, AKONING  
alphas from (n,2n)2a

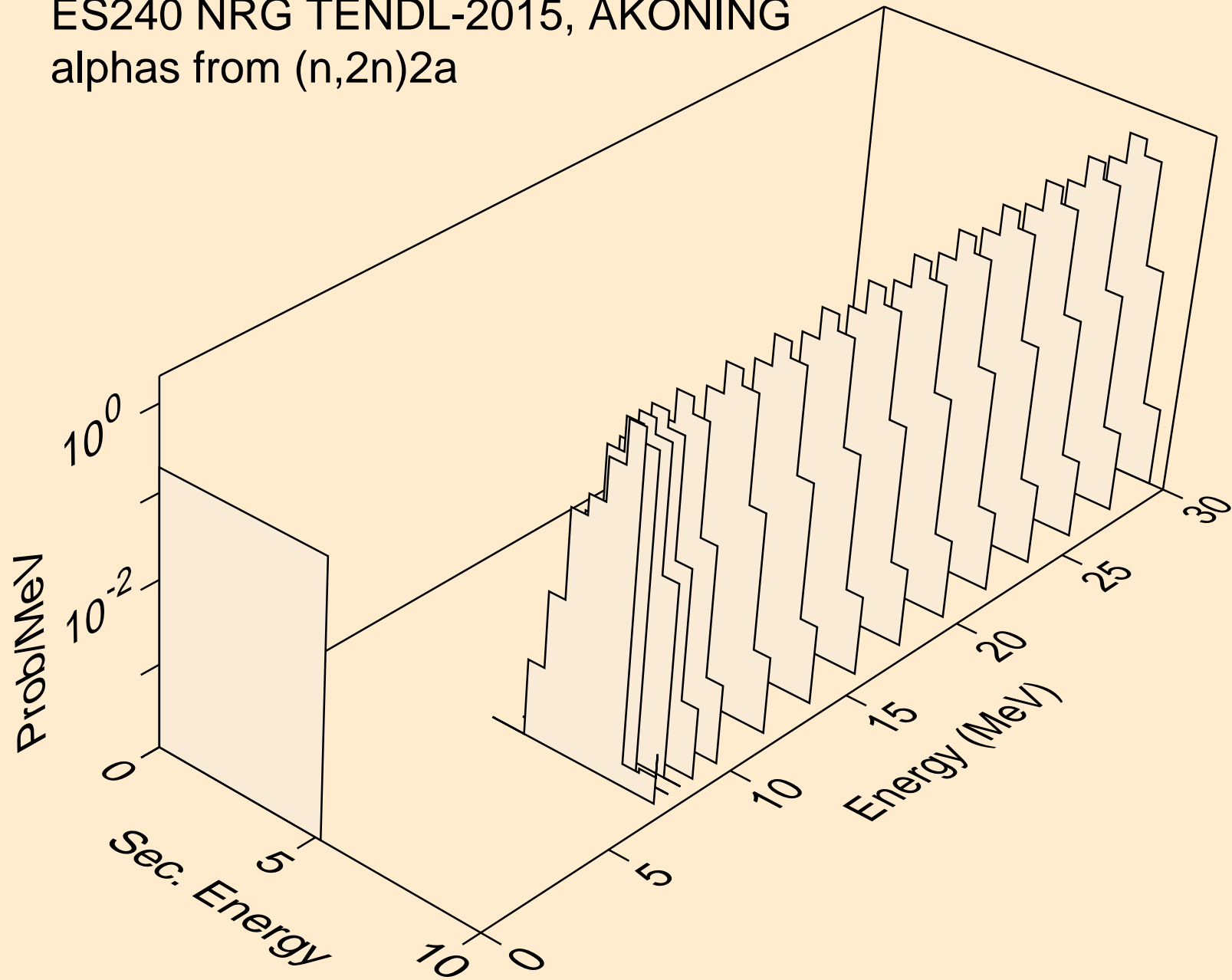

ES240 NRG TENDL-2015, AKONING  
alphas from (n,n\*)d2a

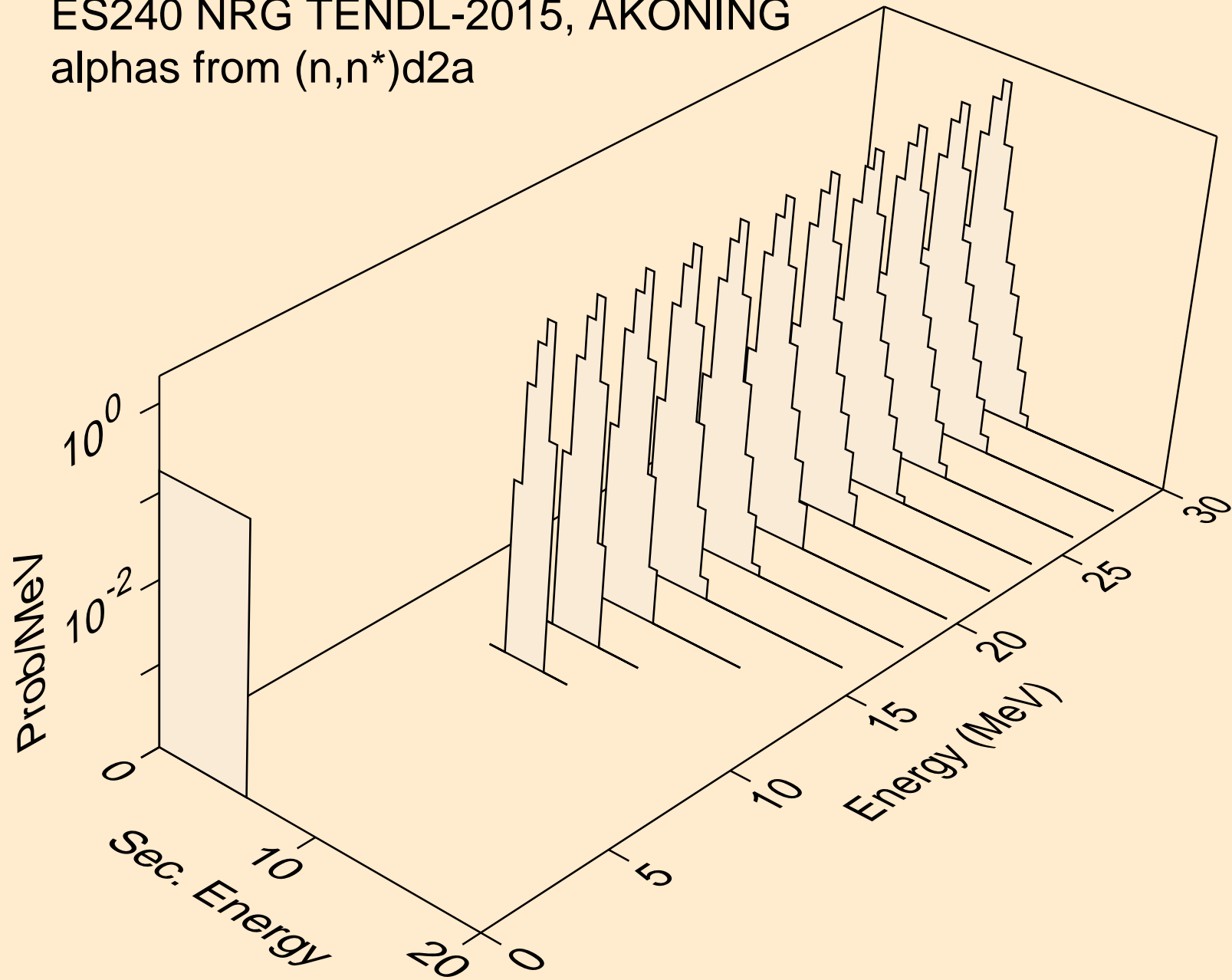

ES240 NRG TENDL-2015, AKONING  
alphas from (n,n\*)t2a

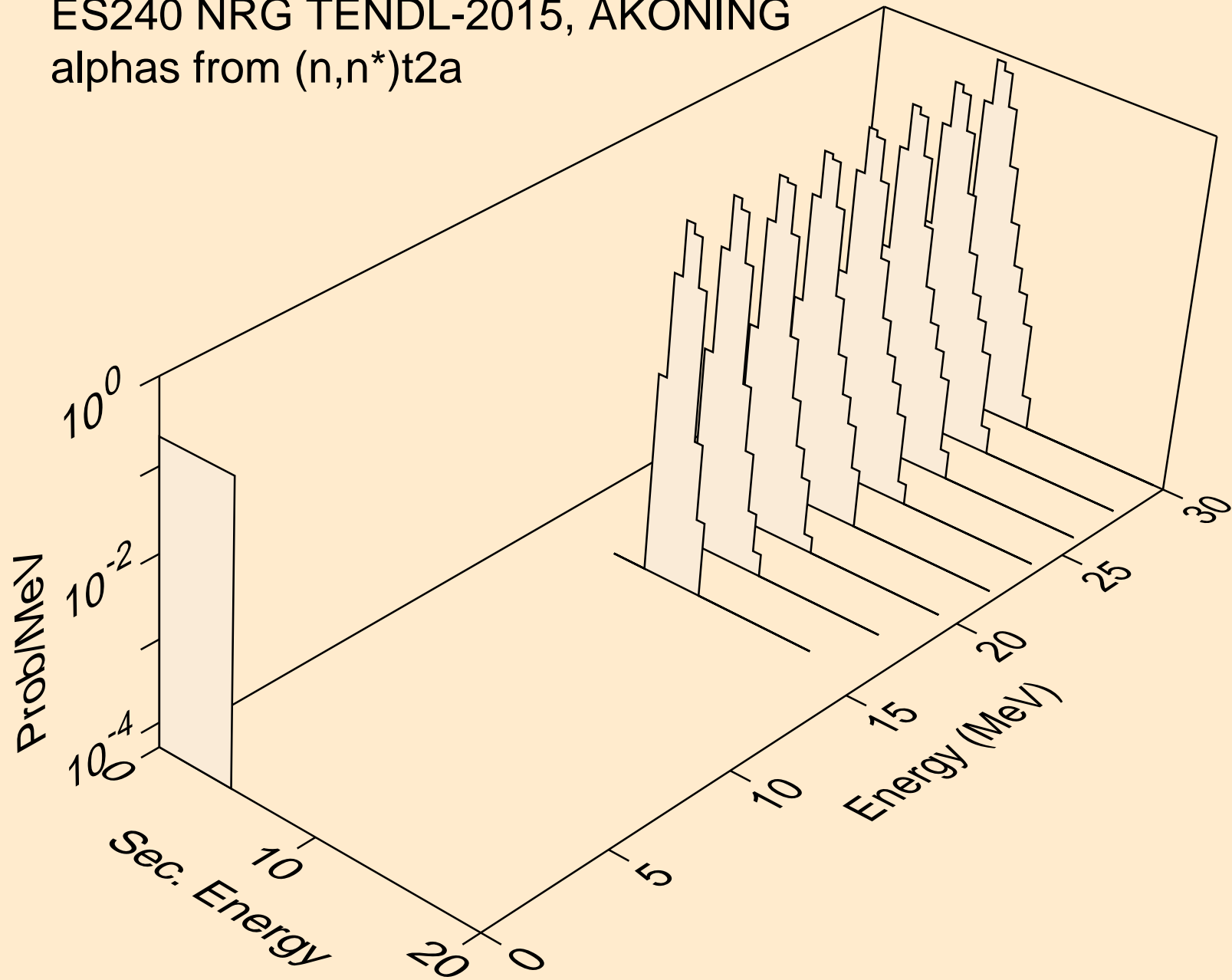

ES240 NRG TENDL-2015, AKONING  
alphas from (n,npa)

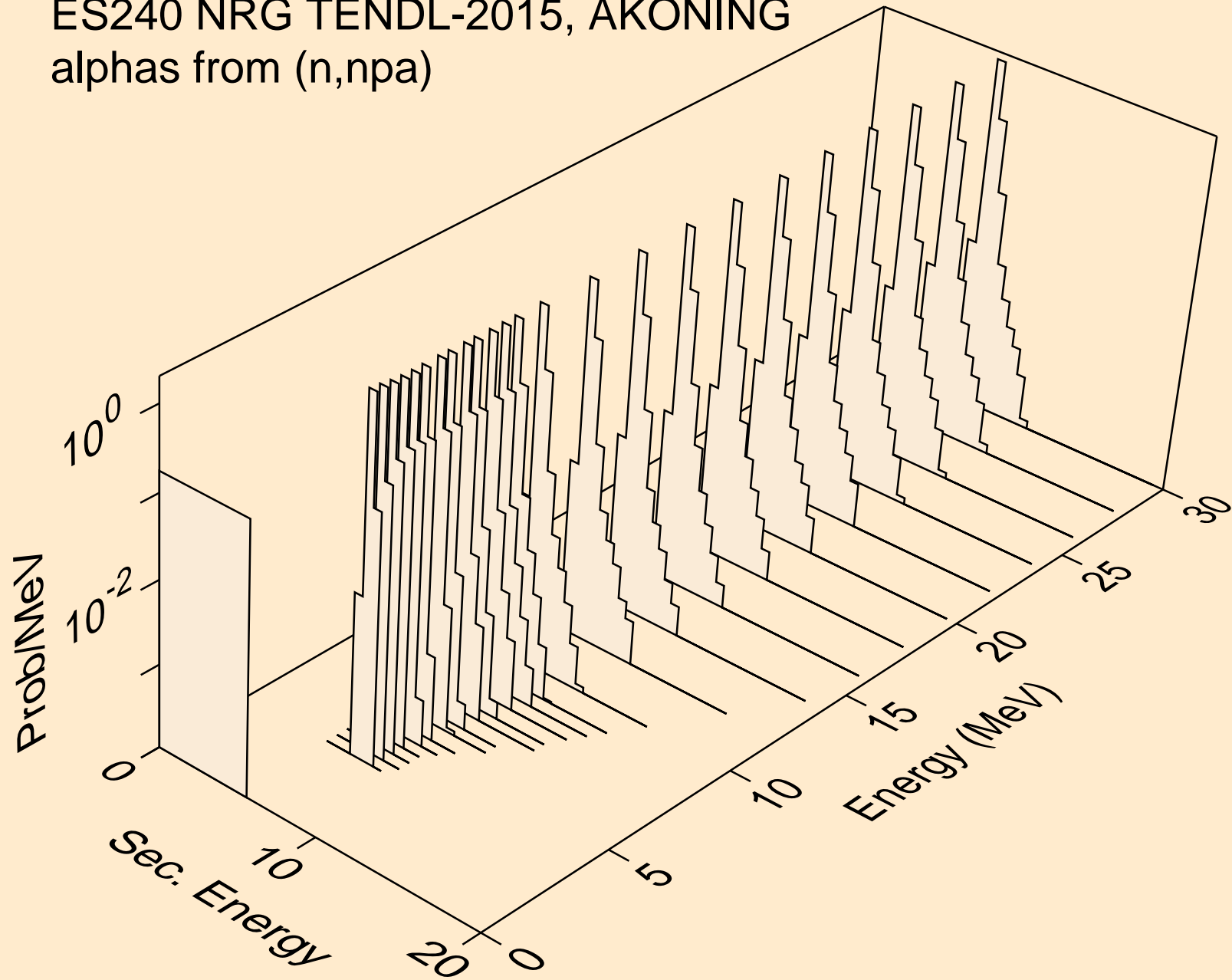

ES240 NRG TENDL-2015, AKONING  
alphas from (n,a)

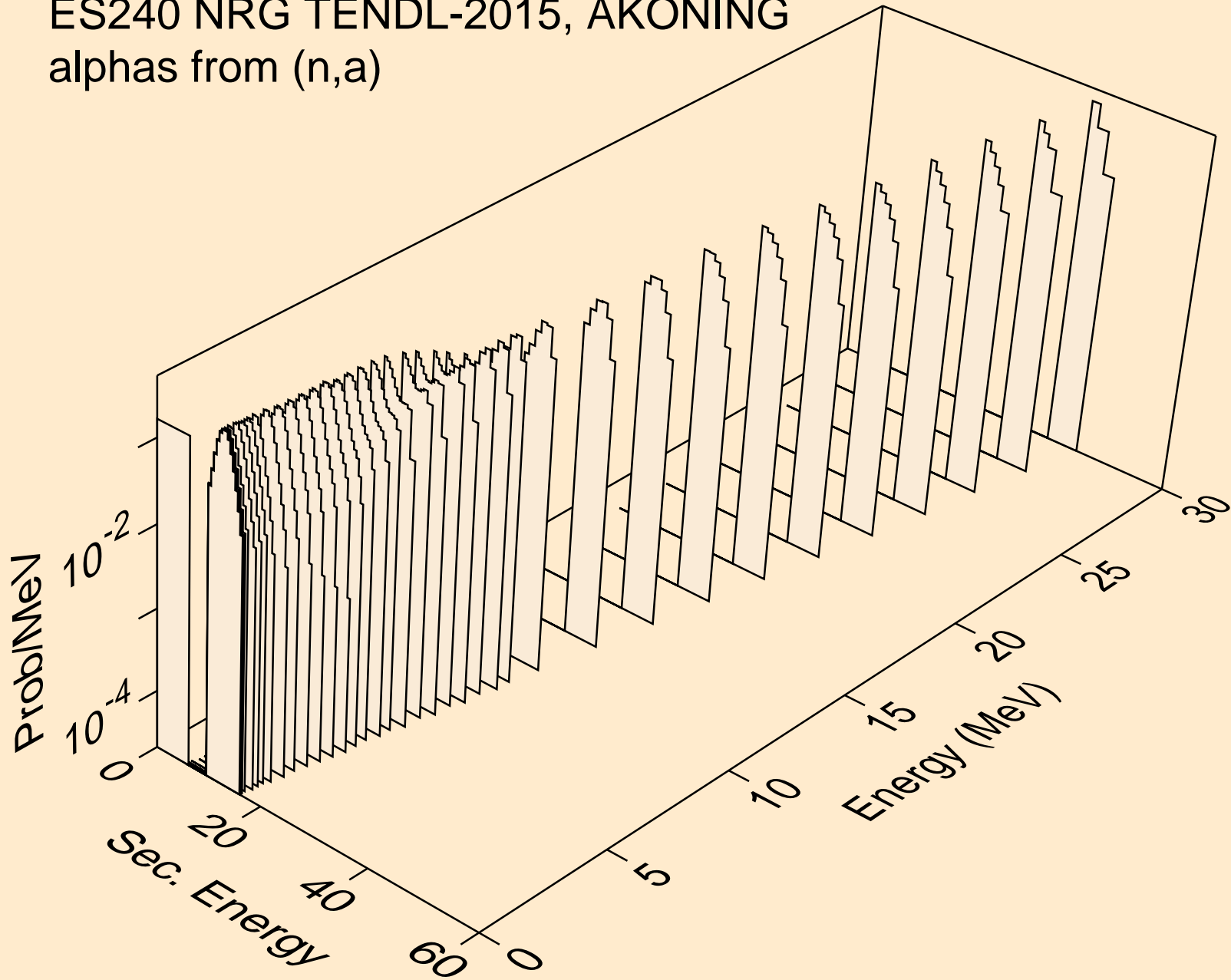

ES240 NRG TENDL-2015, AKONING  
alphas from (n,2a)

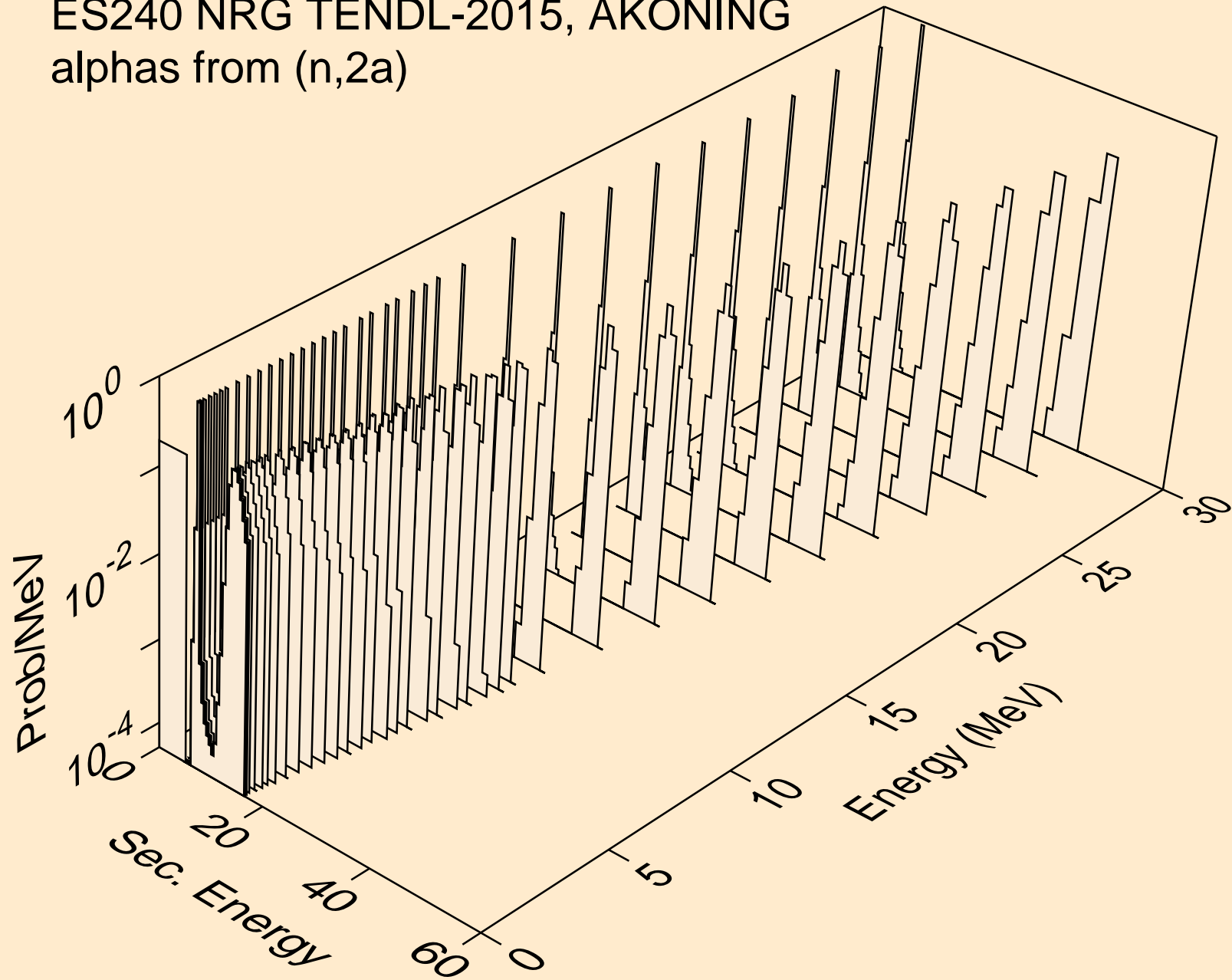

ES240 NRG TENDL-2015, AKONING  
alphas from (n,3a)

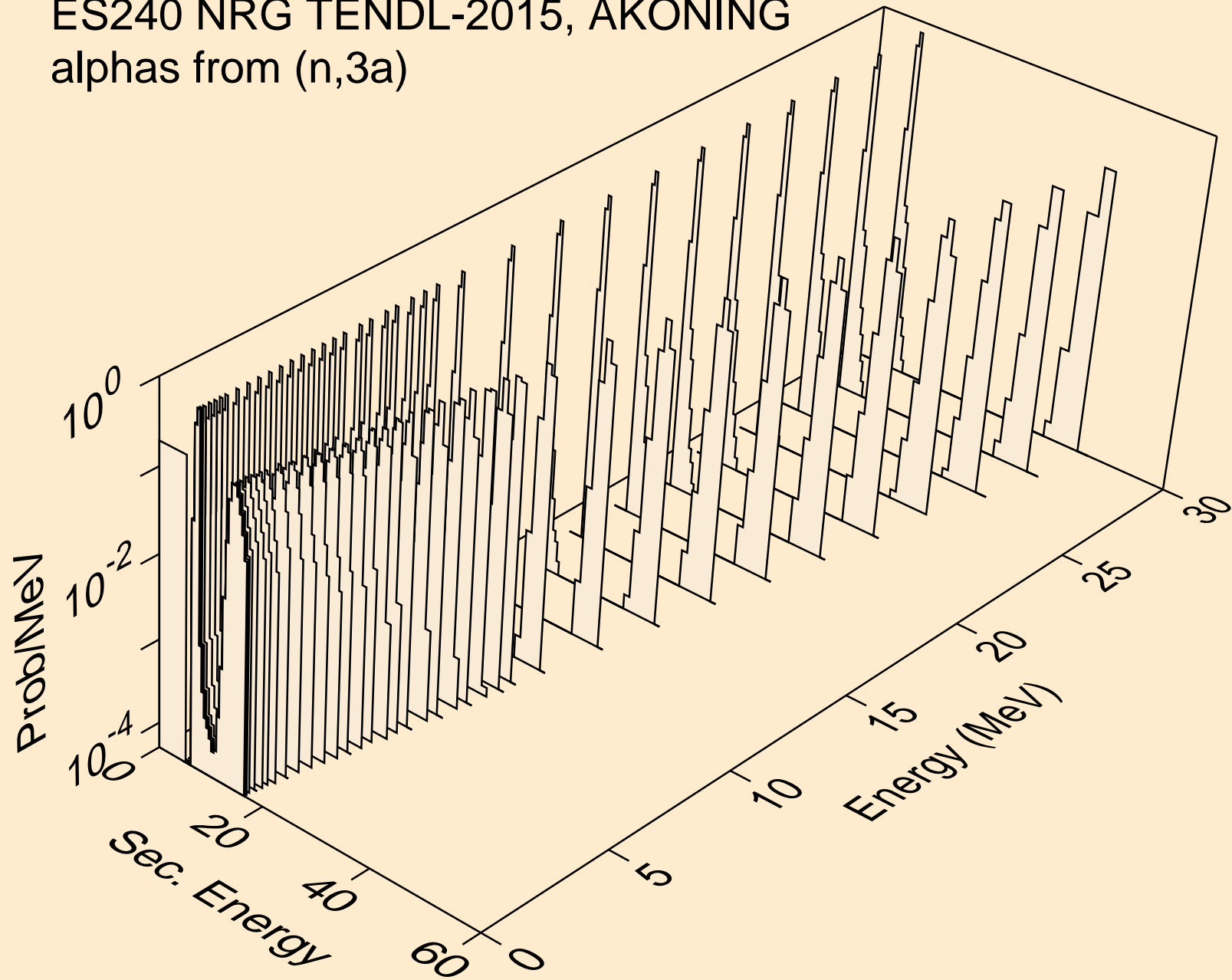



ES240 NRG TENDL-2015, AKONING  
alphas from (n,pa)

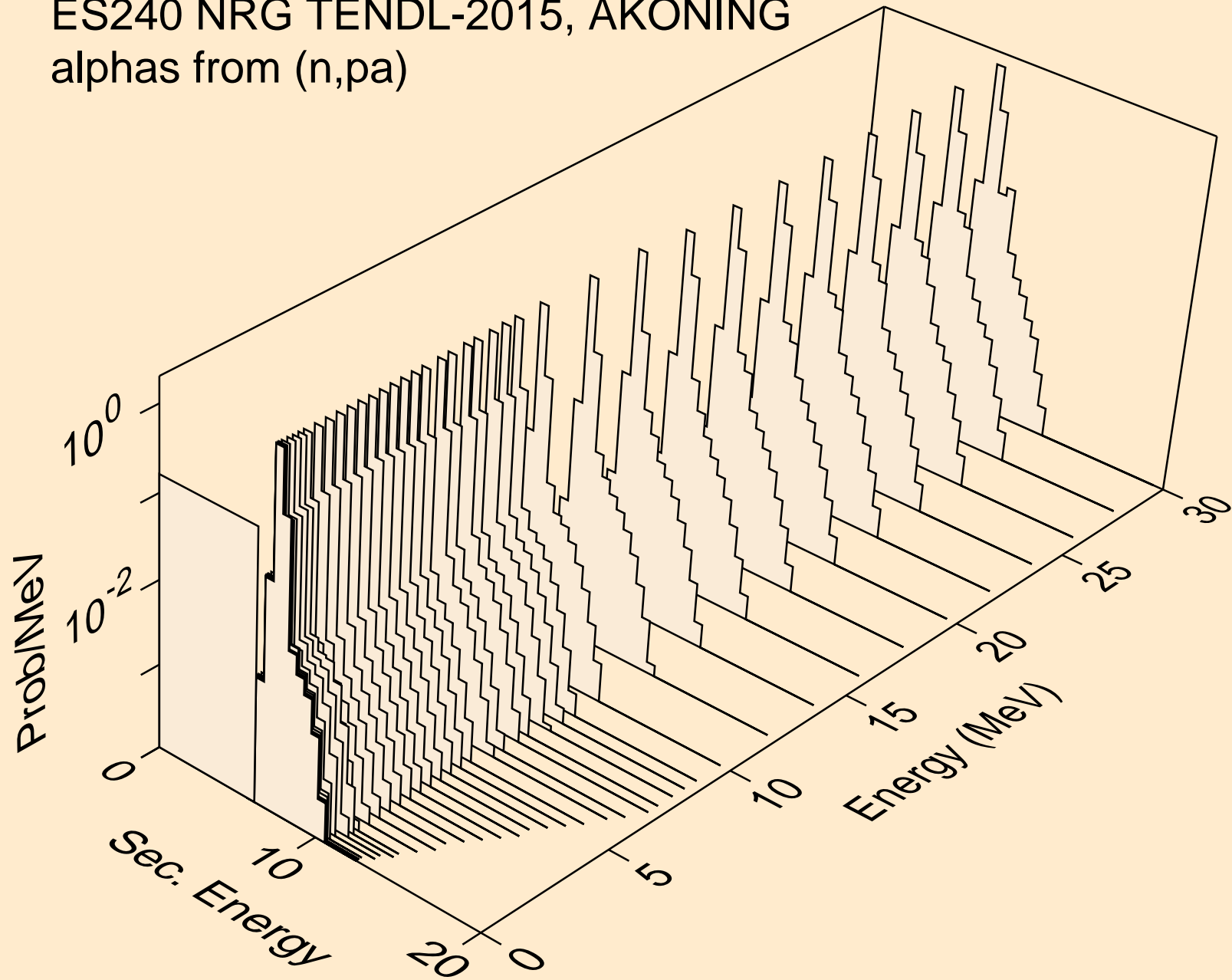

ES240 NRG TENDL-2015, AKONING  
alphas from (n,t2a)

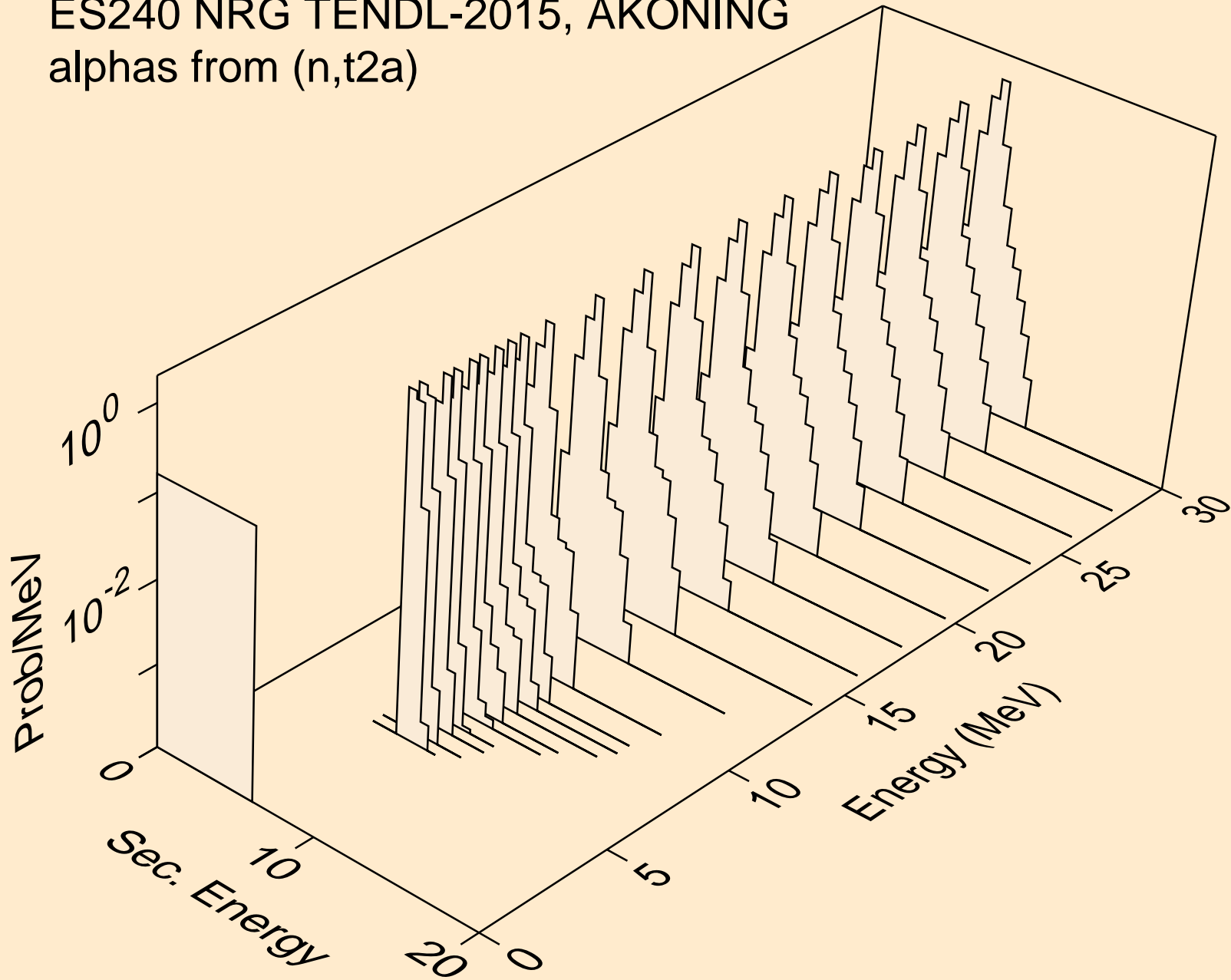

ES240 NRG TENDL-2015, AKONING  
alphas from (n,d2a)

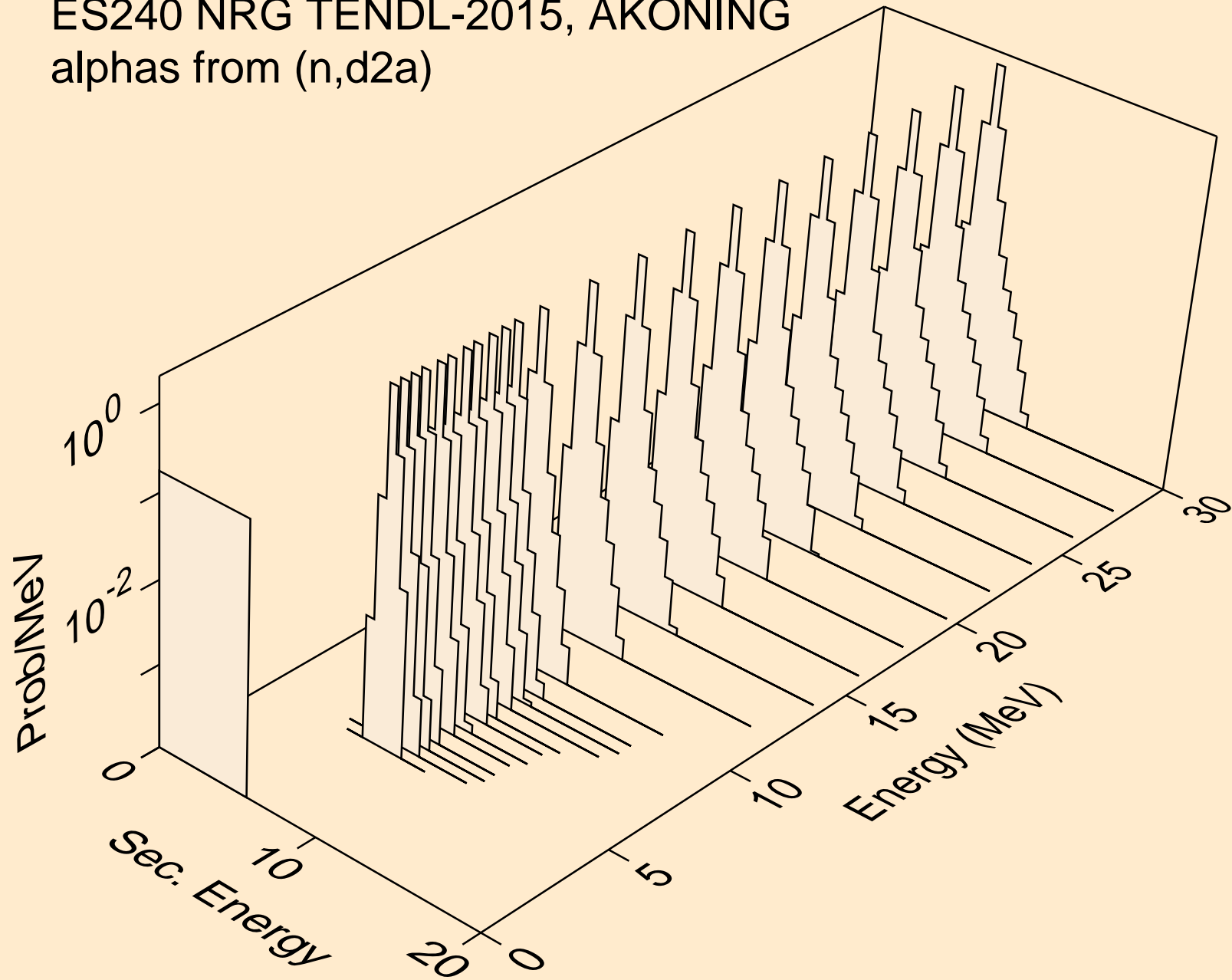

ES240 NRG TENDL-2015, AKONING  
alphas from (n,da)

