

# ES242 NRG TENDL-2015, AKONING

## Principal cross sections

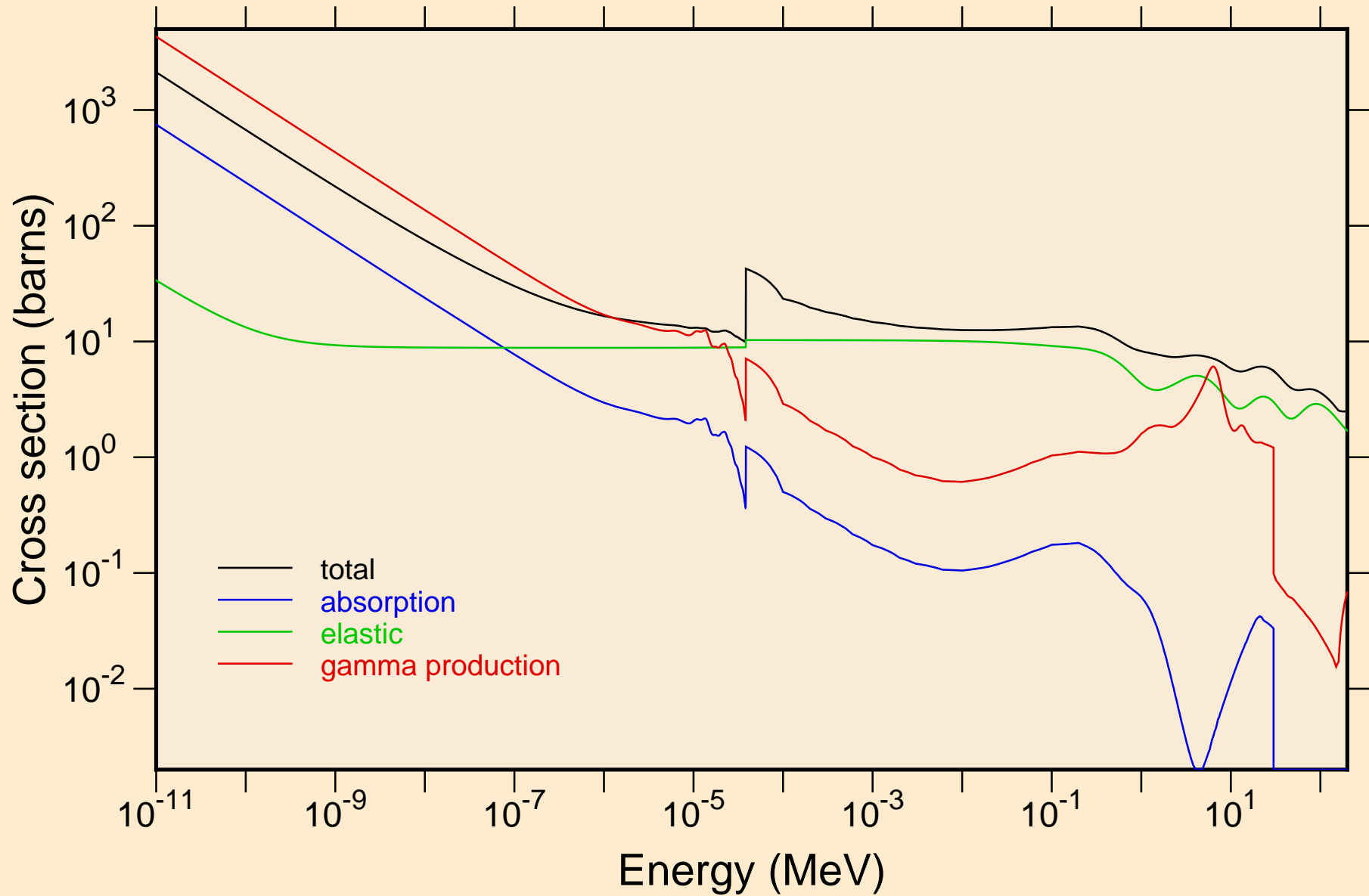

# ES242 NRG TENDL-2015, AKONING

## Non-threshold reactions

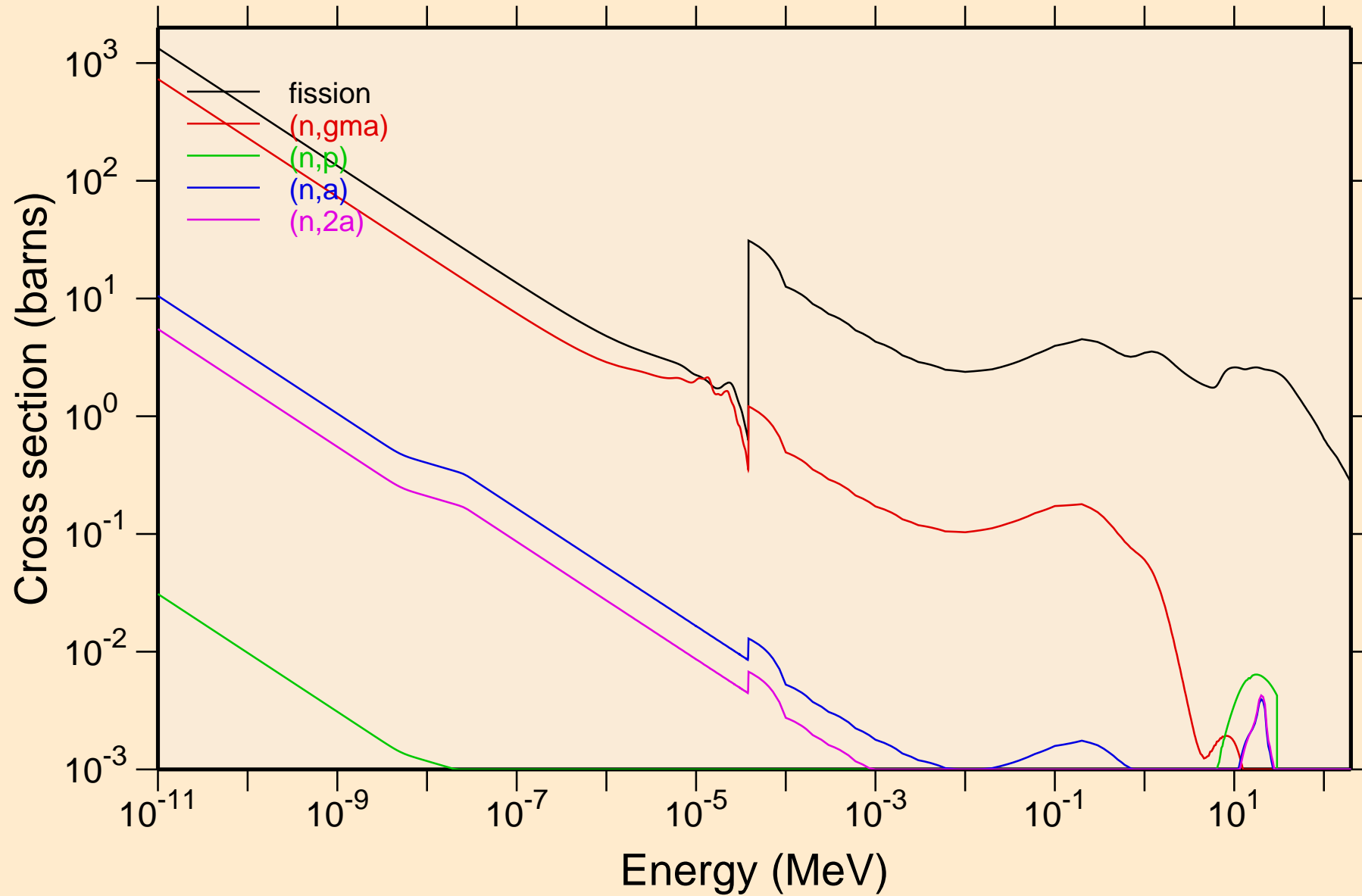

# ES242 NRG TENDL-2015, AKONING

## Non-threshold reactions

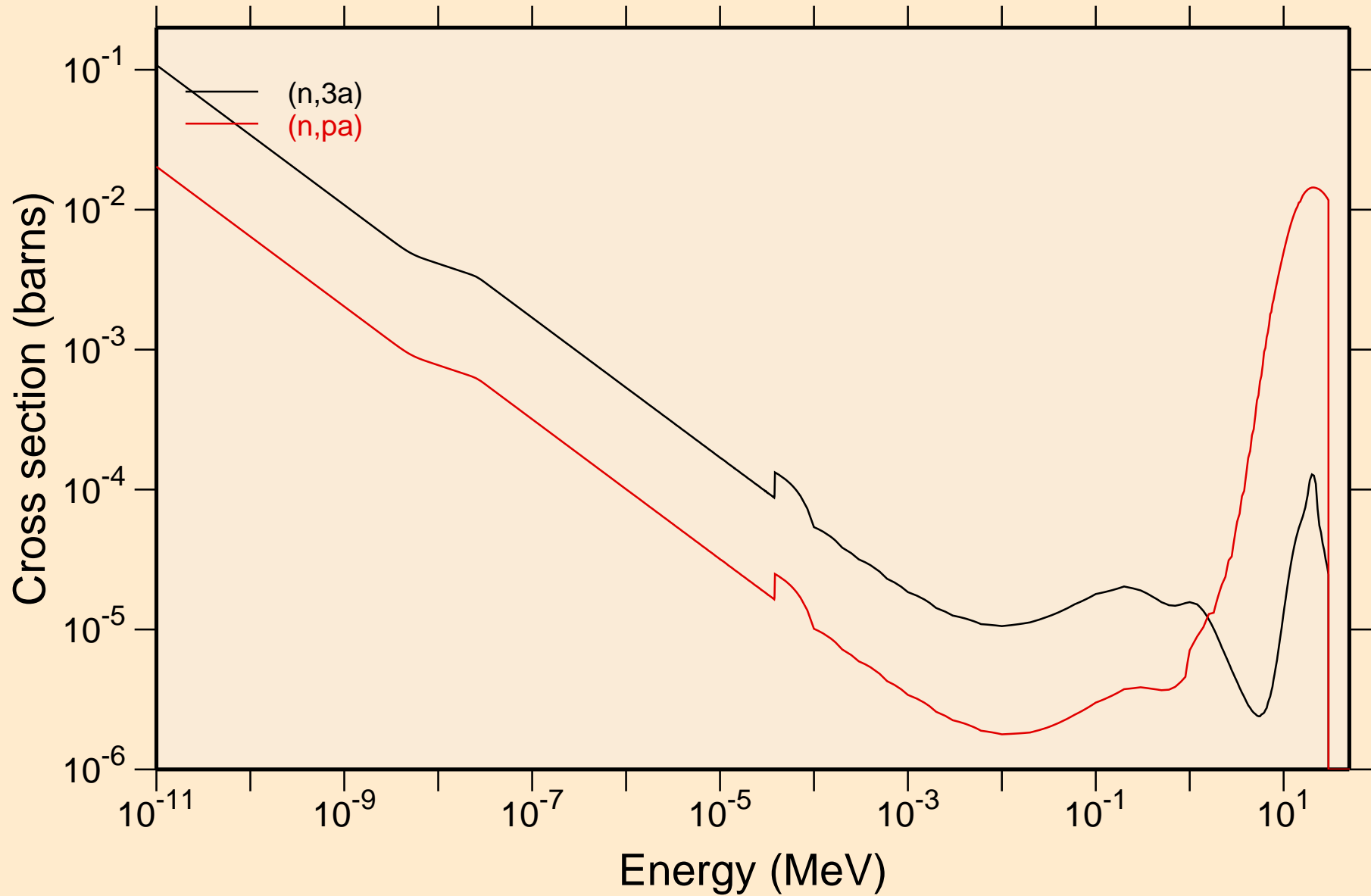

# ES242 NRG TENDL-2015, AKONING

## Principal cross sections

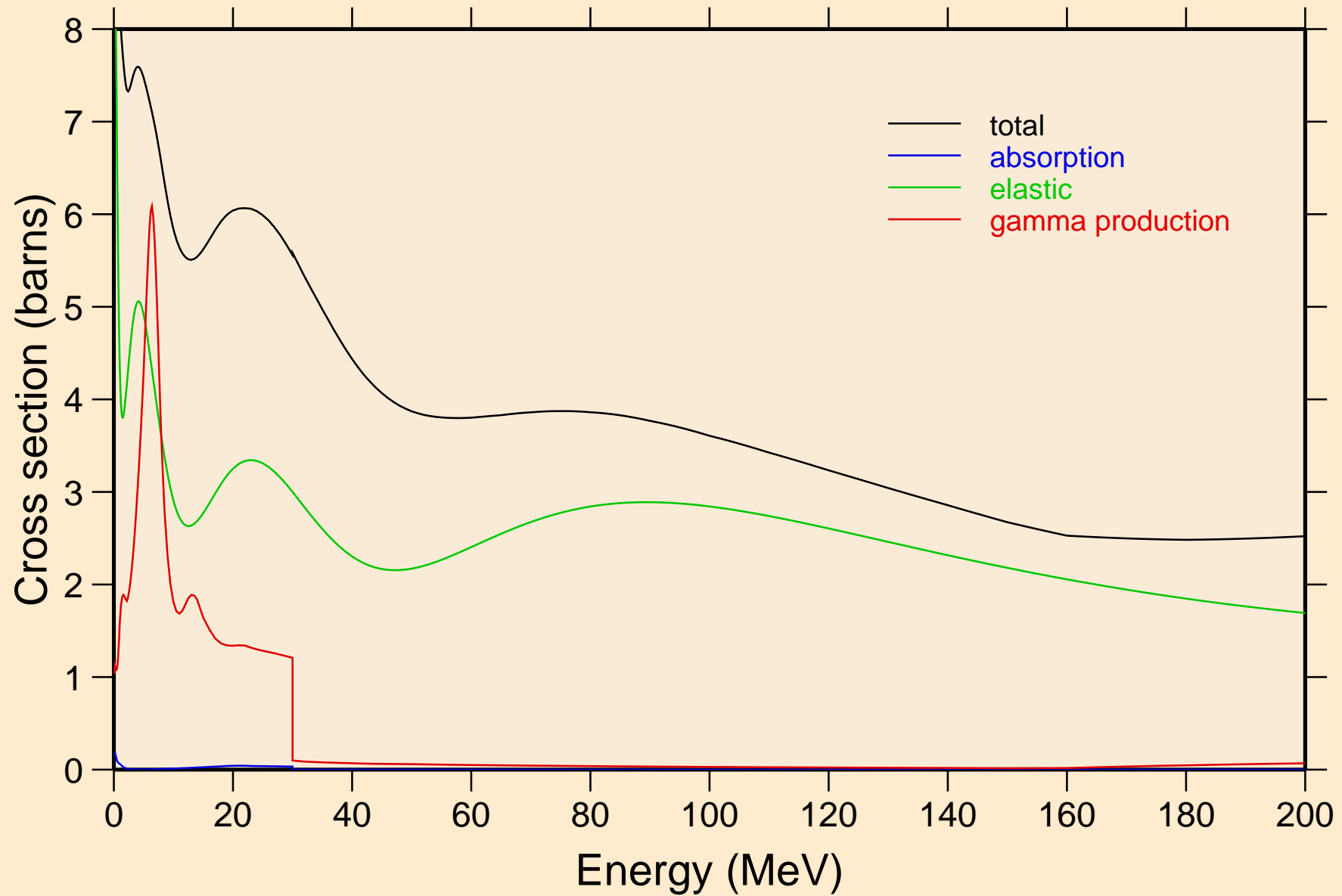

# ES242 NRG TENDL-2015, AKONING

## Non-threshold reactions

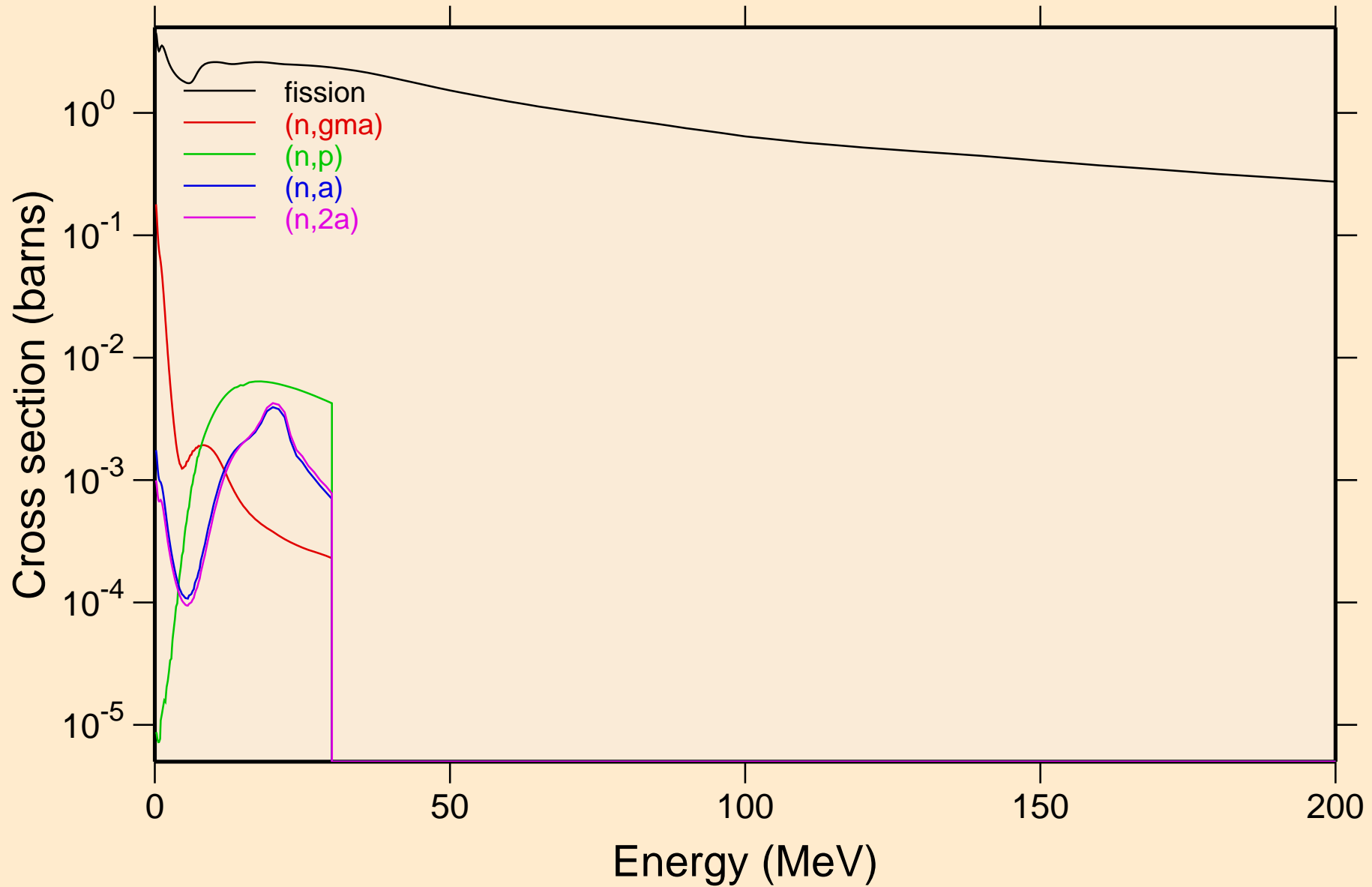

# ES242 NRG TENDL-2015, AKONING

## Non-threshold reactions

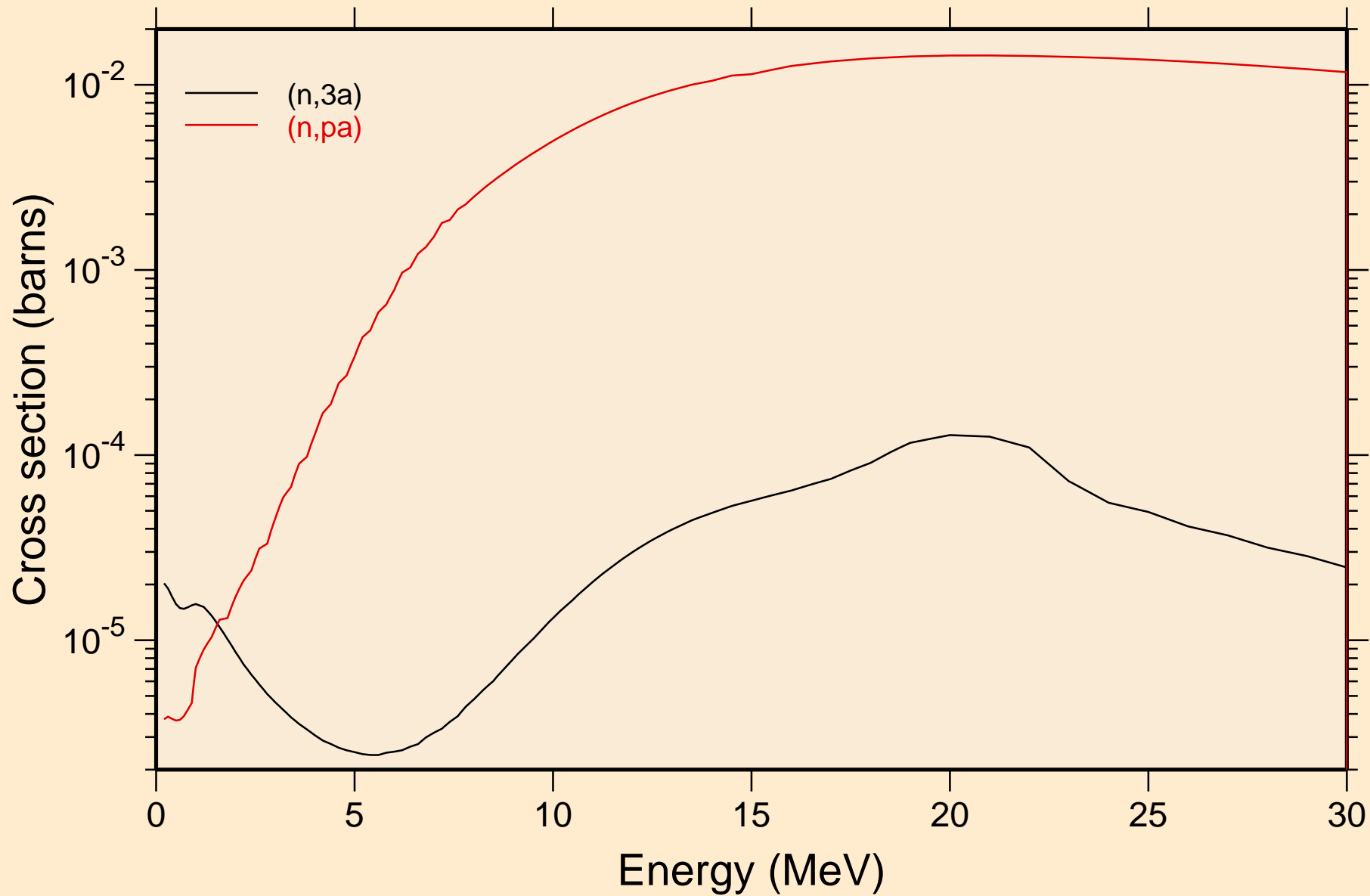

ES242 NRG TENDL-2015, AKONING  
Inelastic levels

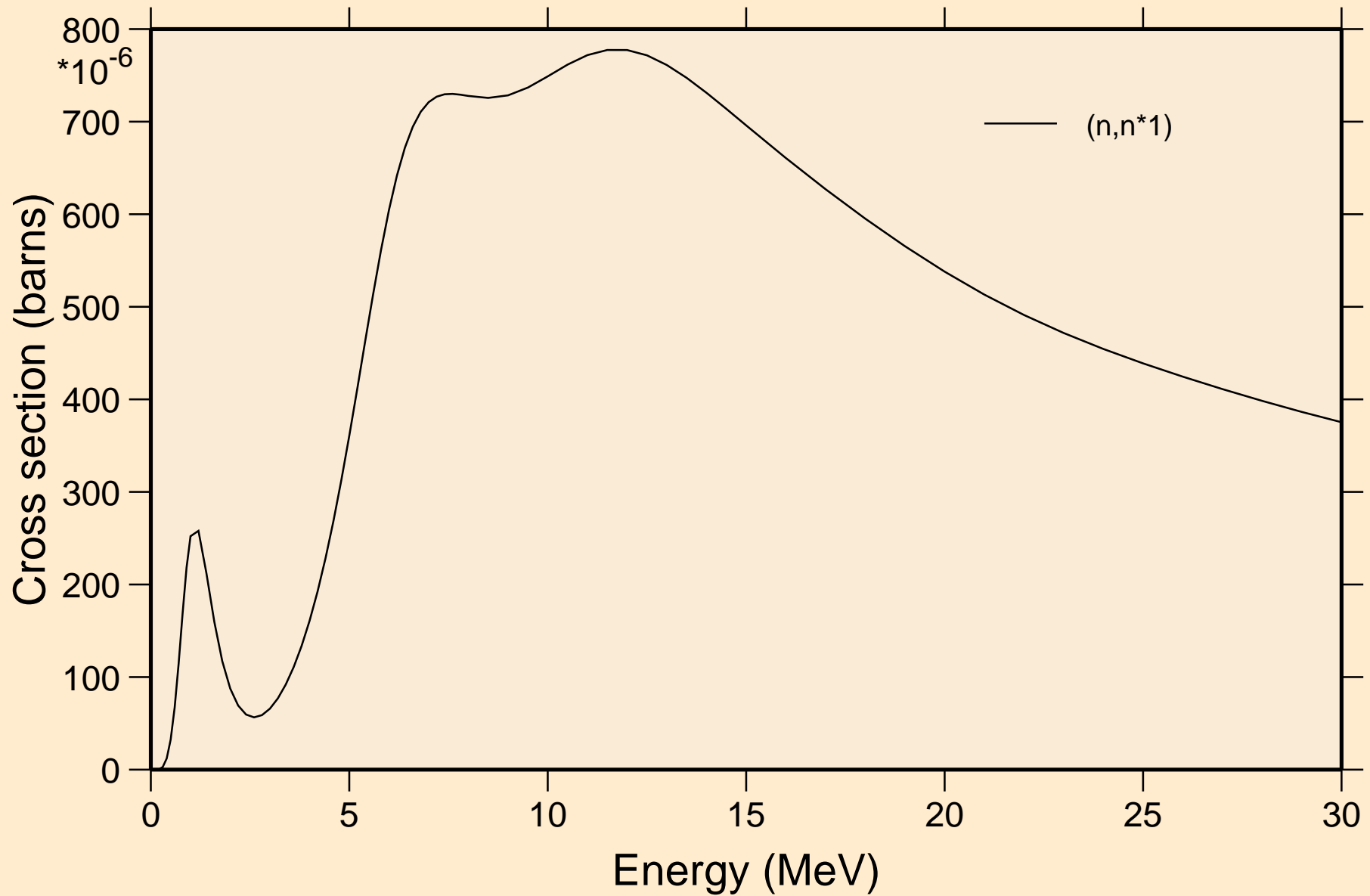

# ES242 NRG TENDL-2015, AKONING

## Threshold reactions

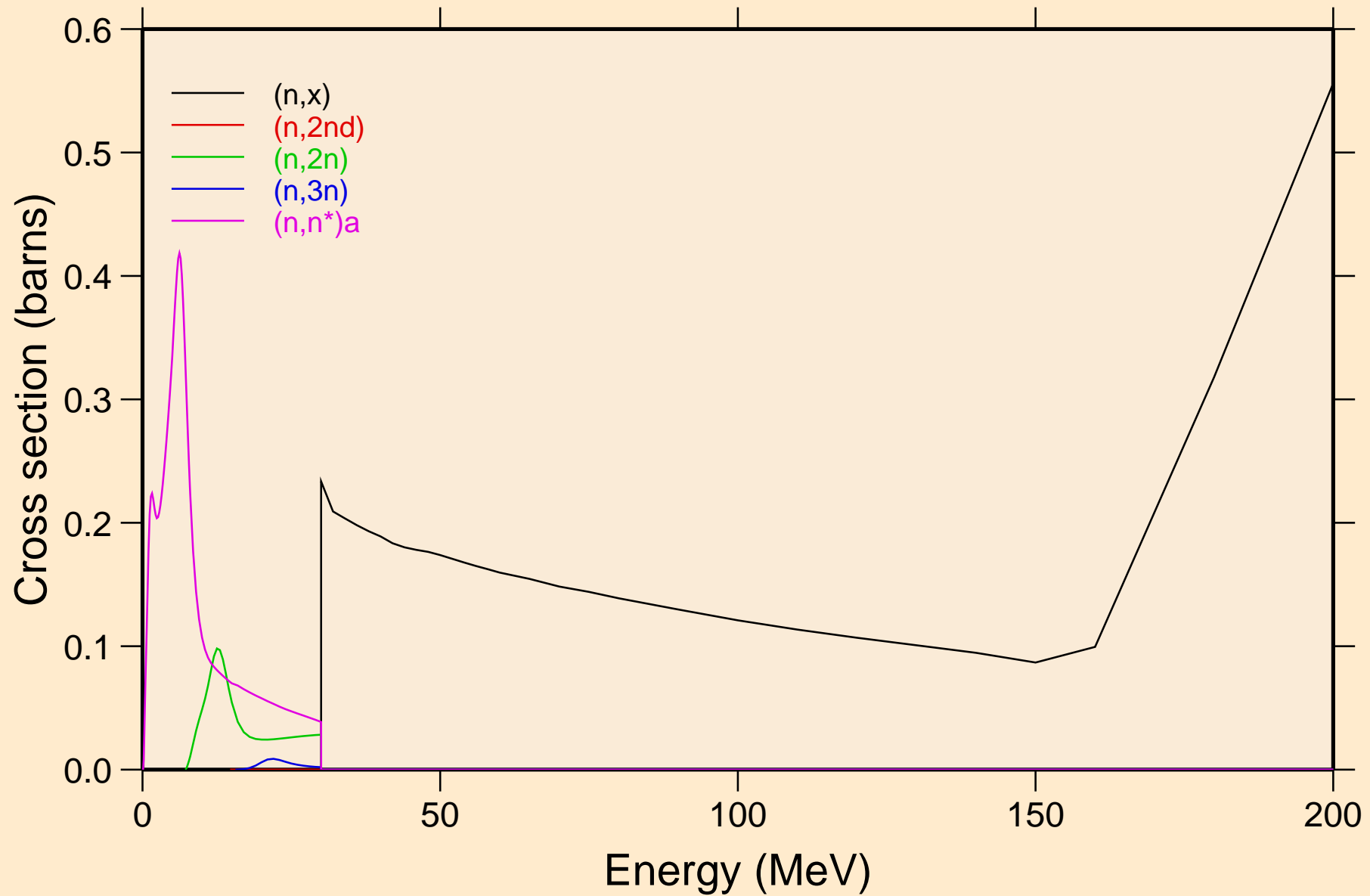



# ES242 NRG TENDL-2015, AKONING

## Threshold reactions

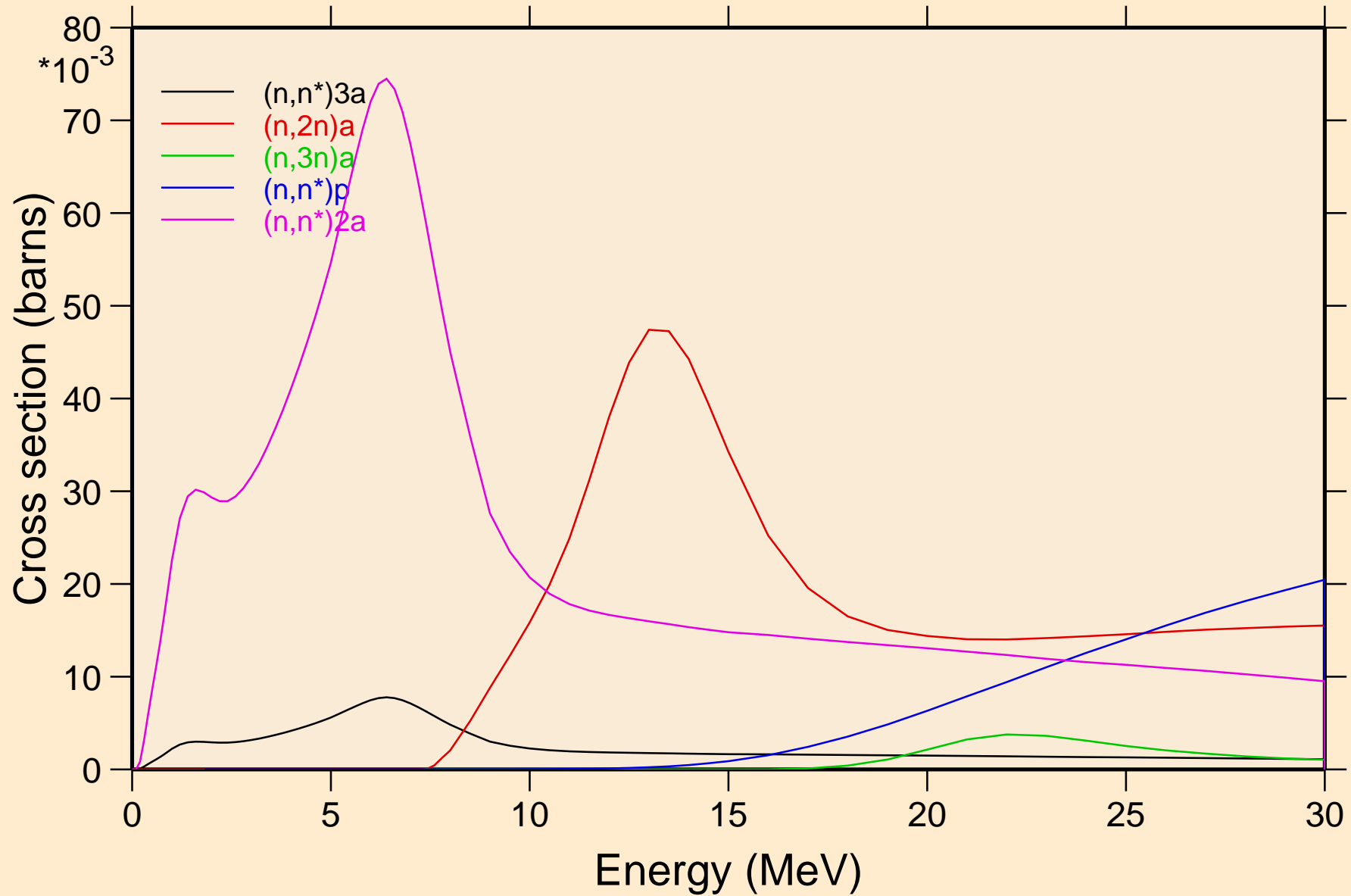

# ES242 NRG TENDL-2015, AKONING

## Threshold reactions

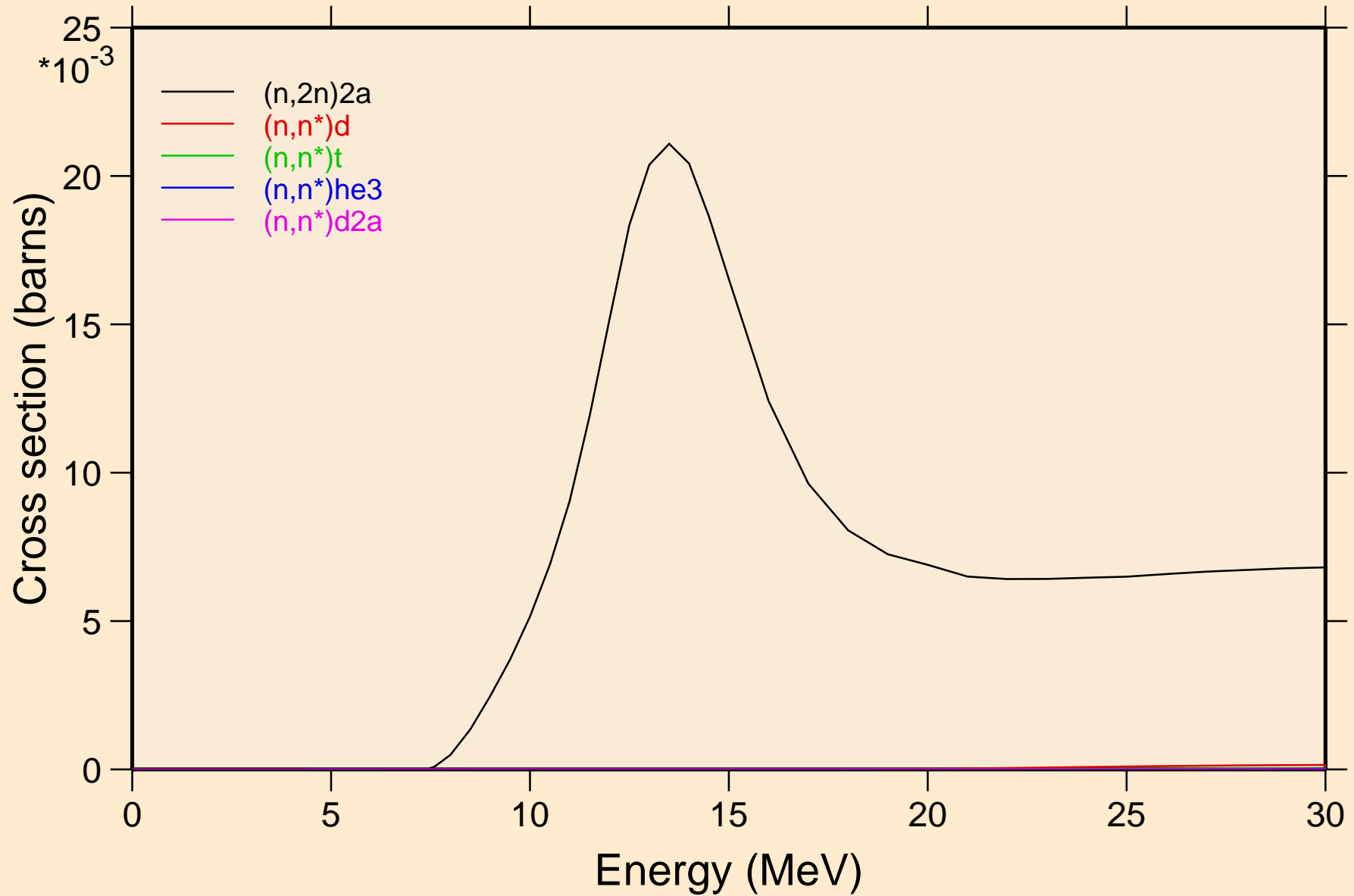

# ES242 NRG TENDL-2015, AKONING

## Threshold reactions

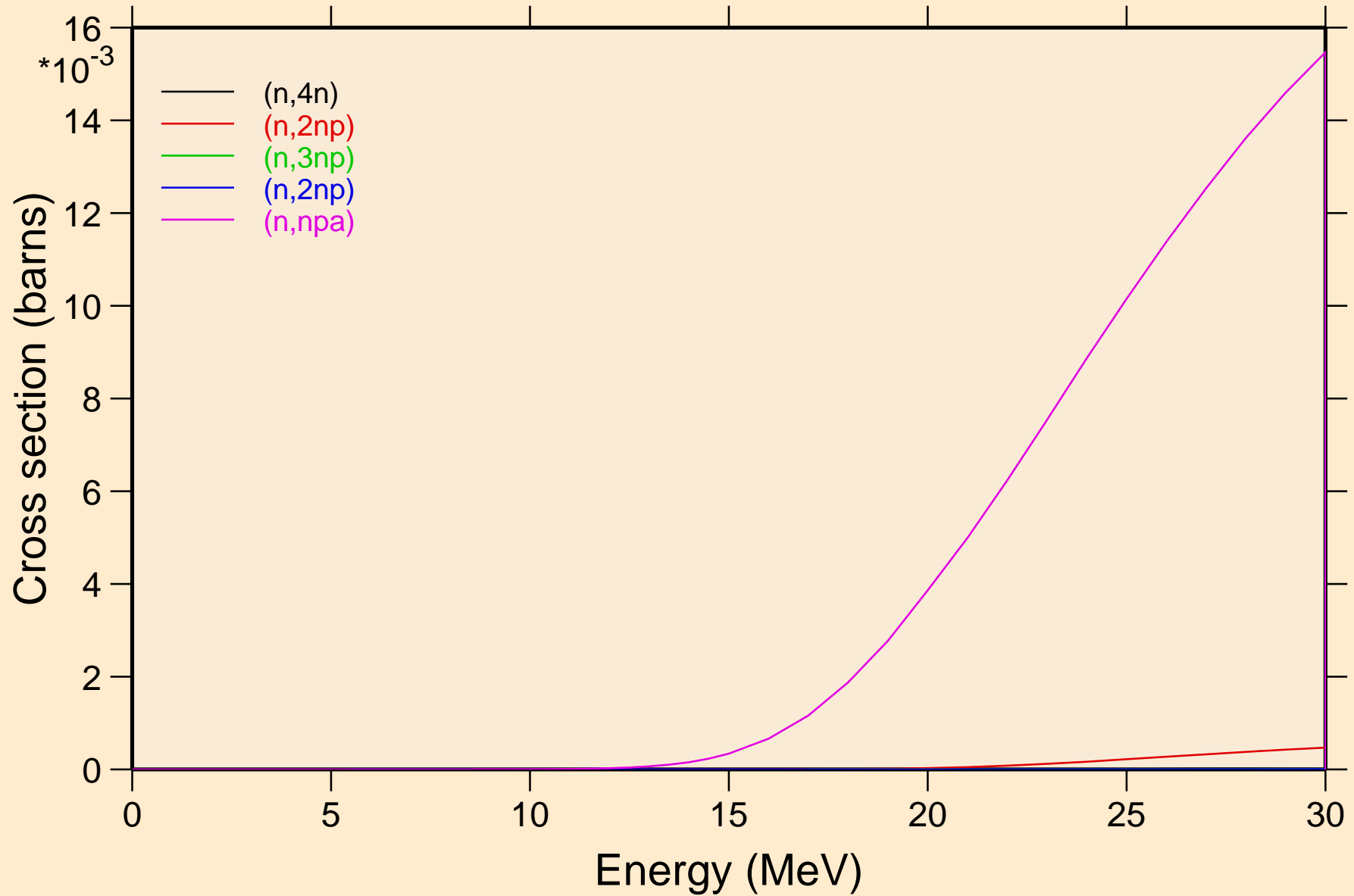

# ES242 NRG TENDL-2015, AKONING

## Threshold reactions

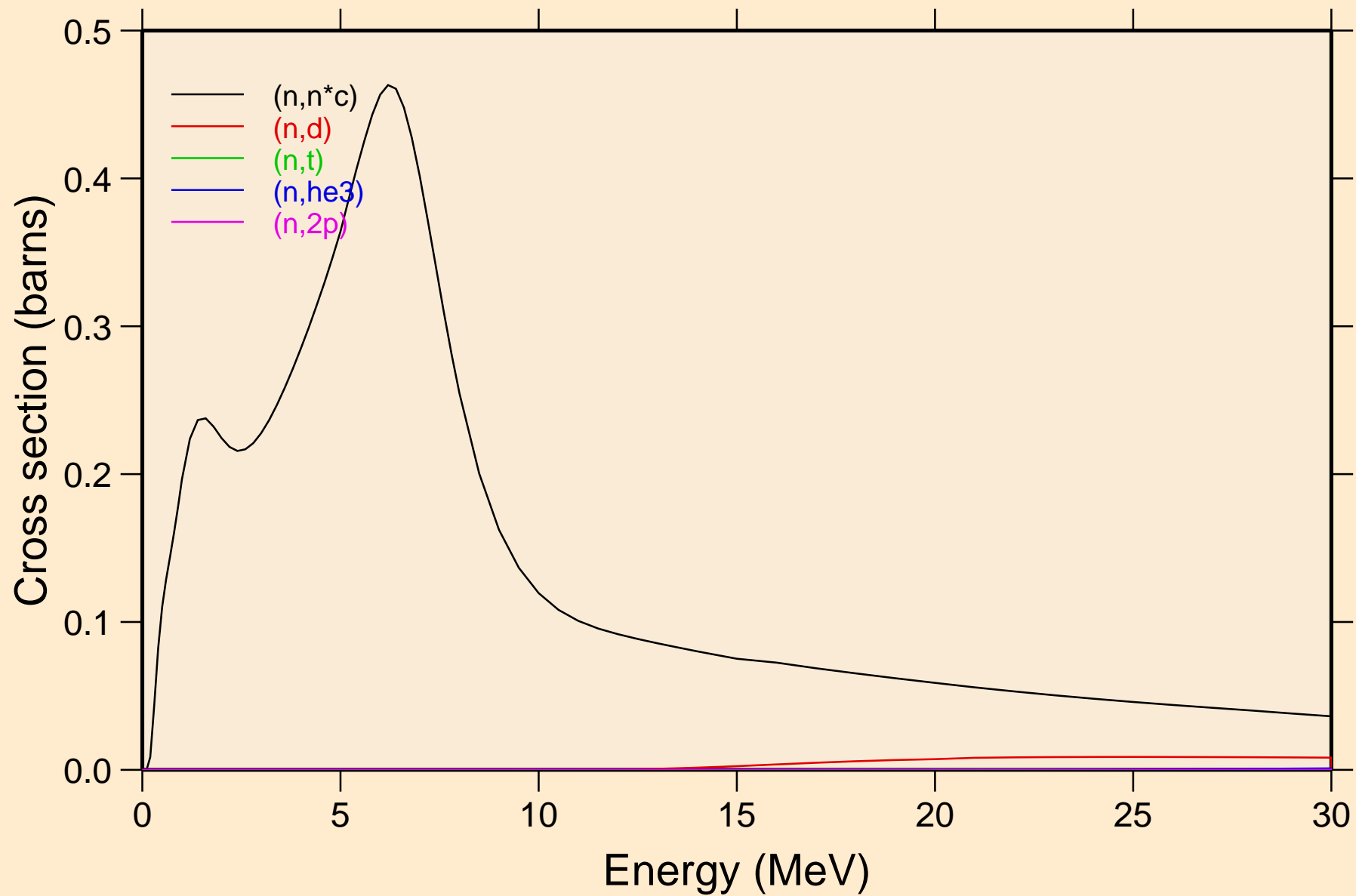

# ES242 NRG TENDL-2015, AKONING

## Threshold reactions

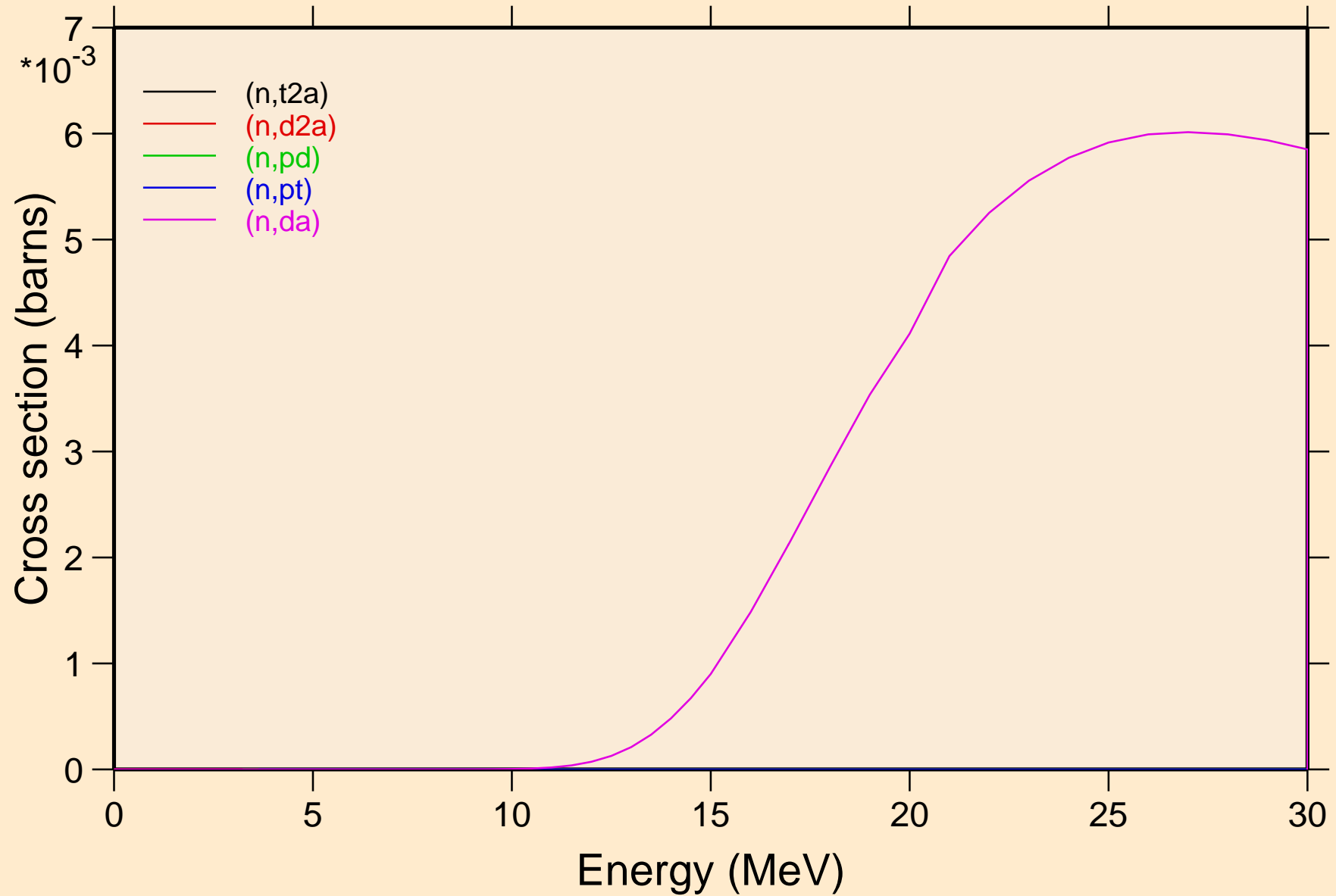

ES242 NRG TENDL-2015, AKONING  
angular distribution for elastic

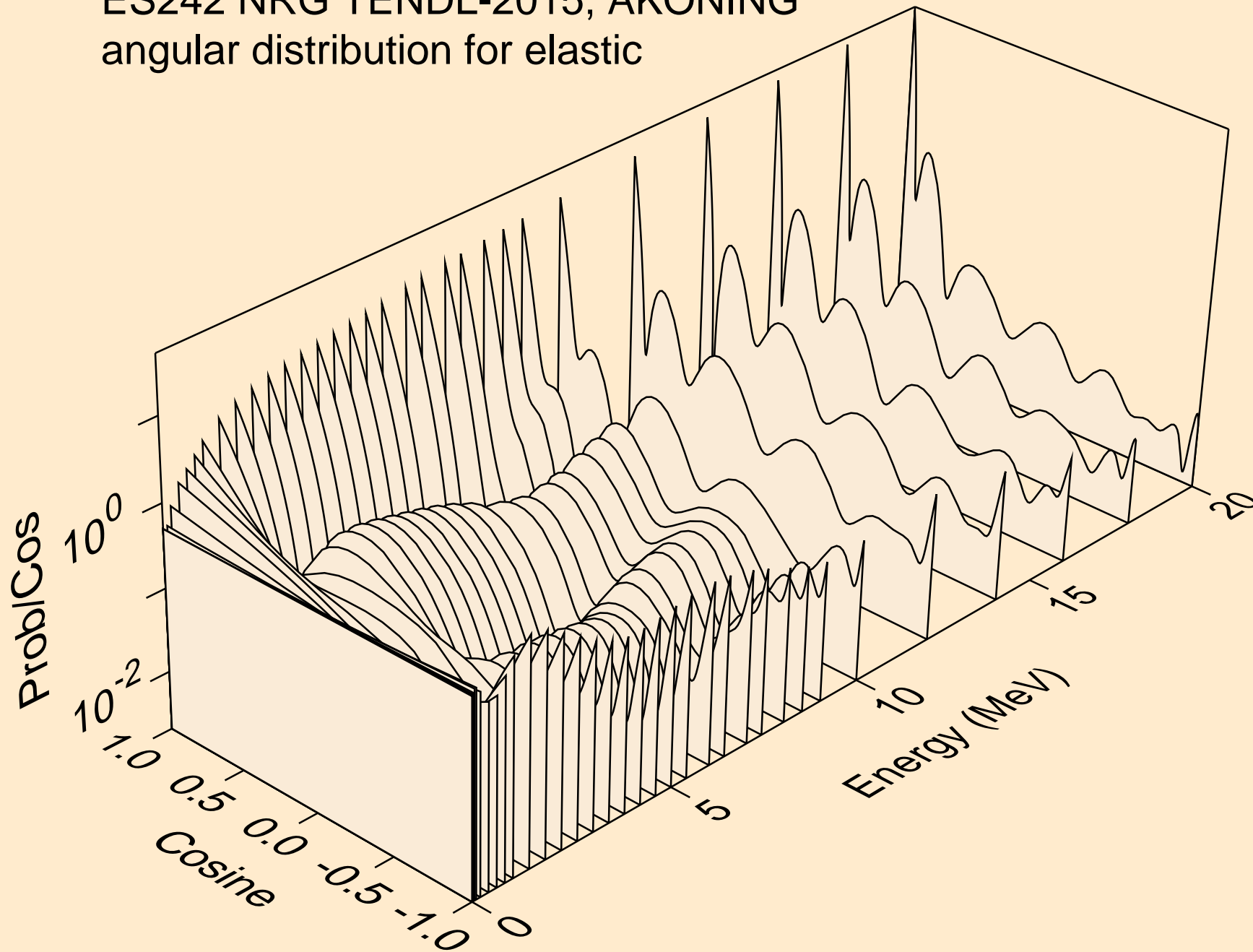

ES242 NRG TENDL-2015, AKONING  
angular distribution for elastic

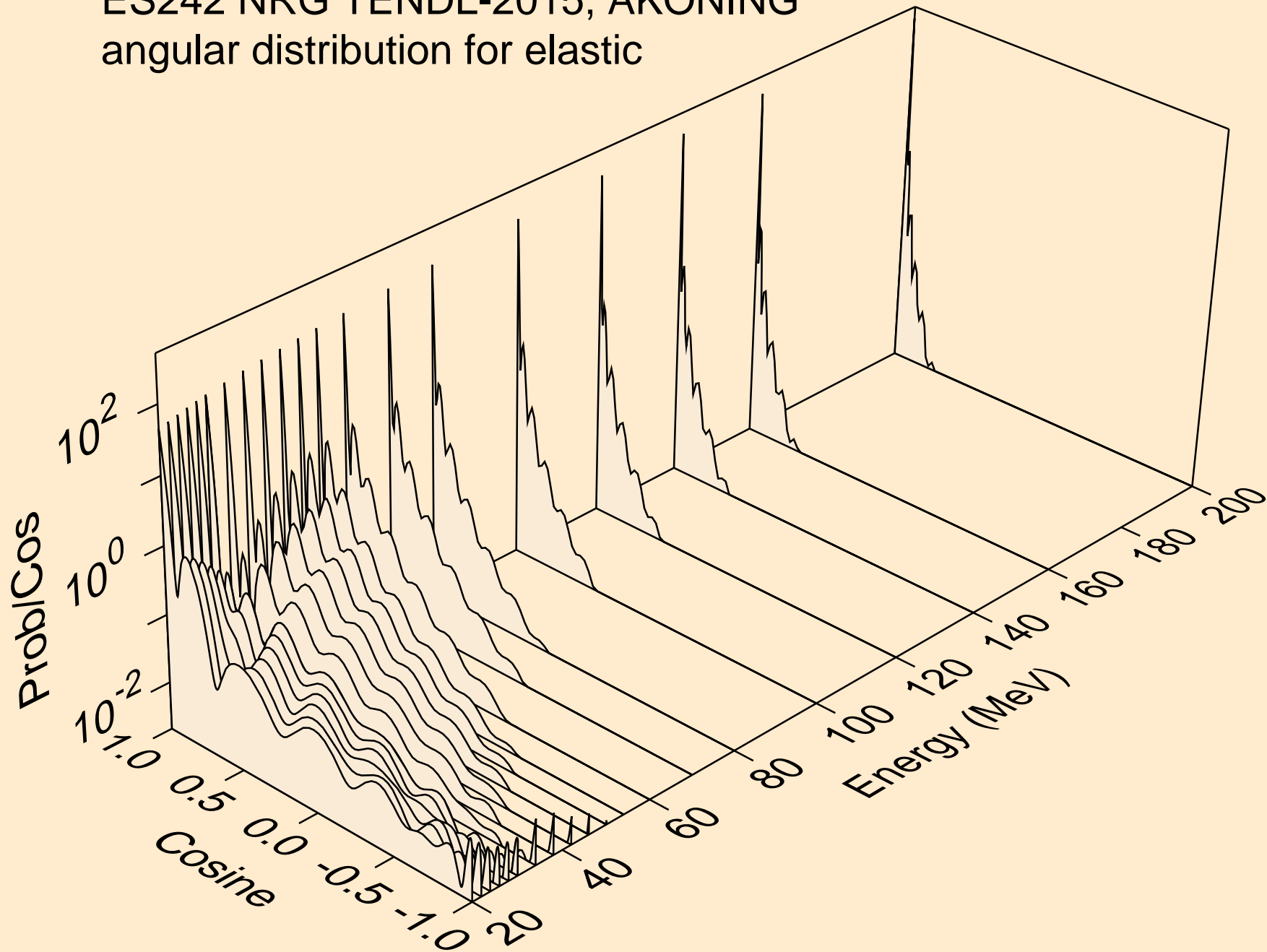

ES242 NRG TENDL-2015, AKONING  
angular distribution for (n,n\*1)

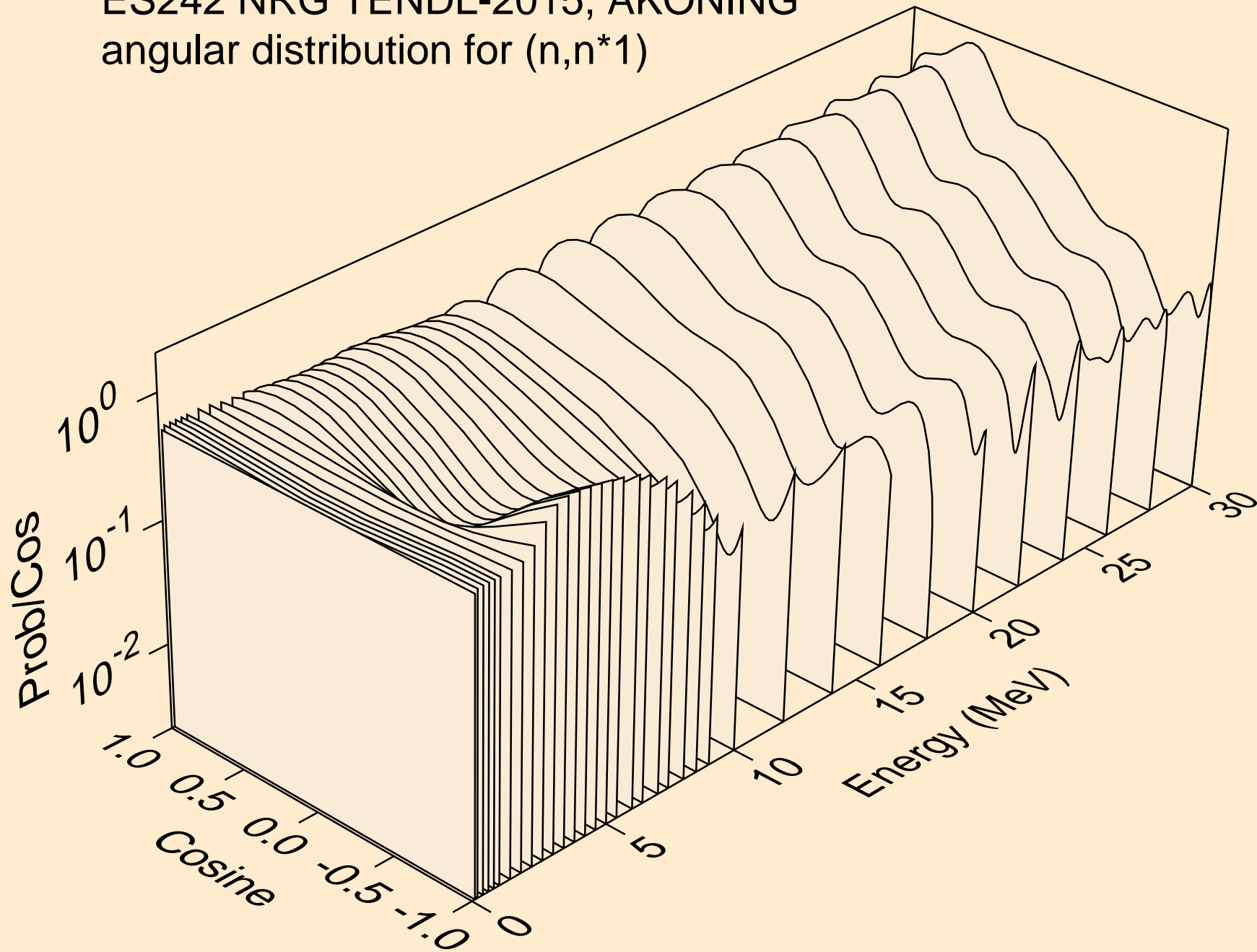



# ES242 NRG TENDL-2015, AKONING

Total fission nubar

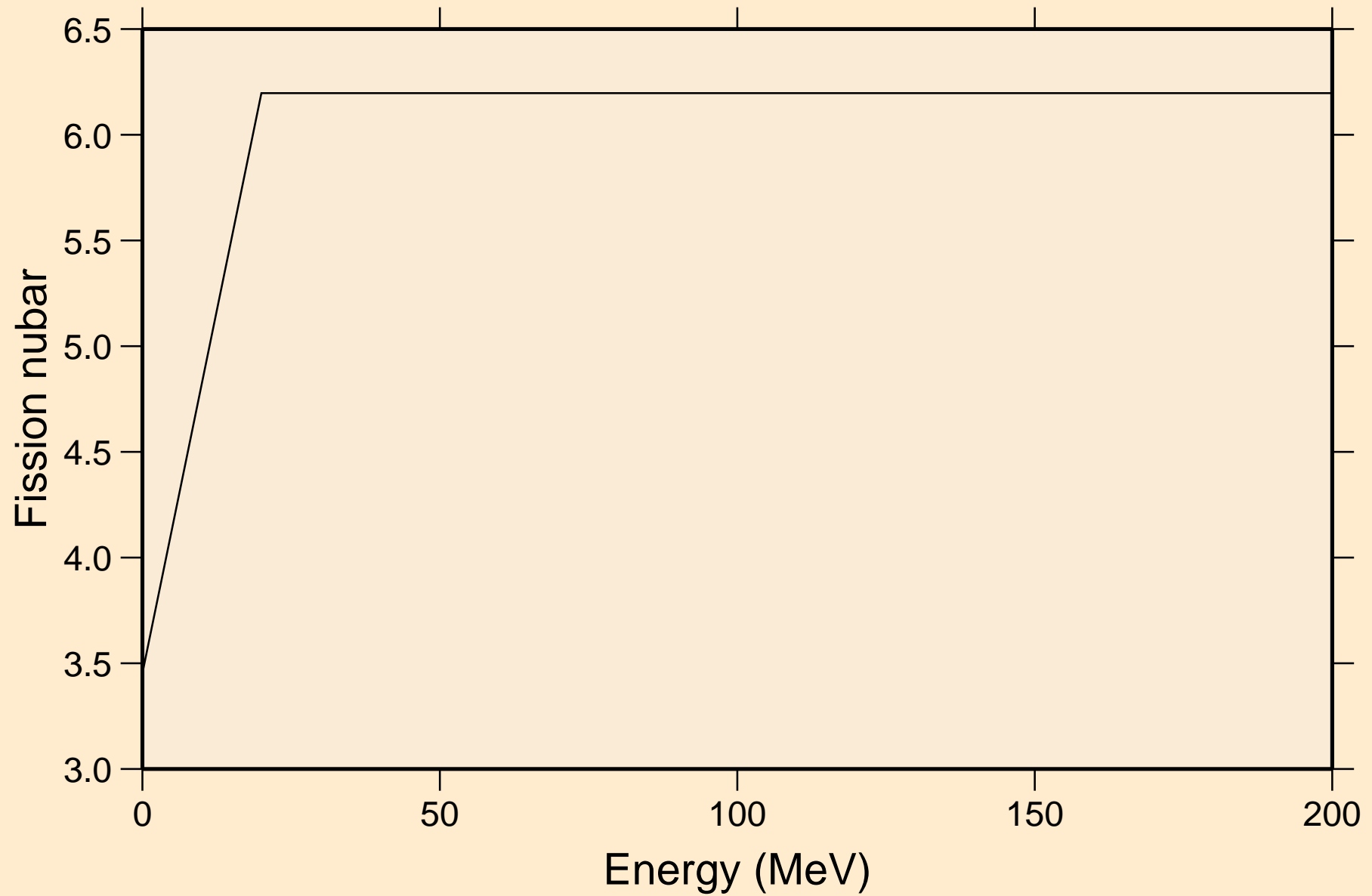

ES242 NRG TENDL-2015, AKONING  
Neutron emission for (n,x)

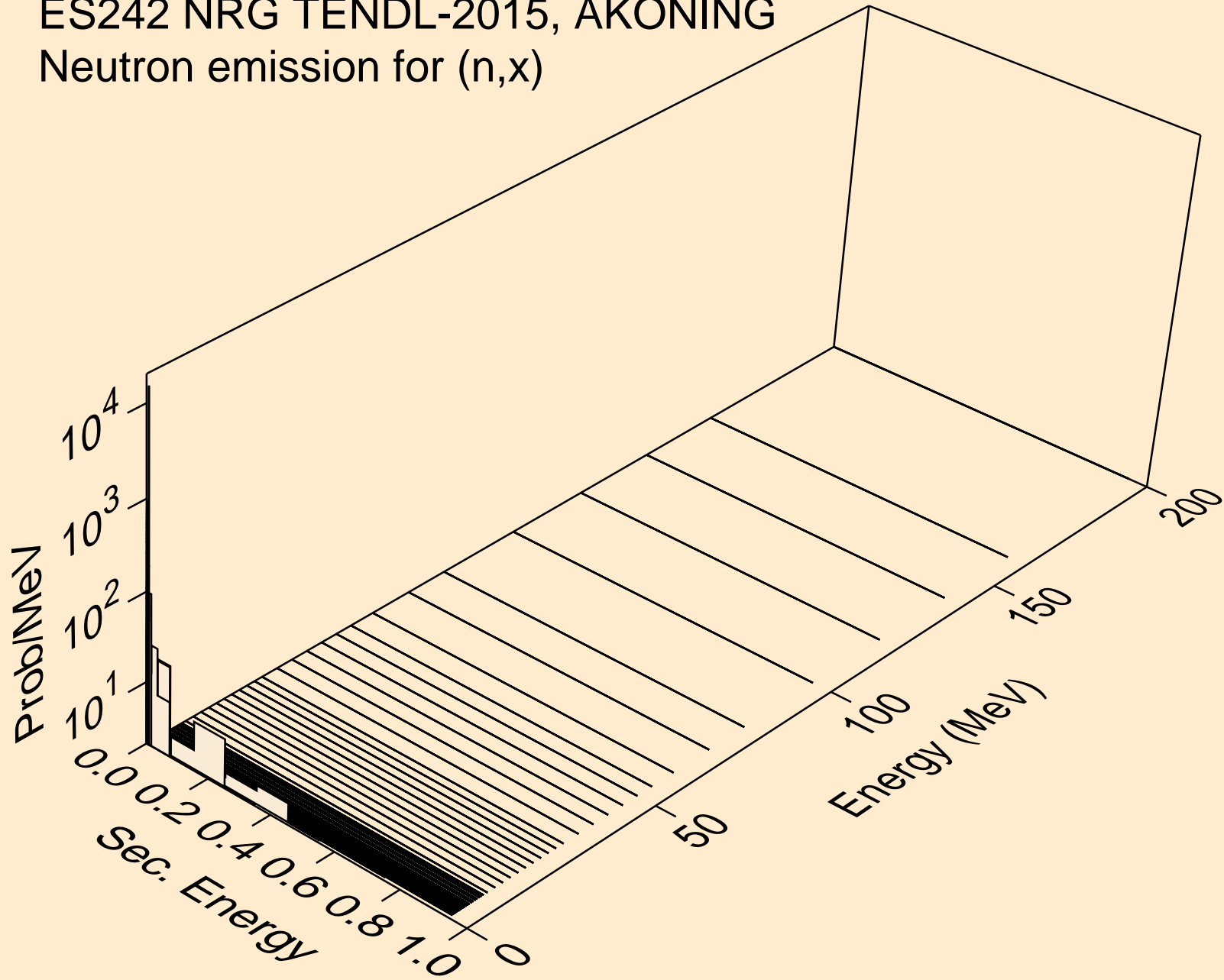

ES242 NRG TENDL-2015, AKONING  
Neutron emission for (n,2nd)

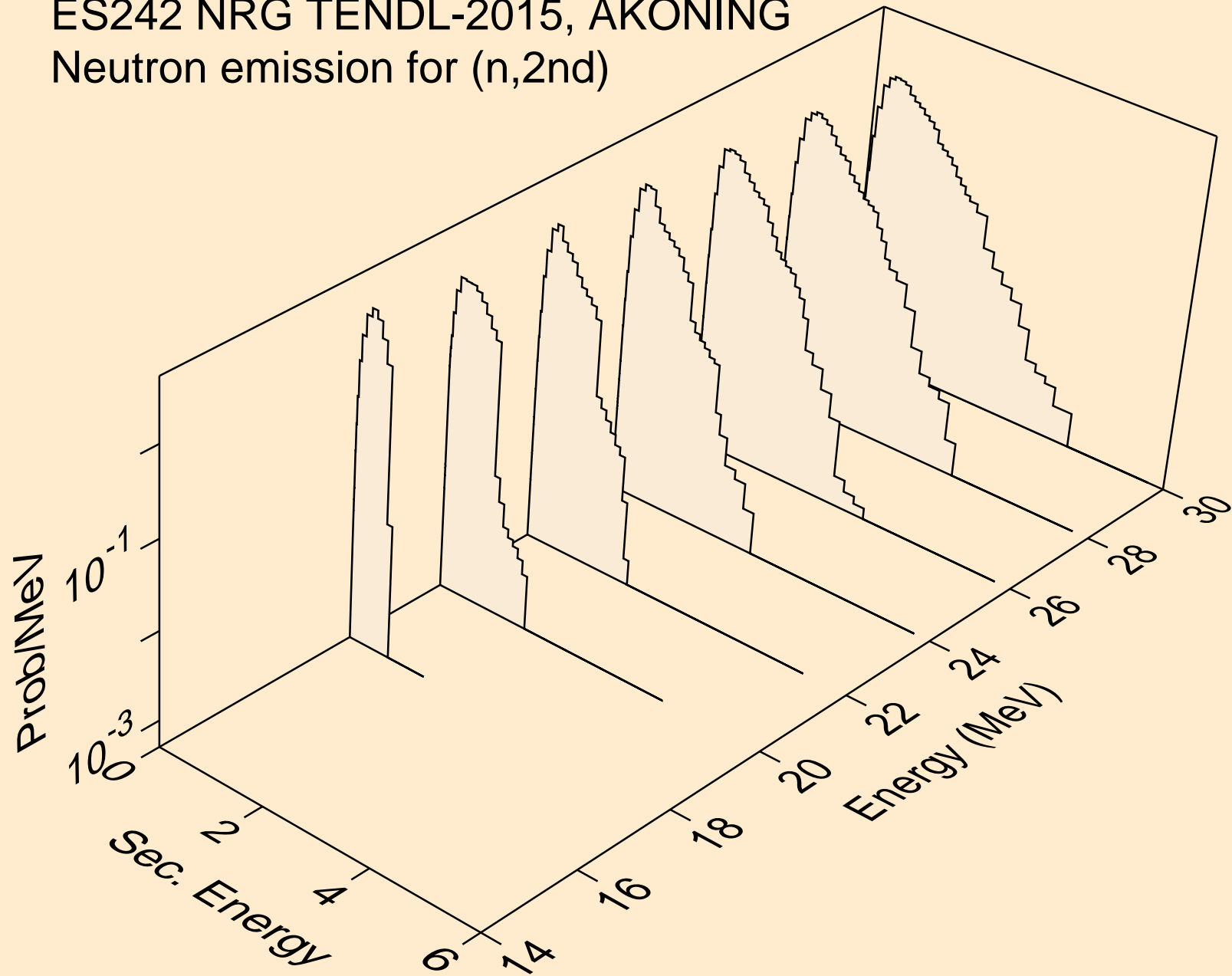

ES242 NRG TENDL-2015, AKONING  
Neutron emission for (n,2n)

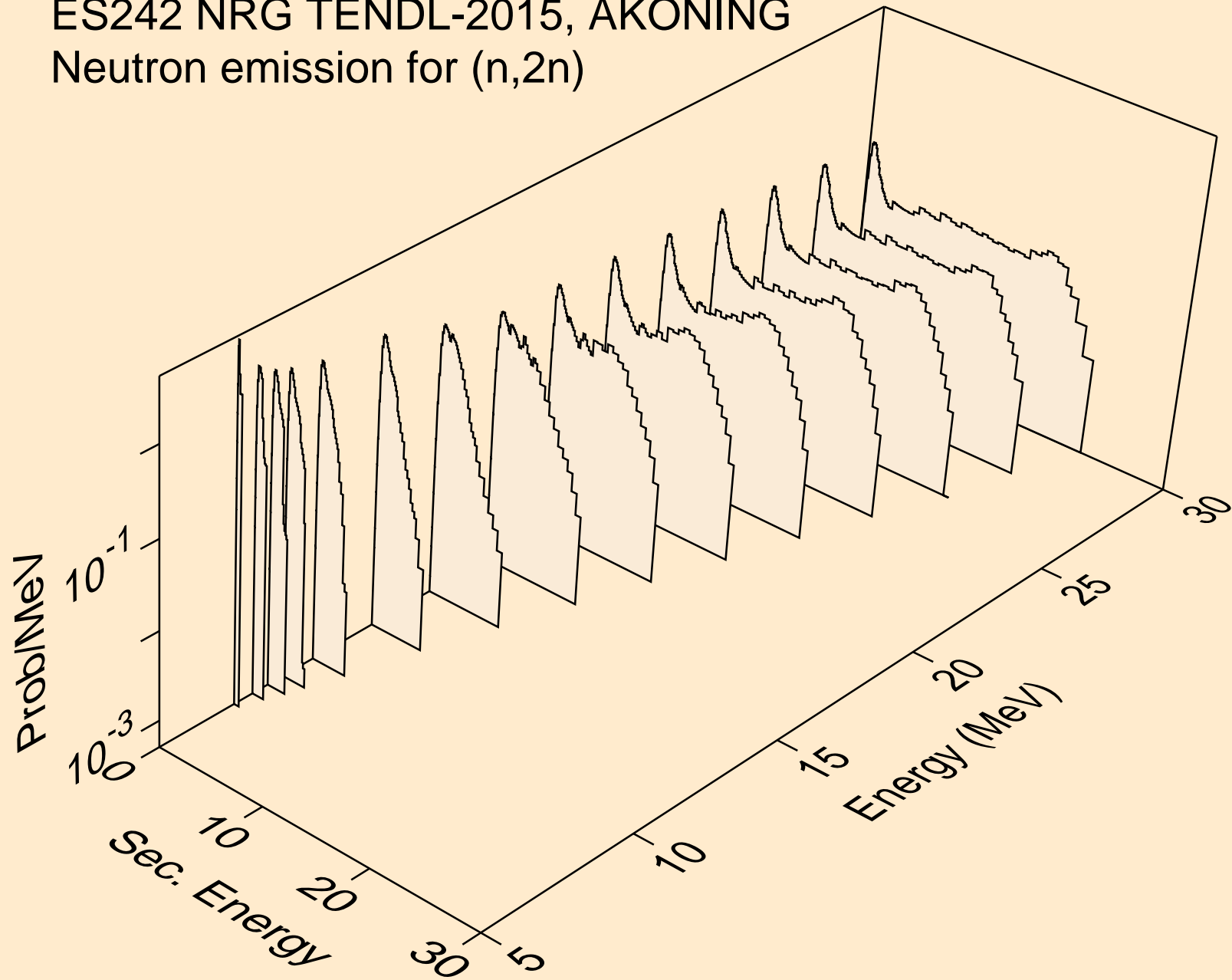

ES242 NRG TENDL-2015, AKONING  
Neutron emission for (n,3n)

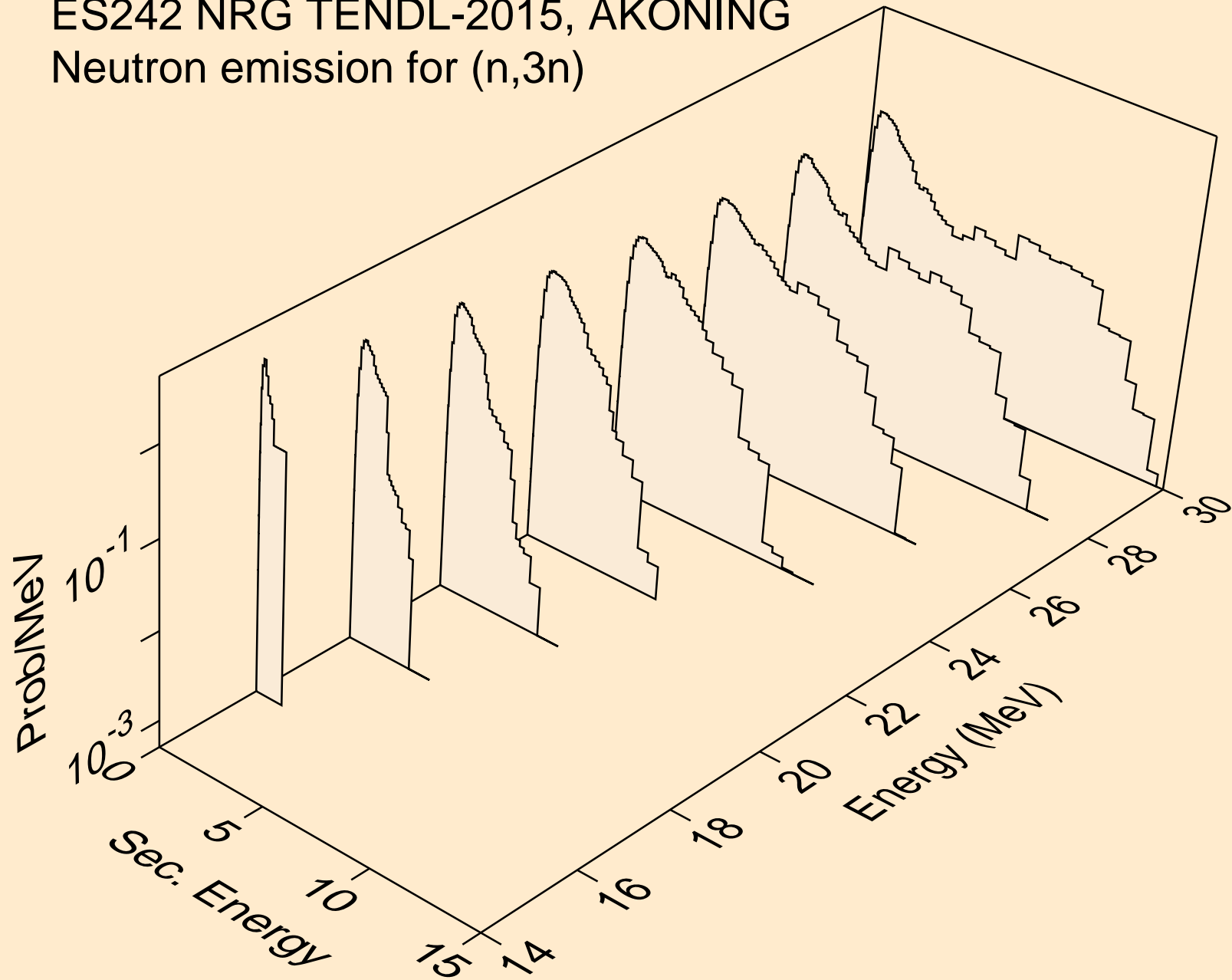

ES242 NRG TENDL-2015, AKONING  
Neutron emission for fission

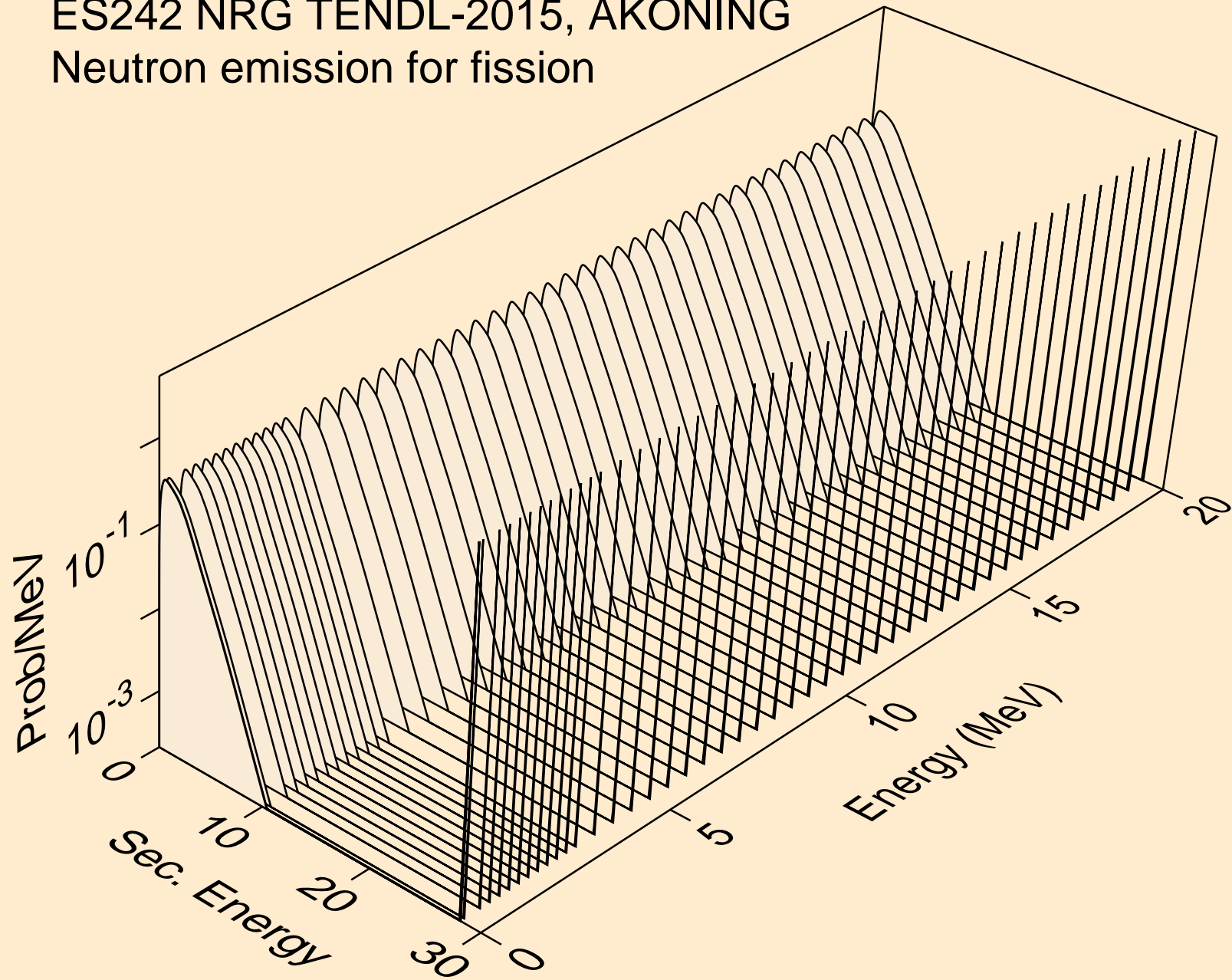

ES242 NRG TENDL-2015, AKONING  
Neutron emission for (n,n\*)a

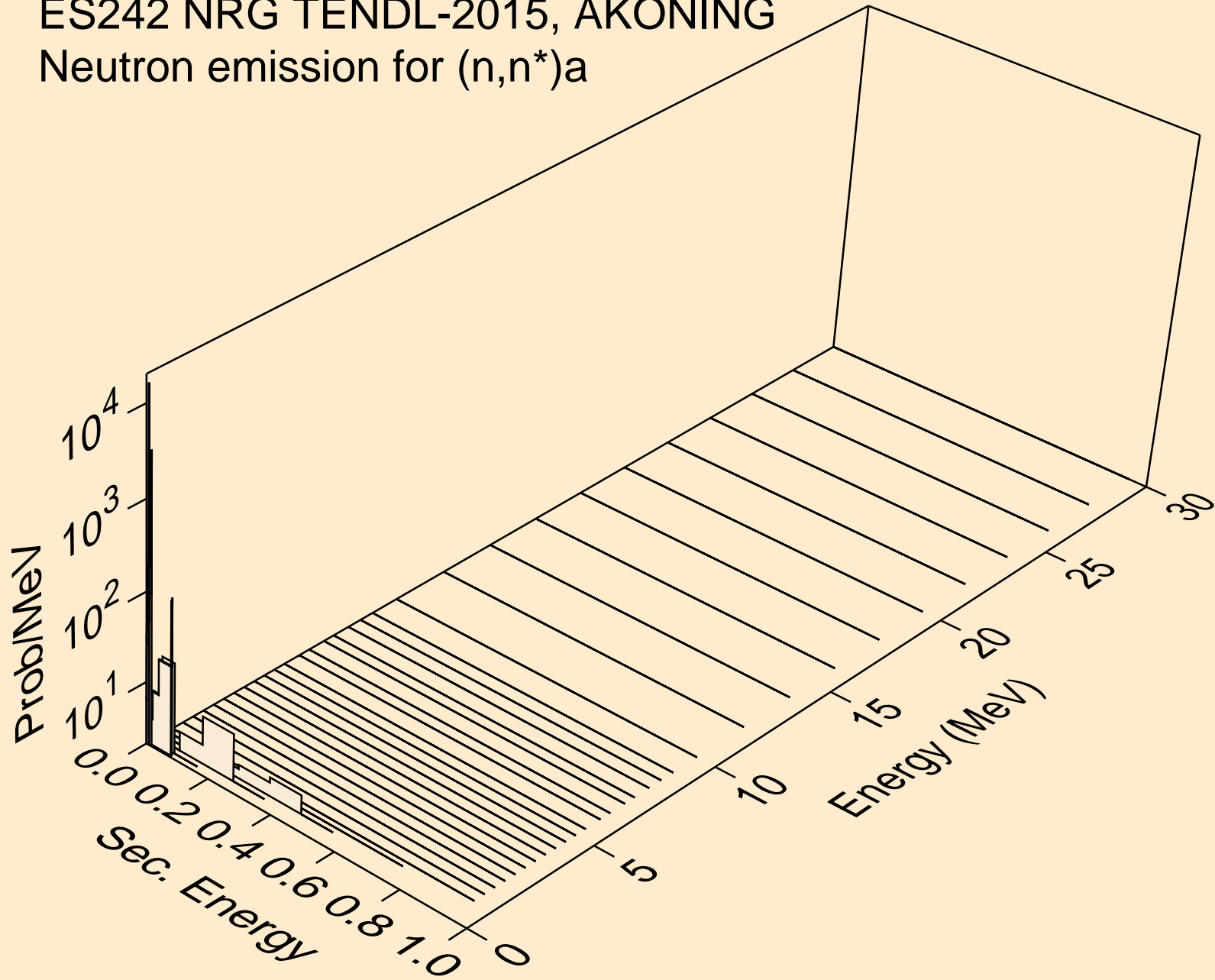

ES242 NRG TENDL-2015, AKONING  
Neutron emission for (n,n\*)3a

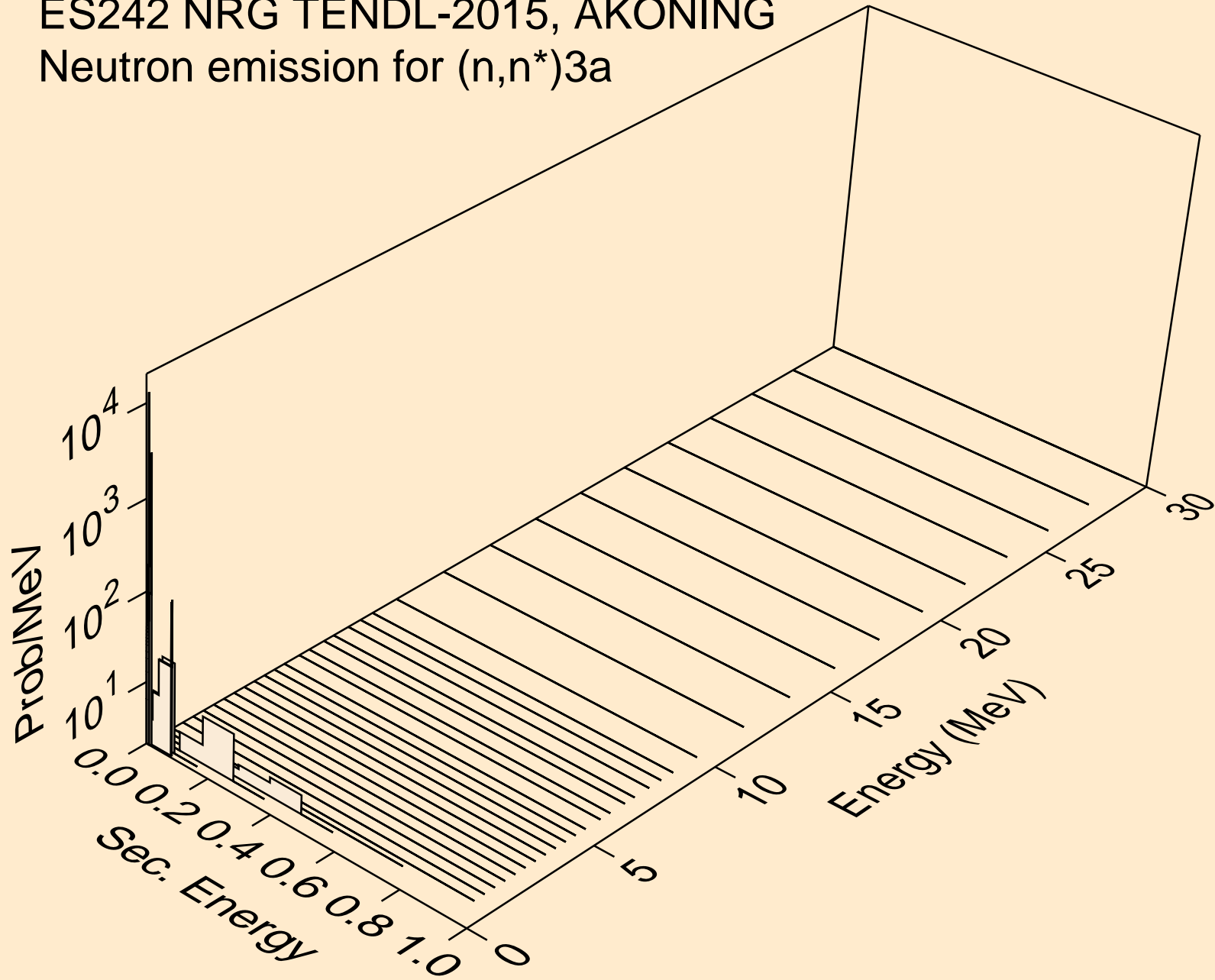



ES242 NRG TENDL-2015, AKONING  
Neutron emission for (n,2n)a

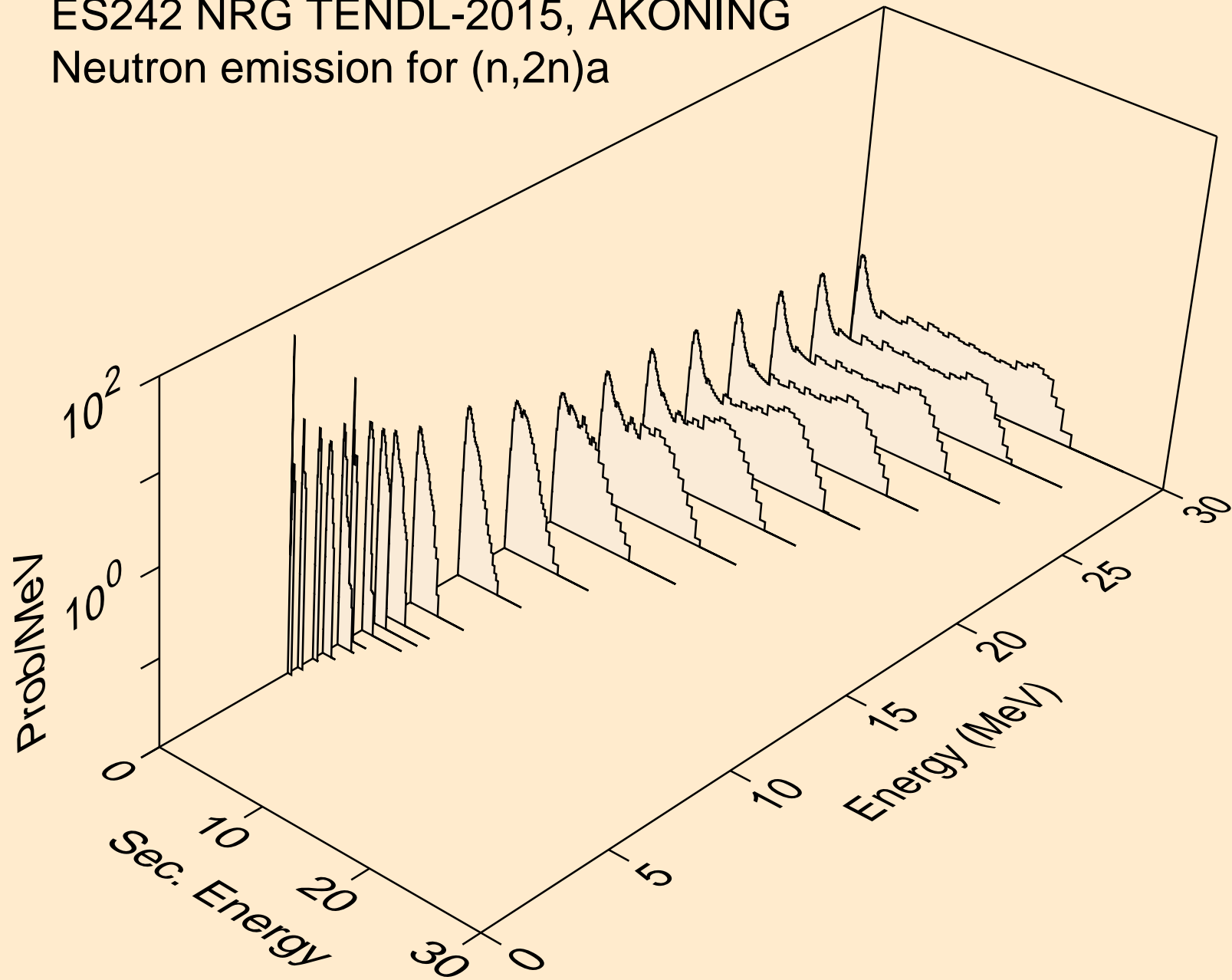

ES242 NRG TENDL-2015, AKONING  
Neutron emission for (n,3n)a

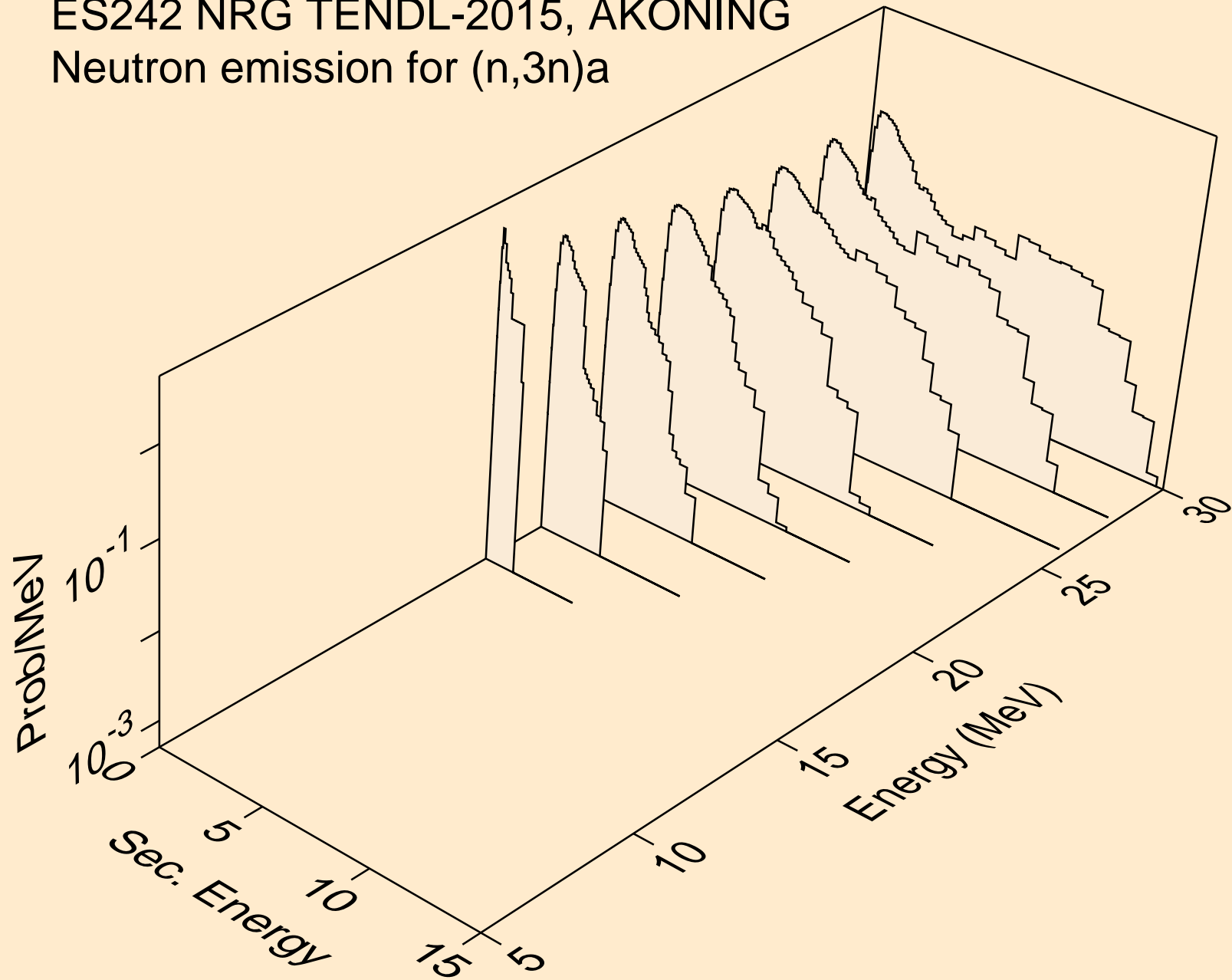

ES242 NRG TENDL-2015, AKONING  
Neutron emission for (n,n\*)p

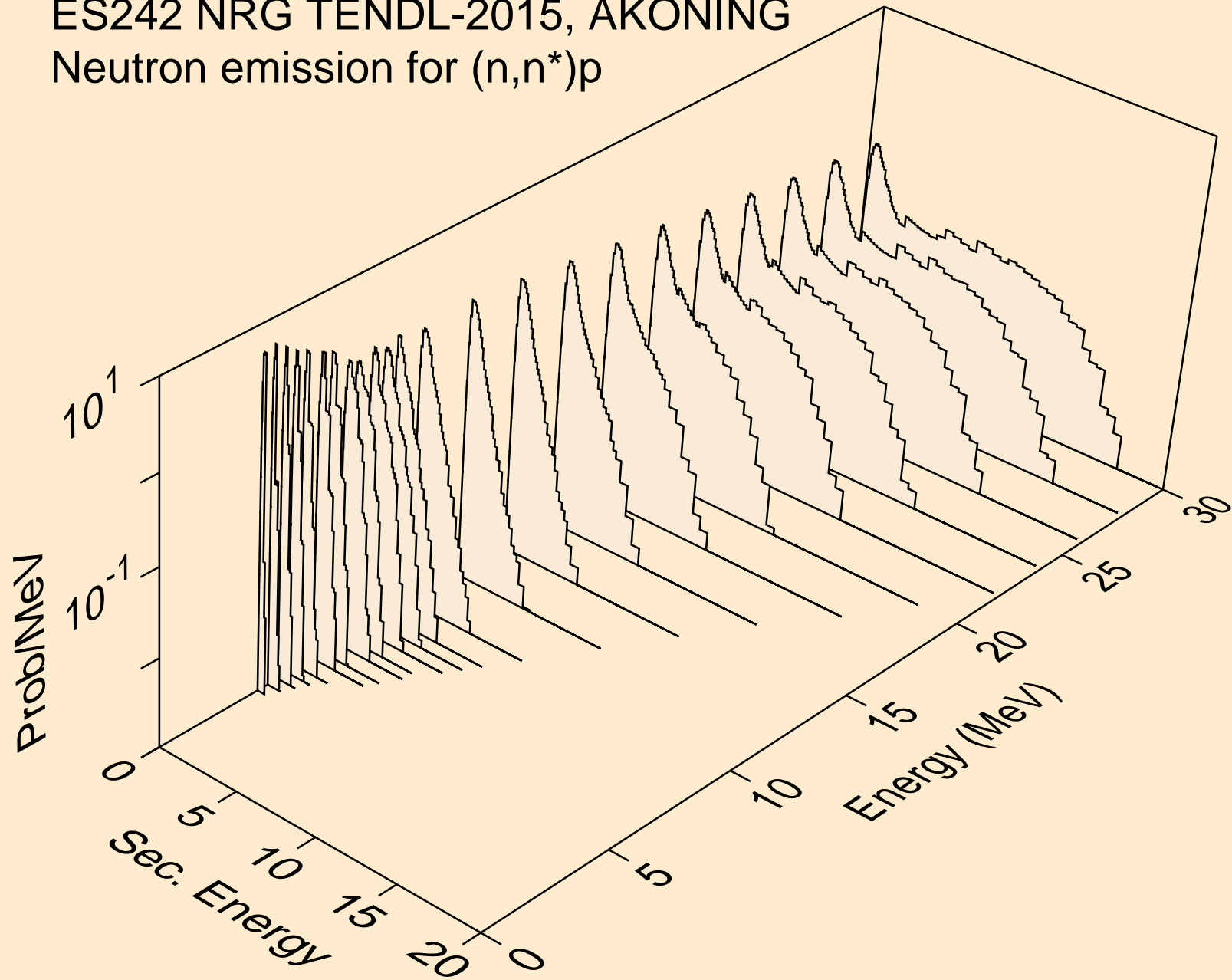

ES242 NRG TENDL-2015, AKONING  
Neutron emission for (n,n\*)2a

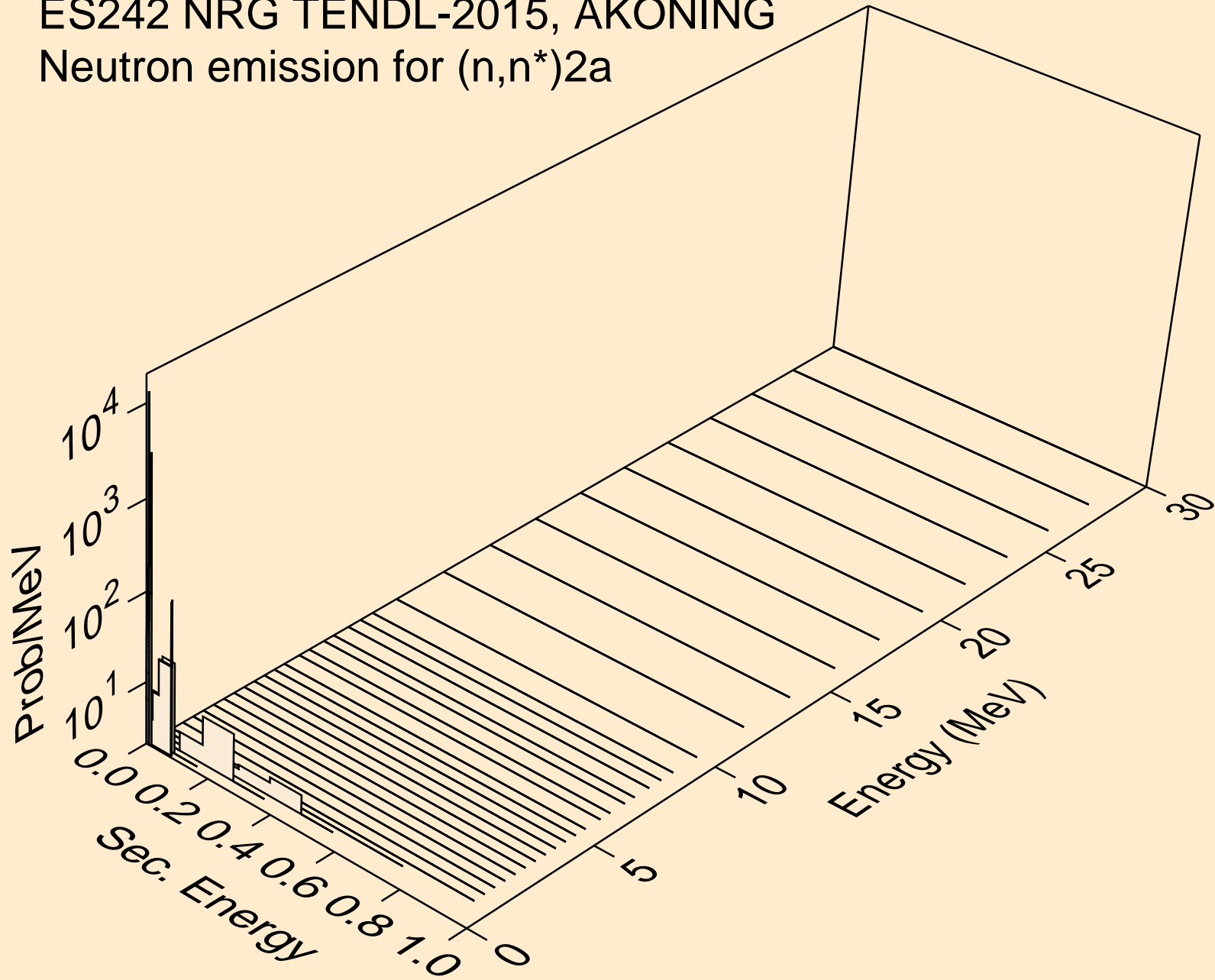

ES242 NRG TENDL-2015, AKONING  
Neutron emission for (n,2n)2a

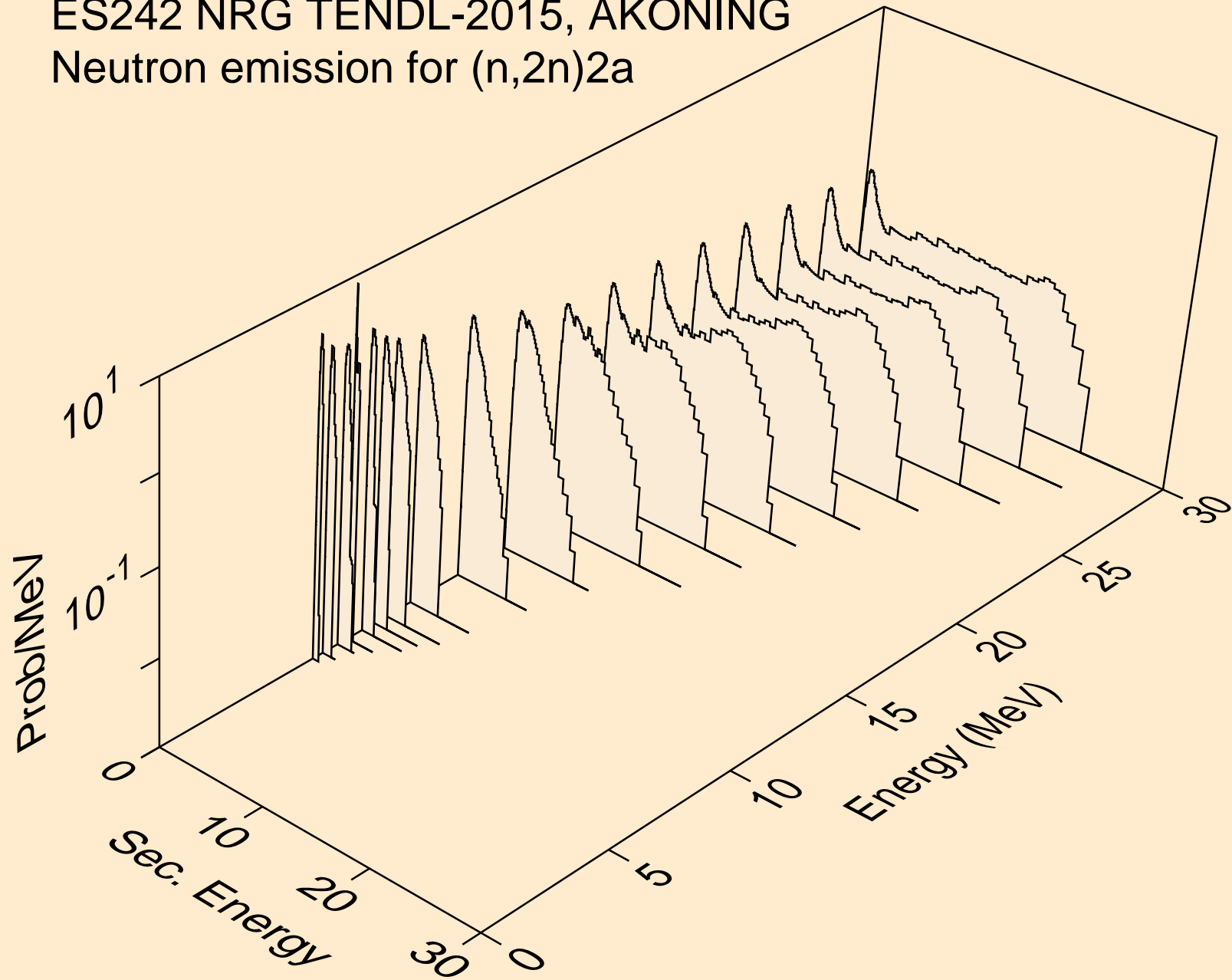

ES242 NRG TENDL-2015, AKONING  
Neutron emission for (n,n\*)d

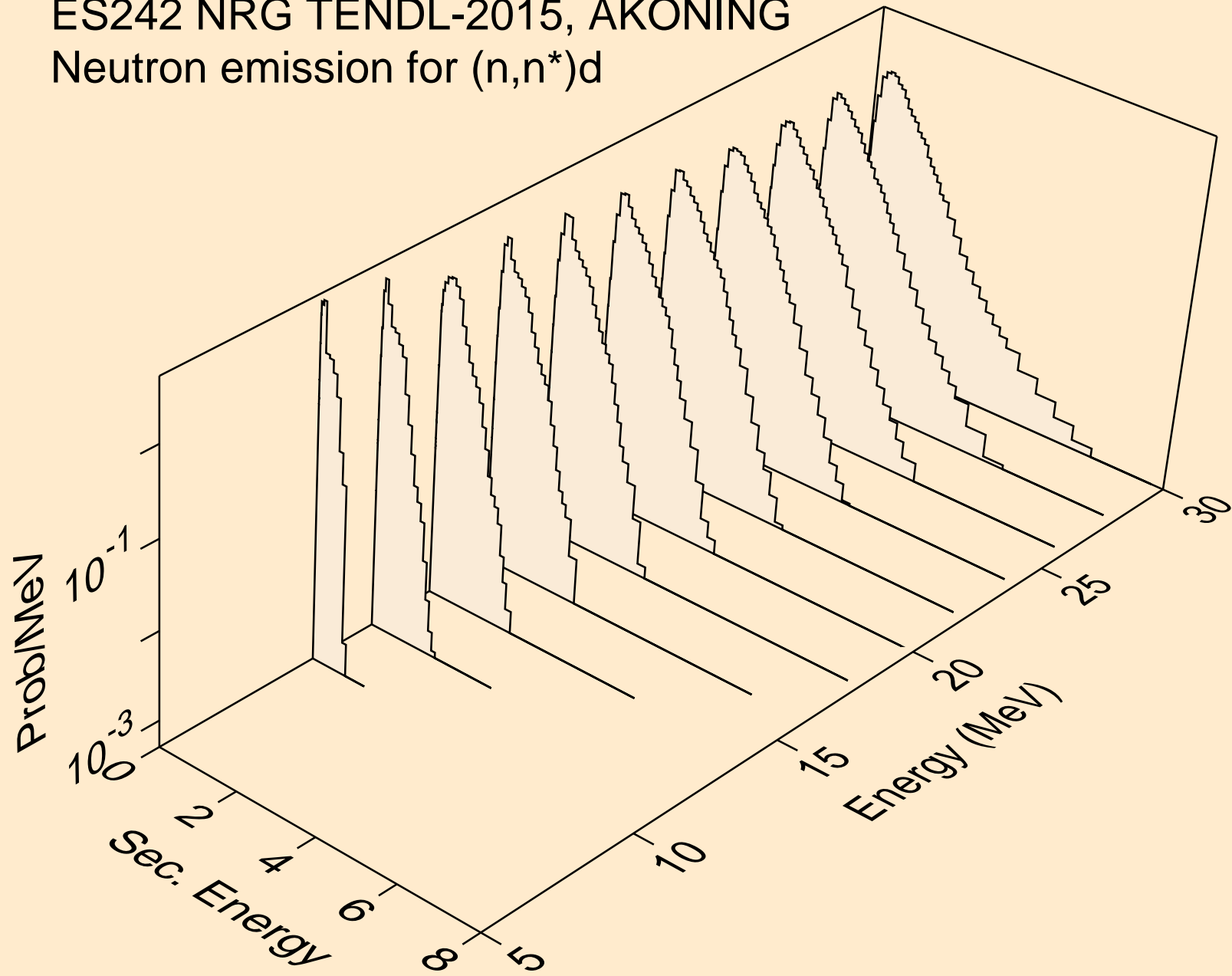

ES242 NRG TENDL-2015, AKONING  
Neutron emission for (n,n\*)t

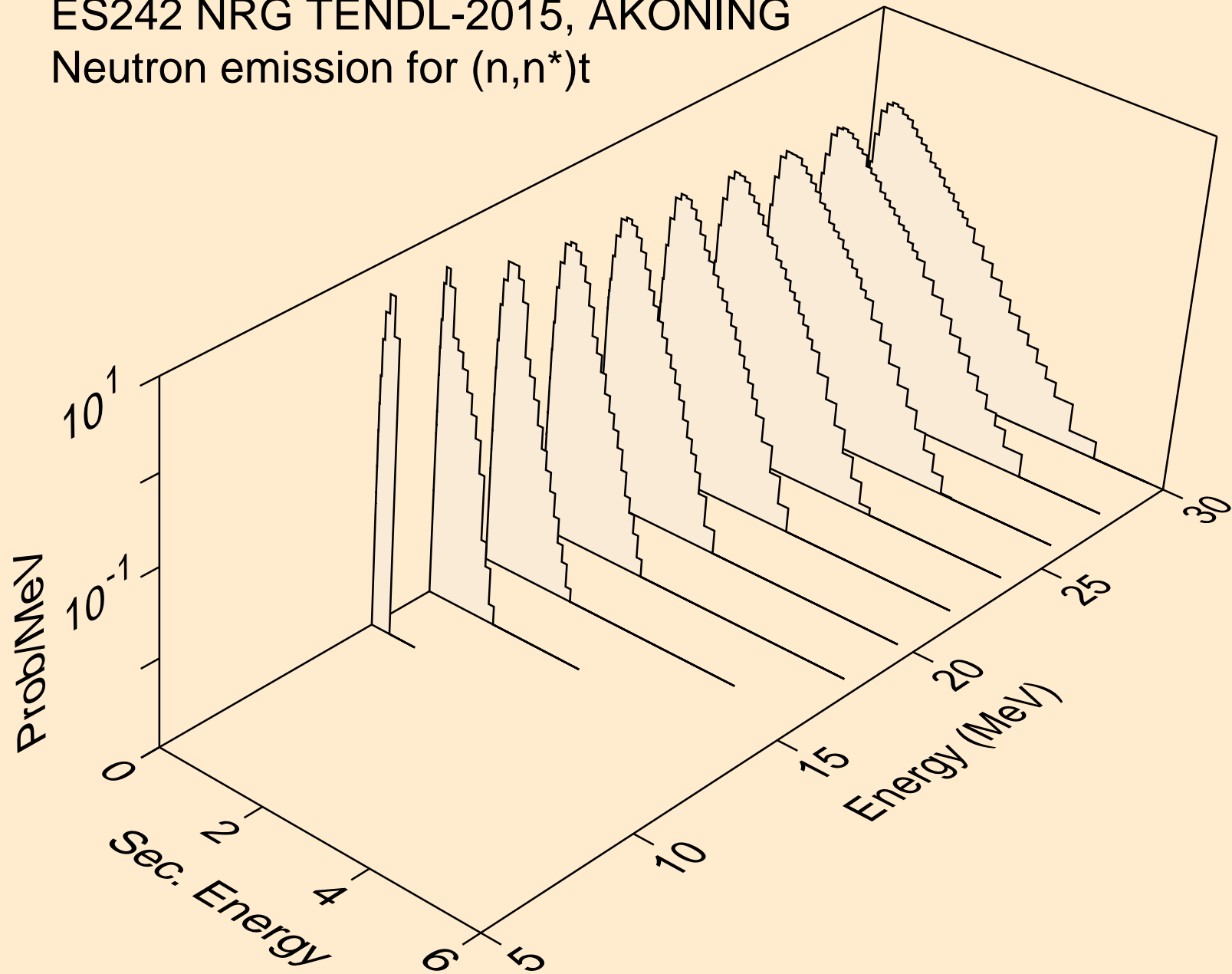

ES242 NRG TENDL-2015, AKONING  
Neutron emission for (n,n\*)he3

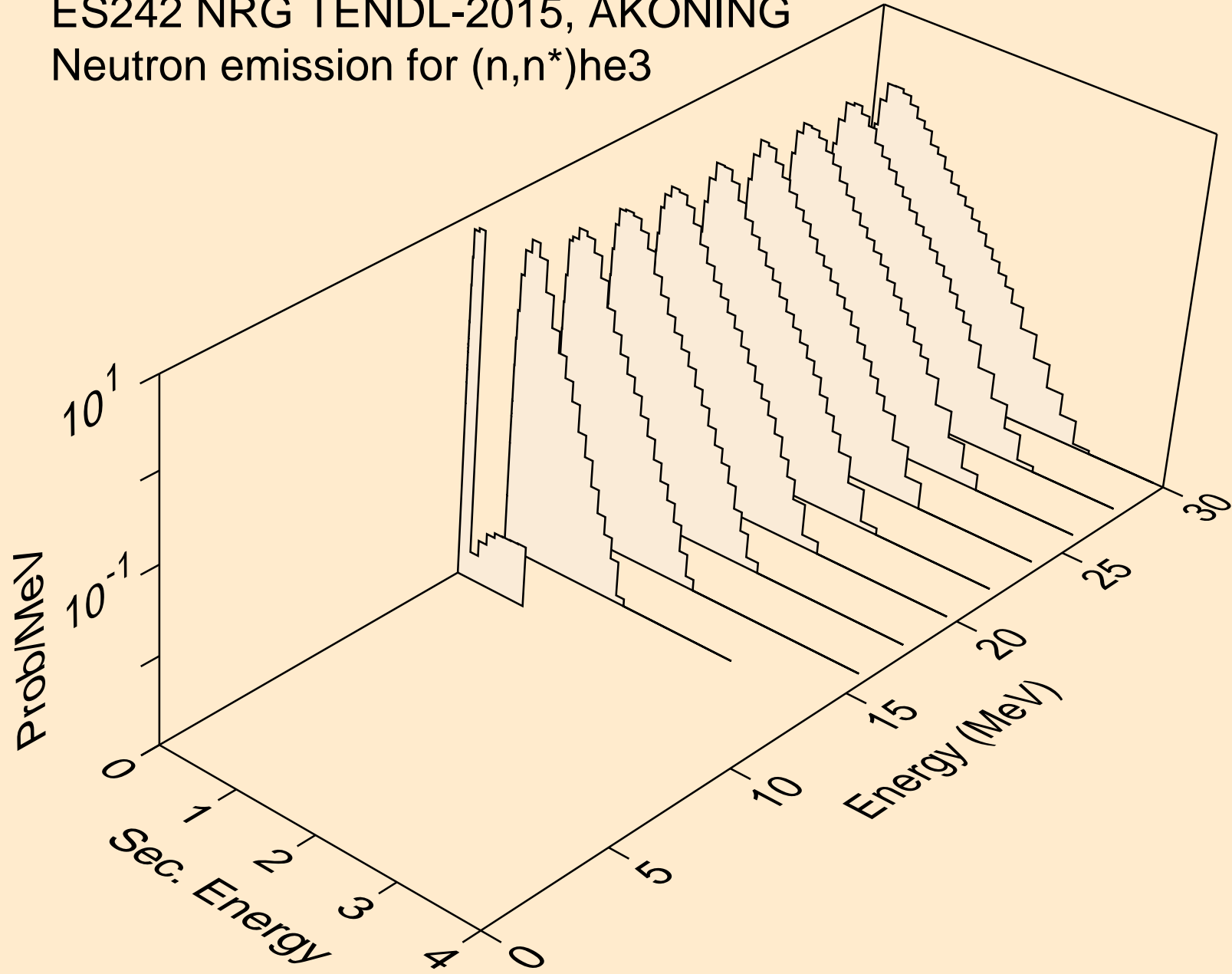



ES242 NRG TENDL-2015, AKONING  
Neutron emission for (n,n\*)d2a

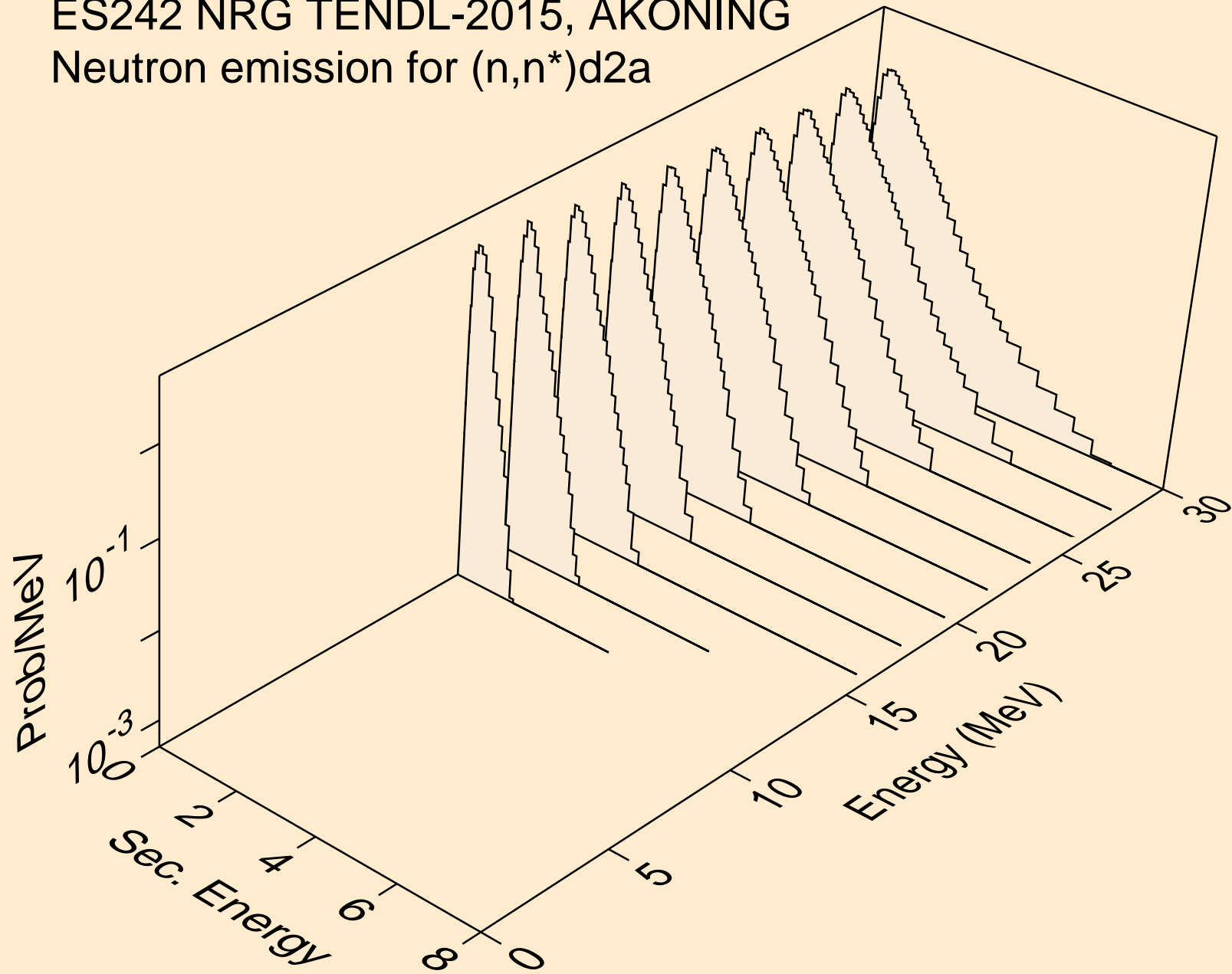

ES242 NRG TENDL-2015, AKONING  
Neutron emission for (n,4n)

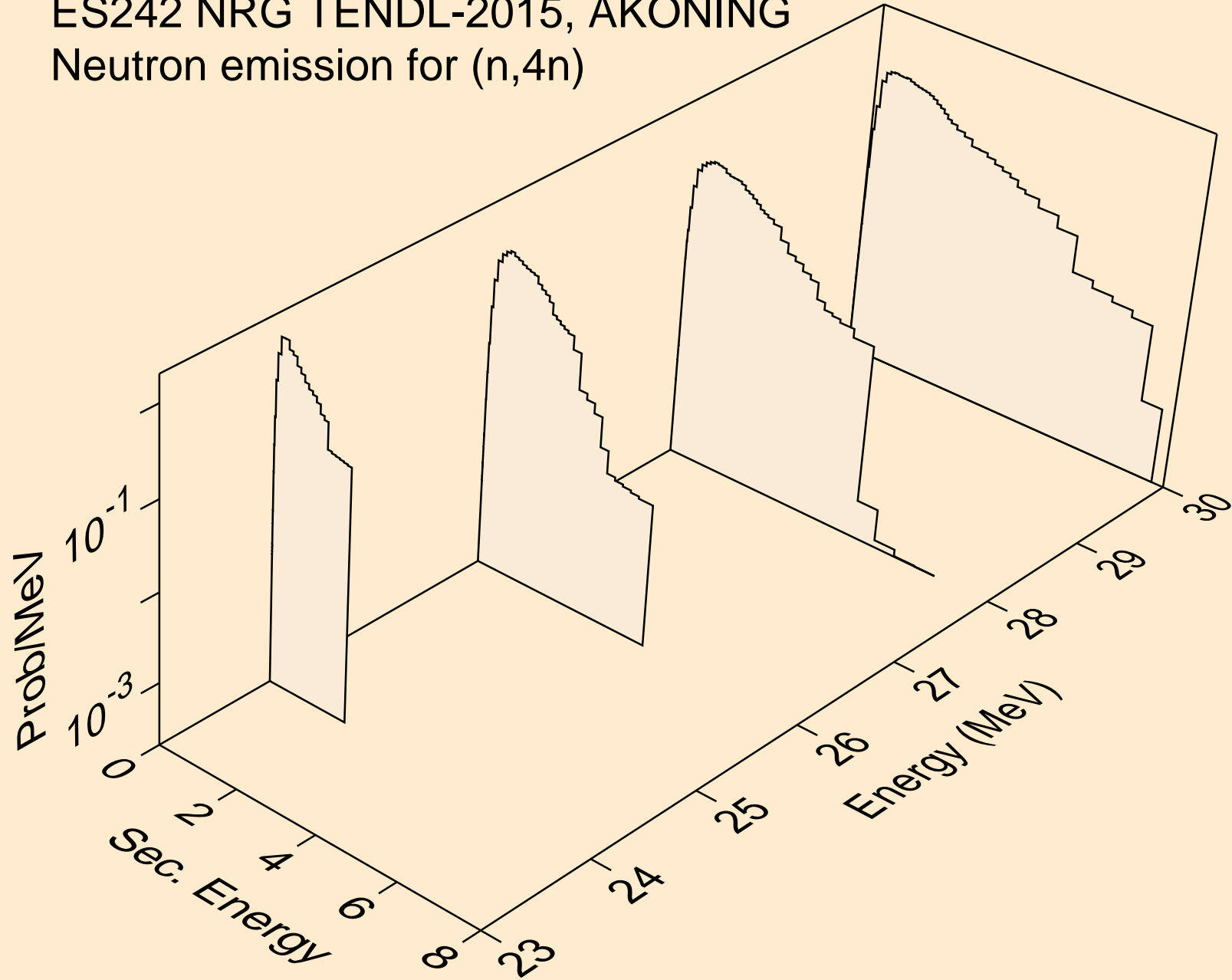

ES242 NRG TENDL-2015, AKONING  
Neutron emission for (n,2np)

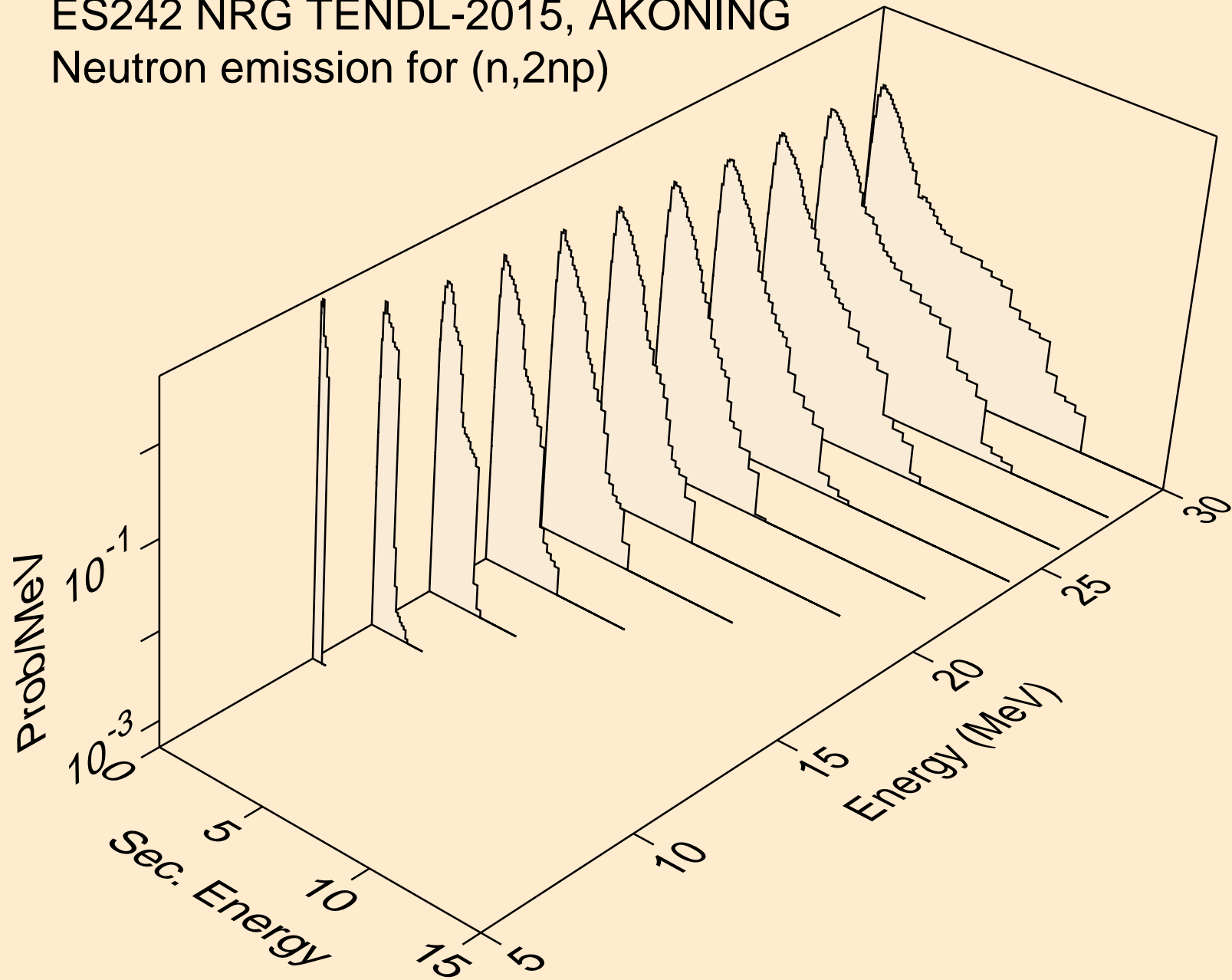

ES242 NRG TENDL-2015, AKONING  
Neutron emission for (n,3np)

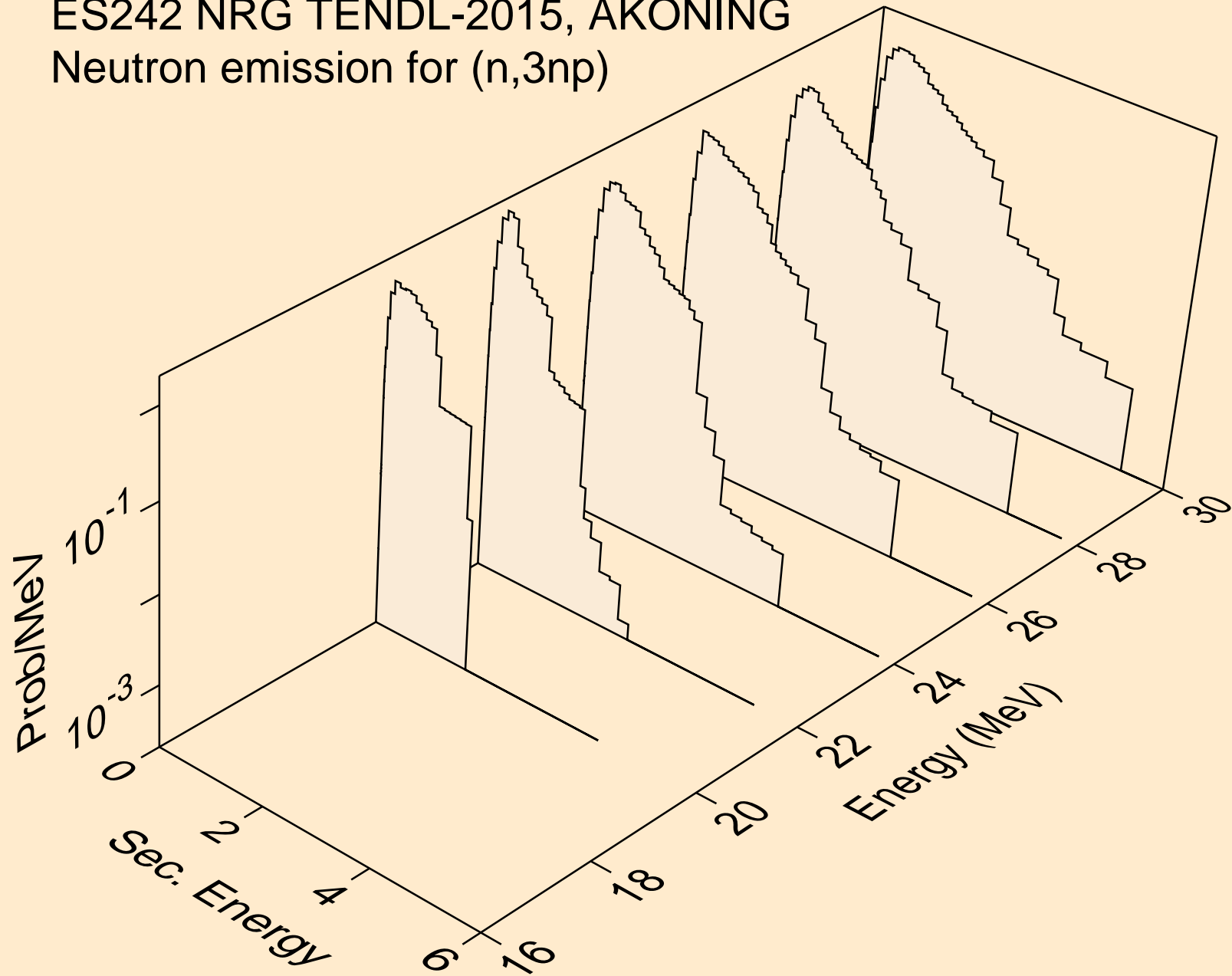

ES242 NRG TENDL-2015, AKONING  
Neutron emission for (n,2np)

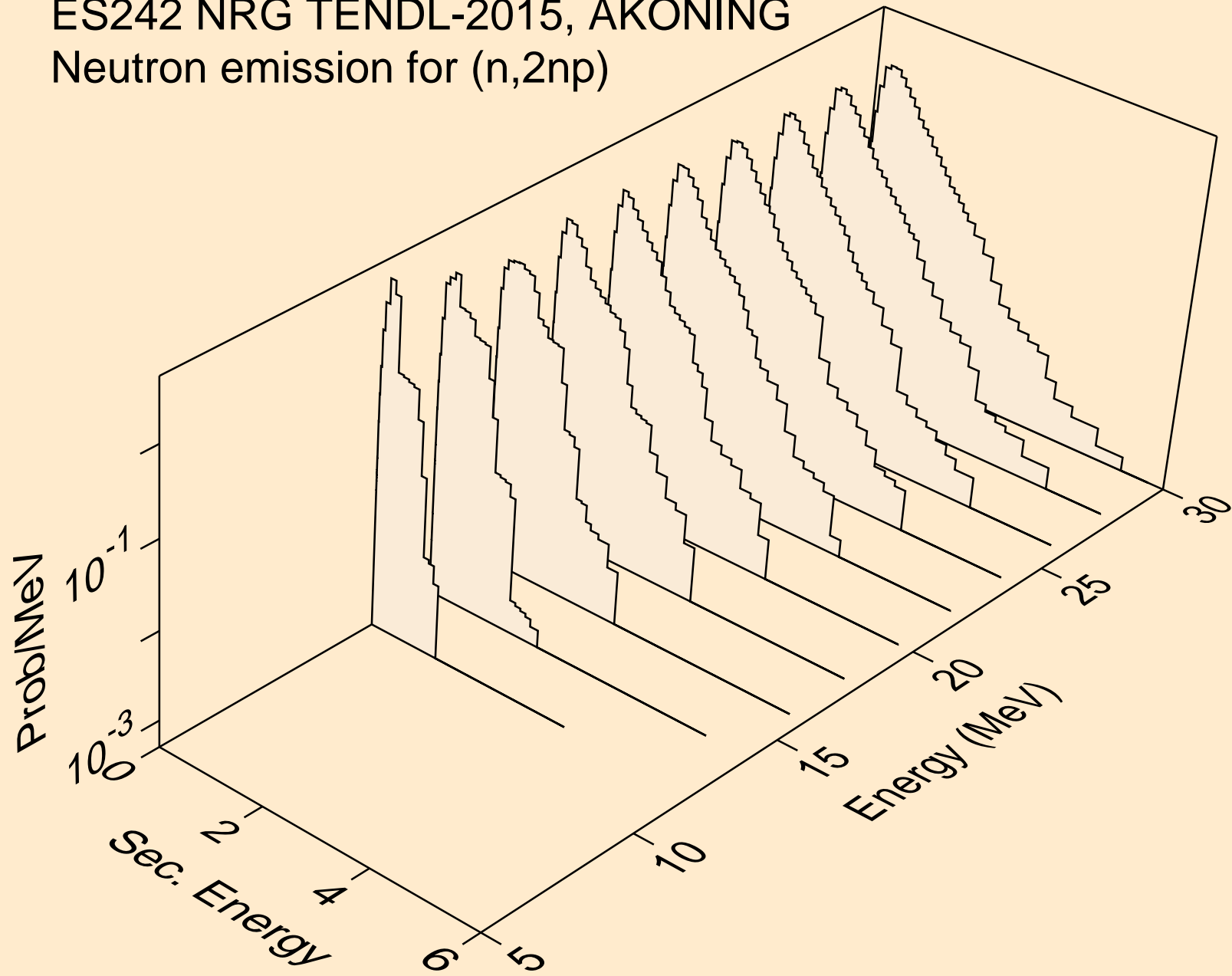

ES242 NRG TENDL-2015, AKONING  
Neutron emission for (n,npa)

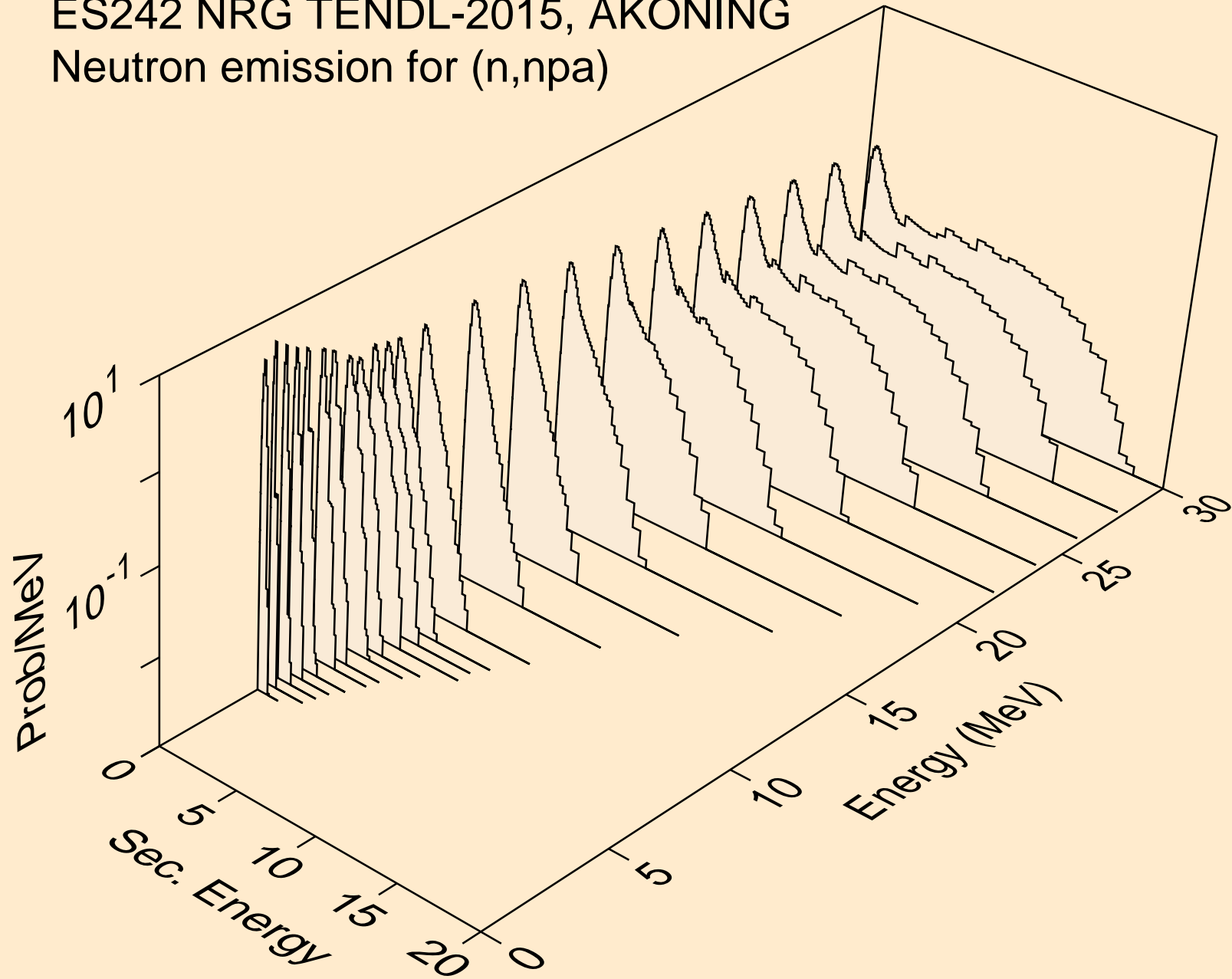

ES242 NRG TENDL-2015, AKONING  
Neutron emission for (n,n\*c)

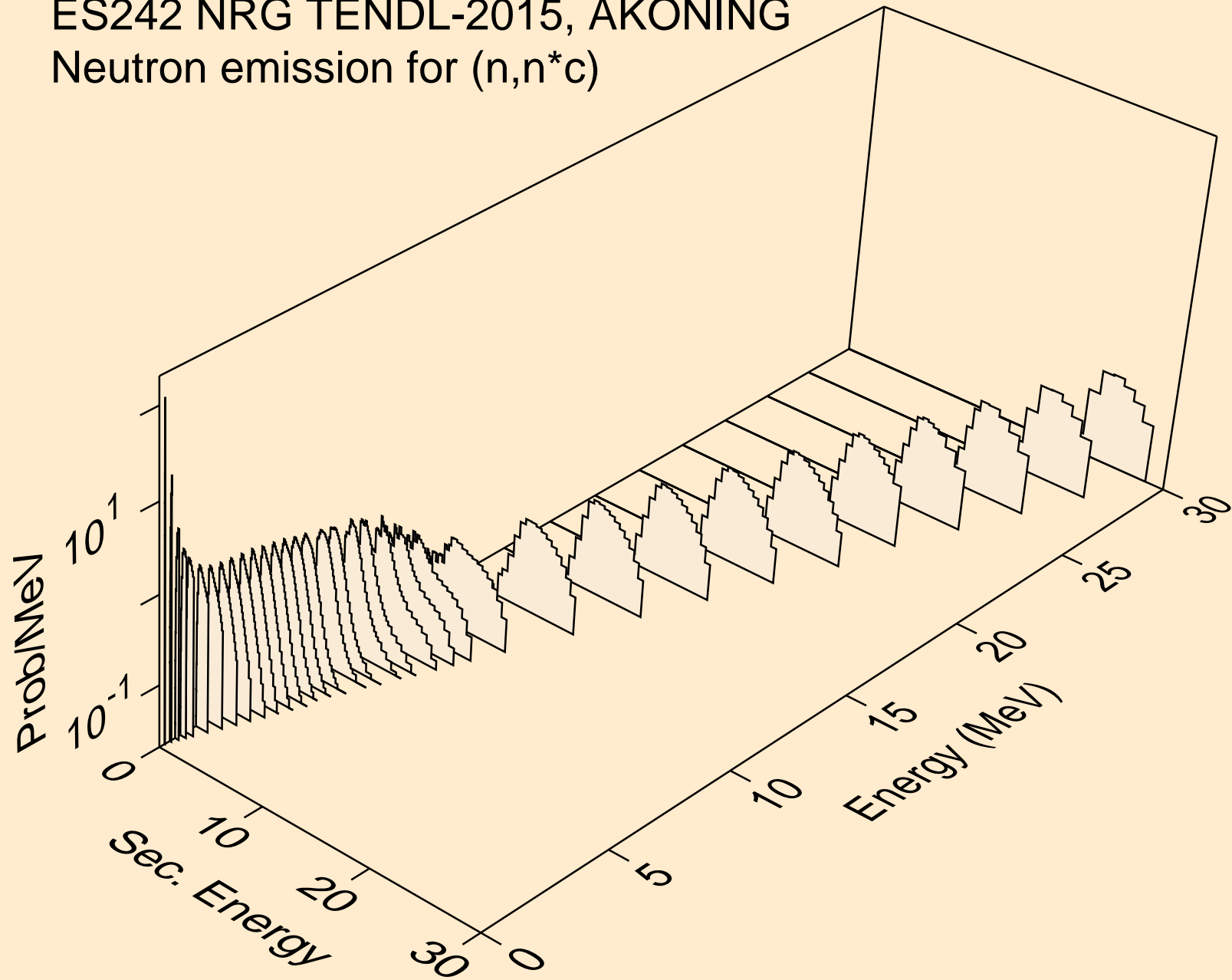

# ES242 NRG TENDL-2015, AKONING

Delayed nubar

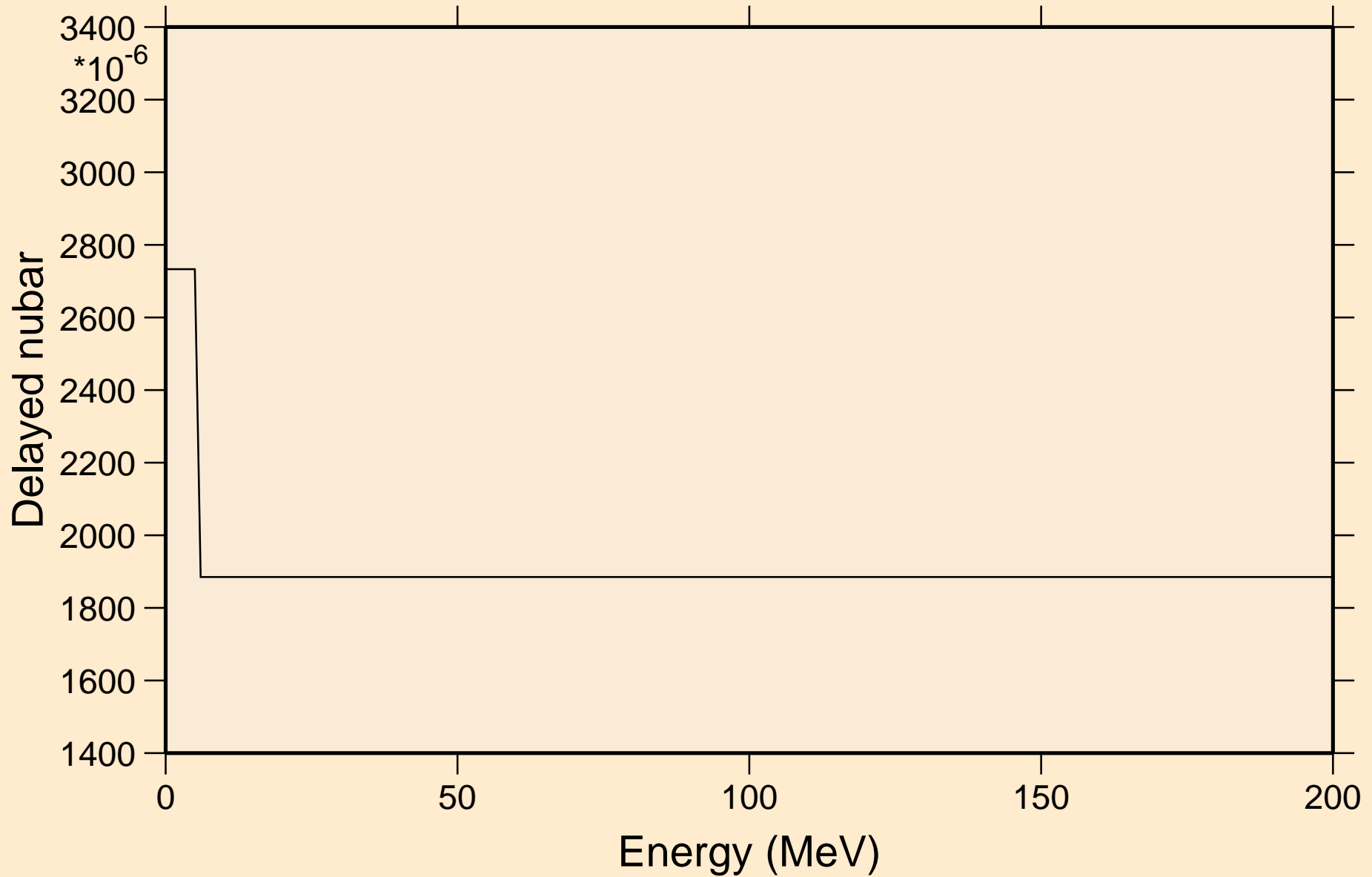



# ES242 NRG TENDL-2015, AKONING

## Delayed neutron spectra

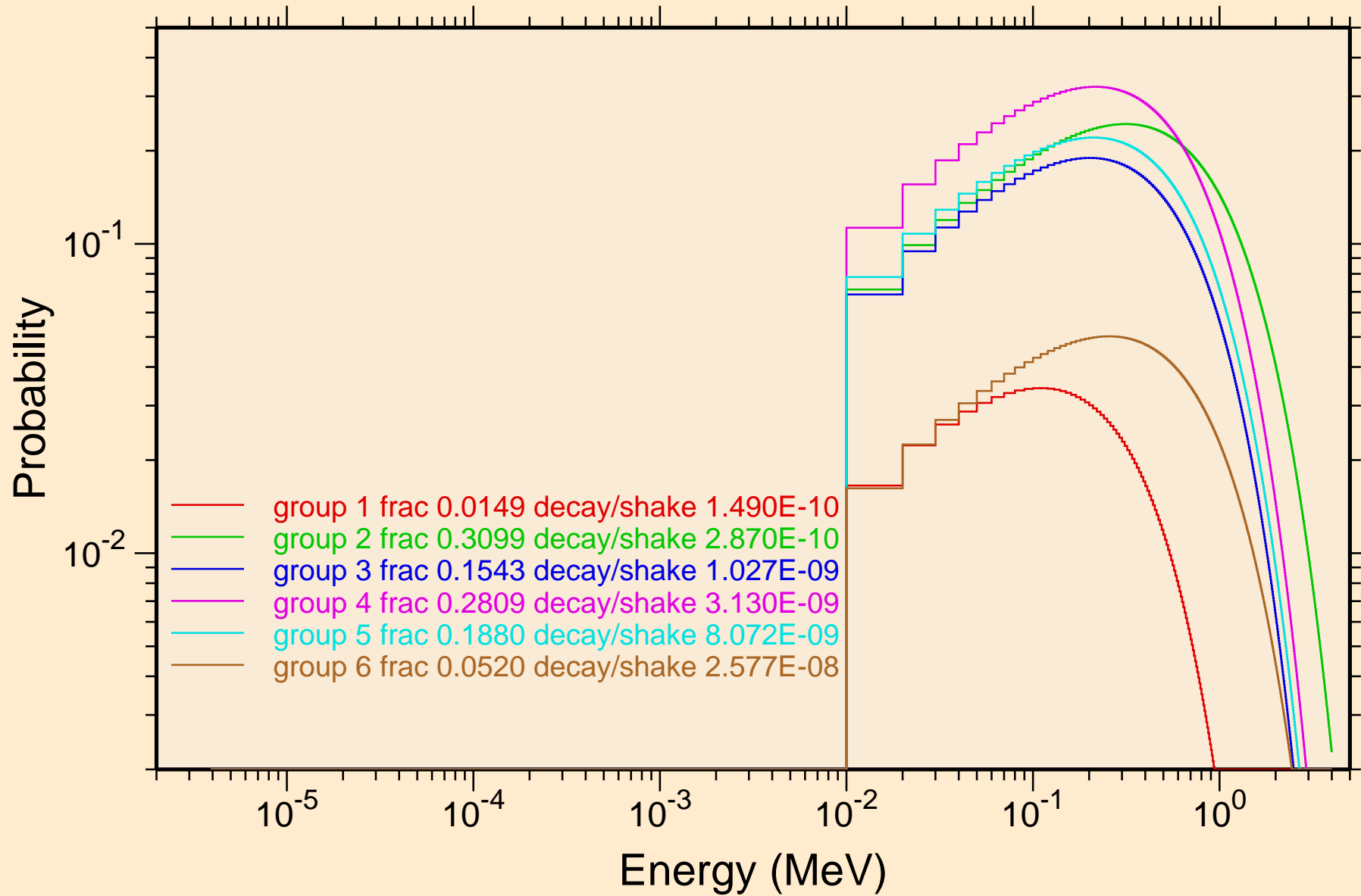

ES242 NRG TENDL-2015, AKONING  
Photon emission for (n,x)

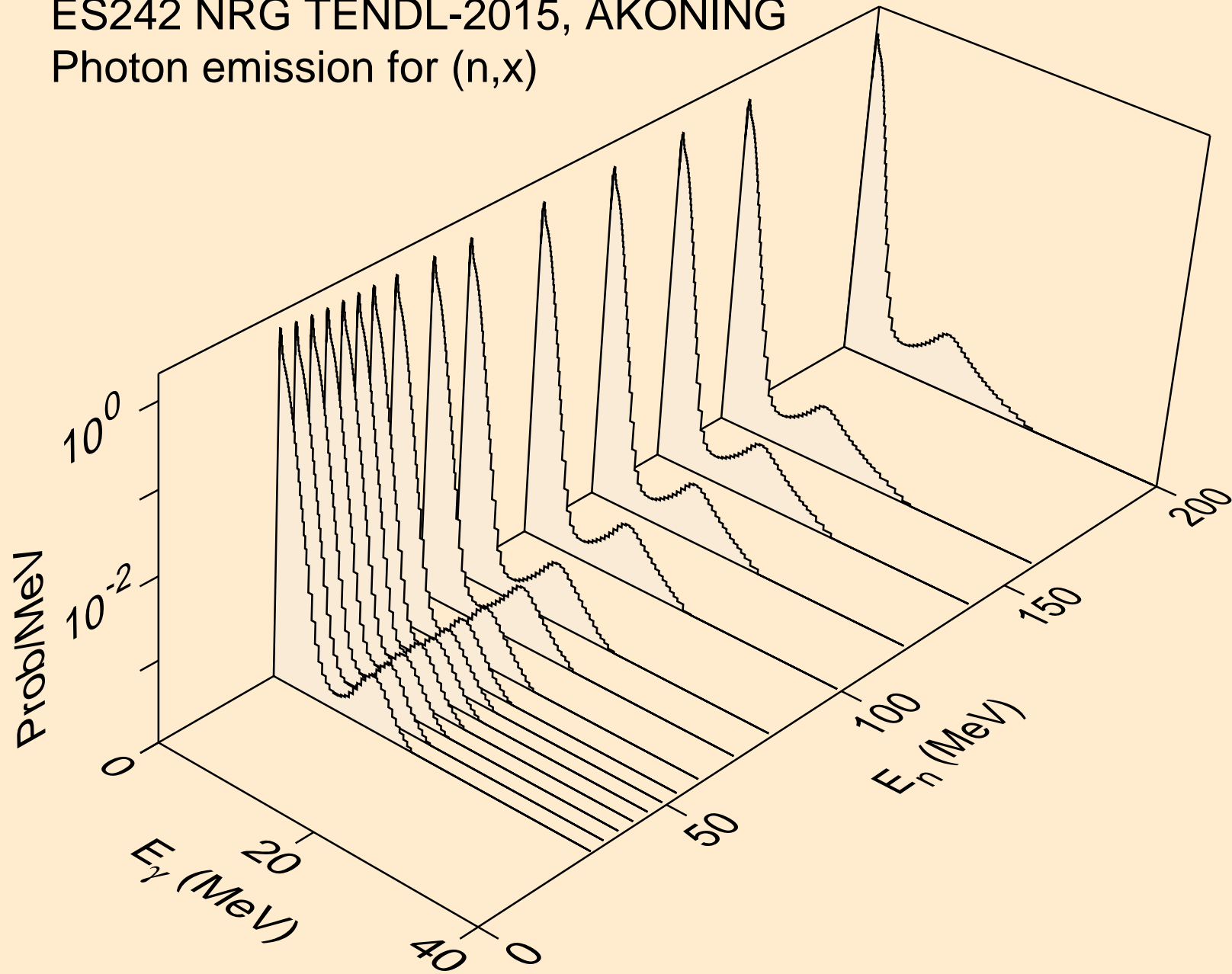

ES242 NRG TENDL-2015, AKONING  
Photon emission for (n,2nd)

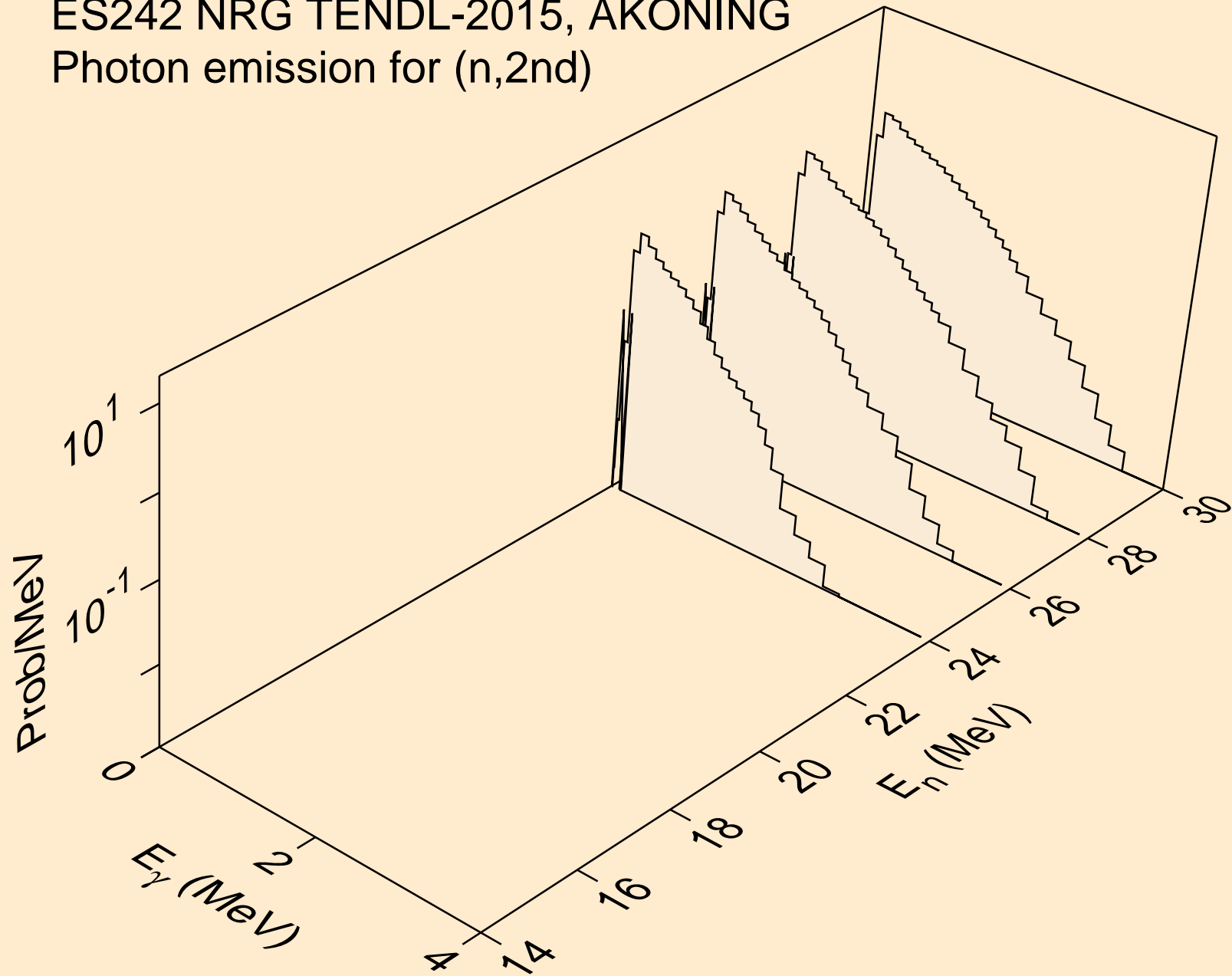

ES242 NRG TENDL-2015, AKONING  
Photon emission for (n,2n)

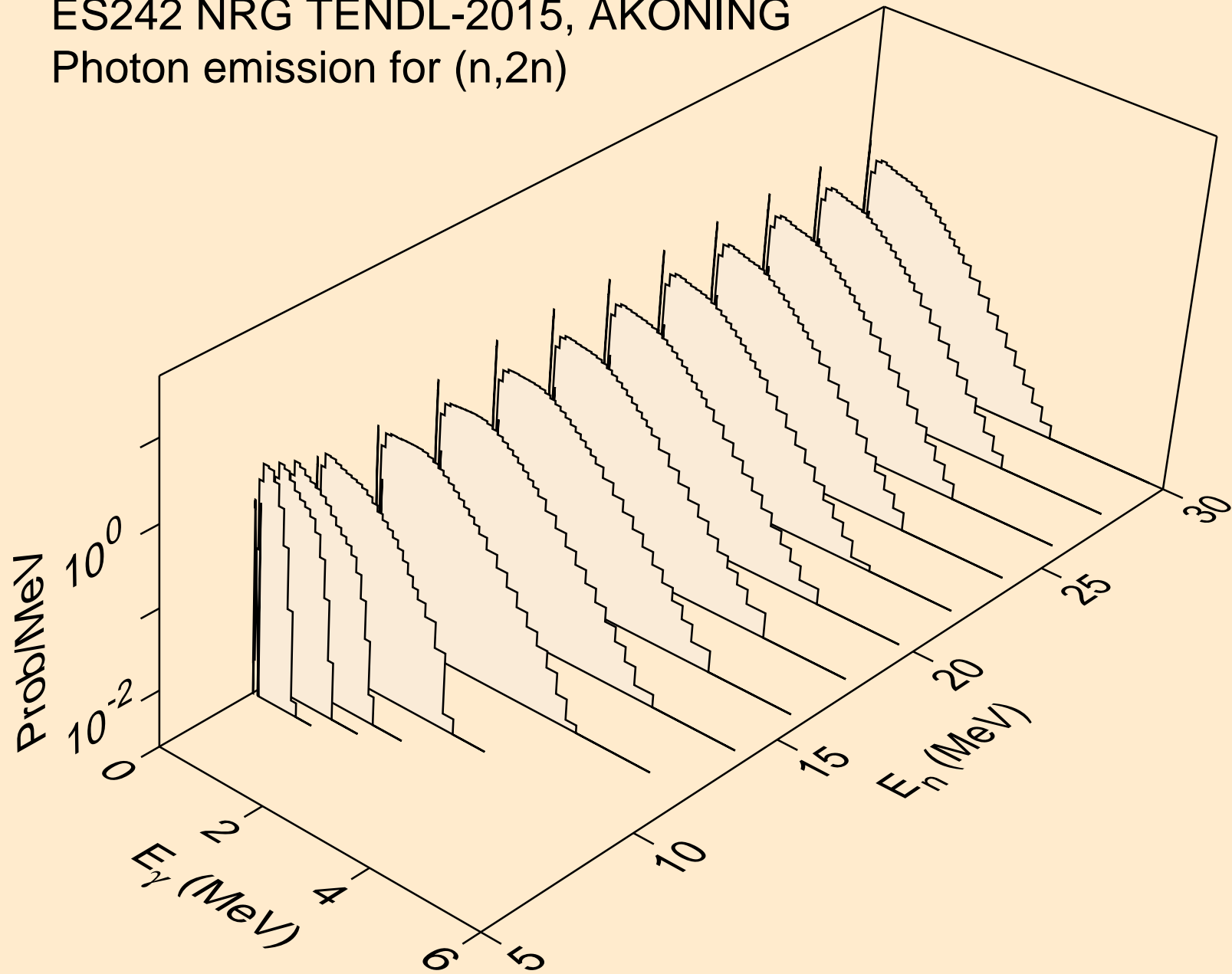

ES242 NRG TENDL-2015, AKONING  
Photon emission for (n,3n)

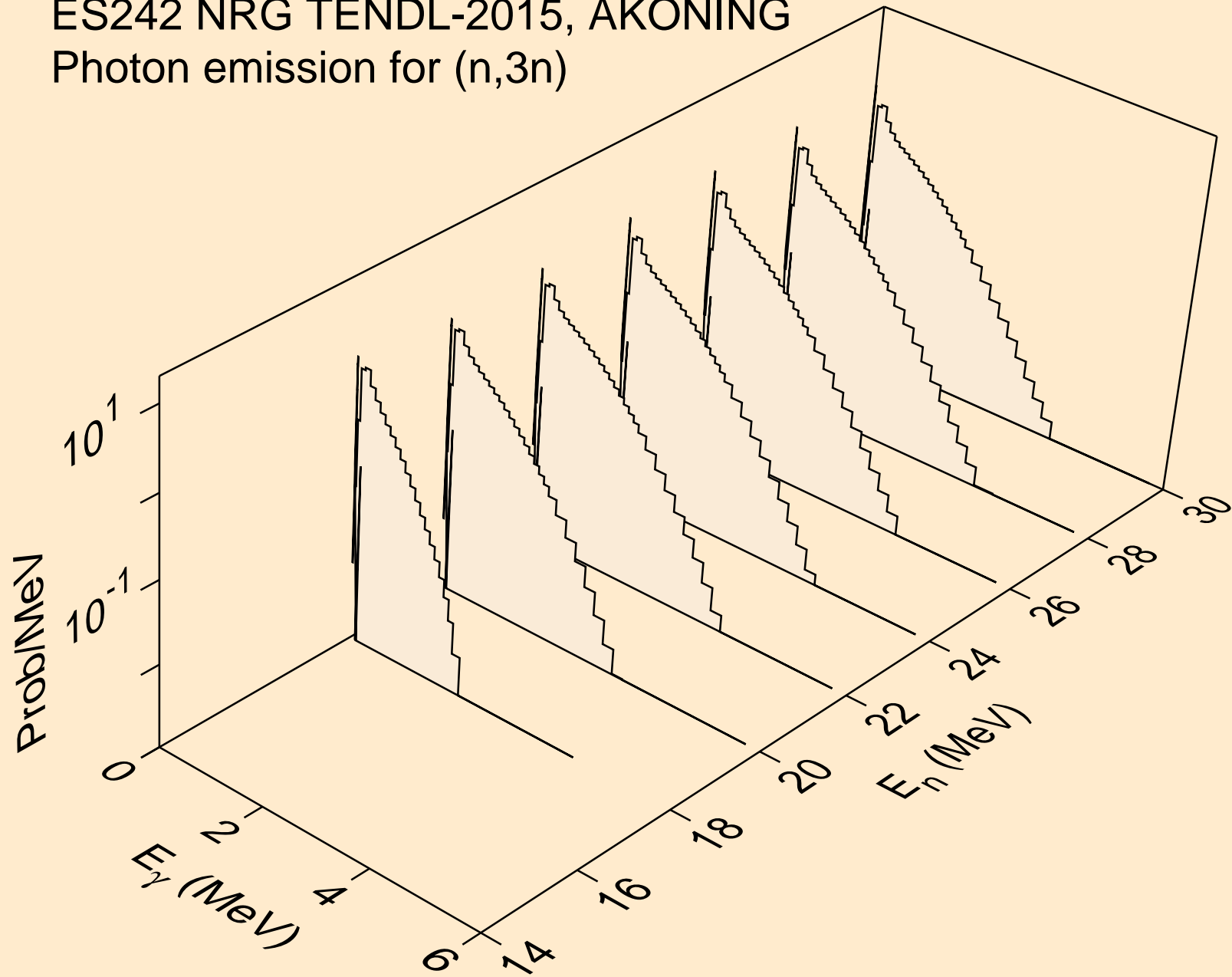

ES242 NRG TENDL-2015, AKONING  
Photon emission for (n,n\*)a

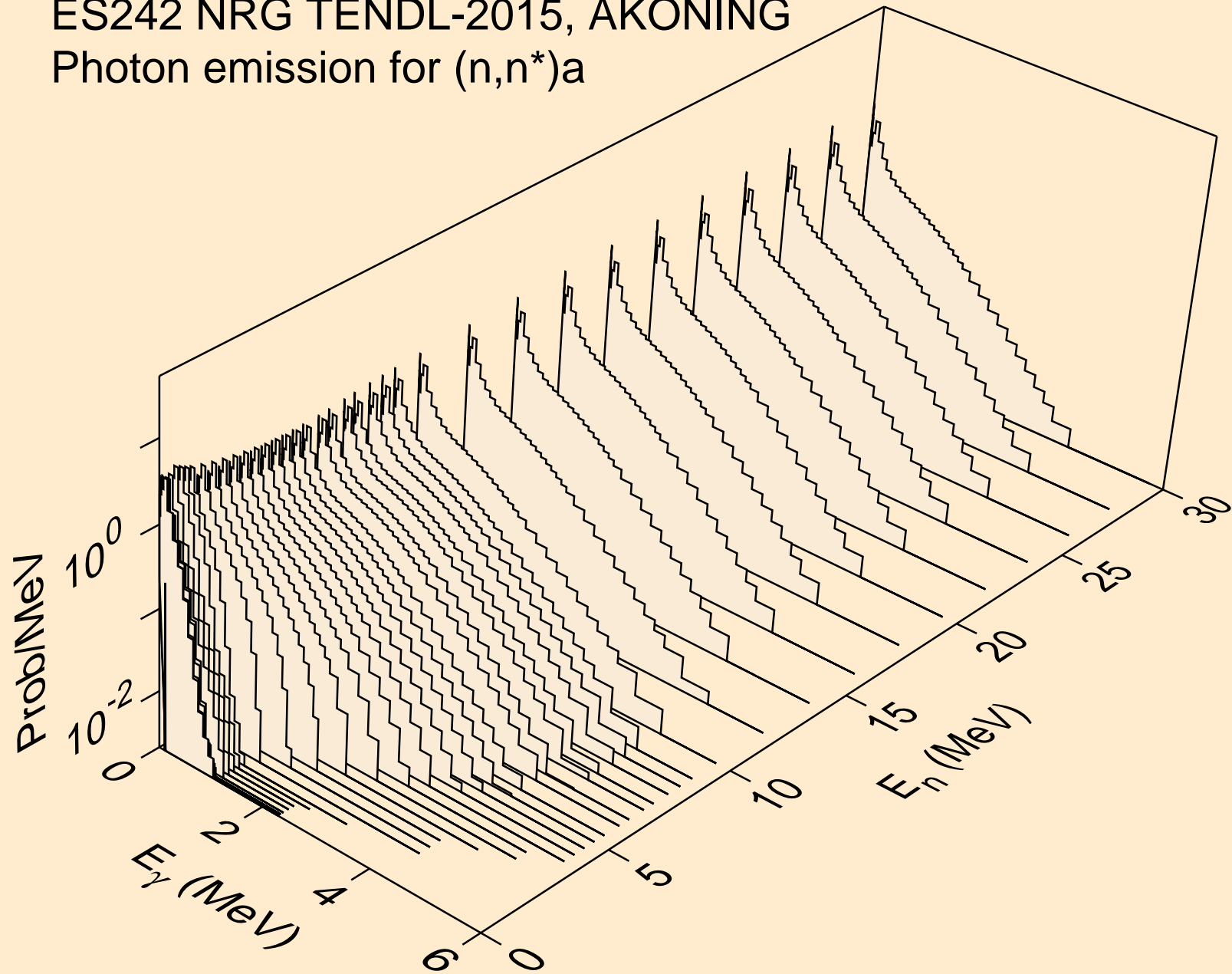

ES242 NRG TENDL-2015, AKONING  
Photon emission for (n,n\*)3a

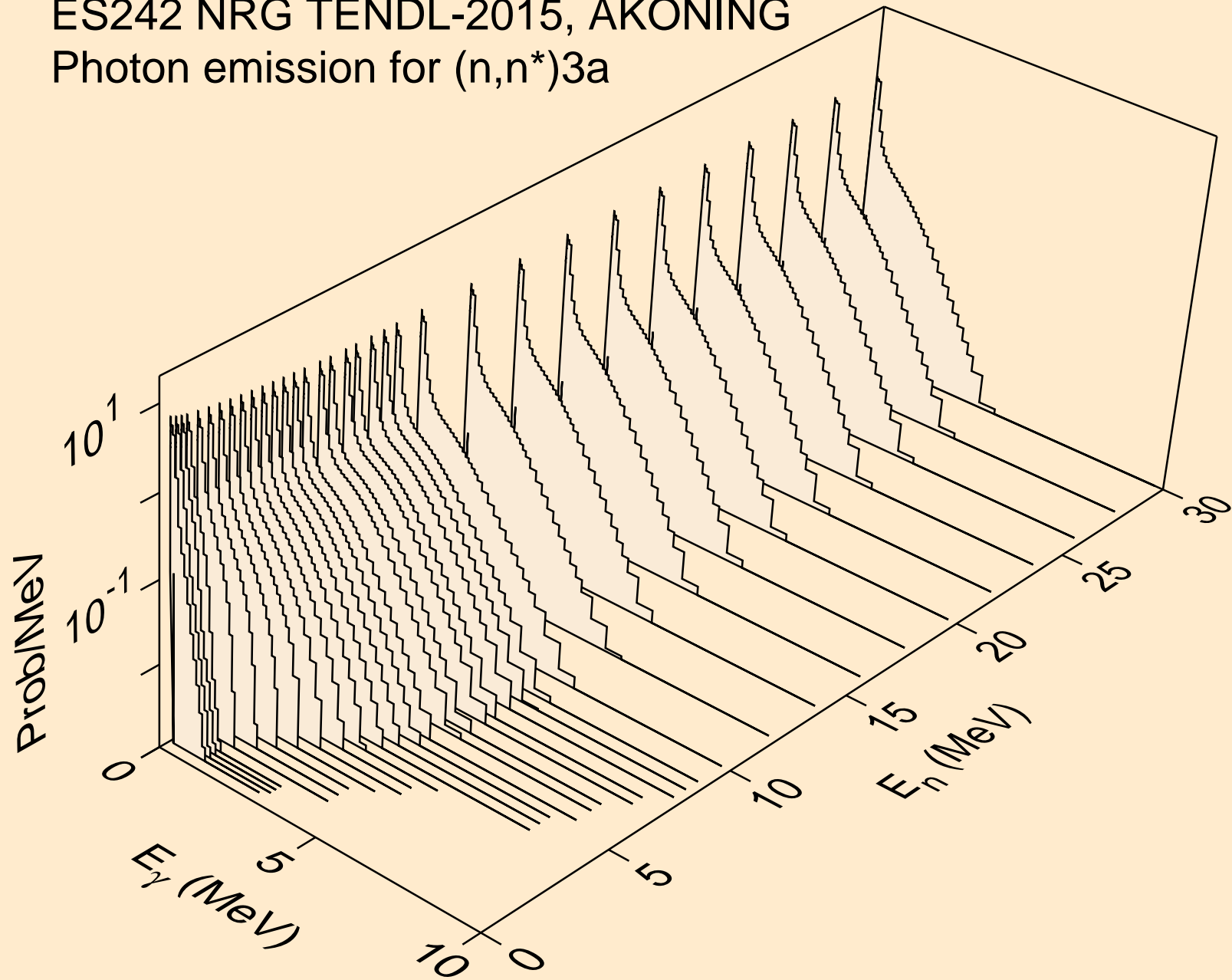

ES242 NRG TENDL-2015, AKONING  
Photon emission for (n,2n)a

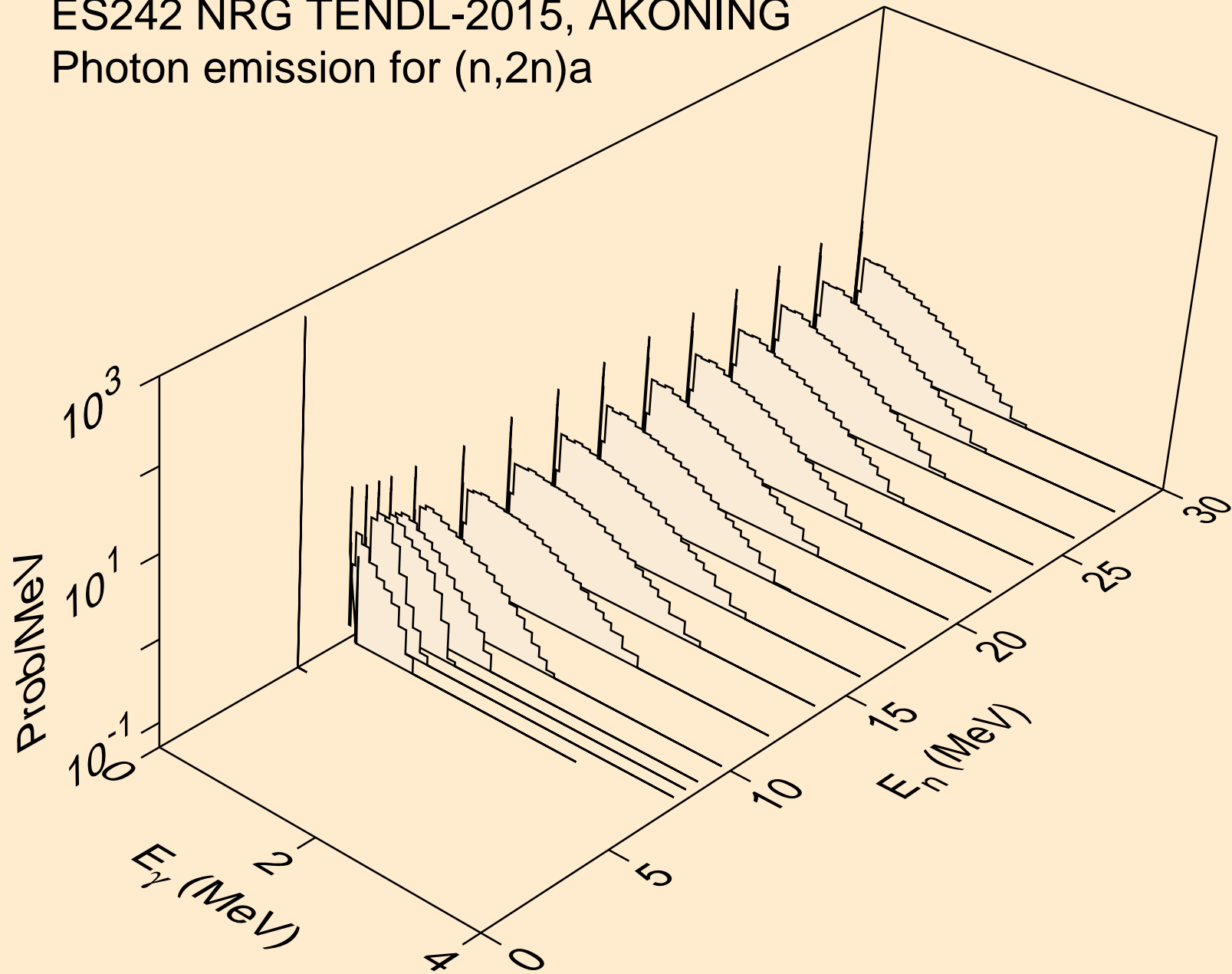



ES242 NRG TENDL-2015, AKONING  
Photon emission for (n,3n)a

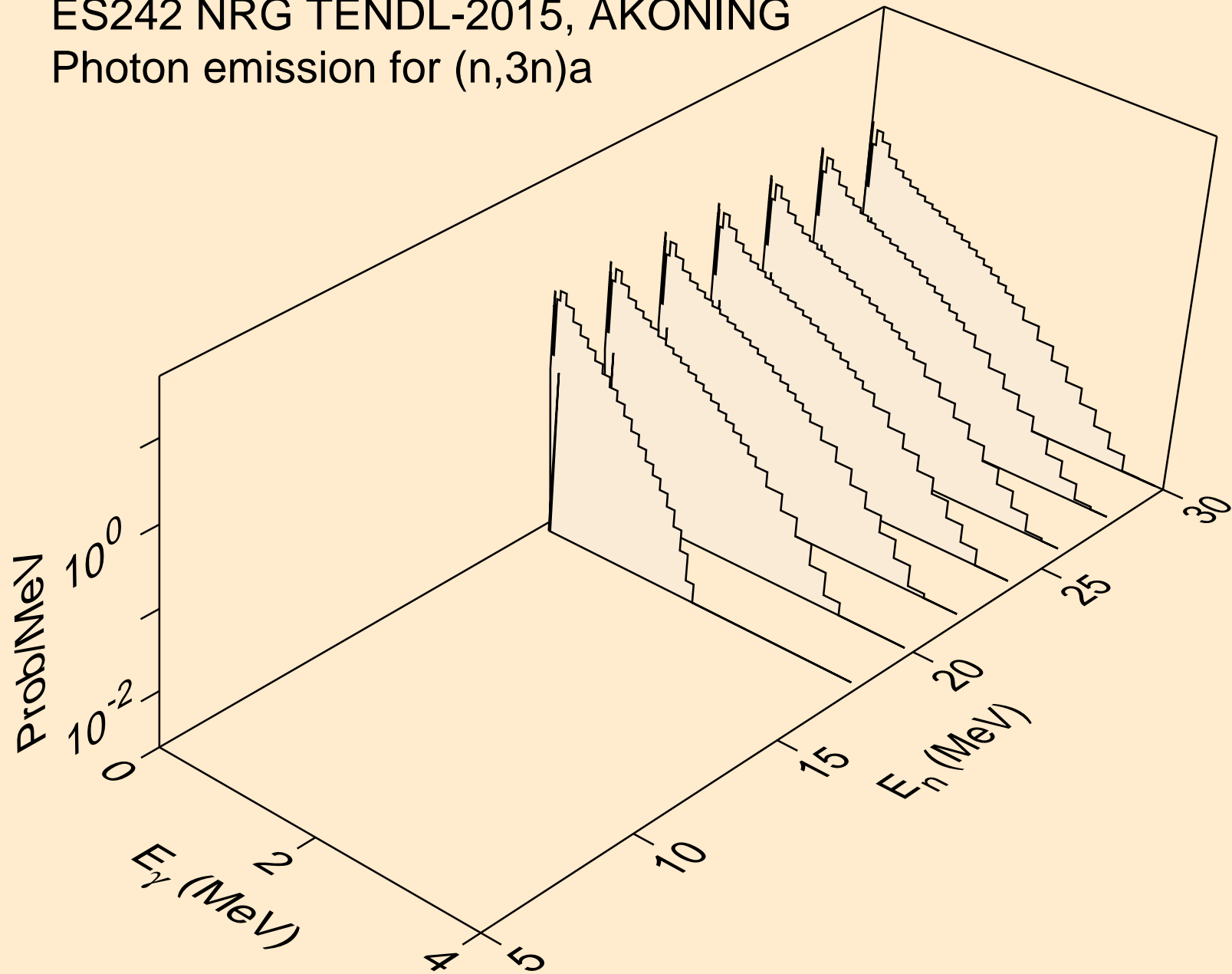

ES242 NRG TENDL-2015, AKONING  
Photon emission for (n,n\*)p

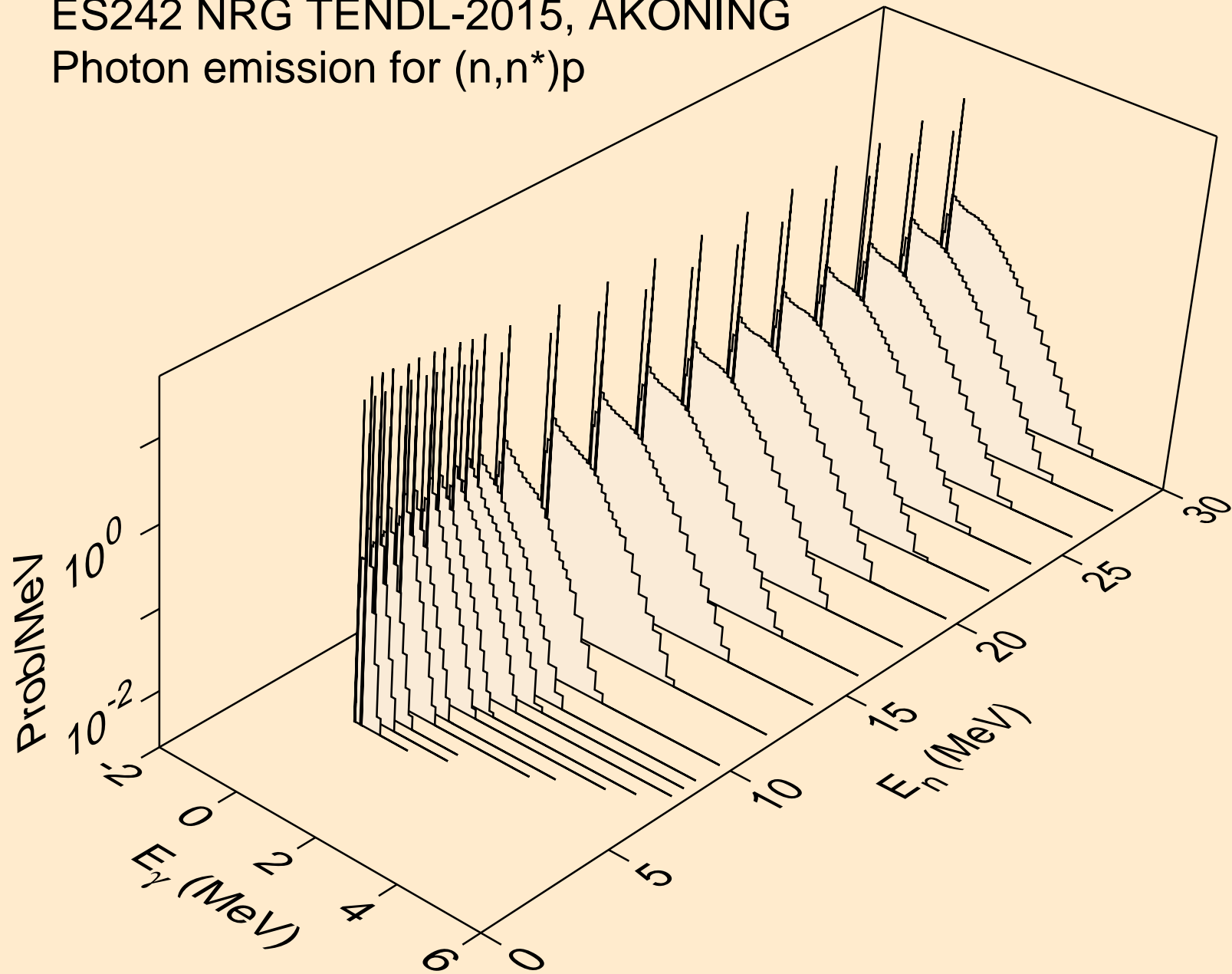

ES242 NRG TENDL-2015, AKONING  
Photon emission for (n,n\*)2a

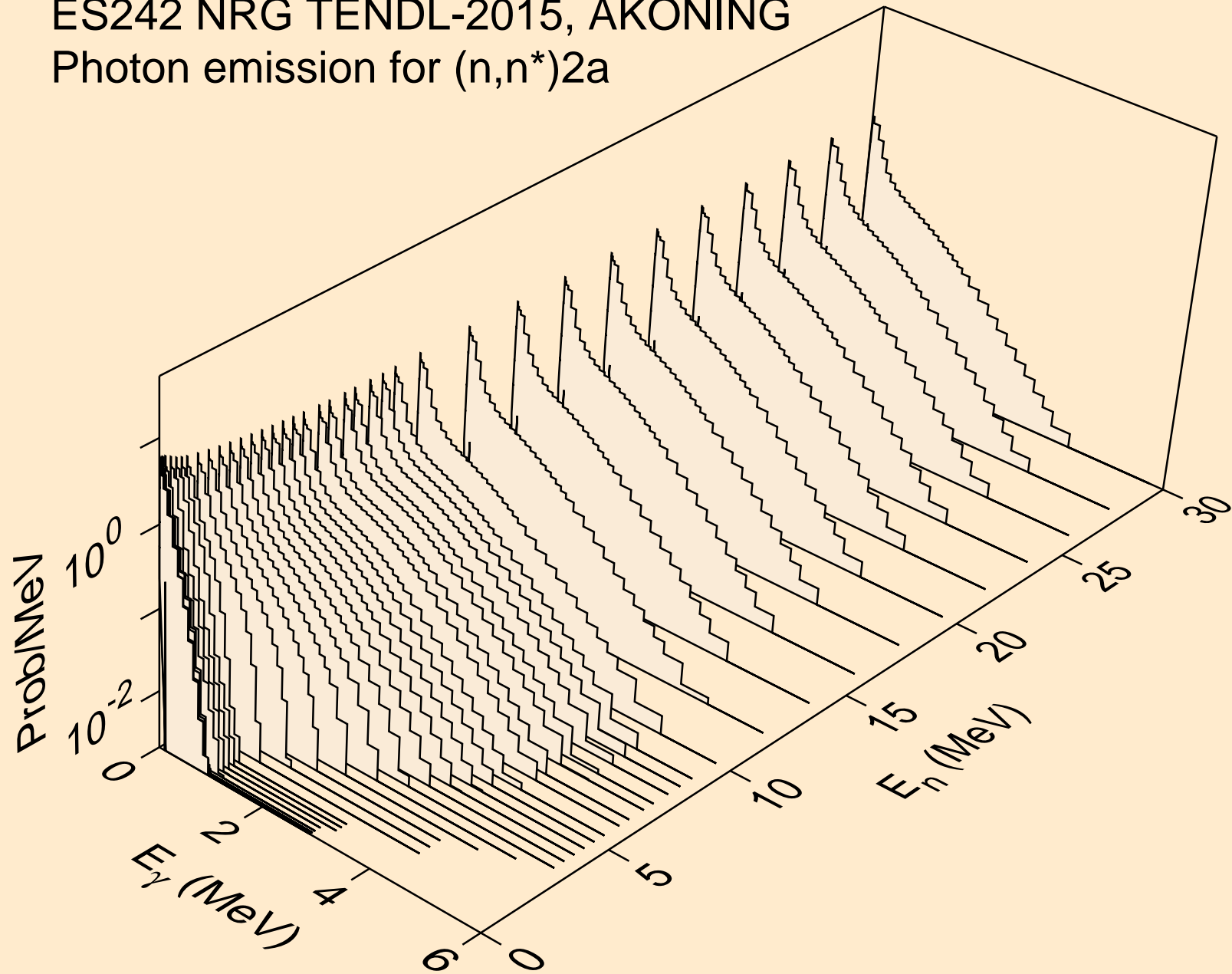

ES242 NRG TENDL-2015, AKONING  
Photon emission for (n,2n)2a

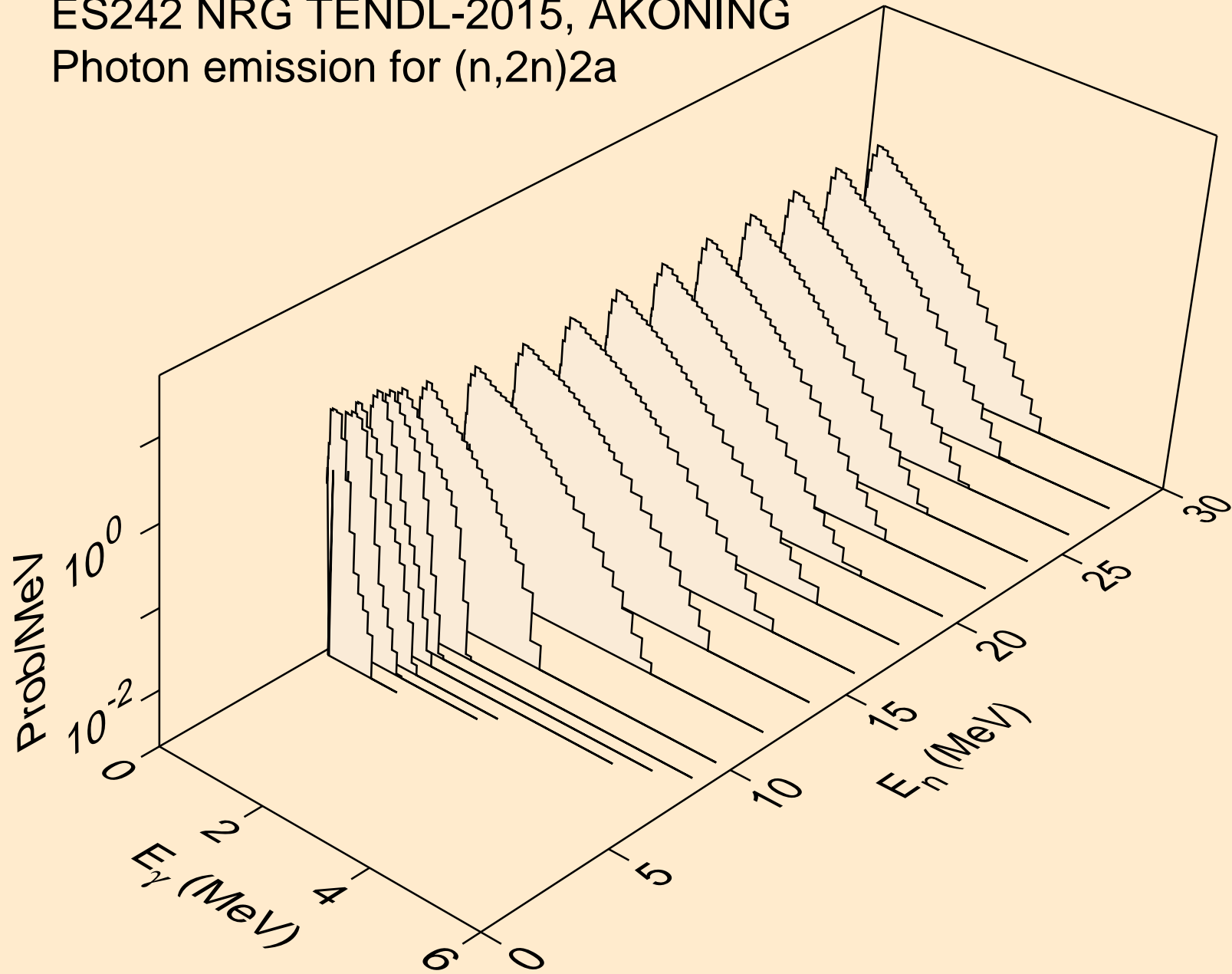

ES242 NRG TENDL-2015, AKONING  
Photon emission for (n,n\*)d

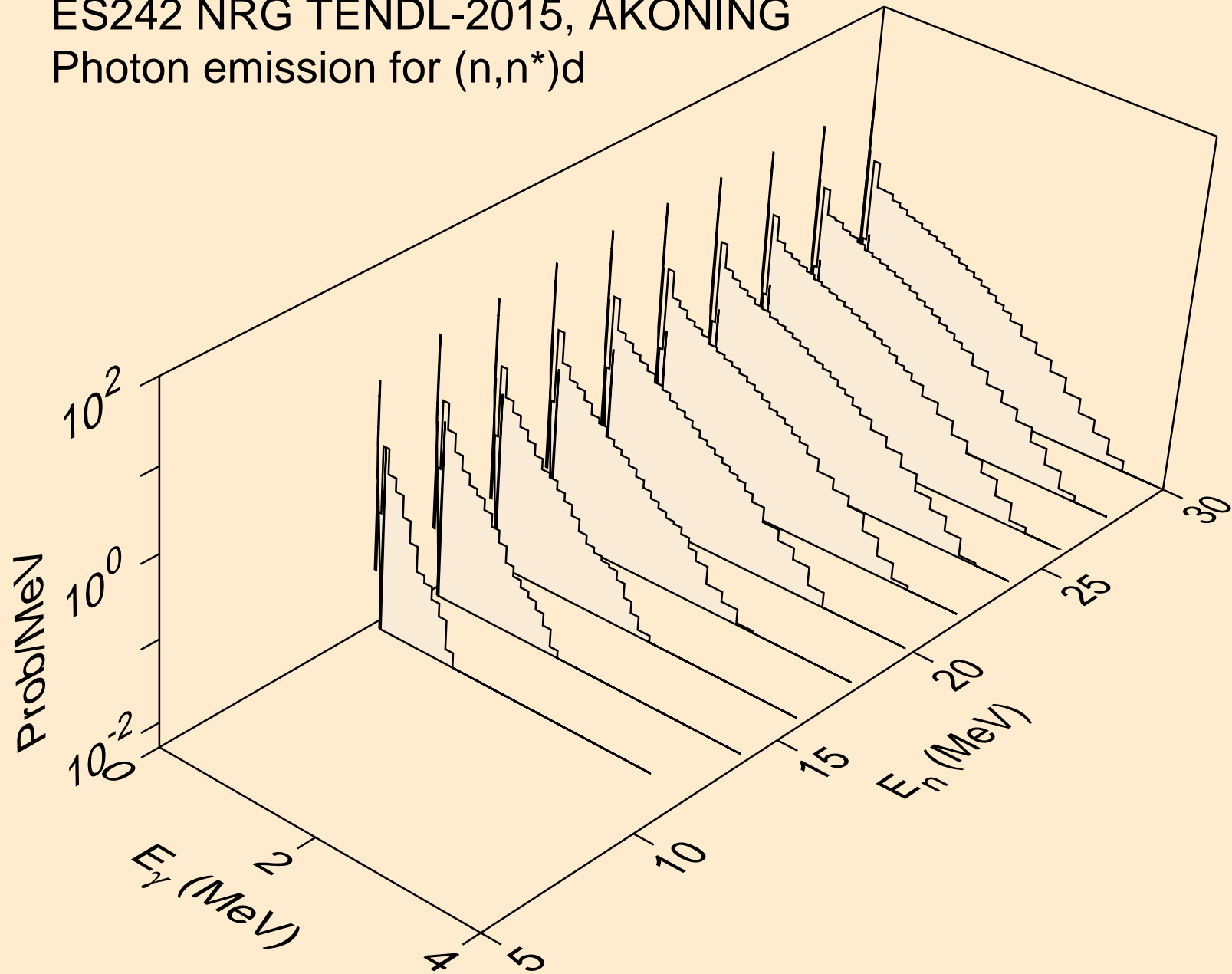

ES242 NRG TENDL-2015, AKONING  
Photon emission for (n,n\*)t

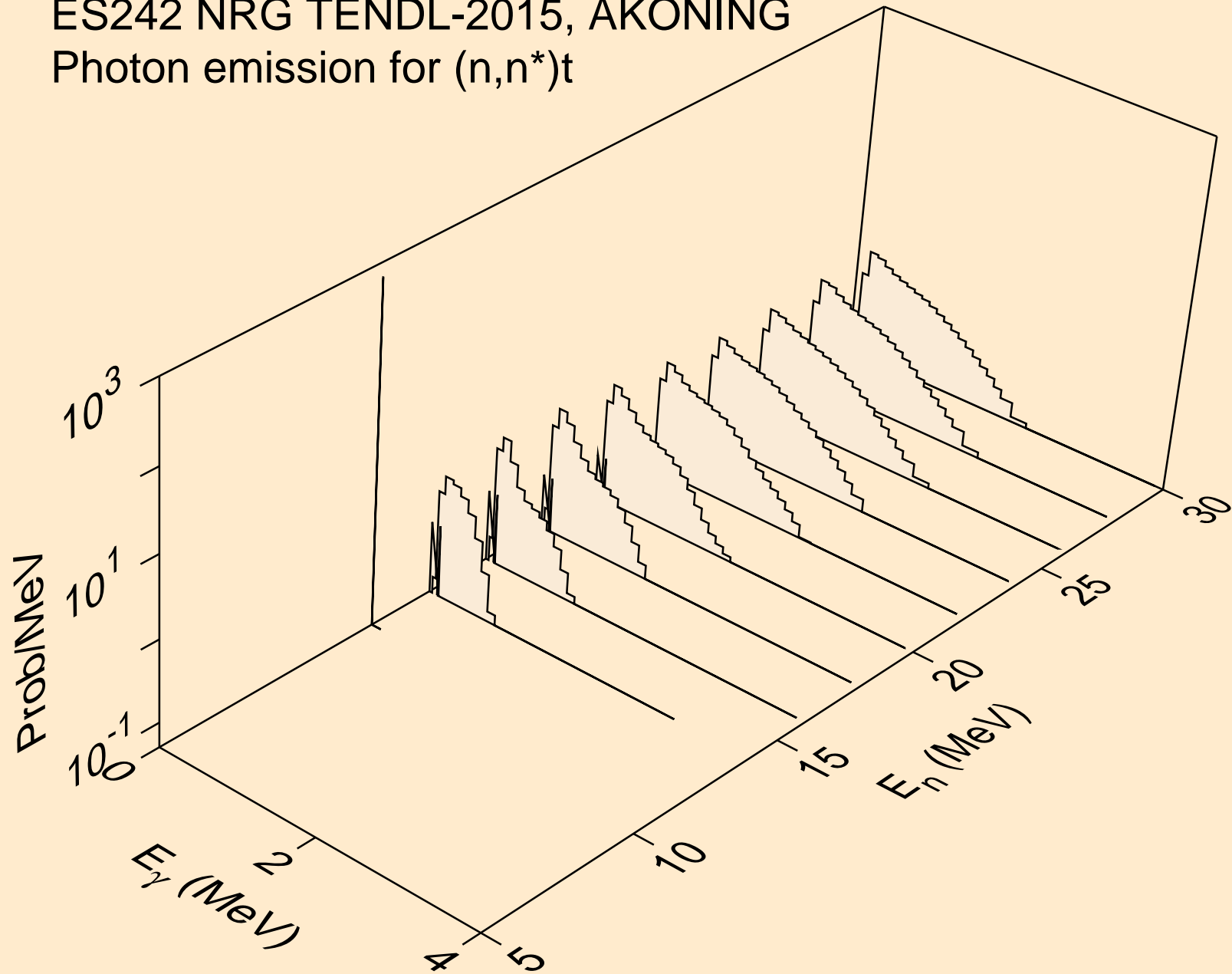

ES242 NRG TENDL-2015, AKONING  
Photon emission for (n,n\*)he3

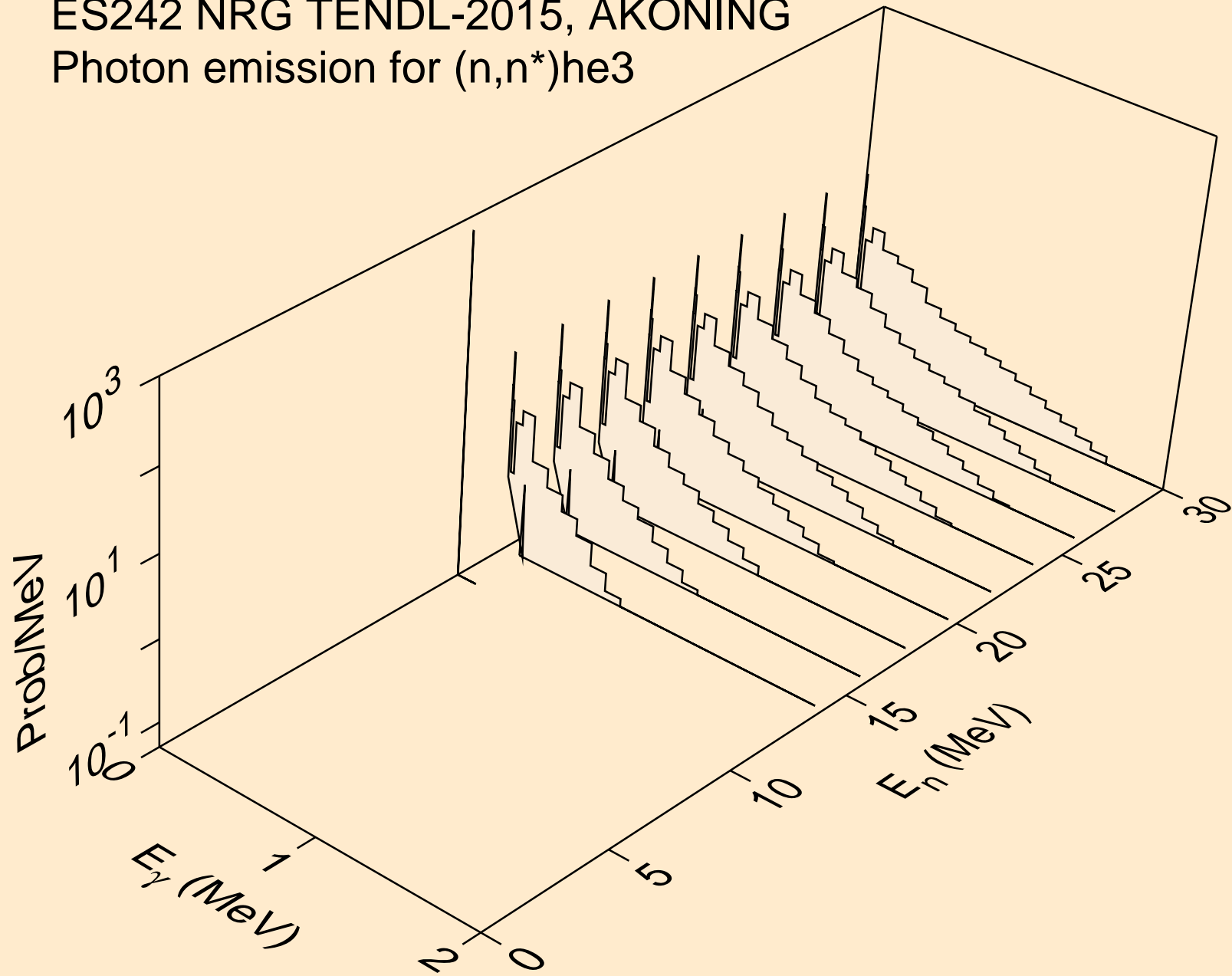

ES242 NRG TENDL-2015, AKONING  
Photon emission for (n,n\*)d2a

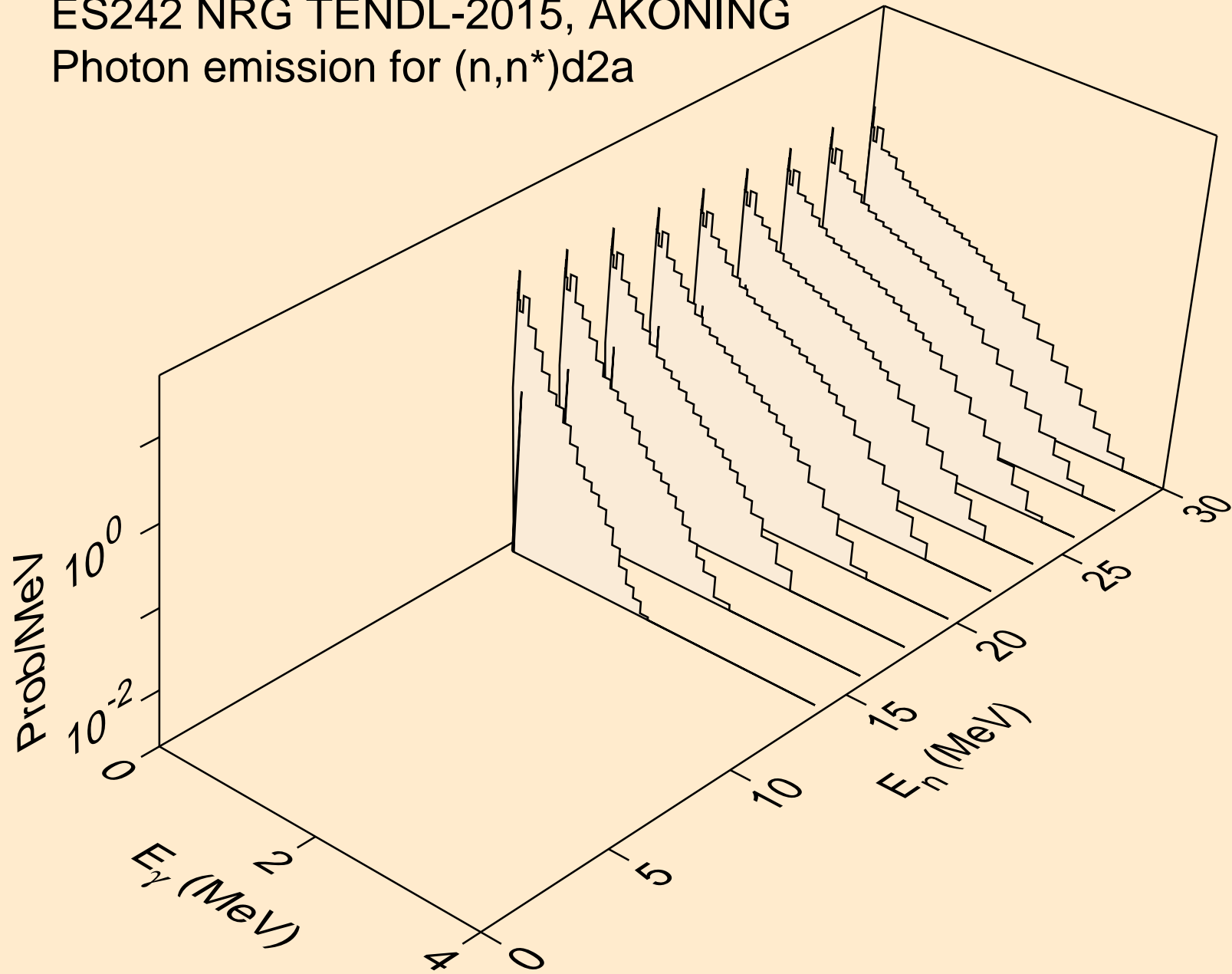



ES242 NRG TENDL-2015, AKONING  
Photon emission for (n,4n)

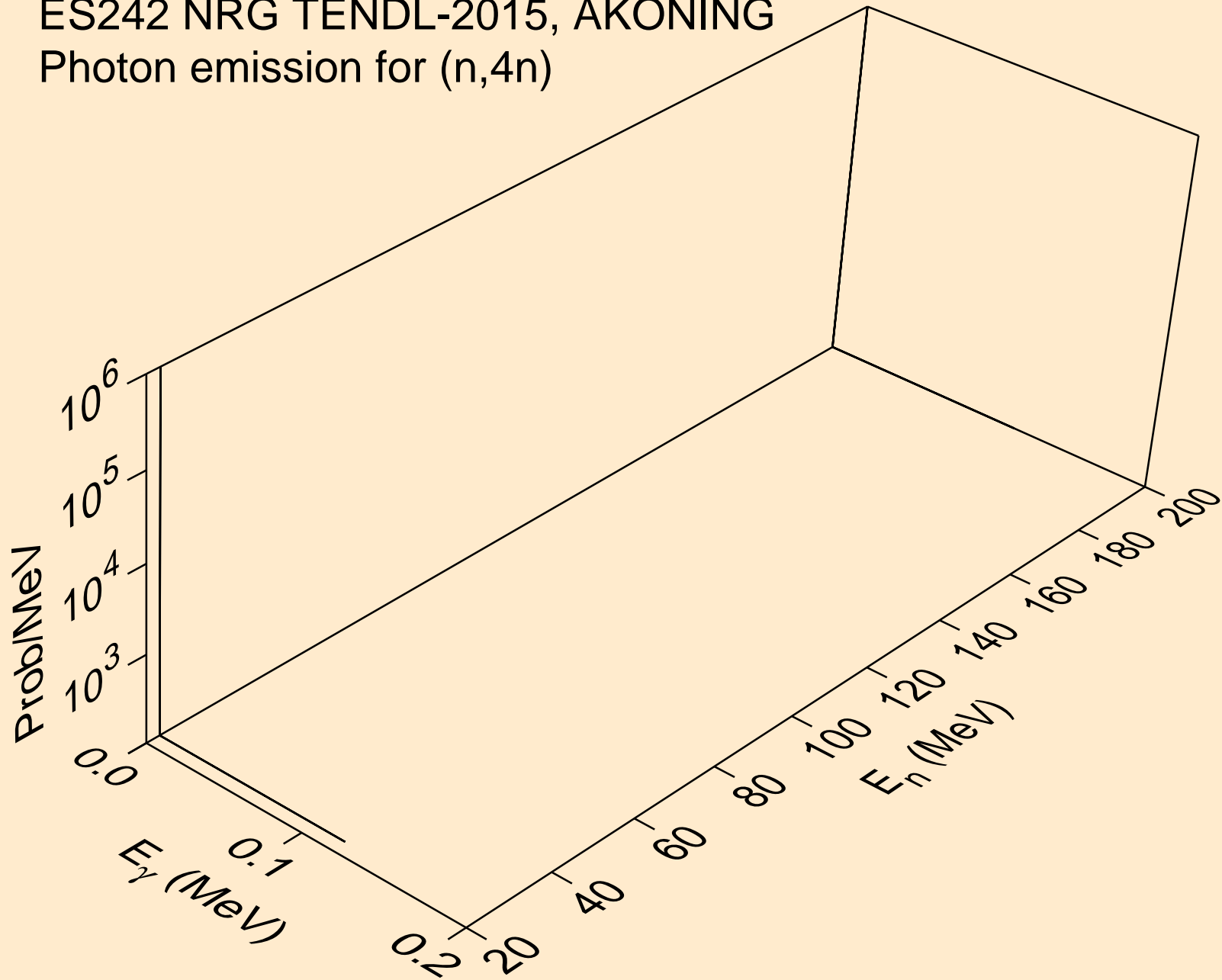

ES242 NRG TENDL-2015, AKONING  
Photon emission for (n,2np)

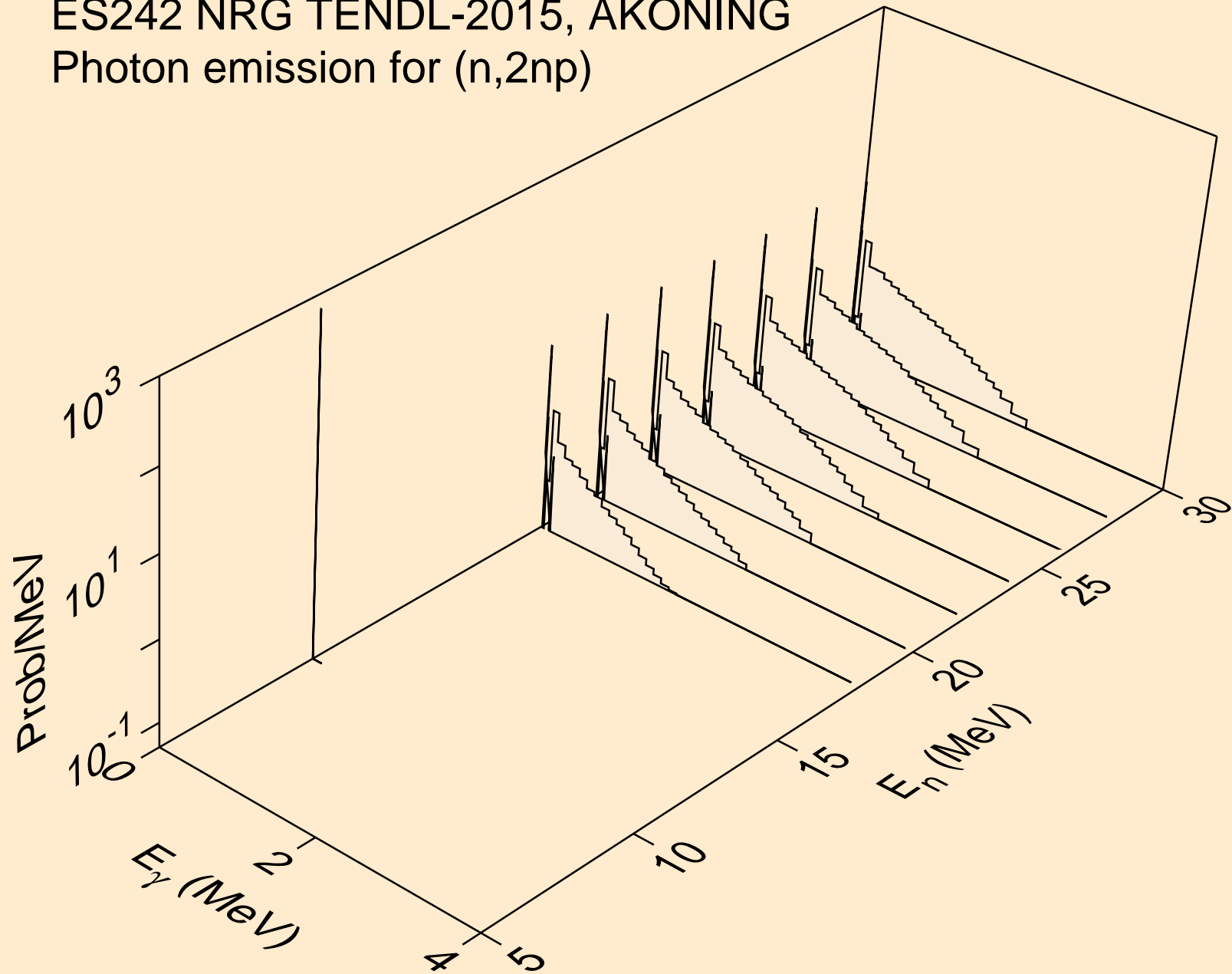

ES242 NRG TENDL-2015, AKONING  
Photon emission for (n,3np)

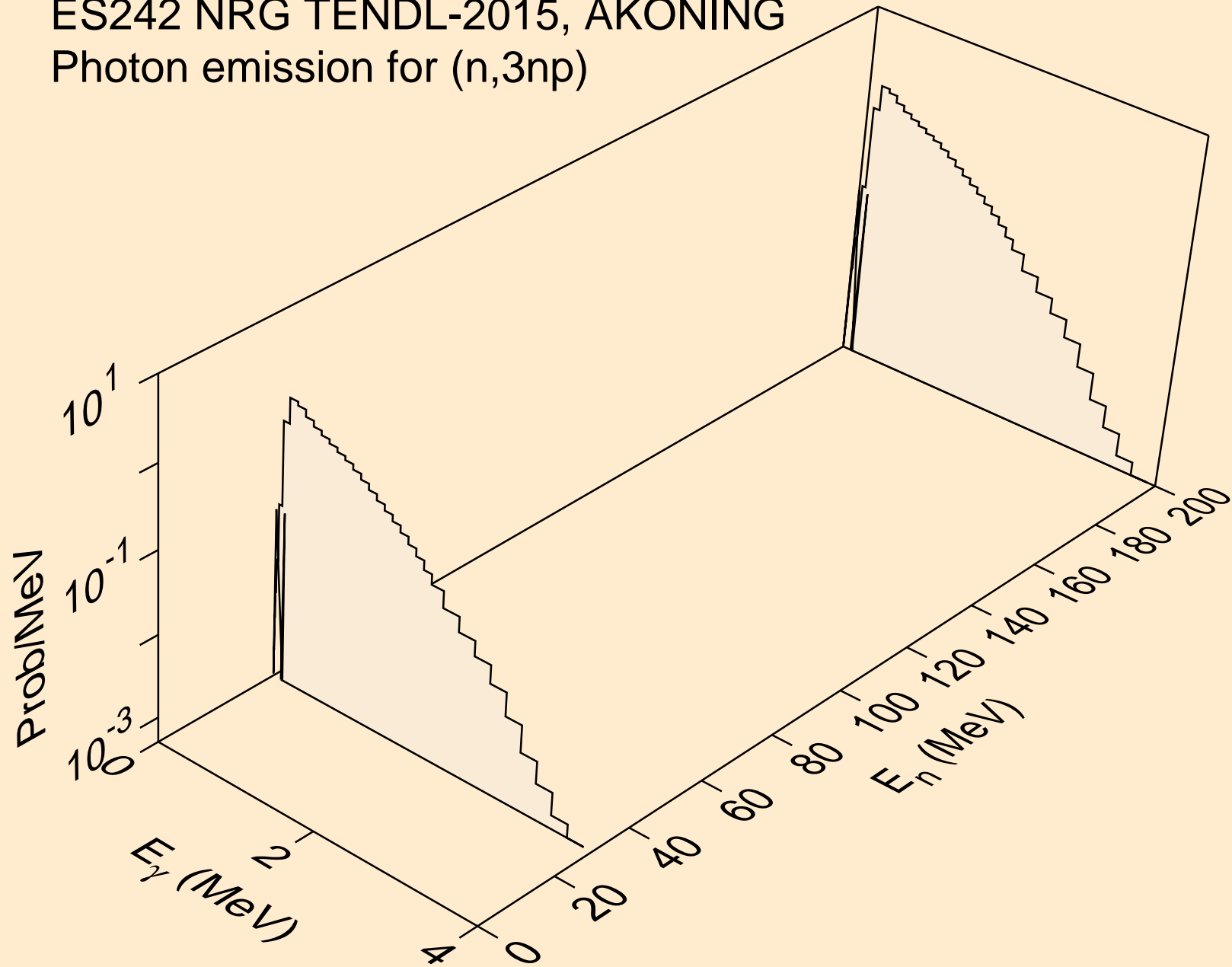

ES242 NRG TENDL-2015, AKONING  
Photon emission for (n,2np)

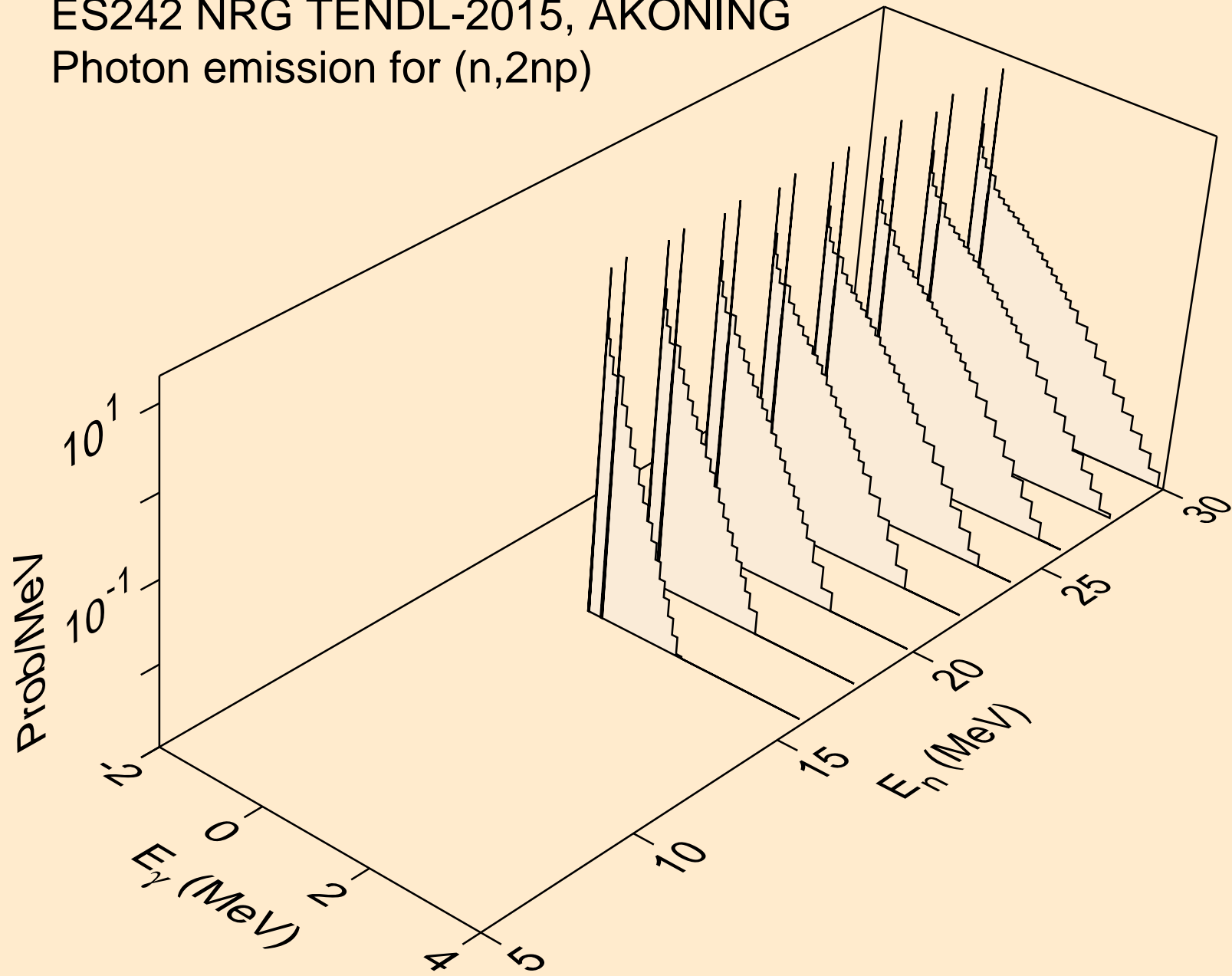

ES242 NRG TENDL-2015, AKONING  
Photon emission for (n,npa)

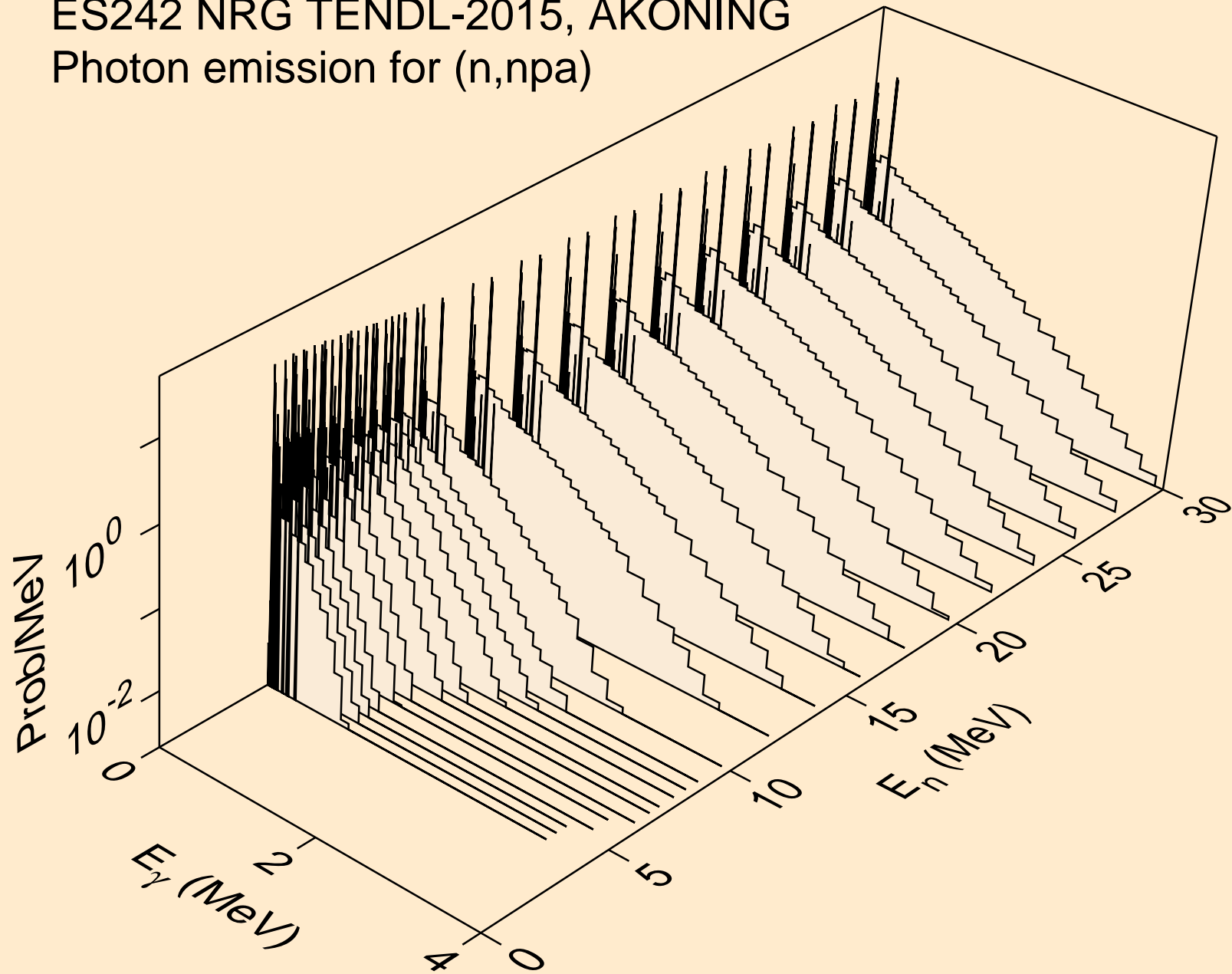

ES242 NRG TENDL-2015, AKONING  
Photon emission for (n,n\*c)

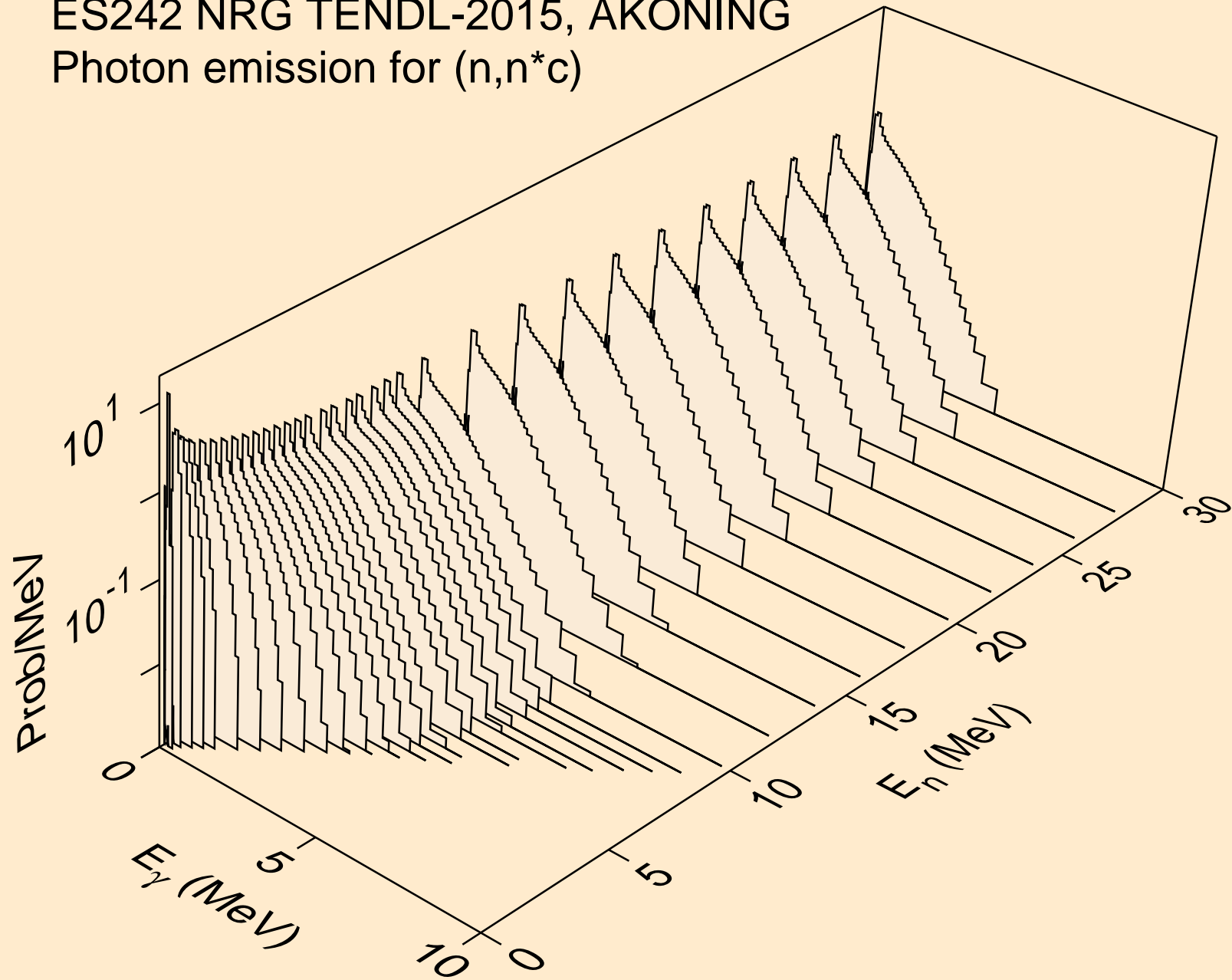

ES242 NRG TENDL-2015, AKONING  
Photon emission for (n,gma)

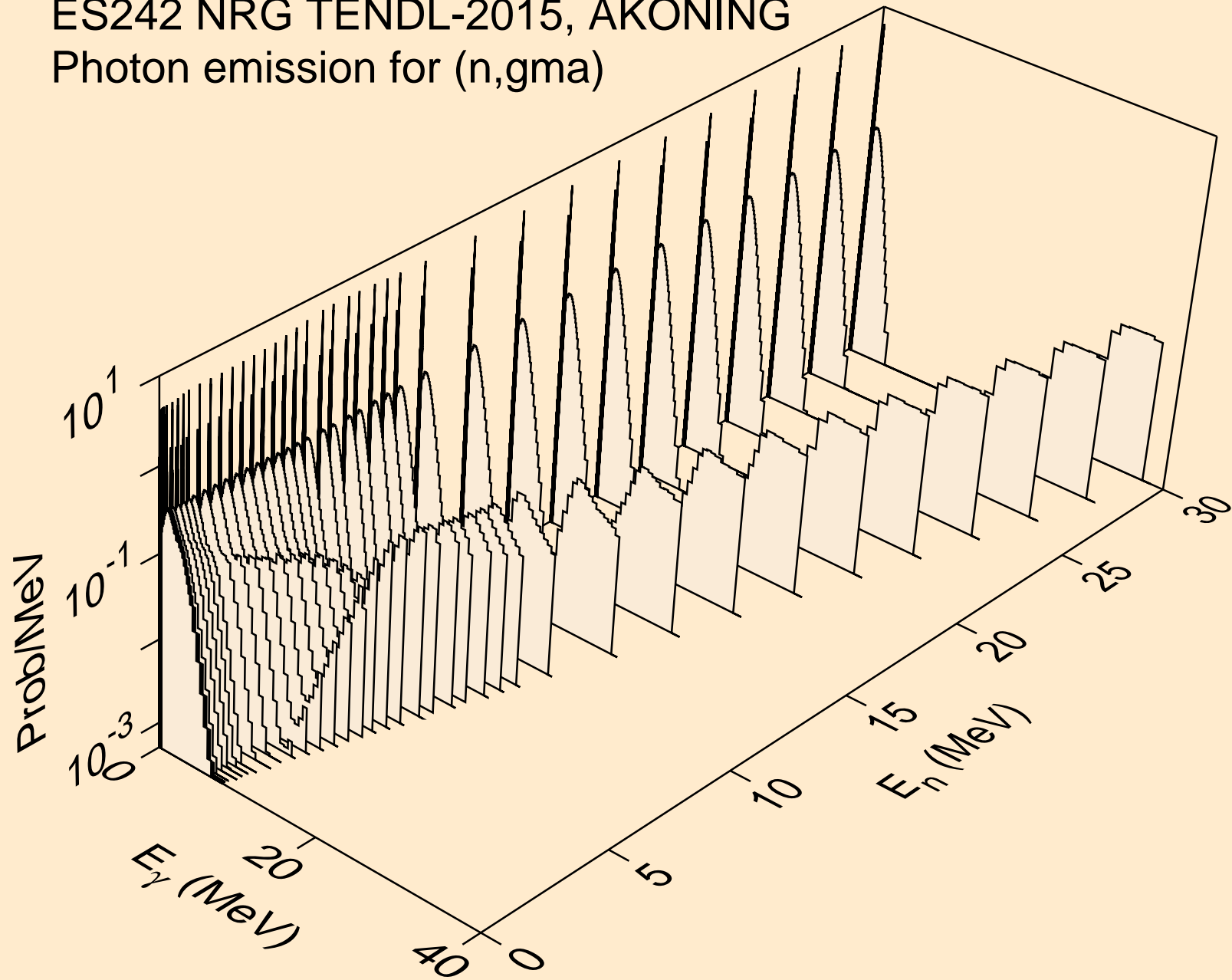

ES242 NRG TENDL-2015, AKONING  
Photon emission for (n,p)

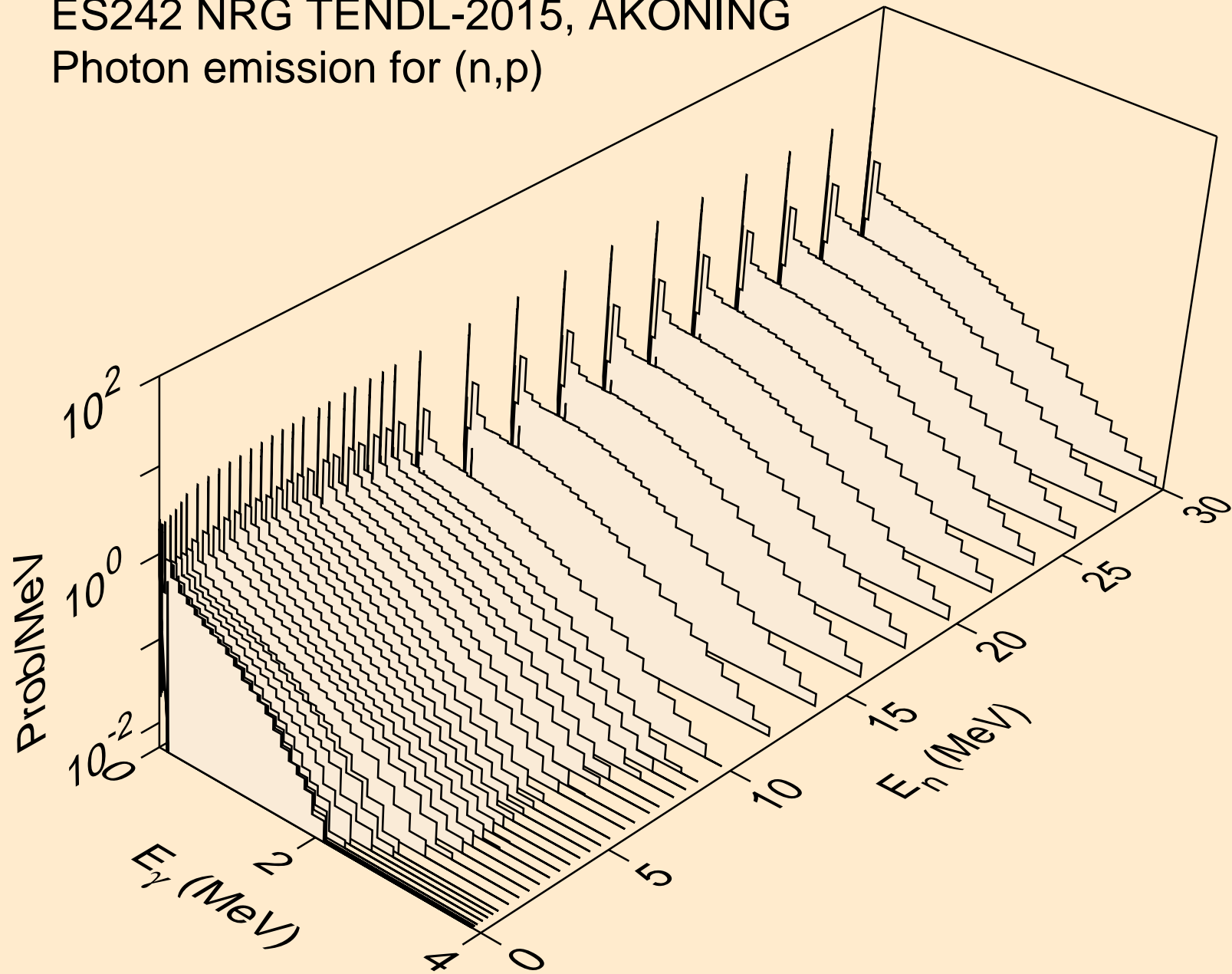



ES242 NRG TENDL-2015, AKONING  
Photon emission for (n,d)

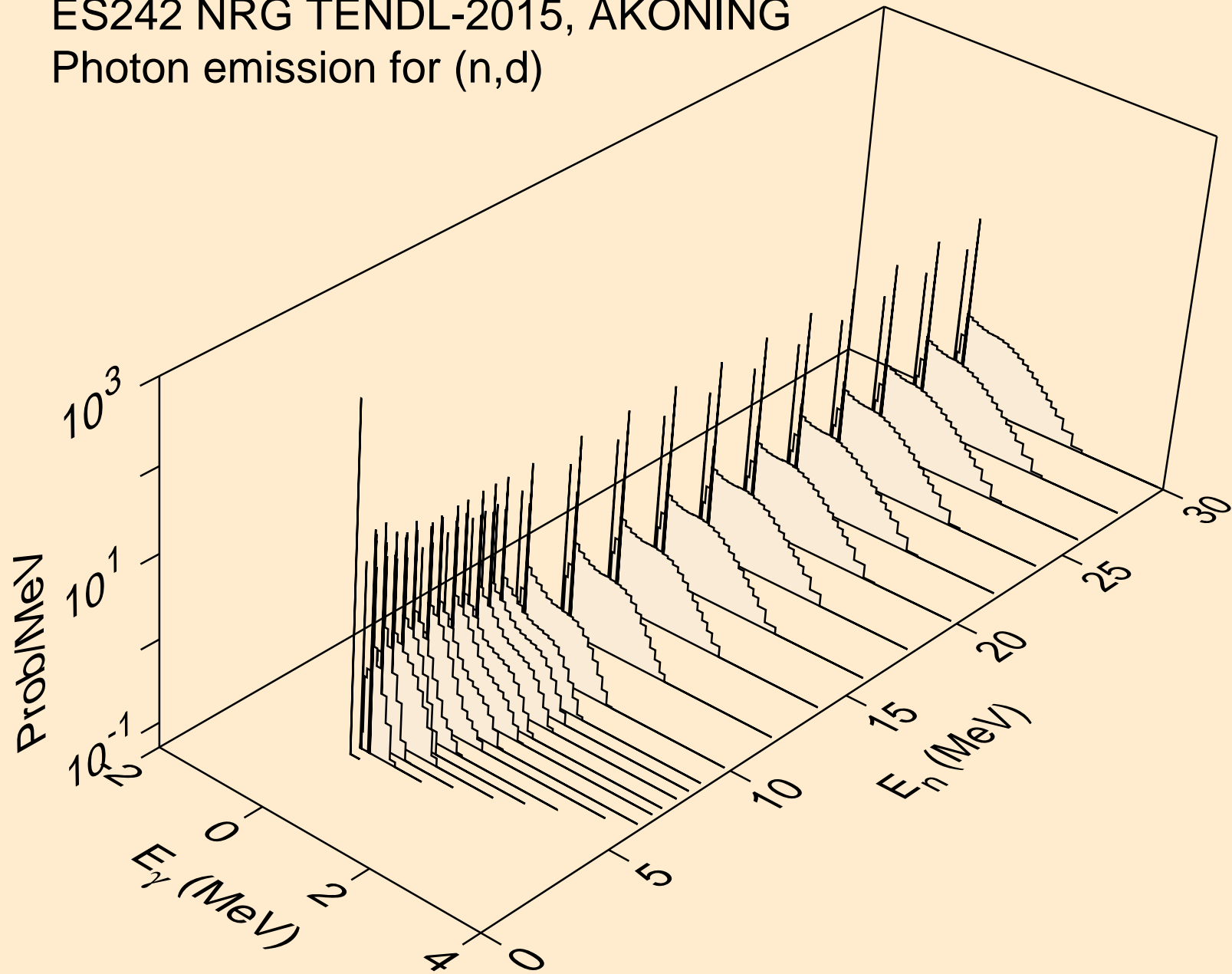

ES242 NRG TENDL-2015, AKONING  
Photon emission for (n,t)

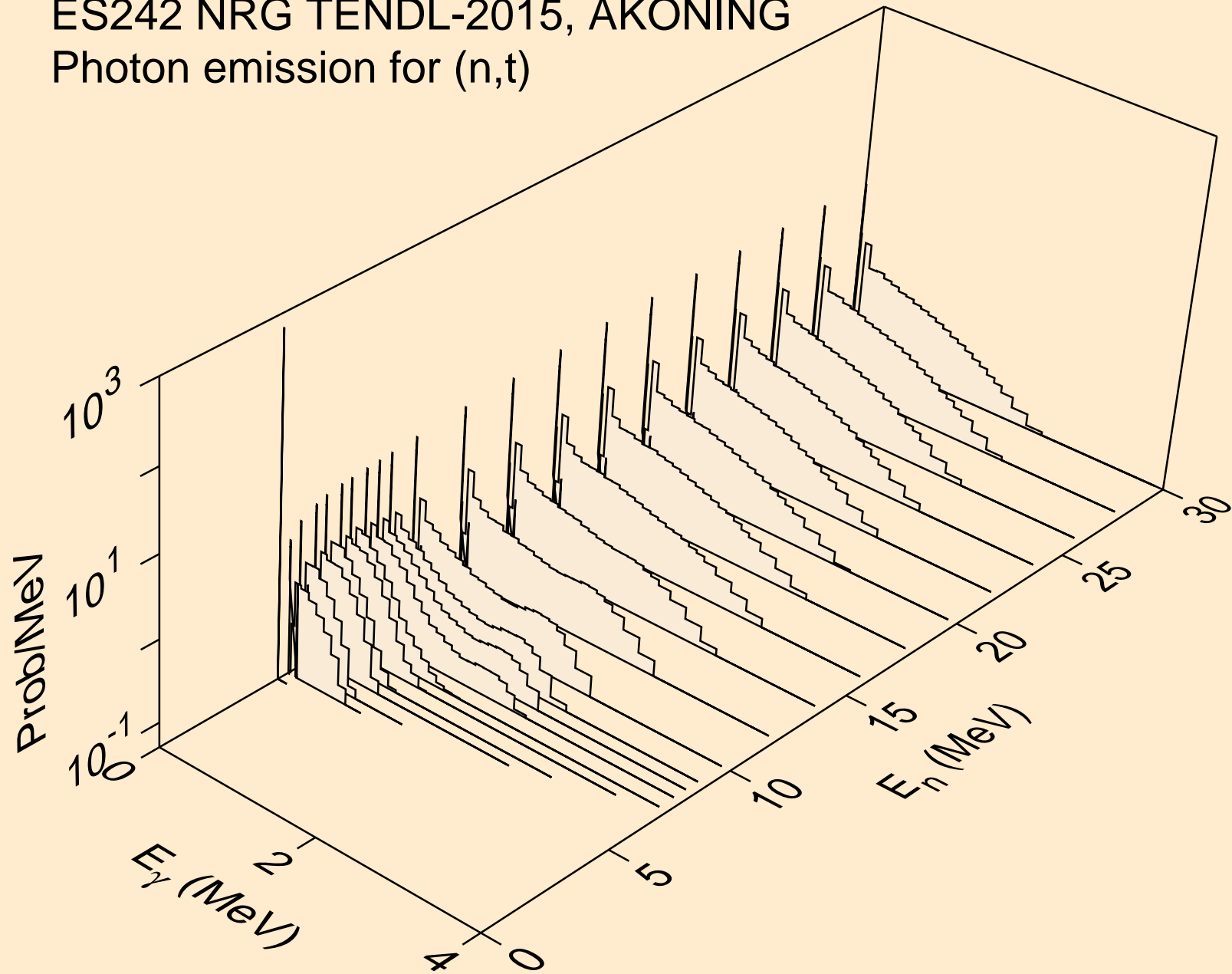

ES242 NRG TENDL-2015, AKONING  
Photon emission for (n,he3)

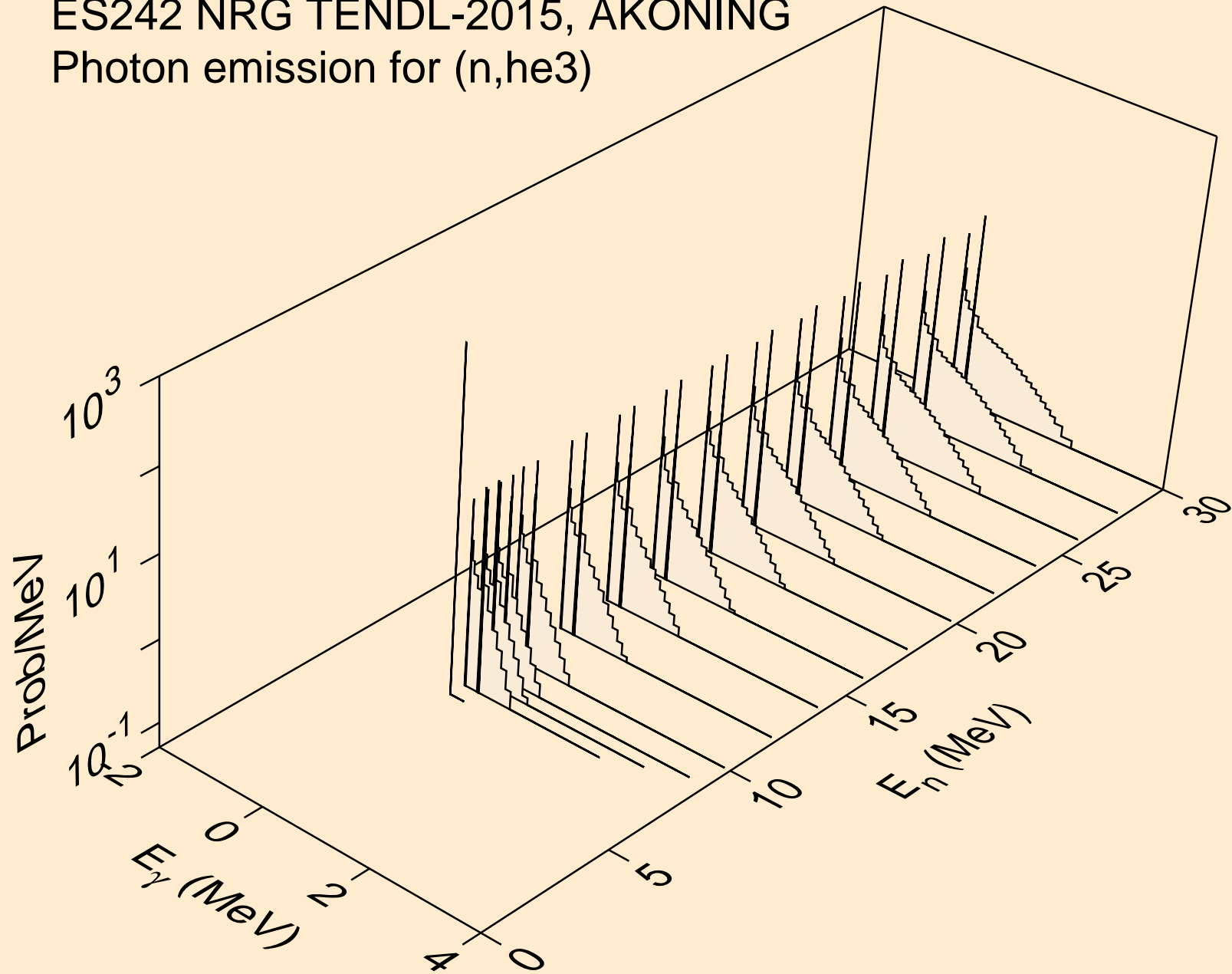

ES242 NRG TENDL-2015, AKONING  
Photon emission for (n,a)

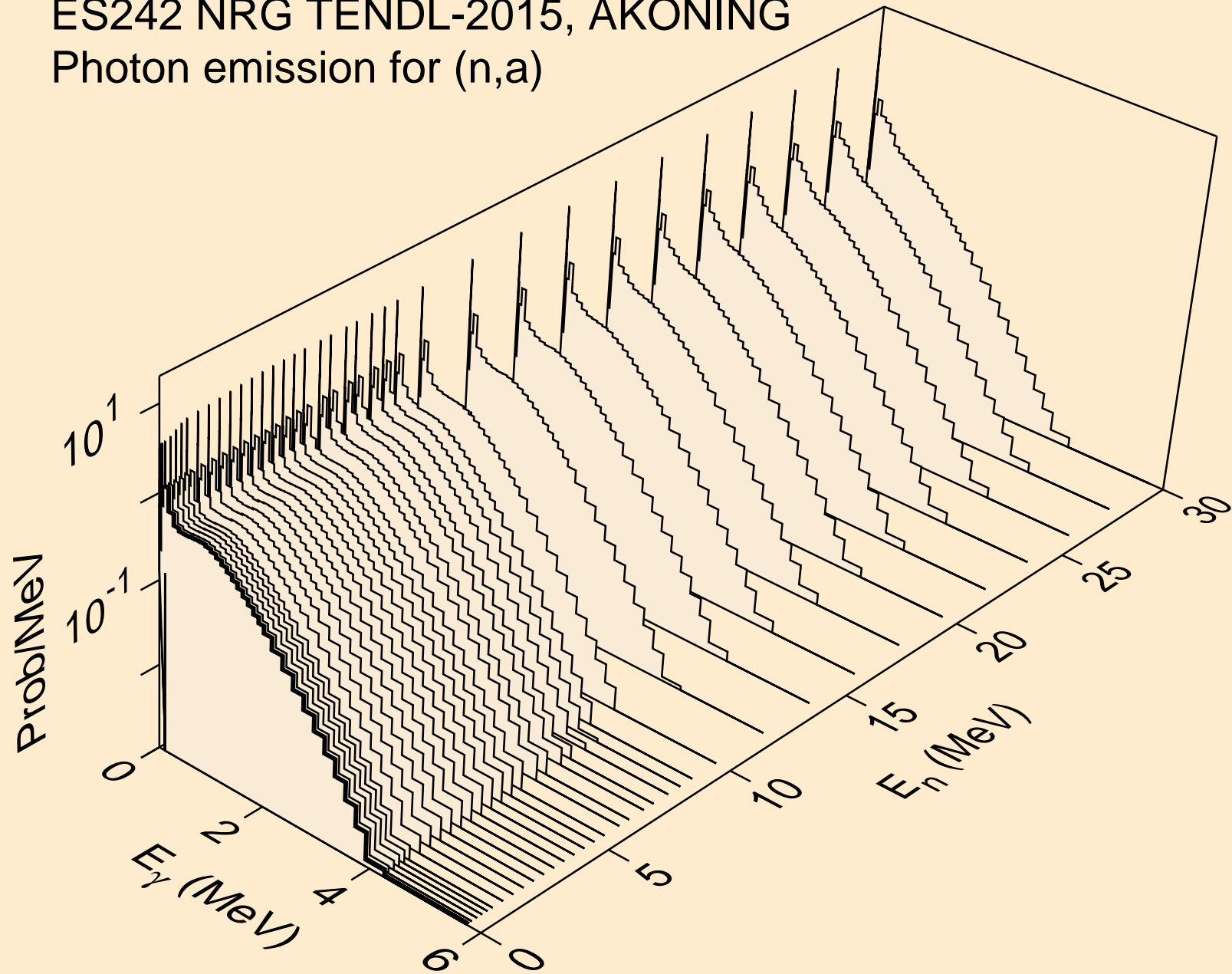

ES242 NRG TENDL-2015, AKONING  
Photon emission for (n,2a)

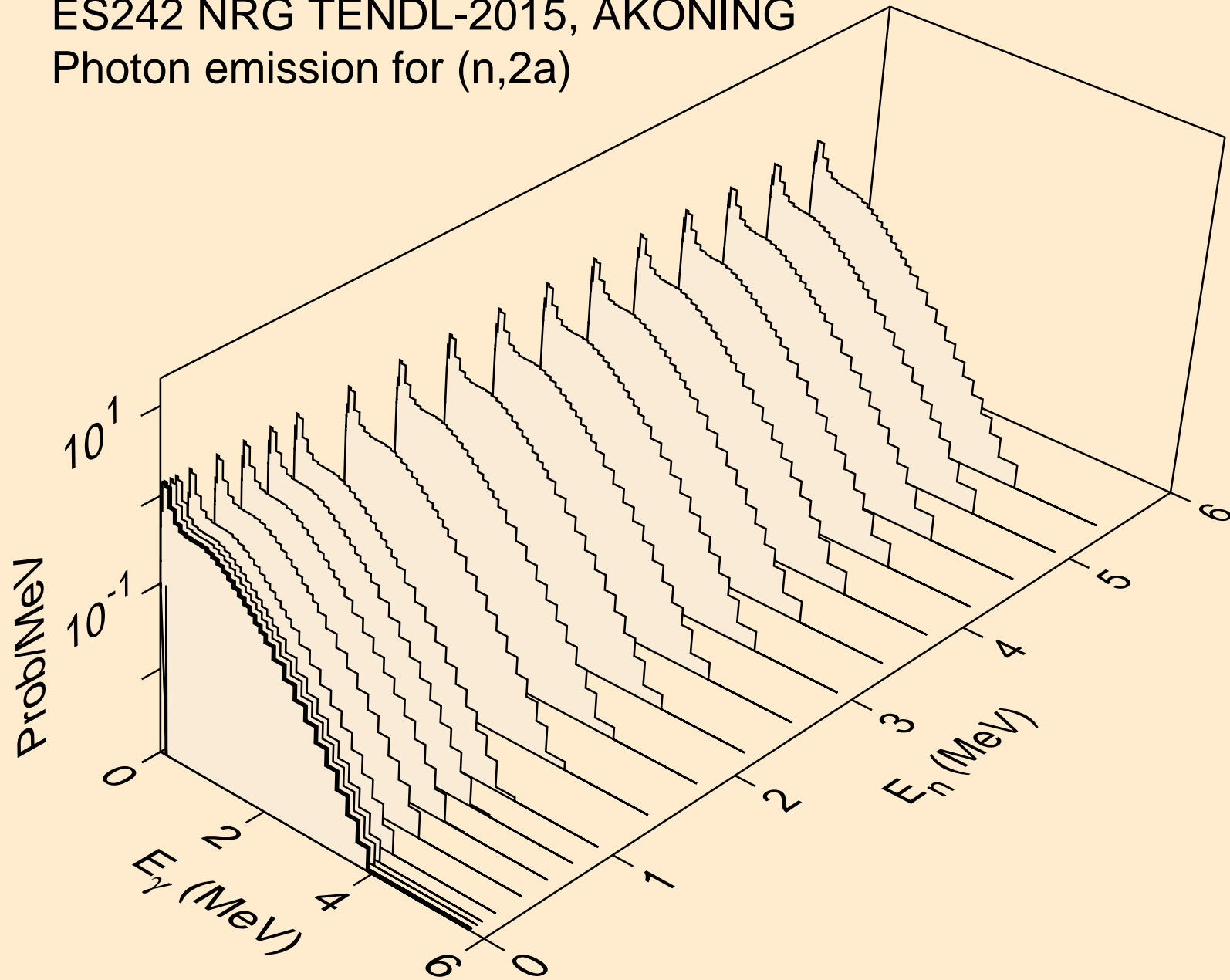

ES242 NRG TENDL-2015, AKONING  
Photon emission for (n,3a)

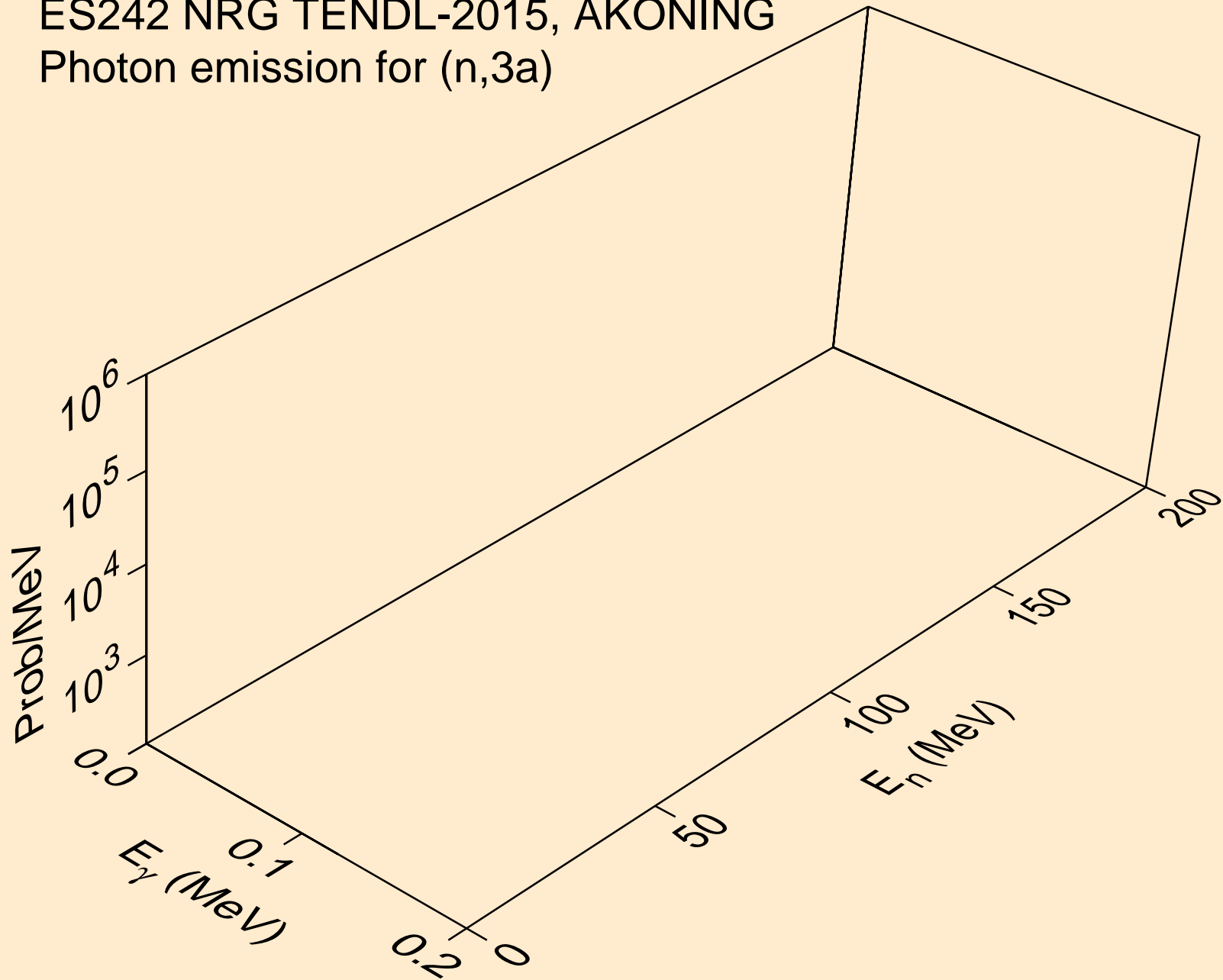

ES242 NRG TENDL-2015, AKONING  
Photon emission for (n,2p)

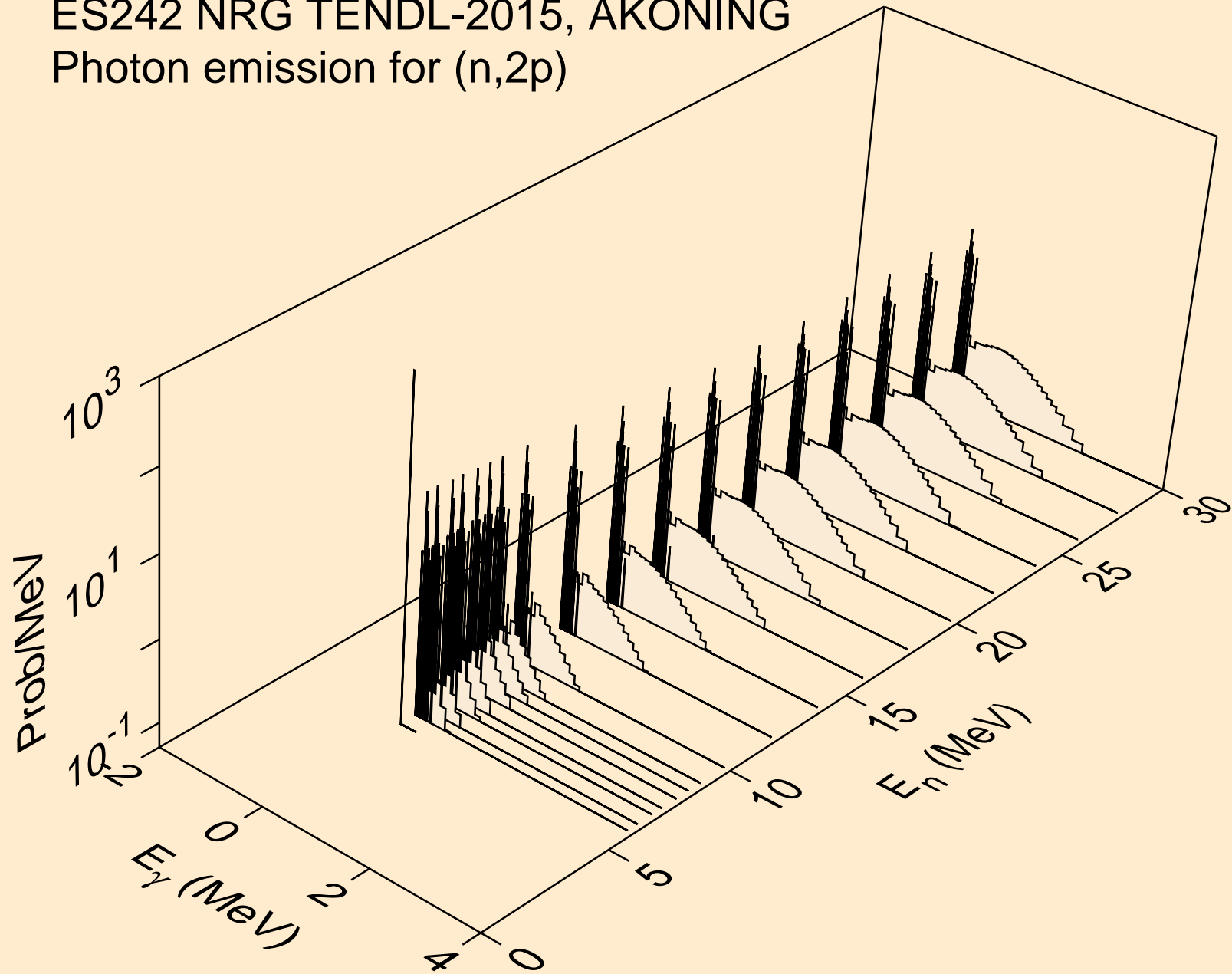

ES242 NRG TENDL-2015, AKONING  
Photon emission for (n,pa)

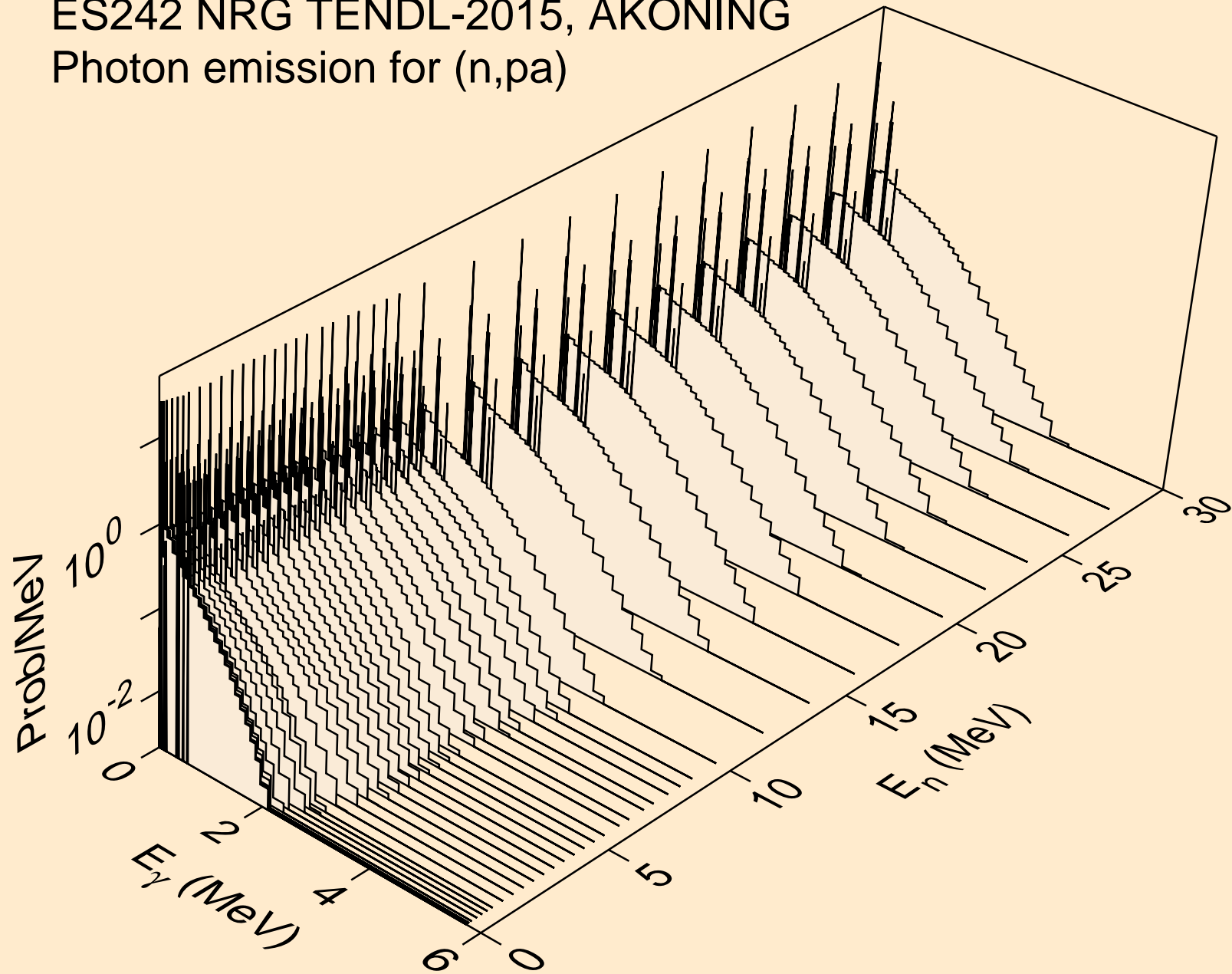



ES242 NRG TENDL-2015, AKONING  
Photon emission for (n,t2a)

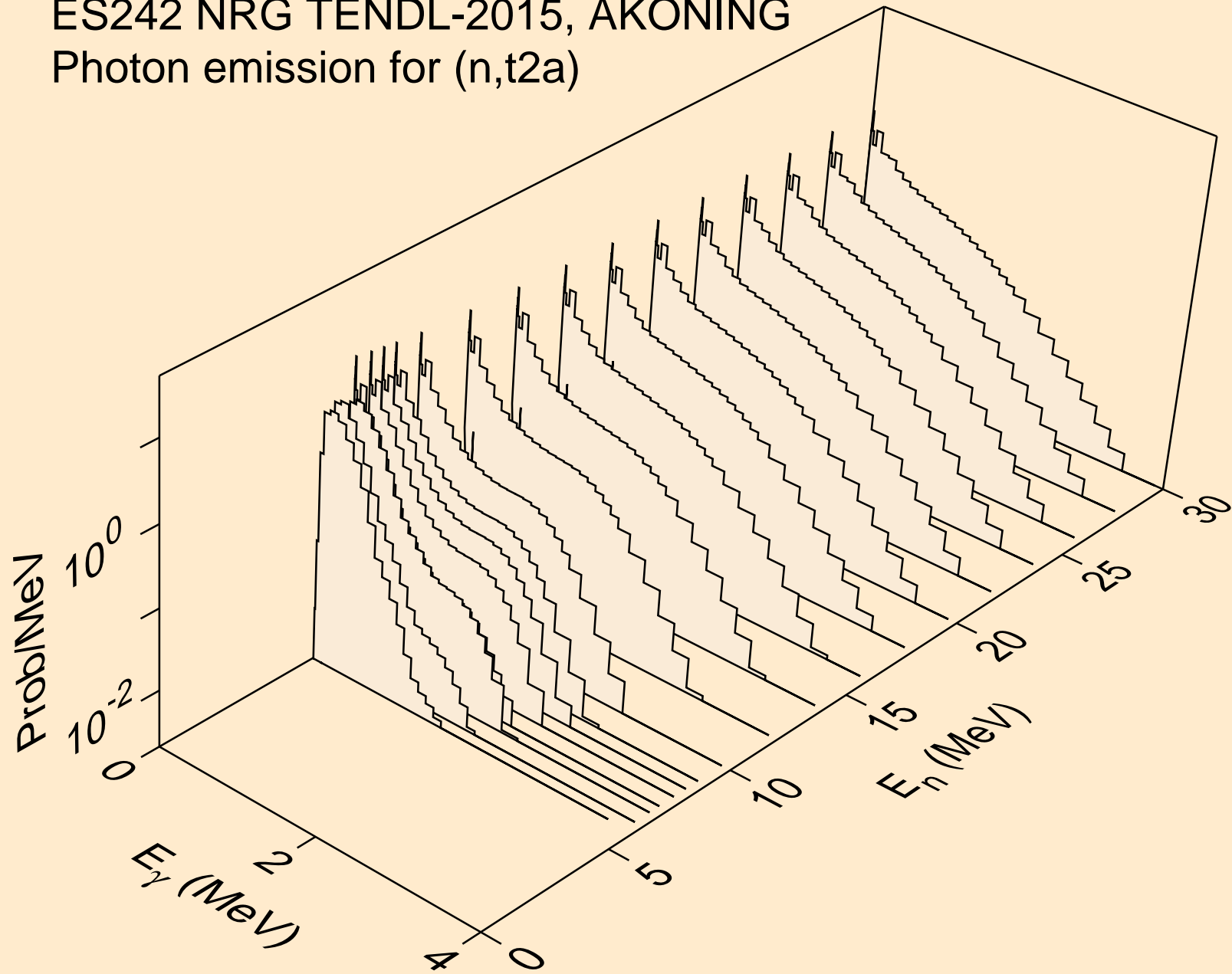

ES242 NRG TENDL-2015, AKONING  
Photon emission for (n,d2a)

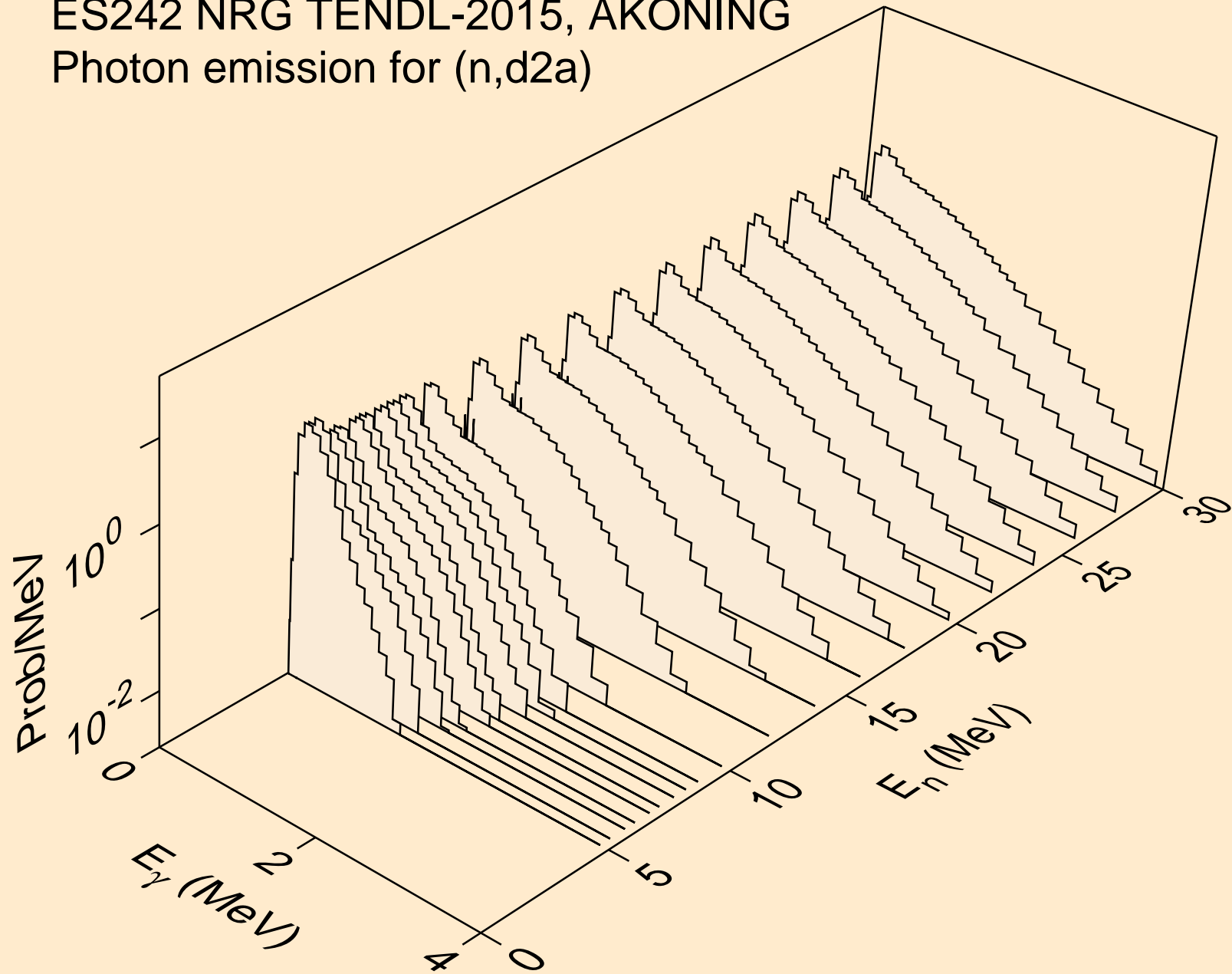

ES242 NRG TENDL-2015, AKONING  
Photon emission for (n,pd)

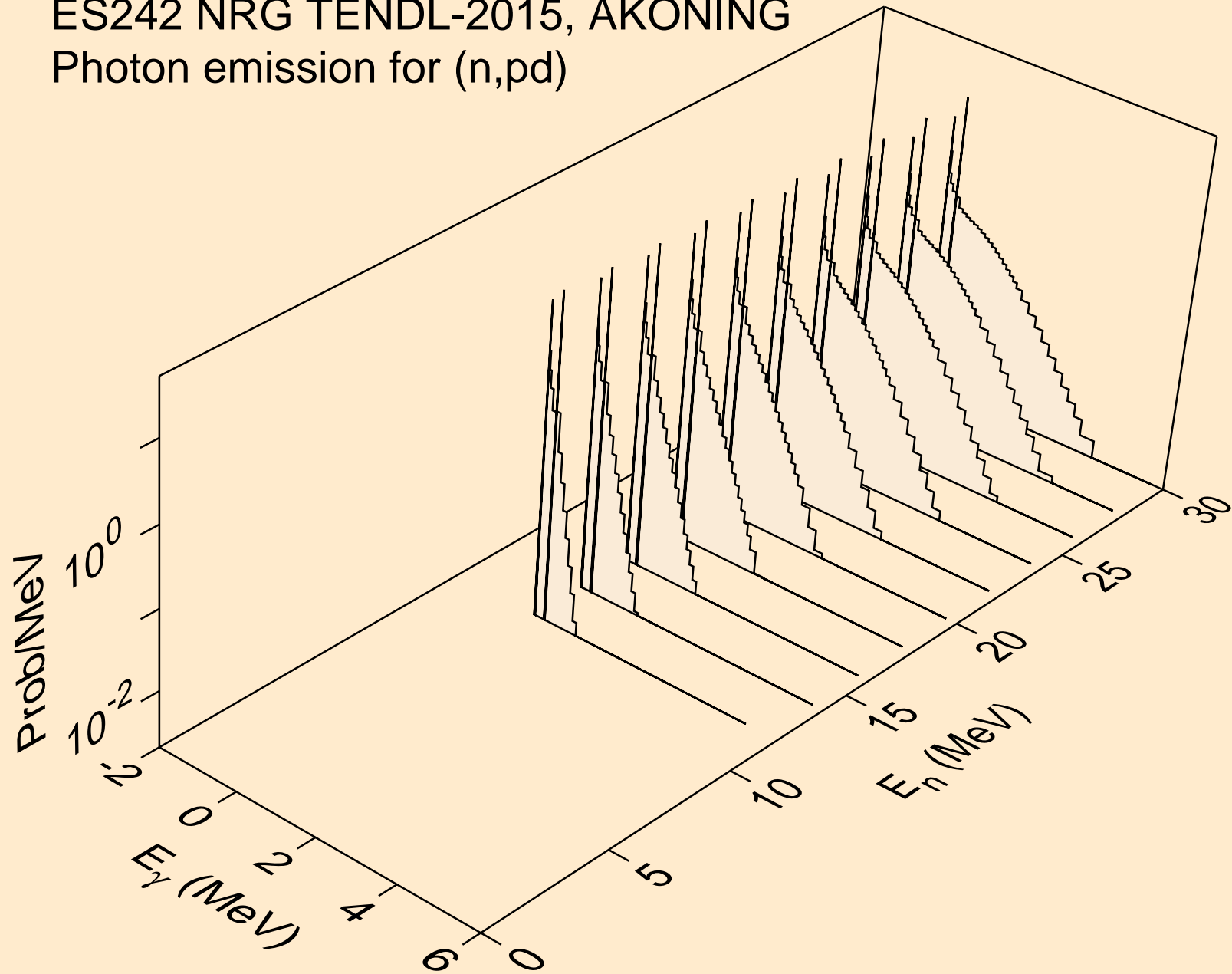

ES242 NRG TENDL-2015, AKONING  
Photon emission for (n,pt)

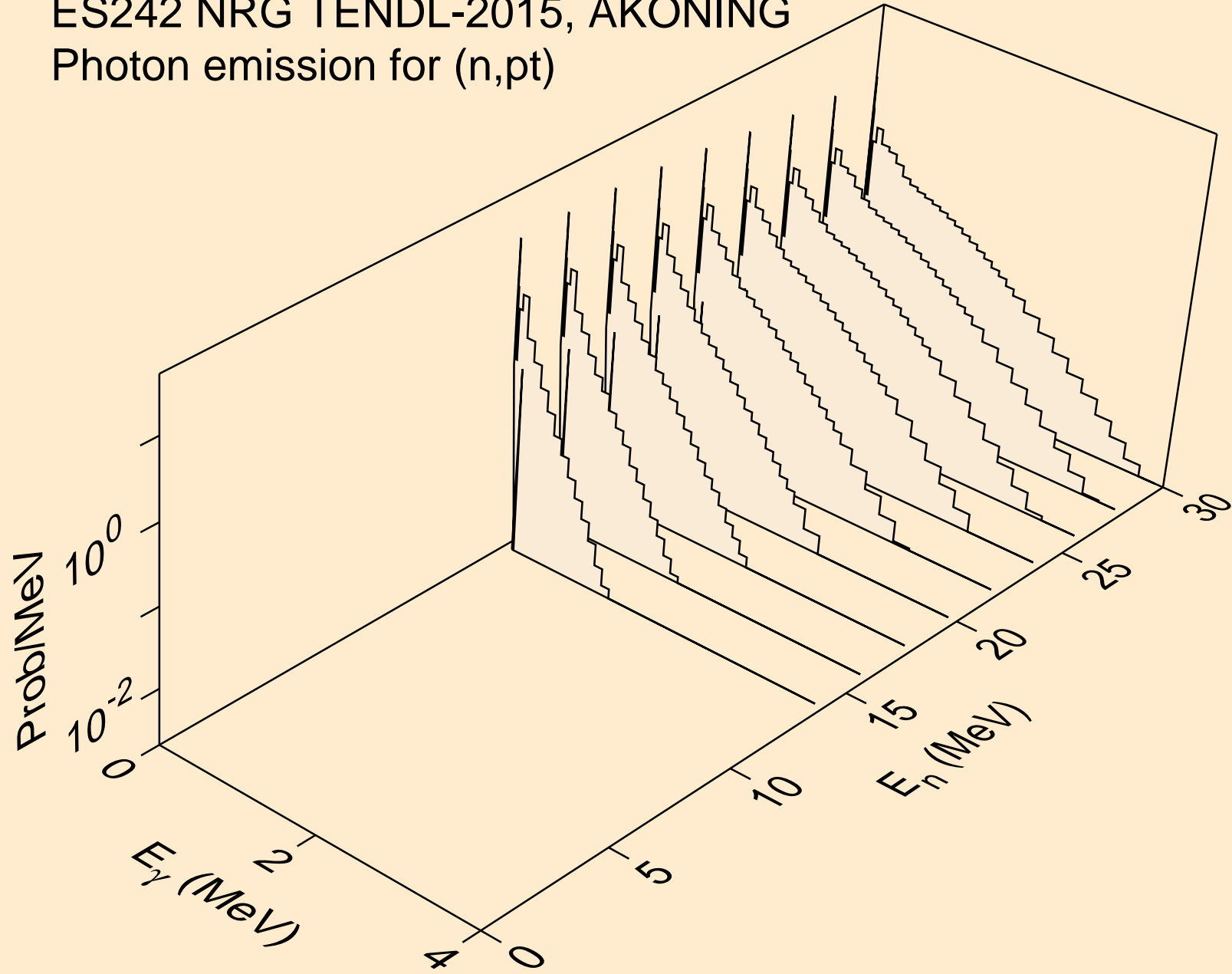

ES242 NRG TENDL-2015, AKONING  
Photon emission for (n,da)

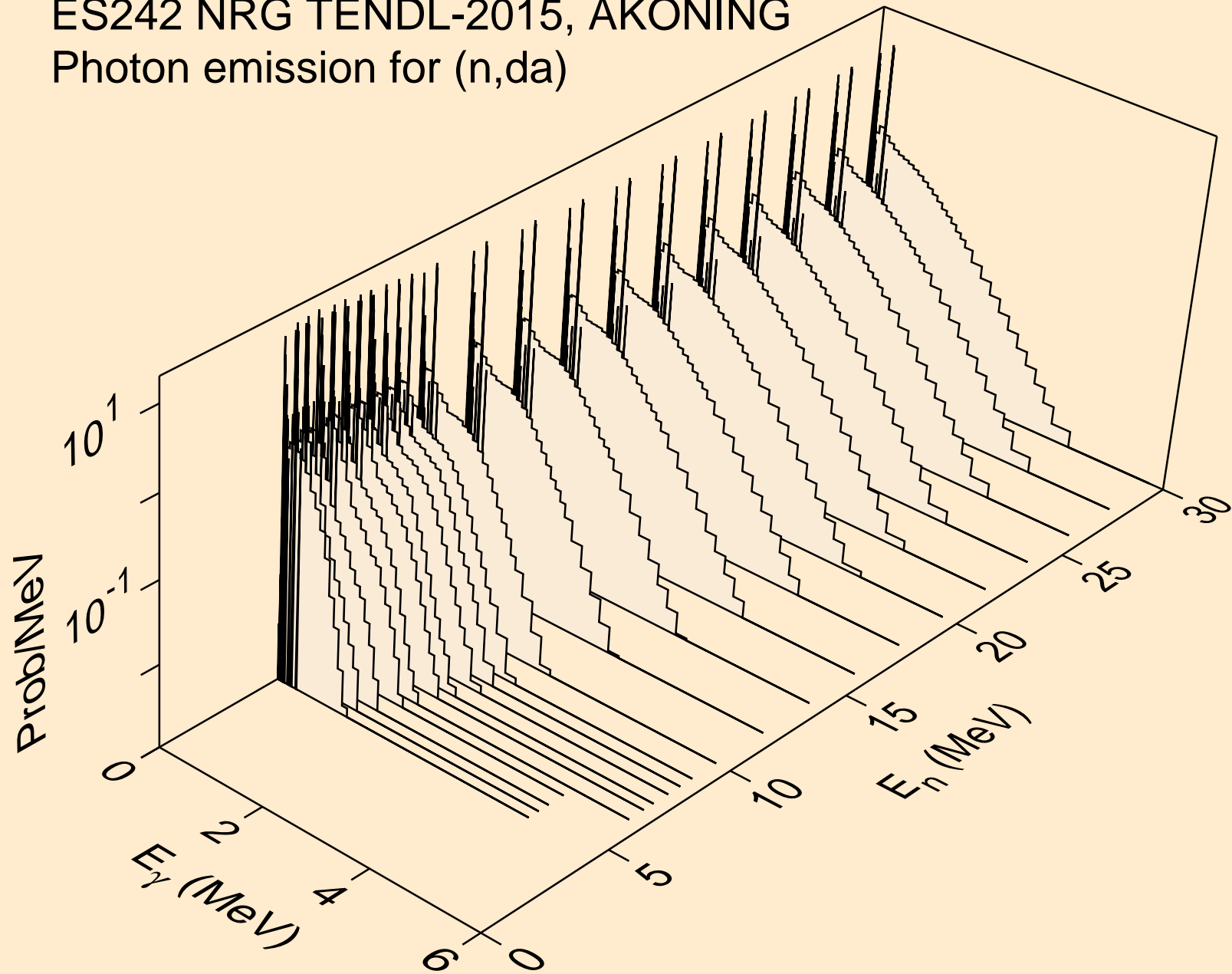

ES242 NRG TENDL-2015, AKONING  
thermal capture photon spectrum

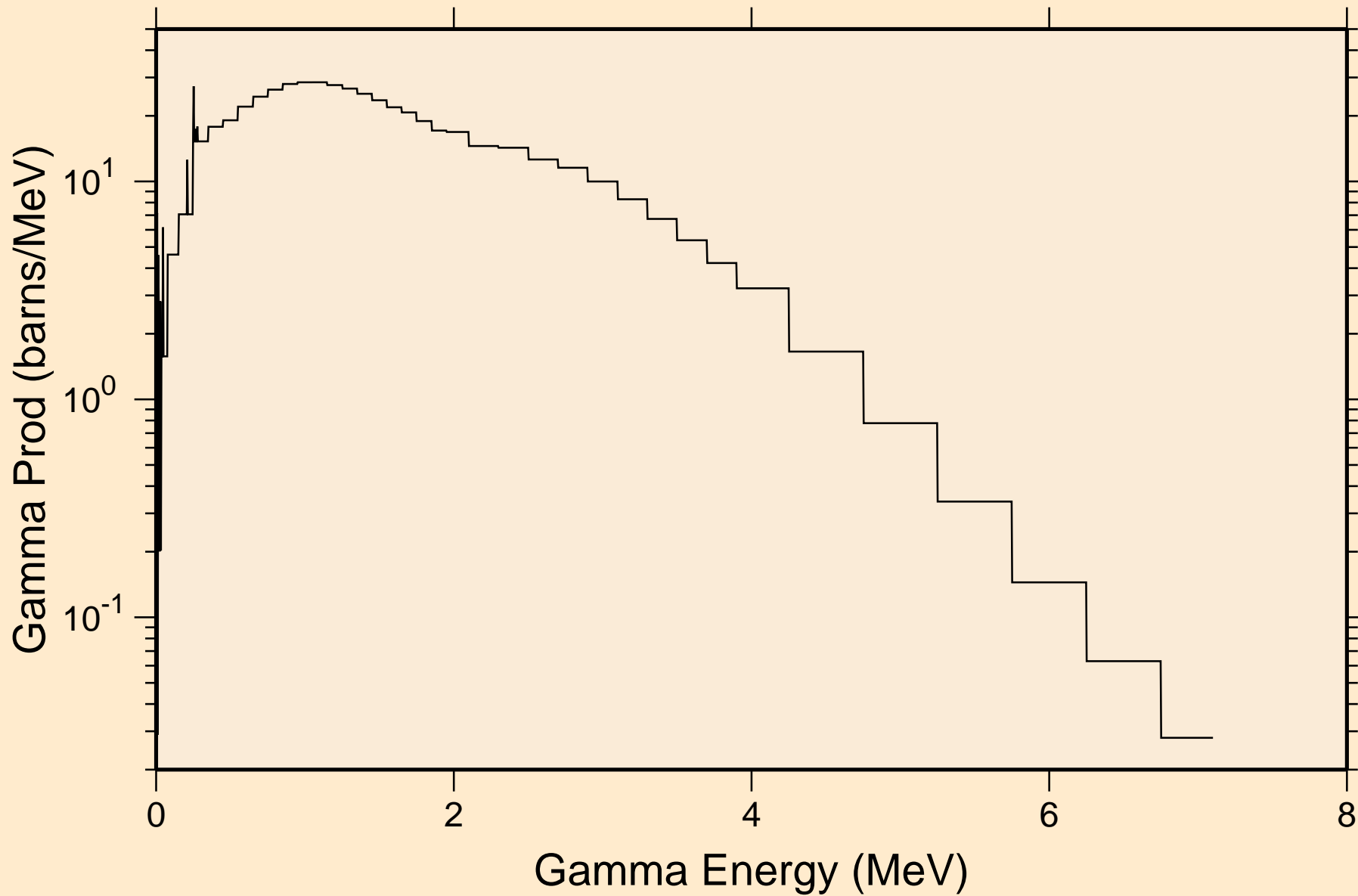

ES242 NRG TENDL-2015, AKONING  
14 MeV photon spectrum

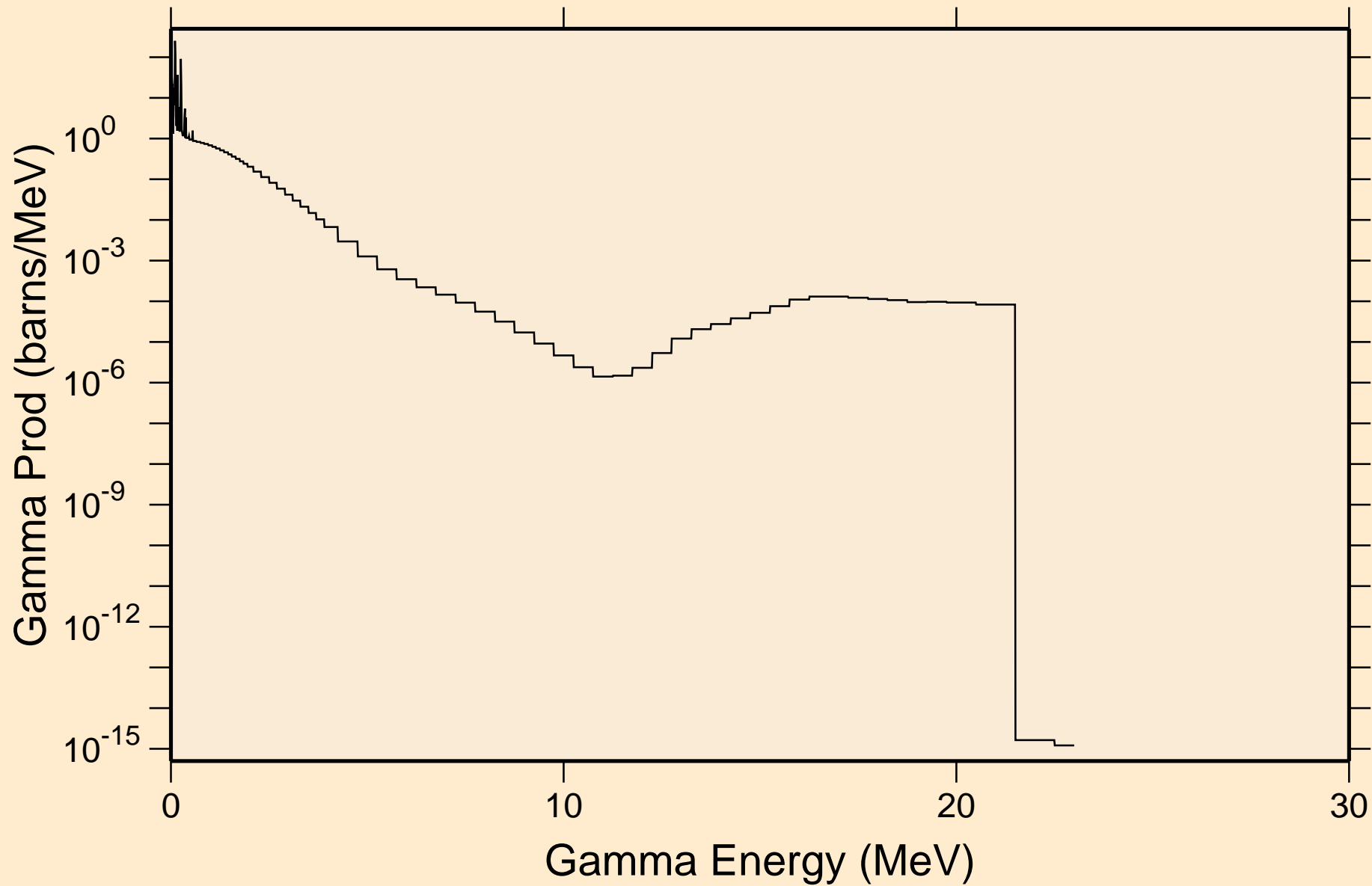

# ES242 NRG TENDL-2015, AKONING

## Particle heating contributions

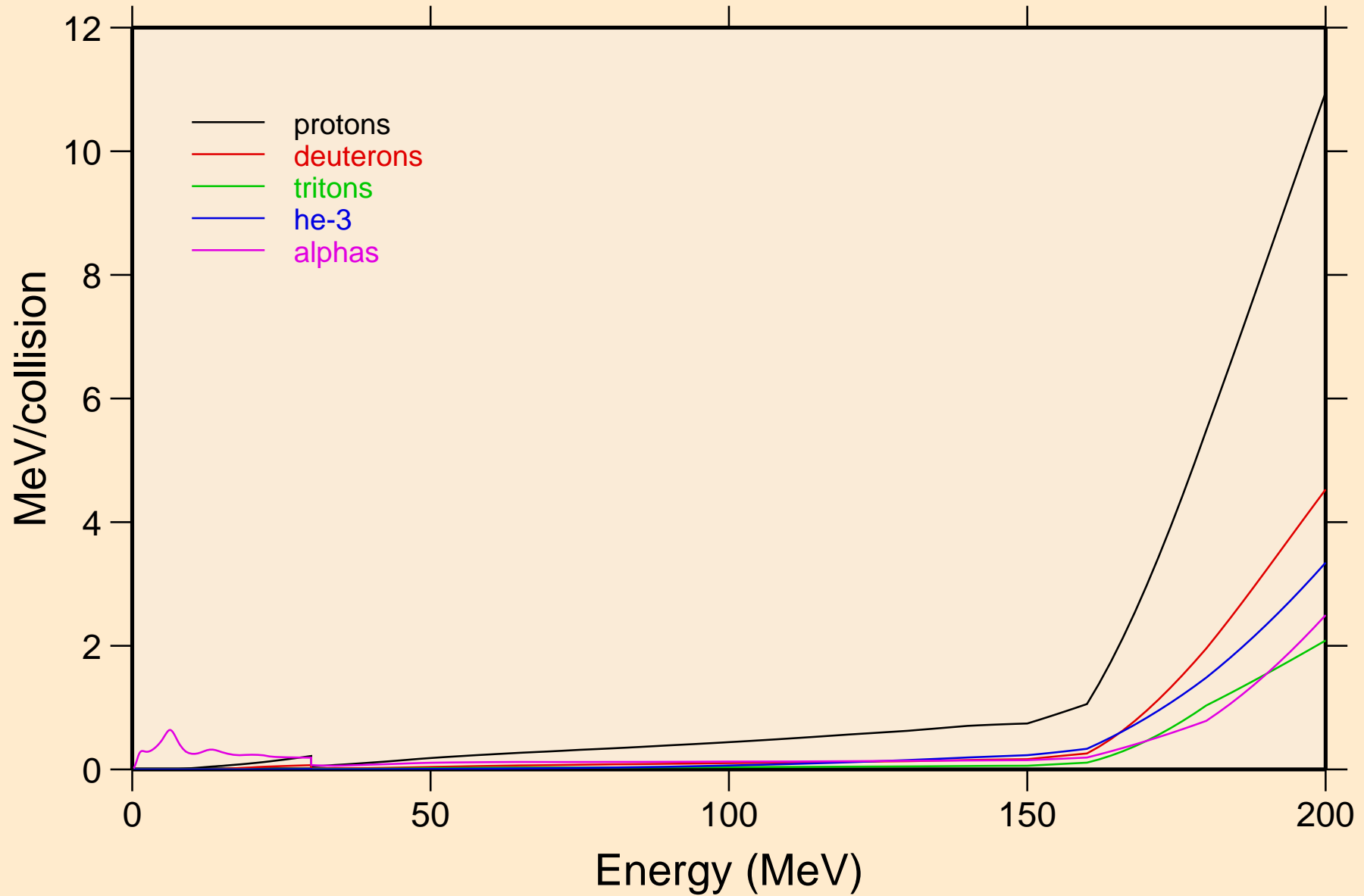



# ES242 NRG TENDL-2015, AKONING

## Recoil Heating

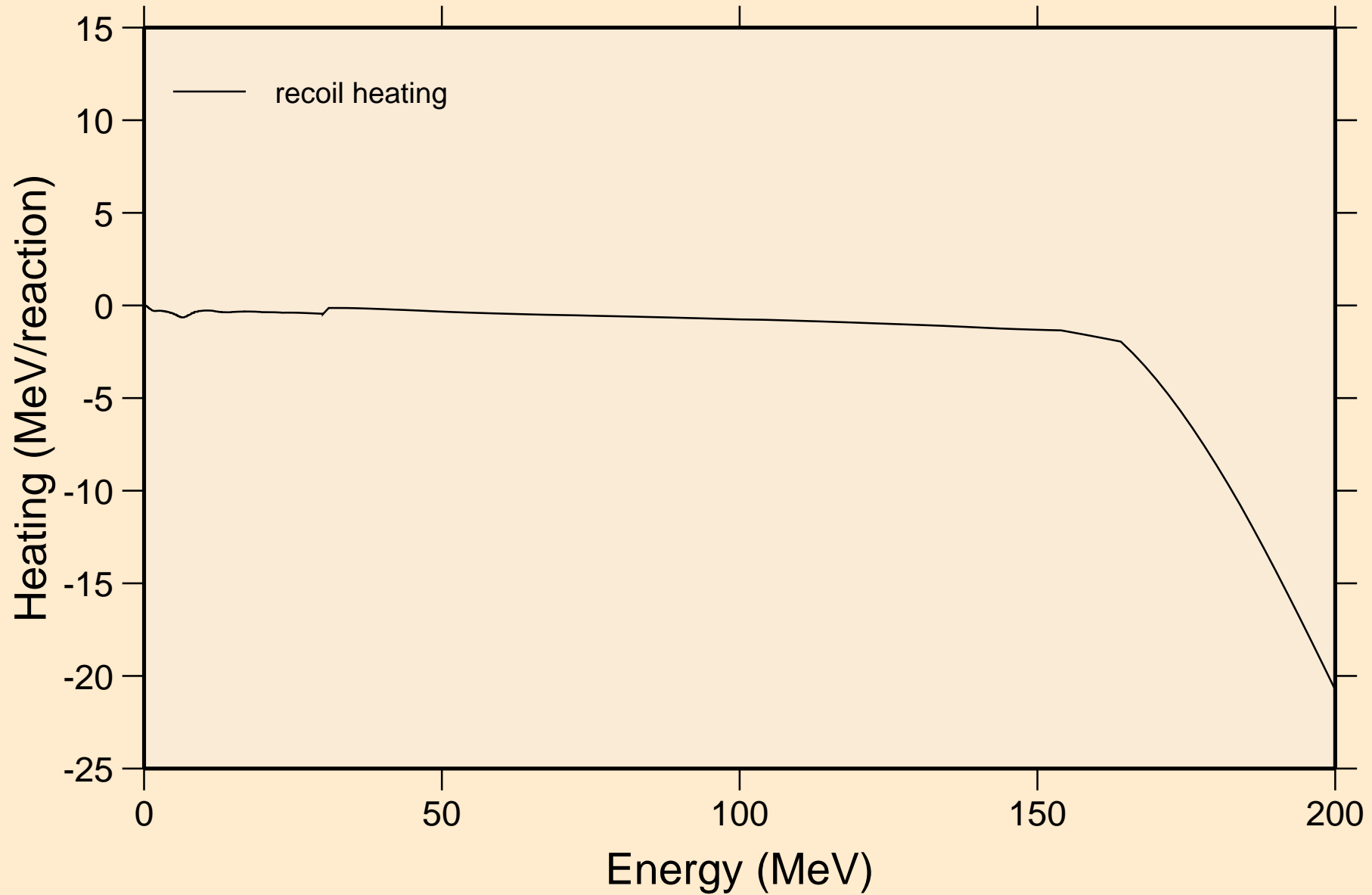

# ES242 NRG TENDL-2015, AKONING

## Particle production cross sections

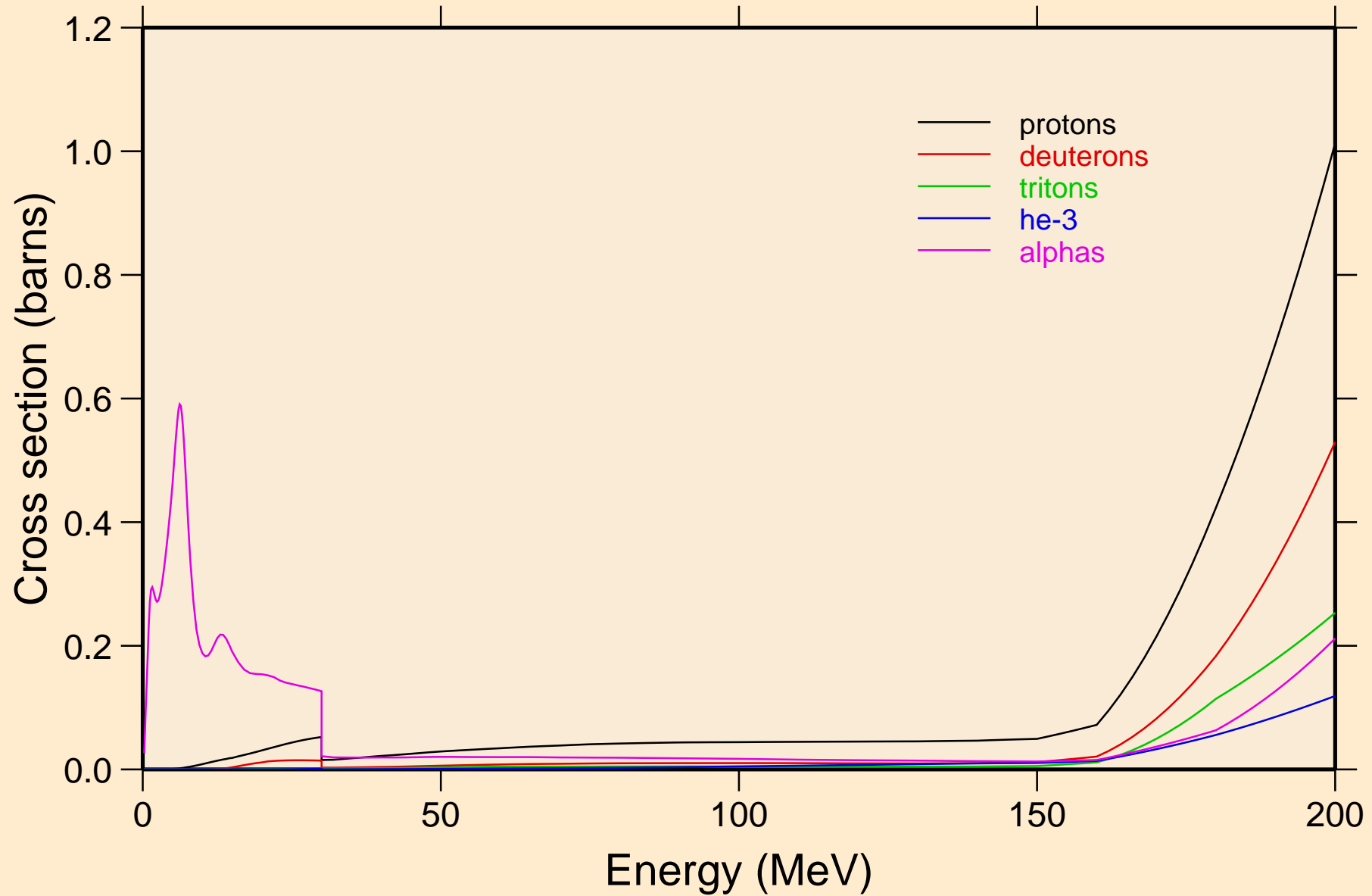

ES242 NRG TENDL-2015, AKONING  
protons from (n,x)

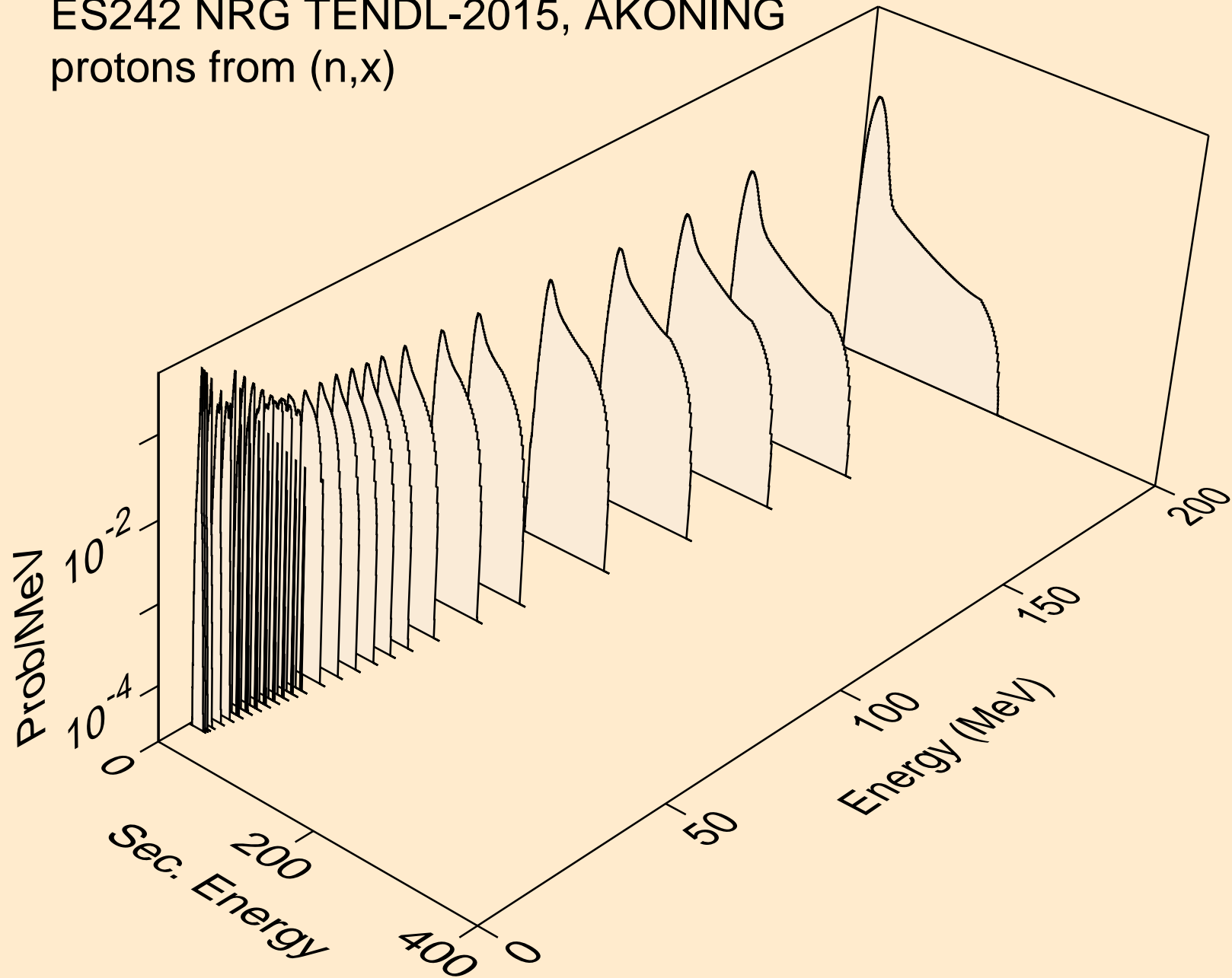

ES242 NRG TENDL-2015, AKONING  
protons from (n,n\*)p

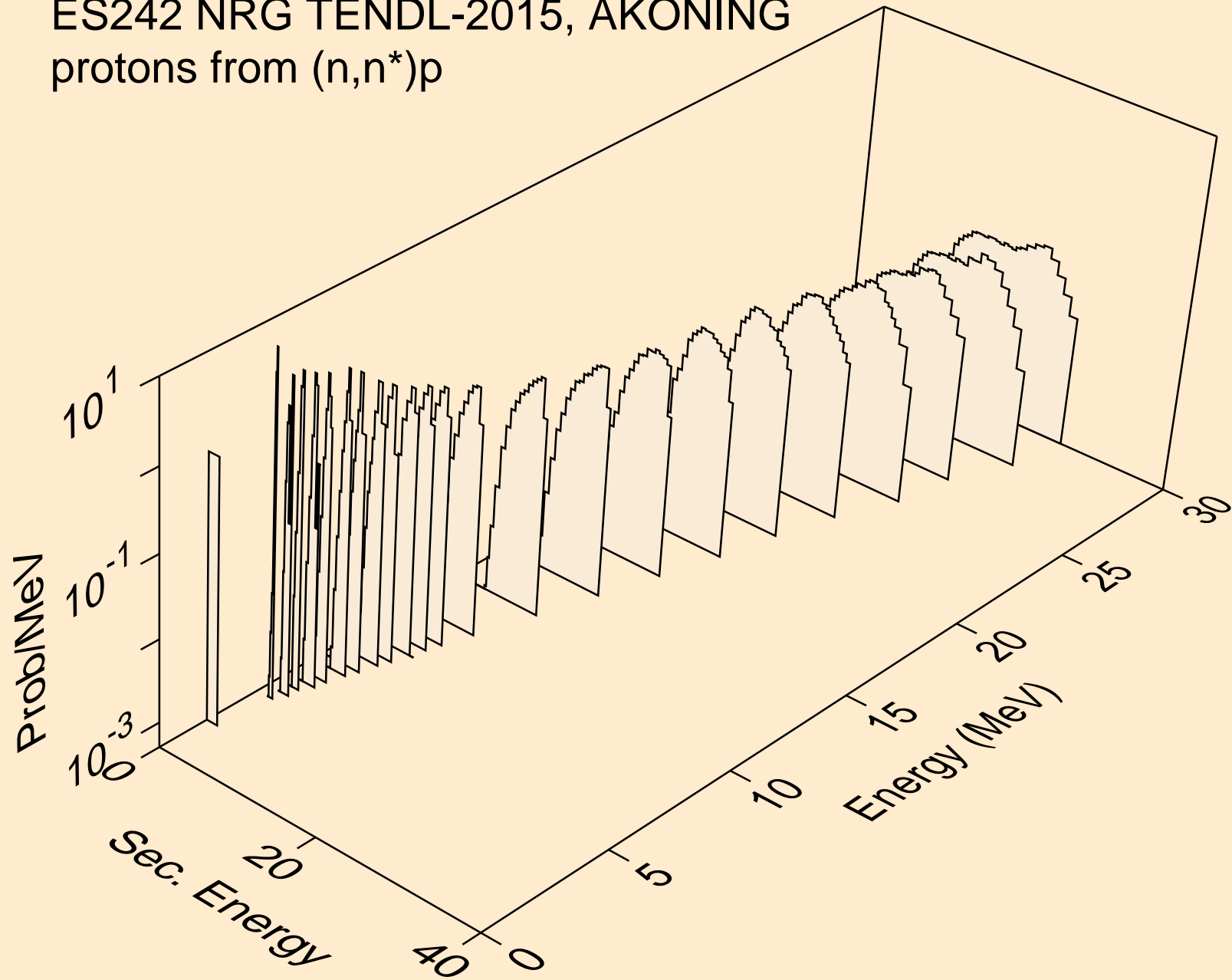

ES242 NRG TENDL-2015, AKONING  
protons from (n,2np)

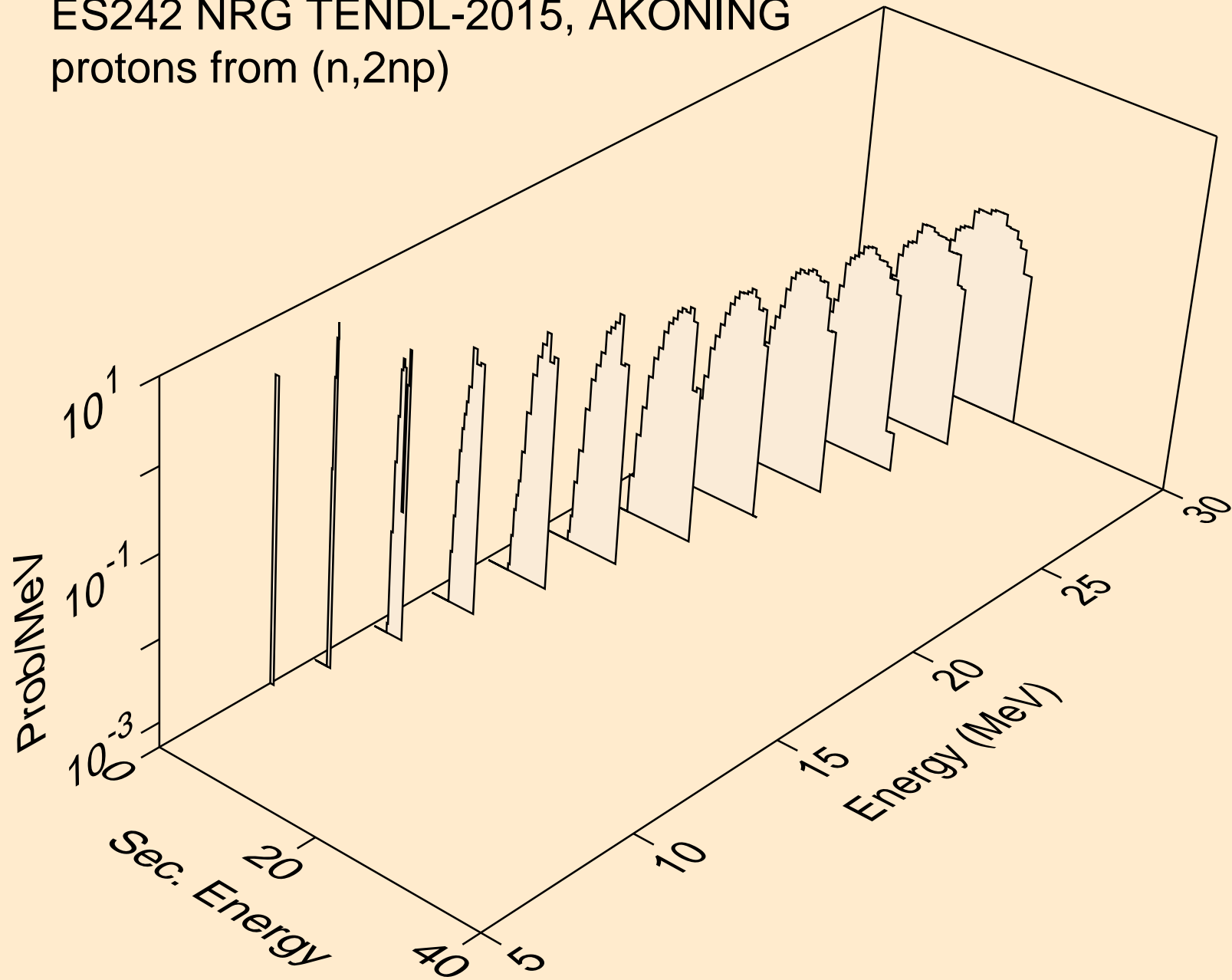

ES242 NRG TENDL-2015, AKONING  
protons from (n,3np)

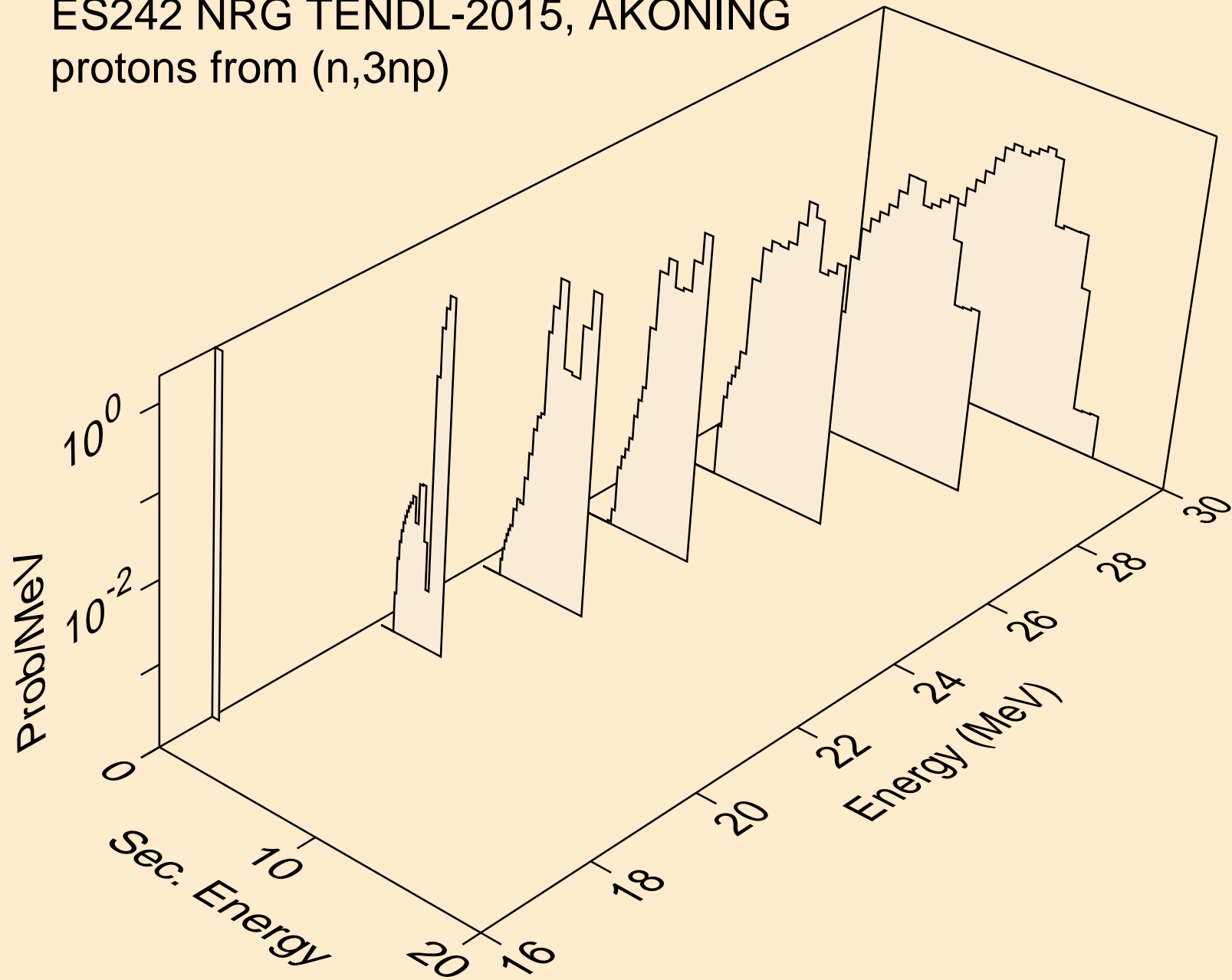

ES242 NRG TENDL-2015, AKONING  
protons from (n,2np)

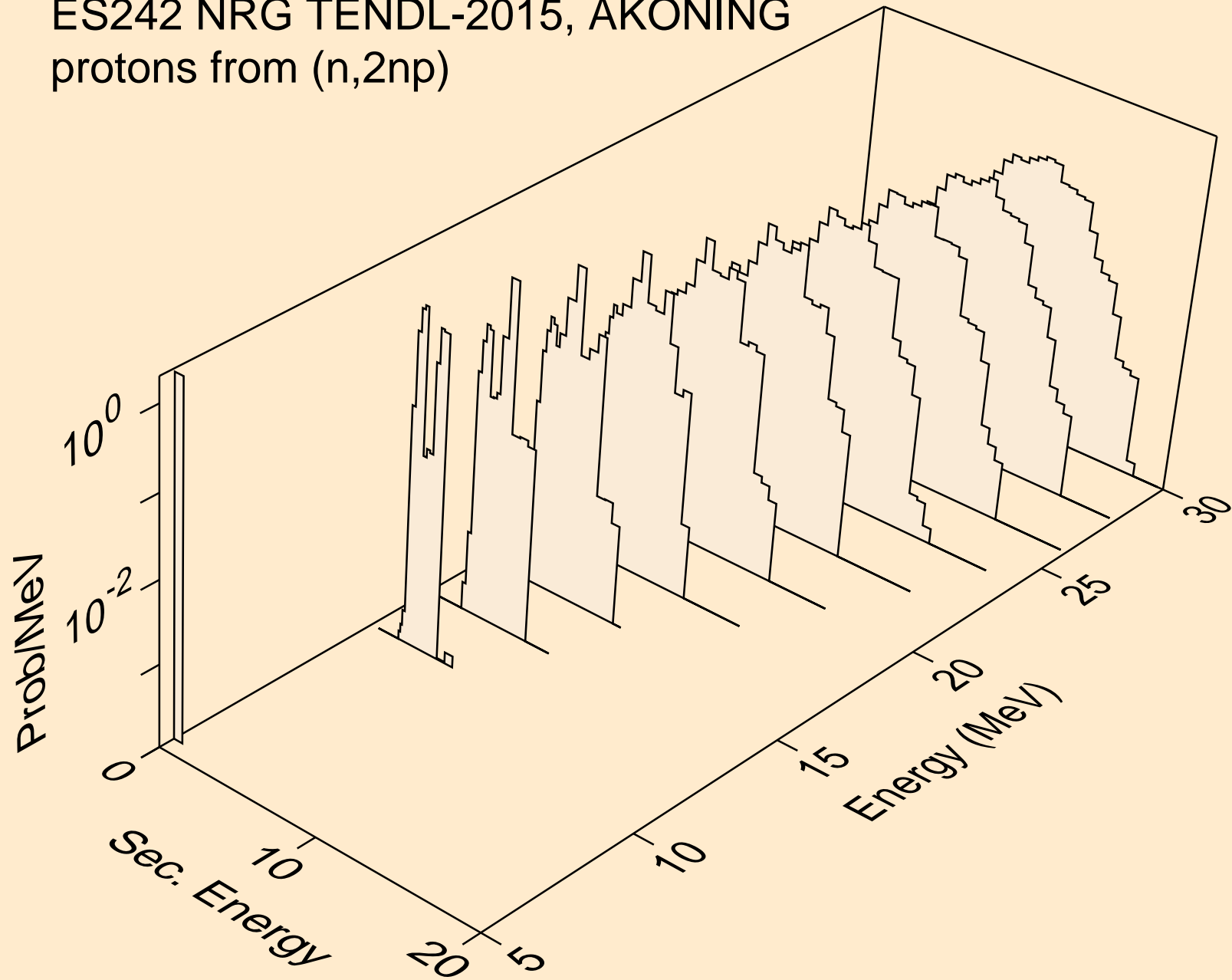

ES242 NRG TENDL-2015, AKONING  
protons from (n,npa)

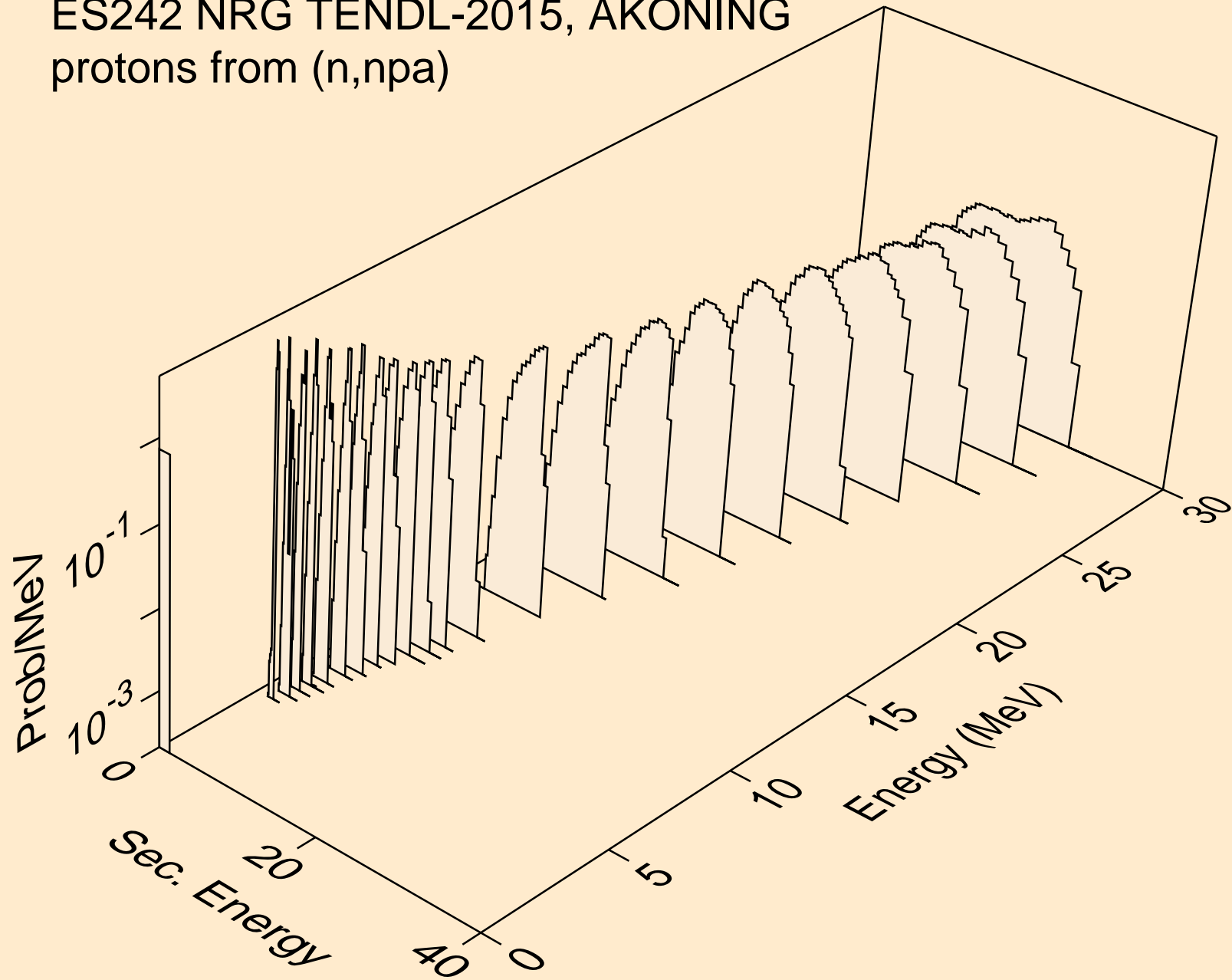



ES242 NRG TENDL-2015, AKONING  
protons from (n,p)

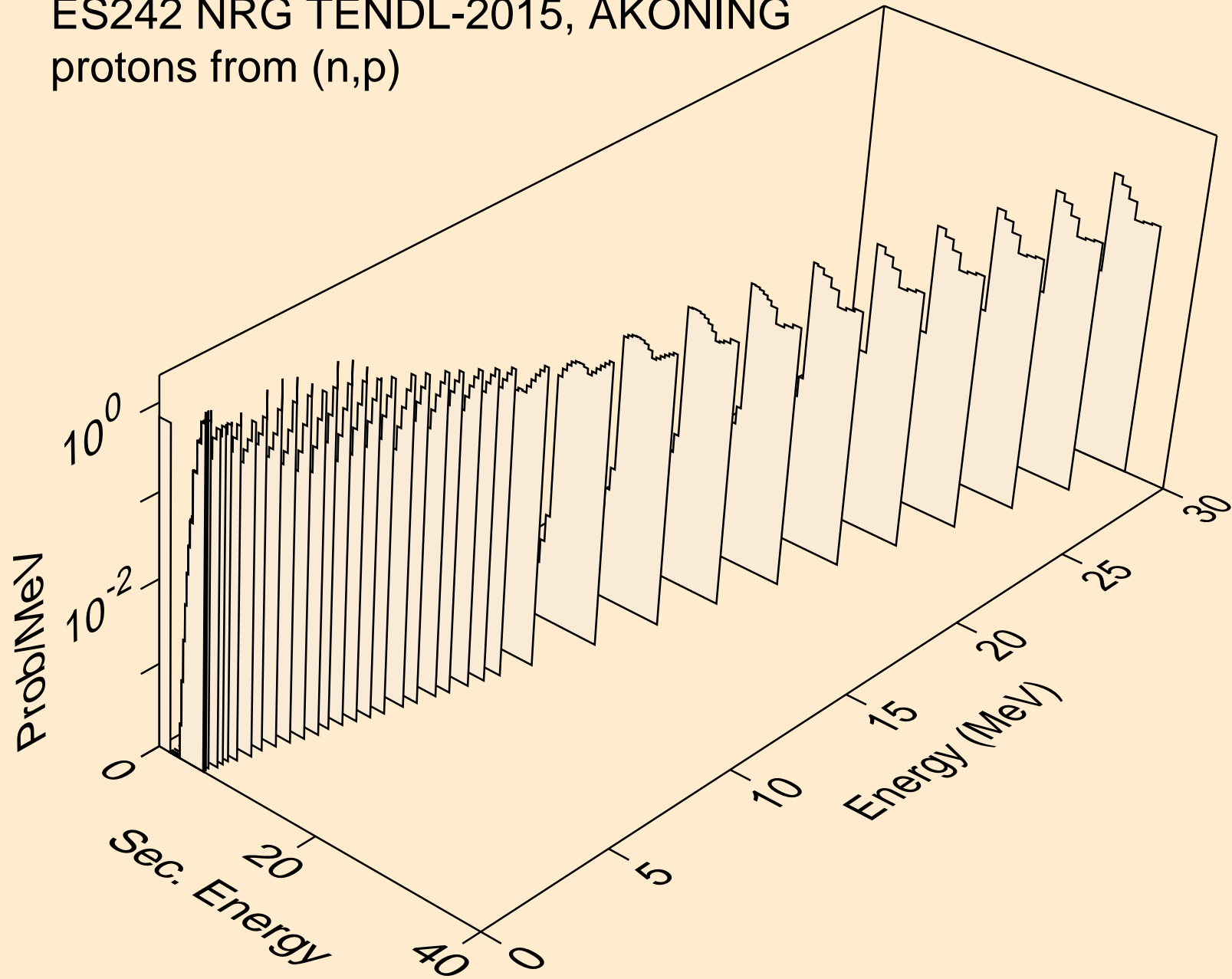

ES242 NRG TENDL-2015, AKONING  
protons from (n,2p)

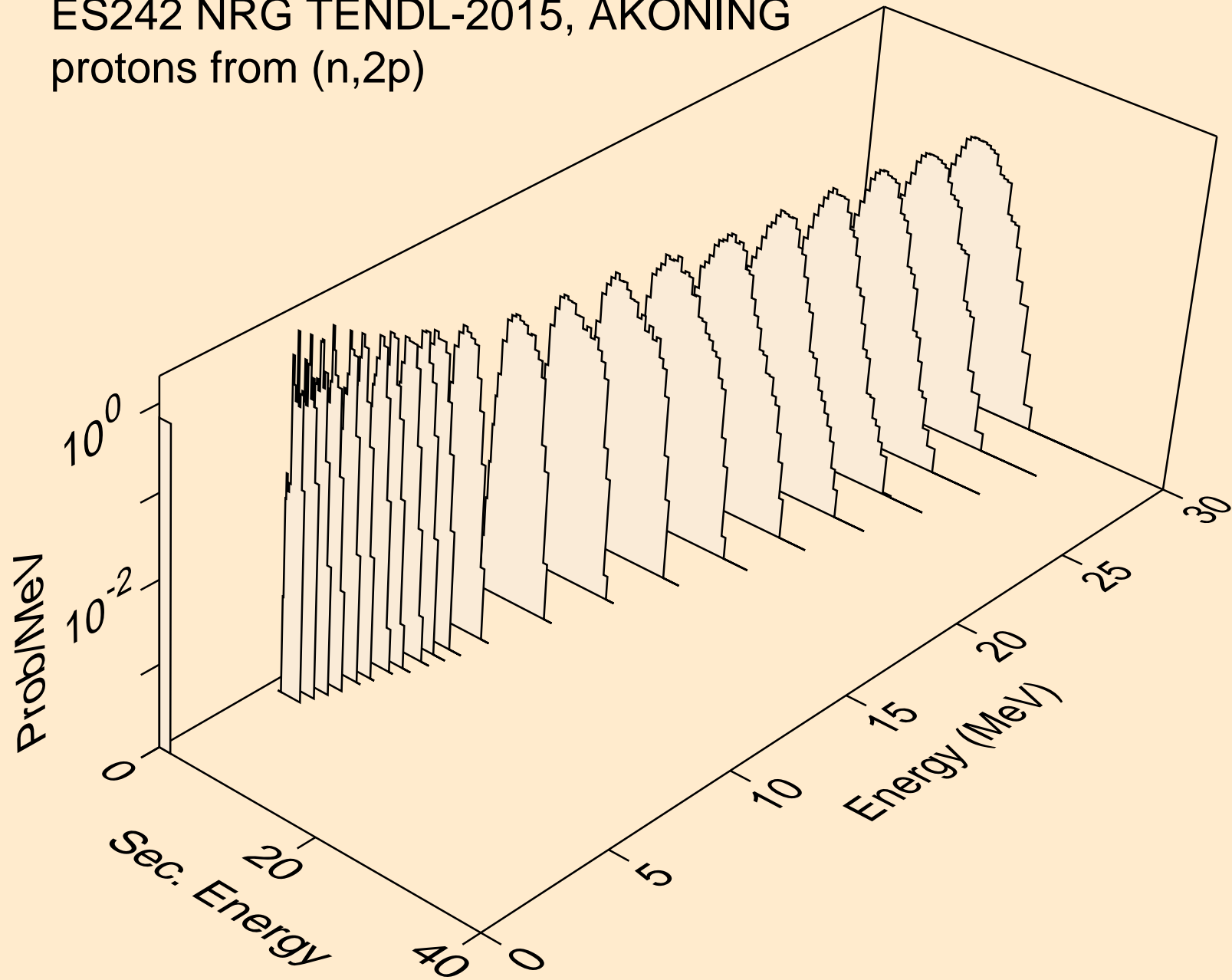

ES242 NRG TENDL-2015, AKONING  
protons from (n,pa)

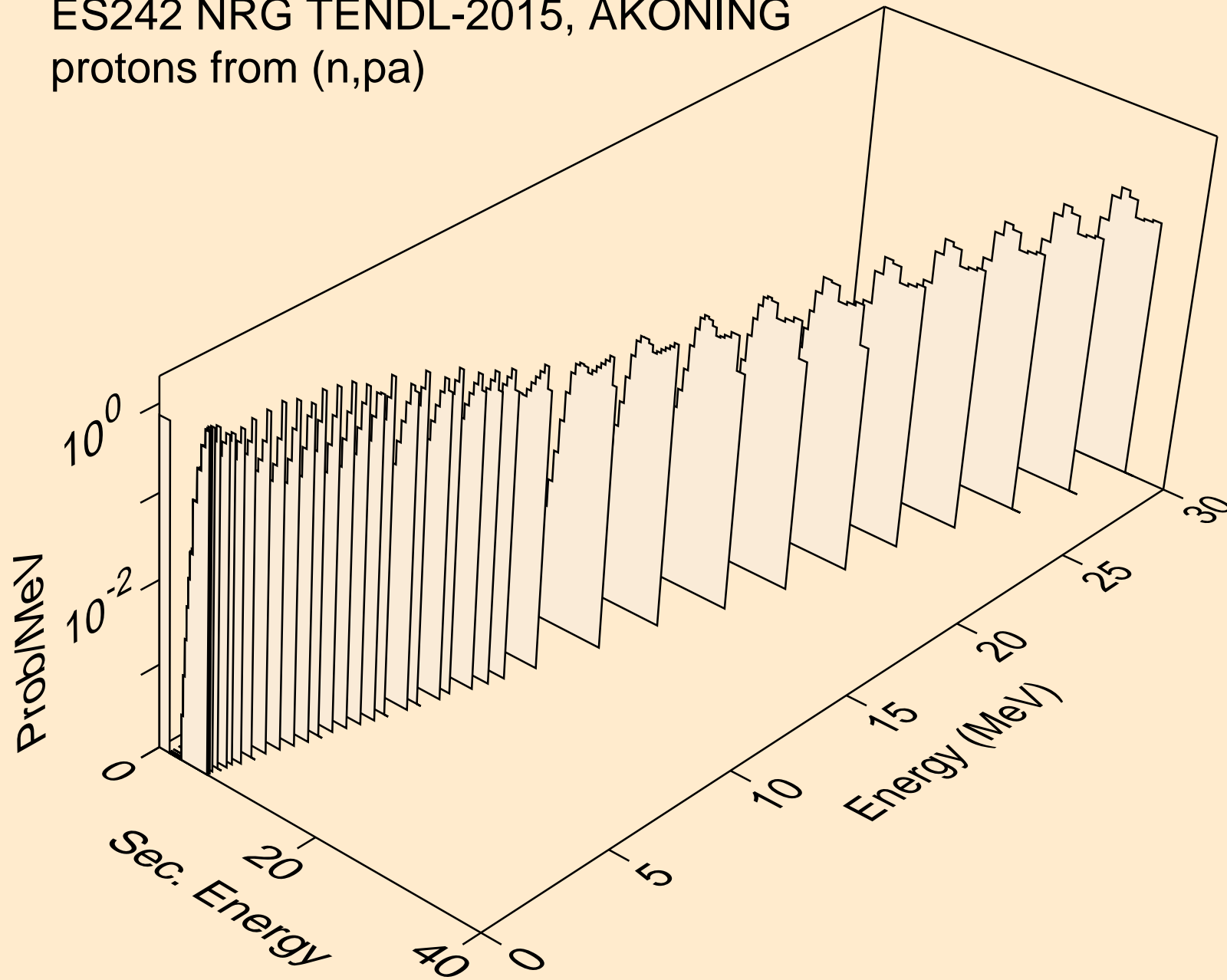

ES242 NRG TENDL-2015, AKONING  
protons from (n,pd)

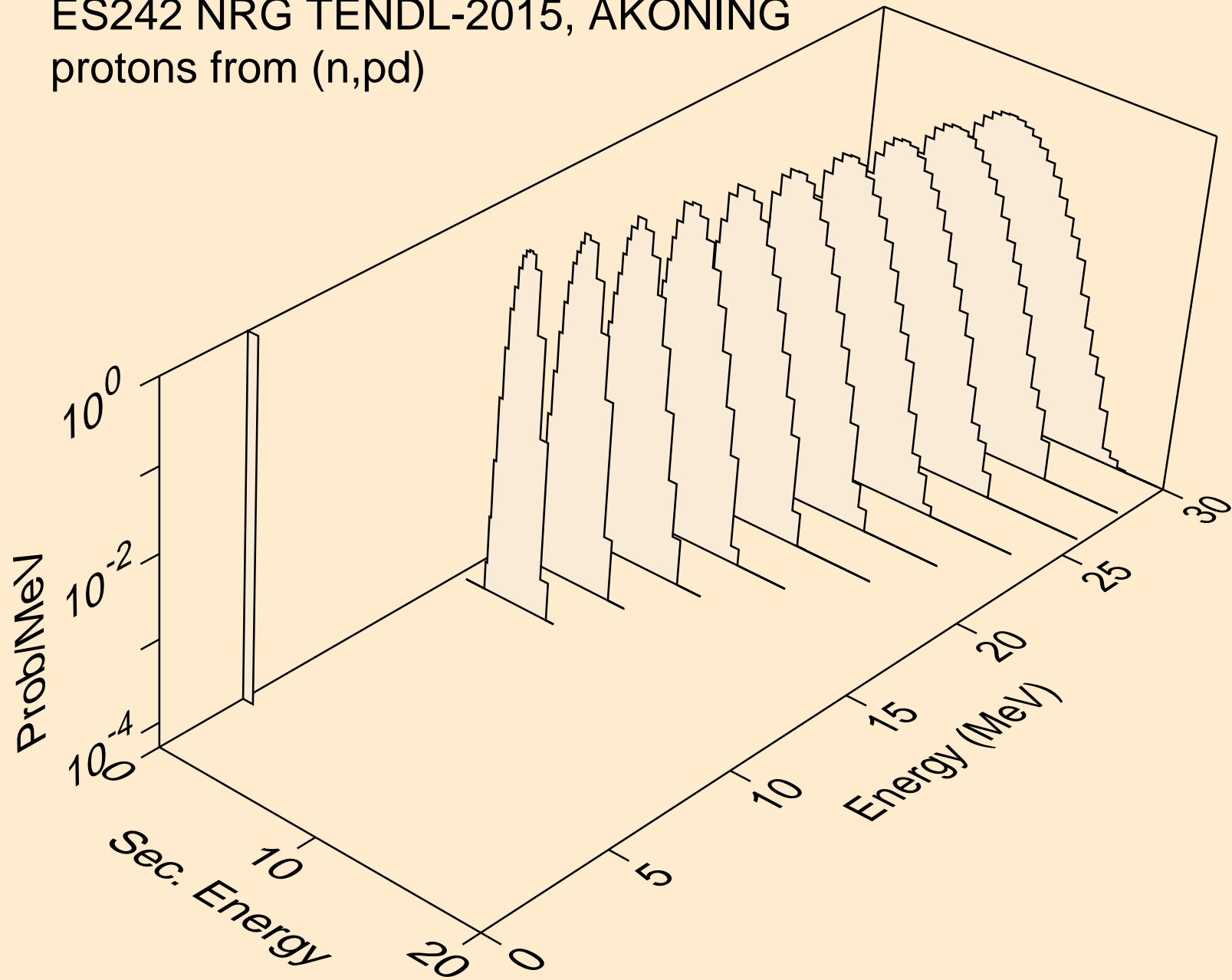

ES242 NRG TENDL-2015, AKONING  
protons from (n,pt)

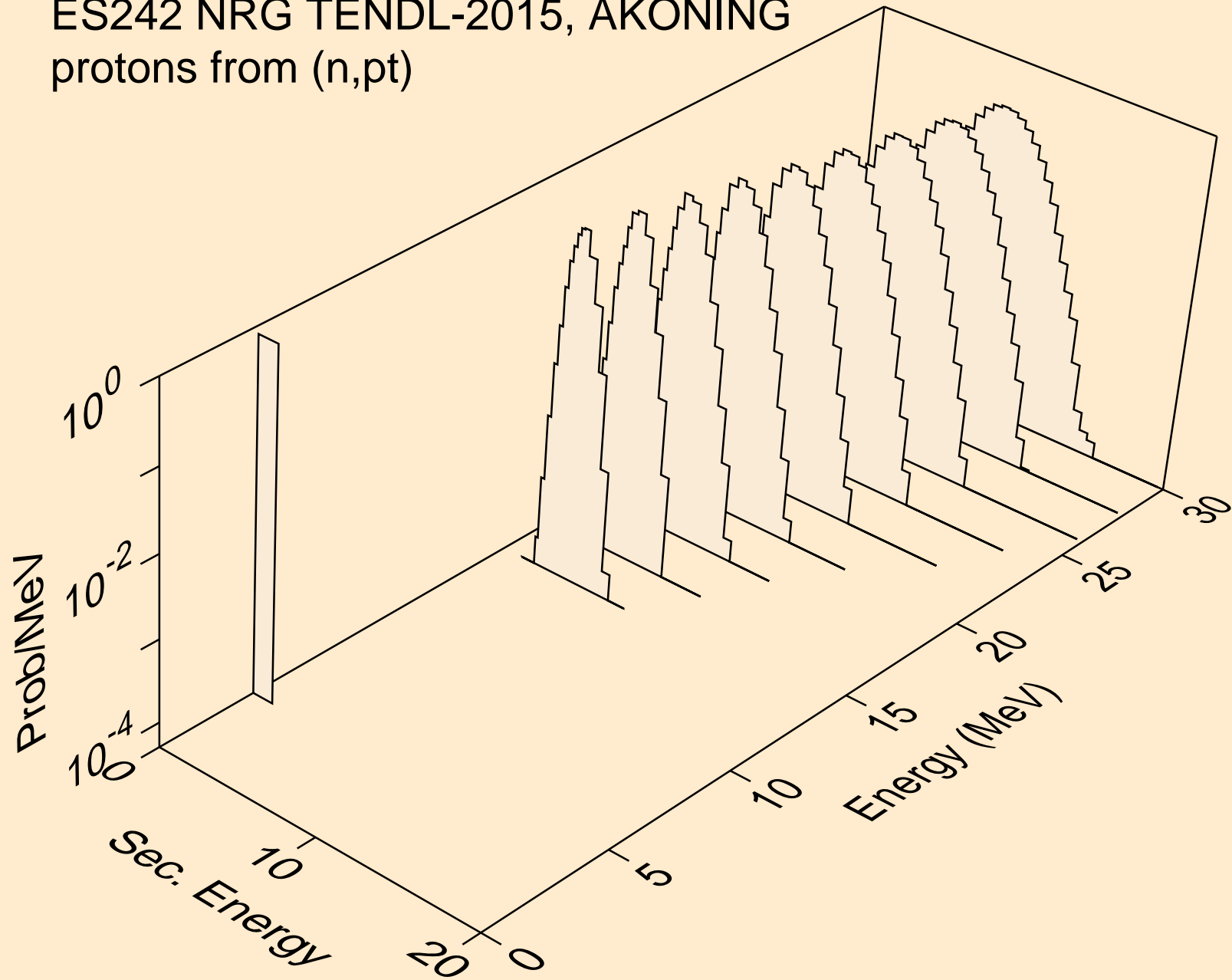

ES242 NRG TENDL-2015, AKONING  
deuterons from (n,x)

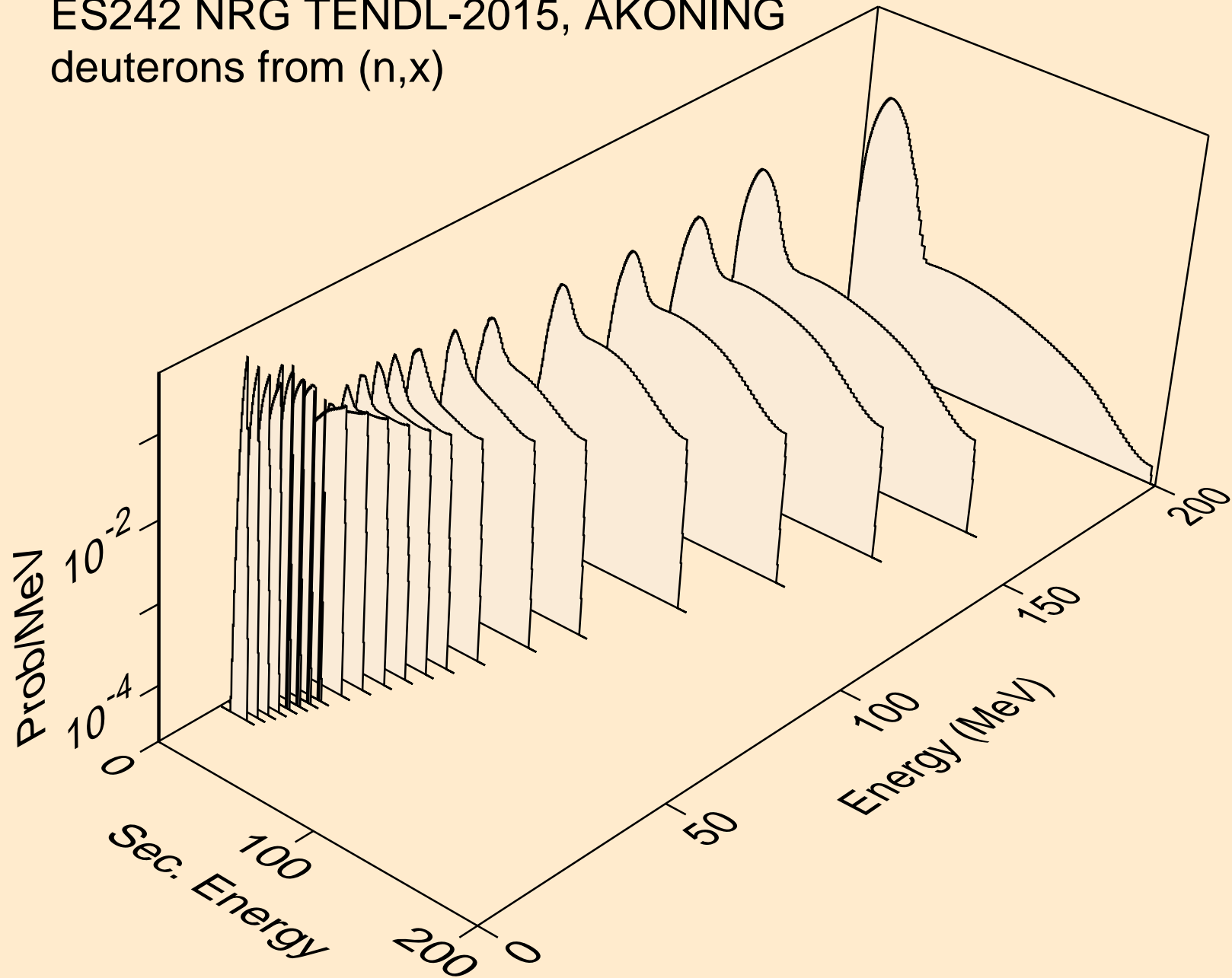

ES242 NRG TENDL-2015, AKONING  
deuterons from (n,2nd)

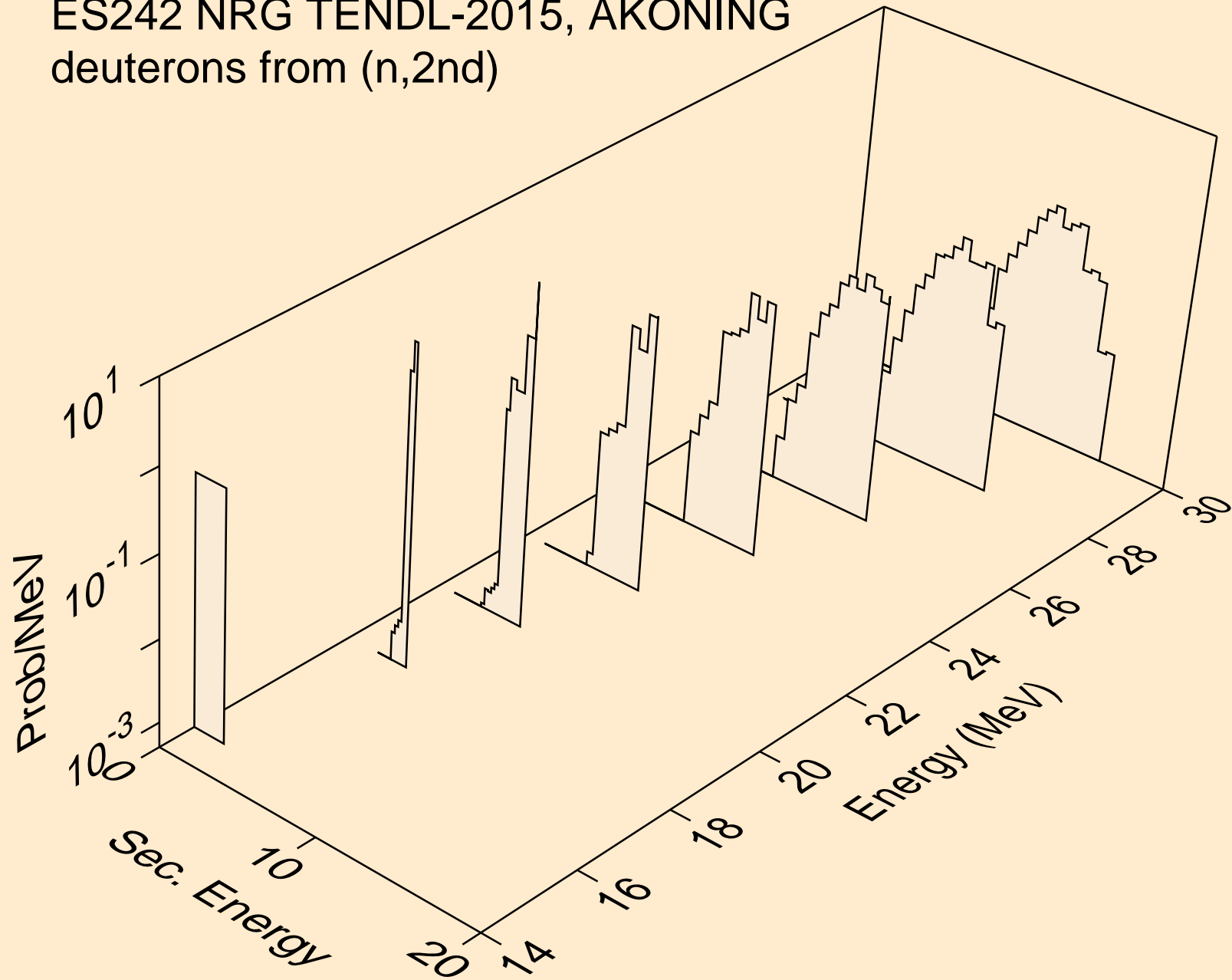

ES242 NRG TENDL-2015, AKONING  
deuterons from (n,n\*)d

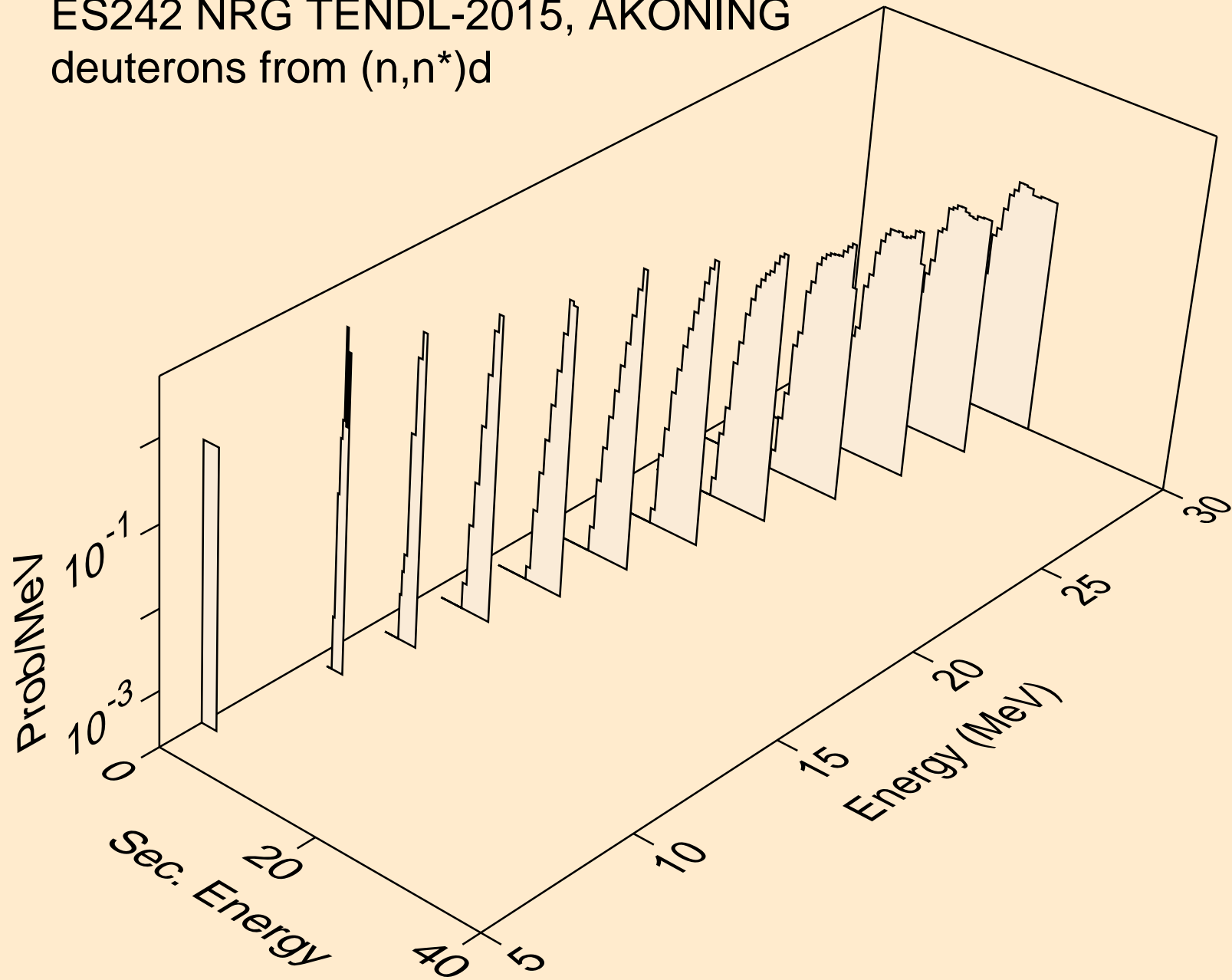



ES242 NRG TENDL-2015, AKONING  
deuterons from (n,n\*)d2a

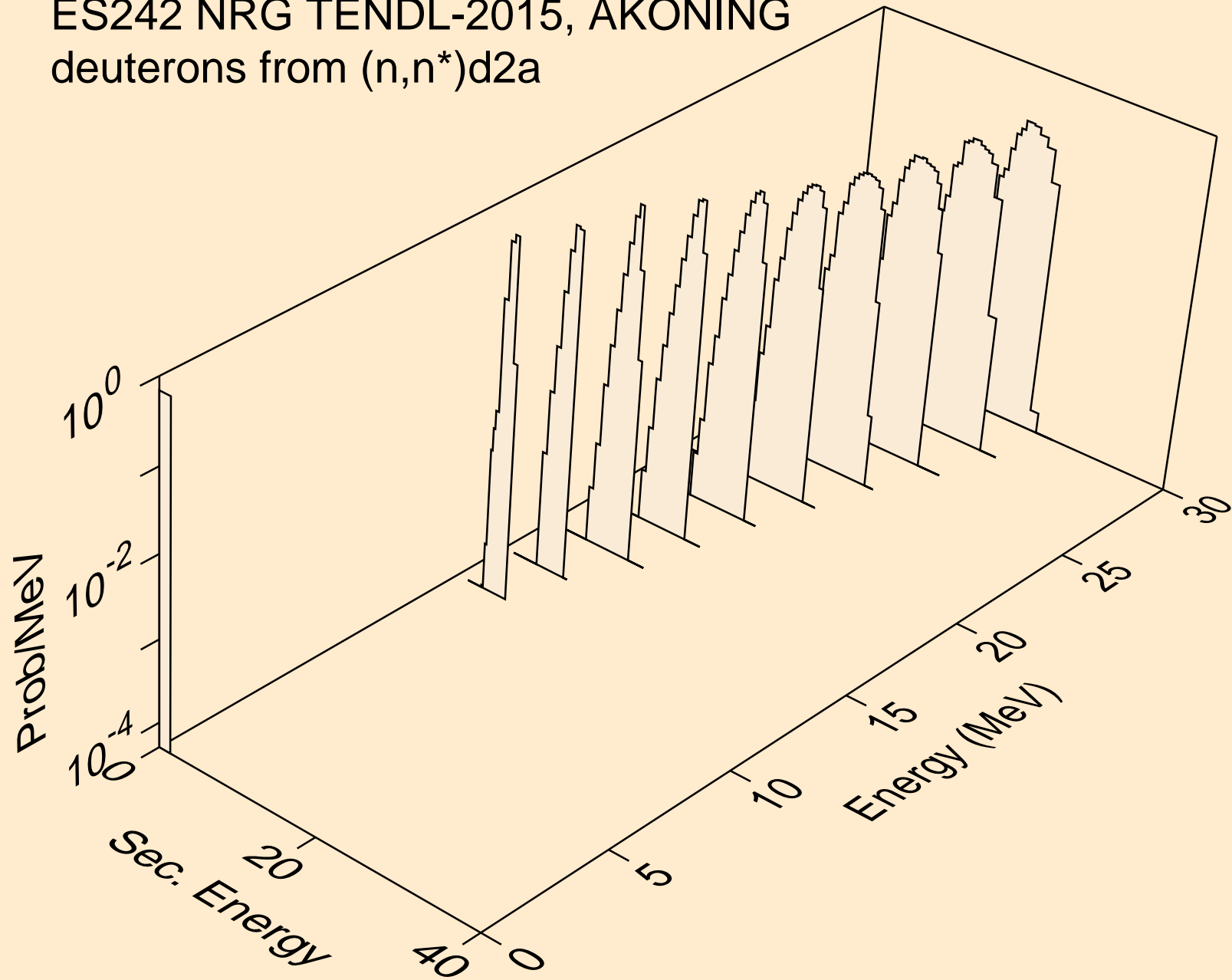

ES242 NRG TENDL-2015, AKONING  
deuterons from (n,d)

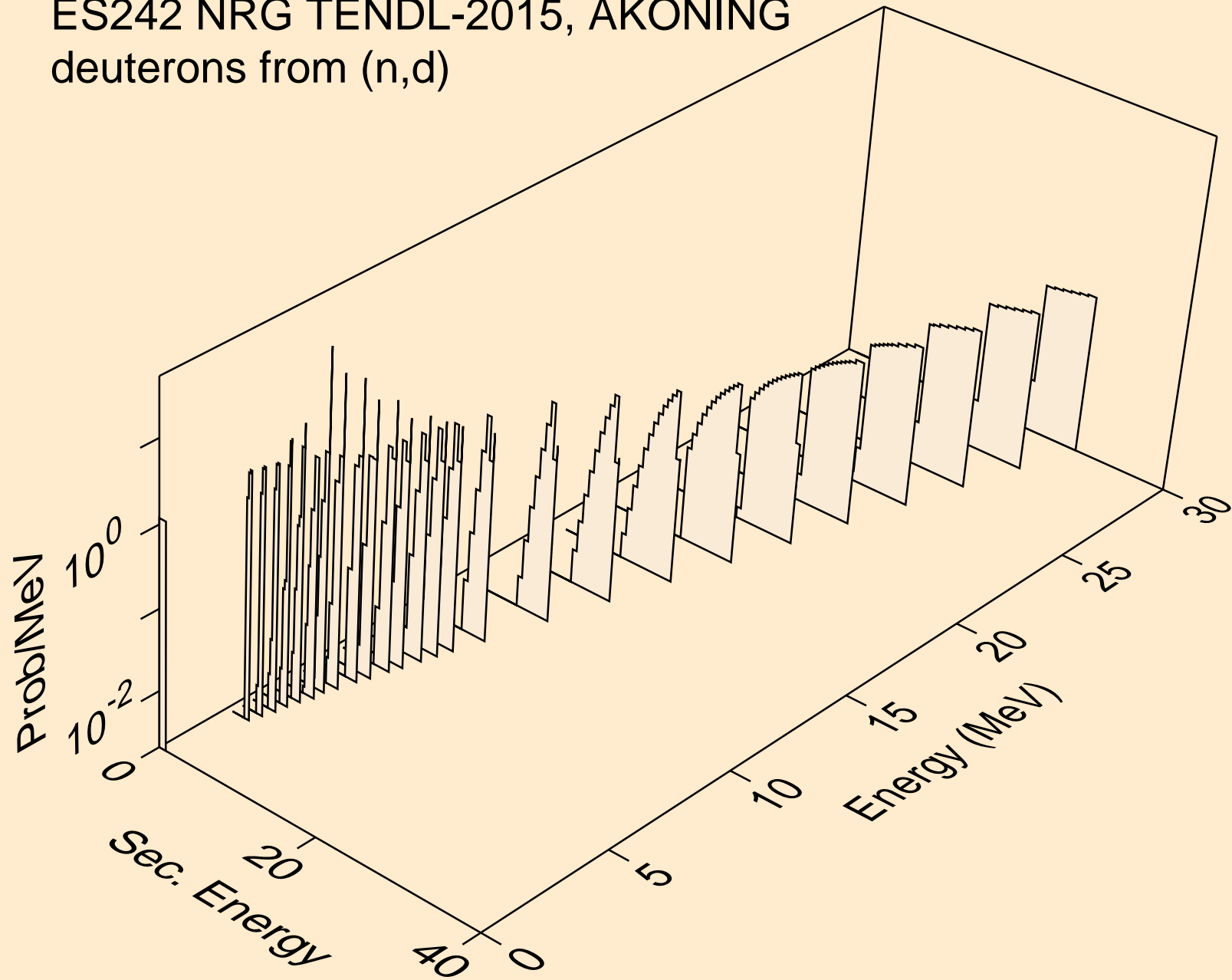

ES242 NRG TENDL-2015, AKONING  
deuterons from (n,d2a)

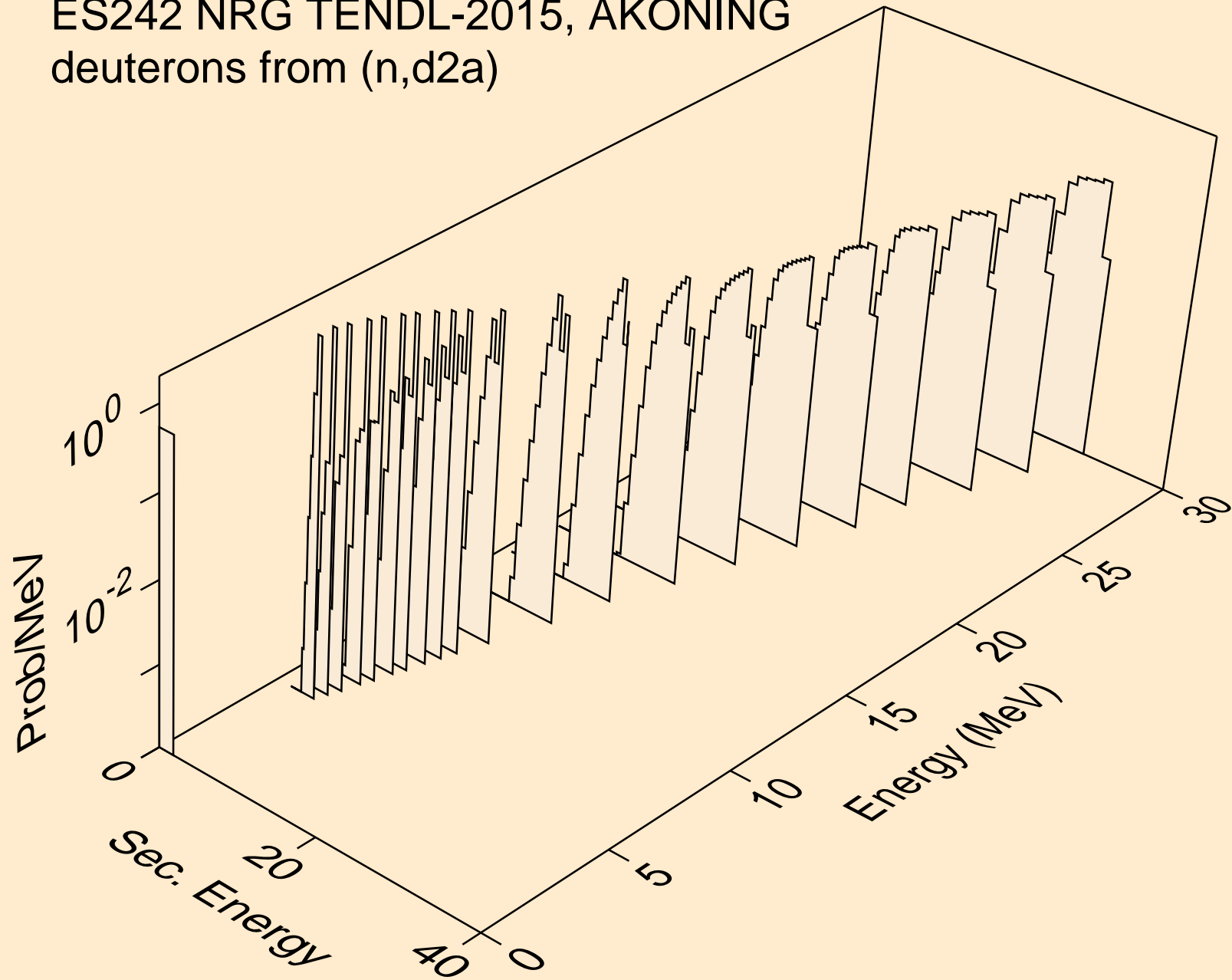

ES242 NRG TENDL-2015, AKONING  
deuterons from (n,pd)

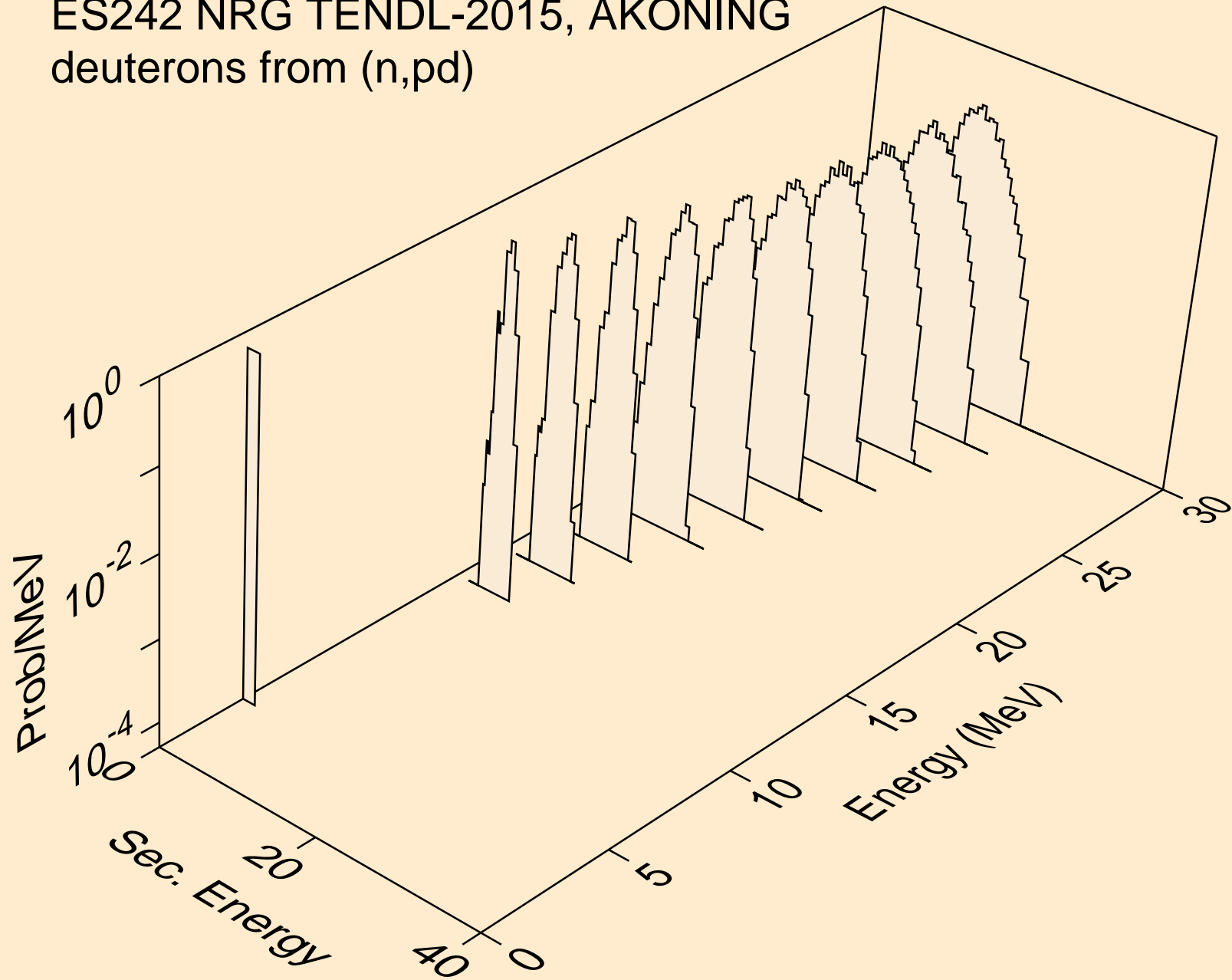

ES242 NRG TENDL-2015, AKONING  
deuterons from (n,da)

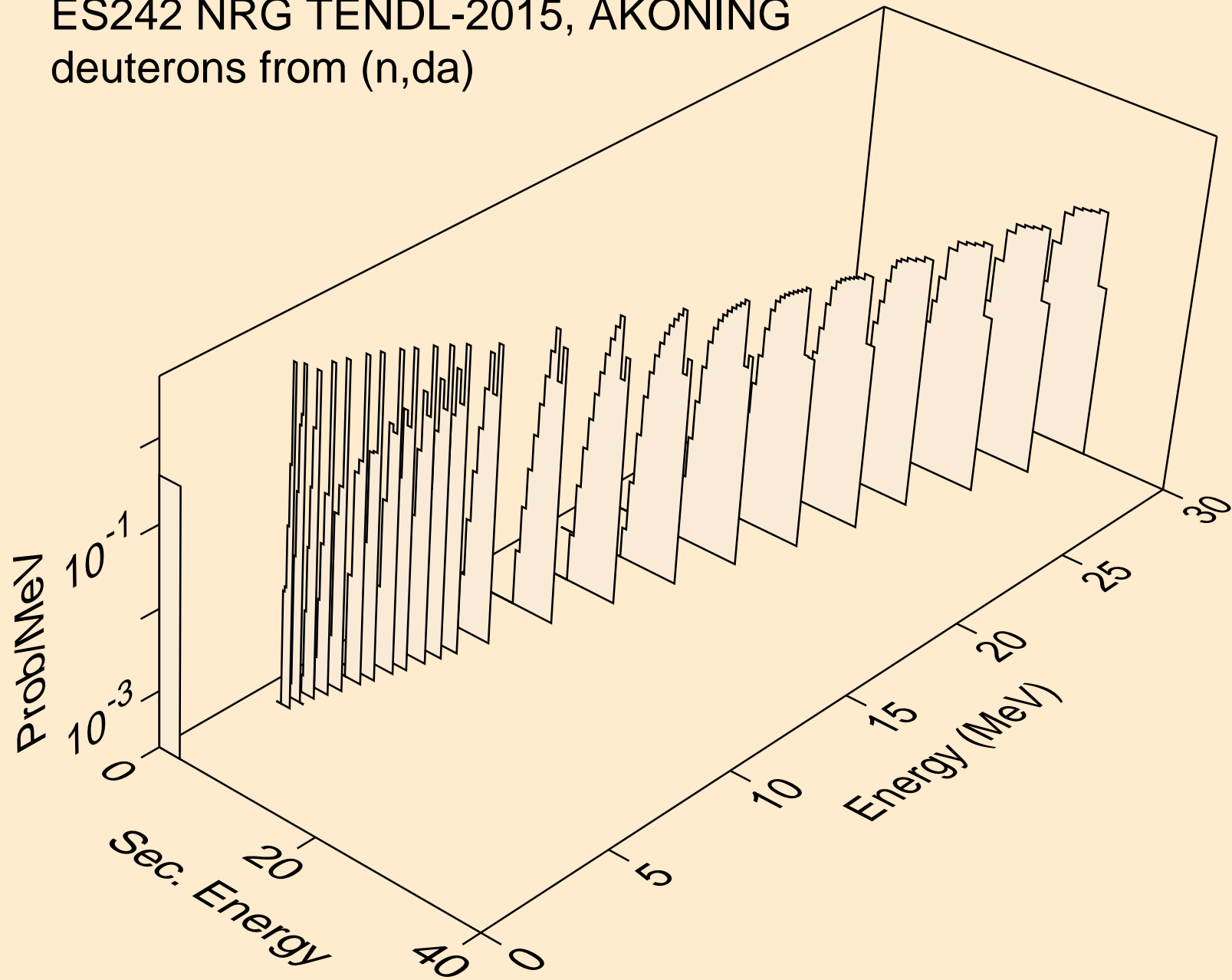

ES242 NRG TENDL-2015, AKONING  
tritons from (n,x)

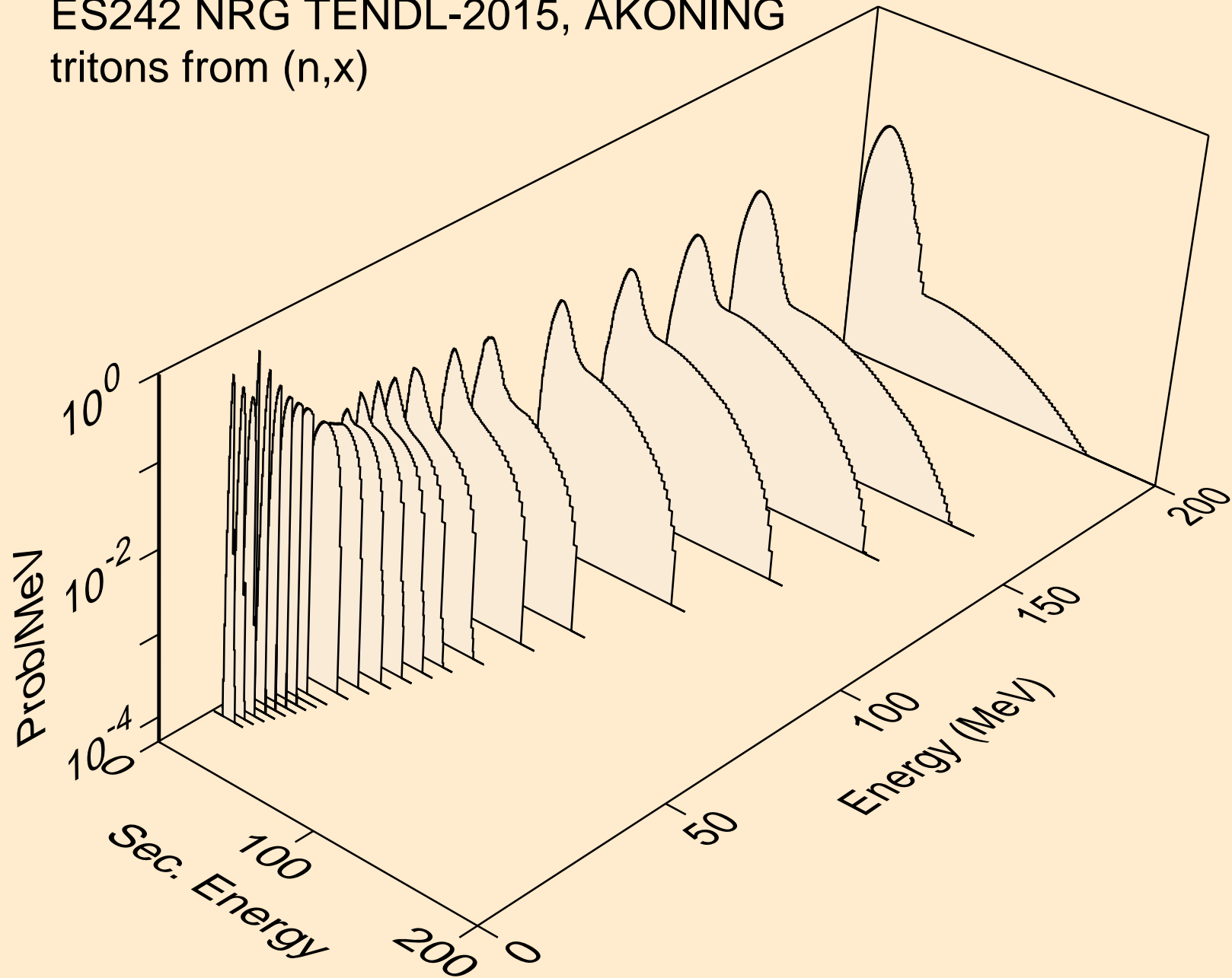

ES242 NRG TENDL-2015, AKONING  
tritons from (n,n\*)t

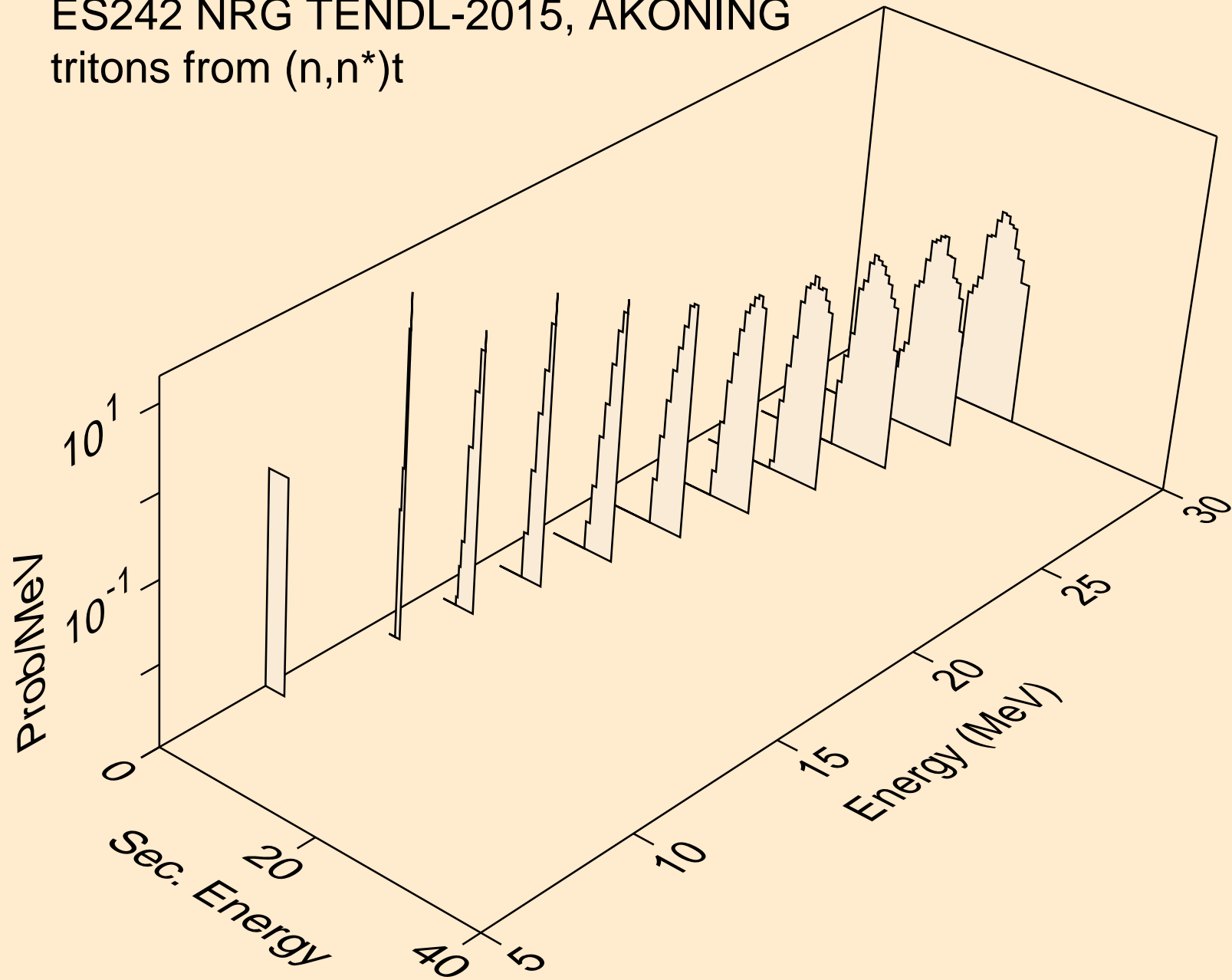

ES242 NRG TENDL-2015, AKONING  
tritons from (n,t)

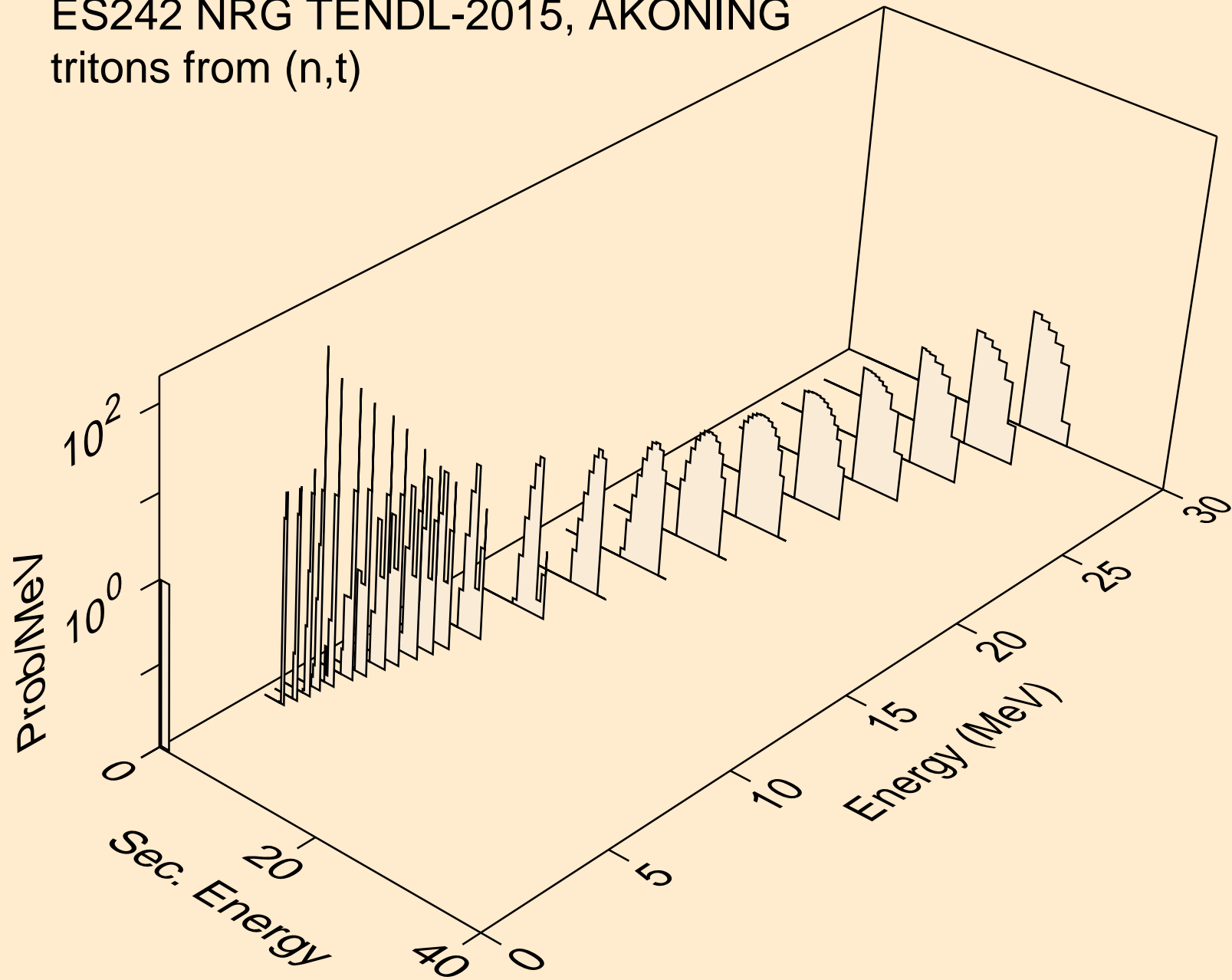



ES242 NRG TENDL-2015, AKONING  
tritons from (n,t2a)

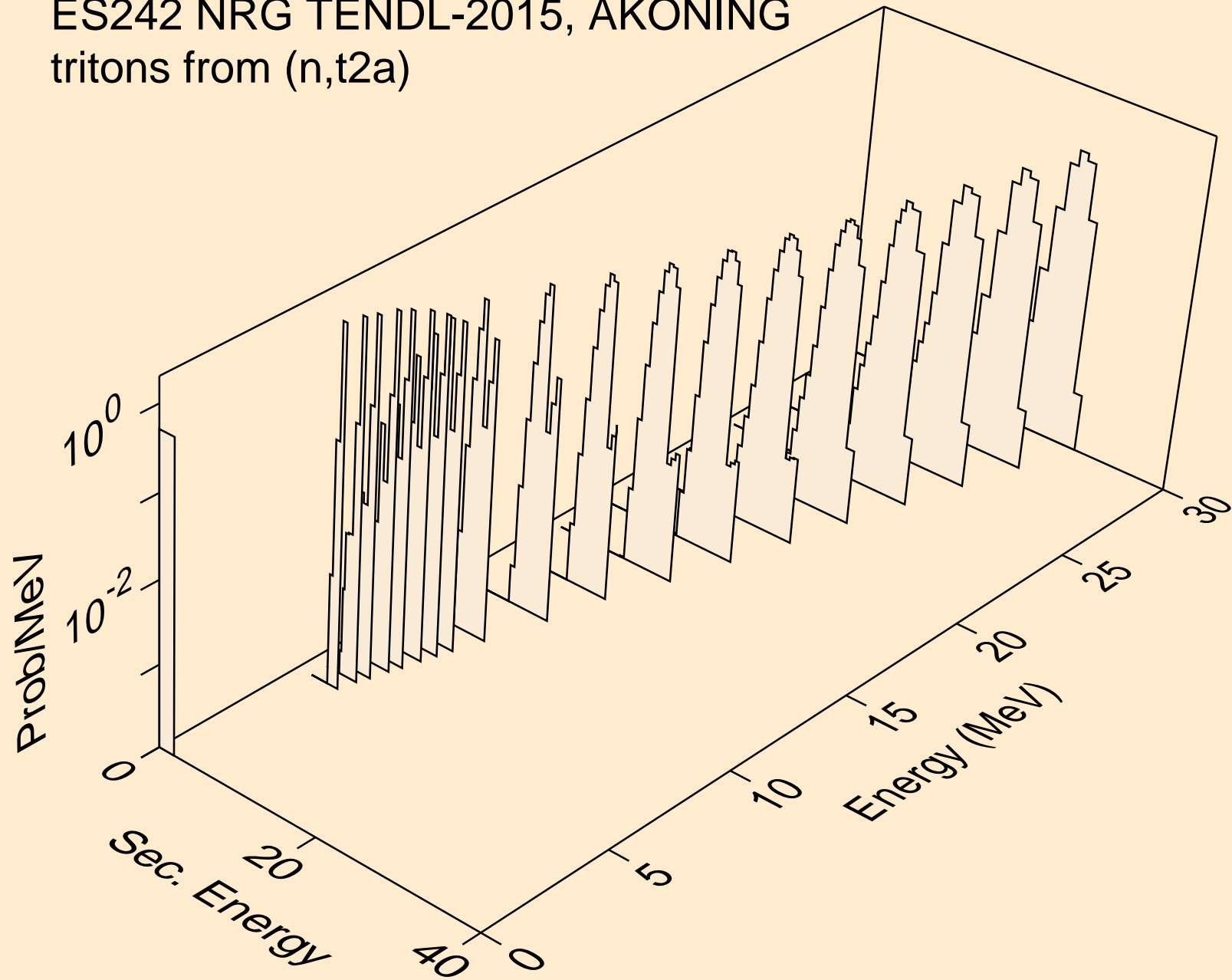

ES242 NRG TENDL-2015, AKONING  
tritons from (n,pt)

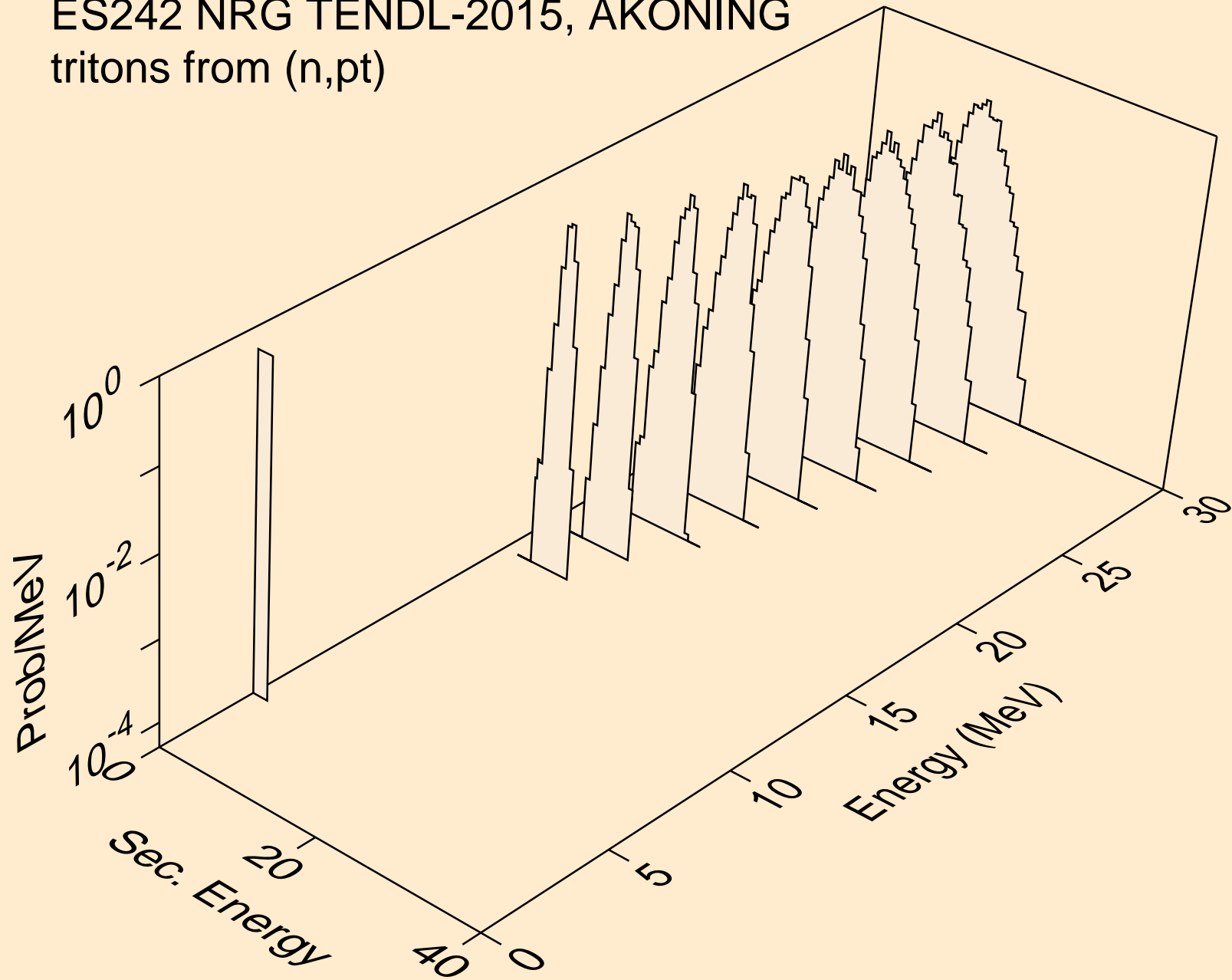

ES242 NRG TENDL-2015, AKONING  
he3s from (n,x)

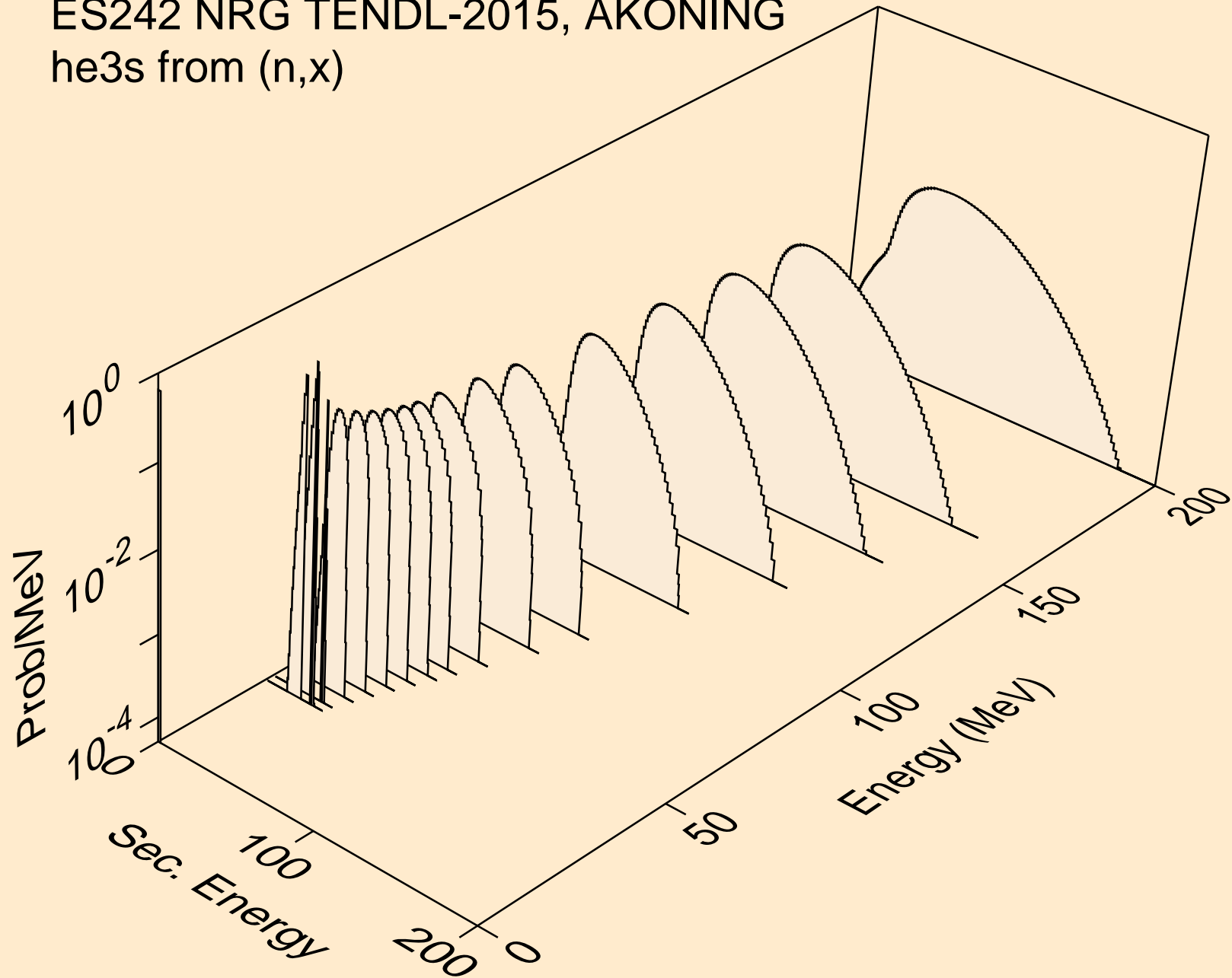

ES242 NRG TENDL-2015, AKONING  
he3s from (n,n\*)he3

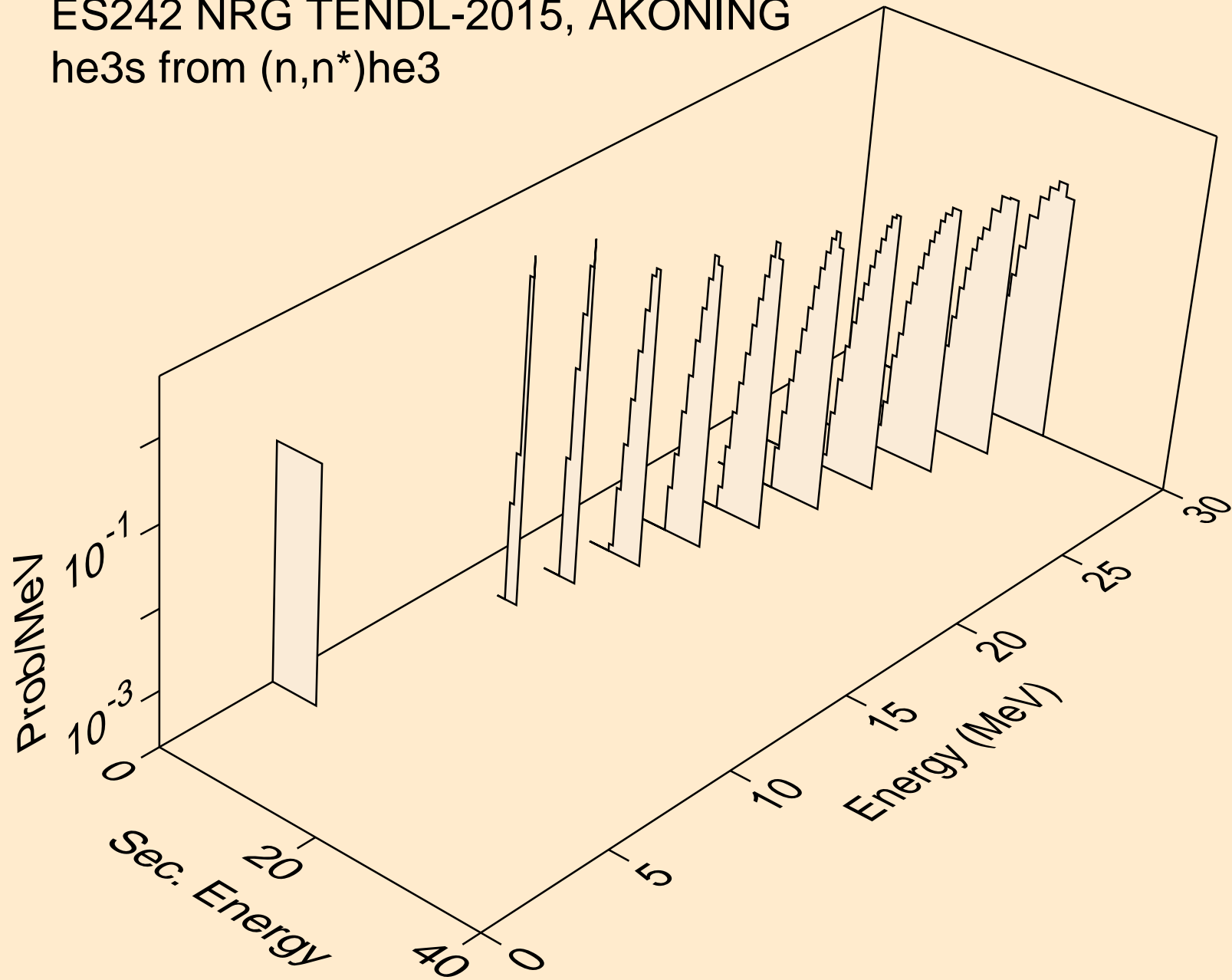

ES242 NRG TENDL-2015, AKONING  
he3s from (n,he3)

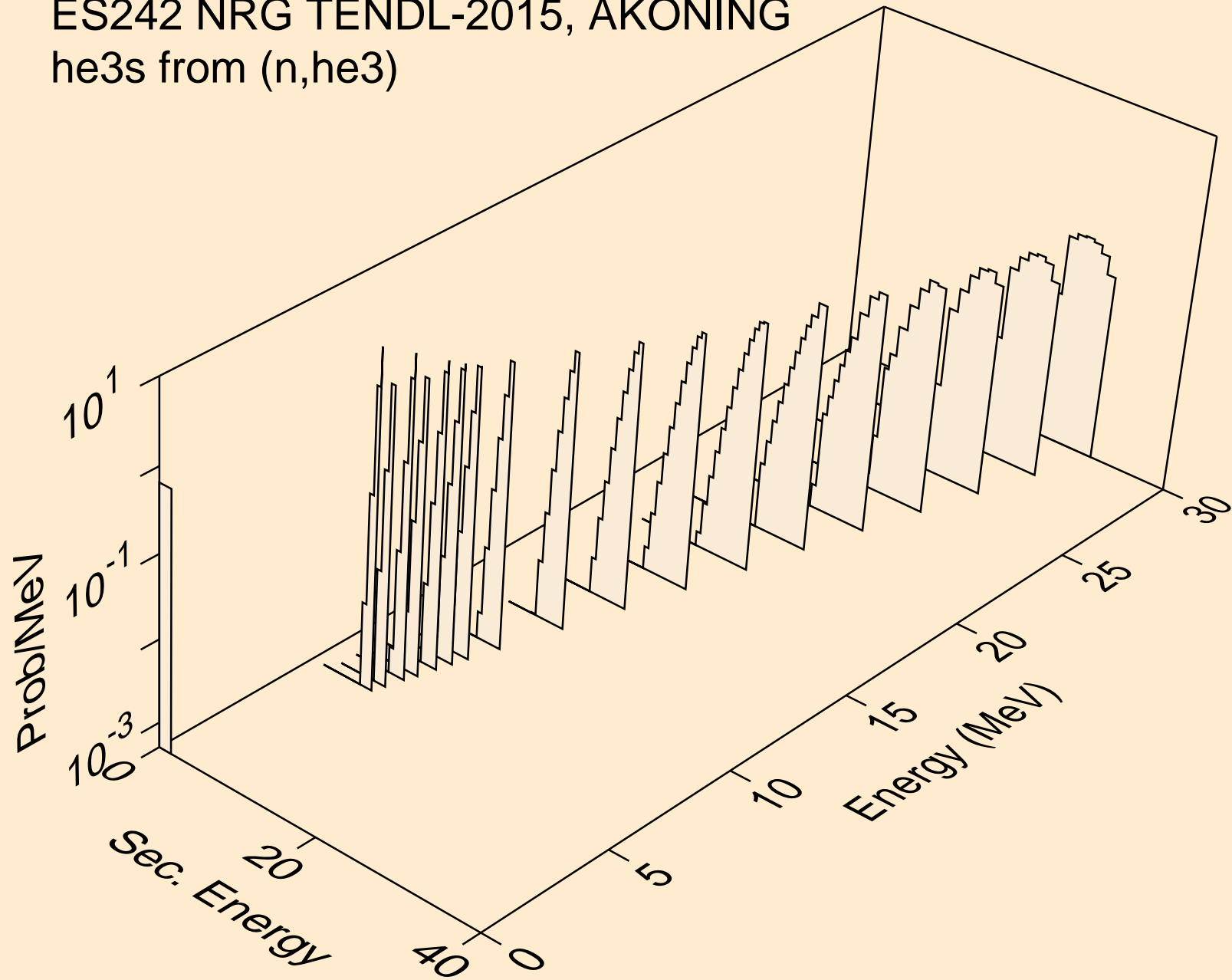

ES242 NRG TENDL-2015, AKONING  
alphas from (n,x)

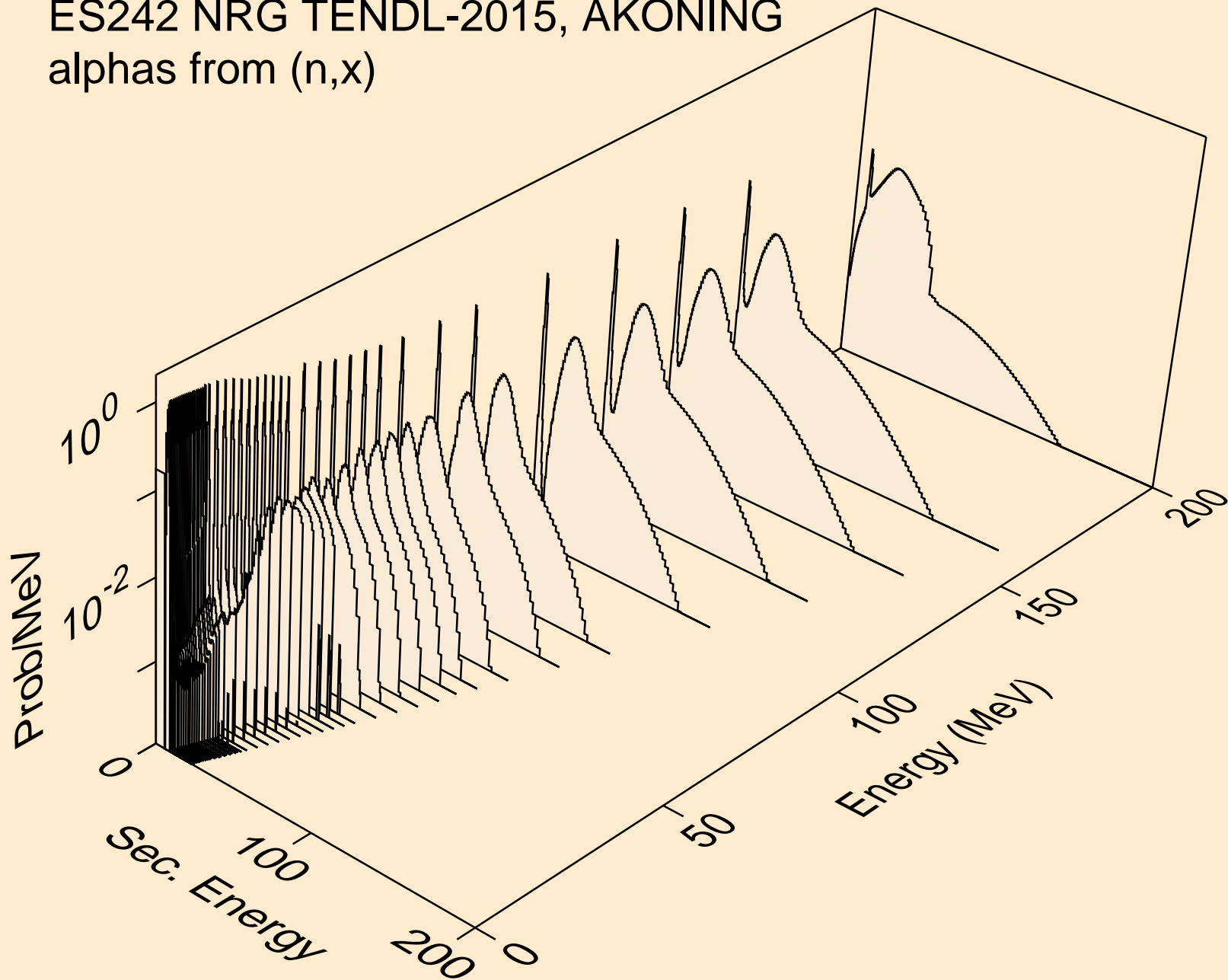

ES242 NRG TENDL-2015, AKONING  
alphas from (n,n\*)a

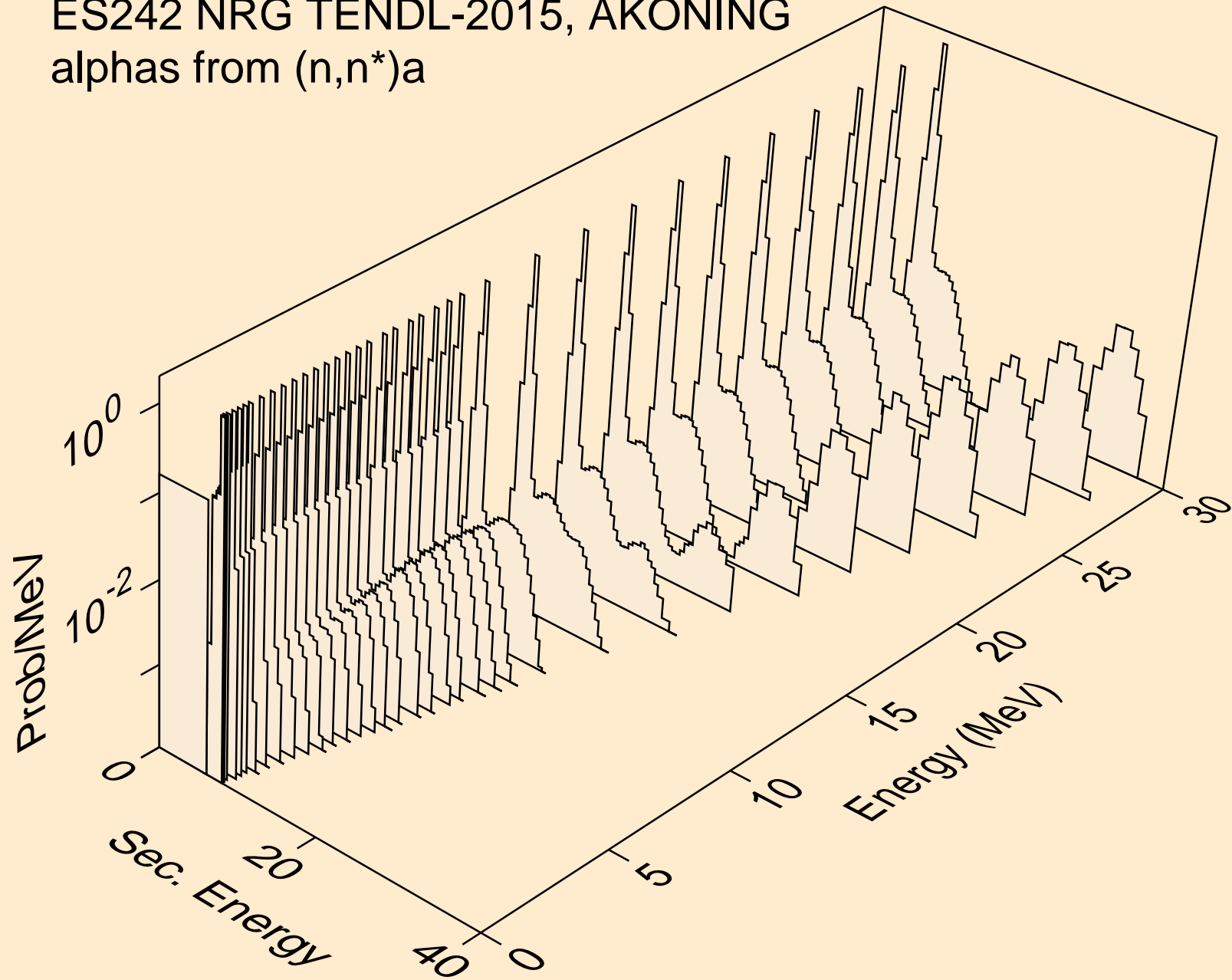

ES242 NRG TENDL-2015, AKONING  
alphas from (n,n\*)3a

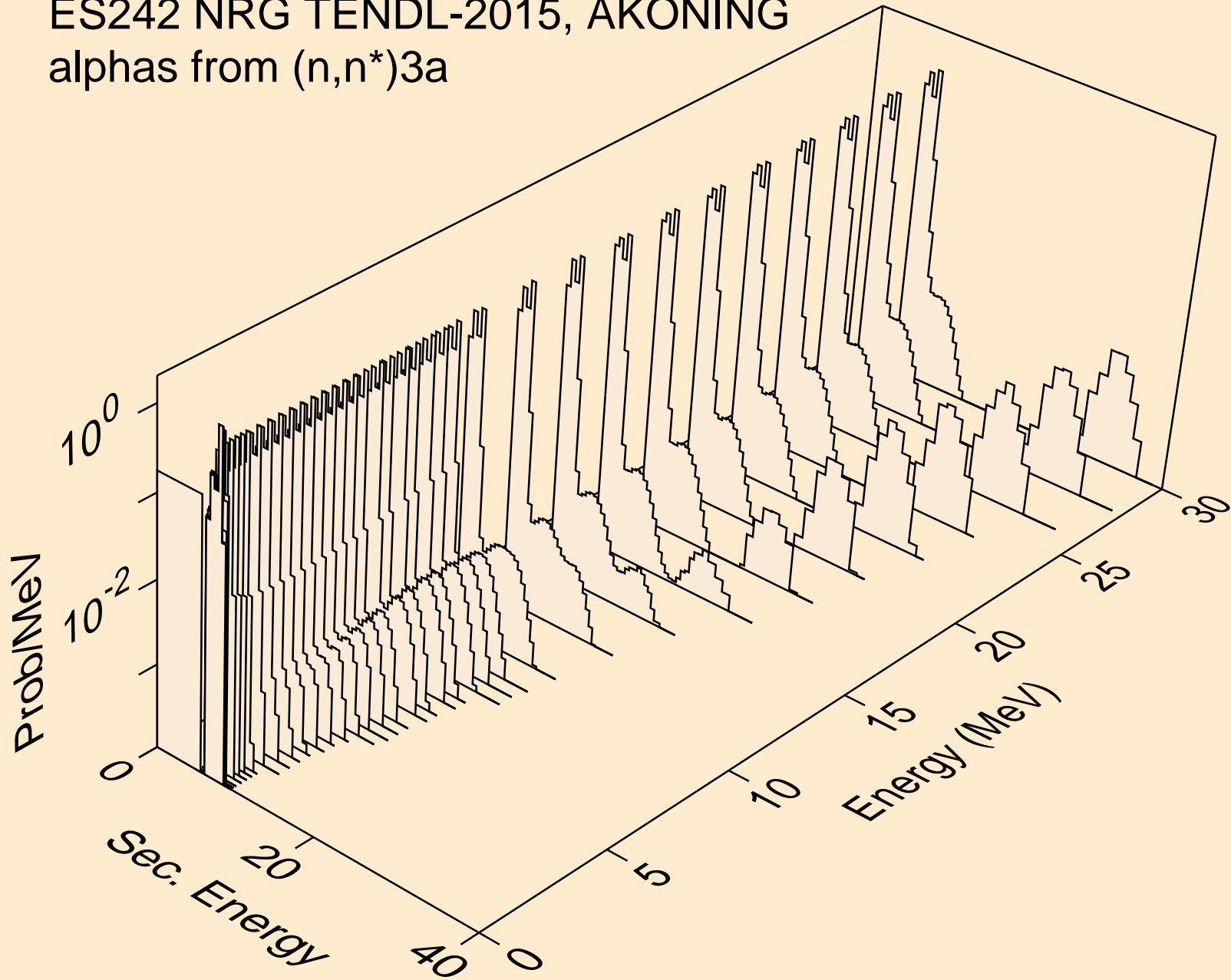



ES242 NRG TENDL-2015, AKONING  
alphas from (n,2n)a

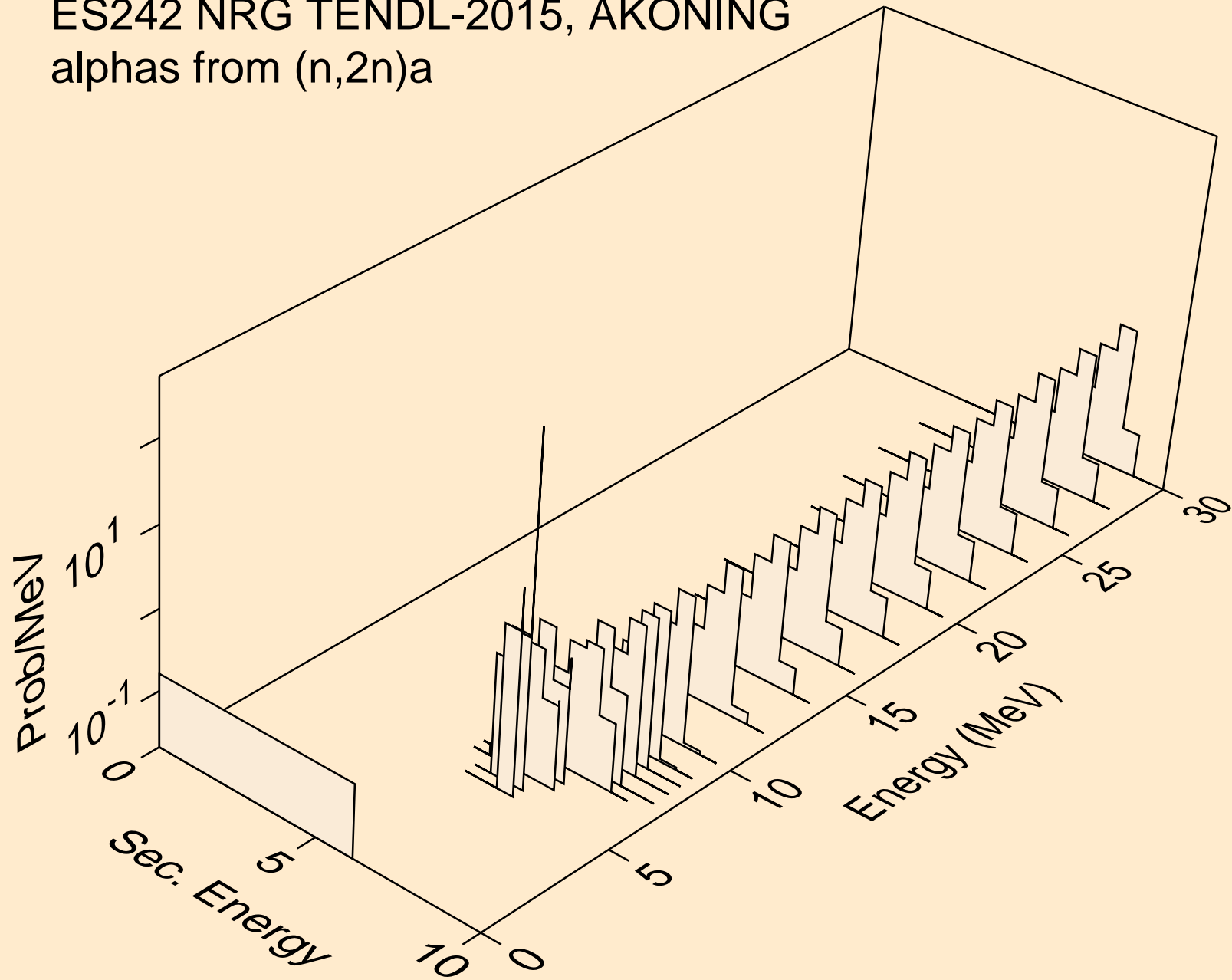

ES242 NRG TENDL-2015, AKONING  
alphas from (n,3n)a

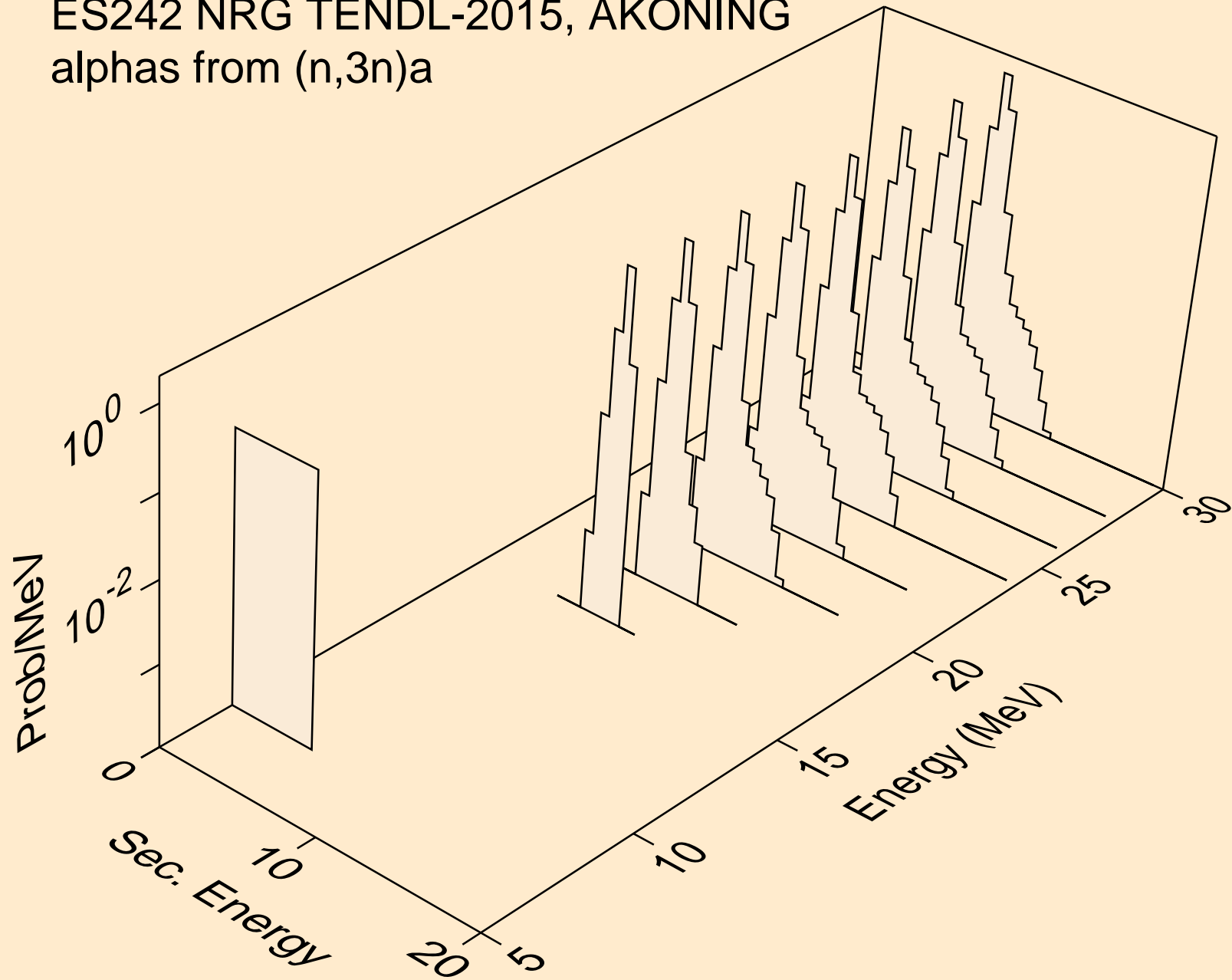

ES242 NRG TENDL-2015, AKONING  
alphas from (n,n\*)2a

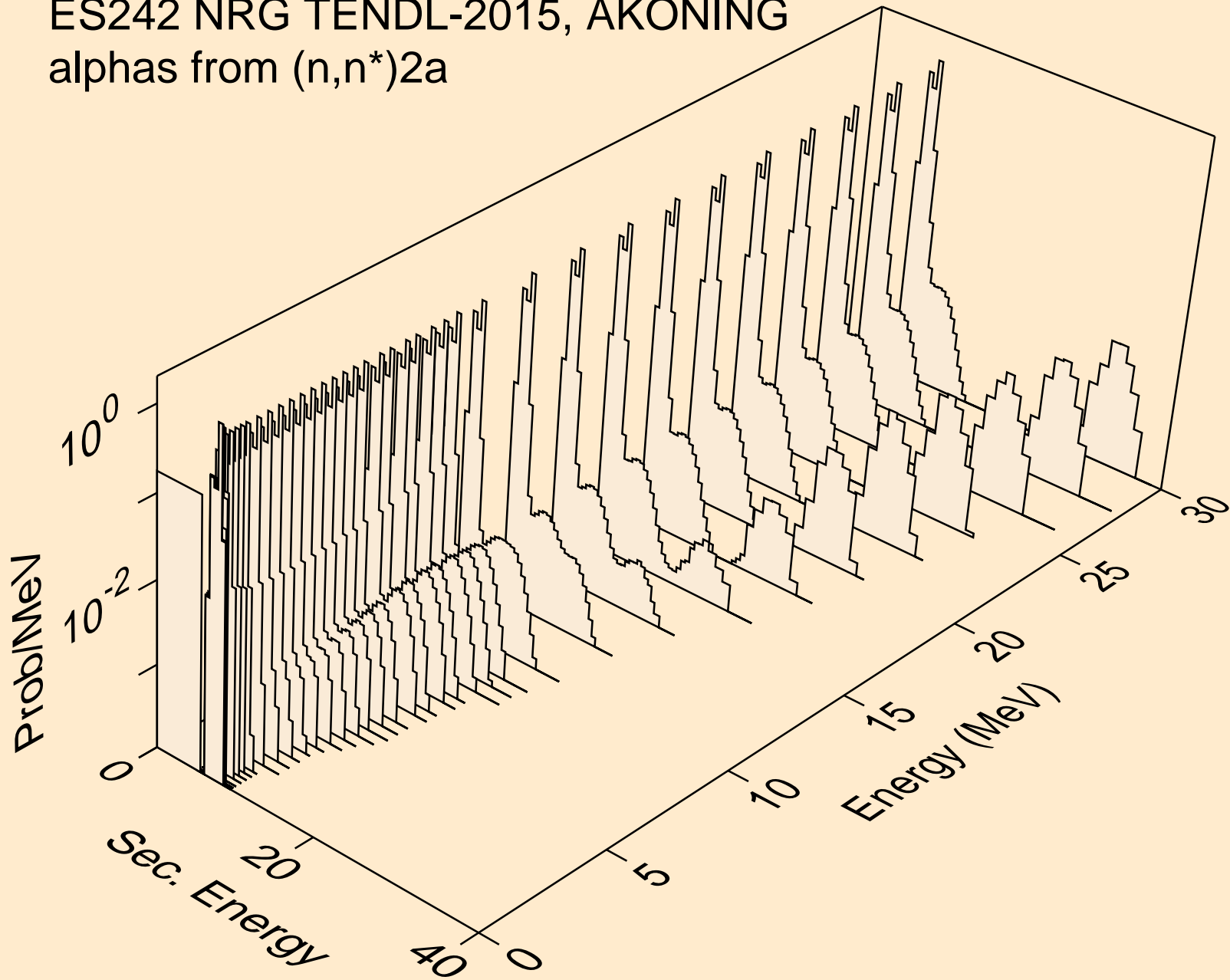

ES242 NRG TENDL-2015, AKONING  
alphas from (n,2n)2a

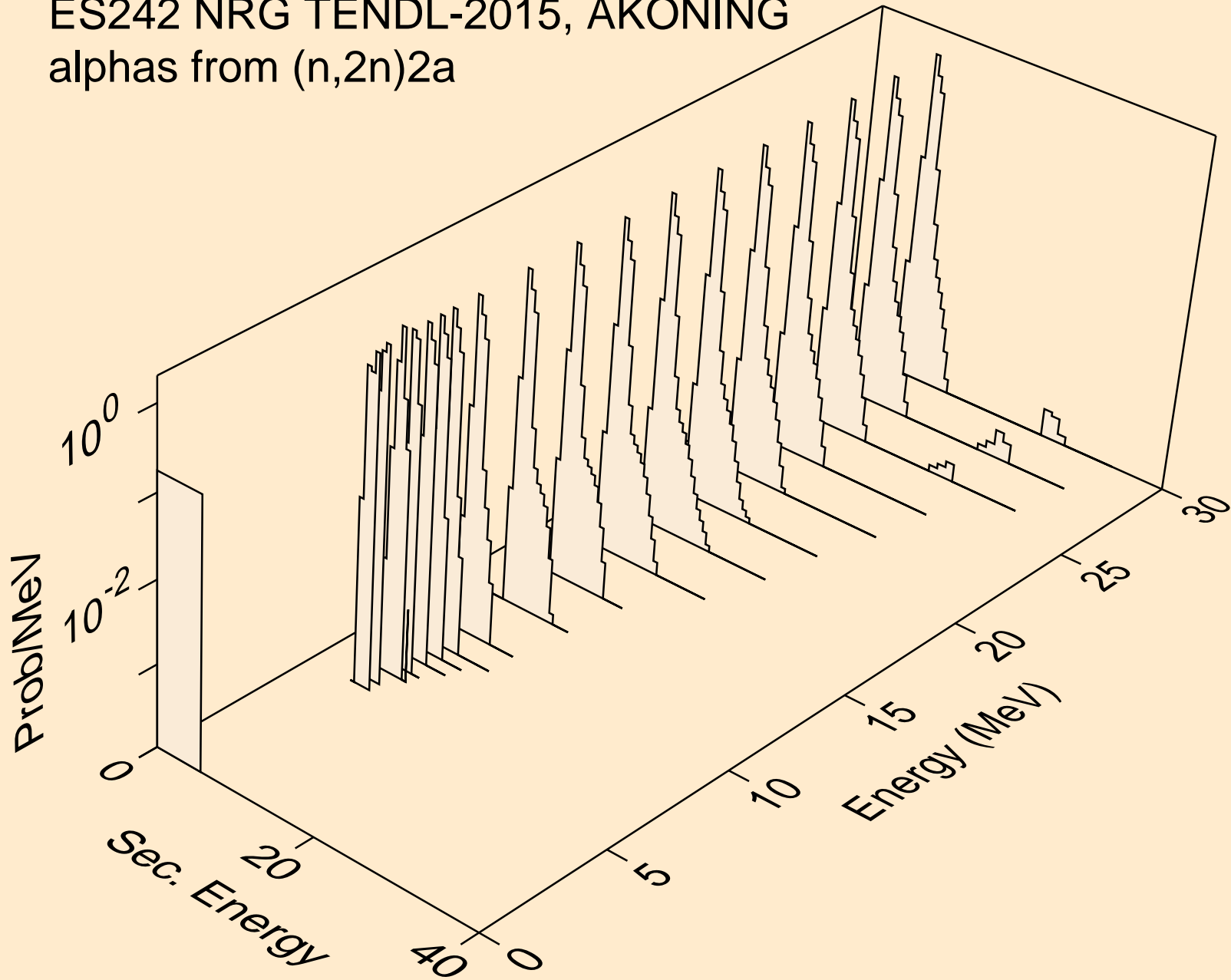

ES242 NRG TENDL-2015, AKONING  
alphas from (n,n\*)d2a

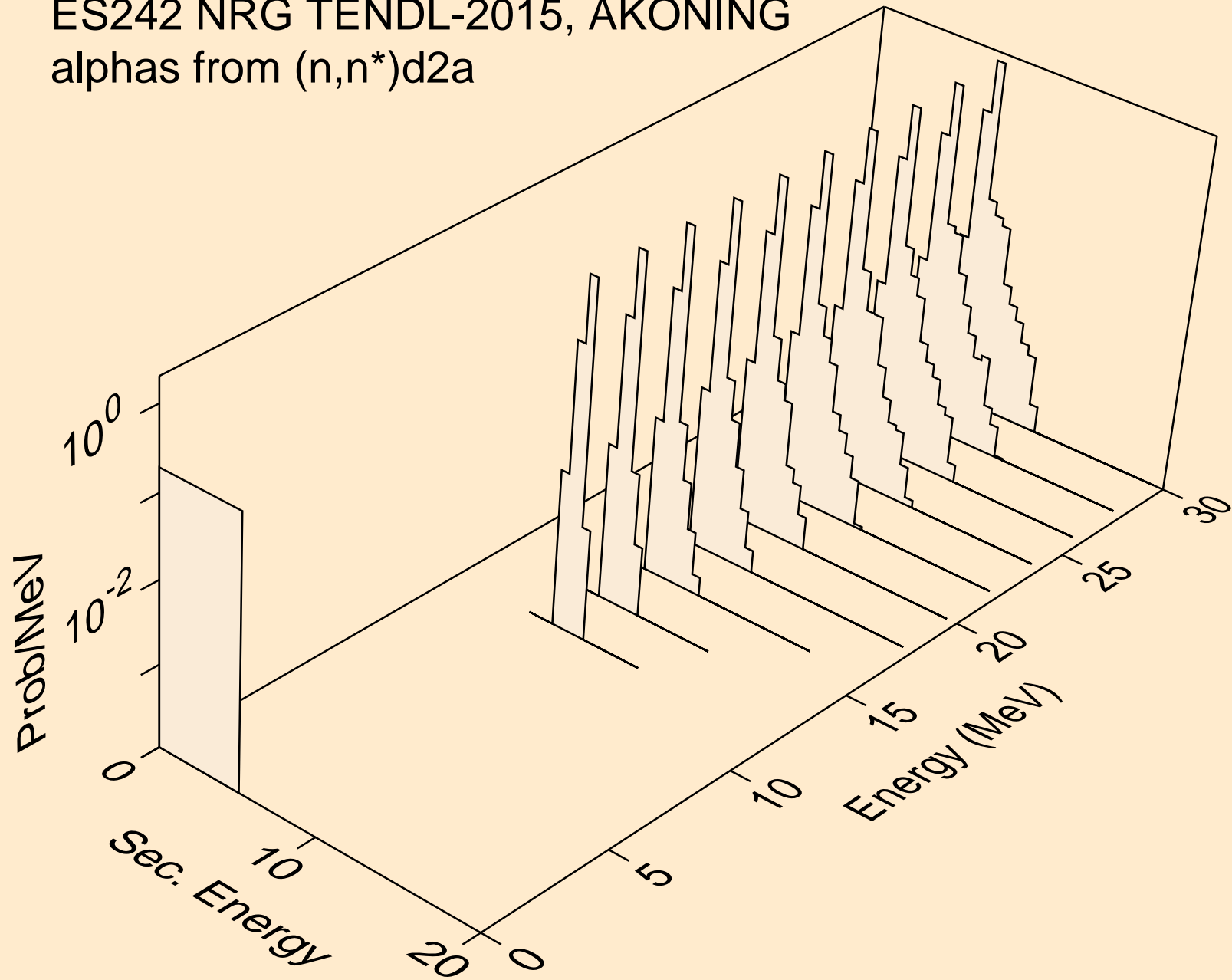

ES242 NRG TENDL-2015, AKONING  
alphas from (n,npa)

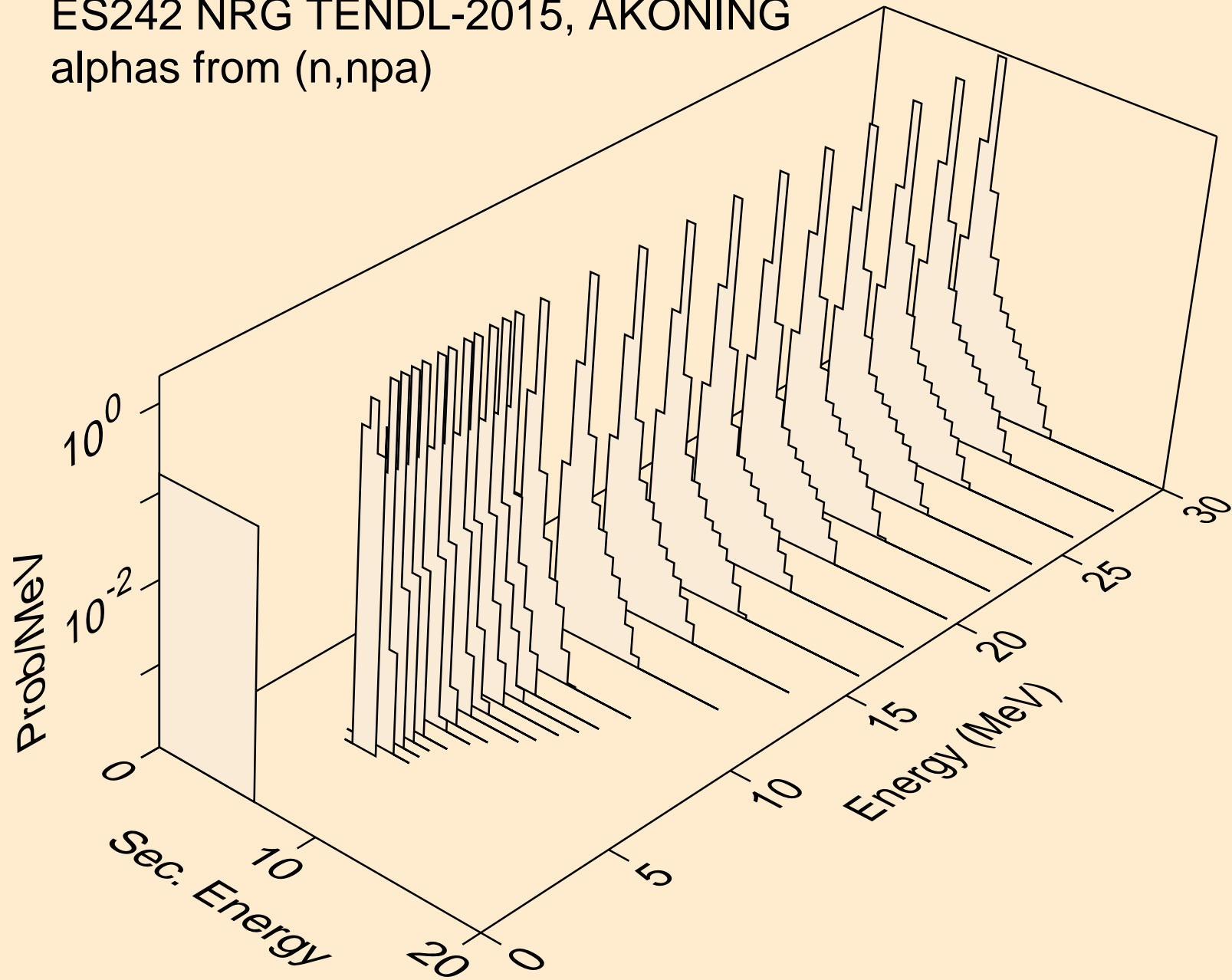

ES242 NRG TENDL-2015, AKONING  
alphas from (n,a)

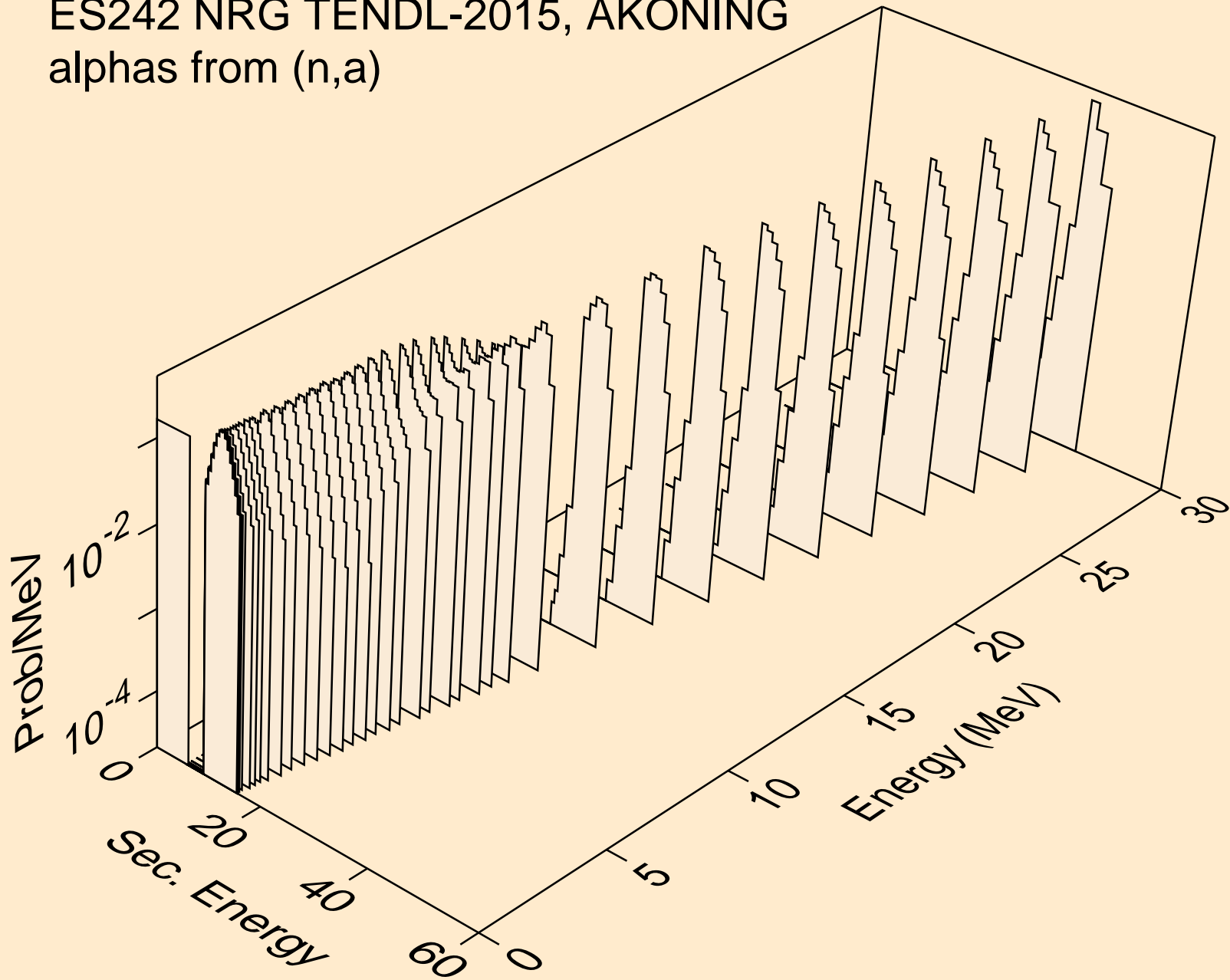

ES242 NRG TENDL-2015, AKONING  
alphas from (n,2a)

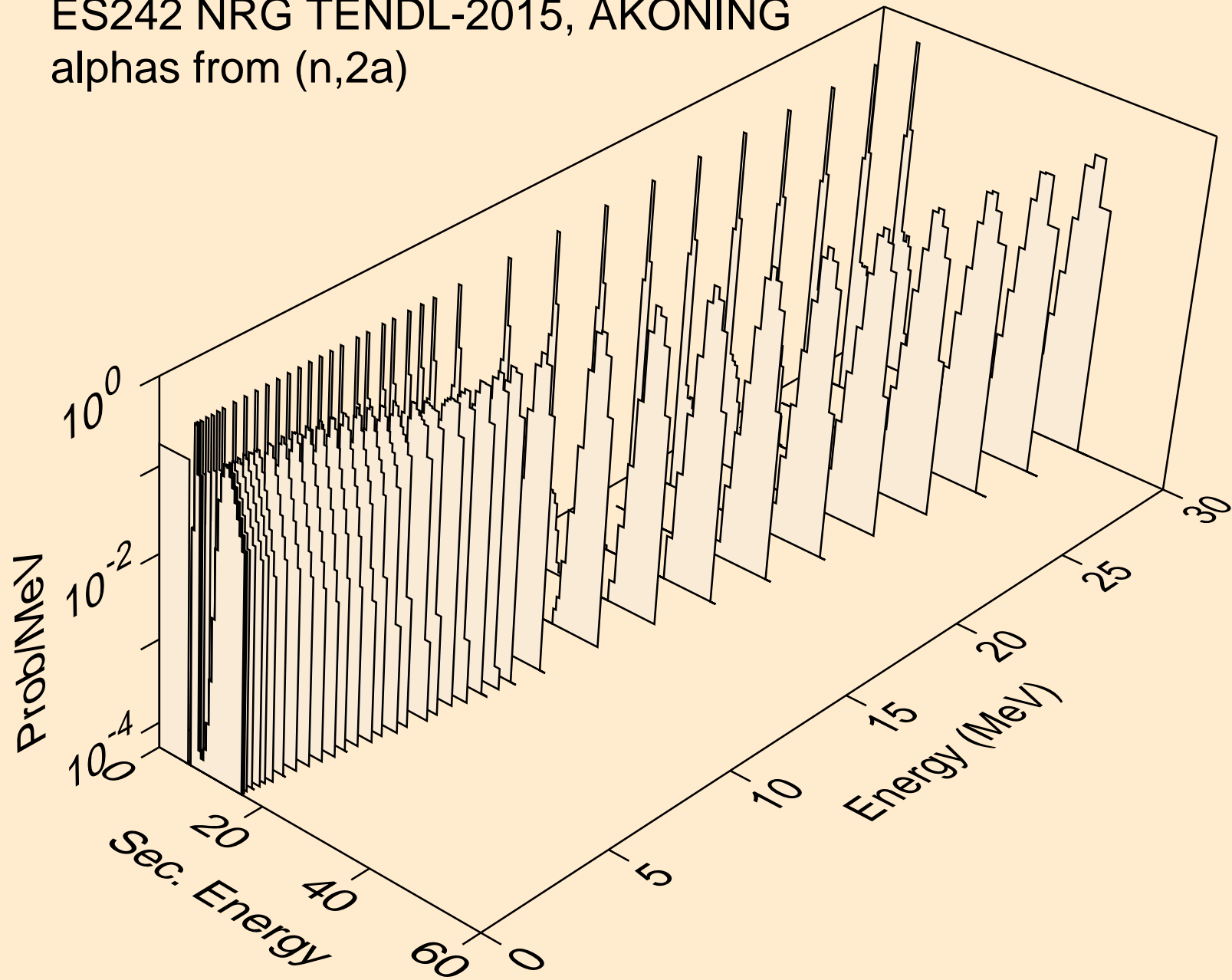



ES242 NRG TENDL-2015, AKONING  
alphas from (n,3a)

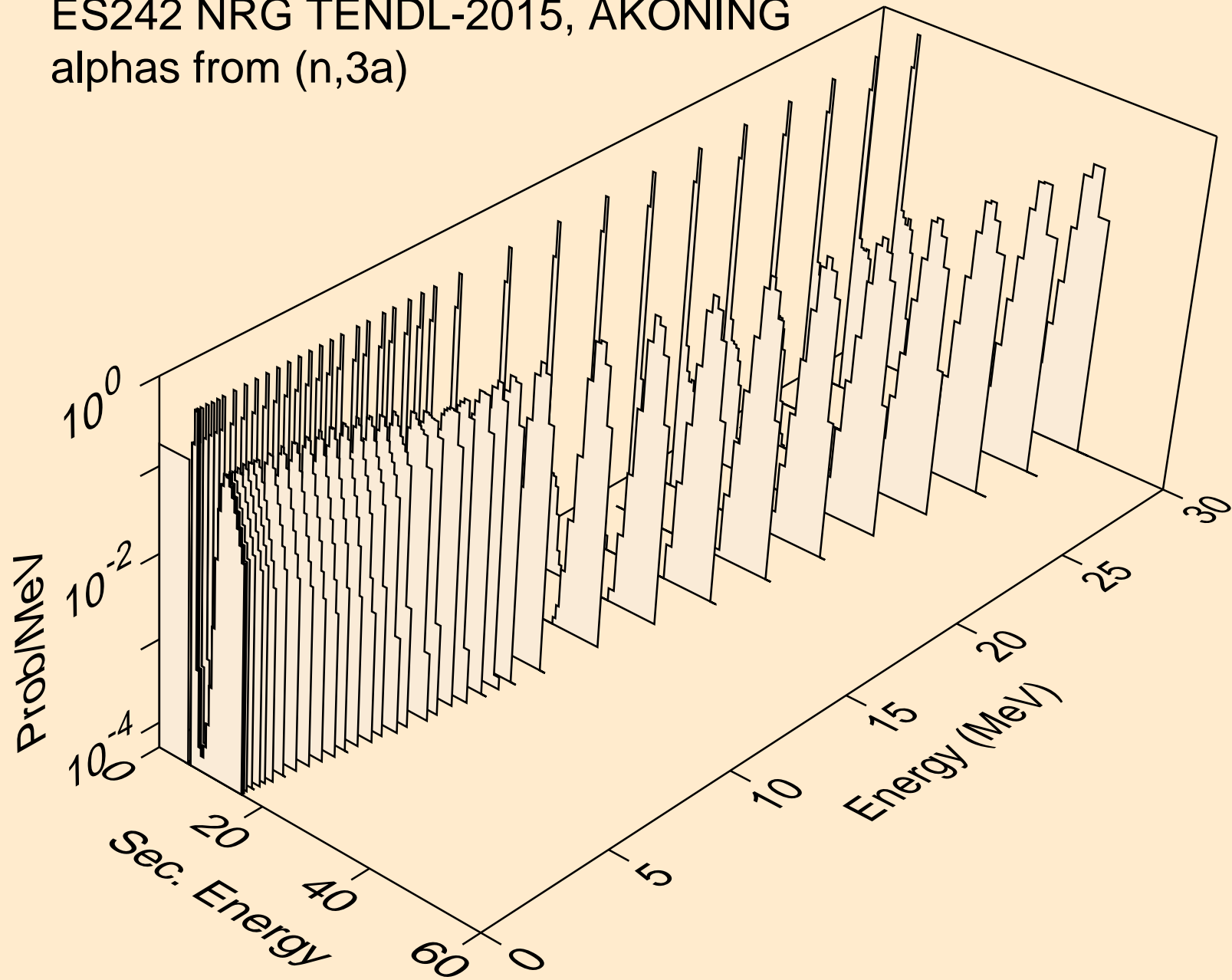

ES242 NRG TENDL-2015, AKONING  
alphas from (n,pa)

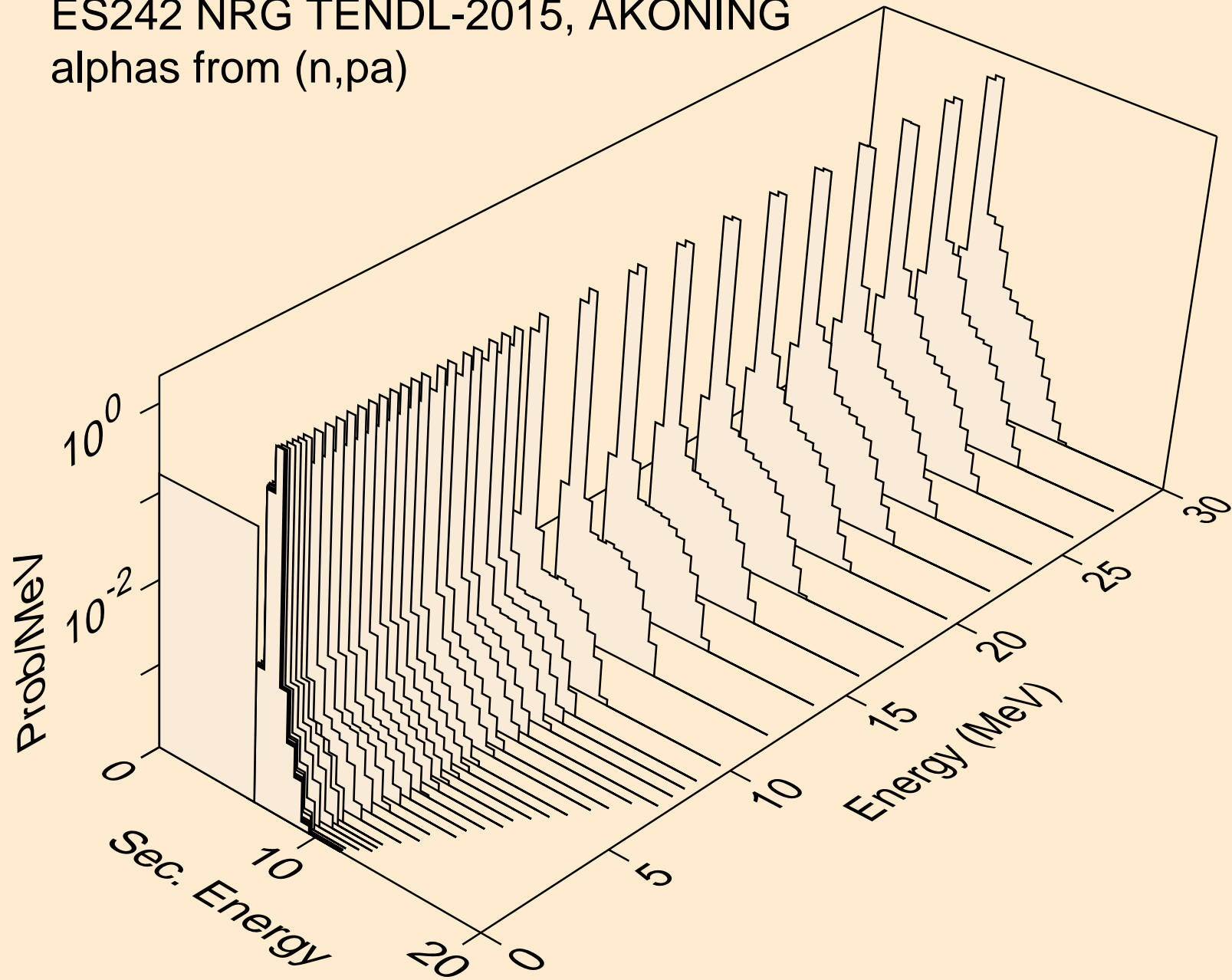

ES242 NRG TENDL-2015, AKONING  
alphas from (n,t2a)

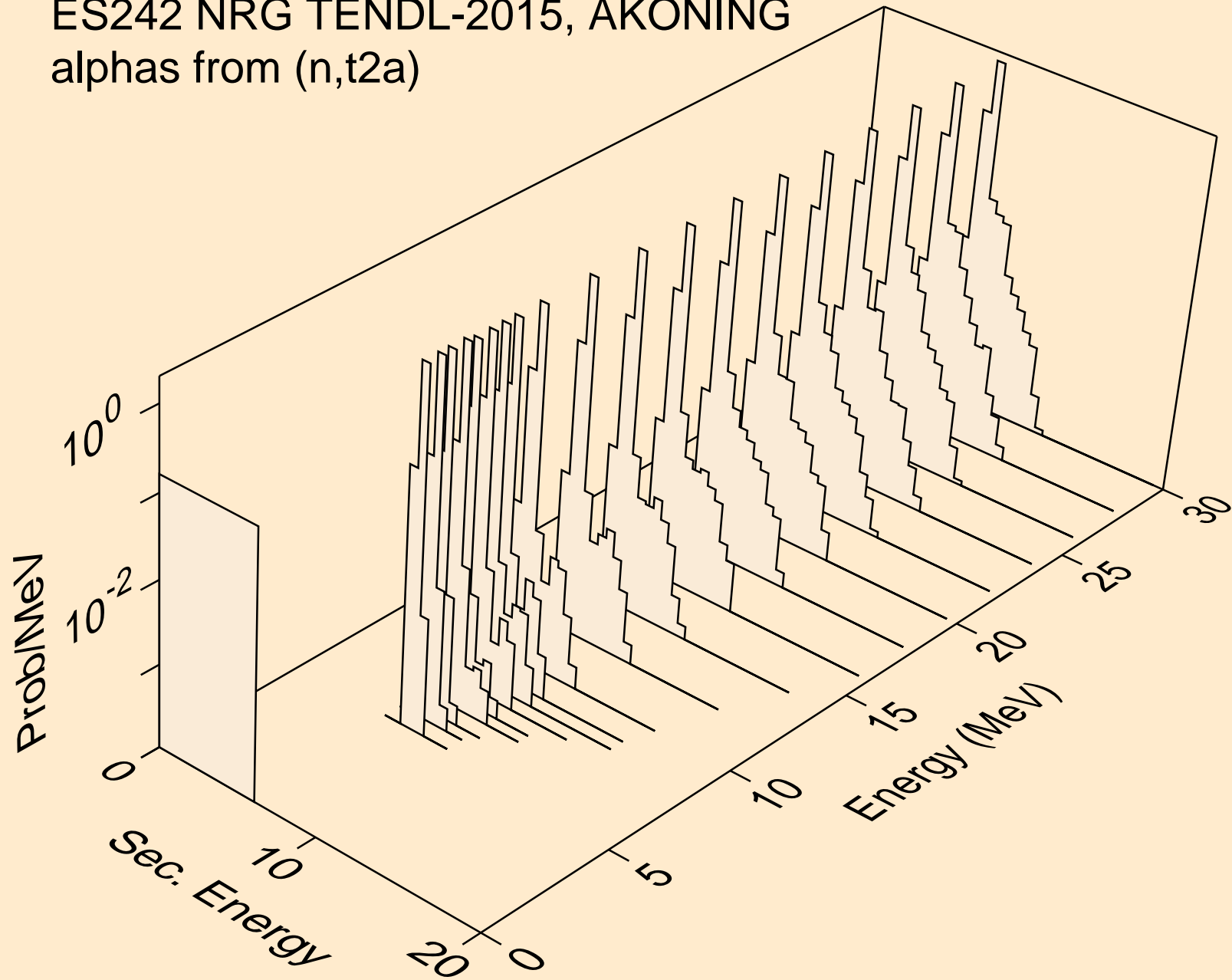

ES242 NRG TENDL-2015, AKONING  
alphas from (n,d2a)

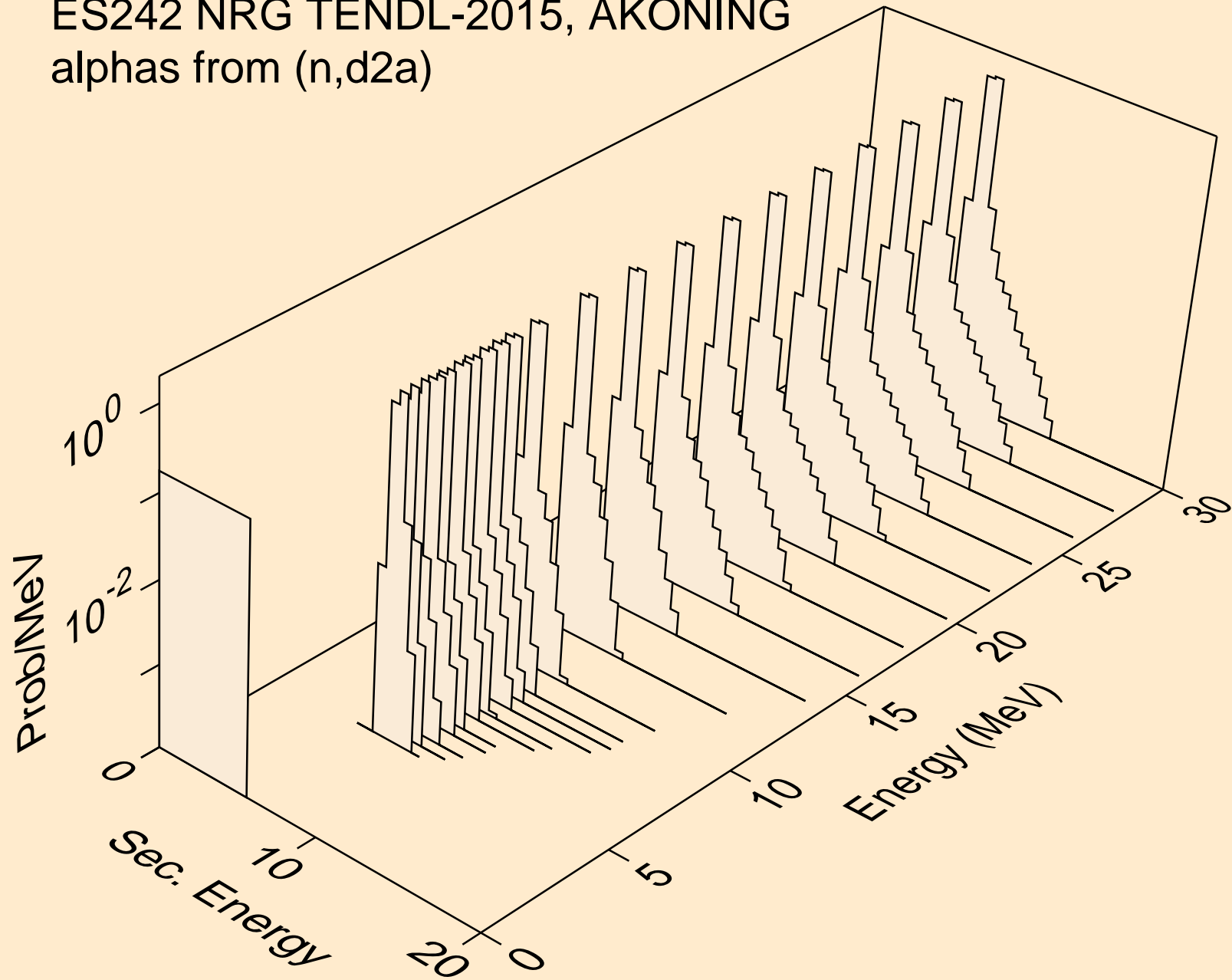

ES242 NRG TENDL-2015, AKONING  
alphas from (n,da)

