

EU135 NRG TENDL-2015, AKONING

Principal cross sections

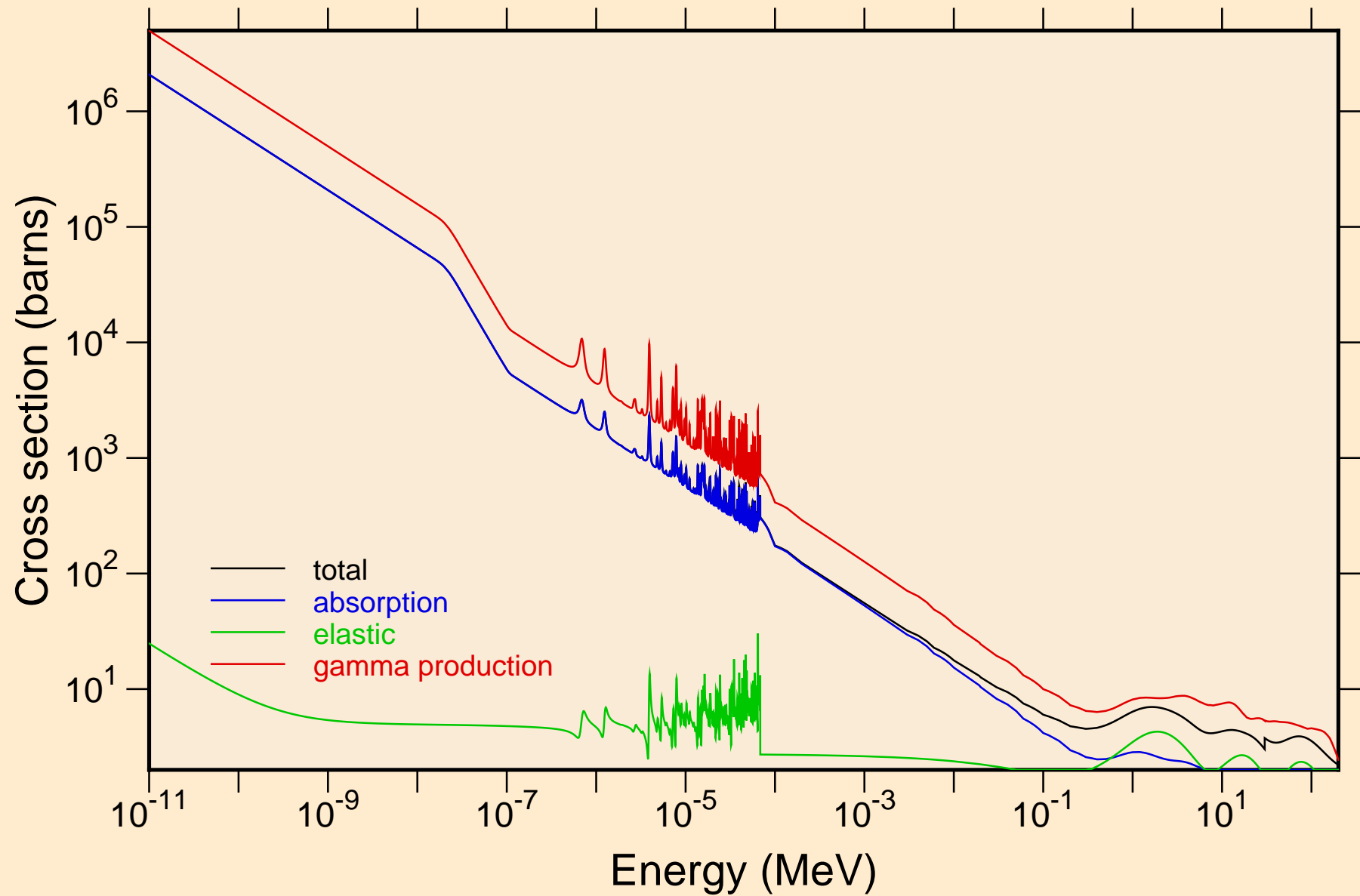

EU135 NRG TENDL-2015, AKONING

resonance total cross section

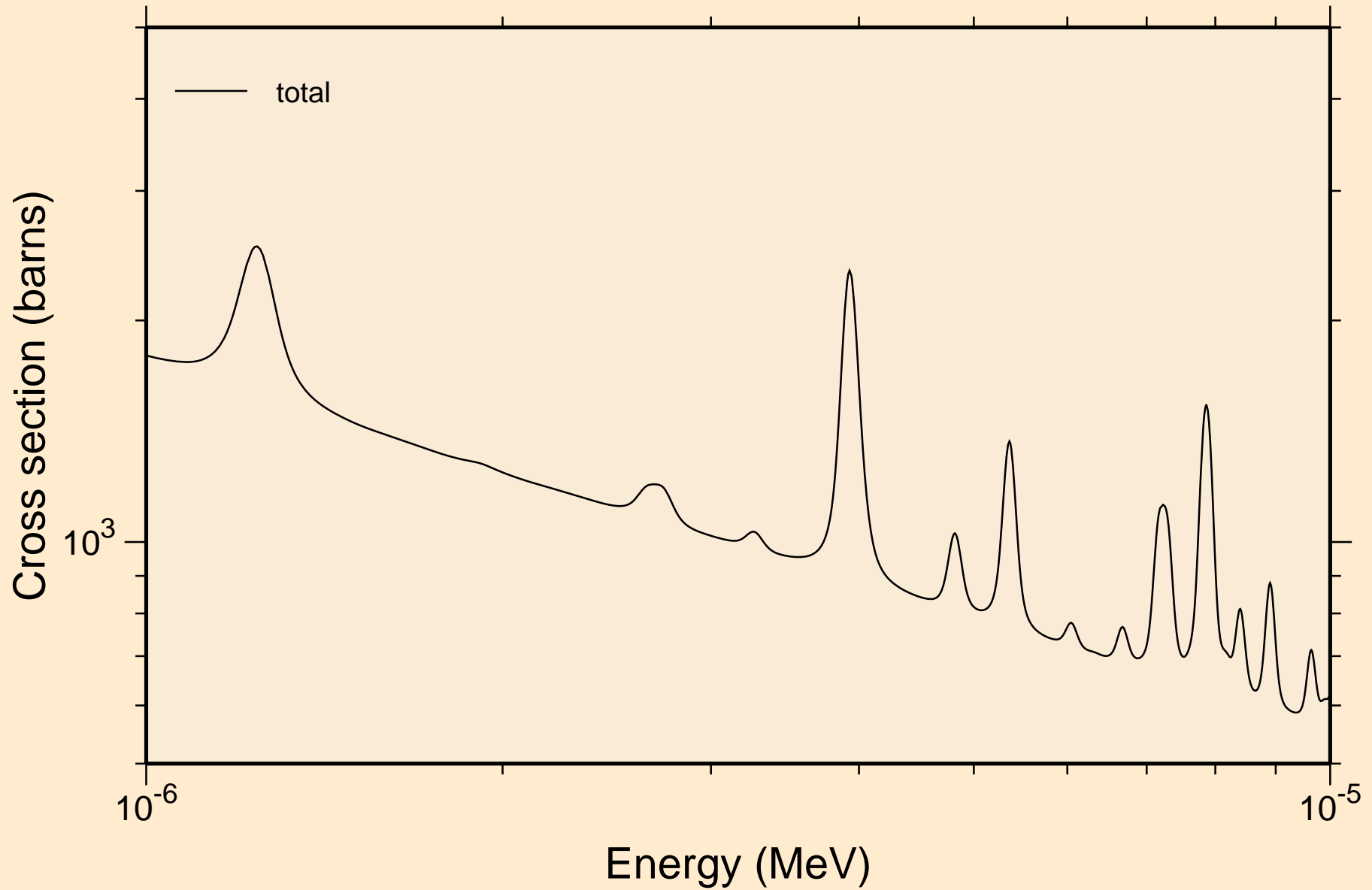

EU135 NRG TENDL-2015, AKONING
resonance total cross section

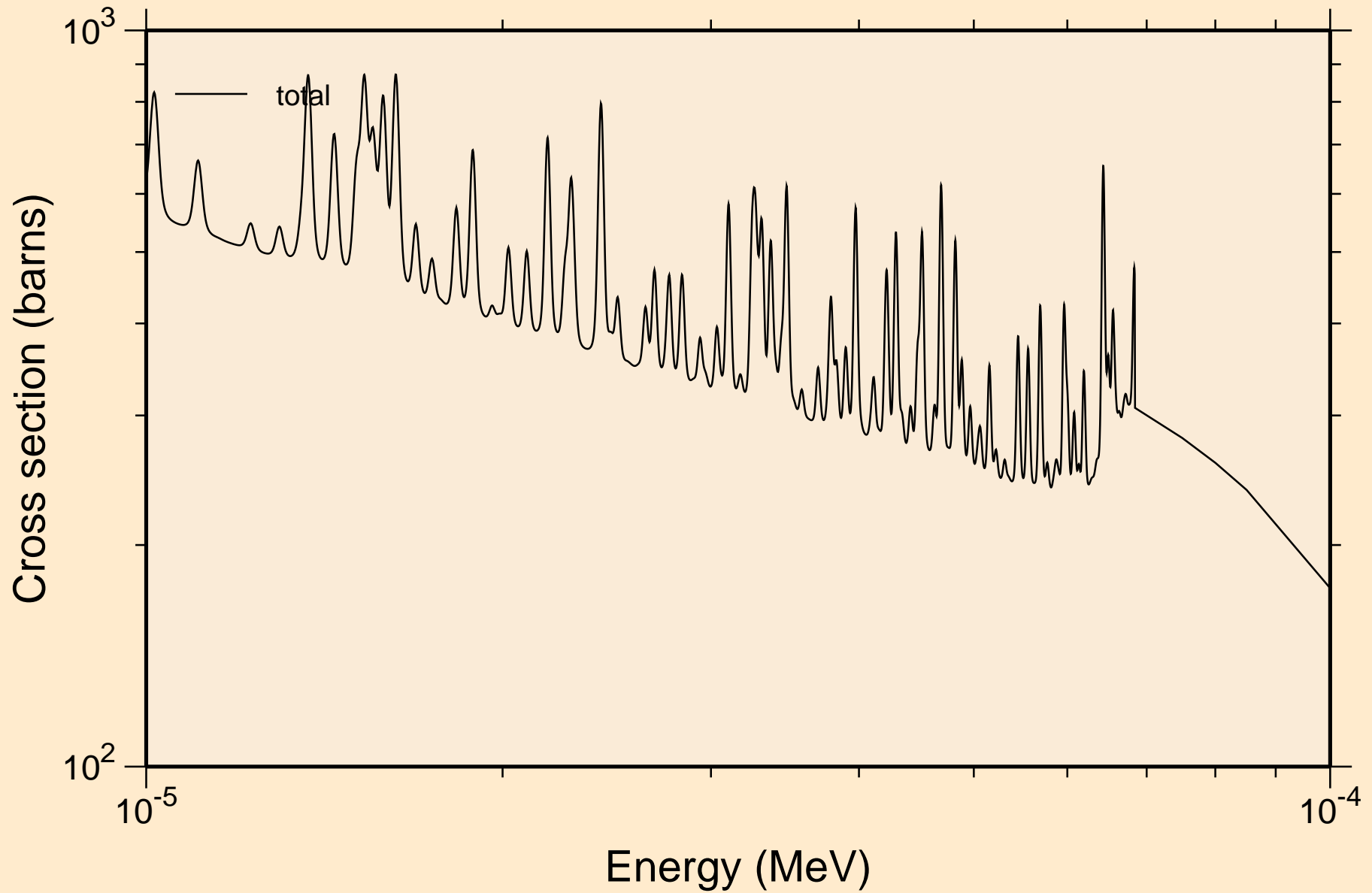

EÜ135 NRG TENDL-2015, AKONING
resonance total cross section

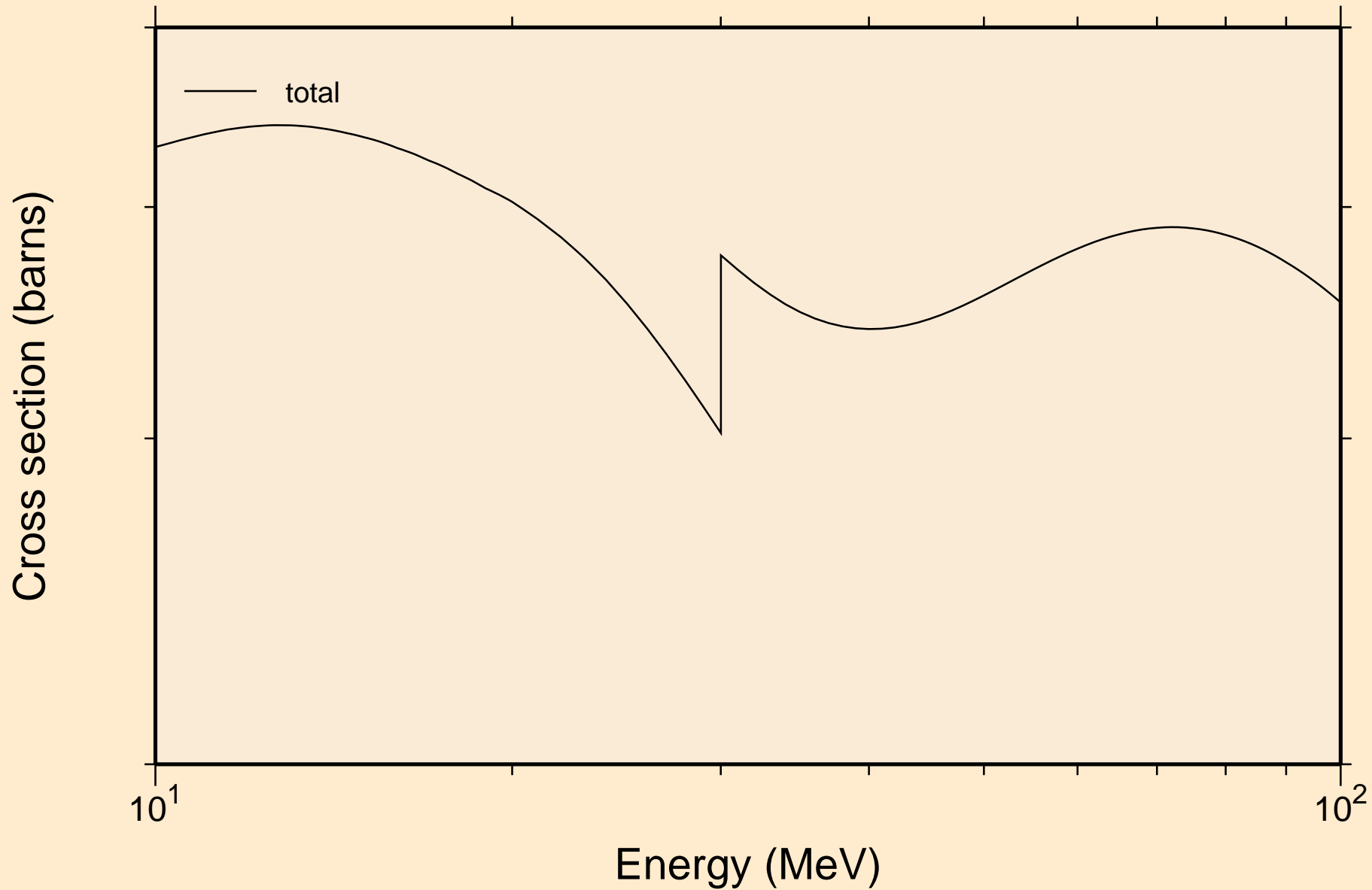

EU135 NRG TENDL-2015, AKONING
resonance absorption cross sections

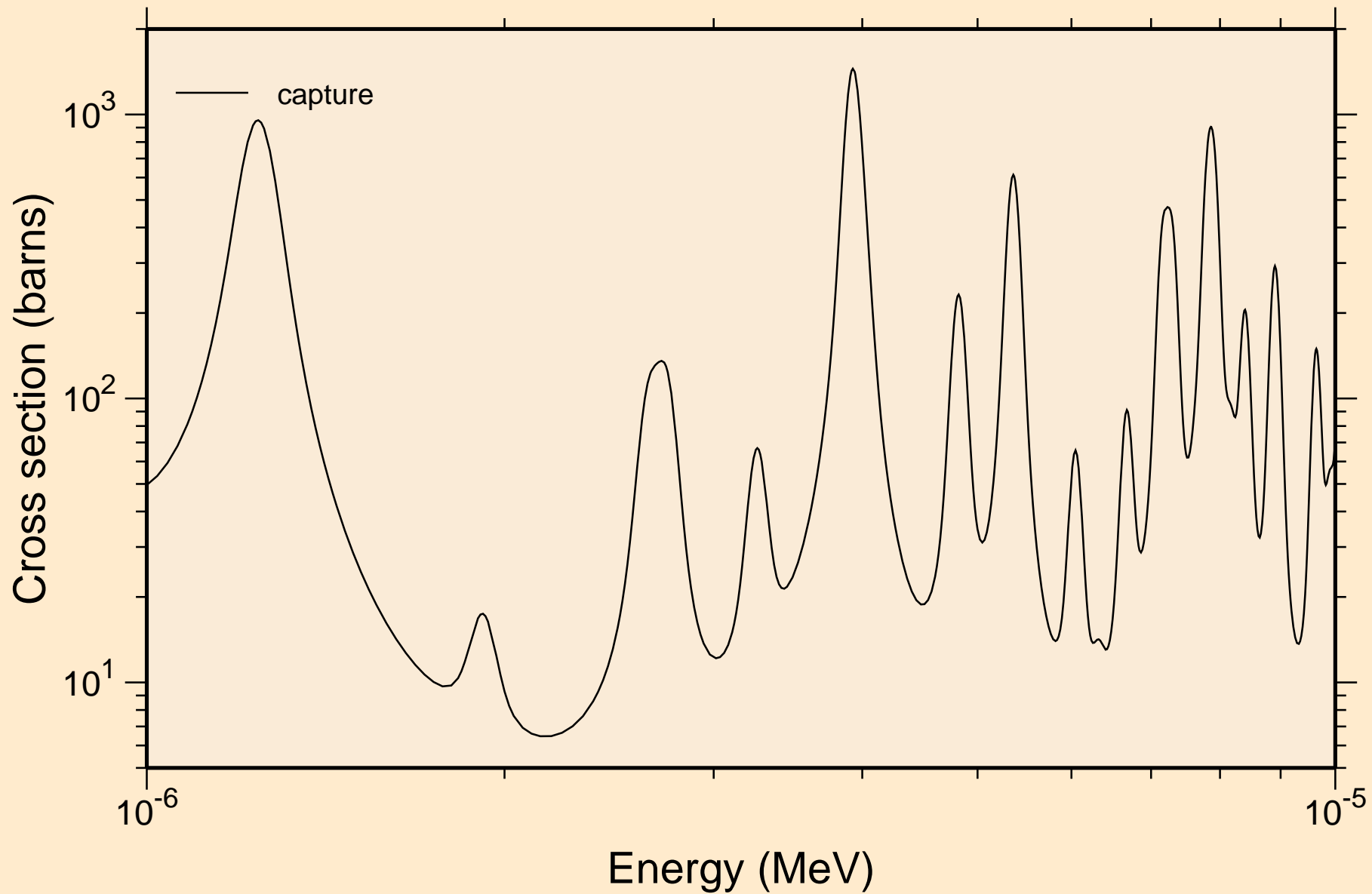

EU135 NRG TENDL-2015, AKONING resonance absorption cross sections

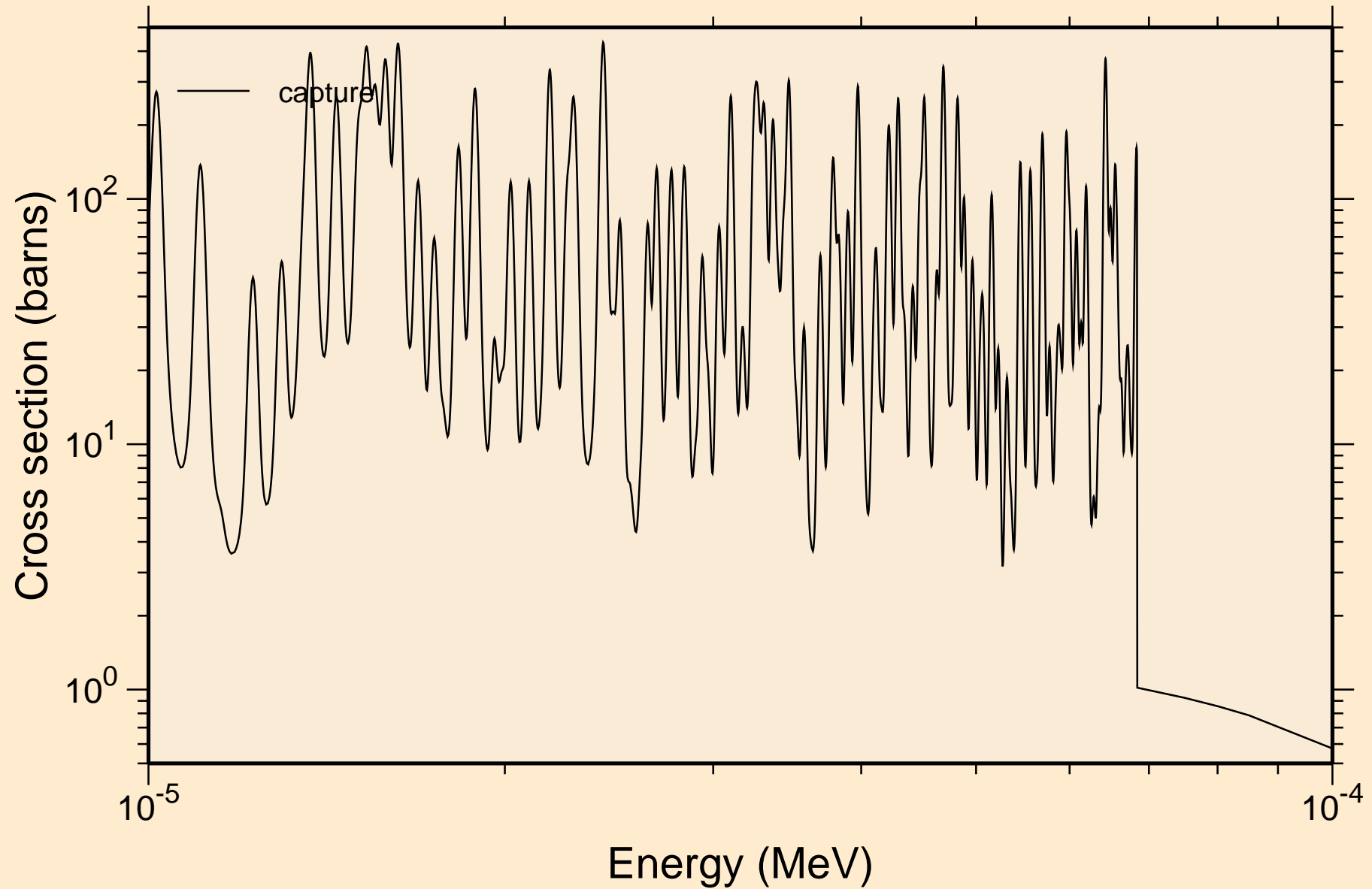

EU135 NRG TENDL-2015, AKONING resonance absorption cross sections

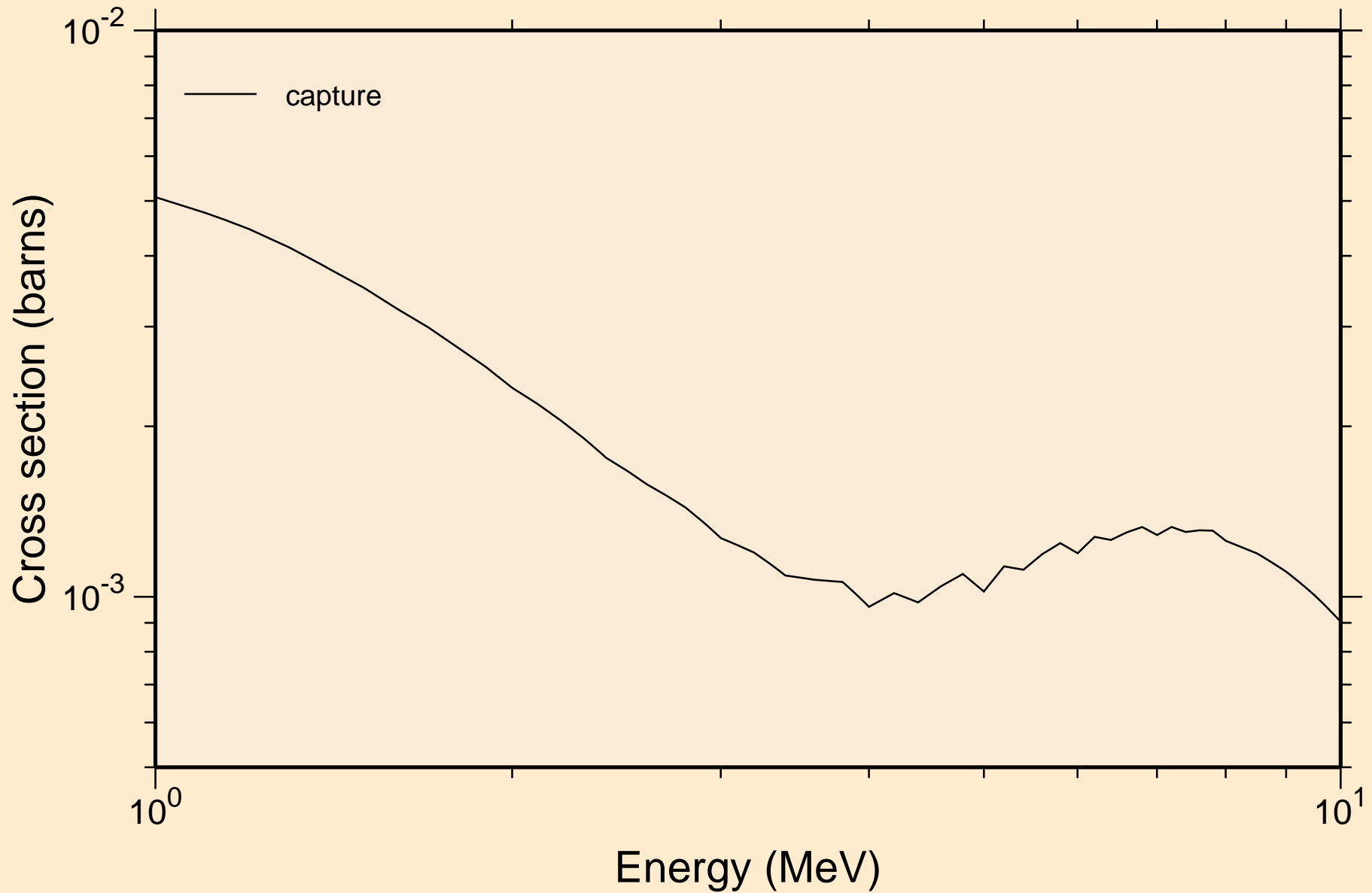

EU135 NRG TENDL-2015, AKONING

Non-threshold reactions

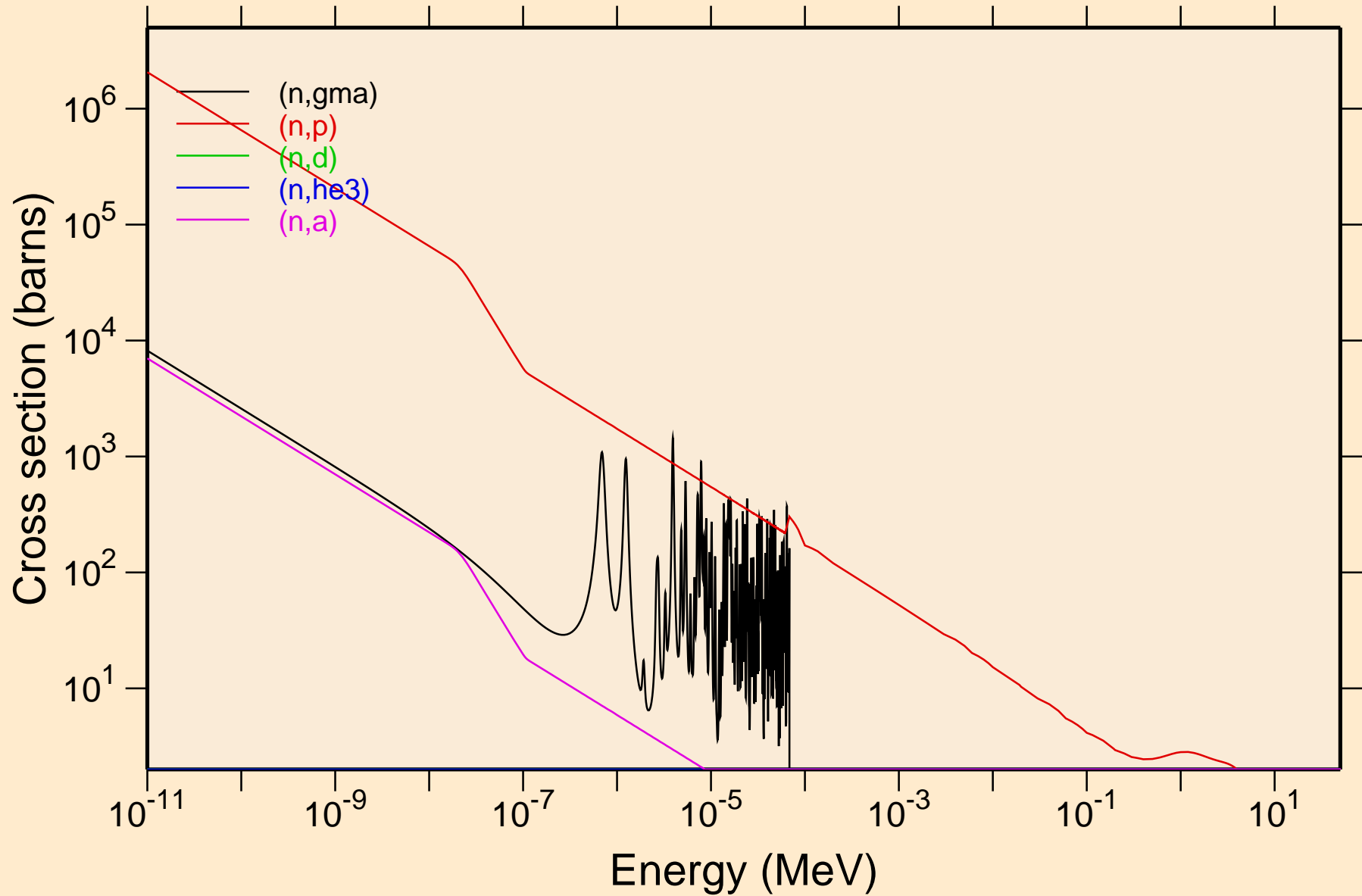

EU135 NRG TENDL-2015, AKONING

Non-threshold reactions

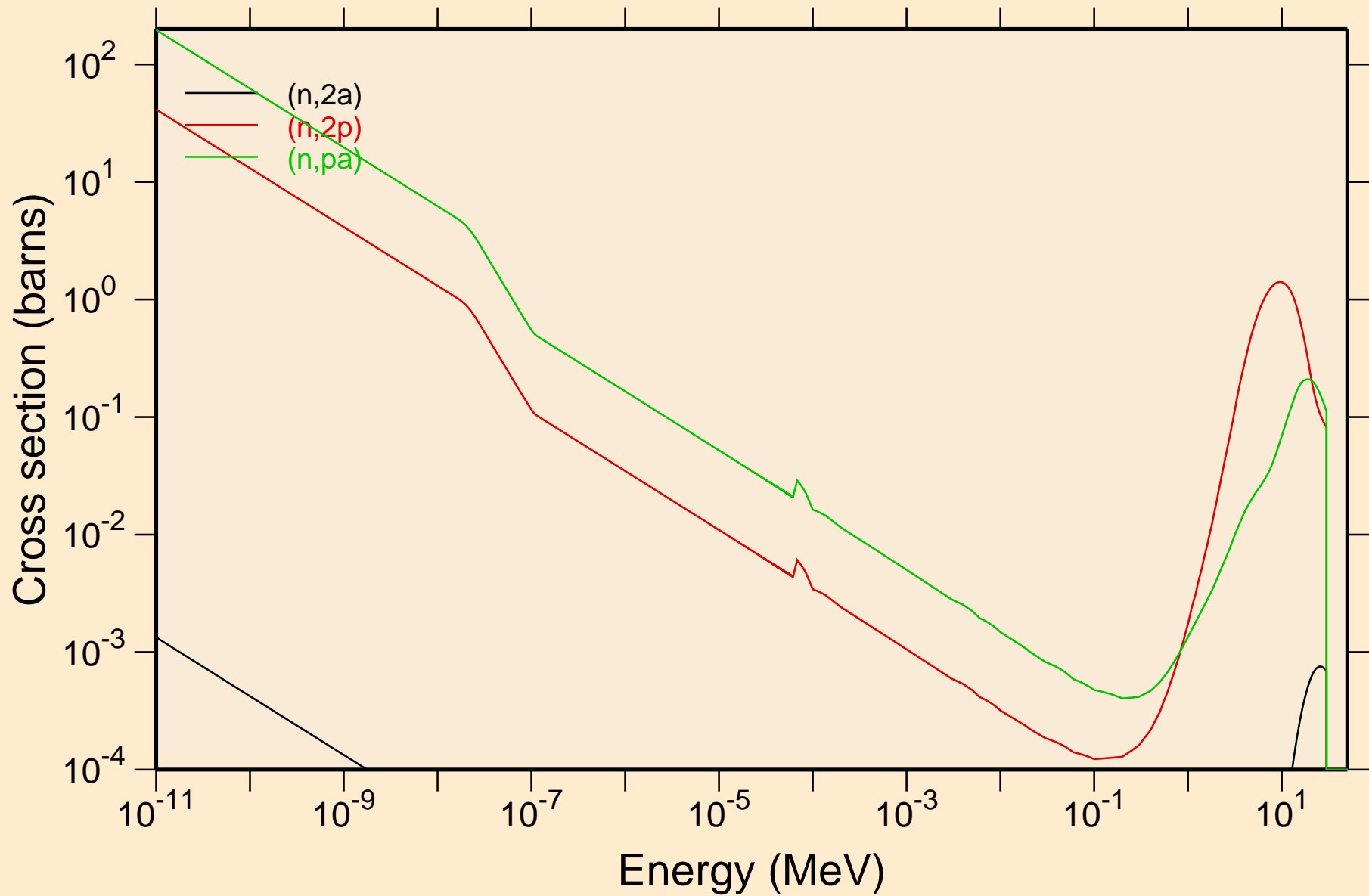

EU135 NRG TENDL-2015, AKONING

Principal cross sections

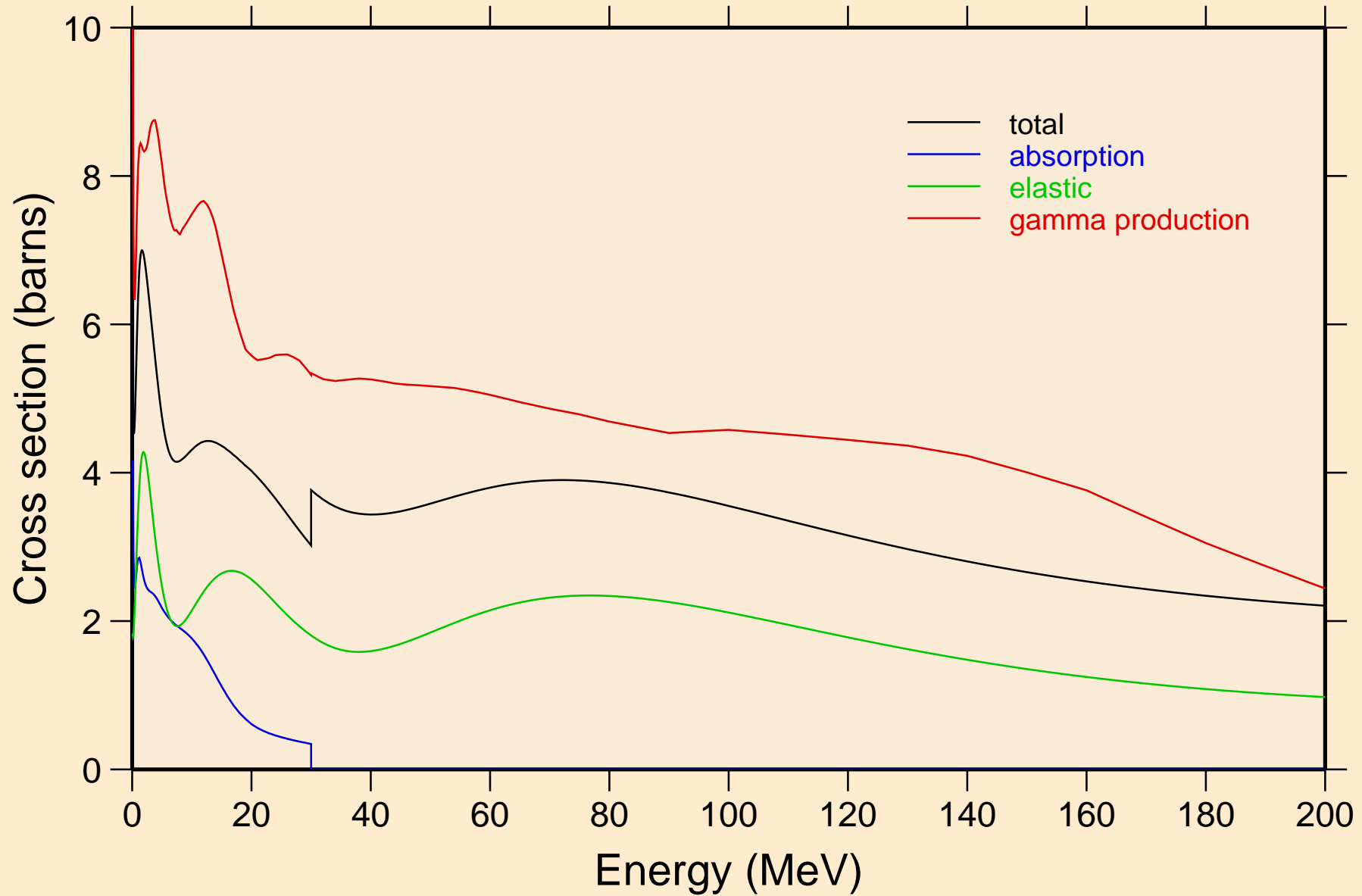

EU135 NRG TENDL-2015, AKONING

Non-threshold reactions

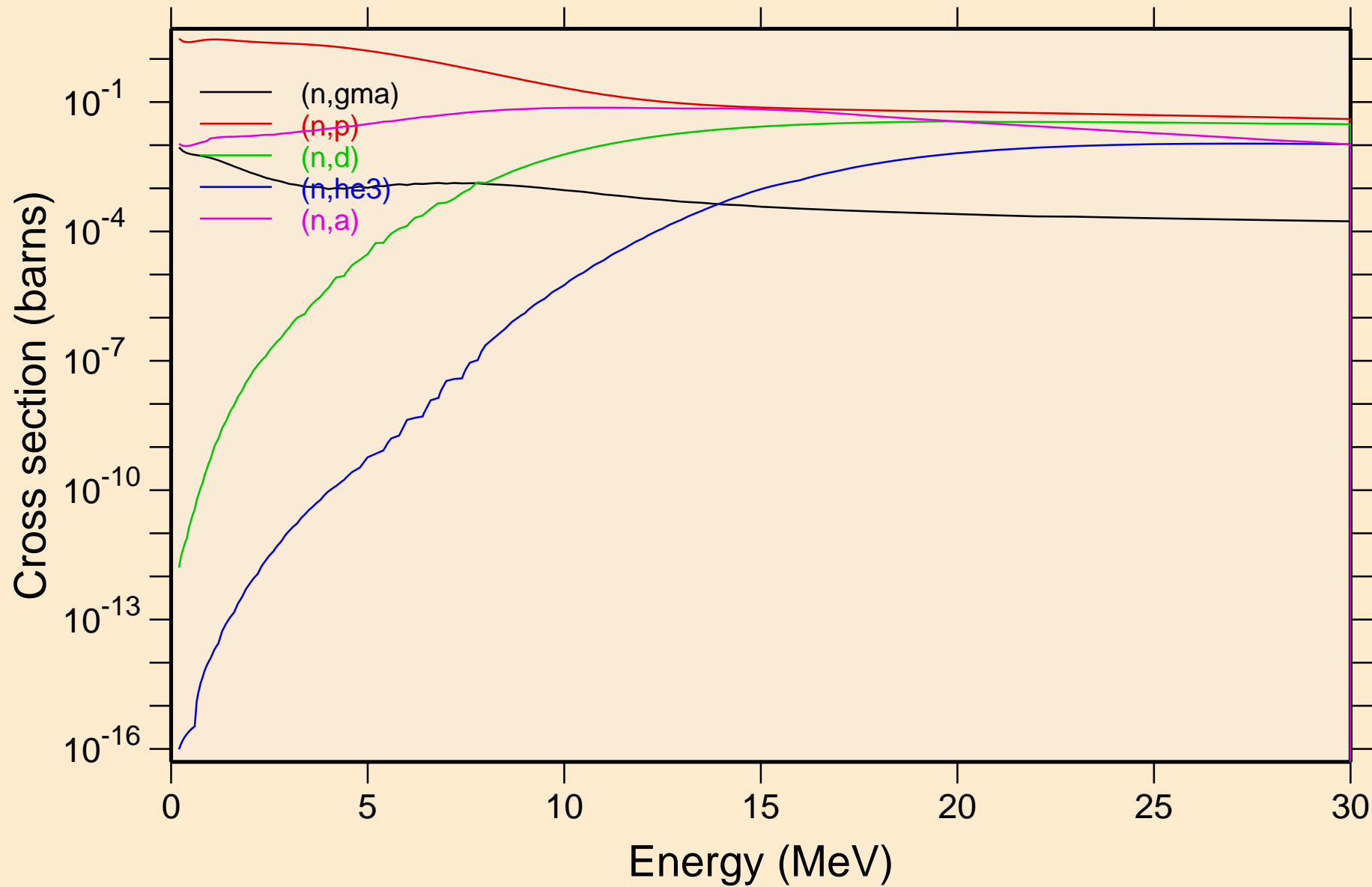

EU135 NRG TENDL-2015, AKONING

Non-threshold reactions

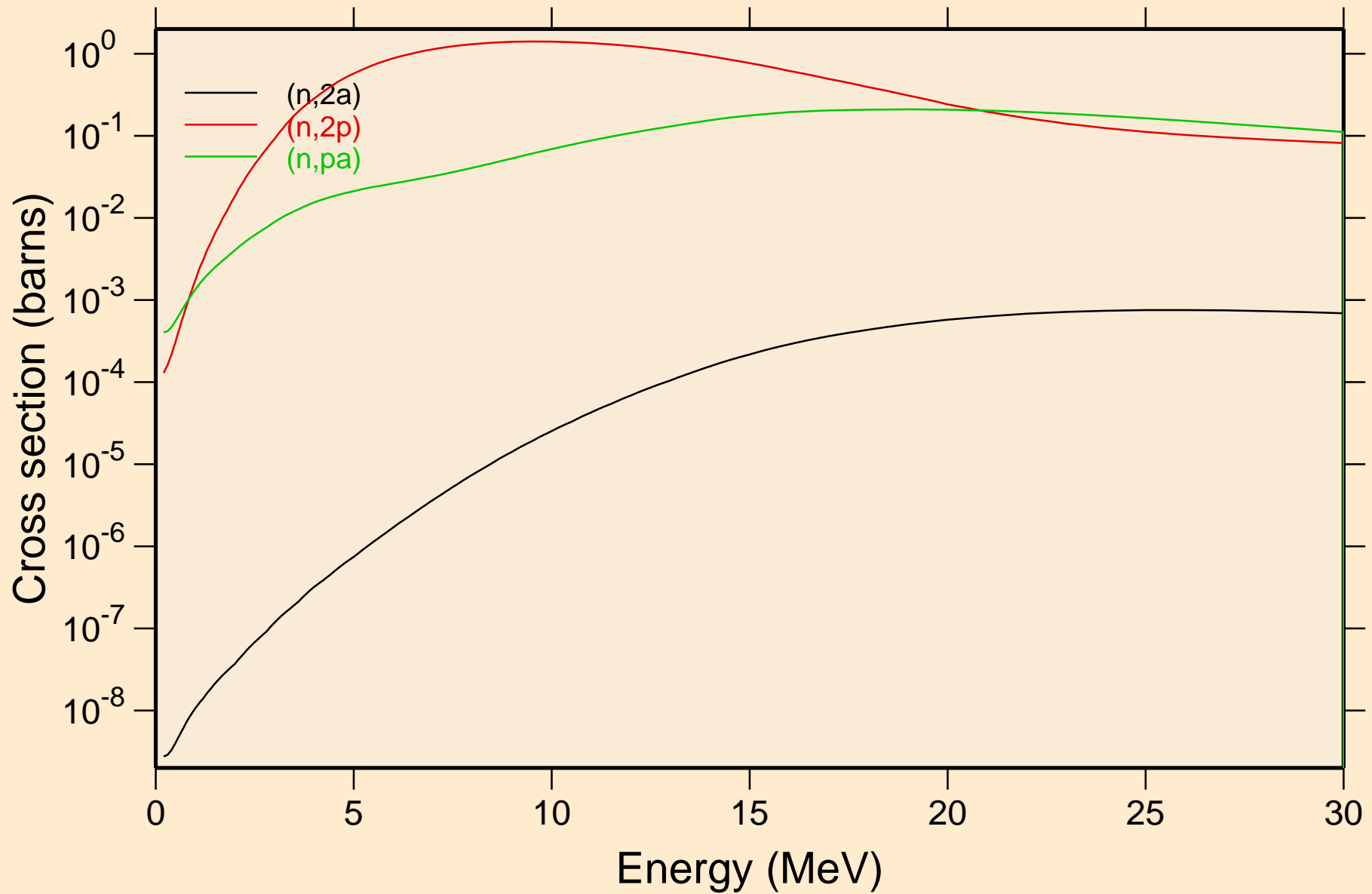

EU135 NRG TENDL-2015, AKONING

Inelastic levels

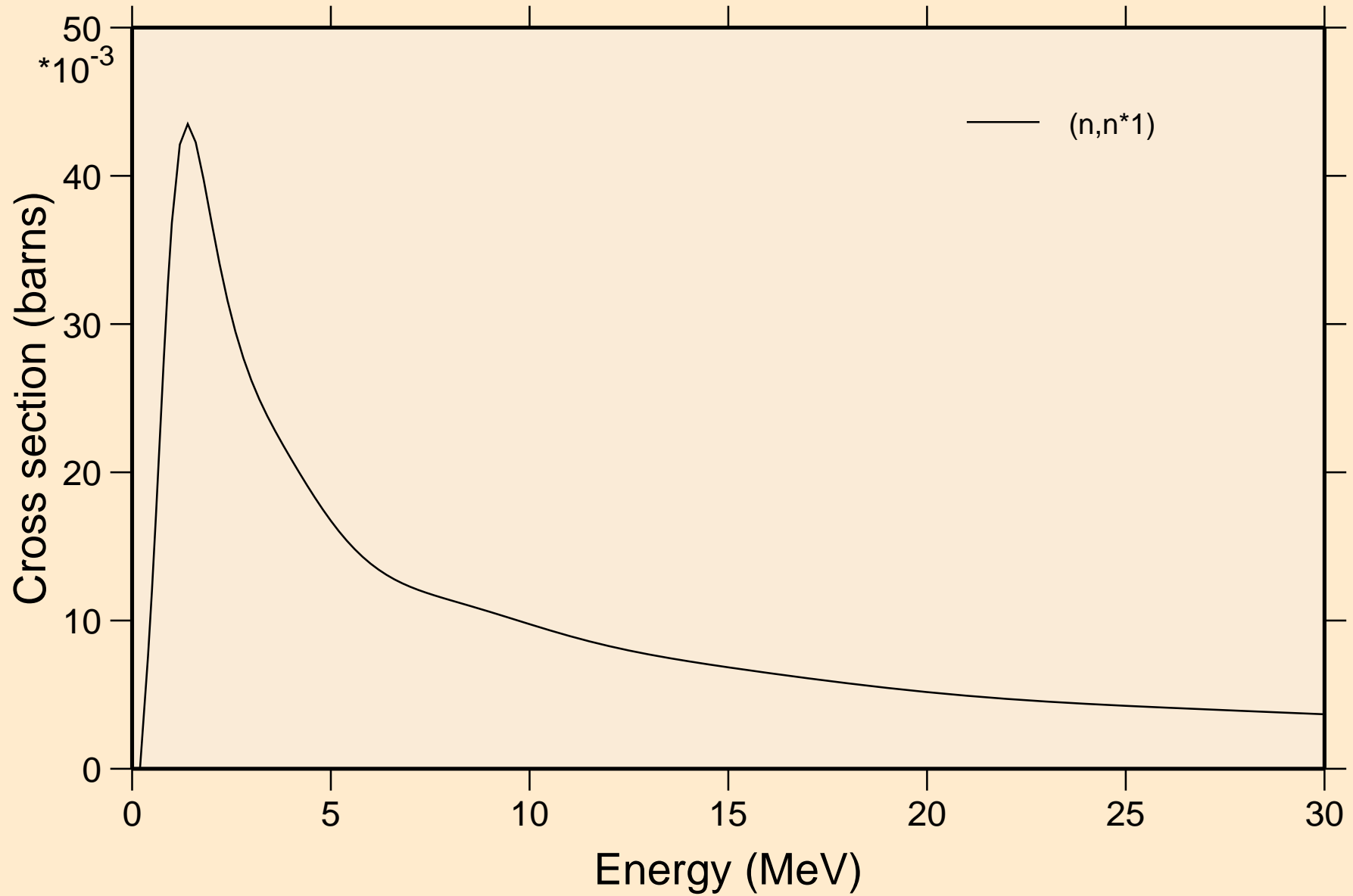

EU135 NRG TENDL-2015, AKONING

Threshold reactions

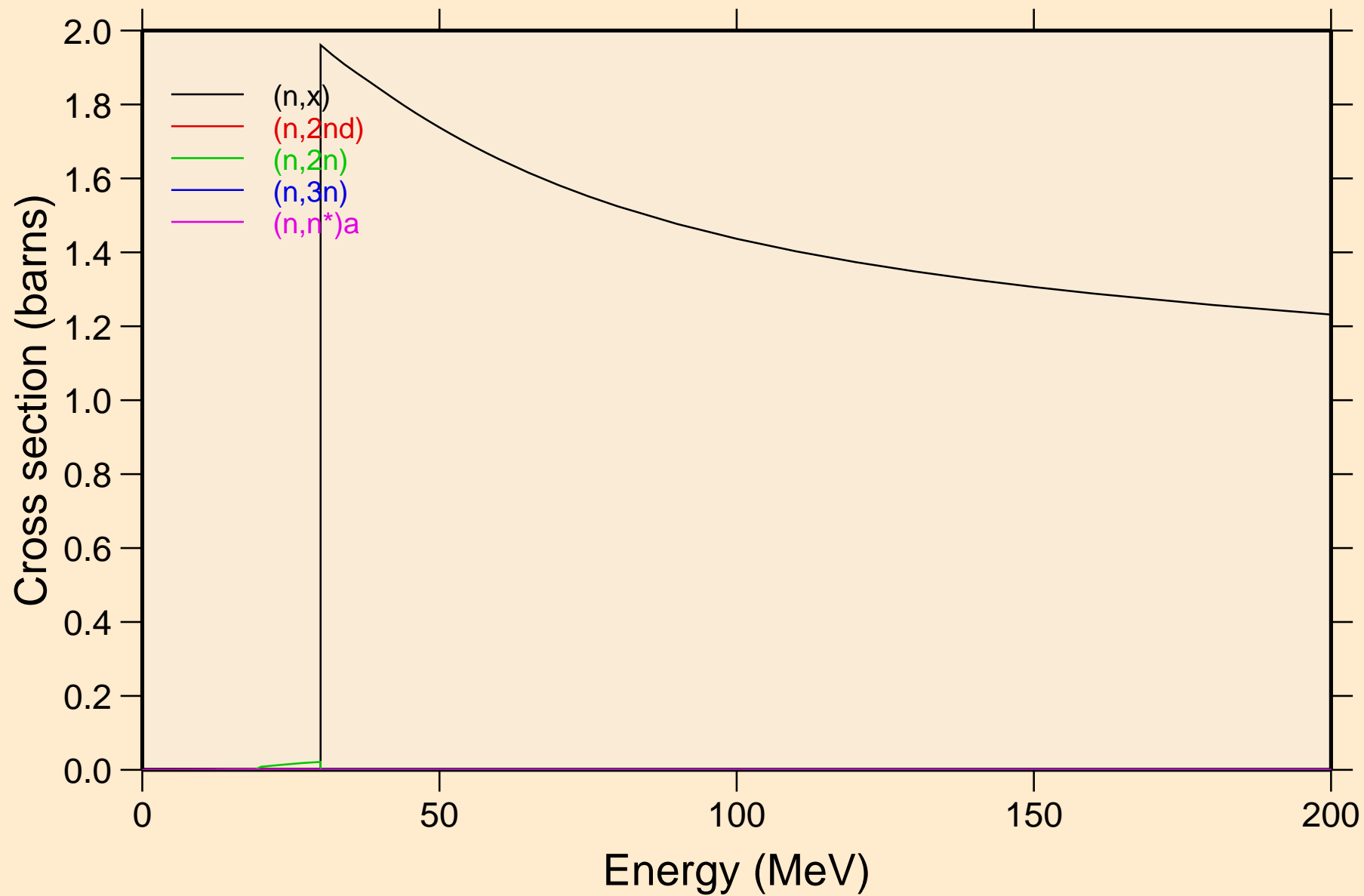

EU135 NRG TENDL-2015, AKONING

Threshold reactions

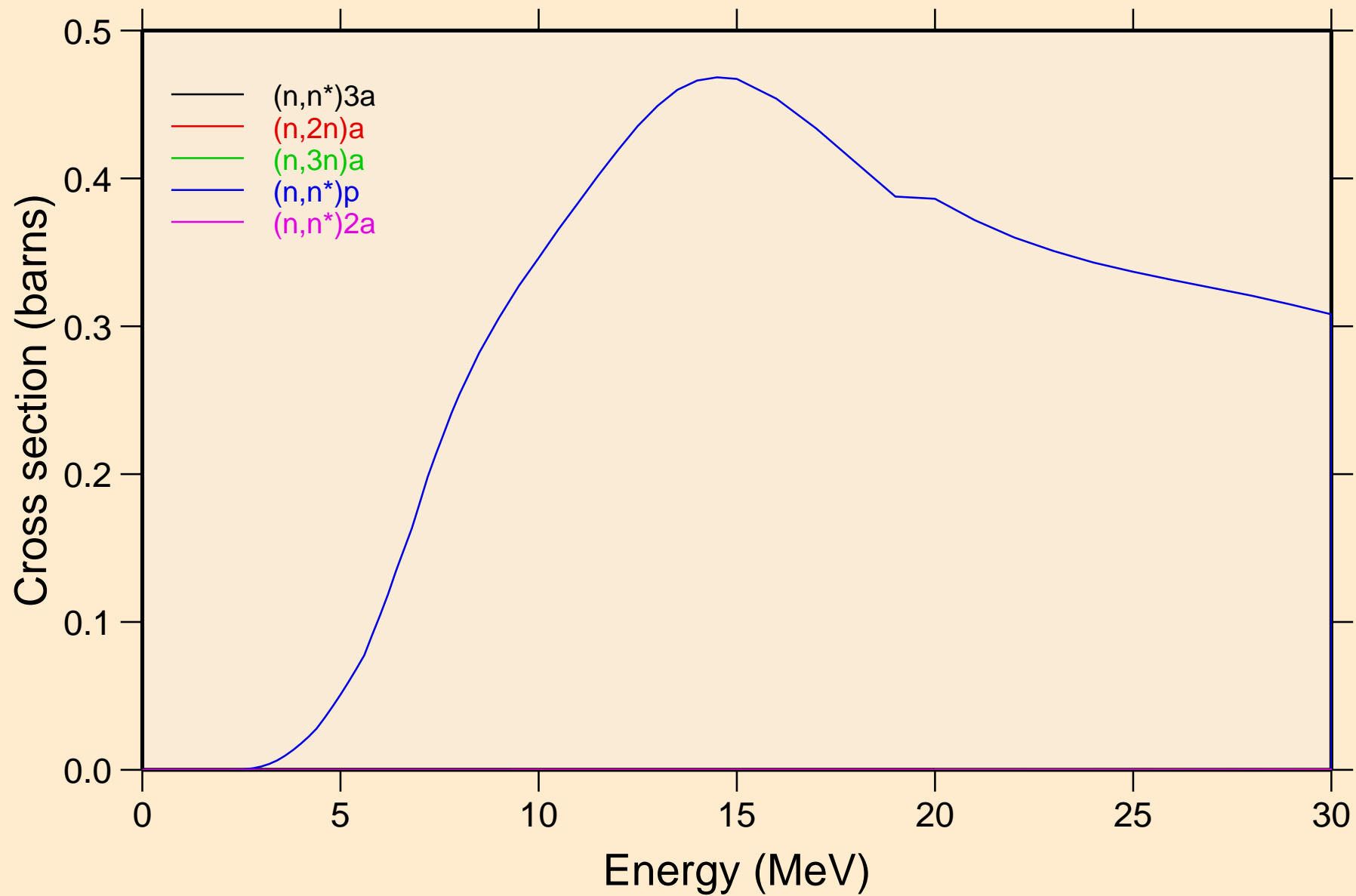

EU135 NRG TENDL-2015, AKONING

Threshold reactions

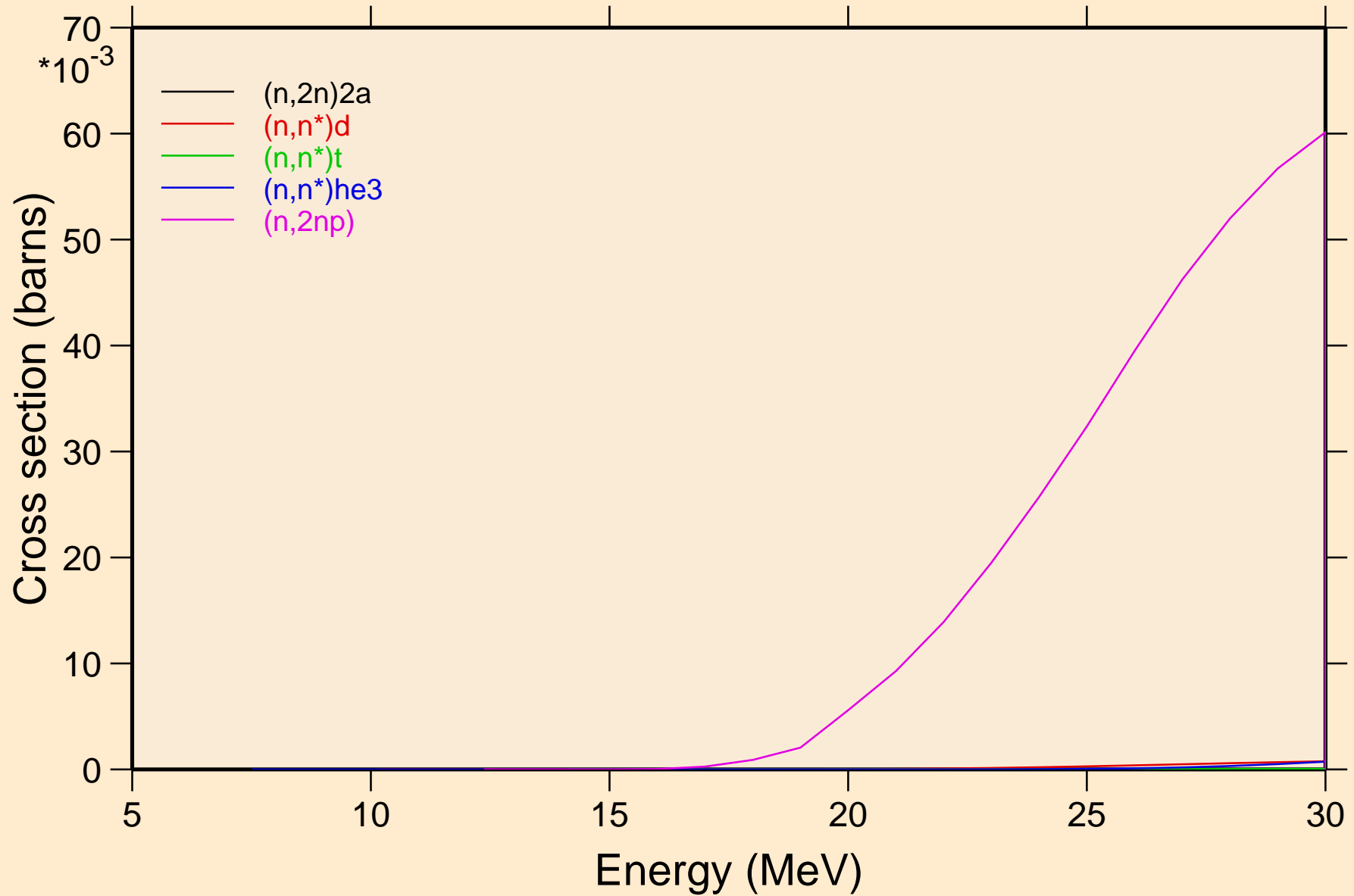

EU135 NRG TENDL-2015, AKONING

Threshold reactions

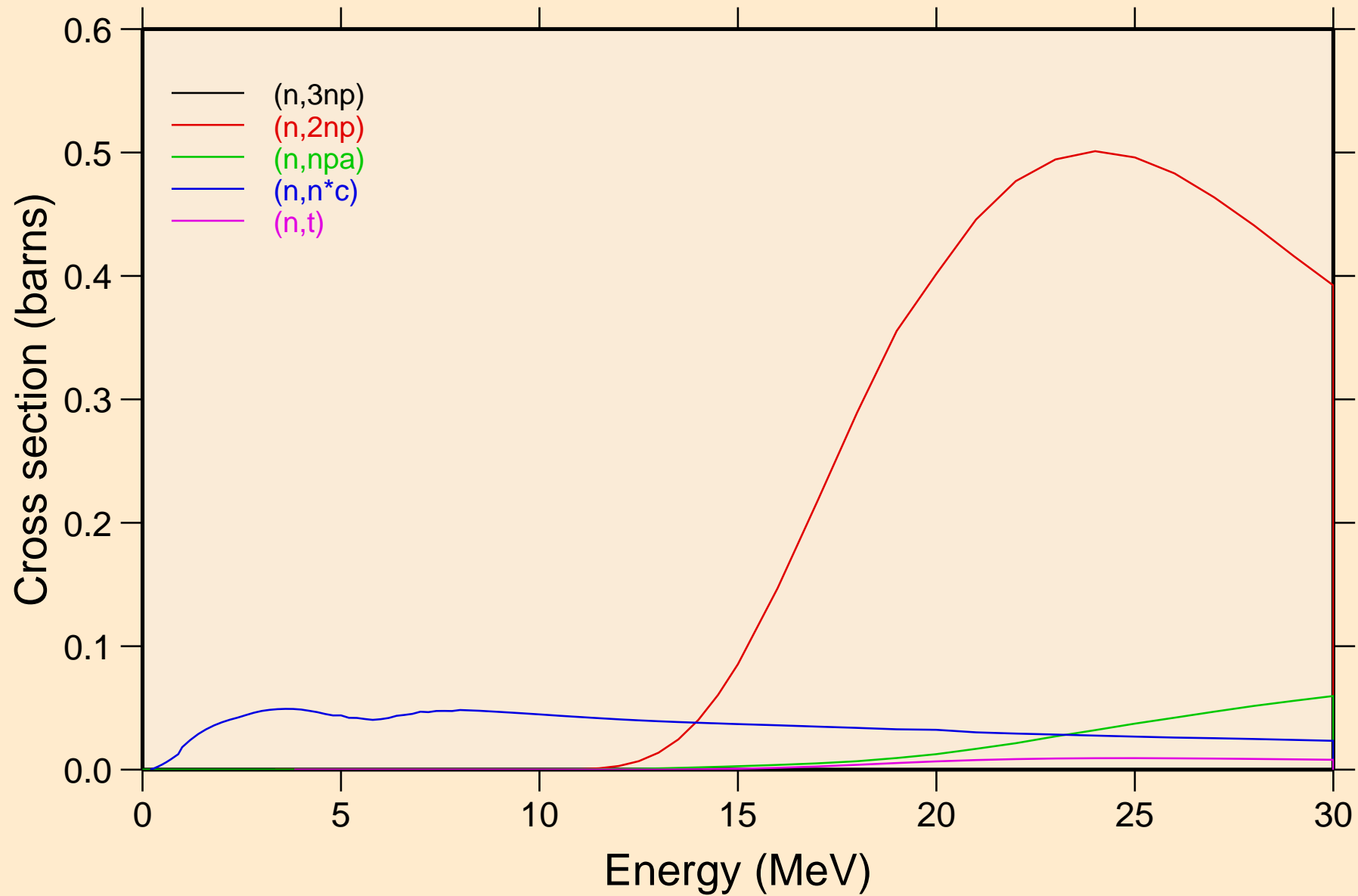

EU135 NRG TENDL-2015, AKONING

Threshold reactions

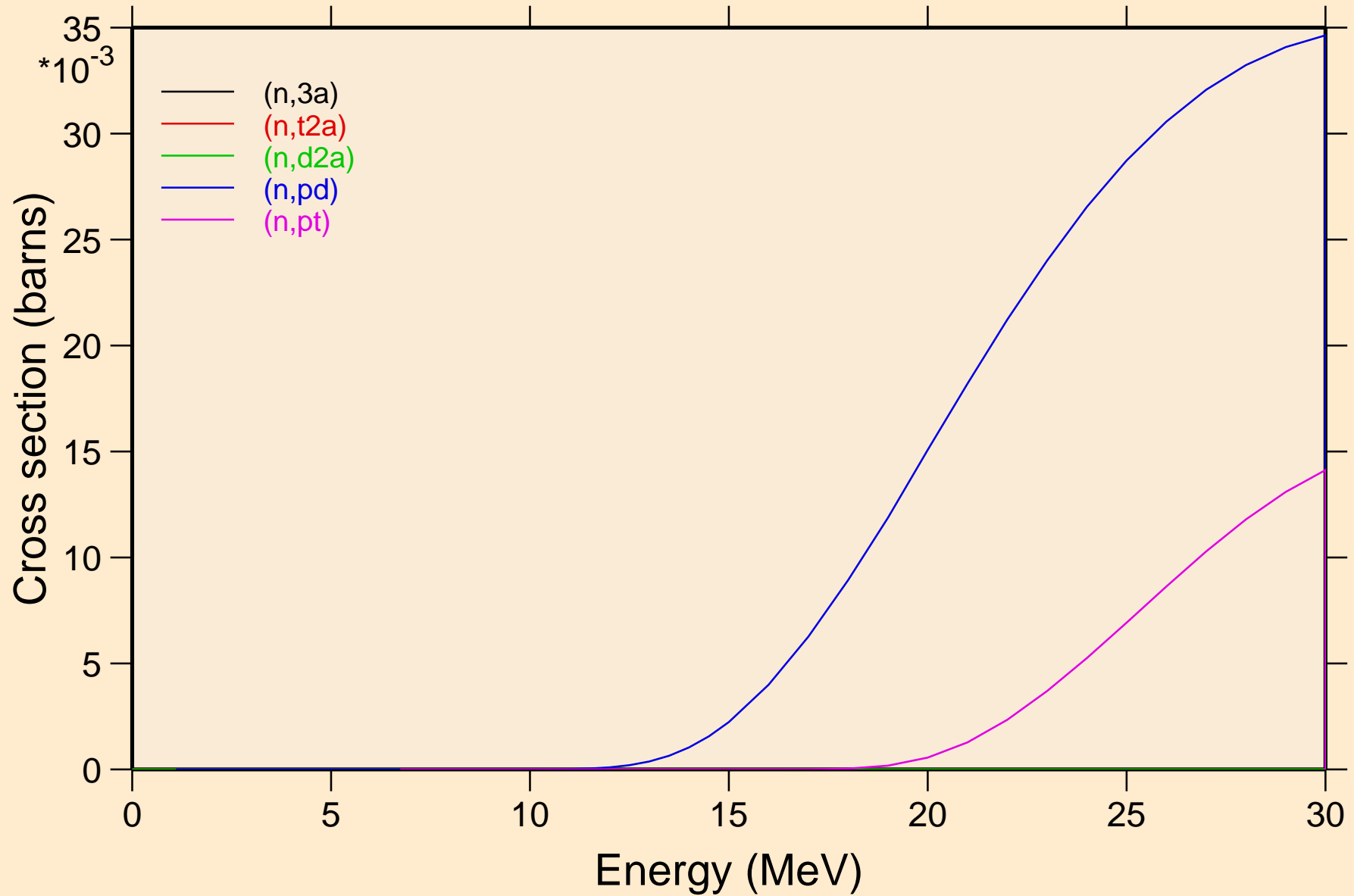

EU135 NRG TENDL-2015, AKONING

Threshold reactions

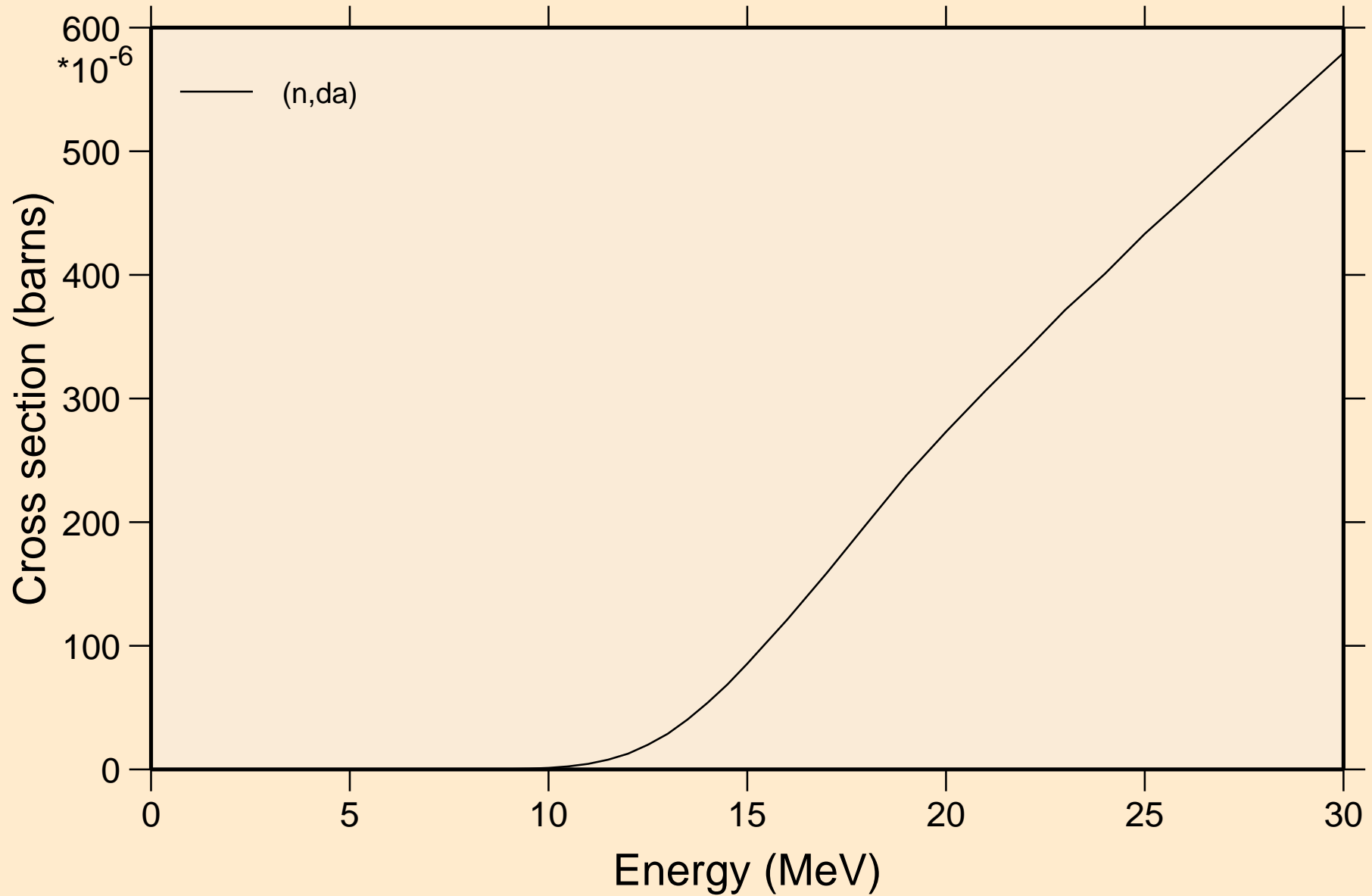

EU135 NRG TENDL-2015, AKONING
angular distribution for elastic

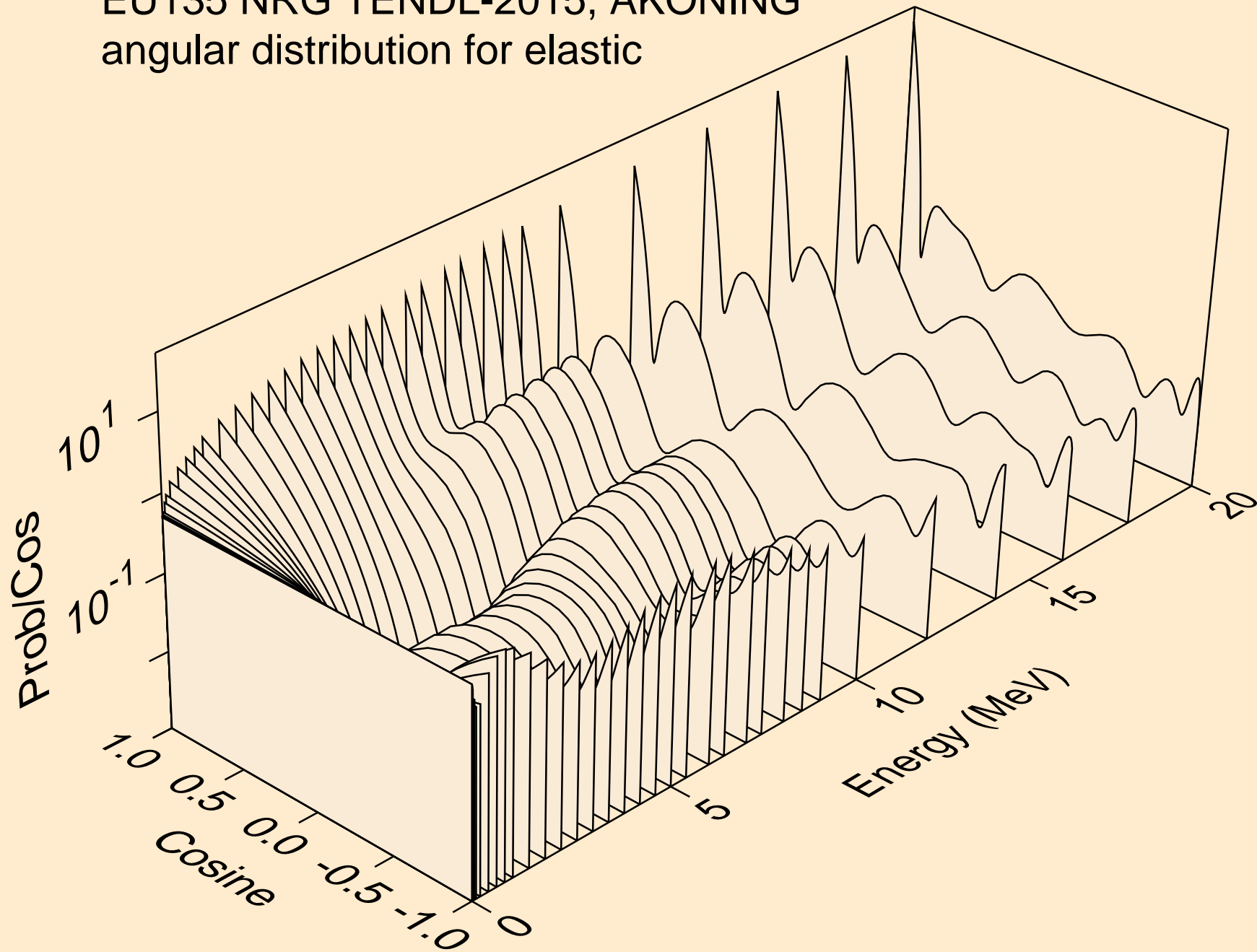

EU135 NRG TENDL-2015, AKONING
angular distribution for elastic

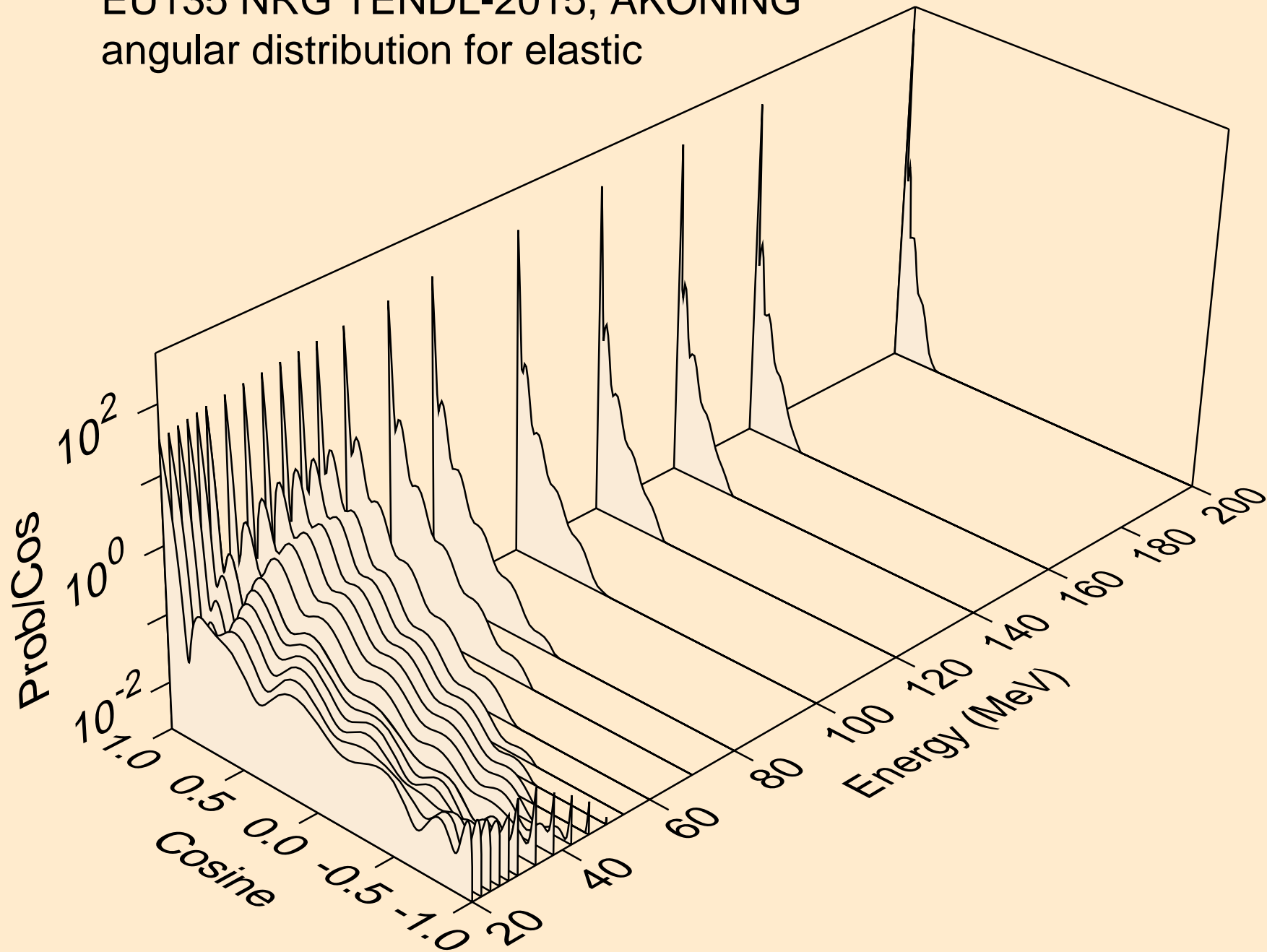

EU135 NRG TENDL-2015, AKONING
angular distribution for (n,n*1)

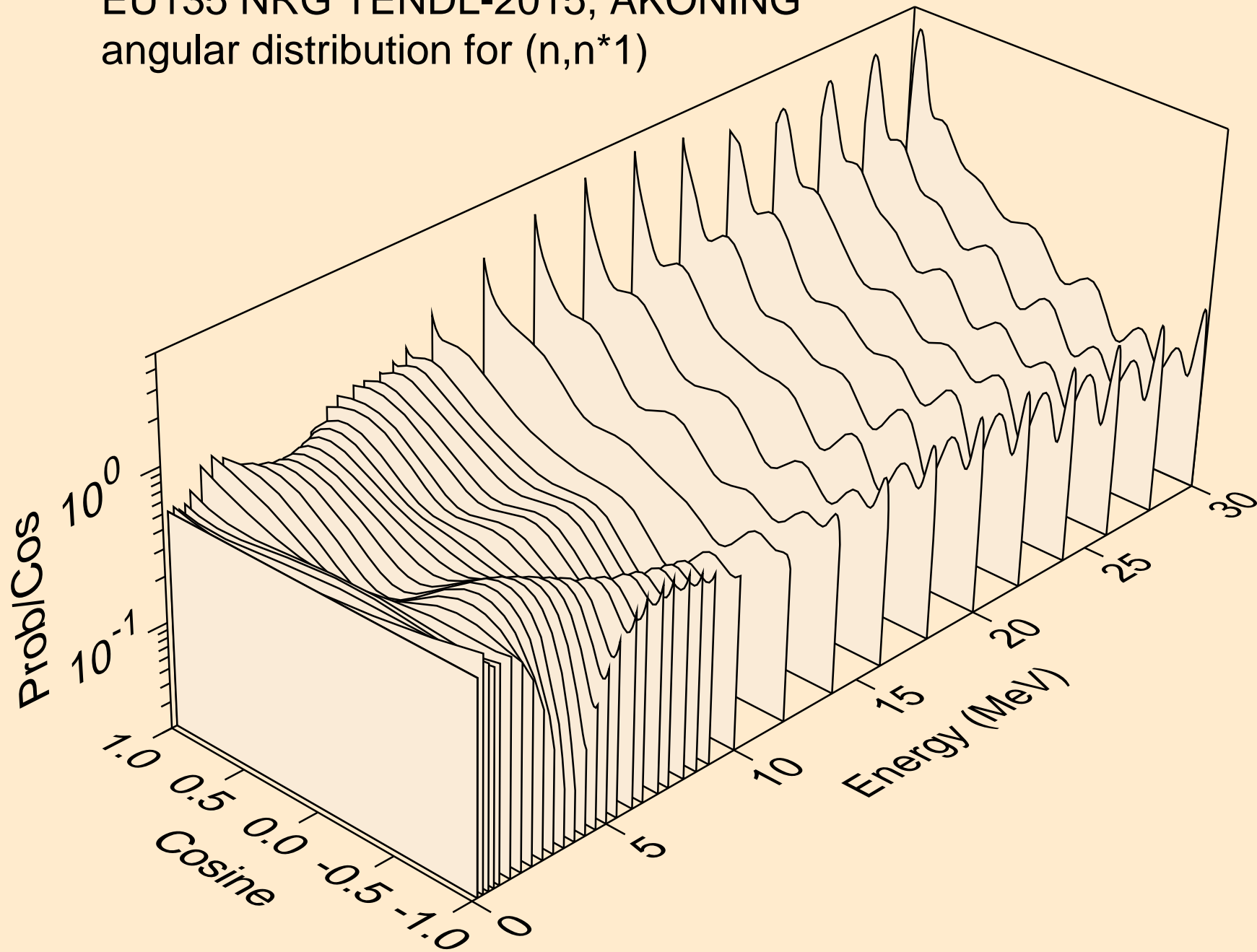

EU135 NRG TENDL-2015, AKONING
Neutron emission for (n,x)

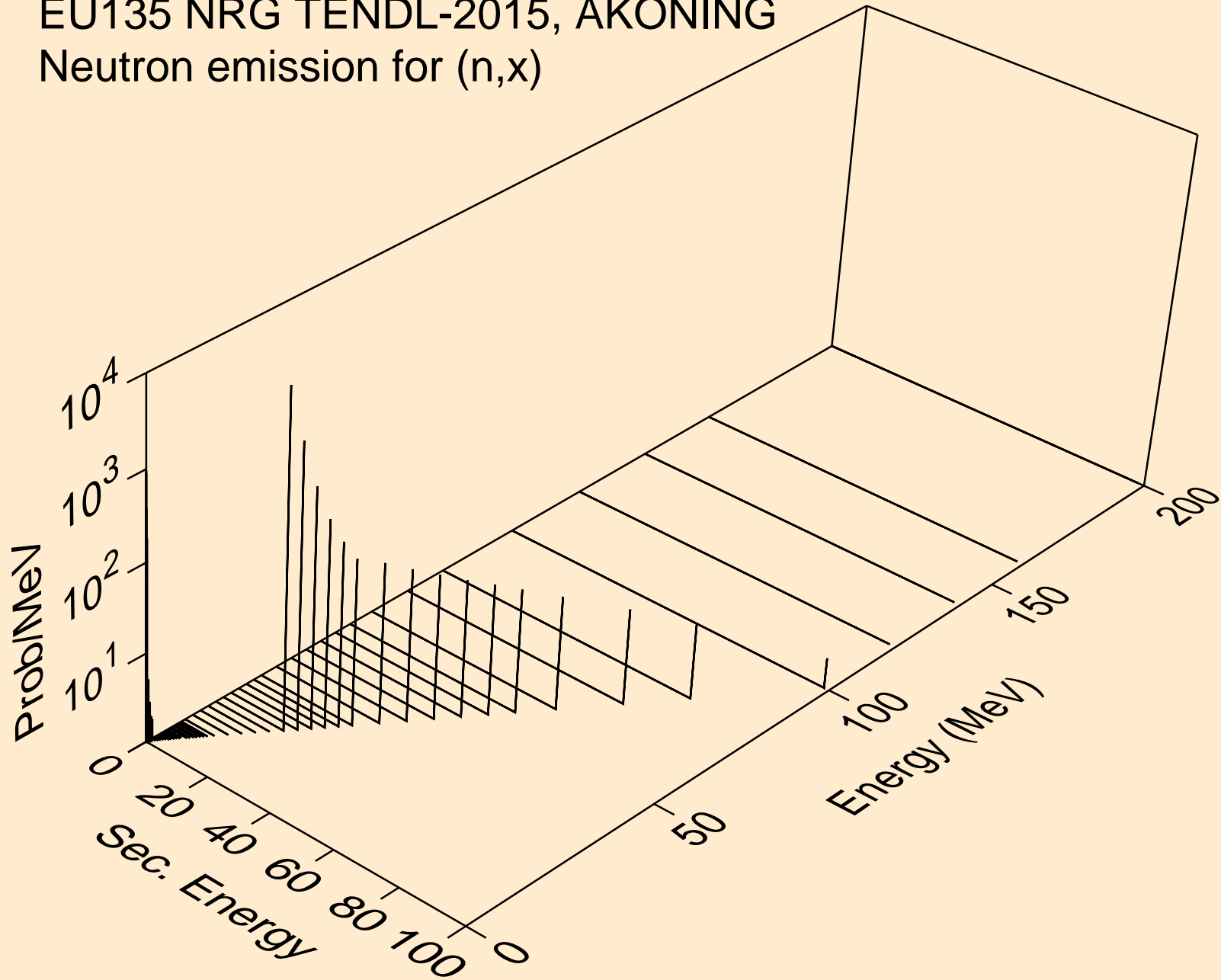

EU135 NRG TENDL-2015, AKONING
Neutron emission for (n,2nd)

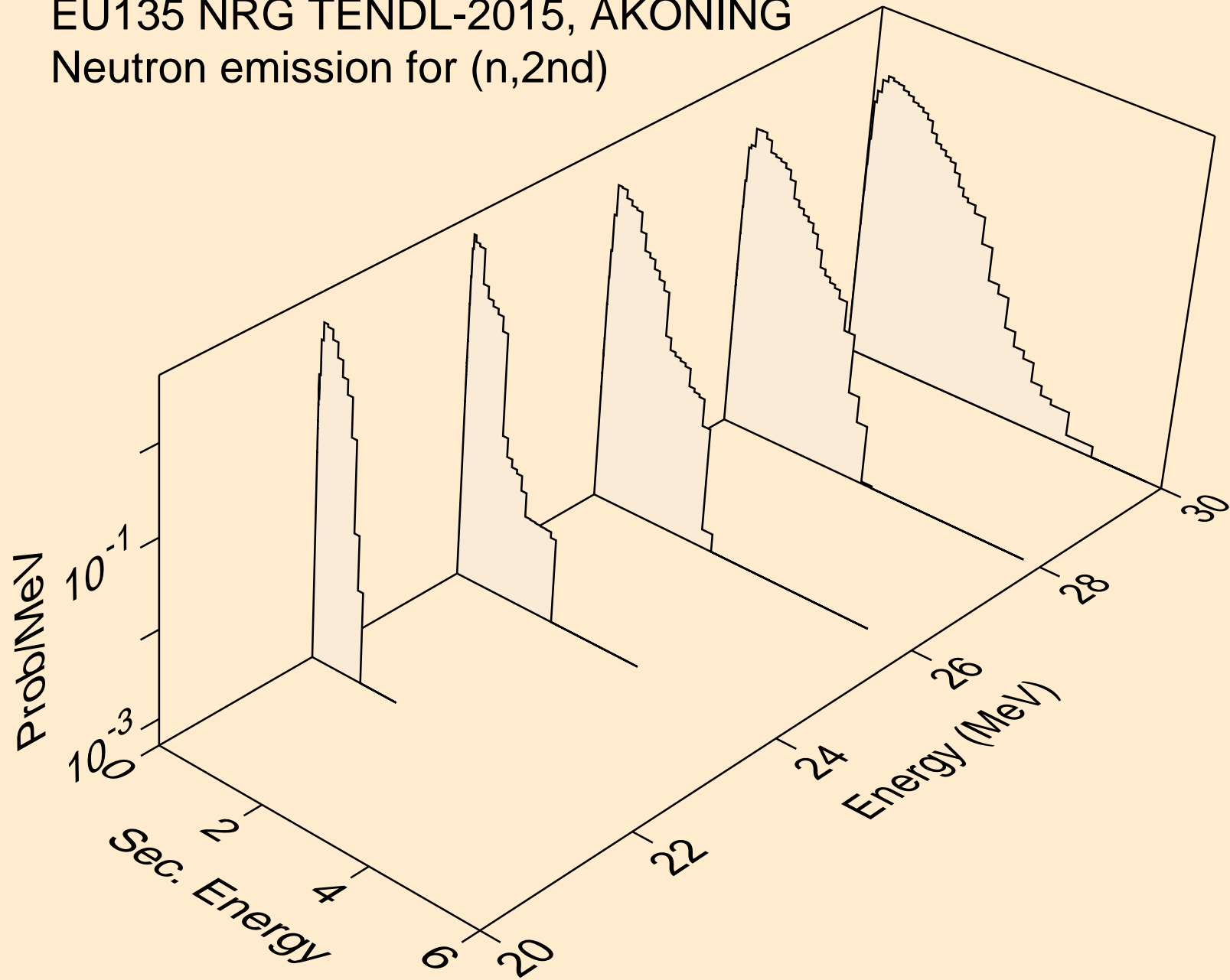

EU135 NRG TENDL-2015, AKONING
Neutron emission for (n,2n)

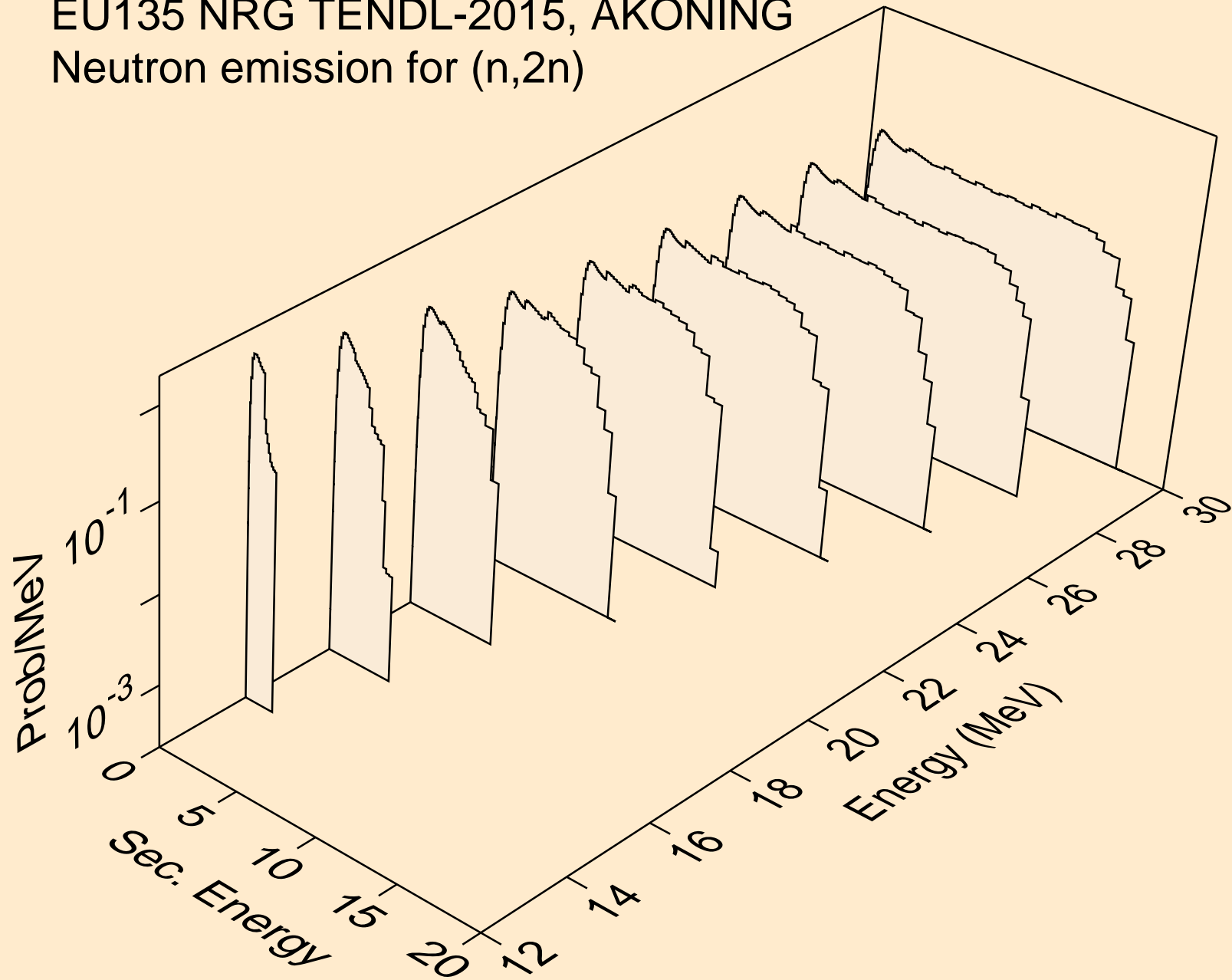

EU135 NRG TENDL-2015, AKONING
Neutron emission for (n,3n)

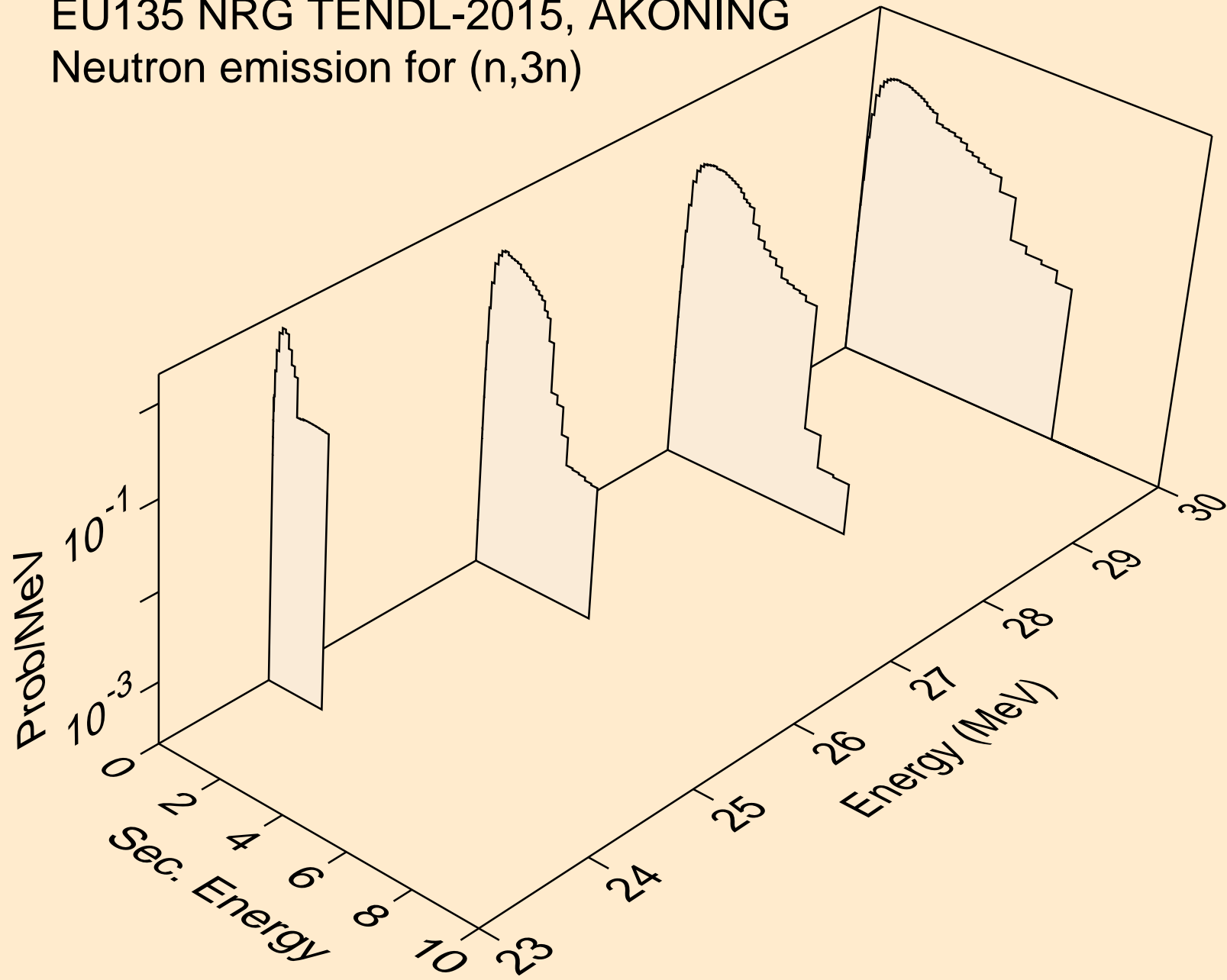

EU135 NRG TENDL-2015, AKONING
Neutron emission for (n,n*)a

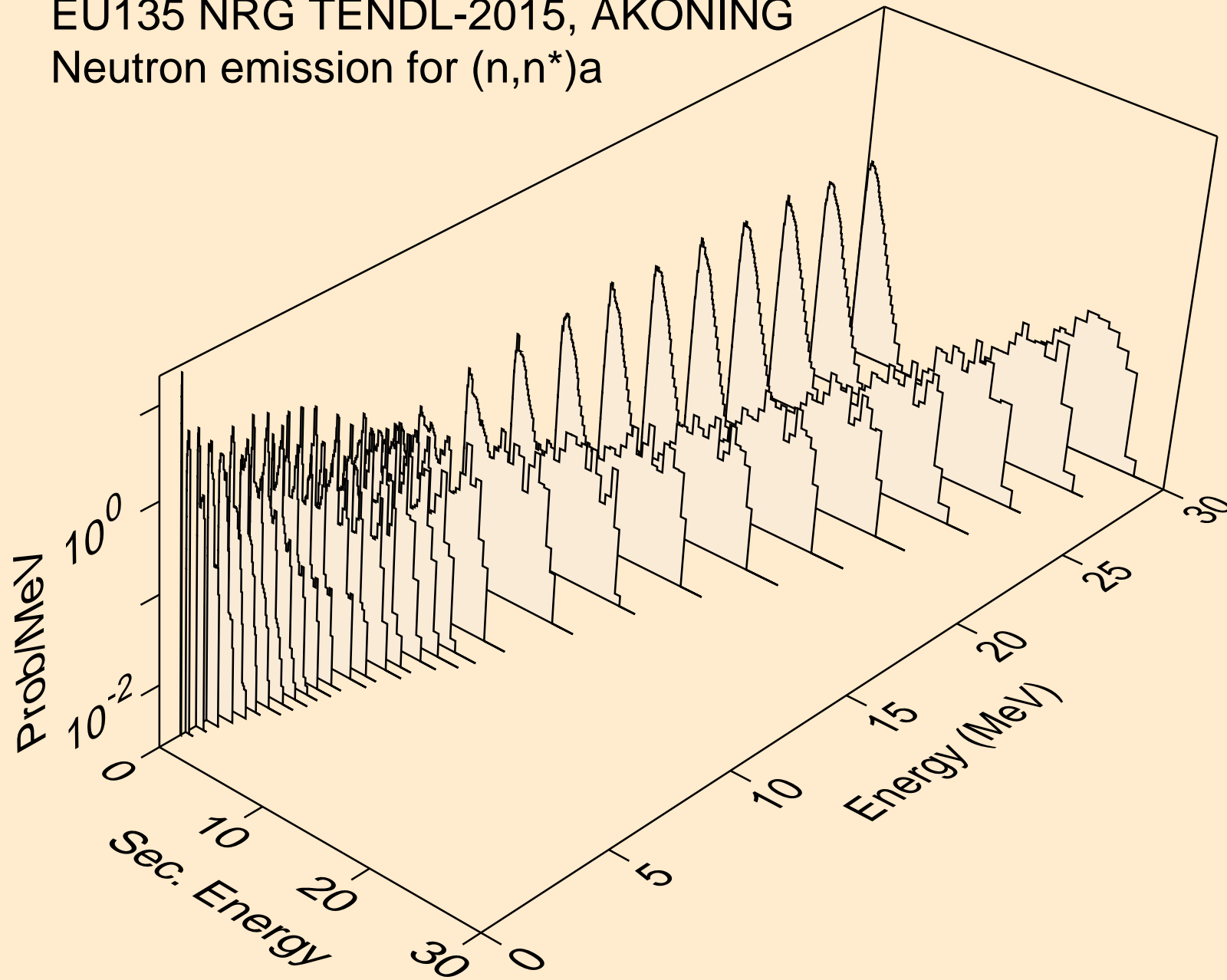

EU135 NRG TENDL-2015, AKONING
Neutron emission for (n,n*)3a

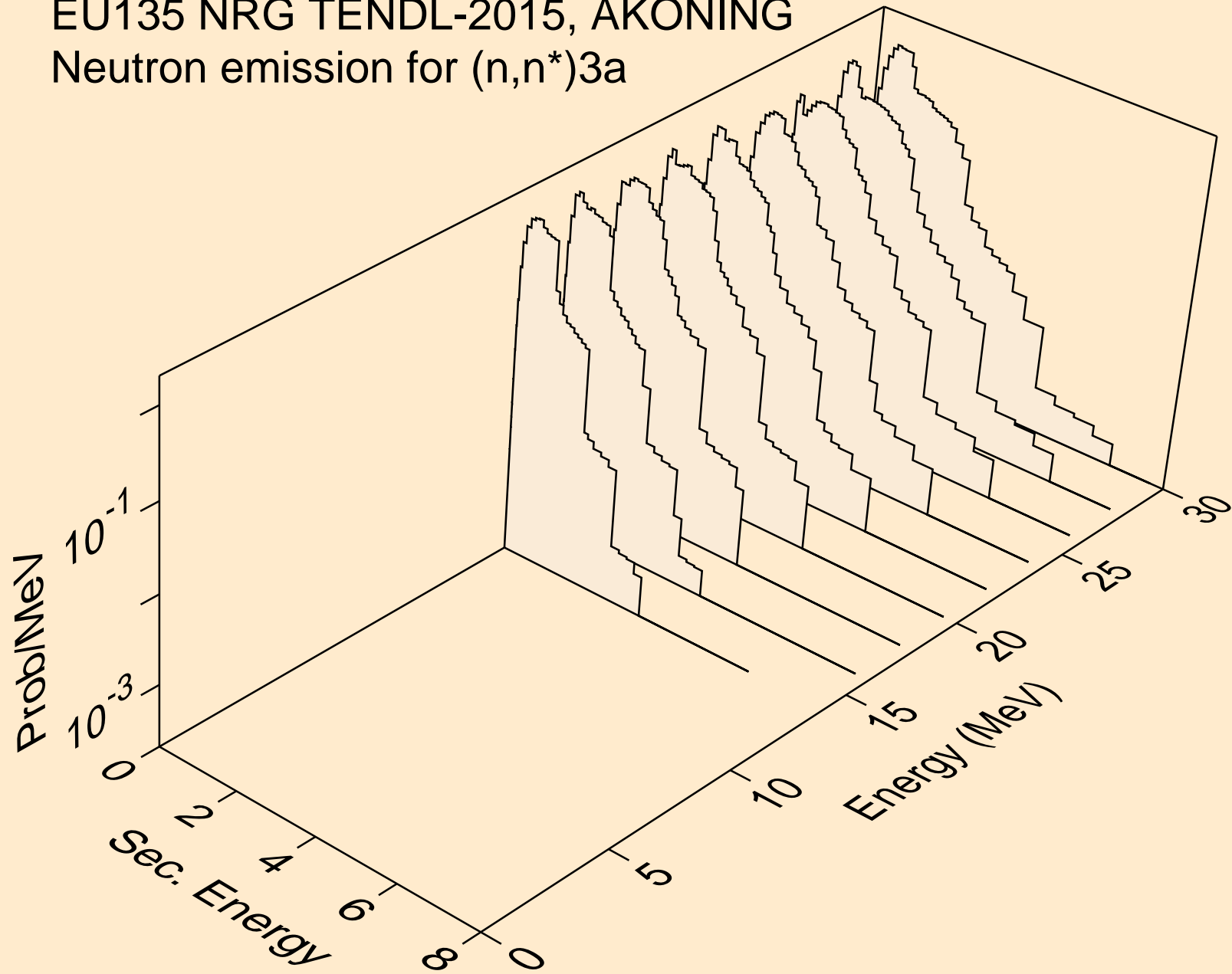

EU135 NRG TENDL-2015, AKONING
Neutron emission for (n,2n)a

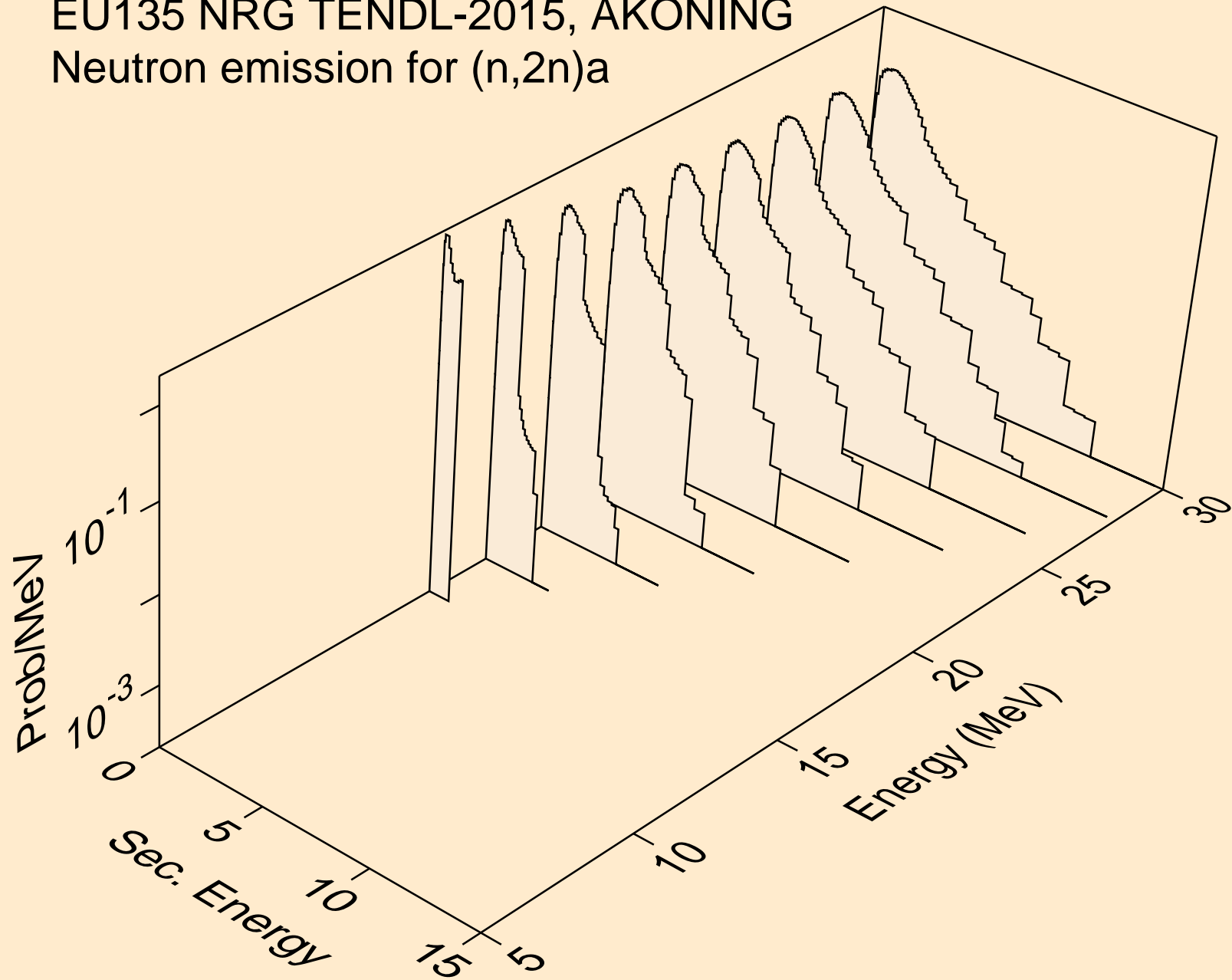

EU135 NRG TENDL-2015, AKONING
Neutron emission for (n,3n)a

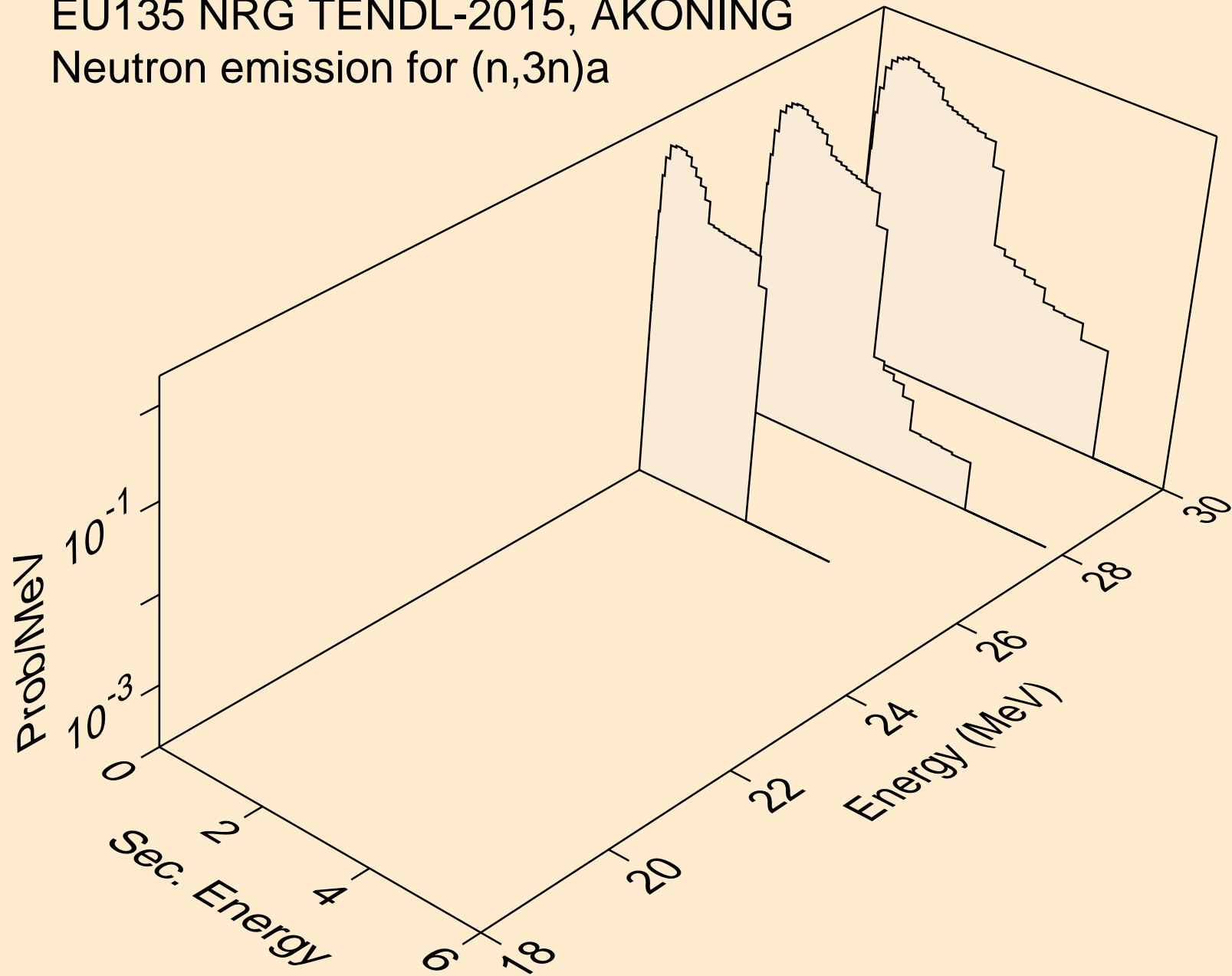

EU135 NRG TENDL-2015, AKONING
Neutron emission for (n,n*)p

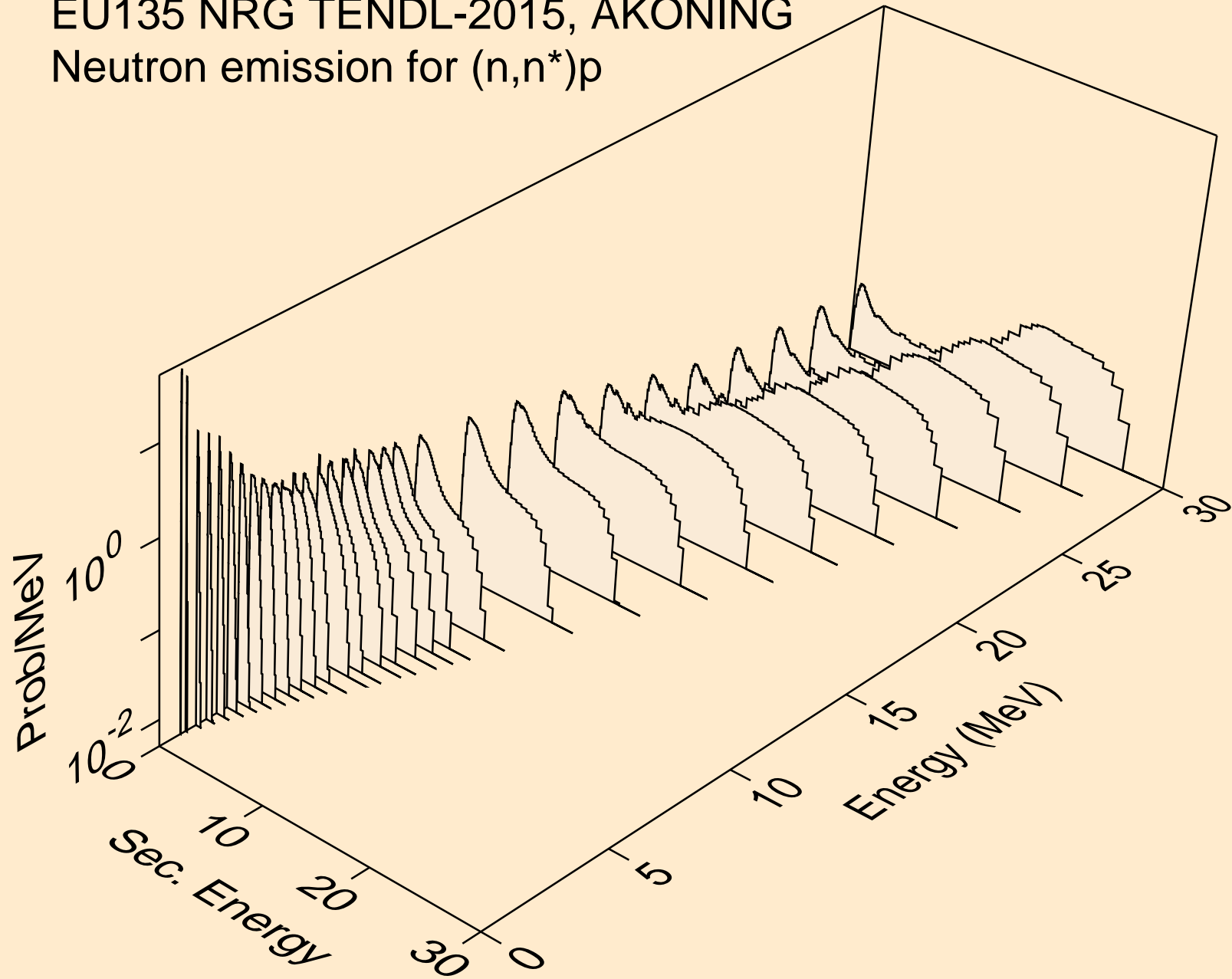

EU135 NRG TENDL-2015, AKONING
Neutron emission for (n,n*)2a

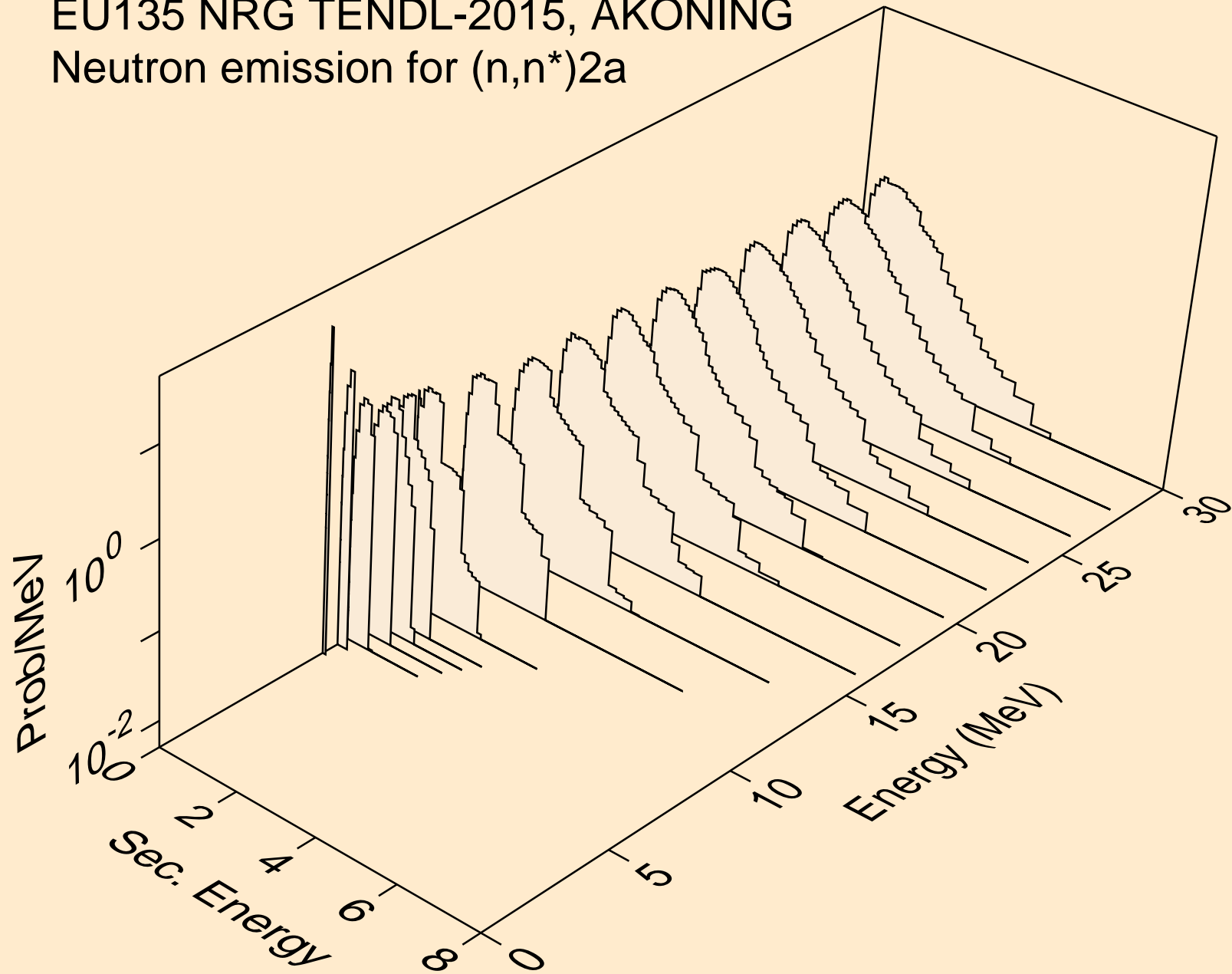

EU135 NRG TENDL-2015, AKONING
Neutron emission for (n,2n)2a

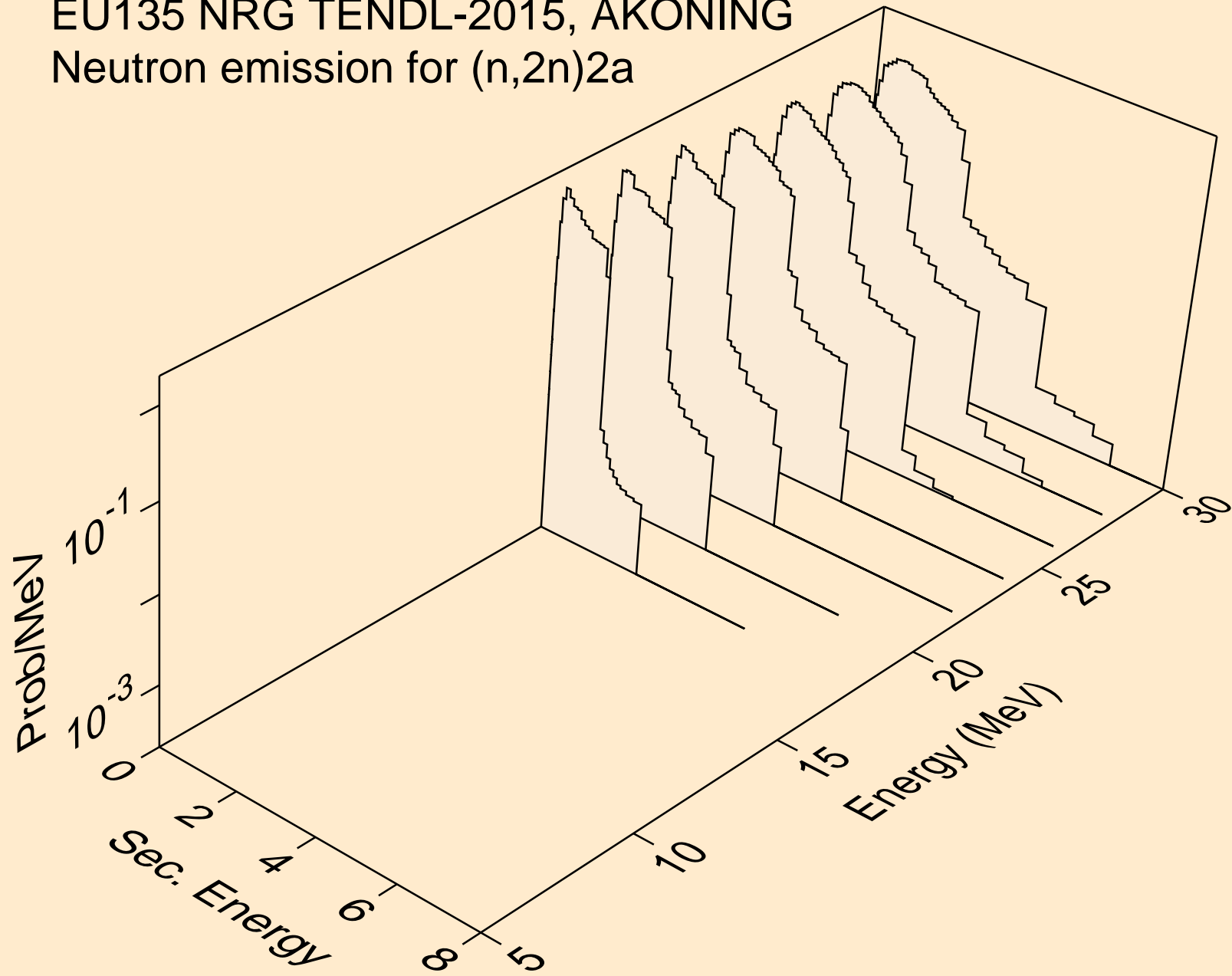

EU135 NRG TENDL-2015, AKONING
Neutron emission for (n,n*)d

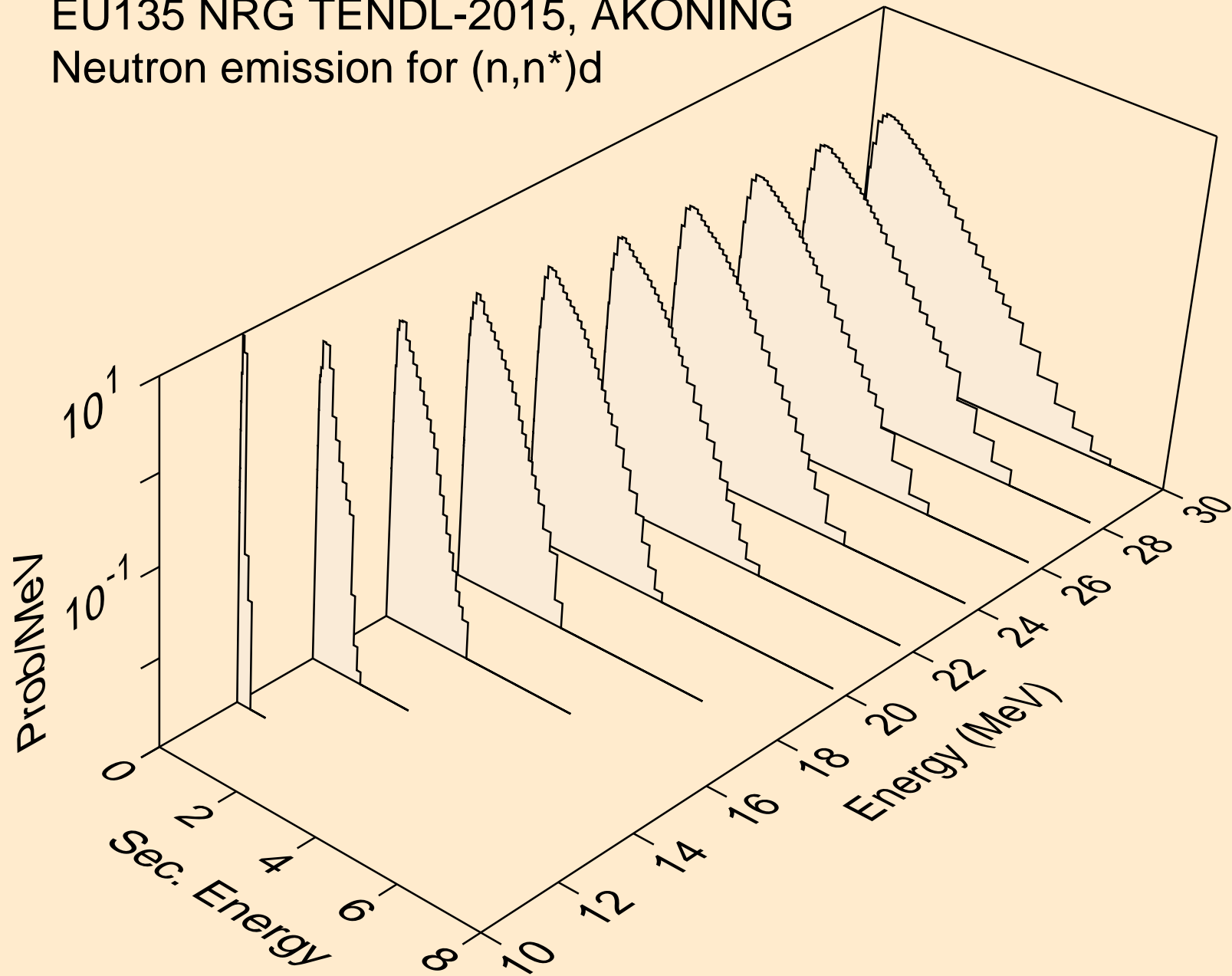

EU135 NRG TENDL-2015, AKONING
Neutron emission for (n,n*)t

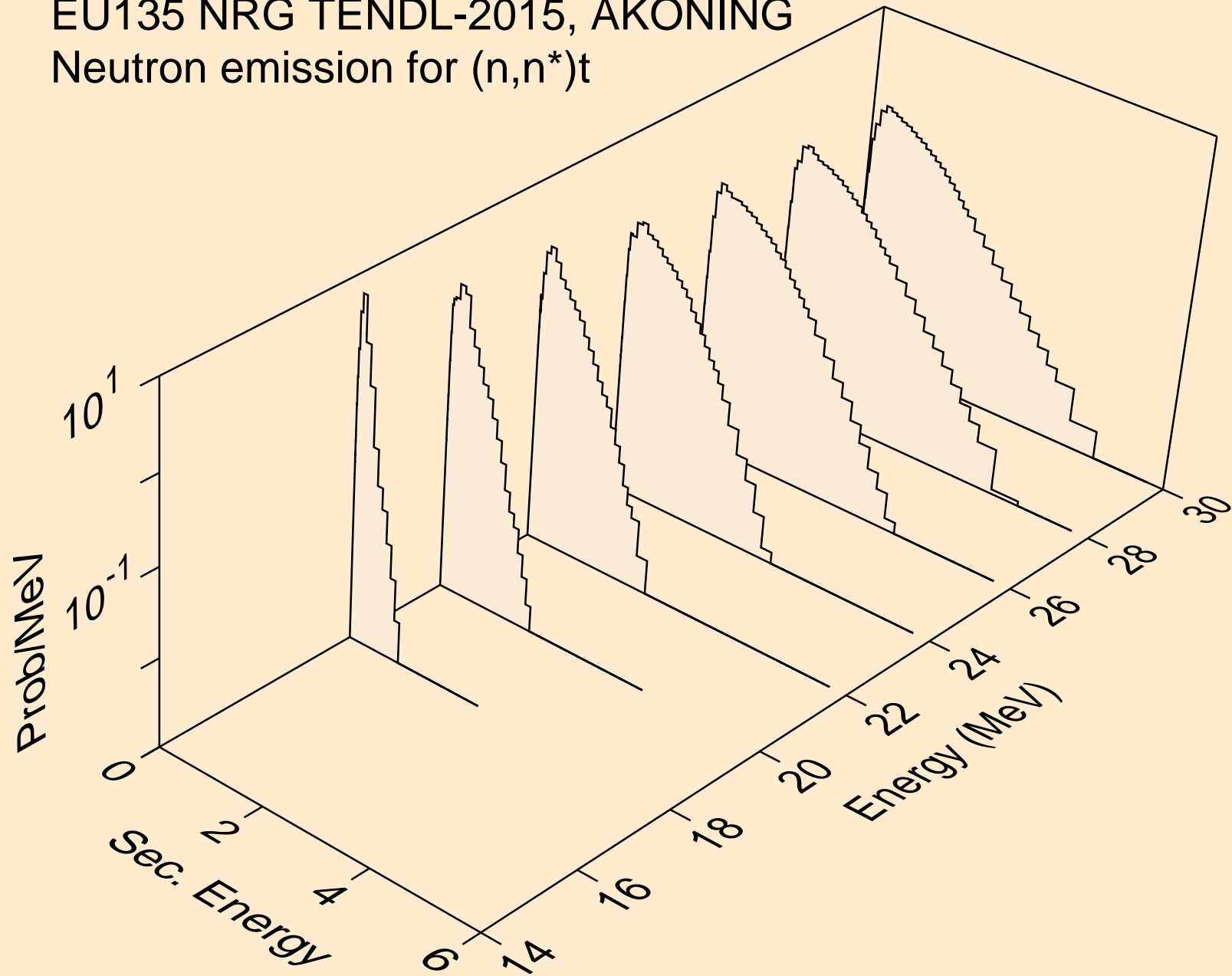

EU135 NRG TENDL-2015, AKONING
Neutron emission for (n,n*)he3

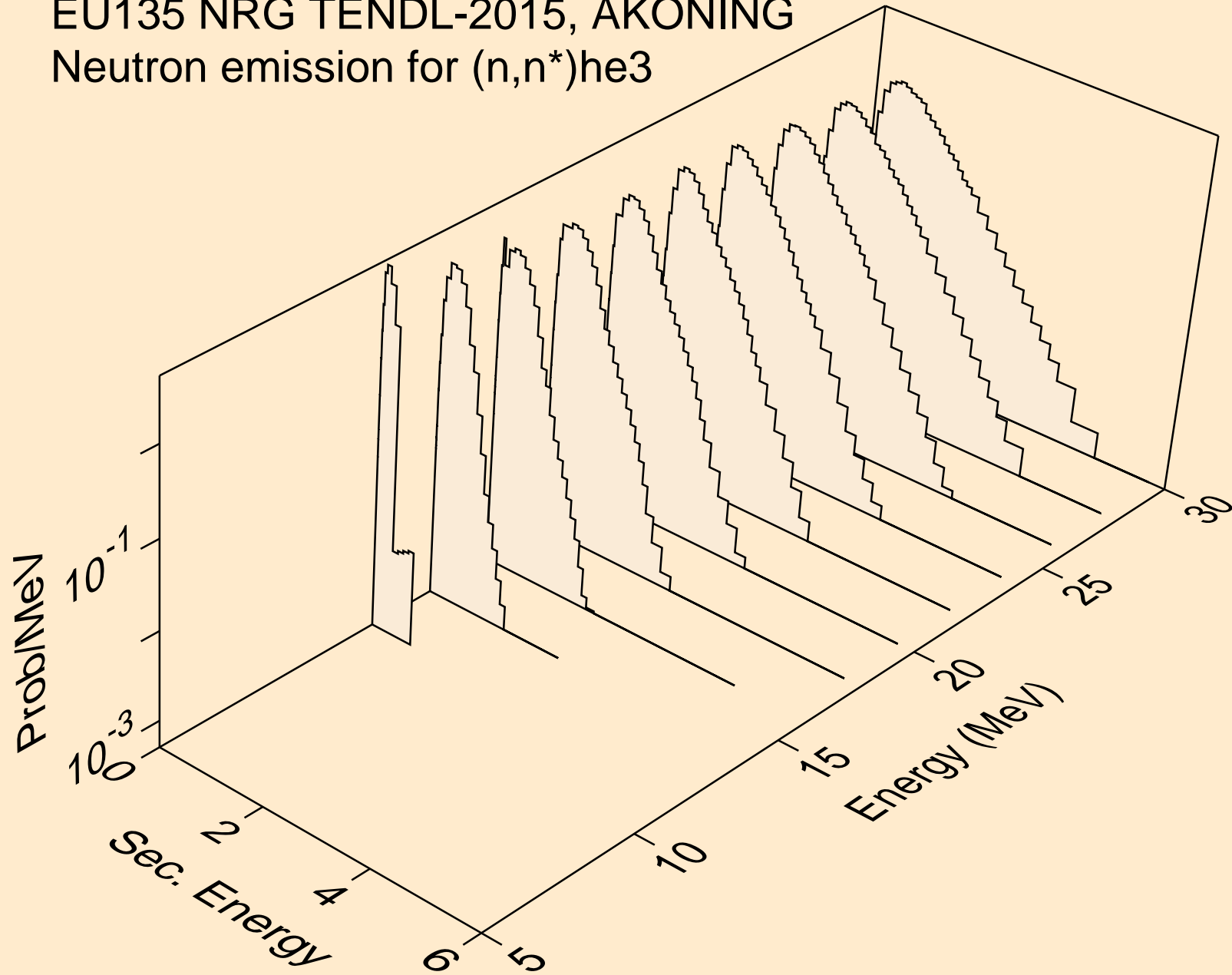

EU135 NRG TENDL-2015, AKONING
Neutron emission for (n,2np)

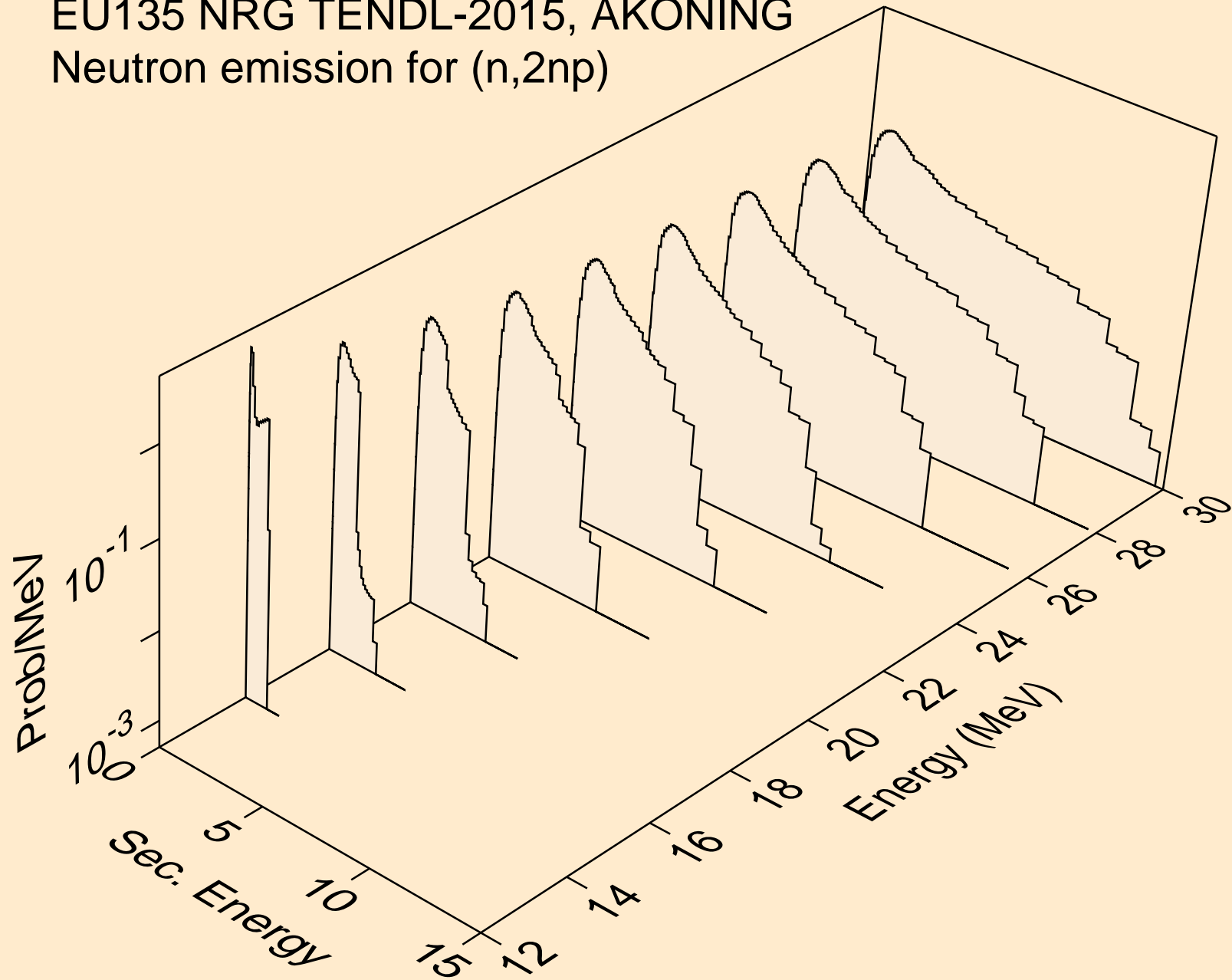

EU135 NRG TENDL-2015, AKONING
Neutron emission for (n,3np)

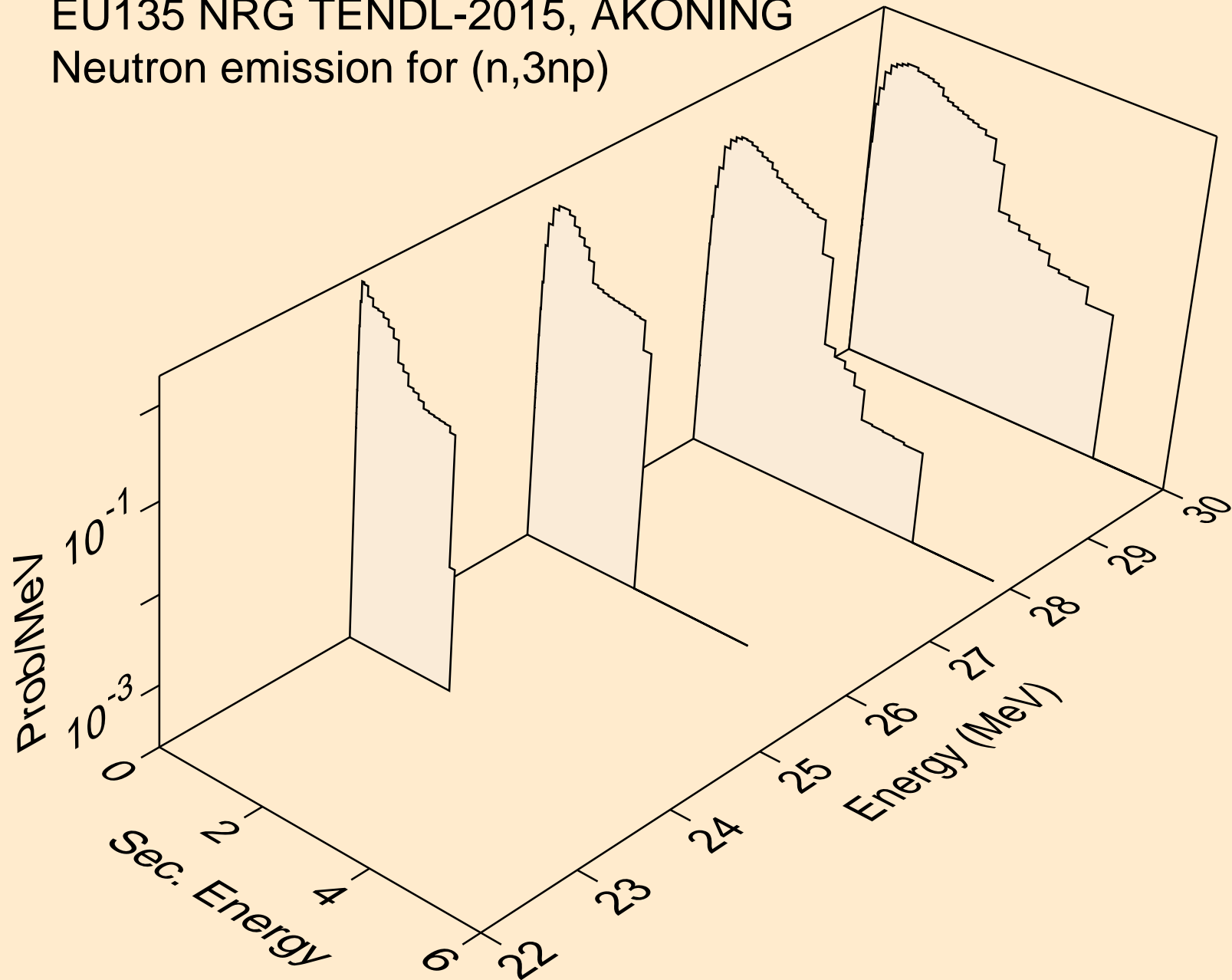

EU135 NRG TENDL-2015, AKONING
Neutron emission for (n,2np)

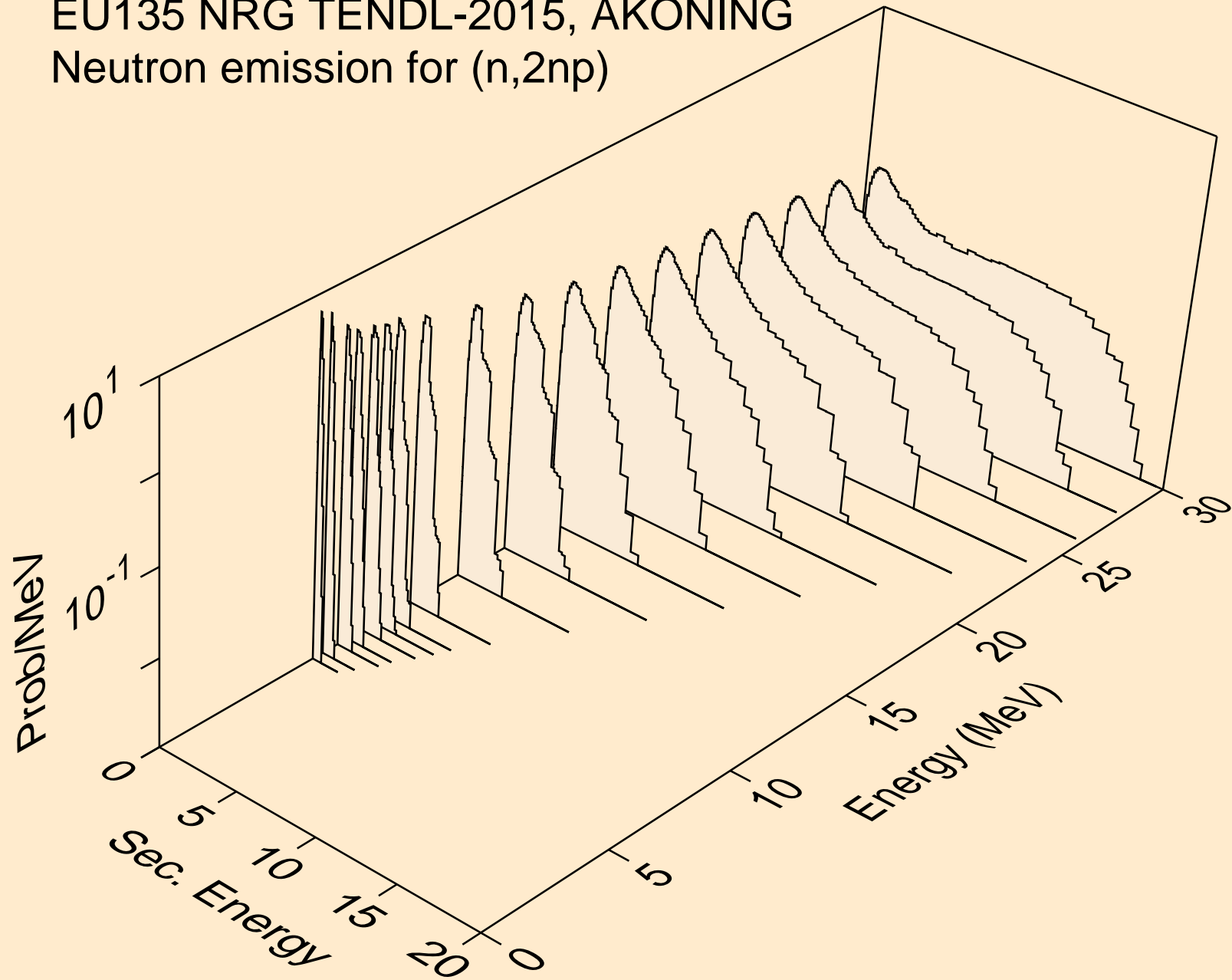

EU135 NRG TENDL-2015, AKONING
Neutron emission for (n,npa)

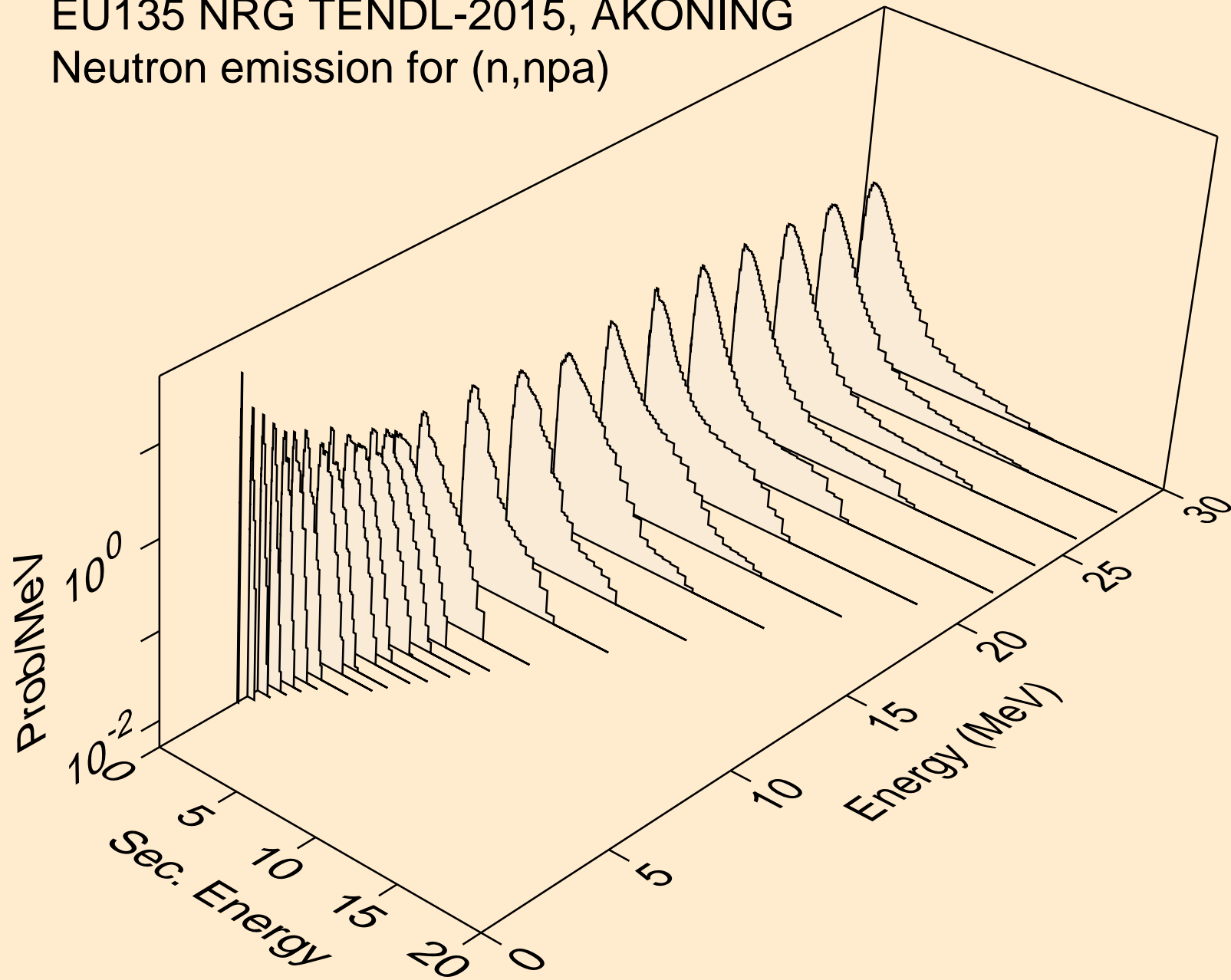

EU135 NRG TENDL-2015, AKONING
Neutron emission for (n,n*c)

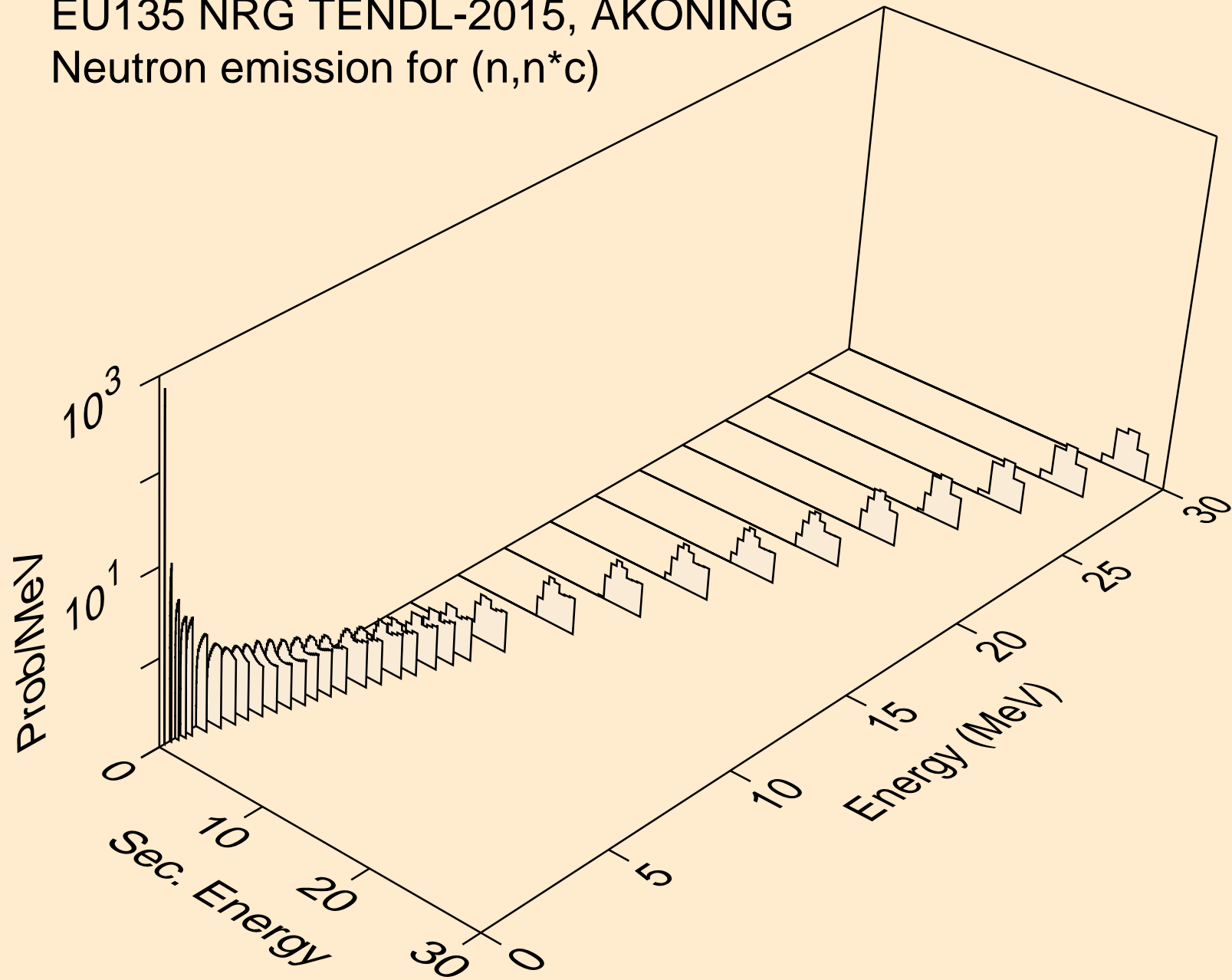

EU135 NRG TENDL-2015, AKONING
Photon emission for (n,x)

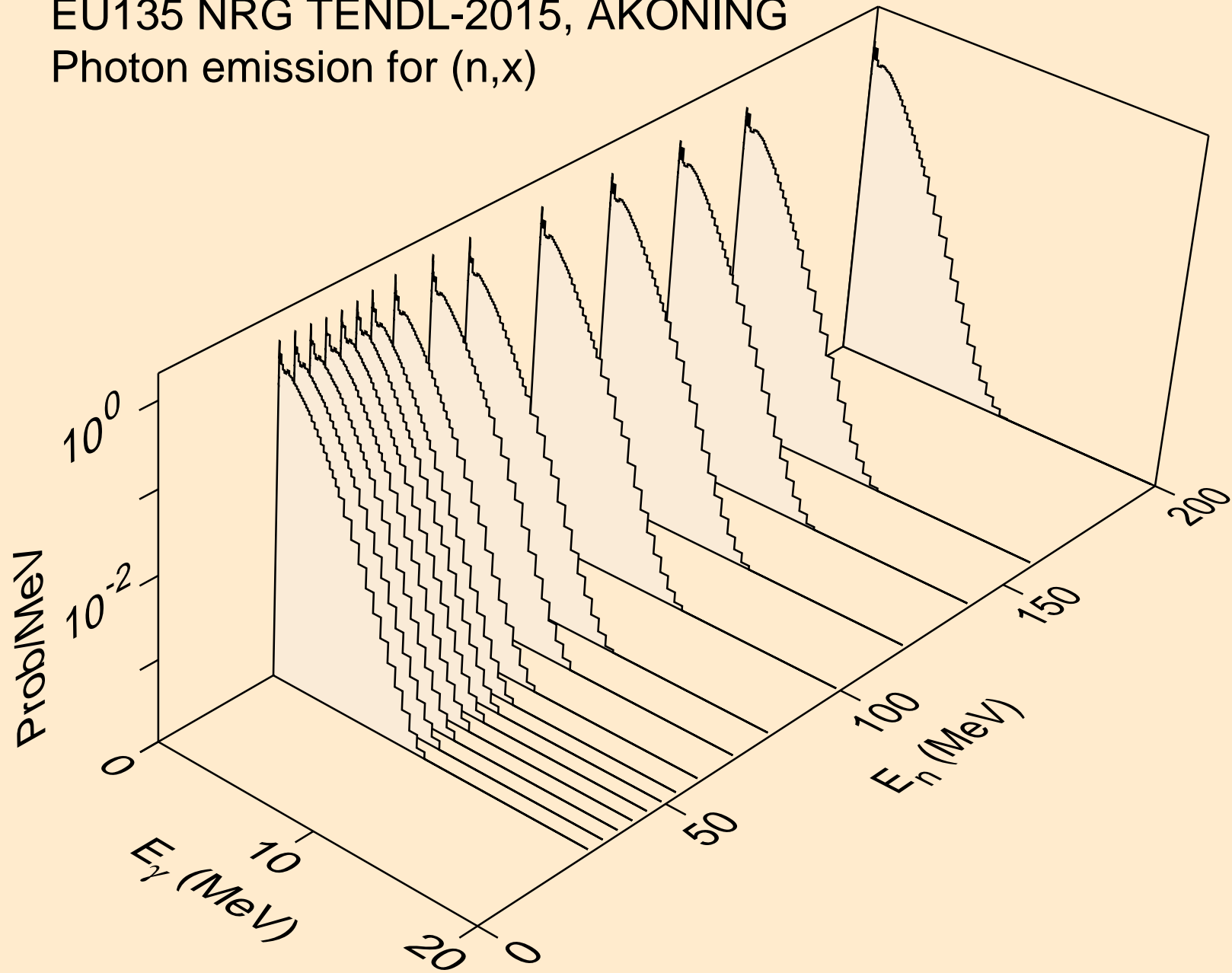

EU135 NRG TENDL-2015, AKONING
Photon emission for (n,2nd)

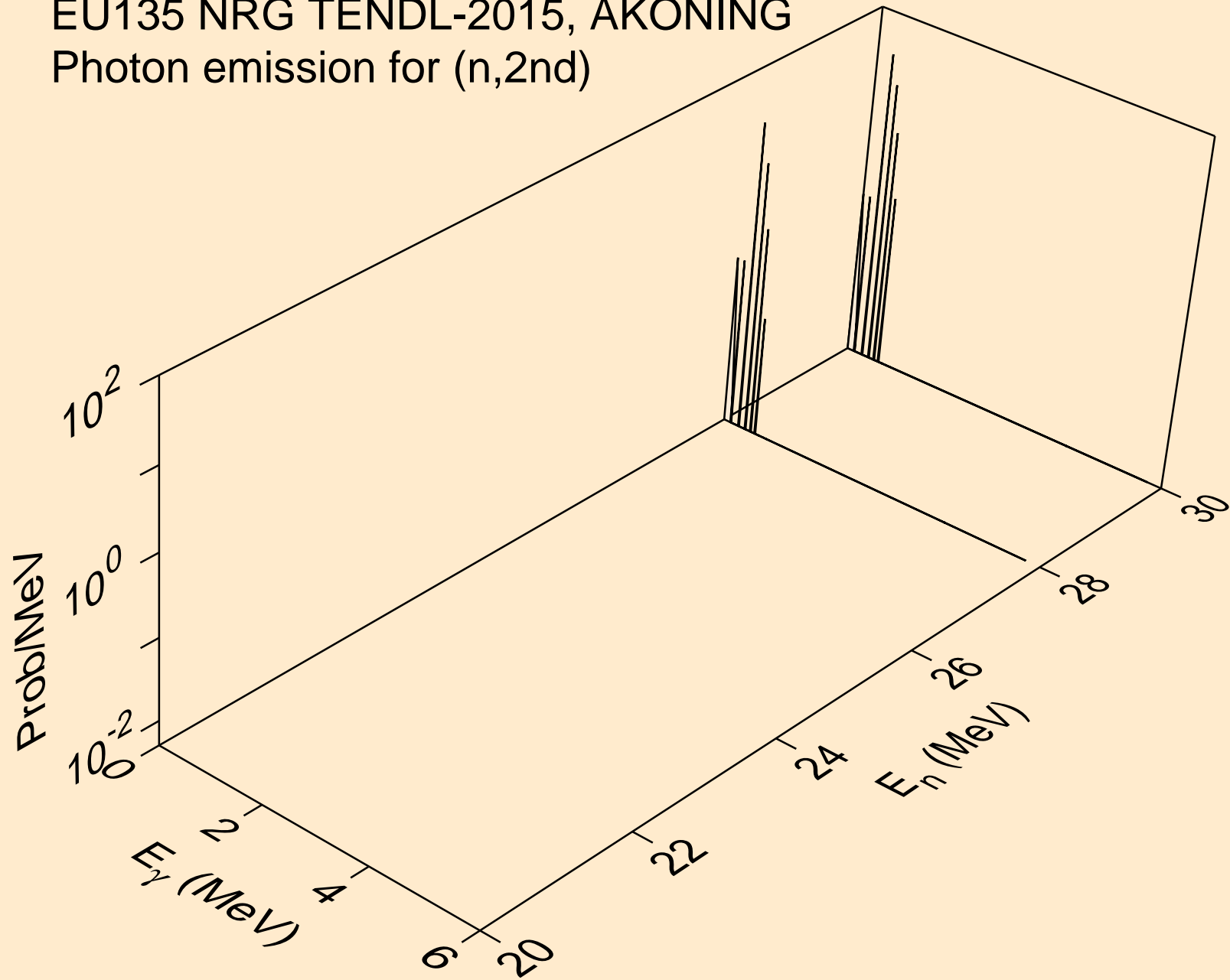

EU135 NRG TENDL-2015, AKONING
Photon emission for (n,2n)

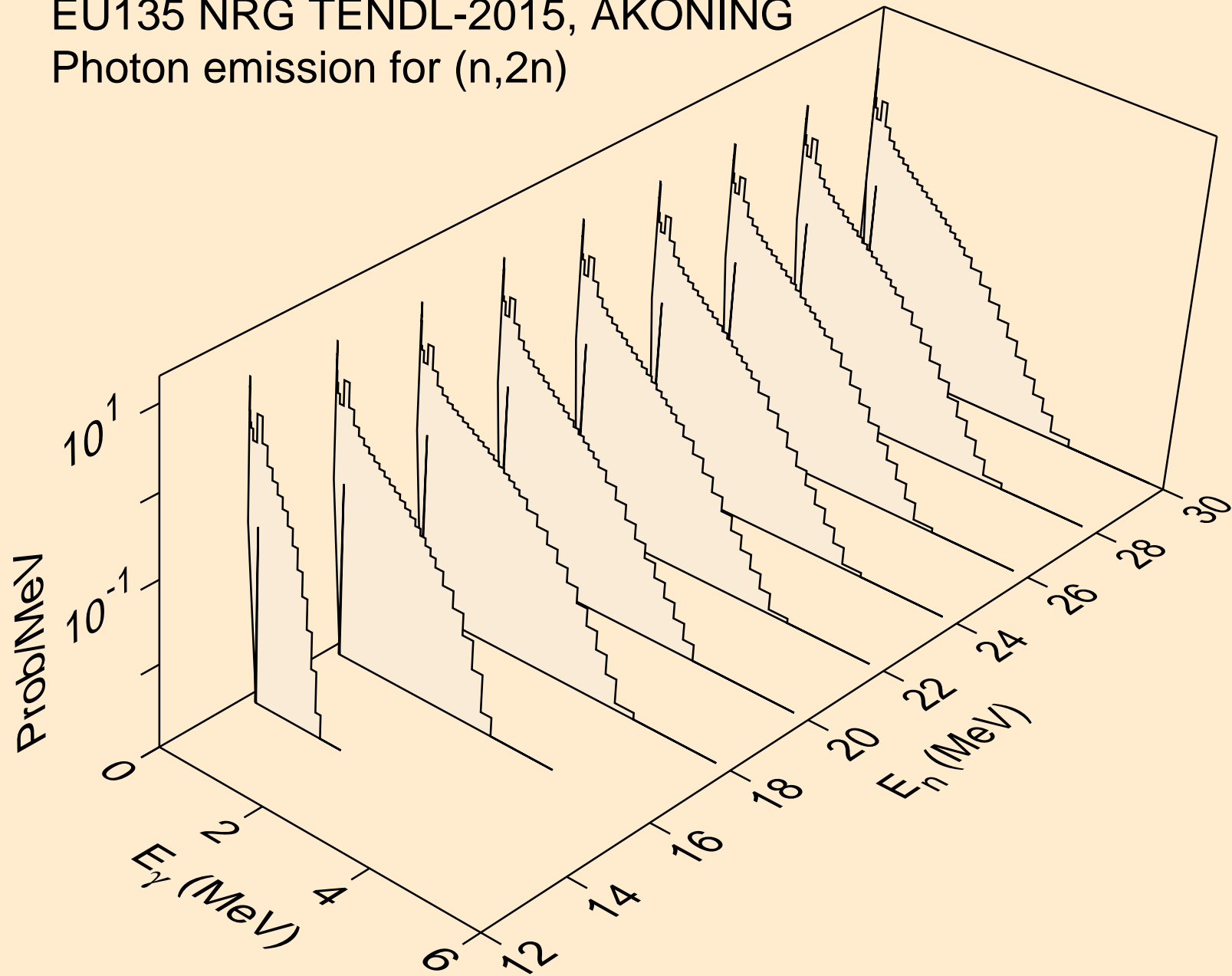

EU135 NRG TENDL-2015, AKONING
Photon emission for (n,3n)

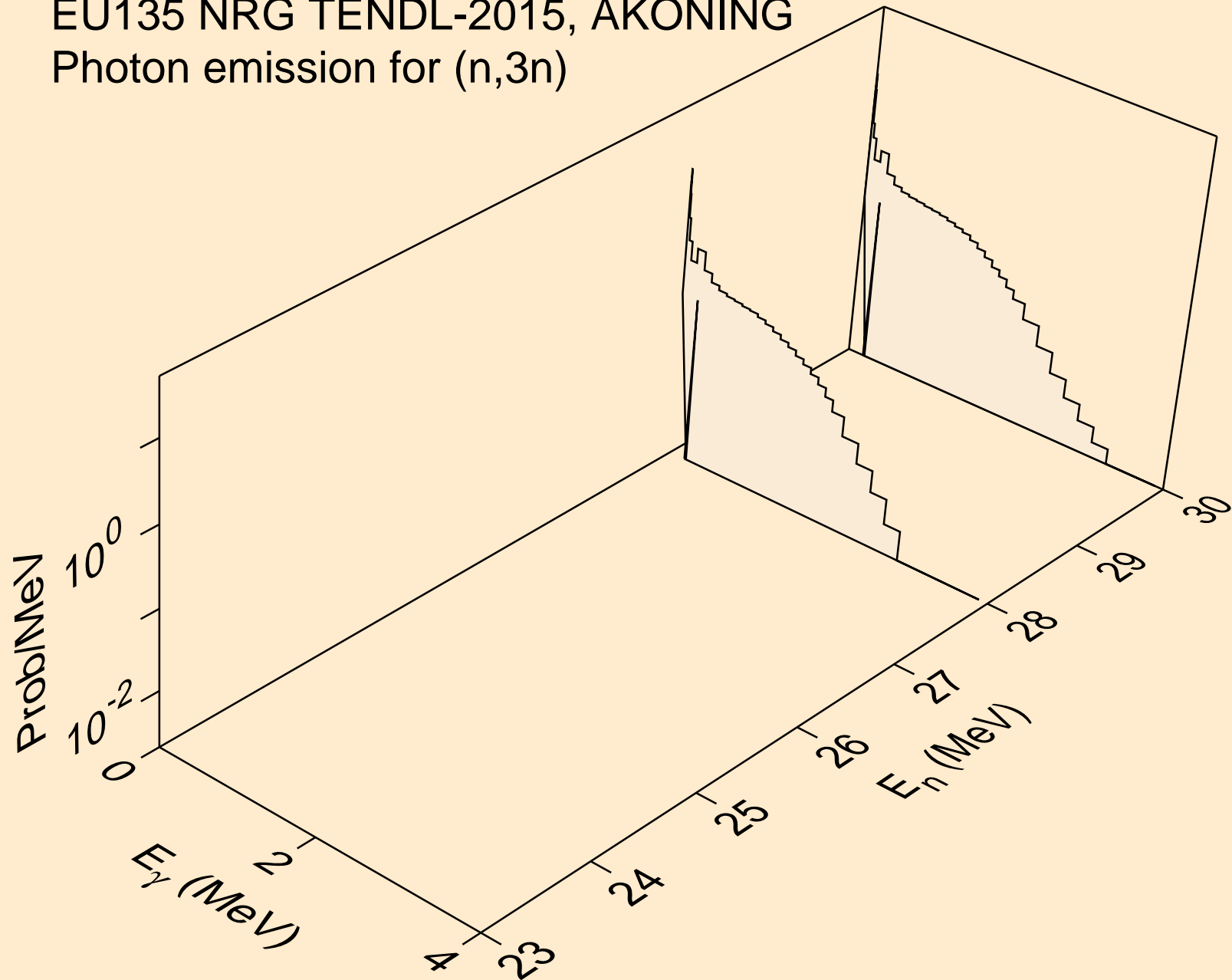

EU135 NRG TENDL-2015, AKONING
Photon emission for (n,n*)a

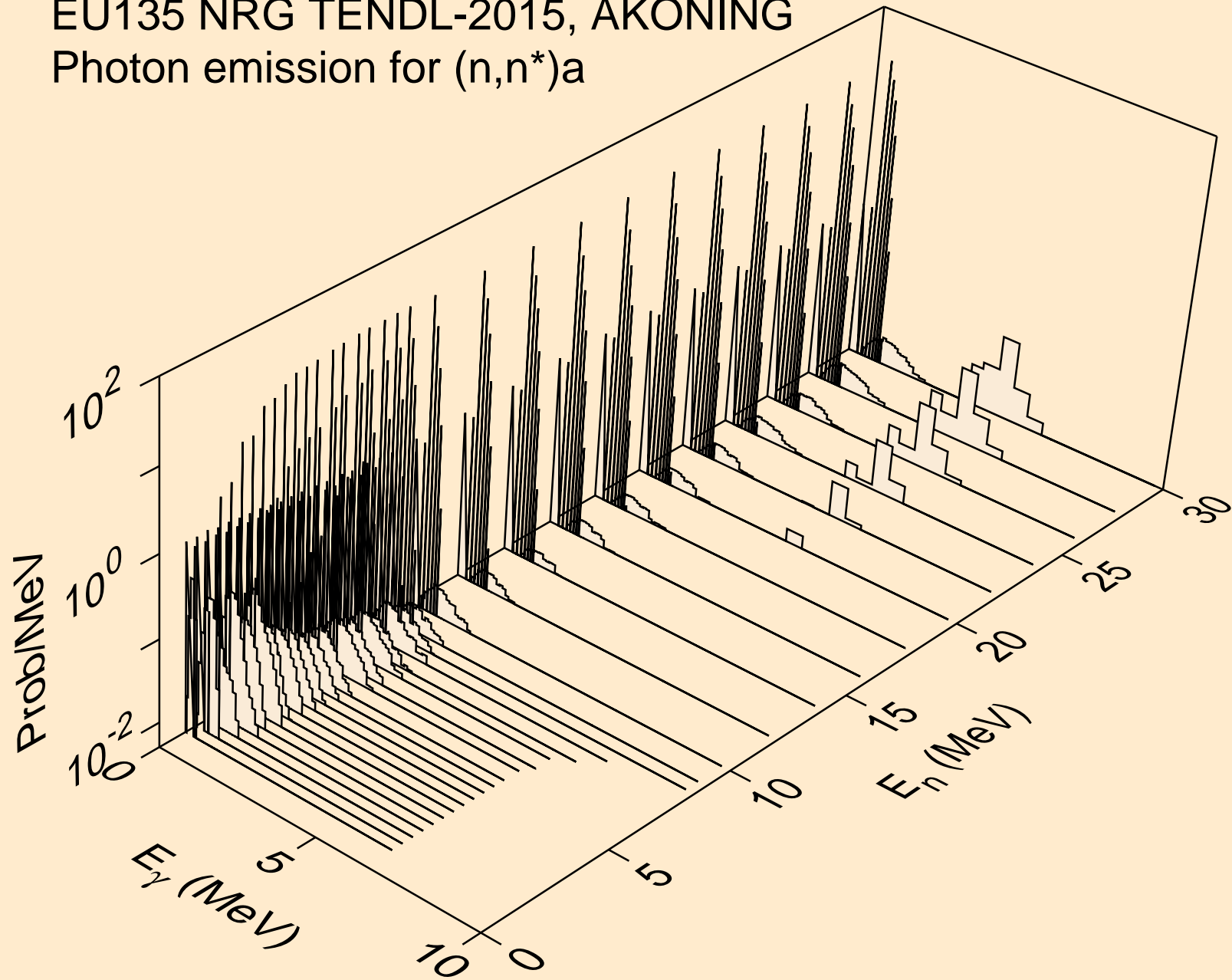

EU135 NRG TENDL-2015, AKONING
Photon emission for (n,n*)3a

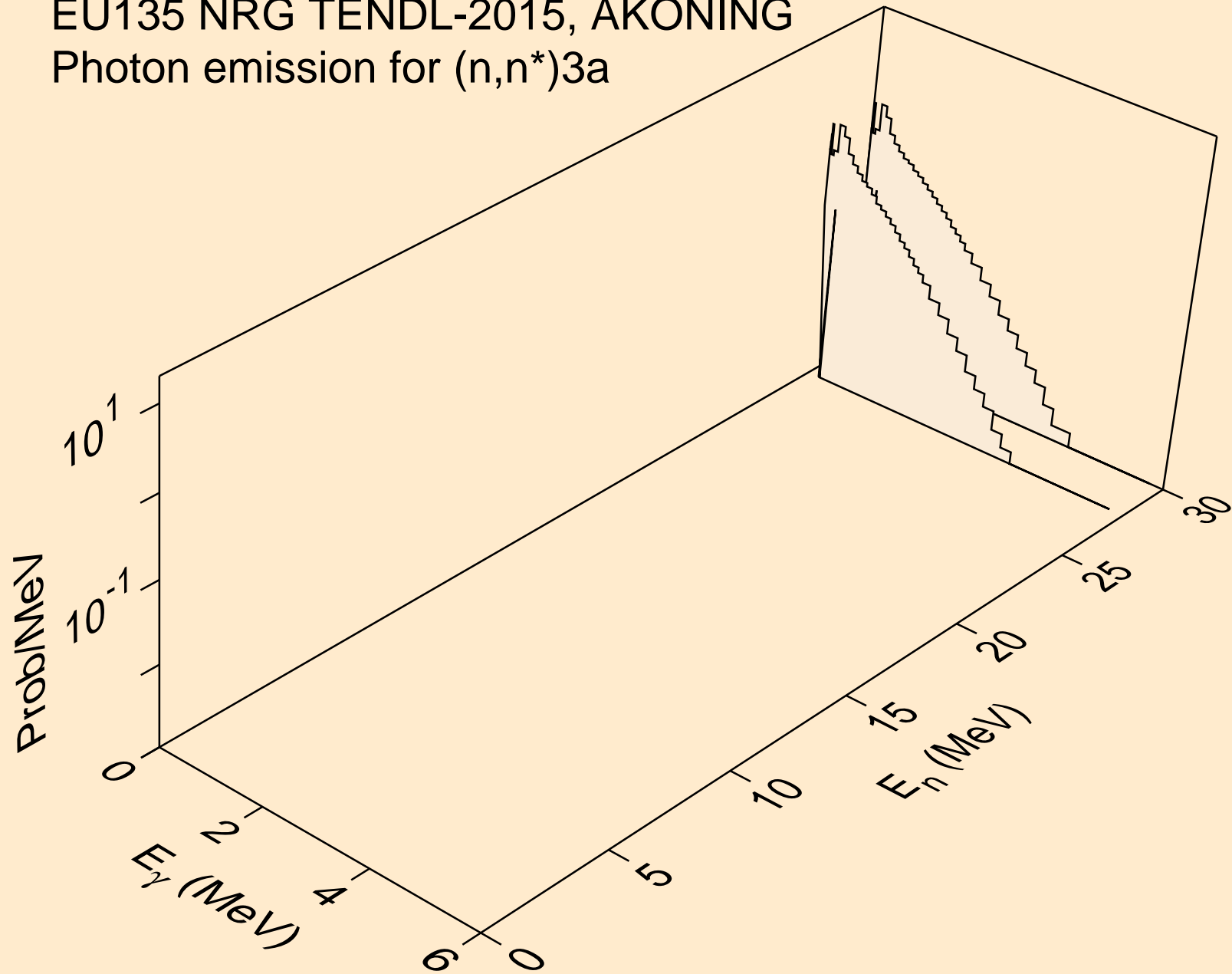

EU135 NRG TENDL-2015, AKONING
Photon emission for (n,2n)a

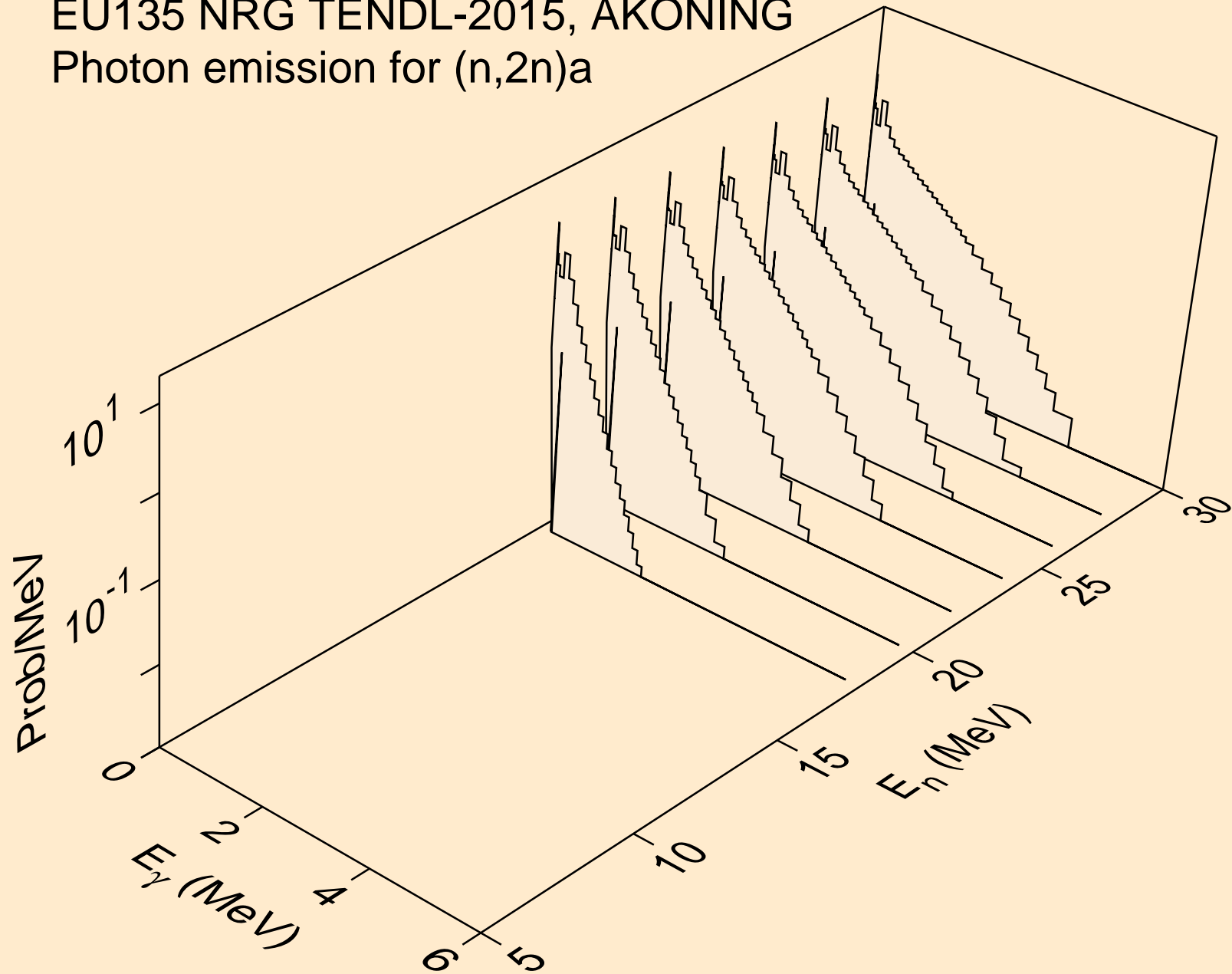

EU135 NRG TENDL-2015, AKONING
Photon emission for (n,3n)a

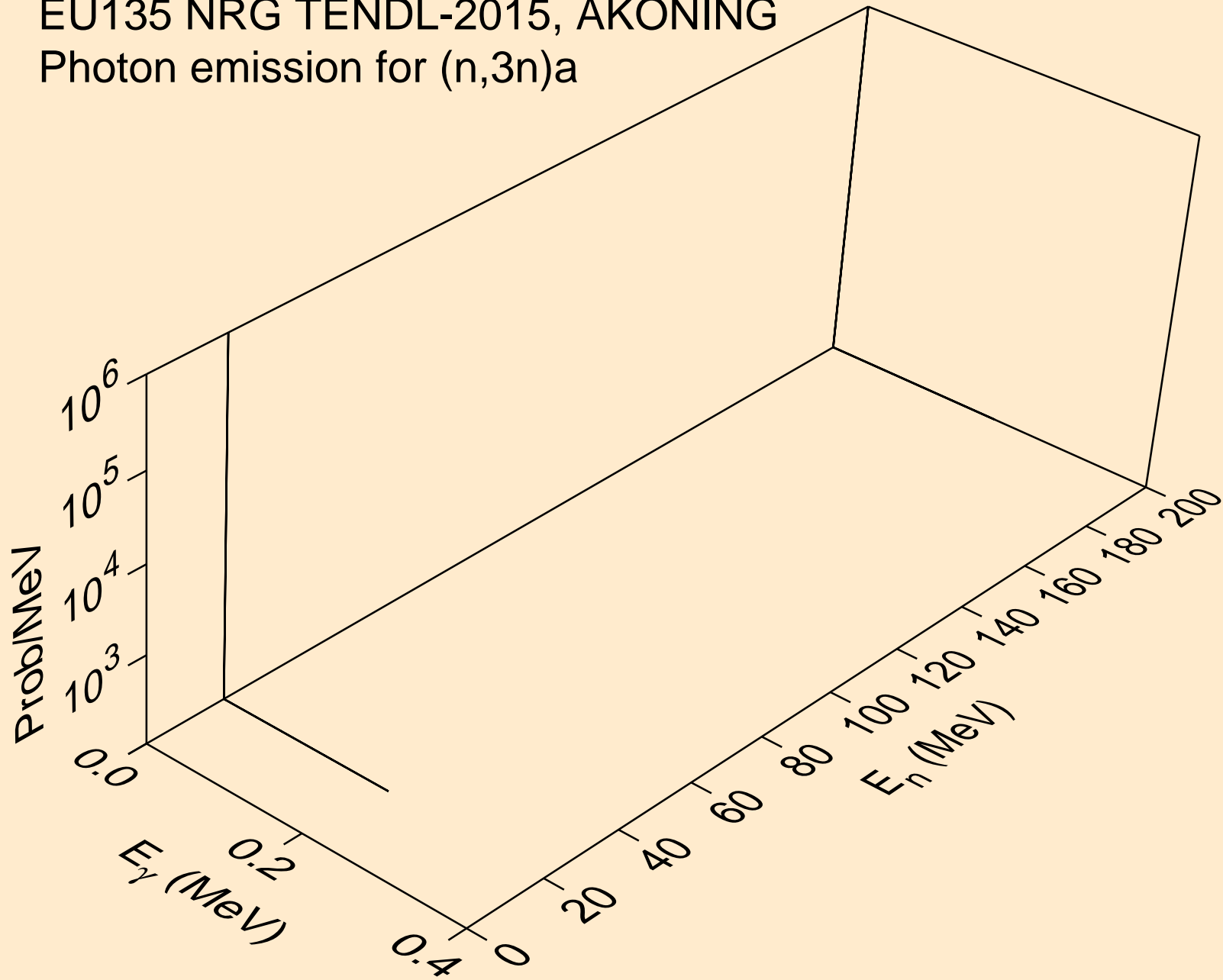

EU135 NRG TENDL-2015, AKONING
Photon emission for (n,n*)p

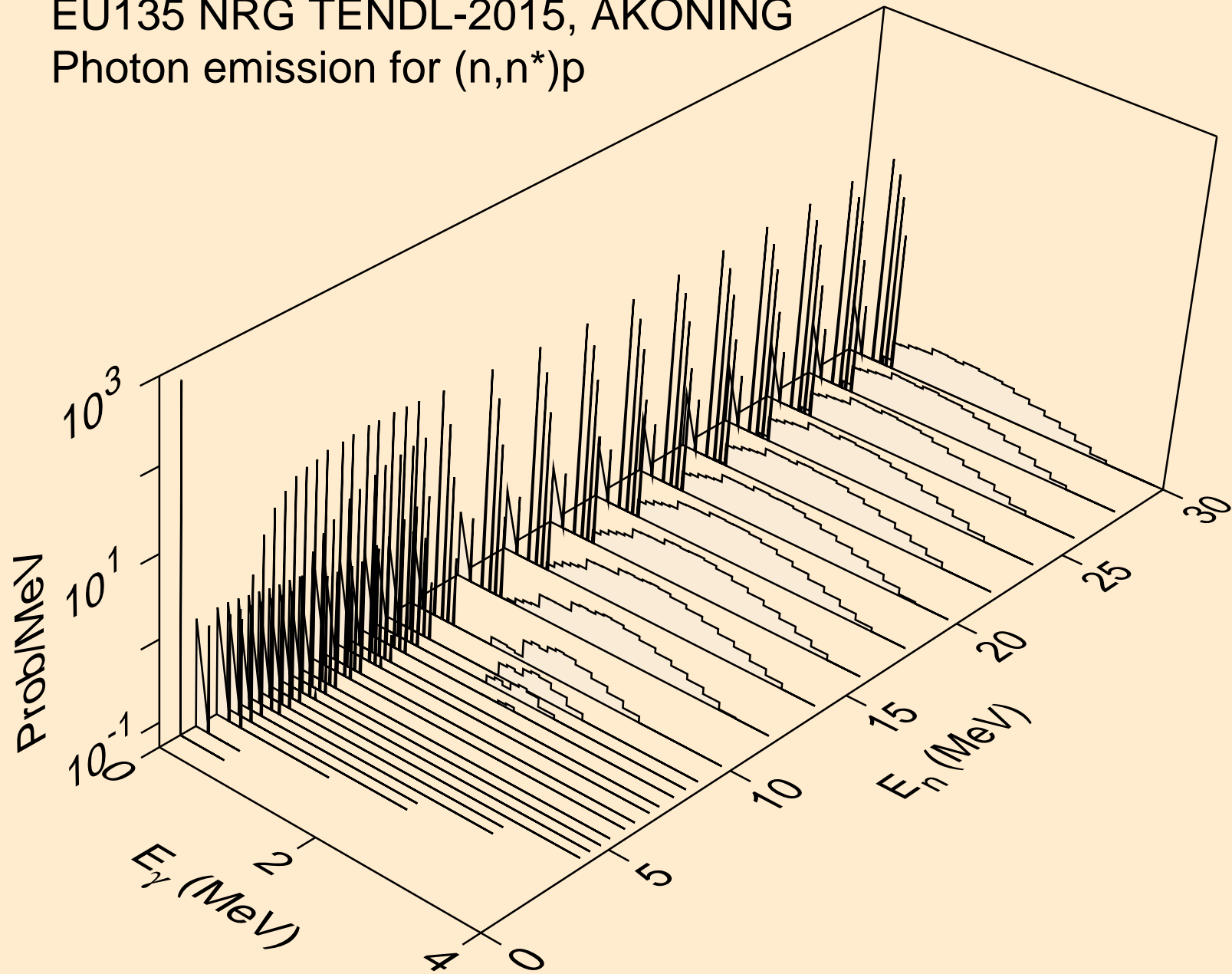

EU135 NRG TENDL-2015, AKONING
Photon emission for (n,n*)2a

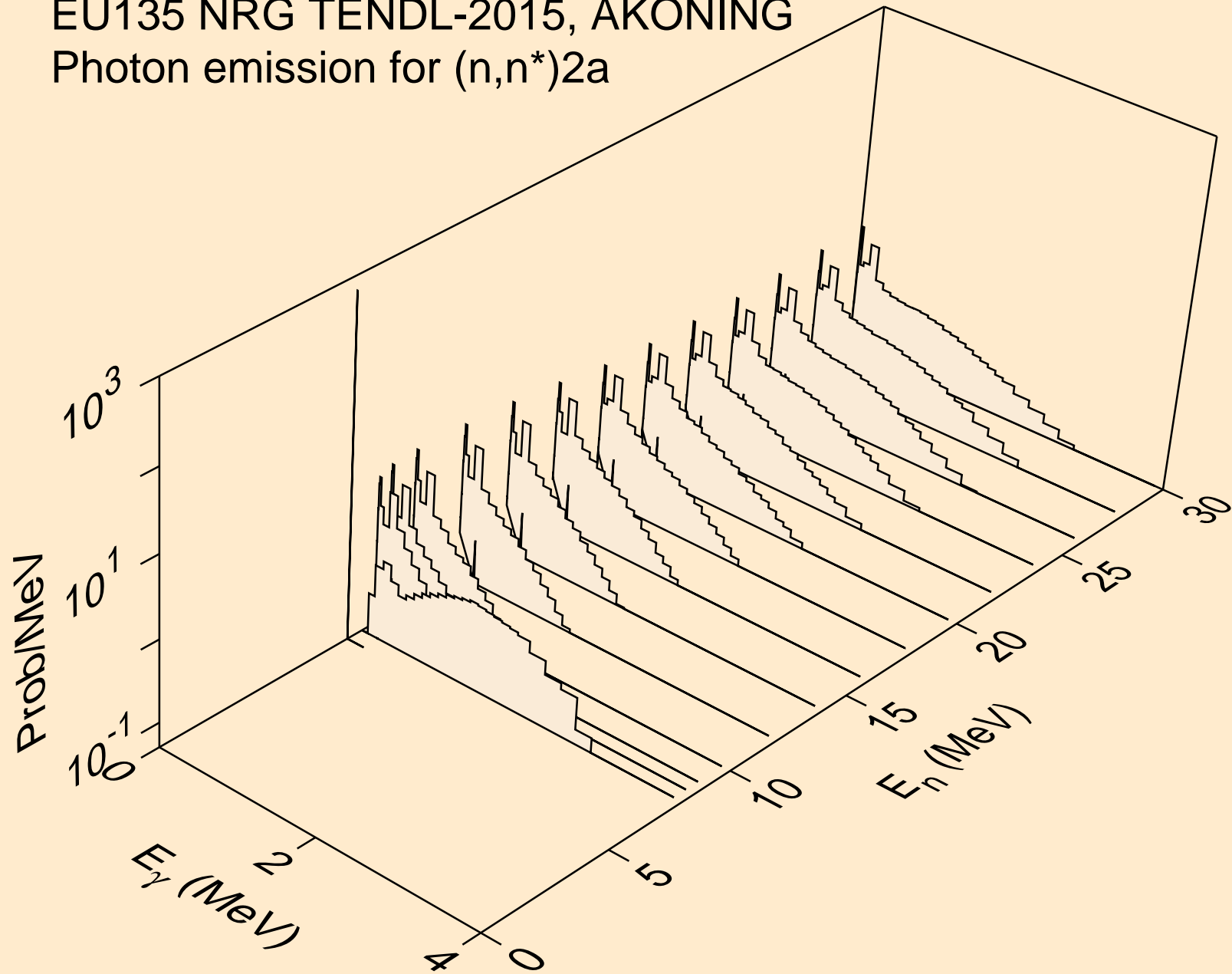

EU135 NRG TENDL-2015, AKONING
Photon emission for (n,2n)2a

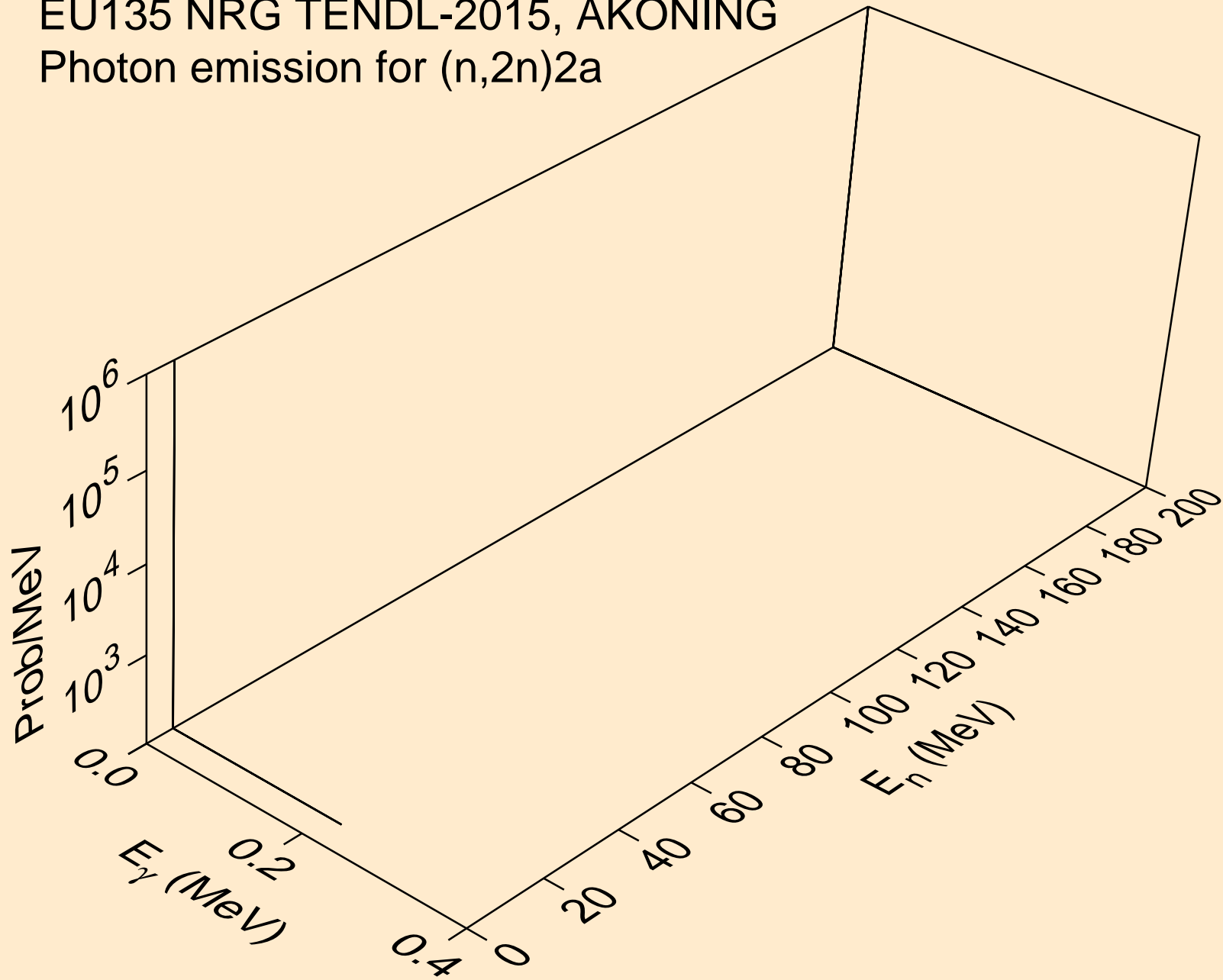

EU135 NRG TENDL-2015, AKONING
Photon emission for (n,n*)d

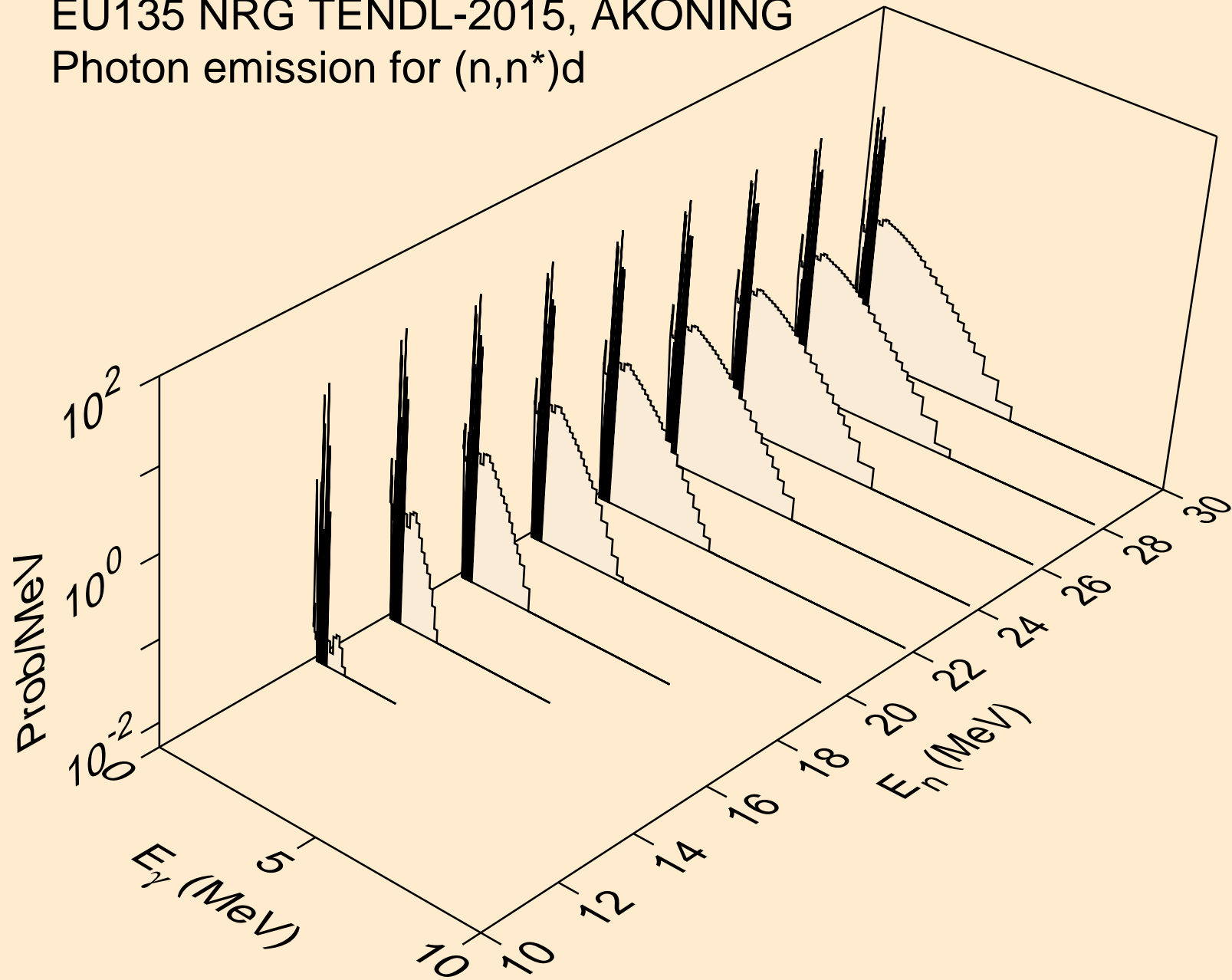

EU135 NRG TENDL-2015, AKONING
Photon emission for (n,n*)t

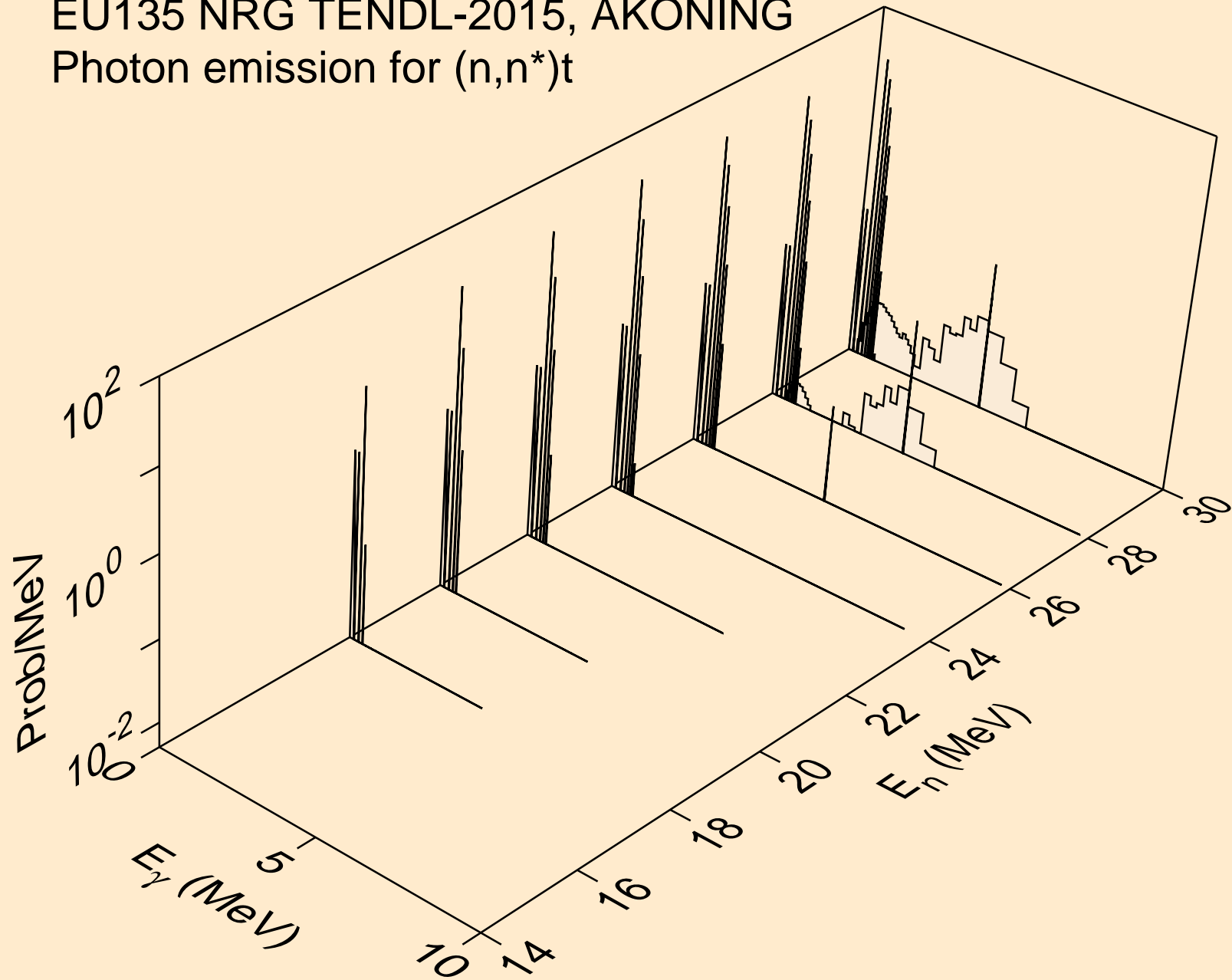

EU135 NRG TENDL-2015, AKONING
Photon emission for (n,n*)he3

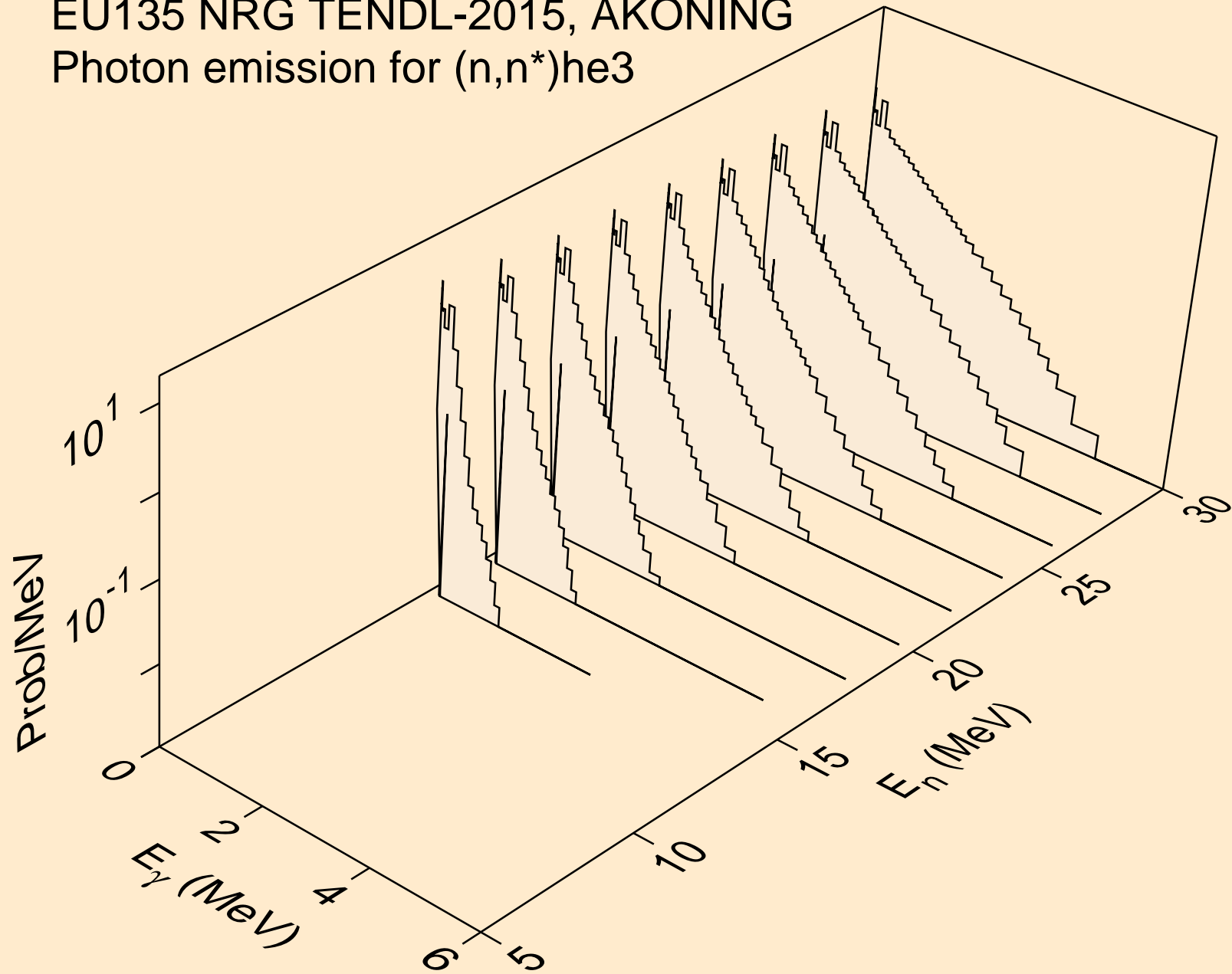

EU135 NRG TENDL-2015, AKONING
Photon emission for (n,2np)

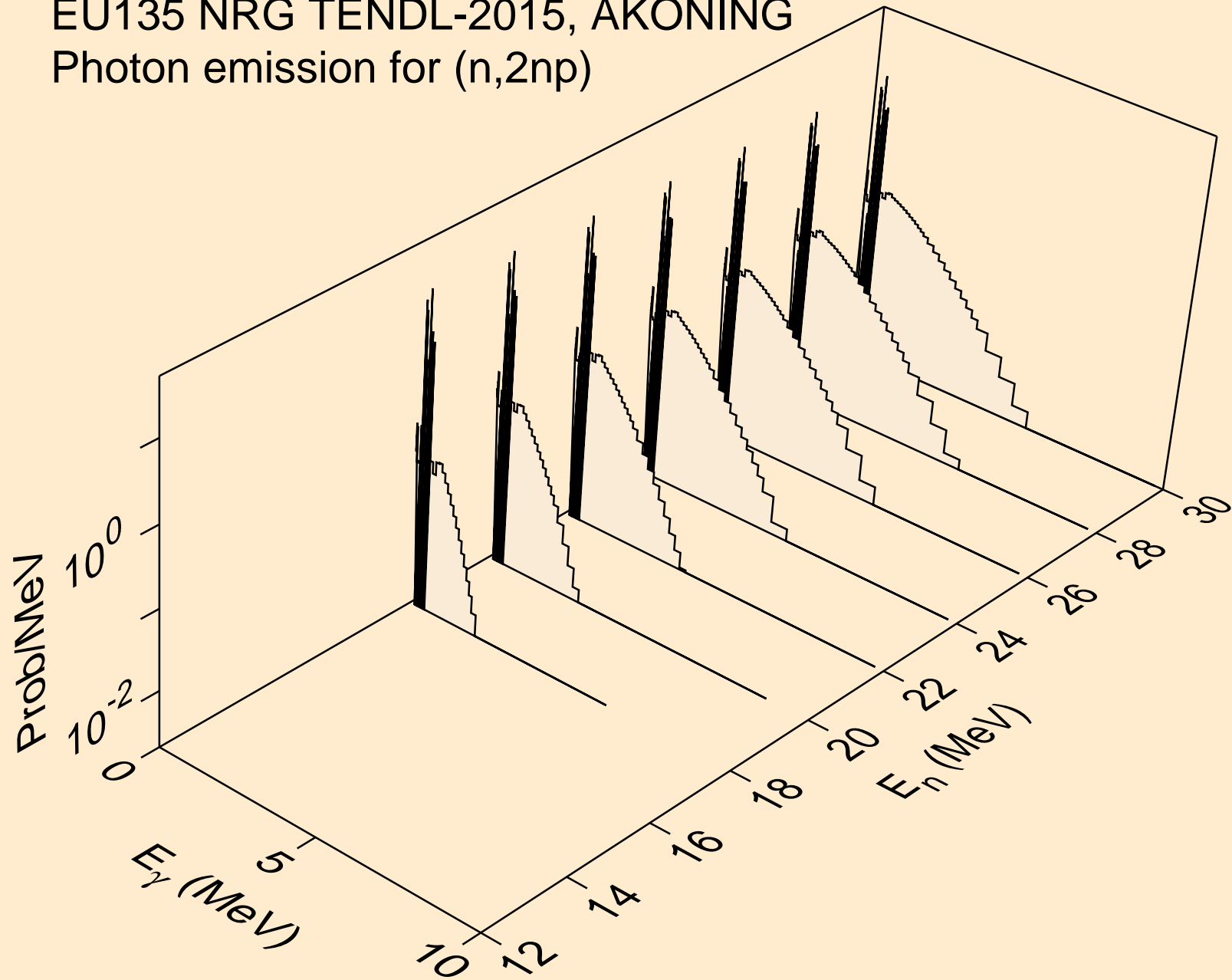

EU135 NRG TENDL-2015, AKONING
Photon emission for (n,3np)

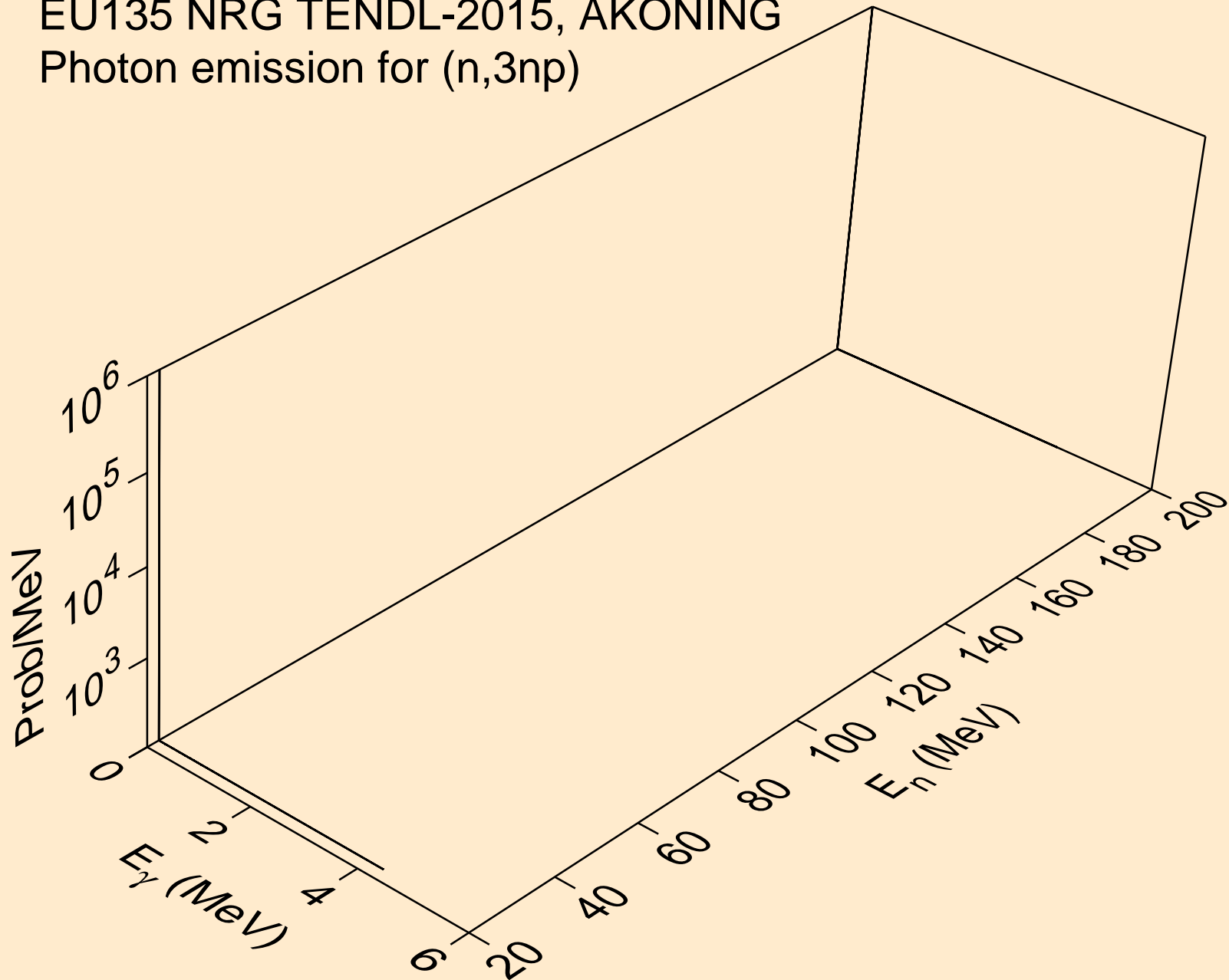

EU135 NRG TENDL-2015, AKONING
Photon emission for (n,2np)

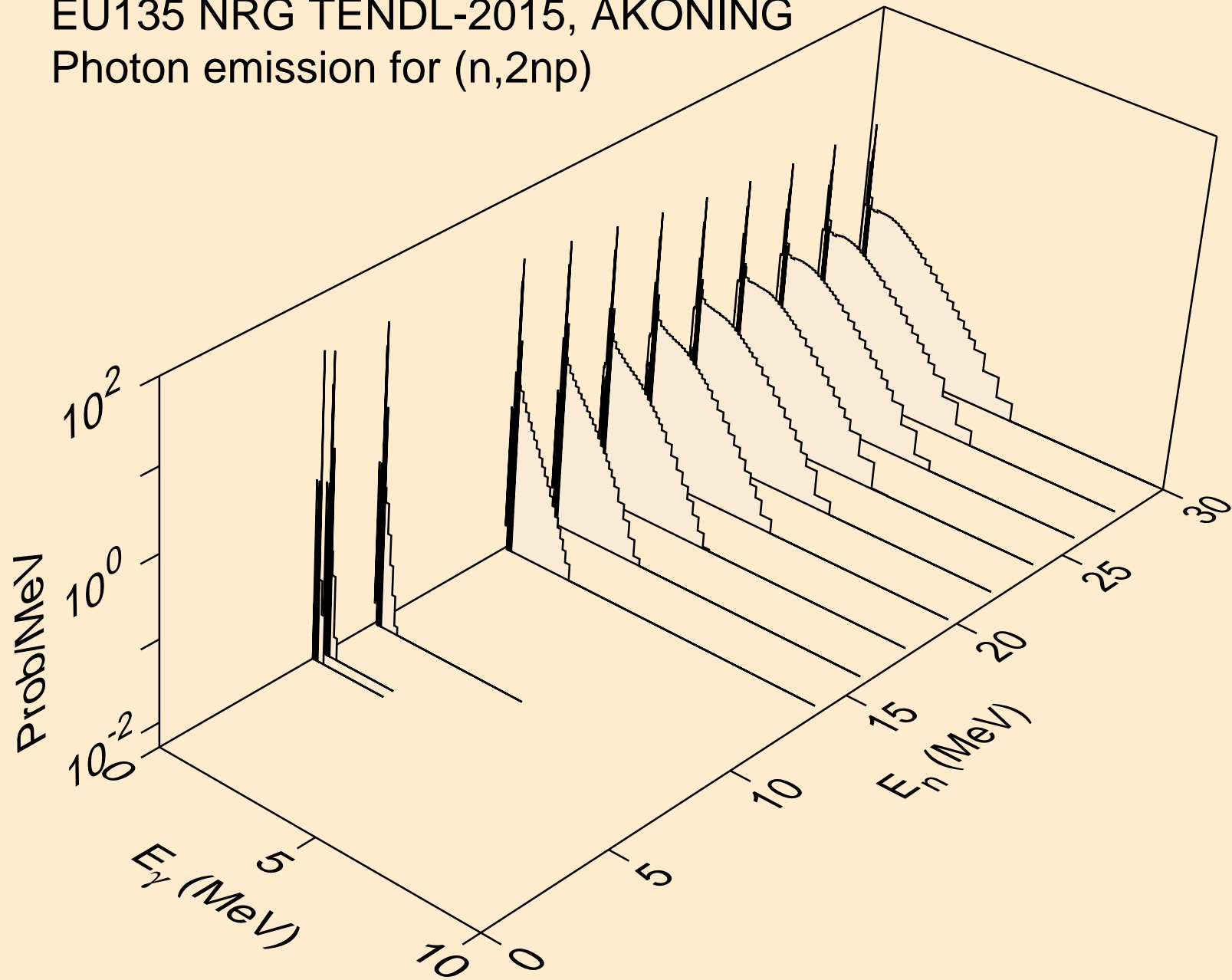

EU135 NRG TENDL-2015, AKONING
Photon emission for (n,npa)

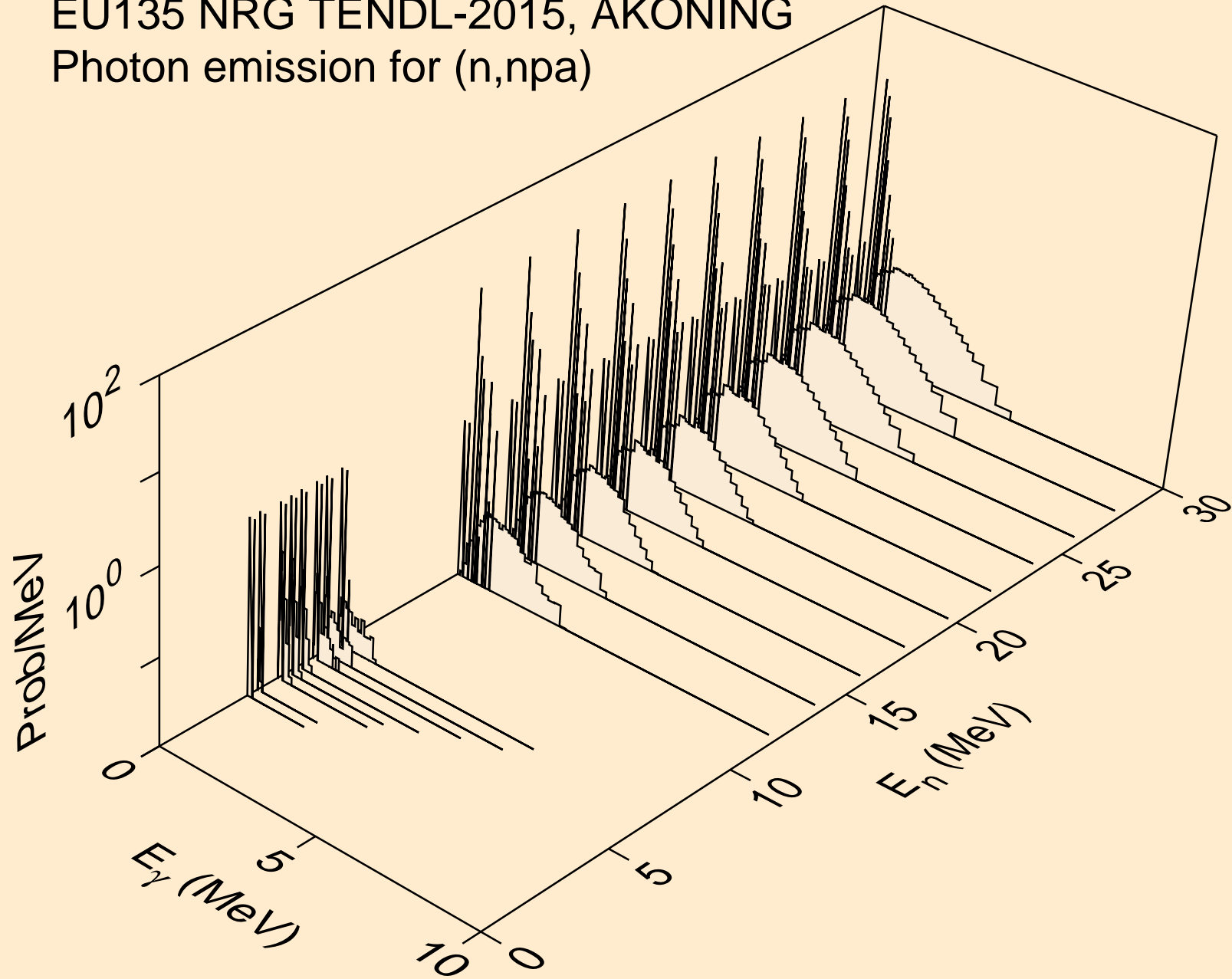

EU135 NRG TENDL-2015, AKONING
Photon emission for (n,n*c)

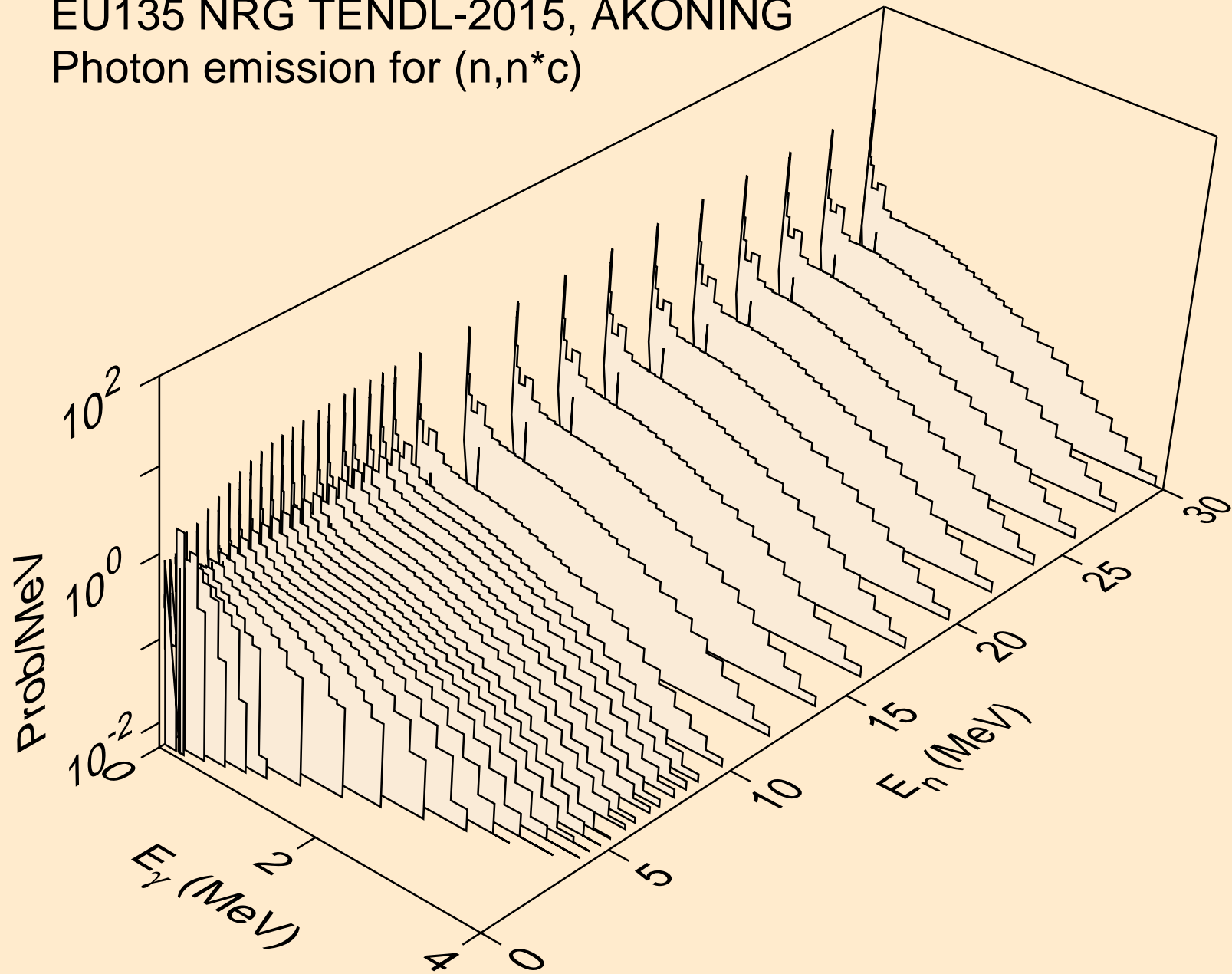

EU135 NRG TENDL-2015, AKONING
Photon emission for (n,gma)

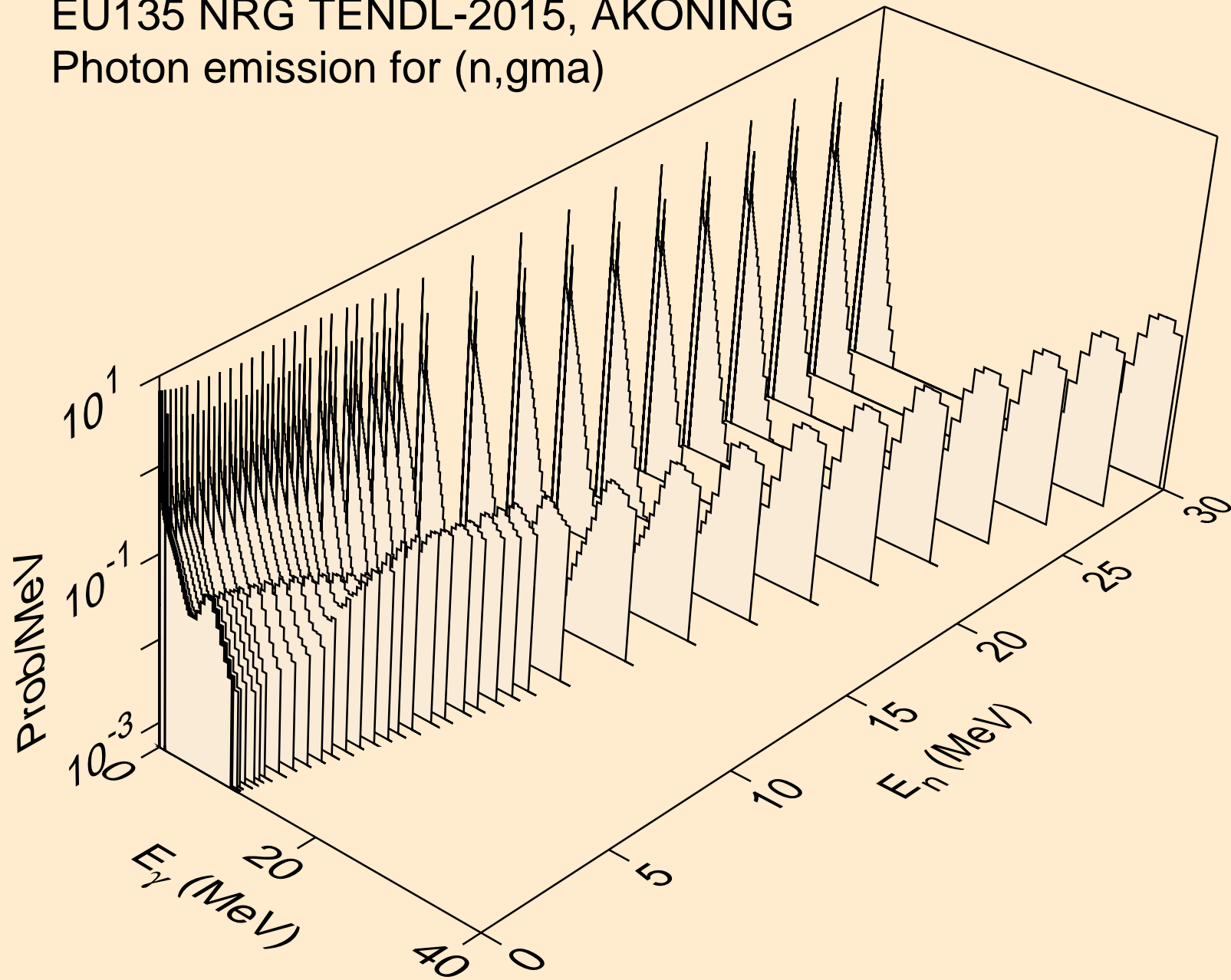

EU135 NRG TENDL-2015, AKONING
Photon emission for (n,p)

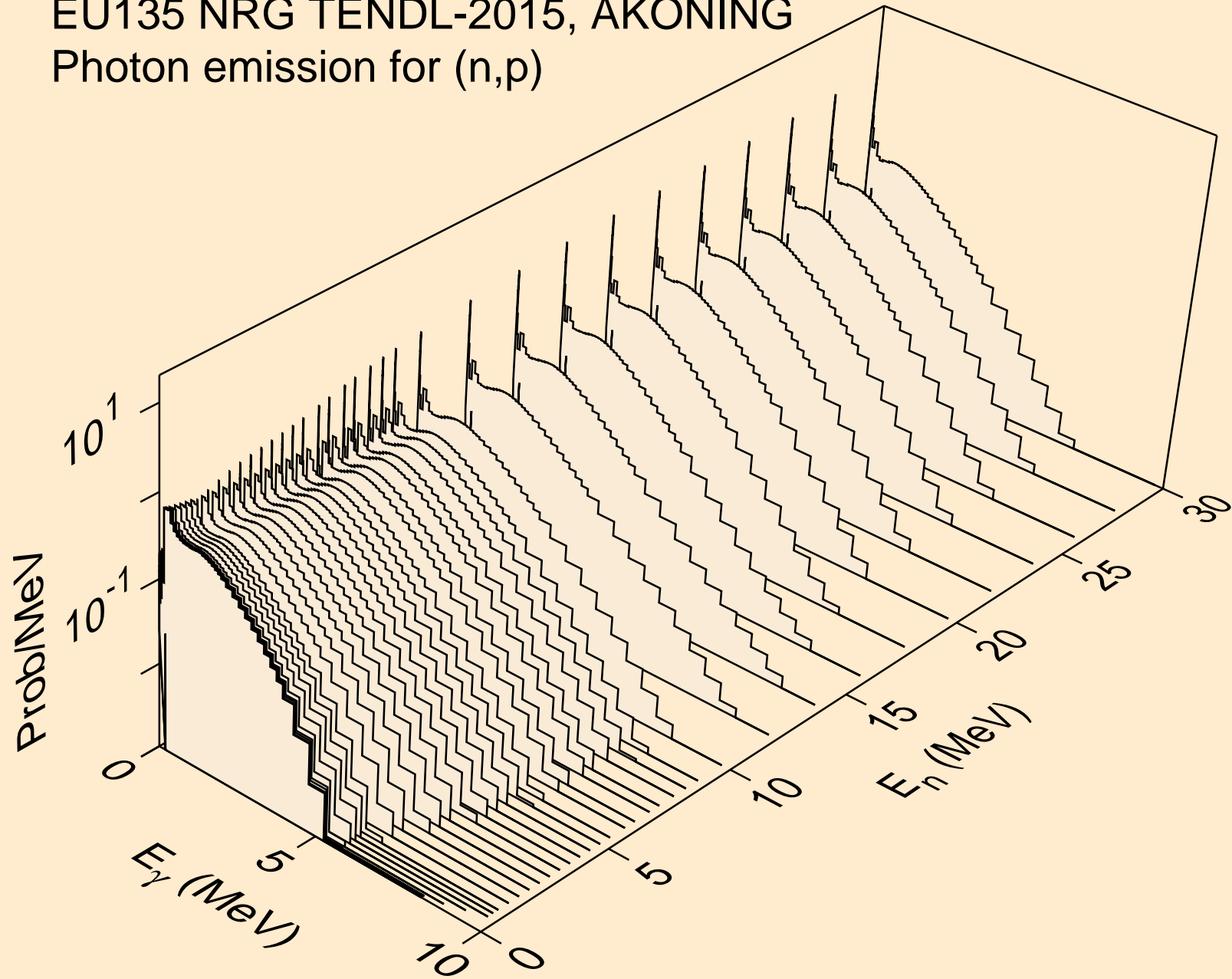

EU135 NRG TENDL-2015, AKONING
Photon emission for (n,d)

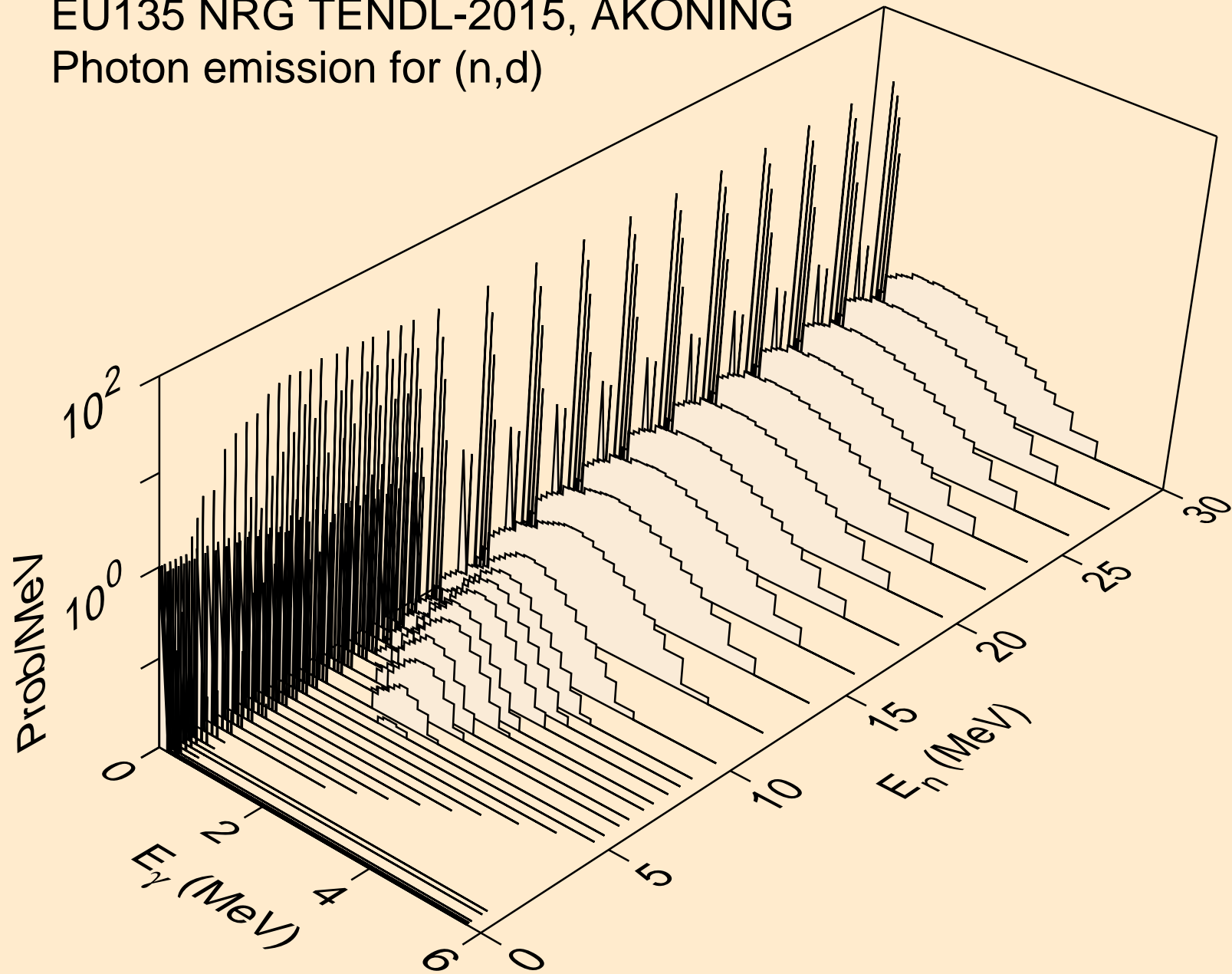

EU135 NRG TENDL-2015, AKONING
Photon emission for (n,t)

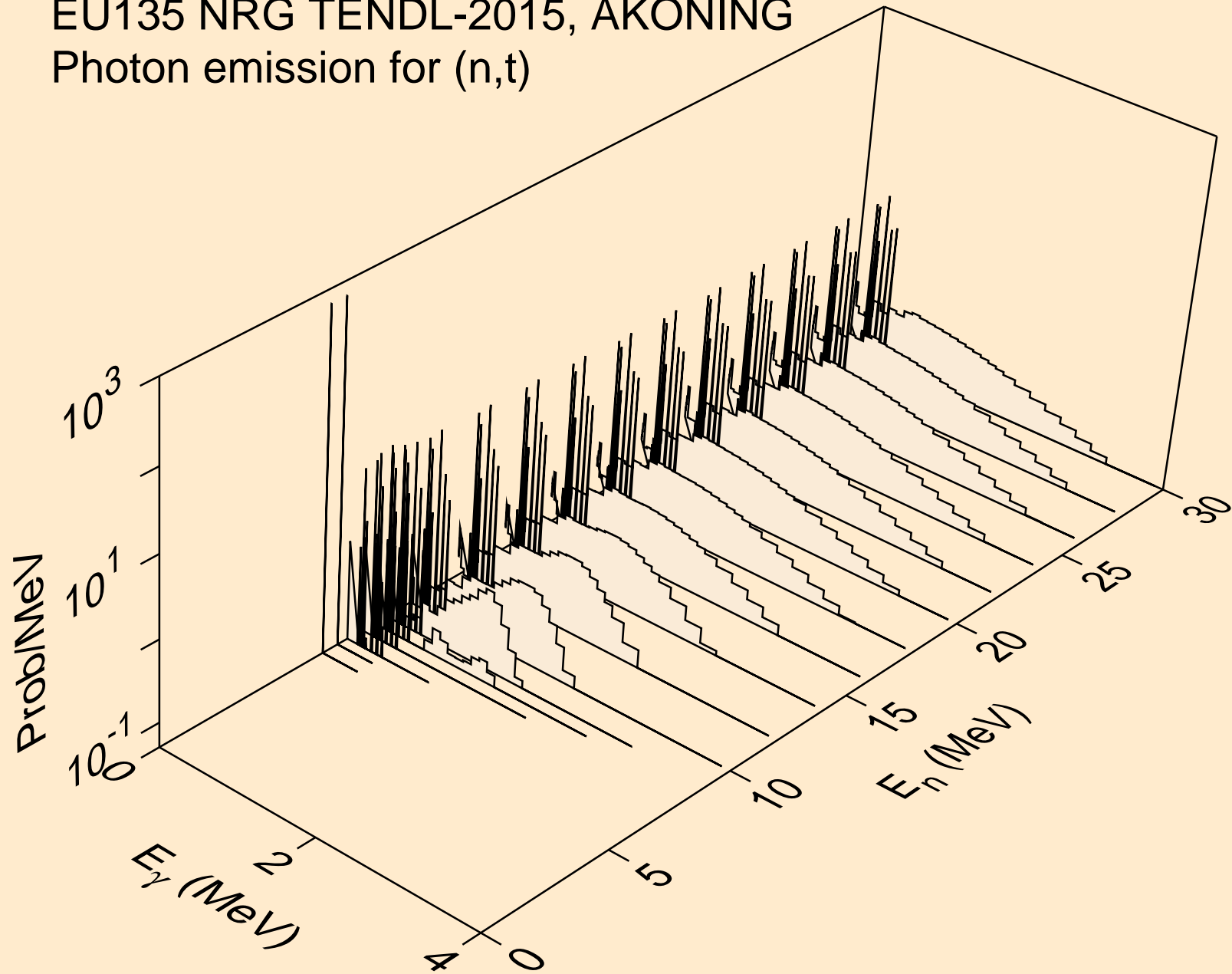

EU135 NRG TENDL-2015, AKONING
Photon emission for (n,he3)

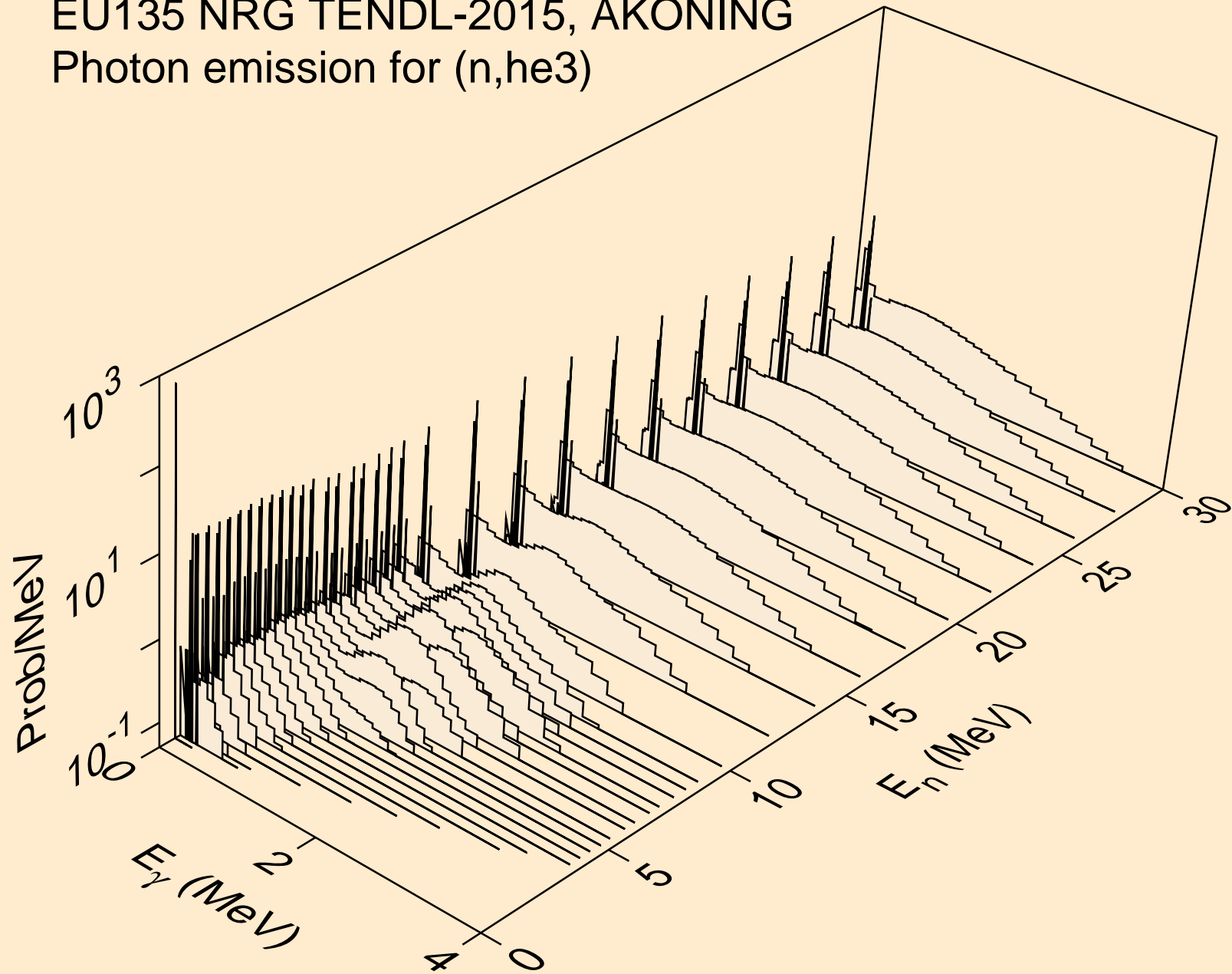

EU135 NRG TENDL-2015, AKONING
Photon emission for (n,a)

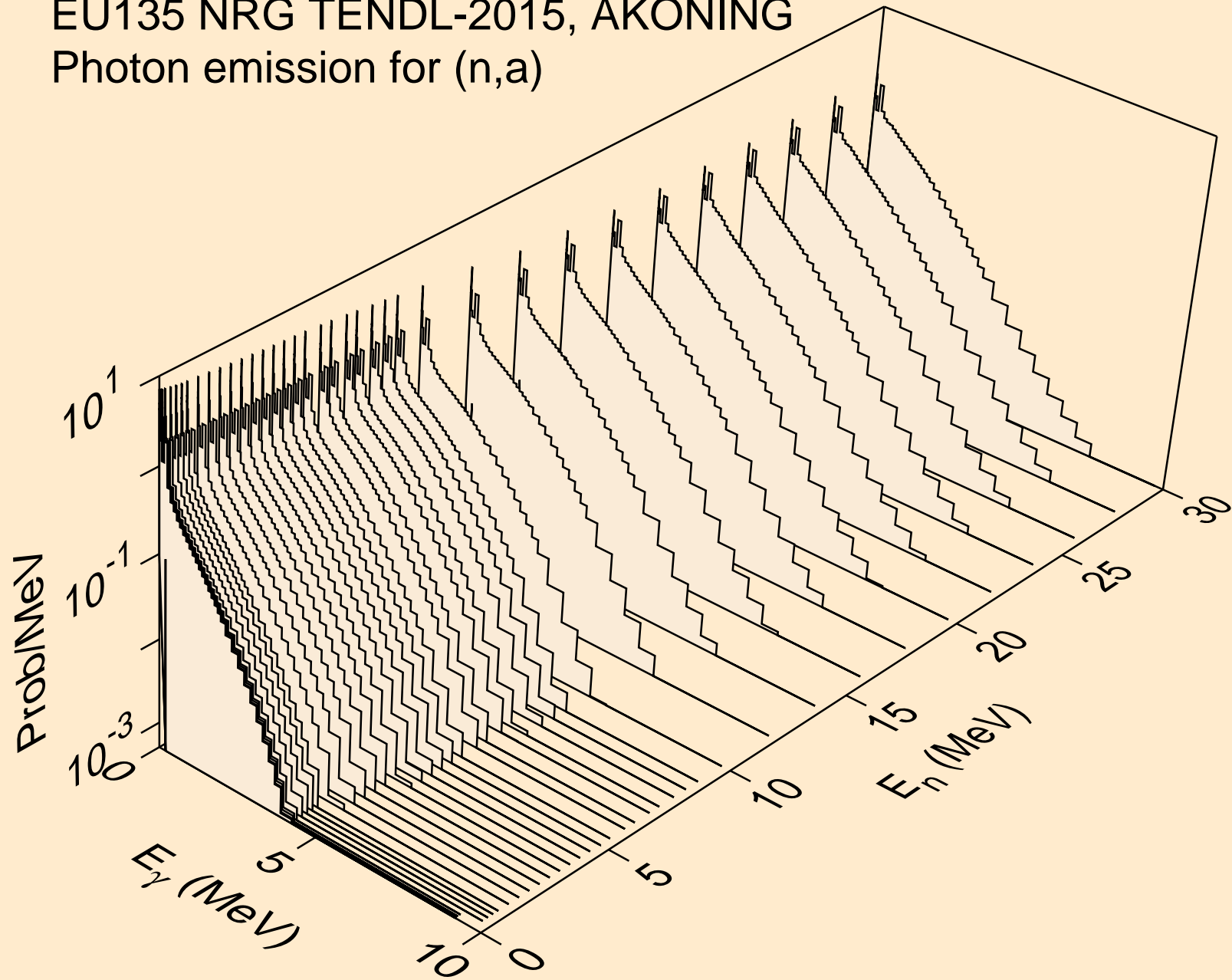

EU135 NRG TENDL-2015, AKONING
Photon emission for (n,2a)

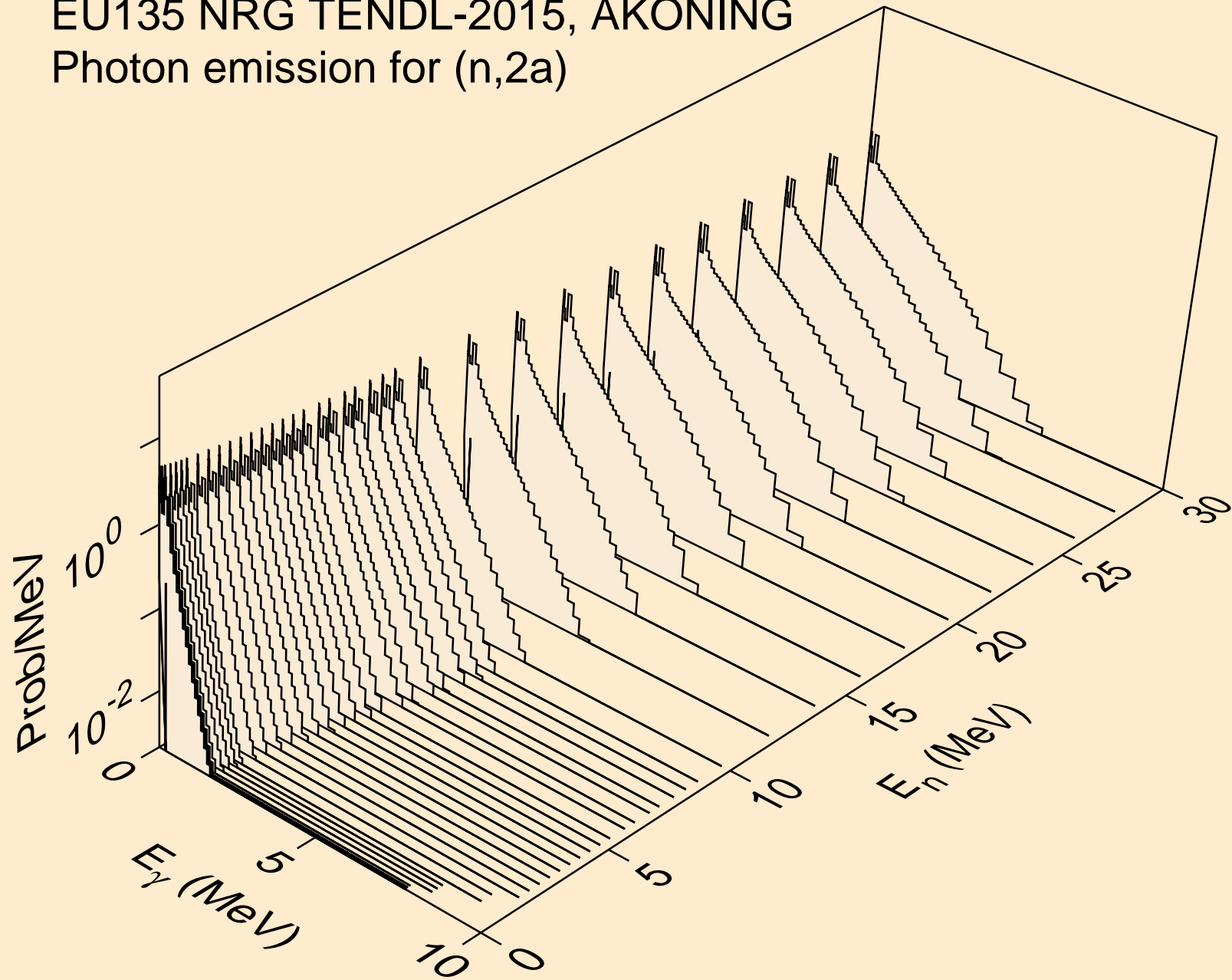

EU135 NRG TENDL-2015, AKONING
Photon emission for (n,3a)

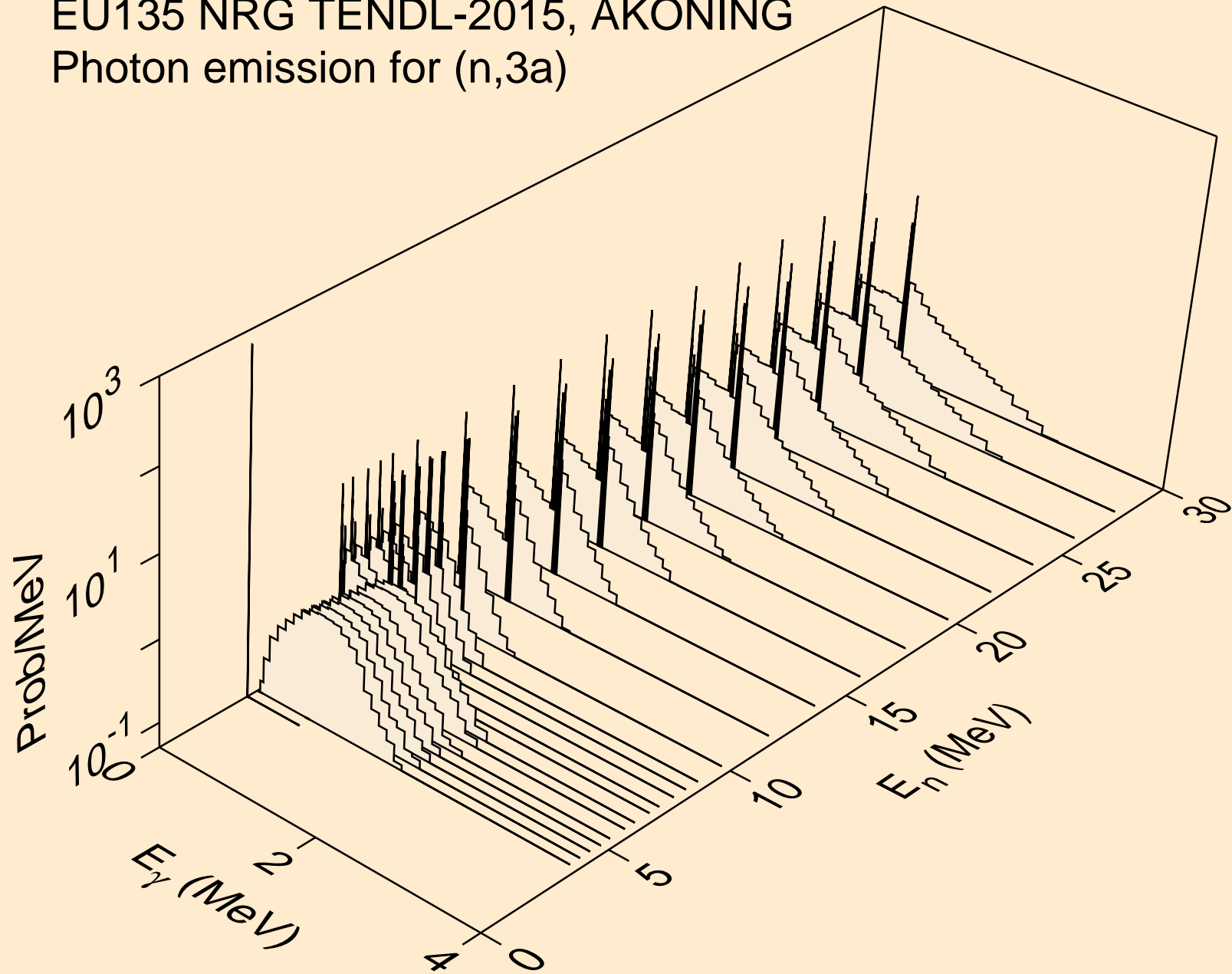

EU135 NRG TENDL-2015, AKONING
Photon emission for (n,2p)

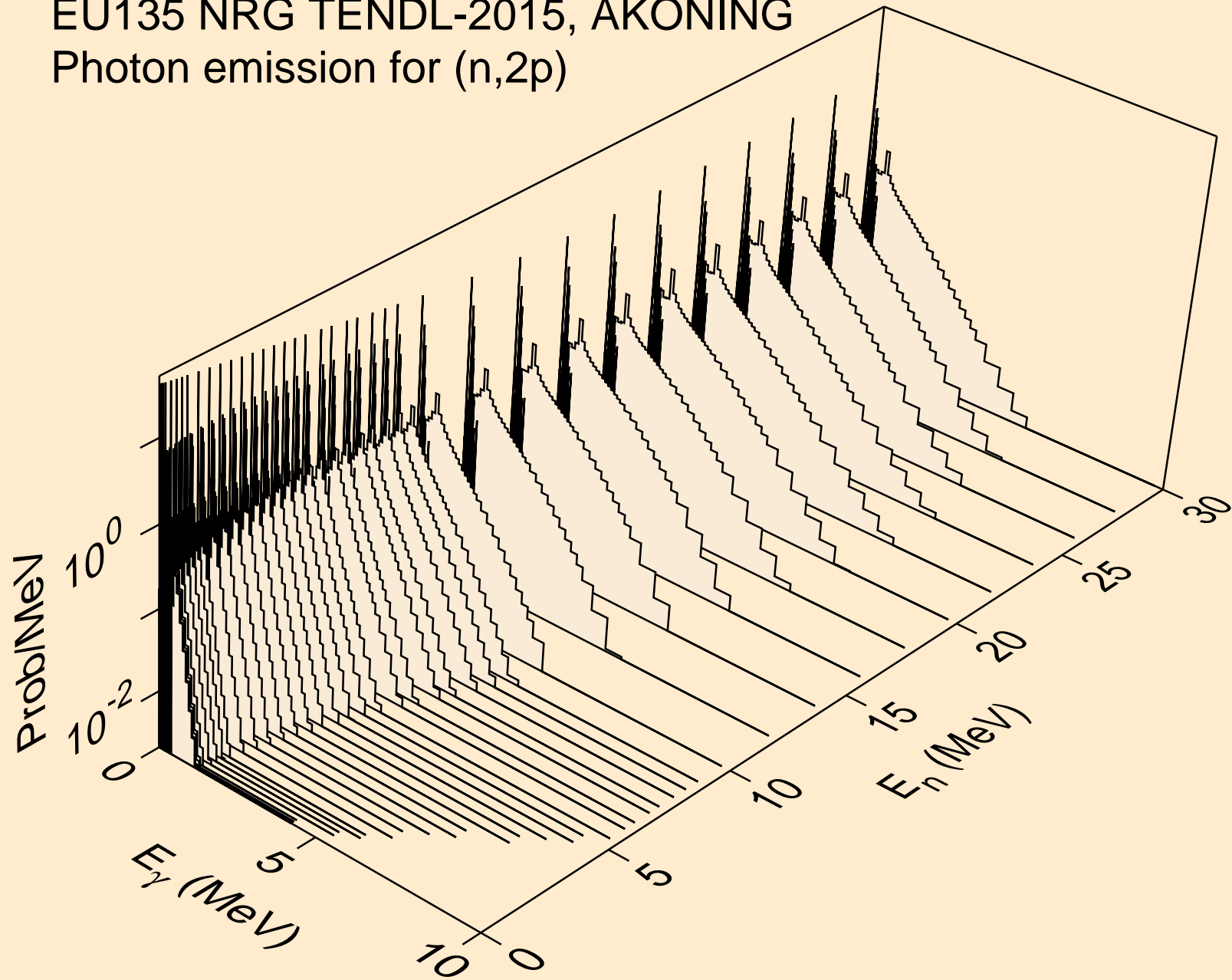

EU135 NRG TENDL-2015, AKONING
Photon emission for (n,p α)

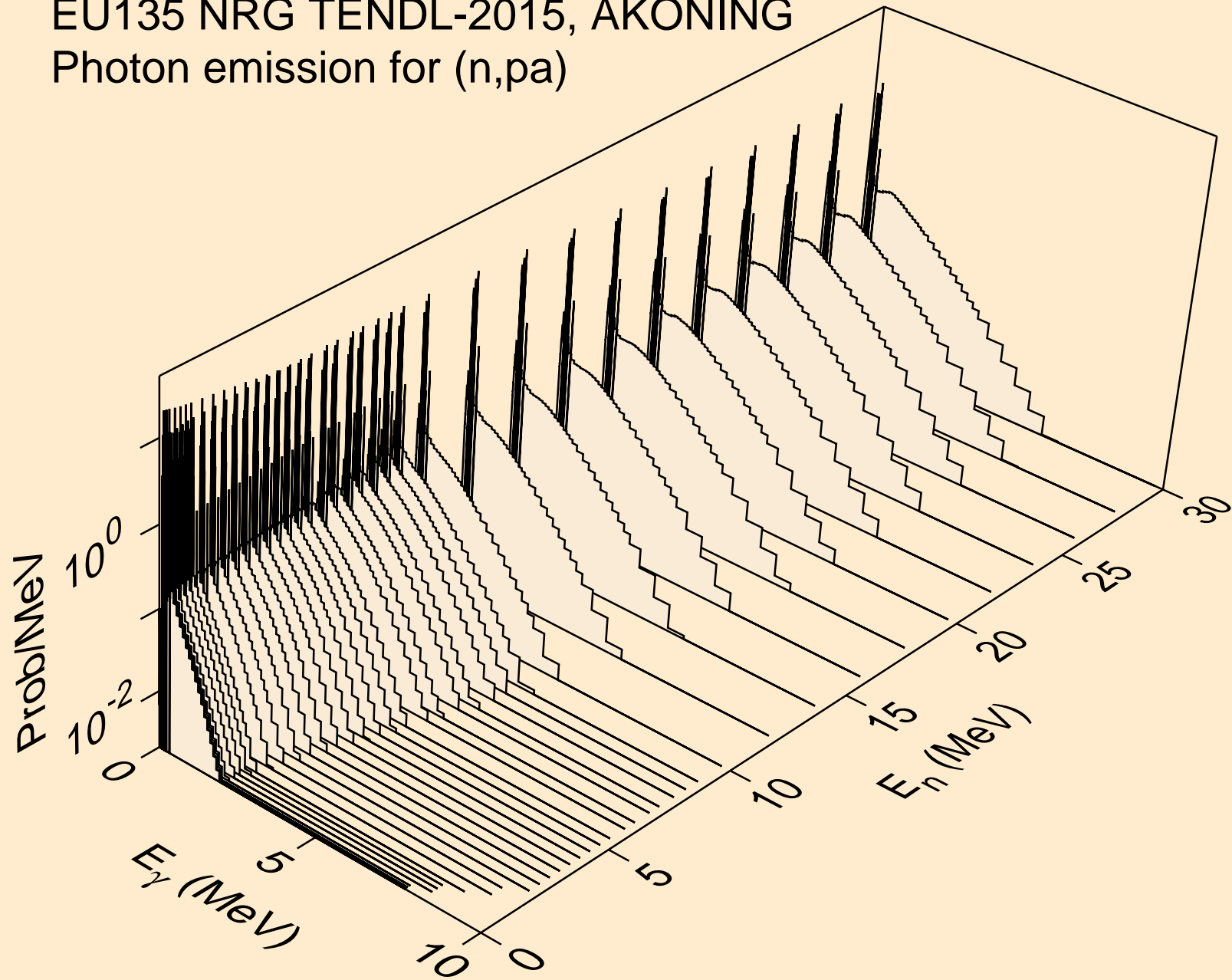

EU135 NRG TENDL-2015, AKONING
Photon emission for (n,t2a)

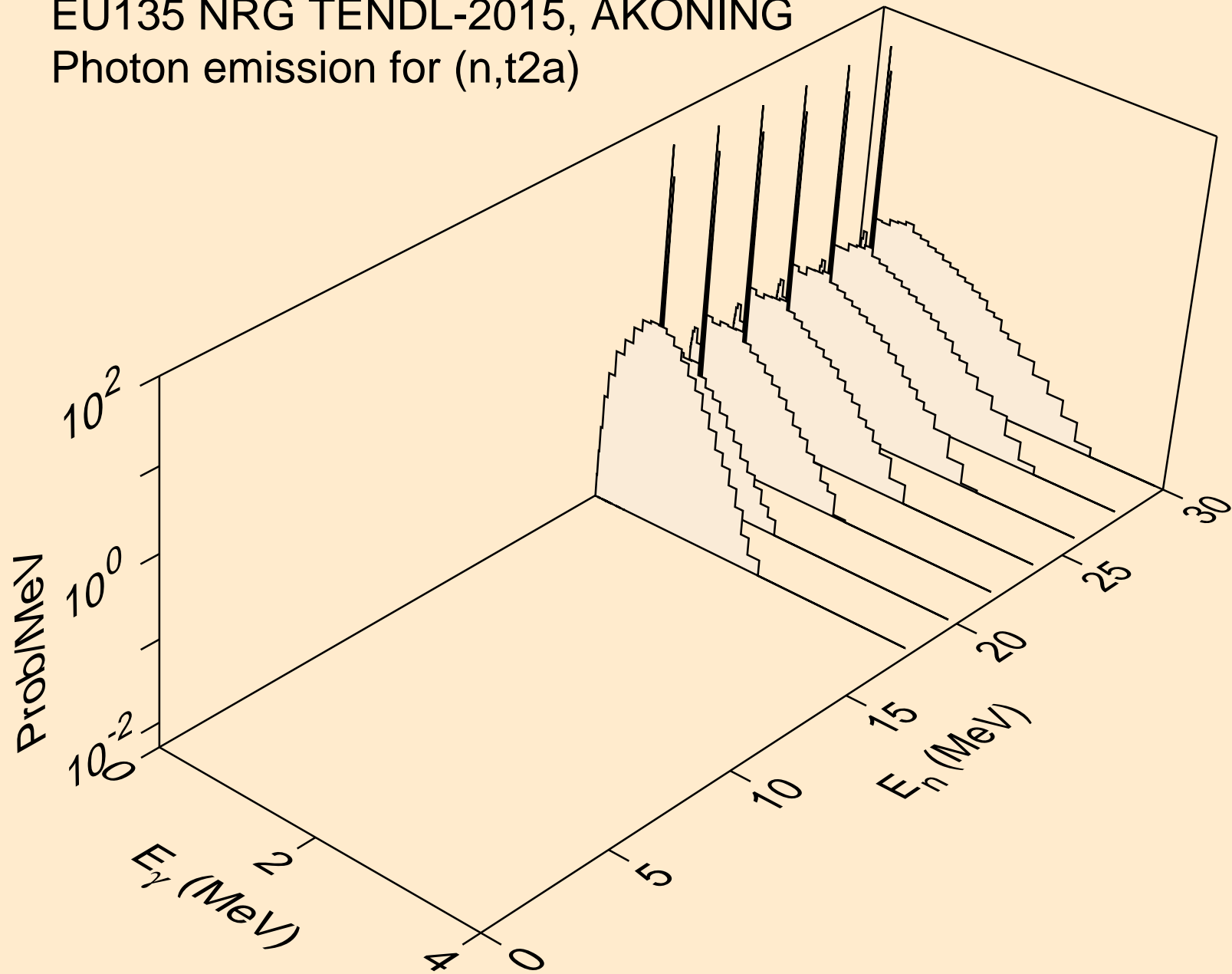

EU135 NRG TENDL-2015, AKONING
Photon emission for (n,d2a)

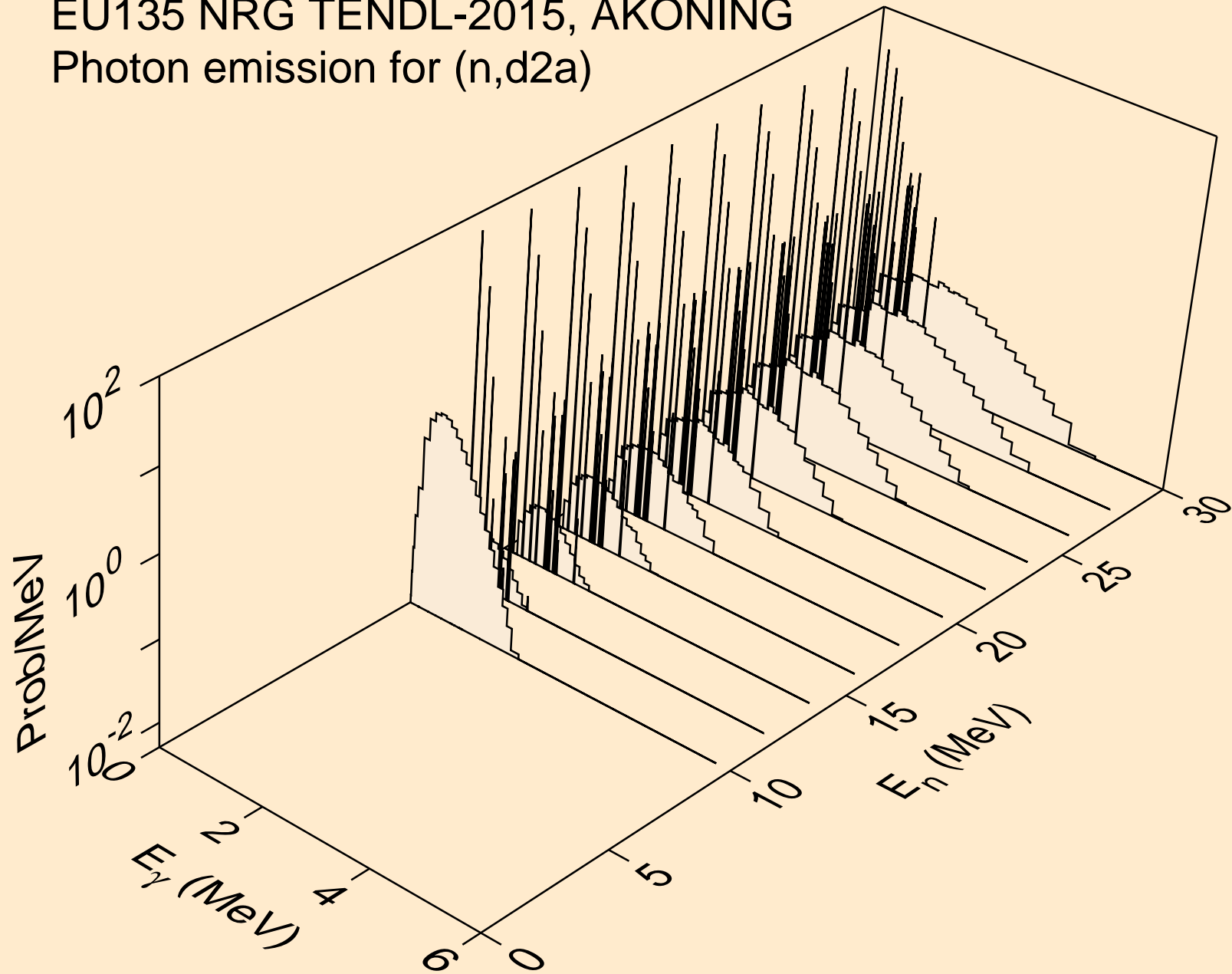

EU135 NRG TENDL-2015, AKONING
Photon emission for (n,pd)

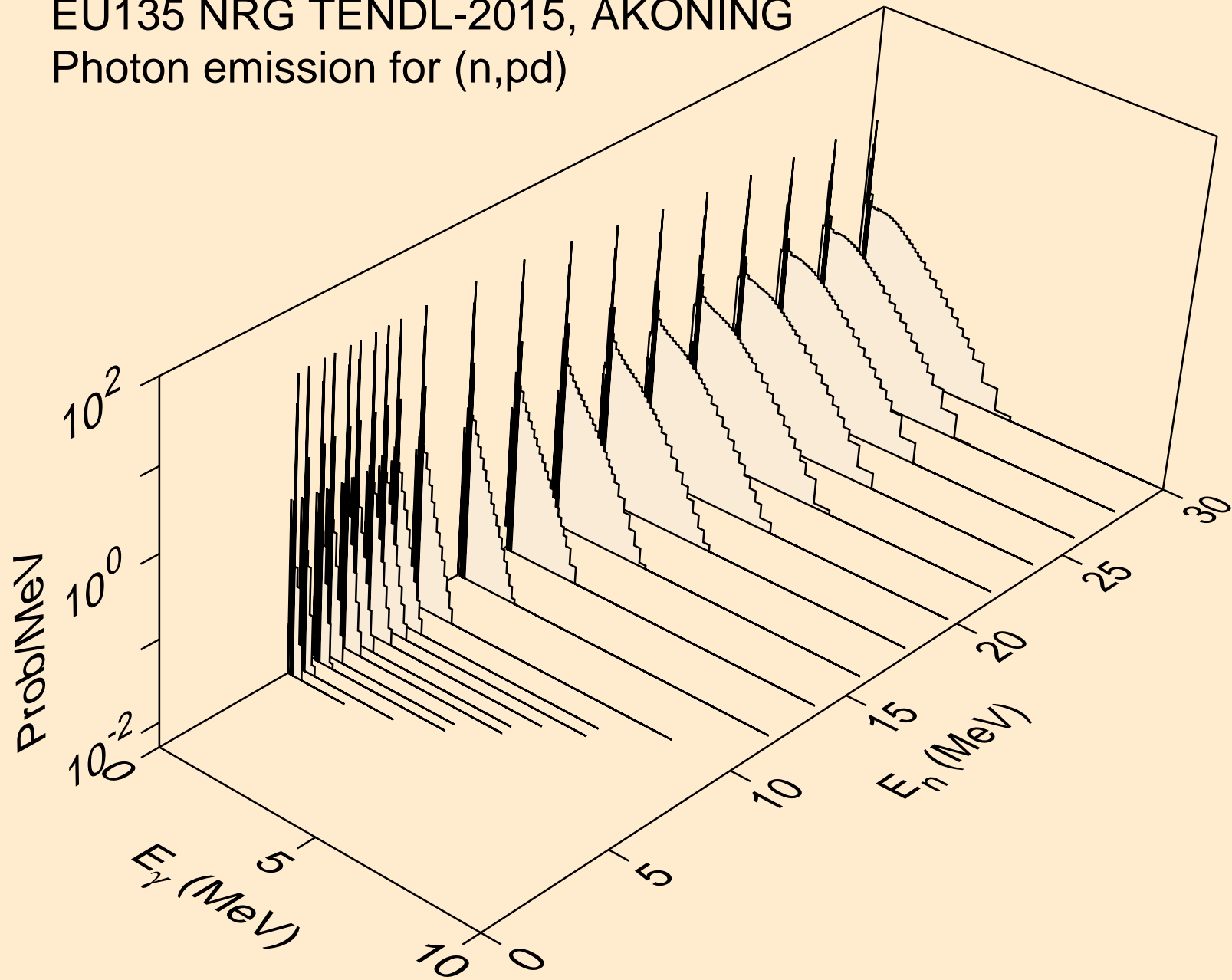

EU135 NRG TENDL-2015, AKONING

Photon emission for (n,pt)

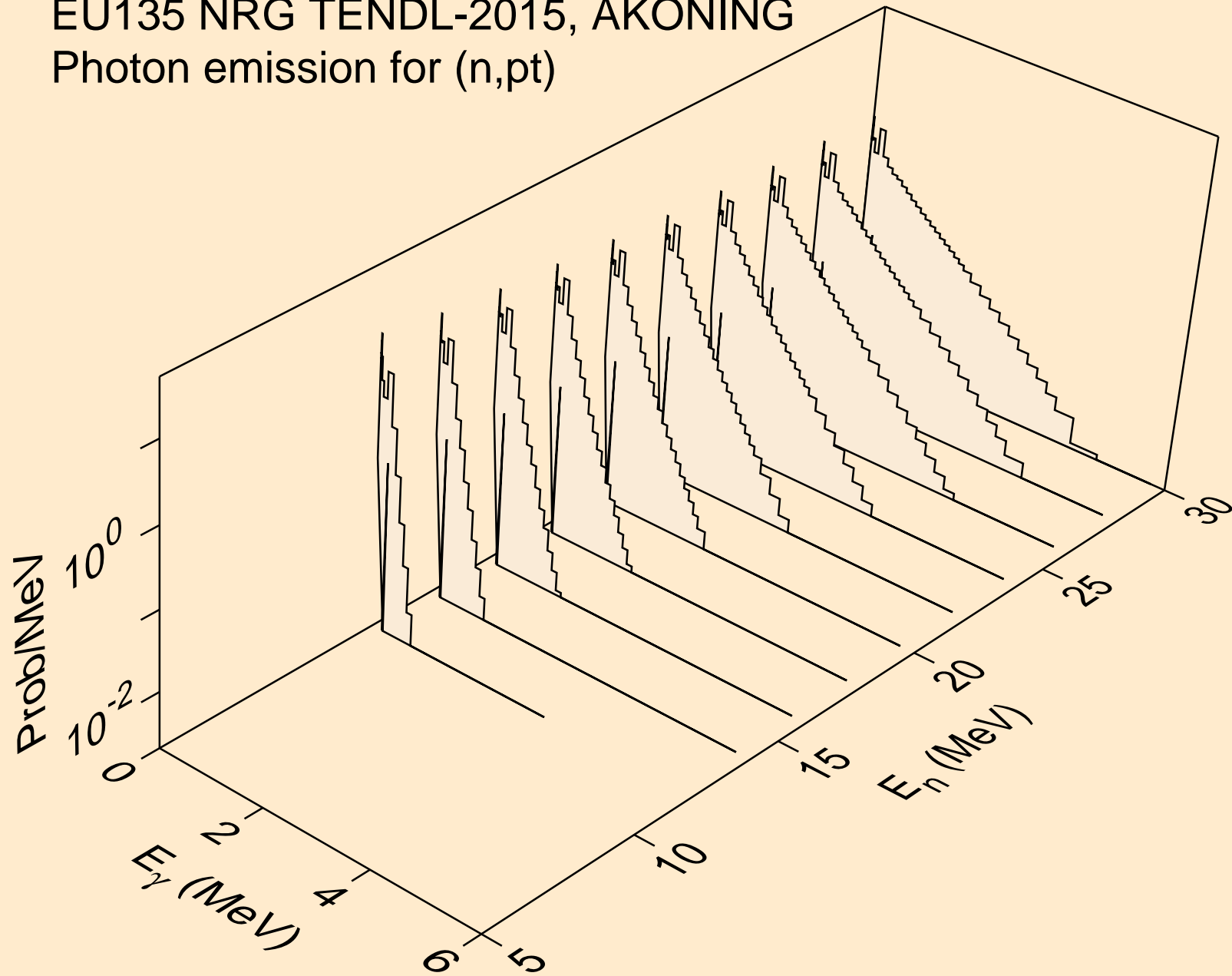

EU135 NRG TENDL-2015, AKONING
Photon emission for (n,da)

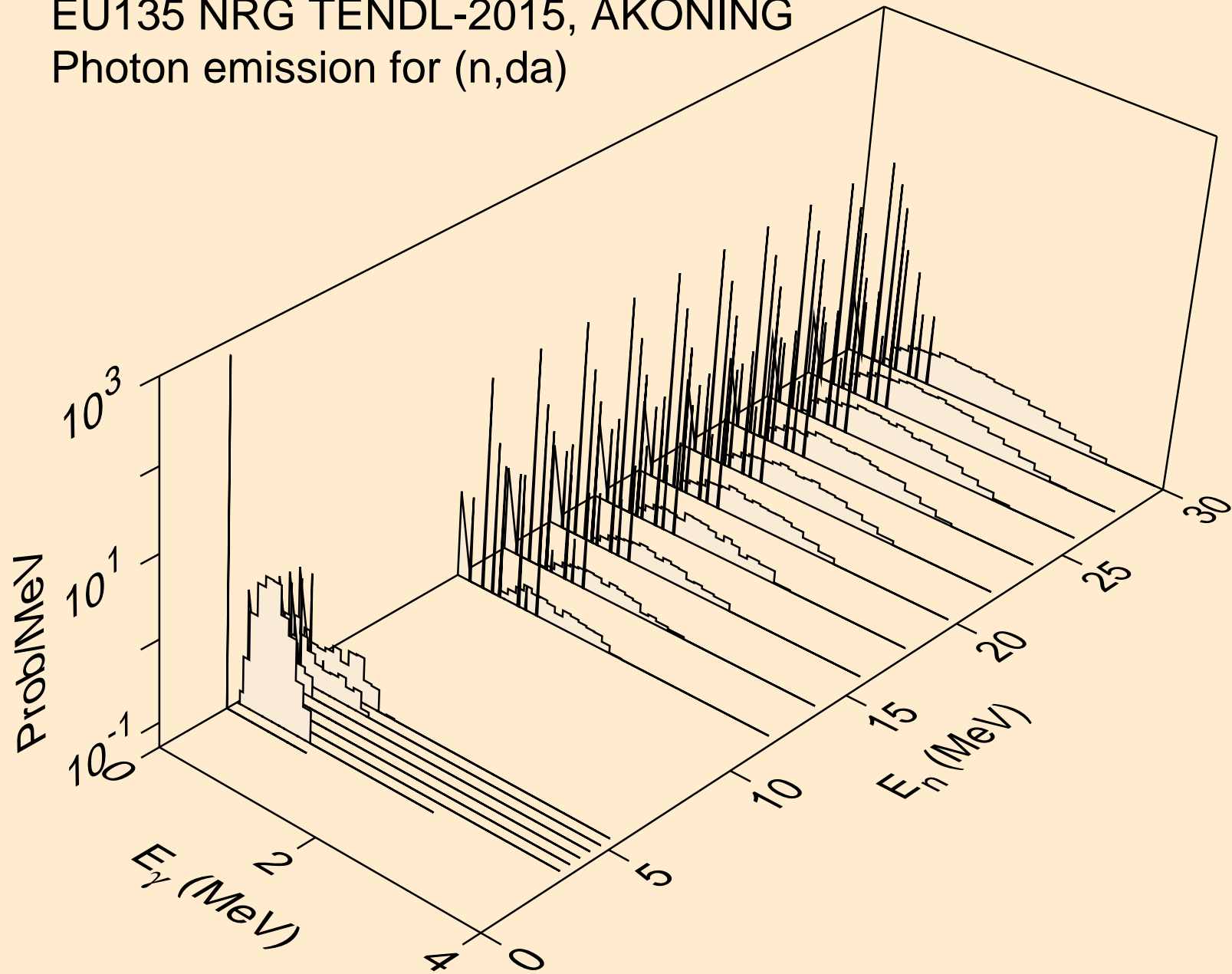

EU135 NRG TENDL-2015, AKONING
thermal capture photon spectrum

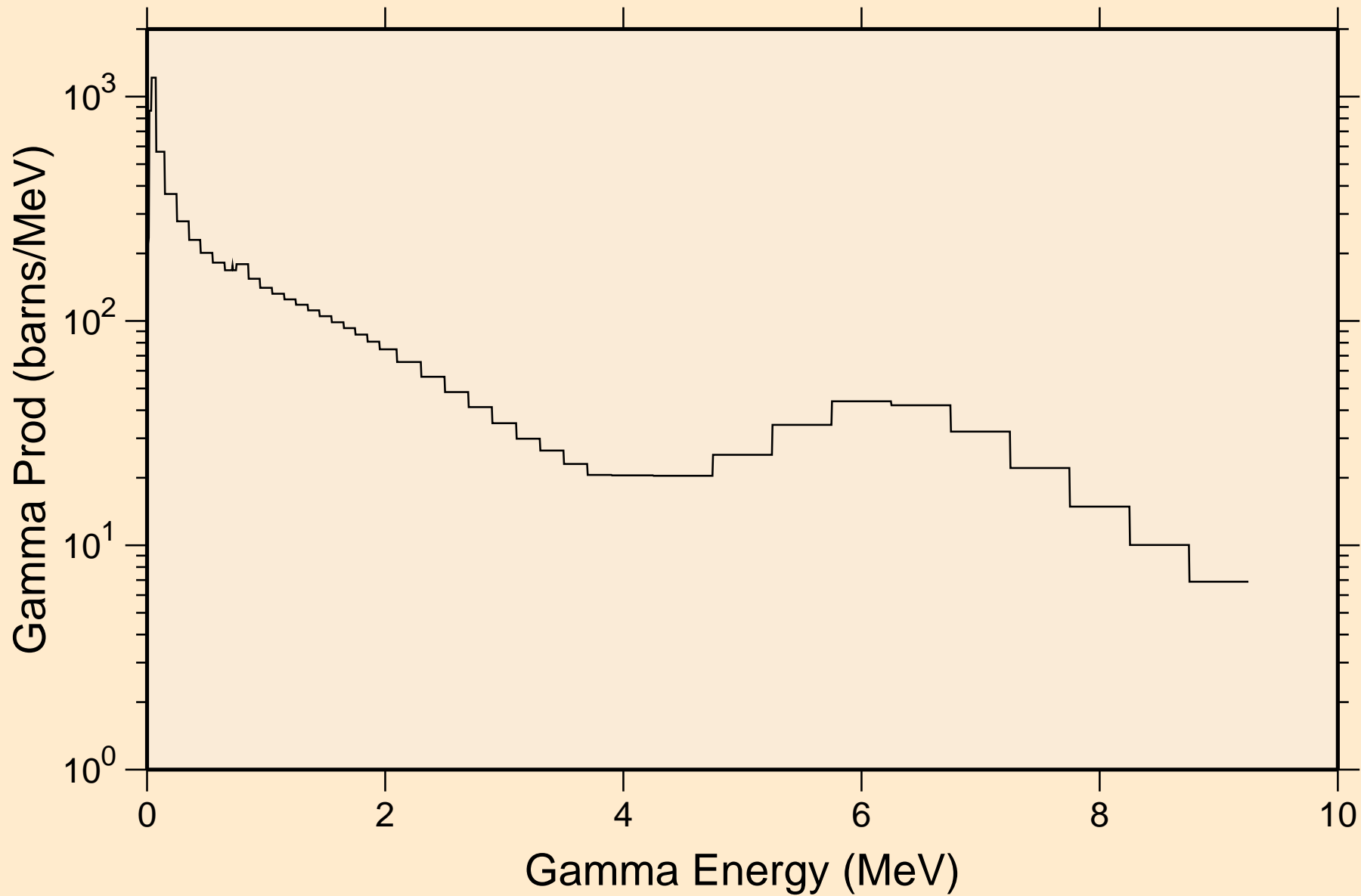

EU135 NRG TENDL-2015, AKONING
14 MeV photon spectrum

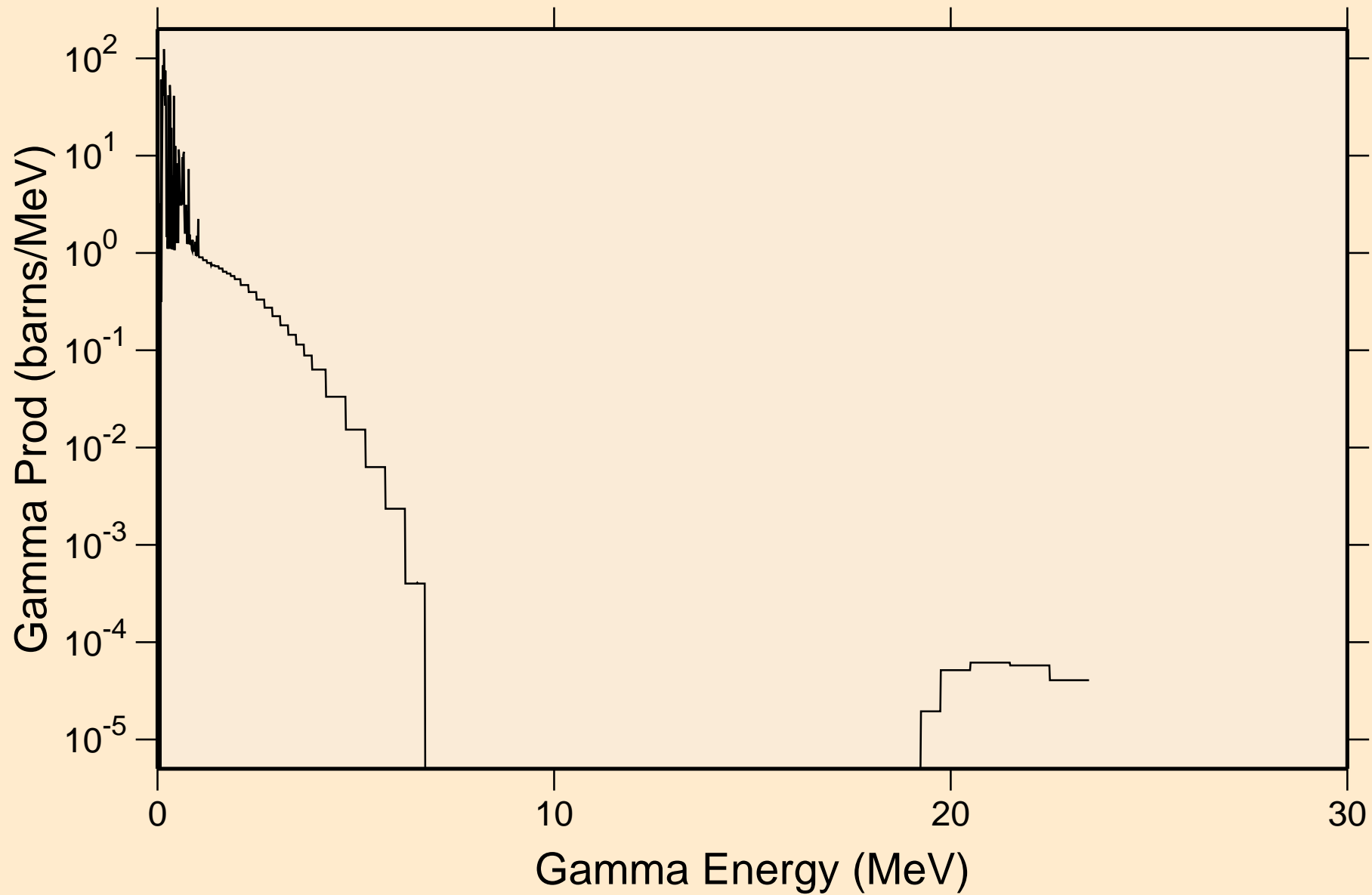

EU135 NRG TENDL-2015, AKONING

Particle heating contributions

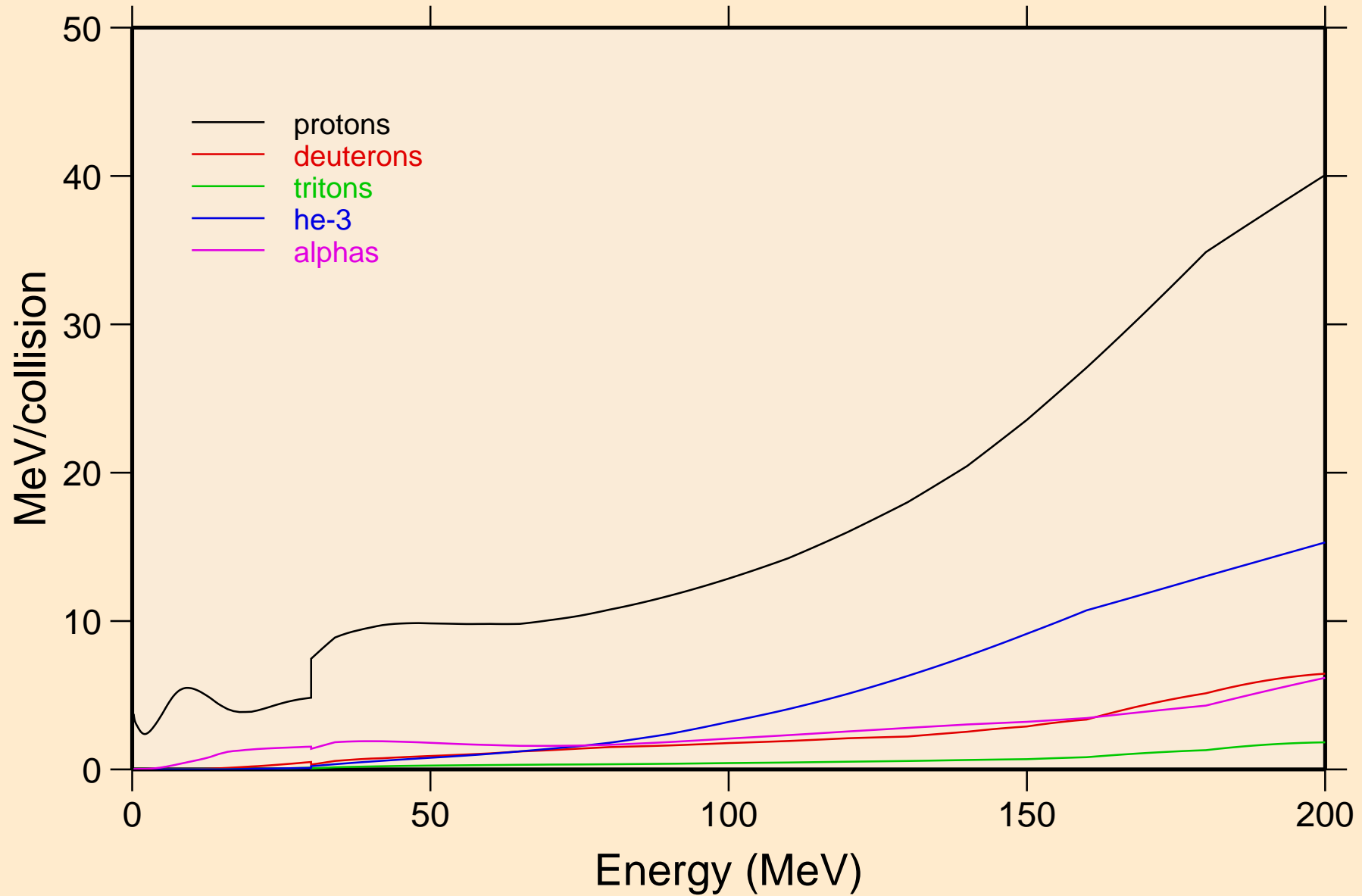

EU135 NRG TENDL-2015, AKONING

Recoil Heating

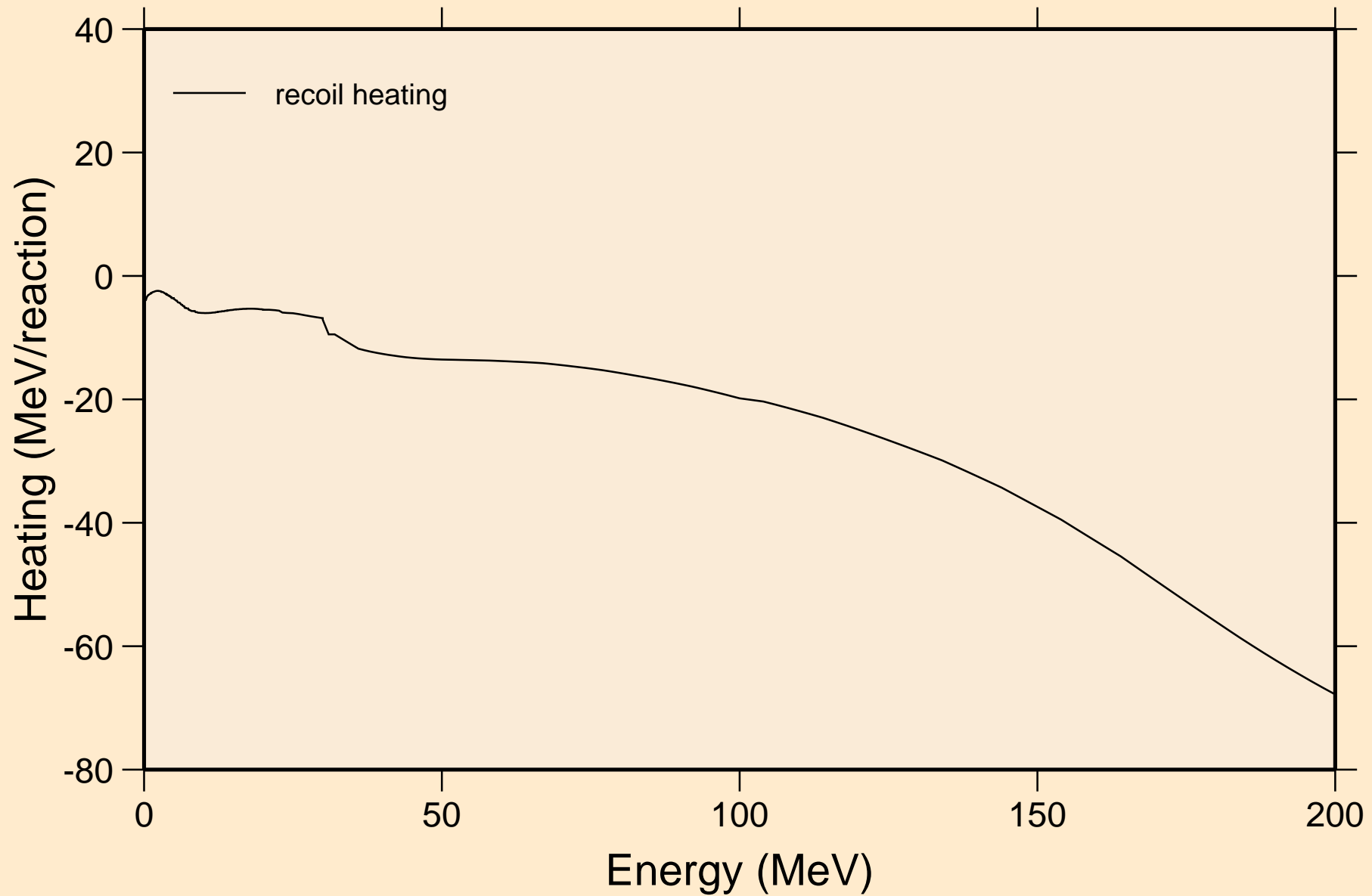

EU135 NRG TENDL-2015, AKONING

Particle production cross sections

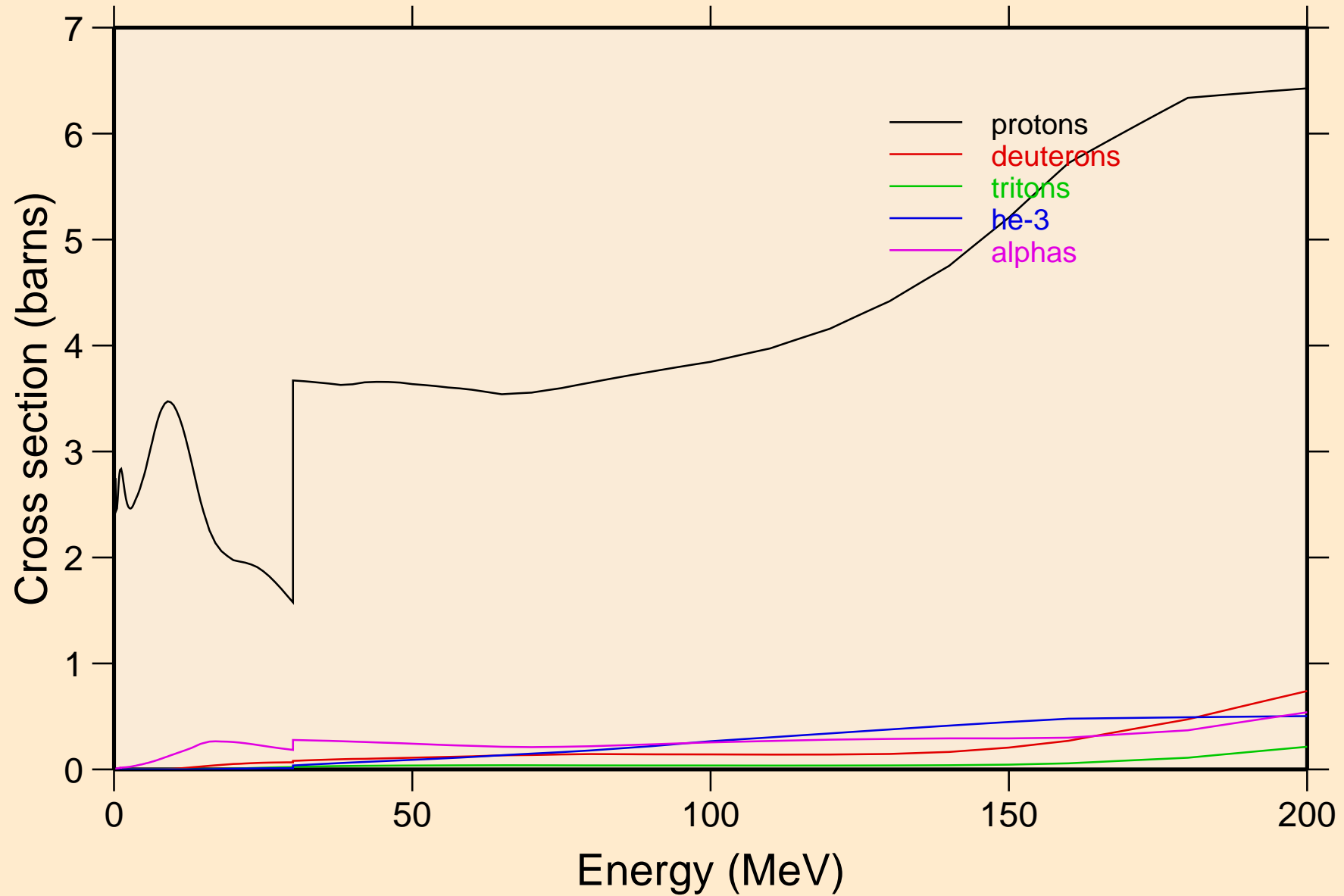

EU135 NRG TENDL-2015, AKONING
protons from (n,x)

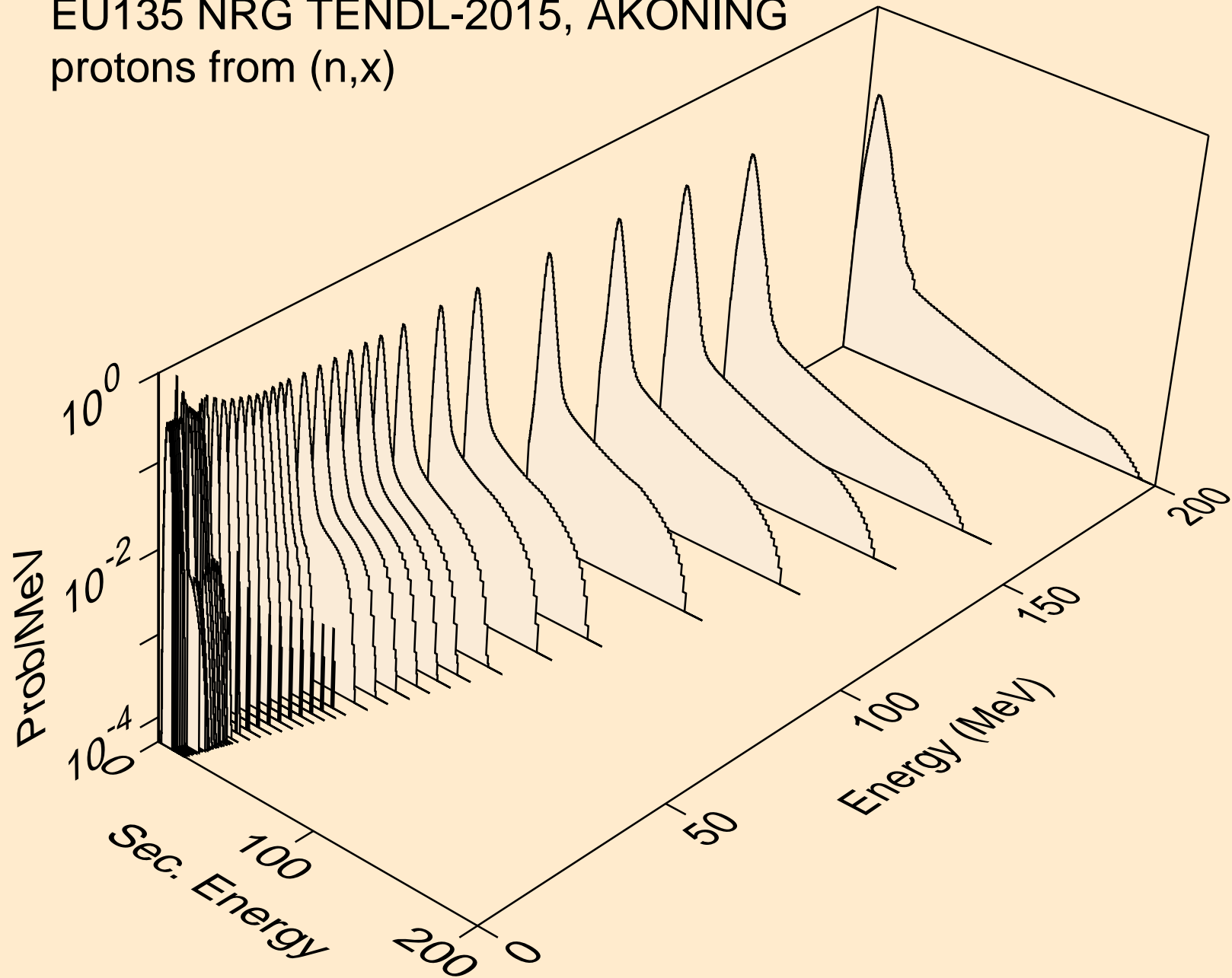

EU135 NRG TENDL-2015, AKONING
protons from (n,n*)p

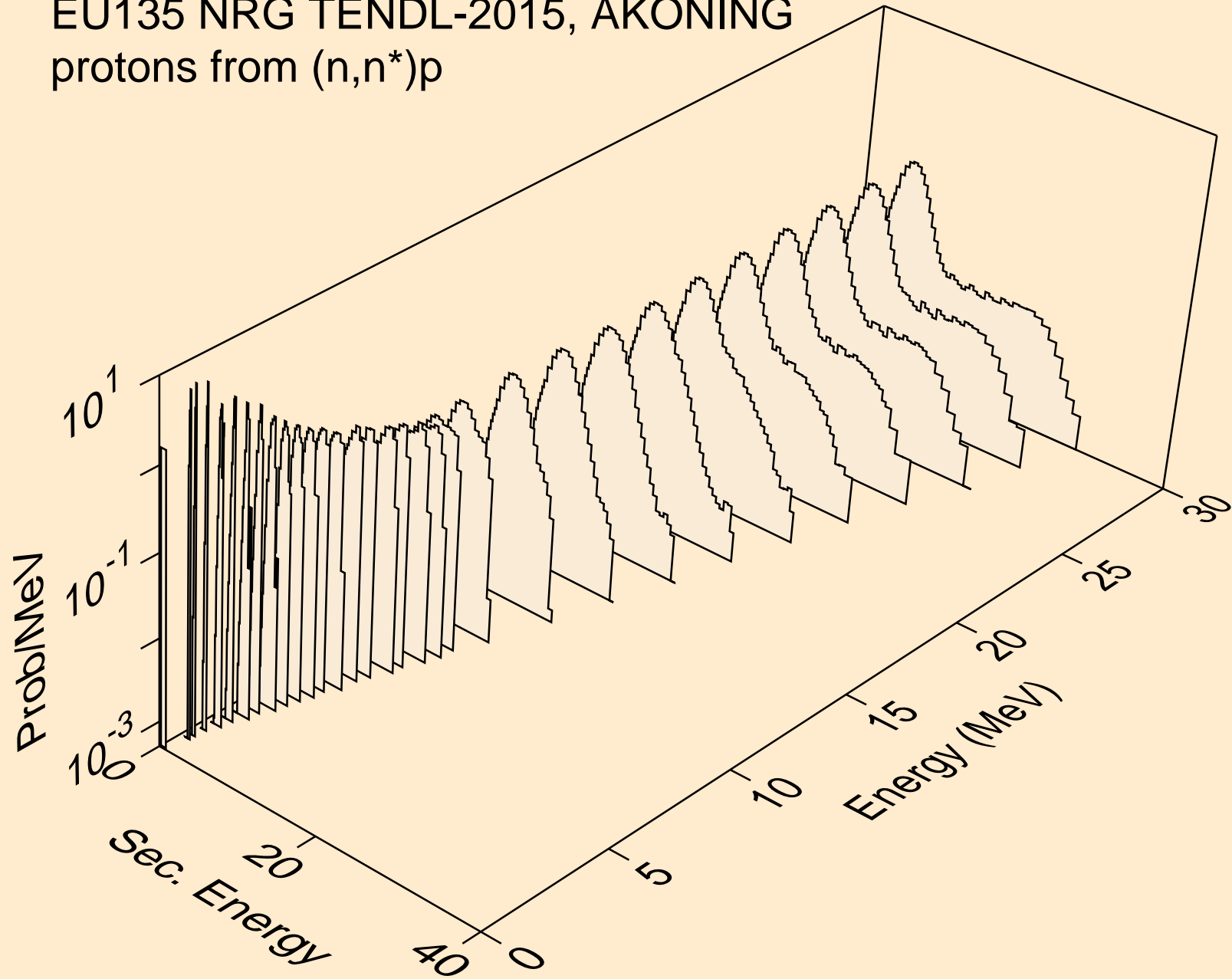

EU135 NRG TENDL-2015, AKONING
protons from (n,2np)

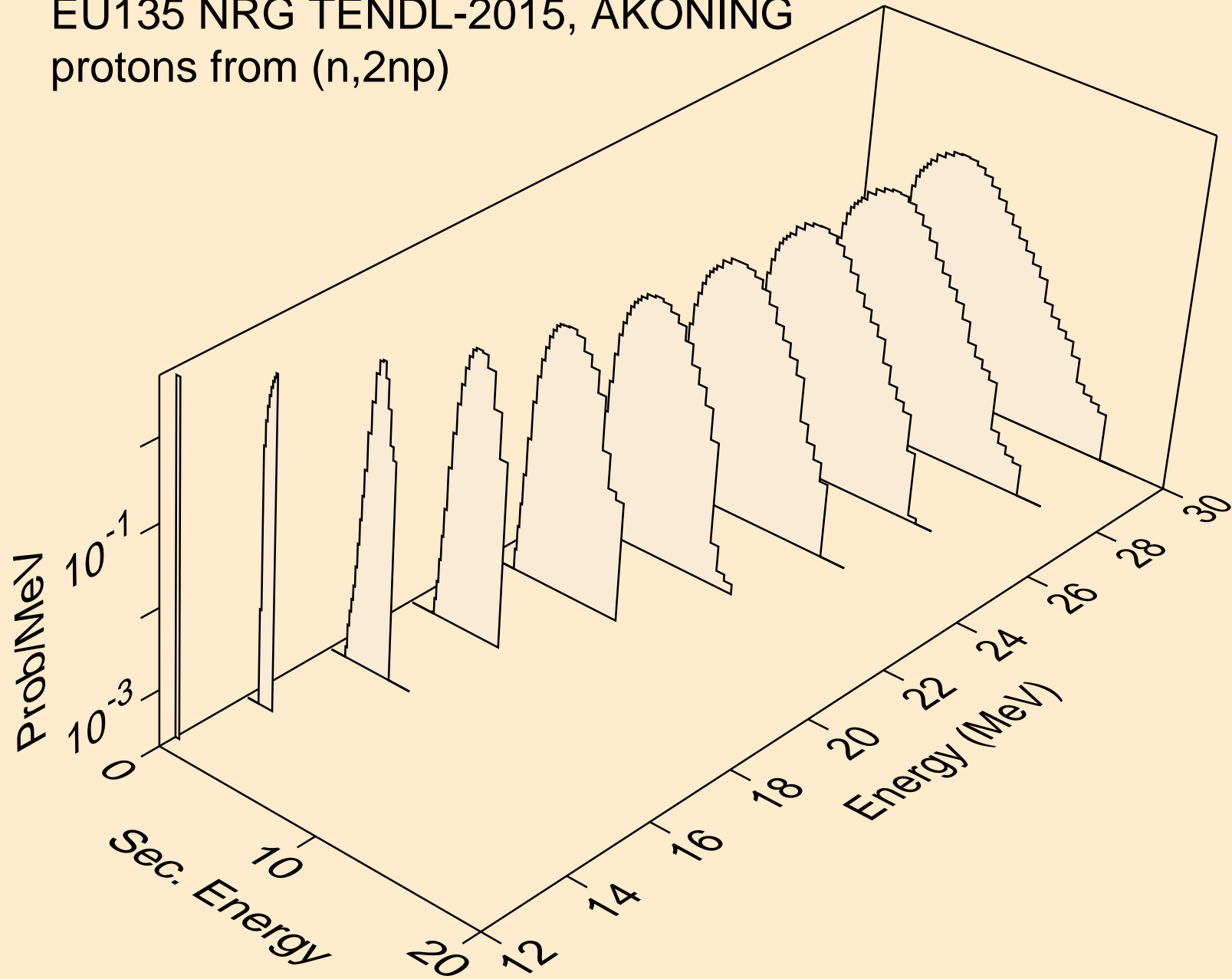

EU135 NRG TENDL-2015, AKONING
protons from (n,3np)

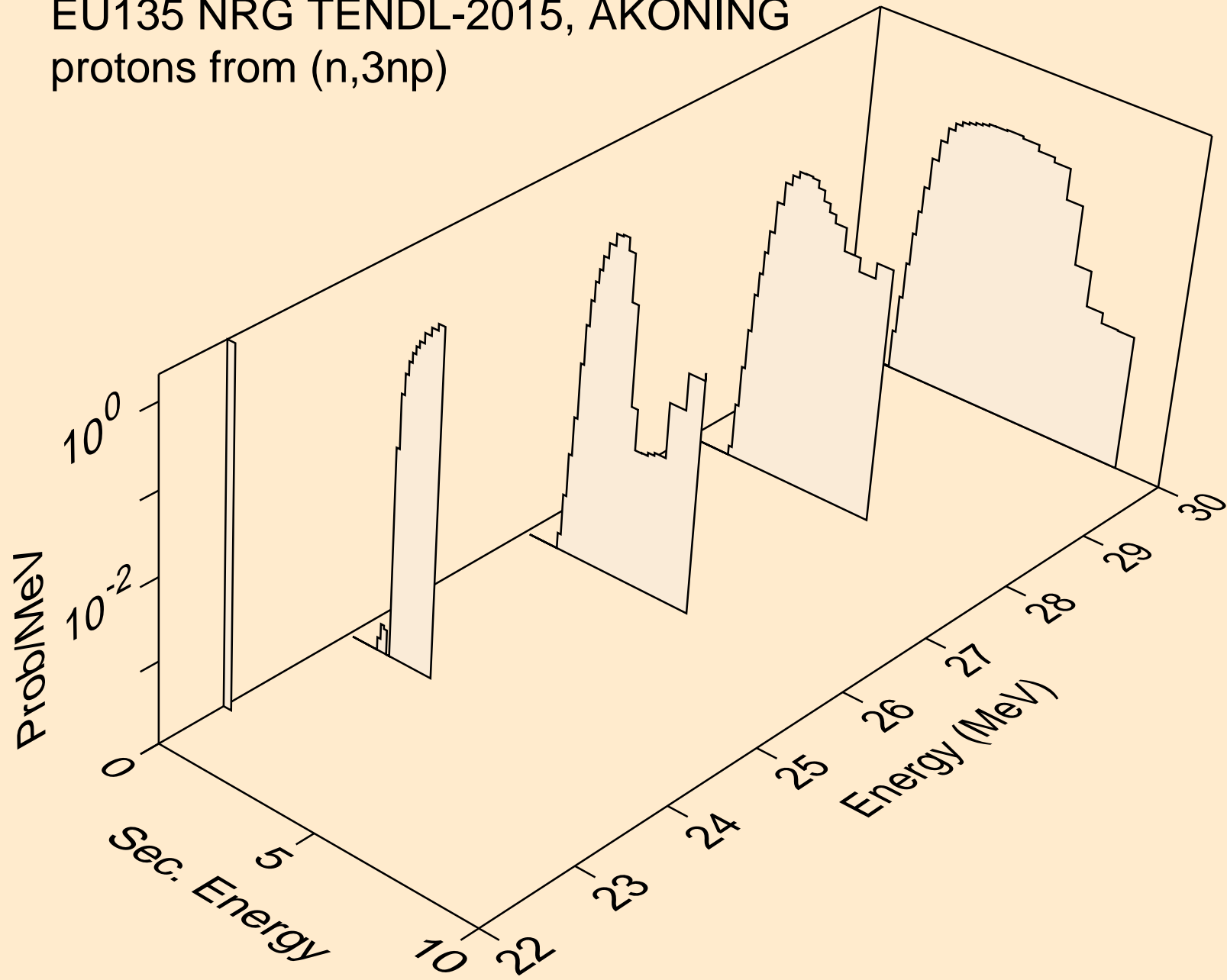

EU135 NRG TENDL-2015, AKONING
protons from (n,2np)

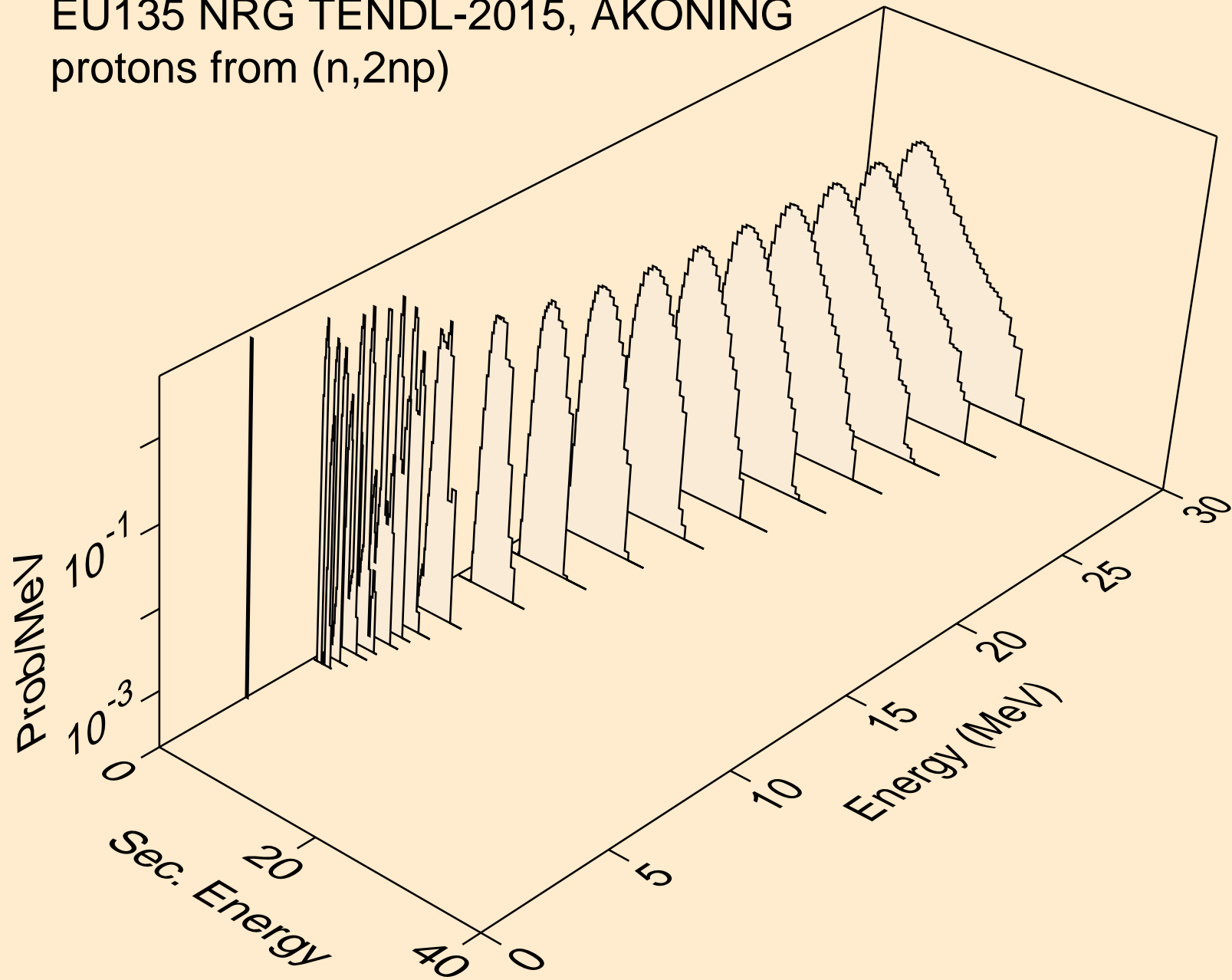

EU135 NRG TENDL-2015, AKONING
protons from (n,npa)

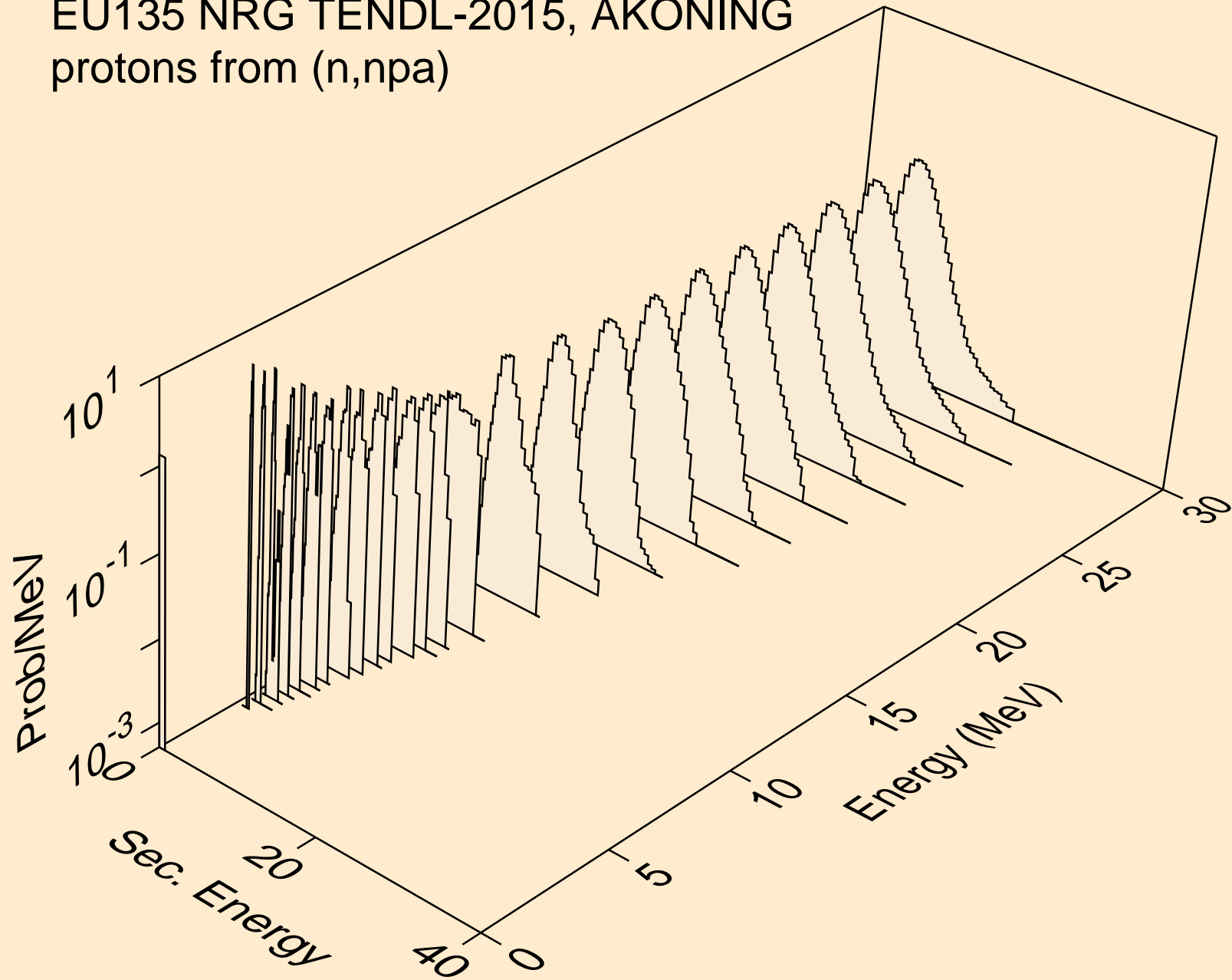

EU135 NRG TENDL-2015, AKONING
protons from (n,p)

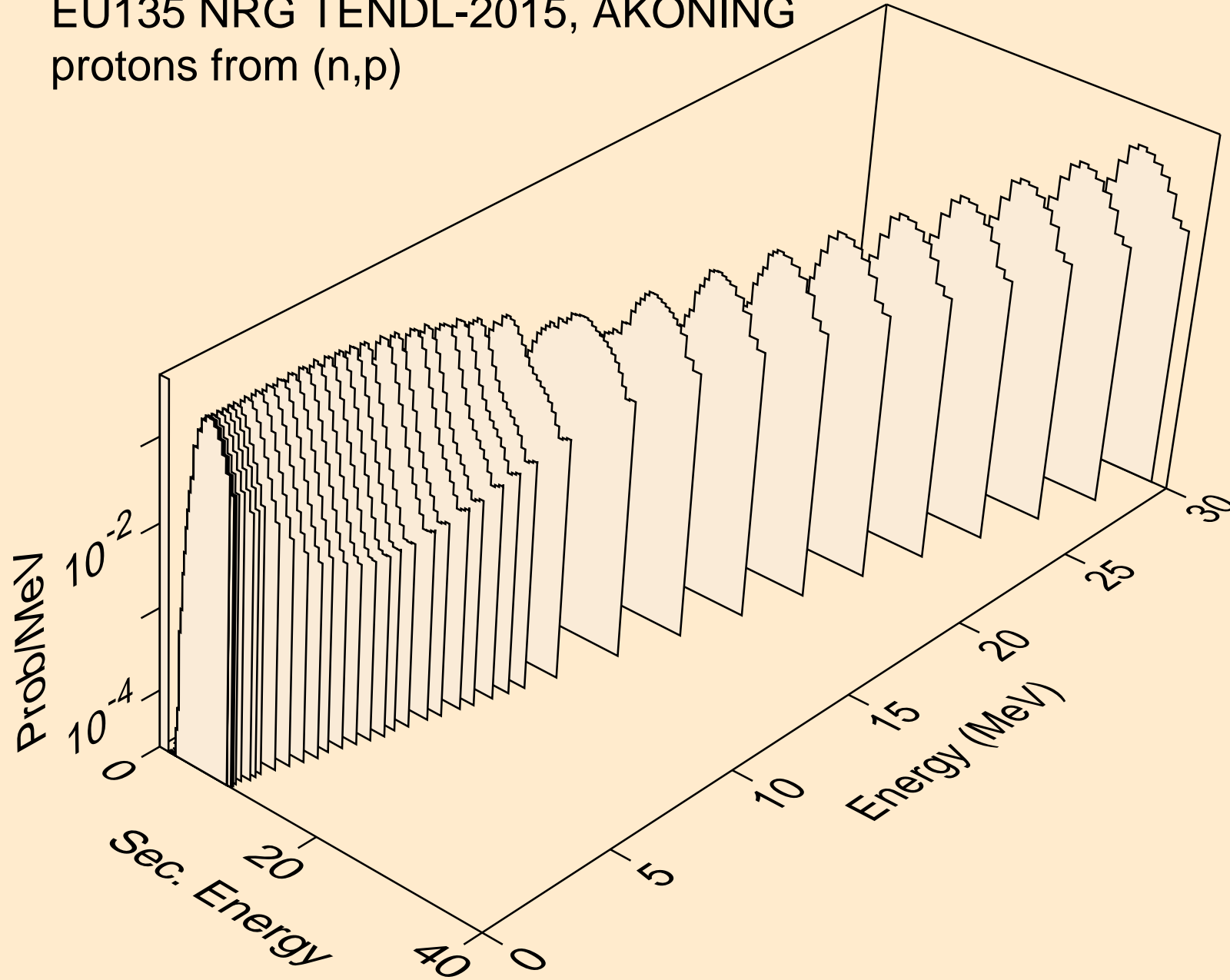

EU135 NRG TENDL-2015, AKONING
protons from (n,2p)

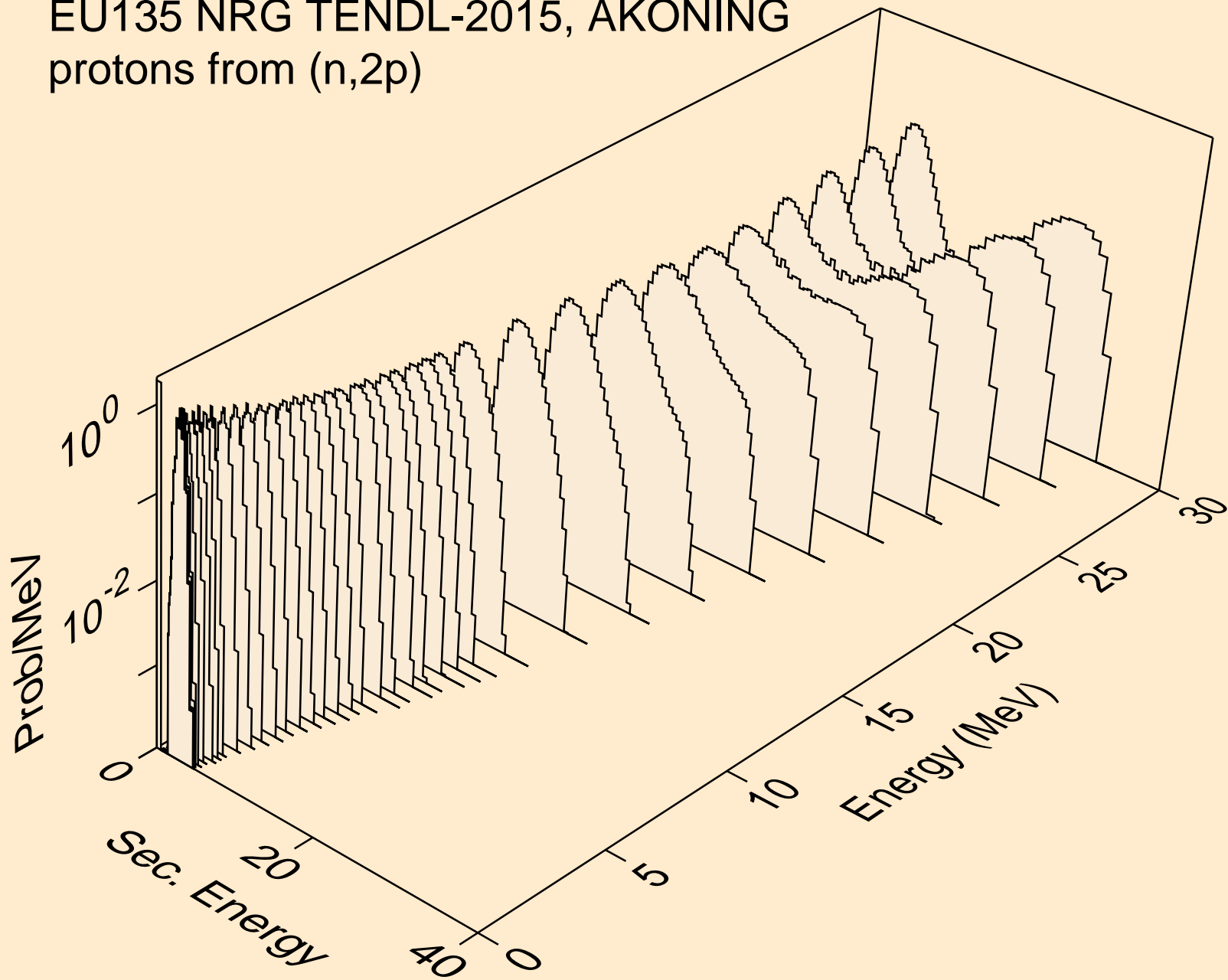

EU135 NRG TENDL-2015, AKONING
protons from (n,pa)

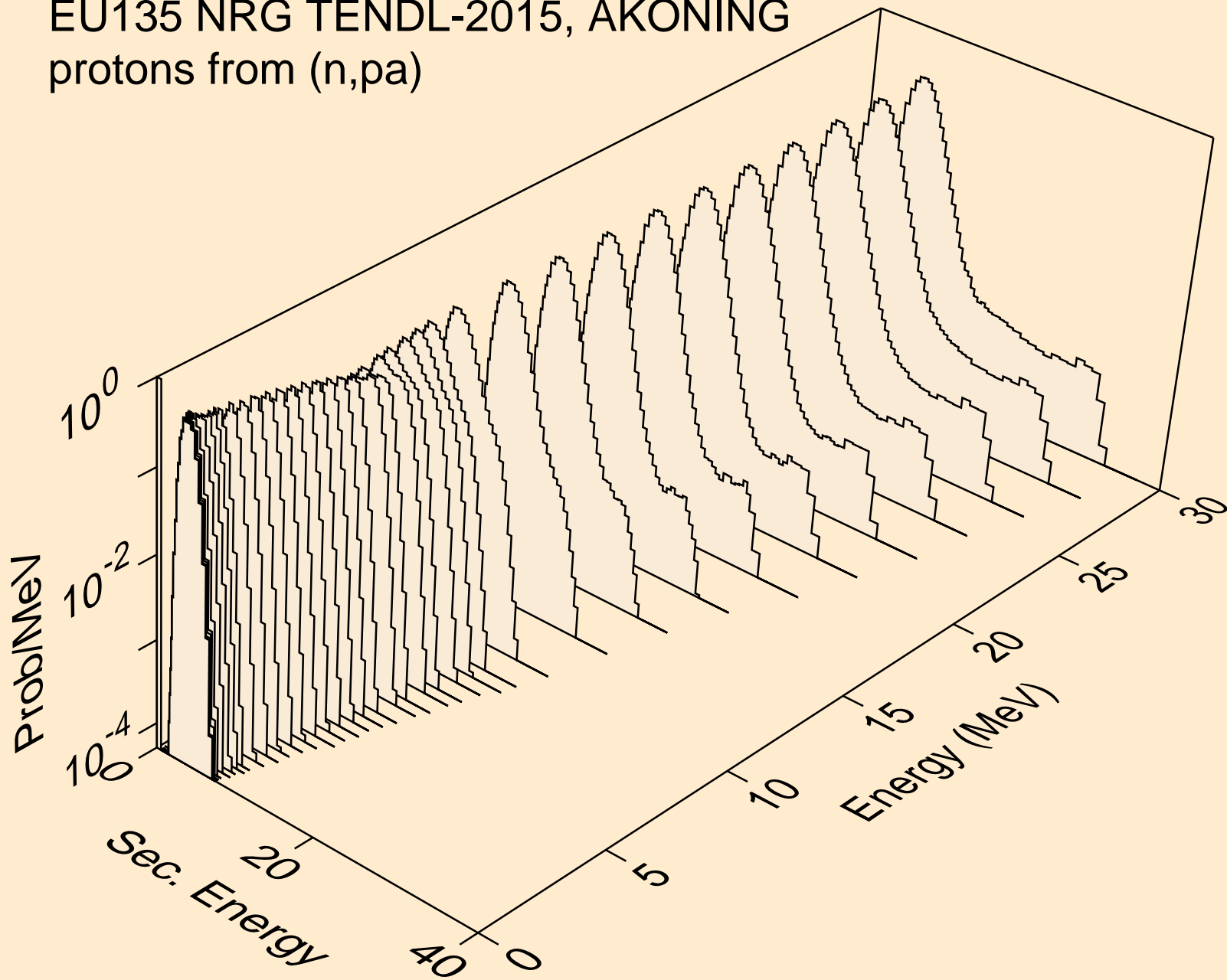

EU135 NRG TENDL-2015, AKONING
protons from (n,pd)

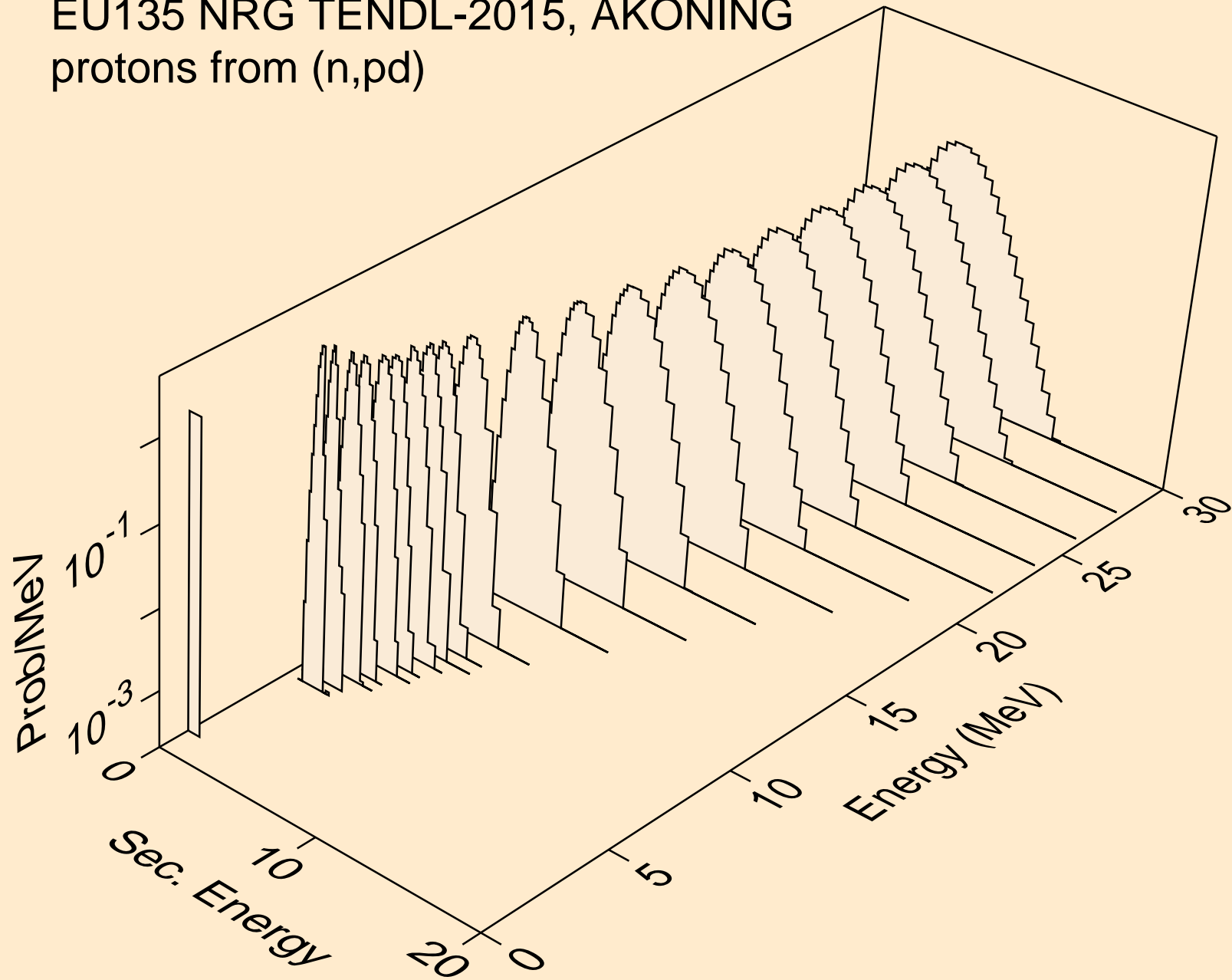

EU135 NRG TENDL-2015, AKONING
protons from (n,pt)

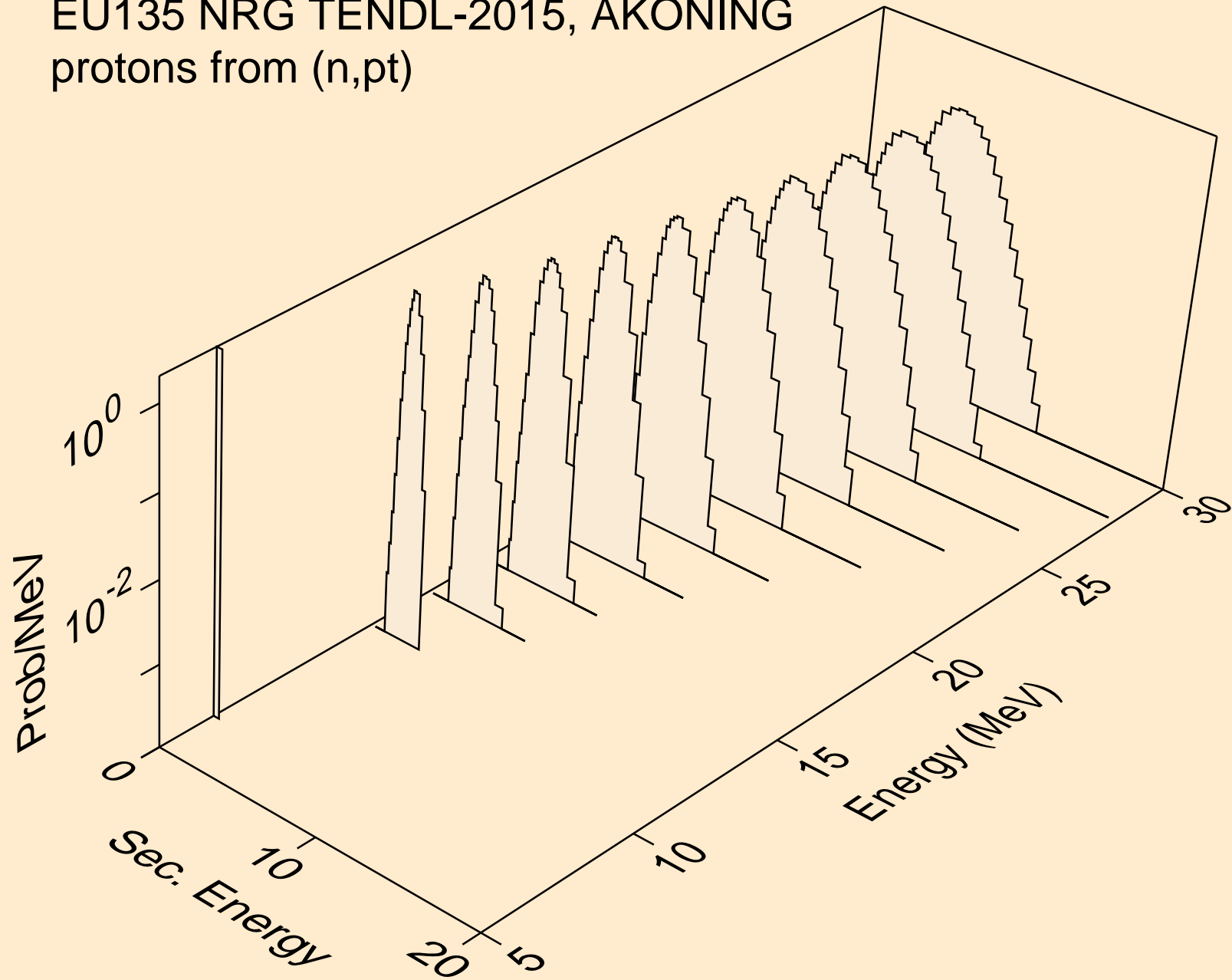

EU135 NRG TENDL-2015, AKONING
deuterons from (n,x)

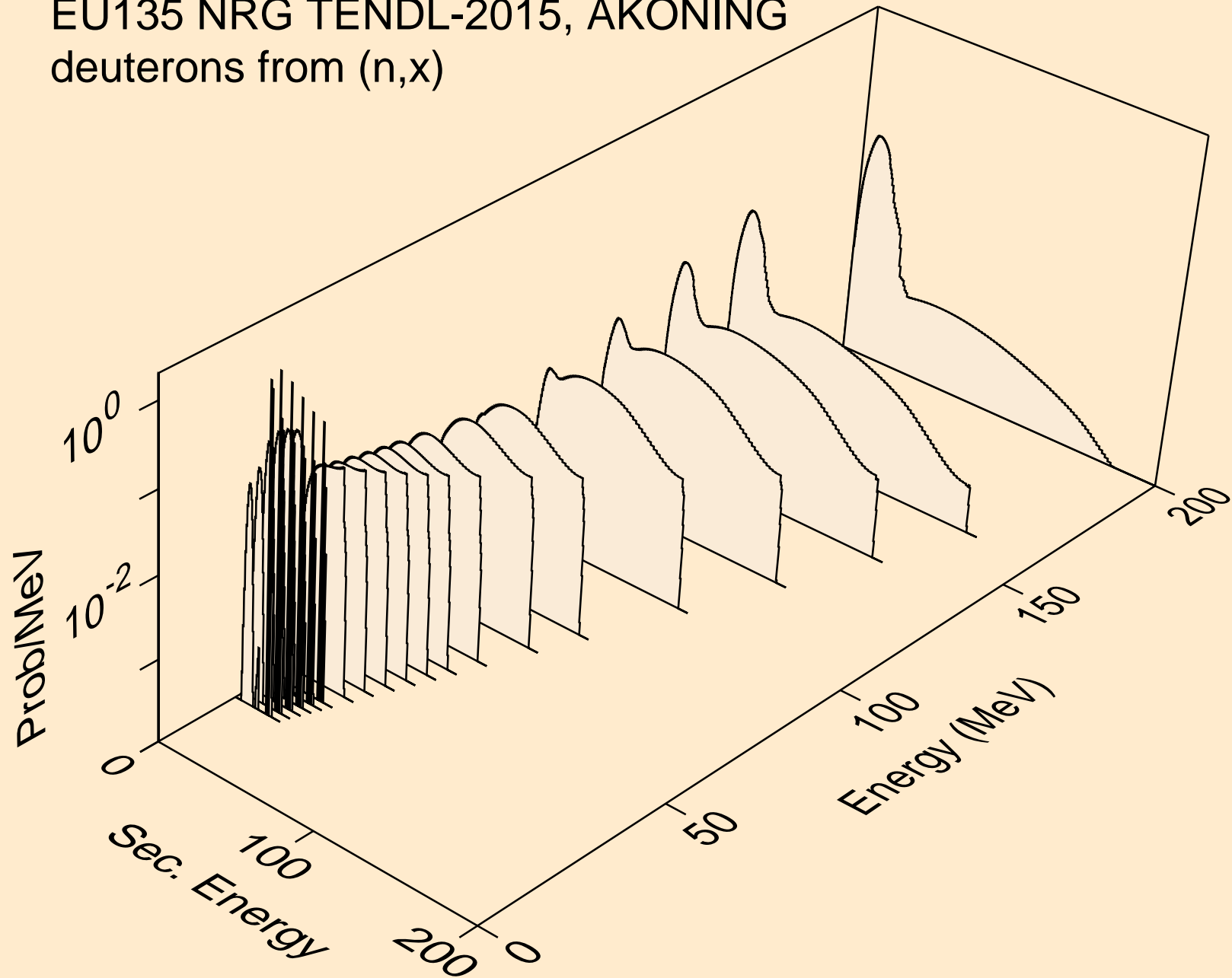

EU135 NRG TENDL-2015, AKONING
deuterons from (n,2nd)

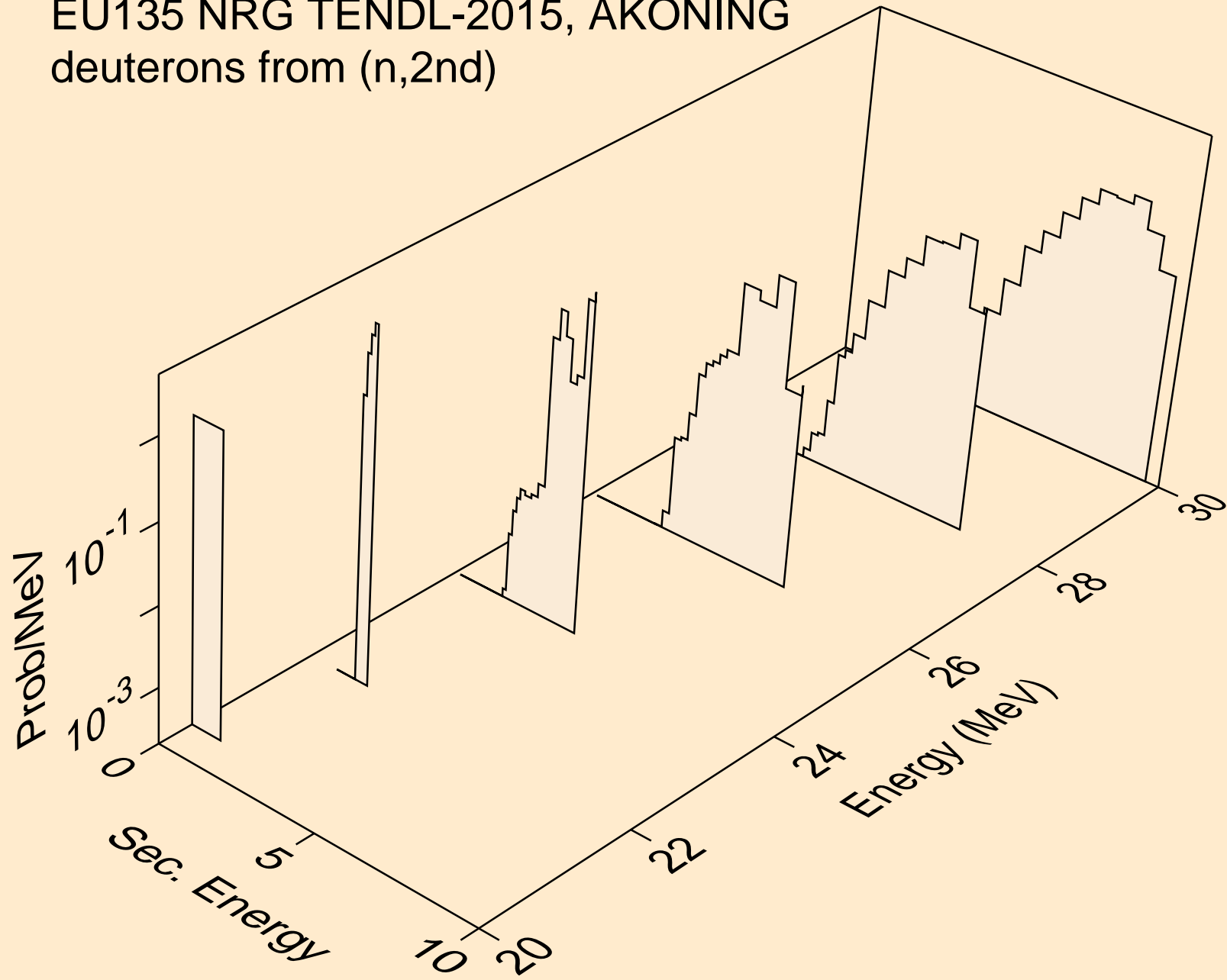

EU135 NRG TENDL-2015, AKONING
deuterons from (n,n*)d

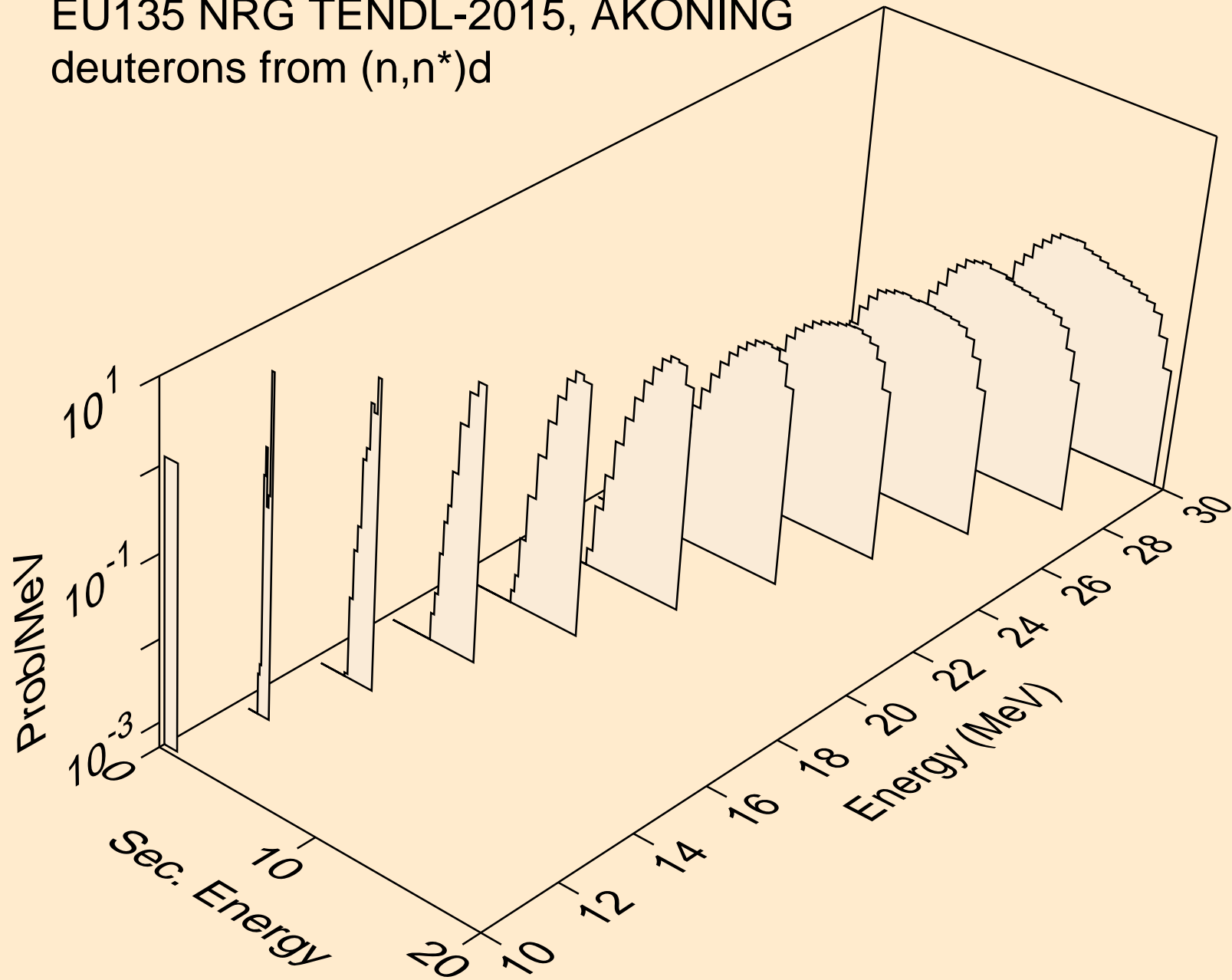

EU135 NRG TENDL-2015, AKONING
deuterons from (n,d)

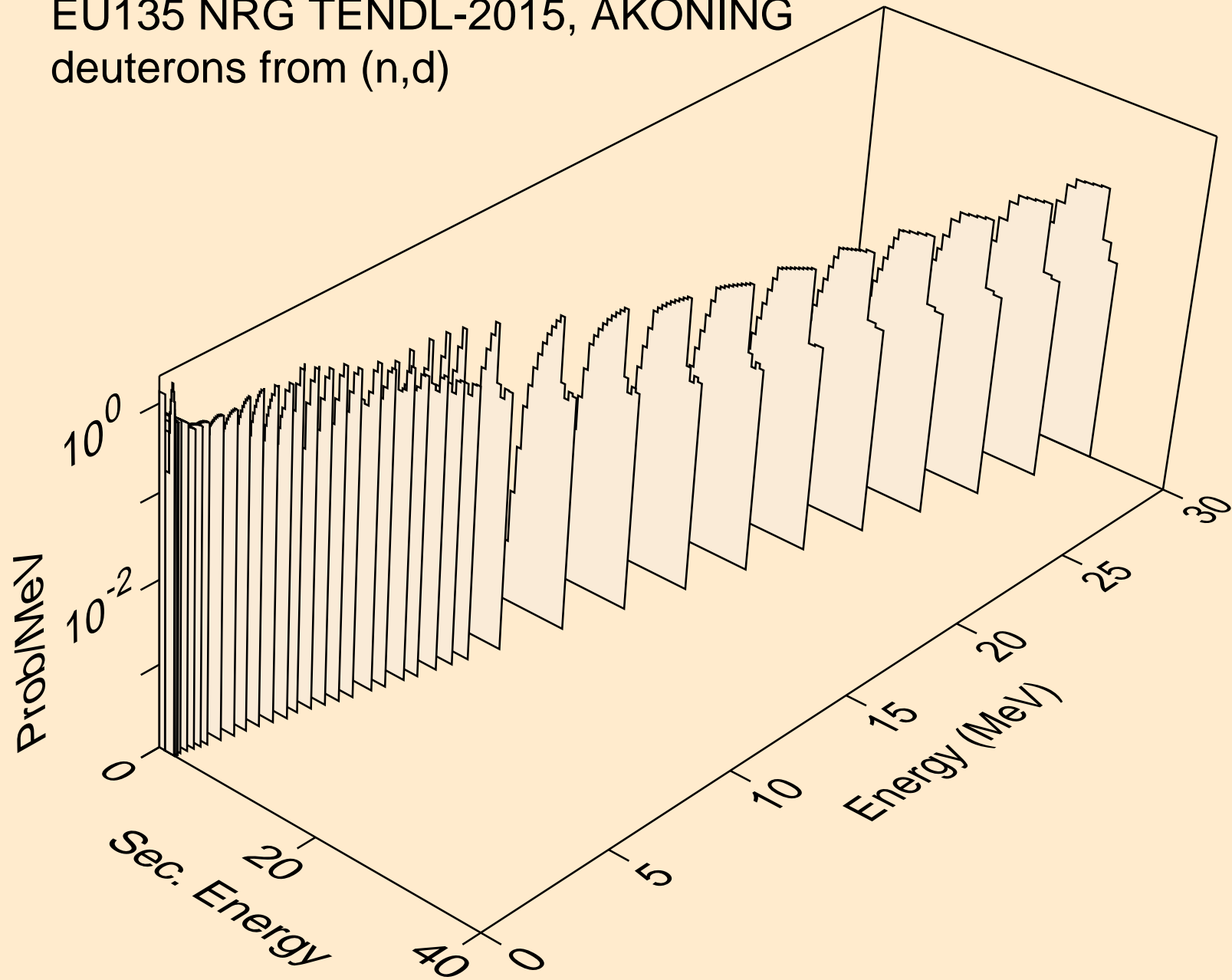

EU135 NRG TENDL-2015, AKONING
deuterons from (n,d2a)

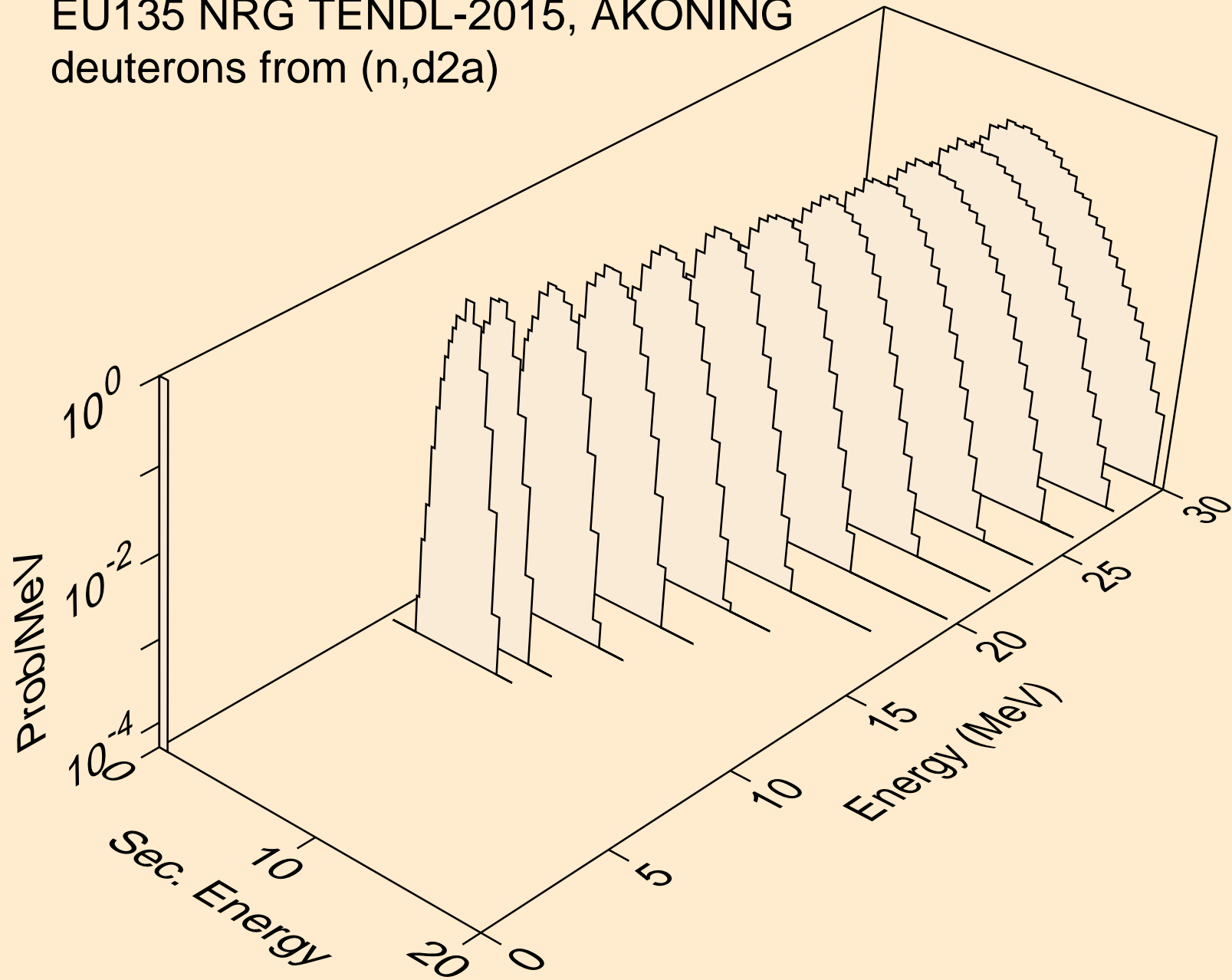

EU135 NRG TENDL-2015, AKONING
deuterons from (n,pd)

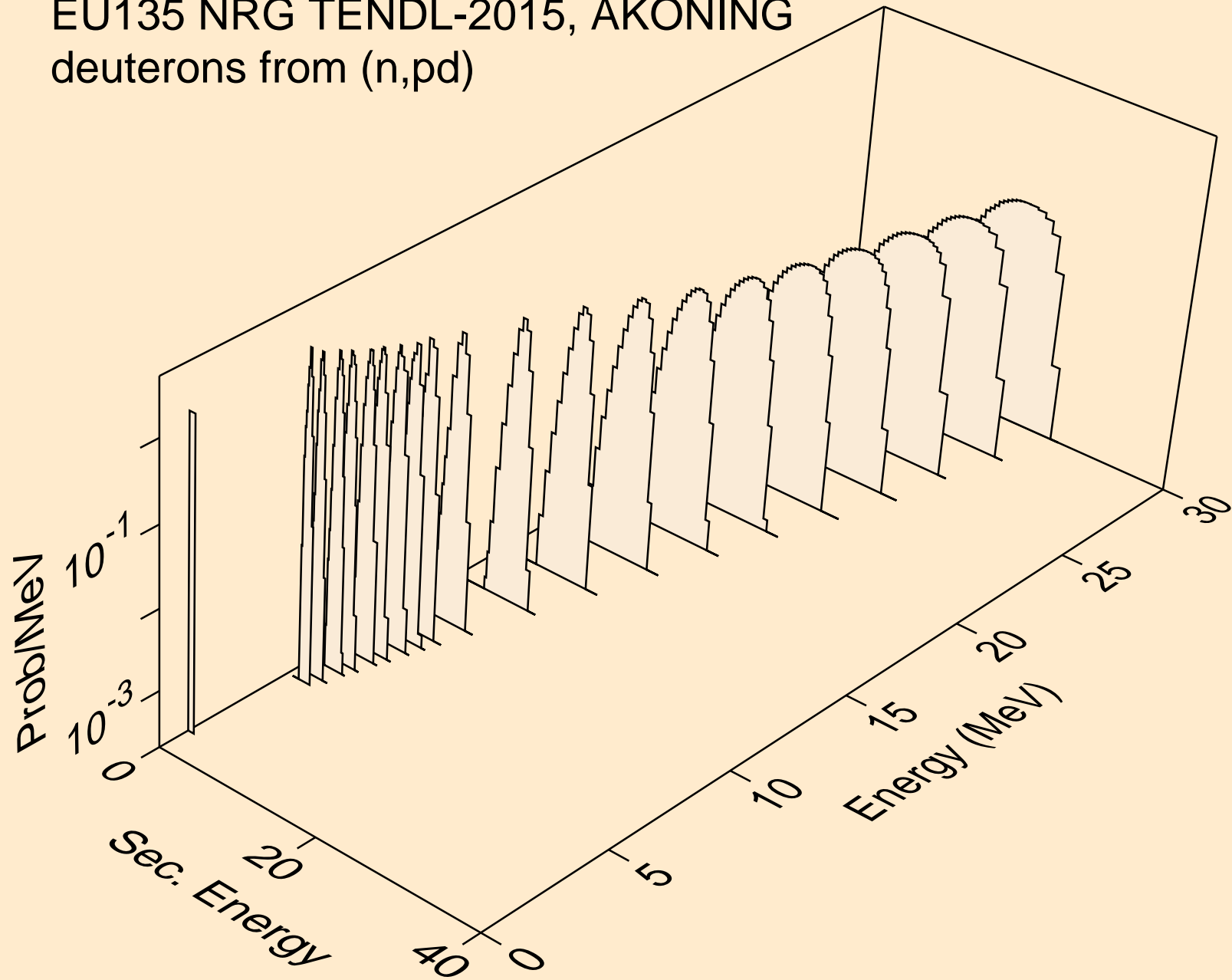

EU135 NRG TENDL-2015, AKONING
deuterons from (n,da)

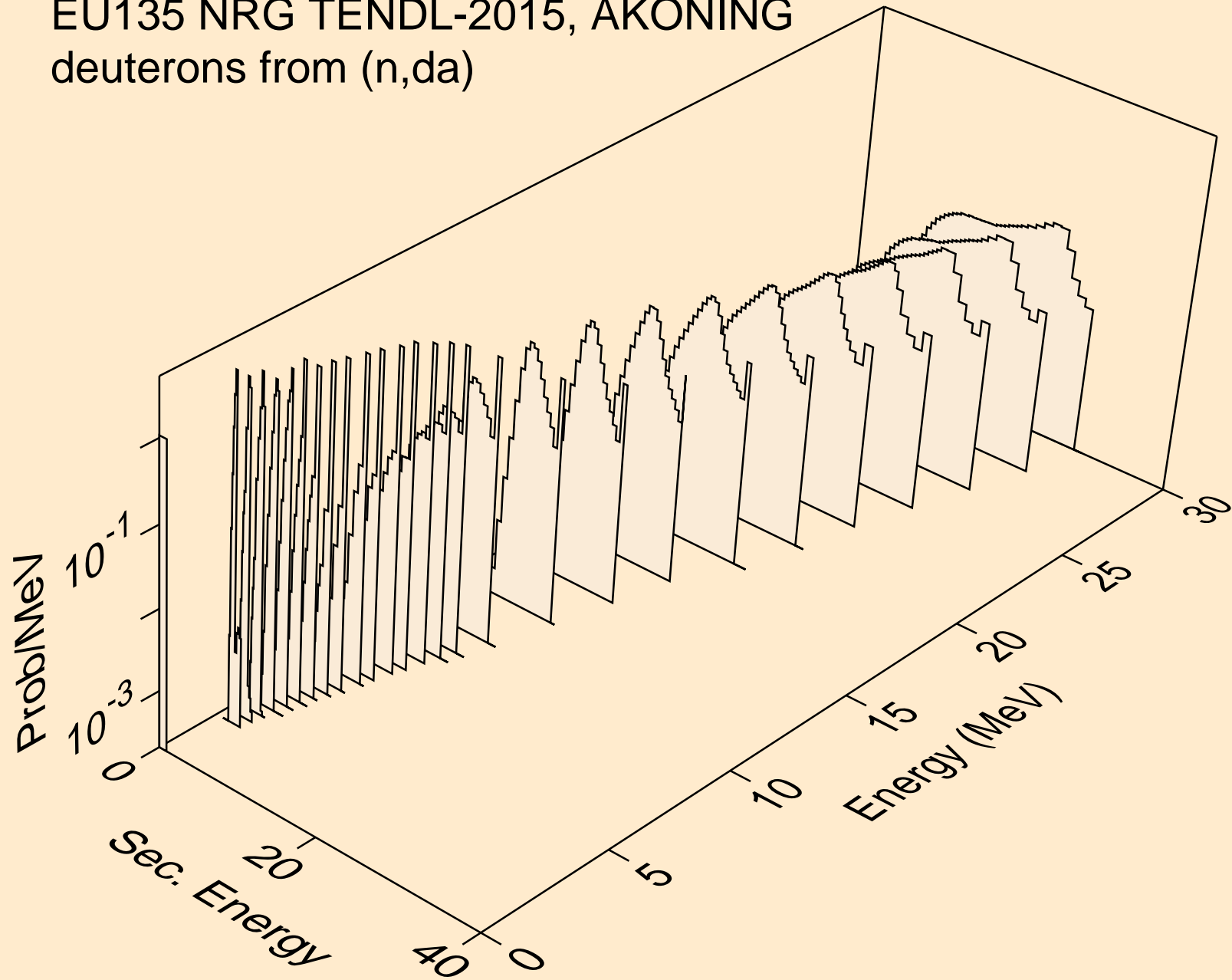

EU135 NRG TENDL-2015, AKONING
tritons from (n,x)

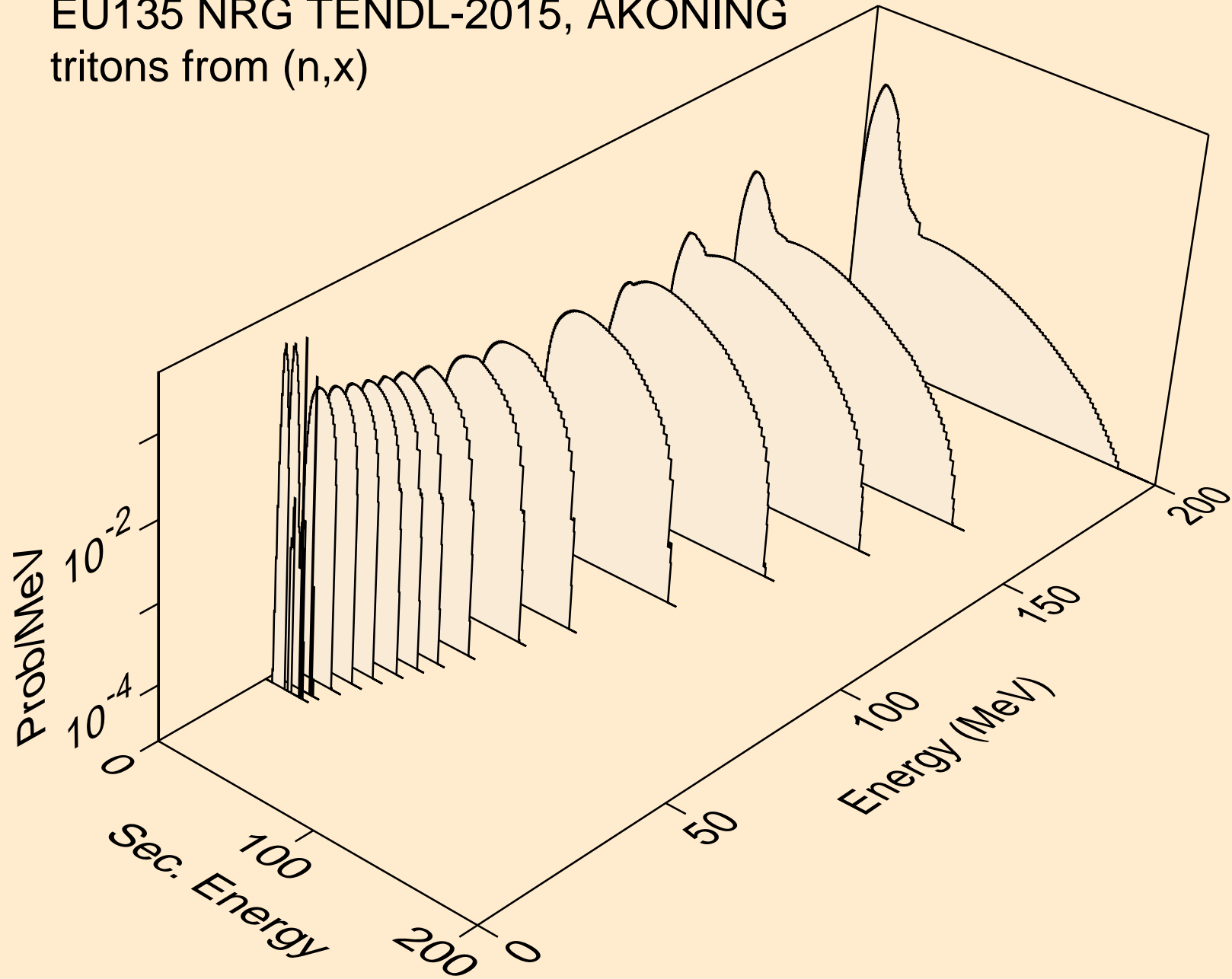

EU135 NRG TENDL-2015, AKONING
tritons from (n,n*)t

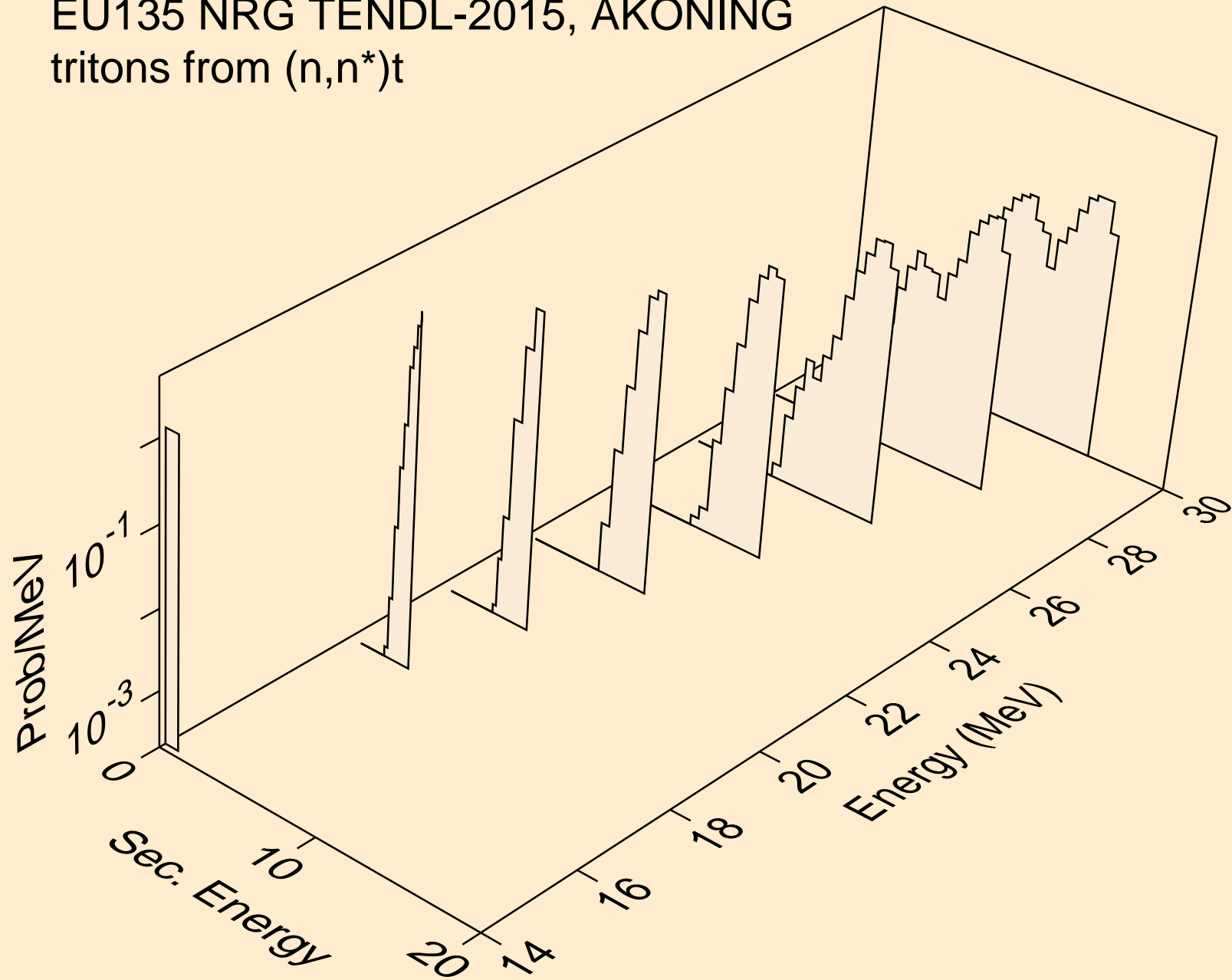

EU135 NRG TENDL-2015, AKONING
tritons from (n,t)

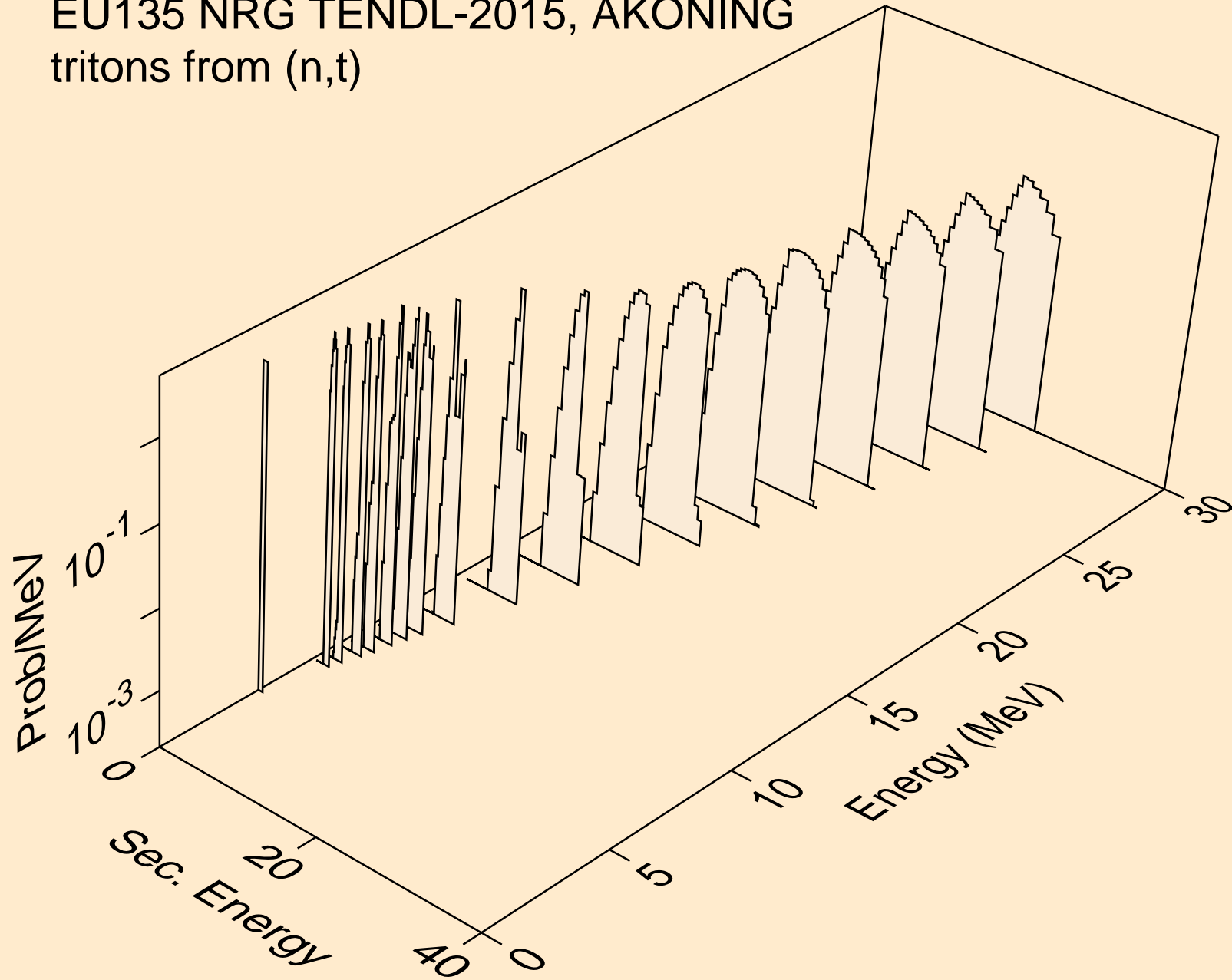

EU135 NRG TENDL-2015, AKONING
tritons from (n,t2a)

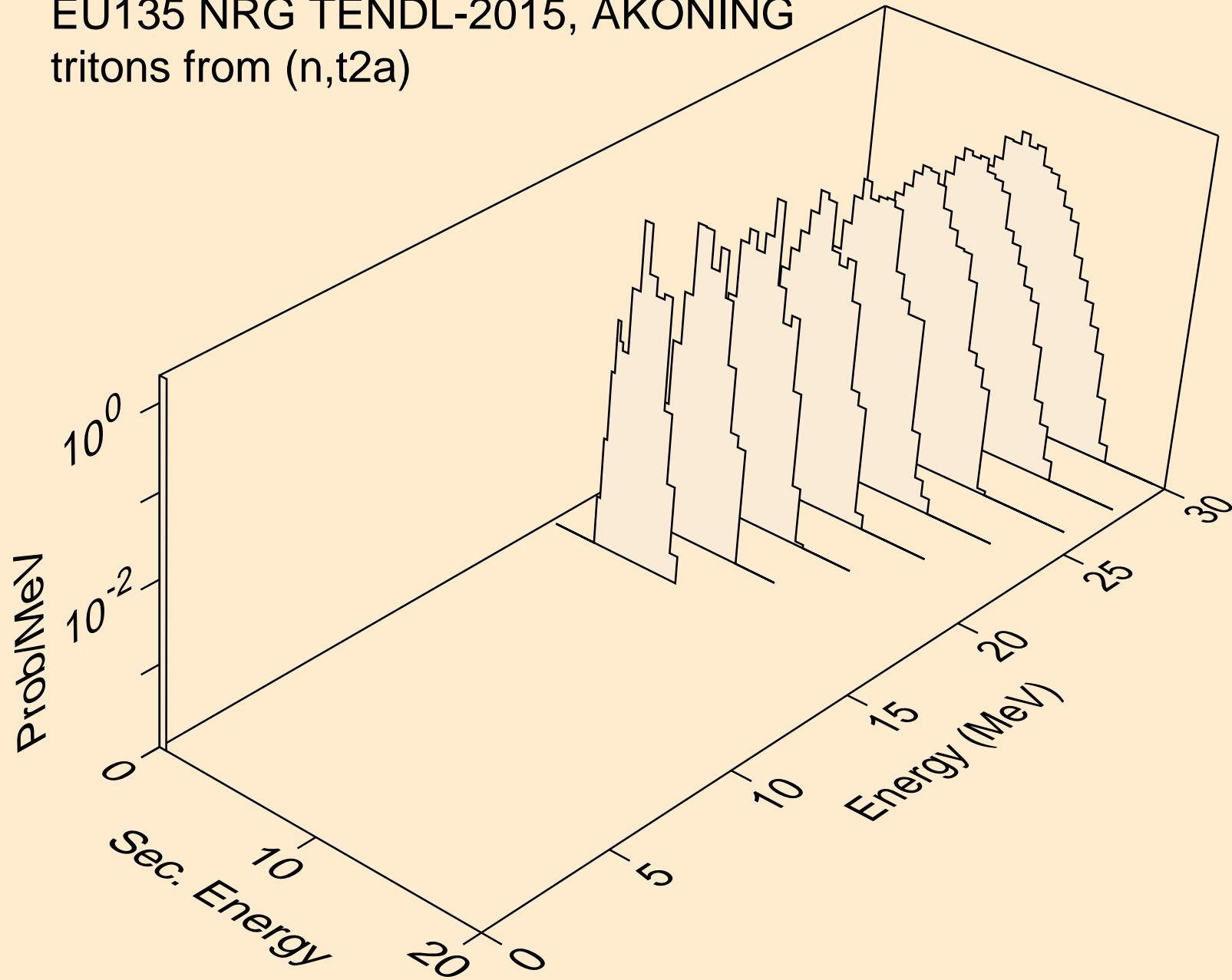

EU135 NRG TENDL-2015, AKONING
tritons from (n,pt)

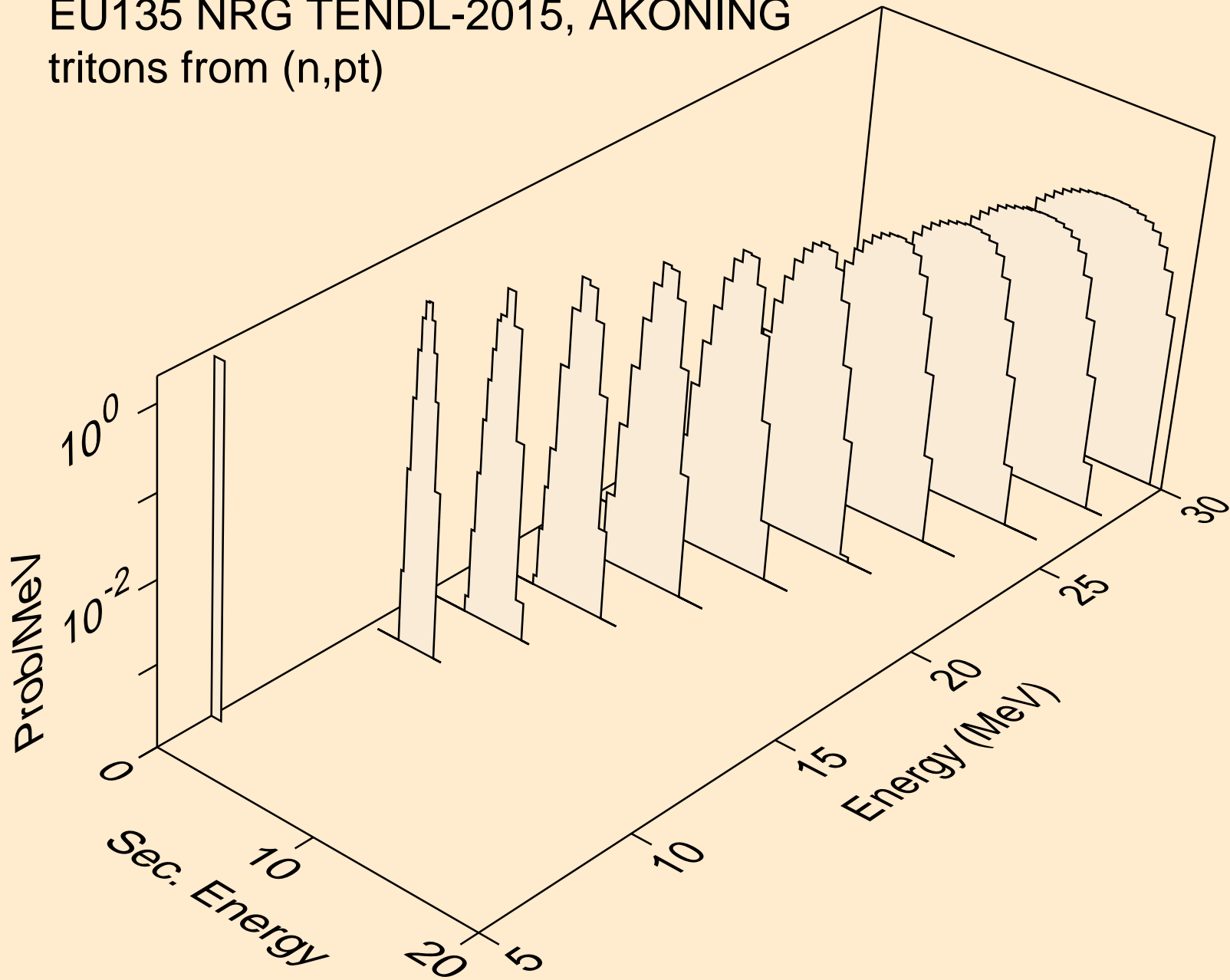

EU135 NRG TENDL-2015, AKONING
he3s from (n,x)

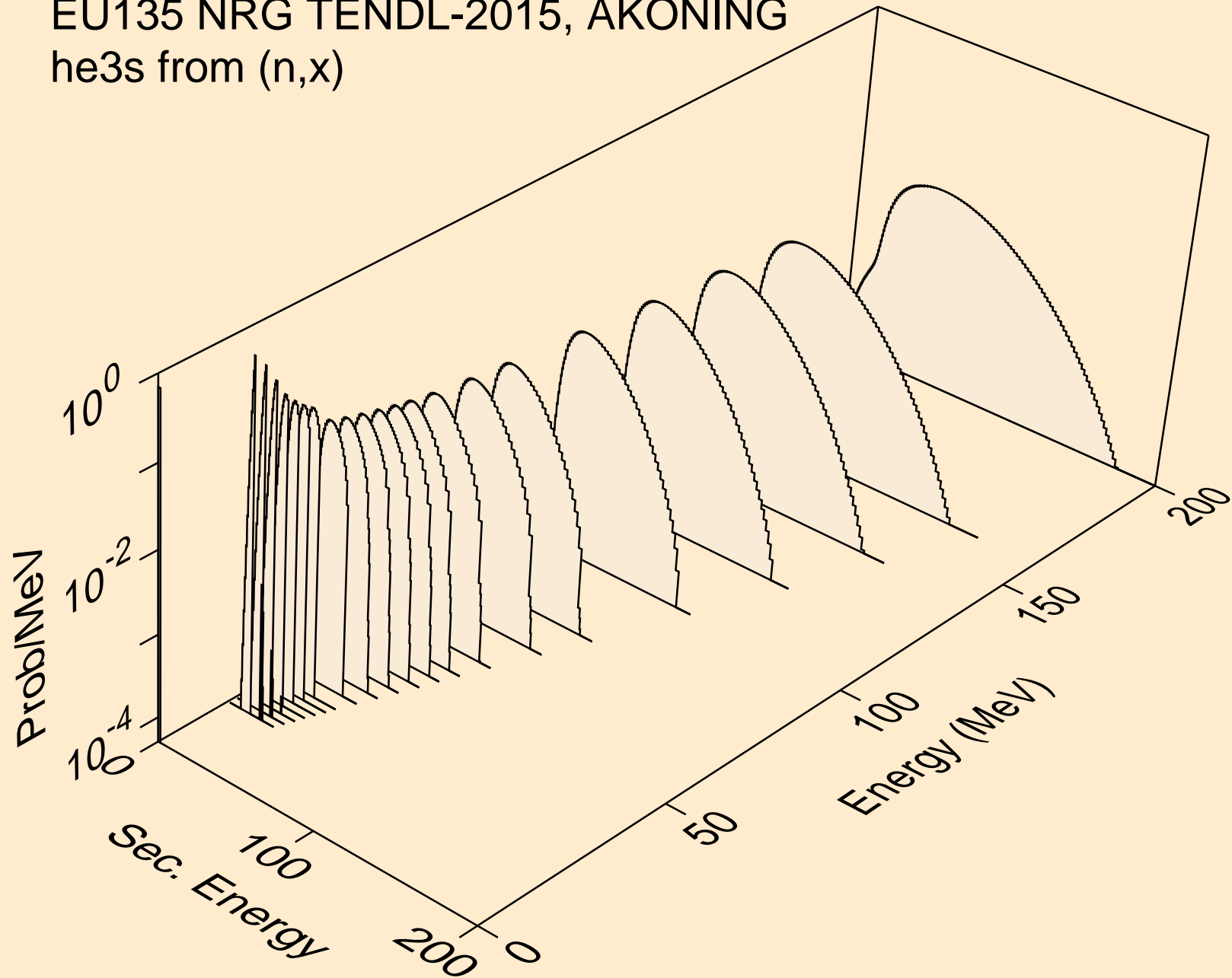

EU135 NRG TENDL-2015, AKONING
he3s from (n,n*)he3

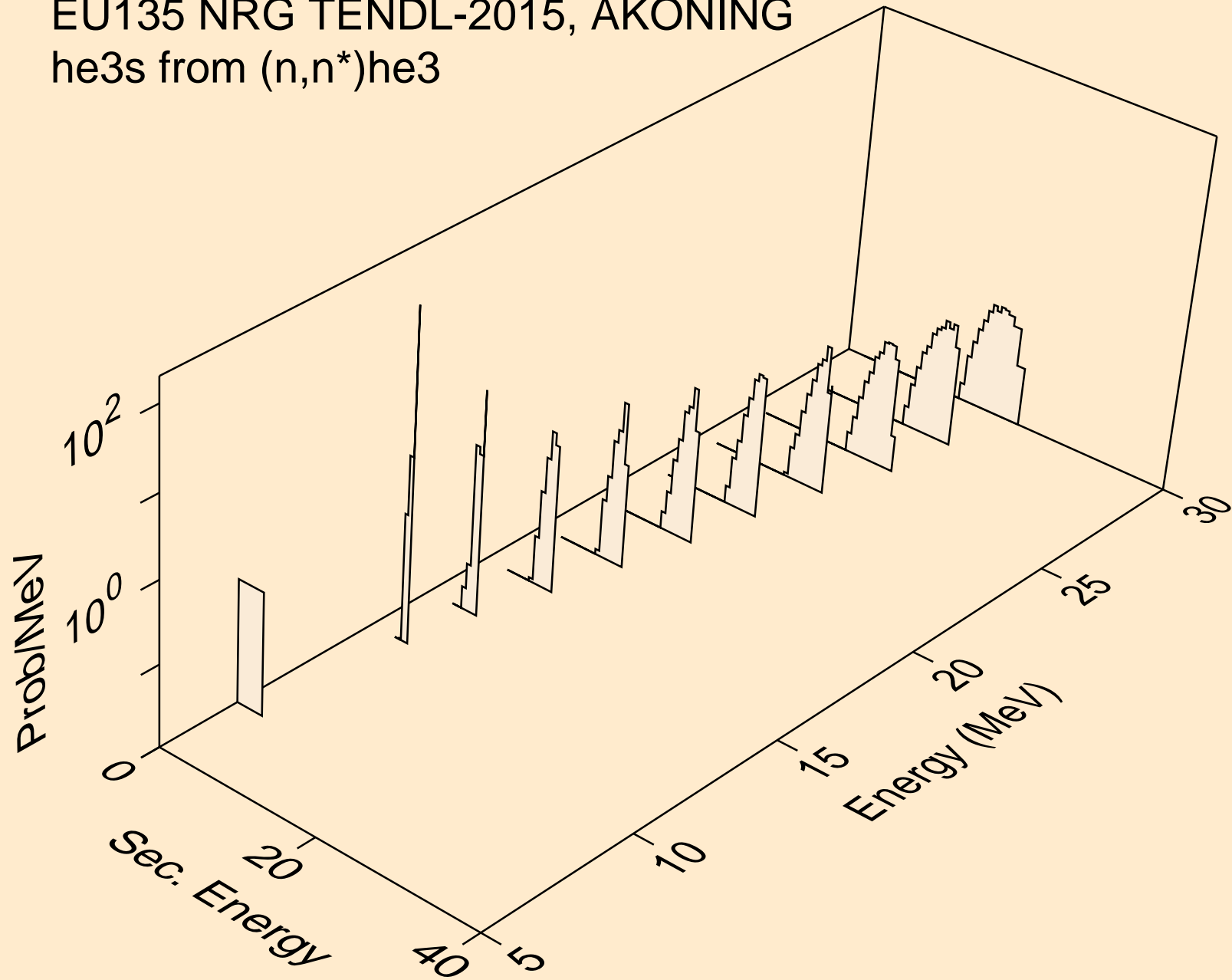

EU135 NRG TENDL-2015, AKONING
he3s from (n,he3)

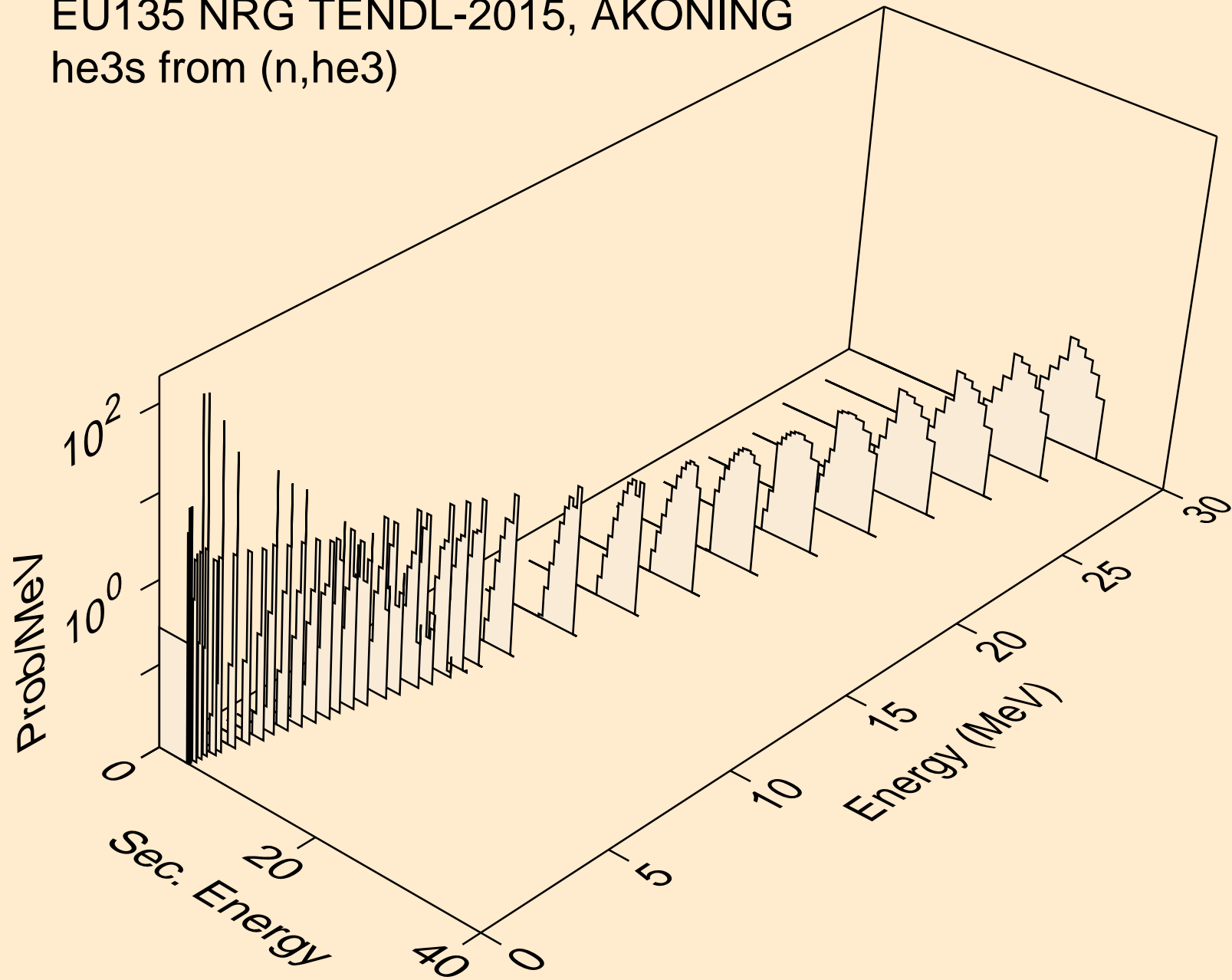

EU135 NRG TENDL-2015, AKONING
alphas from (n,x)

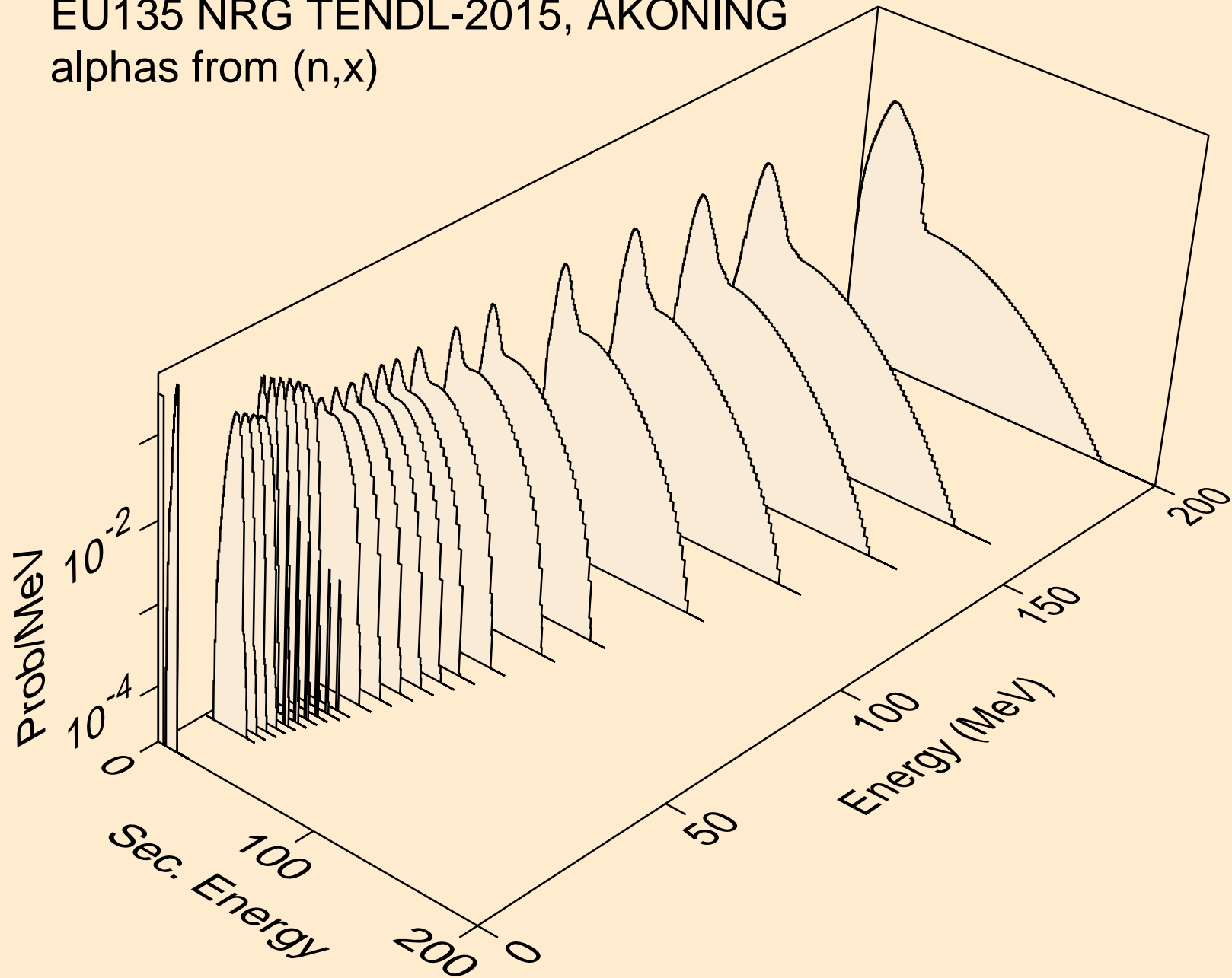

EU135 NRG TENDL-2015, AKONING
alphas from (n,n*)a

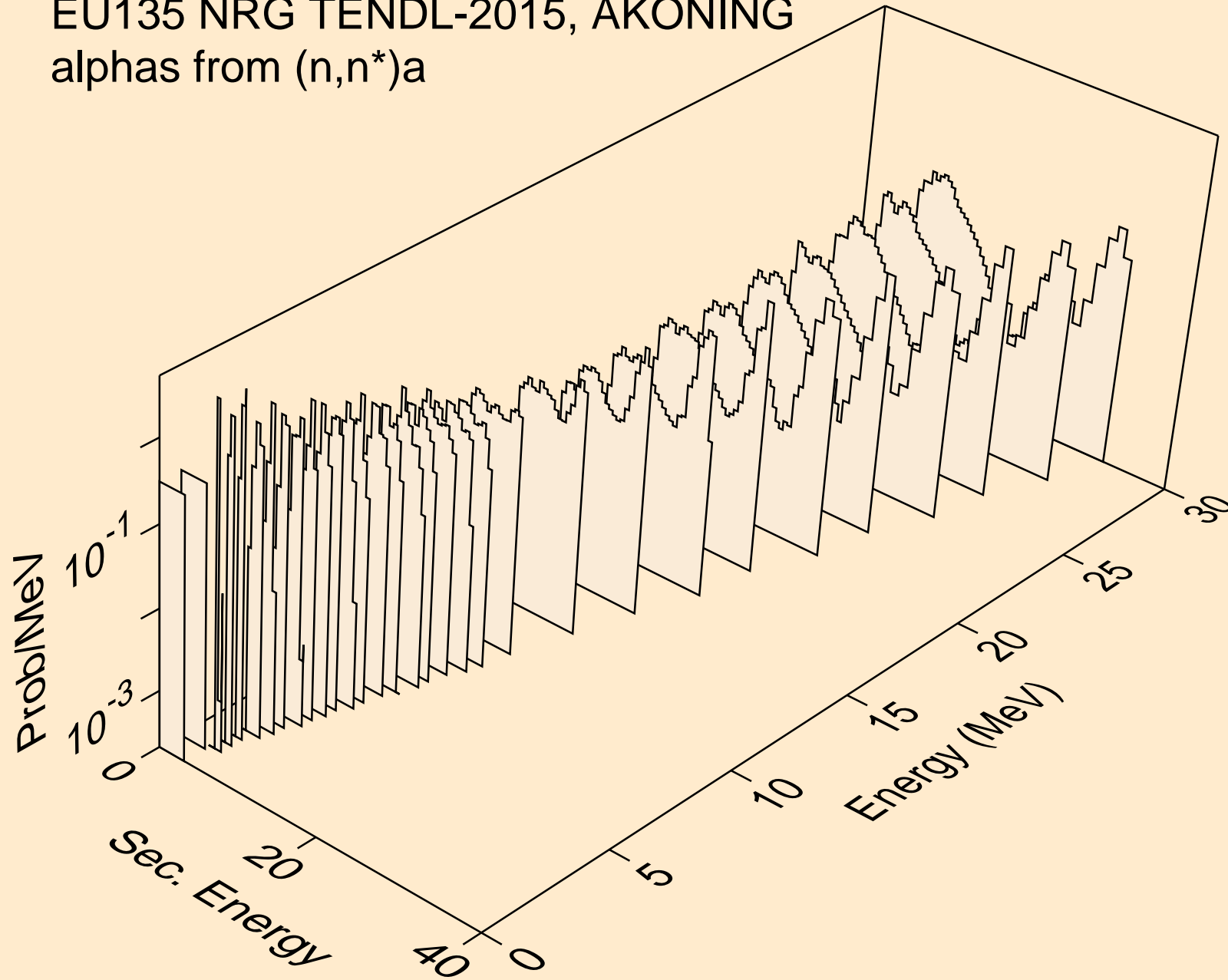

EU135 NRG TENDL-2015, AKONING
alphas from (n,n*)3a

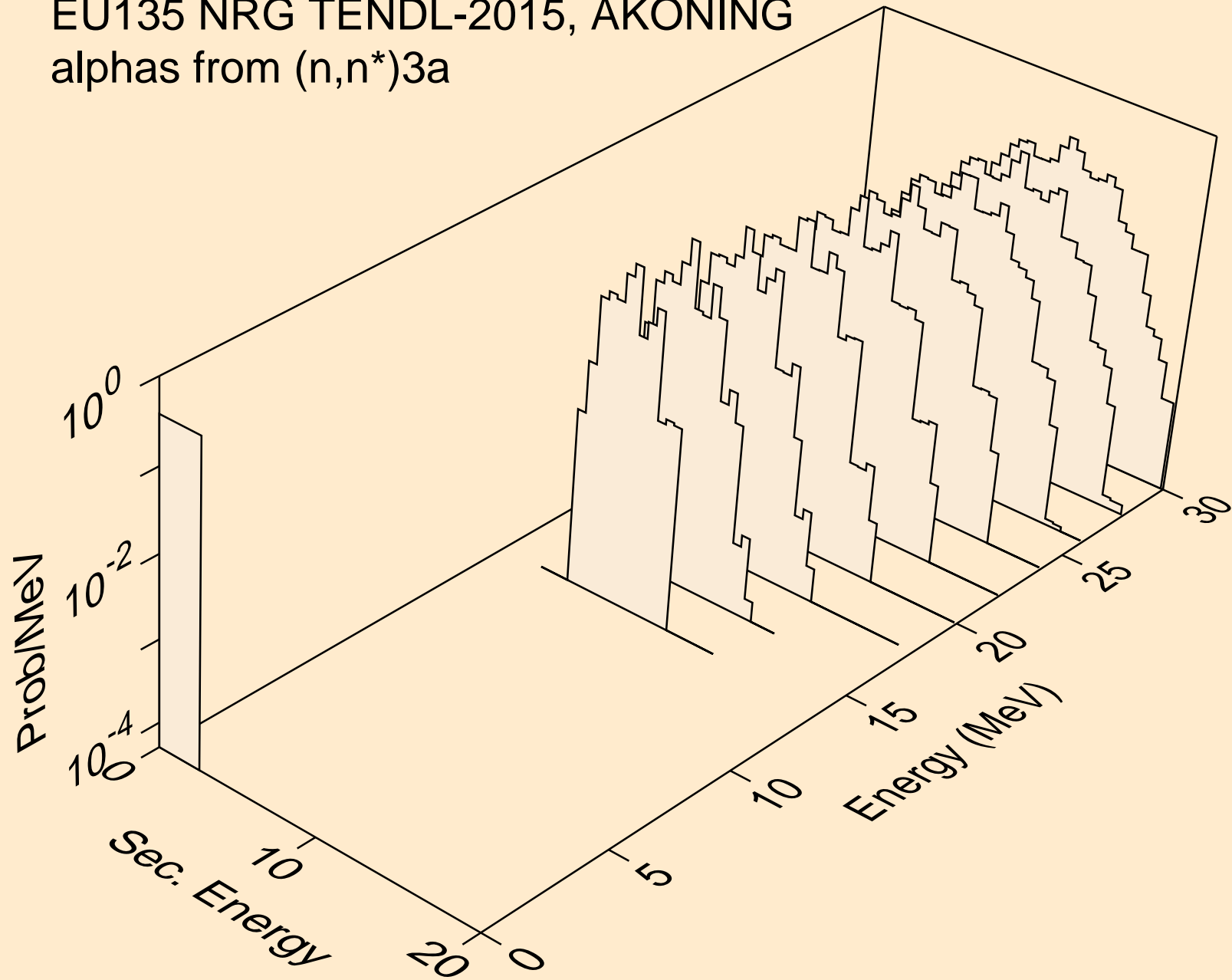

EU135 NRG TENDL-2015, AKONING
alphas from (n,2n)a

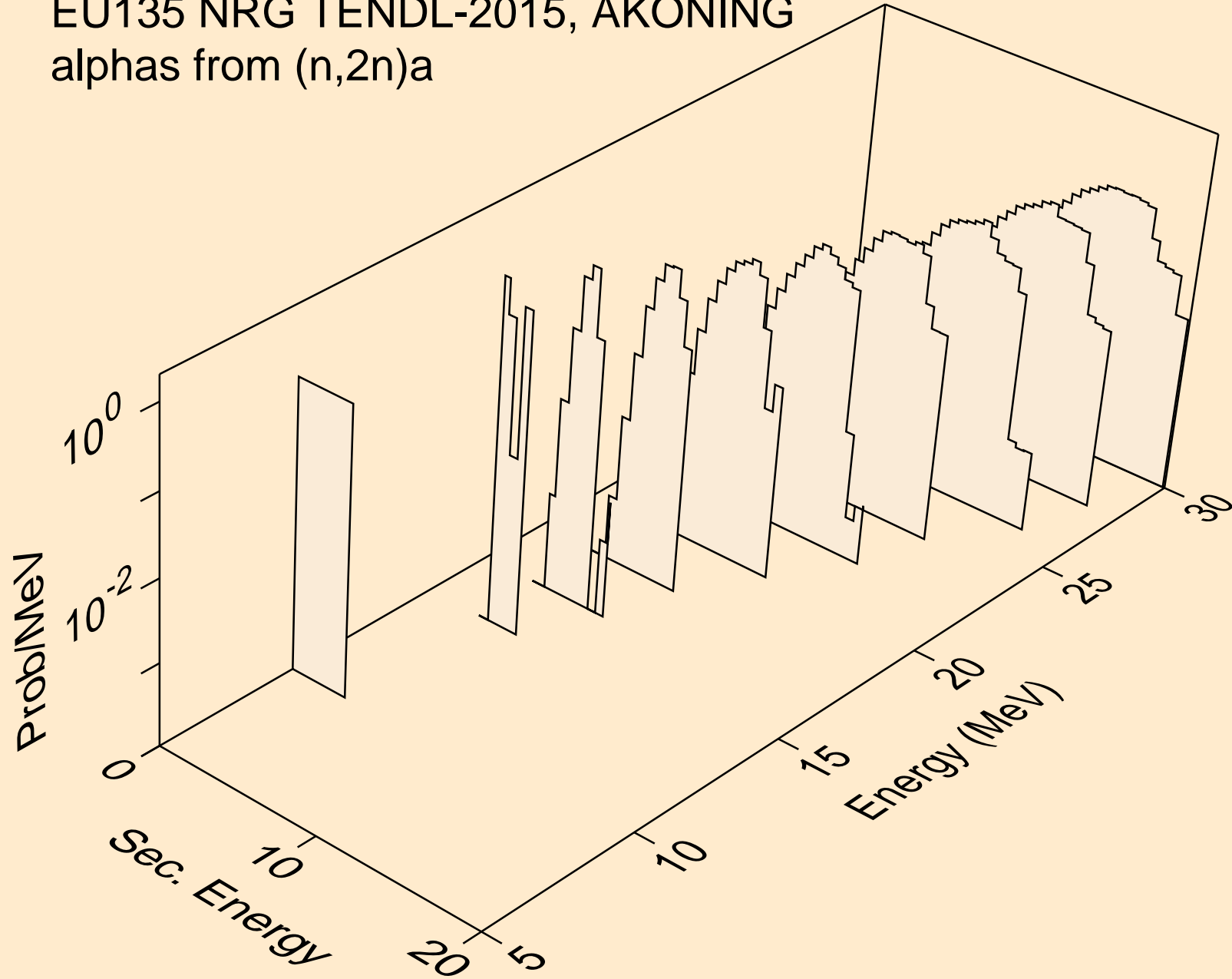

EU135 NRG TENDL-2015, AKONING
alphas from (n,3n)a

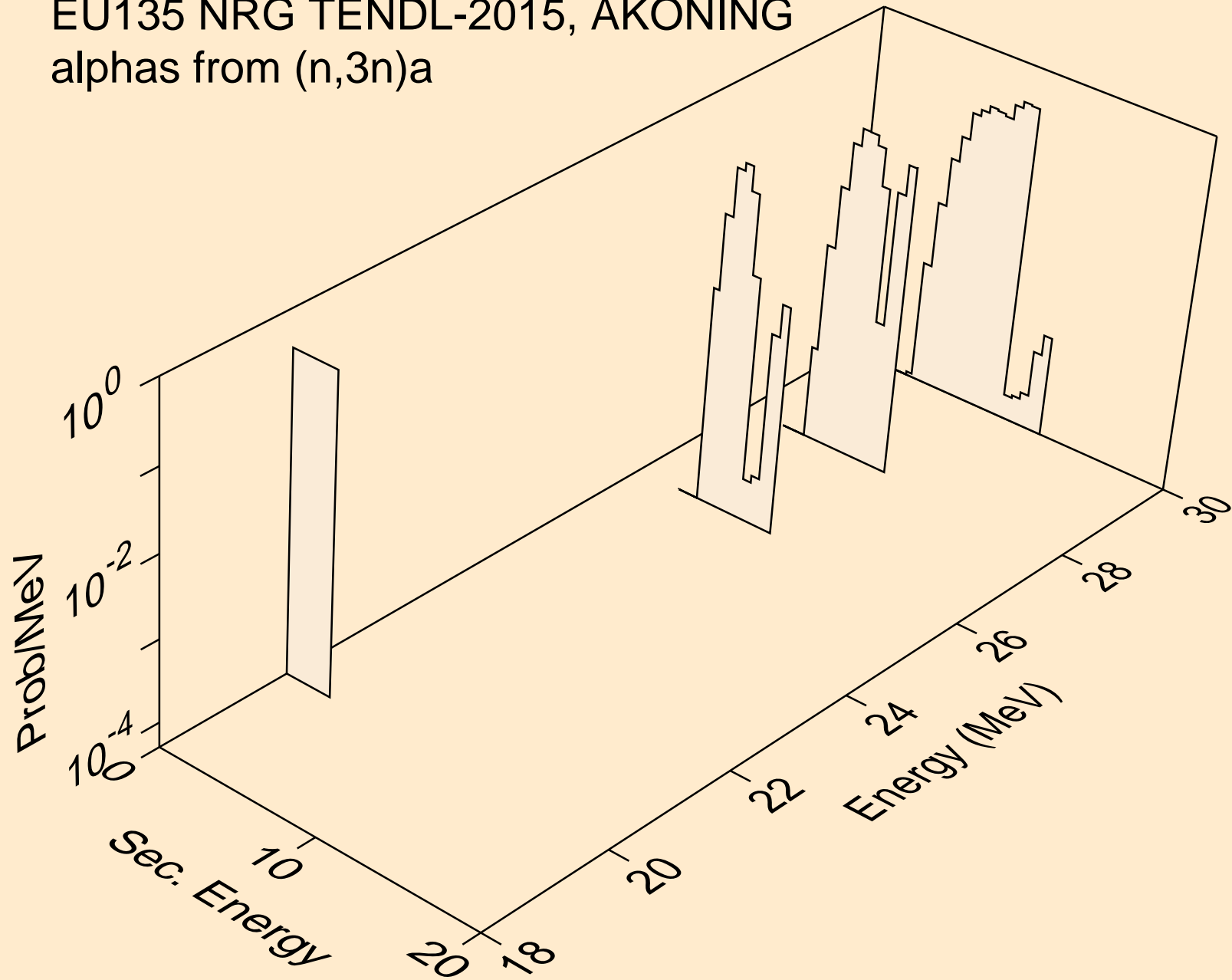

EU135 NRG TENDL-2015, AKONING
alphas from (n,n*)2a

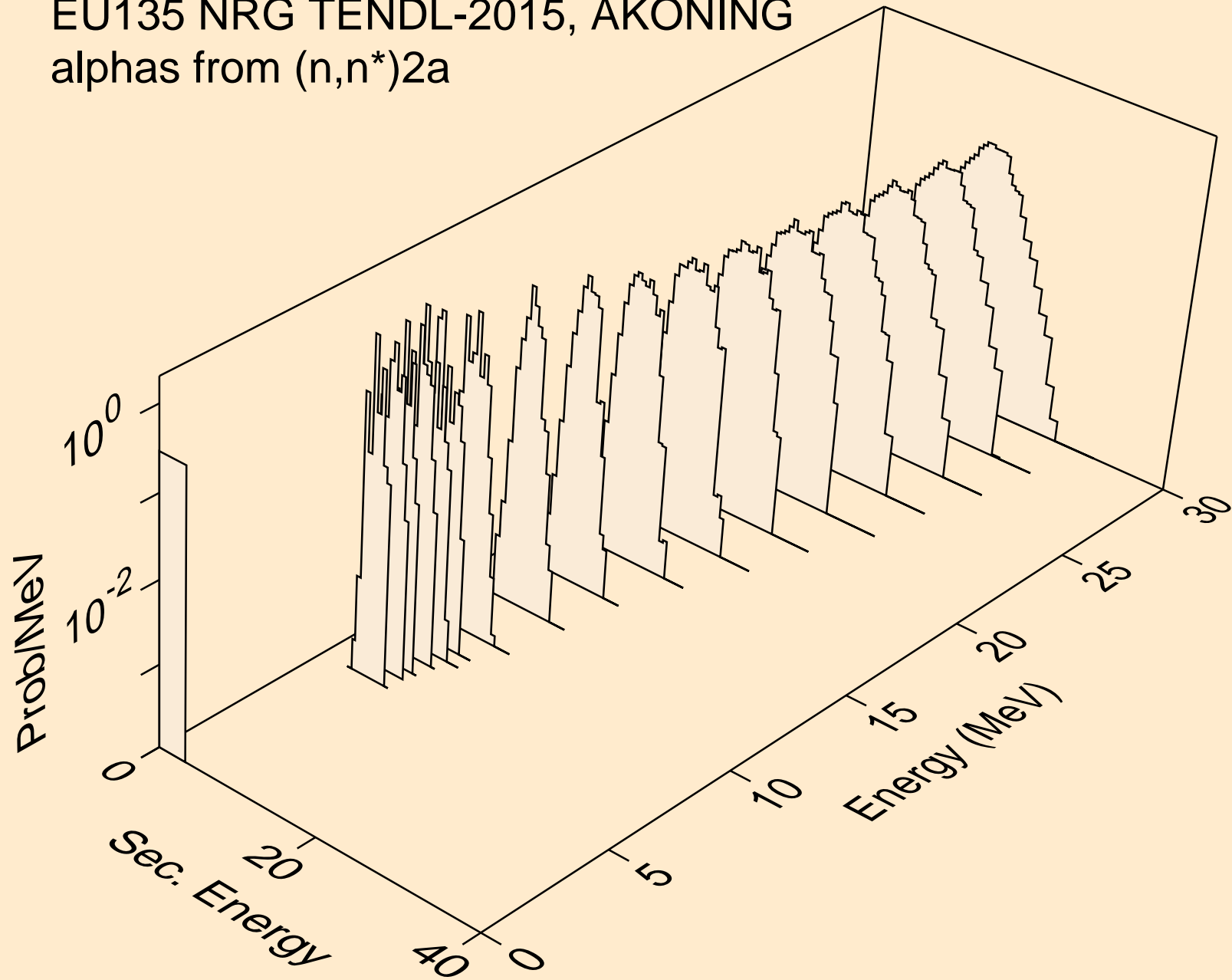

EU135 NRG TENDL-2015, AKONING
alphas from (n,2n)2a

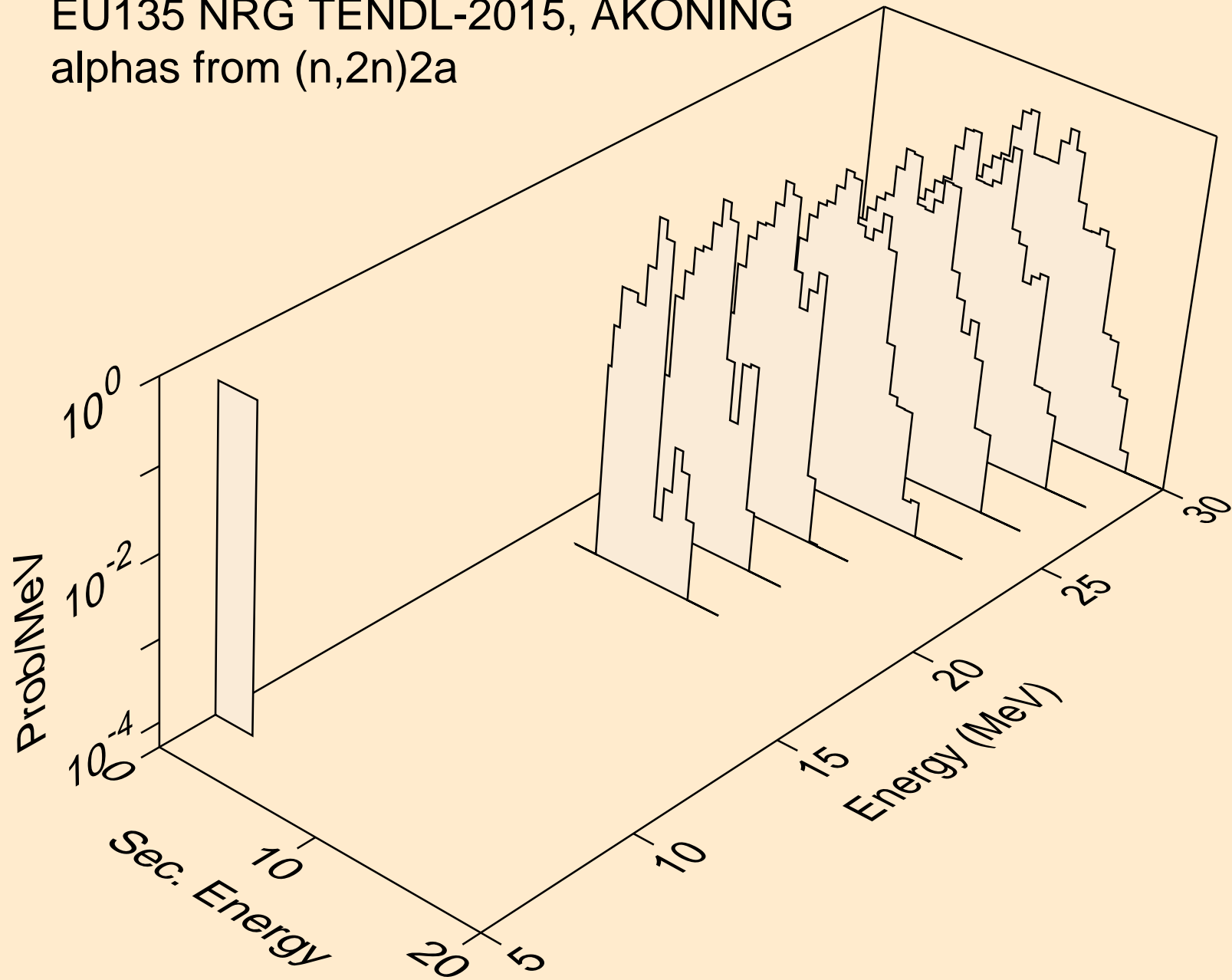

EU135 NRG TENDL-2015, AKONING
alphas from (n,npa)

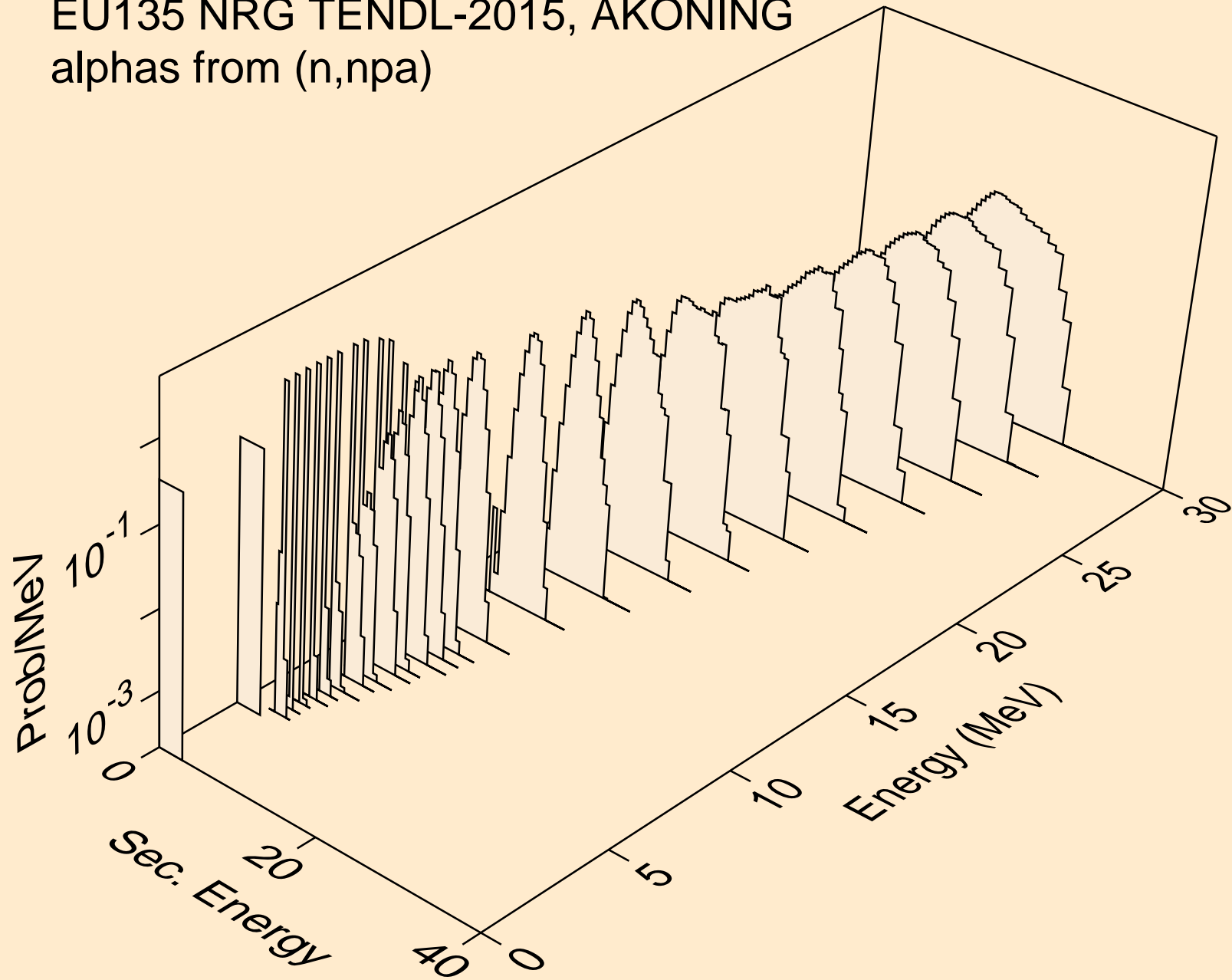

EU135 NRG TENDL-2015, AKONING
alphas from (n,a)

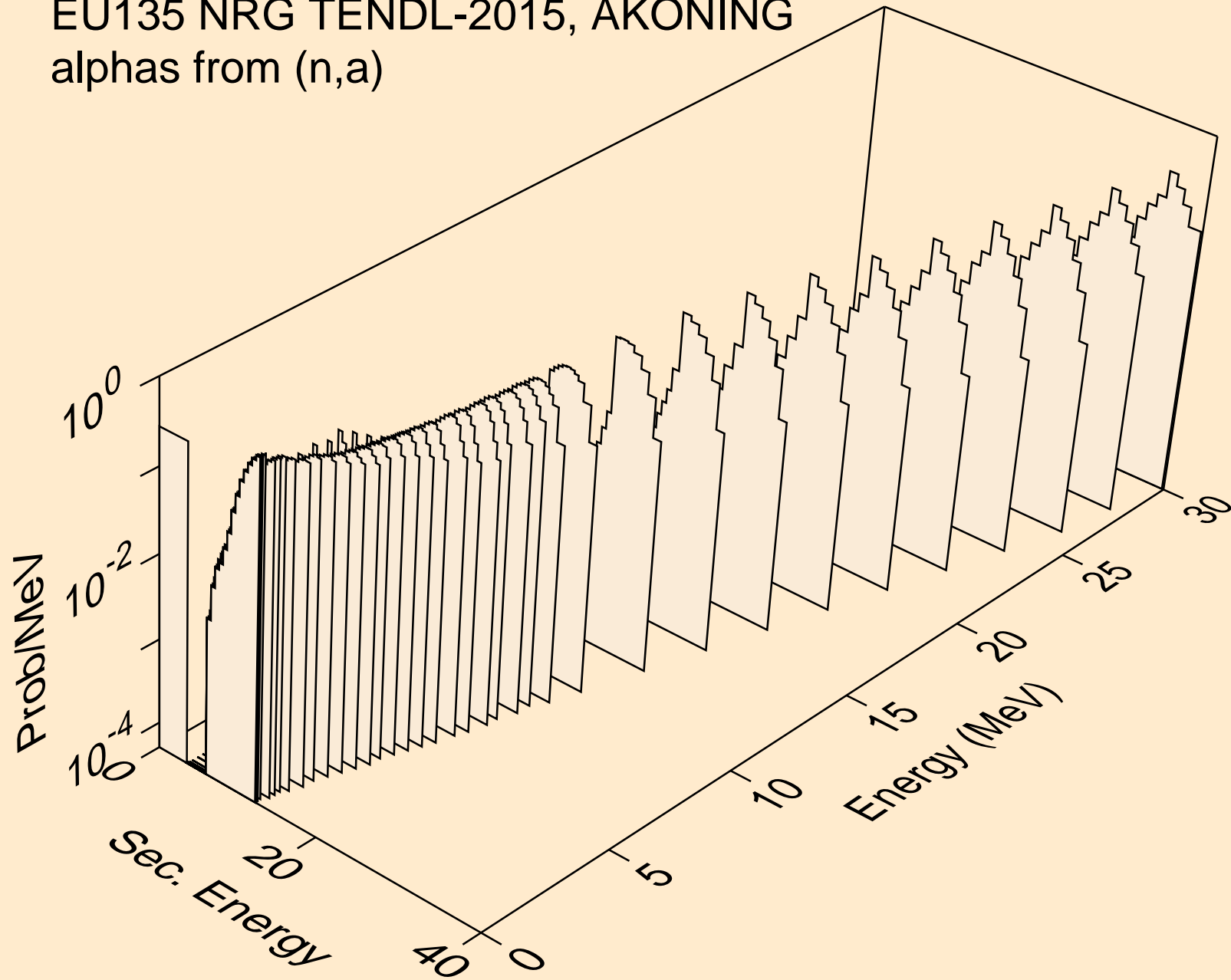

EU135 NRG TENDL-2015, AKONING
alphas from (n,2a)

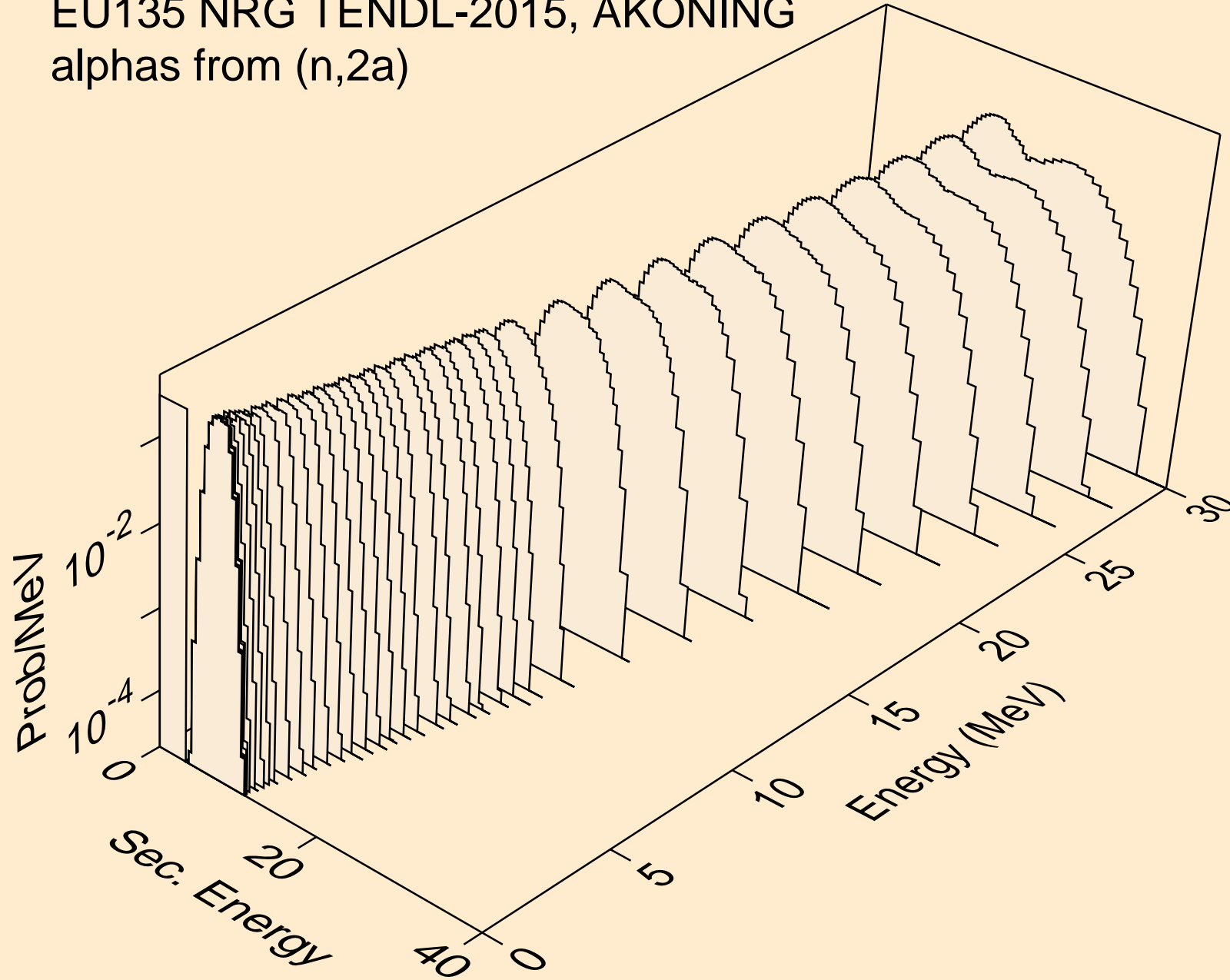

EU135 NRG TENDL-2015, AKONING
alphas from (n,3a)

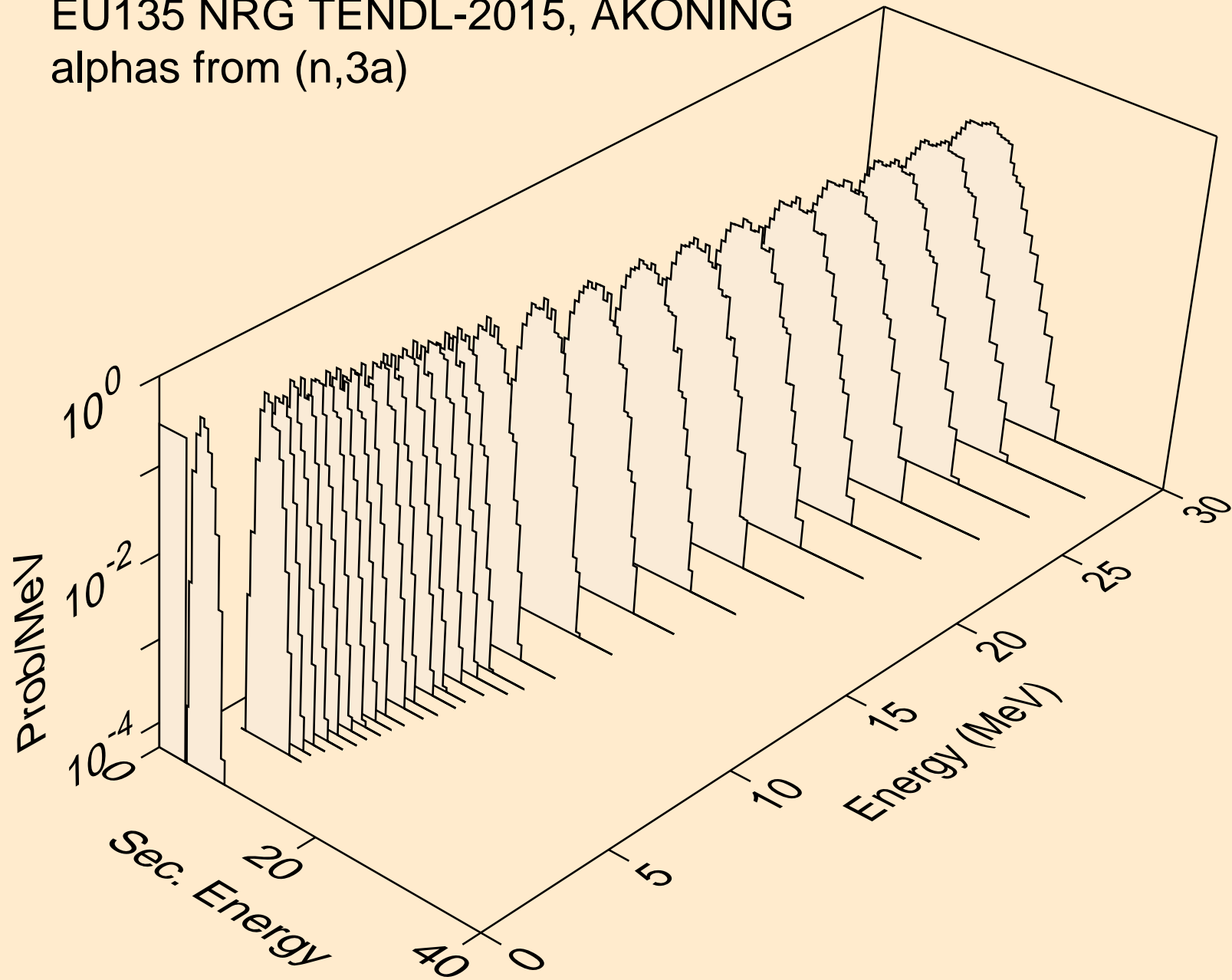

EU135 NRG TENDL-2015, AKONING
alphas from (n,pa)

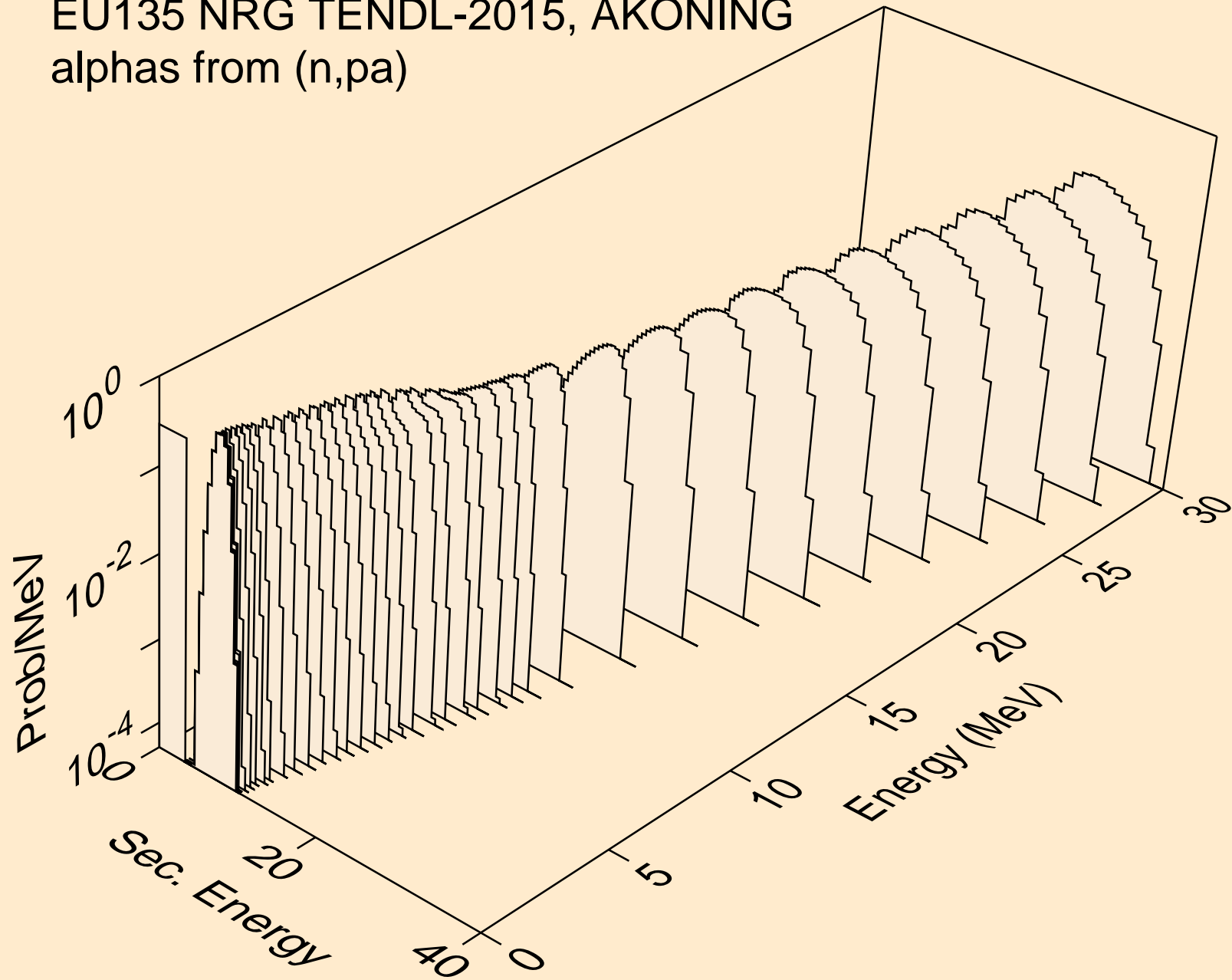

EU135 NRG TENDL-2015, AKONING
alphas from (n,t2a)

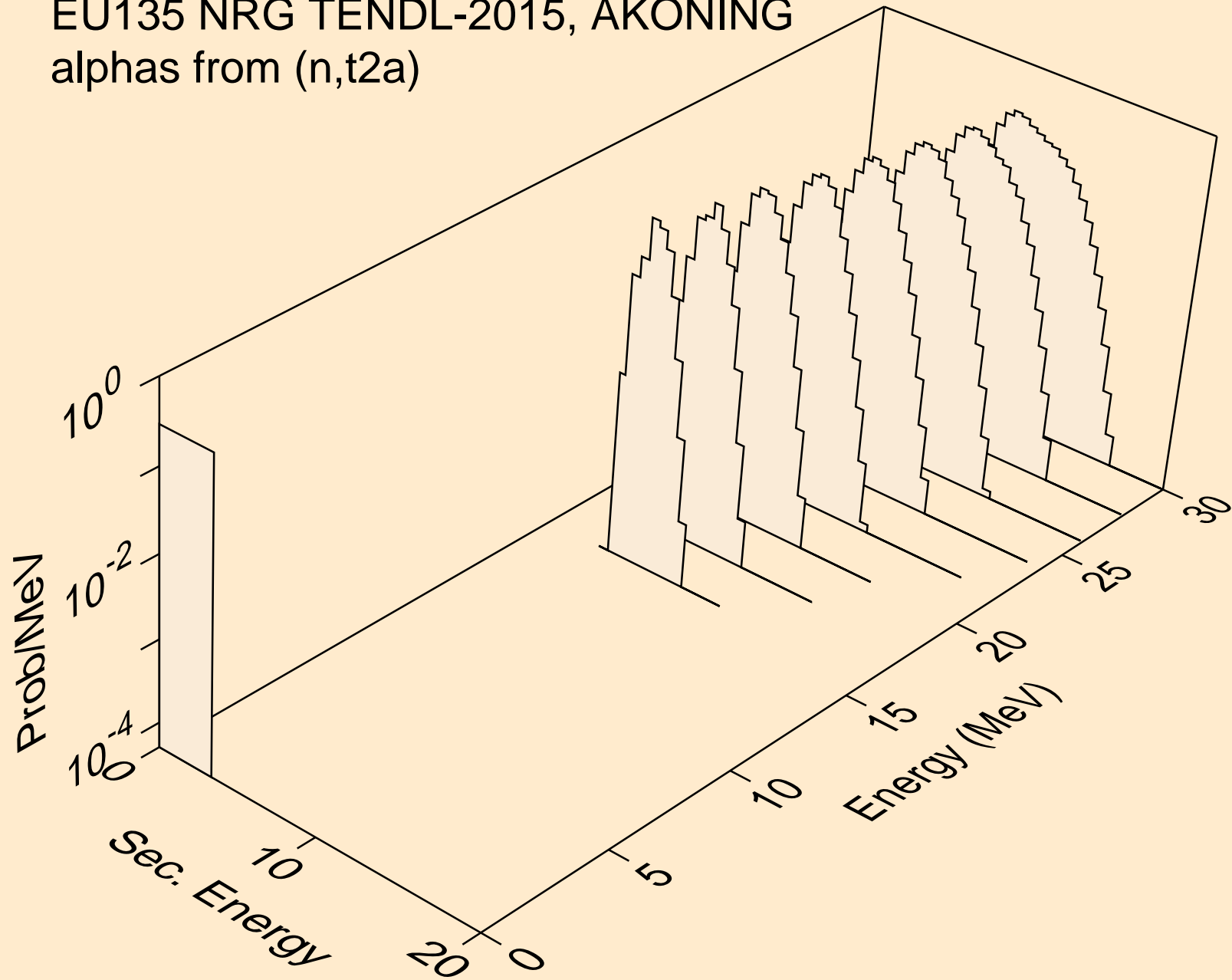

EU135 NRG TENDL-2015, AKONING
alphas from (n,d2a)

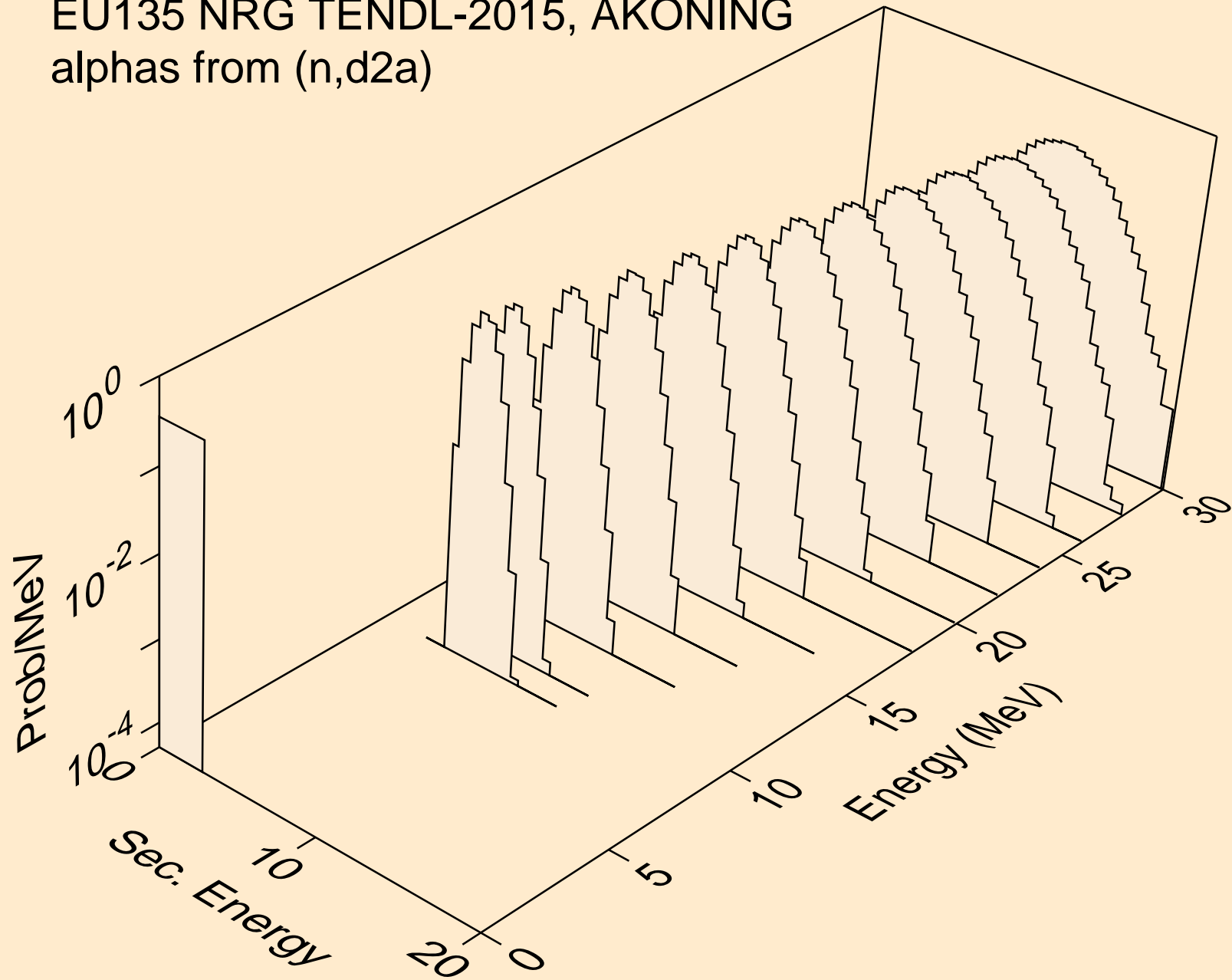

EU135 NRG TENDL-2015, AKONING
alphas from (n,da)

