

EU164 NRG TENDL-2015, AKONING

Principal cross sections

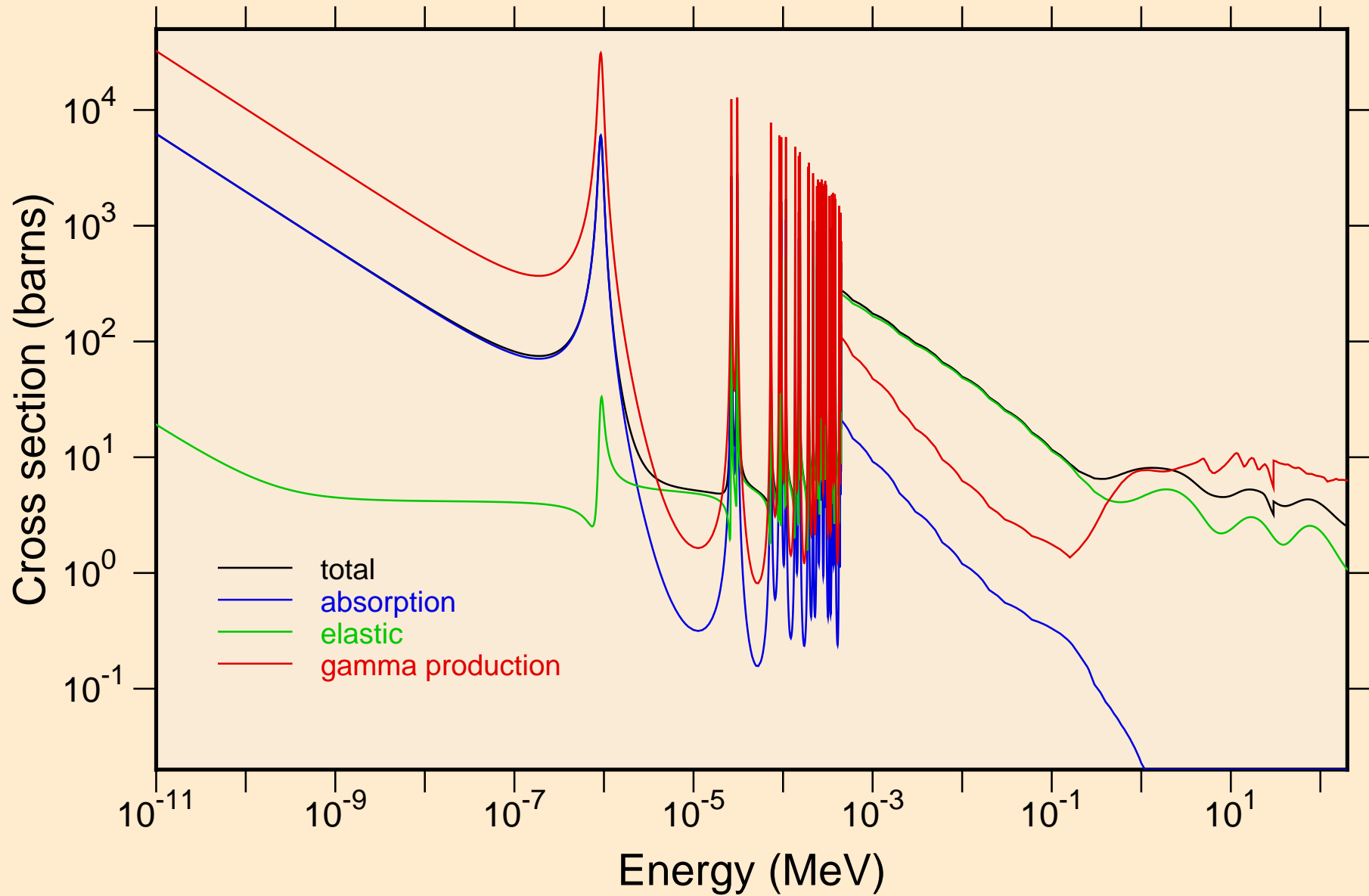

EU164 NRG TENDL-2015, AKONING
resonance total cross section

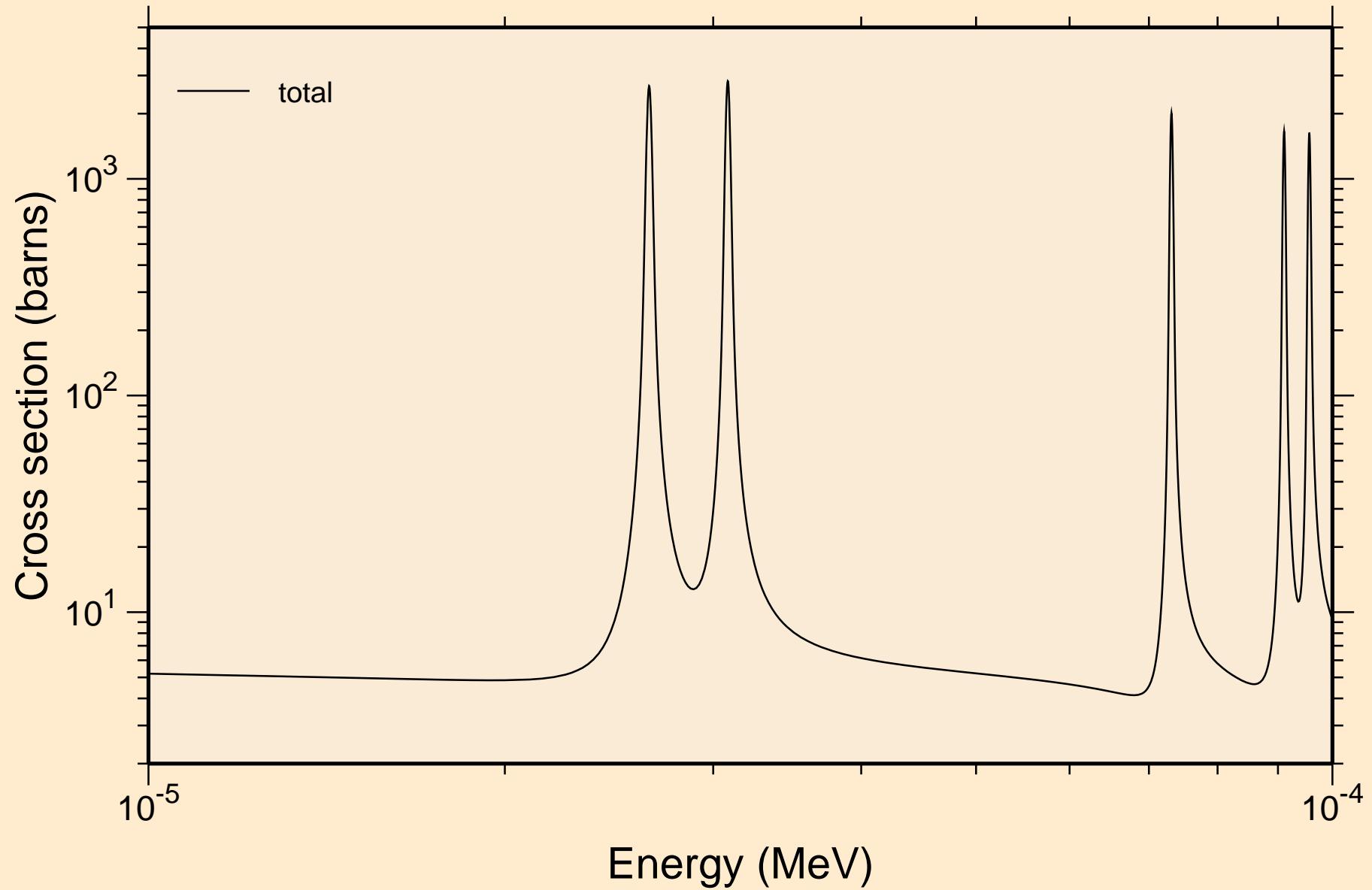

EU164 NRG TENDL-2015, AKONING
resonance total cross section

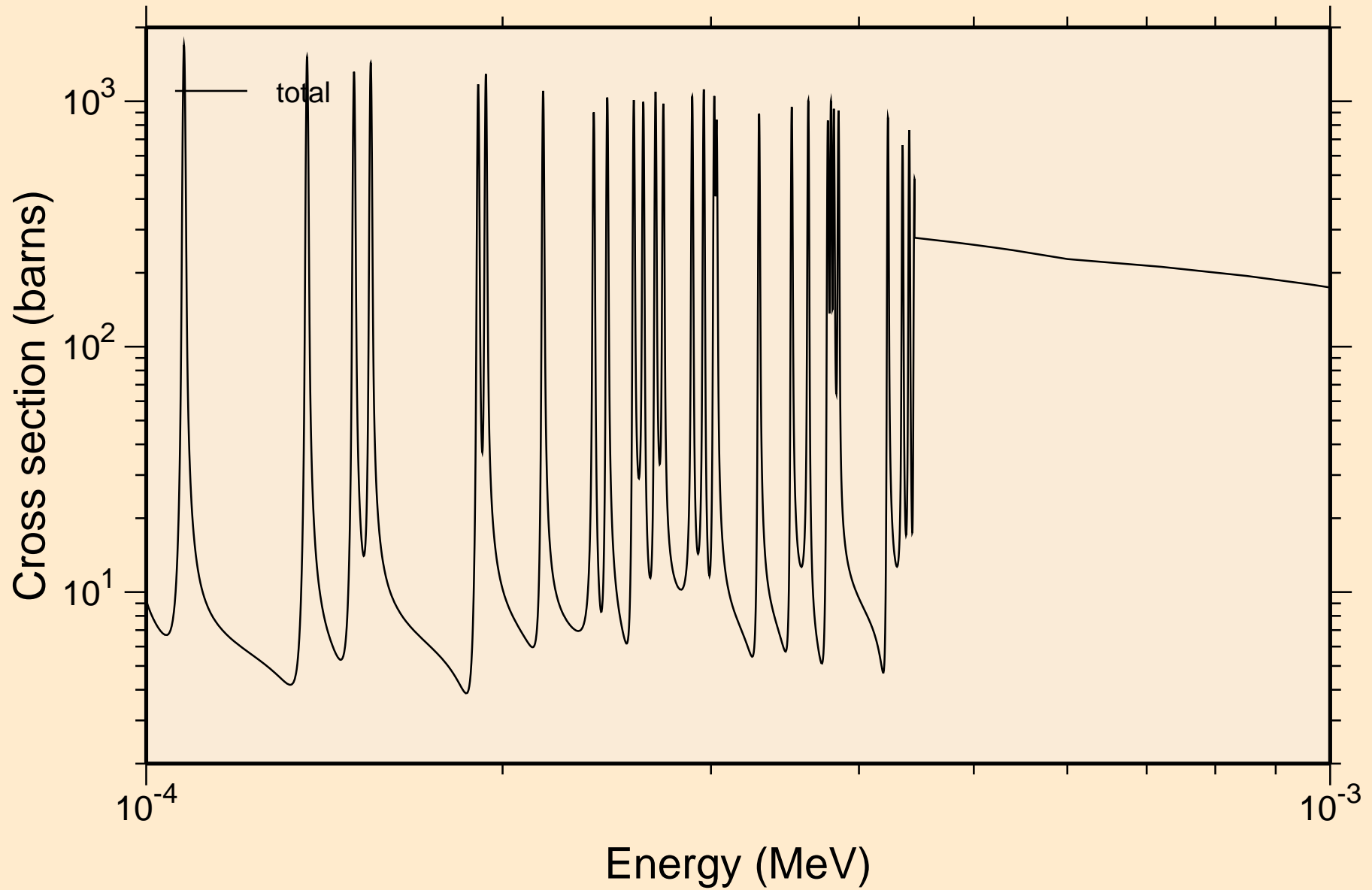

EU164 NRG TENDL-2015, AKONING
resonance total cross section

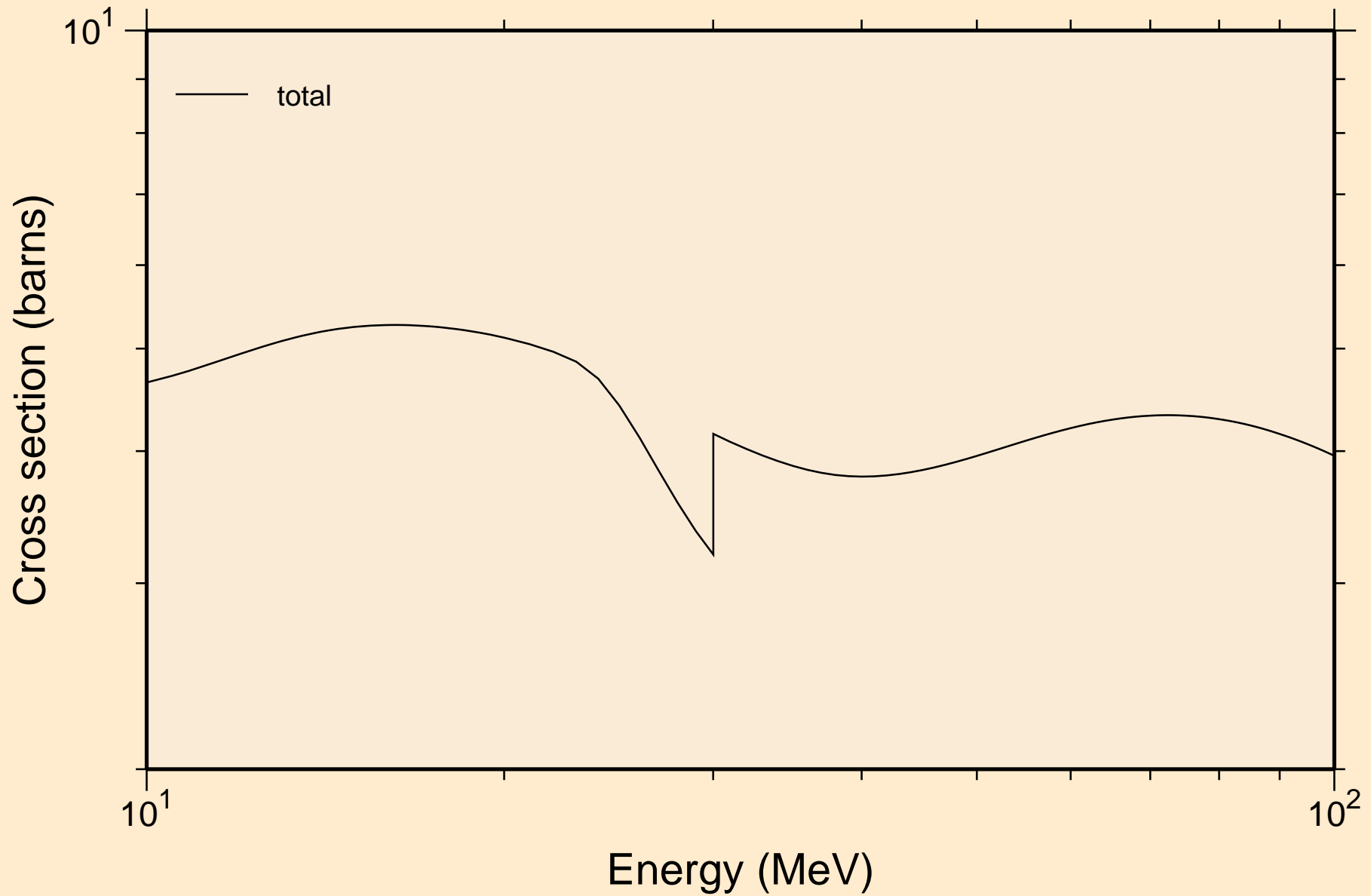

EU164 NRG TENDL-2015, AKONING resonance absorption cross sections

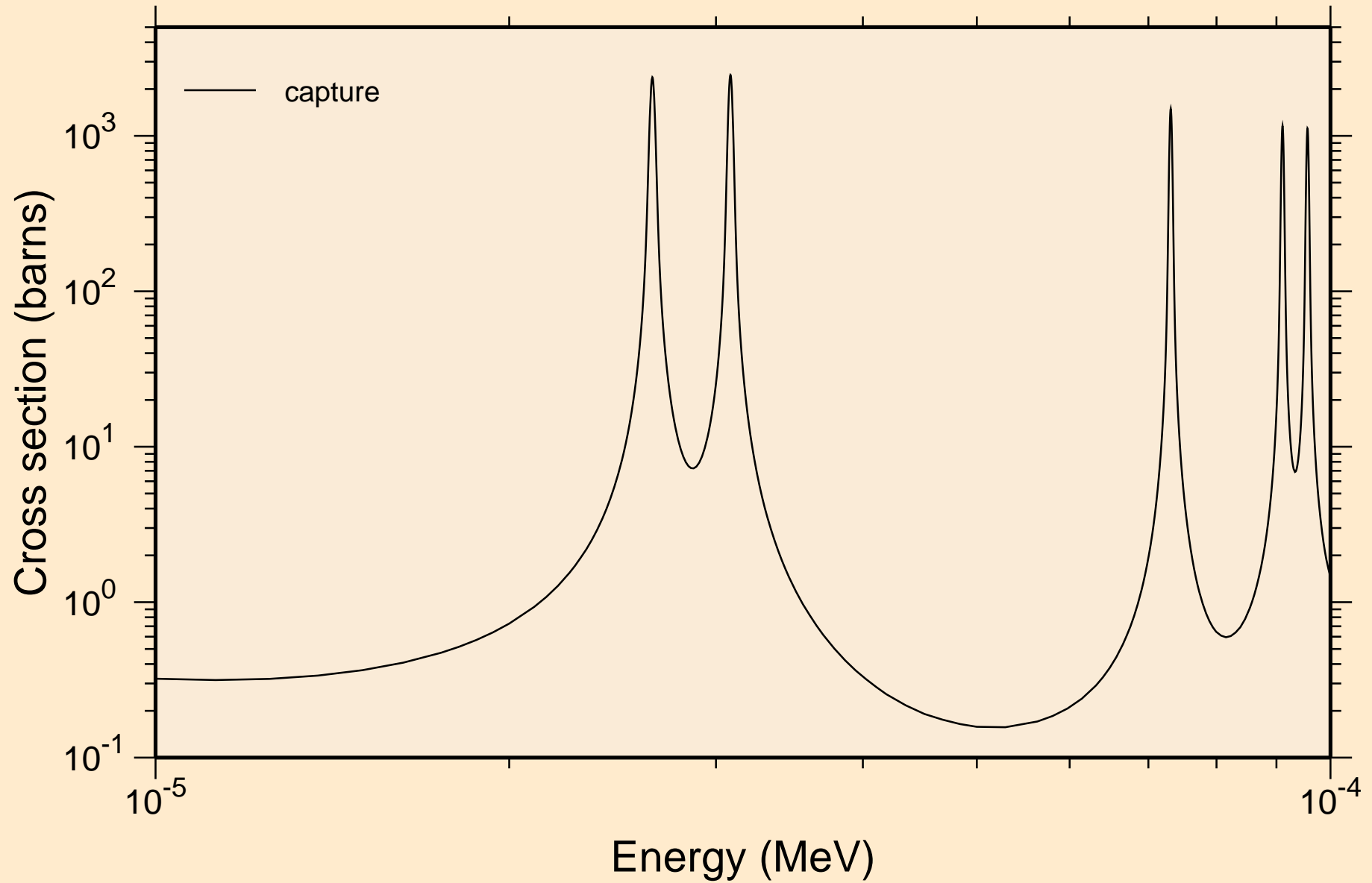

EU164 NRG TENDL-2015, AKONING
resonance absorption cross sections

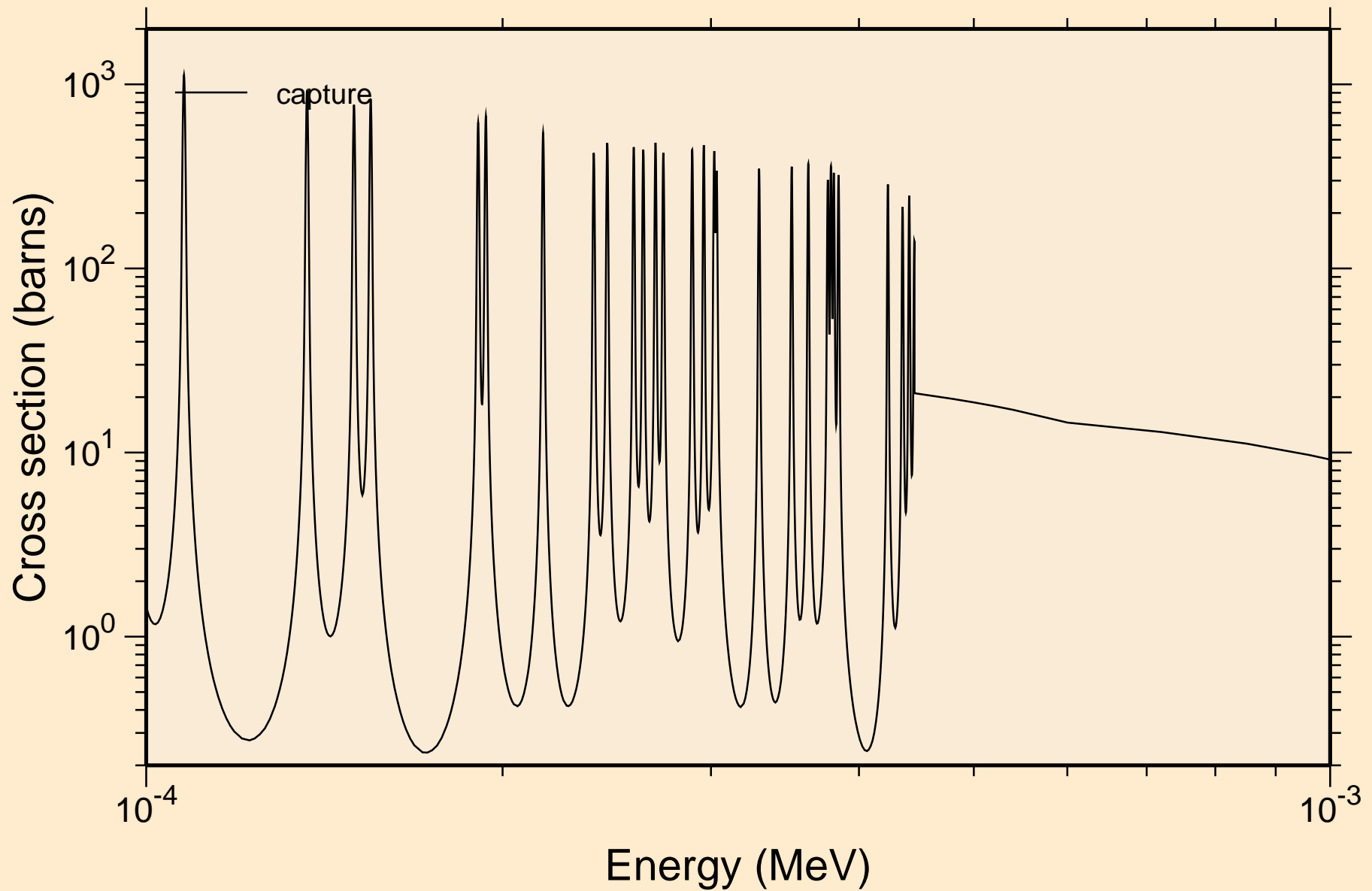

EU164 NRG TENDL-2015, AKONING resonance absorption cross sections

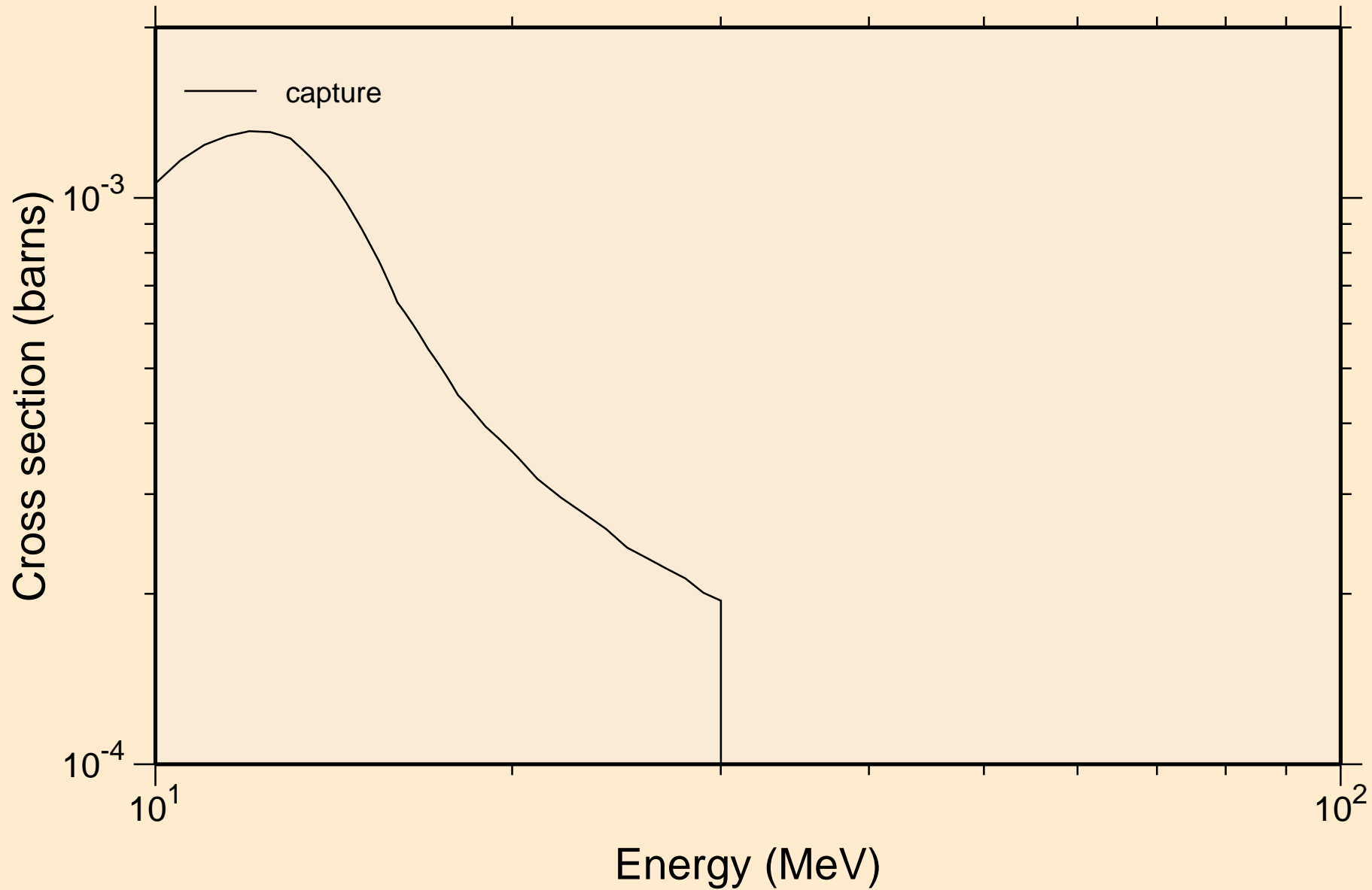

EU164 NRG TENDL-2015, AKONING

Non-threshold reactions

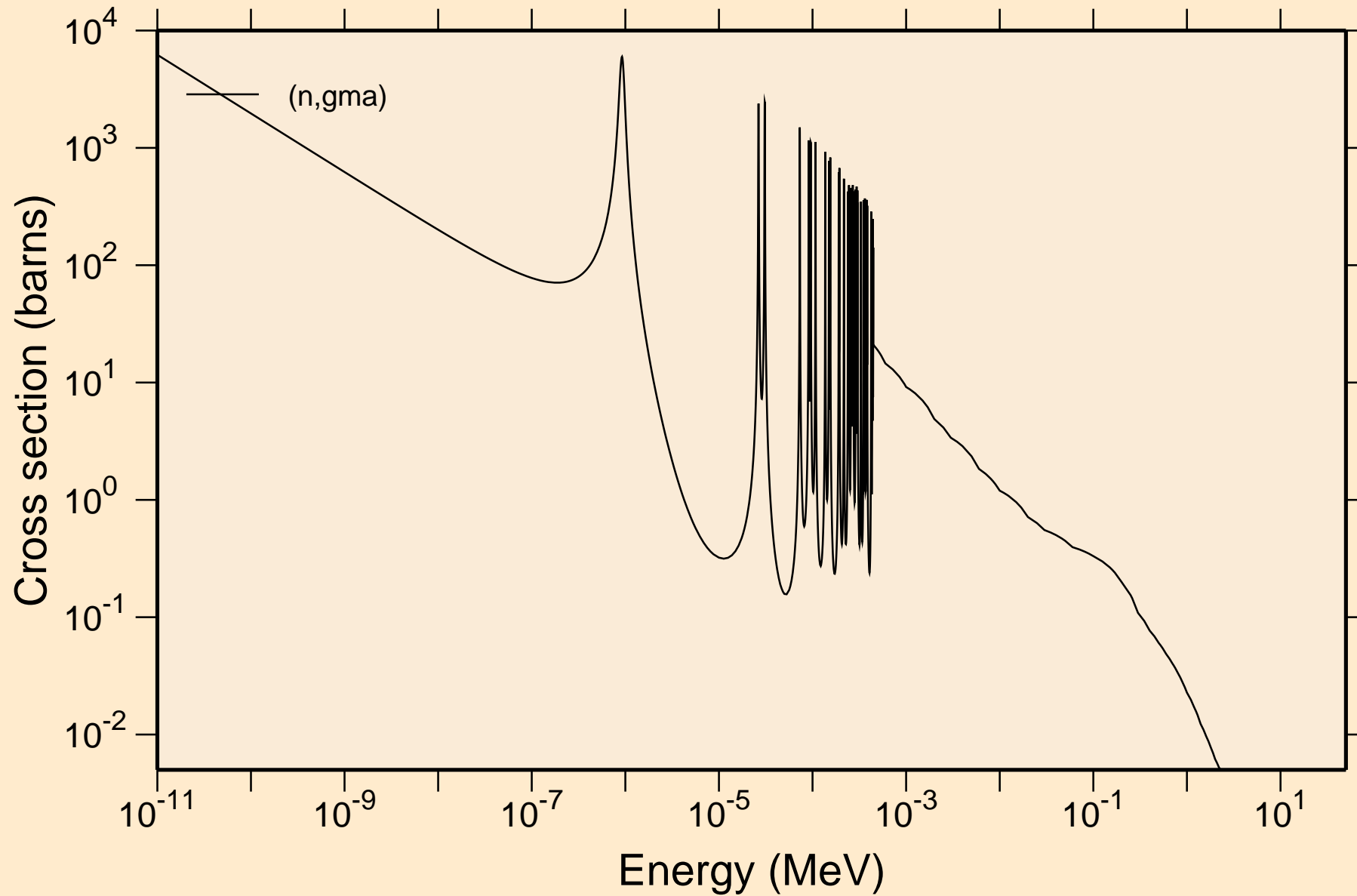

EU164 NRG TENDL-2015, AKONING

Principal cross sections

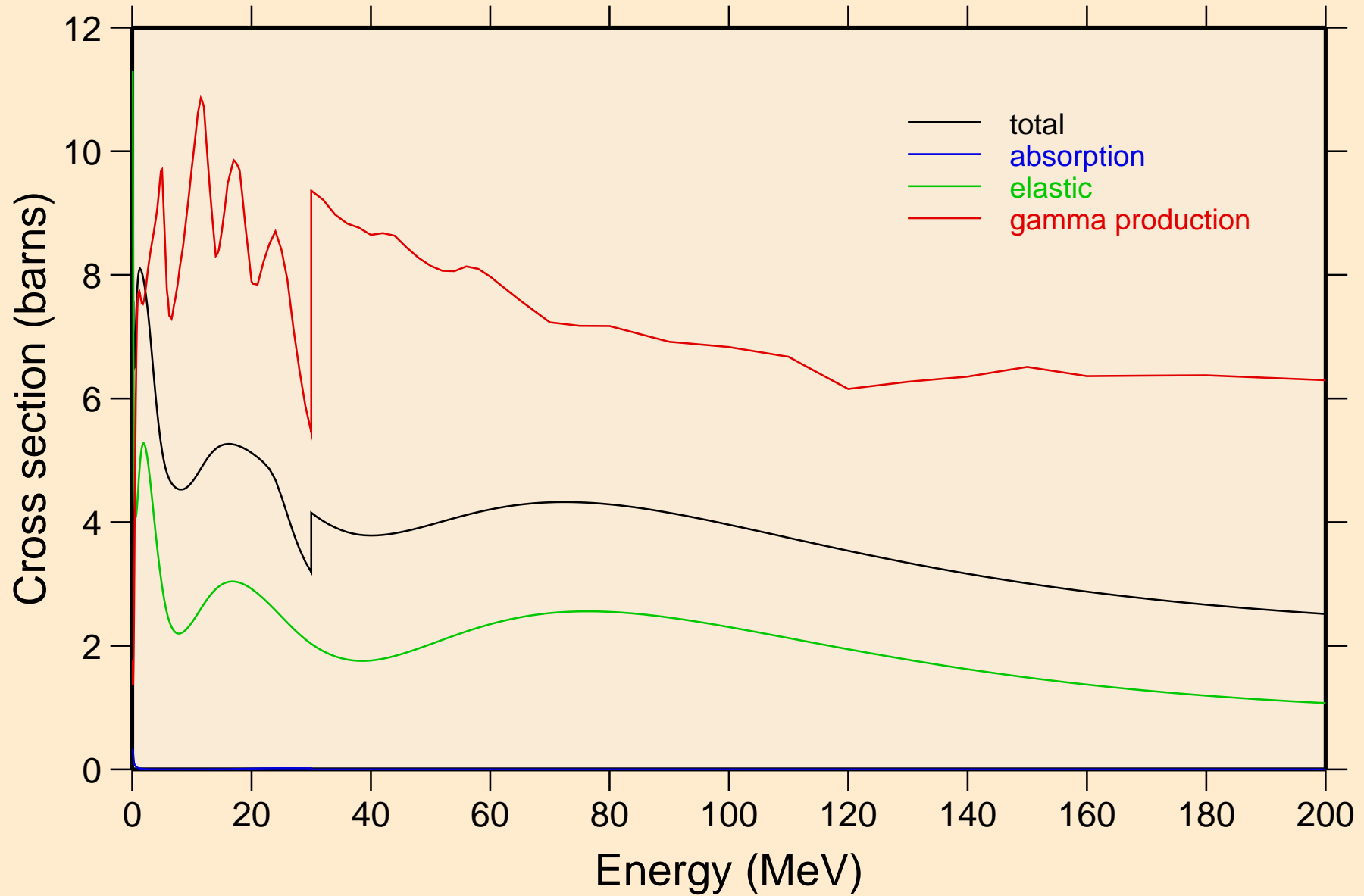

EU164 NRG TENDL-2015, AKONING
Non-threshold reactions

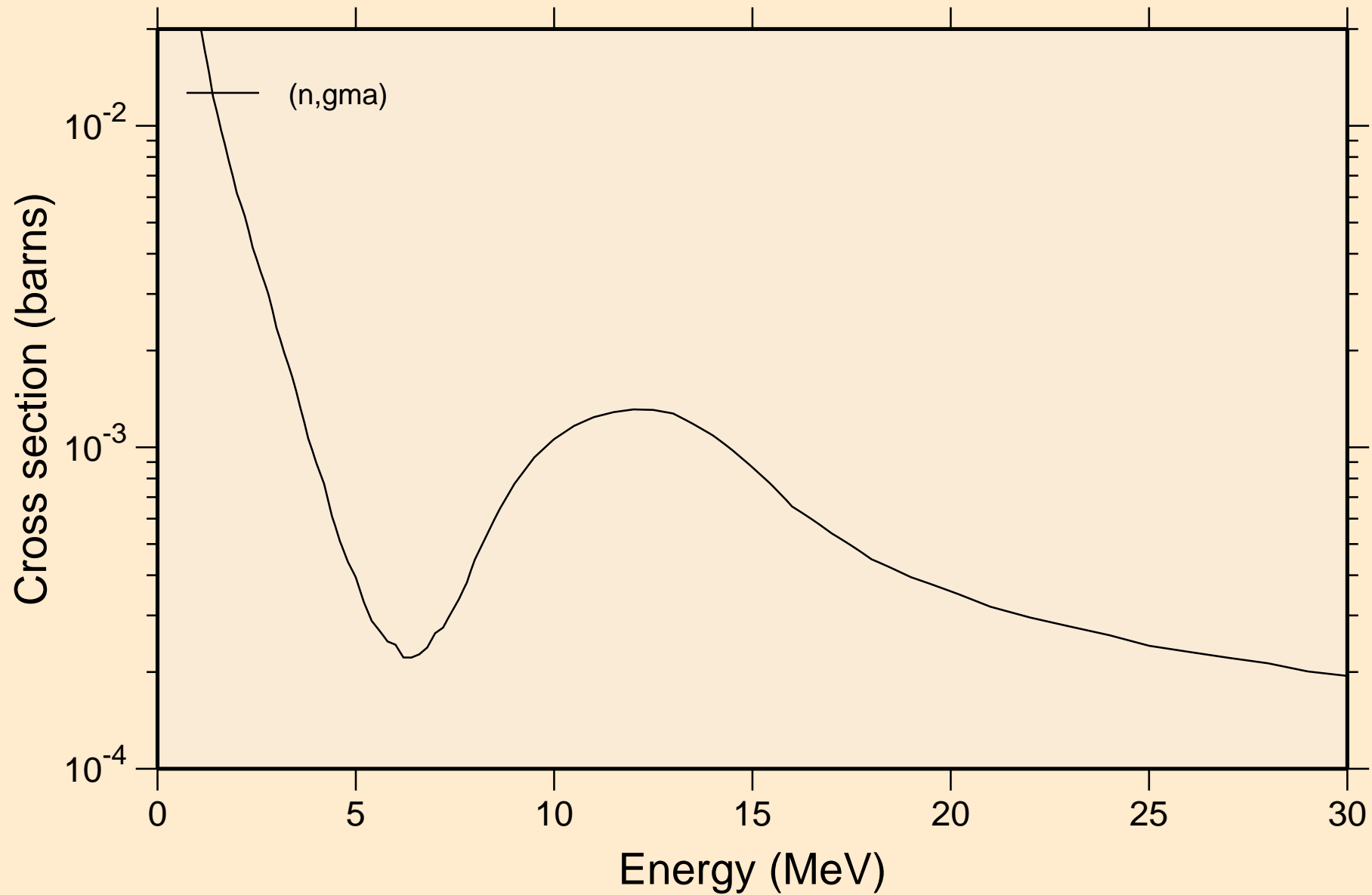

EU164 NRG TENDL-2015, AKONING

Inelastic levels

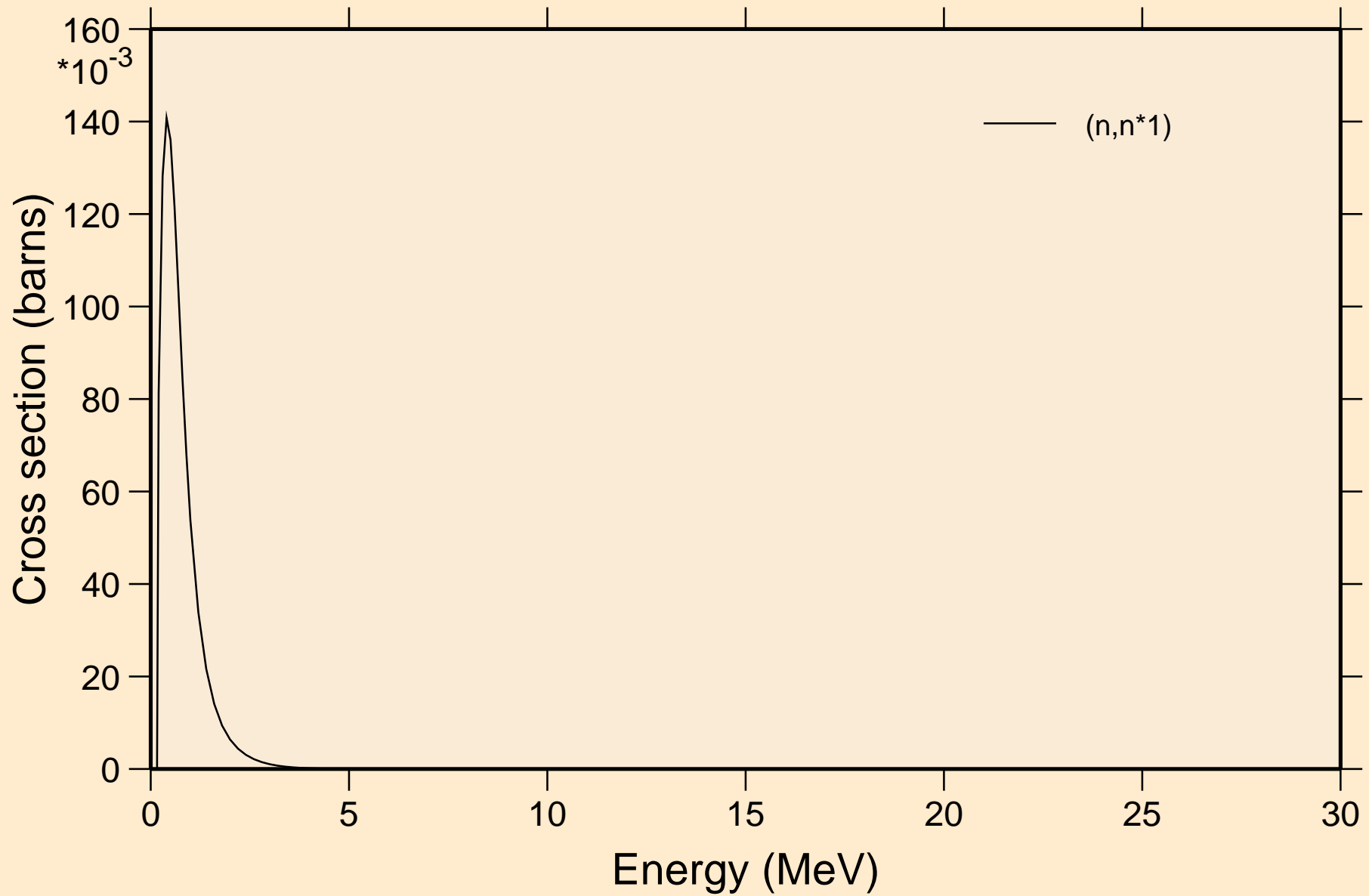

EU164 NRG TENDL-2015, AKONING

Threshold reactions

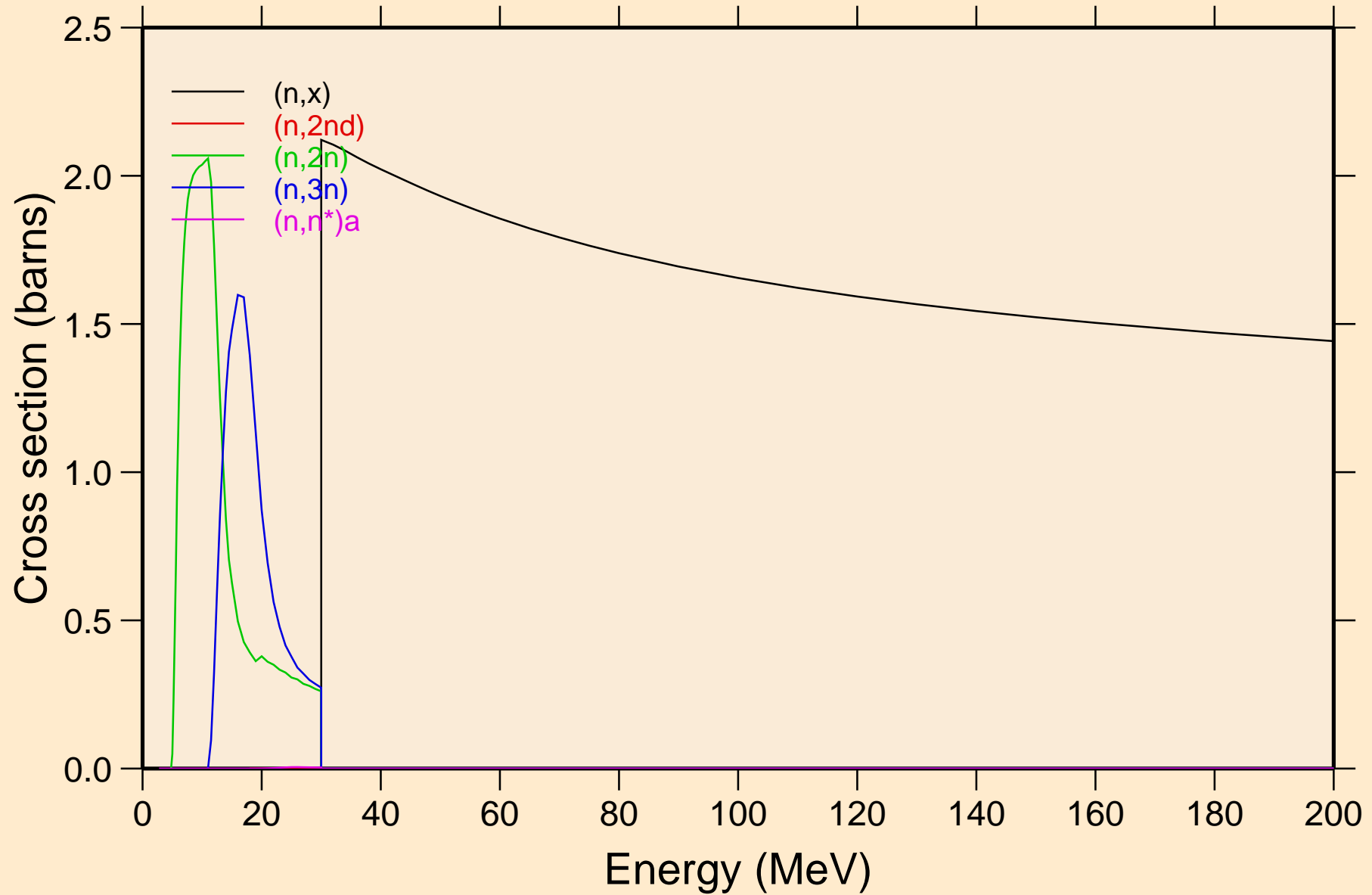

EU164 NRG TENDL-2015, AKONING

Threshold reactions

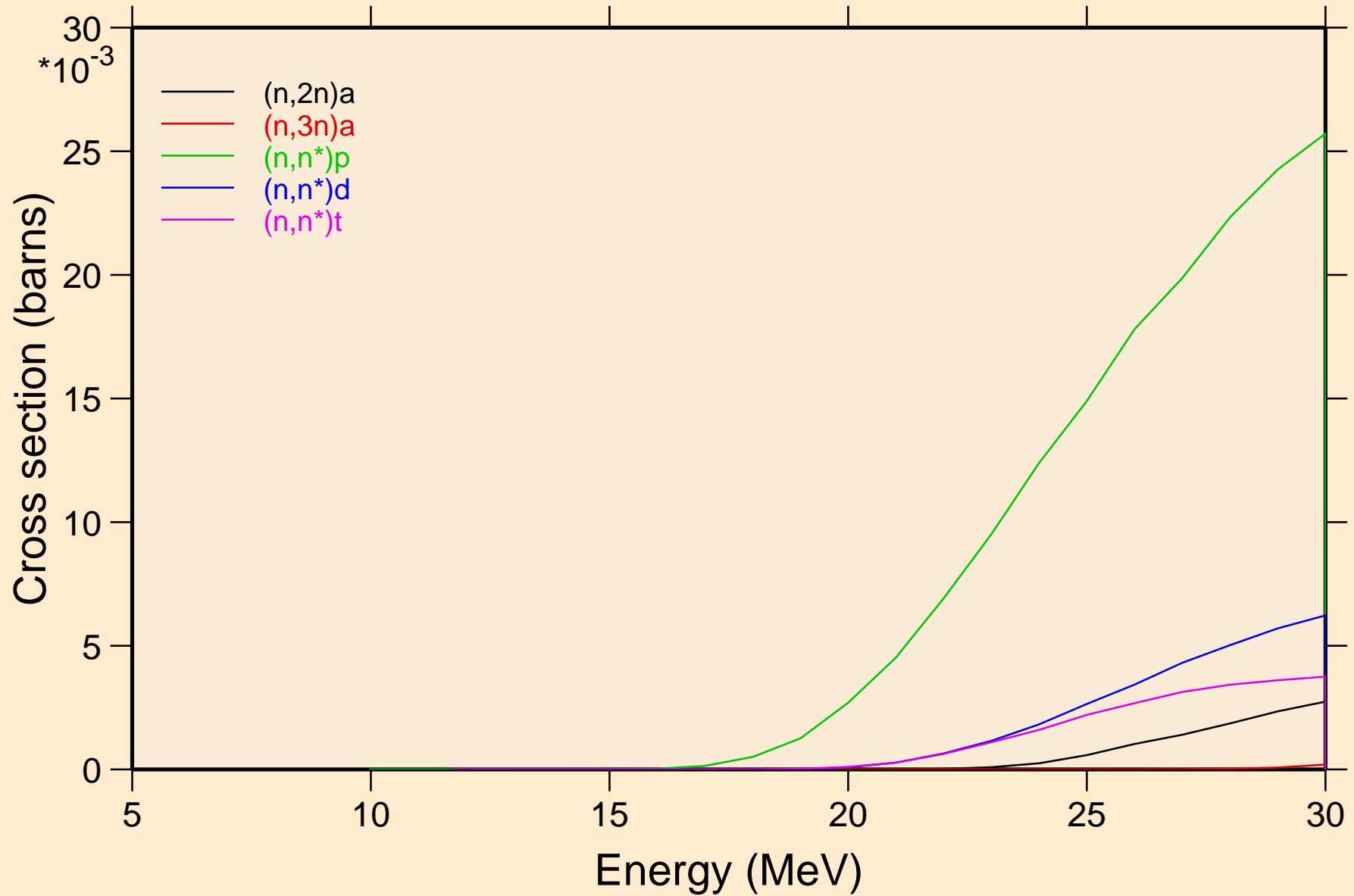

EU164 NRG TENDL-2015, AKONING

Threshold reactions

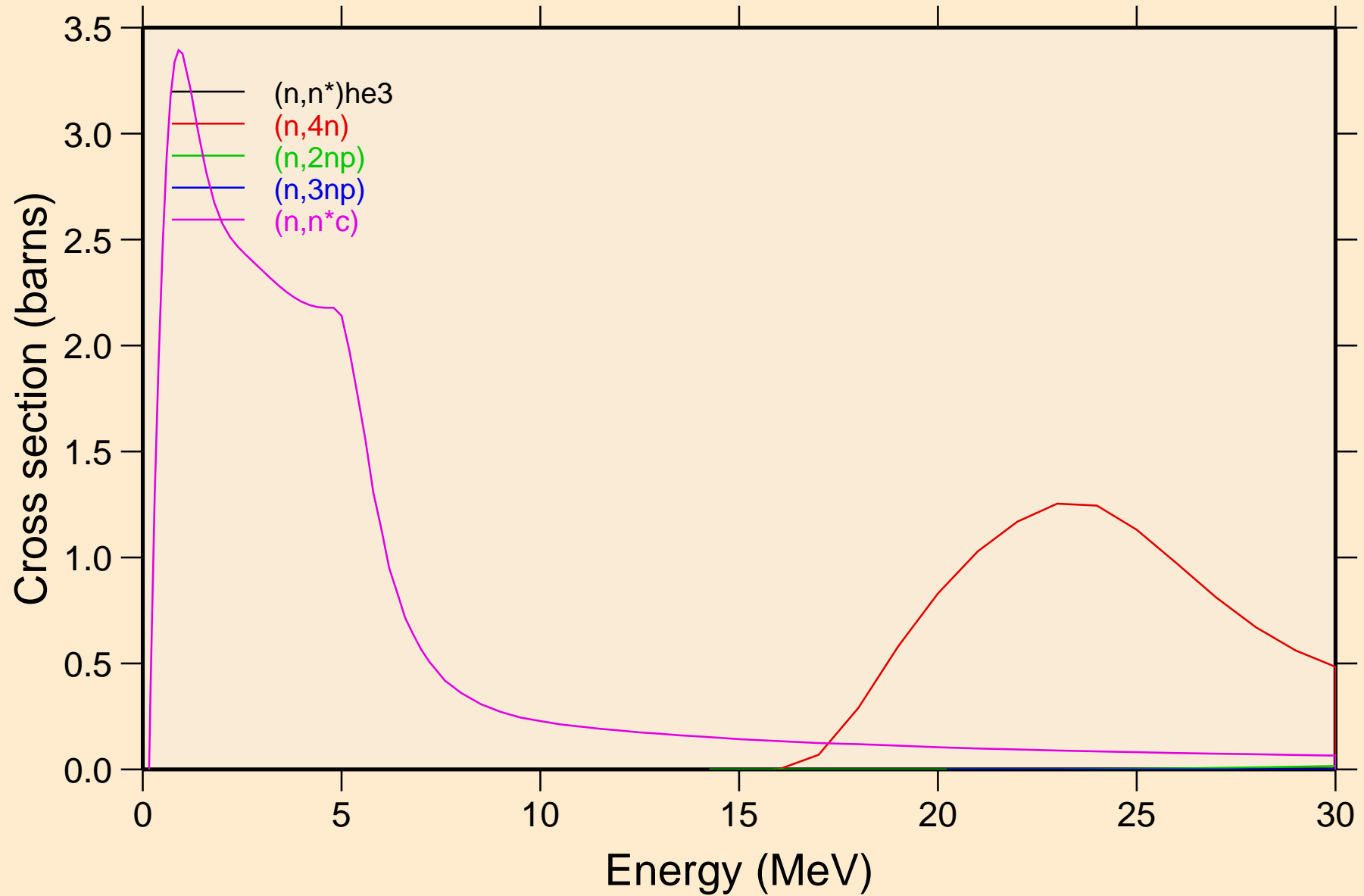

EU164 NRG TENDL-2015, AKONING

Threshold reactions

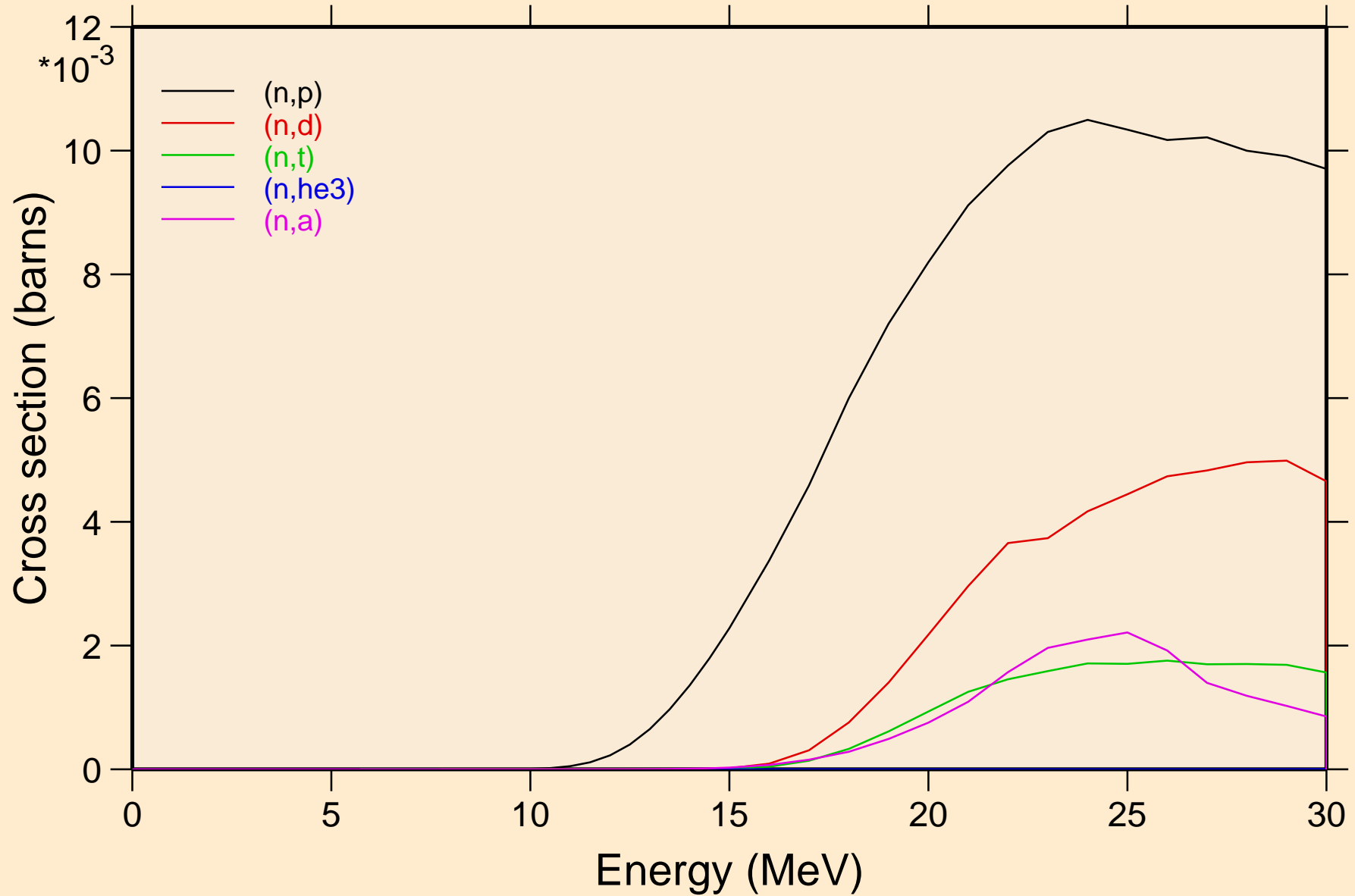

EU164 NRG TENDL-2015, AKONING
angular distribution for elastic

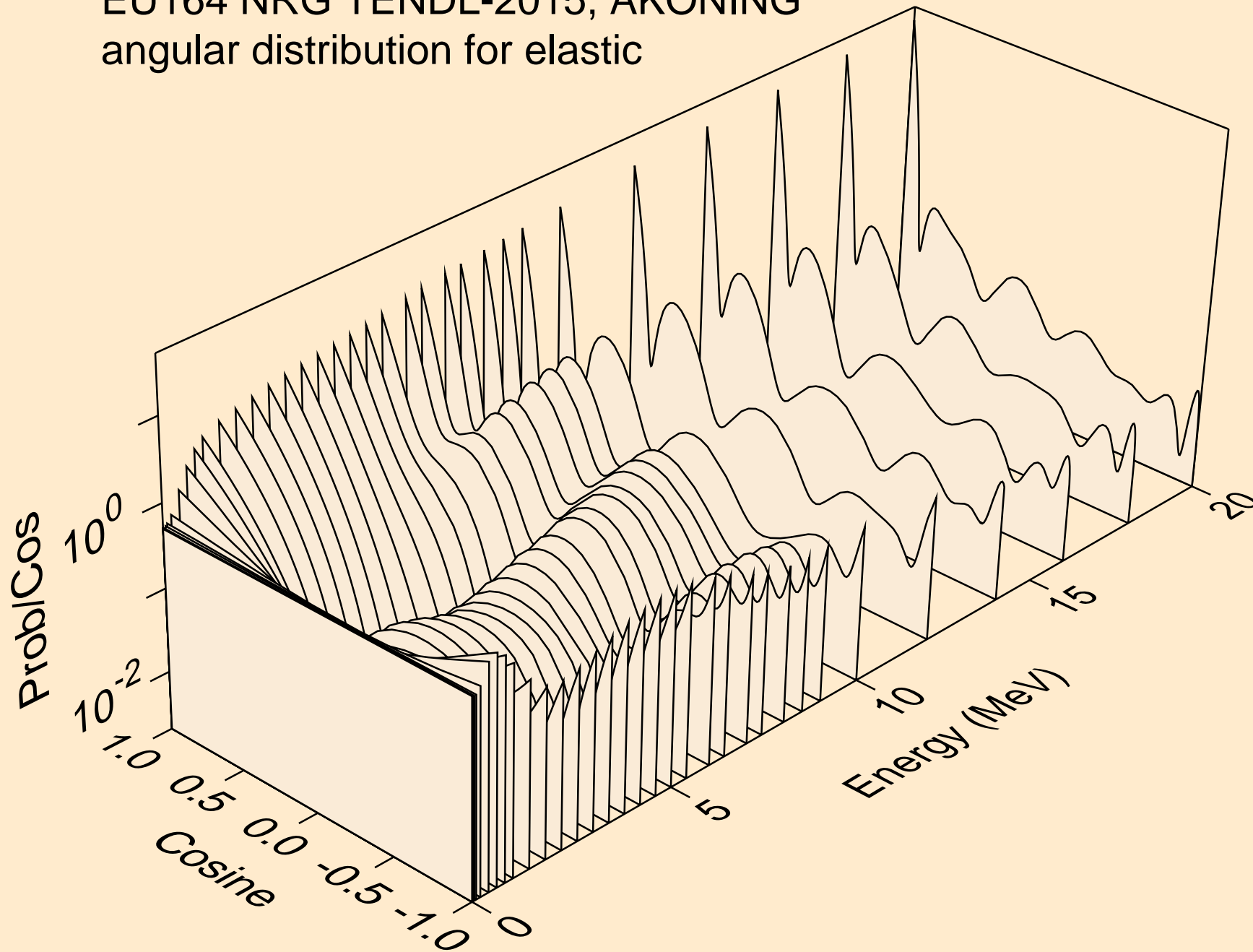

EU164 NRG TENDL-2015, AKONING
angular distribution for elastic

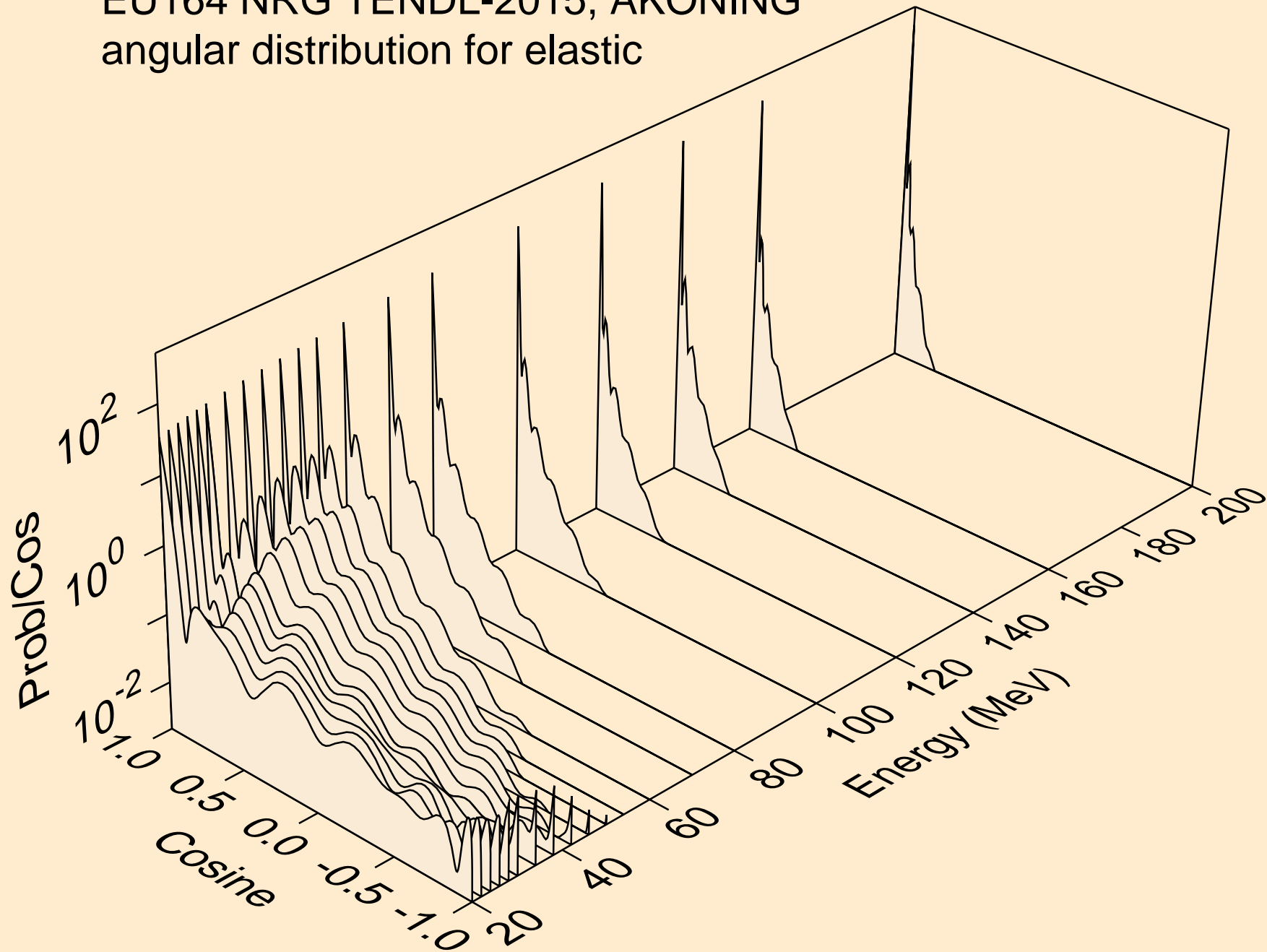

EU164 NRG TENDL-2015, AKONING
angular distribution for (n,n*1)

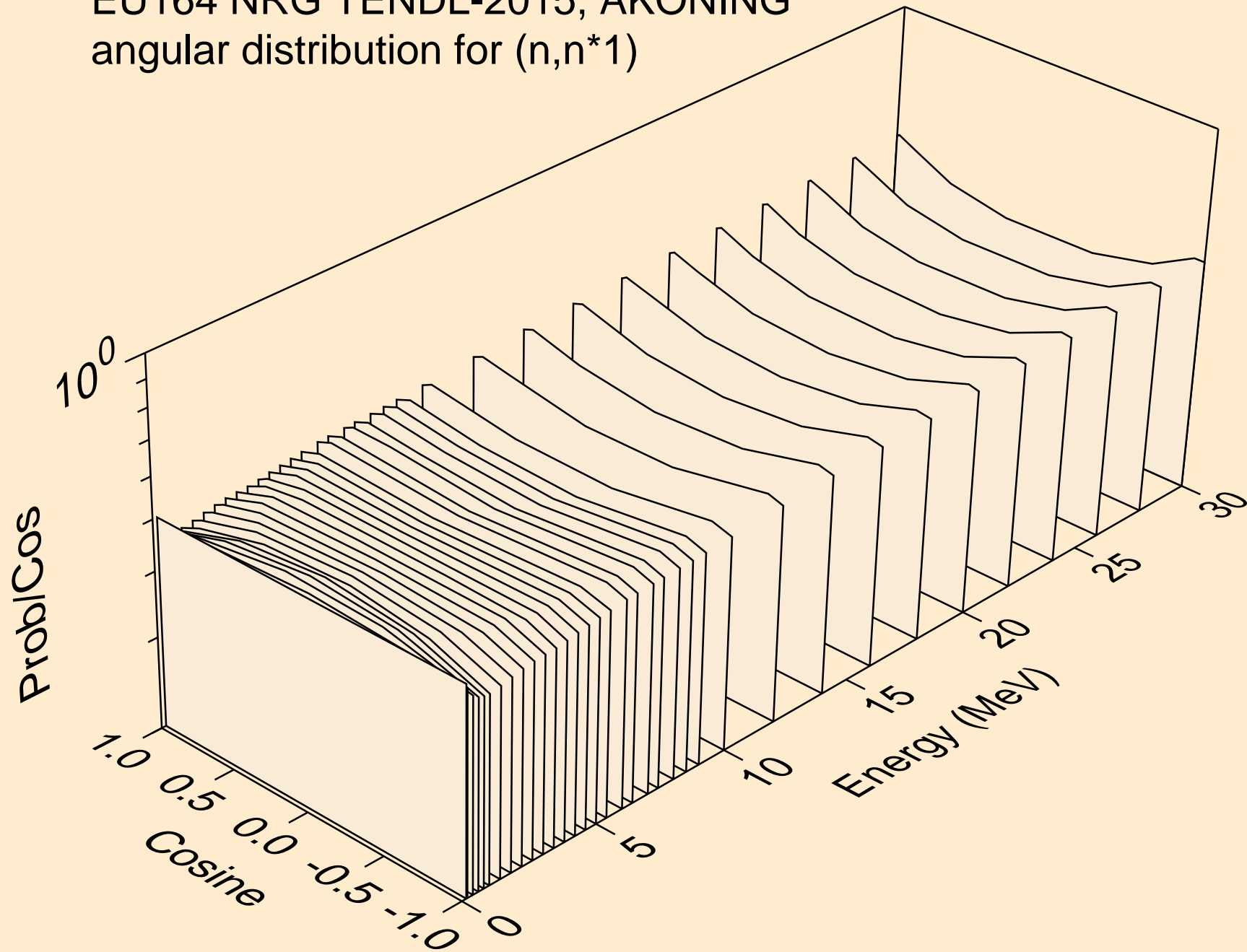

EU164 NRG TENDL-2015, AKONING
Neutron emission for (n,x)

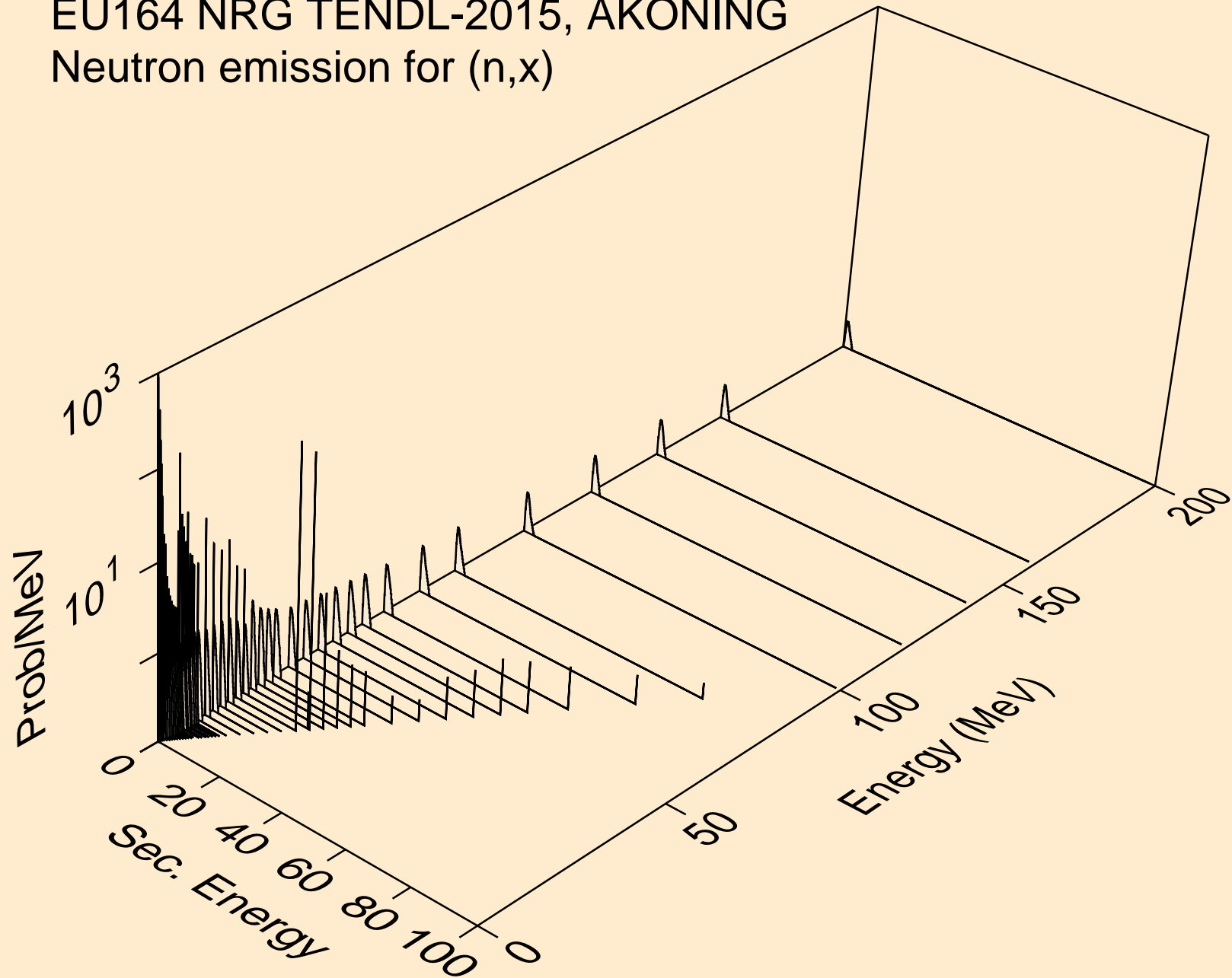

EU164 NRG TENDL-2015, AKONING
Neutron emission for (n,2nd)

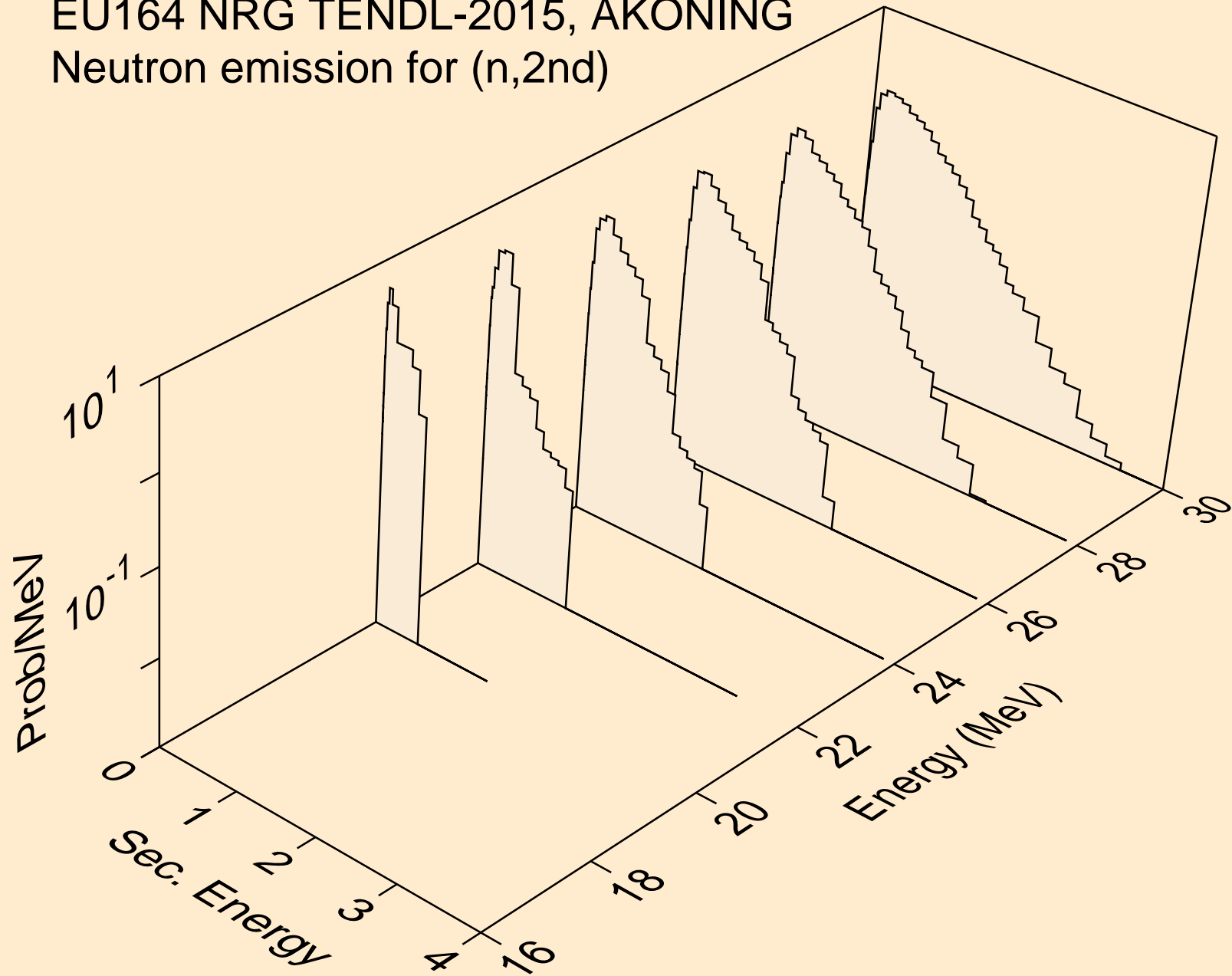

EU164 NRG TENDL-2015, AKONING
Neutron emission for (n,2n)

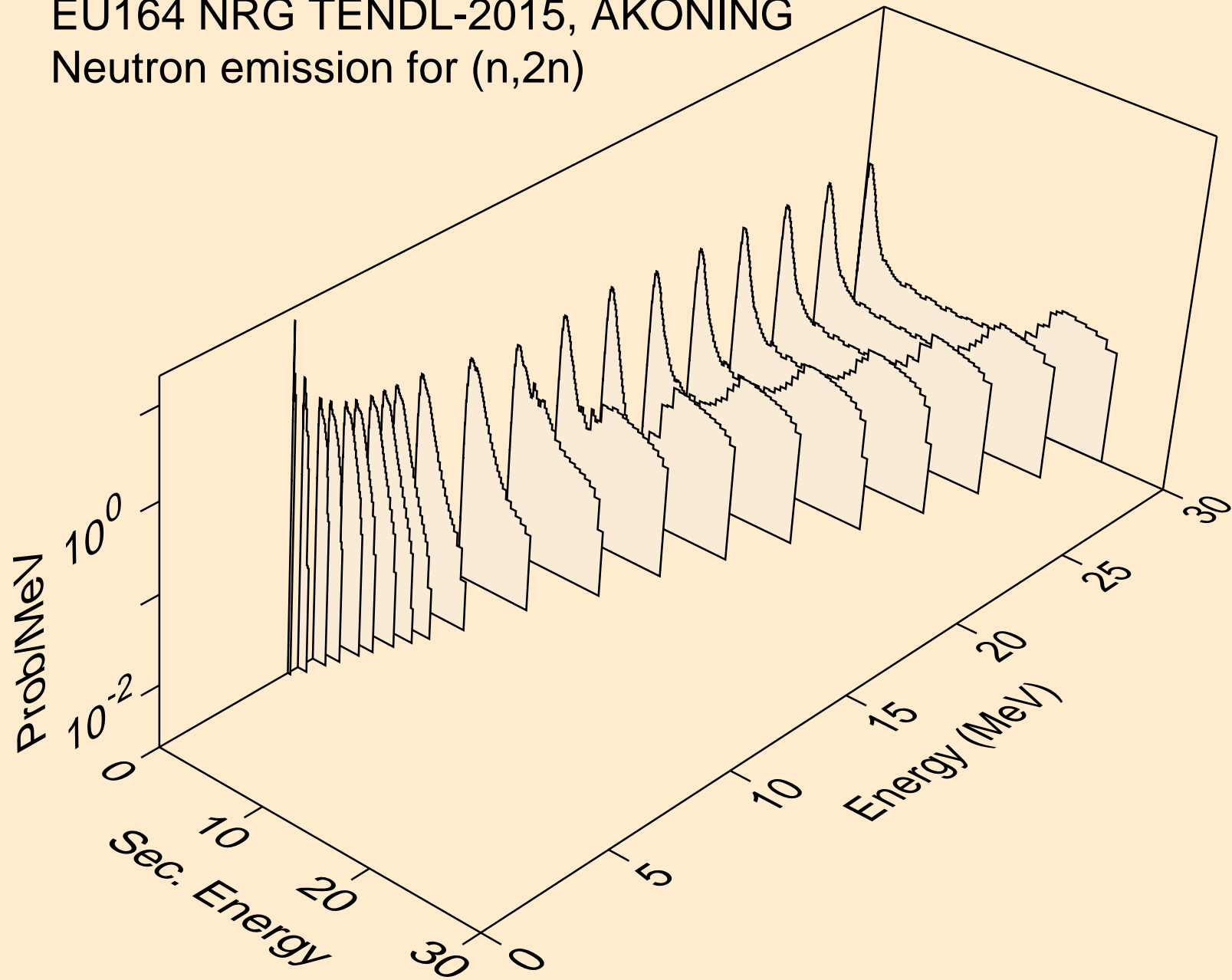

EU164 NRG TENDL-2015, AKONING
Neutron emission for (n,3n)

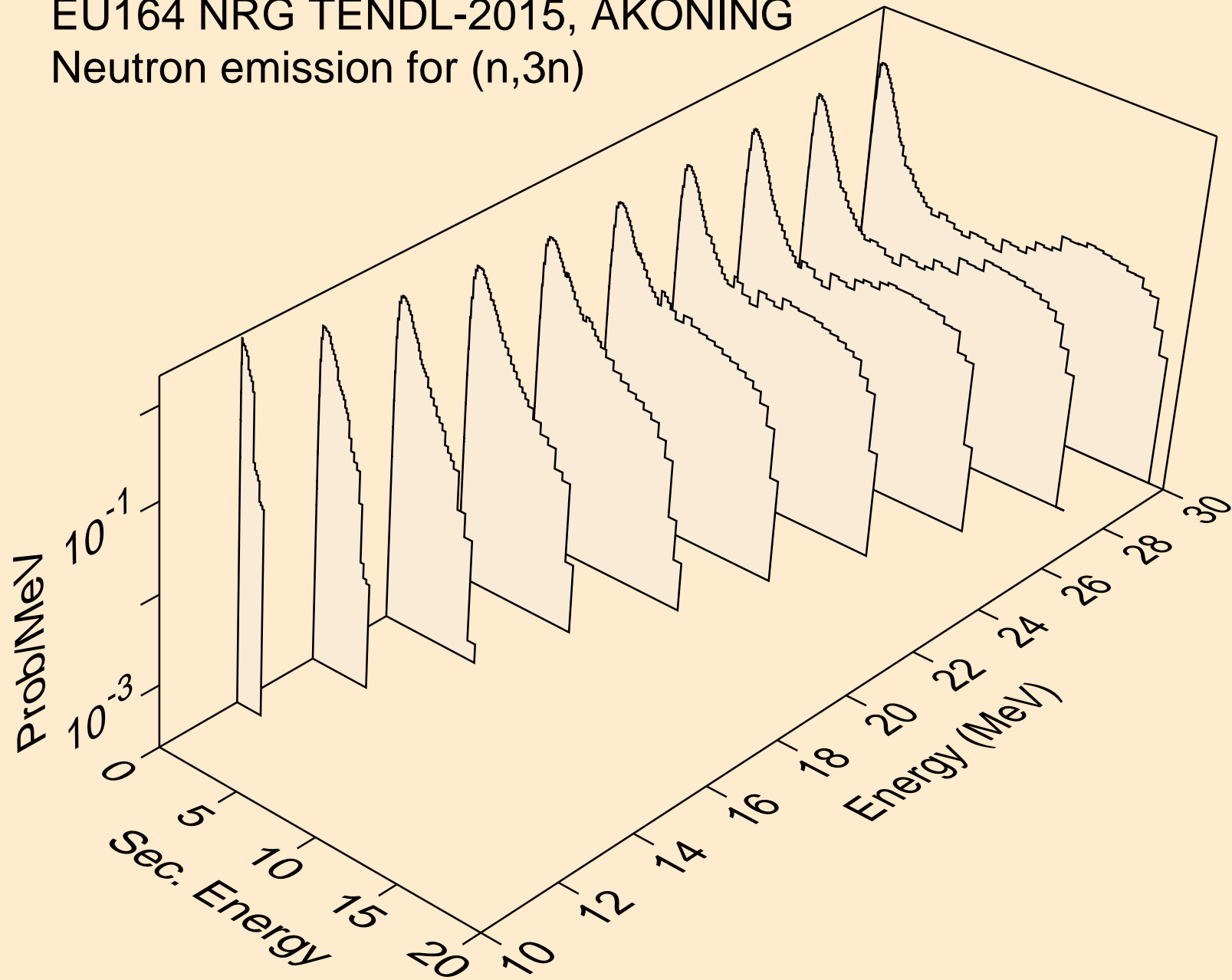

EU164 NRG TENDL-2015, AKONING
Neutron emission for (n,n*)a

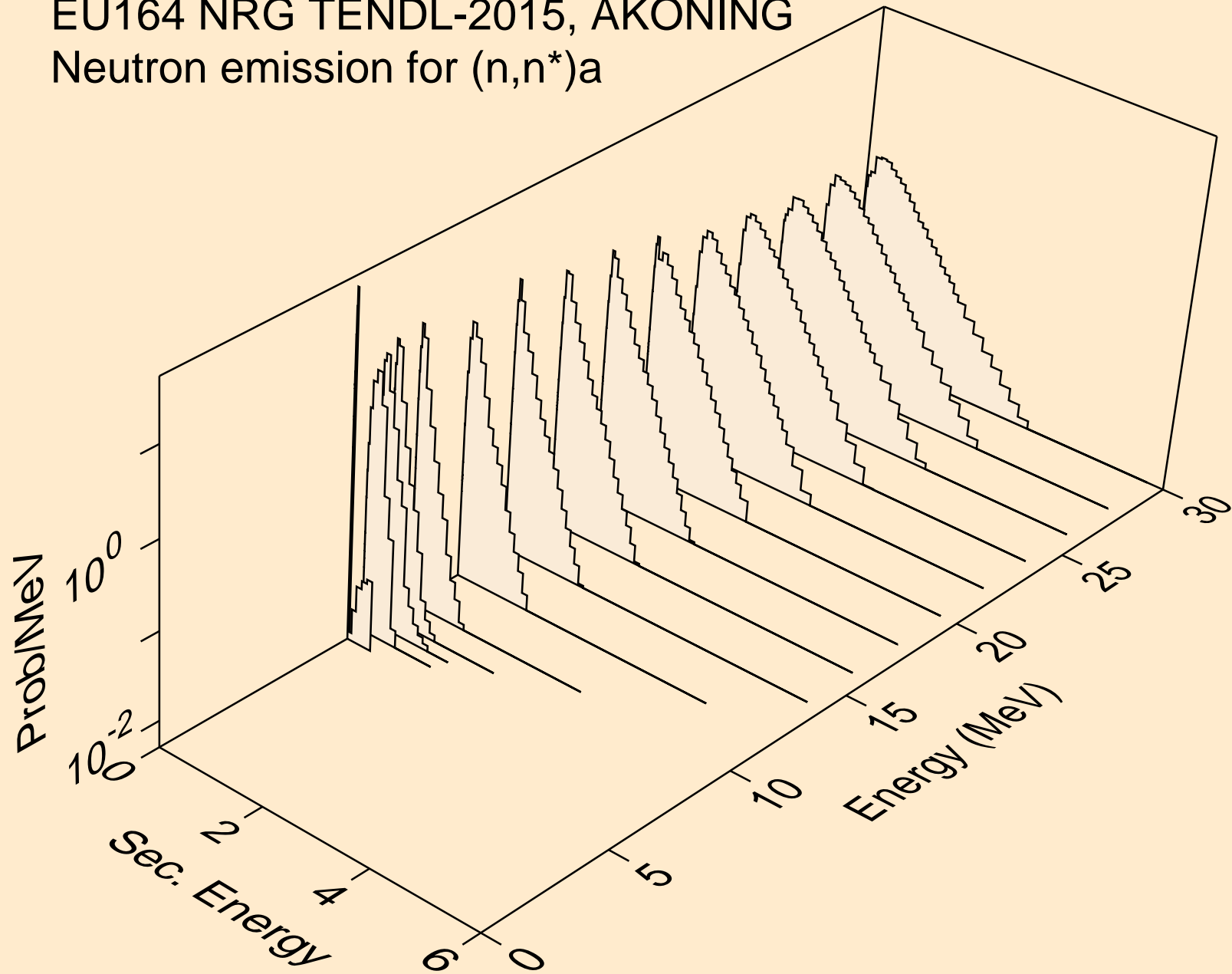

EU164 NRG TENDL-2015, AKONING
Neutron emission for (n,2n)_a

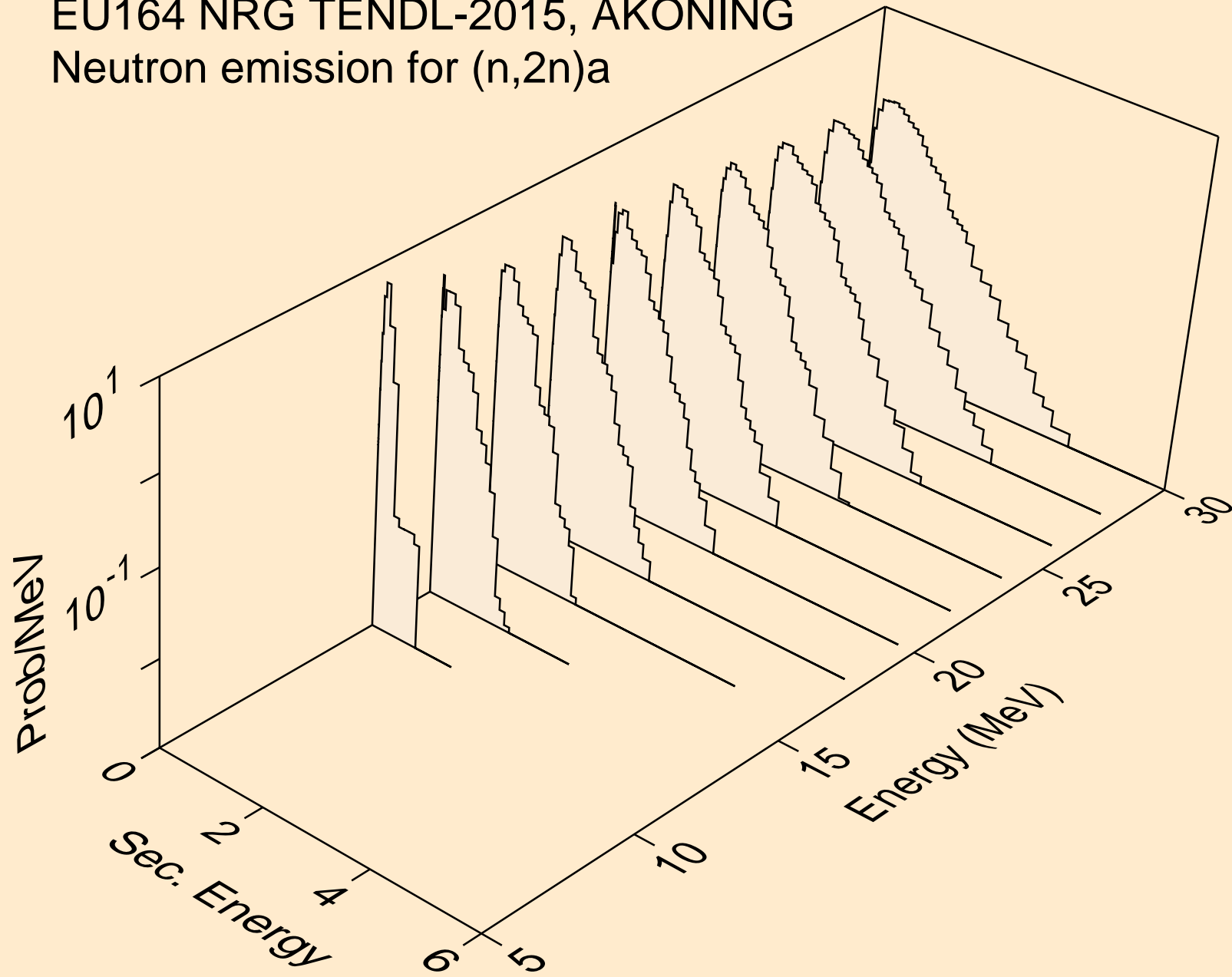

EU164 NRG TENDL-2015, AKONING
Neutron emission for (n,3n)a

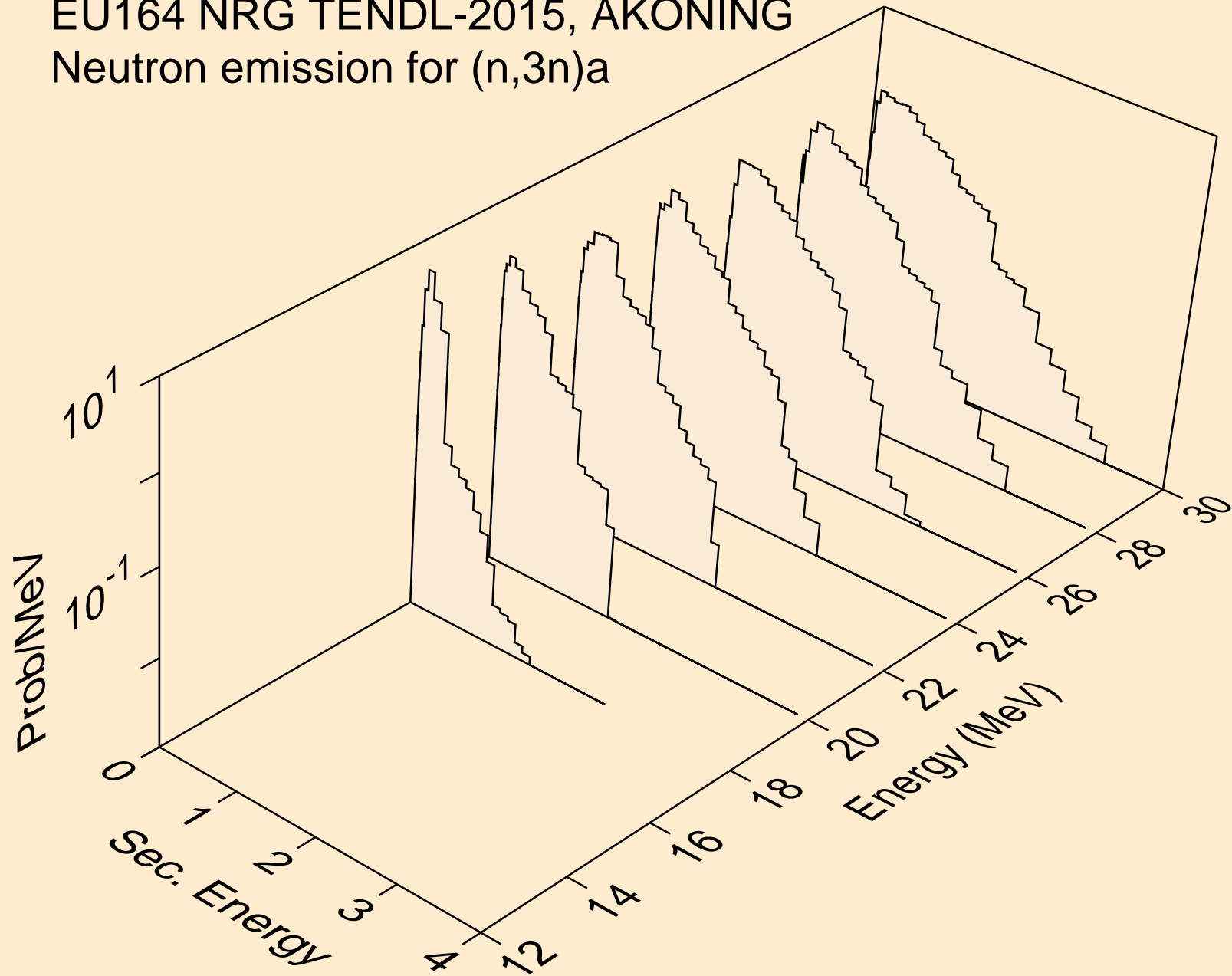

EU164 NRG TENDL-2015, AKONING
Neutron emission for (n,n*)p

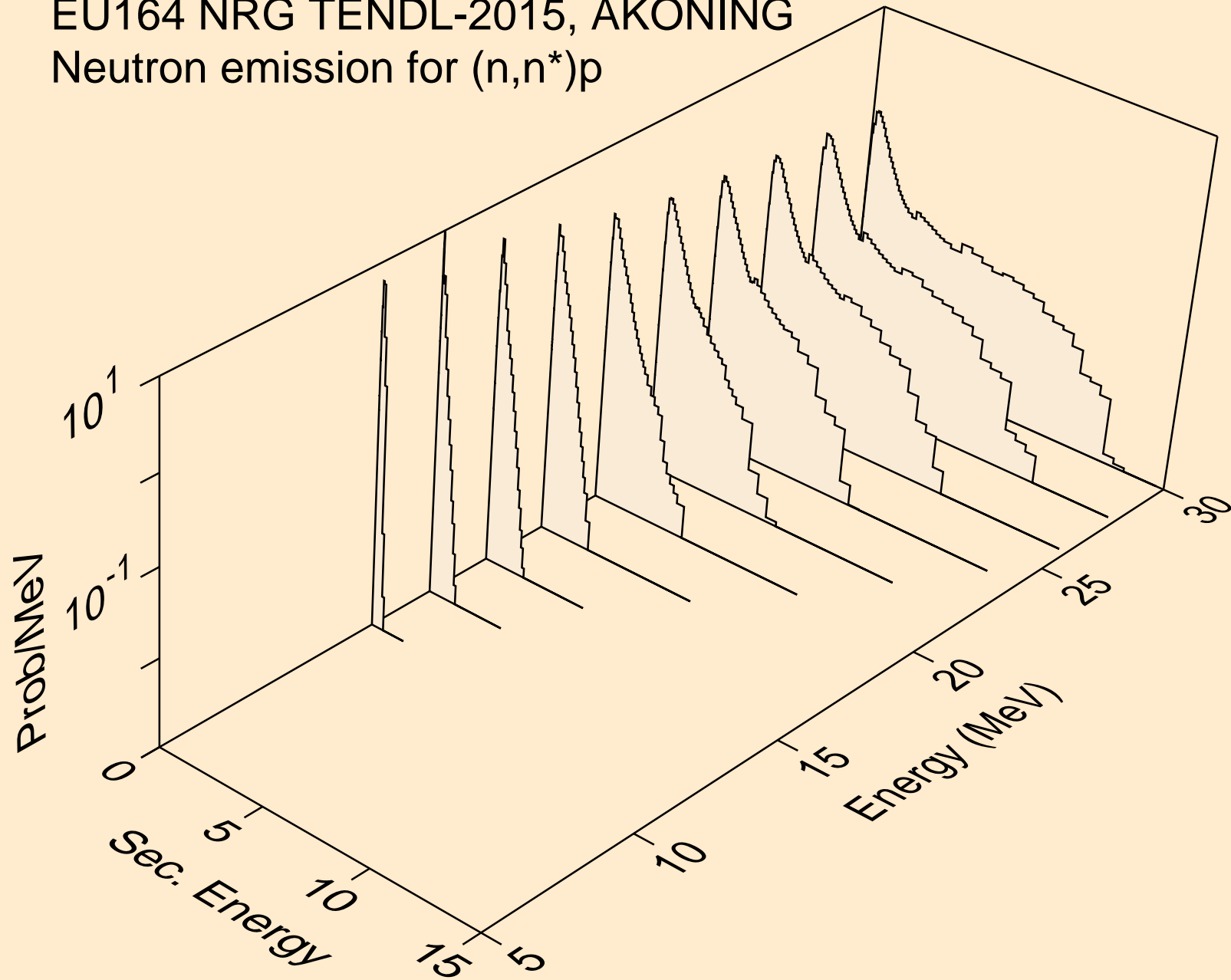

EU164 NRG TENDL-2015, AKONING
Neutron emission for (n,n*)d

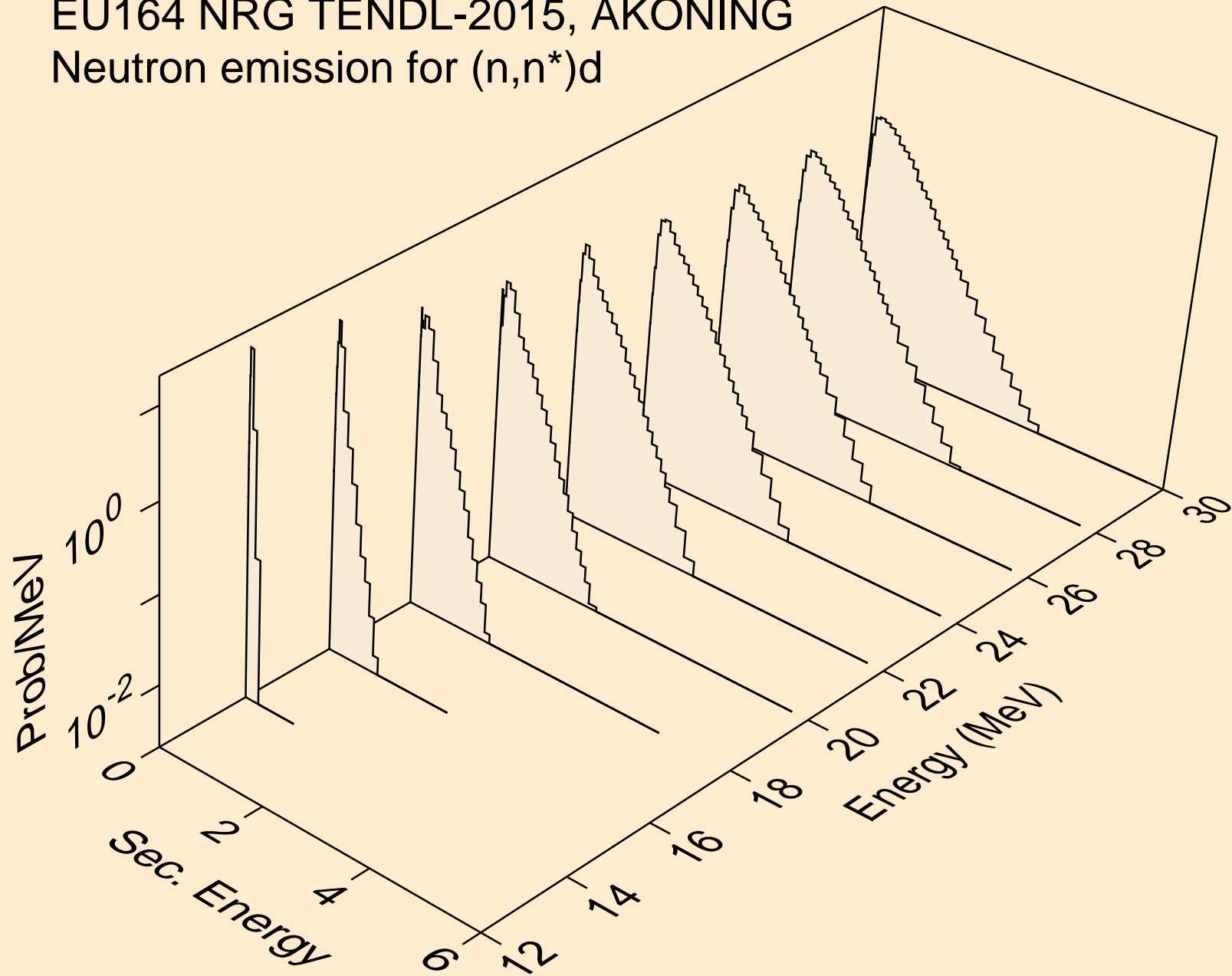

EU164 NRG TENDL-2015, AKONING
Neutron emission for (n,n*)t

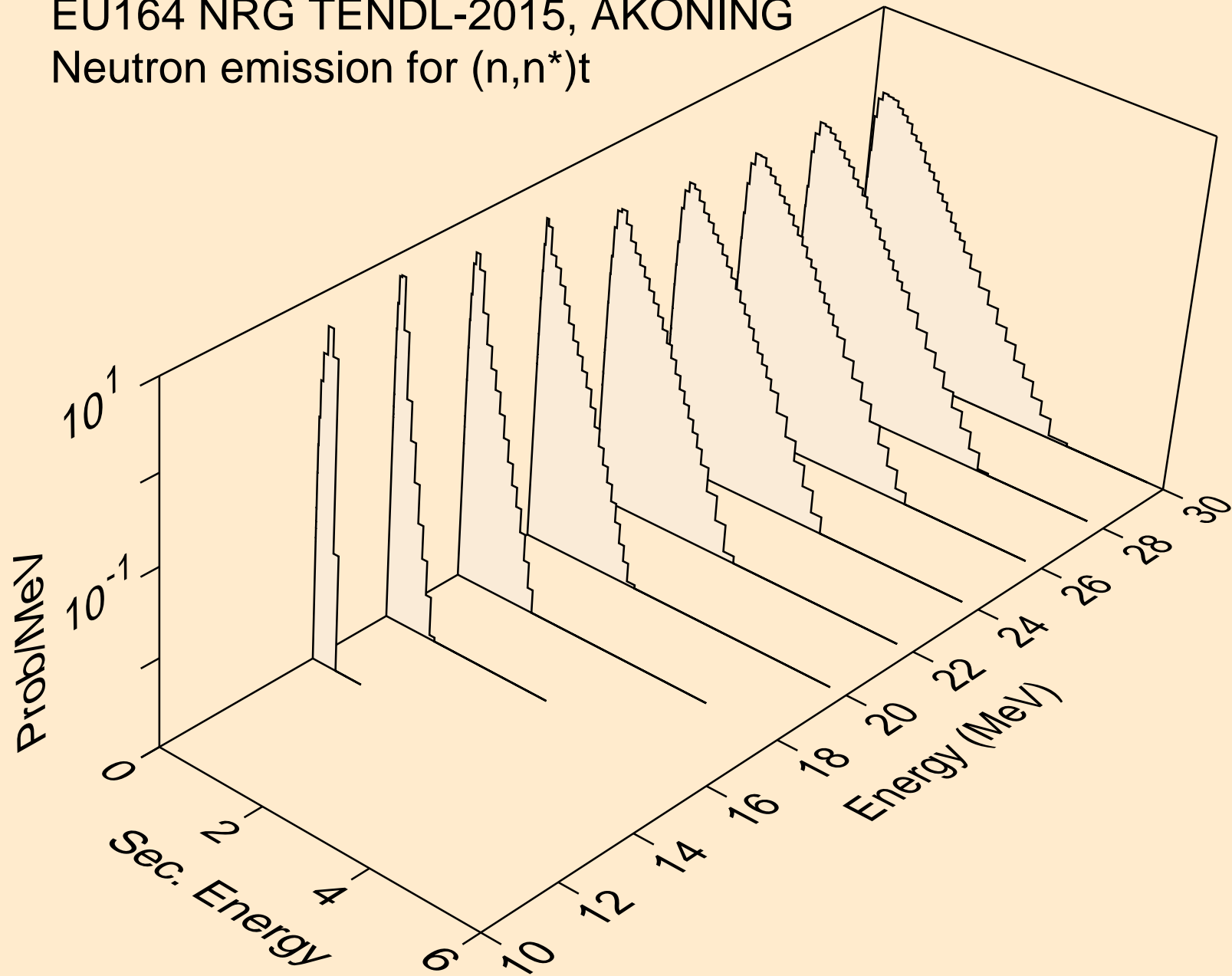

EU164 NRG TENDL-2015, AKONING
Neutron emission for (n,n*)he3

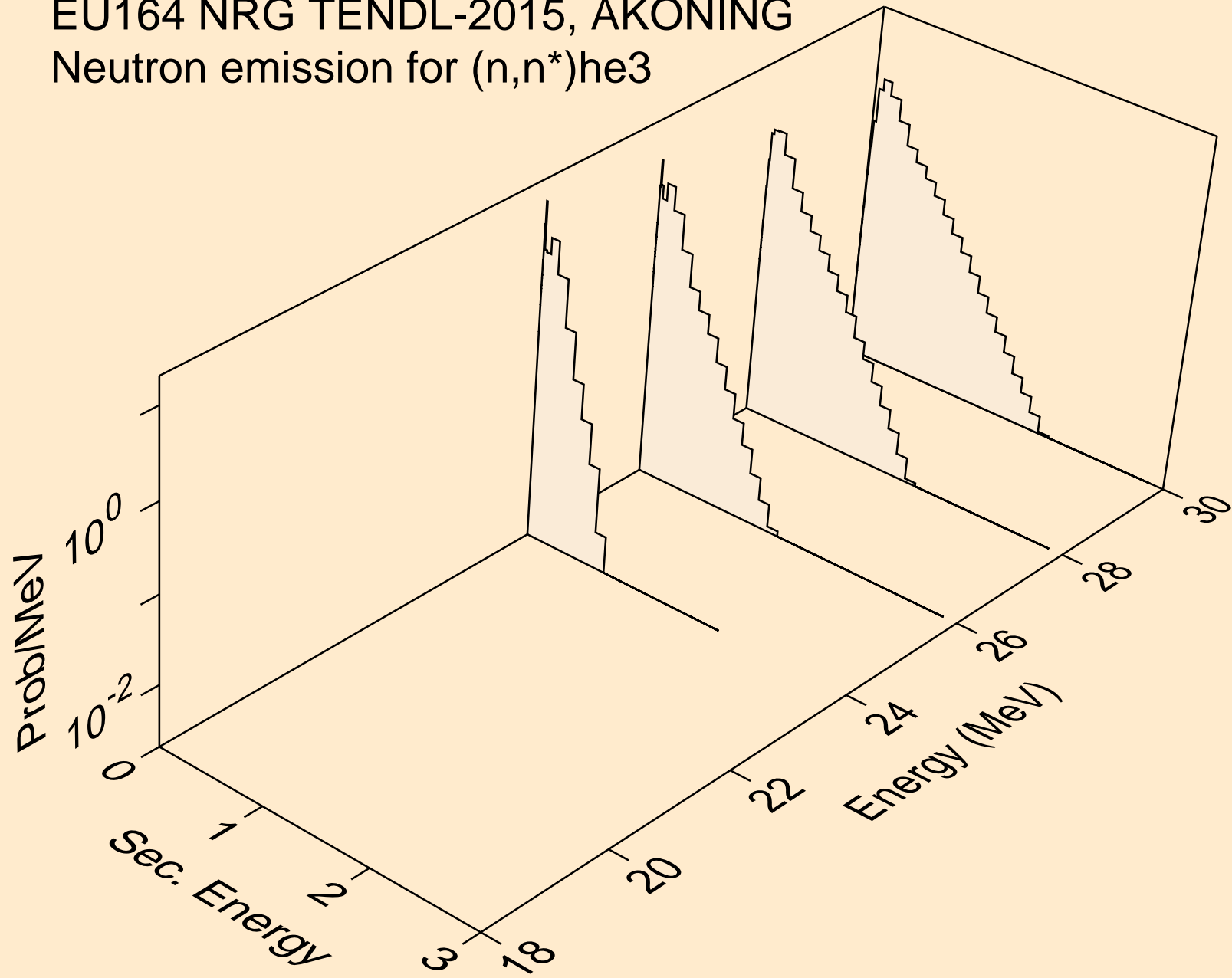

EU164 NRG TENDL-2015, AKONING
Neutron emission for (n,4n)

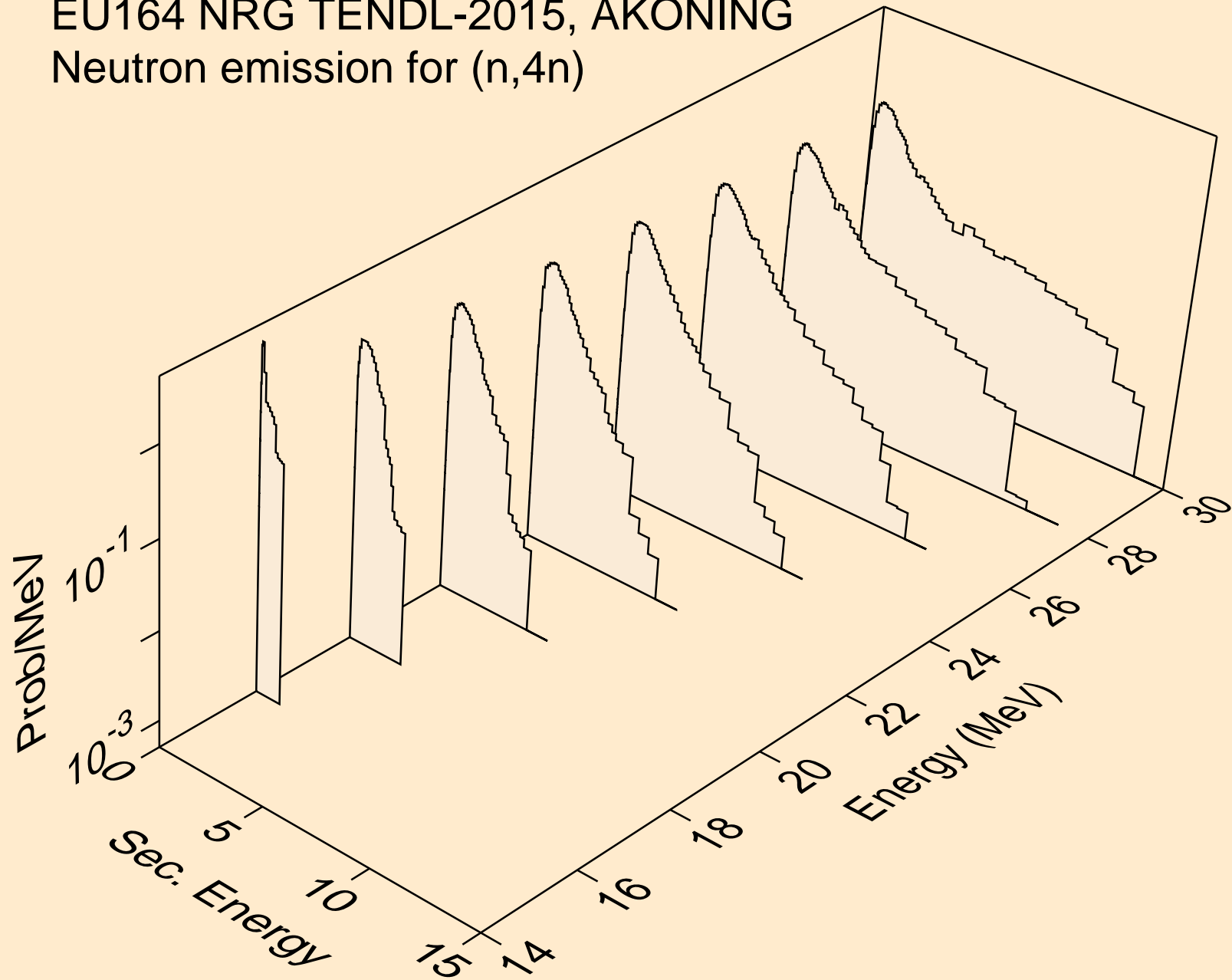

EU164 NRG TENDL-2015, AKONING
Neutron emission for (n,2np)

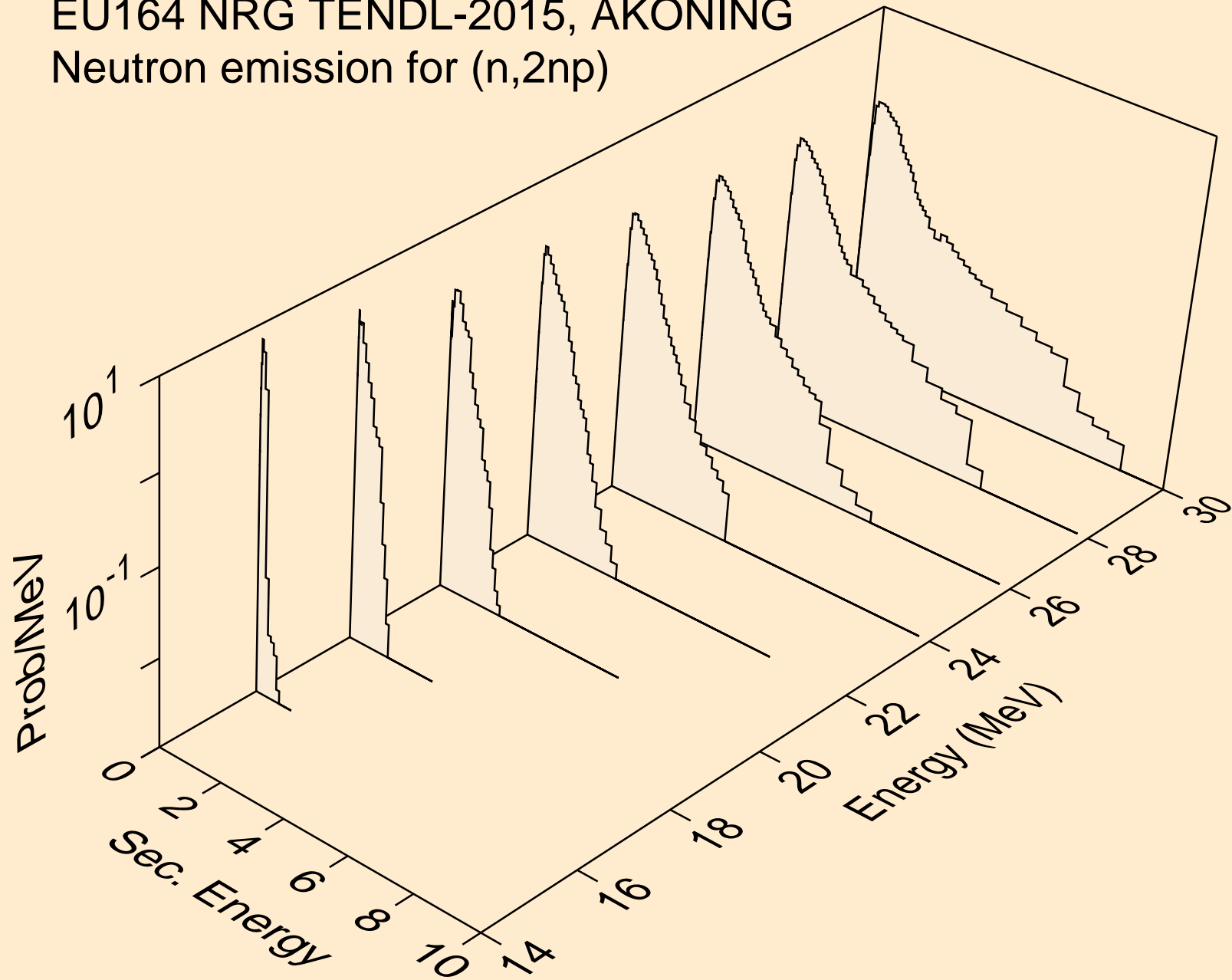

EU164 NRG TENDL-2015, AKONING
Neutron emission for (n,3np)

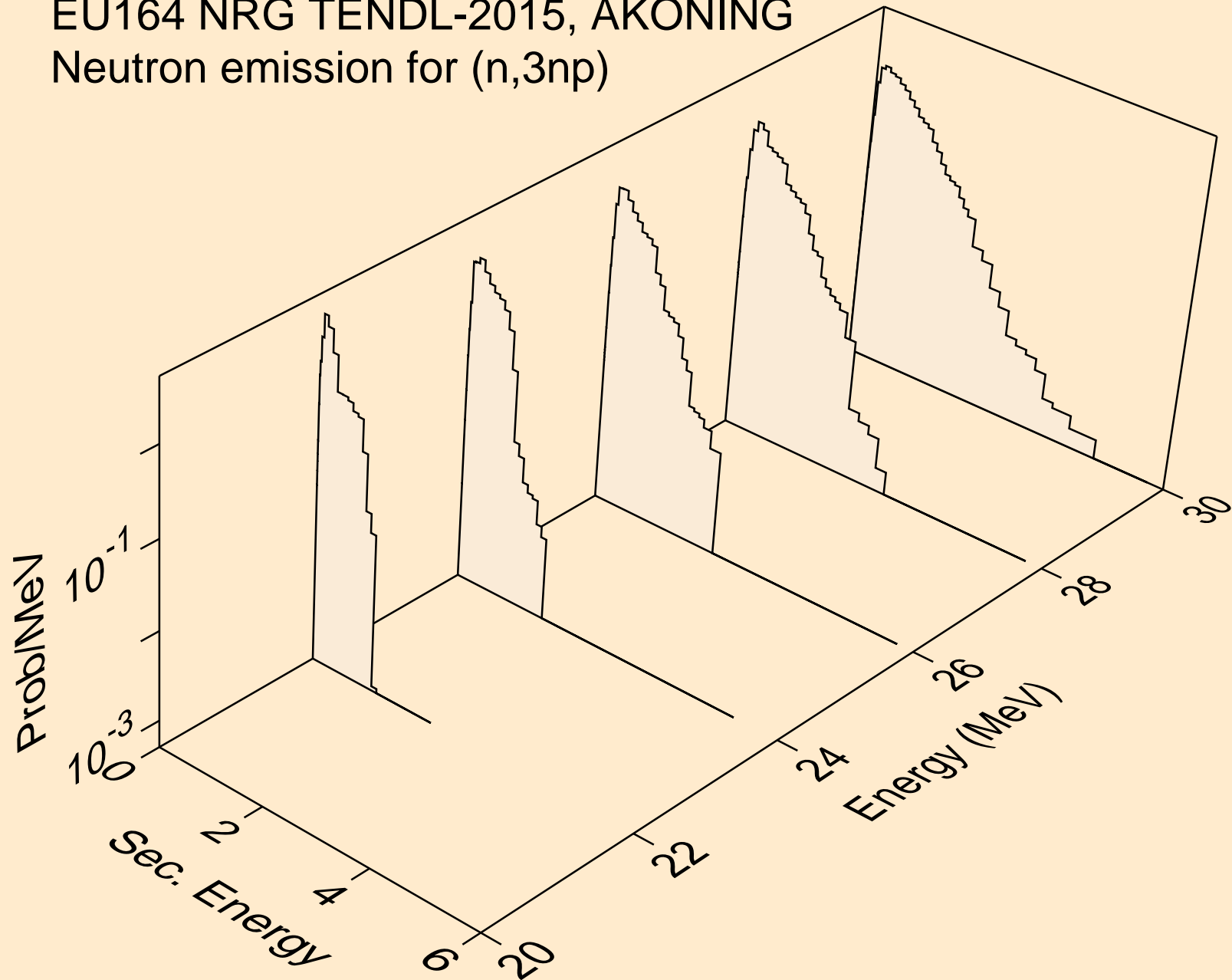

EU164 NRG TENDL-2015, AKONING
Neutron emission for (n,n*c)

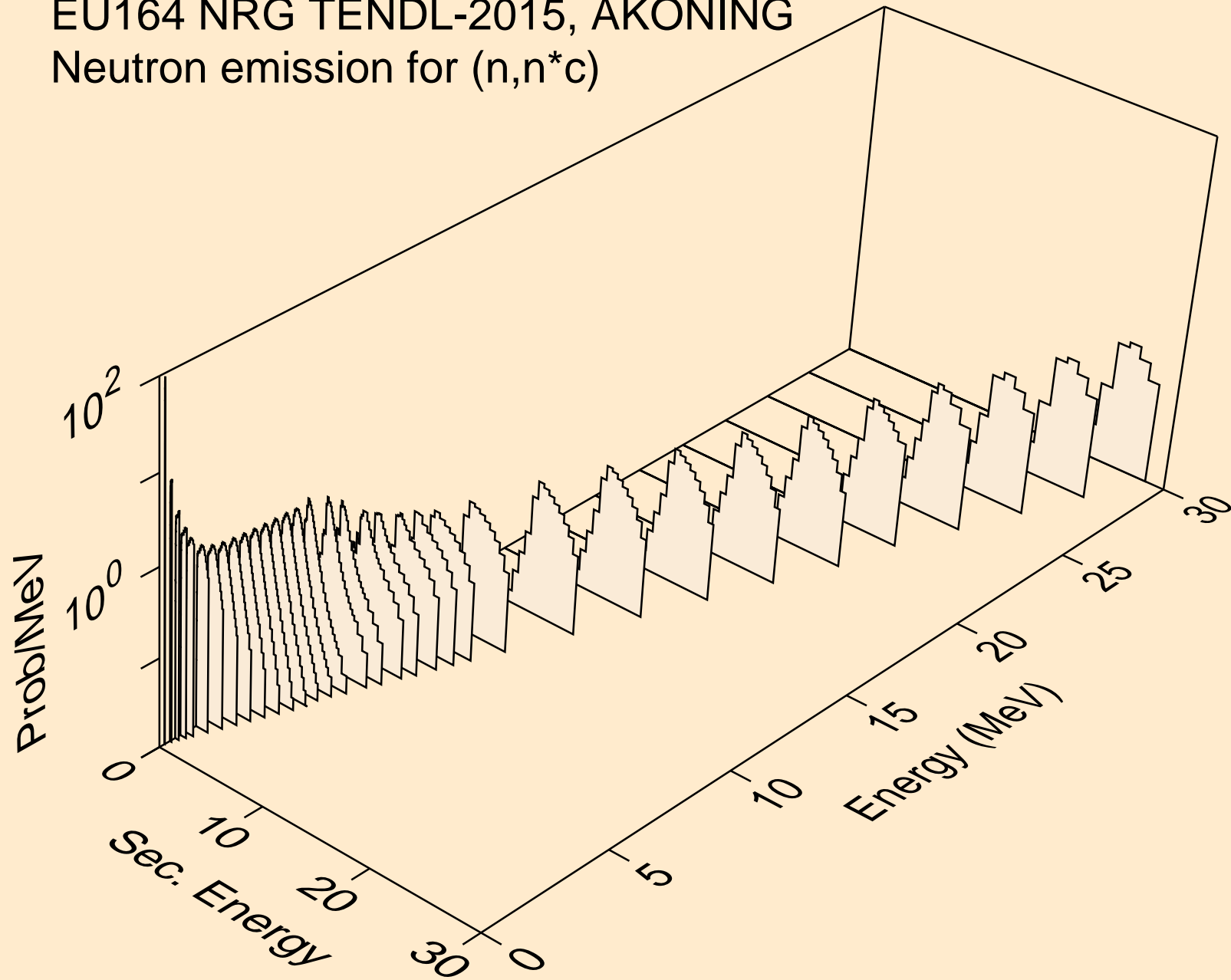

EU164 NRG TENDL-2015, AKONING
Photon emission for (n,x)

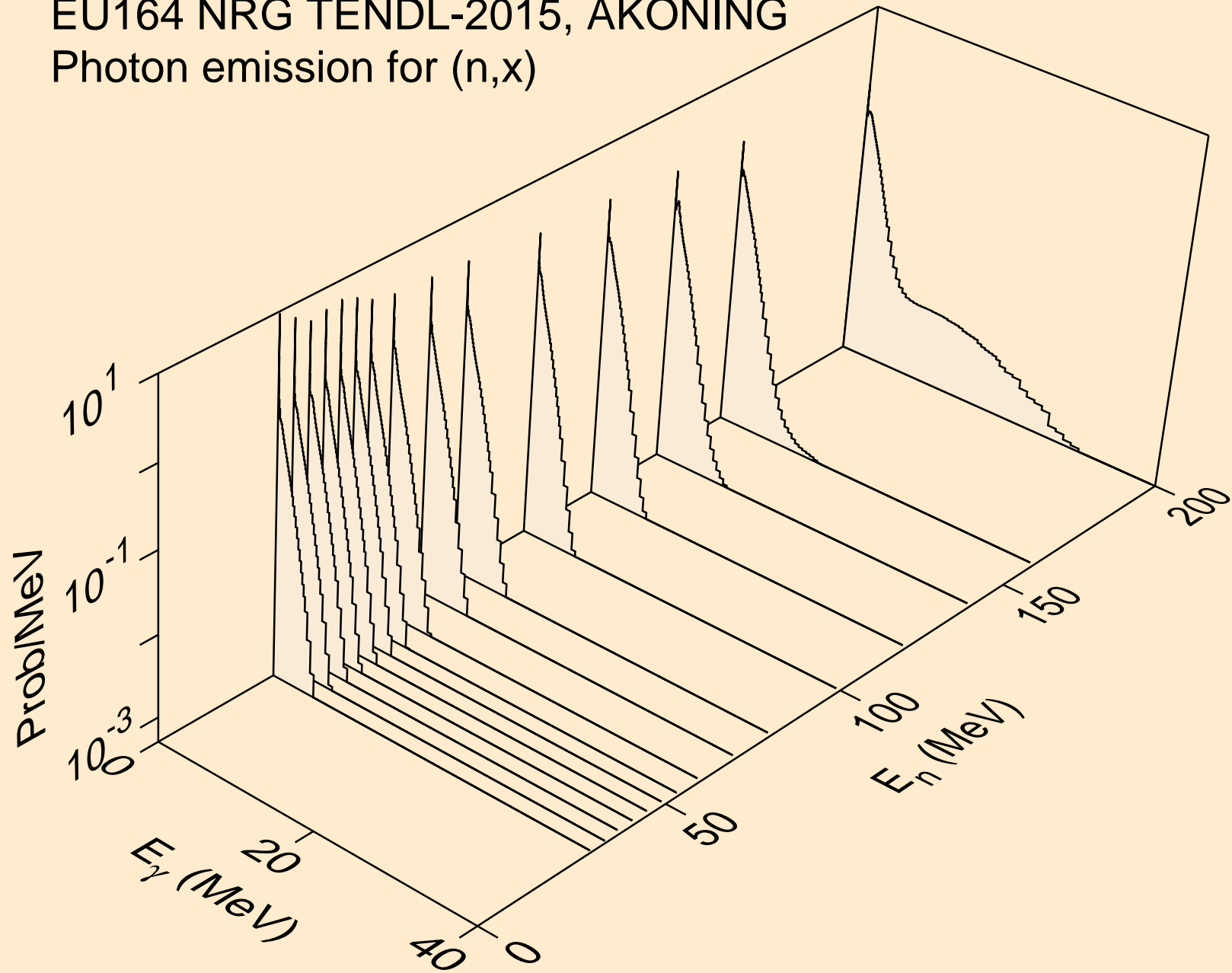

EU164 NRG TENDL-2015, AKONING
Photon emission for (n,2nd)

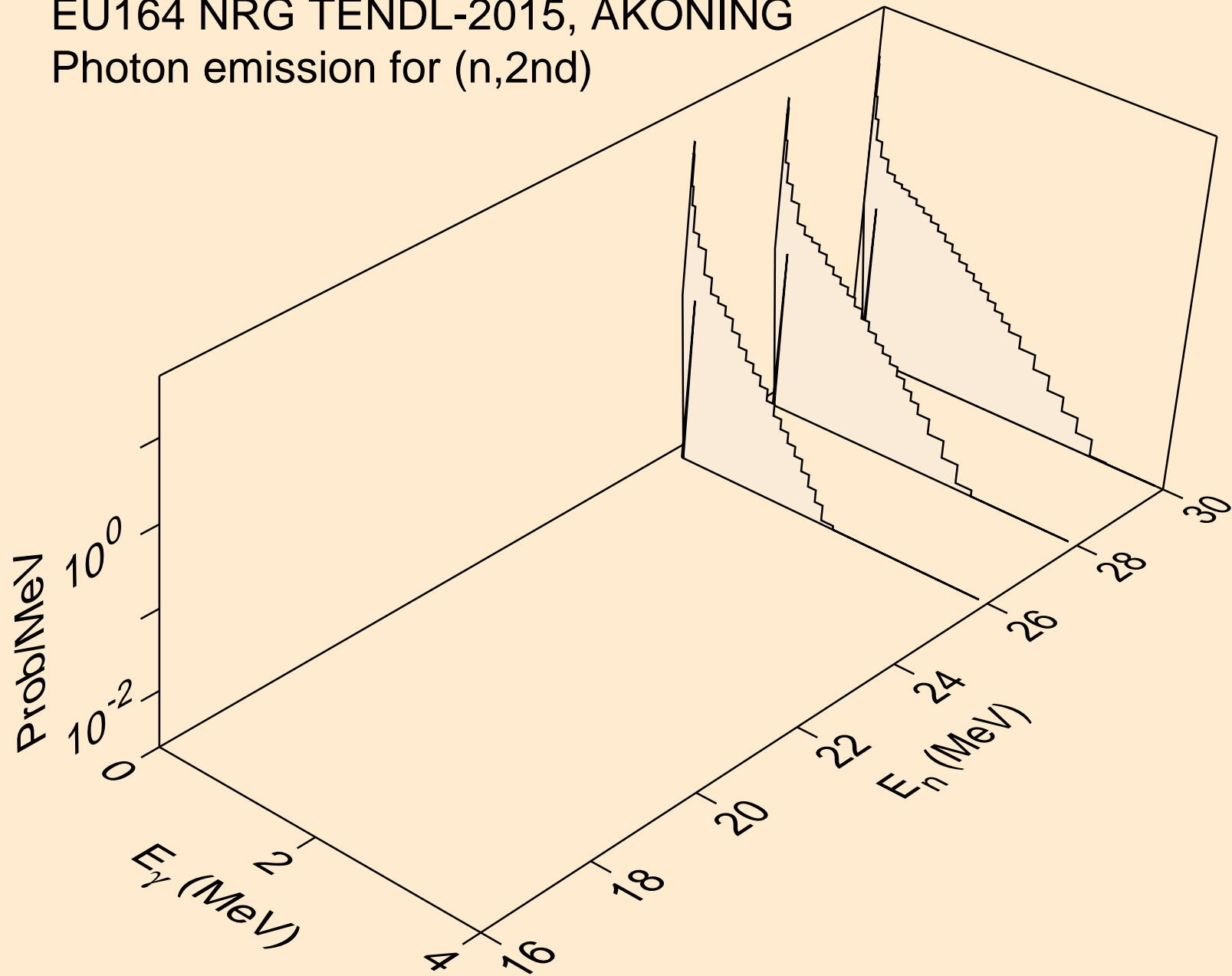

EU164 NRG TENDL-2015, AKONING
Photon emission for (n,2n)

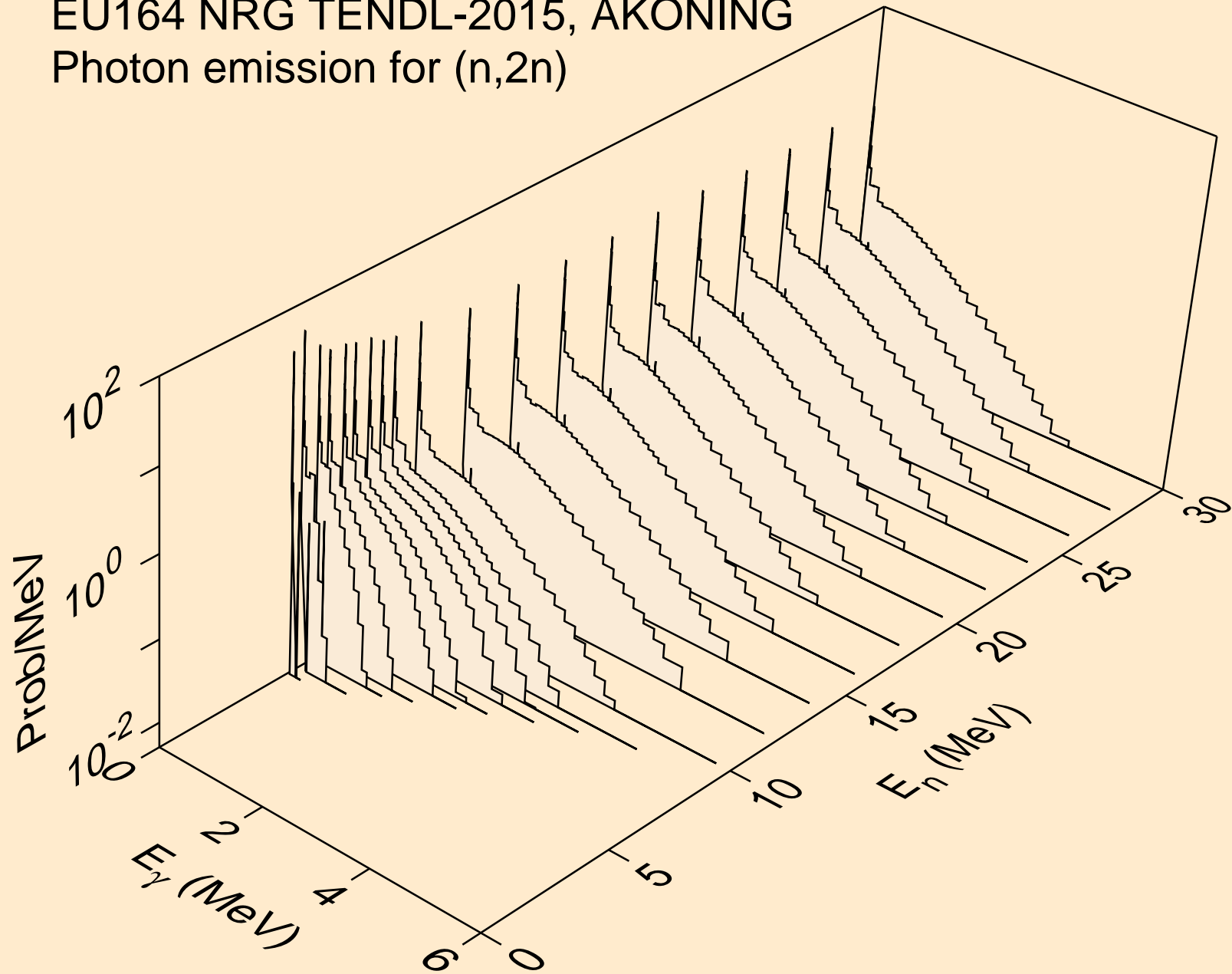

EU164 NRG TENDL-2015, AKONING
Photon emission for (n,3n)

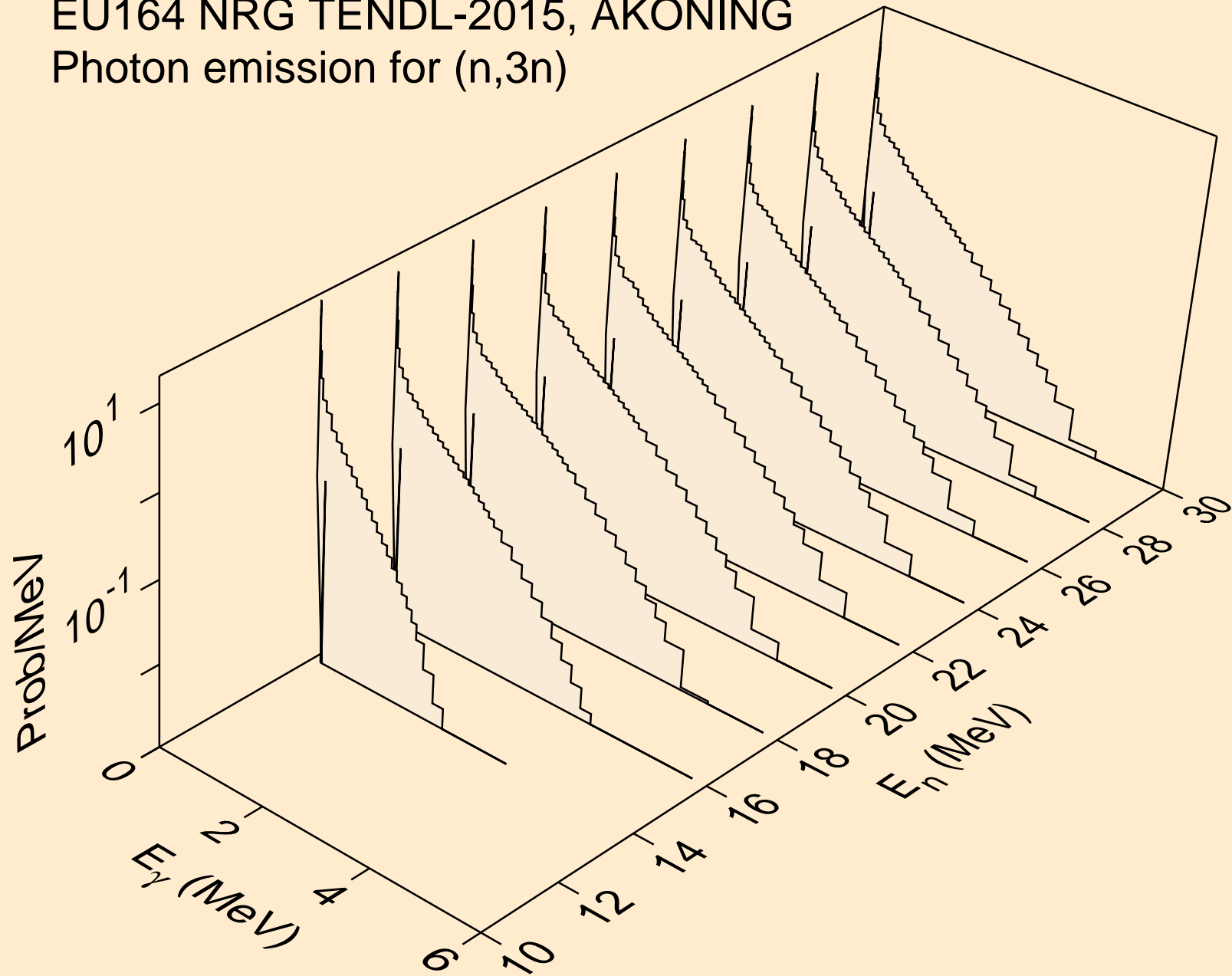

EU164 NRG TENDL-2015, AKONING
Photon emission for (n,n*)a

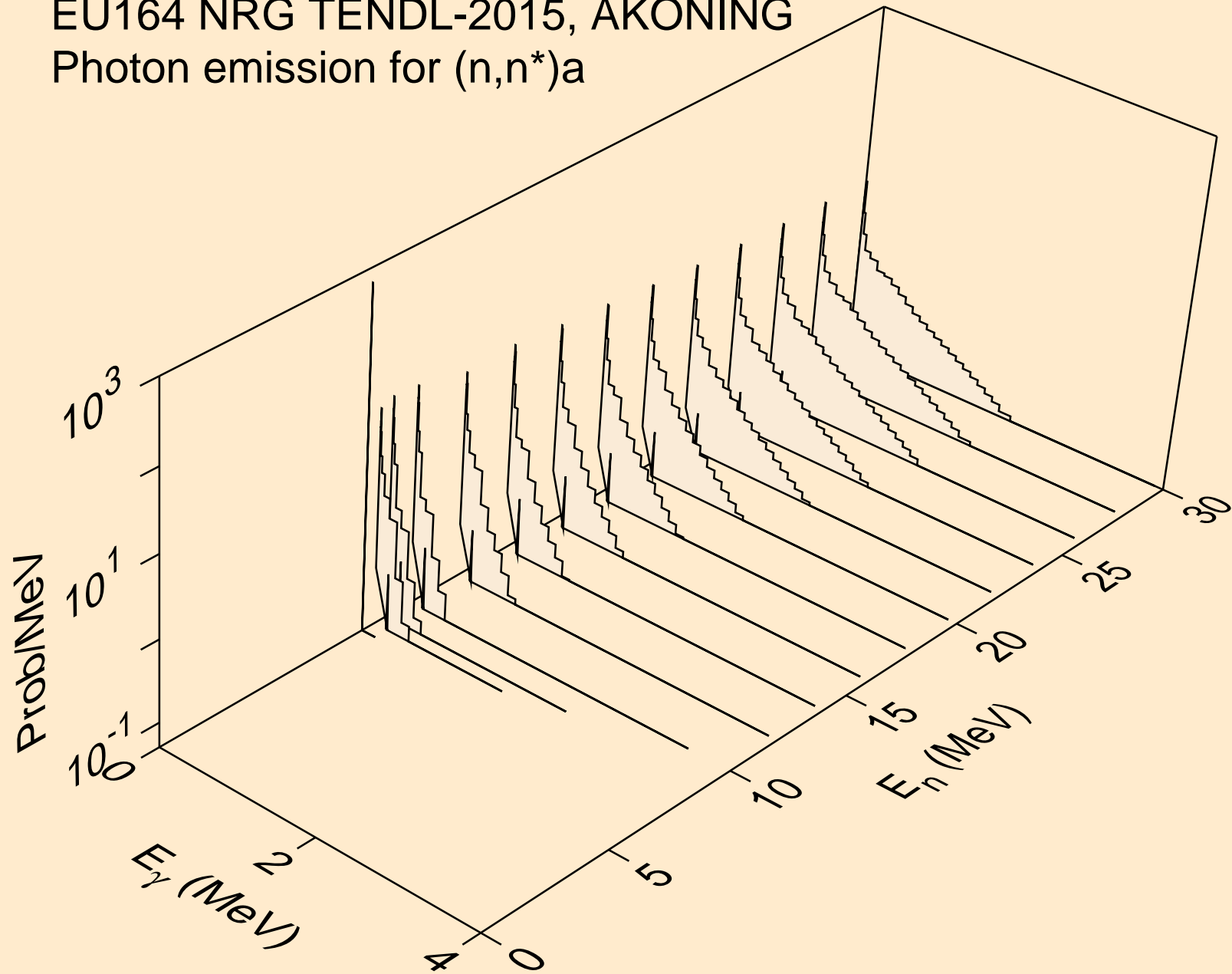

EU164 NRG TENDL-2015, AKONING
Photon emission for (n,2n)a

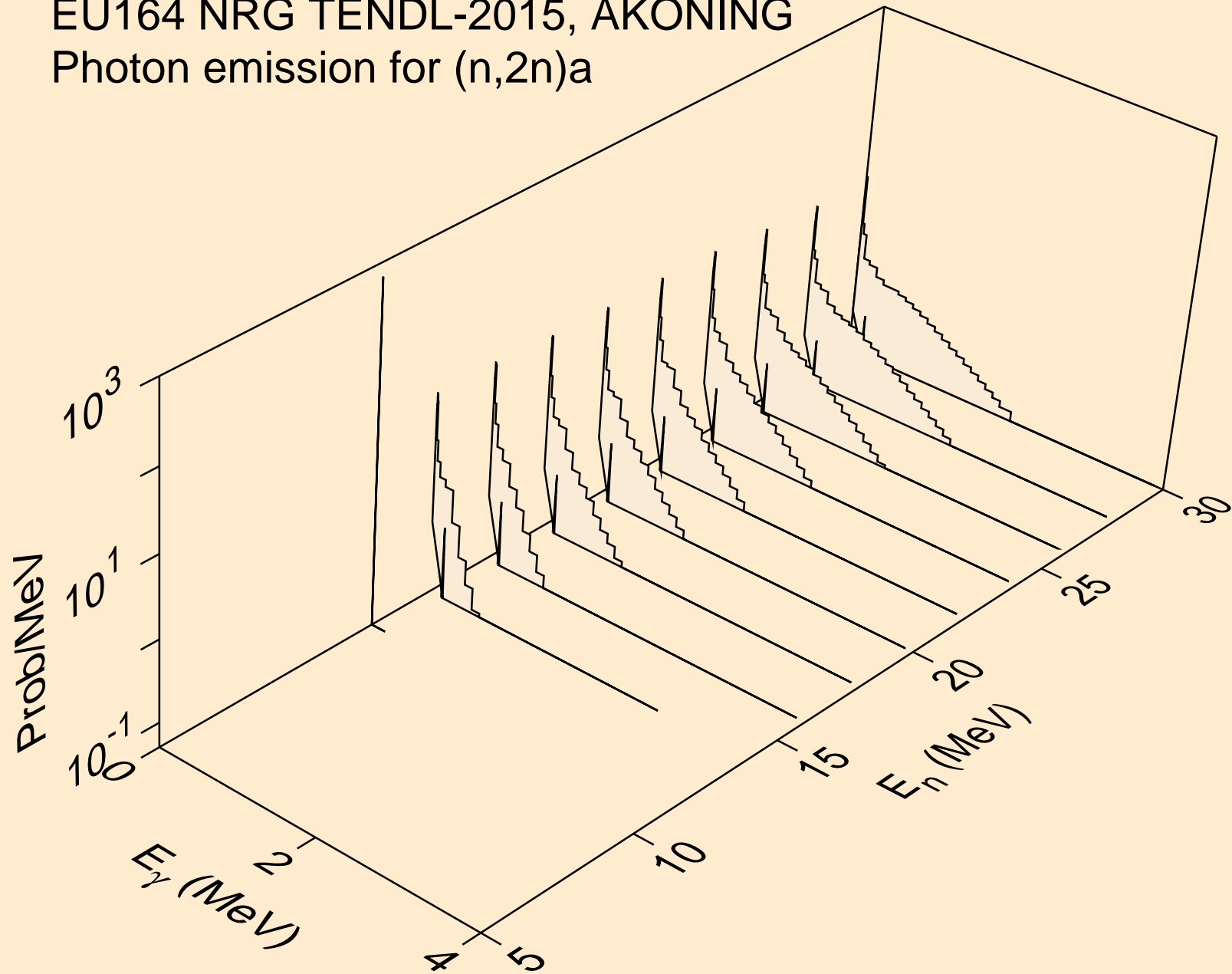

EU164 NRG TENDL-2015, AKONING
Photon emission for (n,3n)a

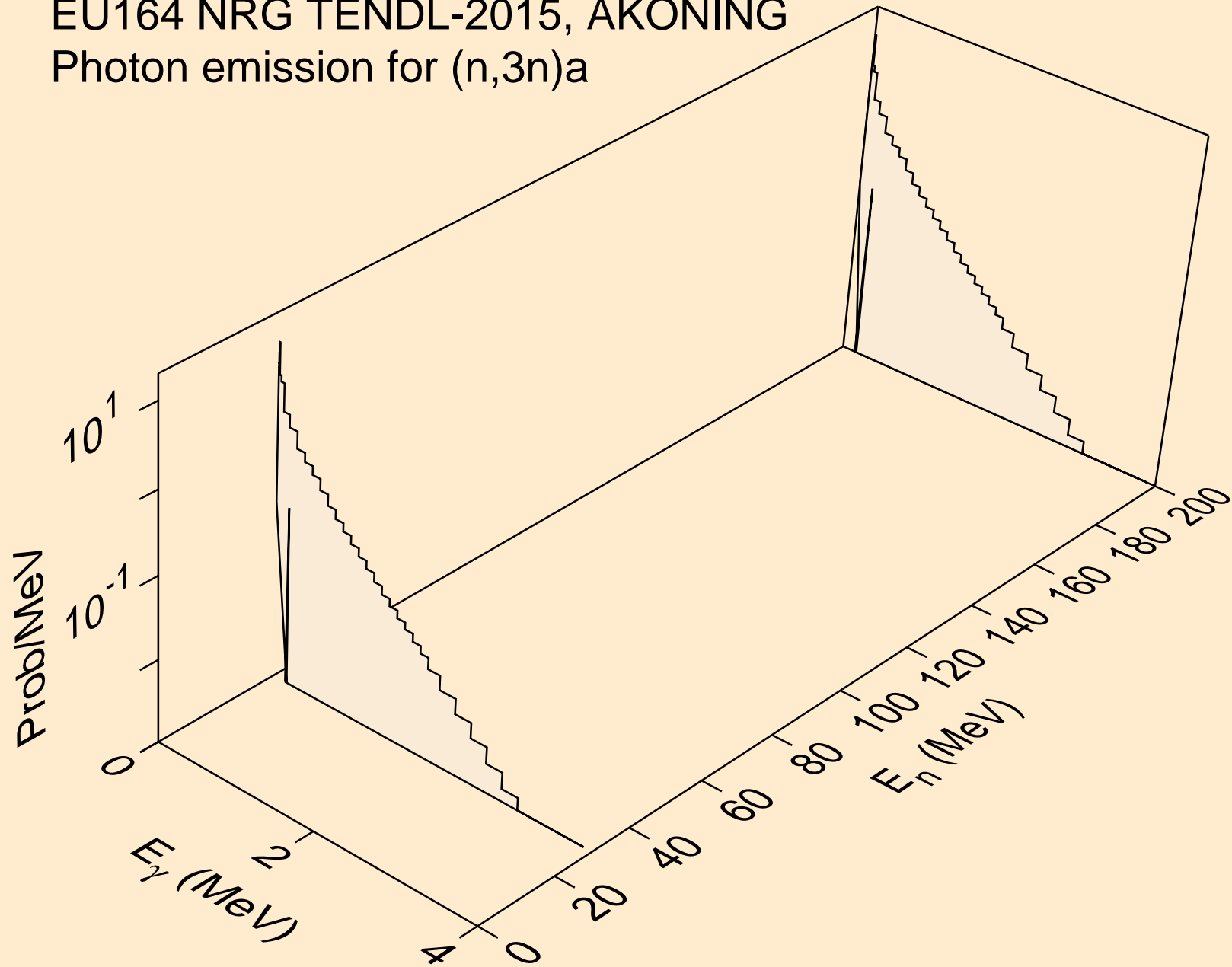

EU164 NRG TENDL-2015, AKONING

Photon emission for (n,n*)p

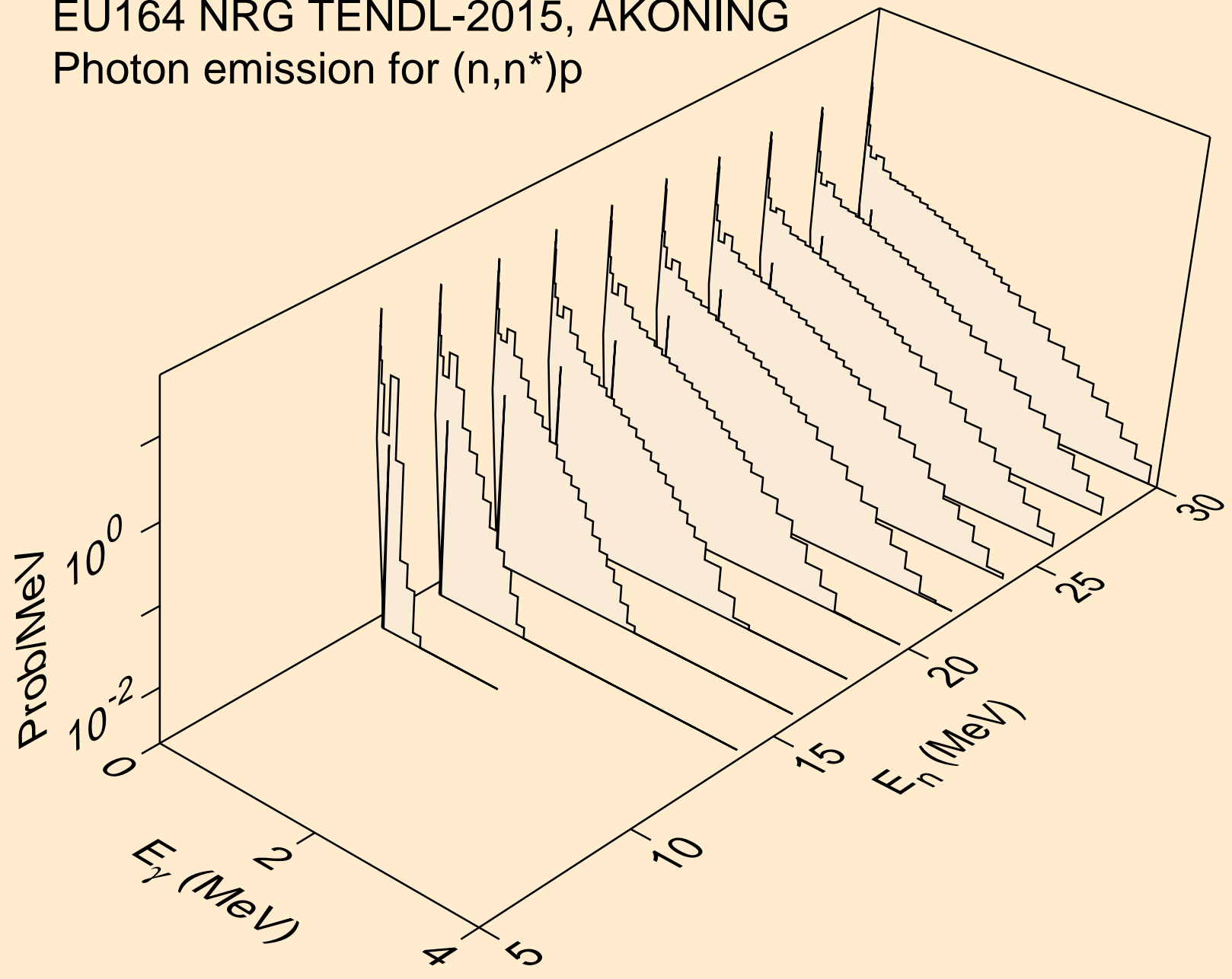

EU164 NRG TENDL-2015, AKONING
Photon emission for (n,n*)d

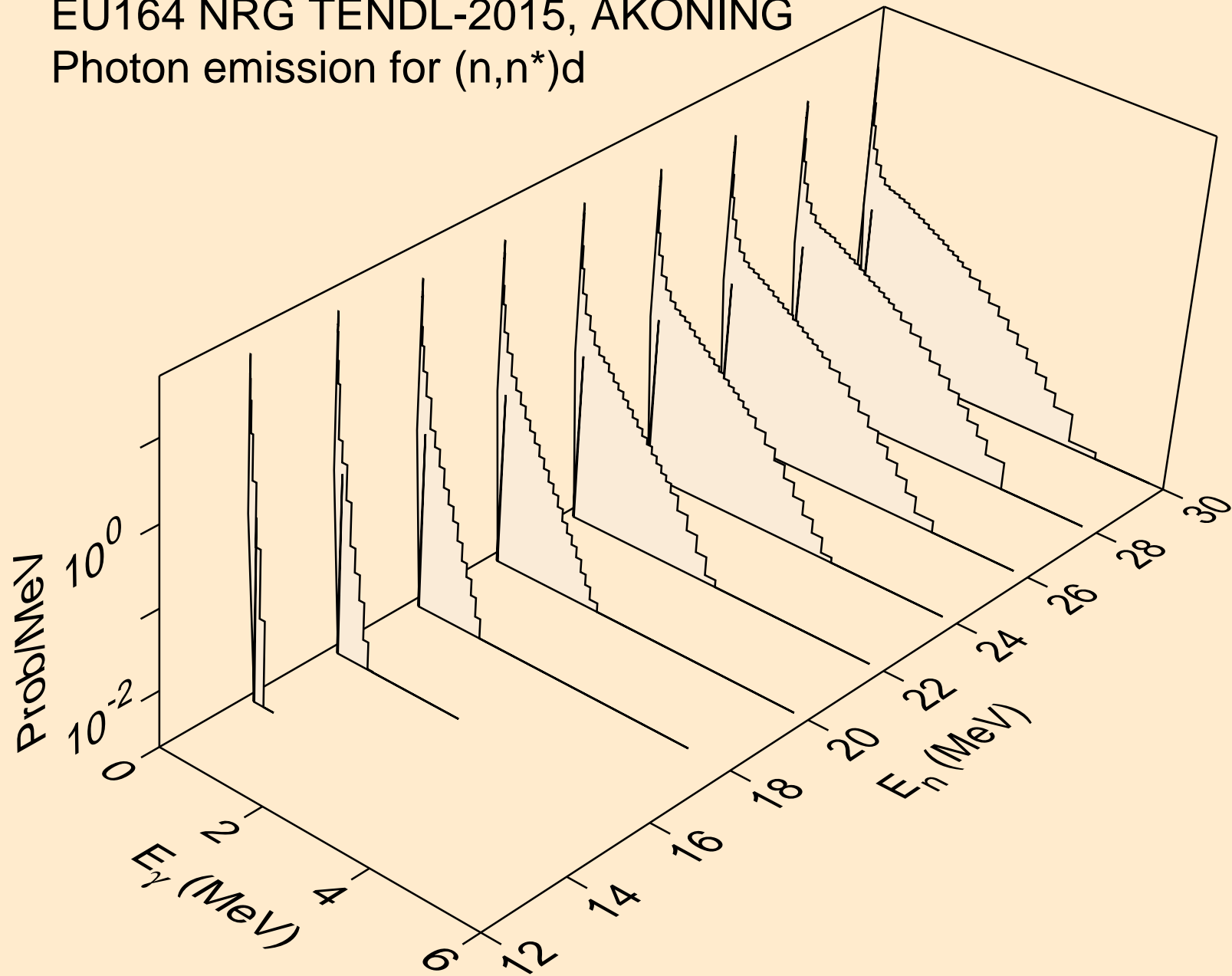

EU164 NRG TENDL-2015, AKONING
Photon emission for (n,n*)t

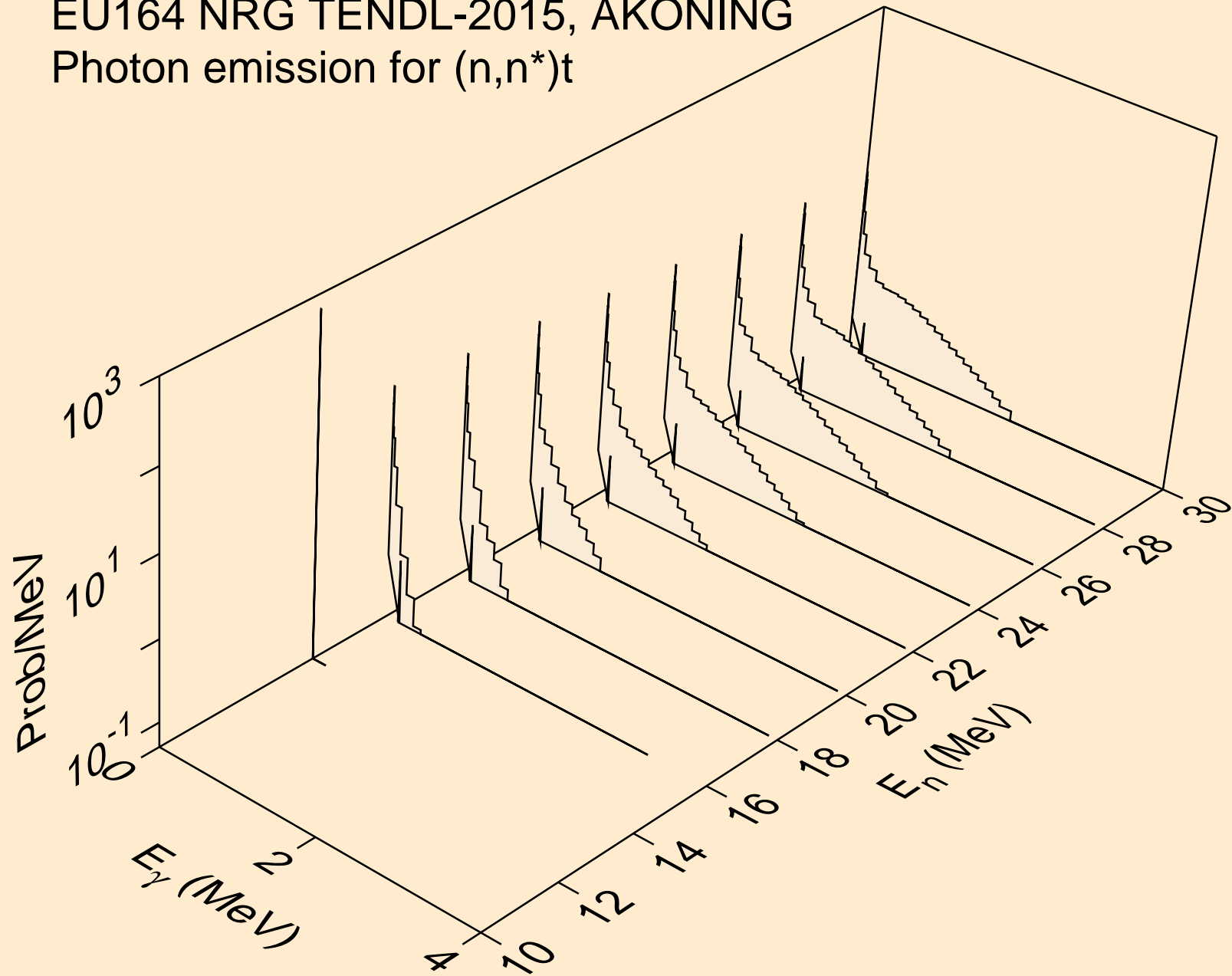

EU164 NRG TENDL-2015, AKONING
Photon emission for (n,n*)he3

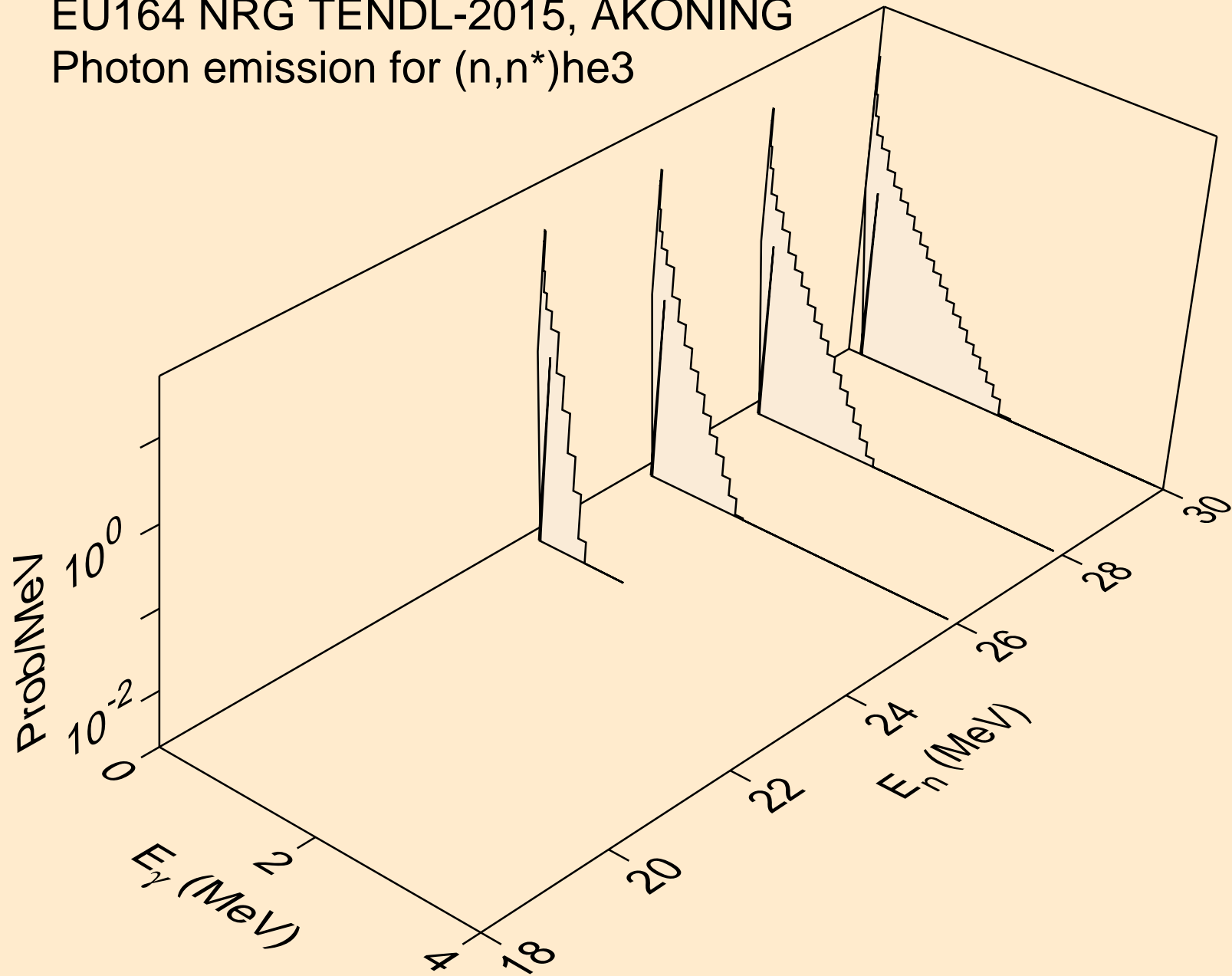

EU164 NRG TENDL-2015, AKONING
Photon emission for (n,4n)

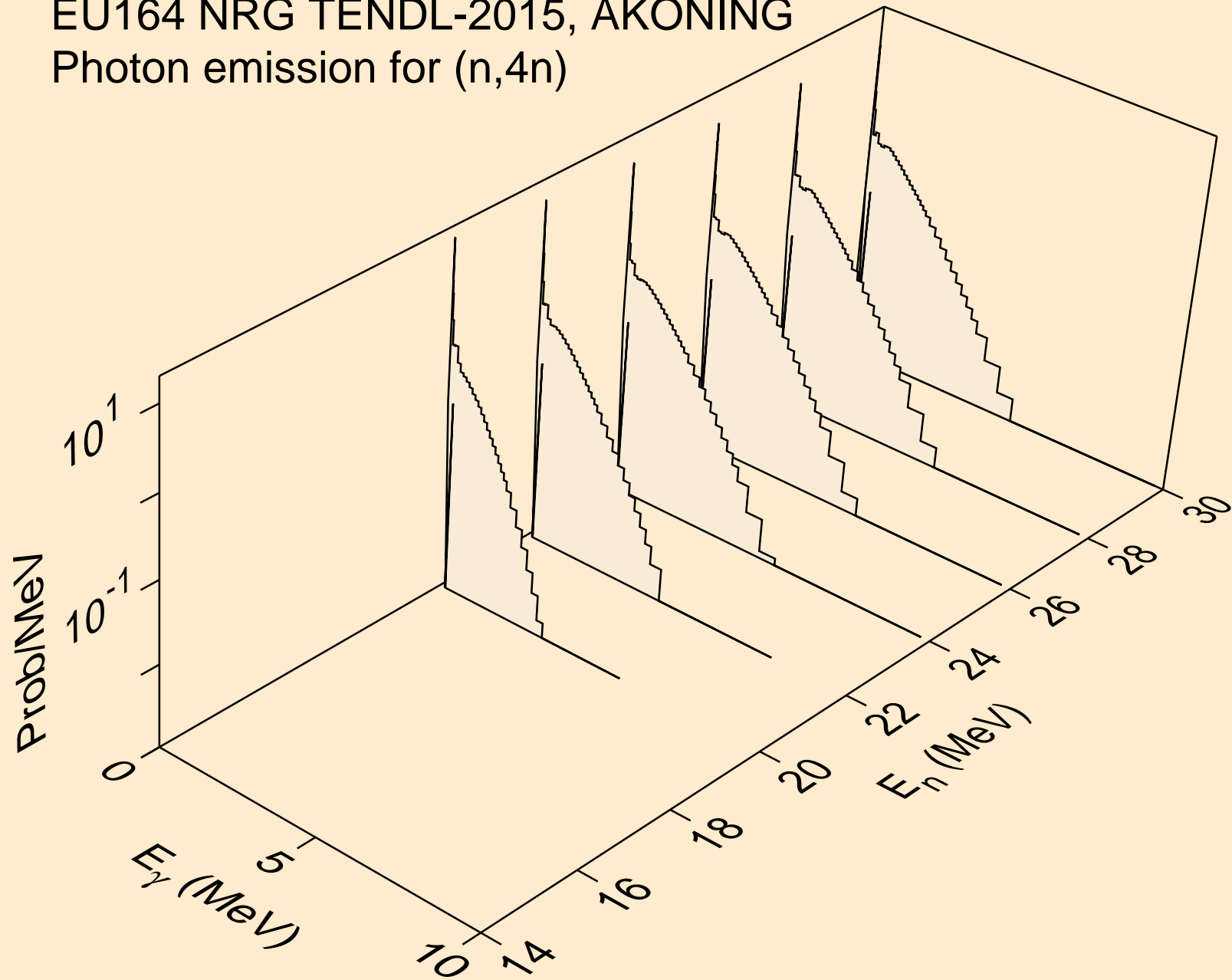

EU164 NRG TENDL-2015, AKONING
Photon emission for (n,2np)

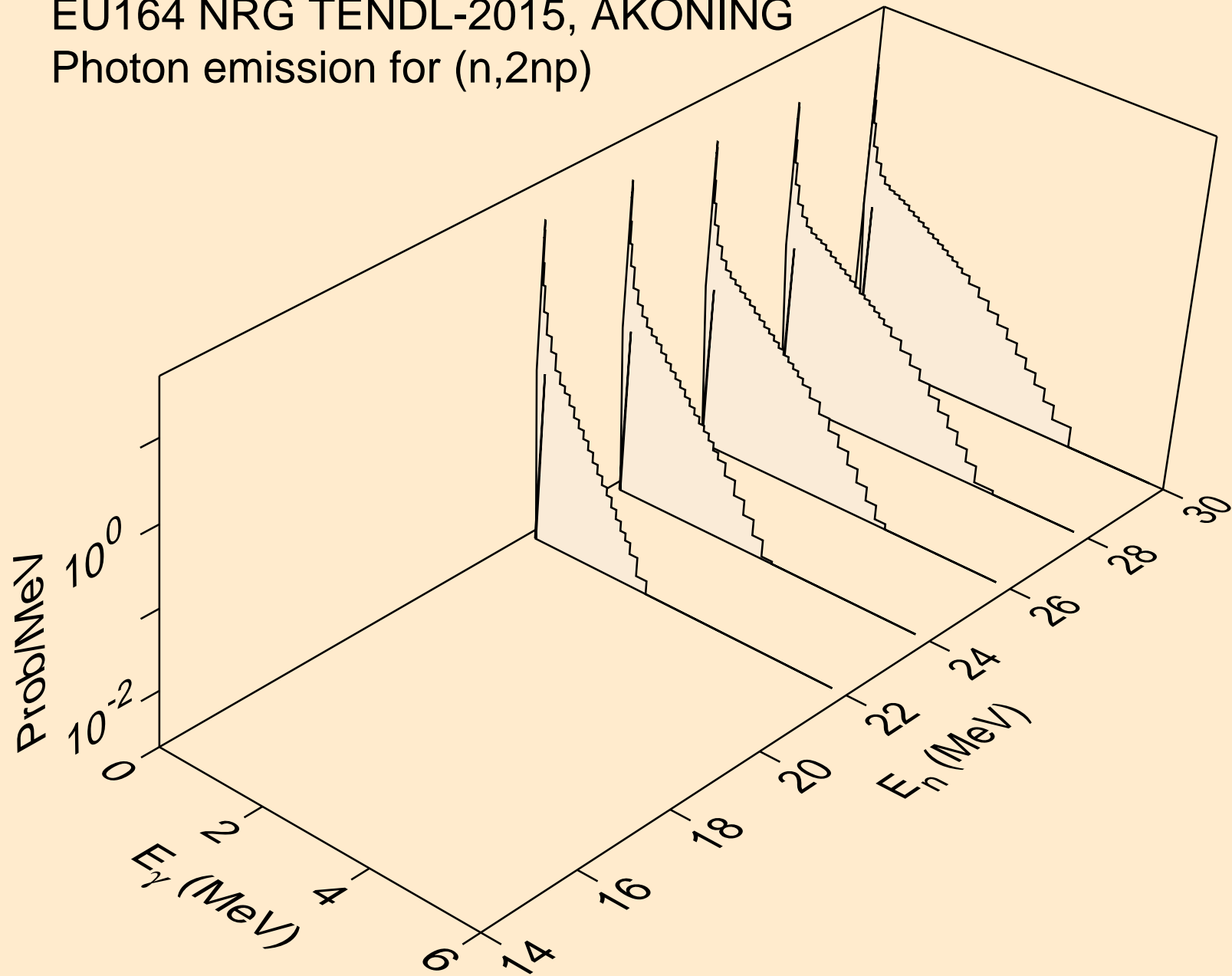

EU164 NRG TENDL-2015, AKONING
Photon emission for (n,3np)

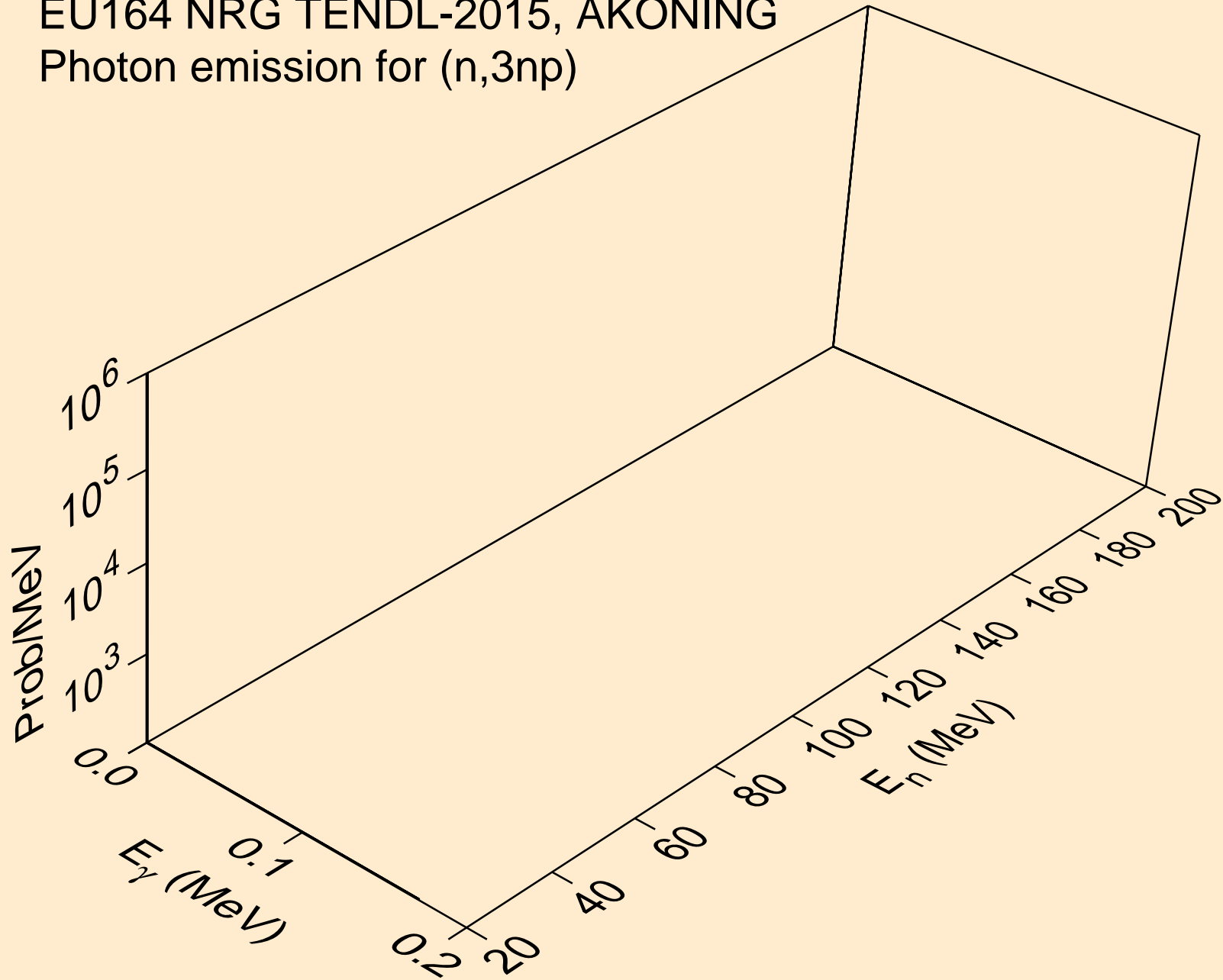

EU164 NRG TENDL-2015, AKONING
Photon emission for (n,n*c)

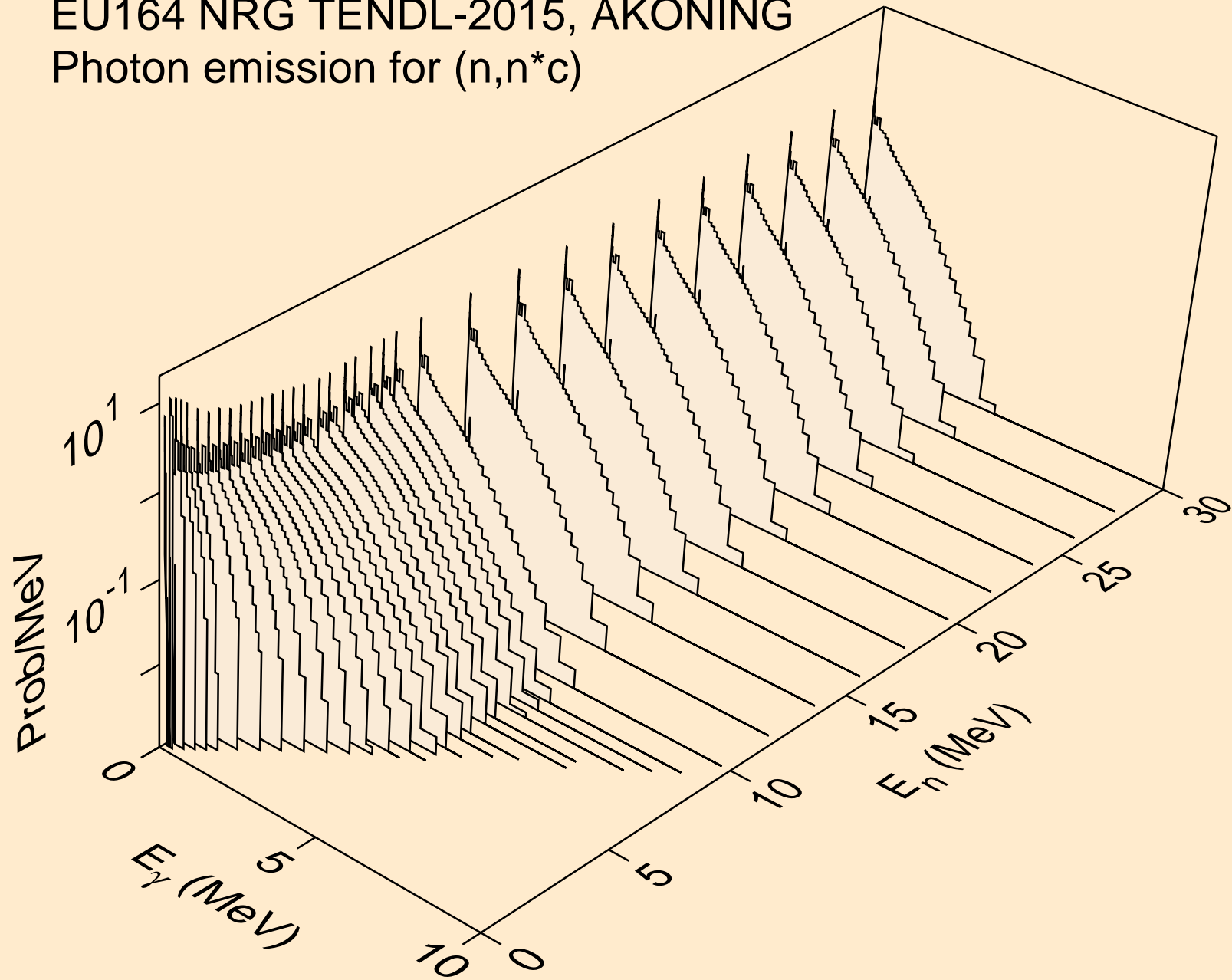

EU164 NRG TENDL-2015, AKONING
Photon emission for (n,gma)

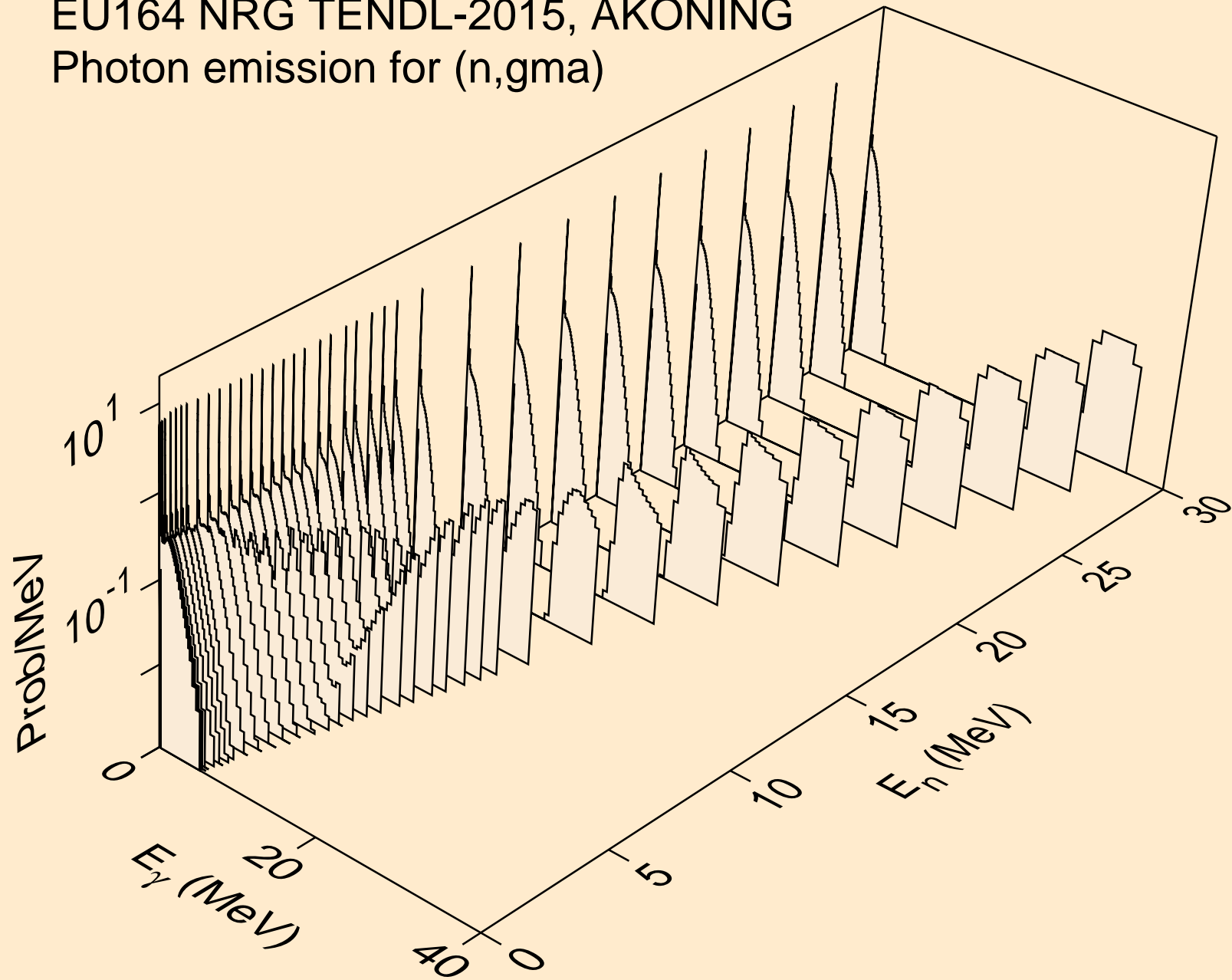

EU164 NRG TENDL-2015, AKONING
Photon emission for (n,p)

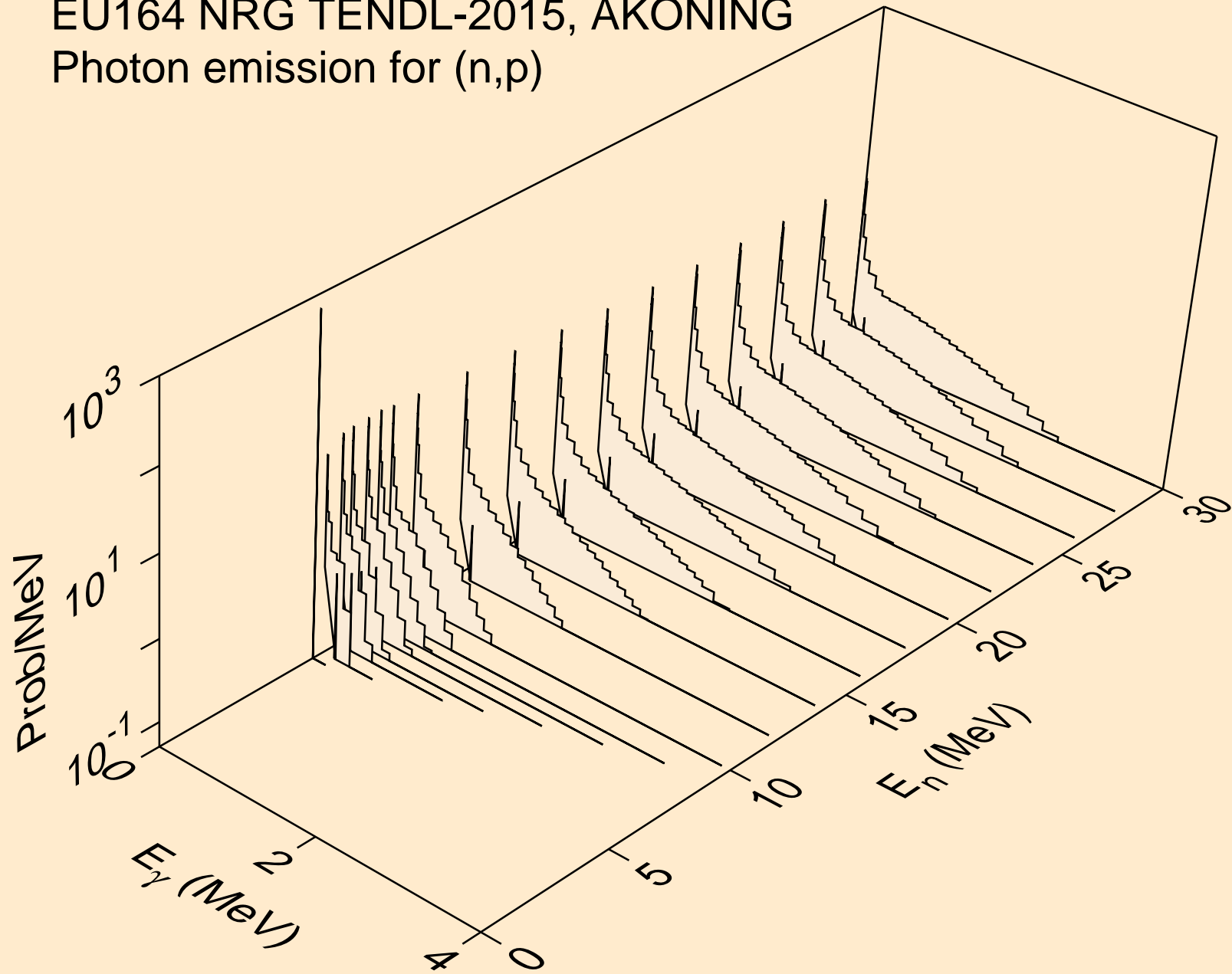

EU164 NRG TENDL-2015, AKONING
Photon emission for (n,d)

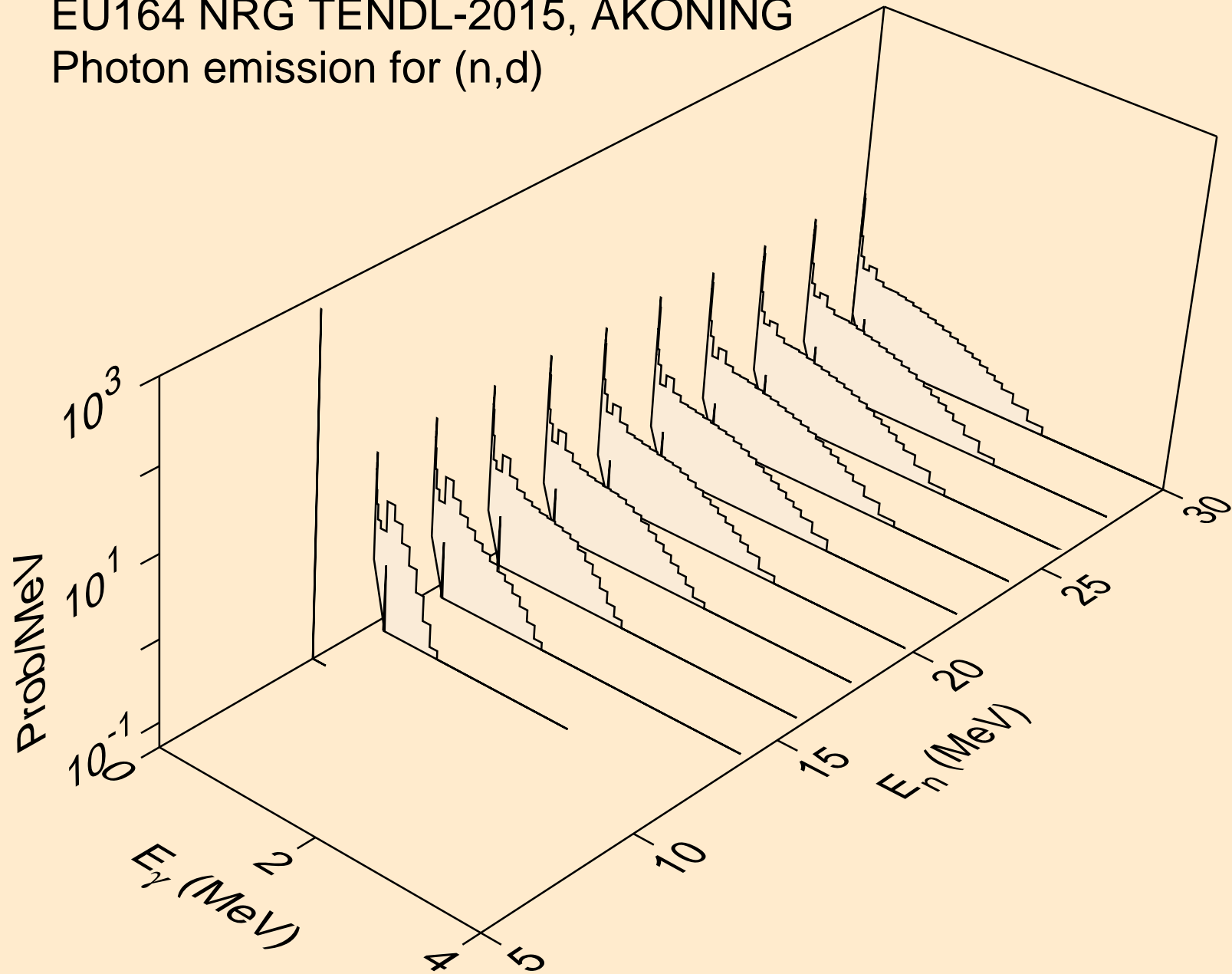

EU164 NRG TENDL-2015, AKONING
Photon emission for (n,t)

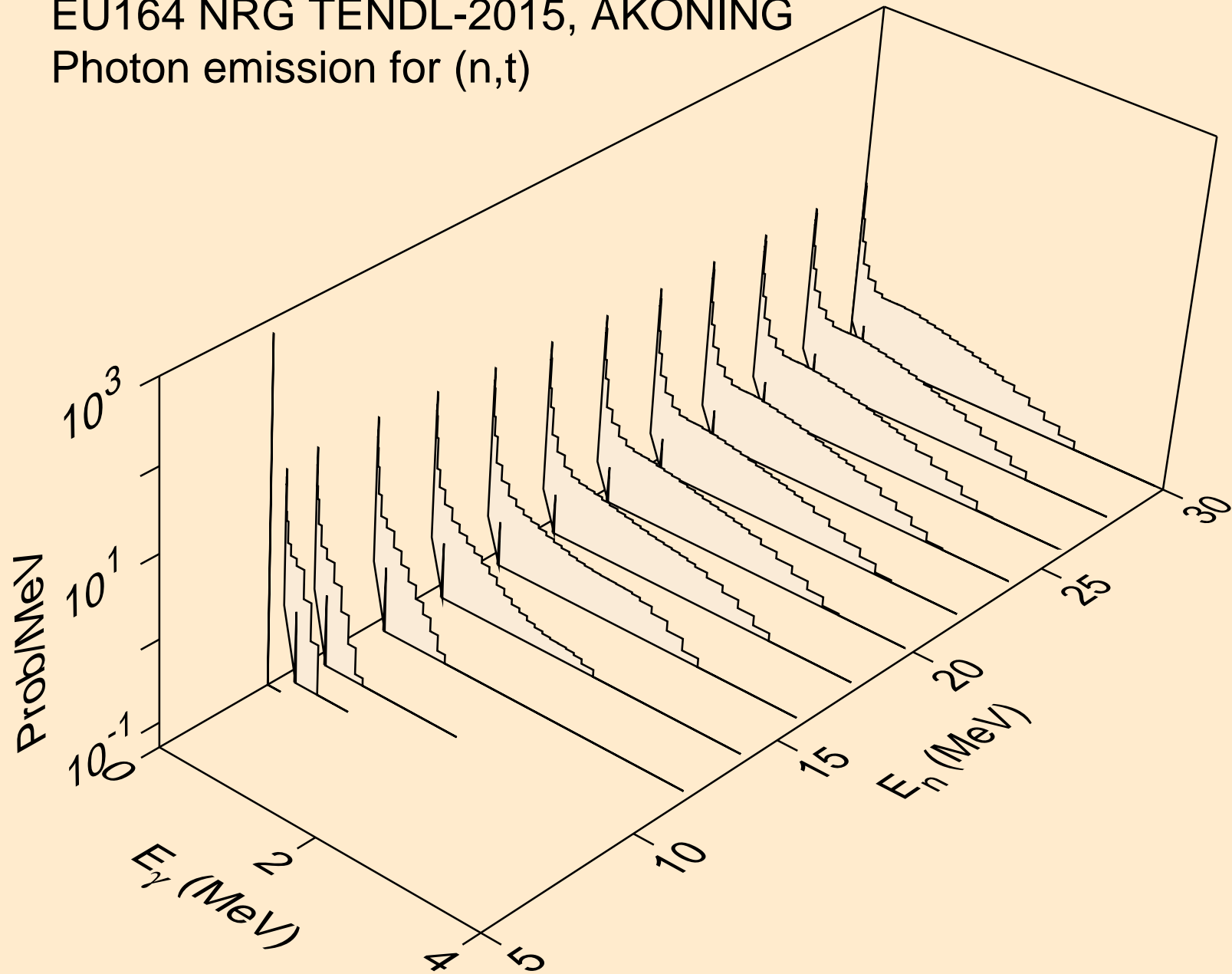

EU164 NRG TENDL-2015, AKONING
Photon emission for (n,he3)

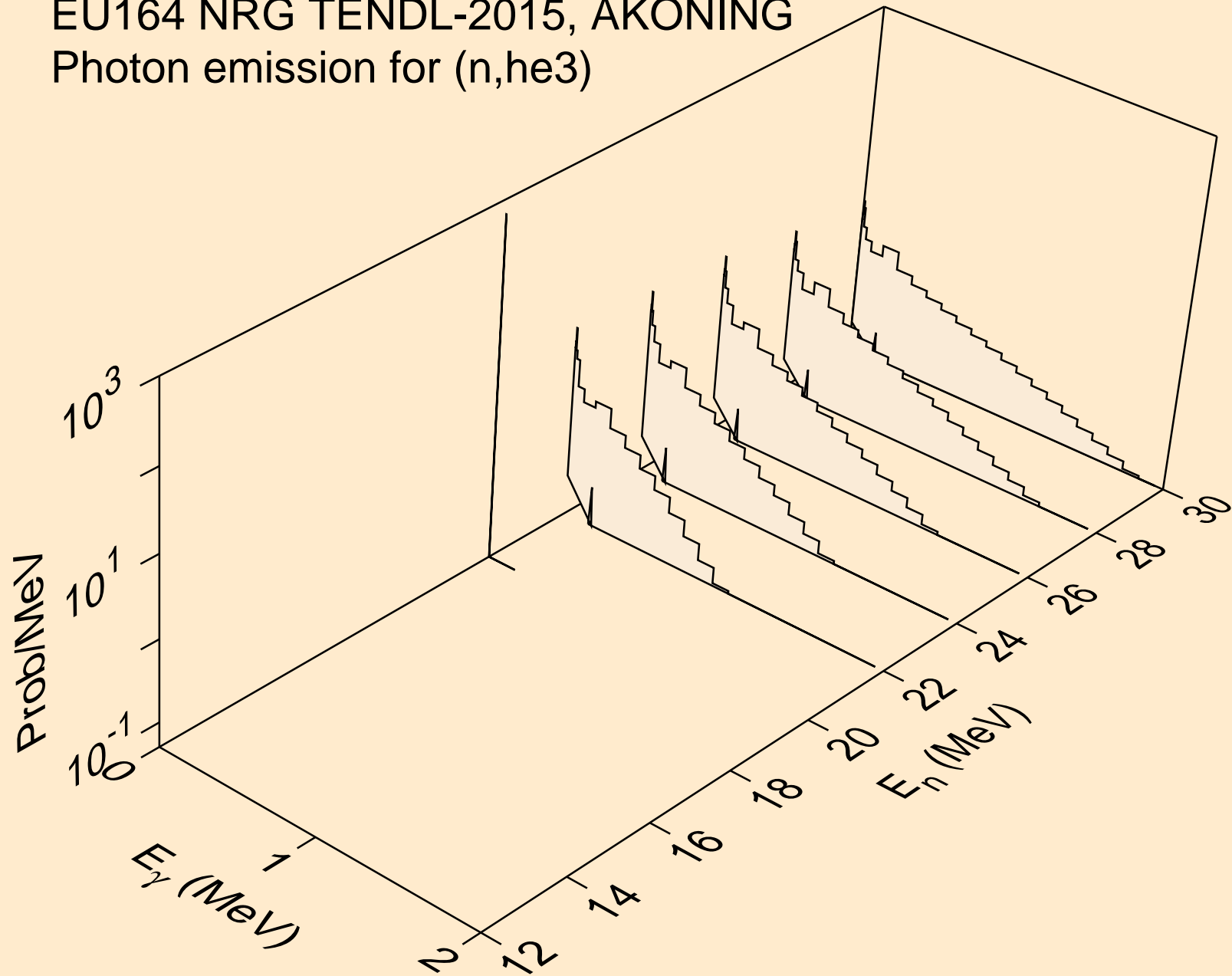

EU164 NRG TENDL-2015, AKONING
Photon emission for (n,a)

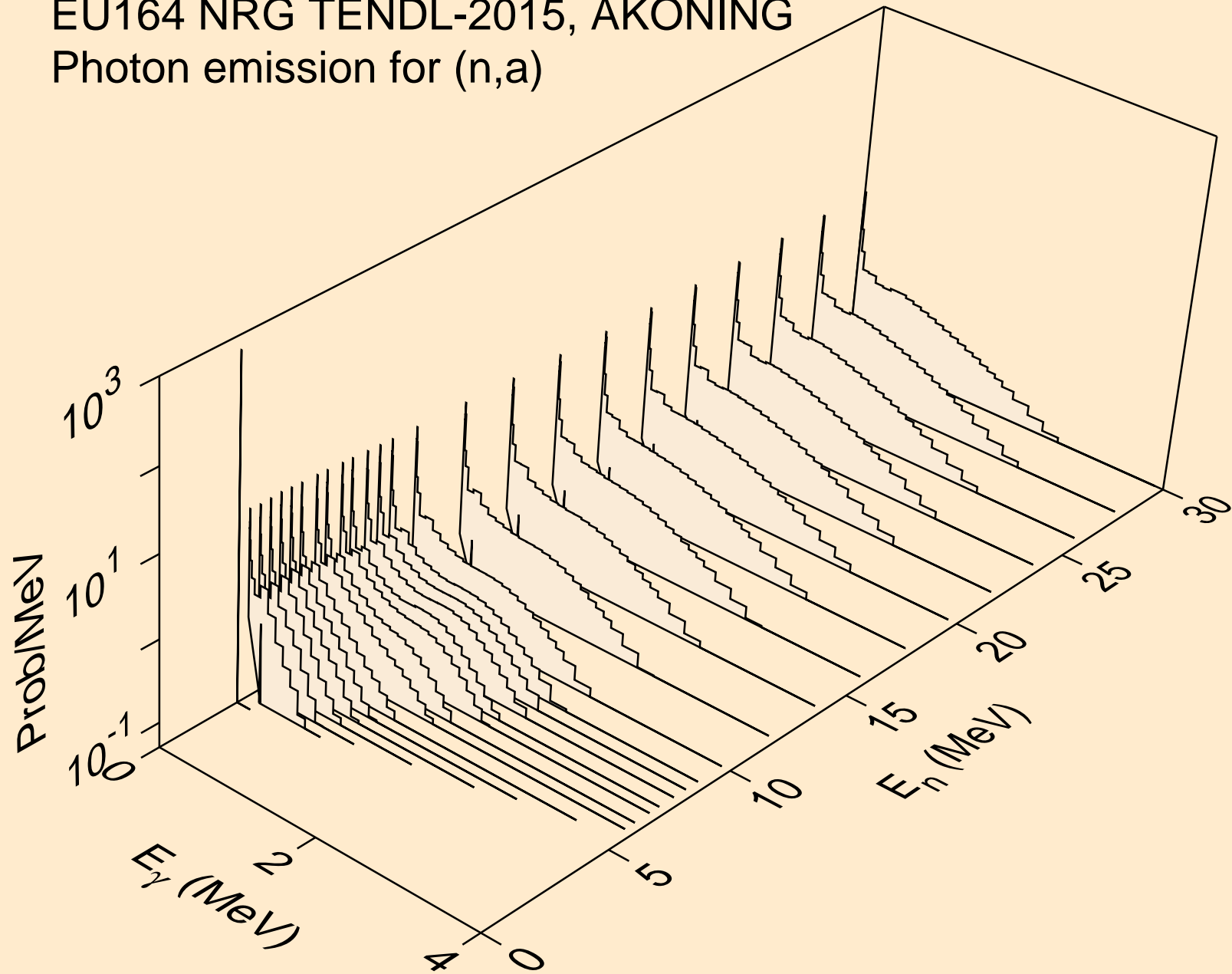

EU164 NRG TENDL-2015, AKONING
thermal capture photon spectrum

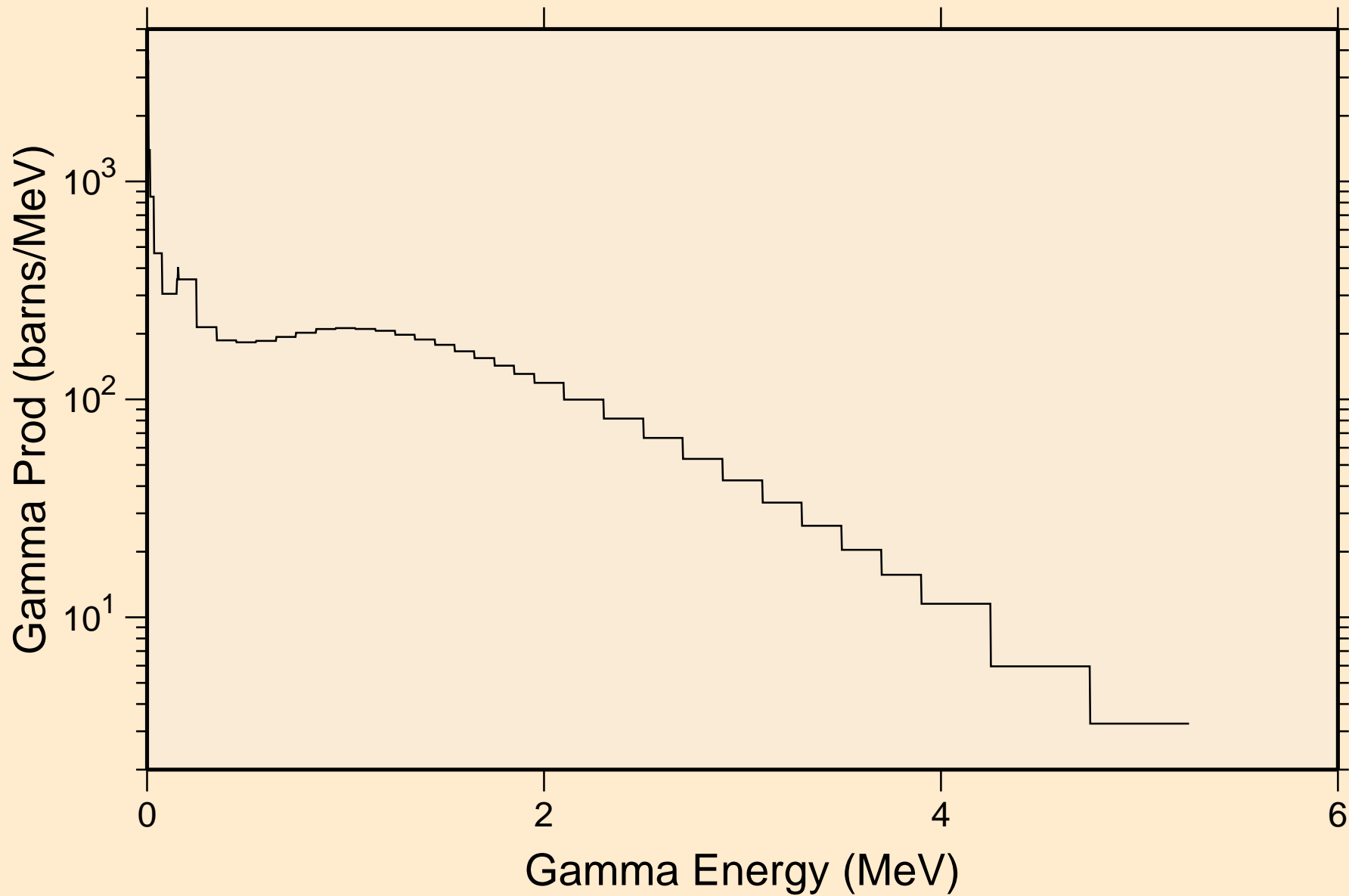

EU164 NRG TENDL-2015, AKONING

14 MeV photon spectrum

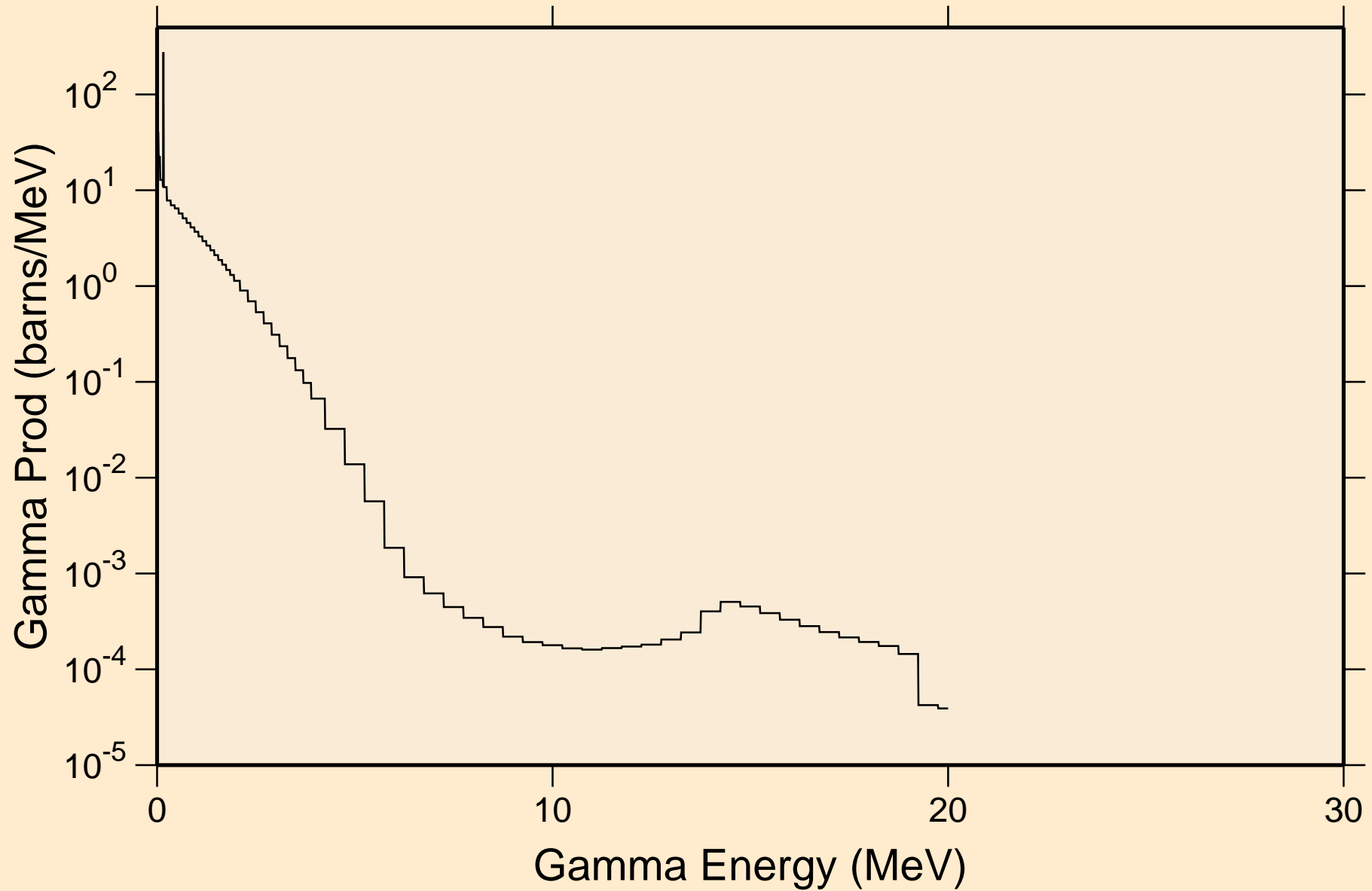

EU164 NRG TENDL-2015, AKONING

Particle heating contributions

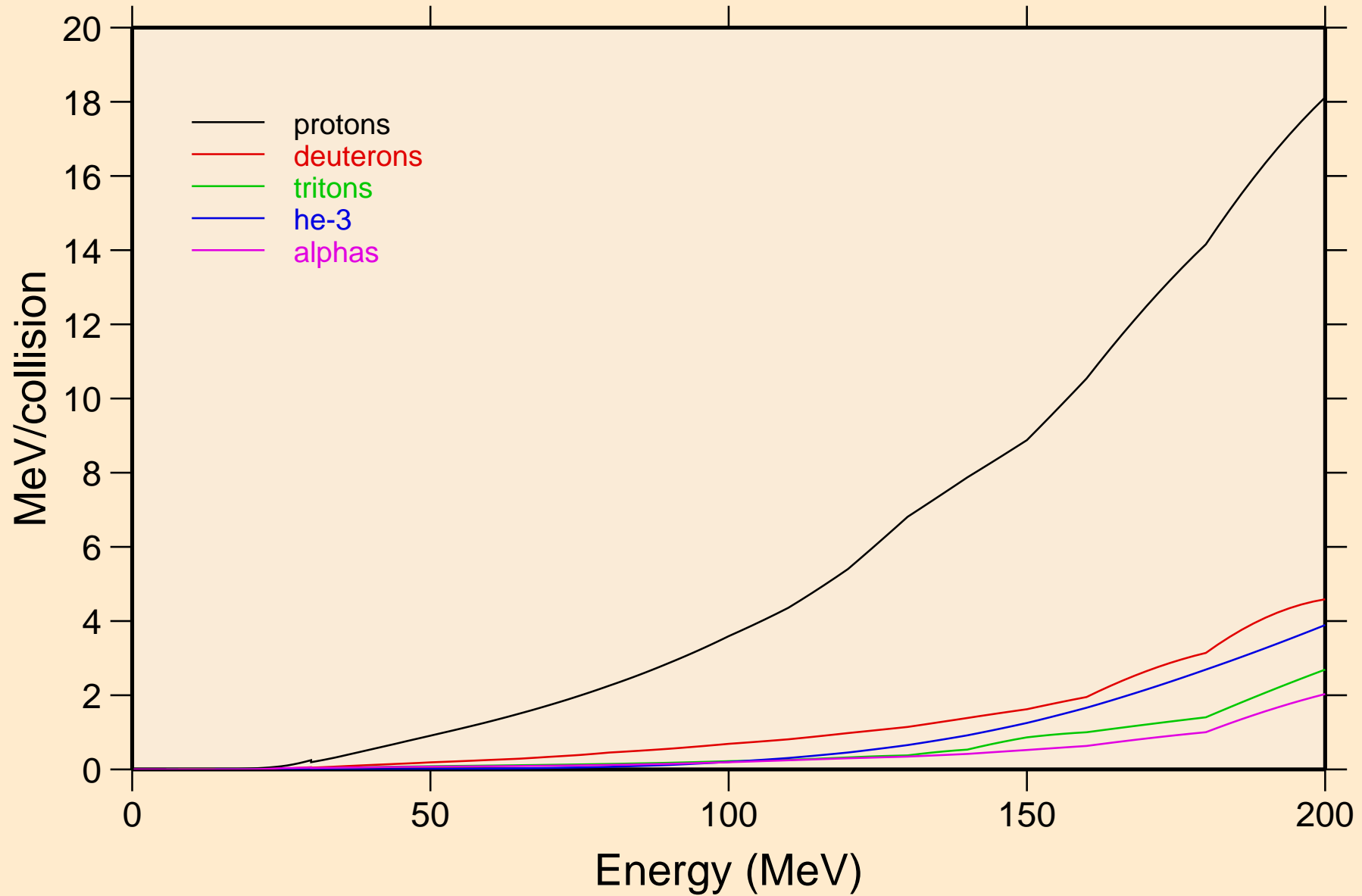

EU164 NRG TENDL-2015, AKONING

Recoil Heating

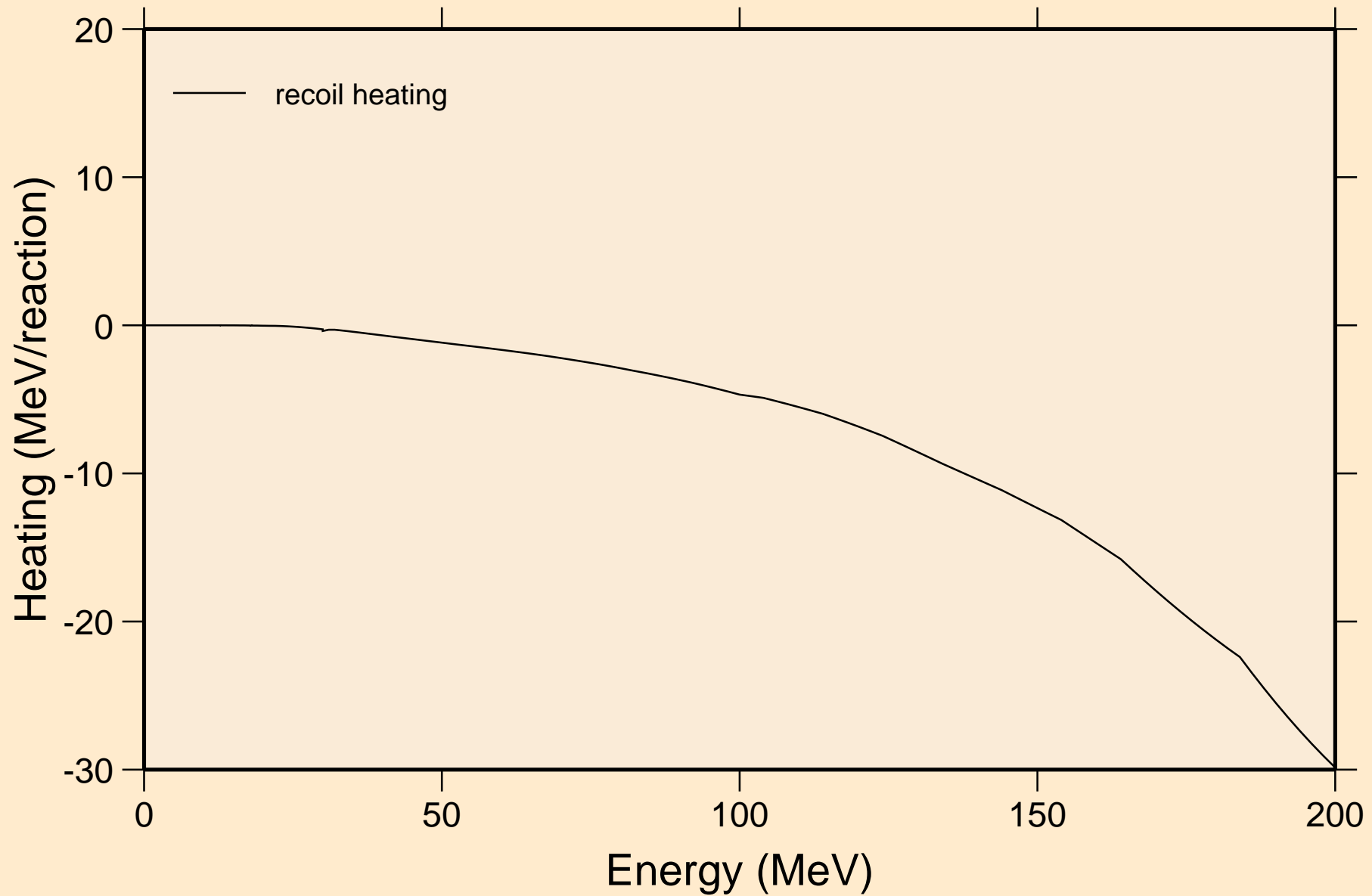

EU164 NRG TENDL-2015, AKONING

Particle production cross sections

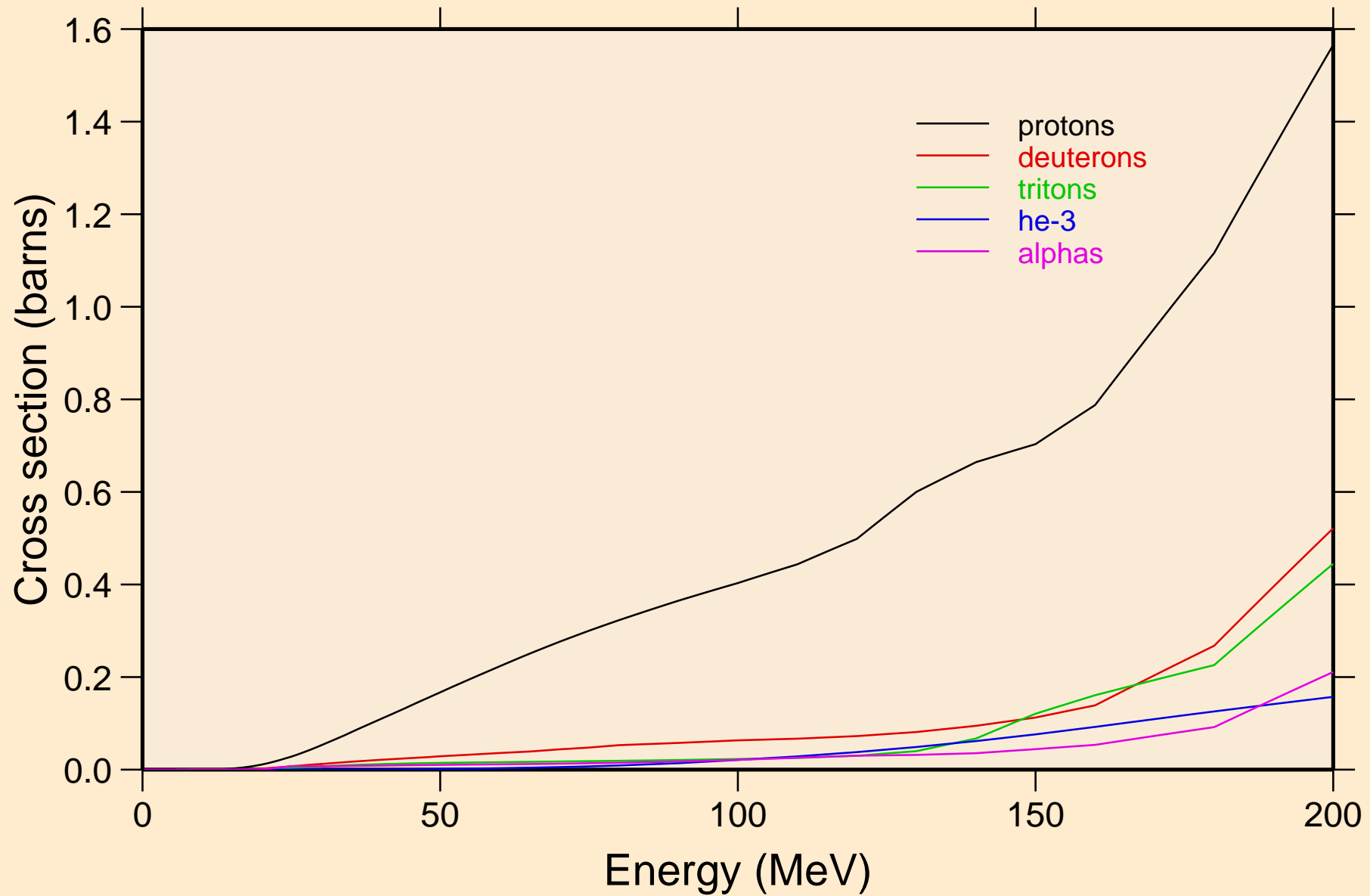

EU164 NRG TENDL-2015, AKONING
protons from (n,x)

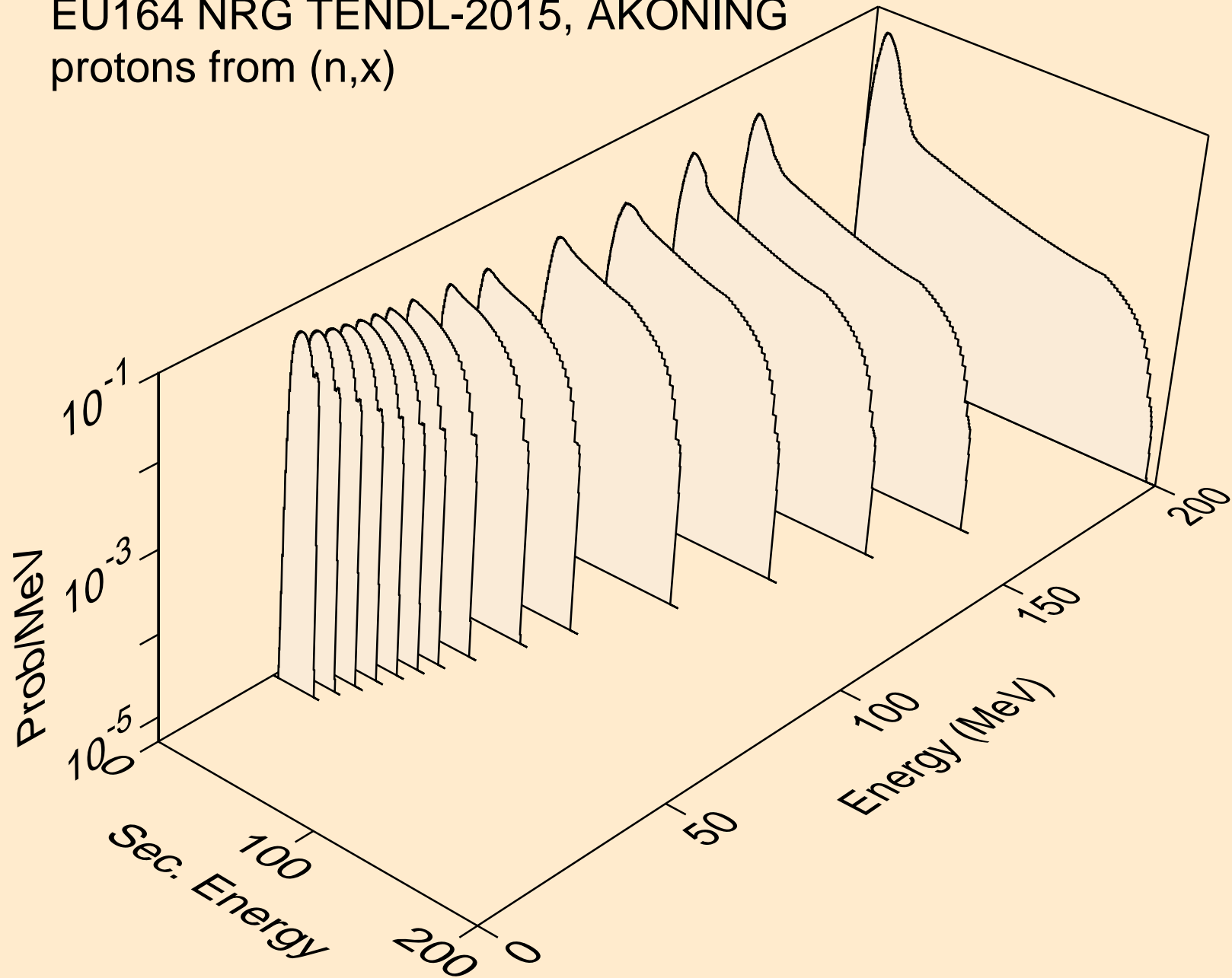

EU164 NRG TENDL-2015, AKONING
protons from (n,n*)p

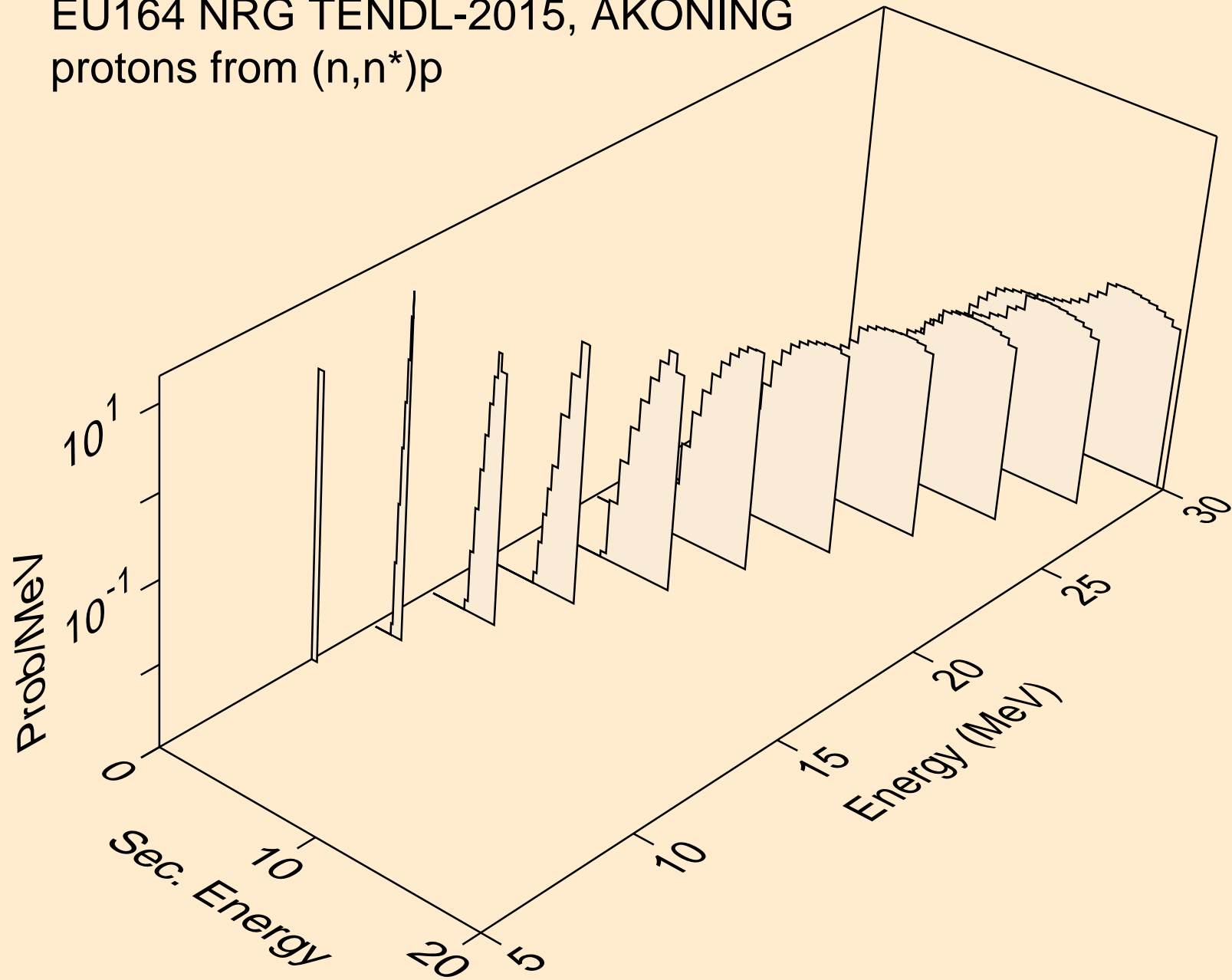

EU164 NRG TENDL-2015, AKONING
protons from (n,2np)

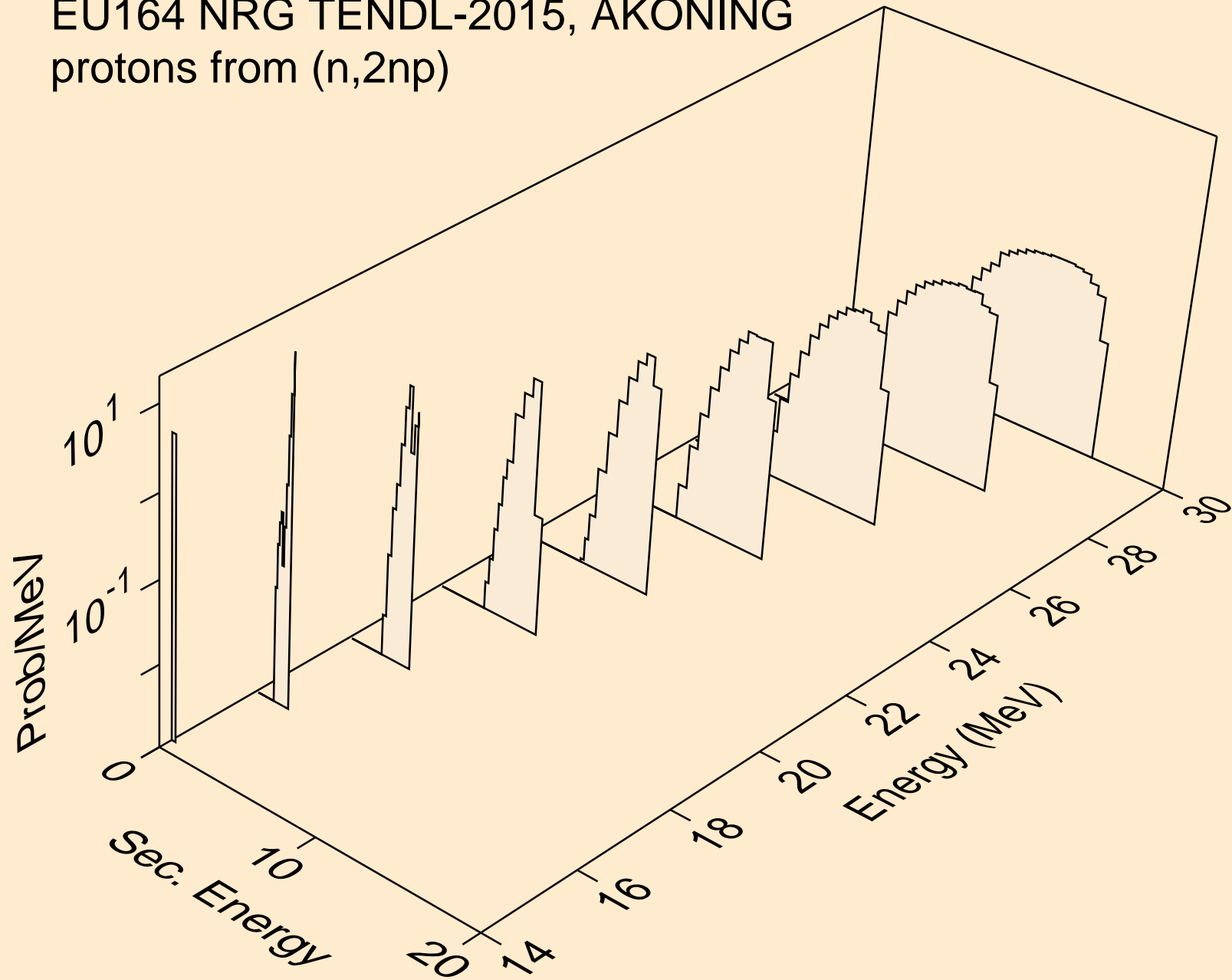

EU164 NRG TENDL-2015, AKONING
protons from (n,3np)

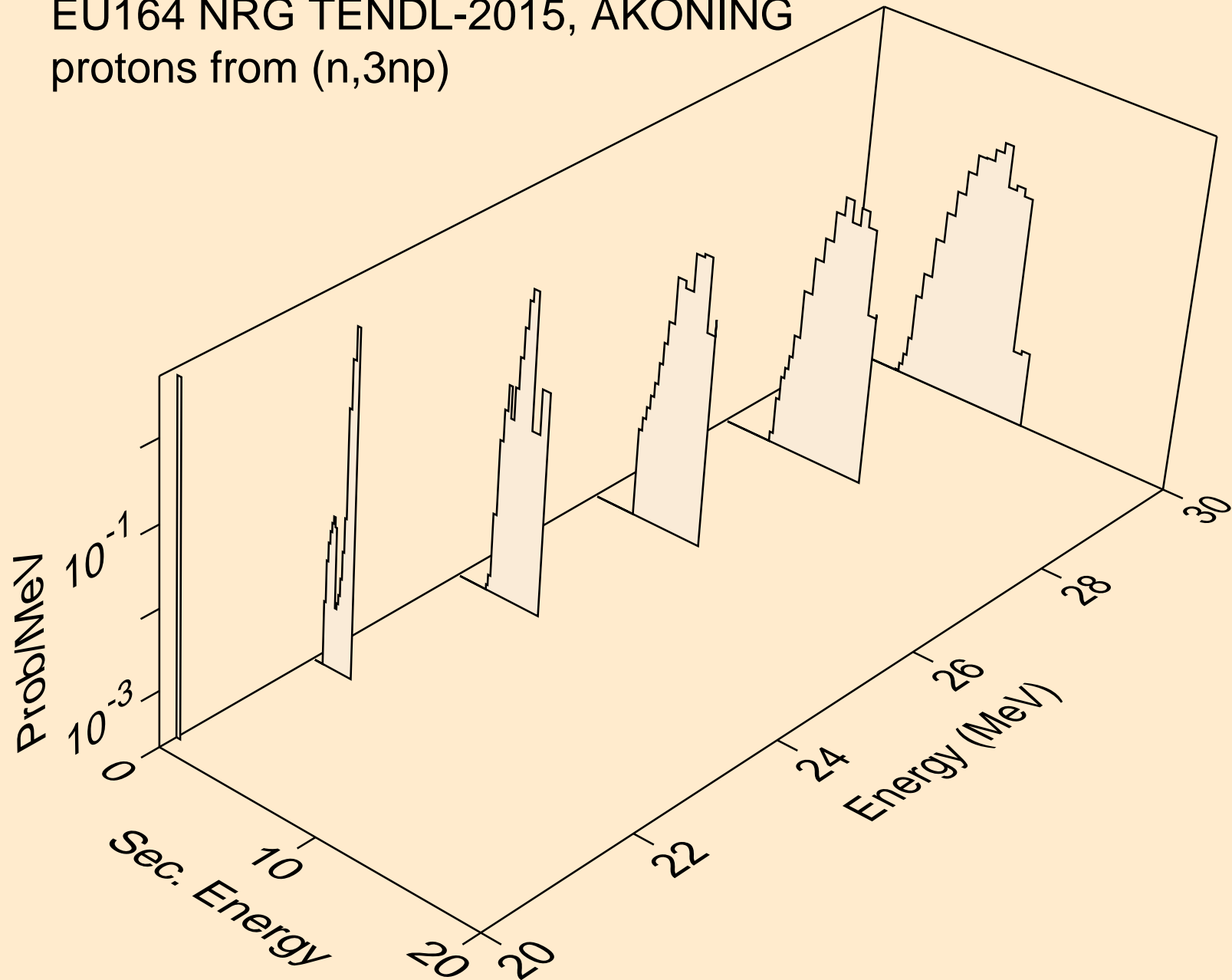

EU164 NRG TENDL-2015, AKONING
protons from (n,p)

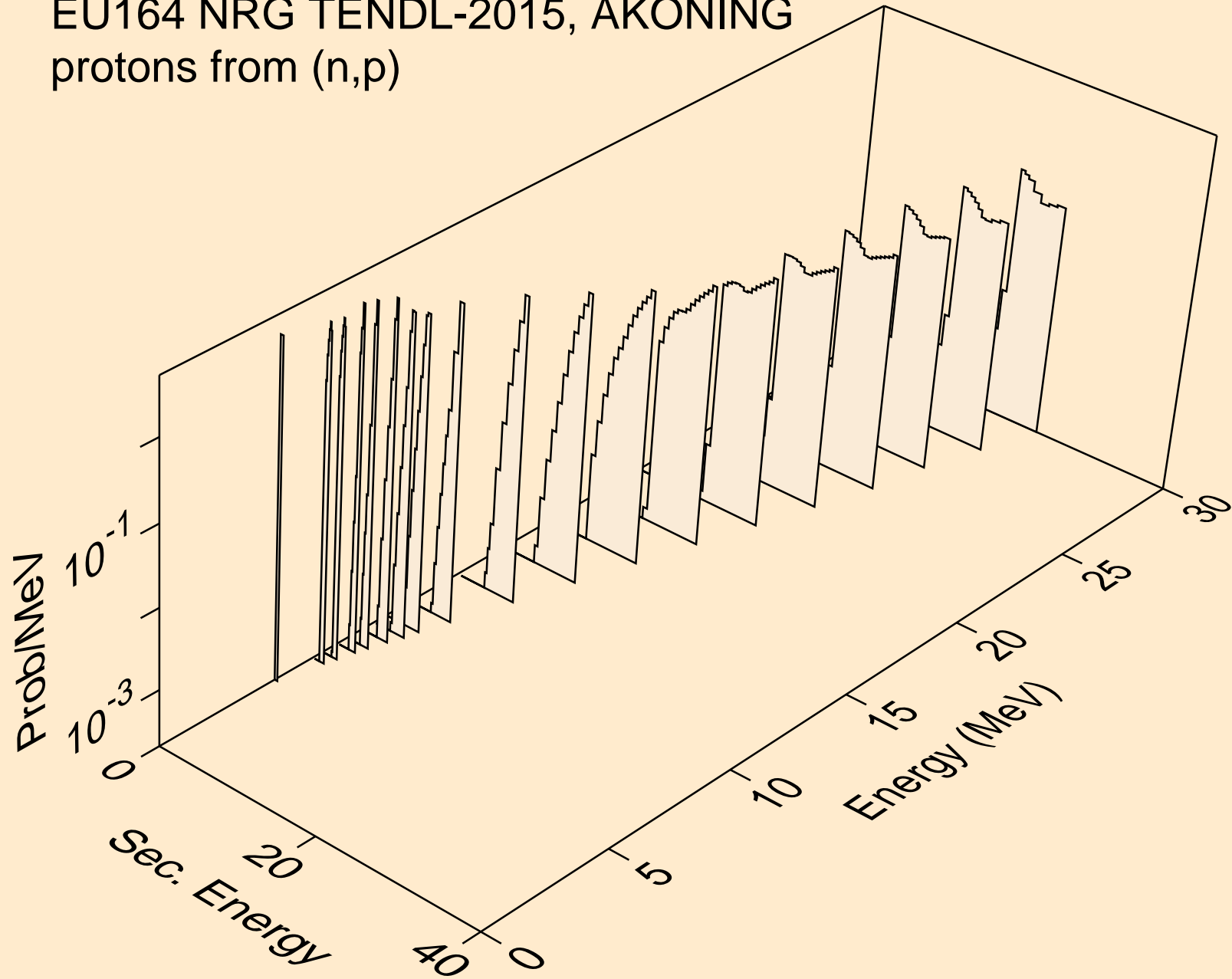

EU164 NRG TENDL-2015, AKONING
deuterons from (n,x)

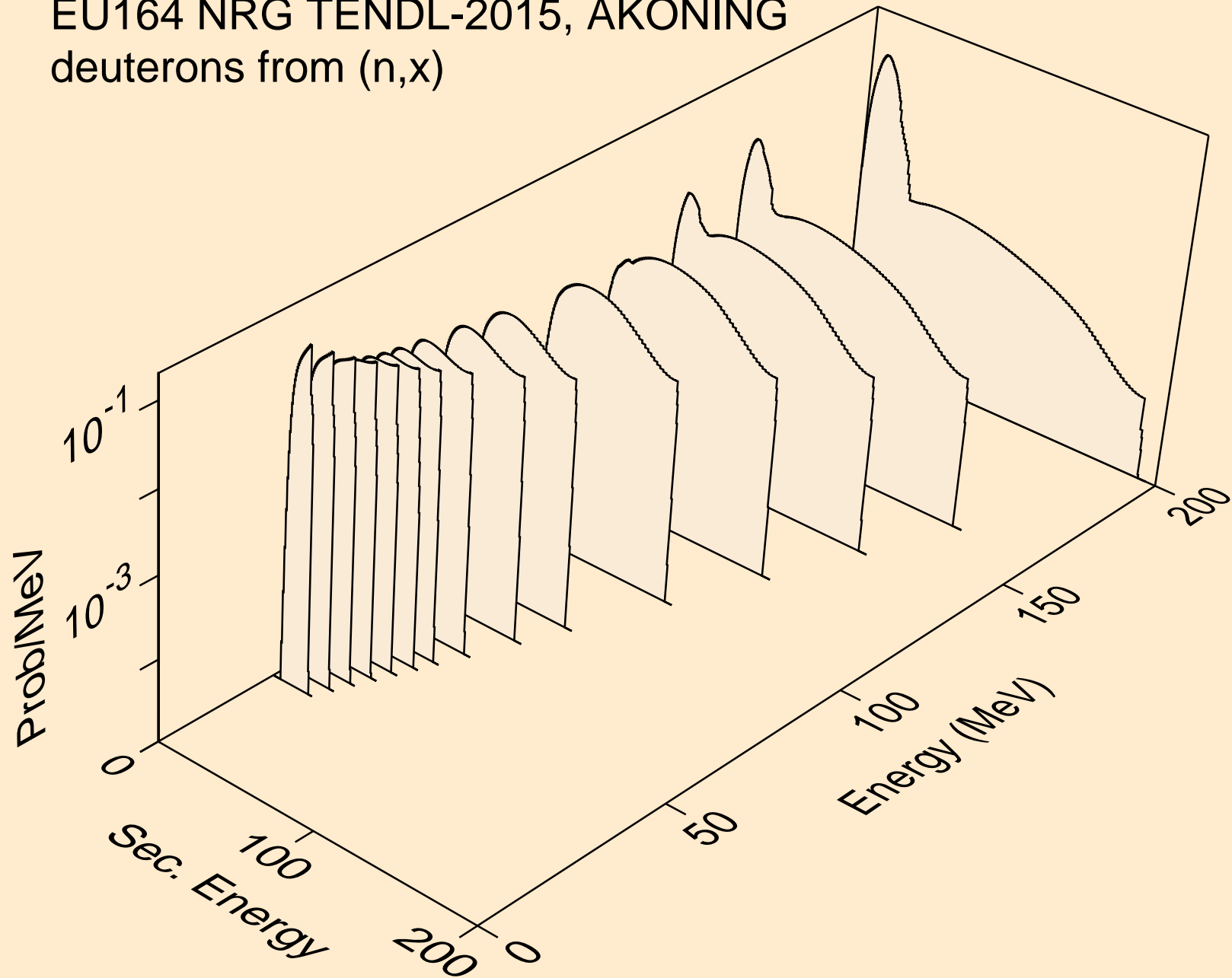

EU164 NRG TENDL-2015, AKONING
deuterons from (n,2nd)

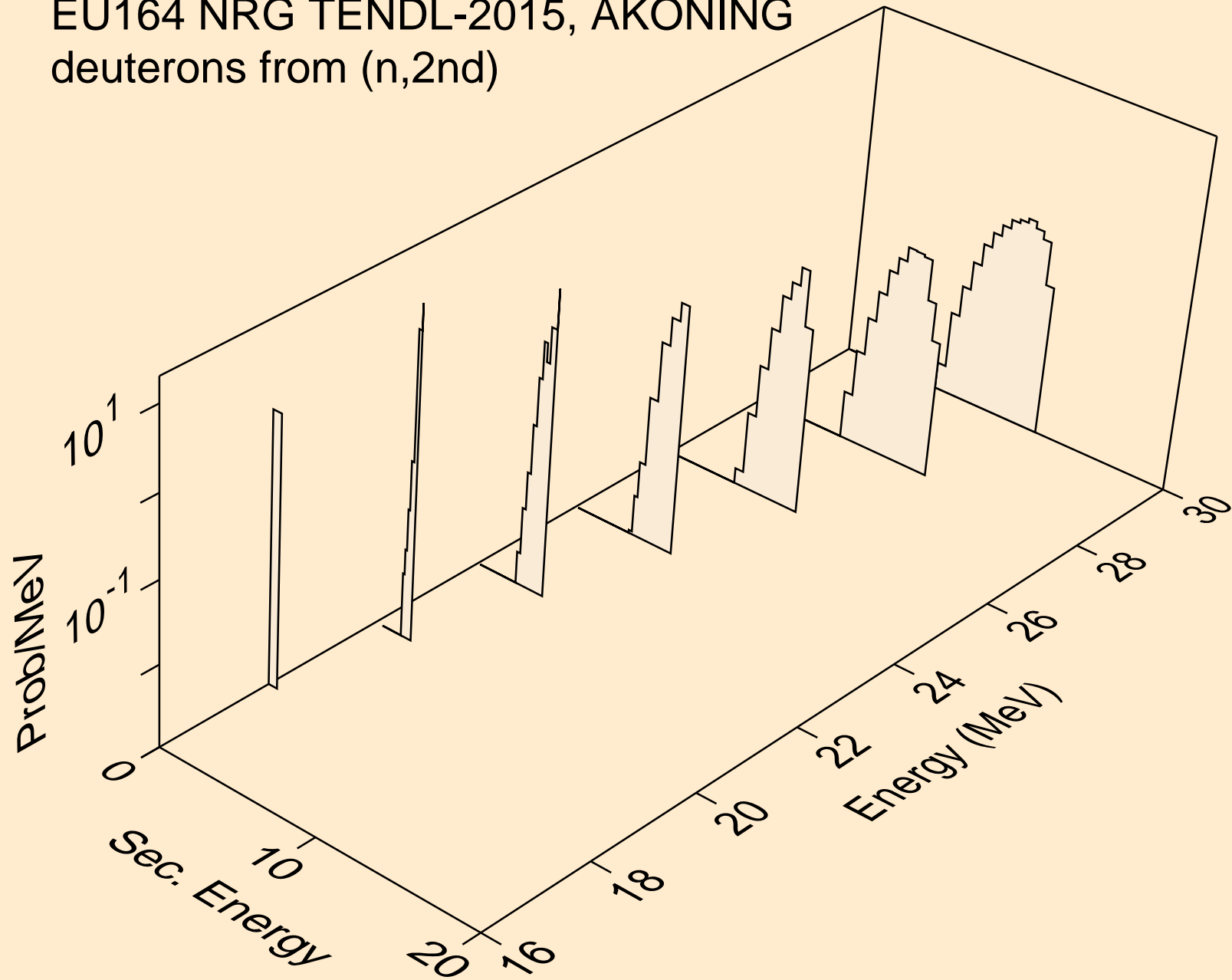

EU164 NRG TENDL-2015, AKONING
deuterons from (n,n*)d

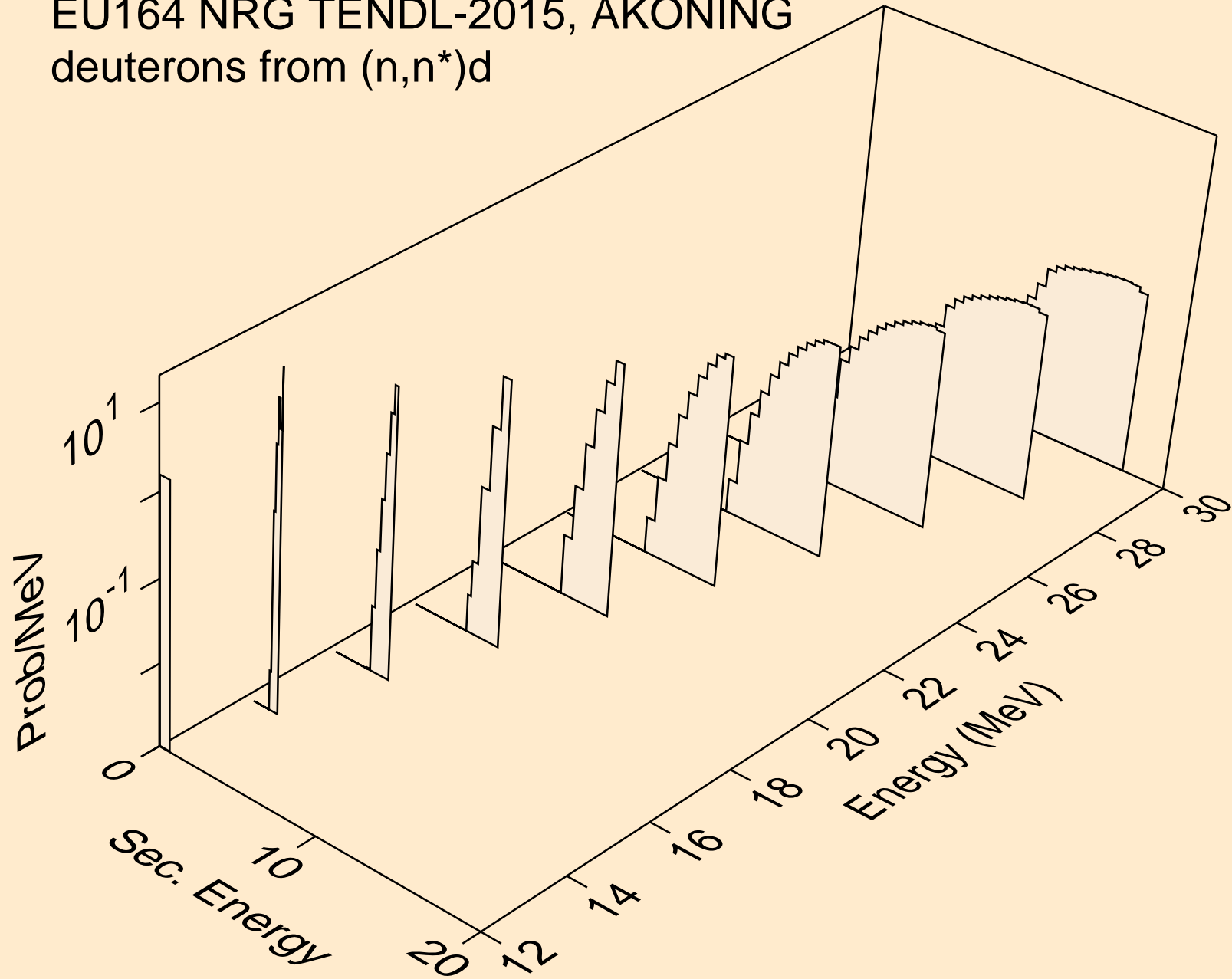

EU164 NRG TENDL-2015, AKONING
deuterons from (n,d)

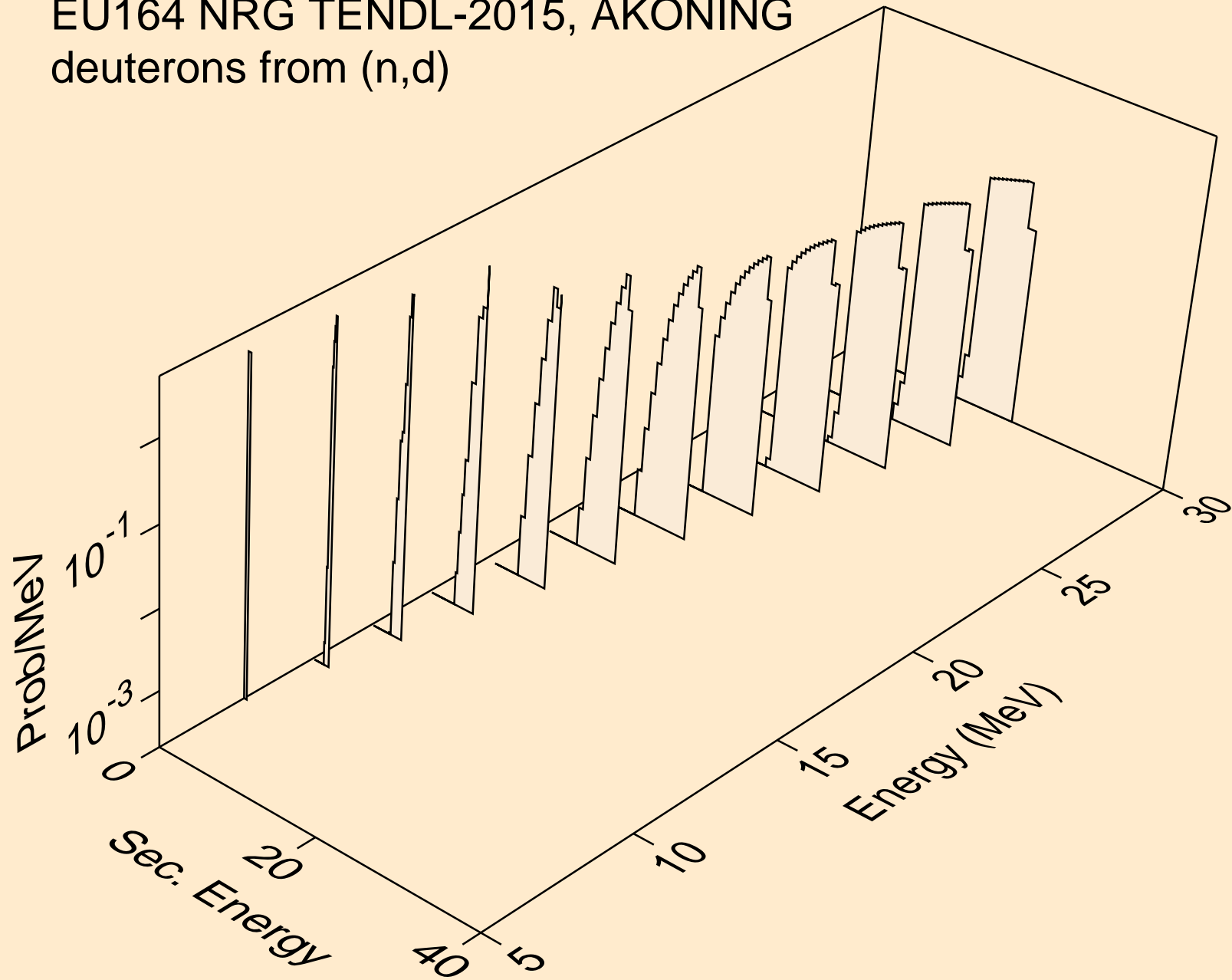

EU164 NRG TENDL-2015, AKONING
tritons from (n,x)

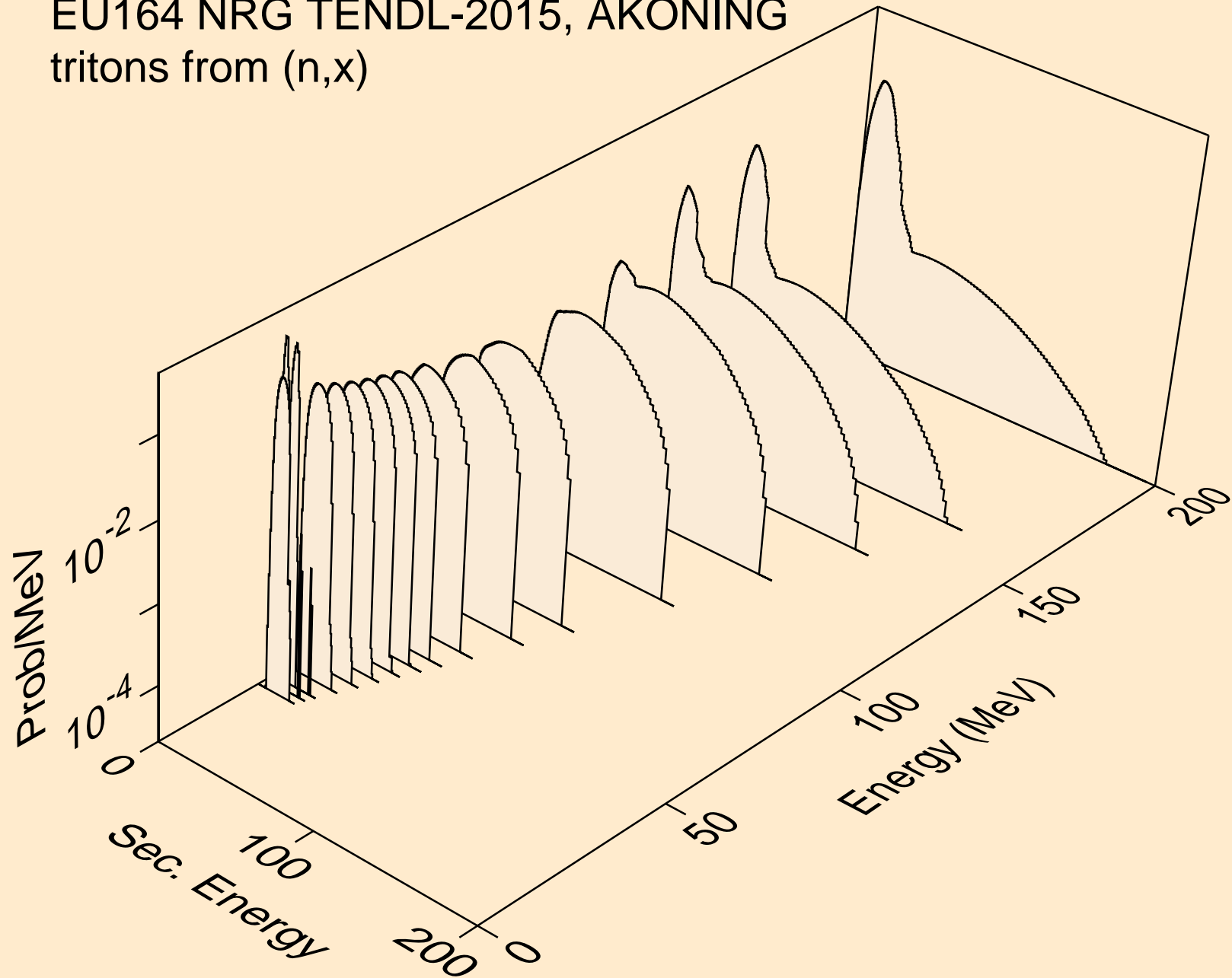

EU164 NRG TENDL-2015, AKONING
tritons from (n,n*)t

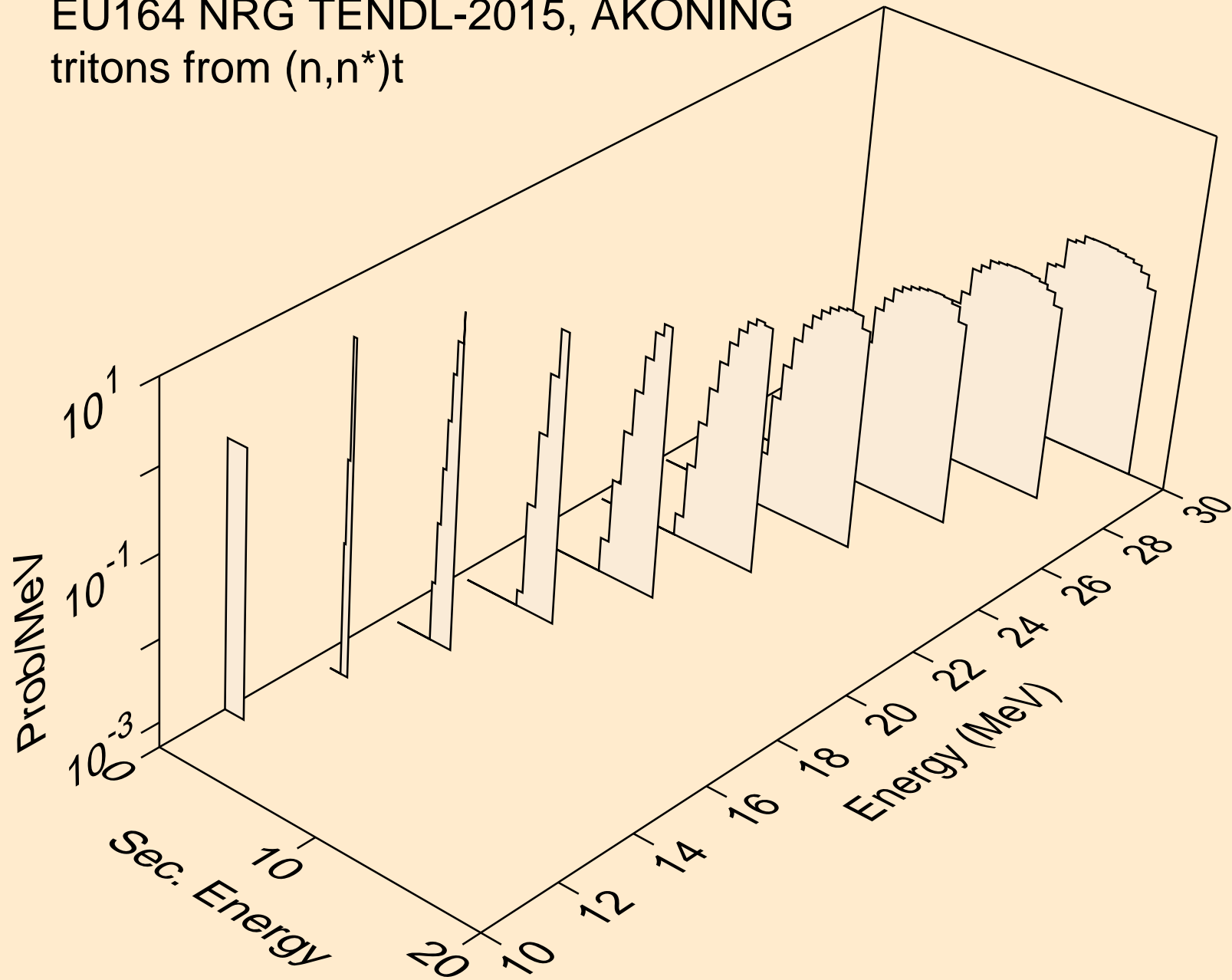

EU164 NRG TENDL-2015, AKONING
tritons from (n,t)

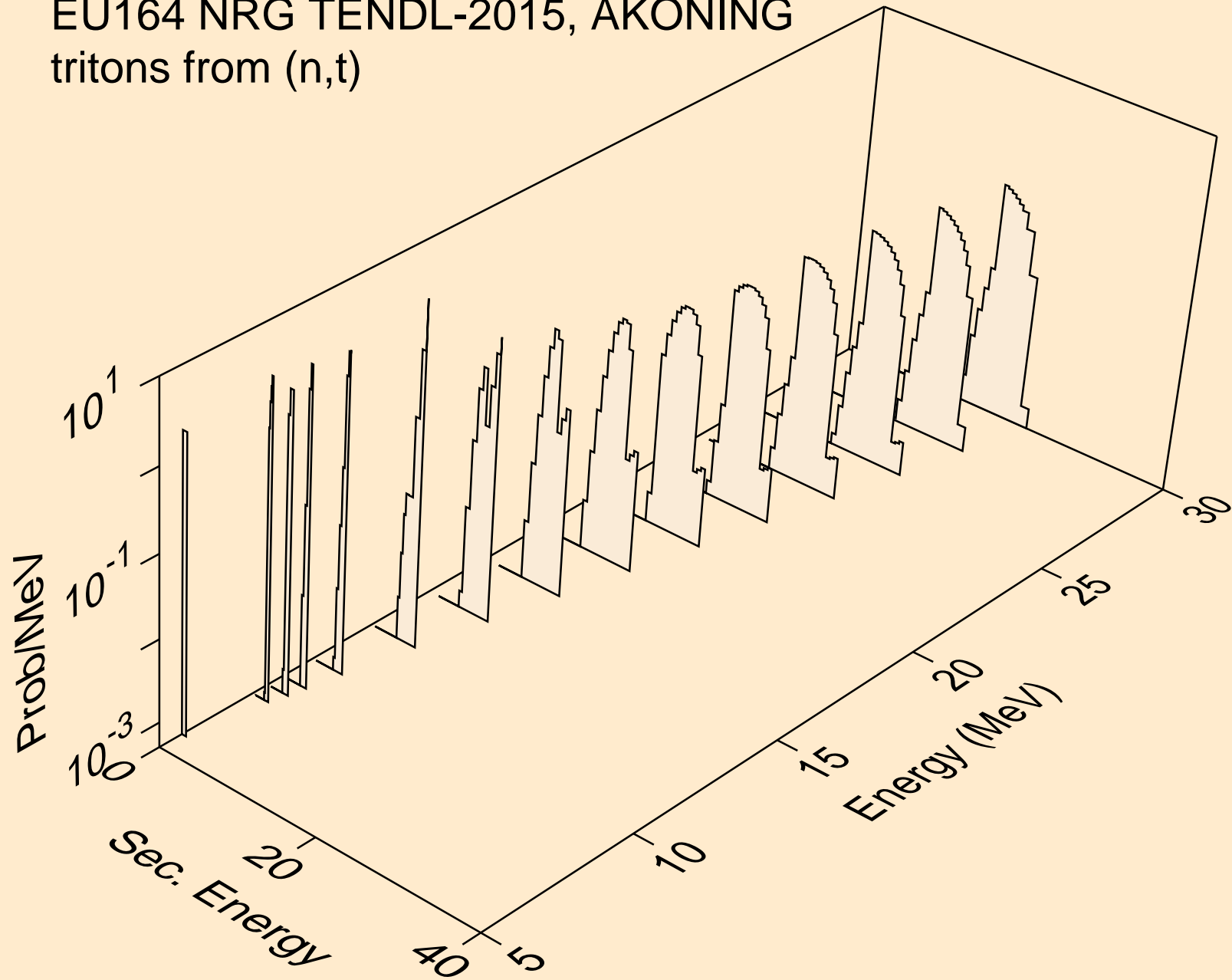

EU164 NRG TENDL-2015, AKONING
he3s from (n,x)

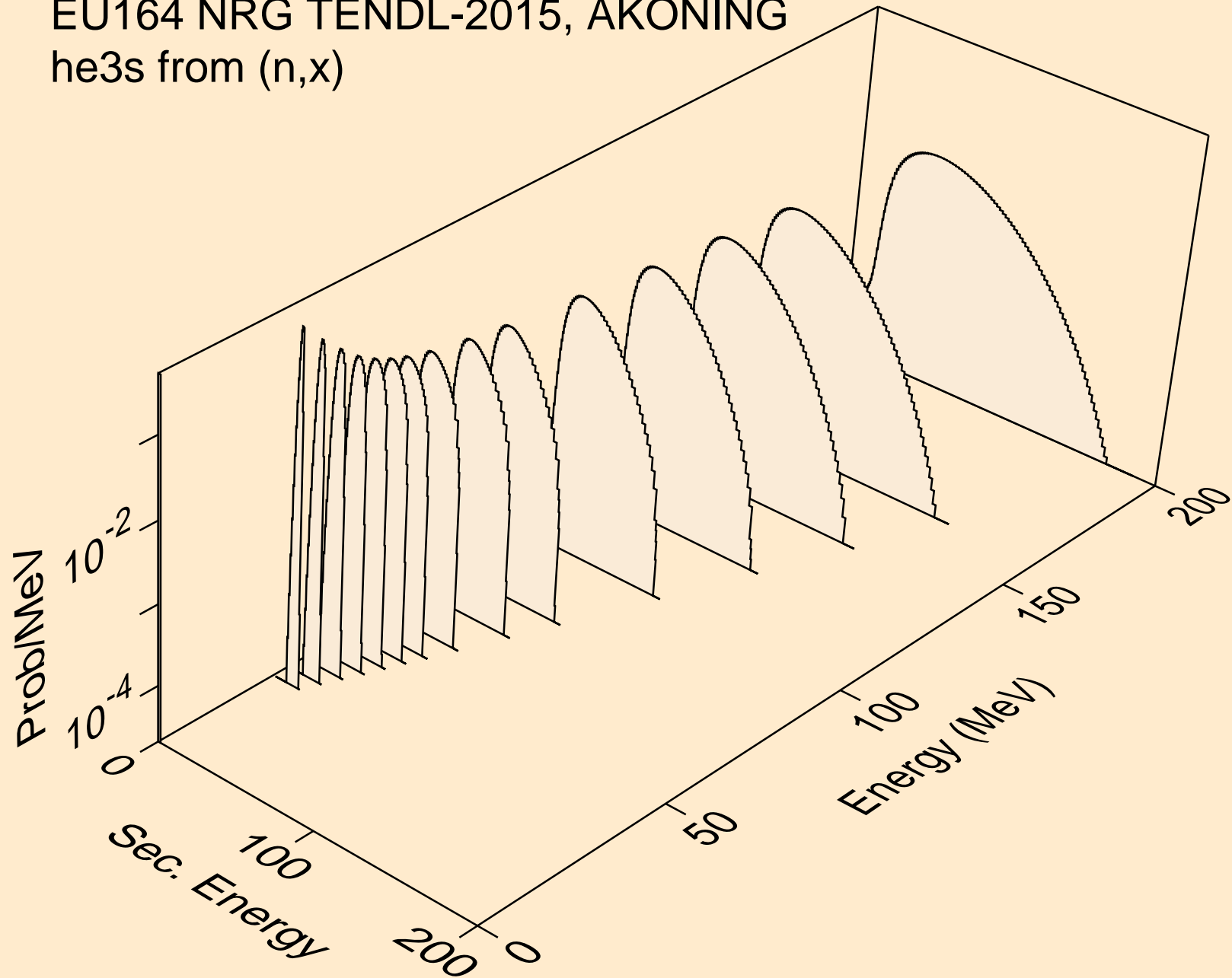

EU164 NRG TENDL-2015, AKONING
he3s from (n,n*)he3

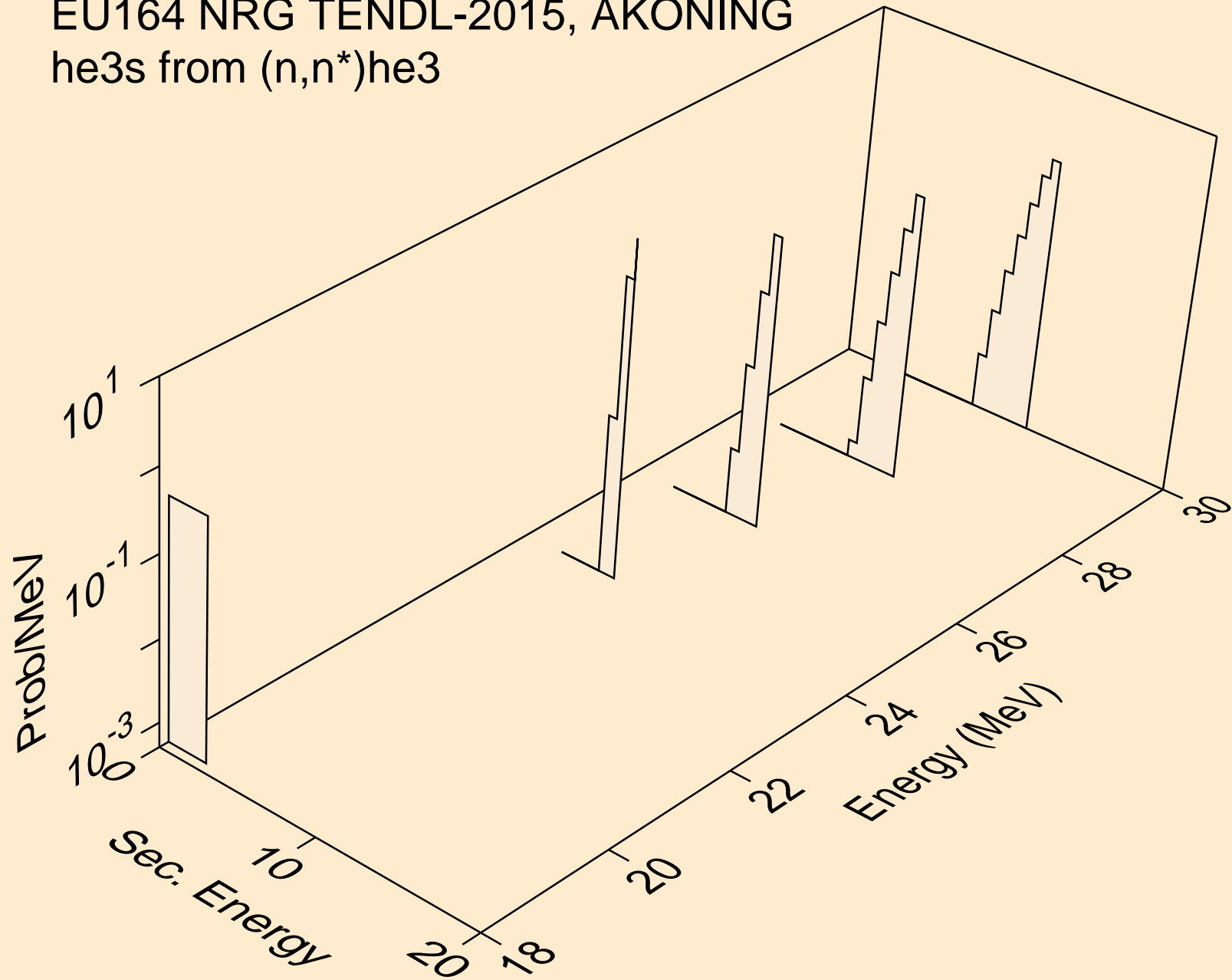

EU164 NRG TENDL-2015, AKONING
he3s from (n,he3)

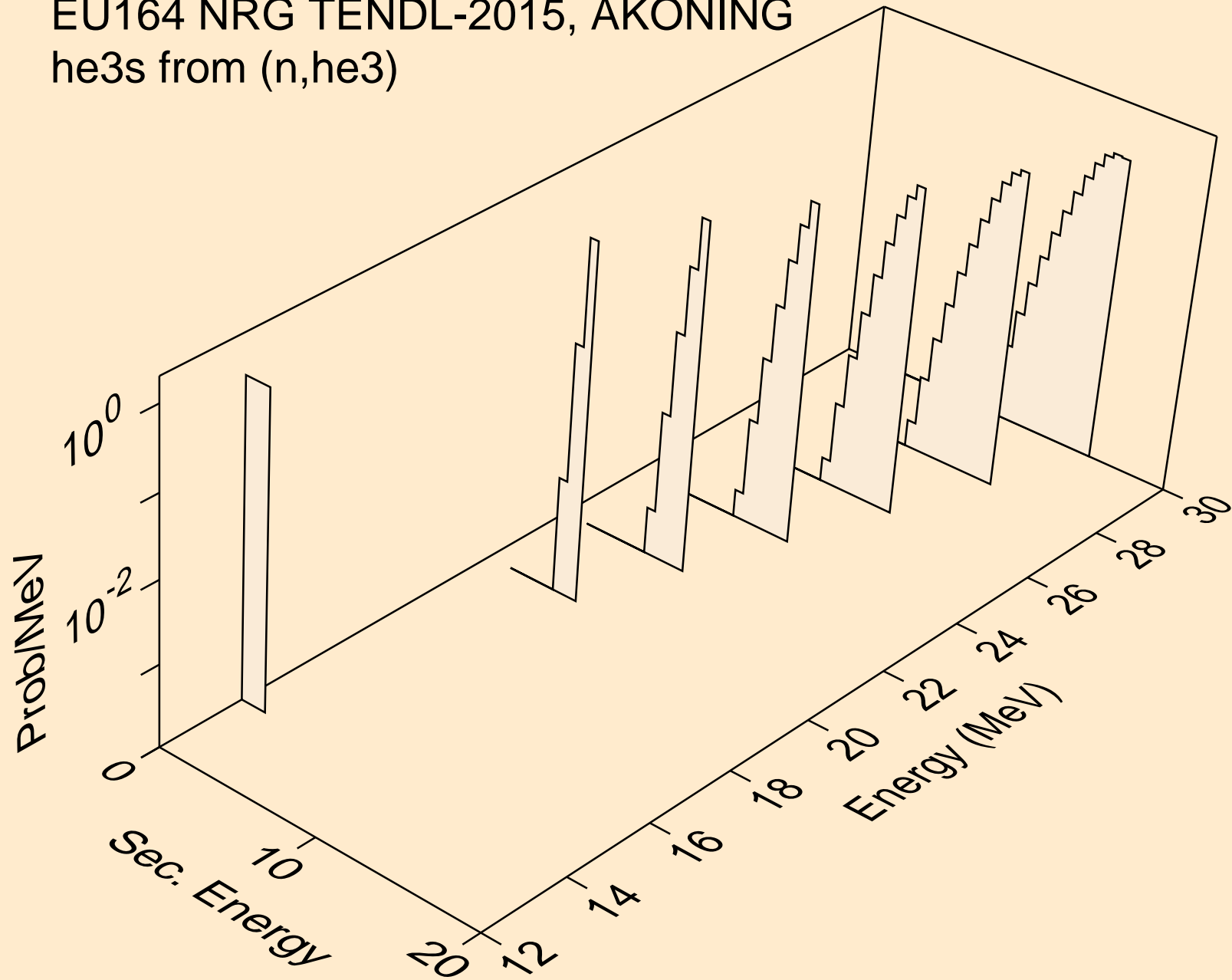

EU164 NRG TENDL-2015, AKONING
alphas from (n,x)

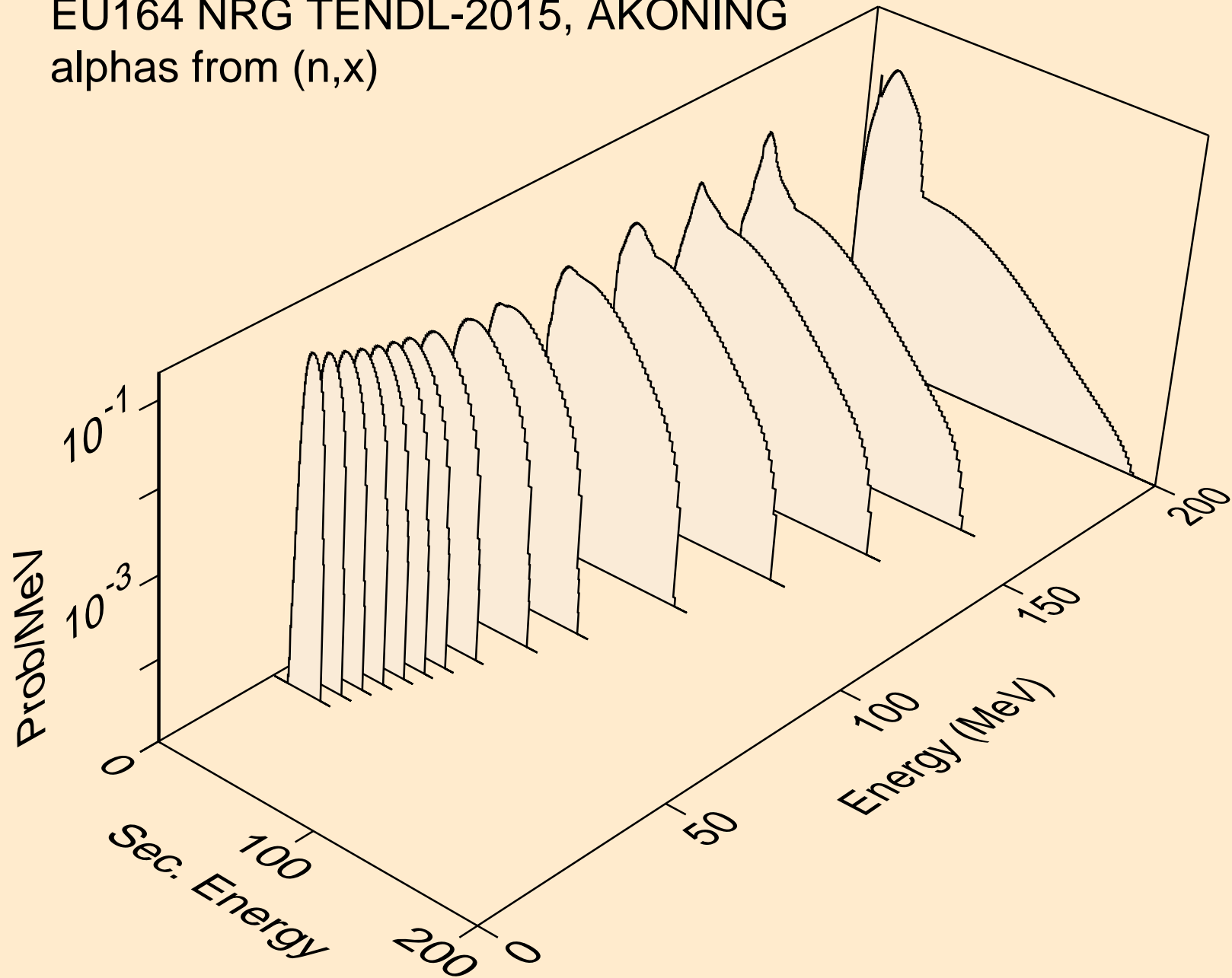

EU164 NRG TENDL-2015, AKONING
alphas from (n,n*)a

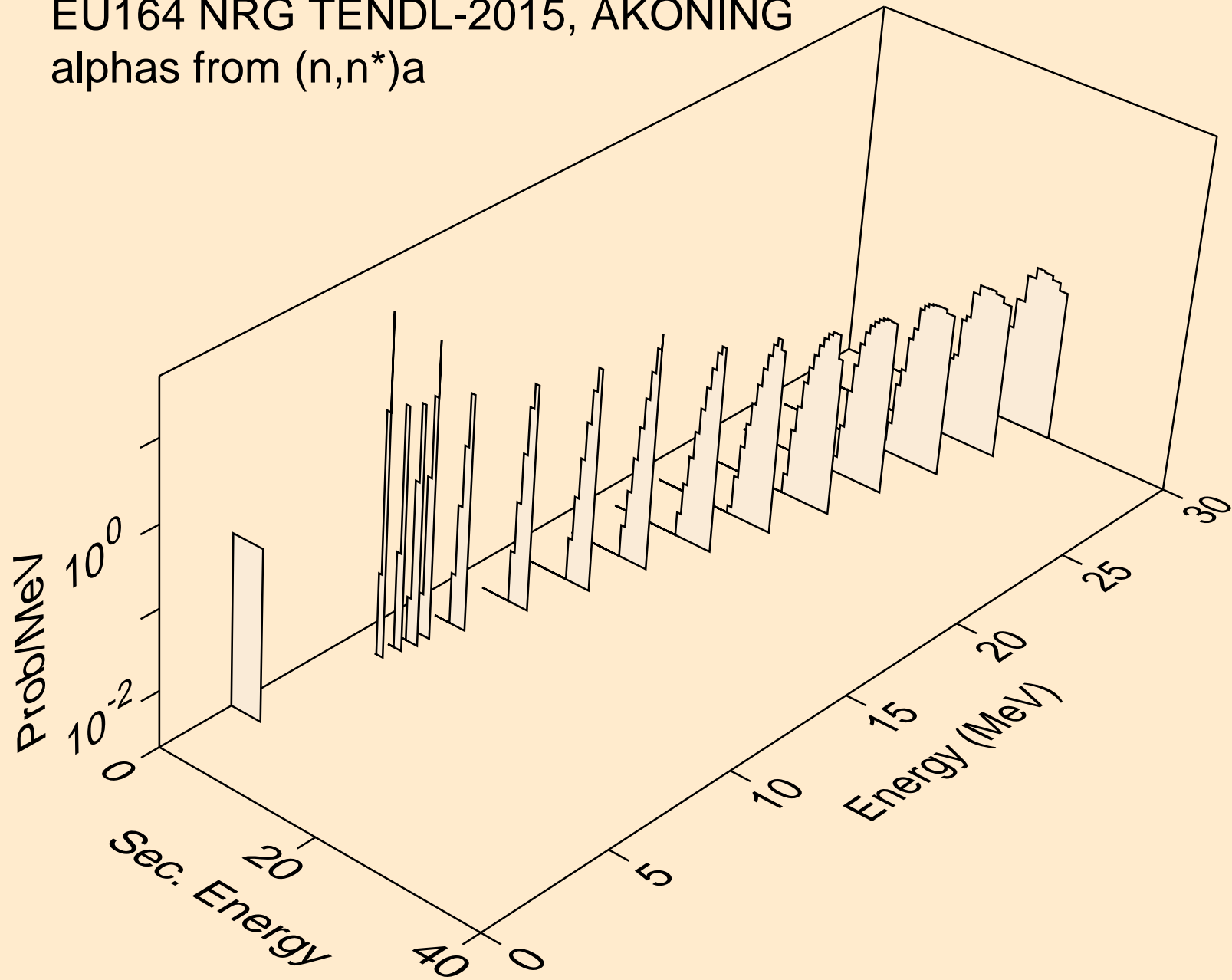

EU164 NRG TENDL-2015, AKONING
alphas from (n,2n)a

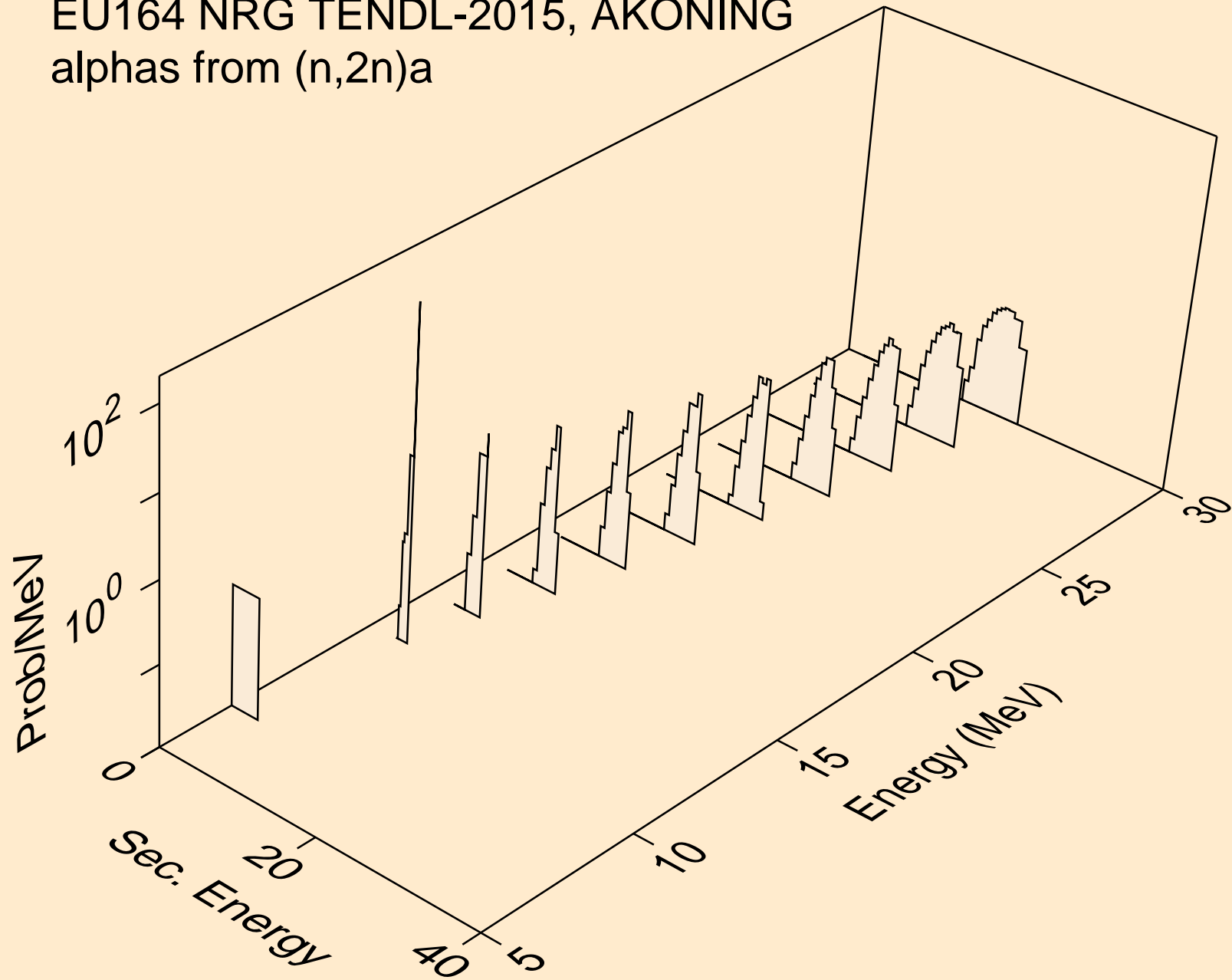

EU164 NRG TENDL-2015, AKONING
alphas from (n,3n)a

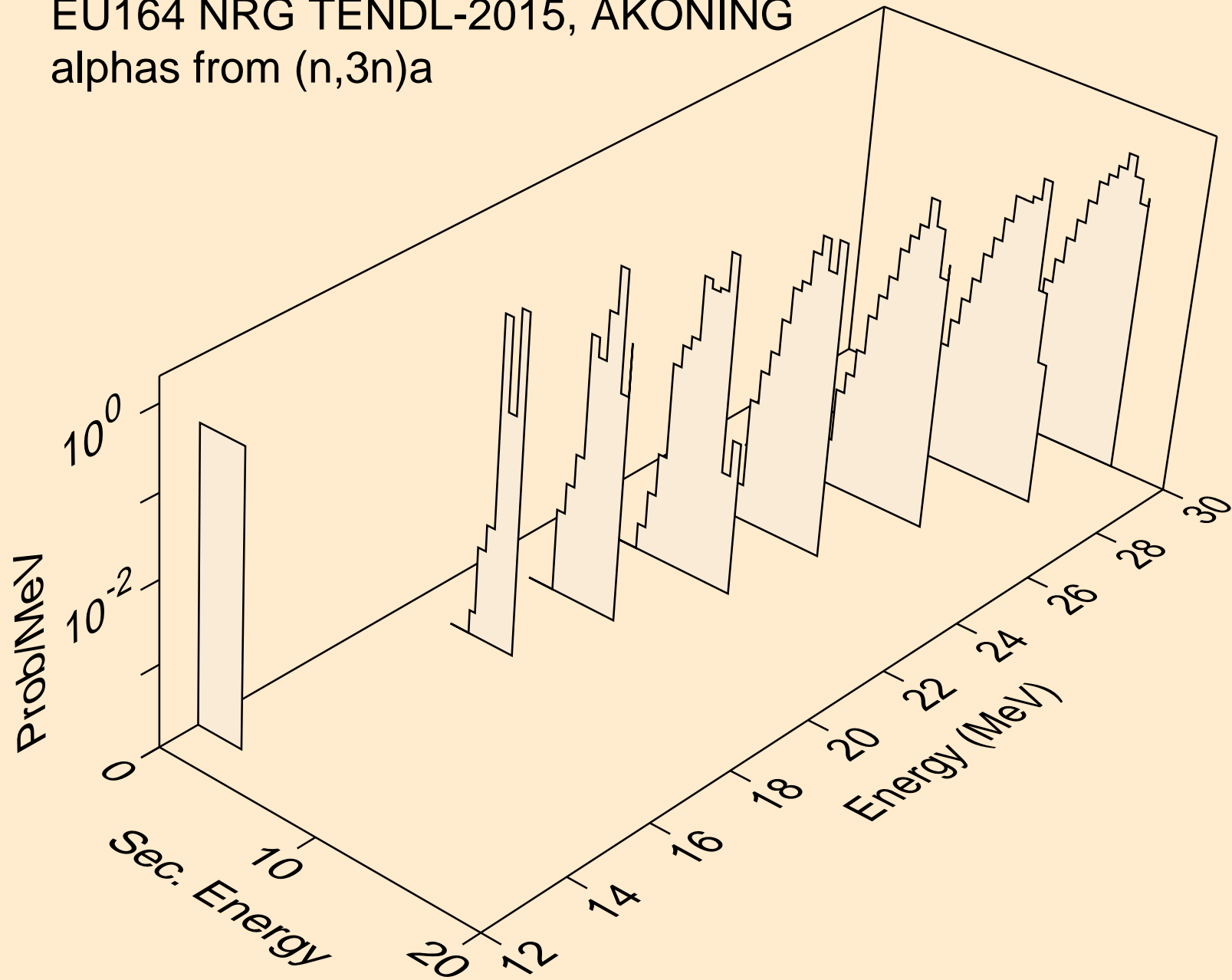

EU164 NRG TENDL-2015, AKONING
alphas from (n,a)

