

FL289 NRG TENDL-2015, AKONING

Principal cross sections

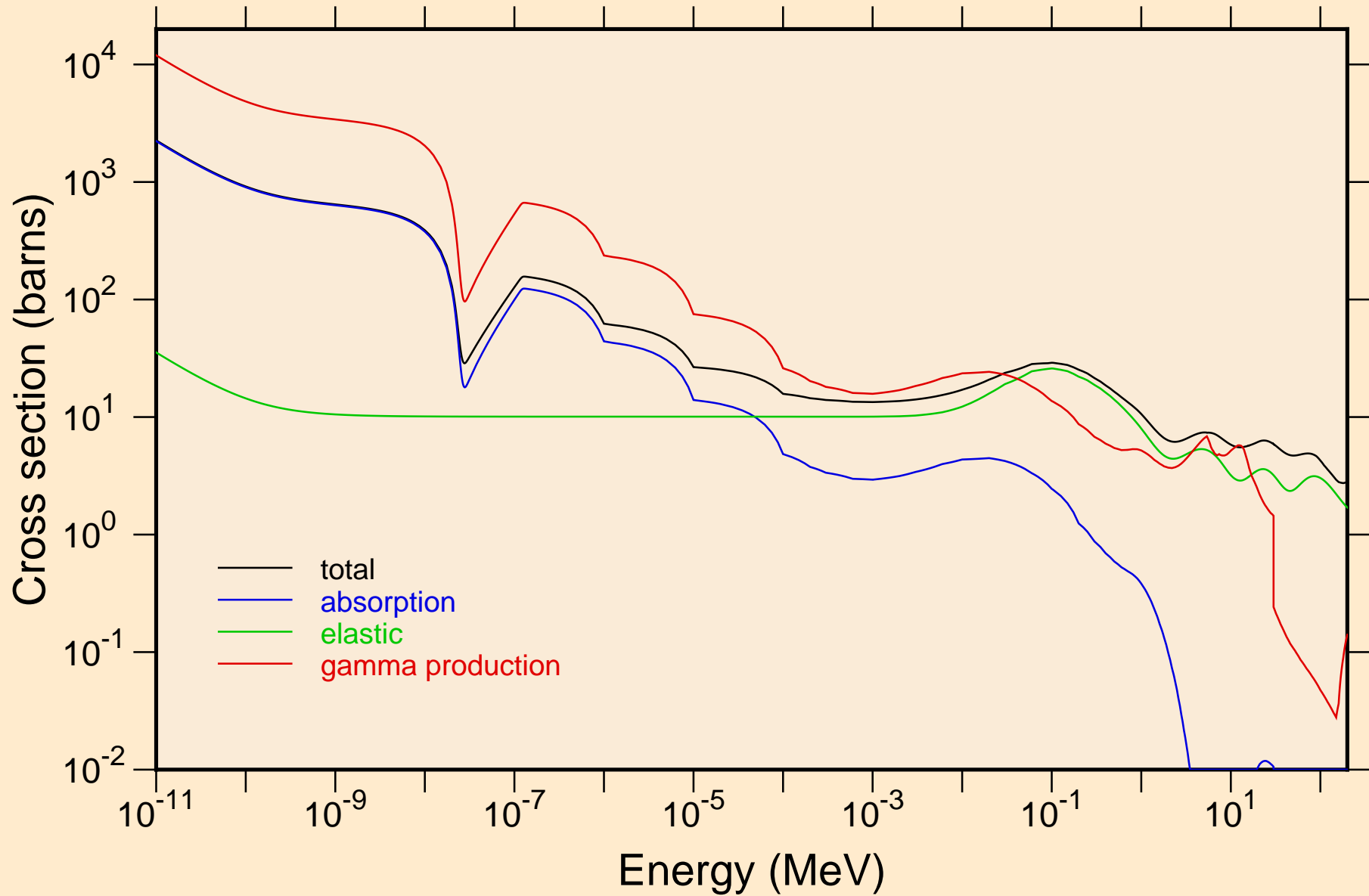

FL289 NRG TENDL-2015, AKONING

Non-threshold reactions

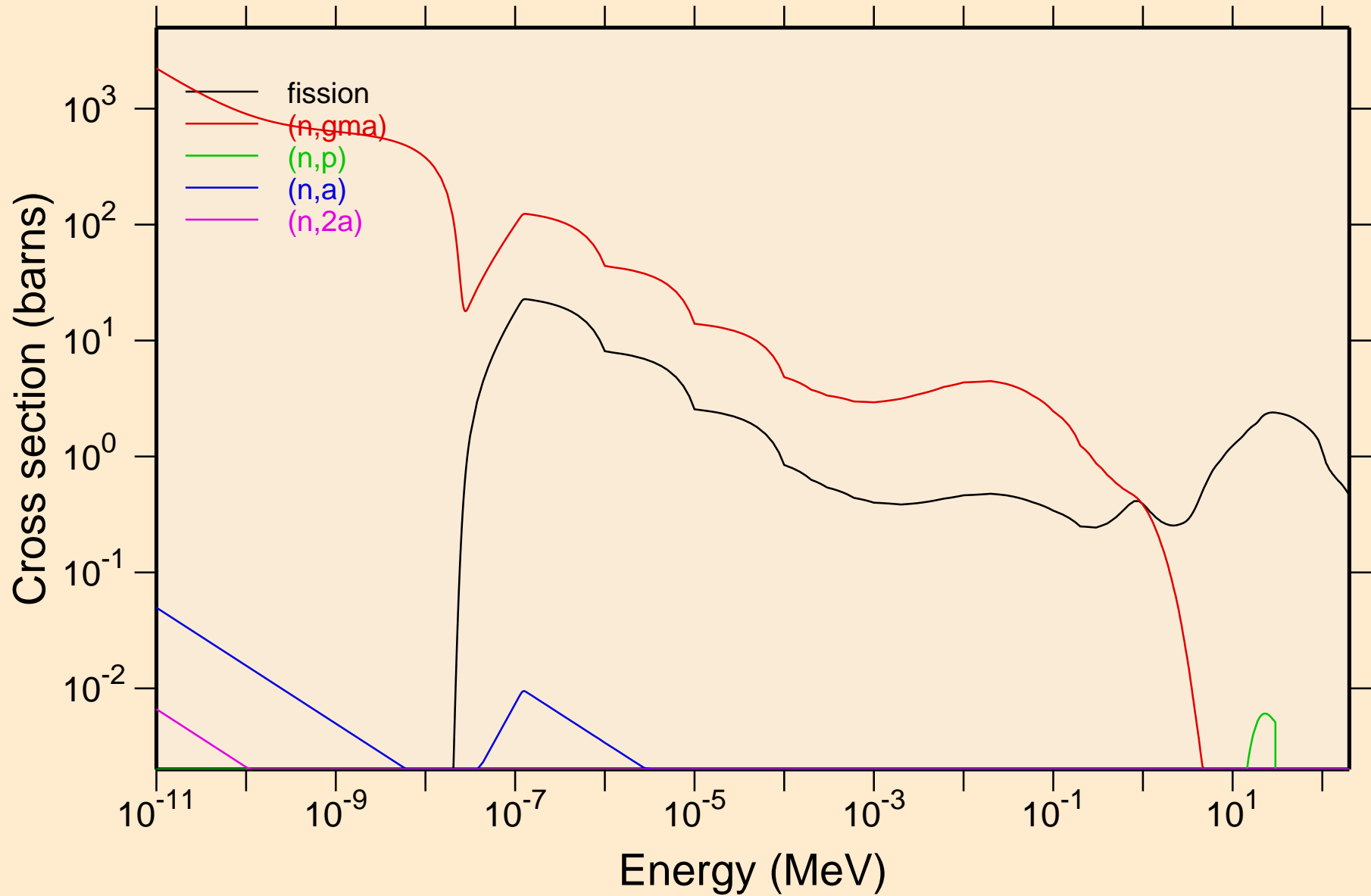

FL289 NRG TENDL-2015, AKONING
Non-threshold reactions

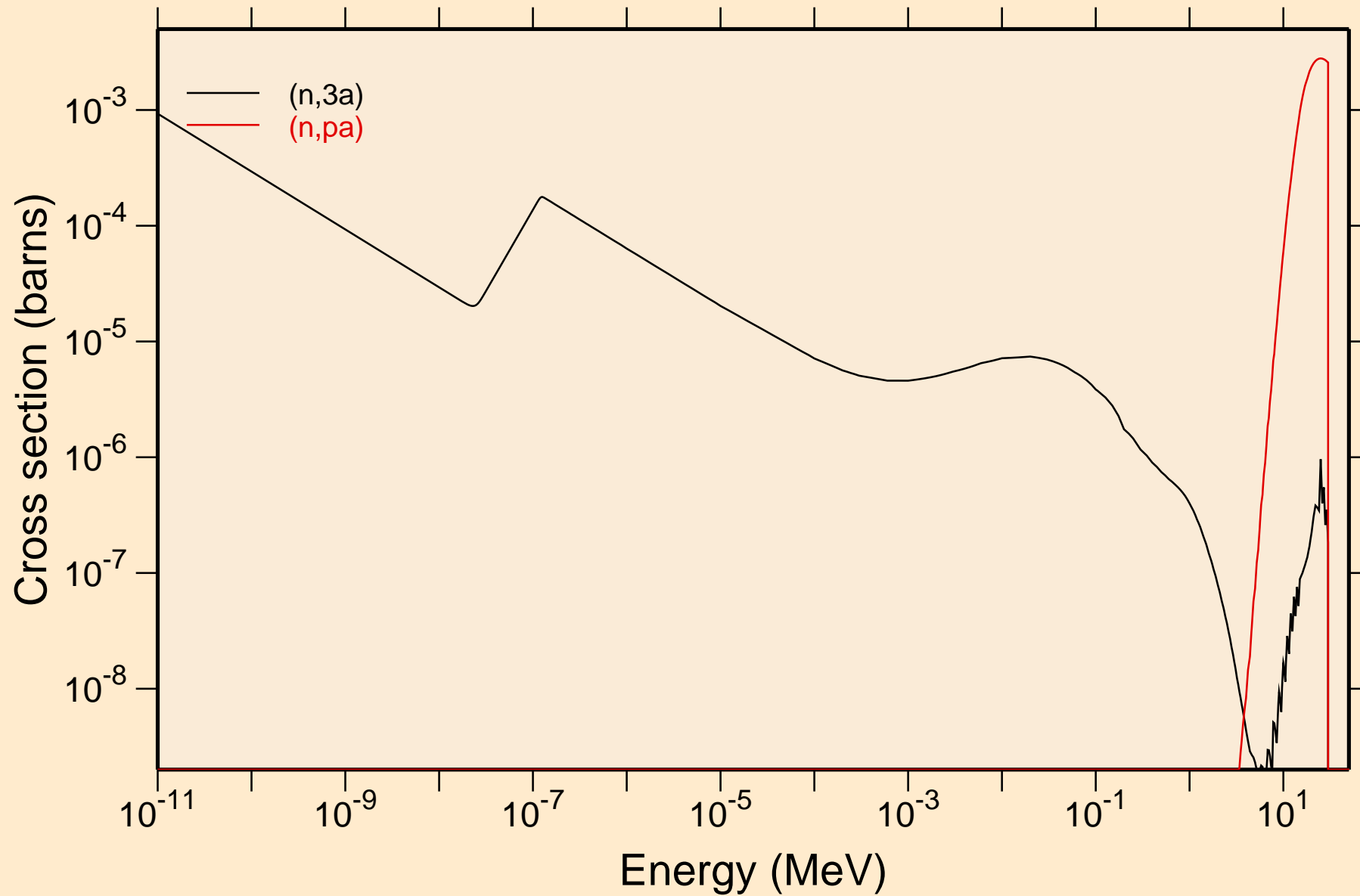

FL289 NRG TENDL-2015, AKONING

Principal cross sections

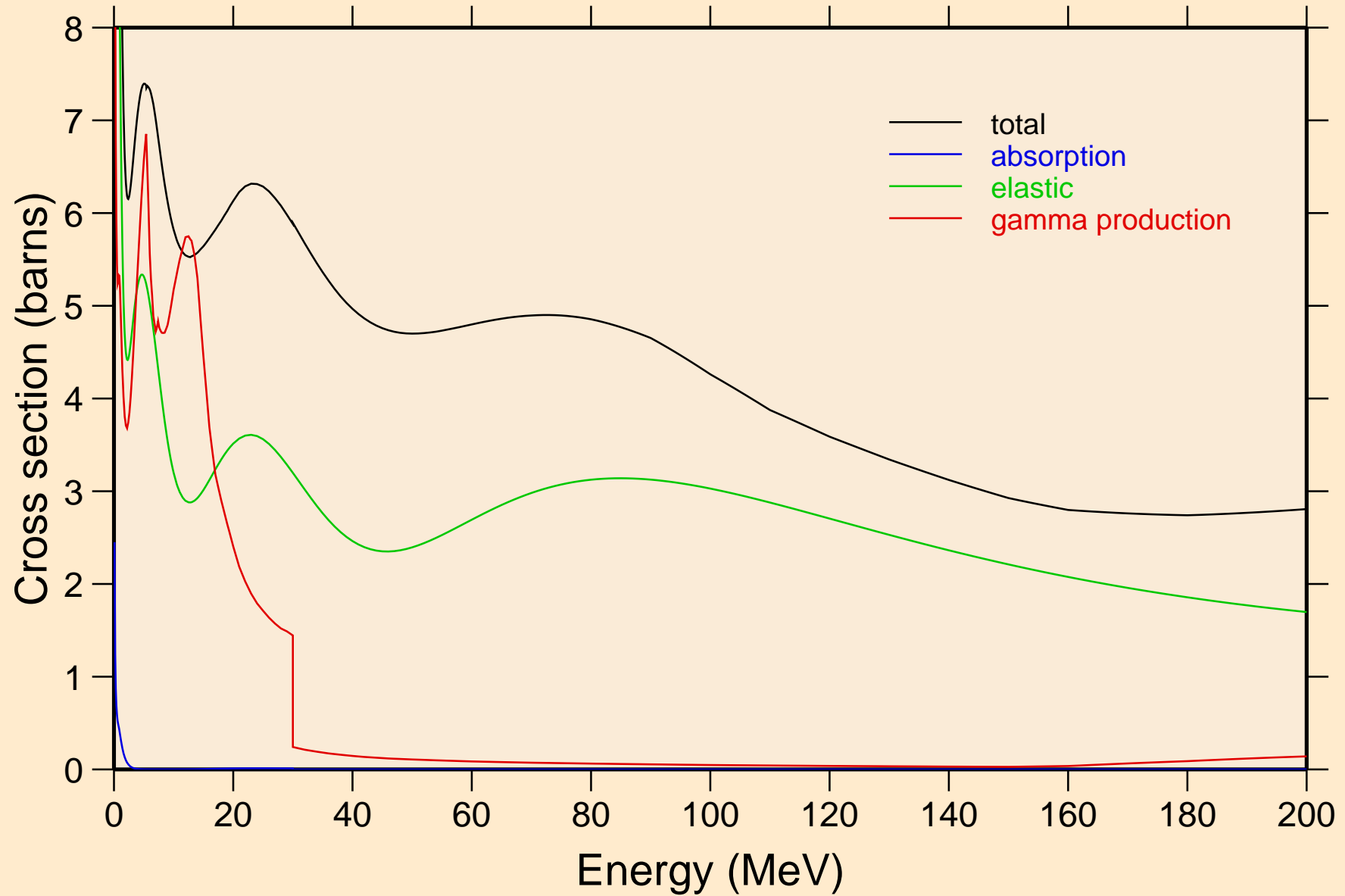

FL289 NRG TENDL-2015, AKONING

Non-threshold reactions

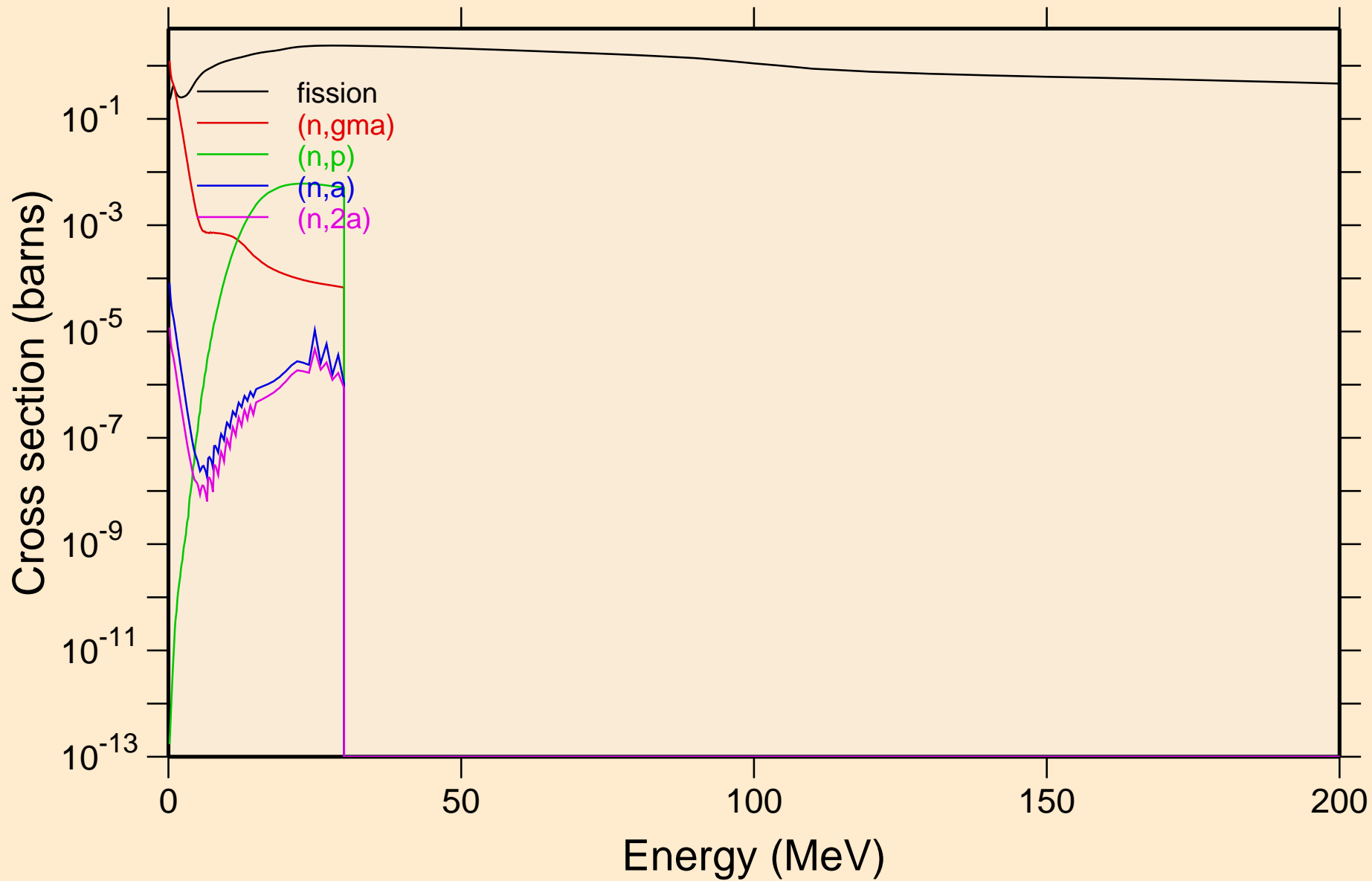

FL289 NRG TENDL-2015, AKONING

Non-threshold reactions

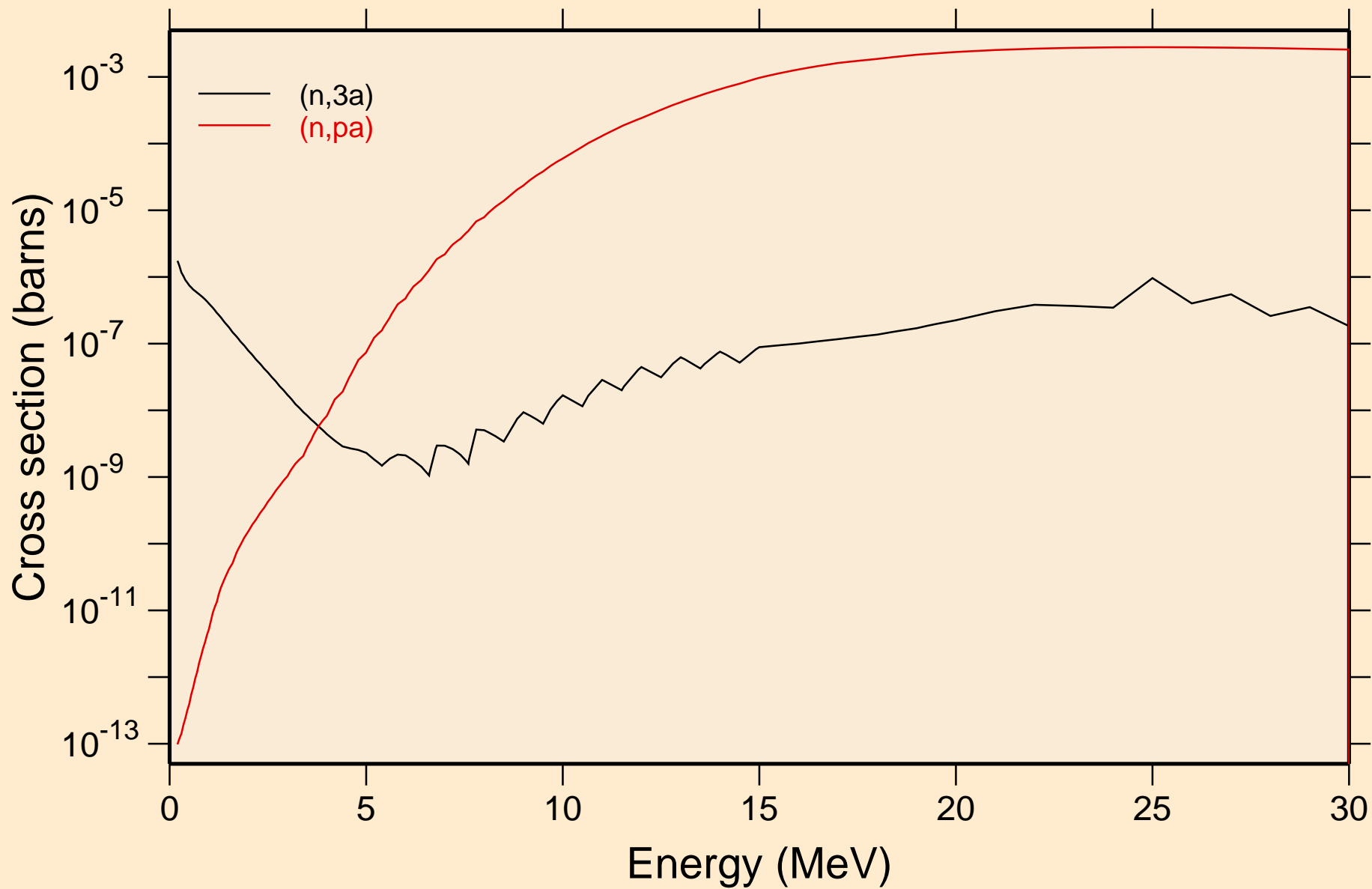

FL289 NRG TENDL-2015, AKONING
Inelastic levels

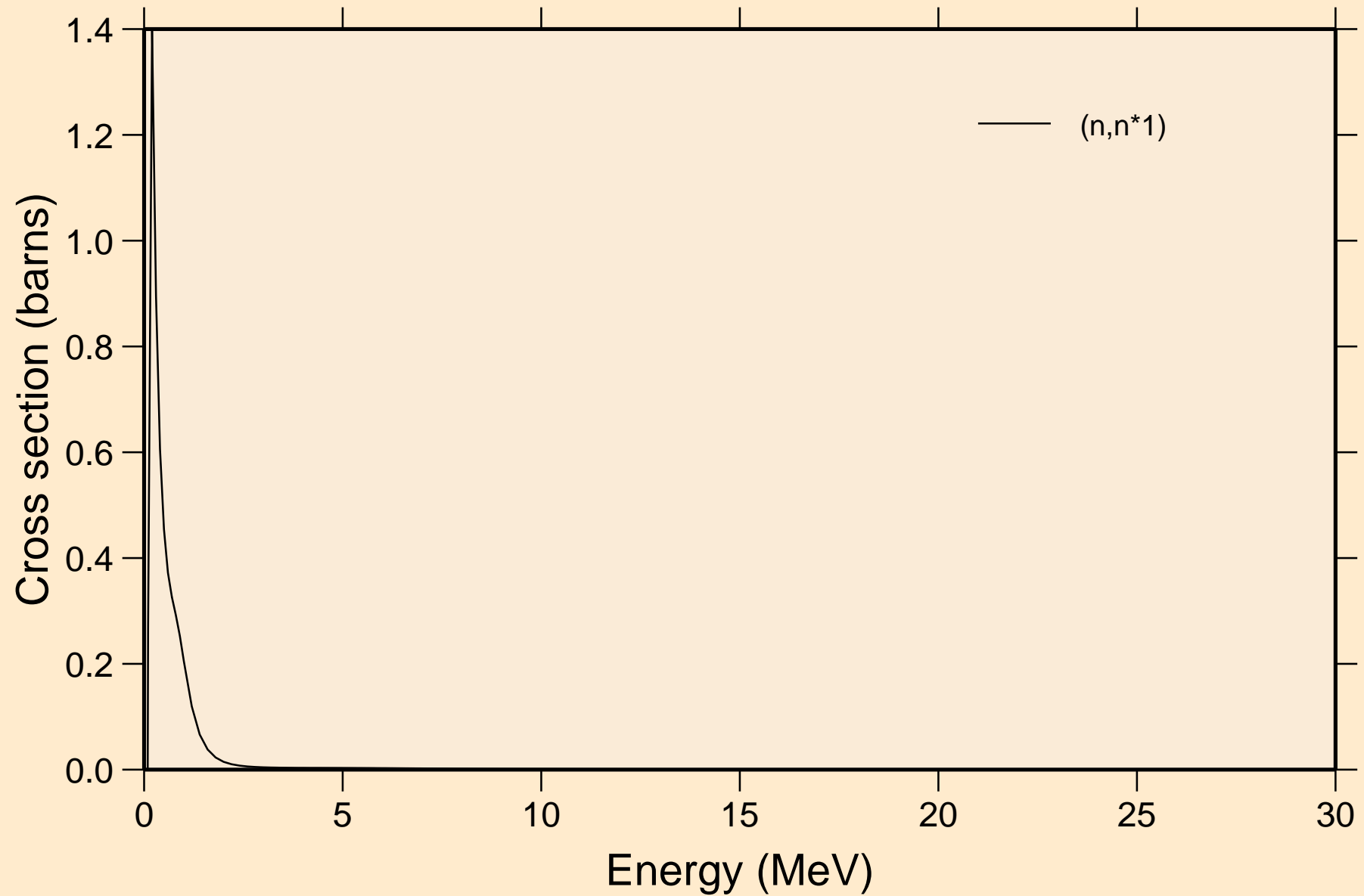

FL289 NRG TENDL-2015, AKONING

Threshold reactions

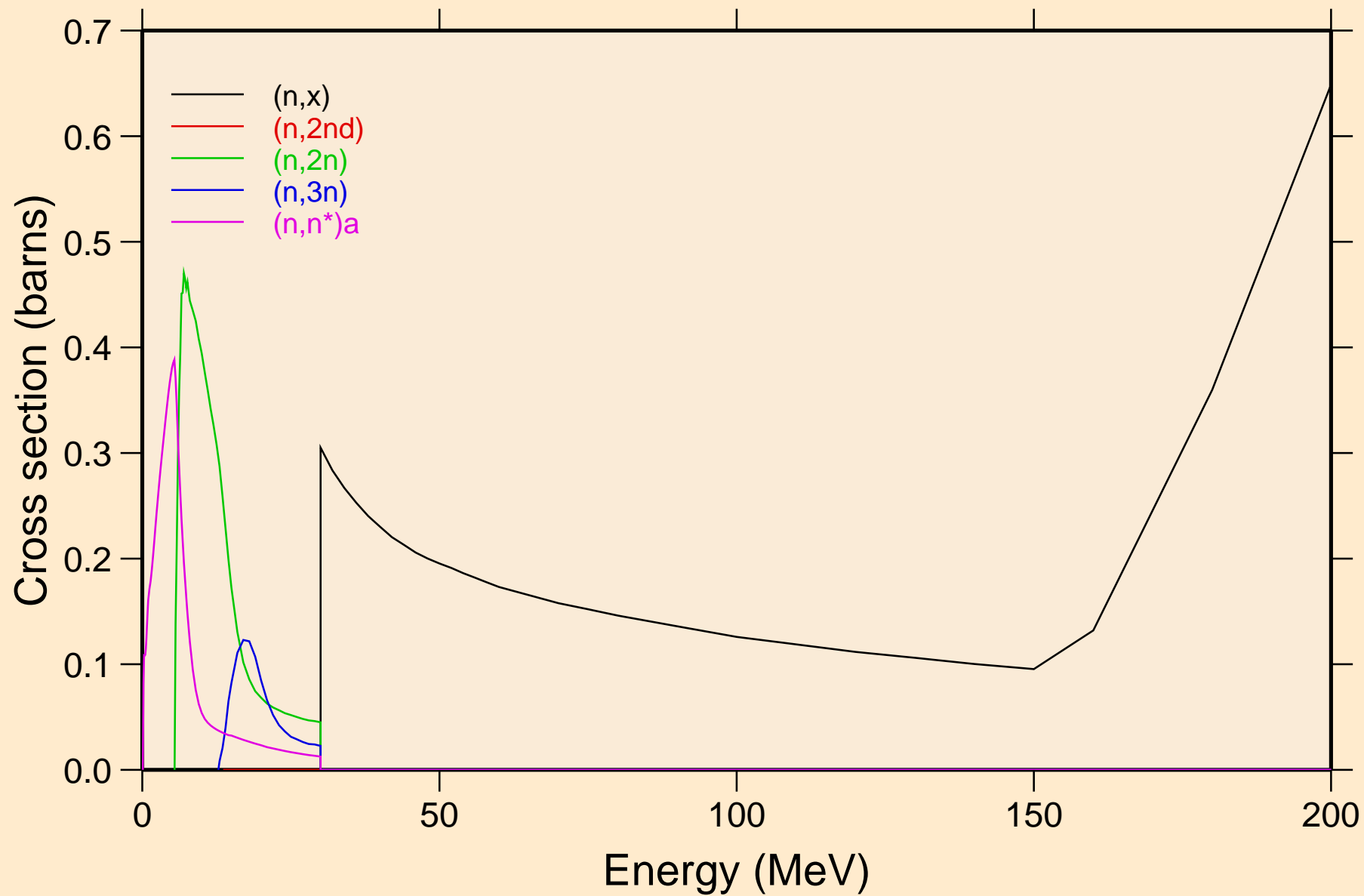

FL289 NRG TENDL-2015, AKONING

Threshold reactions

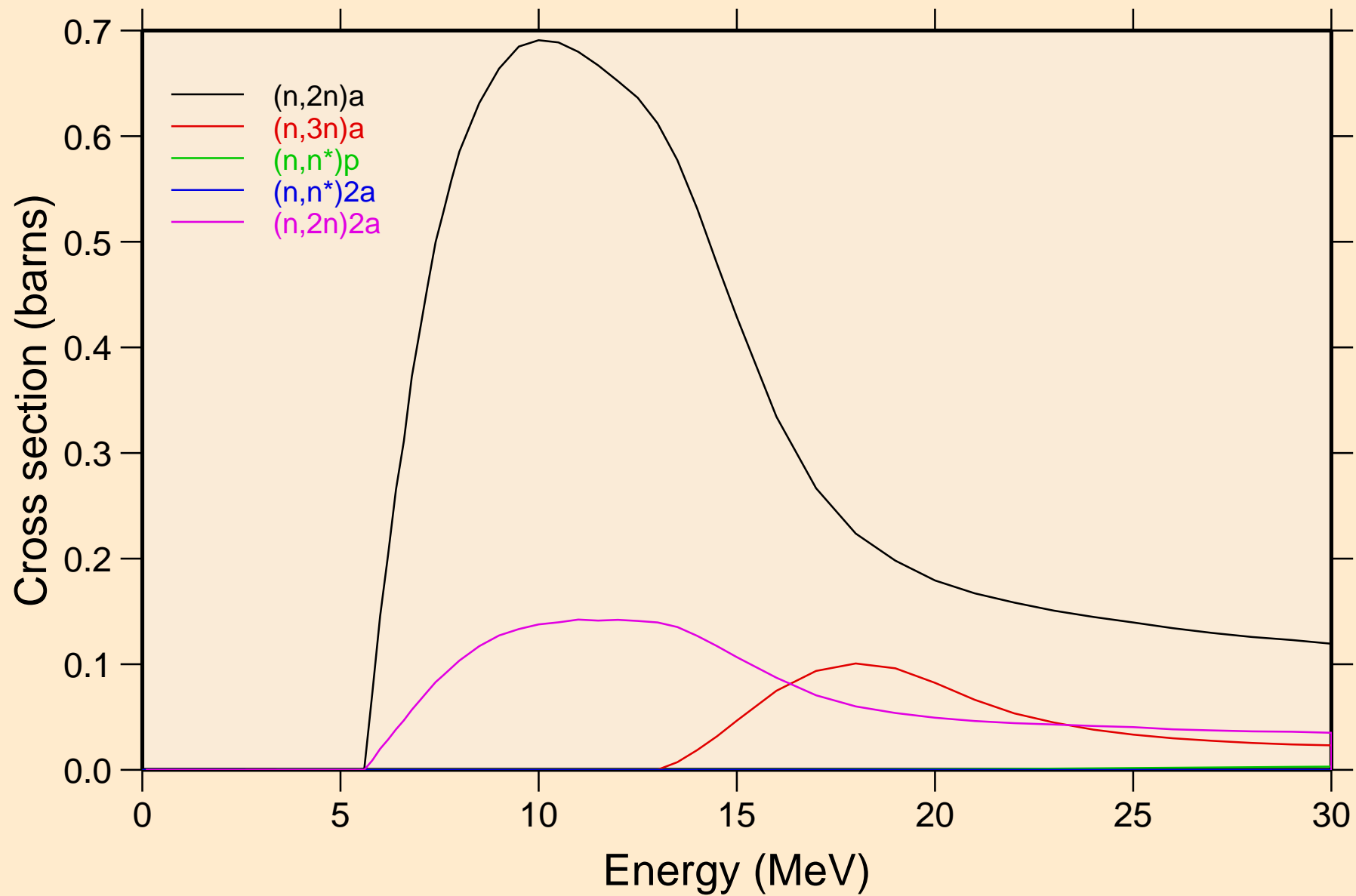

FL289 NRG TENDL-2015, AKONING

Threshold reactions

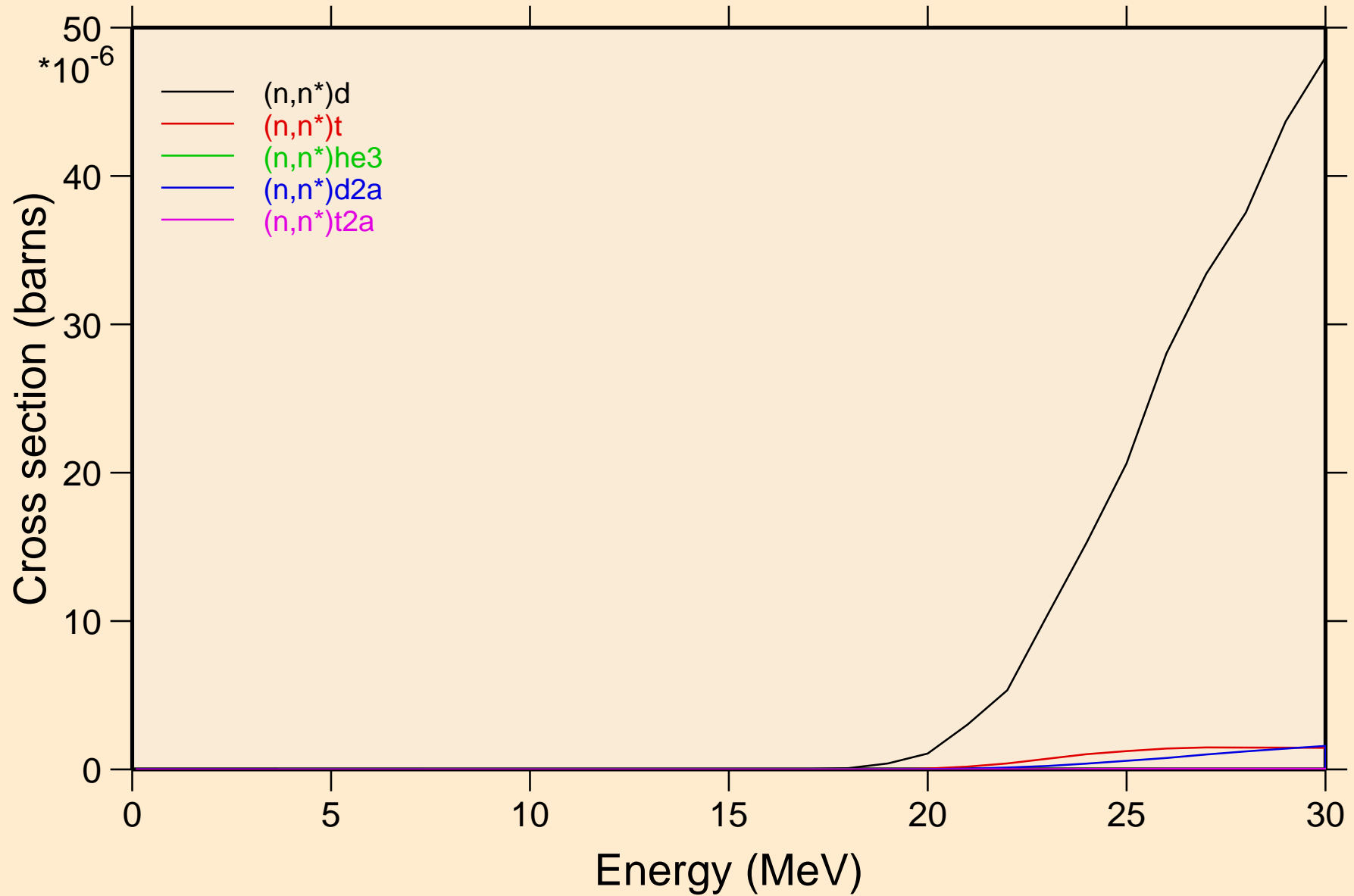

FL289 NRG TENDL-2015, AKONING

Threshold reactions

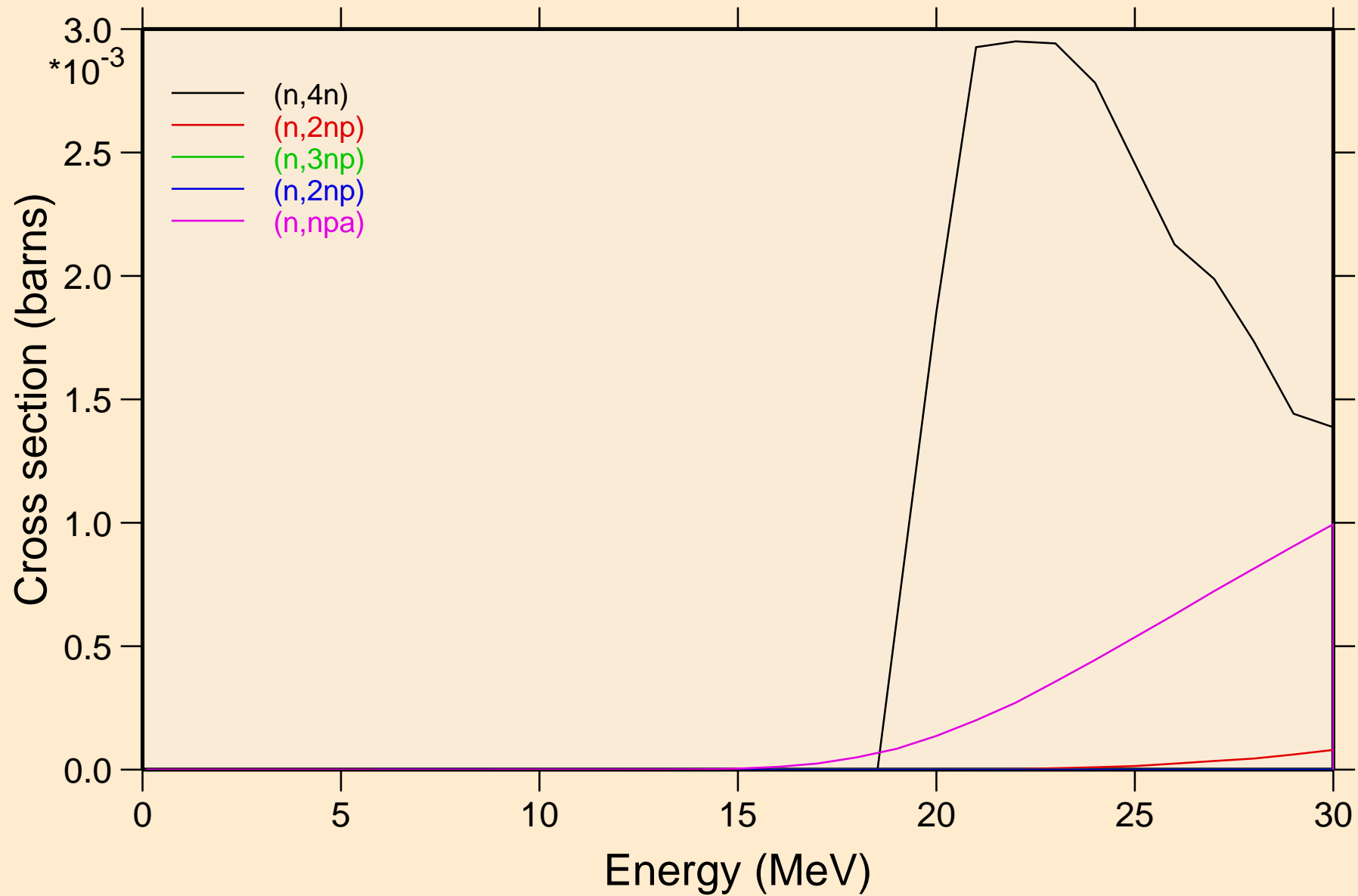

FL289 NRG TENDL-2015, AKONING

Threshold reactions

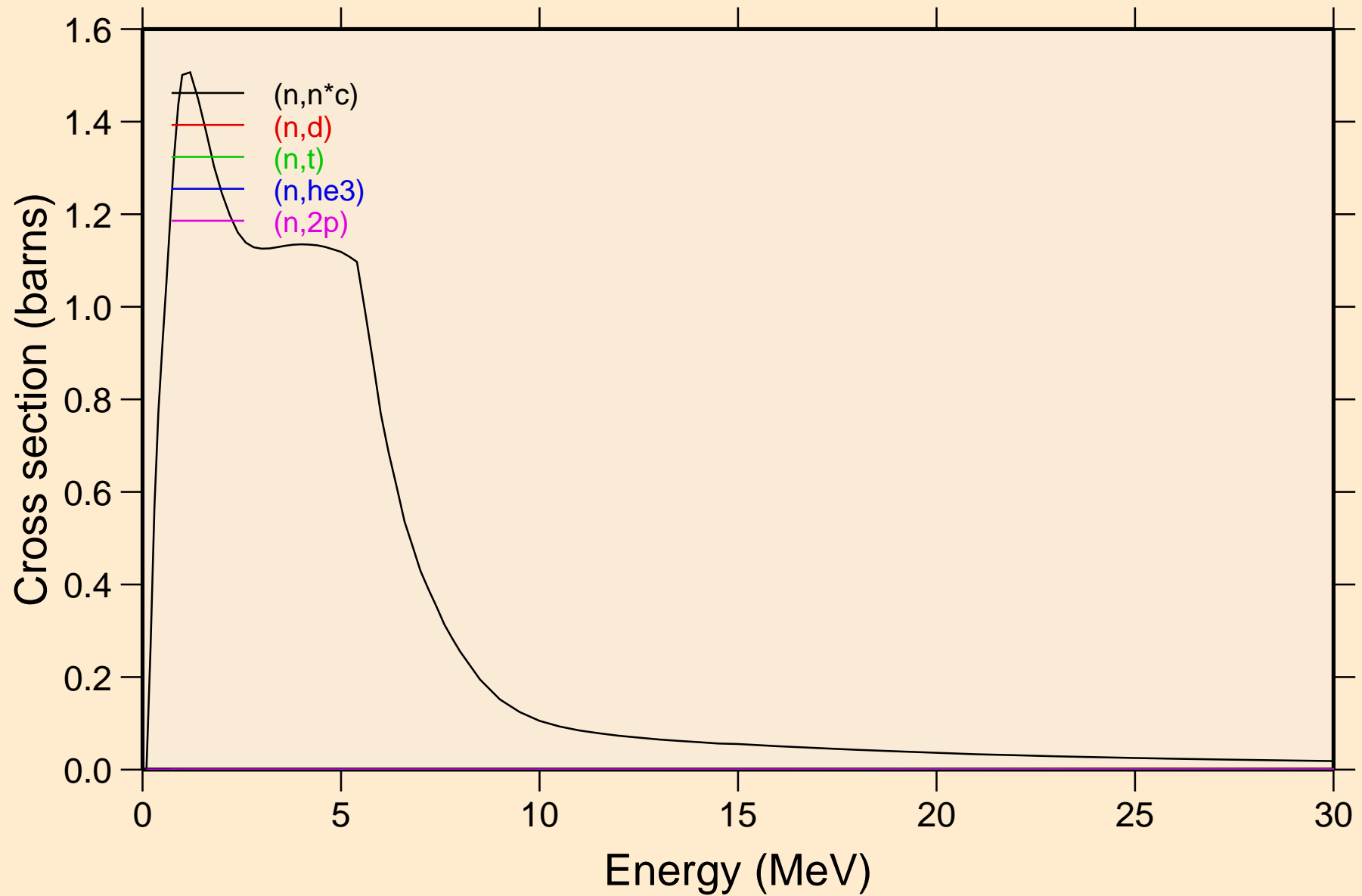

FL289 NRG TENDL-2015, AKONING

Threshold reactions

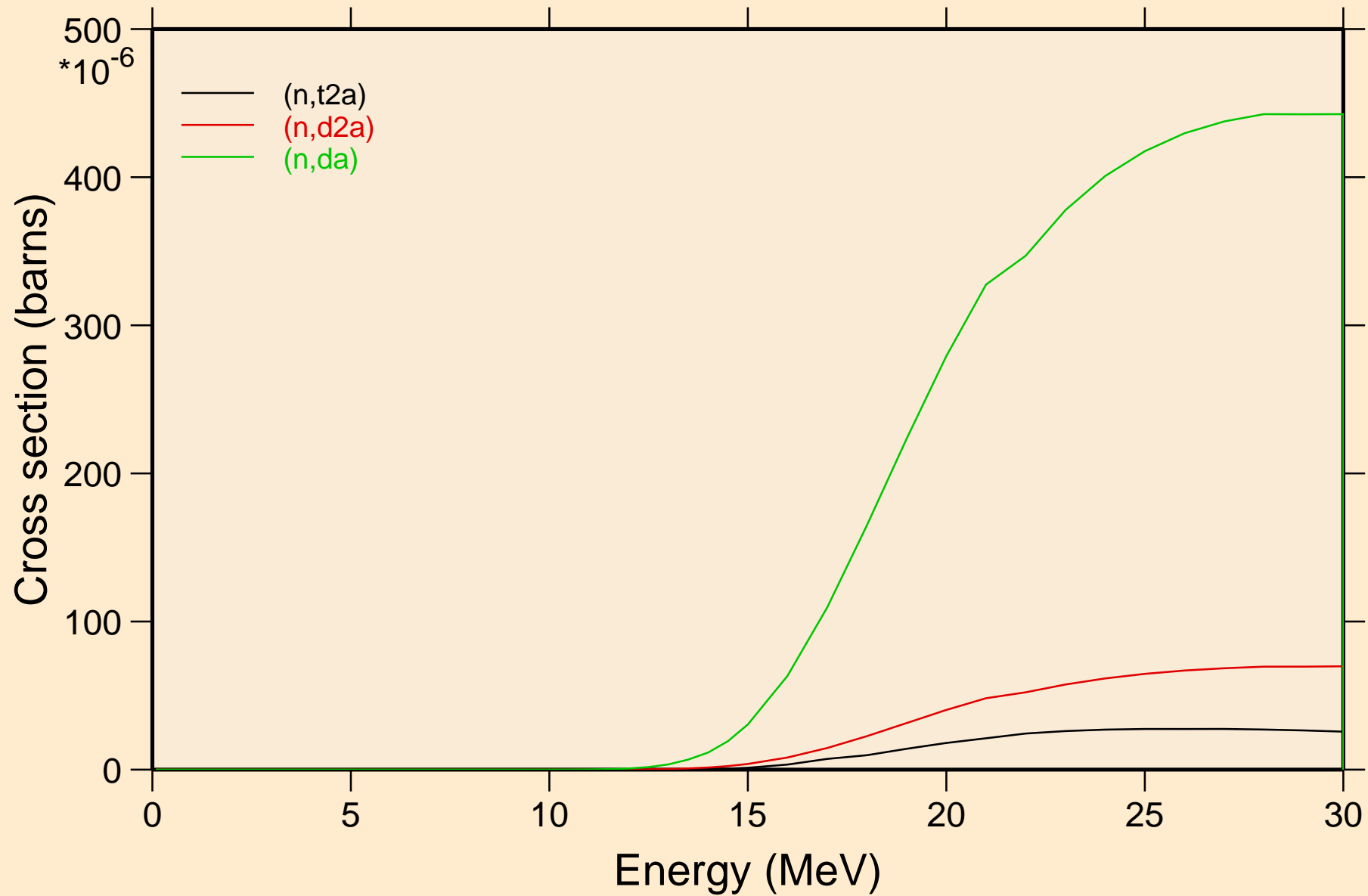

FL289 NRG TENDL-2015, AKONING
angular distribution for elastic

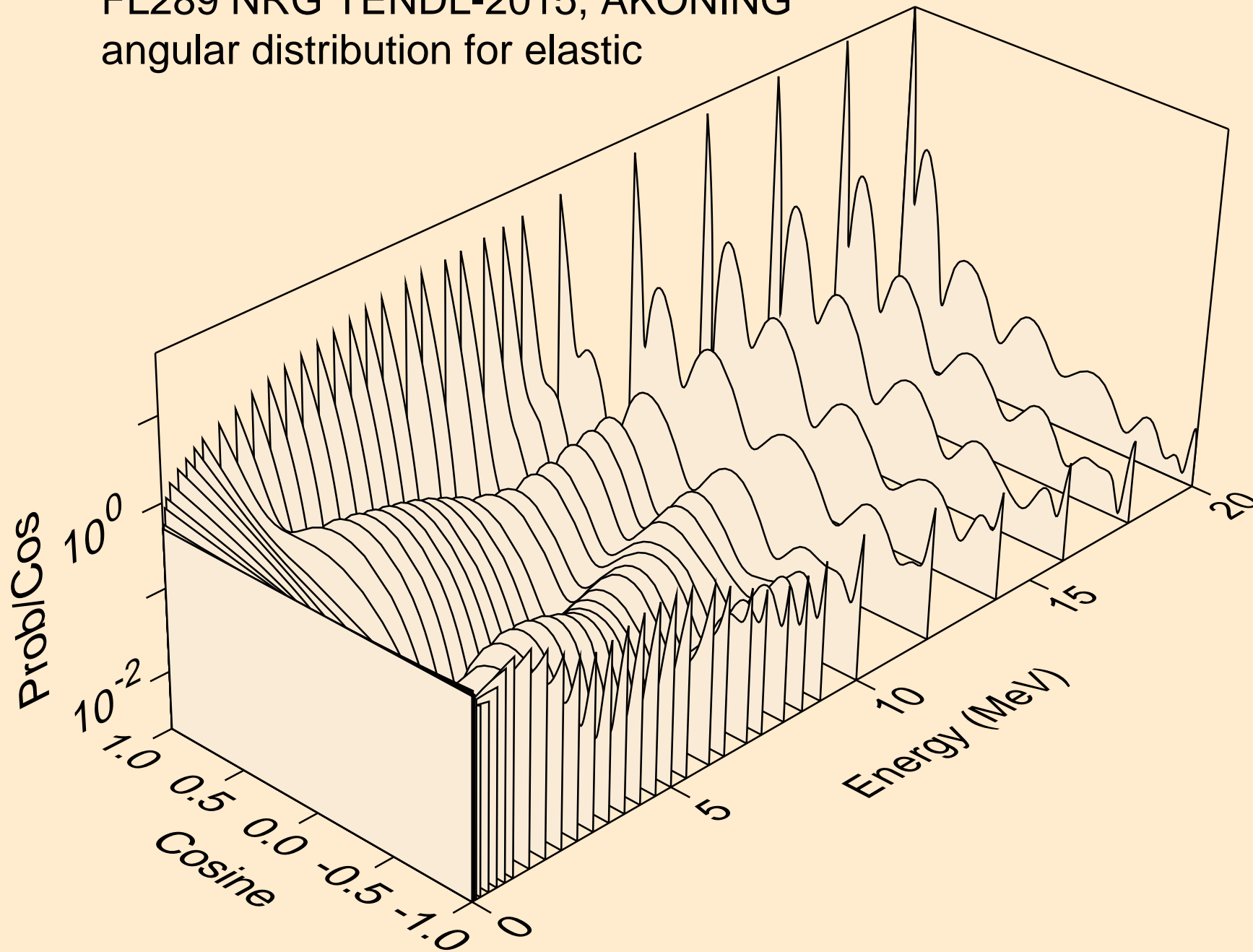

FL289 NRG TENDL-2015, AKONING
angular distribution for elastic

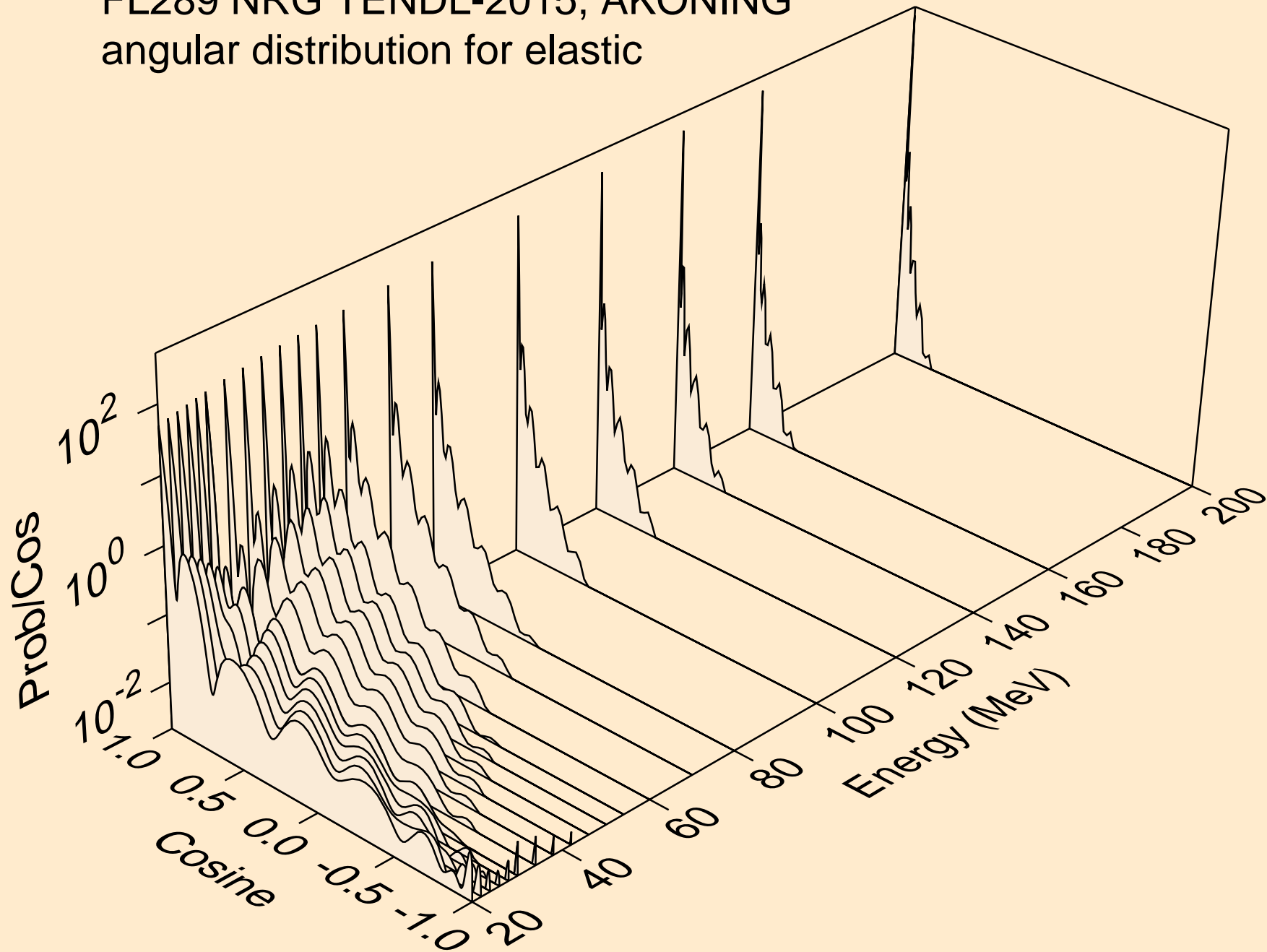

FL289 NRG TENDL-2015, AKONING
angular distribution for (n,n*1)

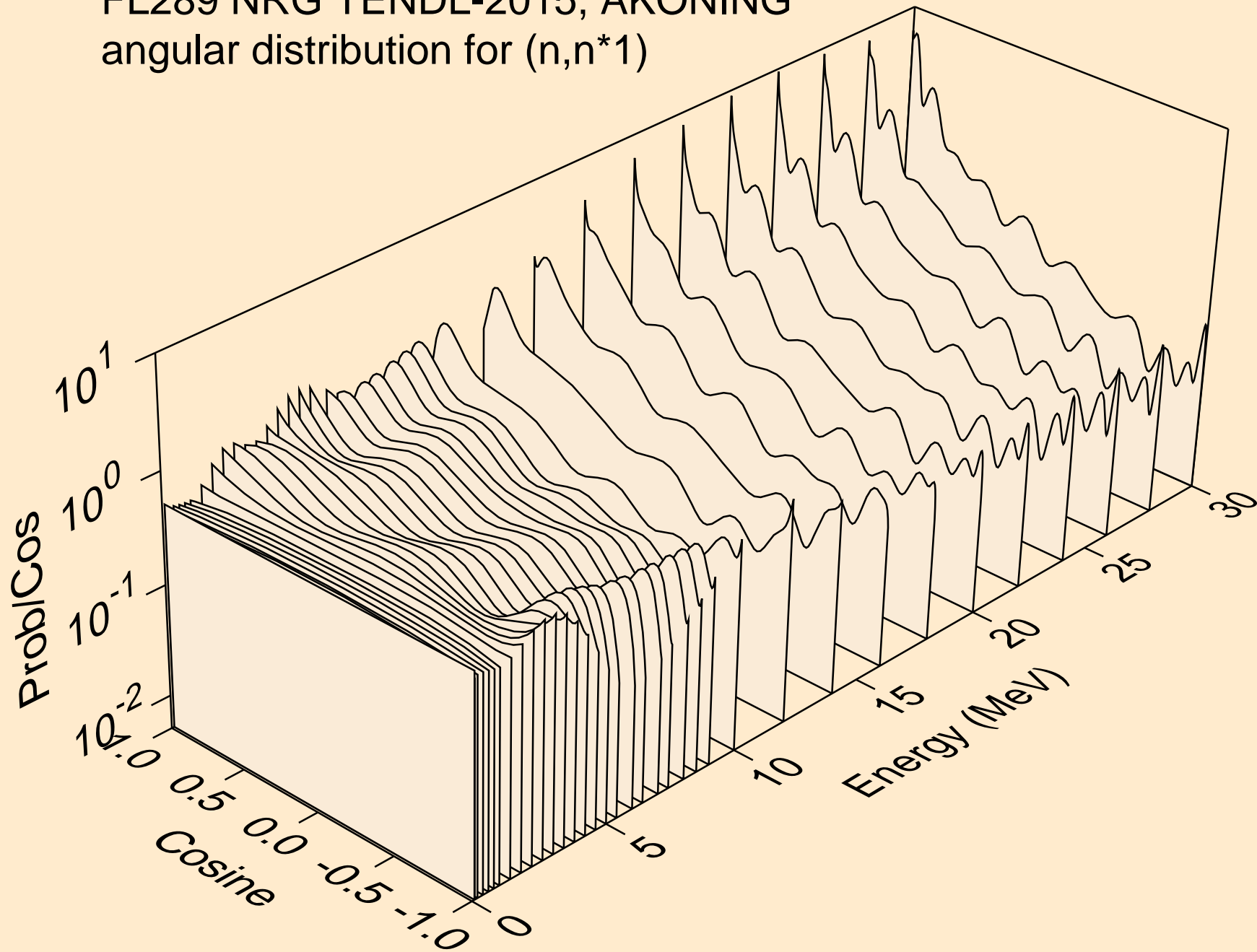

FL289 NRG TENDL-2015, AKONING

Total fission nubar

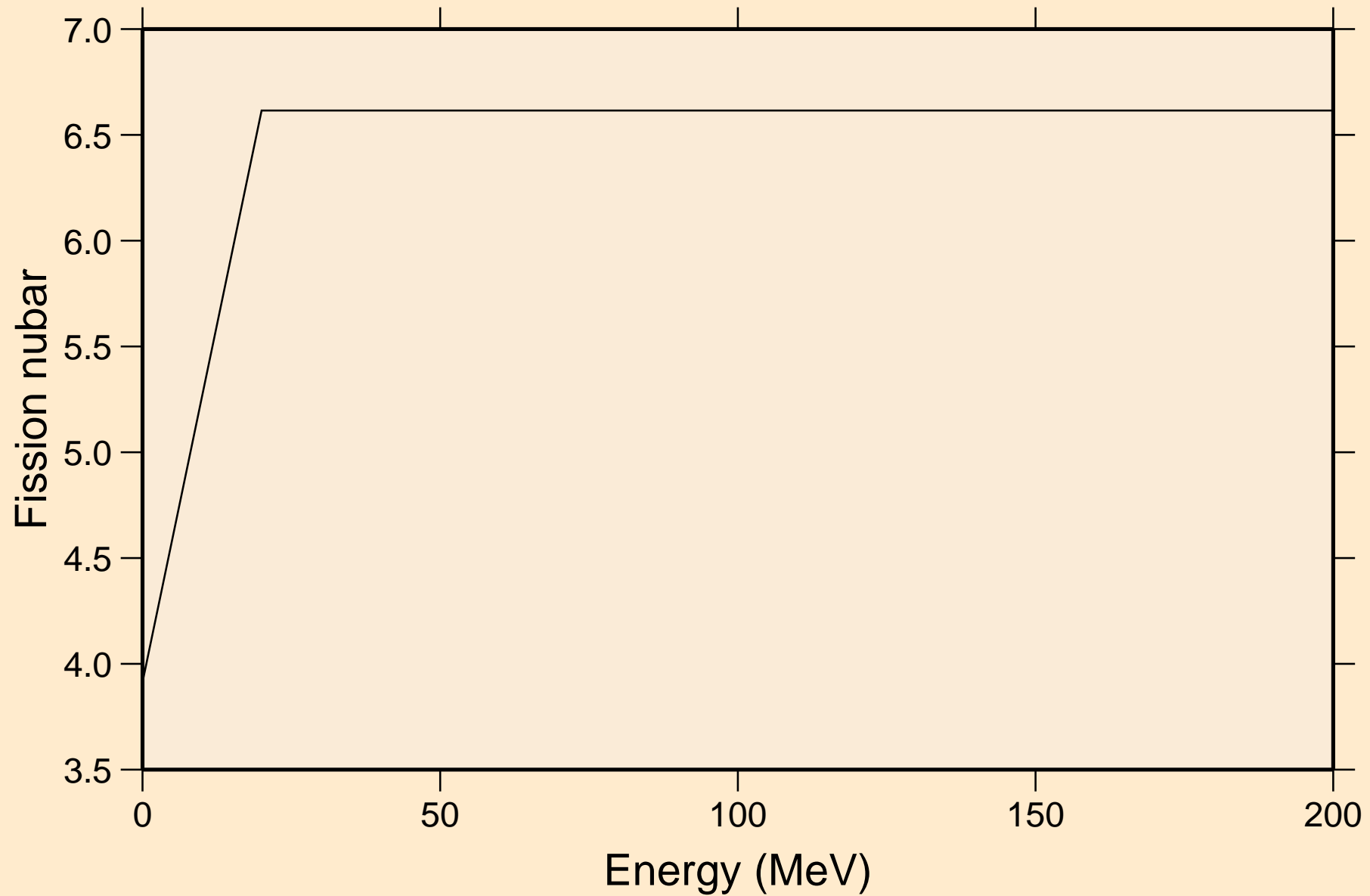

FL289 NRG TENDL-2015, AKONING
Neutron emission for (n,x)

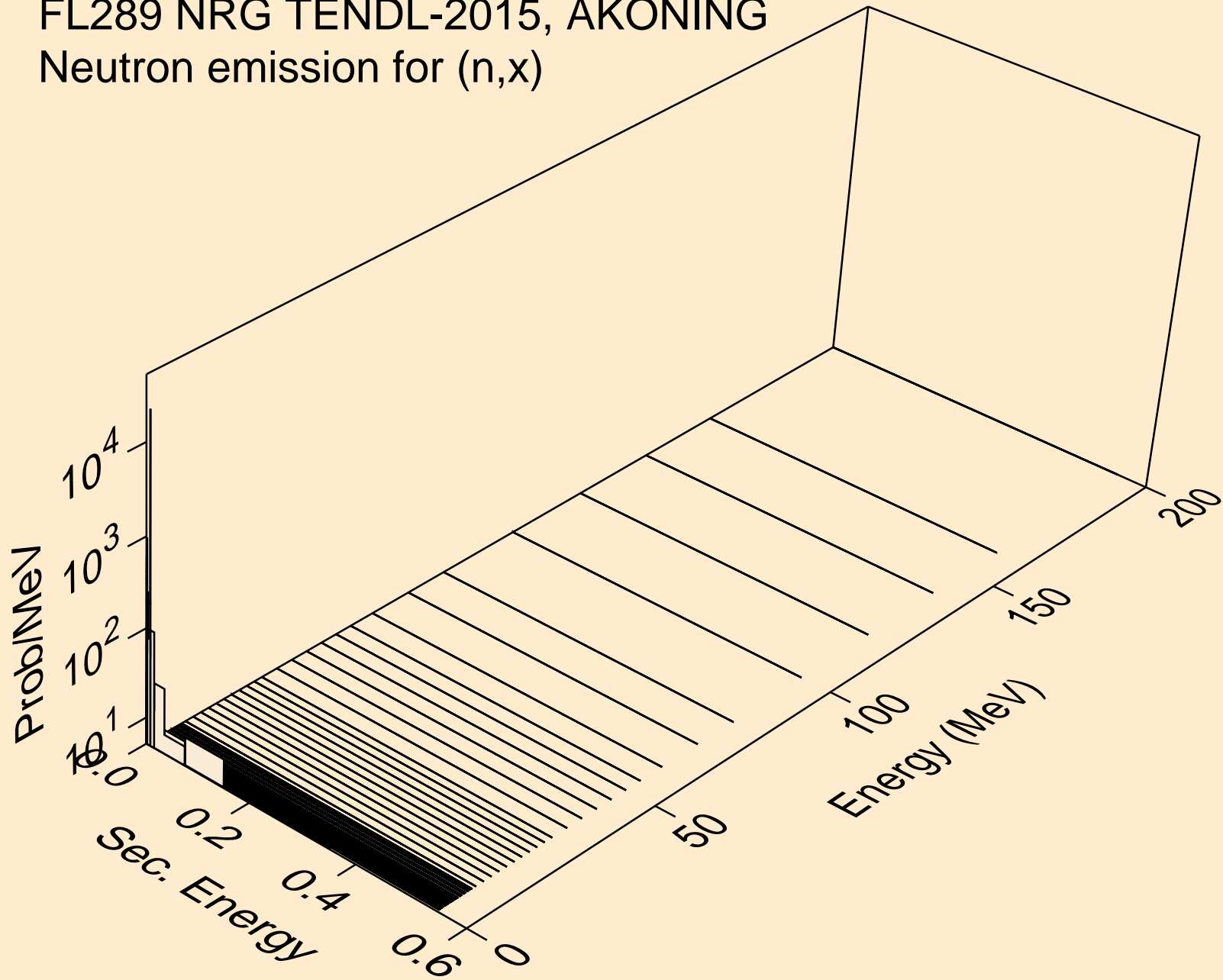

FL289 NRG TENDL-2015, AKONING
Neutron emission for (n,2nd)

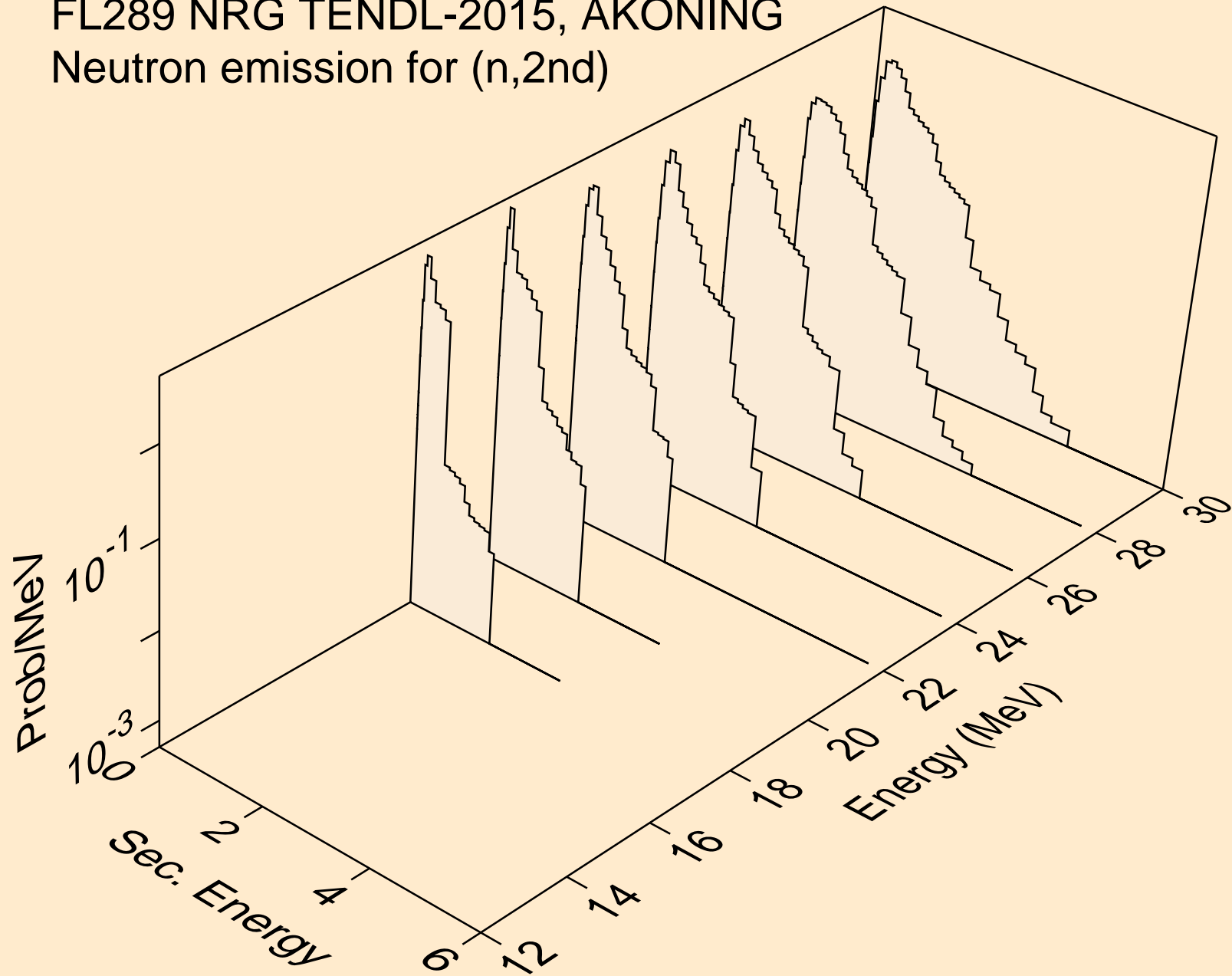

FL289 NRG TENDL-2015, AKONING
Neutron emission for (n,2n)

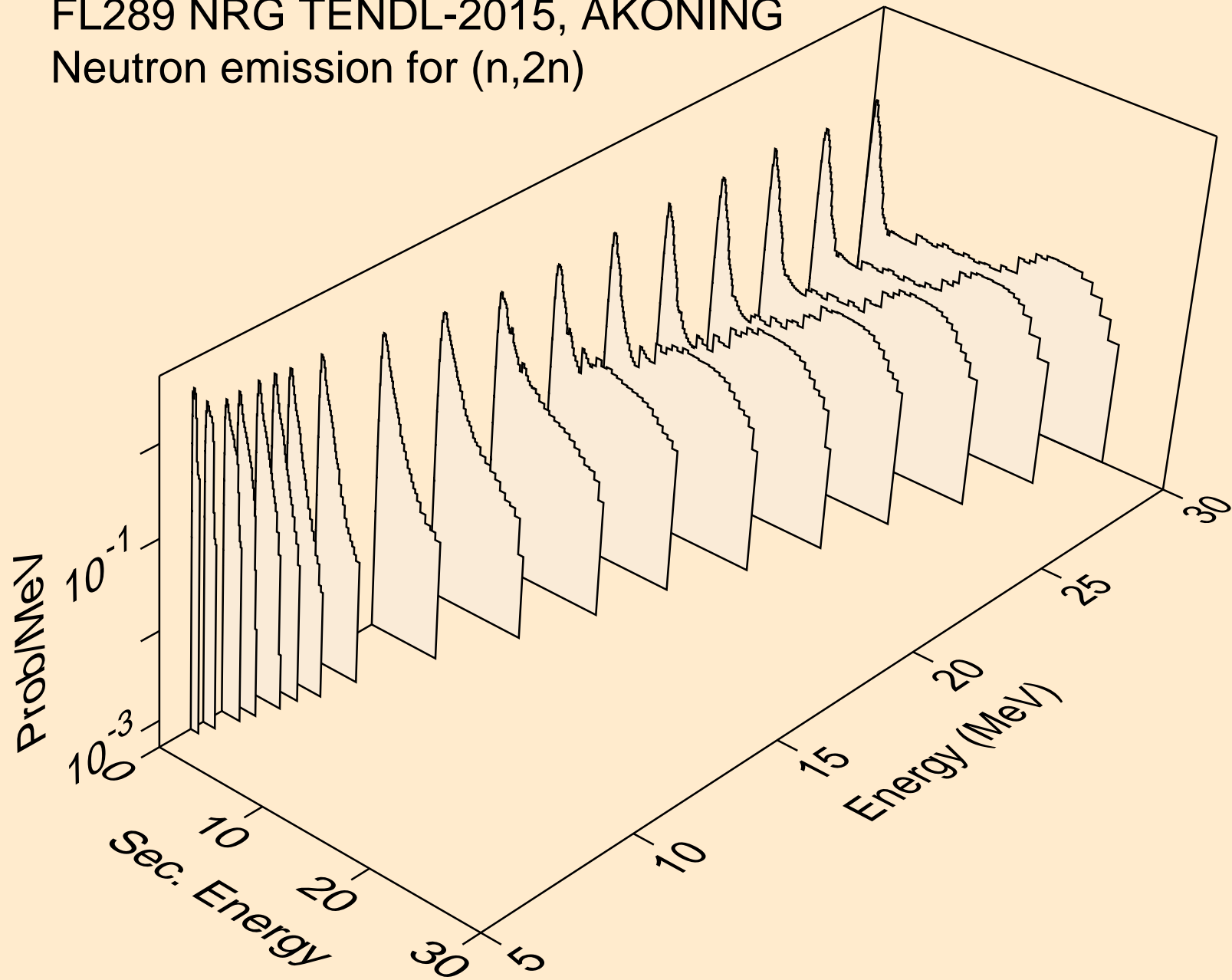

FL289 NRG TENDL-2015, AKONING
Neutron emission for (n,3n)

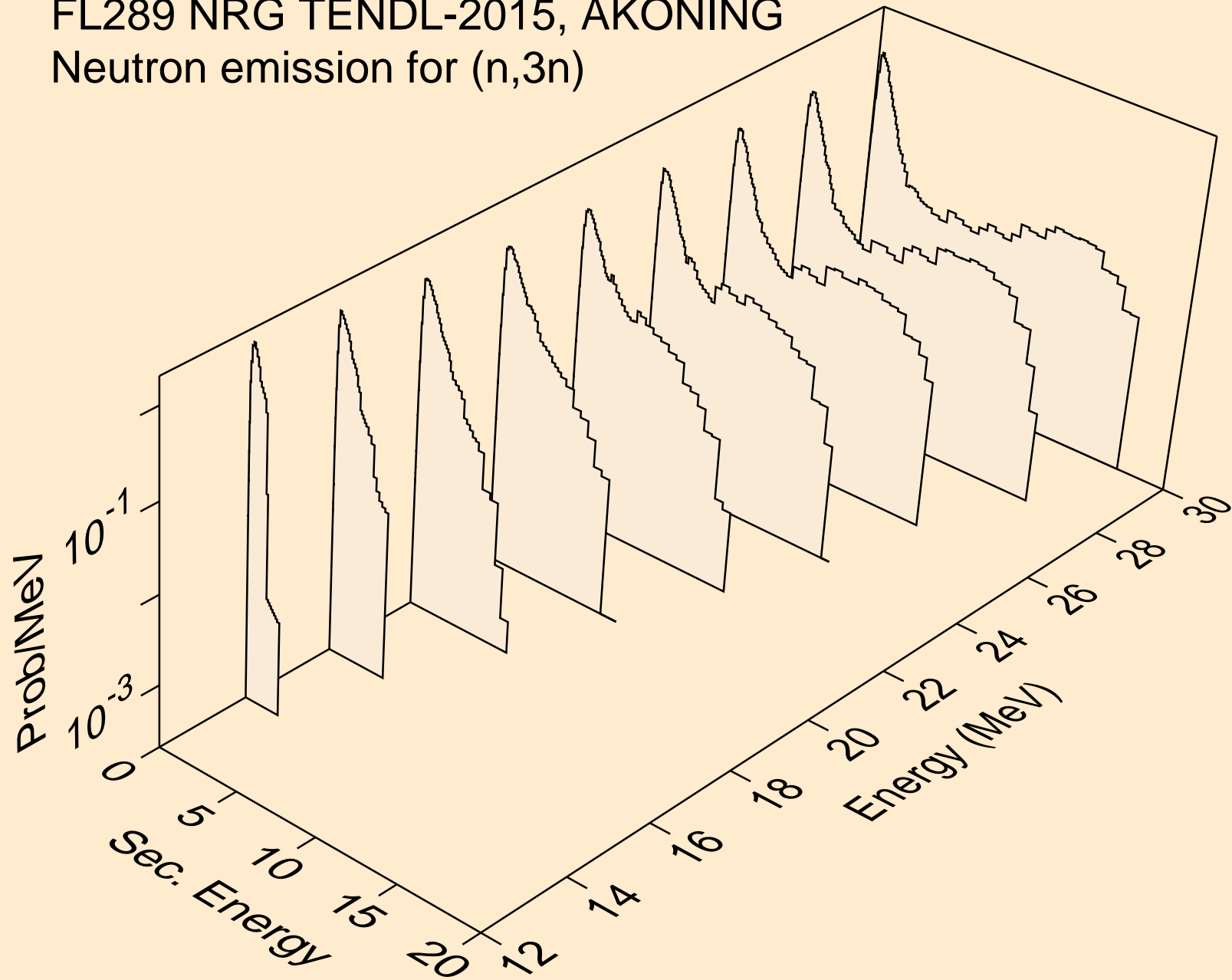

FL289 NRG TENDL-2015, AKONING
Neutron emission for fission

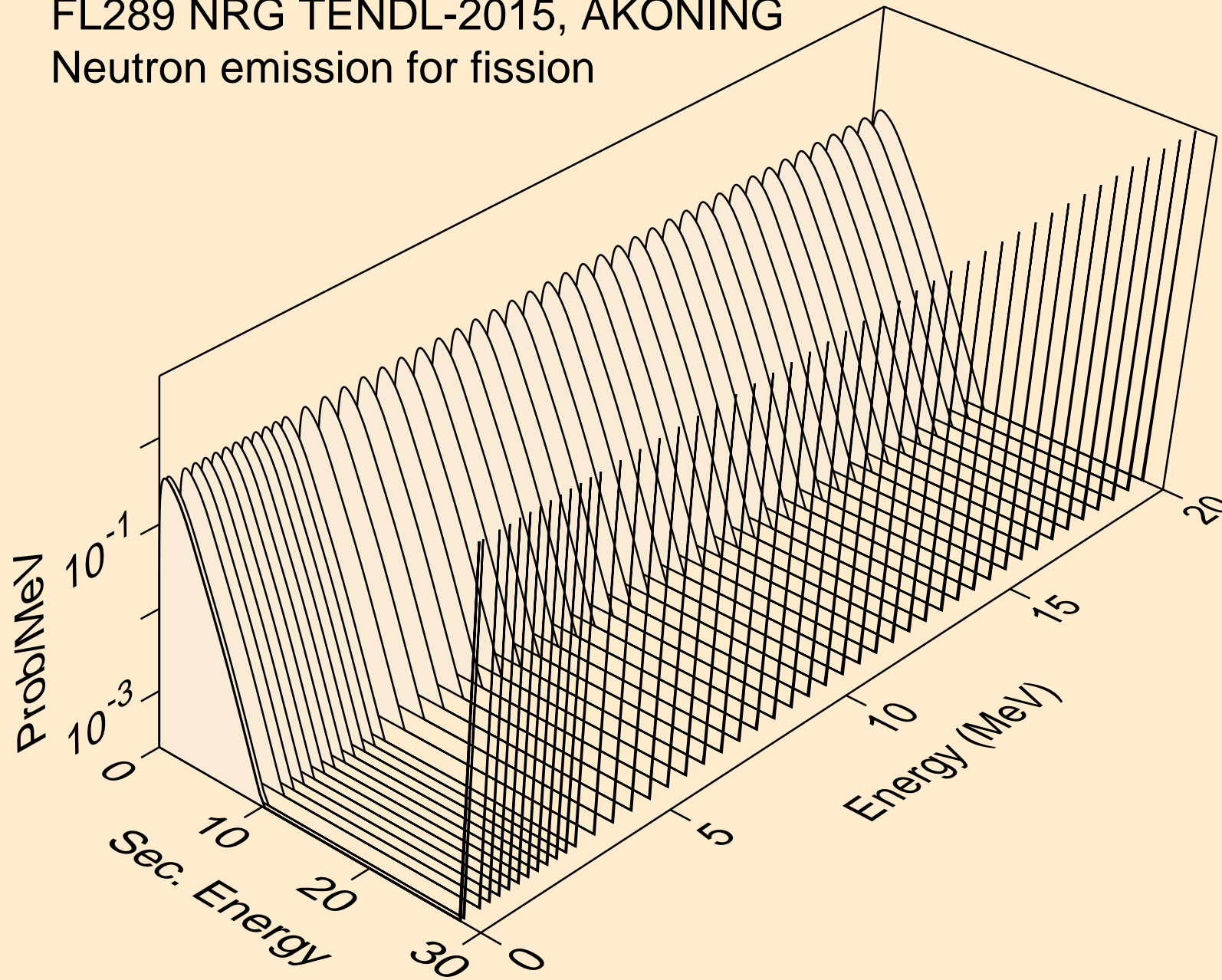

FL289 NRG TENDL-2015, AKONING
Neutron emission for (n,n*)a

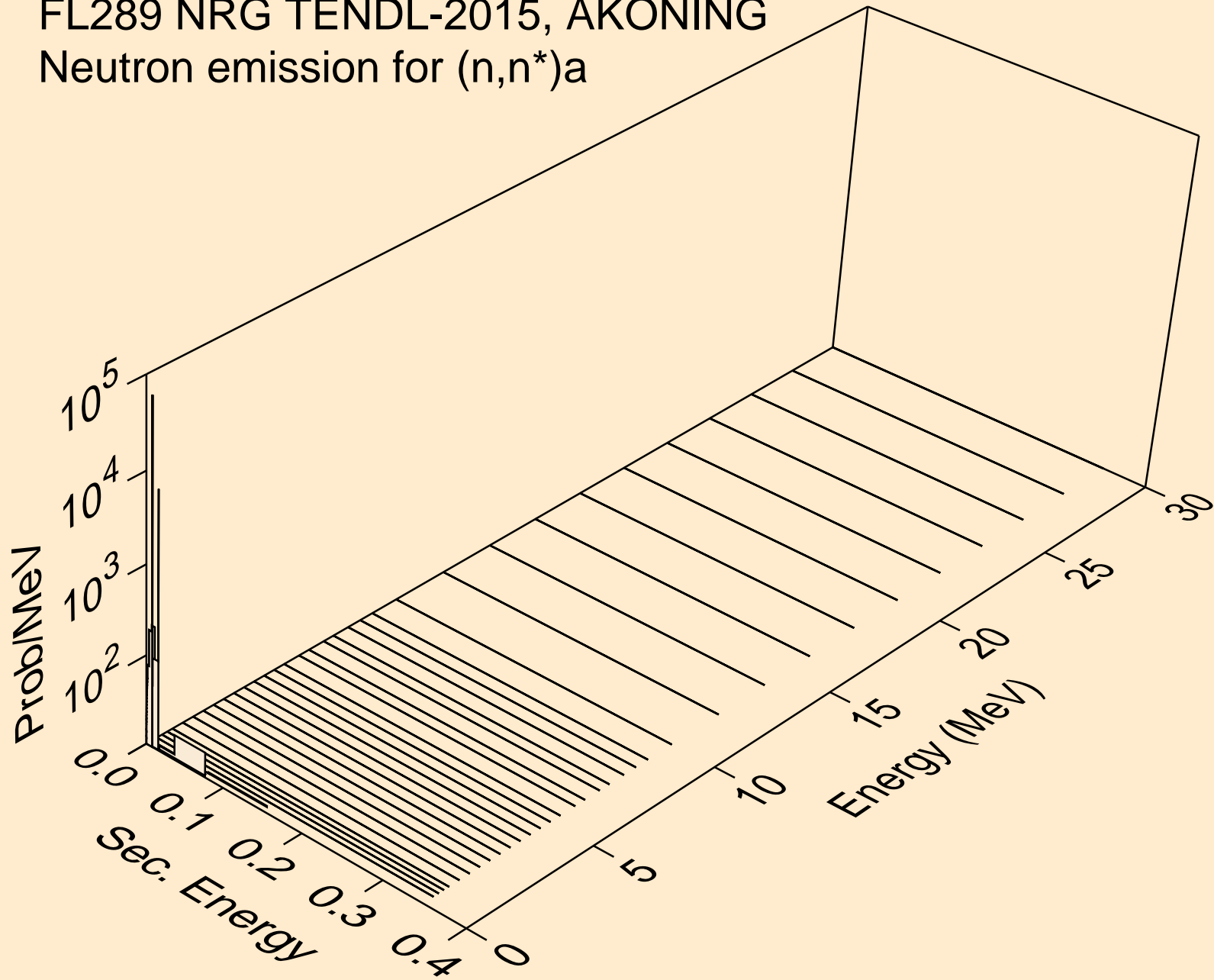

FL289 NRG TENDL-2015, AKONING
Neutron emission for (n,2n)a

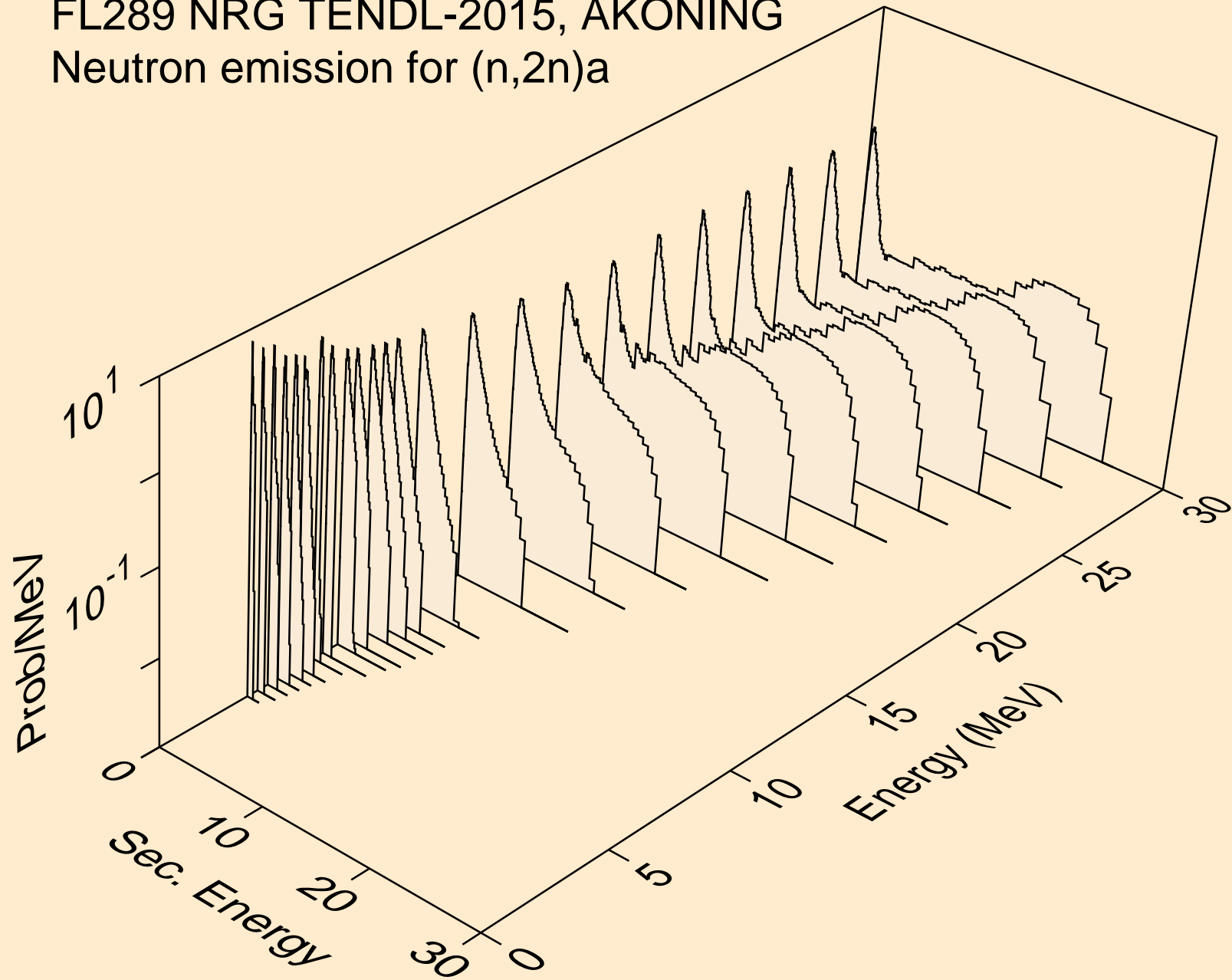

FL289 NRG TENDL-2015, AKONING
Neutron emission for (n,3n)a

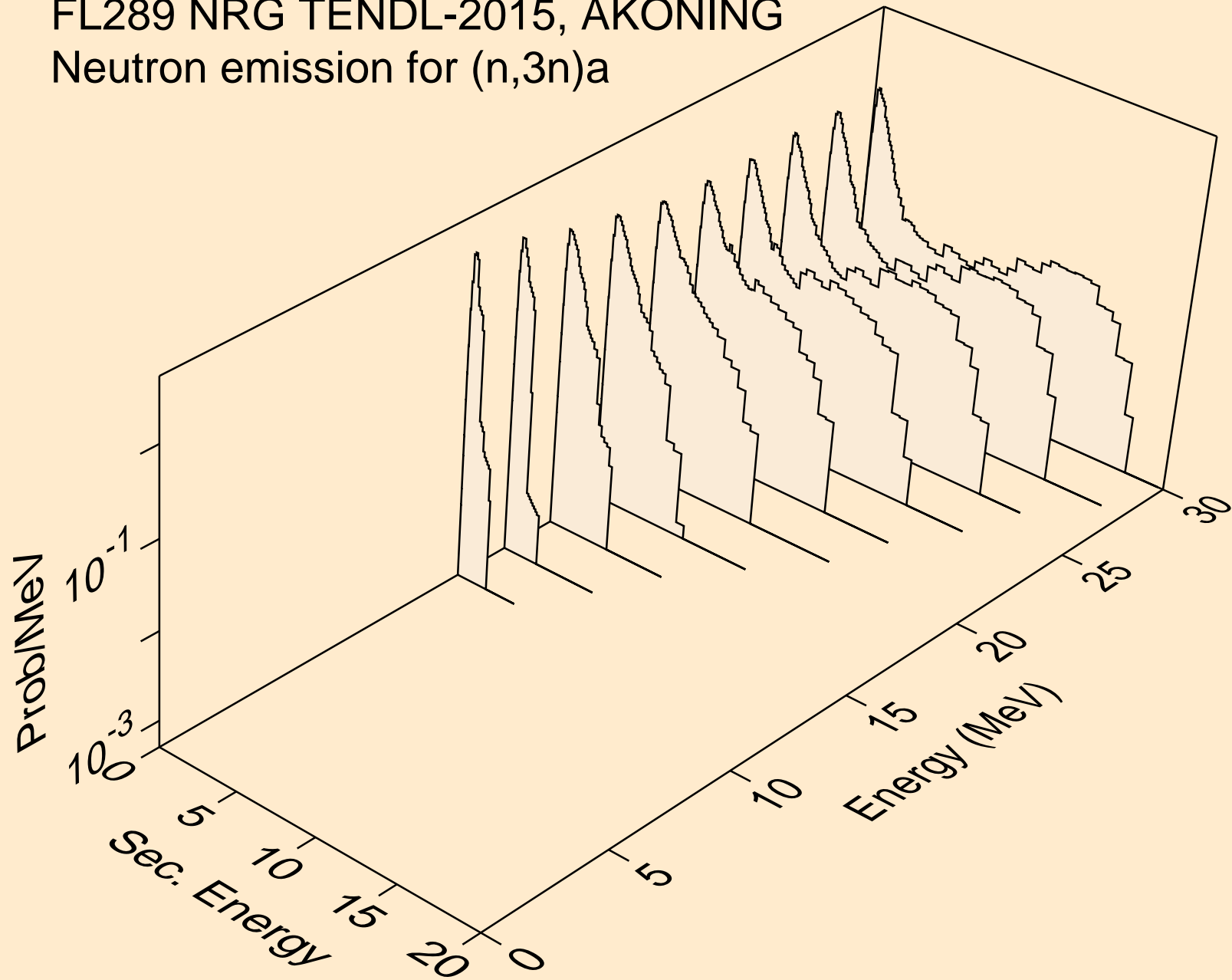

FL289 NRG TENDL-2015, AKONING
Neutron emission for (n,n*)p

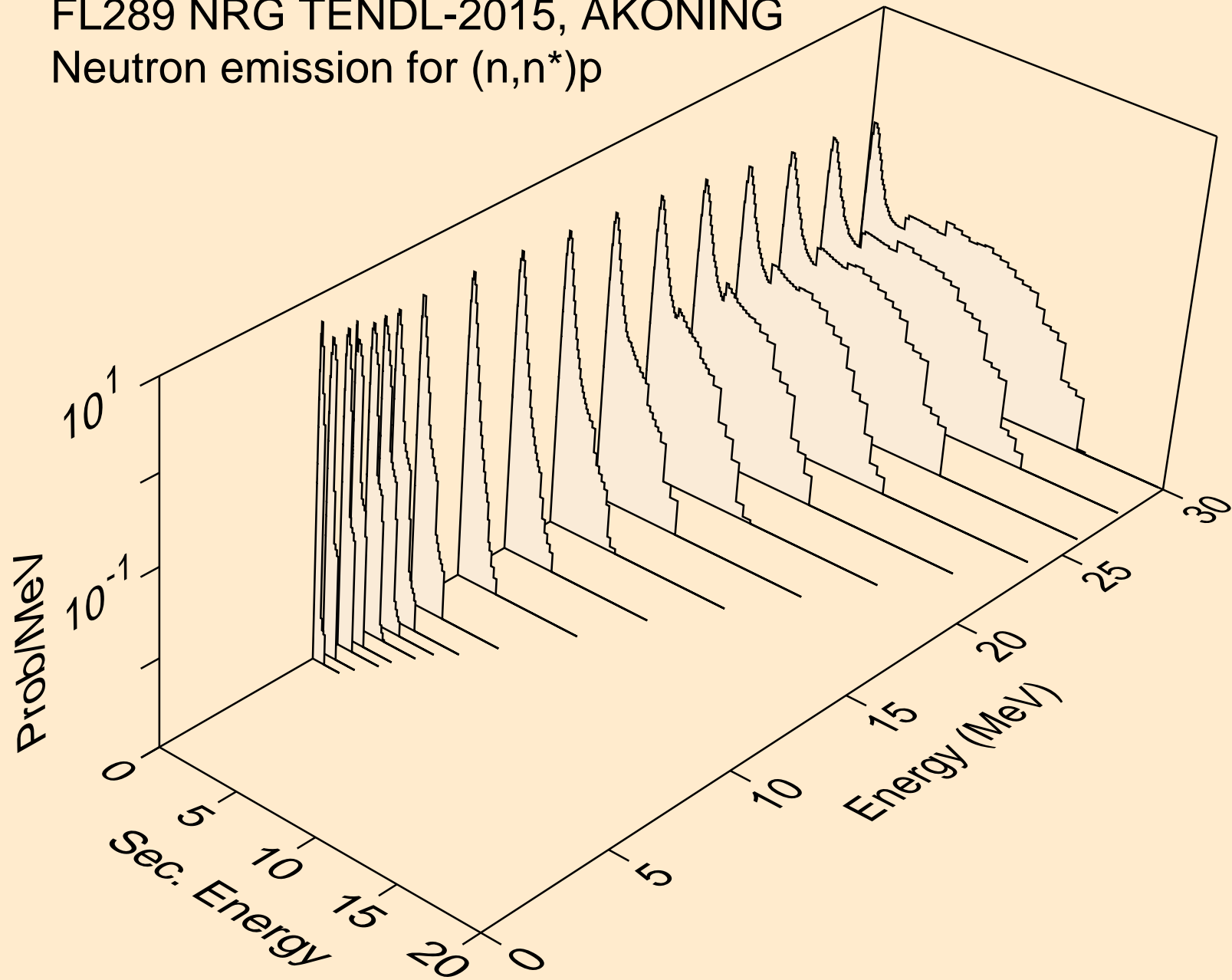

FL289 NRG TENDL-2015, AKONING
Neutron emission for (n,n*)2a

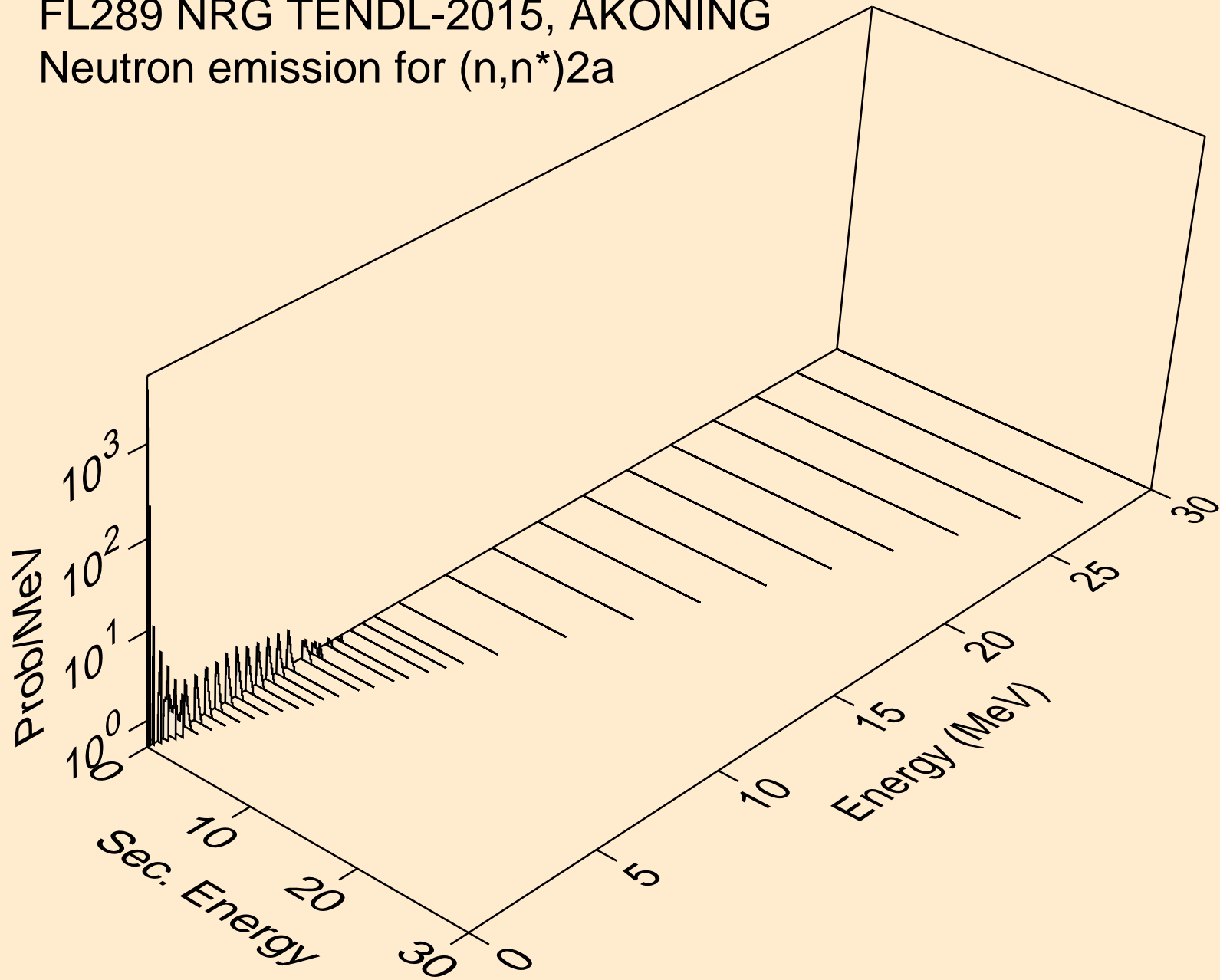

FL289 NRG TENDL-2015, AKONING
Neutron emission for (n,2n)2a

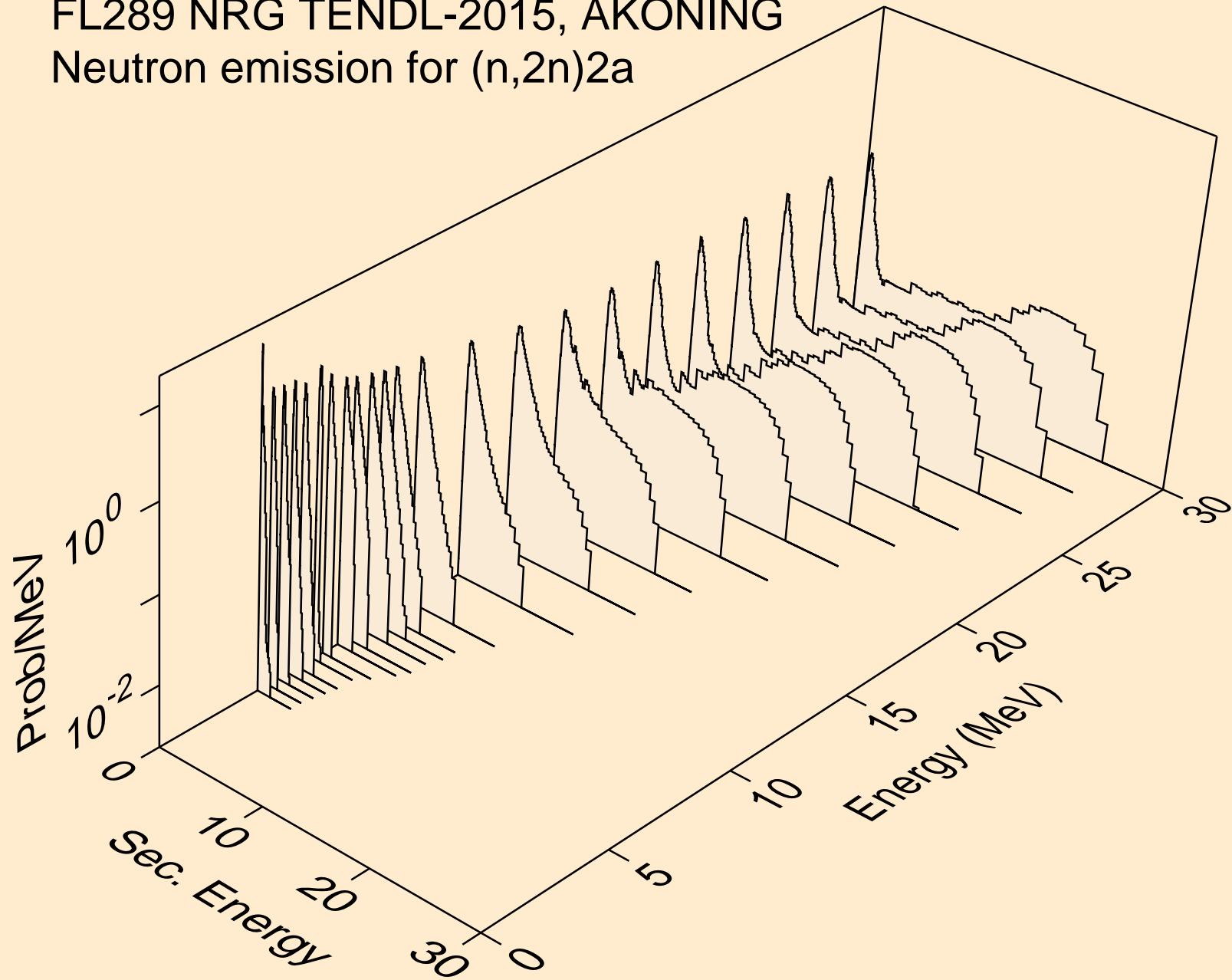

FL289 NRG TENDL-2015, AKONING
Neutron emission for (n,n*)d

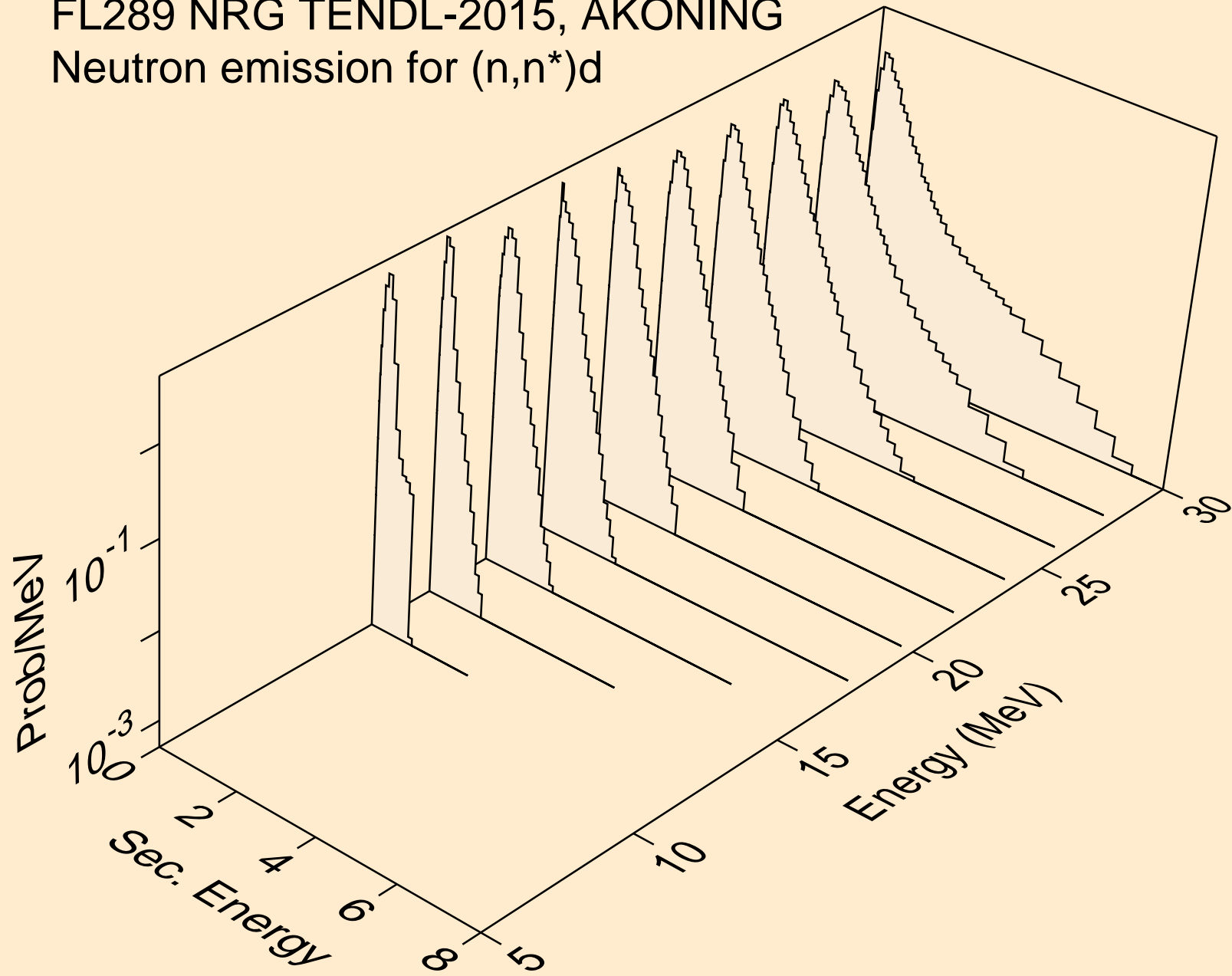

FL289 NRG TENDL-2015, AKONING
Neutron emission for (n,n*)t

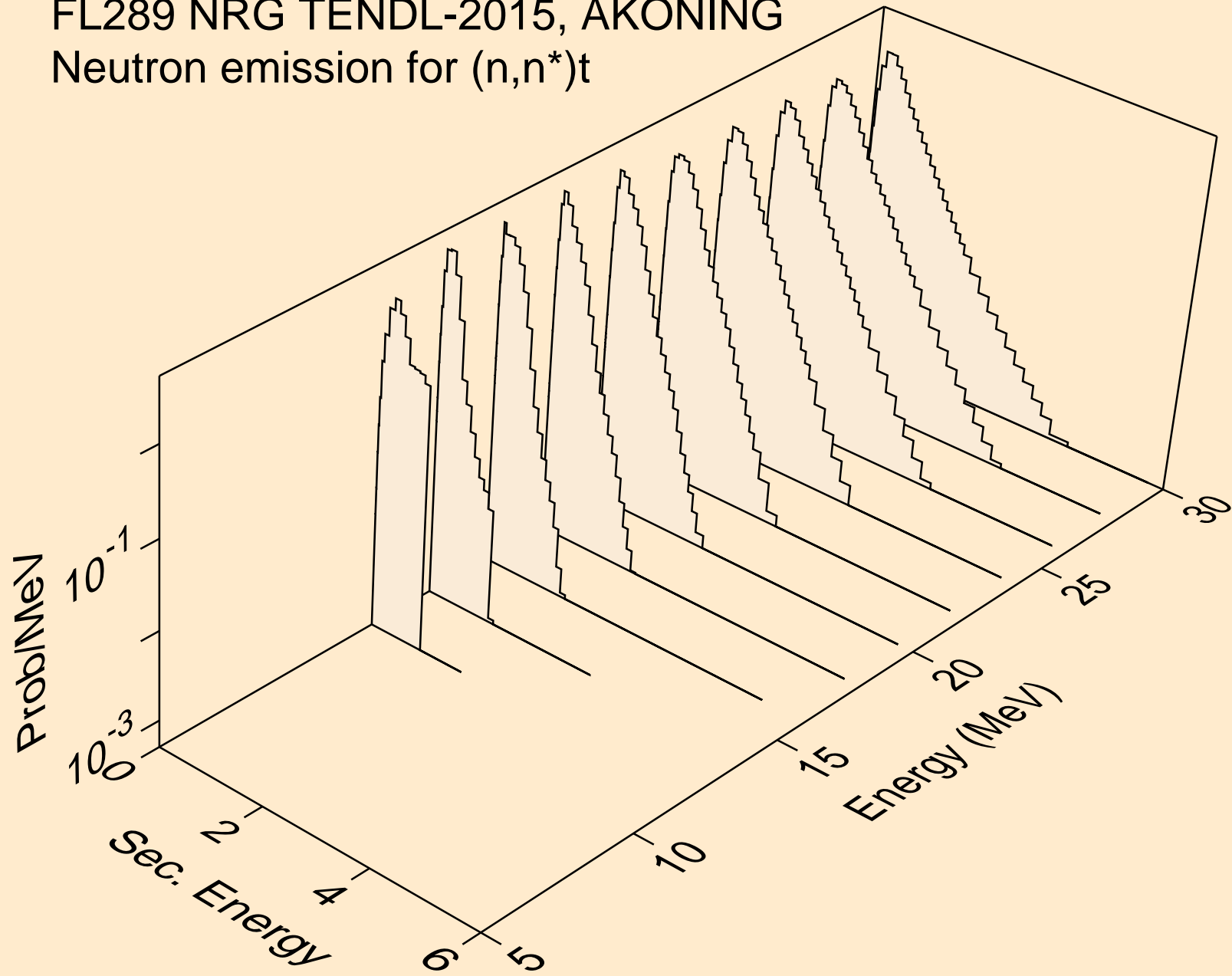

FL289 NRG TENDL-2015, AKONING
Neutron emission for (n,n*)he3

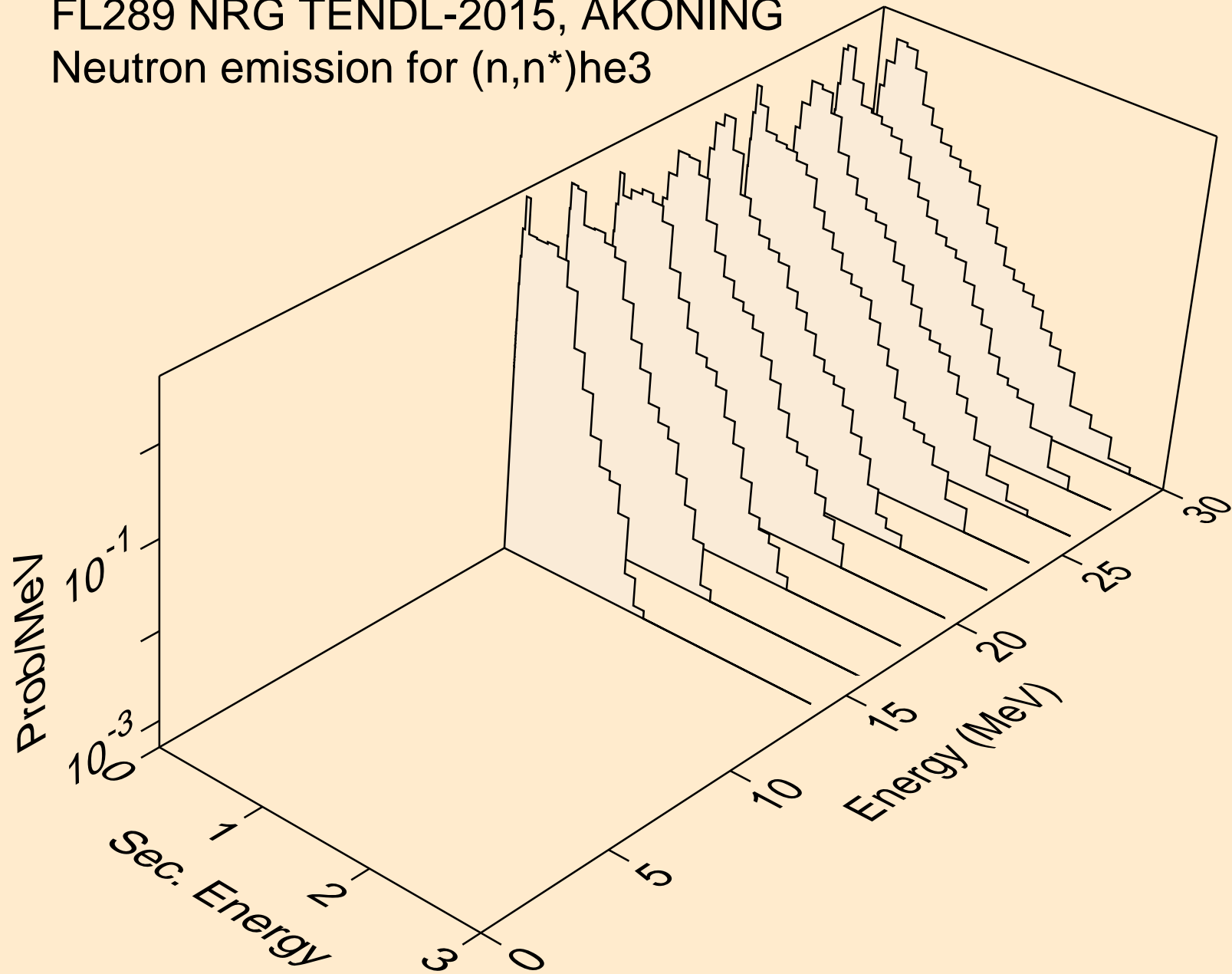

FL289 NRG TENDL-2015, AKONING
Neutron emission for (n,n*)d2a

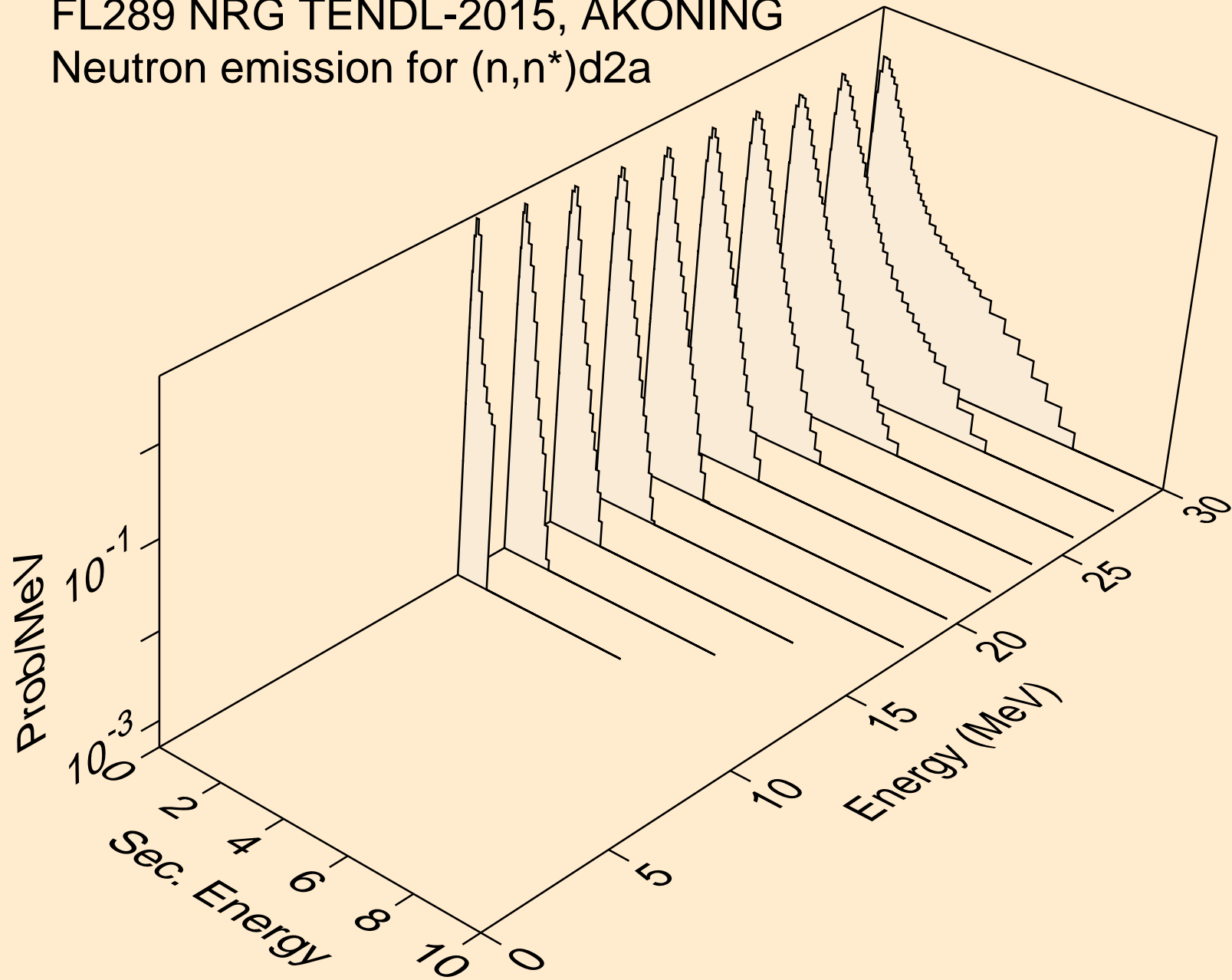

FL289 NRG TENDL-2015, AKONING
Neutron emission for (n,n*)t2a

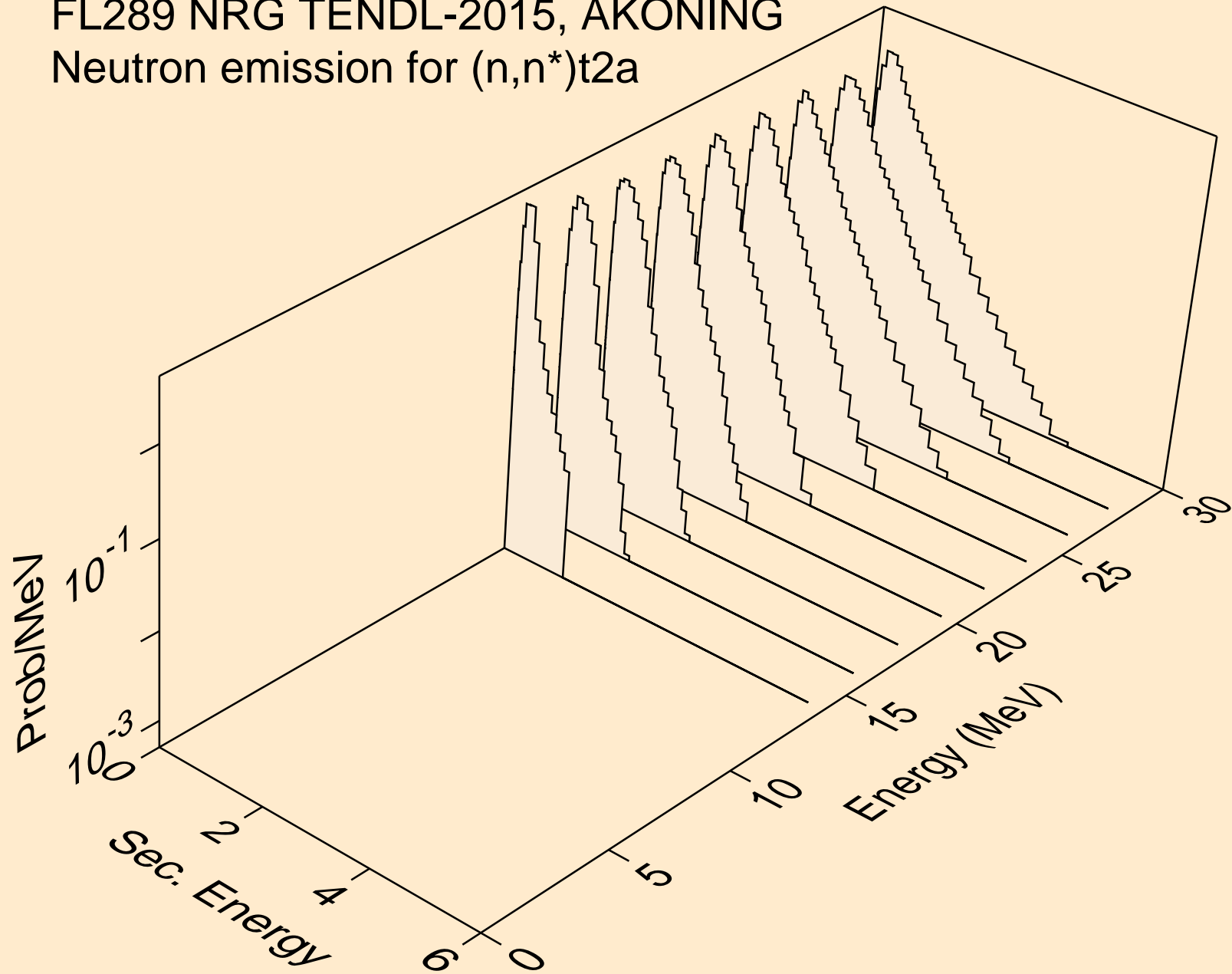

FL289 NRG TENDL-2015, AKONING
Neutron emission for (n,4n)

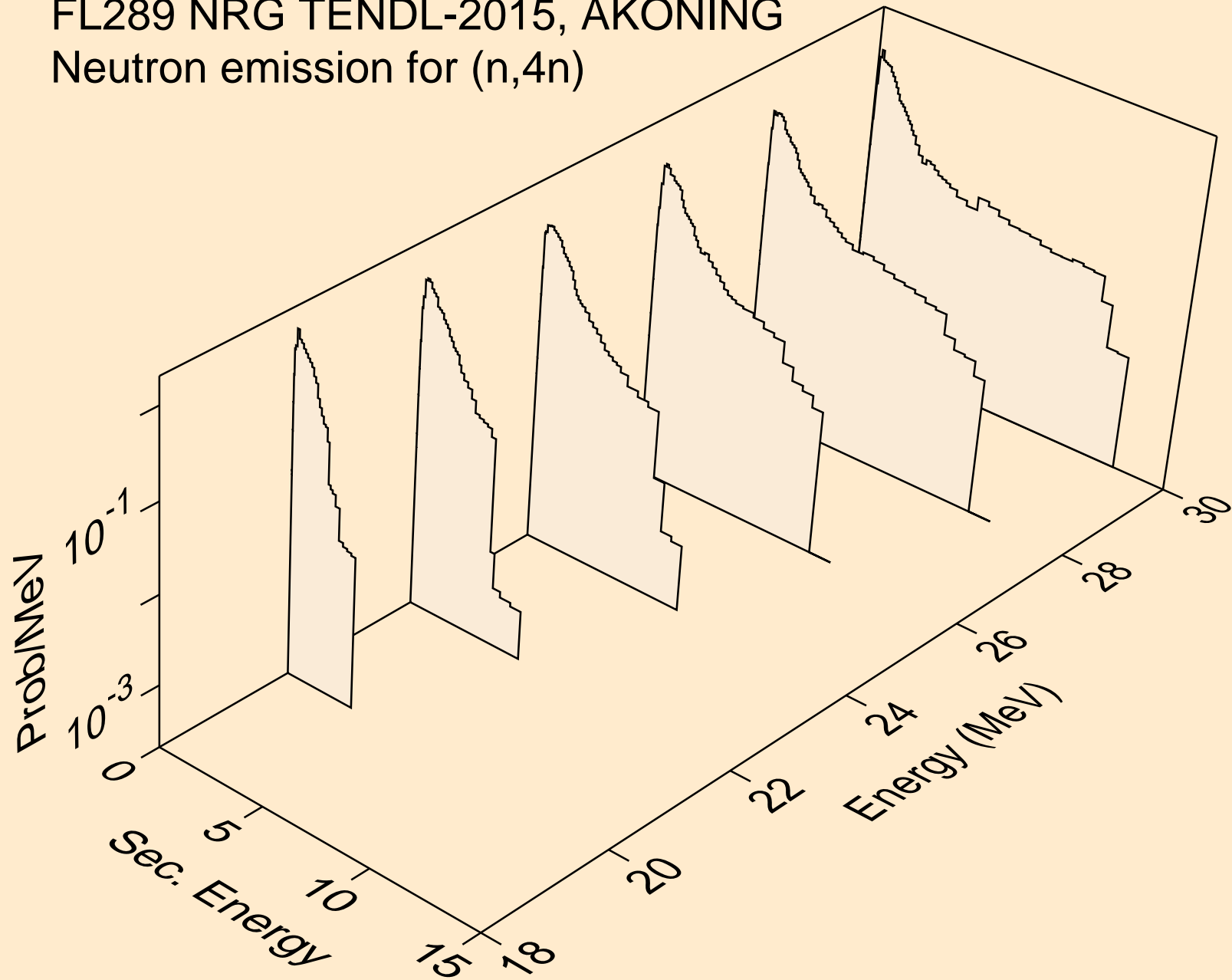

FL289 NRG TENDL-2015, AKONING
Neutron emission for (n,2np)

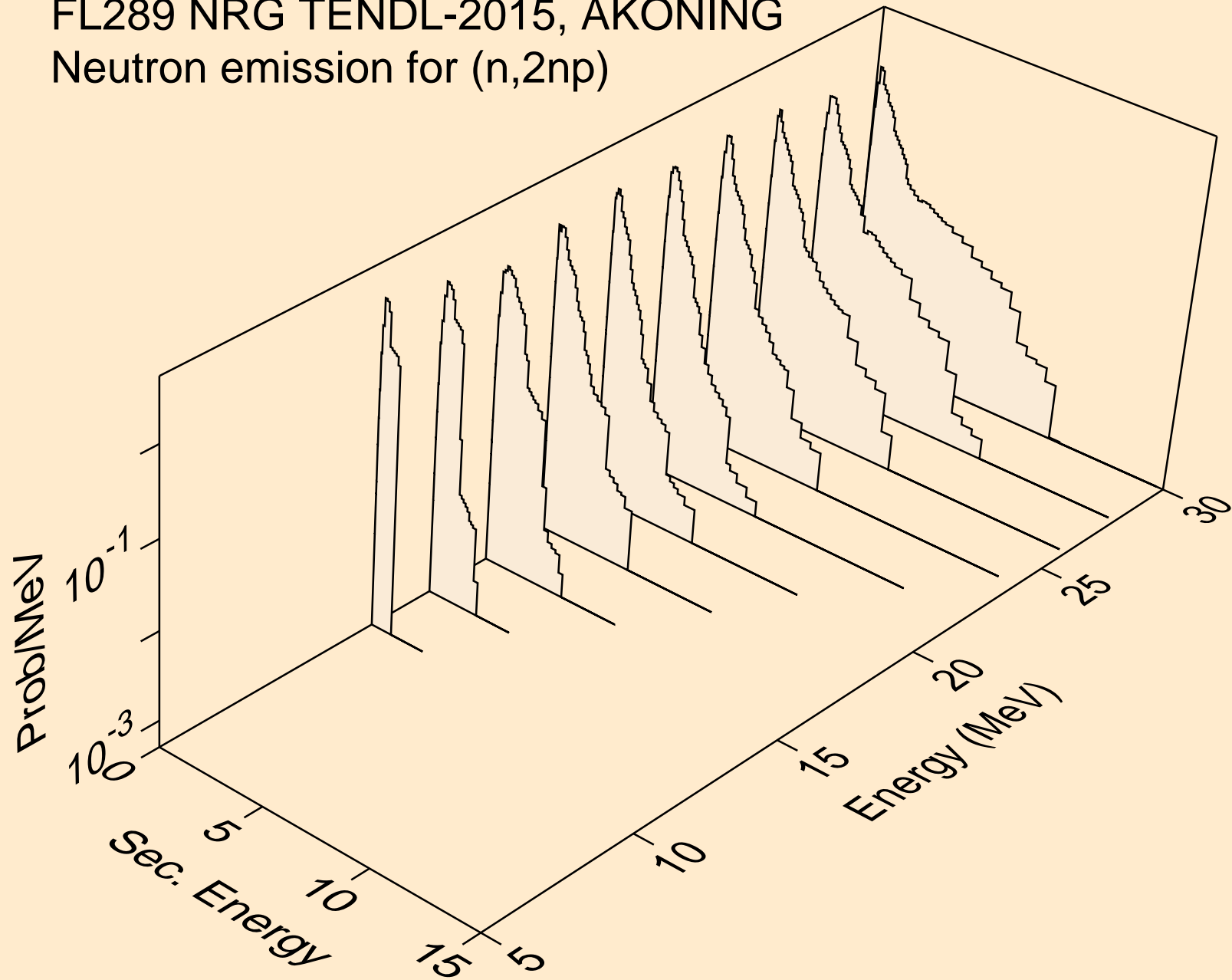

FL289 NRG TENDL-2015, AKONING
Neutron emission for (n,3np)

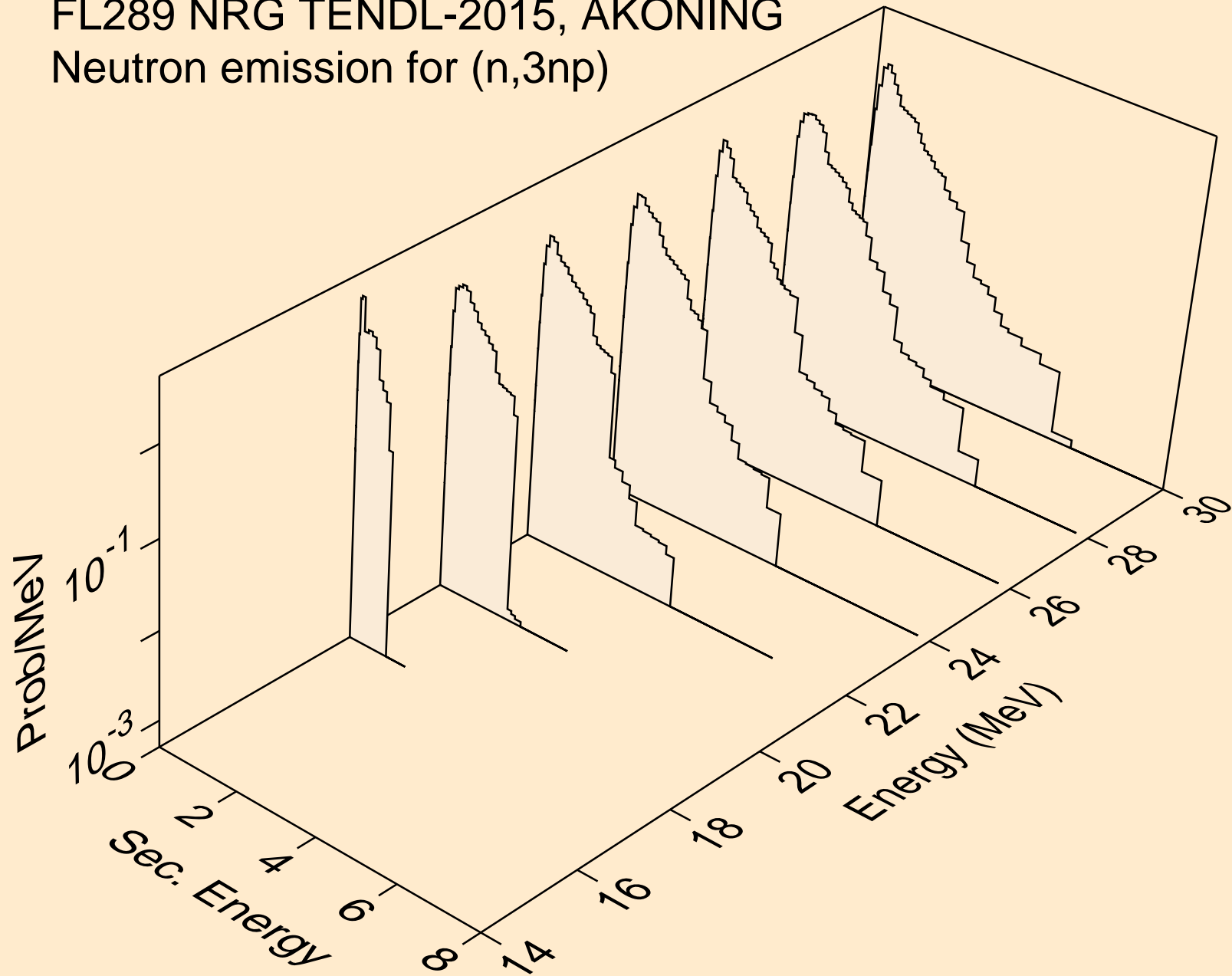

FL289 NRG TENDL-2015, AKONING
Neutron emission for (n,2np)

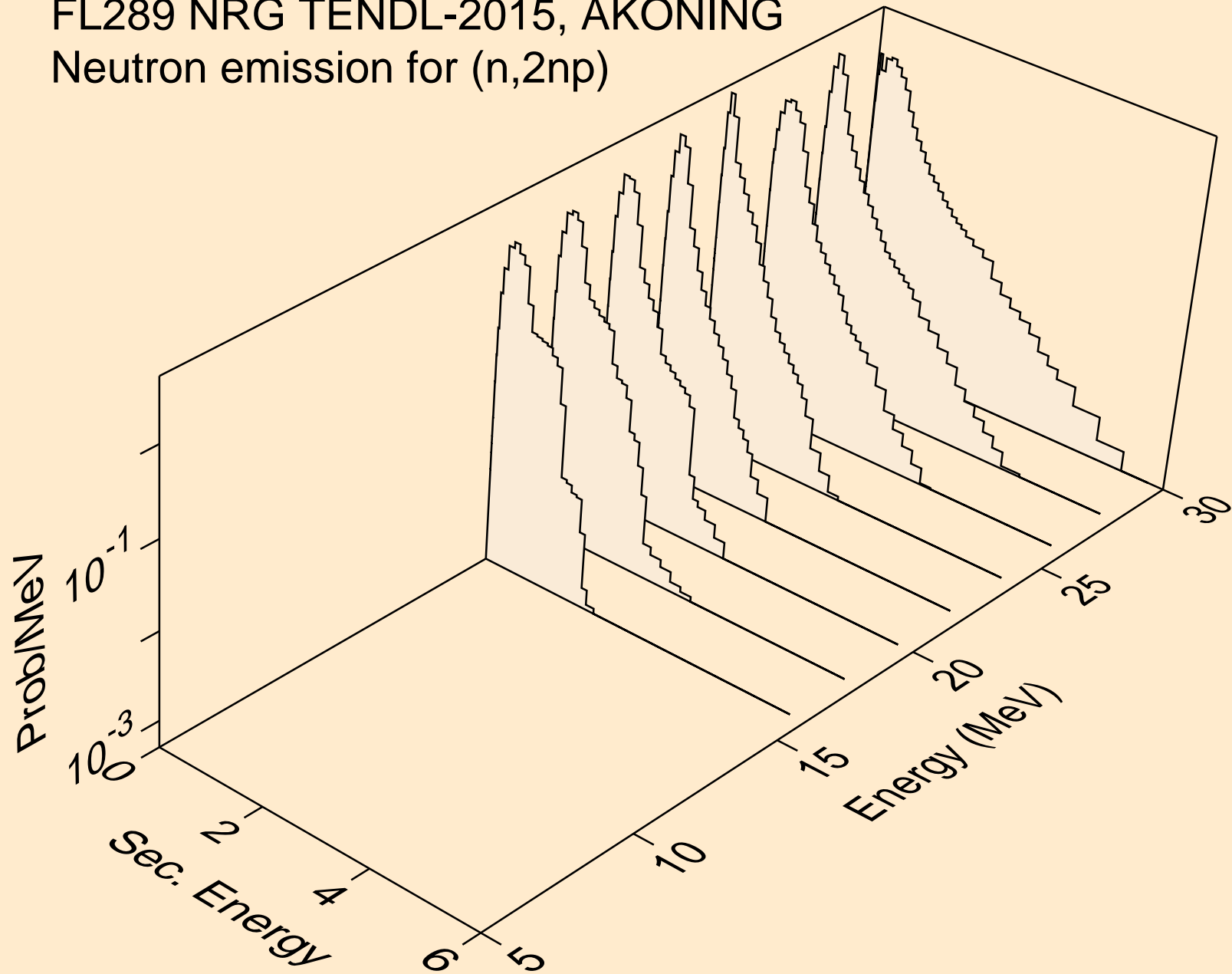

FL289 NRG TENDL-2015, AKONING
Neutron emission for (n,npa)

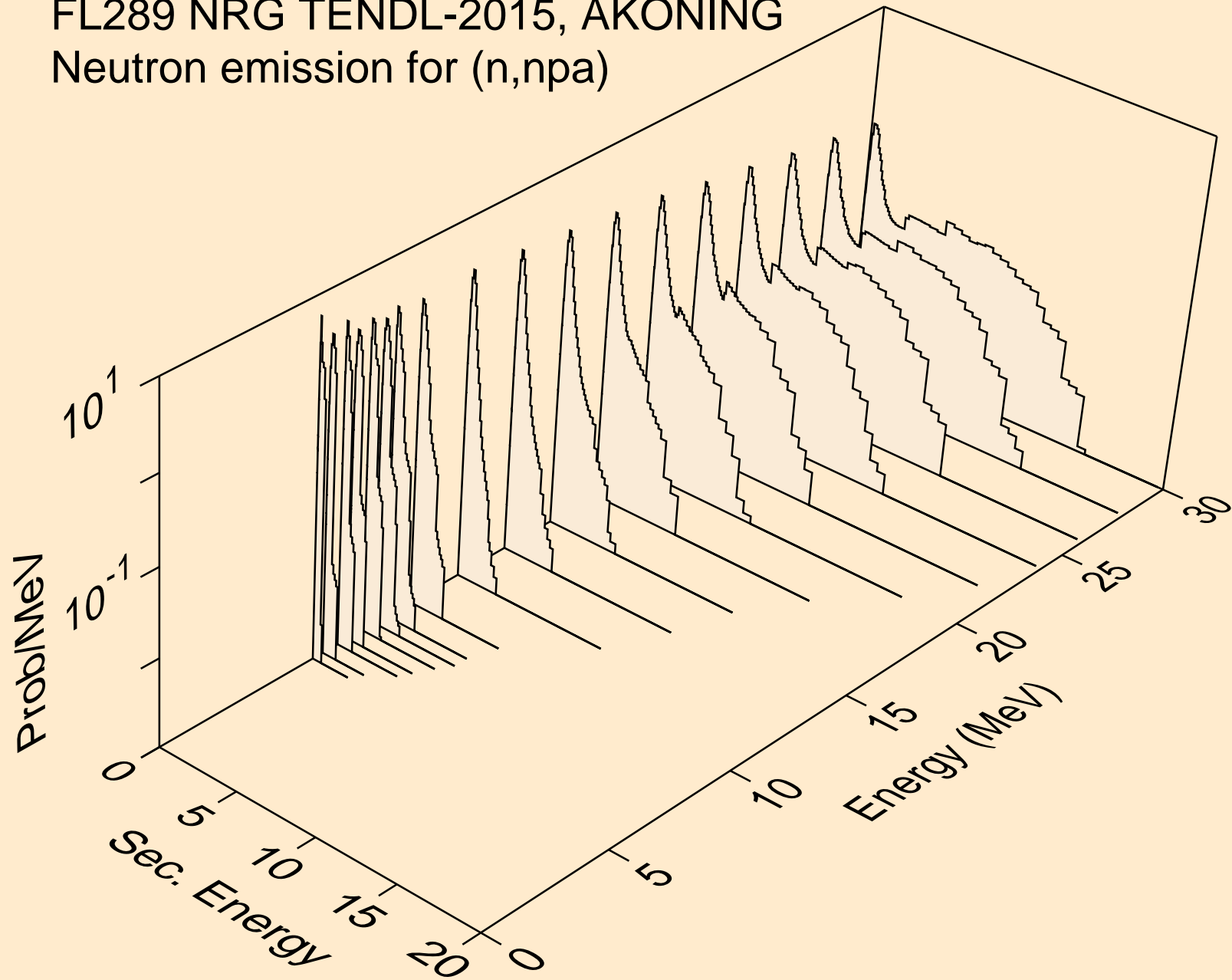

FL289 NRG TENDL-2015, AKONING
Neutron emission for (n,n*c)

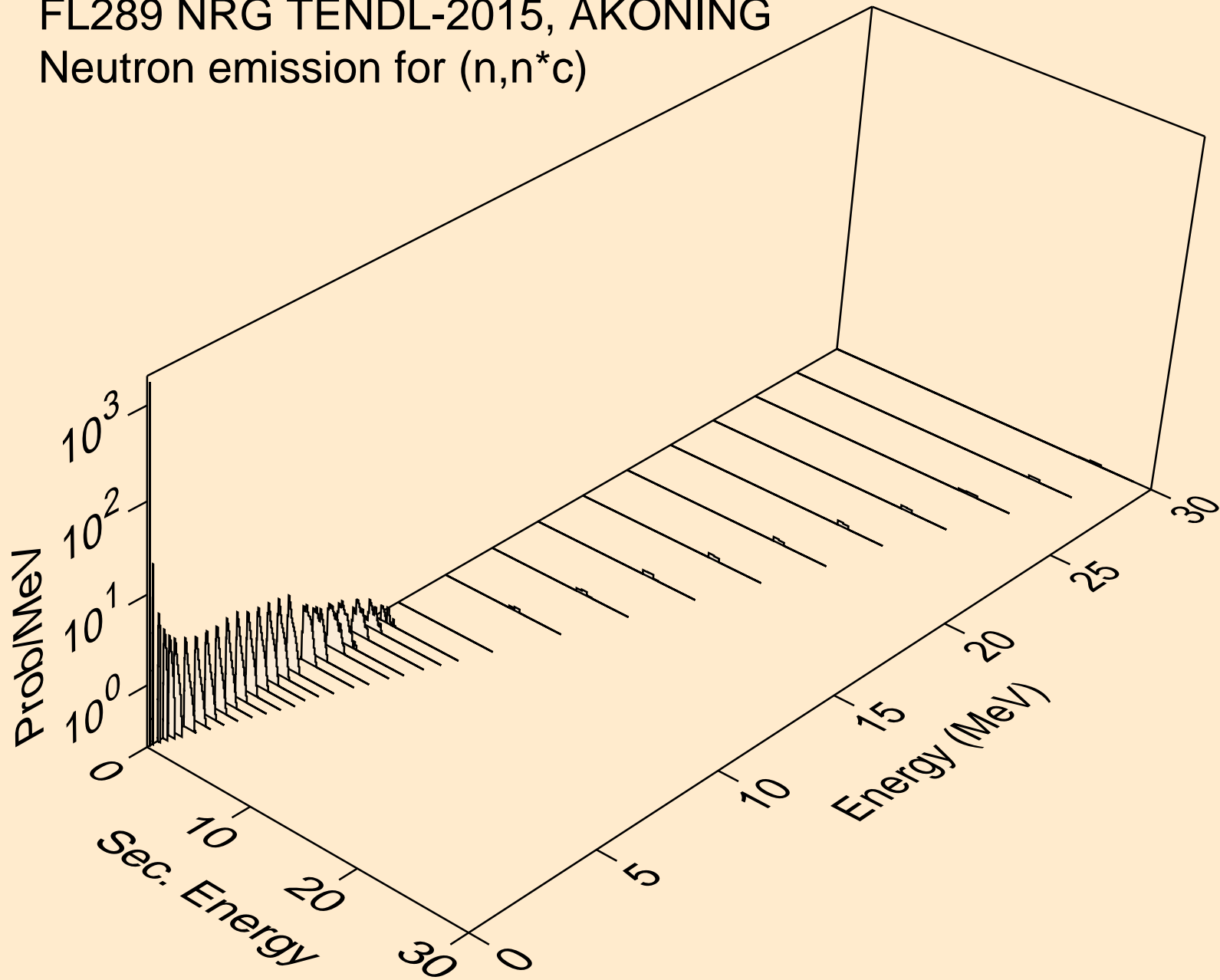

FL289 NRG TENDL-2015, AKONING

Delayed nubar

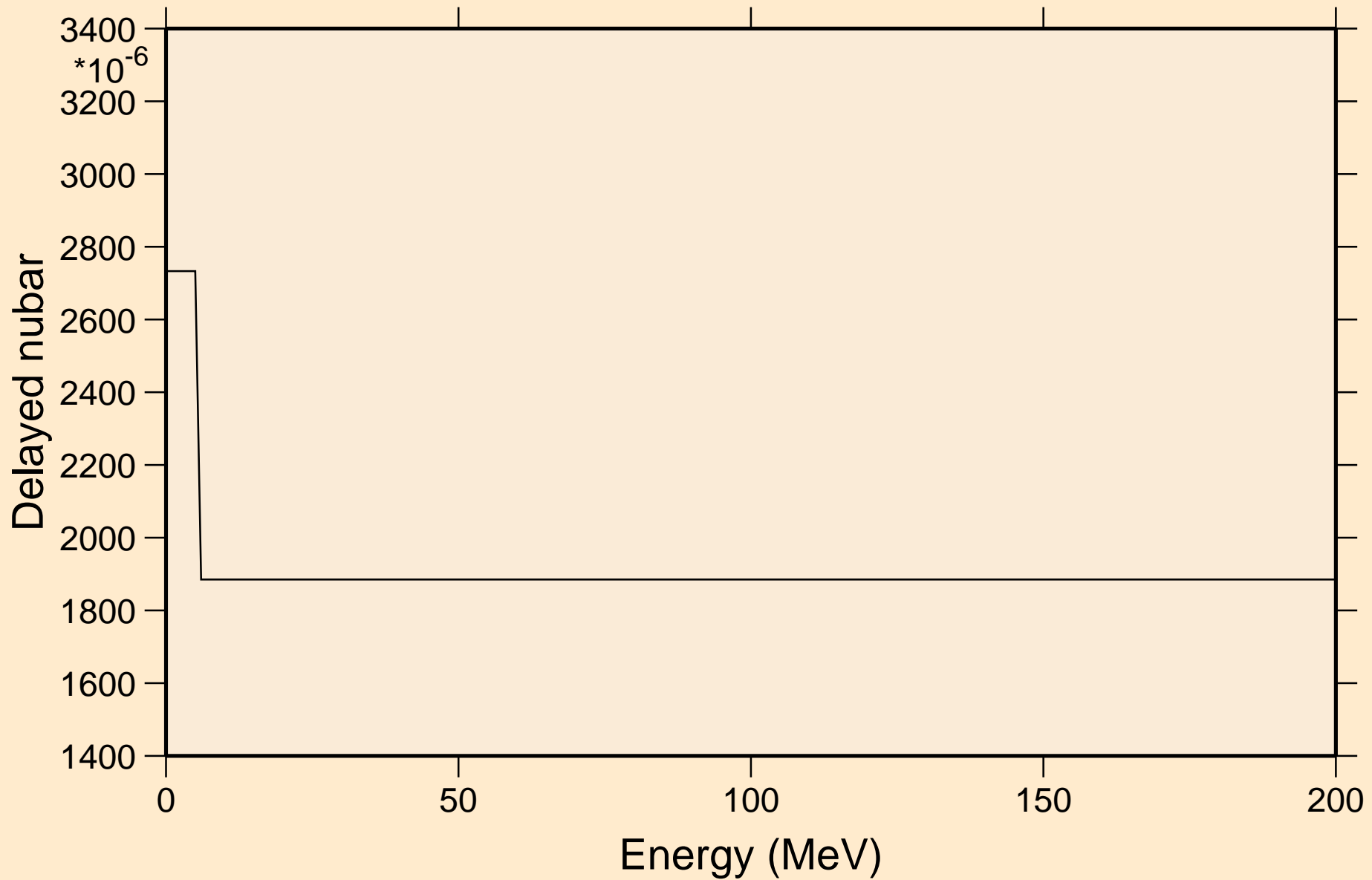

FL289 NRG TENDL-2015, AKONING

Delayed neutron spectra

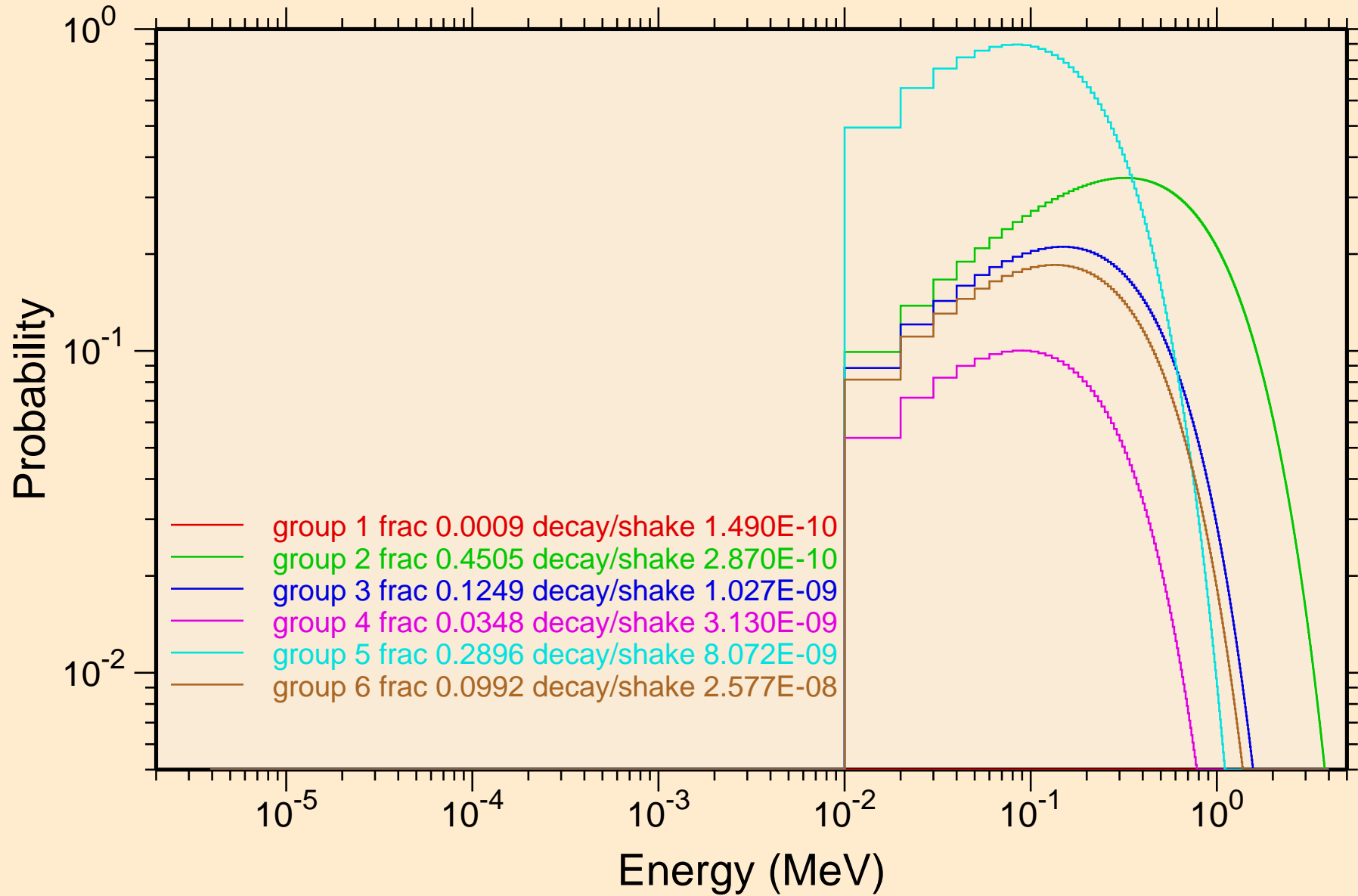

FL289 NRG TENDL-2015, AKONING
Photon emission for (n,x)

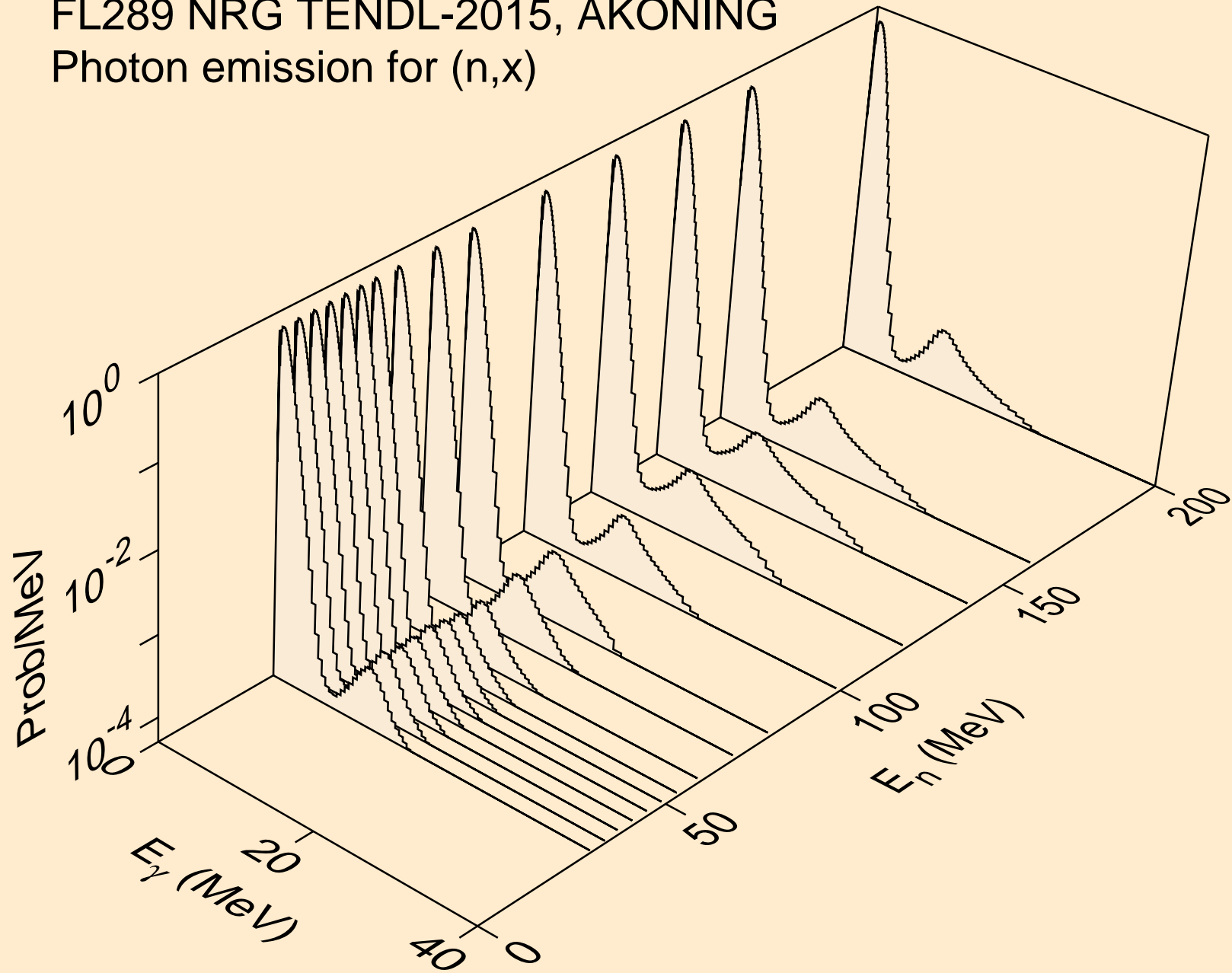

FL289 NRG TENDL-2015, AKONING
Photon emission for (n,2nd)

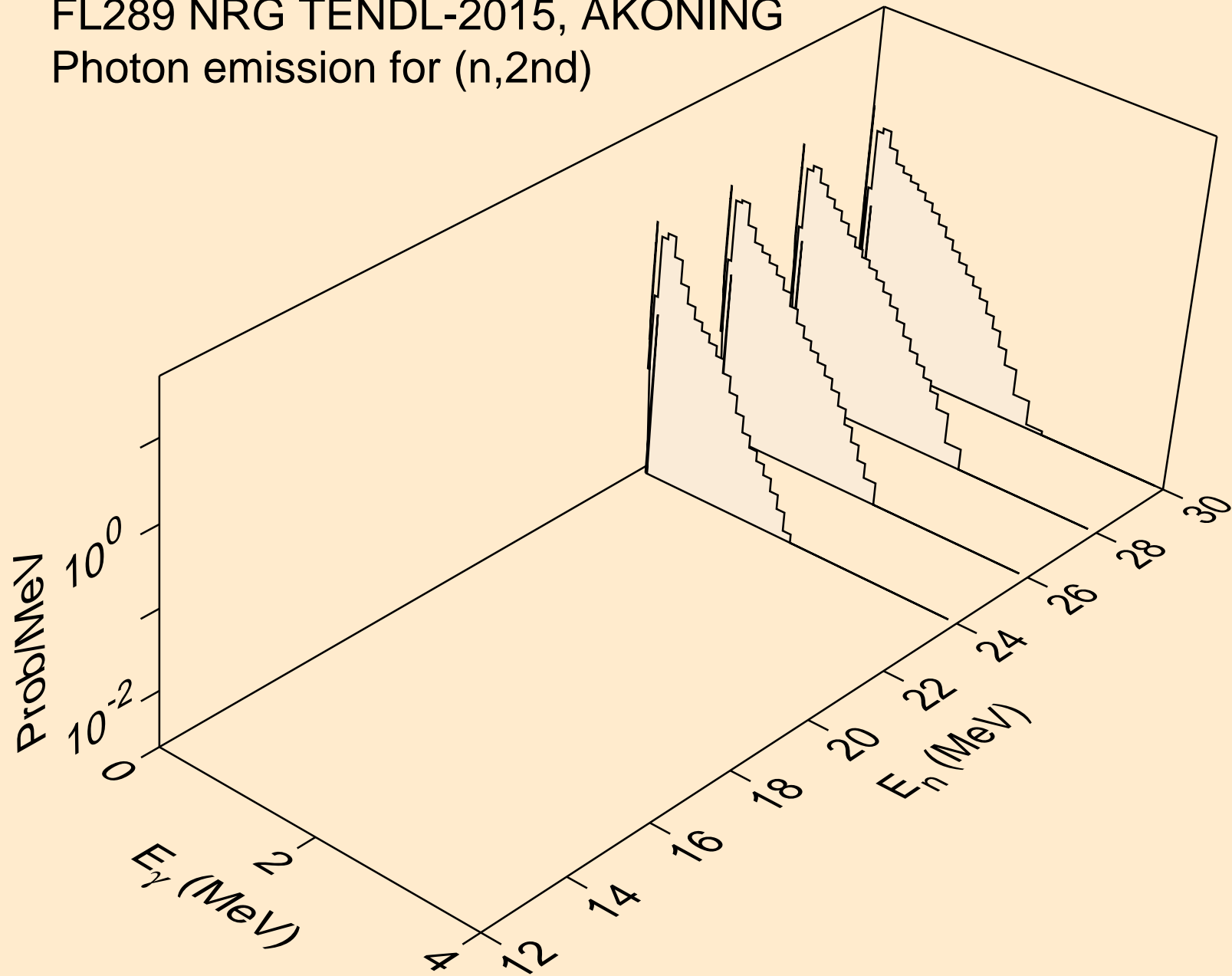

FL289 NRG TENDL-2015, AKONING
Photon emission for (n,2n)

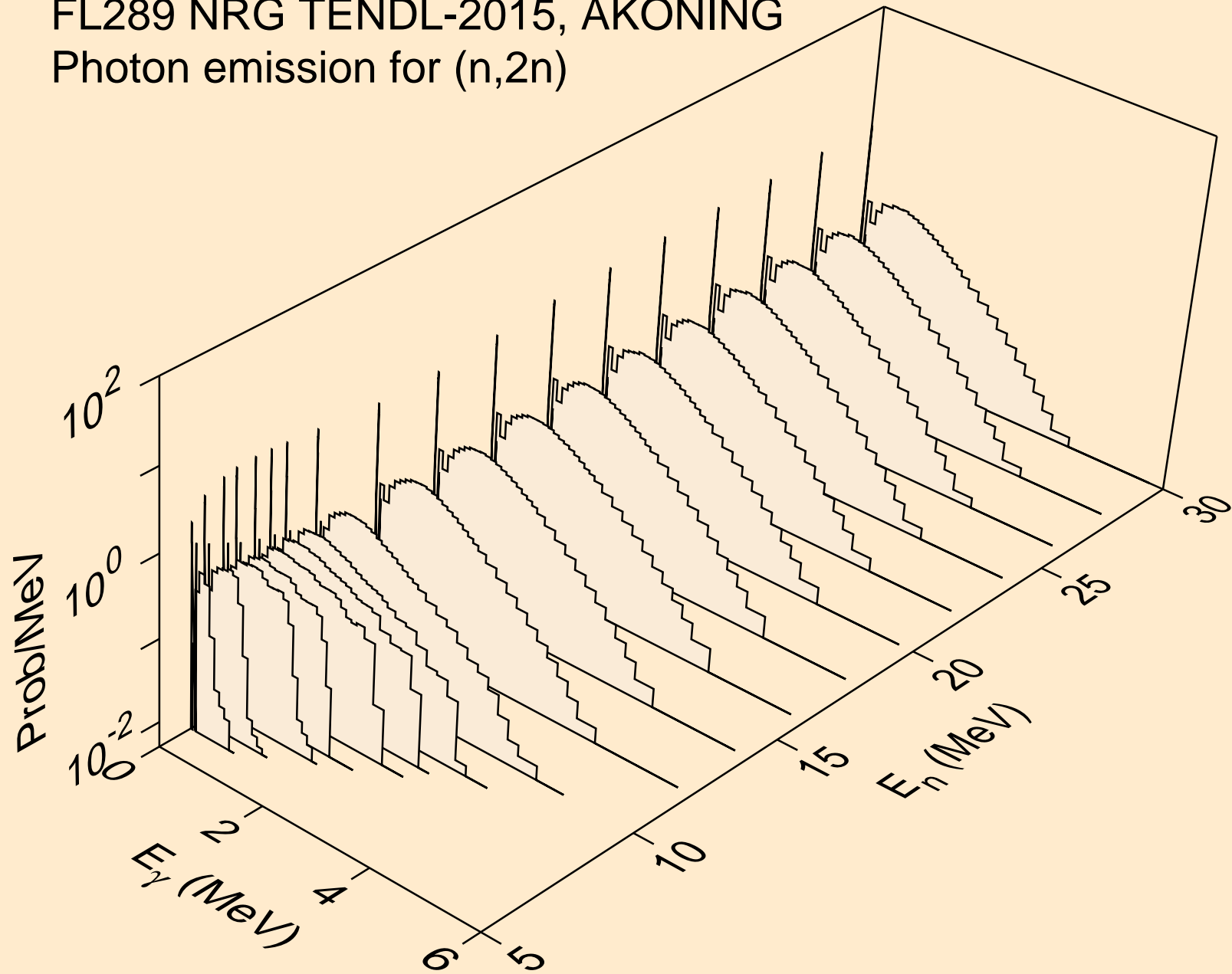

FL289 NRG TENDL-2015, AKONING
Photon emission for (n,3n)

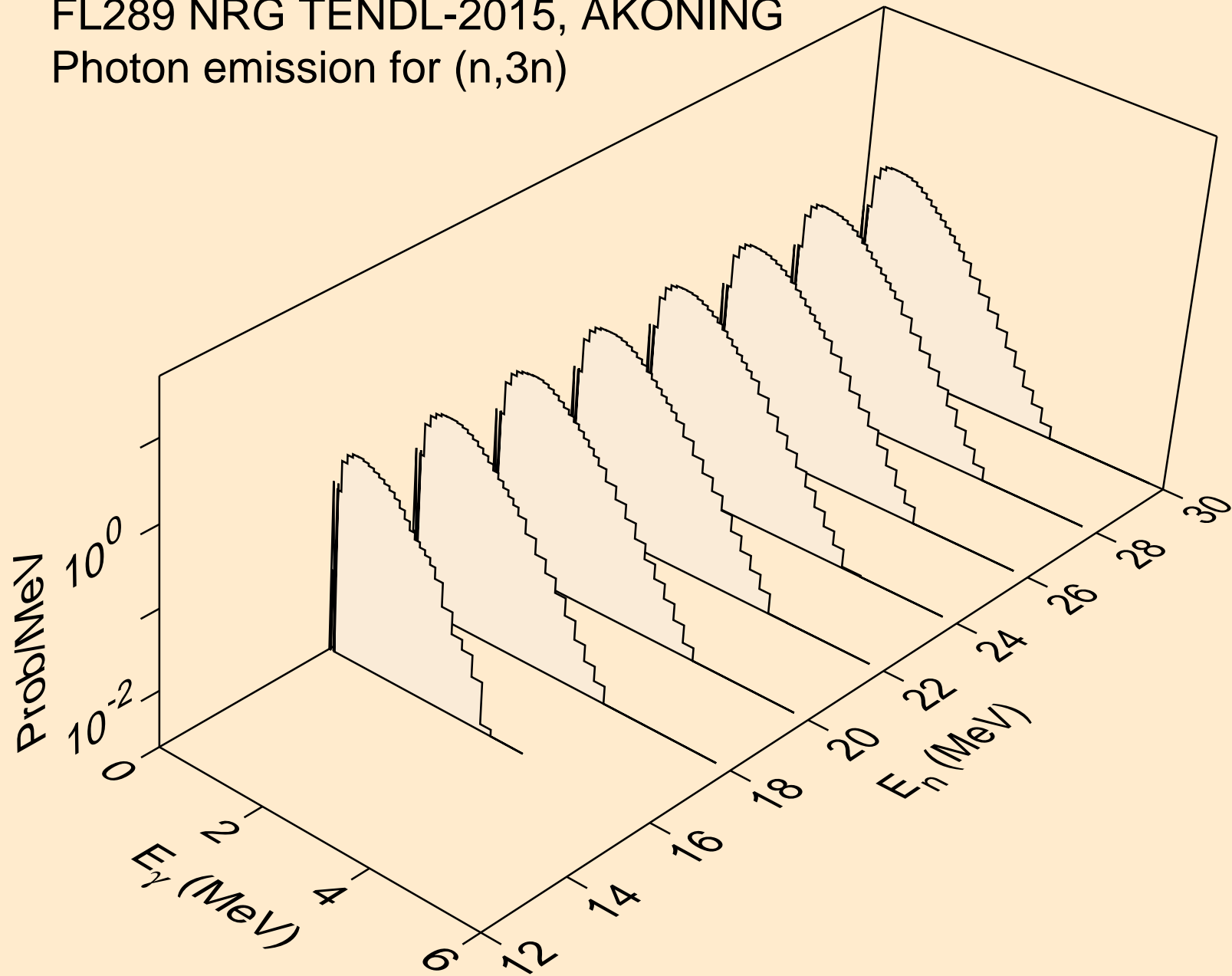

FL289 NRG TENDL-2015, AKONING
Photon emission for (n,n*)a

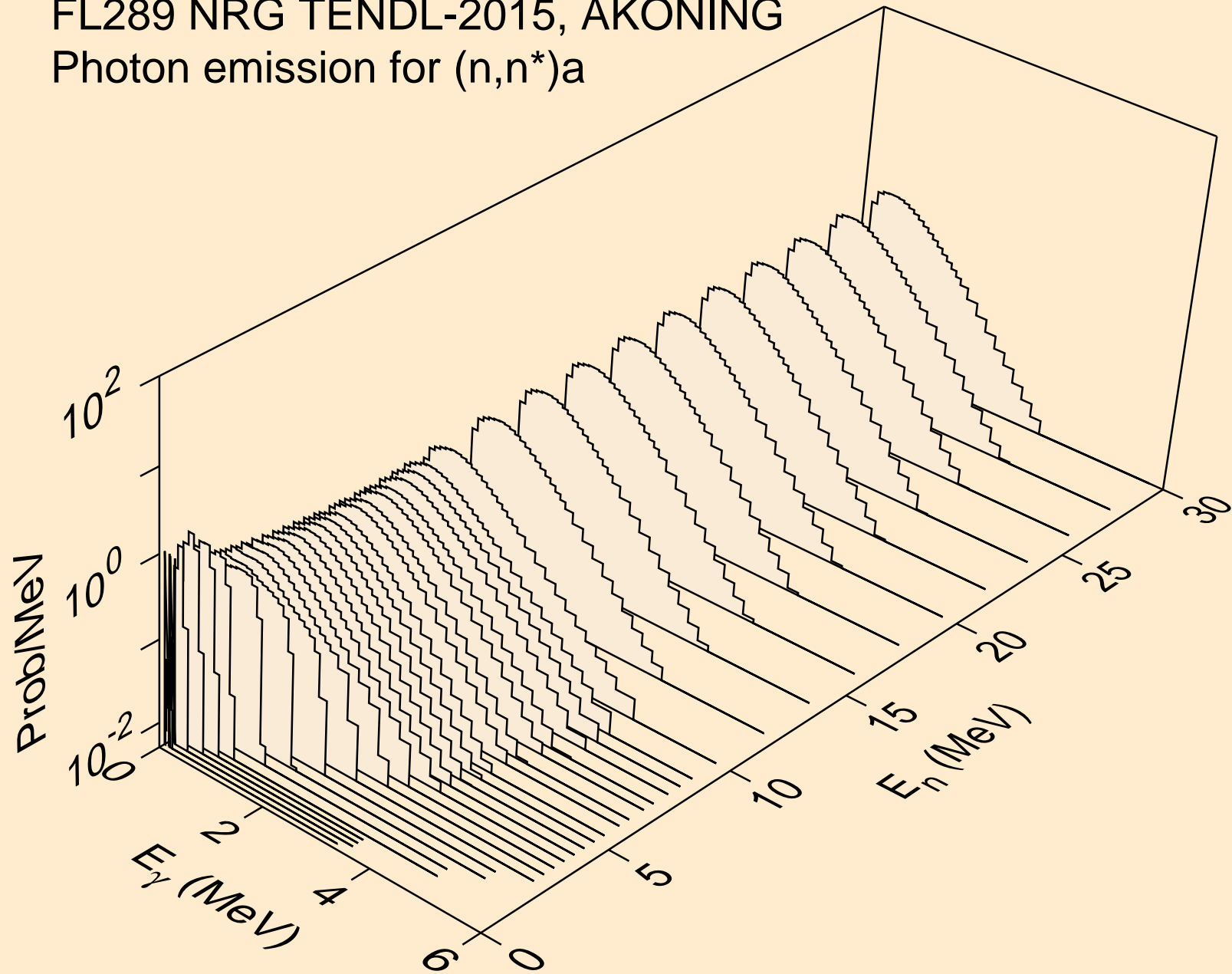

FL289 NRG TENDL-2015, AKONING
Photon emission for (n,2n)a

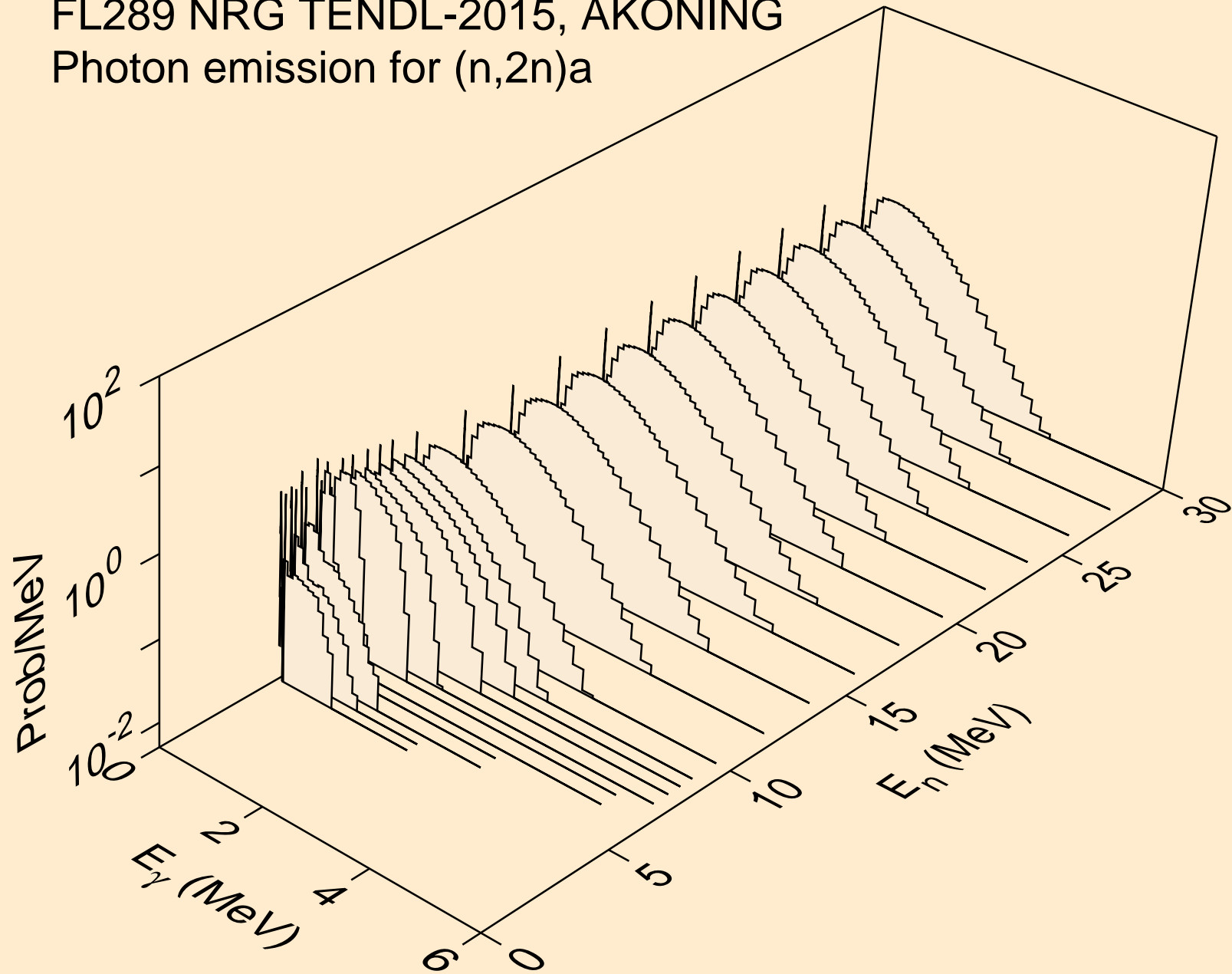

FL289 NRG TENDL-2015, AKONING
Photon emission for (n,3n)a

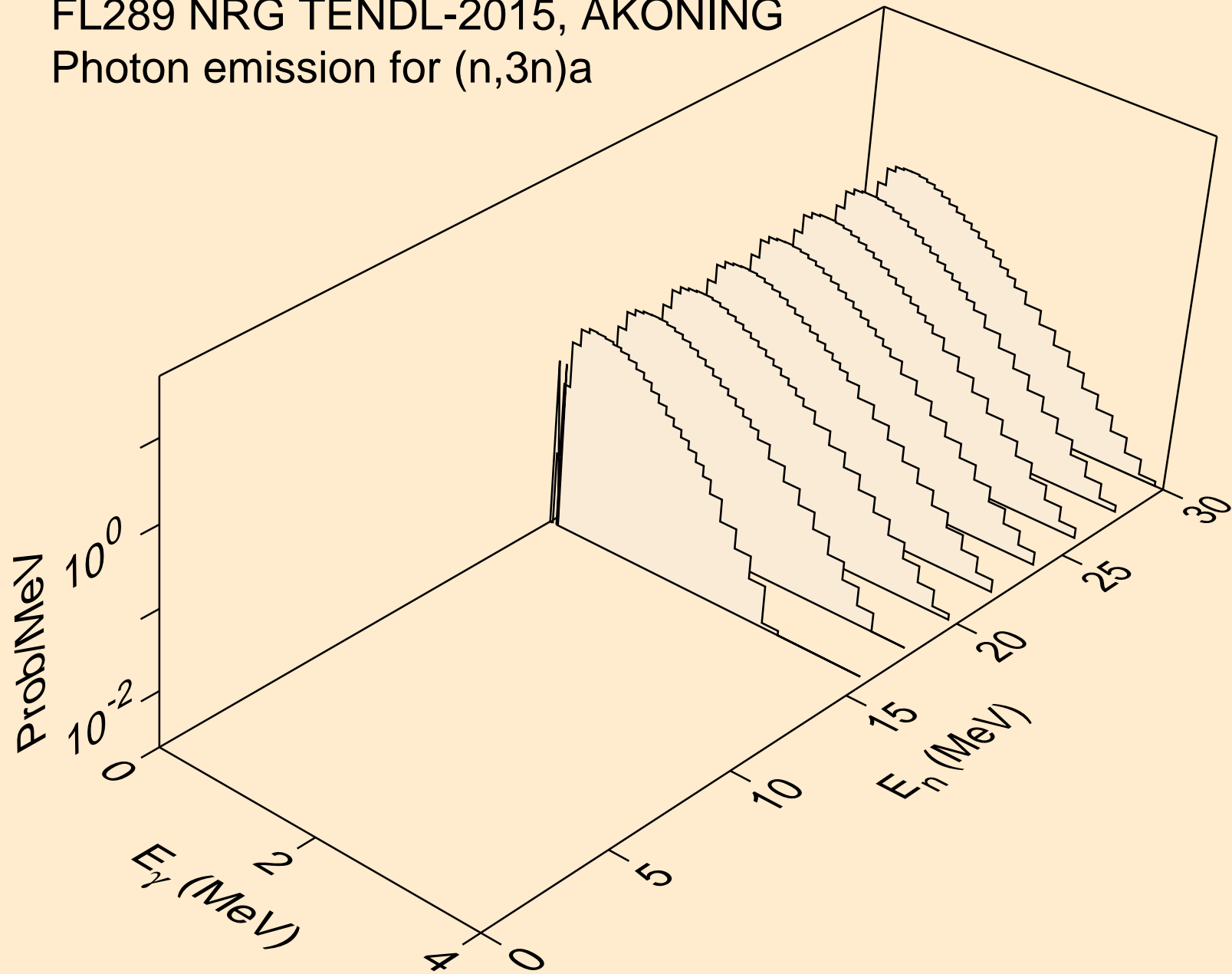

FL289 NRG TENDL-2015, AKONING
Photon emission for (n,n*)p

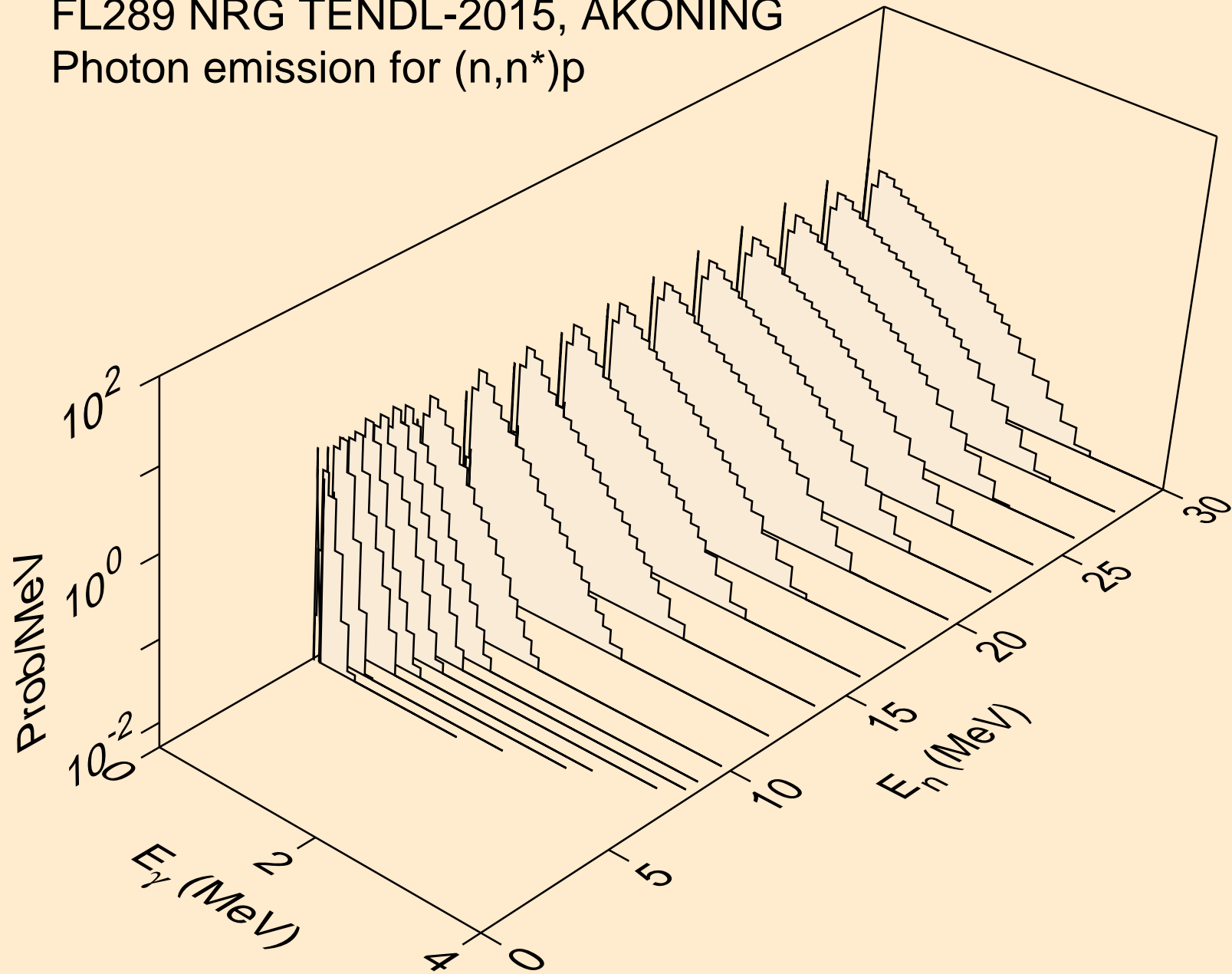

FL289 NRG TENDL-2015, AKONING
Photon emission for (n,n*)2a

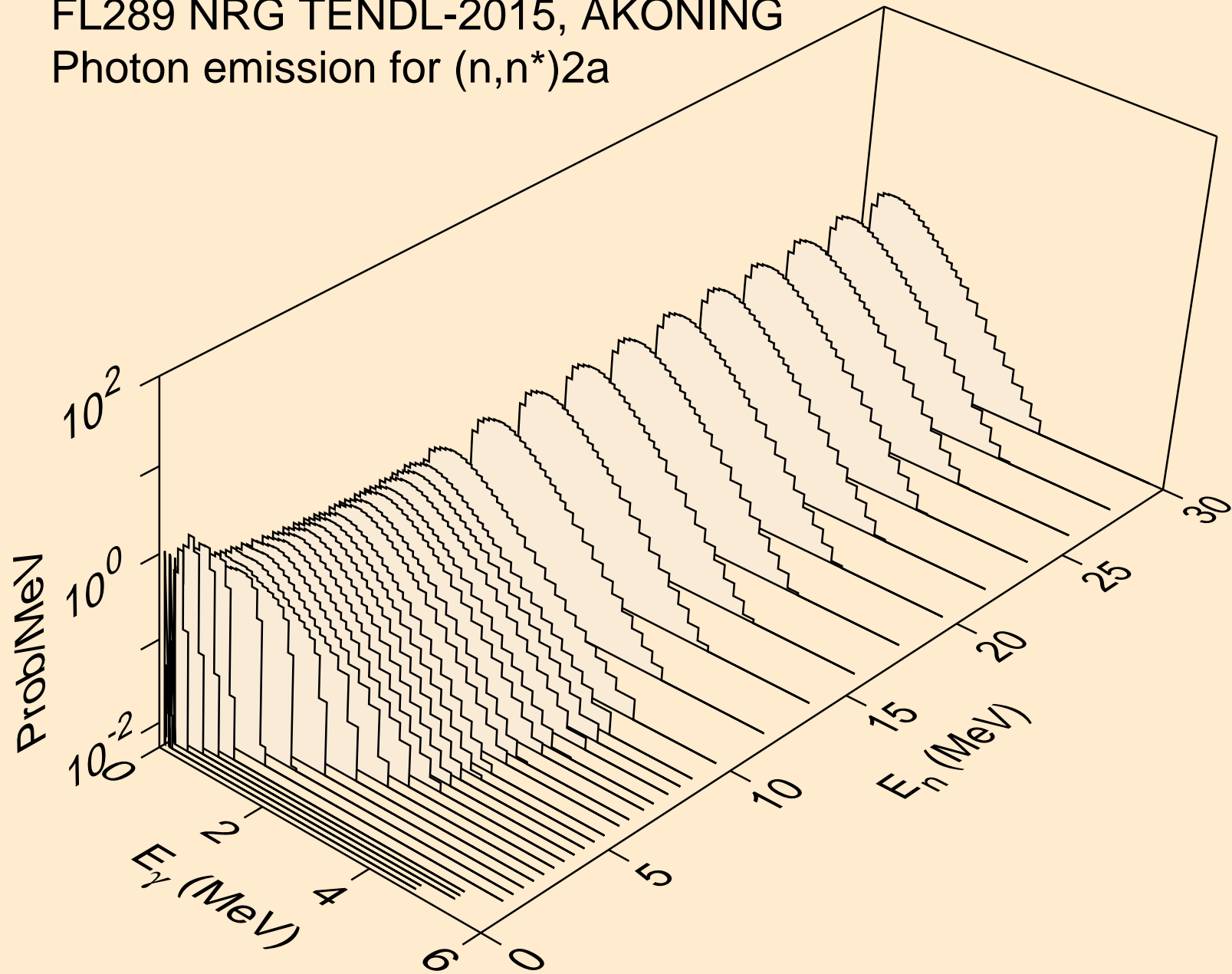

FL289 NRG TENDL-2015, AKONING
Photon emission for (n,2n)2a

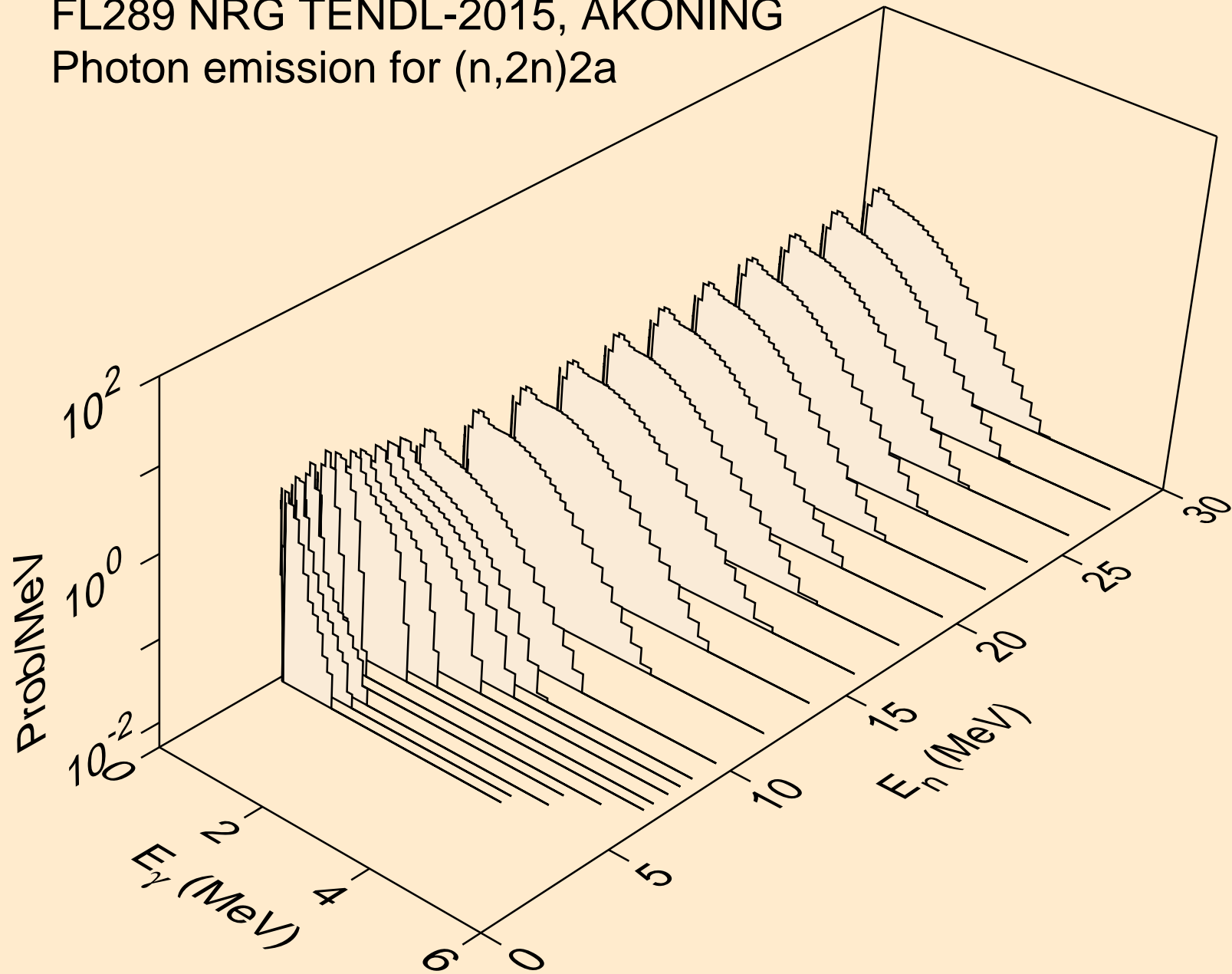

FL289 NRG TENDL-2015, AKONING
Photon emission for (n,n*)d

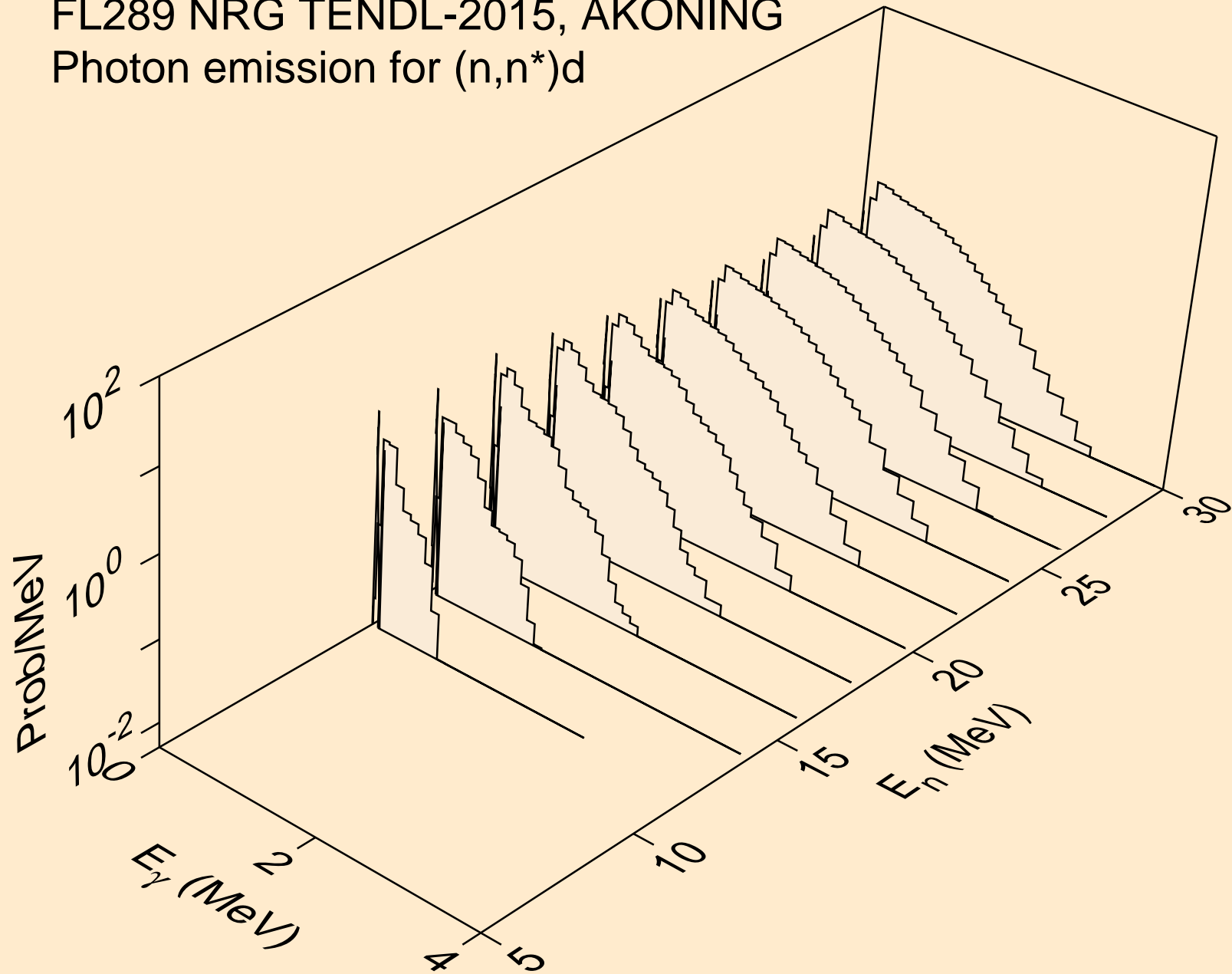

FL289 NRG TENDL-2015, AKONING
Photon emission for (n,n*)t

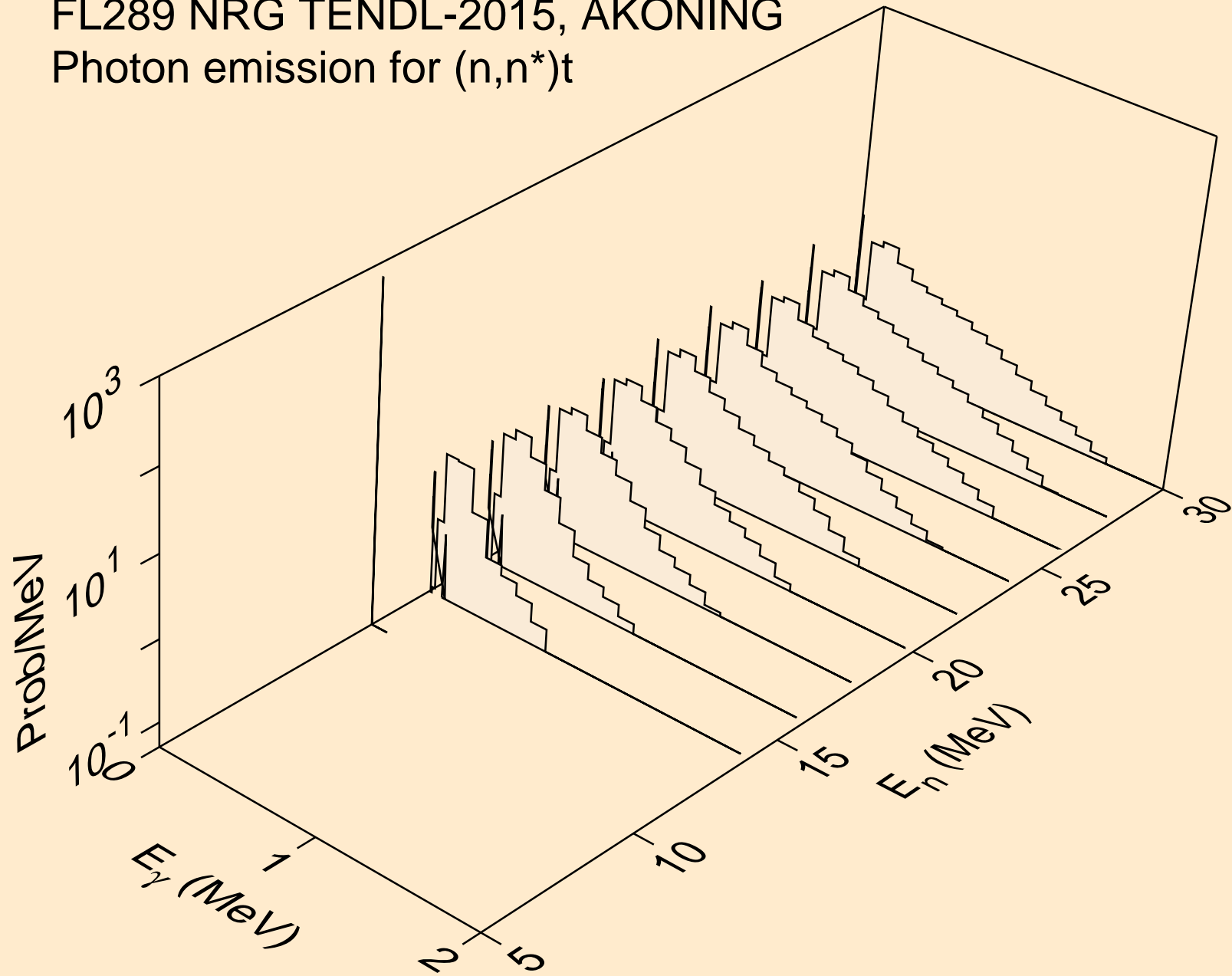

FL289 NRG TENDL-2015, AKONING
Photon emission for (n,n*)he3

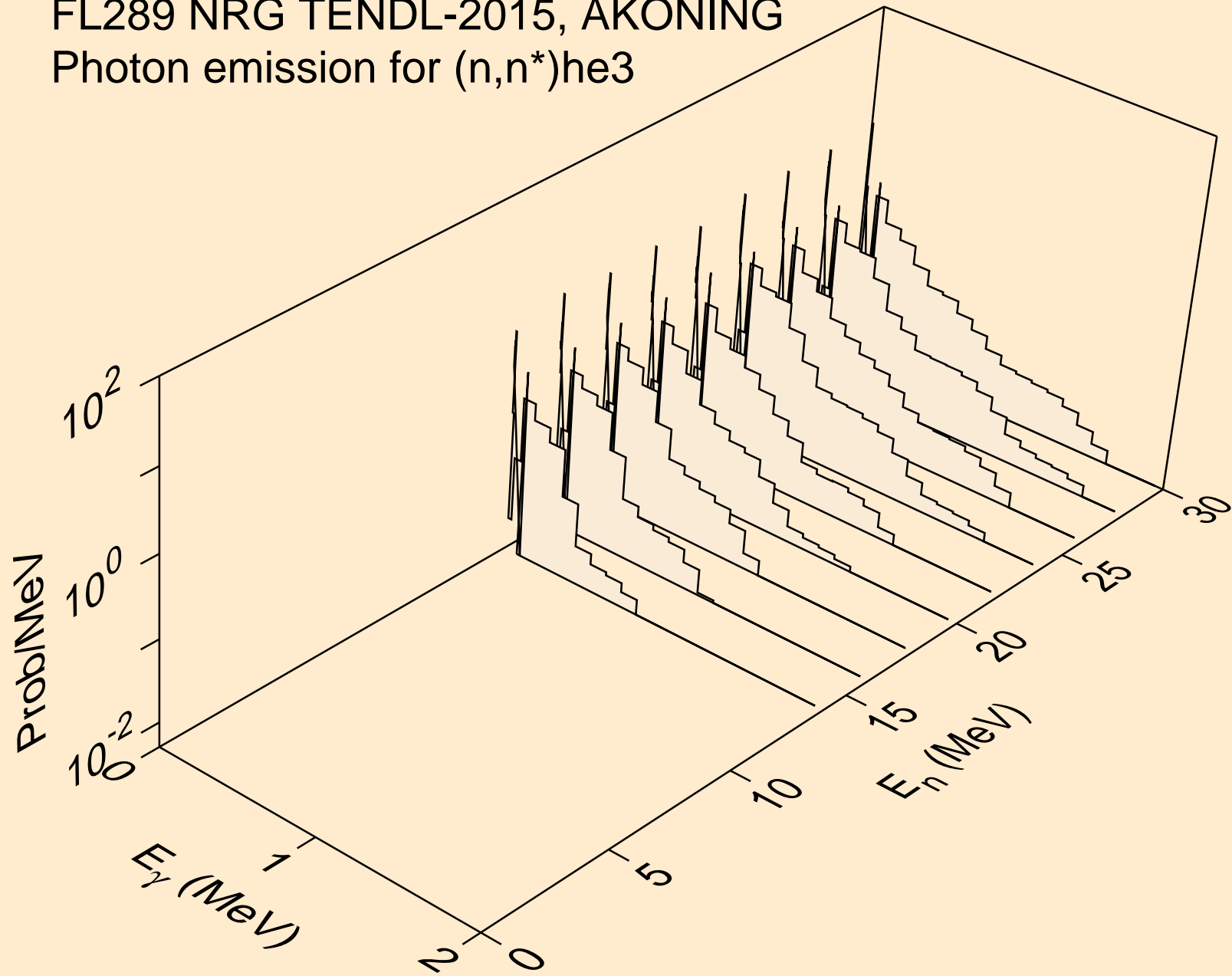

FL289 NRG TENDL-2015, AKONING
Photon emission for (n,n*)d2a

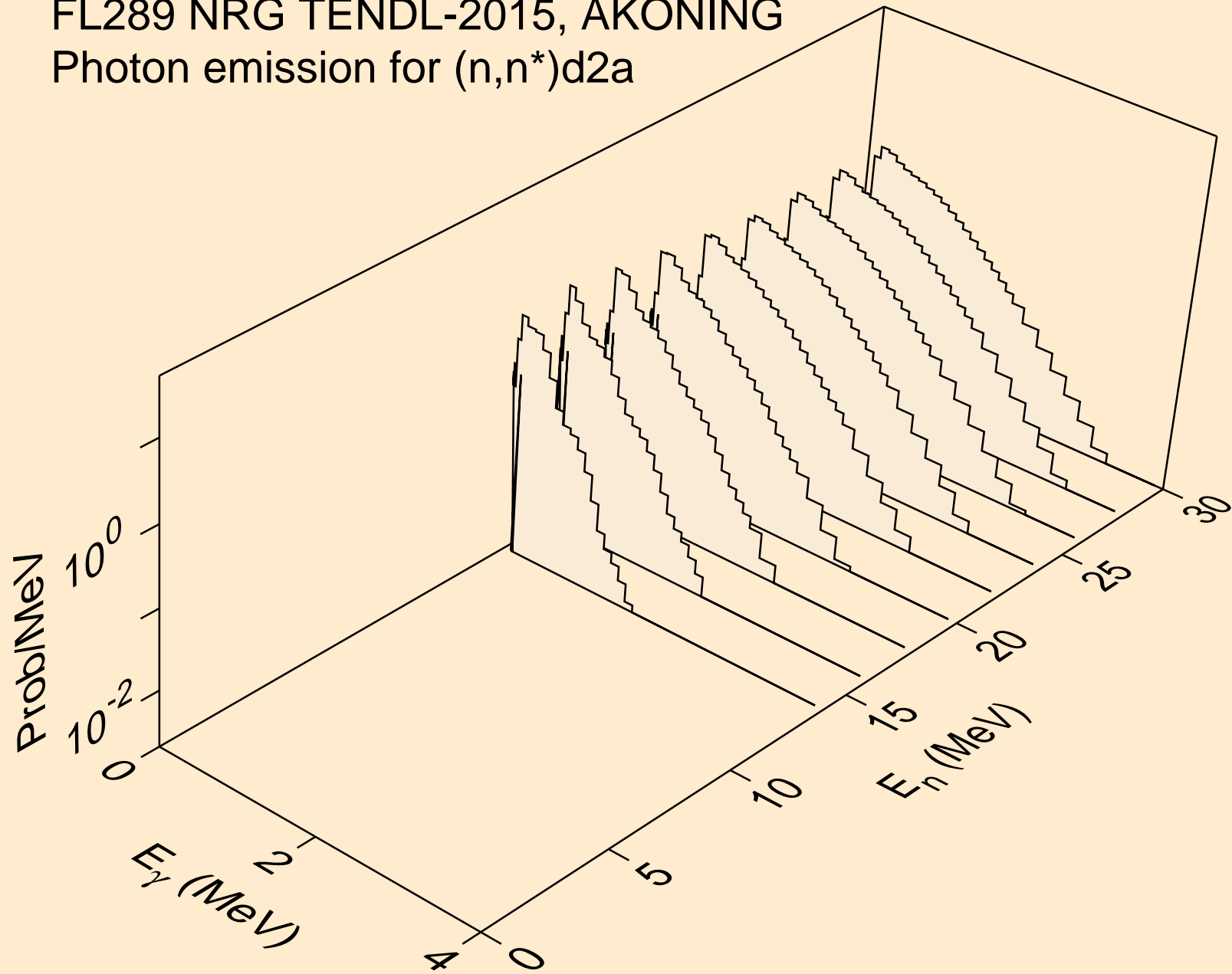

FL289 NRG TENDL-2015, AKONING
Photon emission for (n,n*)t2a

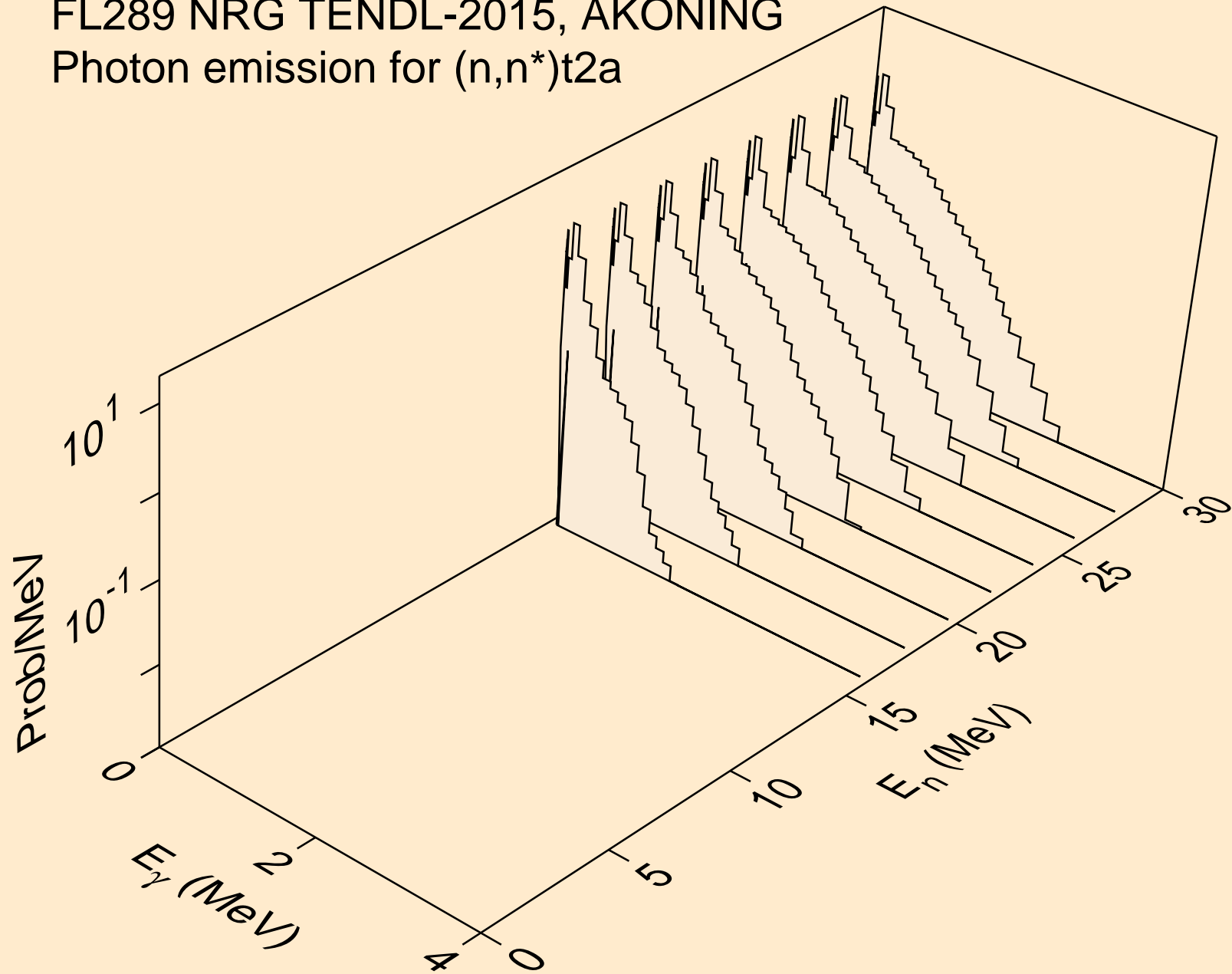

FL289 NRG TENDL-2015, AKONING
Photon emission for (n,4n)

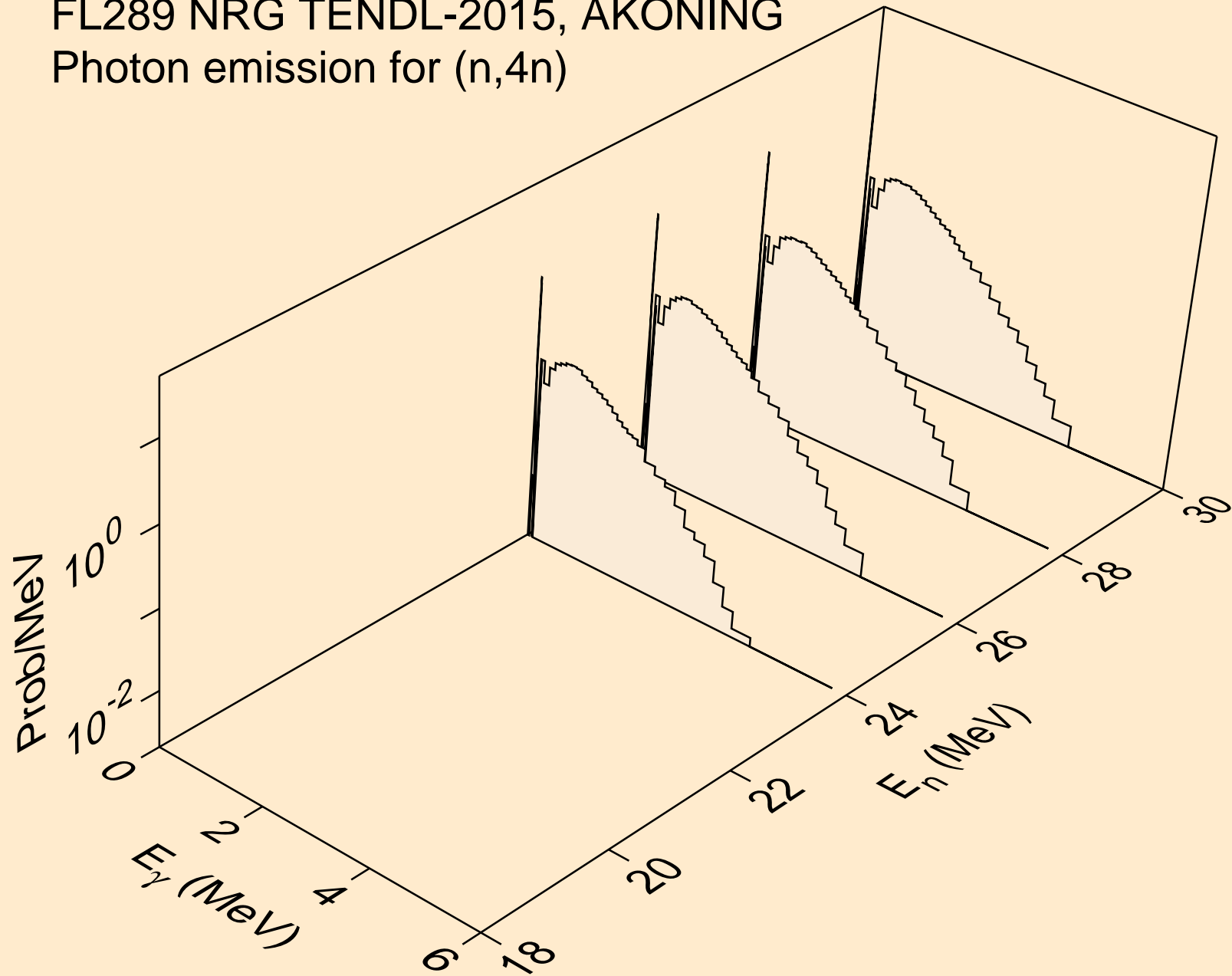

FL289 NRG TENDL-2015, AKONING
Photon emission for (n,2np)

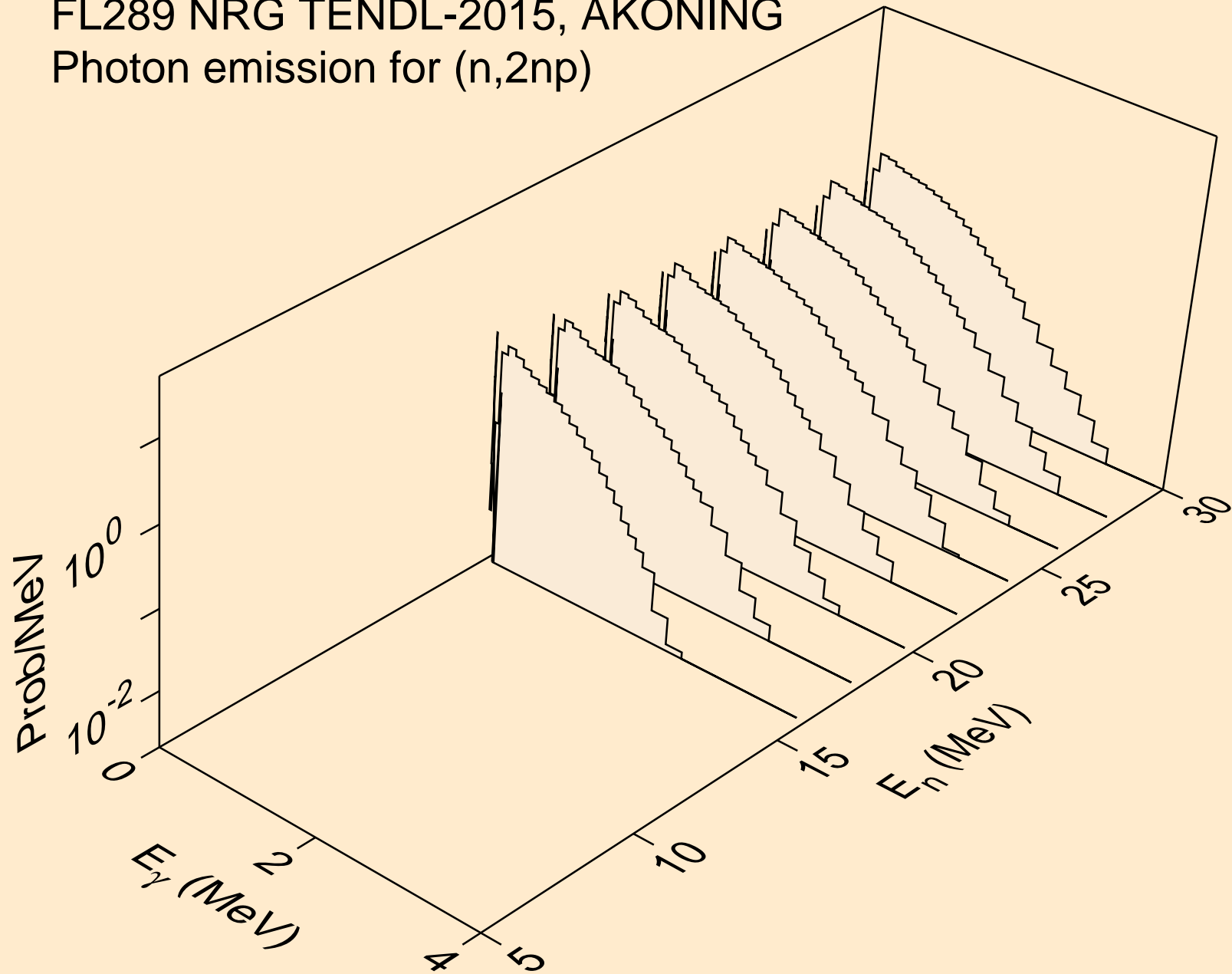

FL289 NRG TENDL-2015, AKONING
Photon emission for (n,3np)

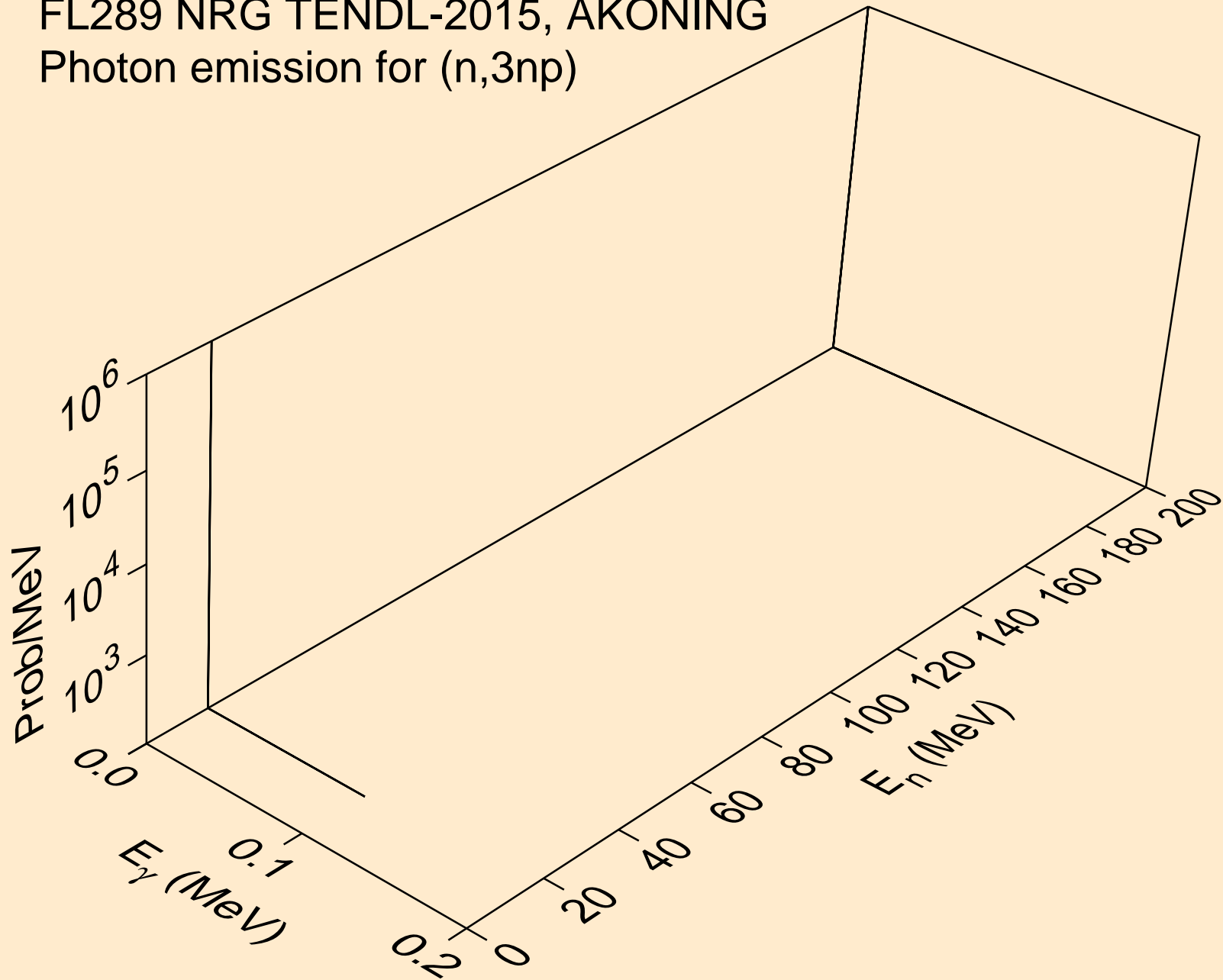

FL289 NRG TENDL-2015, AKONING
Photon emission for (n,2np)

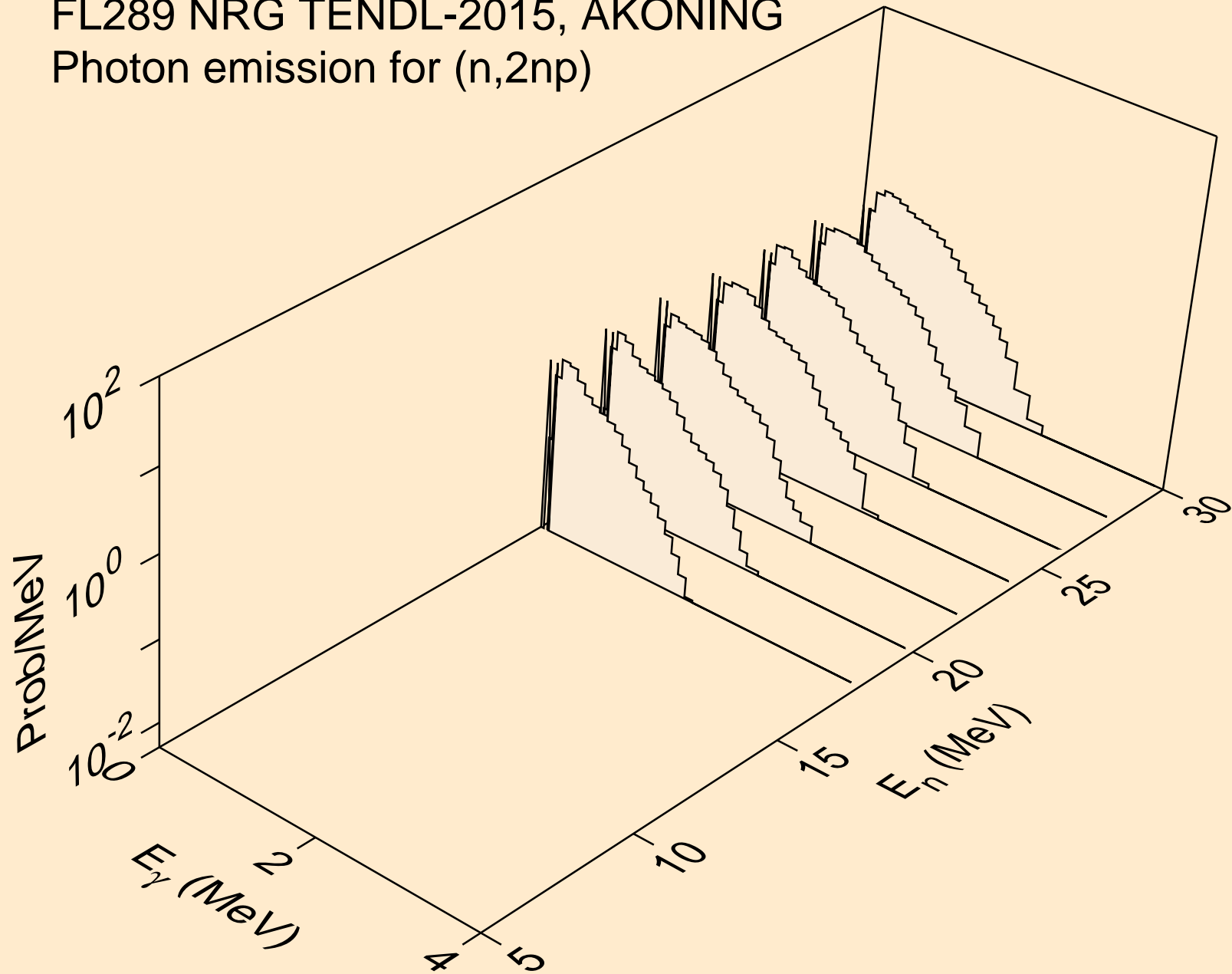

FL289 NRG TENDL-2015, AKONING
Photon emission for (n,npa)

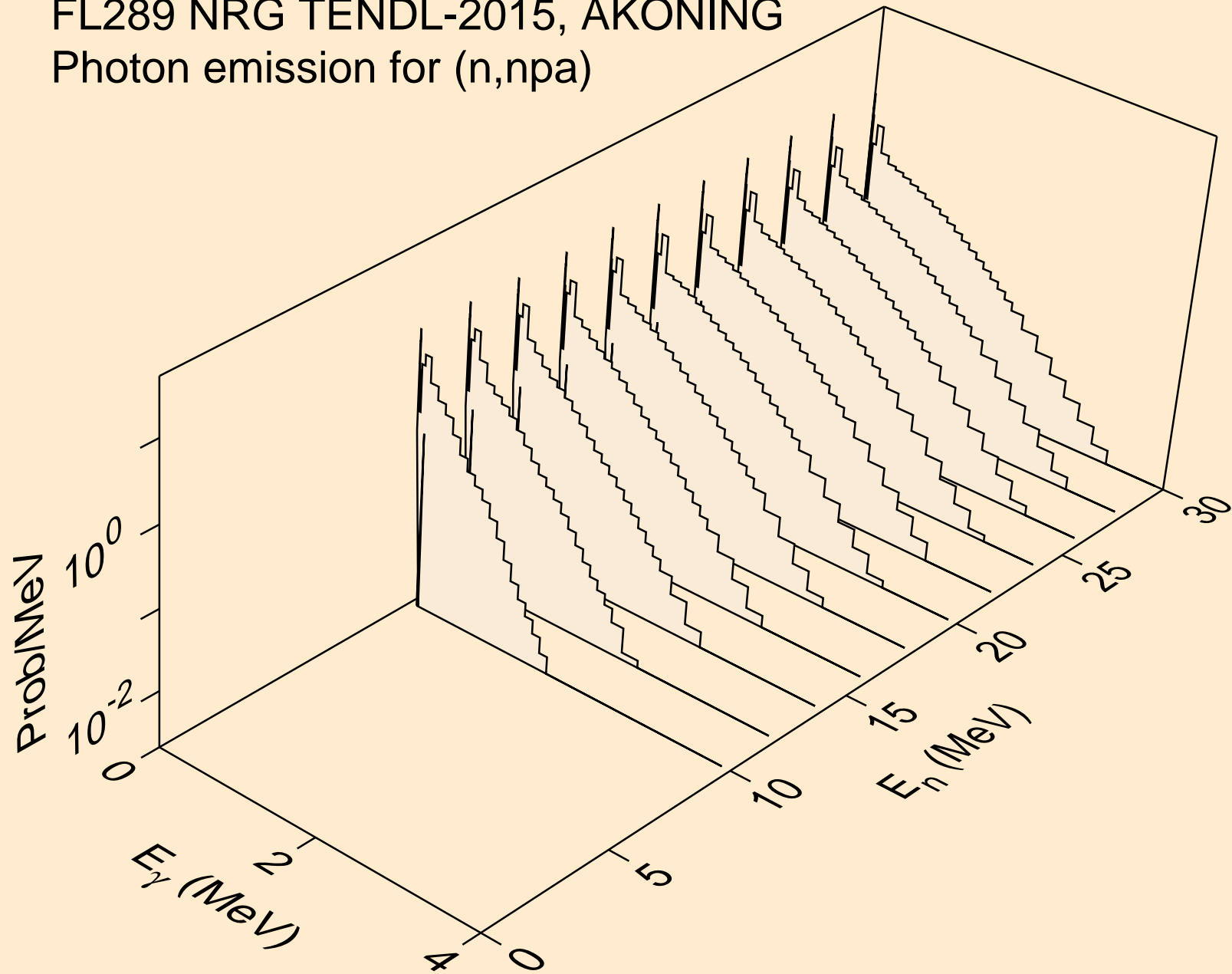

FL289 NRG TENDL-2015, AKONING
Photon emission for (n,n*c)

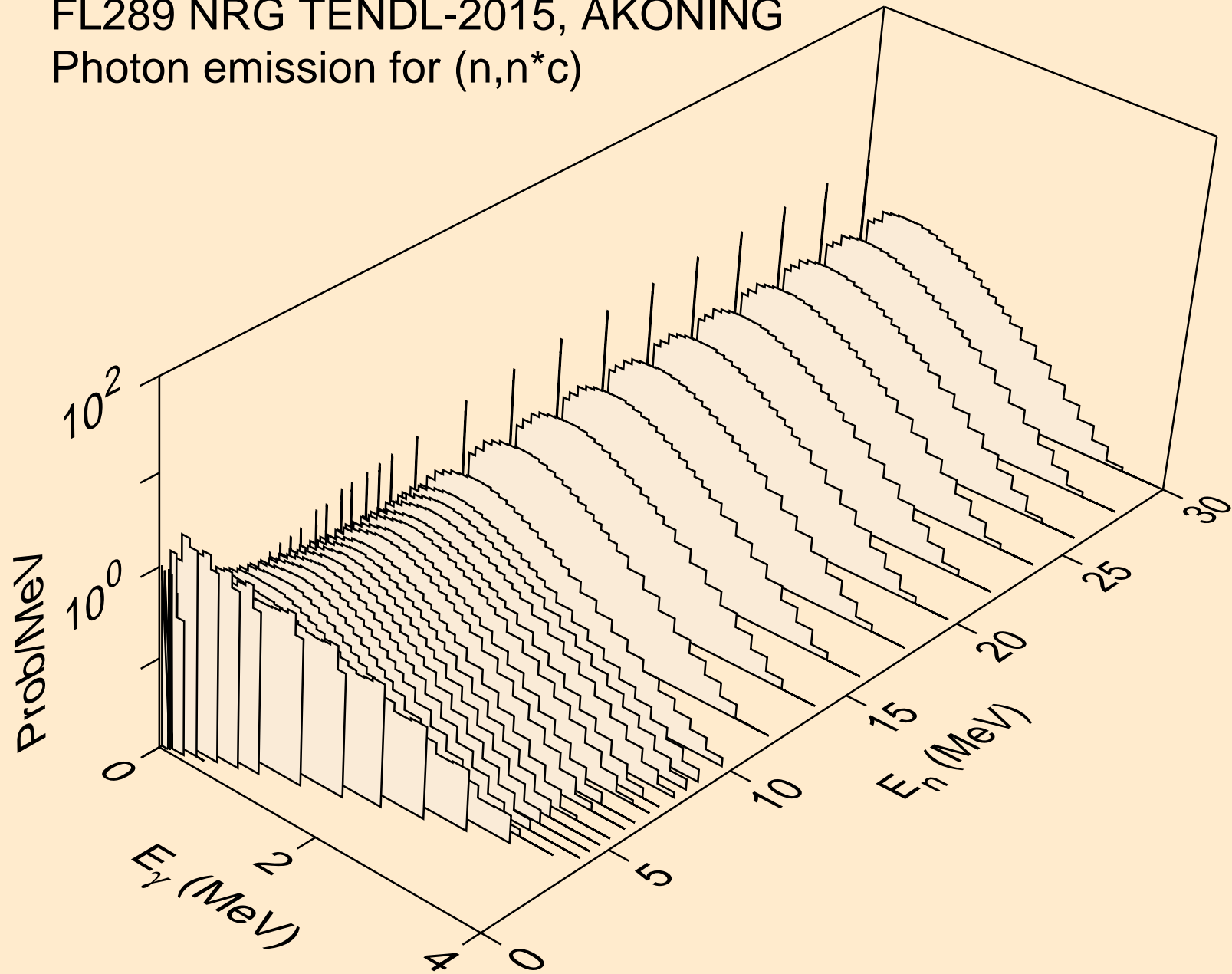

FL289 NRG TENDL-2015, AKONING
Photon emission for (n,gma)

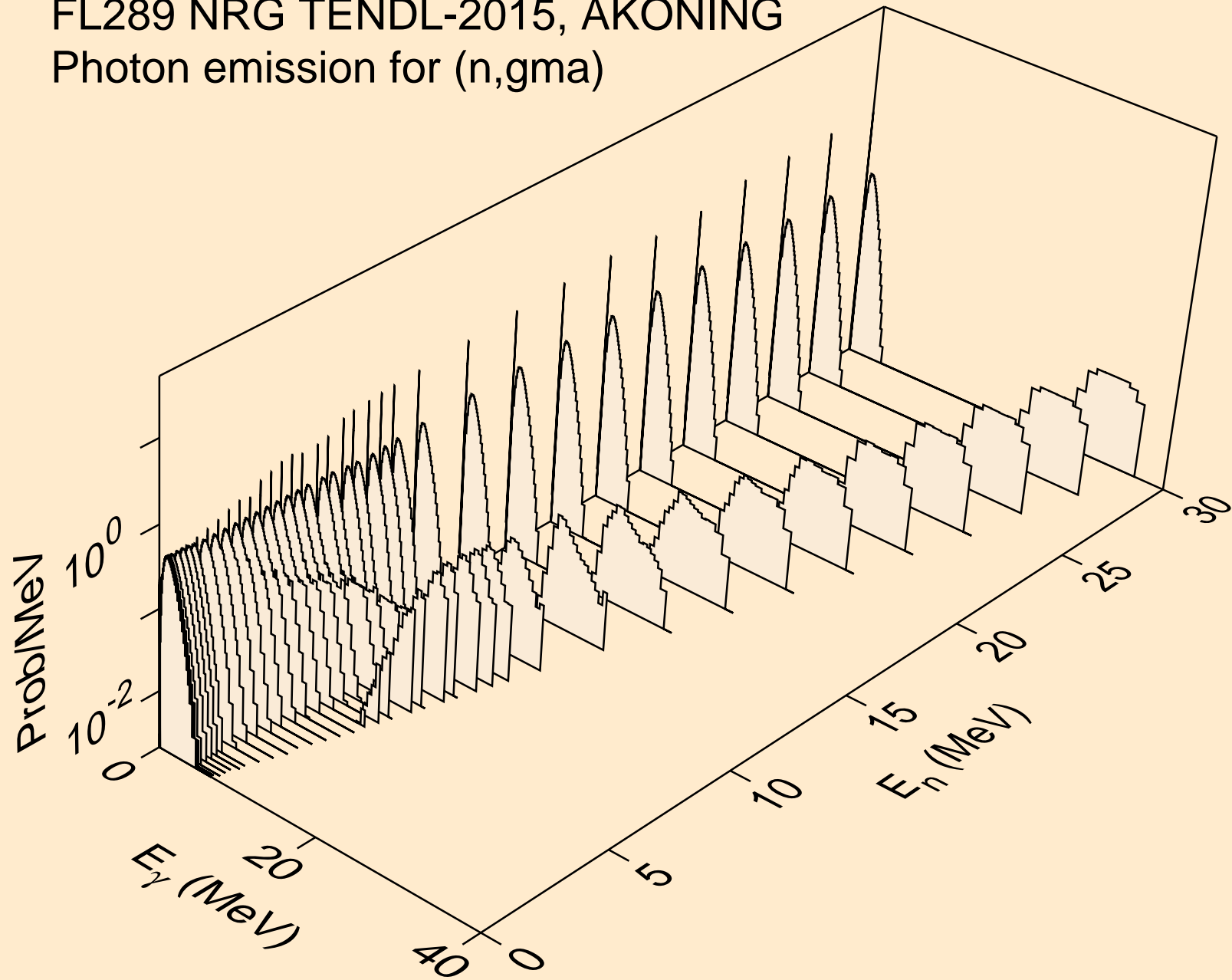

FL289 NRG TENDL-2015, AKONING
Photon emission for (n,p)

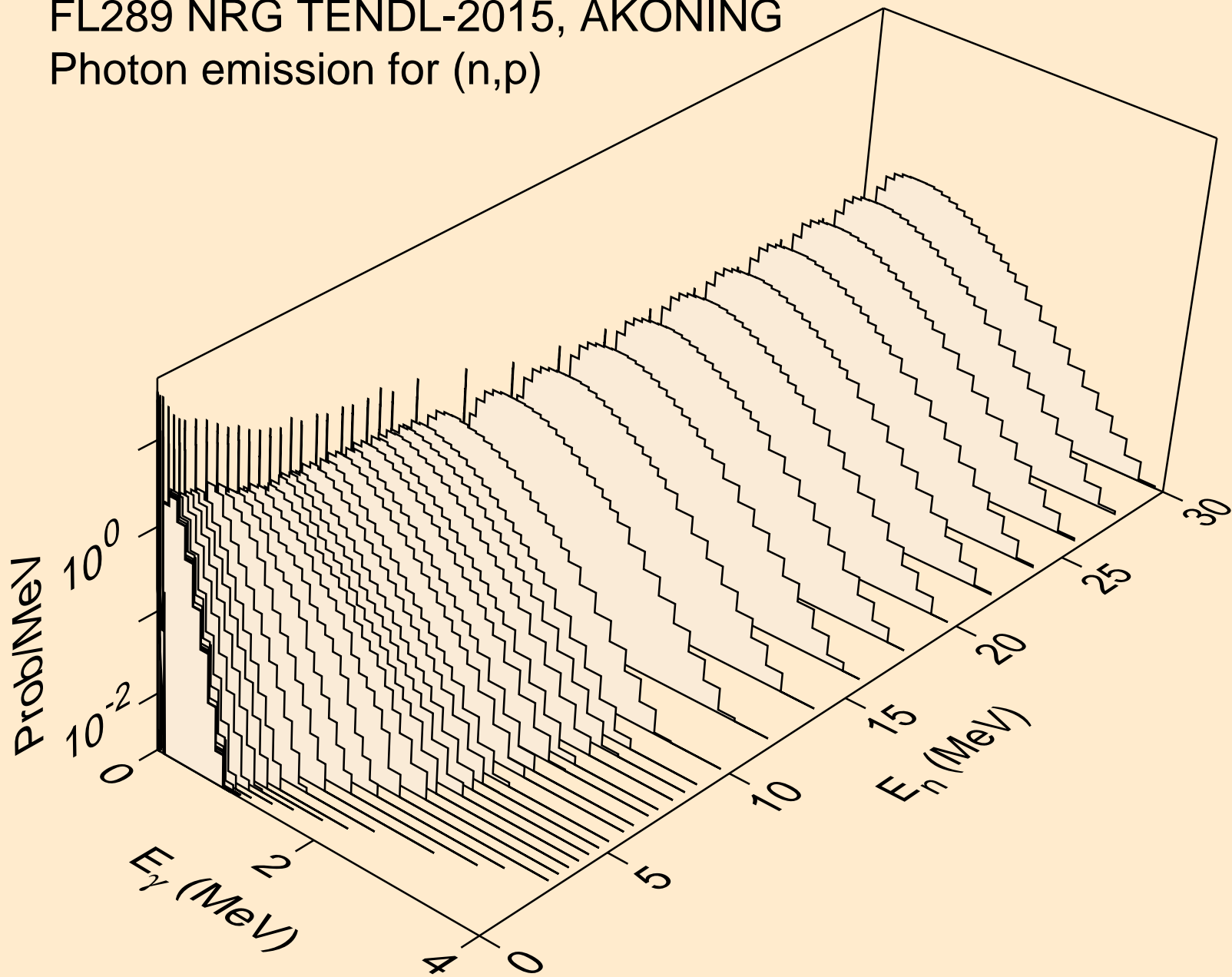

FL289 NRG TENDL-2015, AKONING
Photon emission for (n,d)

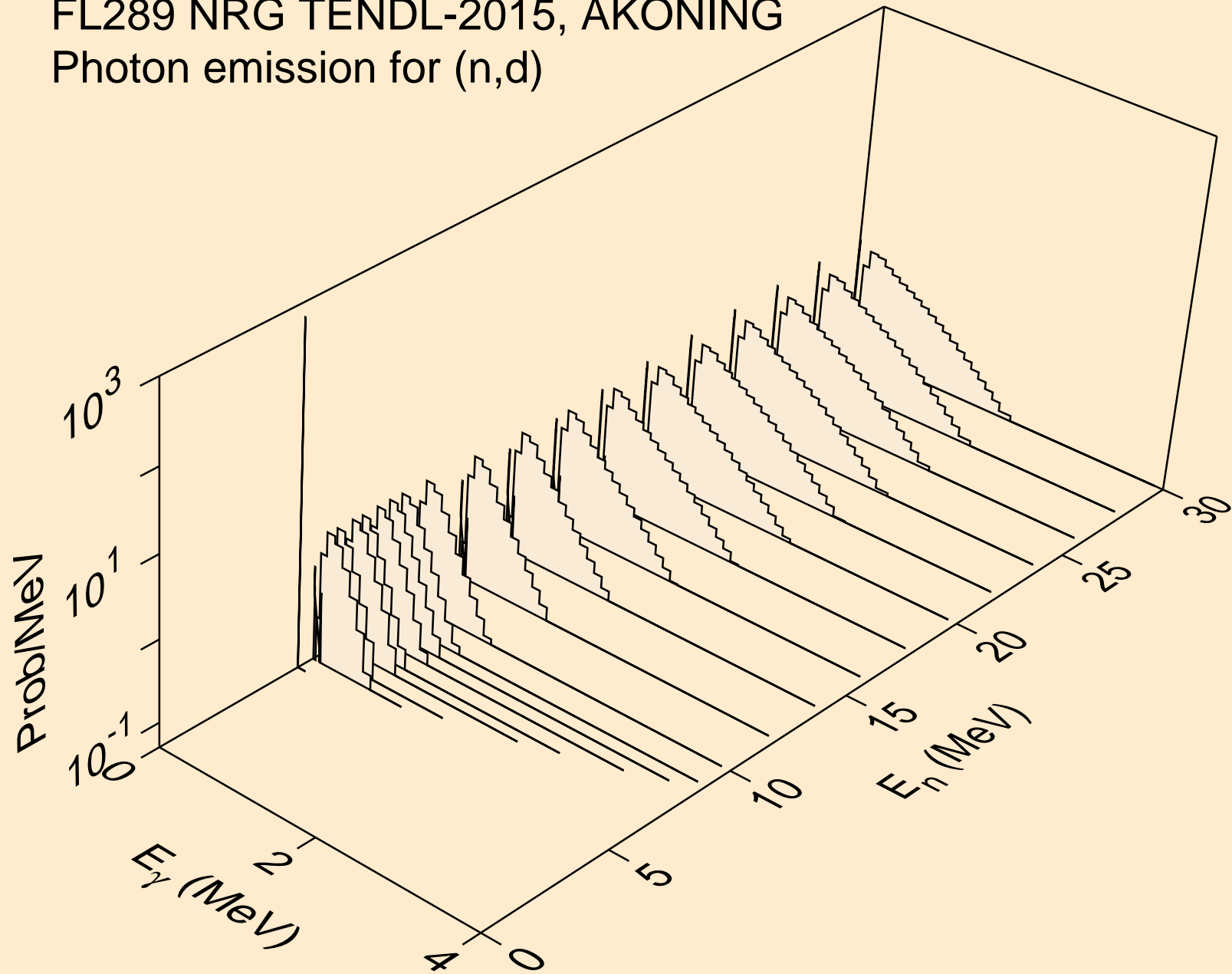

FL289 NRG TENDL-2015, AKONING
Photon emission for (n,t)

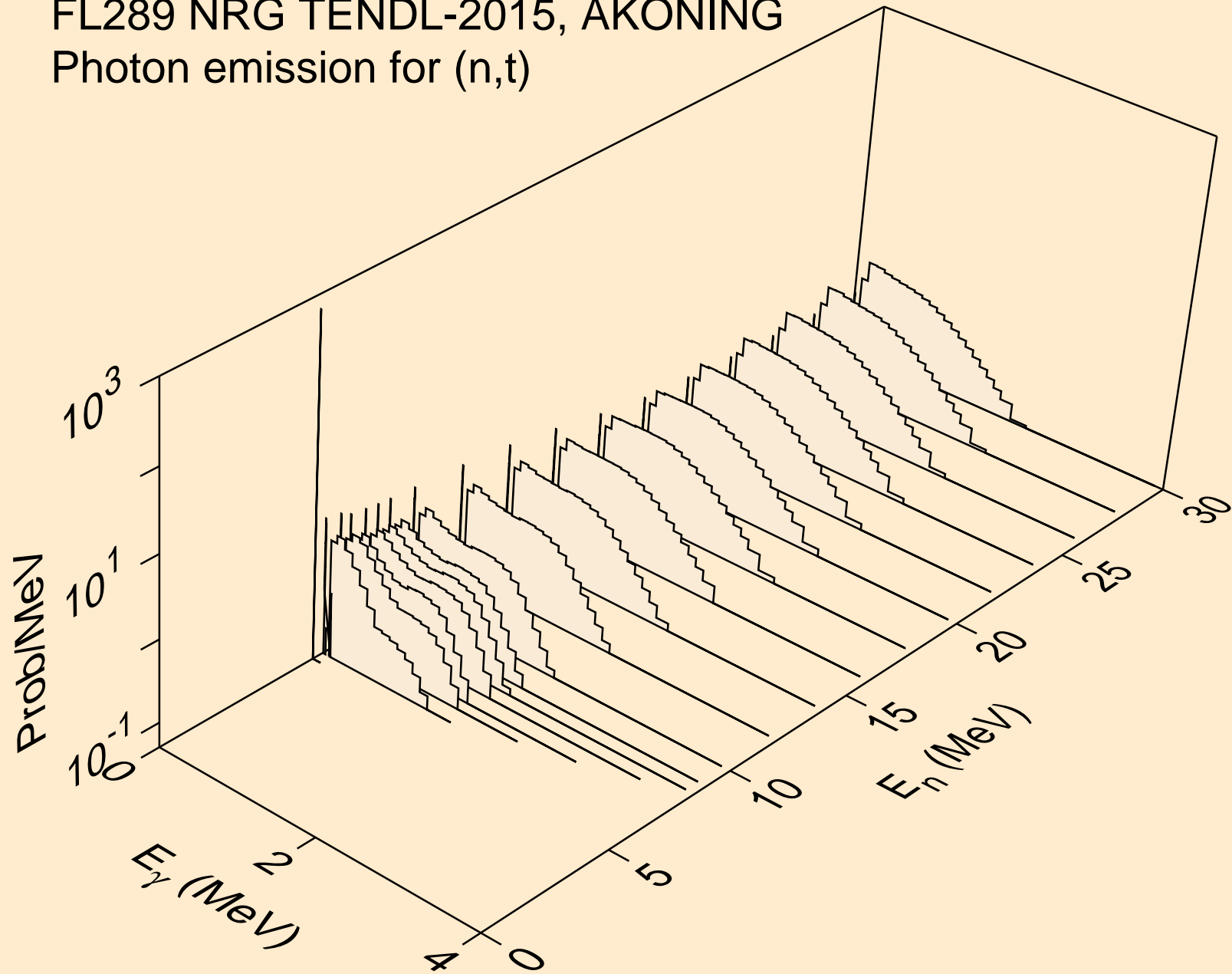

FL289 NRG TENDL-2015, AKONING
Photon emission for (n,he3)

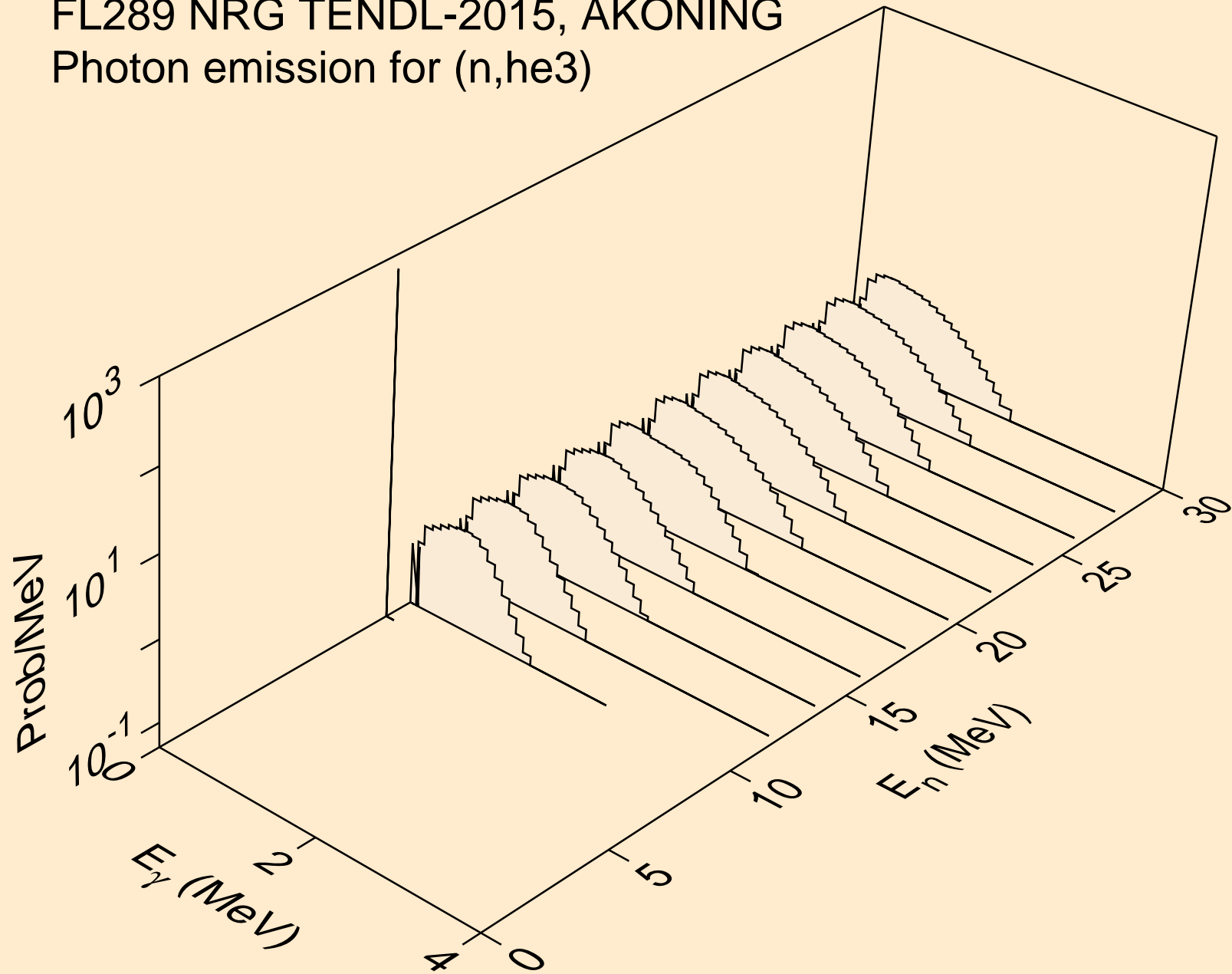

FL289 NRG TENDL-2015, AKONING
Photon emission for (n,a)

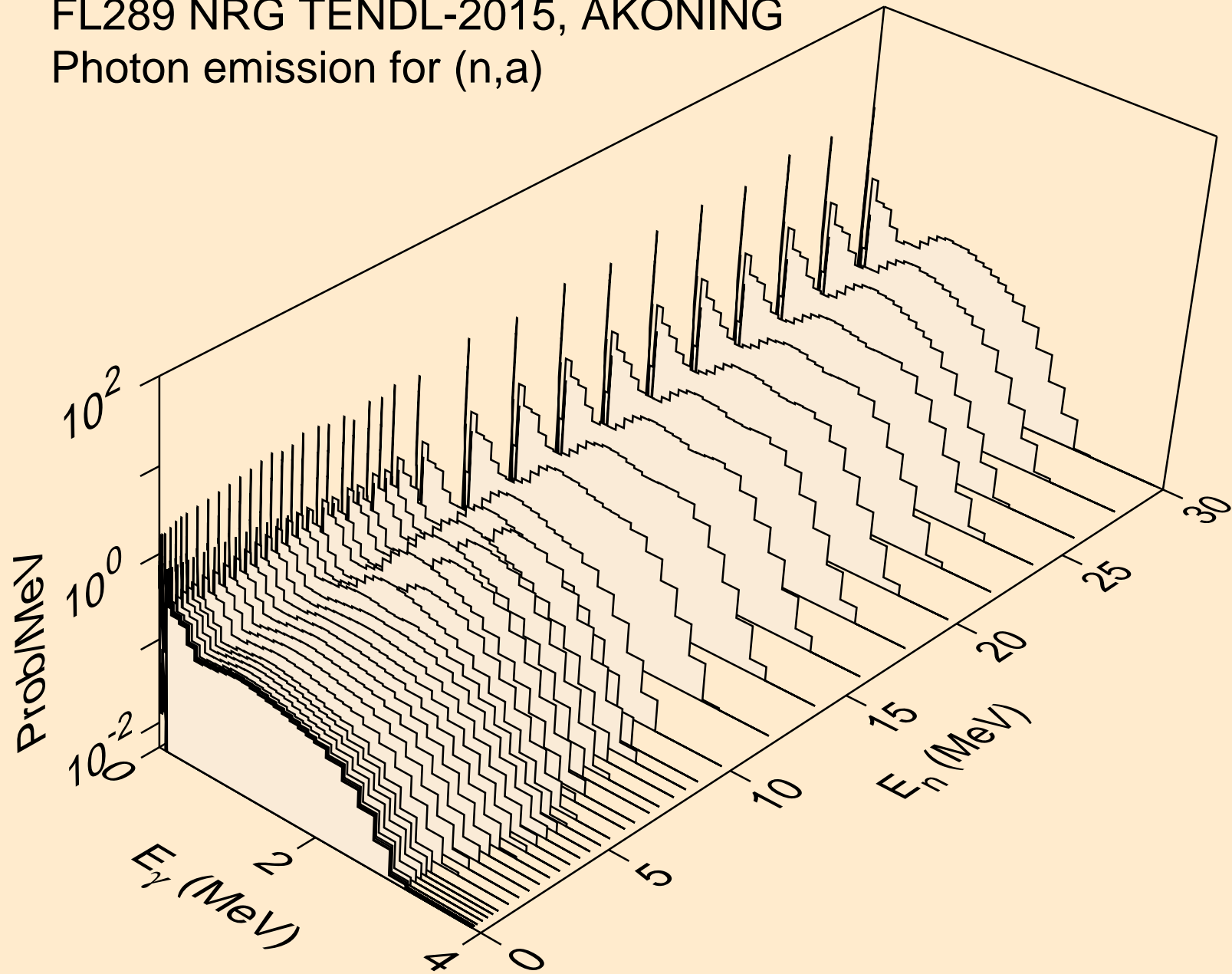

FL289 NRG TENDL-2015, AKONING
Photon emission for (n,2a)

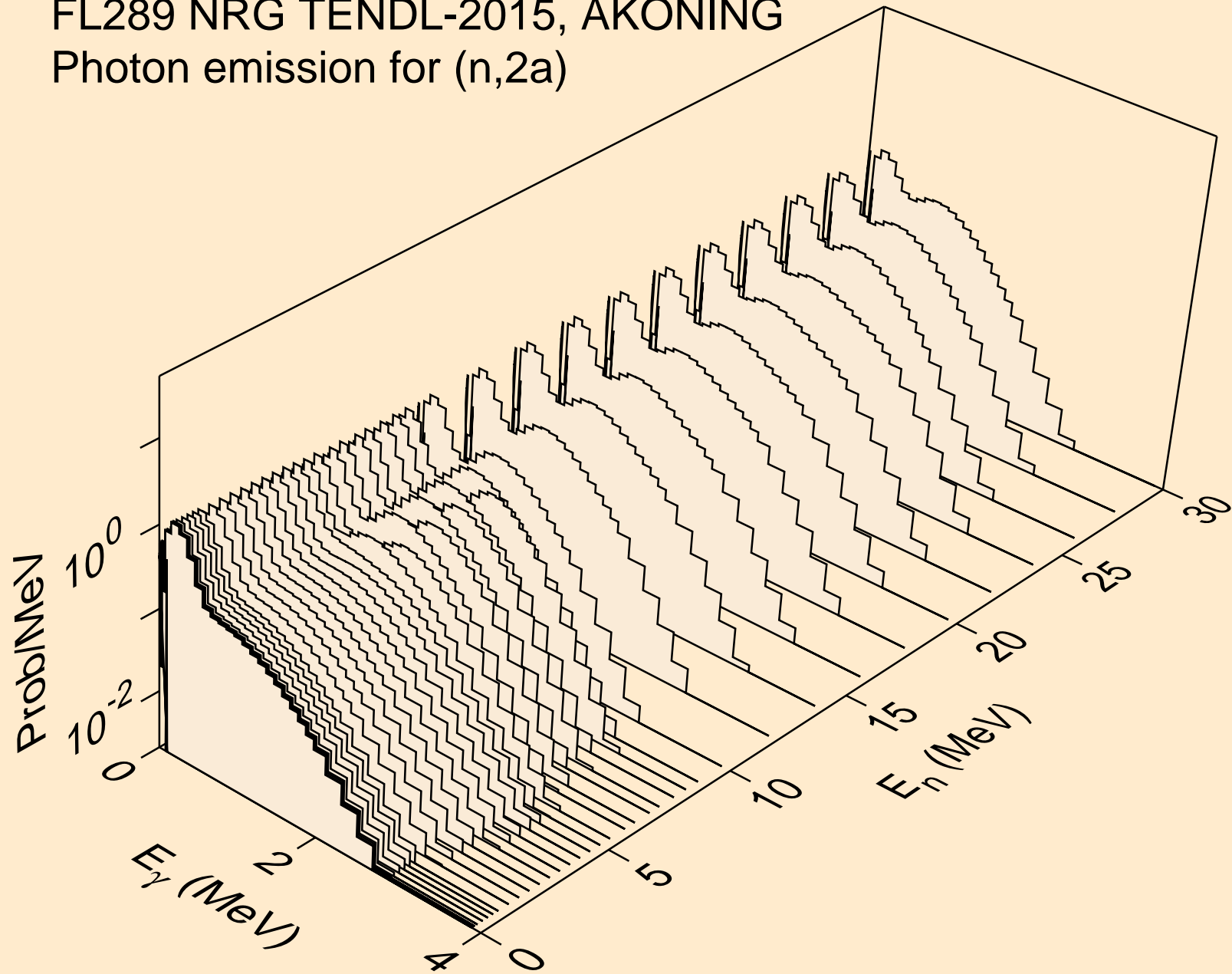

FL289 NRG TENDL-2015, AKONING
Photon emission for (n,3a)

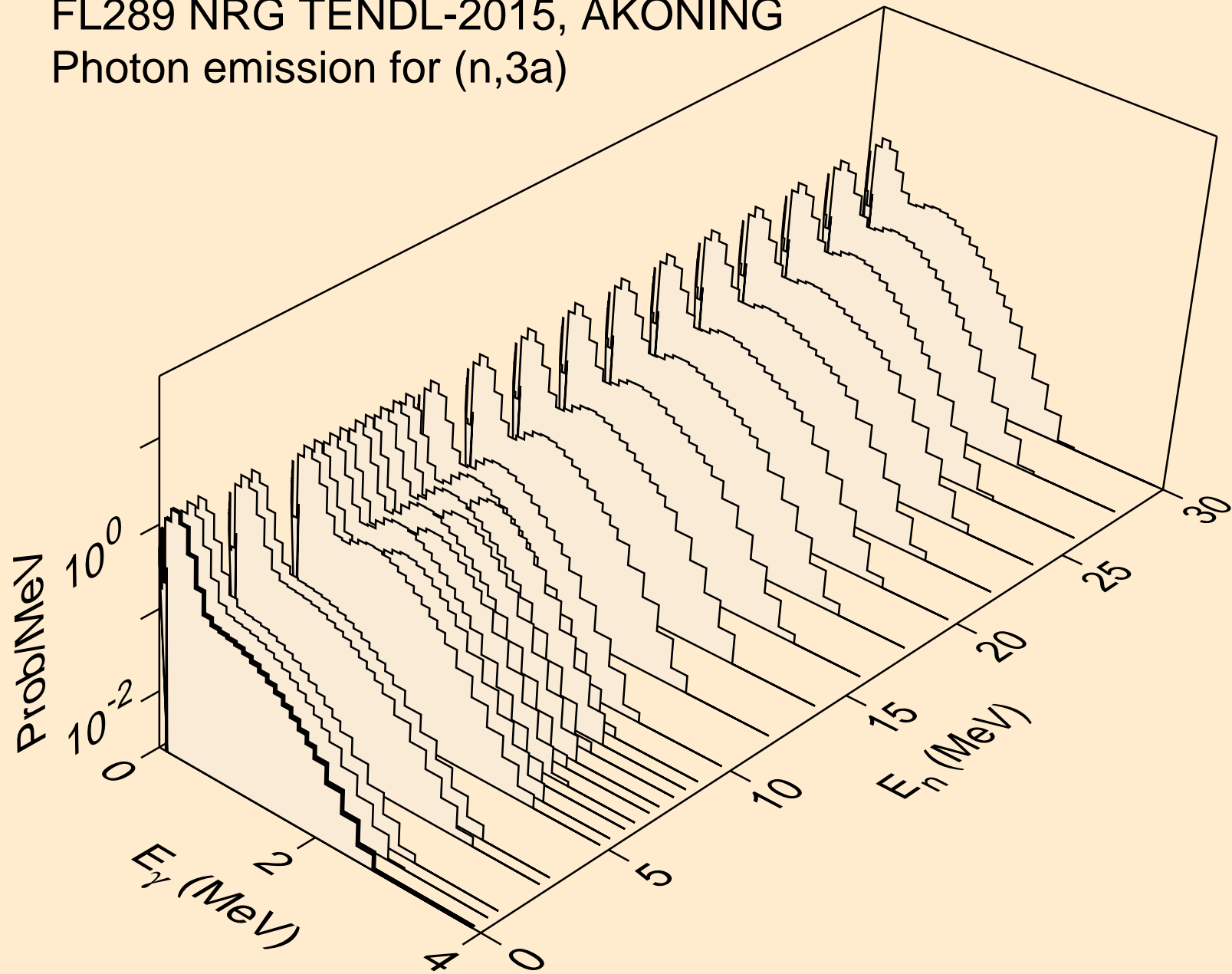

FL289 NRG TENDL-2015, AKONING
Photon emission for (n,2p)

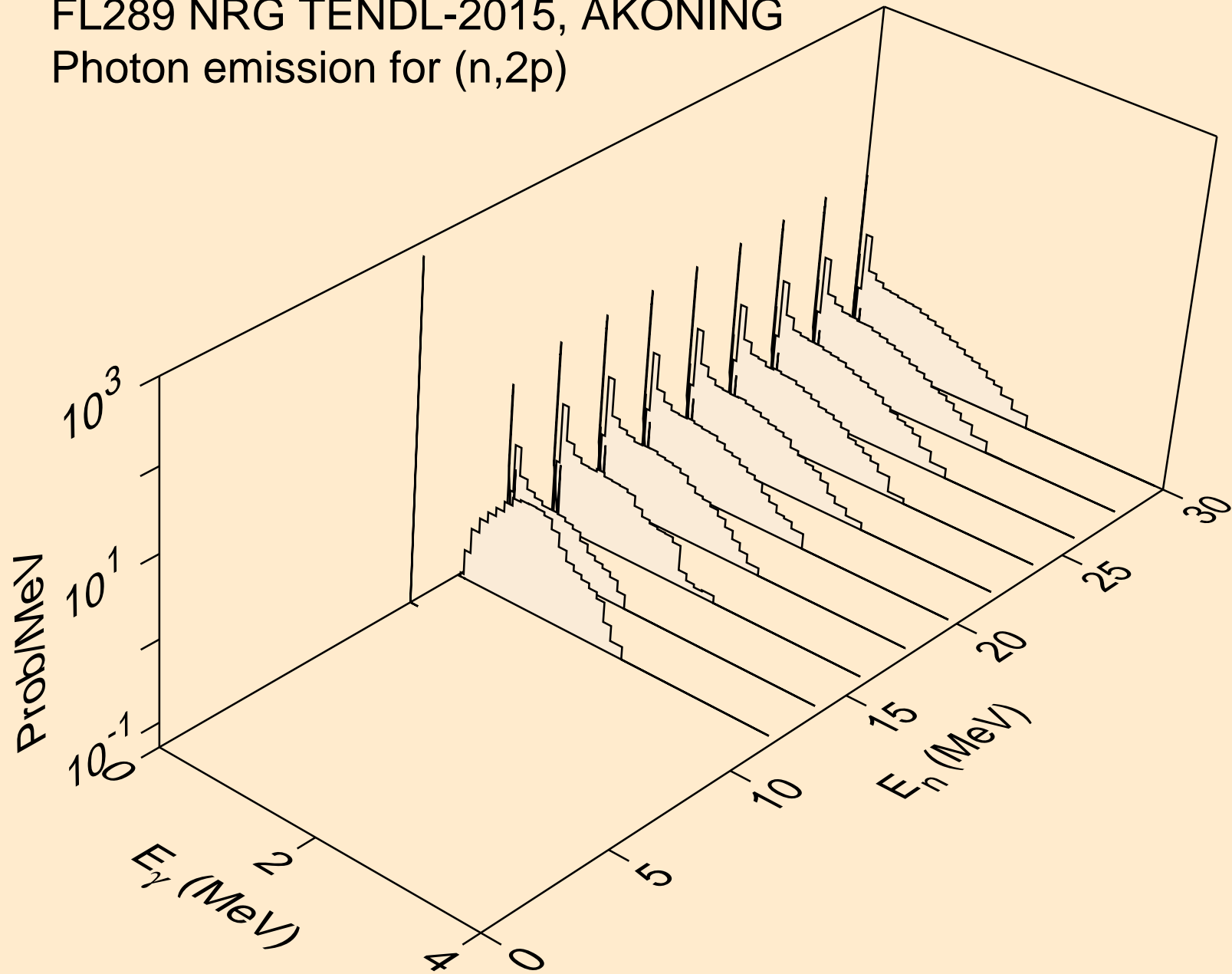

FL289 NRG TENDL-2015, AKONING
Photon emission for (n,p α)

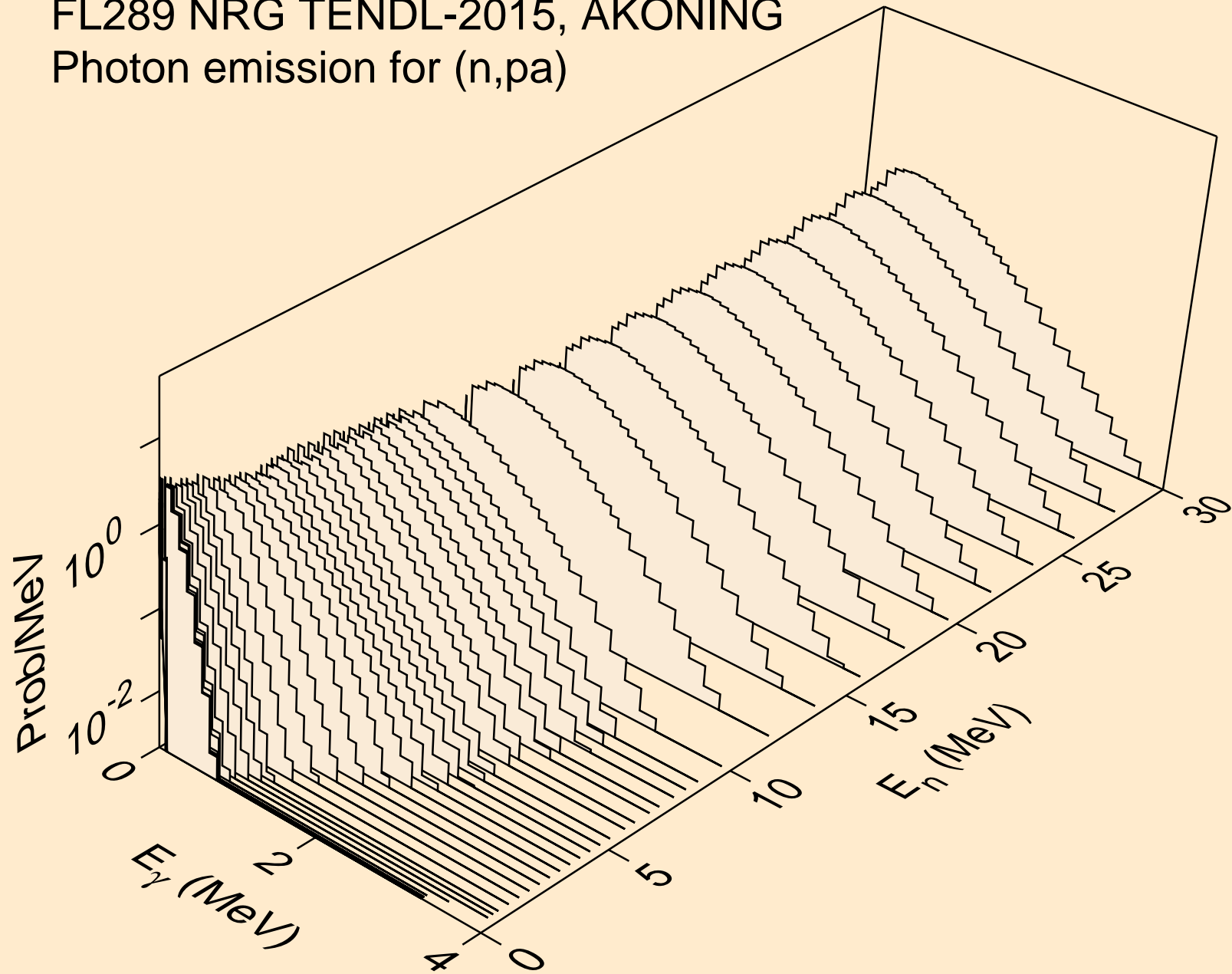

FL289 NRG TENDL-2015, AKONING
Photon emission for (n,t2a)

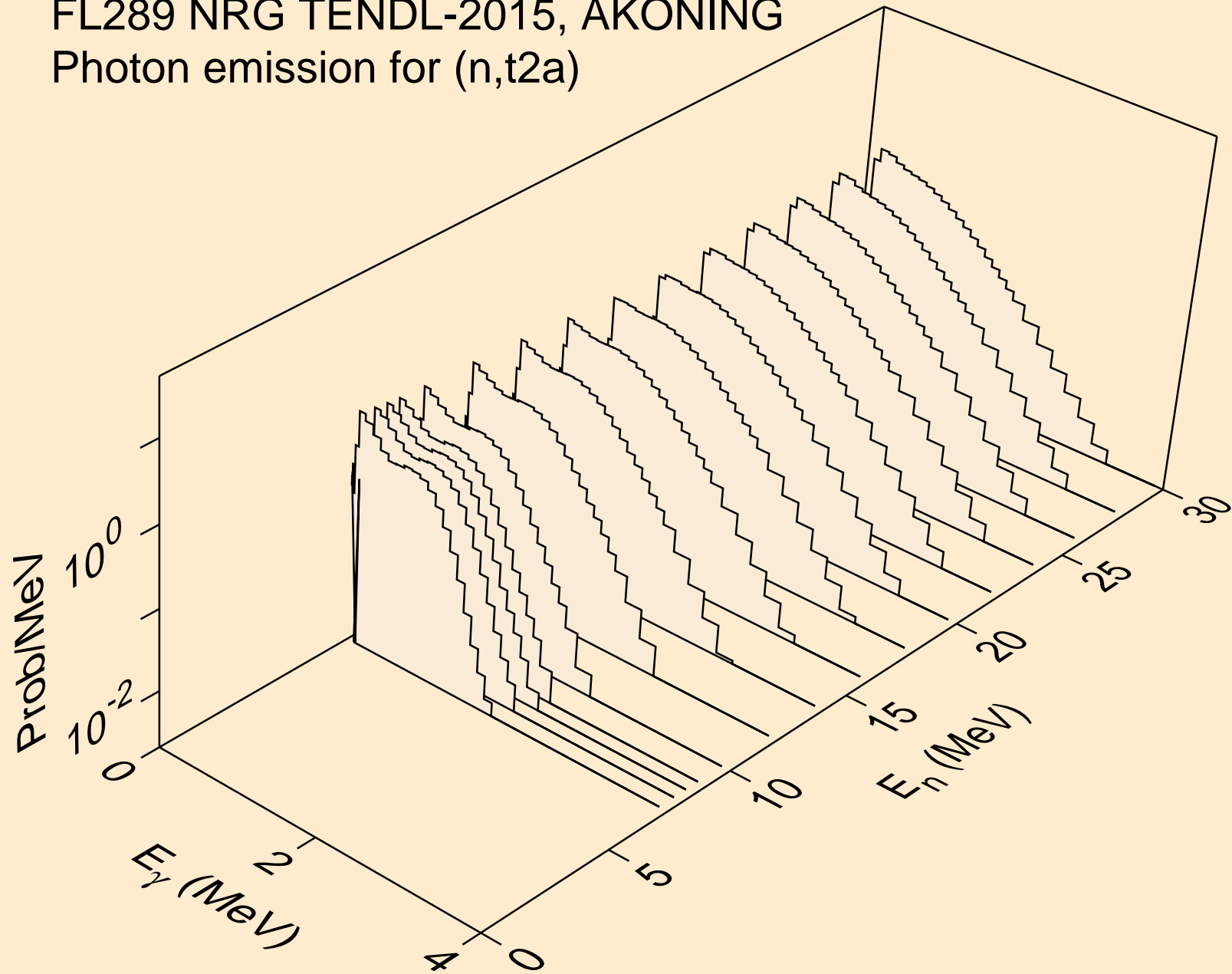

FL289 NRG TENDL-2015, AKONING
Photon emission for (n,d2a)

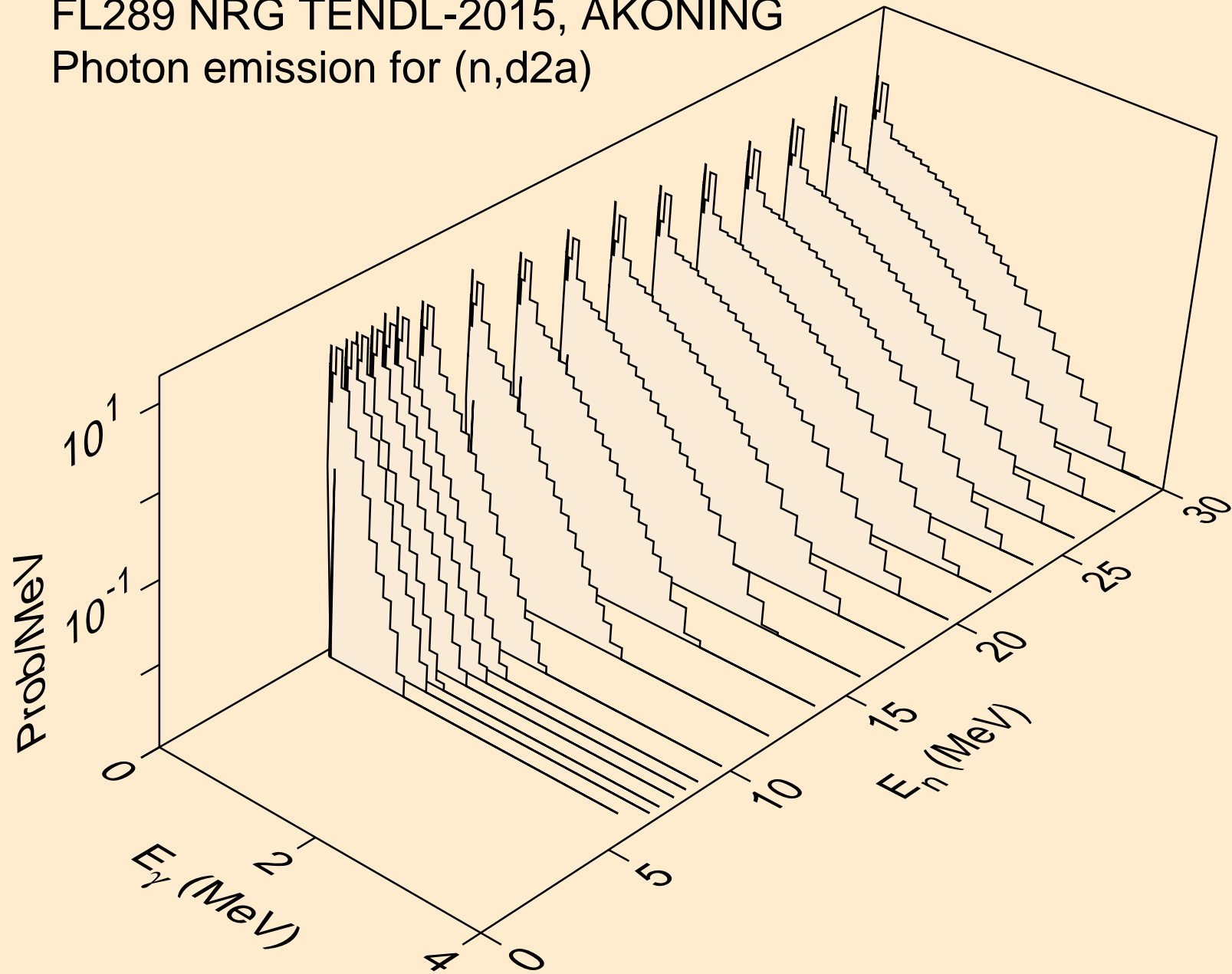

FL289 NRG TENDL-2015, AKONING
Photon emission for (n,da)

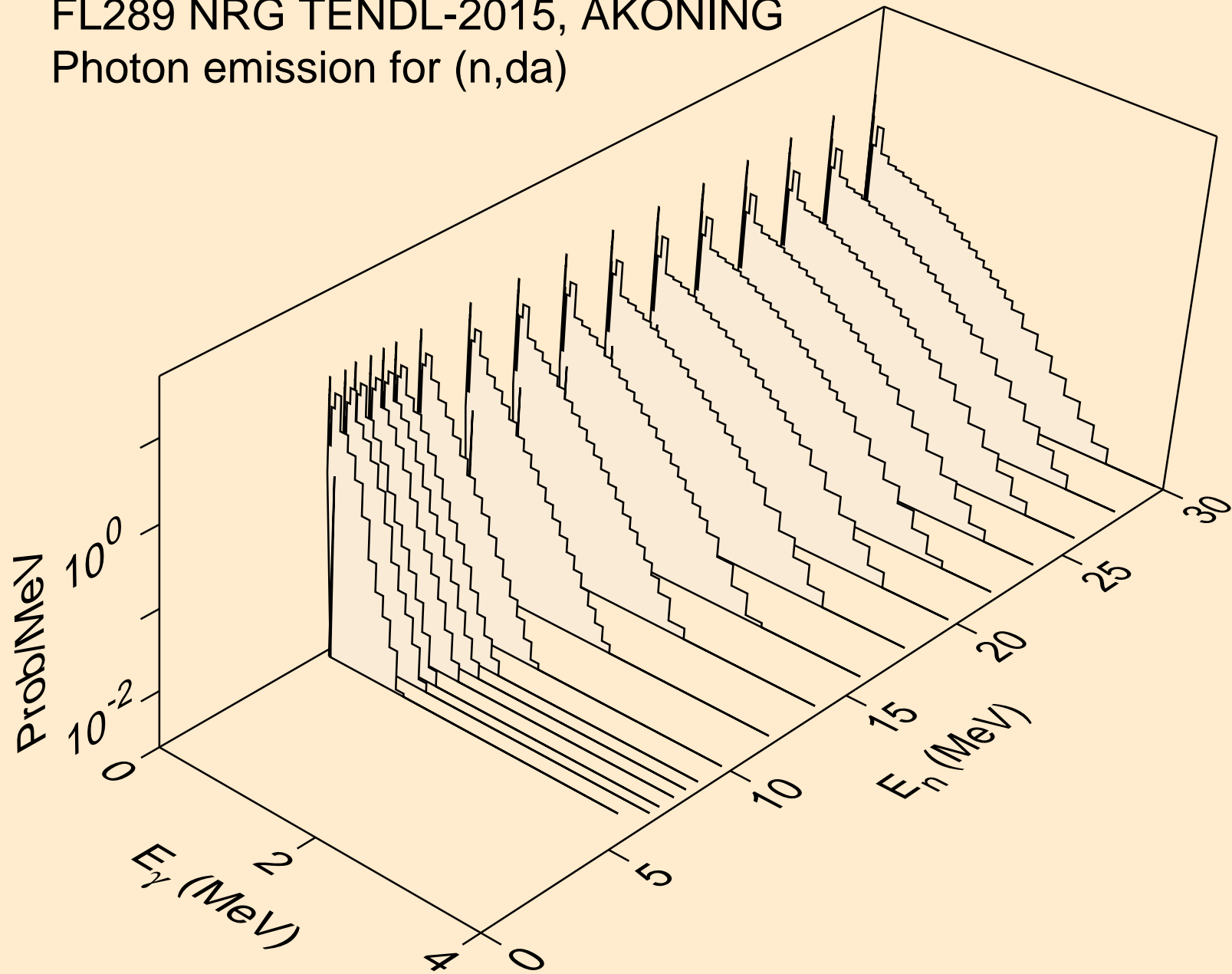

FL289 NRG TENDL-2015, AKONING
thermal capture photon spectrum

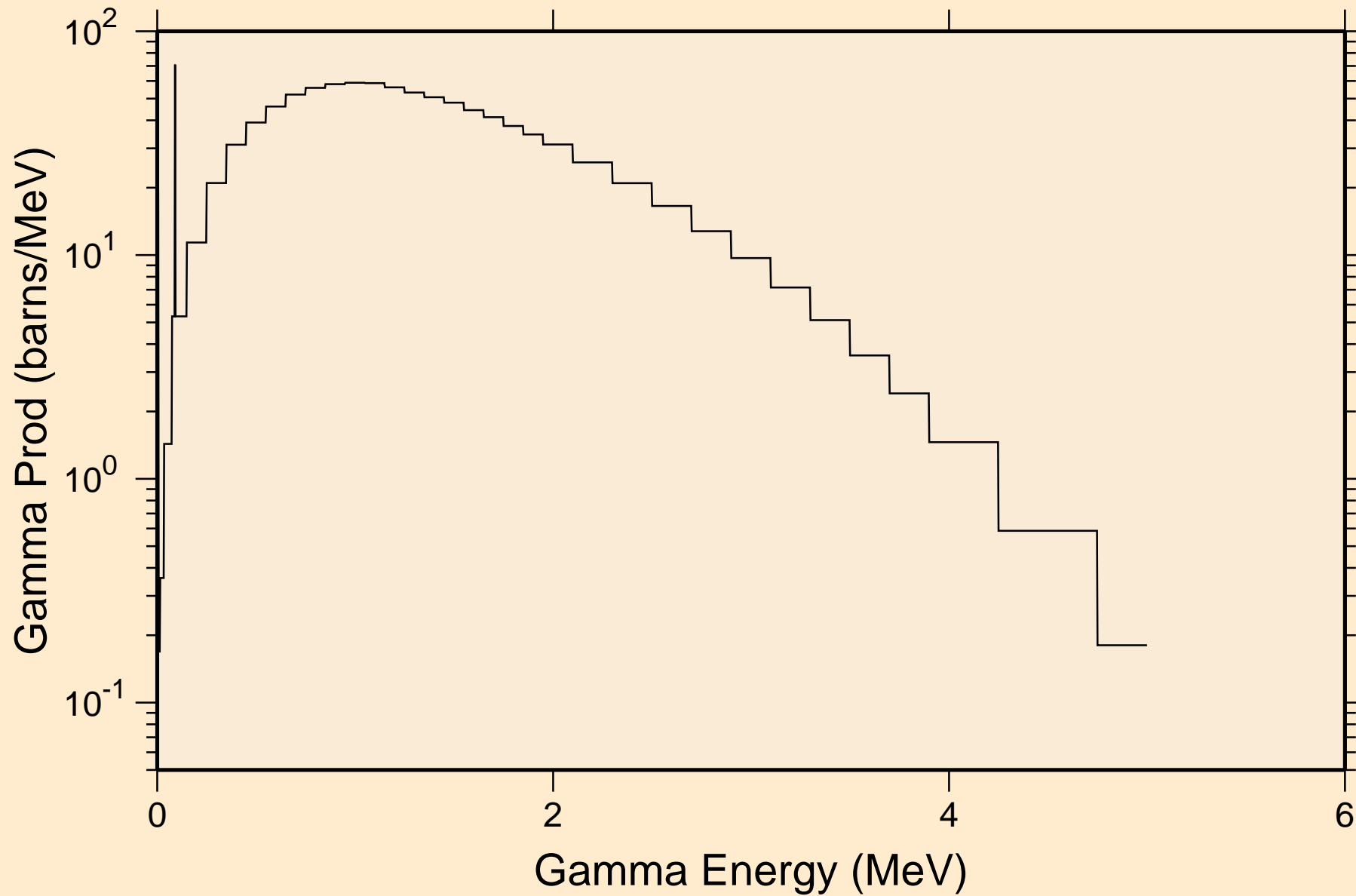

FL289 NRG TENDL-2015, AKONING
14 MeV photon spectrum

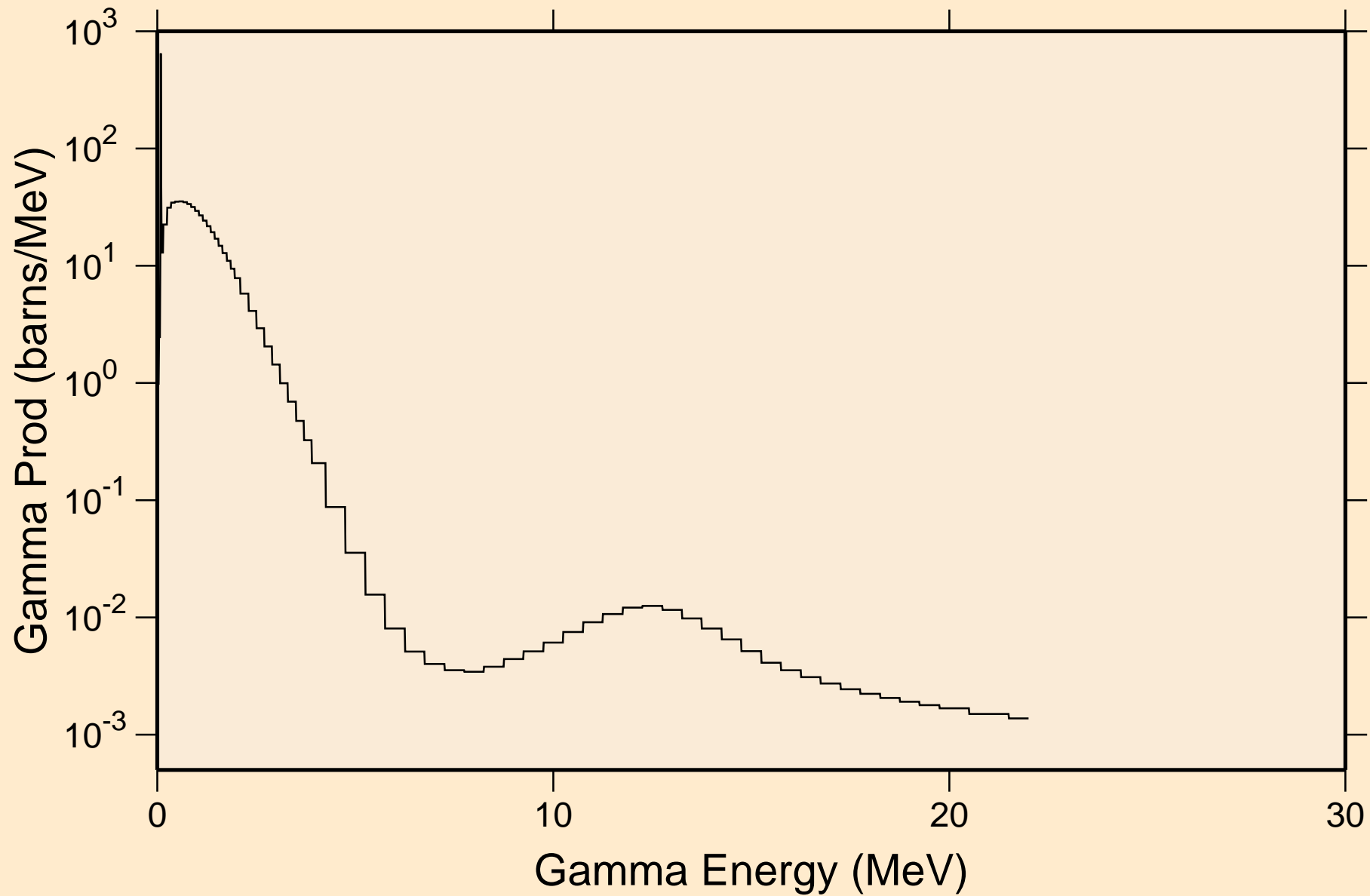

FL289 NRG TENDL-2015, AKONING

Particle heating contributions

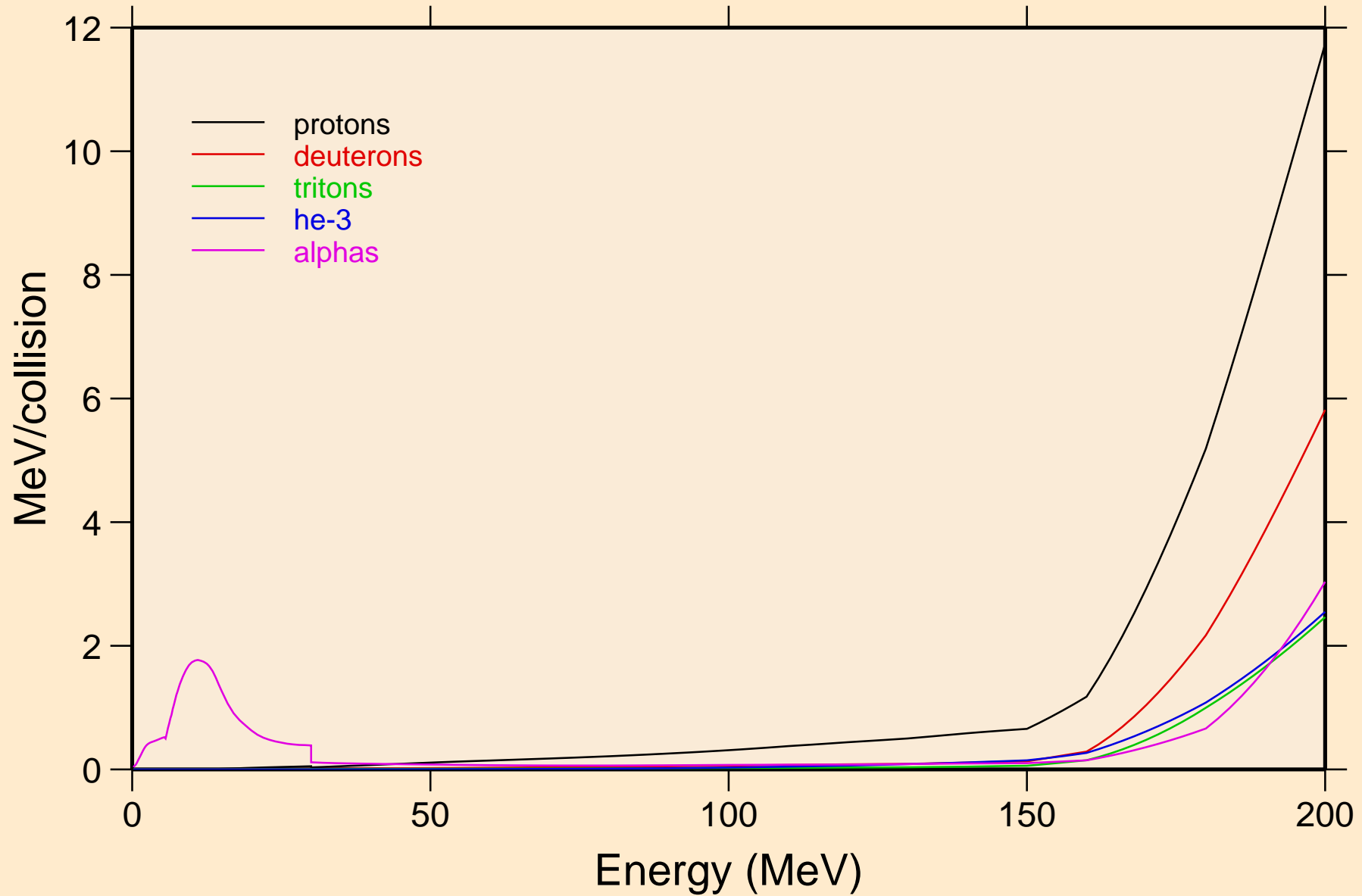

FL289 NRG TENDL-2015, AKONING

Recoil Heating

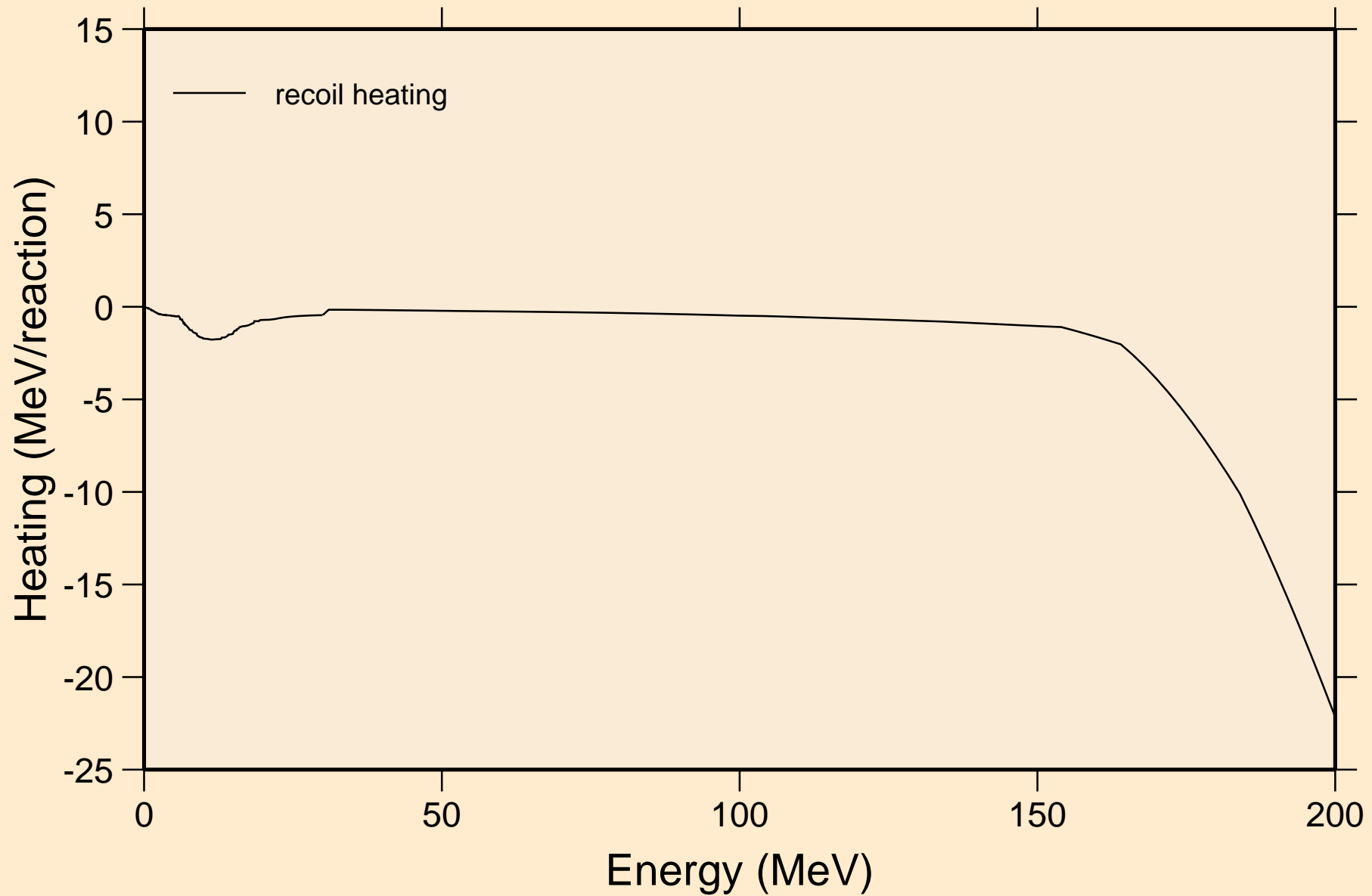

FL289 NRG TENDL-2015, AKONING

Particle production cross sections

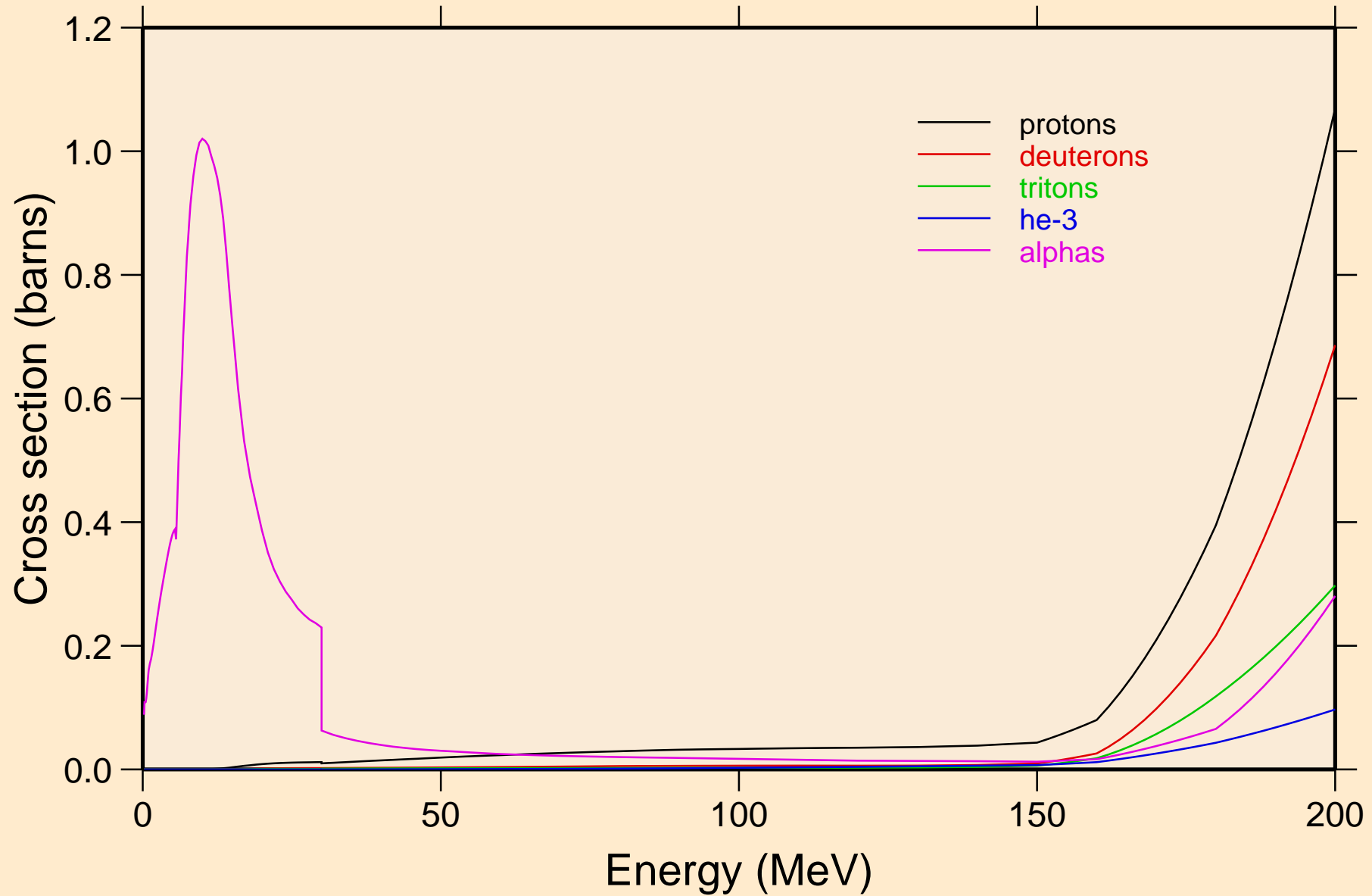

FL289 NRG TENDL-2015, AKONING
protons from (n,x)

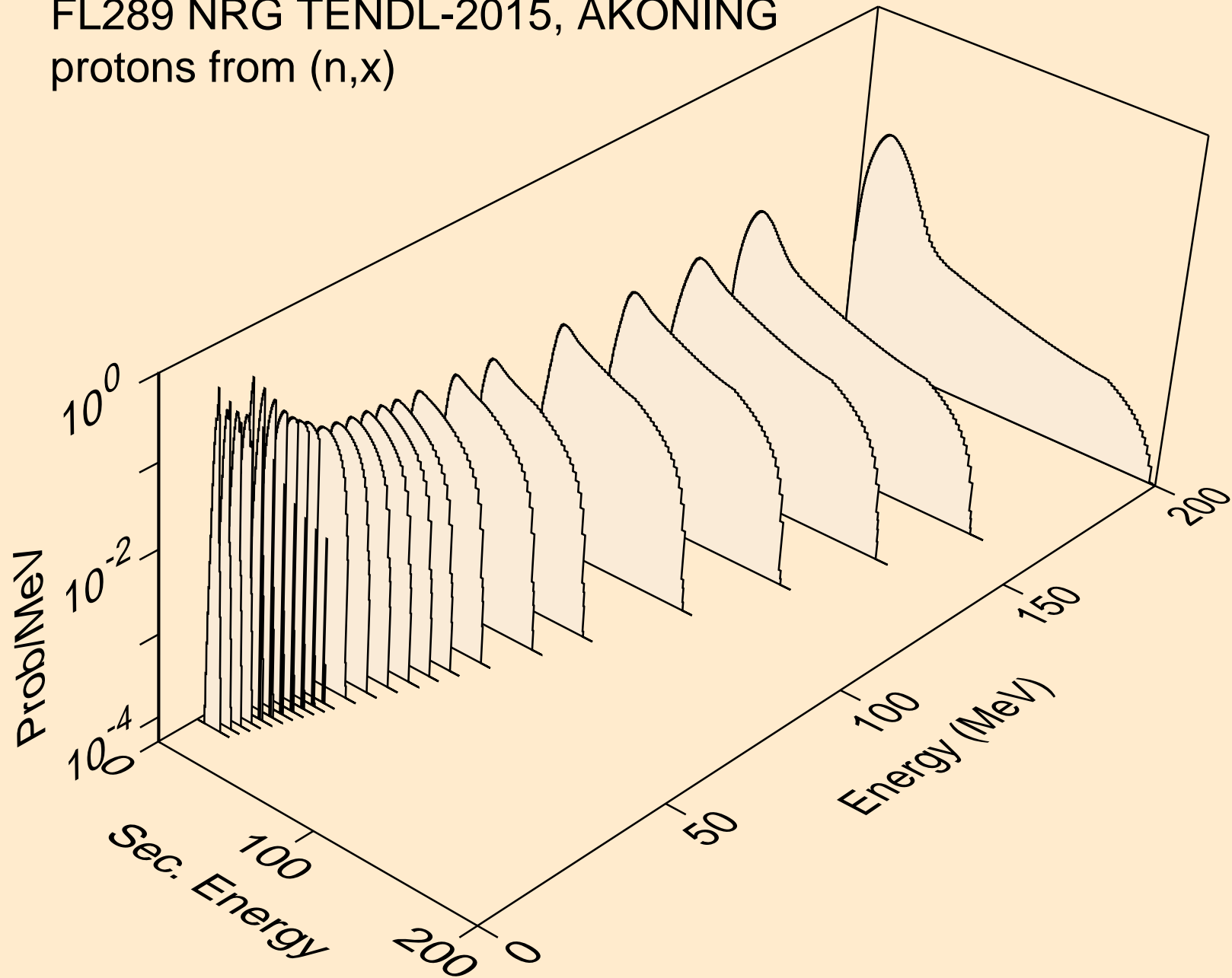

FL289 NRG TENDL-2015, AKONING
protons from (n,n*)p

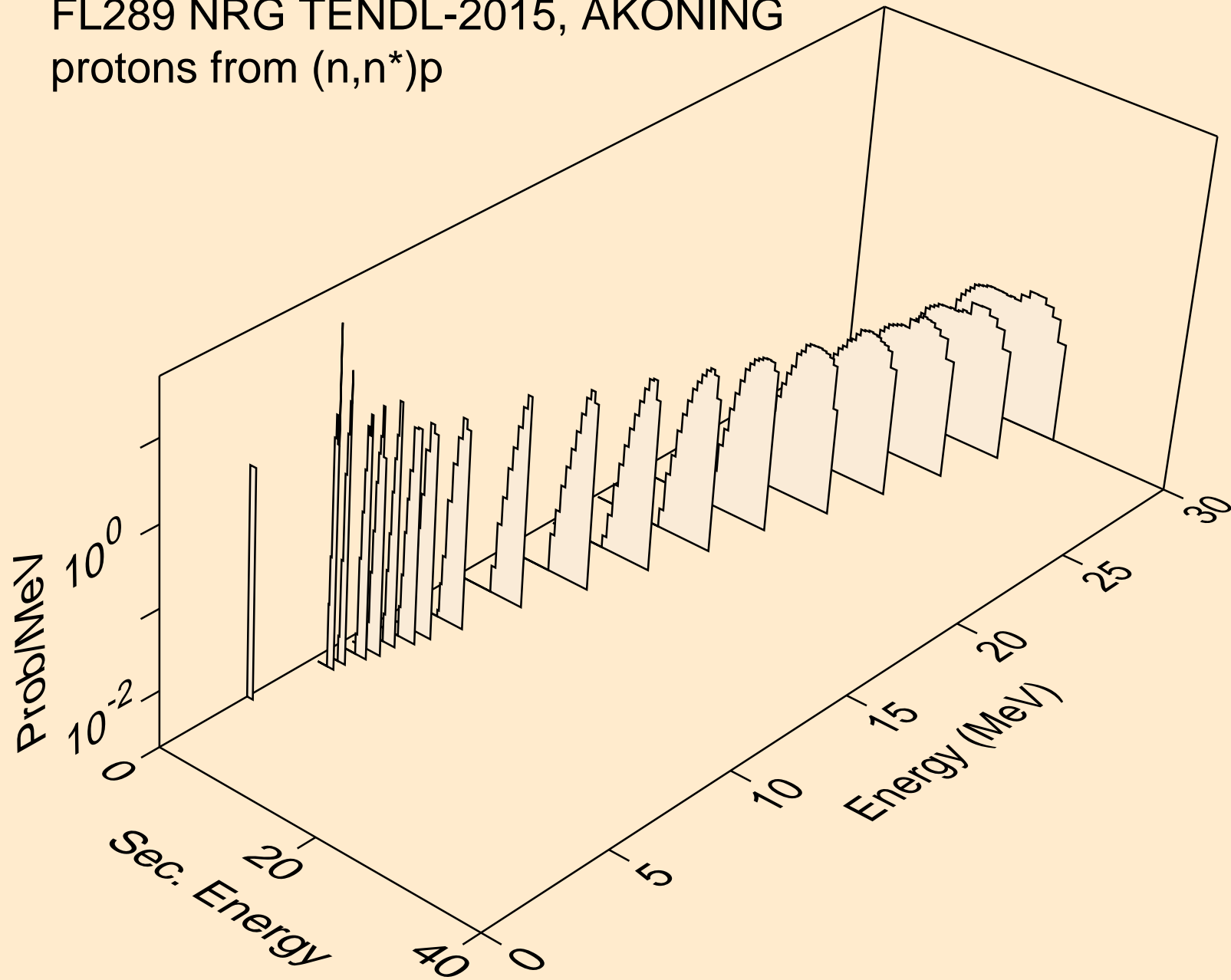

FL289 NRG TENDL-2015, AKONING
protons from (n,2np)

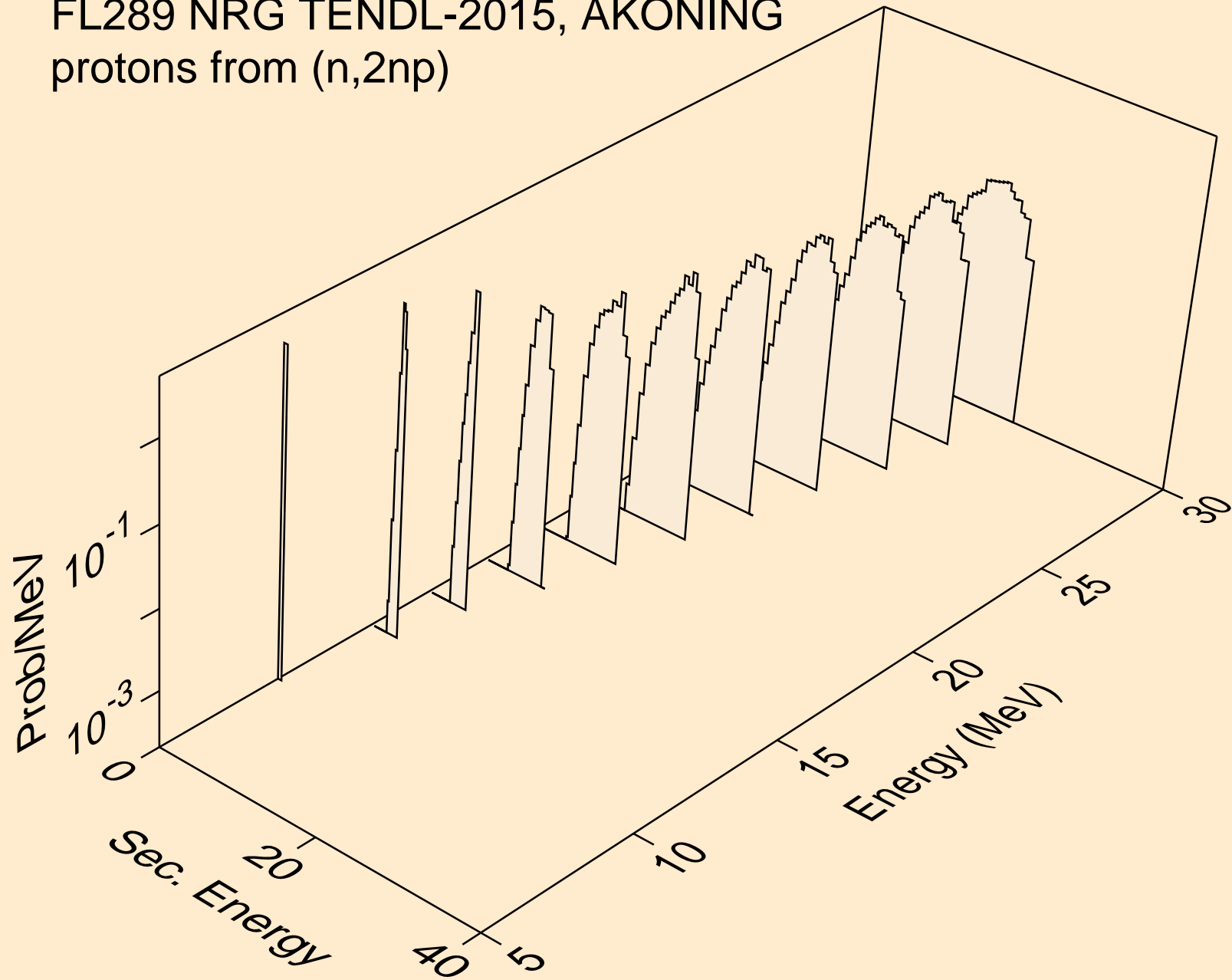

FL289 NRG TENDL-2015, AKONING
protons from (n,3np)

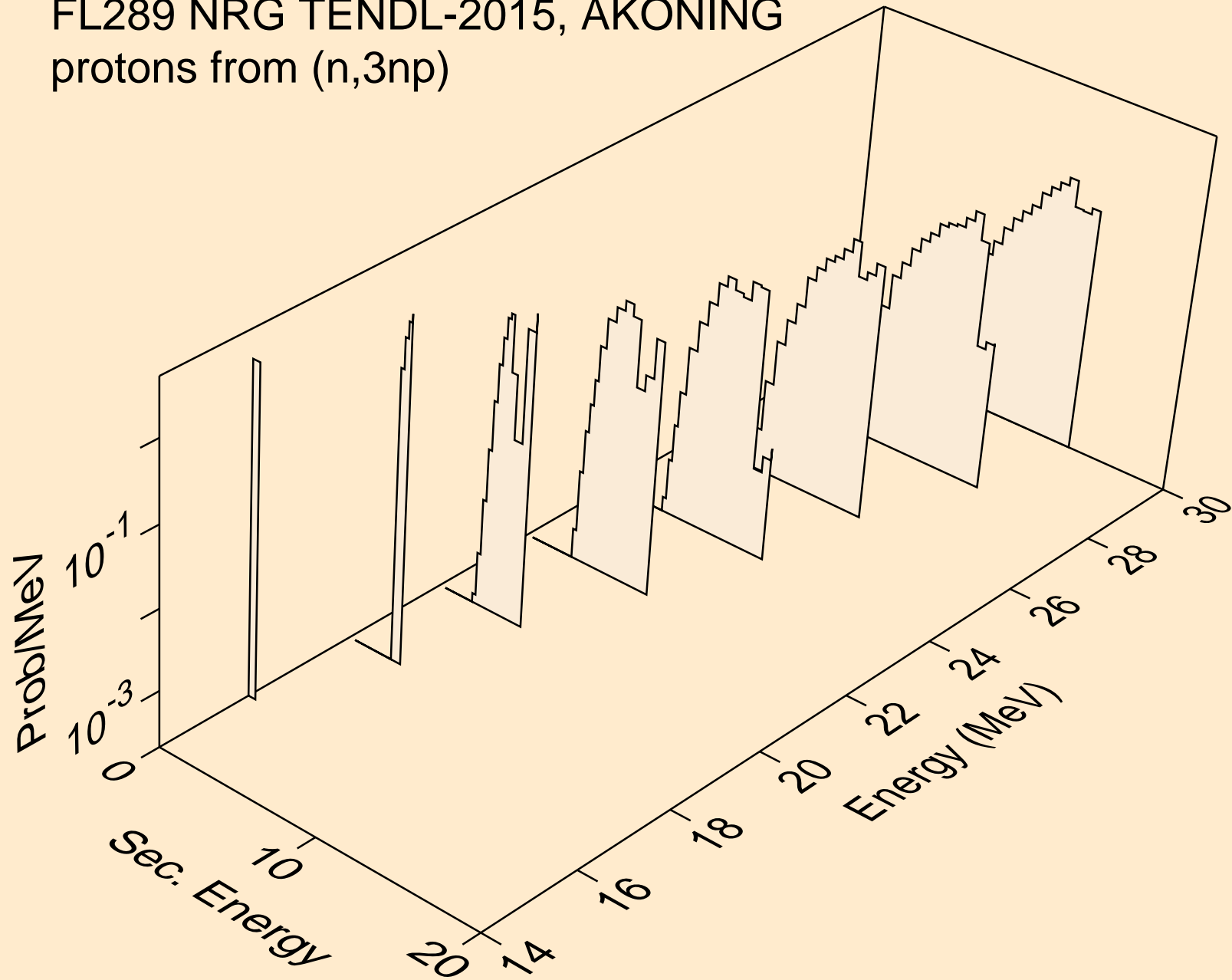

FL289 NRG TENDL-2015, AKONING
protons from (n,2np)

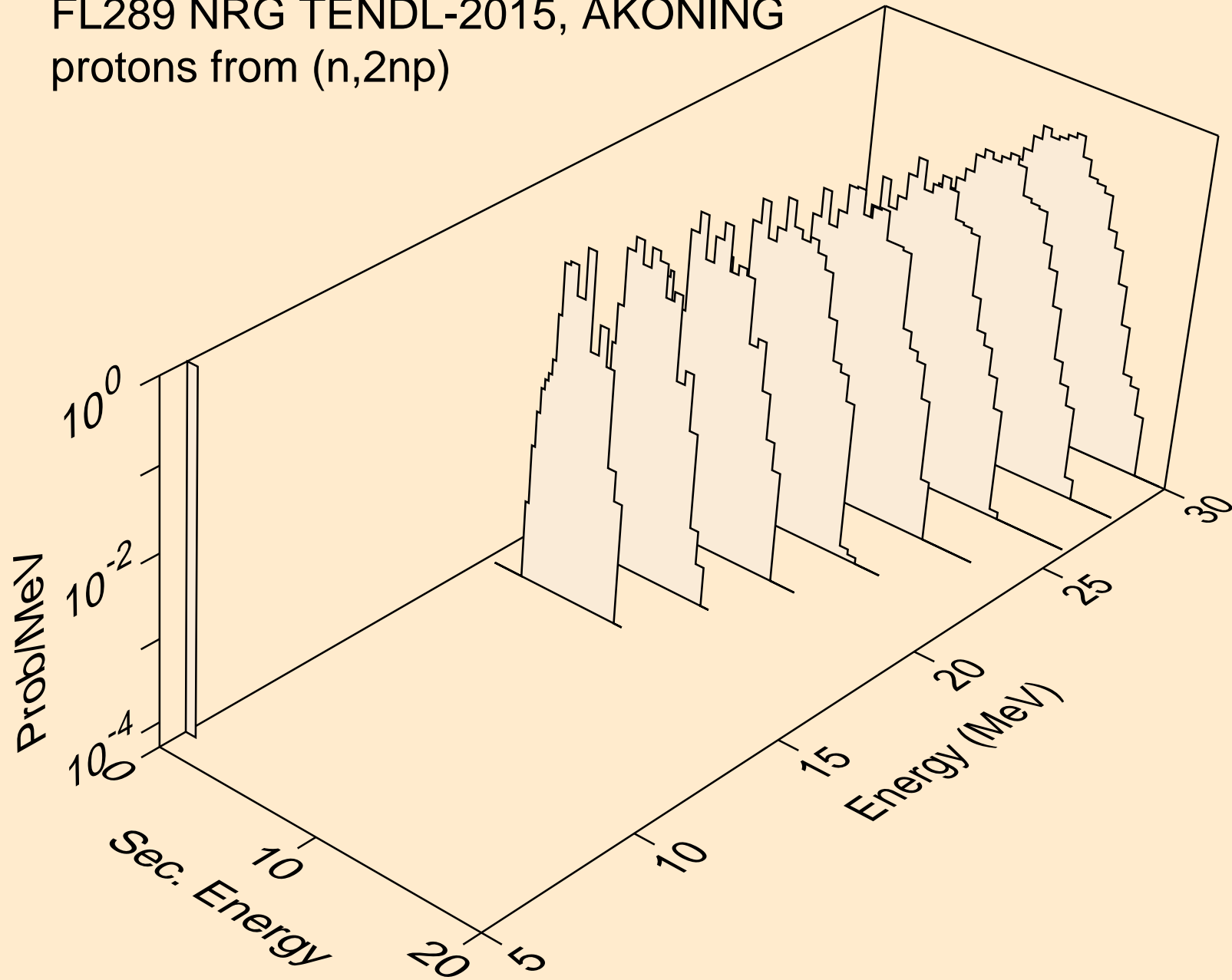

FL289 NRG TENDL-2015, AKONING
protons from (n,npa)

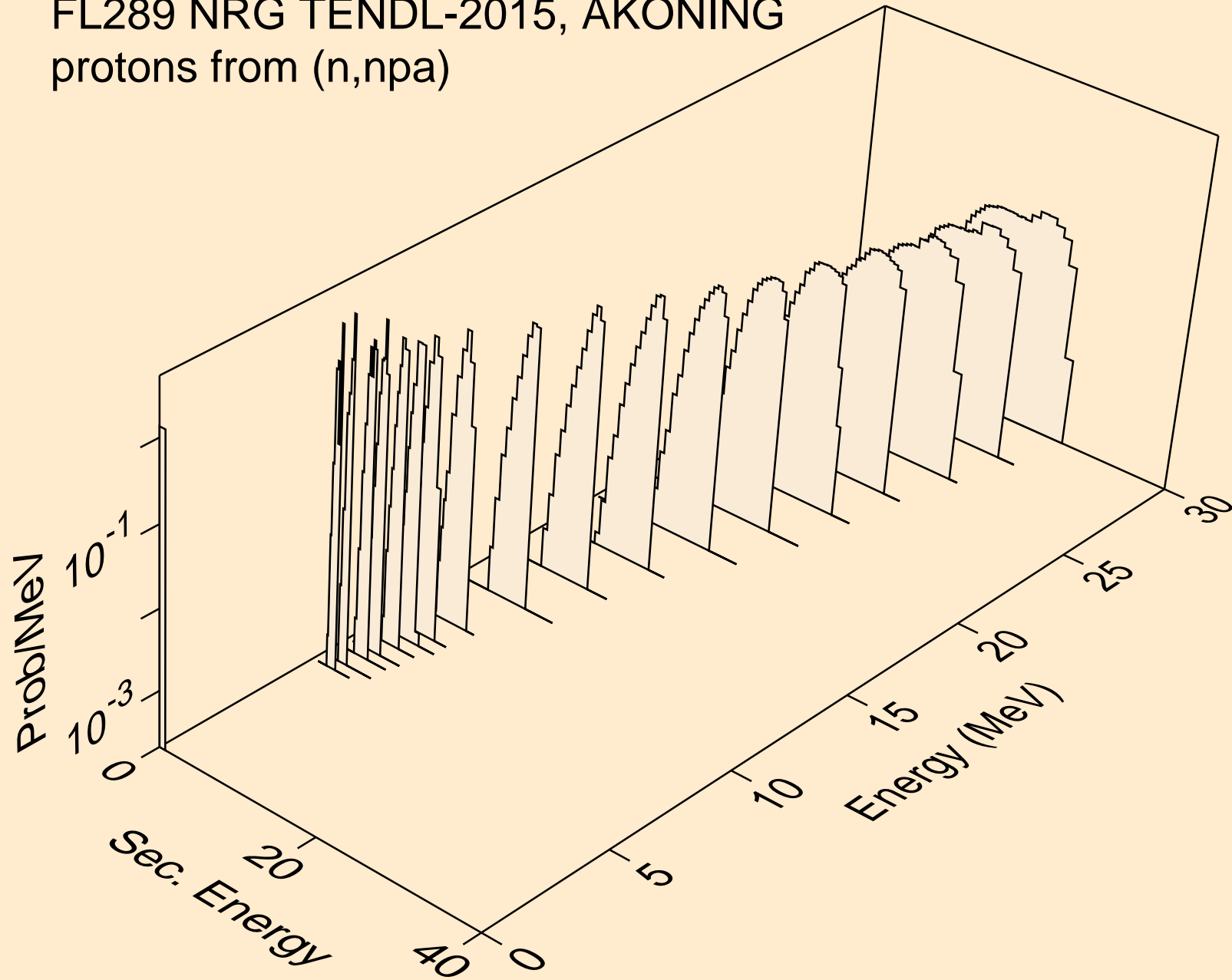

FL289 NRG TENDL-2015, AKONING
protons from (n,p)

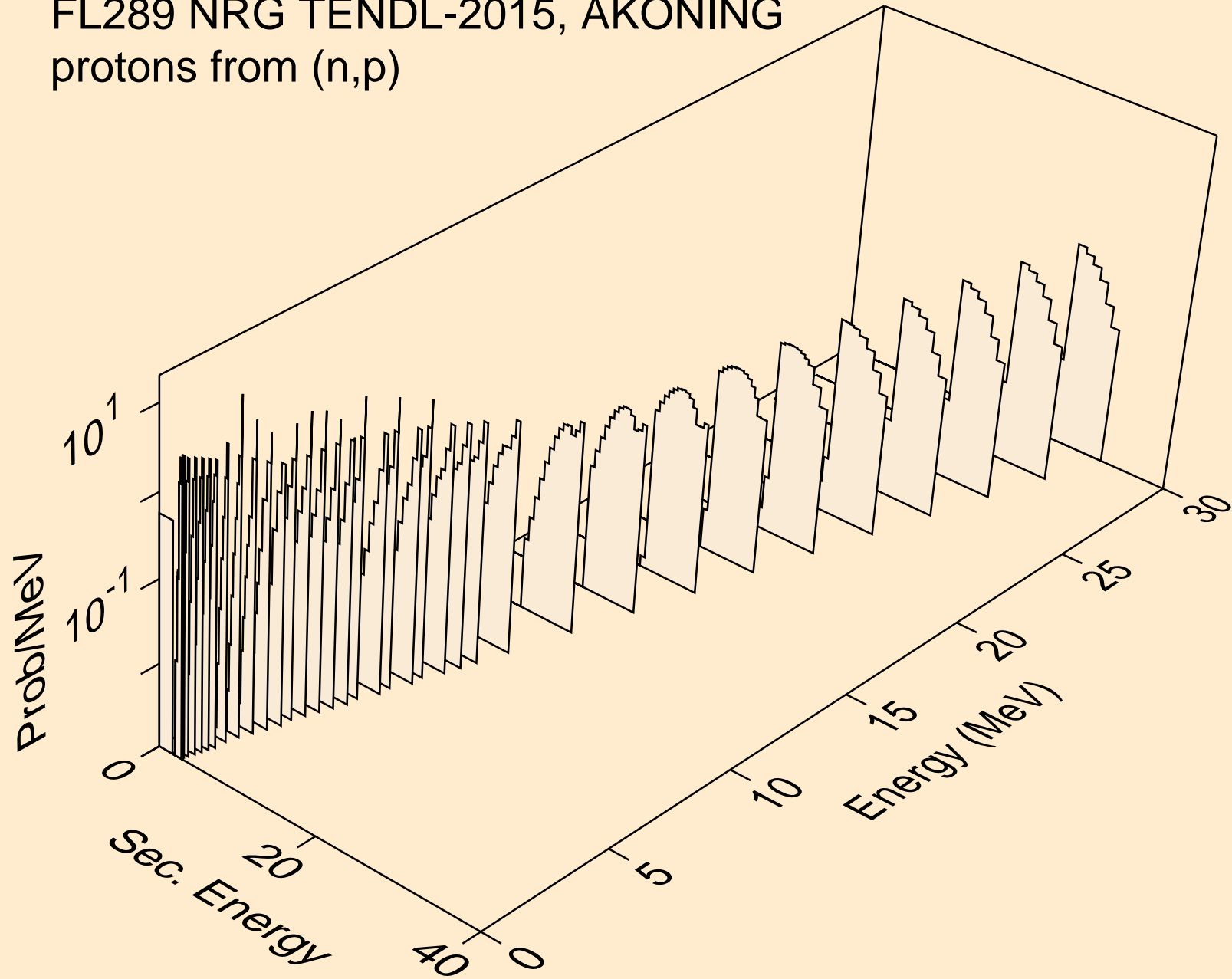

FL289 NRG TENDL-2015, AKONING
protons from (n,2p)

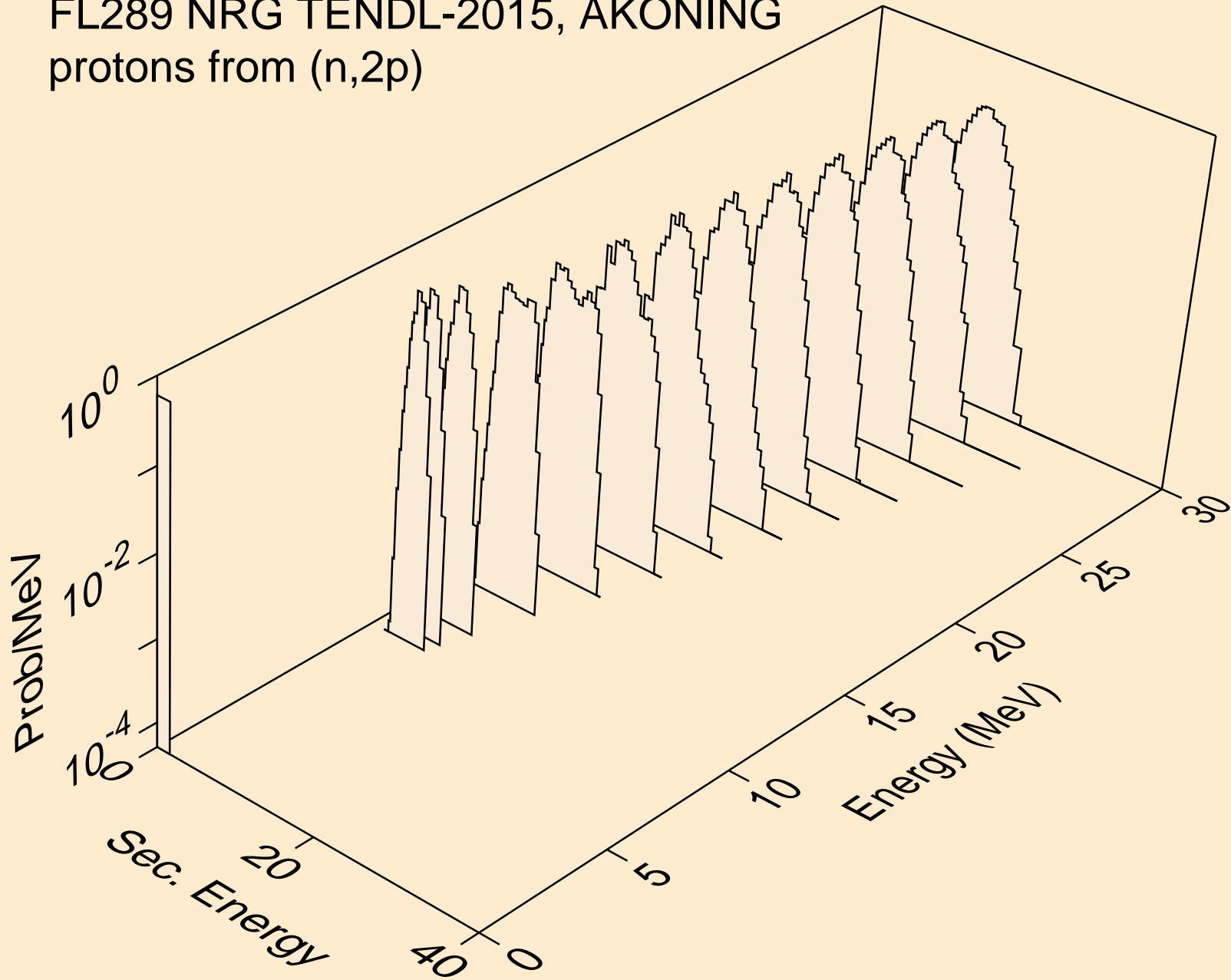

FL289 NRG TENDL-2015, AKONING
protons from (n,pa)

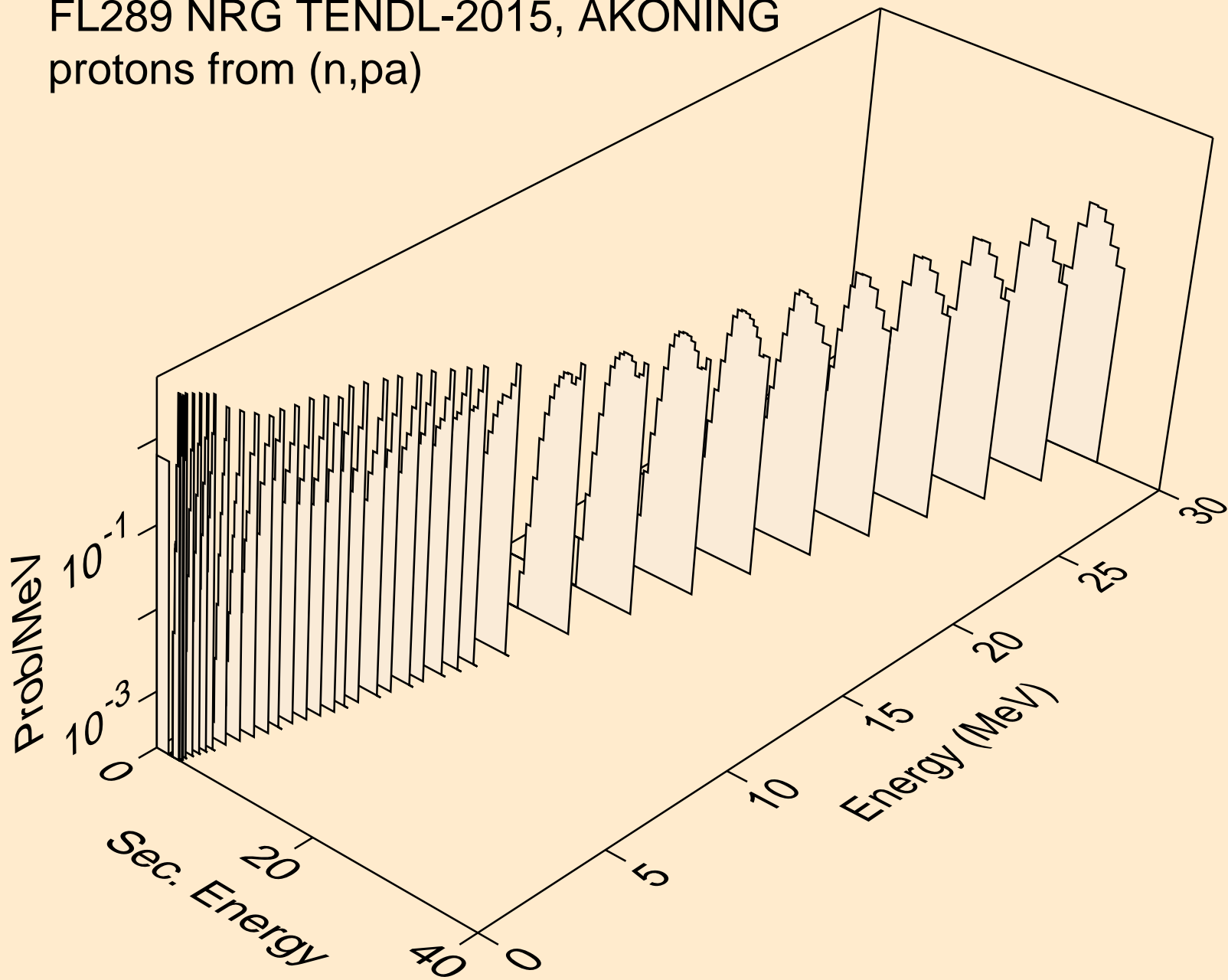

FL289 NRG TENDL-2015, AKONING
deuterons from (n,x)

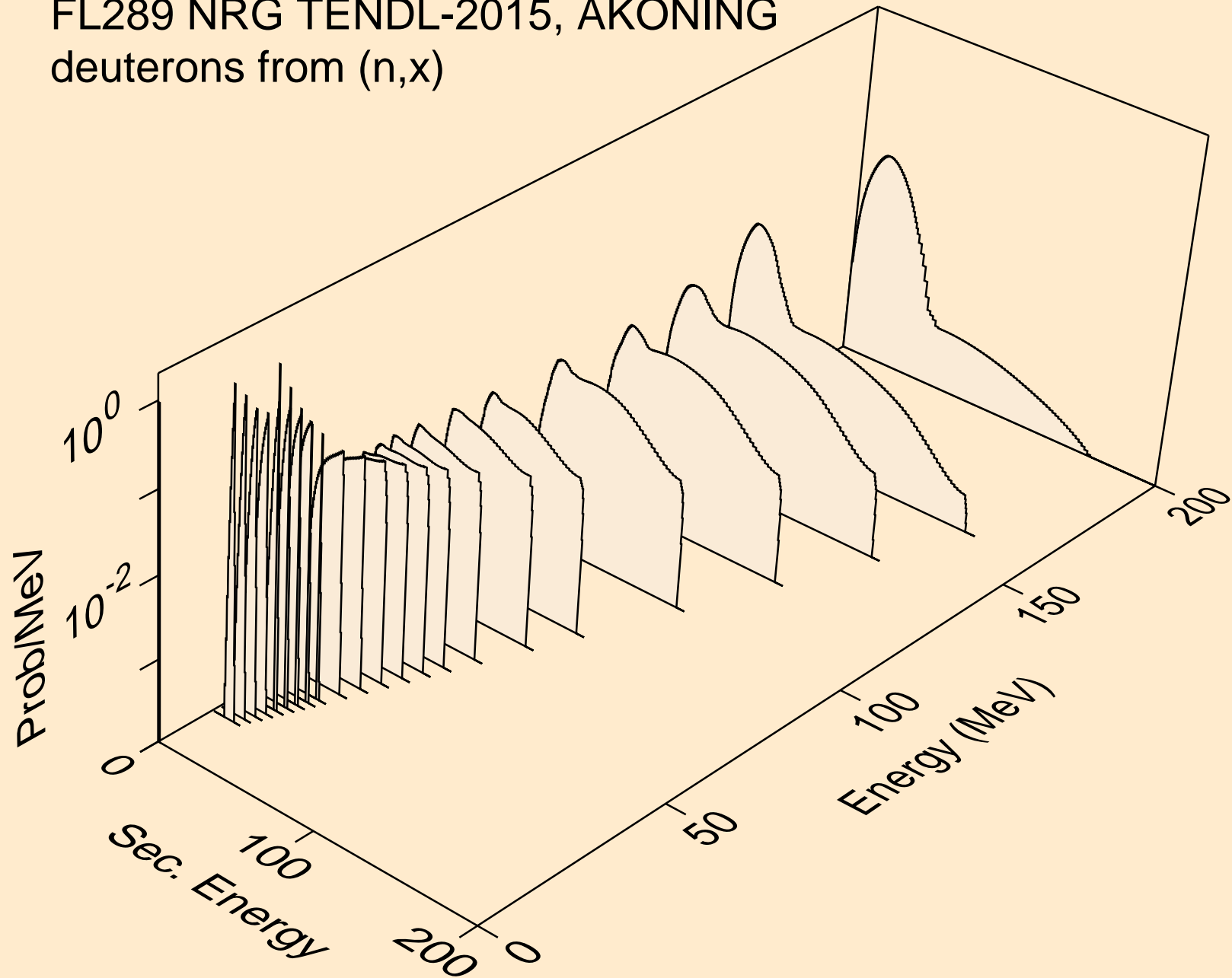

FL289 NRG TENDL-2015, AKONING
deuterons from (n,2nd)

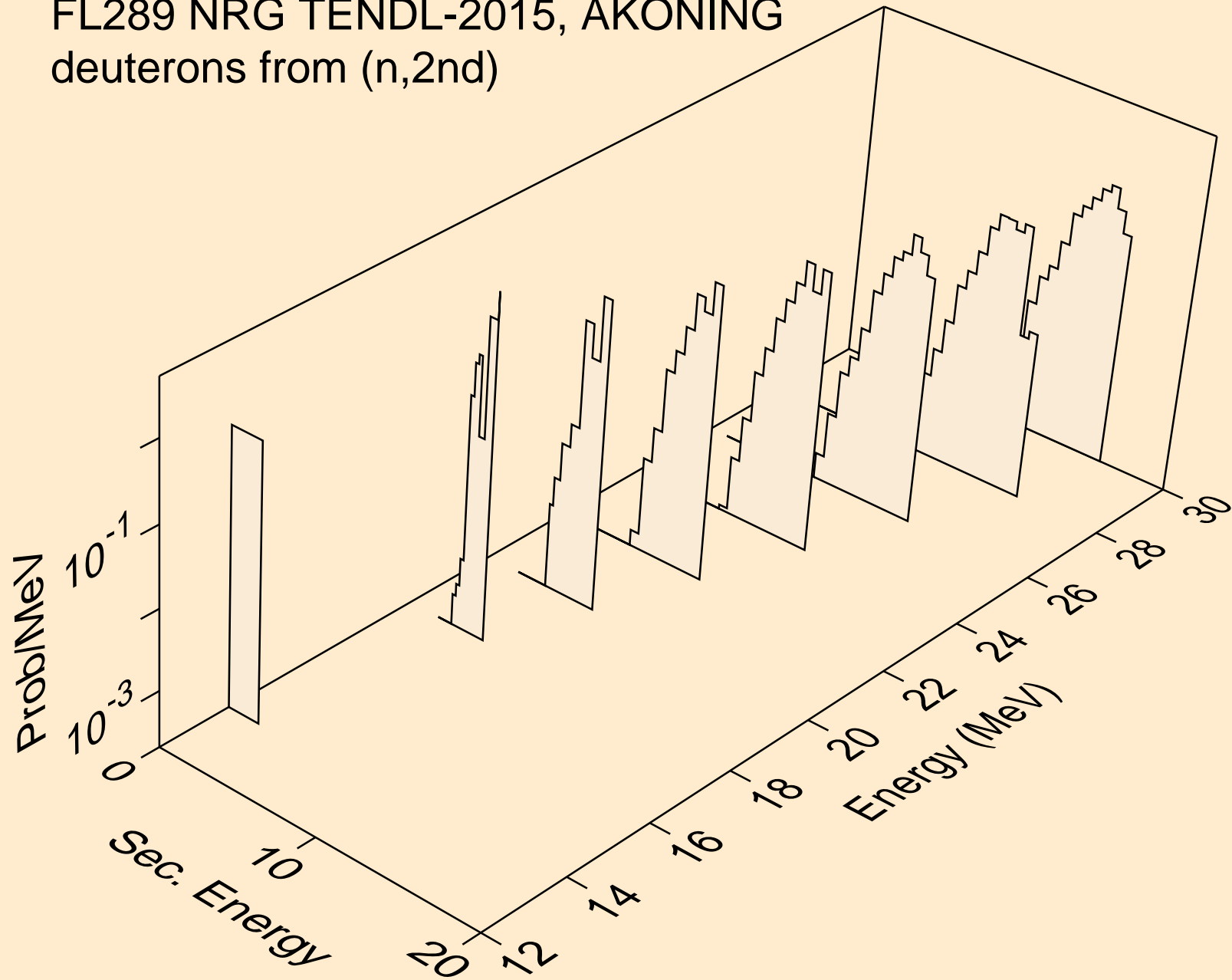

FL289 NRG TENDL-2015, AKONING
deuterons from (n,n*)d

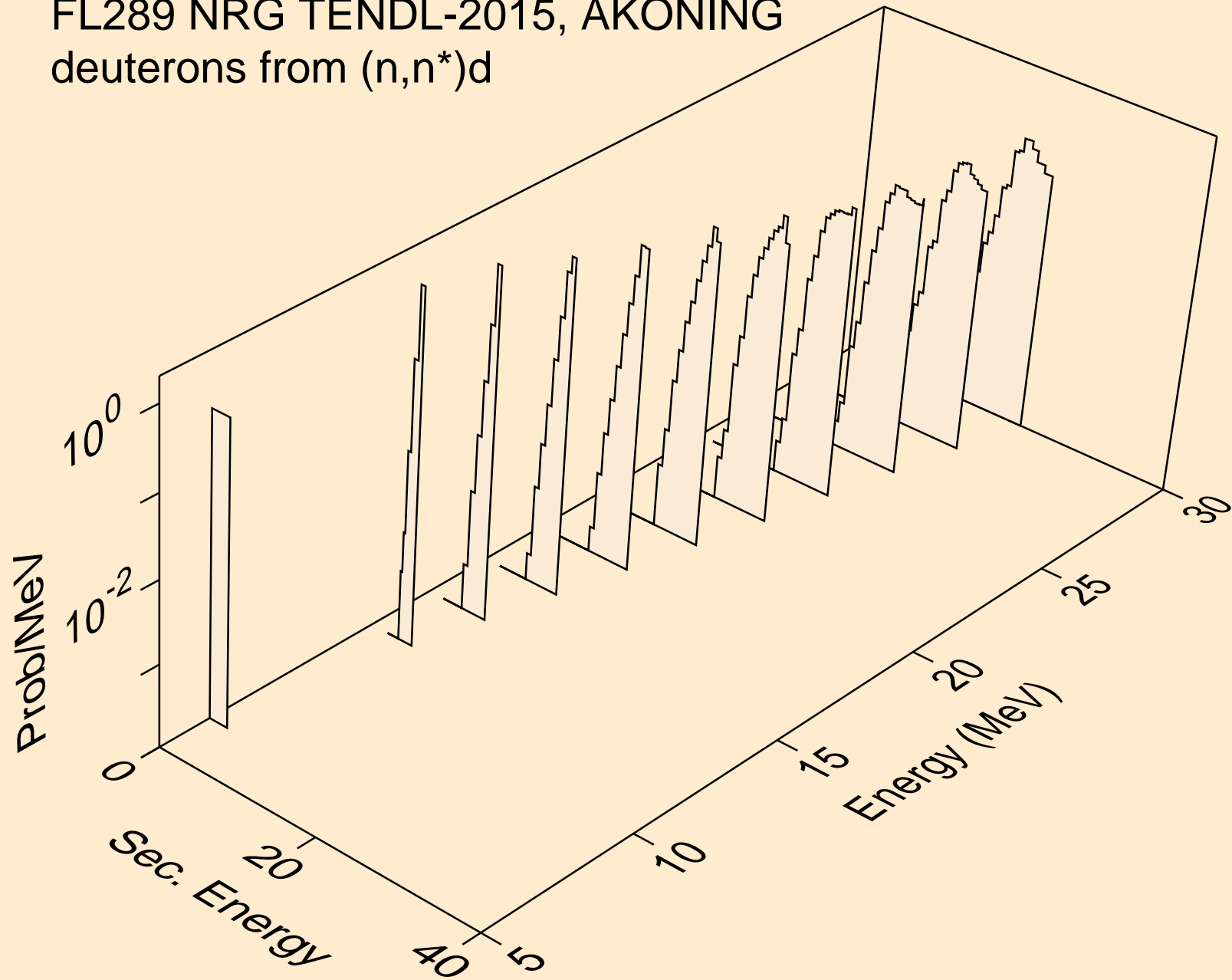

FL289 NRG TENDL-2015, AKONING
deuterons from (n,n*)d2a

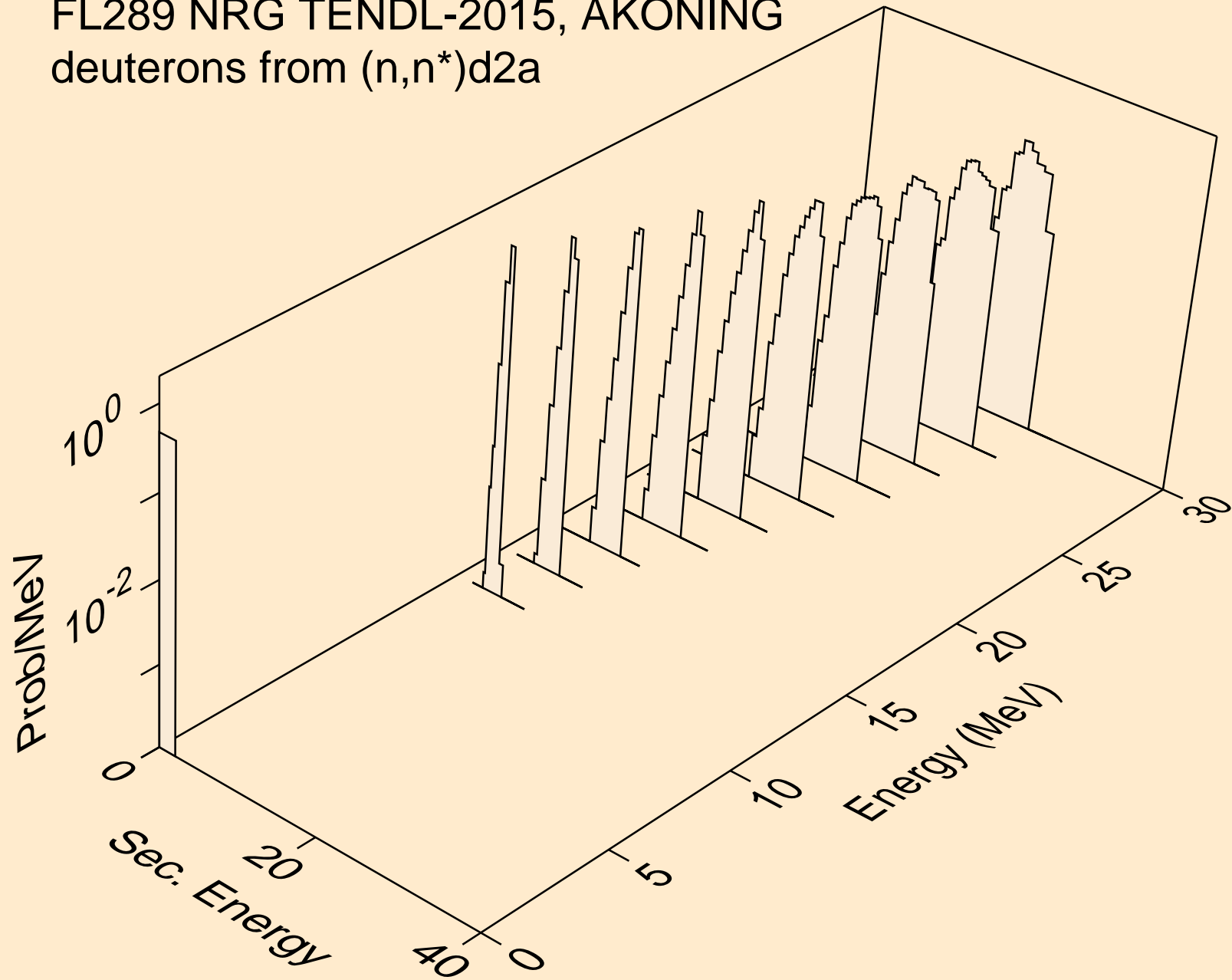

FL289 NRG TENDL-2015, AKONING
deuterons from (n,d)

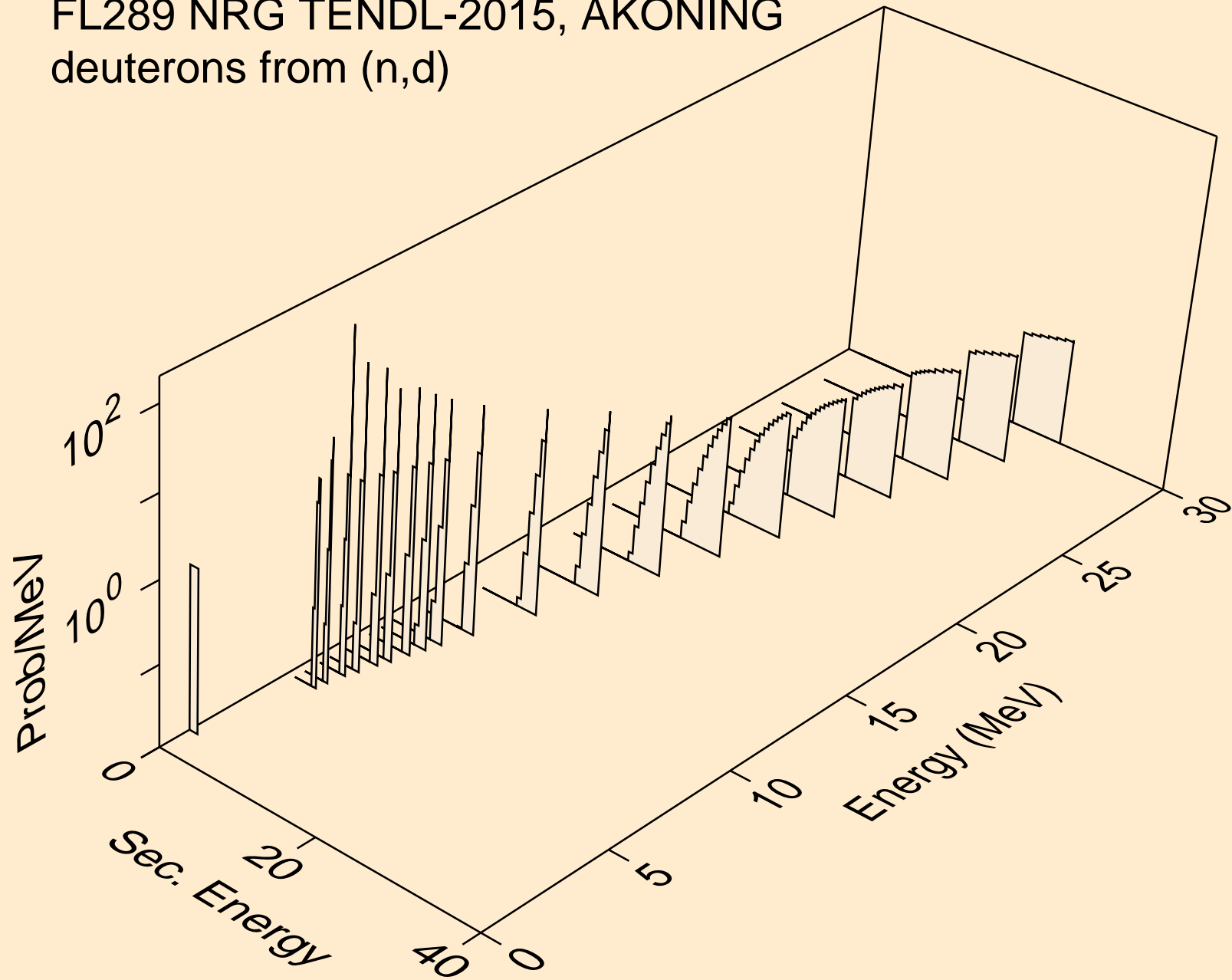

FL289 NRG TENDL-2015, AKONING
deuterons from (n,d2a)

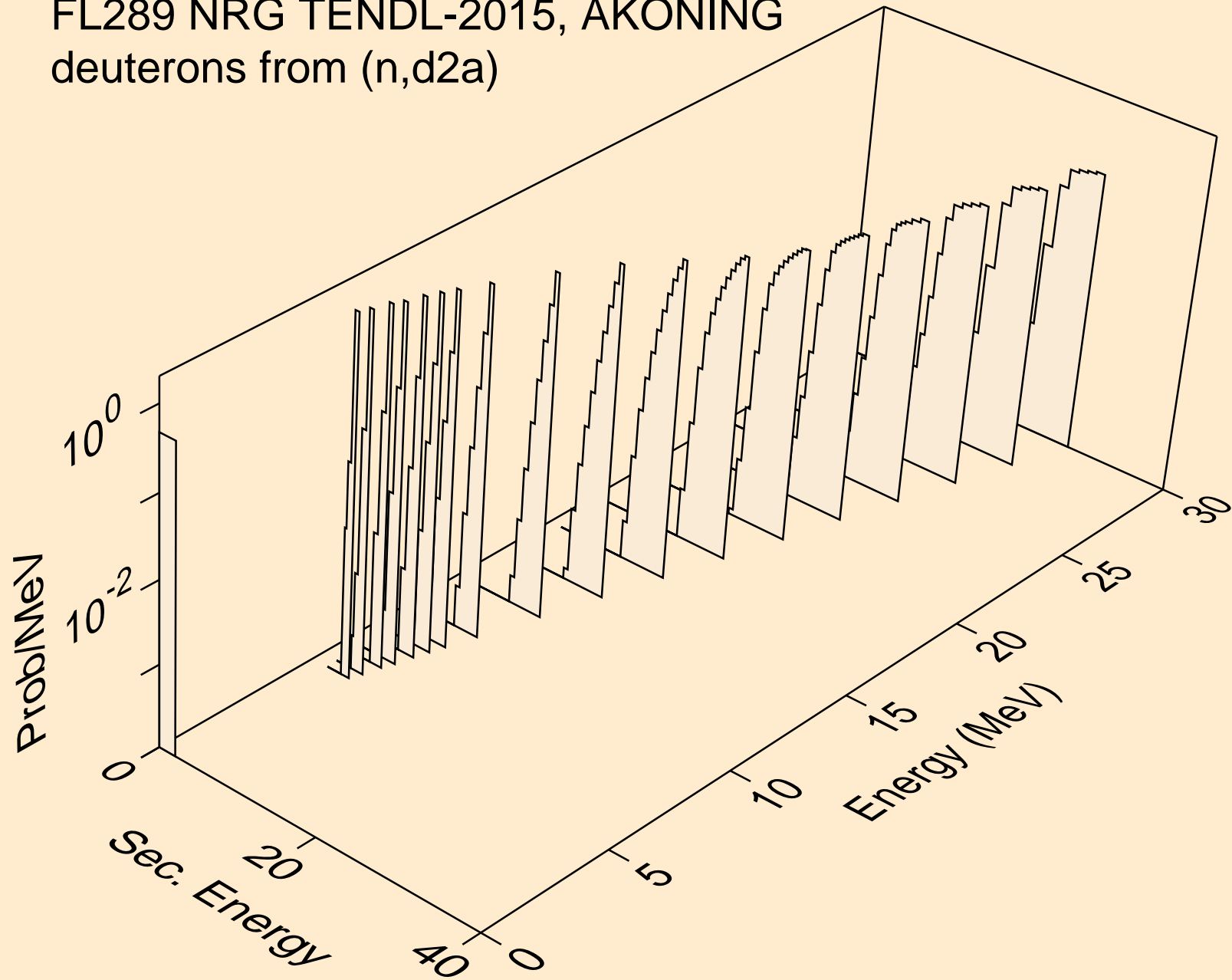

FL289 NRG TENDL-2015, AKONING
deuterons from (n,da)

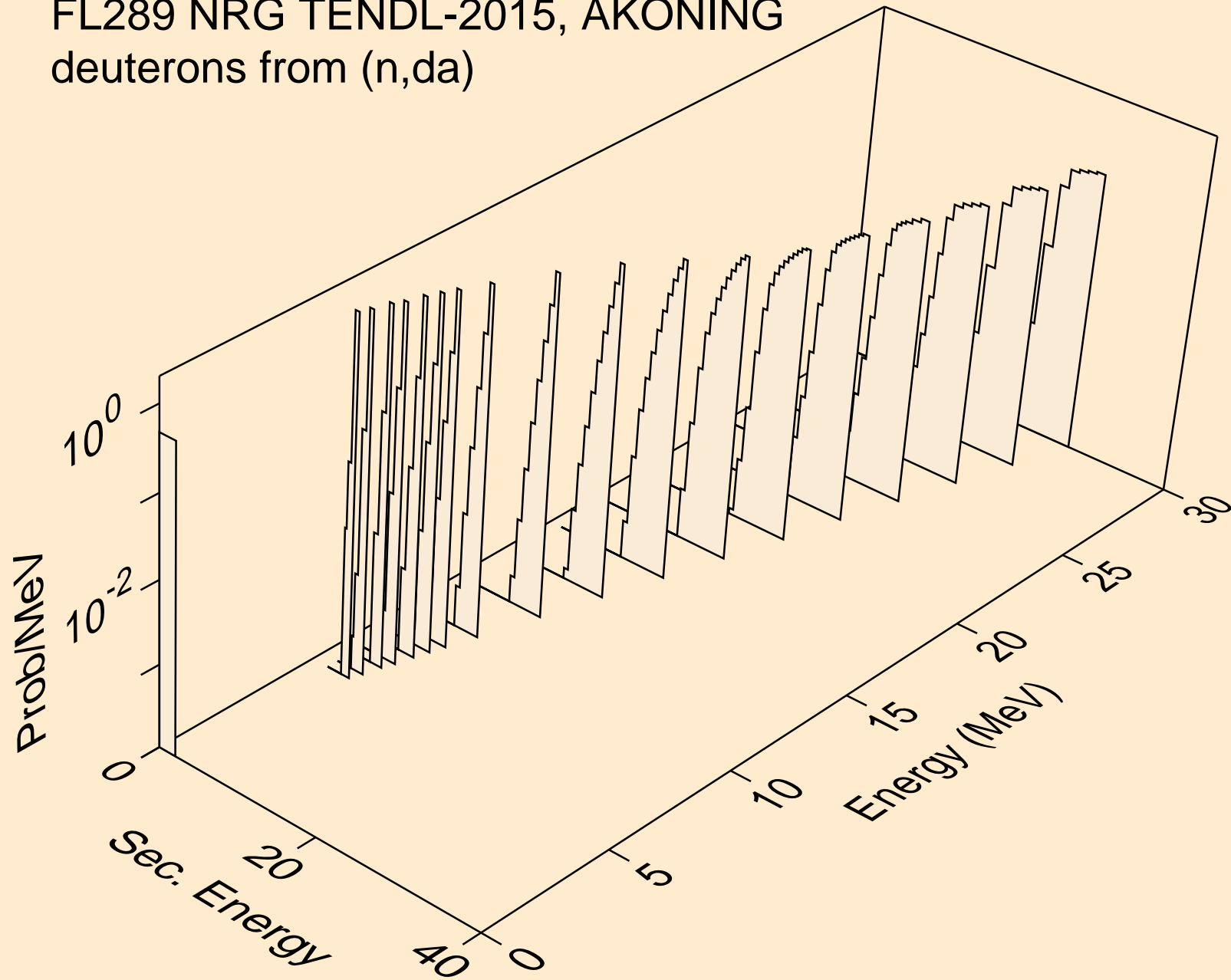

FL289 NRG TENDL-2015, AKONING
tritons from (n,x)

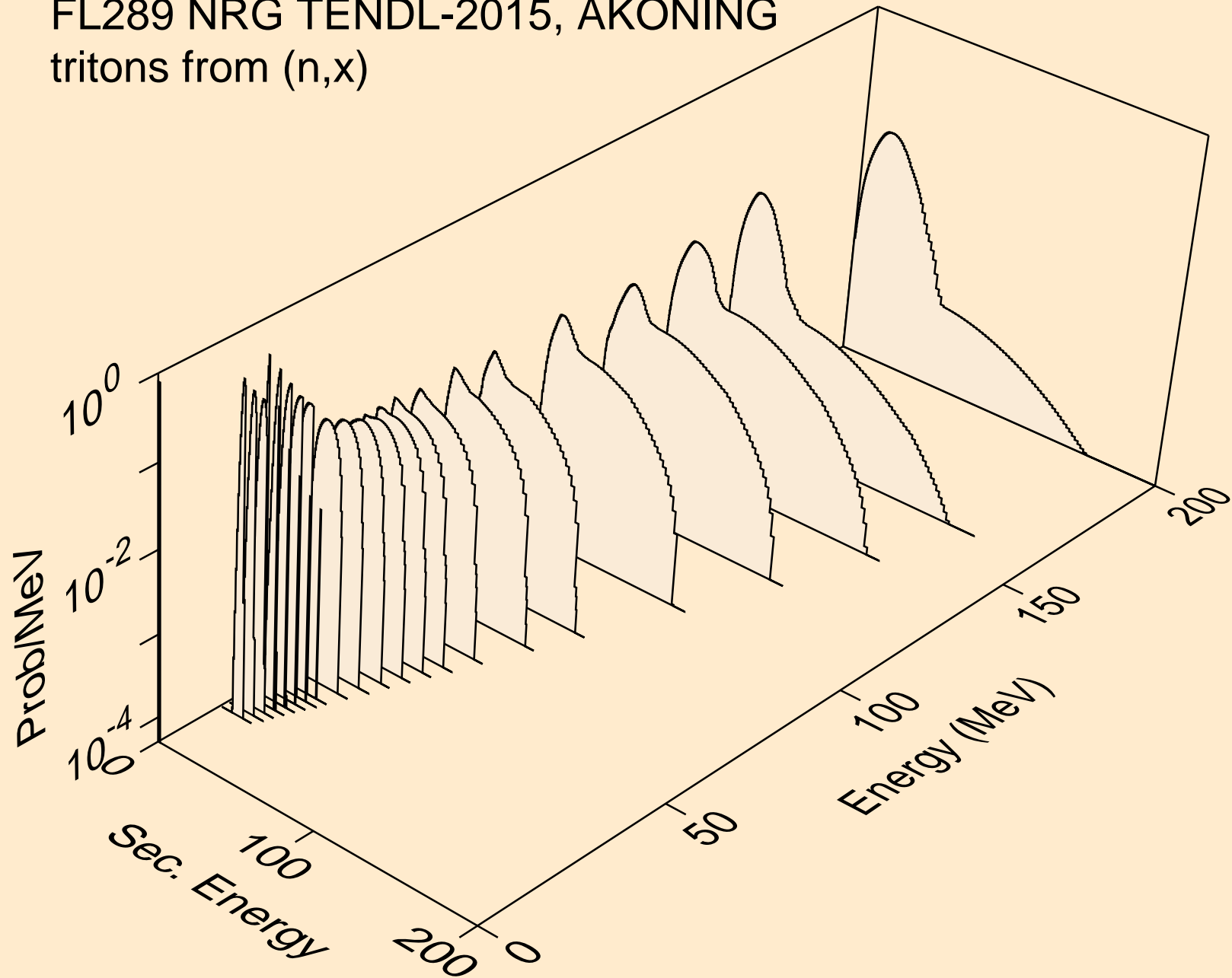

FL289 NRG TENDL-2015, AKONING
tritons from (n,n*)t

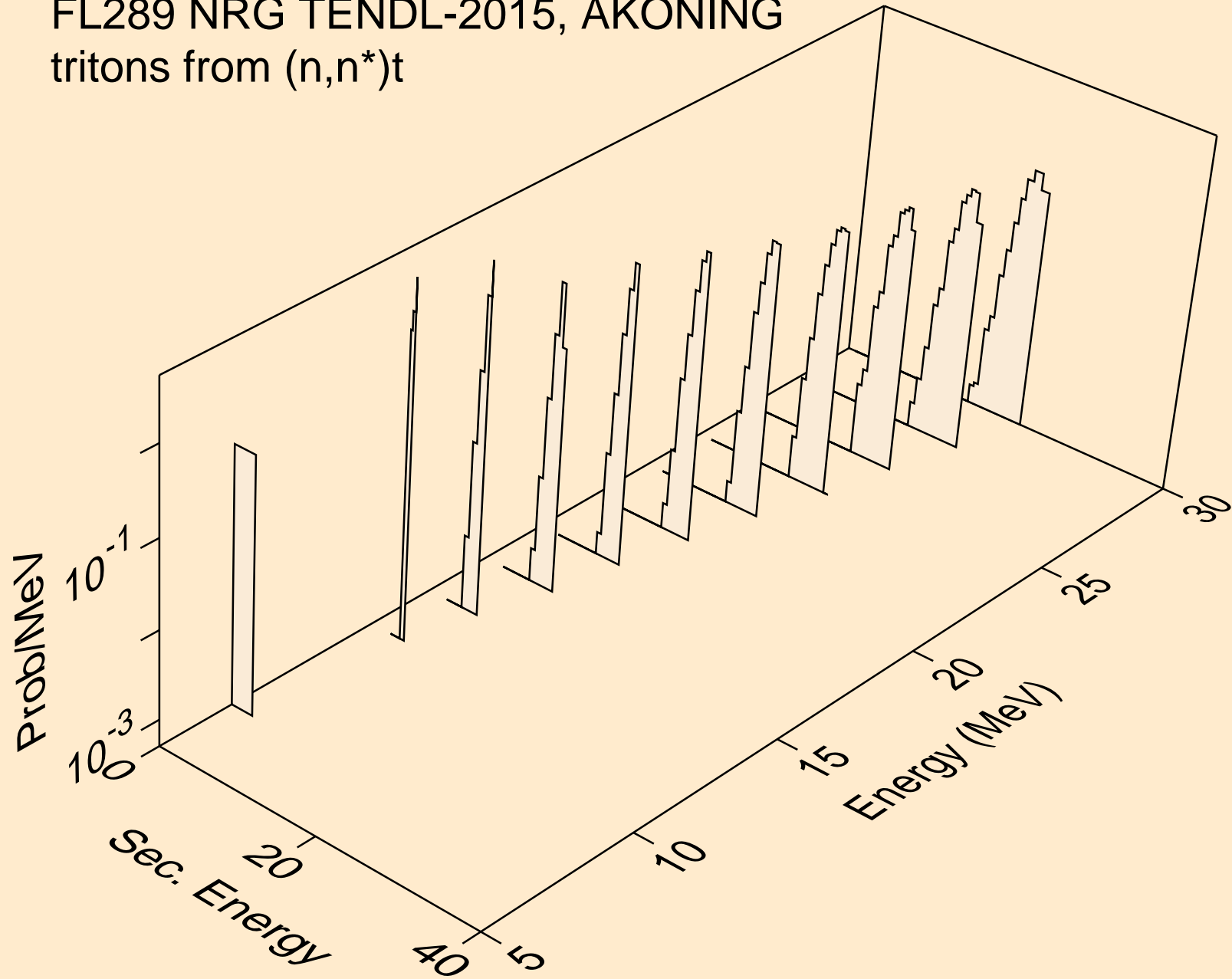

FL289 NRG TENDL-2015, AKONING
tritons from (n,n*)t2a

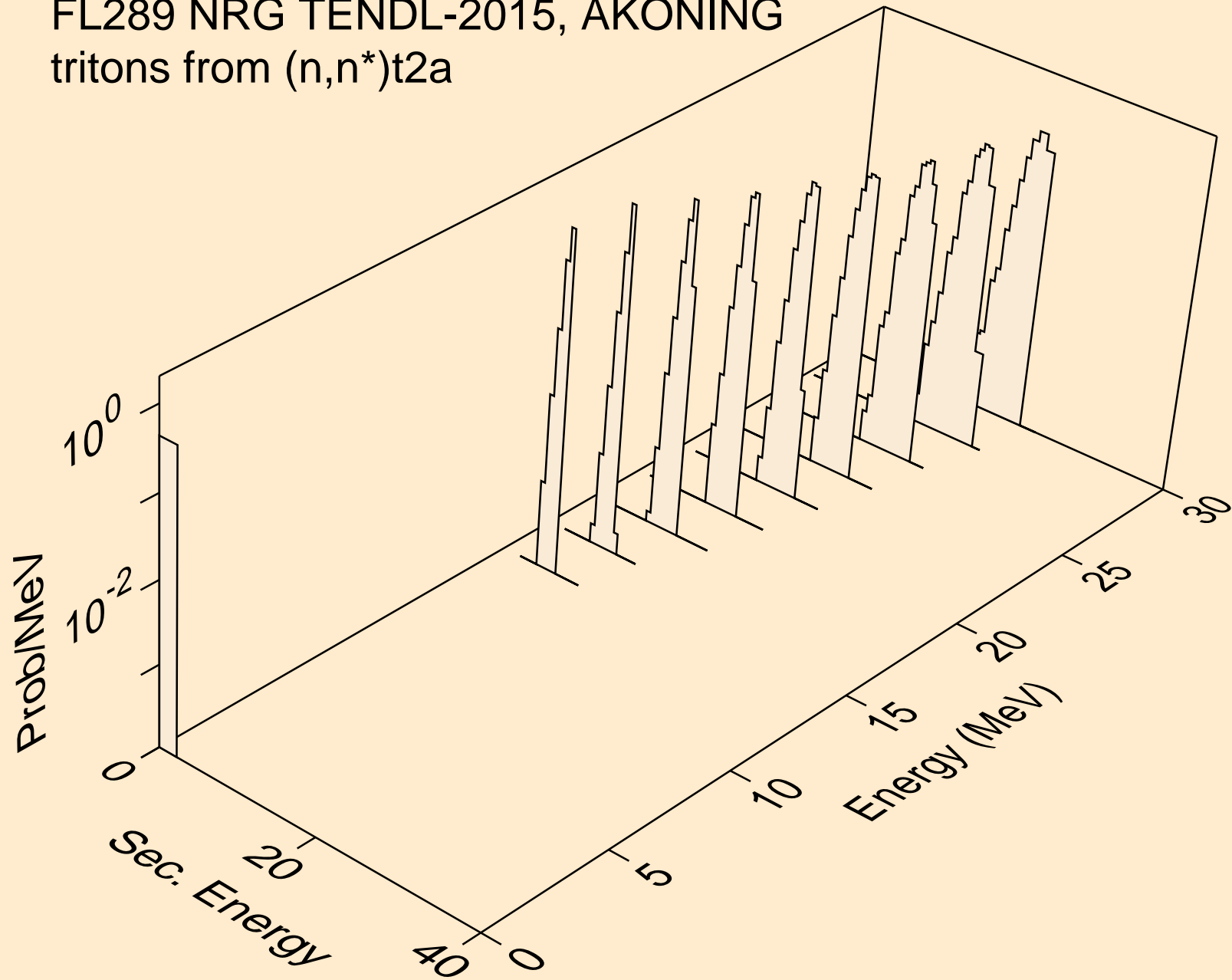

FL289 NRG TENDL-2015, AKONING
tritons from (n,t)

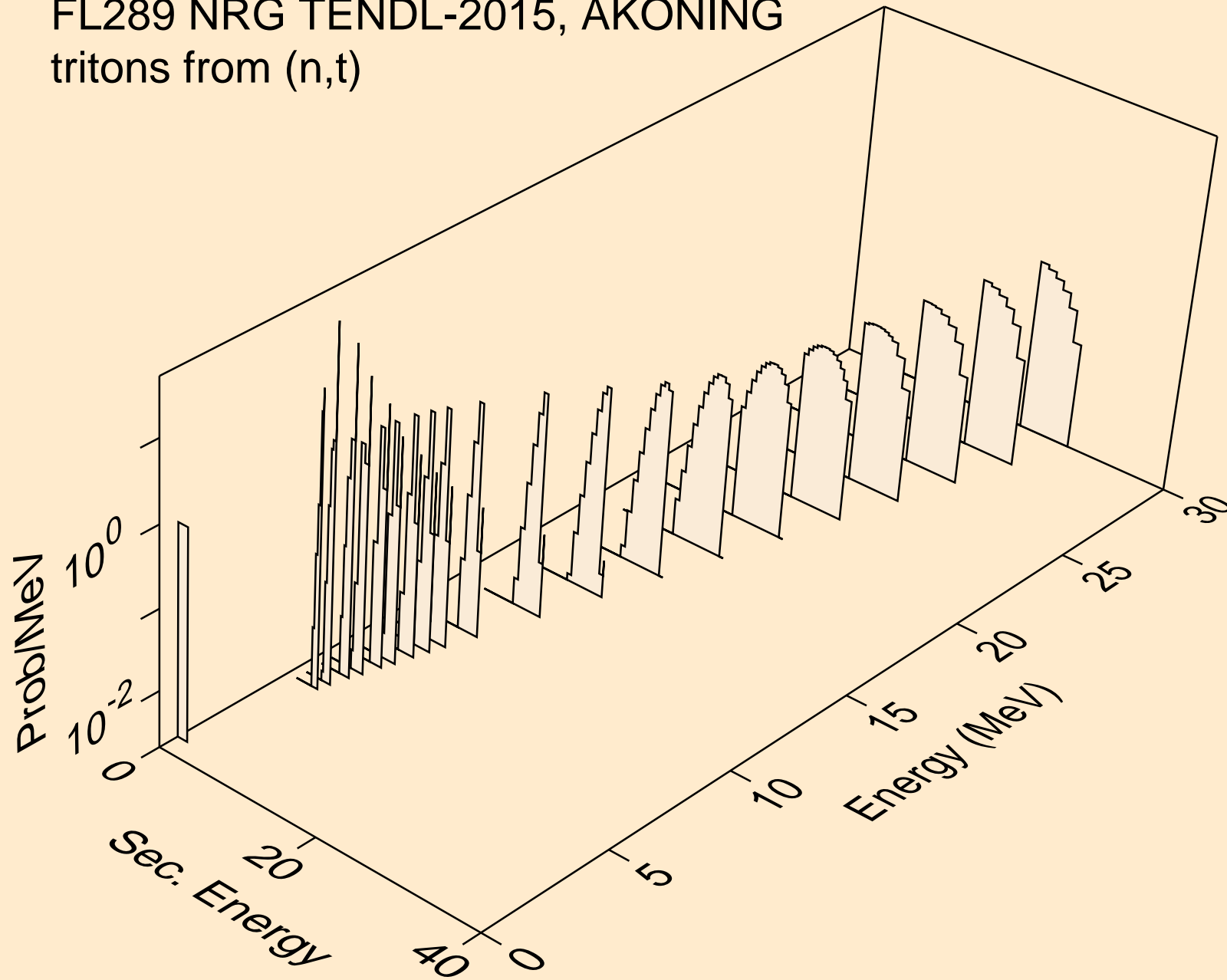

FL289 NRG TENDL-2015, AKONING
tritons from (n,t2a)

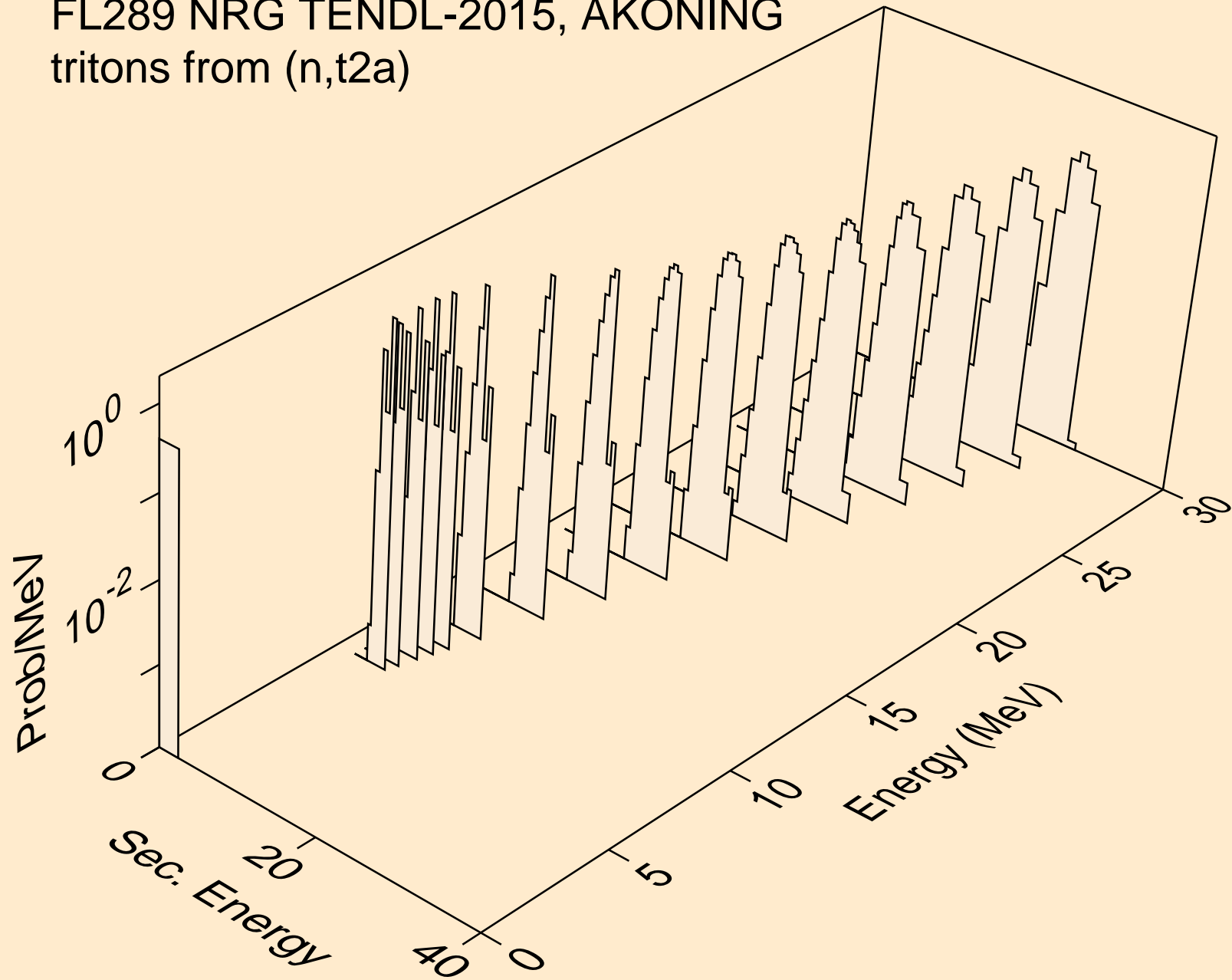

FL289 NRG TENDL-2015, AKONING
he3s from (n,x)

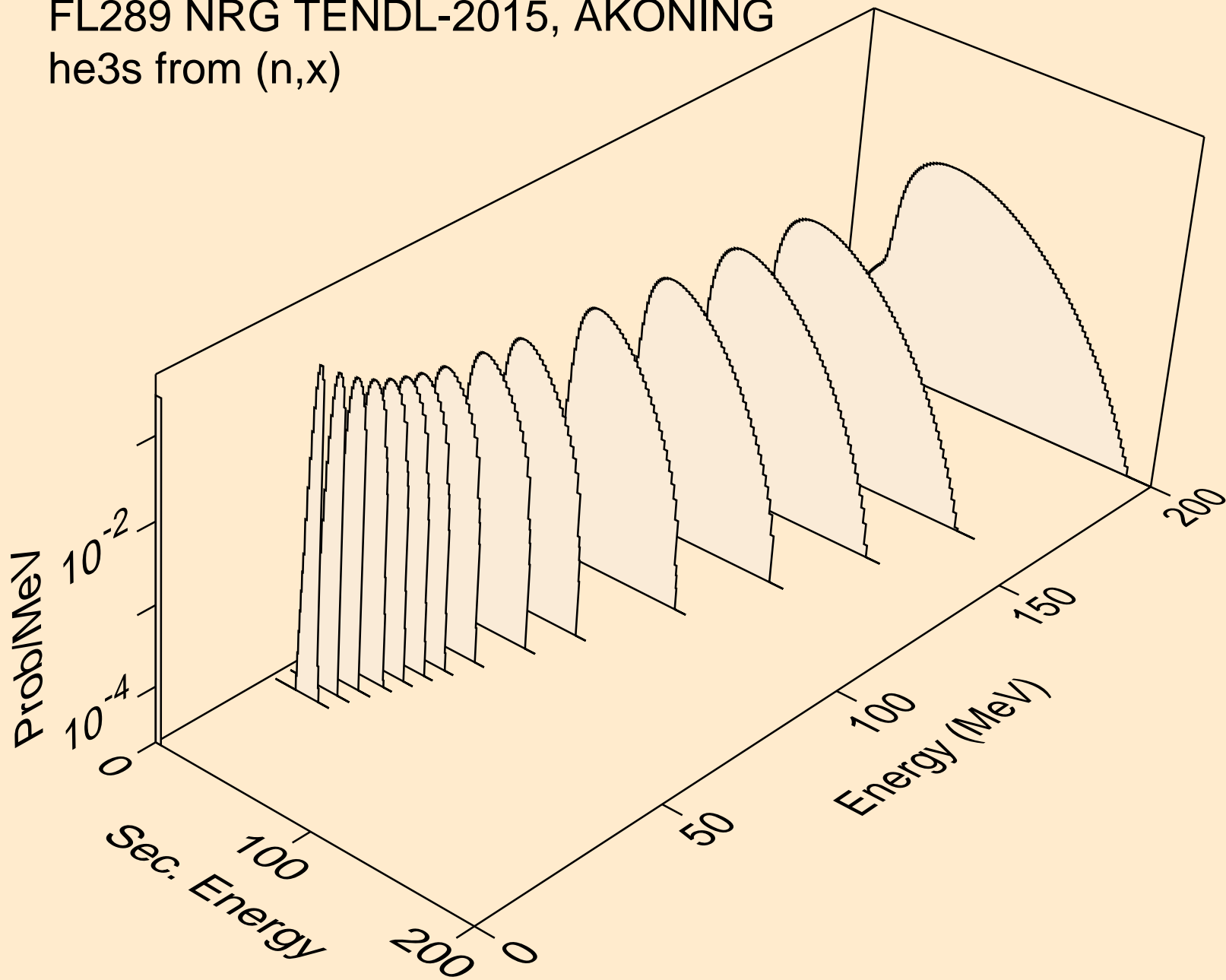

FL289 NRG TENDL-2015, AKONING
he3s from (n,n*)he3

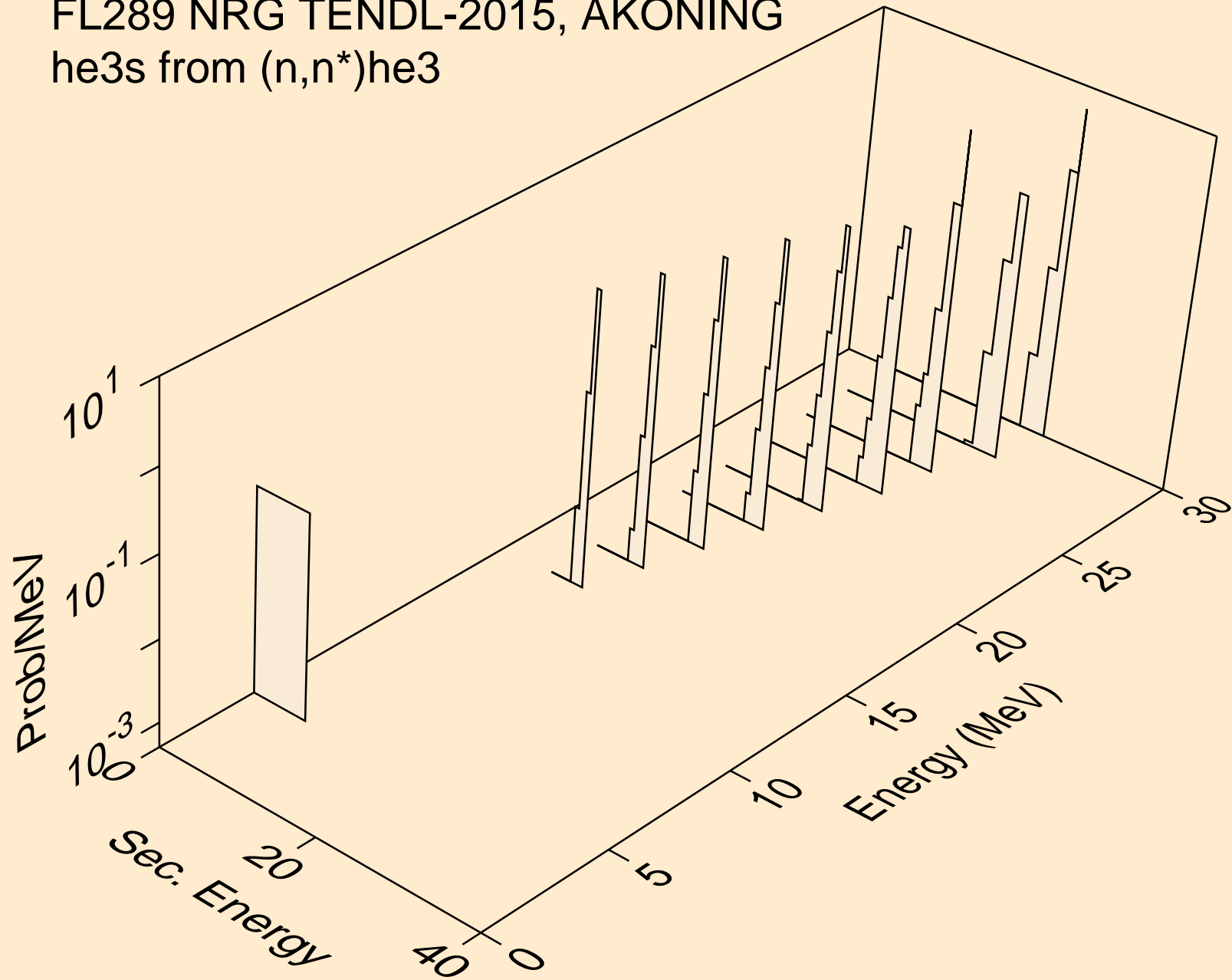

FL289 NRG TENDL-2015, AKONING
he3s from (n,he3)

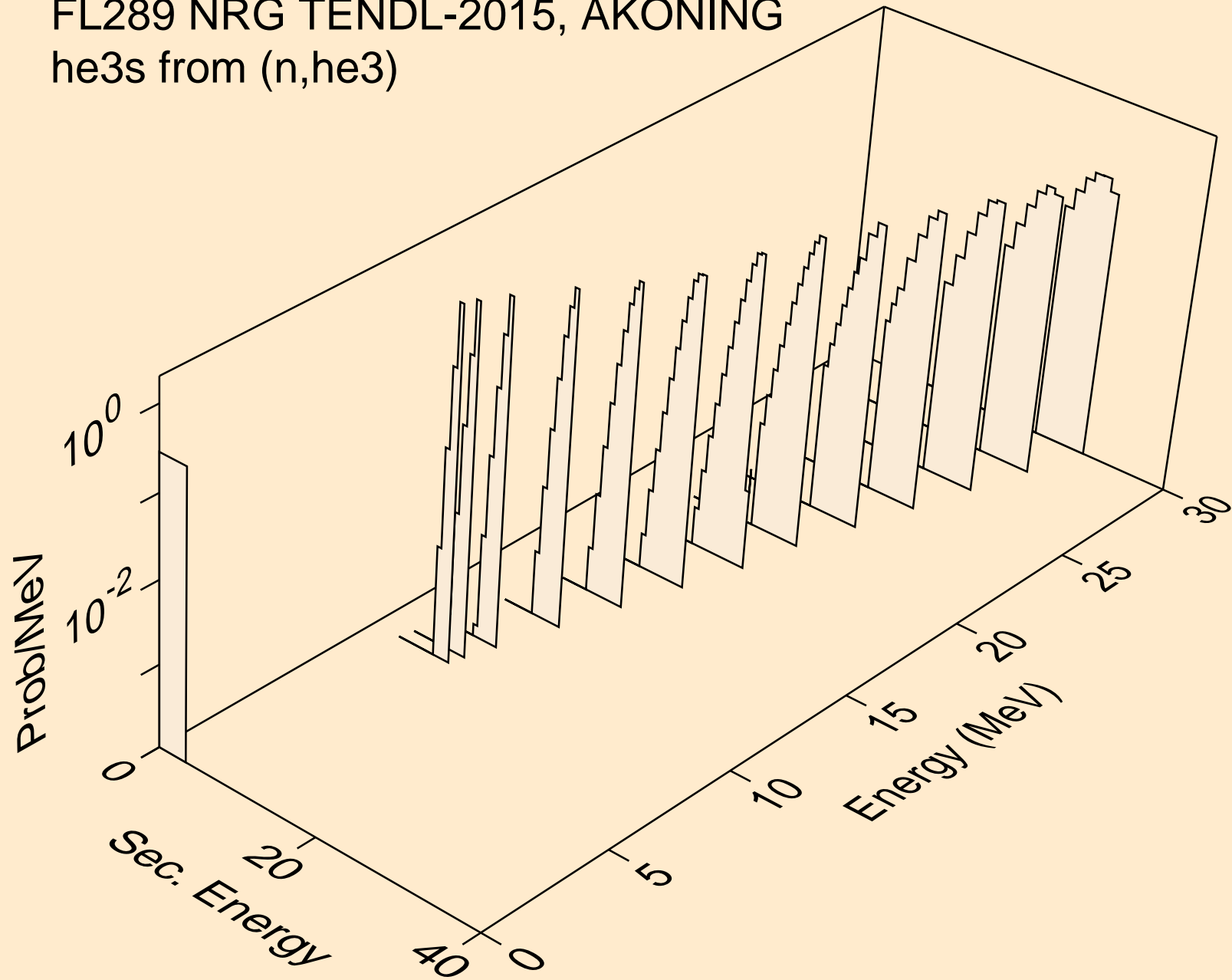

FL289 NRG TENDL-2015, AKONING
alphas from (n,x)

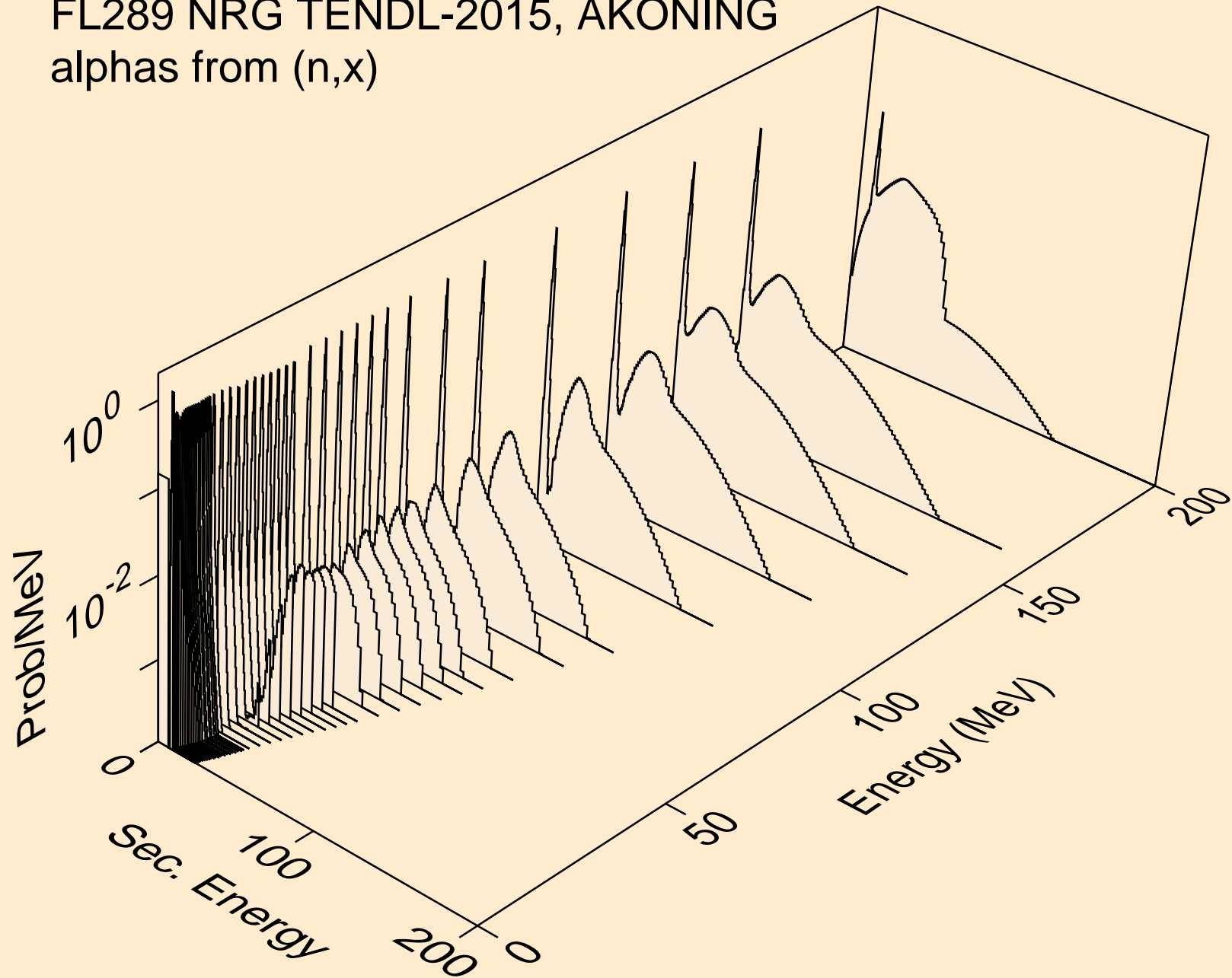

FL289 NRG TENDL-2015, AKONING
alphas from (n,n*)a

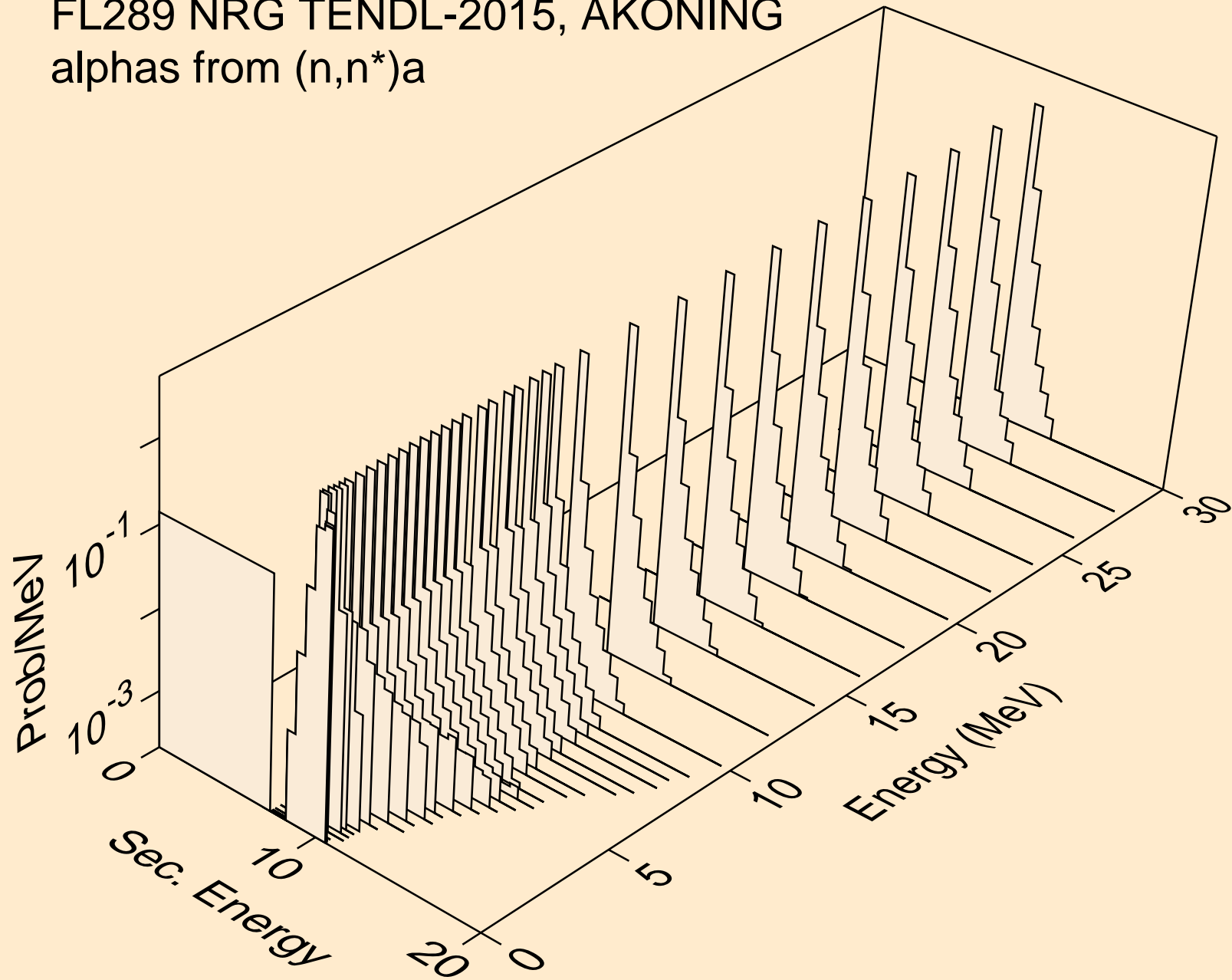

FL289 NRG TENDL-2015, AKONING
alphas from (n,2n)a

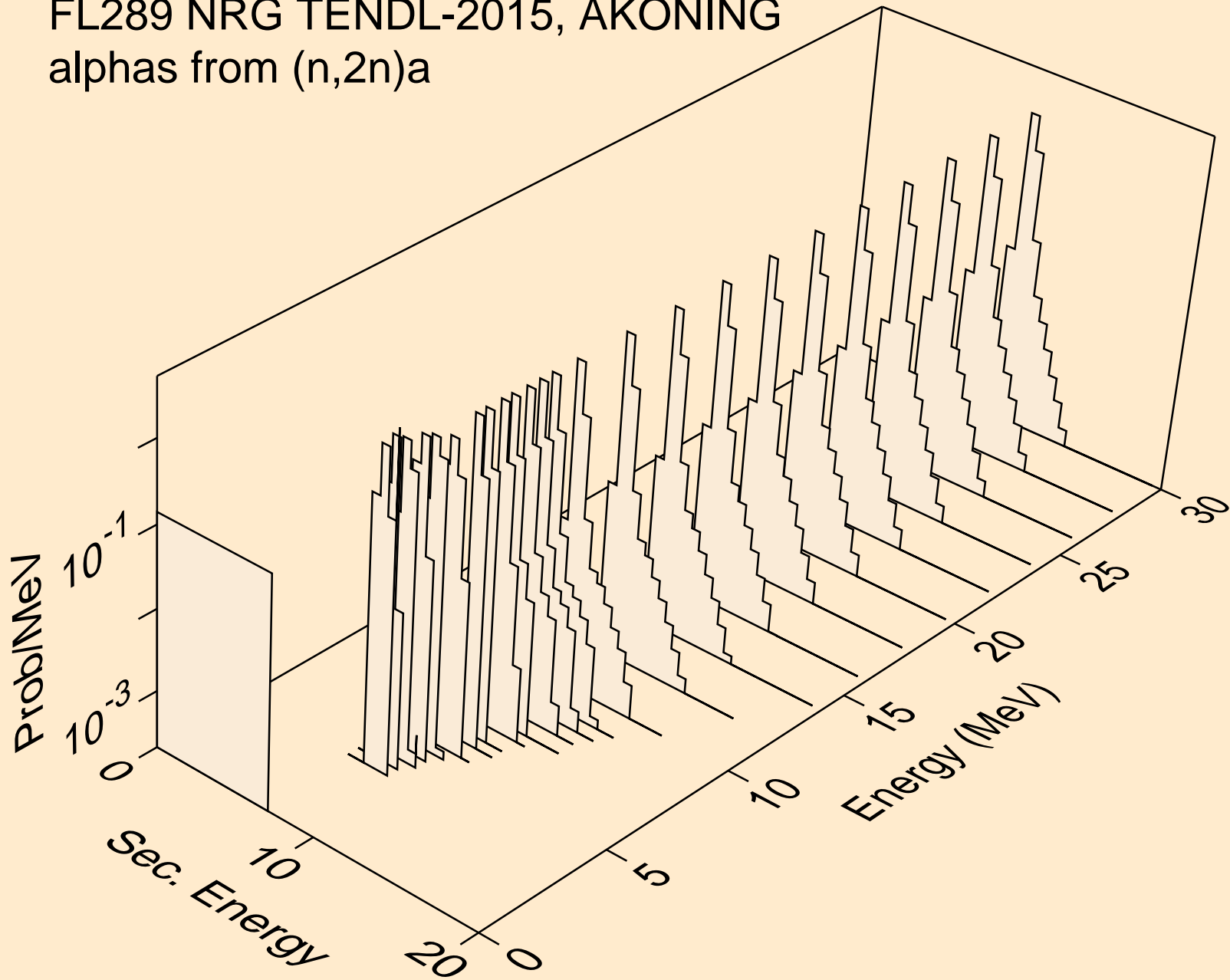

FL289 NRG TENDL-2015, AKONING
alphas from (n,3n)a

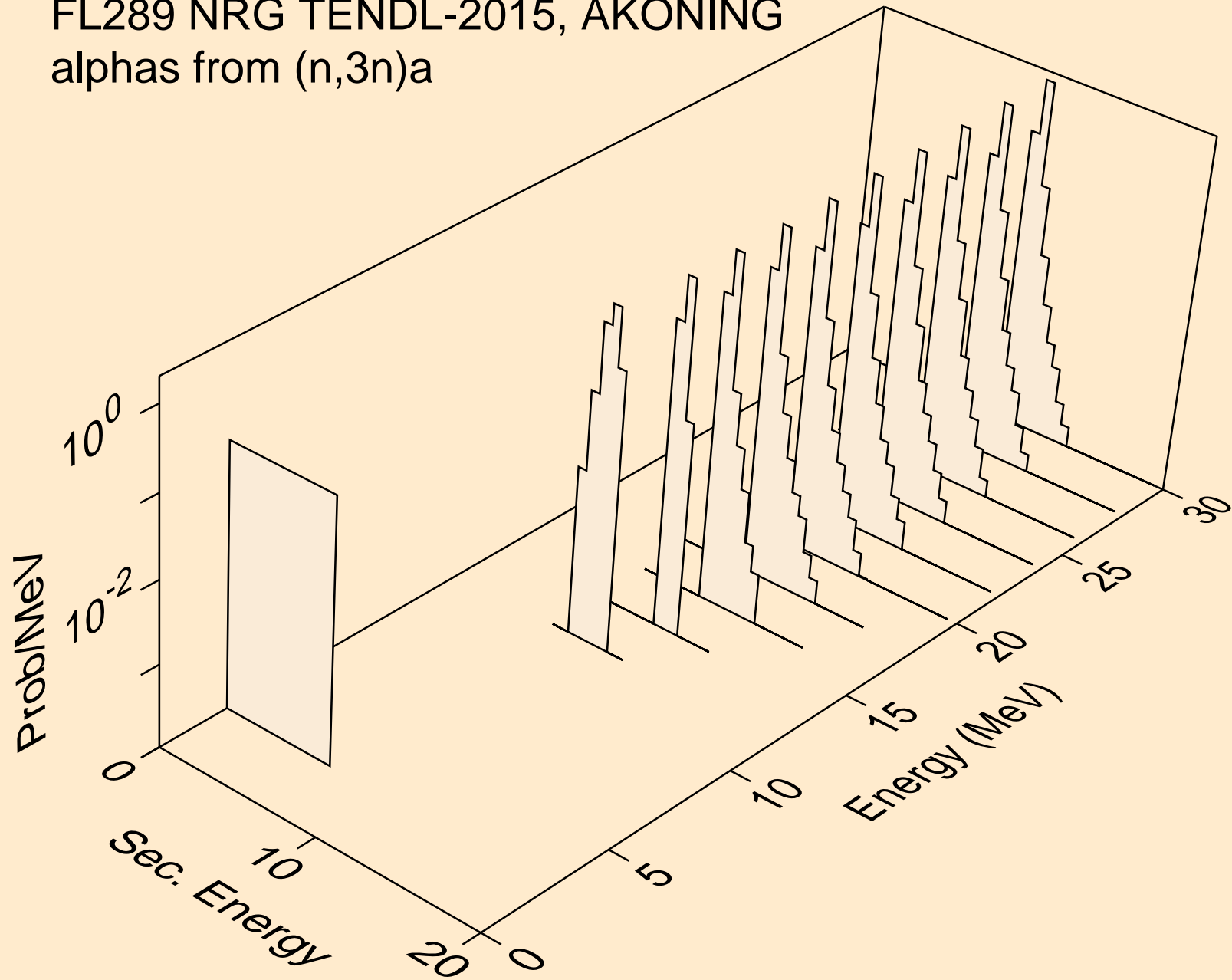

FL289 NRG TENDL-2015, AKONING
alphas from (n,n*)2a

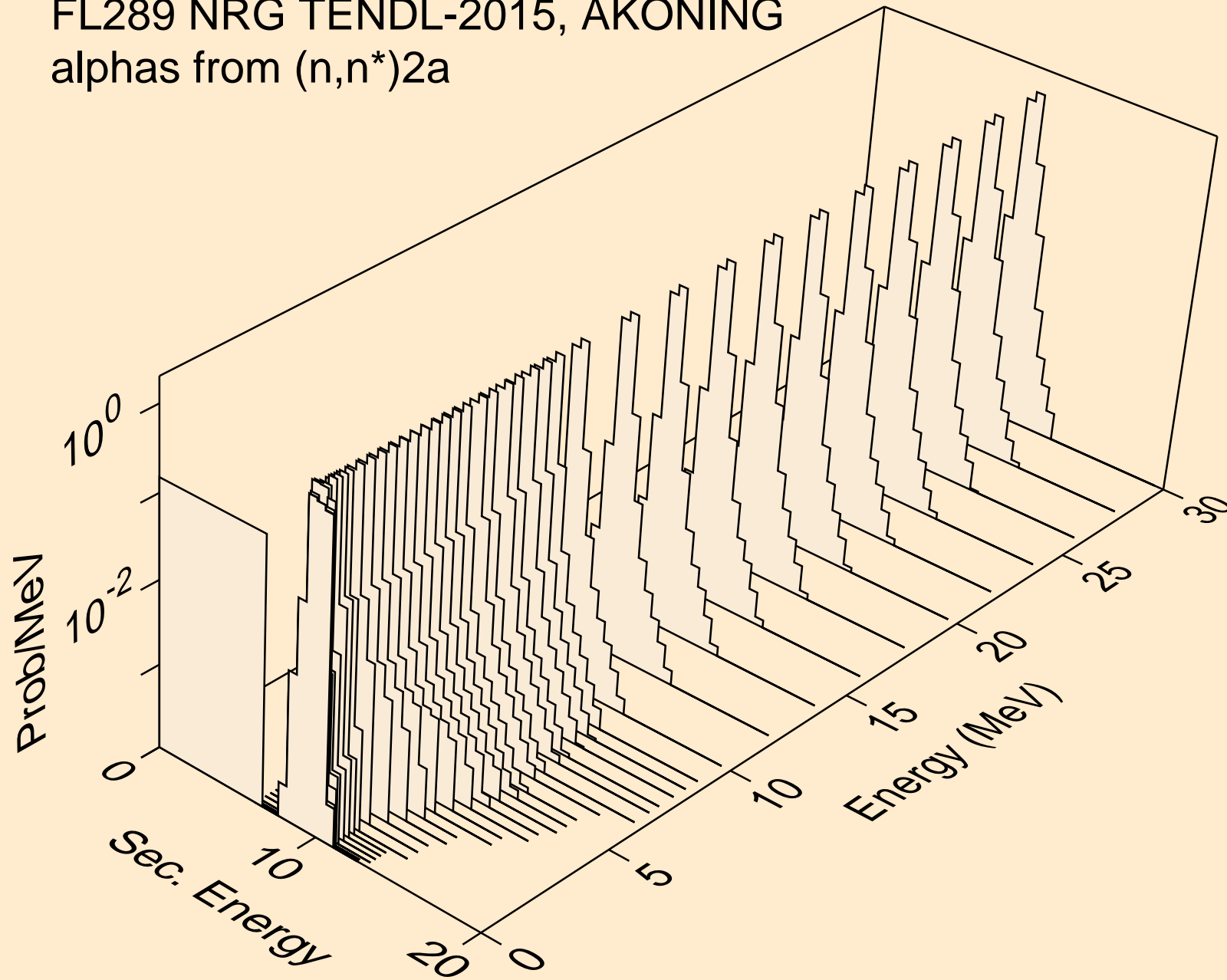

FL289 NRG TENDL-2015, AKONING
alphas from (n,2n)2a

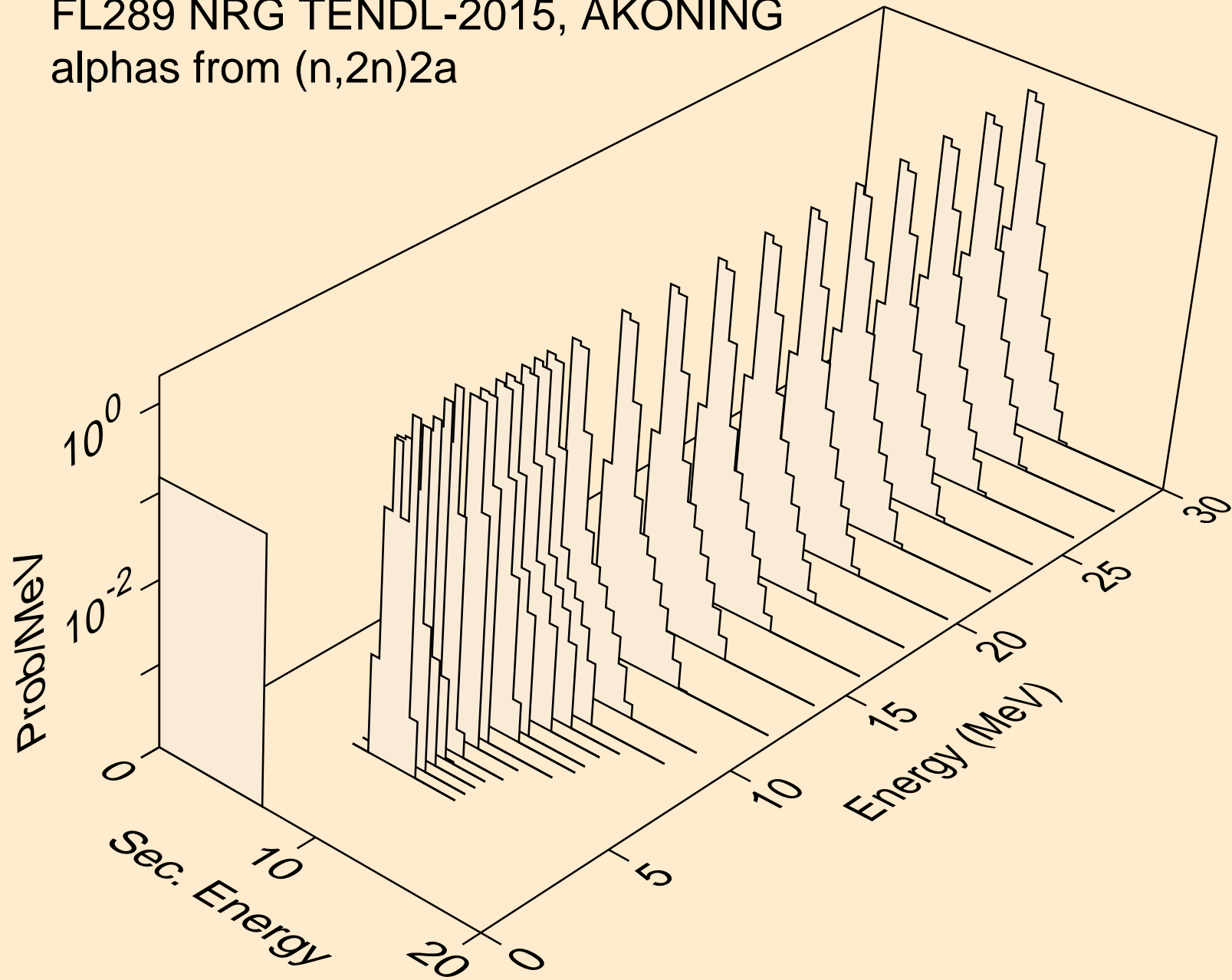

FL289 NRG TENDL-2015, AKONING
alphas from (n,n*)d2a

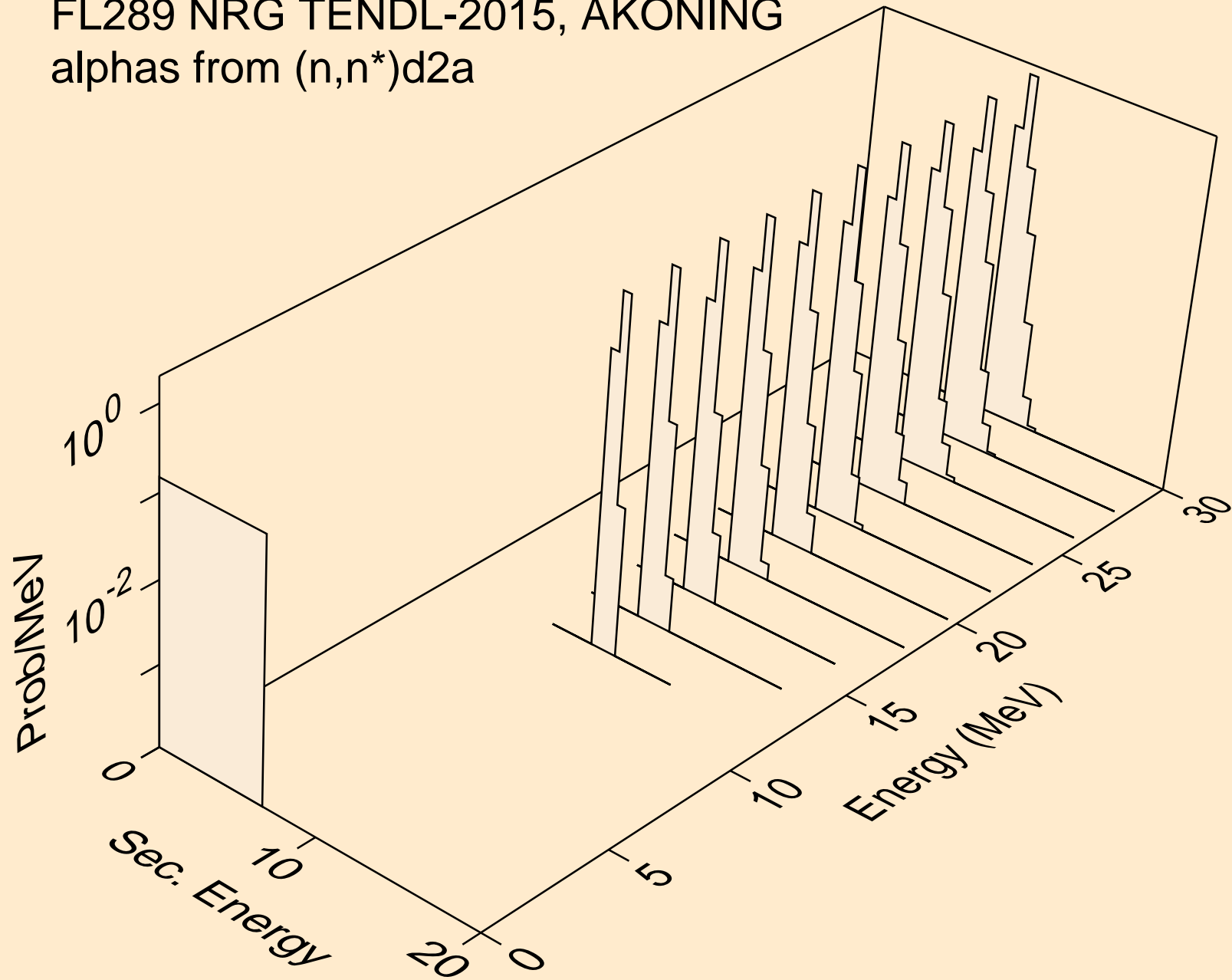

FL289 NRG TENDL-2015, AKONING
alphas from (n,n*)t2a

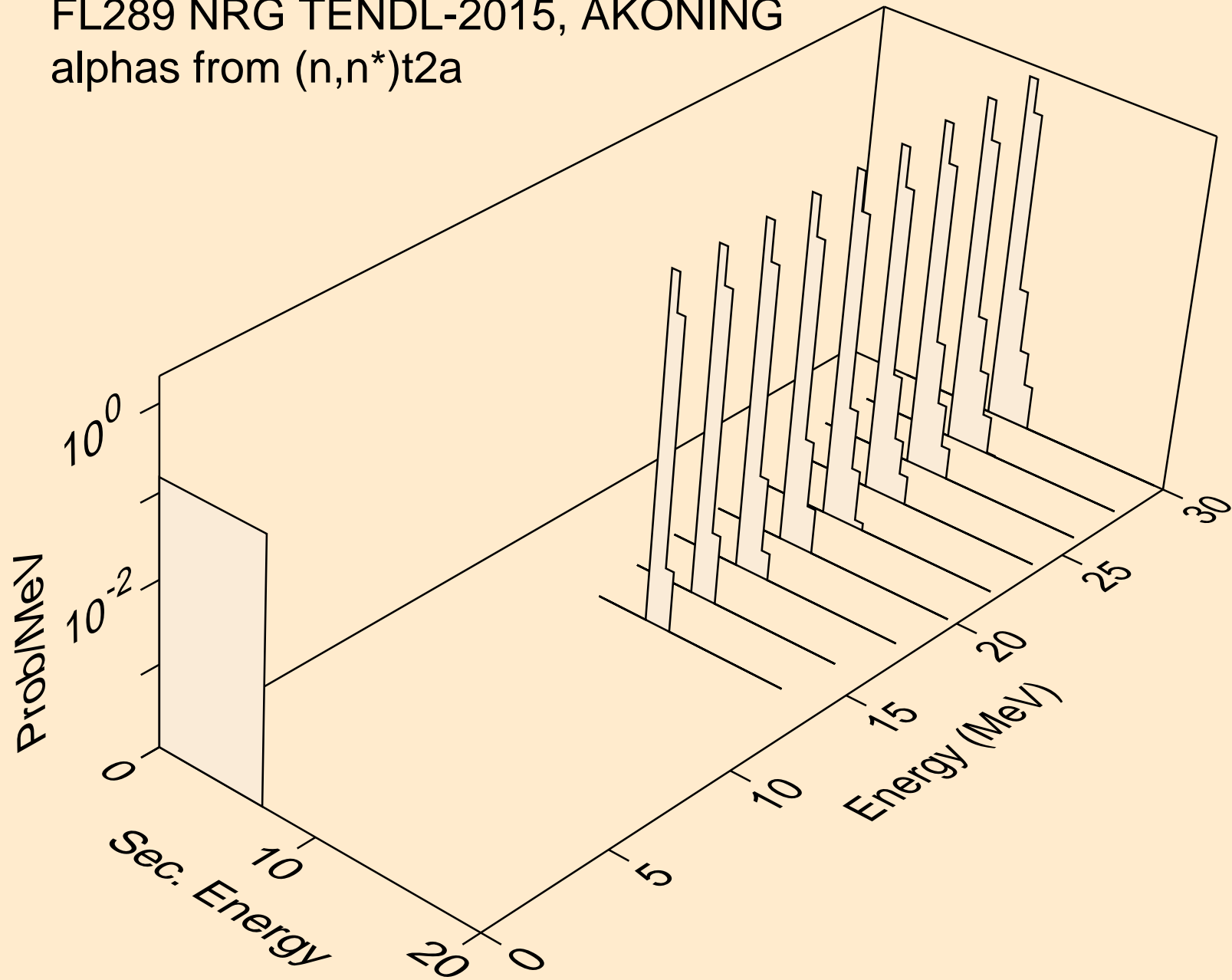

FL289 NRG TENDL-2015, AKONING
alphas from (n,npa)

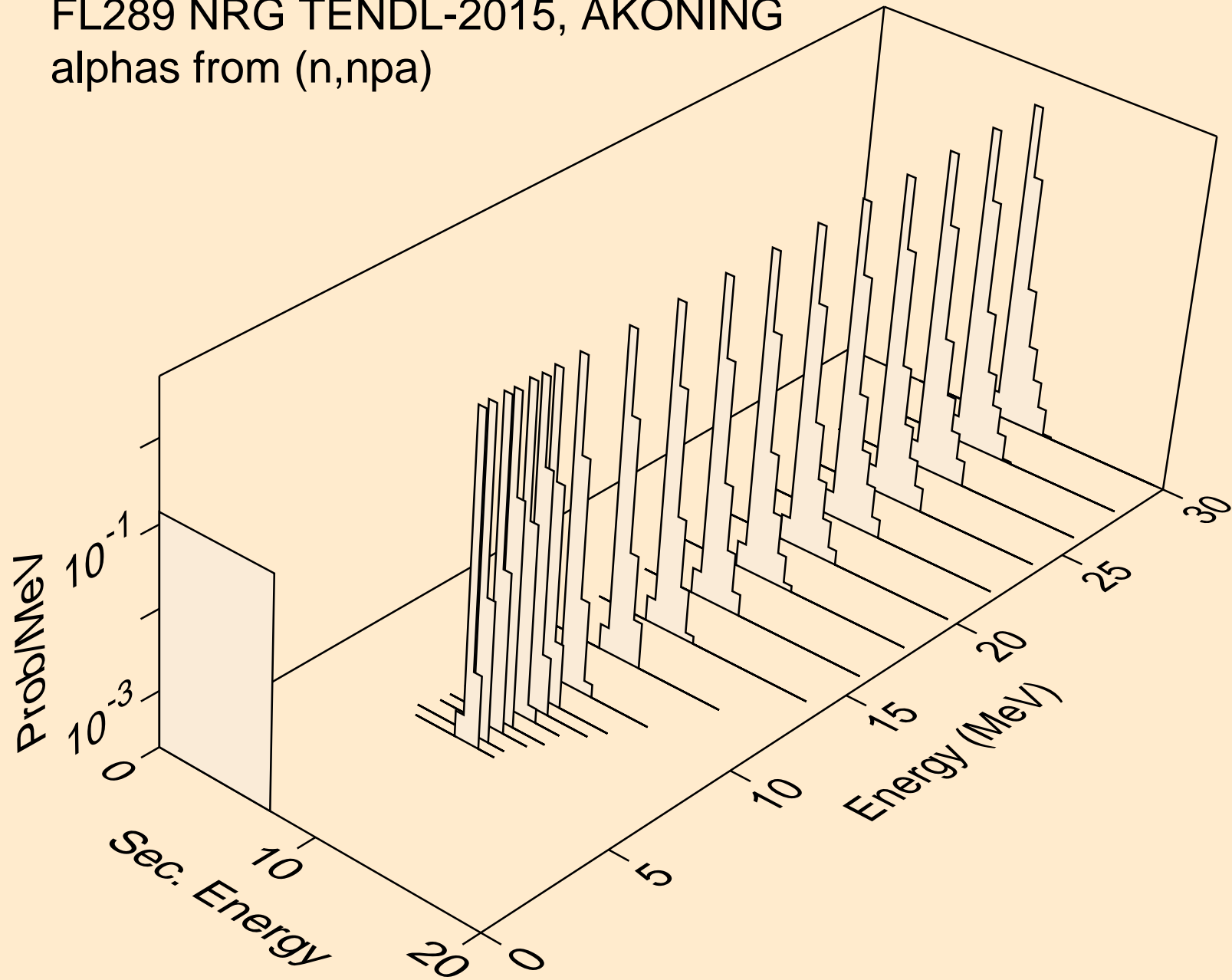

FL289 NRG TENDL-2015, AKONING
alphas from (n,a)

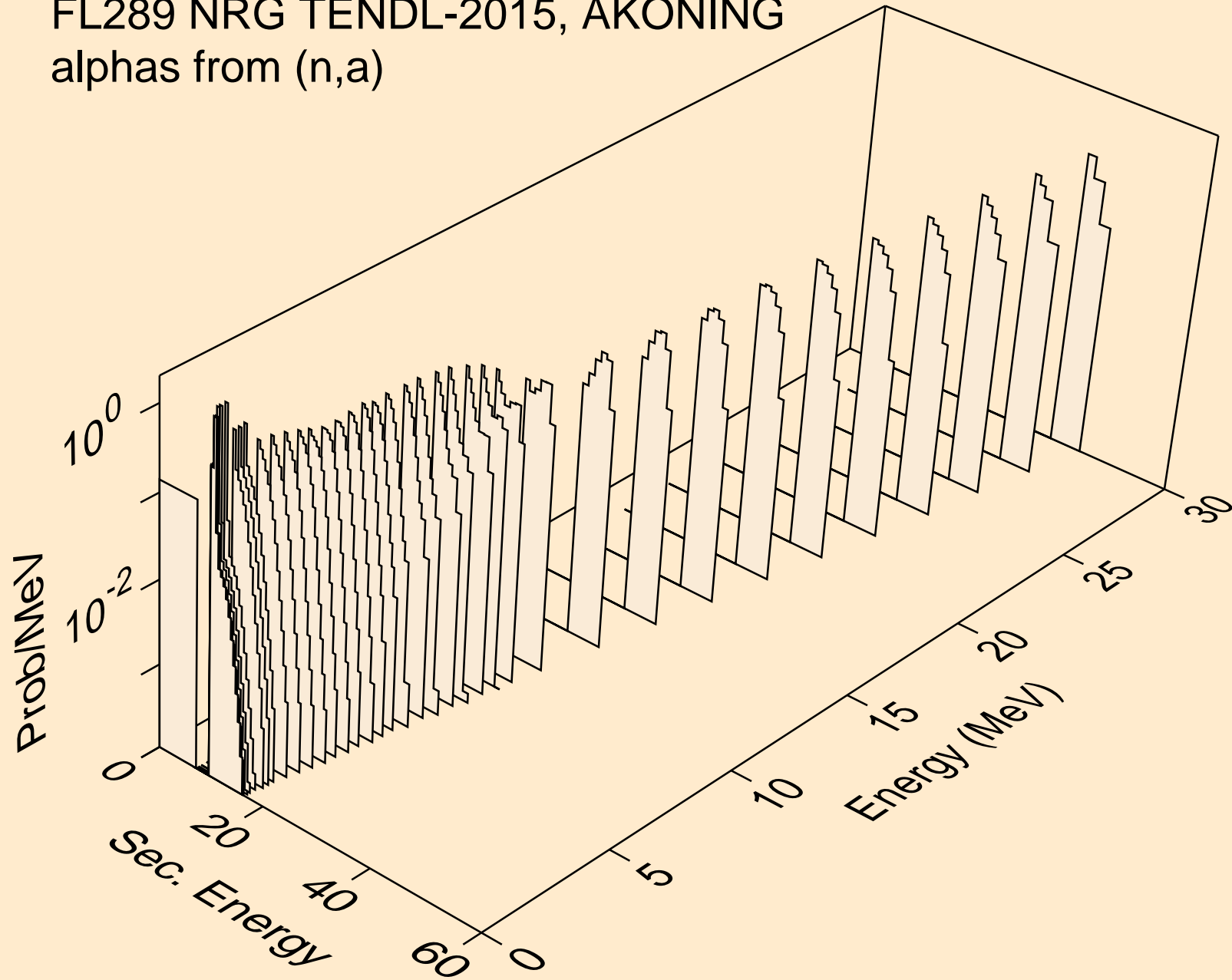

FL289 NRG TENDL-2015, AKONING
alphas from (n,2a)

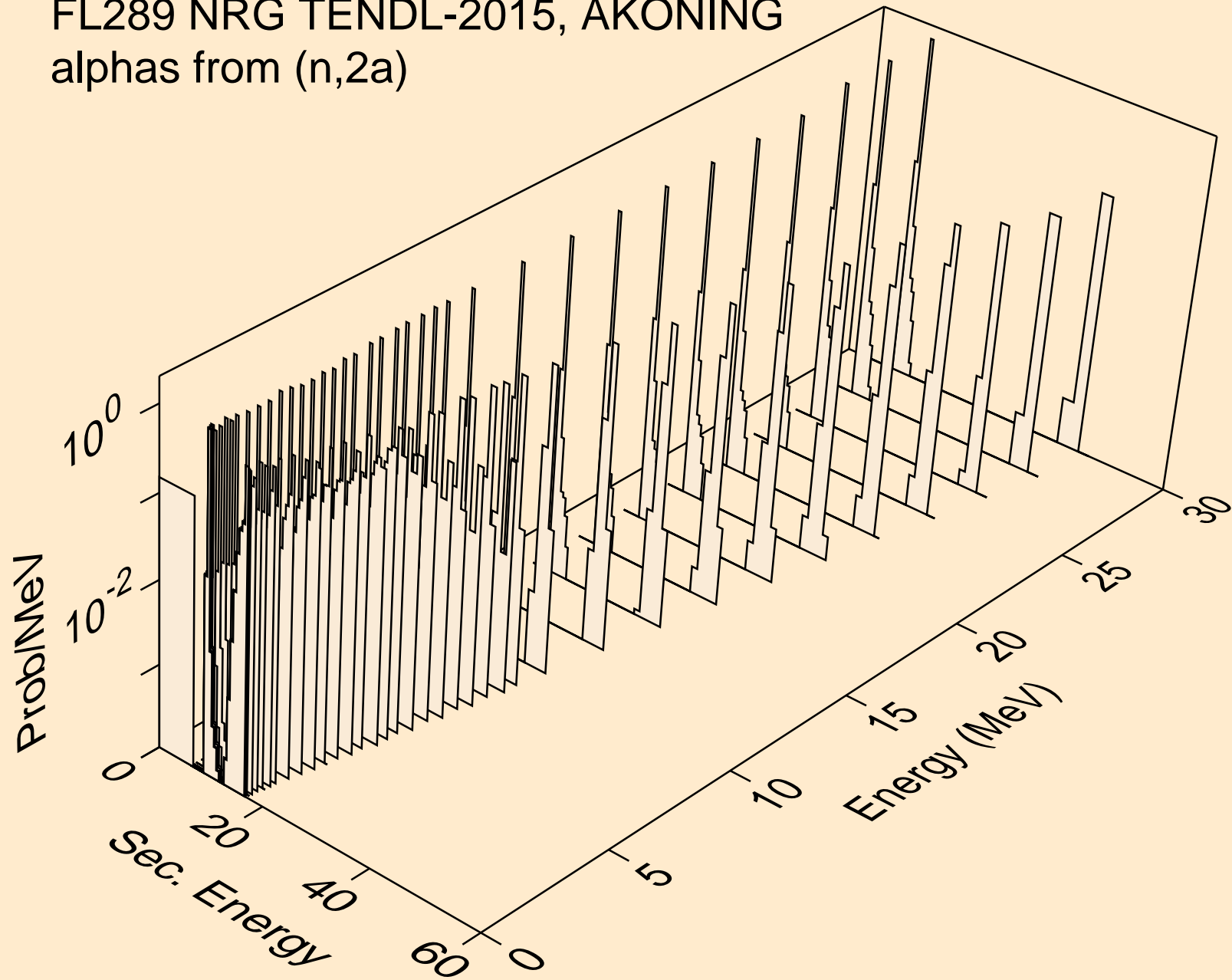

FL289 NRG TENDL-2015, AKONING
alphas from (n,3a)

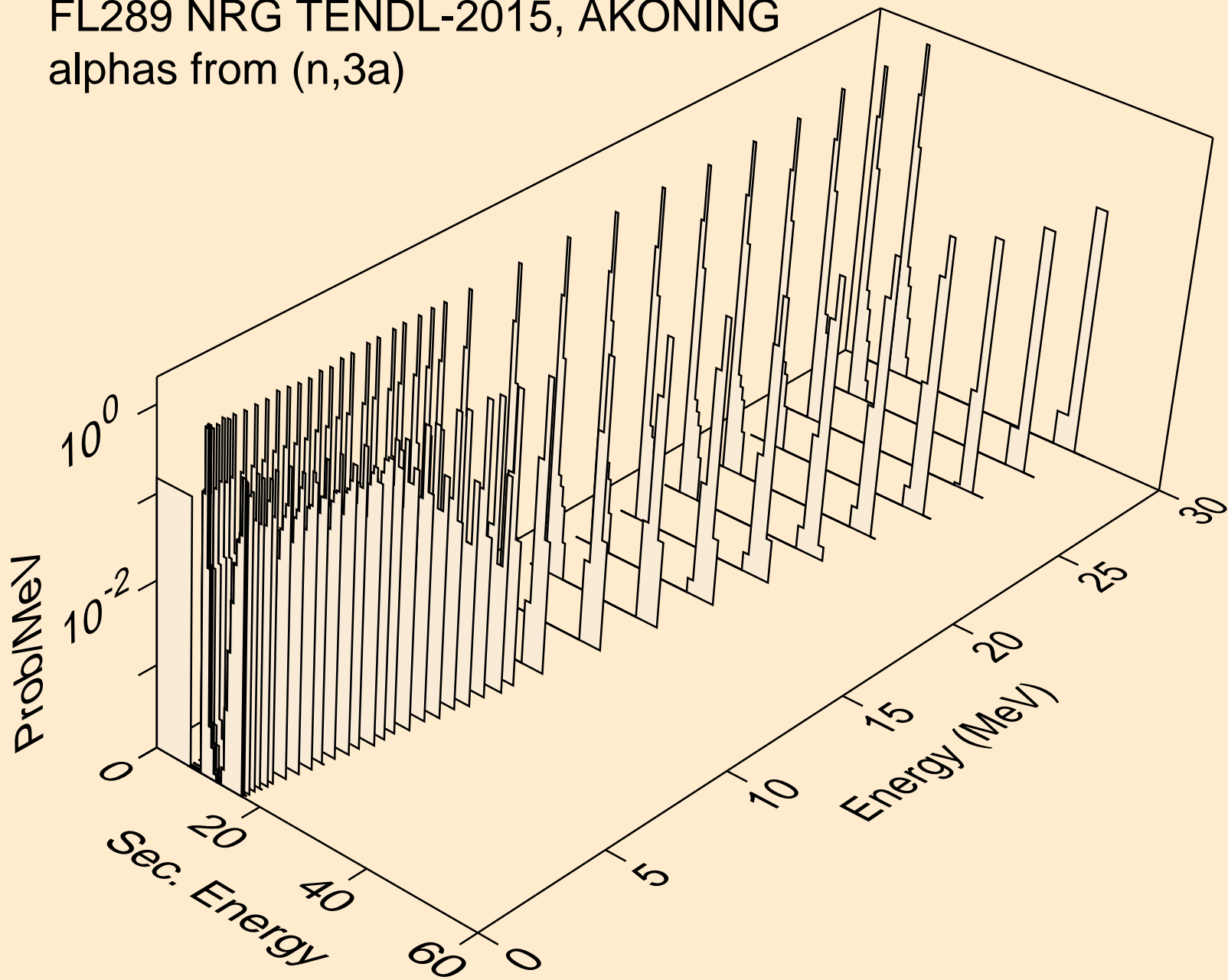

FL289 NRG TENDL-2015, AKONING
alphas from (n,pa)

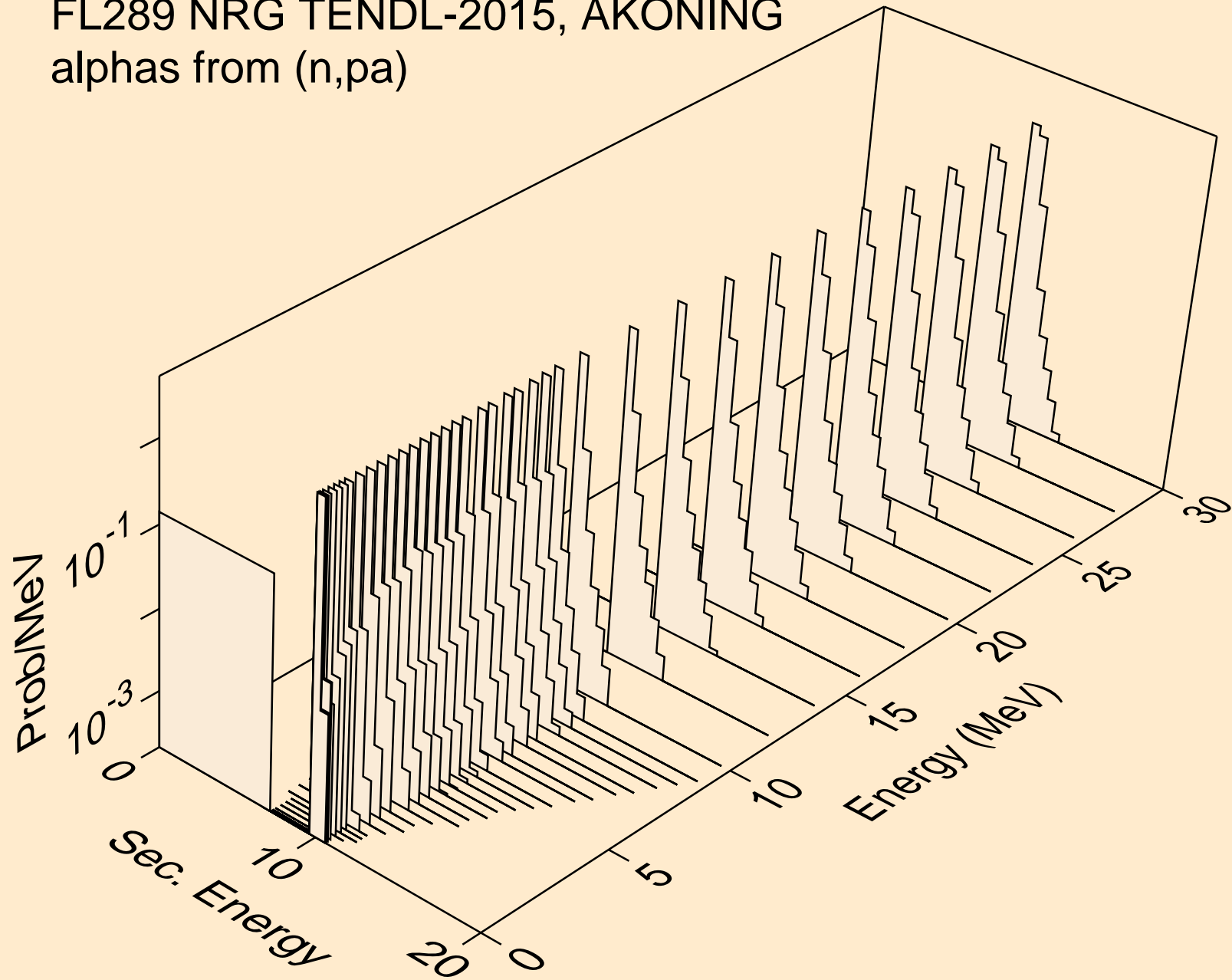

FL289 NRG TENDL-2015, AKONING
alphas from (n,t2a)

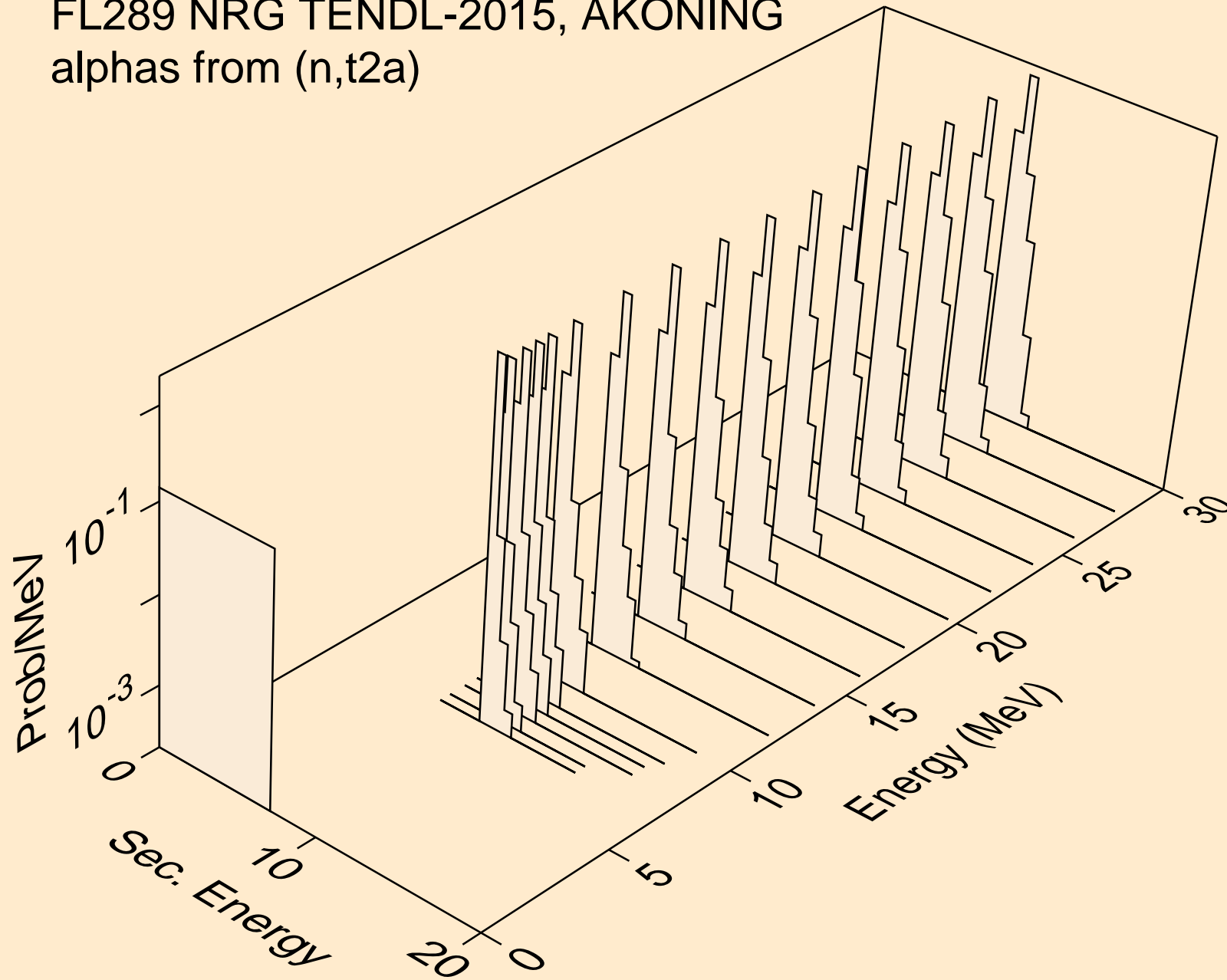

FL289 NRG TENDL-2015, AKONING
alphas from (n,d2a)

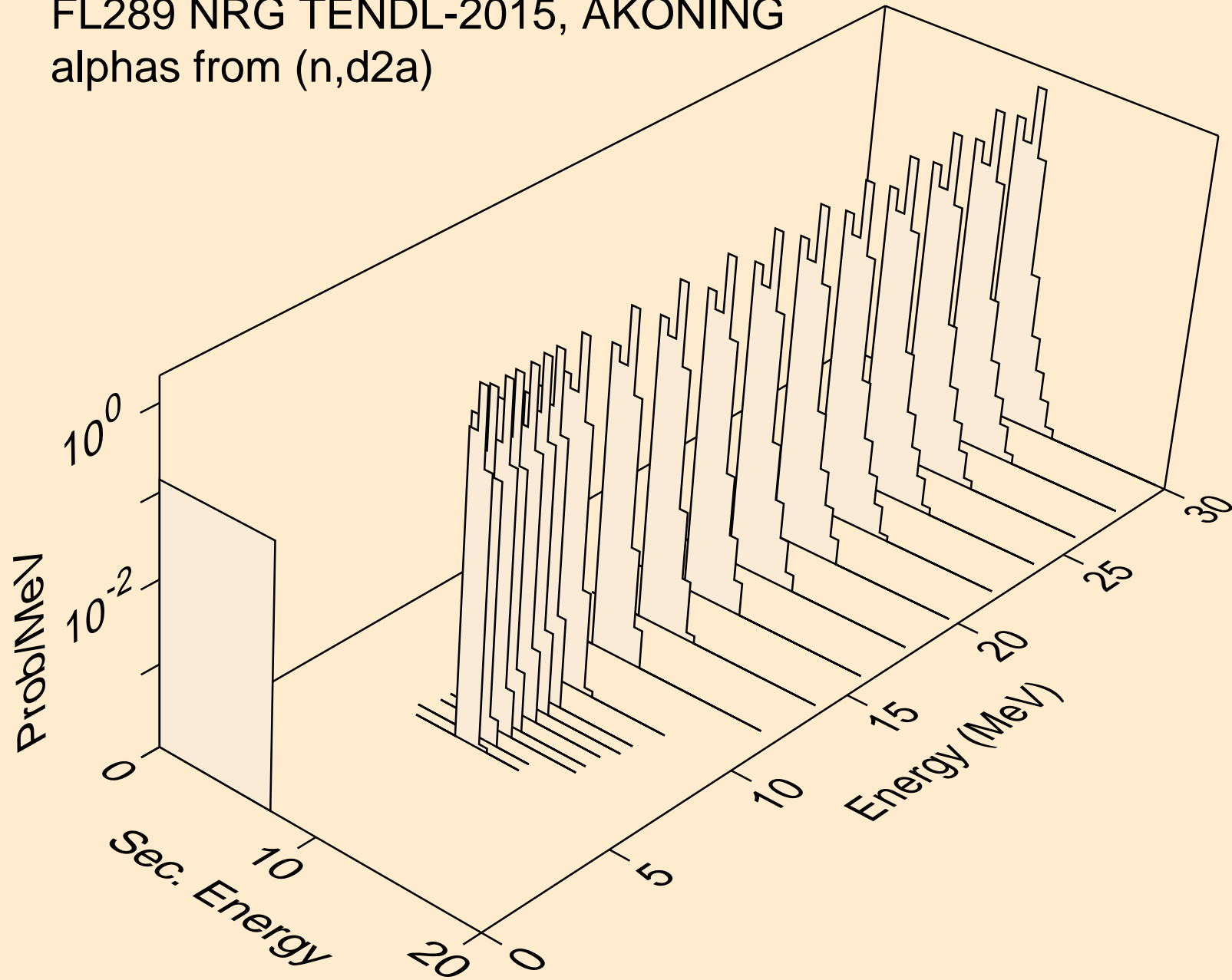

FL289 NRG TENDL-2015, AKONING
alphas from (n,da)

