

GD135 NRG TENDL-2015, AKONING

Principal cross sections

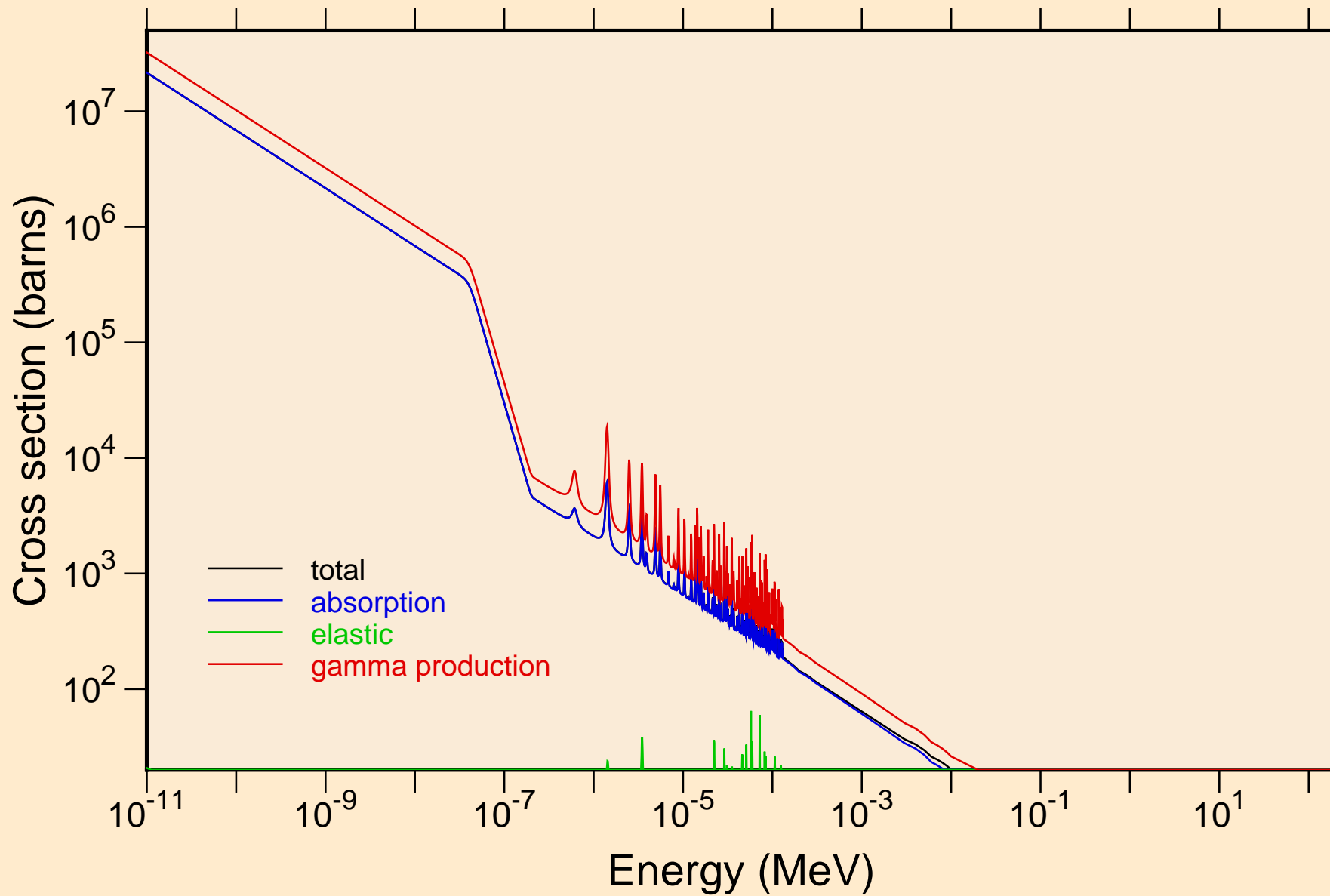

GD135 NRG TENDL-2015, AKONING
resonance total cross section

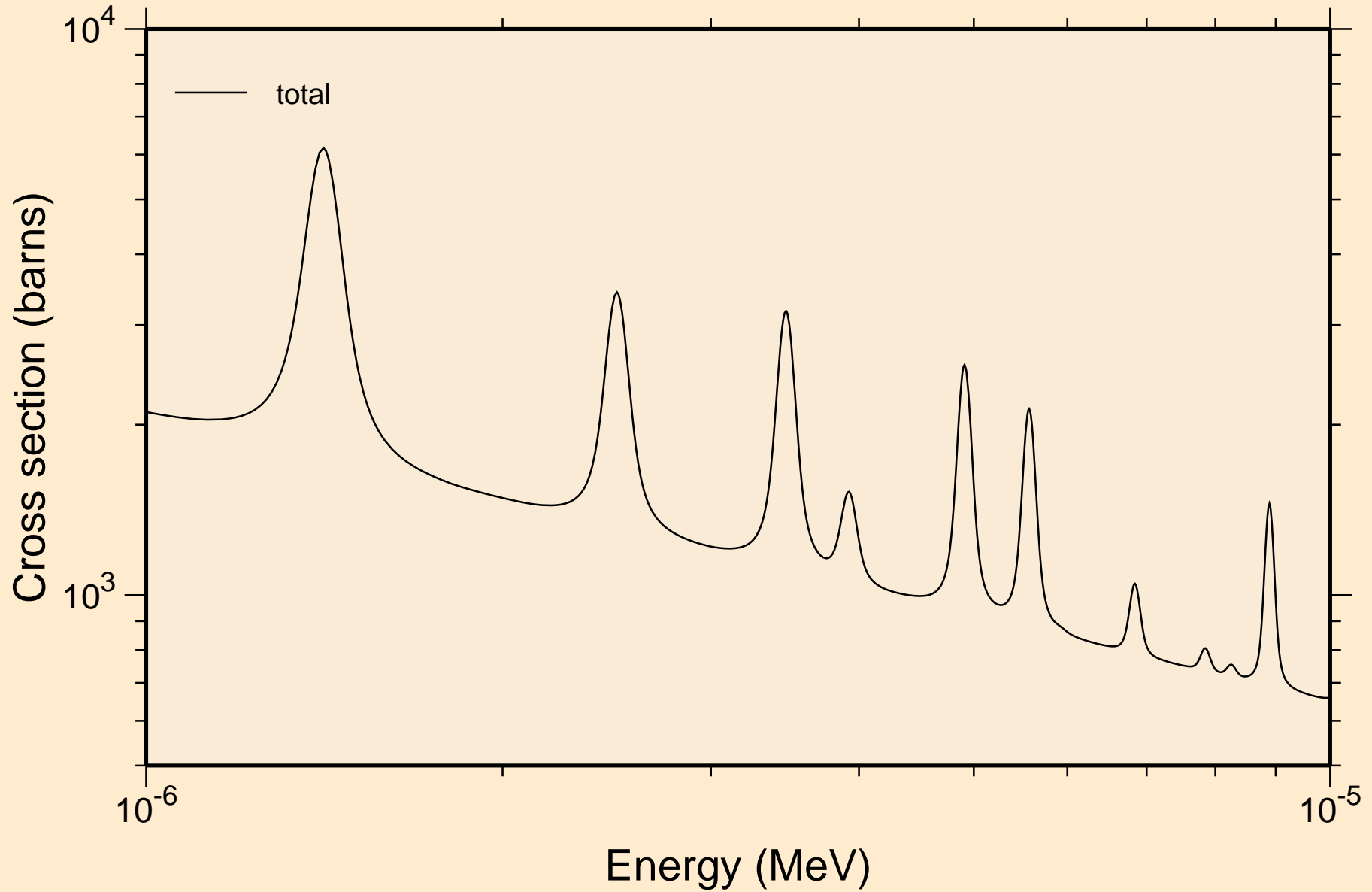

GD135 NRG TENDL-2015, AKONING
resonance total cross section

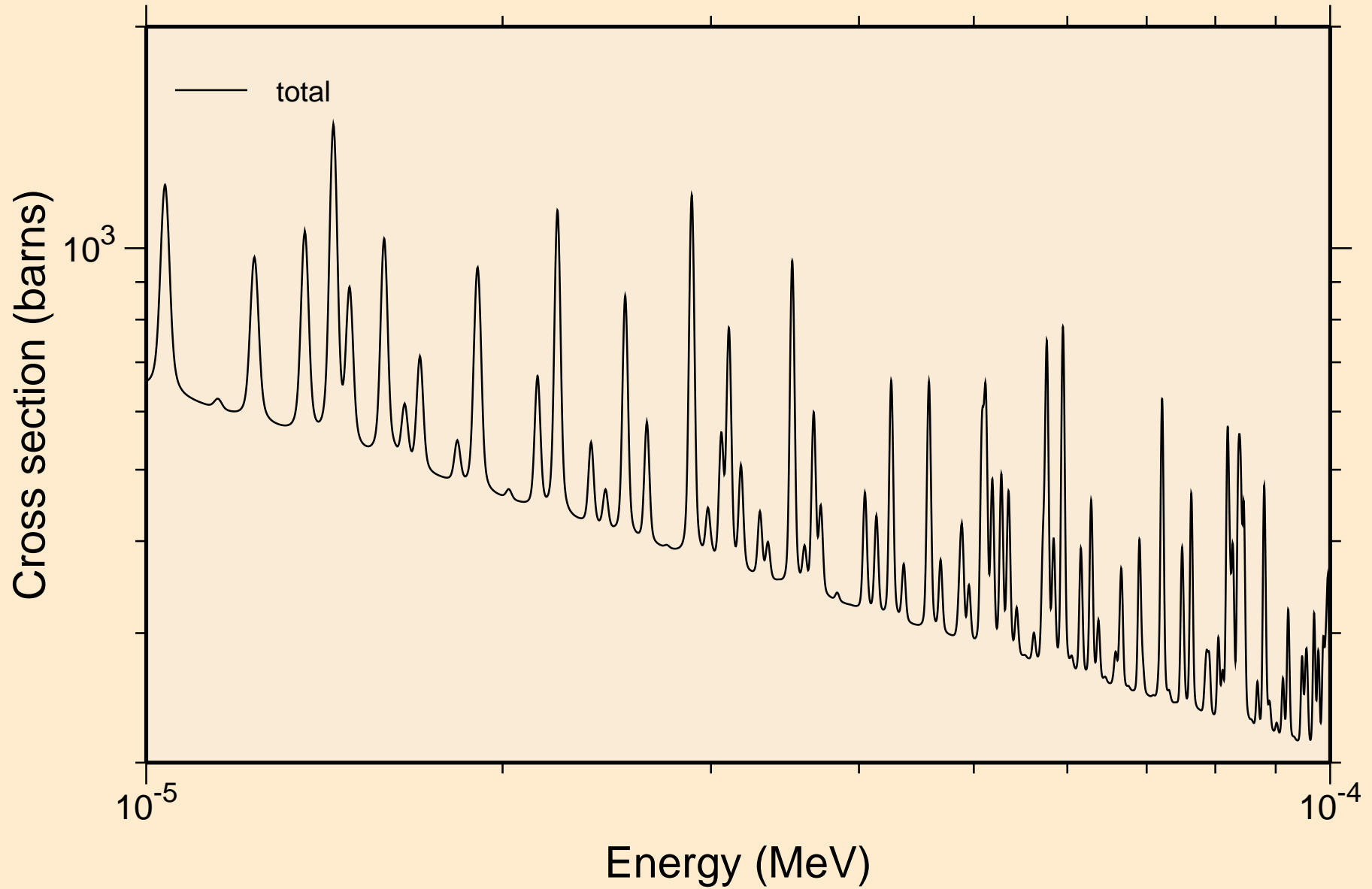

GD135 NRG TENDL-2015, AKONING
resonance total cross section

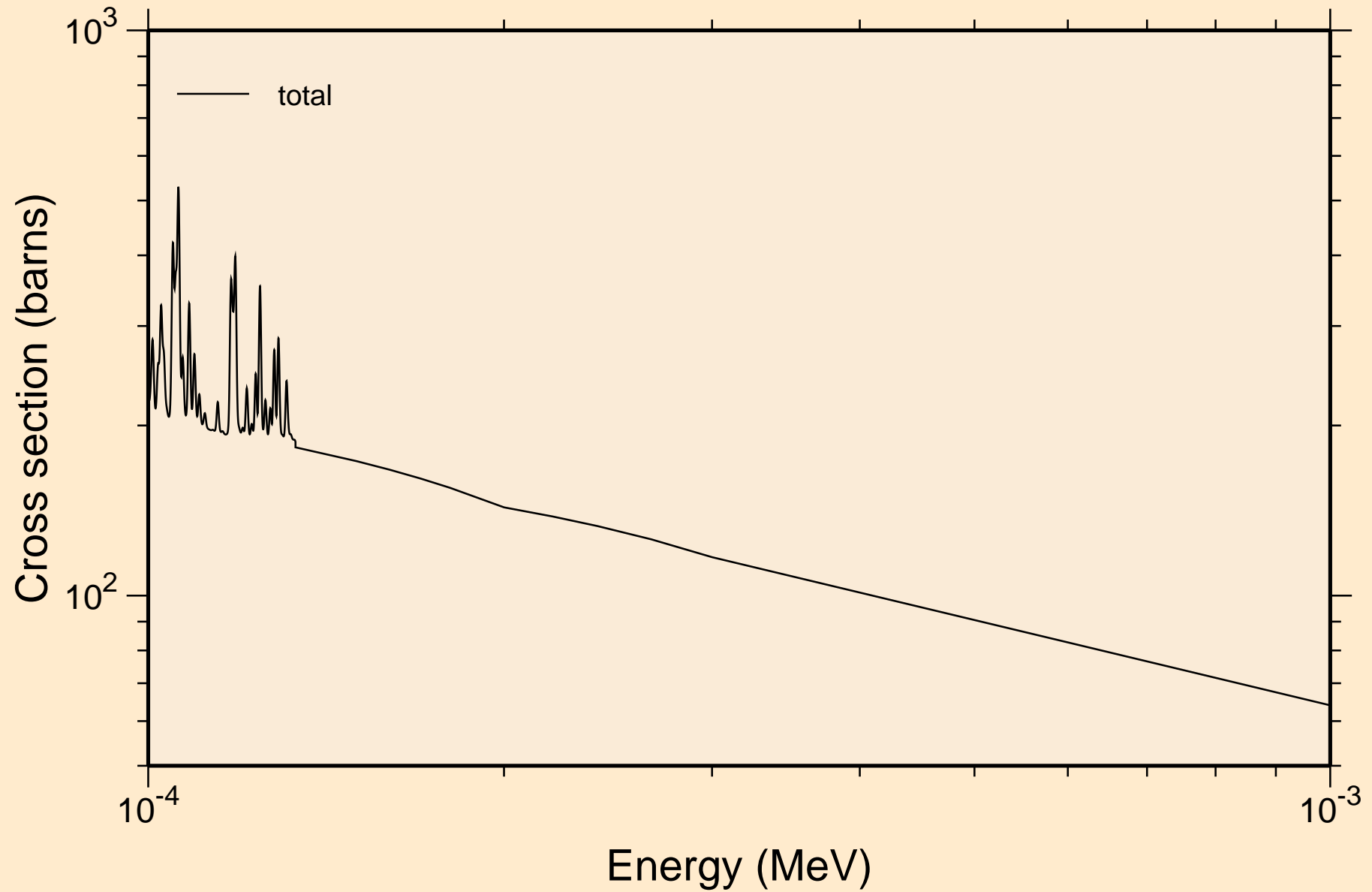

GD135 NRG TENDL-2015, AKONING
resonance total cross section

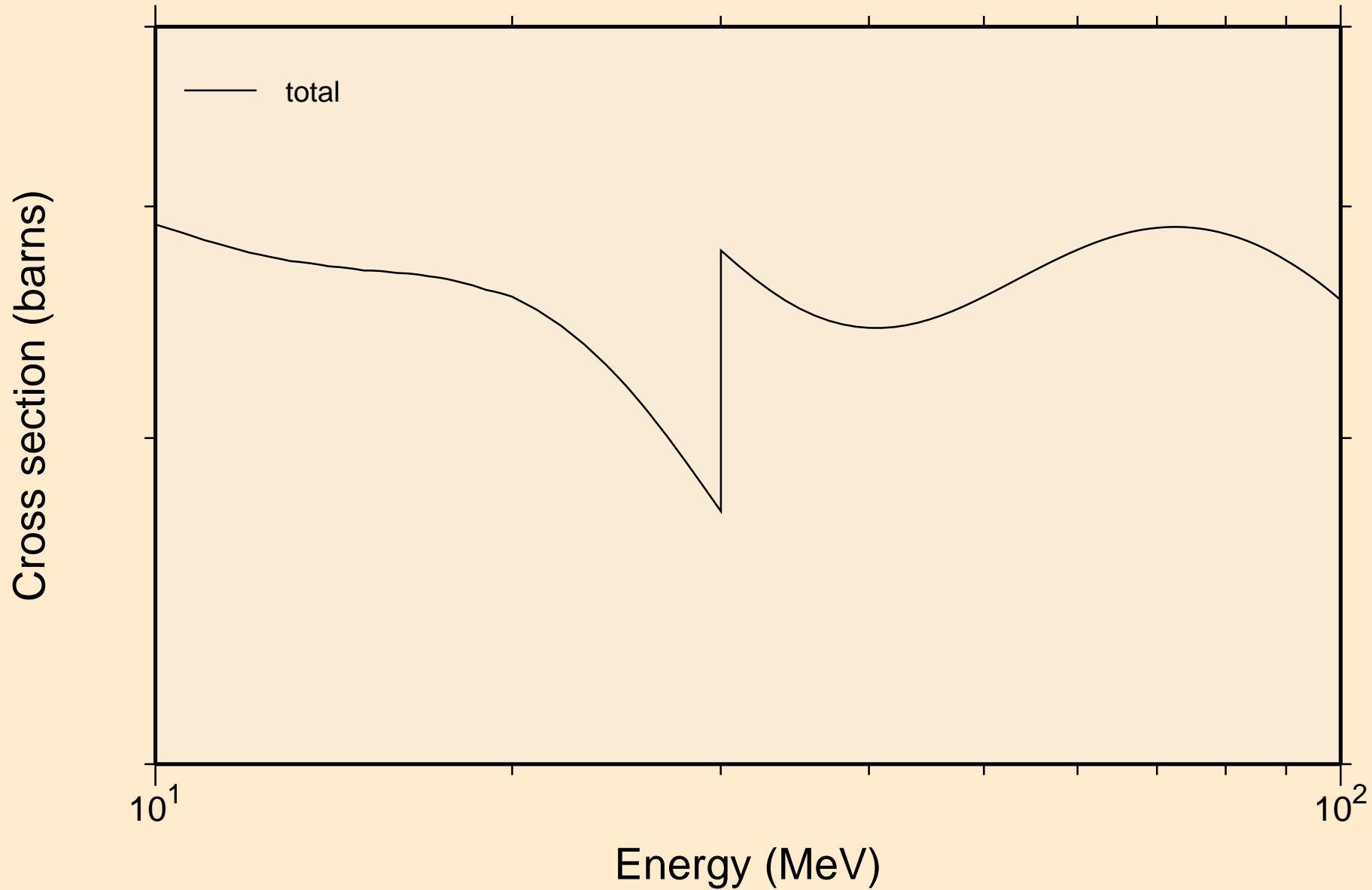

GD135 NRG TENDL-2015, AKONING resonance absorption cross sections

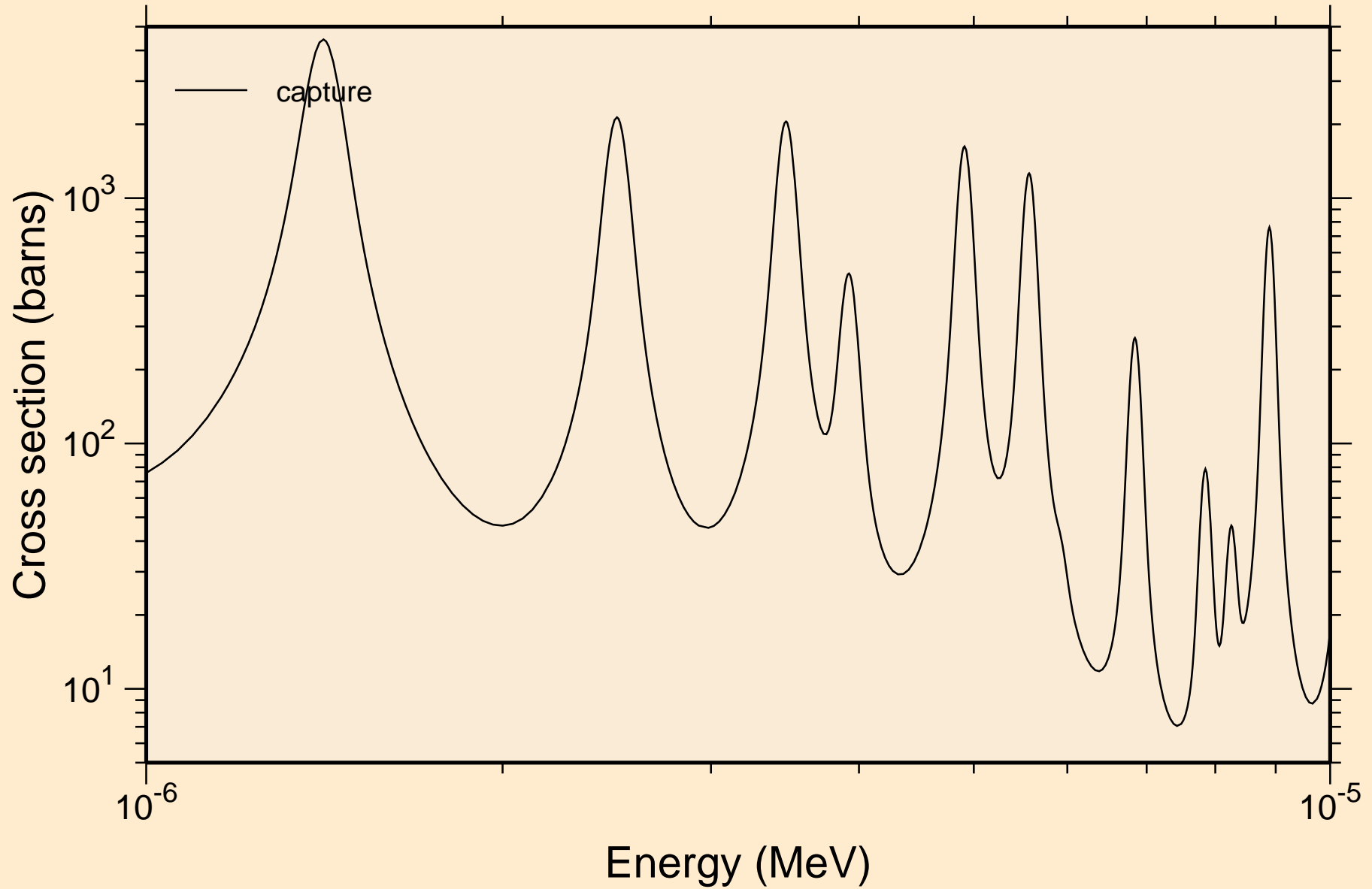

GD135 NRG TENDL-2015, AKONING
resonance absorption cross sections

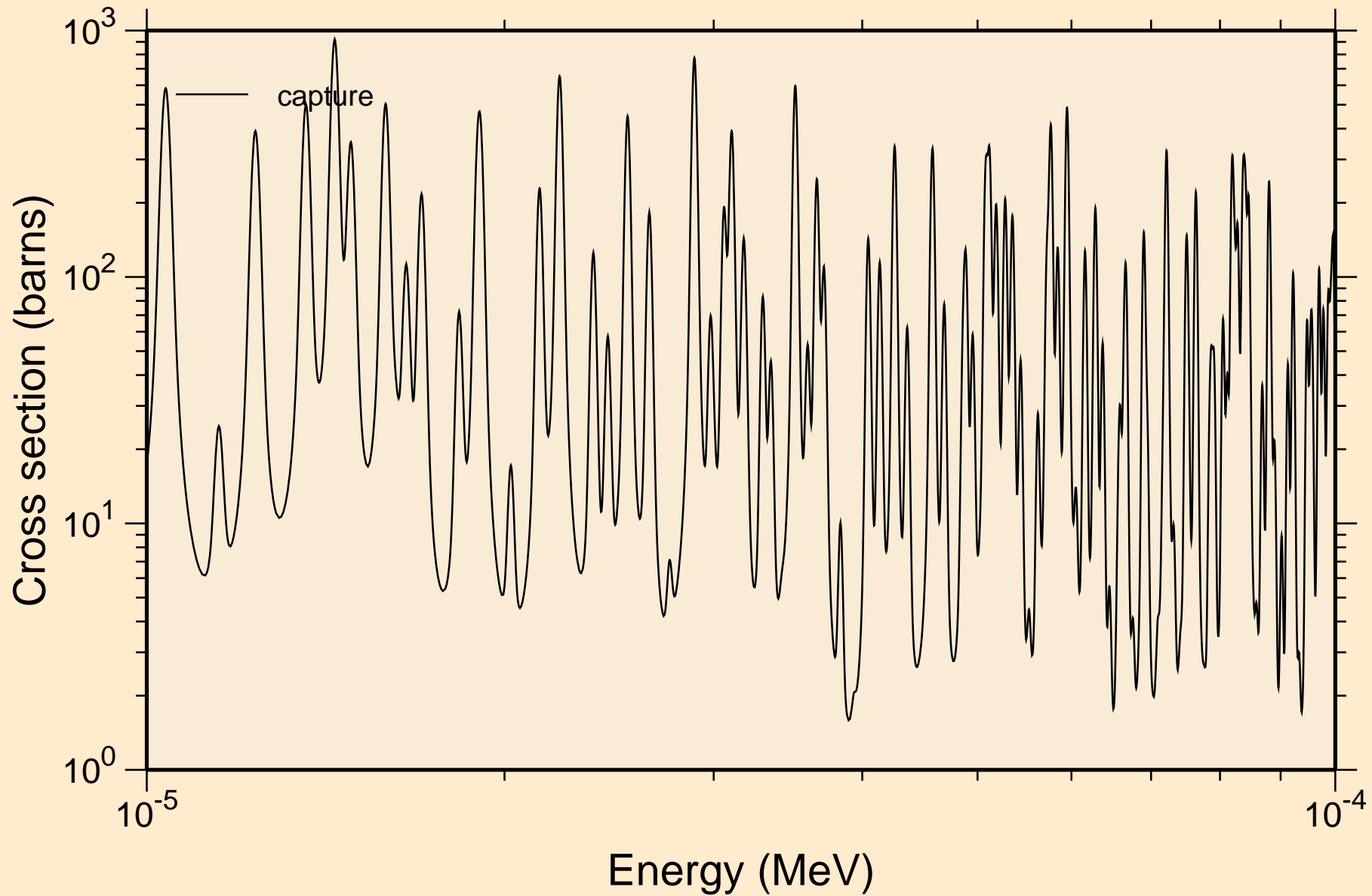

GD135 NRG TENDL-2015, AKONING
resonance absorption cross sections

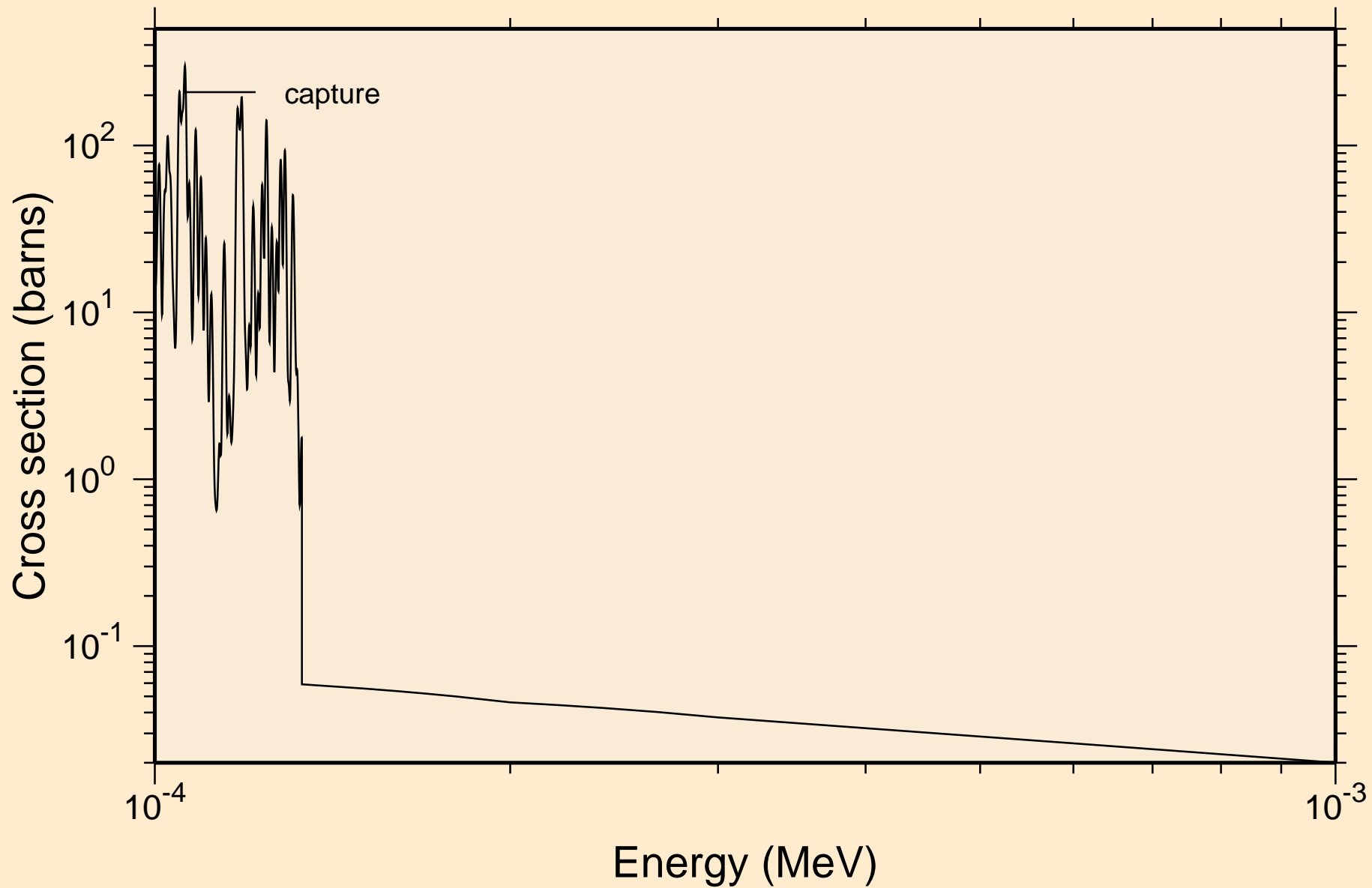

GD135 NRG TENDL-2015, AKONING
resonance absorption cross sections

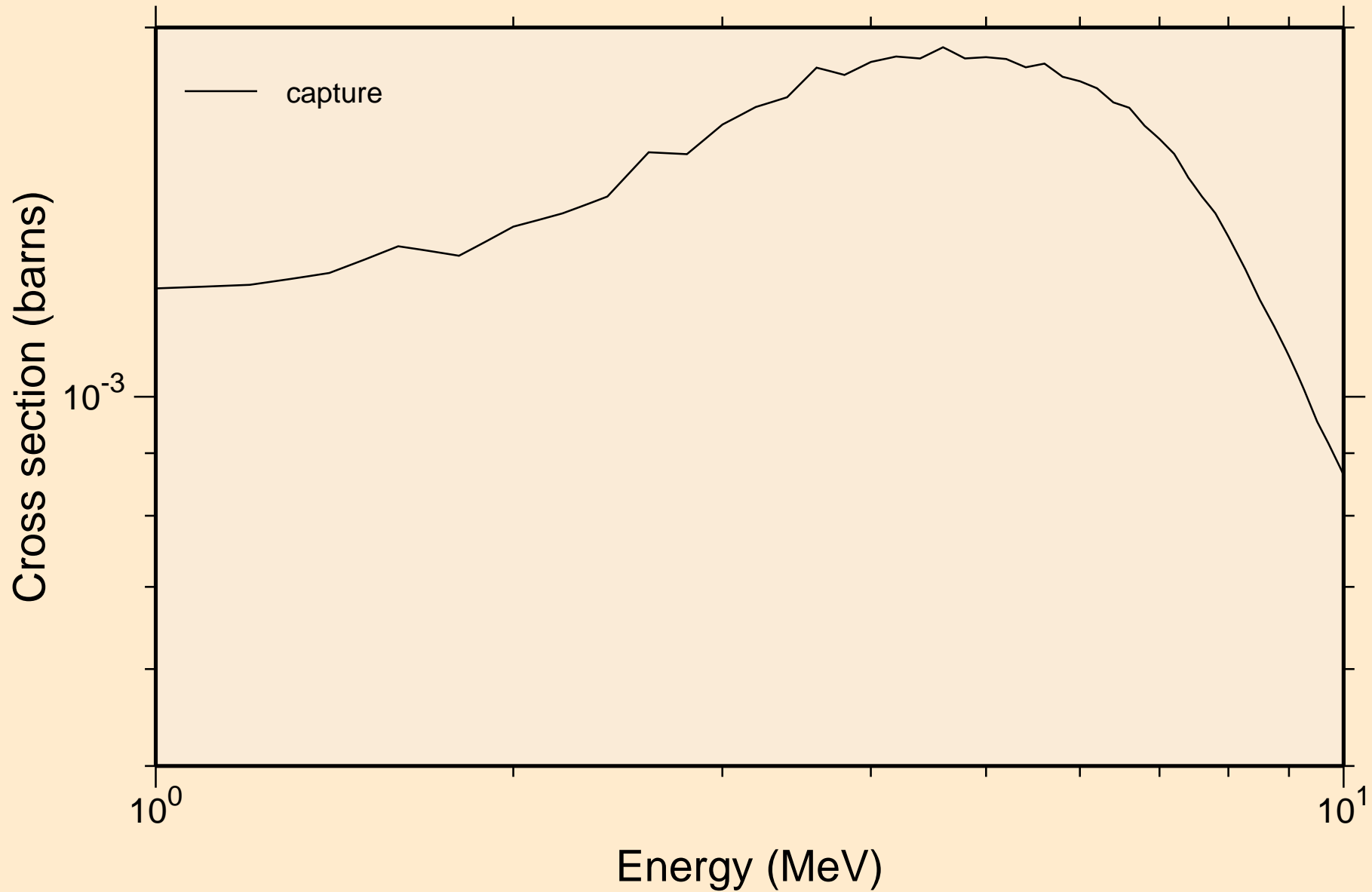

GD135 NRG TENDL-2015, AKONING

Non-threshold reactions

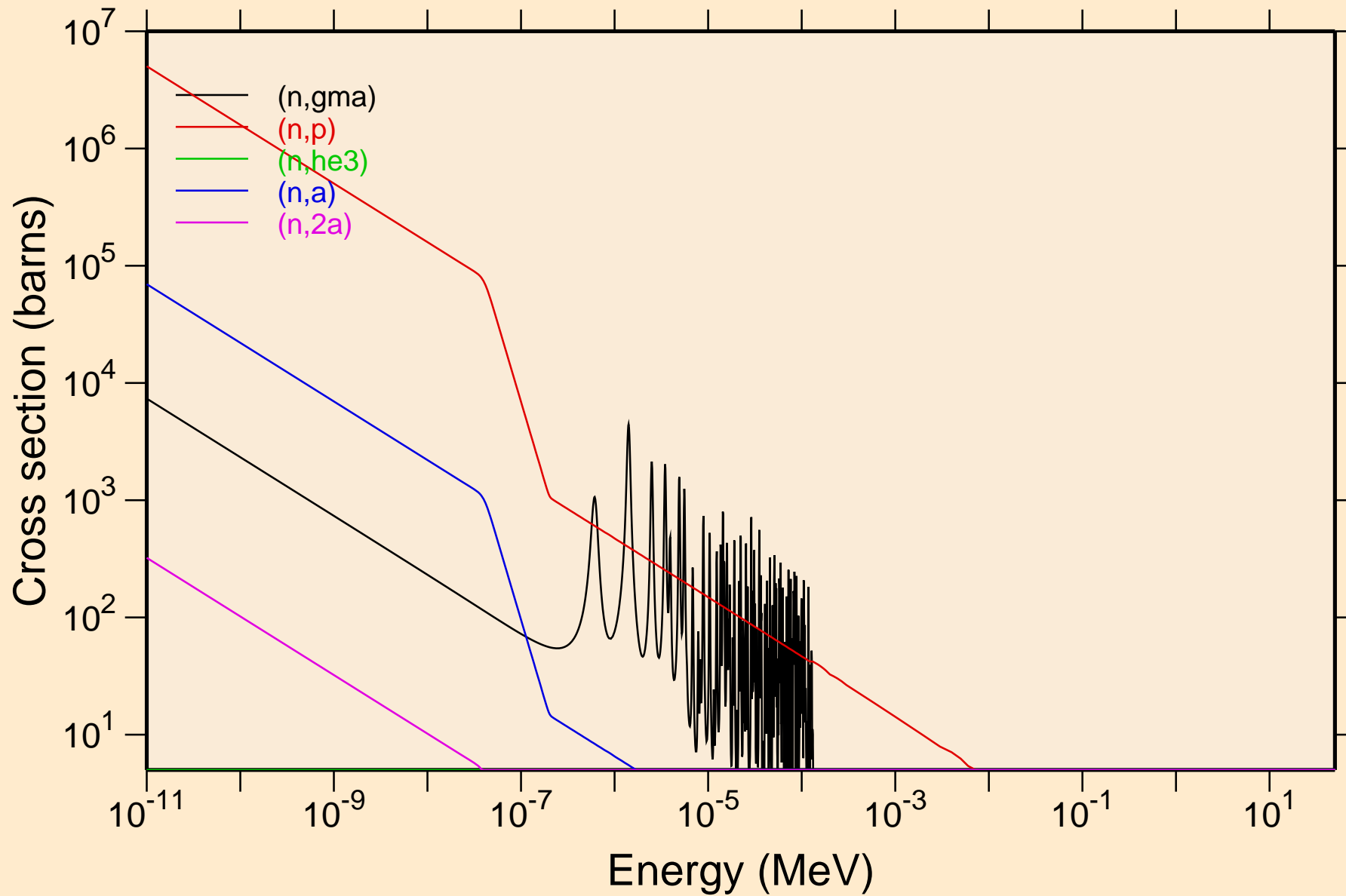

GD135 NRG TENDL-2015, AKONING

Non-threshold reactions

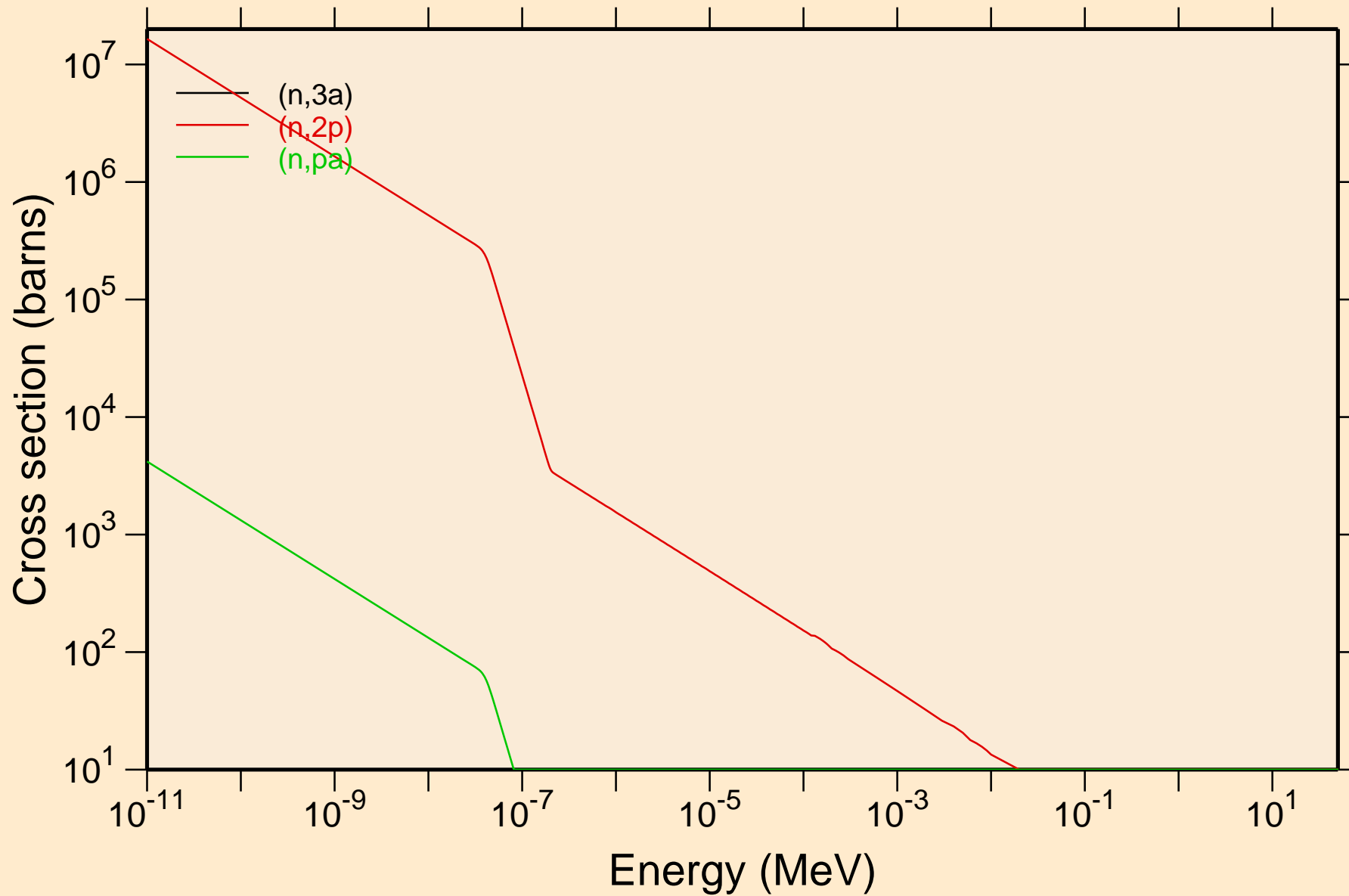

GD135 NRG TENDL-2015, AKONING

Principal cross sections

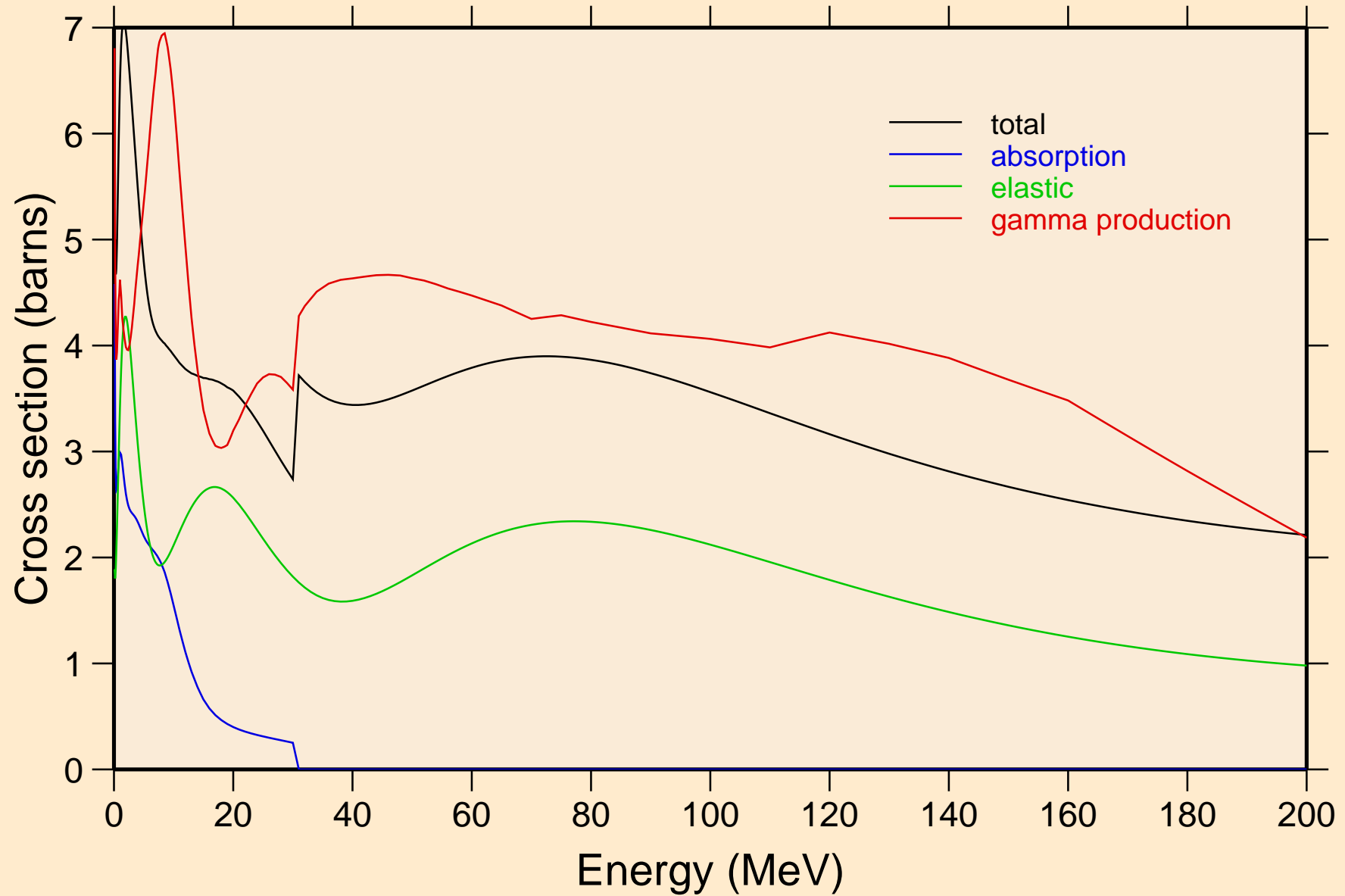

GD135 NRG TENDL-2015, AKONING

Non-threshold reactions

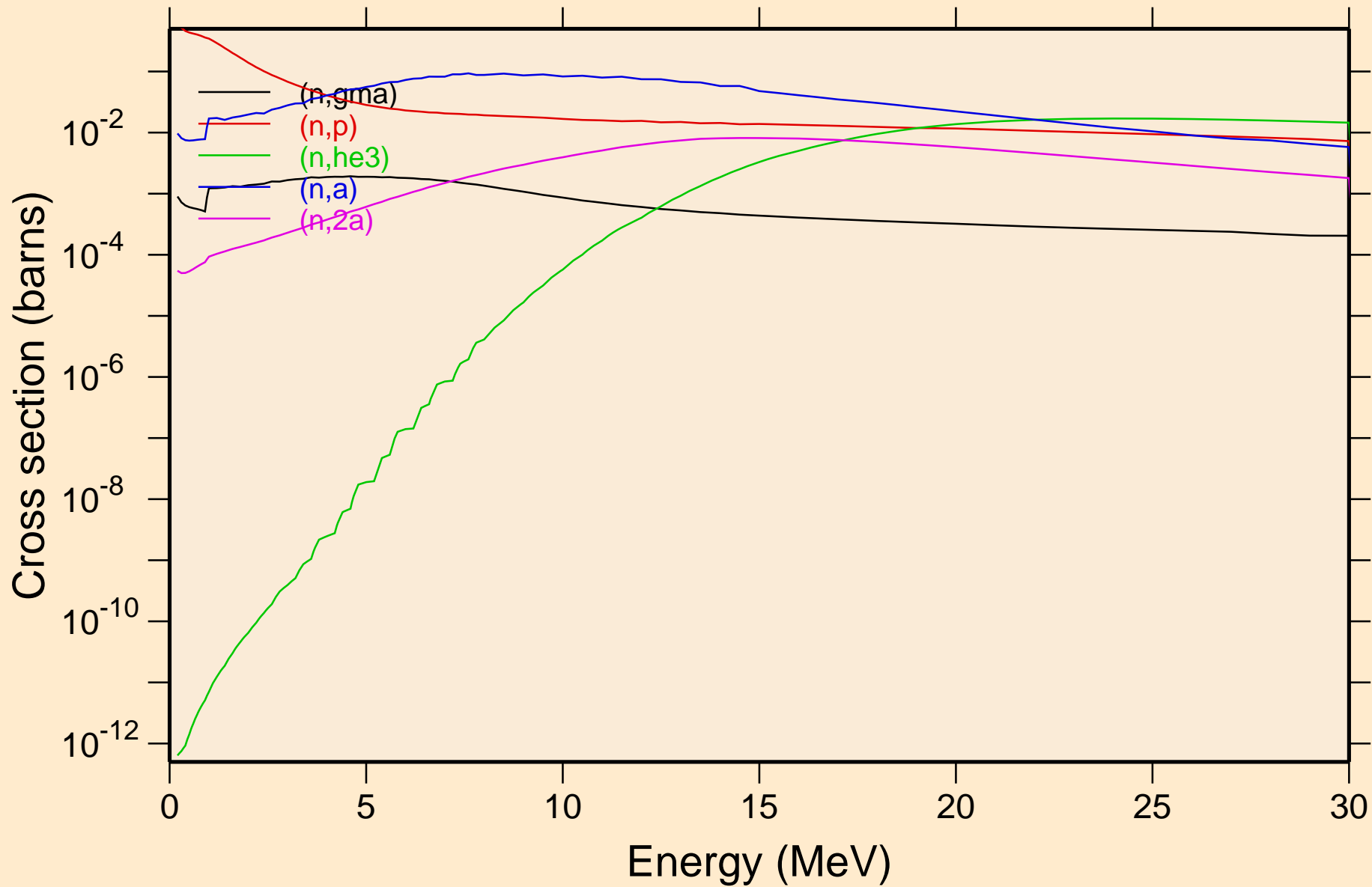

GD135 NRG TENDL-2015, AKONING

Non-threshold reactions

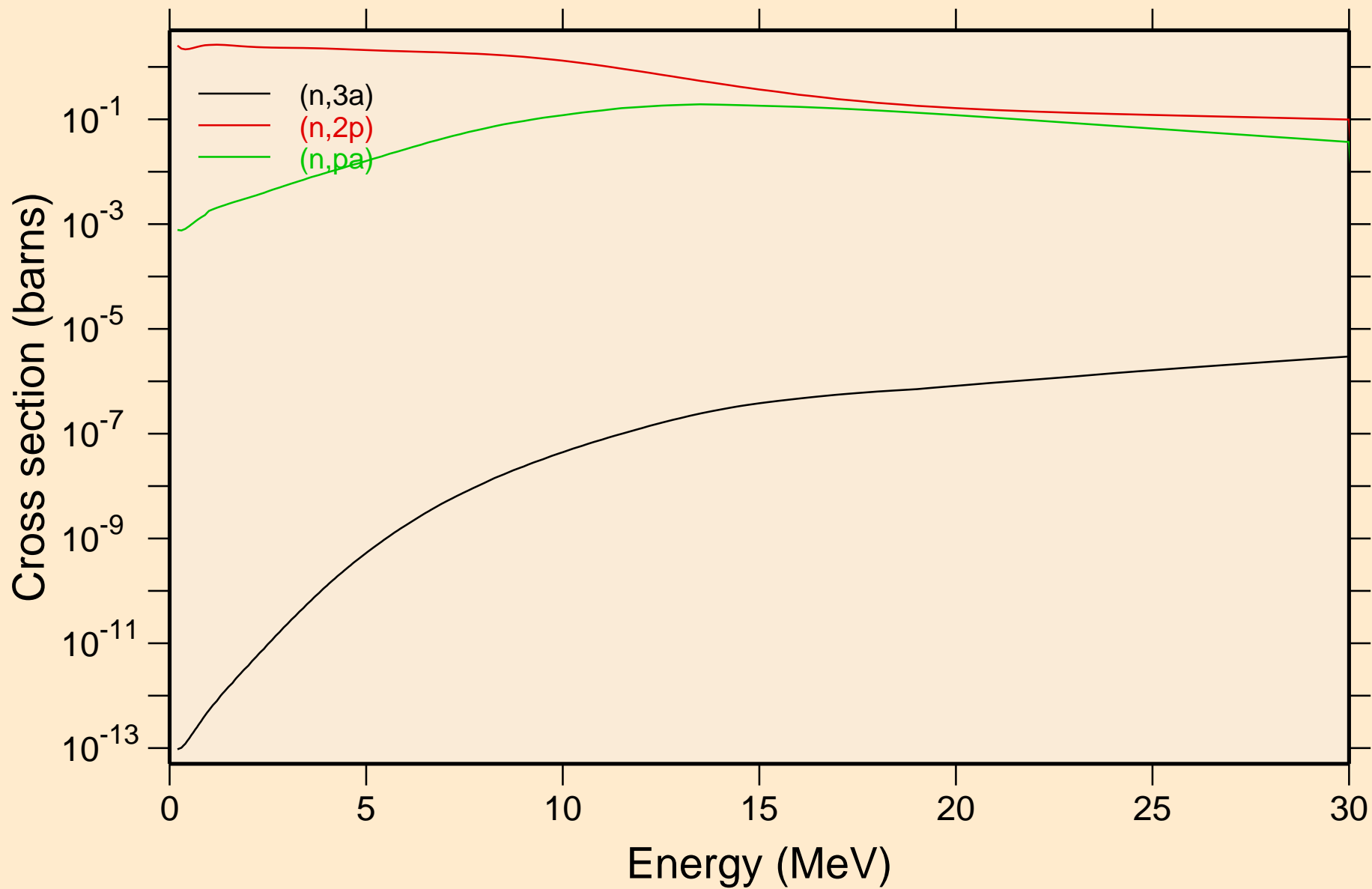

GD135 NRG TENDL-2015, AKONING

Inelastic levels

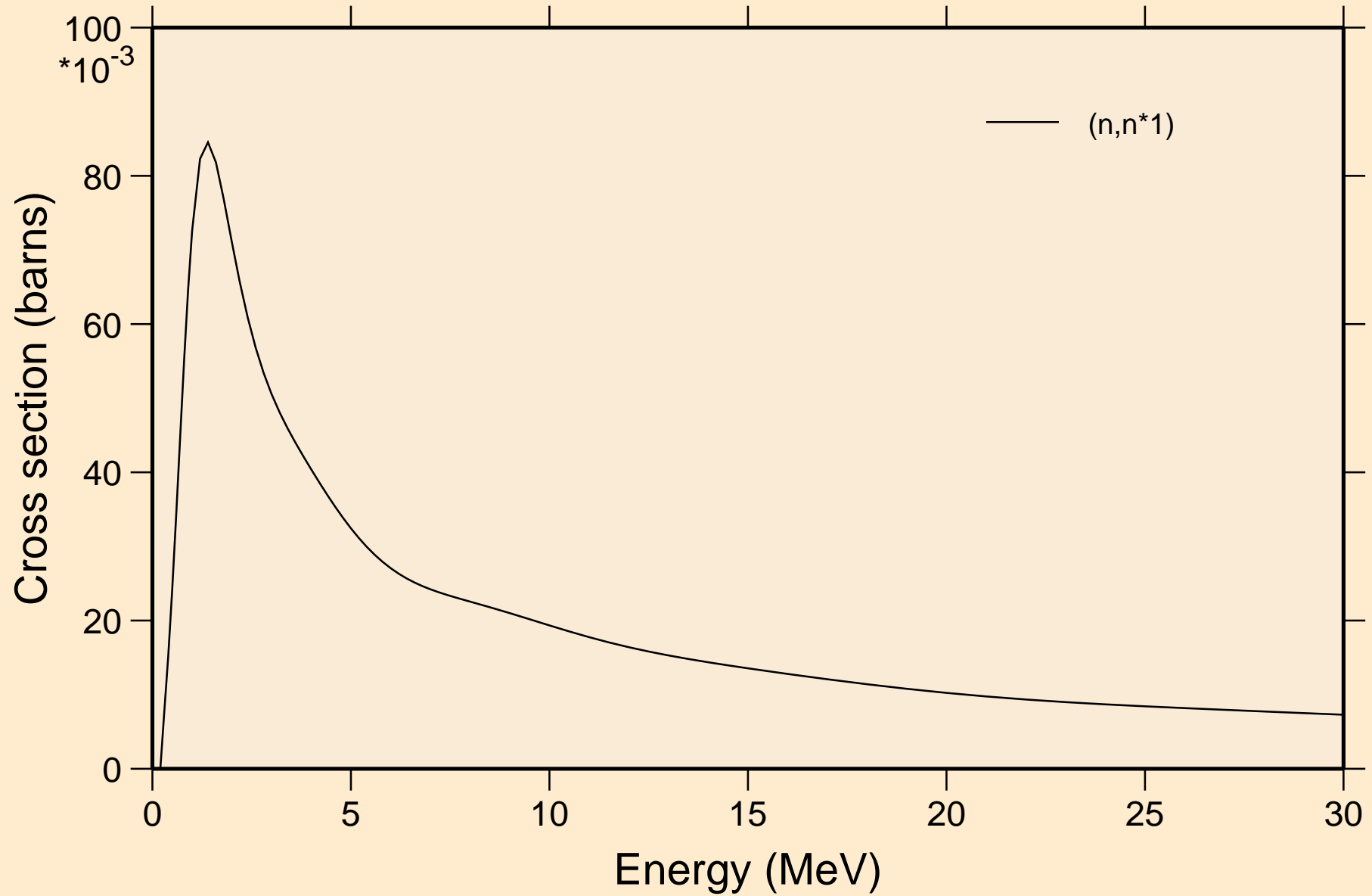

GD135 NRG TENDL-2015, AKONING

Threshold reactions

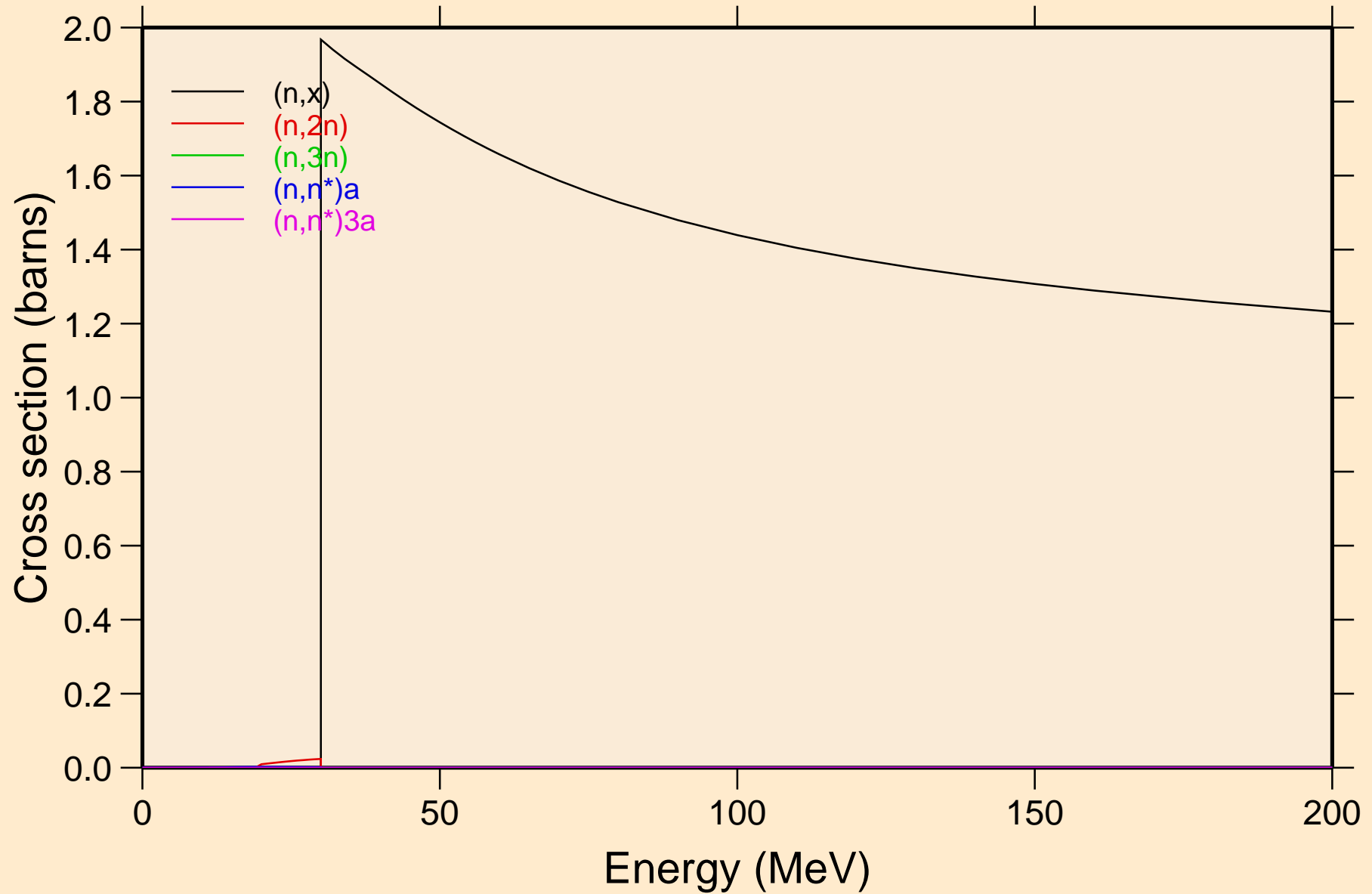

GD135 NRG TENDL-2015, AKONING

Threshold reactions

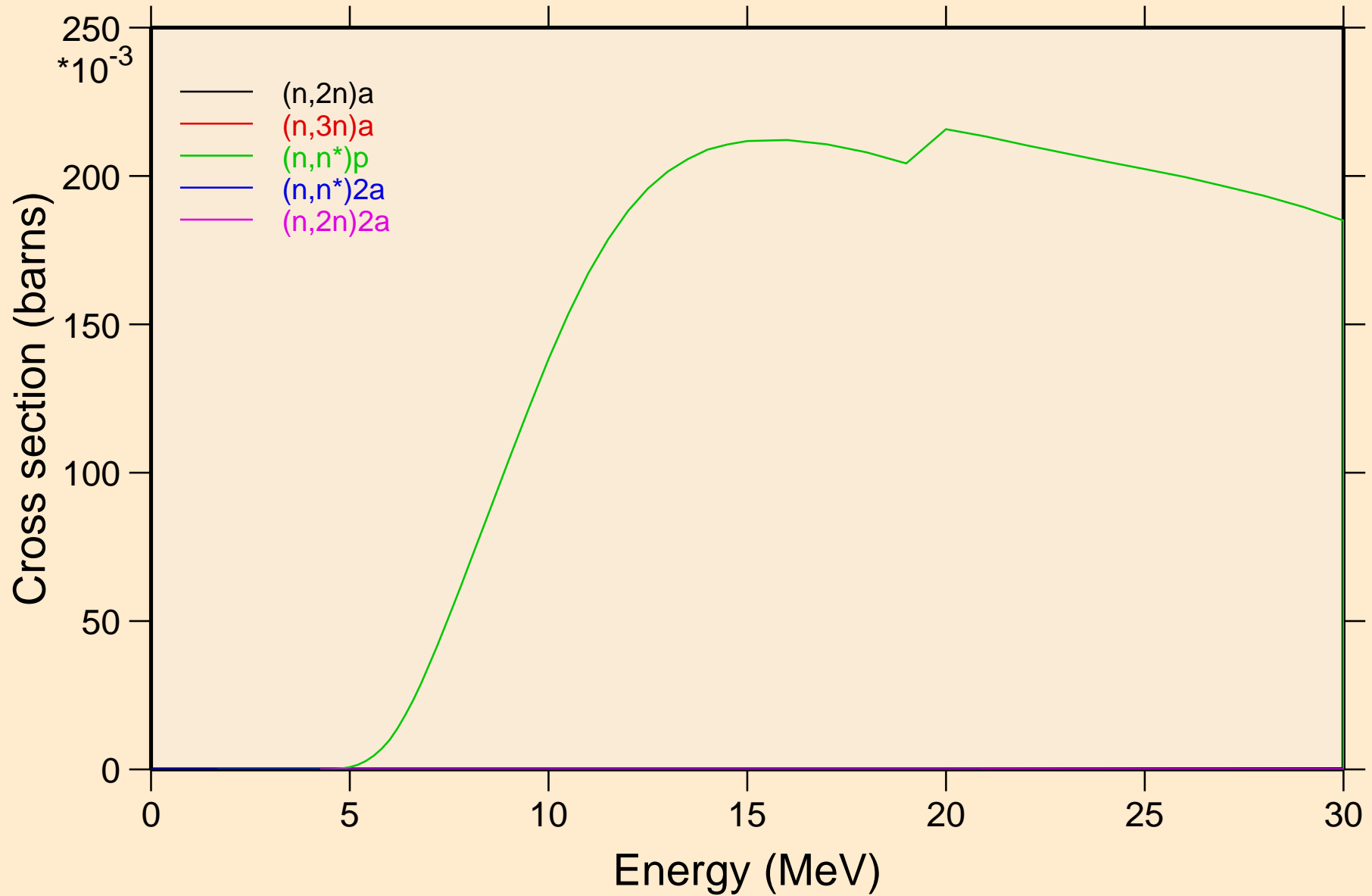

GD135 NRG TENDL-2015, AKONING

Threshold reactions

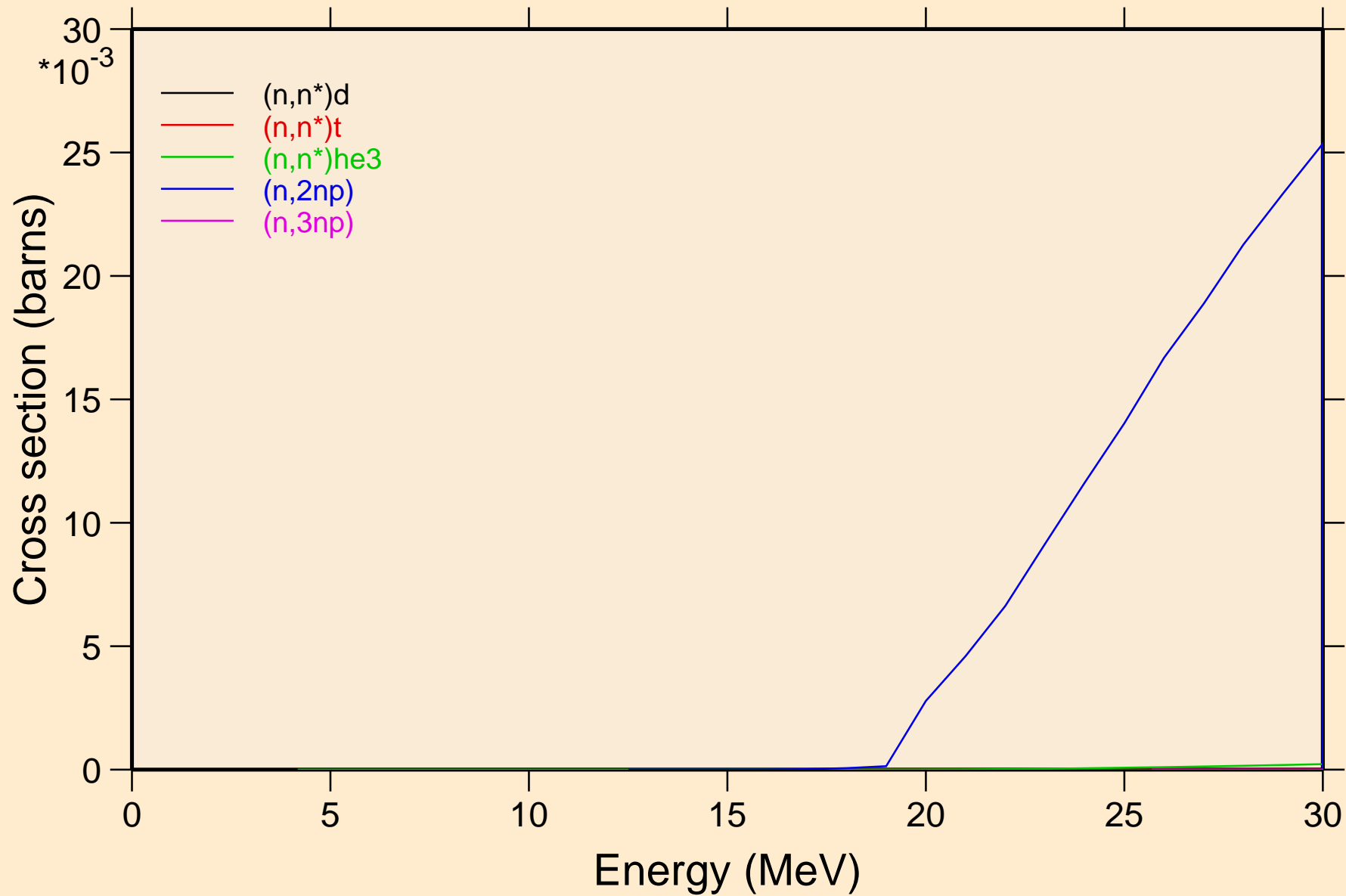

GD135 NRG TENDL-2015, AKONING

Threshold reactions

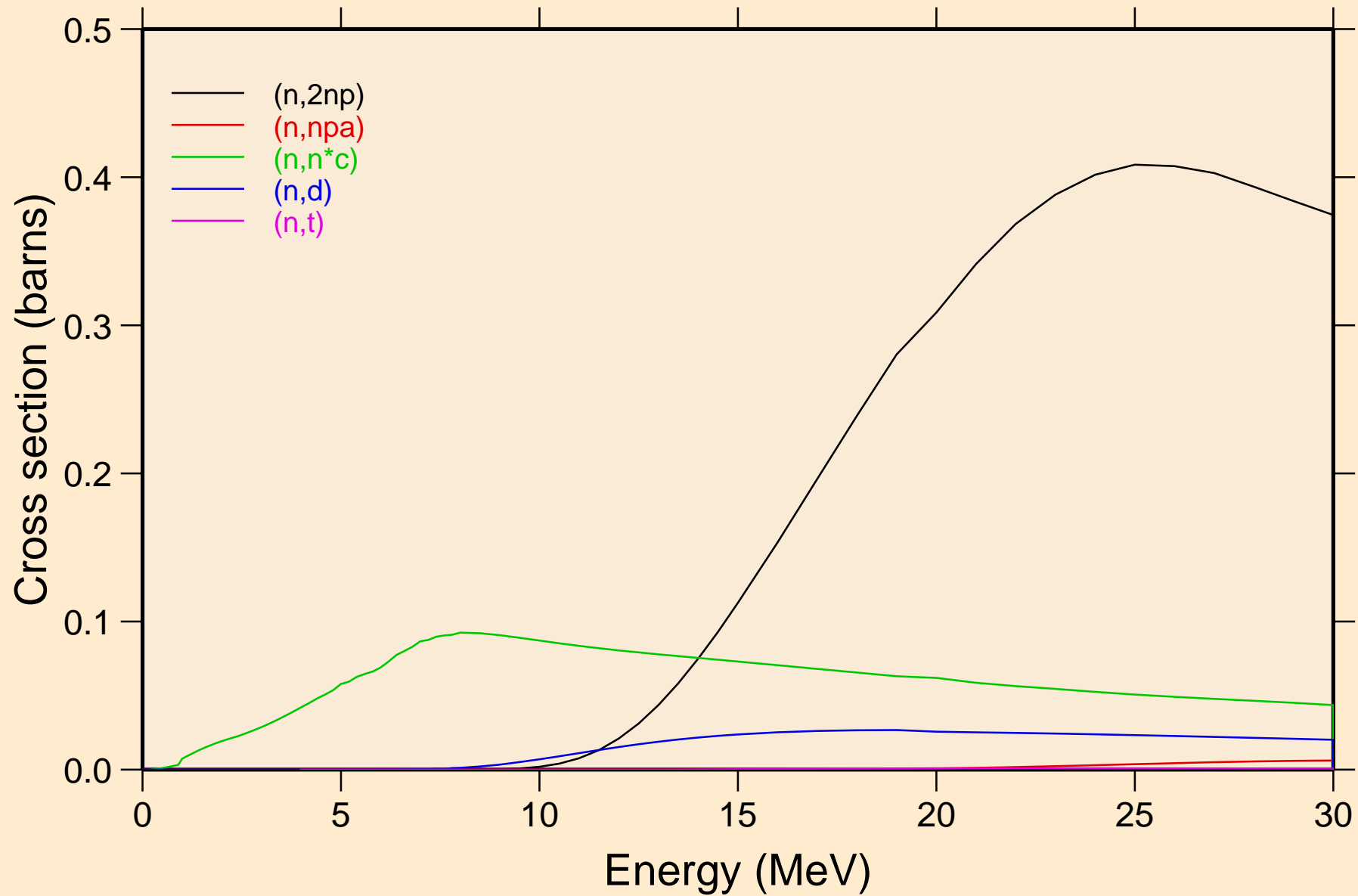

GD135 NRG TENDL-2015, AKONING

Threshold reactions

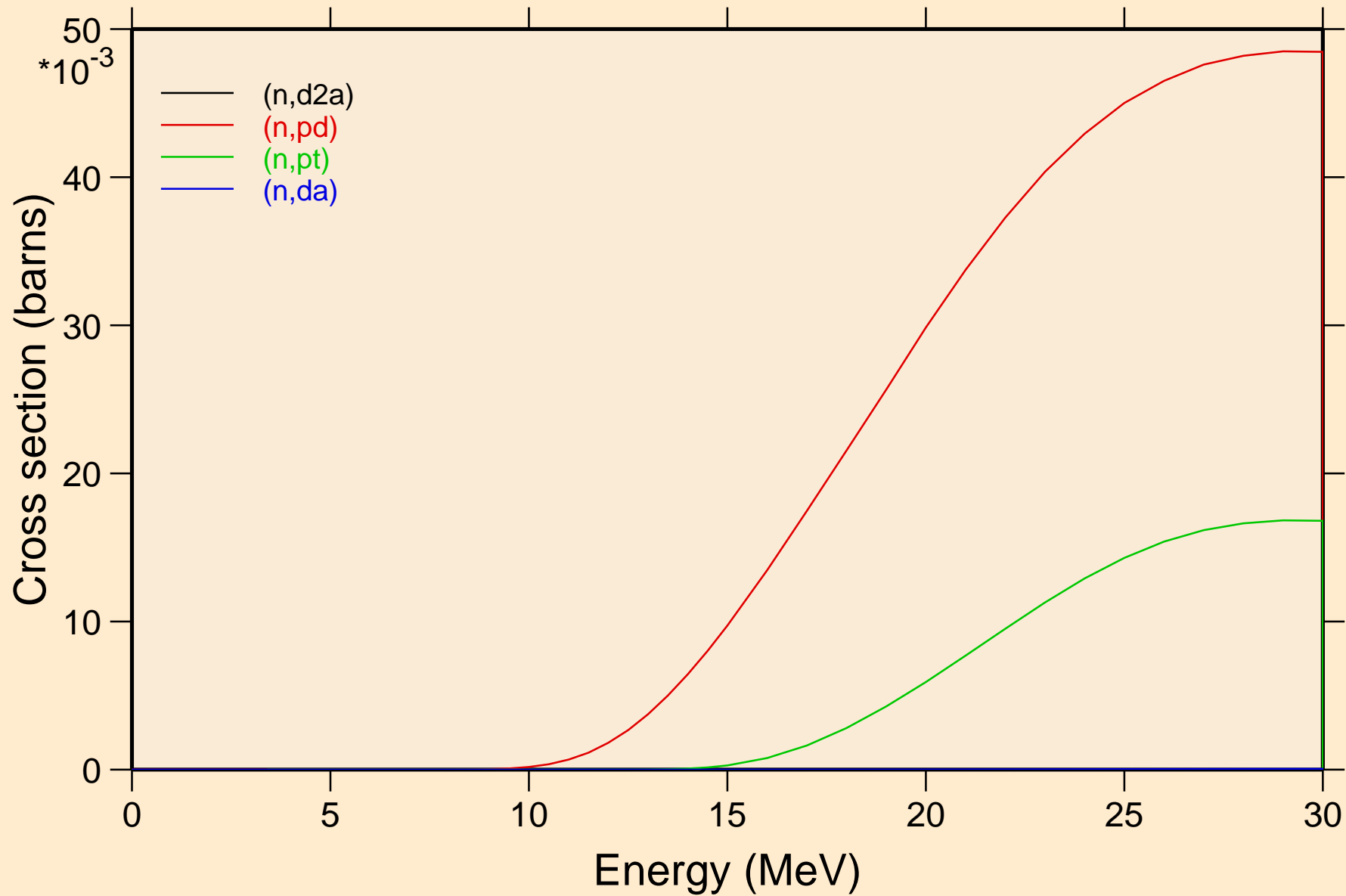

GD135 NRG TENDL-2015, AKONING
angular distribution for elastic

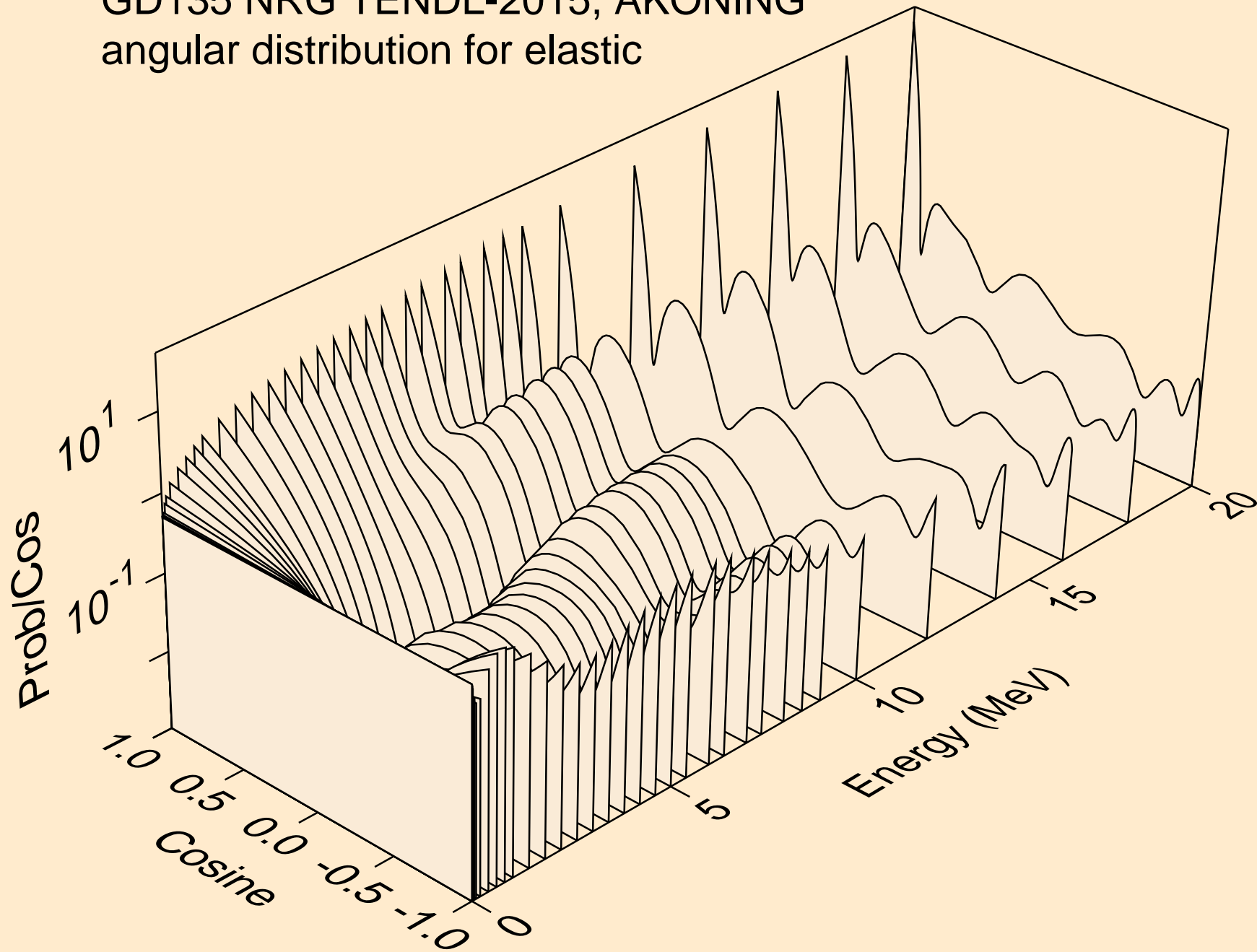

GD135 NRG TENDL-2015, AKONING
angular distribution for elastic

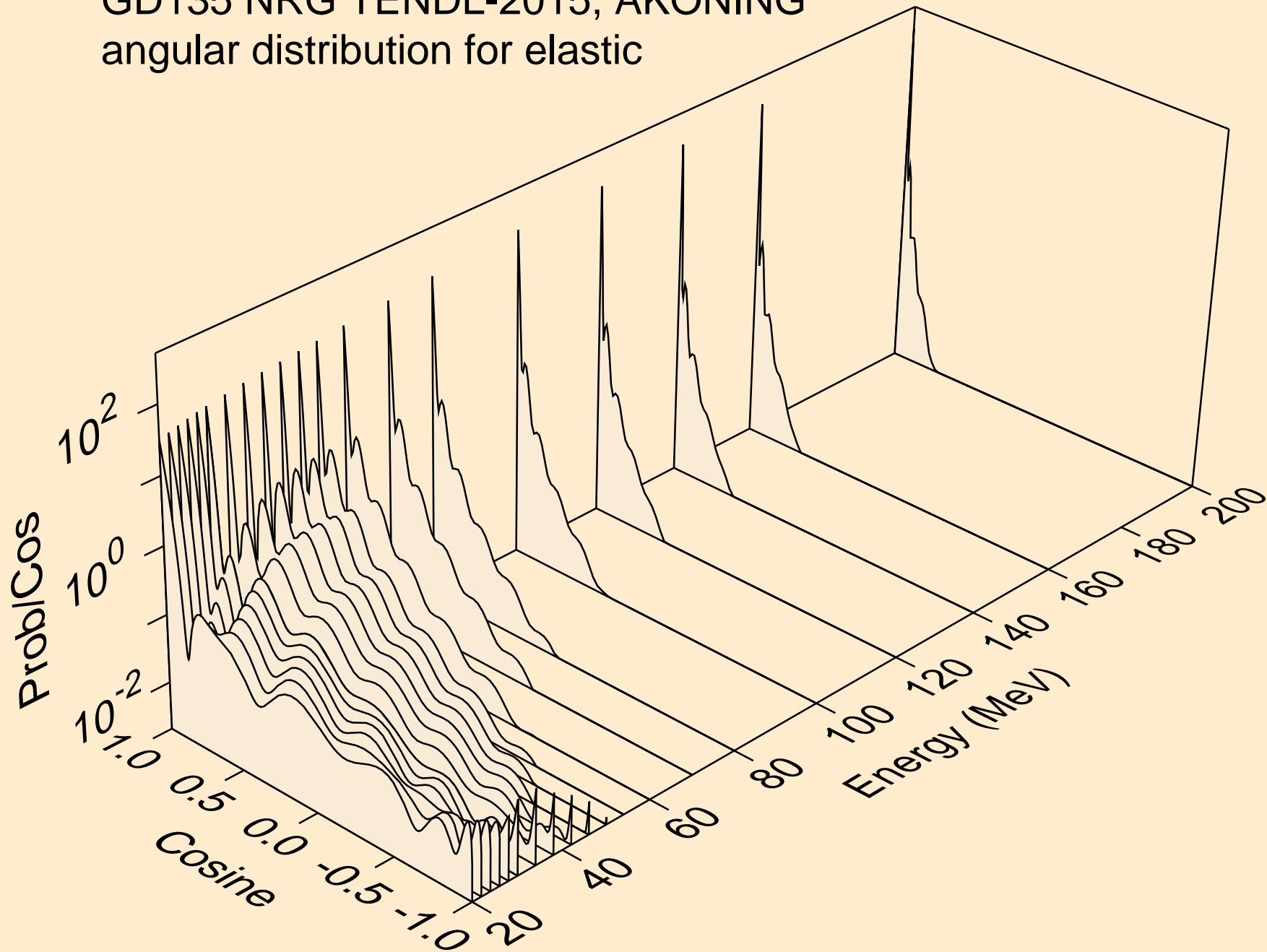

GD135 NRG TENDL-2015, AKONING
angular distribution for (n,n*1)

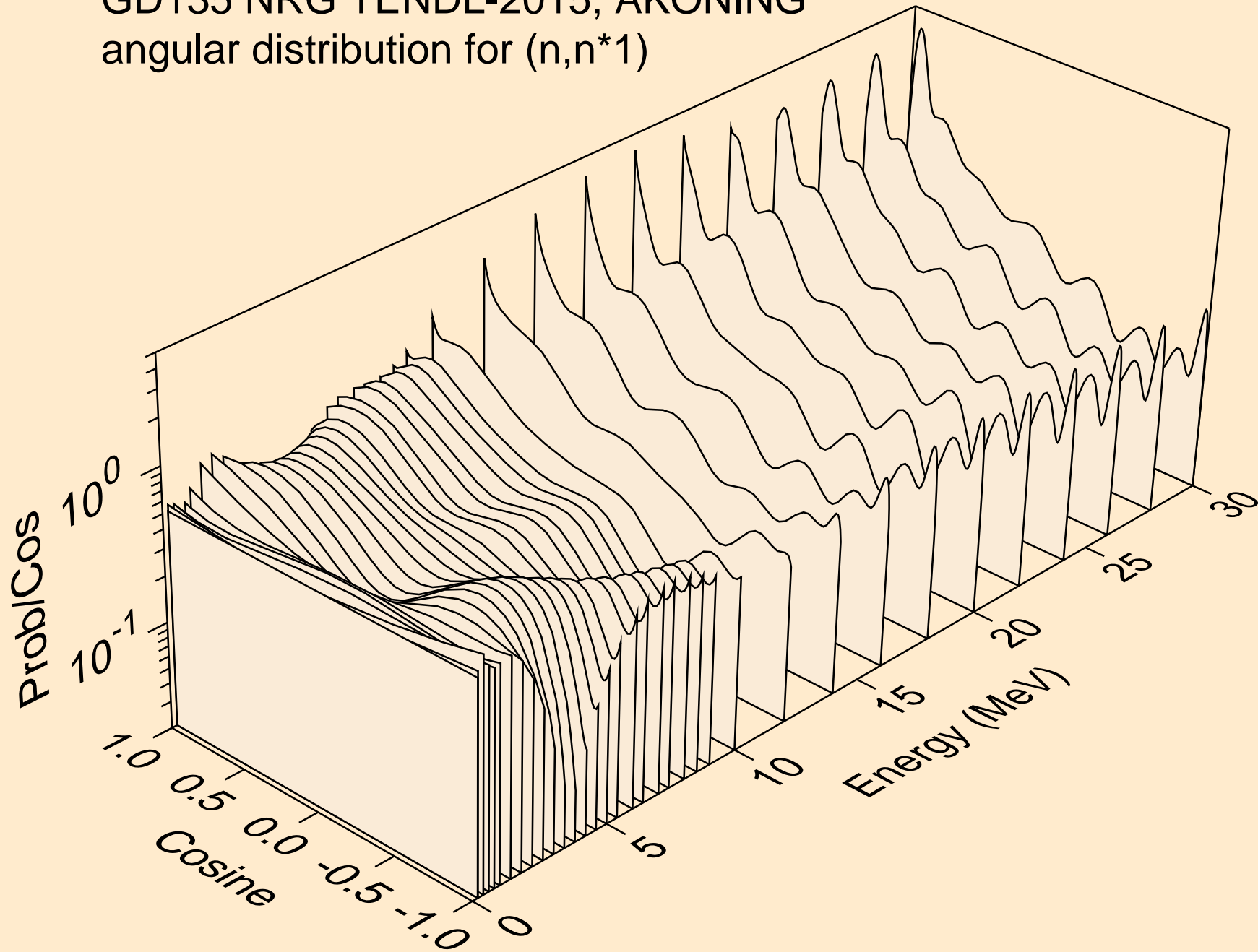

GD135 NRG TENDL-2015, AKONING
Neutron emission for (n,x)

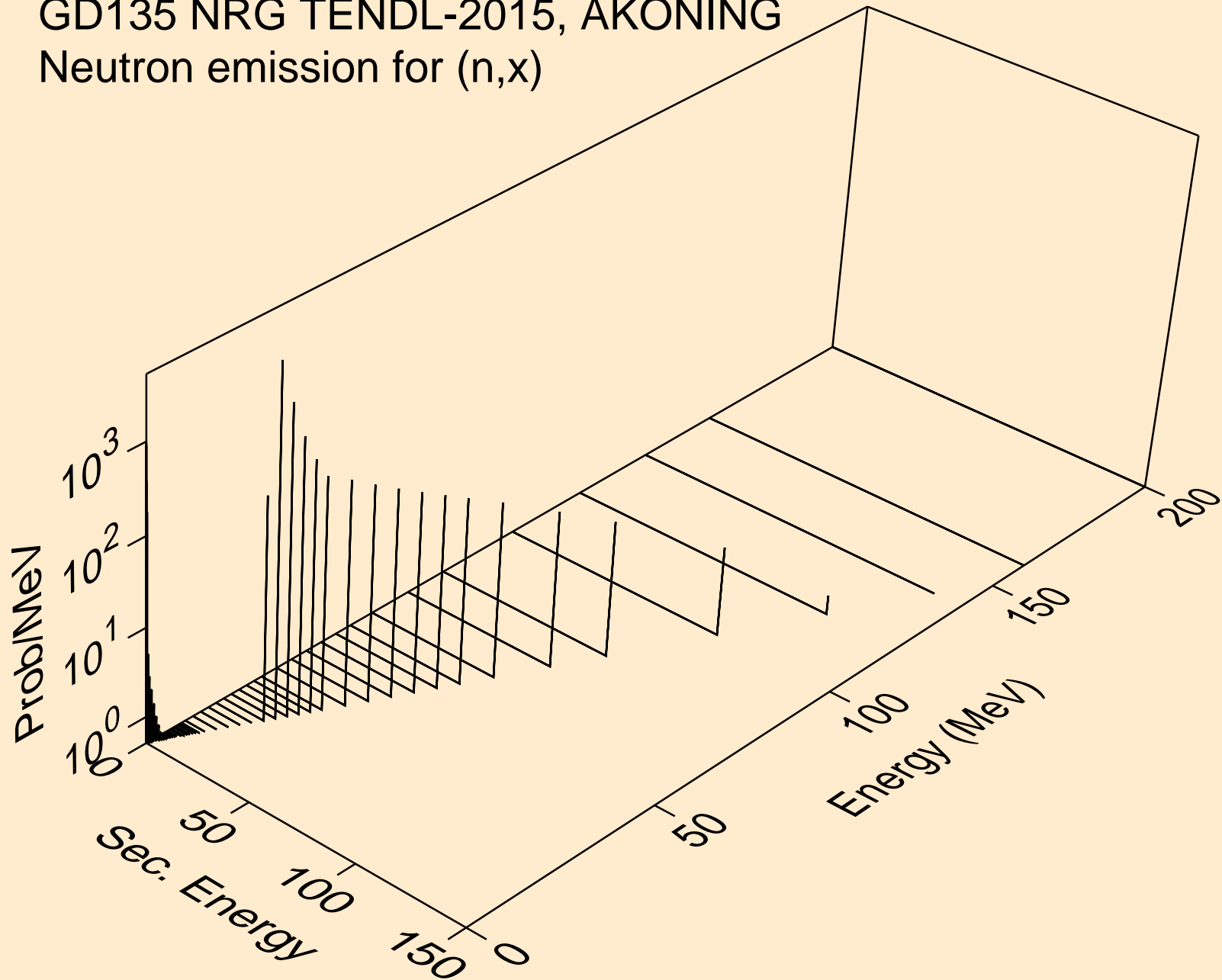

GD135 NRG TENDL-2015, AKONING
Neutron emission for (n,2n)

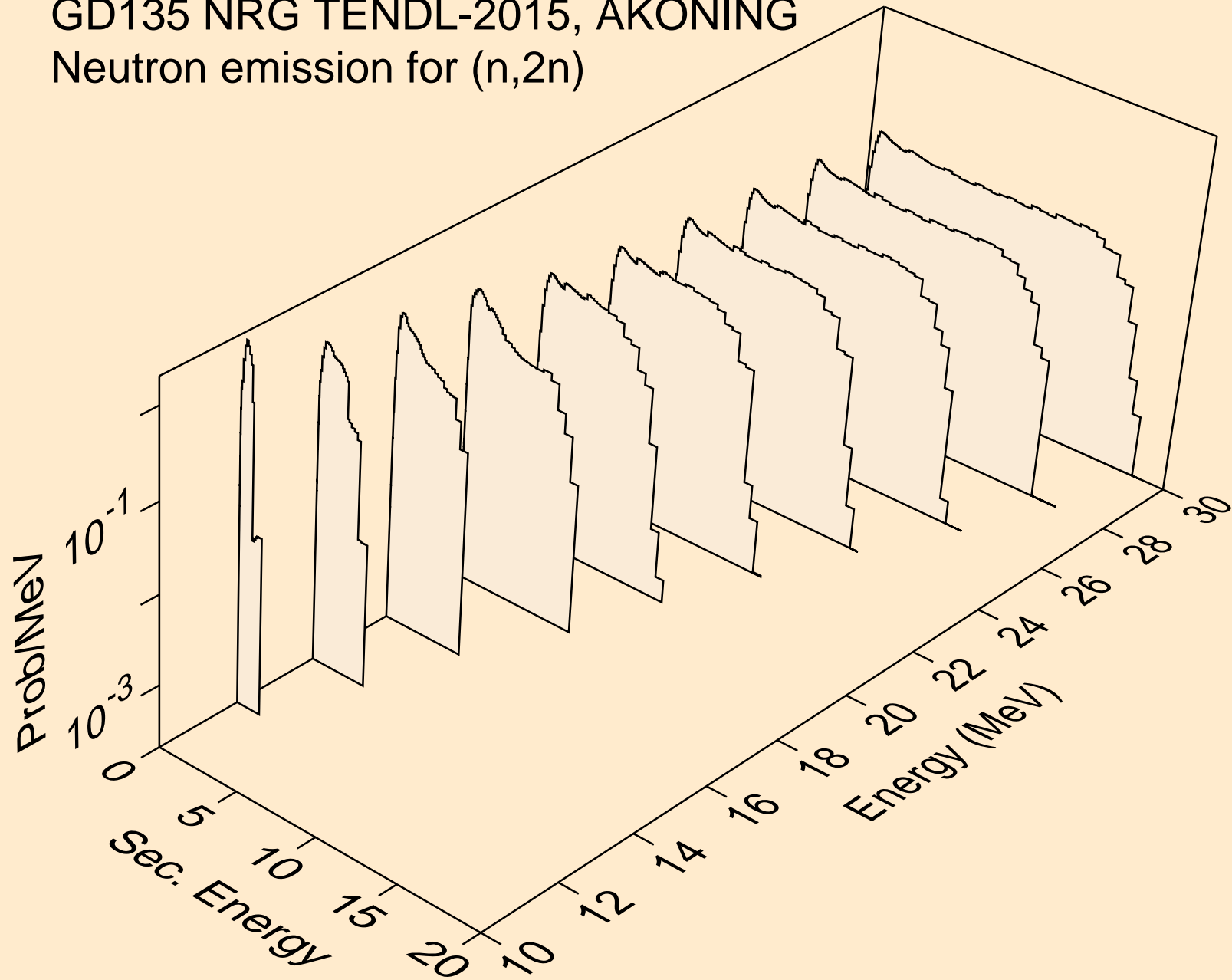

GD135 NRG TENDL-2015, AKONING
Neutron emission for (n,3n)

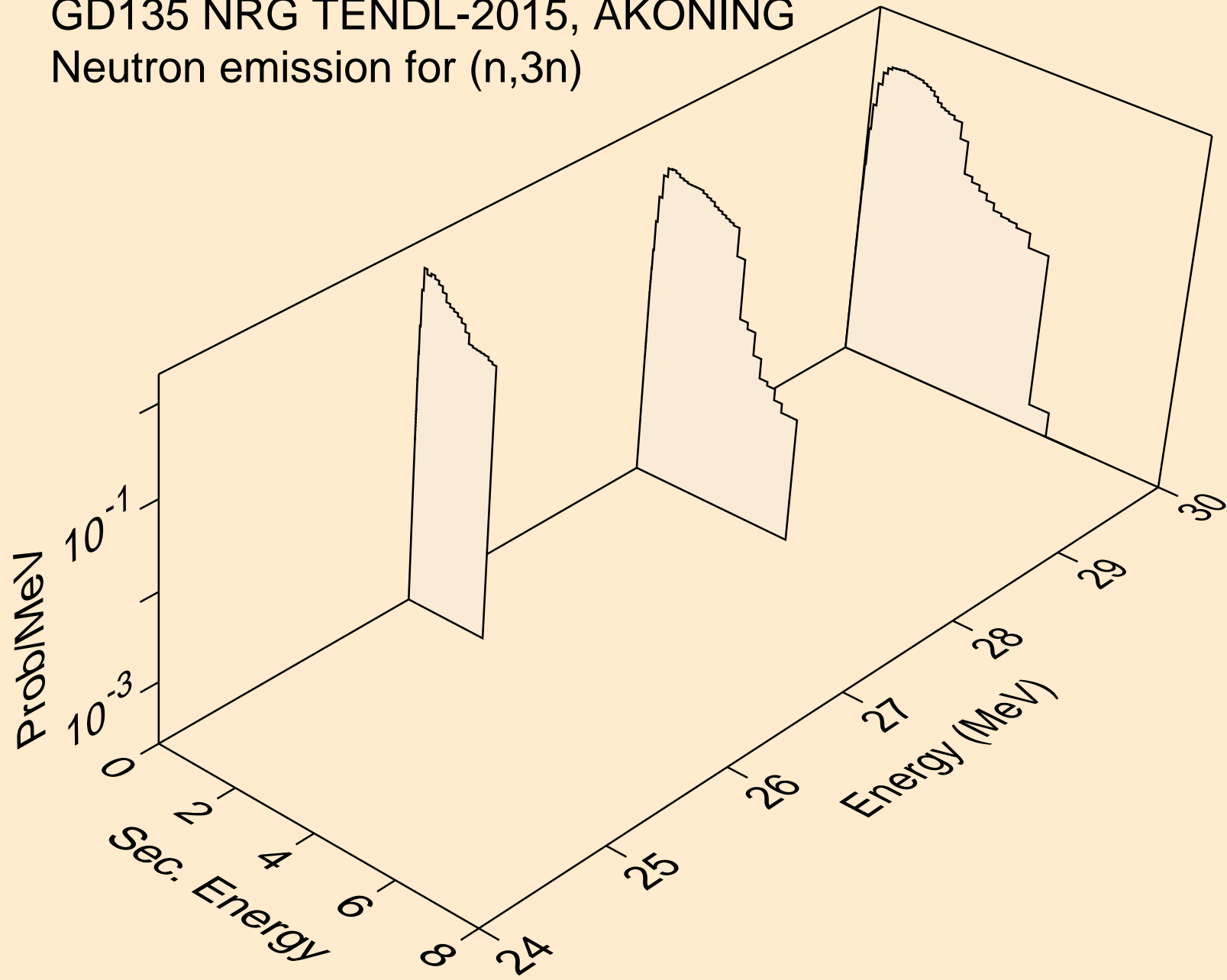

GD135 NRG TENDL-2015, AKONING
Neutron emission for (n,n*)a

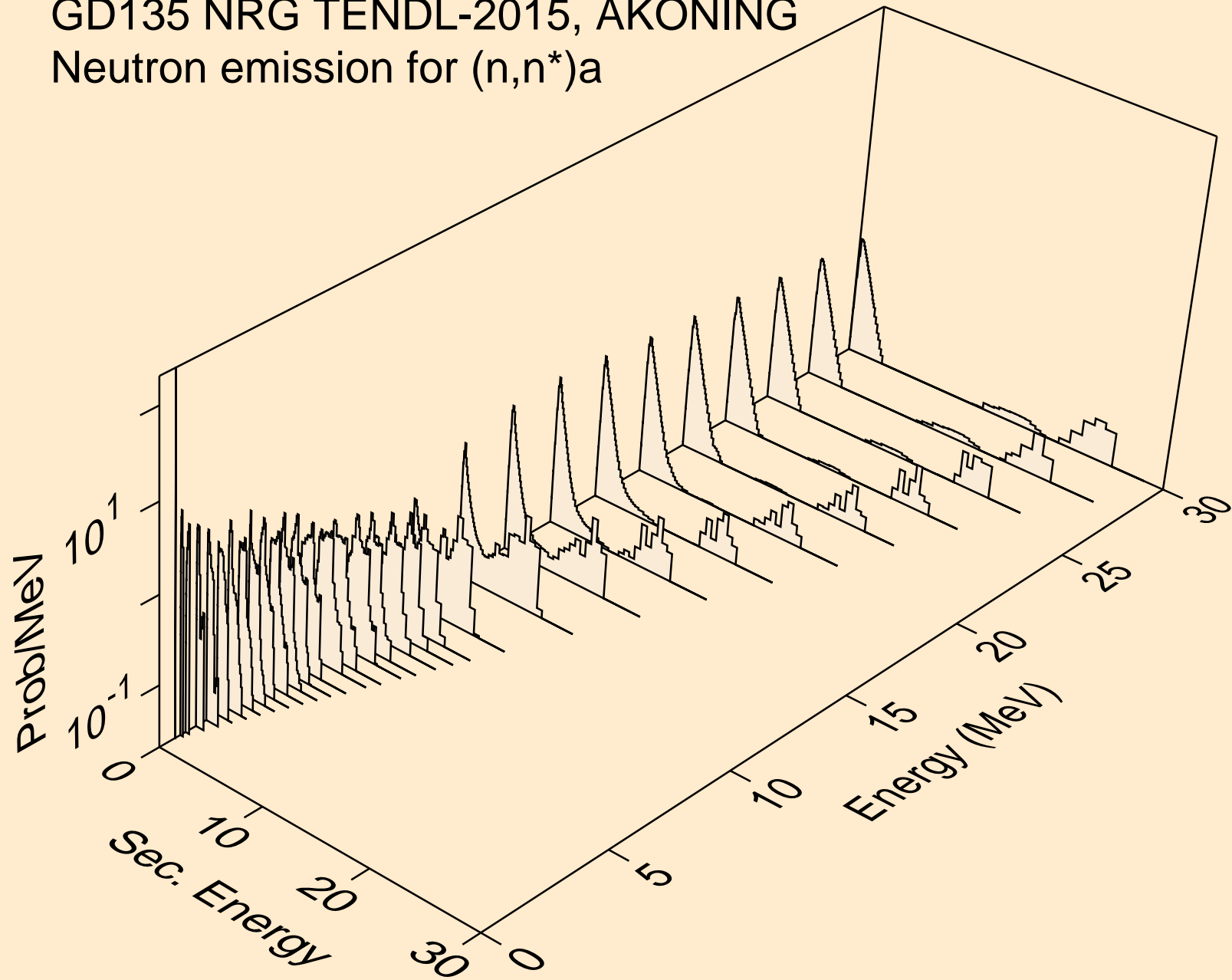

GD135 NRG TENDL-2015, AKONING
Neutron emission for (n,n*)3a

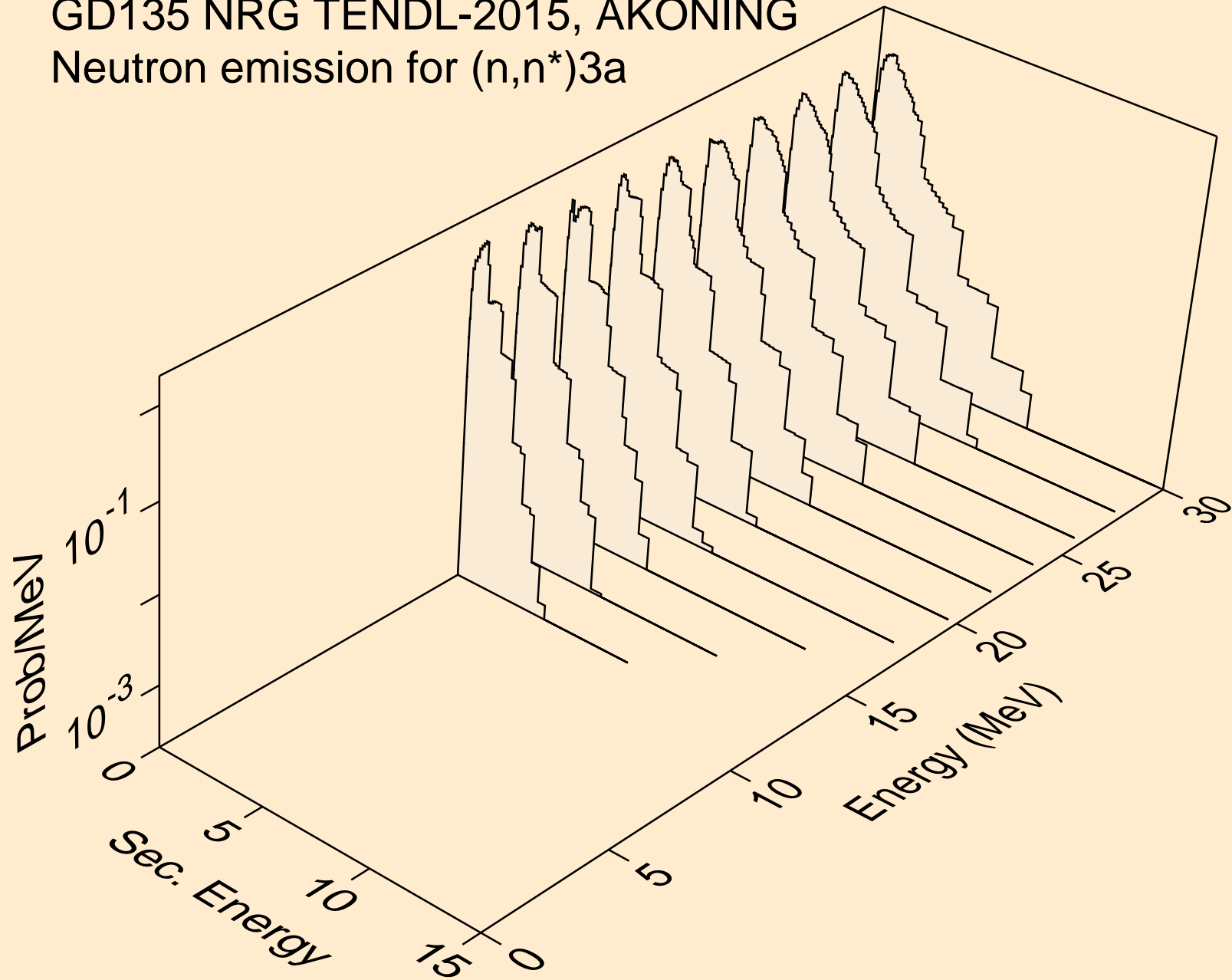

GD135 NRG TENDL-2015, AKONING
Neutron emission for (n,2n)a

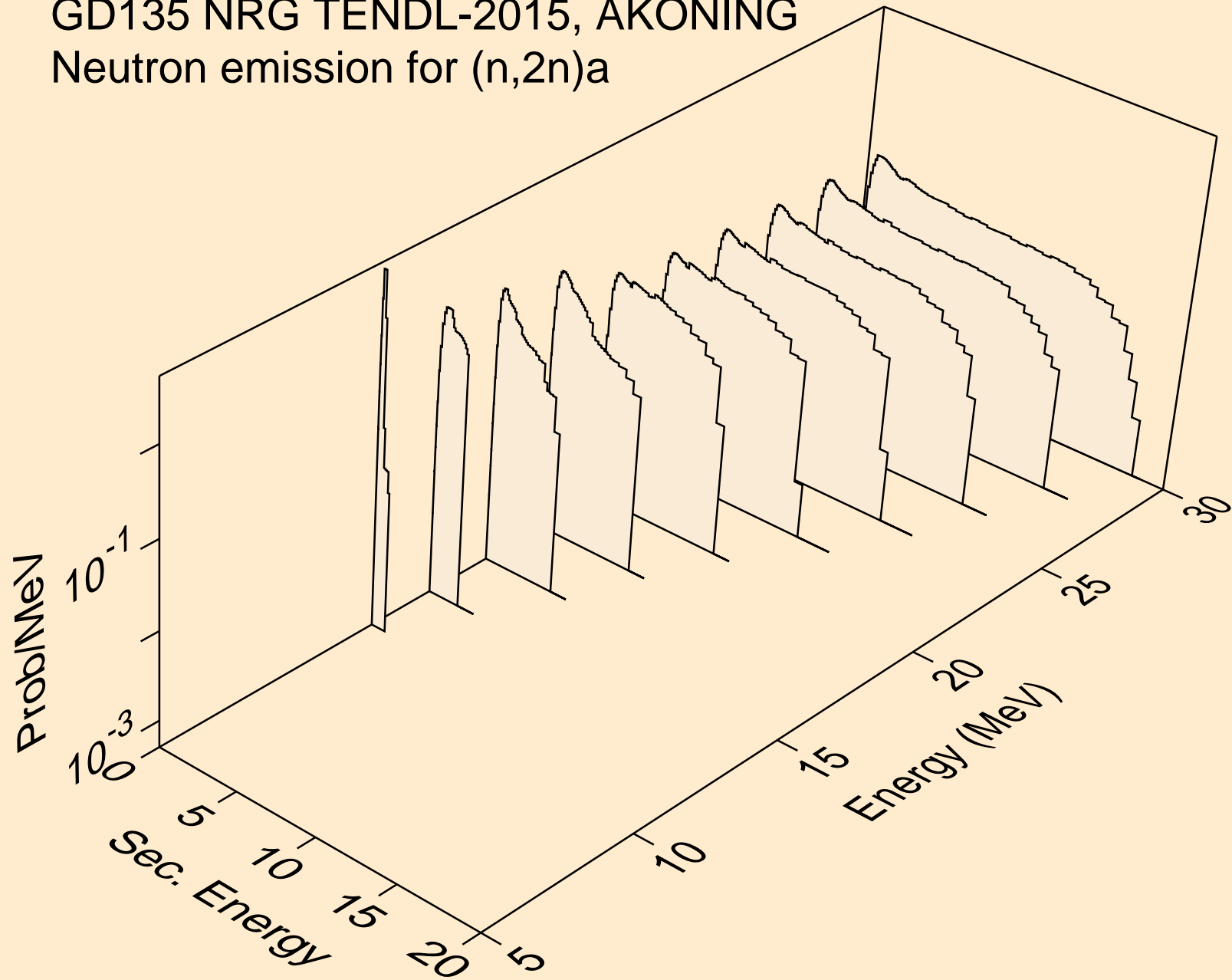

GD135 NRG TENDL-2015, AKONING
Neutron emission for (n,3n)a

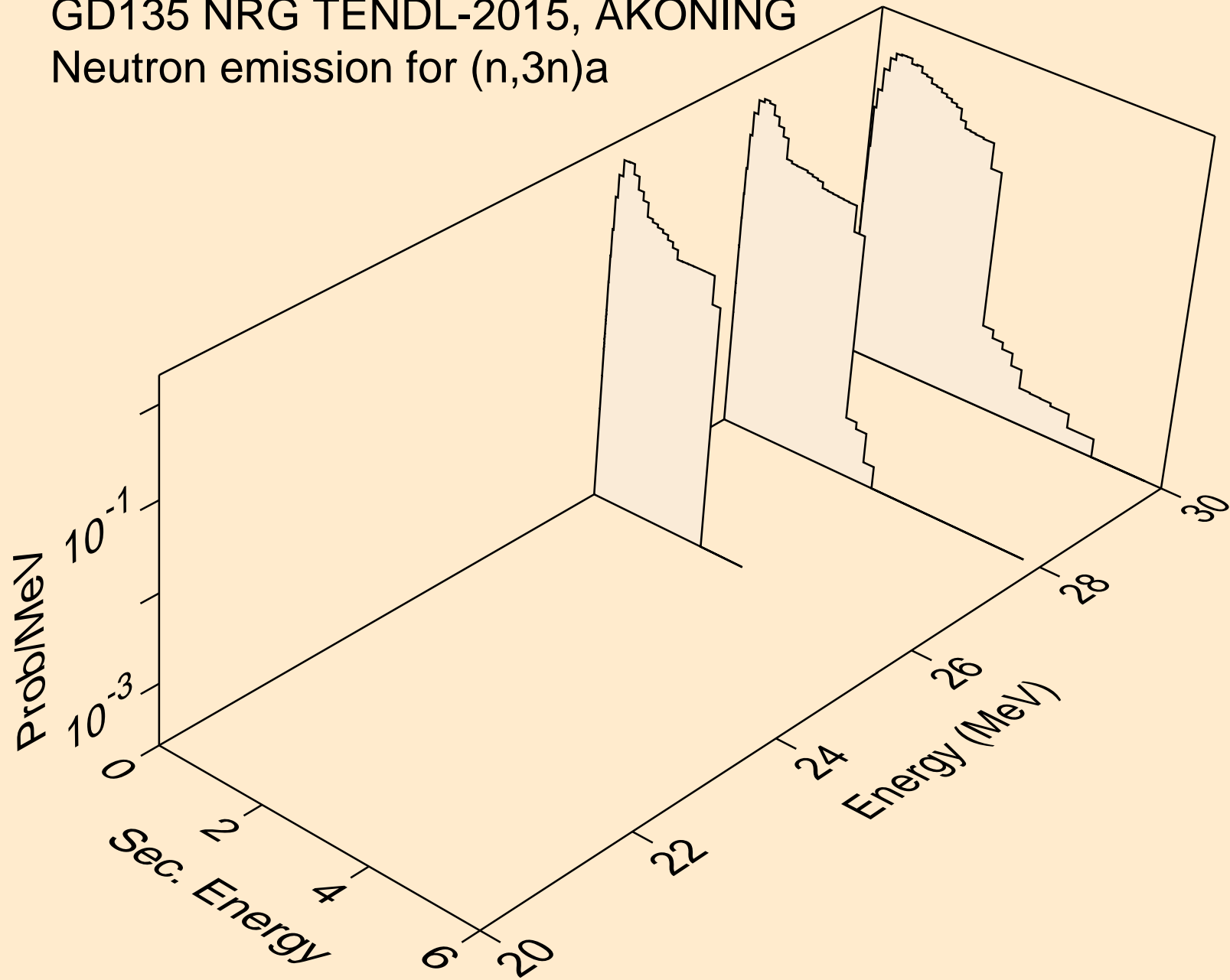

GD135 NRG TENDL-2015, AKONING
Neutron emission for (n,n*)p

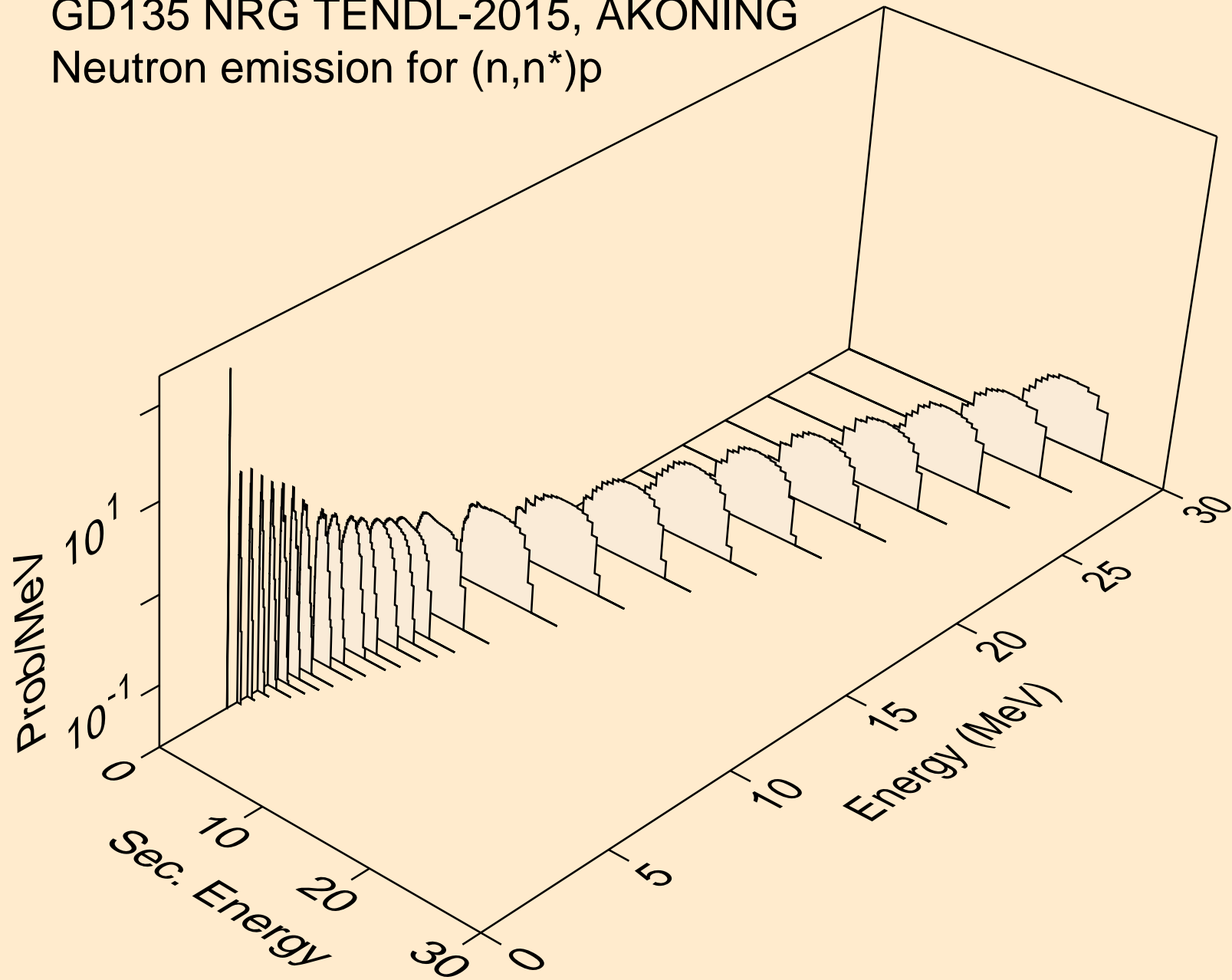

GD135 NRG TENDL-2015, AKONING
Neutron emission for (n,n*)2a

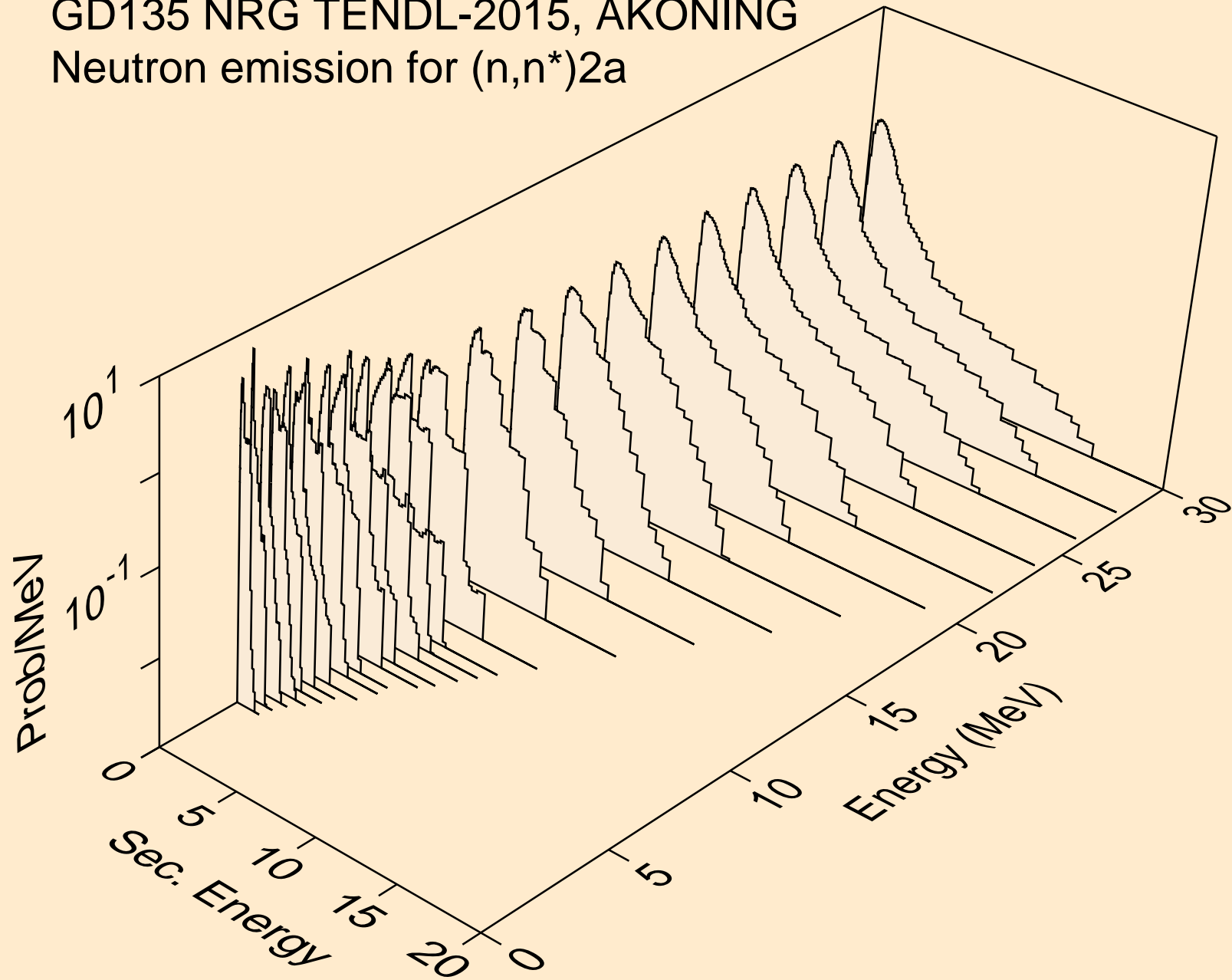

GD135 NRG TENDL-2015, AKONING
Neutron emission for (n,2n)2a

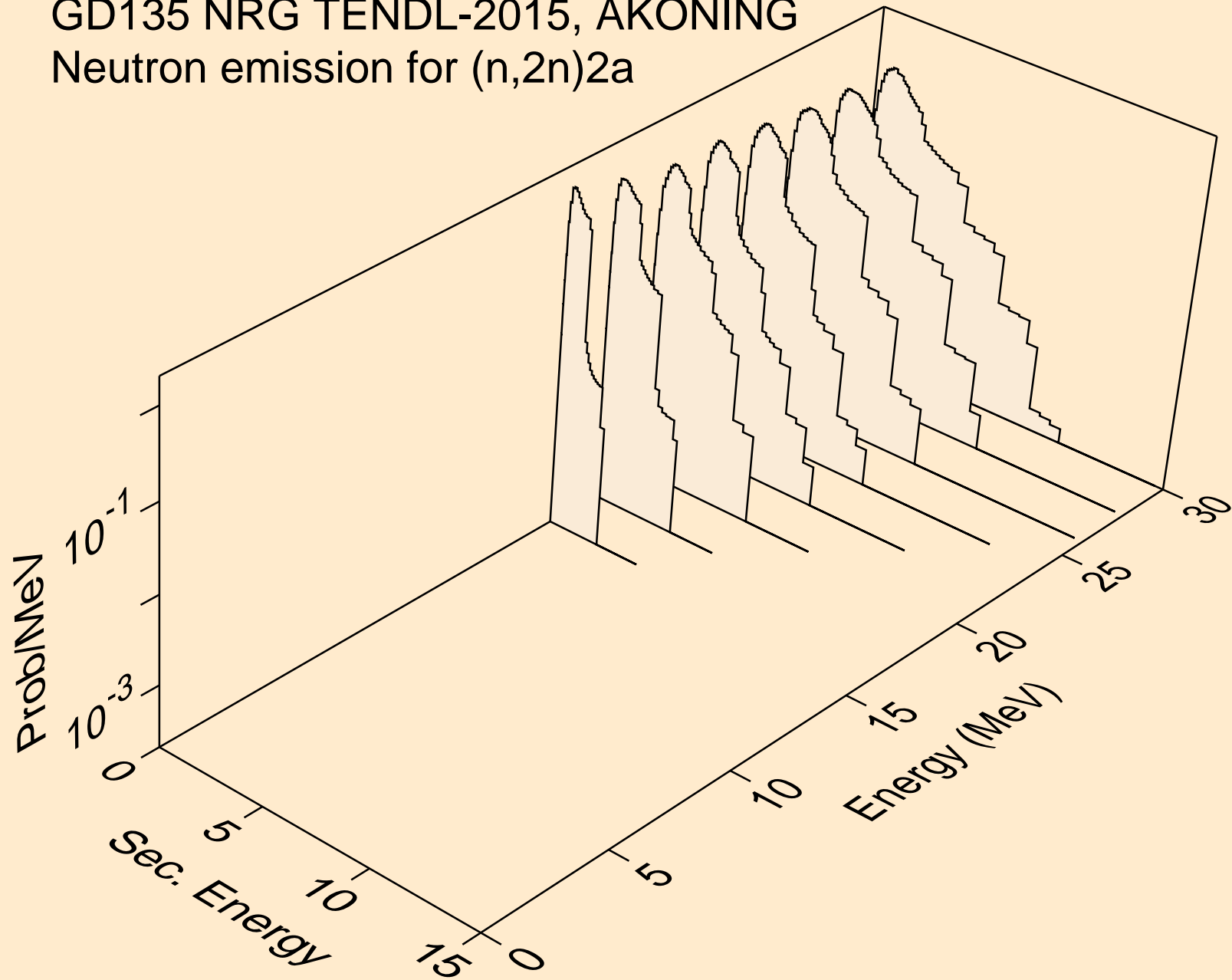

GD135 NRG TENDL-2015, AKONING
Neutron emission for (n,n*)d

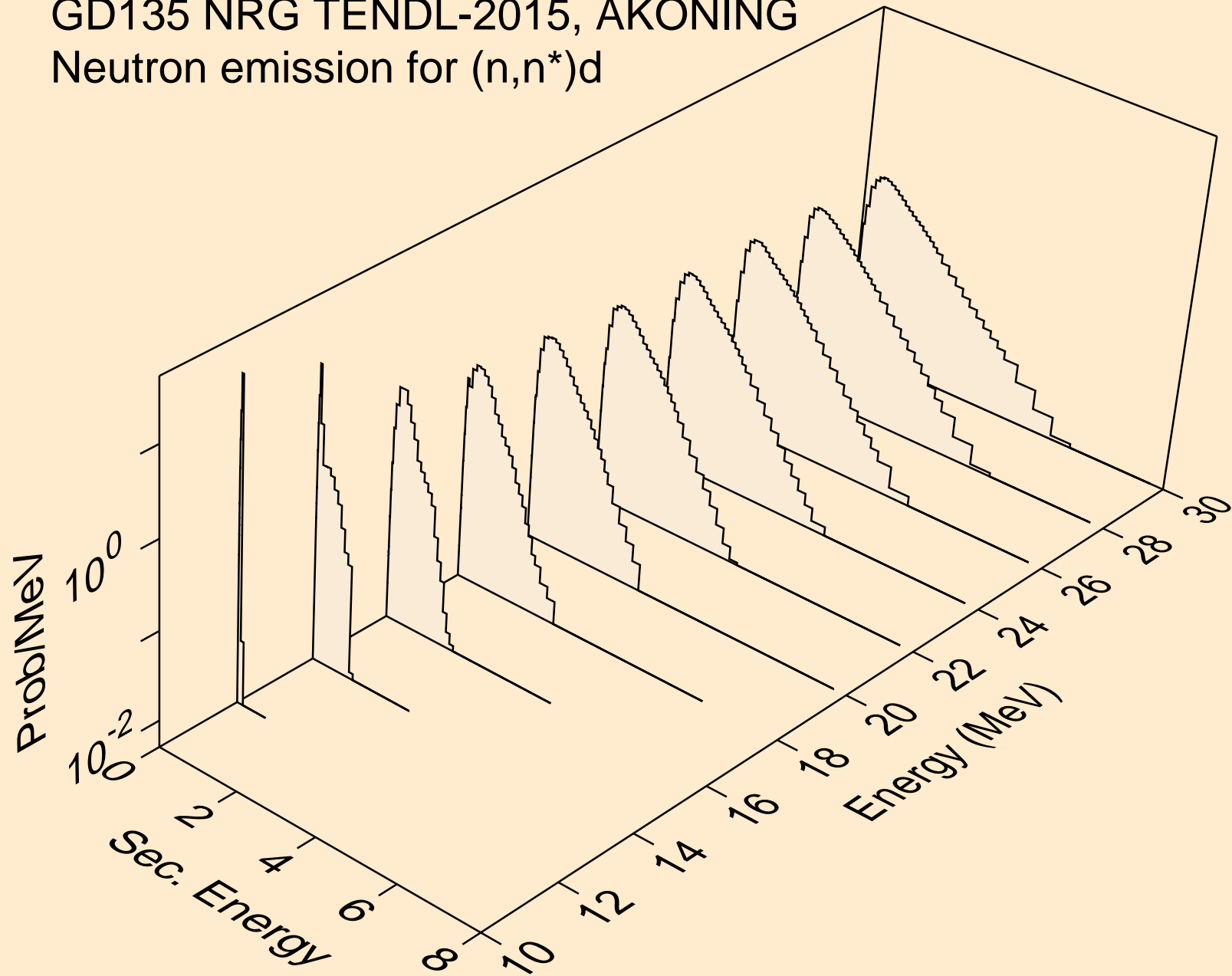

GD135 NRG TENDL-2015, AKONING
Neutron emission for (n,n*)t

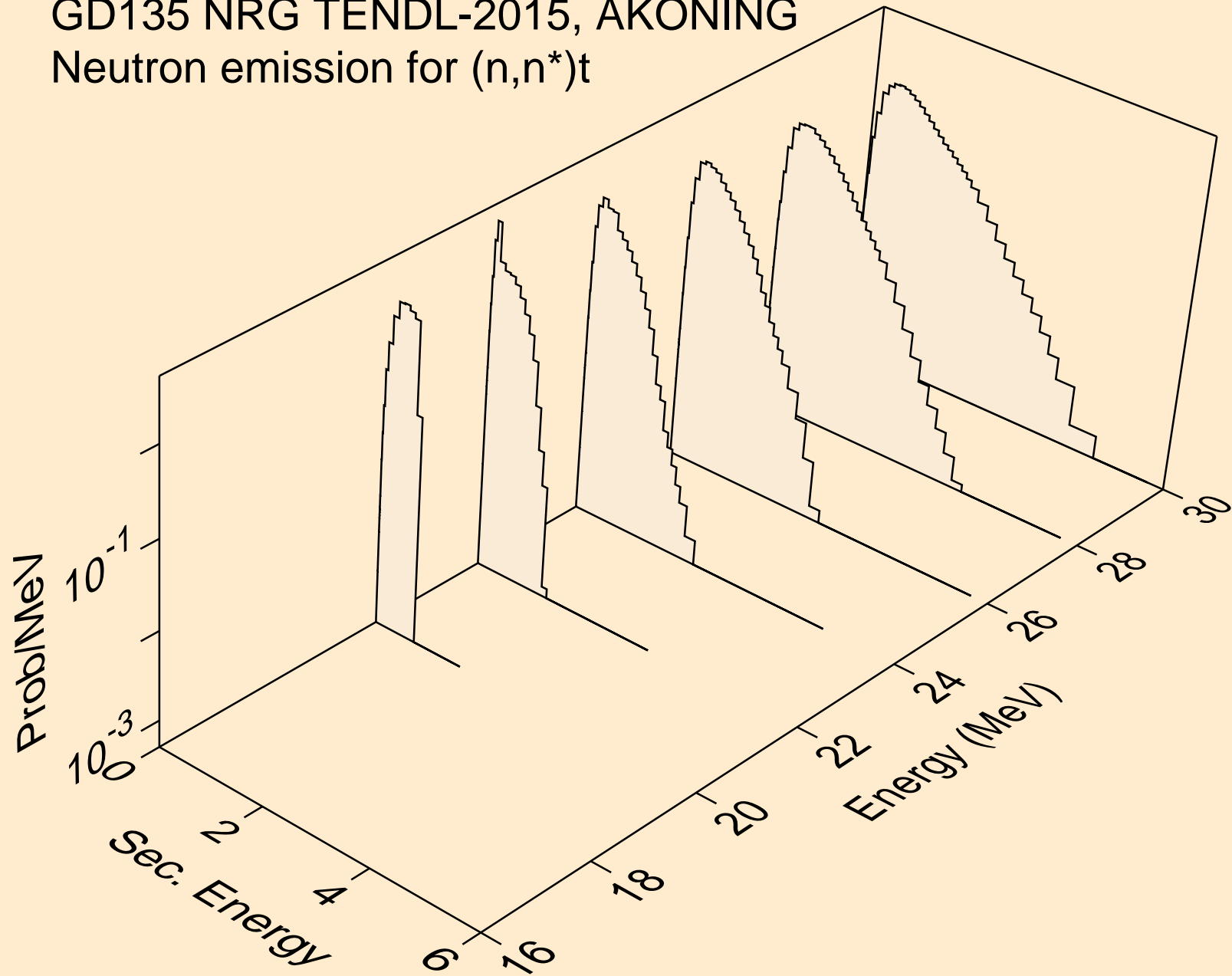

GD135 NRG TENDL-2015, AKONING
Neutron emission for (n,n*)he3

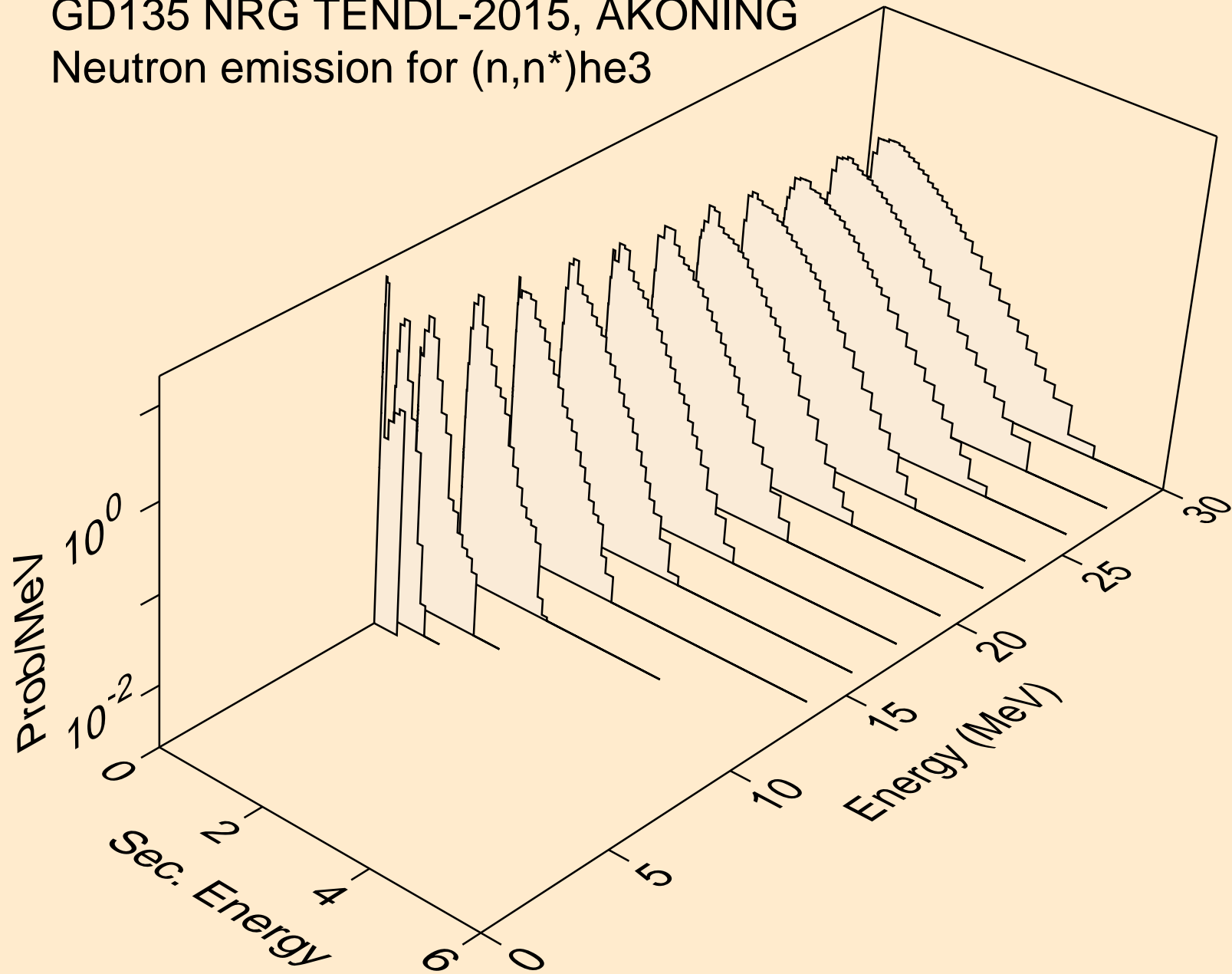

GD135 NRG TENDL-2015, AKONING
Neutron emission for (n,2np)

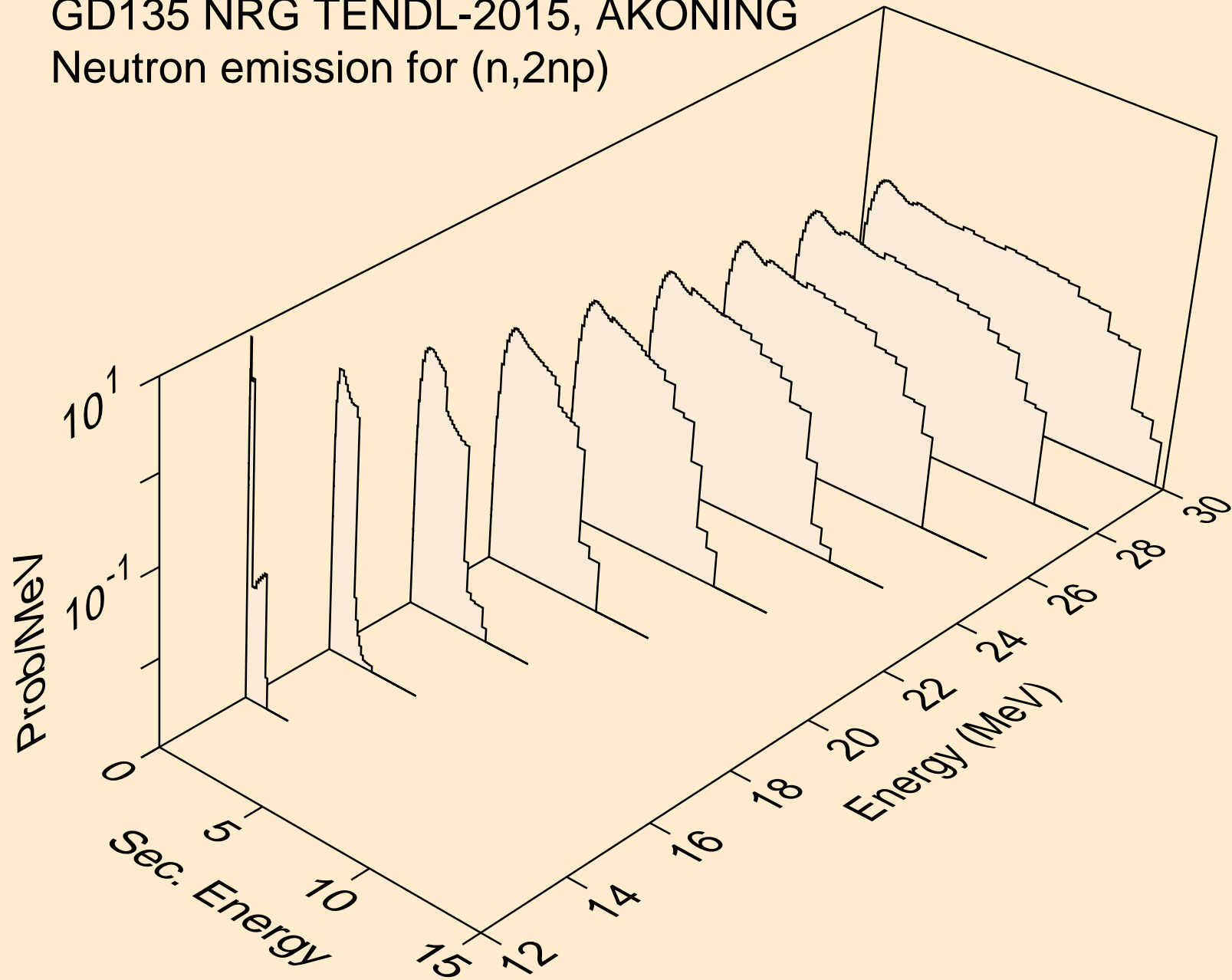

GD135 NRG TENDL-2015, AKONING
Neutron emission for (n,3np)

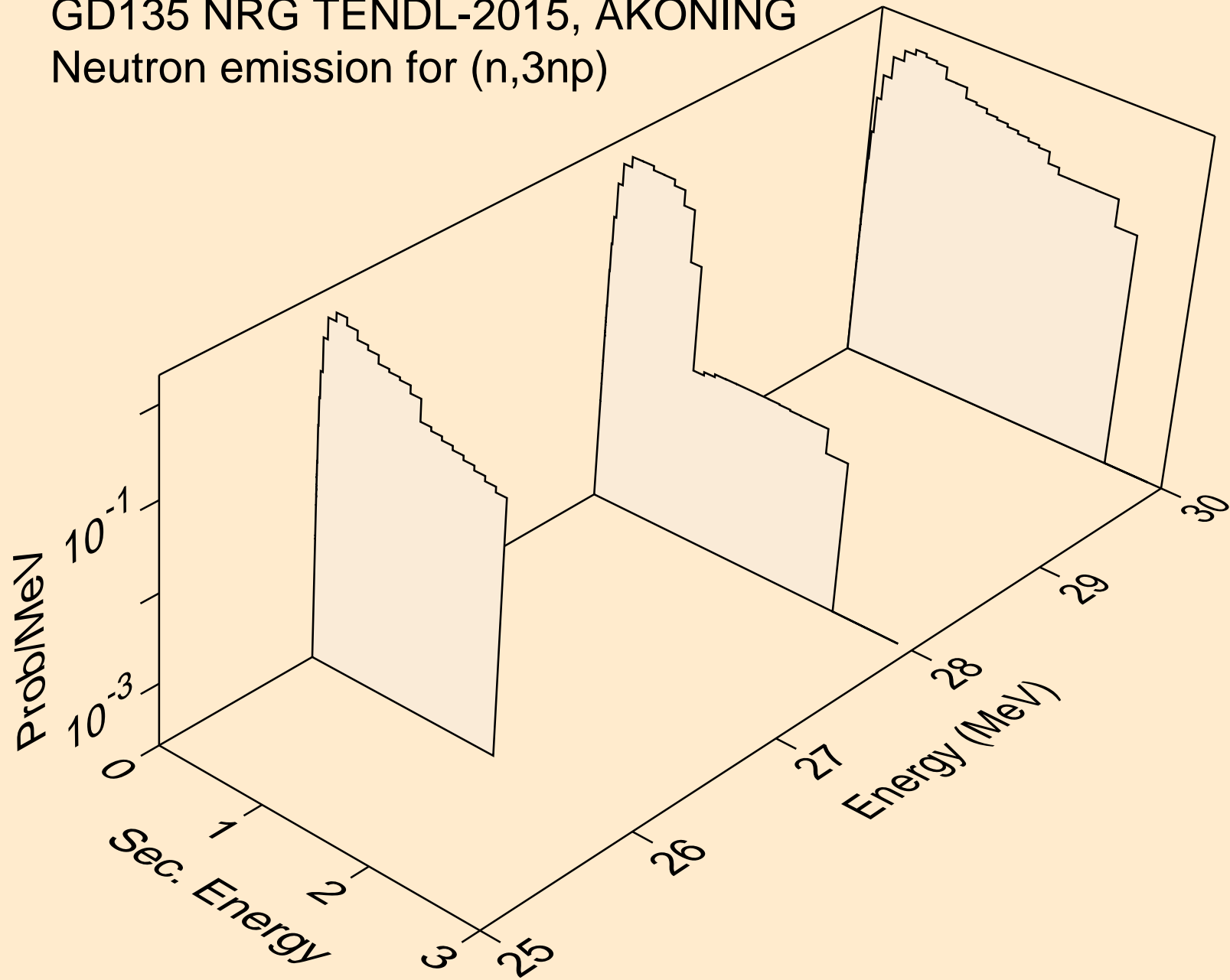

GD135 NRG TENDL-2015, AKONING
Neutron emission for (n,2np)

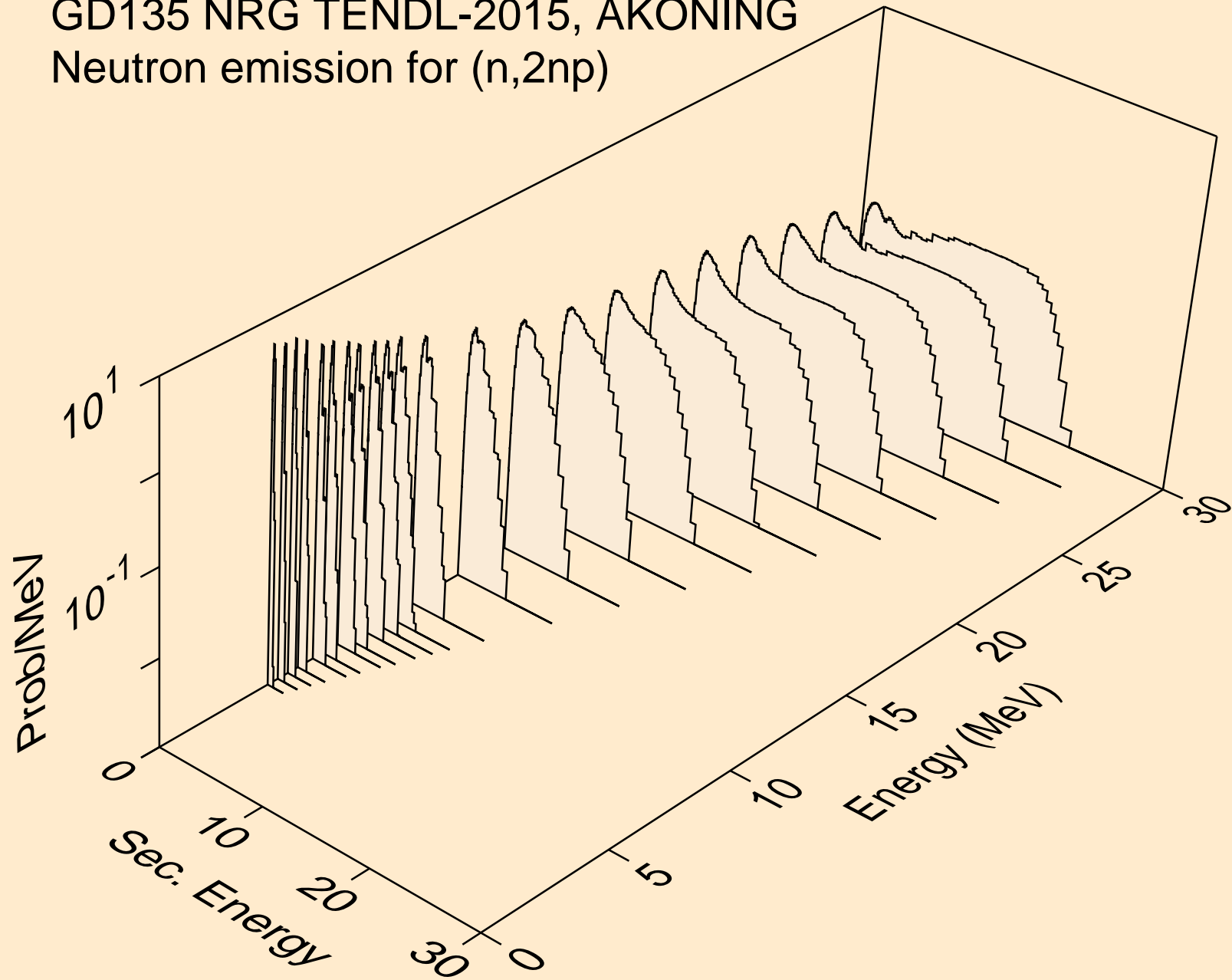

GD135 NRG TENDL-2015, AKONING
Neutron emission for (n,npa)

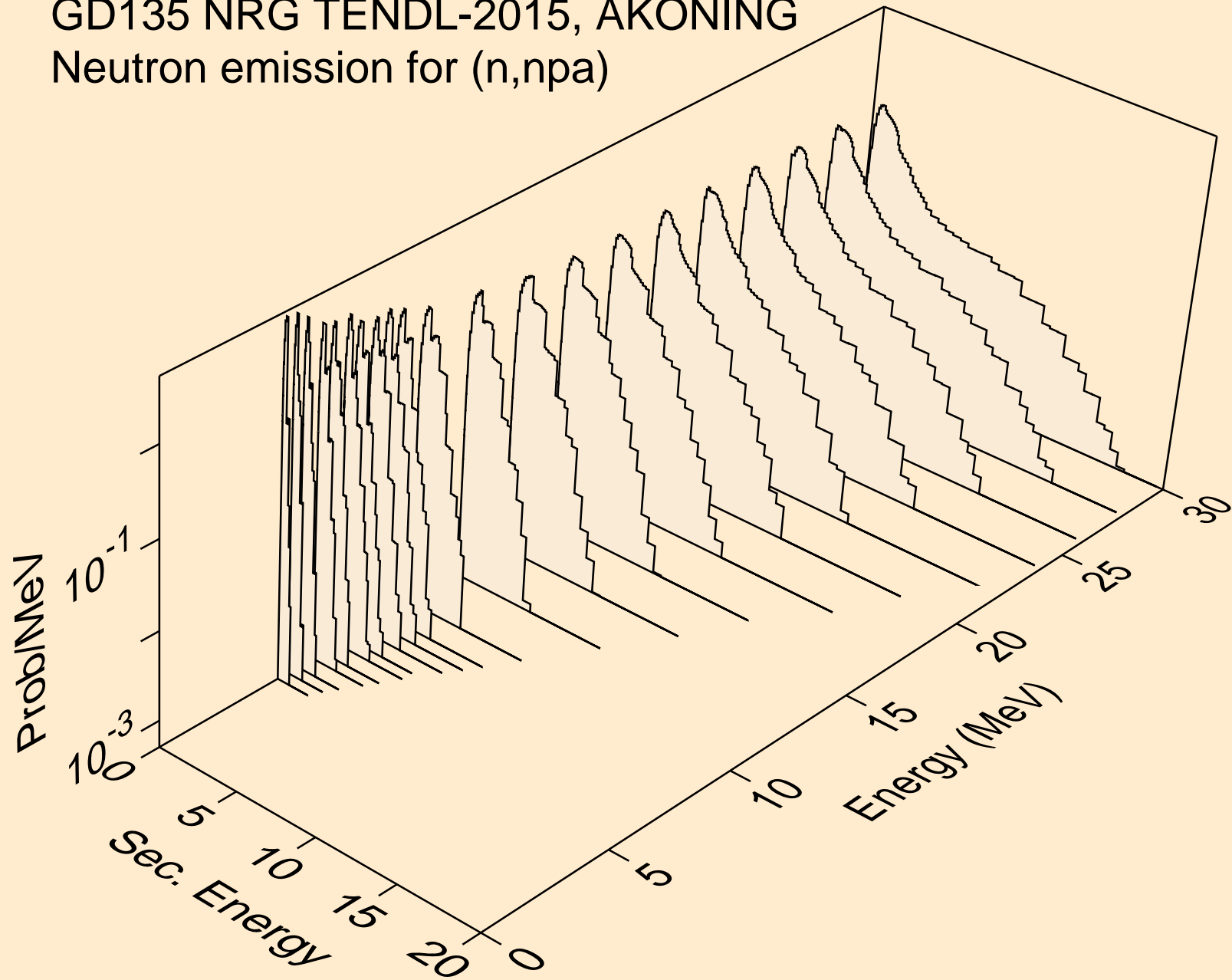

GD135 NRG TENDL-2015, AKONING
Neutron emission for (n,n*c)

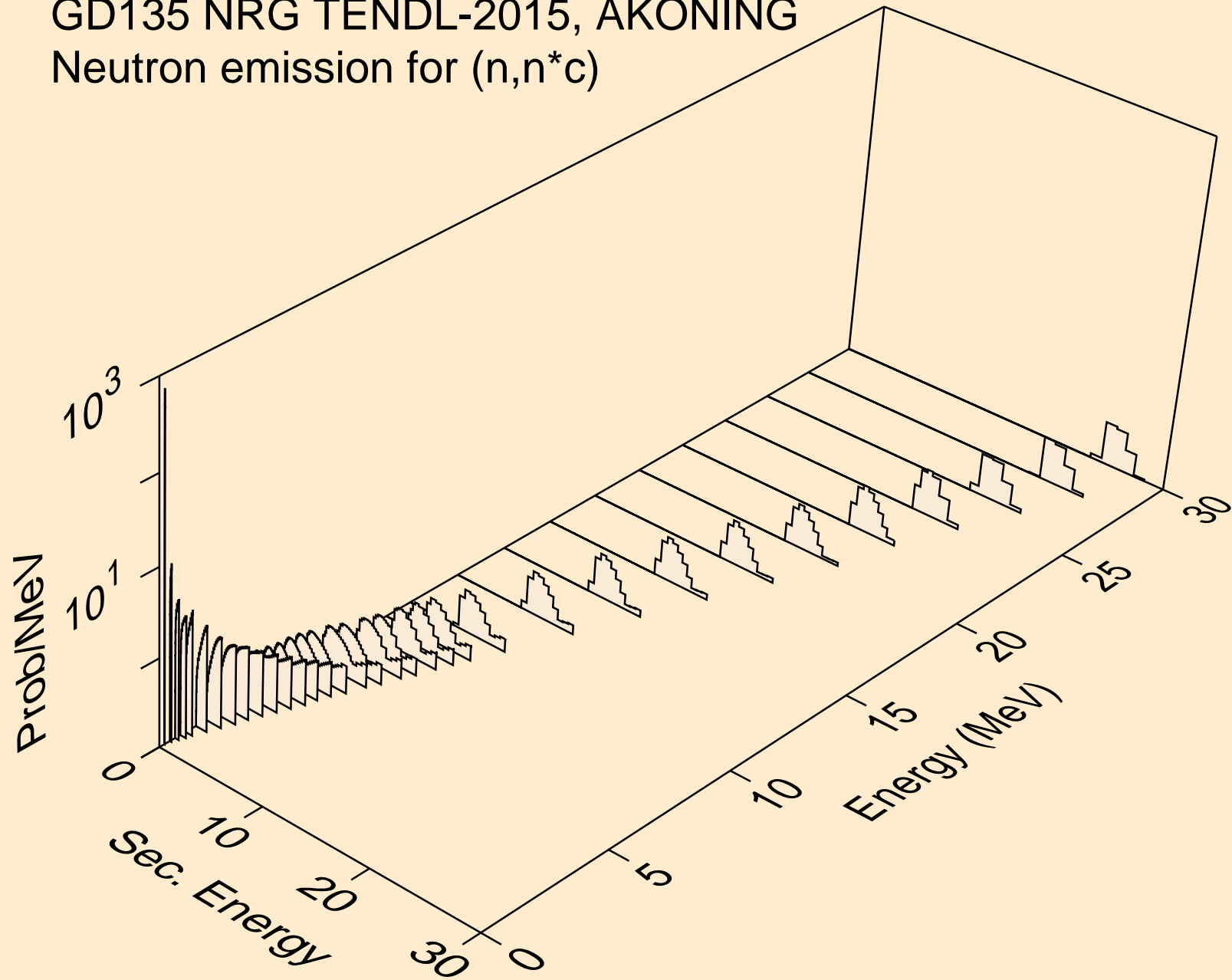

GD135 NRG TENDL-2015, AKONING
Photon emission for (n,x)

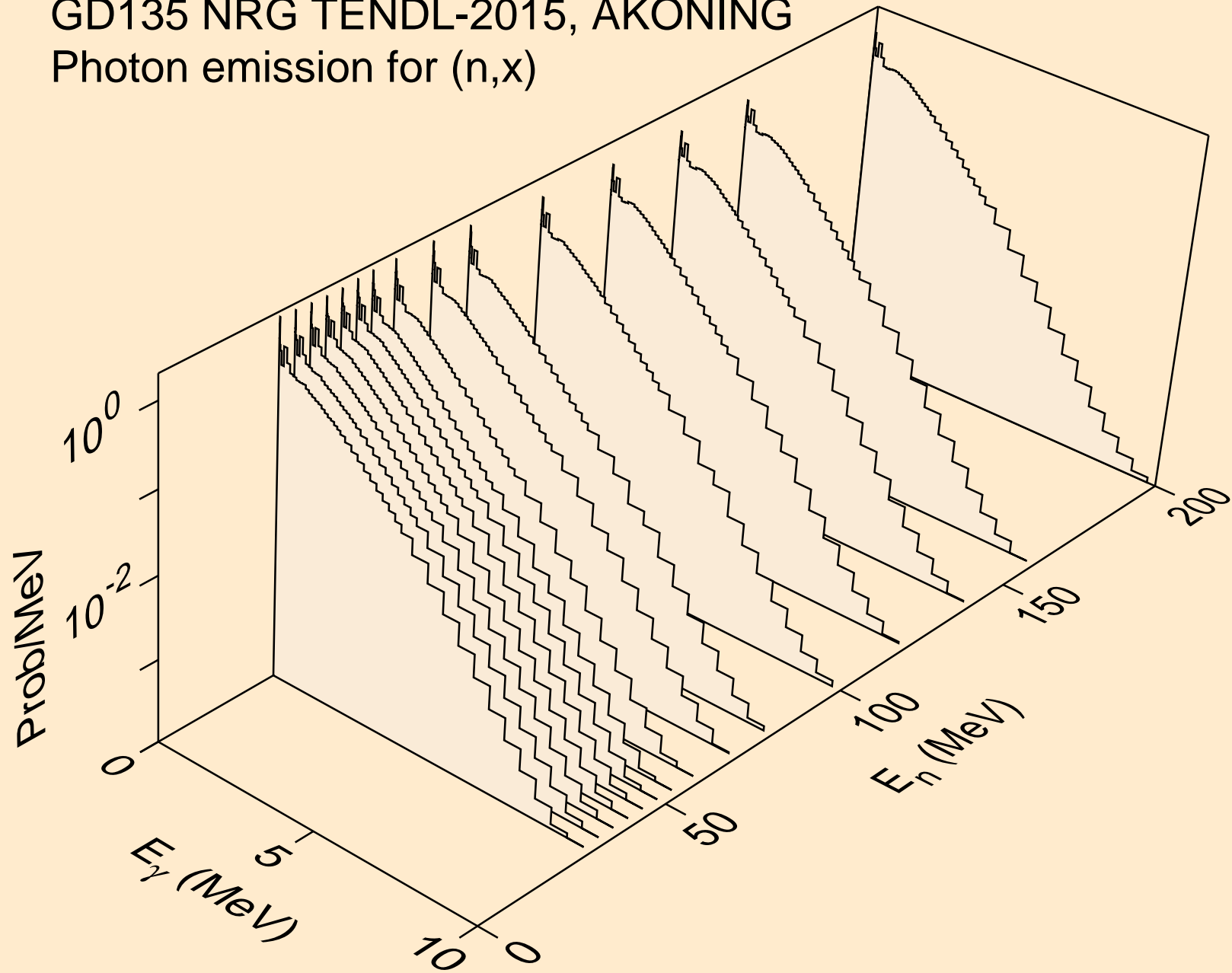

GD135 NRG TENDL-2015, AKONING
Photon emission for (n,2n)

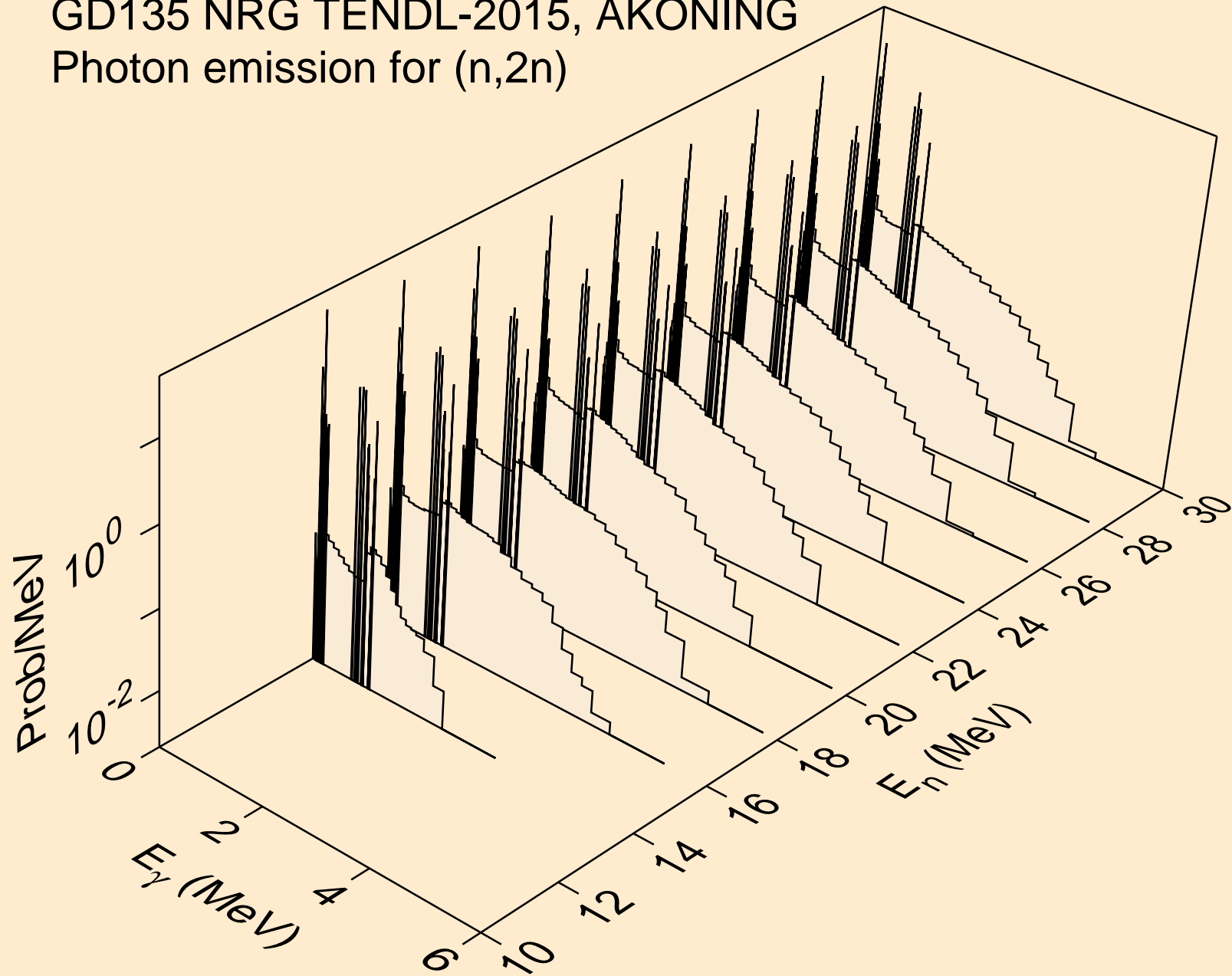

GD135 NRG TENDL-2015, AKONING
Photon emission for (n,3n)

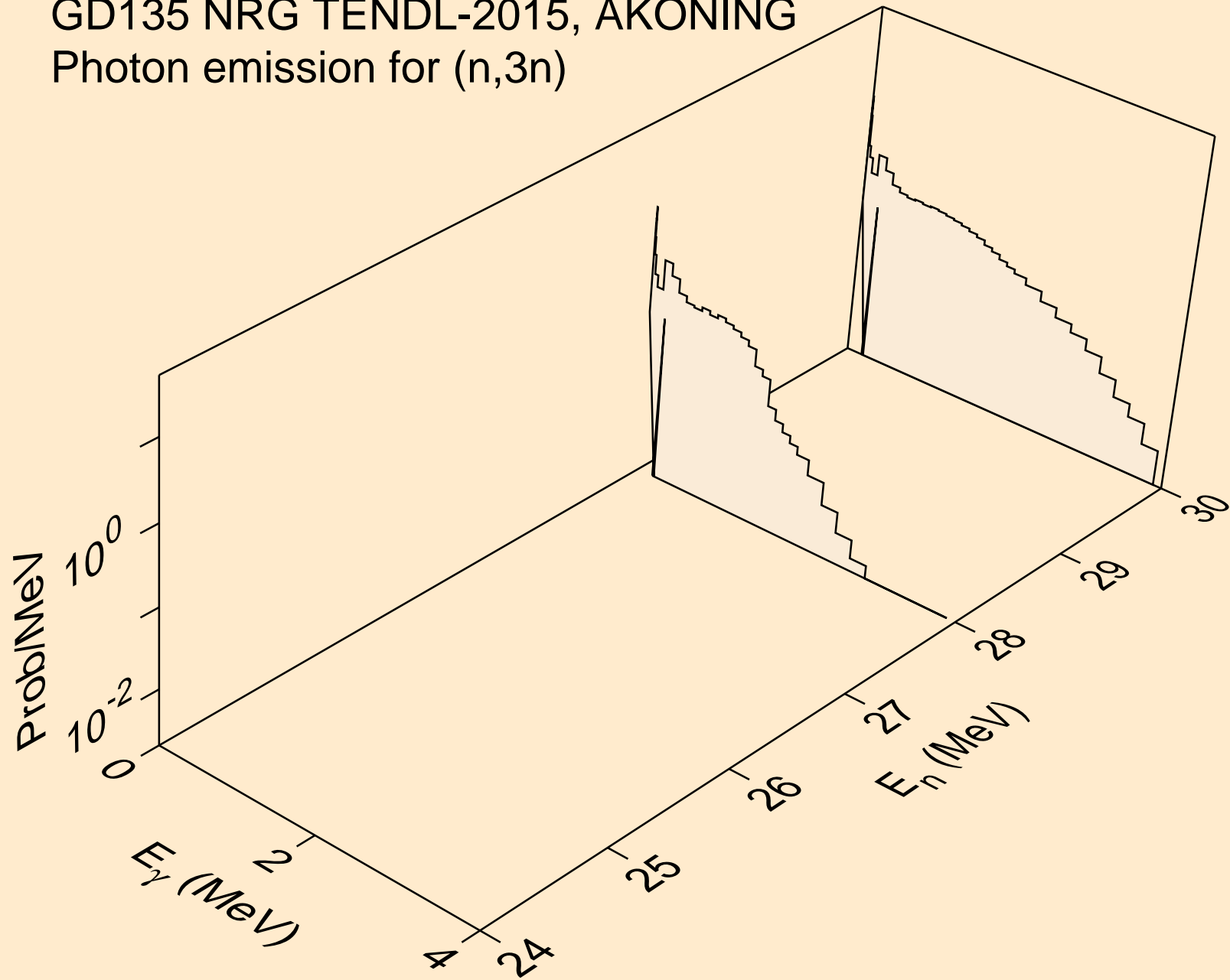

GD135 NRG TENDL-2015, AKONING
Photon emission for (n,n*)a

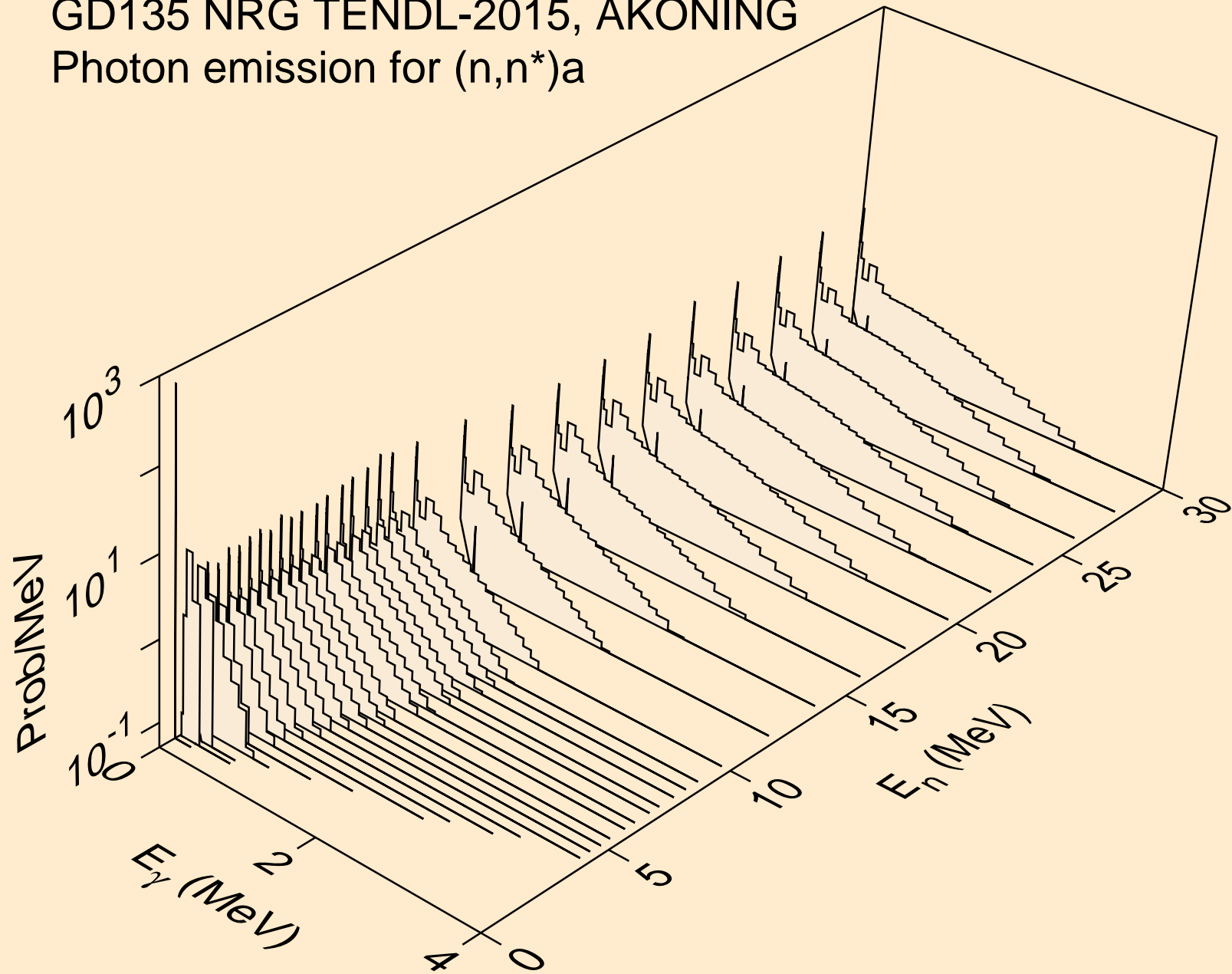

GD135 NRG TENDL-2015, AKONING
Photon emission for (n,n*)3a

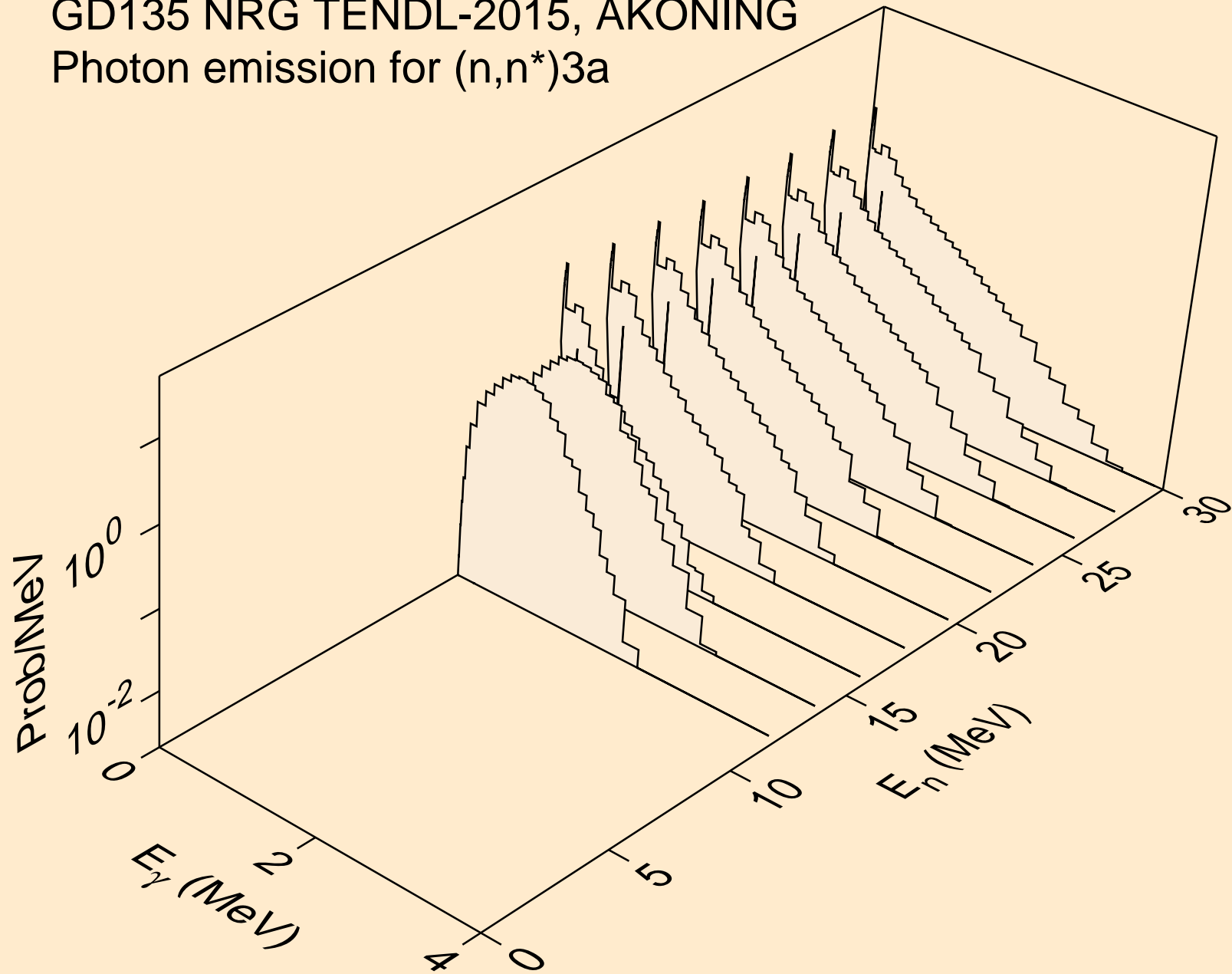

GD135 NRG TENDL-2015, AKONING
Photon emission for (n,2n)a

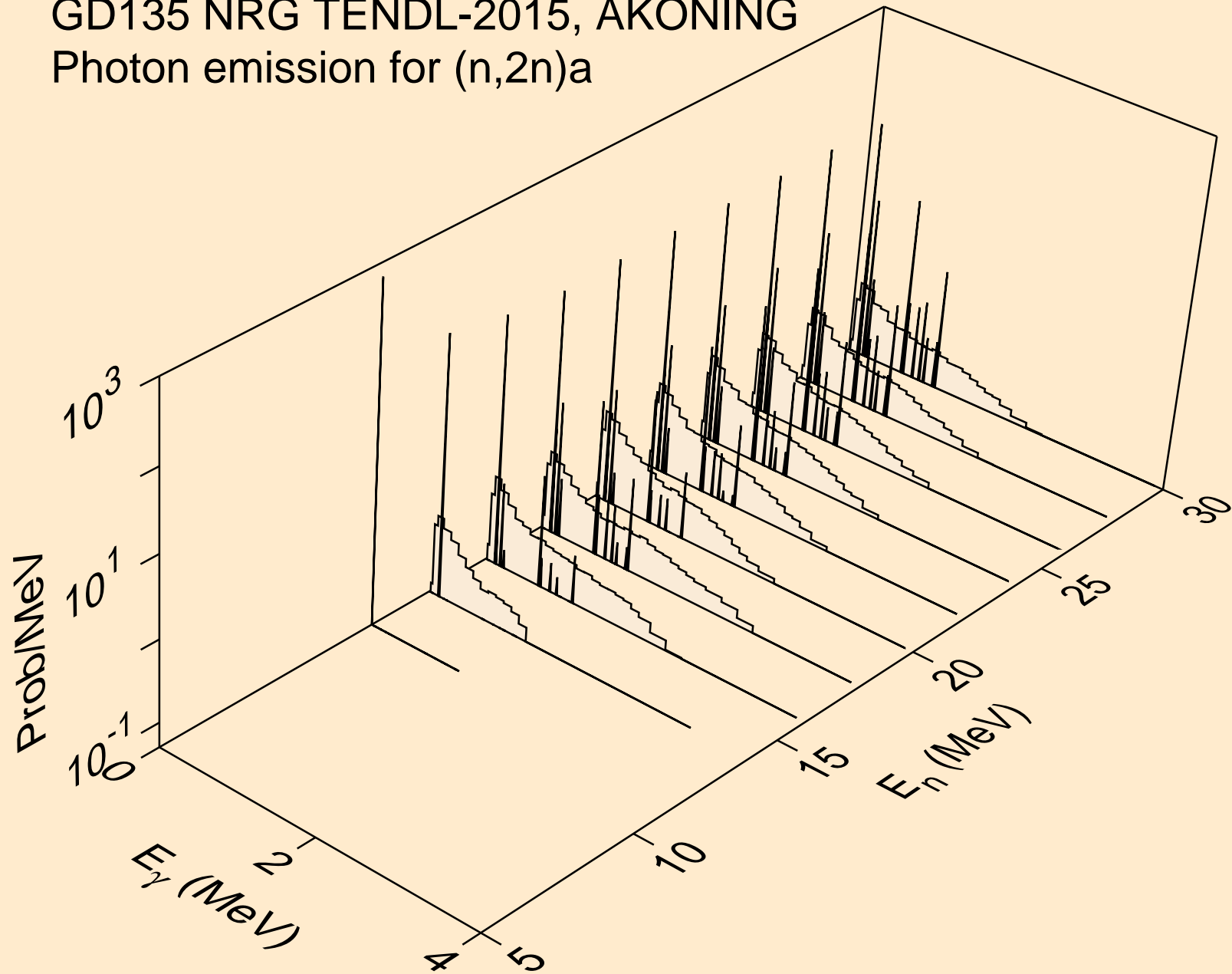

GD135 NRG TENDL-2015, AKONING
Photon emission for (n,3n)a

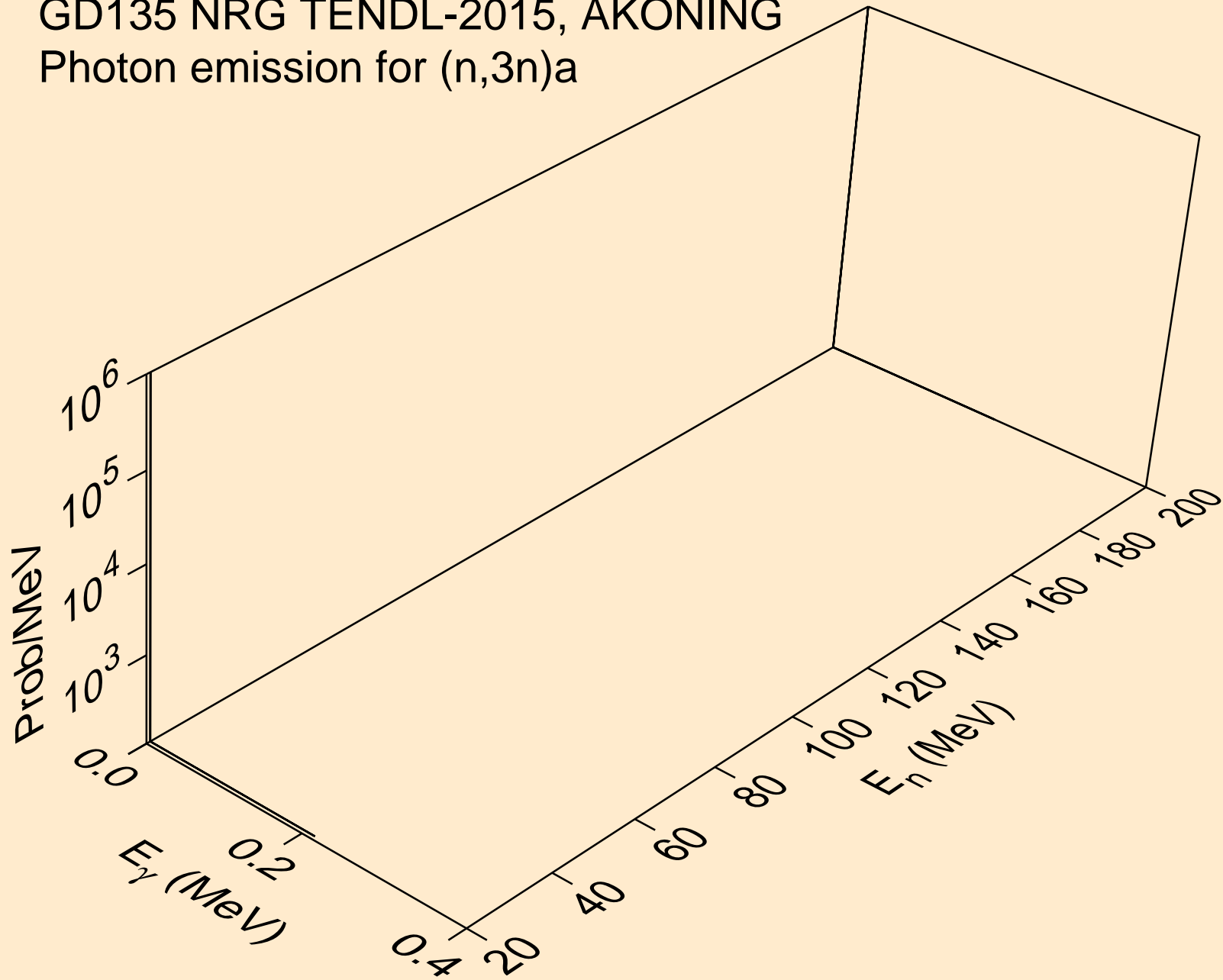

GD135 NRG TENDL-2015, AKONING
Photon emission for (n,n*)p

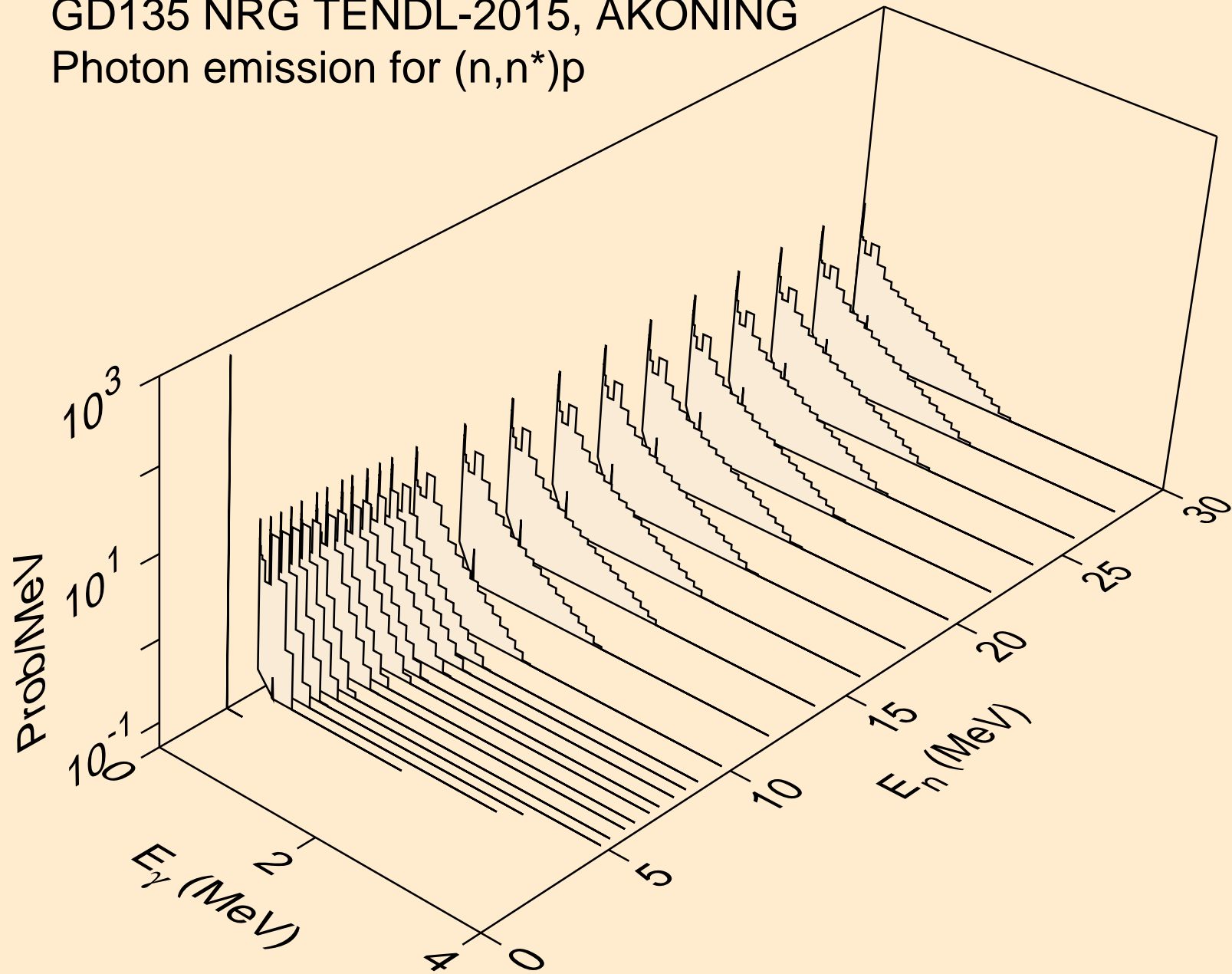

GD135 NRG TENDL-2015, AKONING
Photon emission for (n,n*)2a

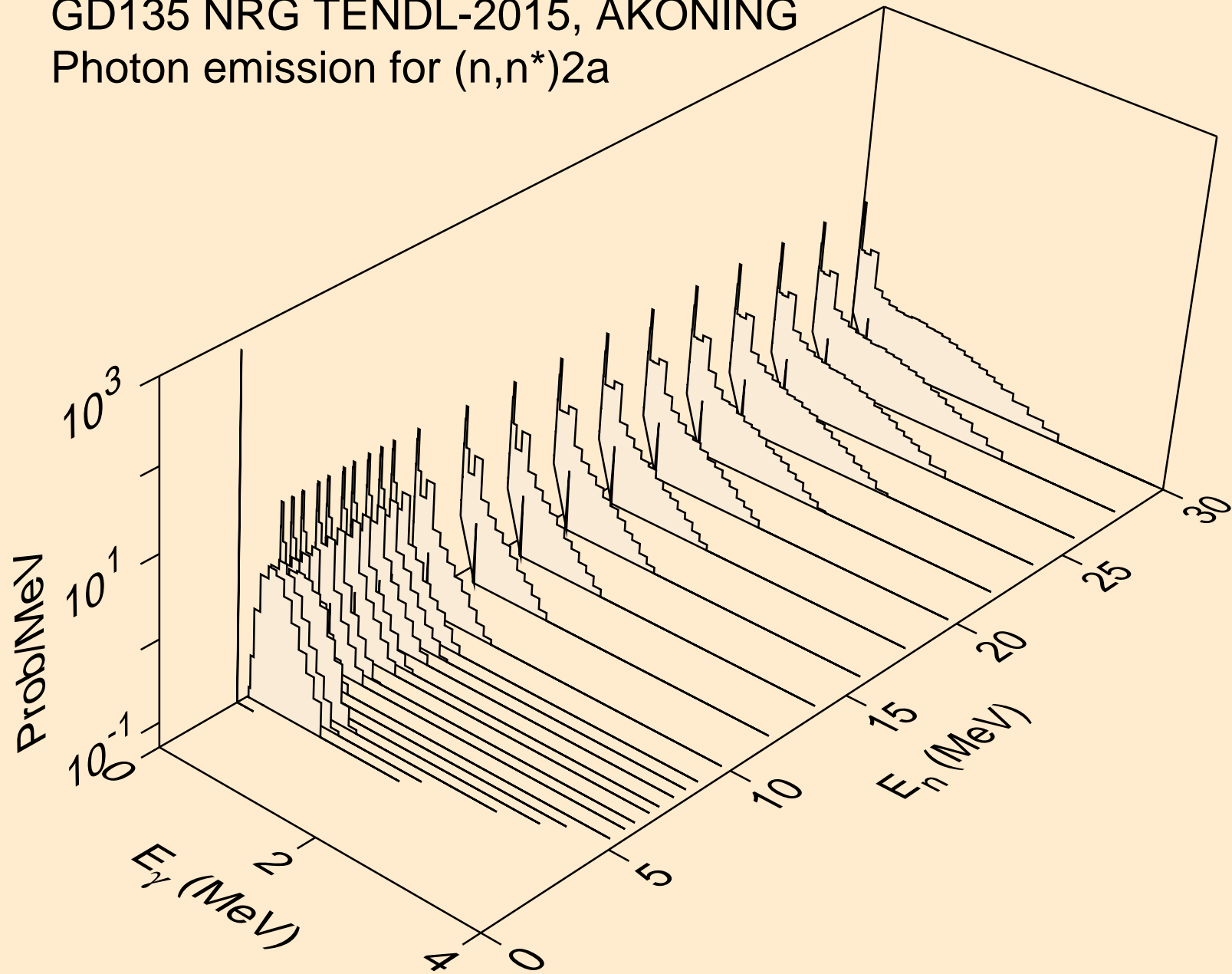

GD135 NRG TENDL-2015, AKONING
Photon emission for (n,2n)2a

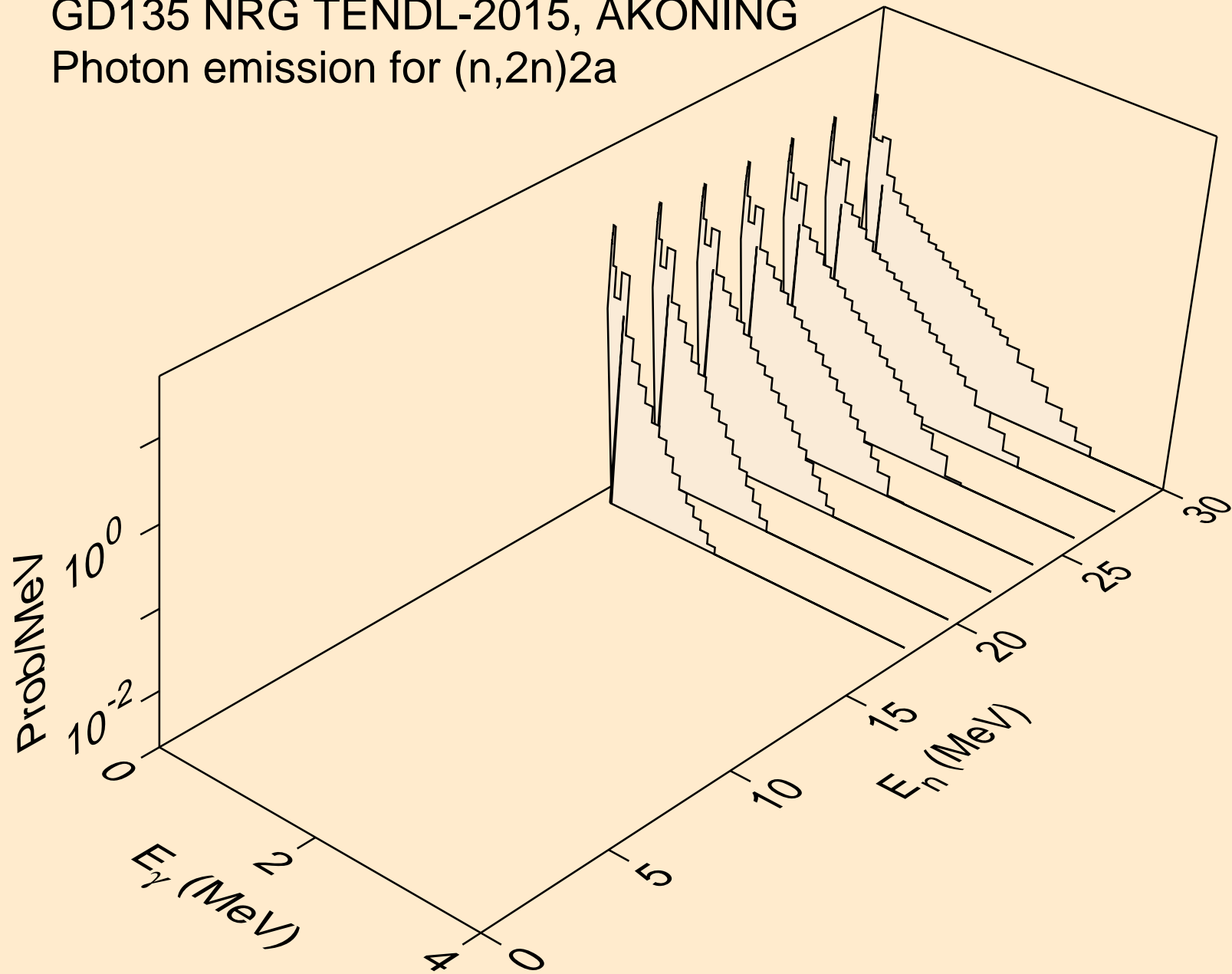

GD135 NRG TENDL-2015, AKONING
Photon emission for (n,n*)d

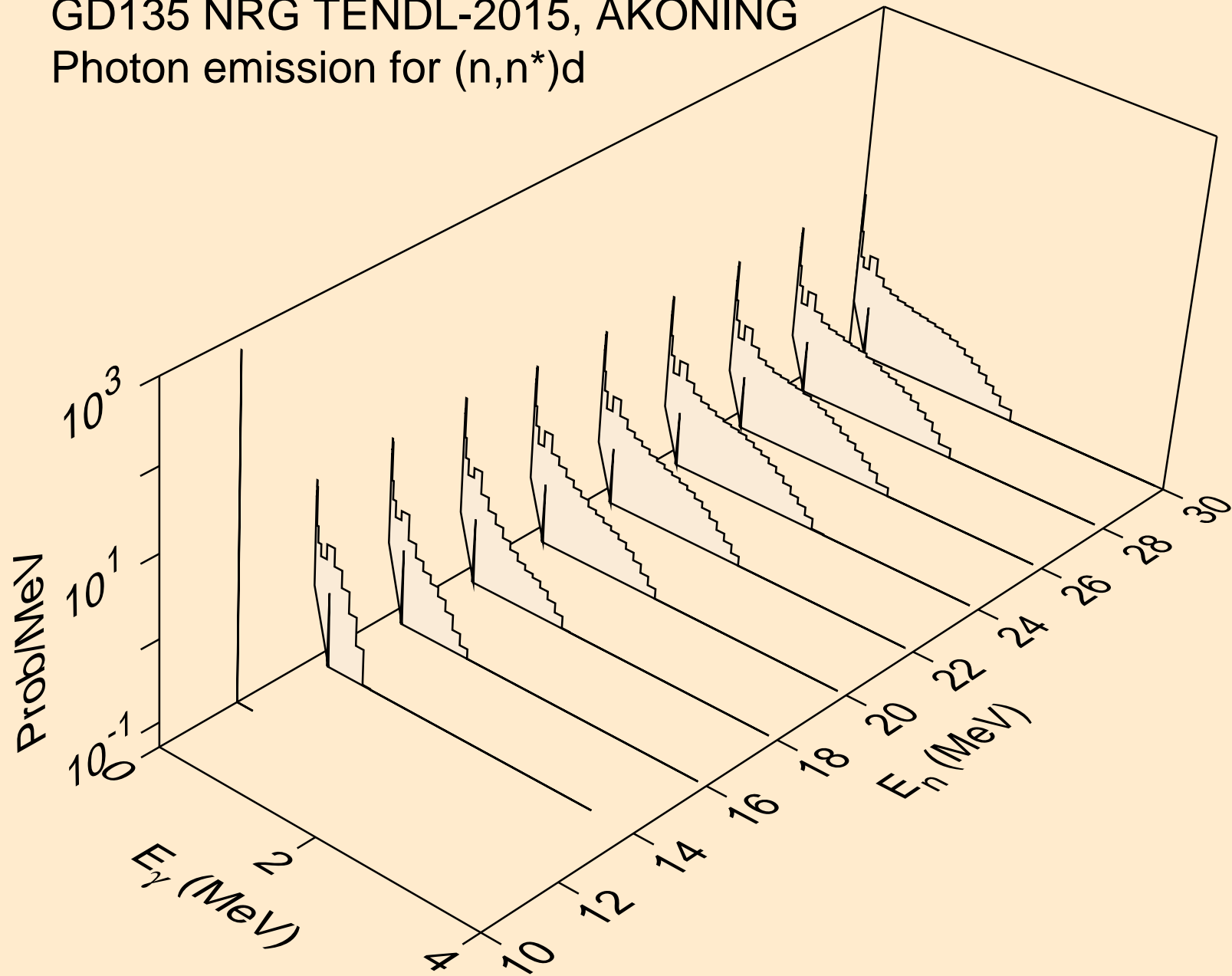

GD135 NRG TENDL-2015, AKONING
Photon emission for (n,n*)t

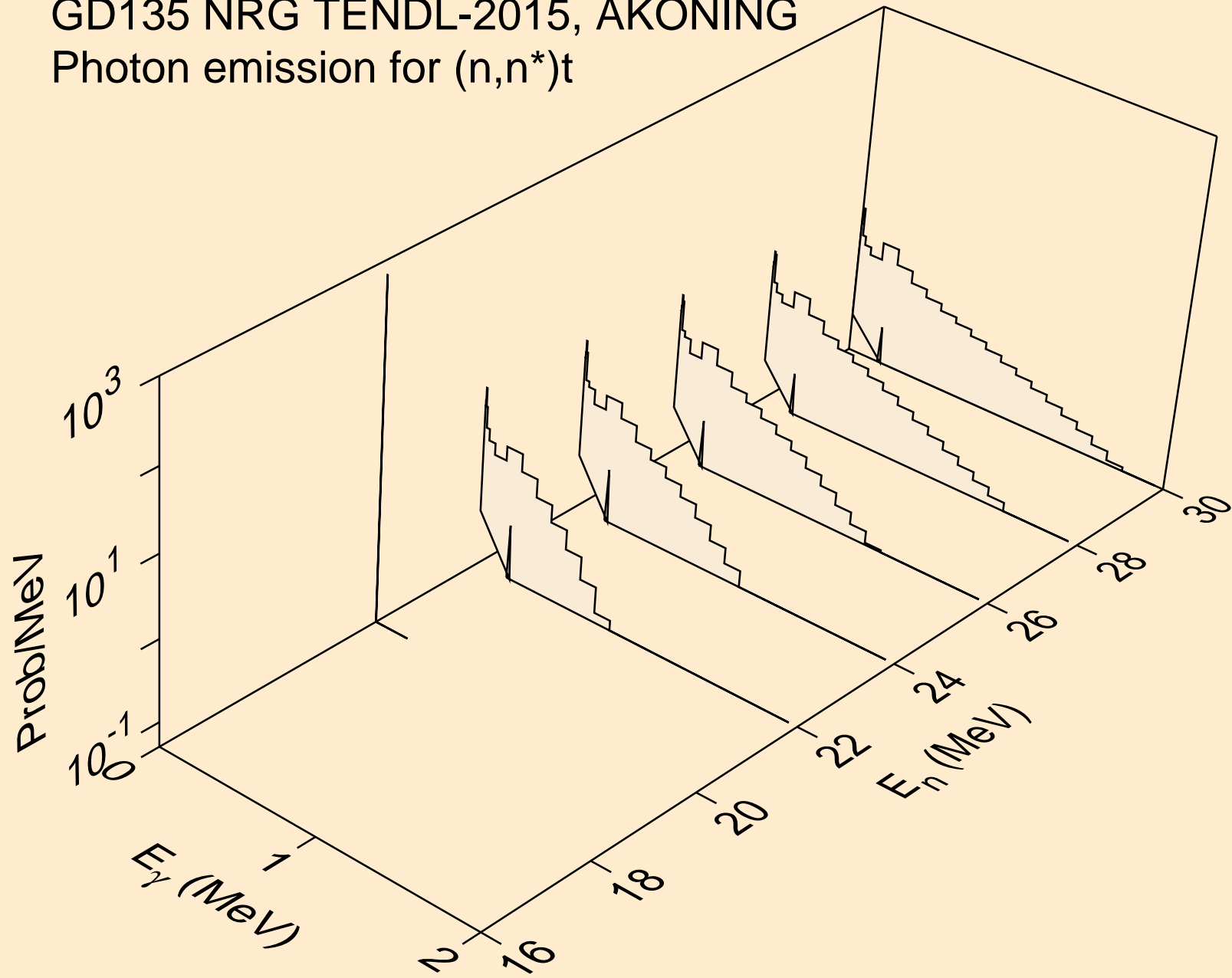

GD135 NRG TENDL-2015, AKONING
Photon emission for (n,n*)he3

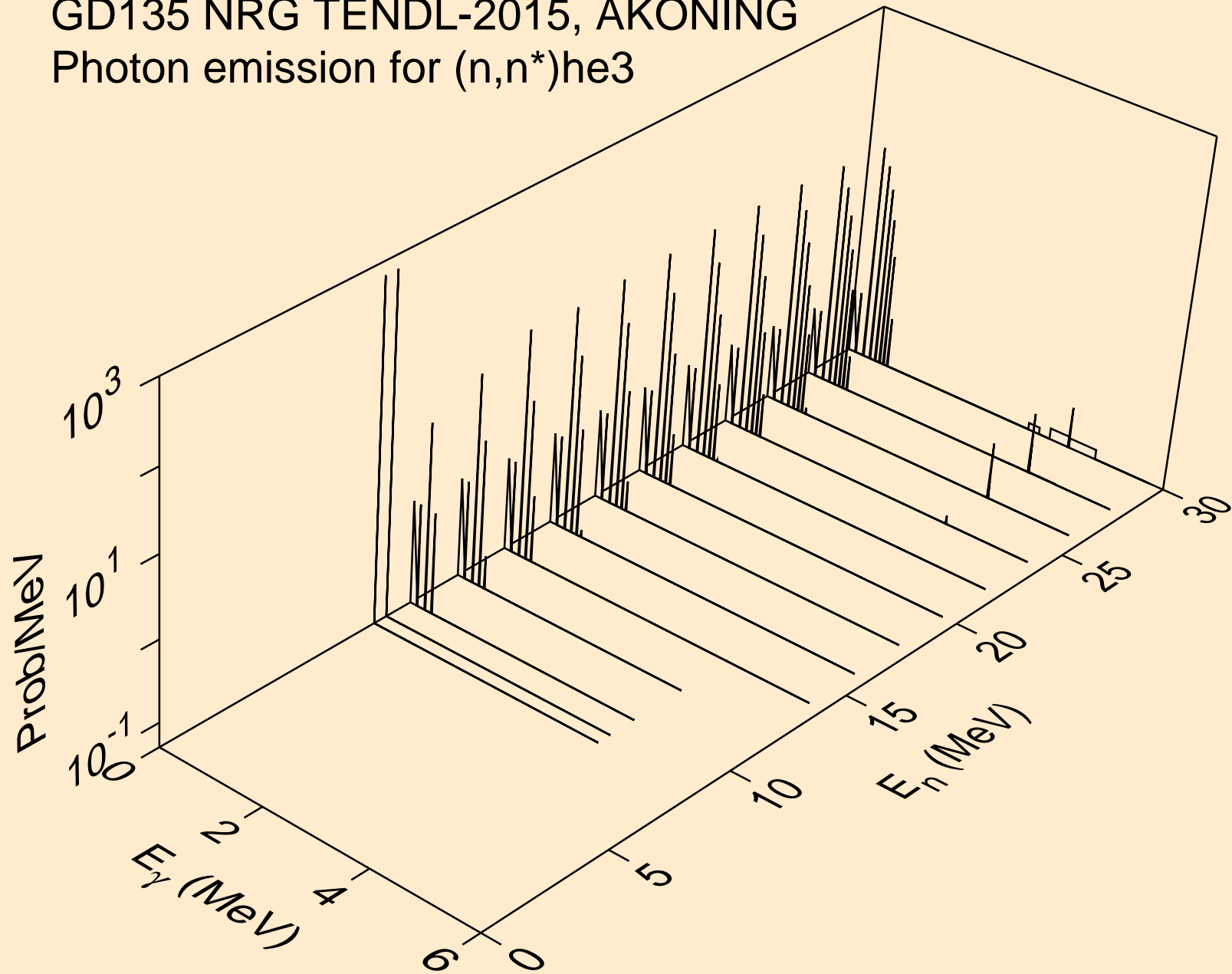

GD135 NRG TENDL-2015, AKONING
Photon emission for (n,2np)

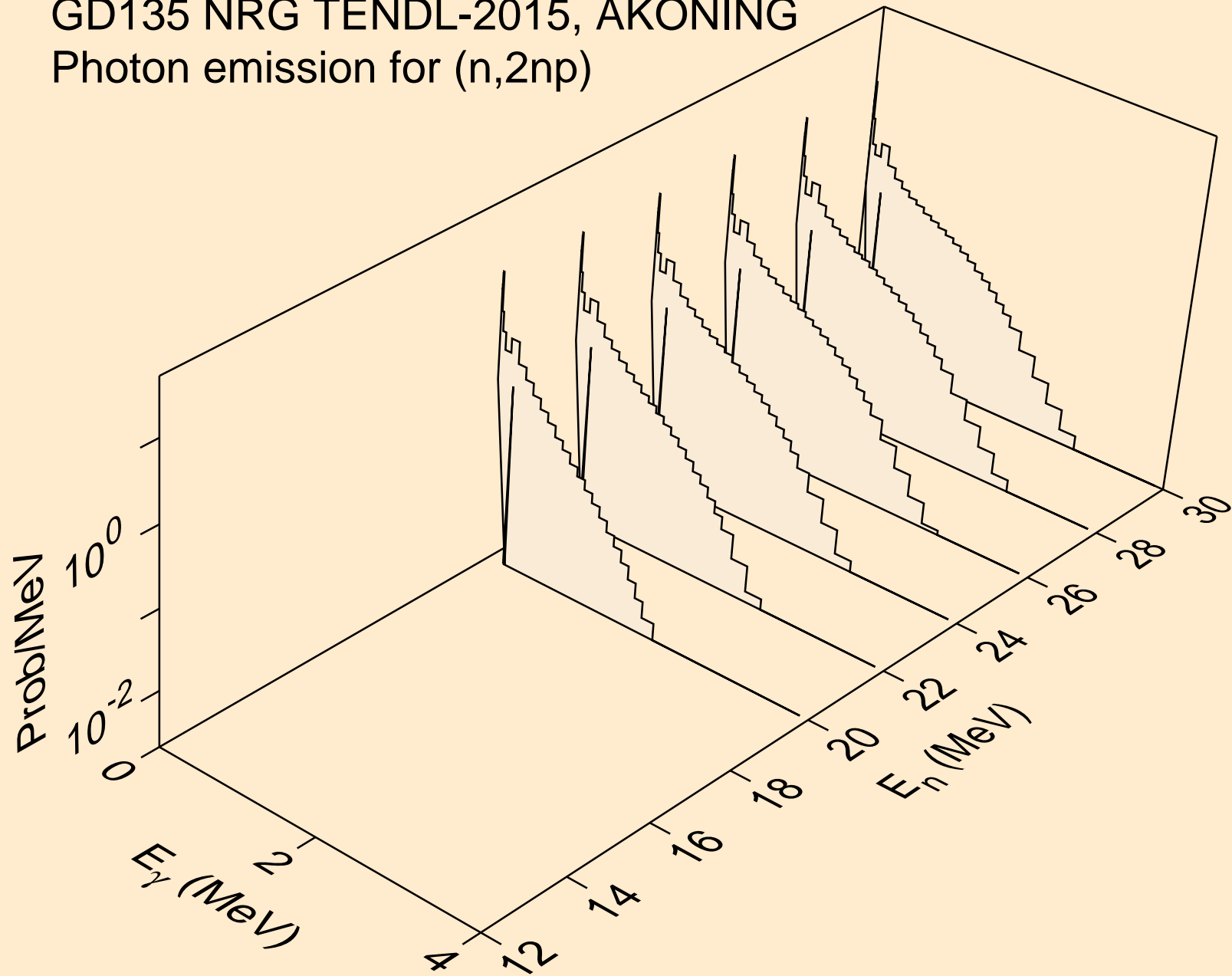

GD135 NRG TENDL-2015, AKONING
Photon emission for (n,3np)

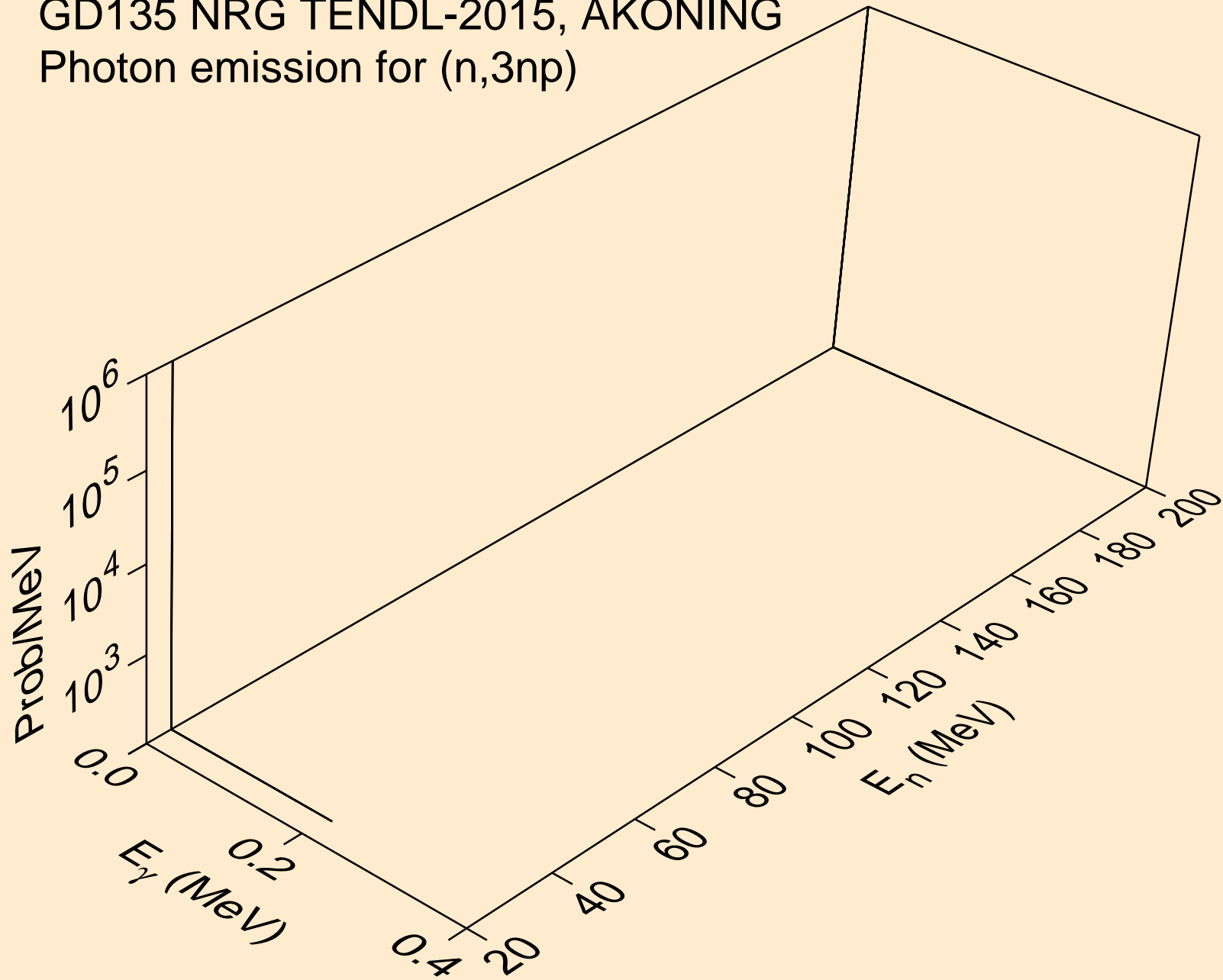

GD135 NRG TENDL-2015, AKONING
Photon emission for (n,2np)

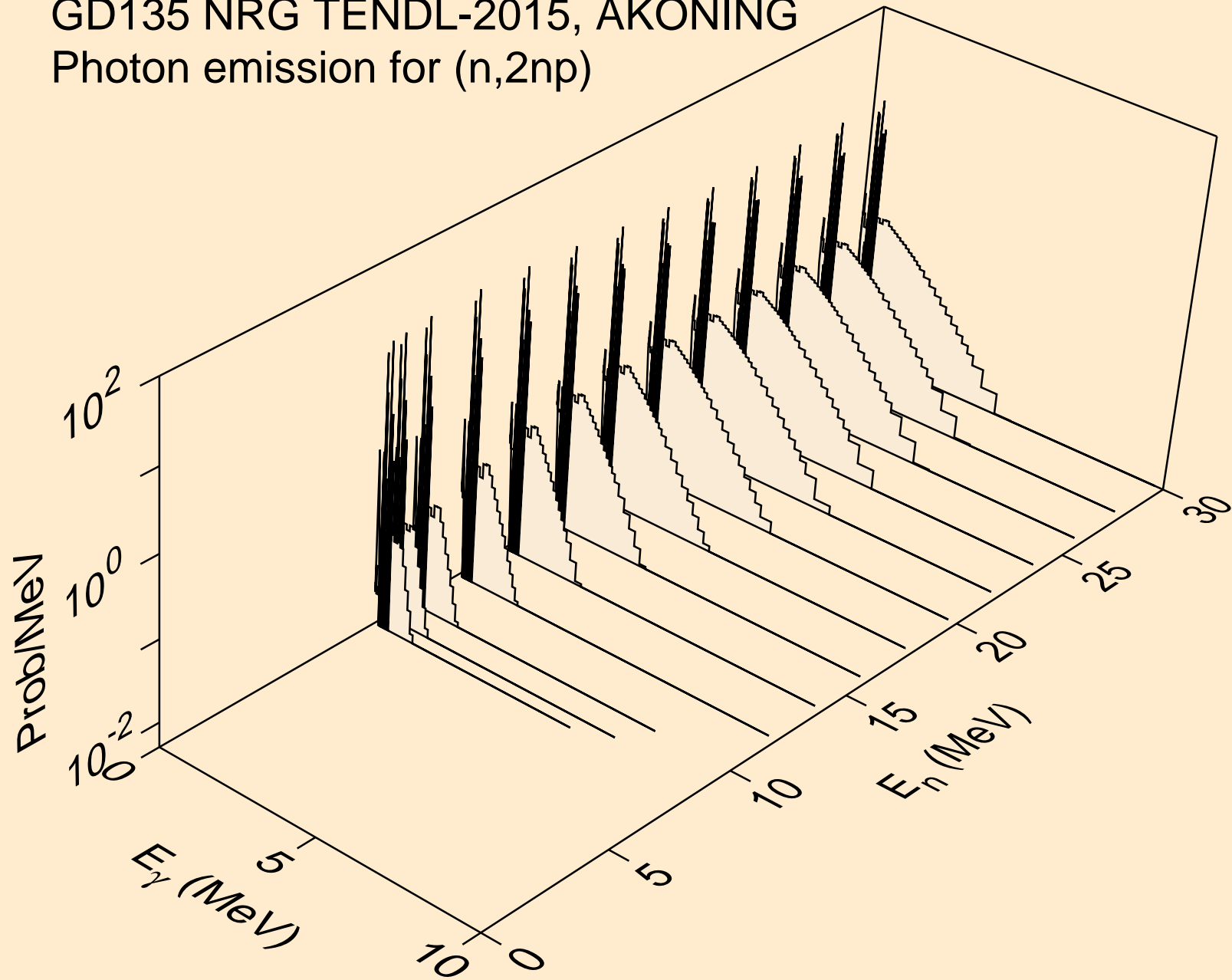

GD135 NRG TENDL-2015, AKONING
Photon emission for (n,npa)

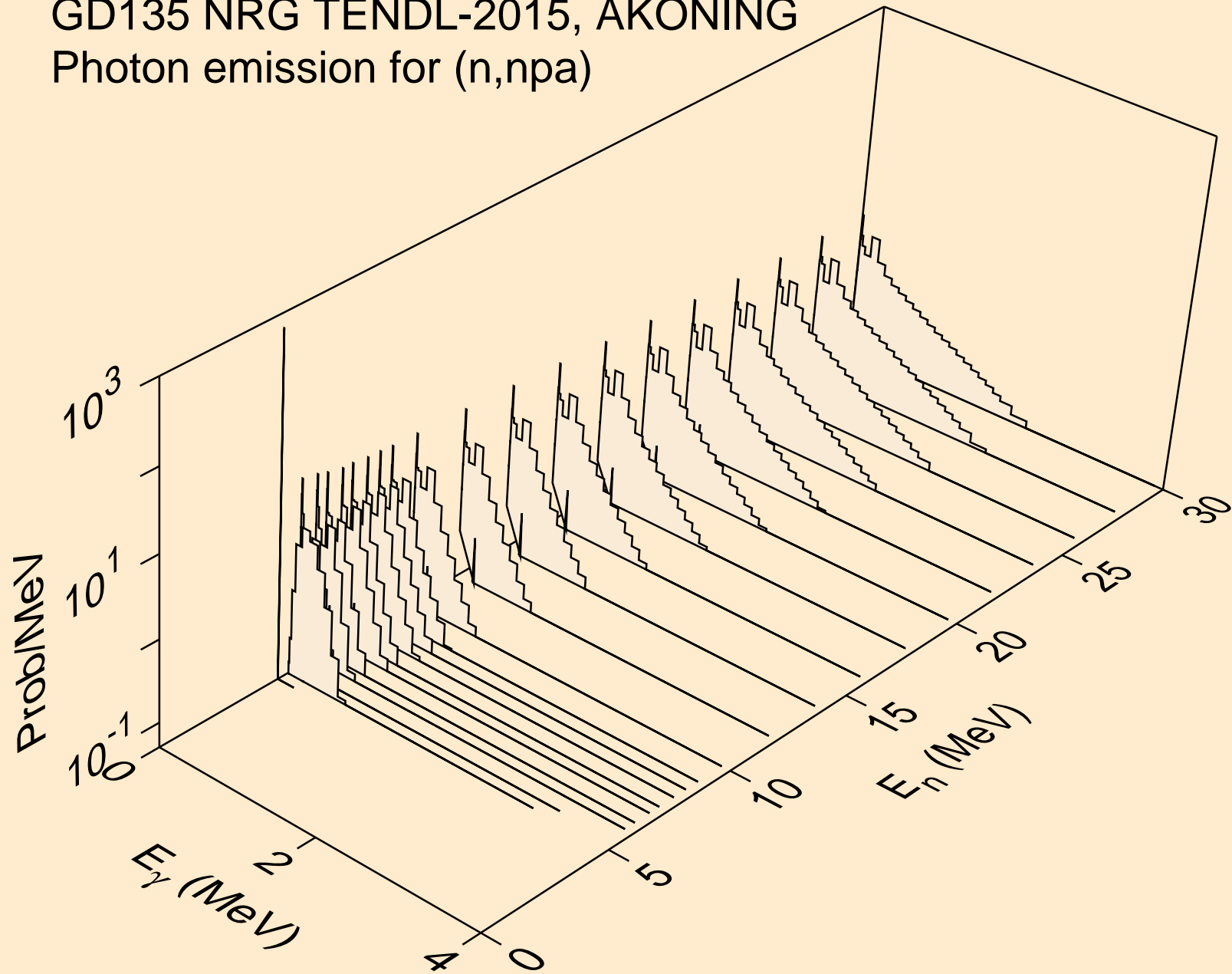

GD135 NRG TENDL-2015, AKONING
Photon emission for (n,n*c)

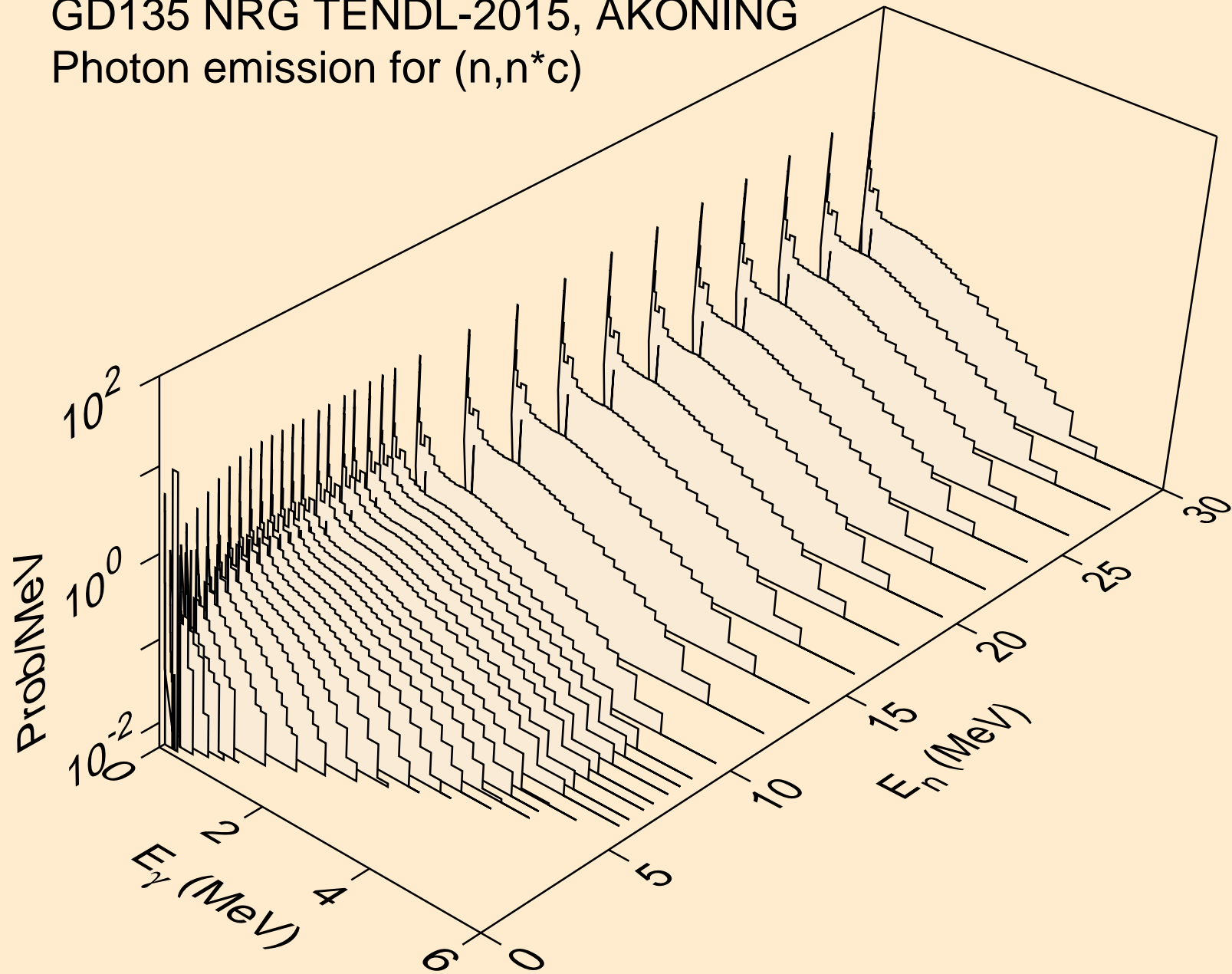

GD135 NRG TENDL-2015, AKONING
Photon emission for (n,gma)

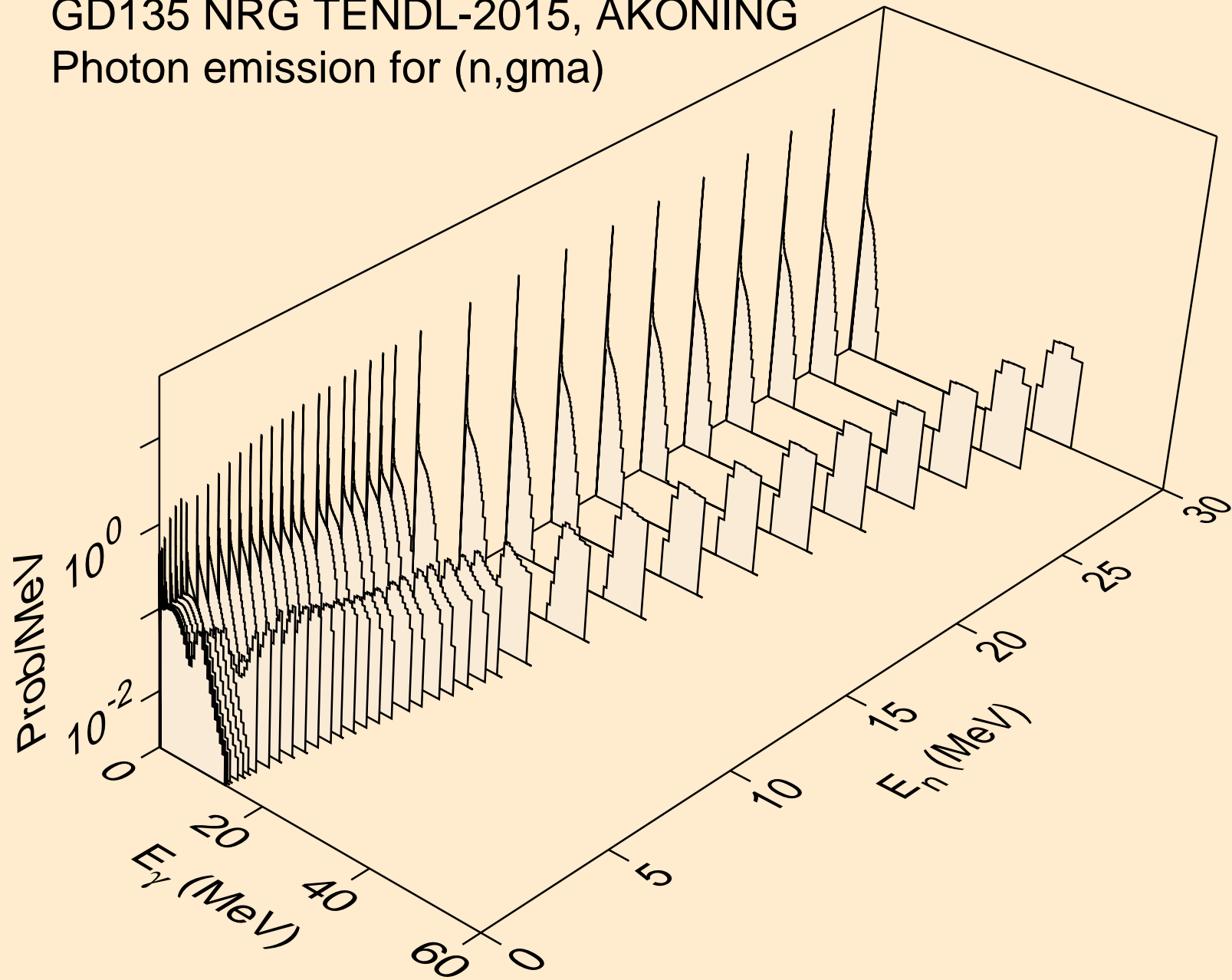

GD135 NRG TENDL-2015, AKONING
Photon emission for (n,p)

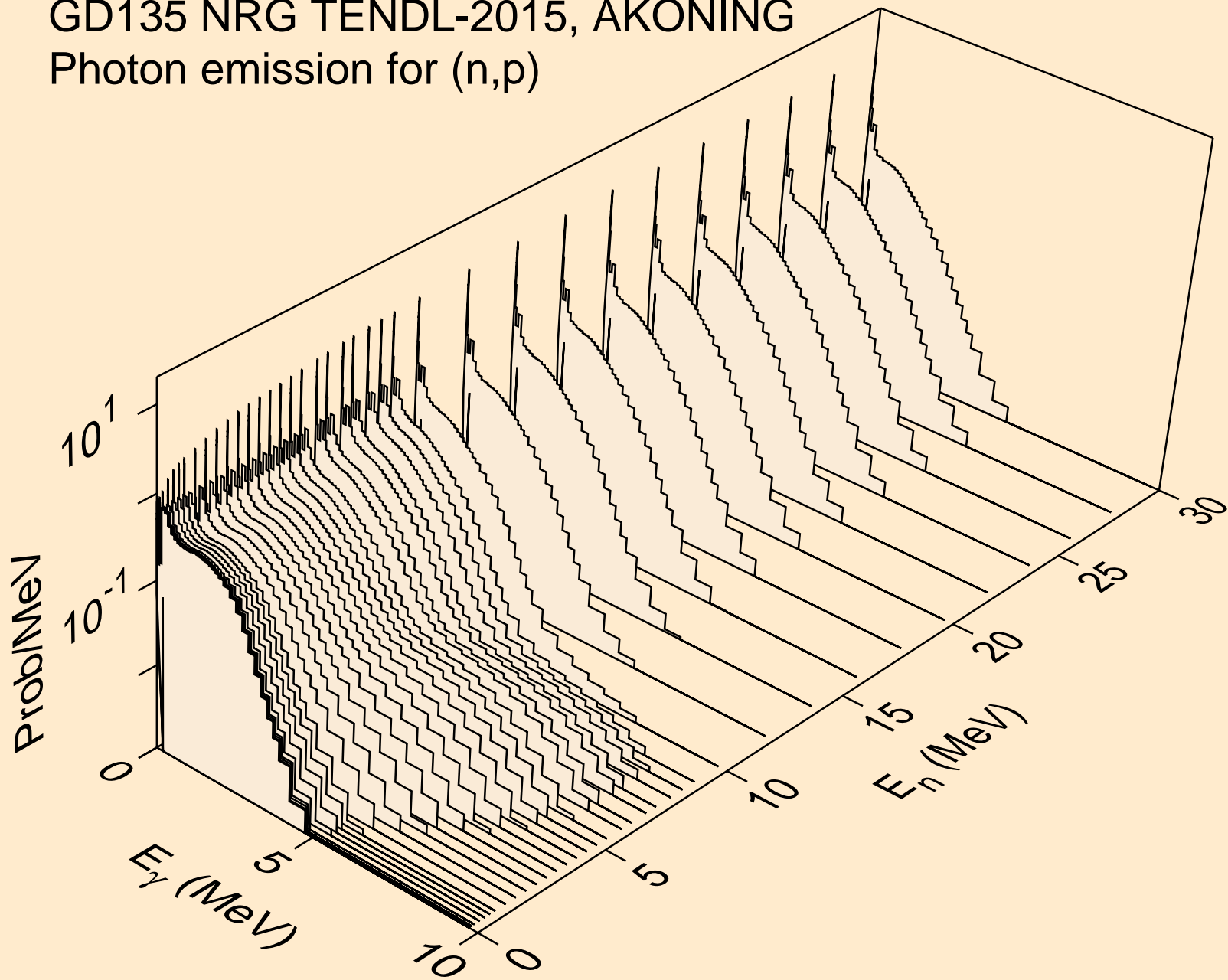

GD135 NRG TENDL-2015, AKONING
Photon emission for (n,d)

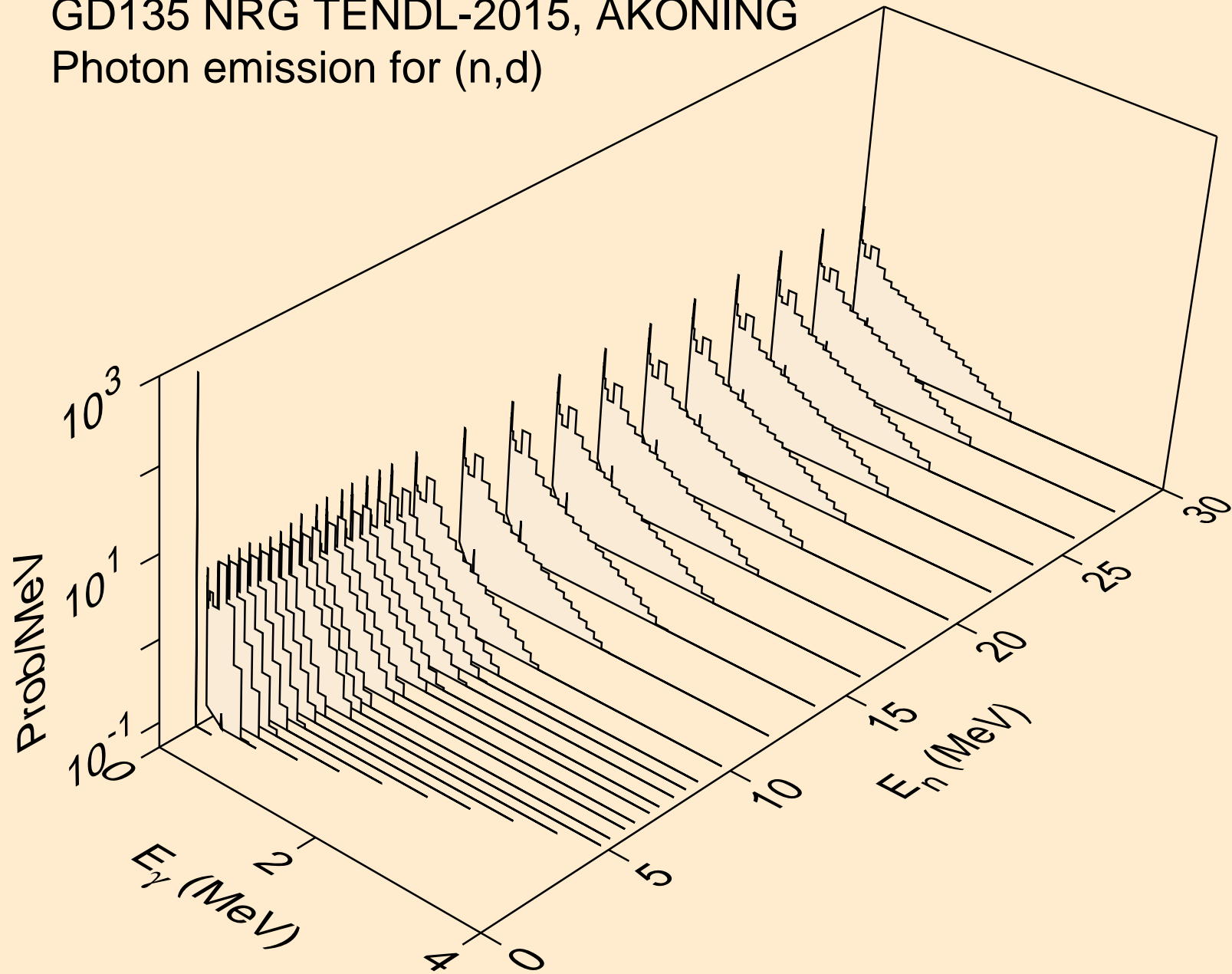

GD135 NRG TENDL-2015, AKONING
Photon emission for (n,t)

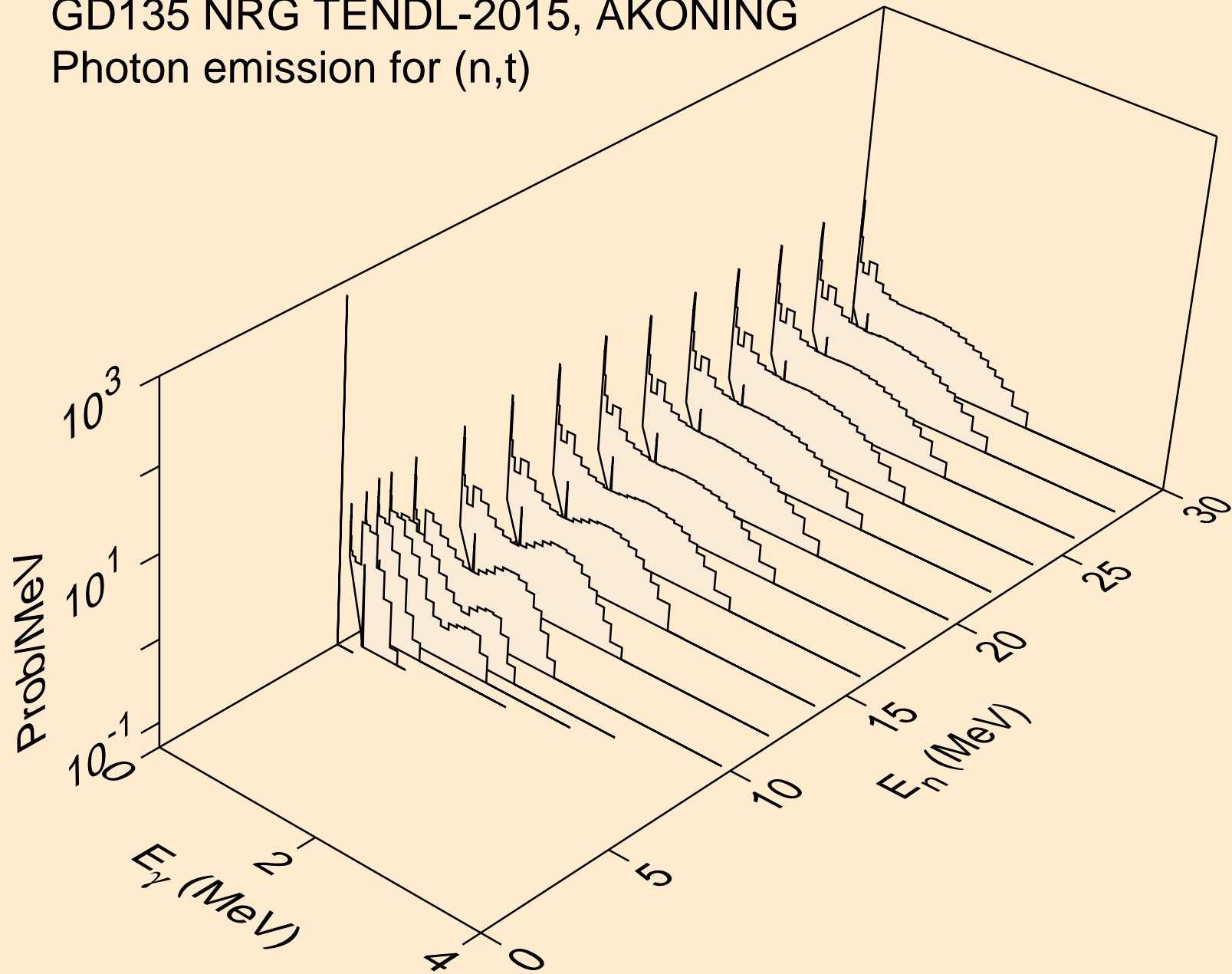

GD135 NRG TENDL-2015, AKONING
Photon emission for (n,he3)

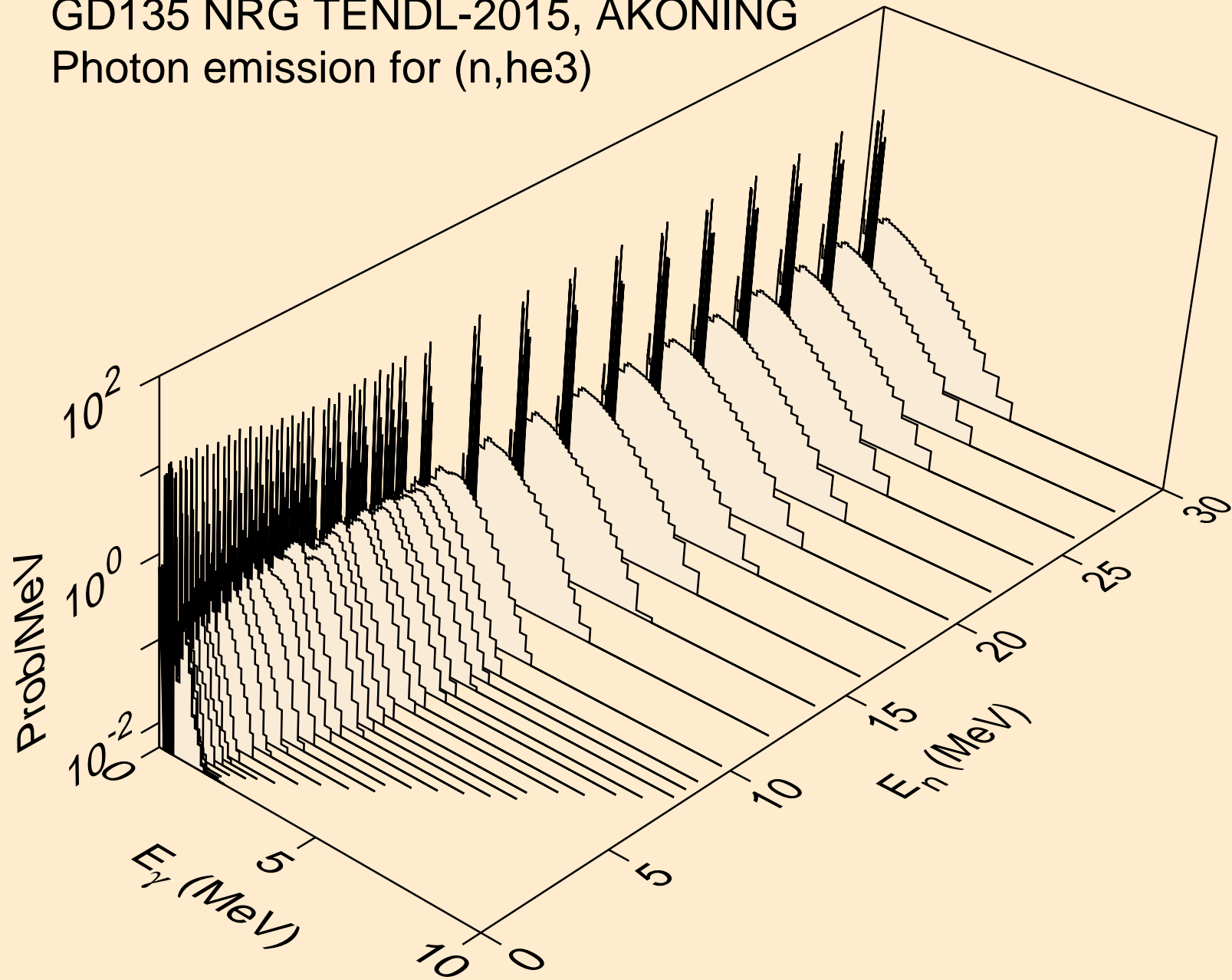

GD135 NRG TENDL-2015, AKONING
Photon emission for (n,a)

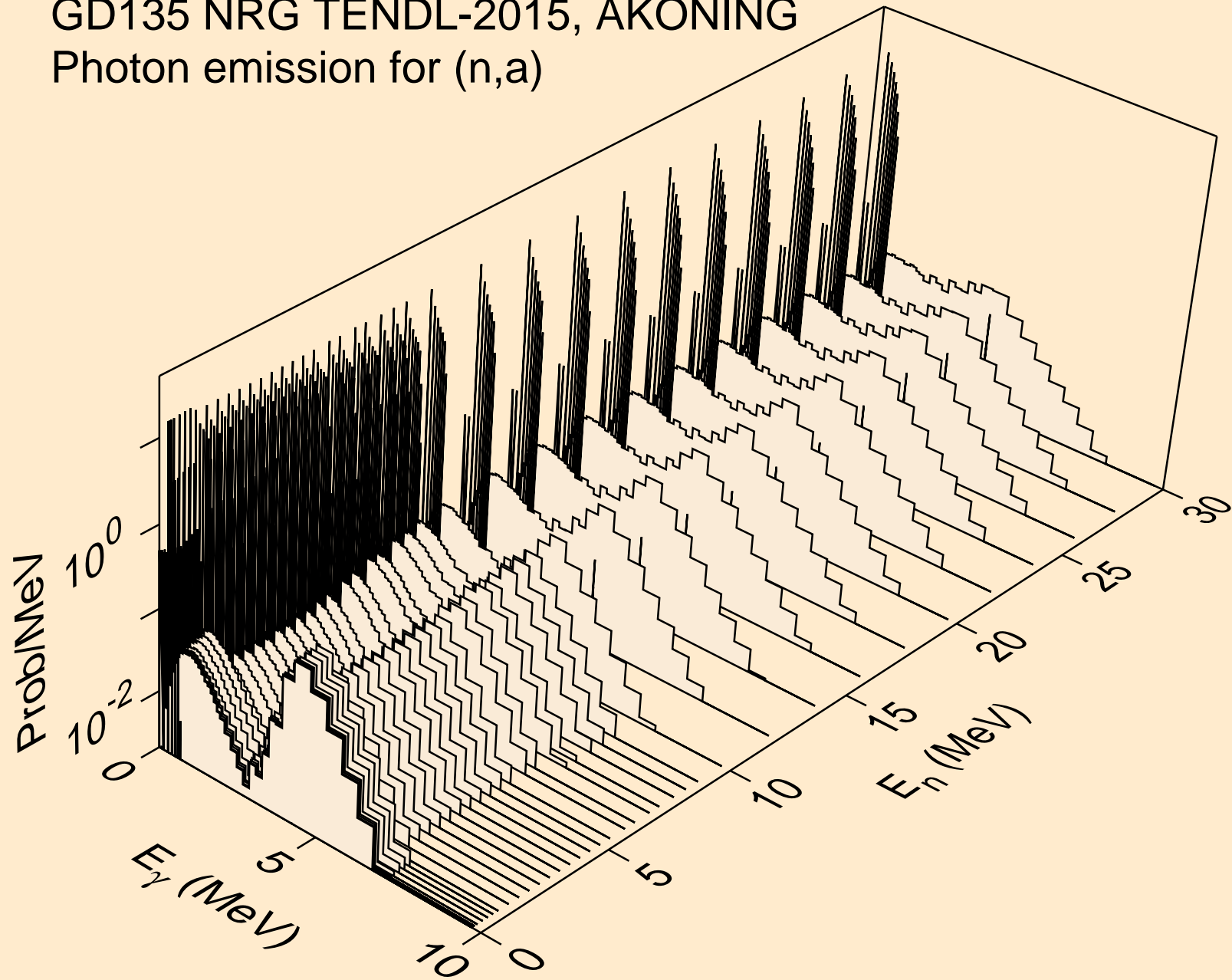

GD135 NRG TENDL-2015, AKONING
Photon emission for (n,2a)

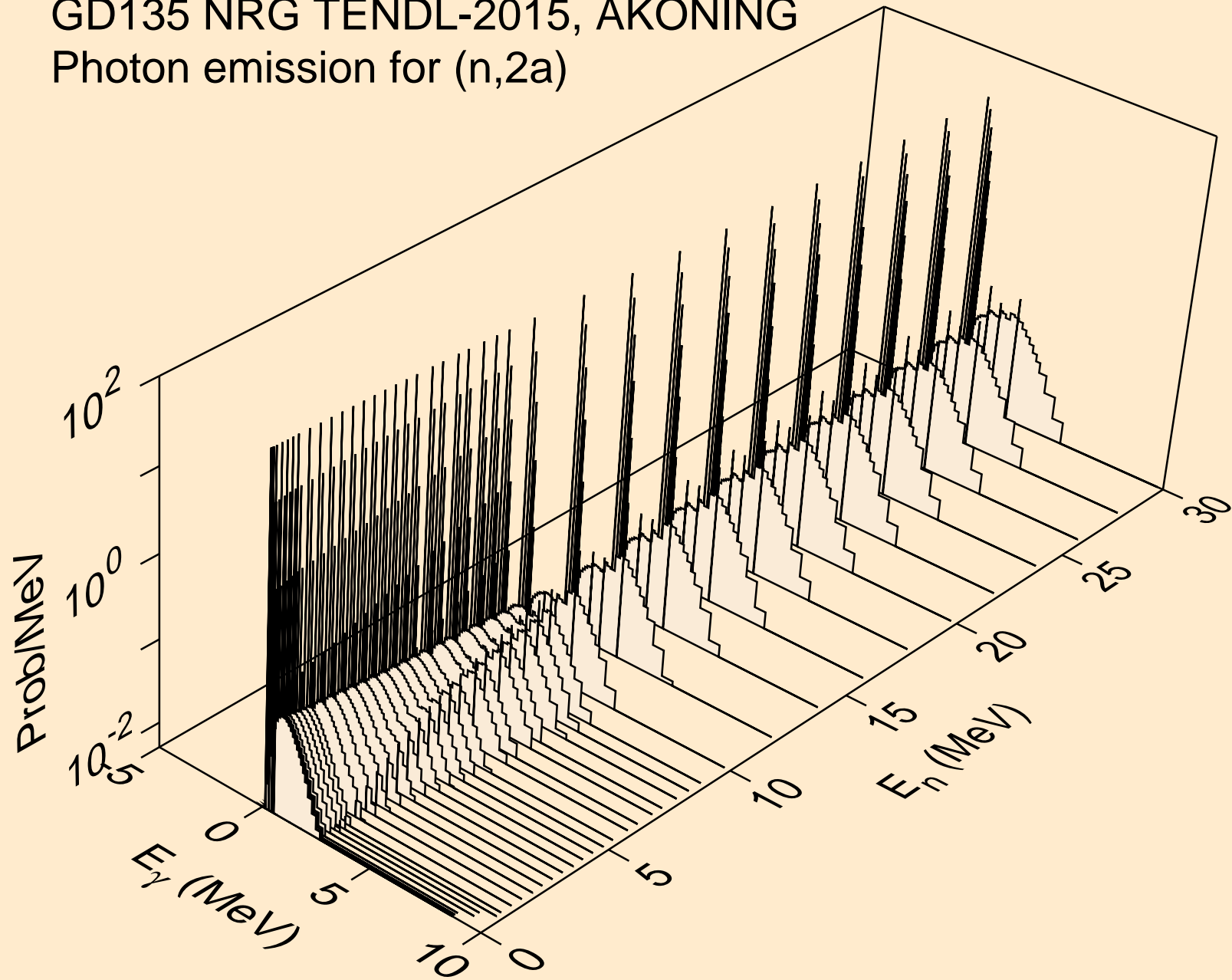

GD135 NRG TENDL-2015, AKONING
Photon emission for (n,3a)

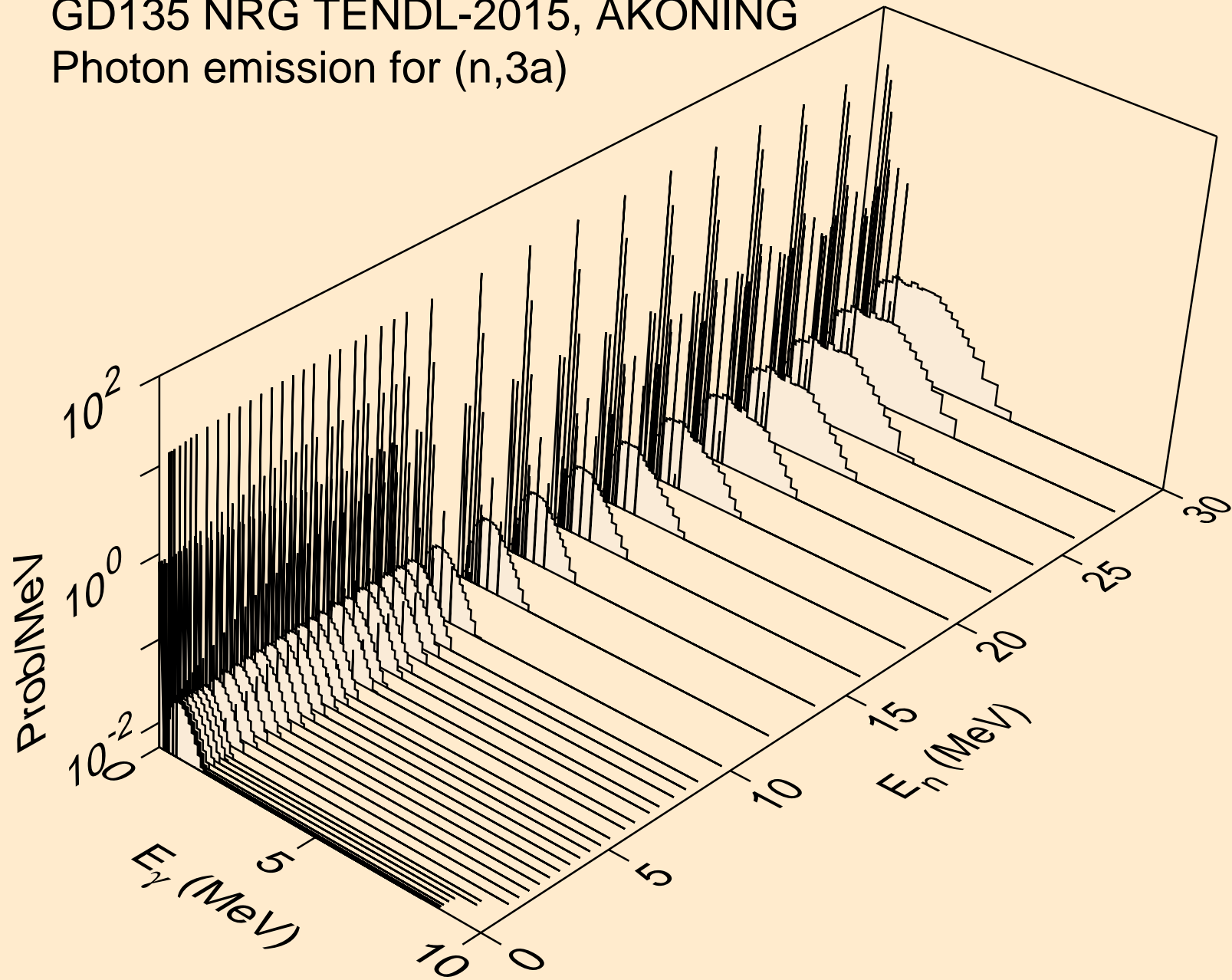

GD135 NRG TENDL-2015, AKONING
Photon emission for (n,2p)

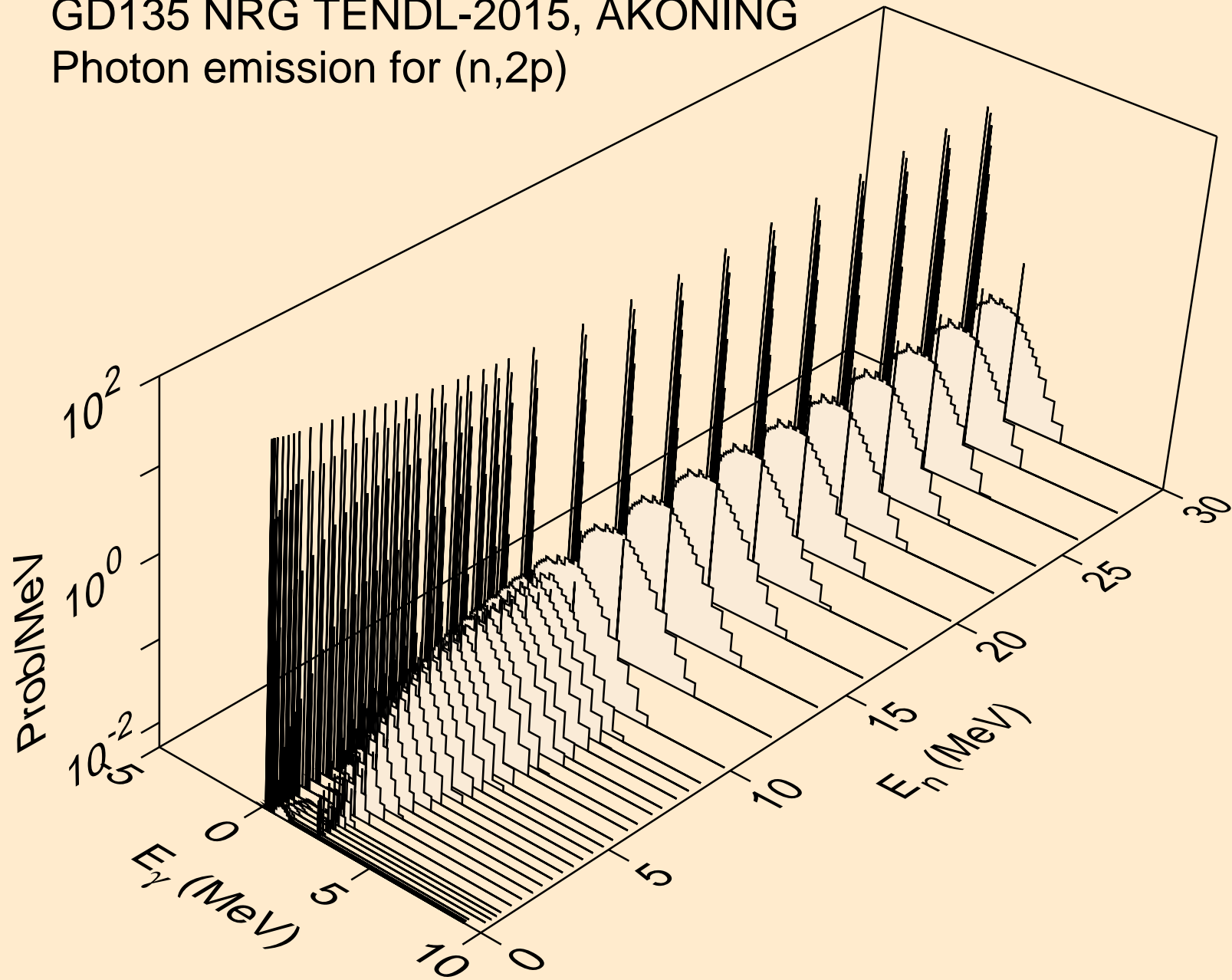

GD135 NRG TENDL-2015, AKONING
Photon emission for (n,p α)

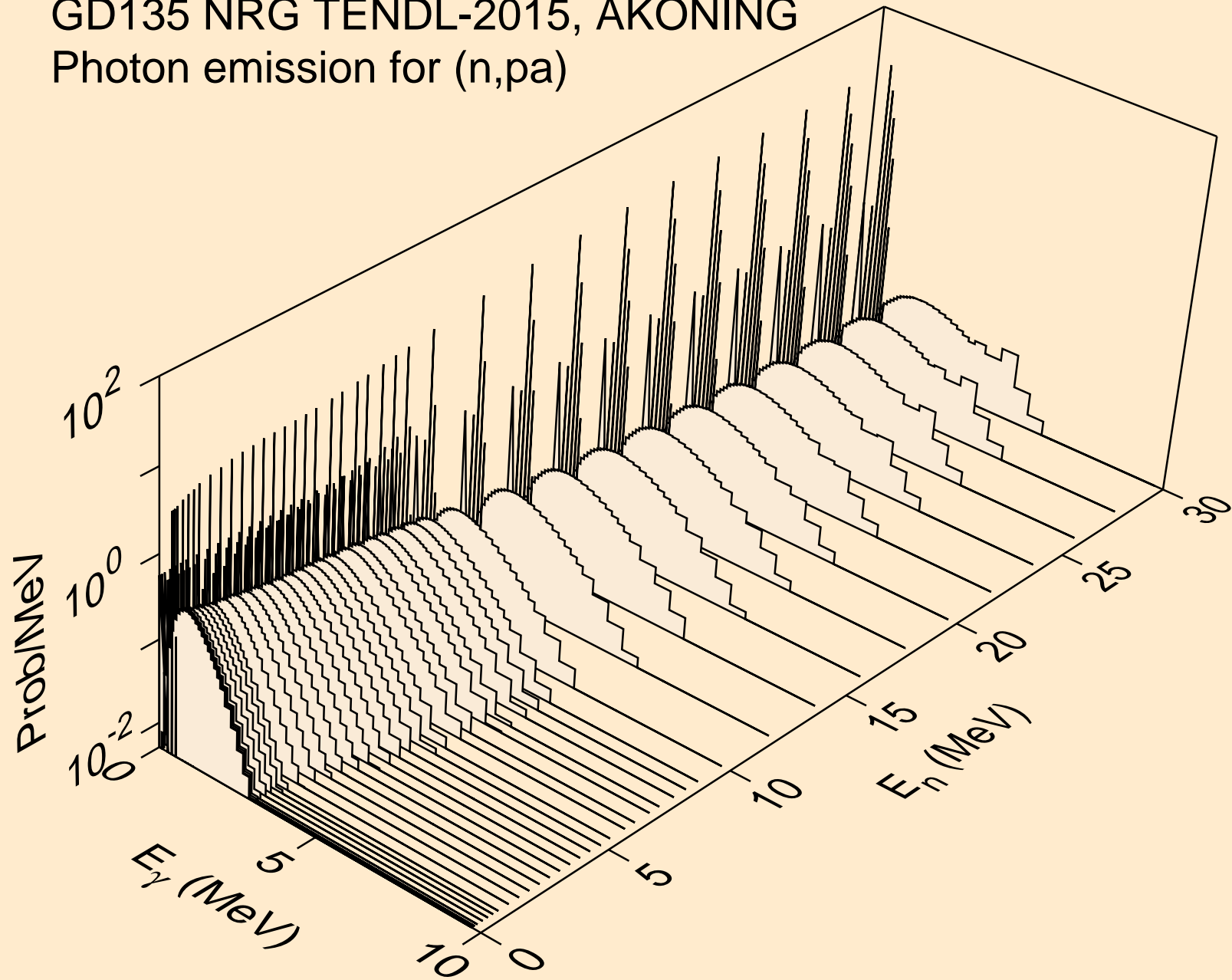

GD135 NRG TENDL-2015, AKONING
Photon emission for (n,d2a)

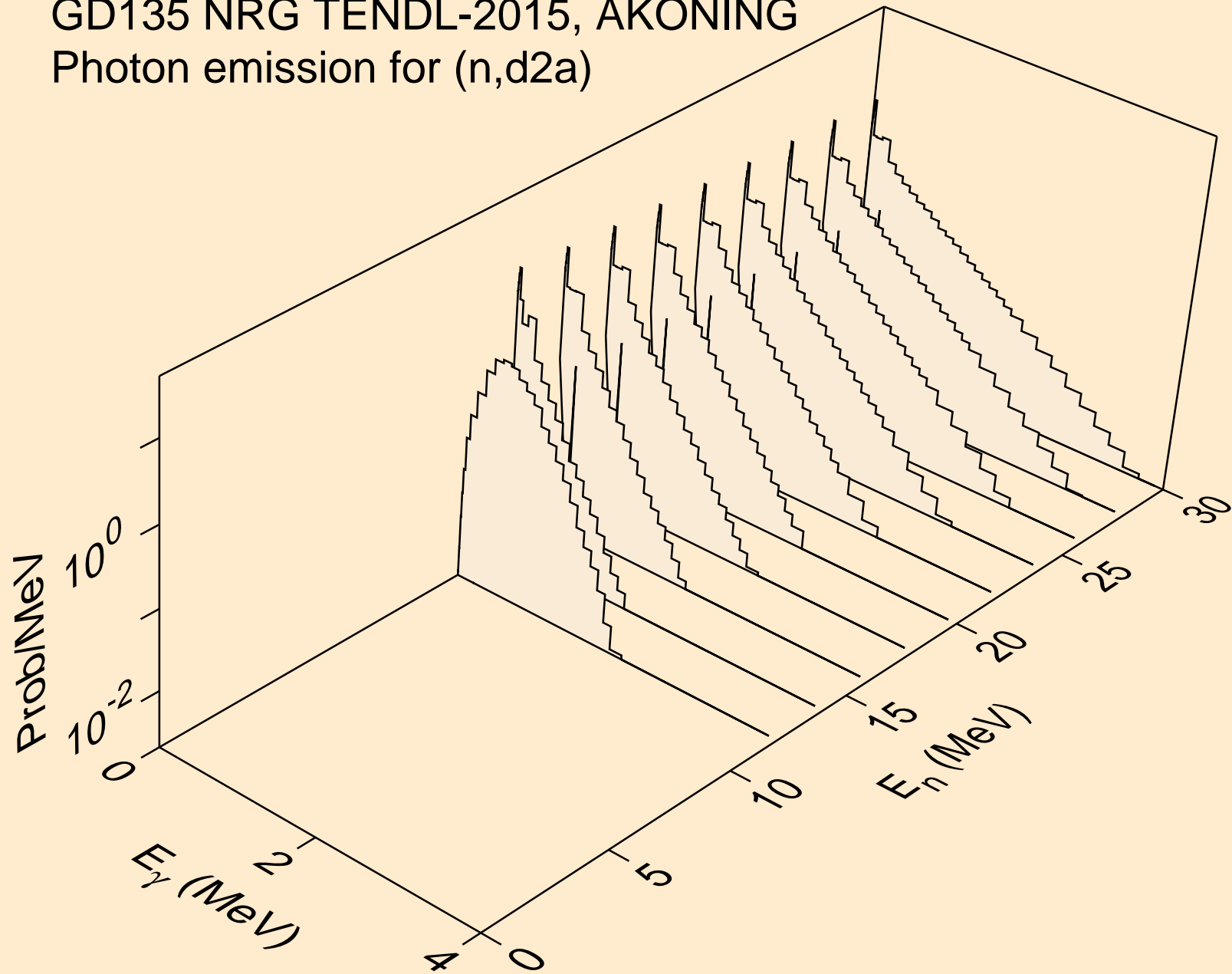

GD135 NRG TENDL-2015, AKONING
Photon emission for (n,pd)

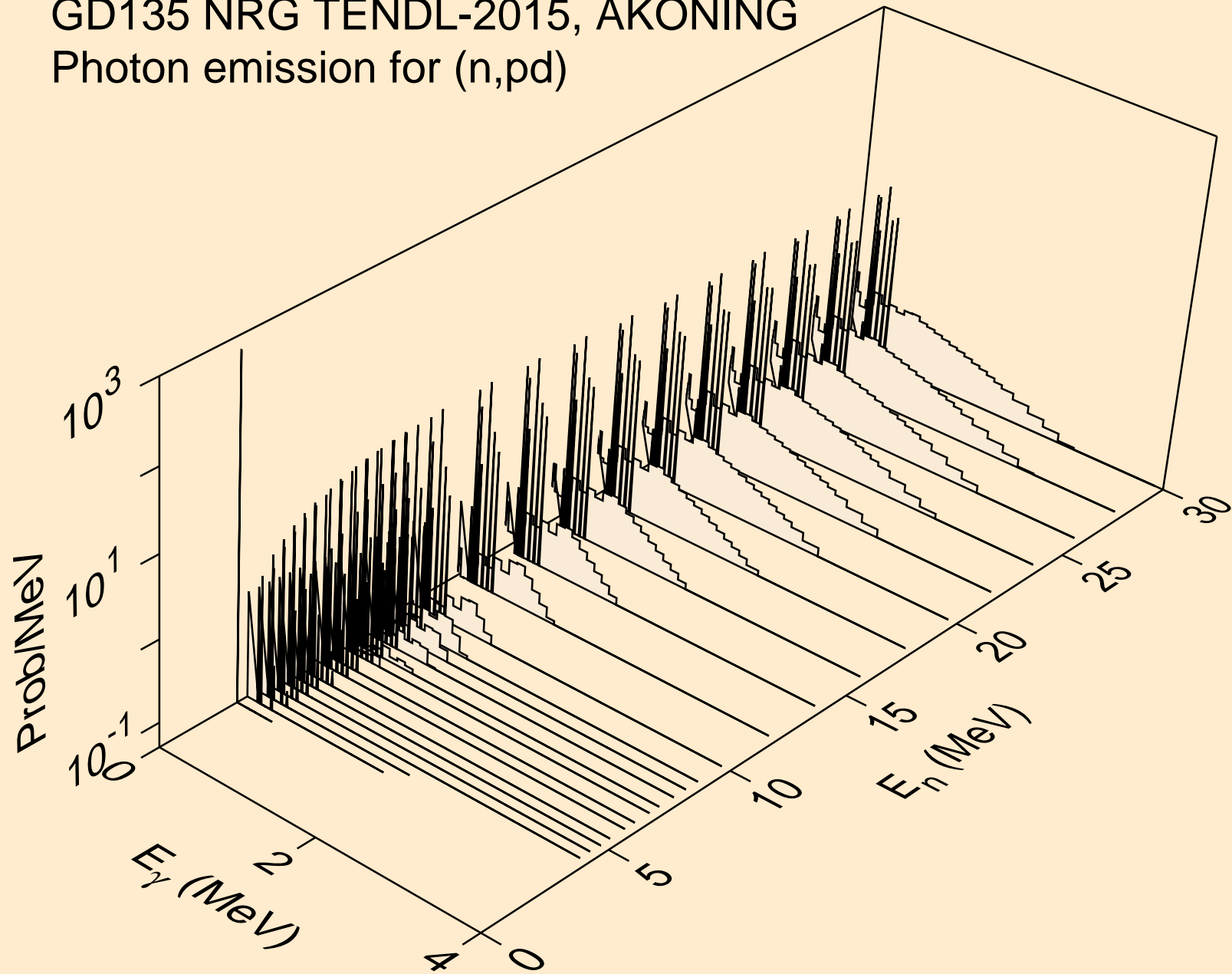

GD135 NRG TENDL-2015, AKONING
Photon emission for (n,pt)

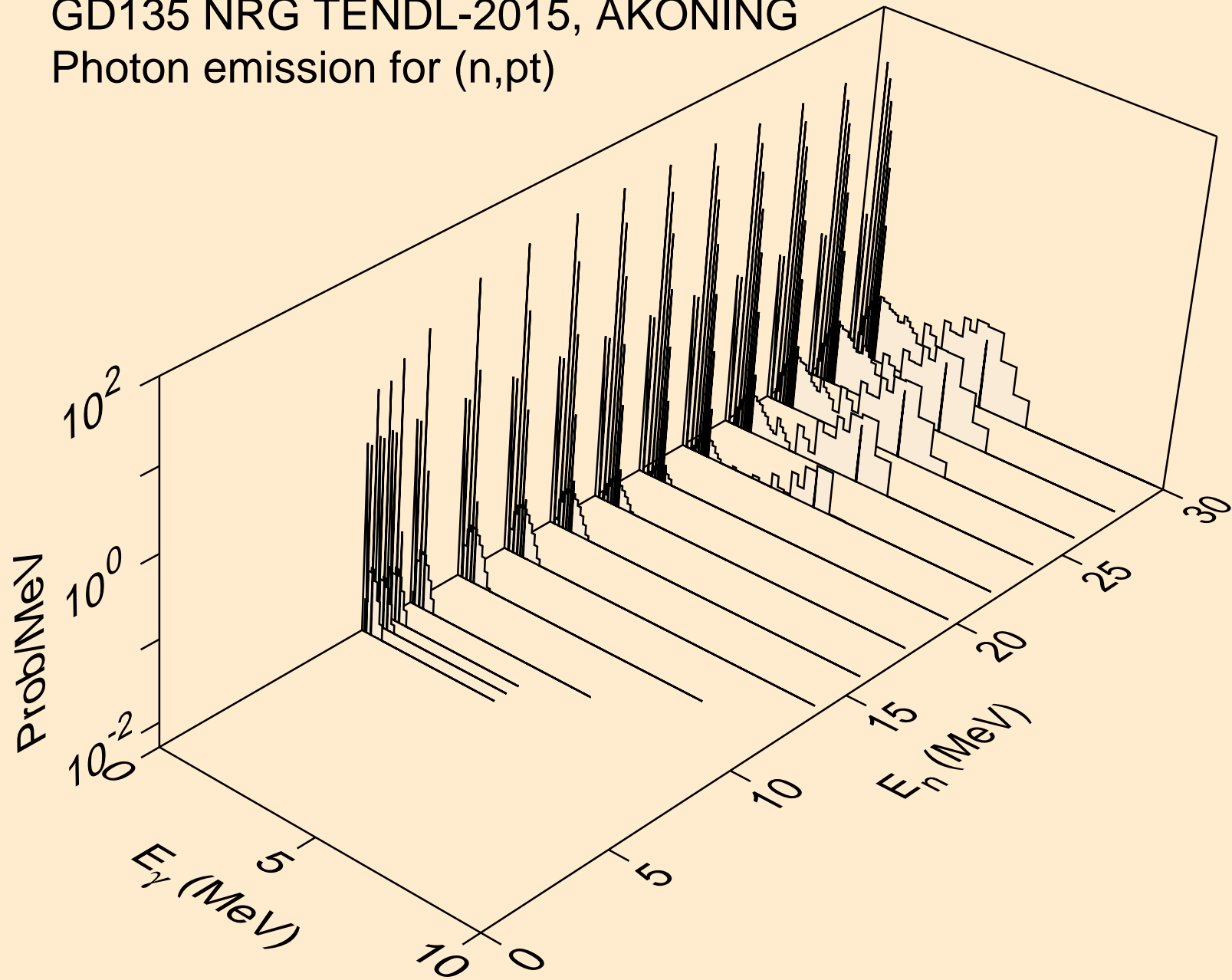

GD135 NRG TENDL-2015, AKONING
Photon emission for (n,da)

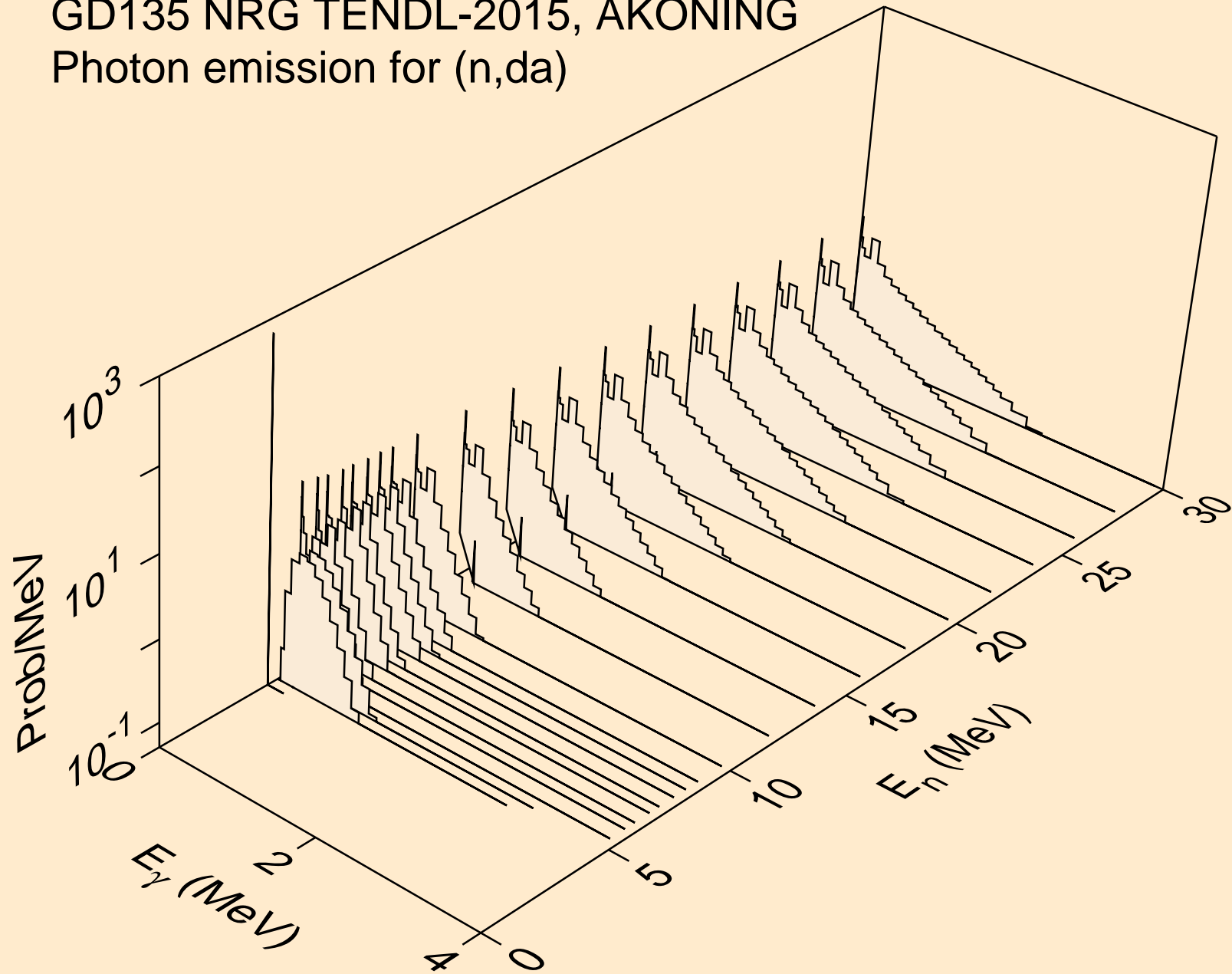

GD135 NRG TENDL-2015, AKONING
thermal capture photon spectrum

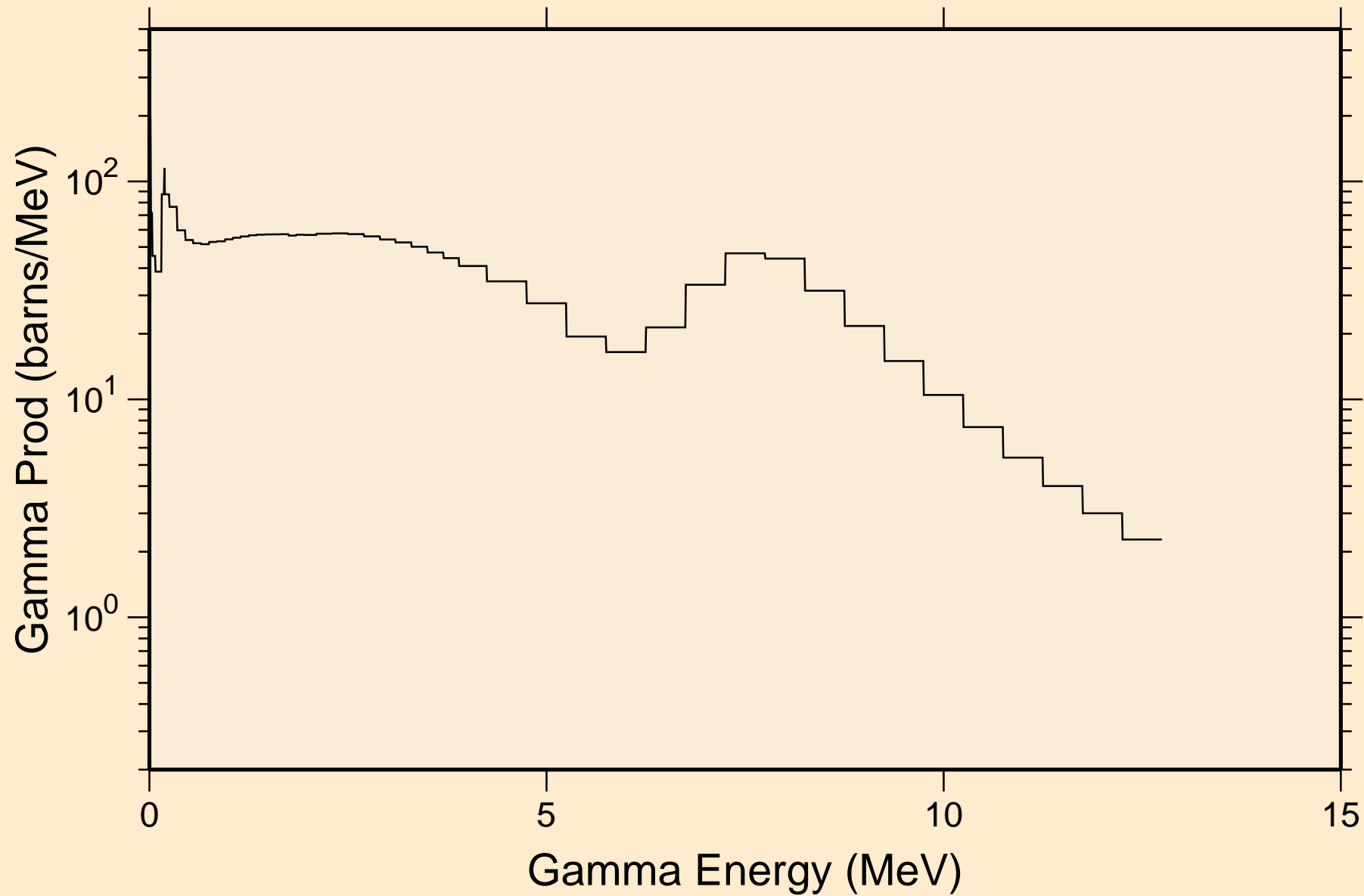

GD135 NRG TENDL-2015, AKONING
14 MeV photon spectrum

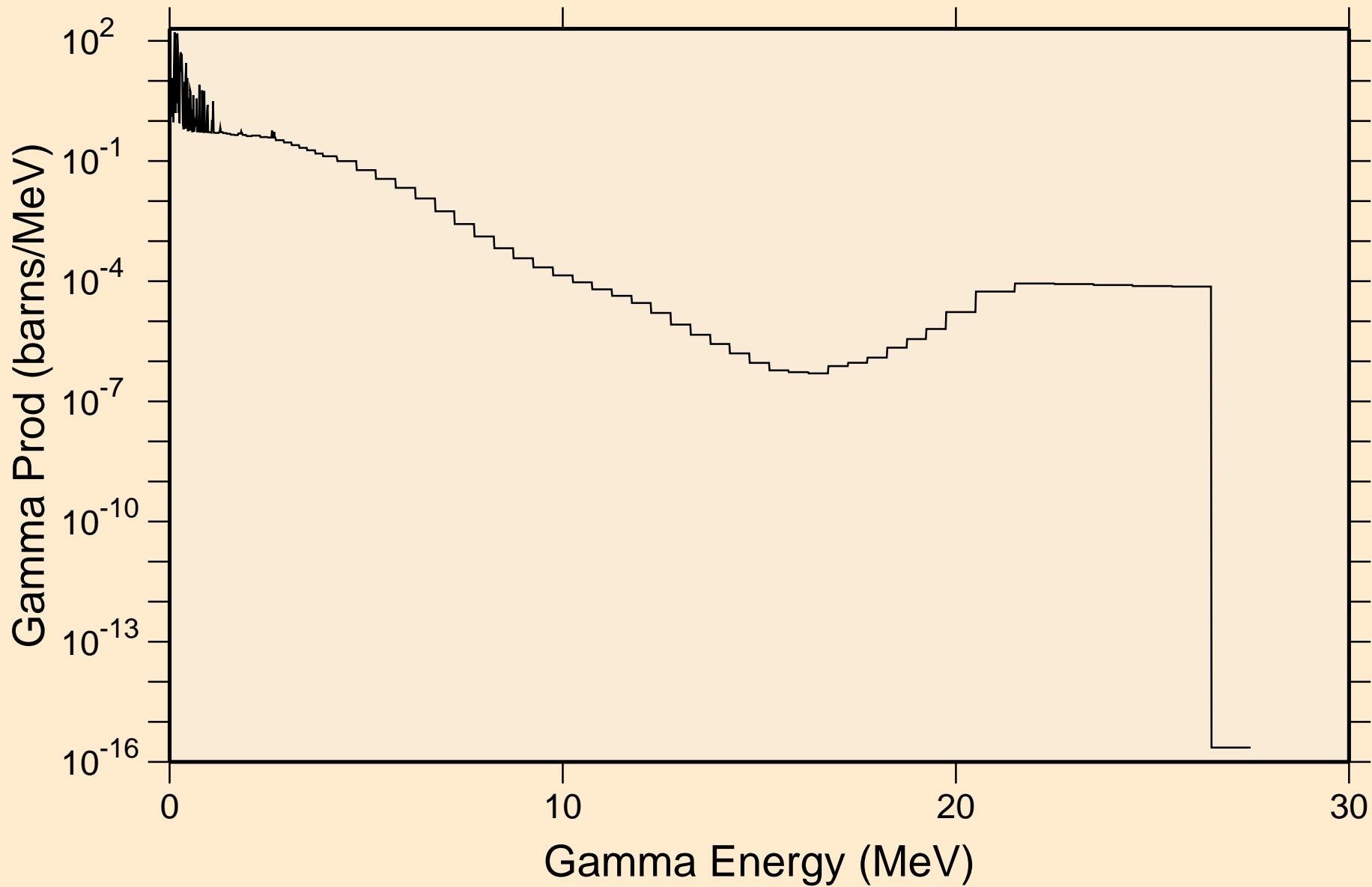

GD135 NRG TENDL-2015, AKONING

Particle heating contributions

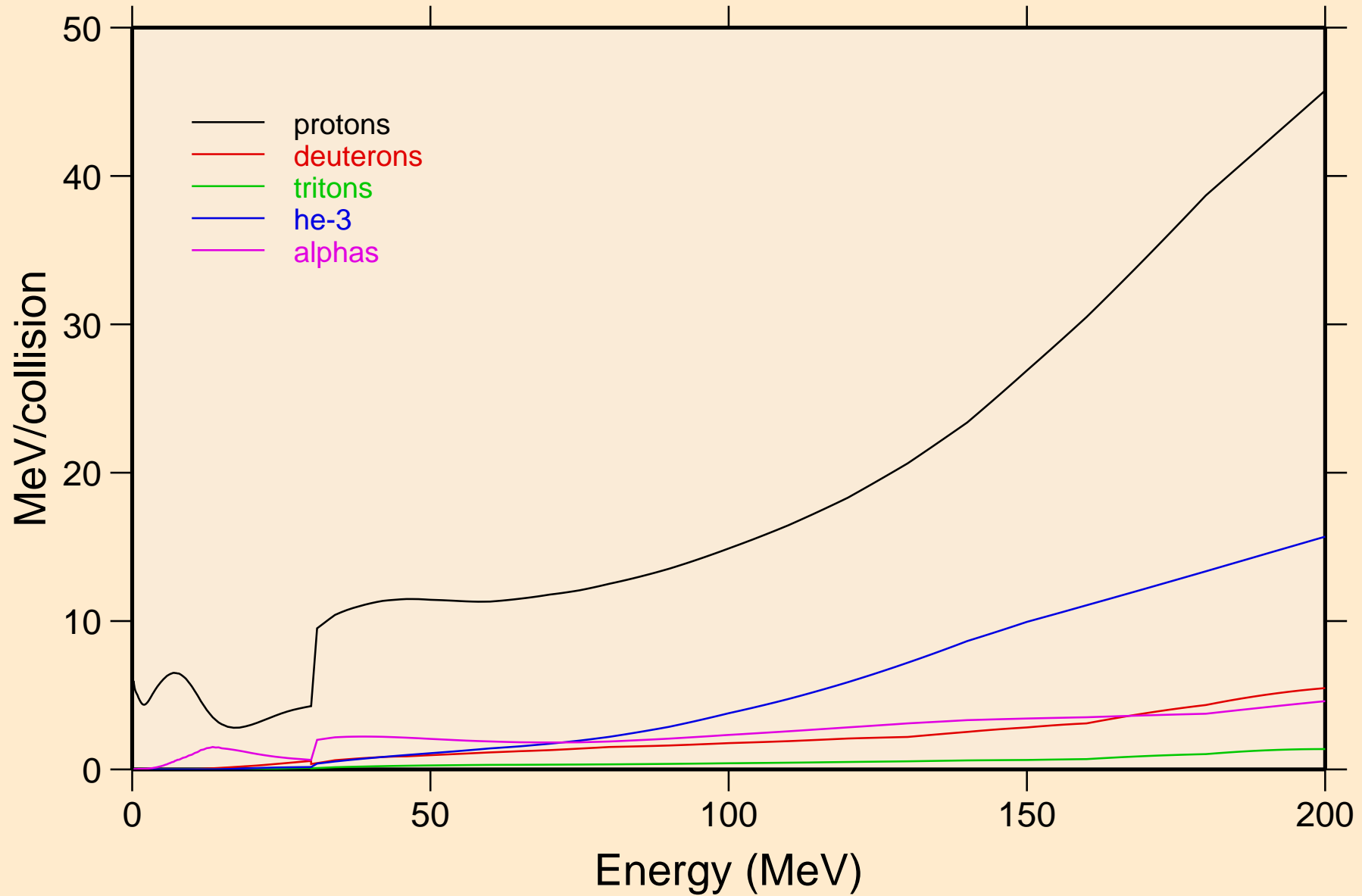

GD135 NRG TENDL-2015, AKONING

Recoil Heating

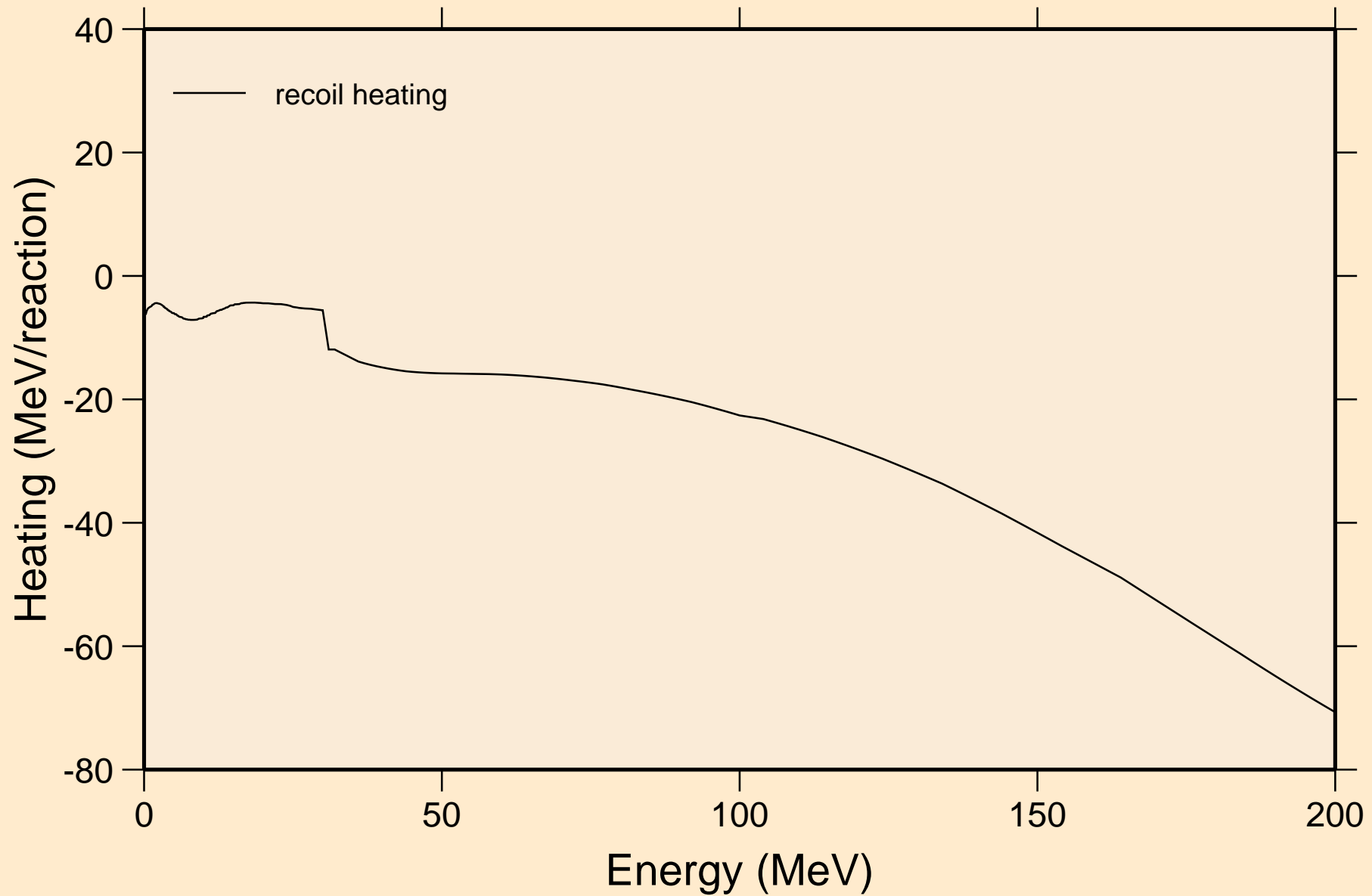

GD135 NRG TENDL-2015, AKONING

Particle production cross sections

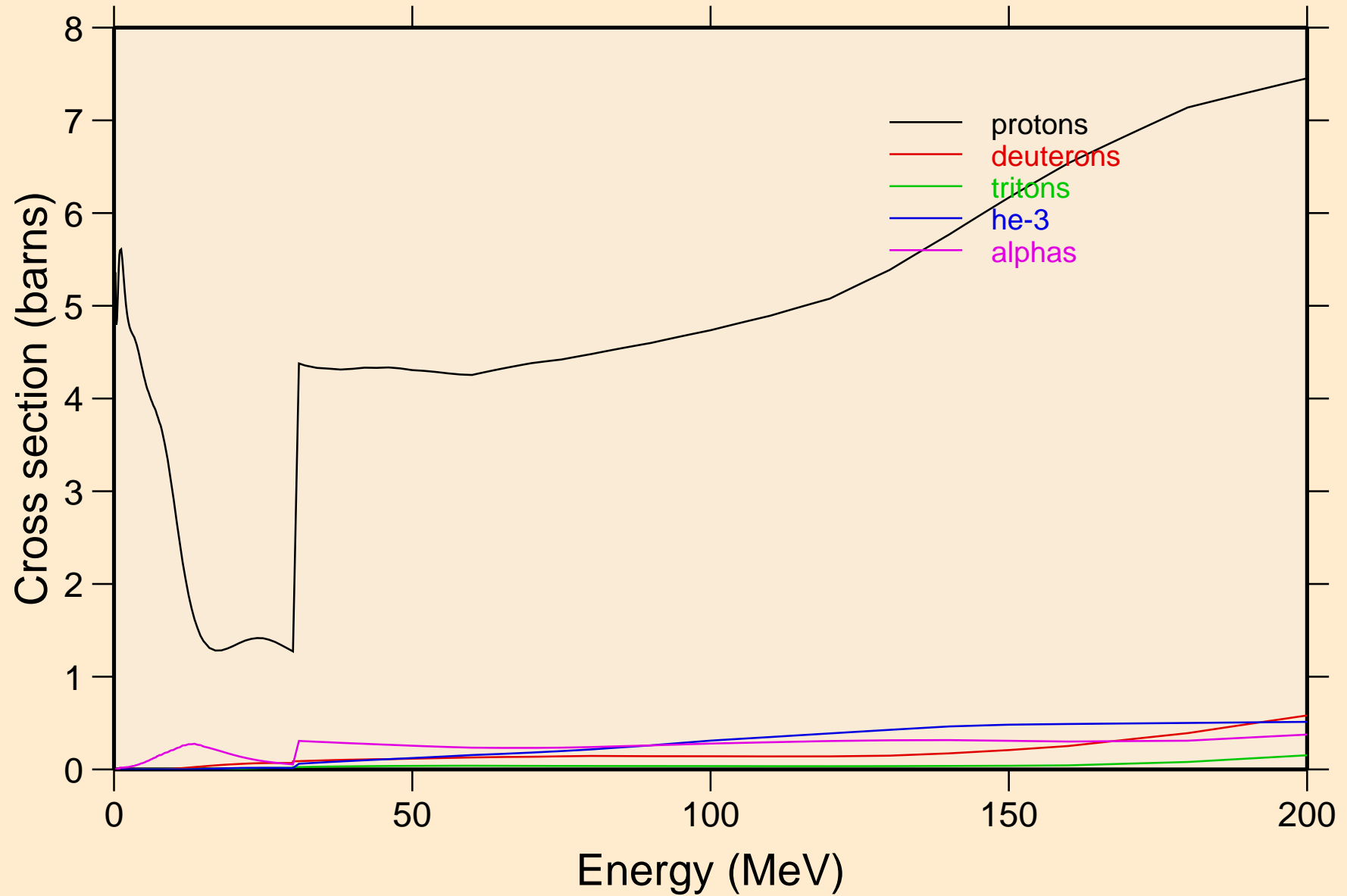

GD135 NRG TENDL-2015, AKONING
protons from (n,x)

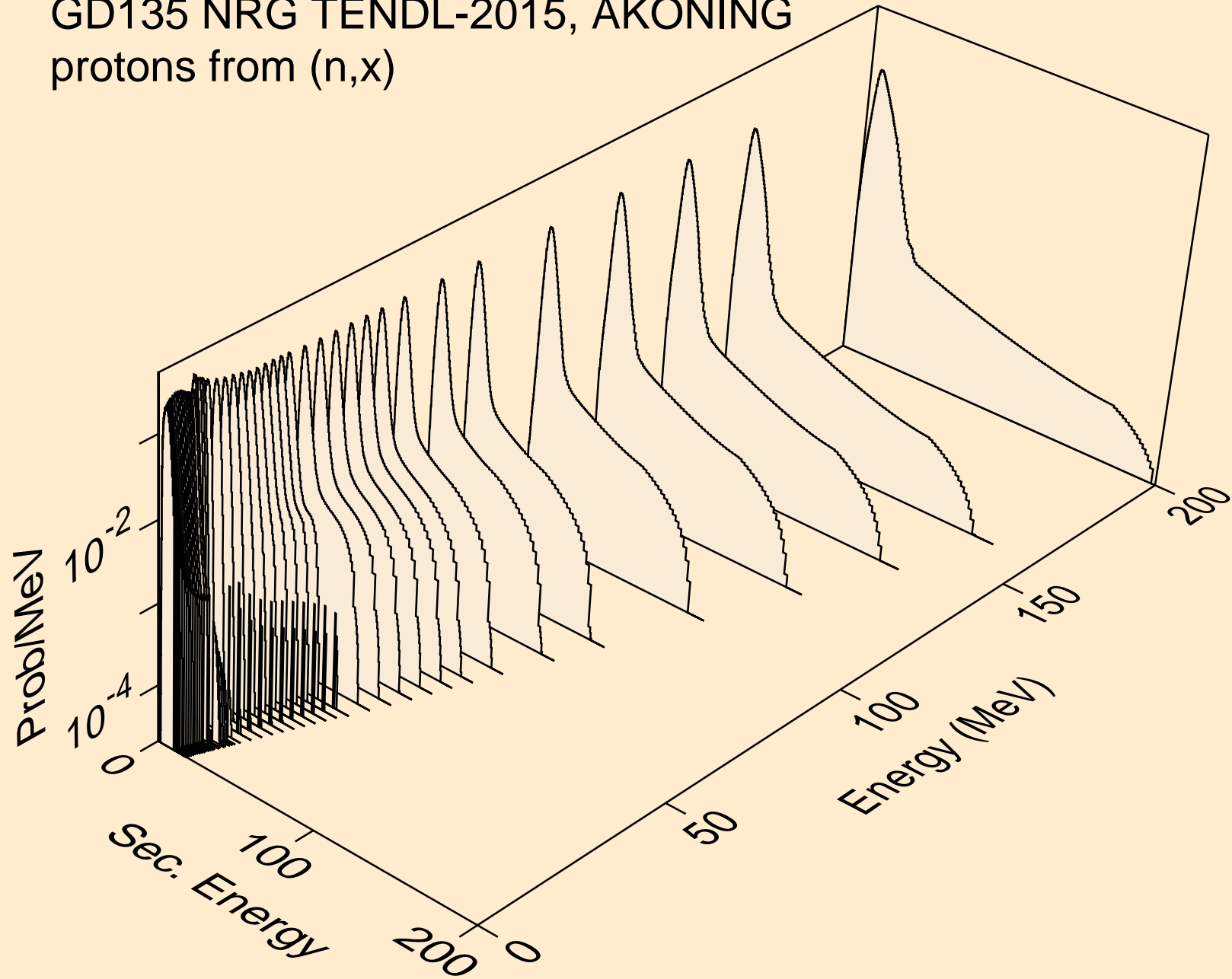

GD135 NRG TENDL-2015, AKONING
protons from (n,n*)p

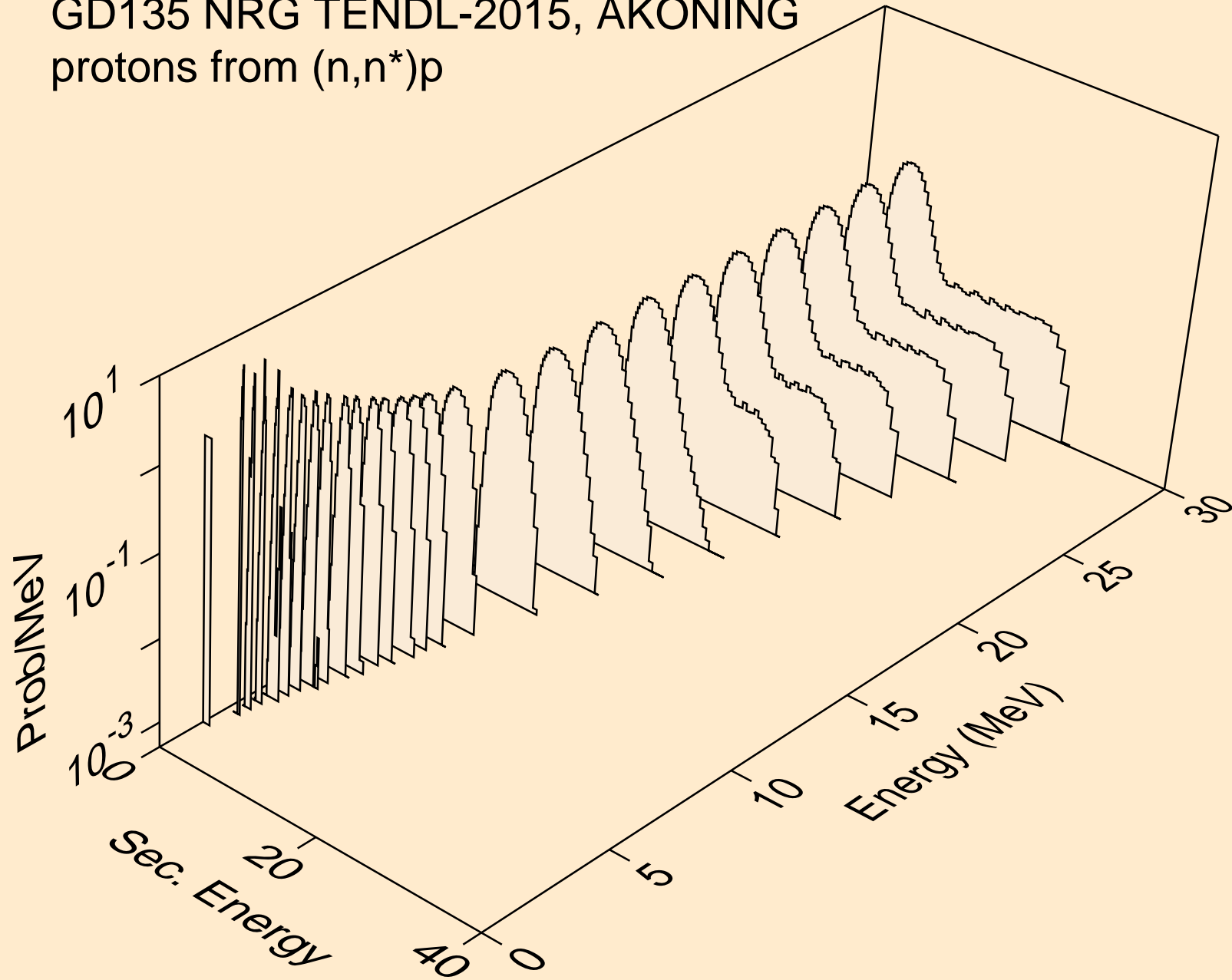

GD135 NRG TENDL-2015, AKONING
protons from (n,2np)

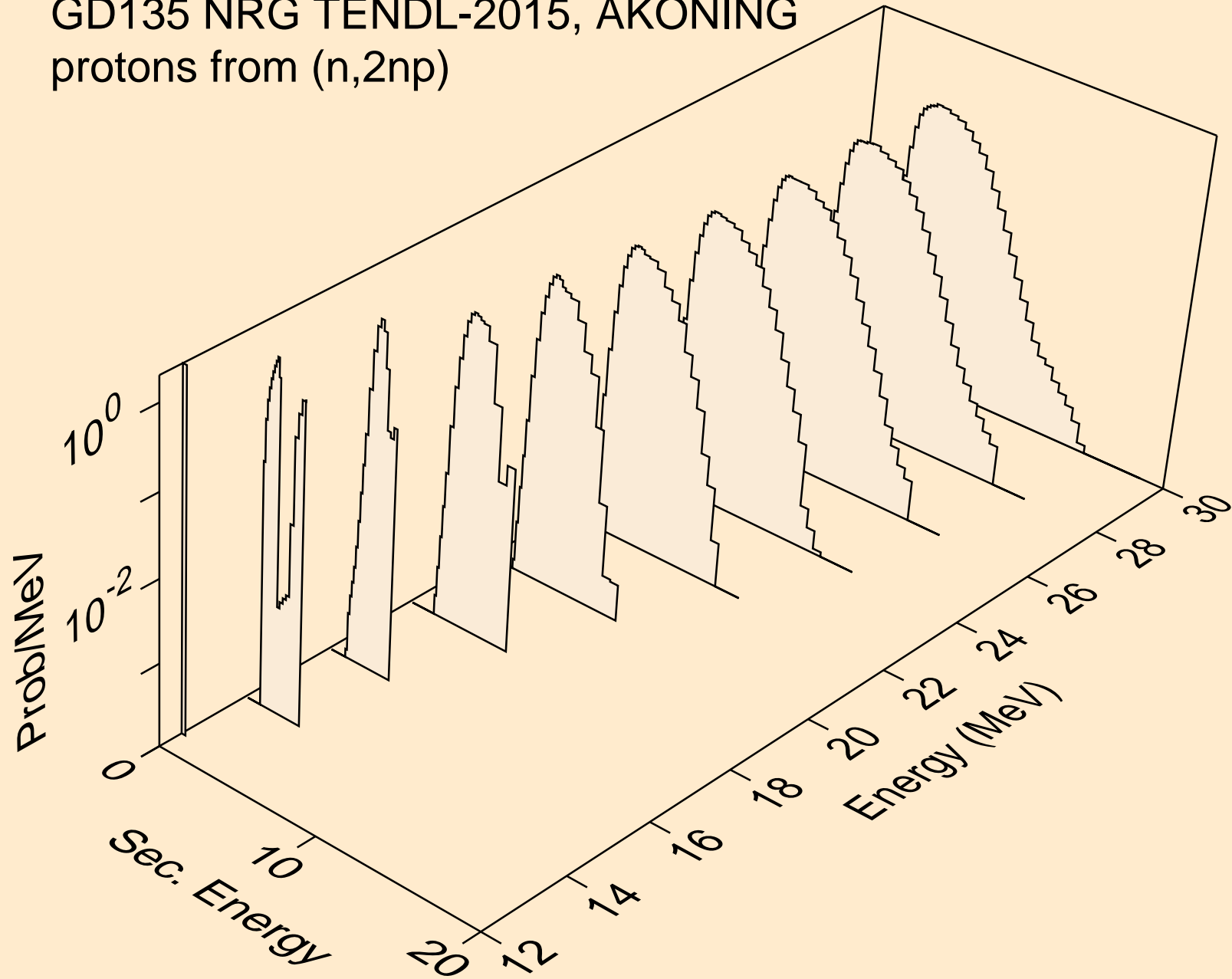

GD135 NRG TENDL-2015, AKONING
protons from (n,3np)

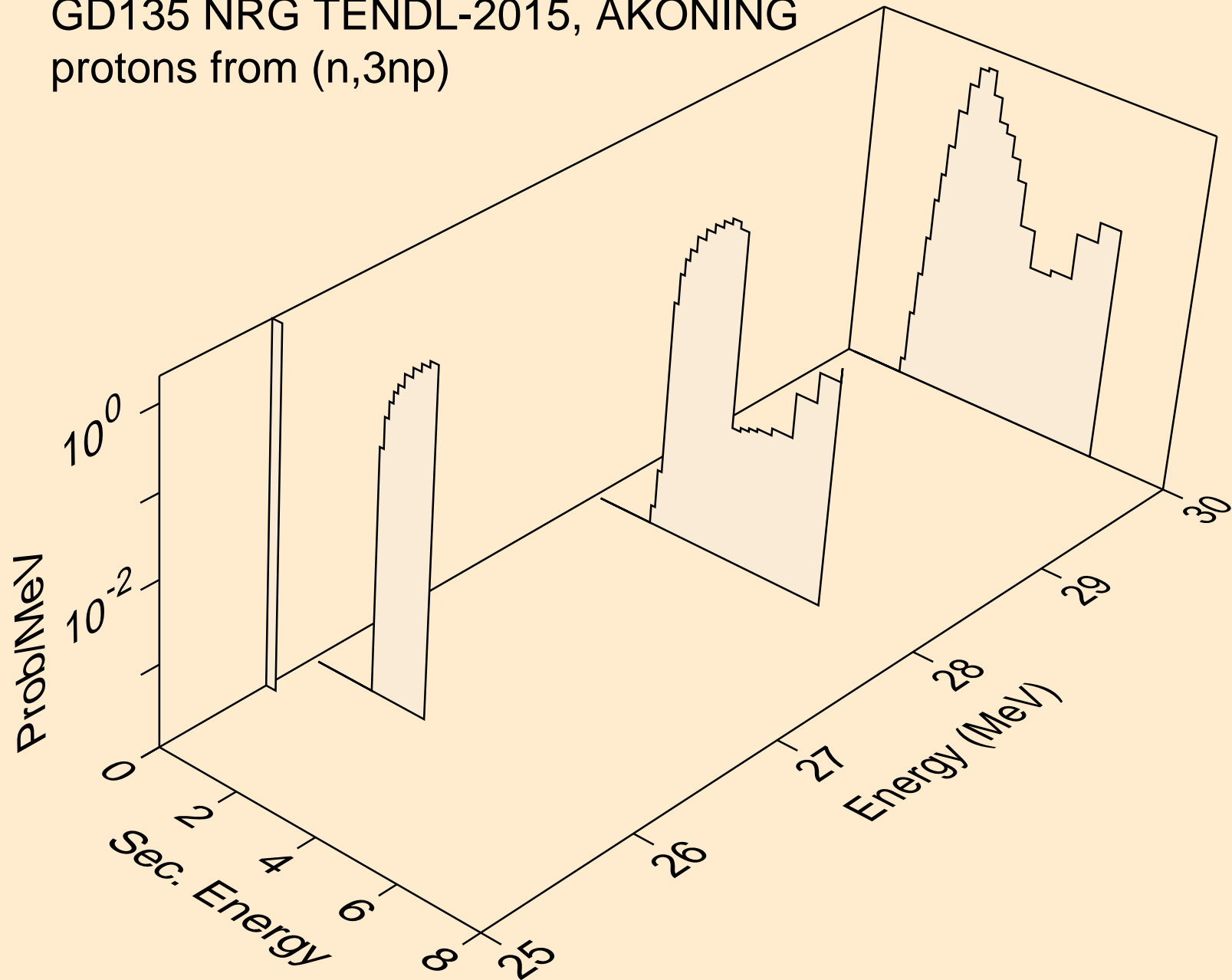

GD135 NRG TENDL-2015, AKONING
protons from (n,2np)

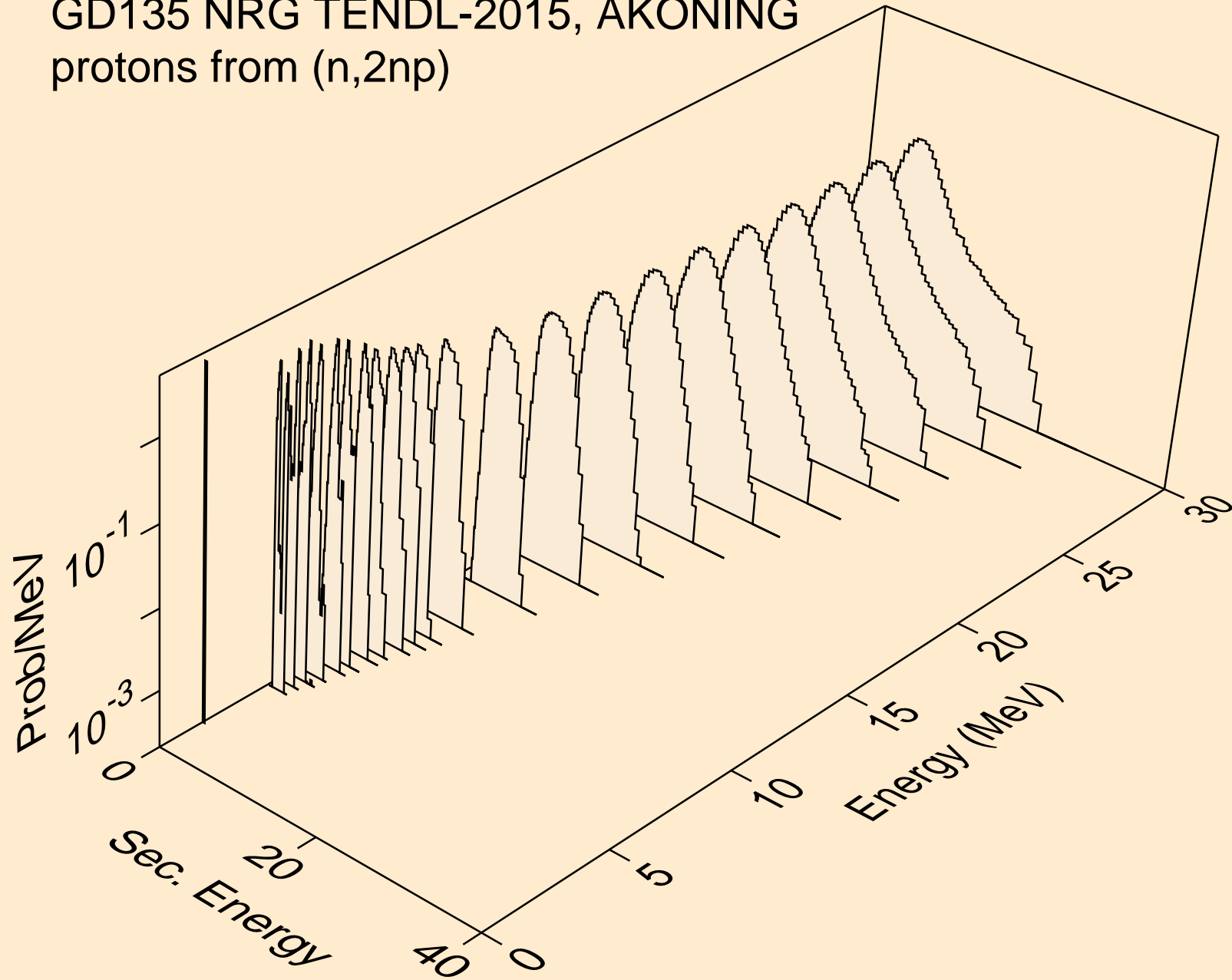

GD135 NRG TENDL-2015, AKONING
protons from (n,npa)

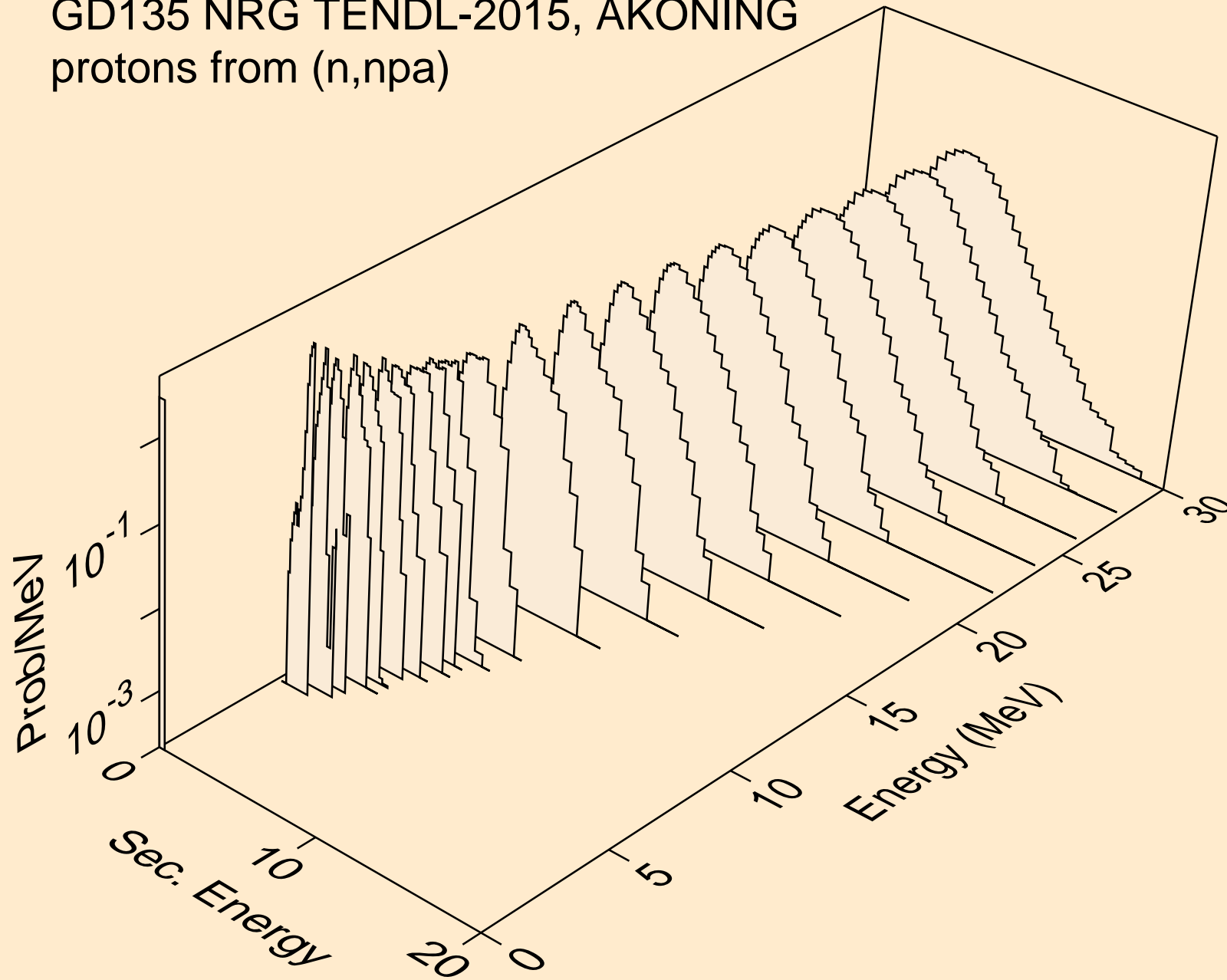

GD135 NRG TENDL-2015, AKONING
protons from (n,p)

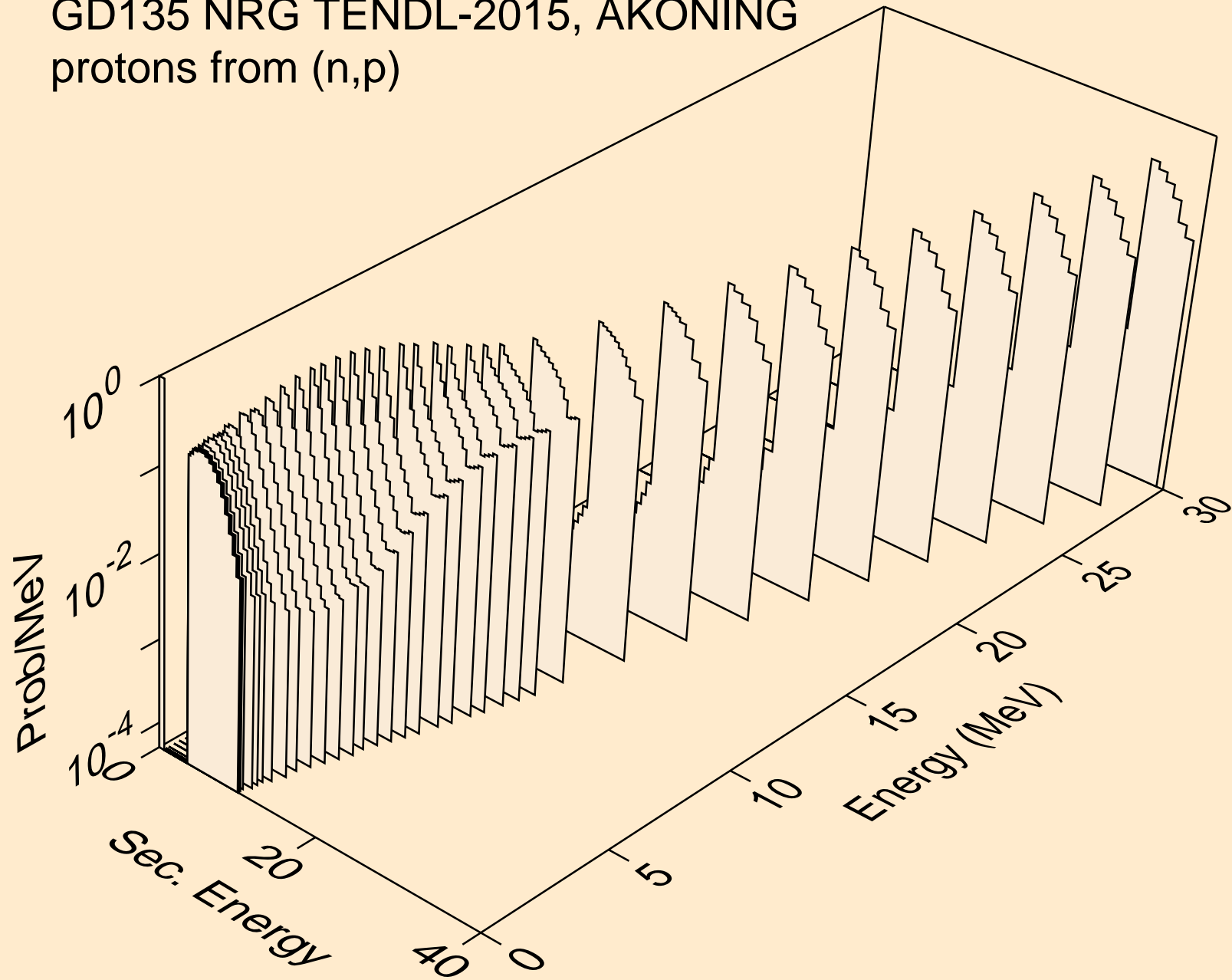

GD135 NRG TENDL-2015, AKONING
protons from (n,2p)

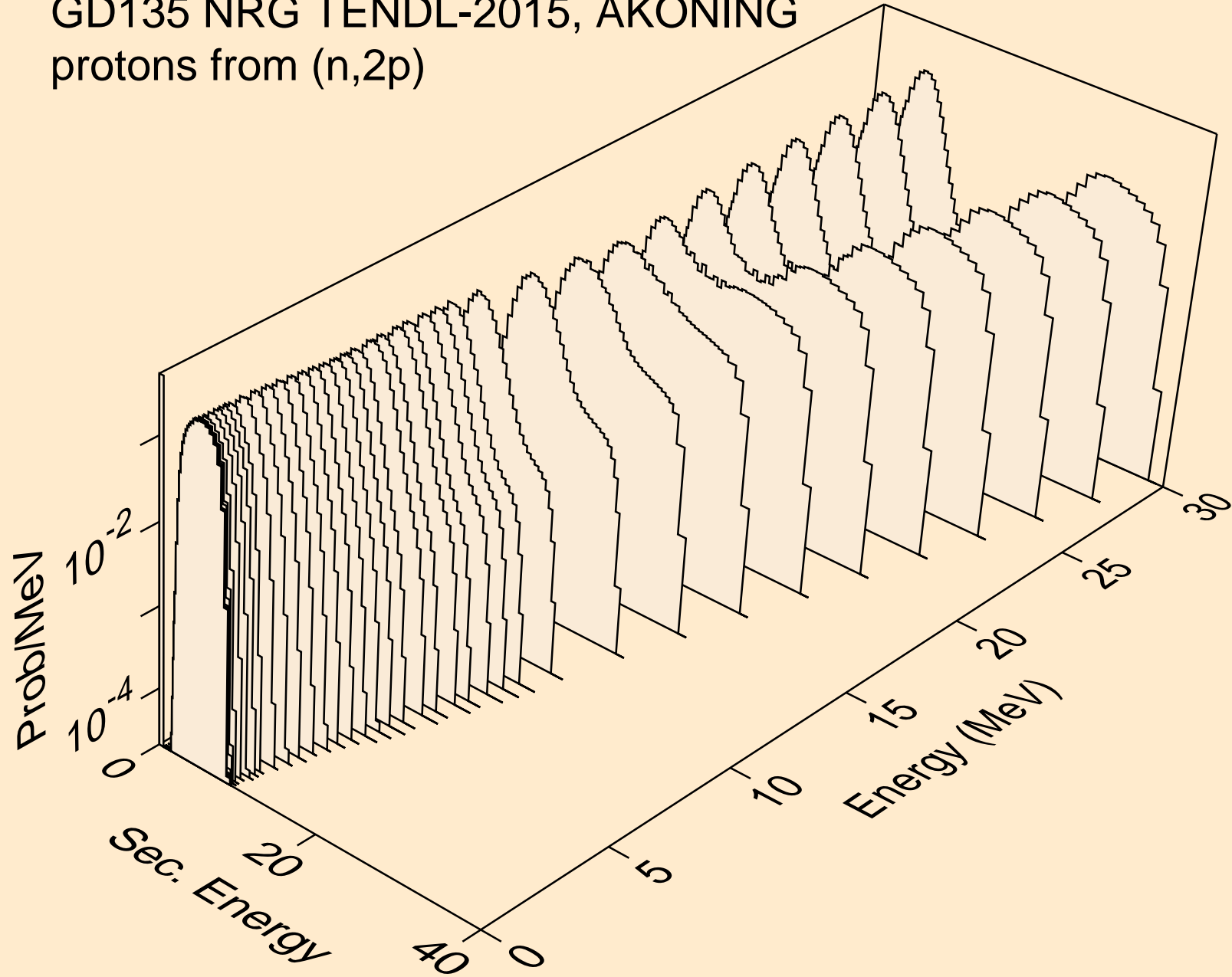

GD135 NRG TENDL-2015, AKONING
protons from (n,pa)

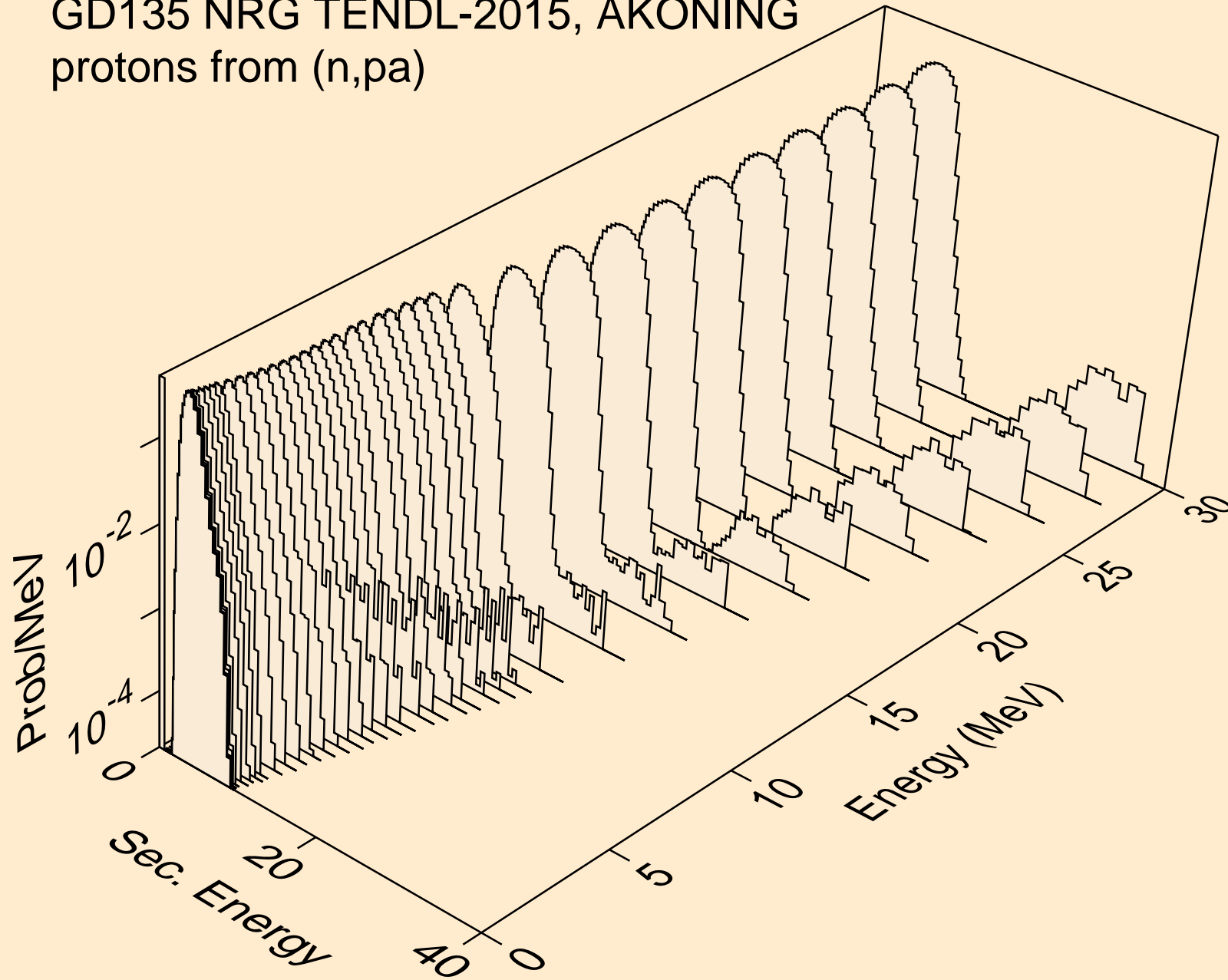

GD135 NRG TENDL-2015, AKONING
protons from (n,pd)

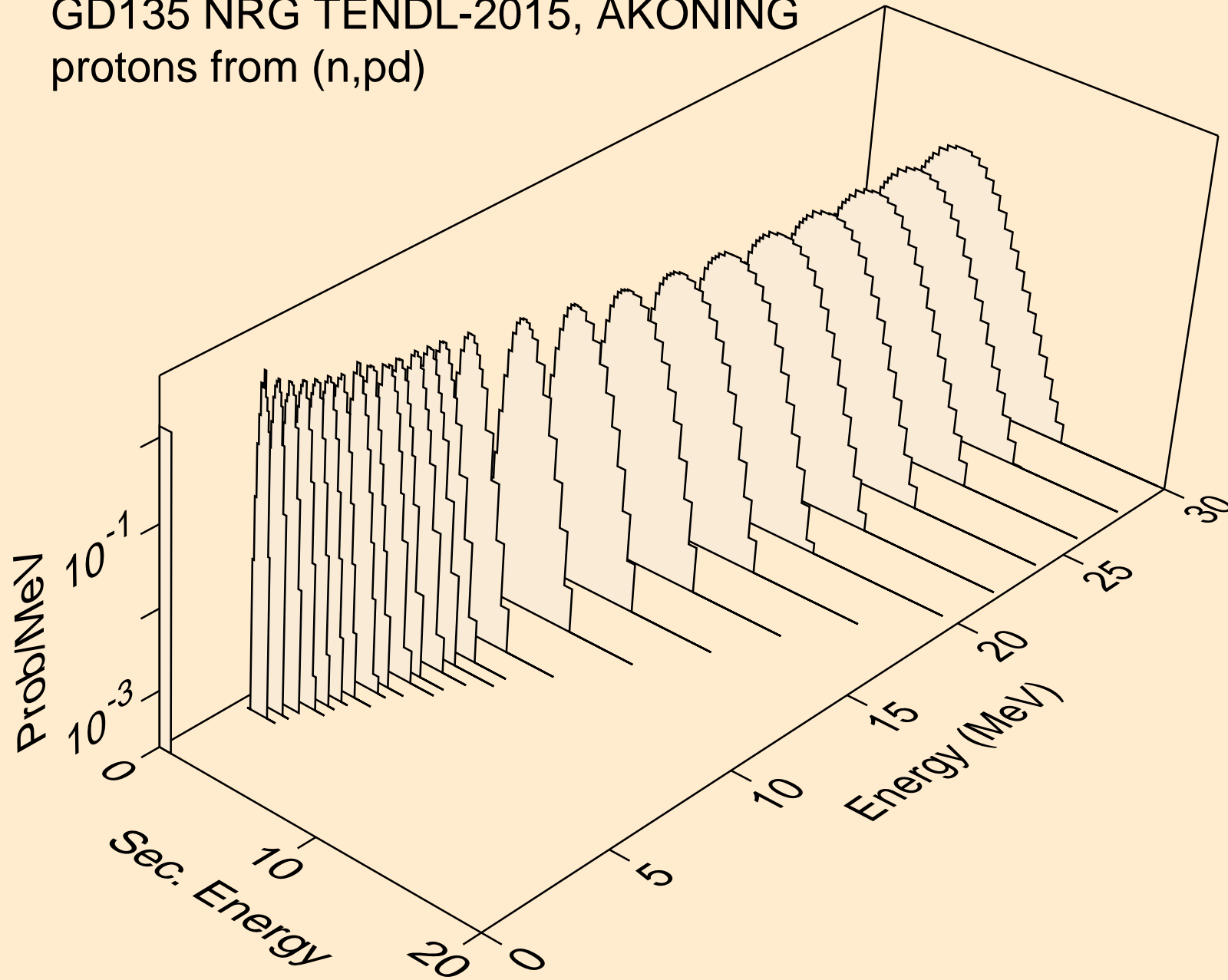

GD135 NRG TENDL-2015, AKONING
protons from (n,pt)

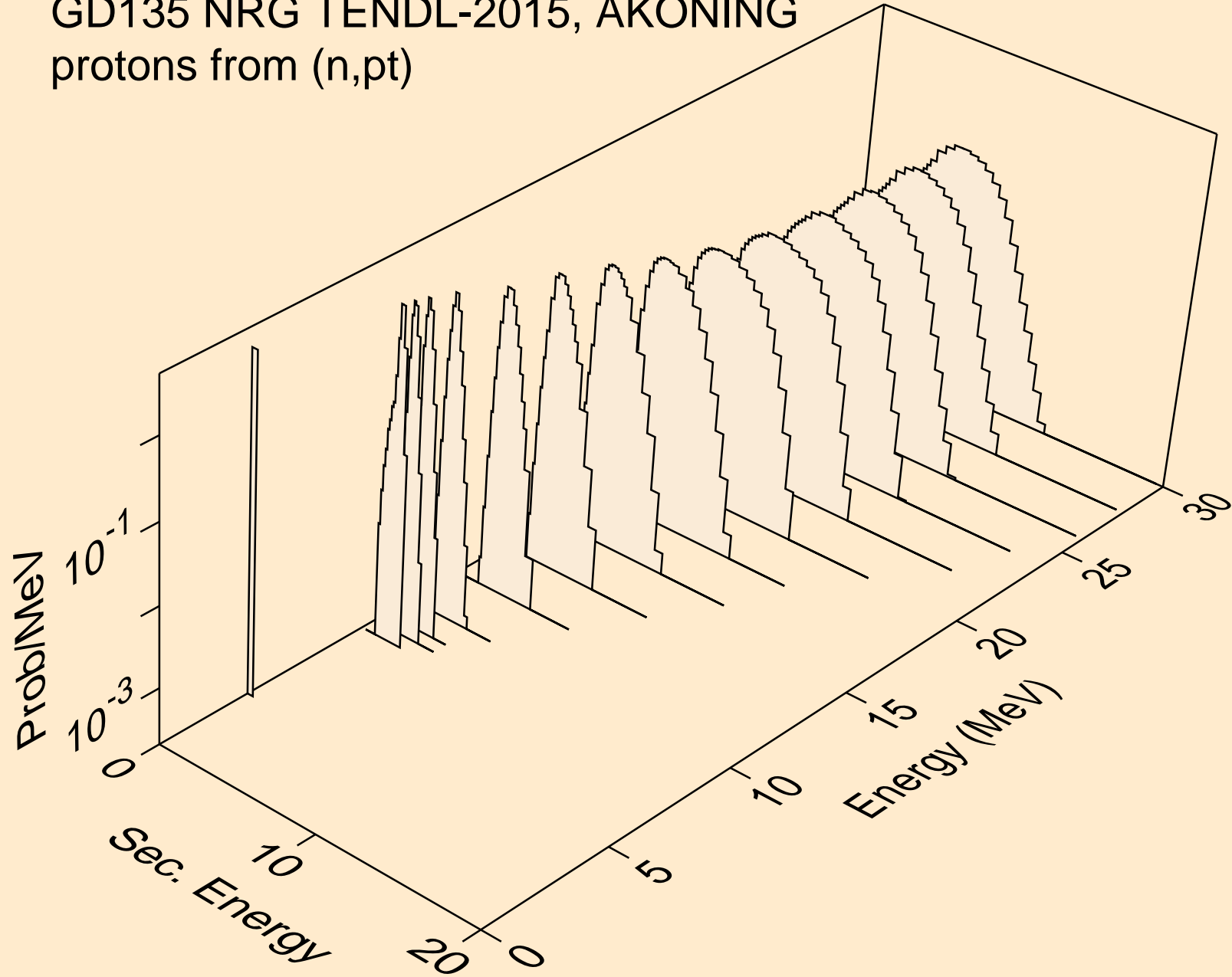

GD135 NRG TENDL-2015, AKONING
deuterons from (n,x)

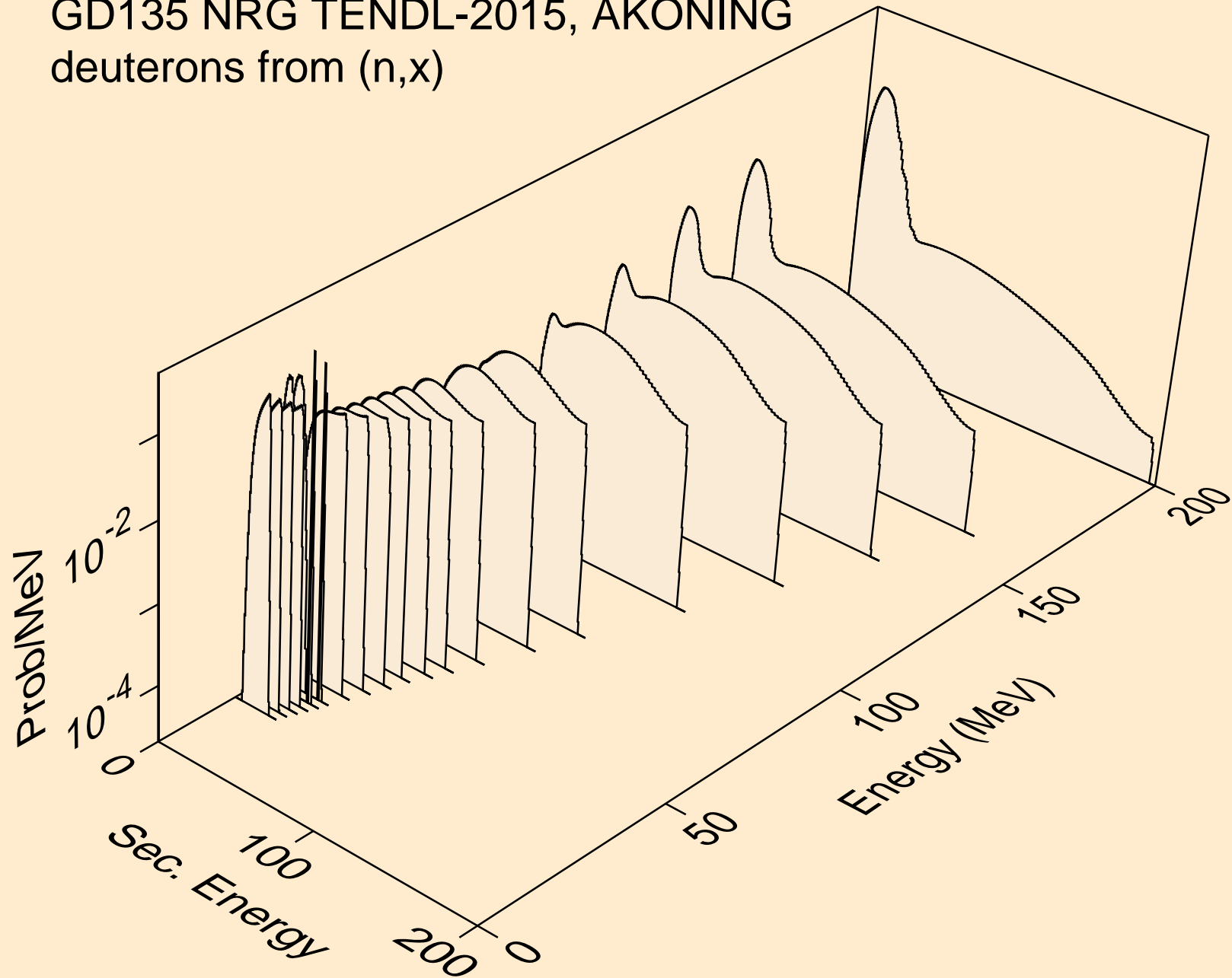

GD135 NRG TENDL-2015, AKONING
deuterons from (n,n*)d

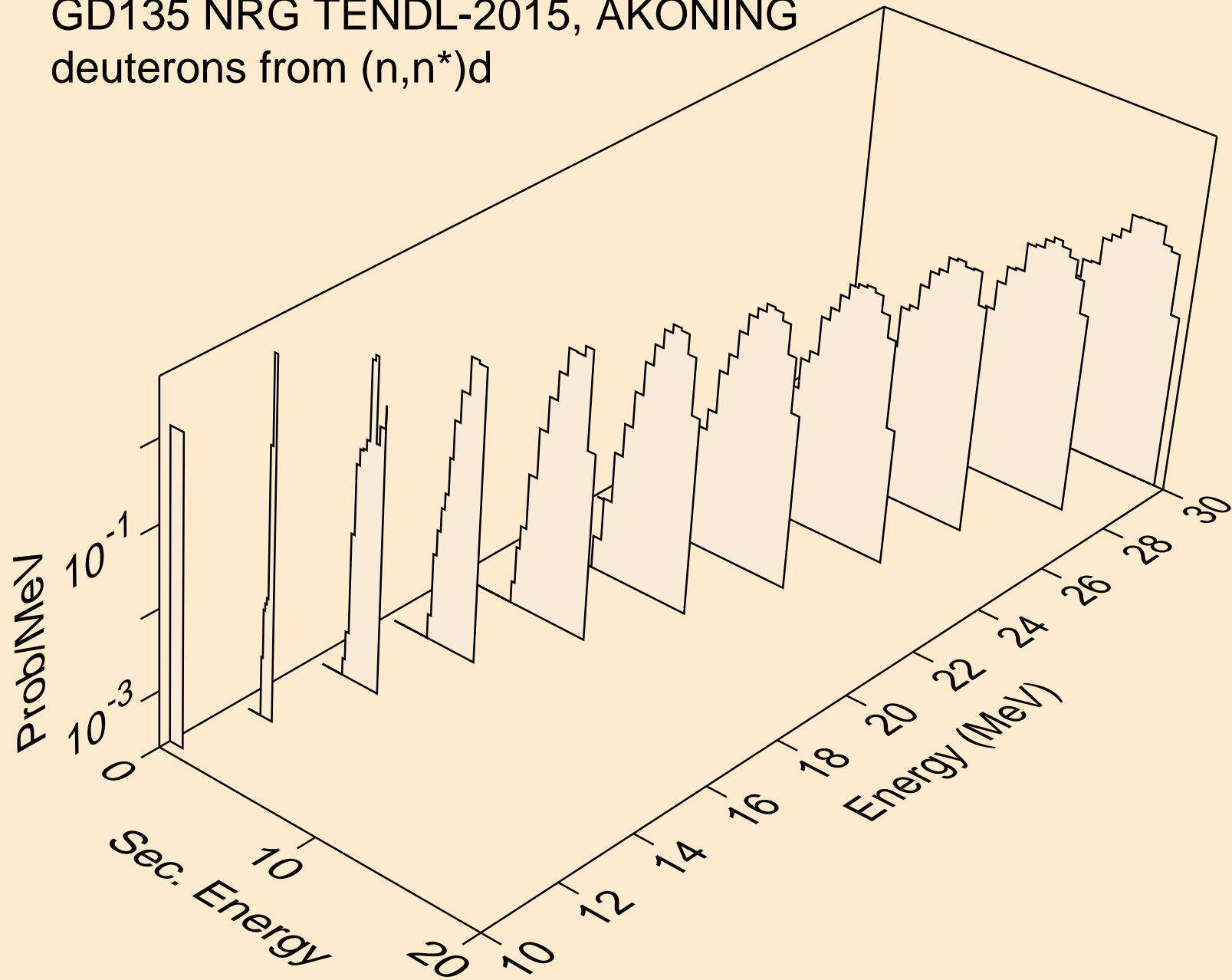

GD135 NRG TENDL-2015, AKONING
deuterons from (n,d)

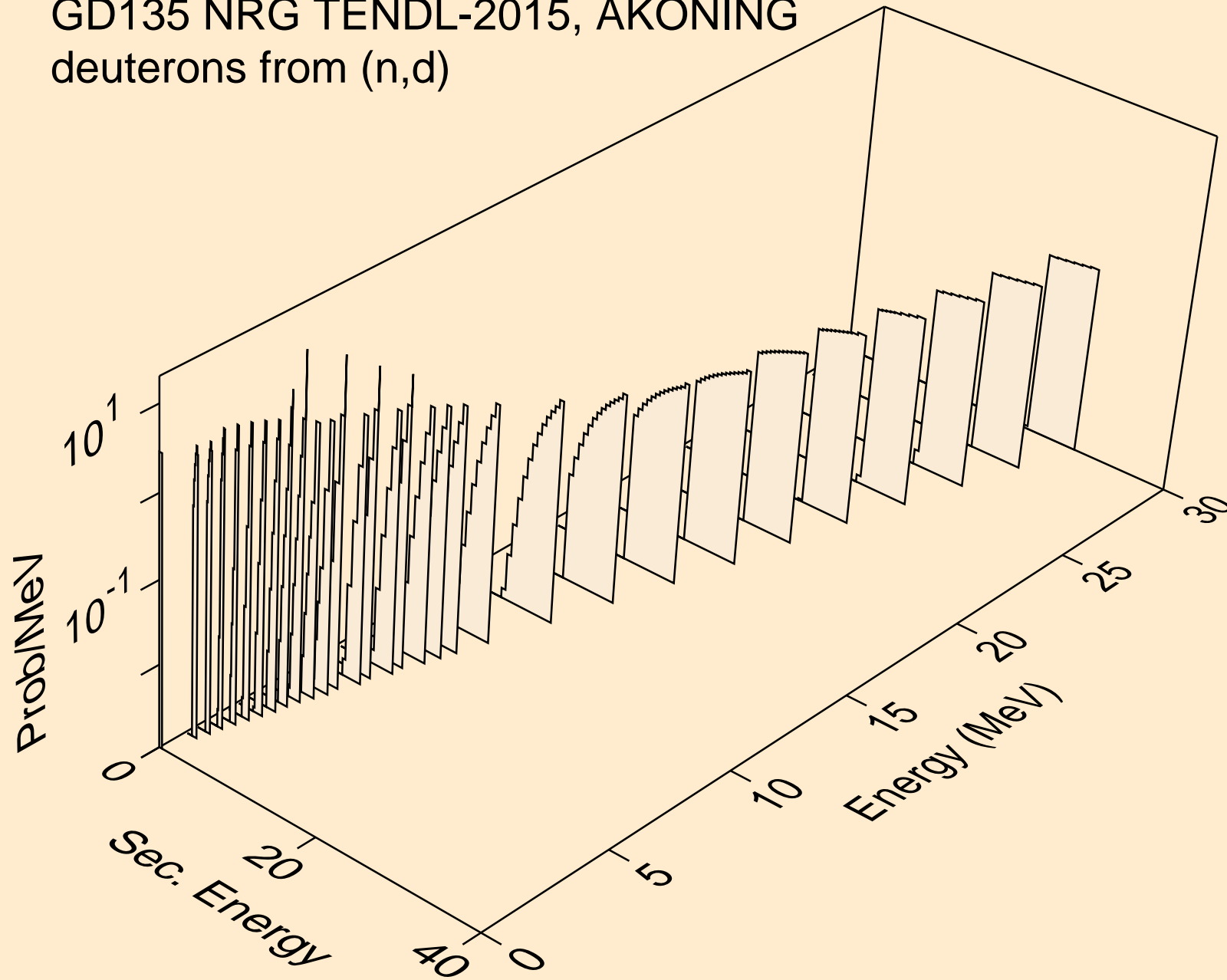

GD135 NRG TENDL-2015, AKONING
deuterons from (n,d2a)

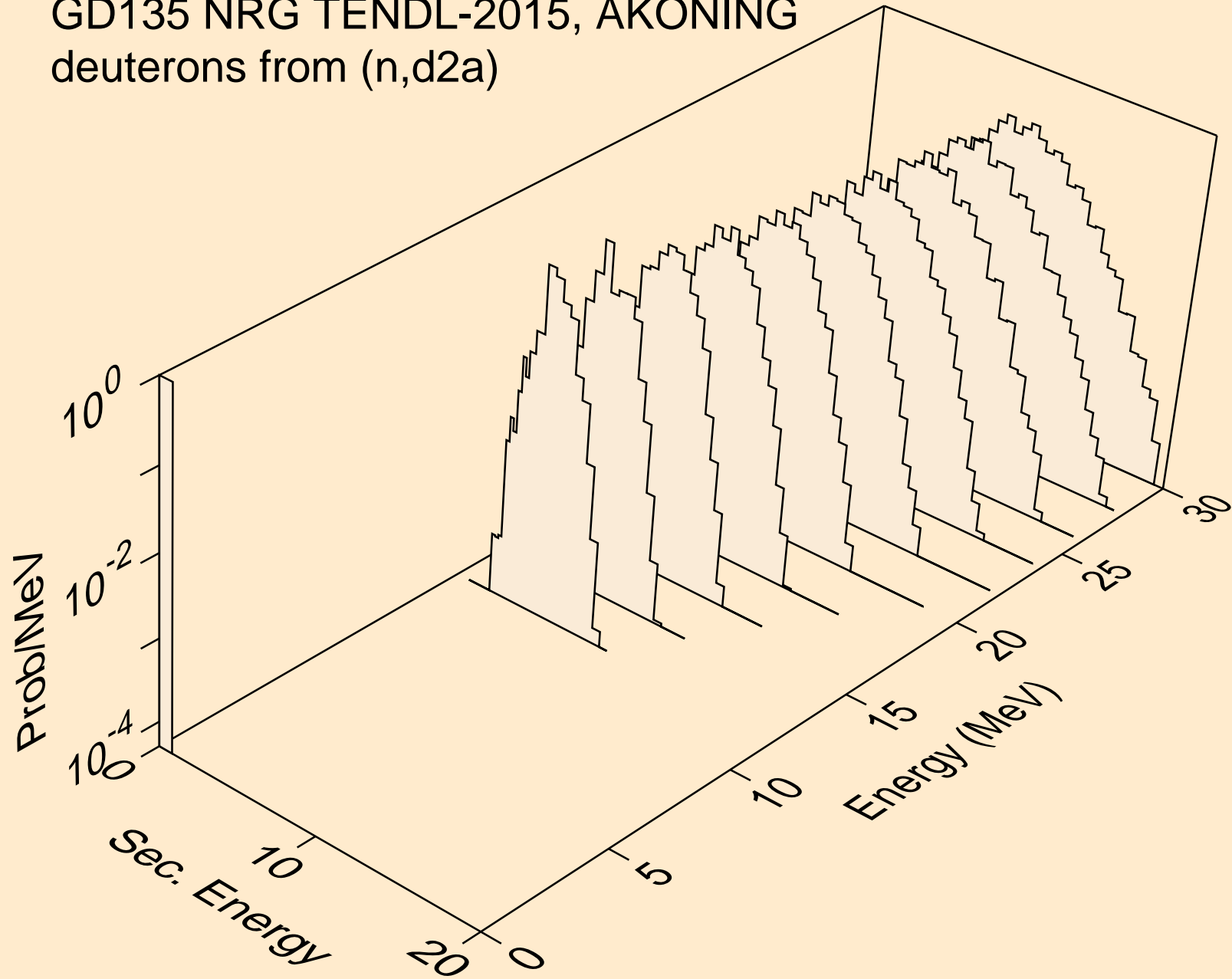

GD135 NRG TENDL-2015, AKONING
deuterons from (n,pd)

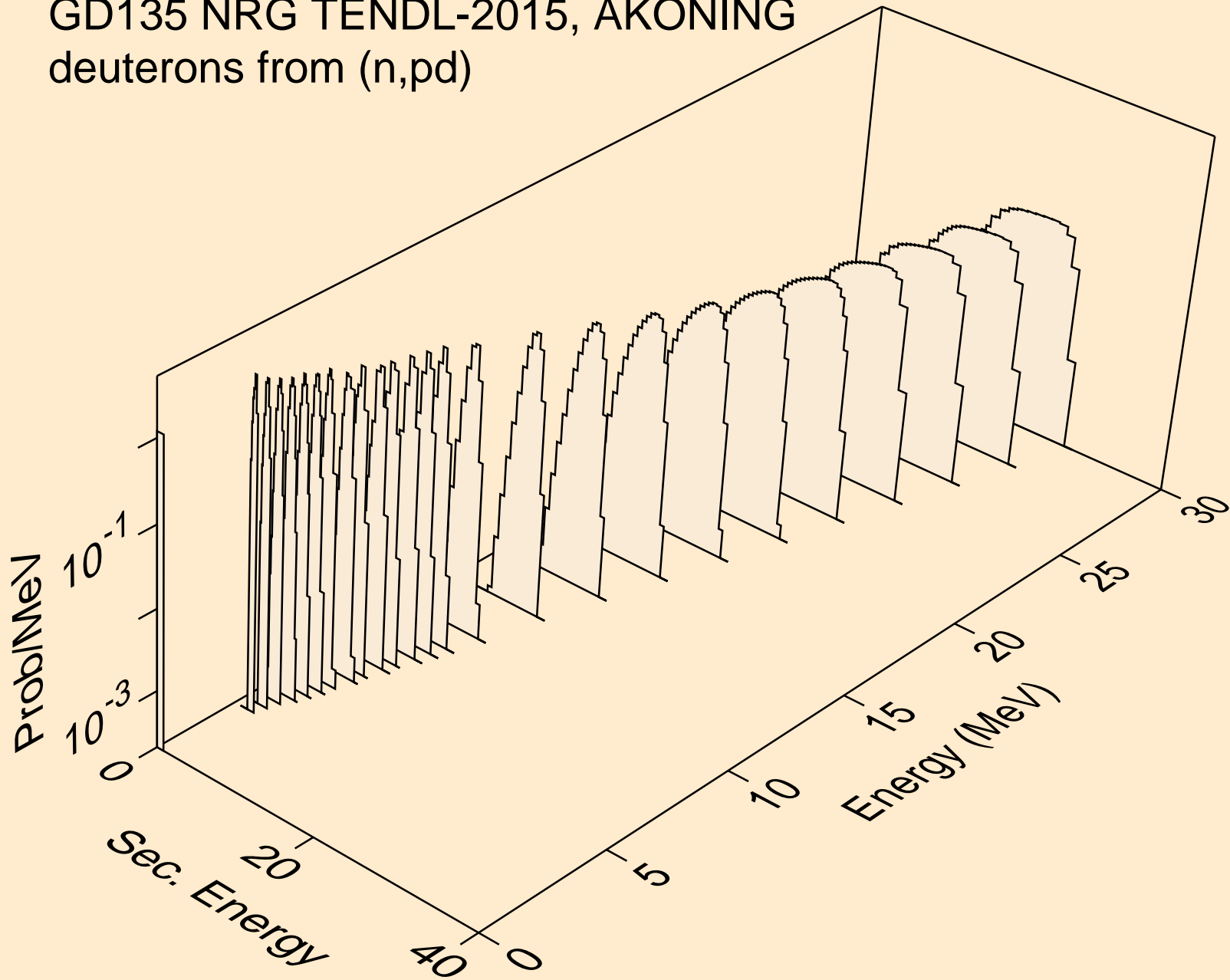

GD135 NRG TENDL-2015, AKONING
deuterons from (n,da)

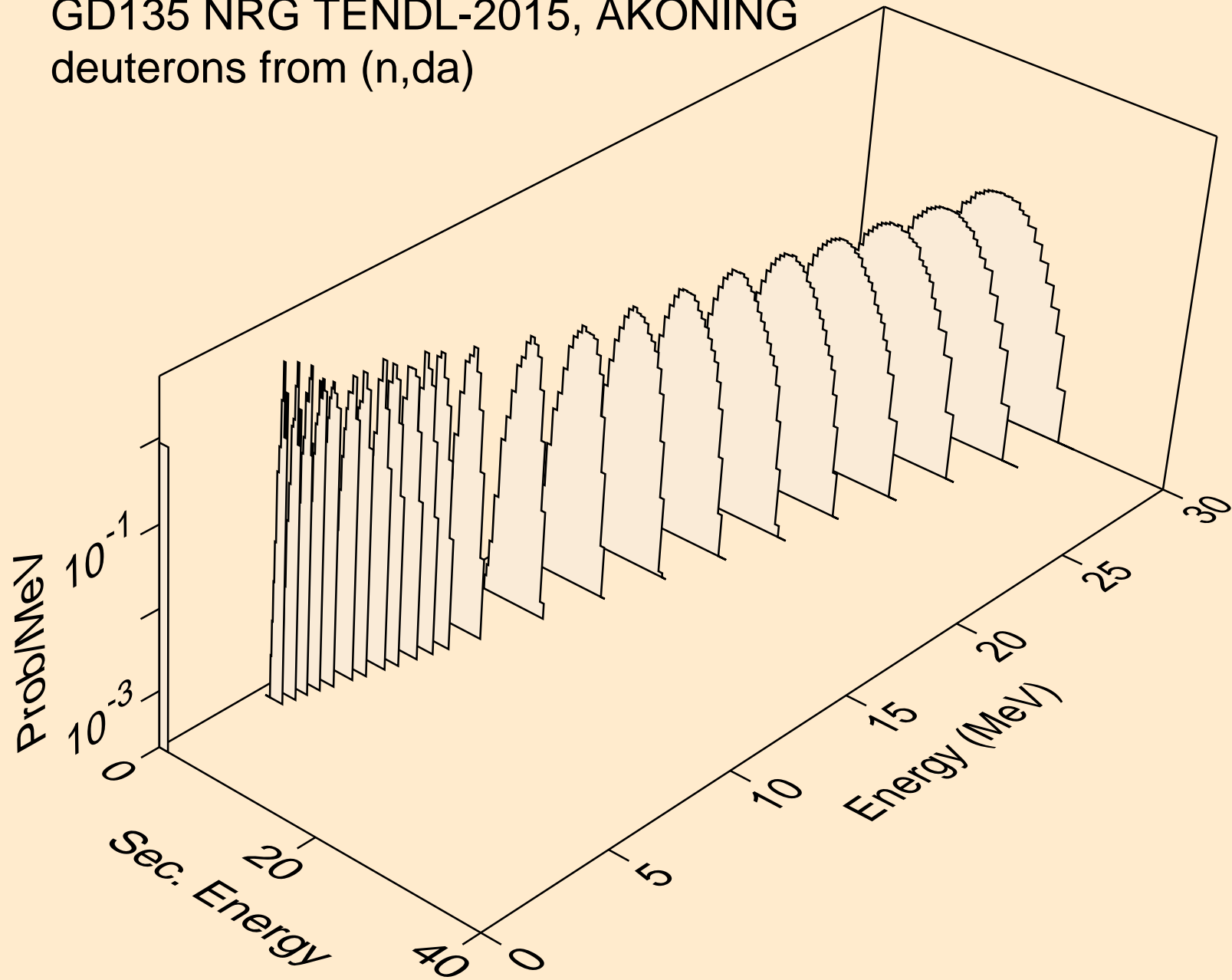

GD135 NRG TENDL-2015, AKONING
tritons from (n,x)

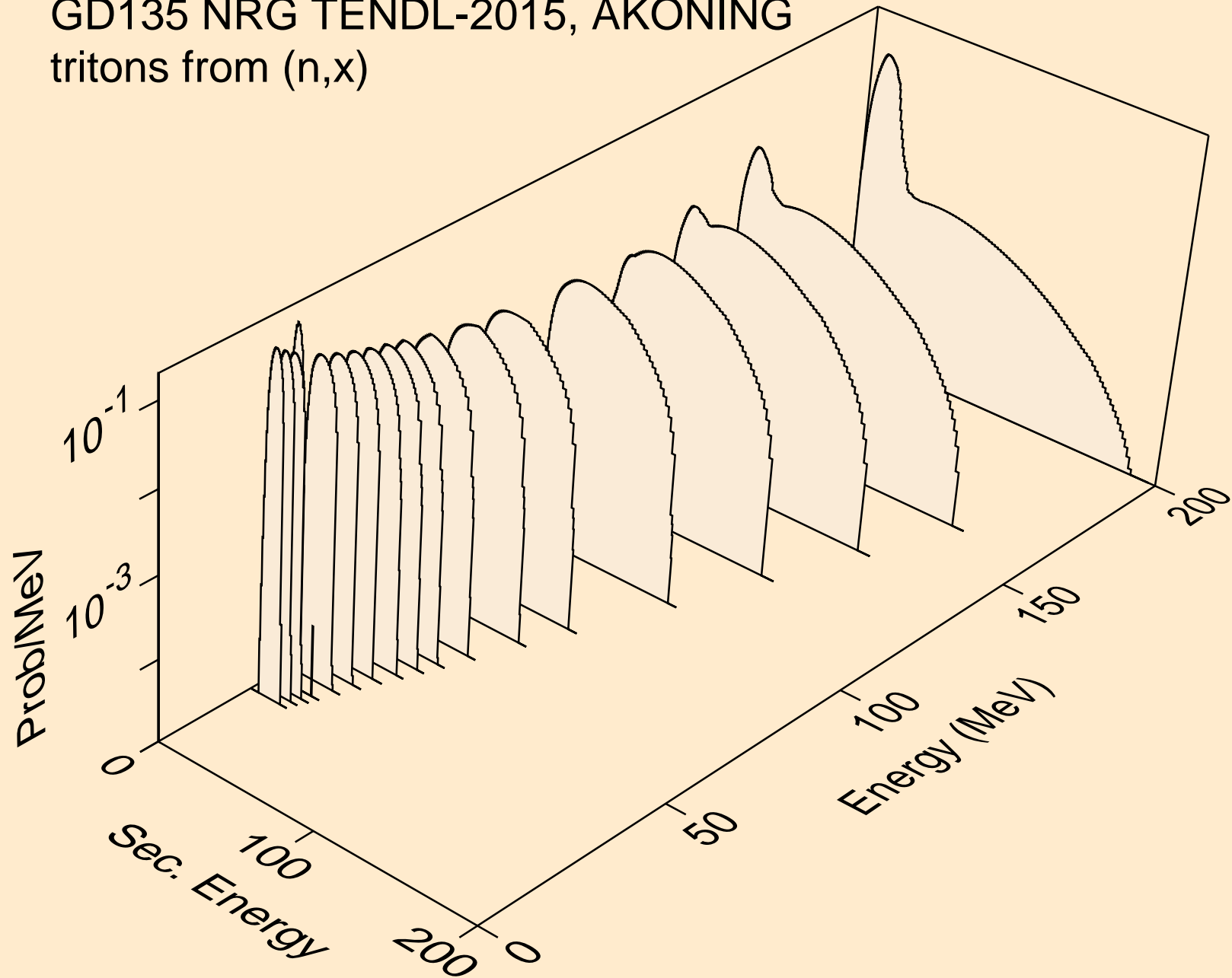

GD135 NRG TENDL-2015, AKONING
tritons from (n,n*)t

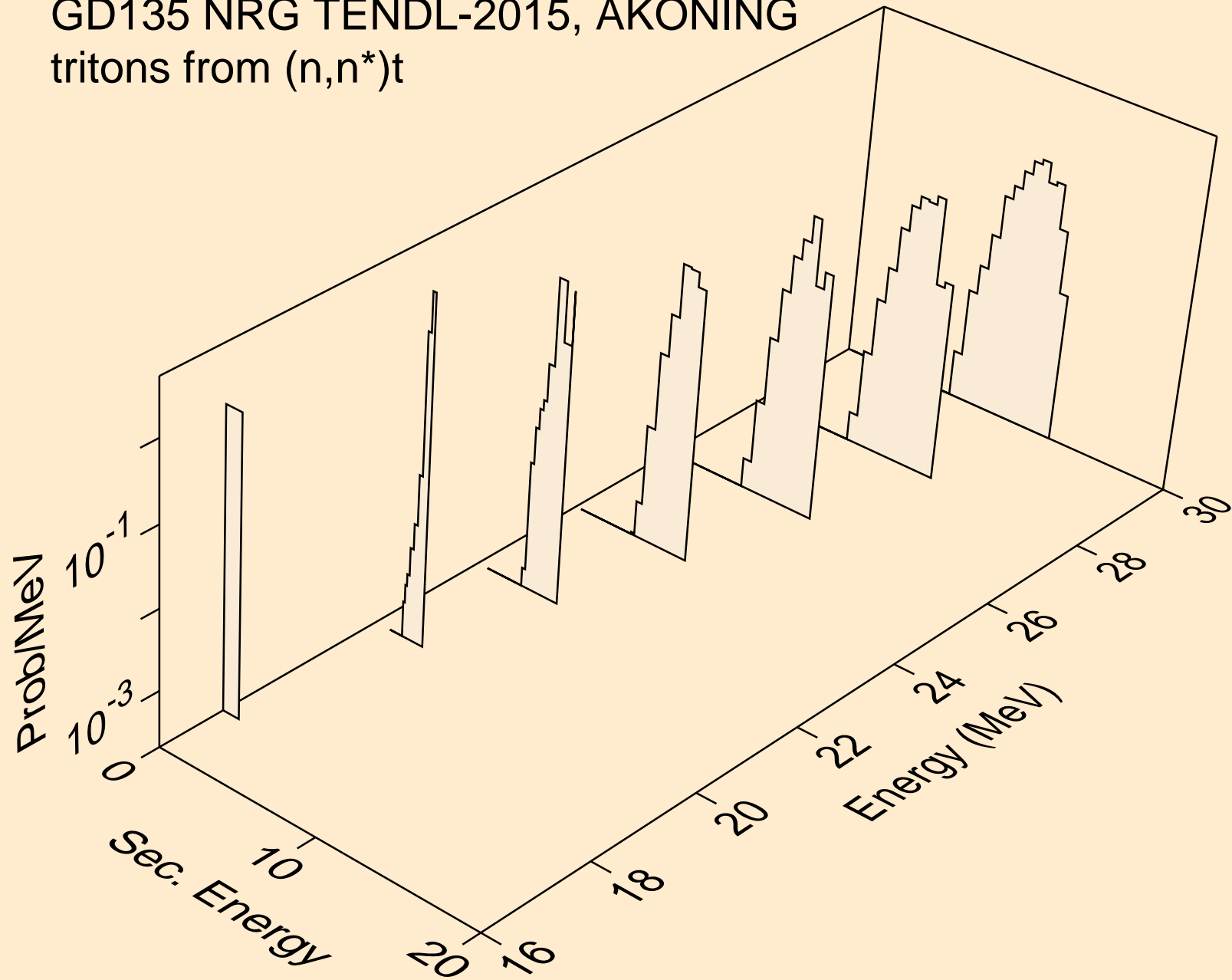

GD135 NRG TENDL-2015, AKONING
tritons from (n,t)

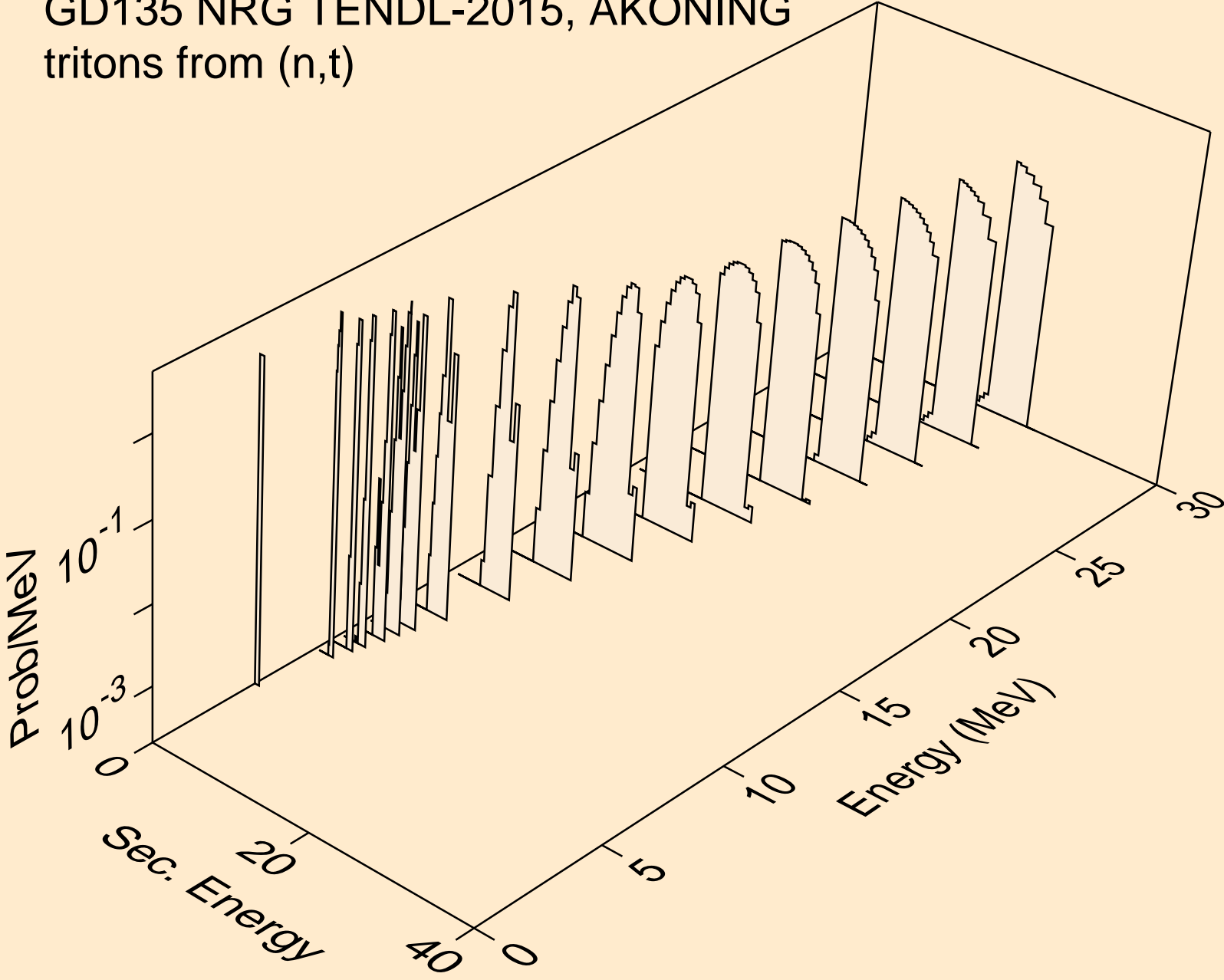

GD135 NRG TENDL-2015, AKONING
tritons from (n,pt)

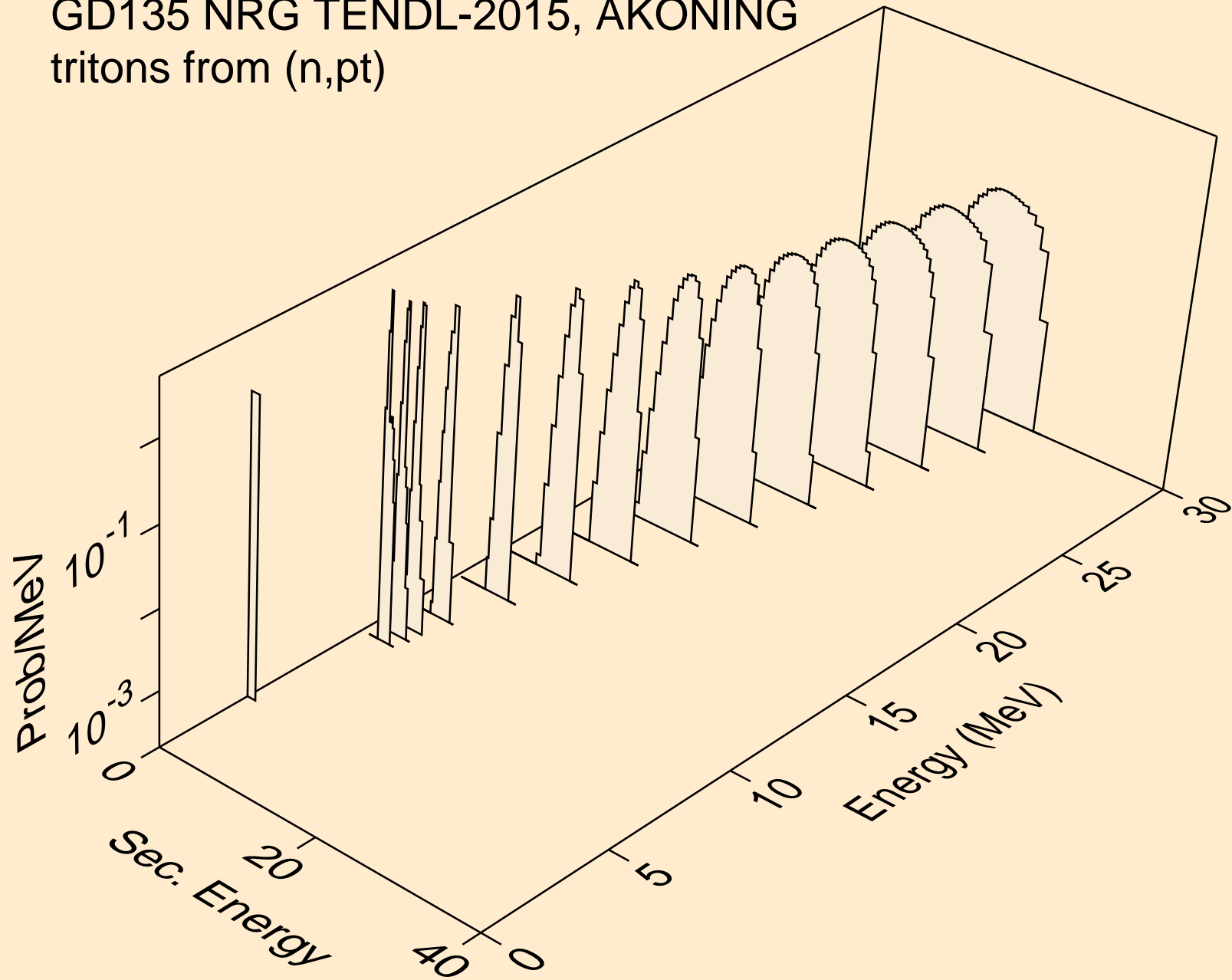

GD135 NRG TENDL-2015, AKONING
he3s from (n,x)

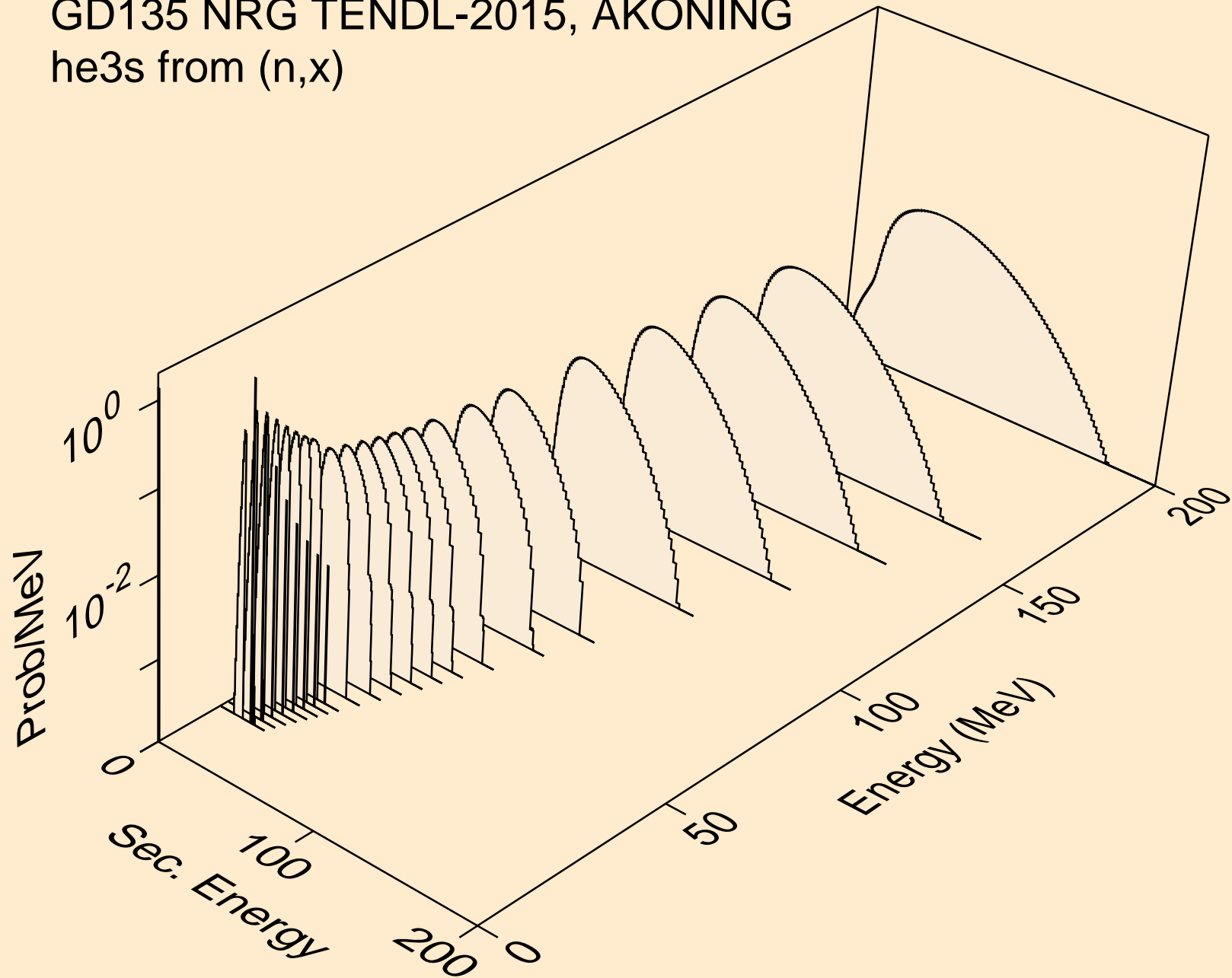

GD135 NRG TENDL-2015, AKONING
he3s from (n,n*)he3

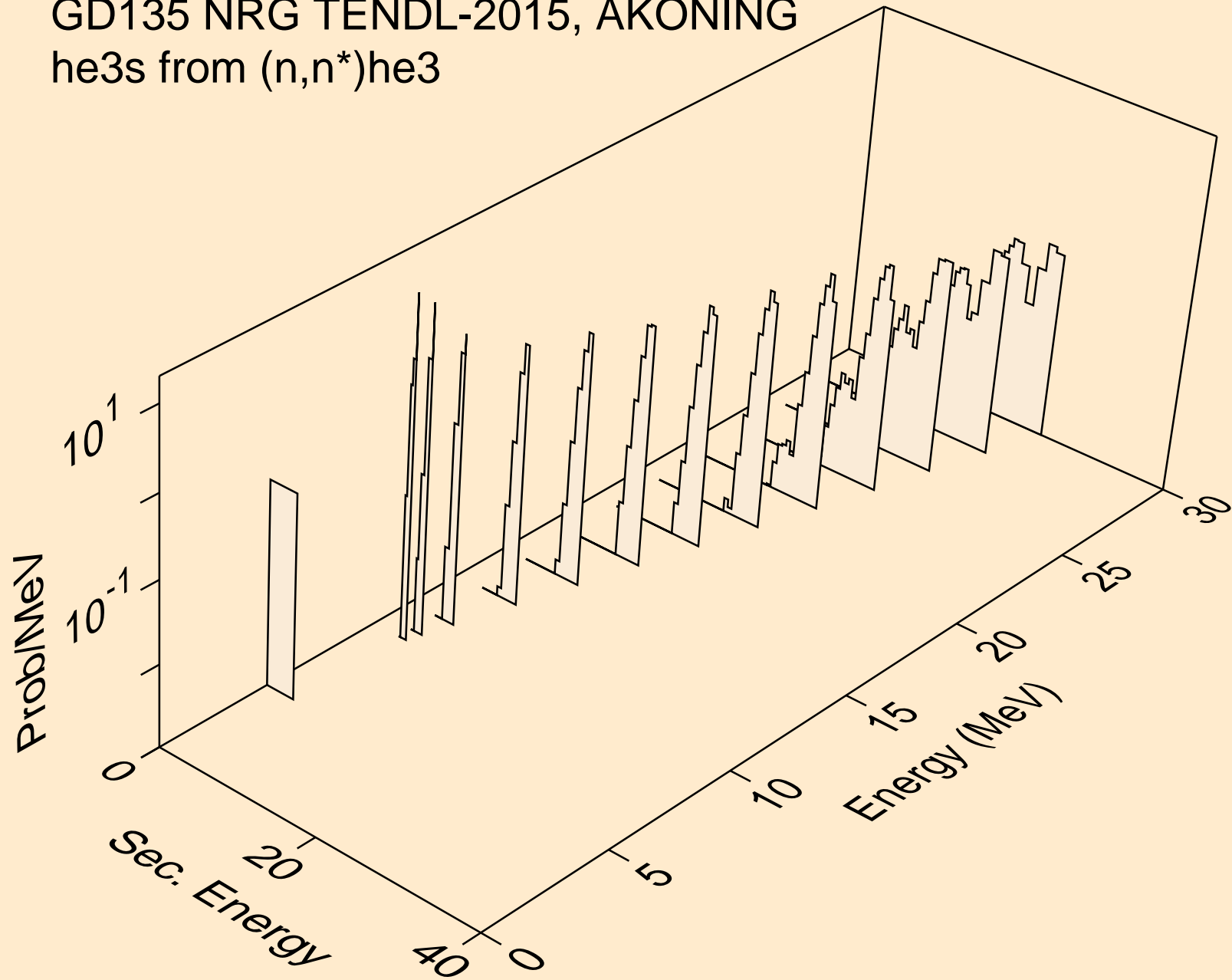

GD135 NRG TENDL-2015, AKONING
he3s from (n,he3)

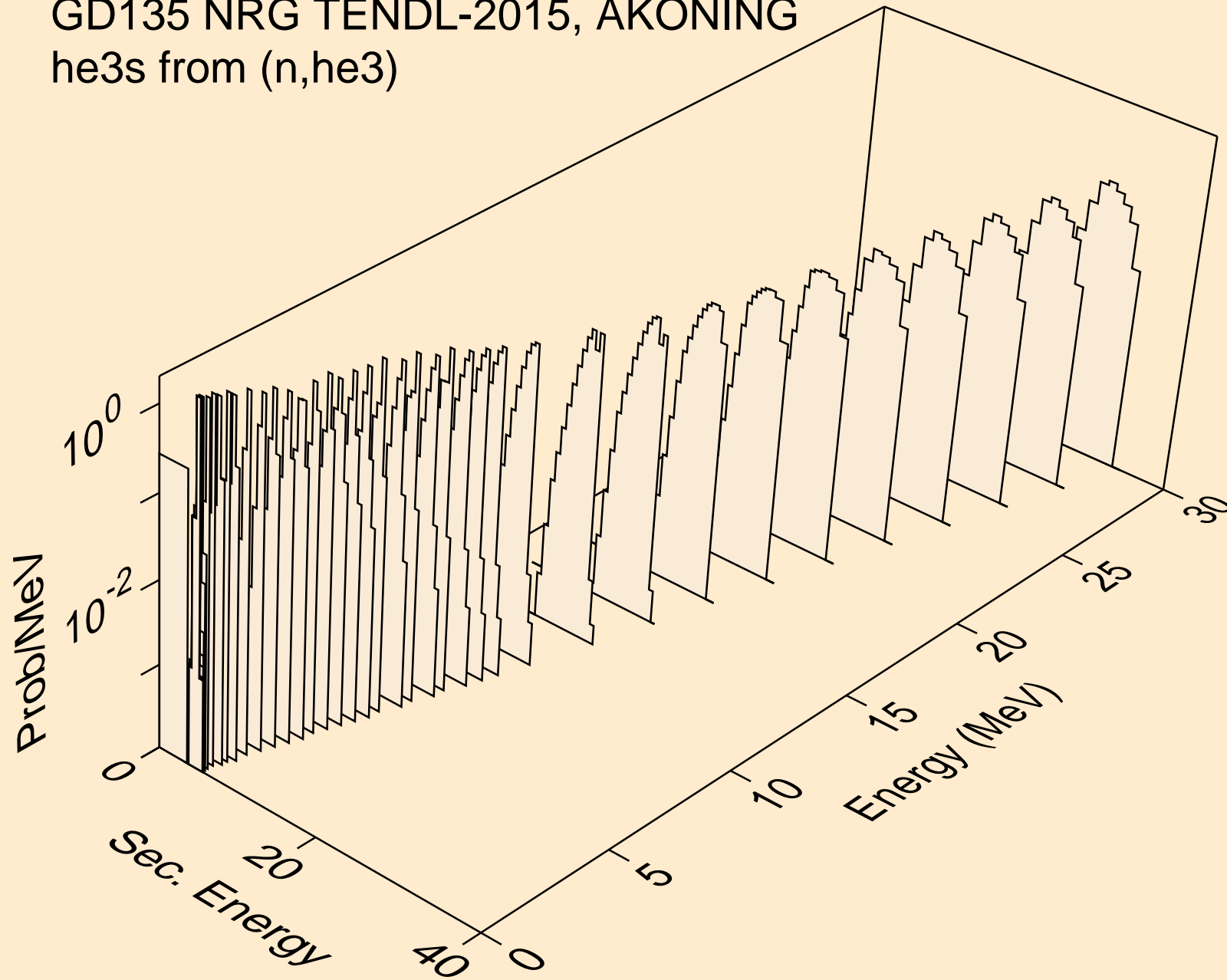

GD135 NRG TENDL-2015, AKONING
alphas from (n,x)

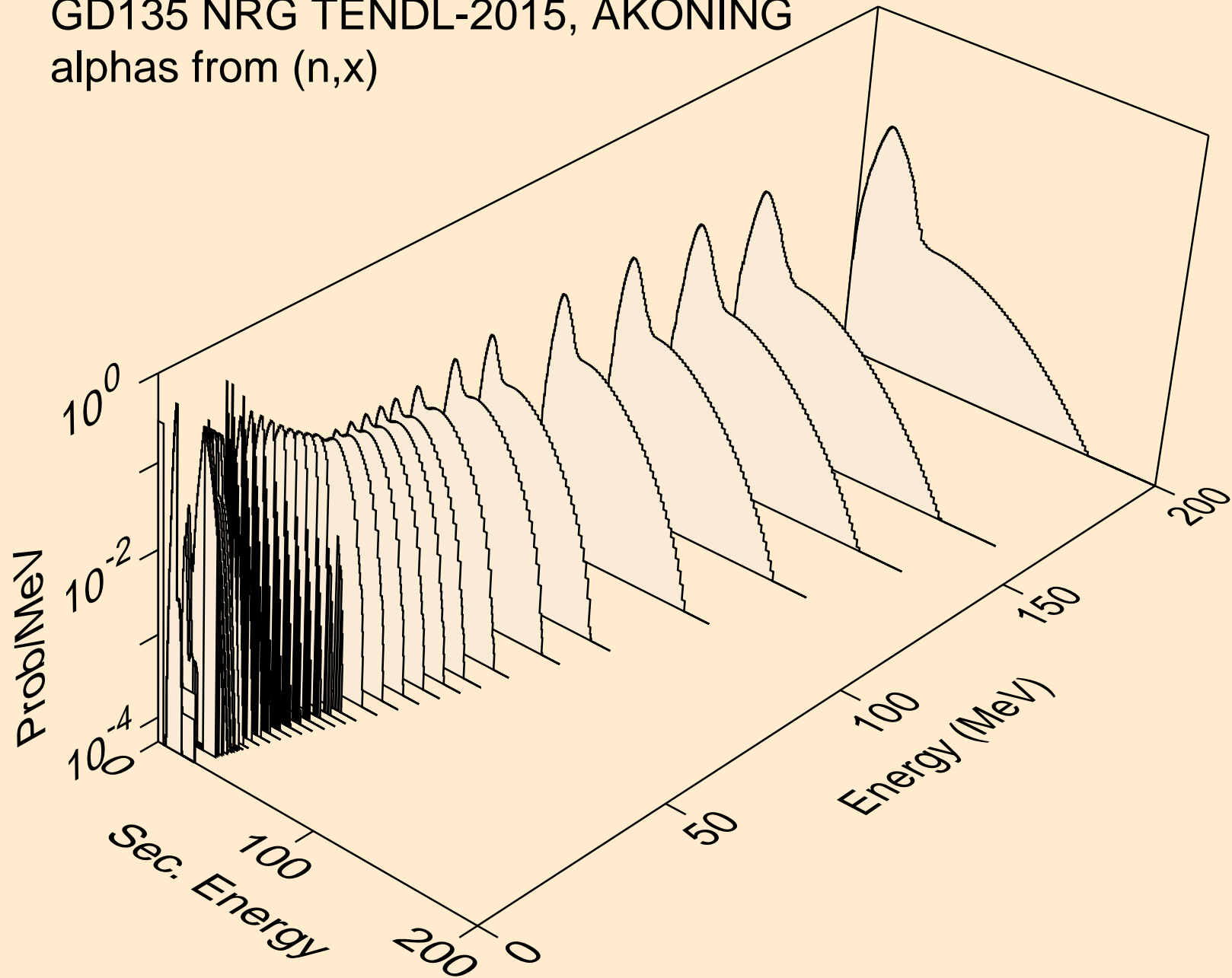

GD135 NRG TENDL-2015, AKONING
alphas from (n,n*)a

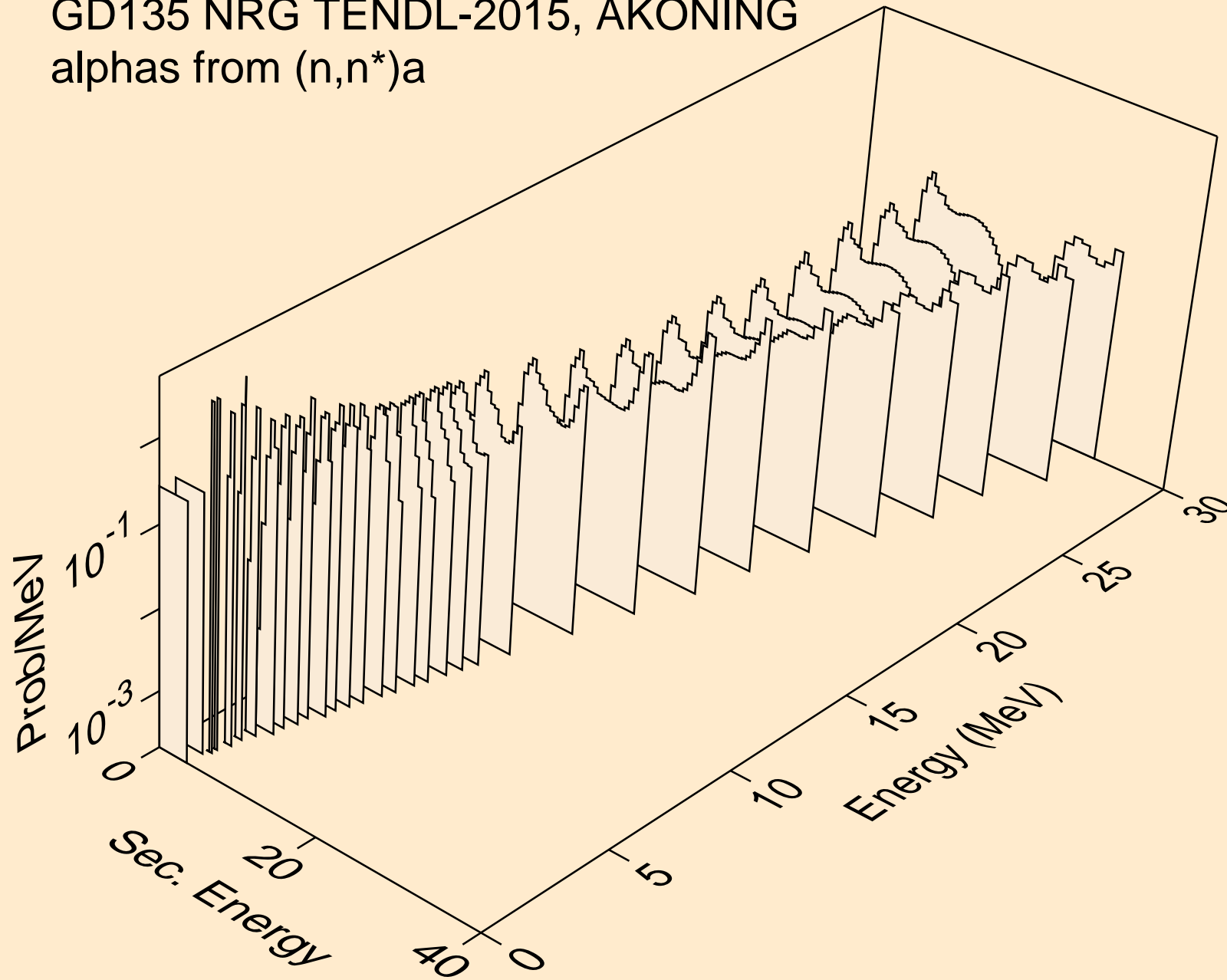

GD135 NRG TENDL-2015, AKONING
alphas from (n,n*)3a

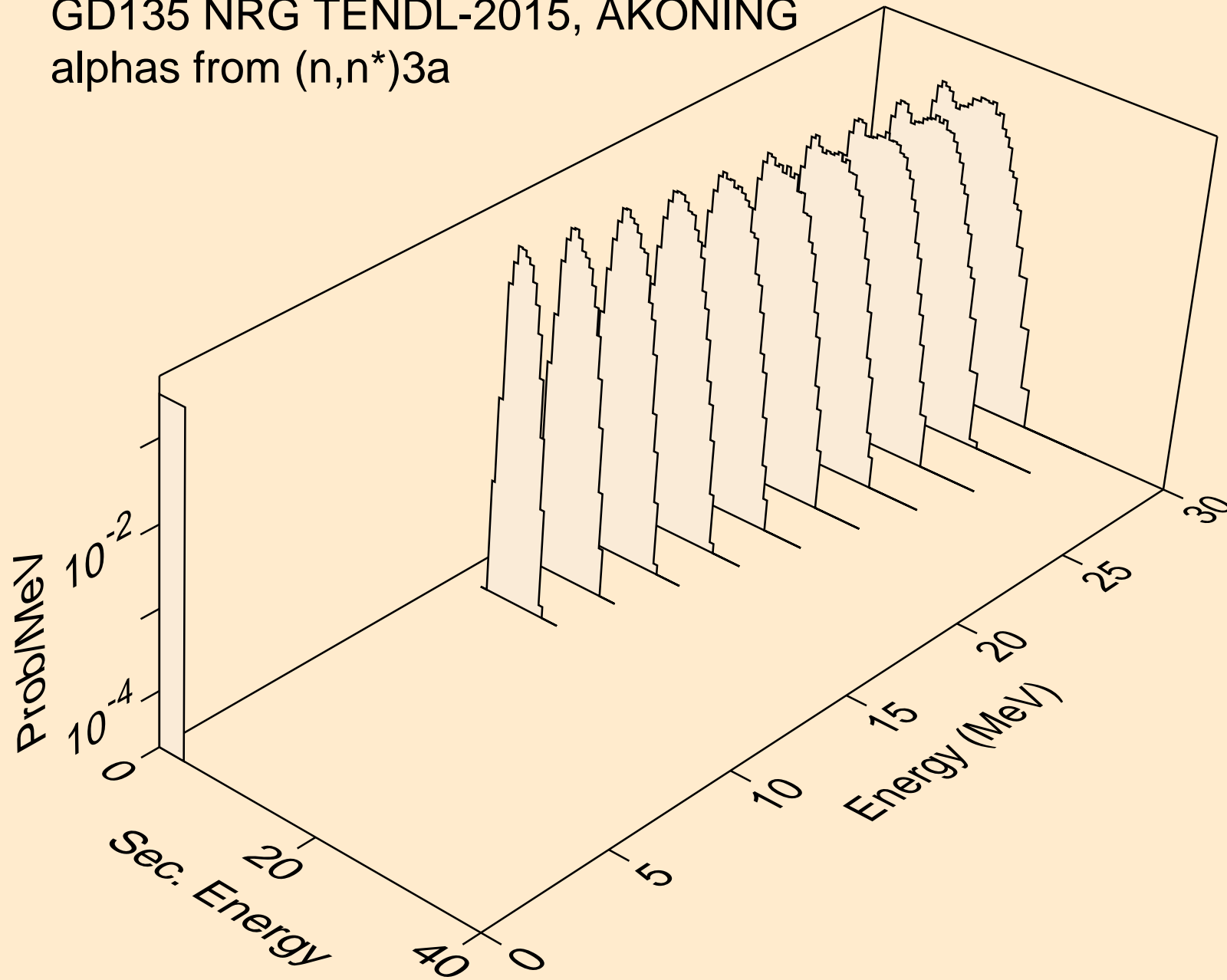

GD135 NRG TENDL-2015, AKONING
alphas from (n,2n)a

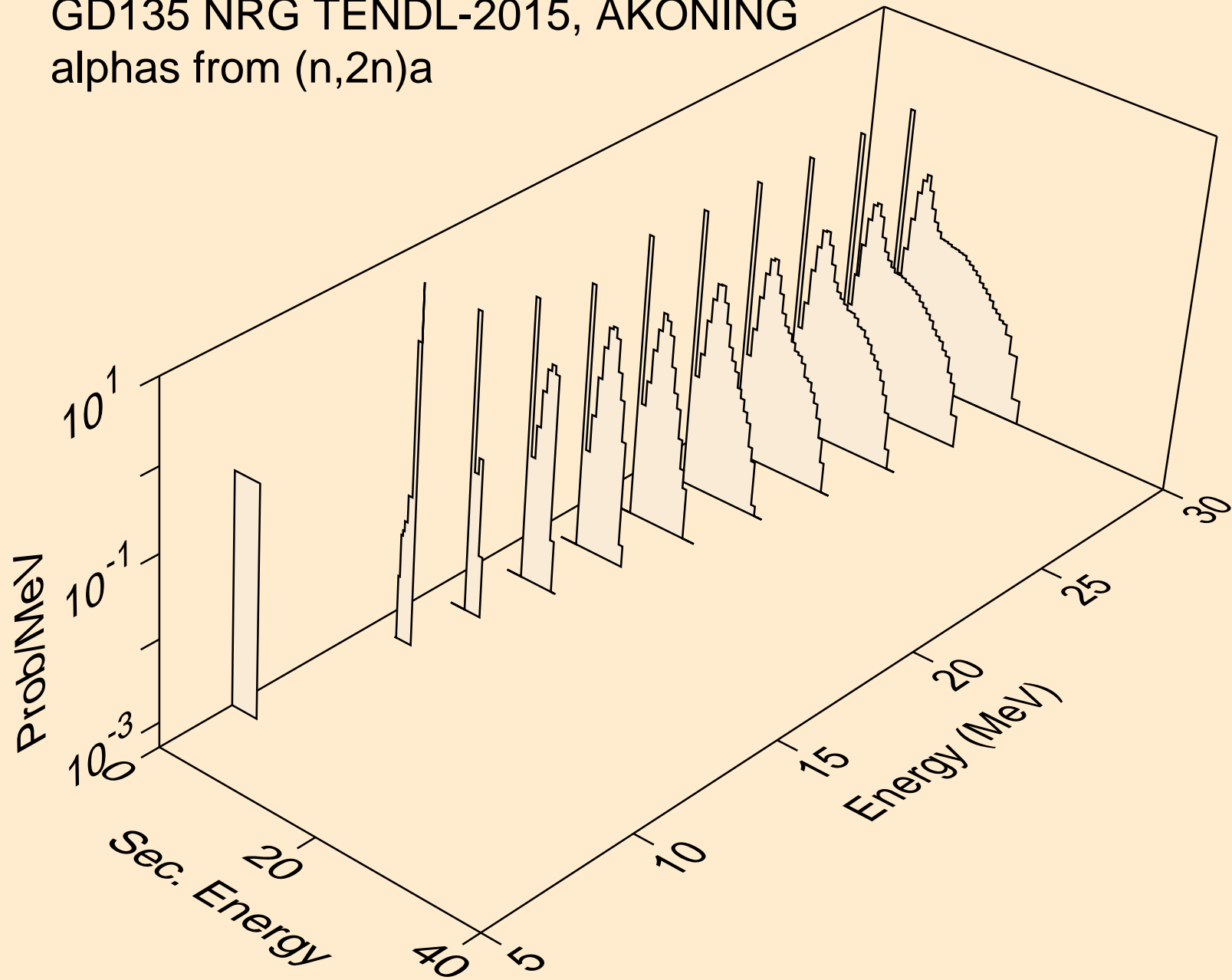

GD135 NRG TENDL-2015, AKONING
alphas from (n,3n)a

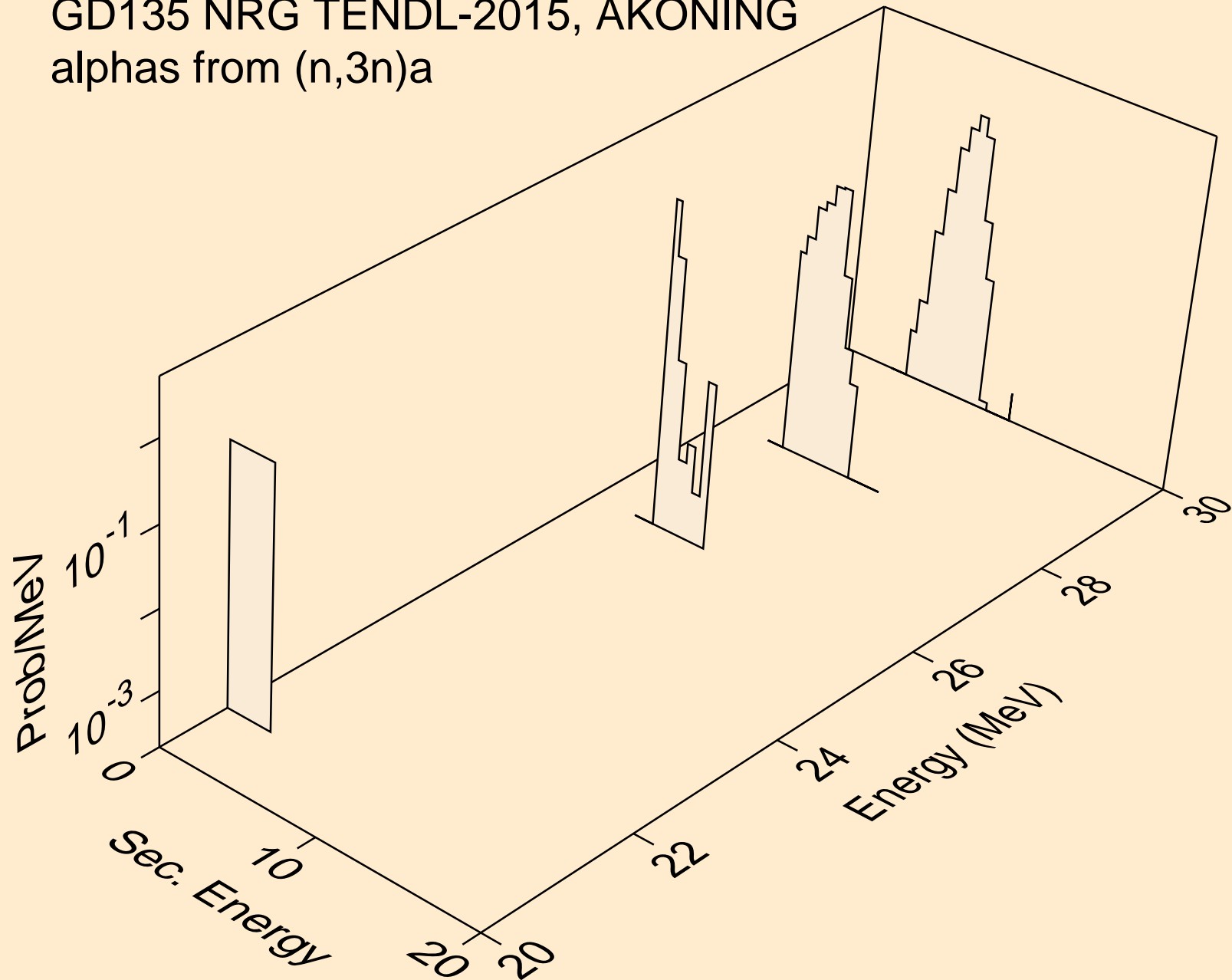

GD135 NRG TENDL-2015, AKONING
alphas from (n,n*)2a

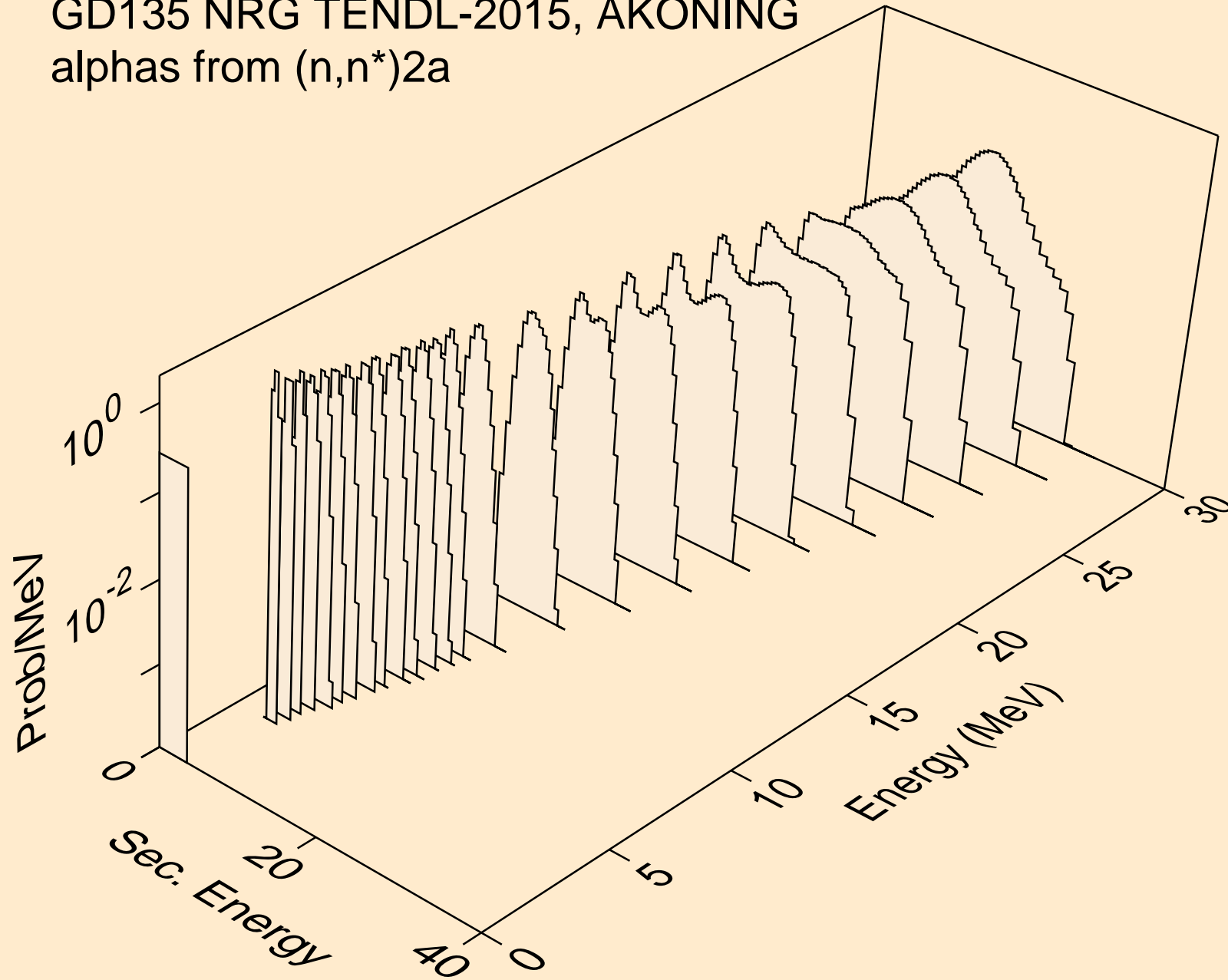

GD135 NRG TENDL-2015, AKONING
alphas from (n,2n)2a

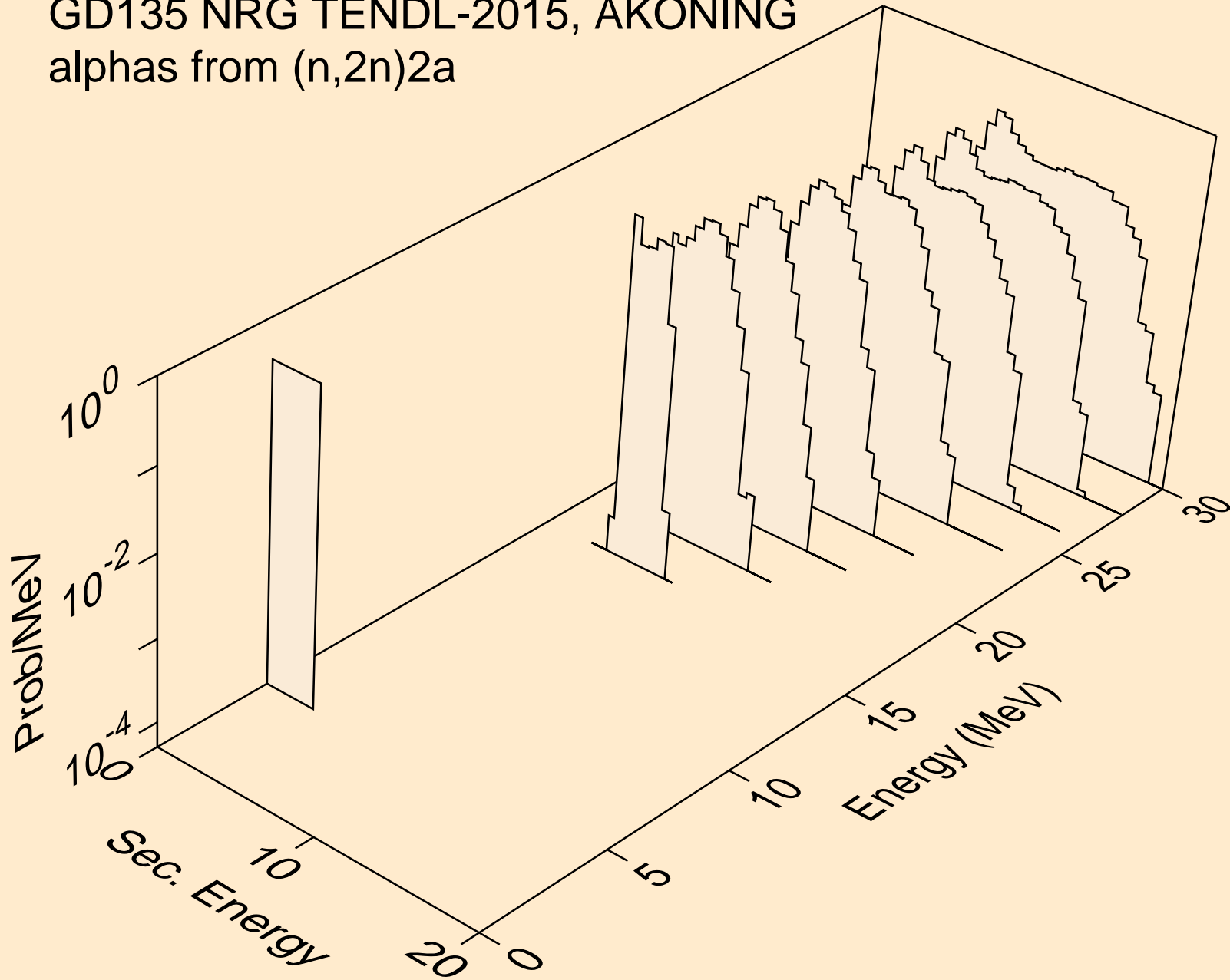

GD135 NRG TENDL-2015, AKONING
alphas from (n,npa)

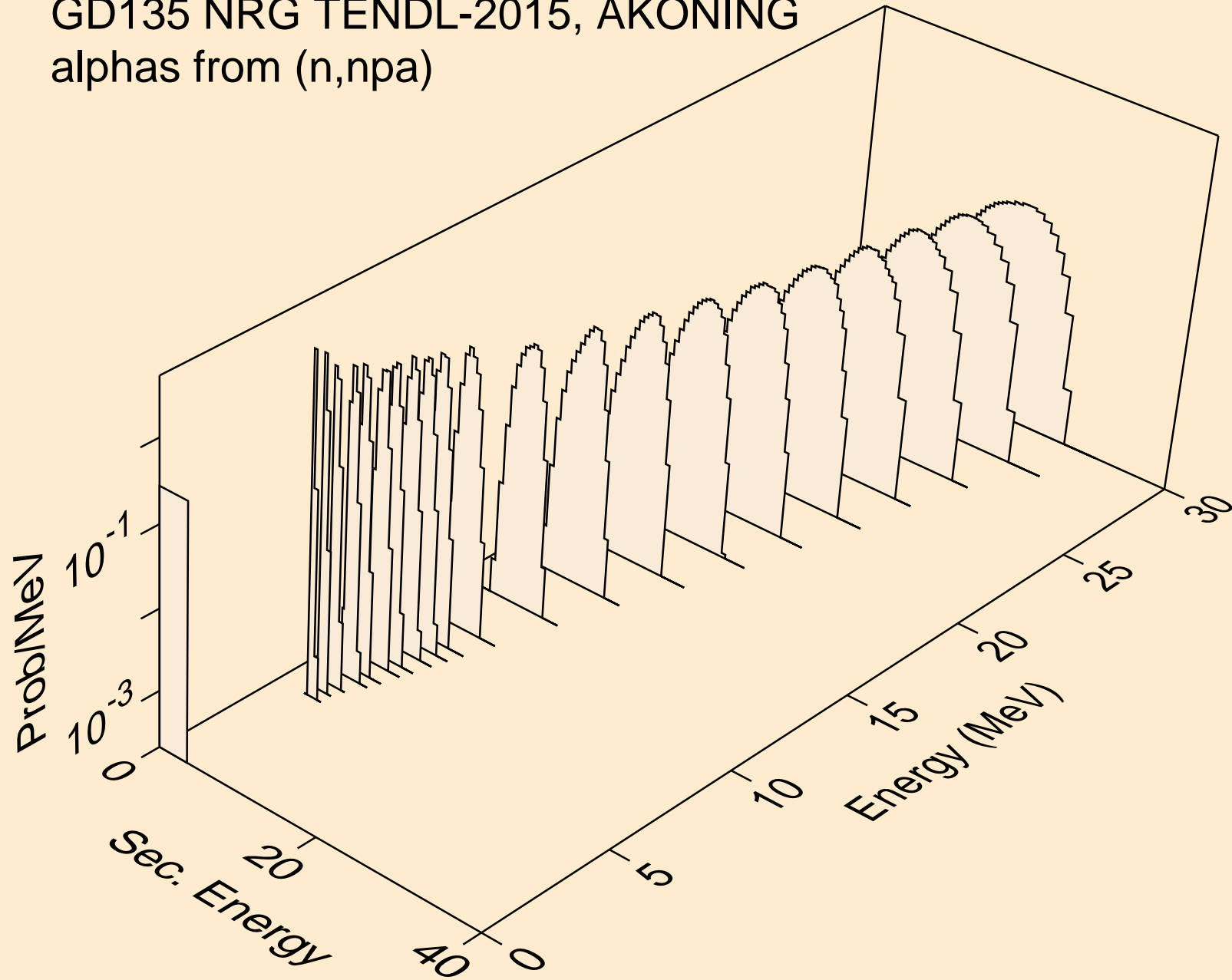

GD135 NRG TENDL-2015, AKONING
alphas from (n,a)

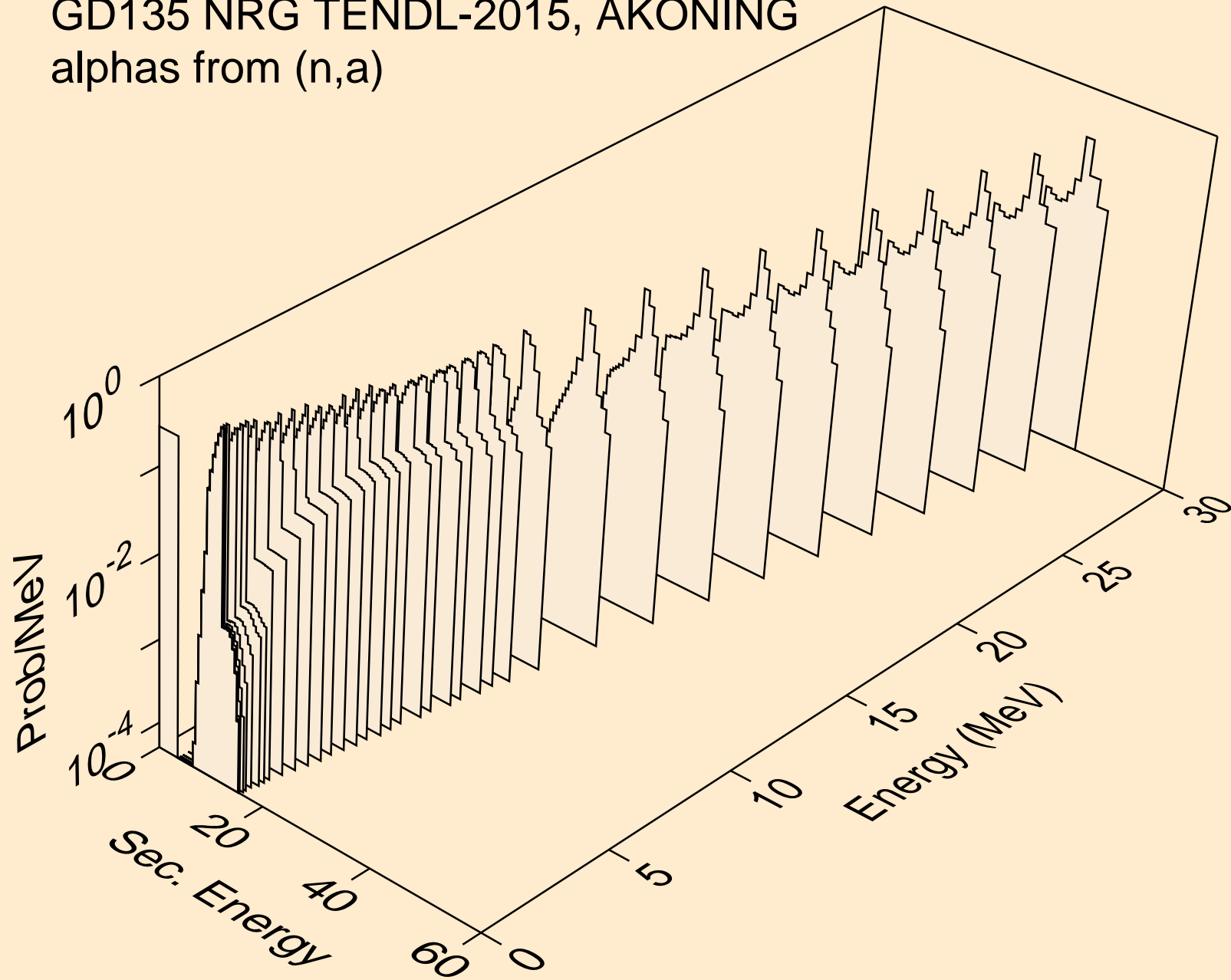

GD135 NRG TENDL-2015, AKONING
alphas from (n,2a)

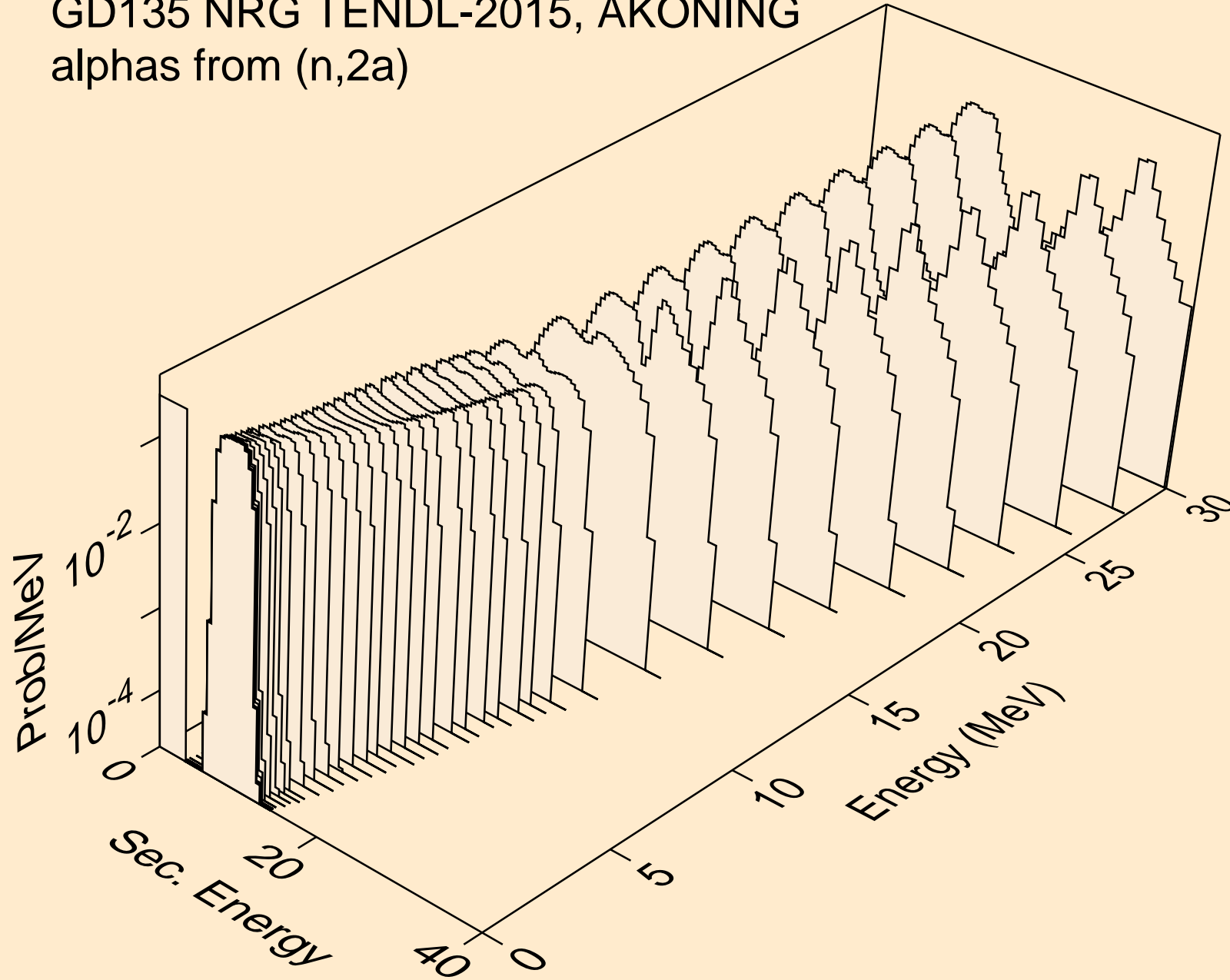

GD135 NRG TENDL-2015, AKONING
alphas from (n,3a)

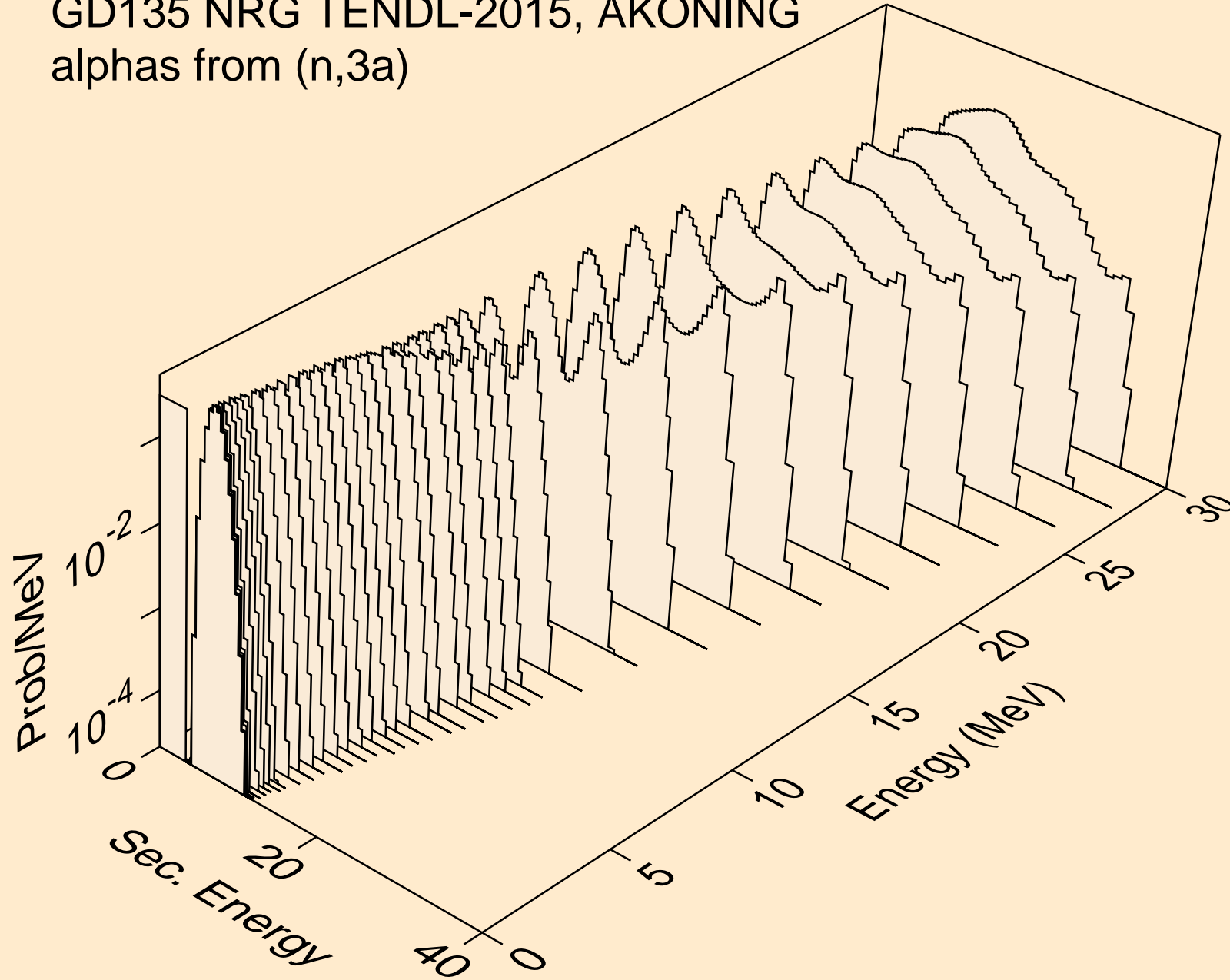

GD135 NRG TENDL-2015, AKONING
alphas from (n,pa)

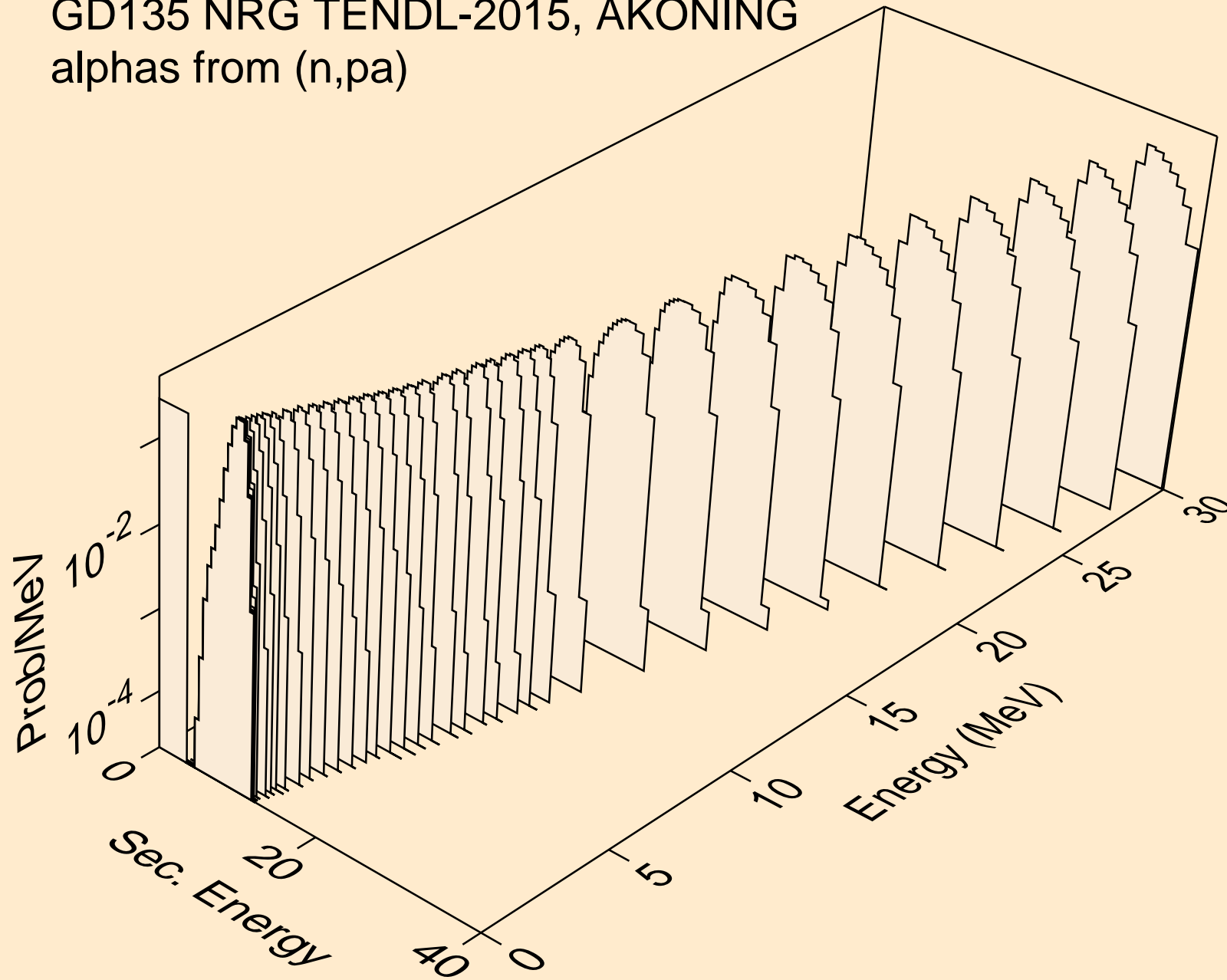

GD135 NRG TENDL-2015, AKONING
alphas from (n,d2a)

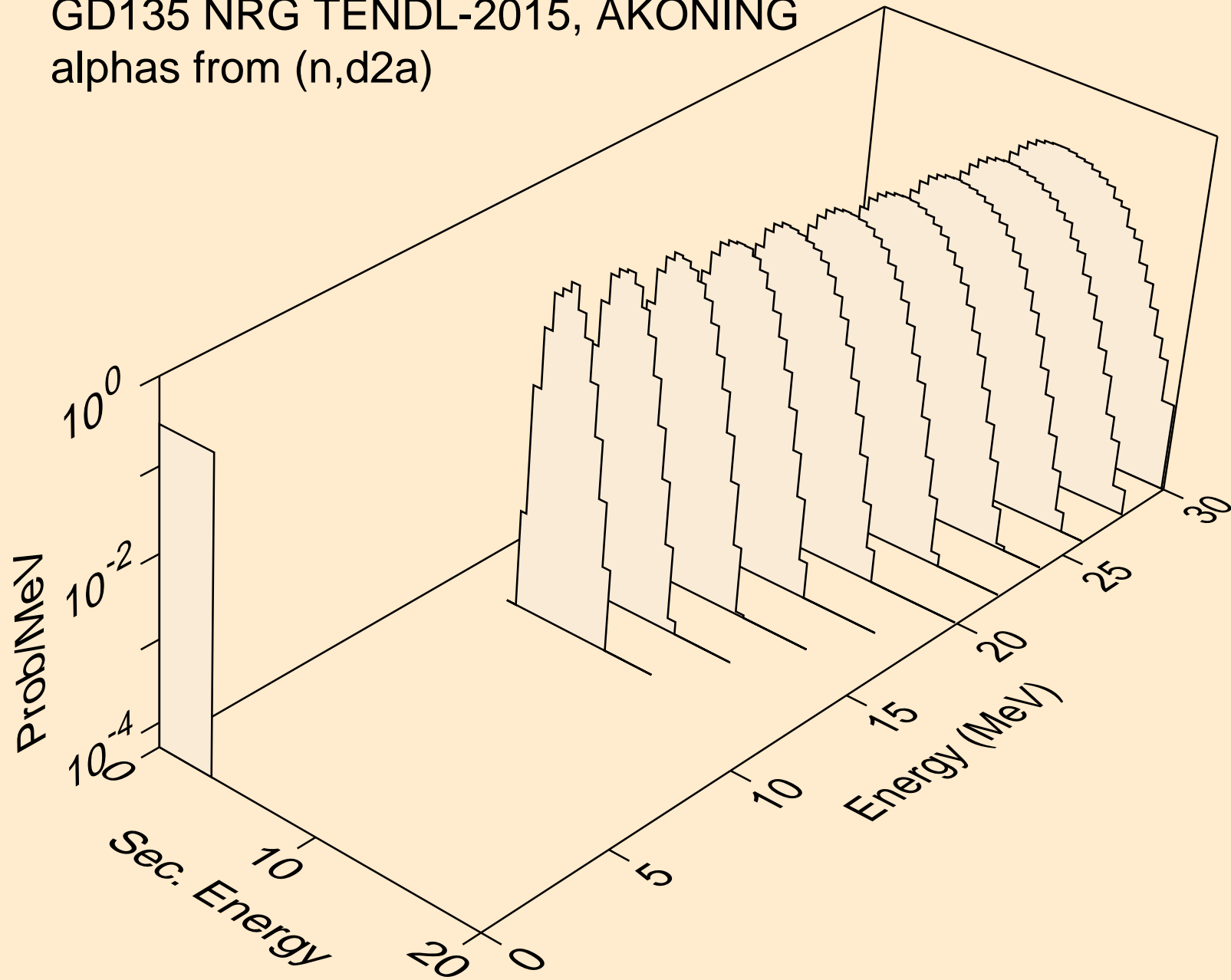

GD135 NRG TENDL-2015, AKONING
alphas from (n,da)

