

GE072 NRG TENDL-2016, AKONING

Principal cross sections

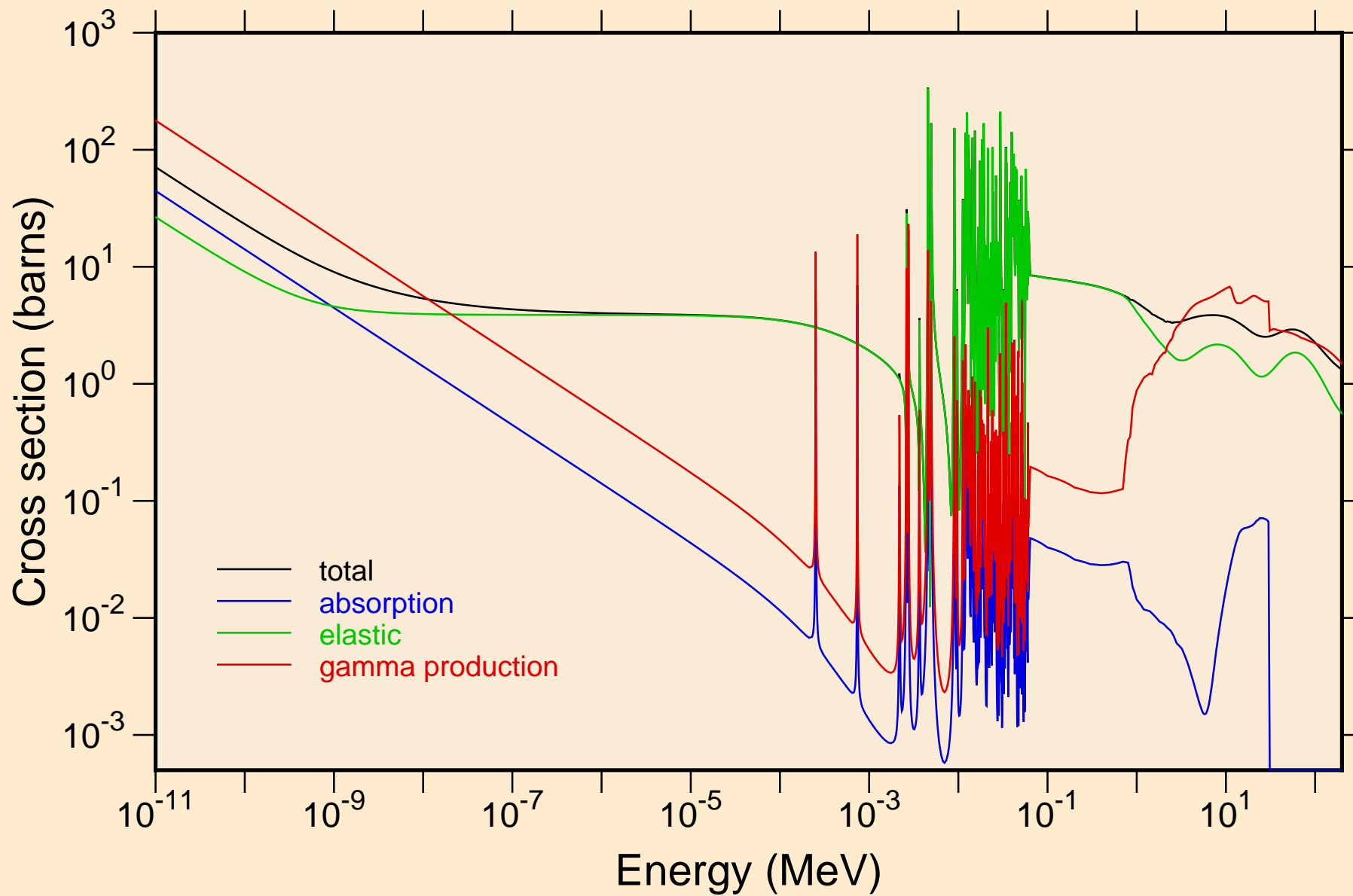

GE072 NRG TENDL-2016, AKONING
resonance total cross section

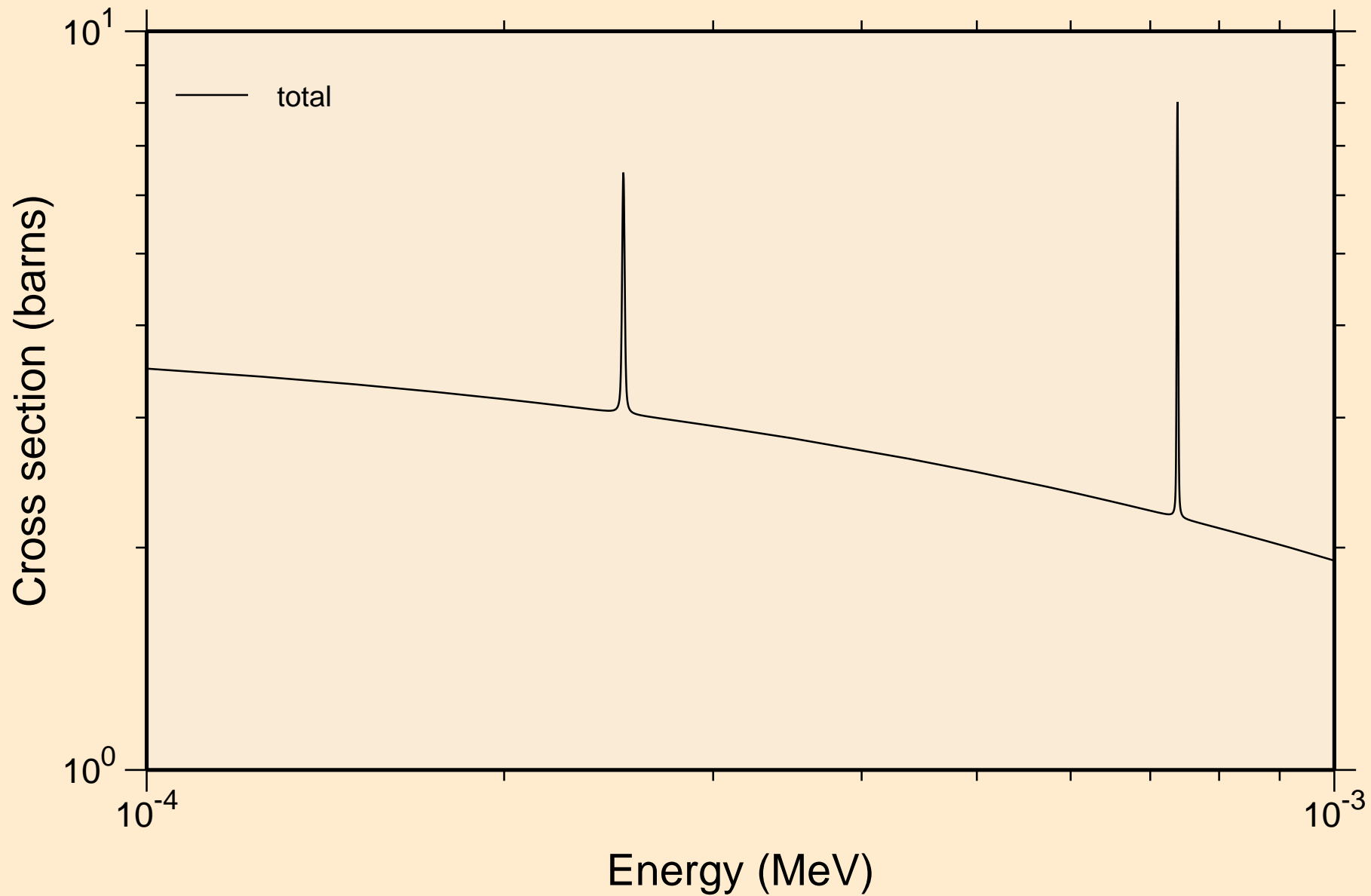

GE072 NRG TENDL-2016, AKONING

resonance total cross section

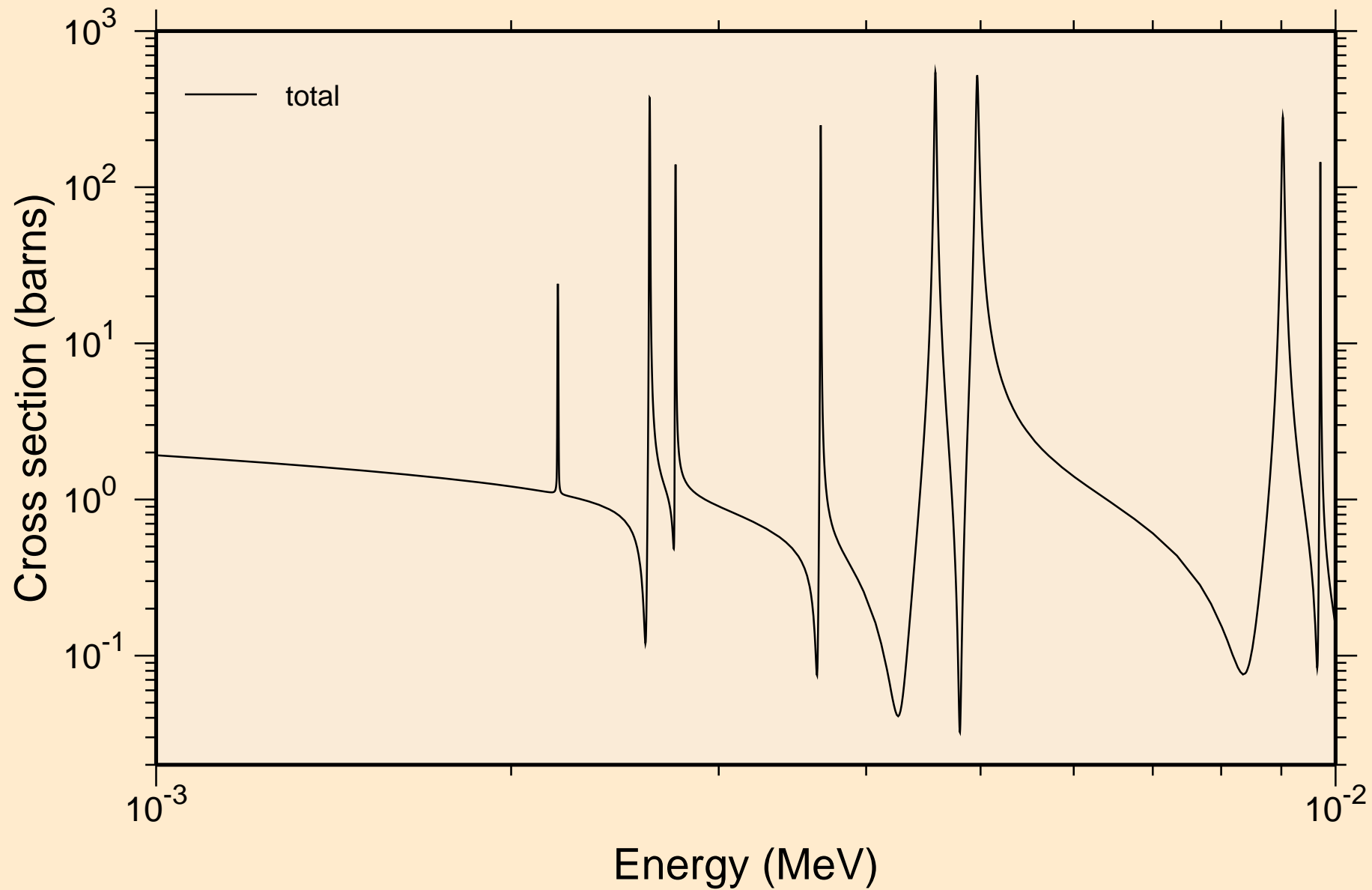

GE072 NRG TENDL-2016, AKONING
resonance total cross section

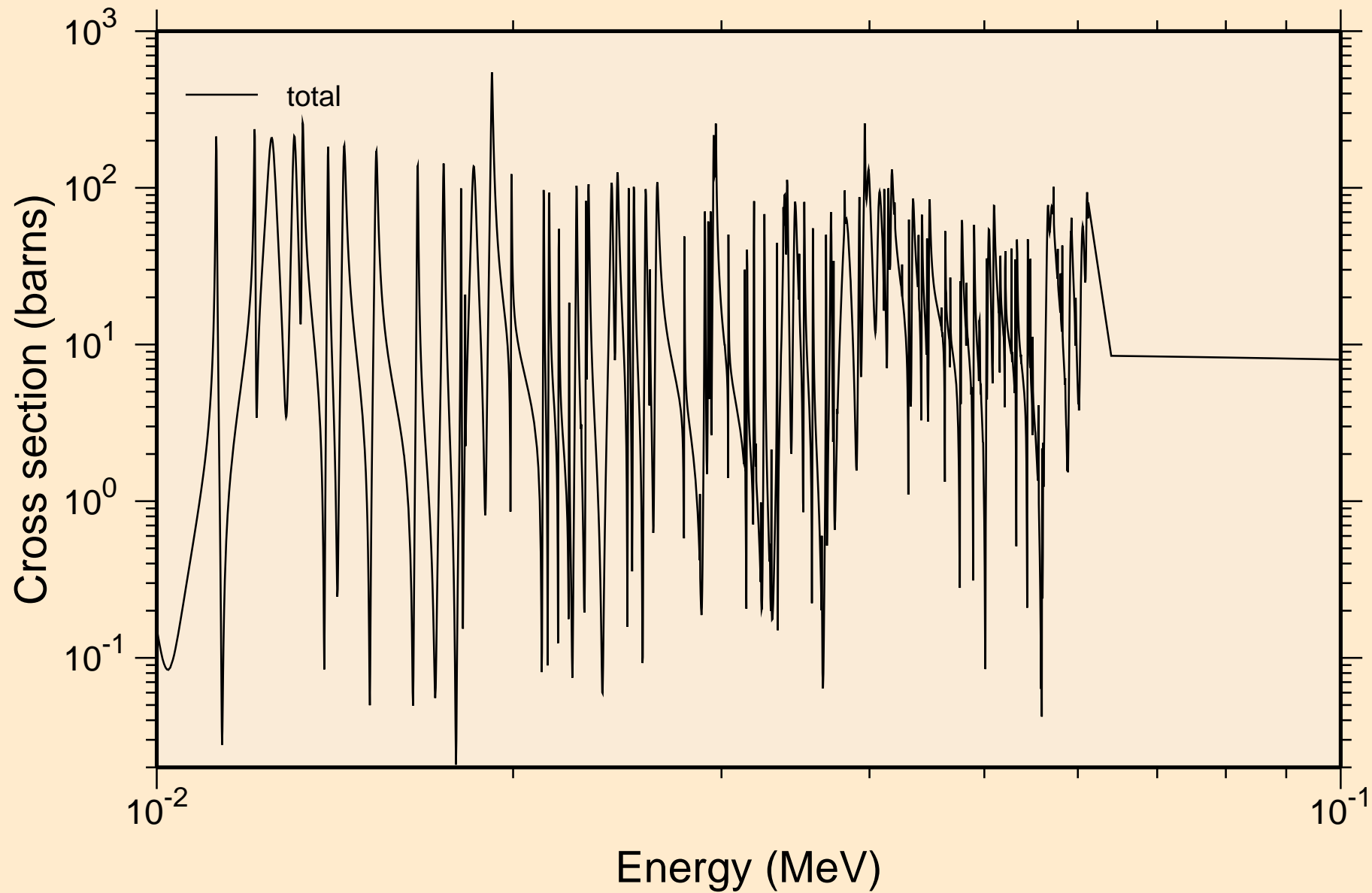

GE072 NRG TENDL-2016, AKONING
resonance total cross section

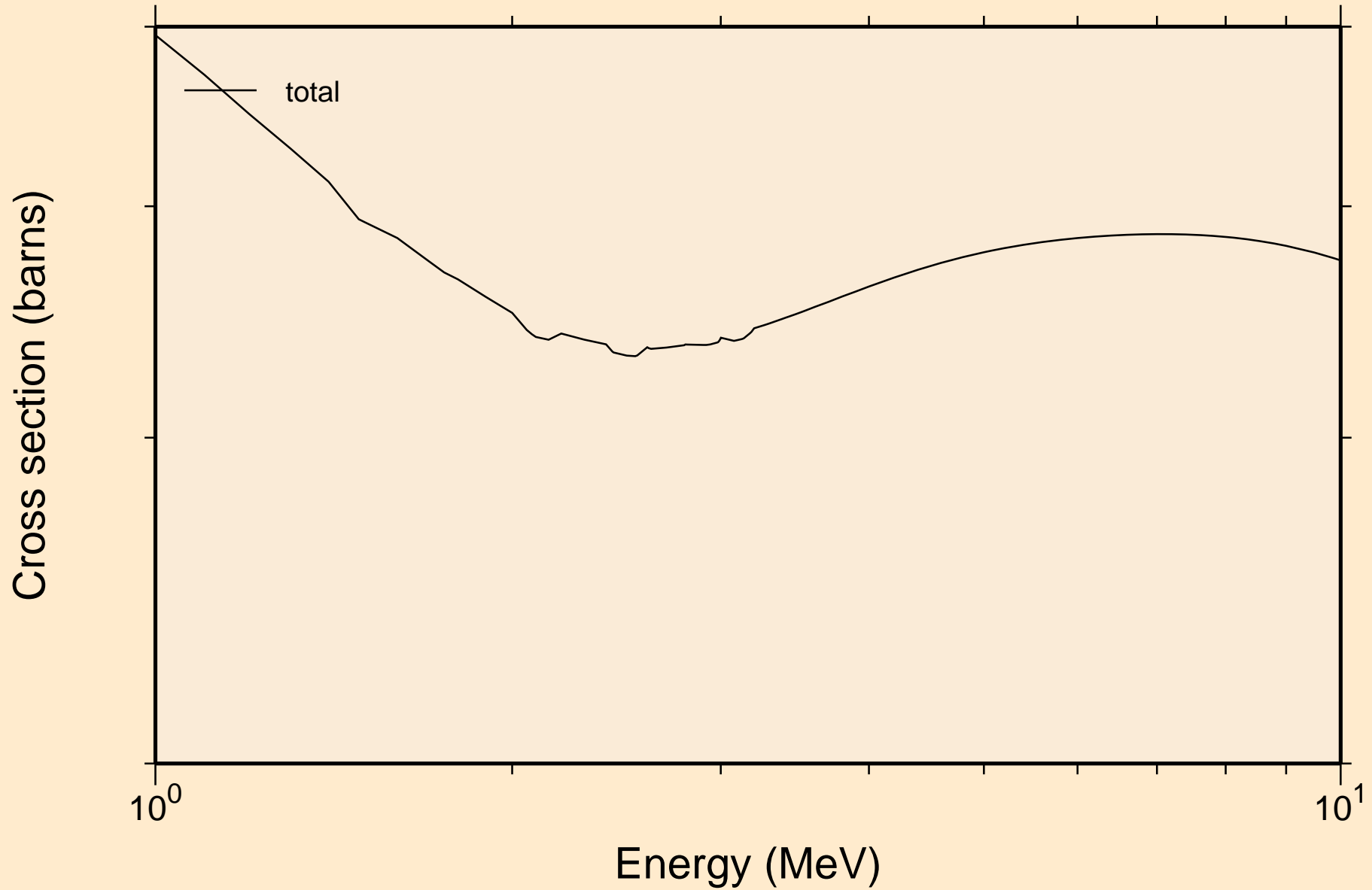

GE072 NRG TENDL-2016, AKONING

resonance absorption cross sections

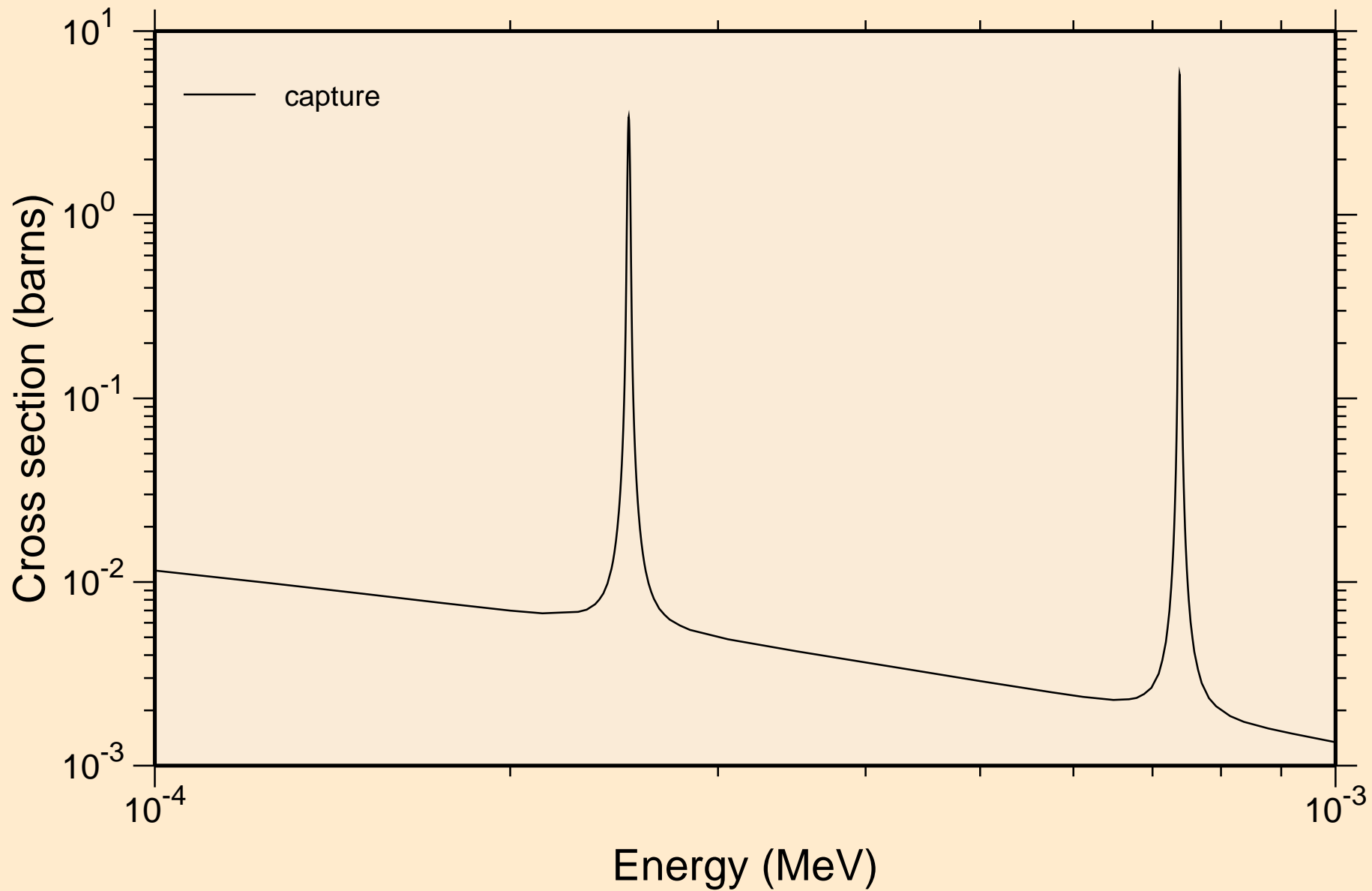

GE072 NRG TENDL-2016, AKONING resonance absorption cross sections

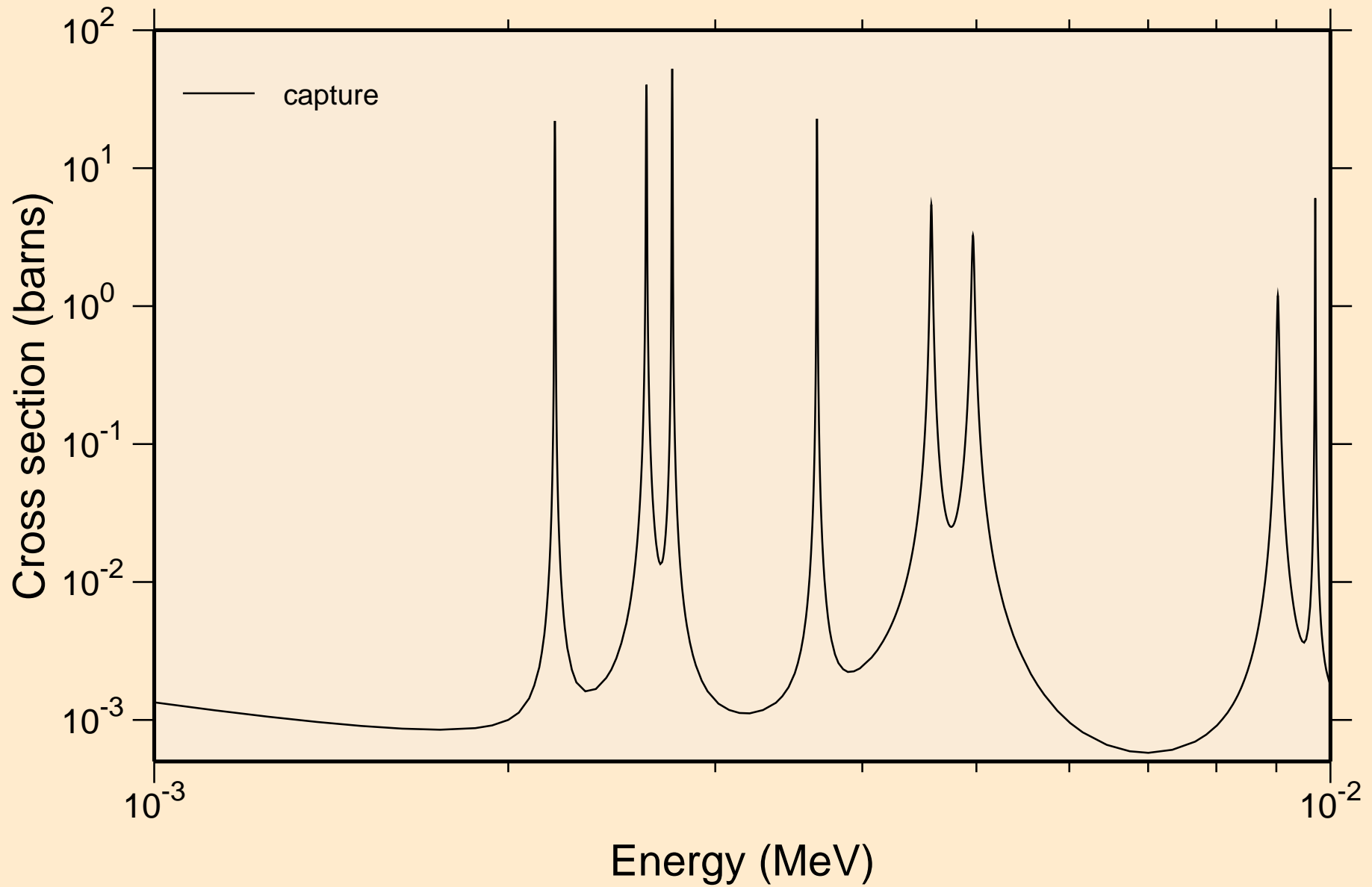

GE072 NRG TENDL-2016, AKONING
resonance absorption cross sections

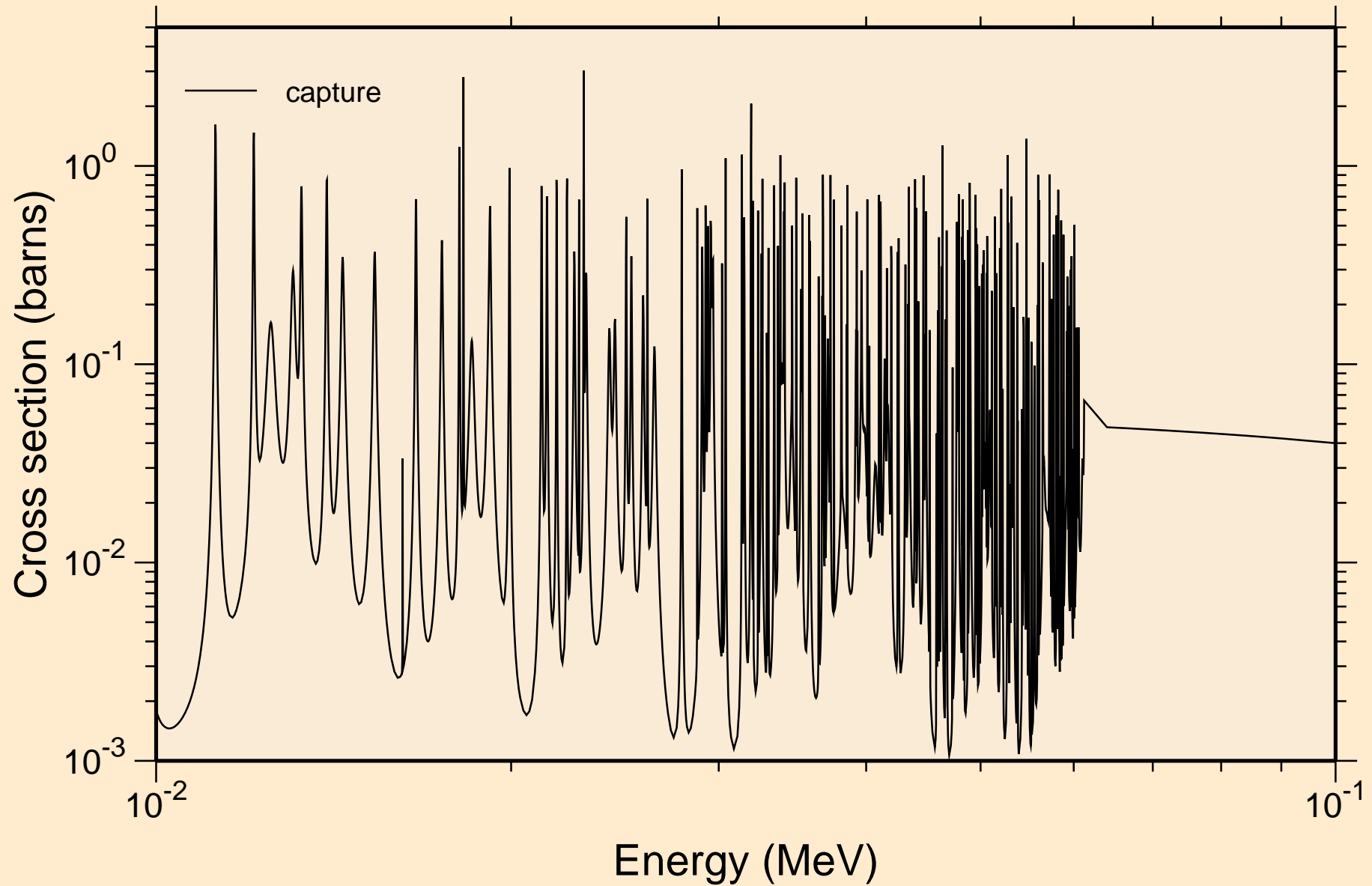

GE072 NRG TENDL-2016, AKONING
resonance absorption cross sections

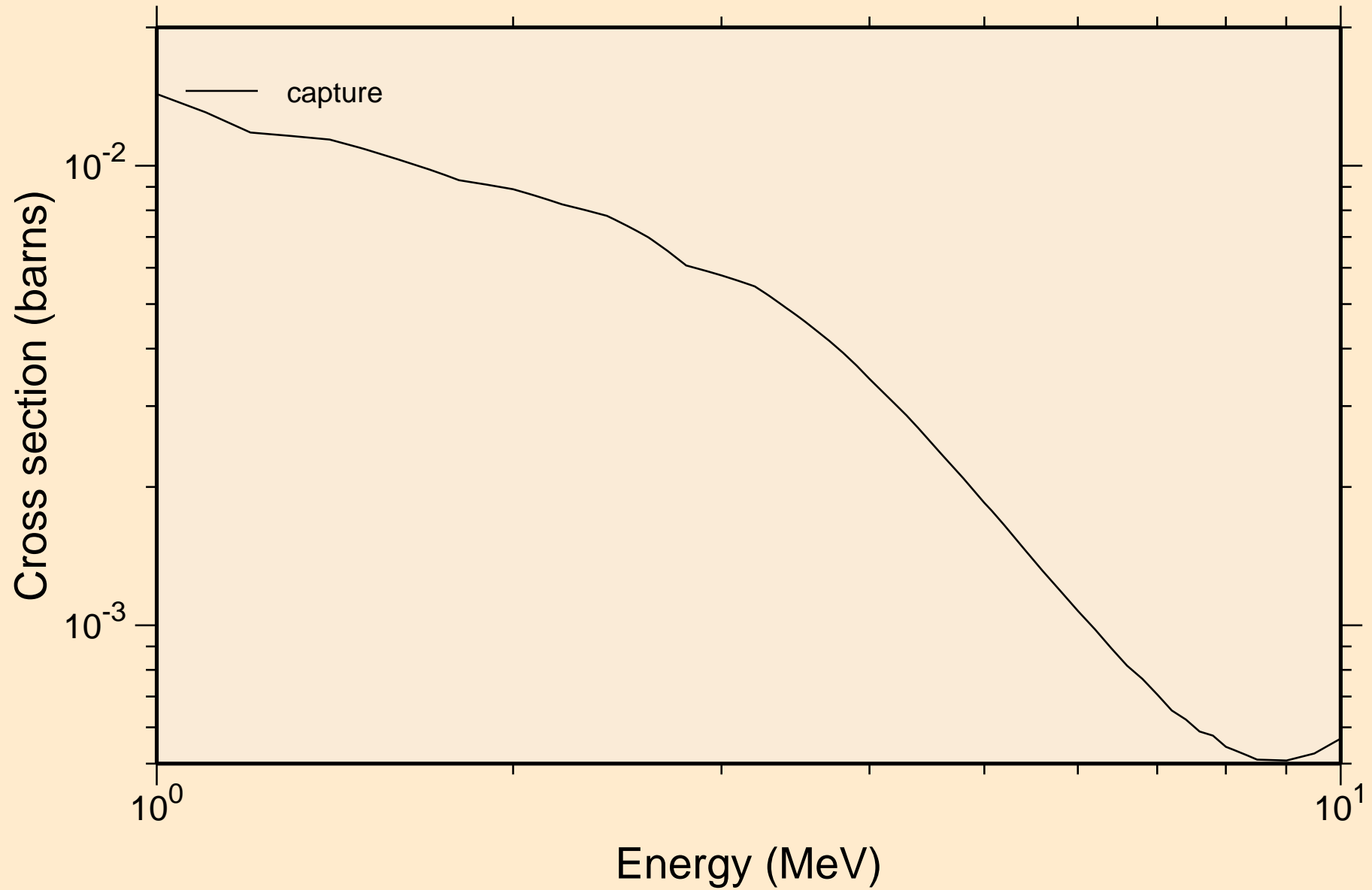

GE072 NRG TENDL-2016, AKONING
Non-threshold reactions

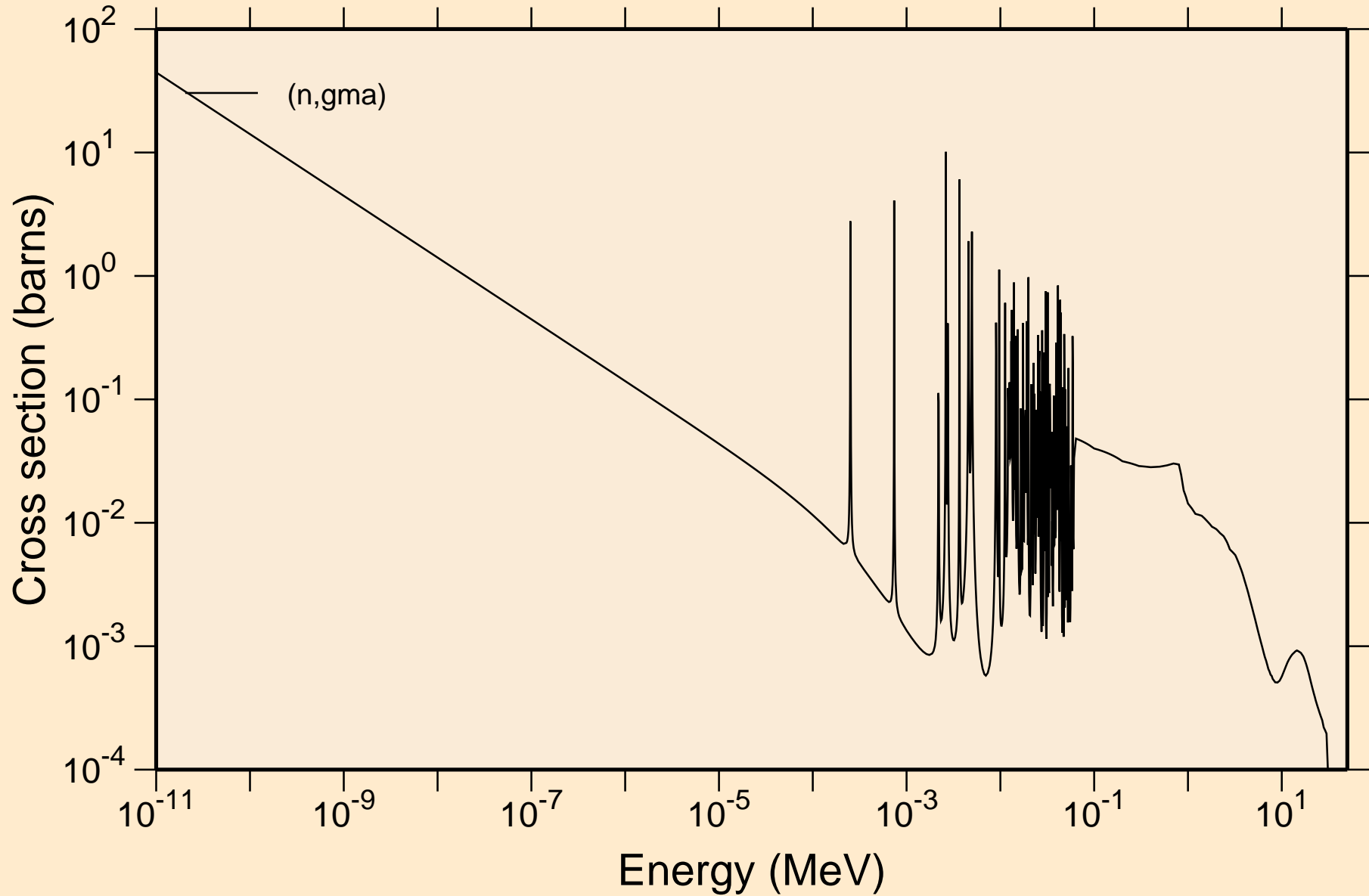

GE072 NRG TENDL-2016, AKONING

Principal cross sections

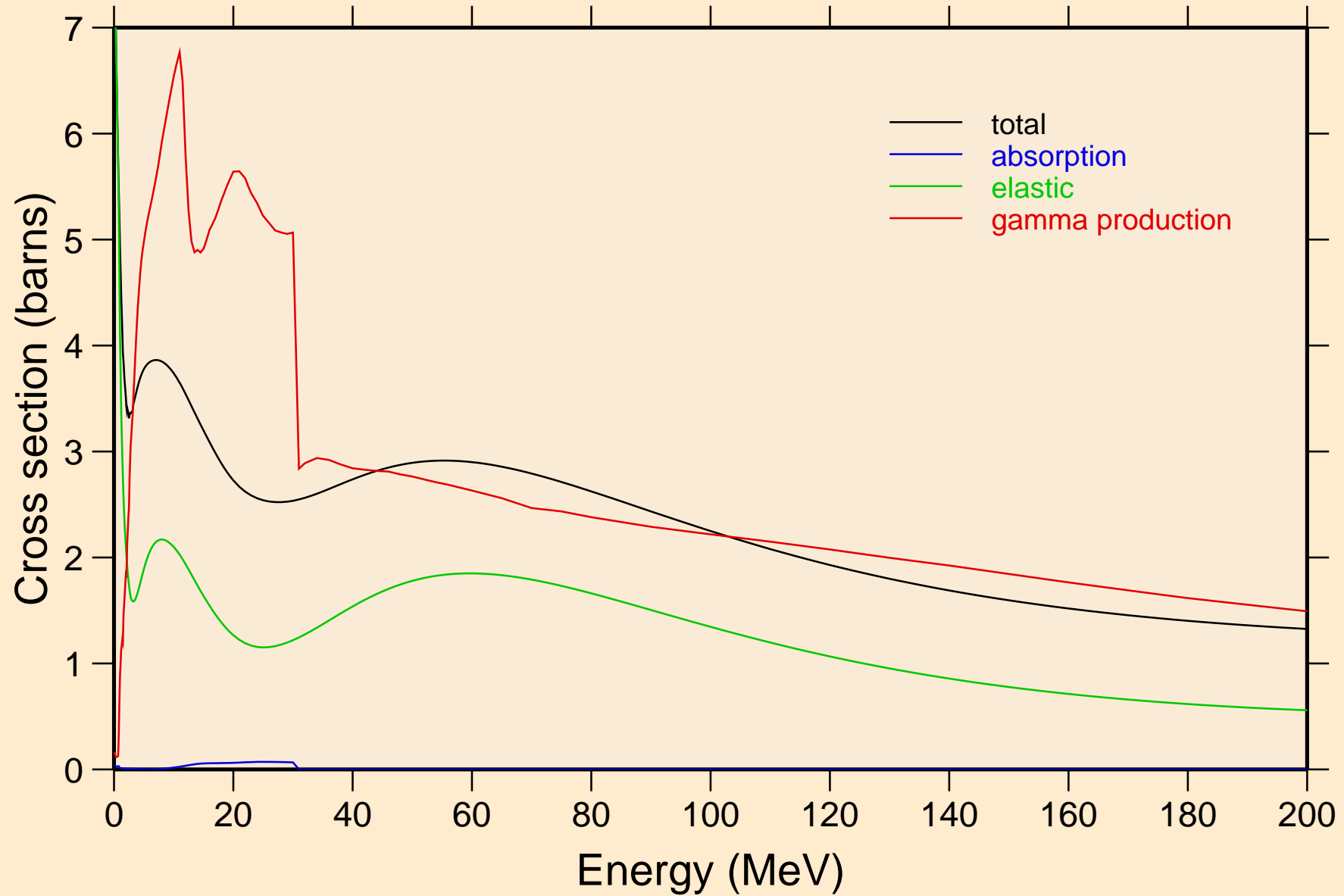

GE072 NRG TENDL-2016, AKONING
Non-threshold reactions

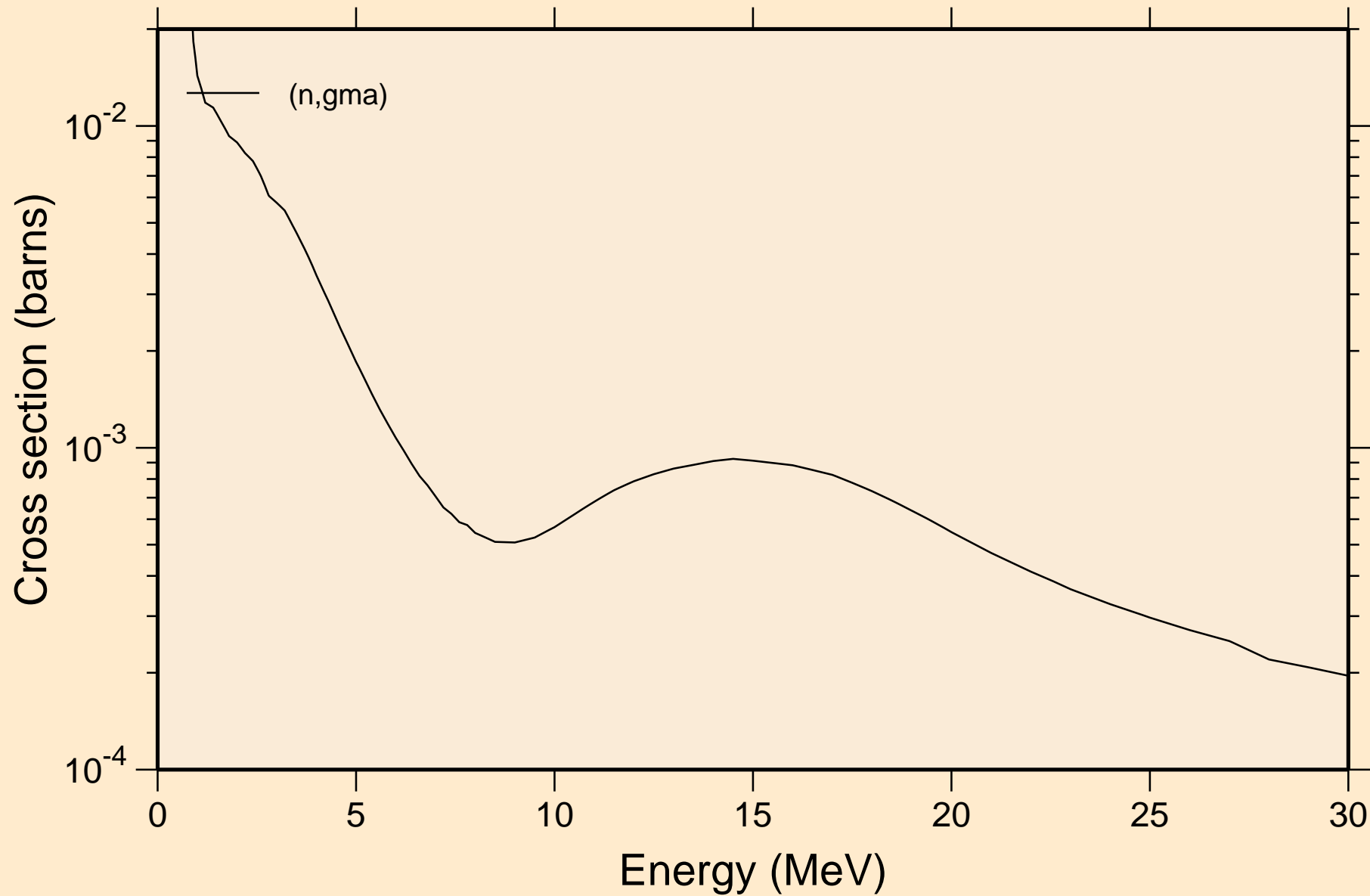

GE072 NRG TENDL-2016, AKONING

Inelastic levels

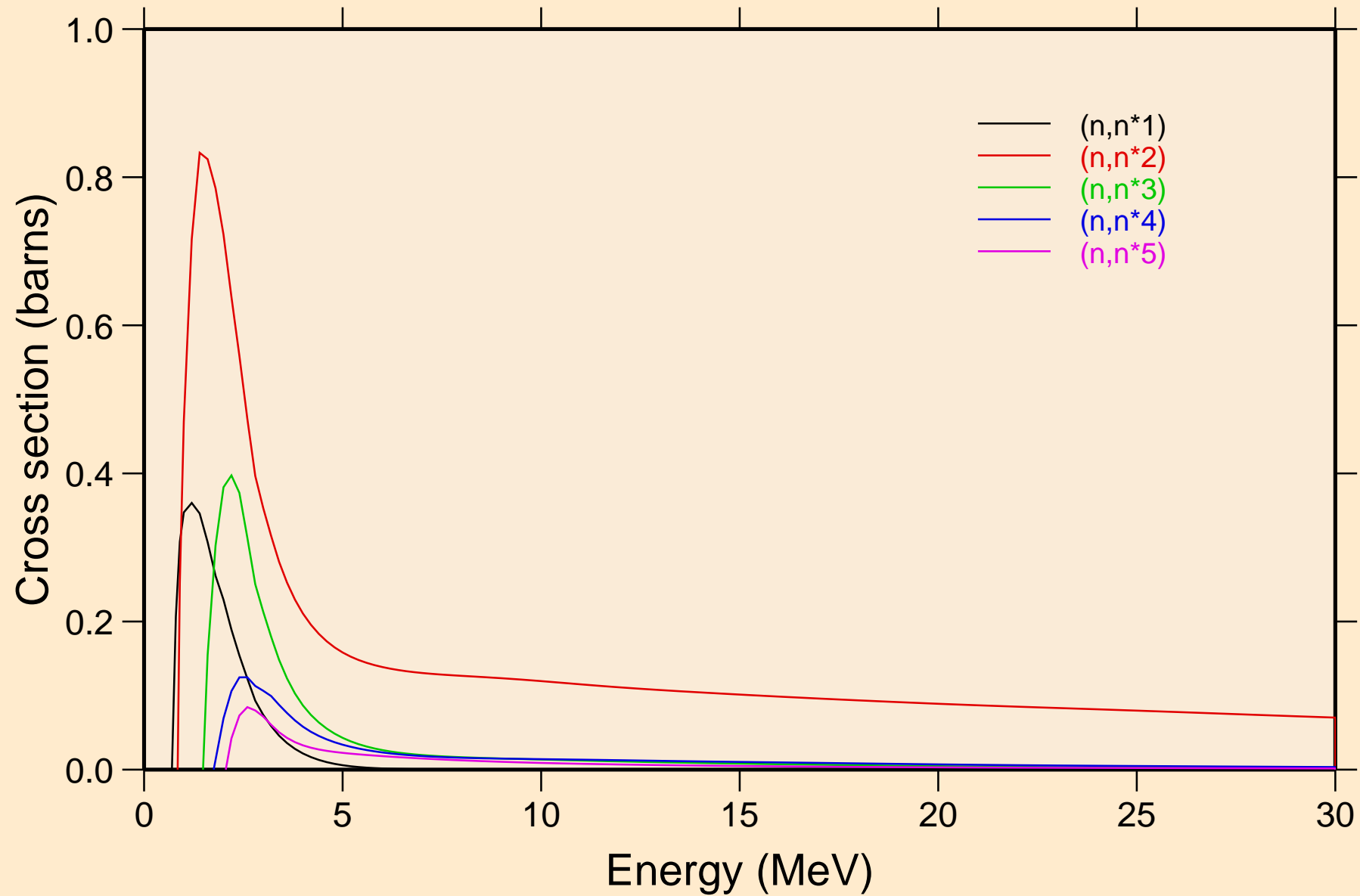

GE072 NRG TENDL-2016, AKONING

Inelastic levels

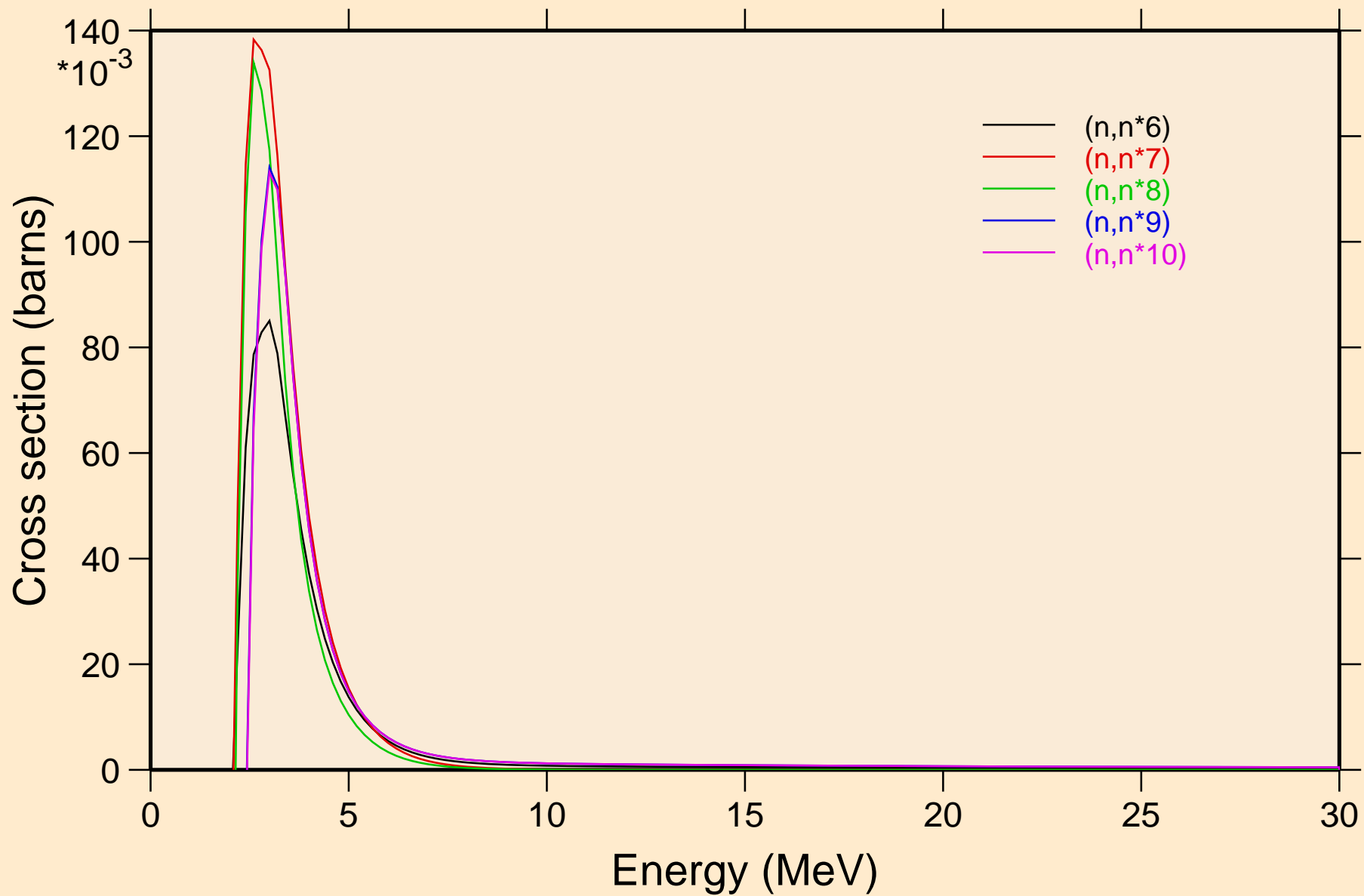

GE072 NRG TENDL-2016, AKONING

Inelastic levels

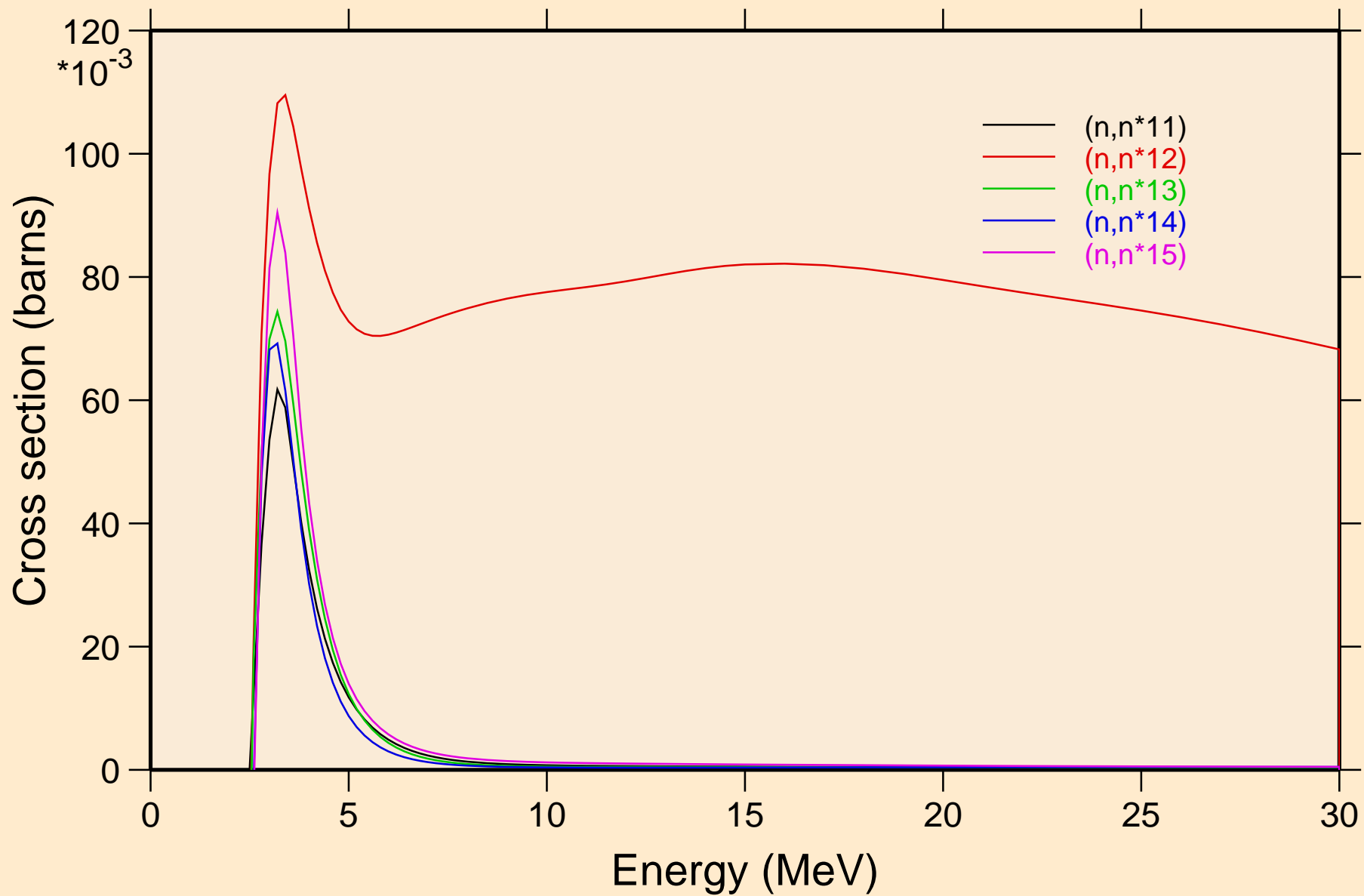

GE072 NRG TENDL-2016, AKONING

Inelastic levels

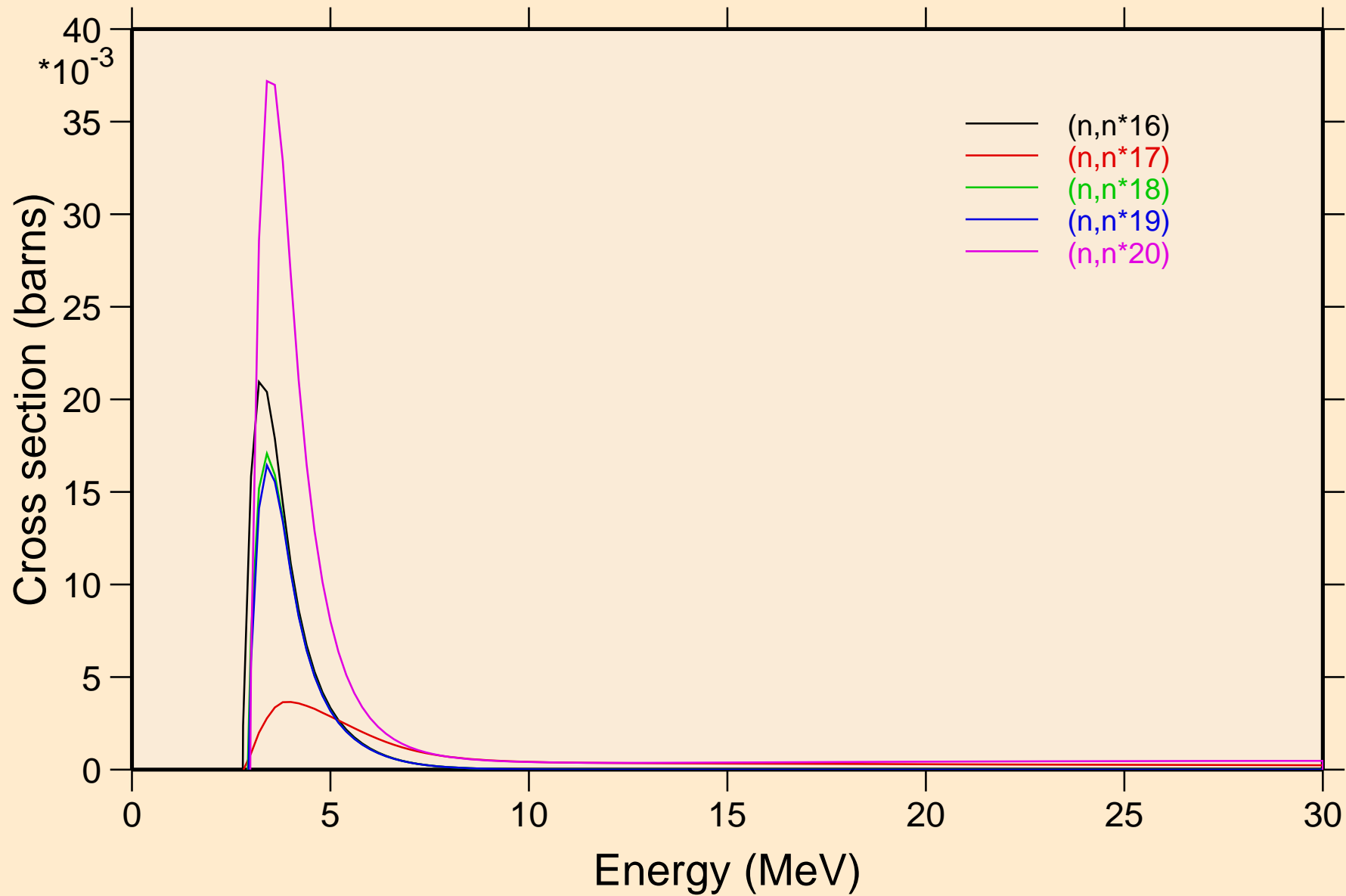

GE072 NRG TENDL-2016, AKONING

Inelastic levels

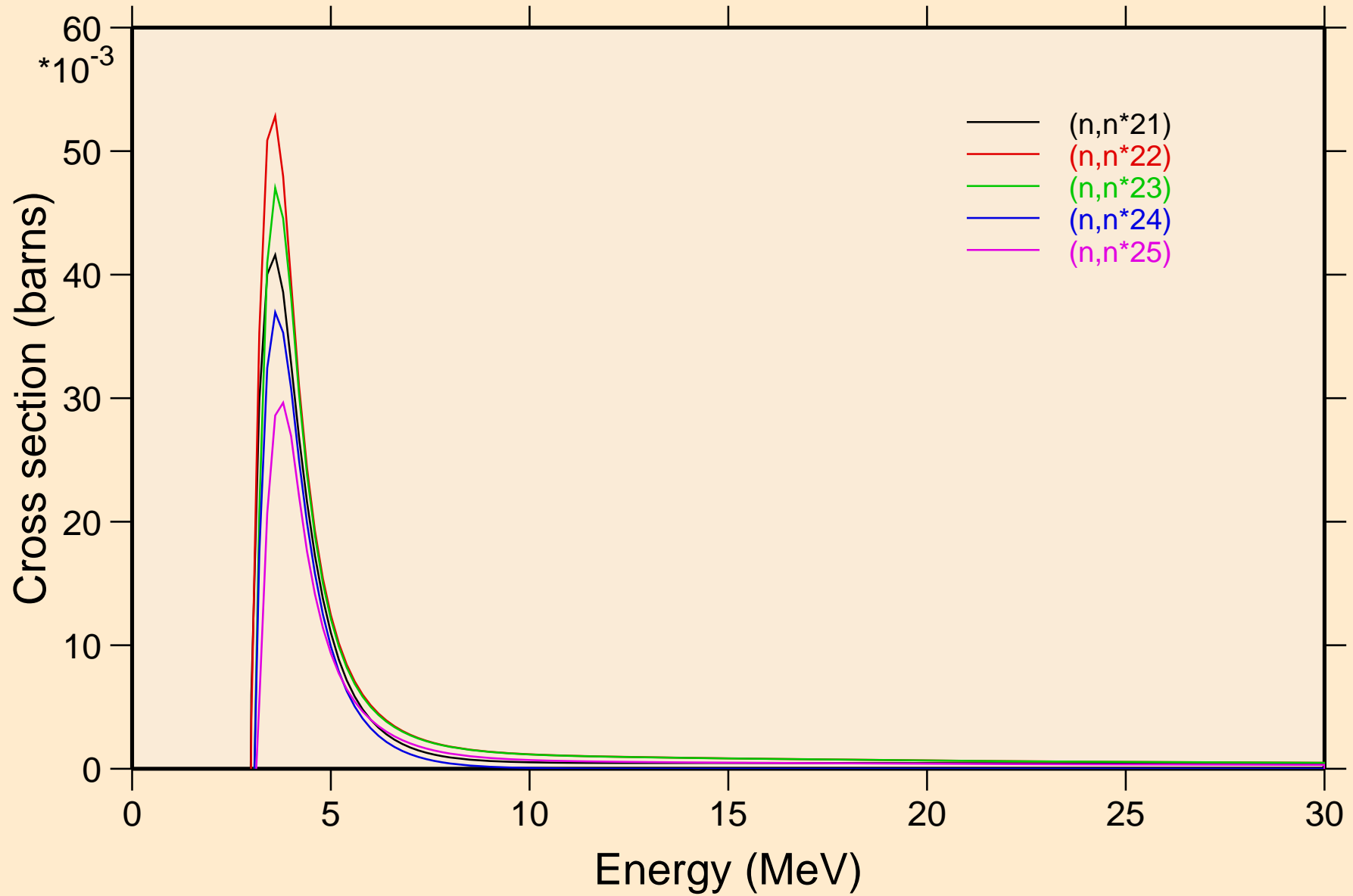

GE072 NRG TENDL-2016, AKONING

Inelastic levels

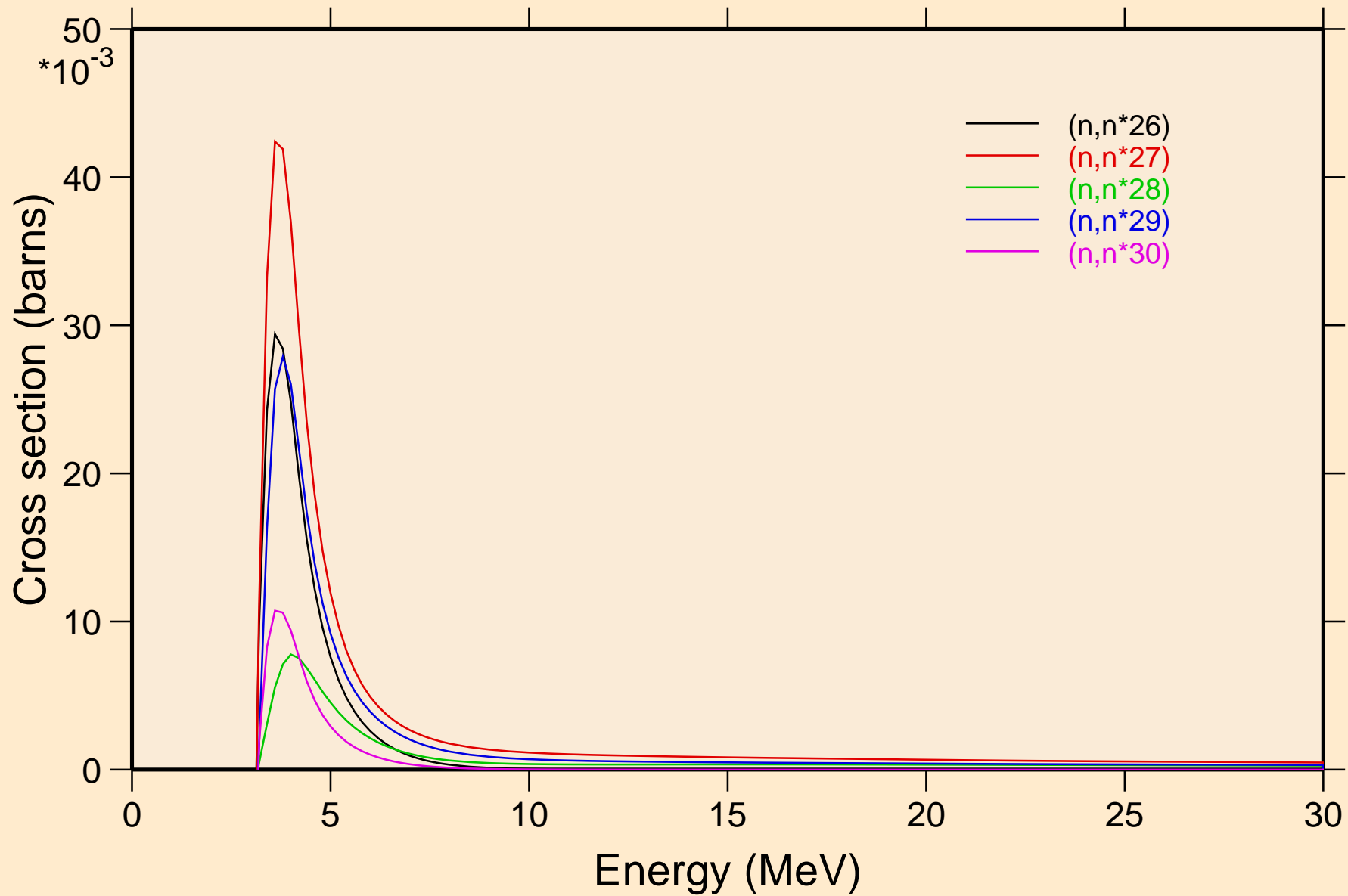

GE072 NRG TENDL-2016, AKONING

Threshold reactions

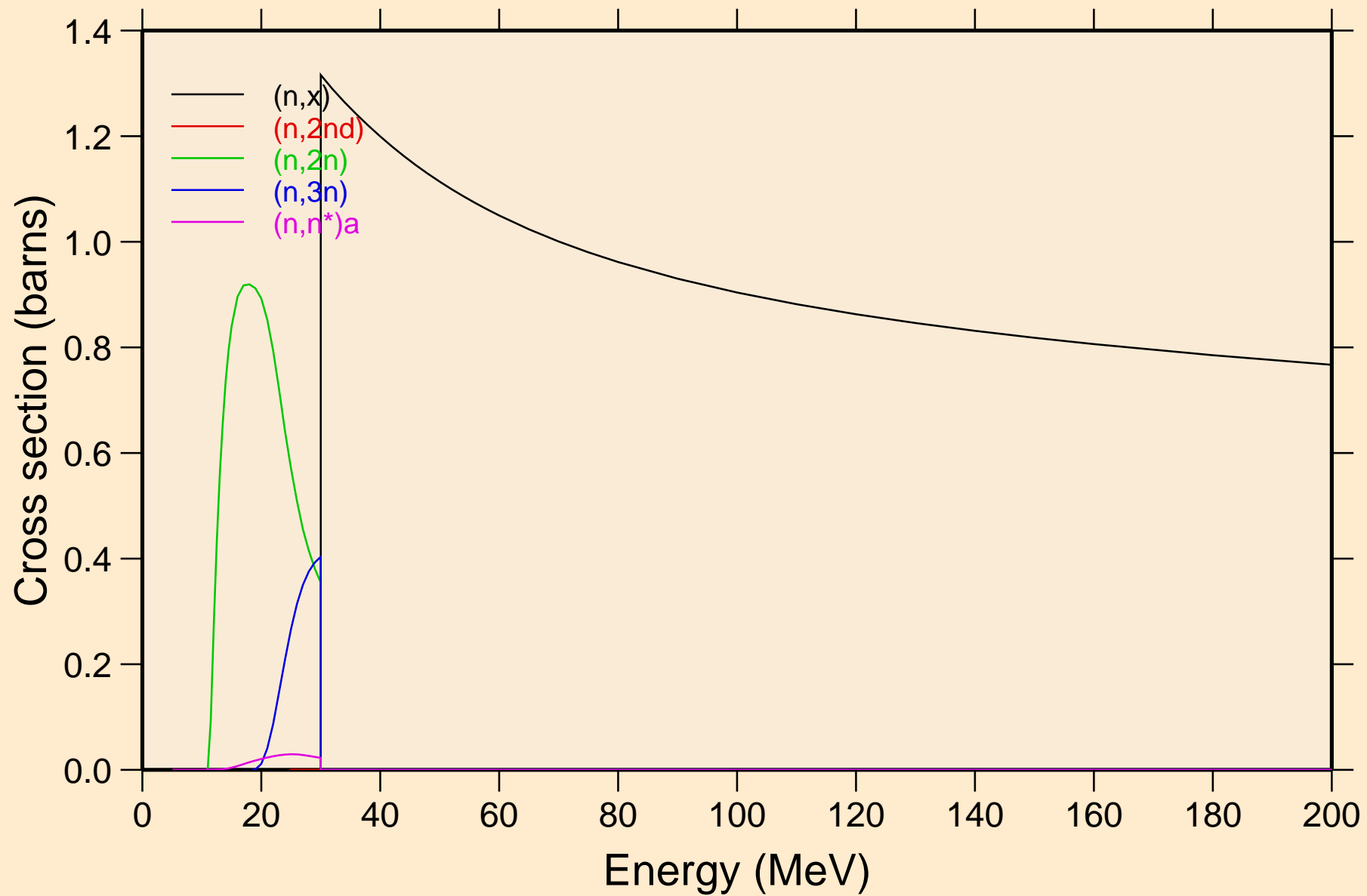

GE072 NRG TENDL-2016, AKONING

Threshold reactions

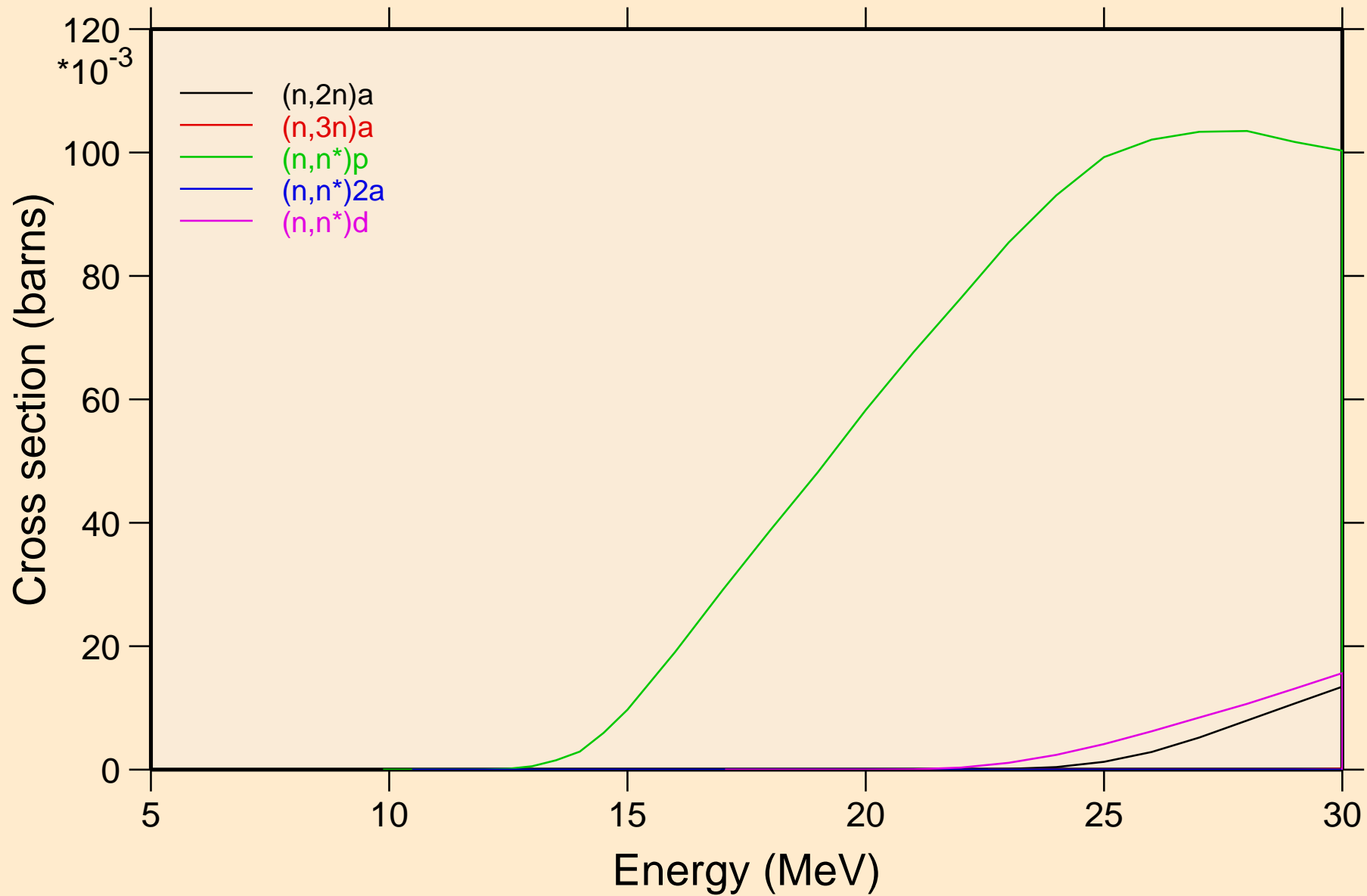

GE072 NRG TENDL-2016, AKONING

Threshold reactions

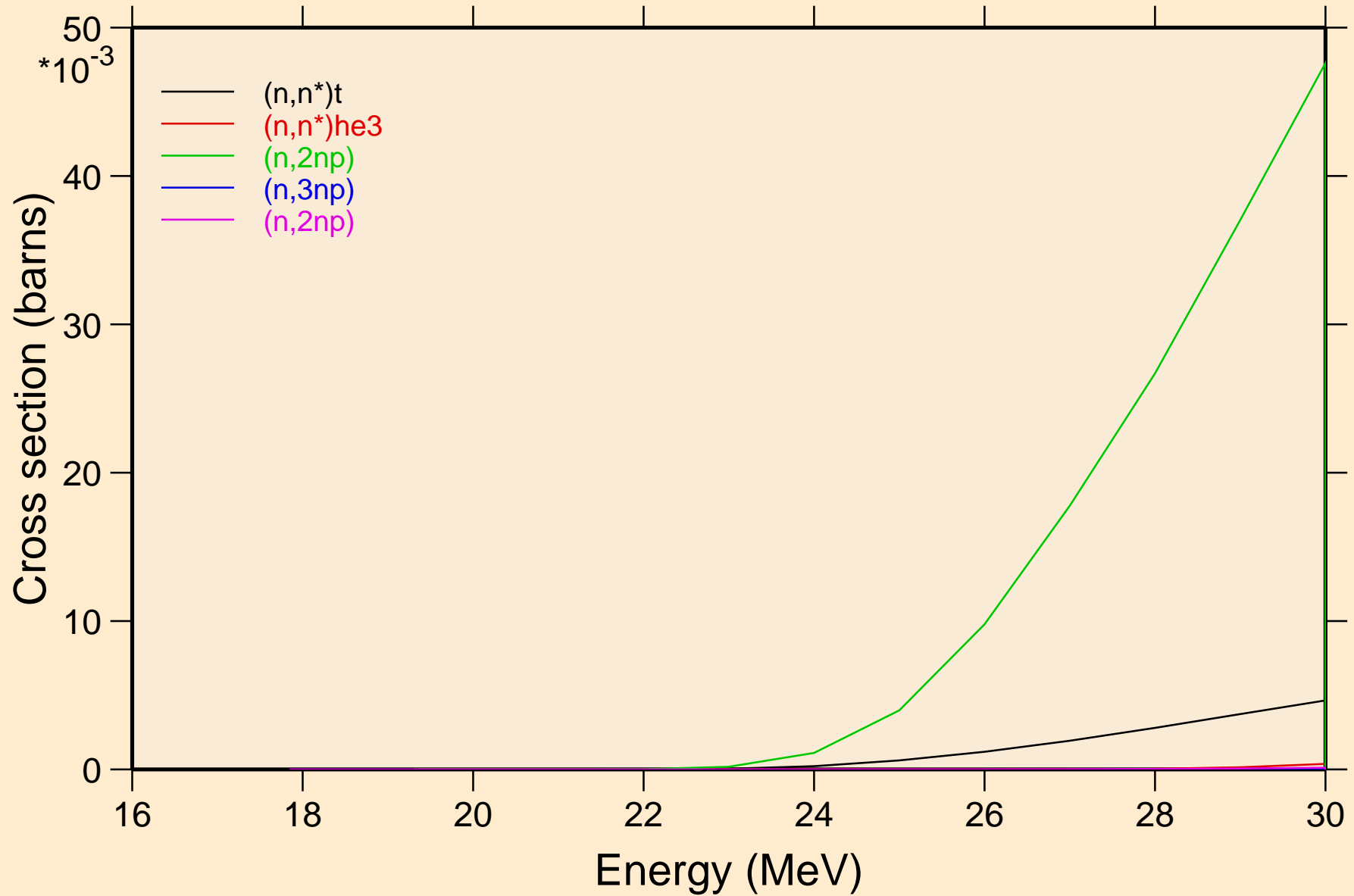

GE072 NRG TENDL-2016, AKONING

Threshold reactions

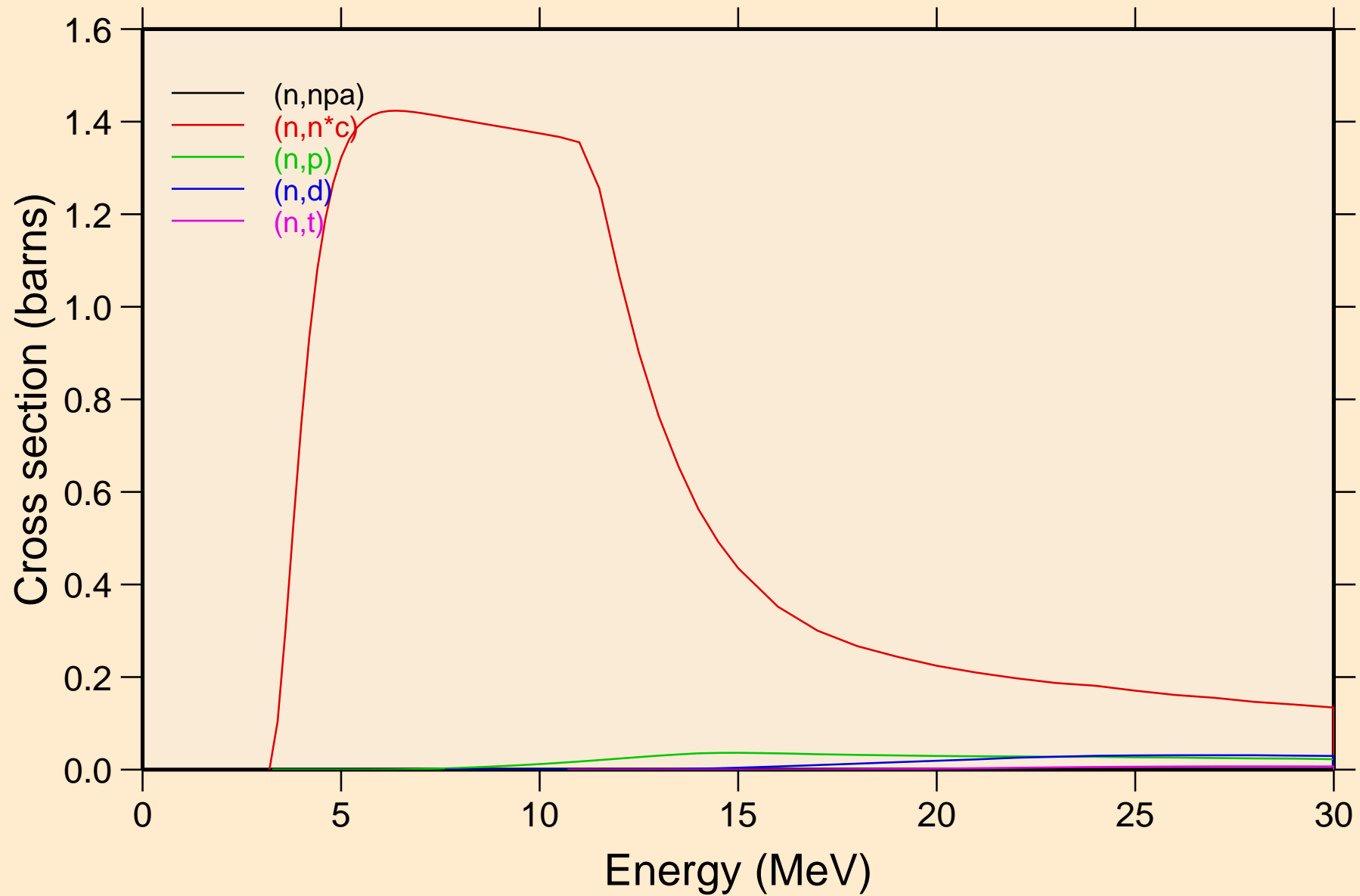

GE072 NRG TENDL-2016, AKONING

Threshold reactions

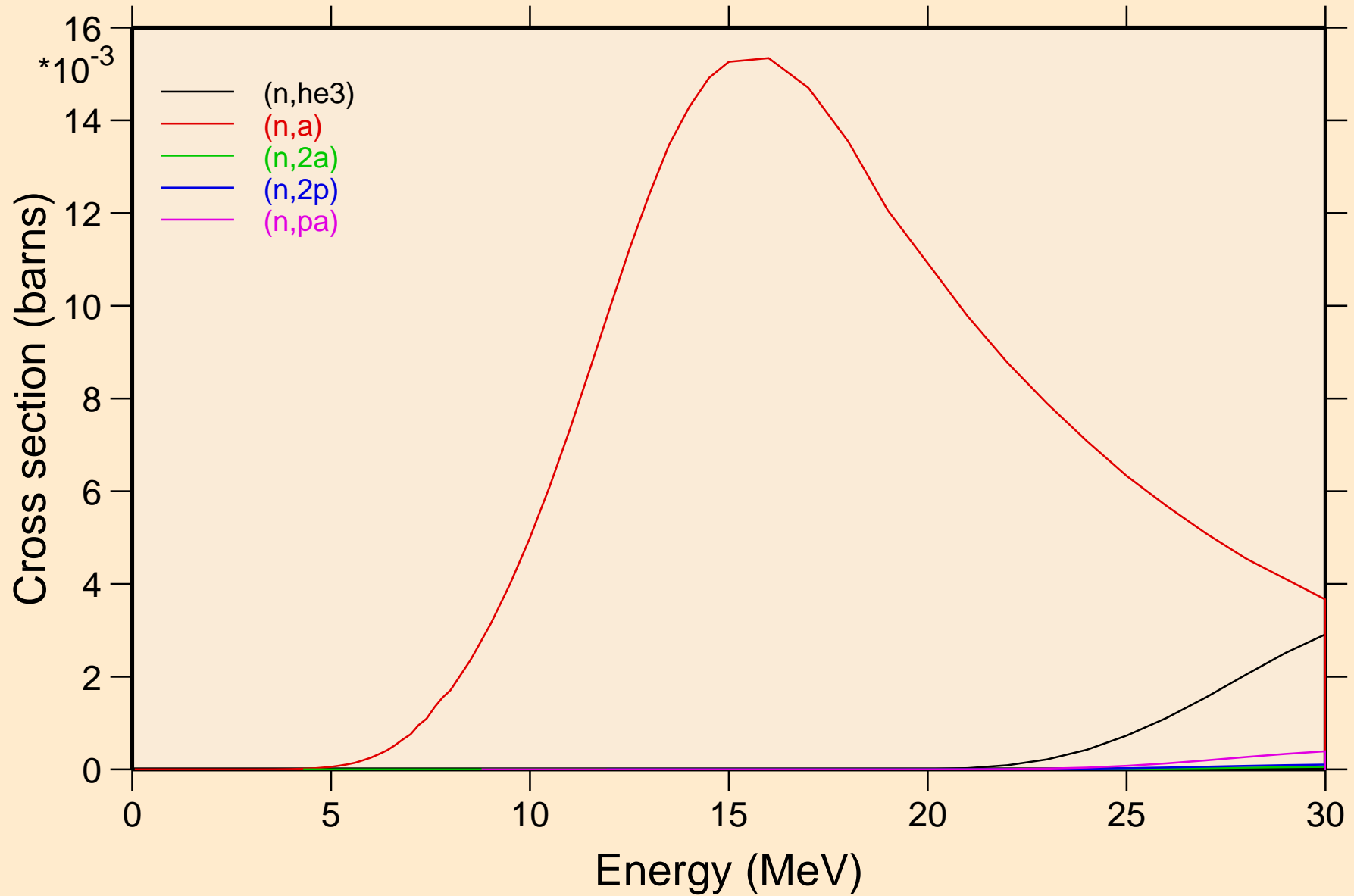

GE072 NRG TENDL-2016, AKONING

Threshold reactions

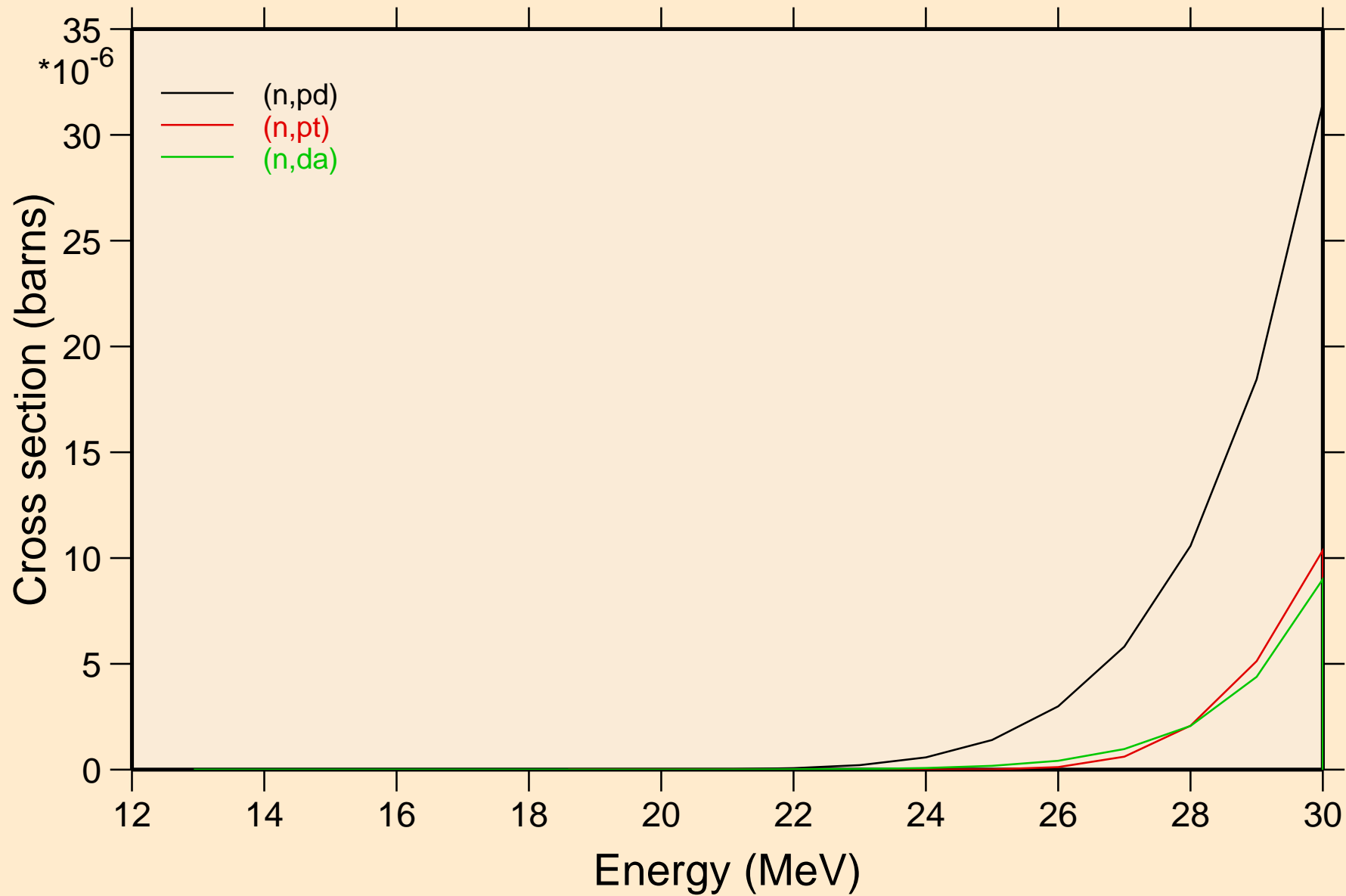

GE072 NRG TENDL-2016, AKONING
angular distribution for elastic

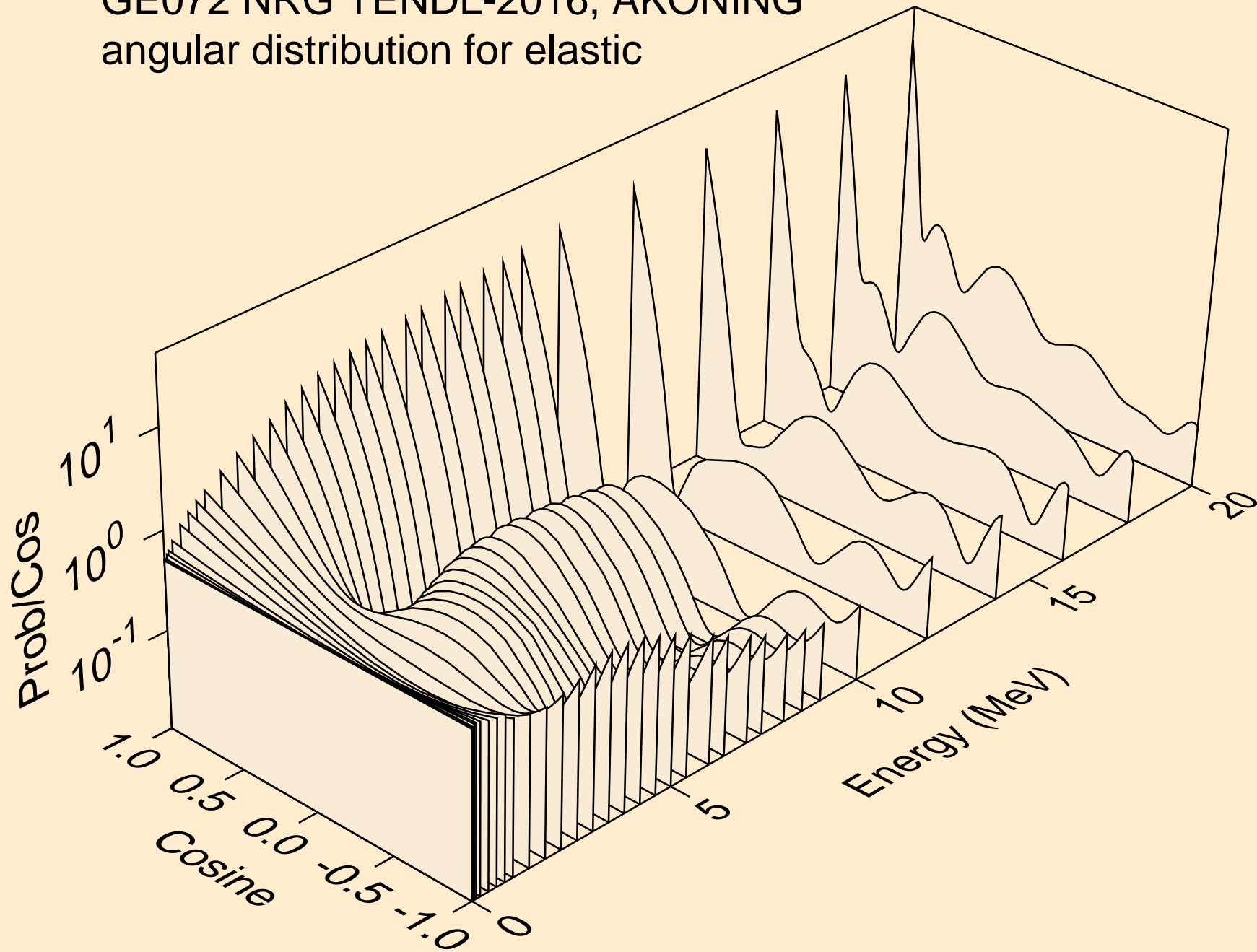

GE072 NRG TENDL-2016, AKONING
angular distribution for elastic

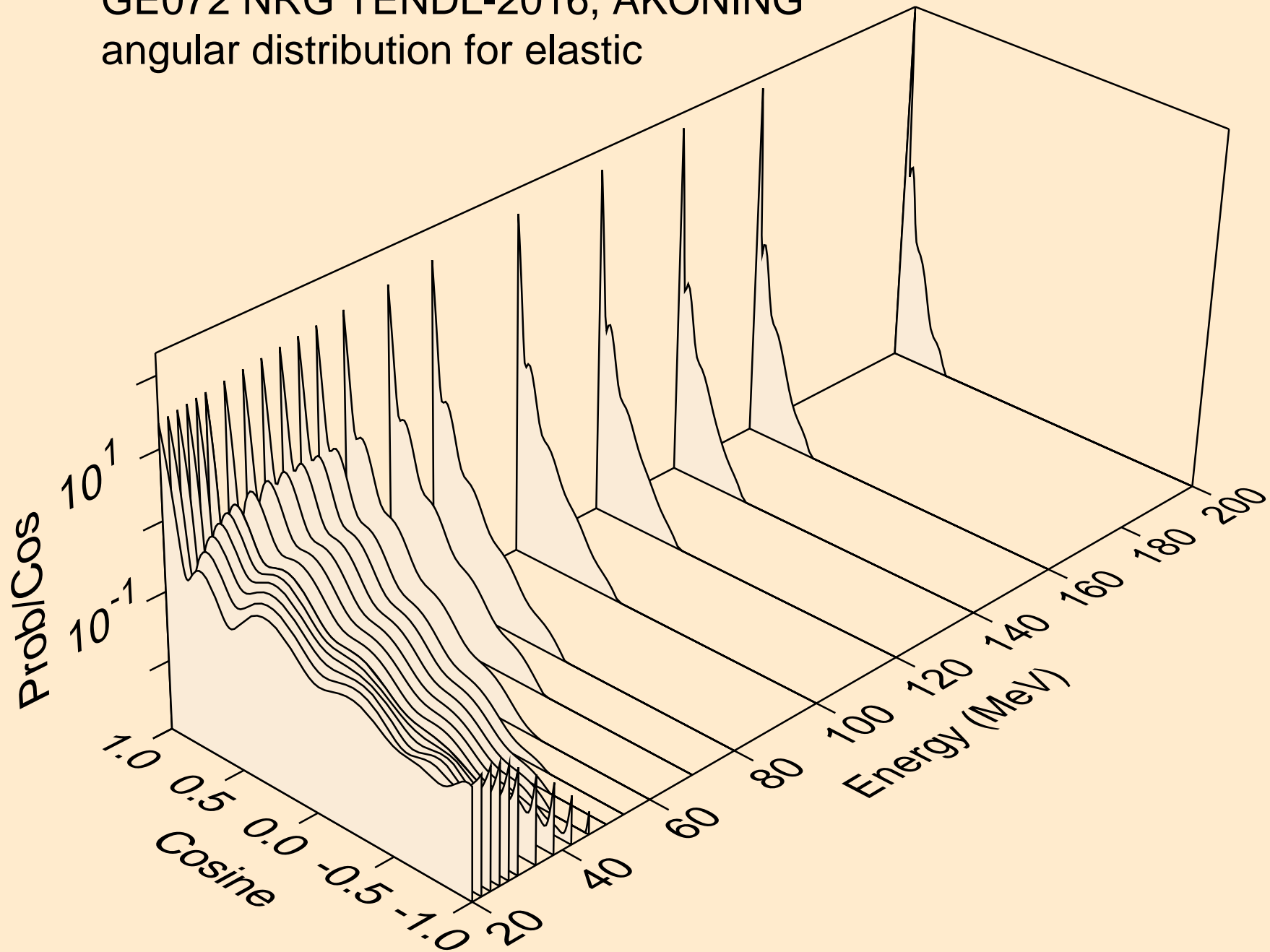

GE072 NRG TENDL-2016, AKONING
angular distribution for (n,n*1)

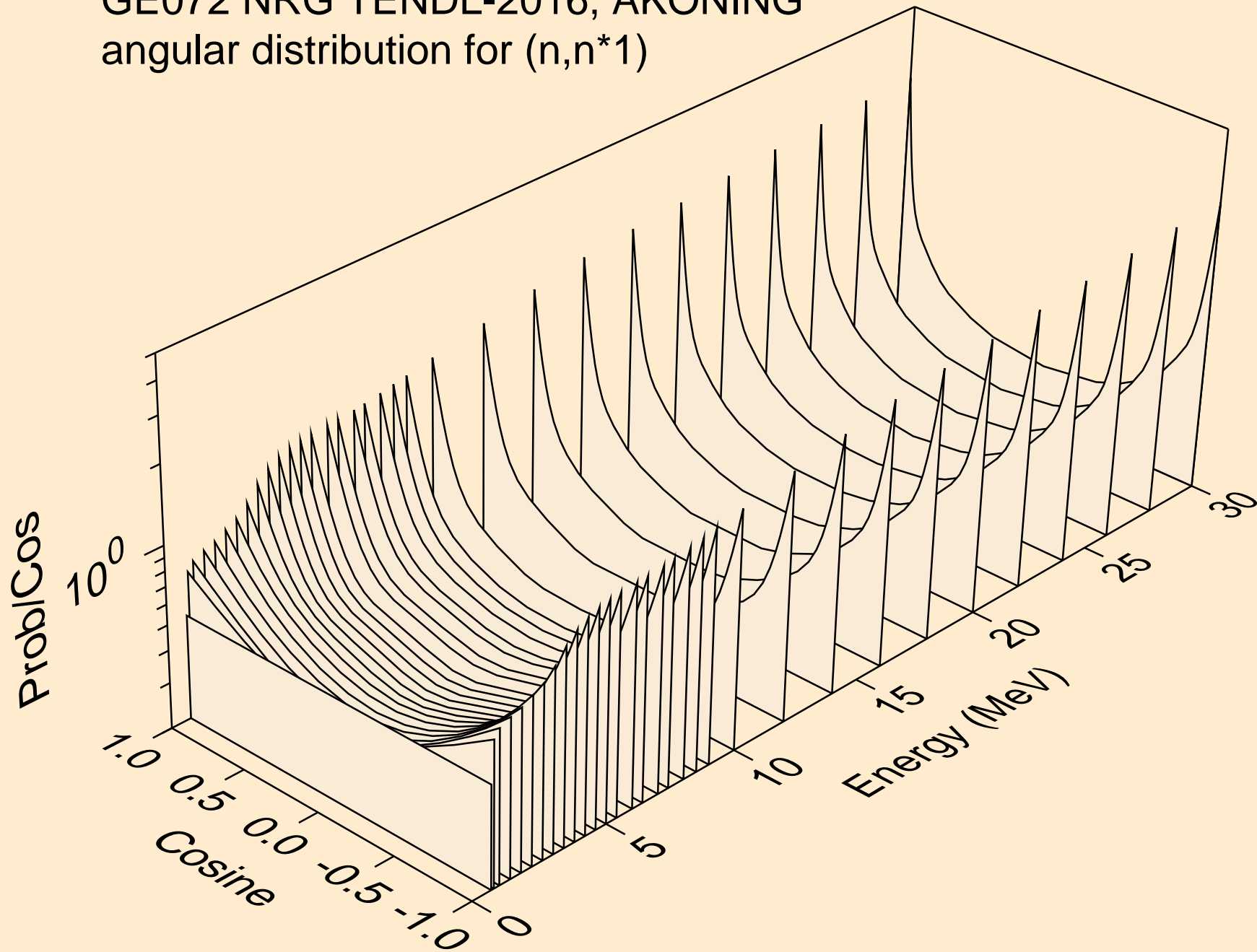

GE072 NRG TENDL-2016, AKONING
angular distribution for (n,n*2)

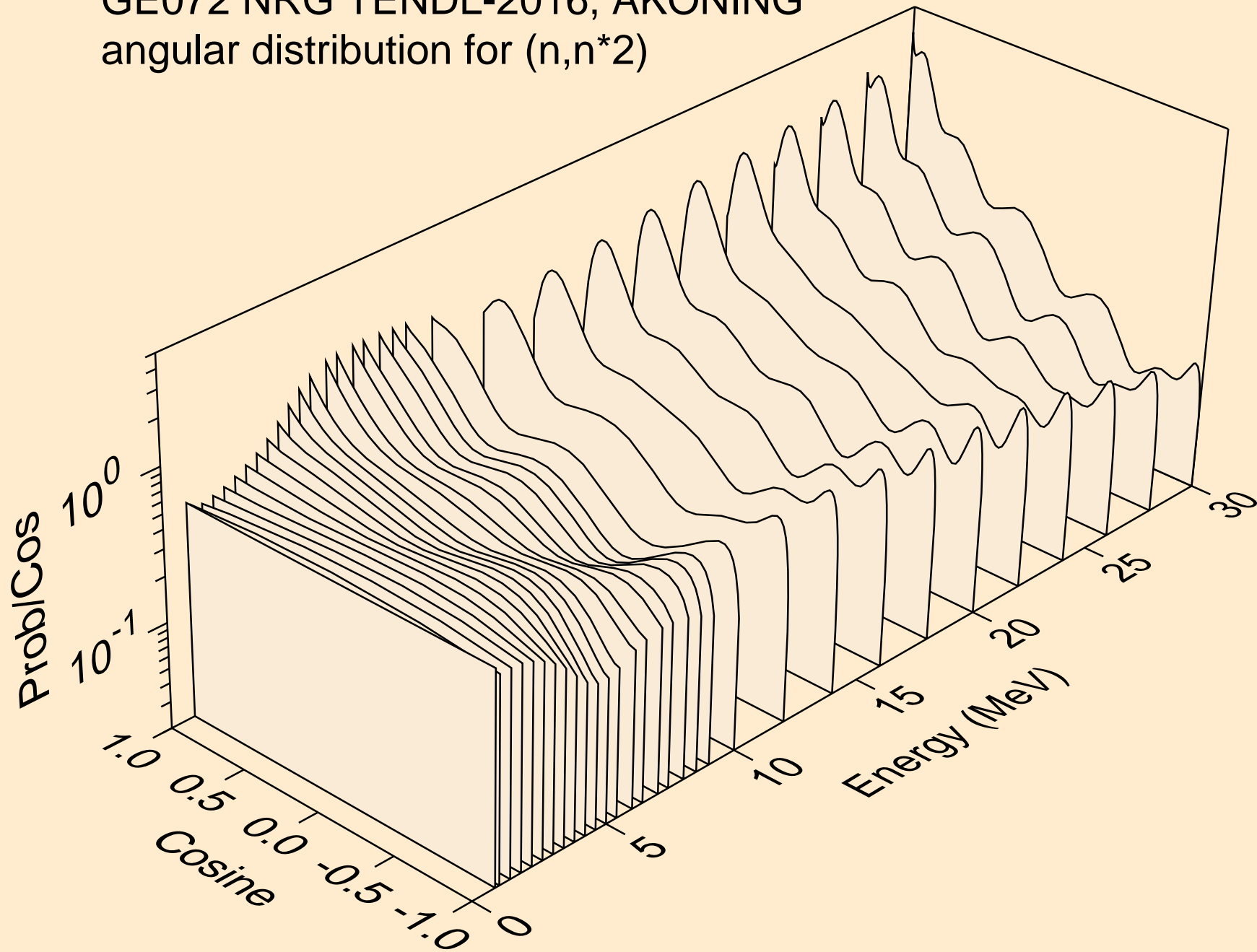

GE072 NRG TENDL-2016, AKONING
angular distribution for (n,n*3)

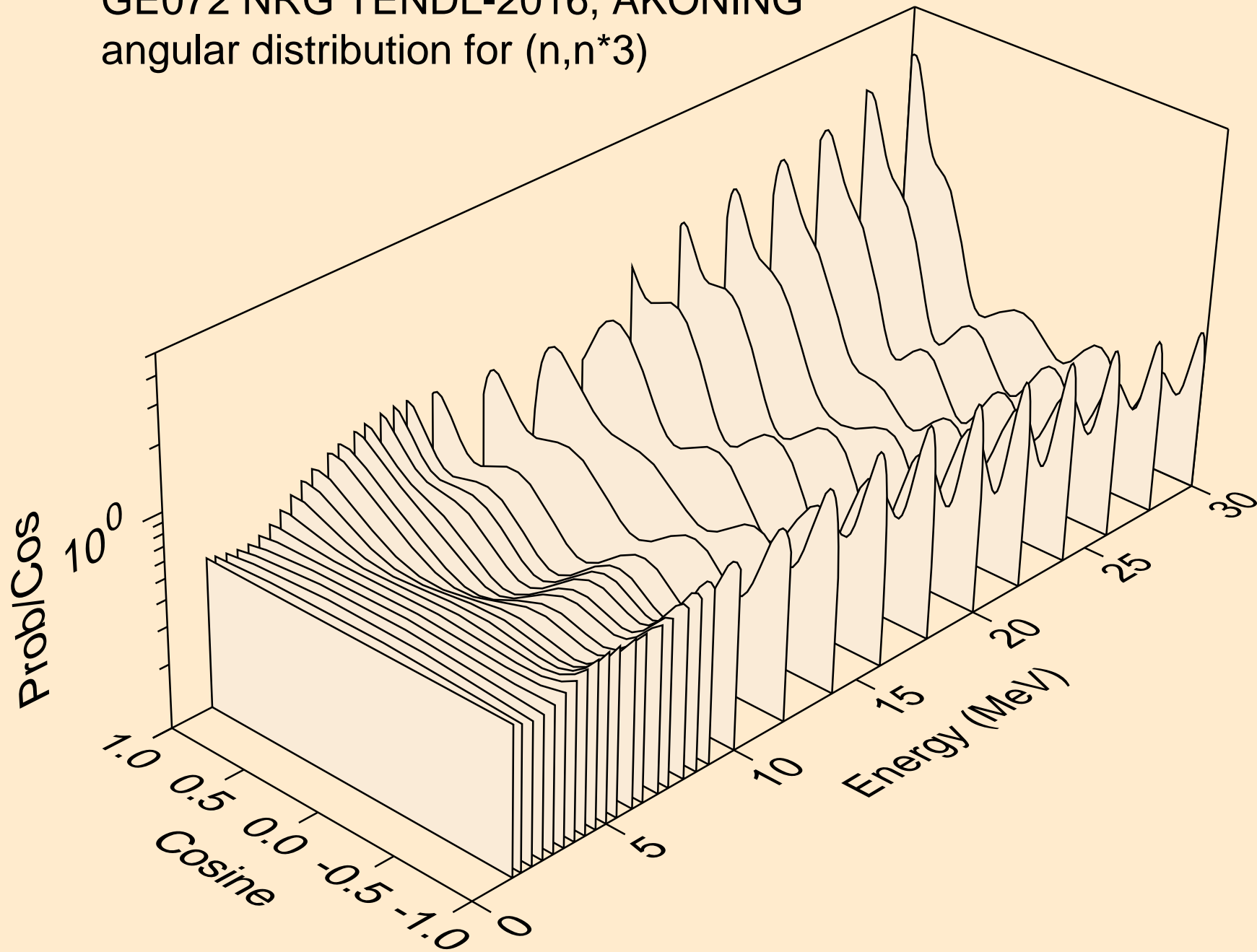

GE072 NRG TENDL-2016, AKONING
angular distribution for (n,n*4)

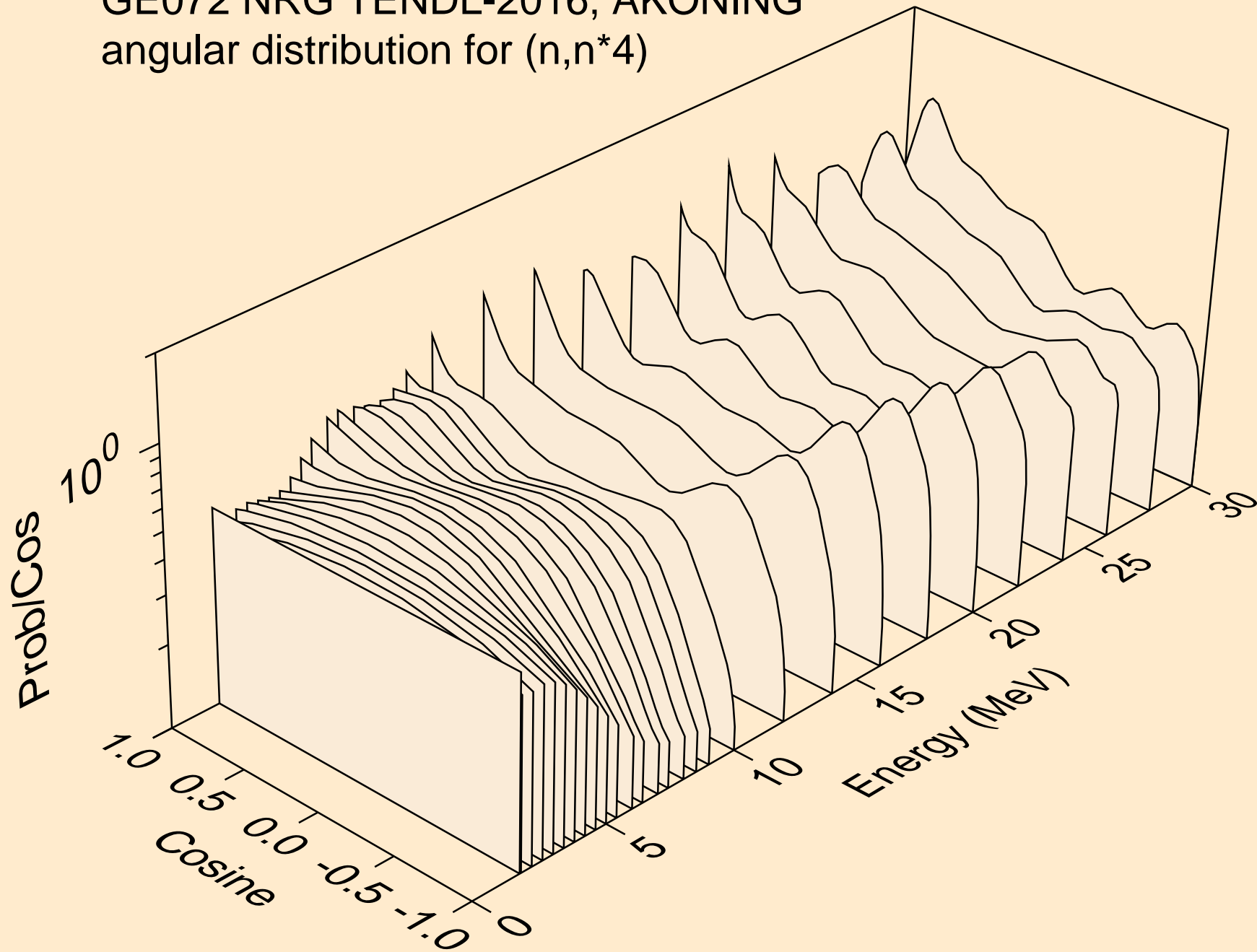

GE072 NRG TENDL-2016, AKONING
angular distribution for (n,n*5)

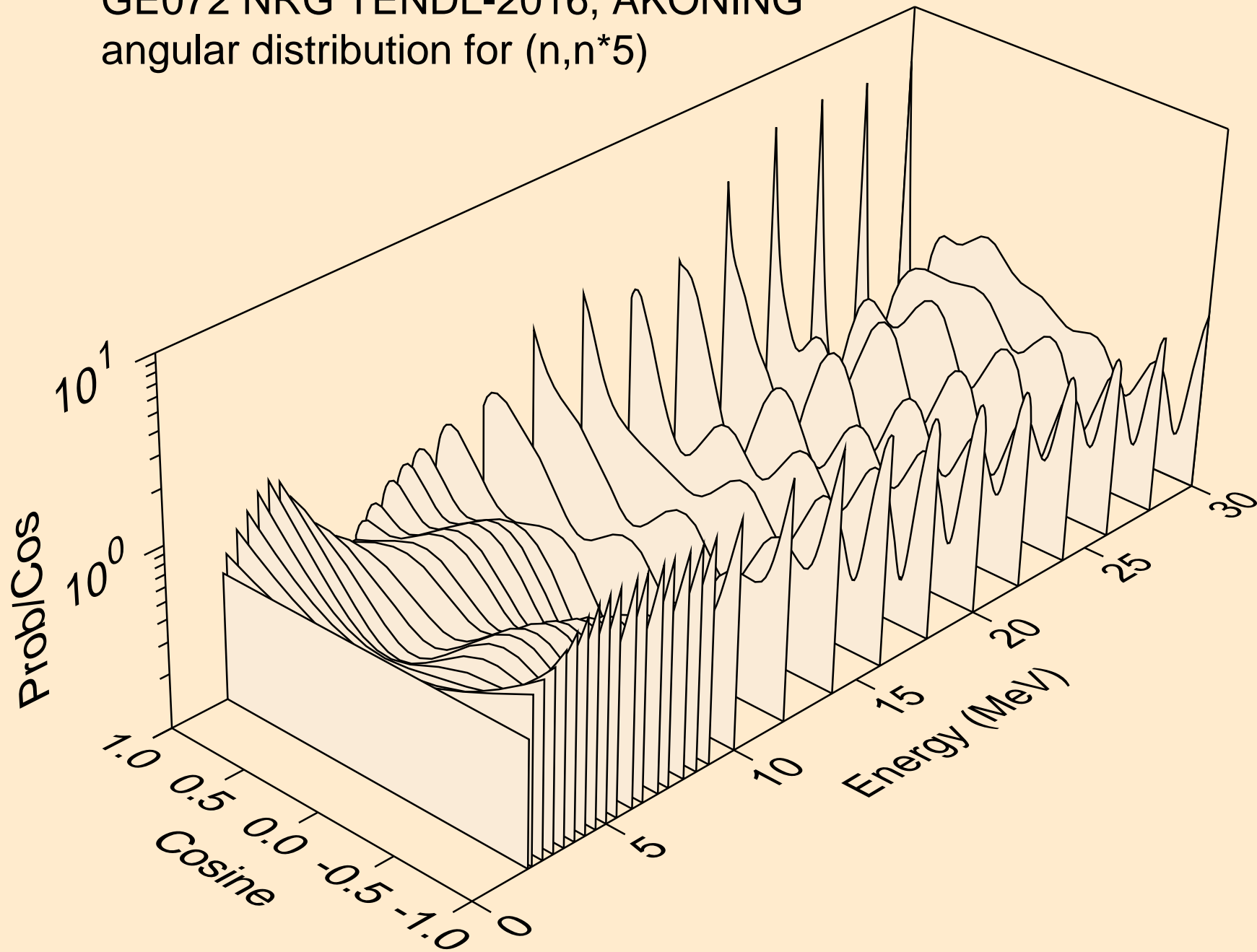

GE072 NRG TENDL-2016, AKONING
angular distribution for (n,n*6)

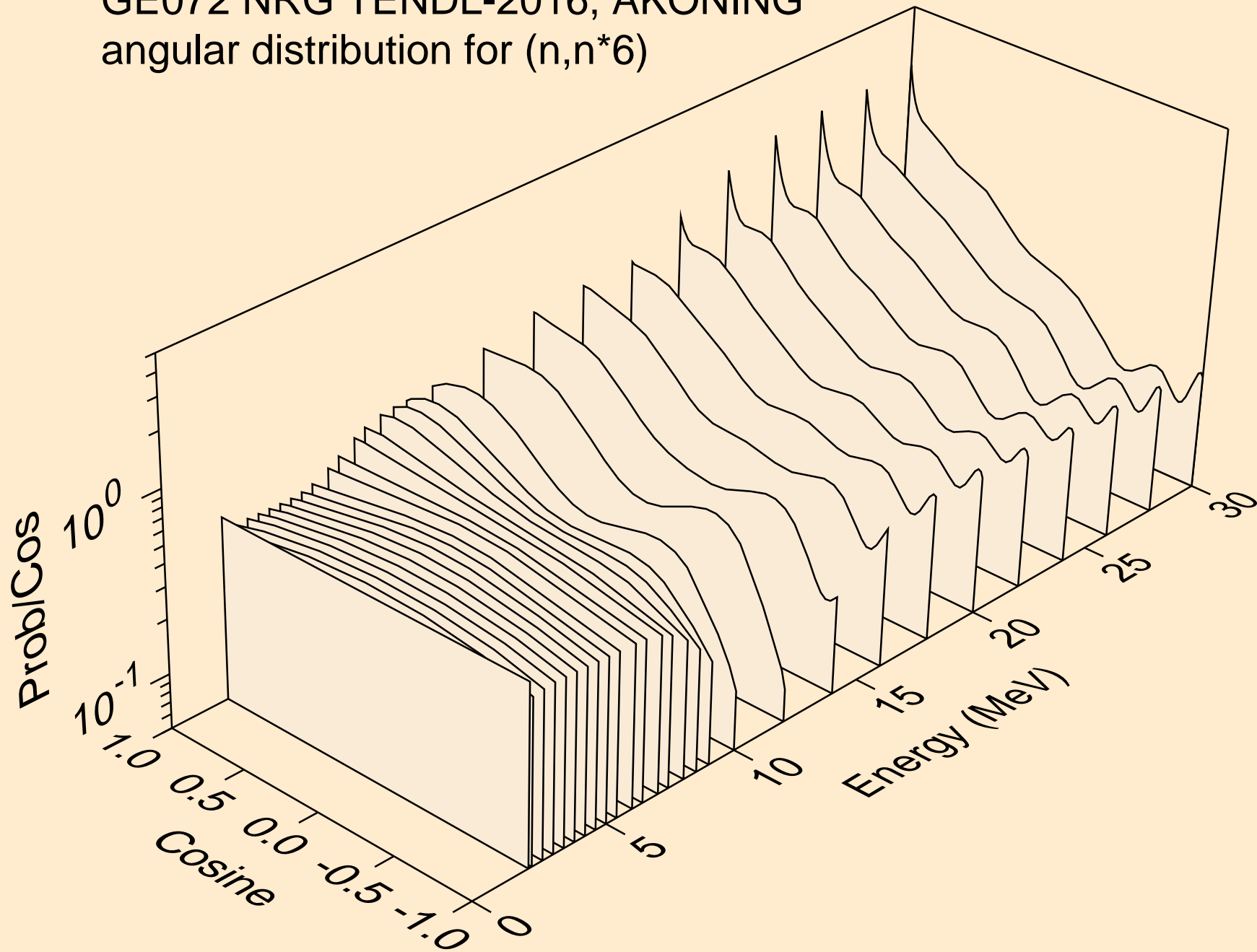

GE072 NRG TENDL-2016, AKONING
angular distribution for (n,n*7)

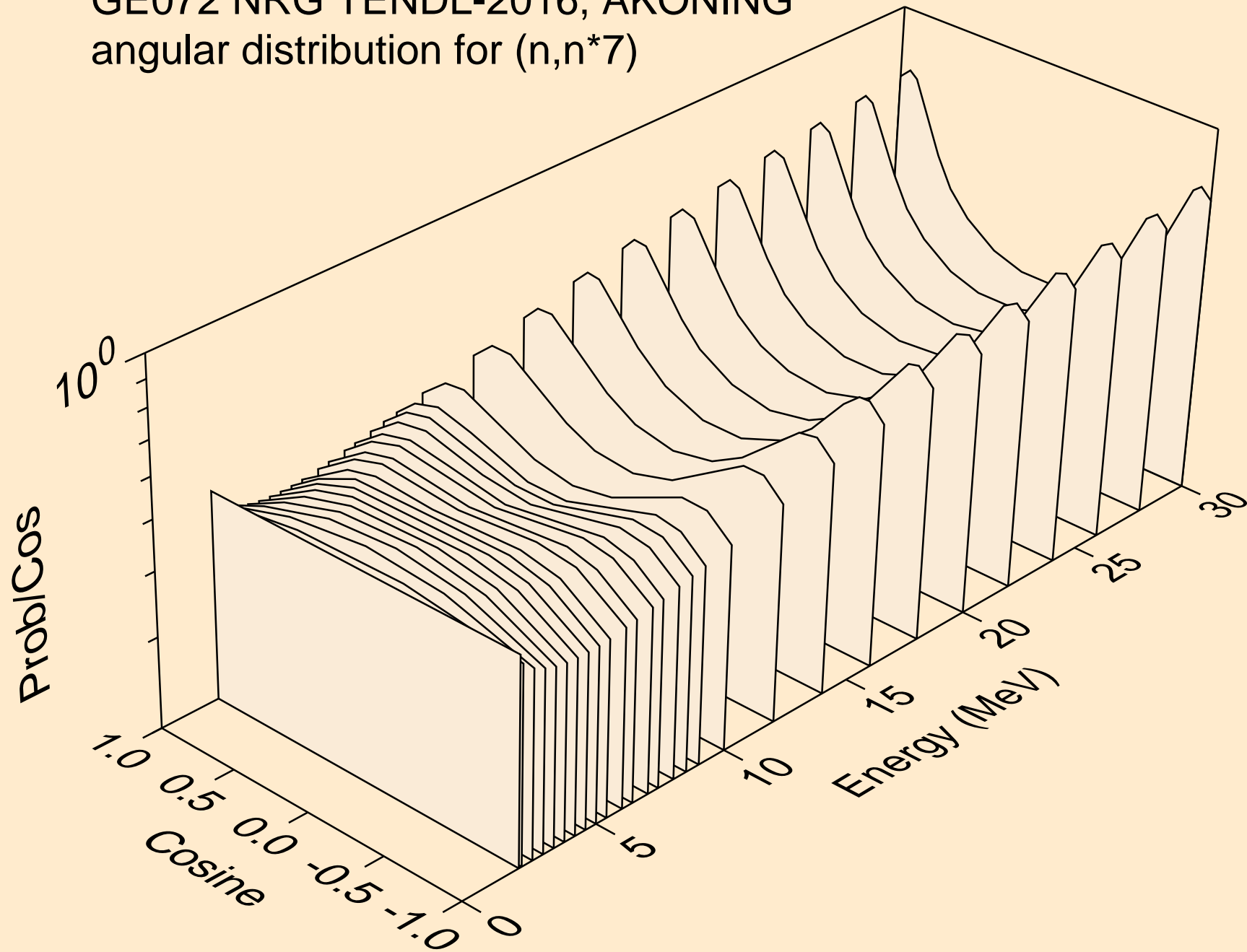

GE072 NRG TENDL-2016, AKONING
angular distribution for (n,n*8)

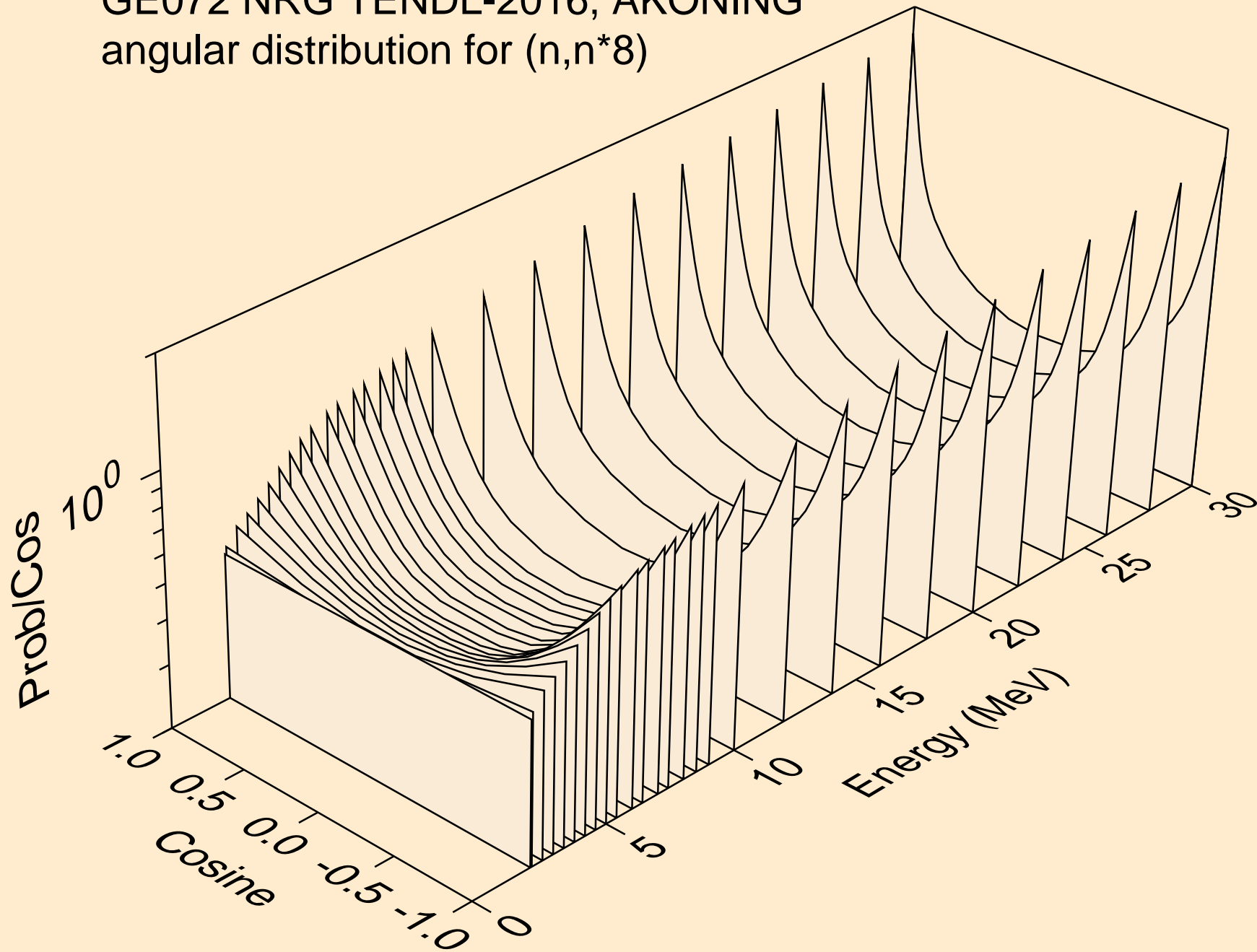

GE072 NRG TENDL-2016, AKONING
angular distribution for (n,n*9)

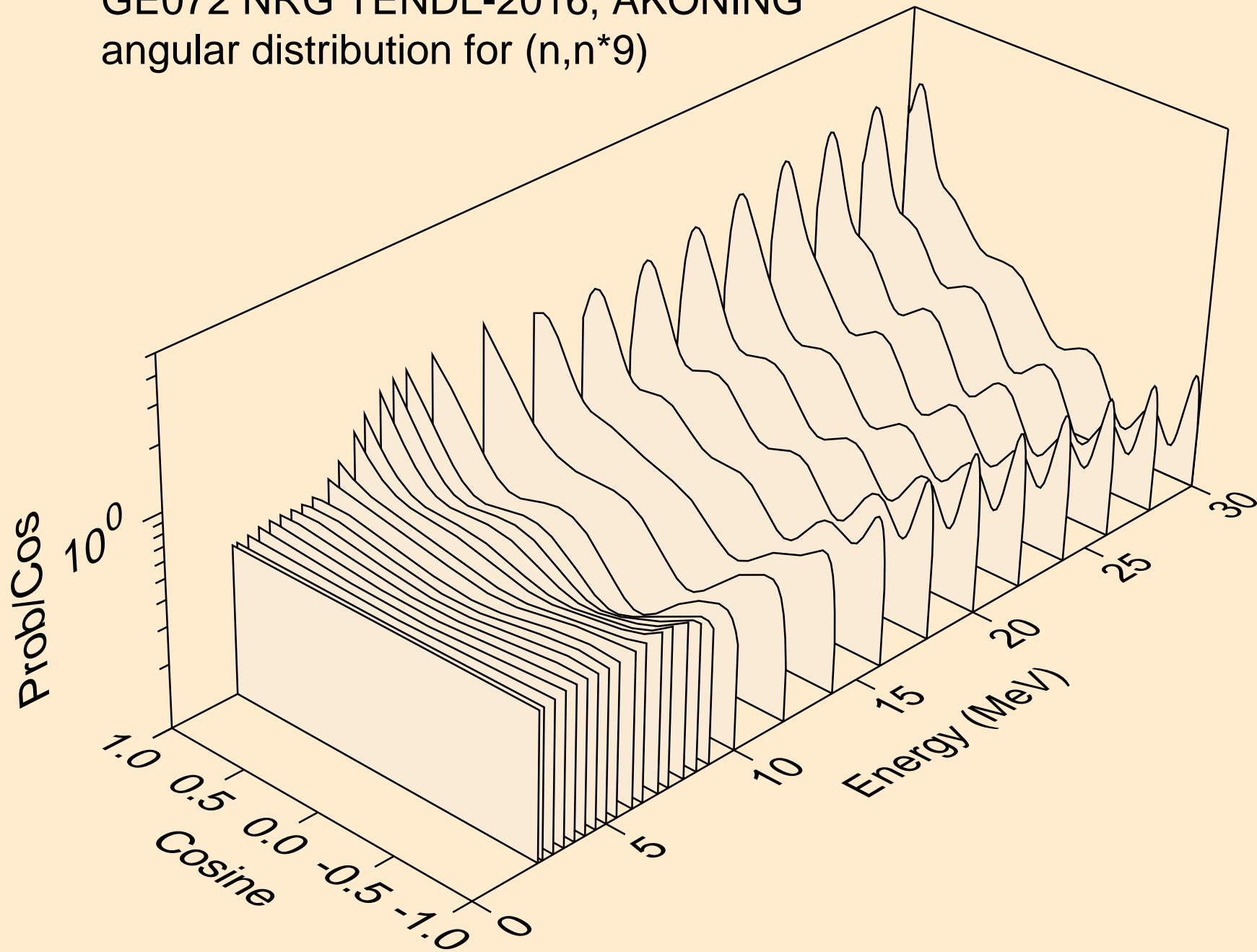

GE072 NRG TENDL-2016, AKONING
angular distribution for (n,n*10)

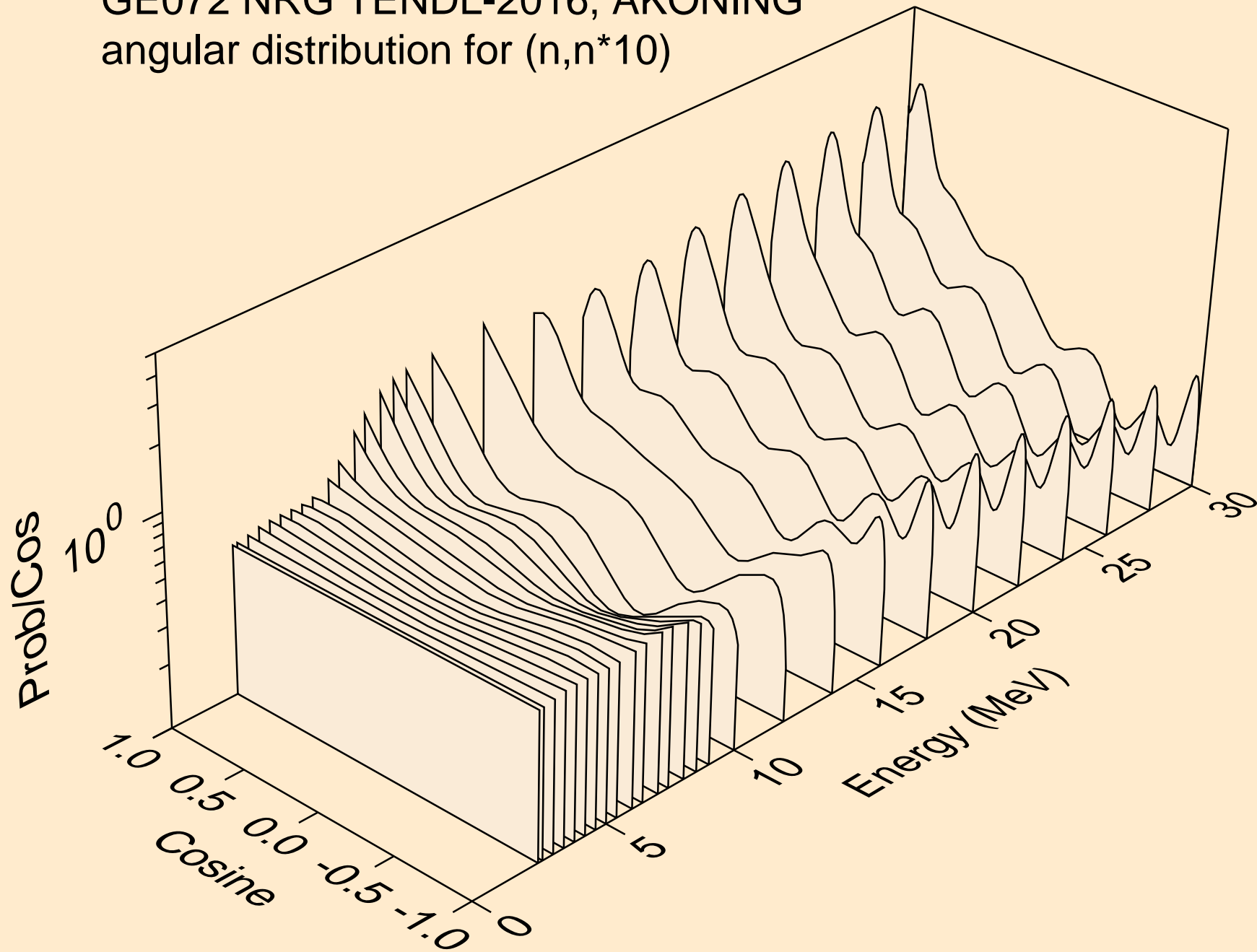

GE072 NRG TENDL-2016, AKONING
angular distribution for (n,n*11)

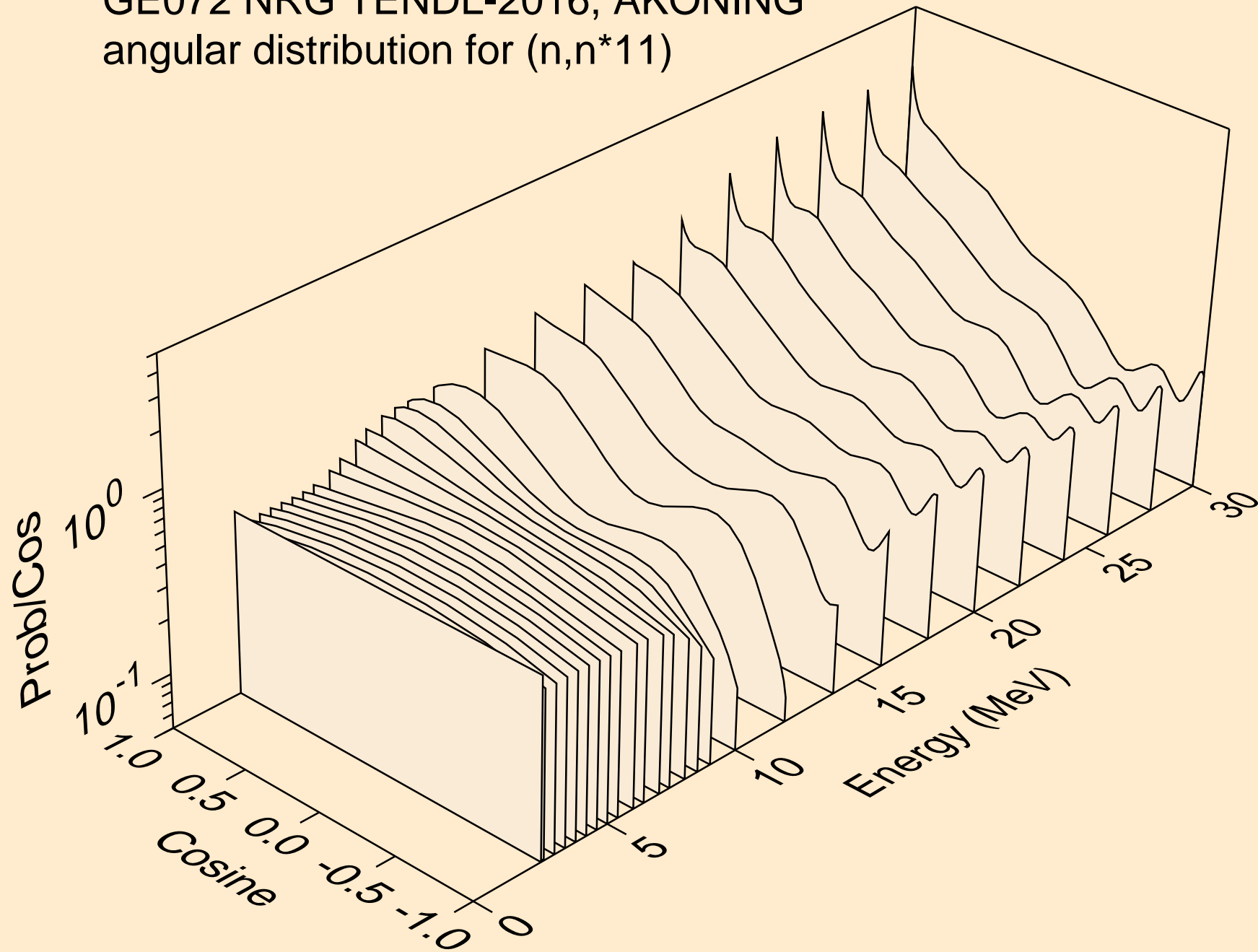

GE072 NRG TENDL-2016, AKONING
angular distribution for (n,n*12)

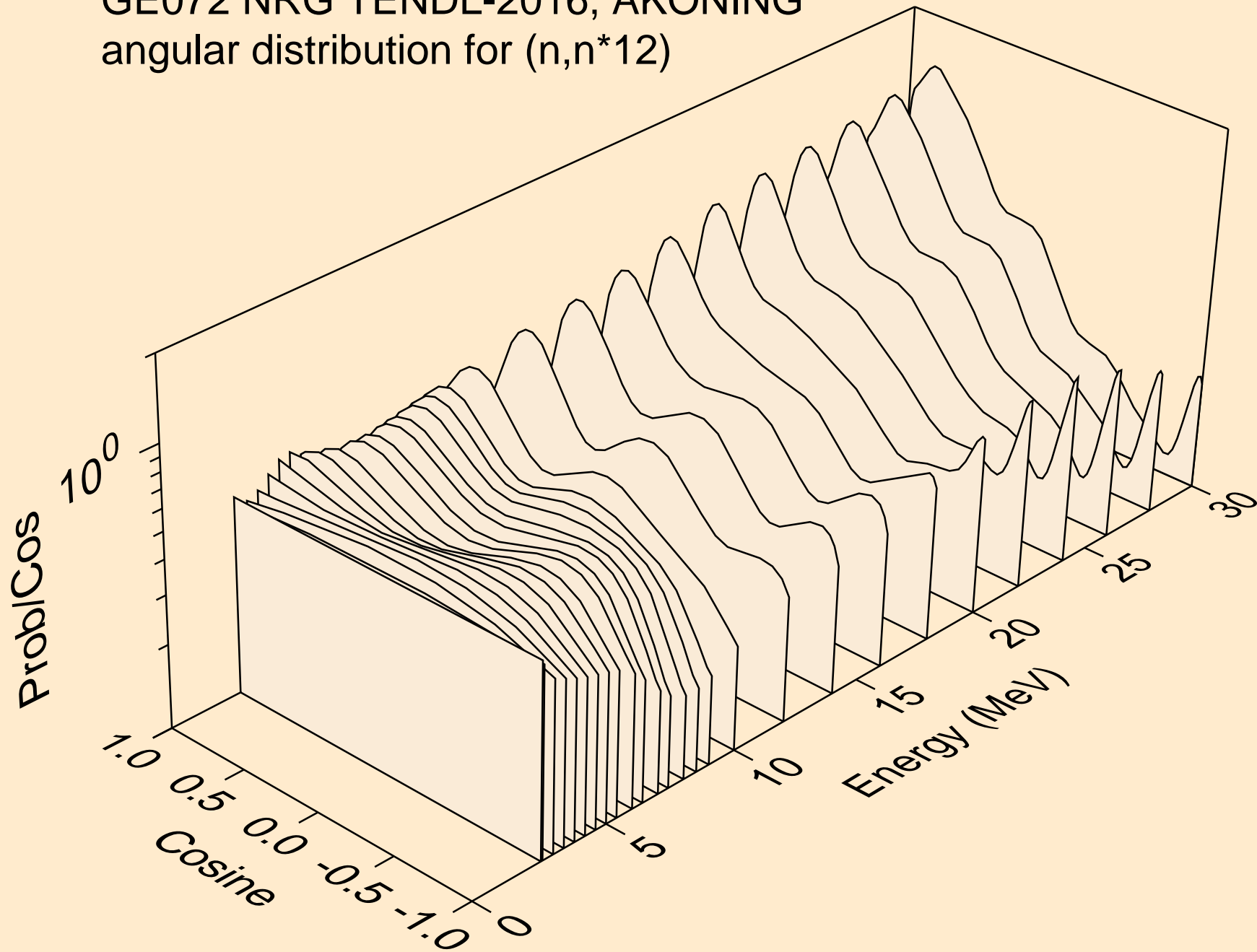

GE072 NRG TENDL-2016, AKONING
angular distribution for (n,n*13)

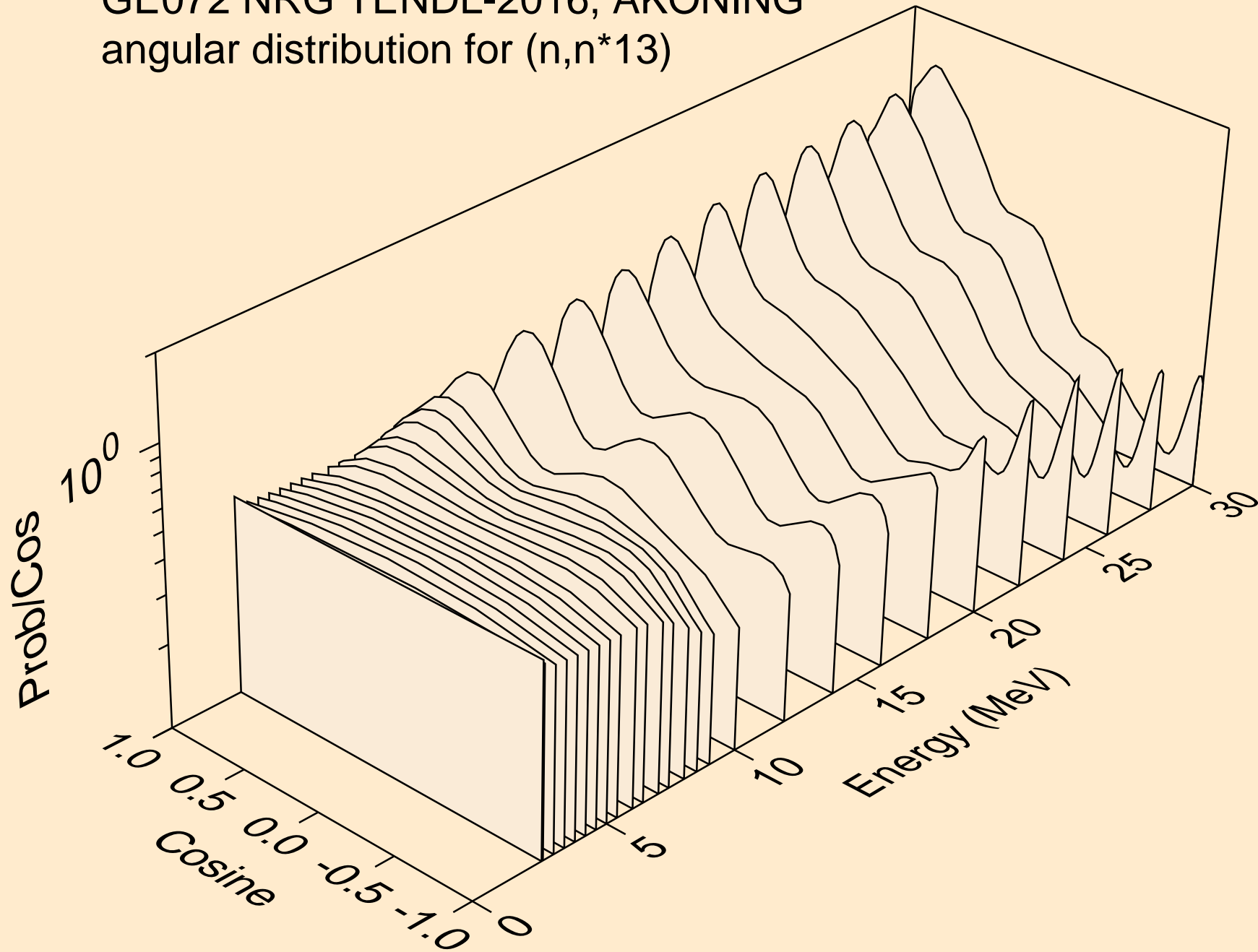

GE072 NRG TENDL-2016, AKONING
angular distribution for (n,n*14)

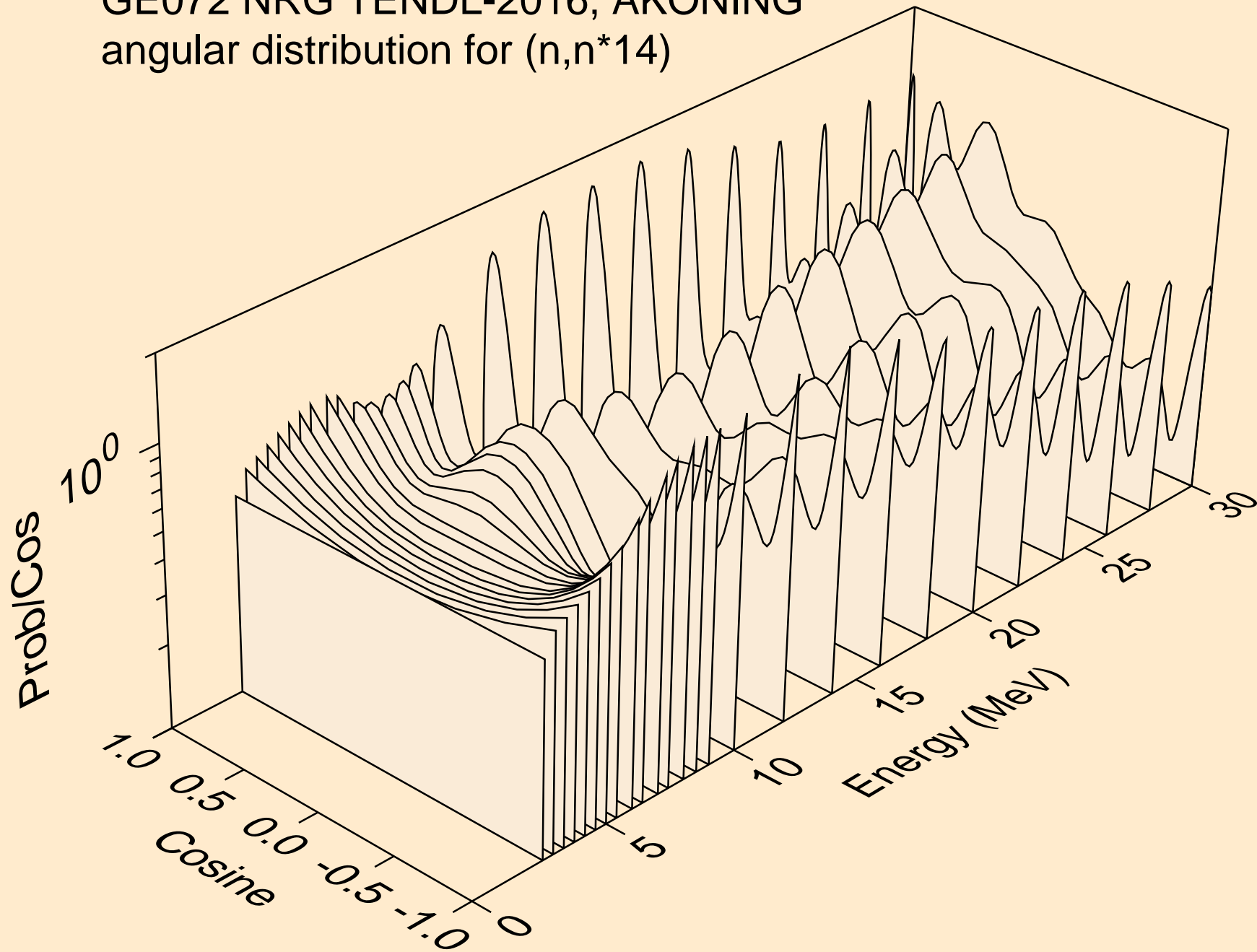

GE072 NRG TENDL-2016, AKONING
angular distribution for (n,n*15)

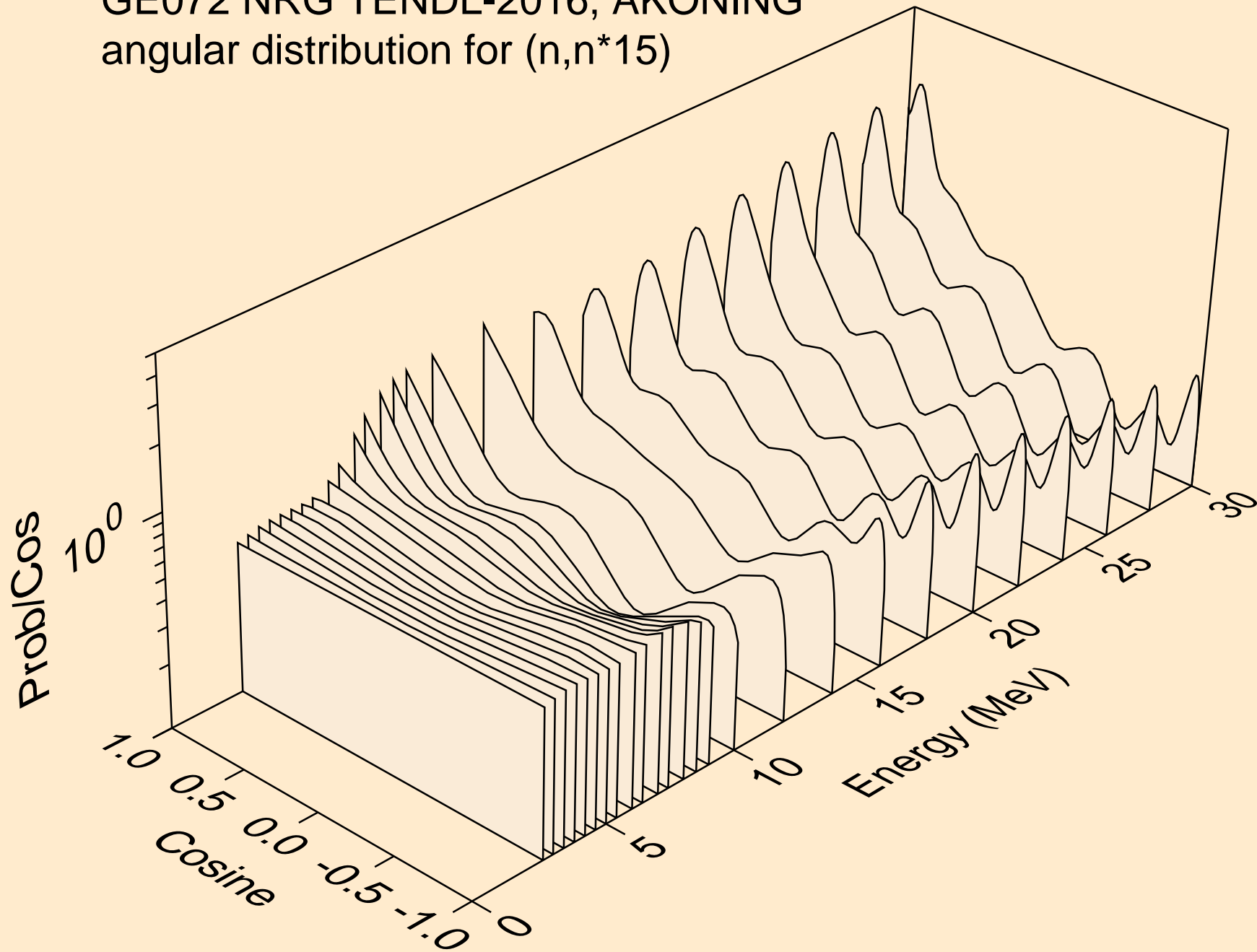

GE072 NRG TENDL-2016, AKONING
angular distribution for (n,n*16)

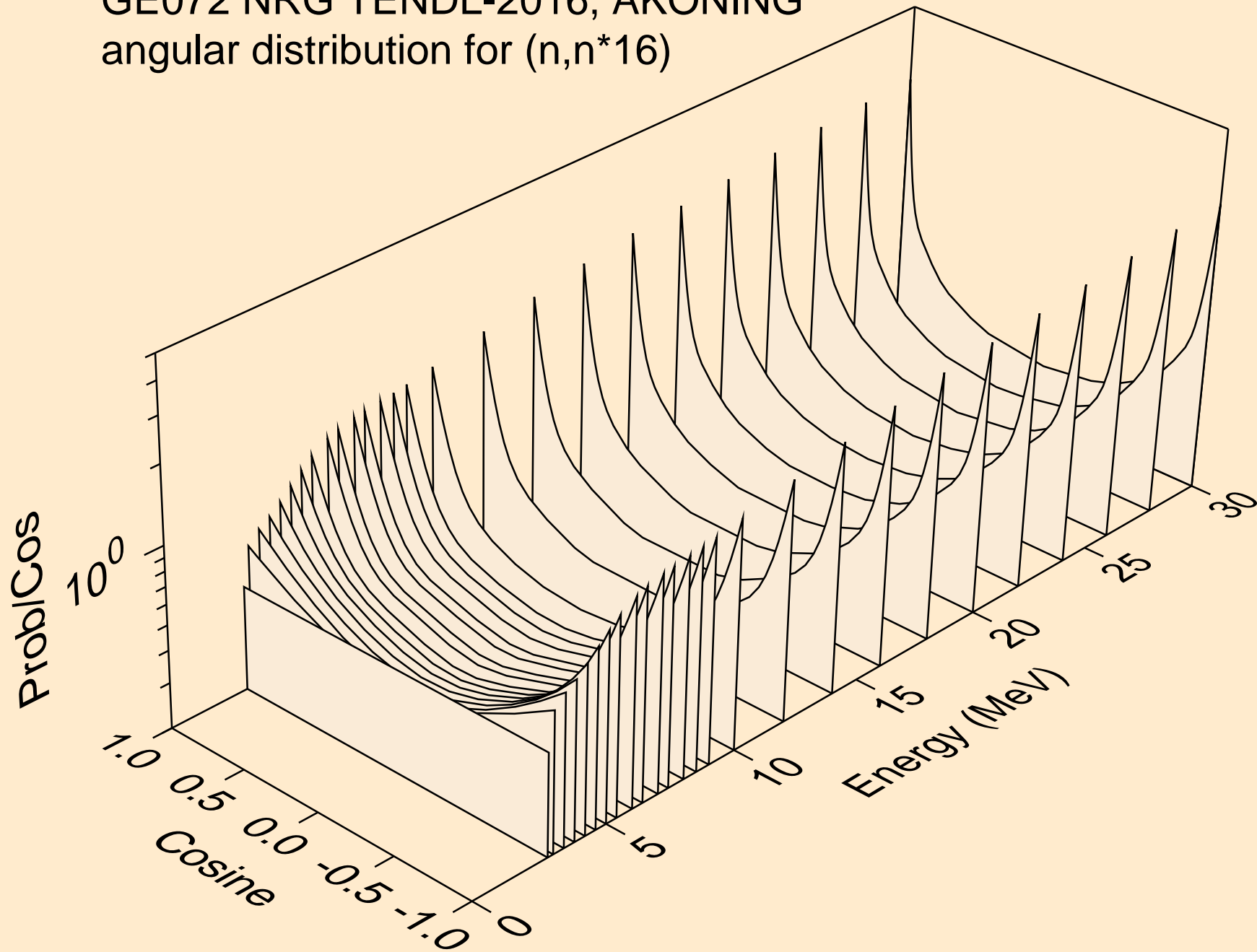

GE072 NRG TENDL-2016, AKONING
angular distribution for (n,n*17)

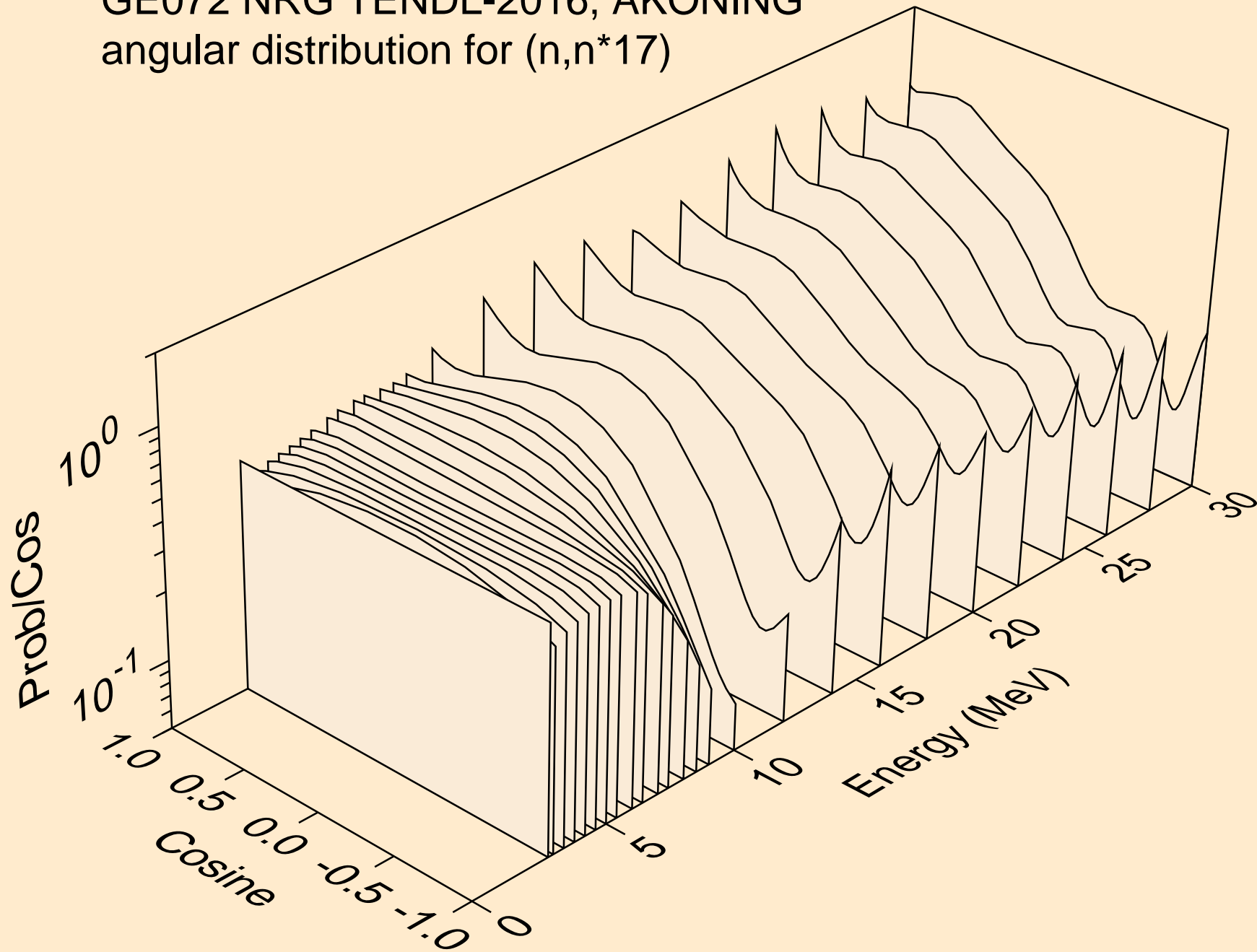

GE072 NRG TENDL-2016, AKONING
angular distribution for (n,n*18)

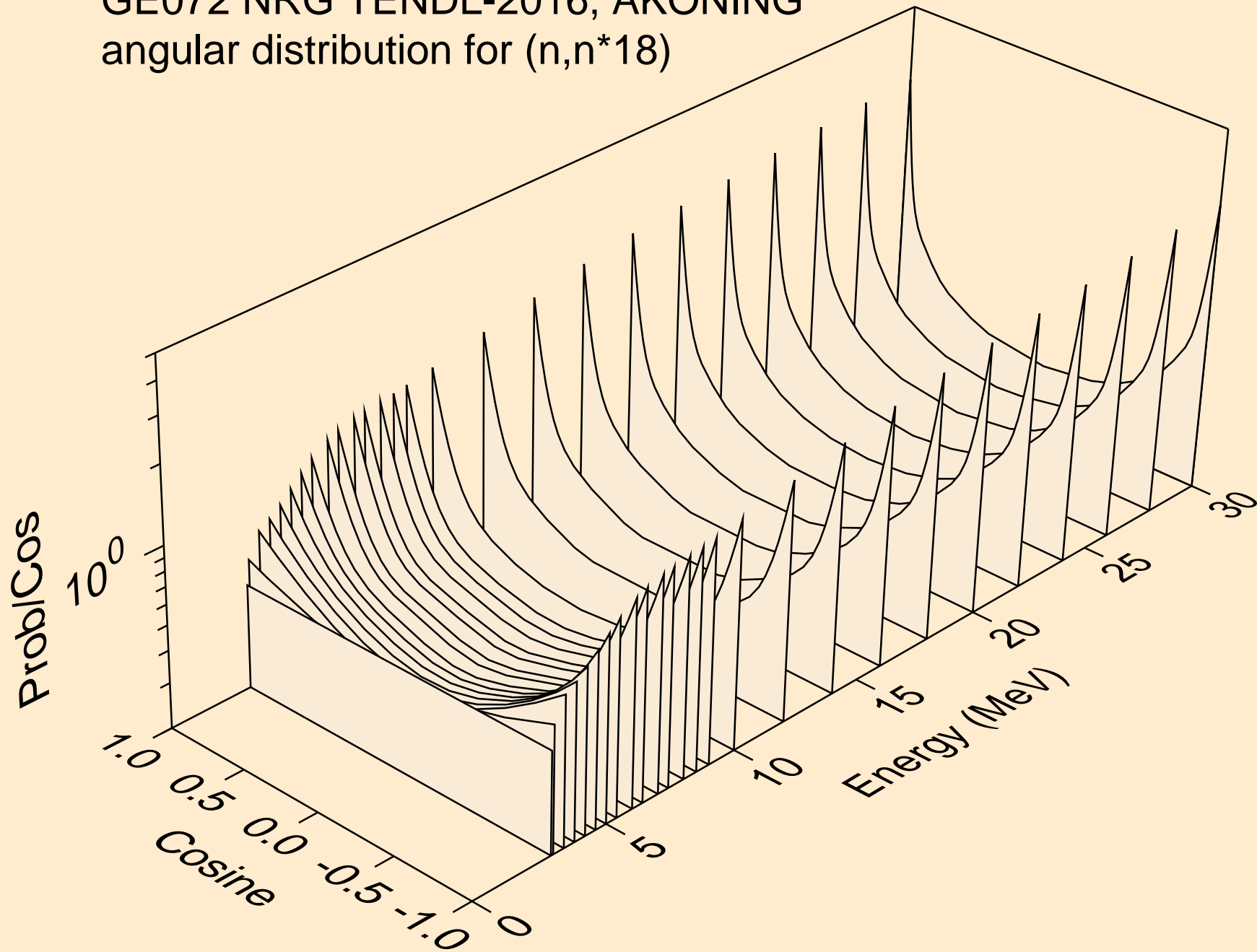

GE072 NRG TENDL-2016, AKONING
angular distribution for (n,n*19)

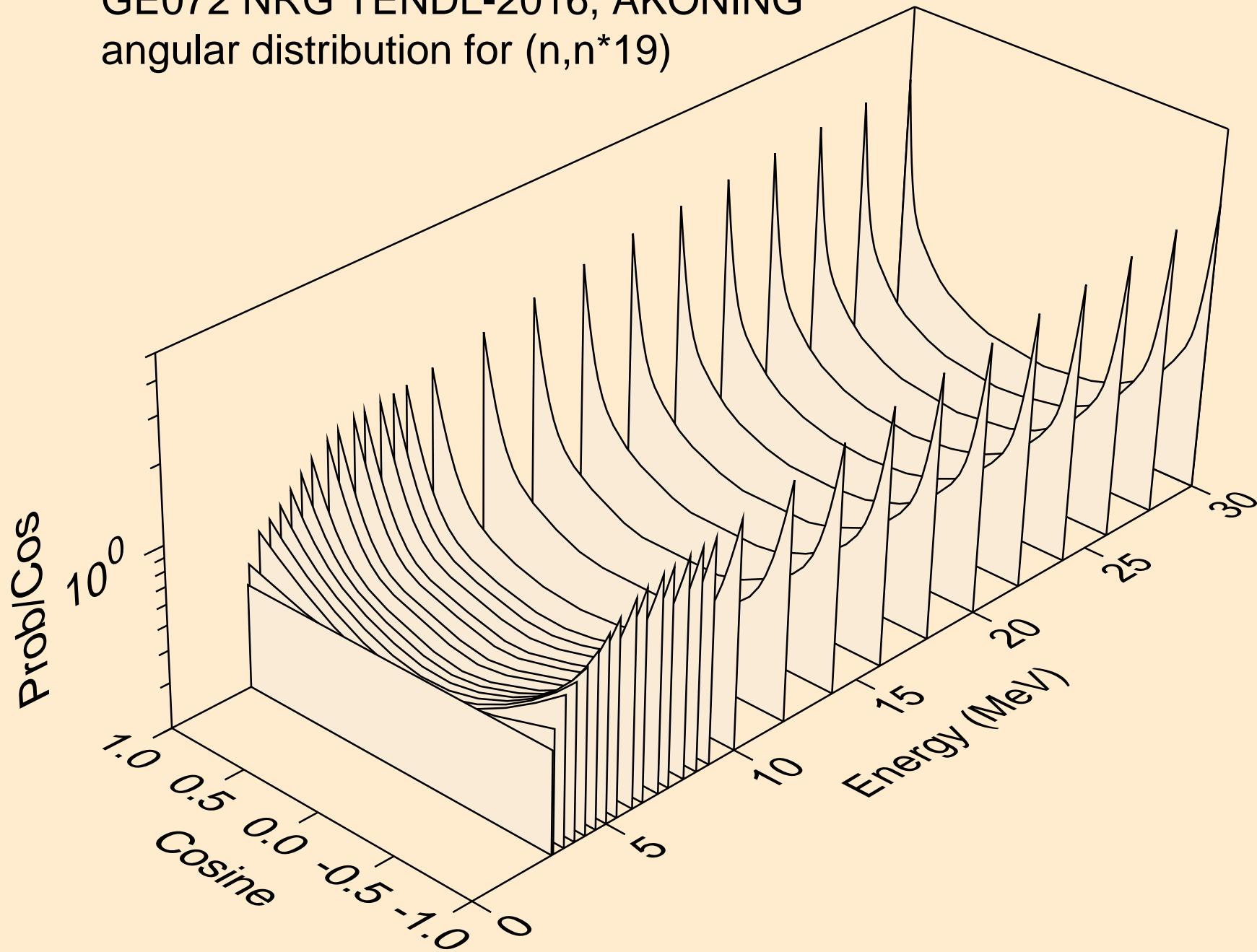

GE072 NRG TENDL-2016, AKONING
angular distribution for (n,n*20)

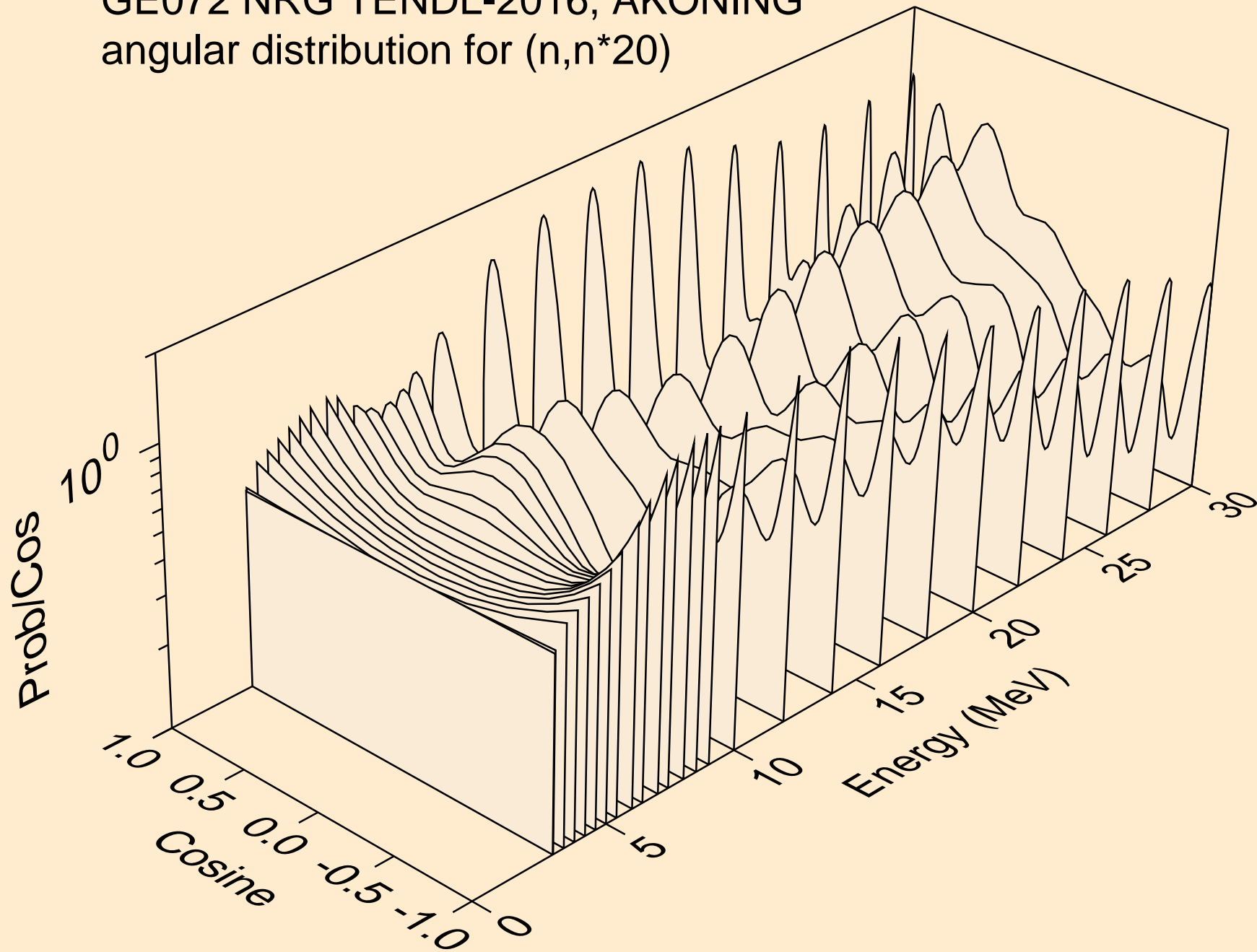

GE072 NRG TENDL-2016, AKONING
angular distribution for (n,n*21)

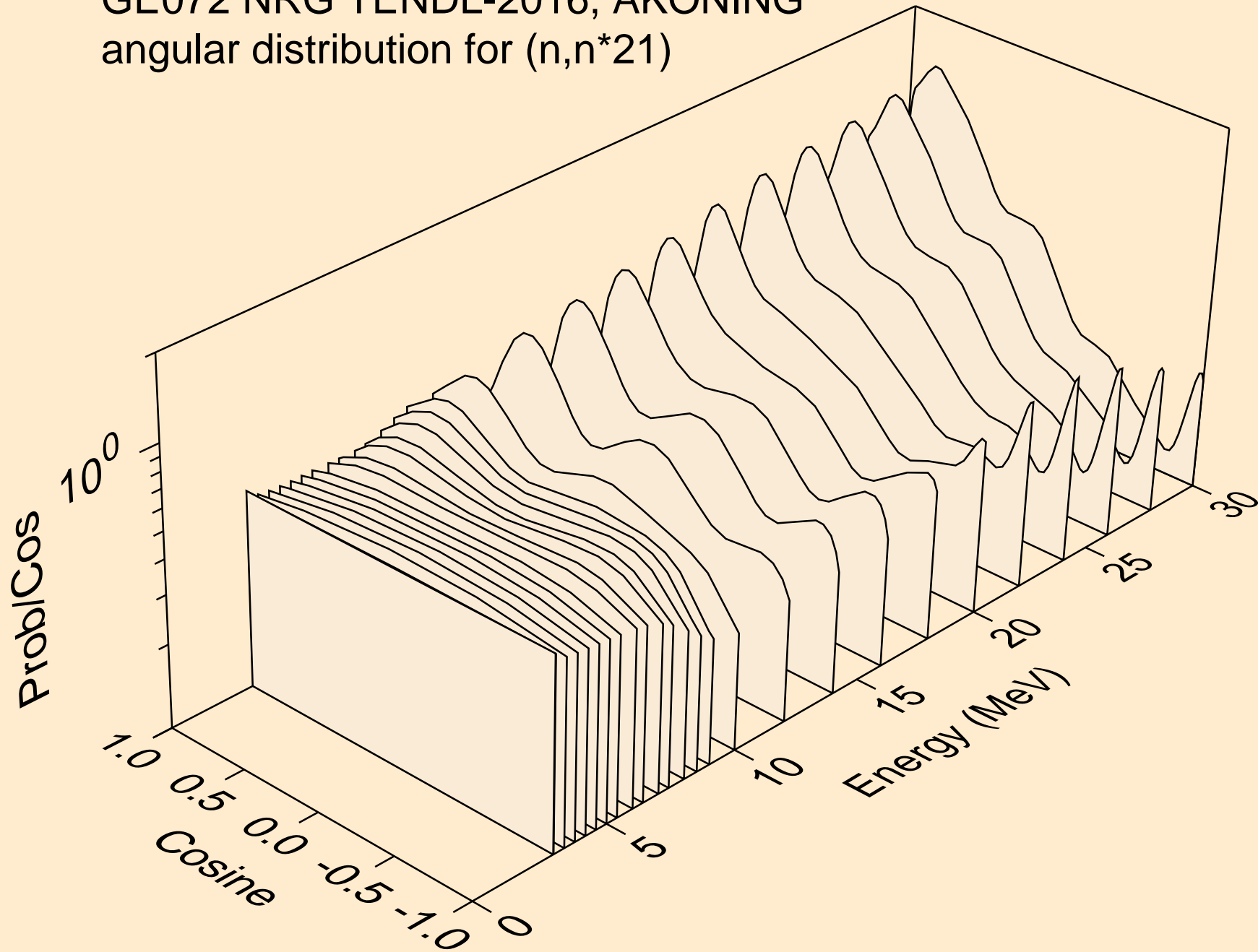

GE072 NRG TENDL-2016, AKONING
angular distribution for (n,n*22)

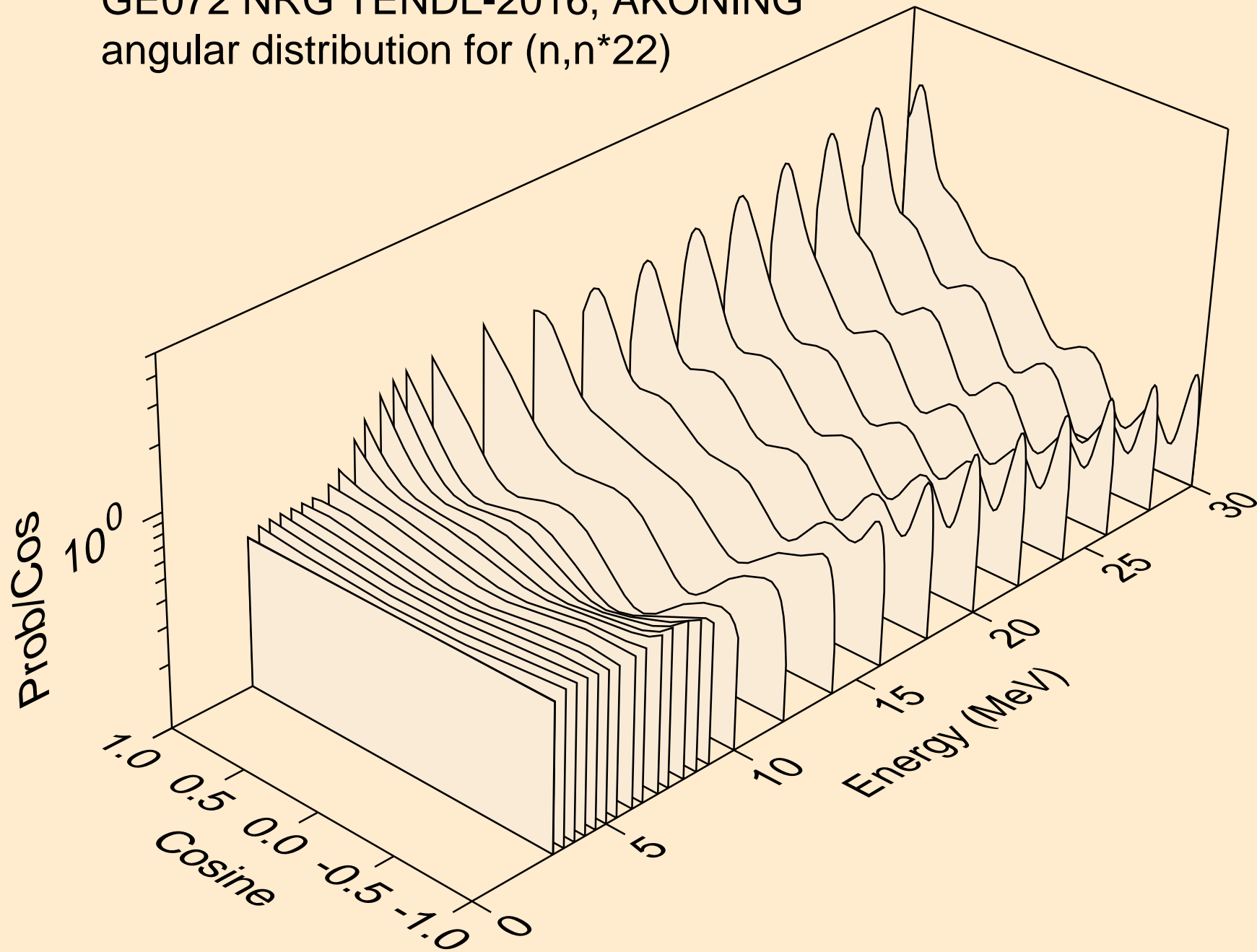

GE072 NRG TENDL-2016, AKONING
angular distribution for (n,n*23)

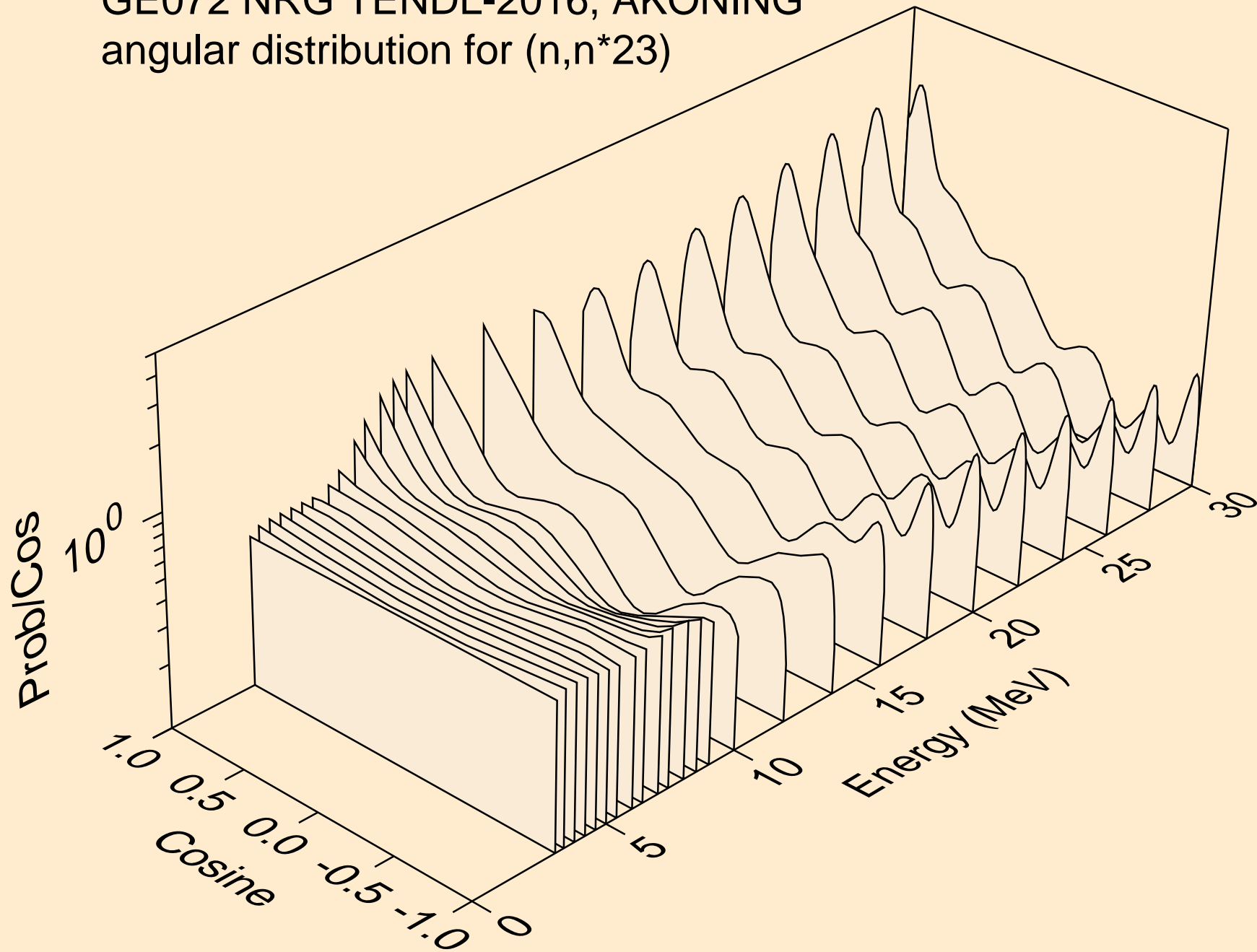

GE072 NRG TENDL-2016, AKONING
angular distribution for (n,n*24)

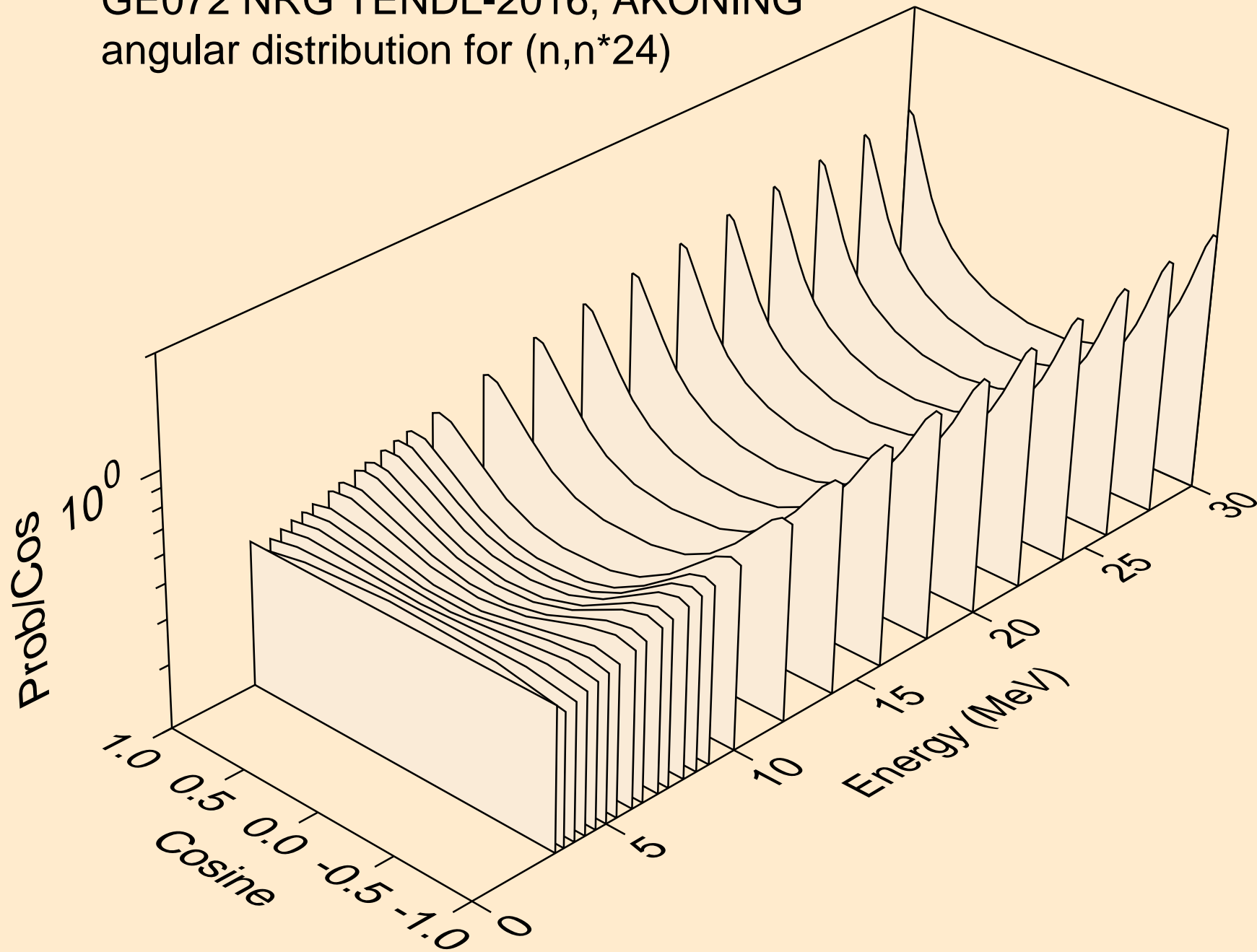

GE072 NRG TENDL-2016, AKONING
angular distribution for (n,n*25)

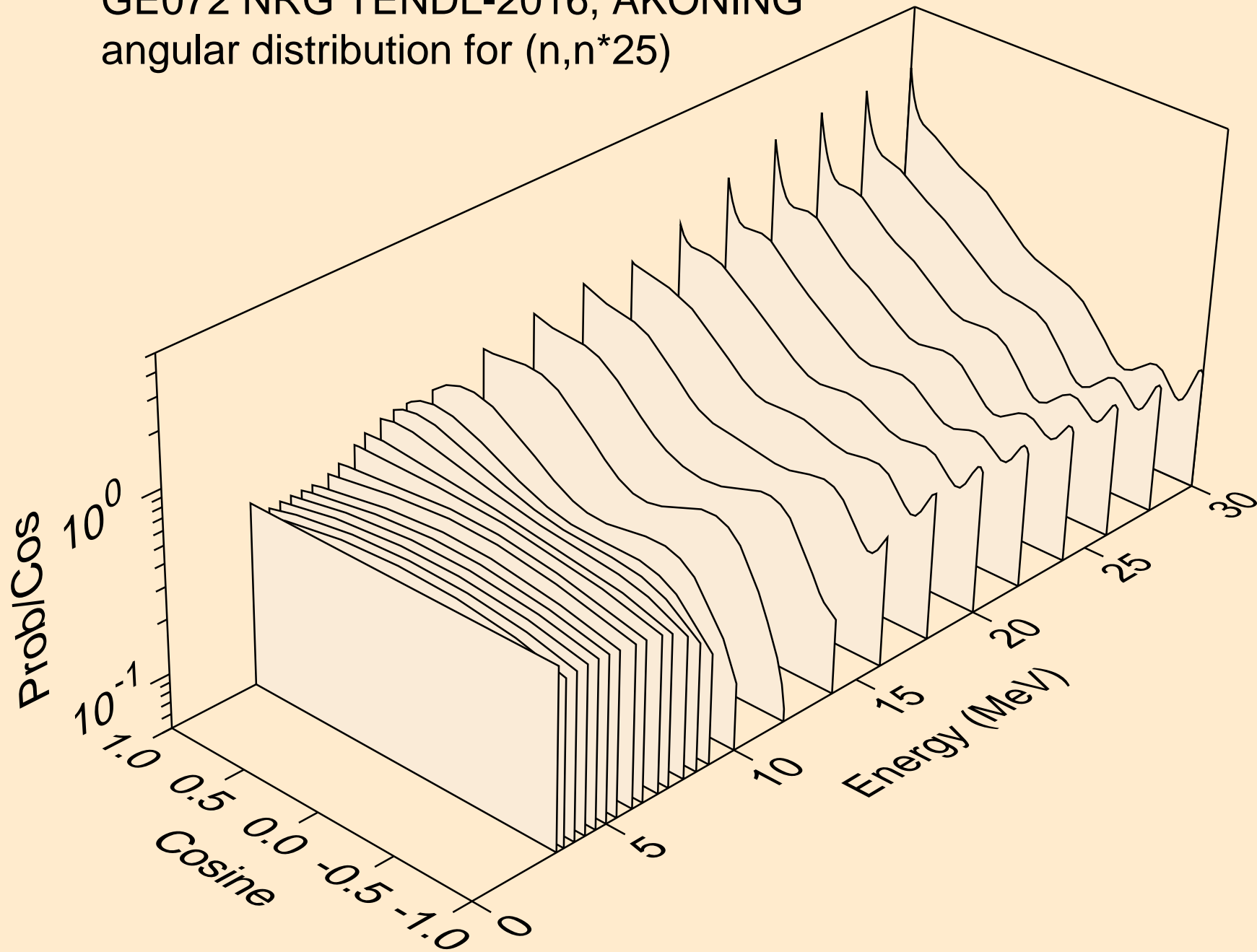

GE072 NRG TENDL-2016, AKONING
angular distribution for (n,n*26)

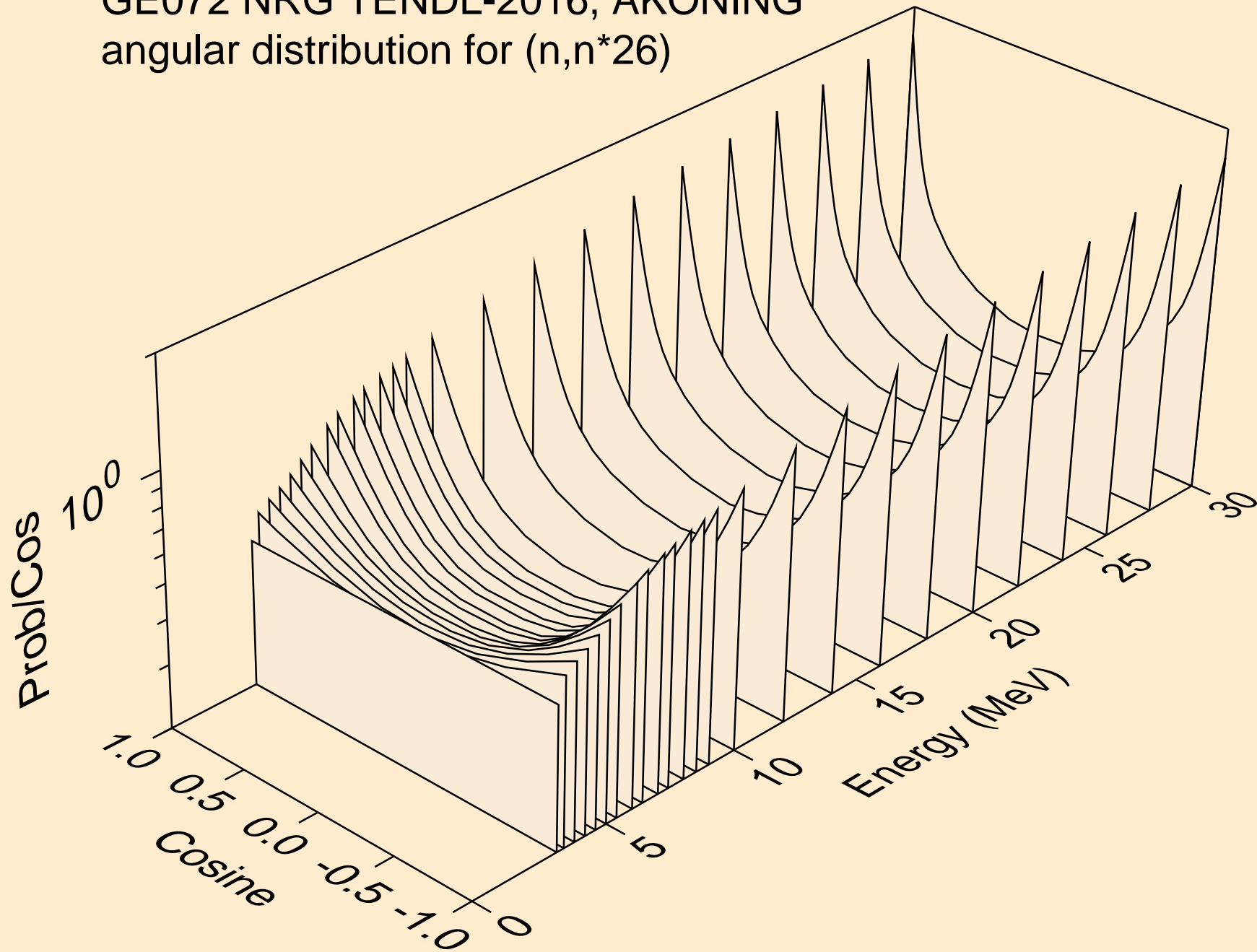

GE072 NRG TENDL-2016, AKONING
angular distribution for (n,n*27)

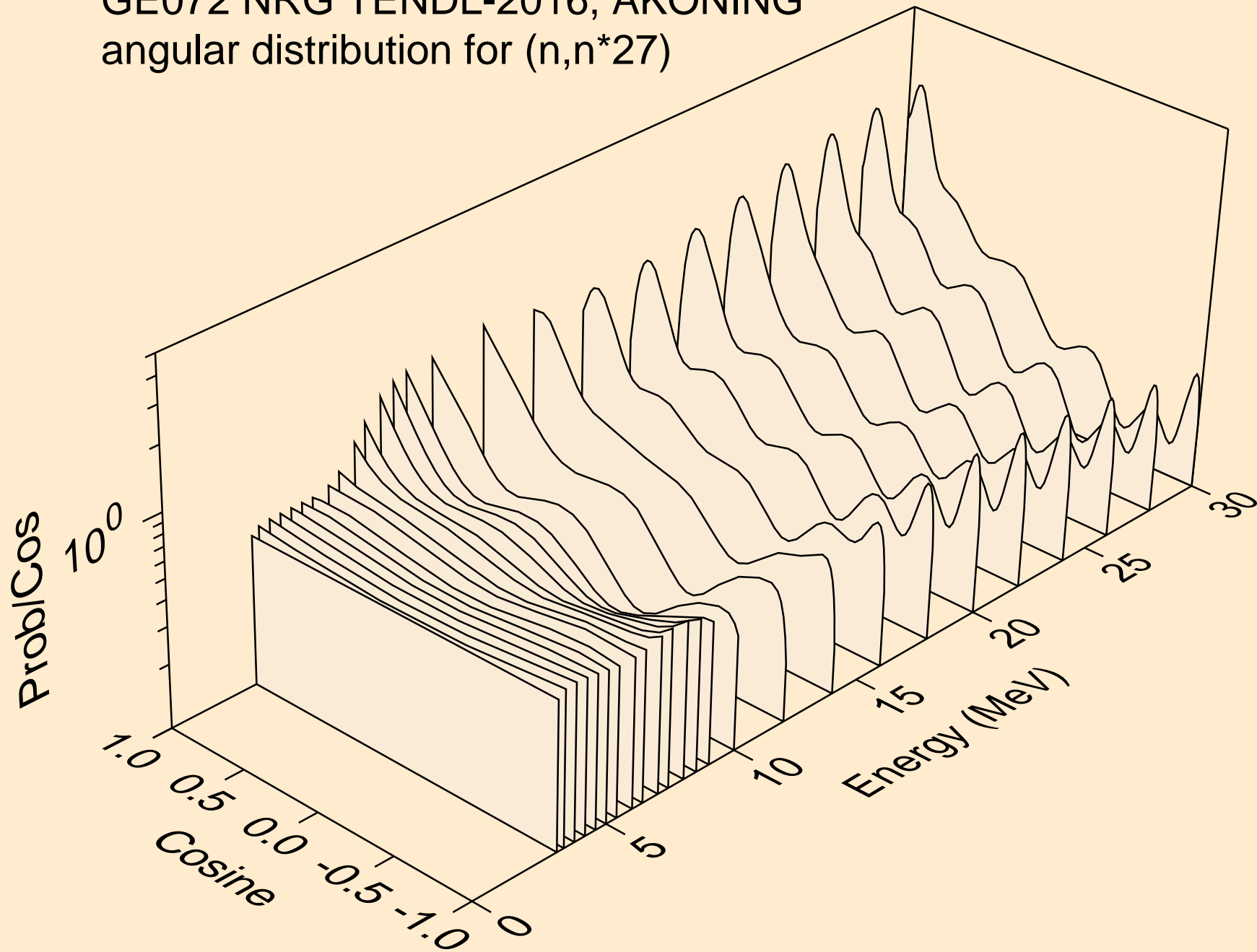

GE072 NRG TENDL-2016, AKONING
angular distribution for (n,n*28)

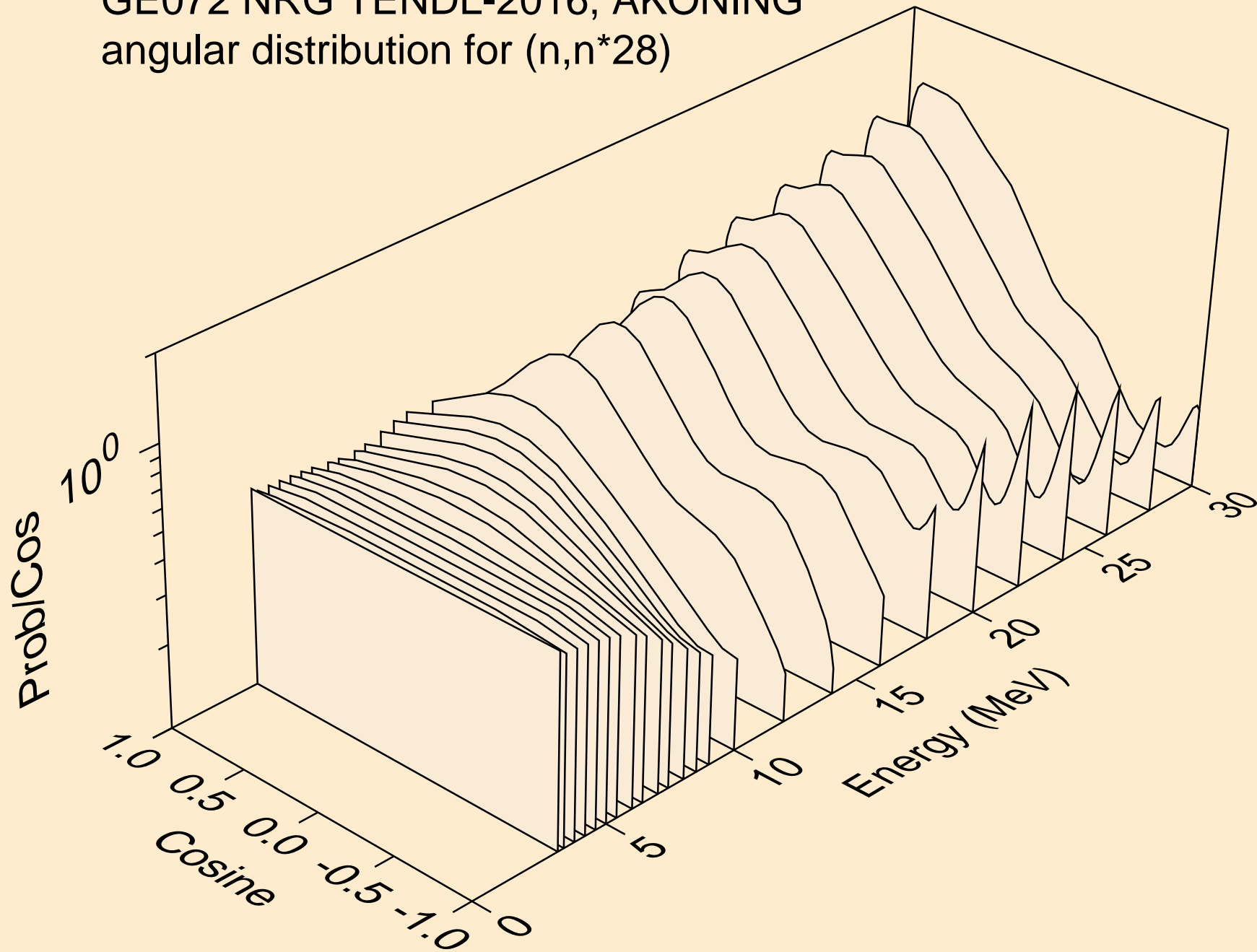

GE072 NRG TENDL-2016, AKONING
angular distribution for (n,n*29)

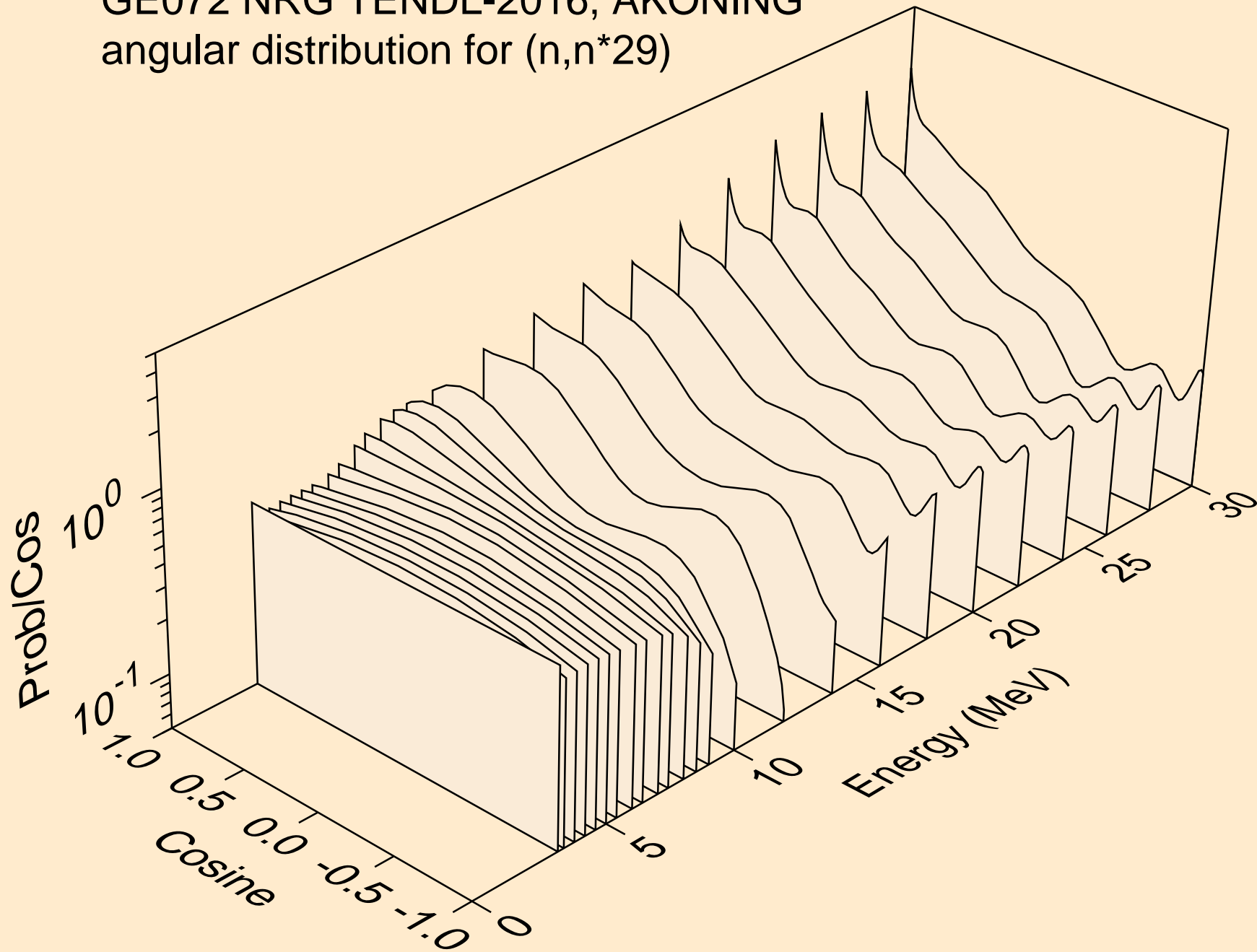

GE072 NRG TENDL-2016, AKONING
angular distribution for (n,n*30)

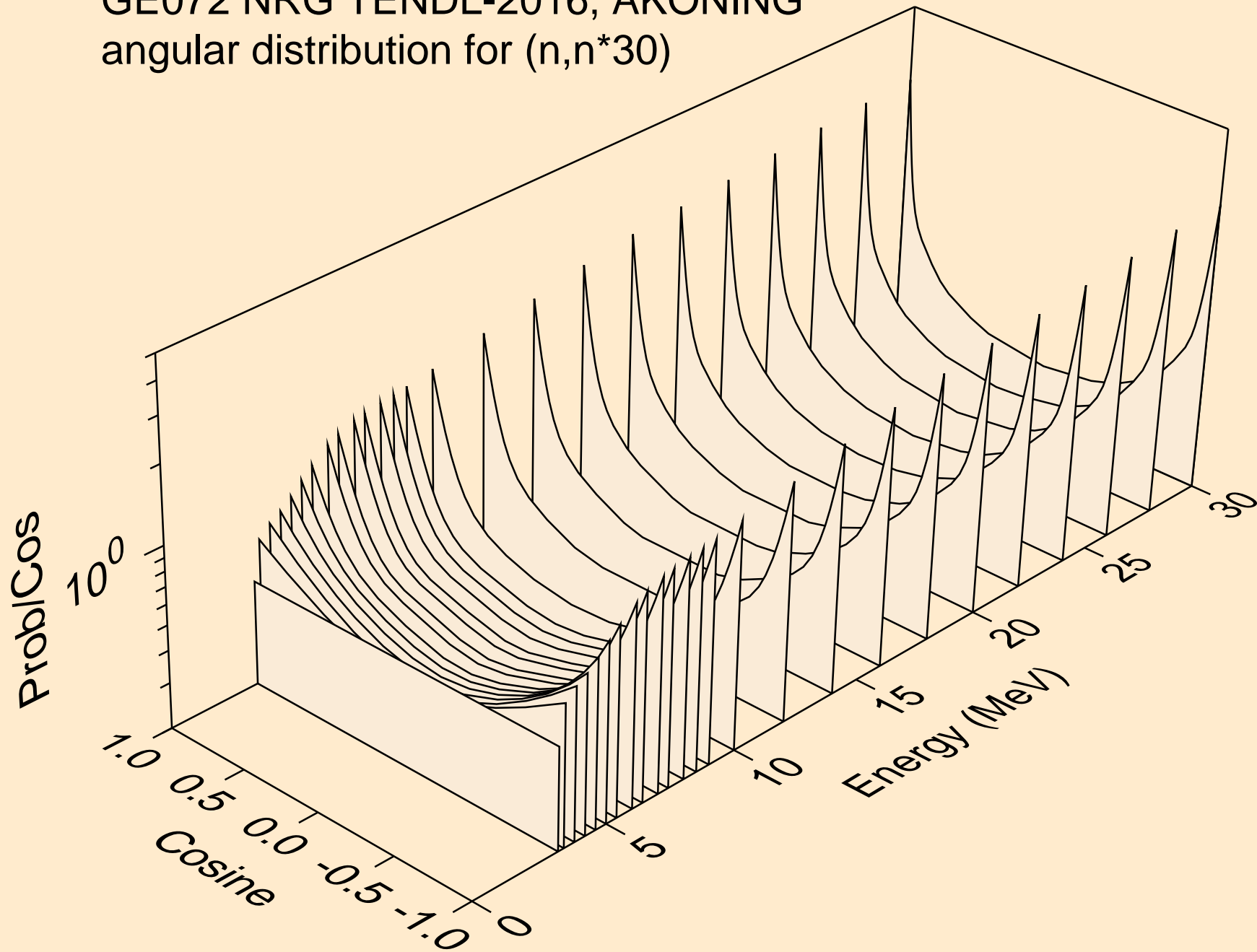

GE072 NRG TENDL-2016, AKONING
Neutron emission for (n,x)

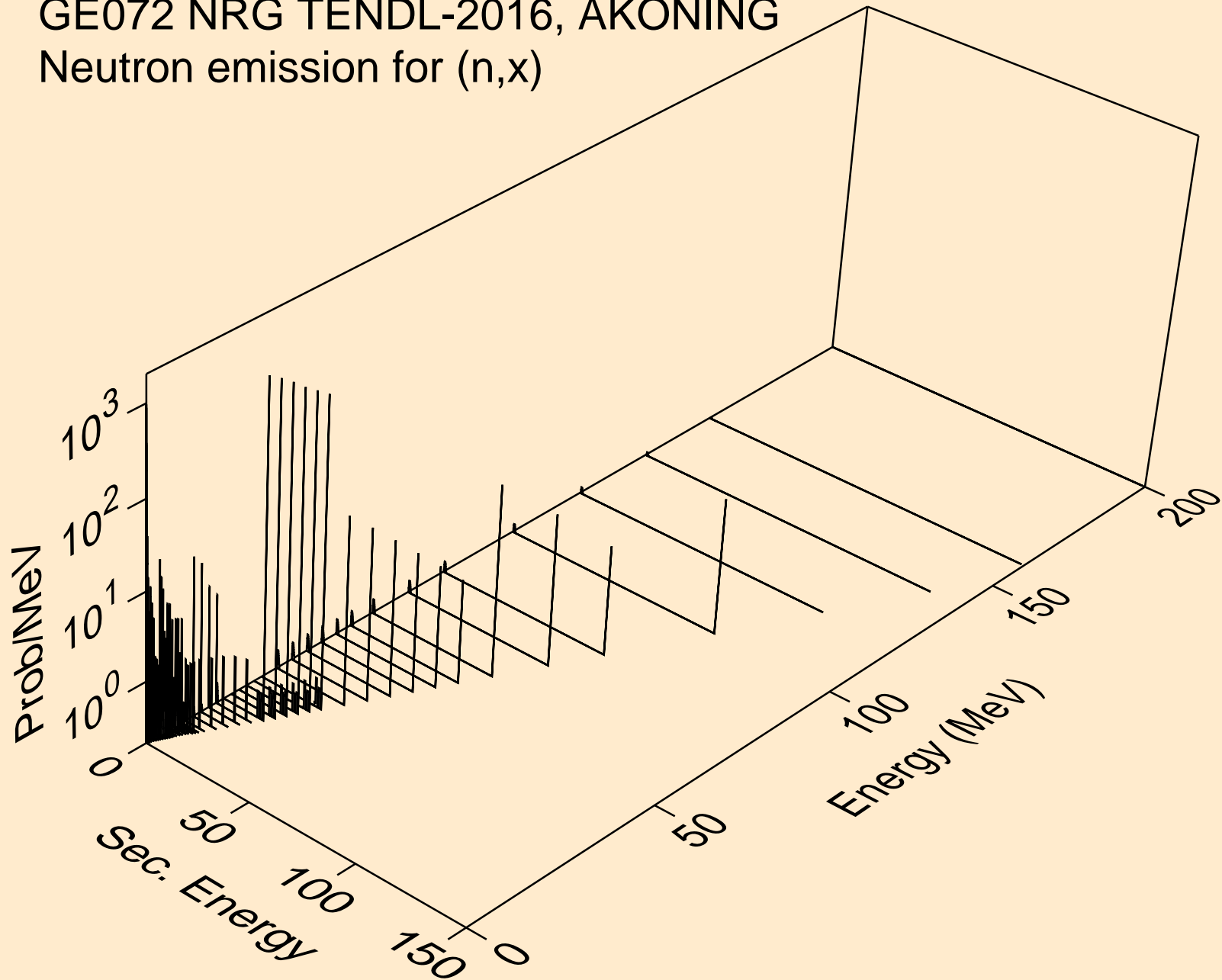

GE072 NRG TENDL-2016, AKONING
Neutron emission for (n,2nd)

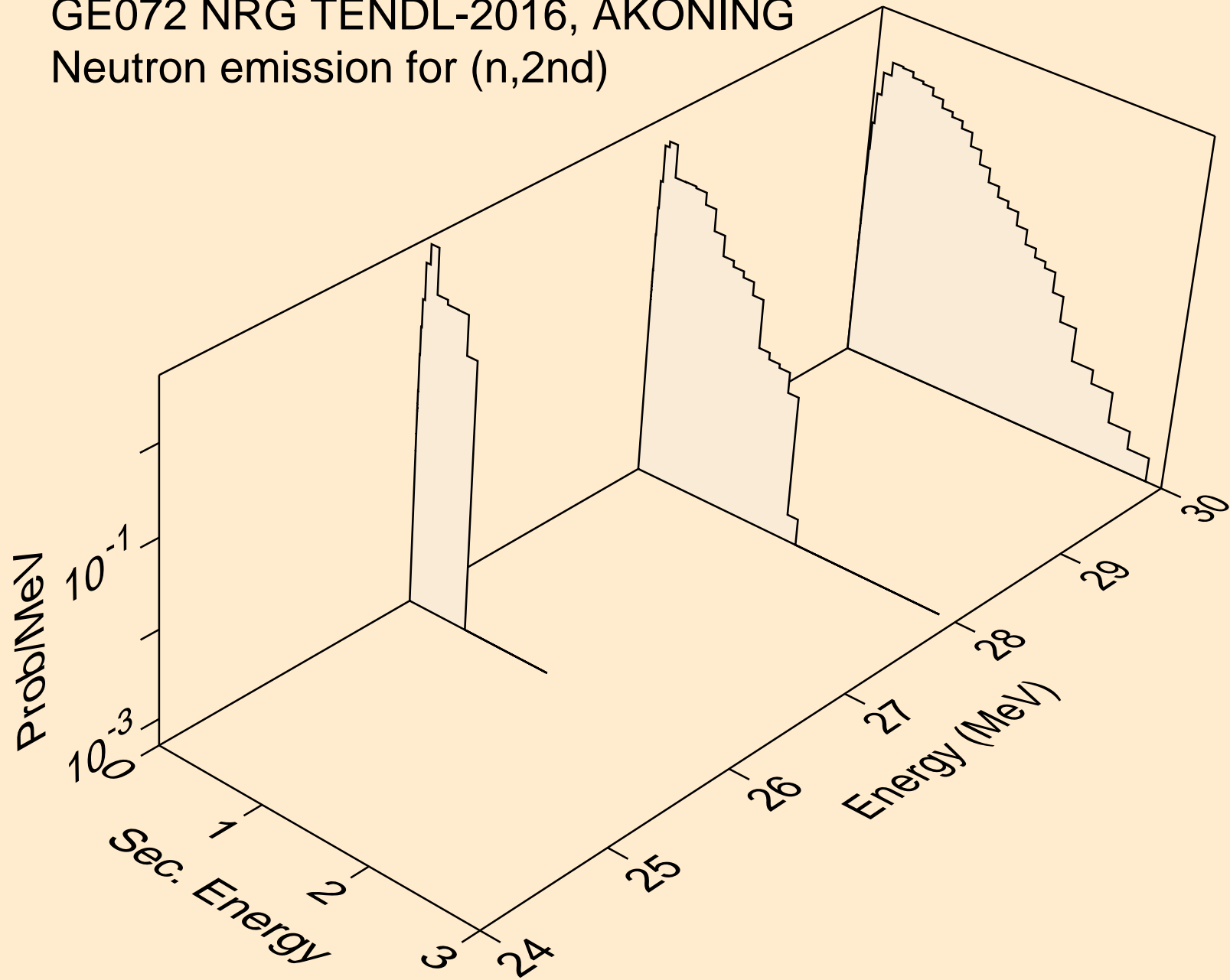

GE072 NRG TENDL-2016, AKONING
Neutron emission for (n,2n)

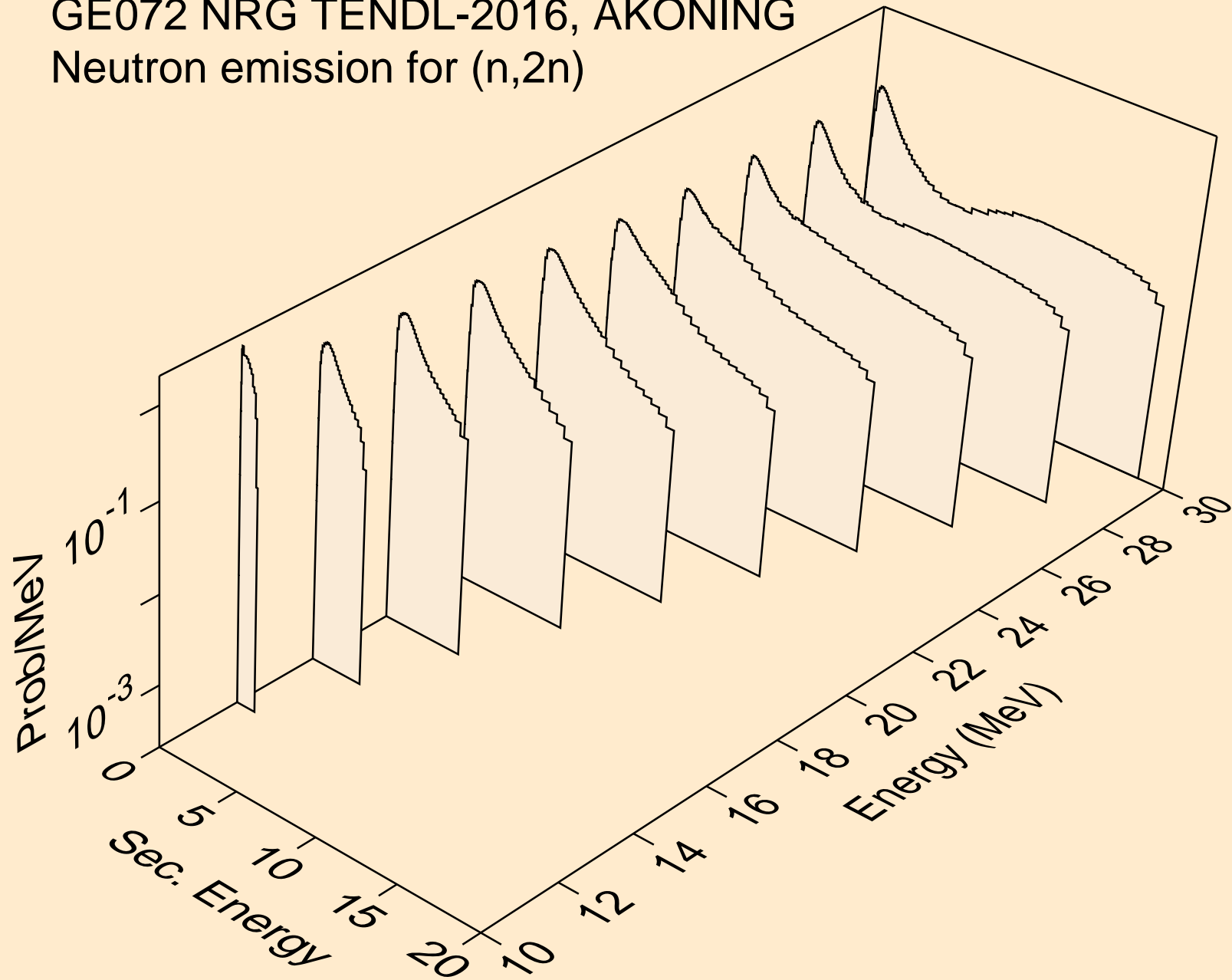

GE072 NRG TENDL-2016, AKONING
Neutron emission for (n,3n)

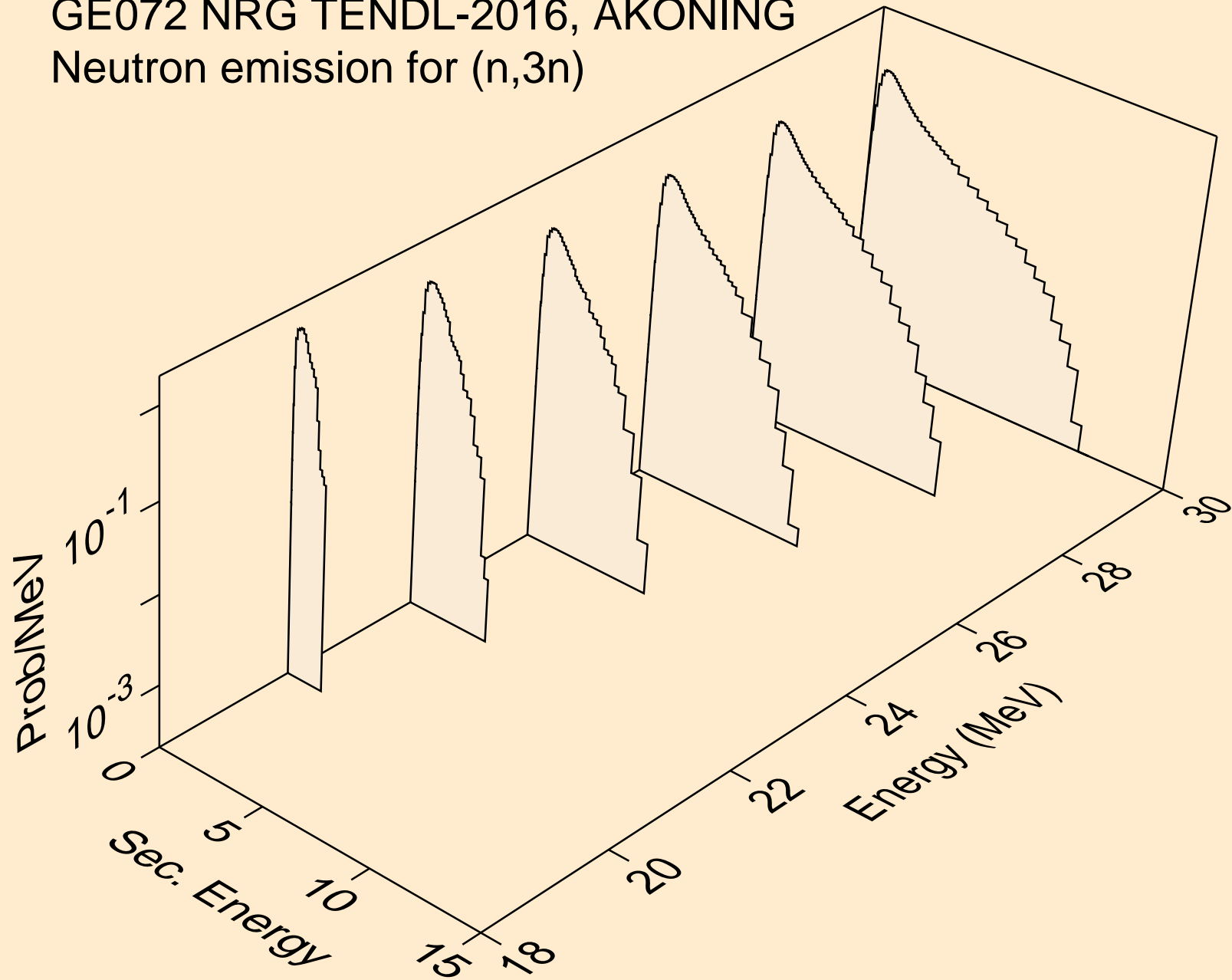

GE072 NRG TENDL-2016, AKONING
Neutron emission for (n,n*)a

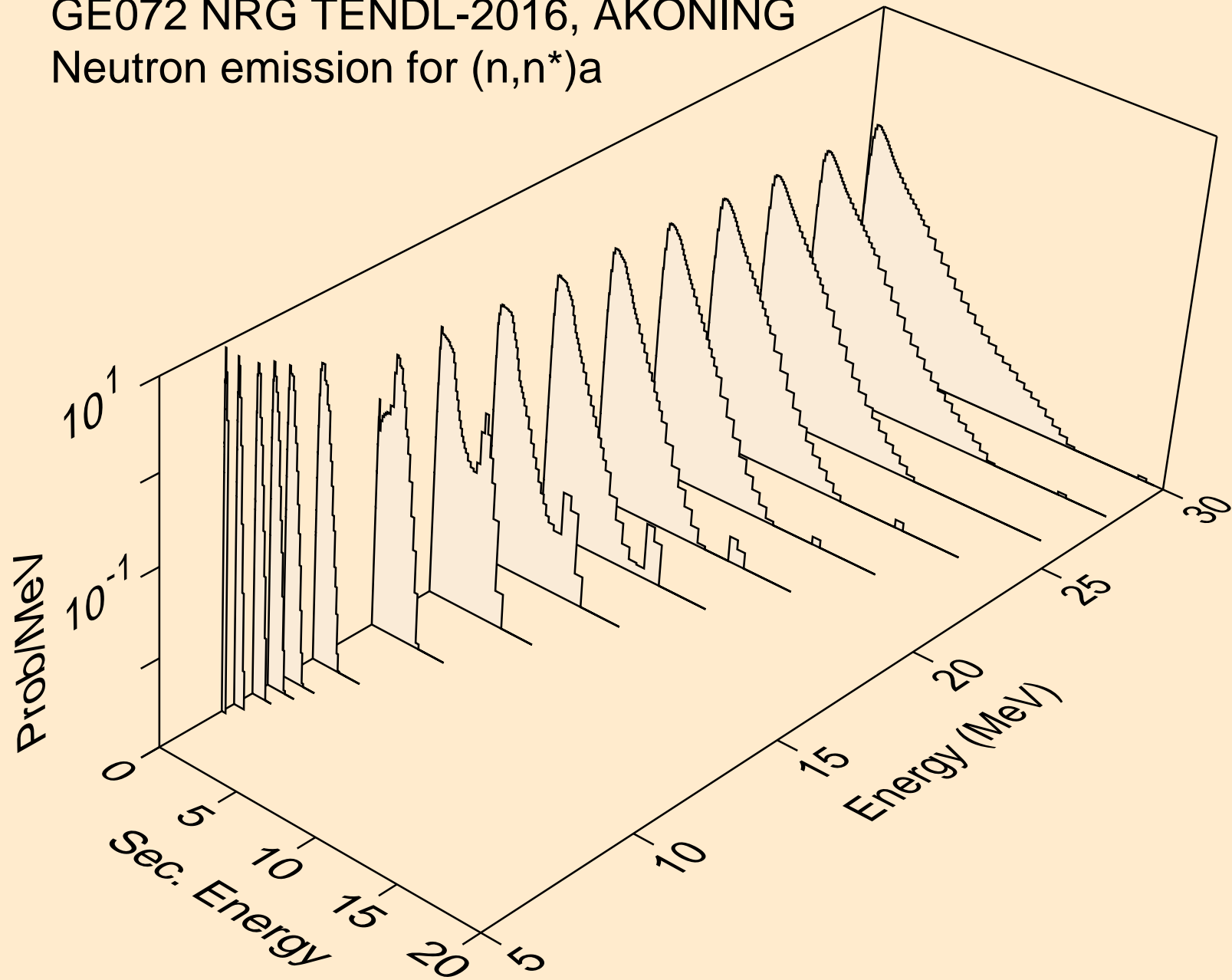

GE072 NRG TENDL-2016, AKONING
Neutron emission for (n,2n)a

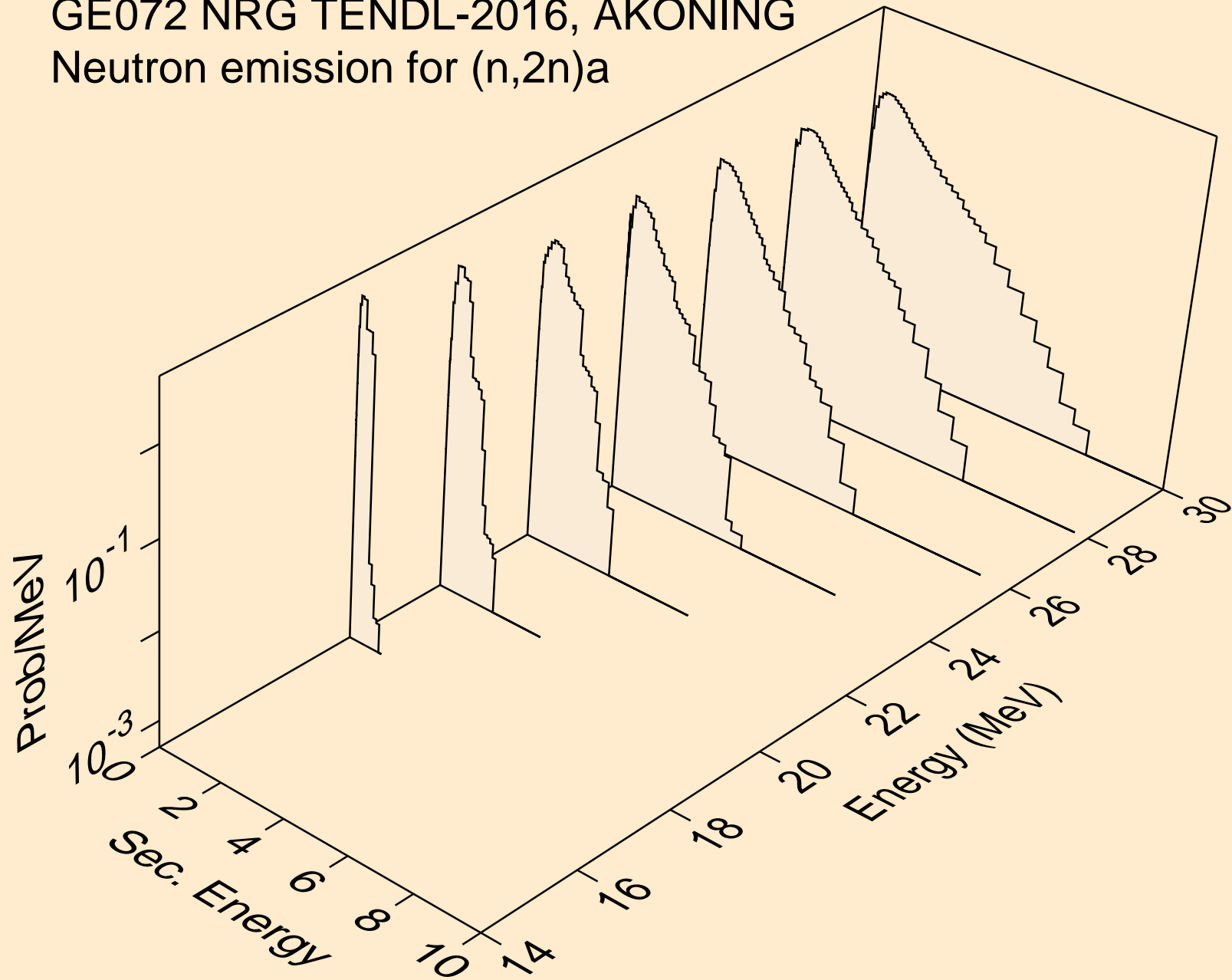

GE072 NRG TENDL-2016, AKONING
Neutron emission for (n,3n)a

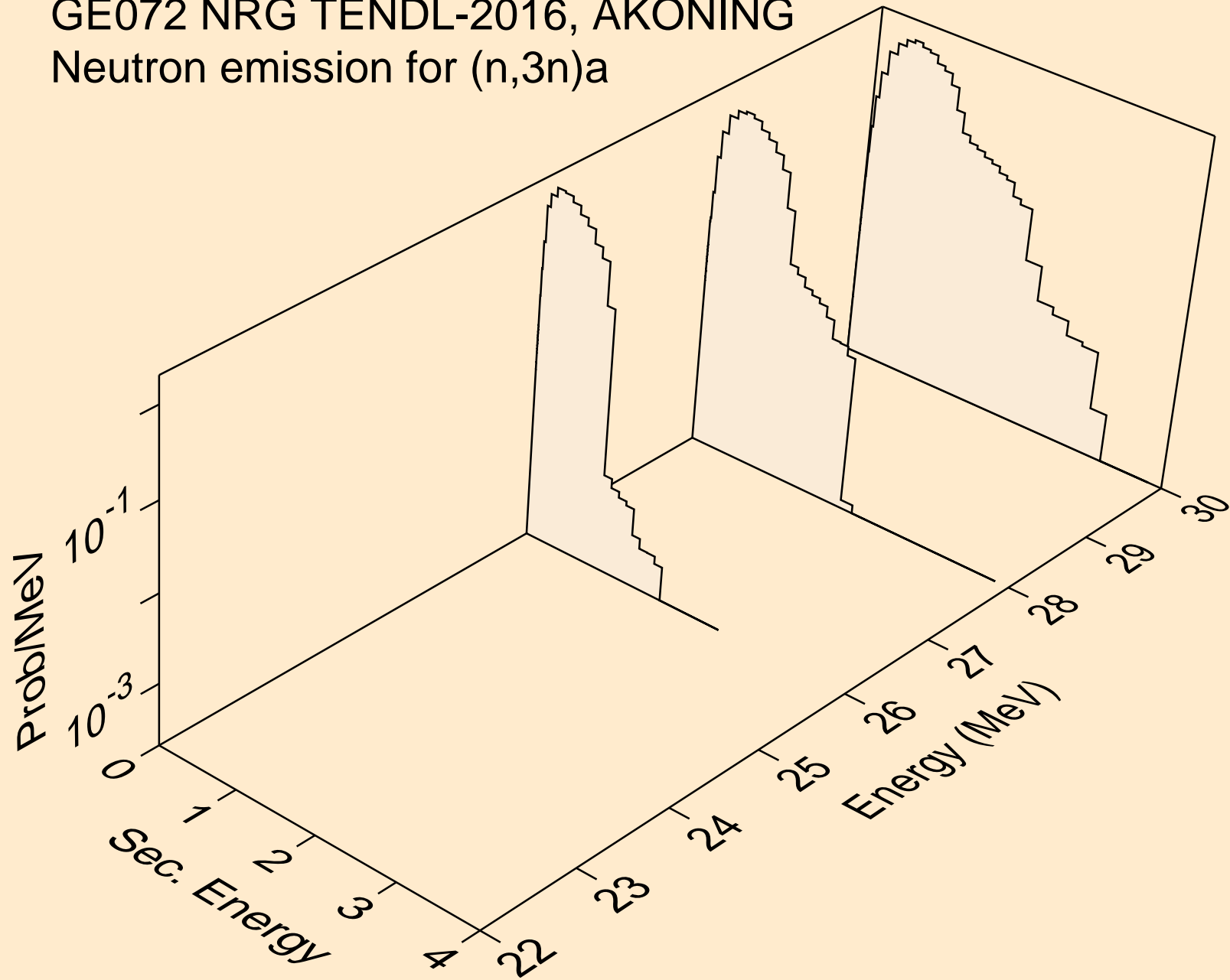

GE072 NRG TENDL-2016, AKONING
Neutron emission for (n,n*)p

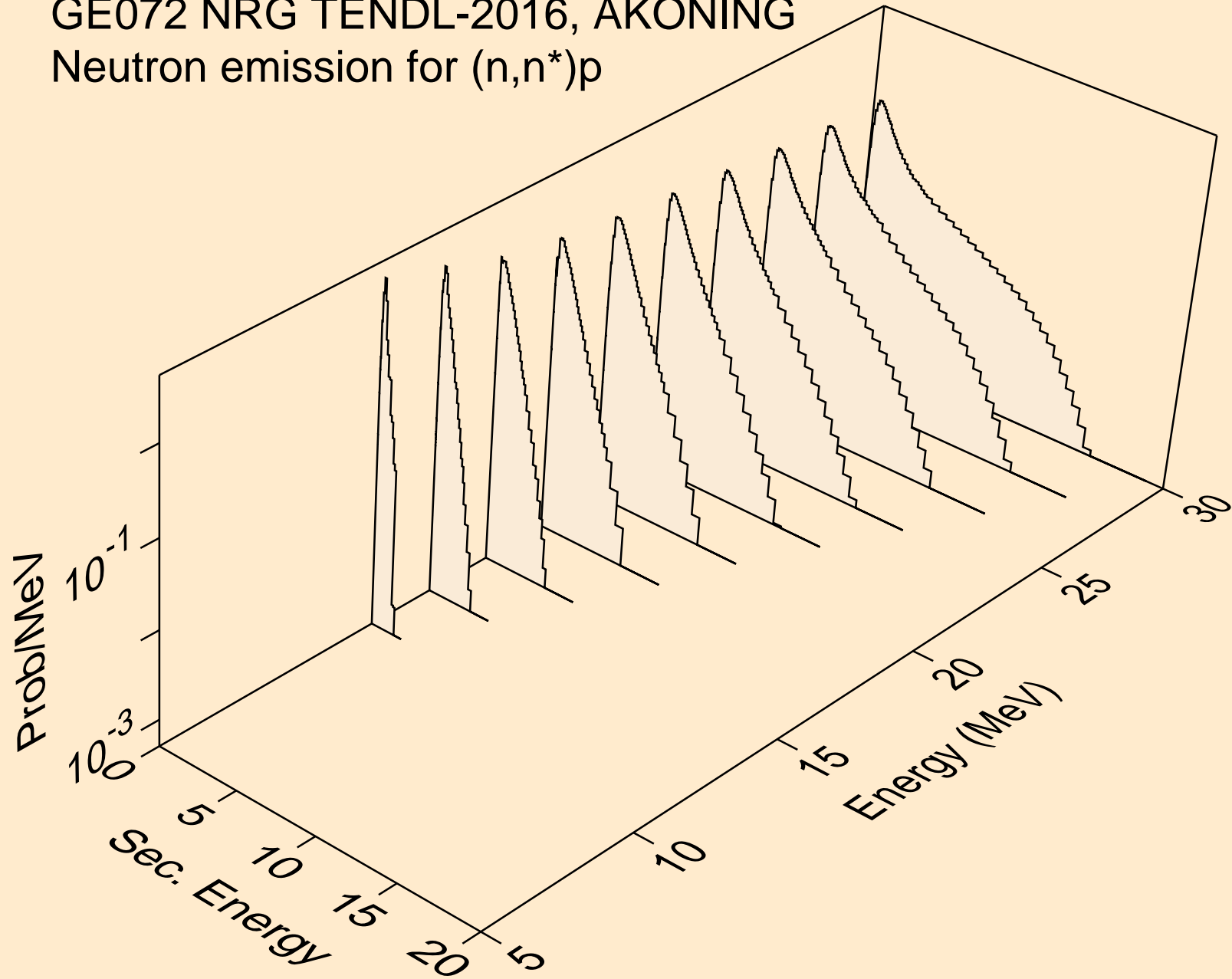

GE072 NRG TENDL-2016, AKONING
Neutron emission for (n,n*)2a

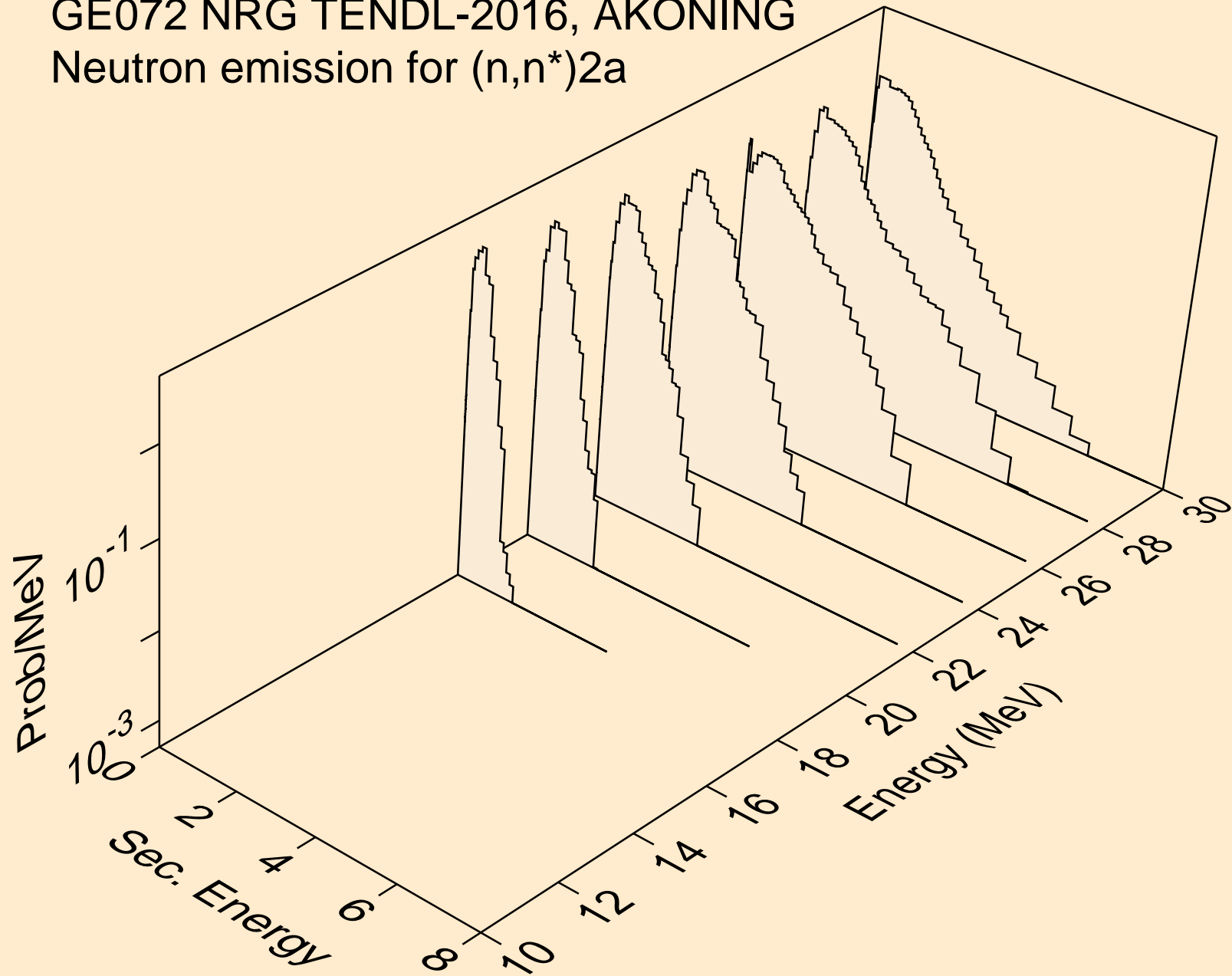

GE072 NRG TENDL-2016, AKONING
Neutron emission for (n,n*)d

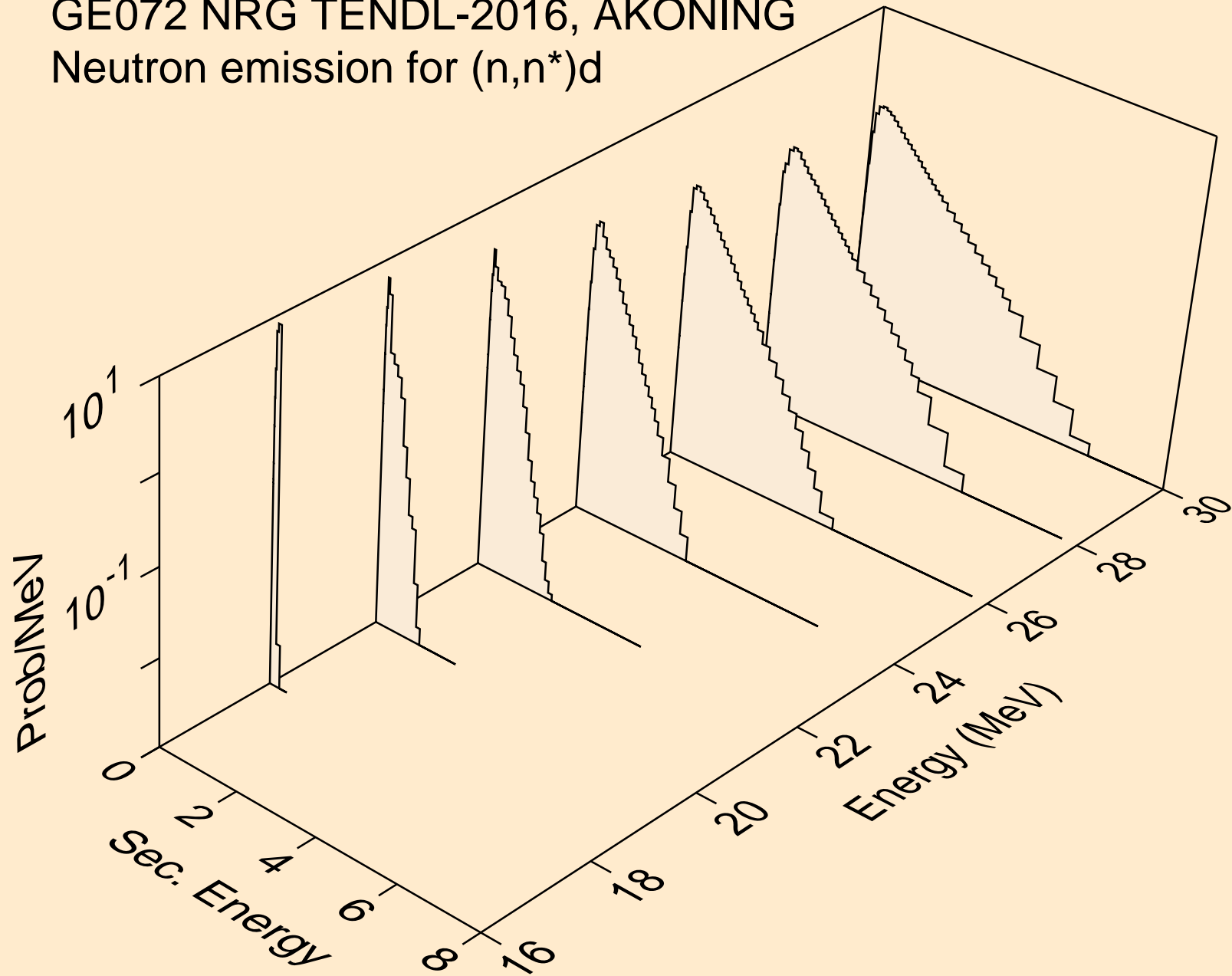

GE072 NRG TENDL-2016, AKONING
Neutron emission for (n,n*)t

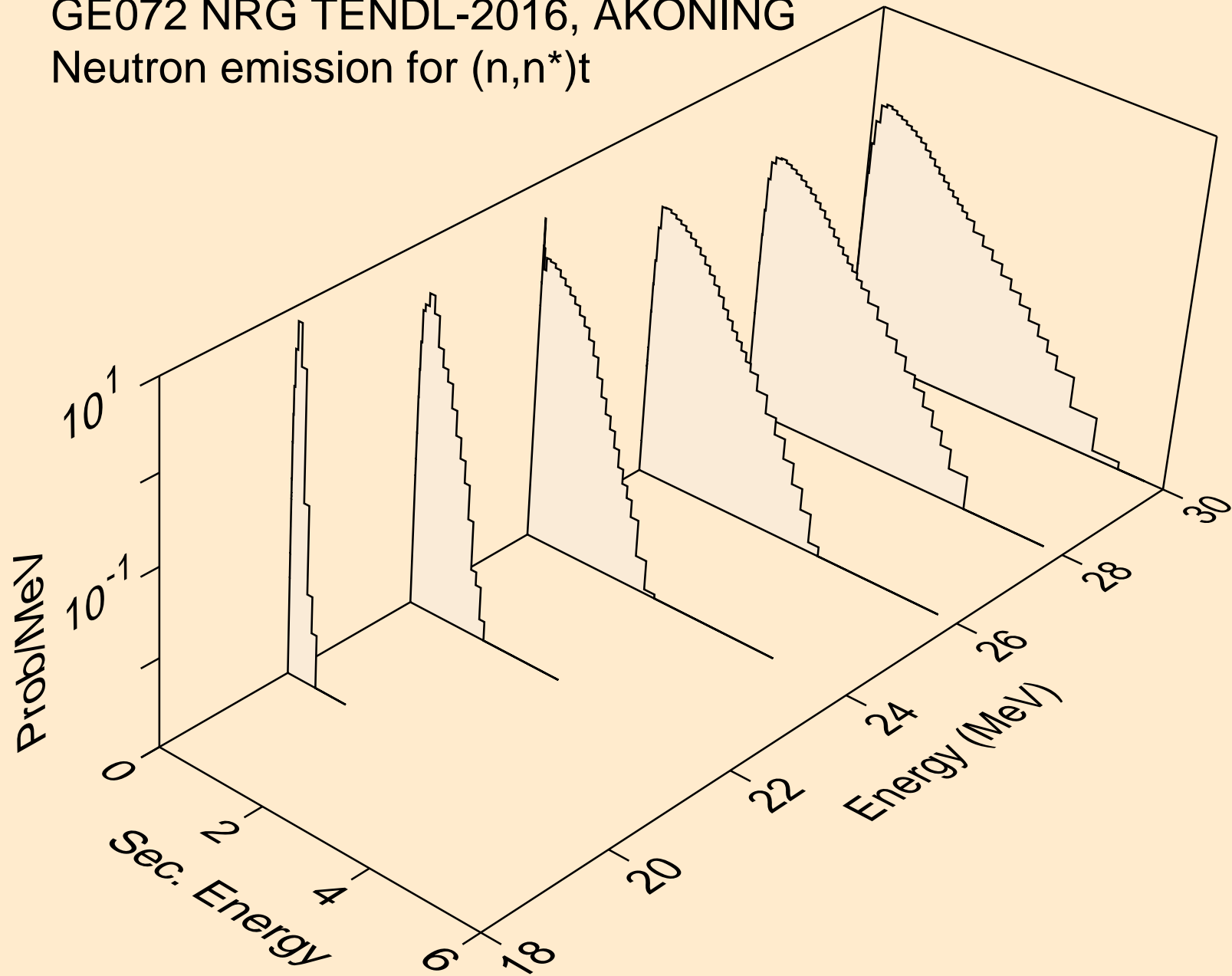

GE072 NRG TENDL-2016, AKONING
Neutron emission for (n,n*)he3

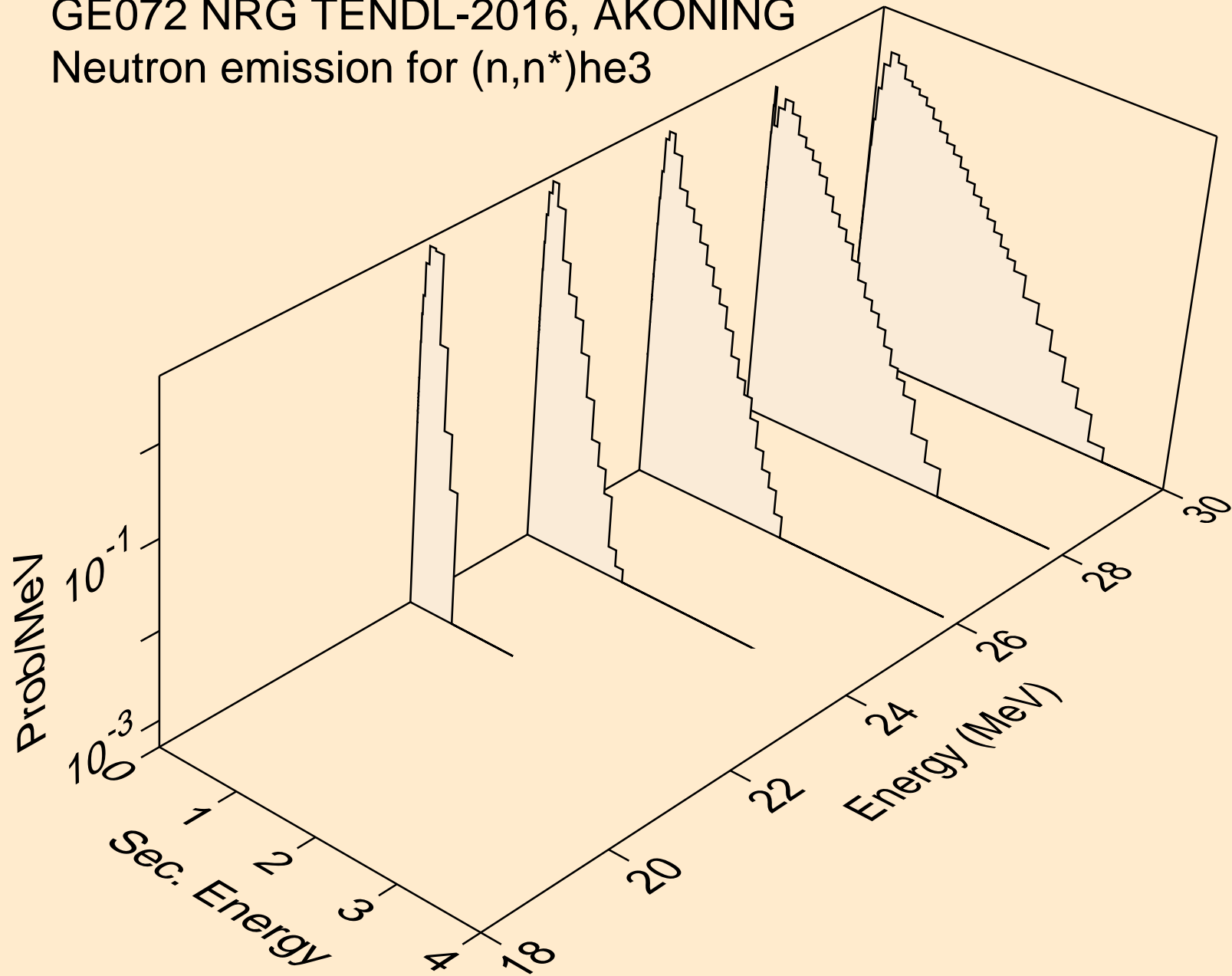

GE072 NRG TENDL-2016, AKONING
Neutron emission for (n,2np)

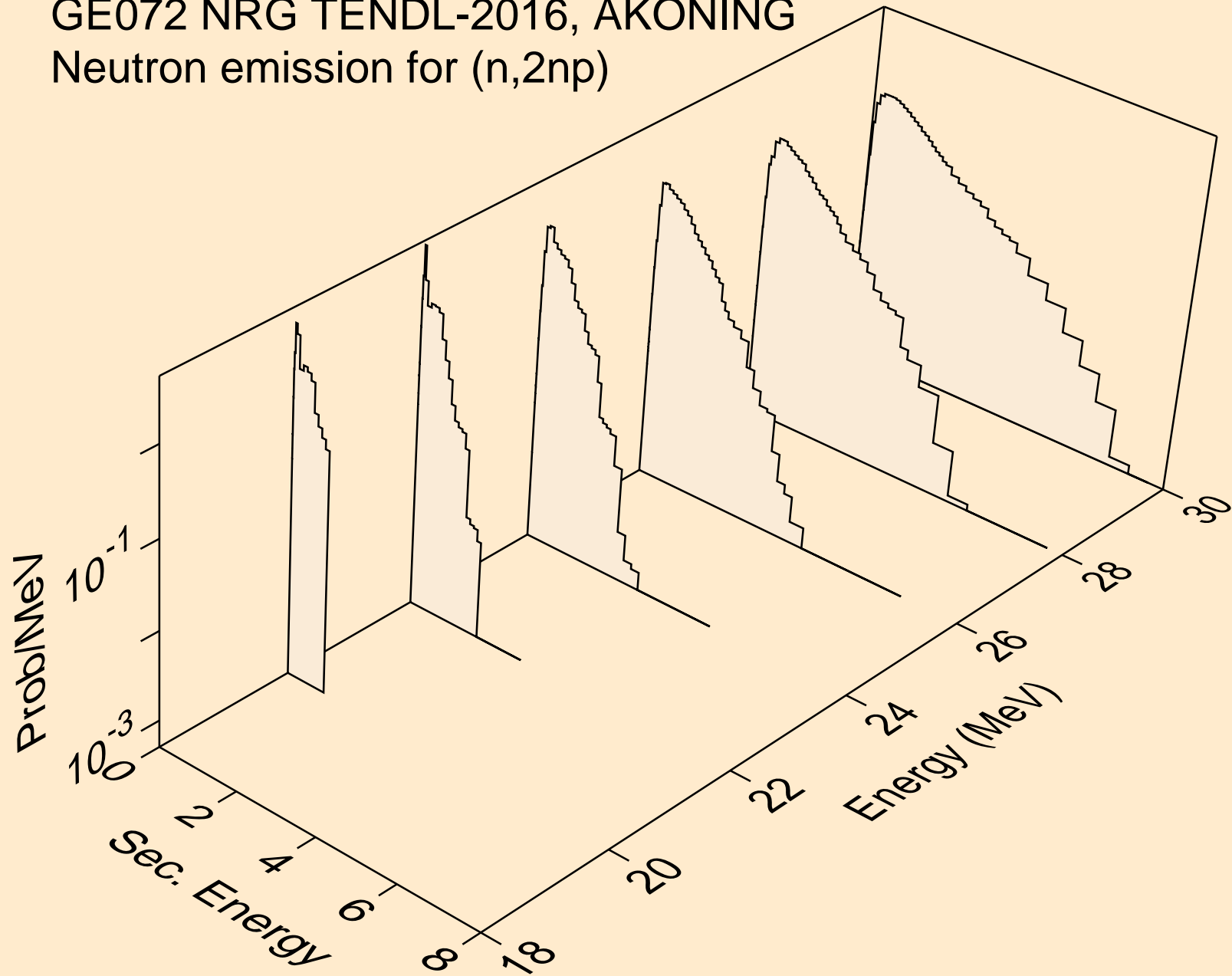

GE072 NRG TENDL-2016, AKONING
Neutron emission for (n,3np)

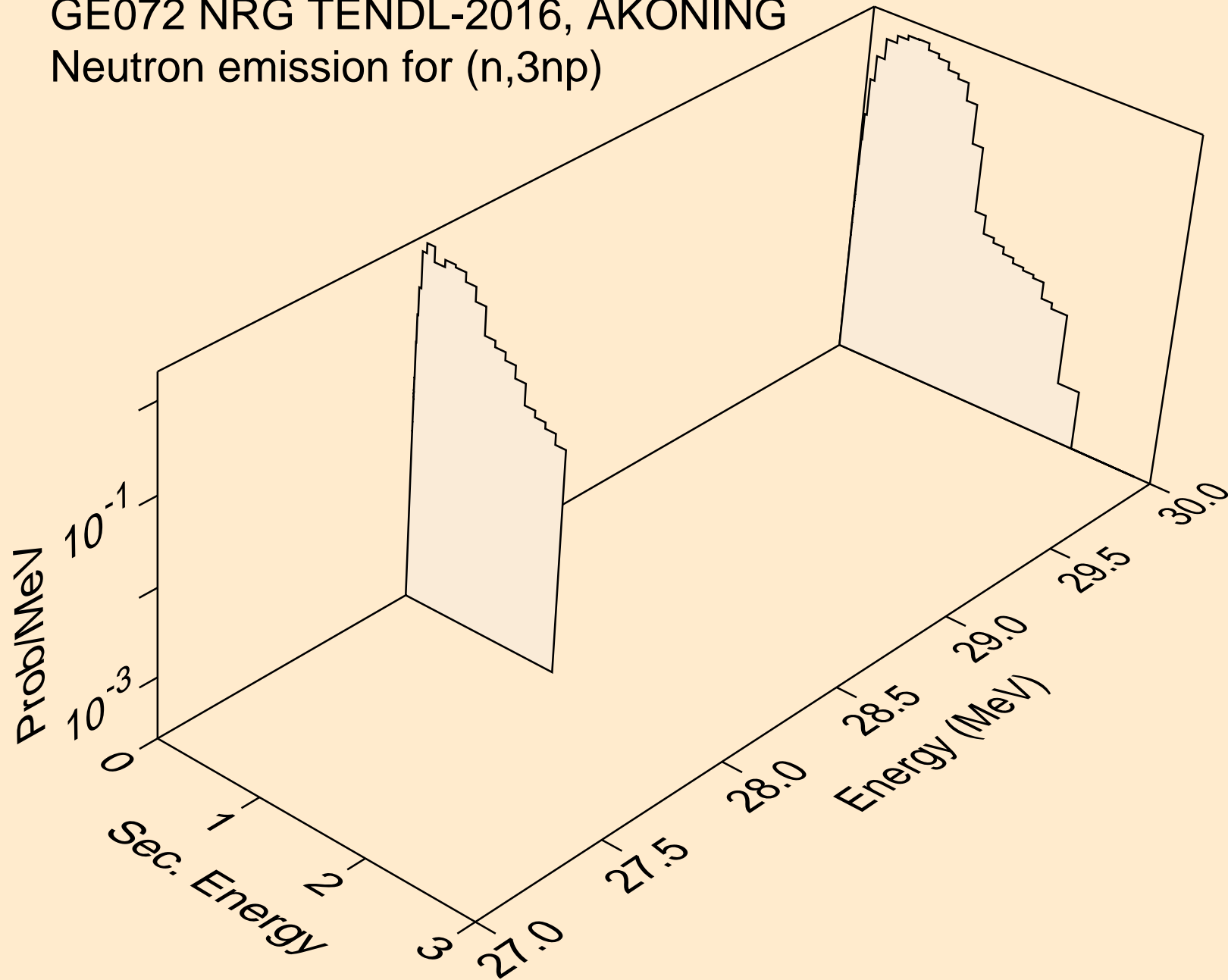

GE072 NRG TENDL-2016, AKONING
Neutron emission for (n,2np)

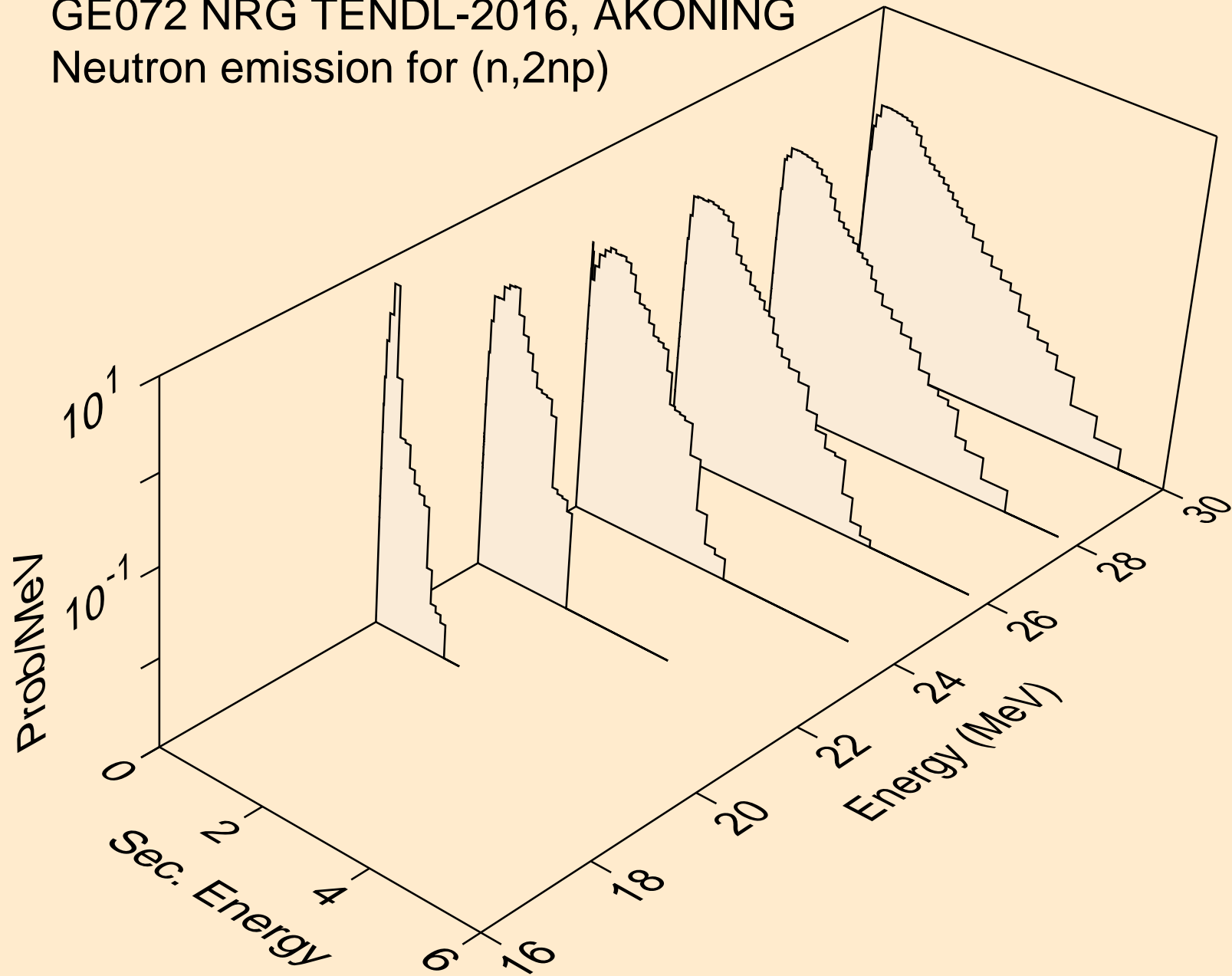

GE072 NRG TENDL-2016, AKONING
Neutron emission for (n,npa)

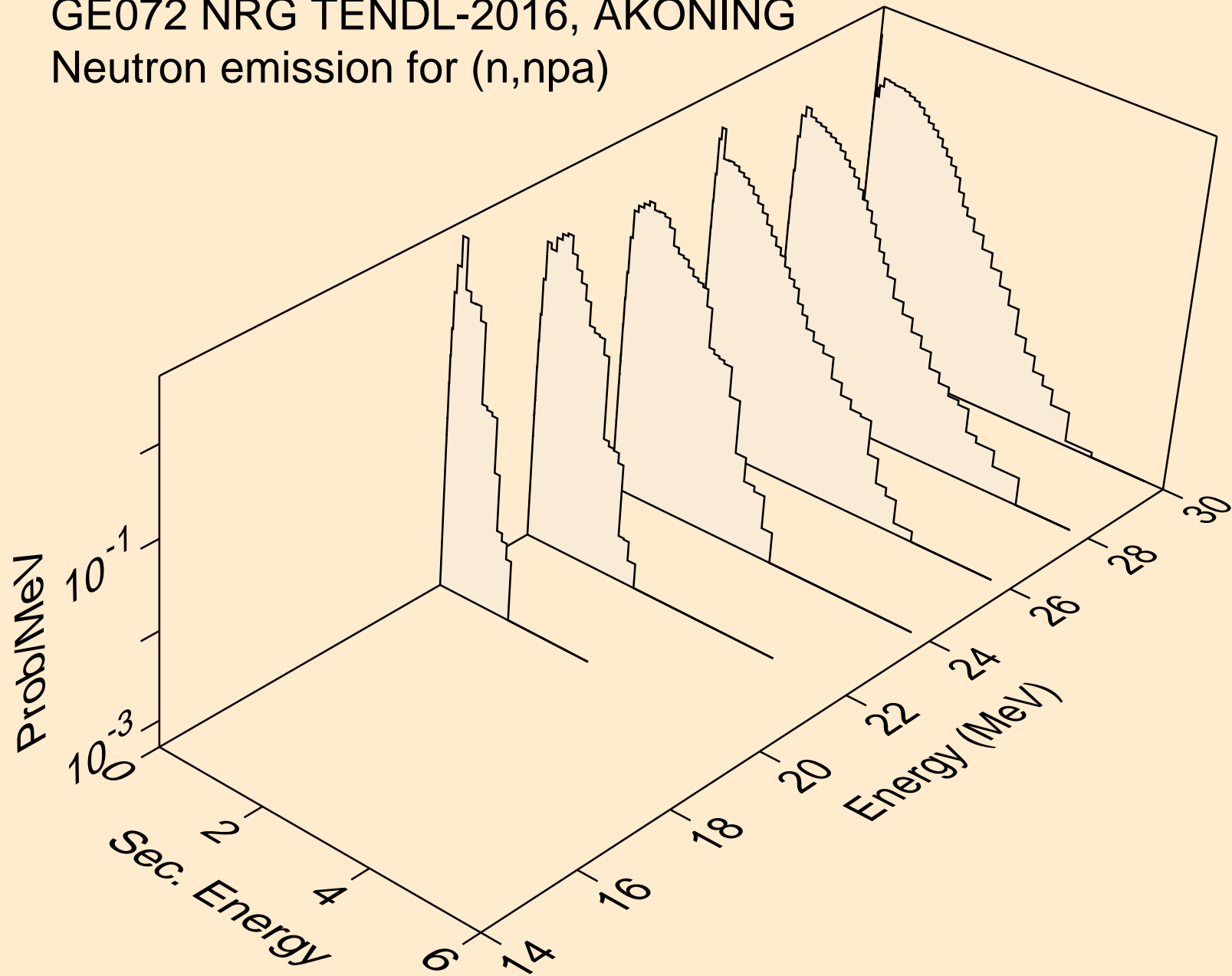

GE072 NRG TENDL-2016, AKONING
Neutron emission for (n,n*c)

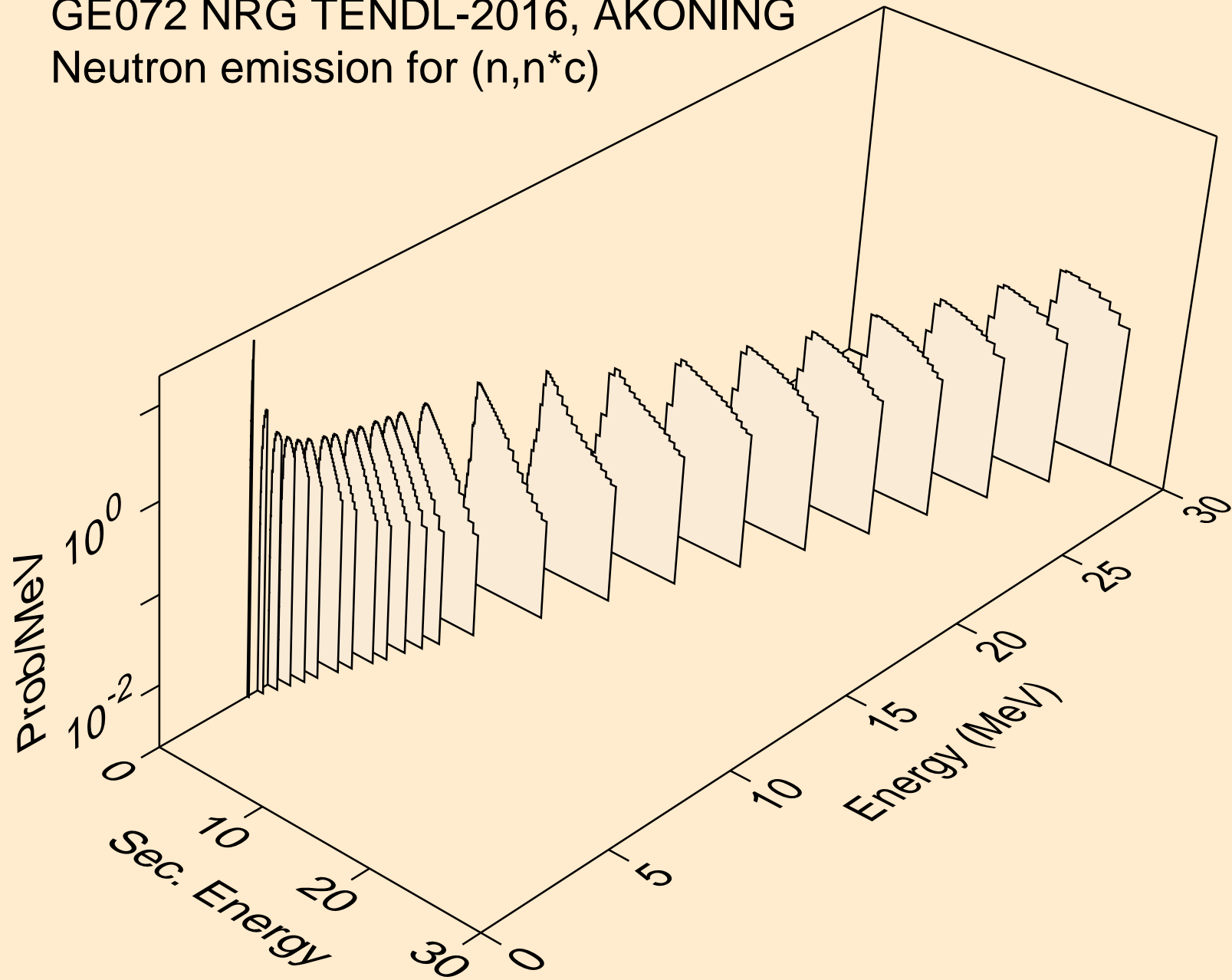

GE072 NRG TENDL-2016, AKONING
Photon emission for (n,x)

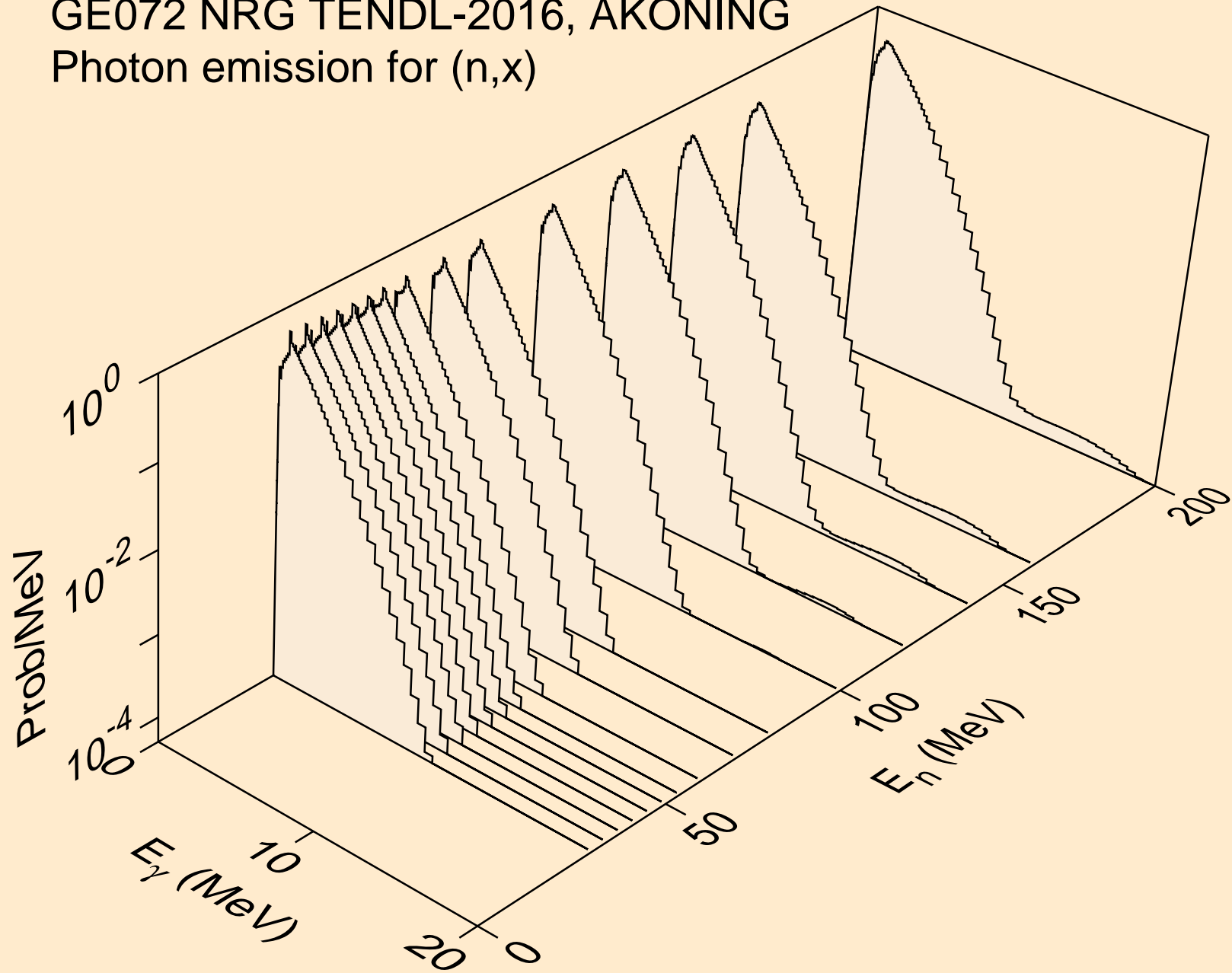

GE072 NRG TENDL-2016, AKONING
Photon emission for (n,2nd)

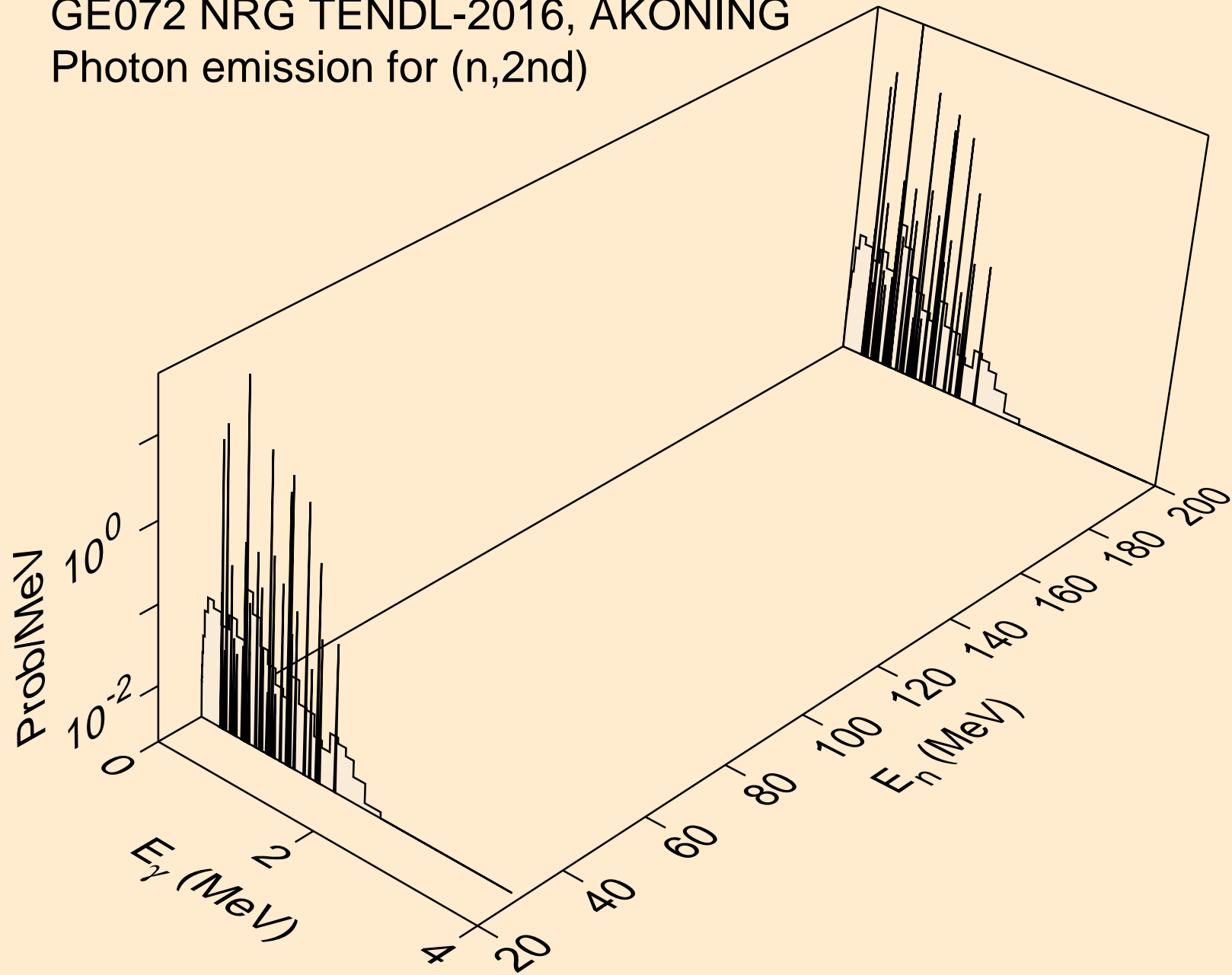

GE072 NRG TENDL-2016, AKONING
Photon emission for (n,2n)

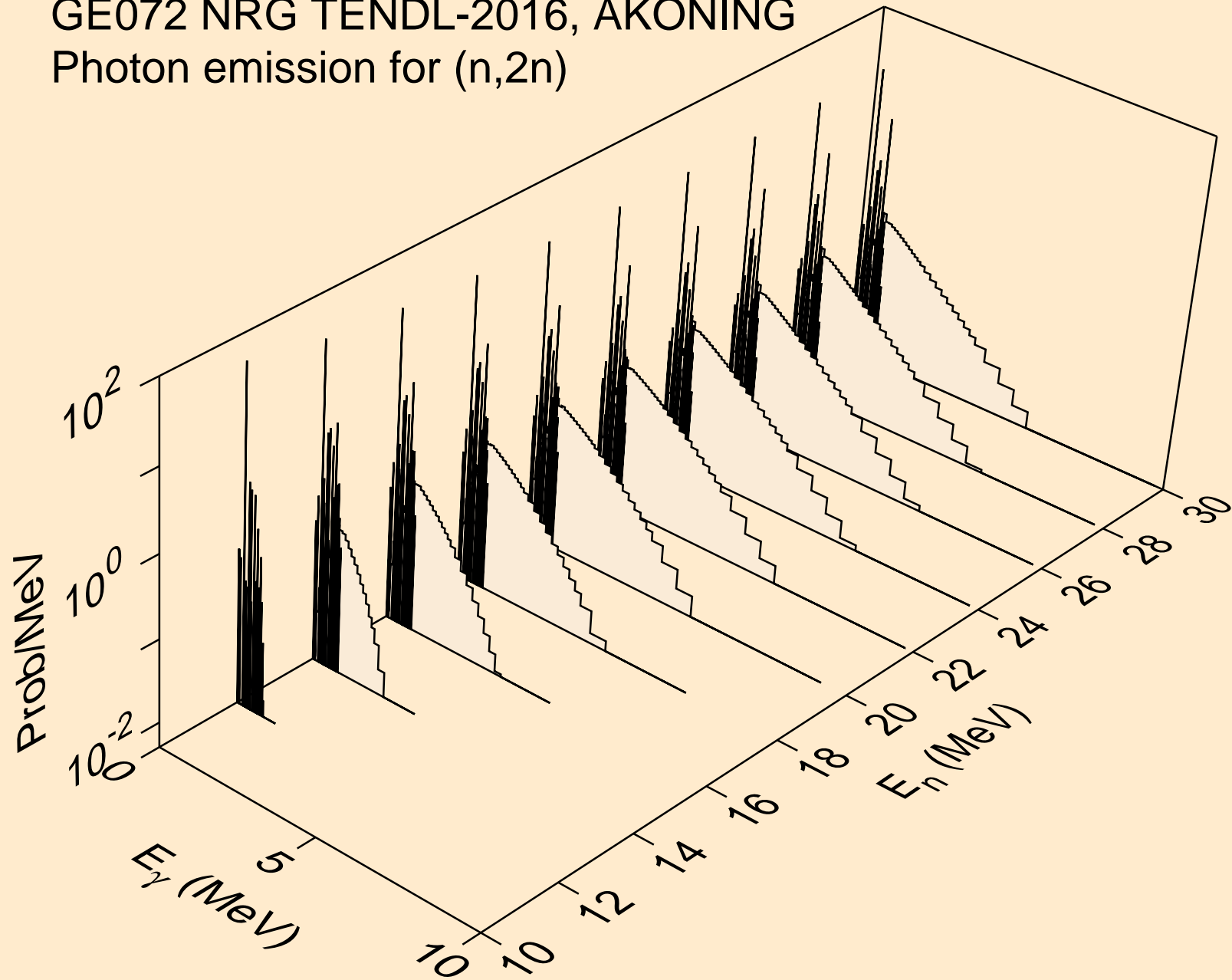

GE072 NRG TENDL-2016, AKONING
Photon emission for (n,3n)

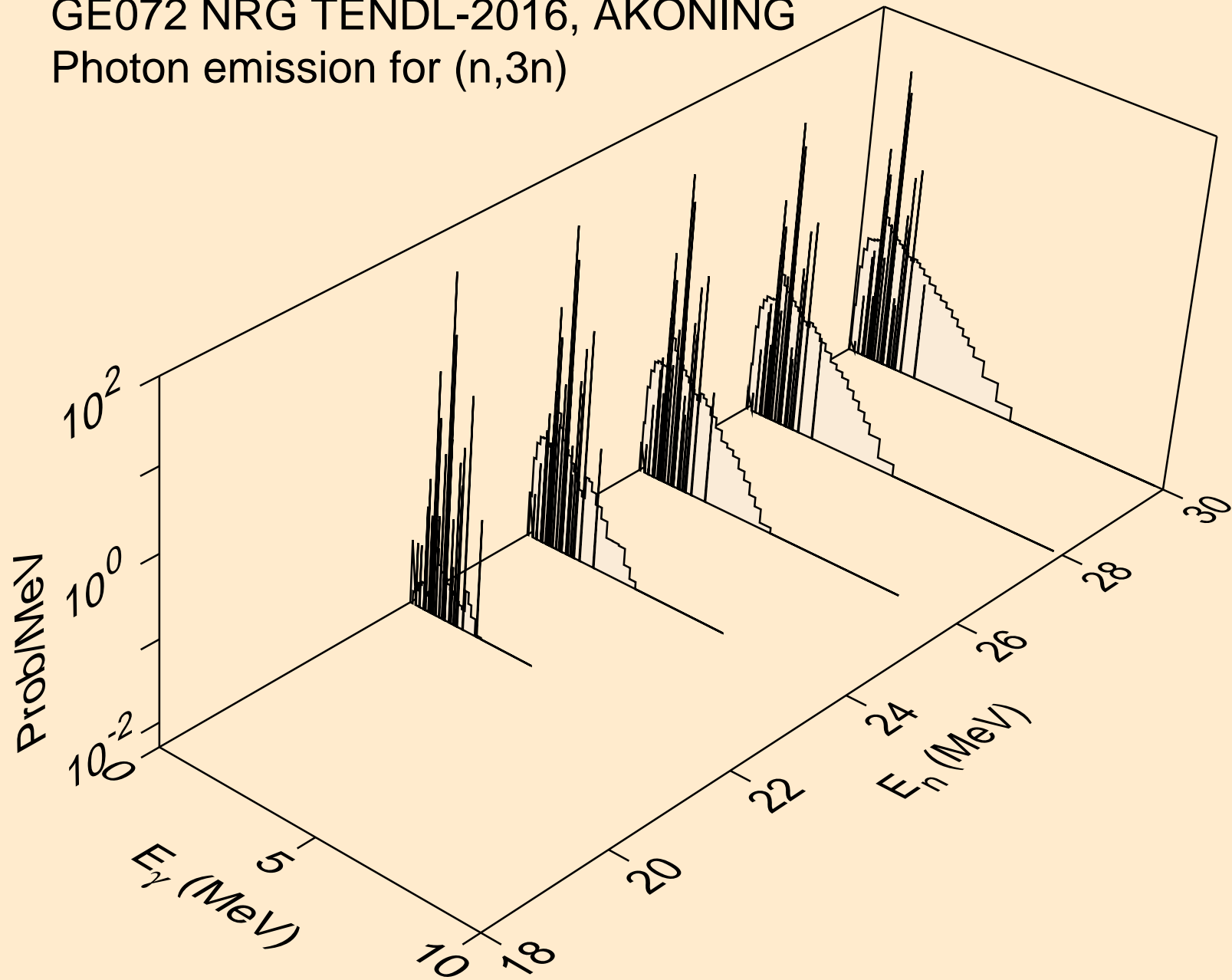

GE072 NRG TENDL-2016, AKONING
Photon emission for (n,n*)a

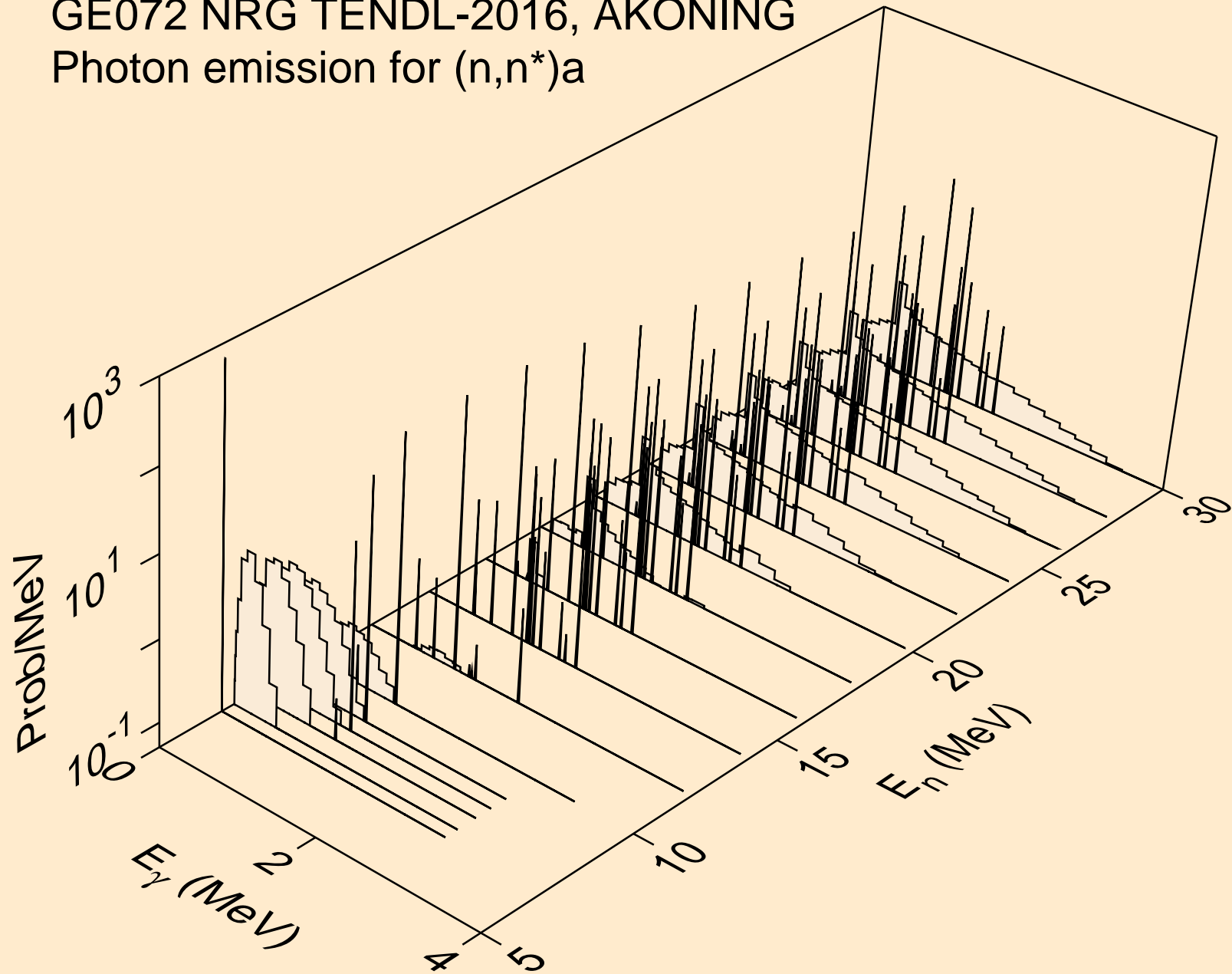

GE072 NRG TENDL-2016, AKONING
Photon emission for (n,2n)a

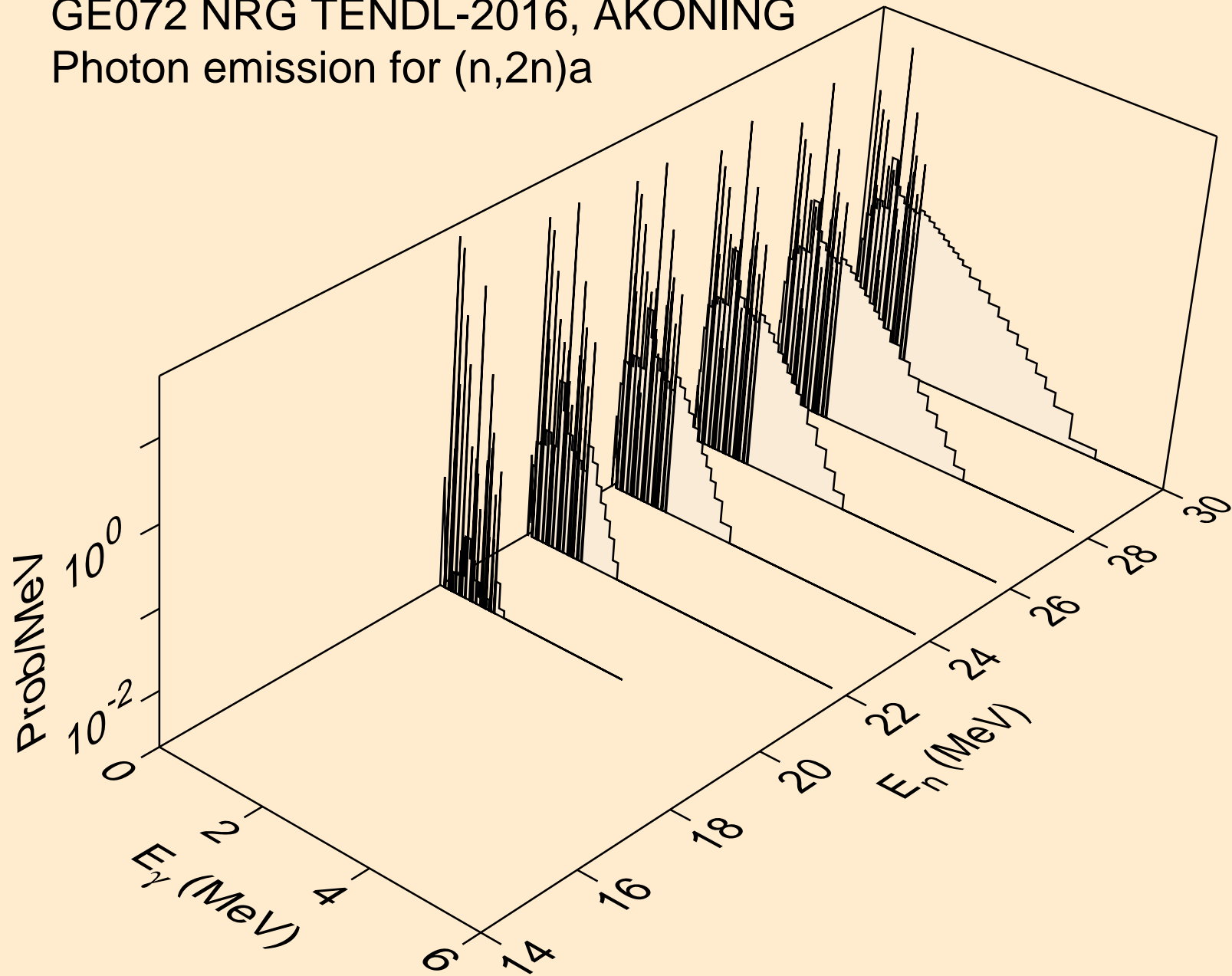

GE072 NRG TENDL-2016, AKONING
Photon emission for (n,3n)a

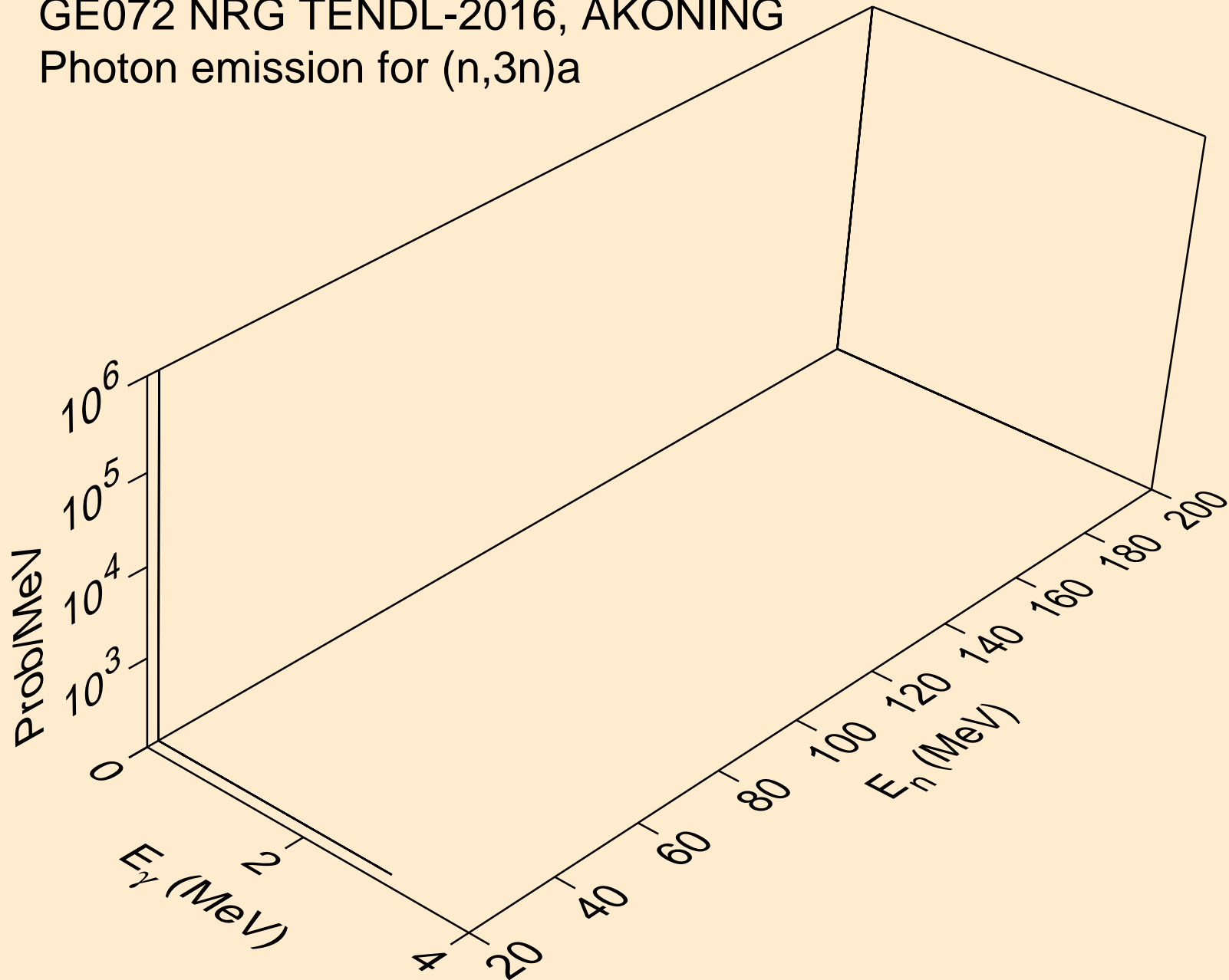

GE072 NRG TENDL-2016, AKONING
Photon emission for (n,n*)p

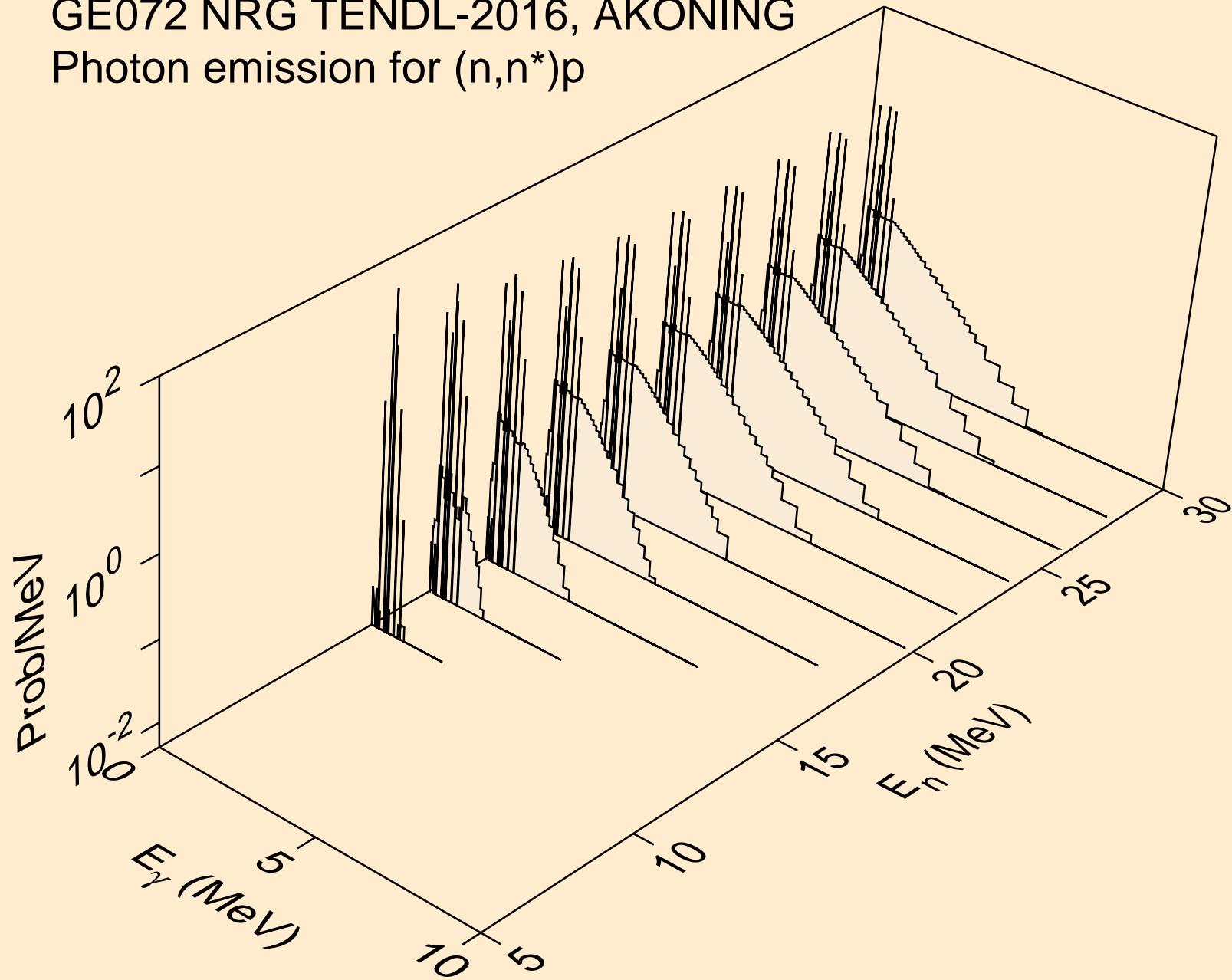

GE072 NRG TENDL-2016, AKONING
Photon emission for (n,n*)2a

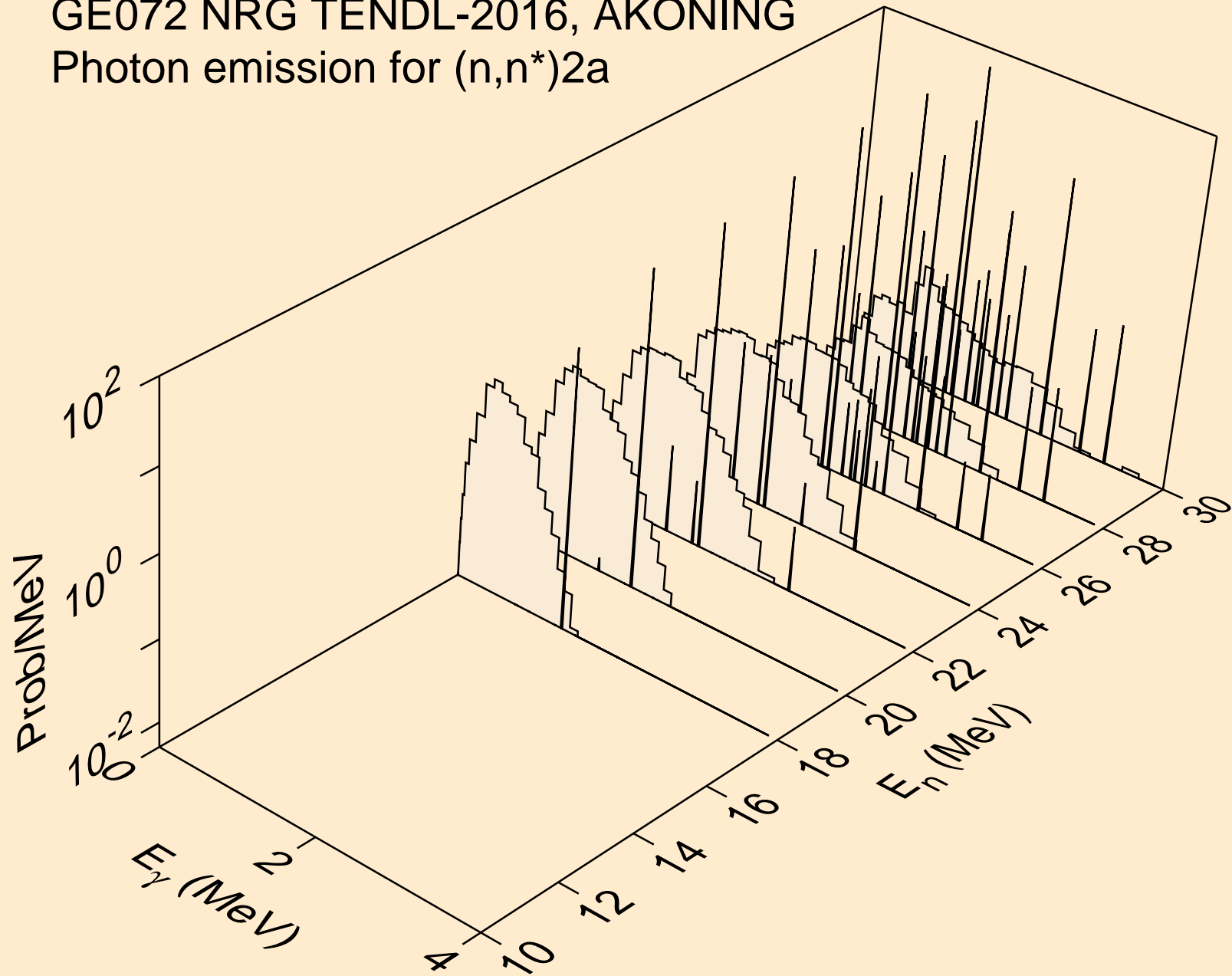

GE072 NRG TENDL-2016, AKONING
Photon emission for (n,n*)d

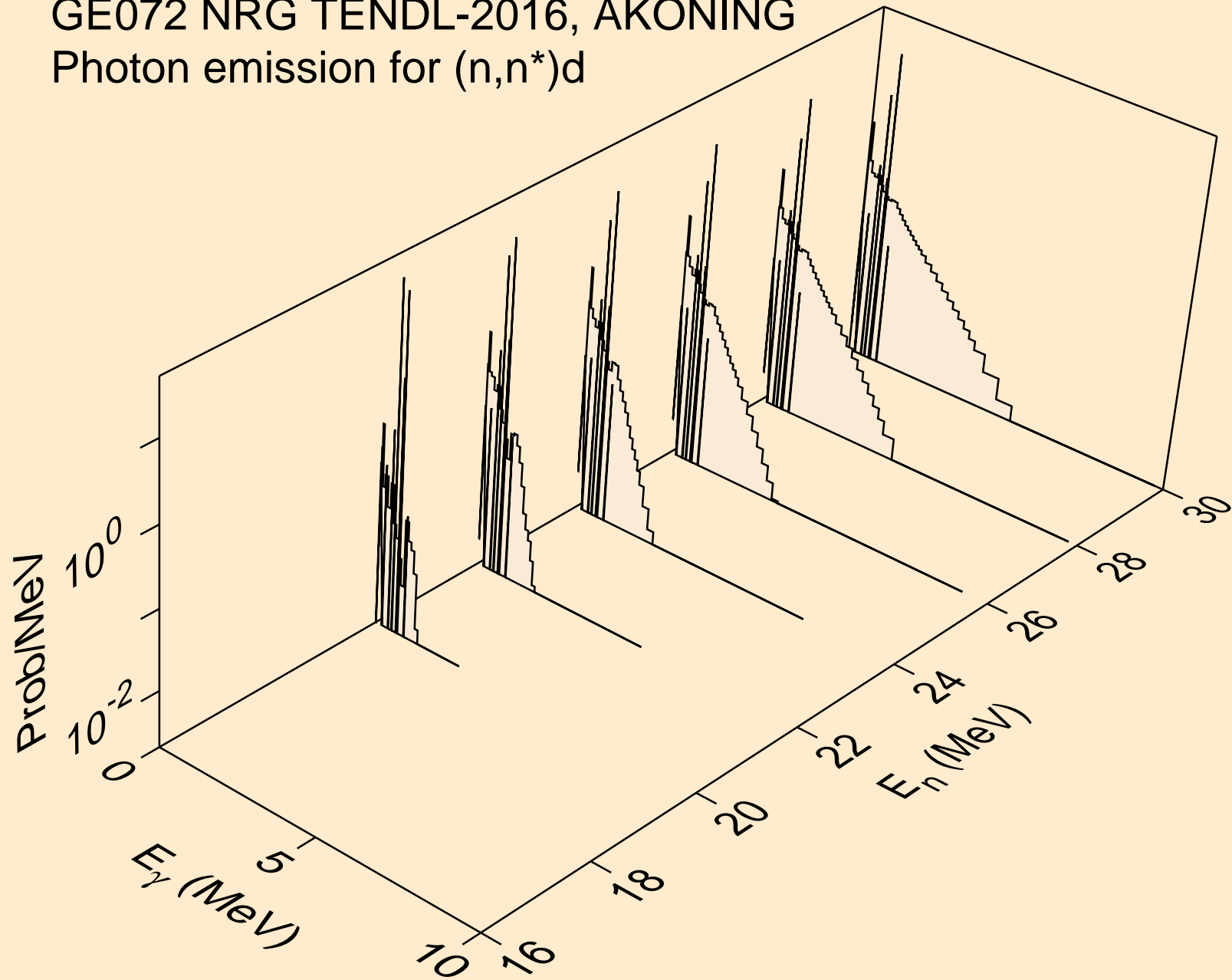

GE072 NRG TENDL-2016, AKONING
Photon emission for (n,n*)t

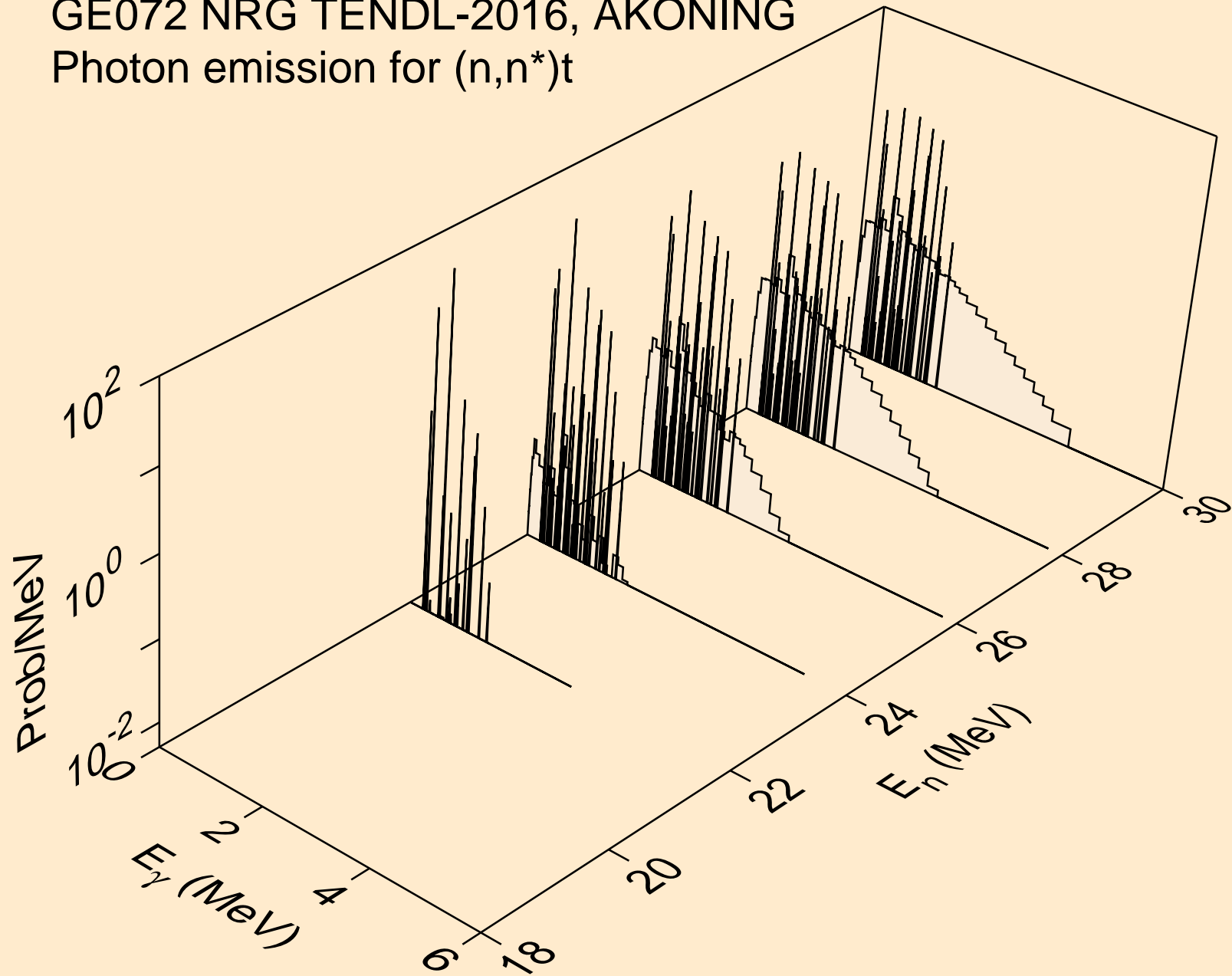

GE072 NRG TENDL-2016, AKONING
Photon emission for (n,n*)he3

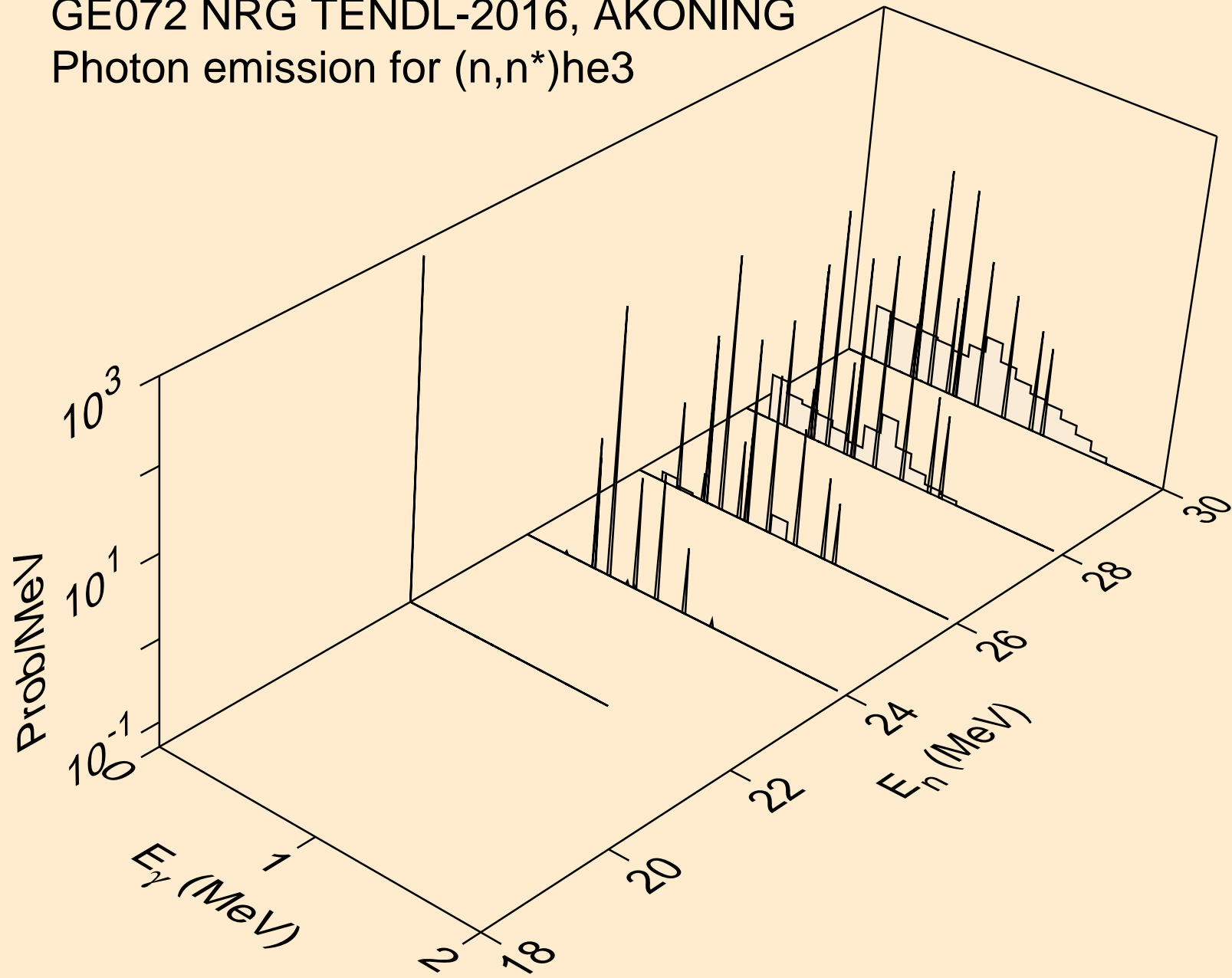

GE072 NRG TENDL-2016, AKONING
Photon emission for (n,2np)

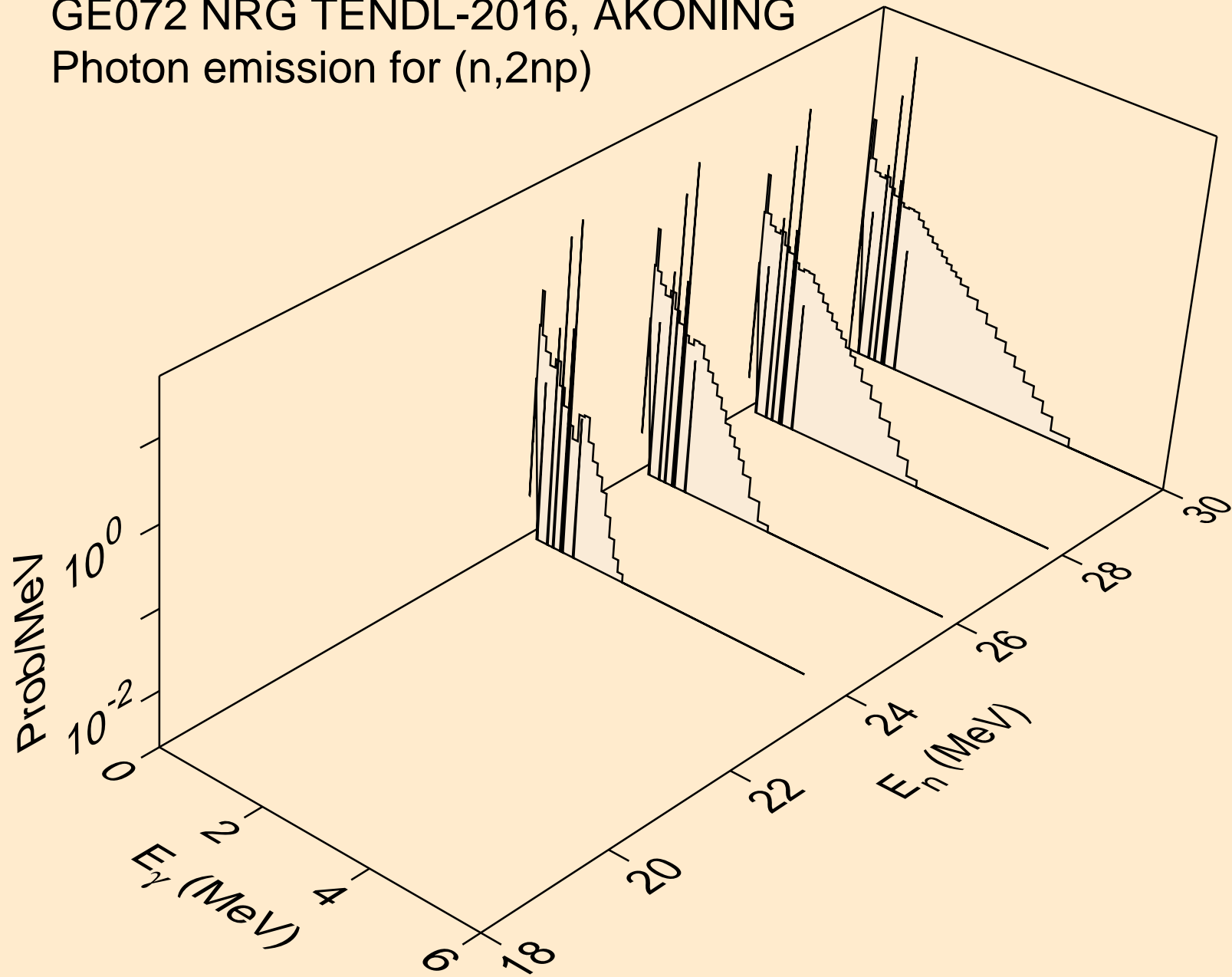

GE072 NRG TENDL-2016, AKONING
Photon emission for (n,3np)

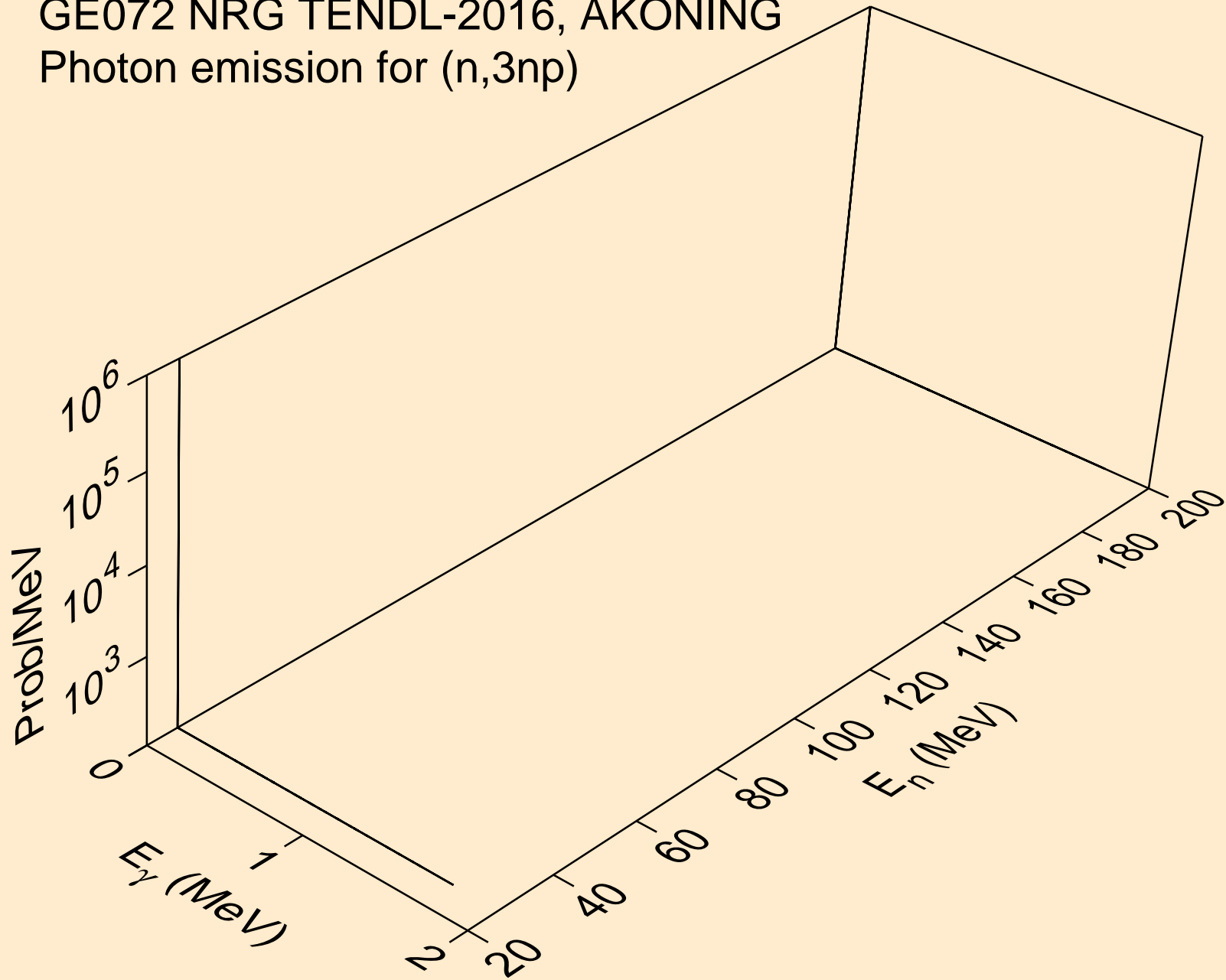

GE072 NRG TENDL-2016, AKONING
Photon emission for (n,2np)

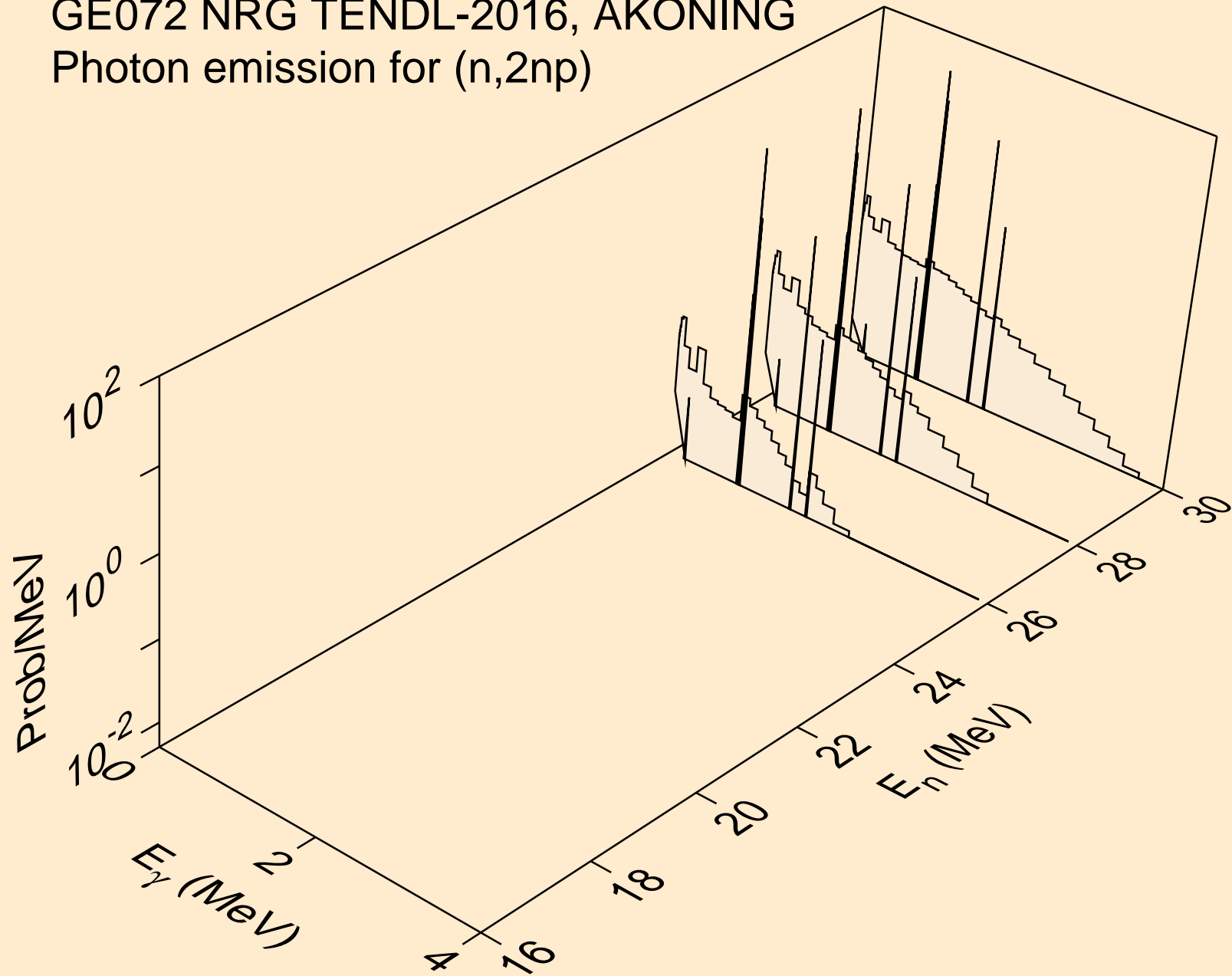

GE072 NRG TENDL-2016, AKONING
Photon emission for (n,npa)

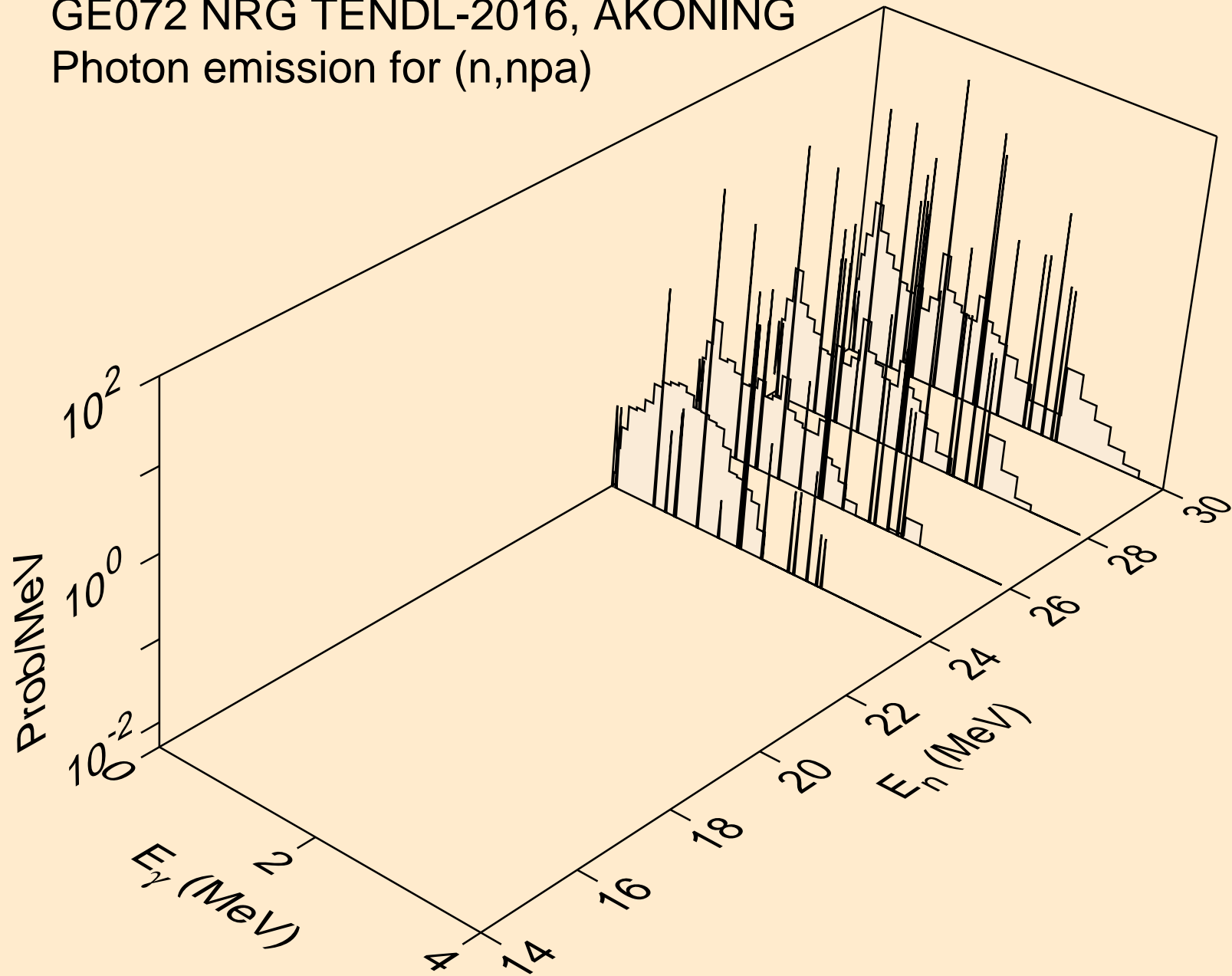

GE072 NRG TENDL-2016, AKONING
Photon emission for (n,n*c)

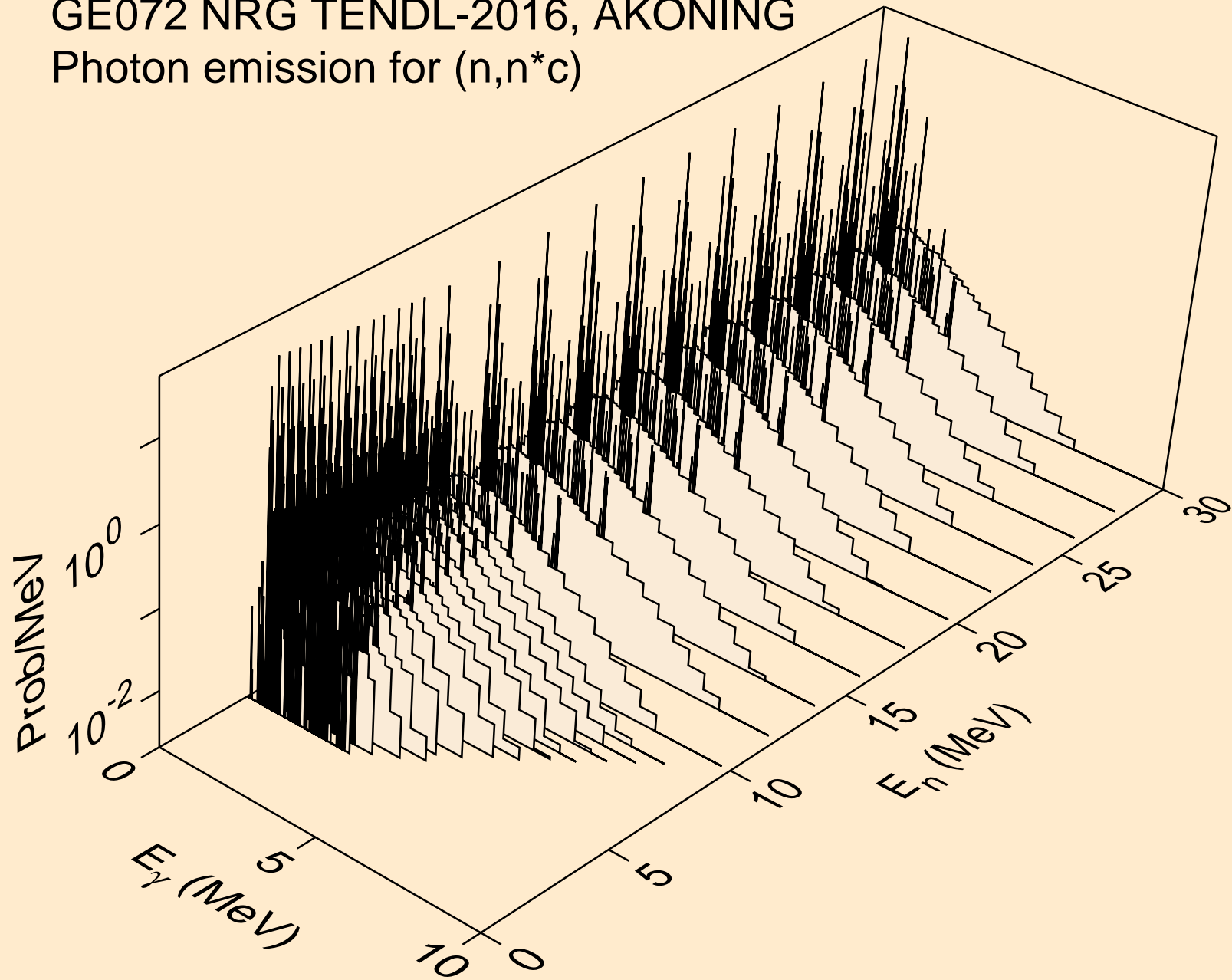

GE072 NRG TENDL-2016, AKONING
Photon emission for (n,gma)

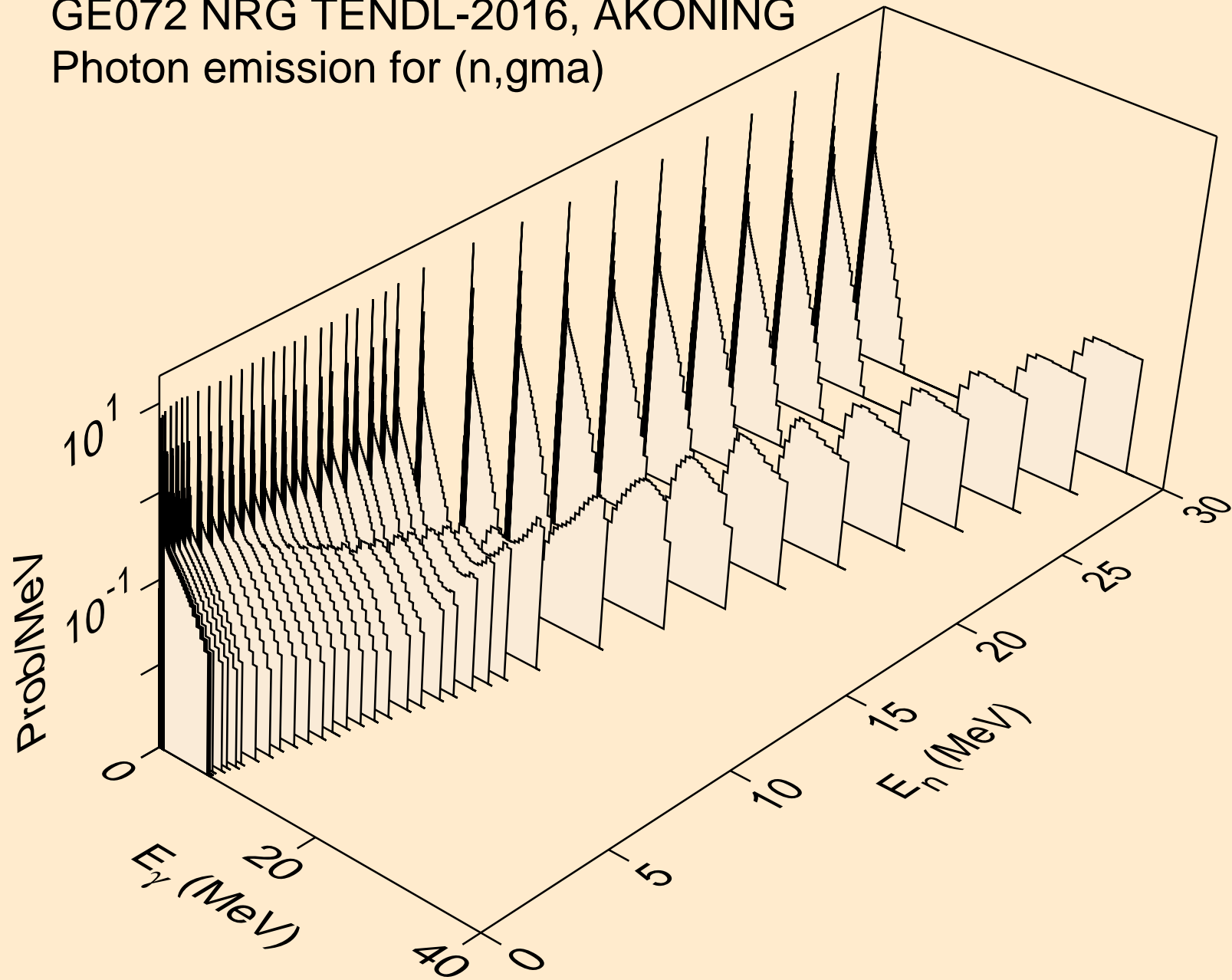

GE072 NRG TENDL-2016, AKONING
Photon emission for (n,p)

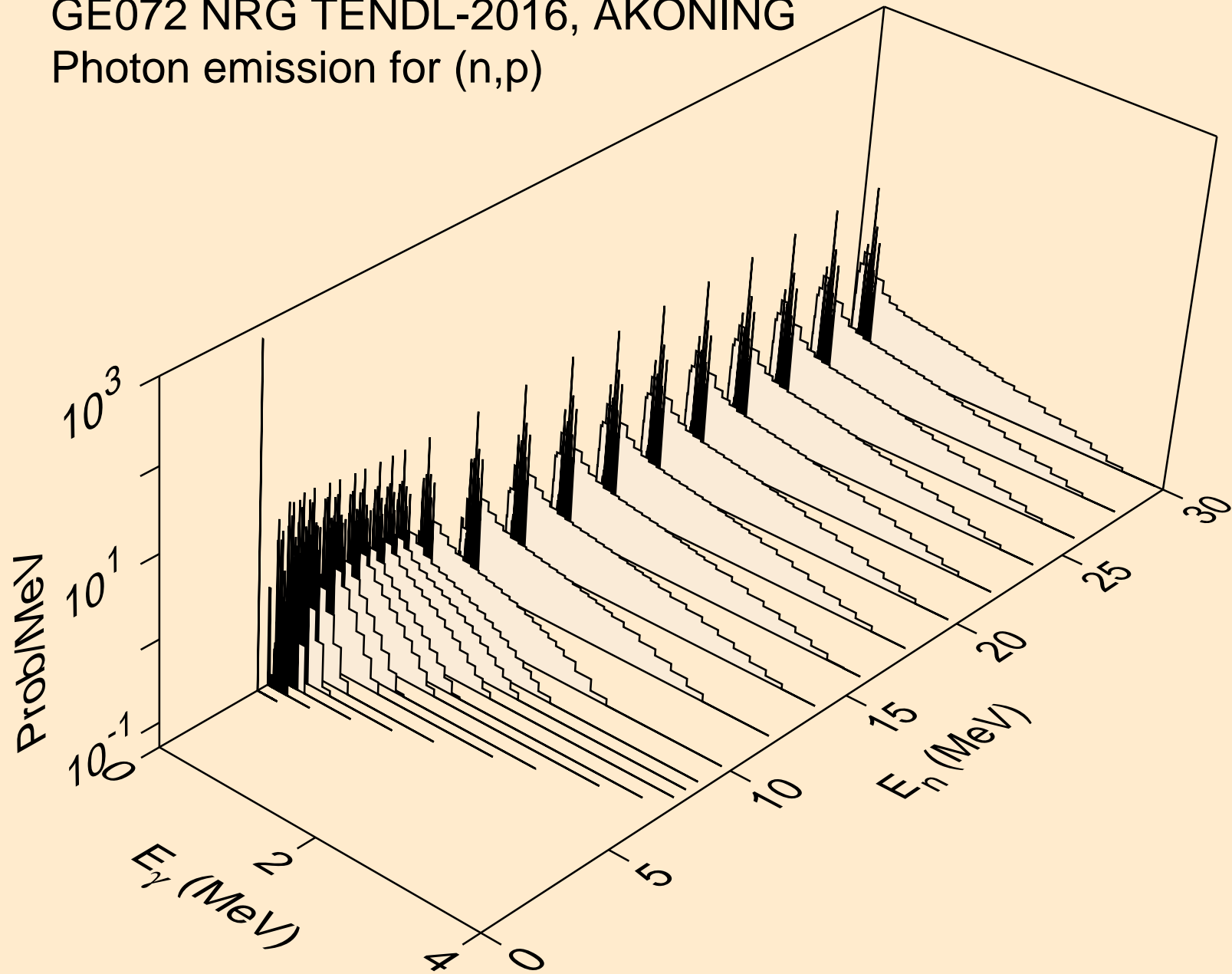

GE072 NRG TENDL-2016, AKONING
Photon emission for (n,d)

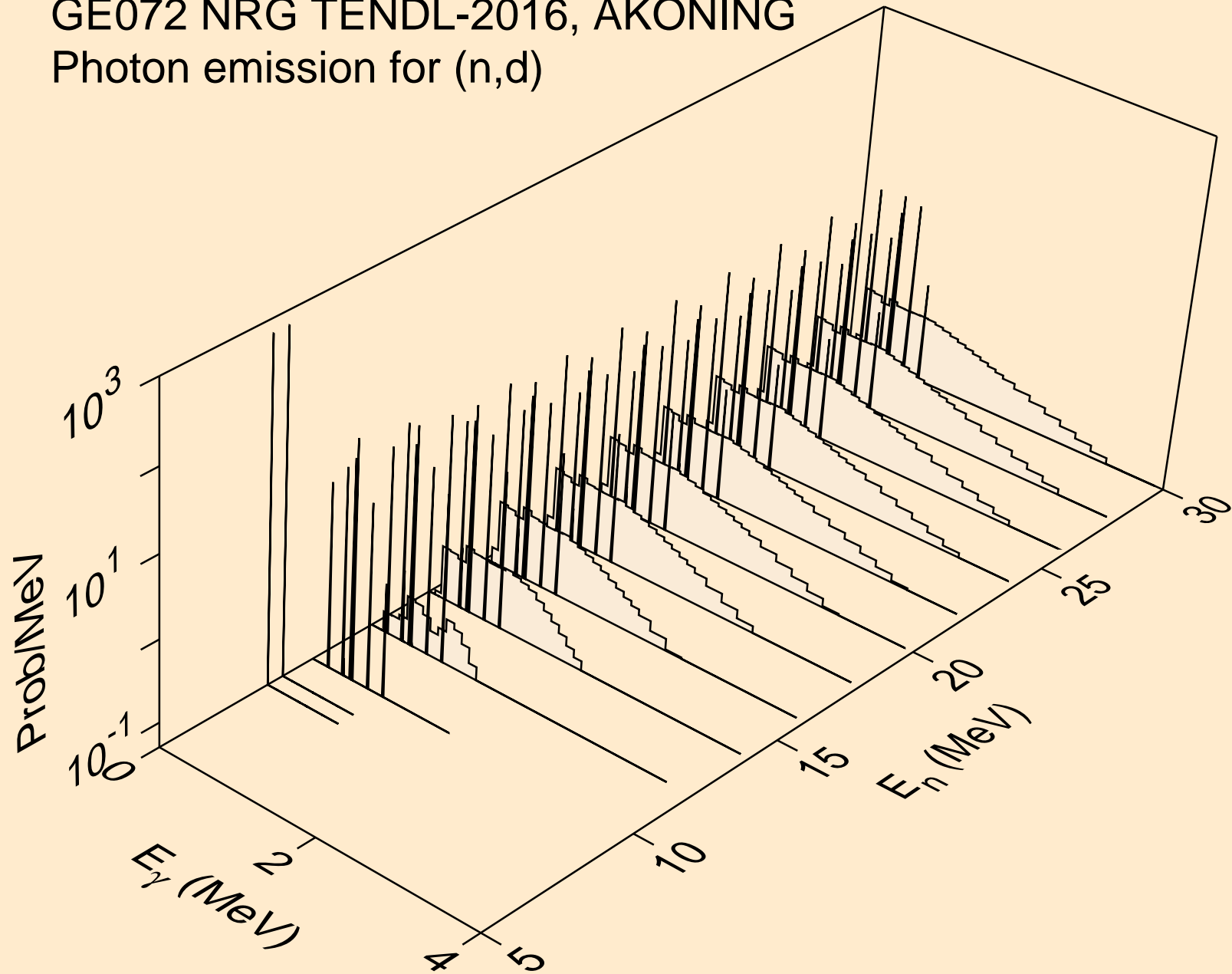

GE072 NRG TENDL-2016, AKONING
Photon emission for (n,t)

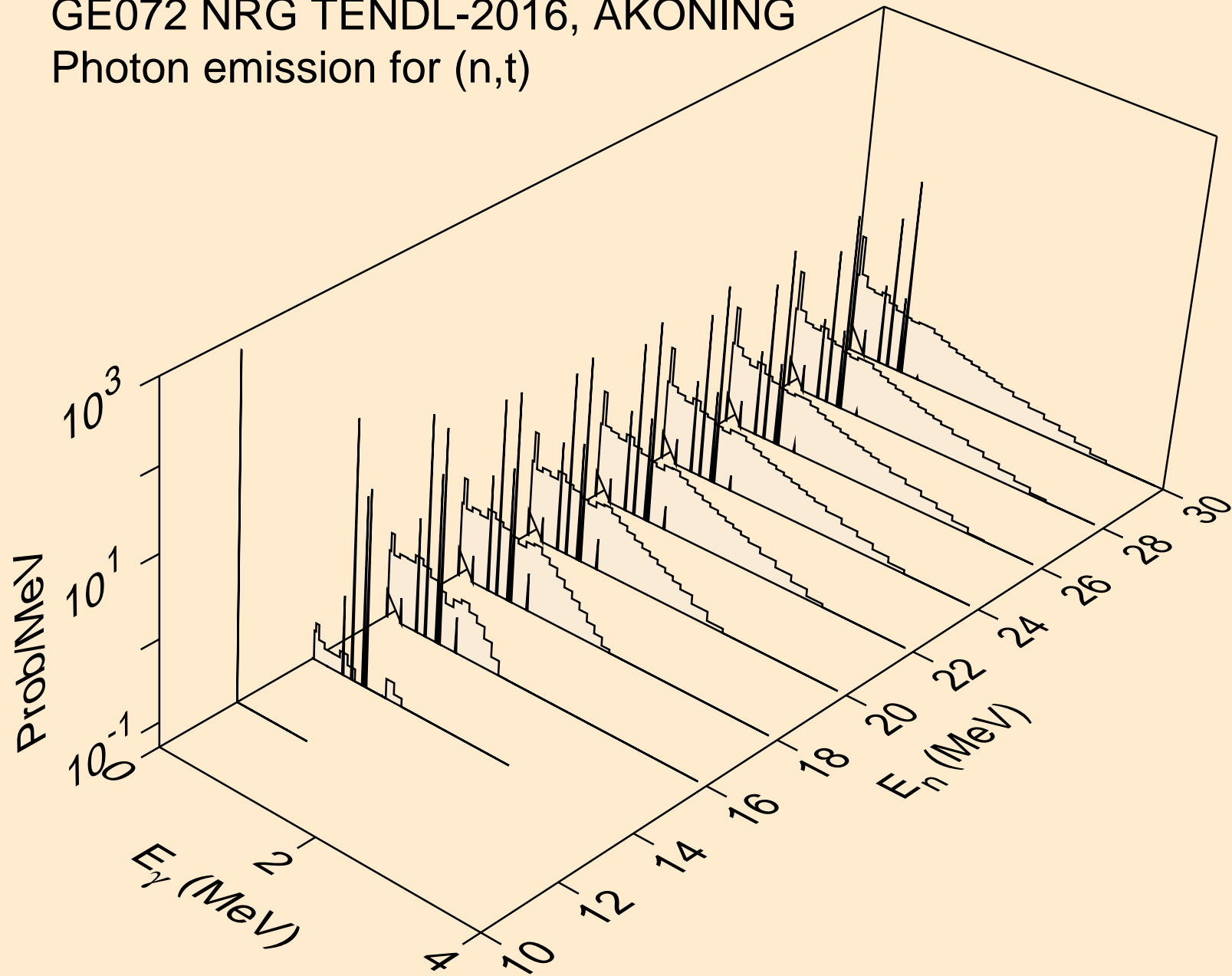

GE072 NRG TENDL-2016, AKONING
Photon emission for (n,he3)

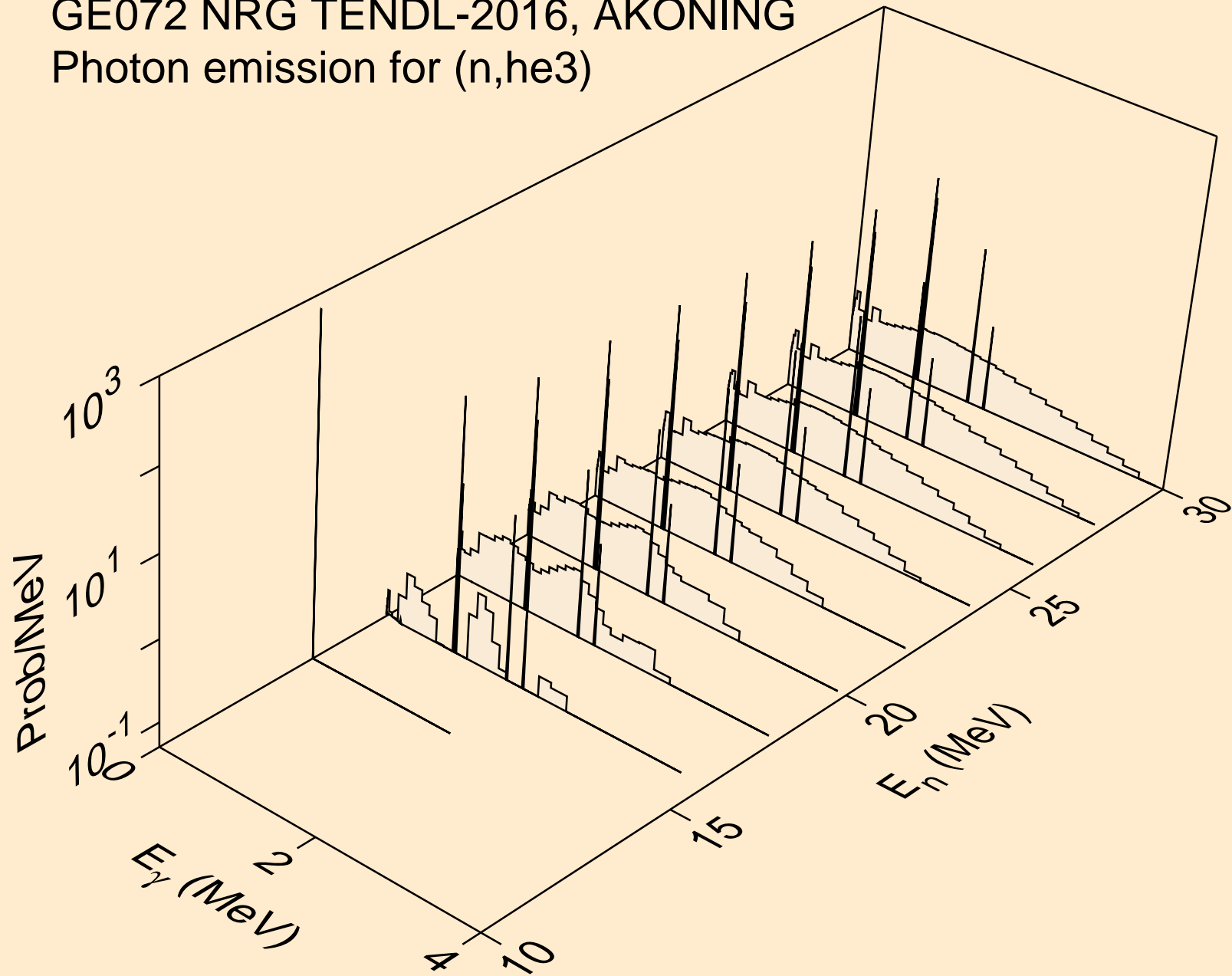

GE072 NRG TENDL-2016, AKONING
Photon emission for (n,a)

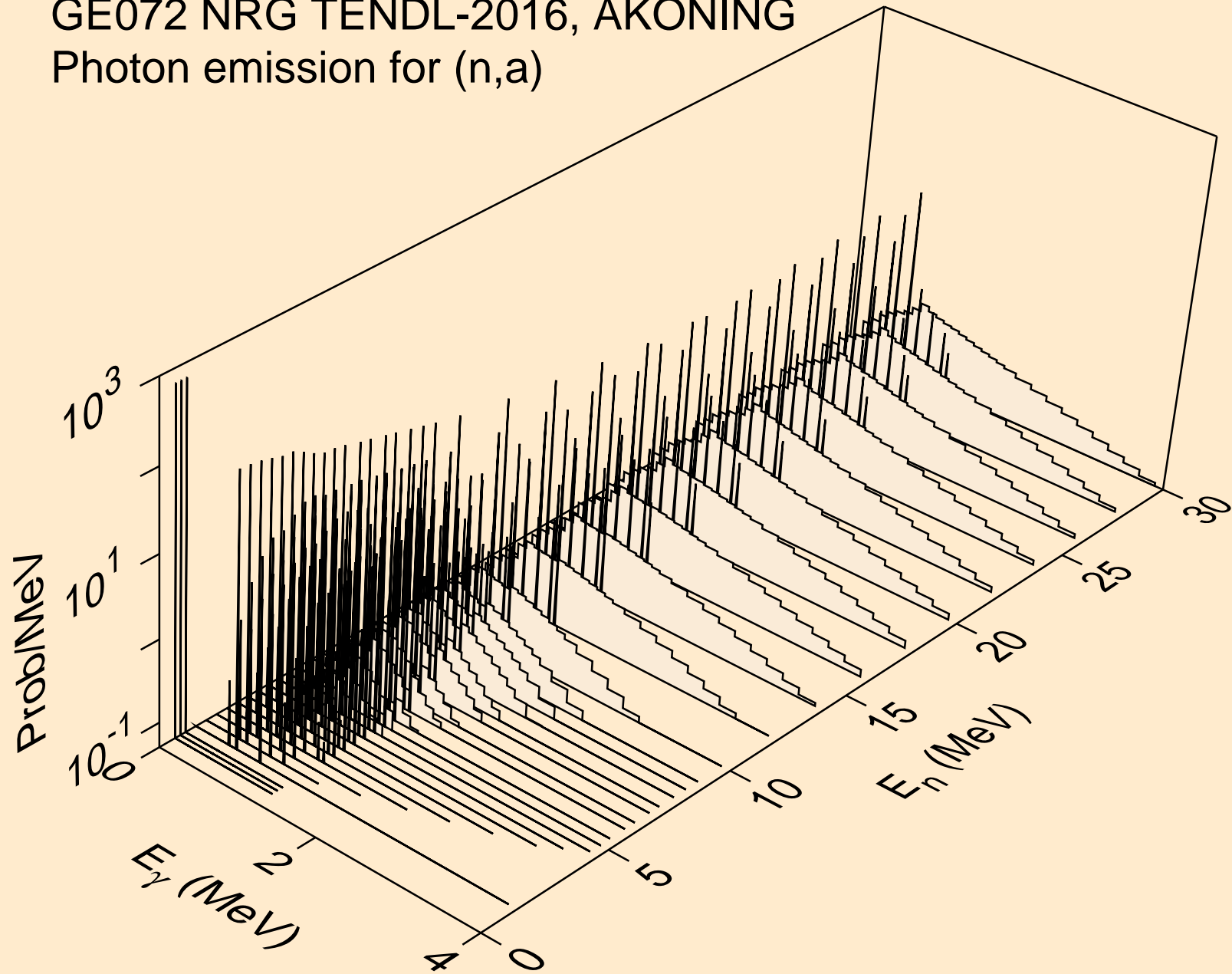

GE072 NRG TENDL-2016, AKONING
Photon emission for (n,2a)

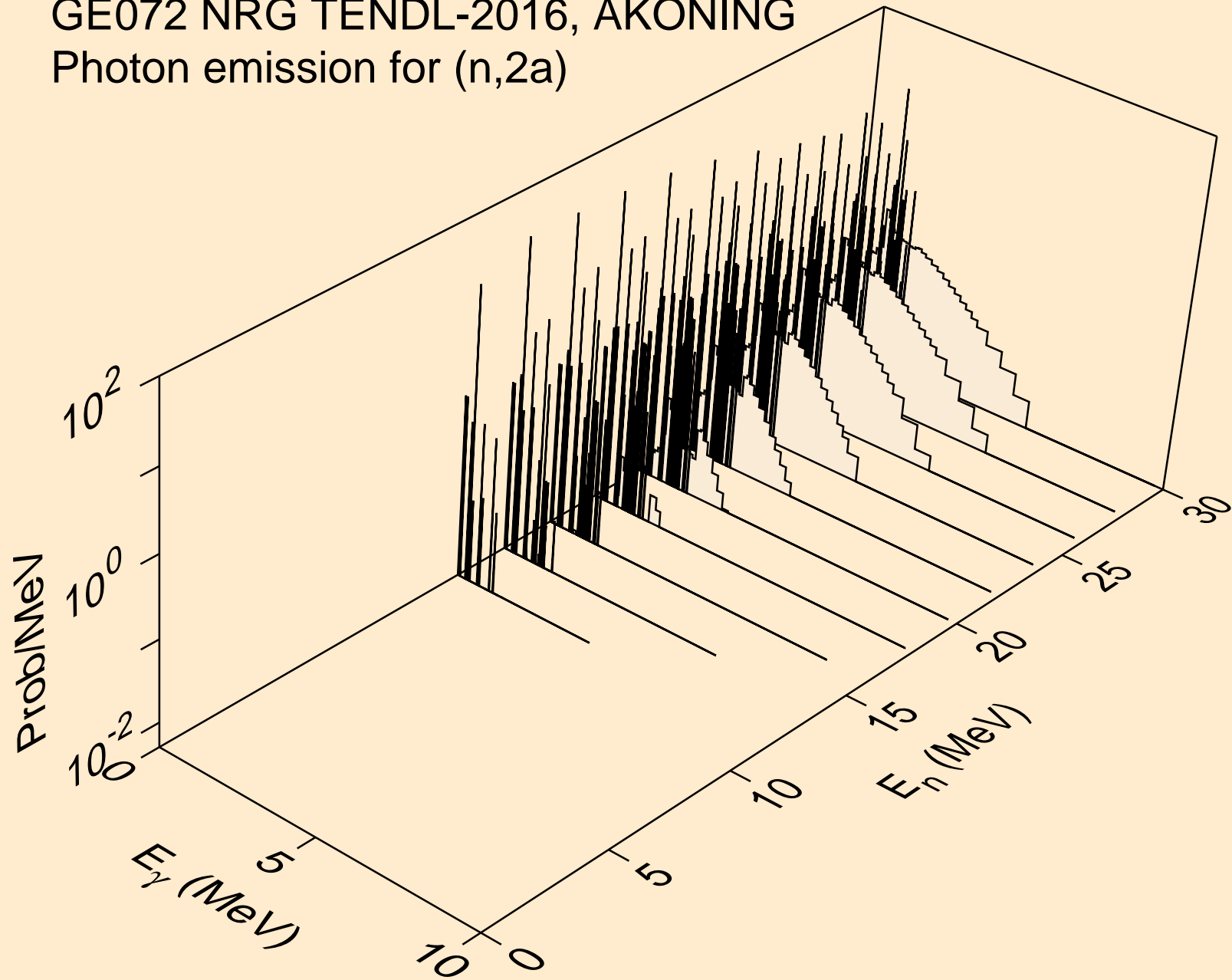

GE072 NRG TENDL-2016, AKONING
Photon emission for (n,2p)

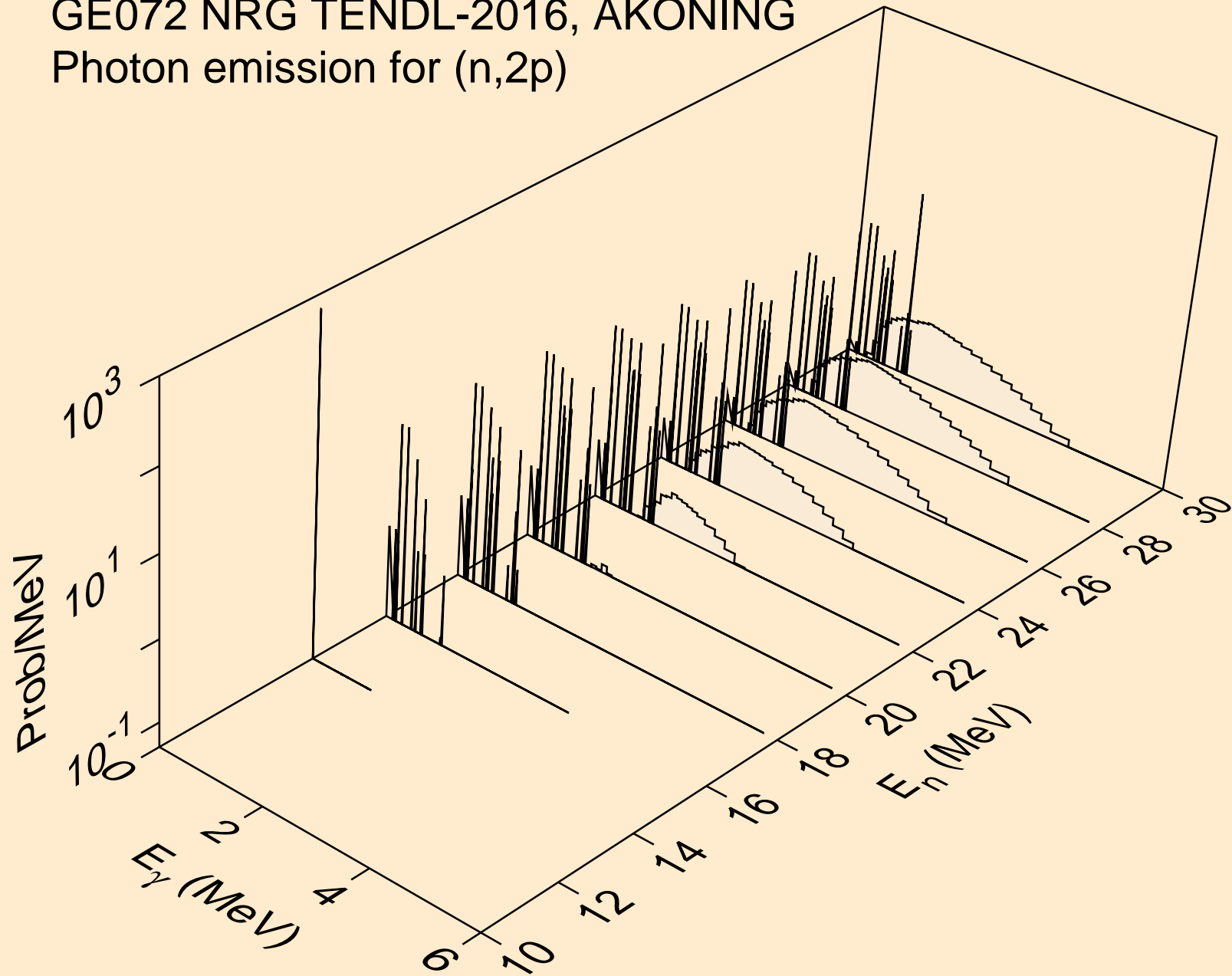

GE072 NRG TENDL-2016, AKONING
Photon emission for (n,pa)

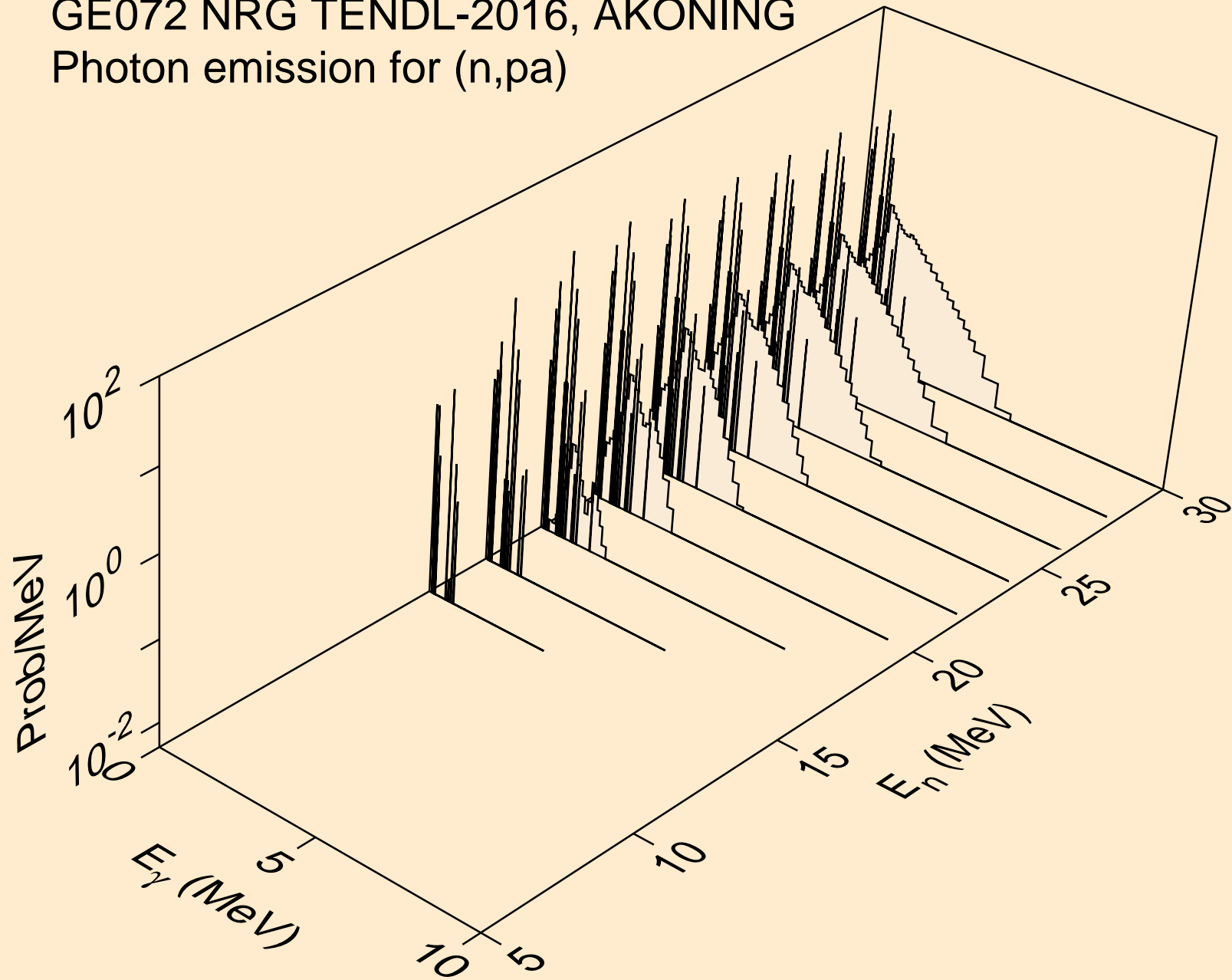

GE072 NRG TENDL-2016, AKONING
Photon emission for (n,pd)

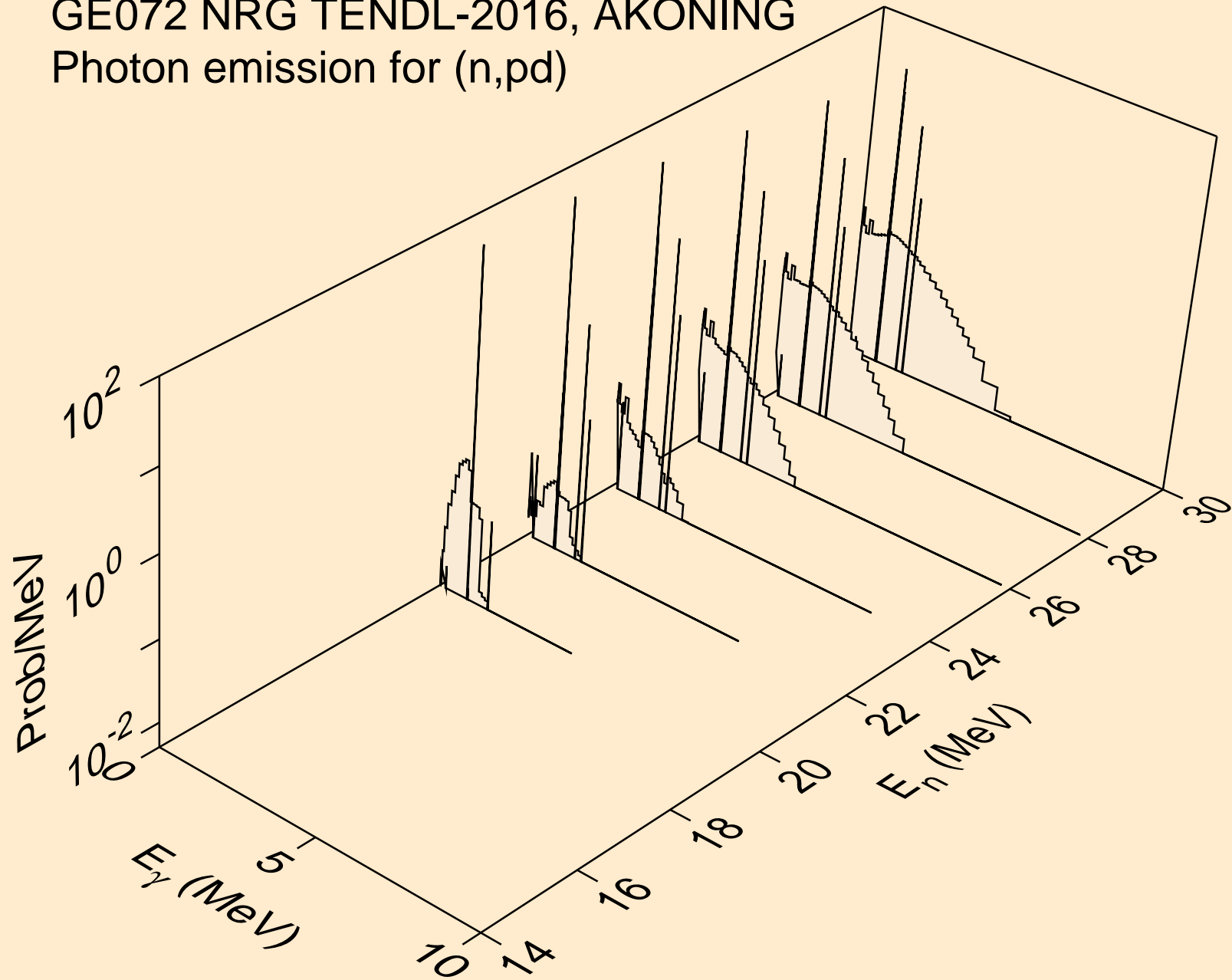

GE072 NRG TENDL-2016, AKONING
Photon emission for (n,pt)

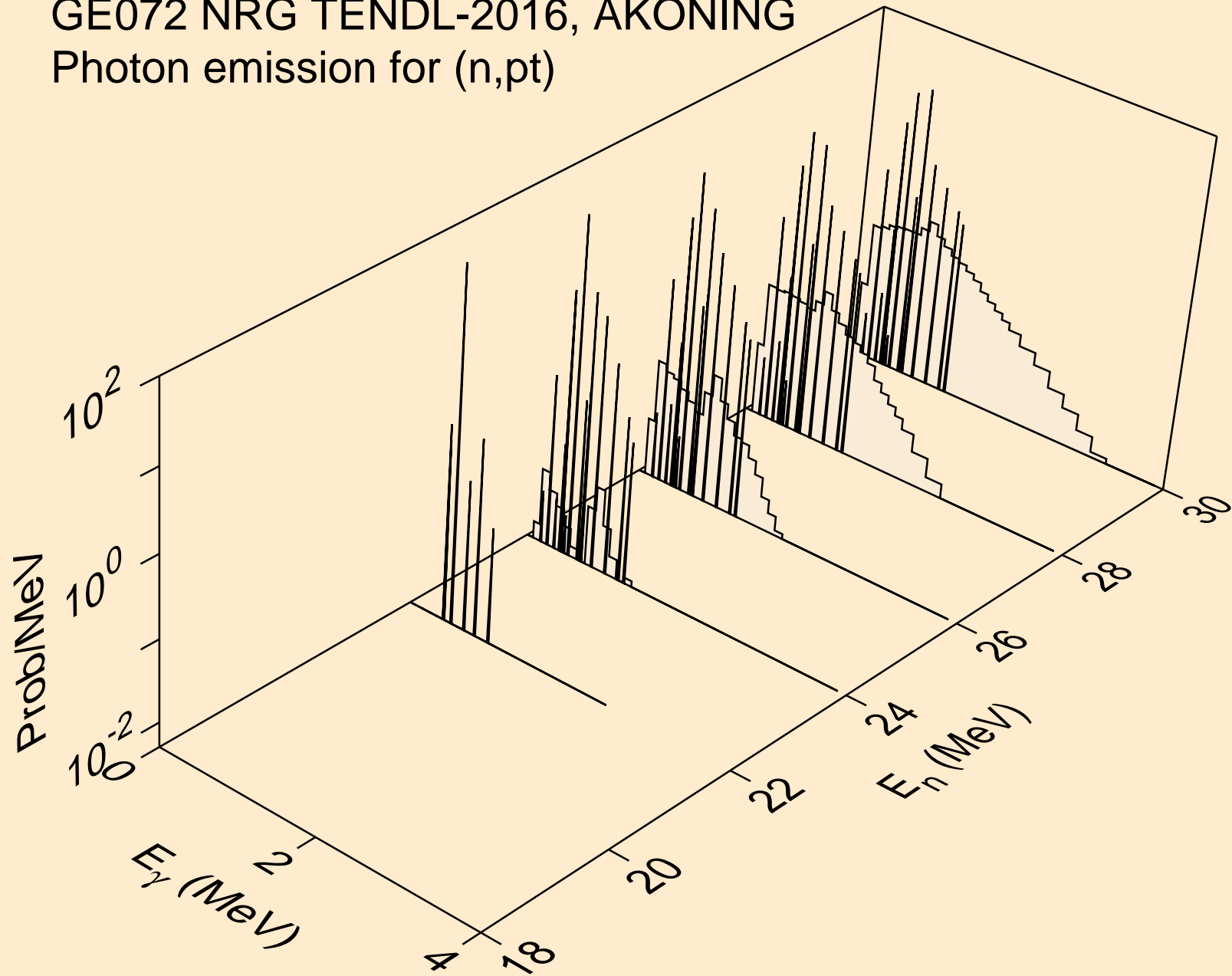

GE072 NRG TENDL-2016, AKONING
Photon emission for (n,da)

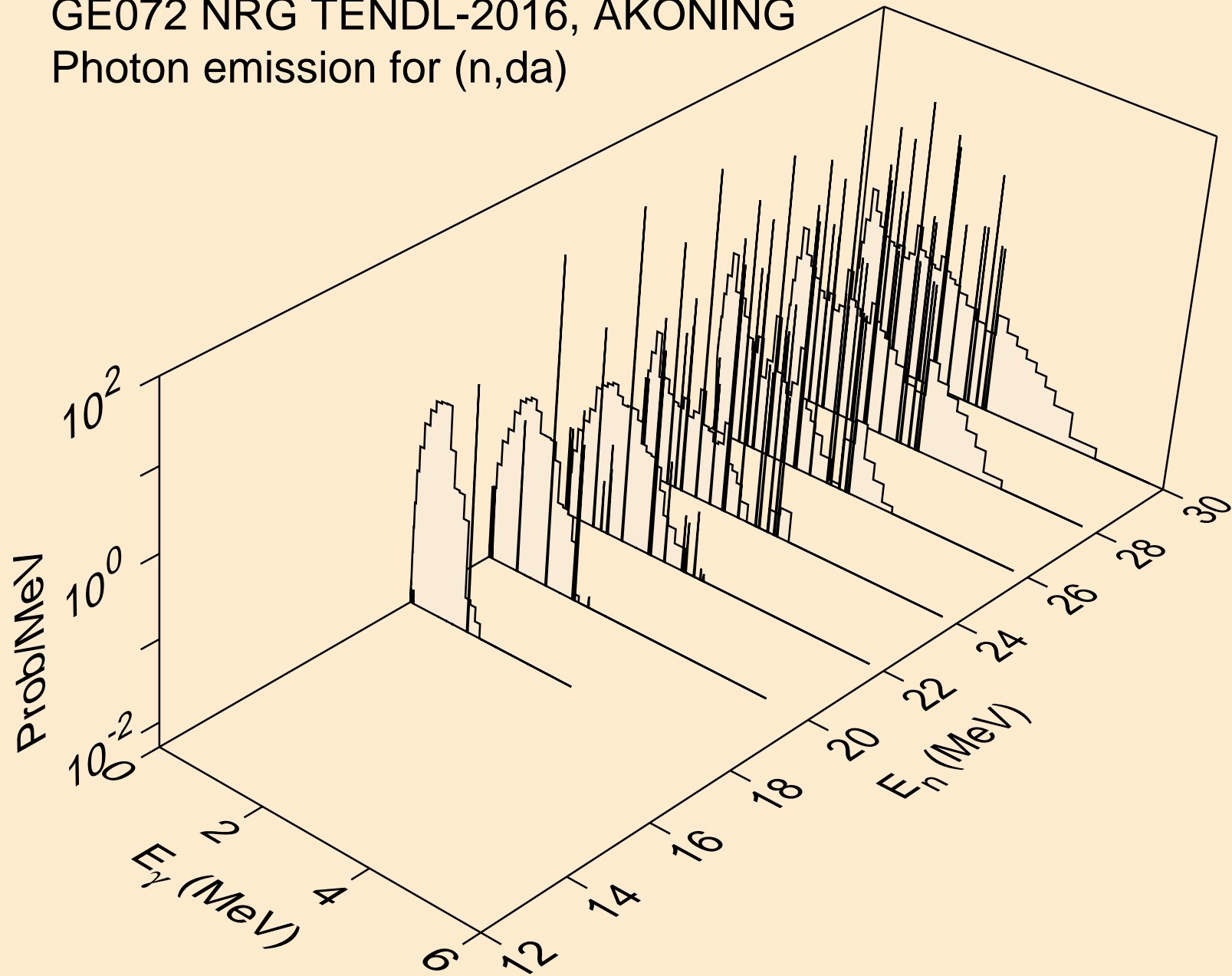

GE072 NRG TENDL-2016, AKONING
thermal capture photon spectrum

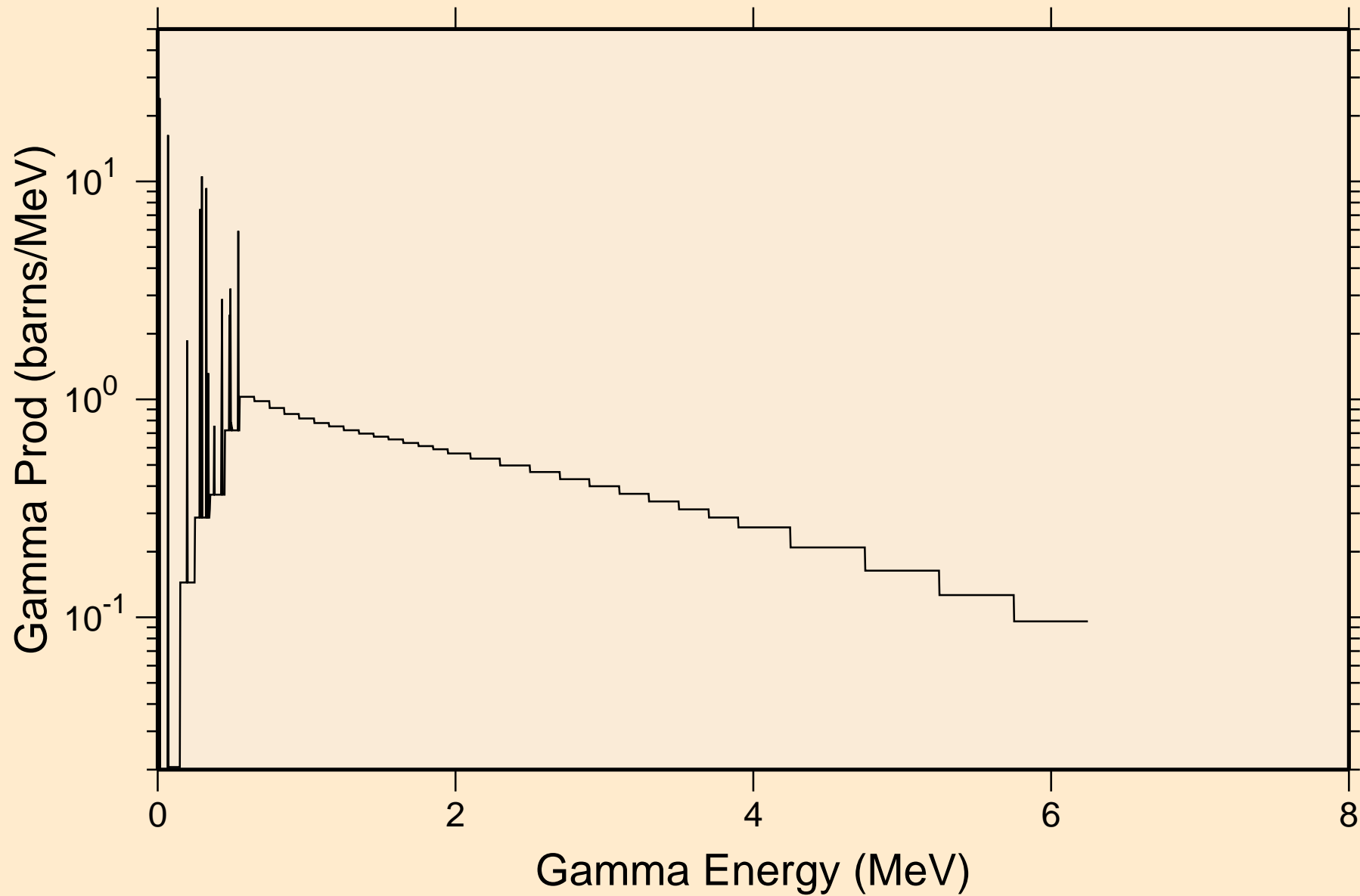

GE072 NRG TENDL-2016, AKONING
14 MeV photon spectrum

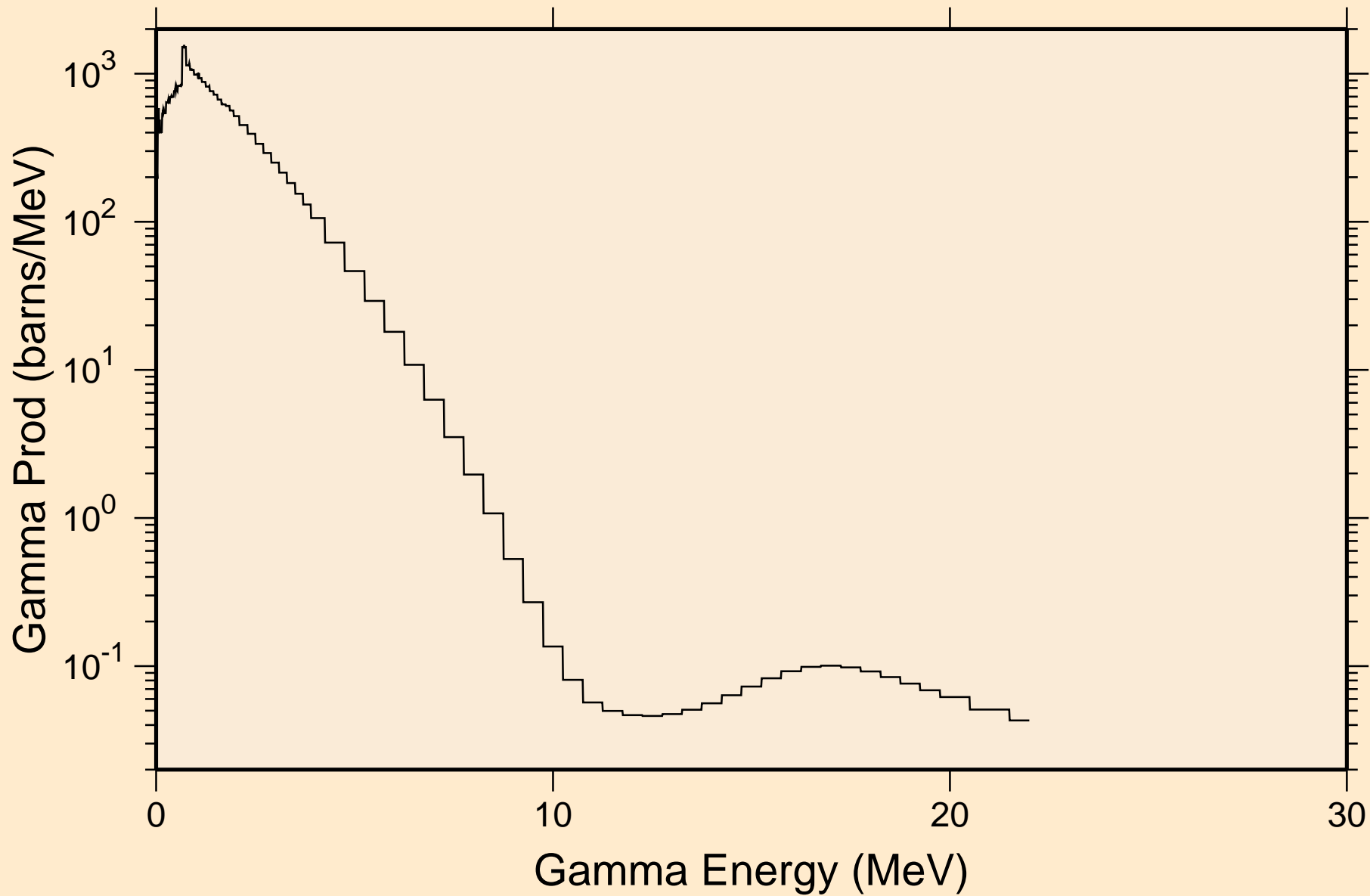

GE072 NRG TENDL-2016, AKONING

Particle heating contributions

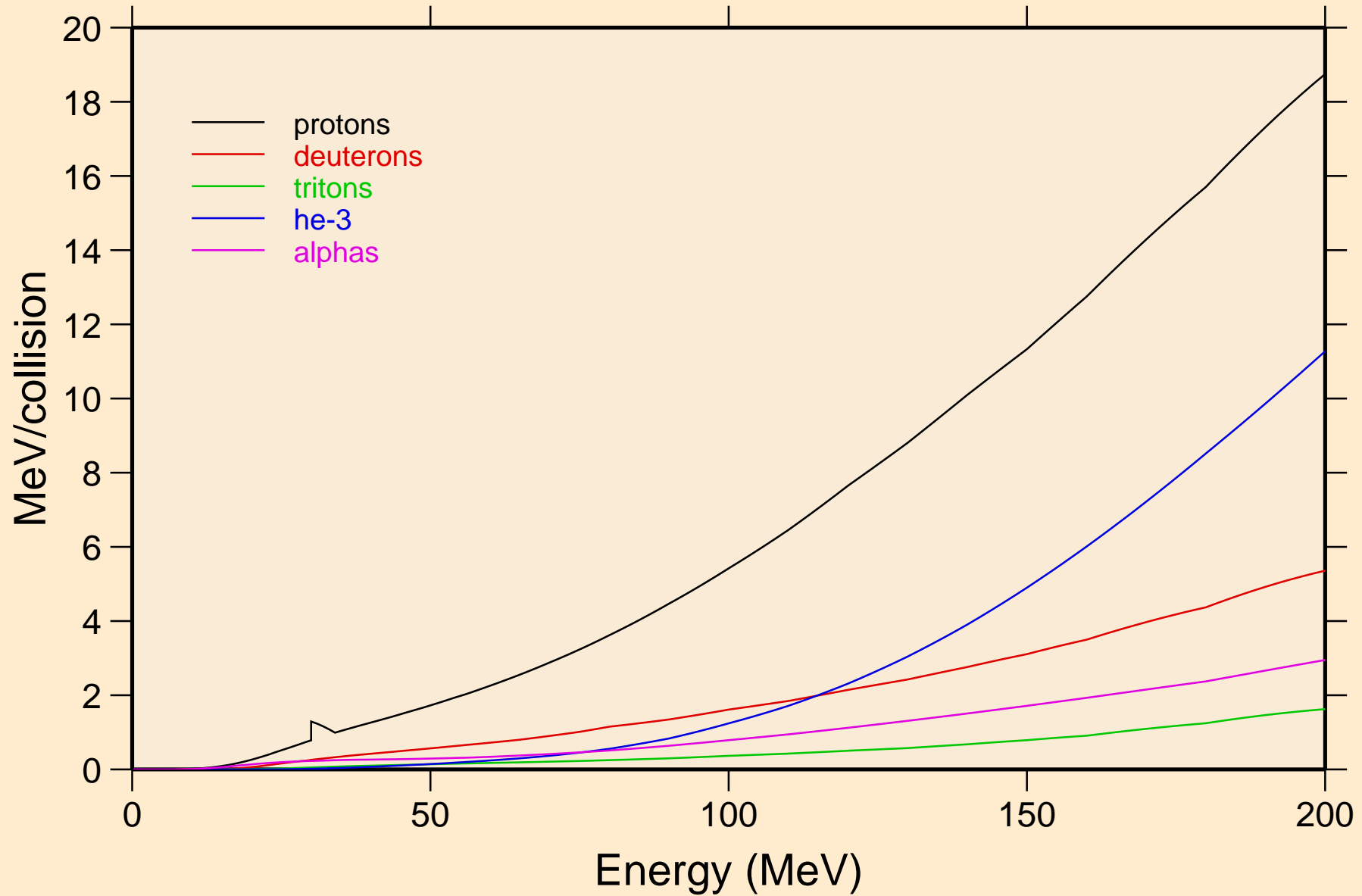

GE072 NRG TENDL-2016, AKONING

Recoil Heating

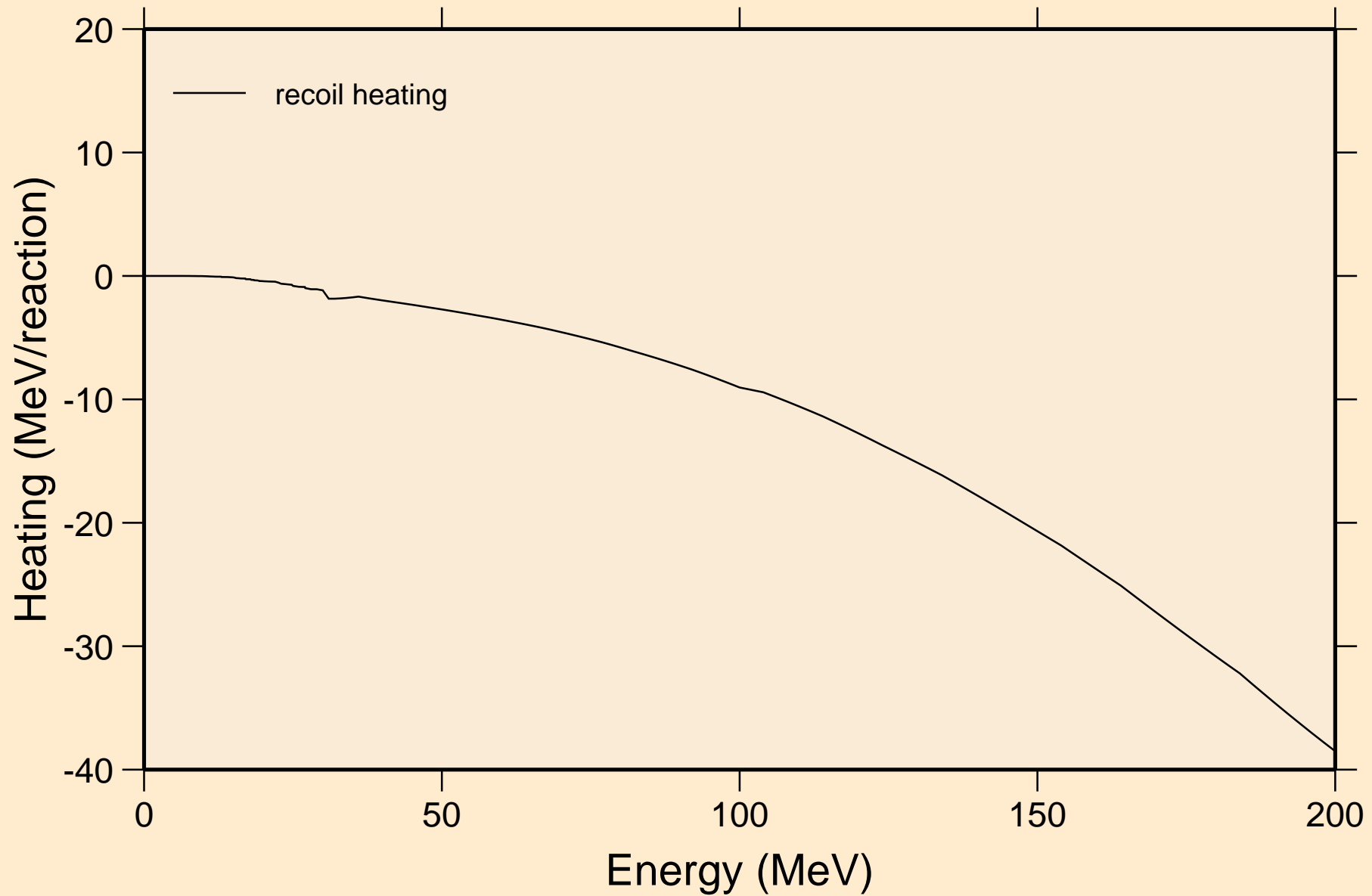

GE072 NRG TENDL-2016, AKONING

Particle production cross sections

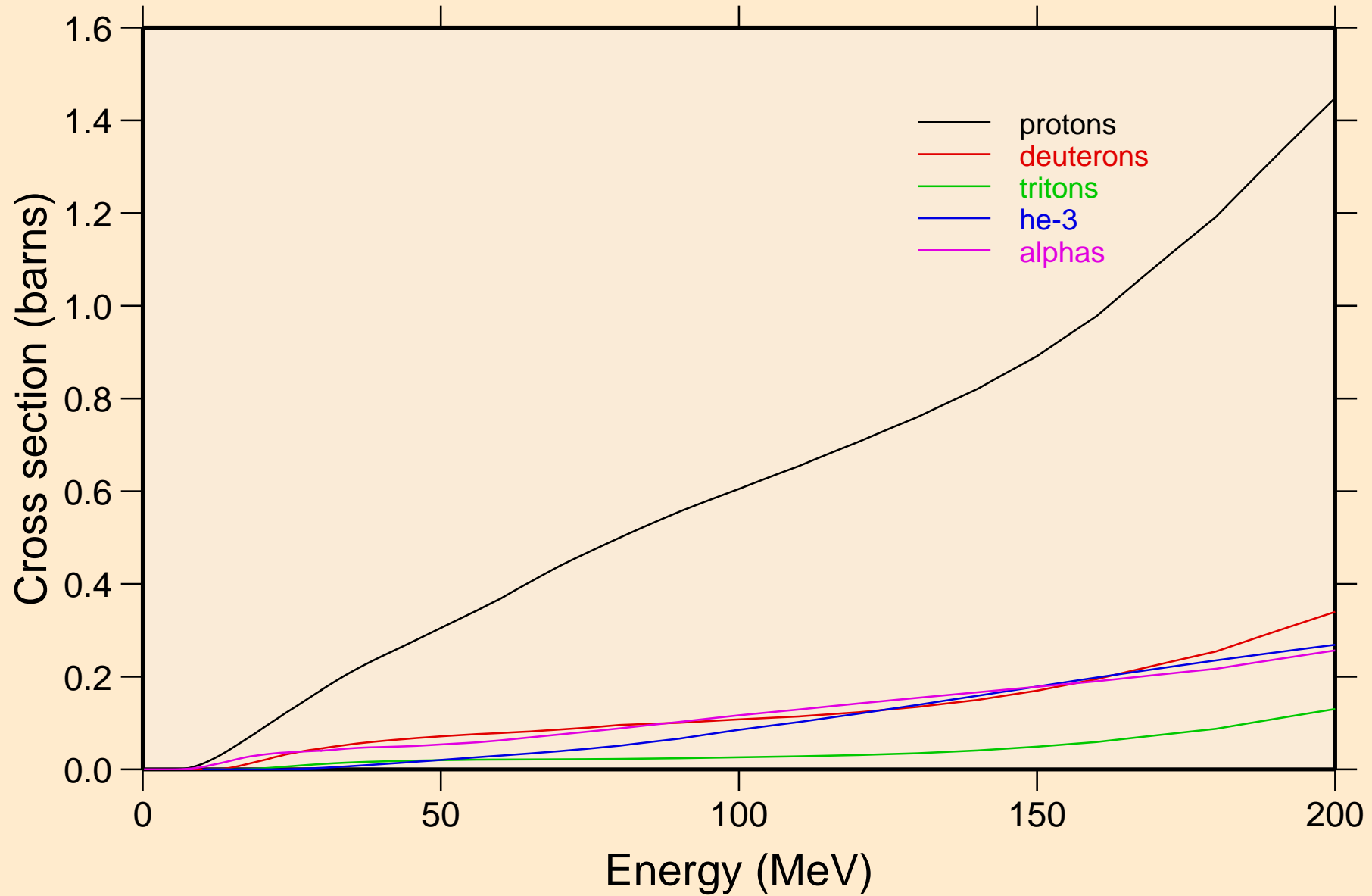

GE072 NRG TENDL-2016, AKONING
protons from (n,x)

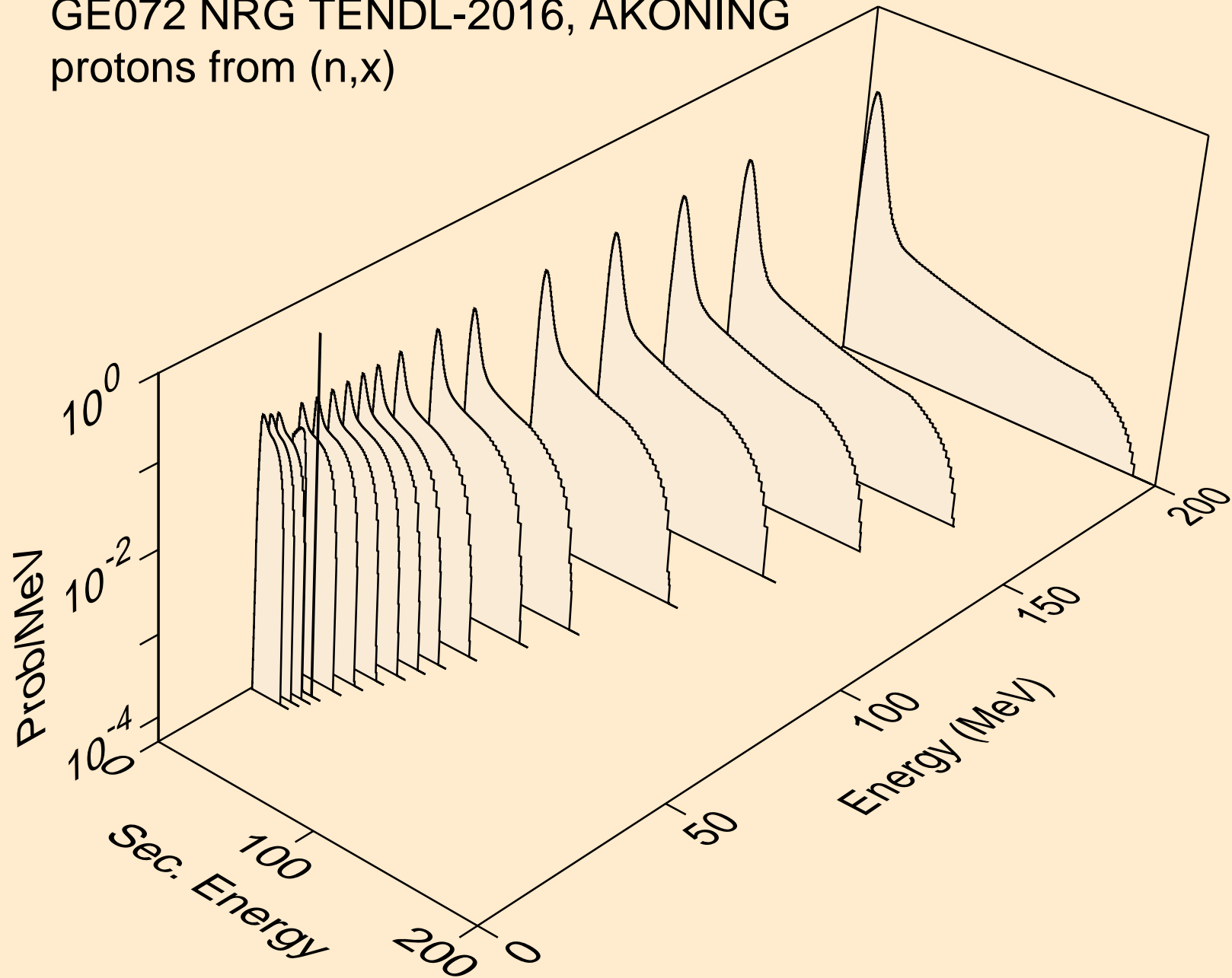

GE072 NRG TENDL-2016, AKONING
protons from (n,n*)p

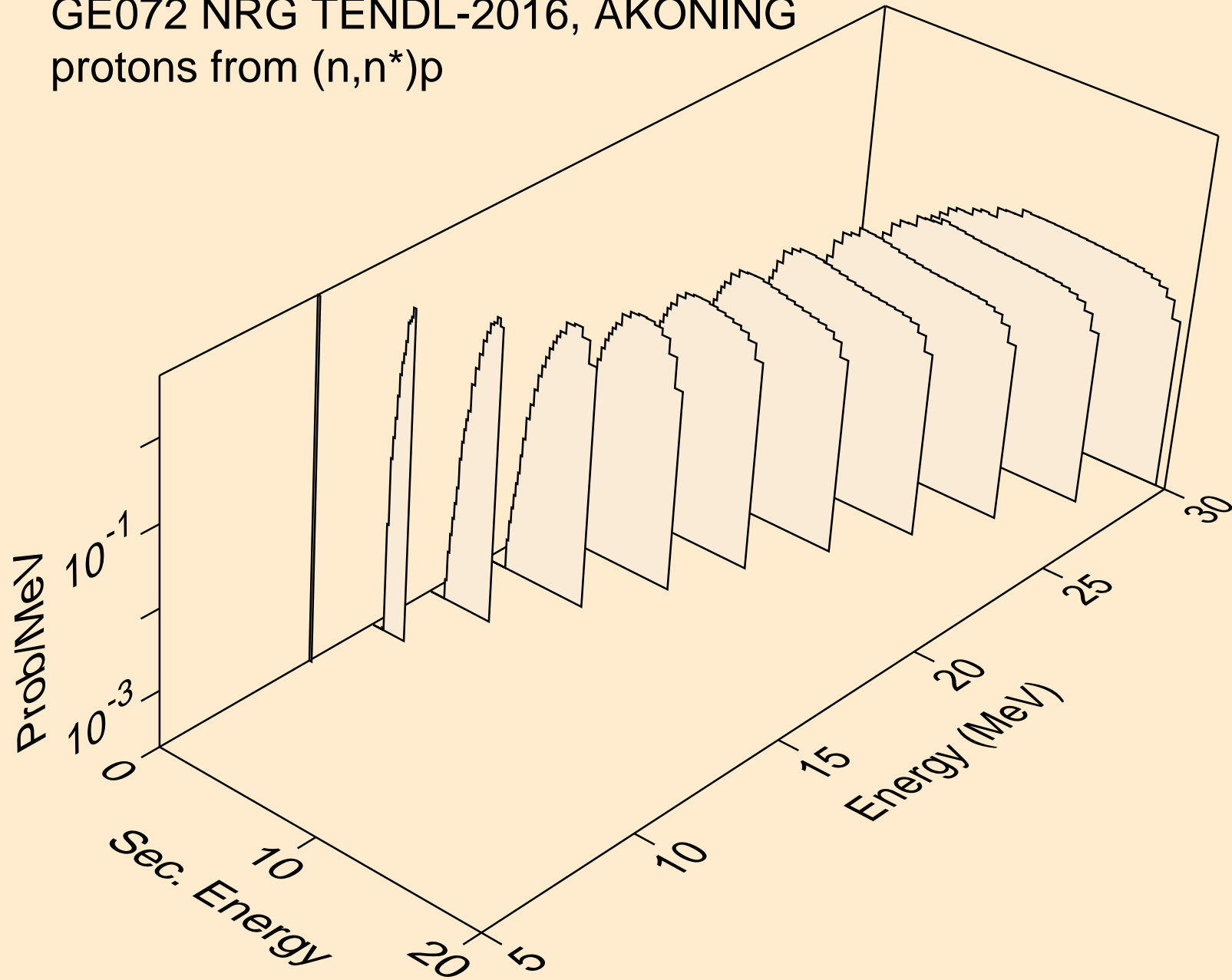

GE072 NRG TENDL-2016, AKONING
protons from (n,2np)

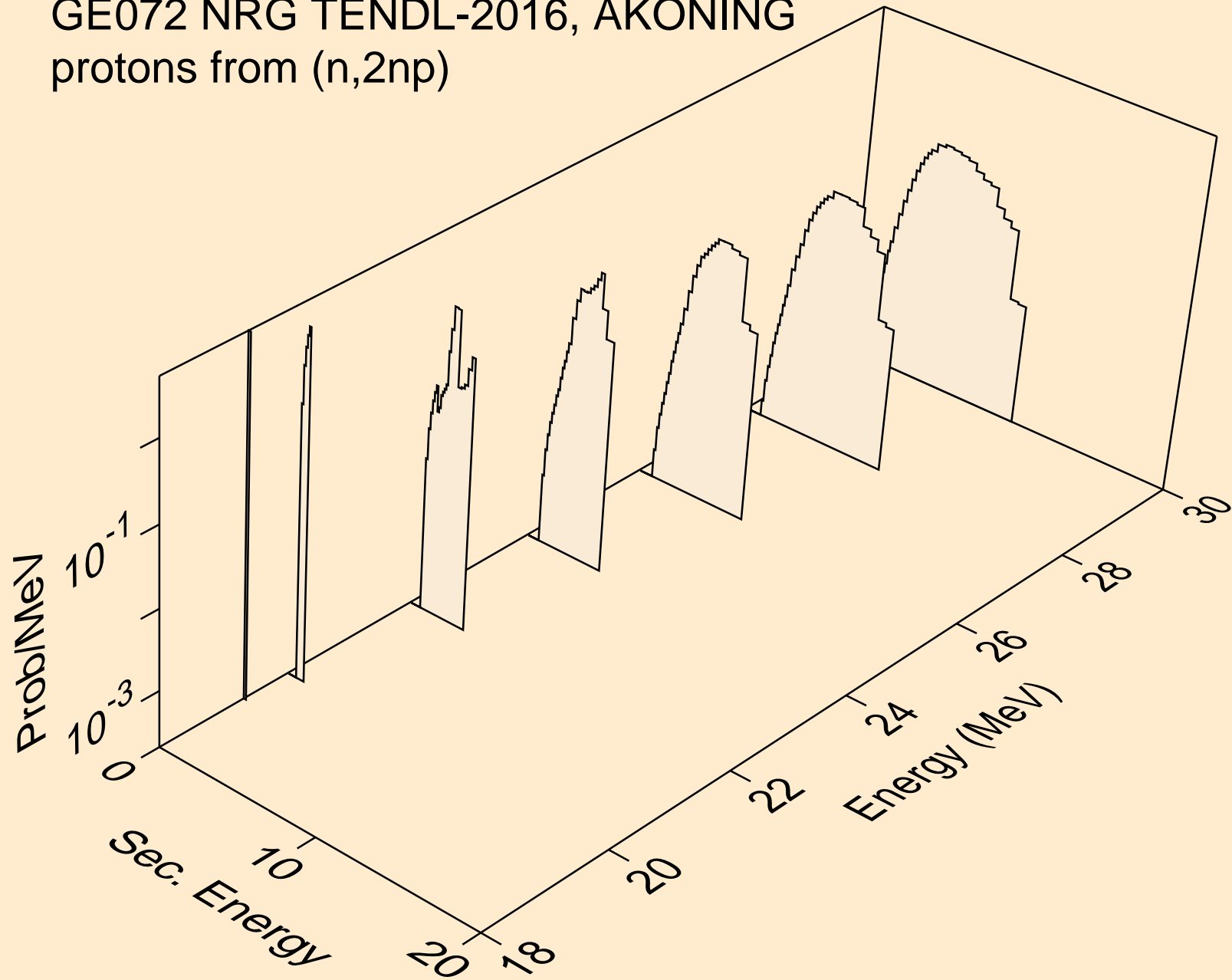

GE072 NRG TENDL-2016, AKONING
protons from (n,3np)

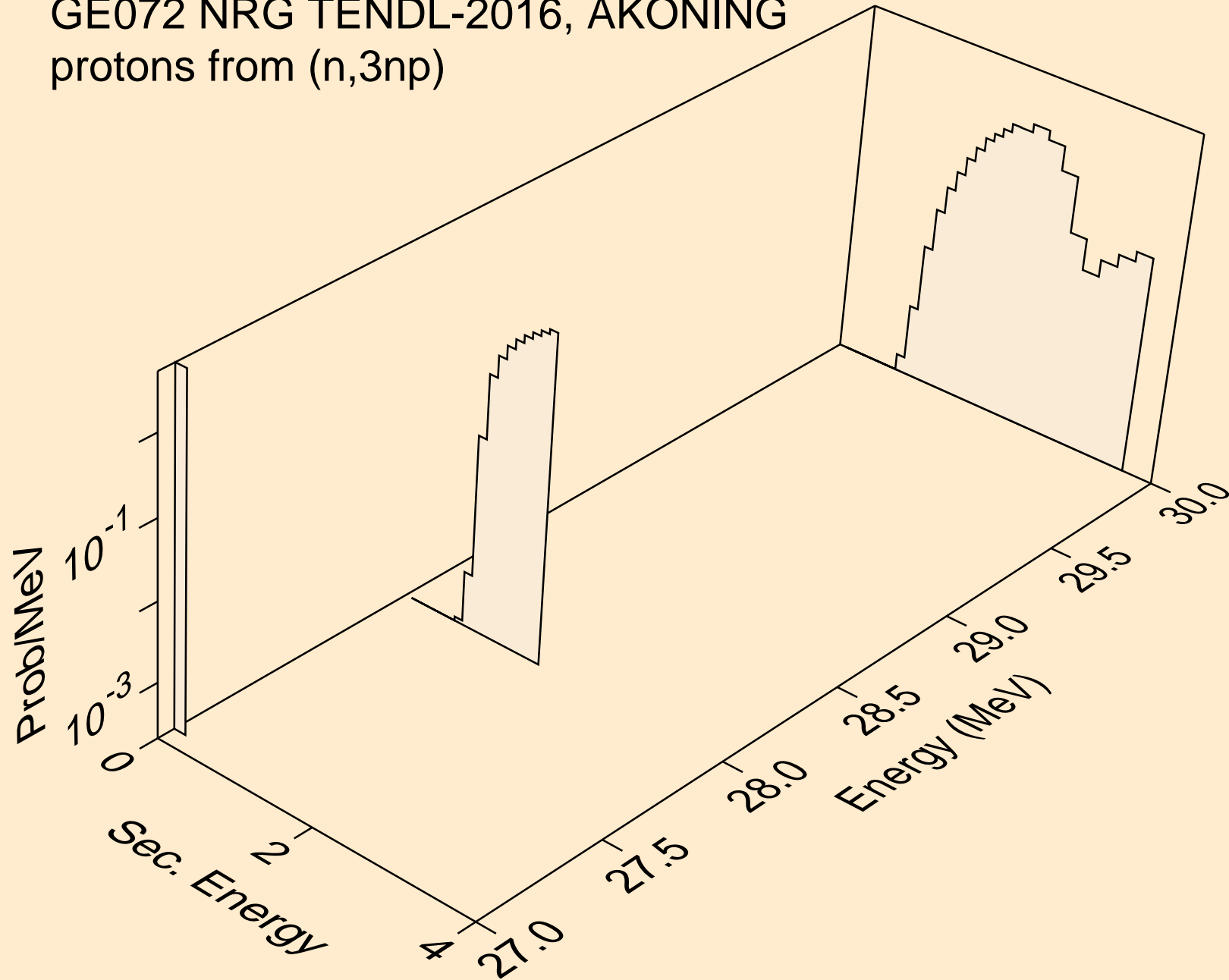

GE072 NRG TENDL-2016, AKONING
protons from (n,2np)

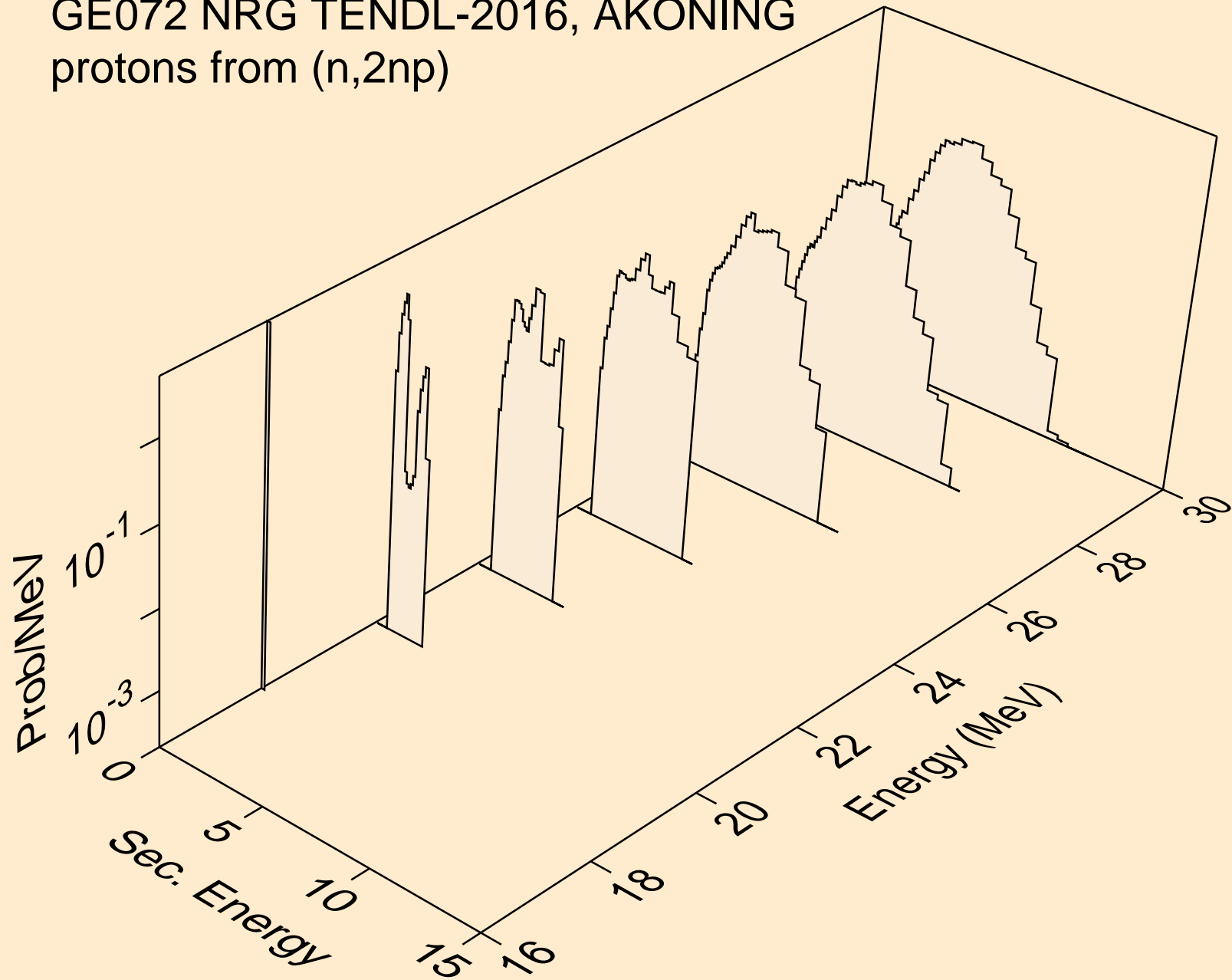

GE072 NRG TENDL-2016, AKONING
protons from (n,npa)

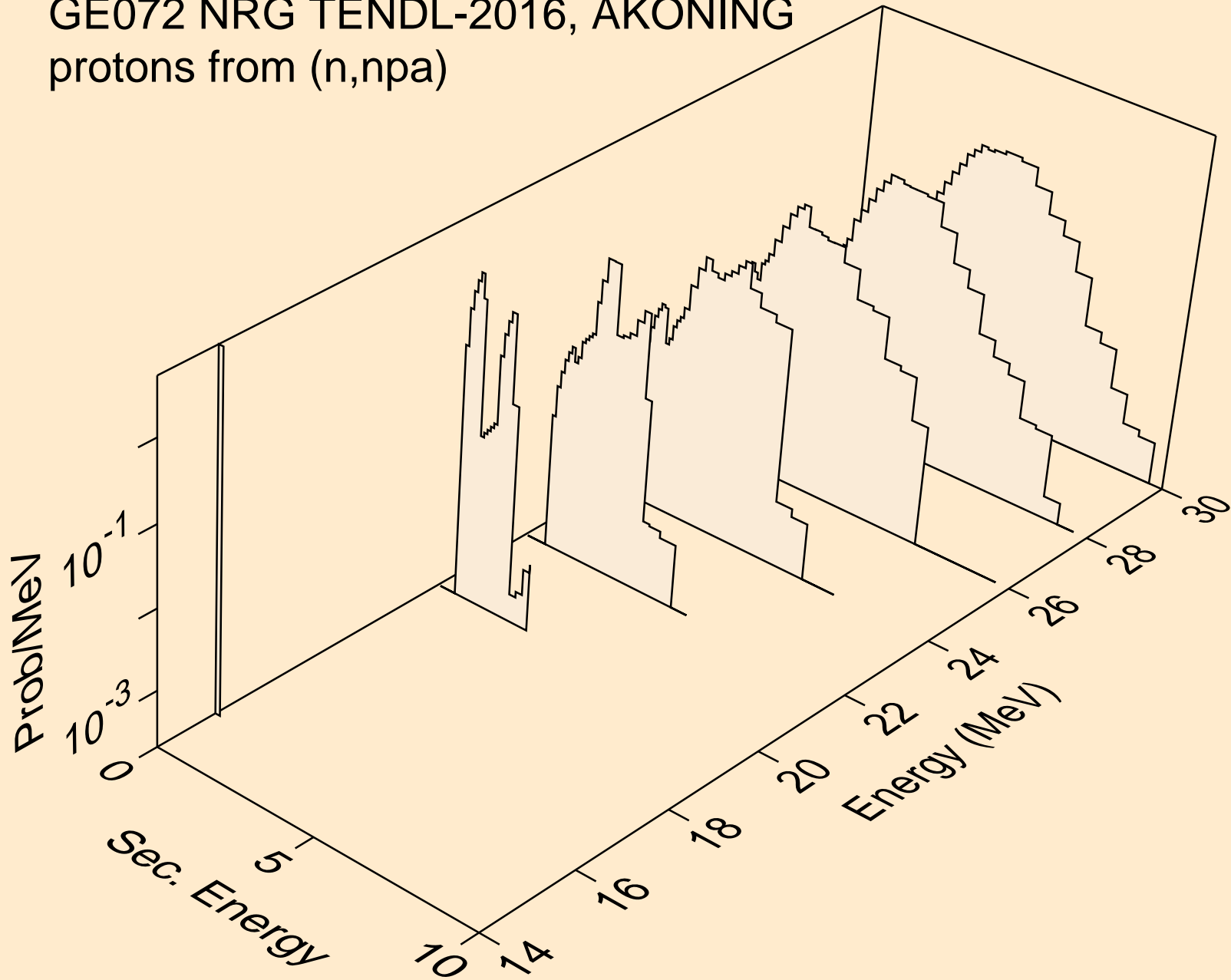

GE072 NRG TENDL-2016, AKONING
protons from (n,p)

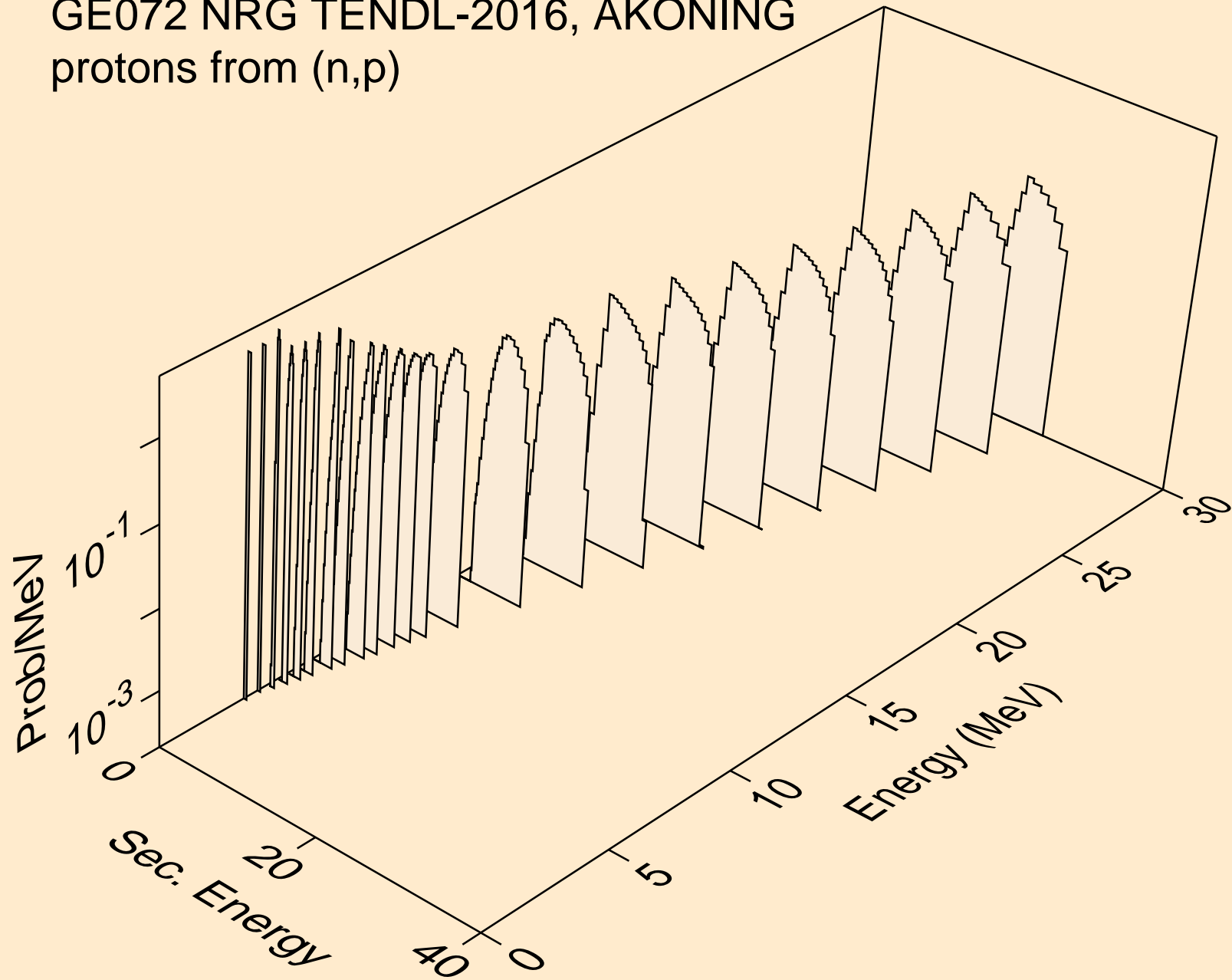

GE072 NRG TENDL-2016, AKONING
protons from (n,2p)

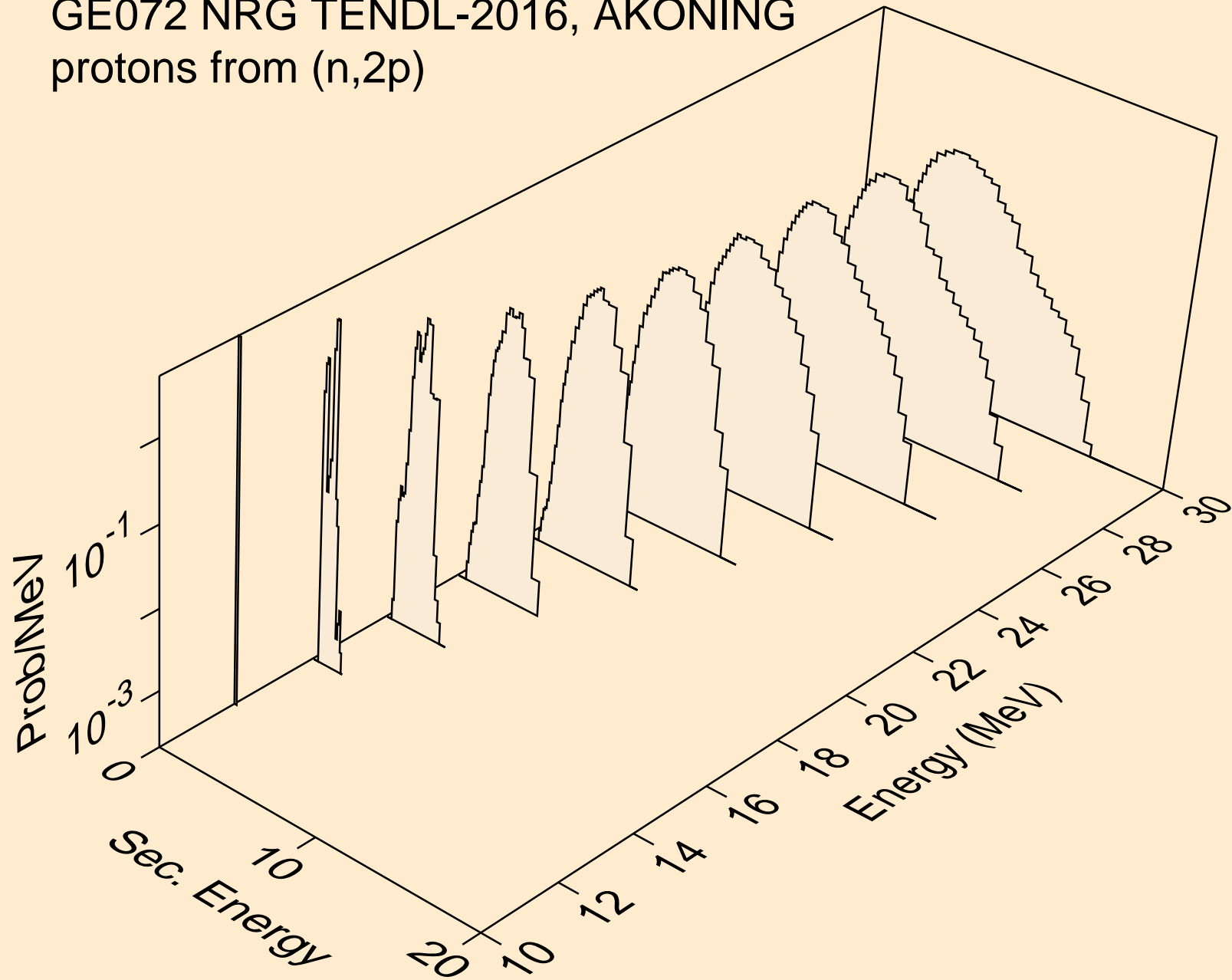

GE072 NRG TENDL-2016, AKONING
protons from (n,pa)

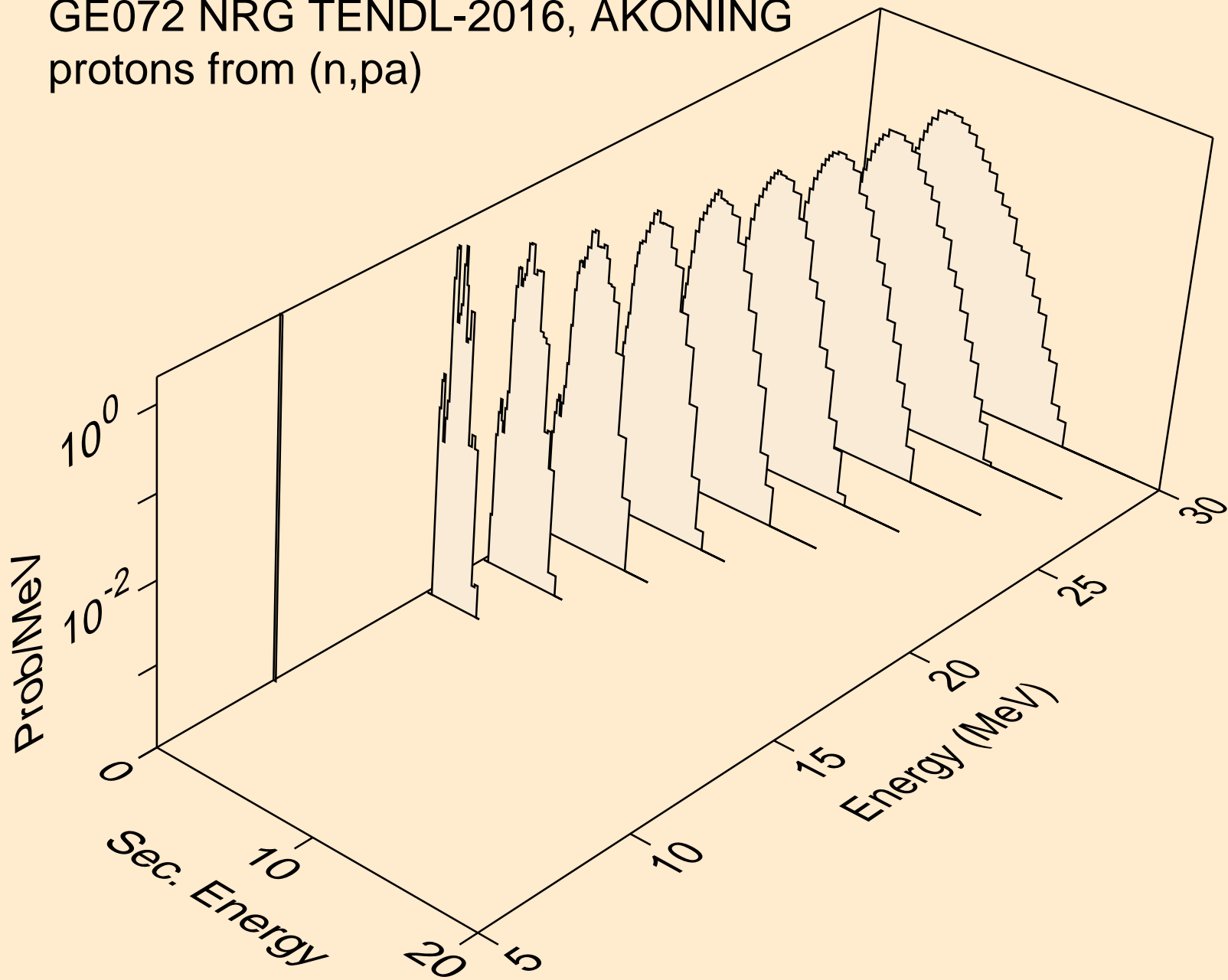

GE072 NRG TENDL-2016, AKONING
protons from (n,pd)

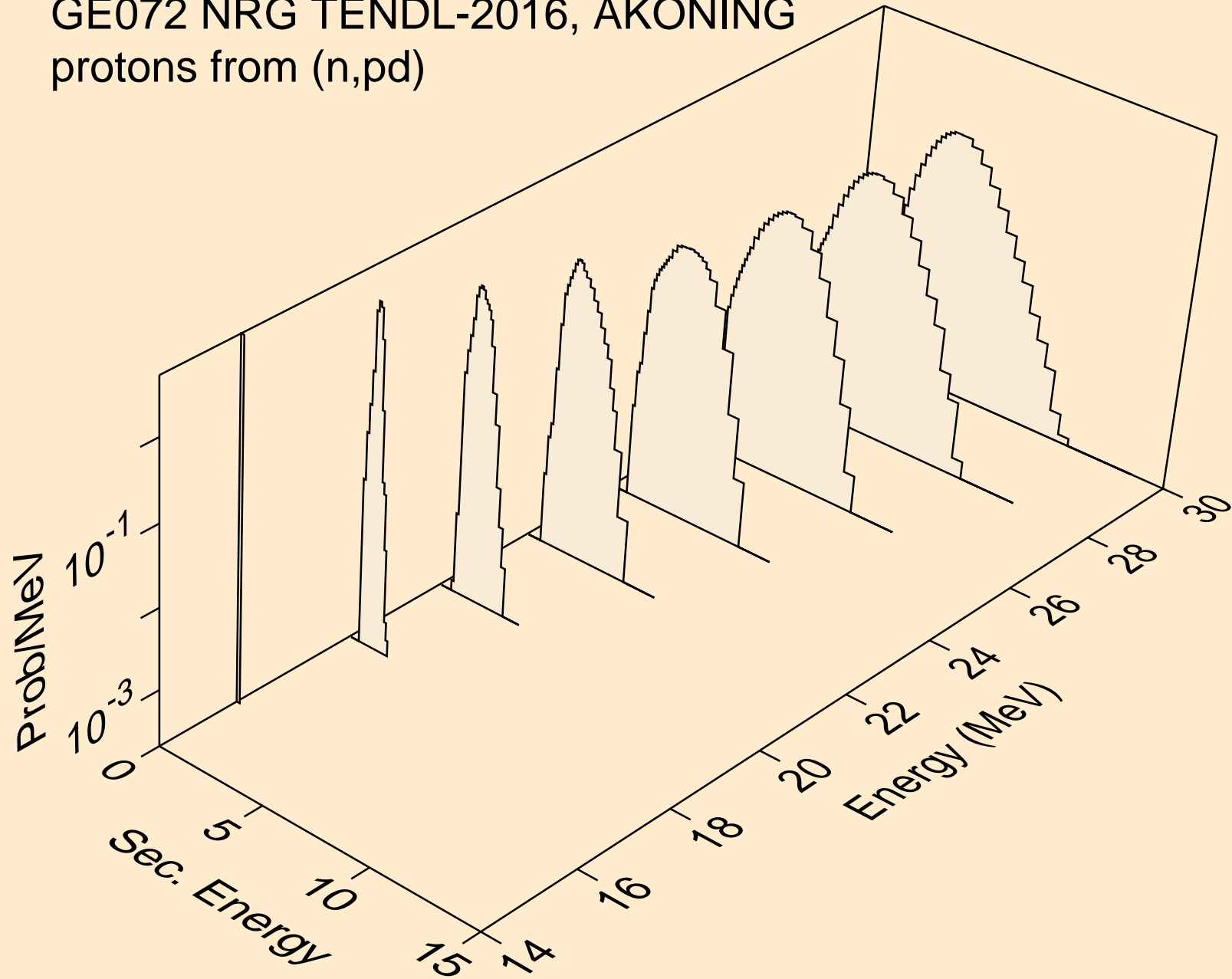

GE072 NRG TENDL-2016, AKONING
protons from (n,pt)

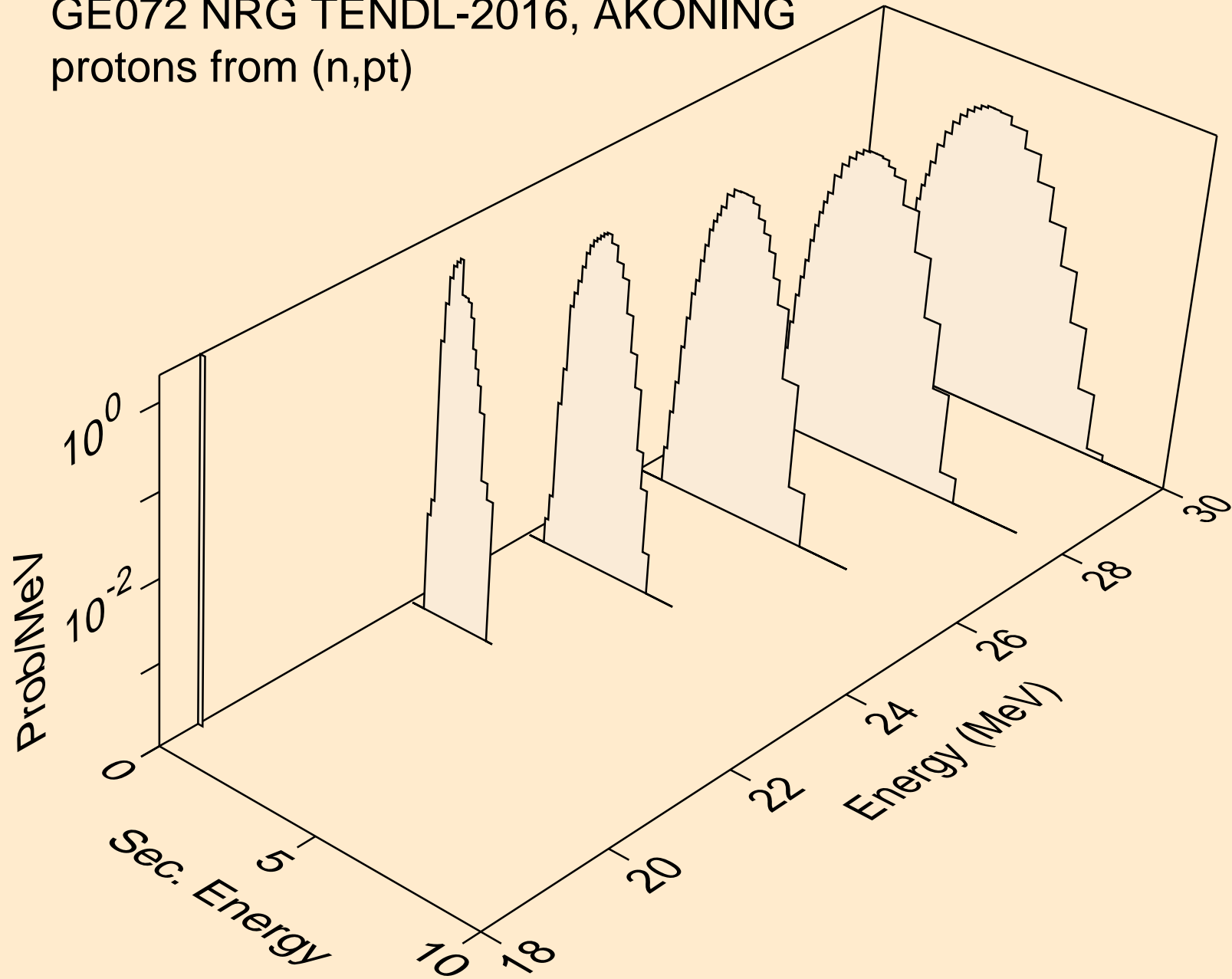

GE072 NRG TENDL-2016, AKONING
deuterons from (n,x)

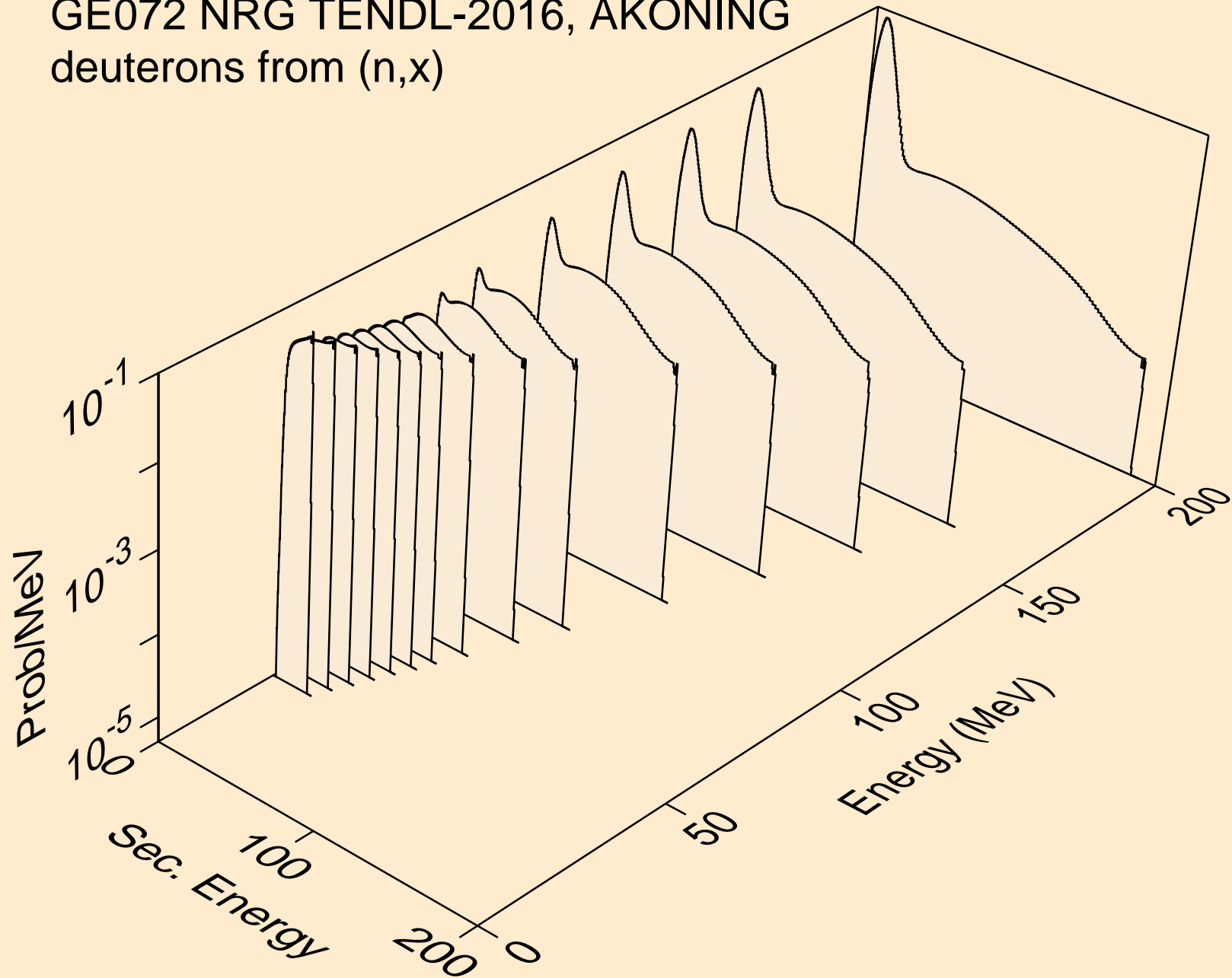

GE072 NRG TENDL-2016, AKONING deuterons from (n,2nd)

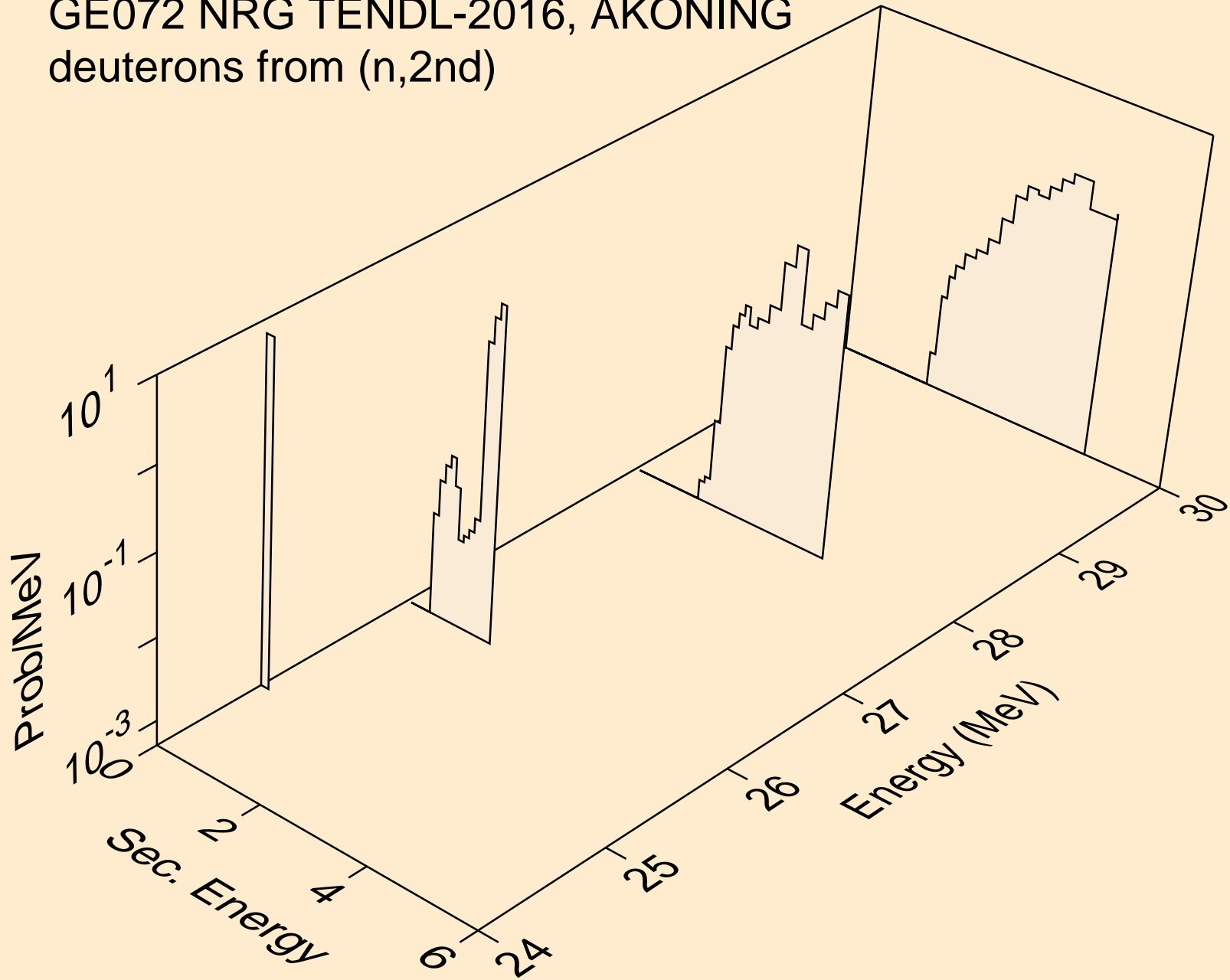

GE072 NRG TENDL-2016, AKONING
deuterons from (n,n*)d

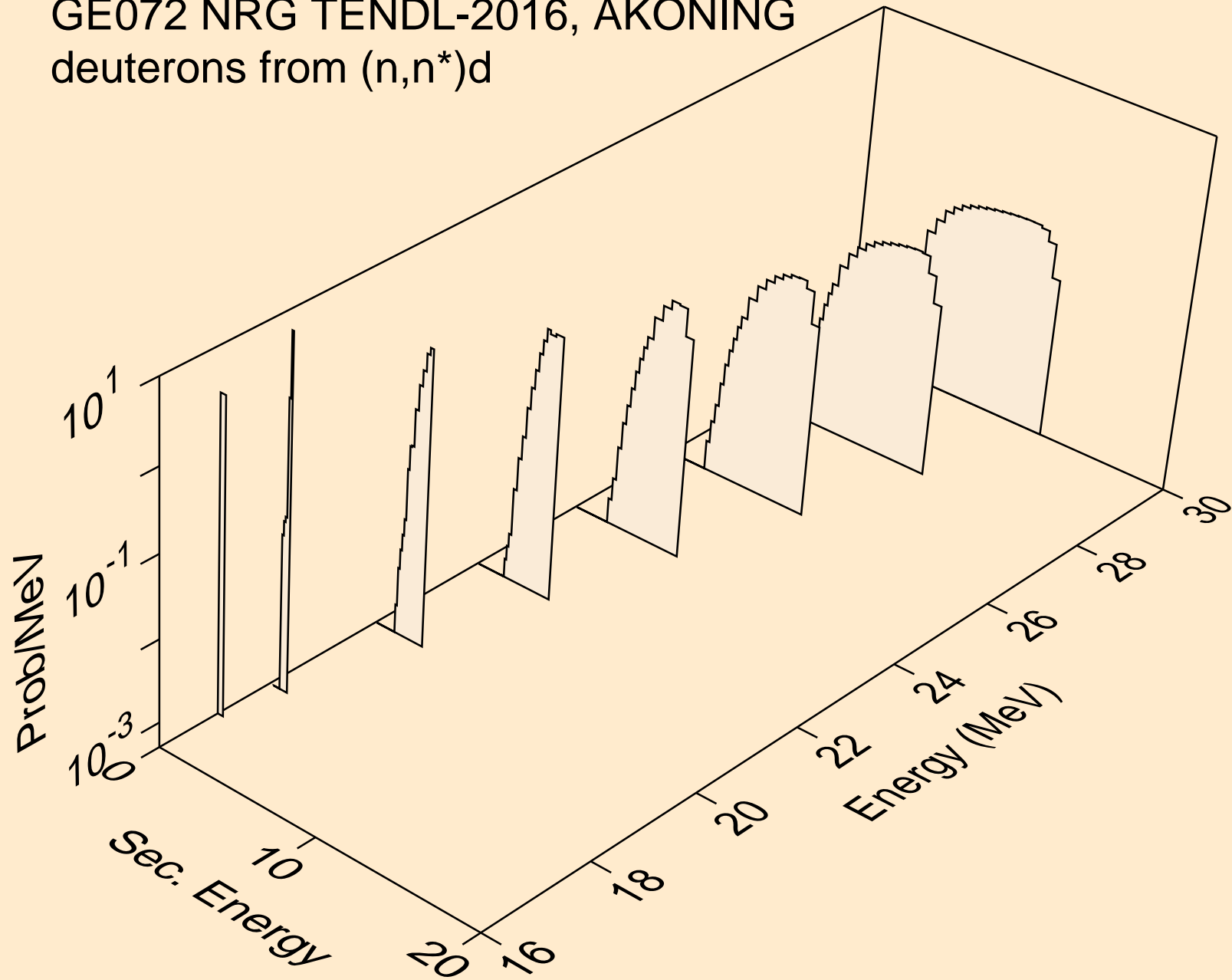

GE072 NRG TENDL-2016, AKONING
deuterons from (n,d)

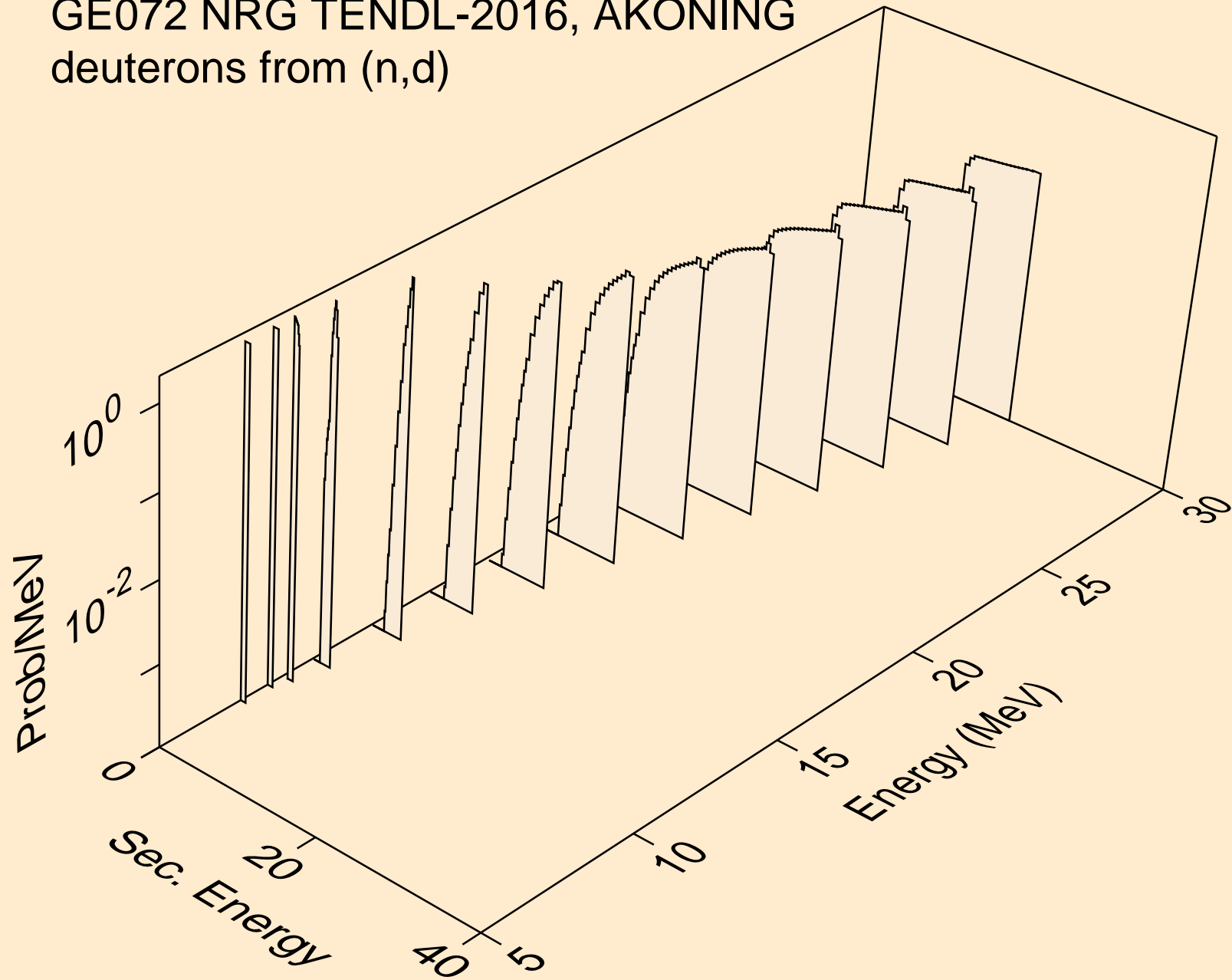

GE072 NRG TENDL-2016, AKONING
deuterons from (n,pd)

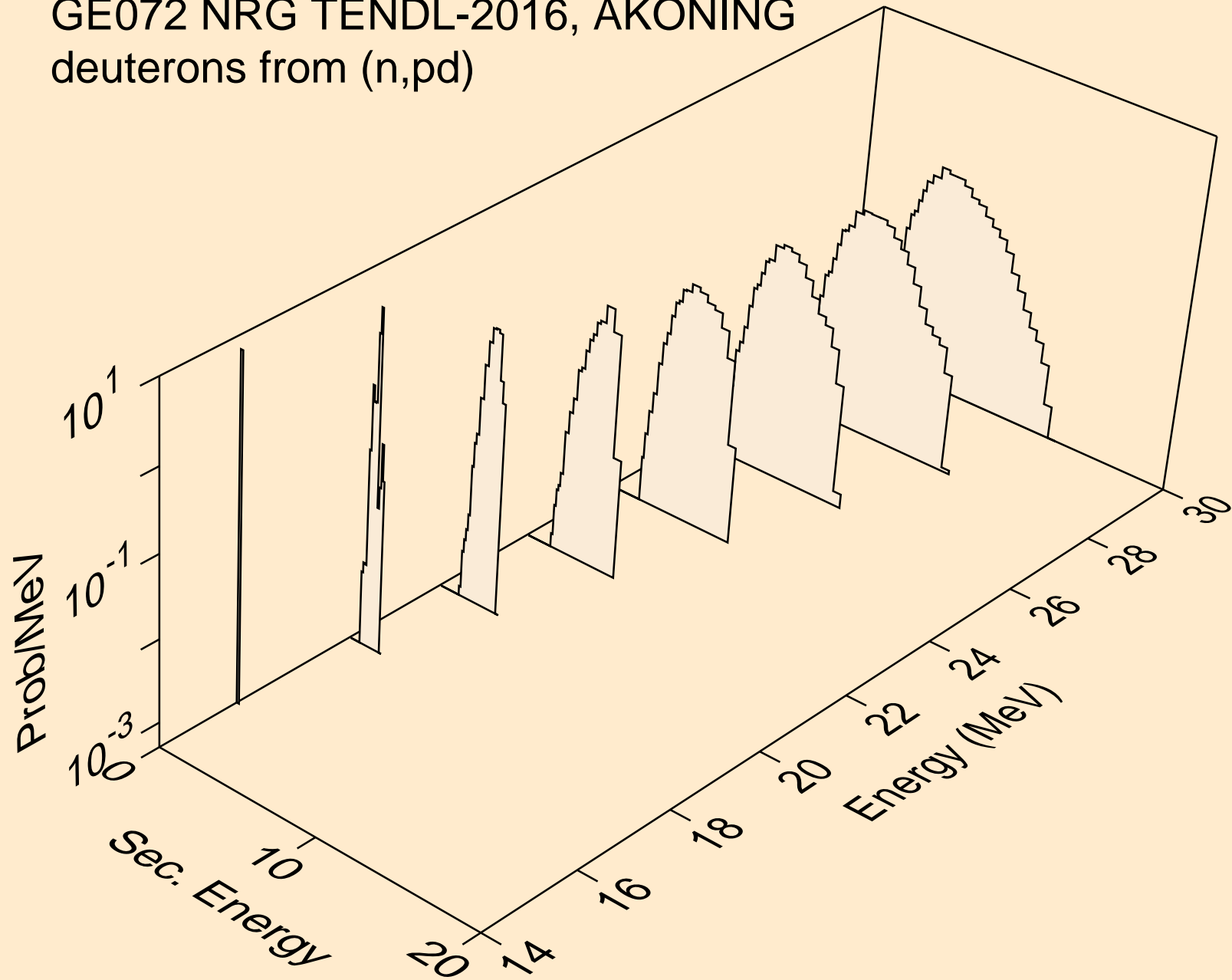

GE072 NRG TENDL-2016, AKONING
deuterons from (n,da)

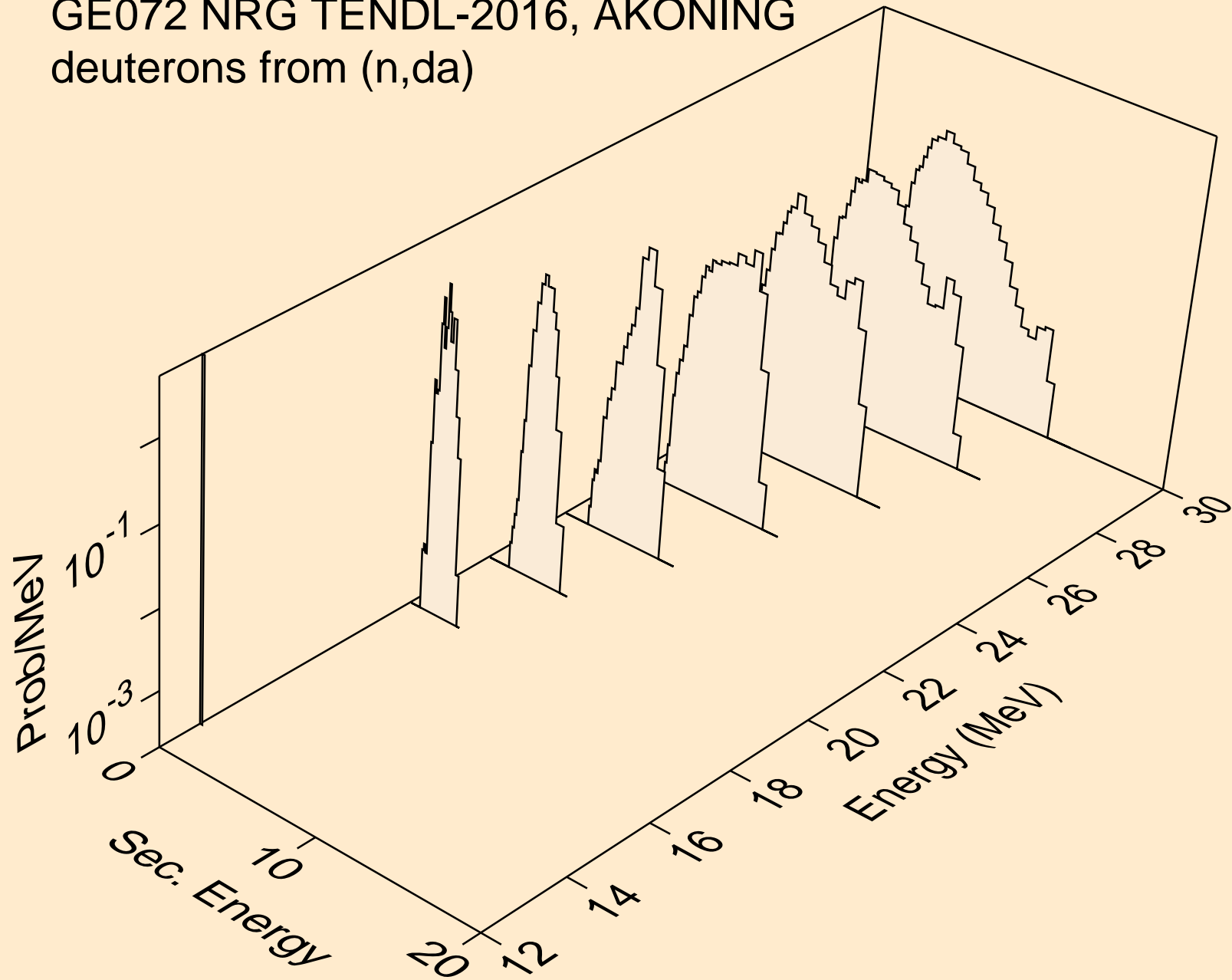

GE072 NRG TENDL-2016, AKONING
tritons from (n,x)

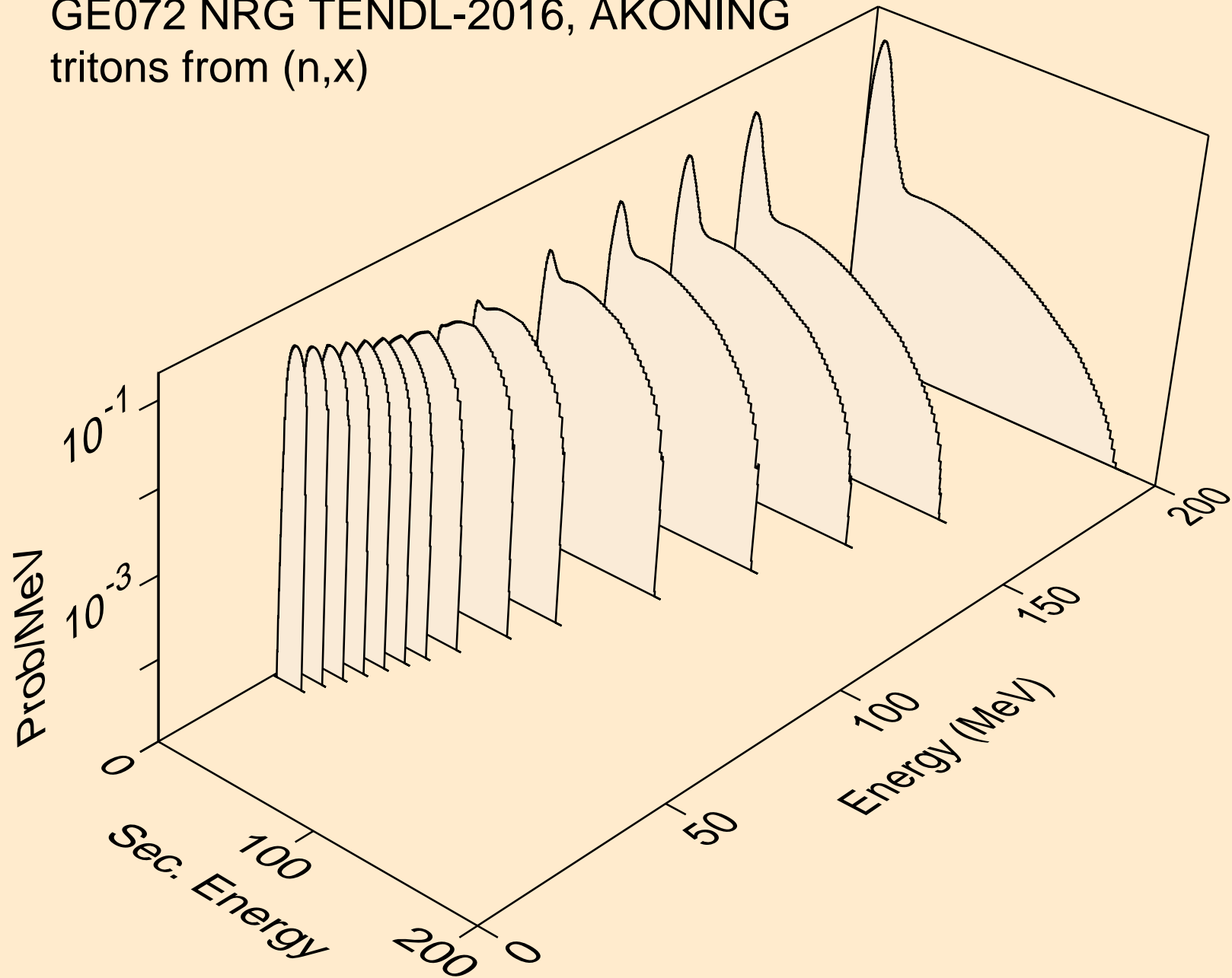

GE072 NRG TENDL-2016, AKONING
tritons from (n,n*)t

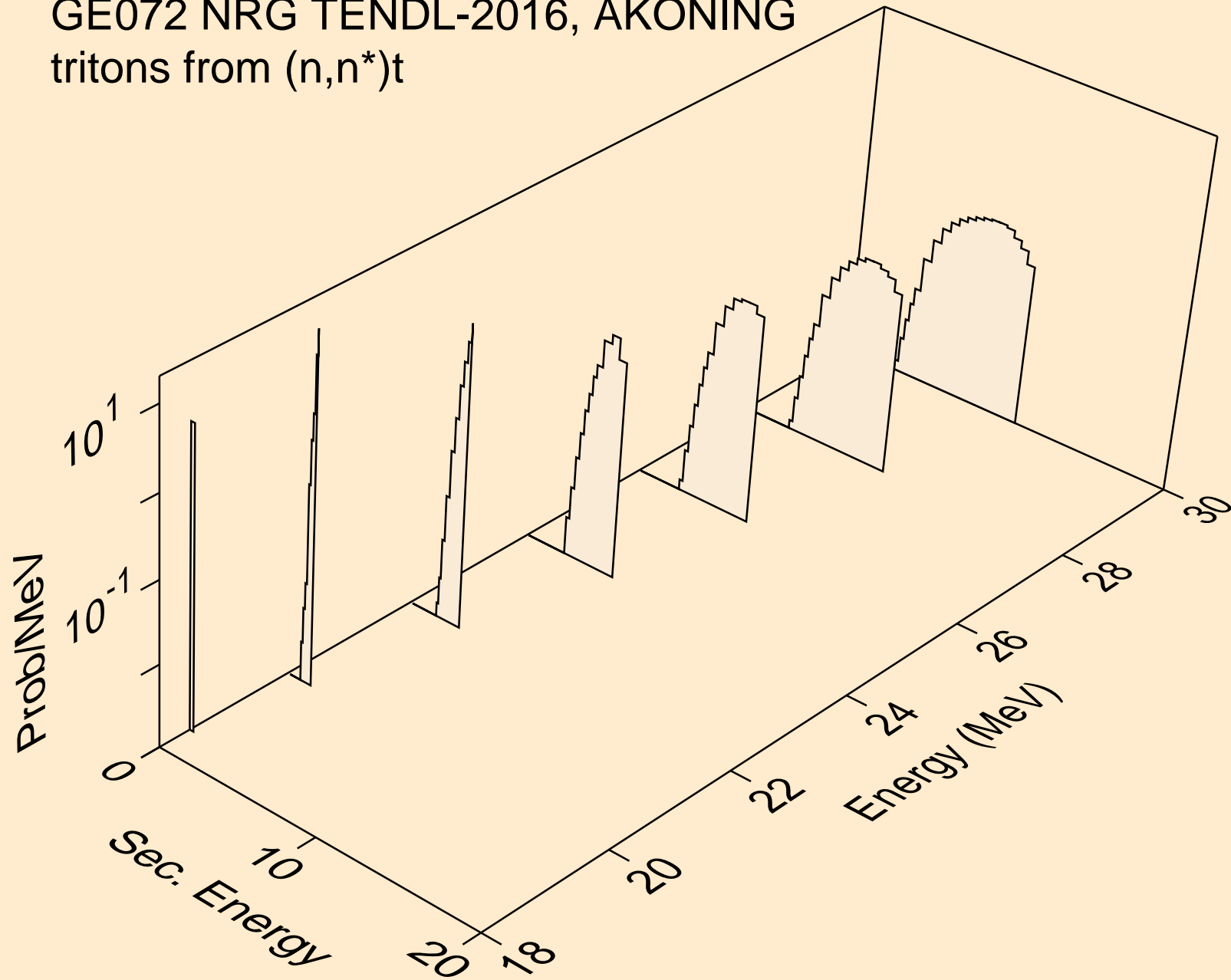

GE072 NRG TENDL-2016, AKONING
tritons from (n,t)

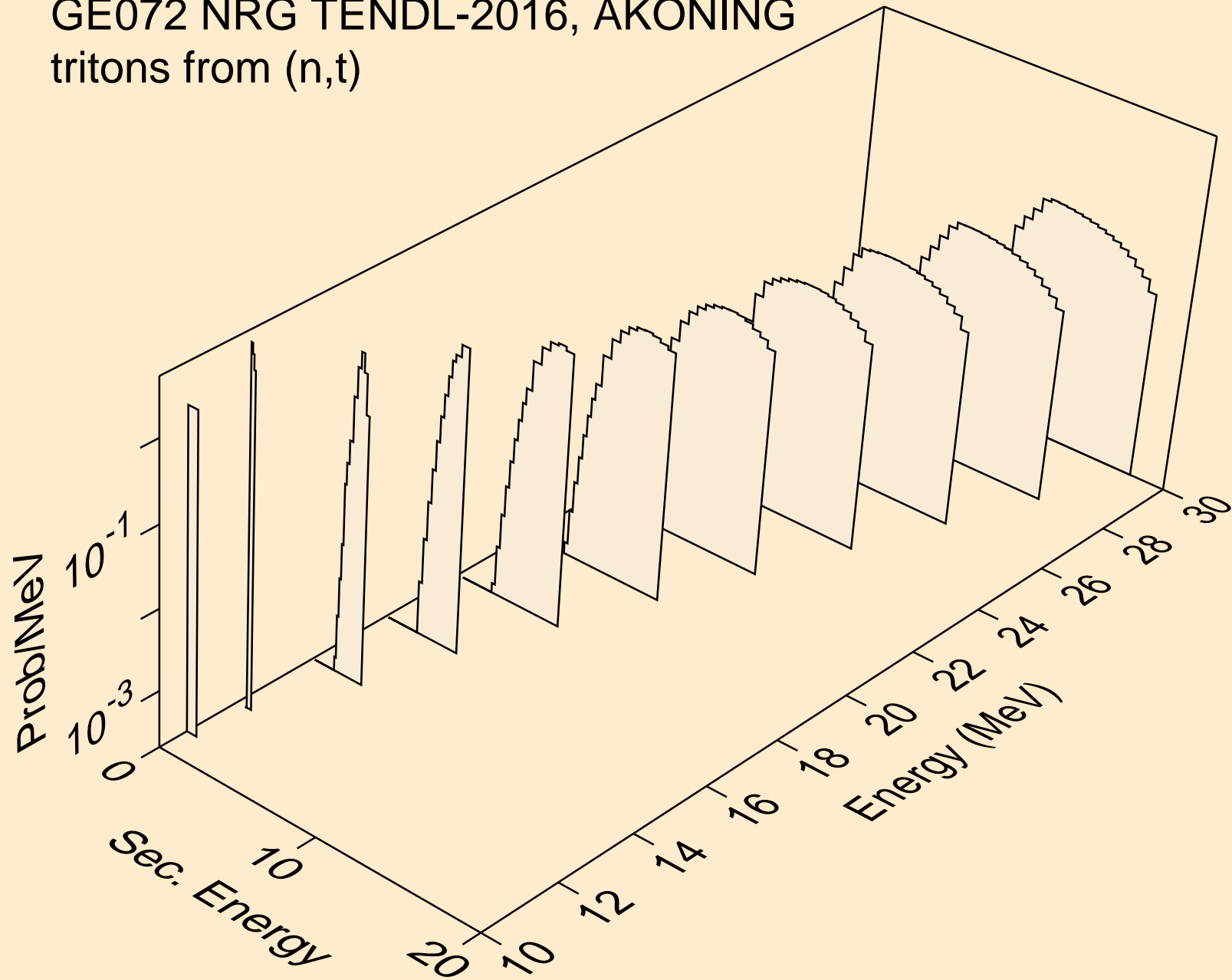

GE072 NRG TENDL-2016, AKONING
tritons from (n,pt)

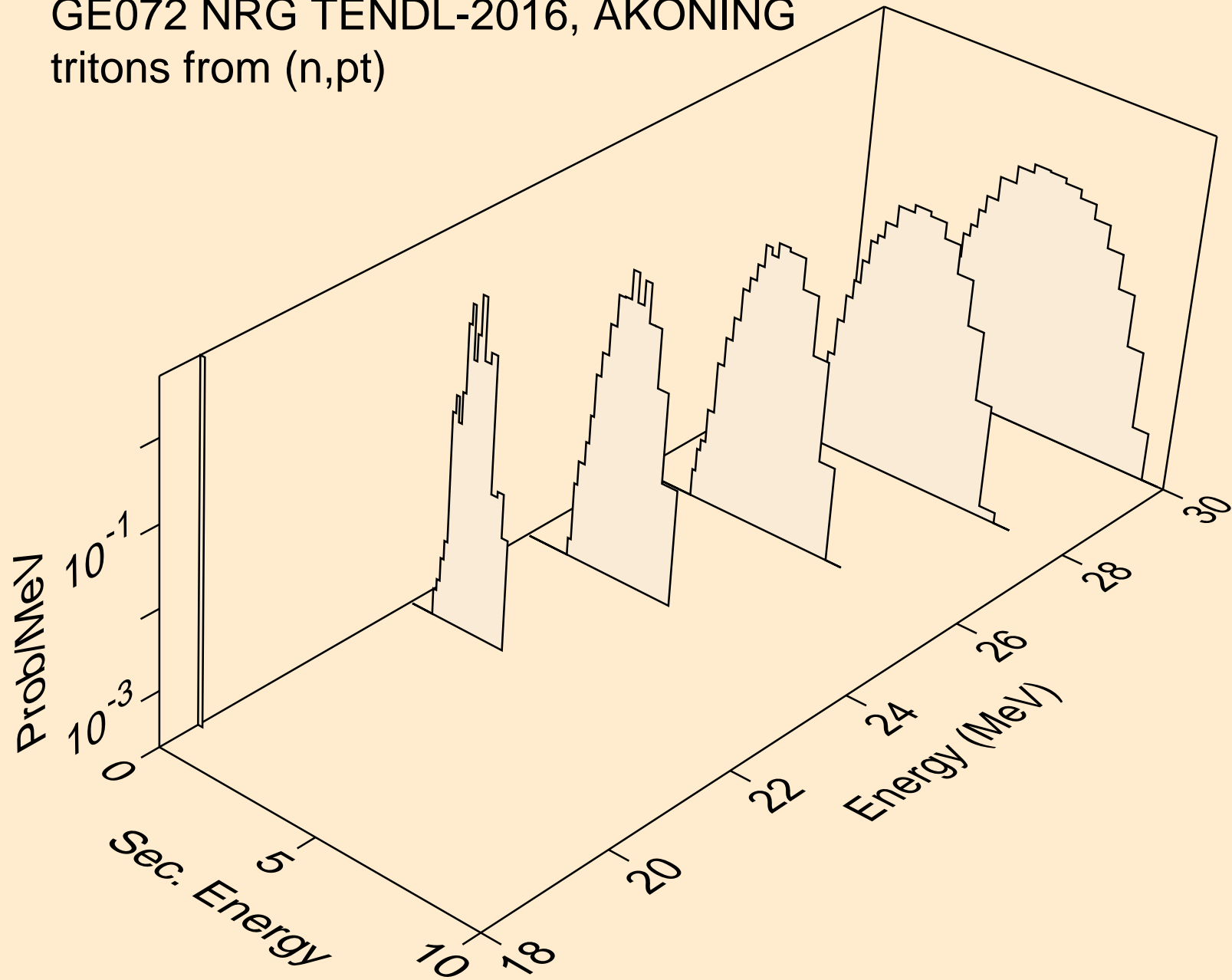

GE072 NRG TENDL-2016, AKONING
he3s from (n,x)

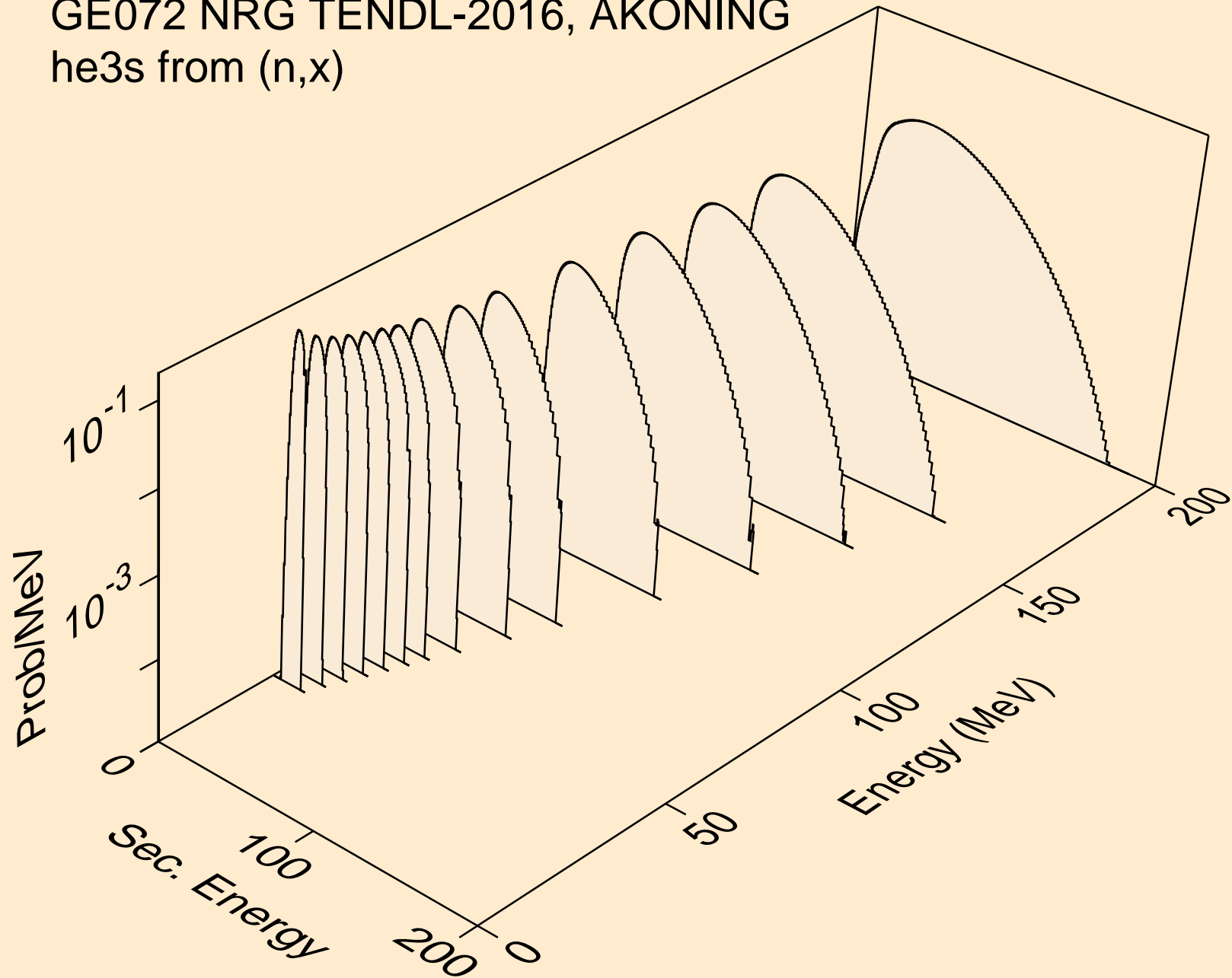

GE072 NRG TENDL-2016, AKONING
he3s from (n,n*)he3

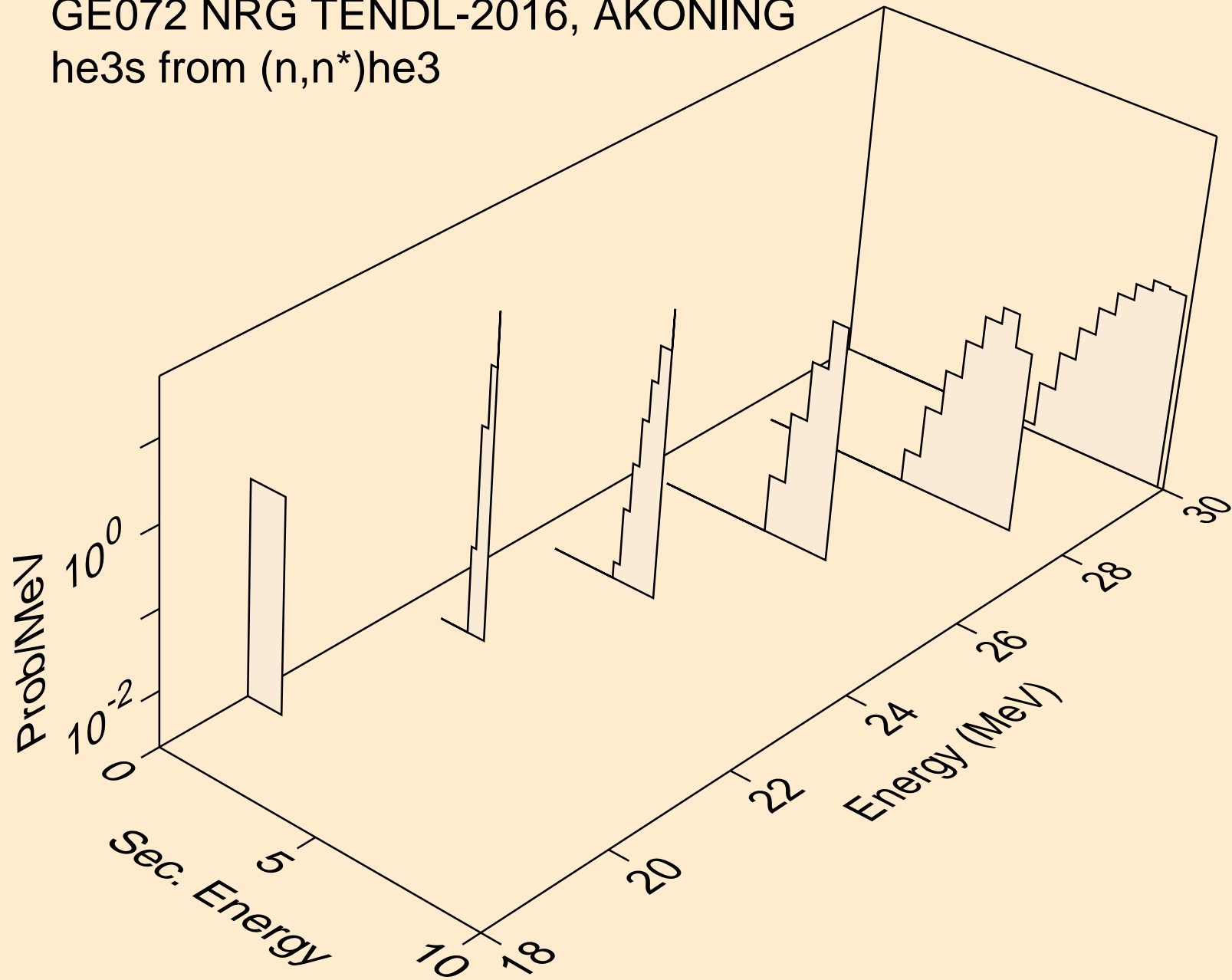

GE072 NRG TENDL-2016, AKONING
he3s from (n,he3)

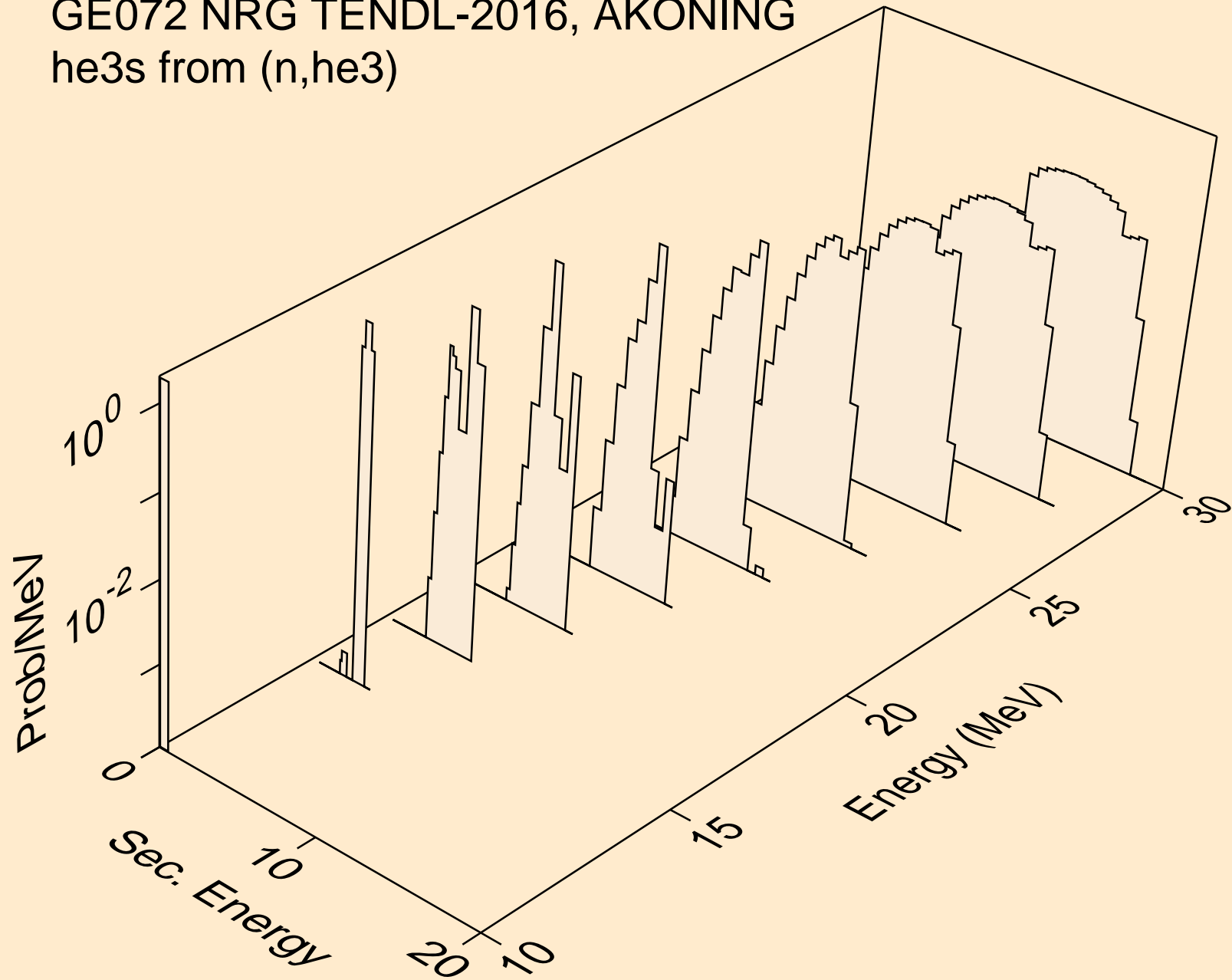

GE072 NRG TENDL-2016, AKONING
alphas from (n,x)

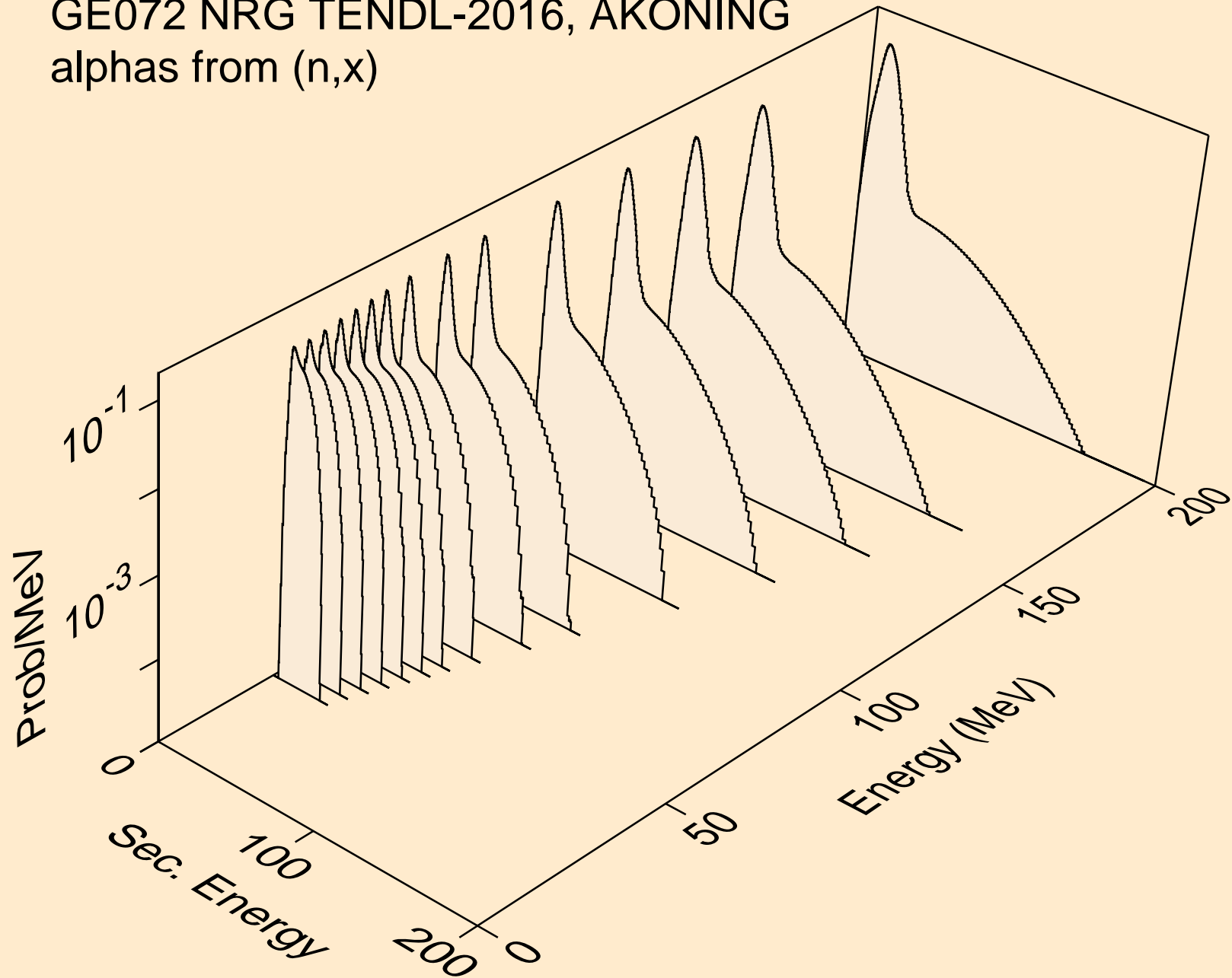

GE072 NRG TENDL-2016, AKONING
alphas from (n,n*)a

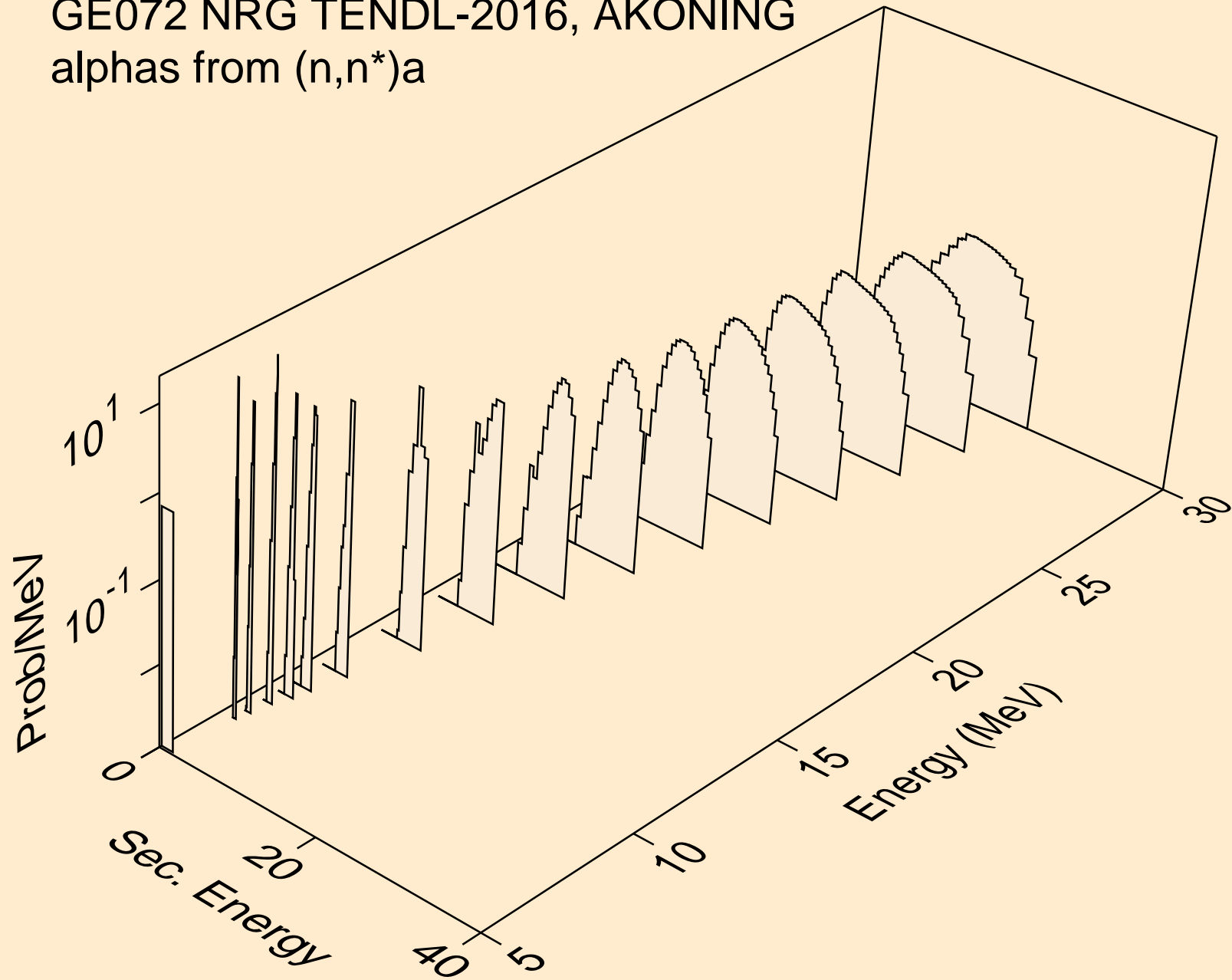

GE072 NRG TENDL-2016, AKONING
alphas from (n,2n)a

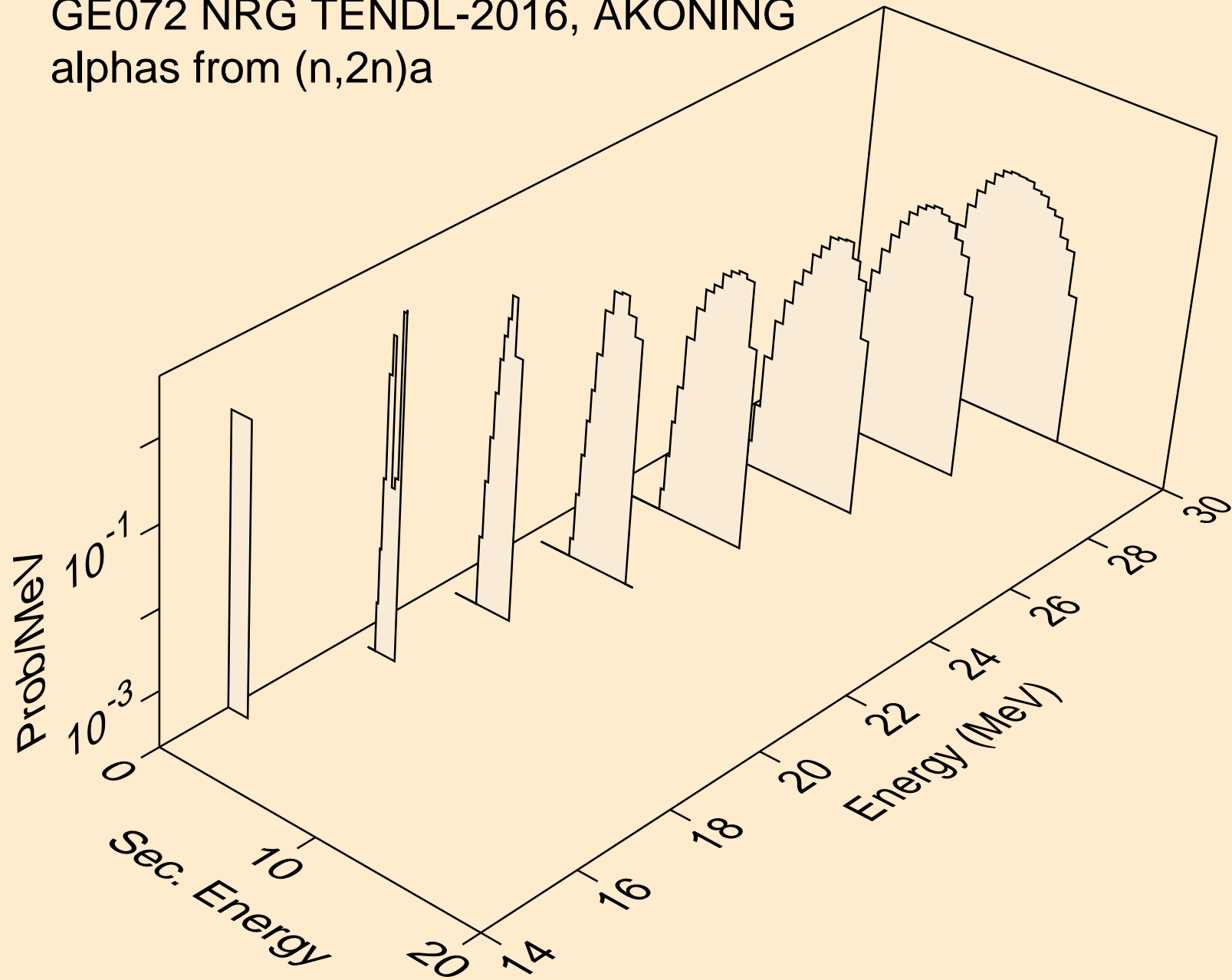

GE072 NRG TENDL-2016, AKONING
alphas from (n,3n)a

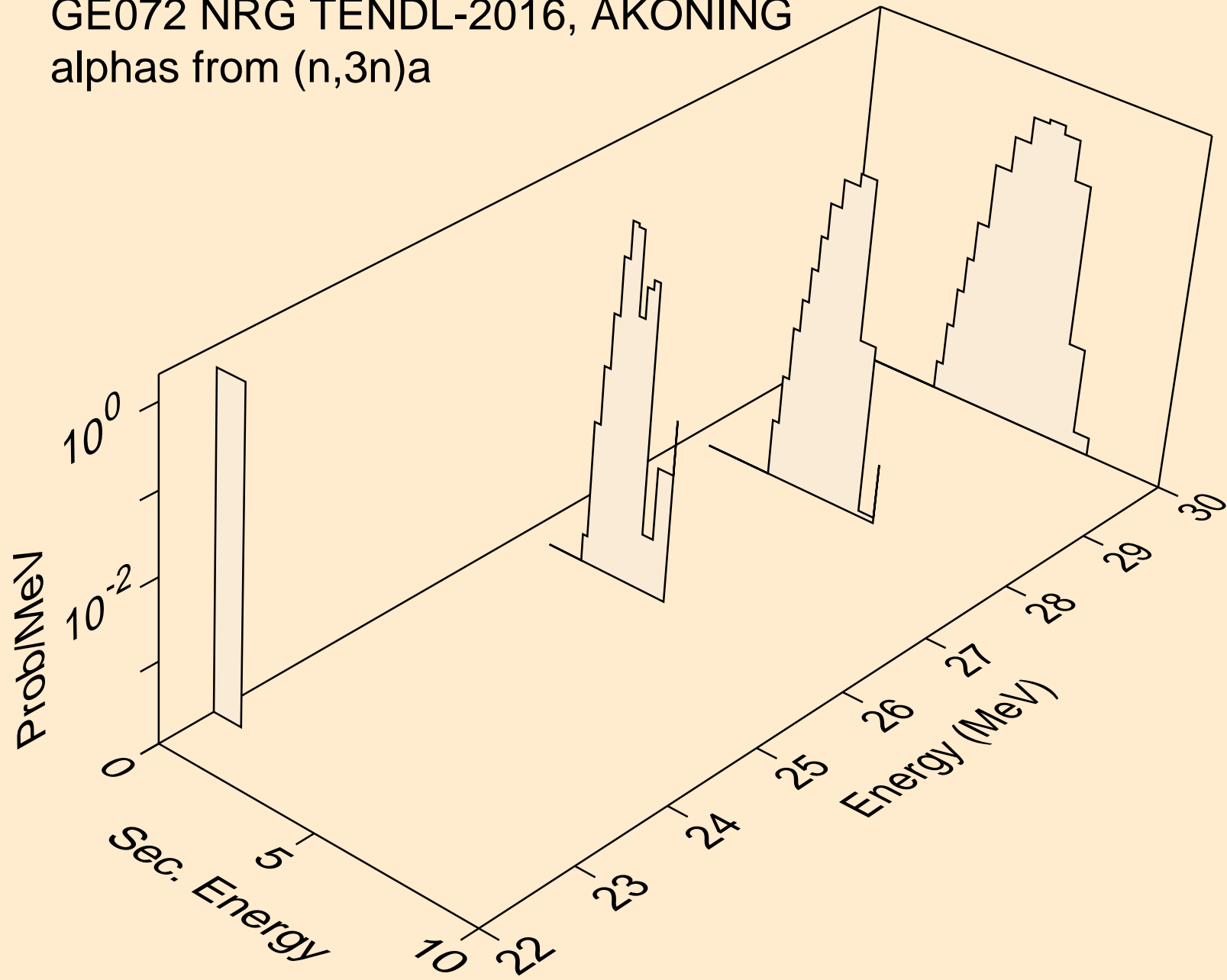

GE072 NRG TENDL-2016, AKONING
alphas from (n,n*)2a

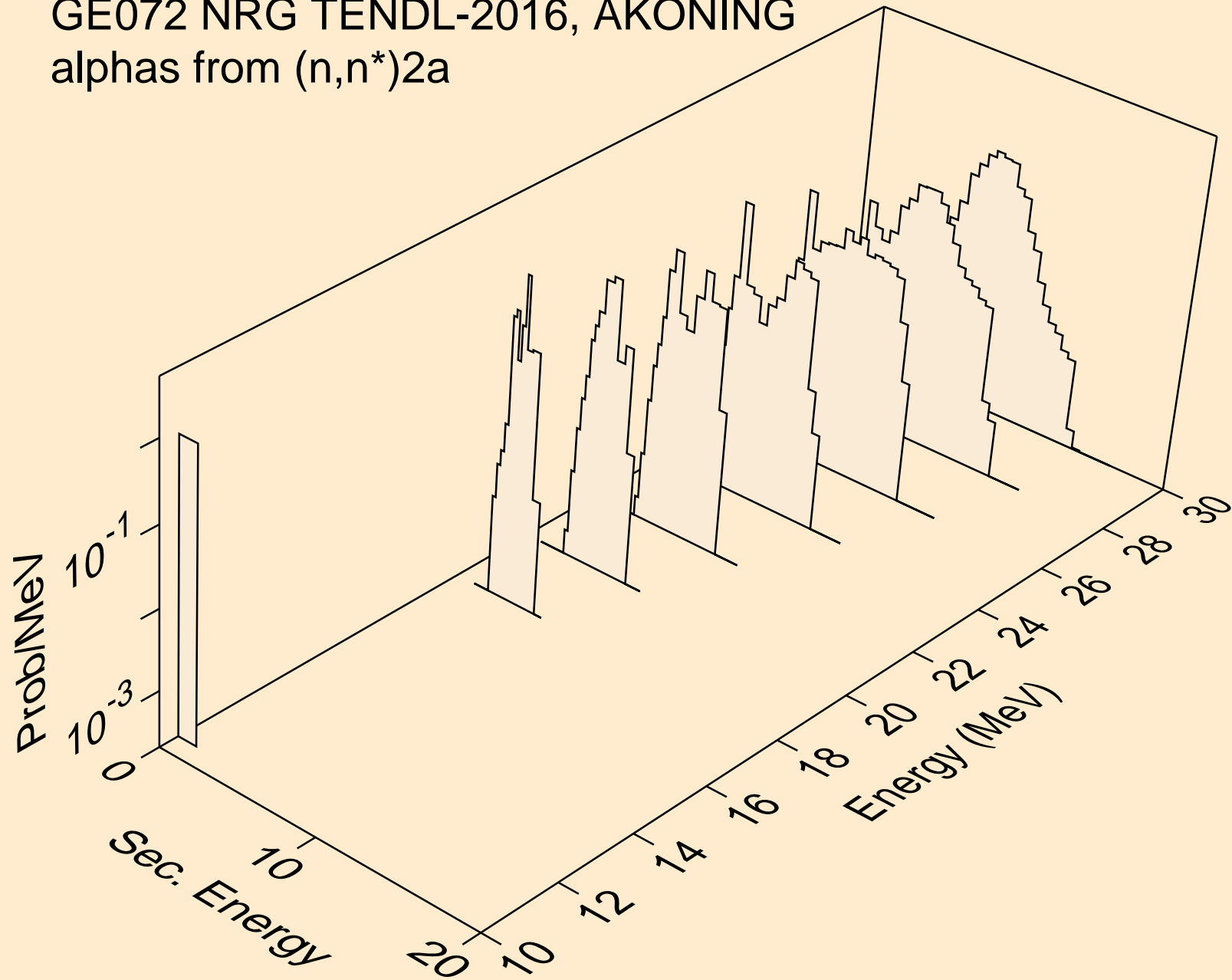

GE072 NRG TENDL-2016, AKONING
alphas from (n,npa)

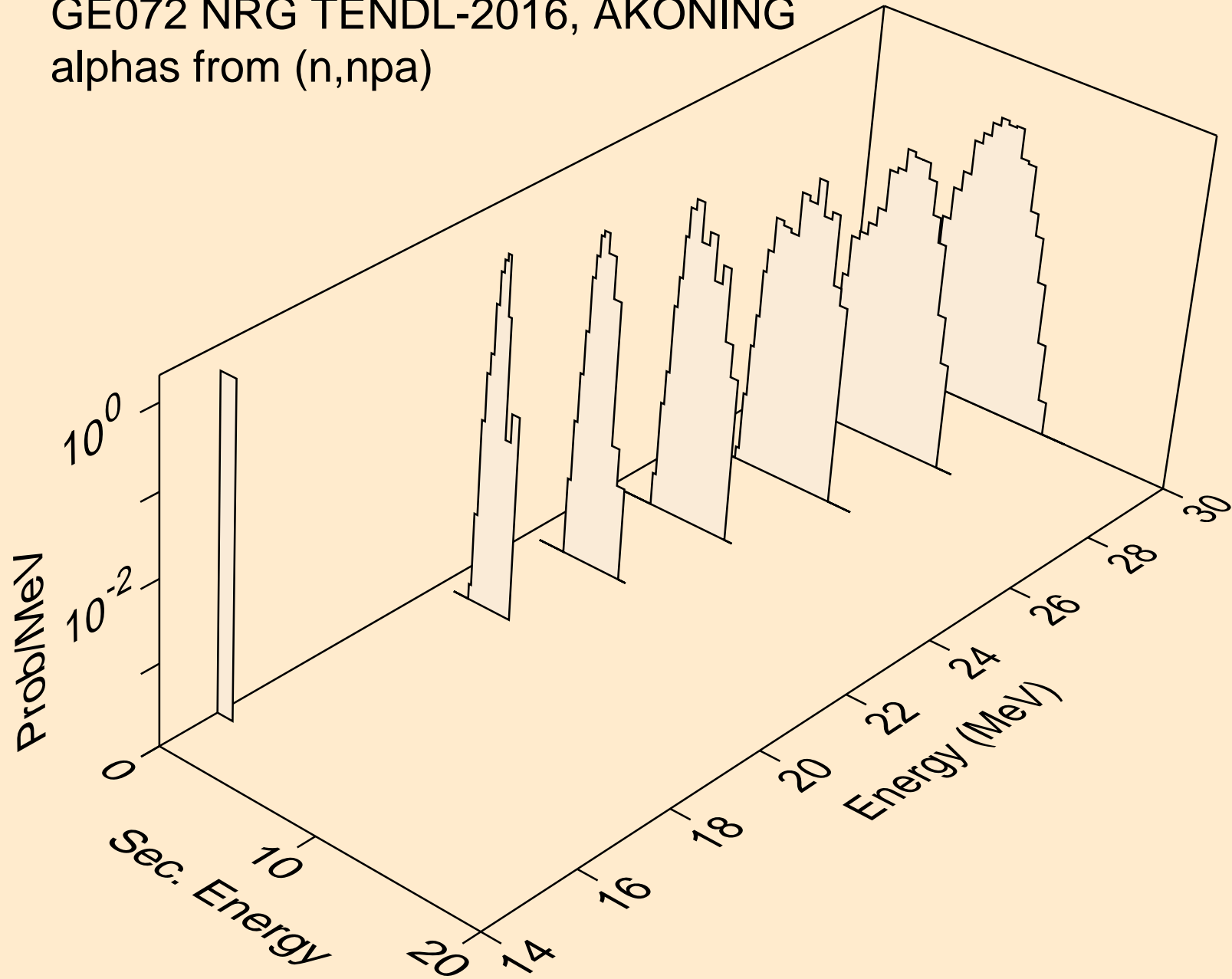

GE072 NRG TENDL-2016, AKONING
alphas from (n,a)

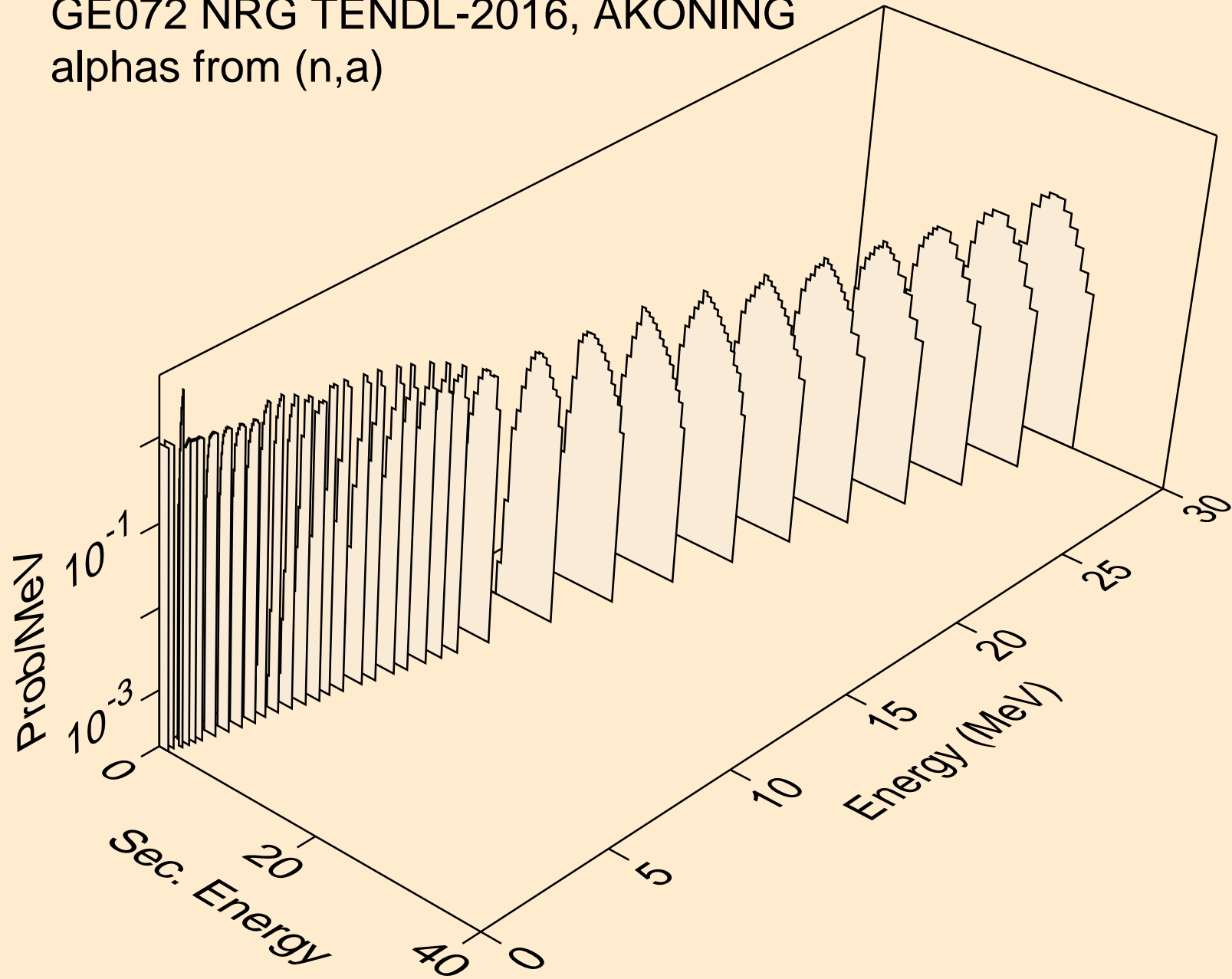

GE072 NRG TENDL-2016, AKONING
alphas from (n,2a)

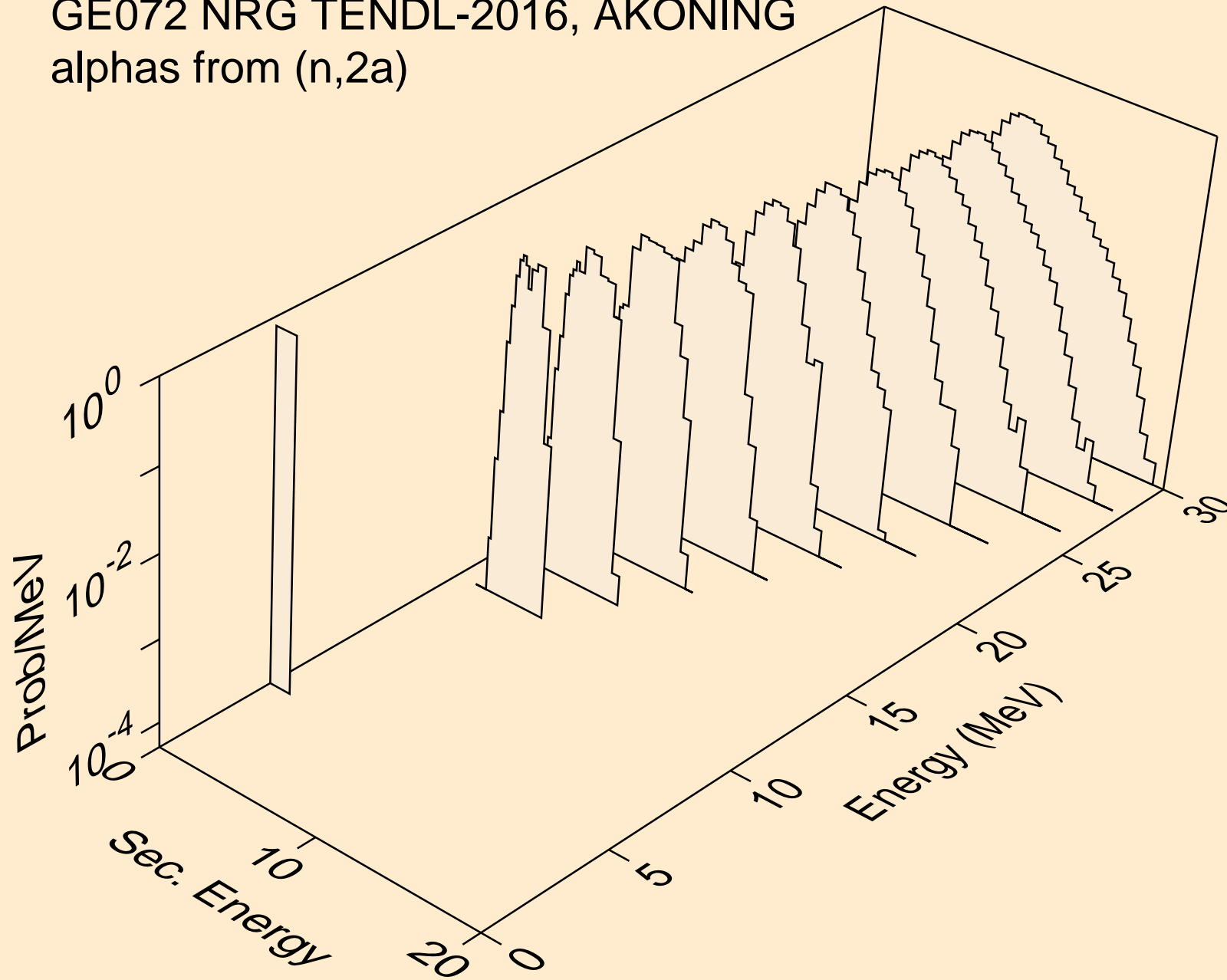

GE072 NRG TENDL-2016, AKONING
alphas from (n,pa)

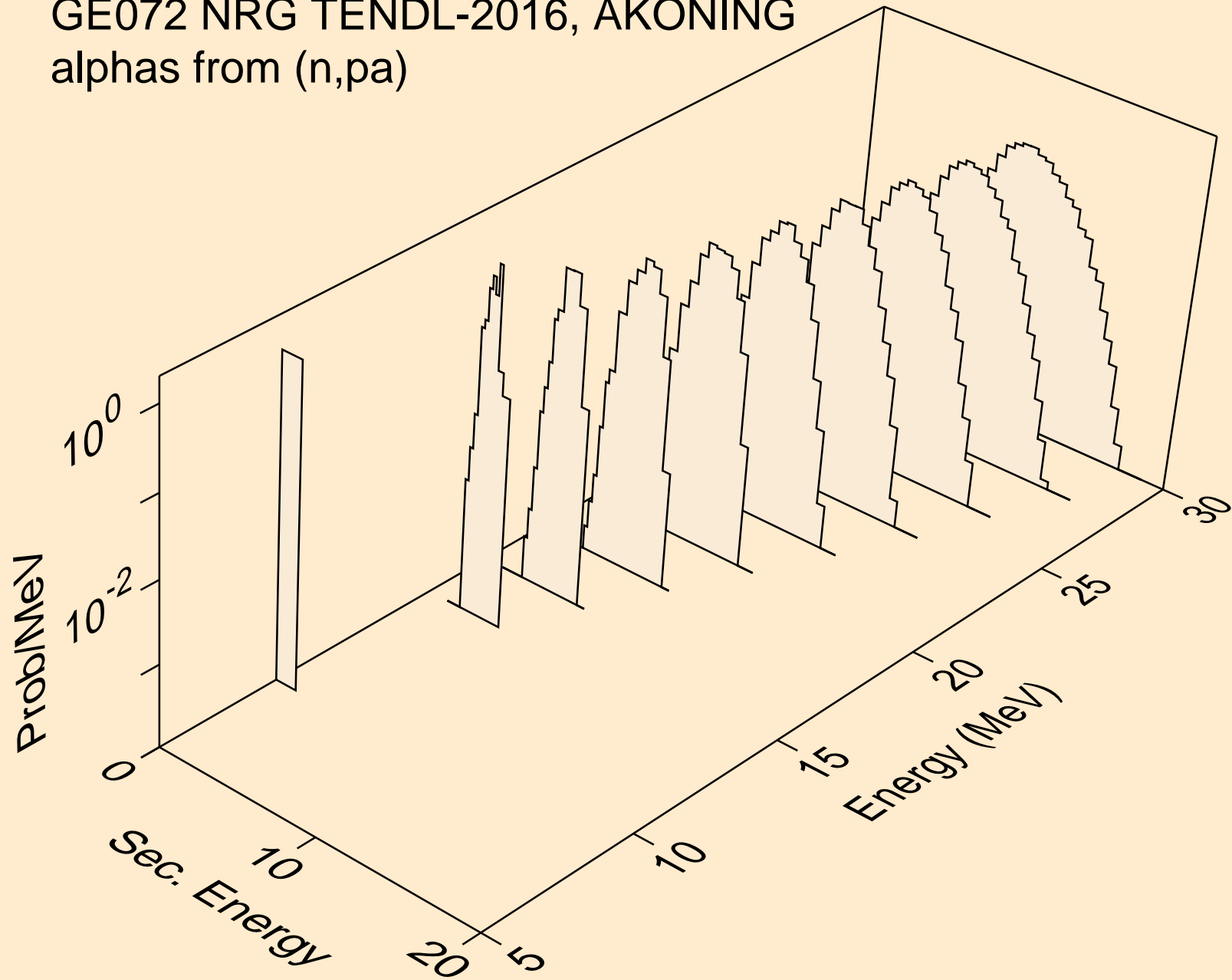

GE072 NRG TENDL-2016, AKONING
alphas from (n,da)

