

HF182 NRG TENDL-2015, AKONING

Principal cross sections

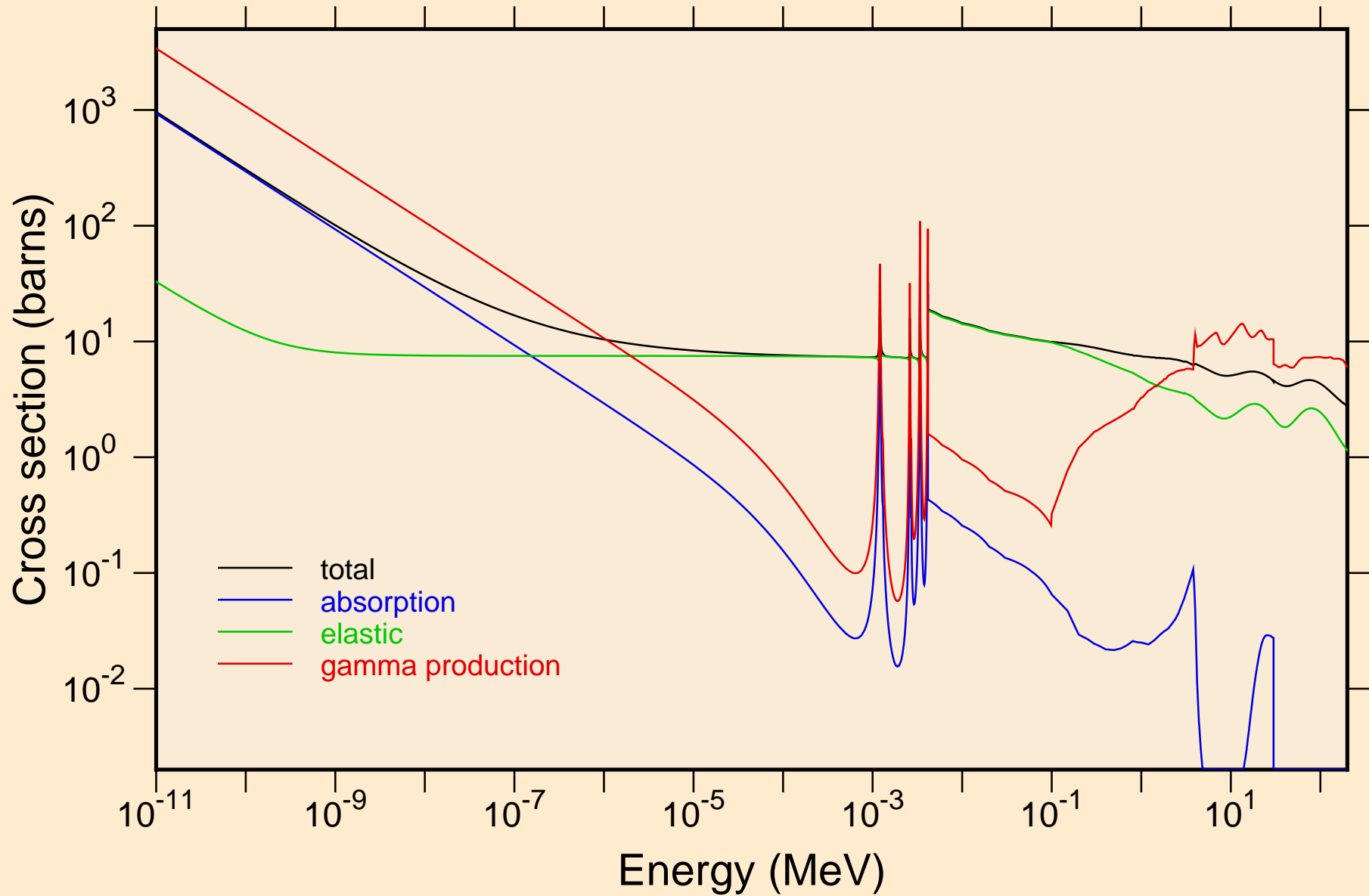

HF182 NRG TENDL-2015, AKONING

Non-threshold reactions

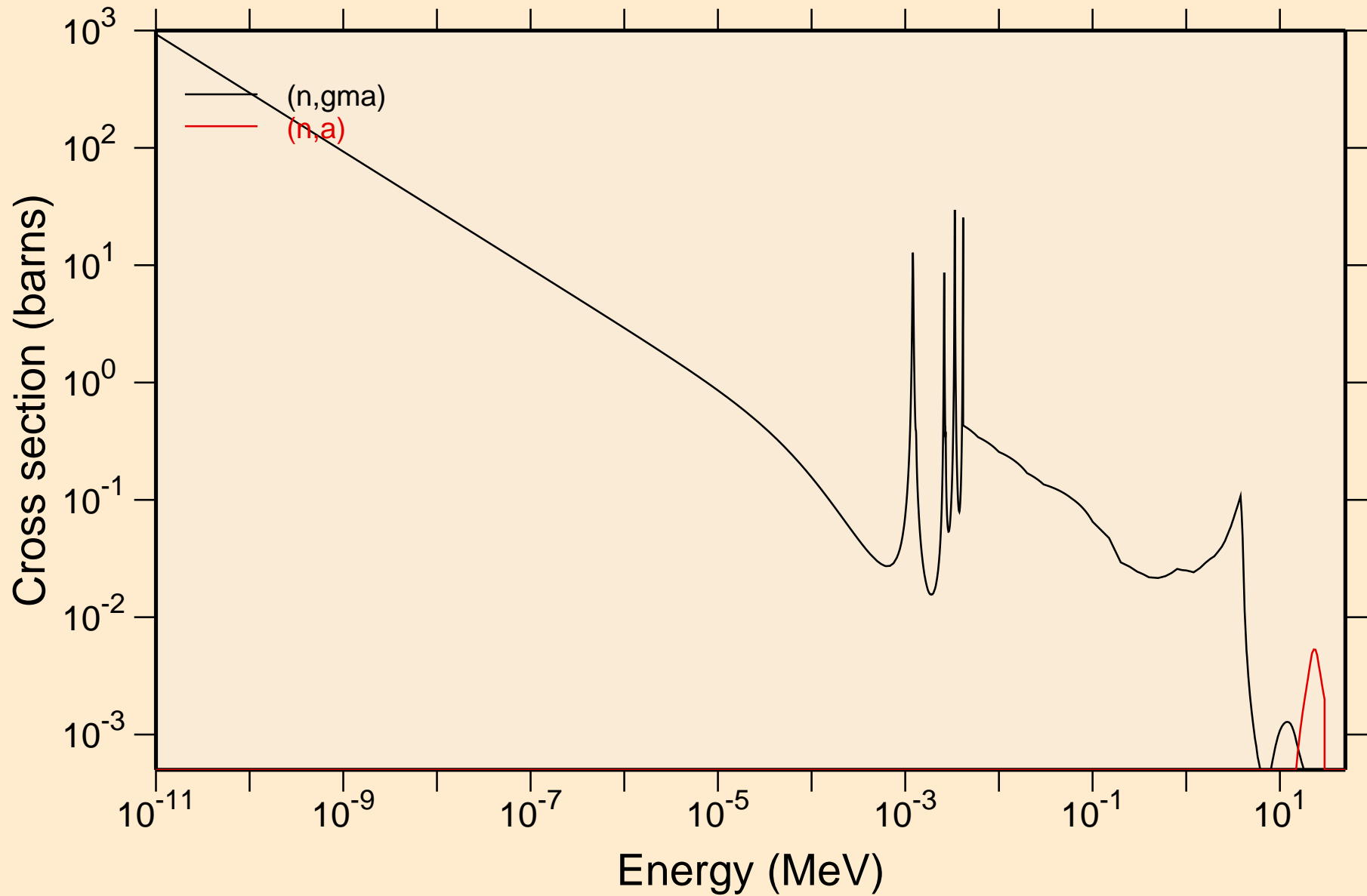

HF182 NRG TENDL-2015, AKONING

Principal cross sections

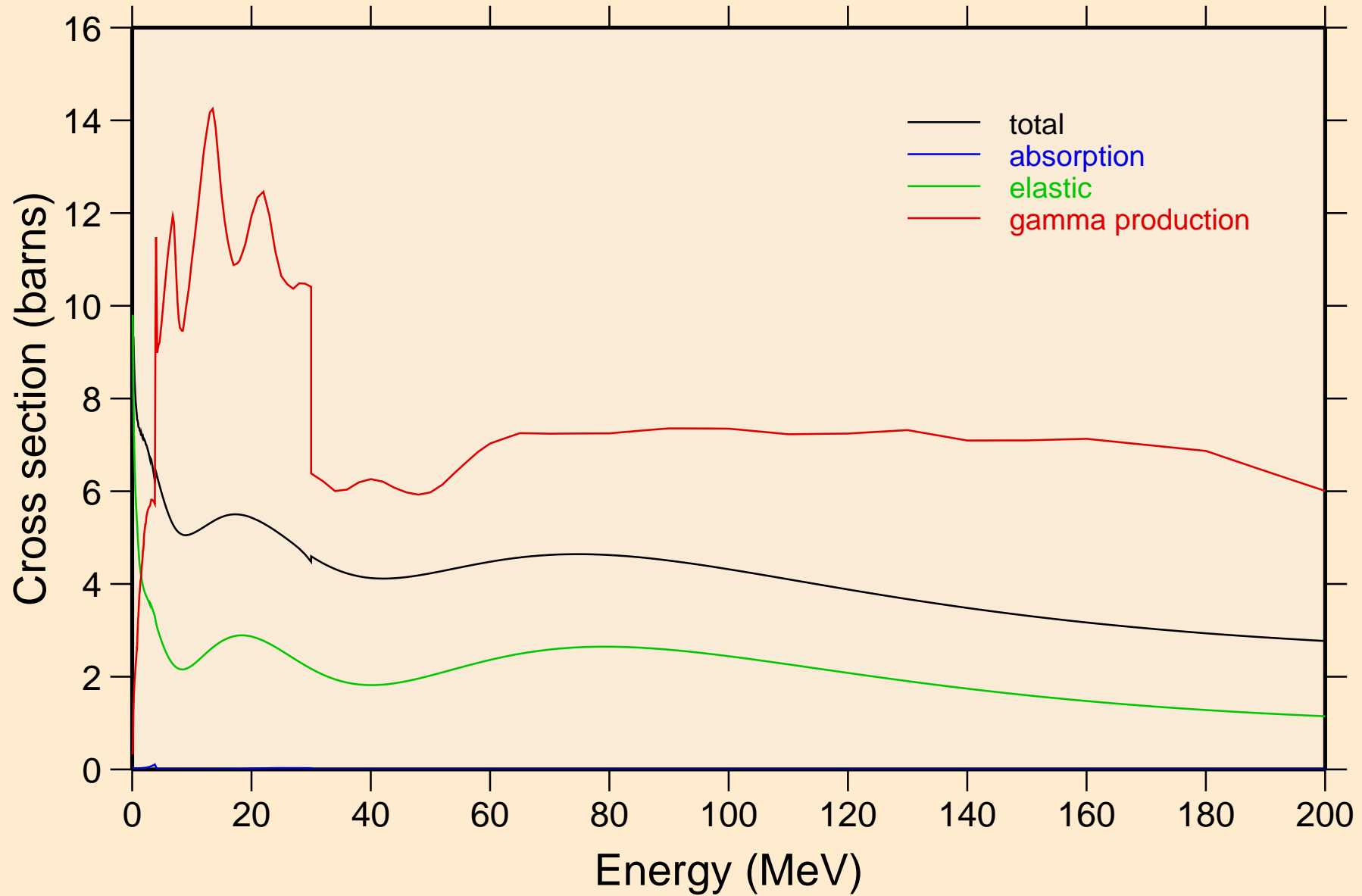

HF182 NRG TENDL-2015, AKONING

Non-threshold reactions

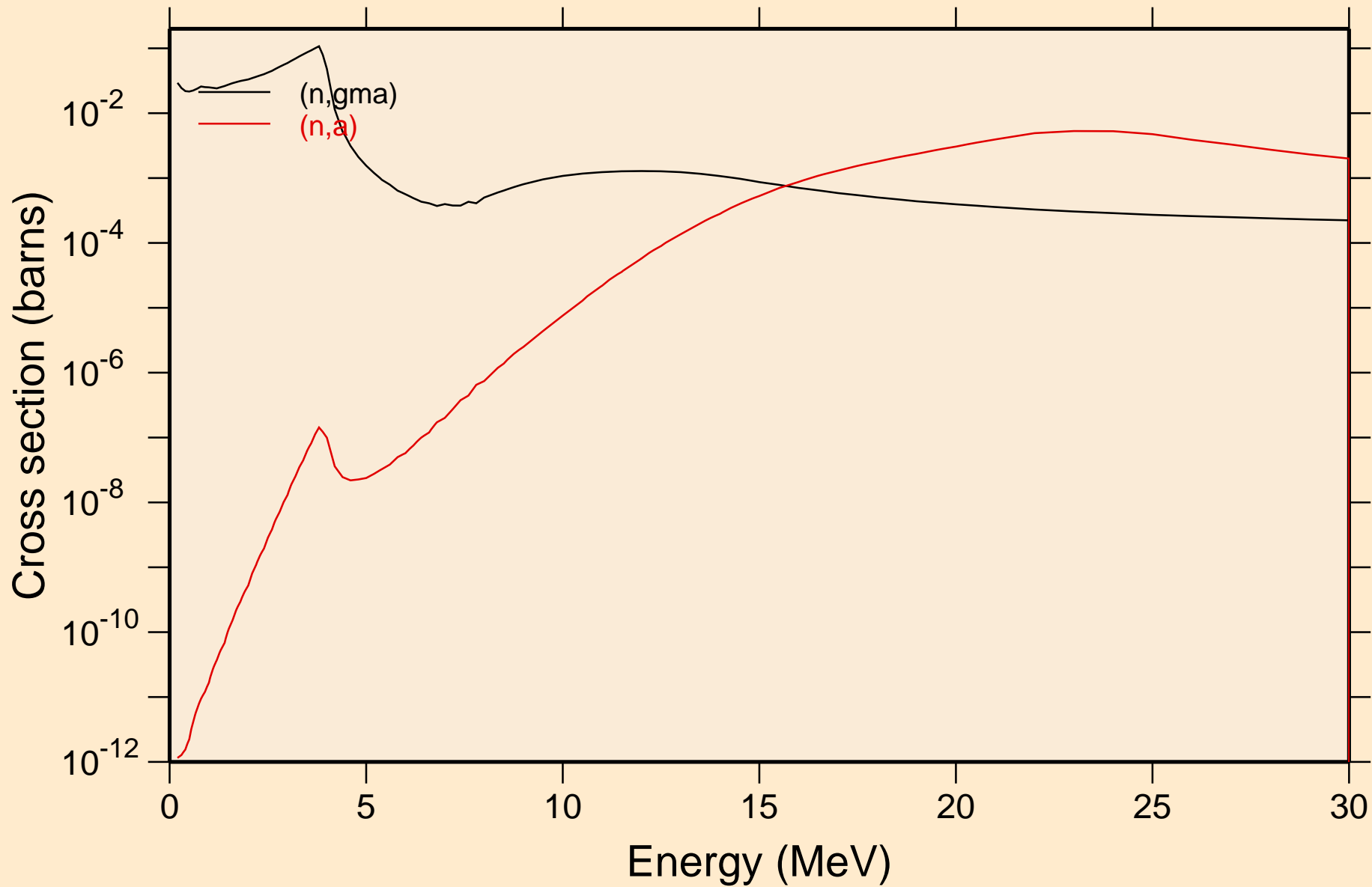

HF182 NRG TENDL-2015, AKONING

Inelastic levels

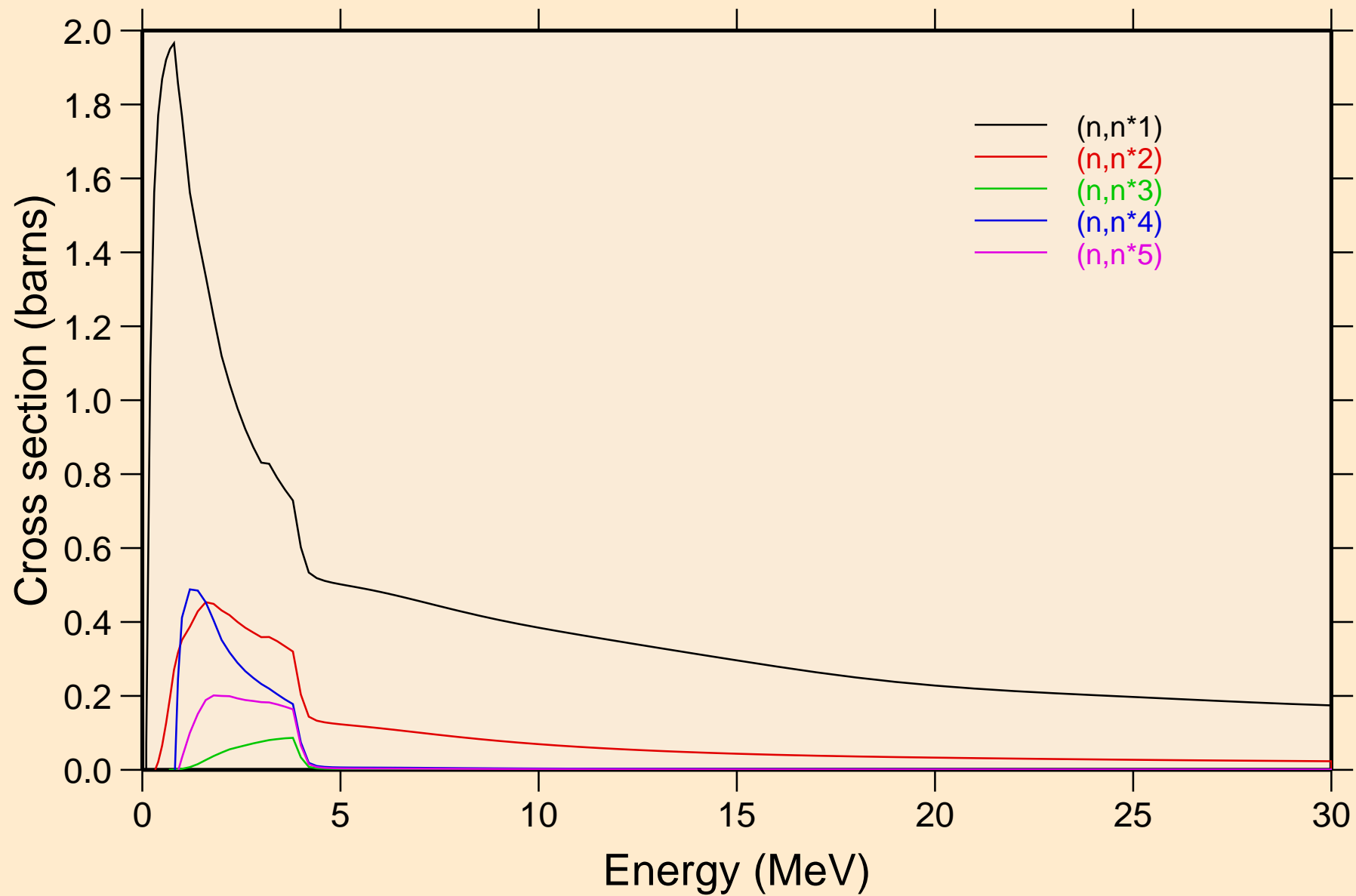

HF182 NRG TENDL-2015, AKONING

Inelastic levels

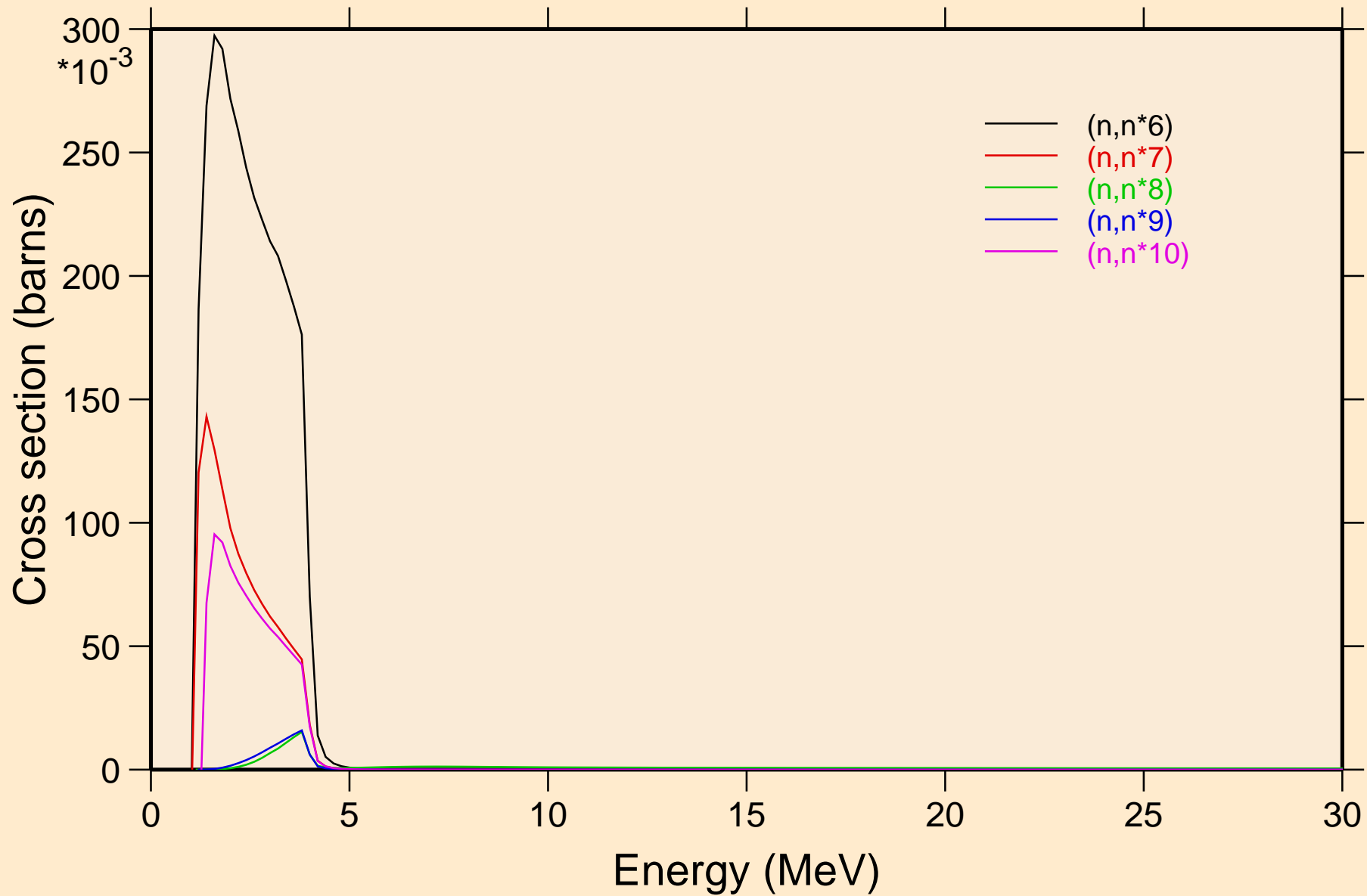

HF182 NRG TENDL-2015, AKONING

Inelastic levels

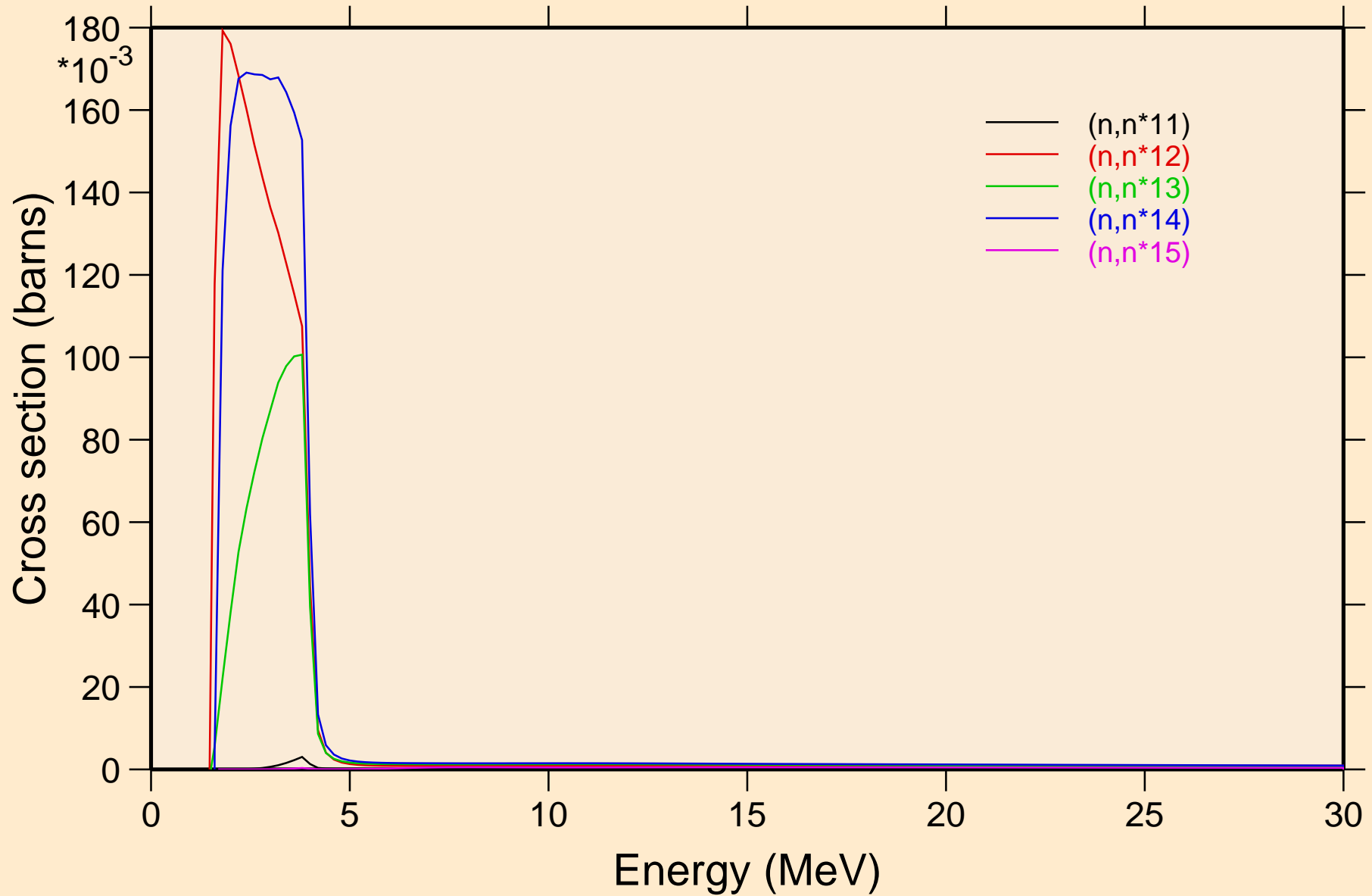

HF182 NRG TENDL-2015, AKONING

Inelastic levels

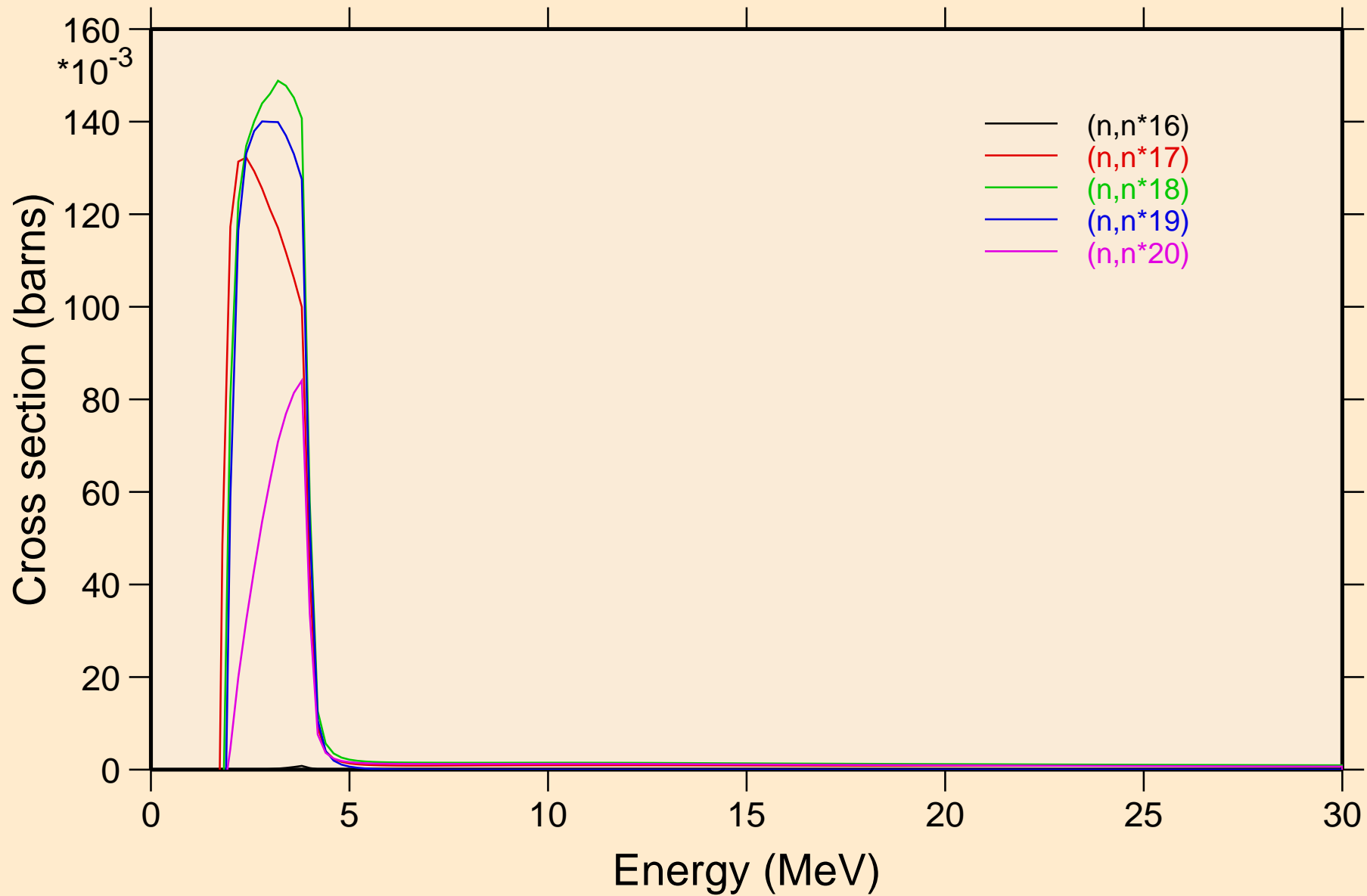

HF182 NRG TENDL-2015, AKONING

Inelastic levels

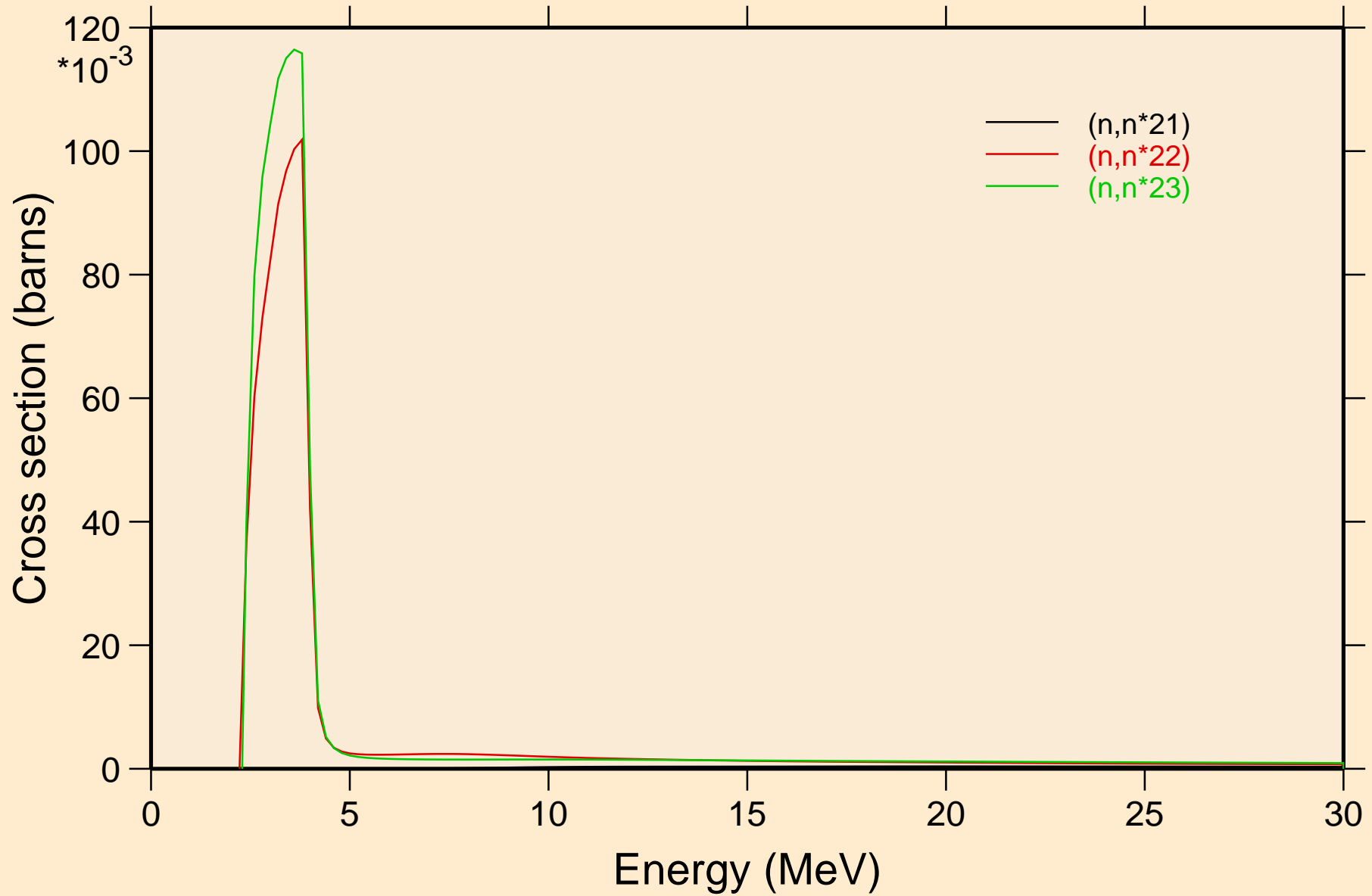

HF182 NRG TENDL-2015, AKONING

Threshold reactions

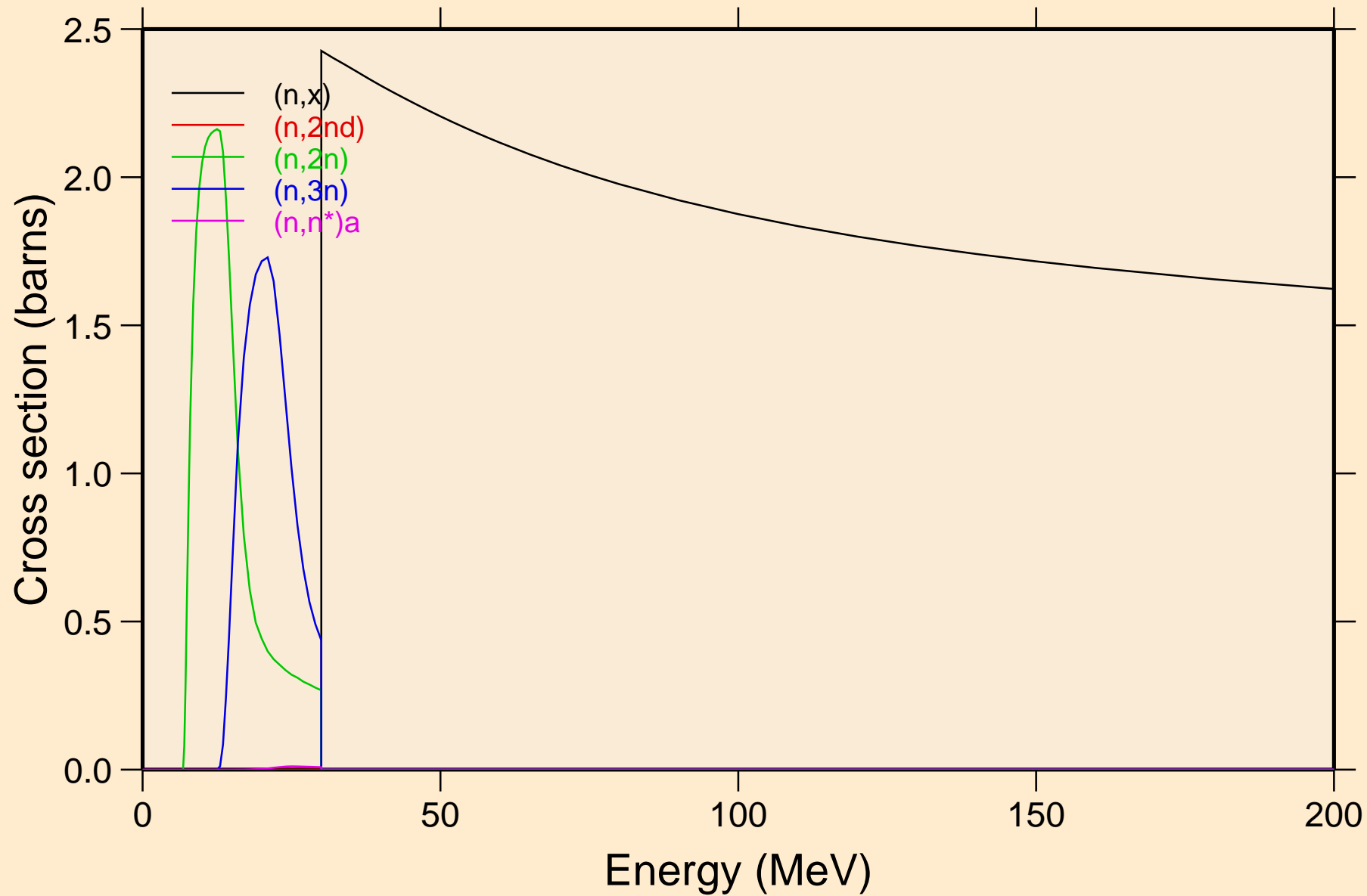

HF182 NRG TENDL-2015, AKONING

Threshold reactions

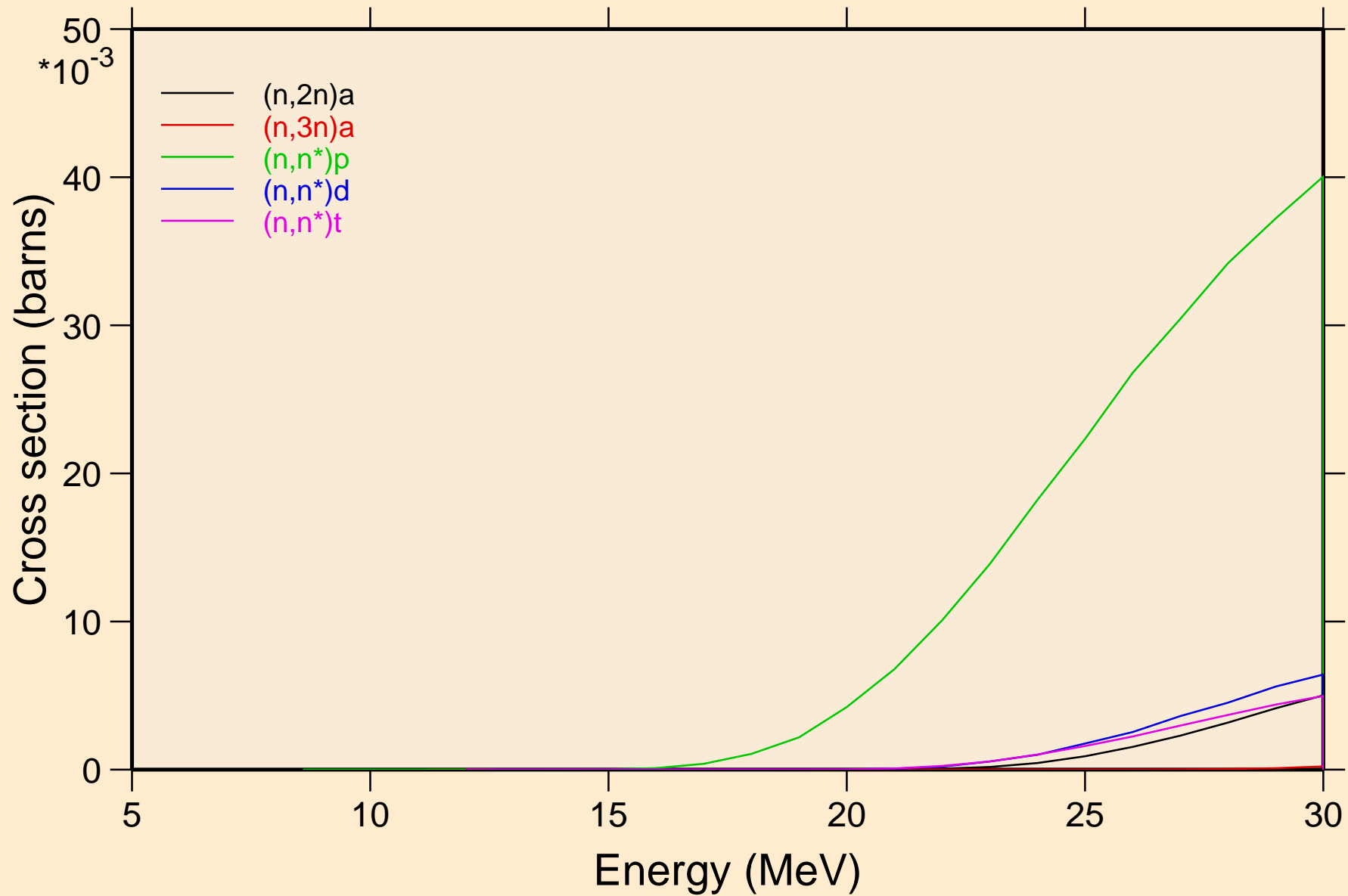

HF182 NRG TENDL-2015, AKONING

Threshold reactions

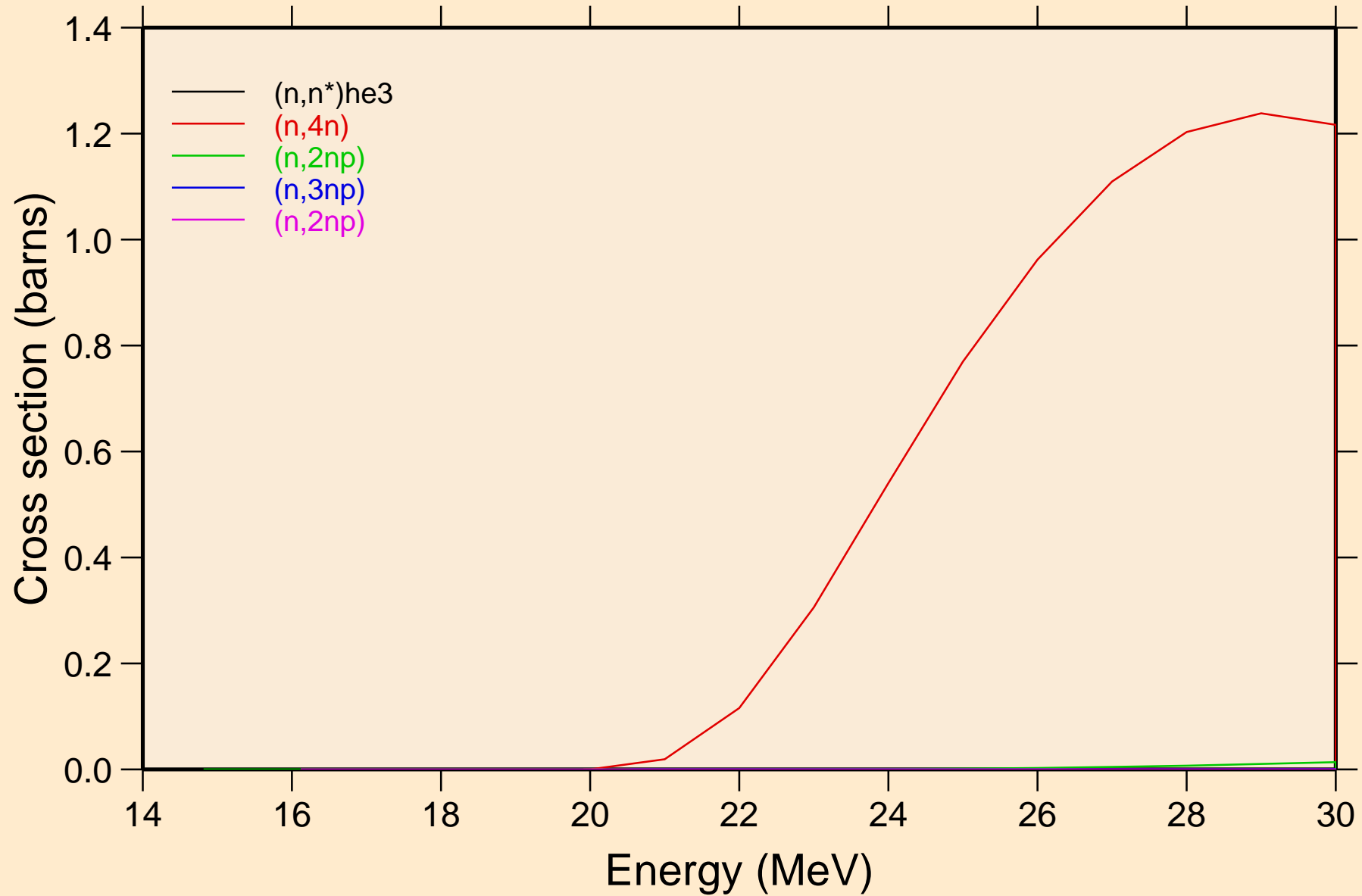

HF182 NRG TENDL-2015, AKONING

Threshold reactions

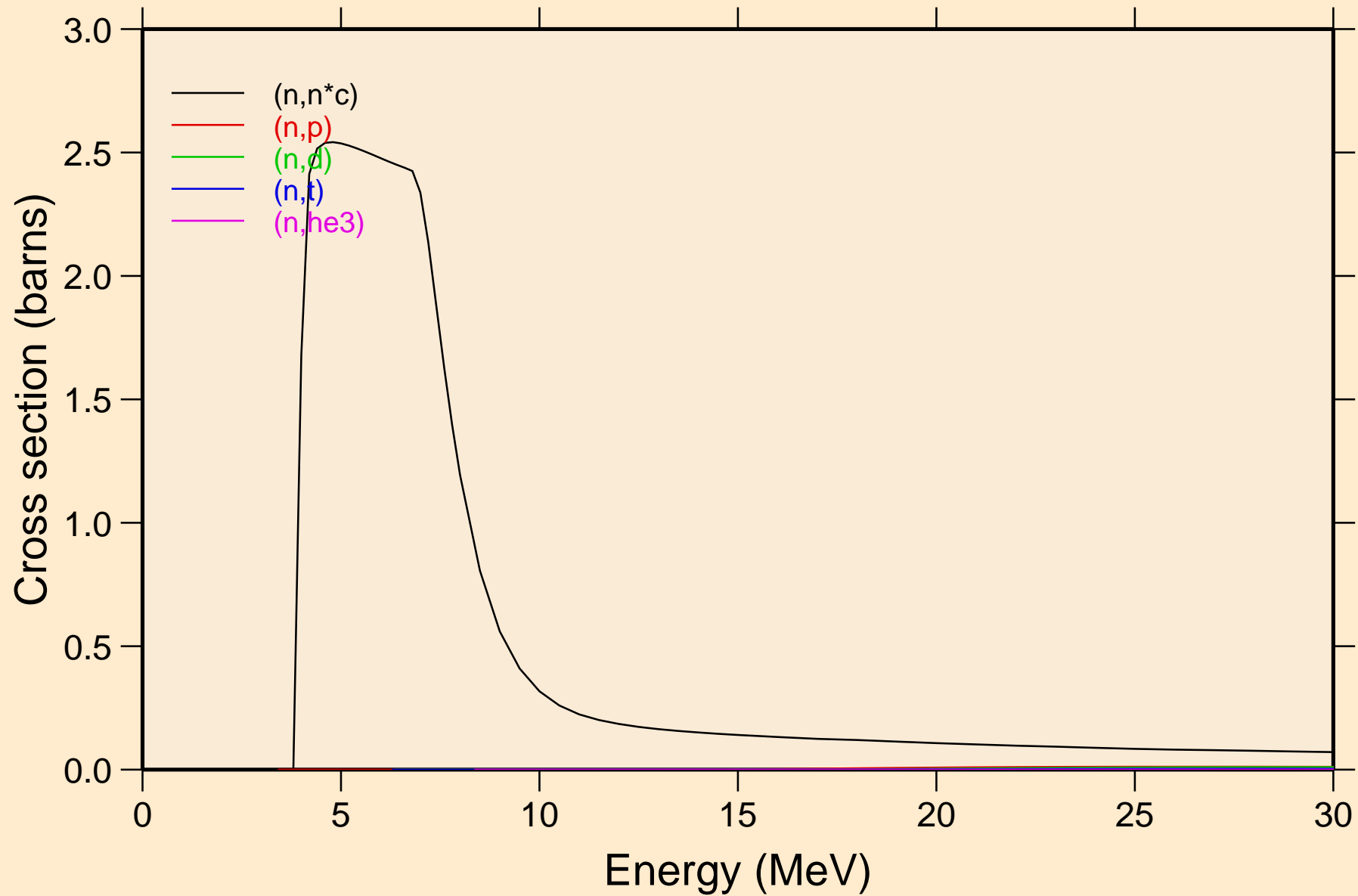

HF182 NRG TENDL-2015, AKONING

Threshold reactions

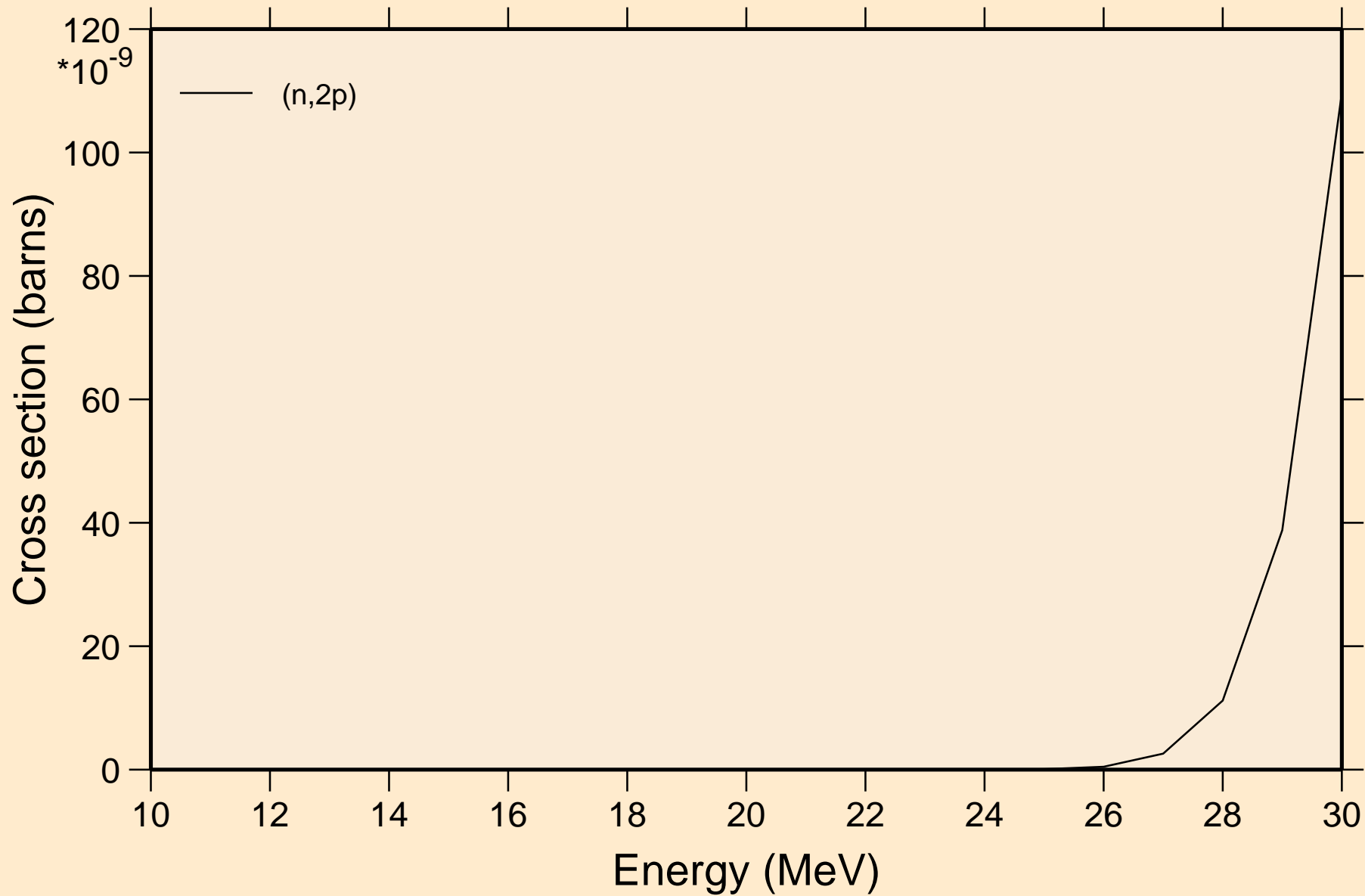

HF182 NRG TENDL-2015, AKONING
angular distribution for elastic

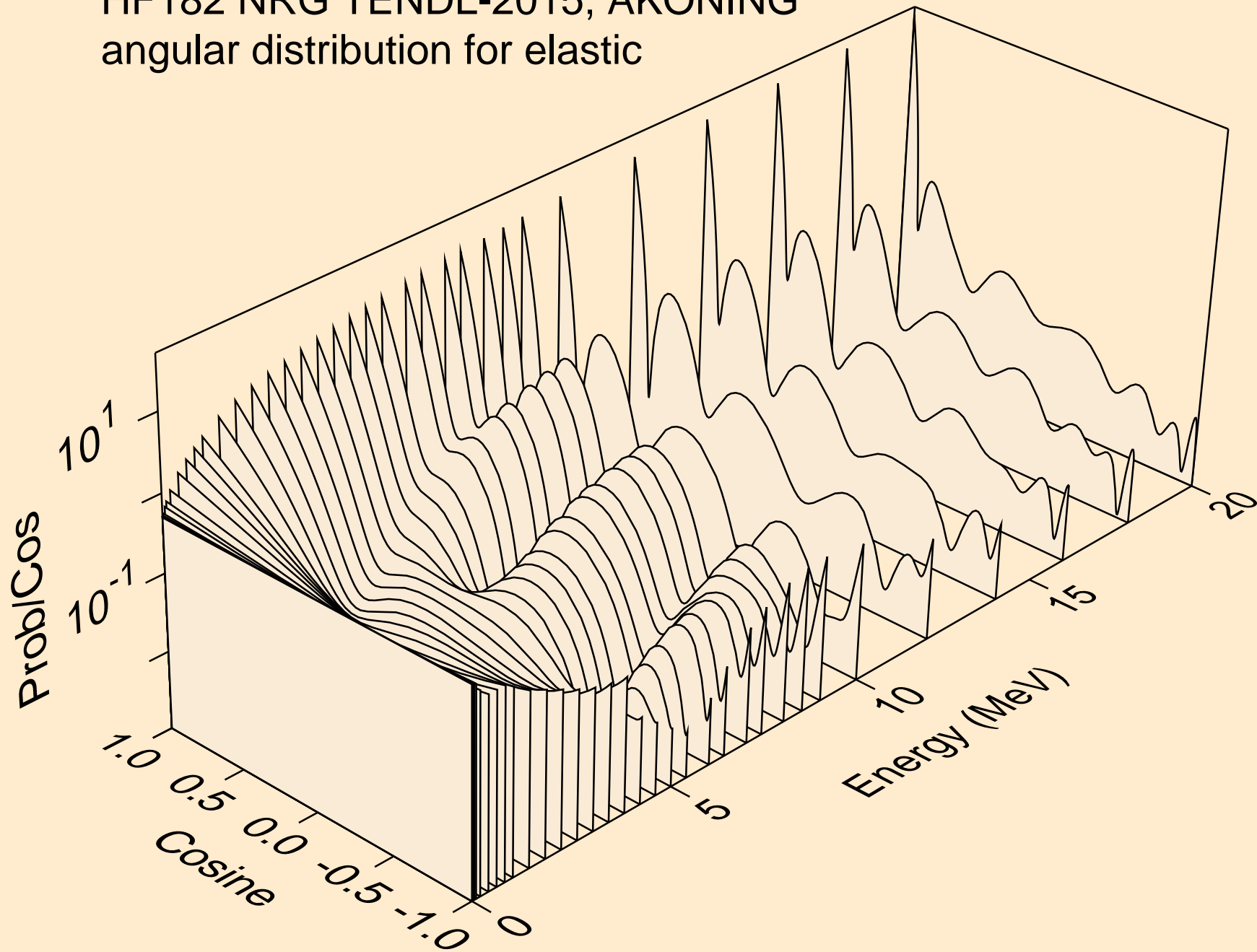

HF182 NRG TENDL-2015, AKONING
angular distribution for elastic

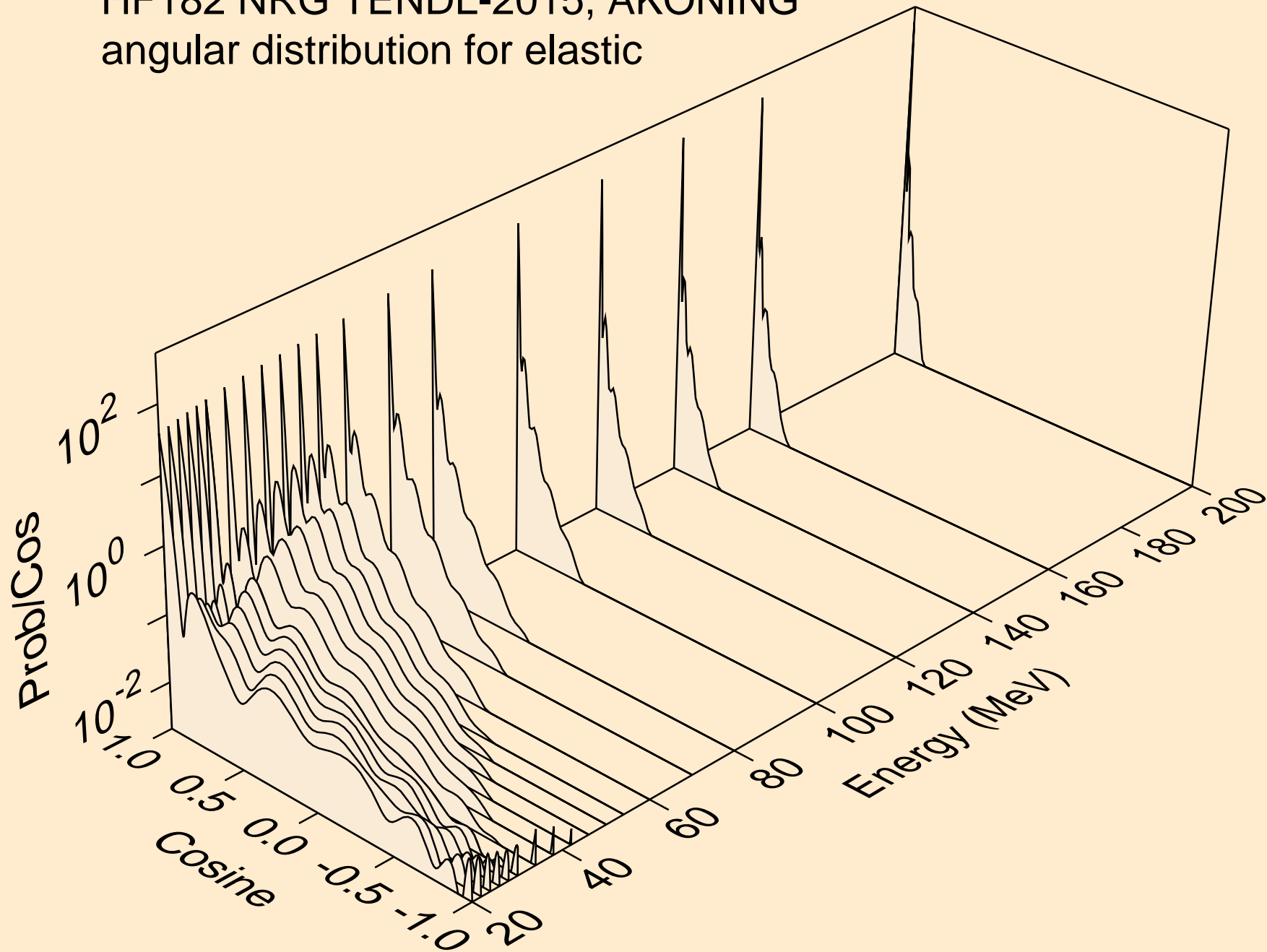

HF182 NRG TENDL-2015, AKONING
angular distribution for (n,n*1)

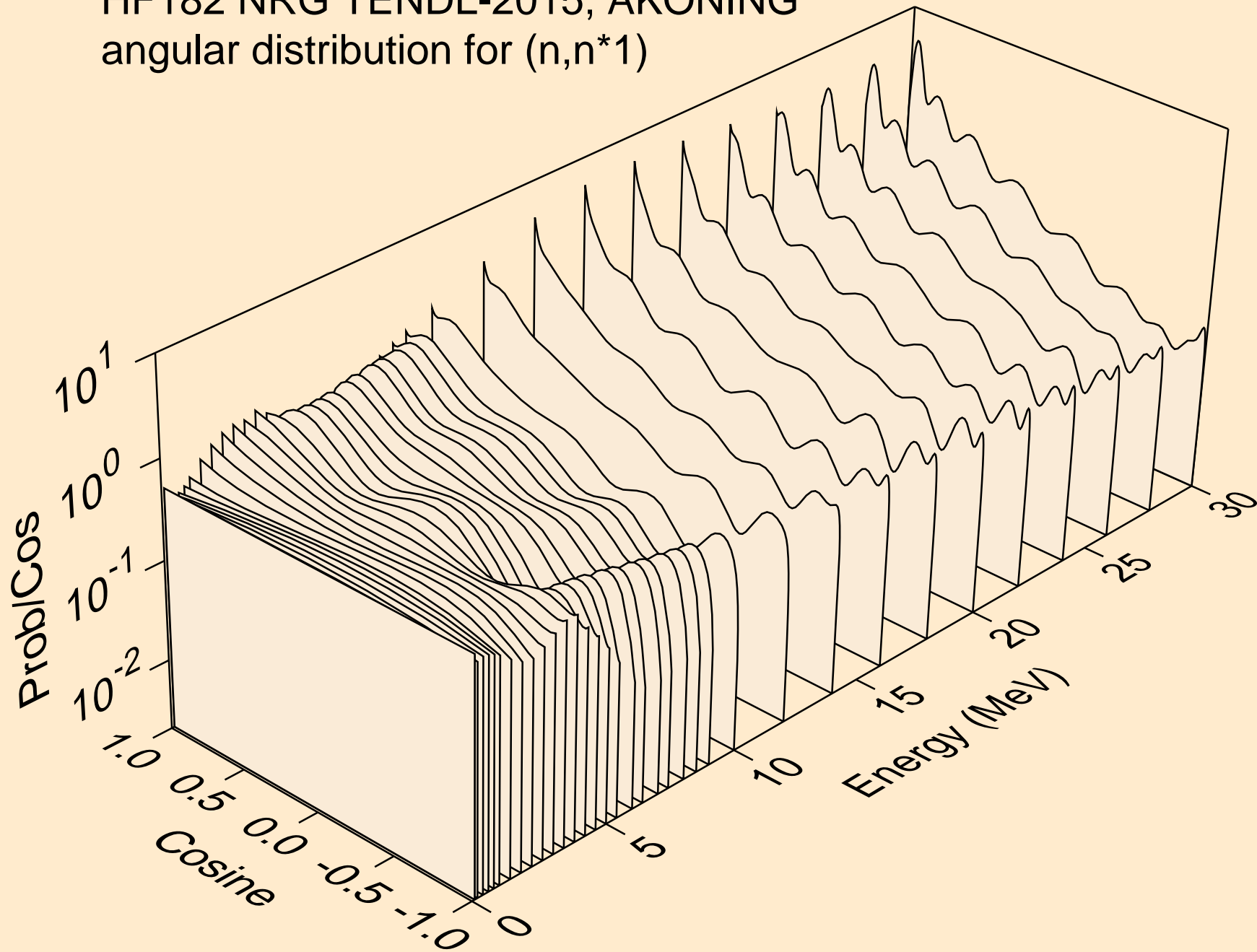

HF182 NRG TENDL-2015, AKONING
angular distribution for (n,n*2)

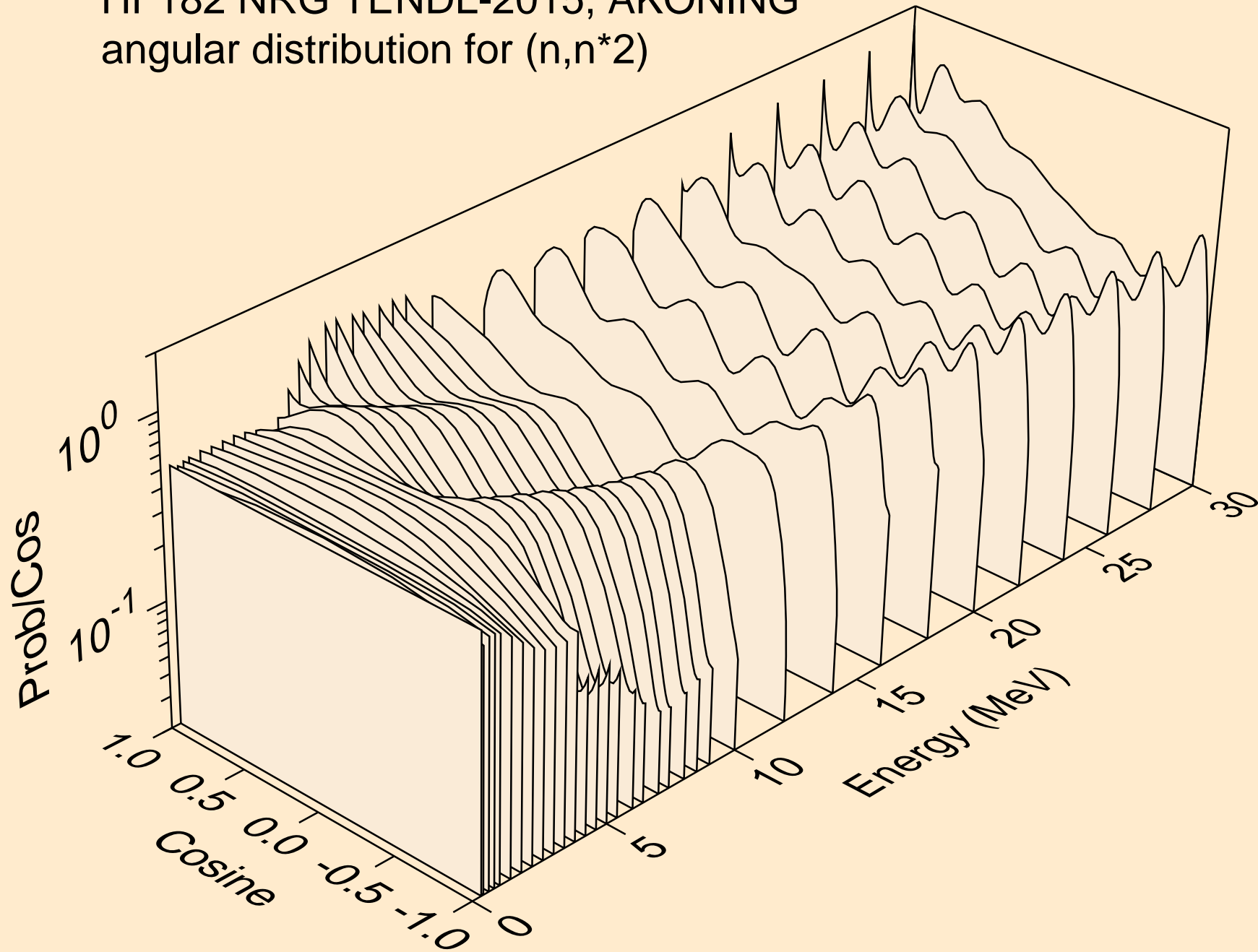

HF182 NRG TENDL-2015, AKONING
angular distribution for (n,n*3)

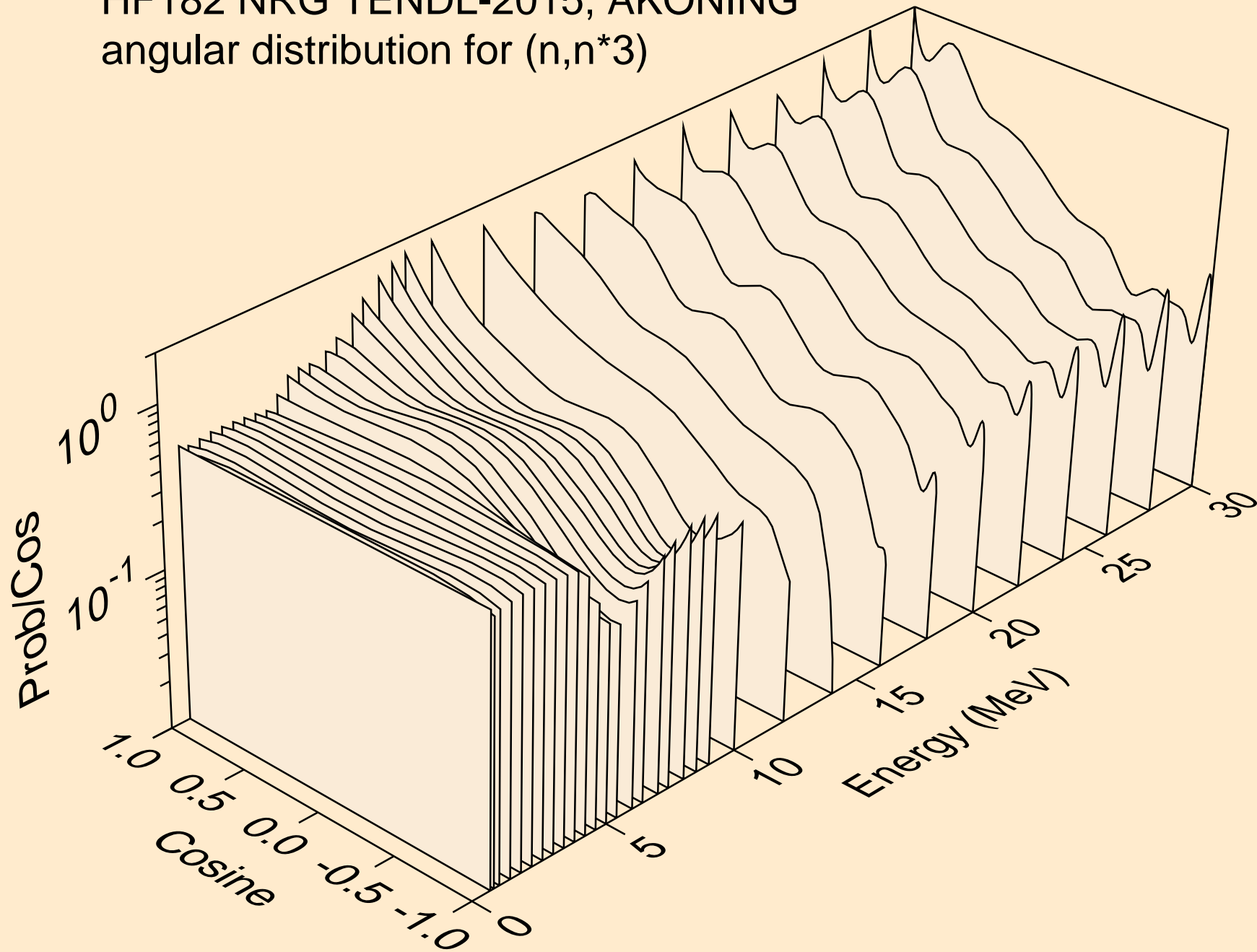

HF182 NRG TENDL-2015, AKONING
angular distribution for (n,n*4)

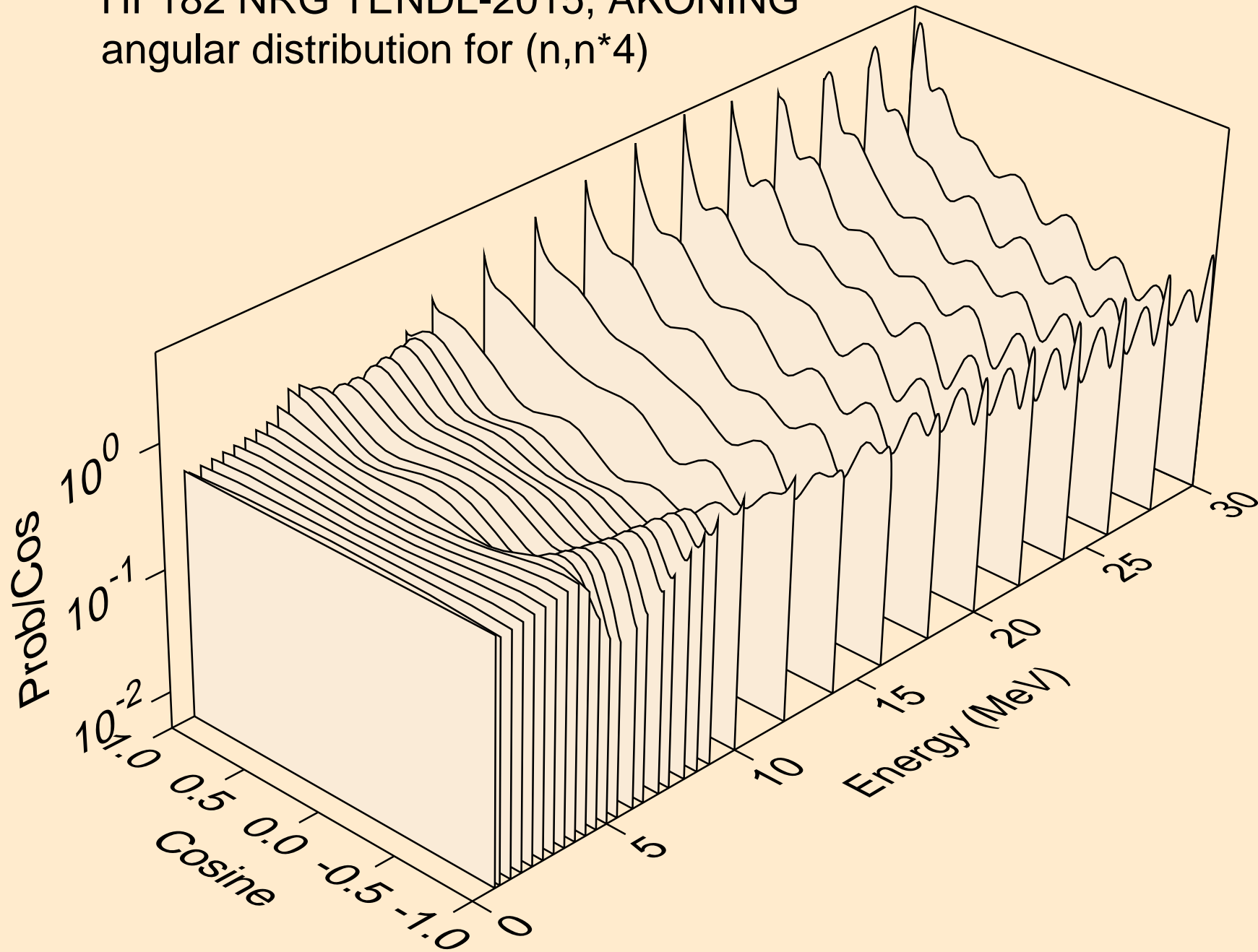

HF182 NRG TENDL-2015, AKONING
angular distribution for (n,n*5)

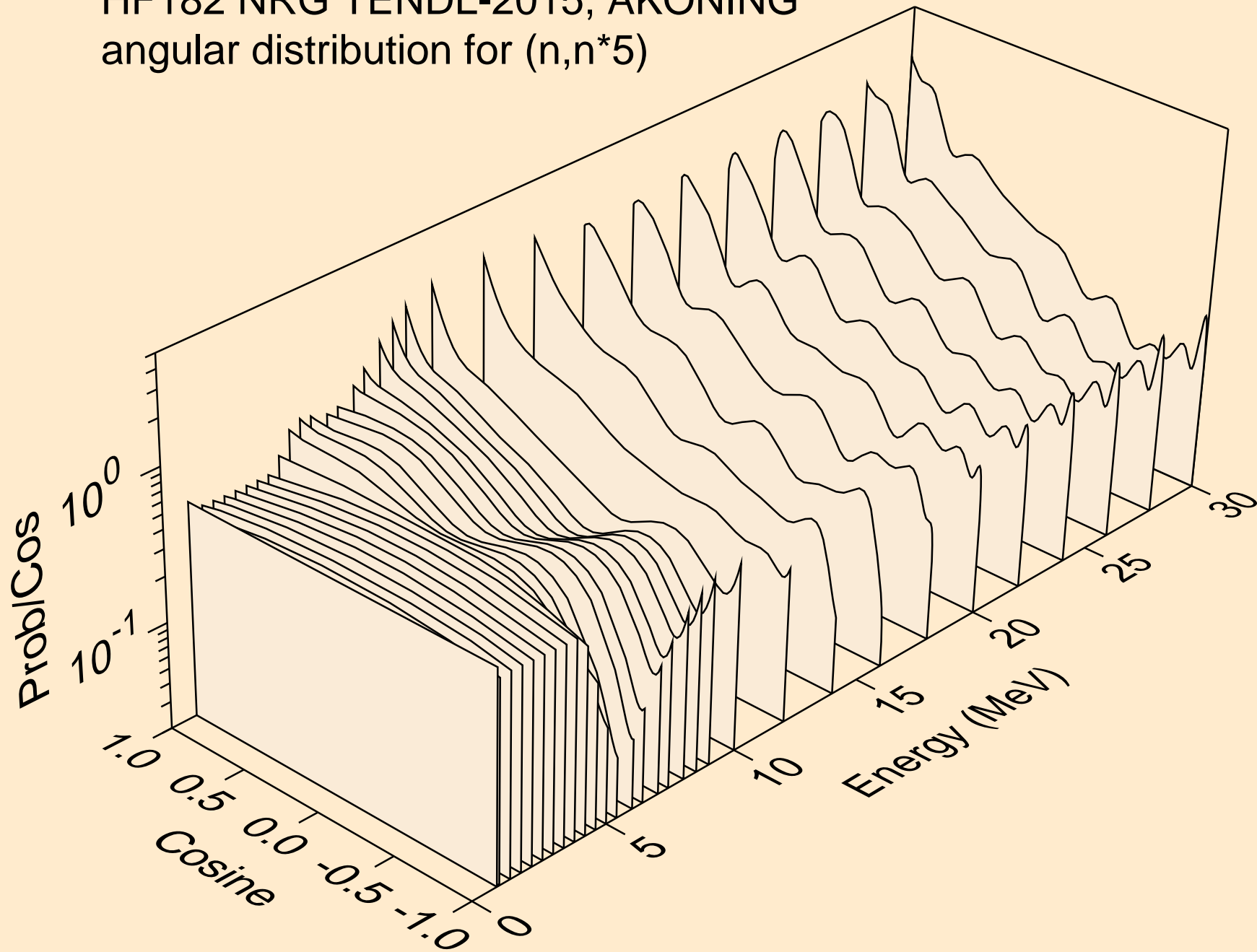

HF182 NRG TENDL-2015, AKONING
angular distribution for (n,n*6)

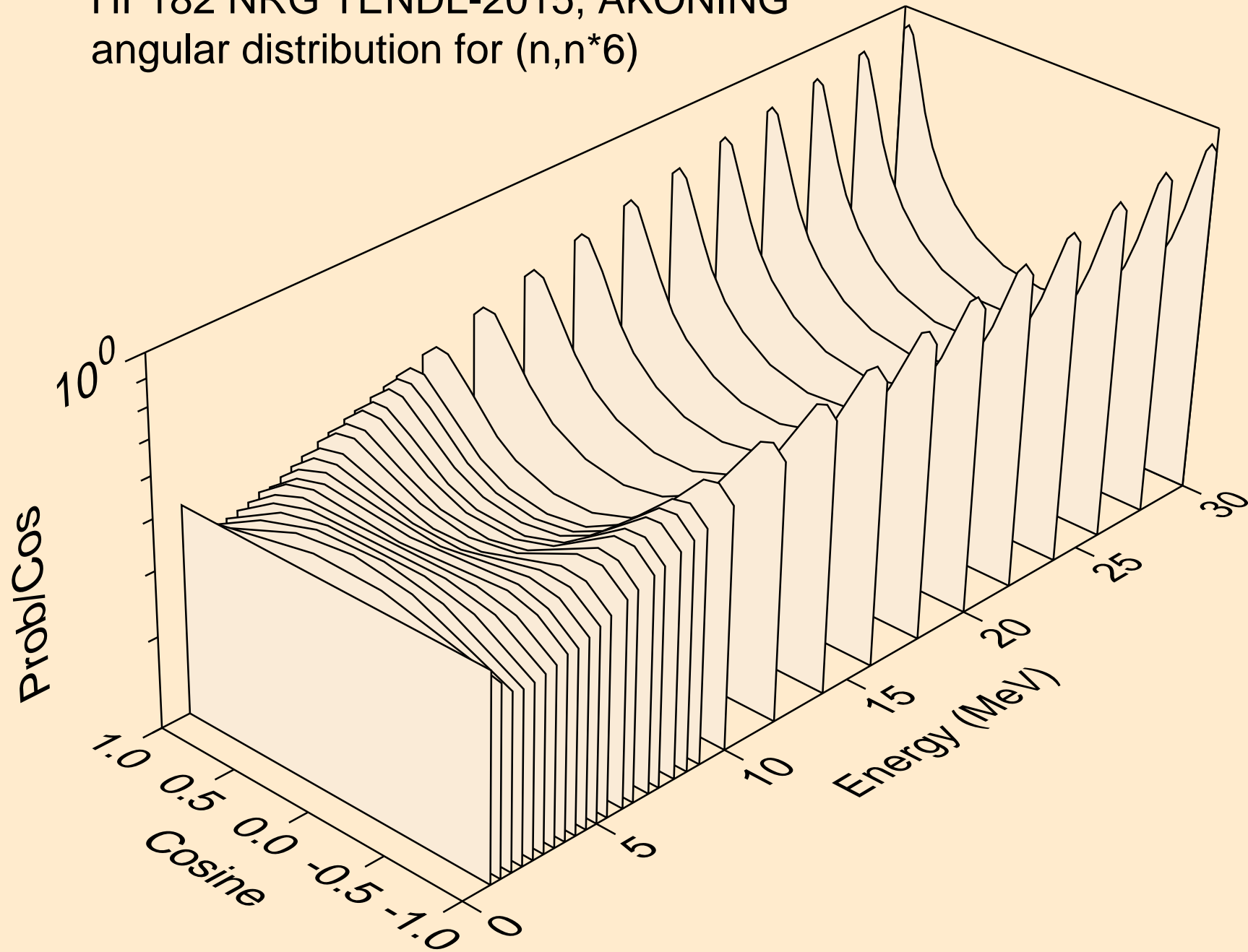

HF182 NRG TENDL-2015, AKONING
angular distribution for (n,n*7)

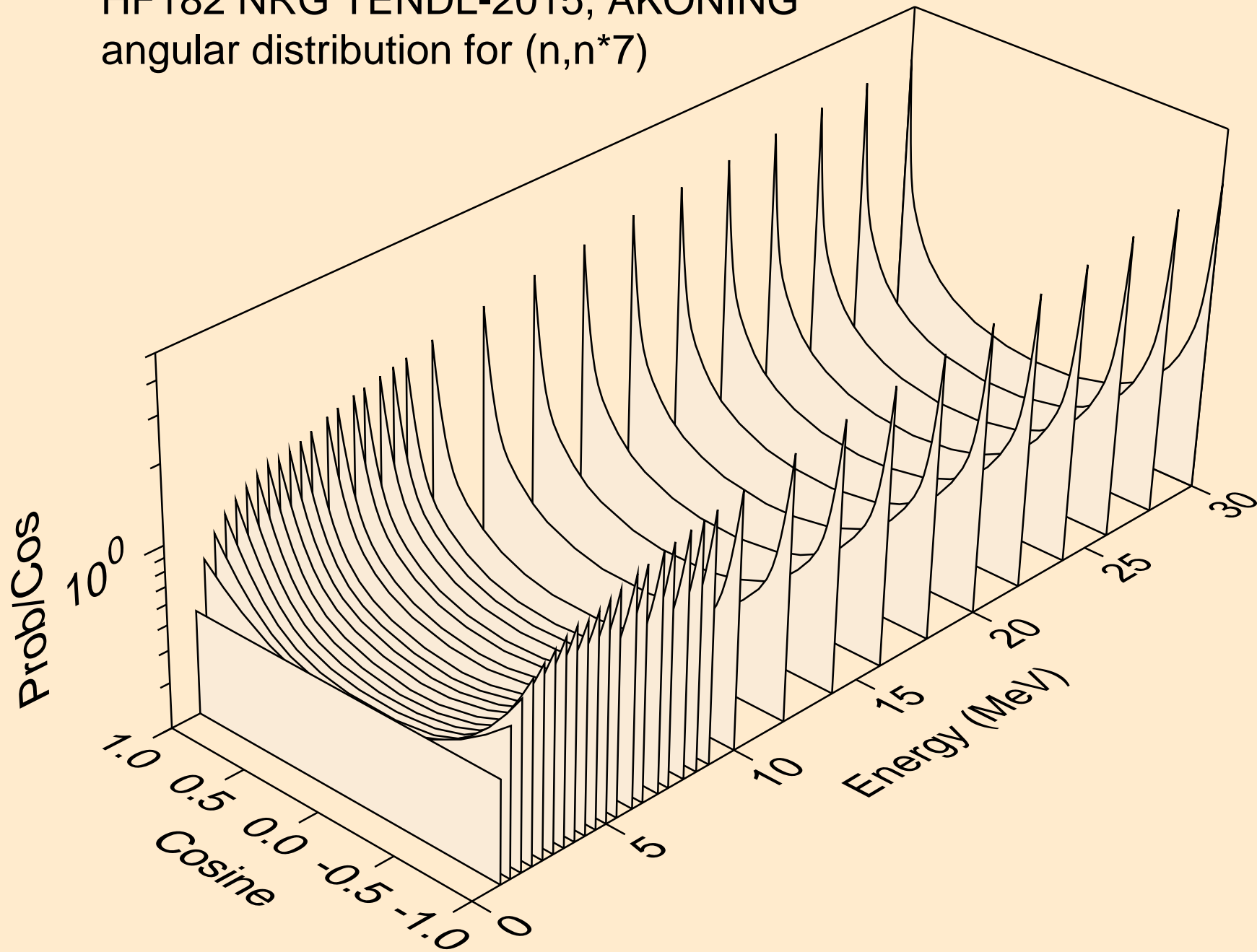

HF182 NRG TENDL-2015, AKONING
angular distribution for (n,n*8)

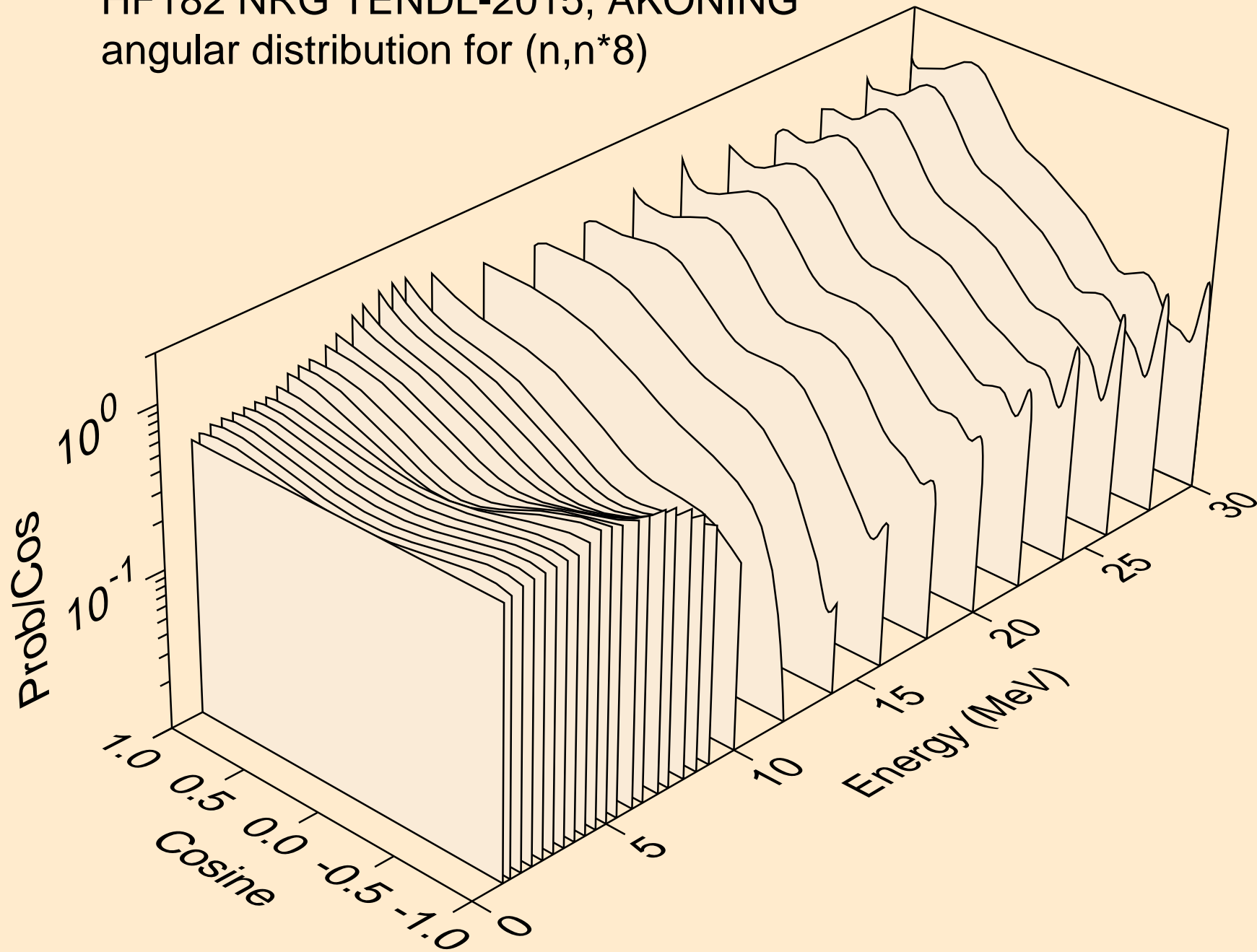

HF182 NRG TENDL-2015, AKONING
angular distribution for (n,n*9)

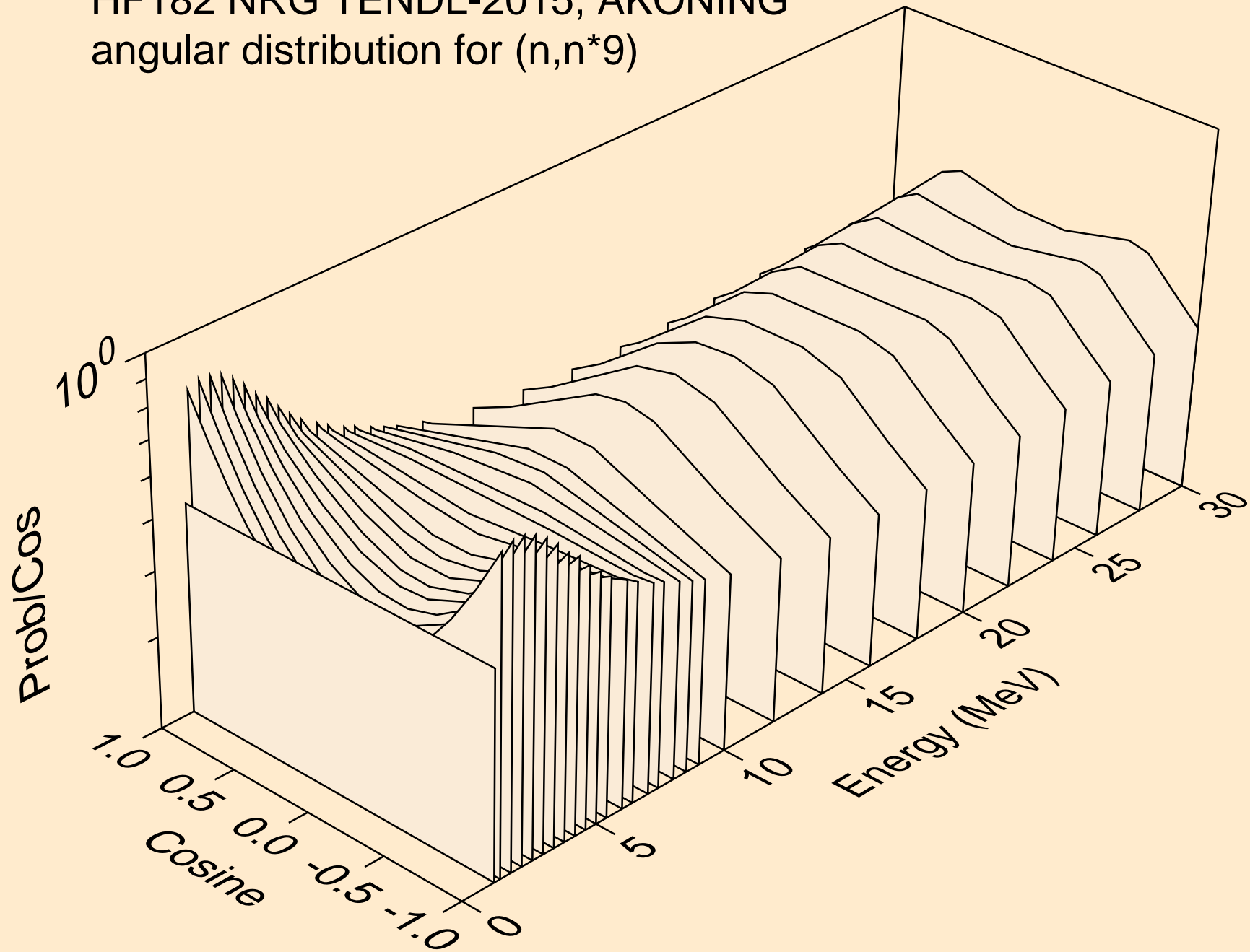

HF182 NRG TENDL-2015, AKONING
angular distribution for (n,n*10)

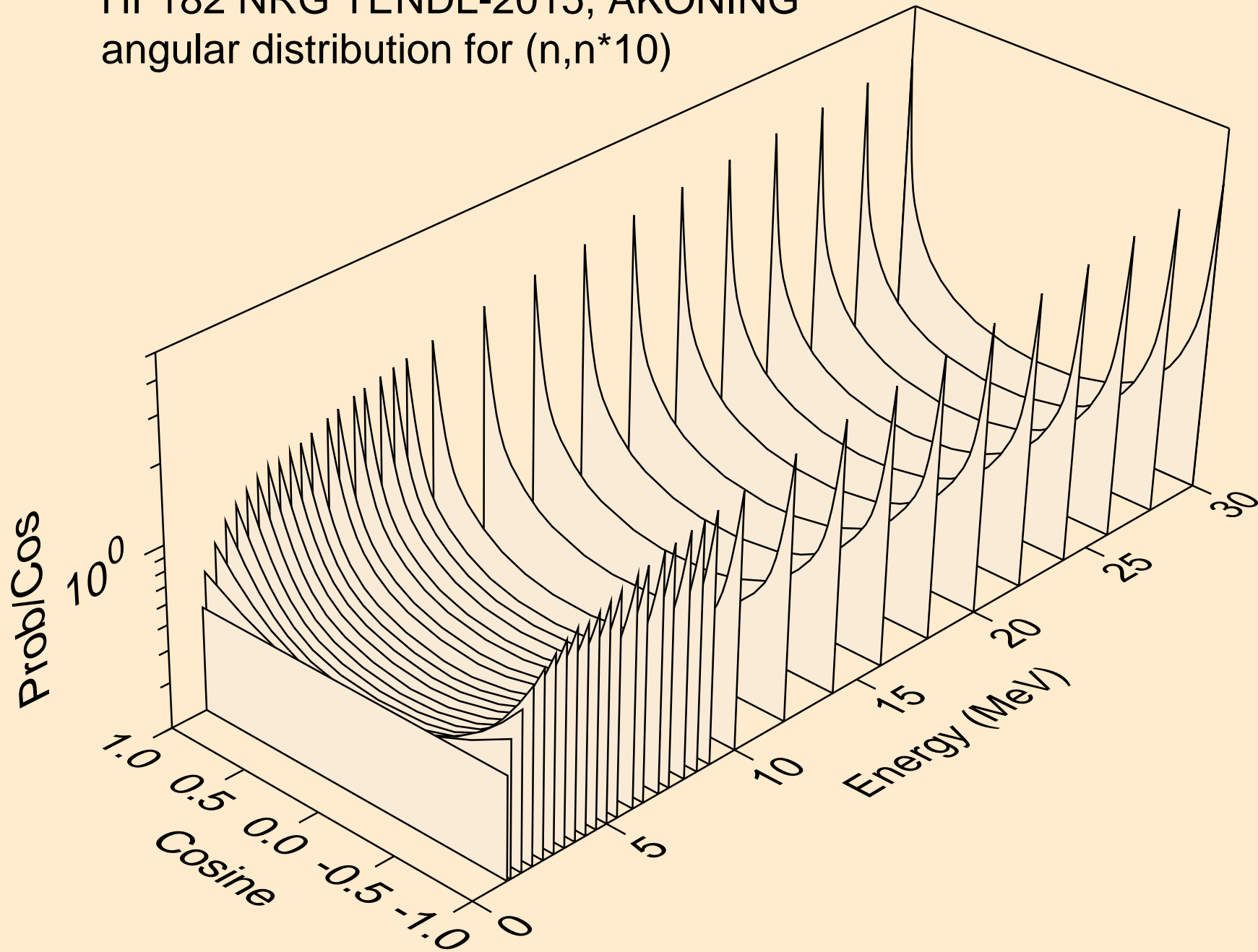

HF182 NRG TENDL-2015, AKONING
angular distribution for (n,n*11)

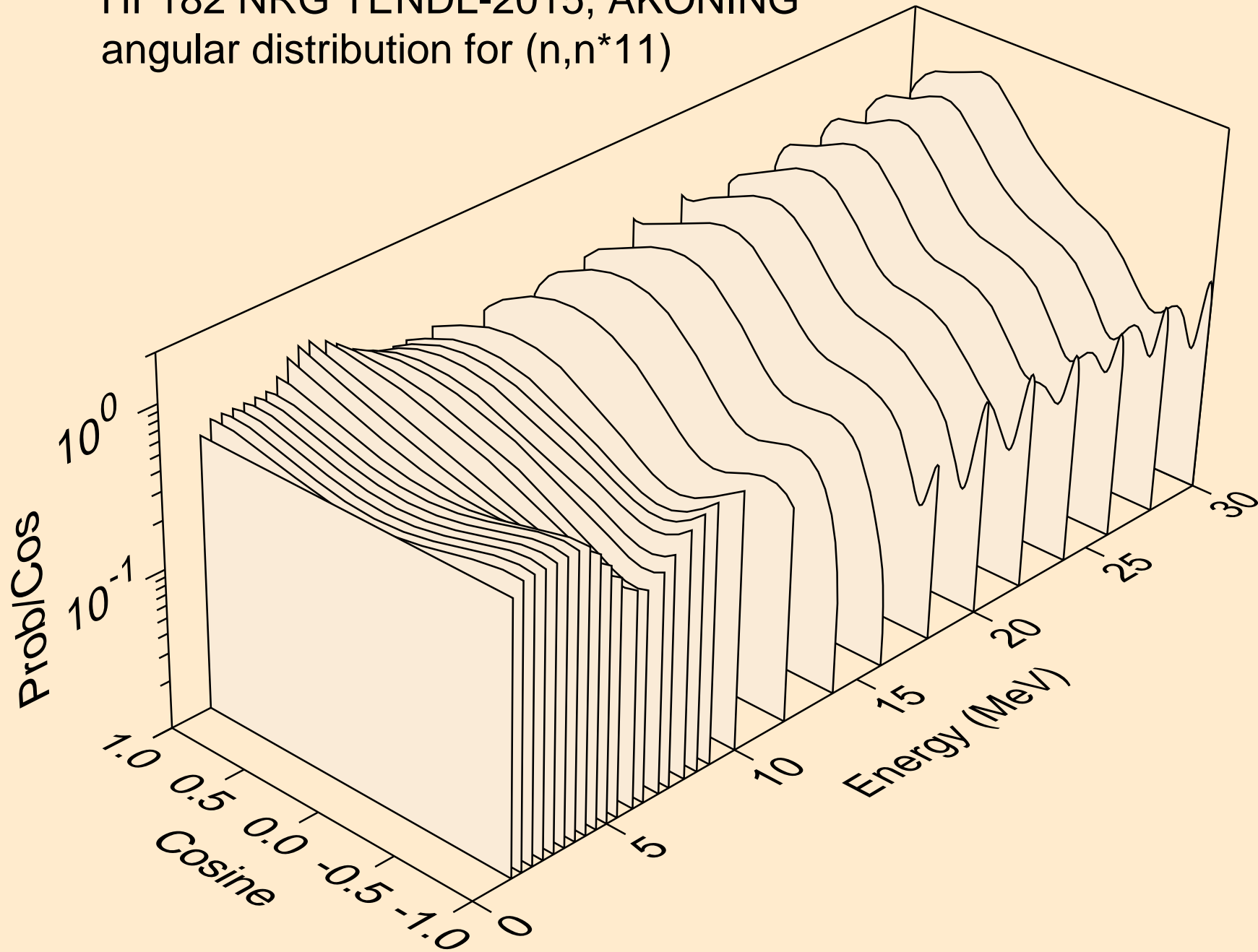

HF182 NRG TENDL-2015, AKONING
angular distribution for (n,n*12)

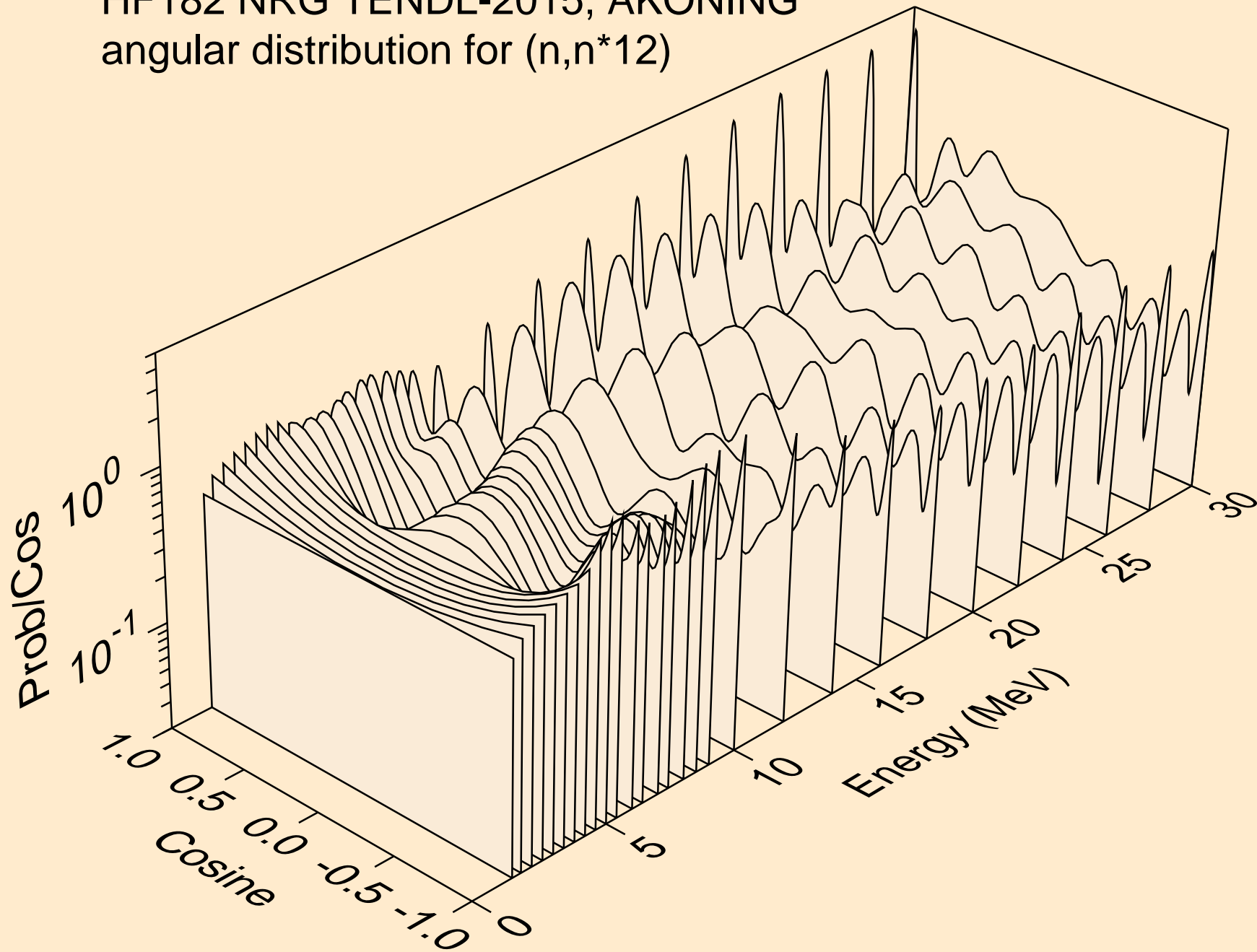

HF182 NRG TENDL-2015, AKONING
angular distribution for (n,n*13)

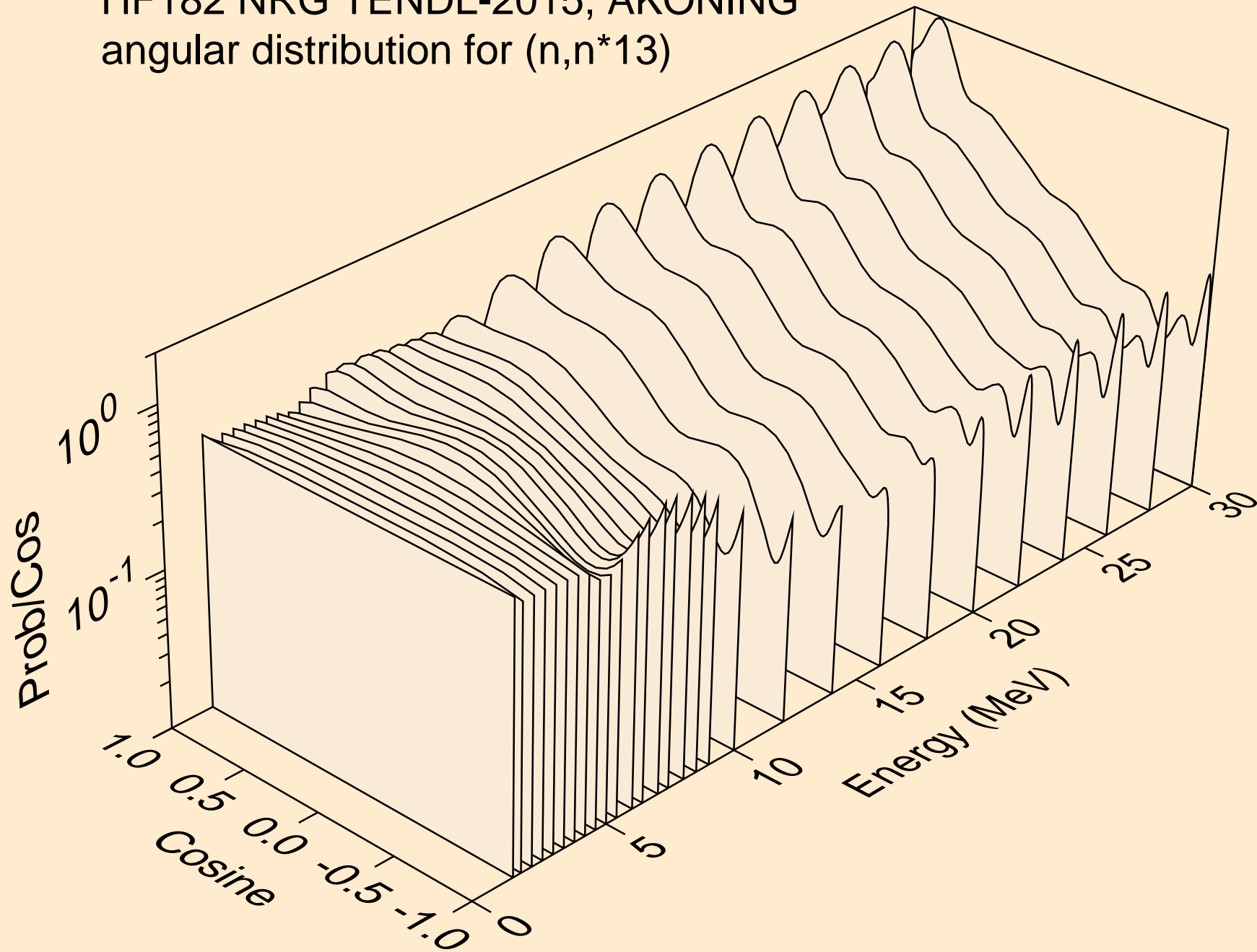

HF182 NRG TENDL-2015, AKONING
angular distribution for (n,n*14)

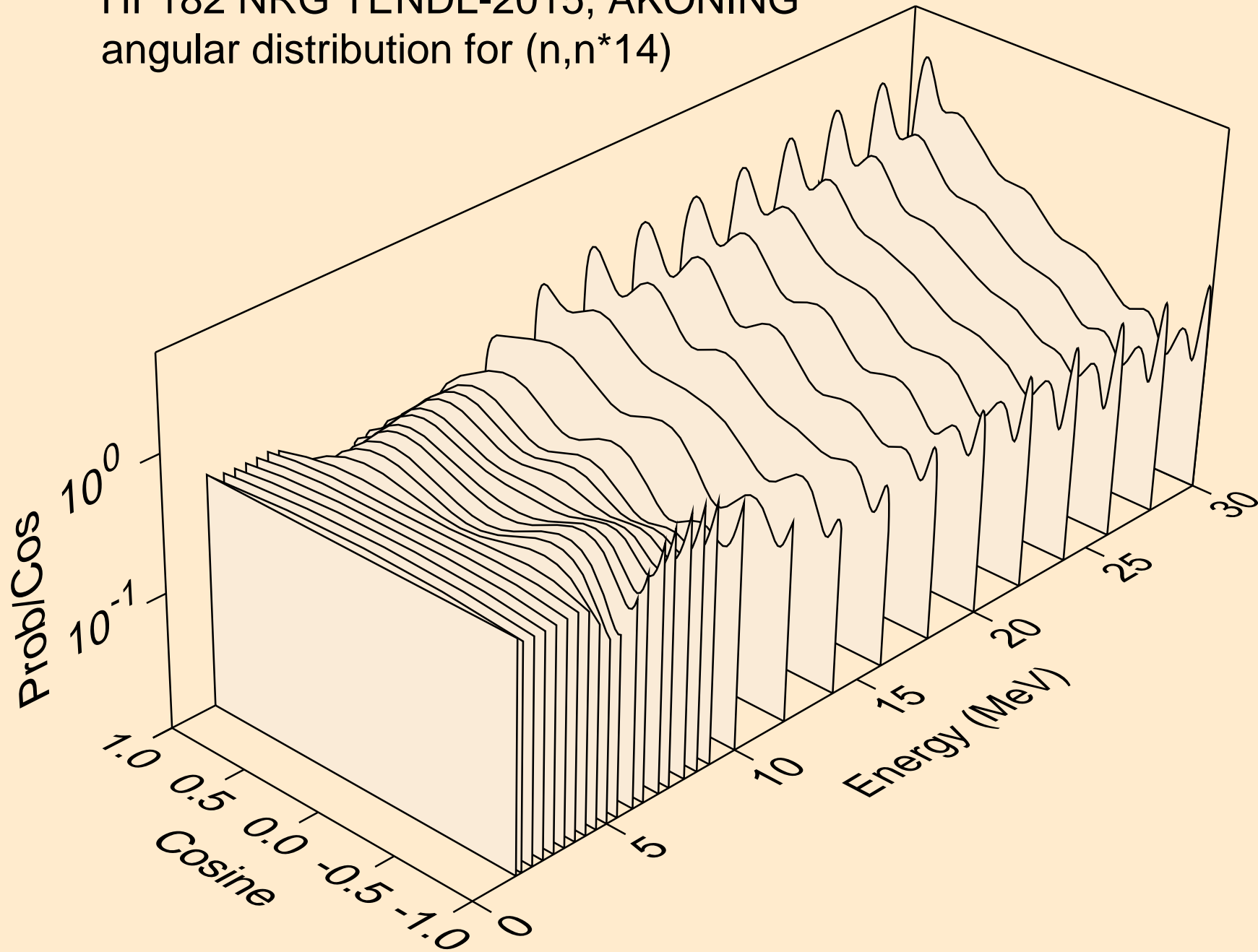

HF182 NRG TENDL-2015, AKONING
angular distribution for (n,n*15)

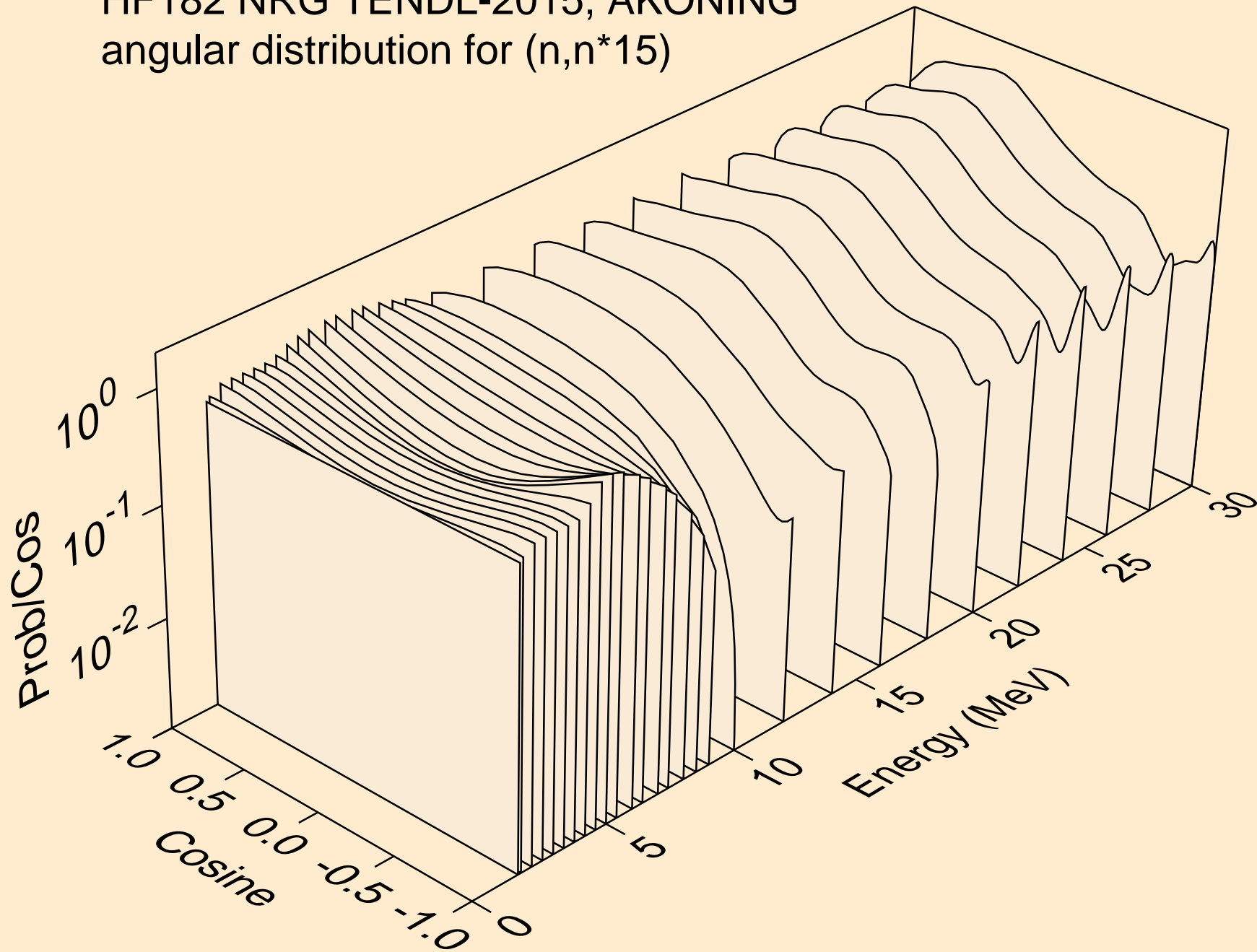

HF182 NRG TENDL-2015, AKONING
angular distribution for (n,n*16)

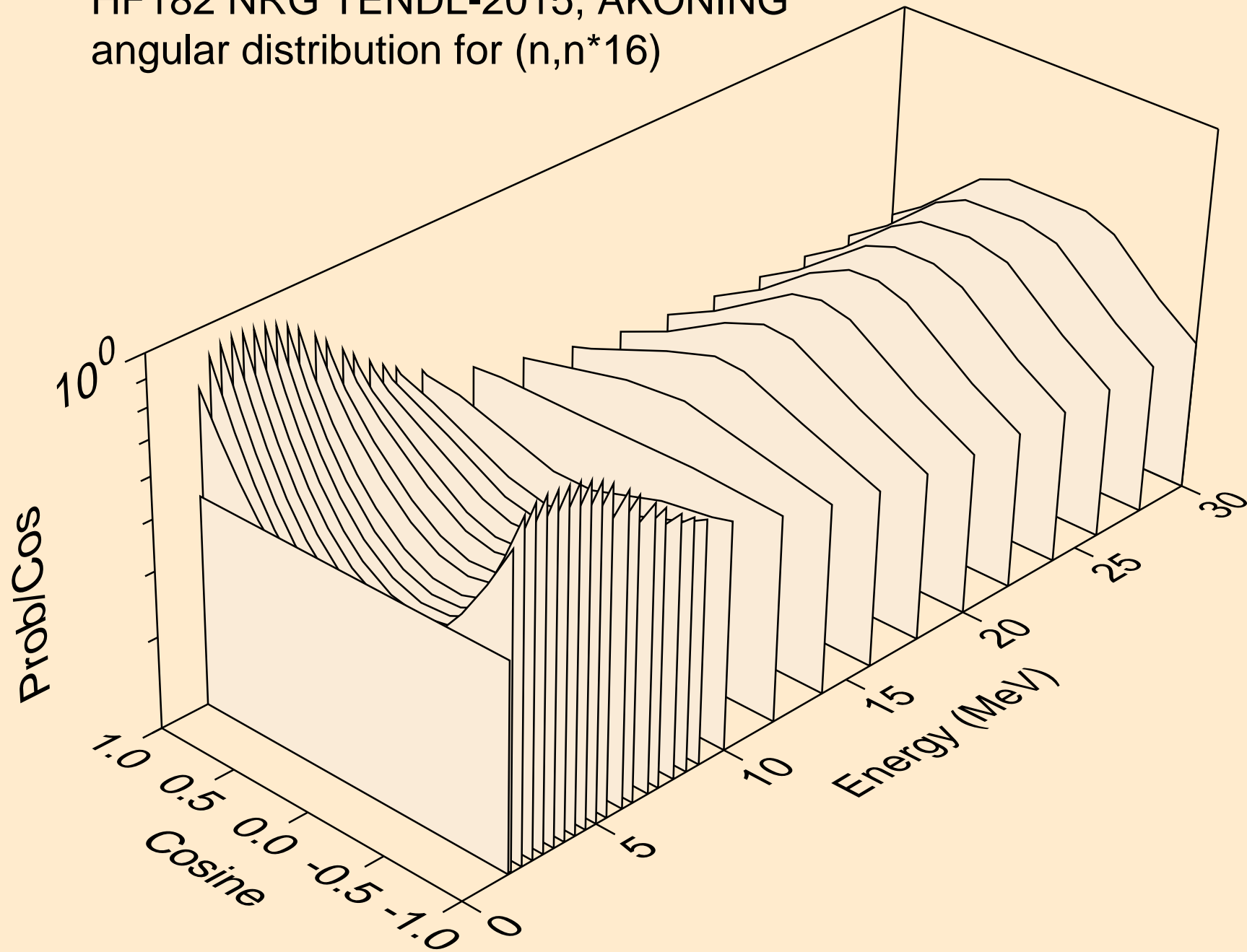

HF182 NRG TENDL-2015, AKONING
angular distribution for (n,n*17)

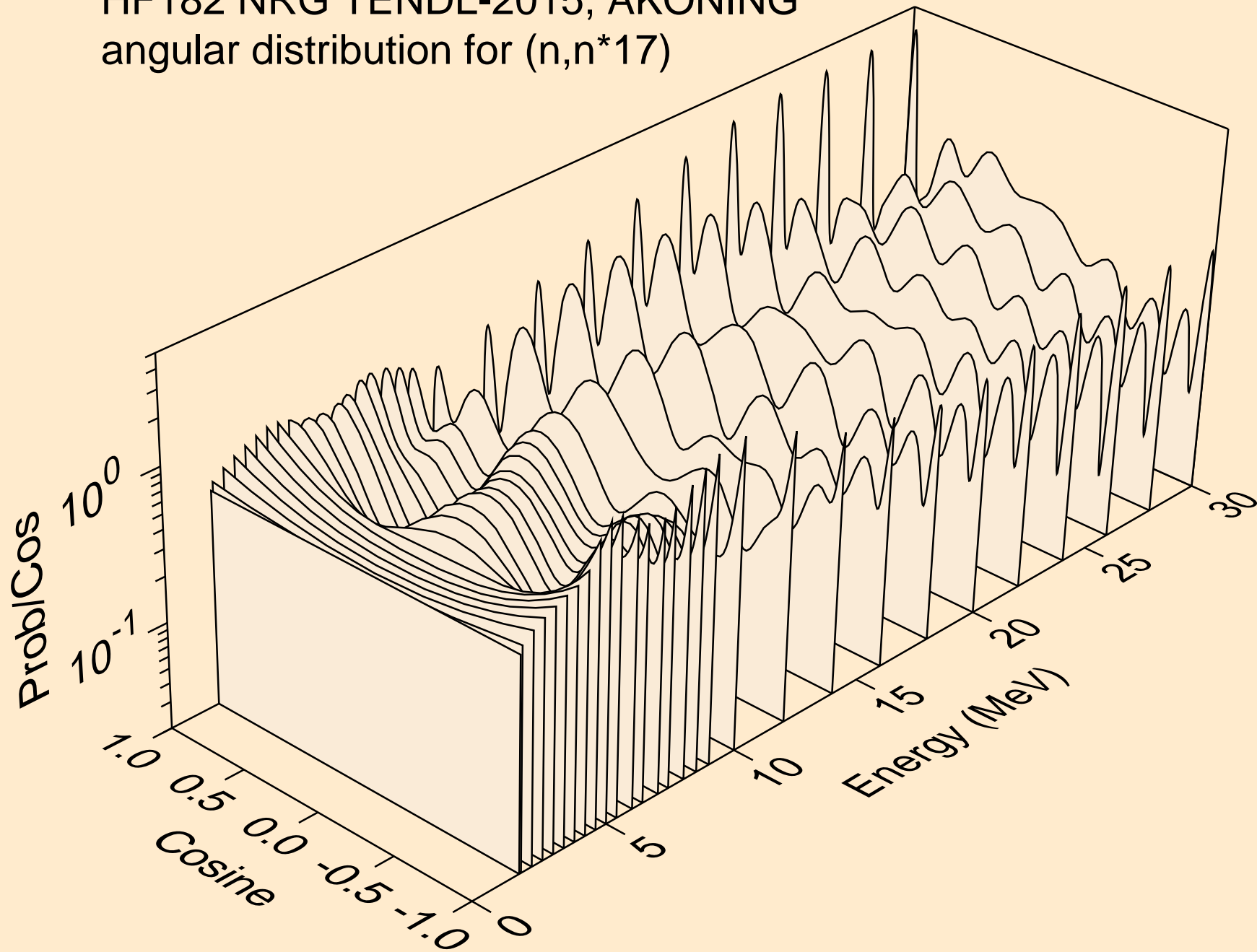

HF182 NRG TENDL-2015, AKONING
angular distribution for (n,n*18)

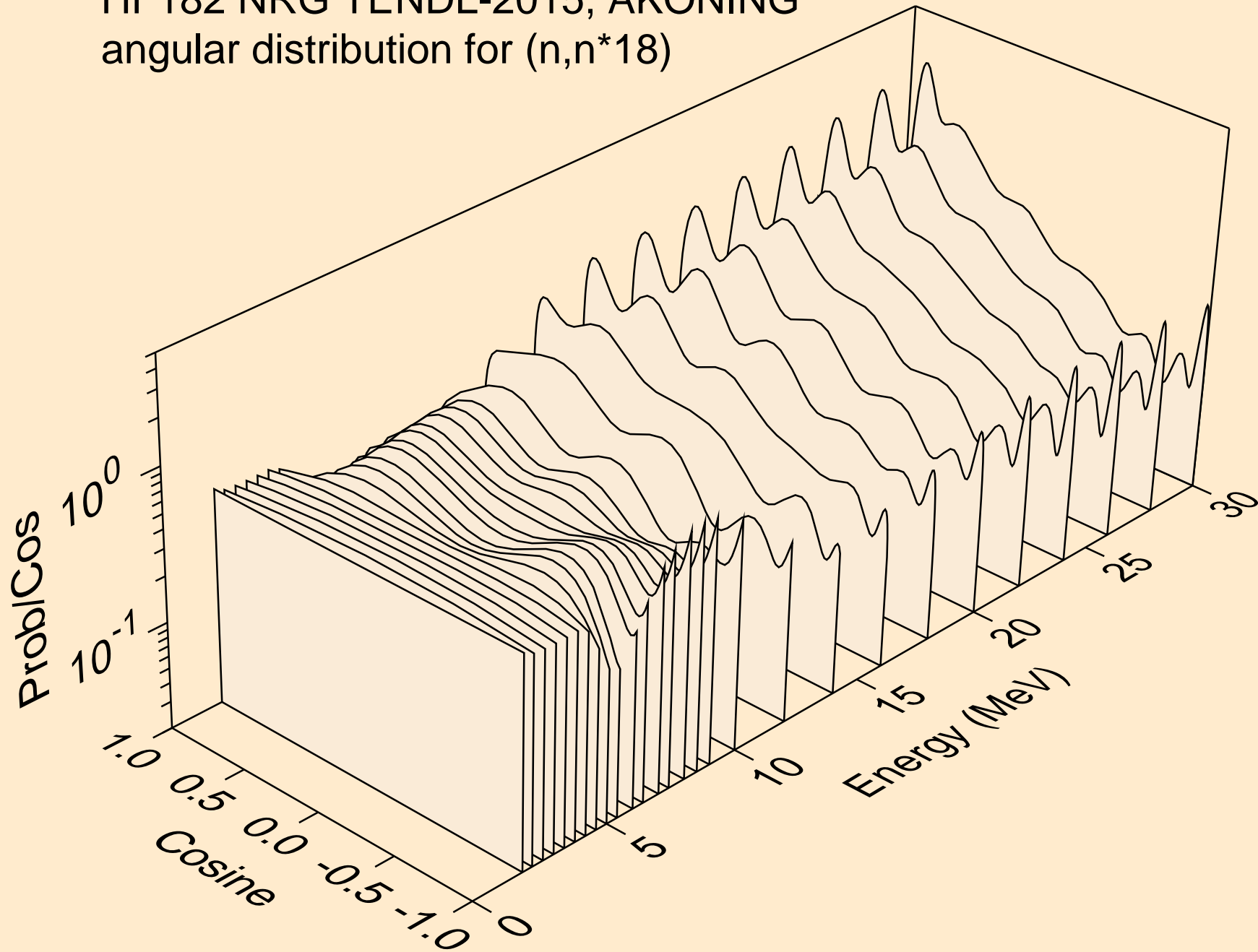

HF182 NRG TENDL-2015, AKONING
angular distribution for (n,n*19)

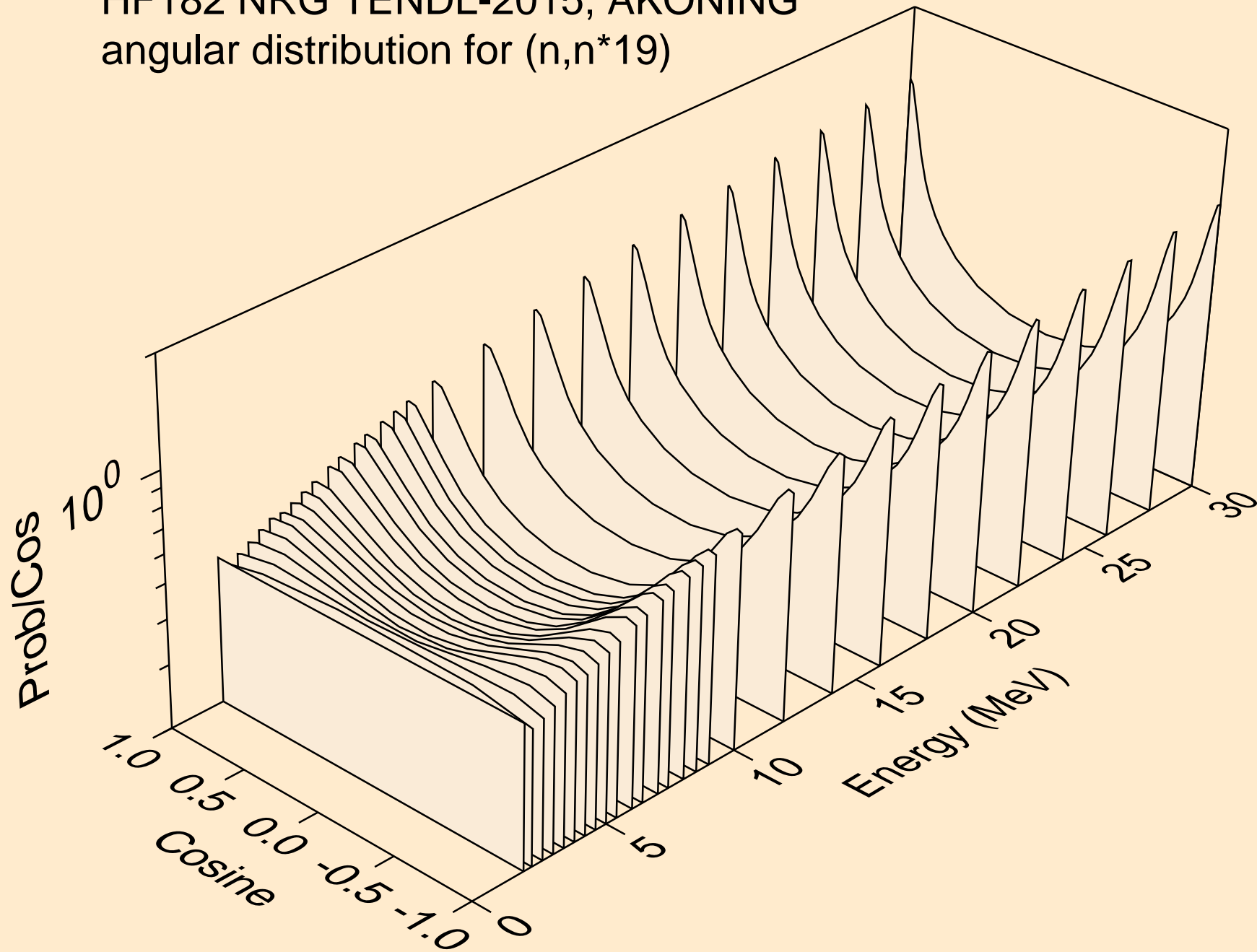

HF182 NRG TENDL-2015, AKONING
angular distribution for (n,n*20)

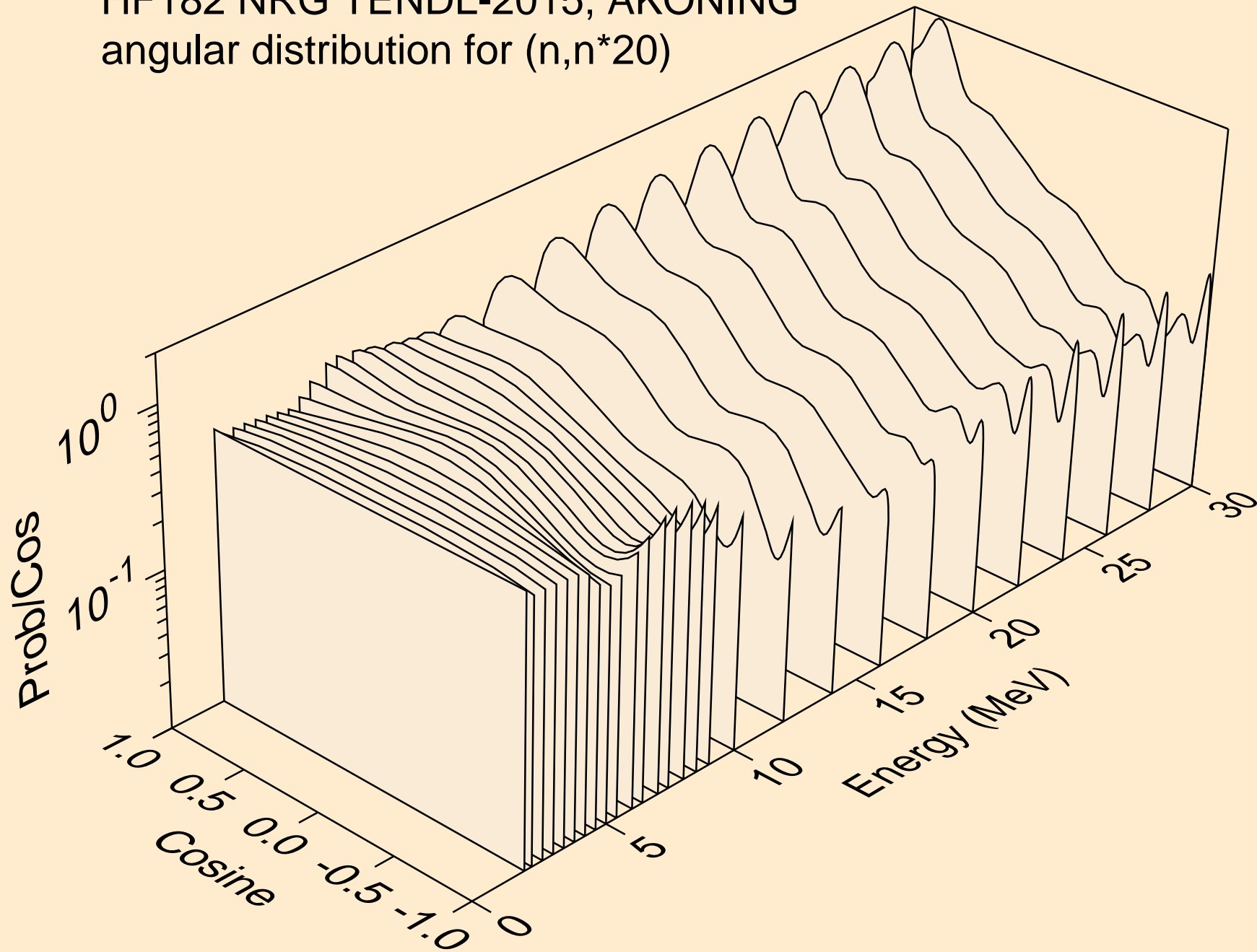

HF182 NRG TENDL-2015, AKONING
angular distribution for (n,n*21)

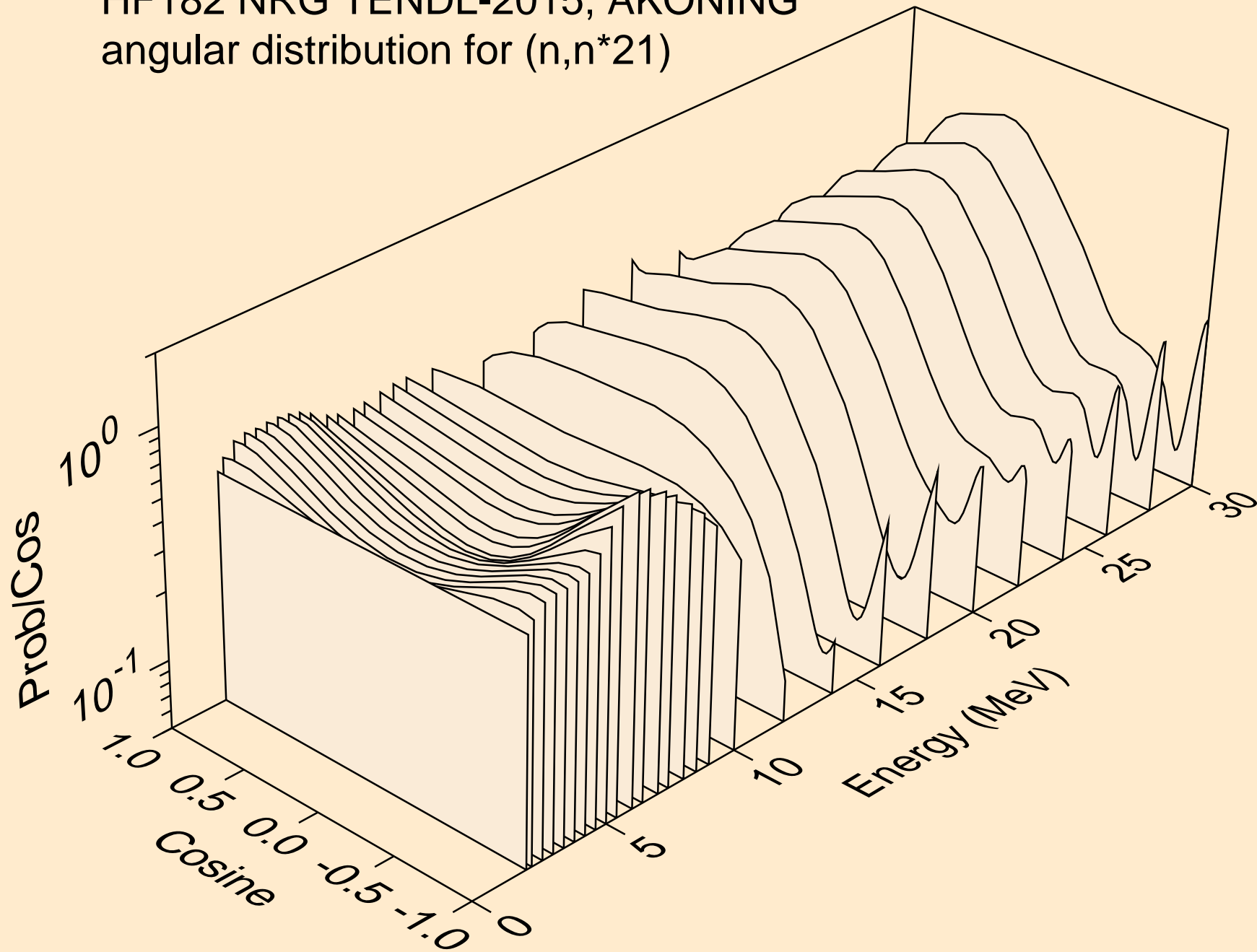

HF182 NRG TENDL-2015, AKONING
angular distribution for (n,n*22)

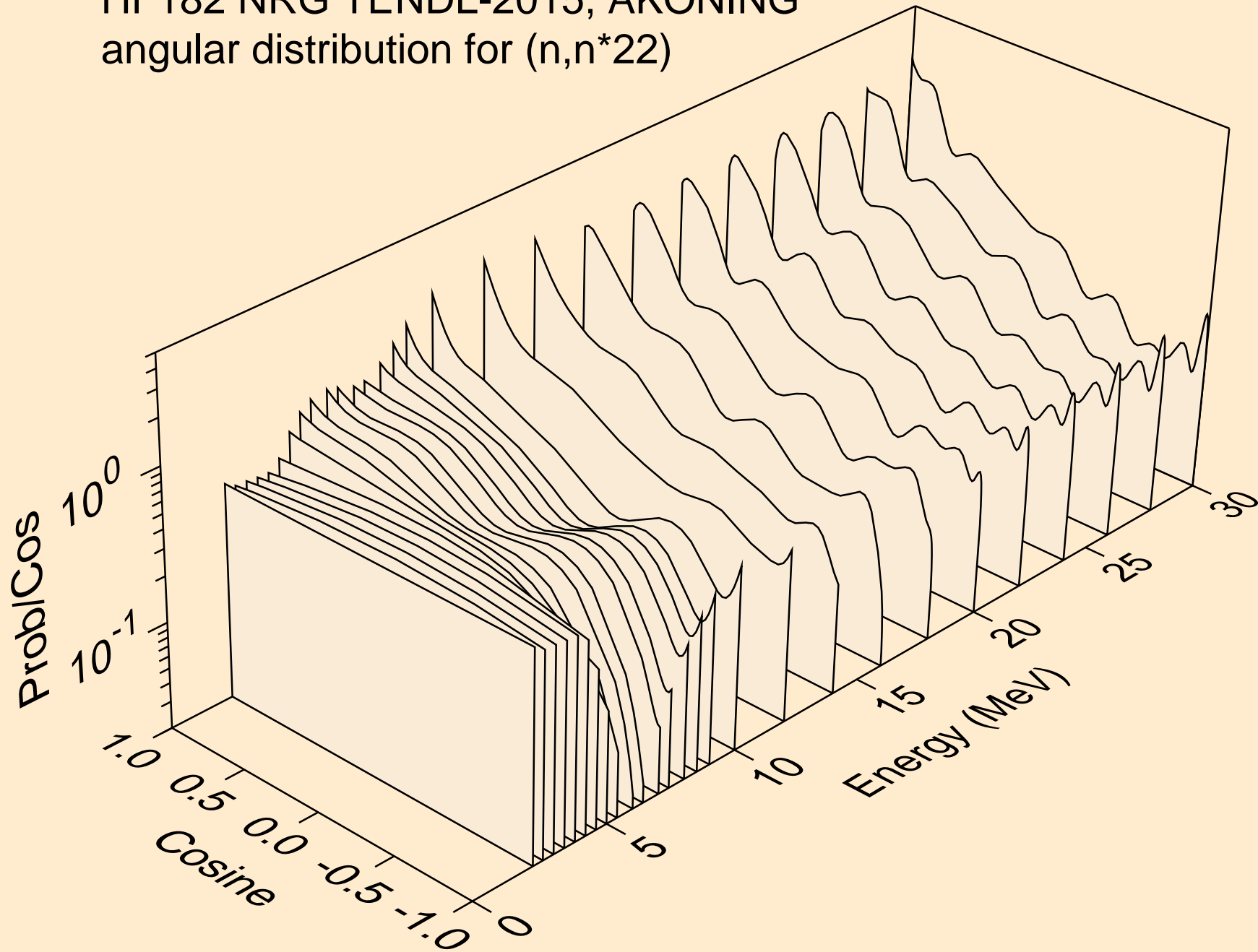

HF182 NRG TENDL-2015, AKONING
angular distribution for (n,n*23)

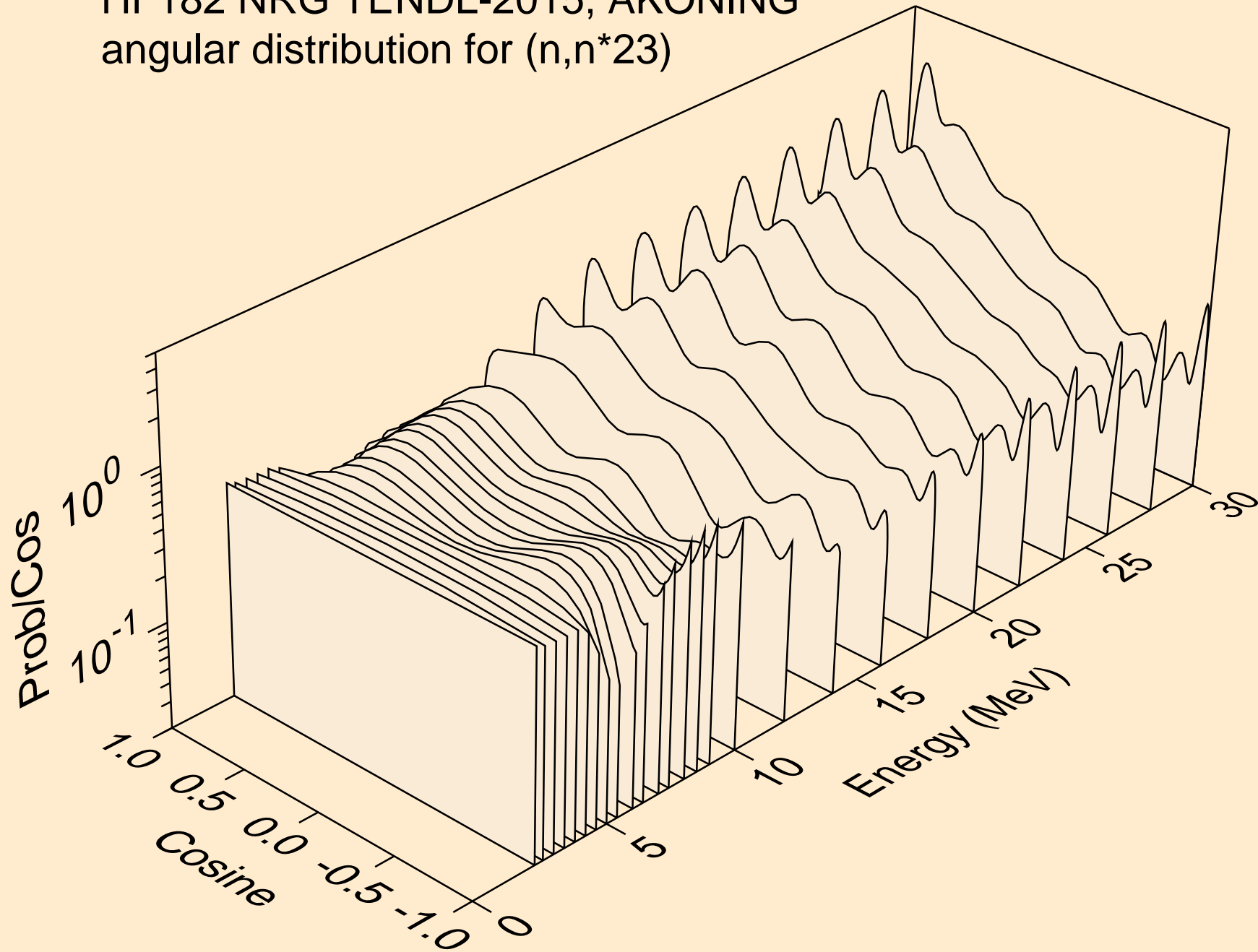

HF182 NRG TENDL-2015, AKONING
Neutron emission for (n,x)

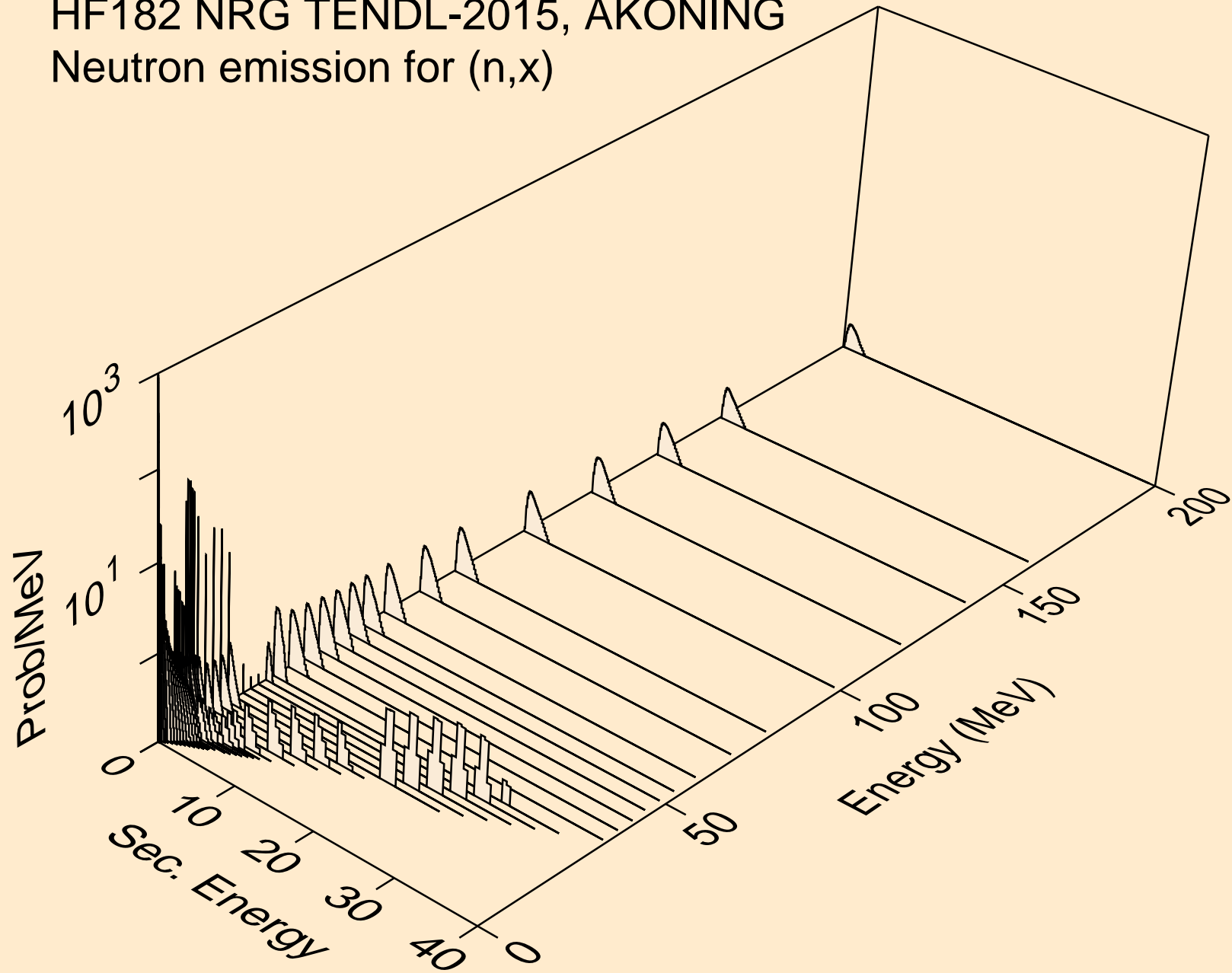

HF182 NRG TENDL-2015, AKONING
Neutron emission for (n,2nd)

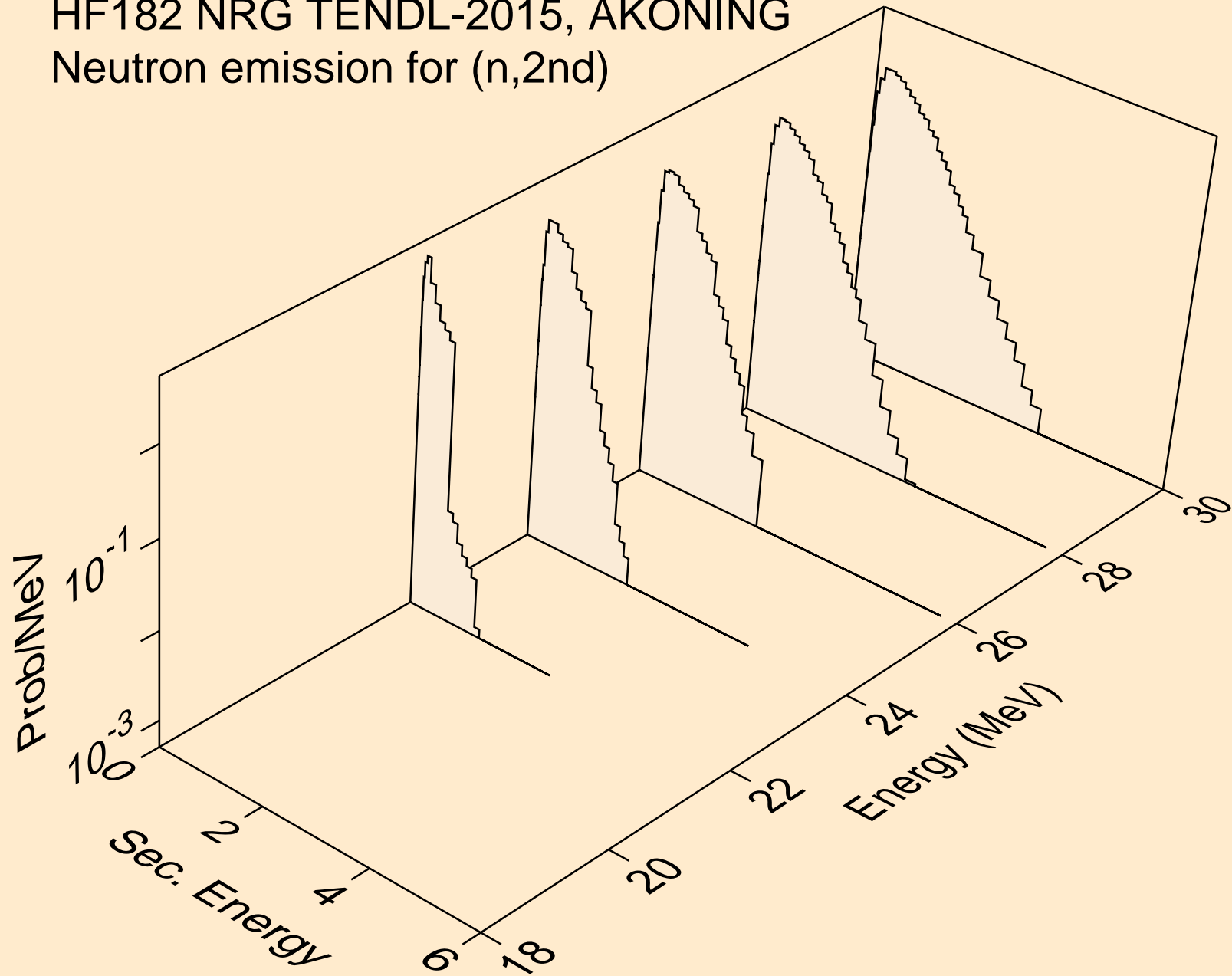

HF182 NRG TENDL-2015, AKONING
Neutron emission for (n,2n)

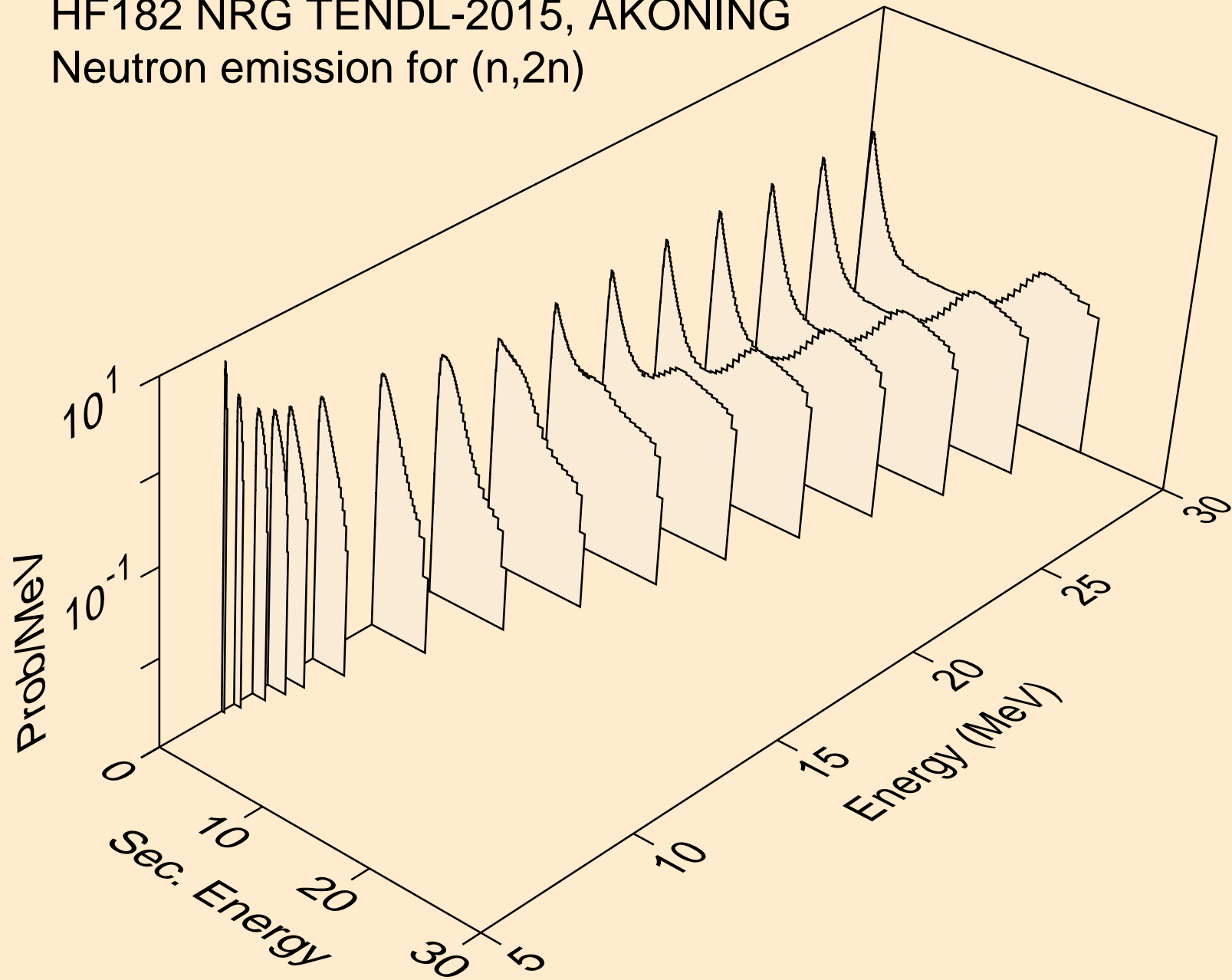

HF182 NRG TENDL-2015, AKONING
Neutron emission for (n,3n)

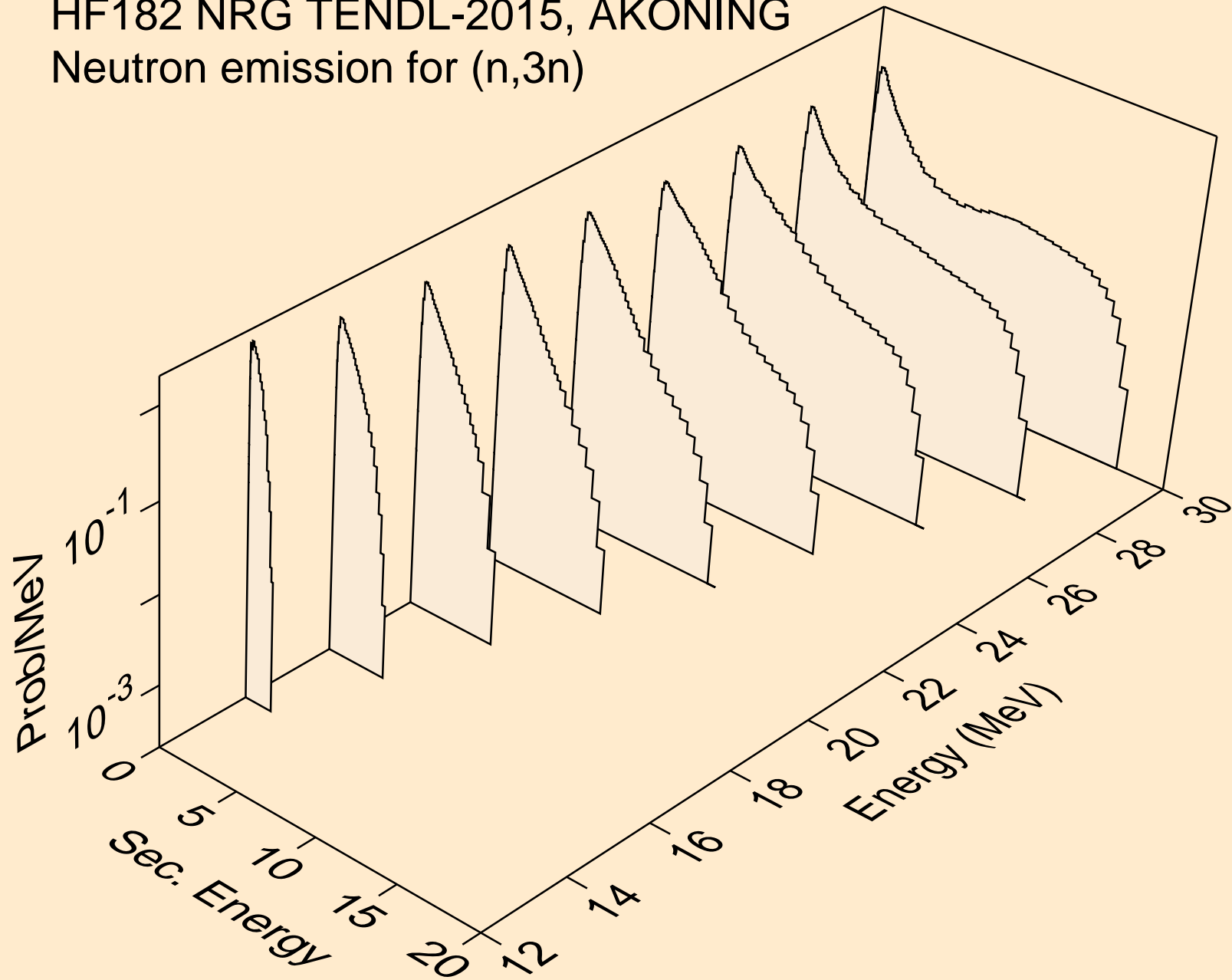

HF182 NRG TENDL-2015, AKONING
Neutron emission for (n,n*)a

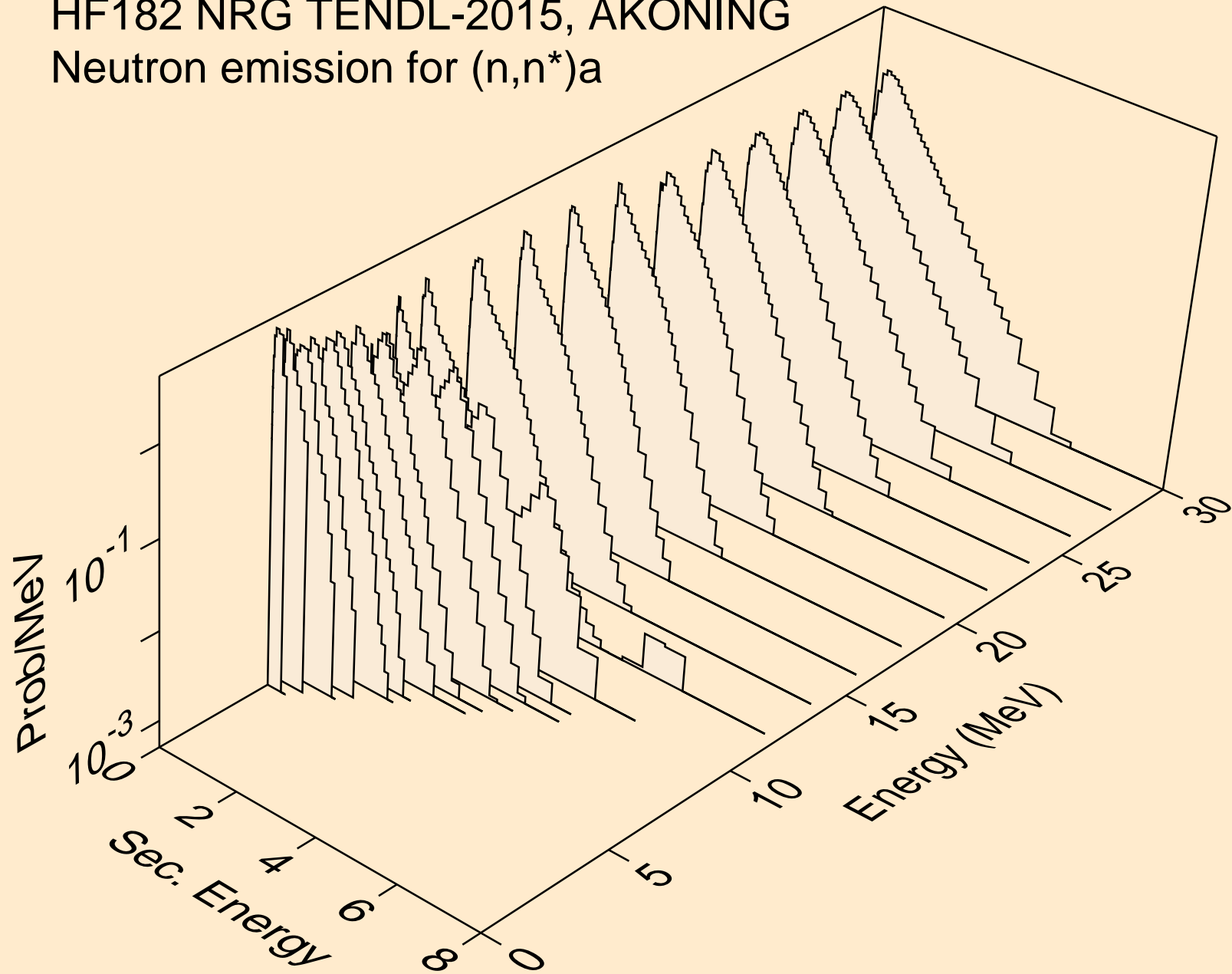

HF182 NRG TENDL-2015, AKONING
Neutron emission for (n,2n)a

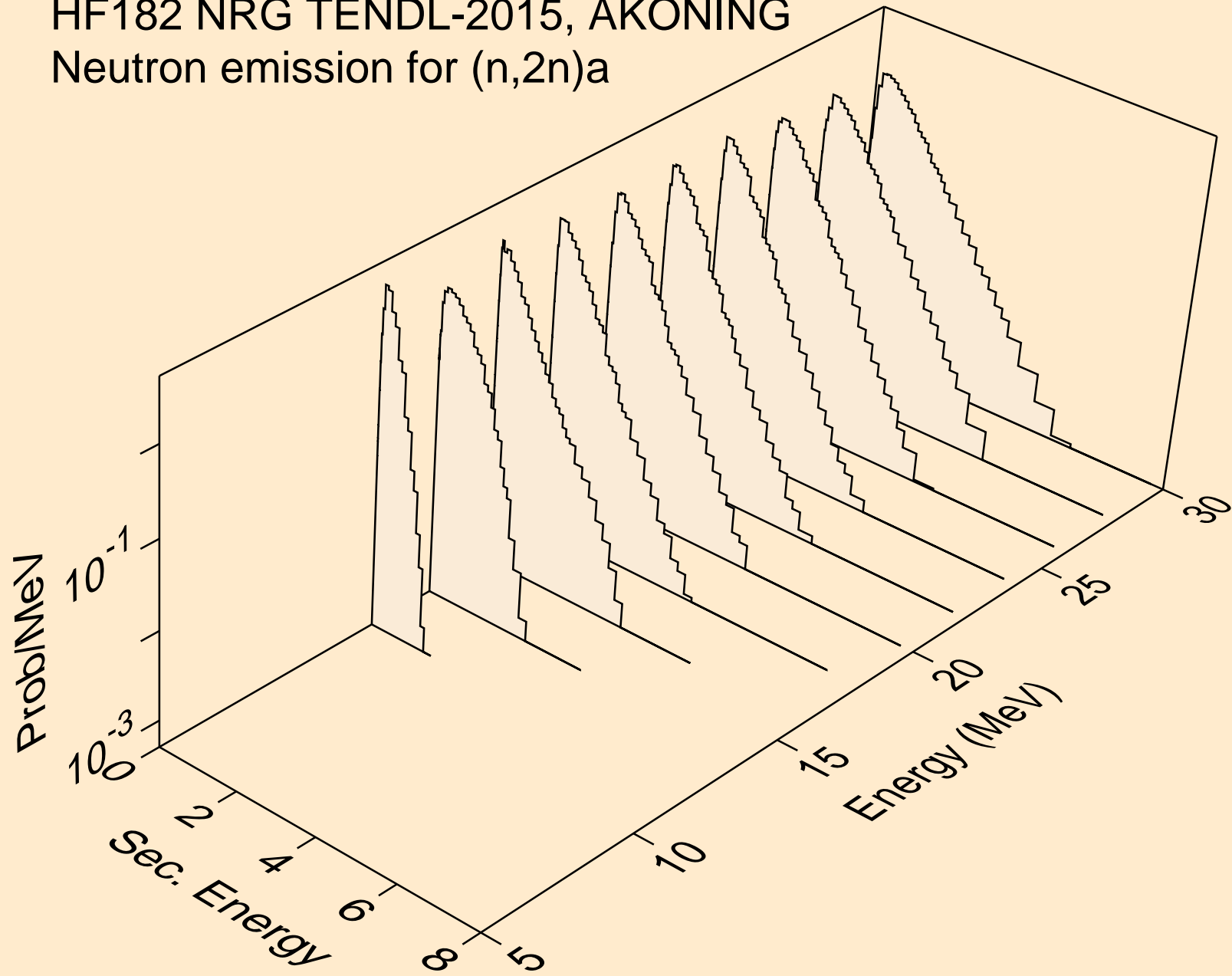

HF182 NRG TENDL-2015, AKONING
Neutron emission for (n,3n)a

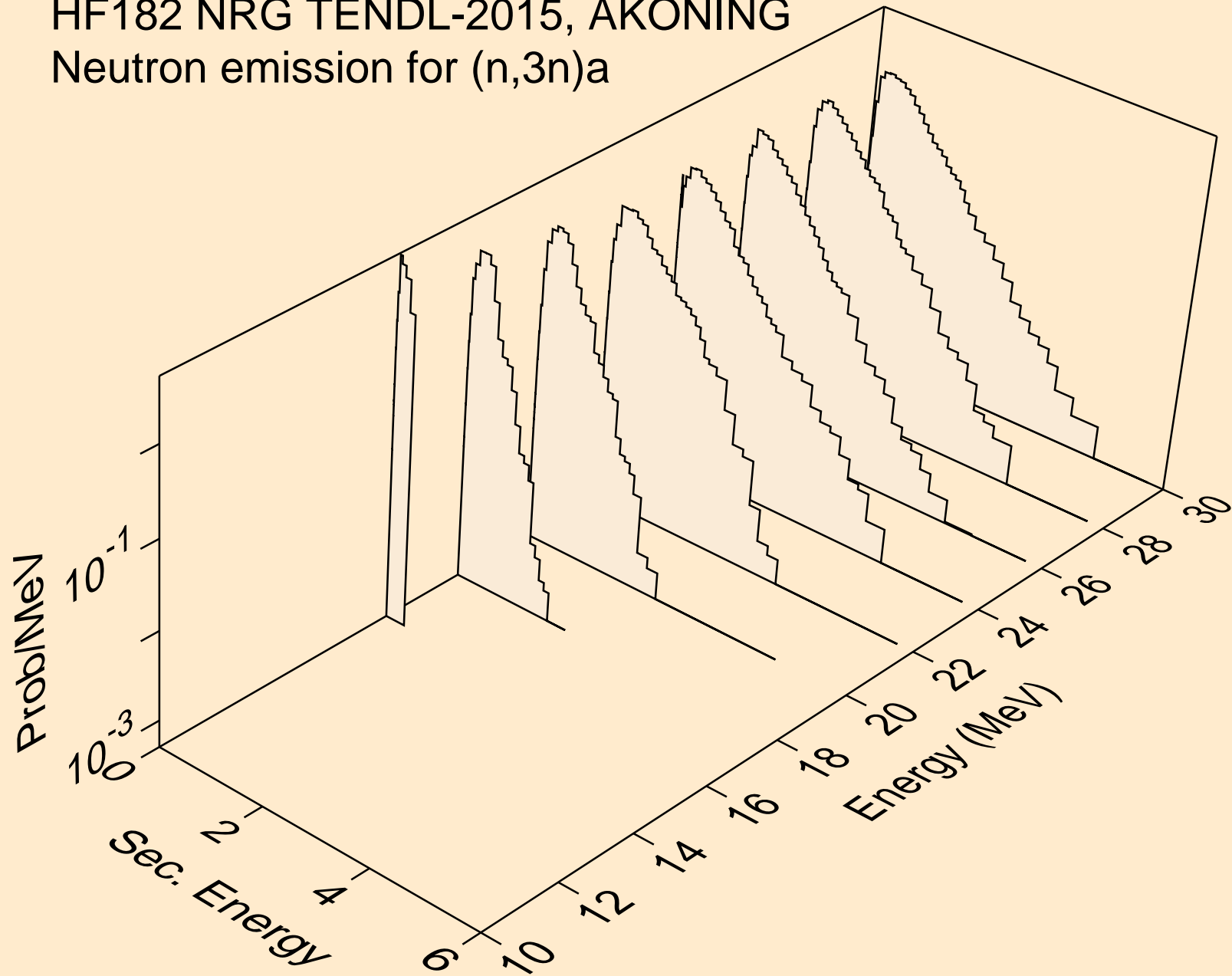

HF182 NRG TENDL-2015, AKONING
Neutron emission for (n,n*)p

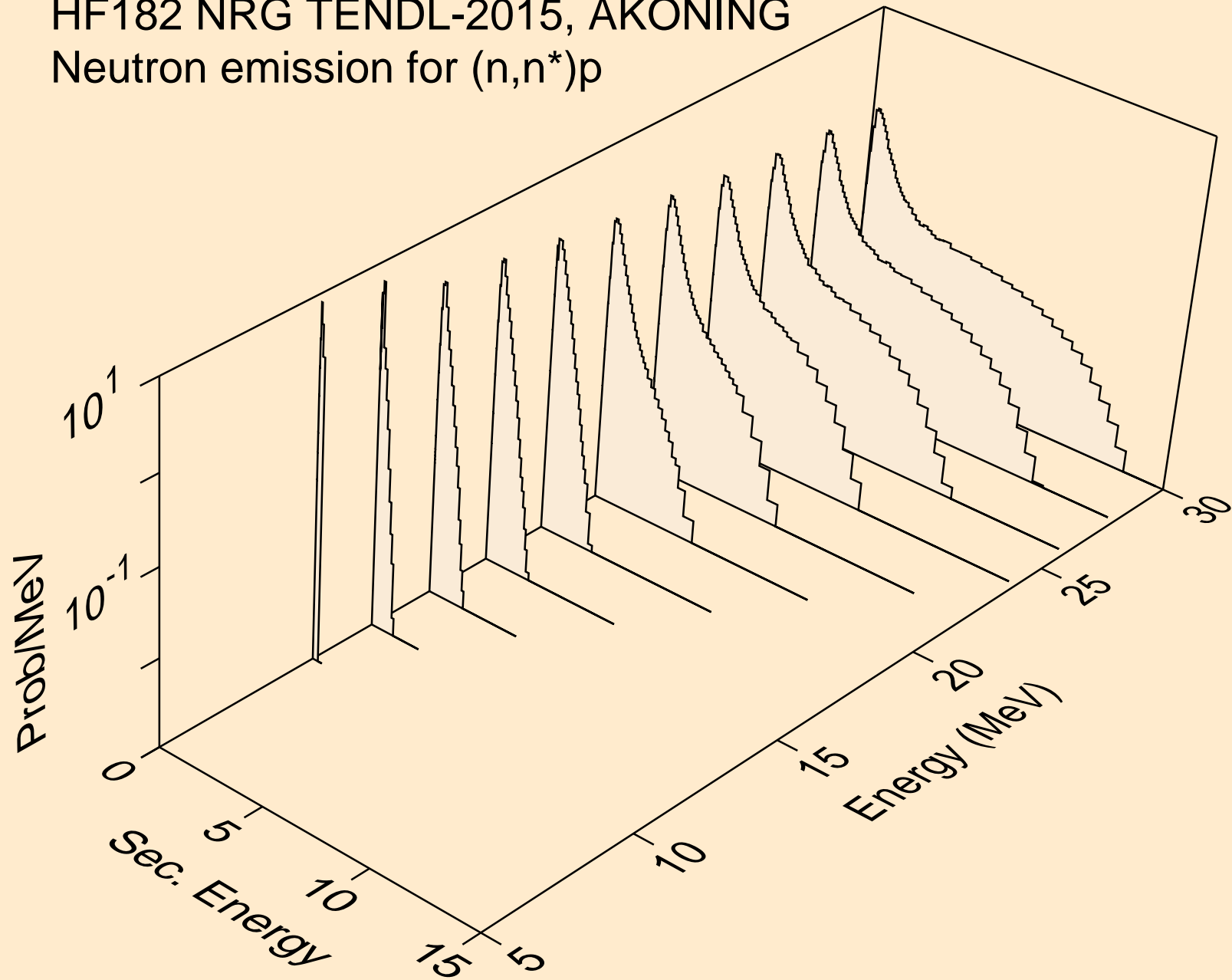

HF182 NRG TENDL-2015, AKONING
Neutron emission for (n,n*)d

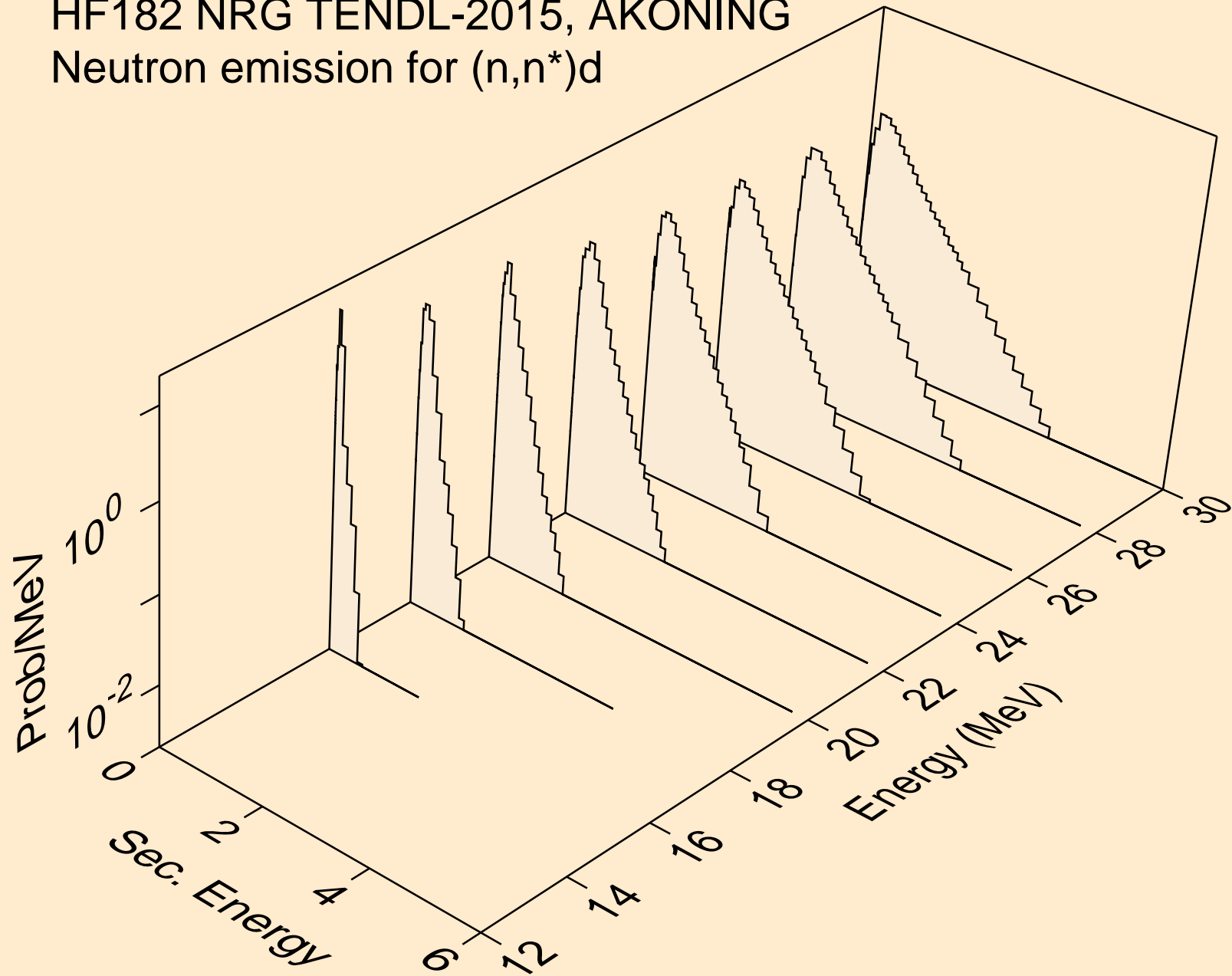

HF182 NRG TENDL-2015, AKONING
Neutron emission for (n,n*)t

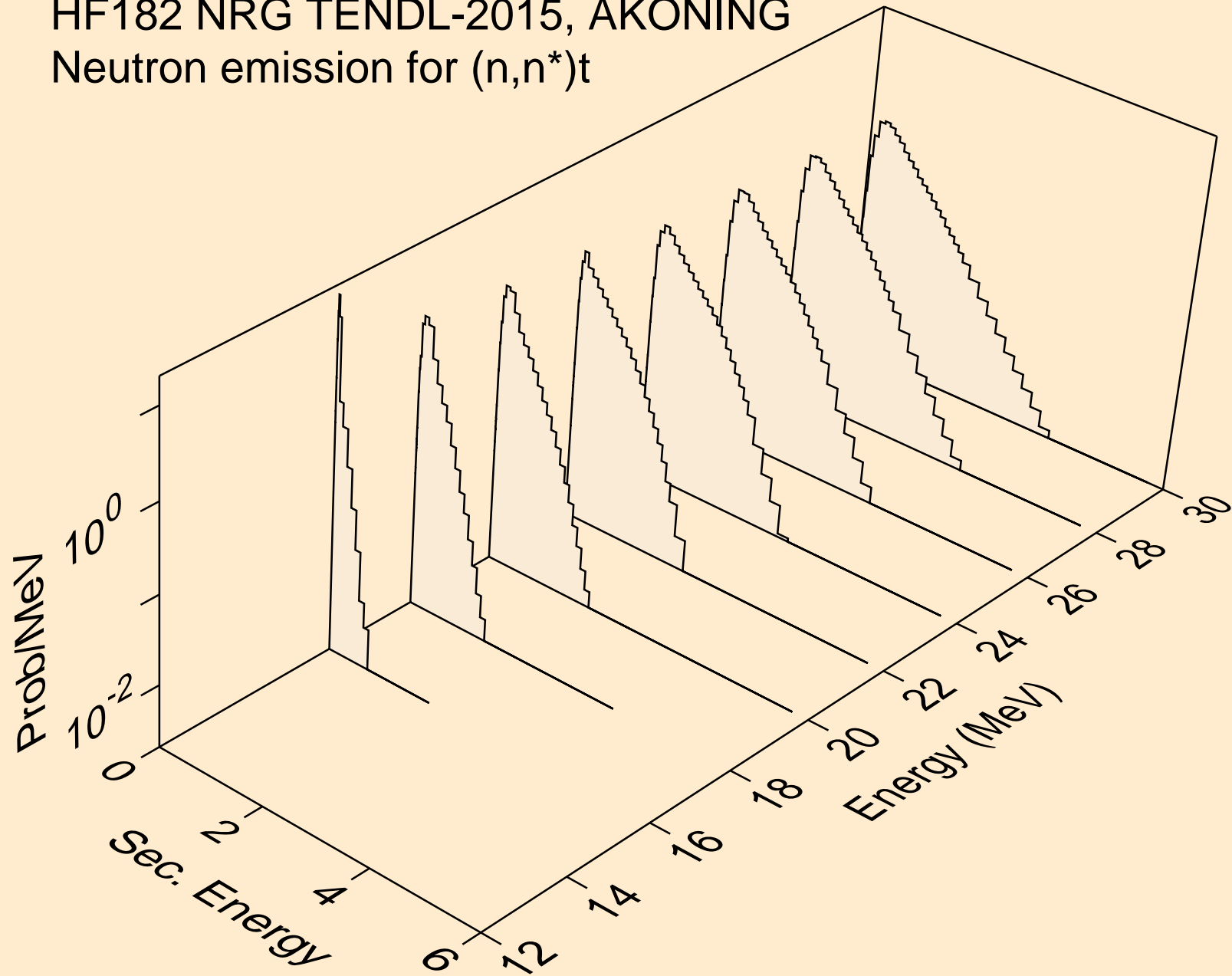

HF182 NRG TENDL-2015, AKONING
Neutron emission for (n,n*)he3

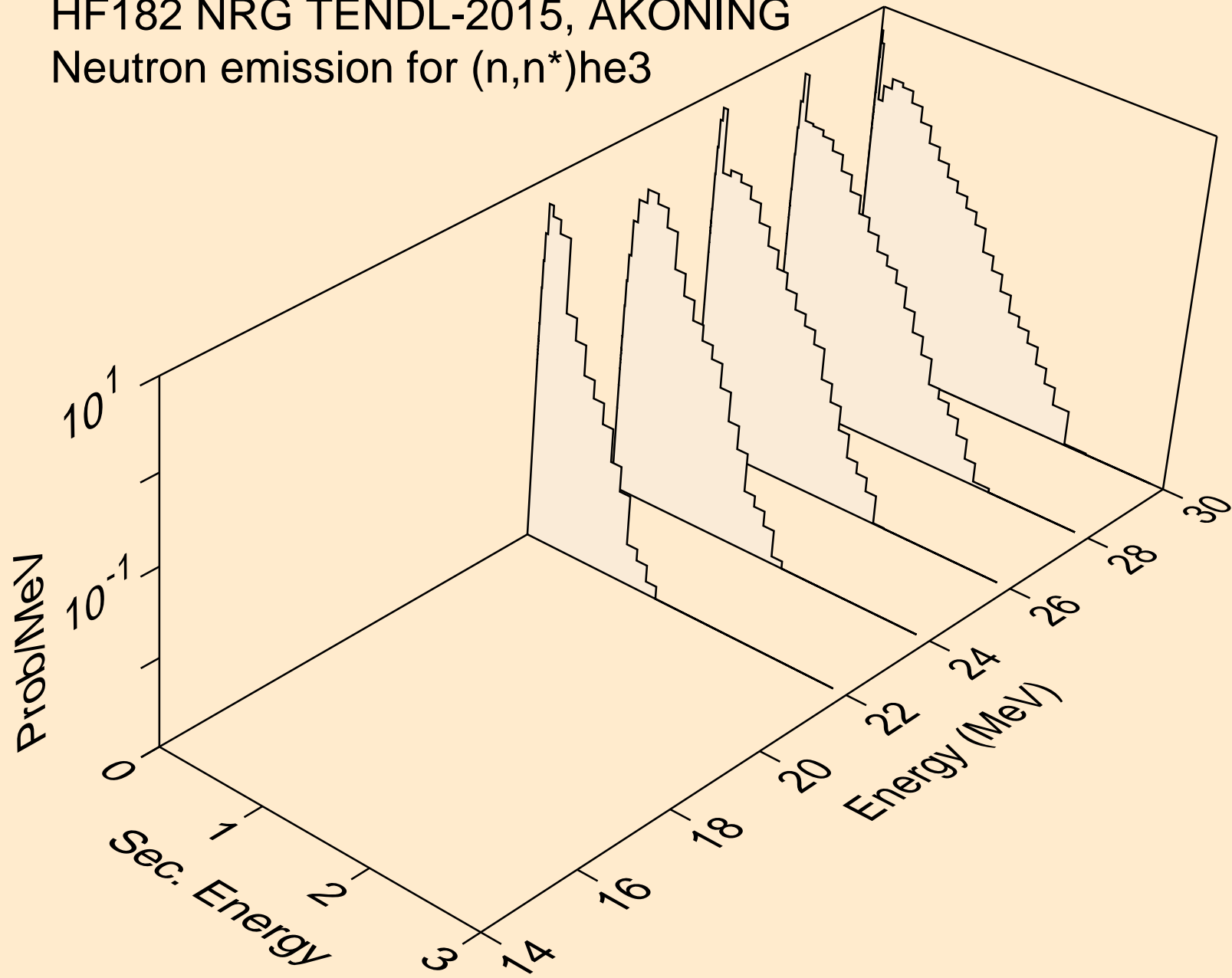

HF182 NRG TENDL-2015, AKONING
Neutron emission for (n,4n)

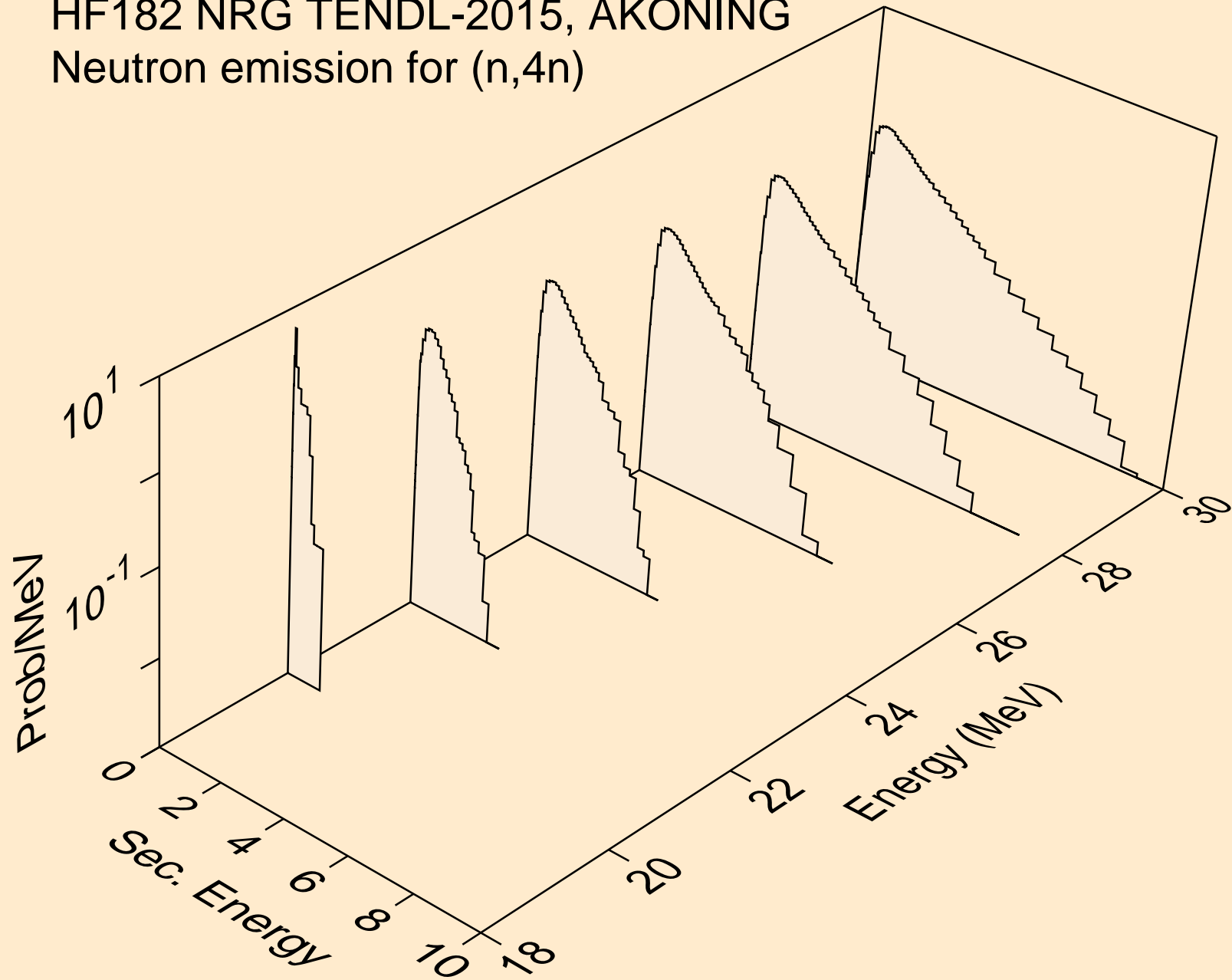

HF182 NRG TENDL-2015, AKONING
Neutron emission for (n,2np)

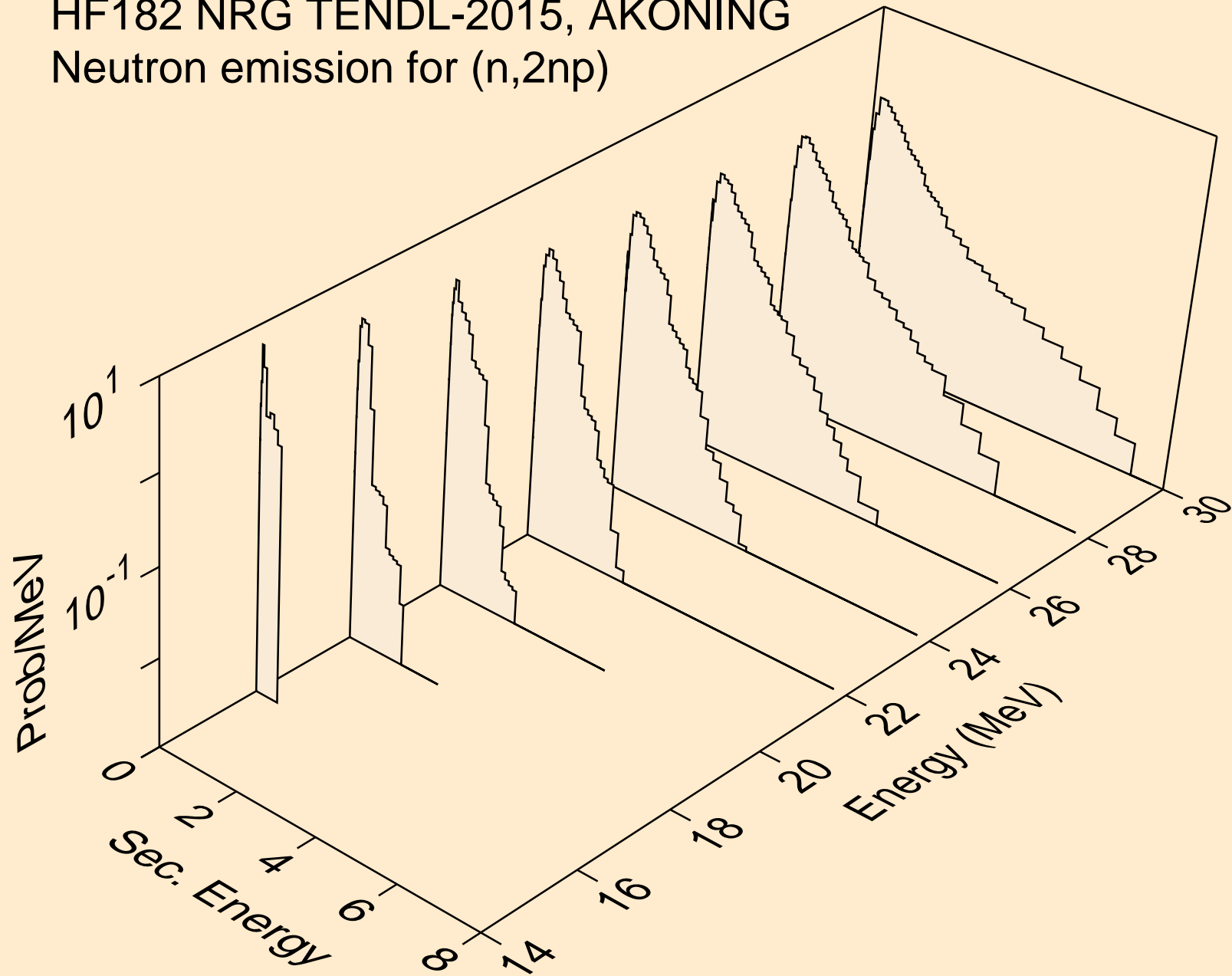

HF182 NRG TENDL-2015, AKONING
Neutron emission for (n,3np)

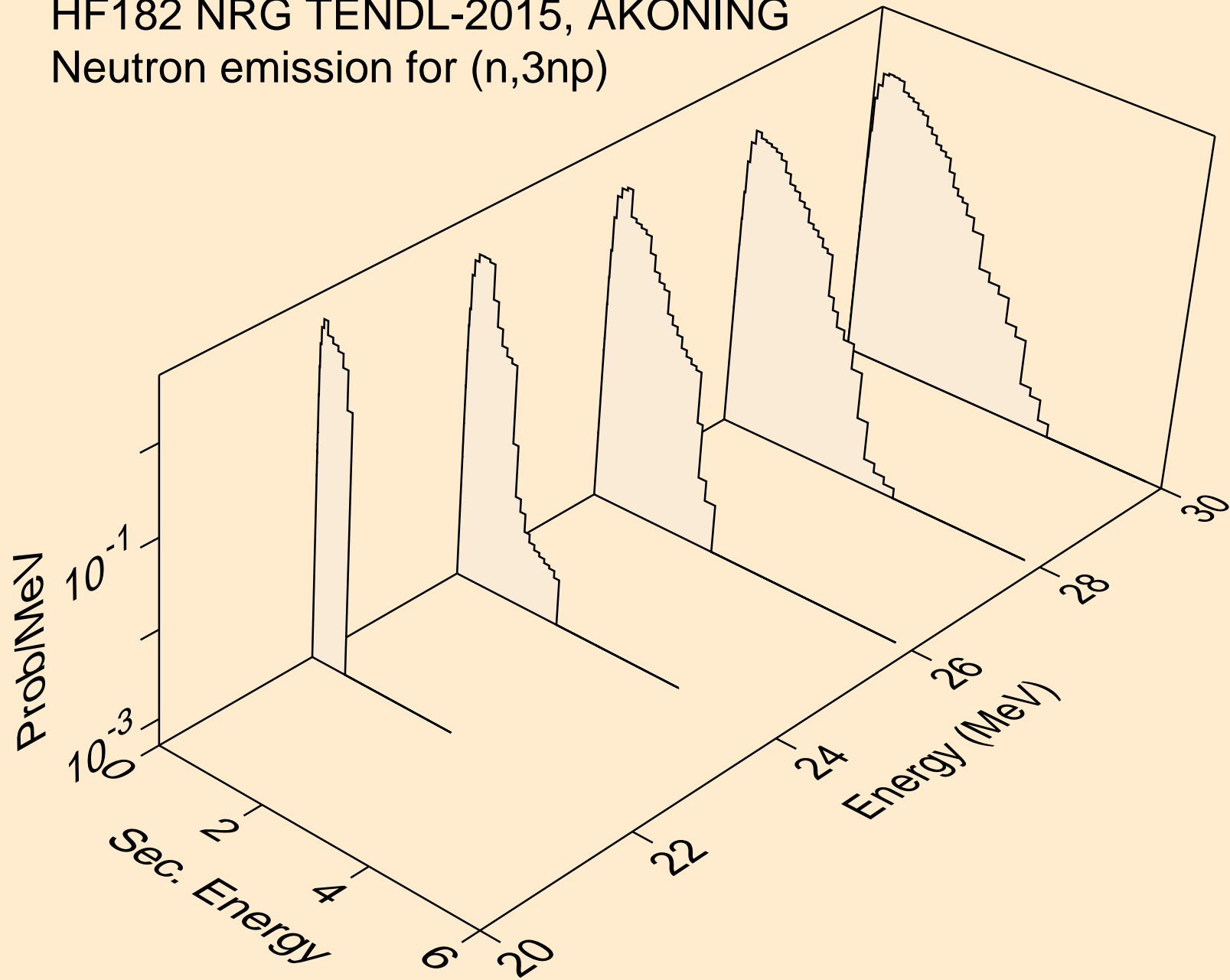

HF182 NRG TENDL-2015, AKONING
Neutron emission for (n,2np)

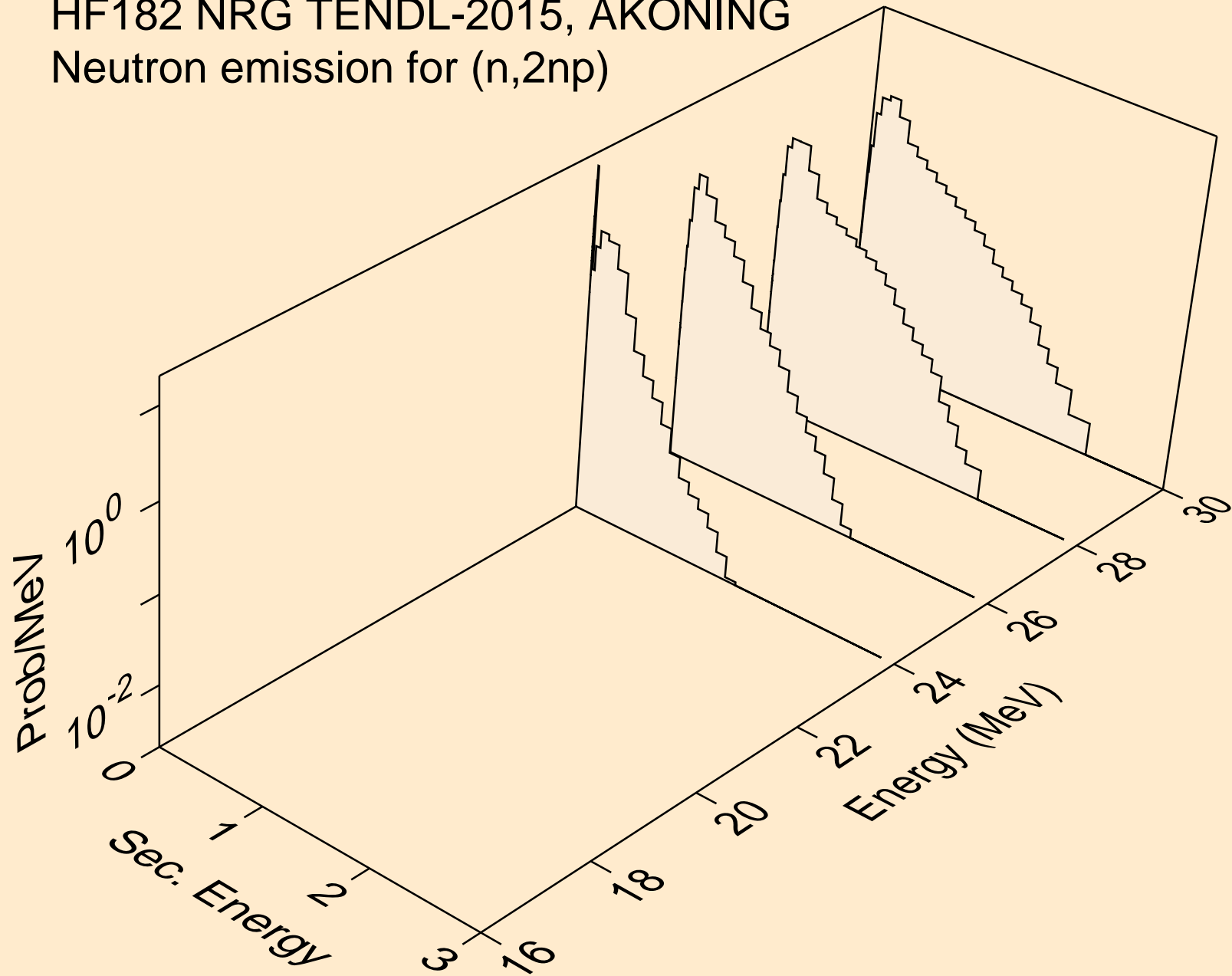

HF182 NRG TENDL-2015, AKONING
Neutron emission for (n,n*c)

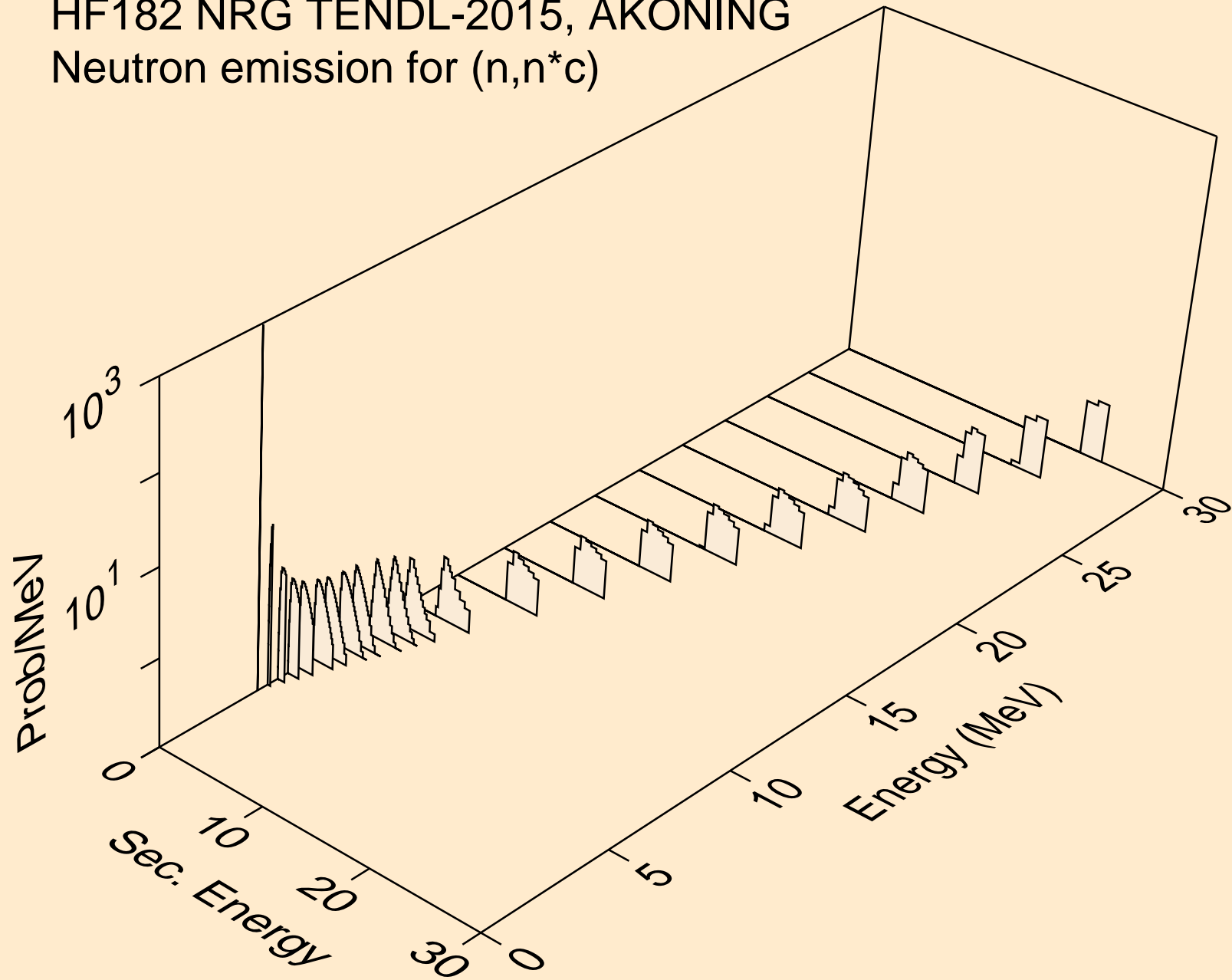

HF182 NRG TENDL-2015, AKONING
Photon emission for (n,x)

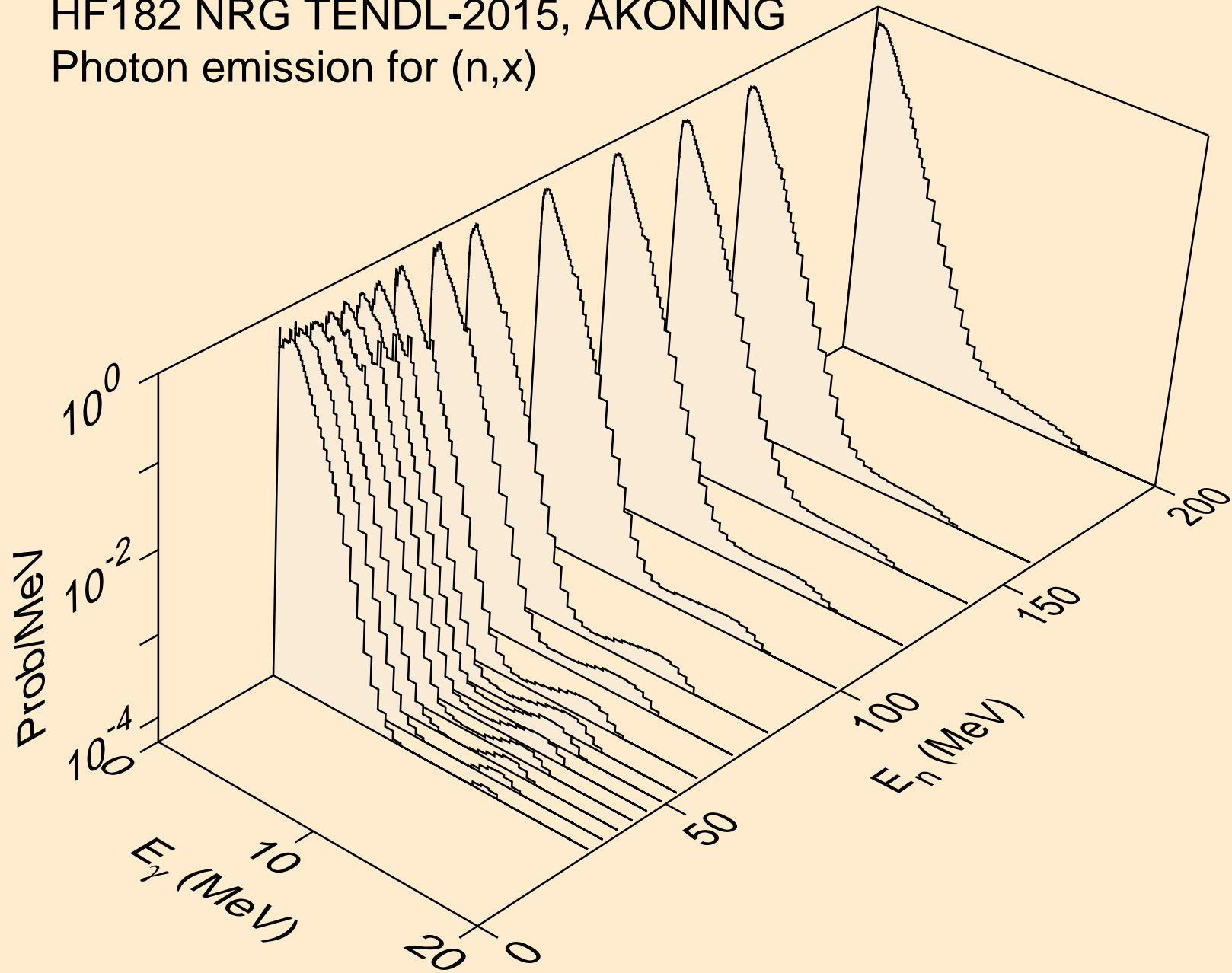

HF182 NRG TENDL-2015, AKONING
Photon emission for (n,2nd)

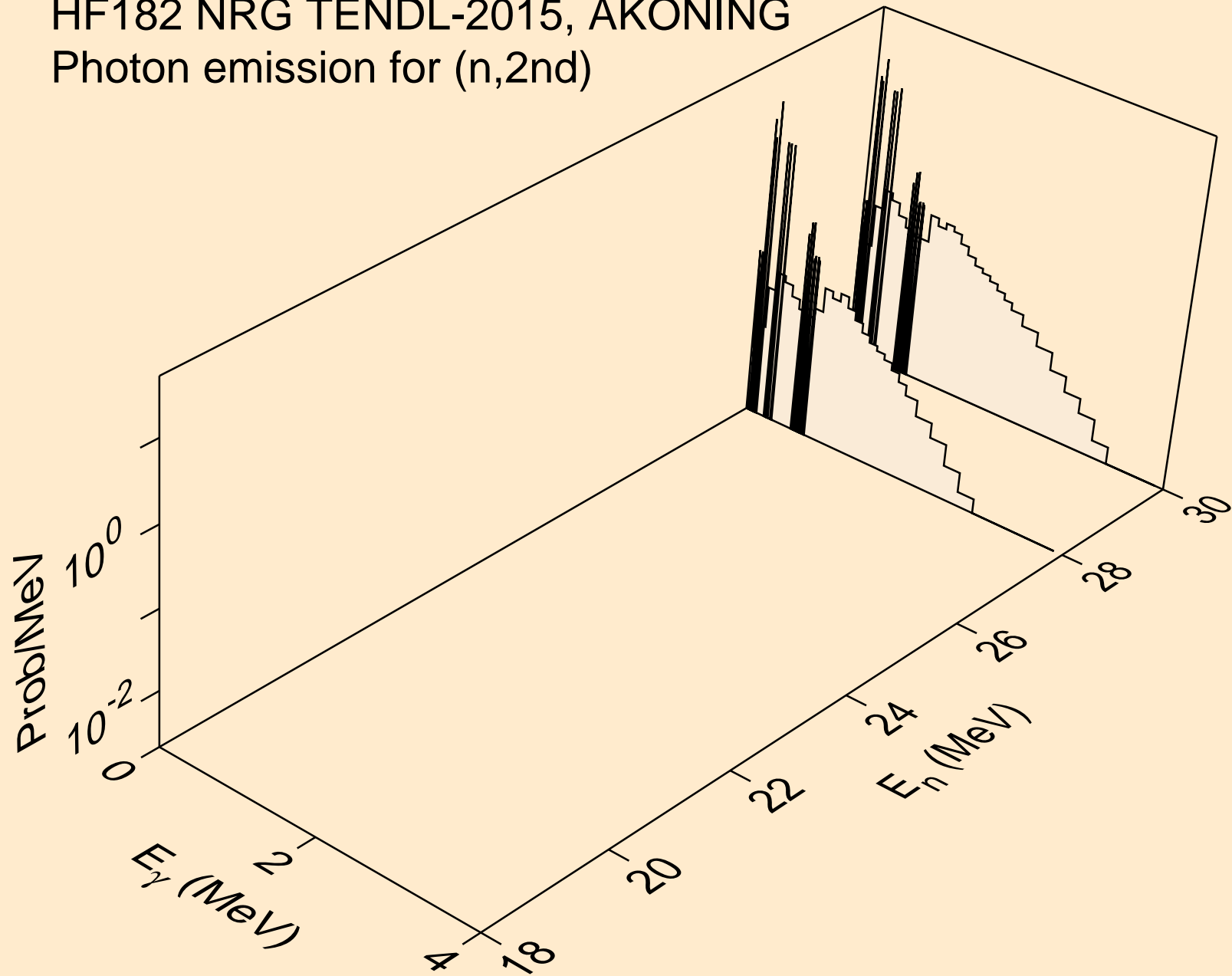

HF182 NRG TENDL-2015, AKONING
Photon emission for (n,2n)

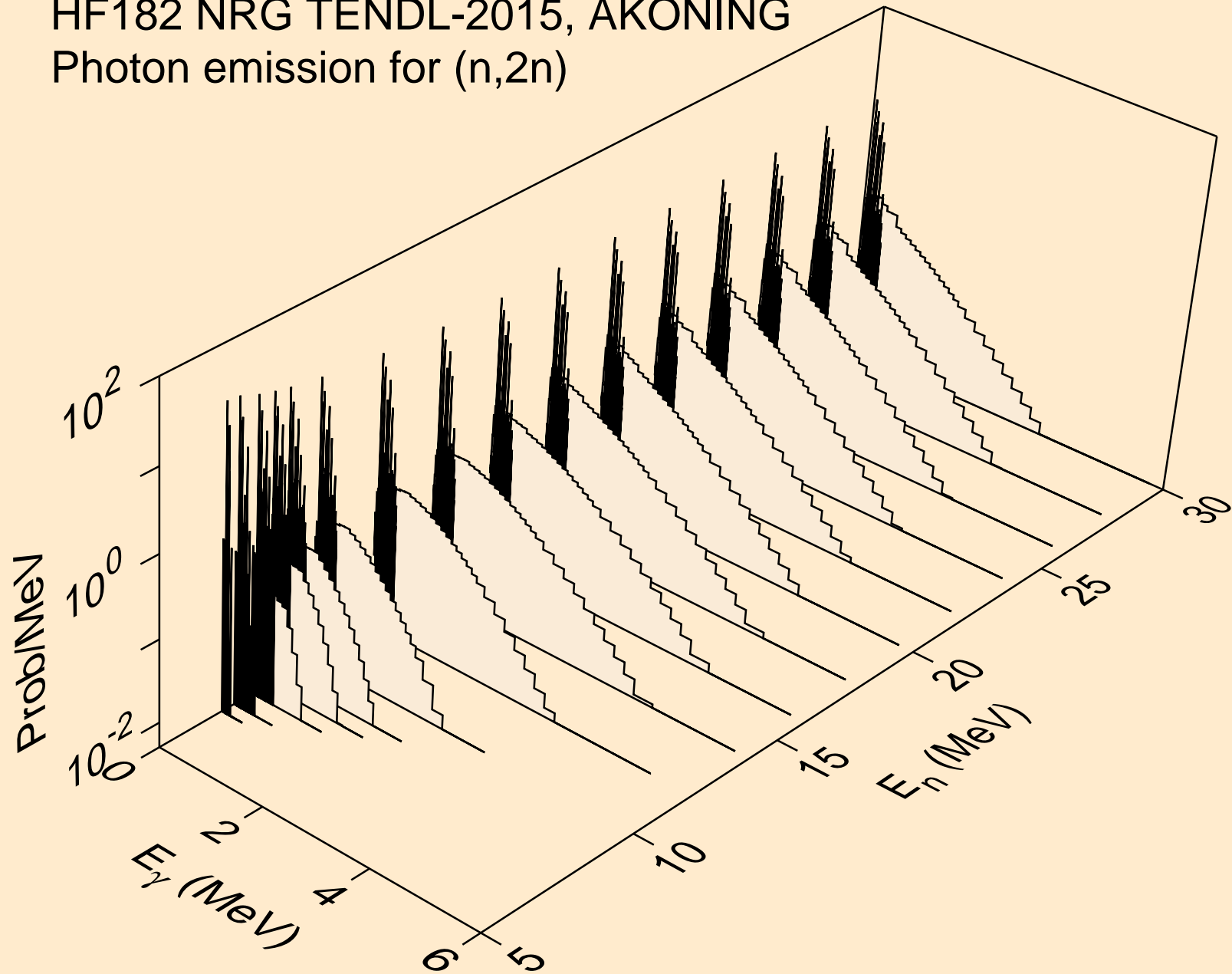

HF182 NRG TENDL-2015, AKONING
Photon emission for (n,3n)

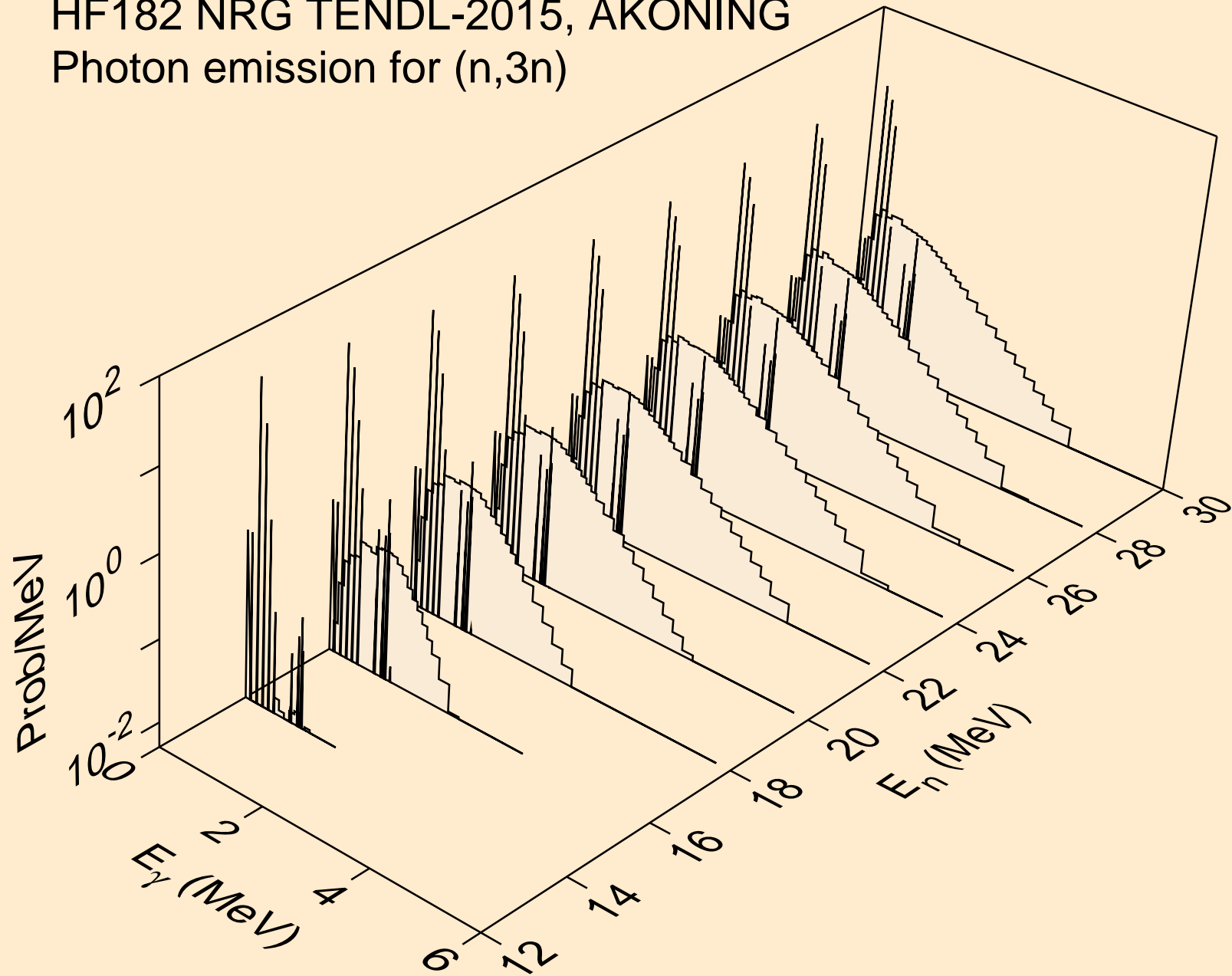

HF182 NRG TENDL-2015, AKONING
Photon emission for (n,n*)a

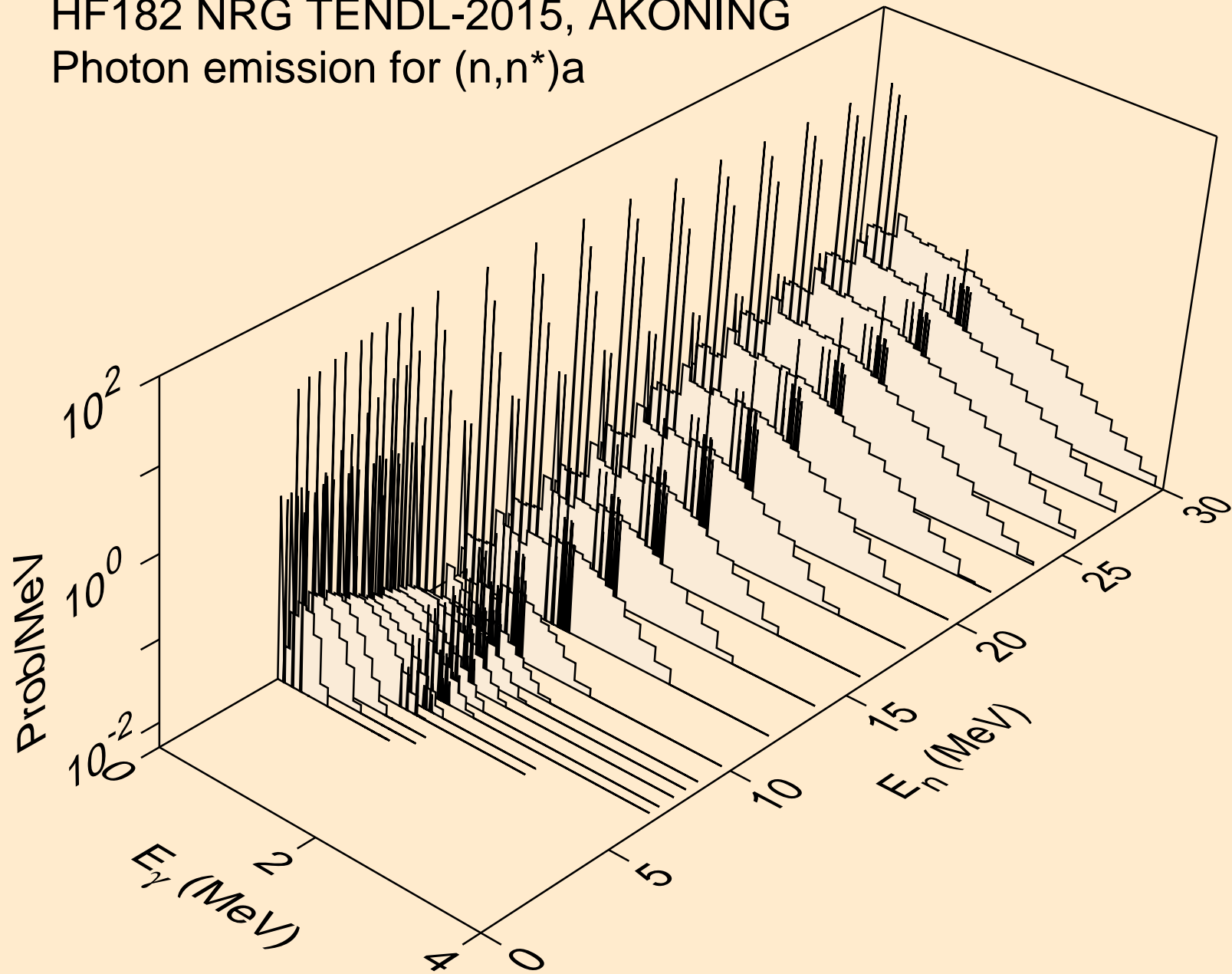

HF182 NRG TENDL-2015, AKONING
Photon emission for (n,2n)_a

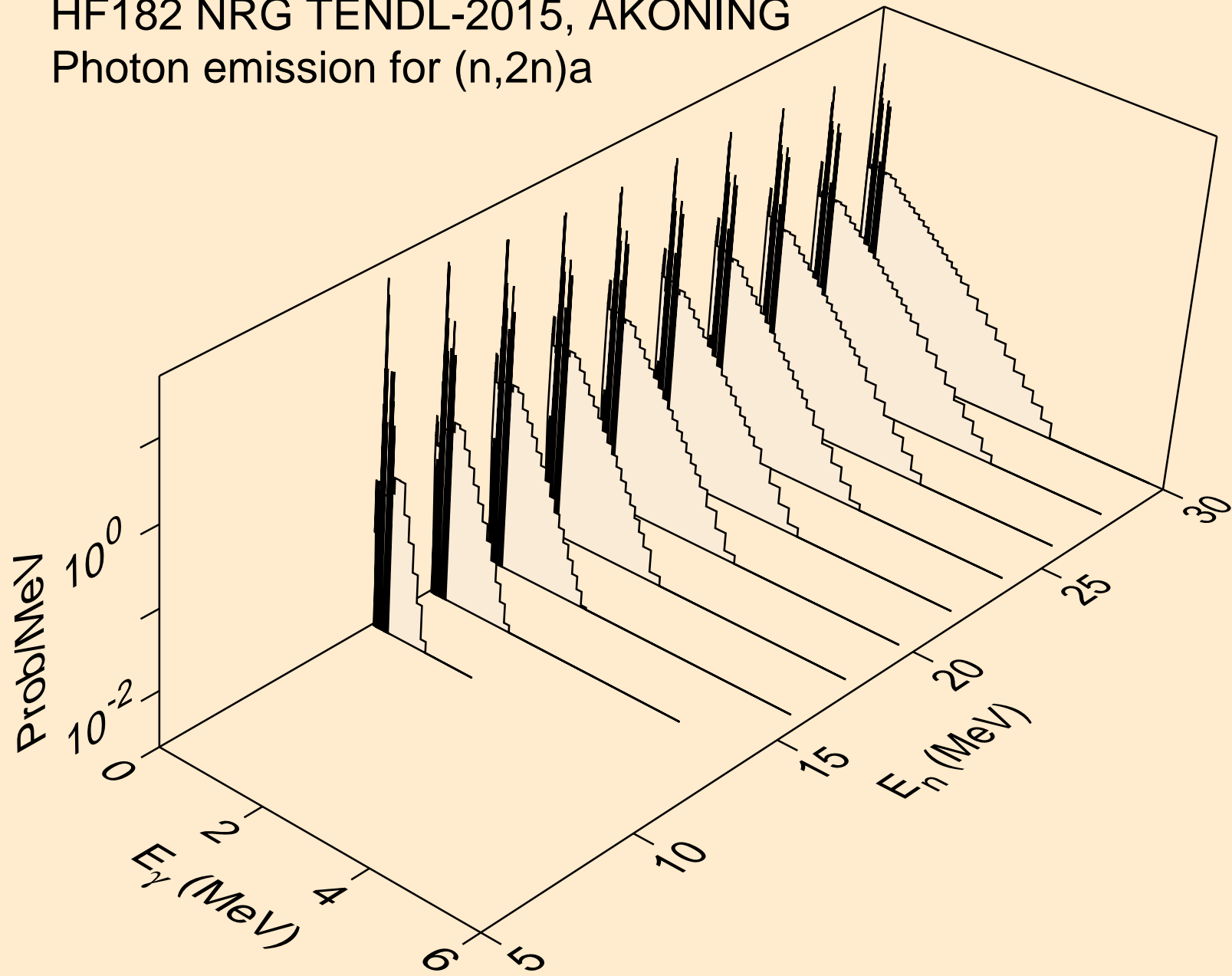

HF182 NRG TENDL-2015, AKONING
Photon emission for (n,3n)a

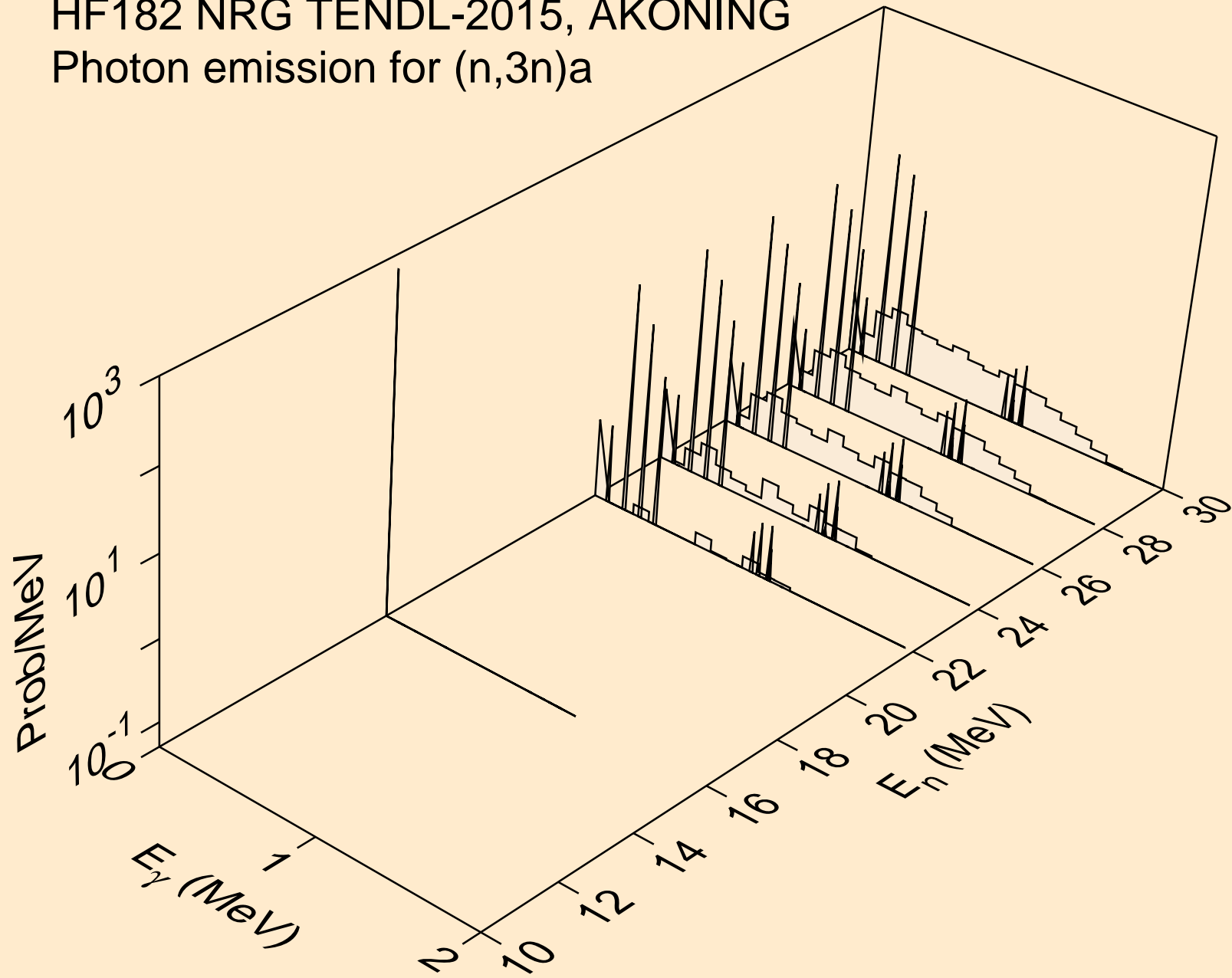

HF182 NRG TENDL-2015, AKONING
Photon emission for (n,n*)p

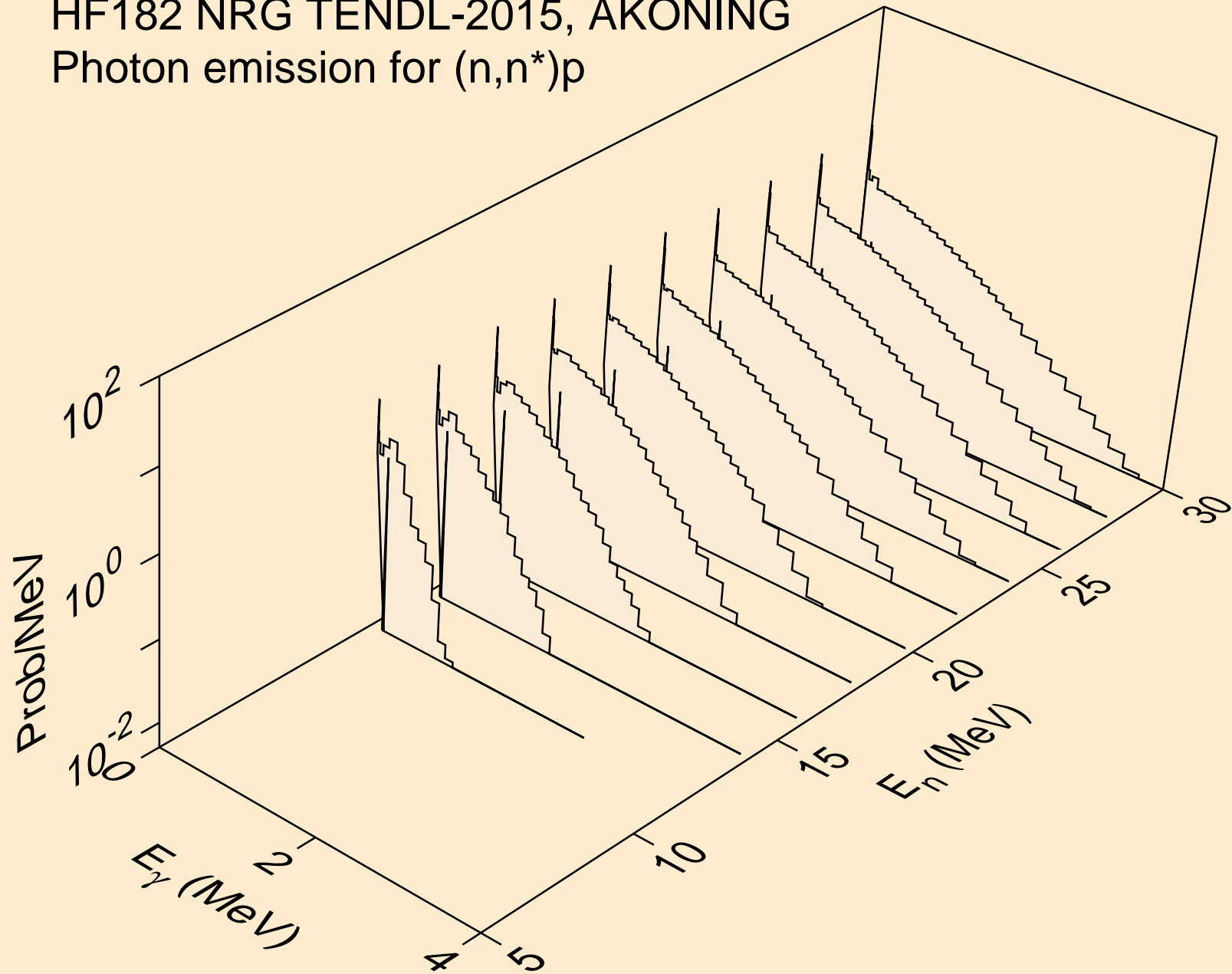

HF182 NRG TENDL-2015, AKONING
Photon emission for (n,n*)d

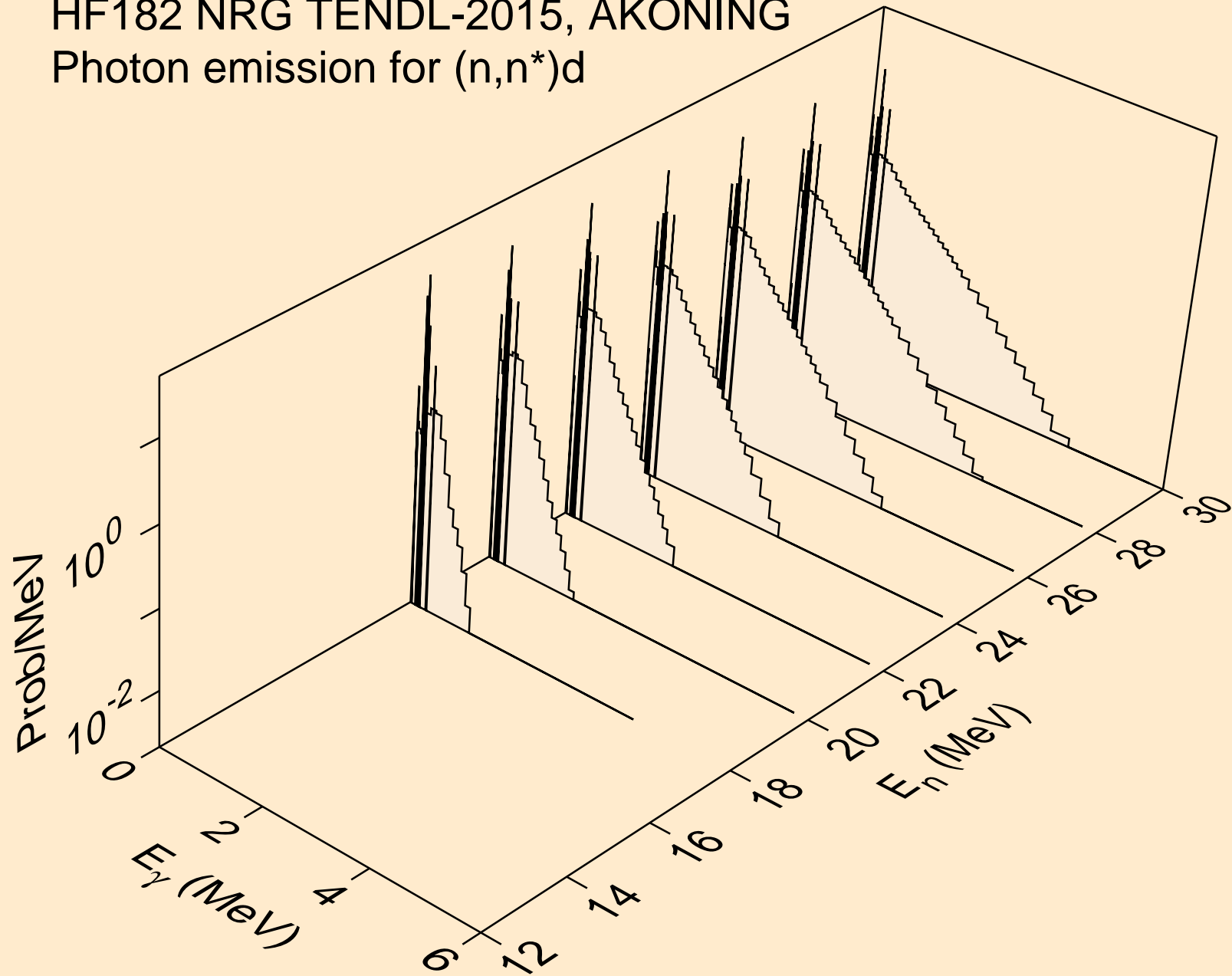

HF182 NRG TENDL-2015, AKONING
Photon emission for (n,n*)t

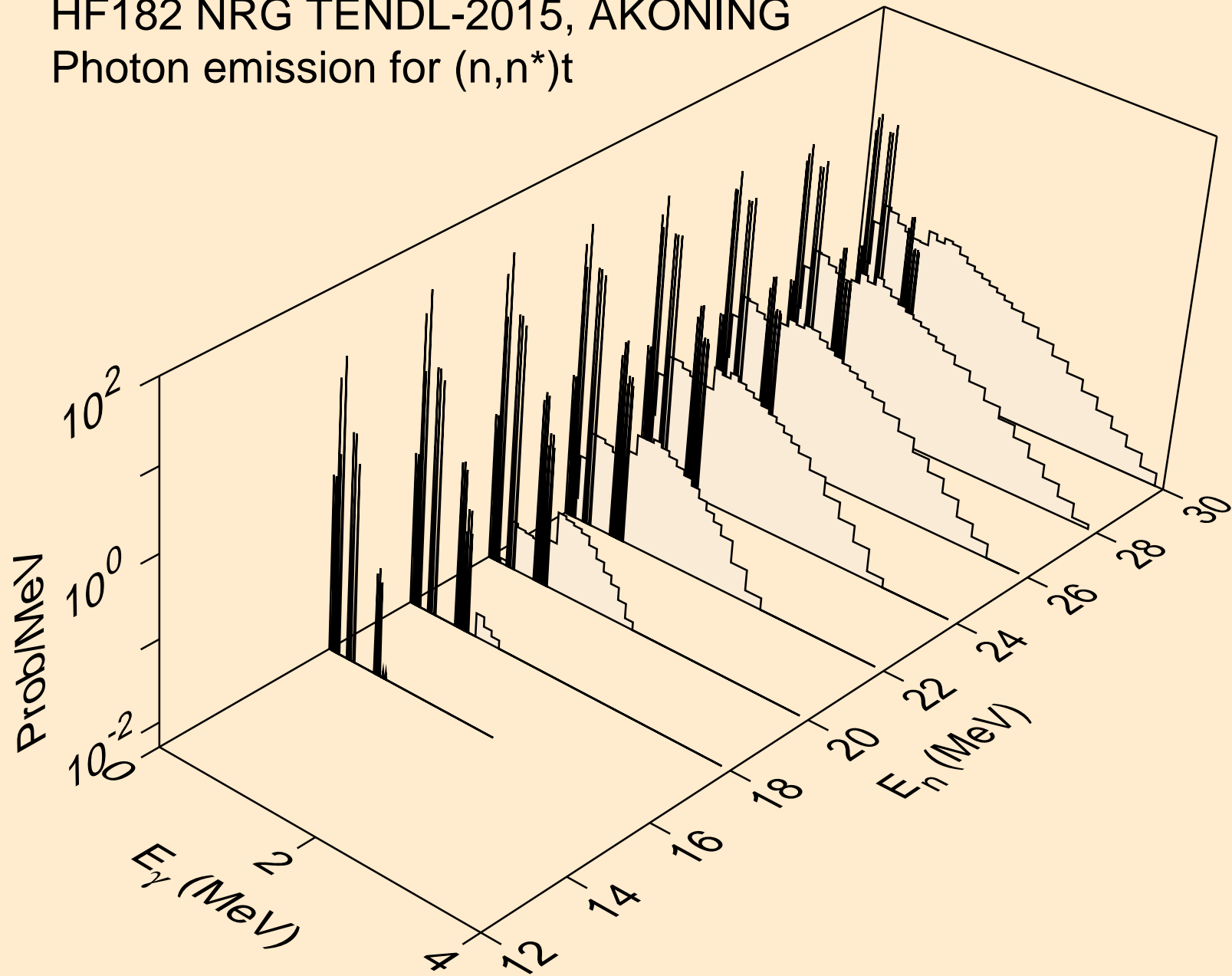

HF182 NRG TENDL-2015, AKONING
Photon emission for (n,n*)he3

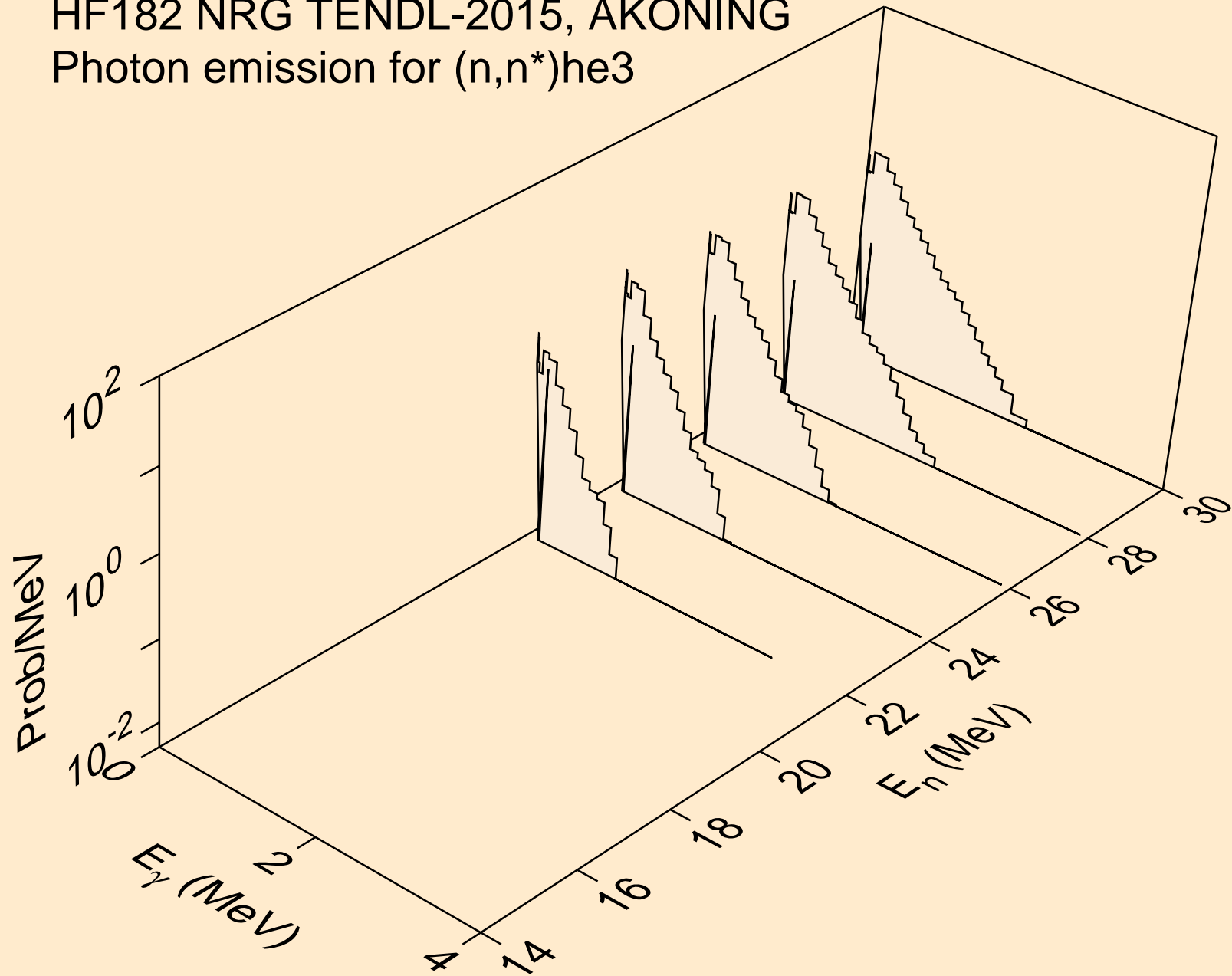

HF182 NRG TENDL-2015, AKONING
Photon emission for (n,4n)

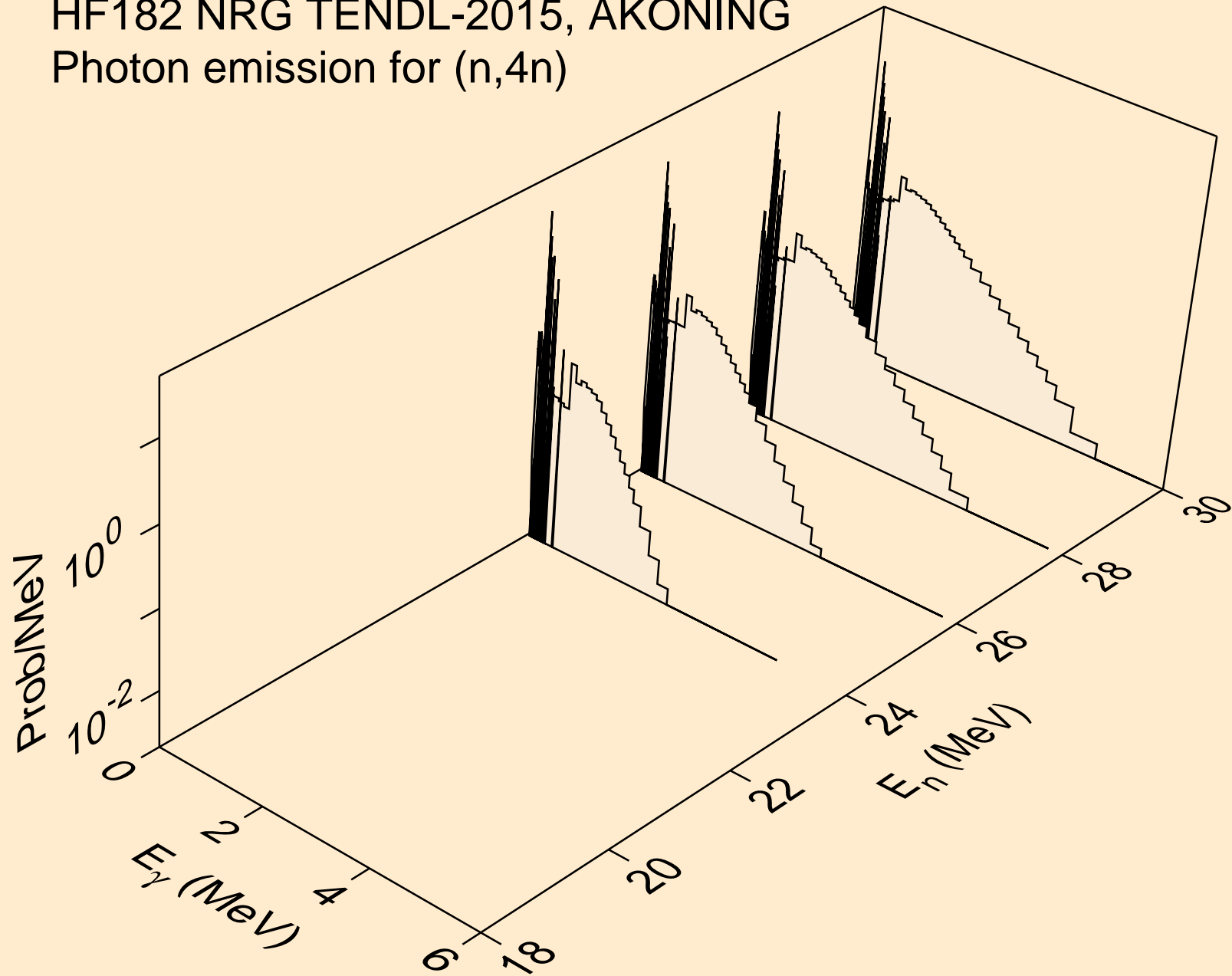

HF182 NRG TENDL-2015, AKONING
Photon emission for (n,2np)

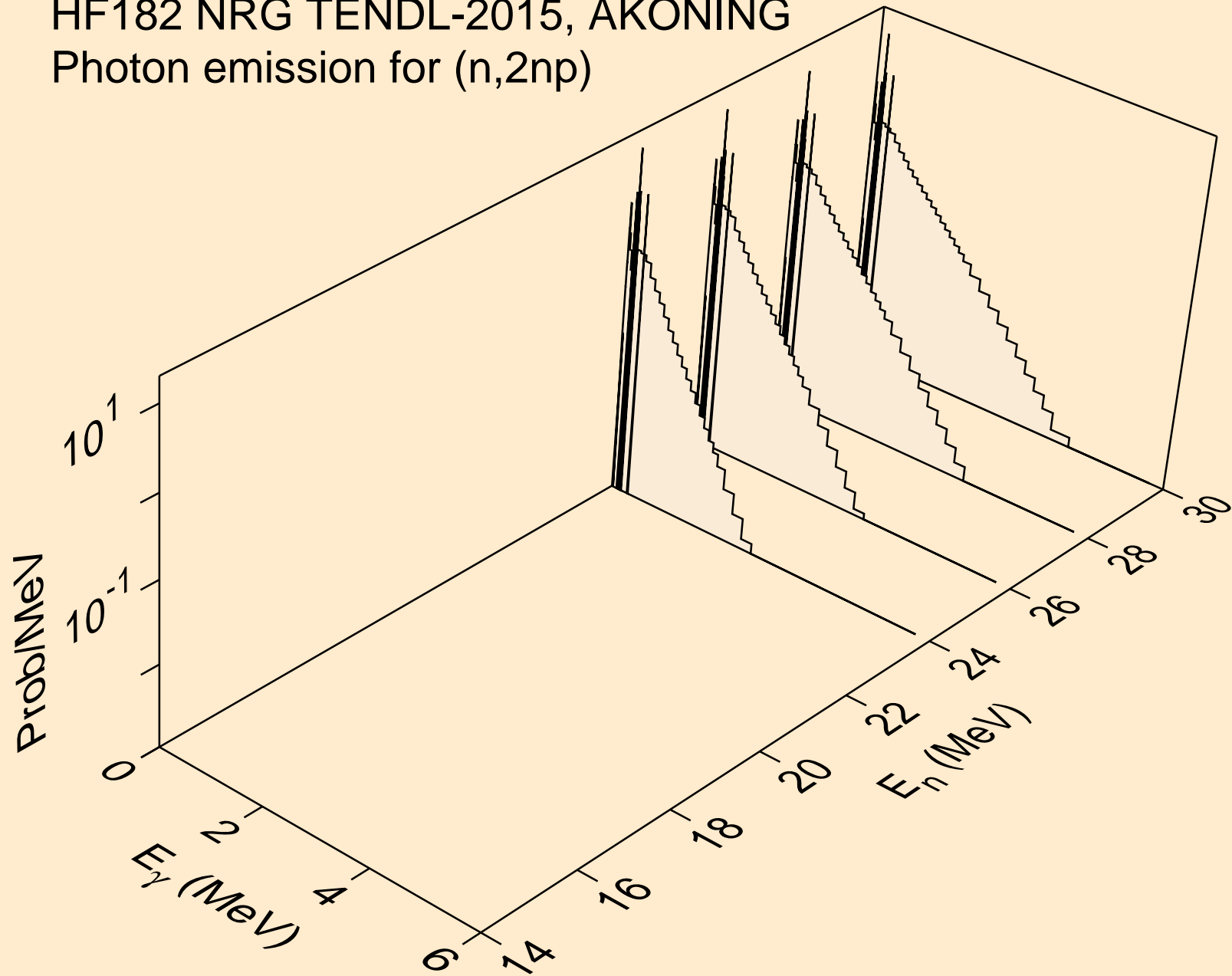

HF182 NRG TENDL-2015, AKONING
Photon emission for (n,3np)

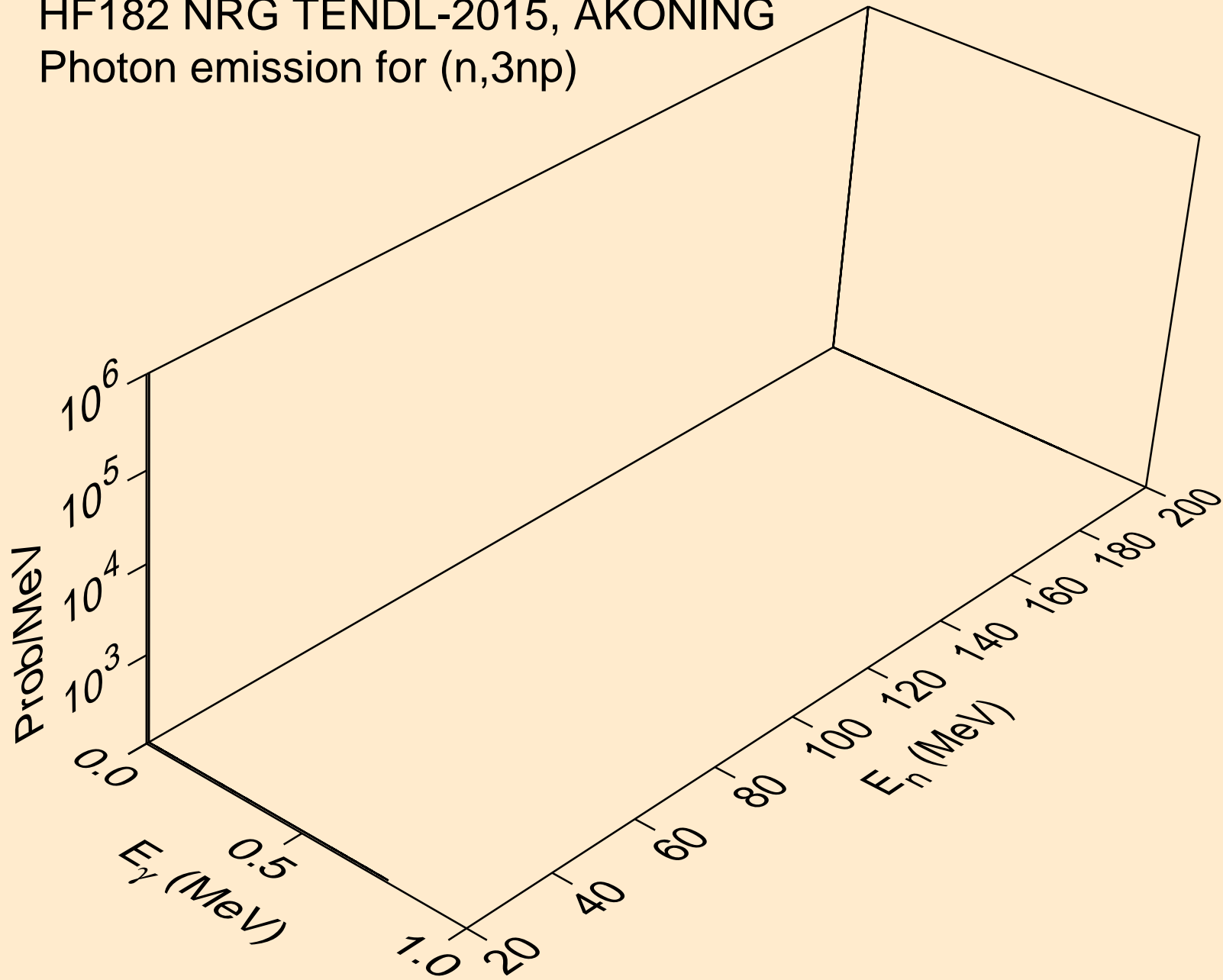

HF182 NRG TENDL-2015, AKONING
Photon emission for (n,2np)

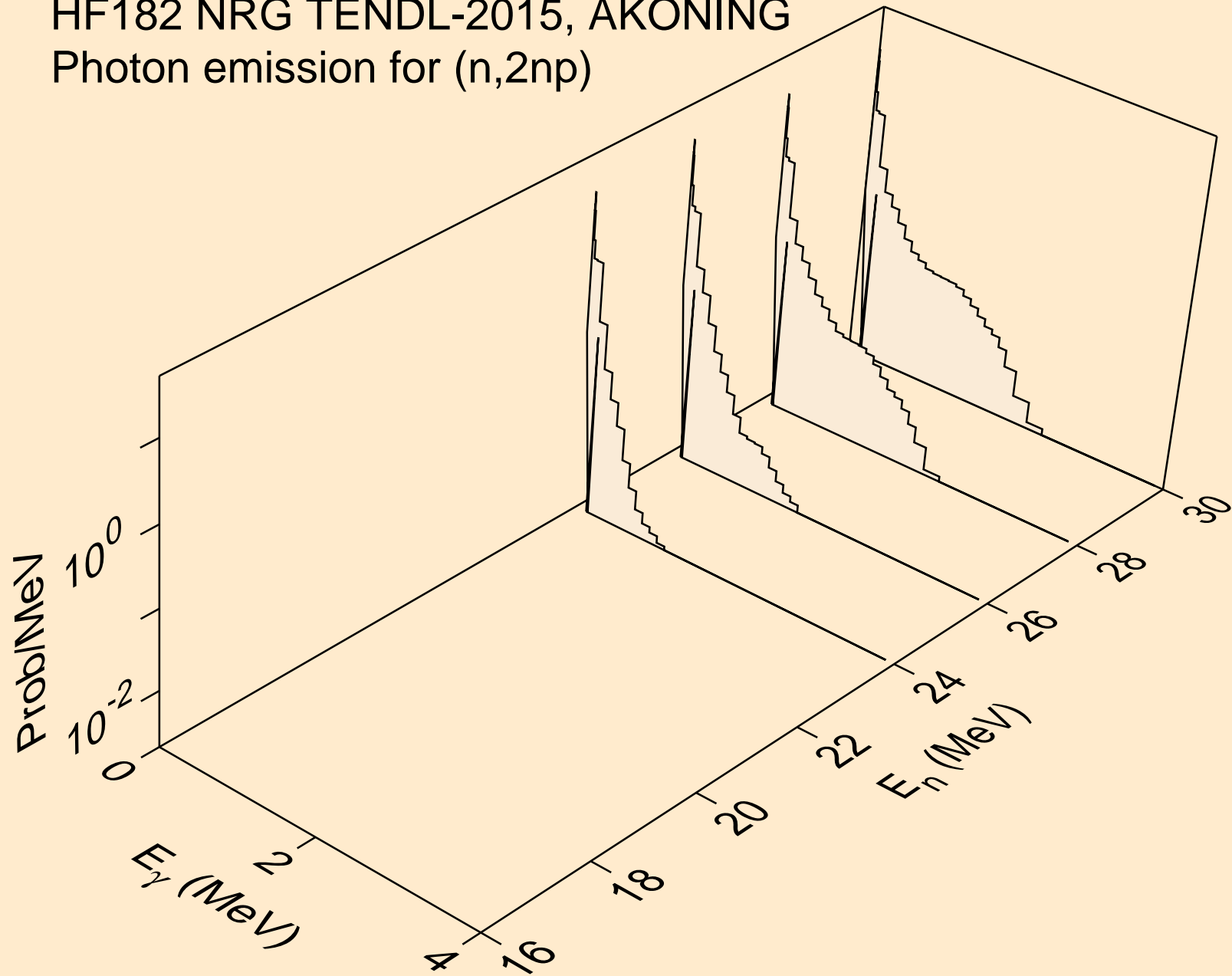

HF182 NRG TENDL-2015, AKONING
Photon emission for (n,n*c)

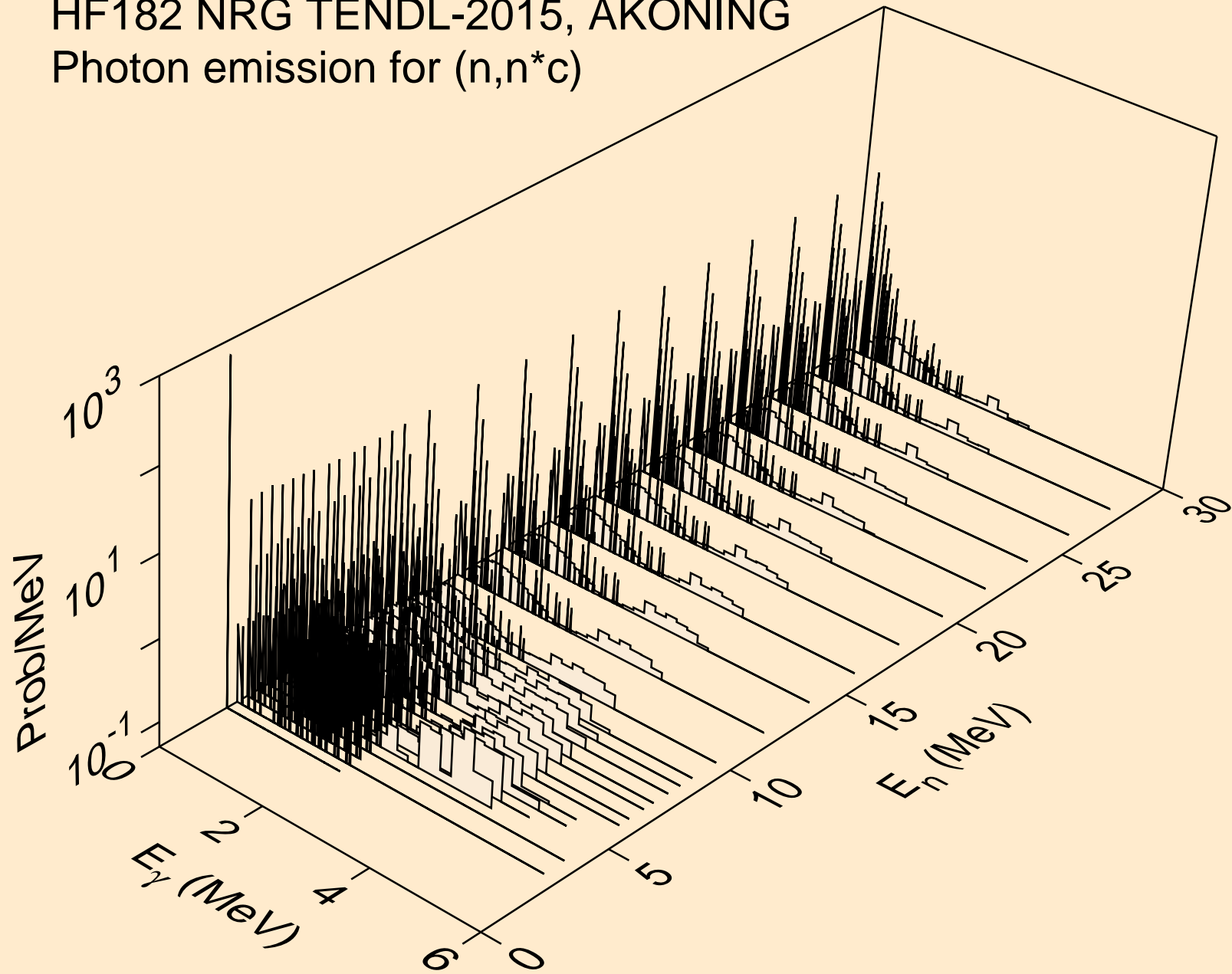

HF182 NRG TENDL-2015, AKONING
Photon emission for (n,gma)

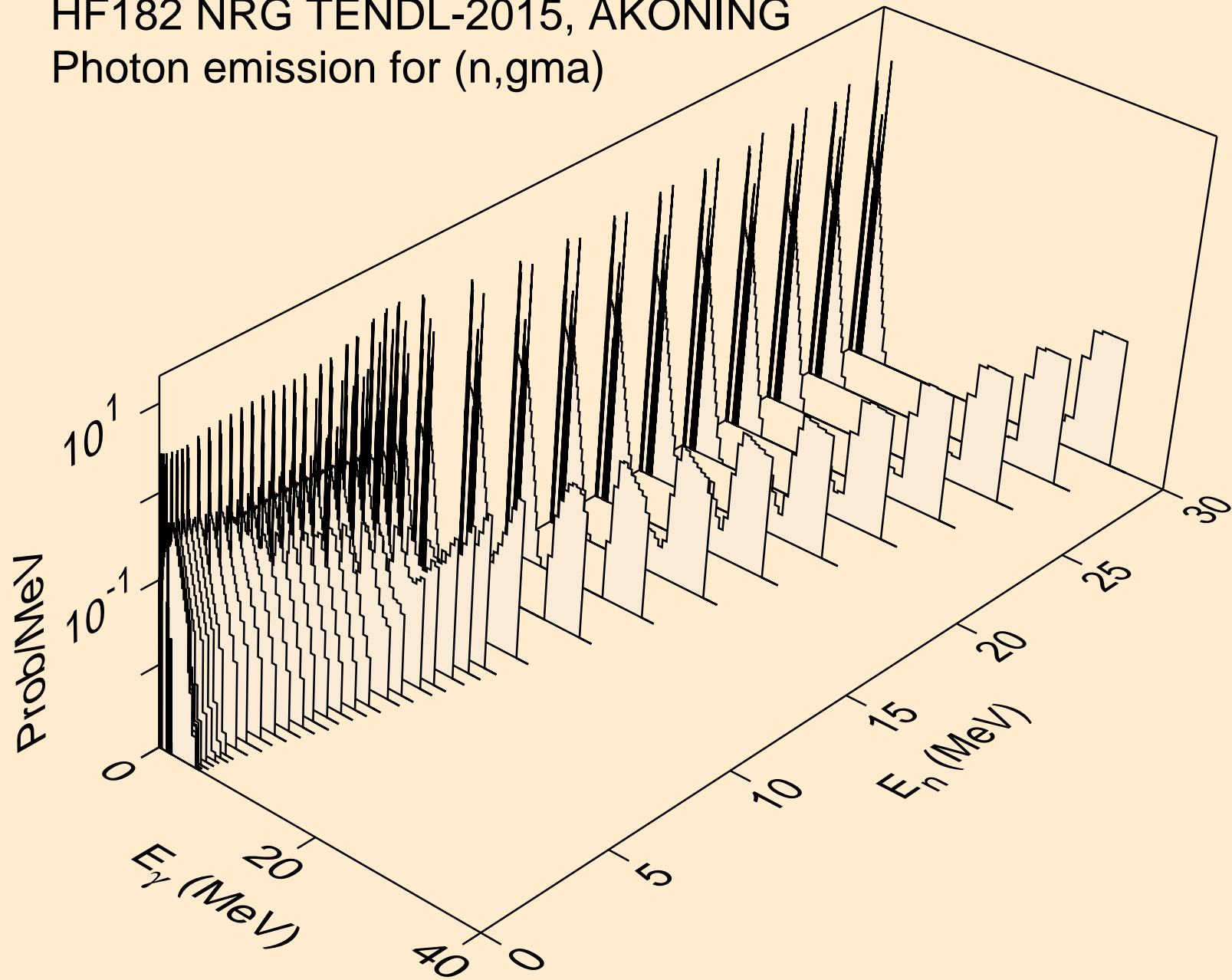

HF182 NRG TENDL-2015, AKONING
Photon emission for (n,p)

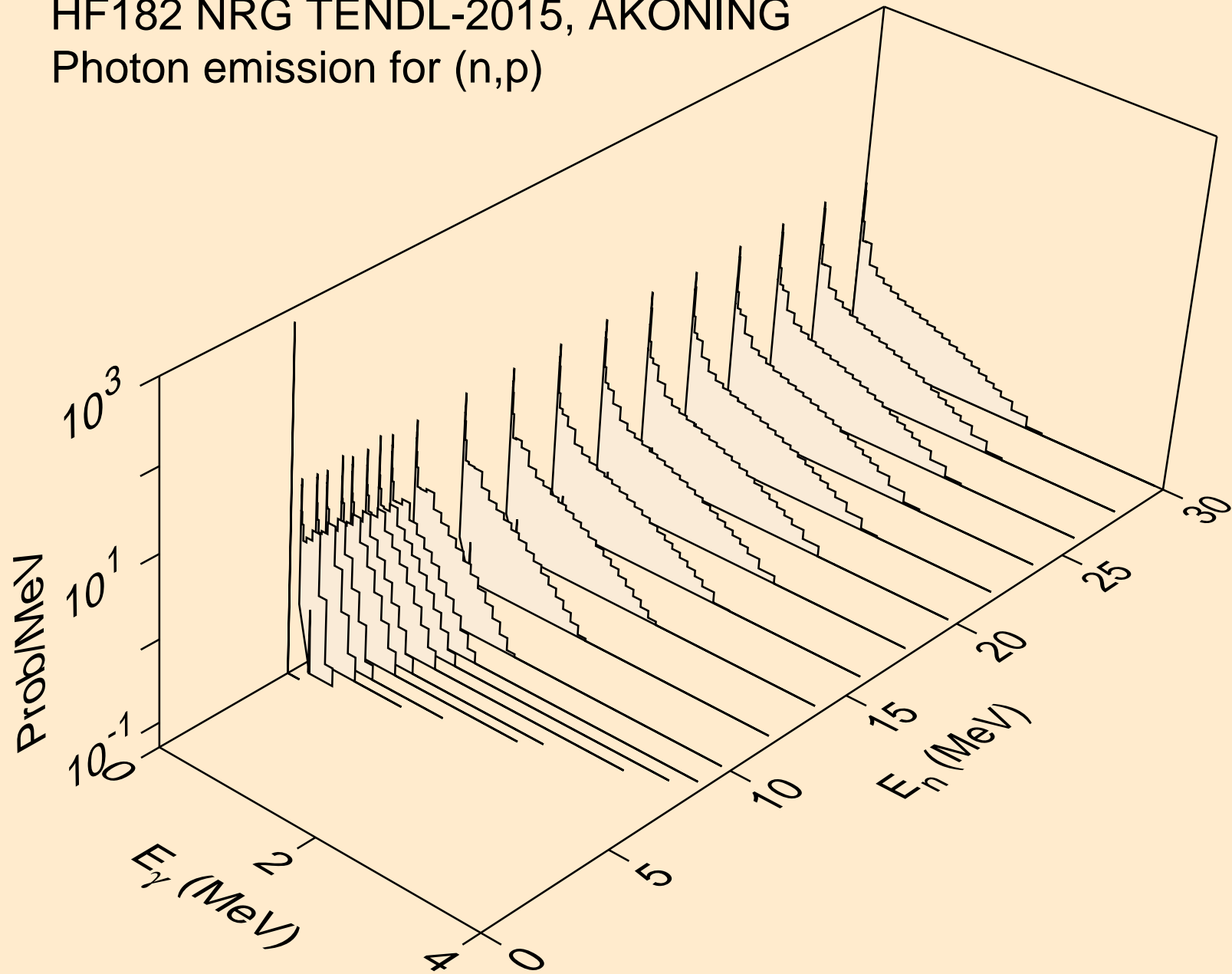

HF182 NRG TENDL-2015, AKONING
Photon emission for (n,d)

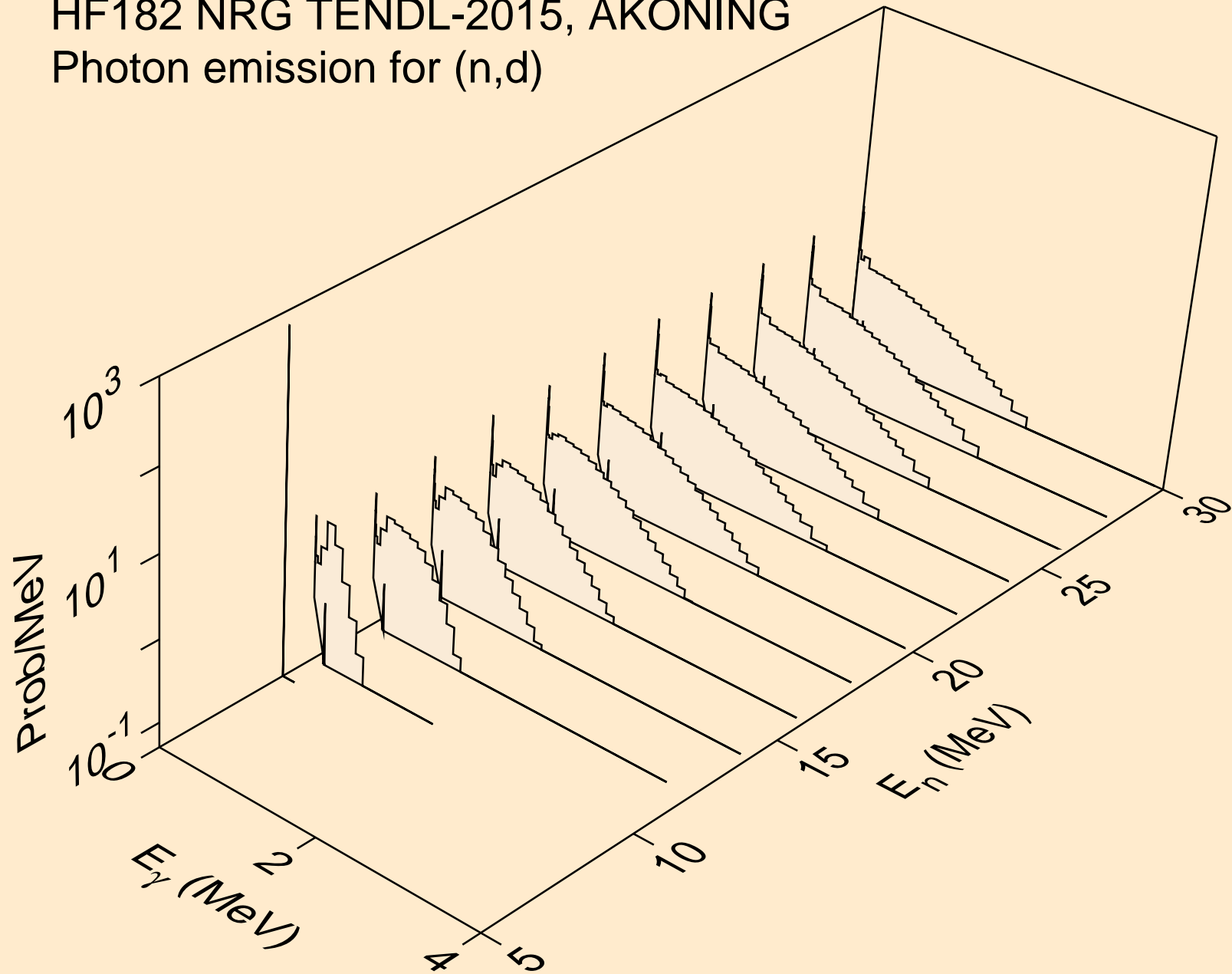

HF182 NRG TENDL-2015, AKONING
Photon emission for (n,t)

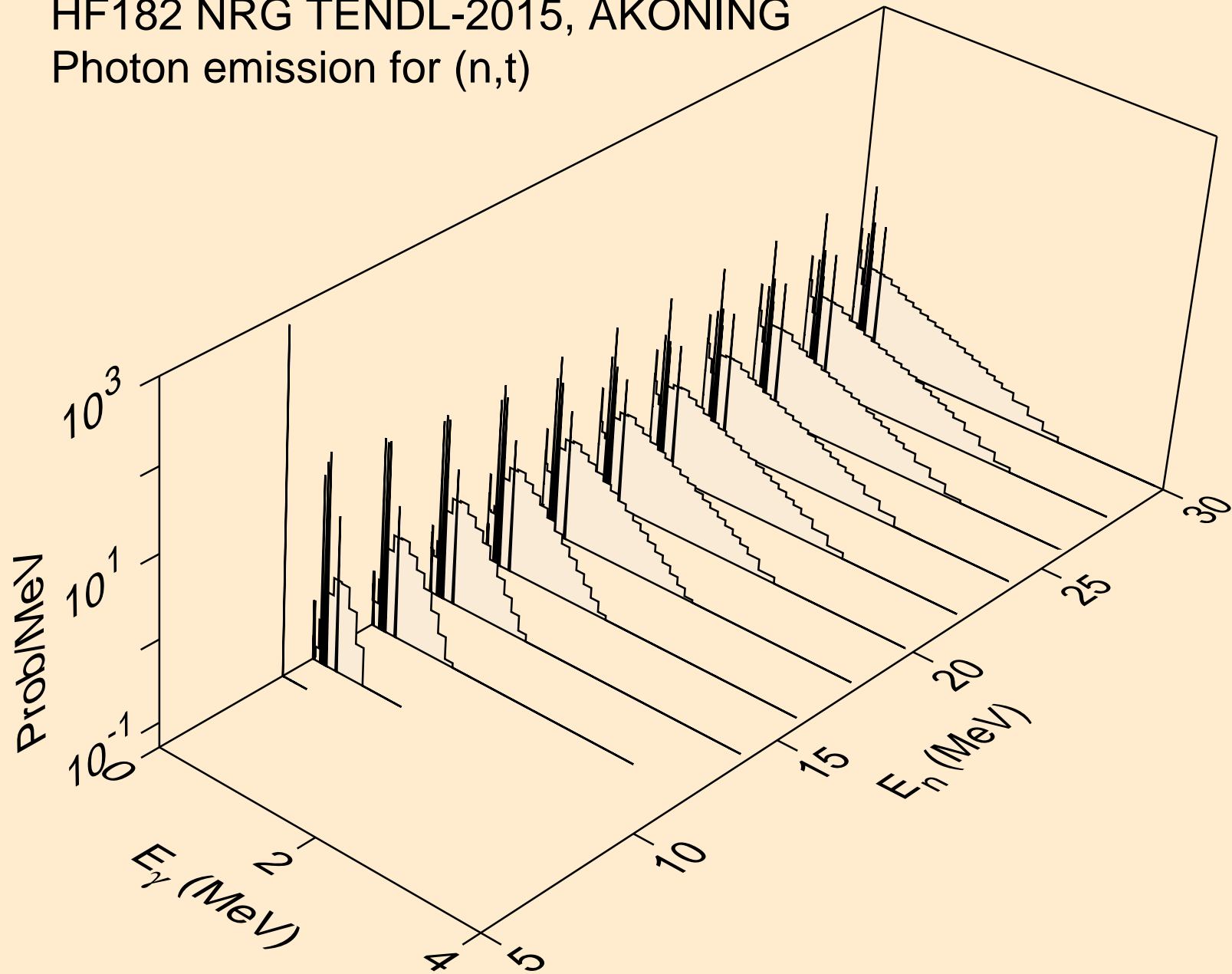

HF182 NRG TENDL-2015, AKONING
Photon emission for (n,he3)

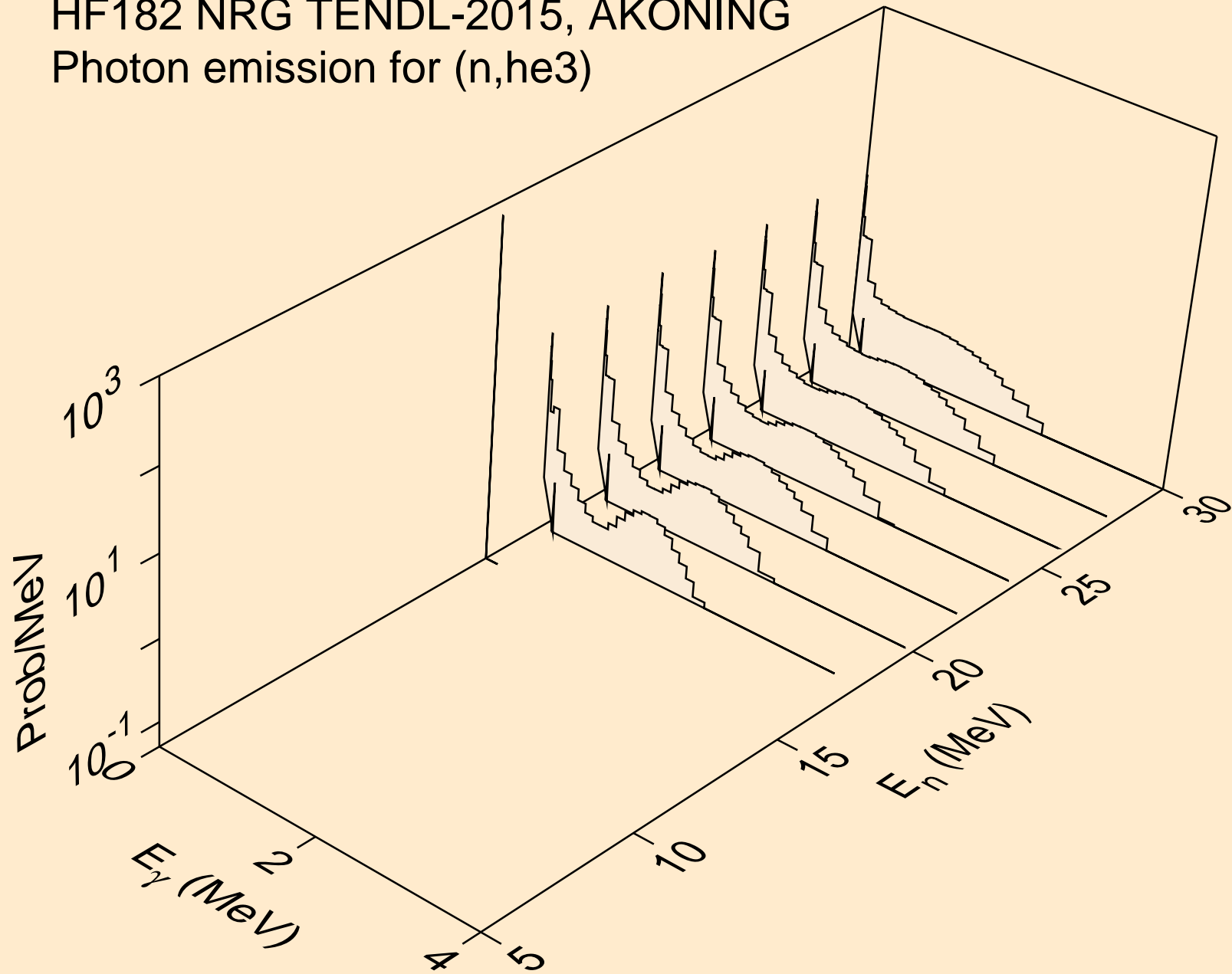

HF182 NRG TENDL-2015, AKONING
Photon emission for (n,a)

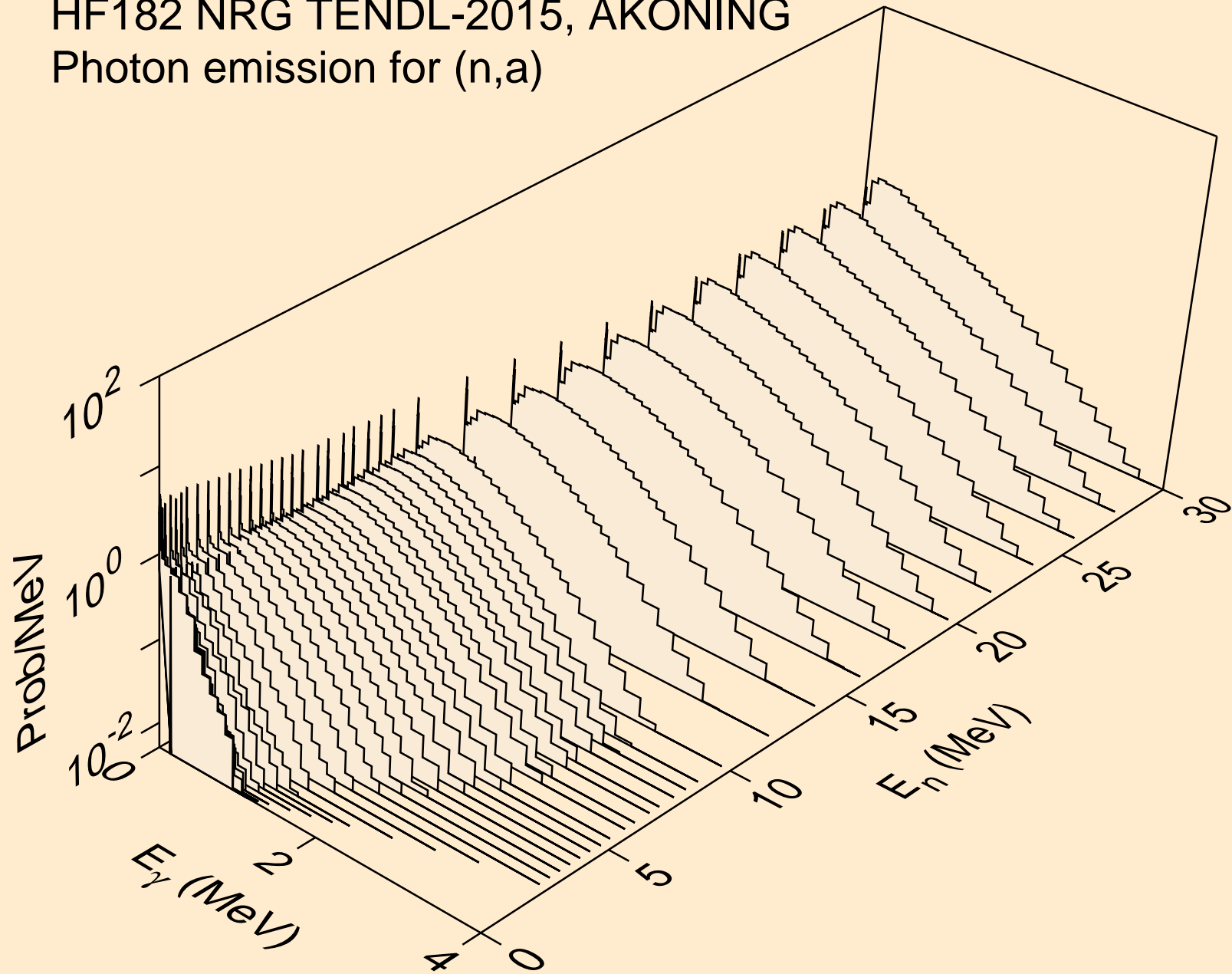

HF182 NRG TENDL-2015, AKONING
Photon emission for (n,2p)

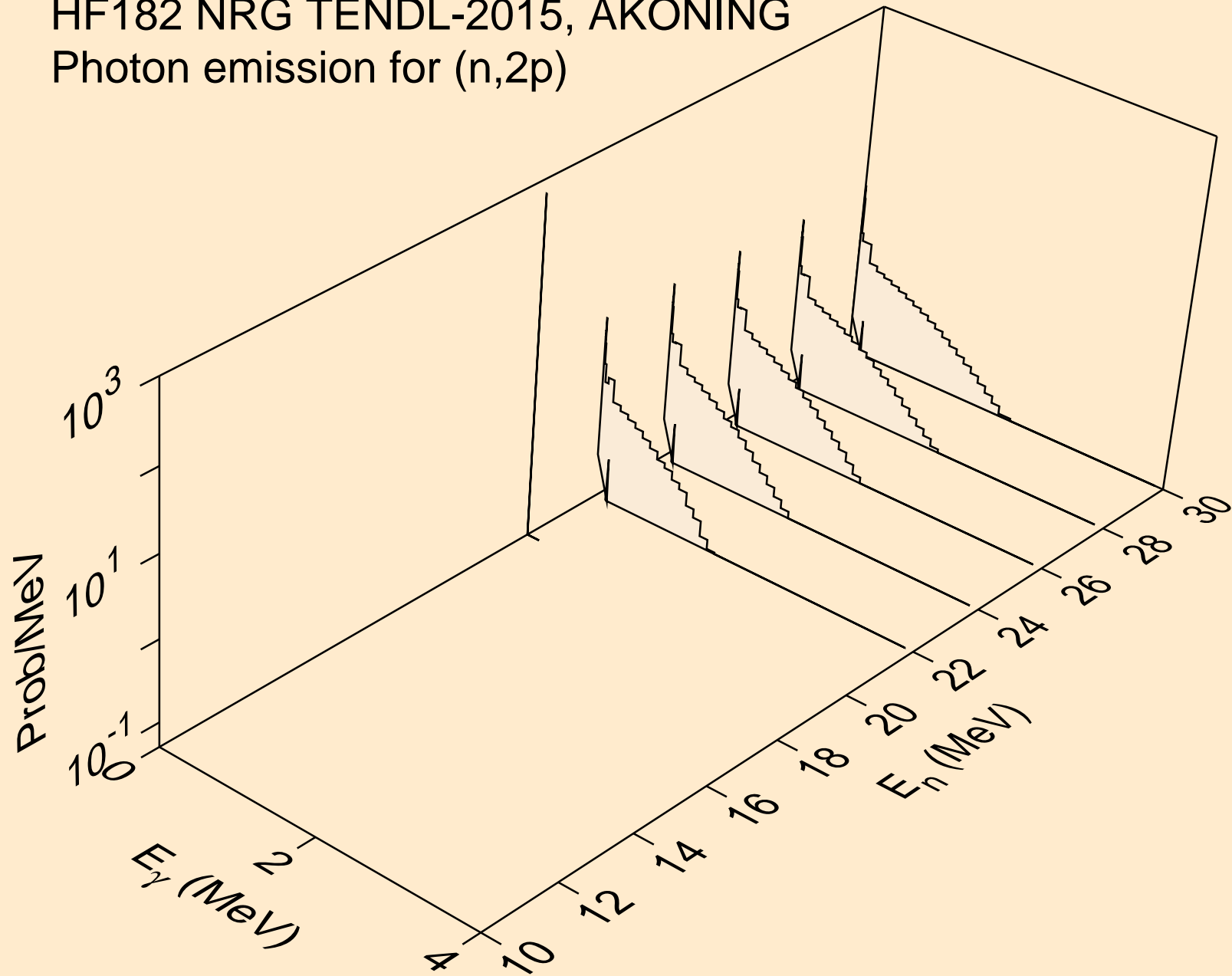

HF182 NRG TENDL-2015, AKONING
thermal capture photon spectrum

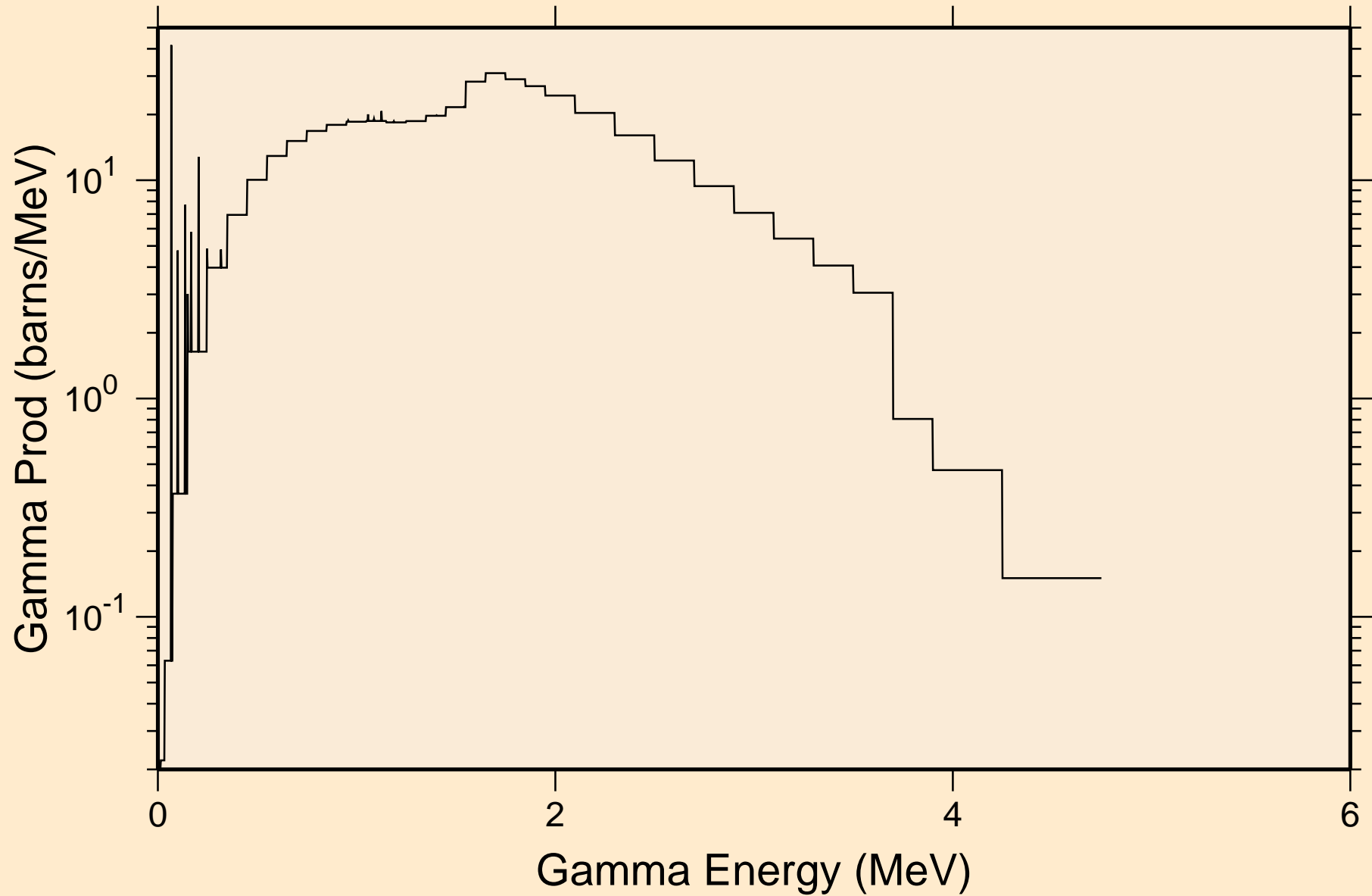

HF182 NRG TENDL-2015, AKONING
14 MeV photon spectrum

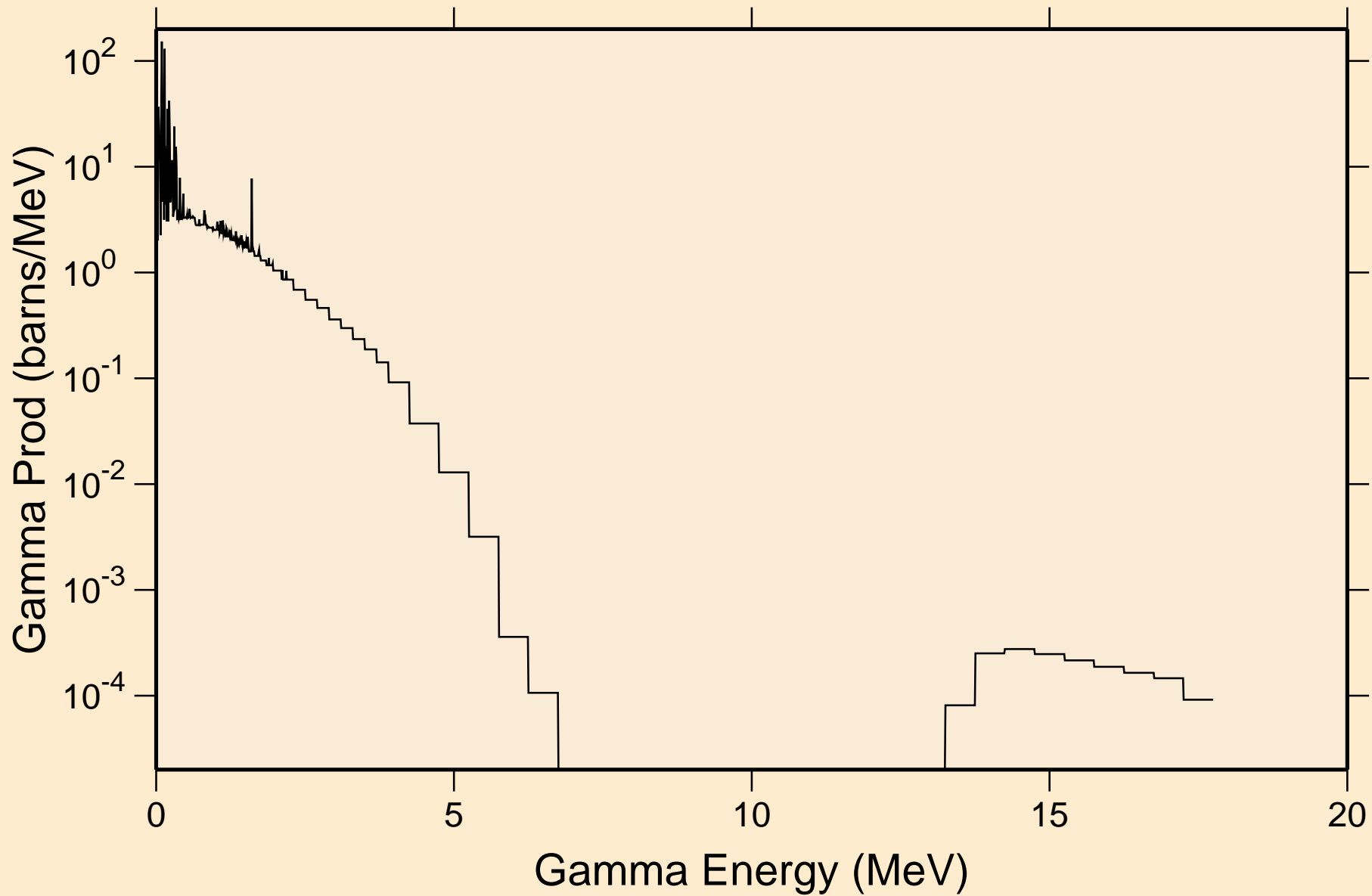

HF182 NRG TENDL-2015, AKONING

Particle heating contributions

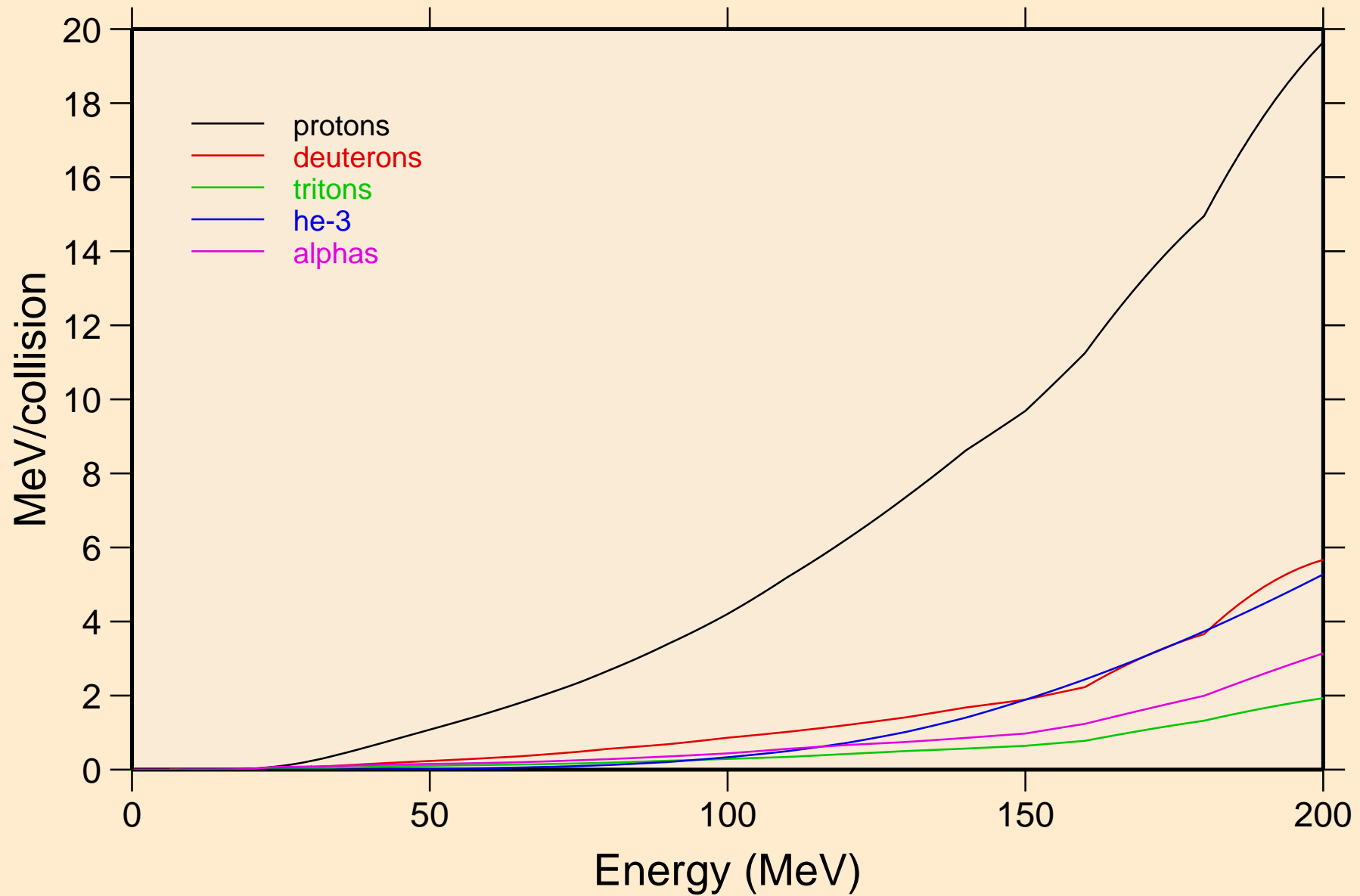

HF182 NRG TENDL-2015, AKONING

Recoil Heating

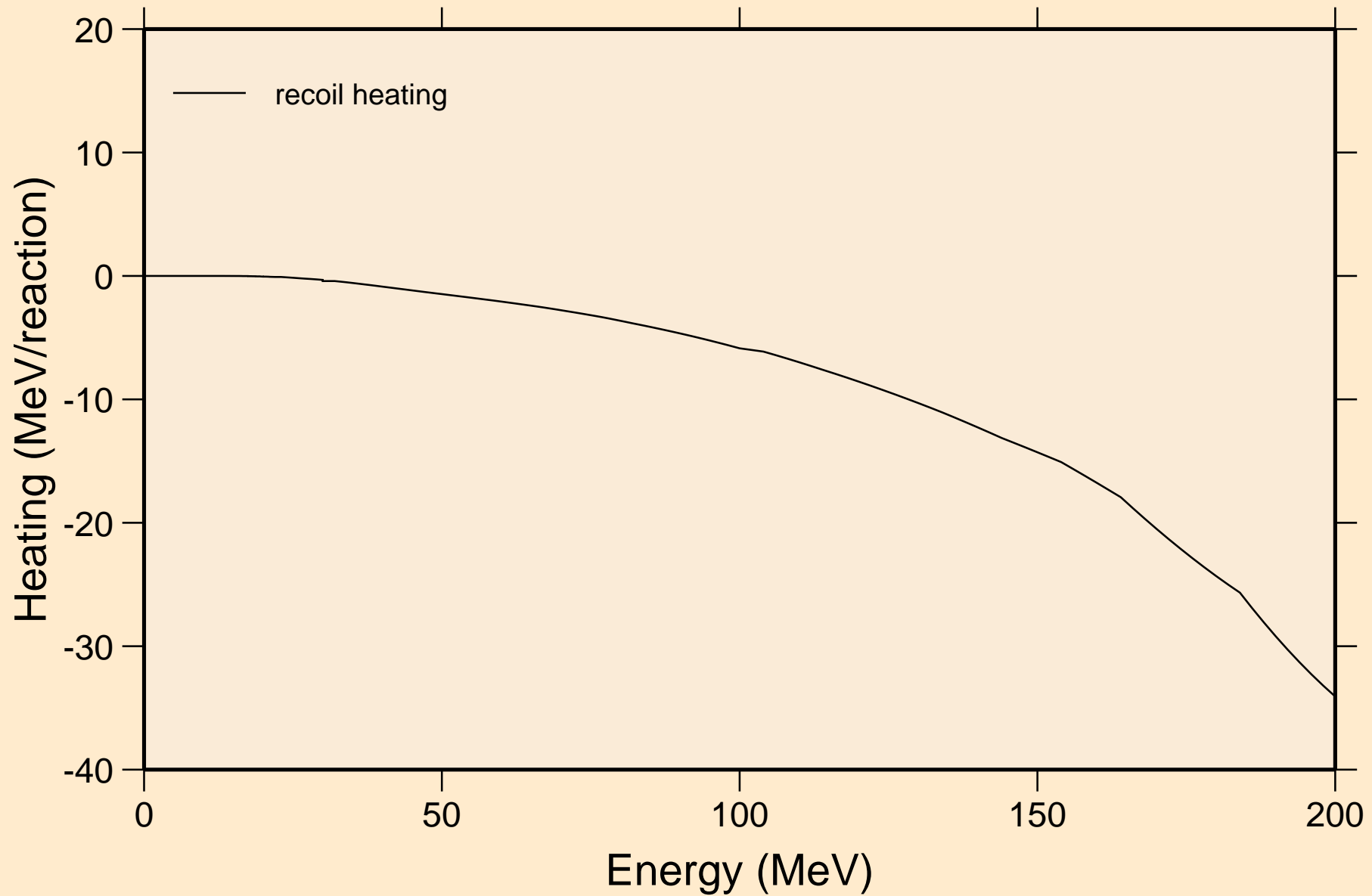

HF182 NRG TENDL-2015, AKONING

Particle production cross sections

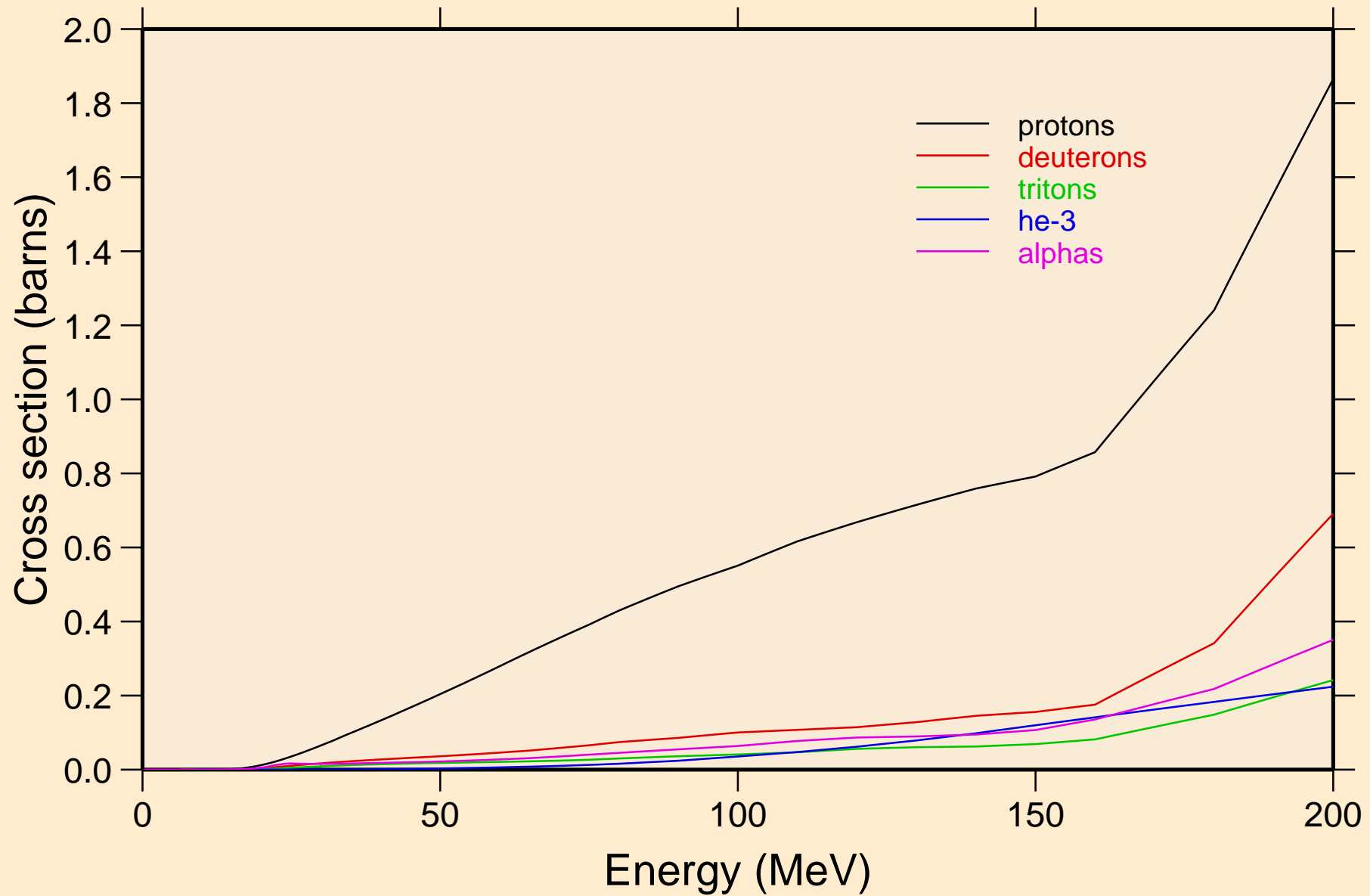

HF182 NRG TENDL-2015, AKONING
protons from (n,x)

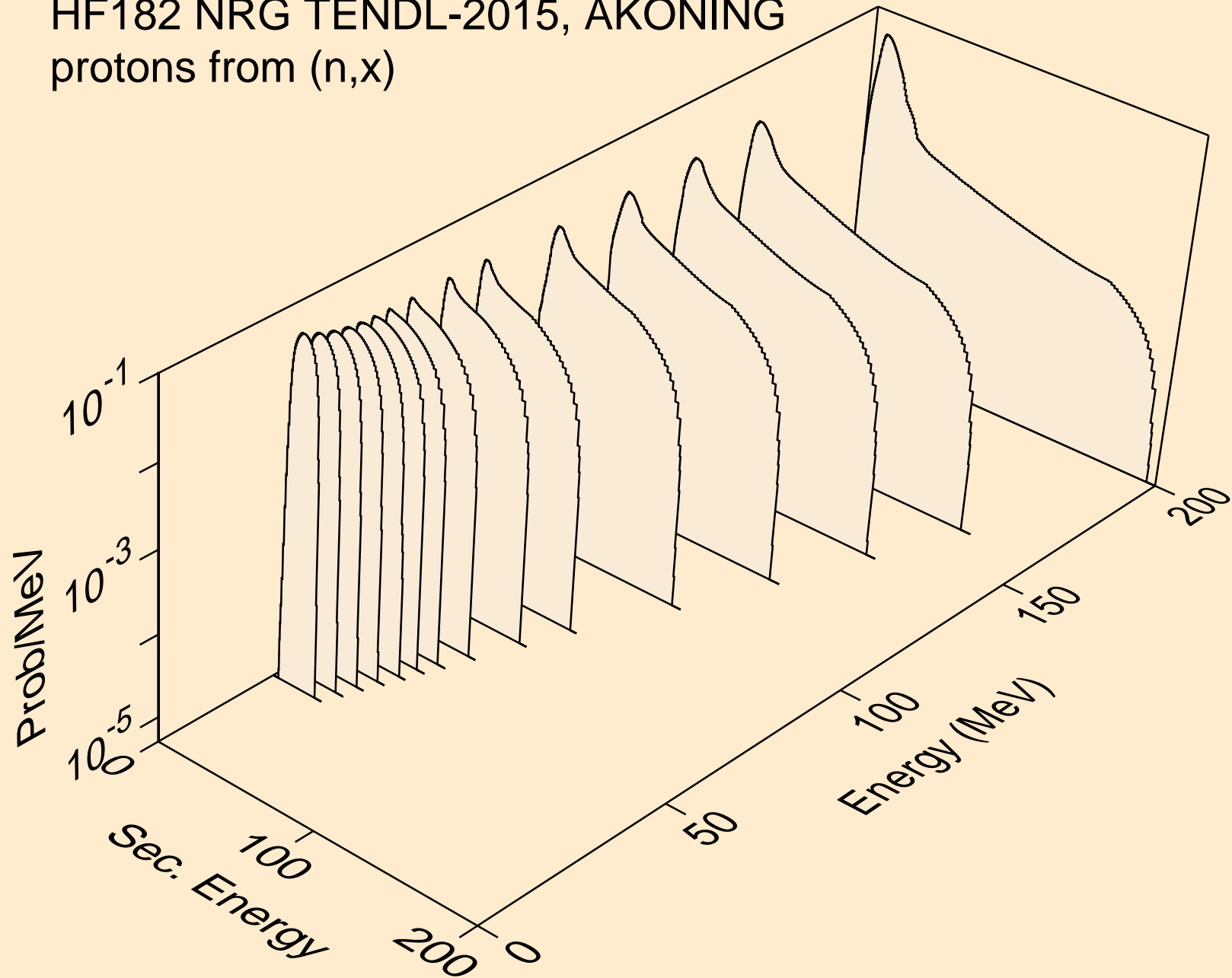

HF182 NRG TENDL-2015, AKONING
protons from (n,n*)p

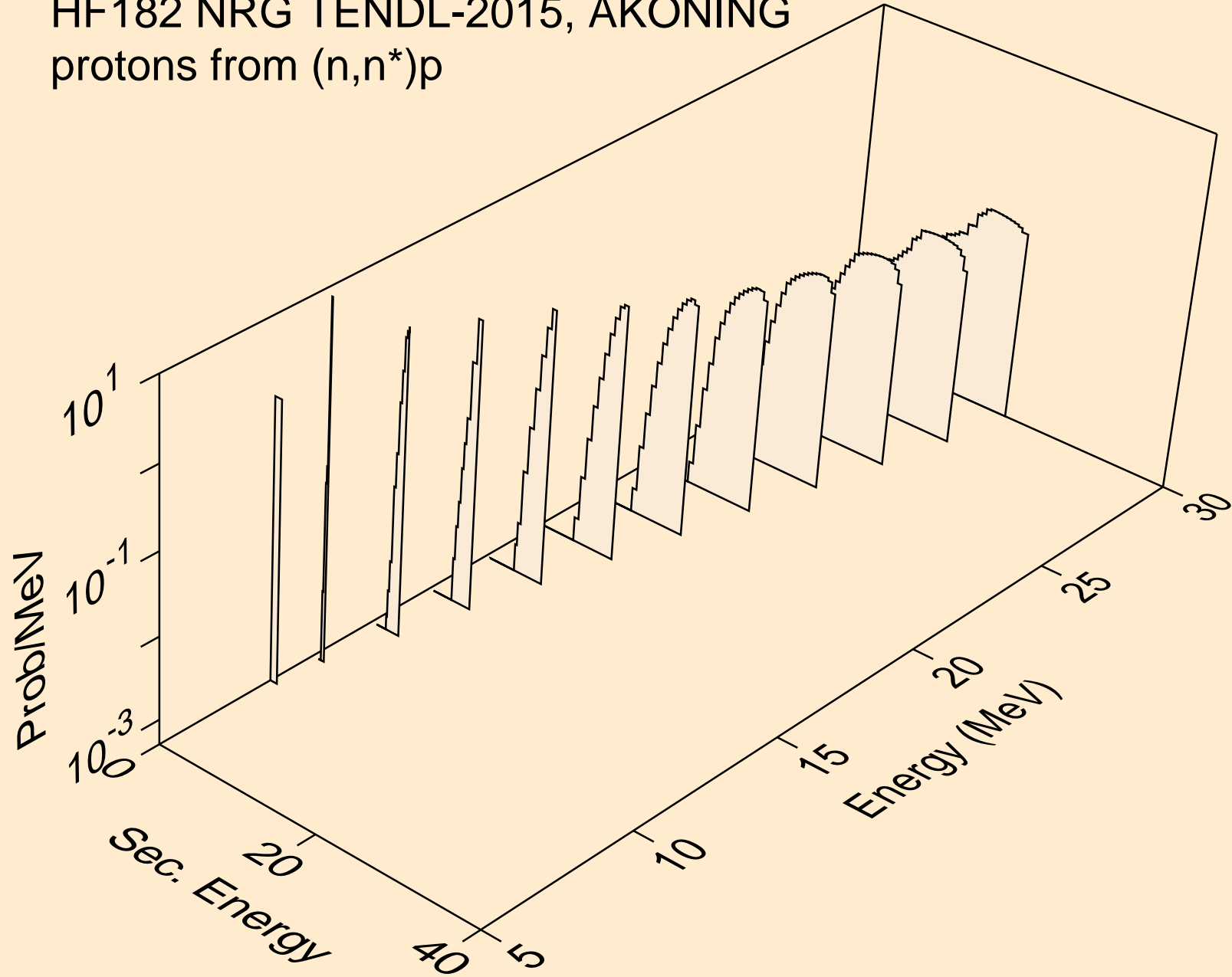

HF182 NRG TENDL-2015, AKONING
protons from (n,2np)

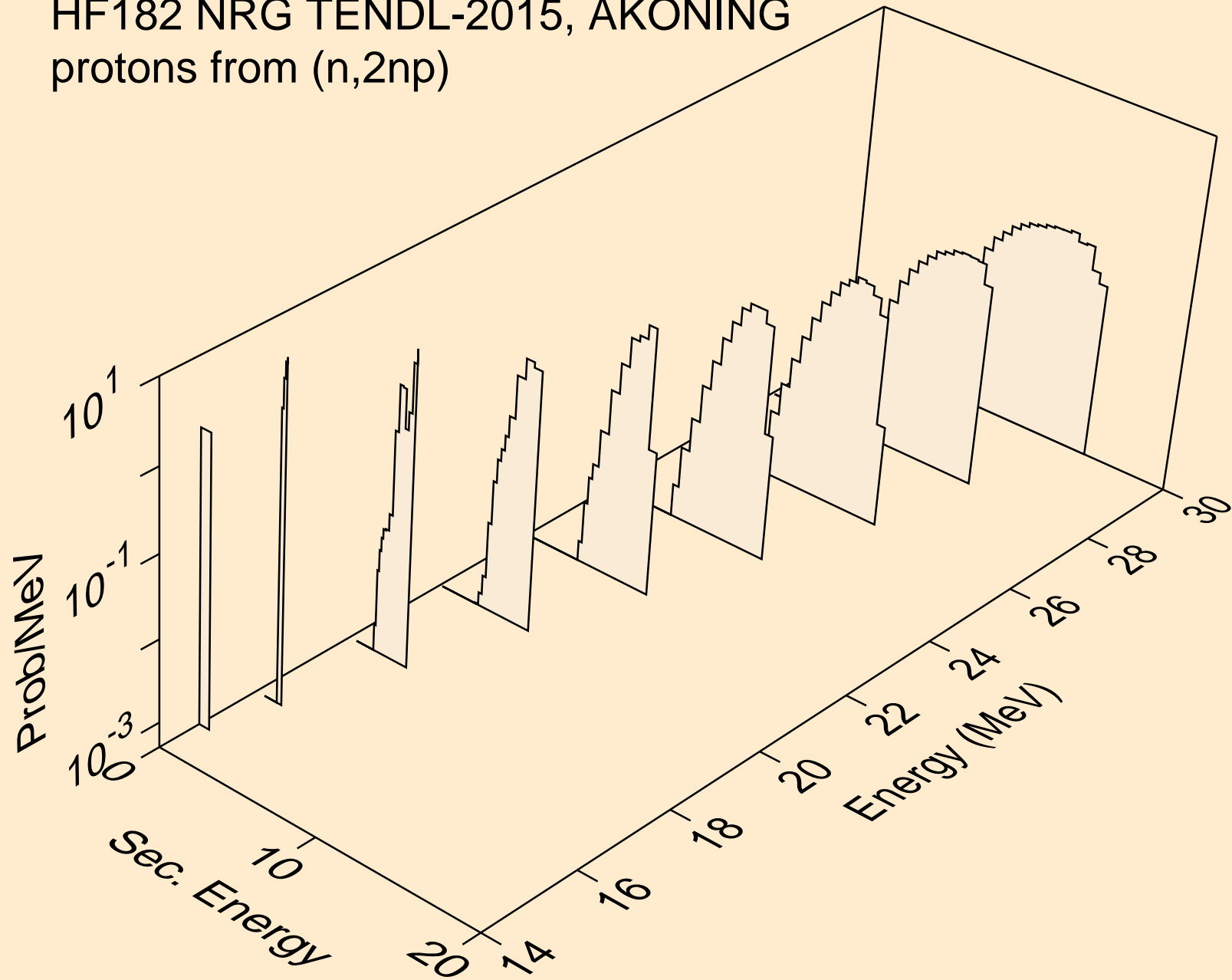

HF182 NRG TENDL-2015, AKONING
protons from (n,3np)

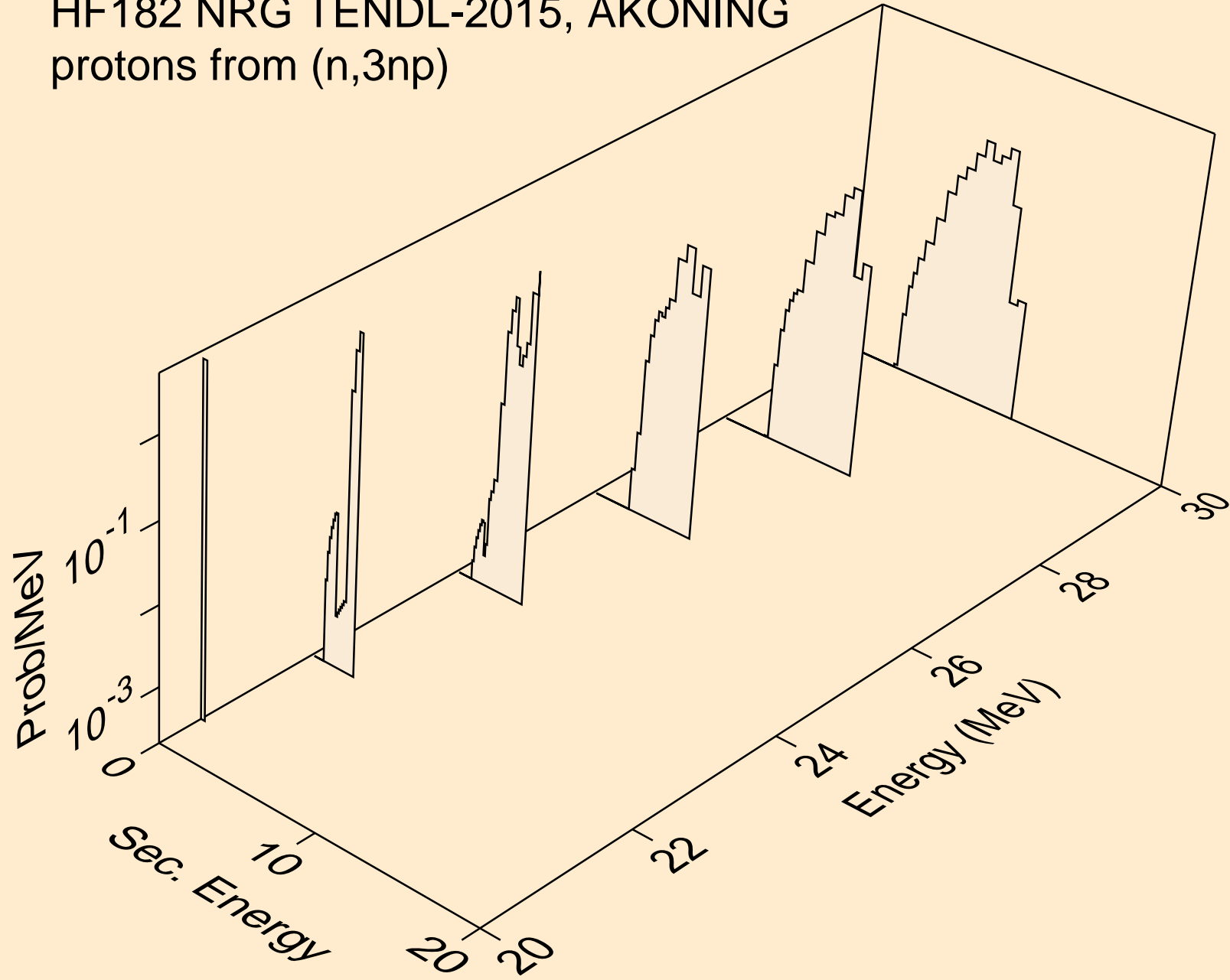

HF182 NRG TENDL-2015, AKONING
protons from (n,2np)

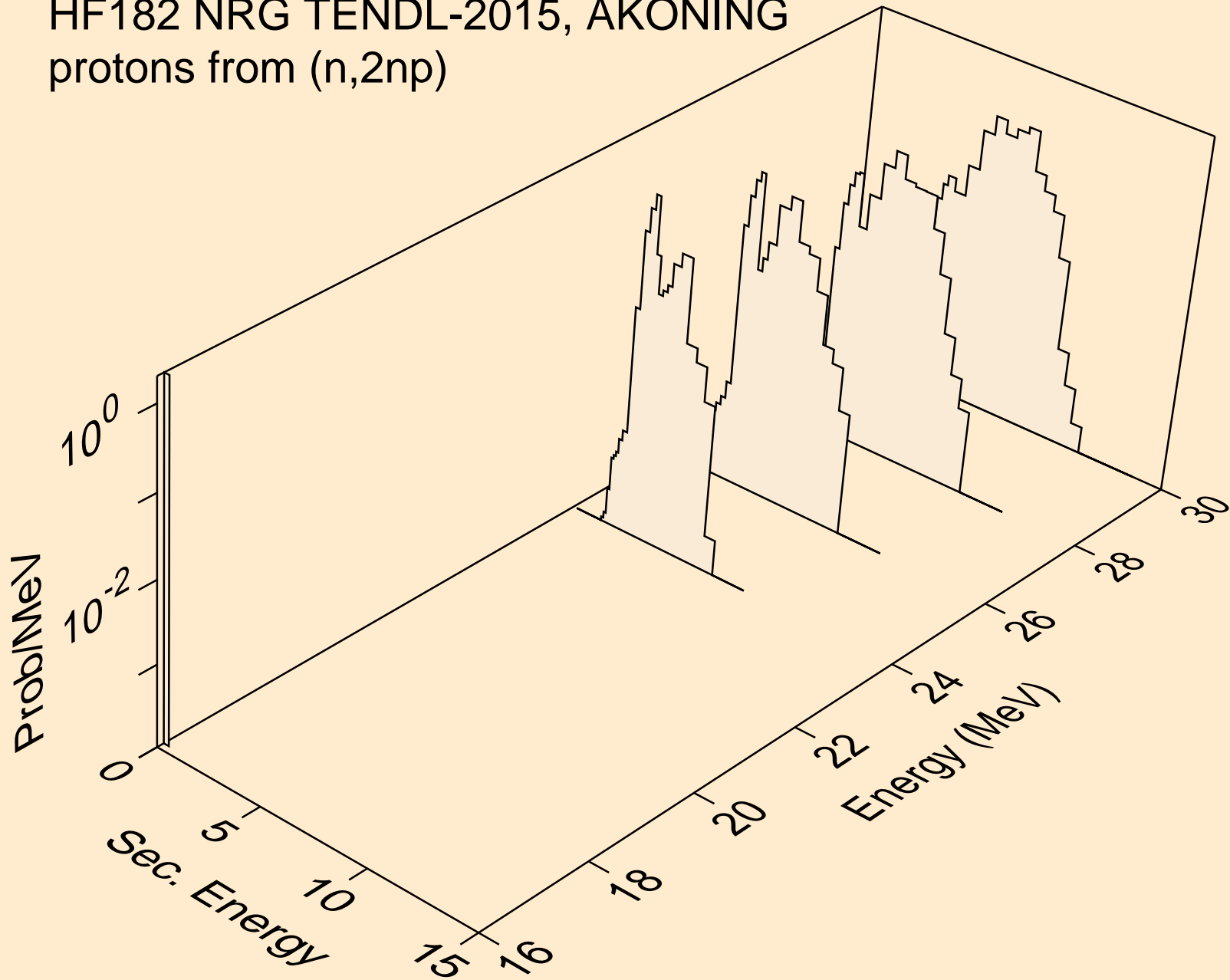

HF182 NRG TENDL-2015, AKONING
protons from (n,p)

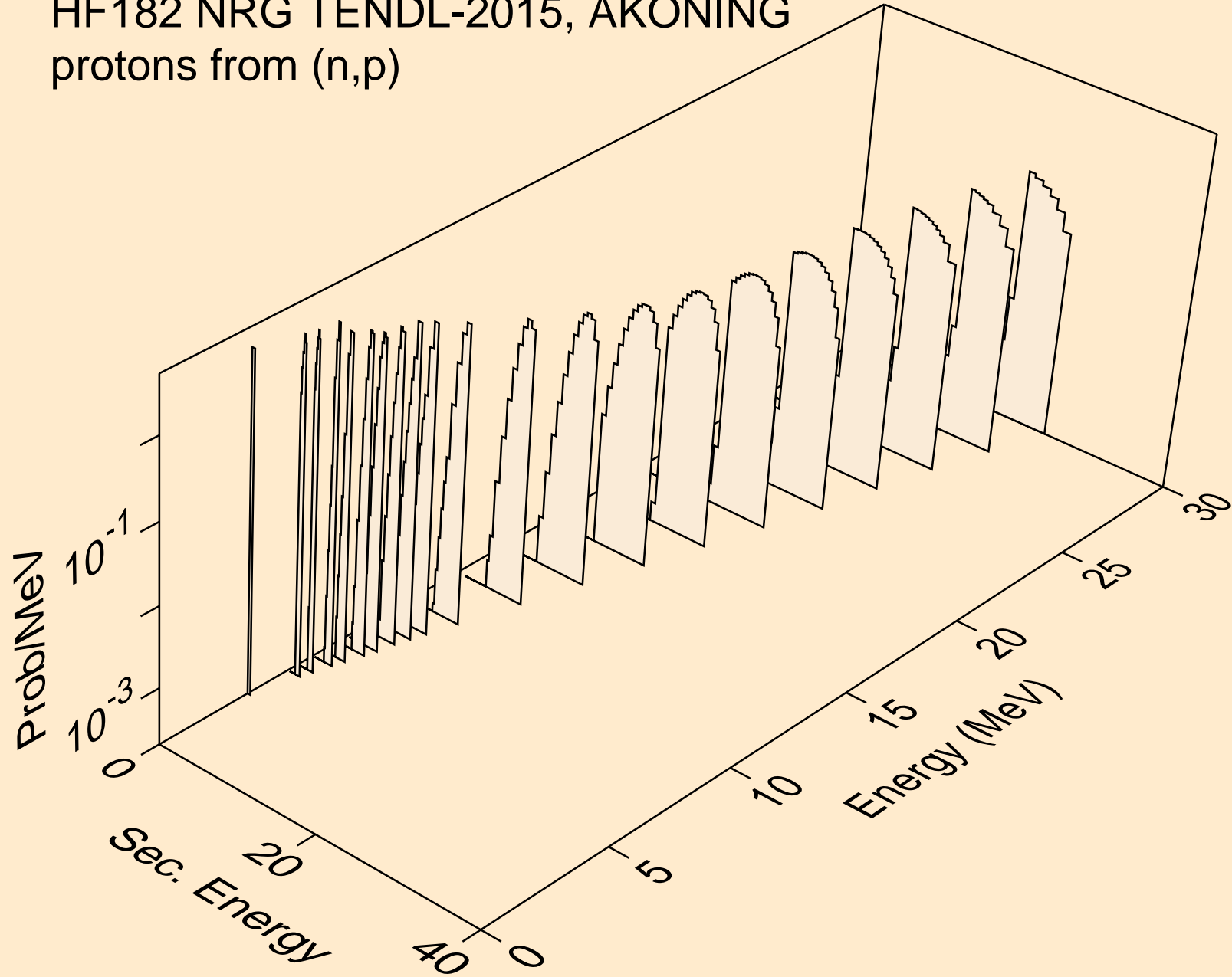

HF182 NRG TENDL-2015, AKONING
protons from (n,2p)

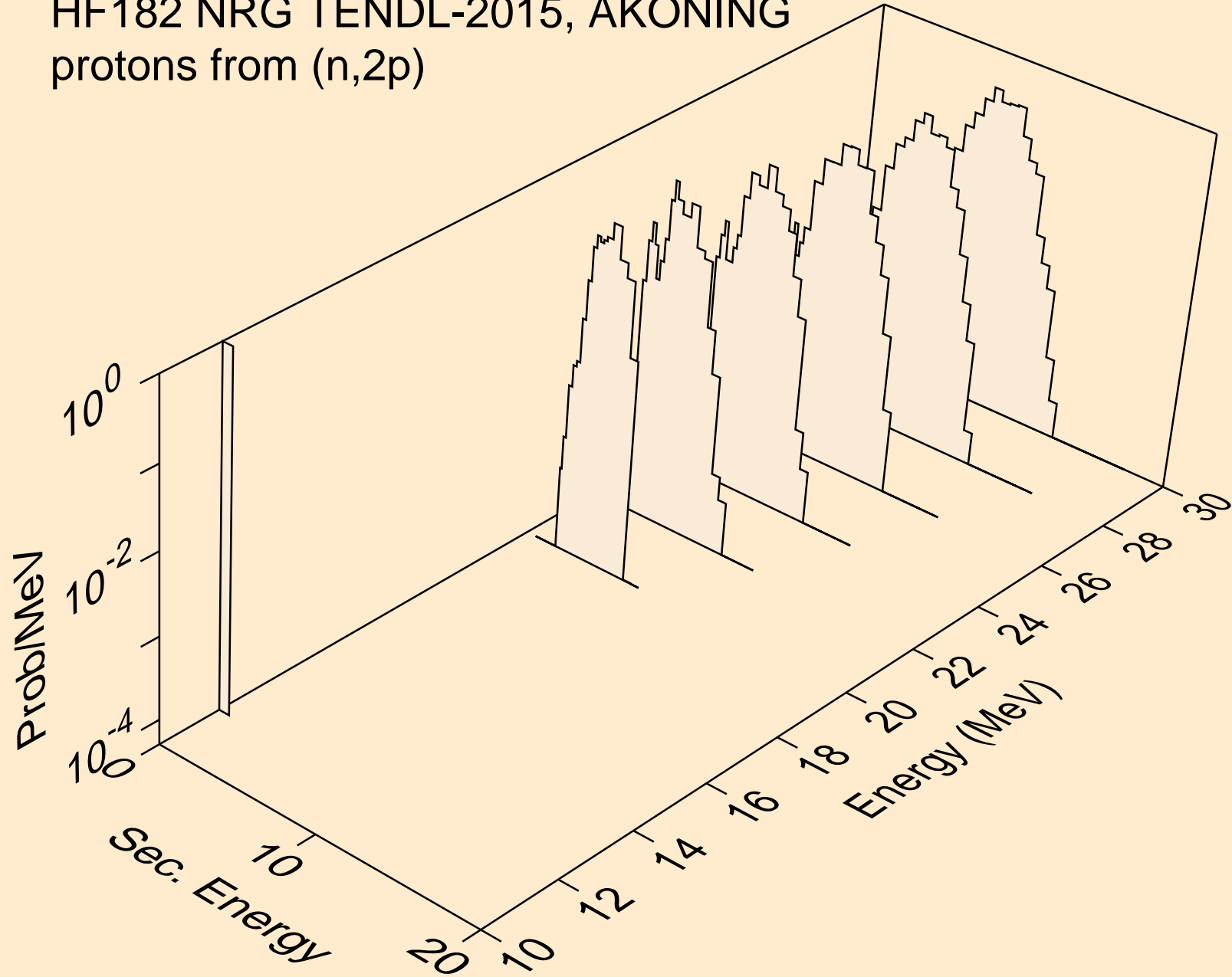

HF182 NRG TENDL-2015, AKONING
deuterons from (n,x)

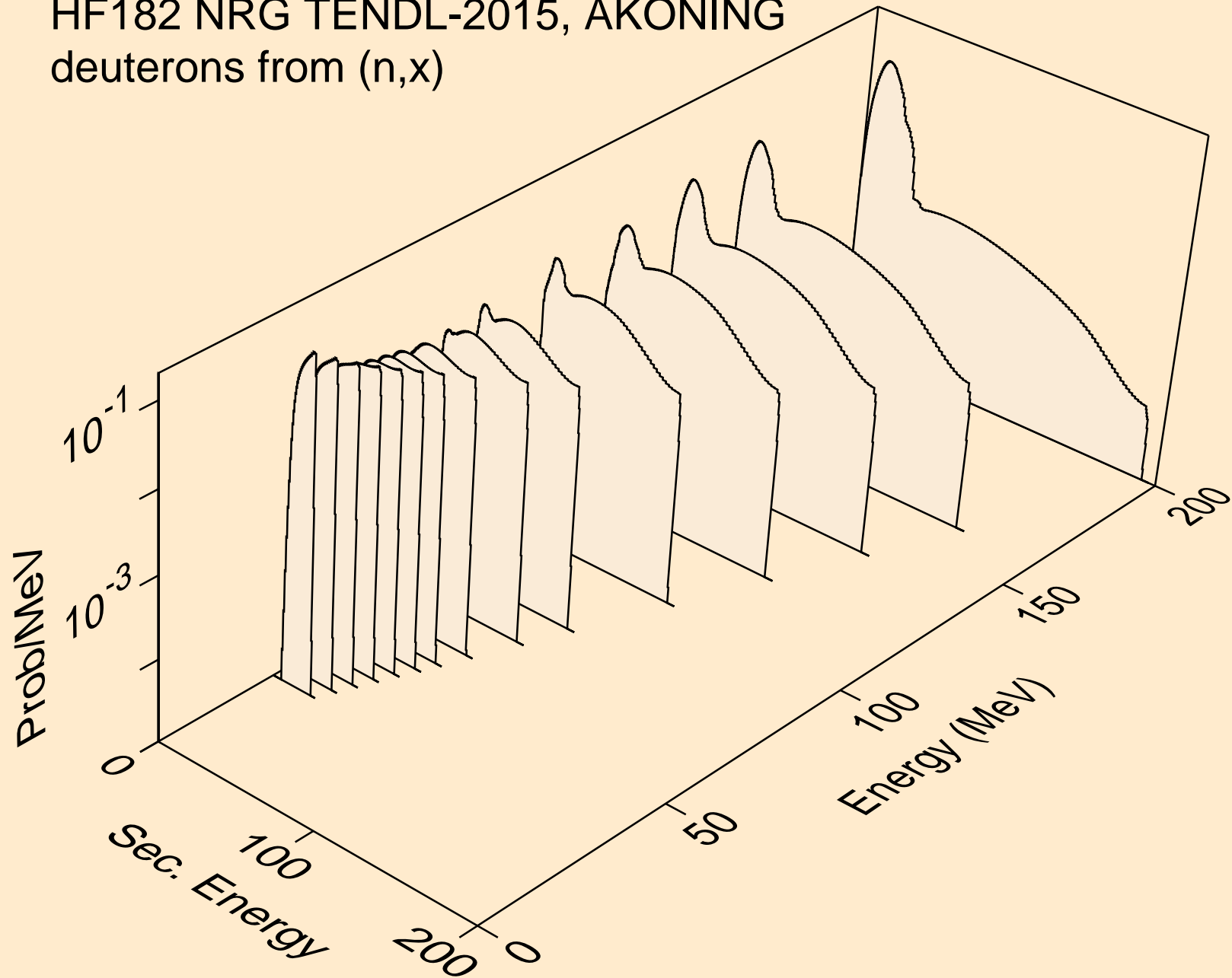

HF182 NRG TENDL-2015, AKONING
deuterons from (n,2nd)

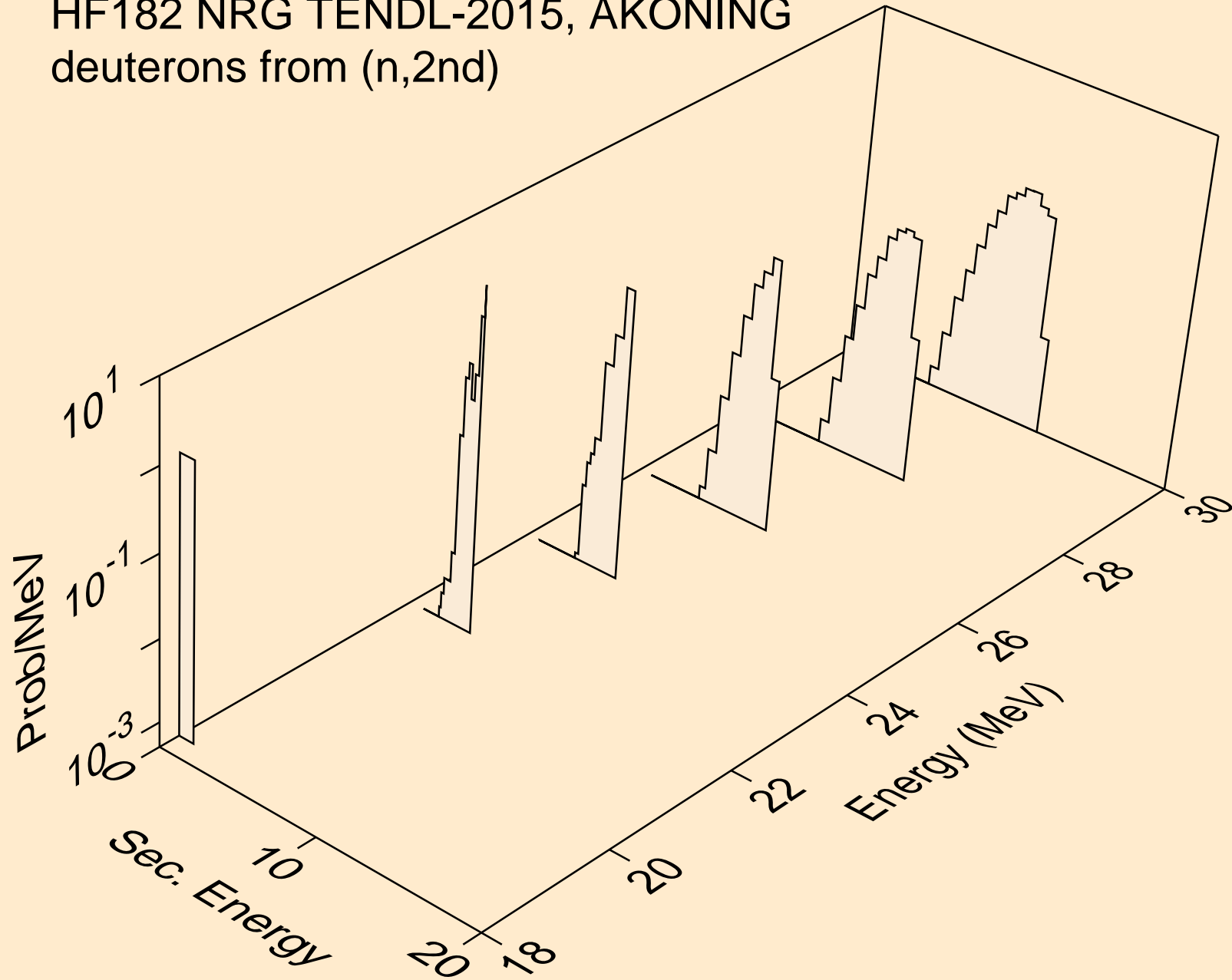

HF182 NRG TENDL-2015, AKONING
deuterons from (n,n*)d

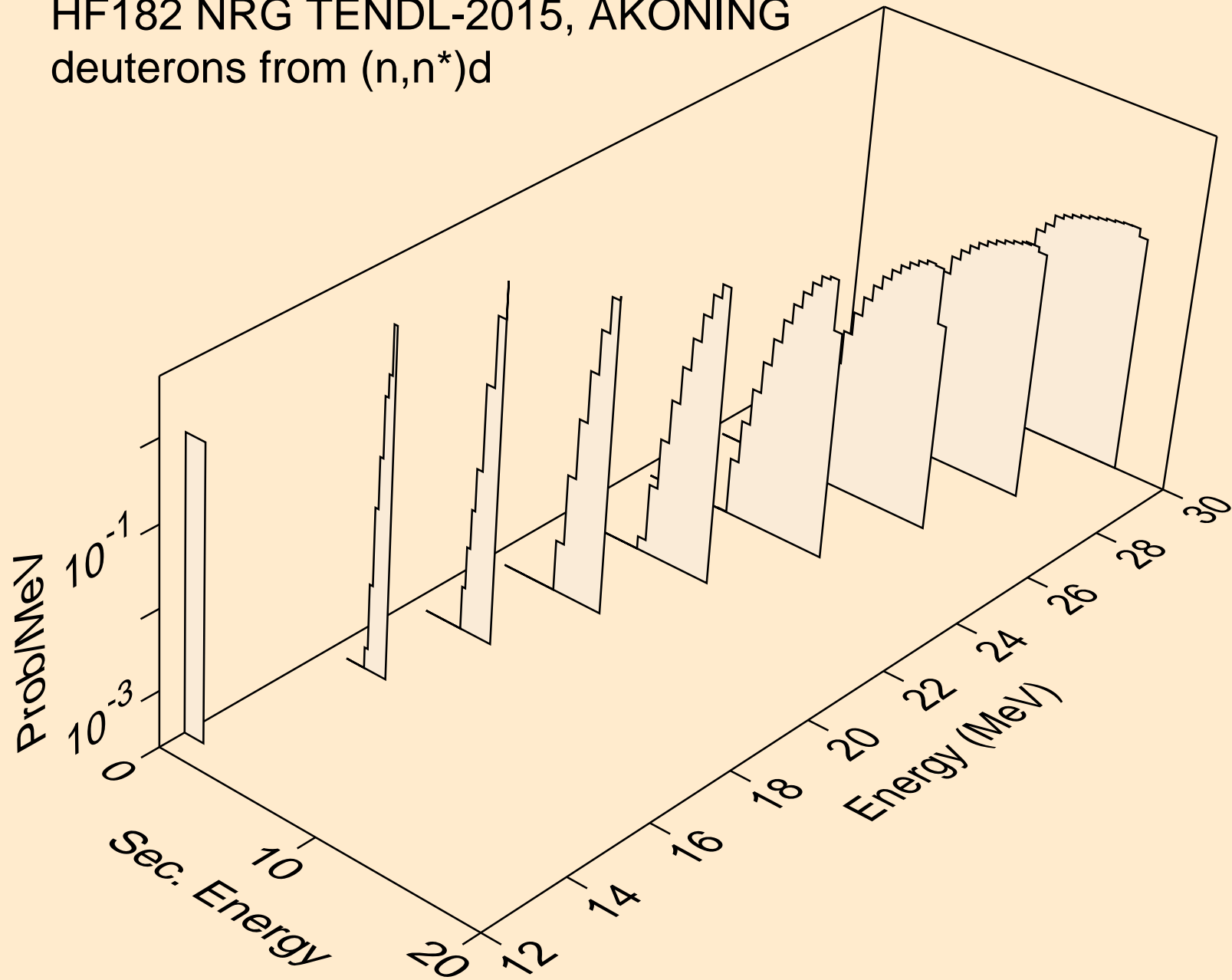

HF182 NRG TENDL-2015, AKONING
deuterons from (n,d)

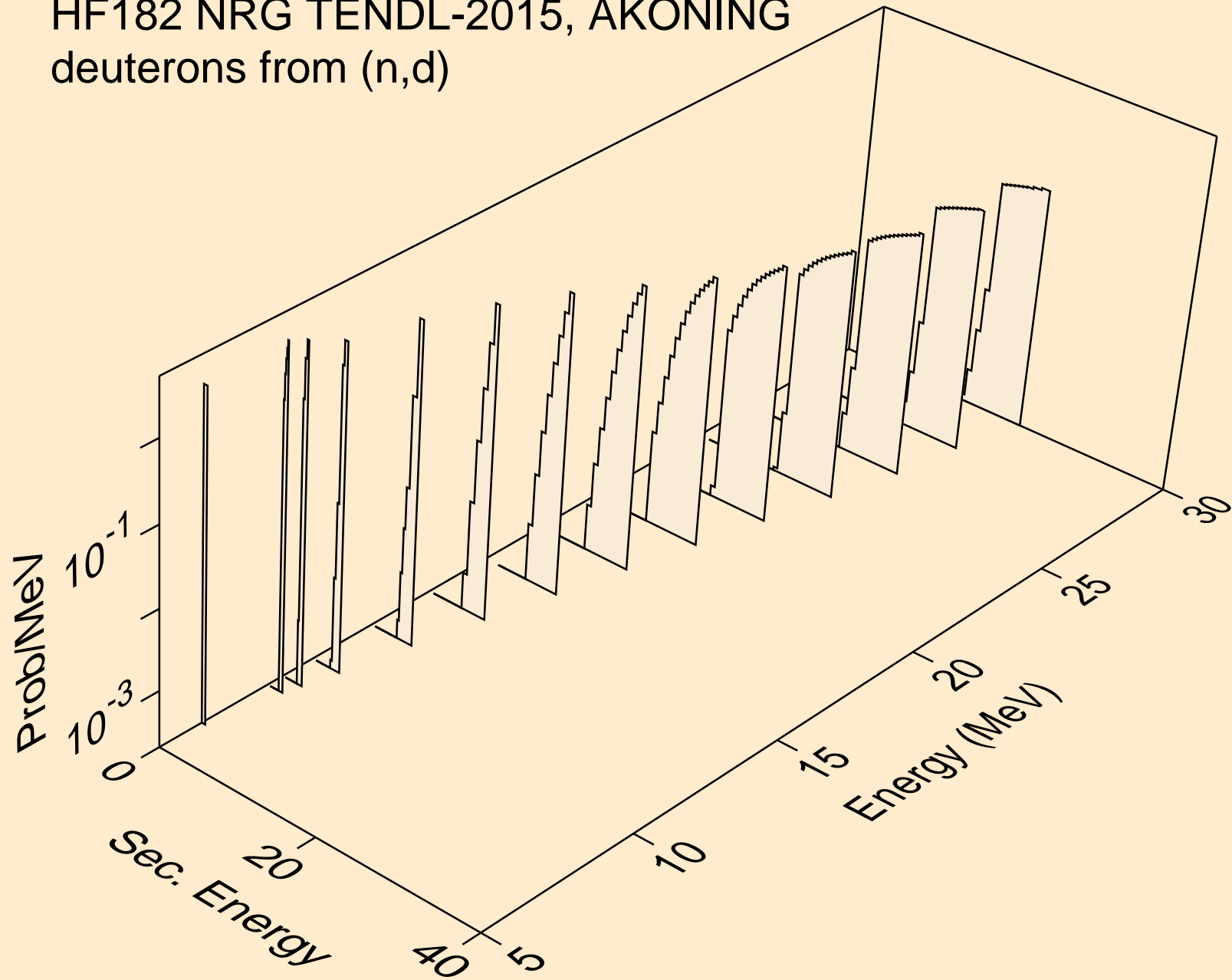

HF182 NRG TENDL-2015, AKONING
tritons from (n,x)

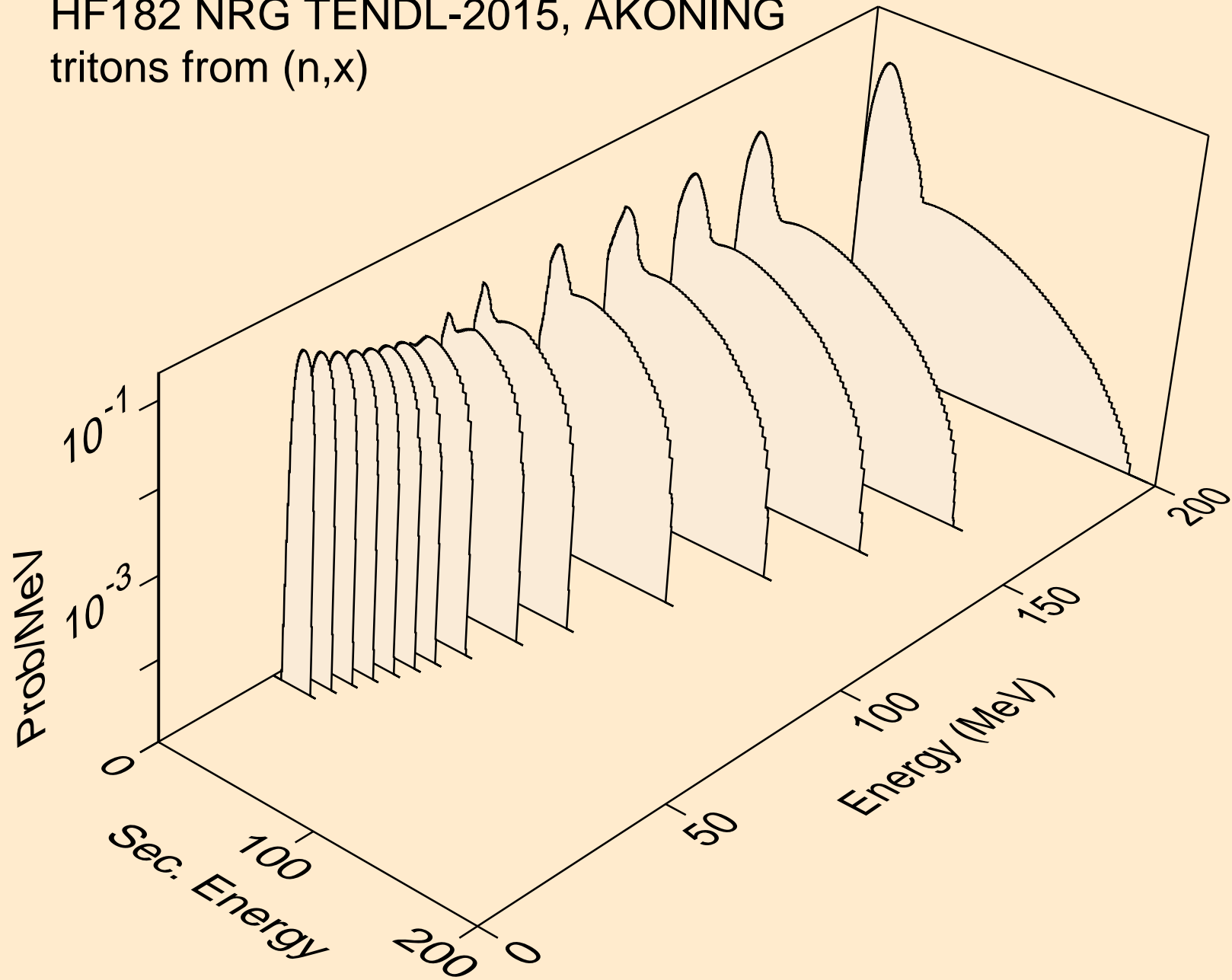

HF182 NRG TENDL-2015, AKONING
tritons from (n,n*)t

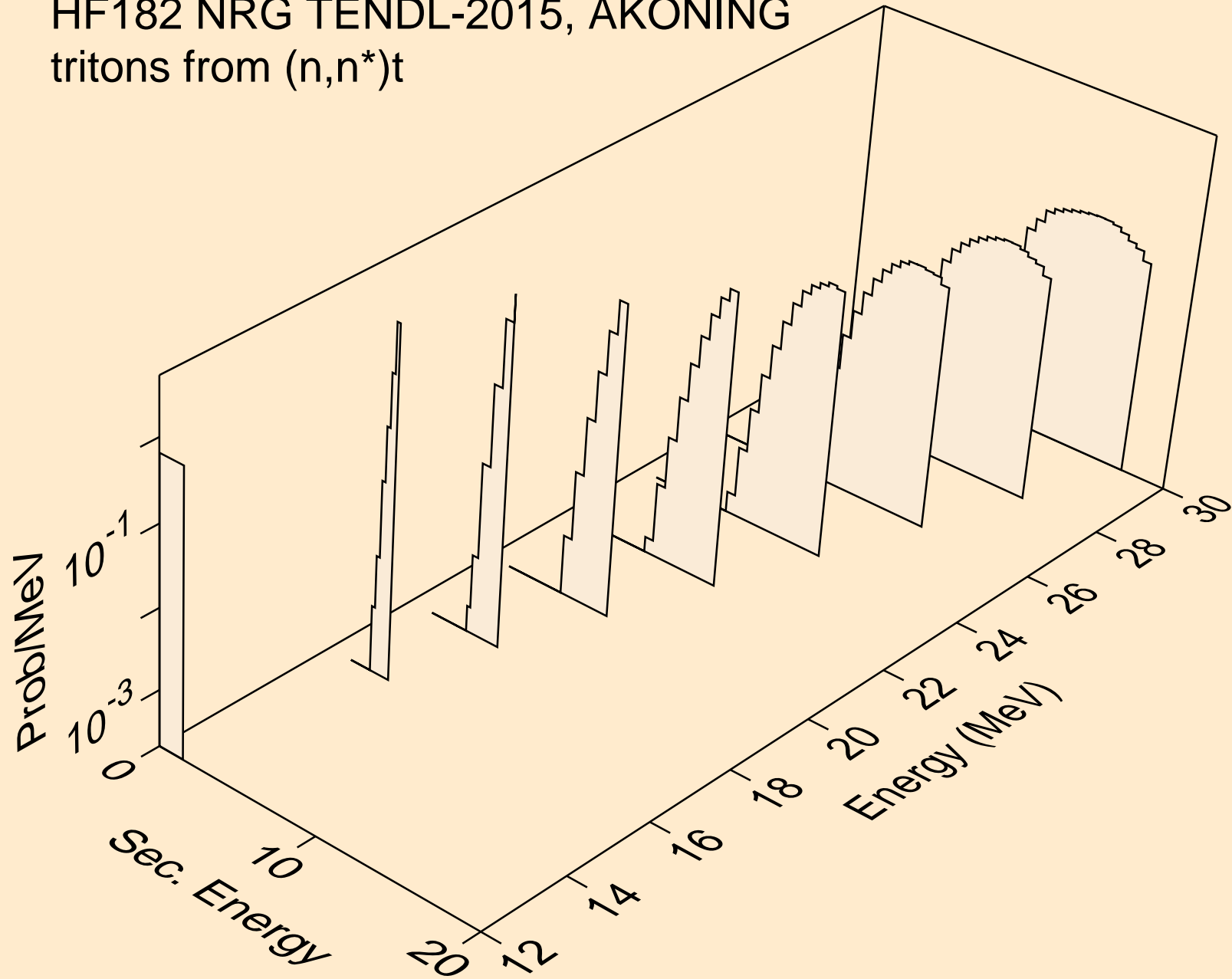

HF182 NRG TENDL-2015, AKONING
tritons from (n,t)

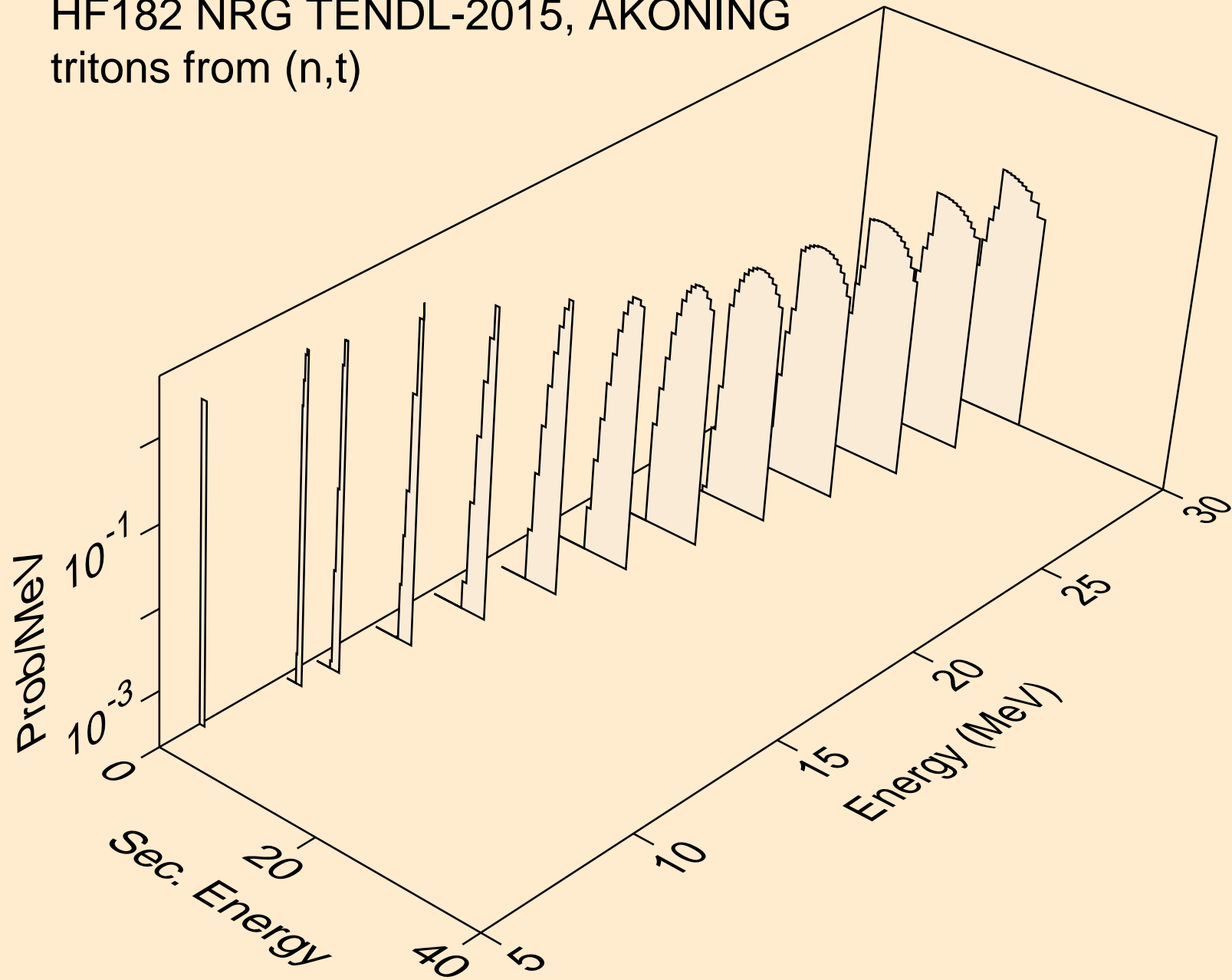

HF182 NRG TENDL-2015, AKONING
he3s from (n,x)

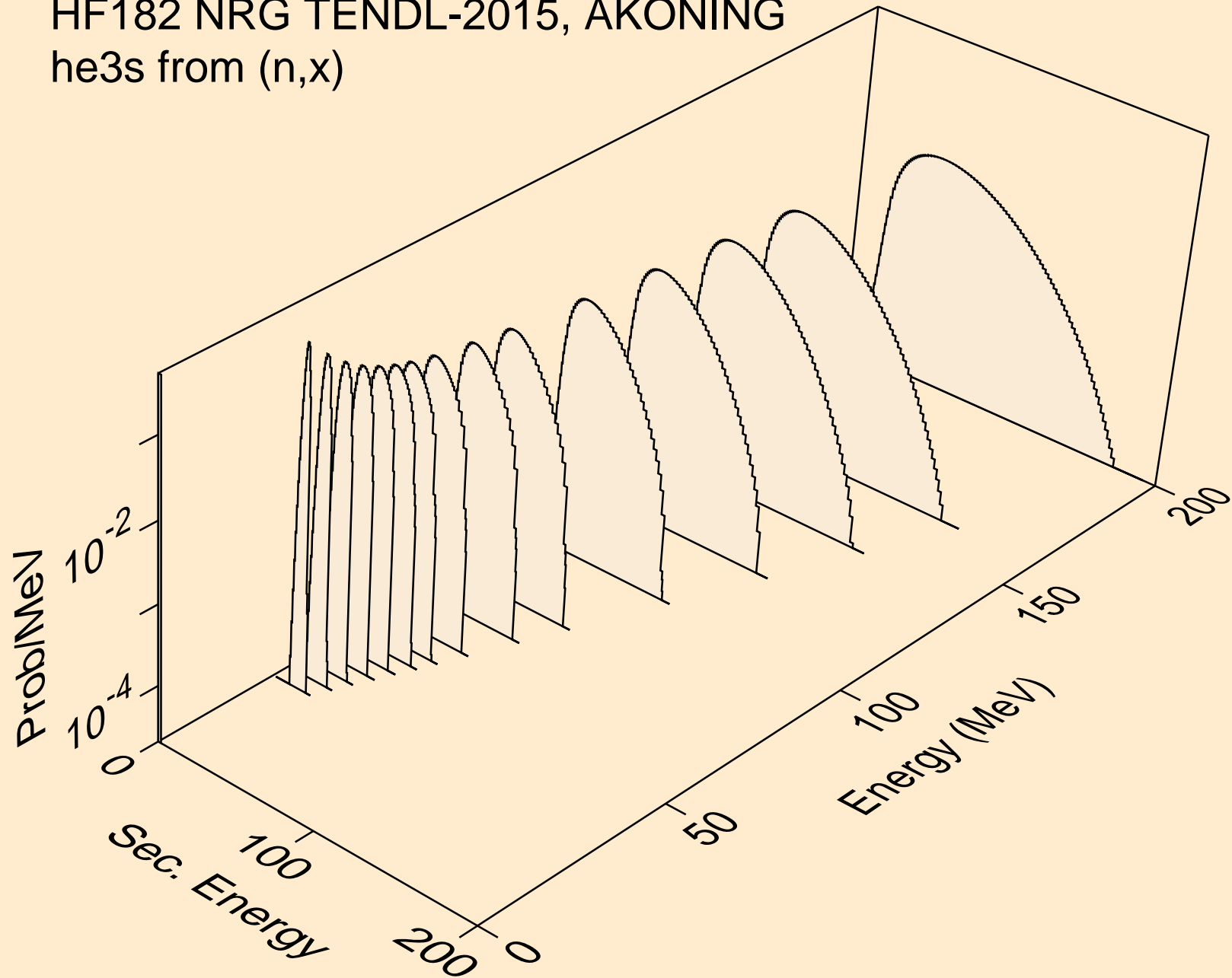

HF182 NRG TENDL-2015, AKONING
he3s from (n,n*)he3

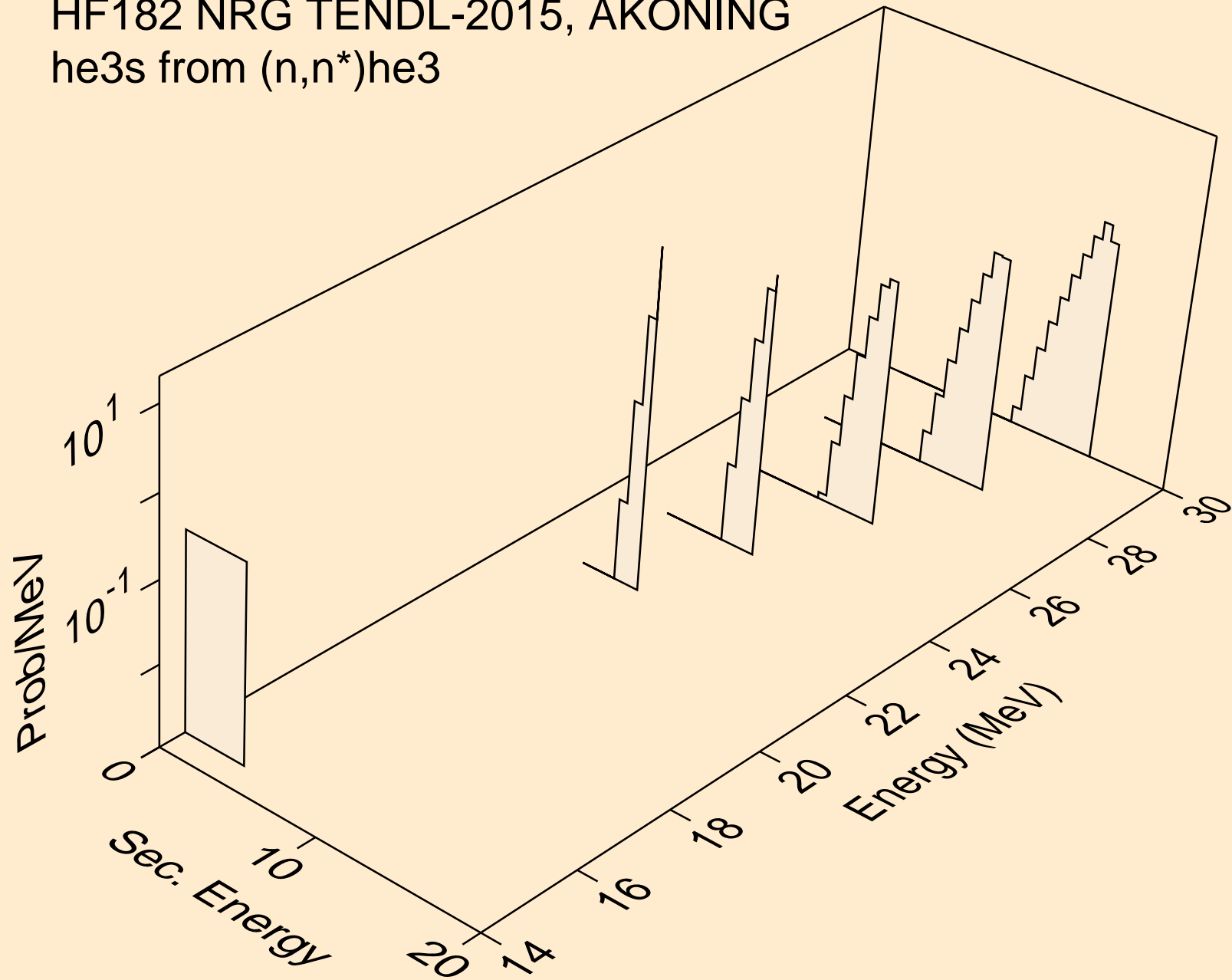

HF182 NRG TENDL-2015, AKONING
he3s from (n,he3)

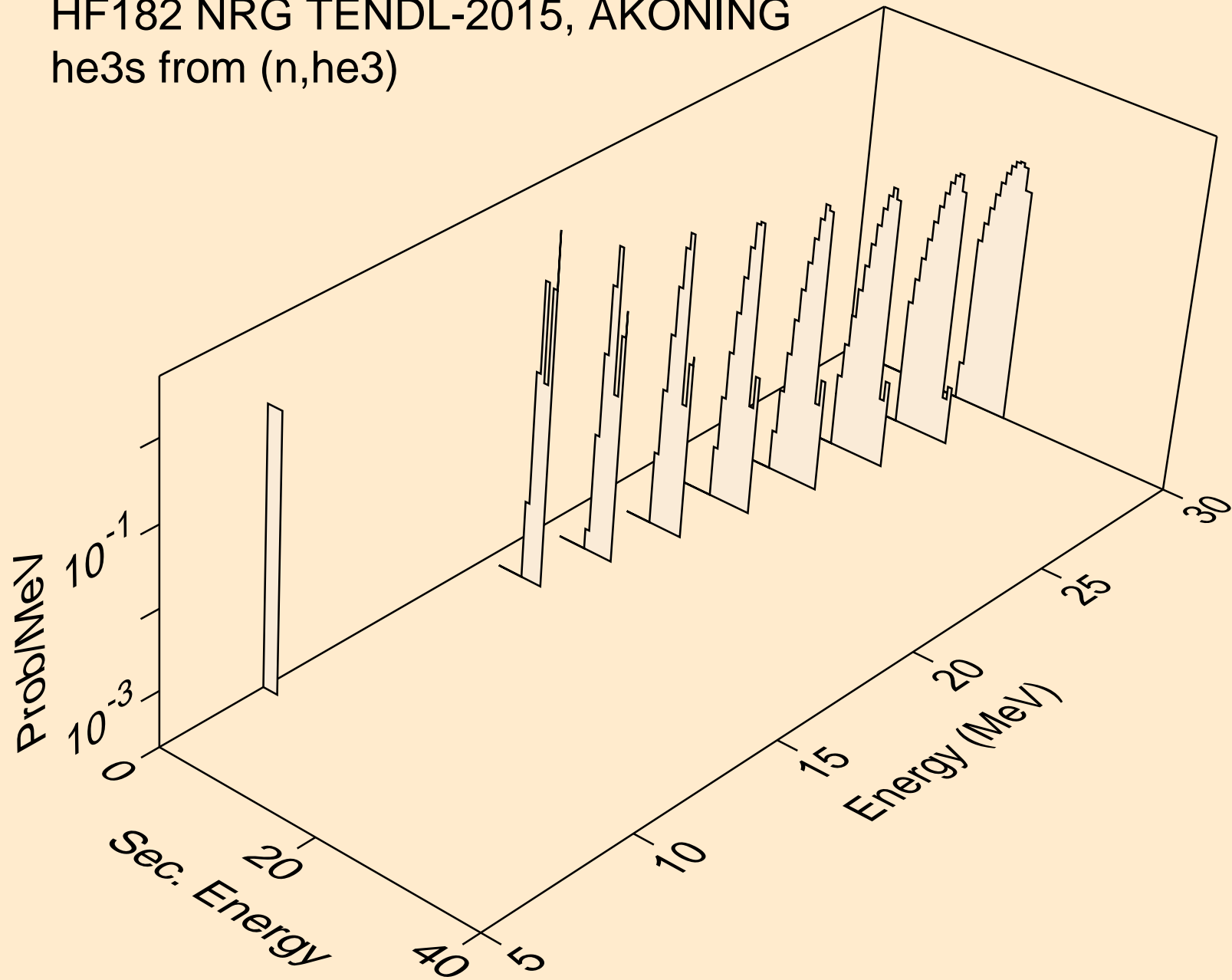

HF182 NRG TENDL-2015, AKONING
alphas from (n,x)

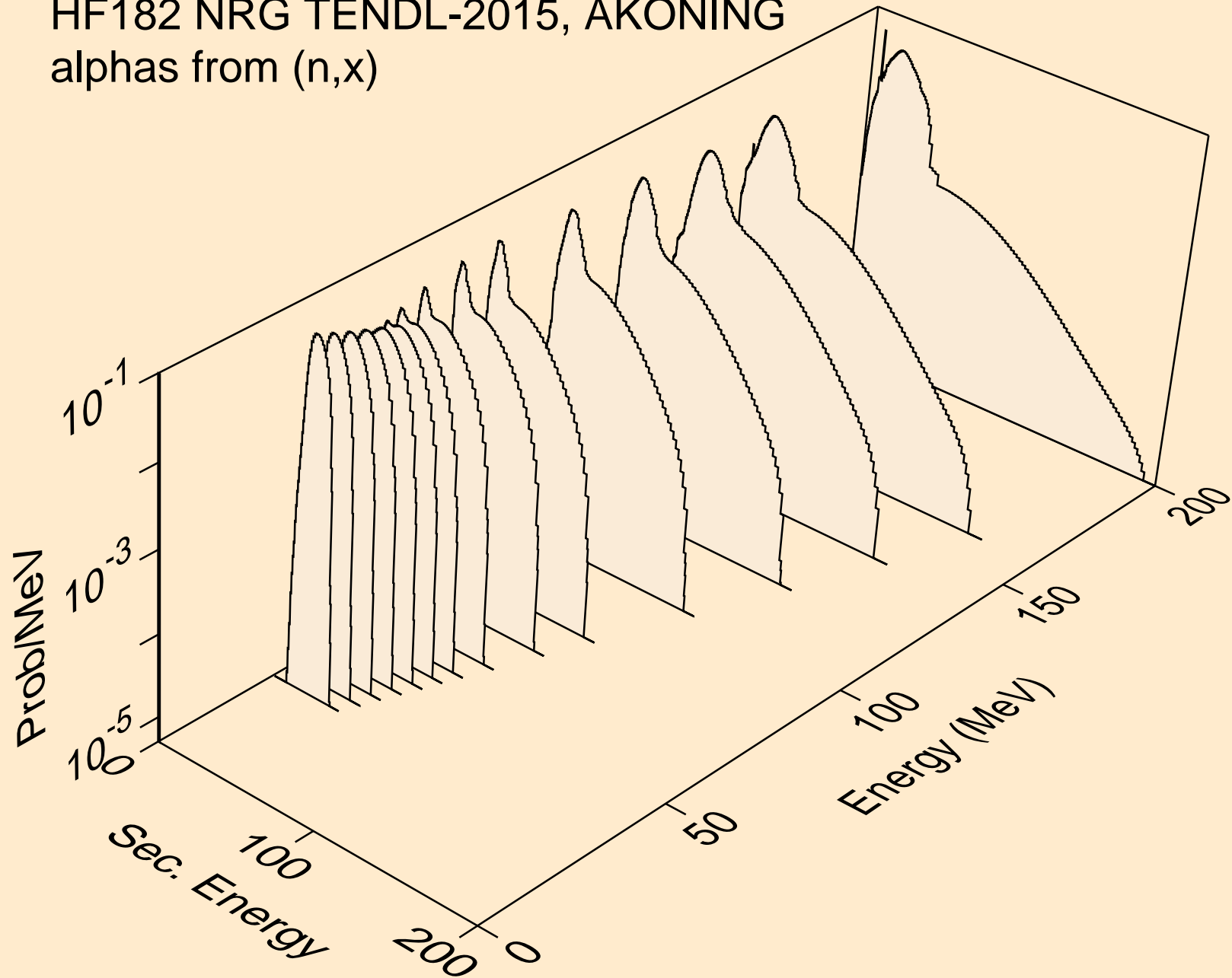

HF182 NRG TENDL-2015, AKONING
alphas from (n,n*)a

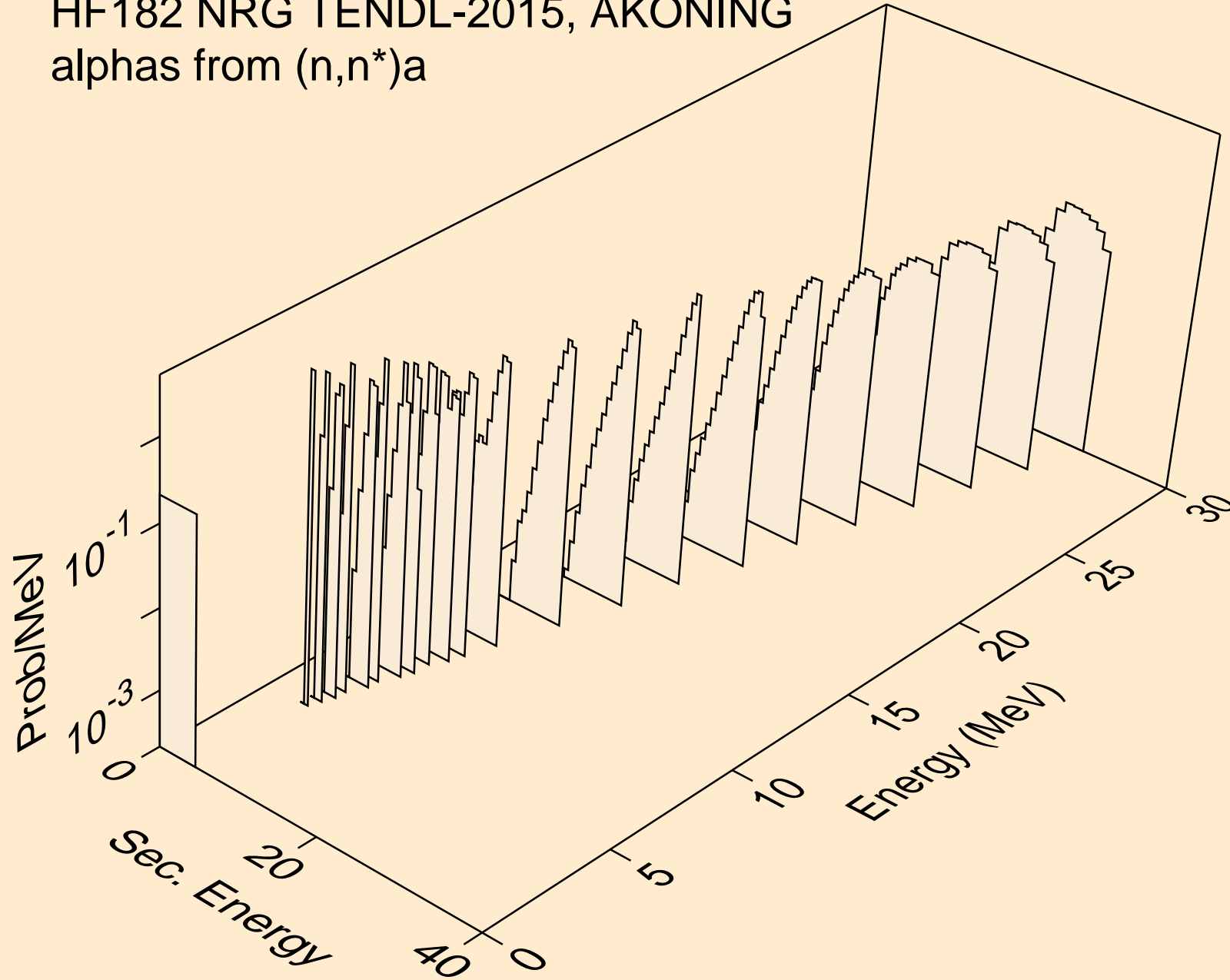

HF182 NRG TENDL-2015, AKONING
alphas from (n,2n)a

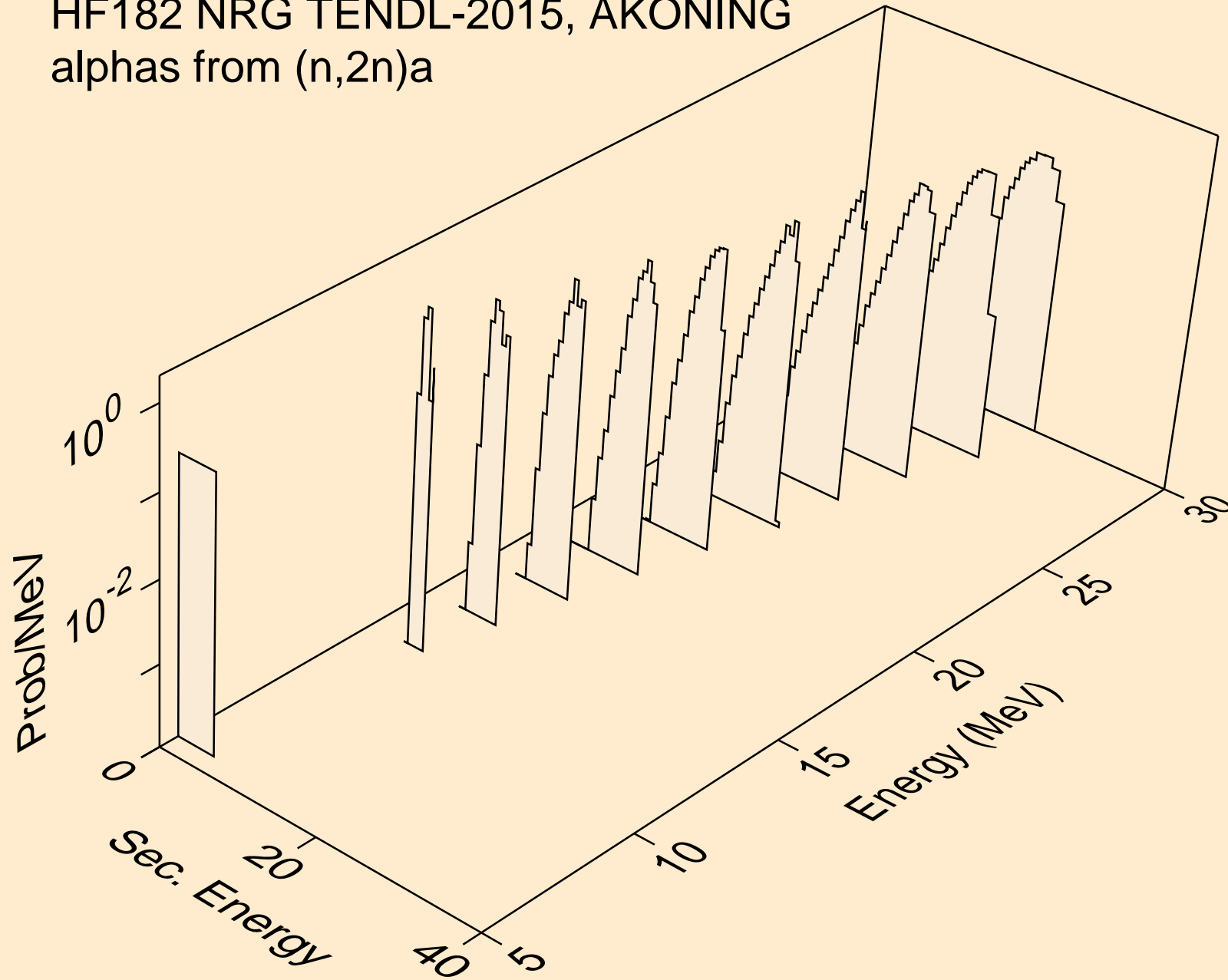

HF182 NRG TENDL-2015, AKONING
alphas from (n,3n)a

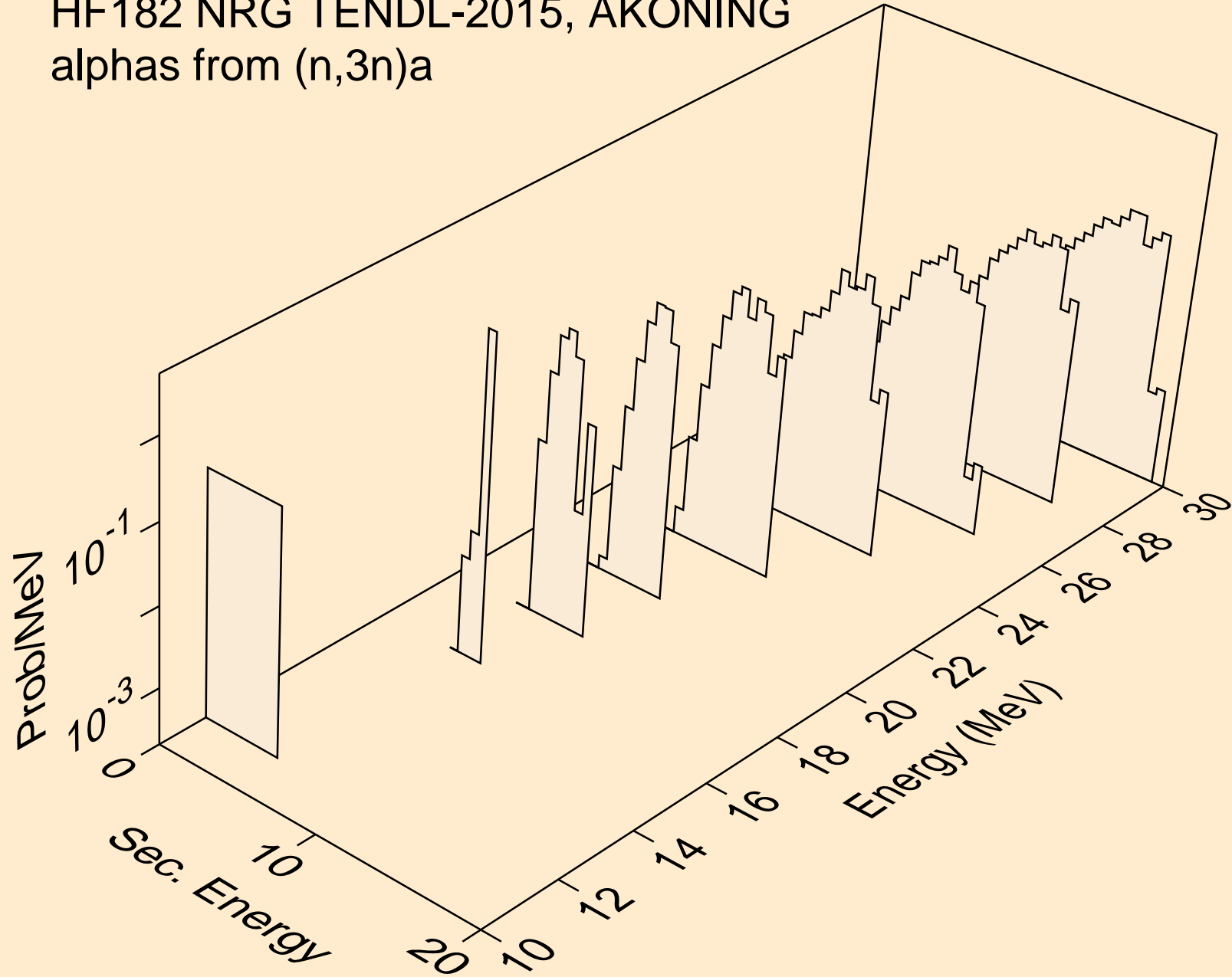

HF182 NRG TENDL-2015, AKONING
alphas from (n,a)

