

# HG199 NRG TENDL-2015, AKONING

## Principal cross sections

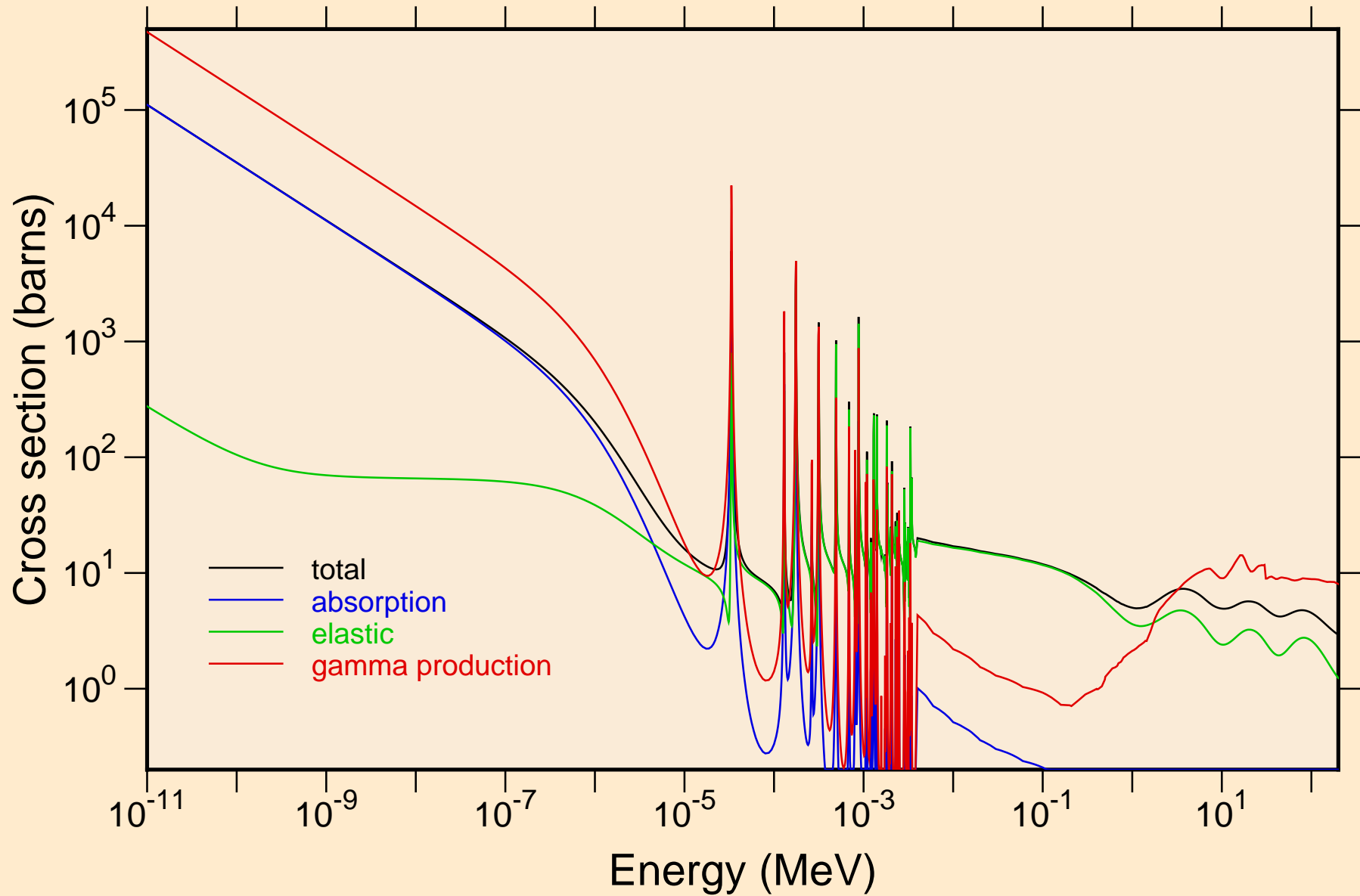

HG199 NRG TENDL-2015, AKONING  
resonance total cross section

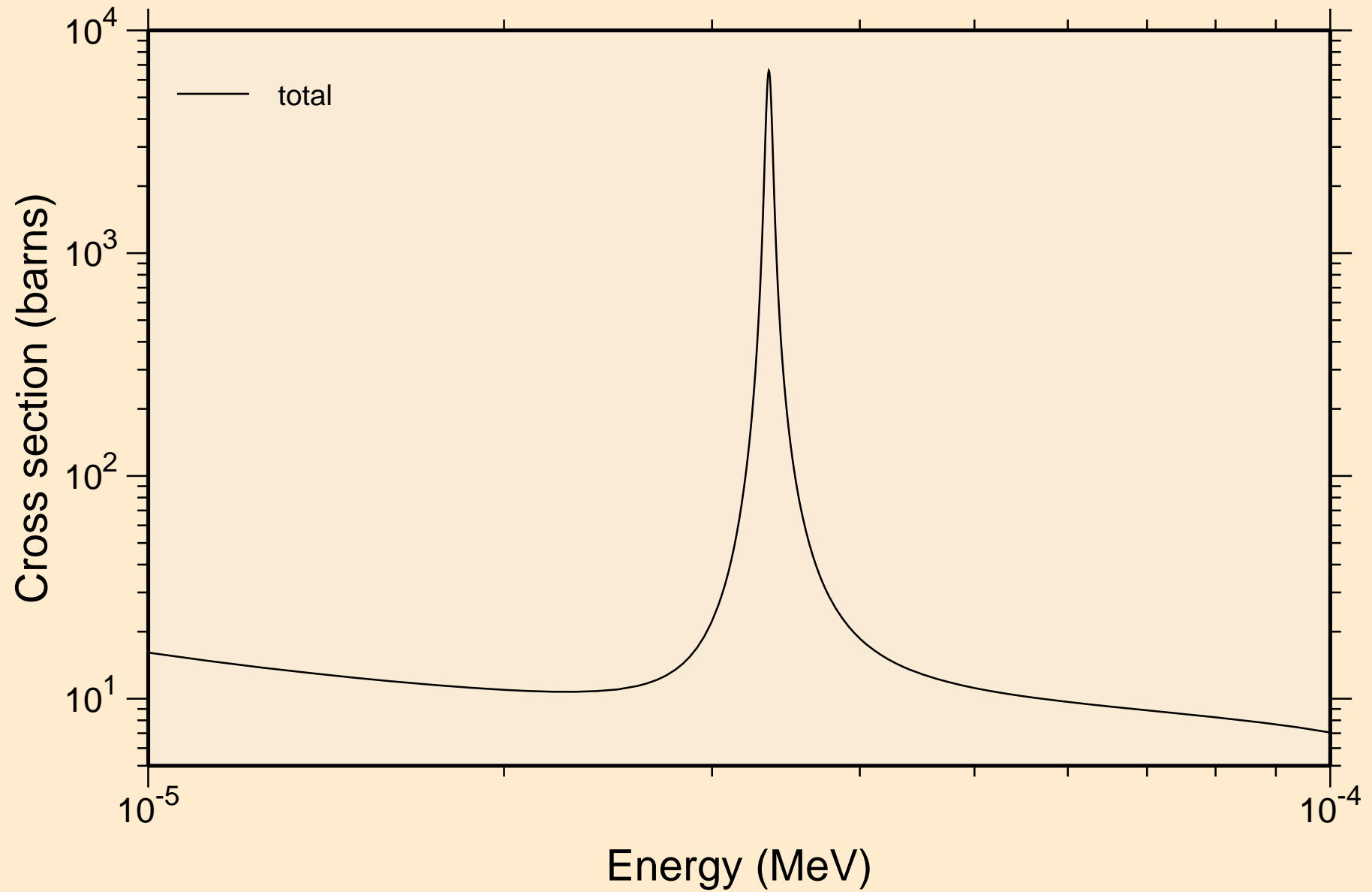

HG199 NRG TENDL-2015, AKONING  
resonance total cross section

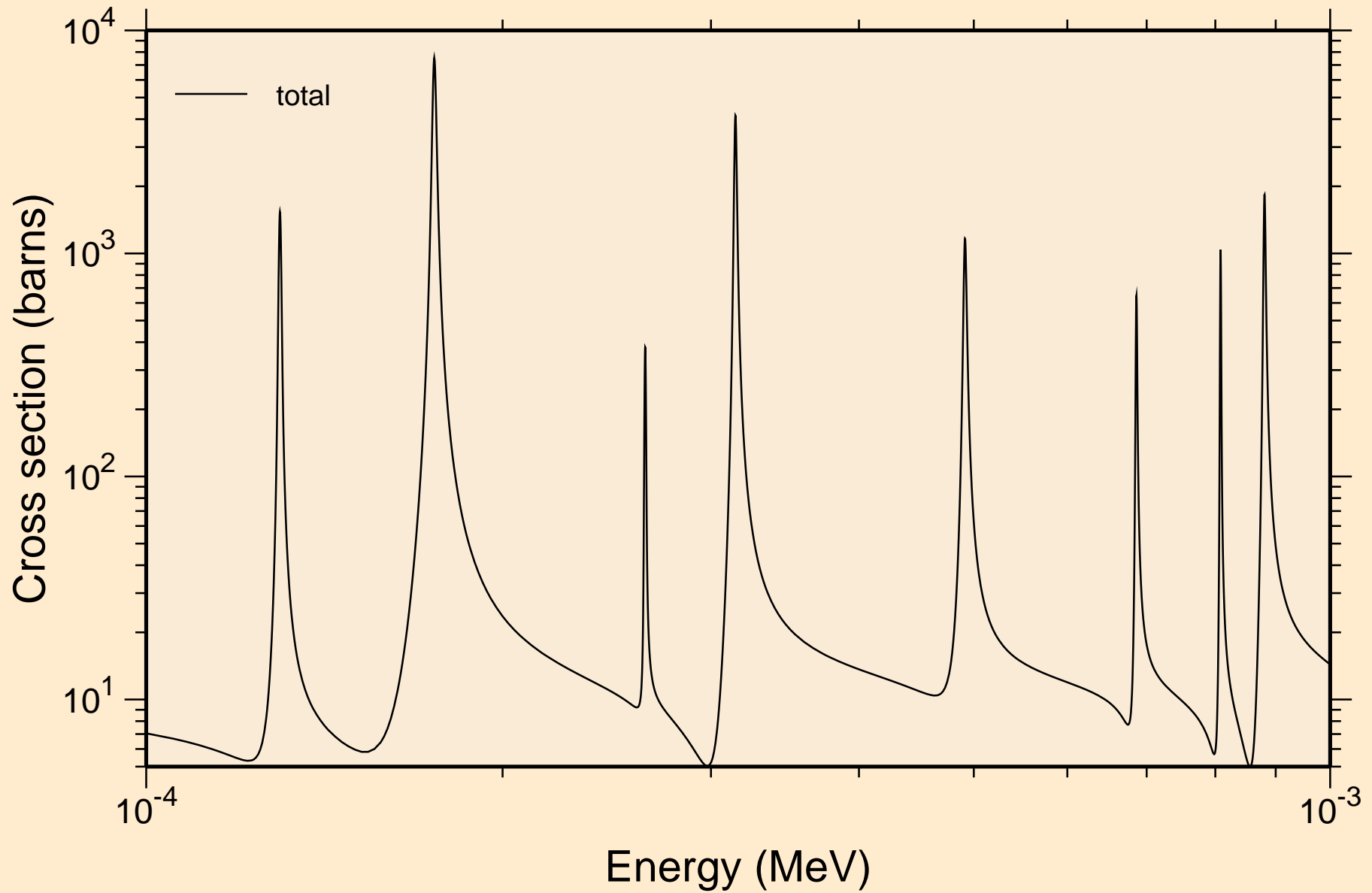

HG199 NRG TENDL-2015, AKONING  
resonance total cross section

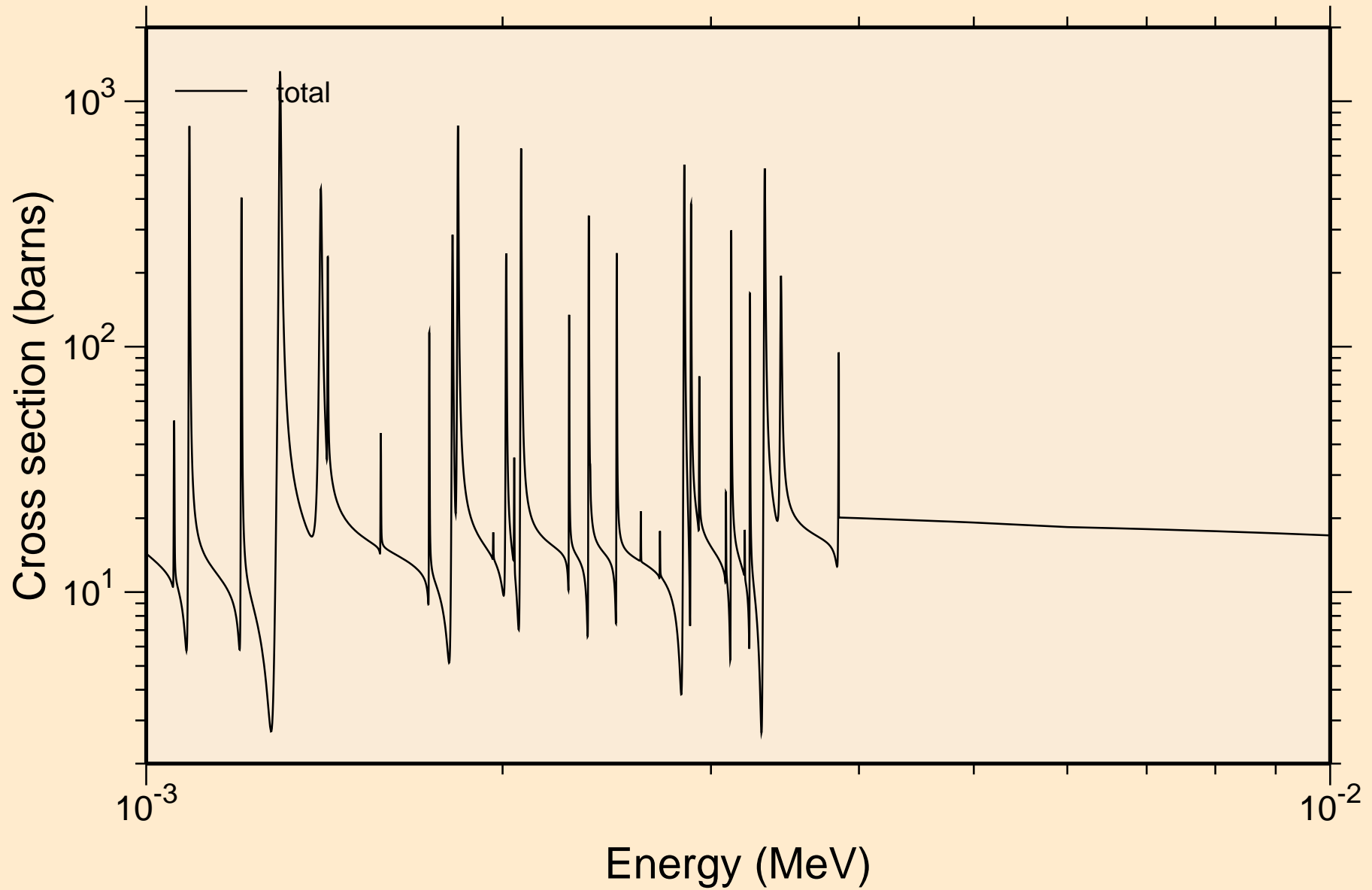

HG199 NRG TENDL-2015, AKONING  
resonance total cross section

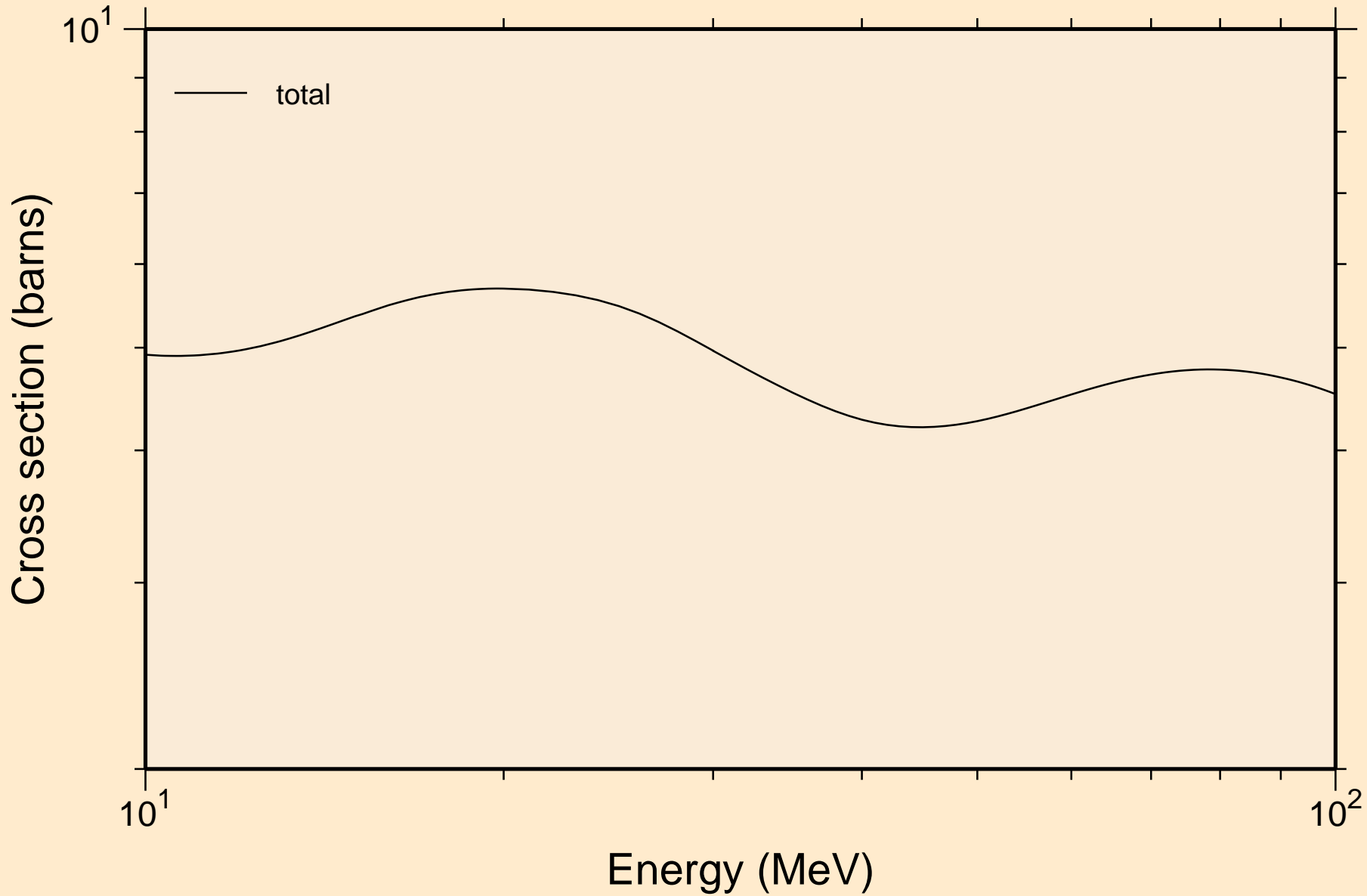

HG199 NRG TENDL-2015, AKONING  
resonance absorption cross sections

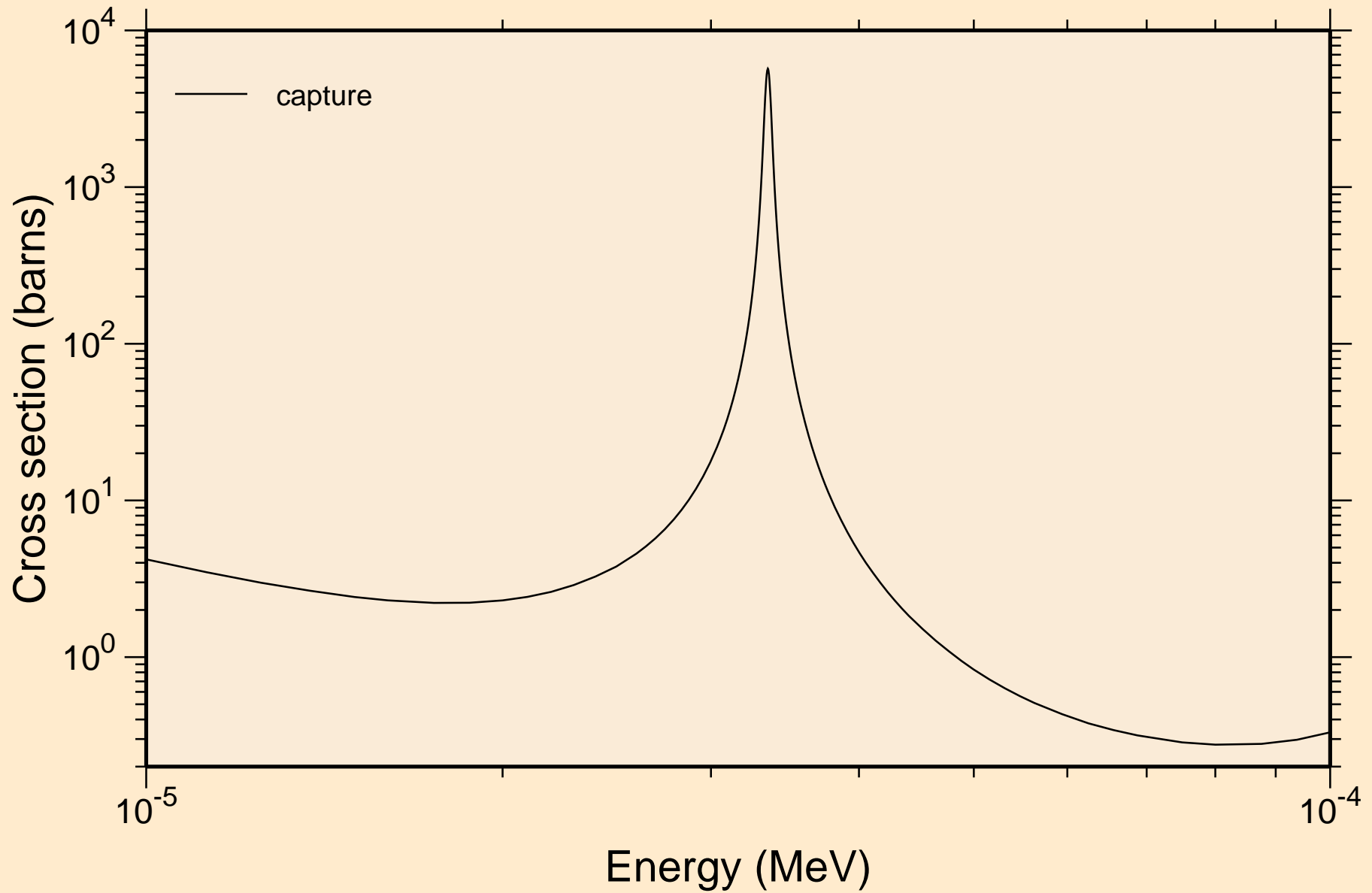

HG199 NRG TENDL-2015, AKONING  
resonance absorption cross sections

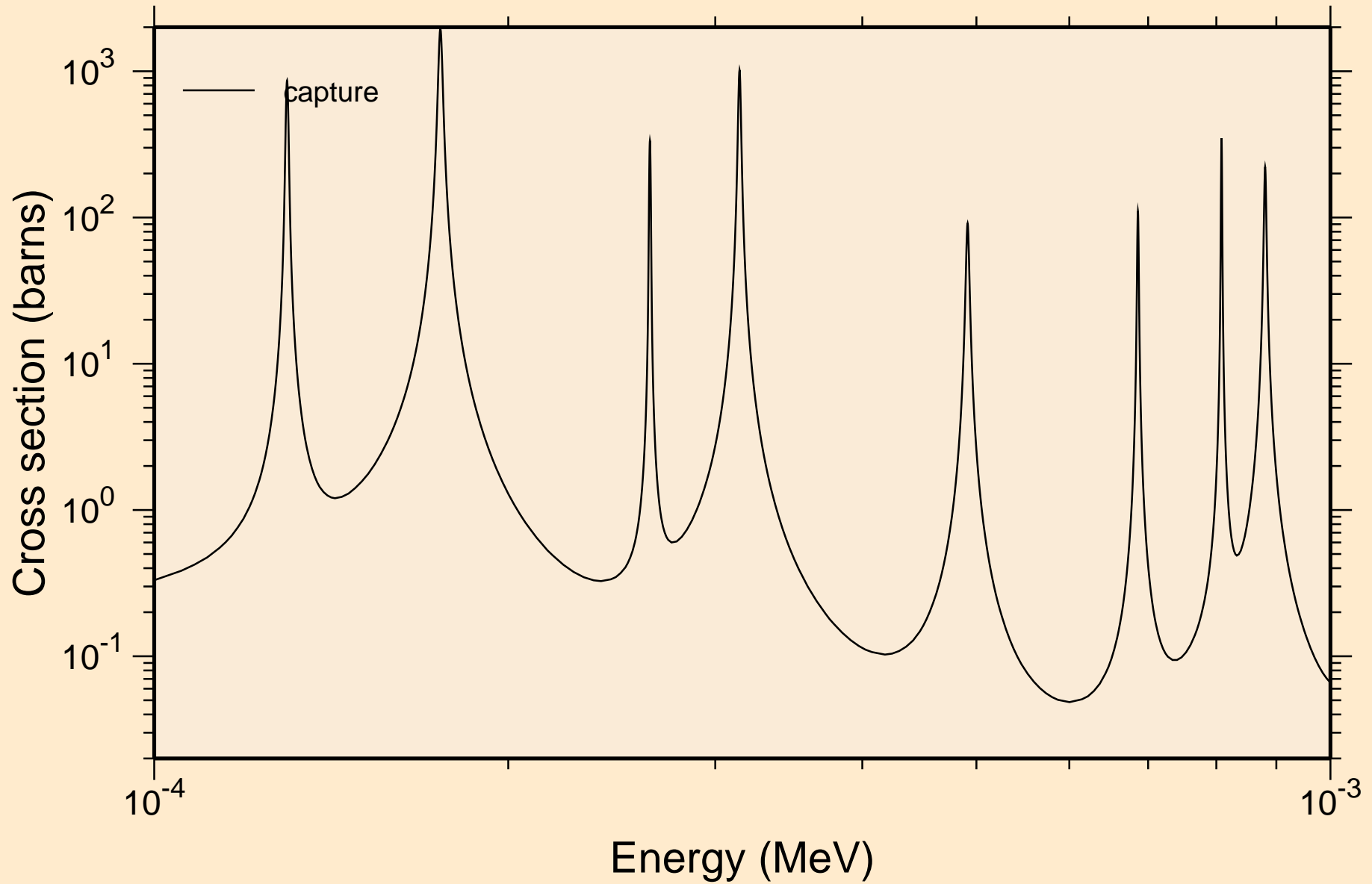

HG199 NRG TENDL-2015, AKONING  
resonance absorption cross sections

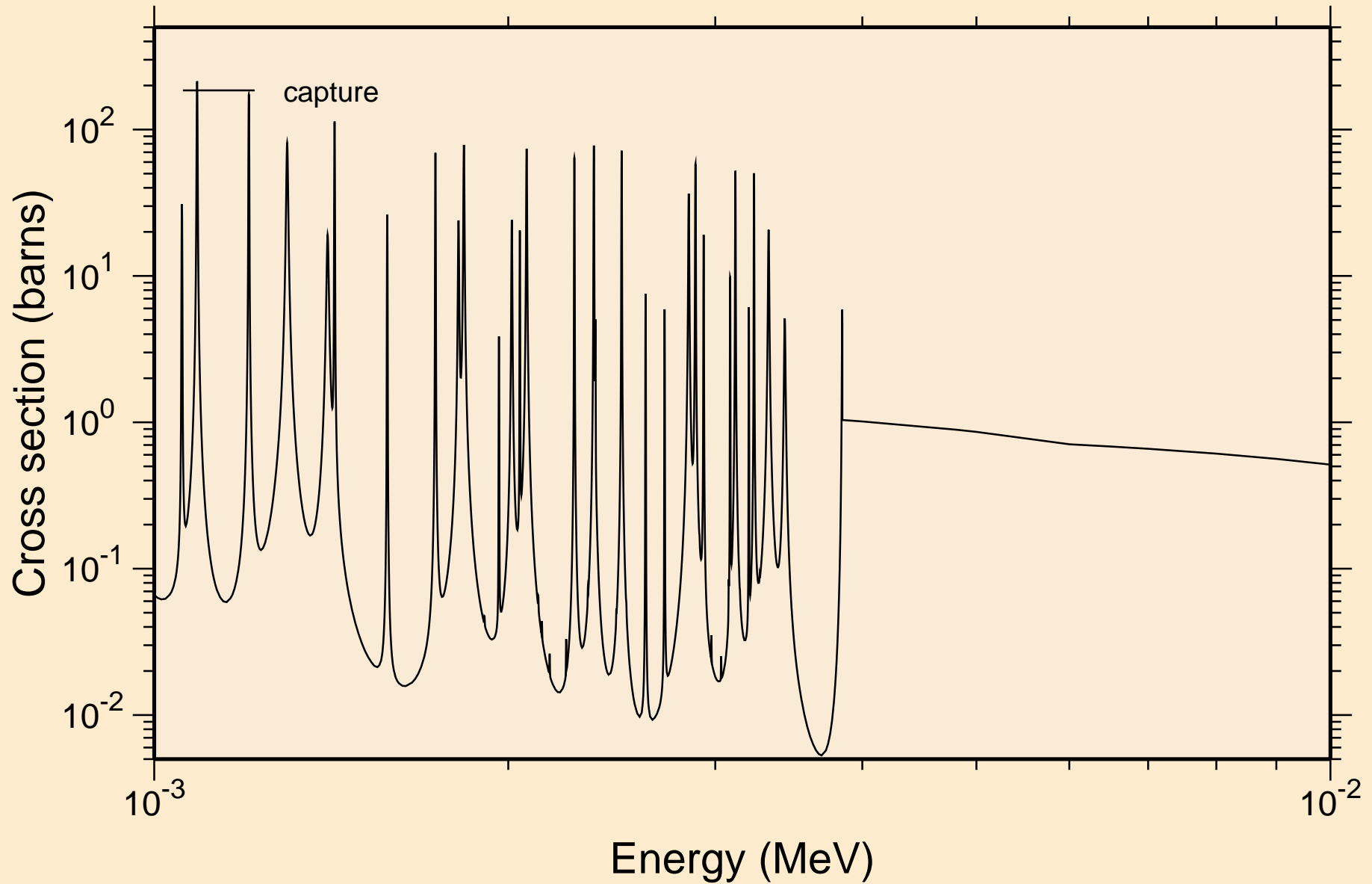



# HG199 NRG TENDL-2015, AKONING resonance absorption cross sections

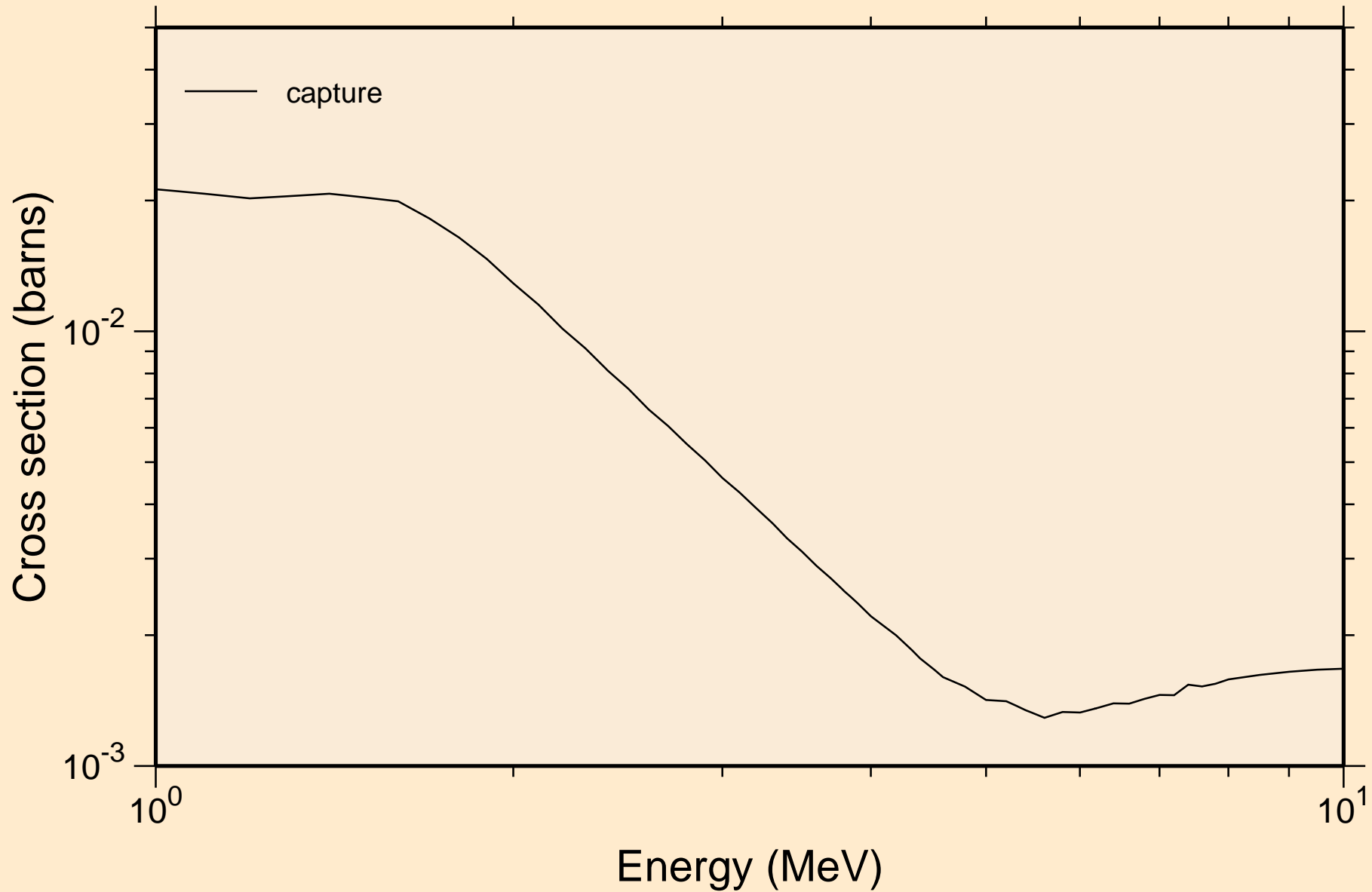

# HG199 NRG TENDL-2015, AKONING

## Non-threshold reactions

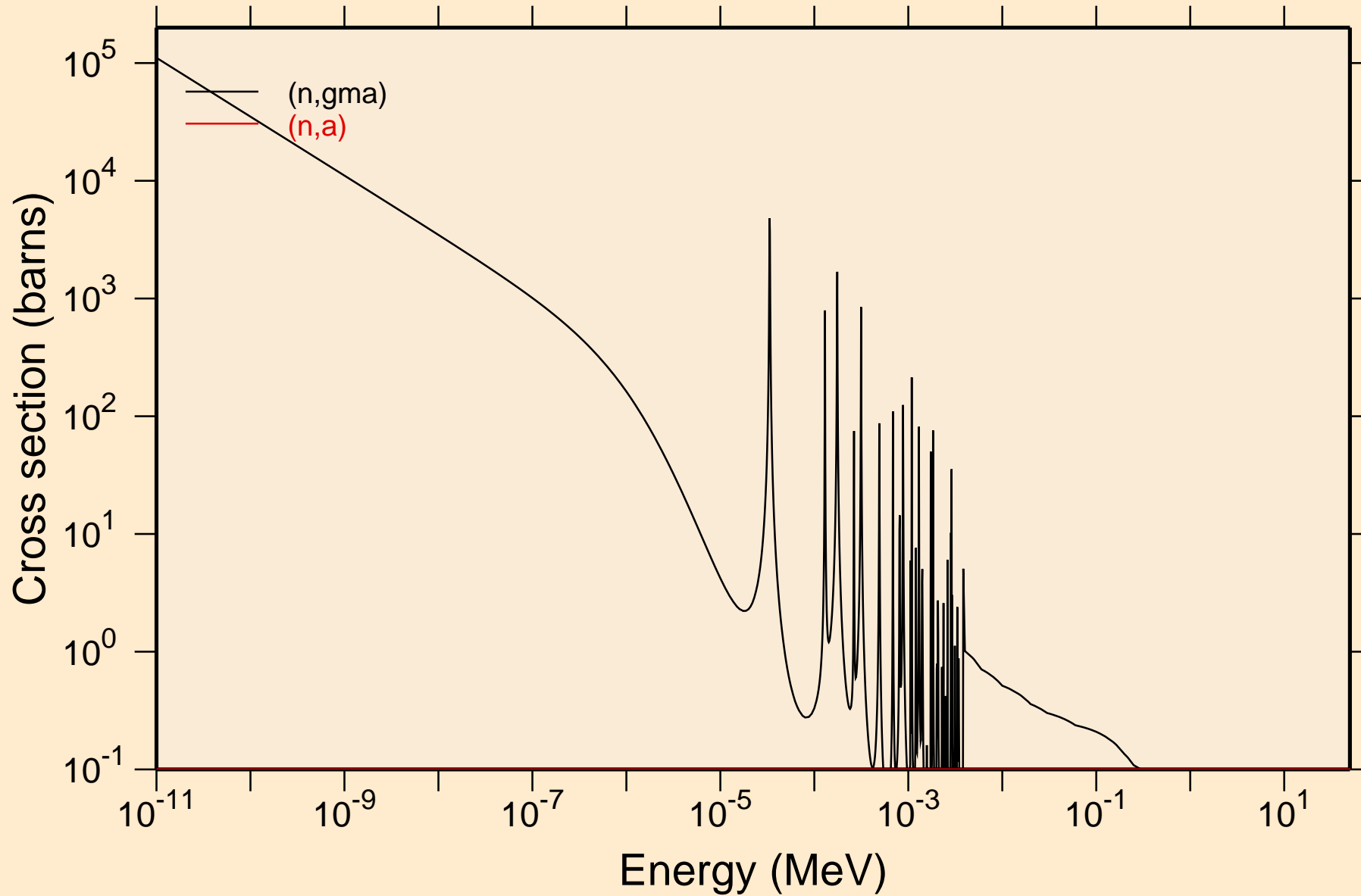

# HG199 NRG TENDL-2015, AKONING

## Principal cross sections

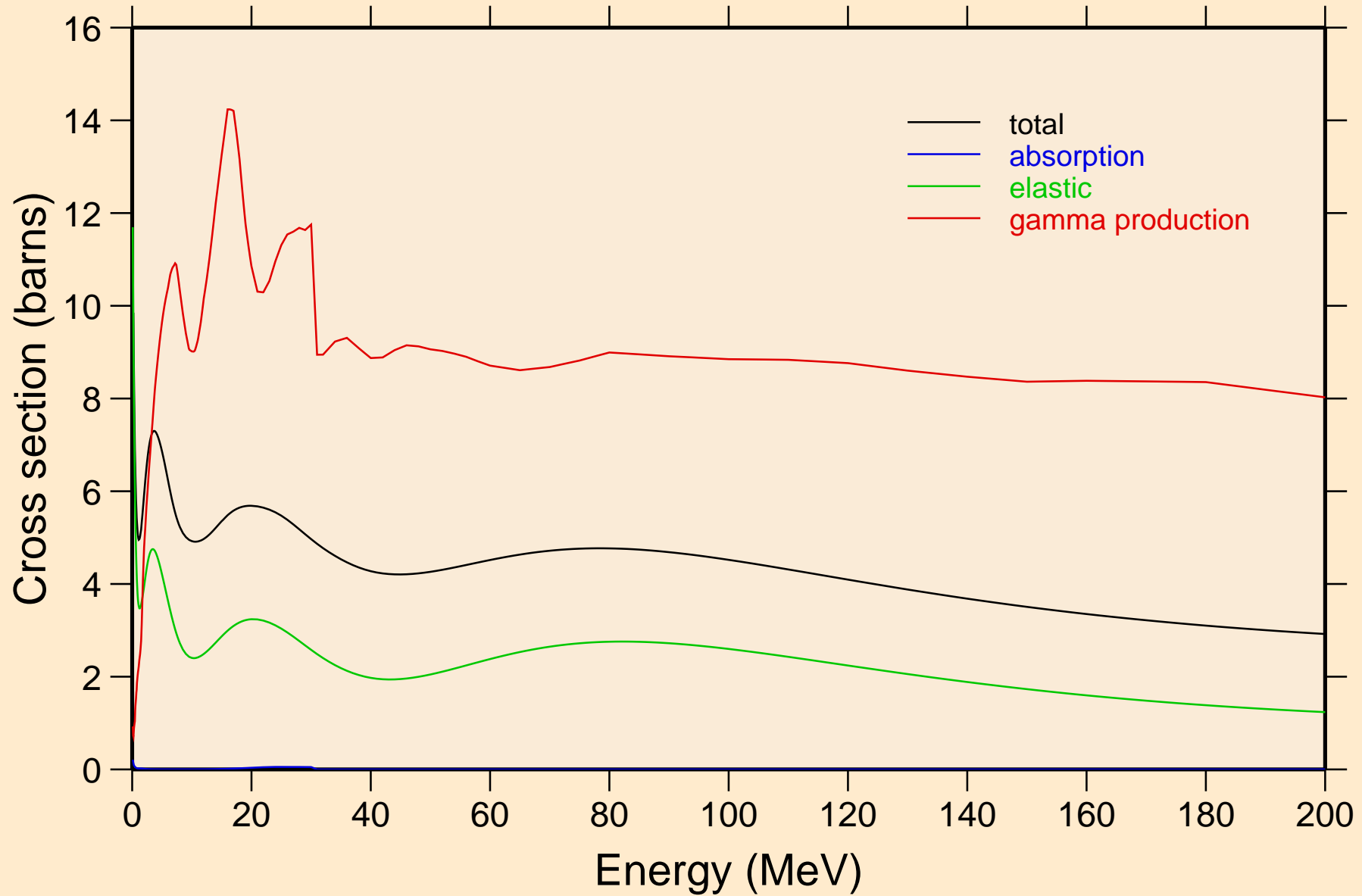

# HG199 NRG TENDL-2015, AKONING

## Non-threshold reactions

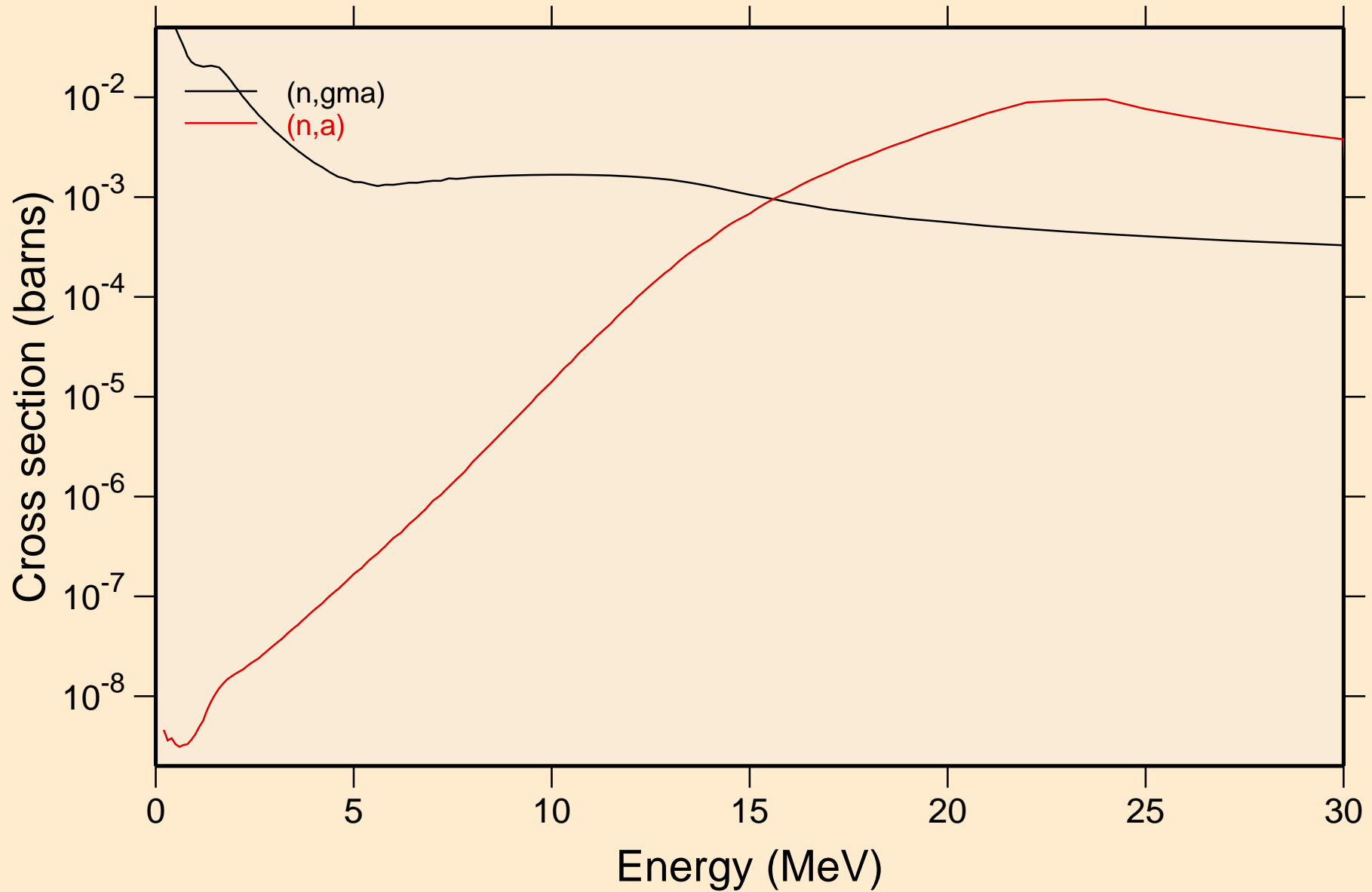

# HG199 NRG TENDL-2015, AKONING

## Inelastic levels

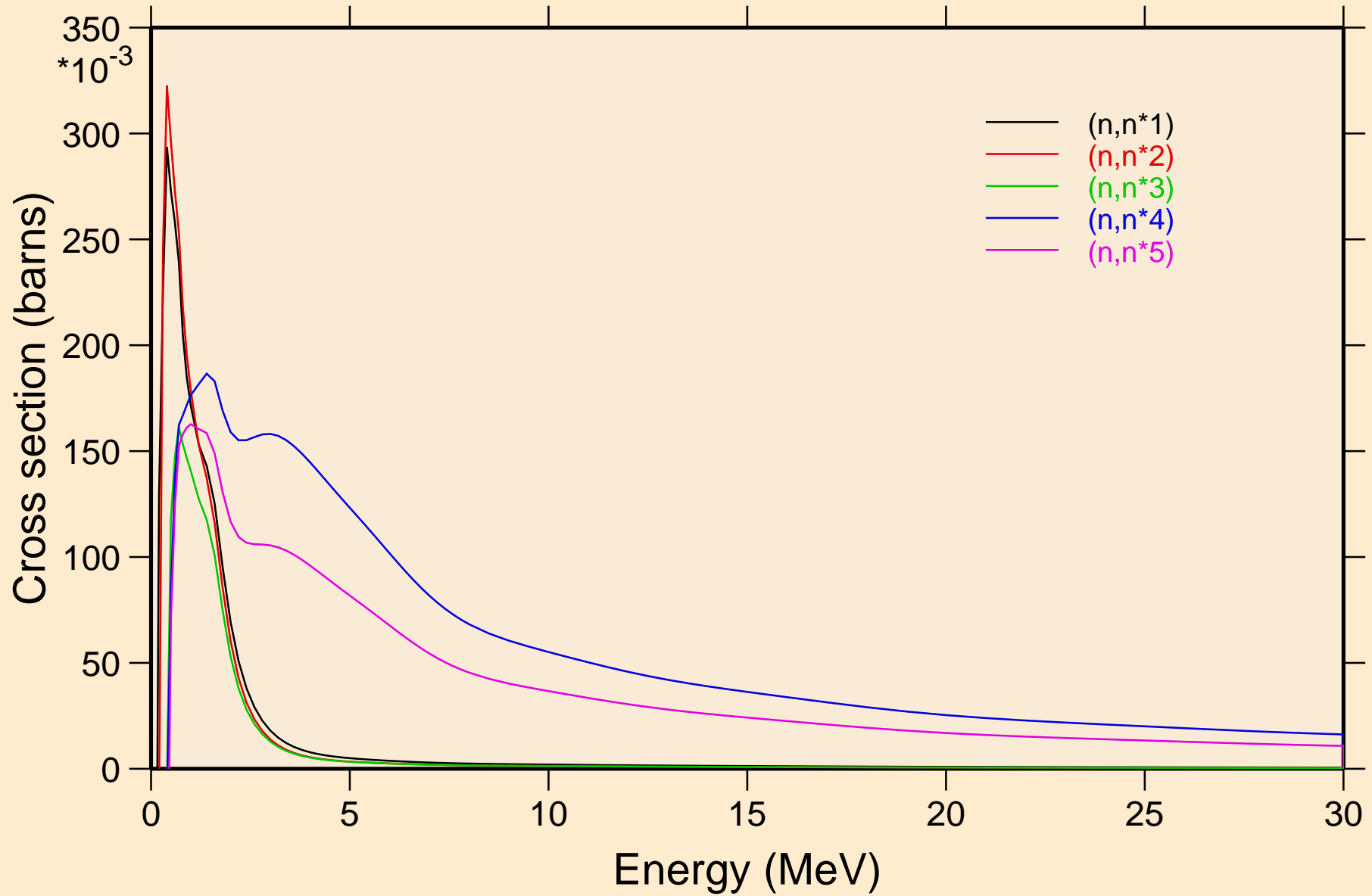

# HG199 NRG TENDL-2015, AKONING

## Inelastic levels

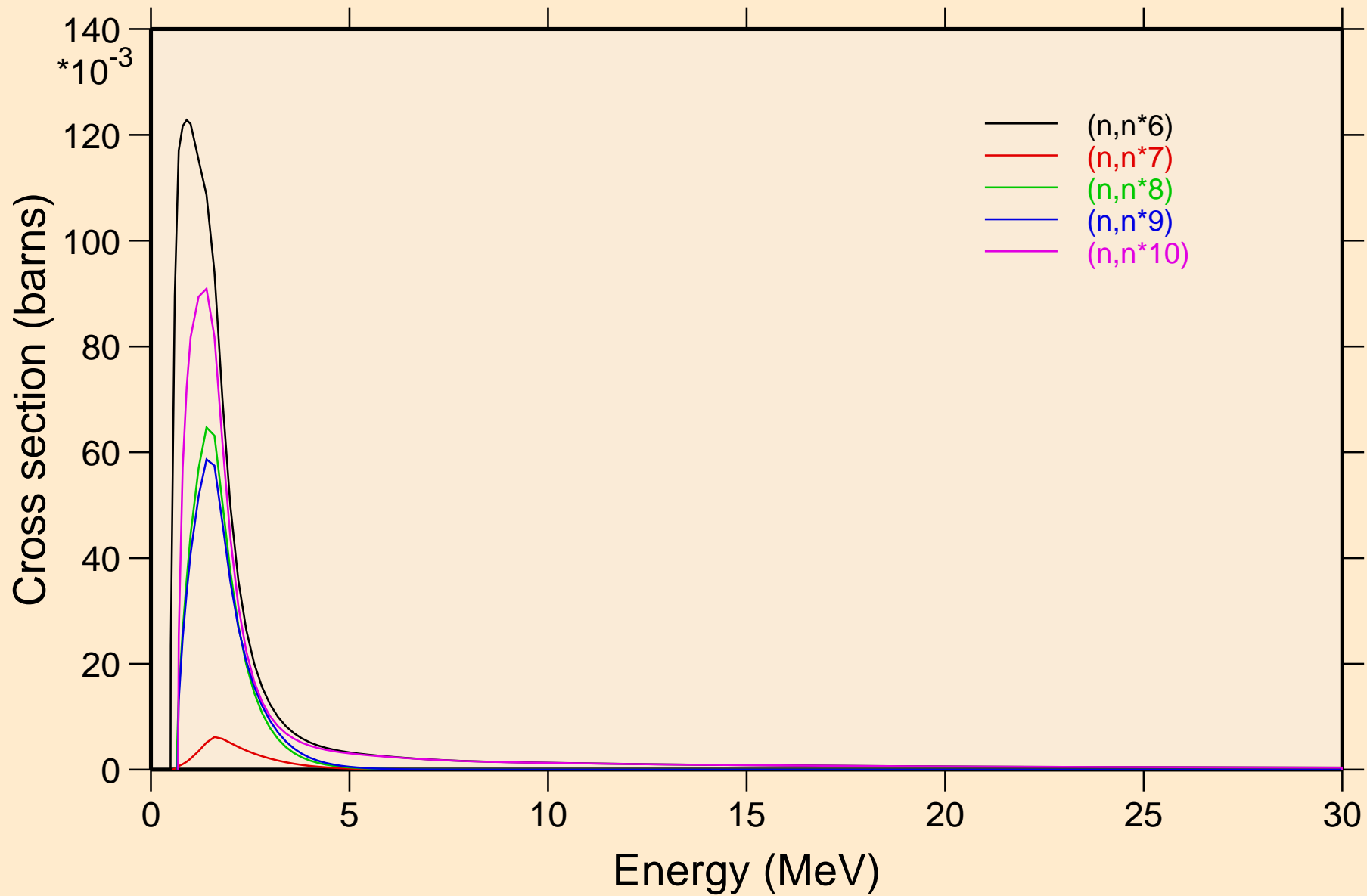

# HG199 NRG TENDL-2015, AKONING

## Inelastic levels

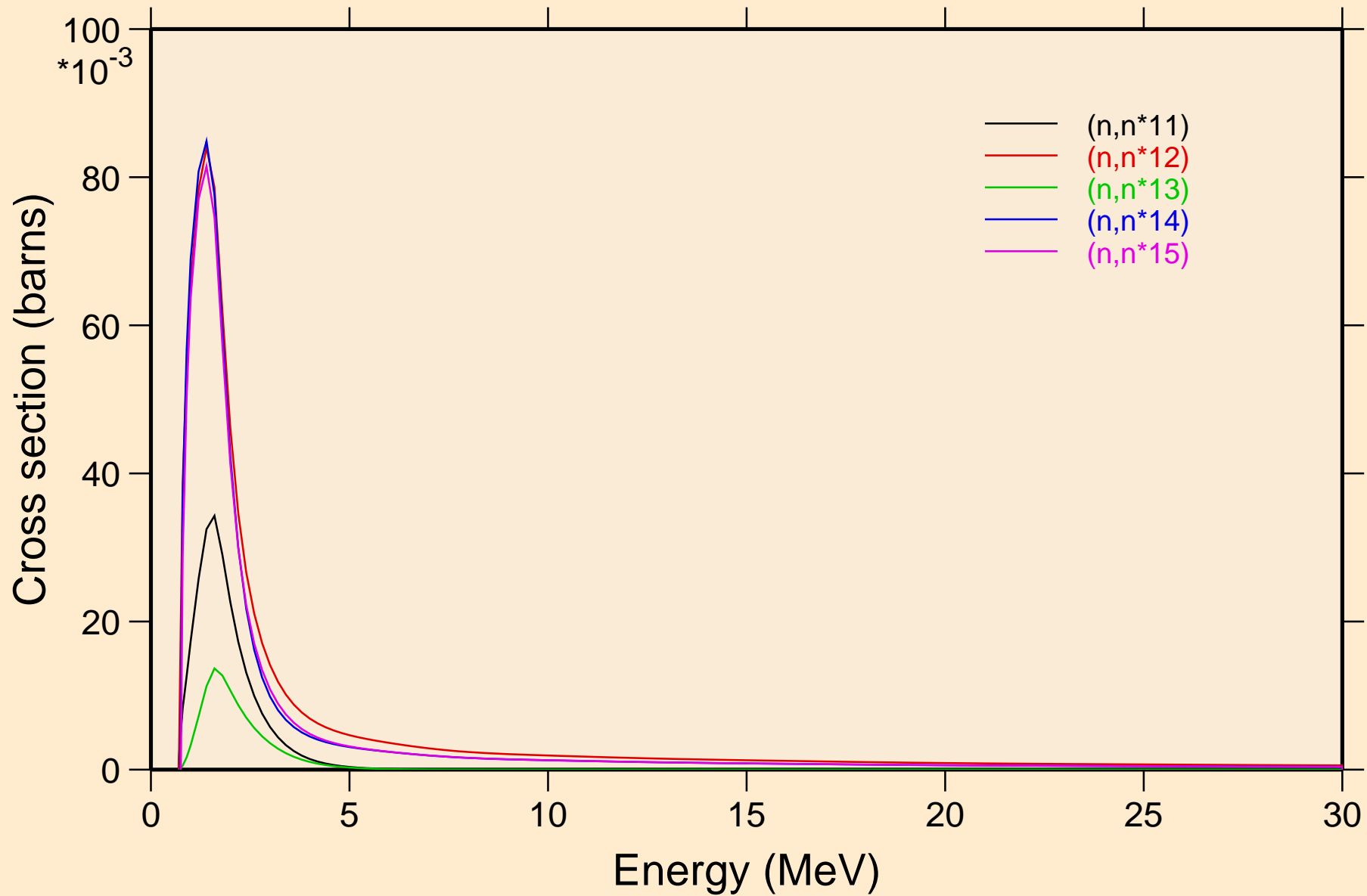

# HG199 NRG TENDL-2015, AKONING

## Inelastic levels

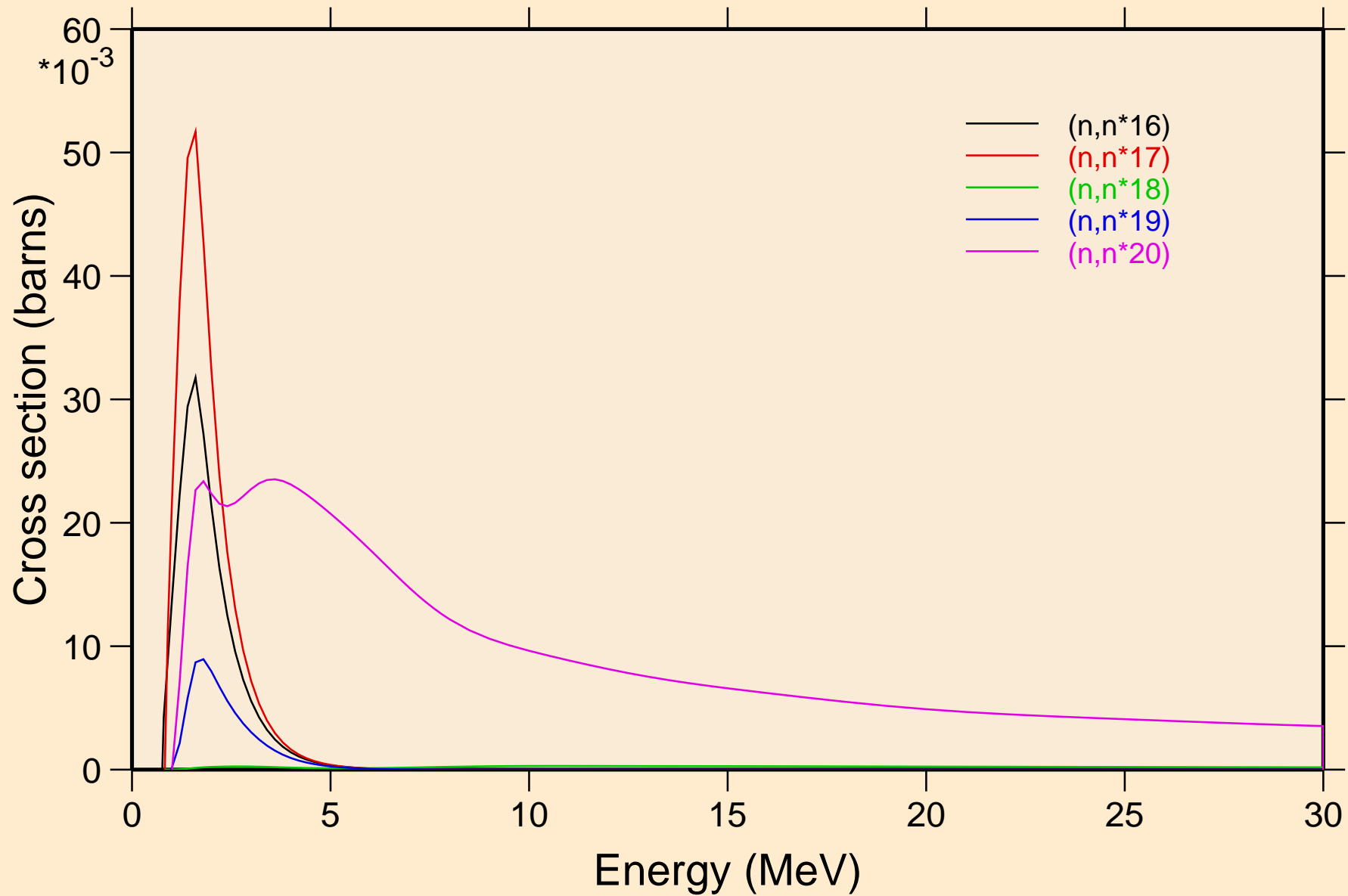



# HG199 NRG TENDL-2015, AKONING

## Inelastic levels

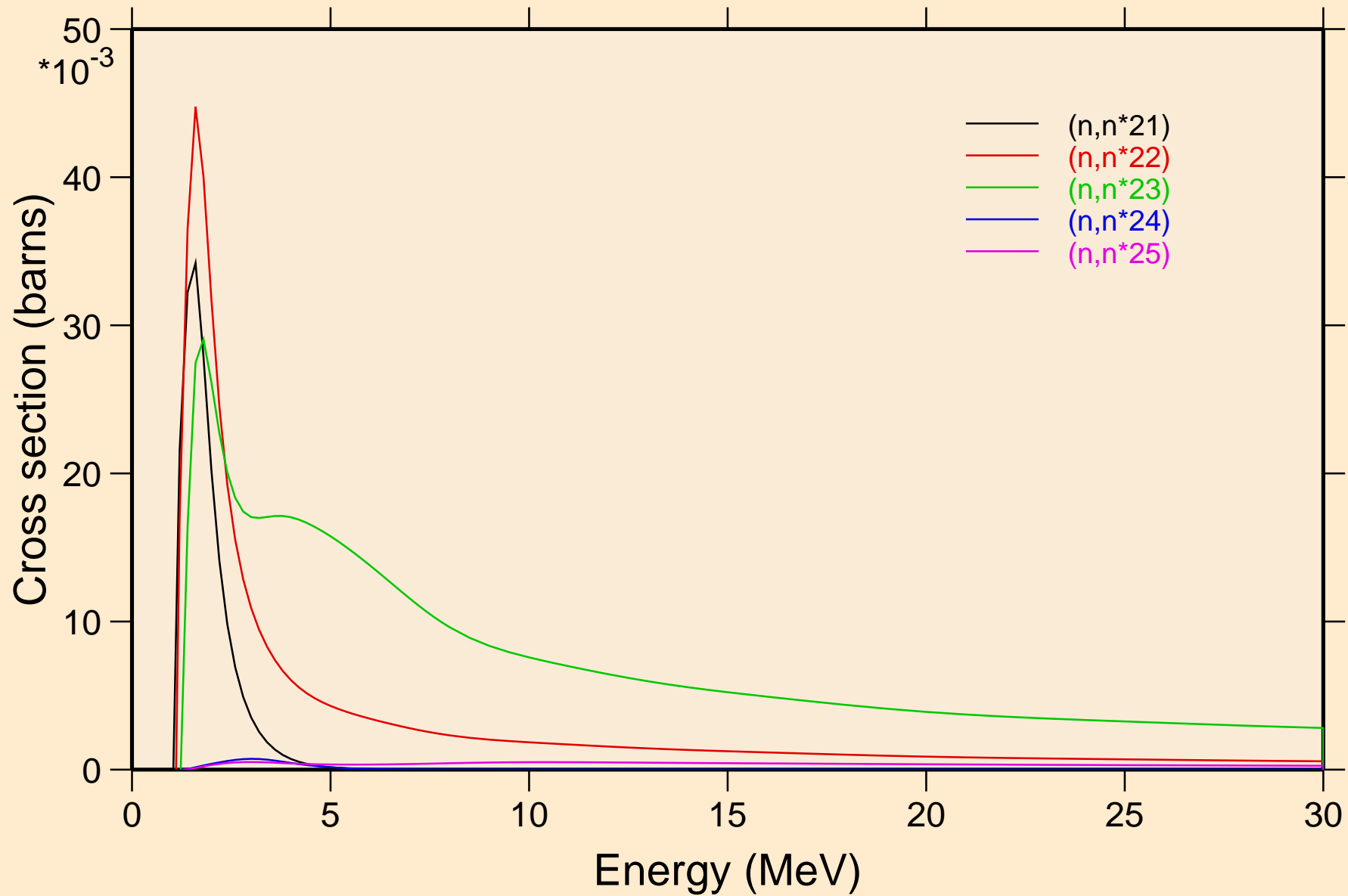

# HG199 NRG TENDL-2015, AKONING

## Inelastic levels

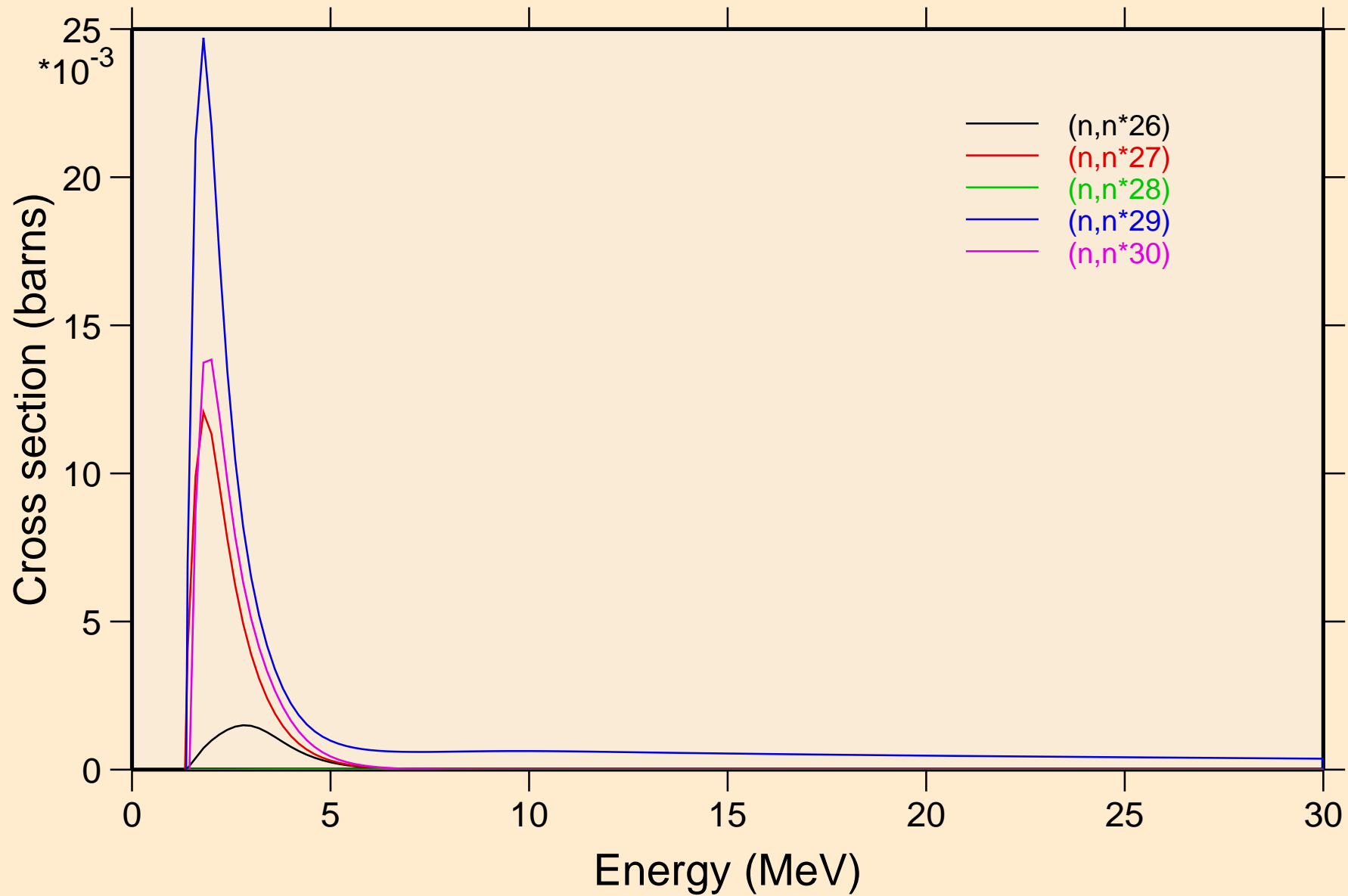

# HG199 NRG TENDL-2015, AKONING

## Threshold reactions

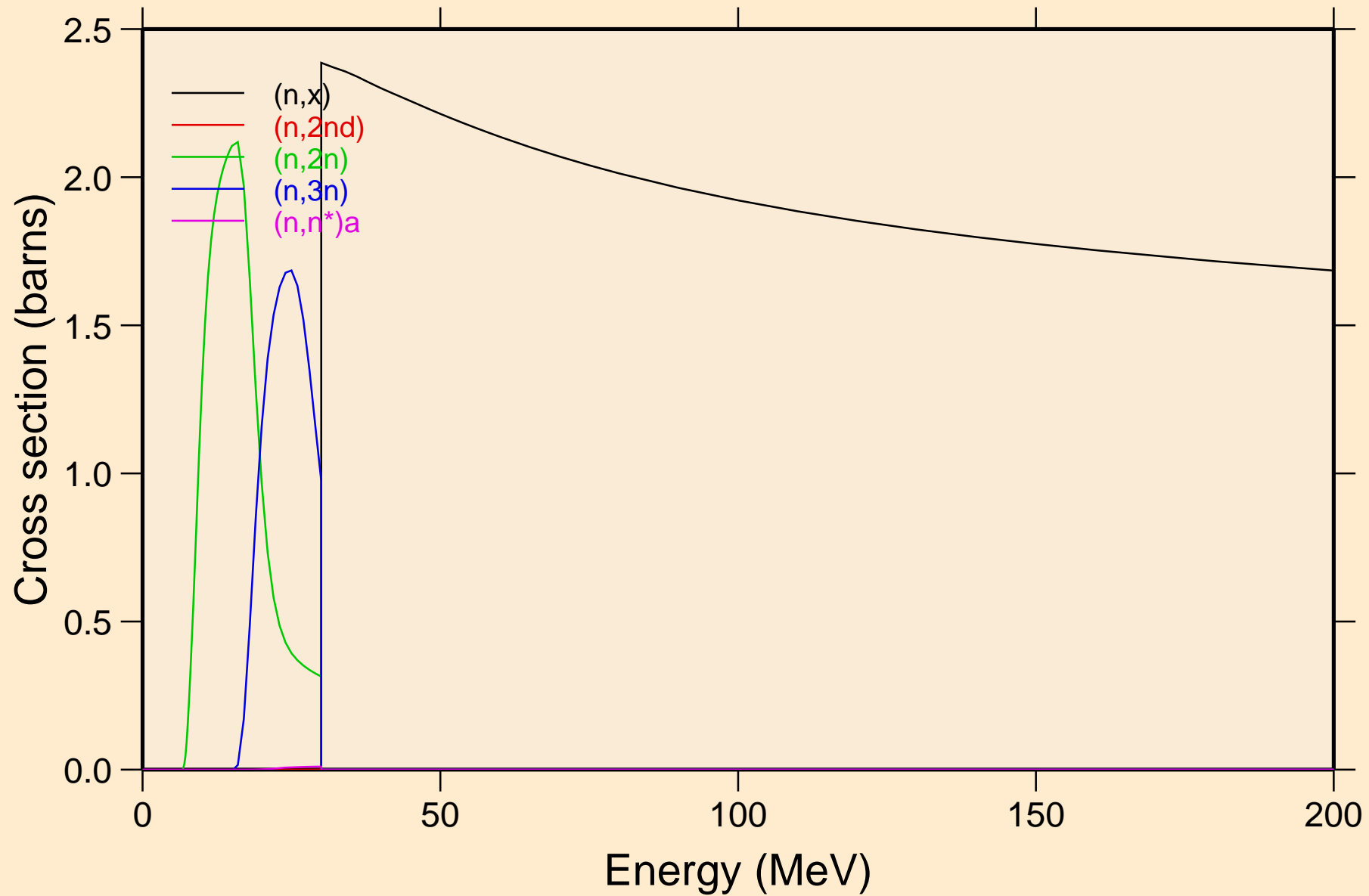

# HG199 NRG TENDL-2015, AKONING

## Threshold reactions

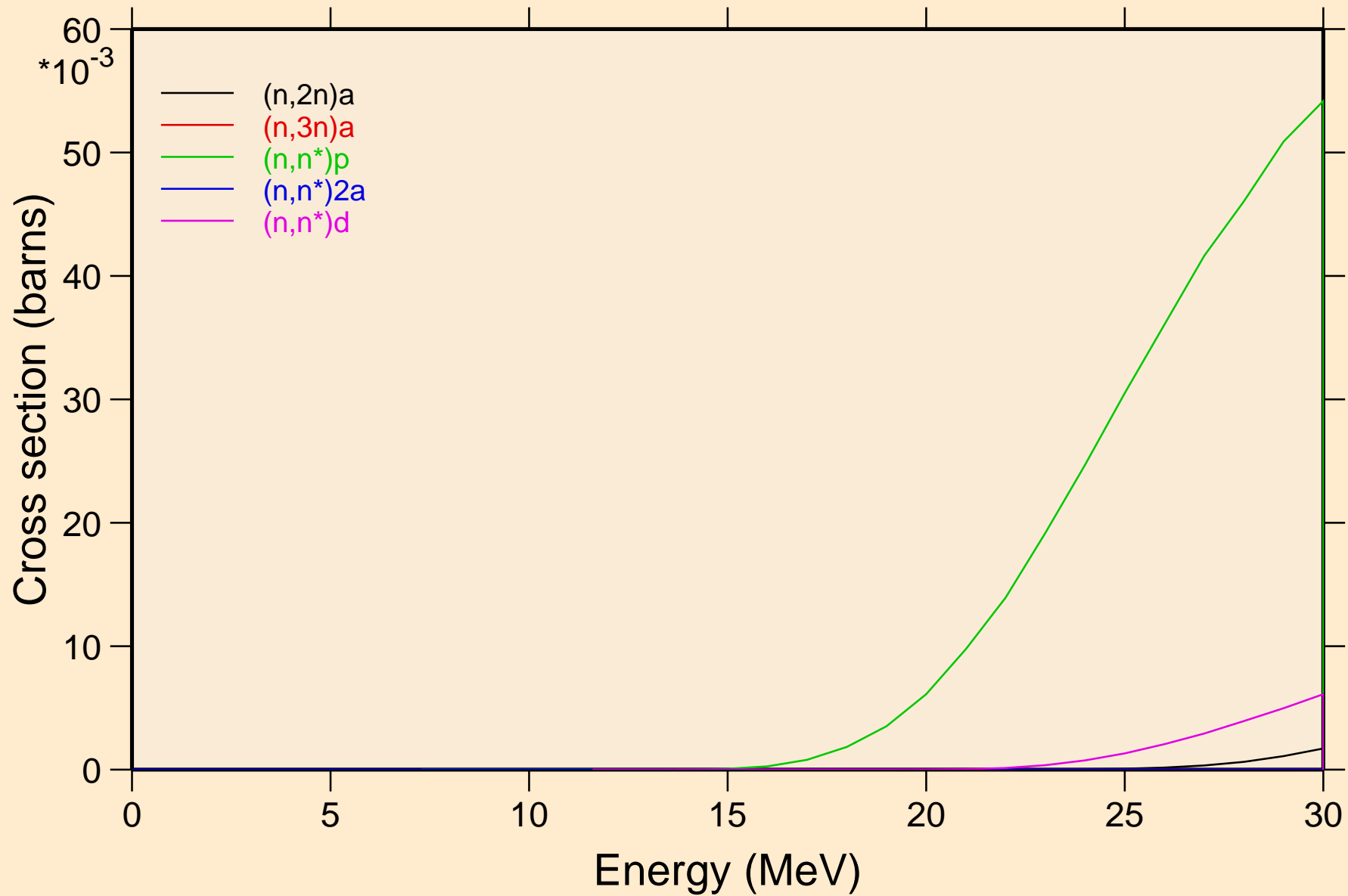

# HG199 NRG TENDL-2015, AKONING

## Threshold reactions

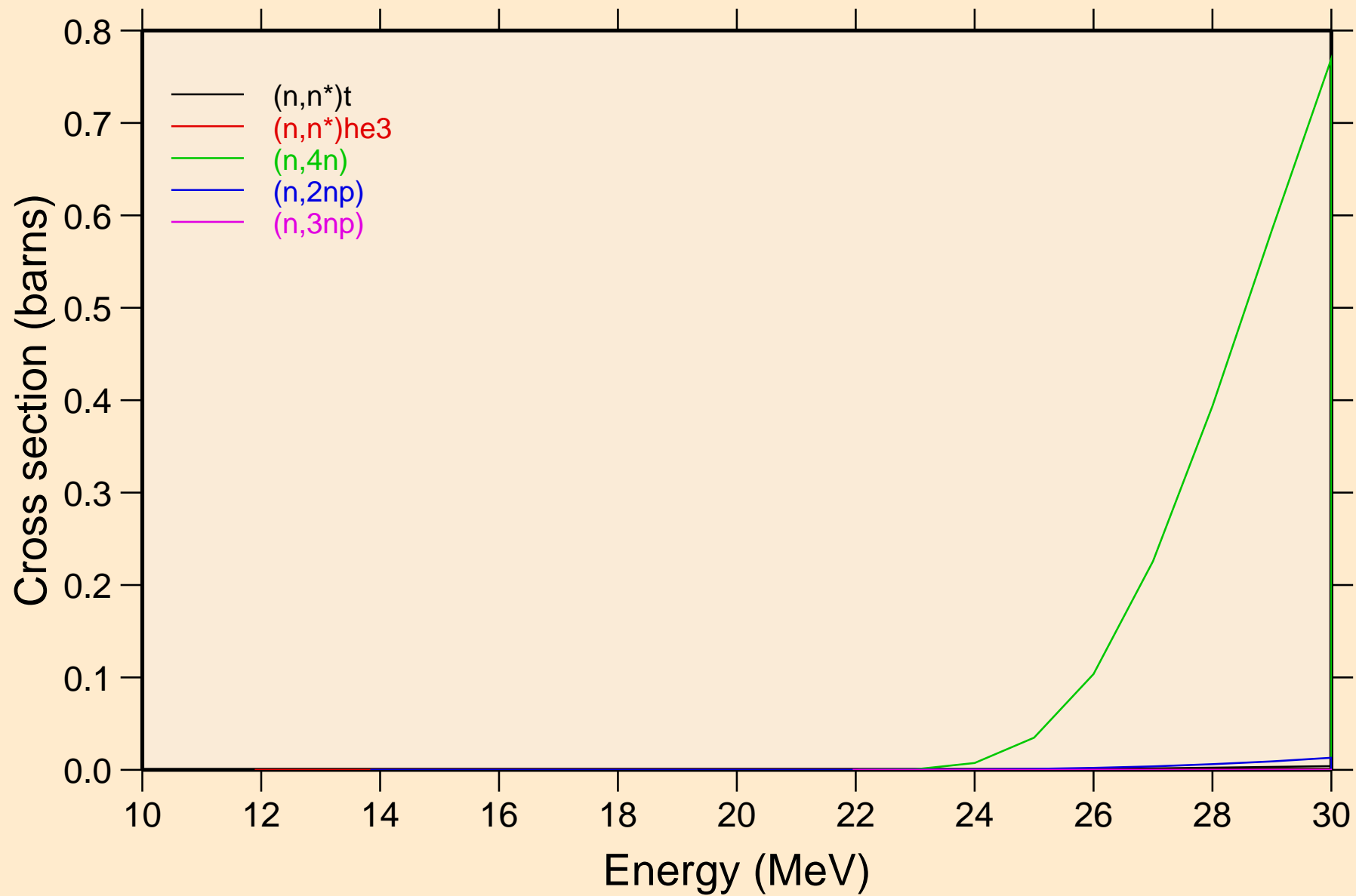

# HG199 NRG TENDL-2015, AKONING

## Threshold reactions

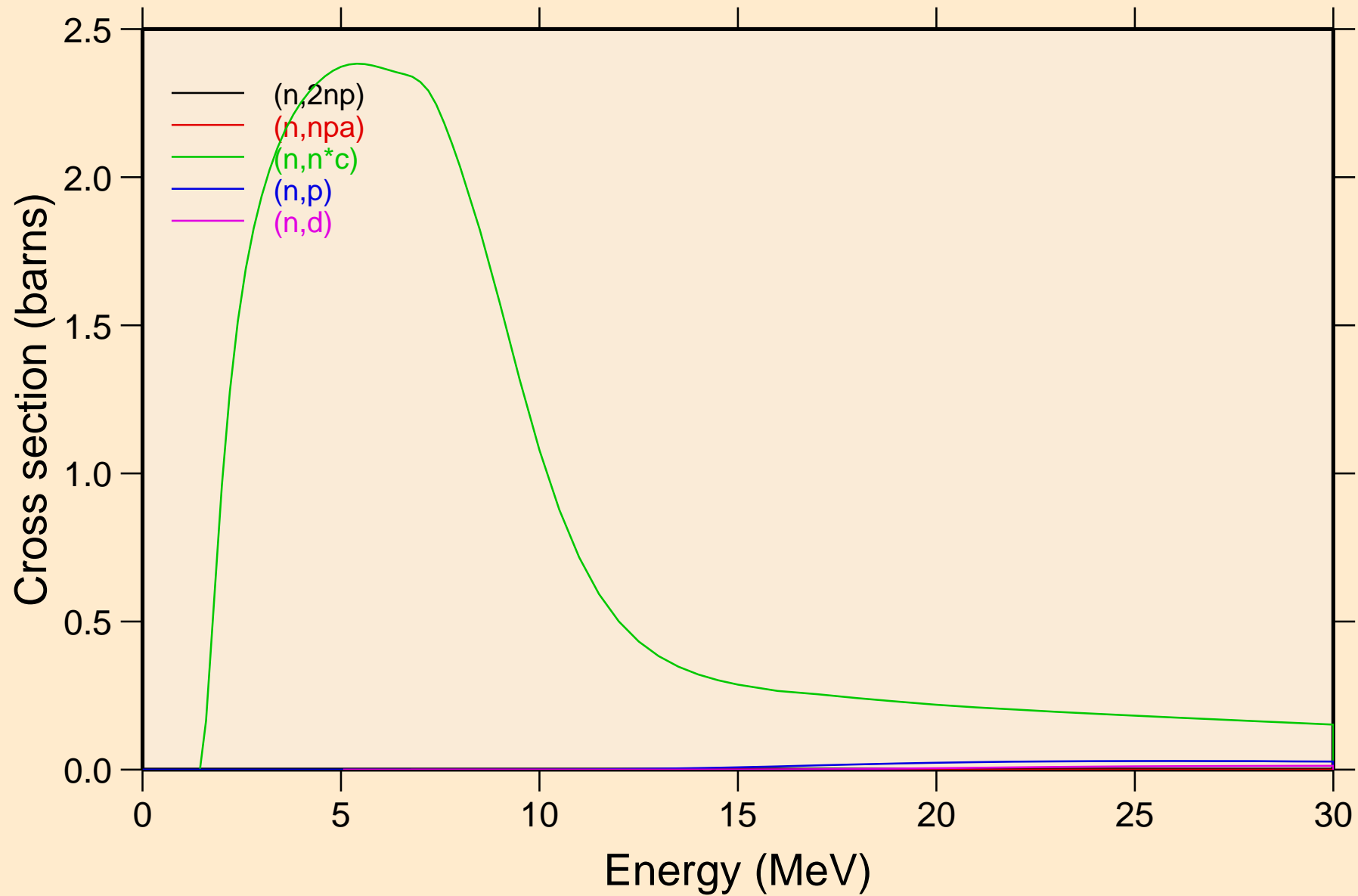

# HG199 NRG TENDL-2015, AKONING

## Threshold reactions

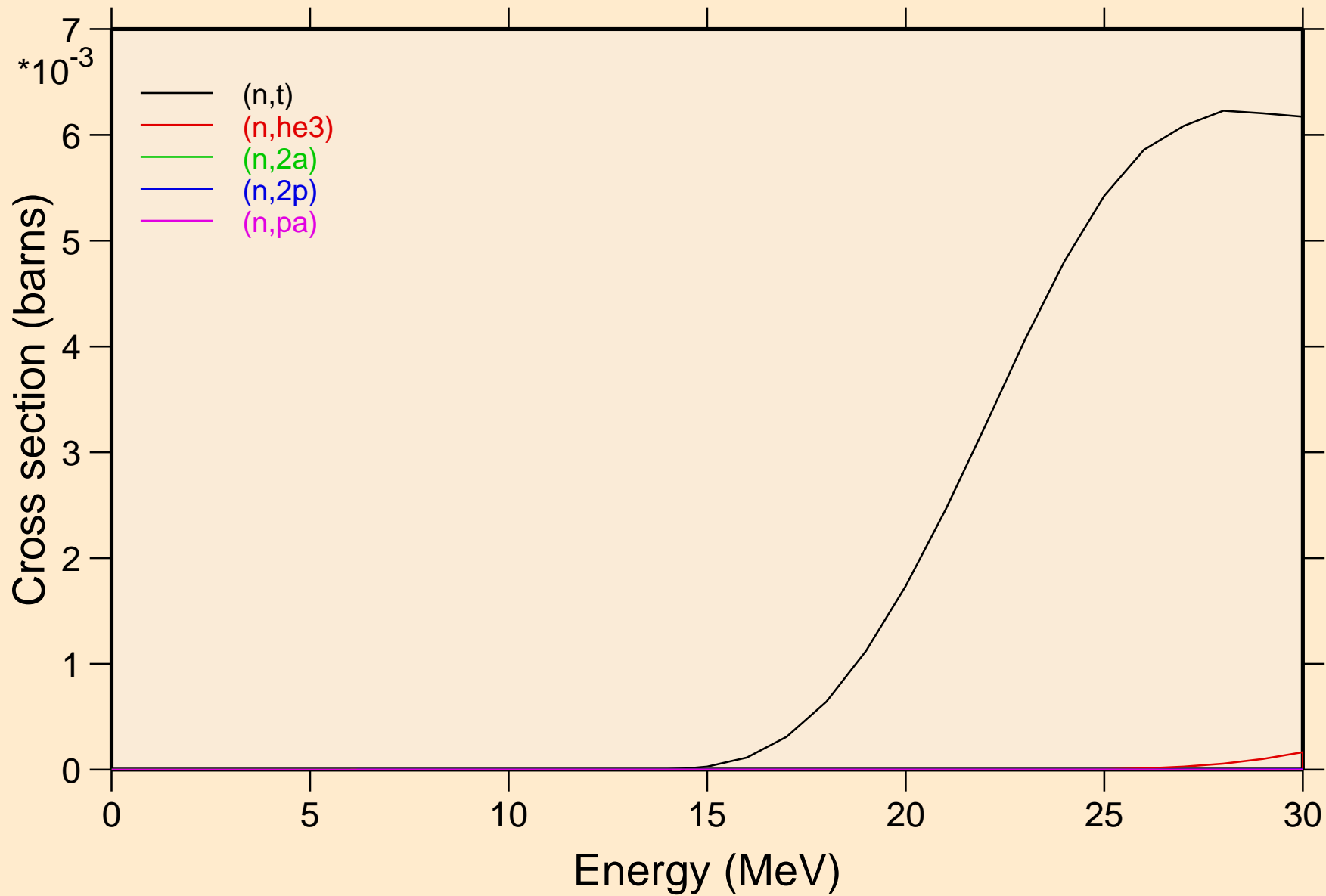

# HG199 NRG TENDL-2015, AKONING

## Threshold reactions

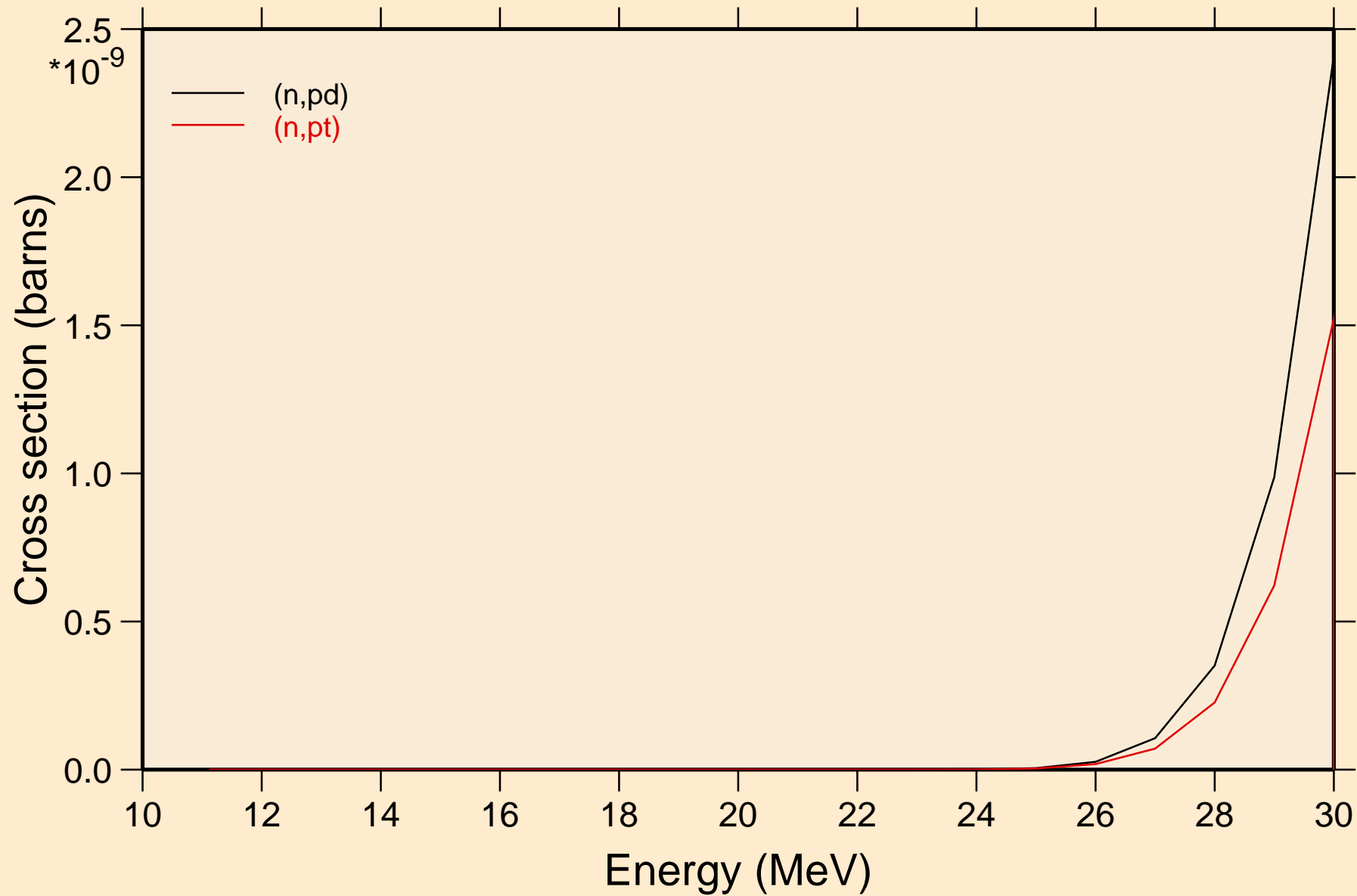



HG199 NRG TENDL-2015, AKONING  
angular distribution for elastic

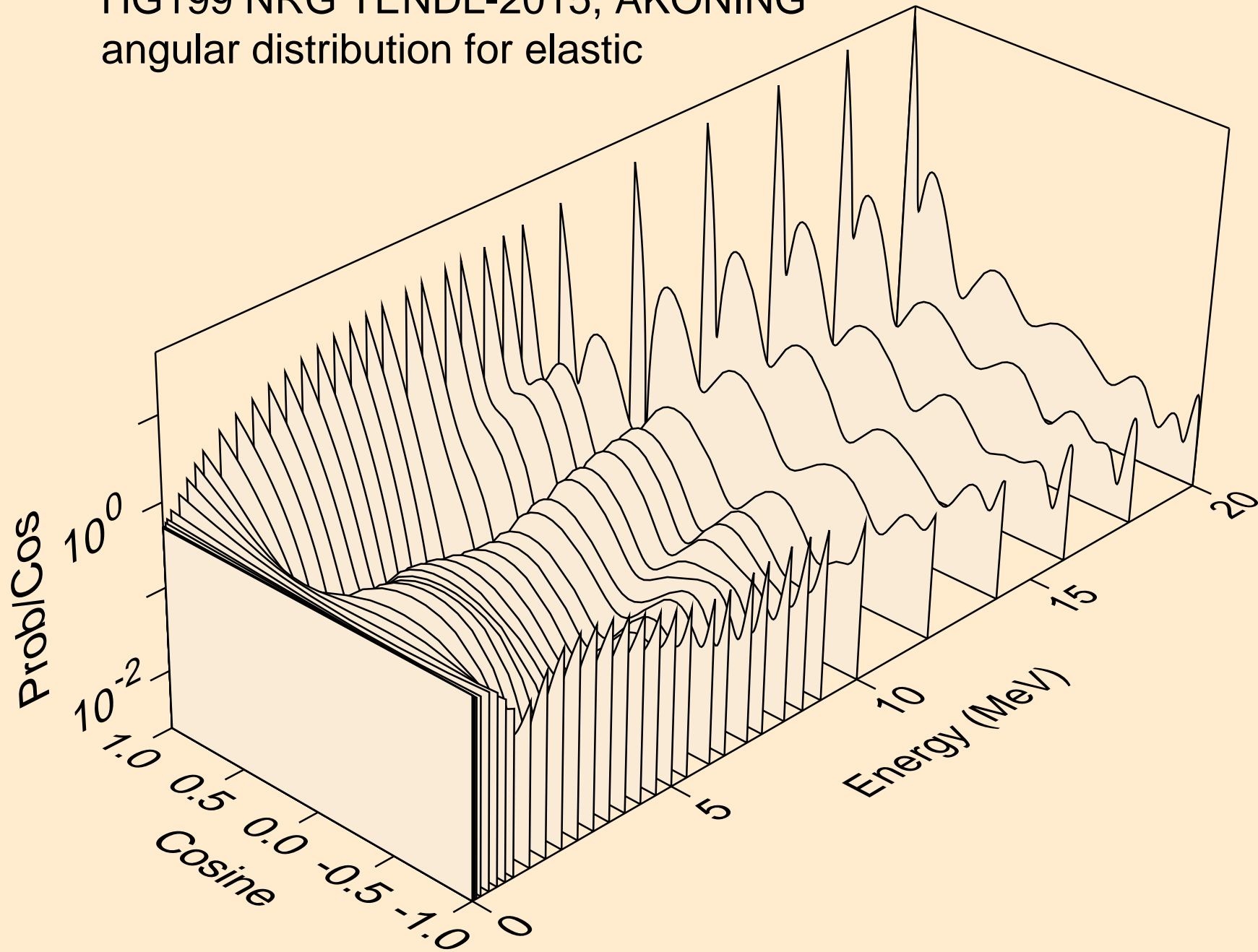

HG199 NRG TENDL-2015, AKONING  
angular distribution for elastic

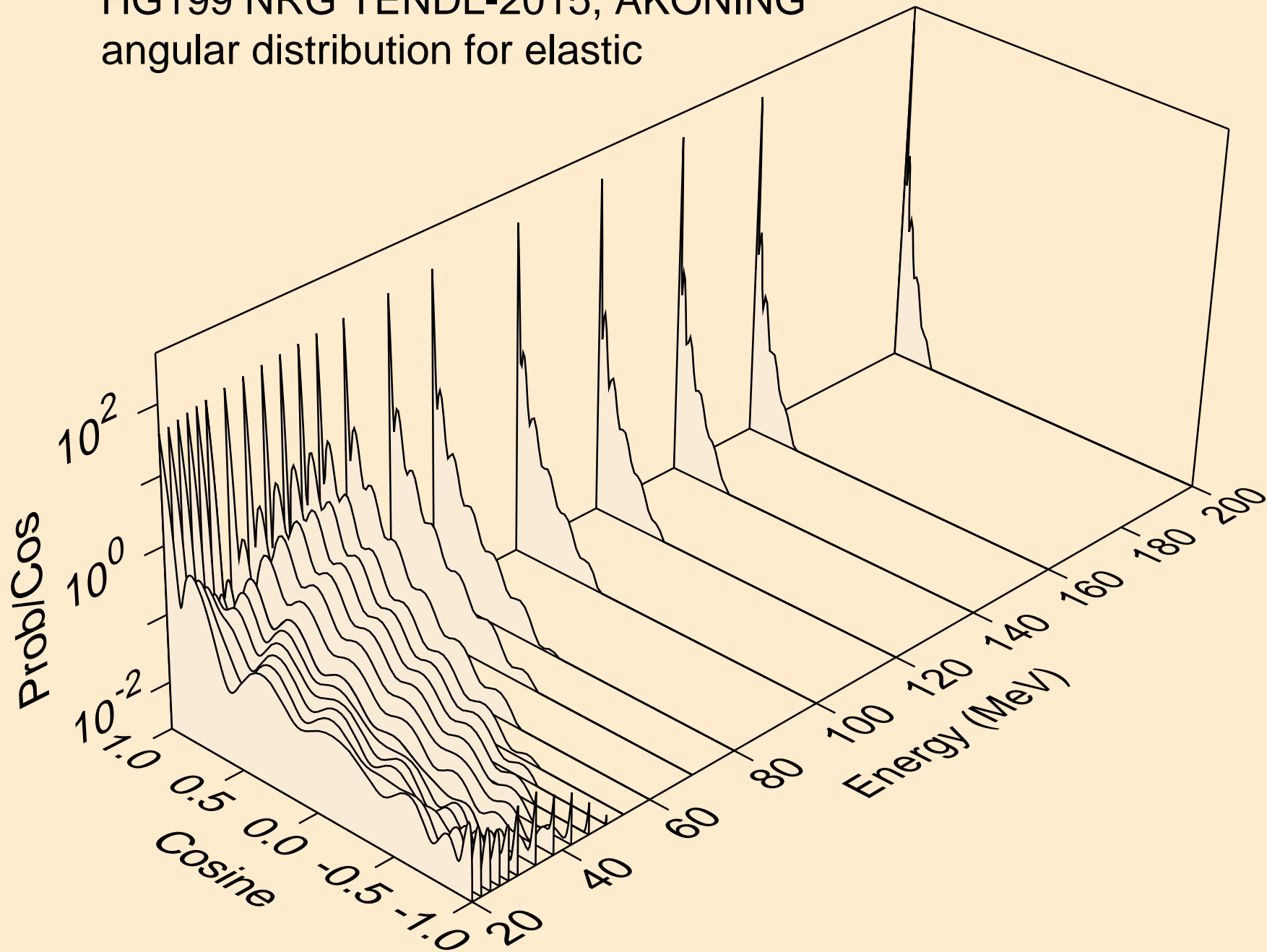

HG199 NRG TENDL-2015, AKONING  
angular distribution for (n,n\*1)

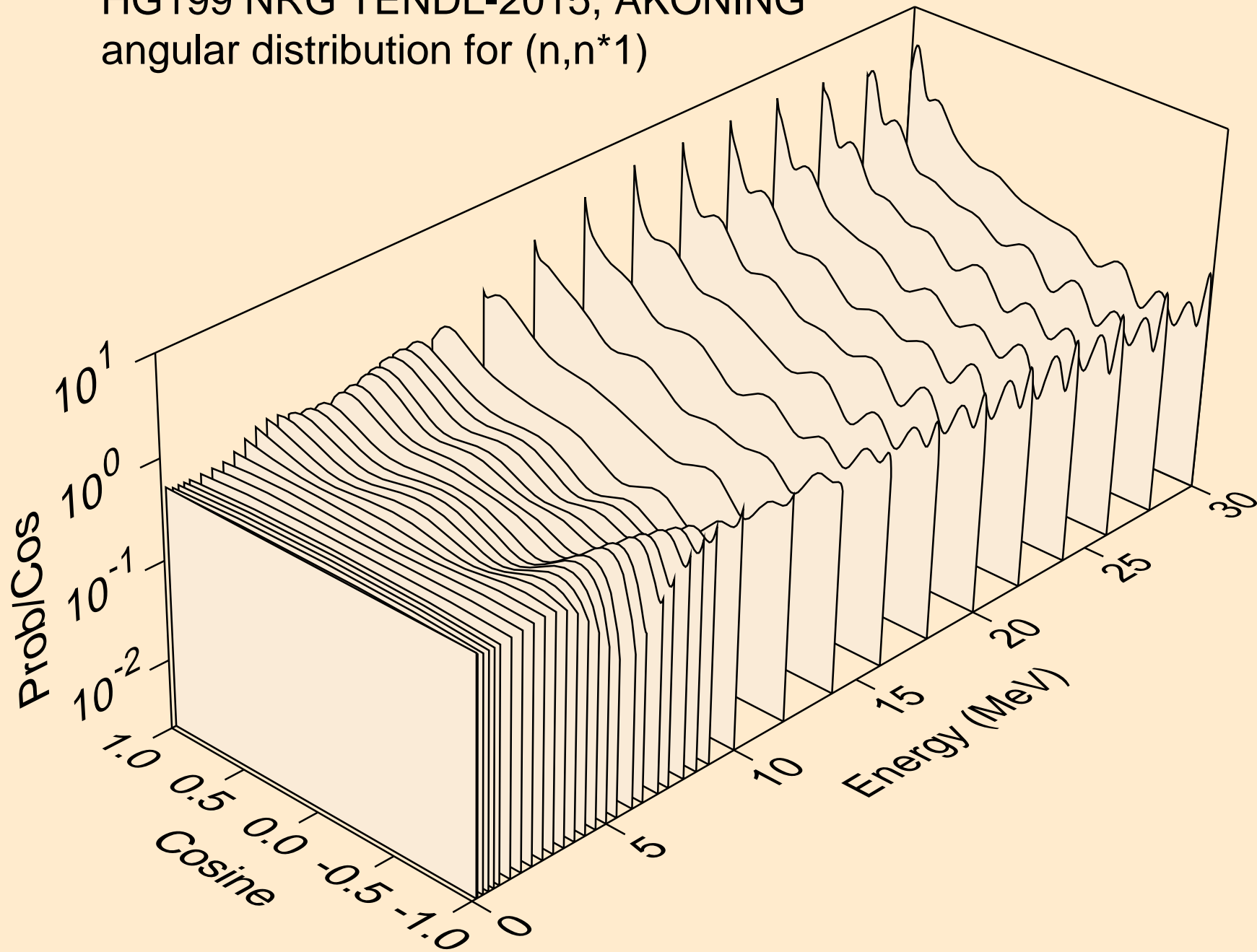

HG199 NRG TENDL-2015, AKONING  
angular distribution for (n,n\*2)

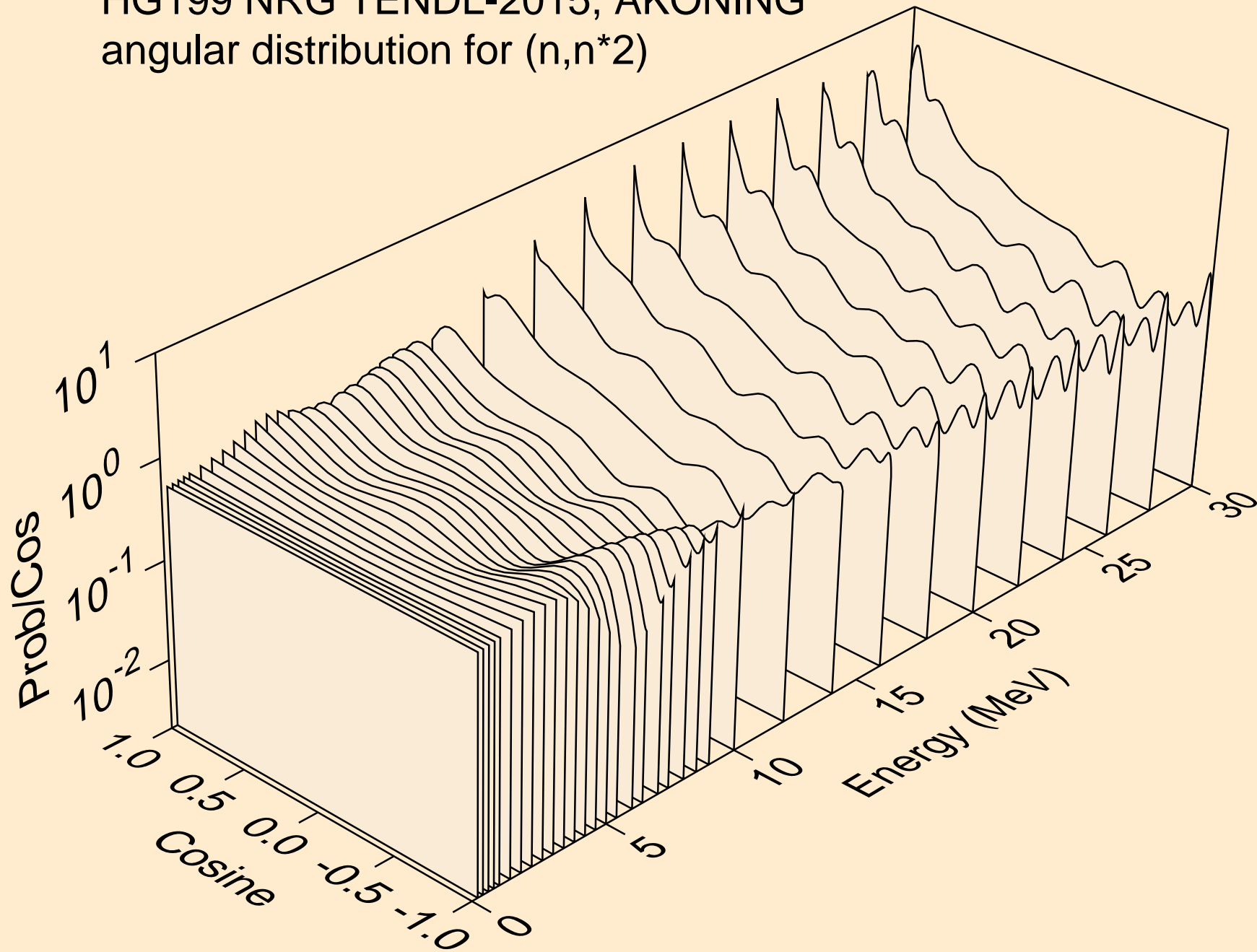

HG199 NRG TENDL-2015, AKONING  
angular distribution for (n,n\*3)

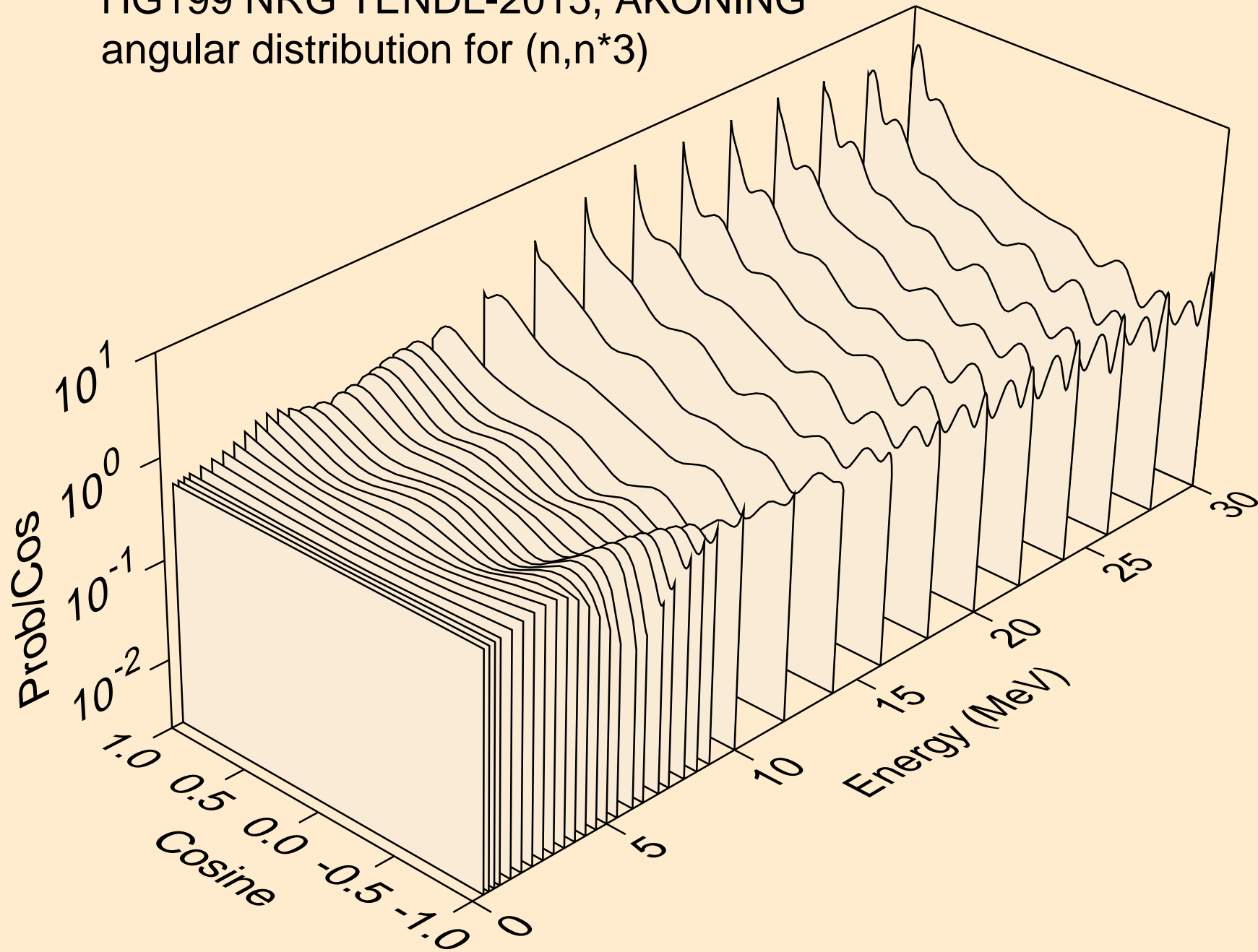

HG199 NRG TENDL-2015, AKONING  
angular distribution for (n,n\*4)

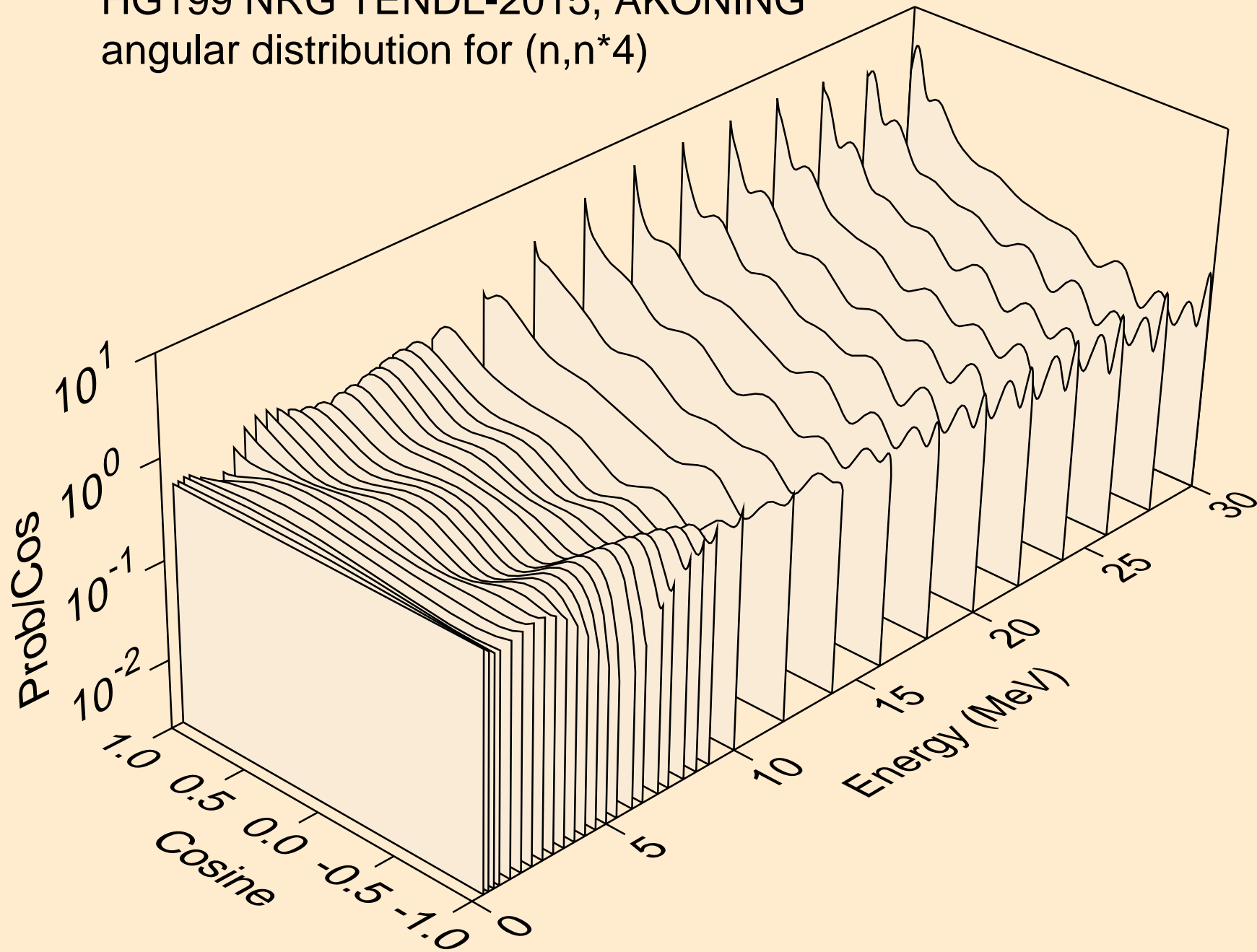

HG199 NRG TENDL-2015, AKONING  
angular distribution for (n,n\*5)

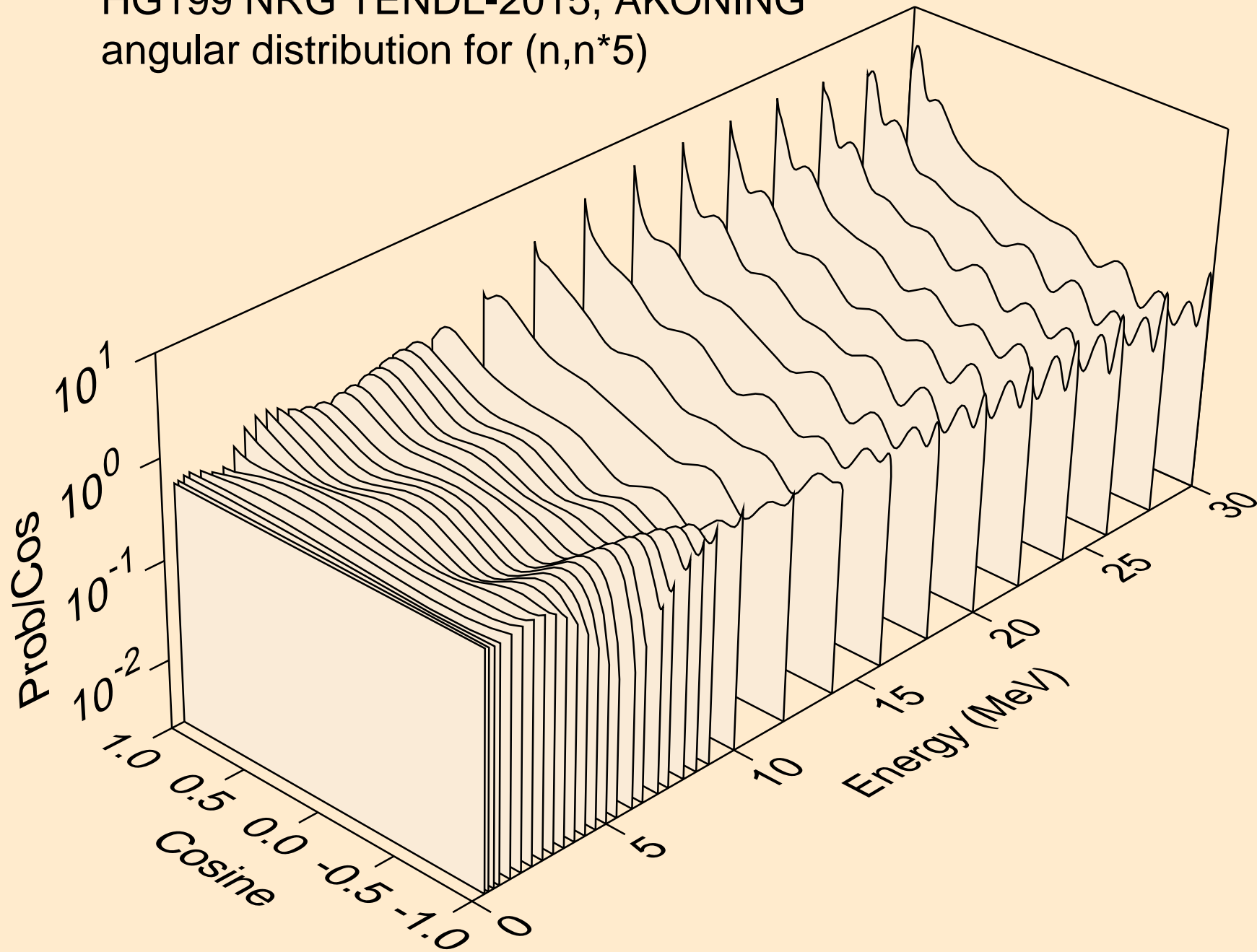

HG199 NRG TENDL-2015, AKONING  
angular distribution for (n,n\*6)

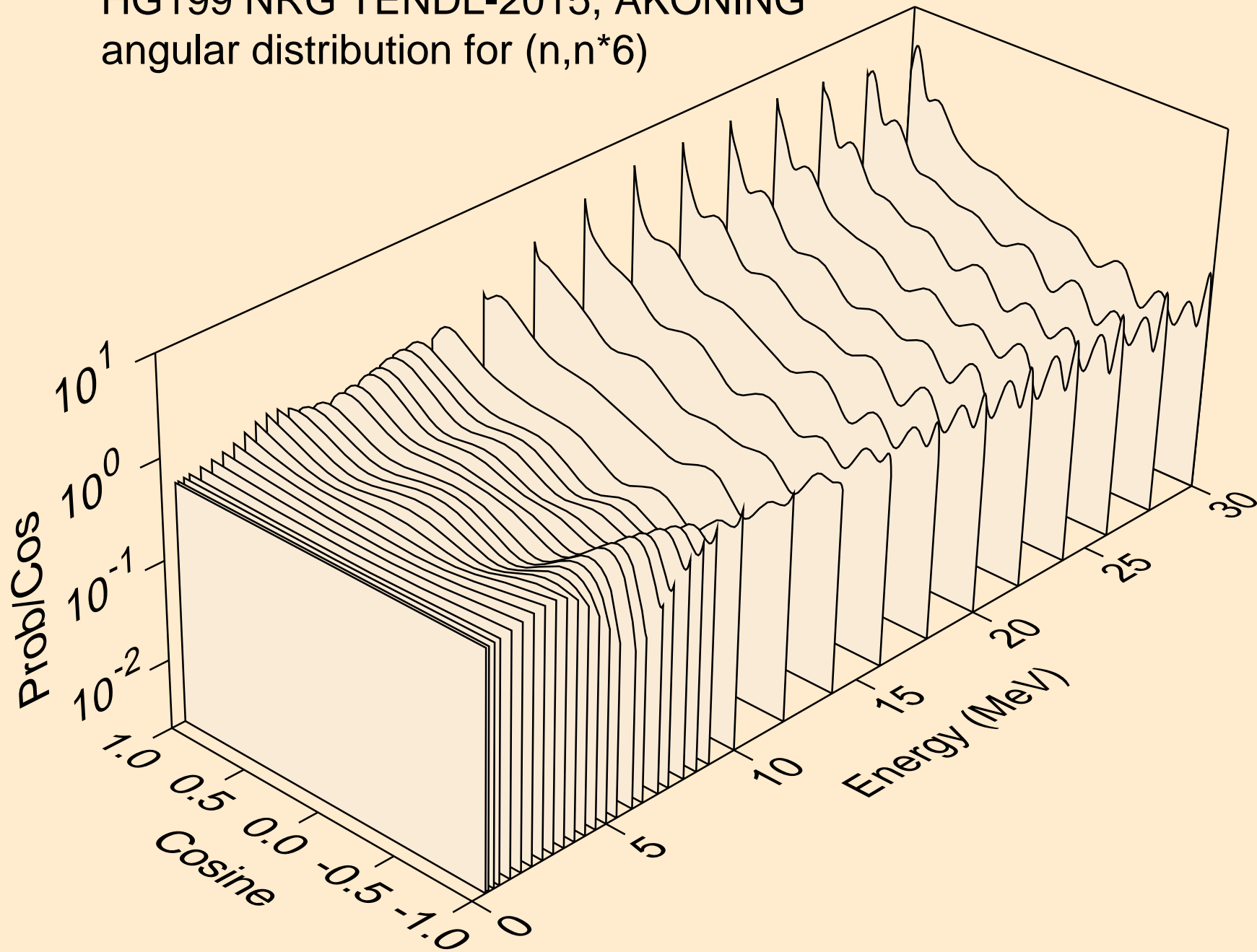



HG199 NRG TENDL-2015, AKONING  
angular distribution for (n,n\*7)

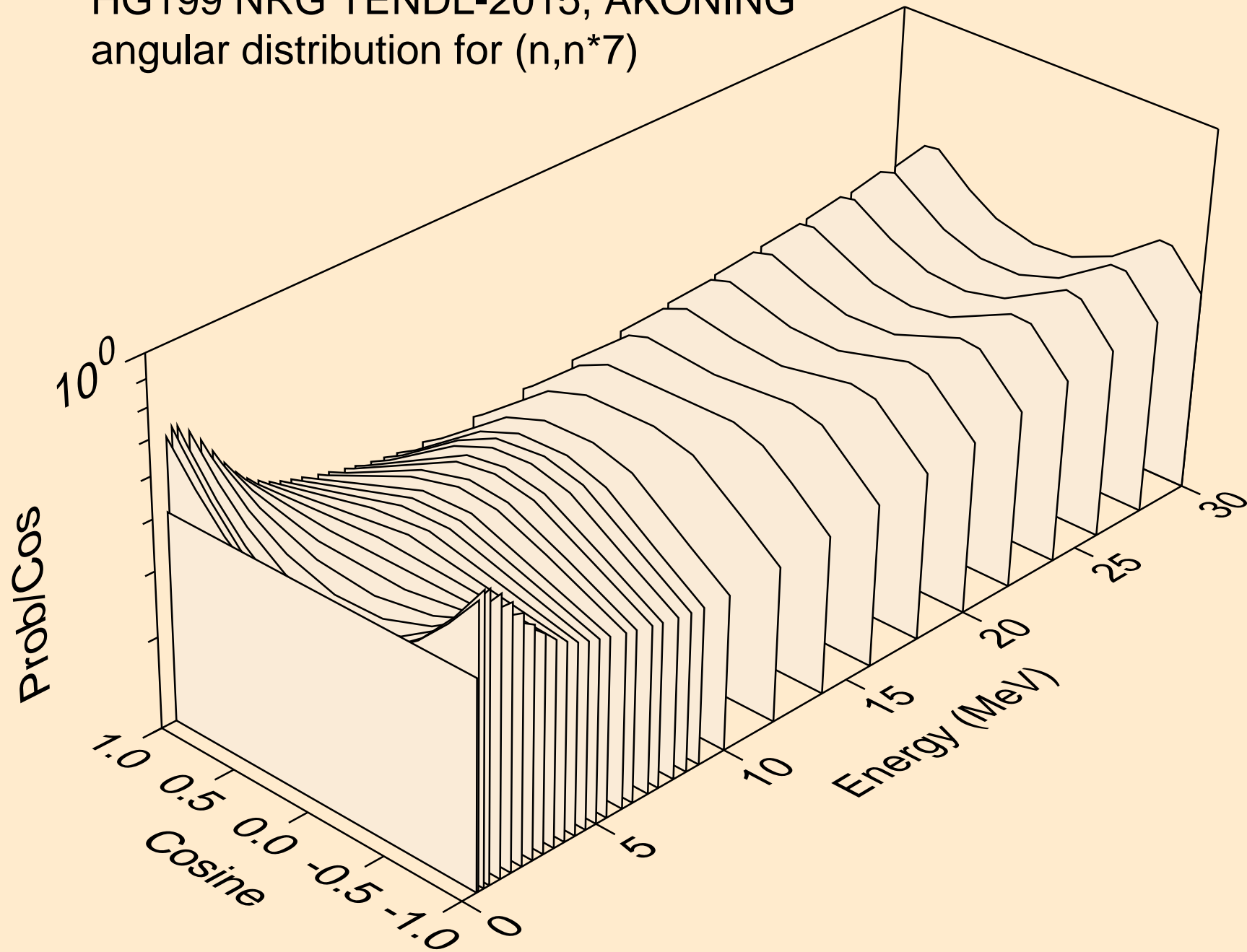

HG199 NRG TENDL-2015, AKONING  
angular distribution for (n,n\*8)

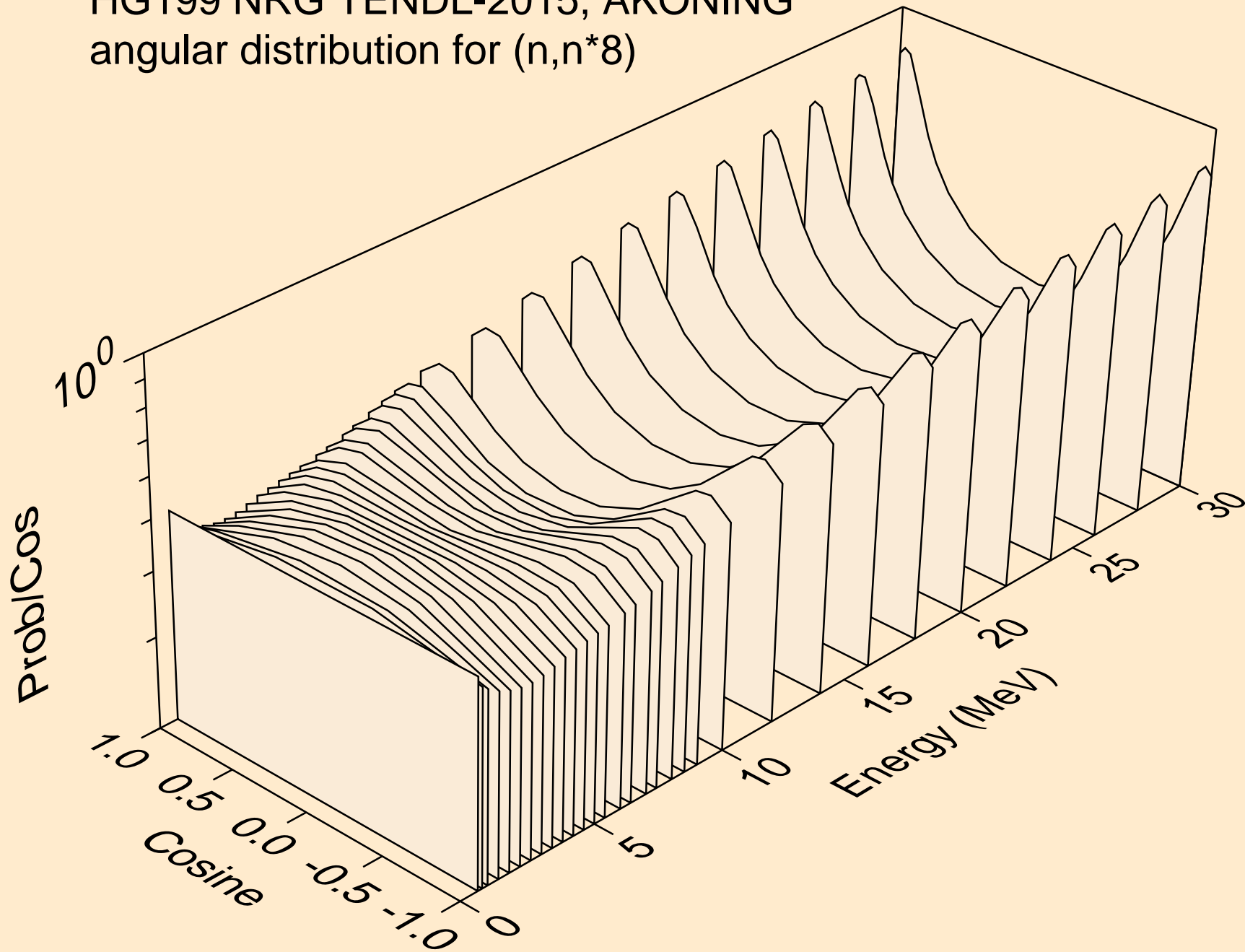

HG199 NRG TENDL-2015, AKONING  
angular distribution for (n,n\*9)

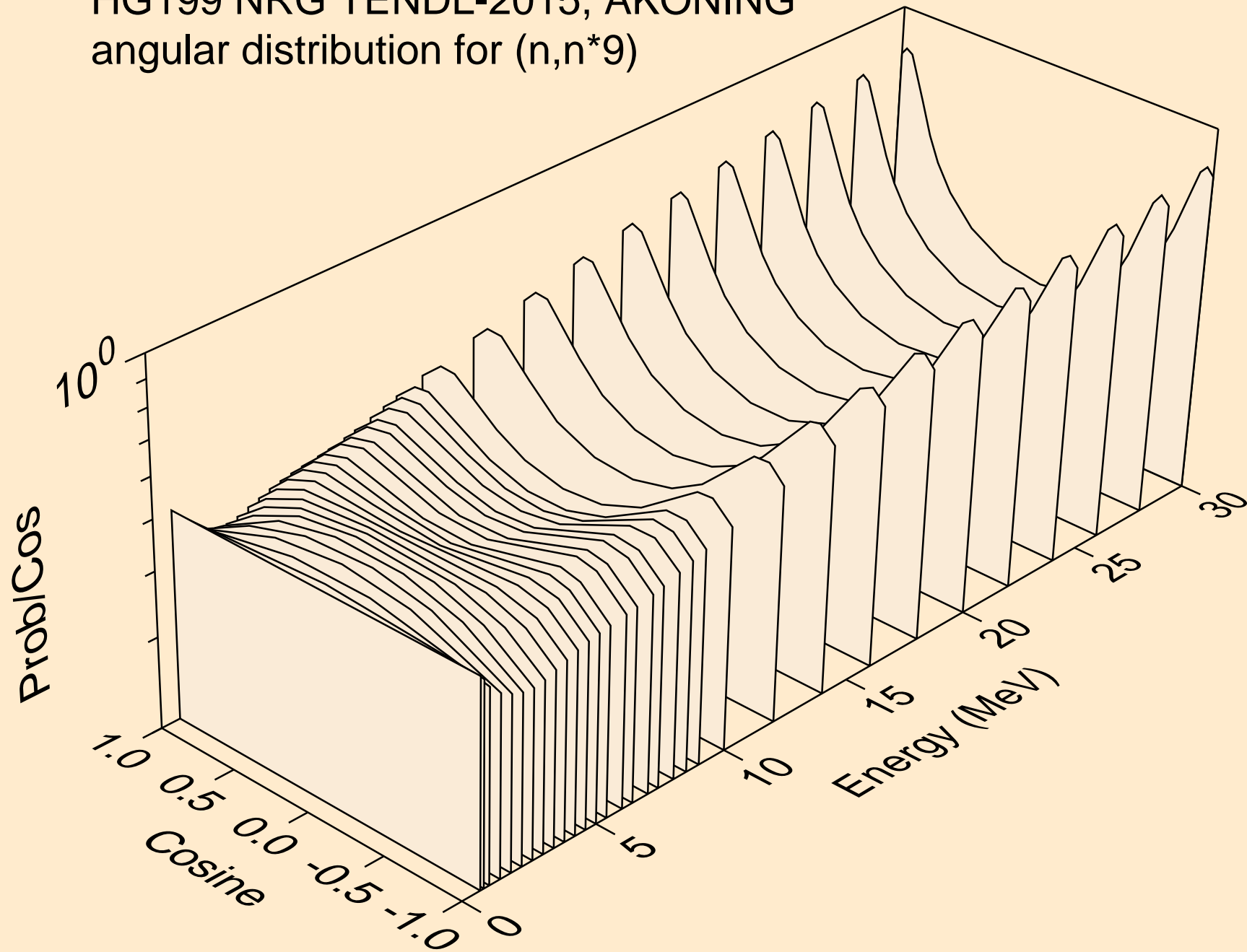

HG199 NRG TENDL-2015, AKONING  
angular distribution for (n,n\*10)

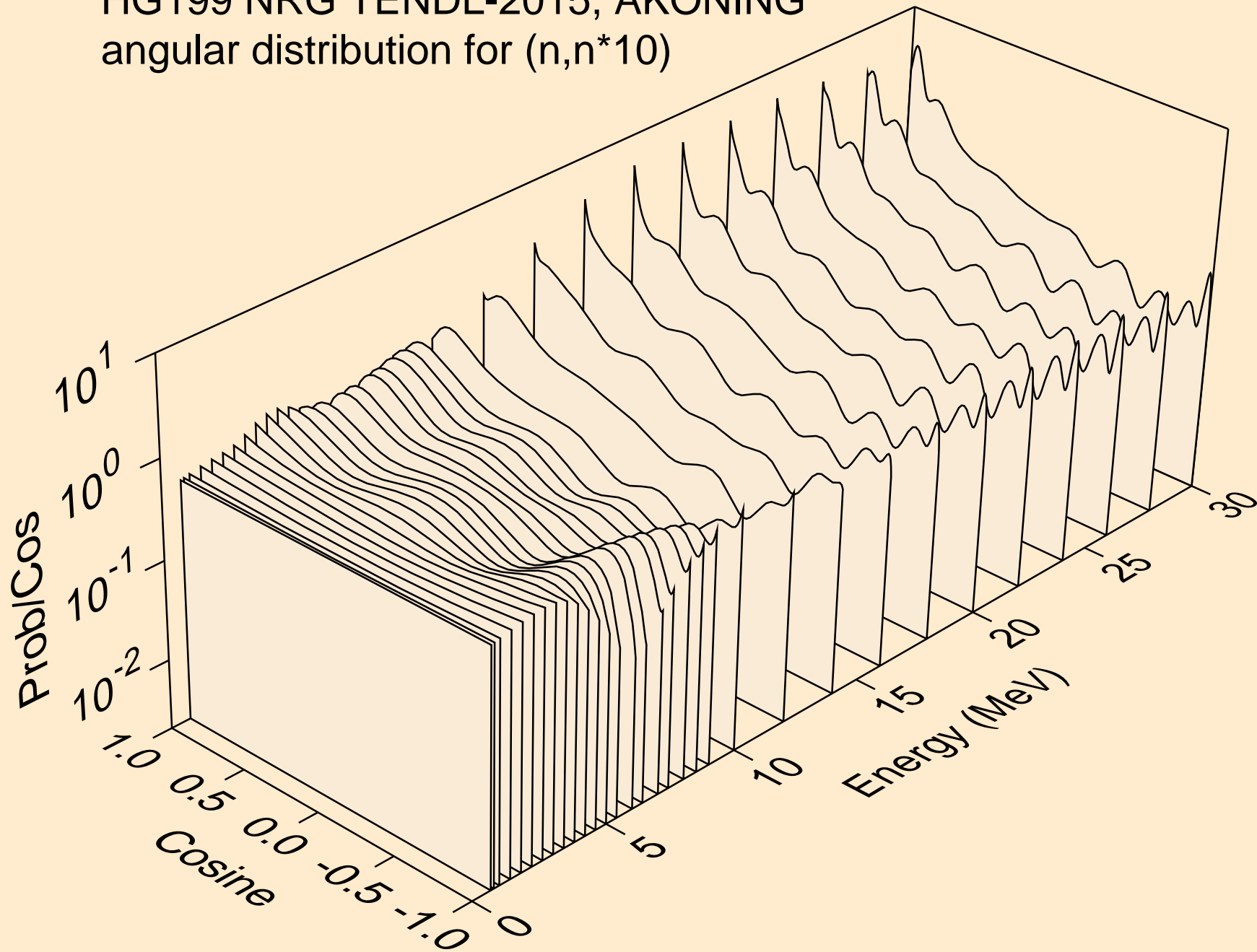

HG199 NRG TENDL-2015, AKONING  
angular distribution for (n,n\*11)

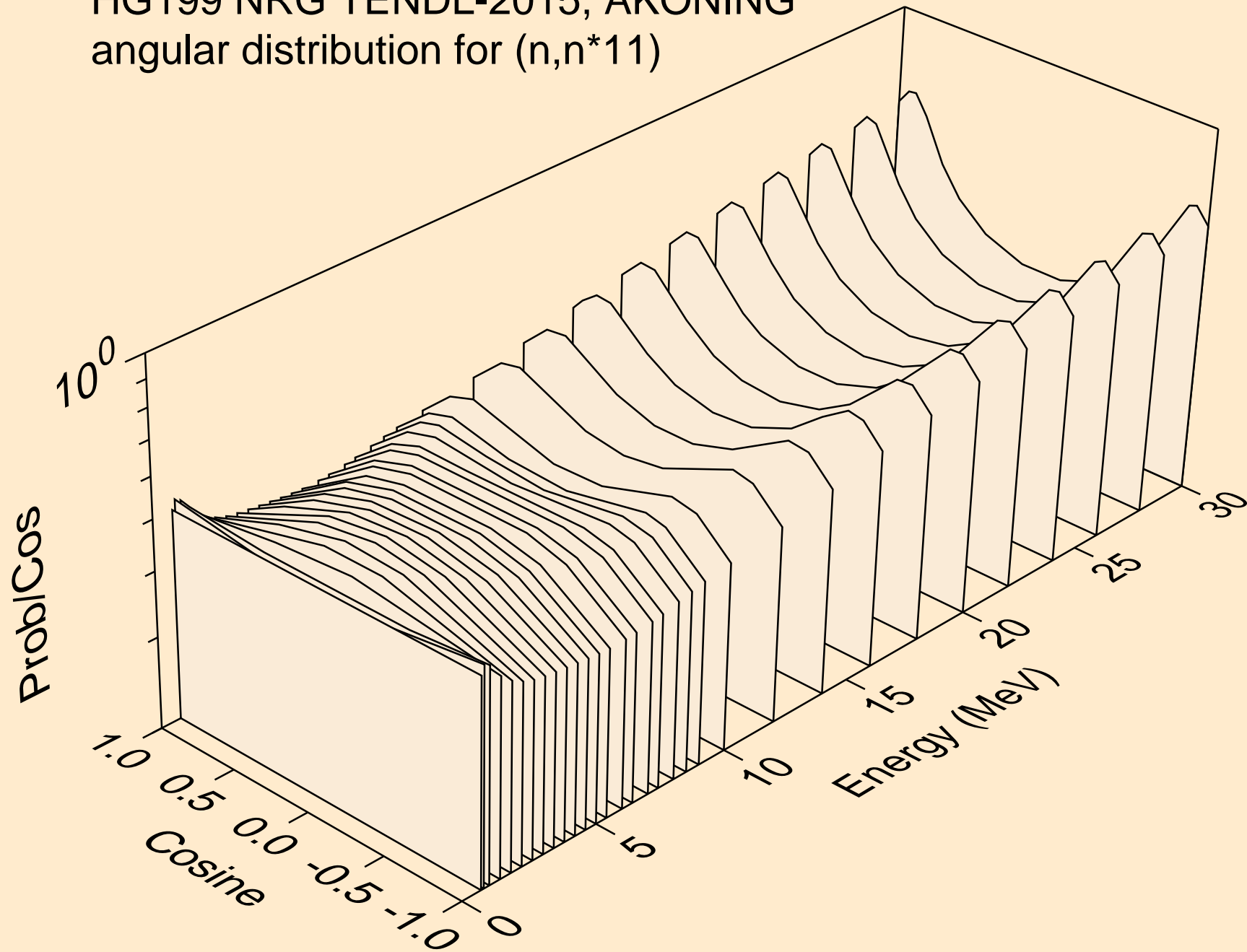

HG199 NRG TENDL-2015, AKONING  
angular distribution for (n,n\*12)

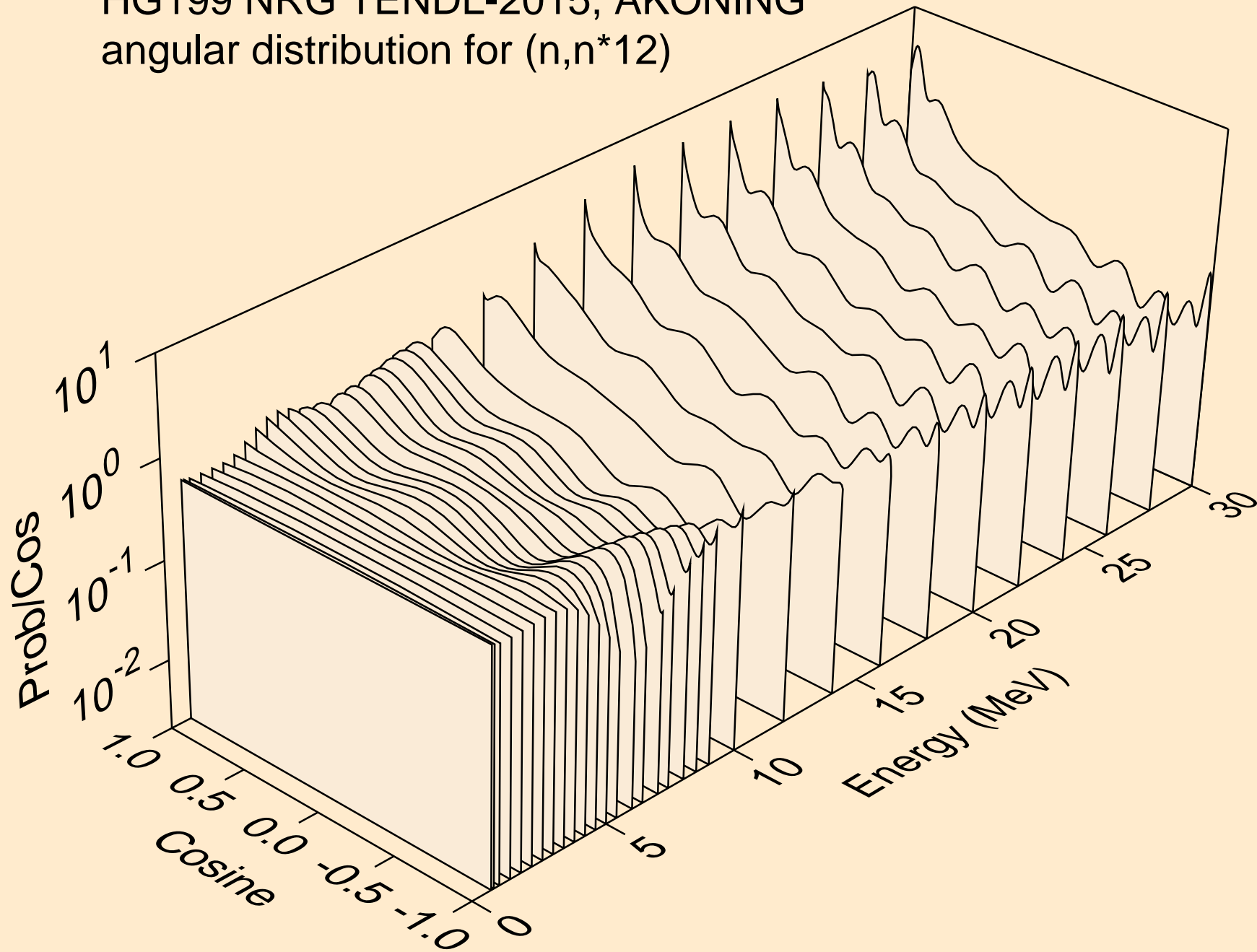

HG199 NRG TENDL-2015, AKONING  
angular distribution for (n,n\*13)

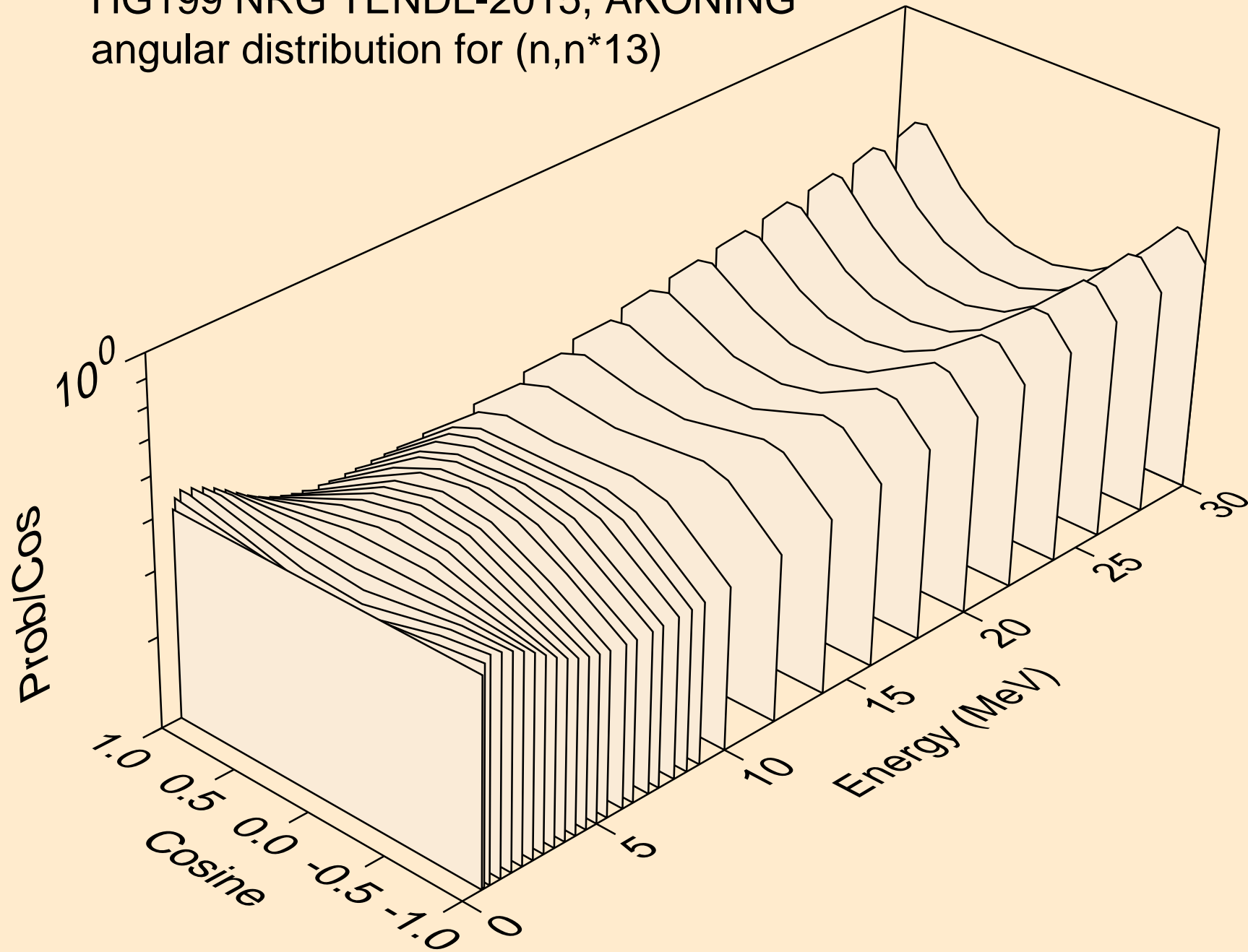

HG199 NRG TENDL-2015, AKONING  
angular distribution for (n,n\*14)

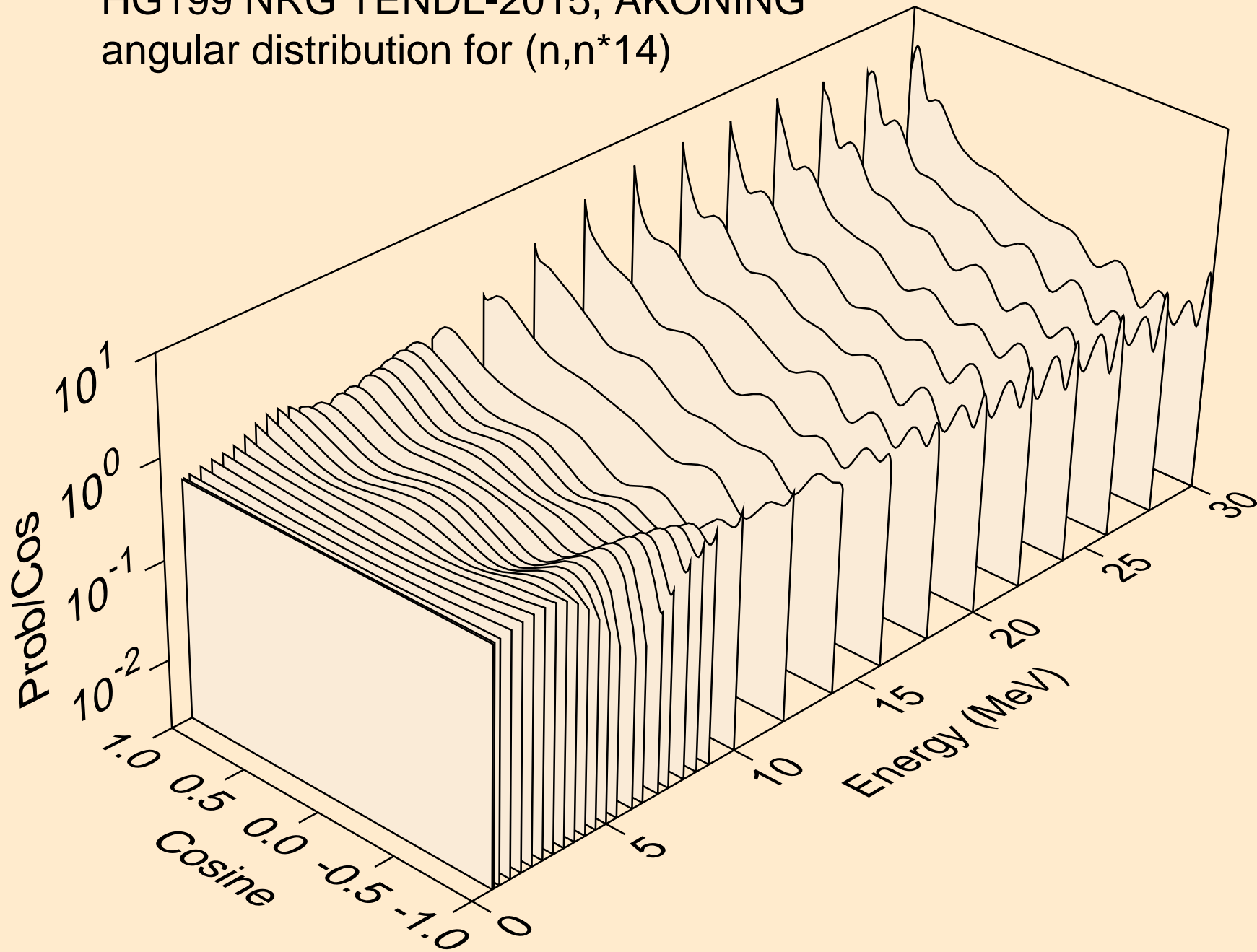



HG199 NRG TENDL-2015, AKONING  
angular distribution for (n,n\*15)

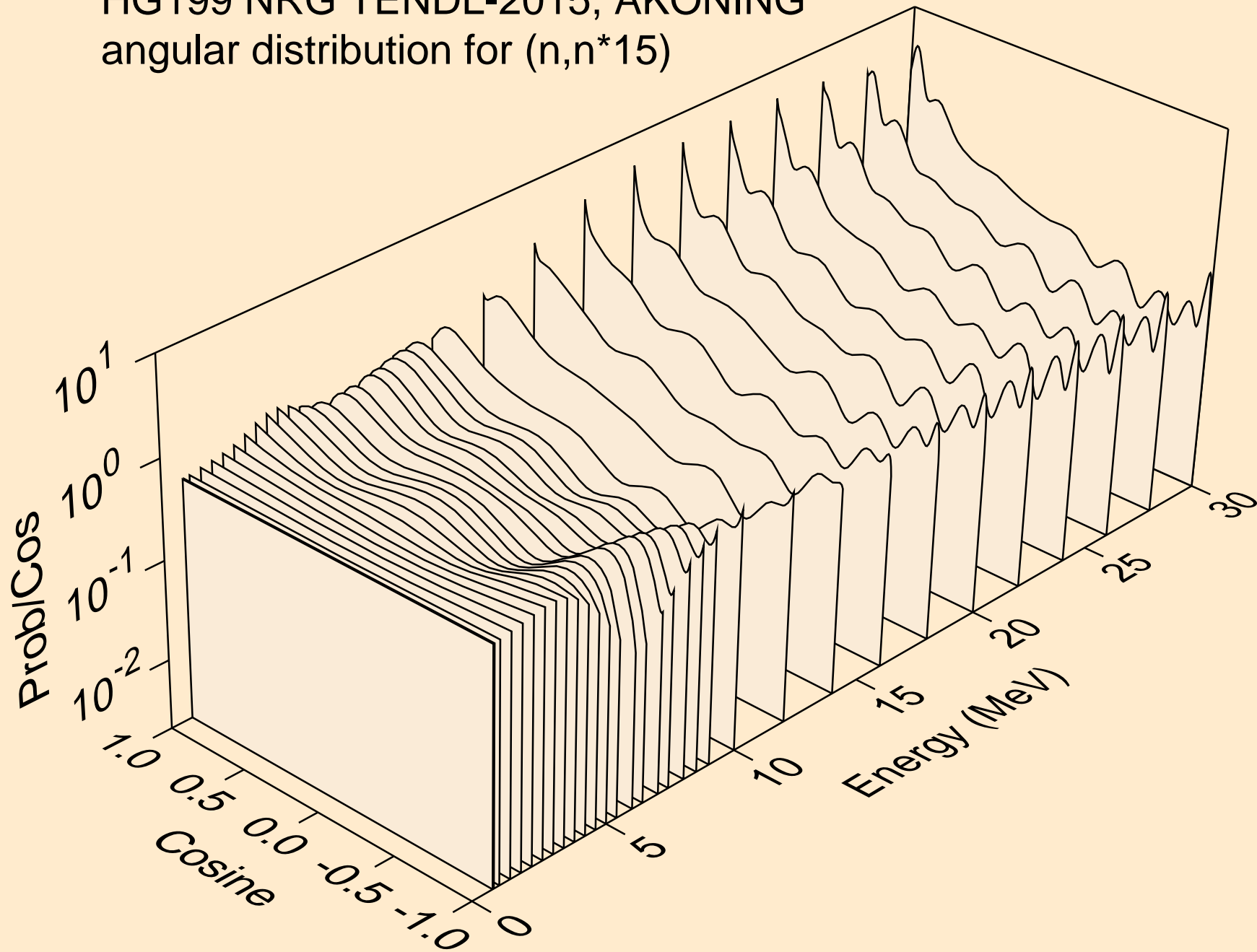

HG199 NRG TENDL-2015, AKONING  
angular distribution for (n,n\*16)

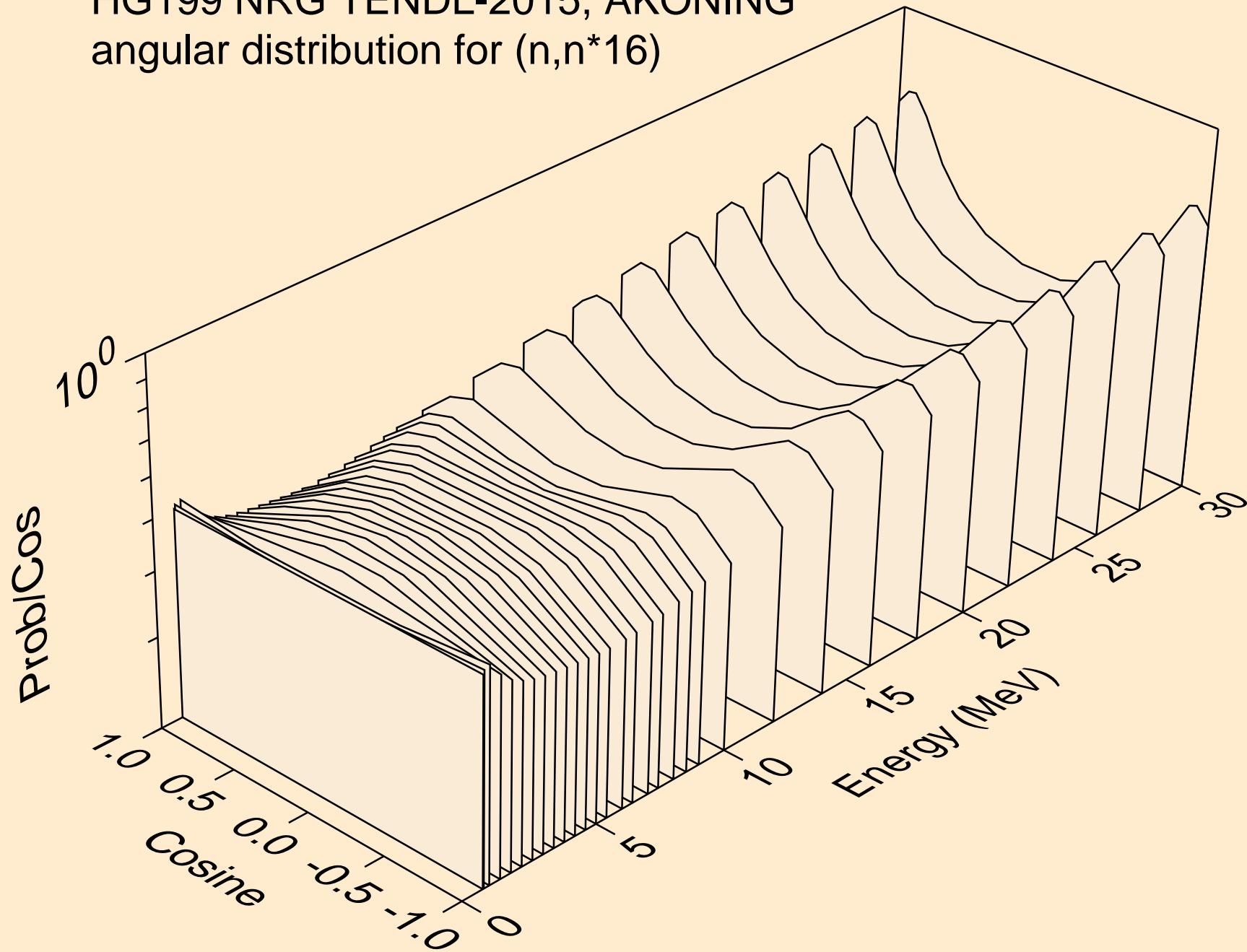

HG199 NRG TENDL-2015, AKONING  
angular distribution for (n,n\*17)

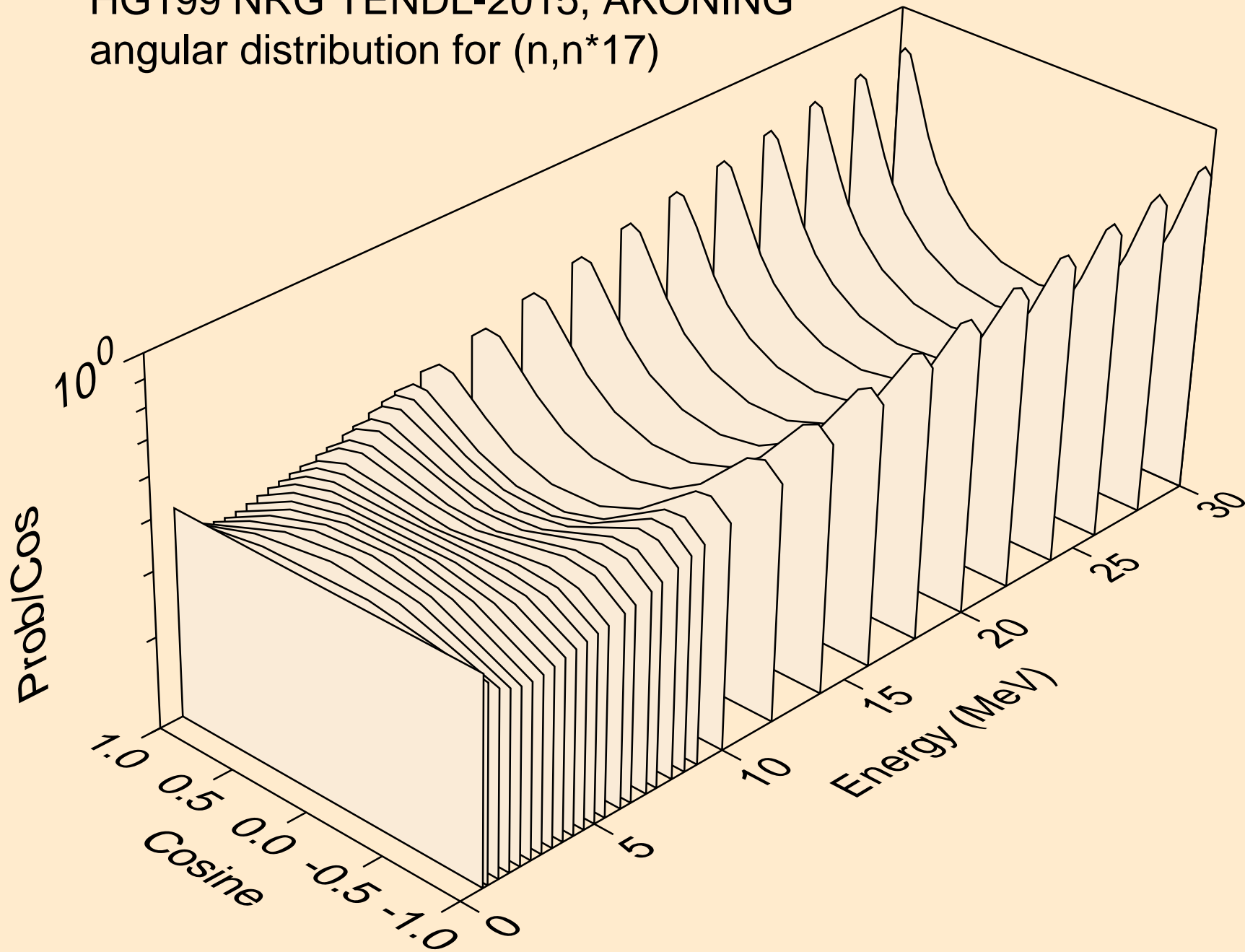

HG199 NRG TENDL-2015, AKONING  
angular distribution for (n,n\*18)

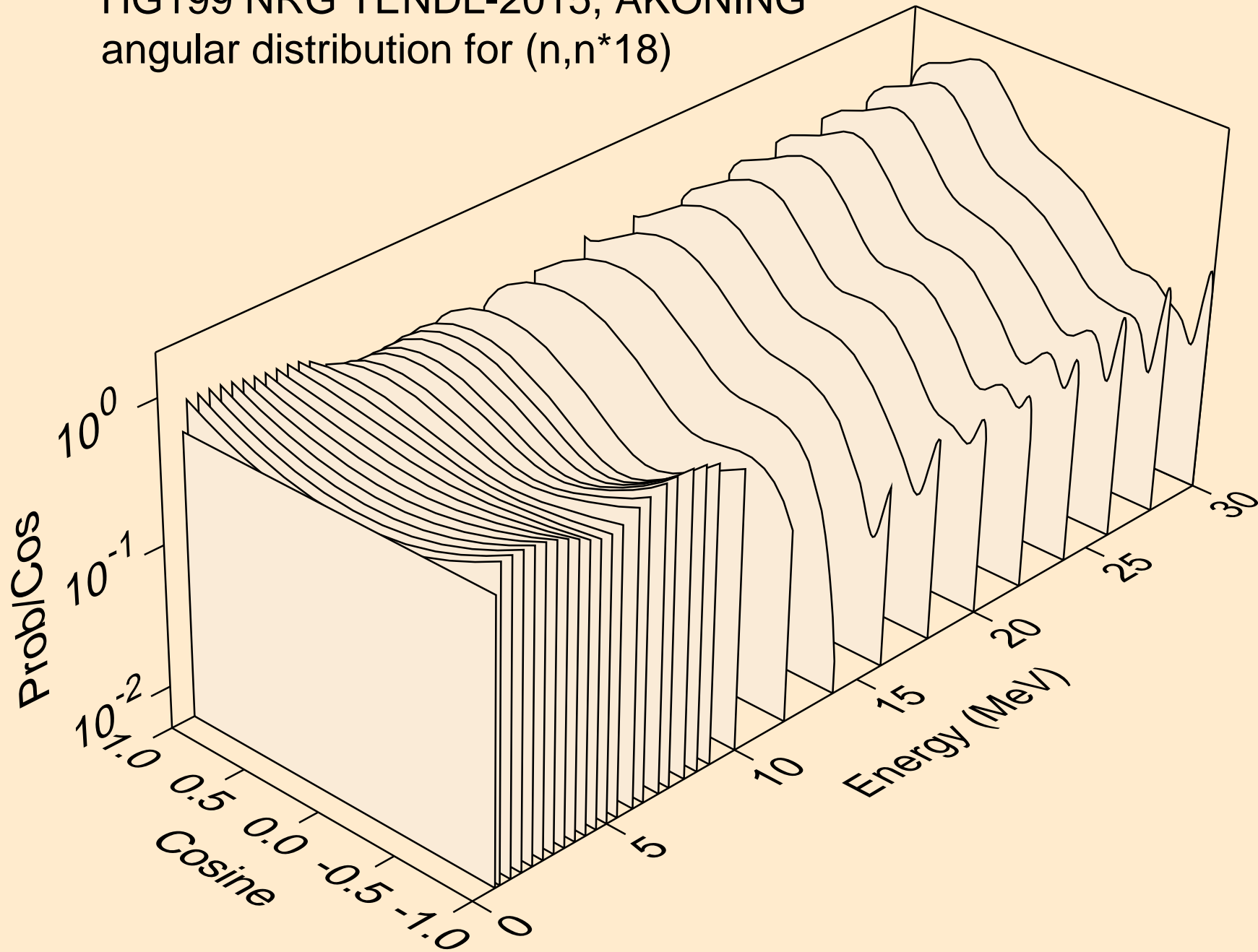

HG199 NRG TENDL-2015, AKONING  
angular distribution for (n,n\*19)

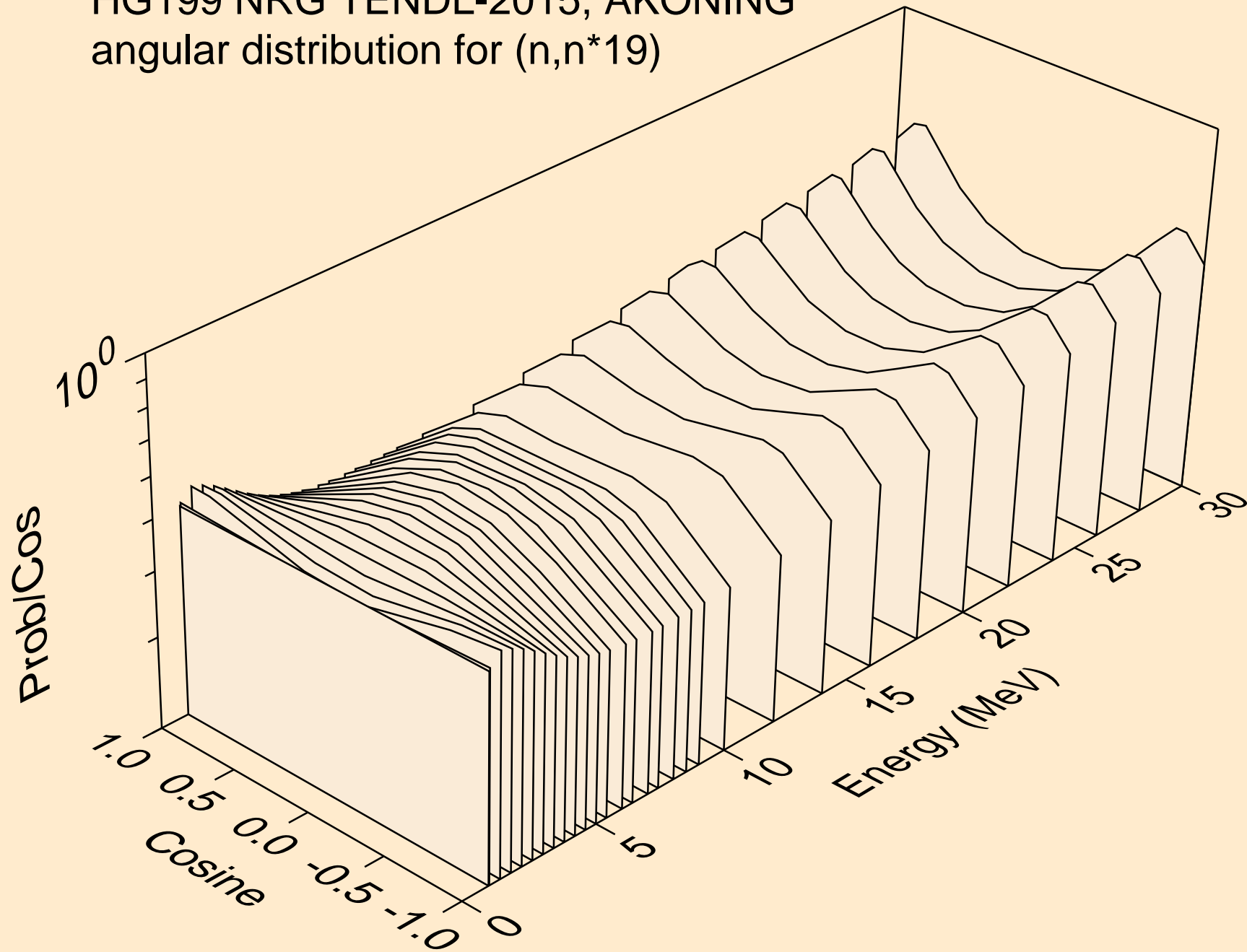

HG199 NRG TENDL-2015, AKONING  
angular distribution for (n,n\*20)

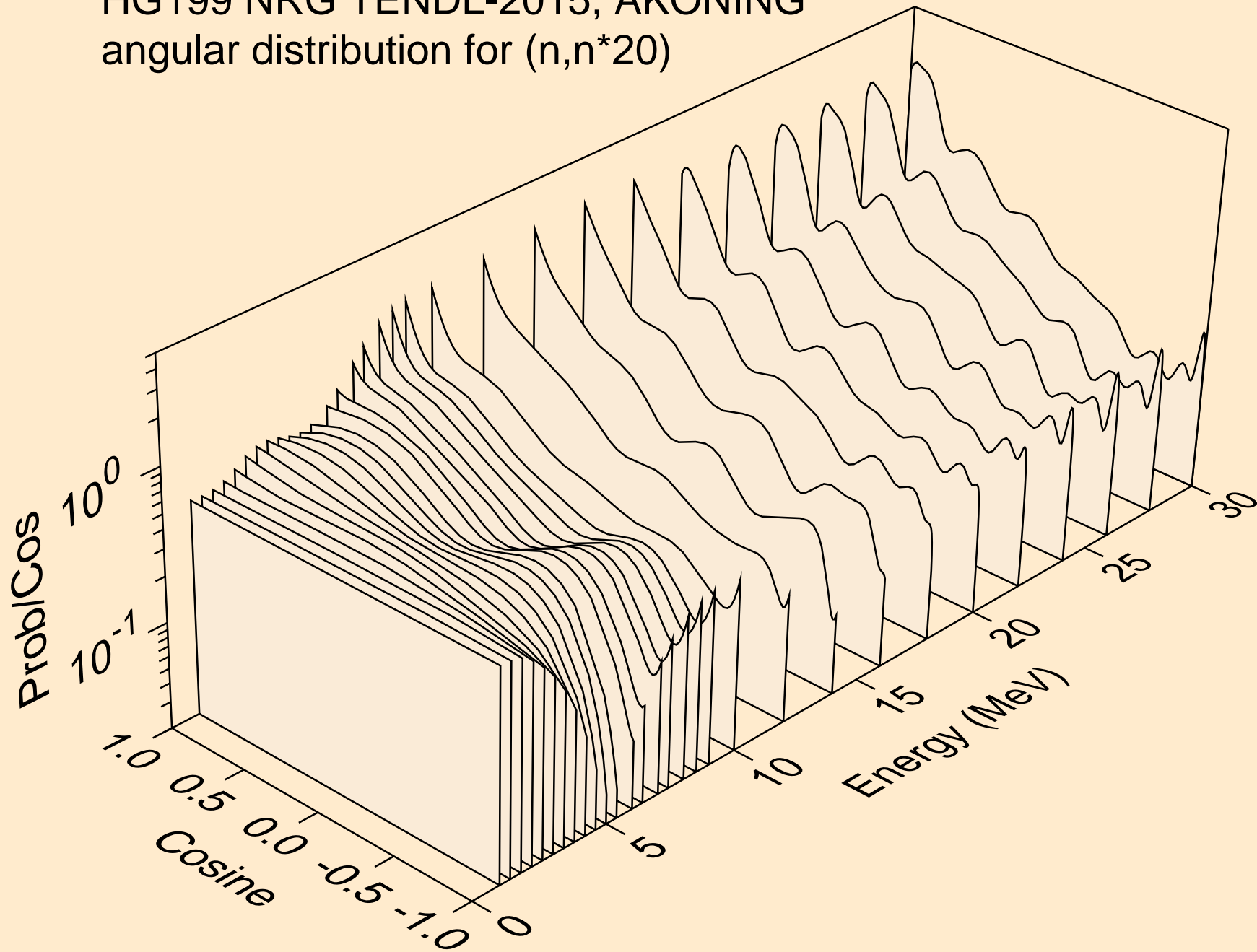

HG199 NRG TENDL-2015, AKONING  
angular distribution for (n,n\*21)

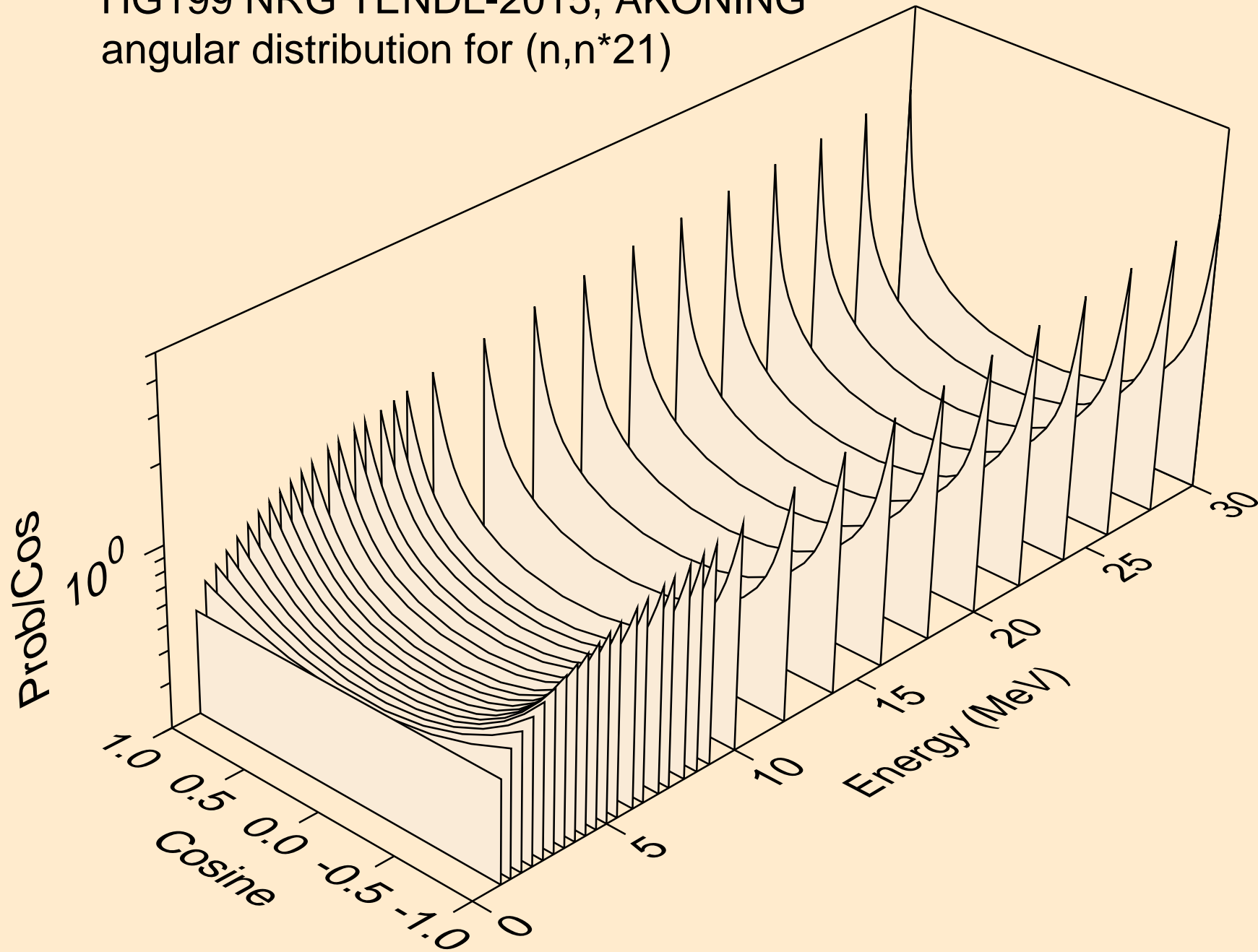

HG199 NRG TENDL-2015, AKONING  
angular distribution for (n,n\*22)

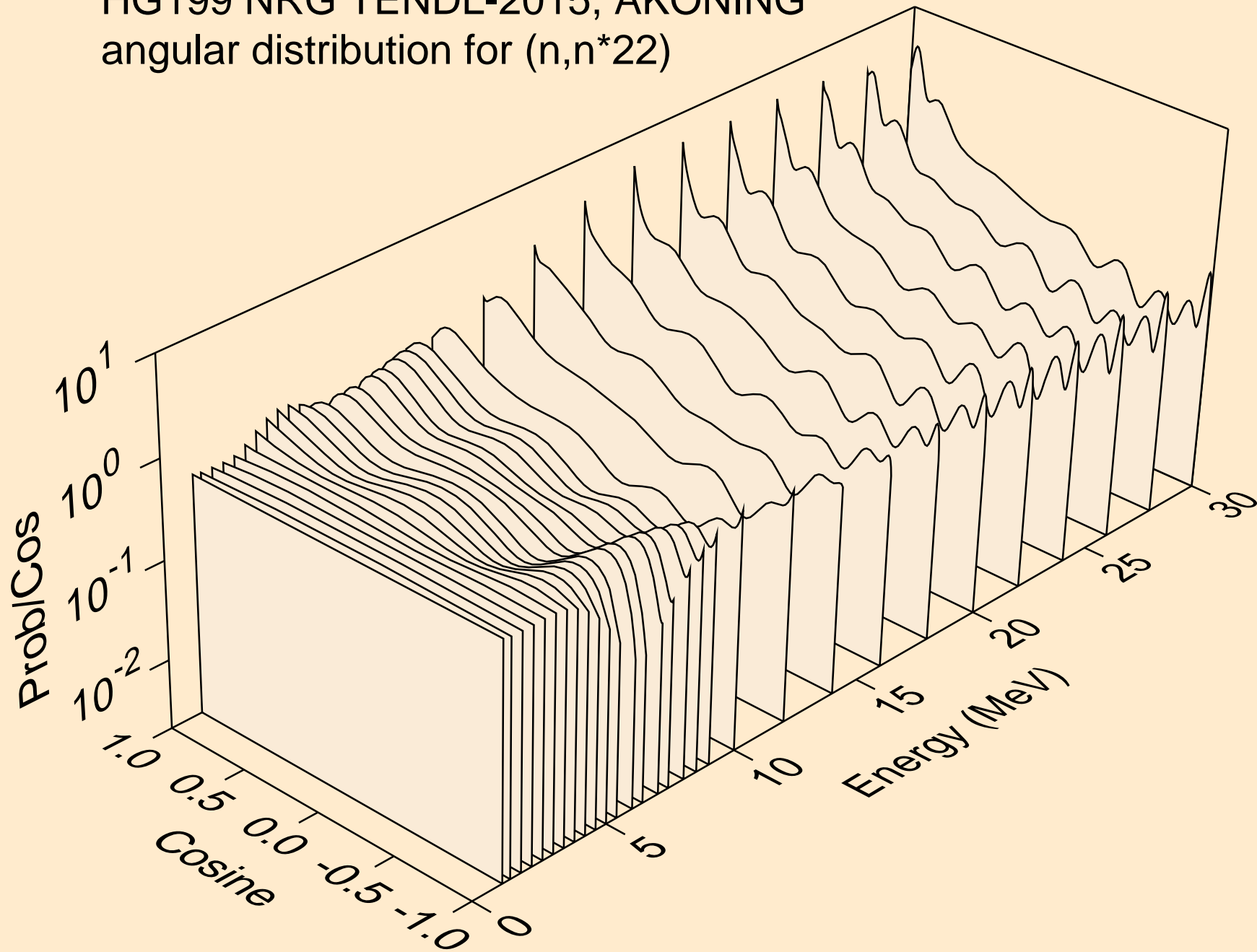



HG199 NRG TENDL-2015, AKONING  
angular distribution for (n,n\*23)

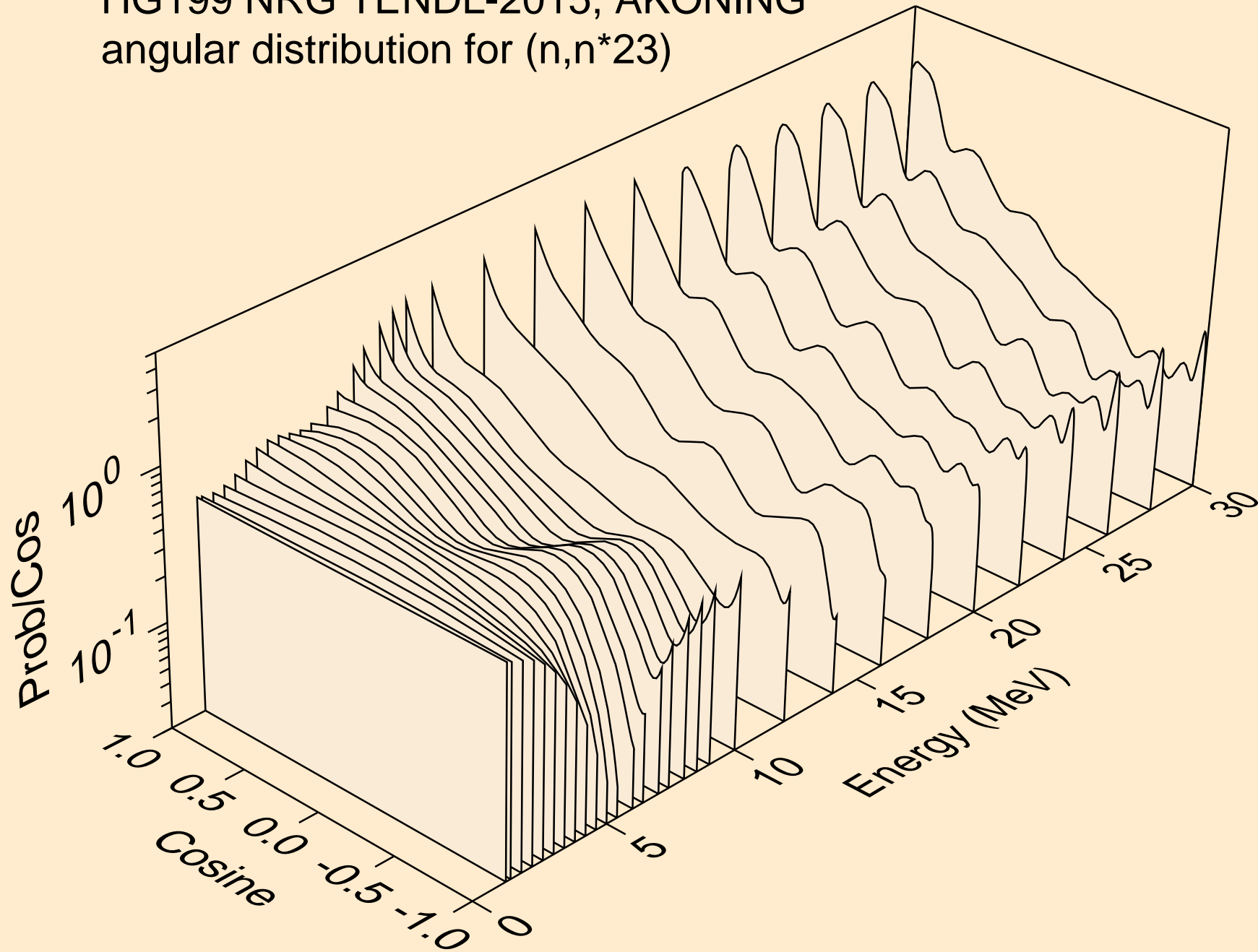

HG199 NRG TENDL-2015, AKONING  
angular distribution for (n,n\*24)

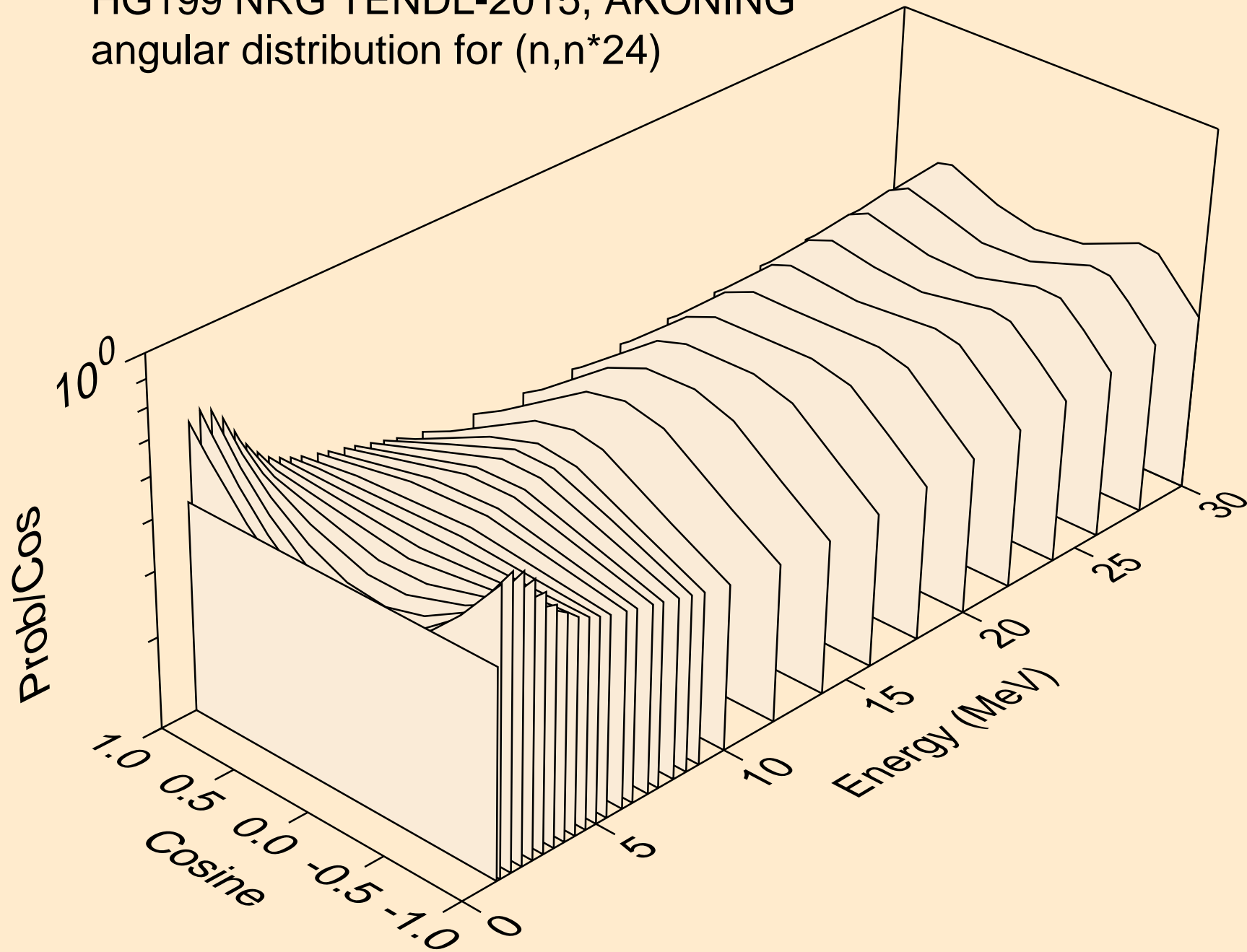

HG199 NRG TENDL-2015, AKONING  
angular distribution for (n,n\*25)

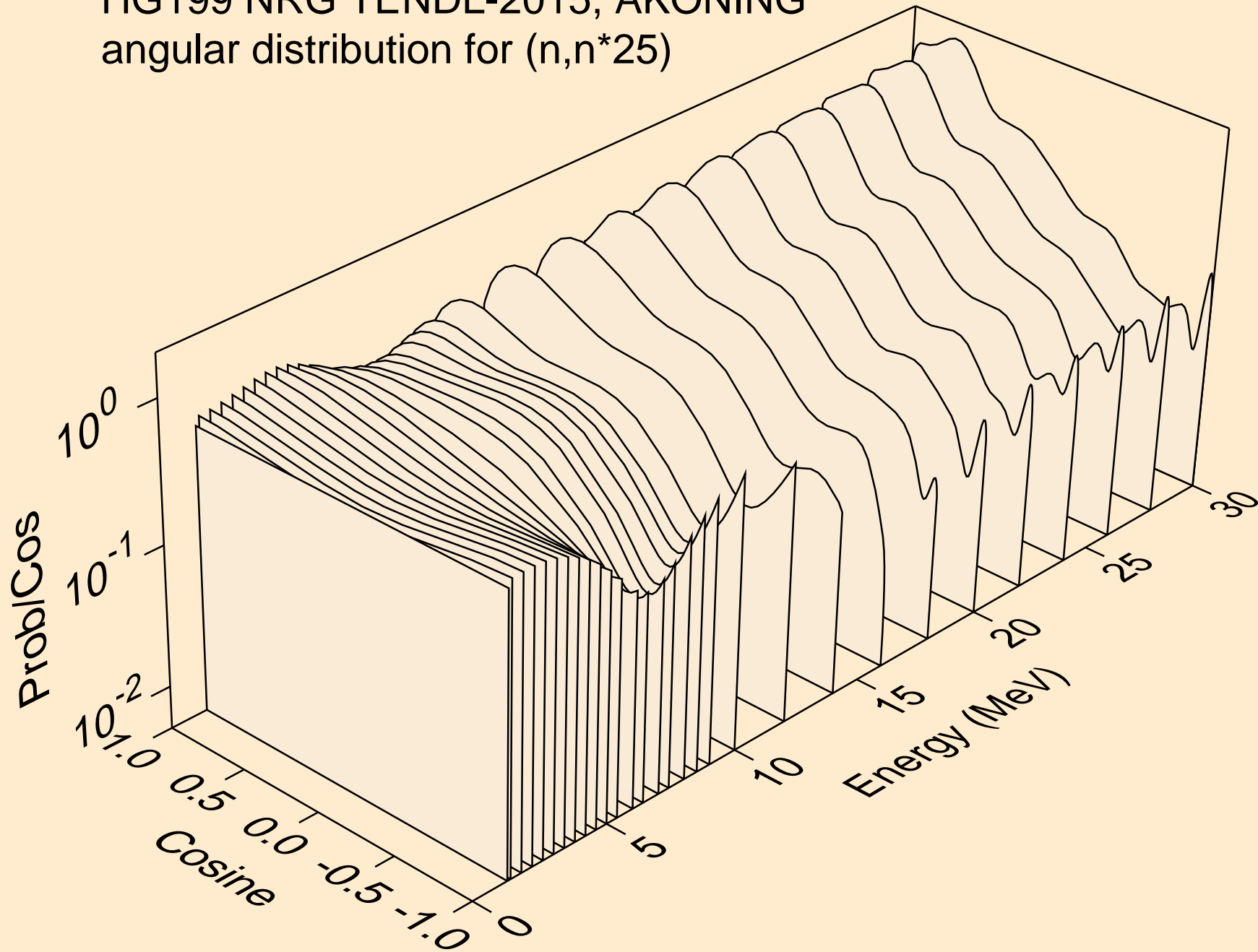

HG199 NRG TENDL-2015, AKONING  
angular distribution for (n,n\*26)

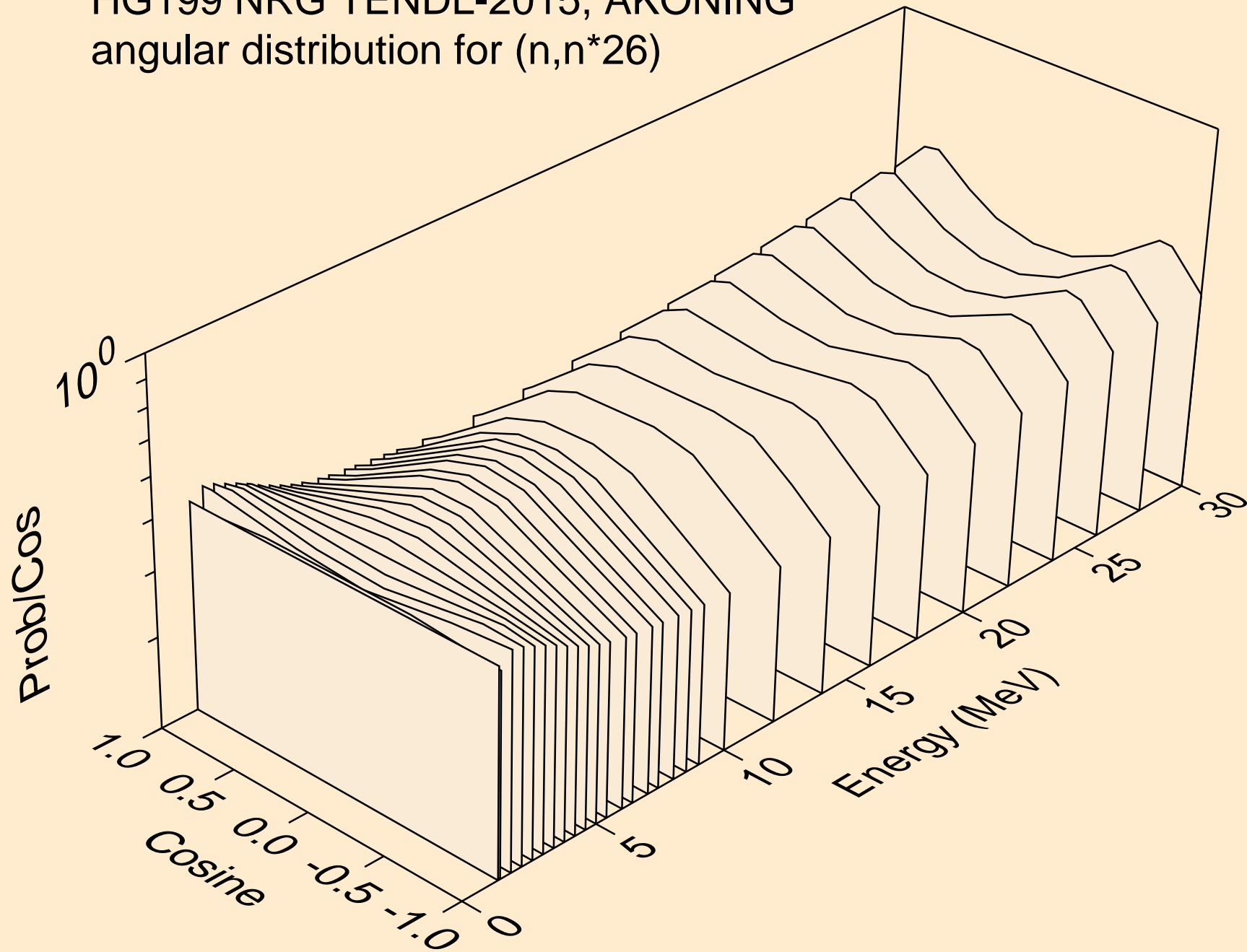

HG199 NRG TENDL-2015, AKONING  
angular distribution for (n,n\*27)

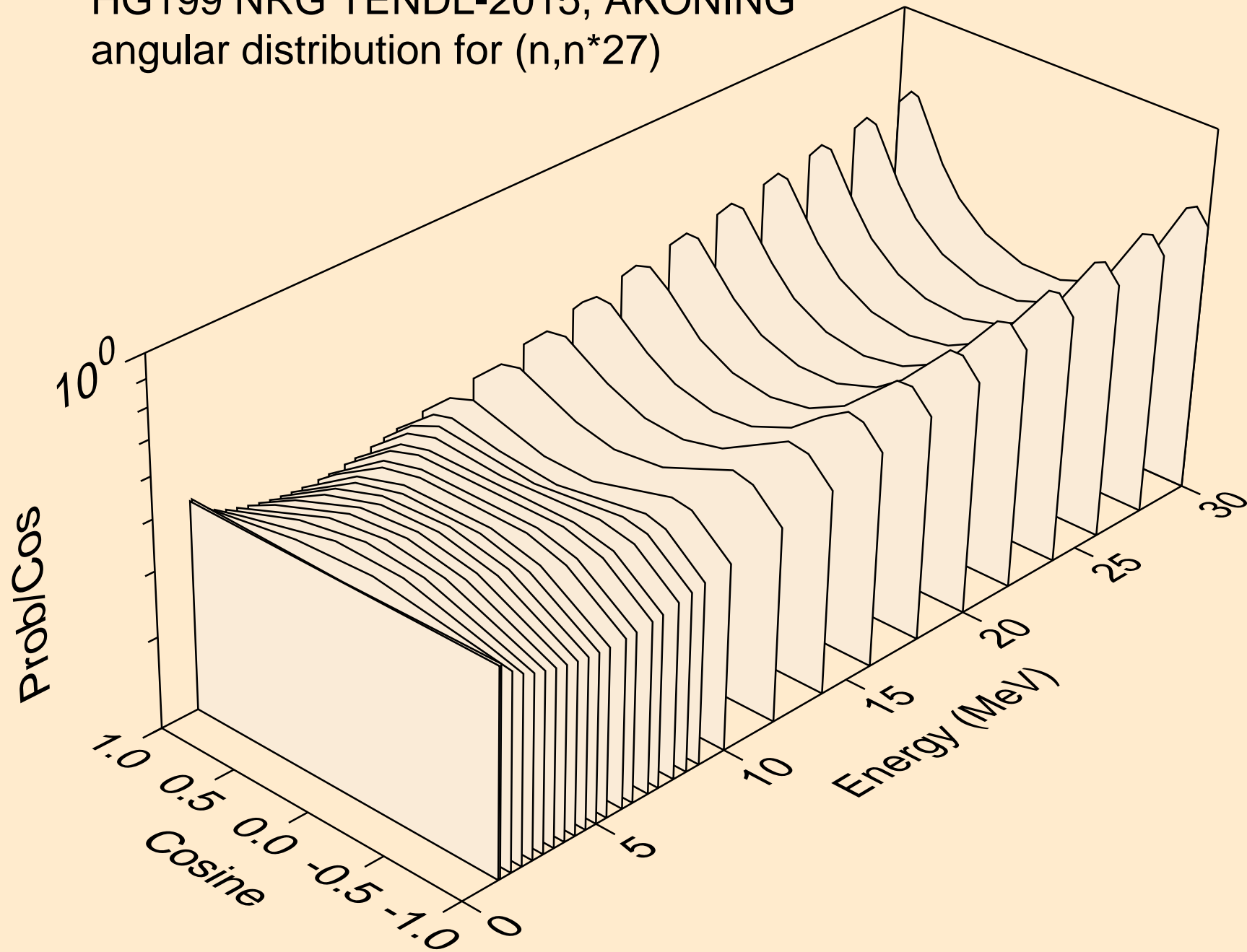

HG199 NRG TENDL-2015, AKONING  
angular distribution for (n,n\*28)

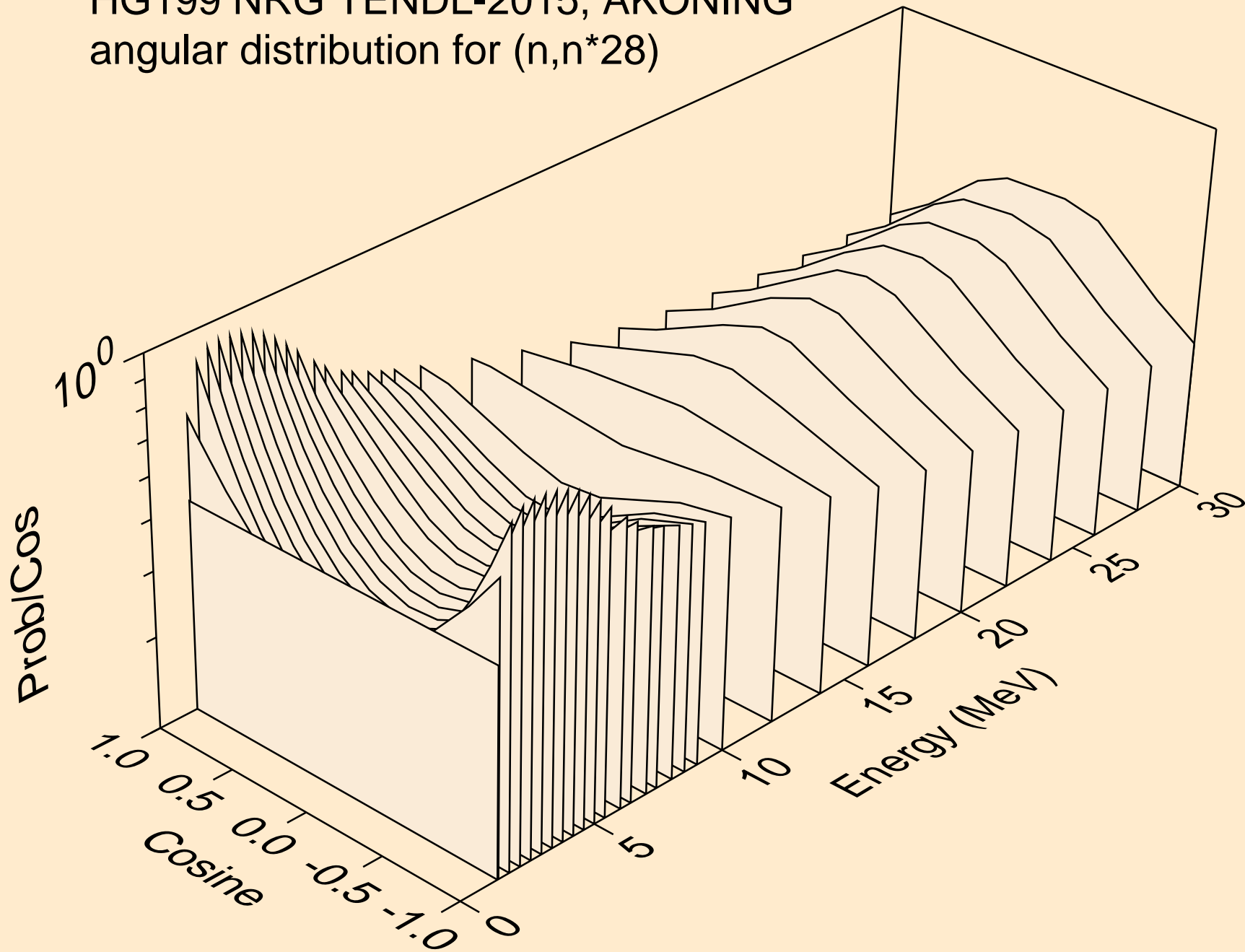

HG199 NRG TENDL-2015, AKONING  
angular distribution for (n,n\*29)

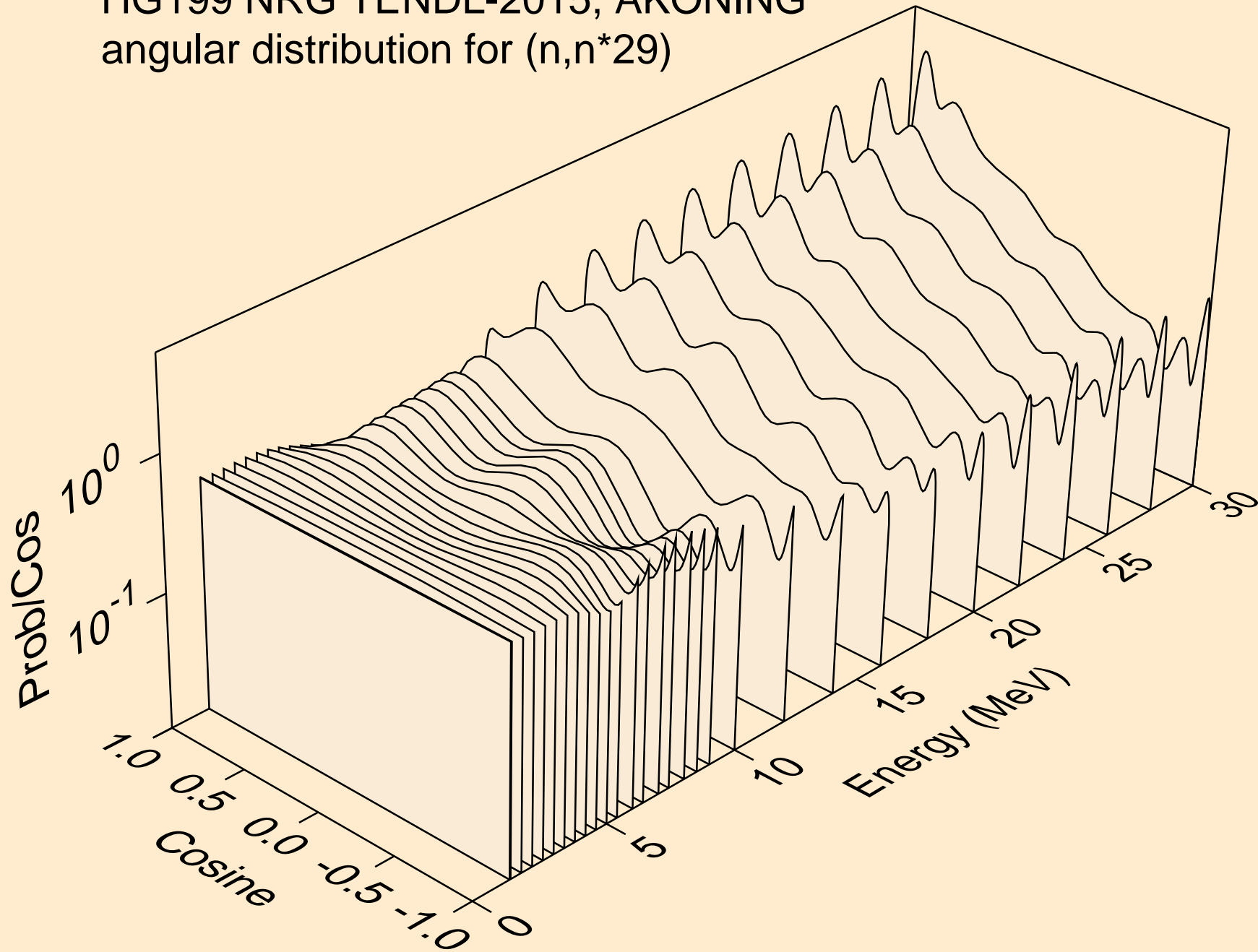

HG199 NRG TENDL-2015, AKONING  
angular distribution for (n,n\*30)

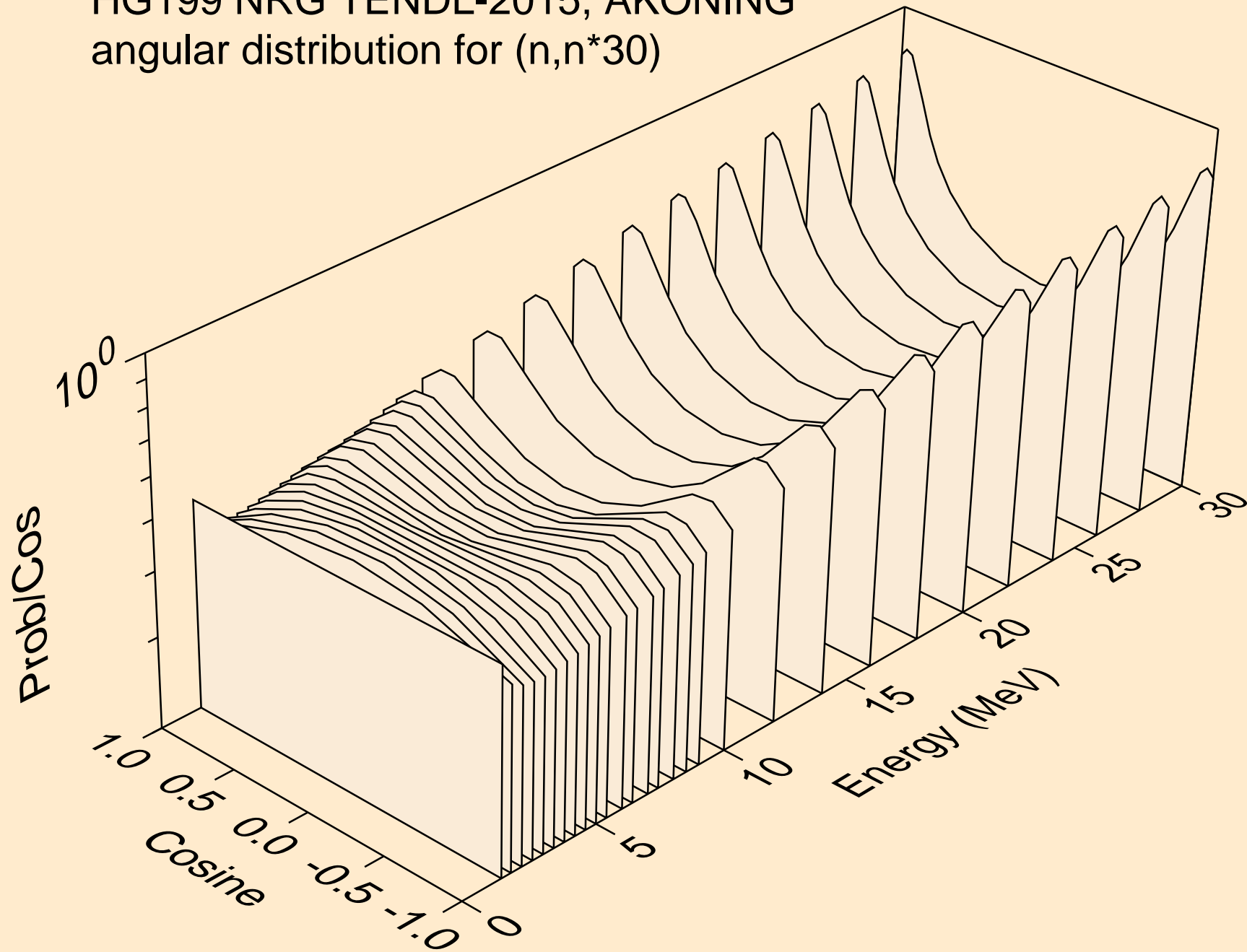



HG199 NRG TENDL-2015, AKONING  
Neutron emission for (n,x)

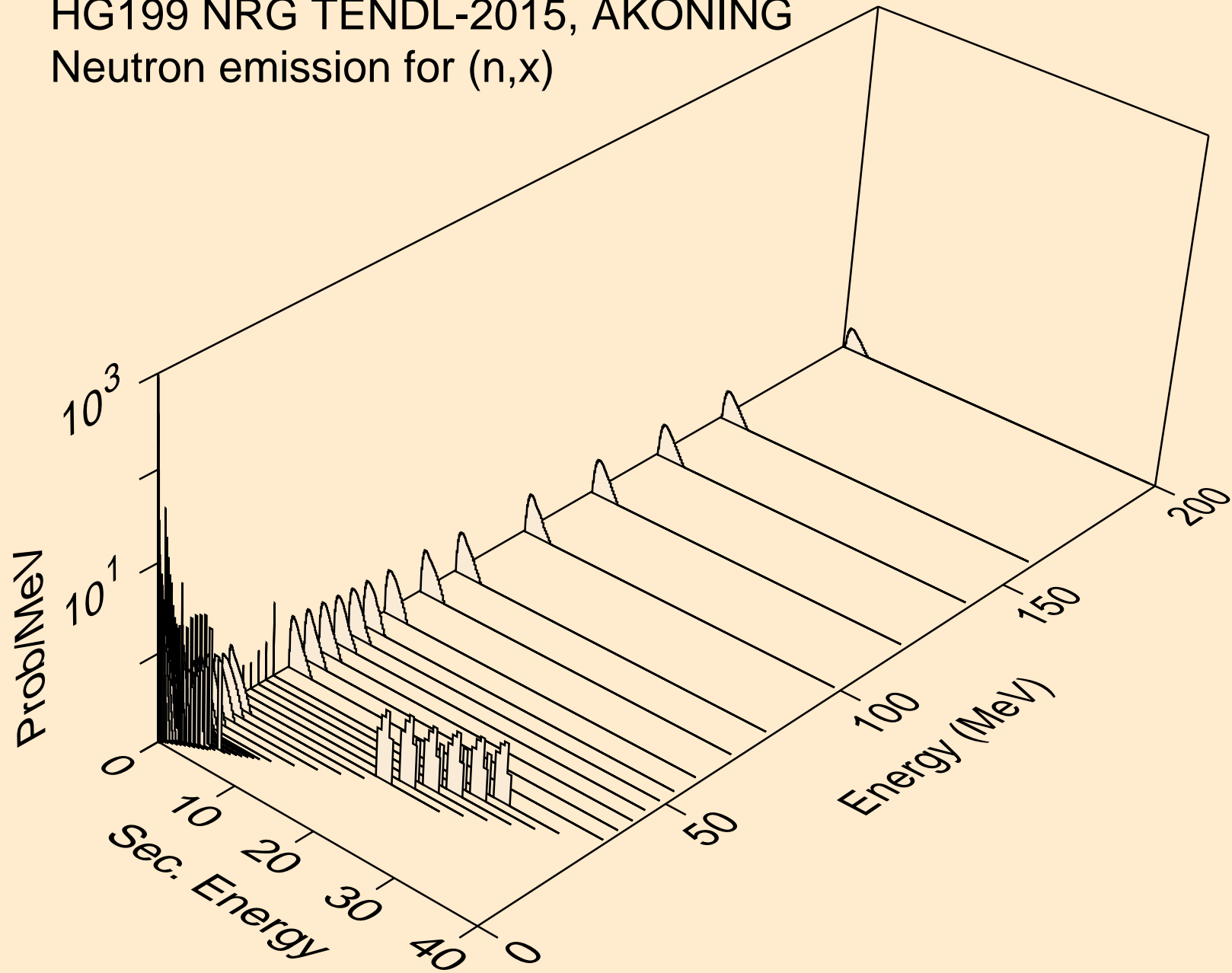

HG199 NRG TENDL-2015, AKONING  
Neutron emission for (n,2nd)

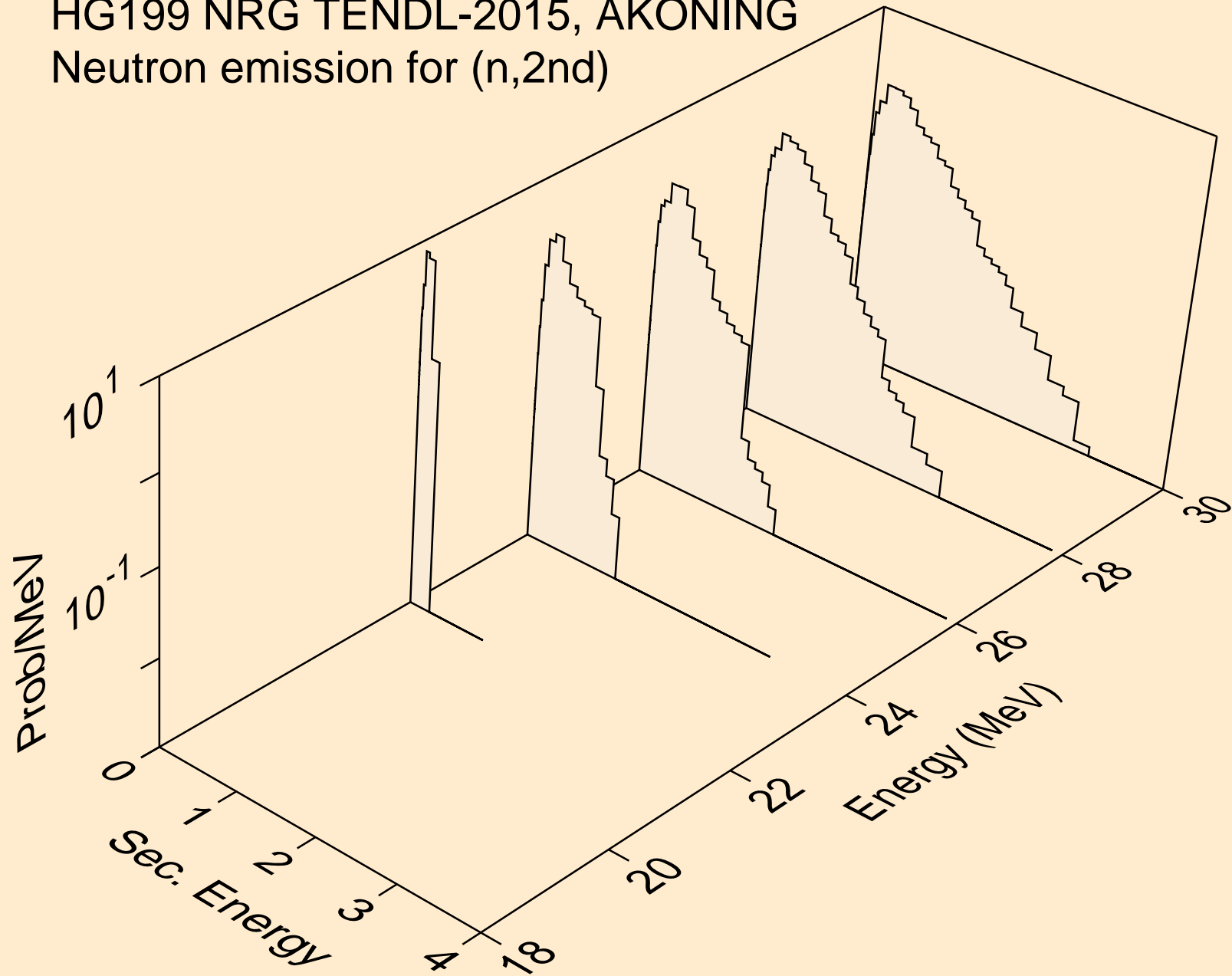

HG199 NRG TENDL-2015, AKONING  
Neutron emission for (n,2n)

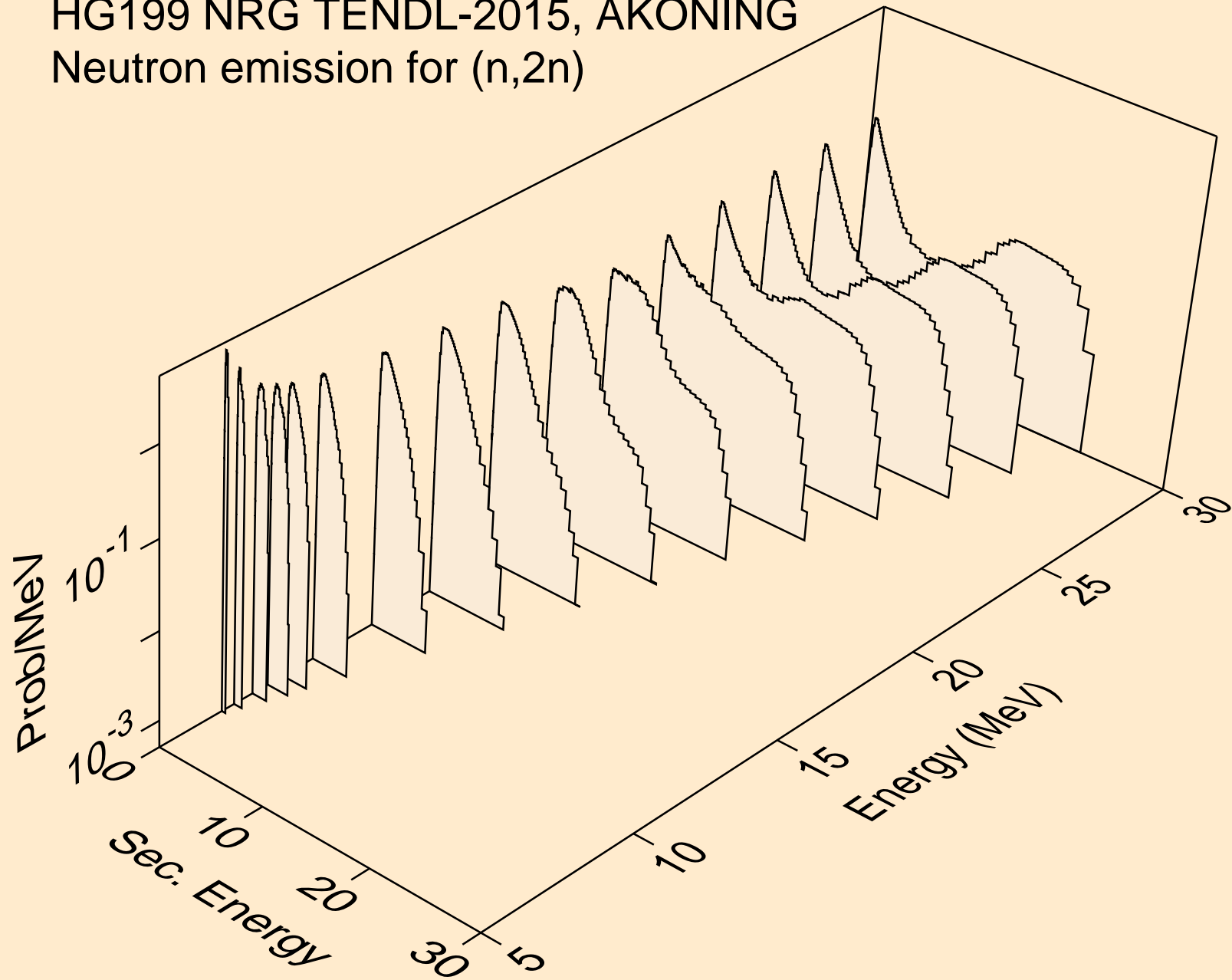

HG199 NRG TENDL-2015, AKONING  
Neutron emission for (n,3n)

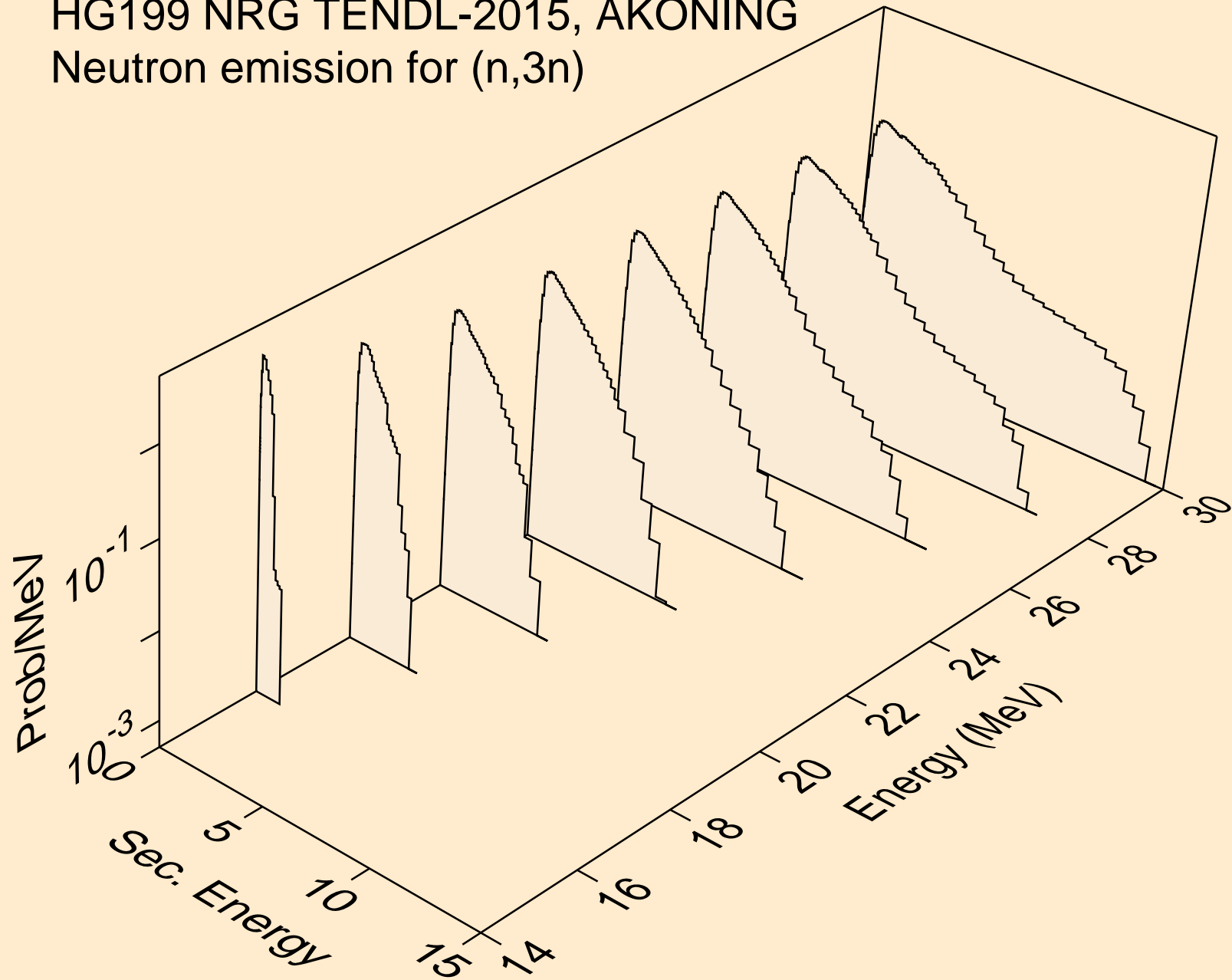

HG199 NRG TENDL-2015, AKONING  
Neutron emission for (n,n\*)a

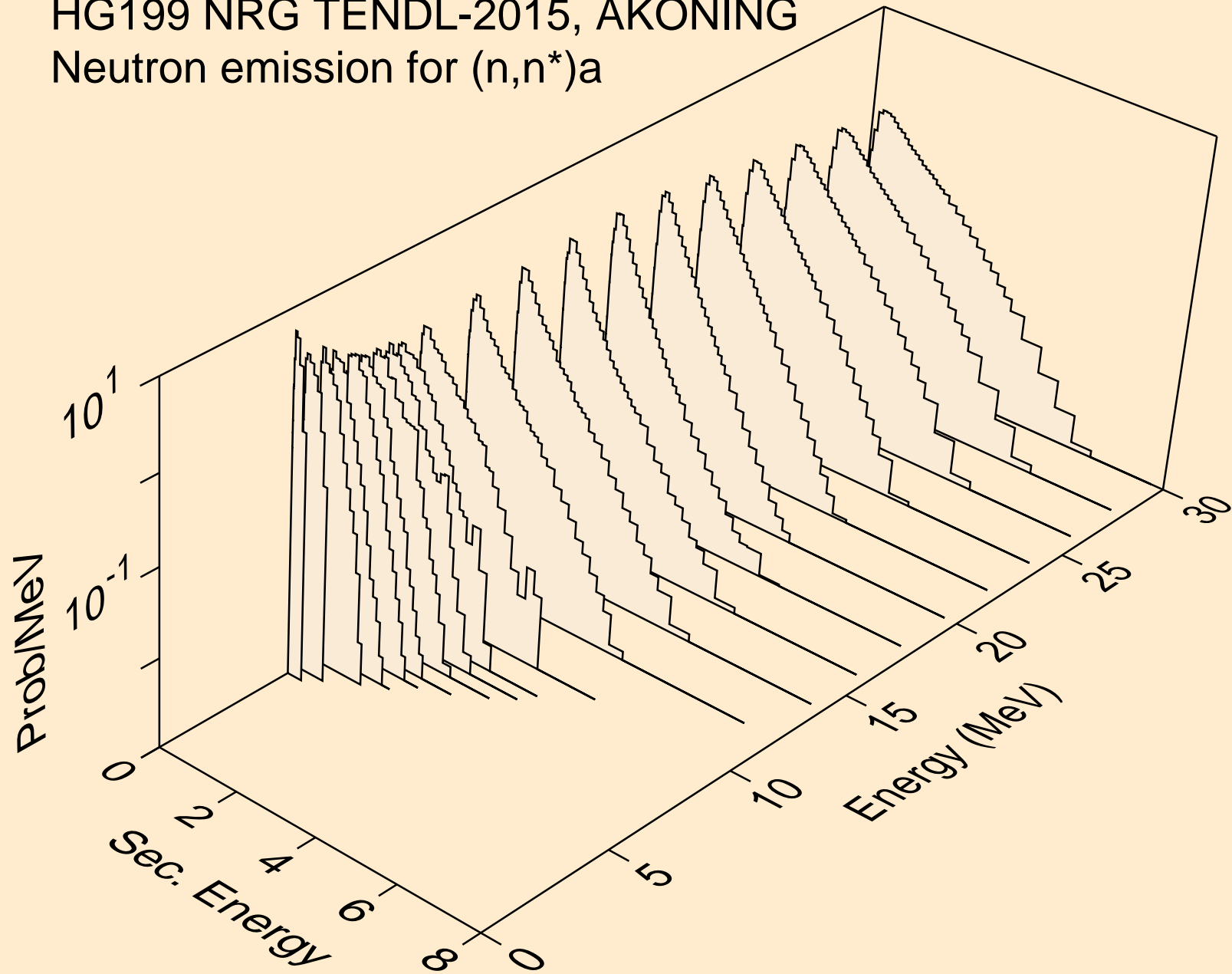

HG199 NRG TENDL-2015, AKONING  
Neutron emission for (n,2n)a

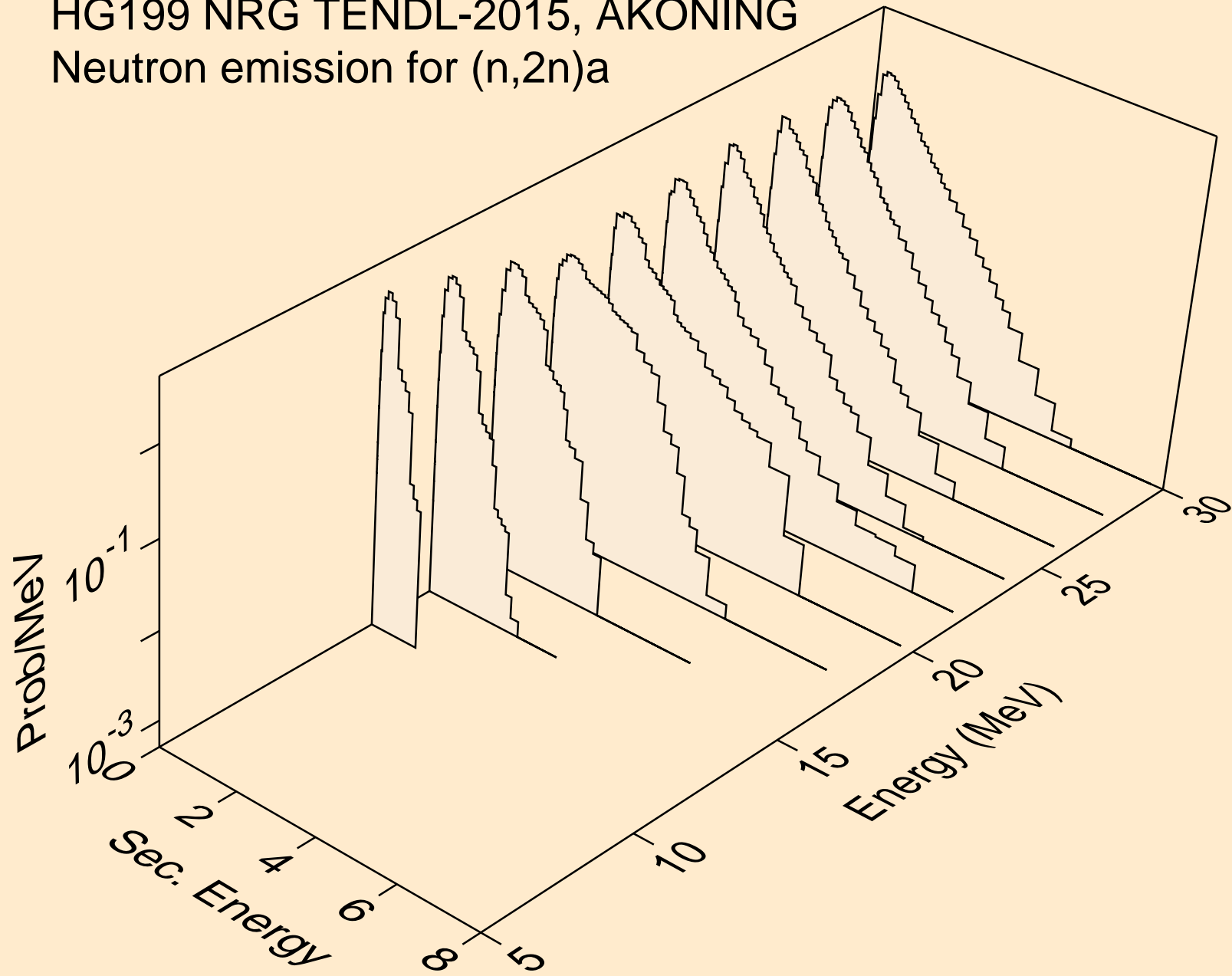

HG199 NRG TENDL-2015, AKONING  
Neutron emission for (n,3n)a

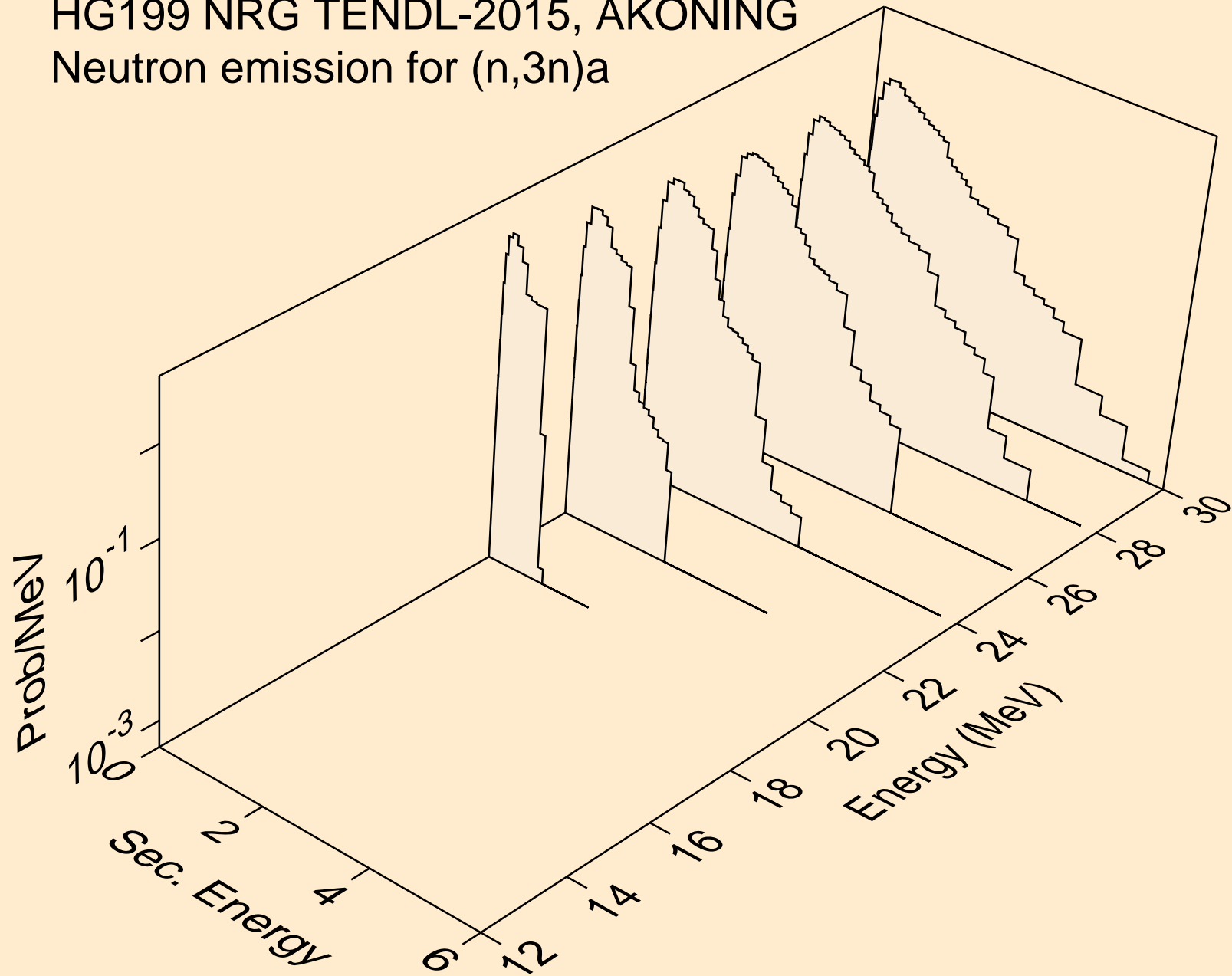

HG199 NRG TENDL-2015, AKONING  
Neutron emission for (n,n\*)p

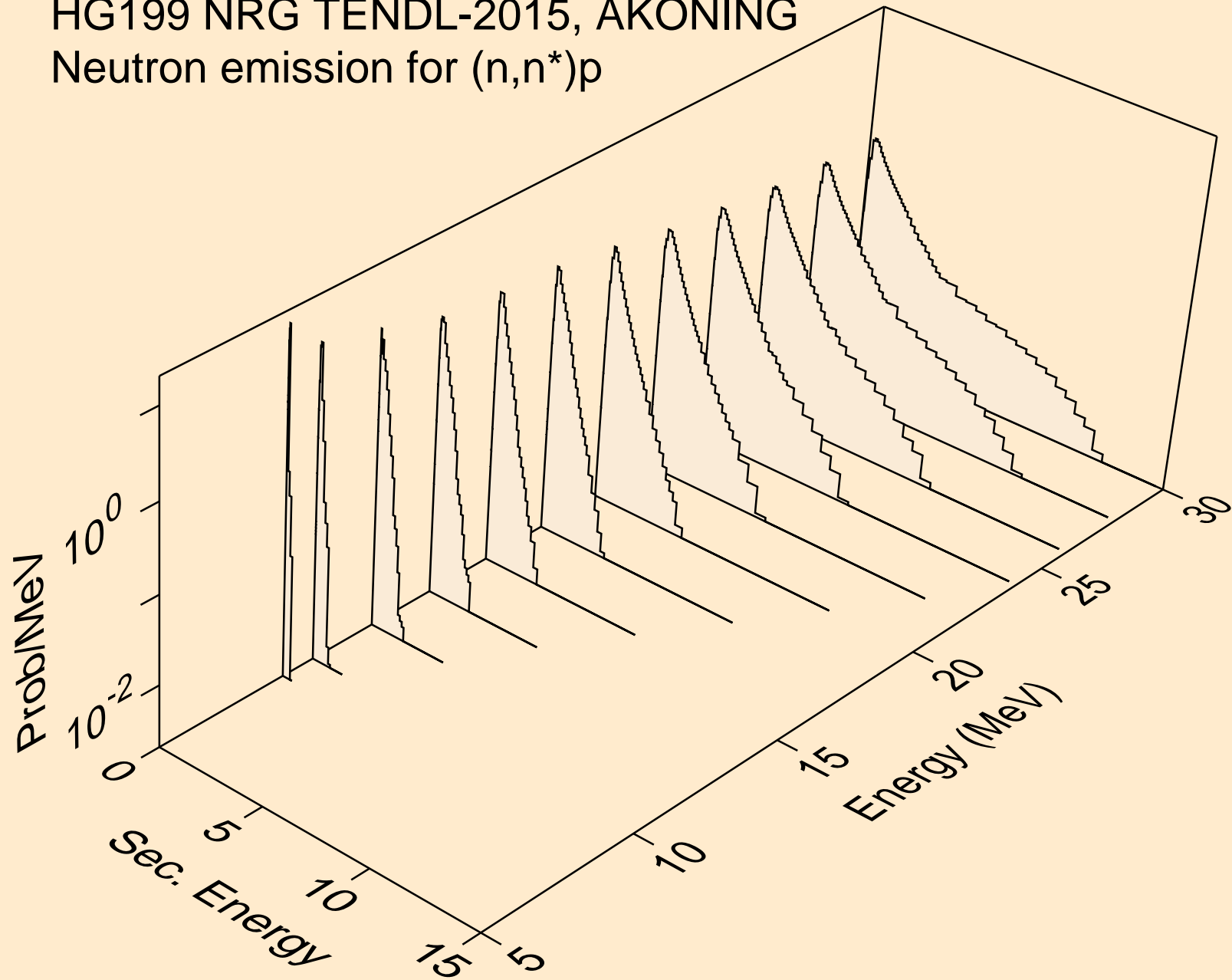



HG199 NRG TENDL-2015, AKONING  
Neutron emission for (n,n\*)2a

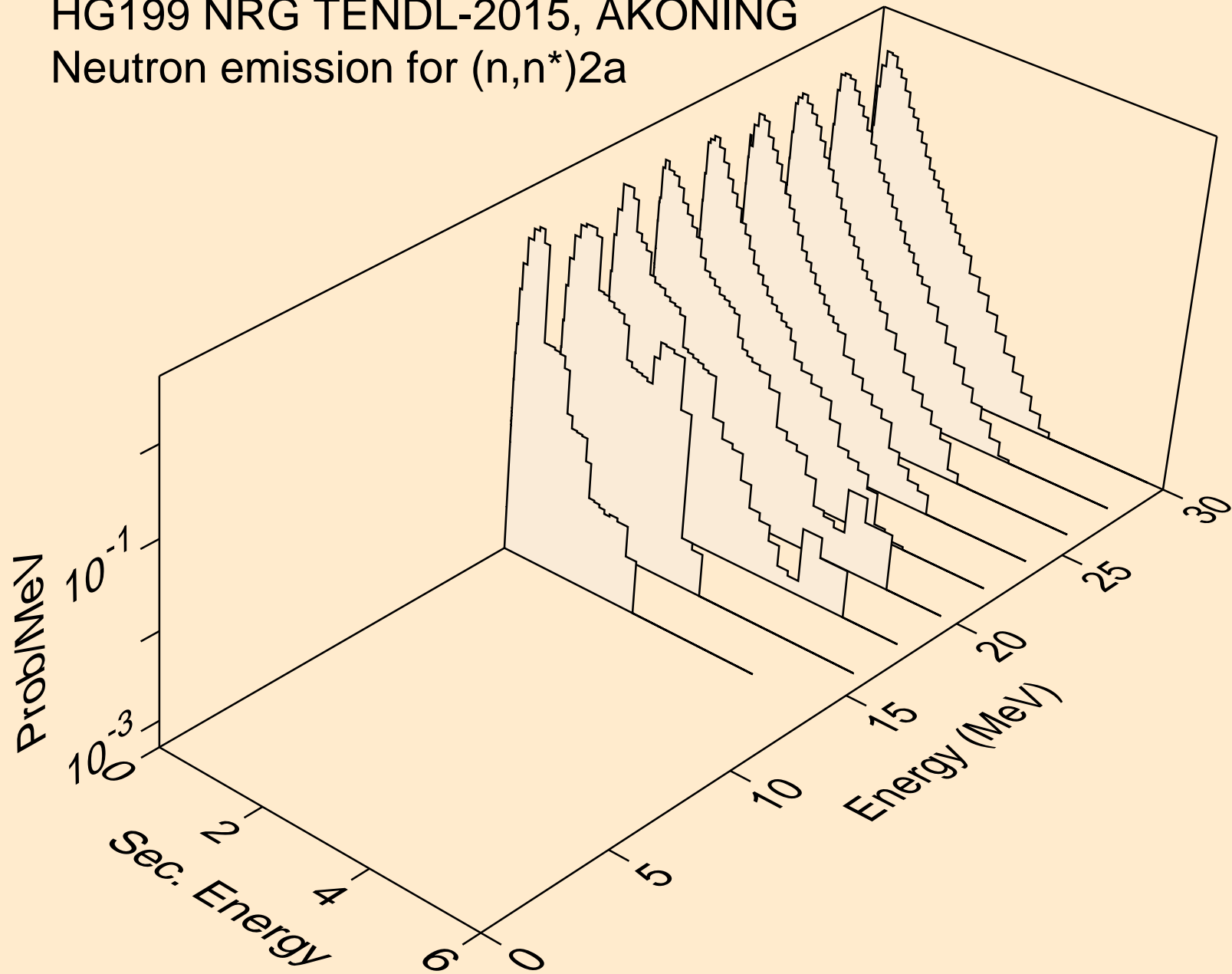

HG199 NRG TENDL-2015, AKONING  
Neutron emission for (n,n\*)d

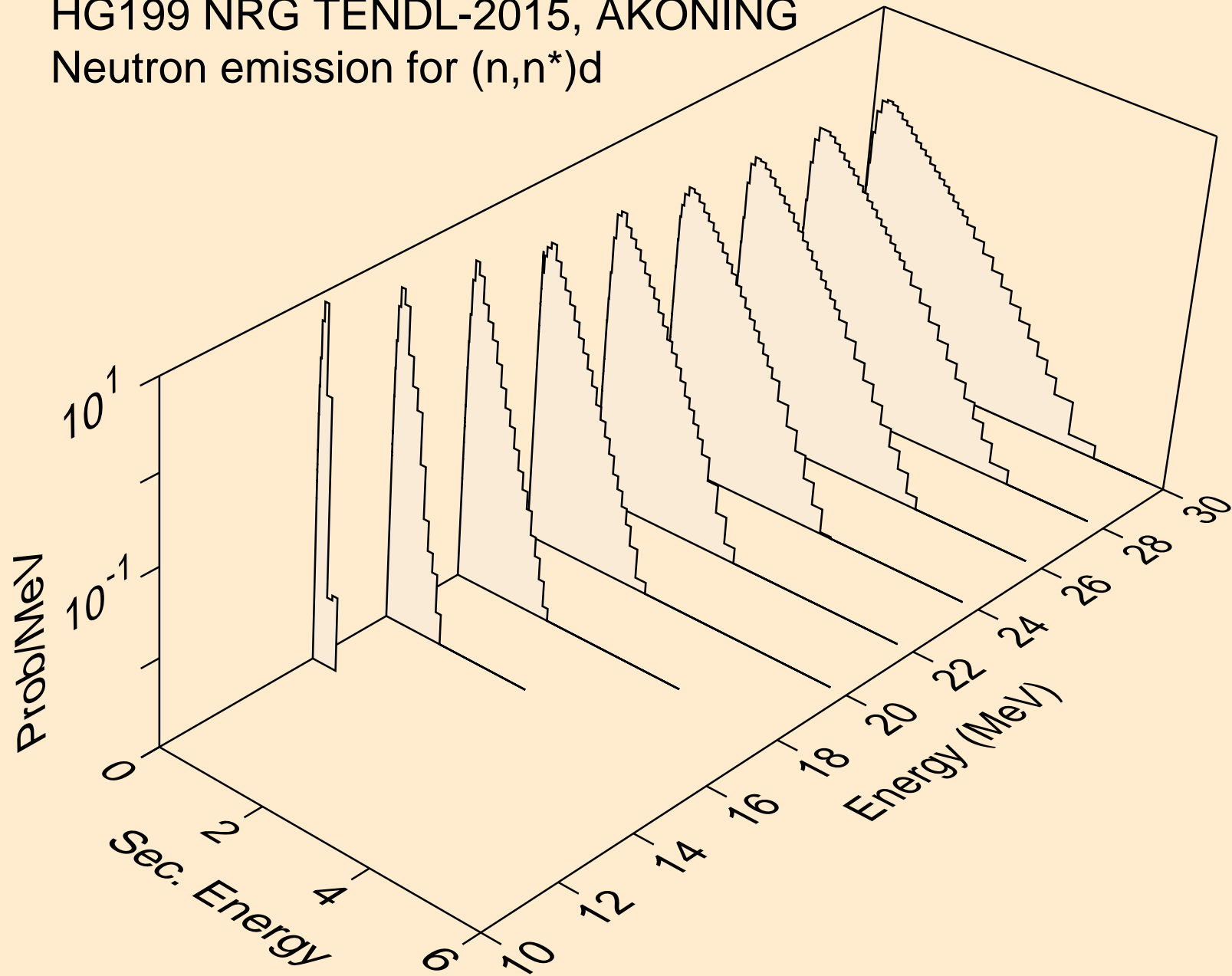

HG199 NRG TENDL-2015, AKONING  
Neutron emission for (n,n\*)t

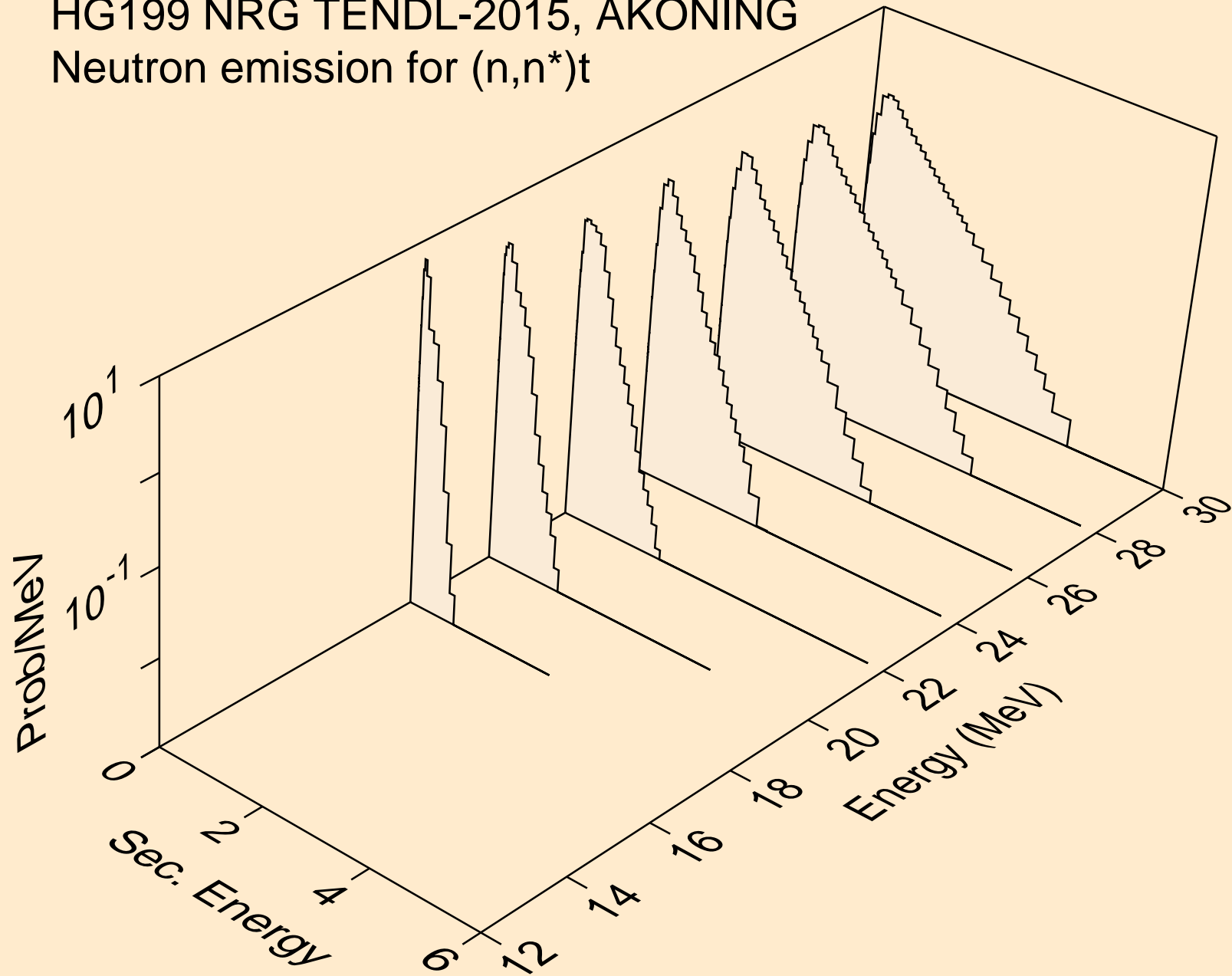

HG199 NRG TENDL-2015, AKONING  
Neutron emission for (n,n\*)he3

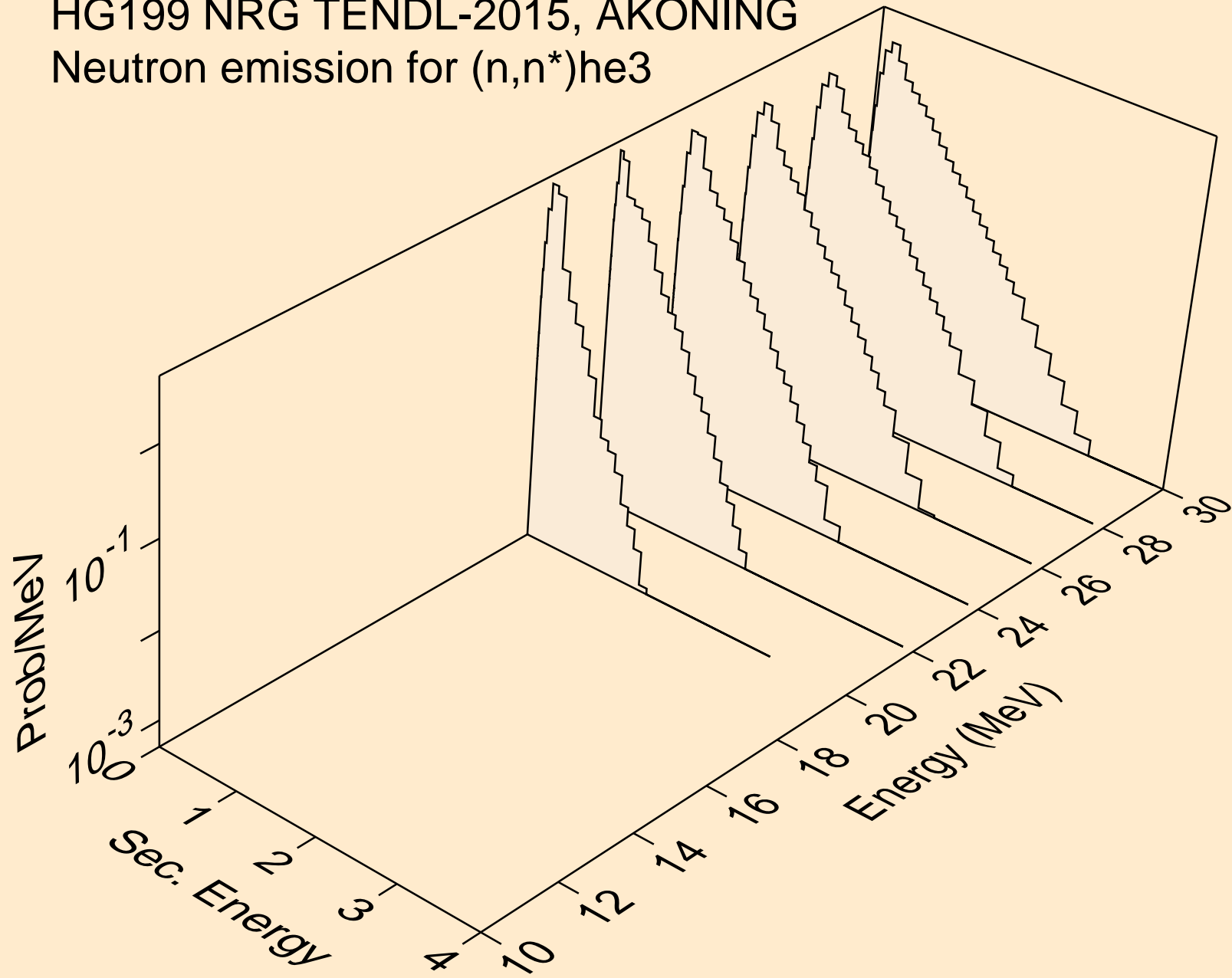

HG199 NRG TENDL-2015, AKONING  
Neutron emission for (n,4n)

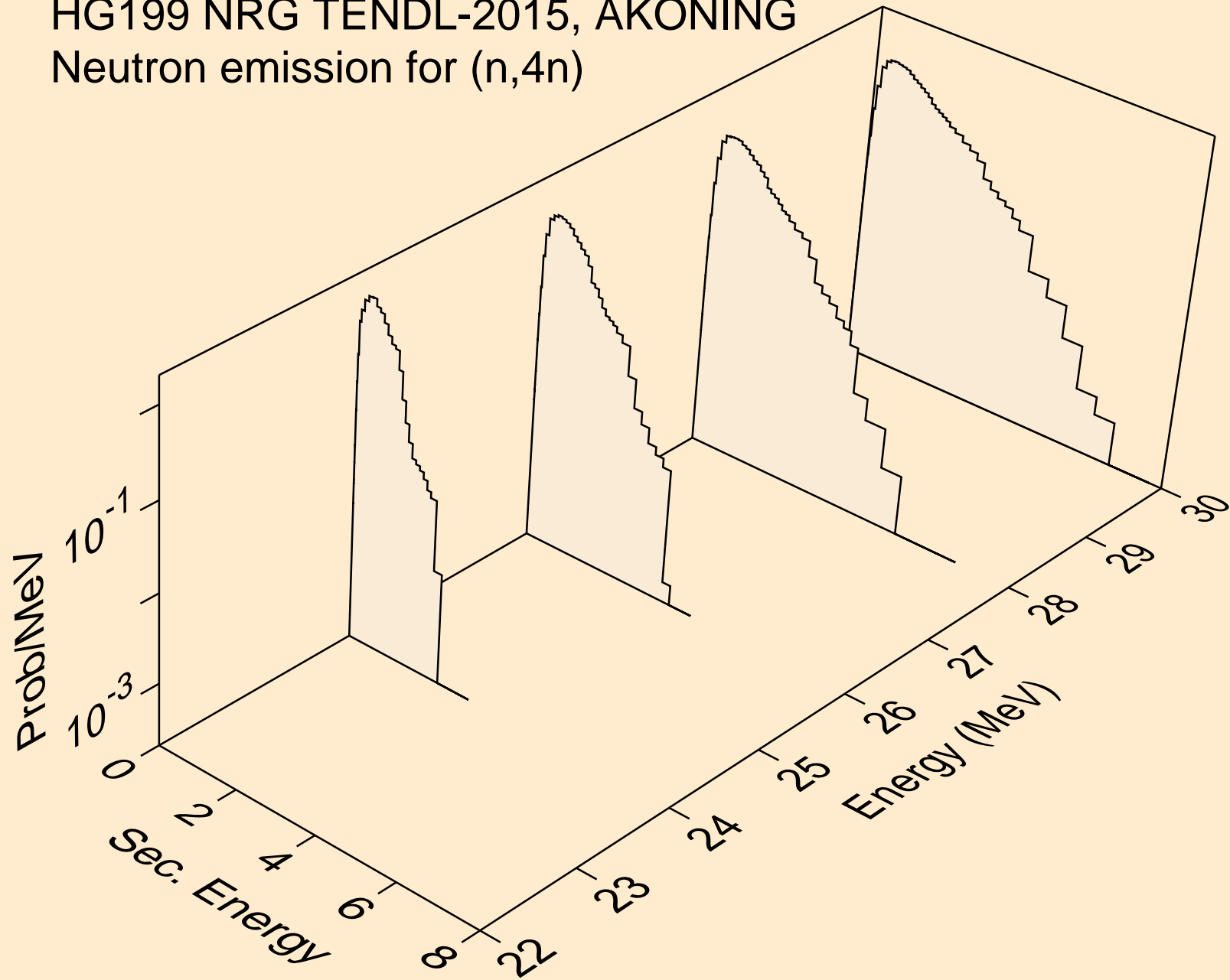

HG199 NRG TENDL-2015, AKONING  
Neutron emission for (n,2np)

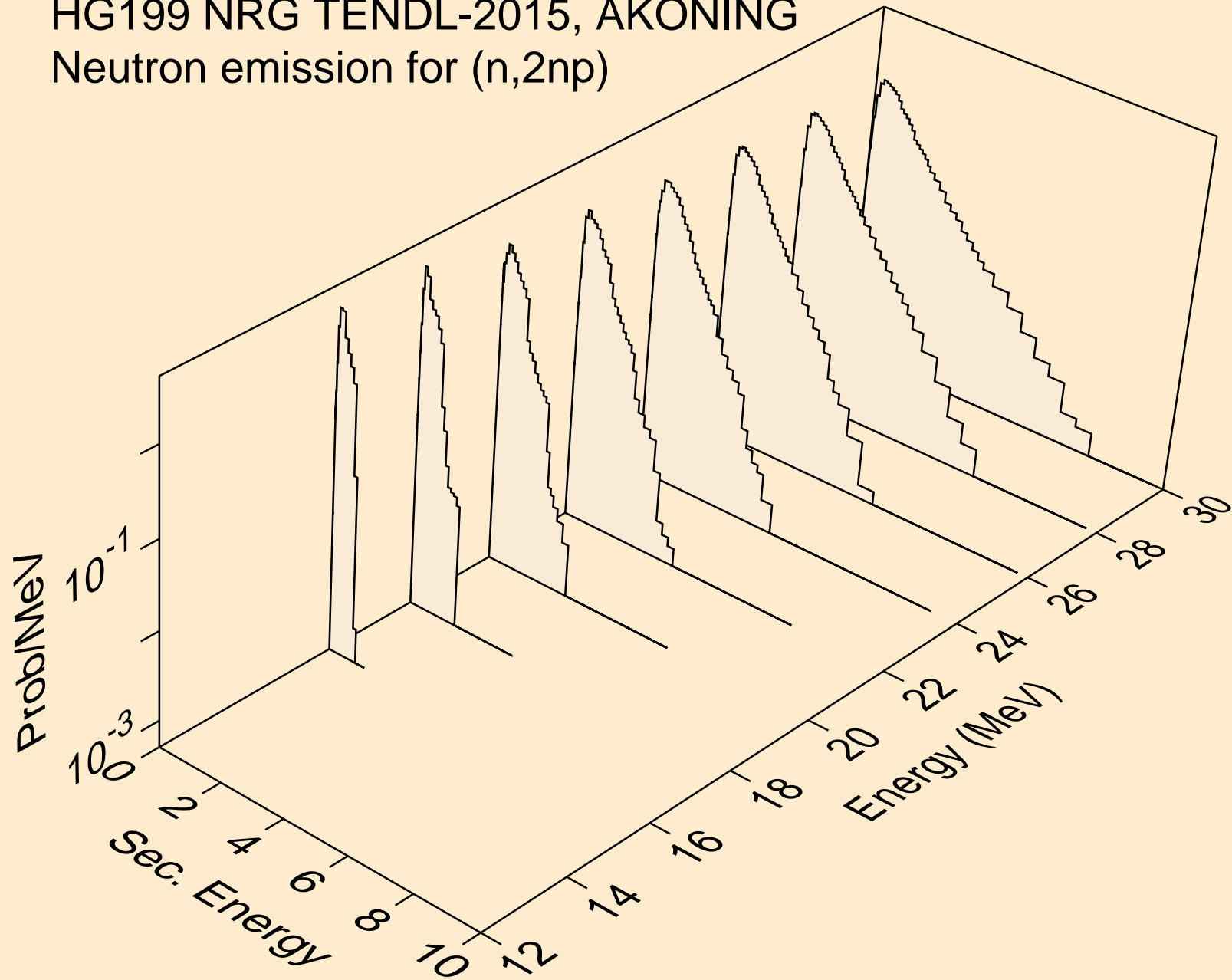

HG199 NRG TENDL-2015, AKONING  
Neutron emission for (n,3np)

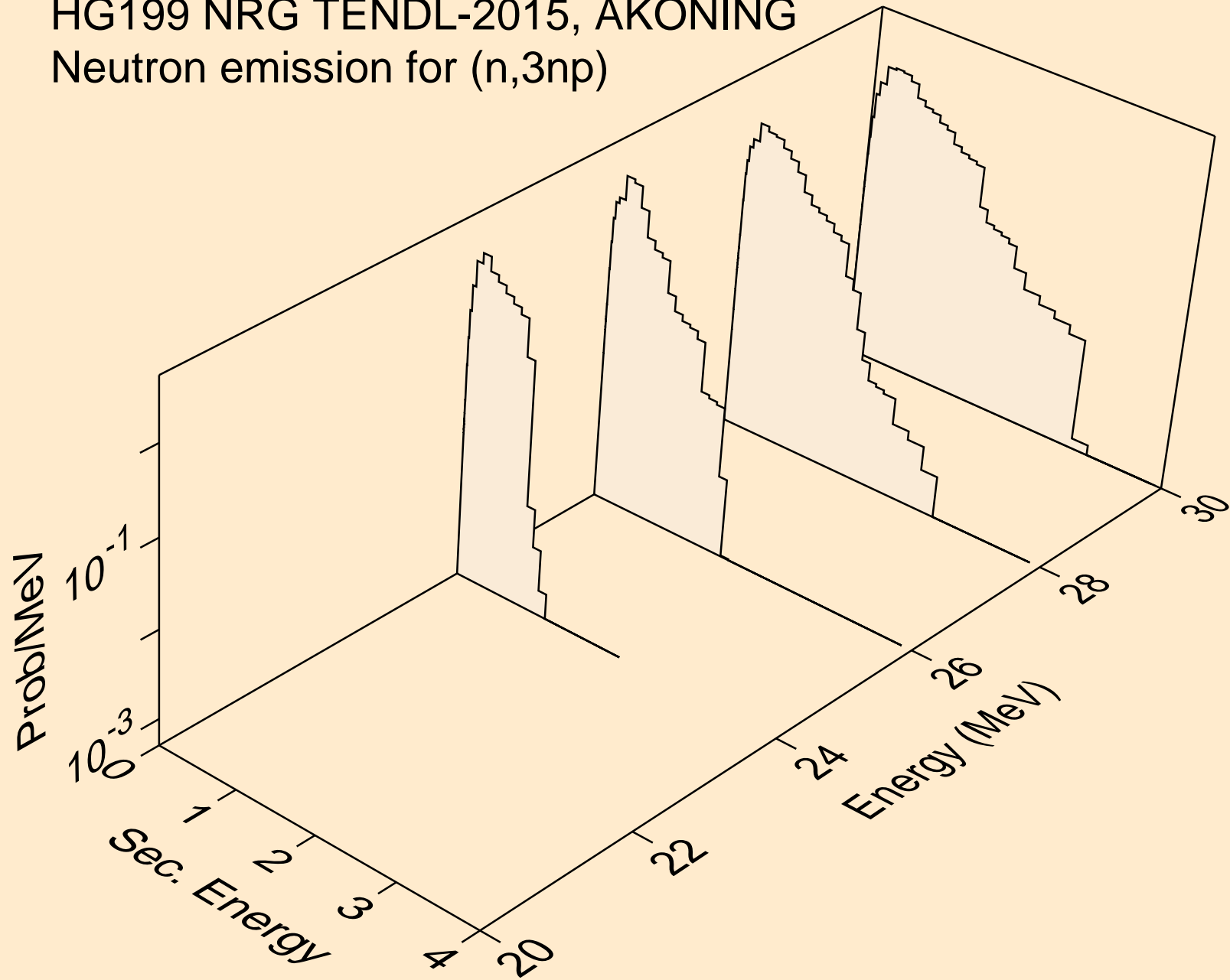

HG199 NRG TENDL-2015, AKONING  
Neutron emission for (n,2np)

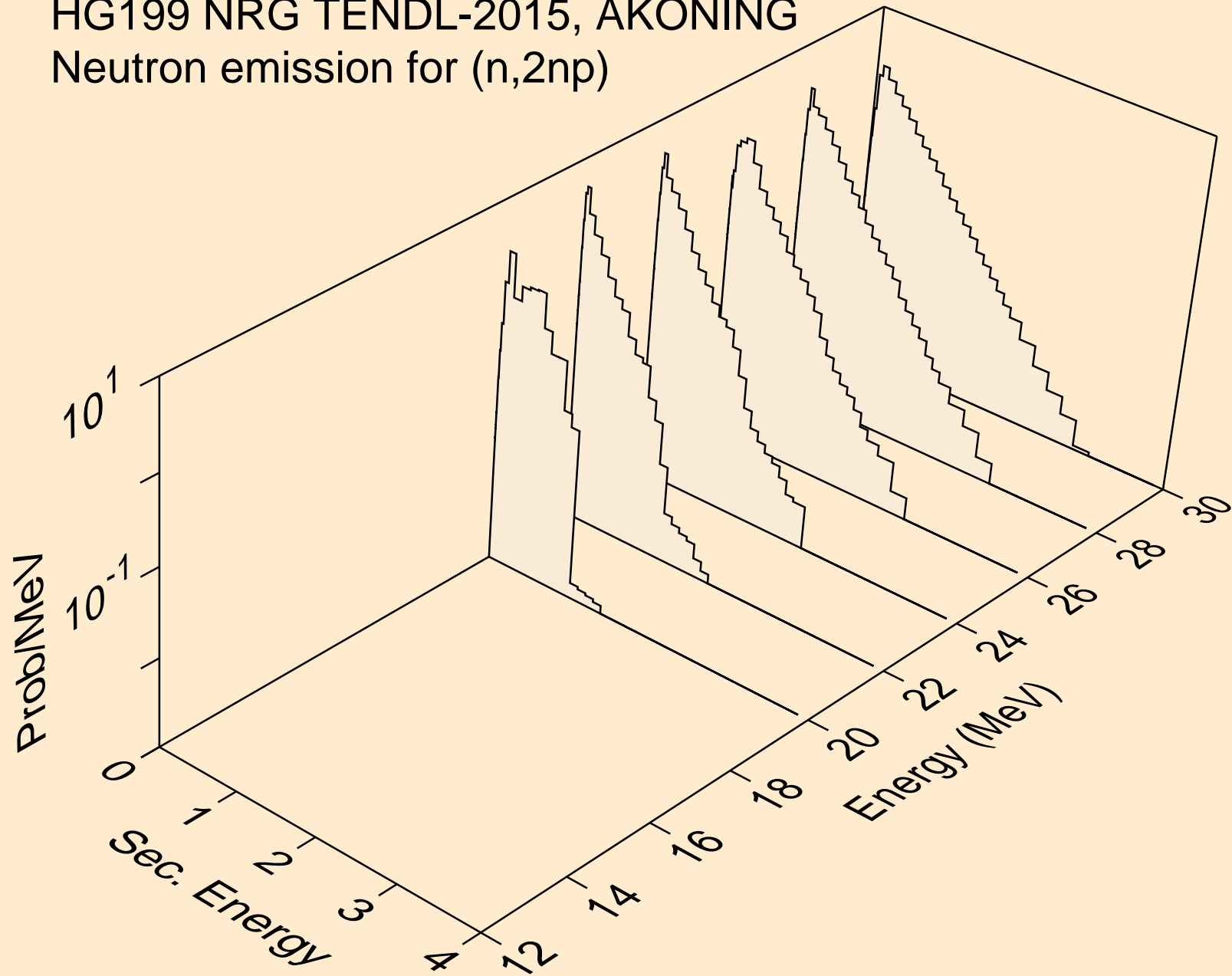



HG199 NRG TENDL-2015, AKONING  
Neutron emission for (n,npa)

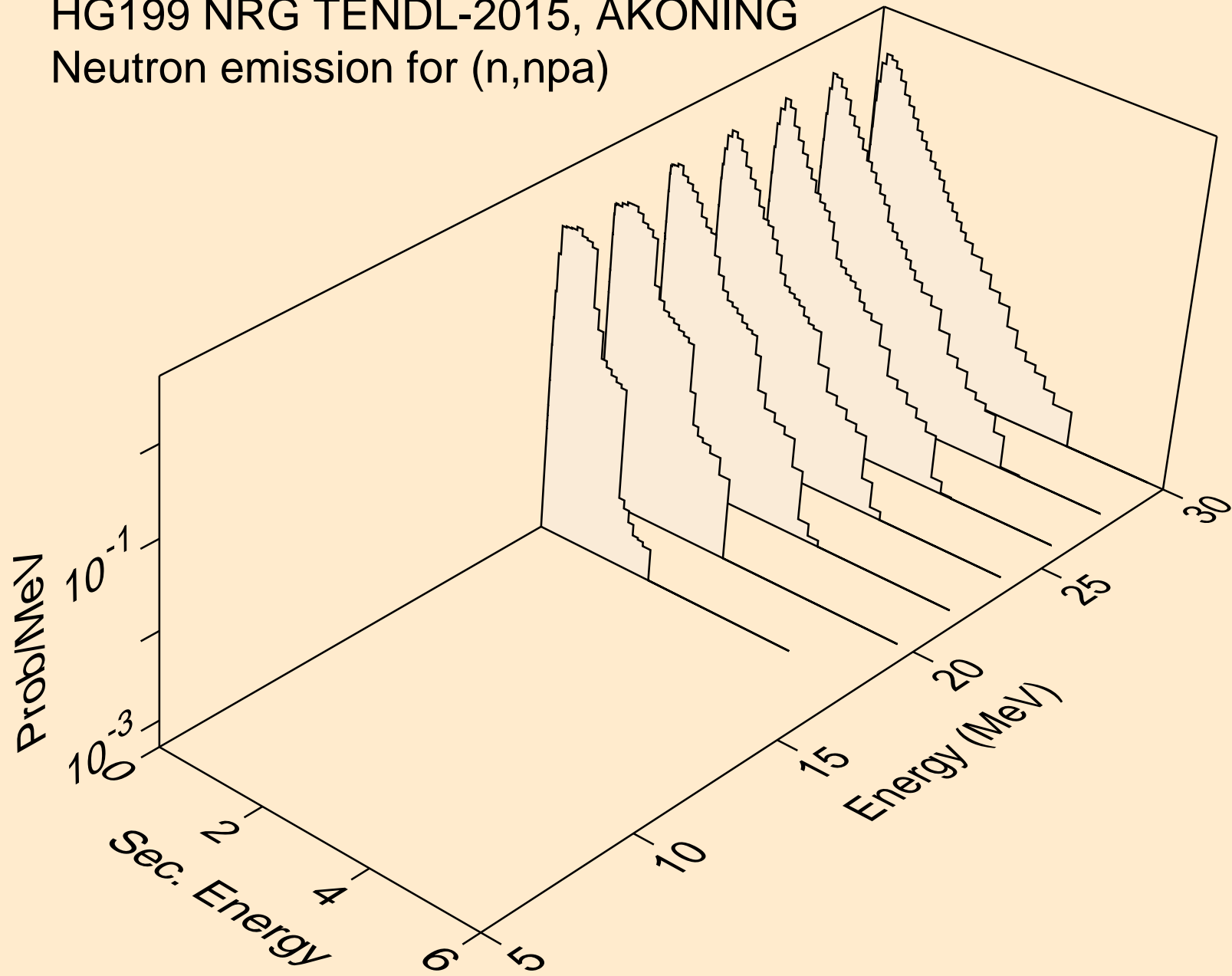

HG199 NRG TENDL-2015, AKONING  
Neutron emission for (n,n\*c)

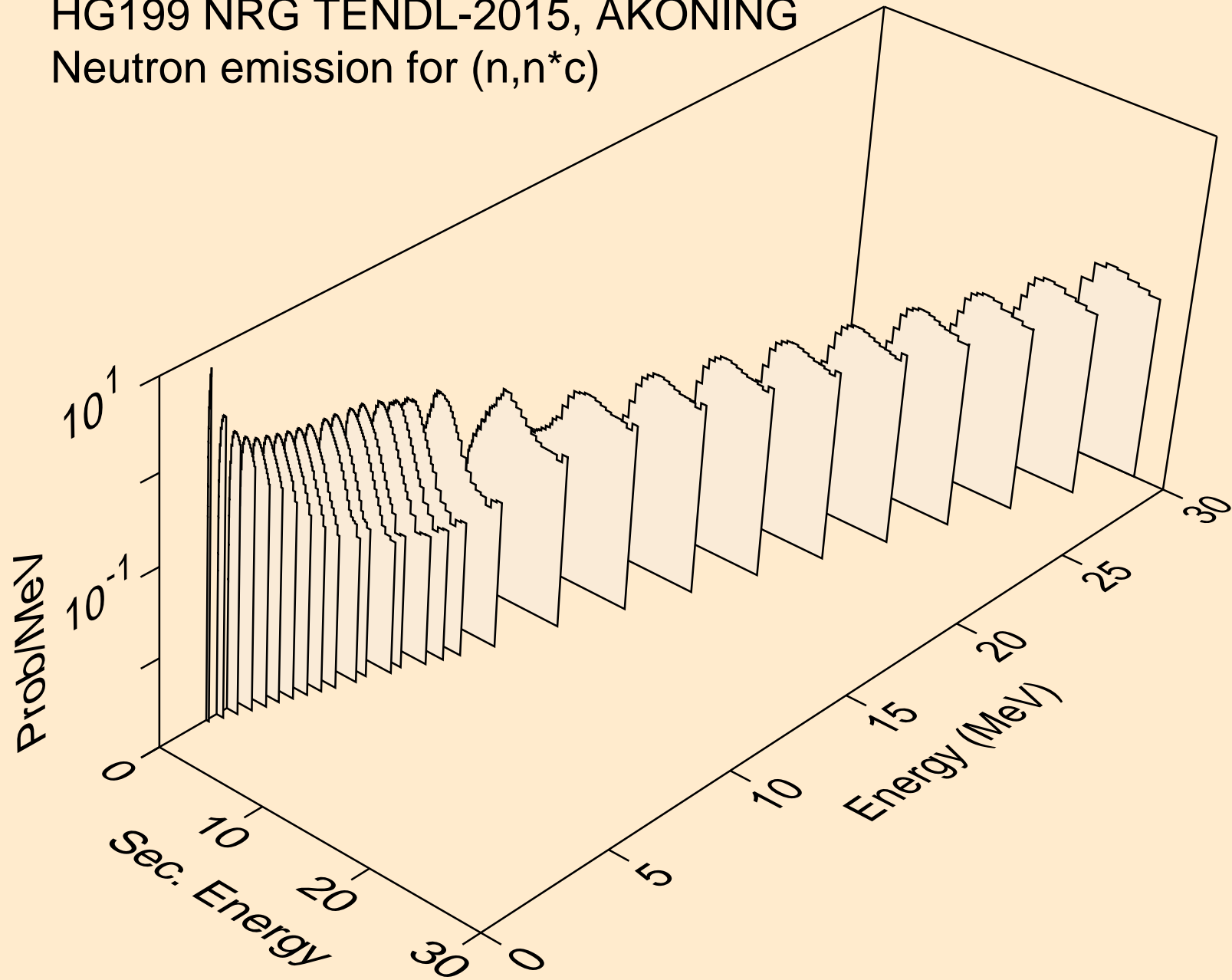

HG199 NRG TENDL-2015, AKONING  
Photon emission for (n,x)

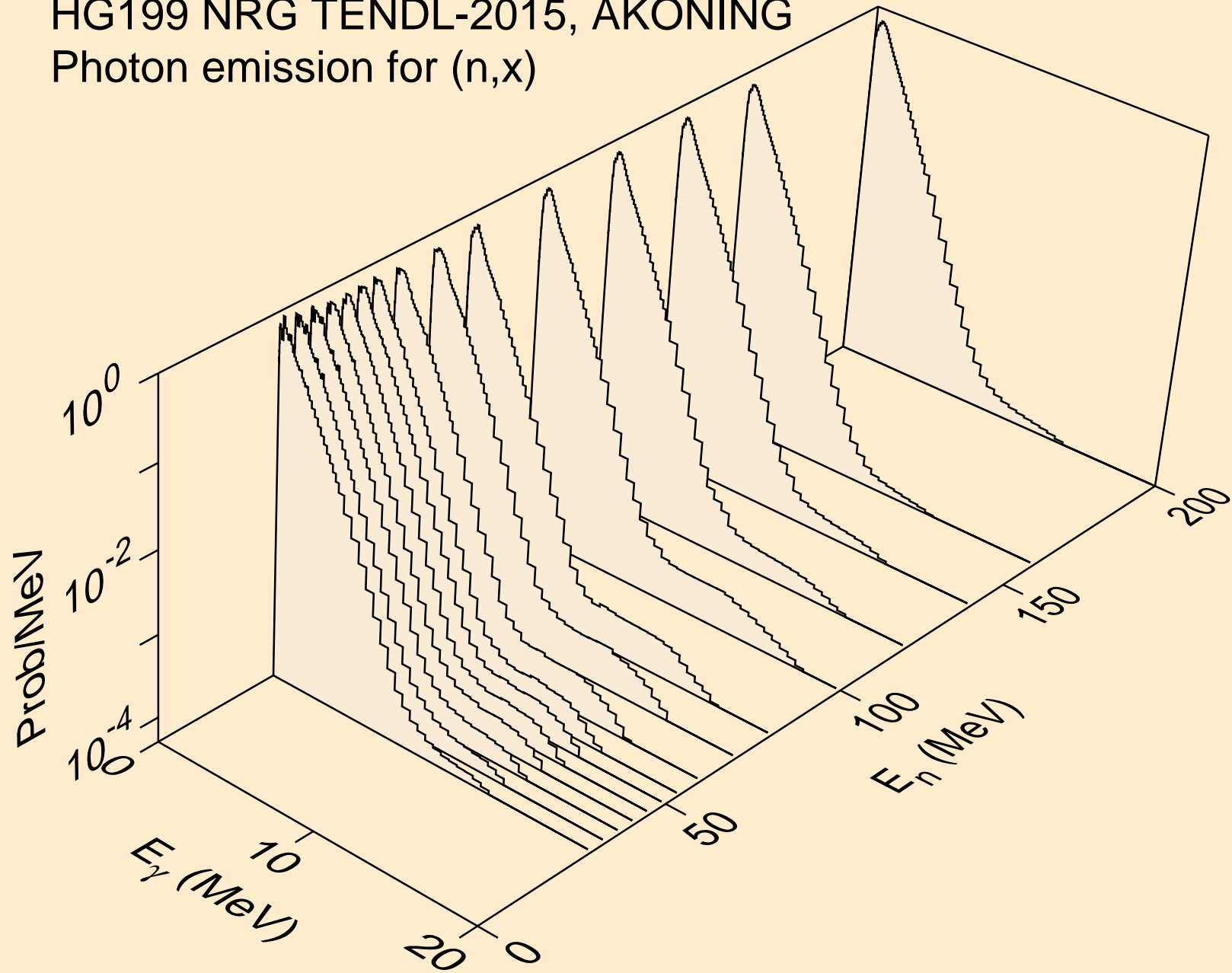

HG199 NRG TENDL-2015, AKONING  
Photon emission for (n,2nd)

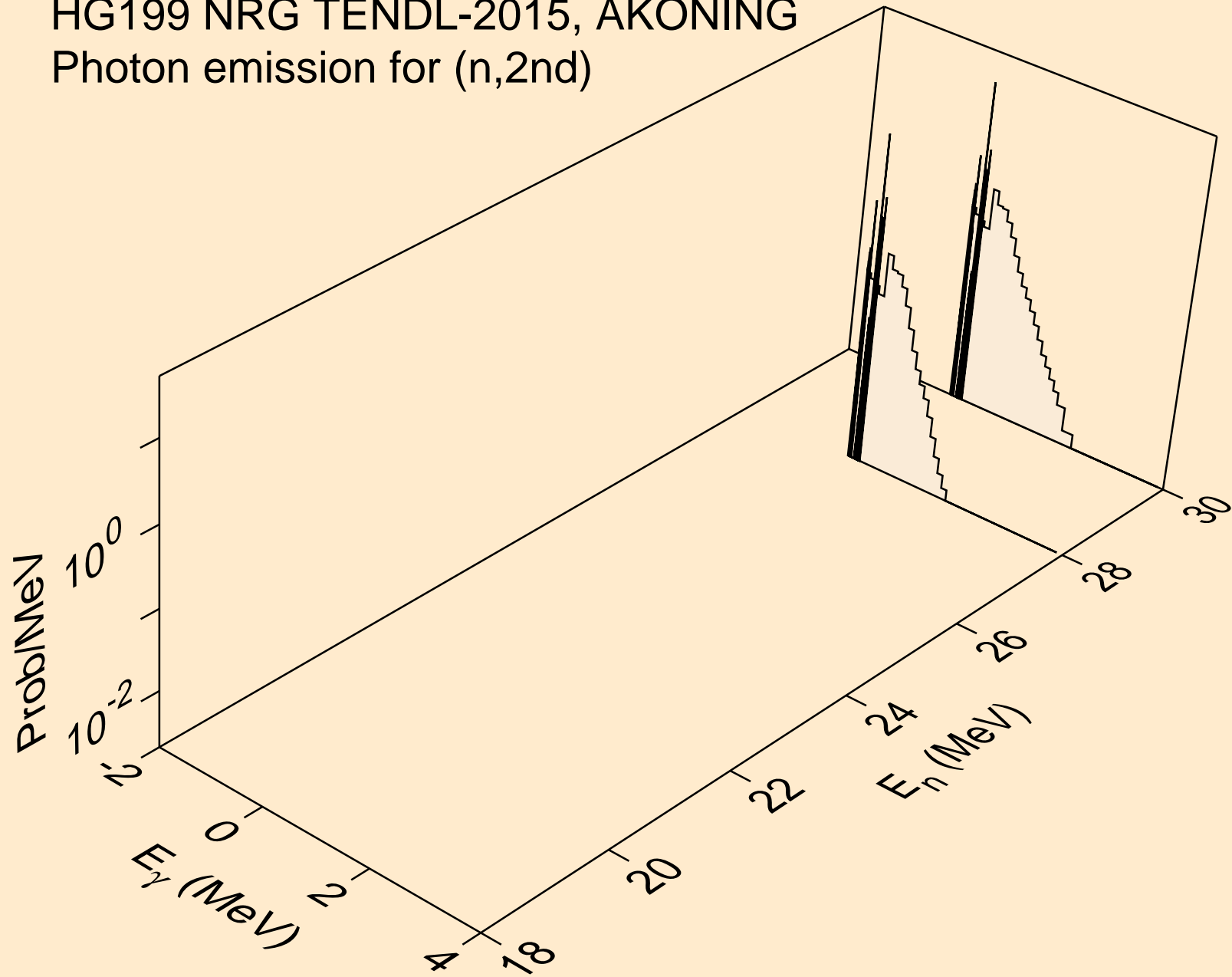

HG199 NRG TENDL-2015, AKONING  
Photon emission for (n,2n)

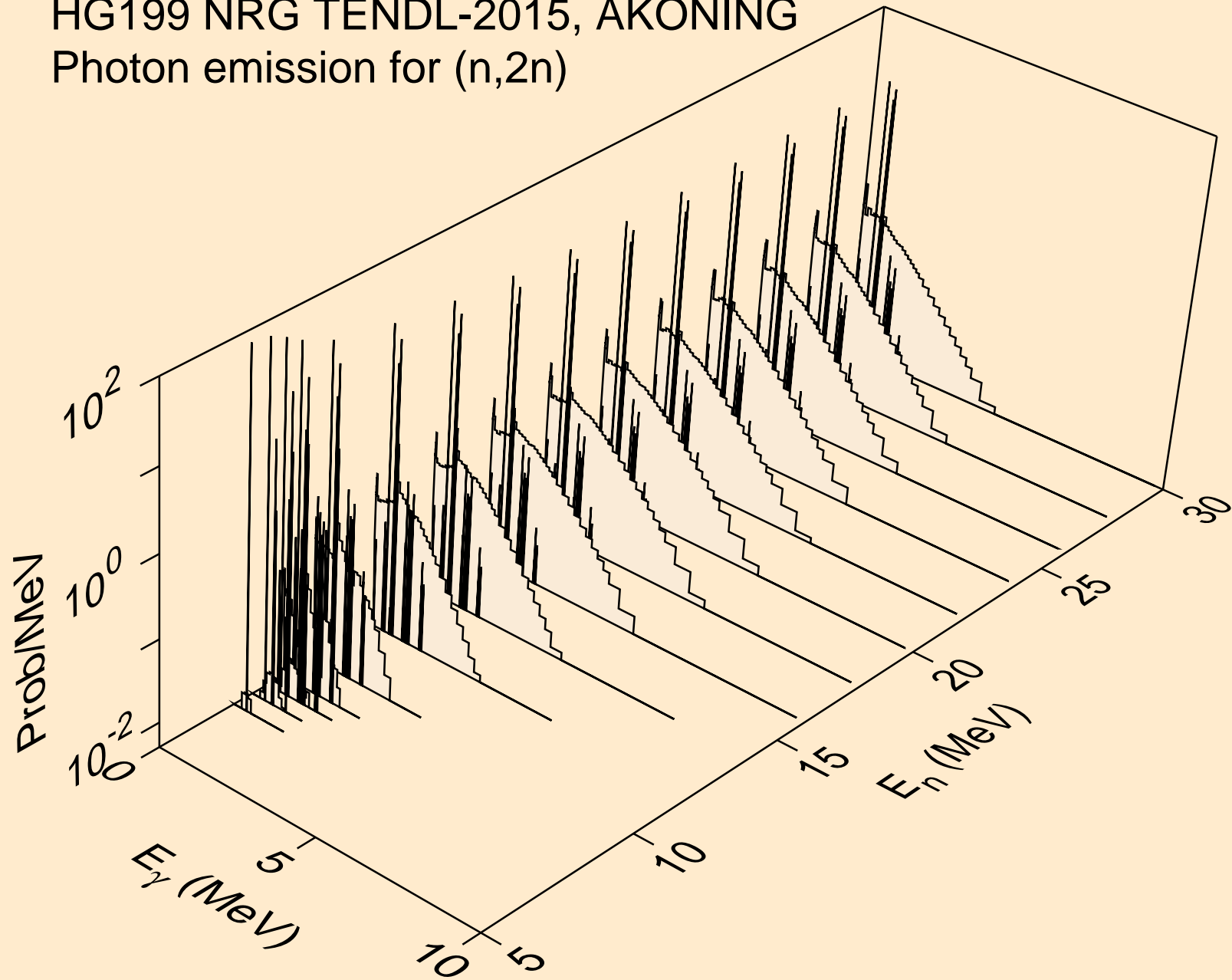

HG199 NRG TENDL-2015, AKONING  
Photon emission for (n,3n)

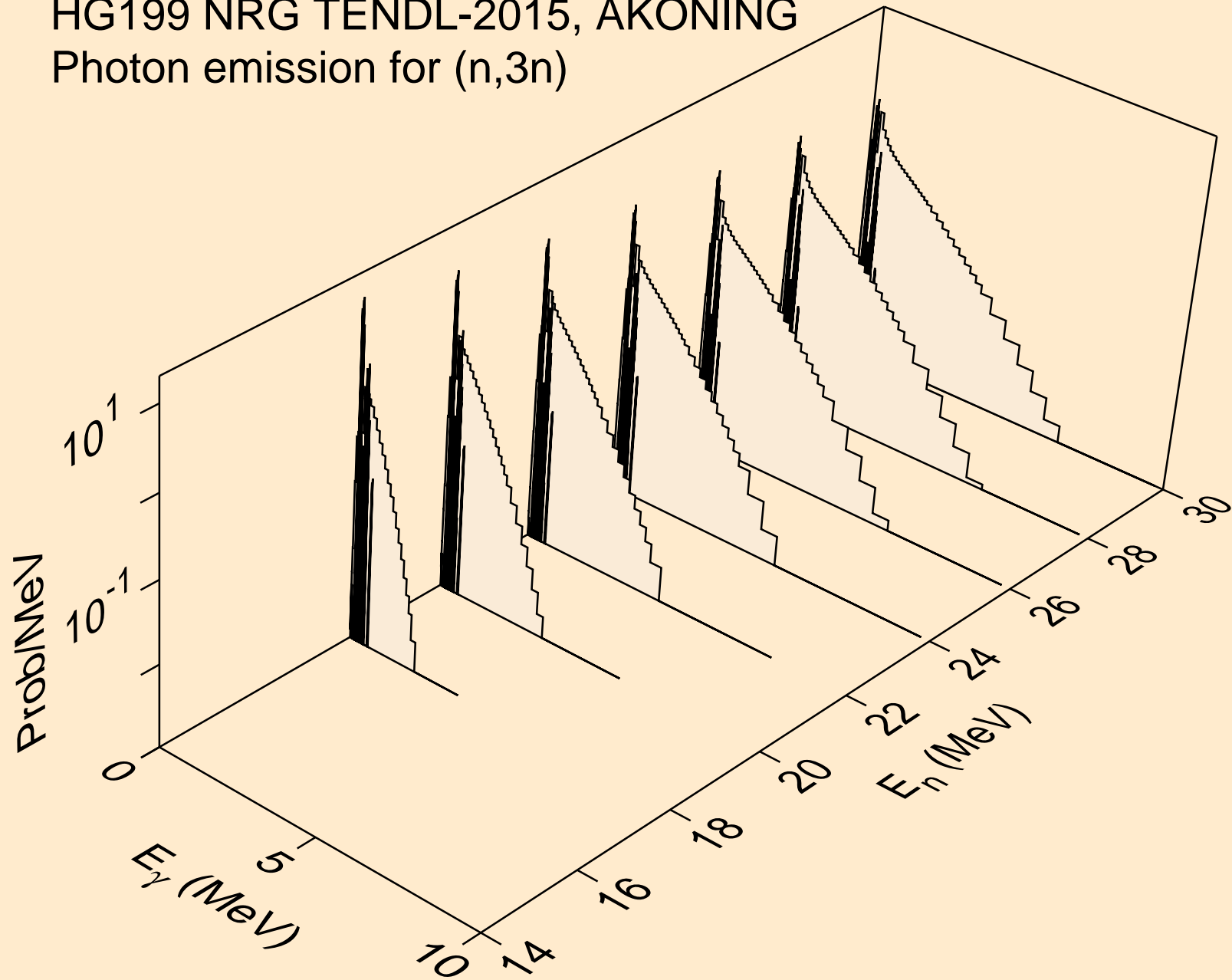

HG199 NRG TENDL-2015, AKONING  
Photon emission for (n,n\*)a

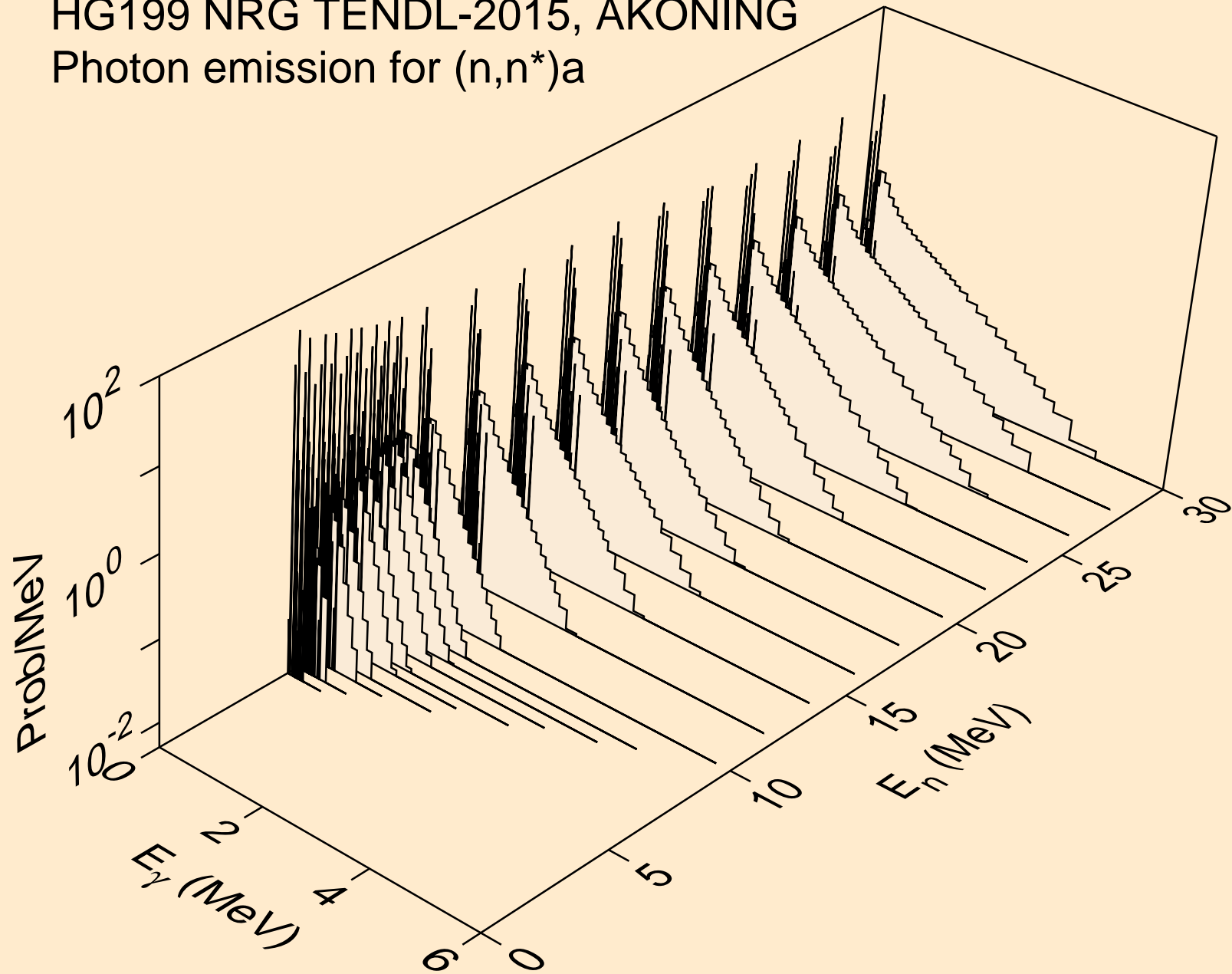

HG199 NRG TENDL-2015, AKONING  
Photon emission for (n,2n)a

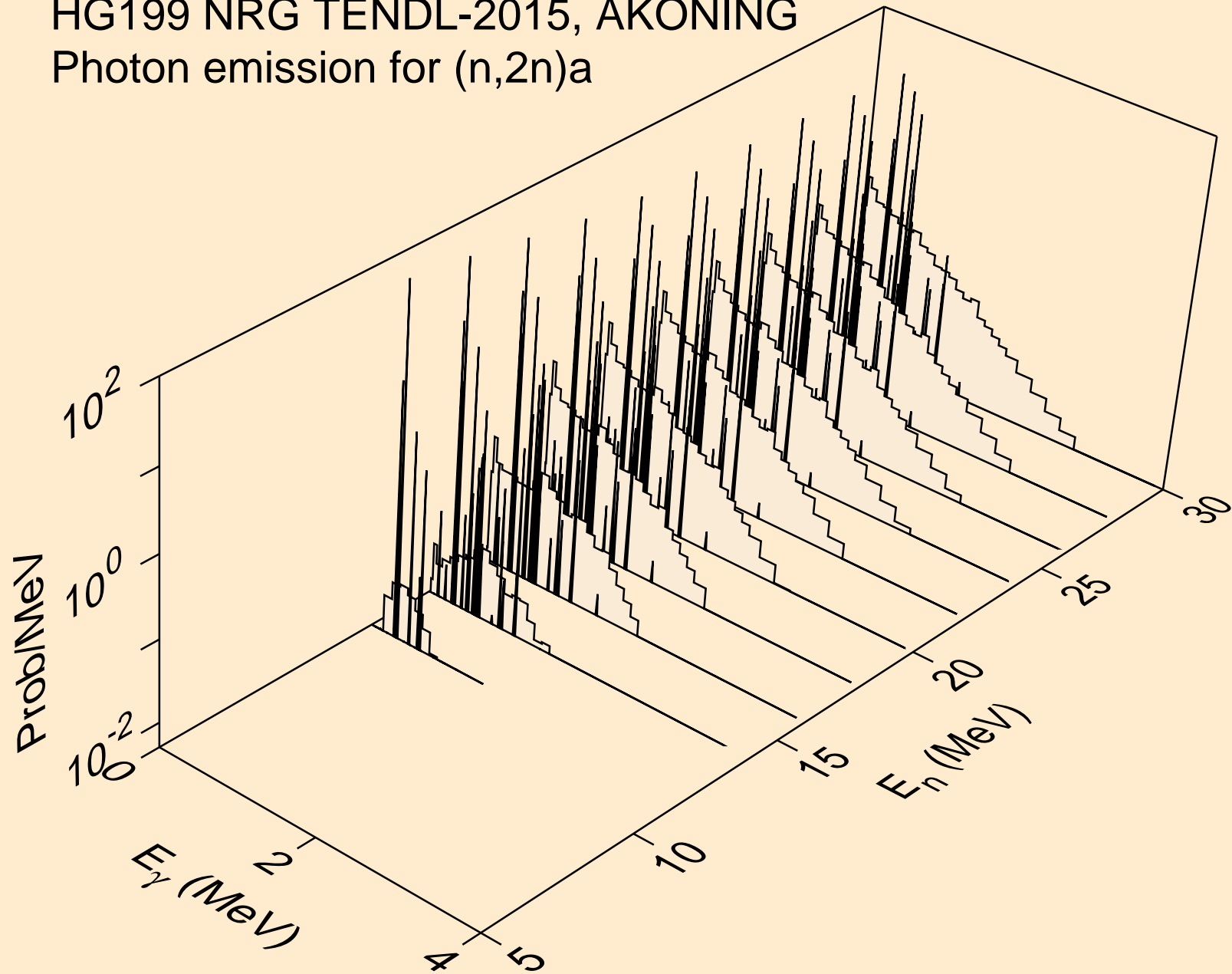



HG199 NRG TENDL-2015, AKONING  
Photon emission for (n,3n)a

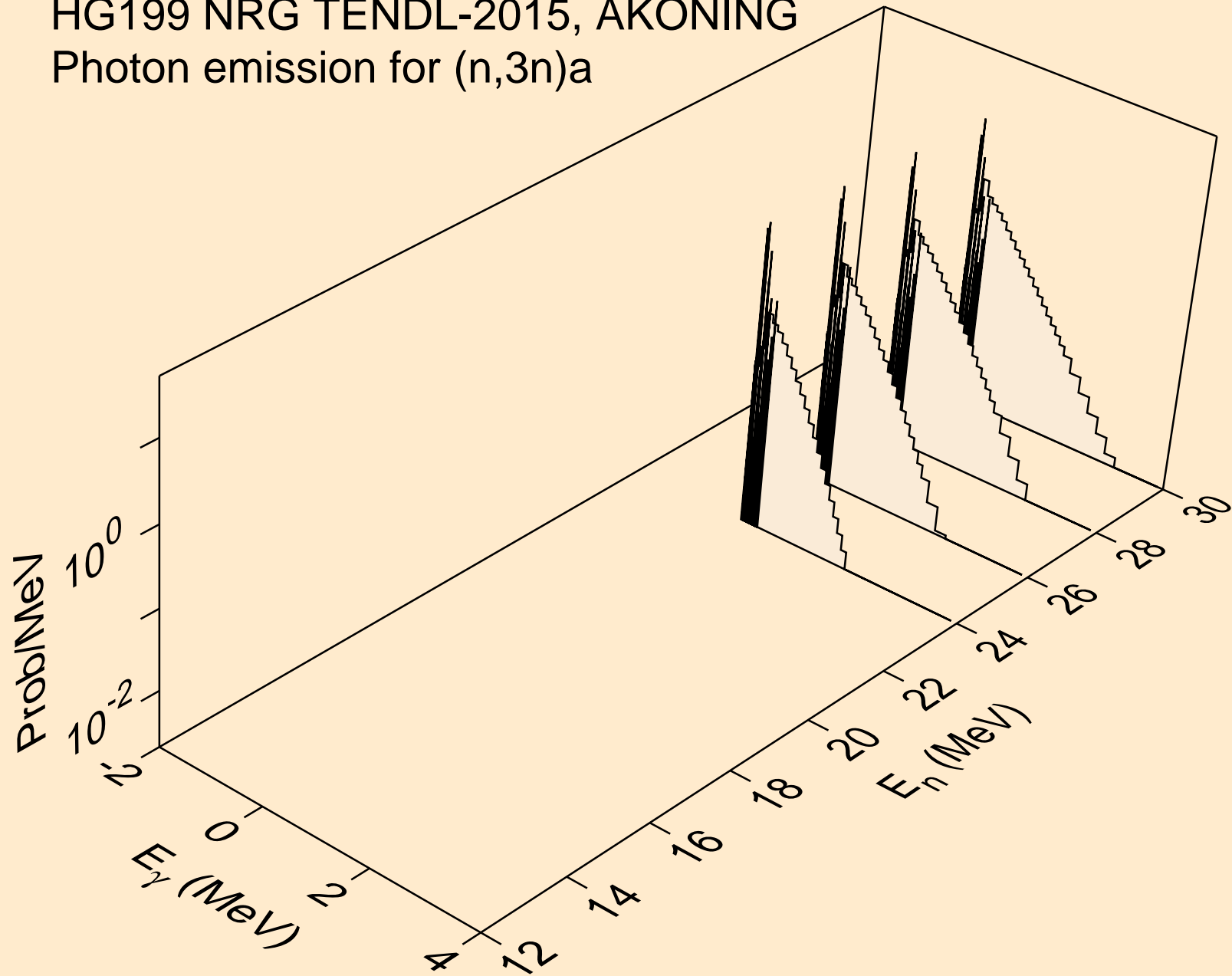

HG199 NRG TENDL-2015, AKONING  
Photon emission for (n,n\*)p

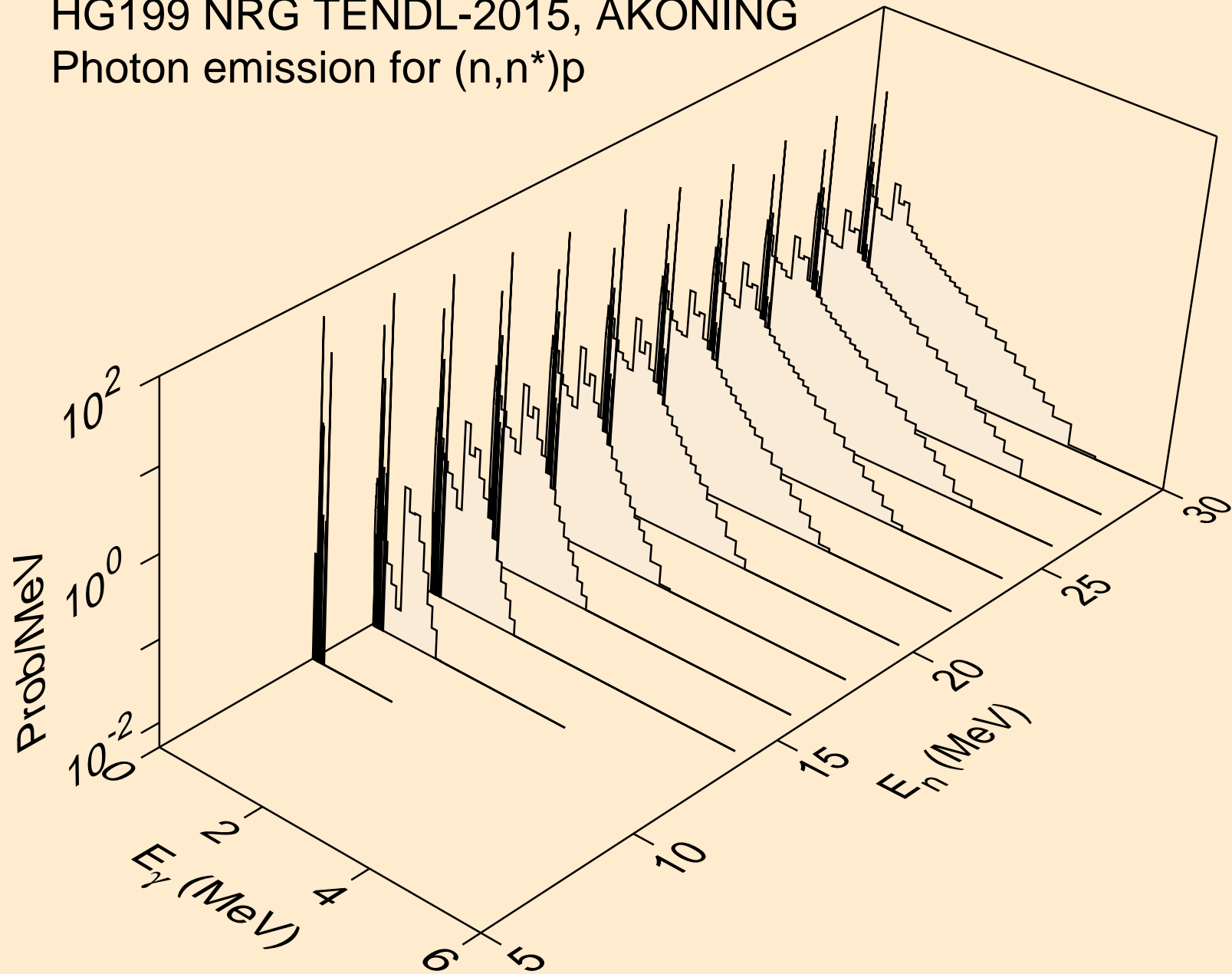

HG199 NRG TENDL-2015, AKONING  
Photon emission for (n,n\*)2a

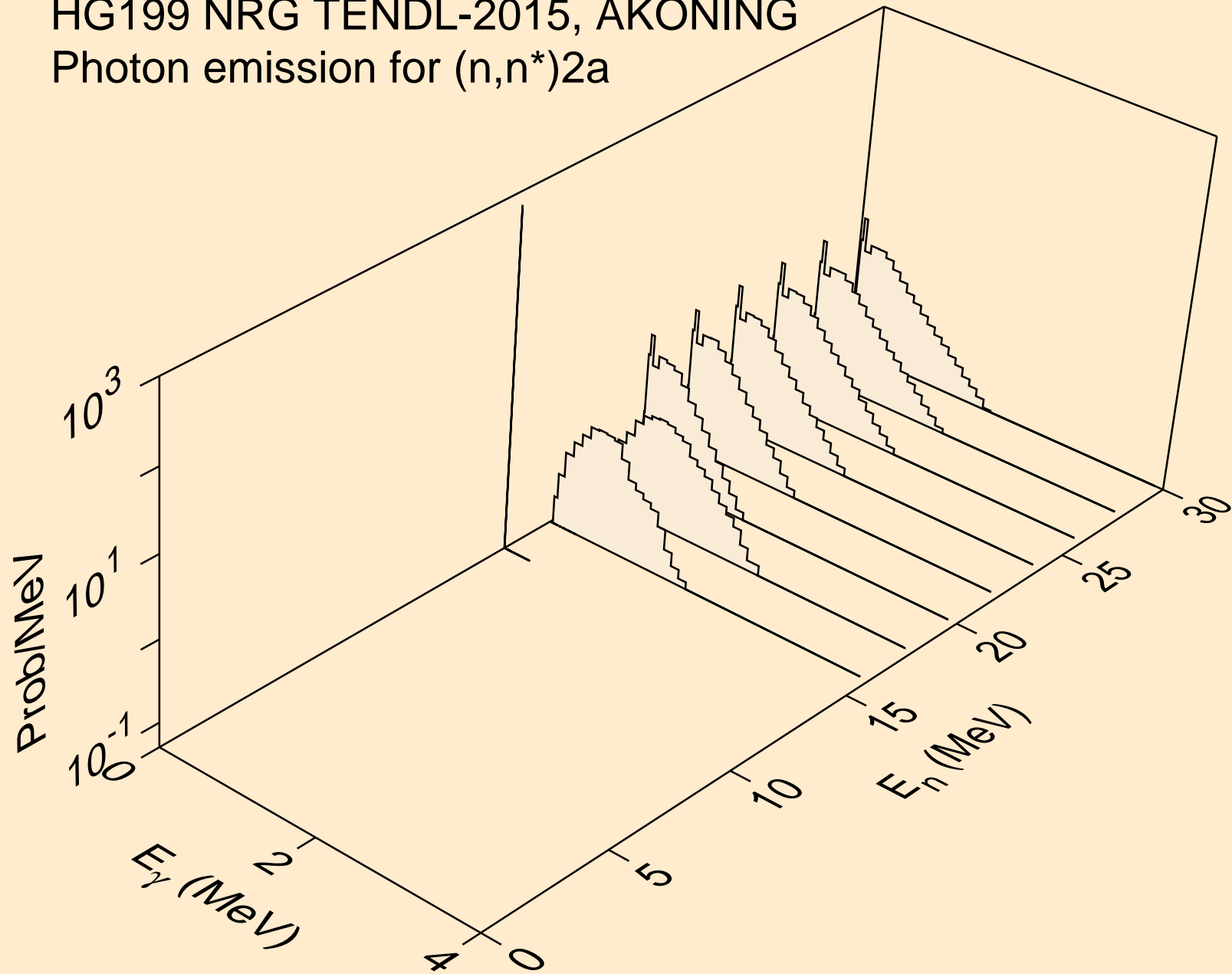

HG199 NRG TENDL-2015, AKONING  
Photon emission for (n,n\*)d

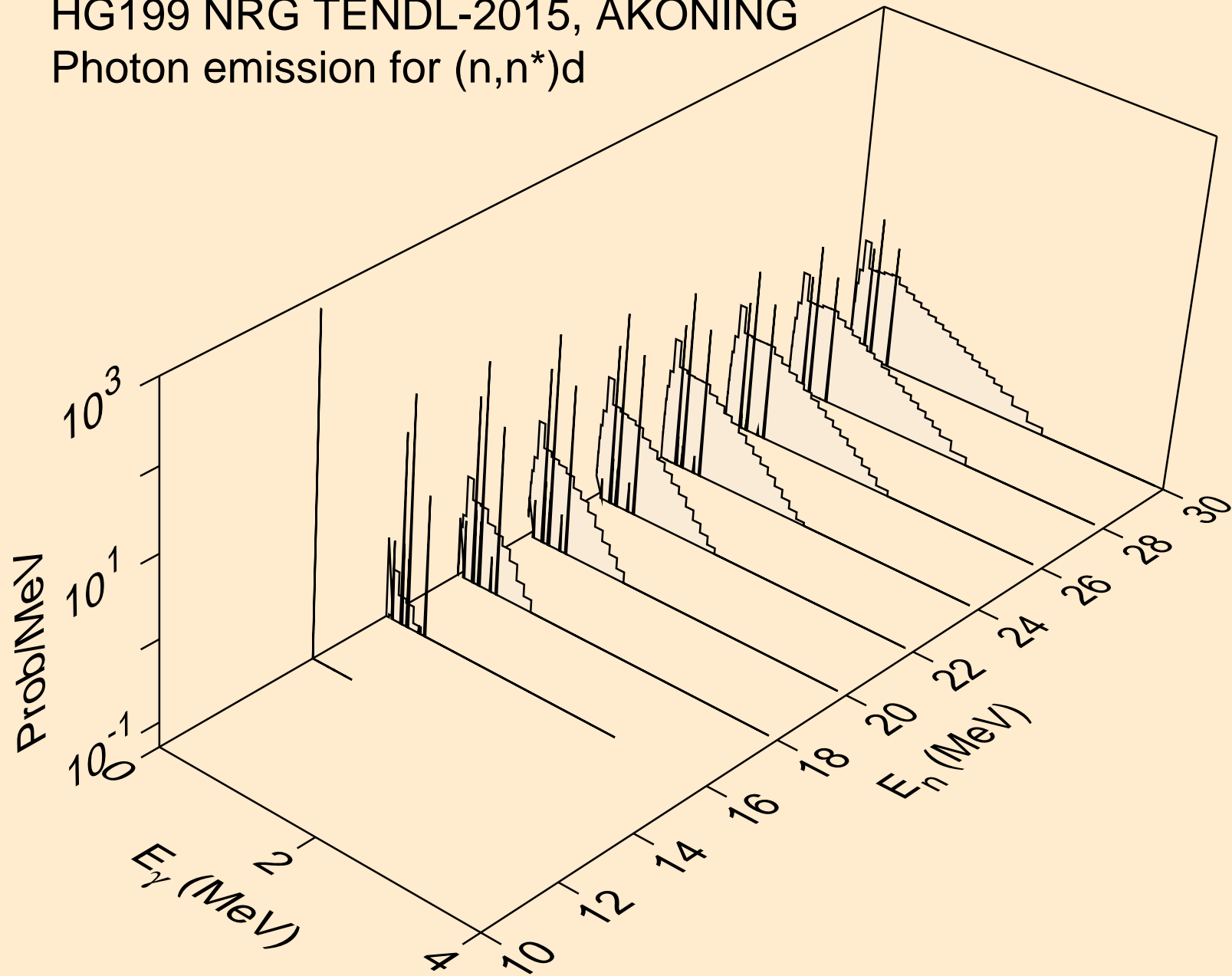

HG199 NRG TENDL-2015, AKONING  
Photon emission for (n,n\*)t

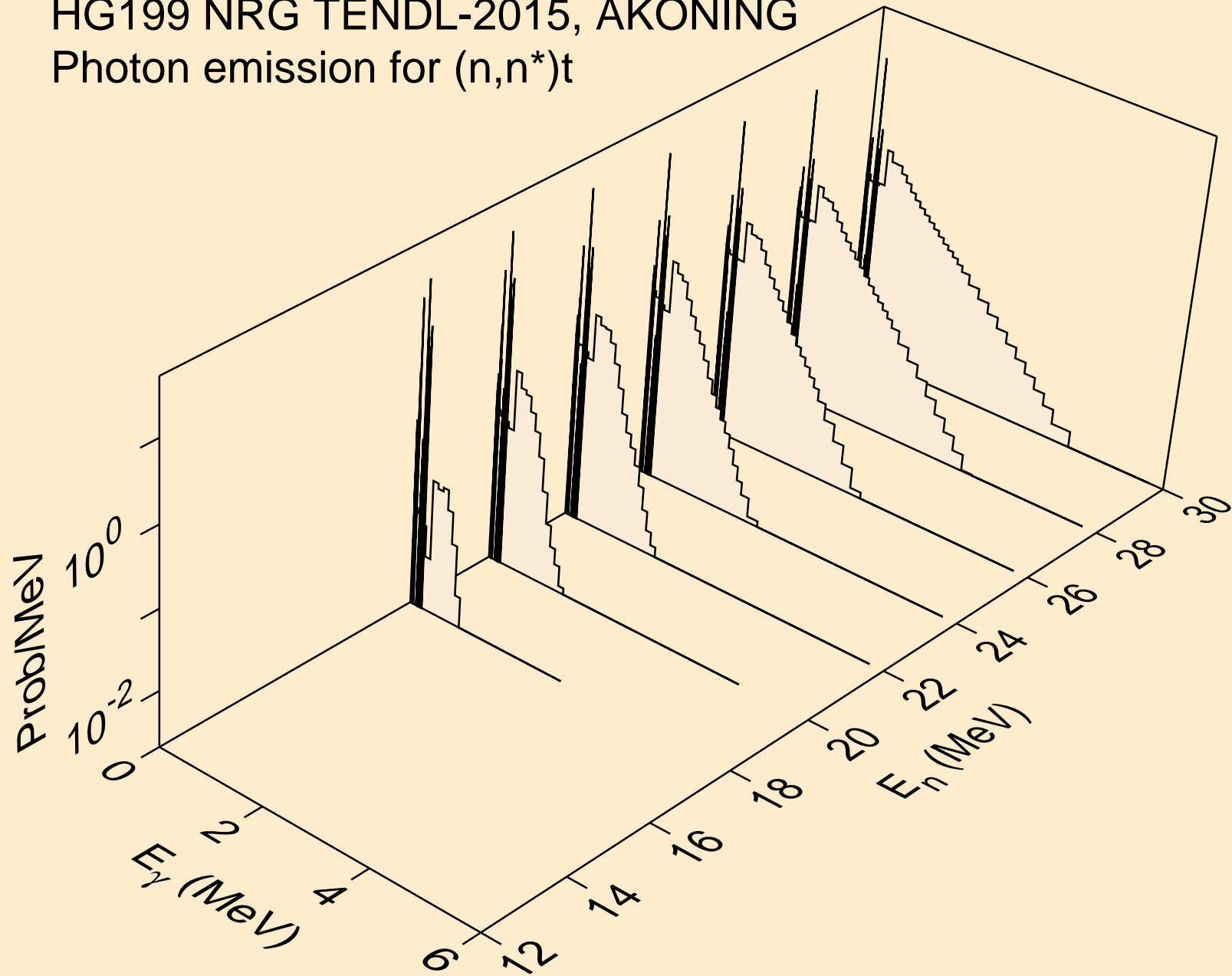

HG199 NRG TENDL-2015, AKONING  
Photon emission for (n,n\*)he3

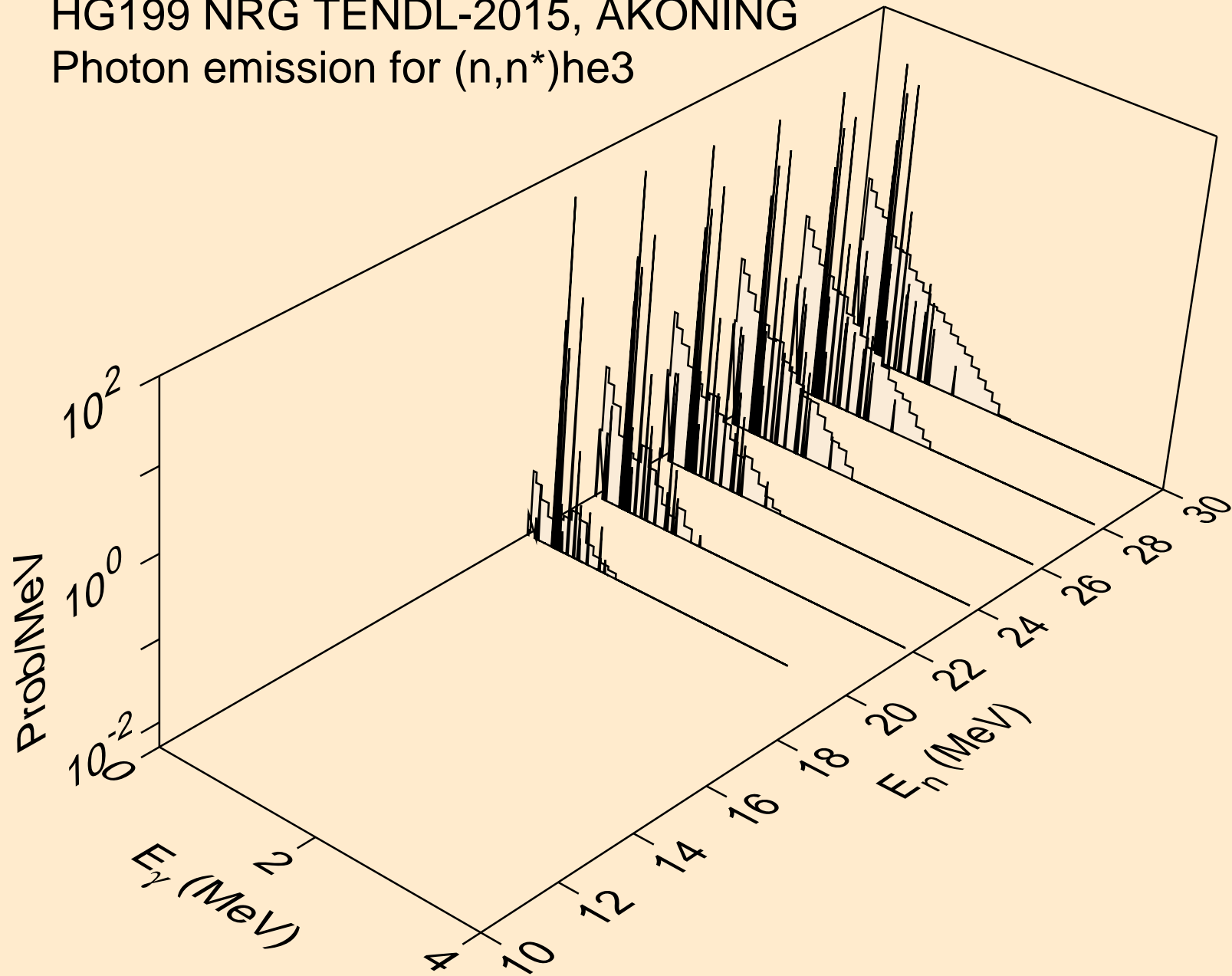

HG199 NRG TENDL-2015, AKONING  
Photon emission for (n,4n)

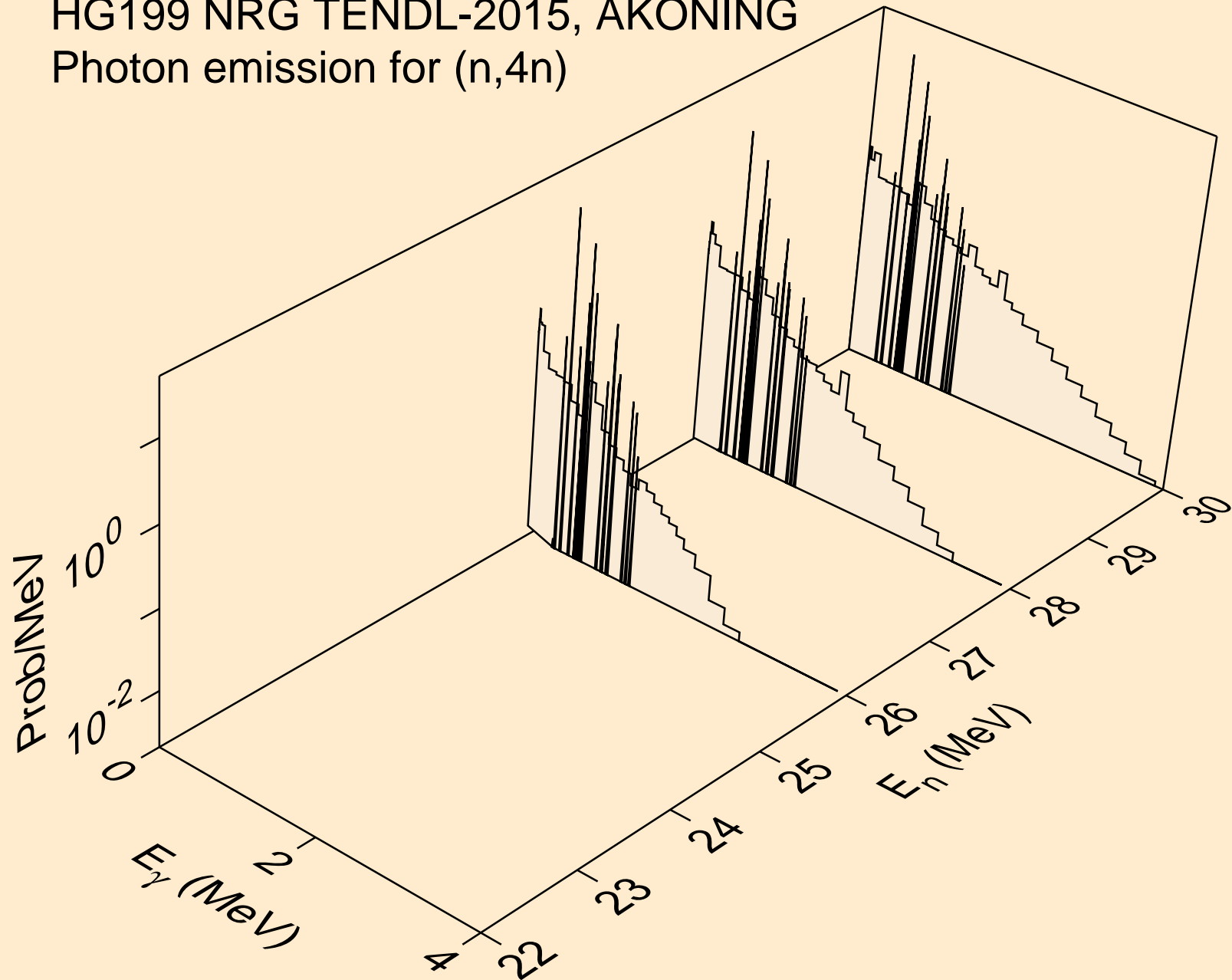

HG199 NRG TENDL-2015, AKONING  
Photon emission for (n,2np)

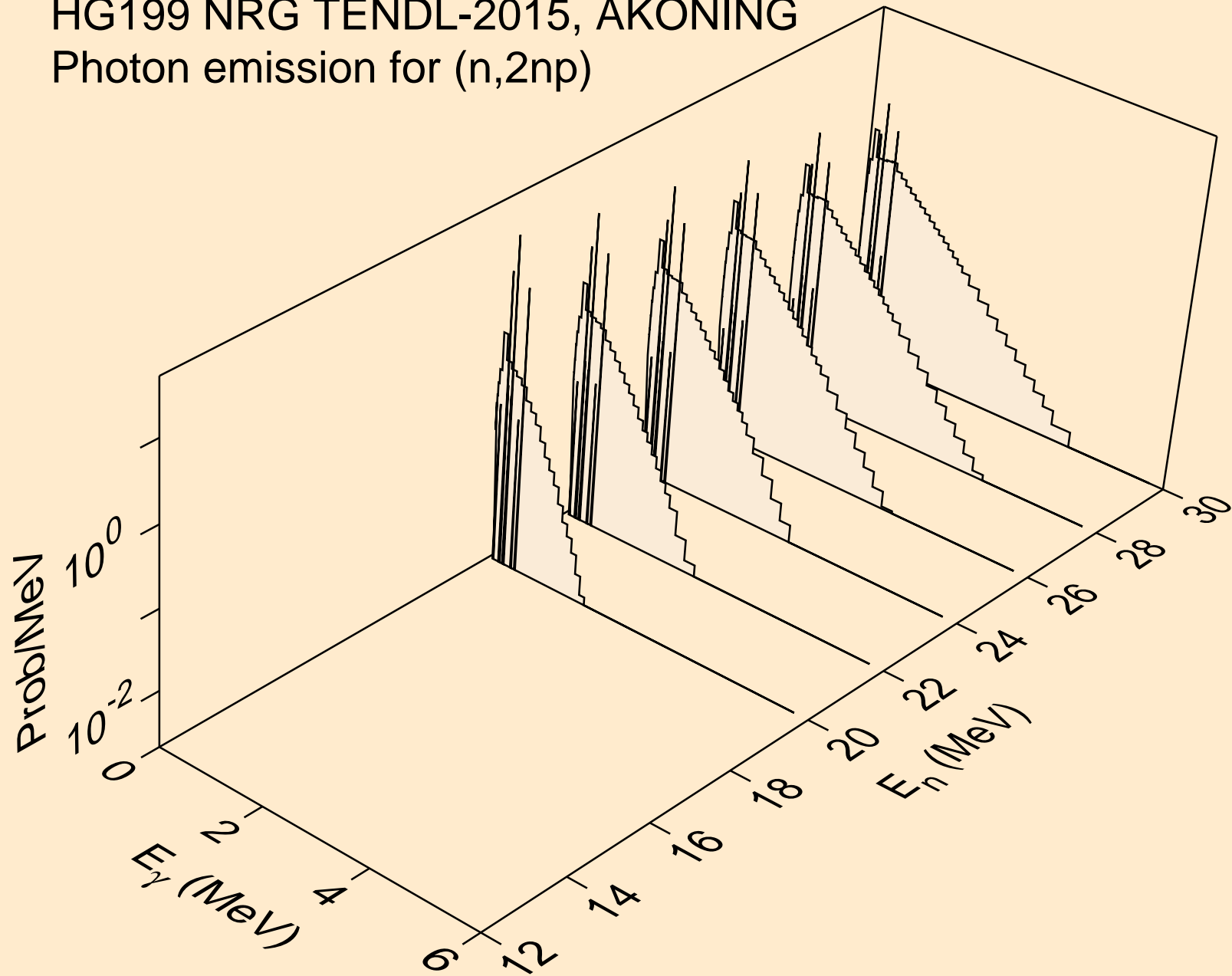



HG199 NRG TENDL-2015, AKONING  
Photon emission for (n,3np)

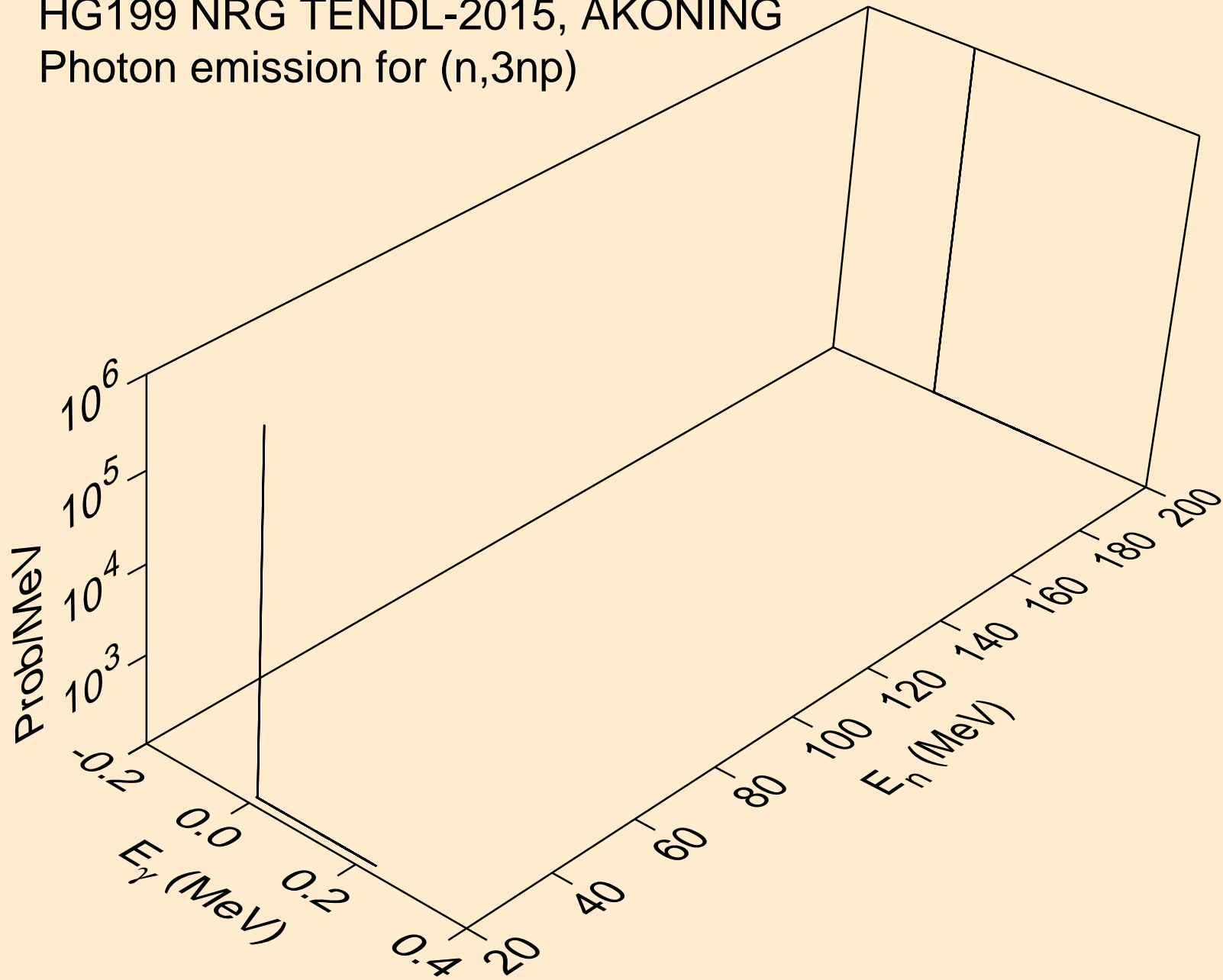

HG199 NRG TENDL-2015, AKONING  
Photon emission for (n,2np)

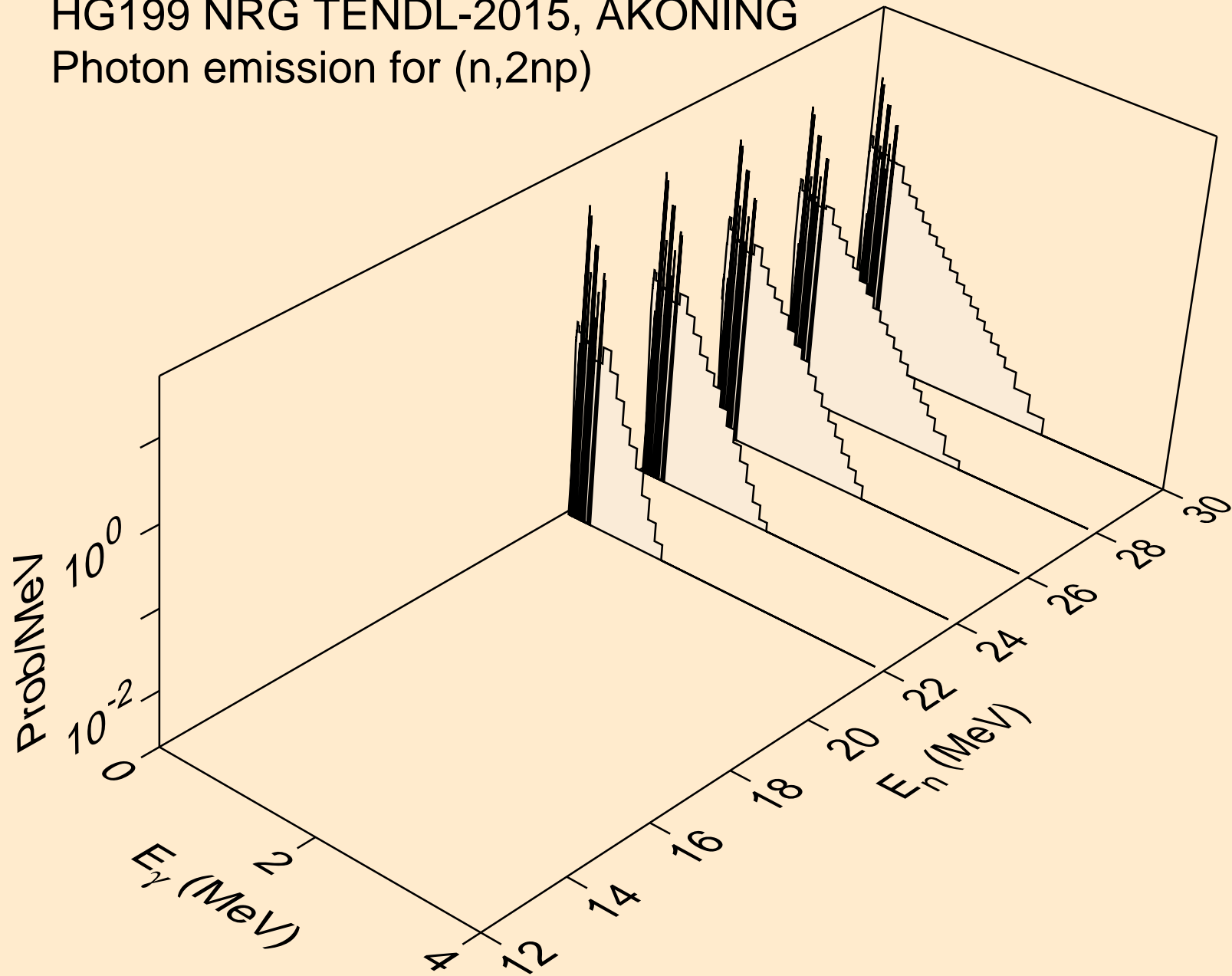

HG199 NRG TENDL-2015, AKONING  
Photon emission for (n,npa)

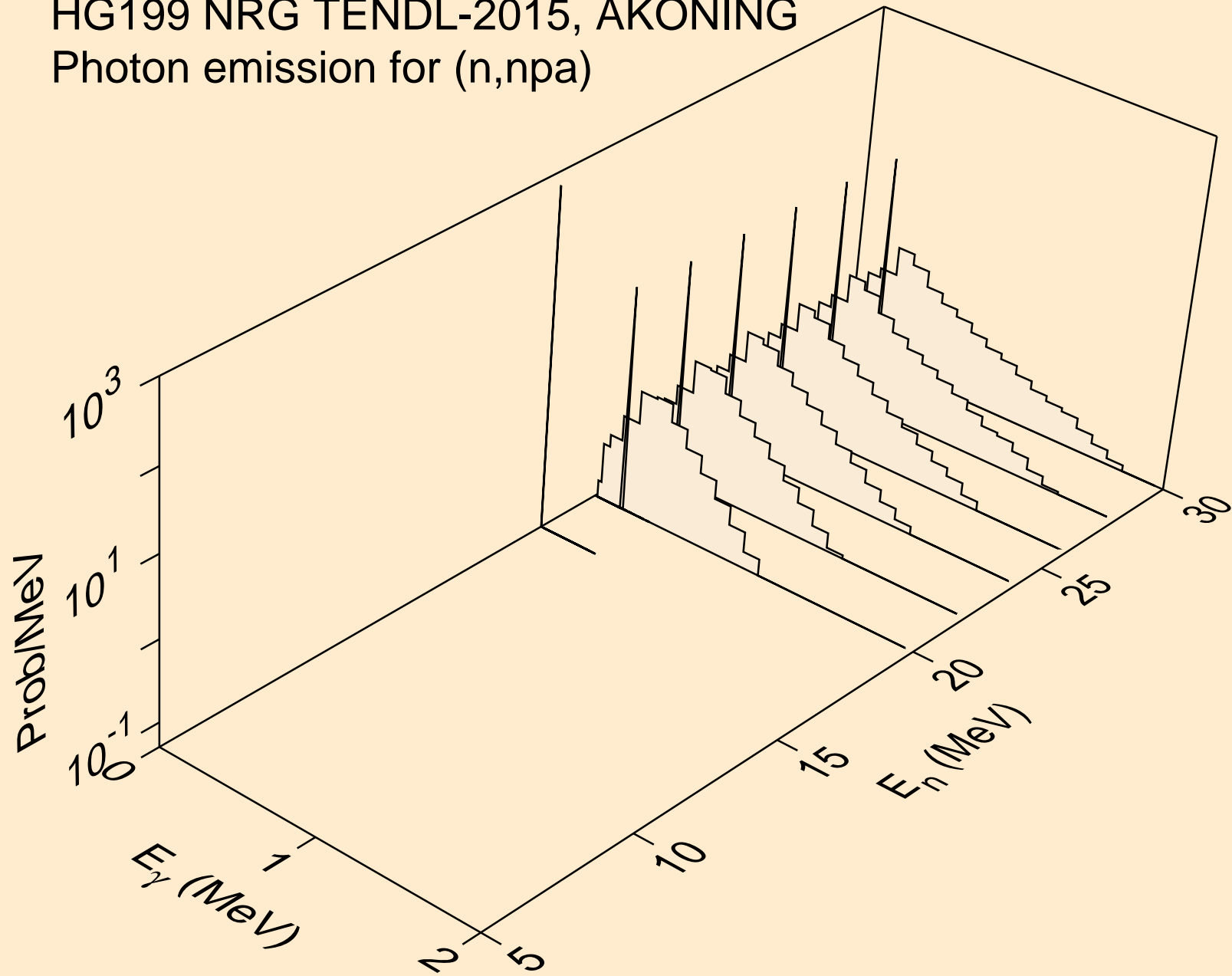

HG199 NRG TENDL-2015, AKONING  
Photon emission for (n,n\*c)

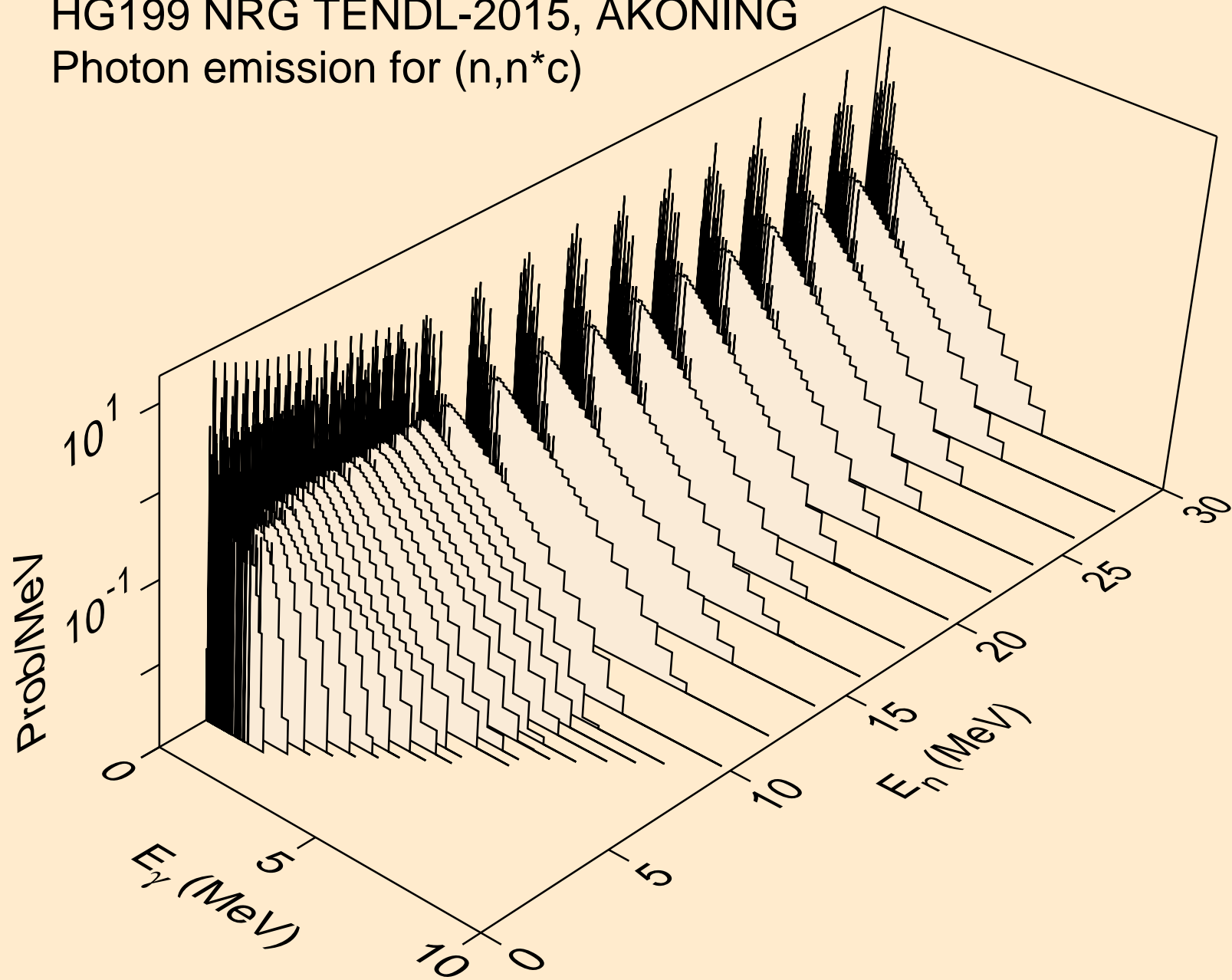

HG199 NRG TENDL-2015, AKONING  
Photon emission for (n,gma)

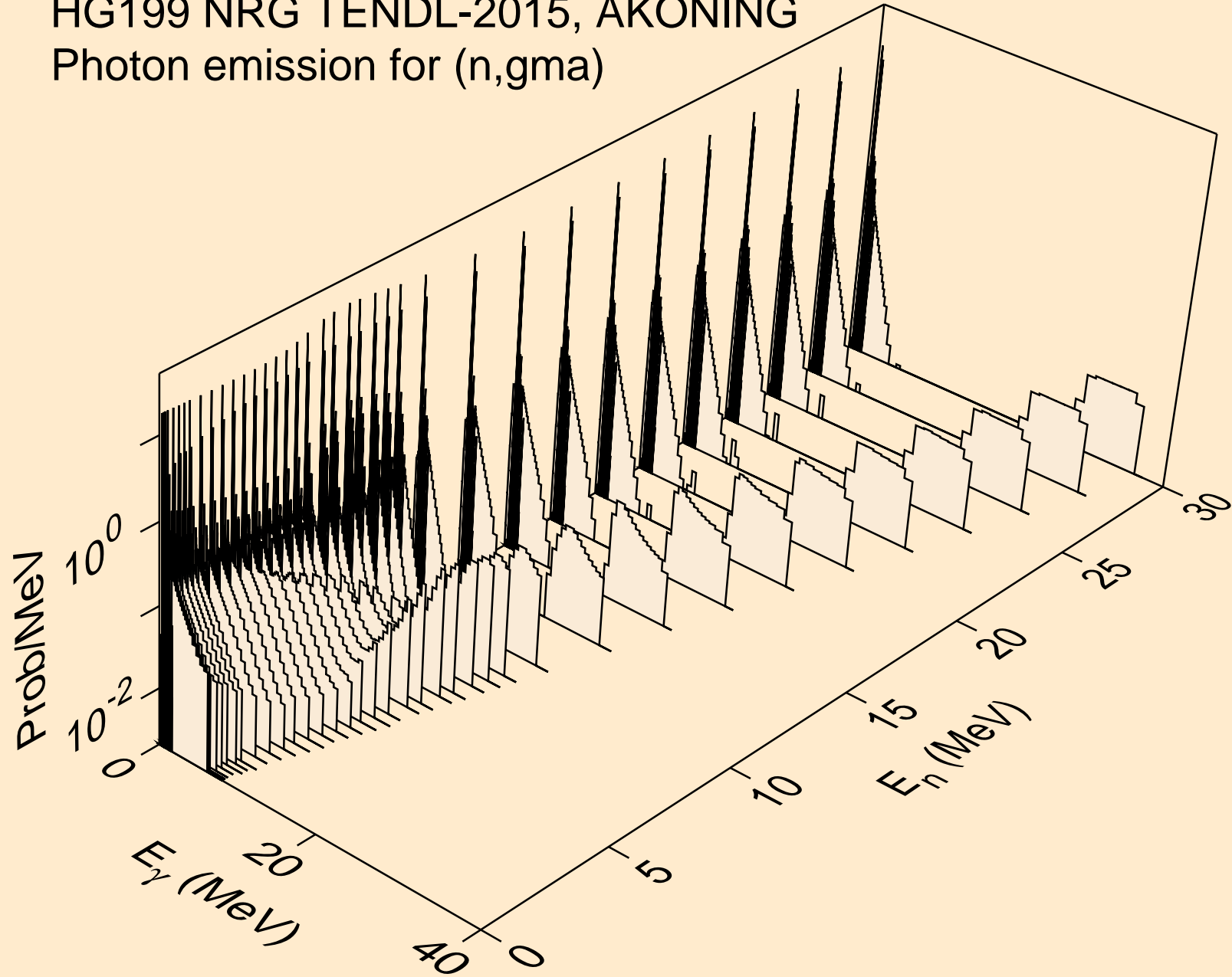

HG199 NRG TENDL-2015, AKONING  
Photon emission for (n,p)

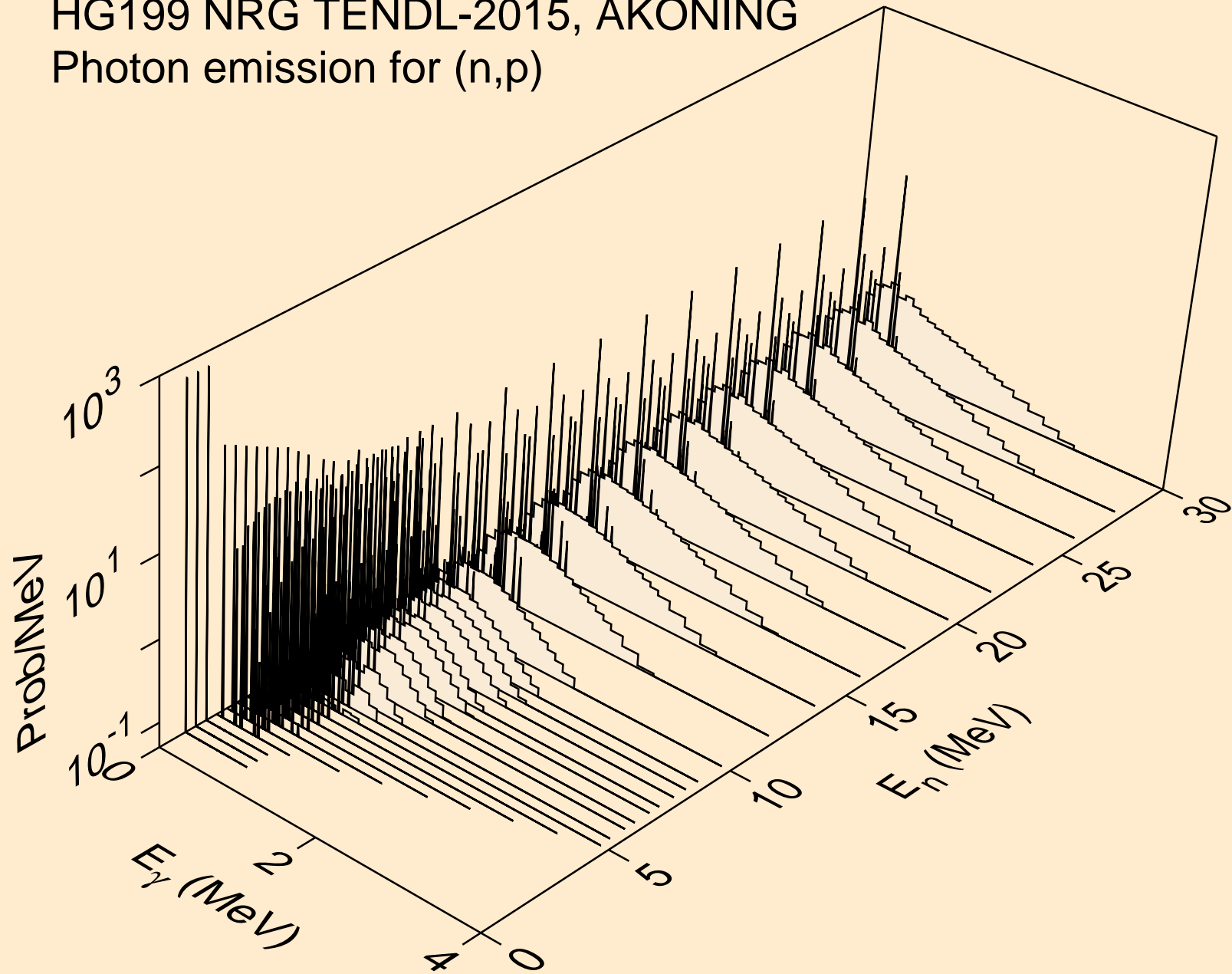

HG199 NRG TENDL-2015, AKONING  
Photon emission for (n,d)

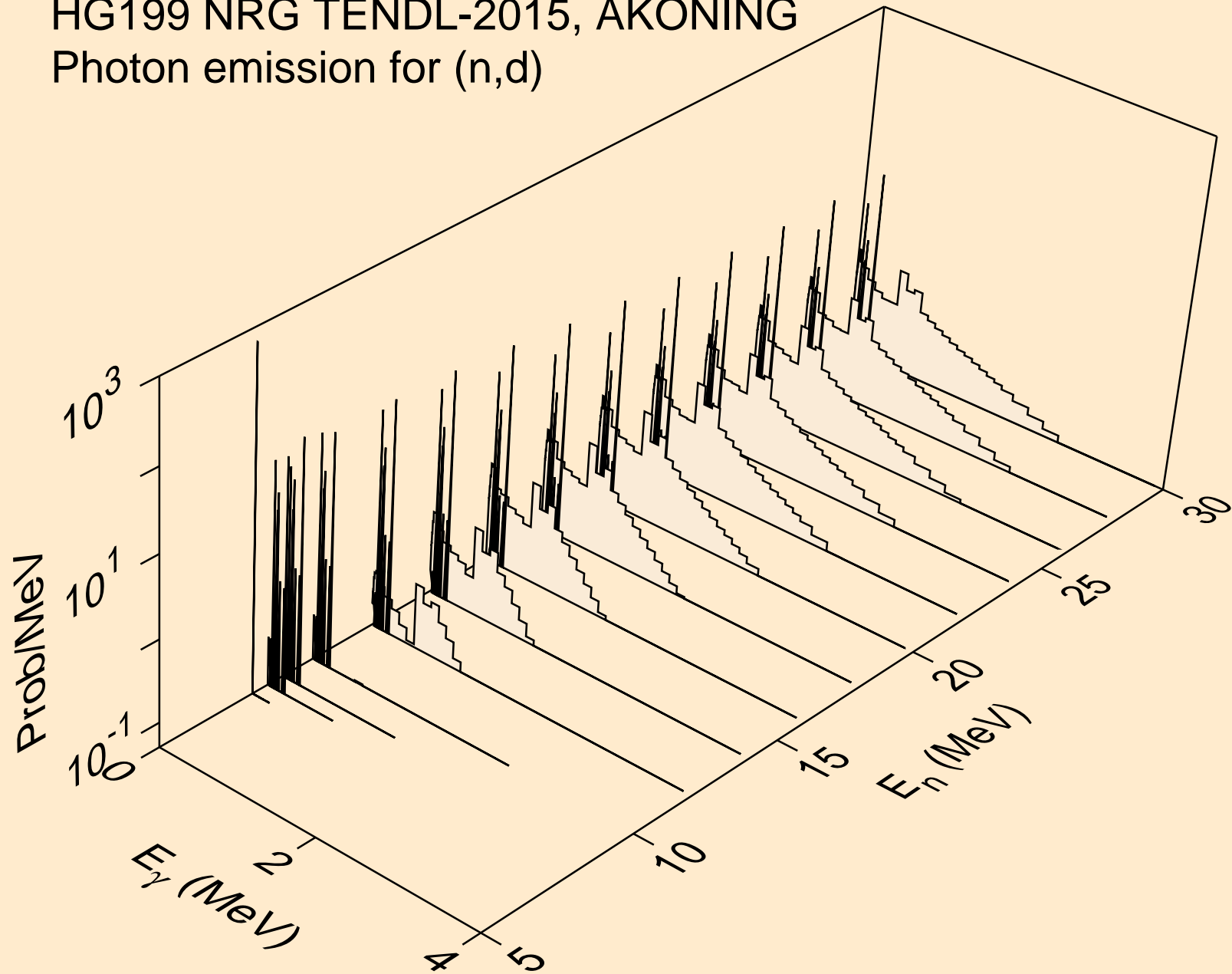

HG199 NRG TENDL-2015, AKONING  
Photon emission for (n,t)

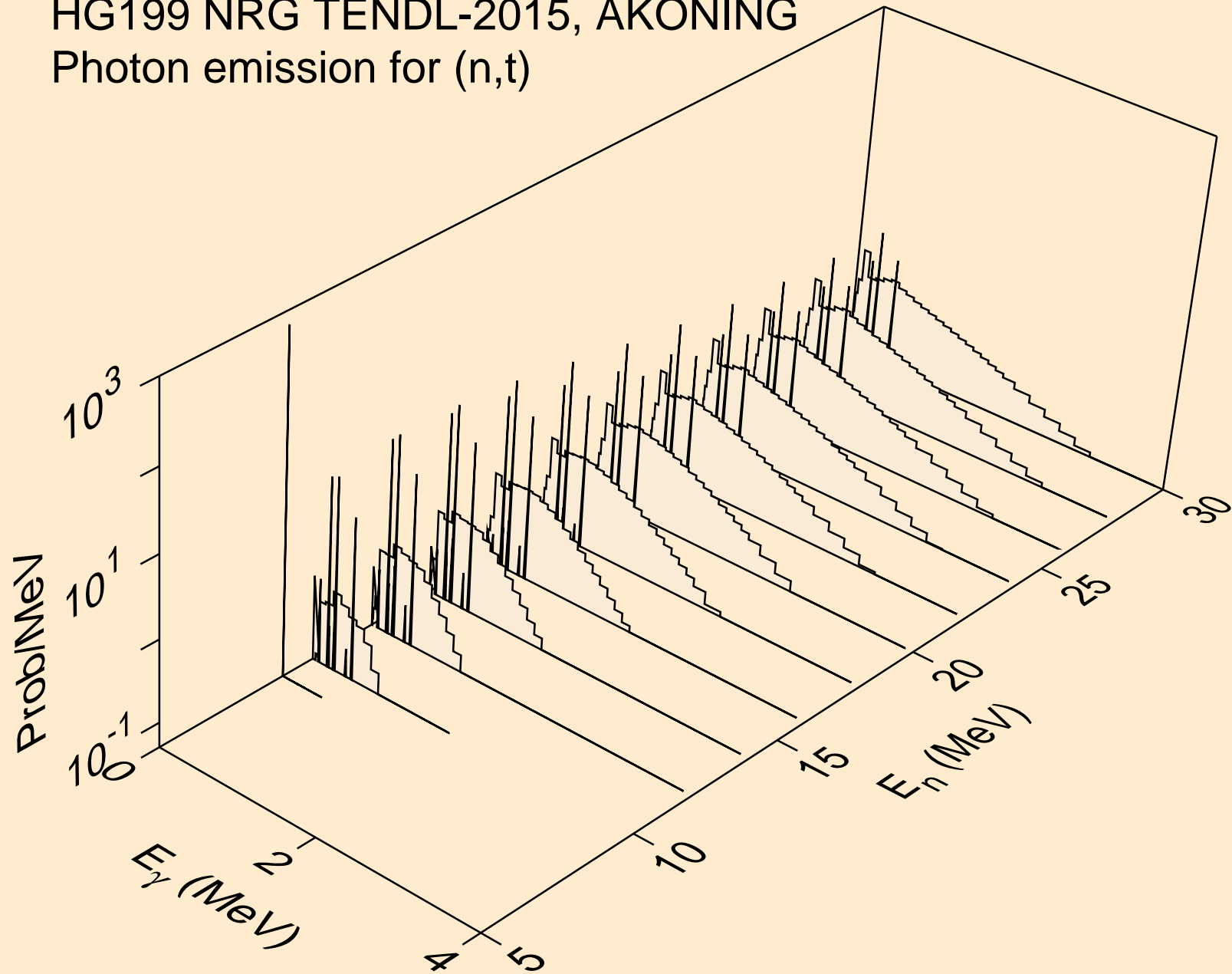



HG199 NRG TENDL-2015, AKONING  
Photon emission for (n,he3)

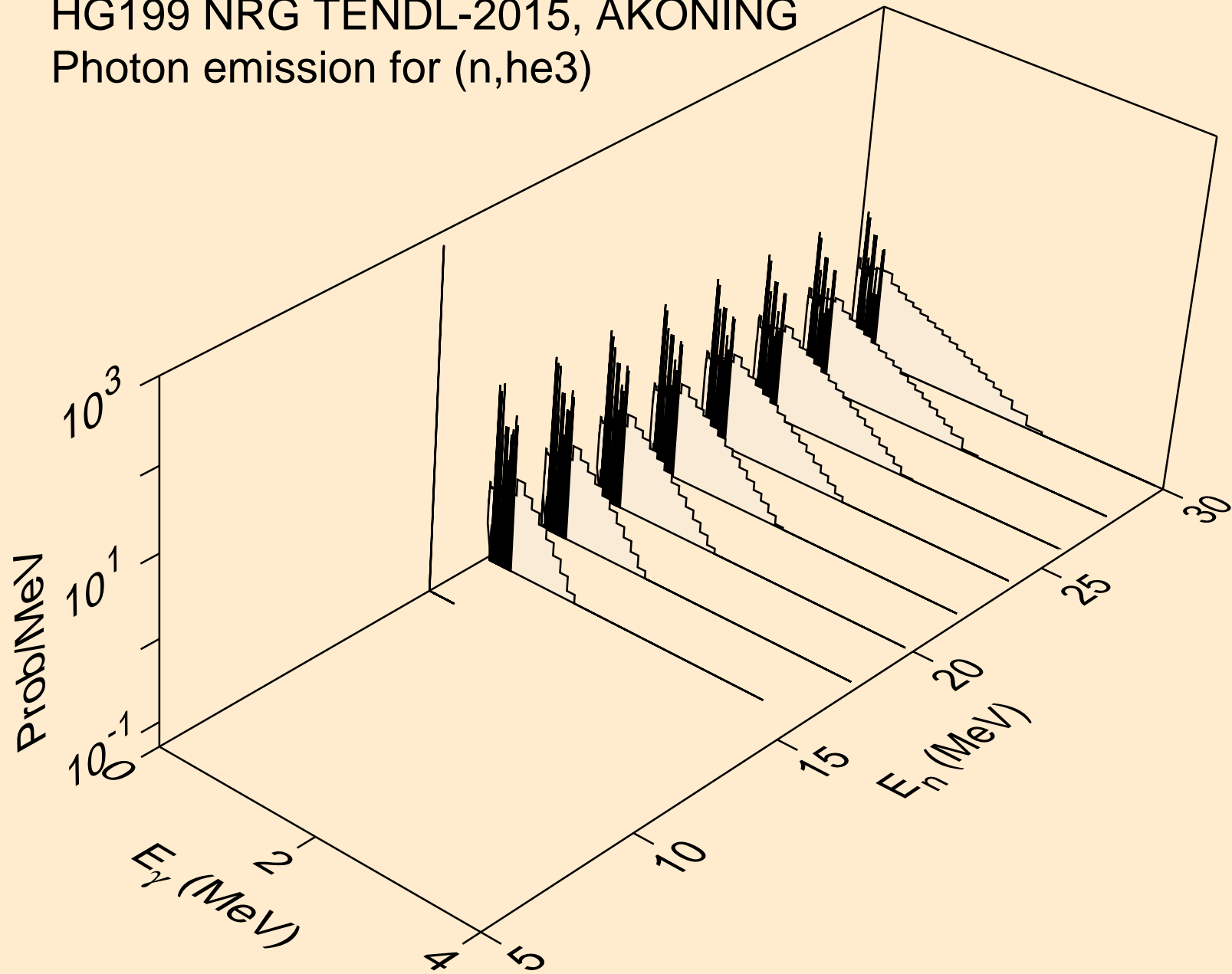

HG199 NRG TENDL-2015, AKONING  
Photon emission for (n,a)

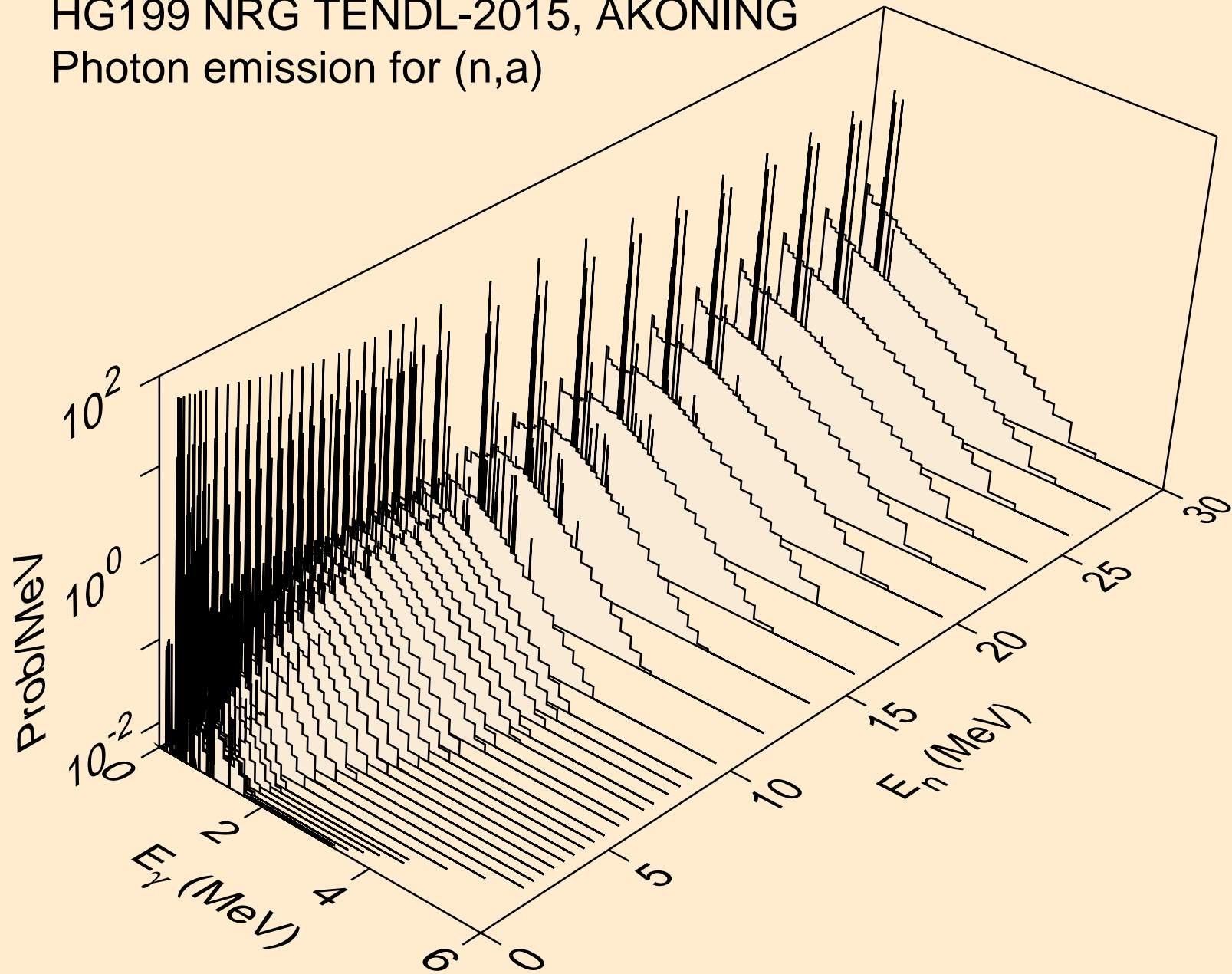

HG199 NRG TENDL-2015, AKONING  
Photon emission for (n,2a)

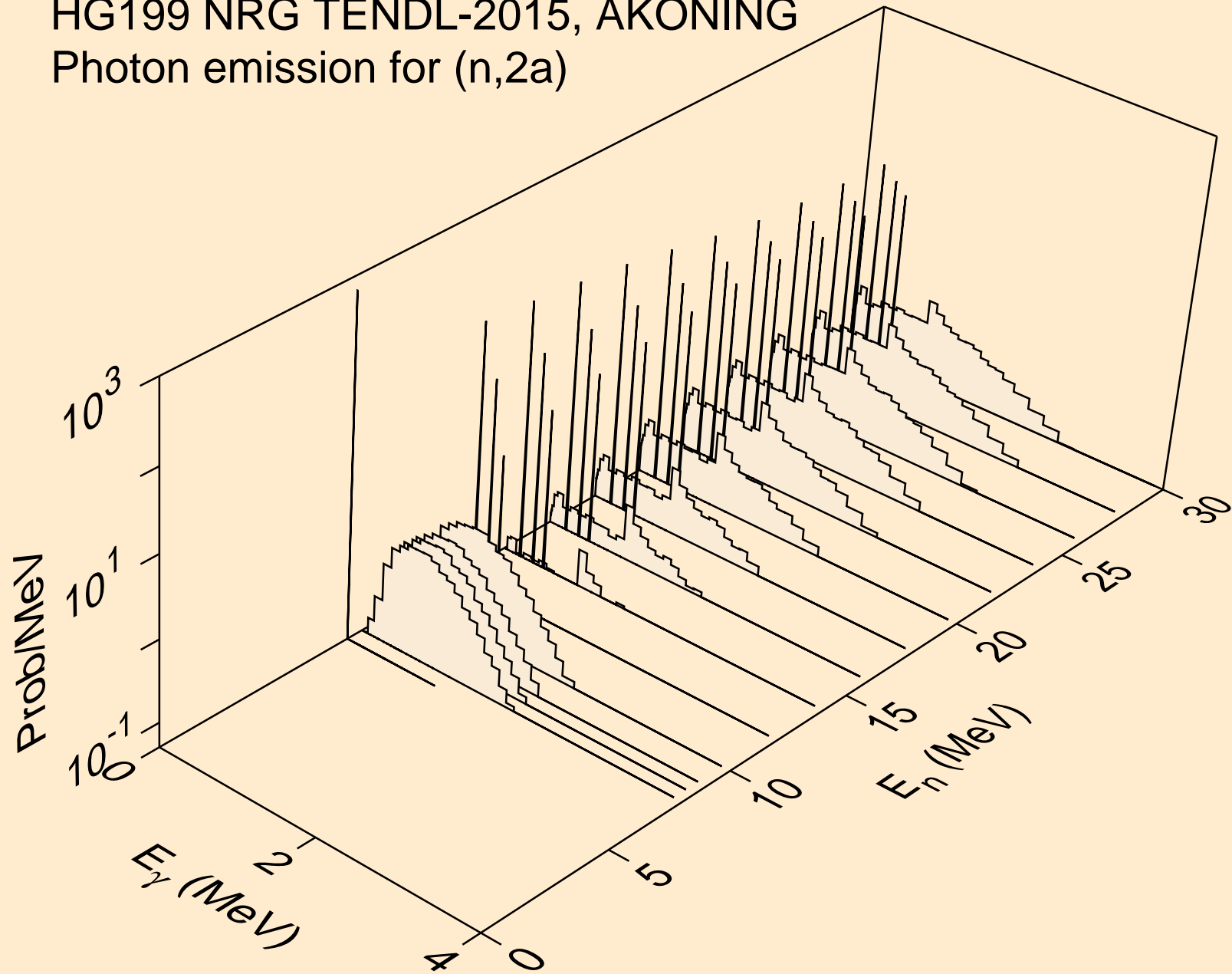

HG199 NRG TENDL-2015, AKONING  
Photon emission for (n,2p)

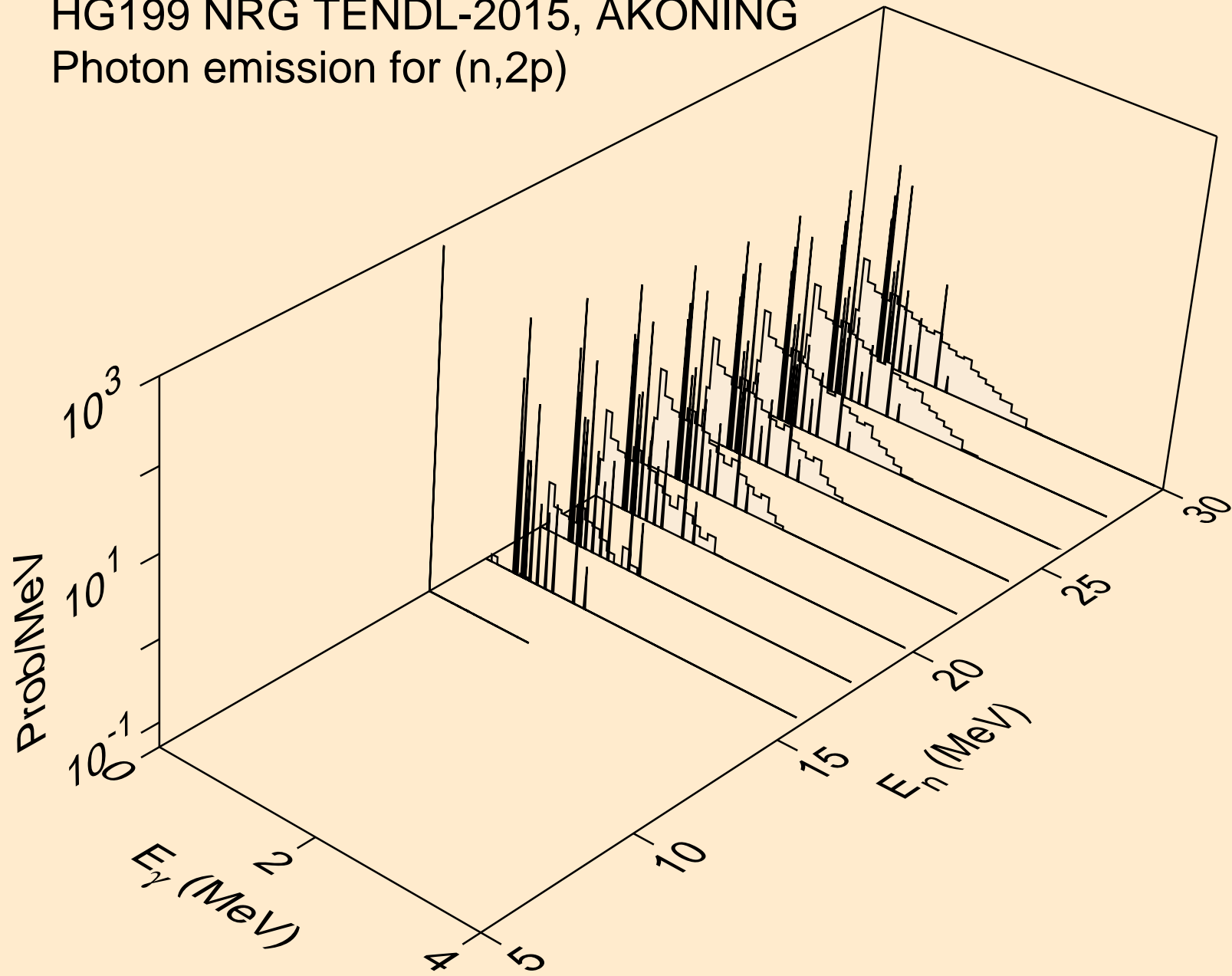

HG199 NRG TENDL-2015, AKONING  
Photon emission for (n,pa)

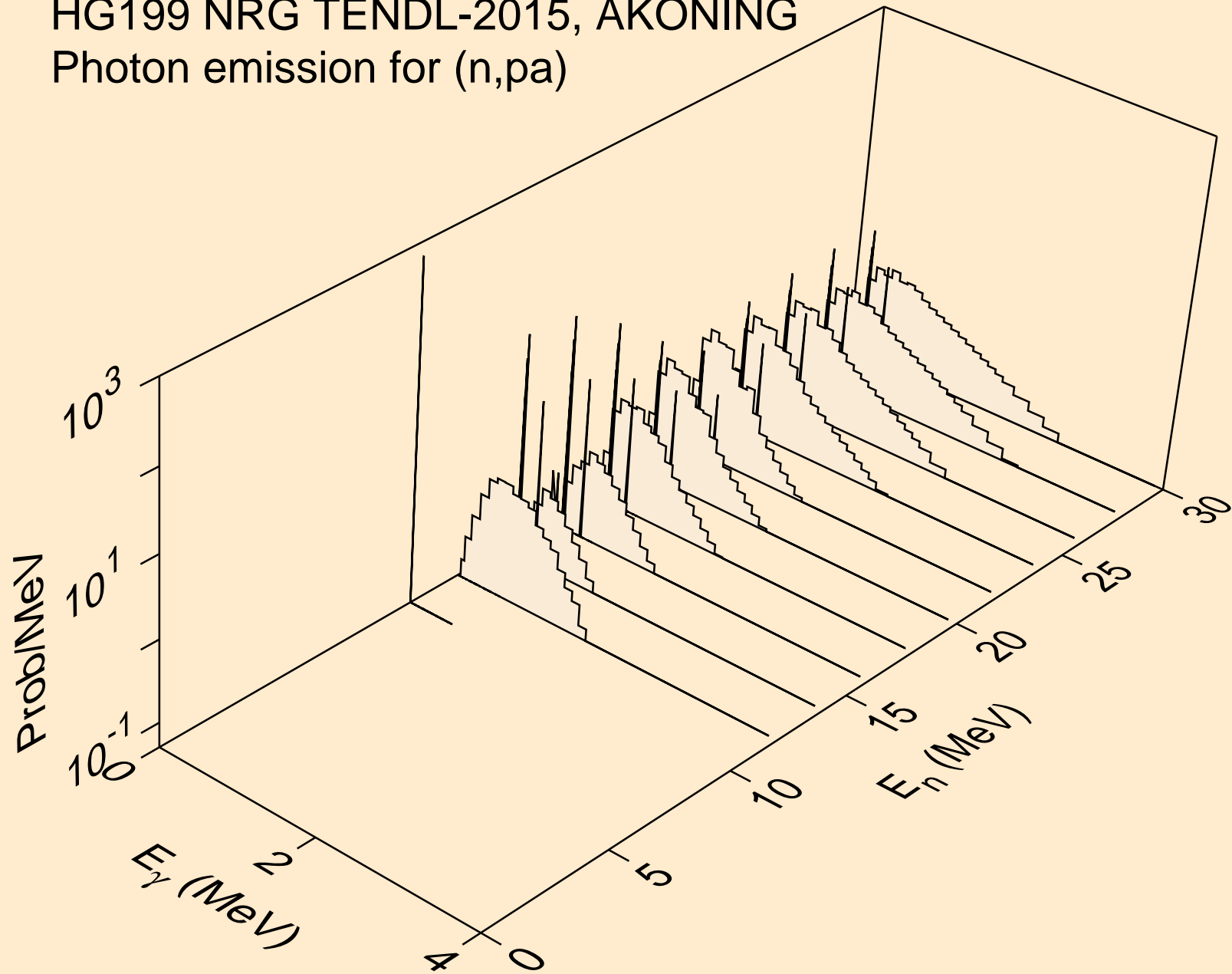

HG199 NRG TENDL-2015, AKONING  
Photon emission for (n,pd)

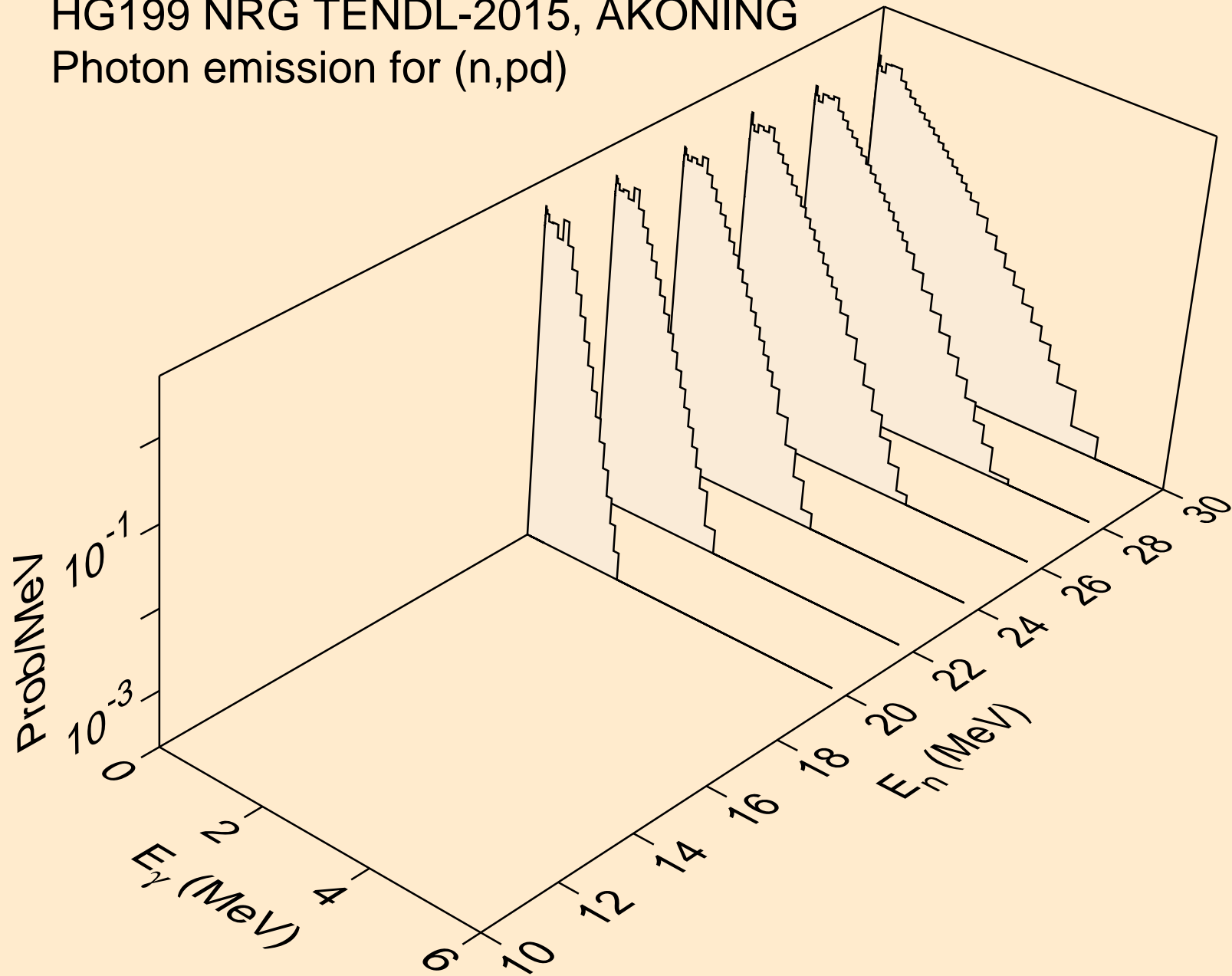

HG199 NRG TENDL-2015, AKONING  
Photon emission for (n,pt)

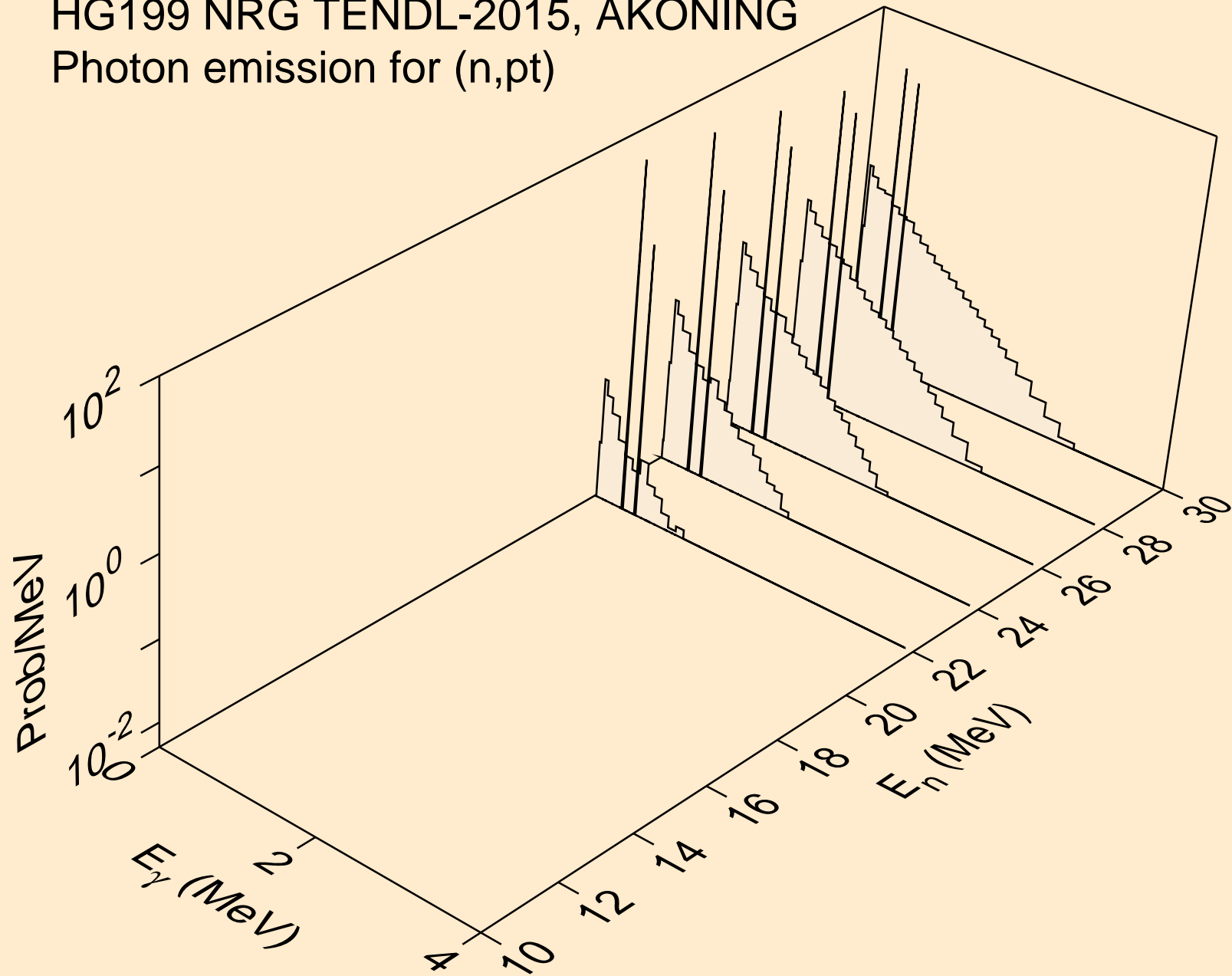

HG199 NRG TENDL-2015, AKONING  
thermal capture photon spectrum

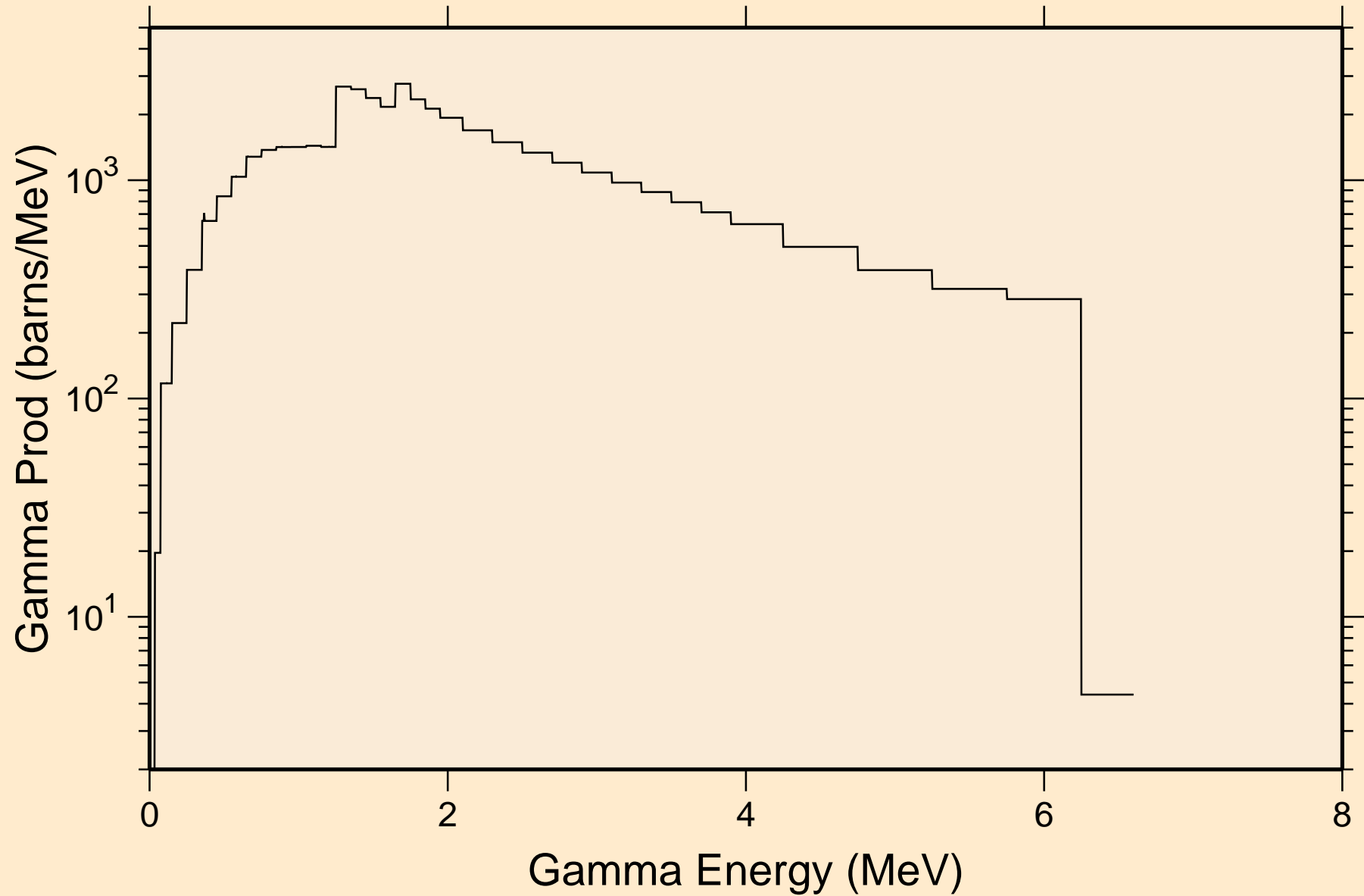



HG199 NRG TENDL-2015, AKONING  
14 MeV photon spectrum

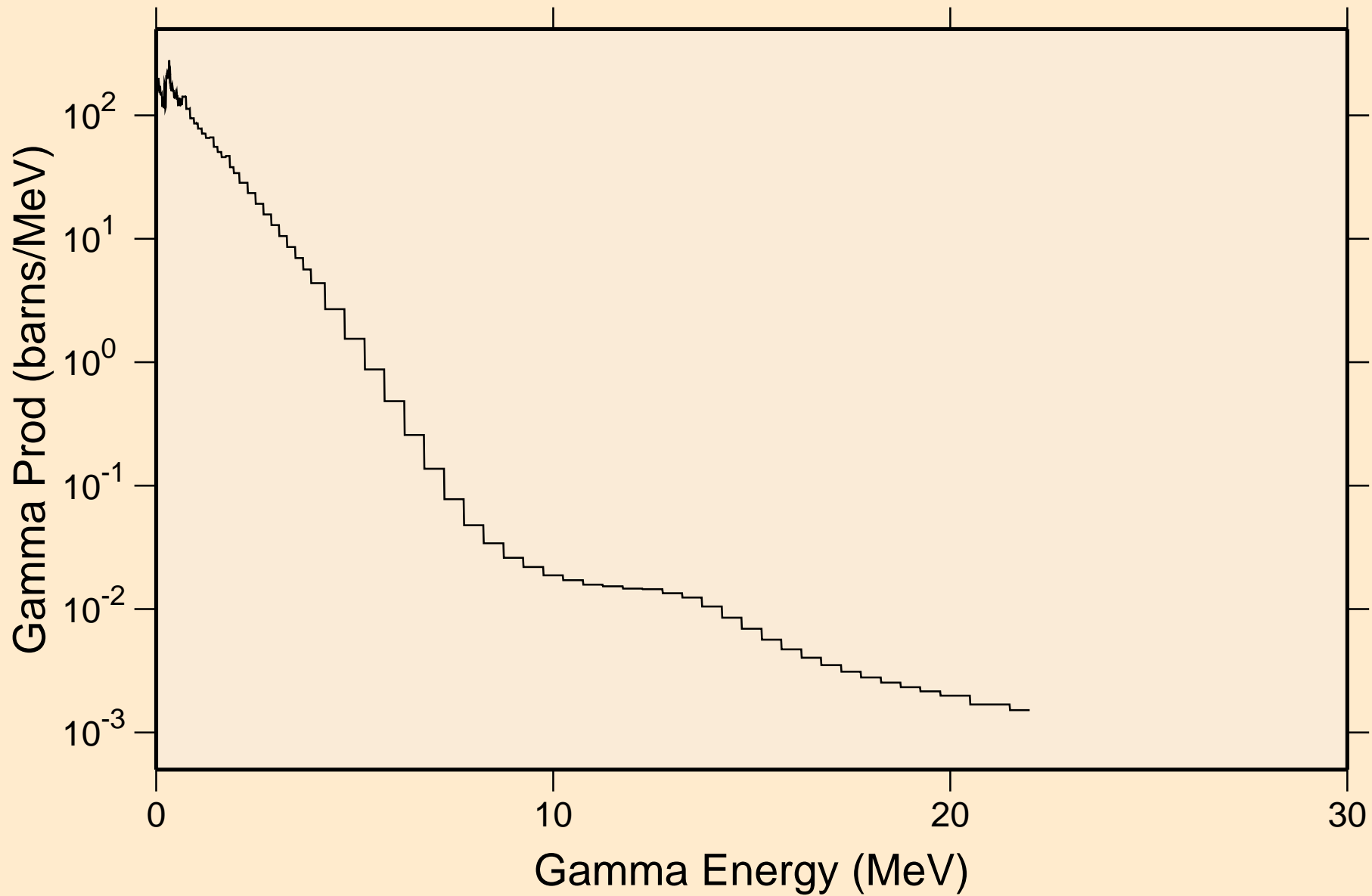

# HG199 NRG TENDL-2015, AKONING

## Particle heating contributions

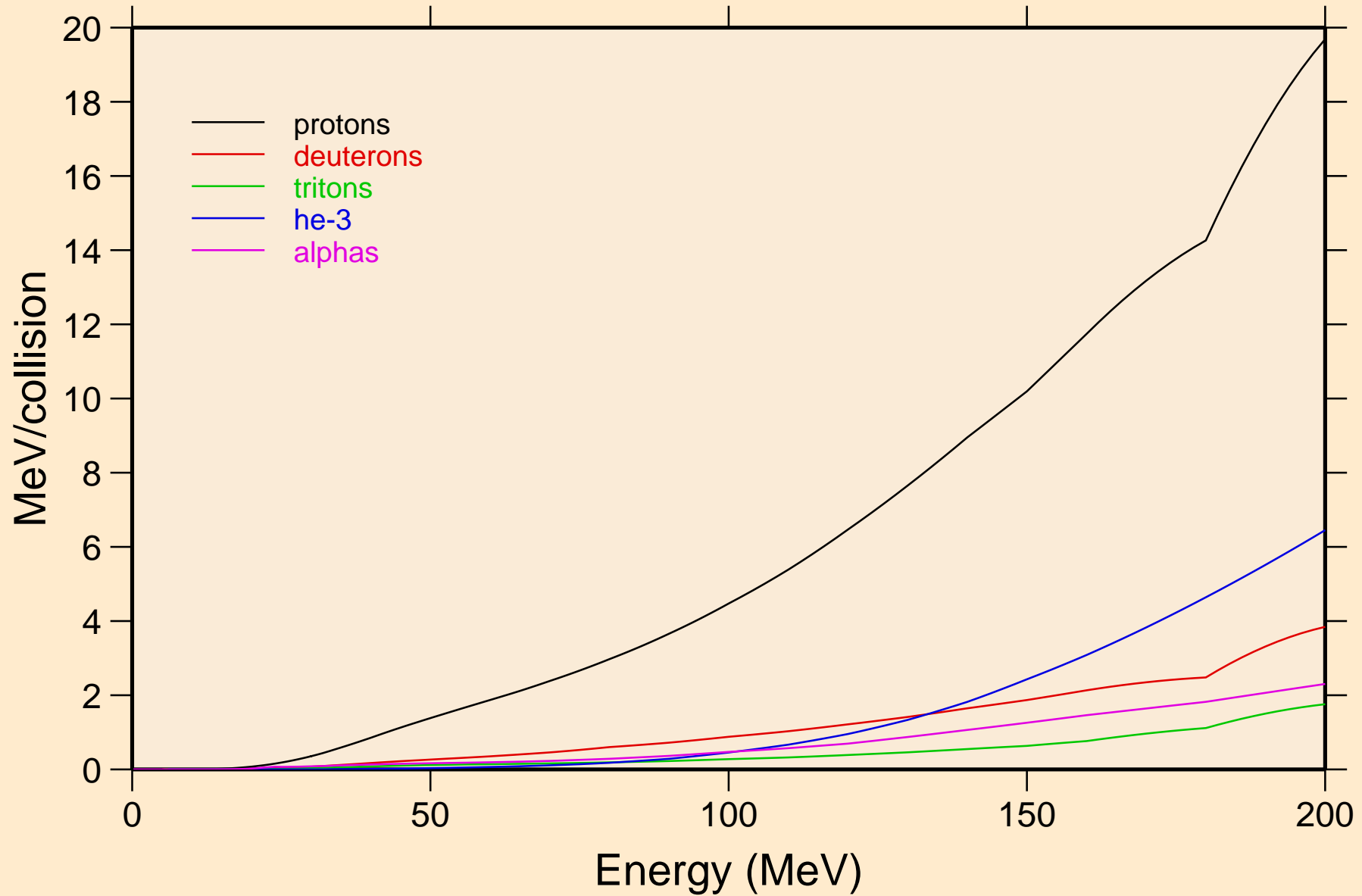

# HG199 NRG TENDL-2015, AKONING

## Recoil Heating

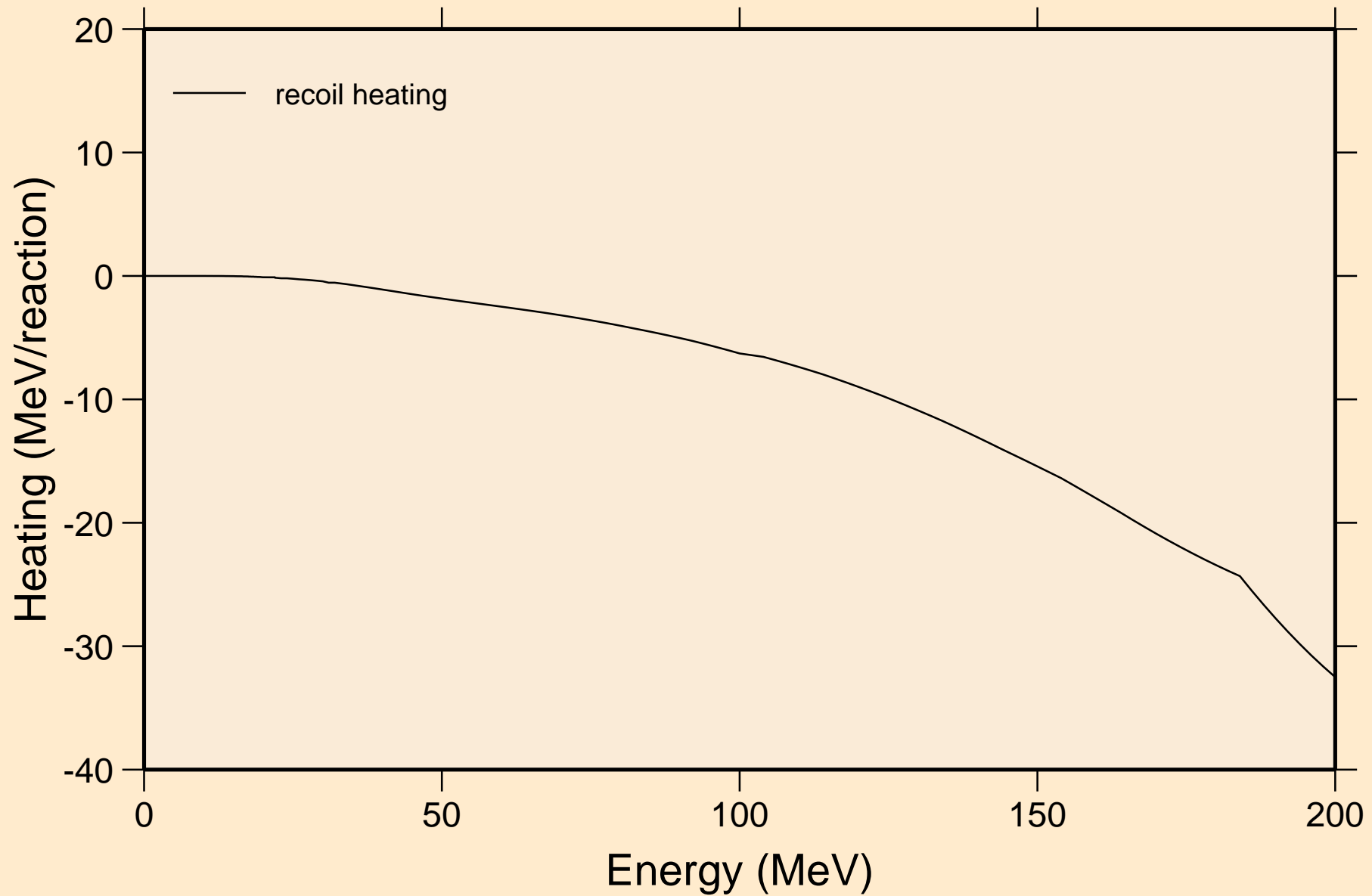

# HG199 NRG TENDL-2015, AKONING

## Particle production cross sections

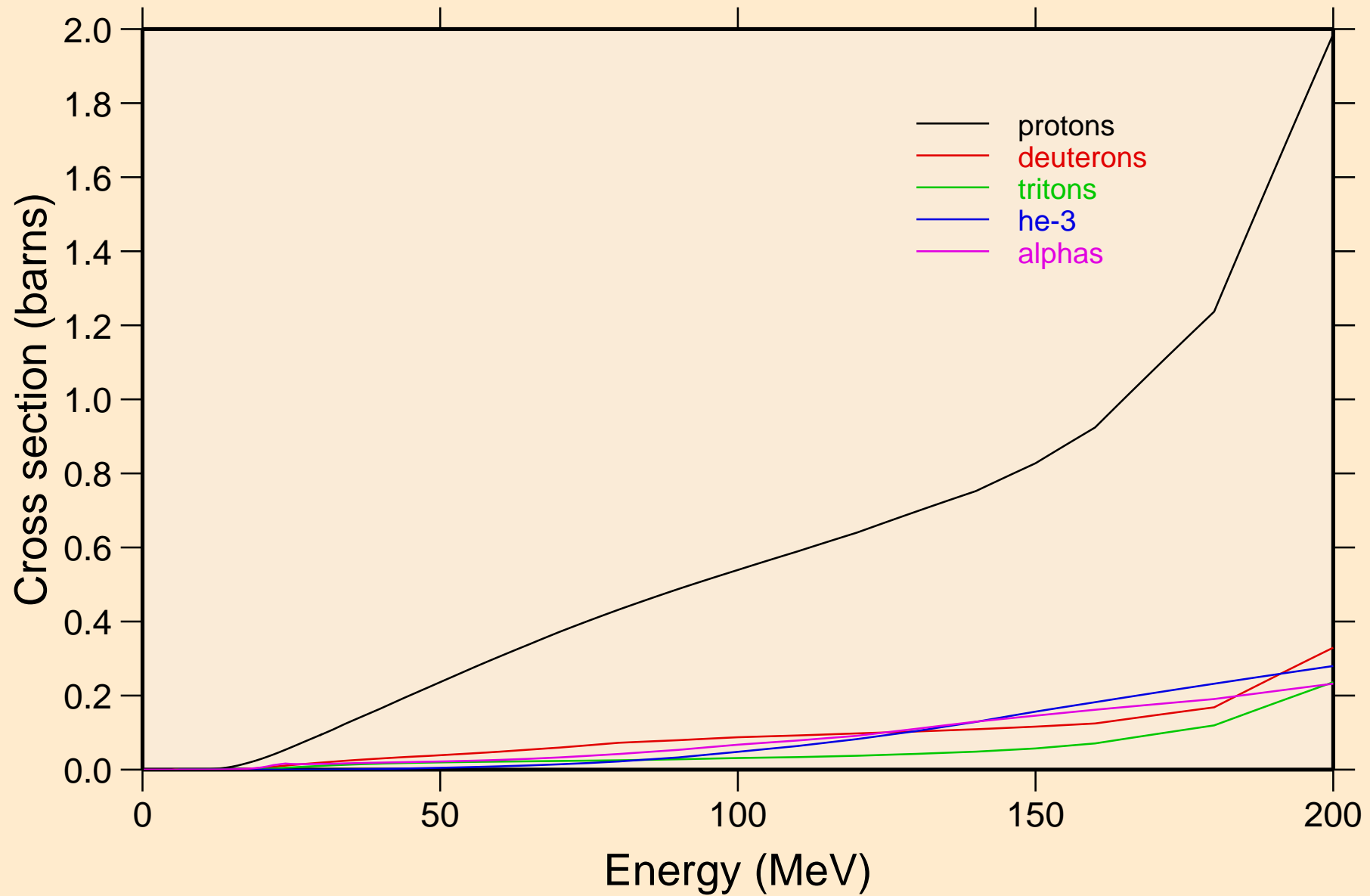

HG199 NRG TENDL-2015, AKONING  
protons from (n,x)

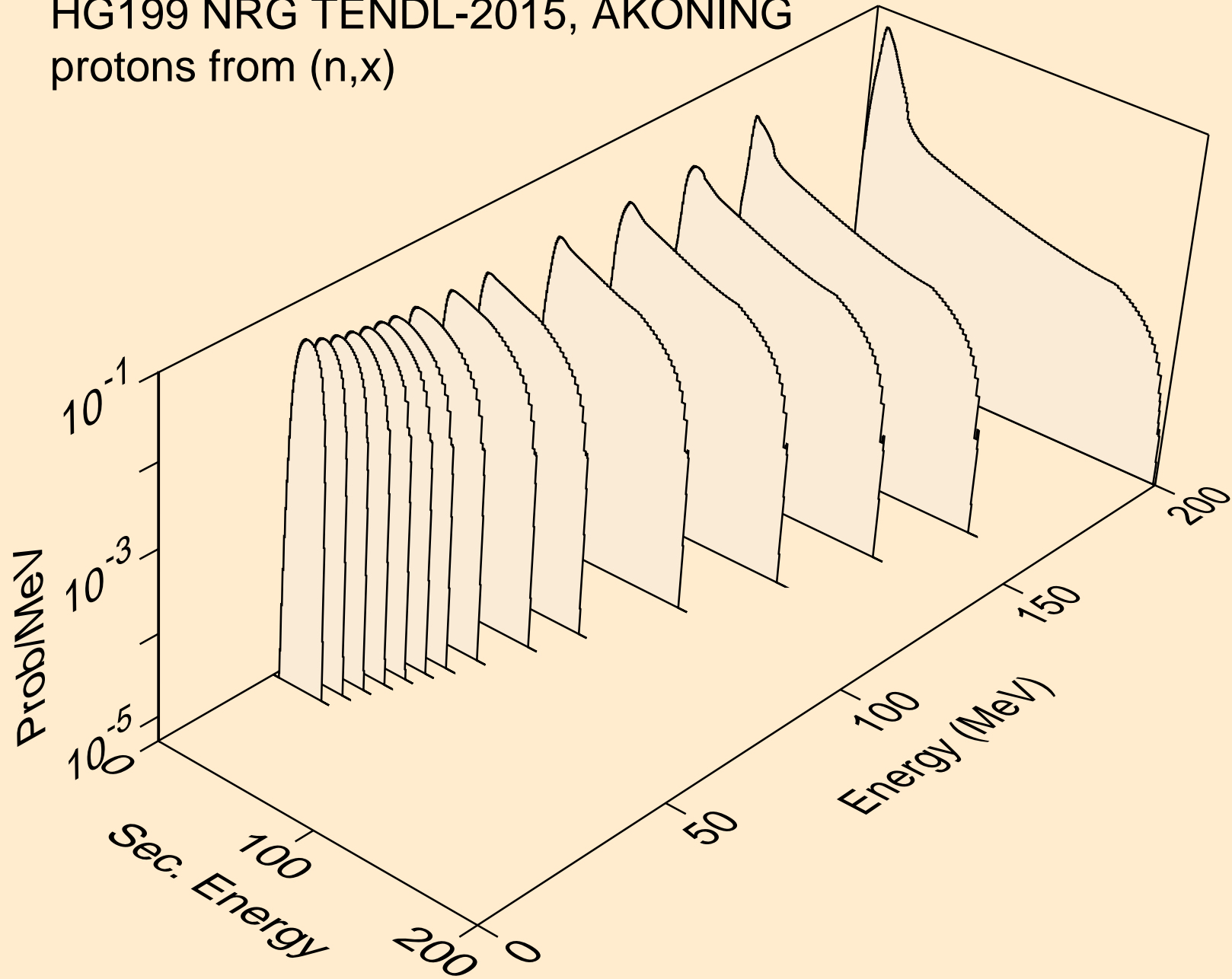

HG199 NRG TENDL-2015, AKONING  
protons from (n,n\*)p

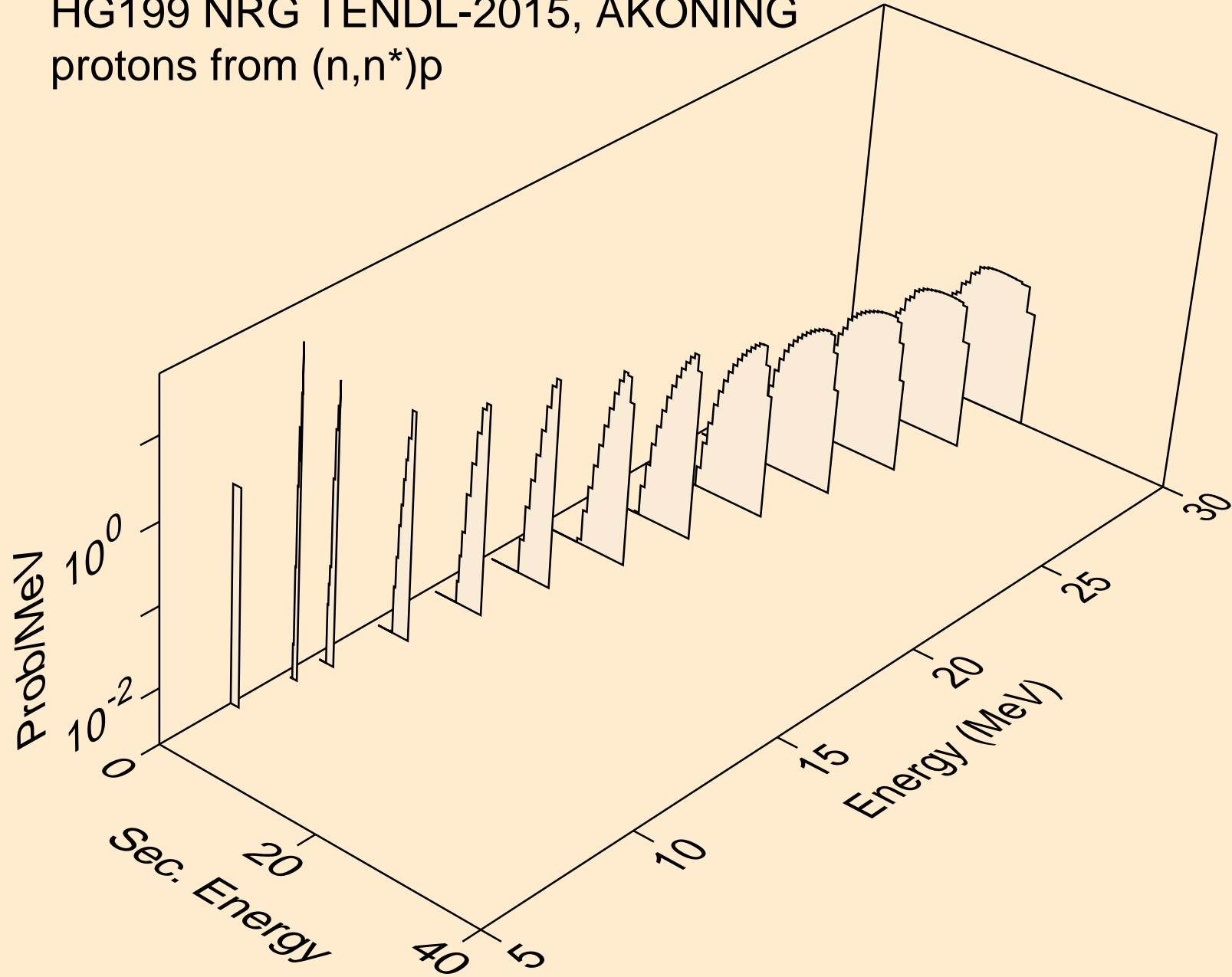

HG199 NRG TENDL-2015, AKONING  
protons from (n,2np)

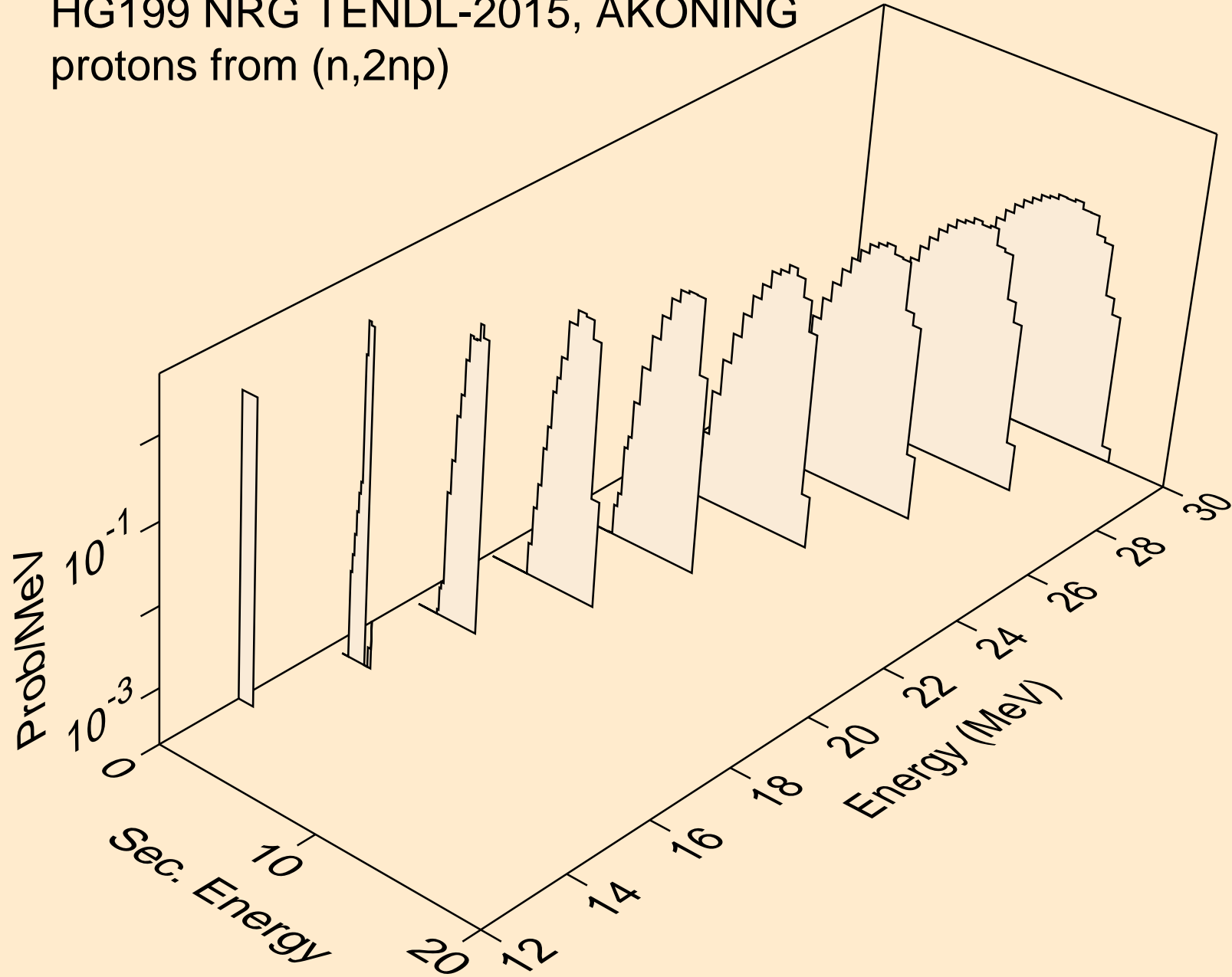

HG199 NRG TENDL-2015, AKONING  
protons from (n,3np)

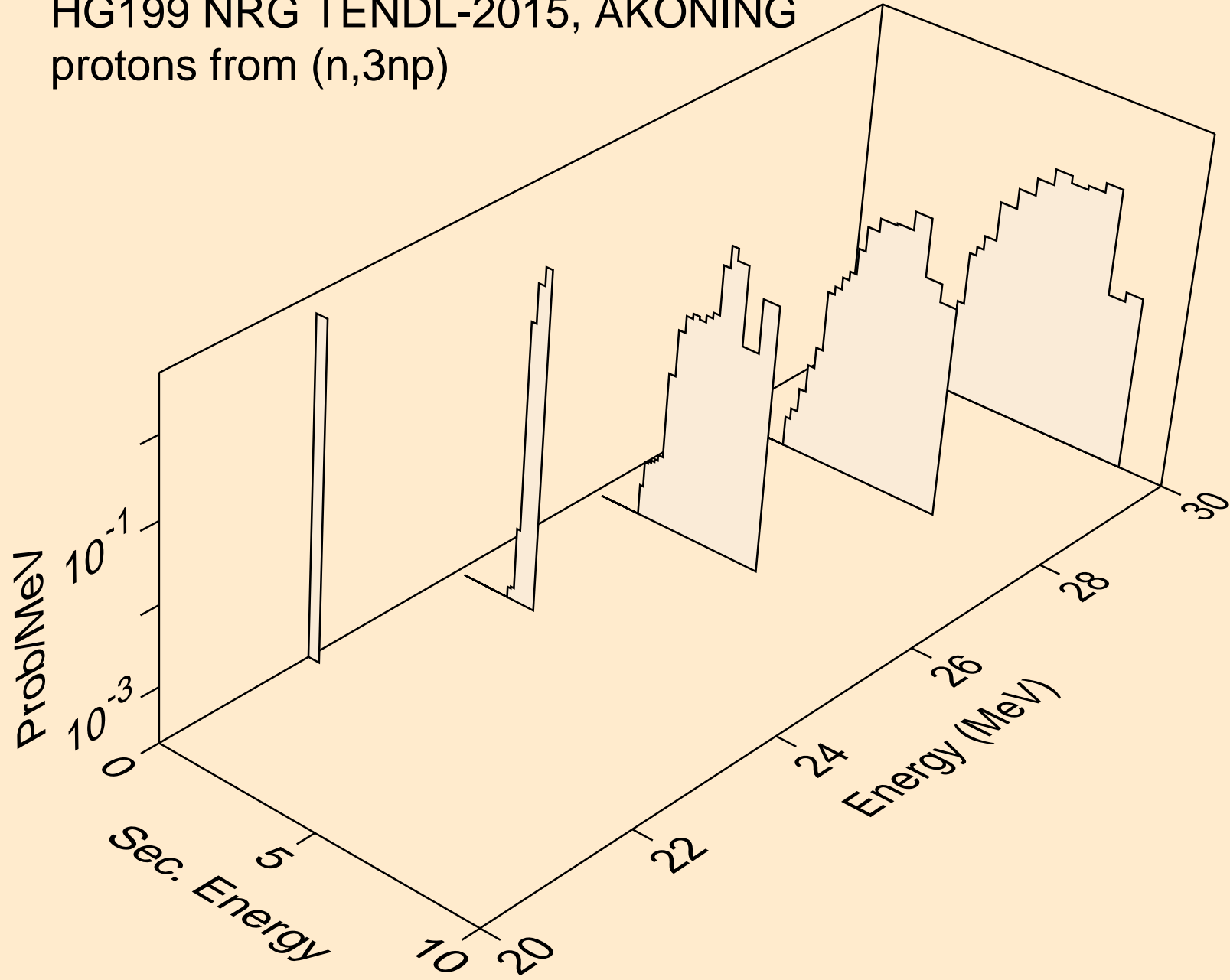



HG199 NRG TENDL-2015, AKONING  
protons from (n,2np)

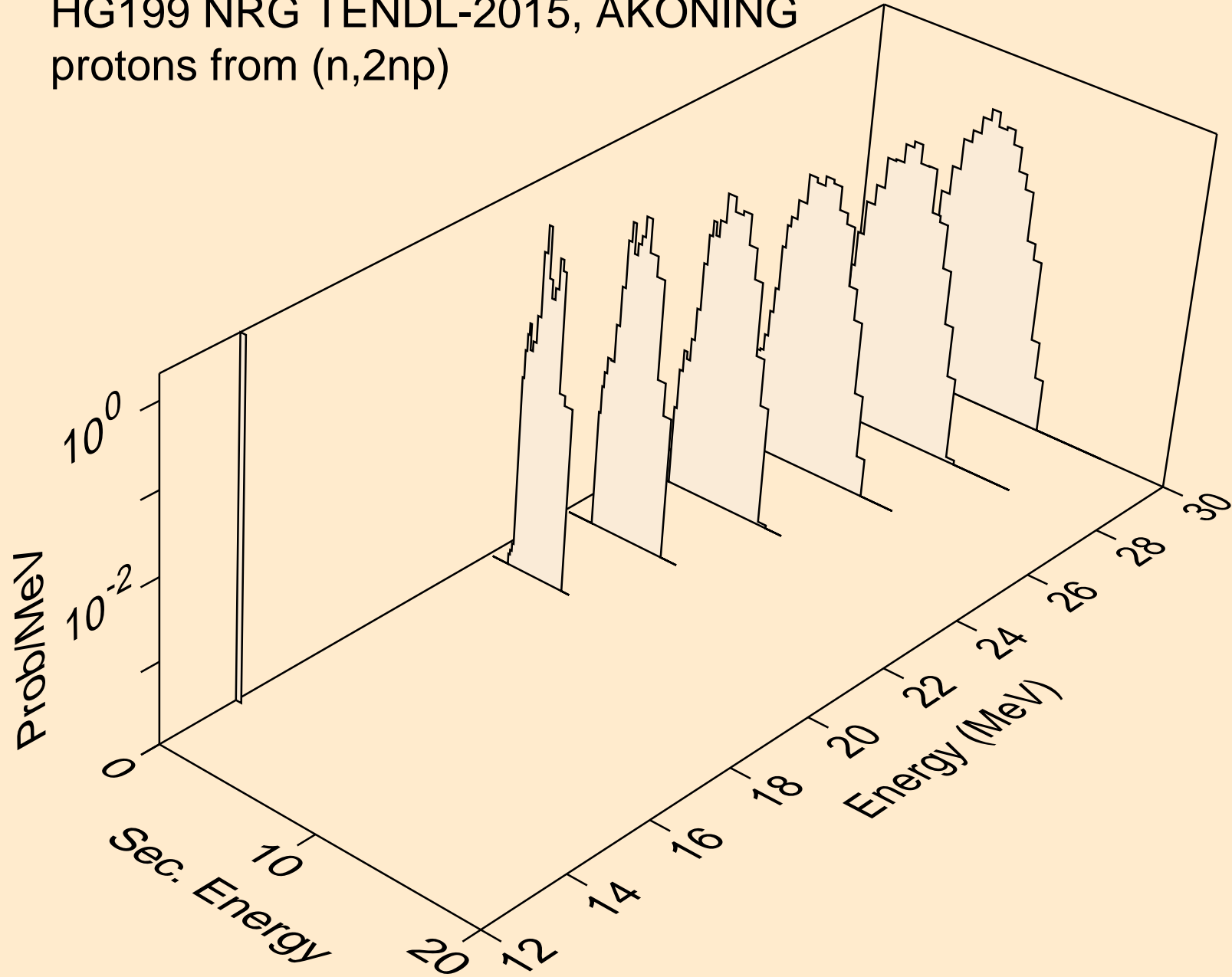

HG199 NRG TENDL-2015, AKONING  
protons from (n,npa)

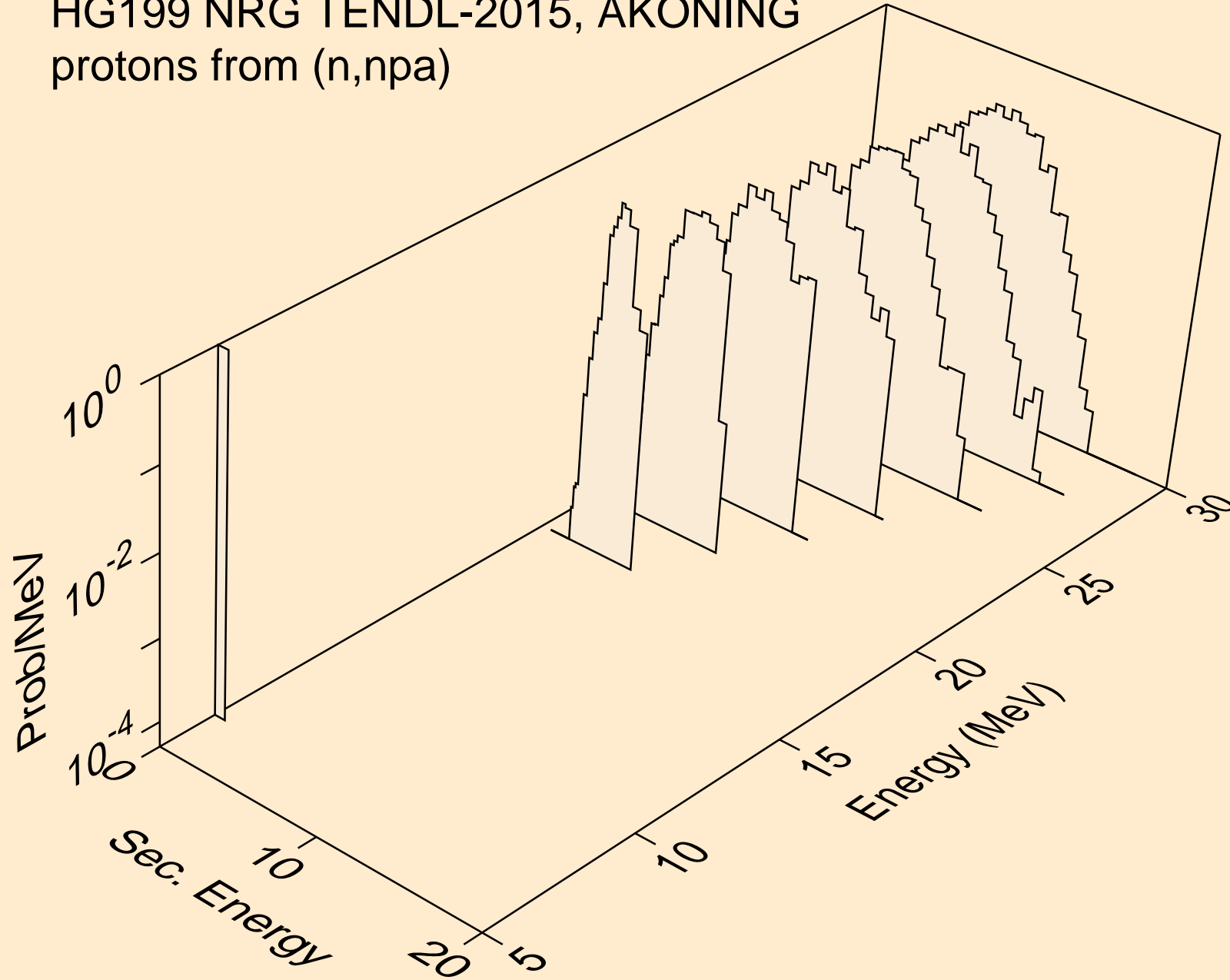

HG199 NRG TENDL-2015, AKONING  
protons from (n,p)

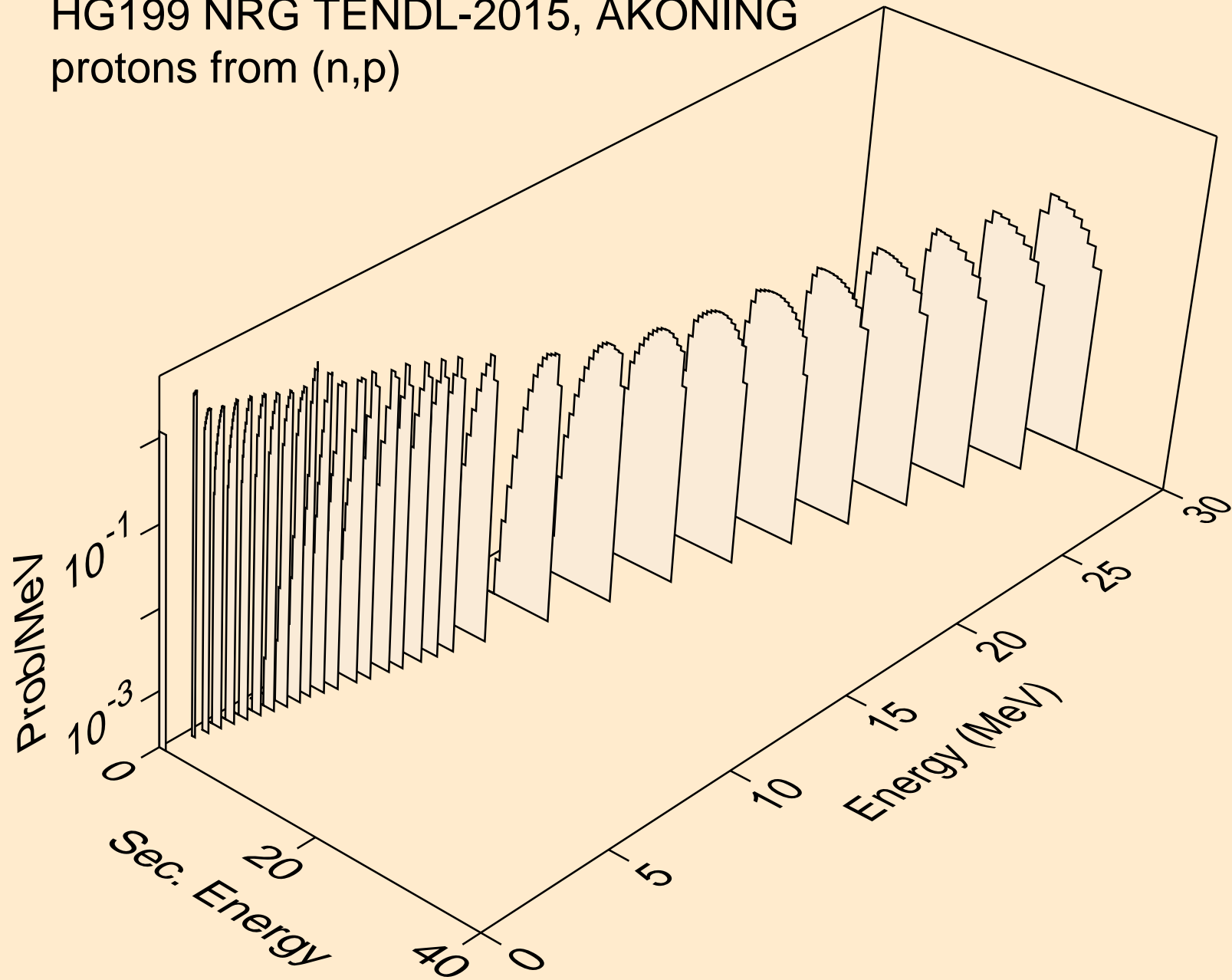

HG199 NRG TENDL-2015, AKONING  
protons from (n,2p)

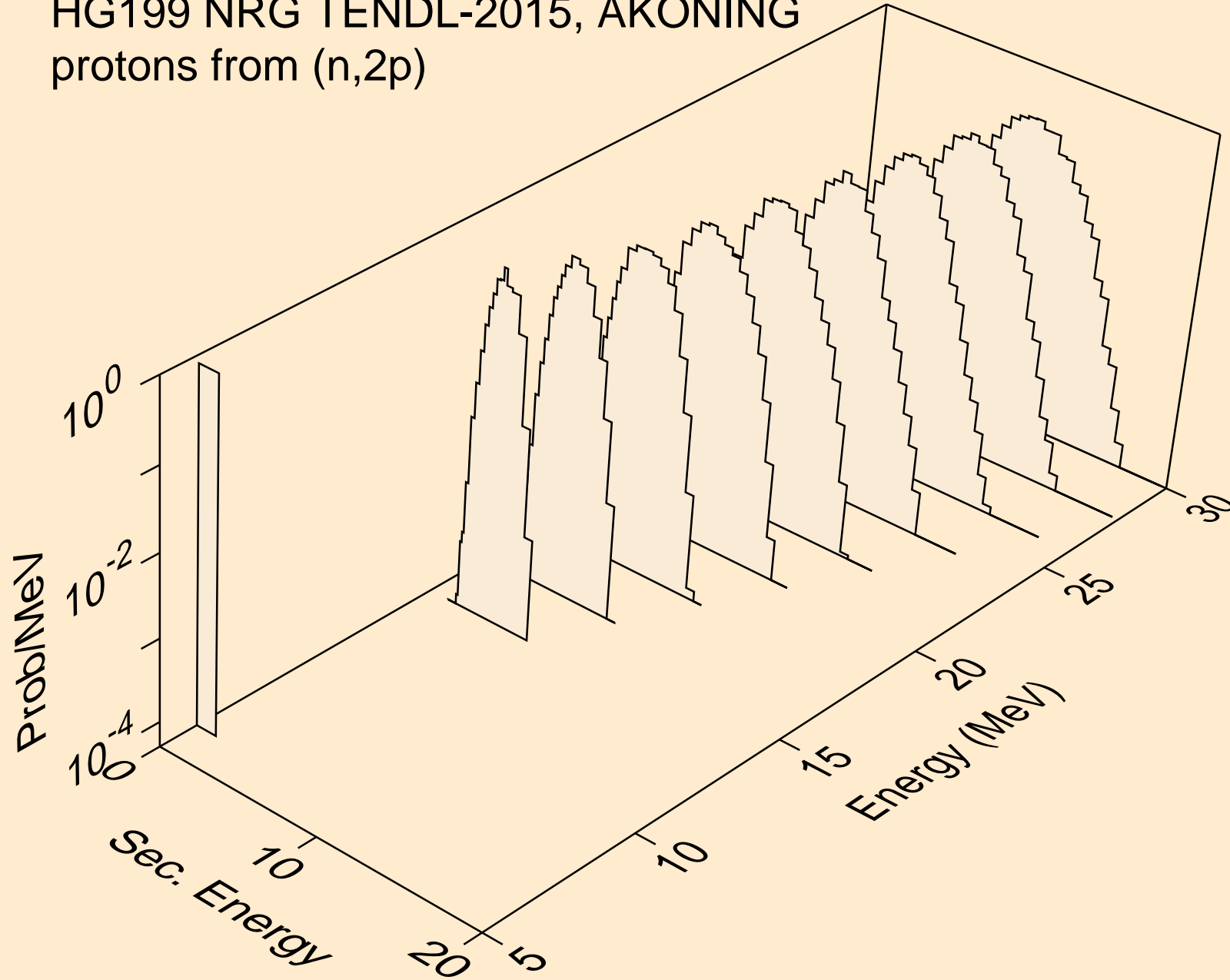

HG199 NRG TENDL-2015, AKONING  
protons from (n,pa)

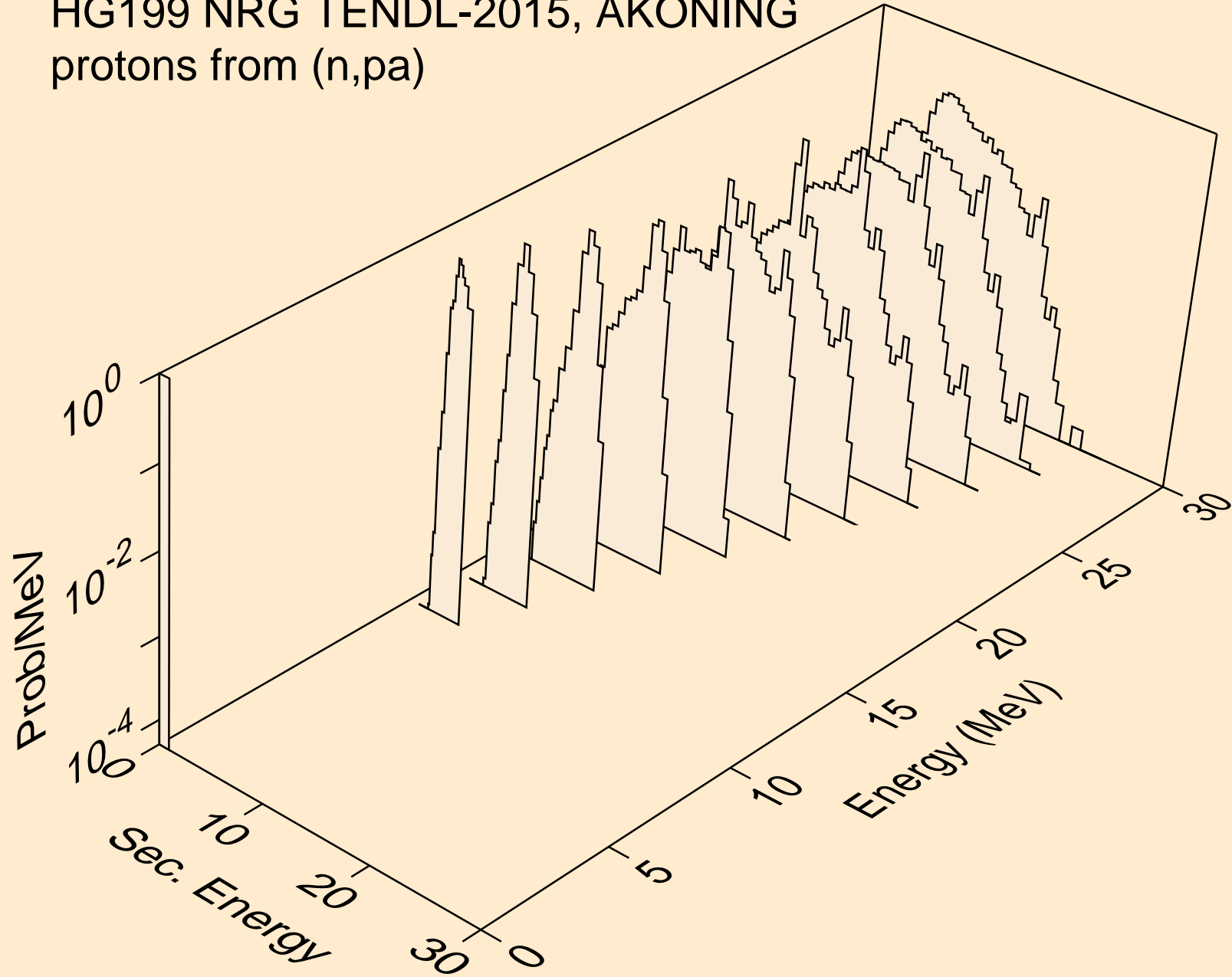

HG199 NRG TENDL-2015, AKONING  
protons from (n,pd)

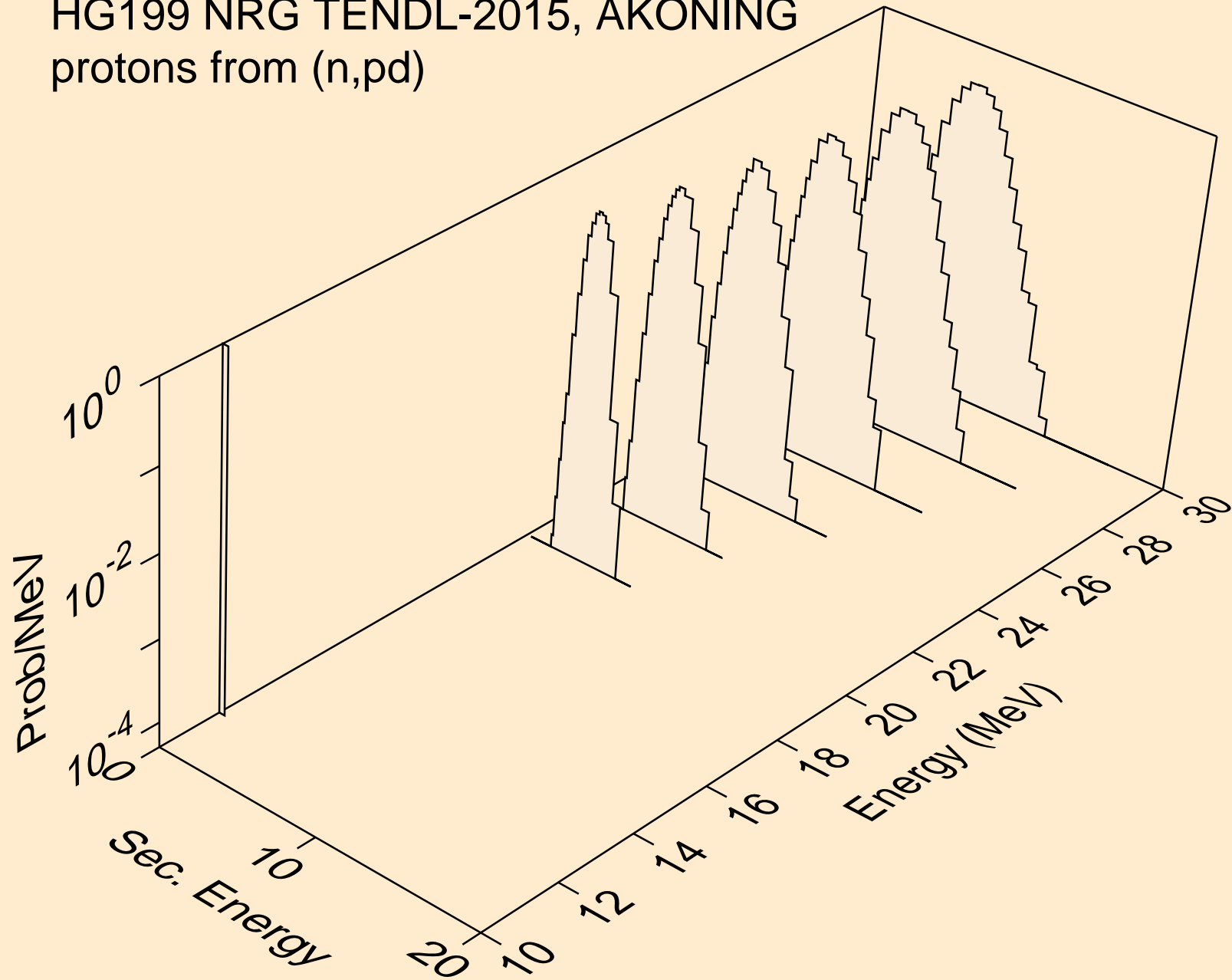

HG199 NRG TENDL-2015, AKONING  
protons from (n,pt)

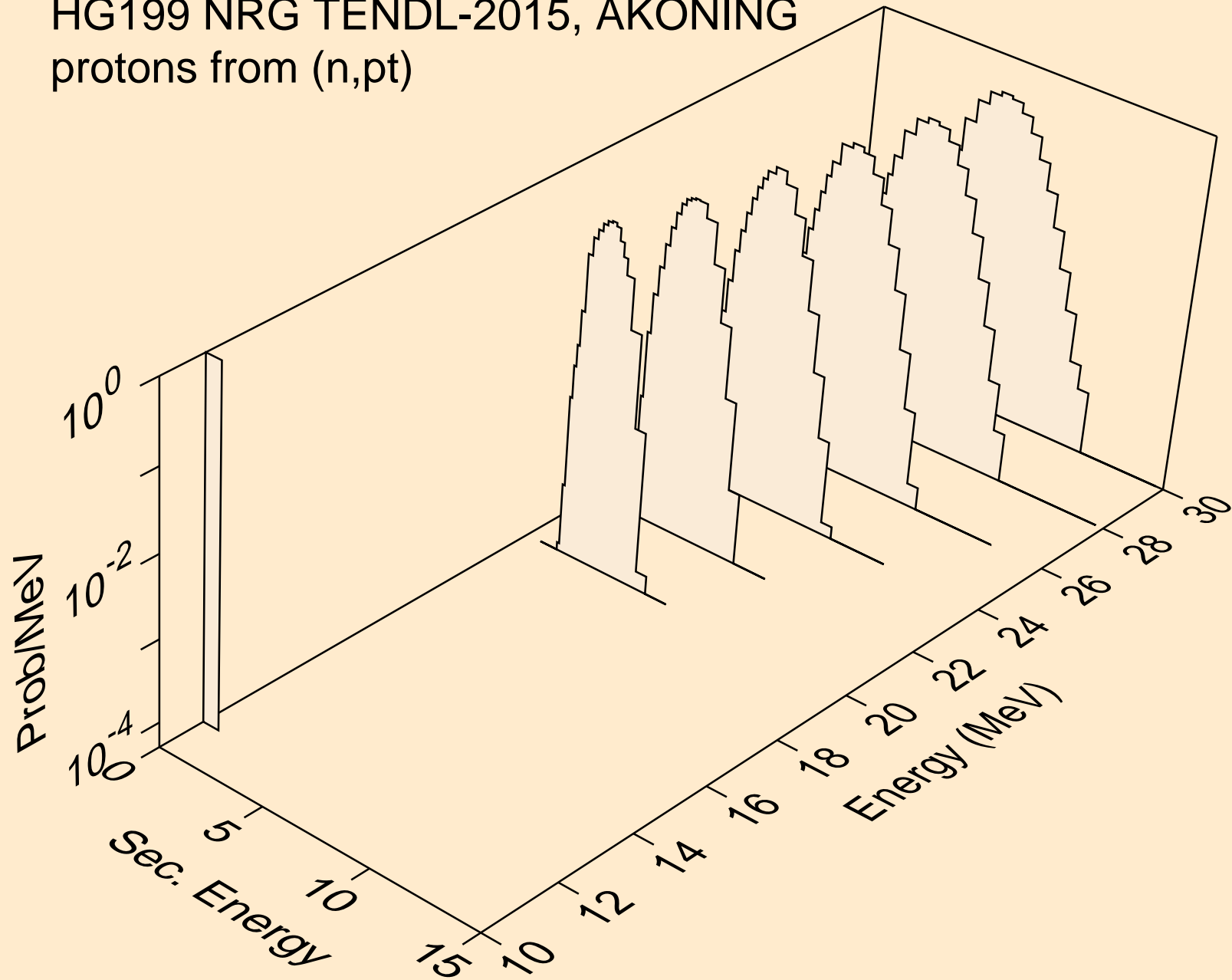

HG199 NRG TENDL-2015, AKONING  
deuterons from (n,x)

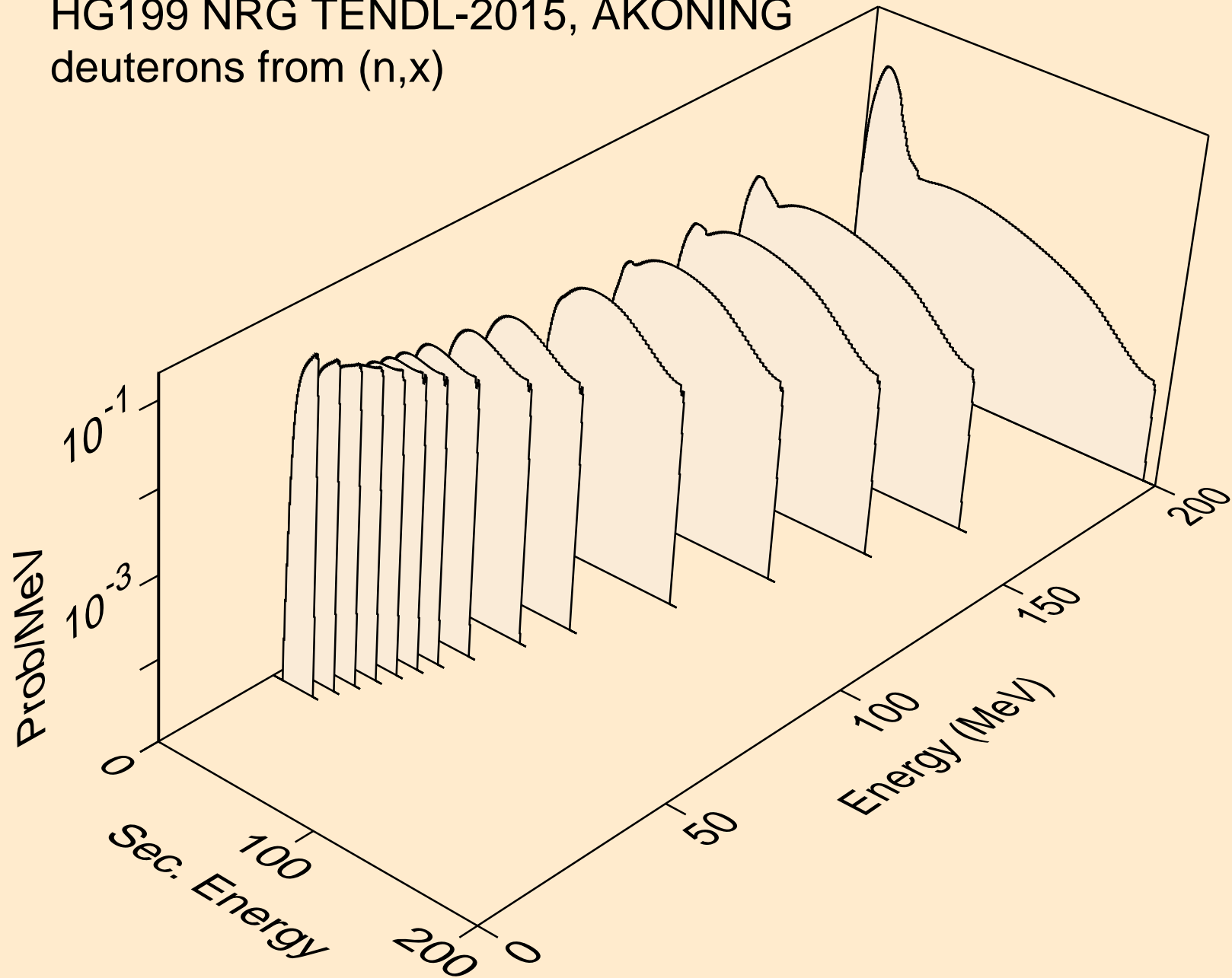



HG199 NRG TENDL-2015, AKONING  
deuterons from (n,2nd)

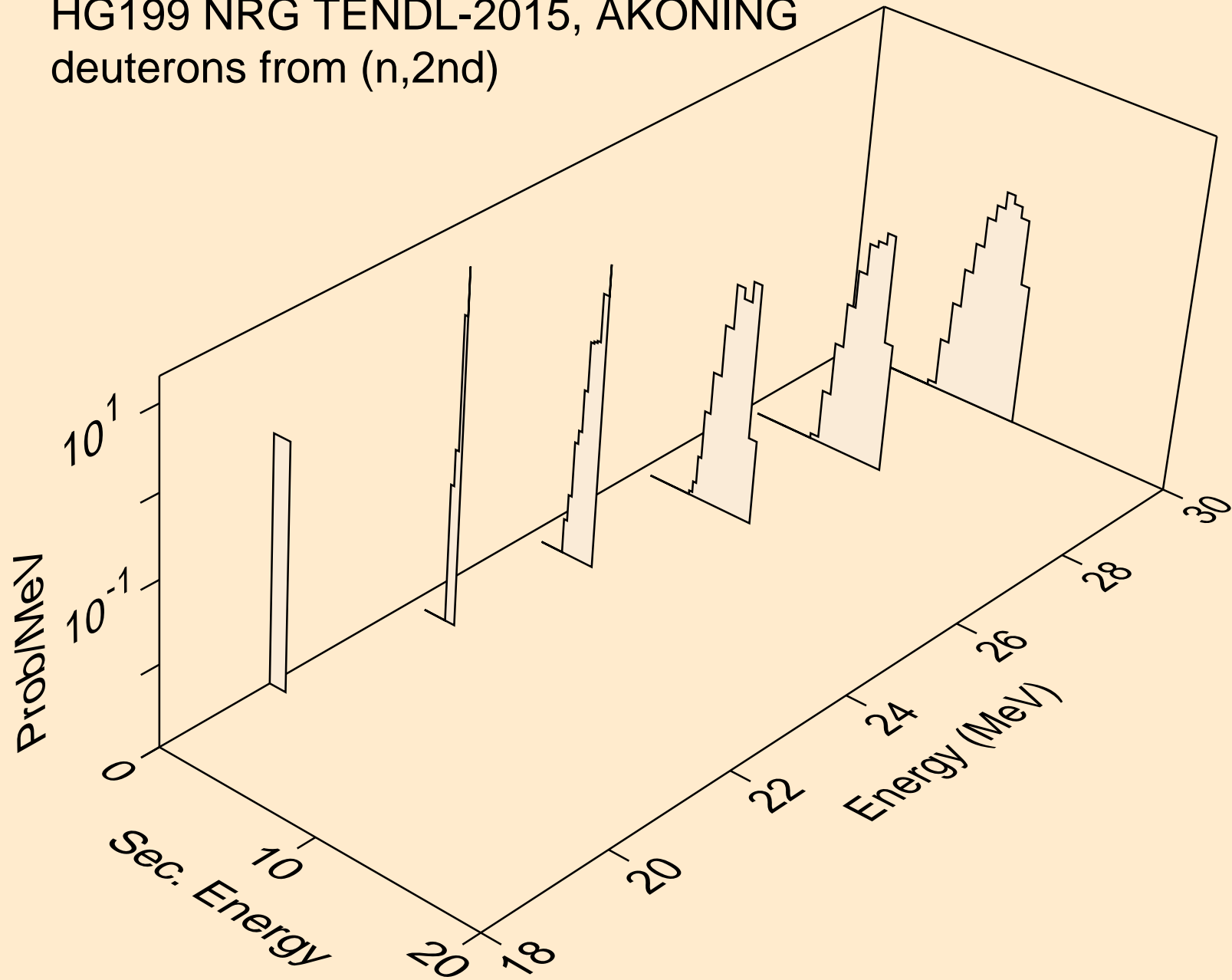

HG199 NRG TENDL-2015, AKONING  
deuterons from (n,n\*)d

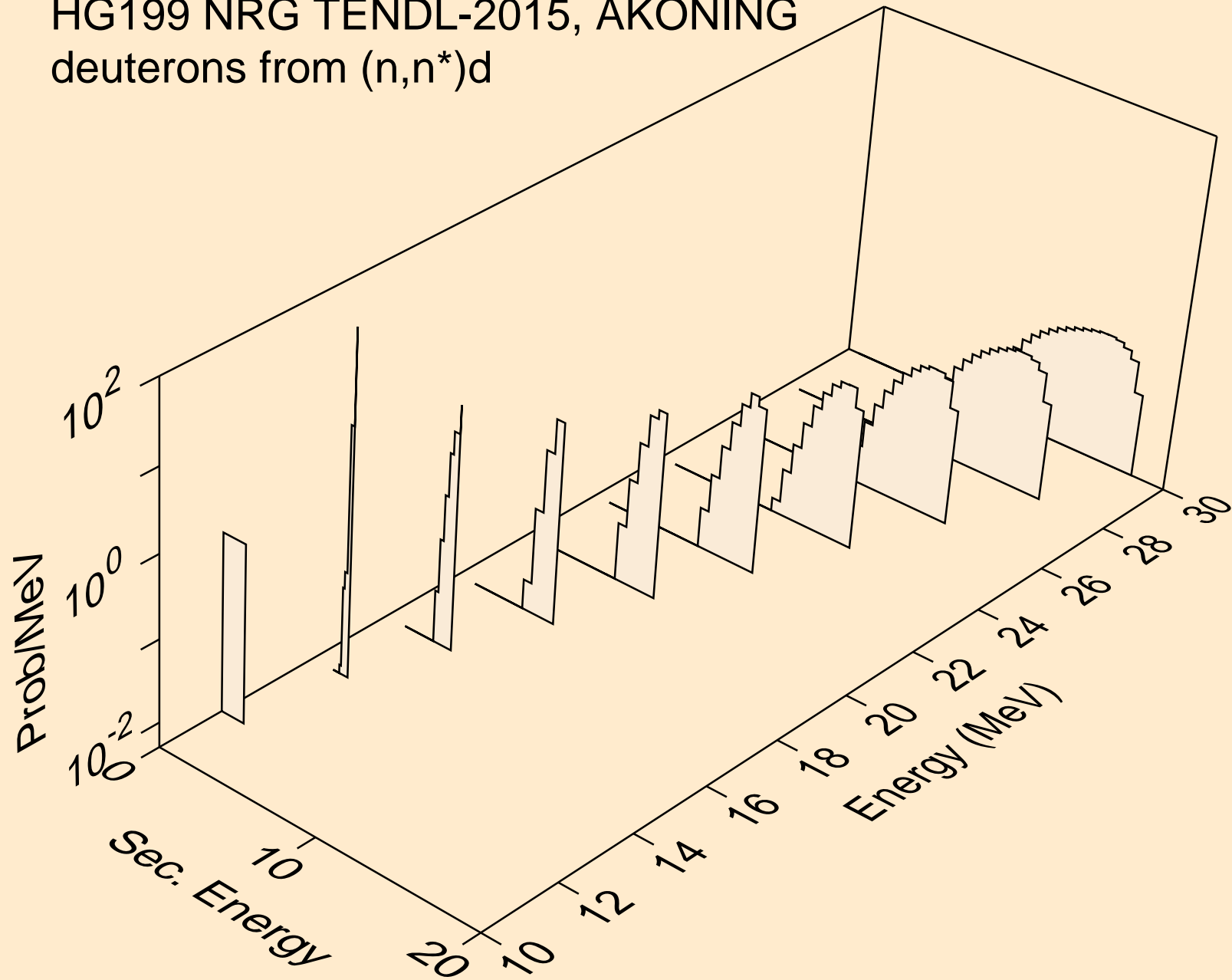

HG199 NRG TENDL-2015, AKONING  
deuterons from (n,d)

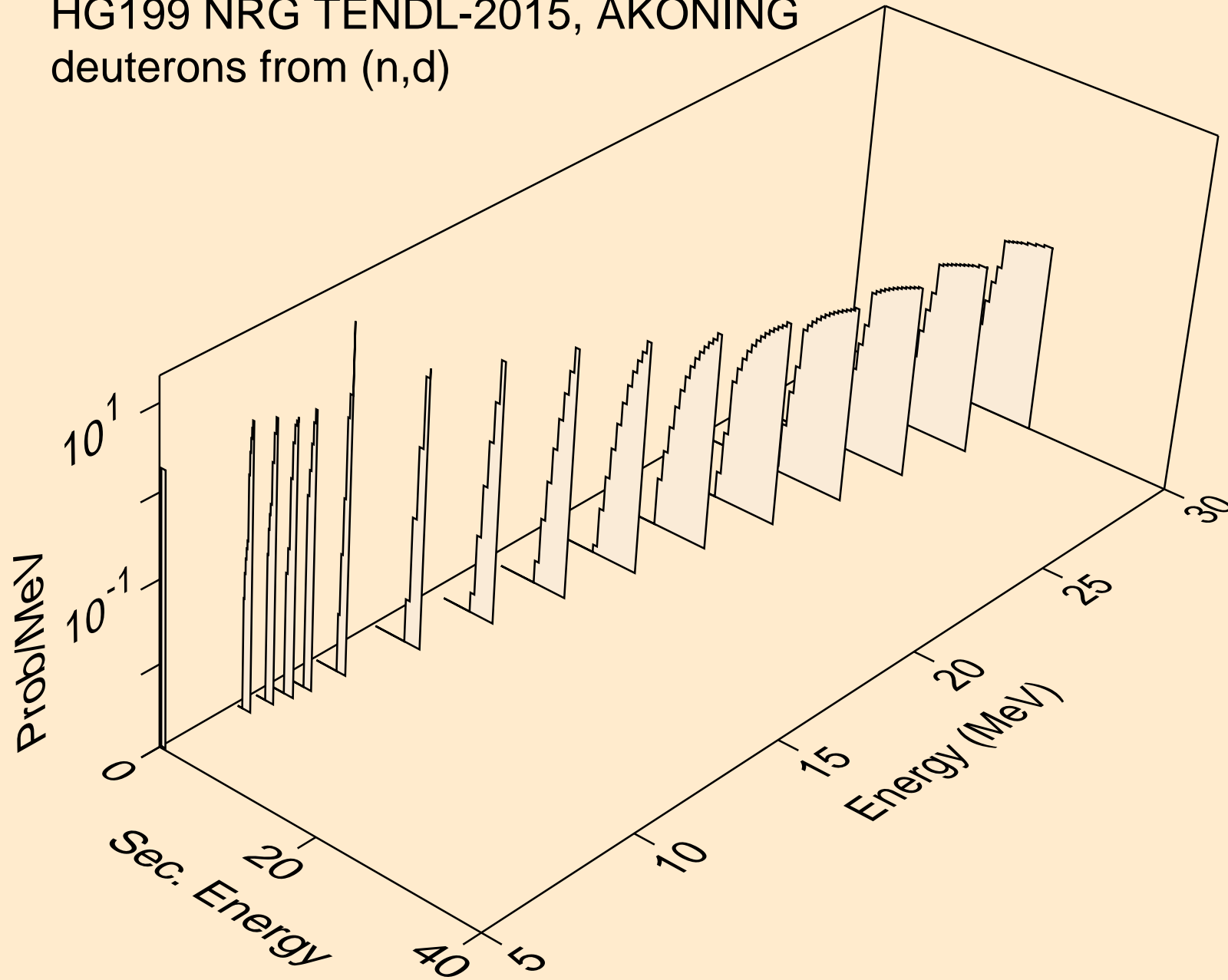

HG199 NRG TENDL-2015, AKONING  
deuterons from (n,pd)

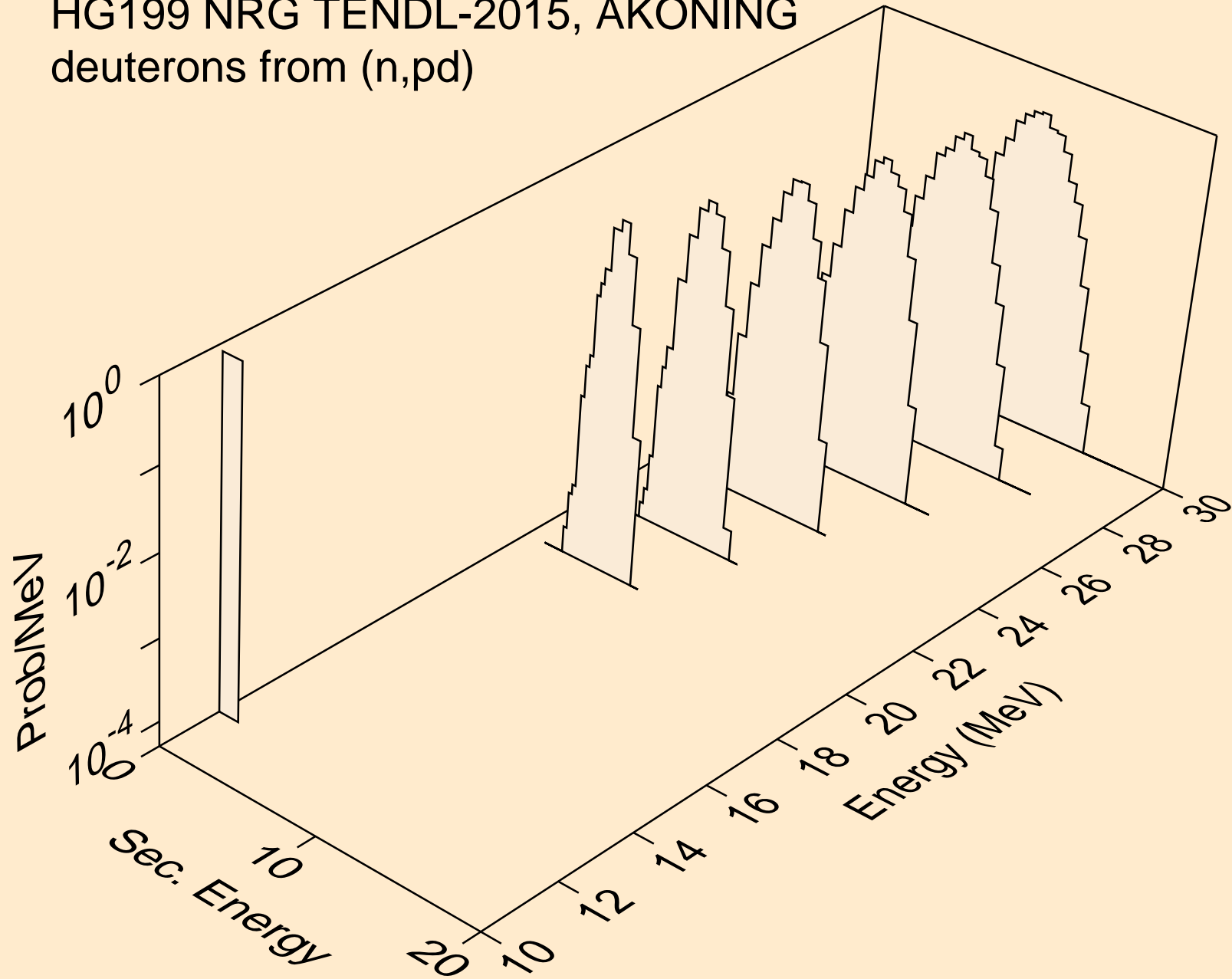

HG199 NRG TENDL-2015, AKONING  
tritons from (n,x)

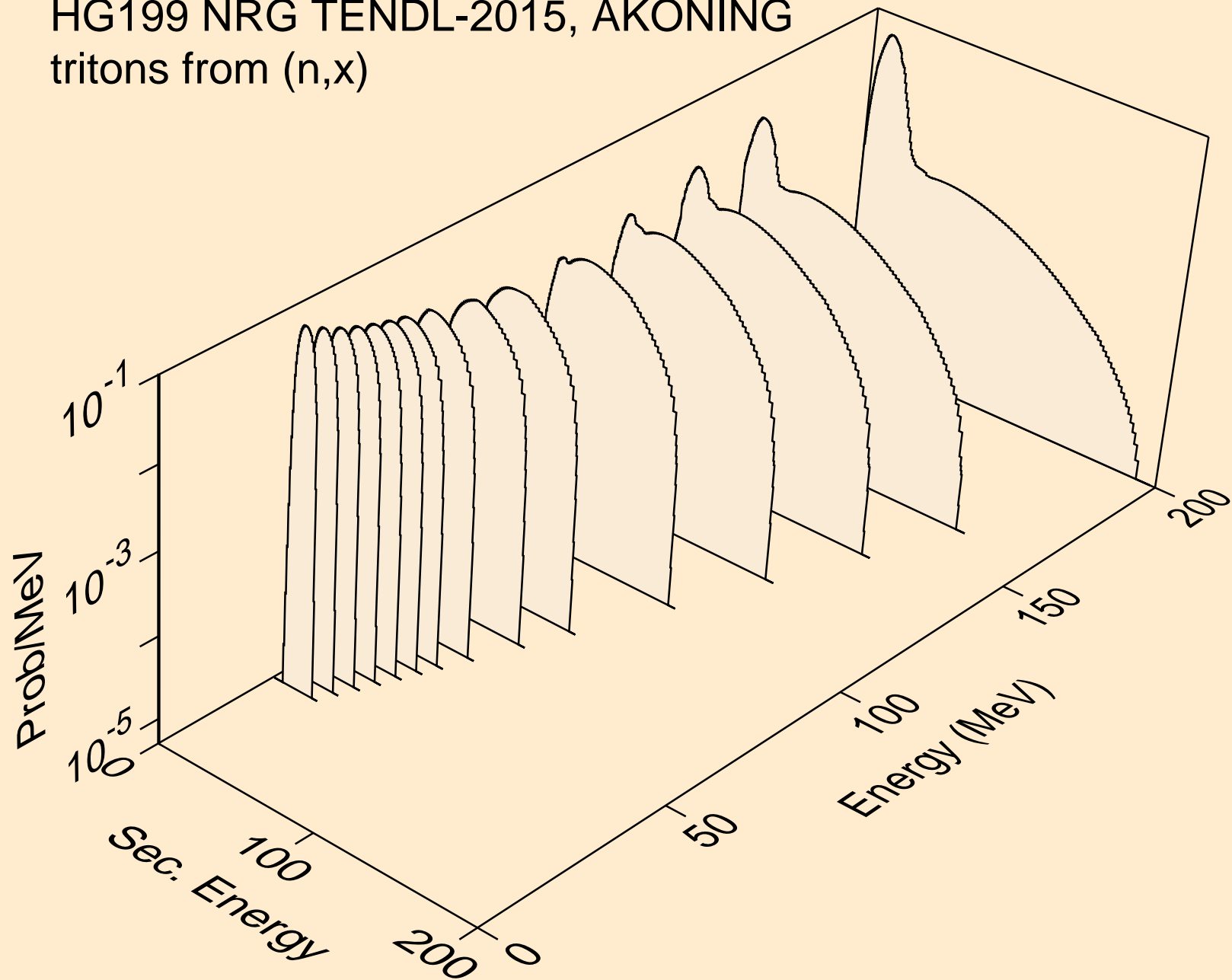

HG199 NRG TENDL-2015, AKONING  
tritons from (n,n\*)t

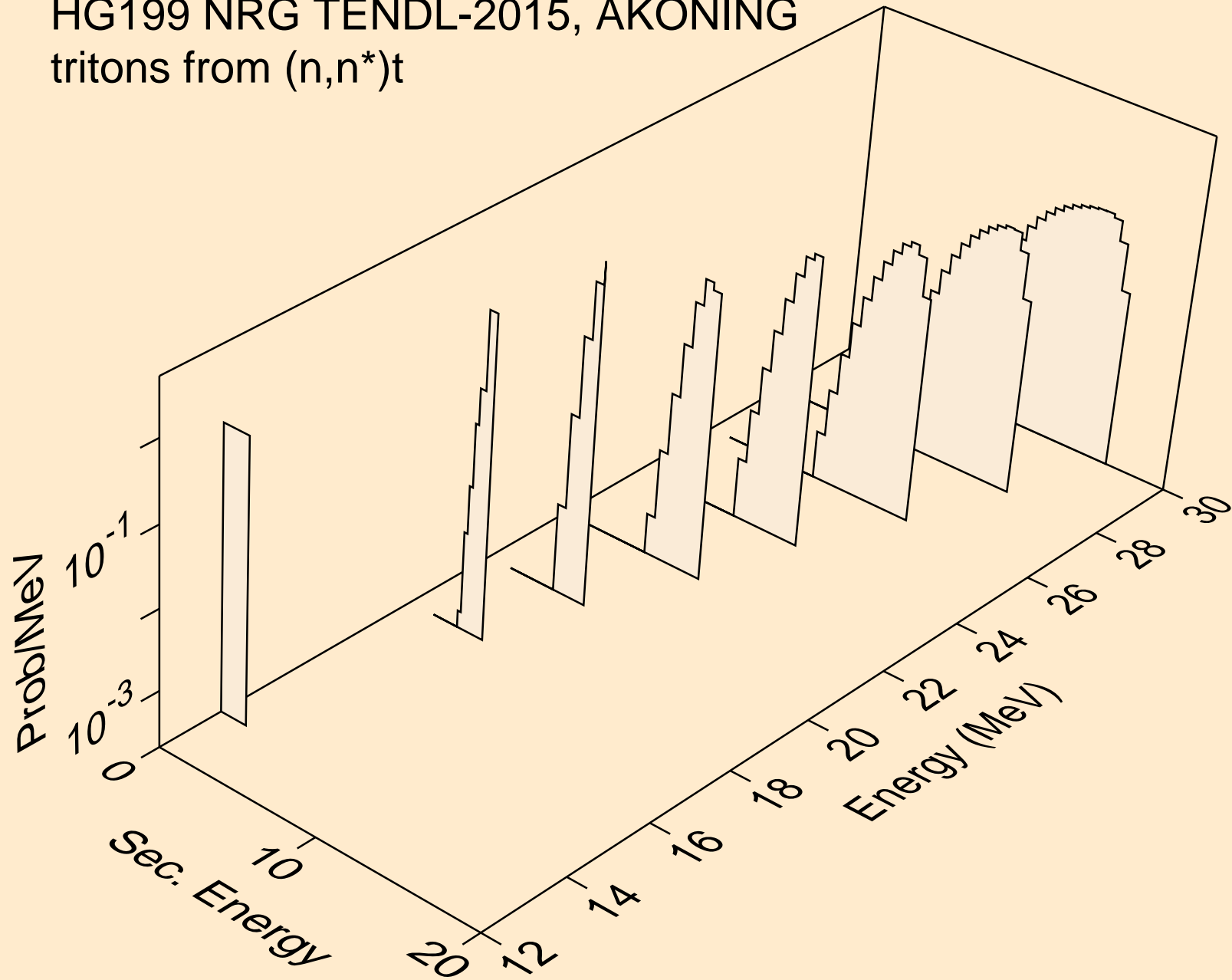

HG199 NRG TENDL-2015, AKONING  
tritons from (n,t)

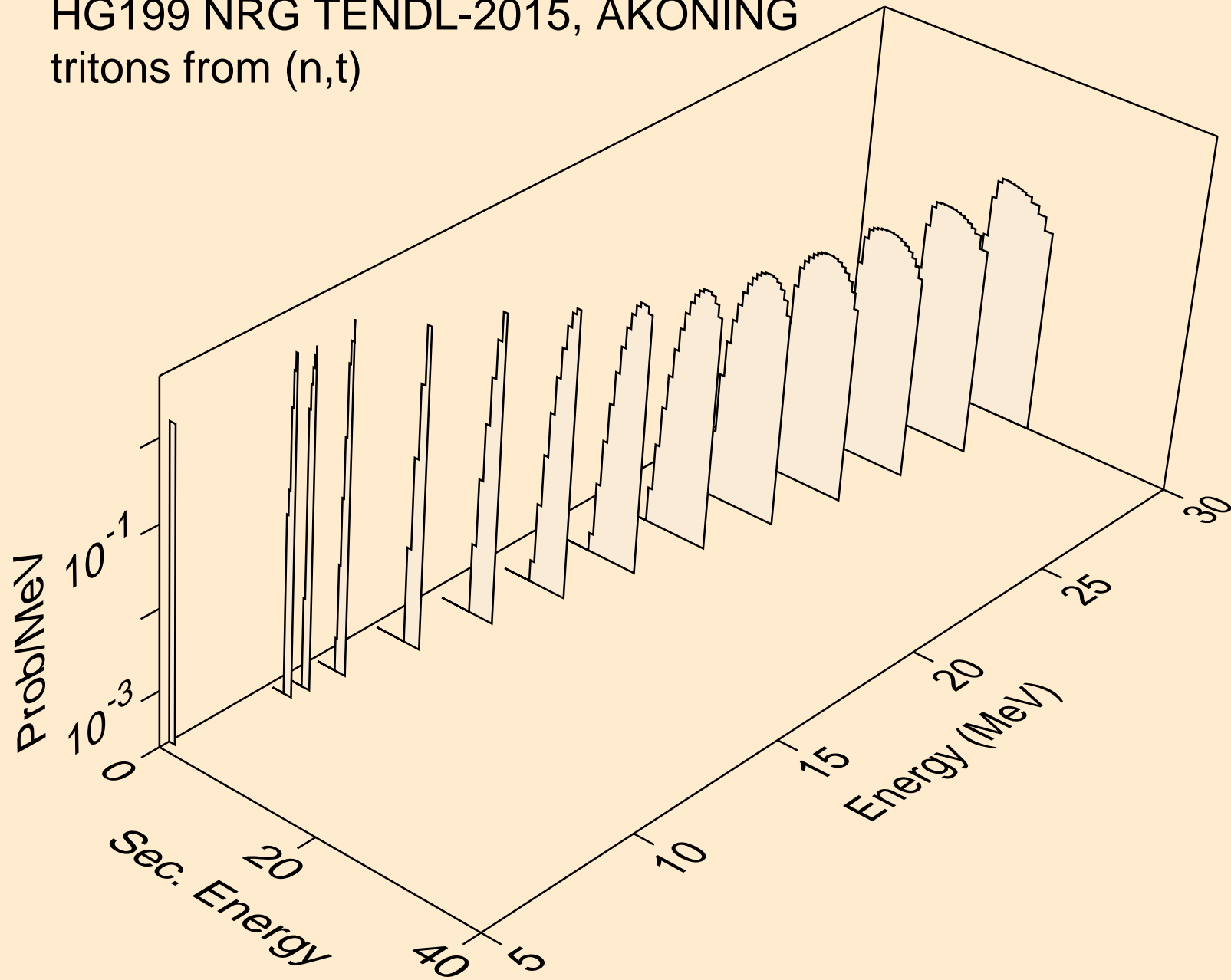

HG199 NRG TENDL-2015, AKONING  
tritons from (n,pt)

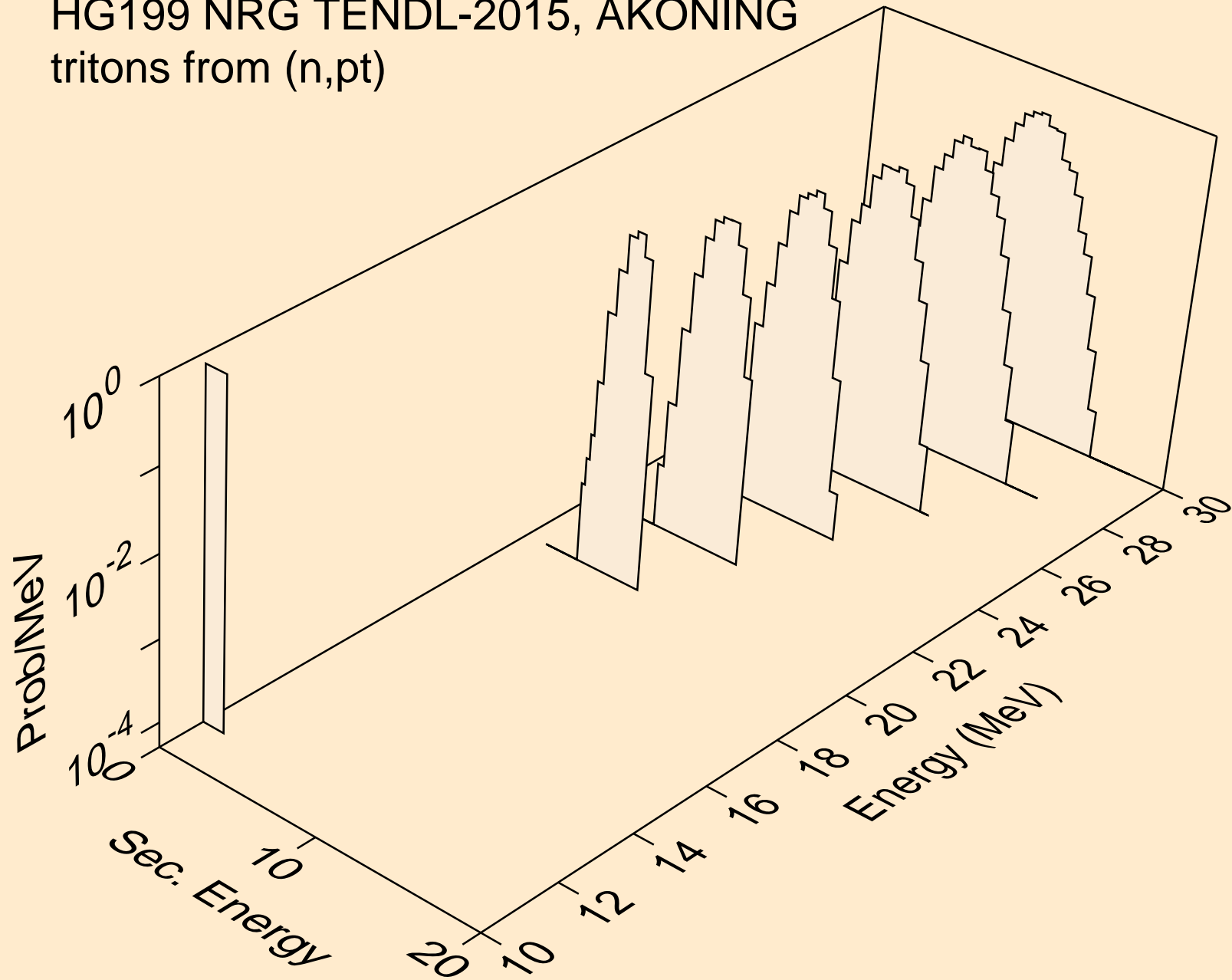



HG199 NRG TENDL-2015, AKONING  
he3s from (n,x)

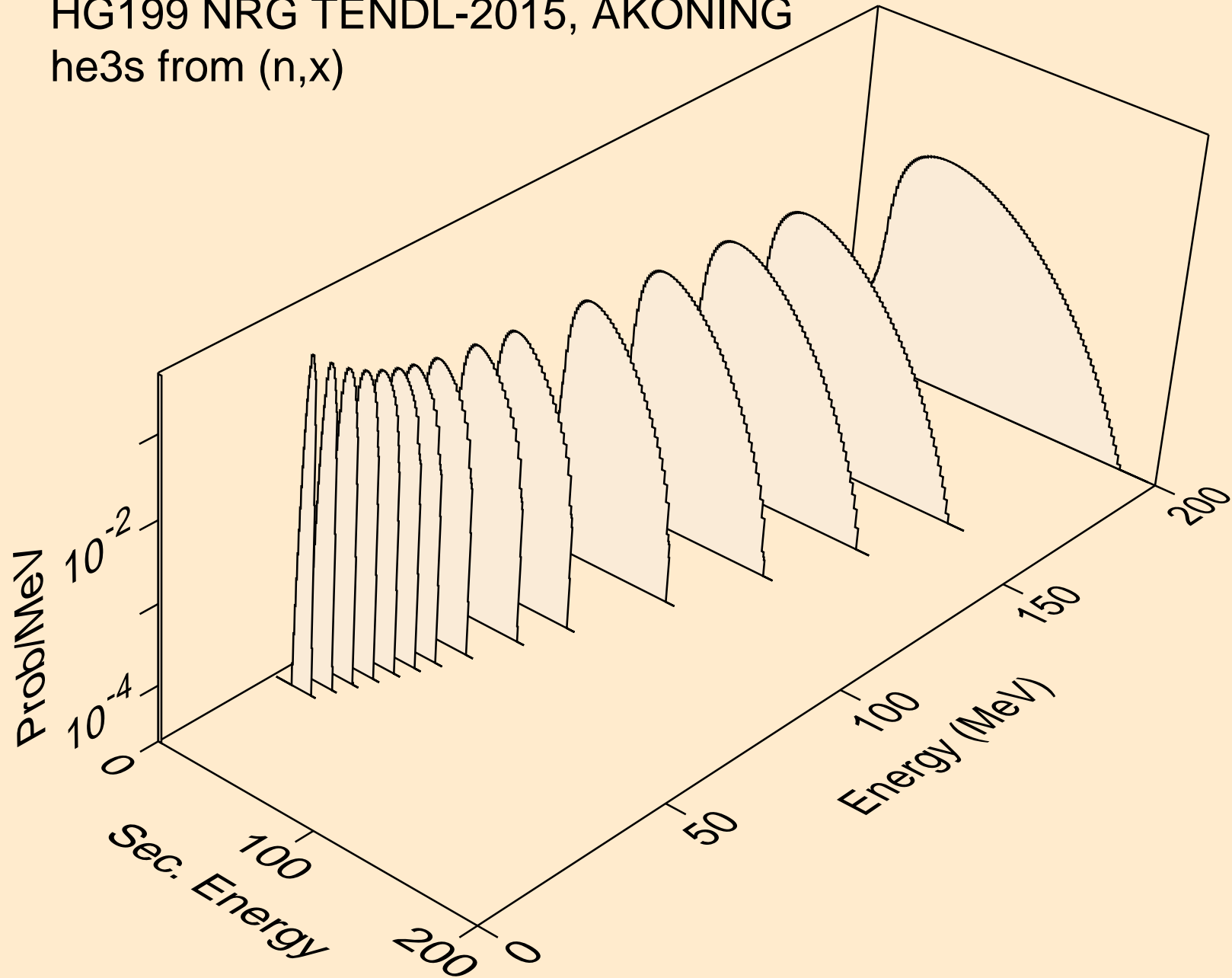

HG199 NRG TENDL-2015, AKONING  
he3s from (n,n\*)he3

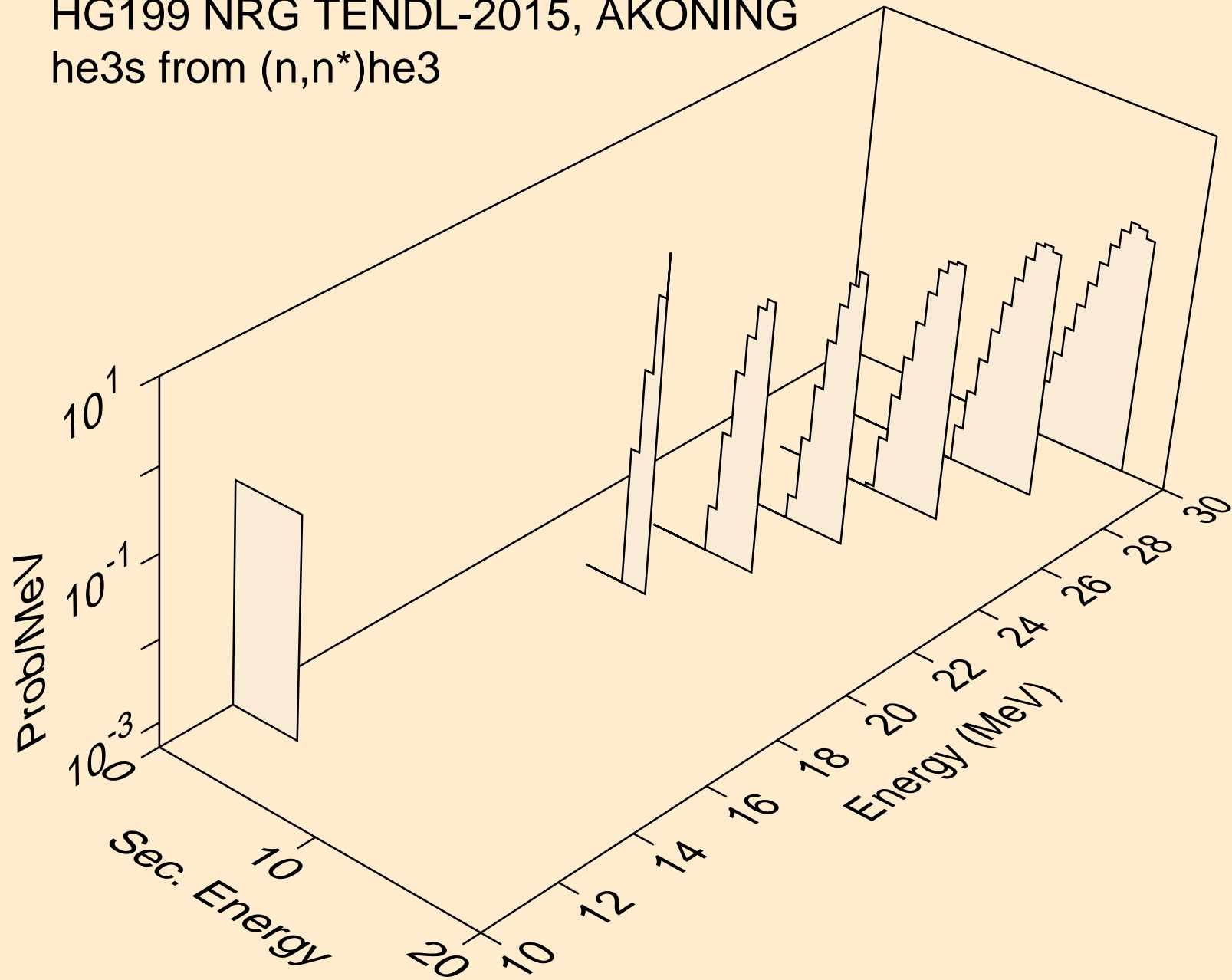

HG199 NRG TENDL-2015, AKONING  
he3s from (n,he3)

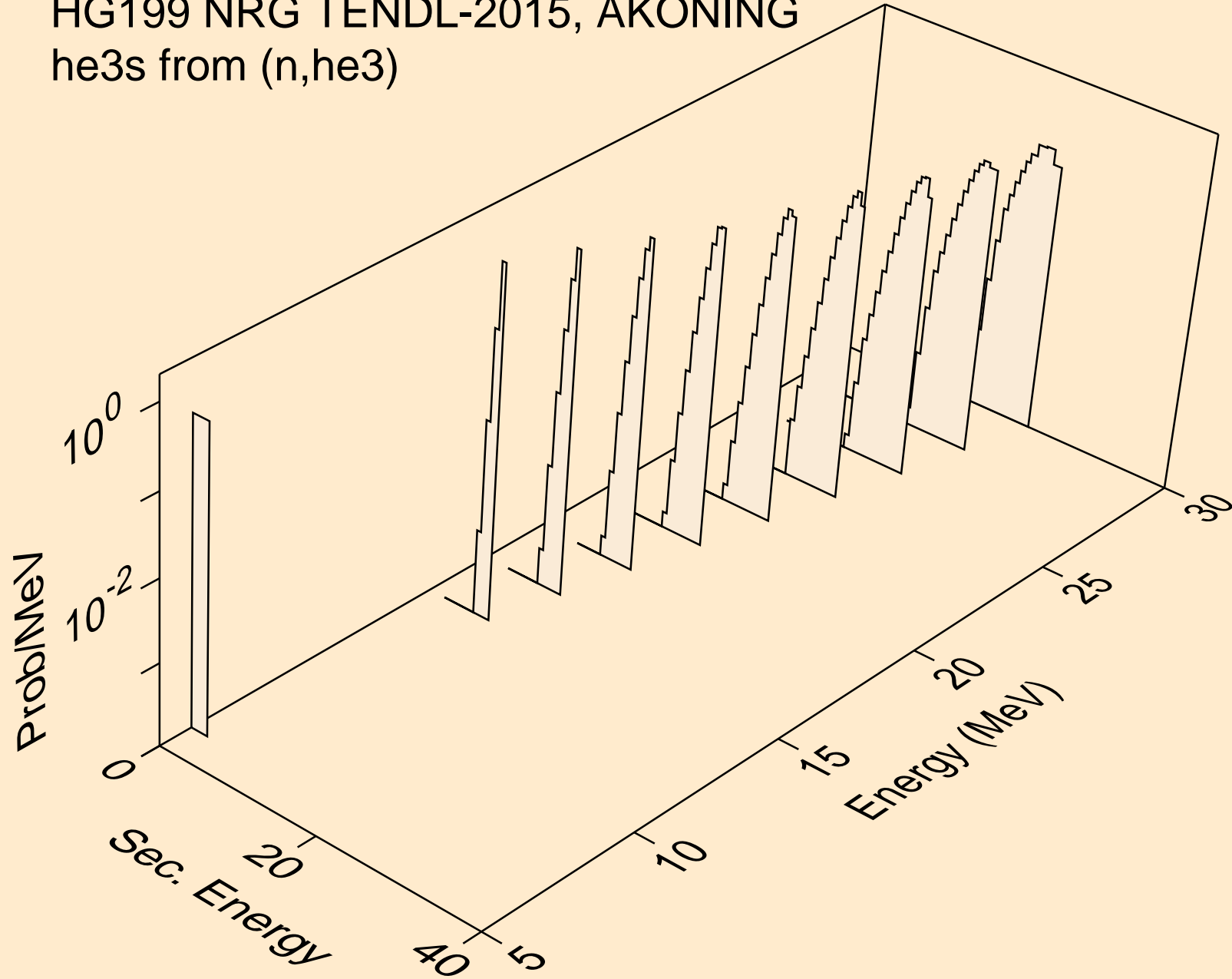

HG199 NRG TENDL-2015, AKONING  
alphas from (n,x)

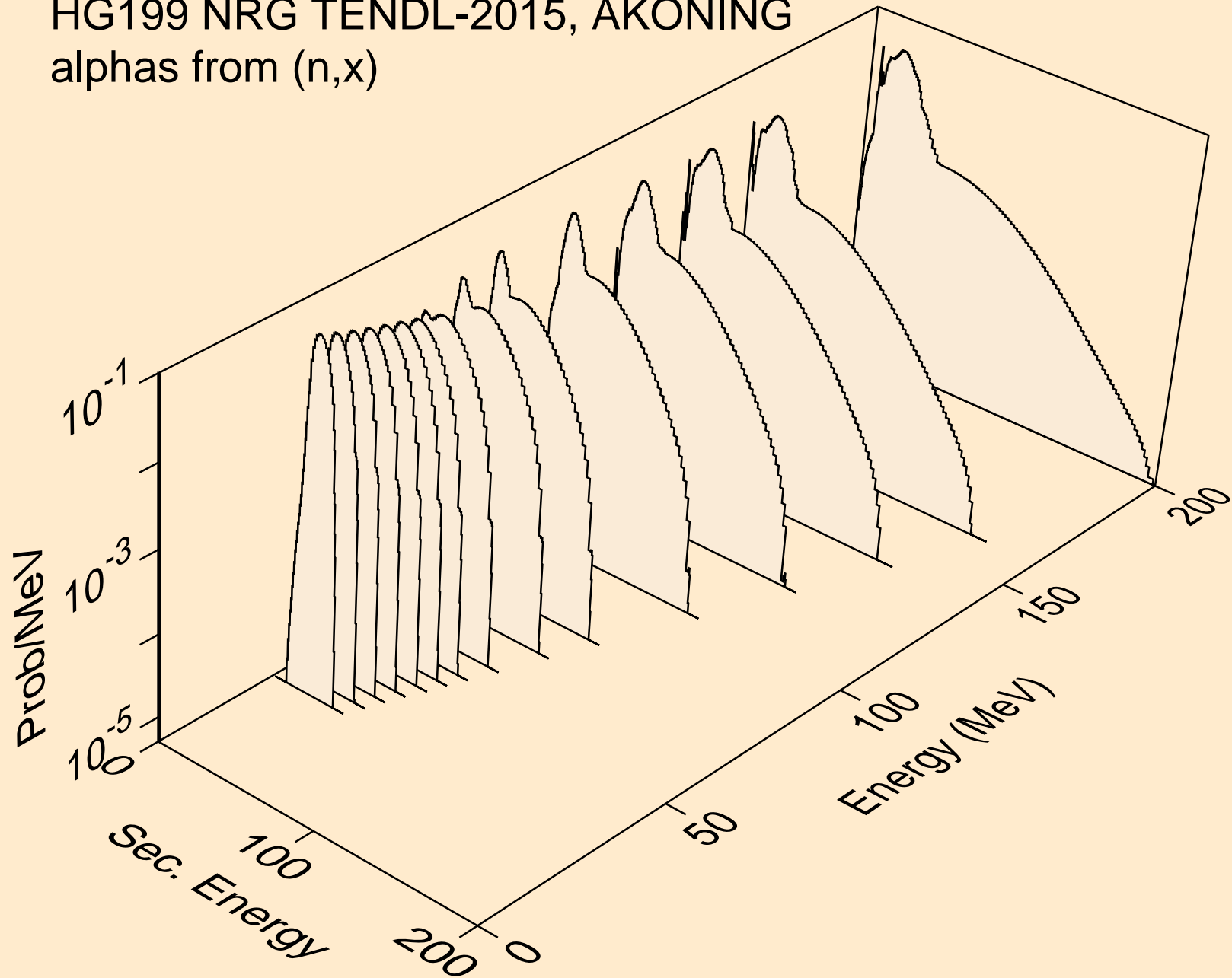

HG199 NRG TENDL-2015, AKONING  
alphas from (n,n\*)a

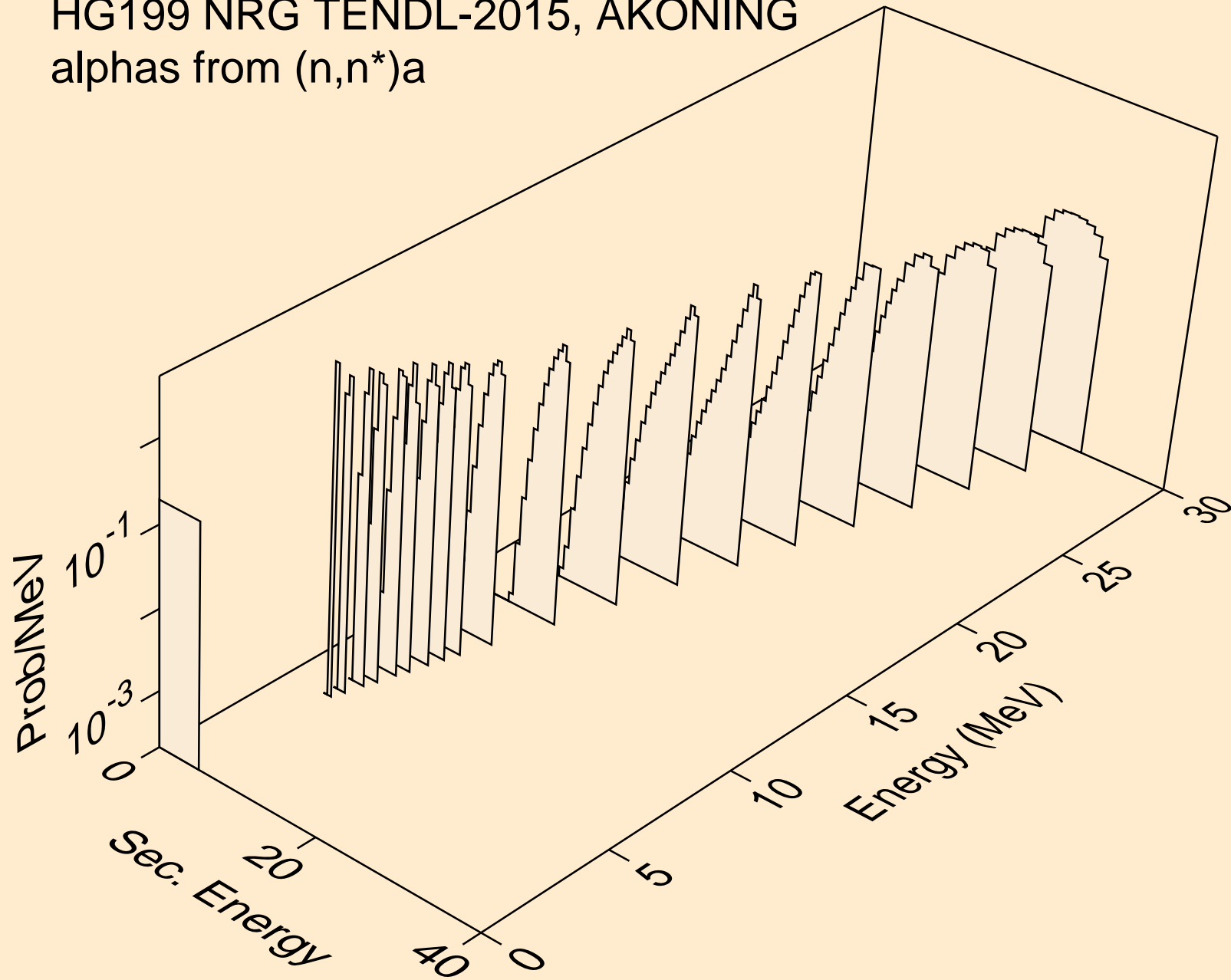

HG199 NRG TENDL-2015, AKONING  
alphas from (n,2n)a

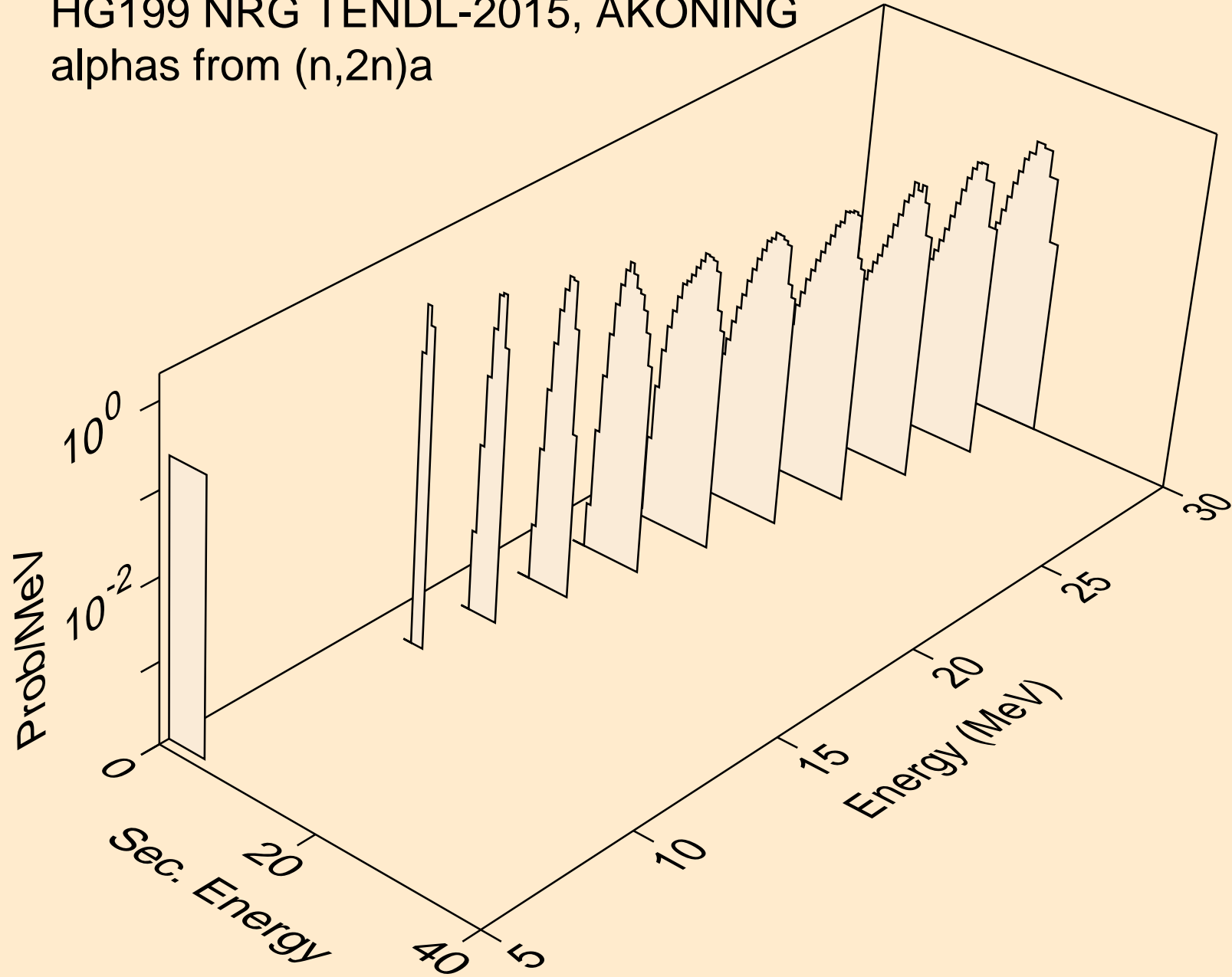

HG199 NRG TENDL-2015, AKONING  
alphas from (n,3n)a

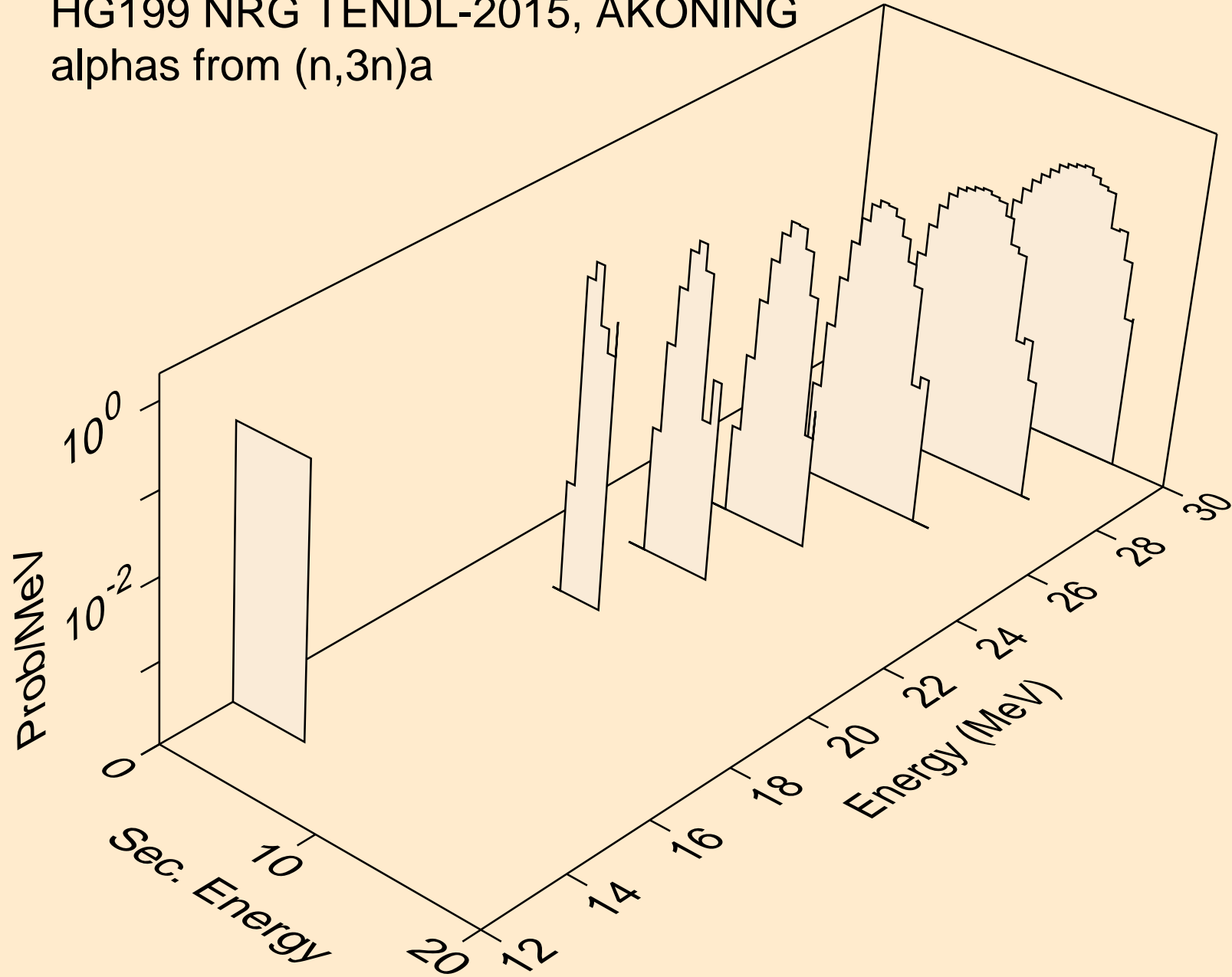

HG199 NRG TENDL-2015, AKONING  
alphas from (n,n\*)2a

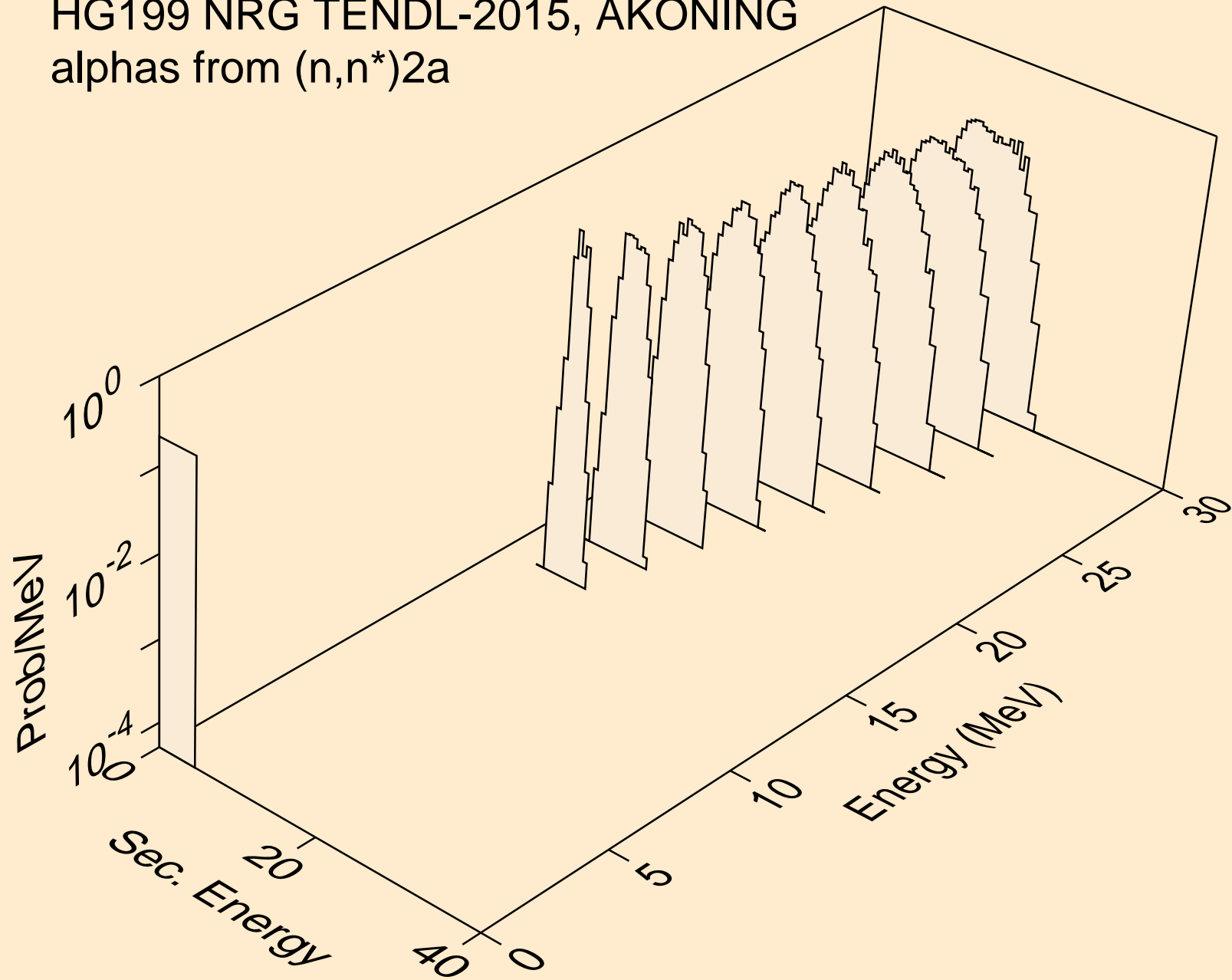



HG199 NRG TENDL-2015, AKONING  
alphas from (n,npa)

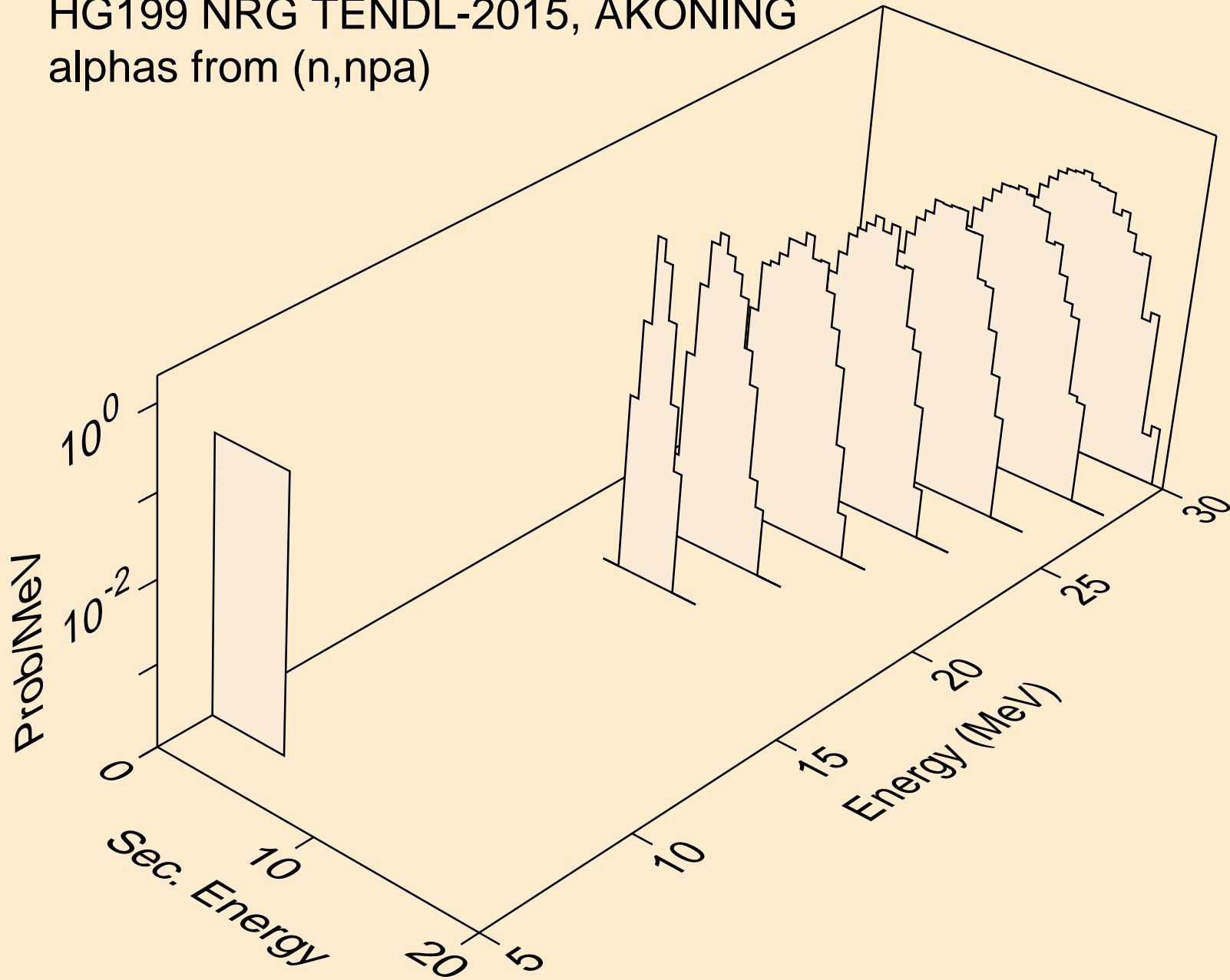

HG199 NRG TENDL-2015, AKONING  
alphas from (n,a)

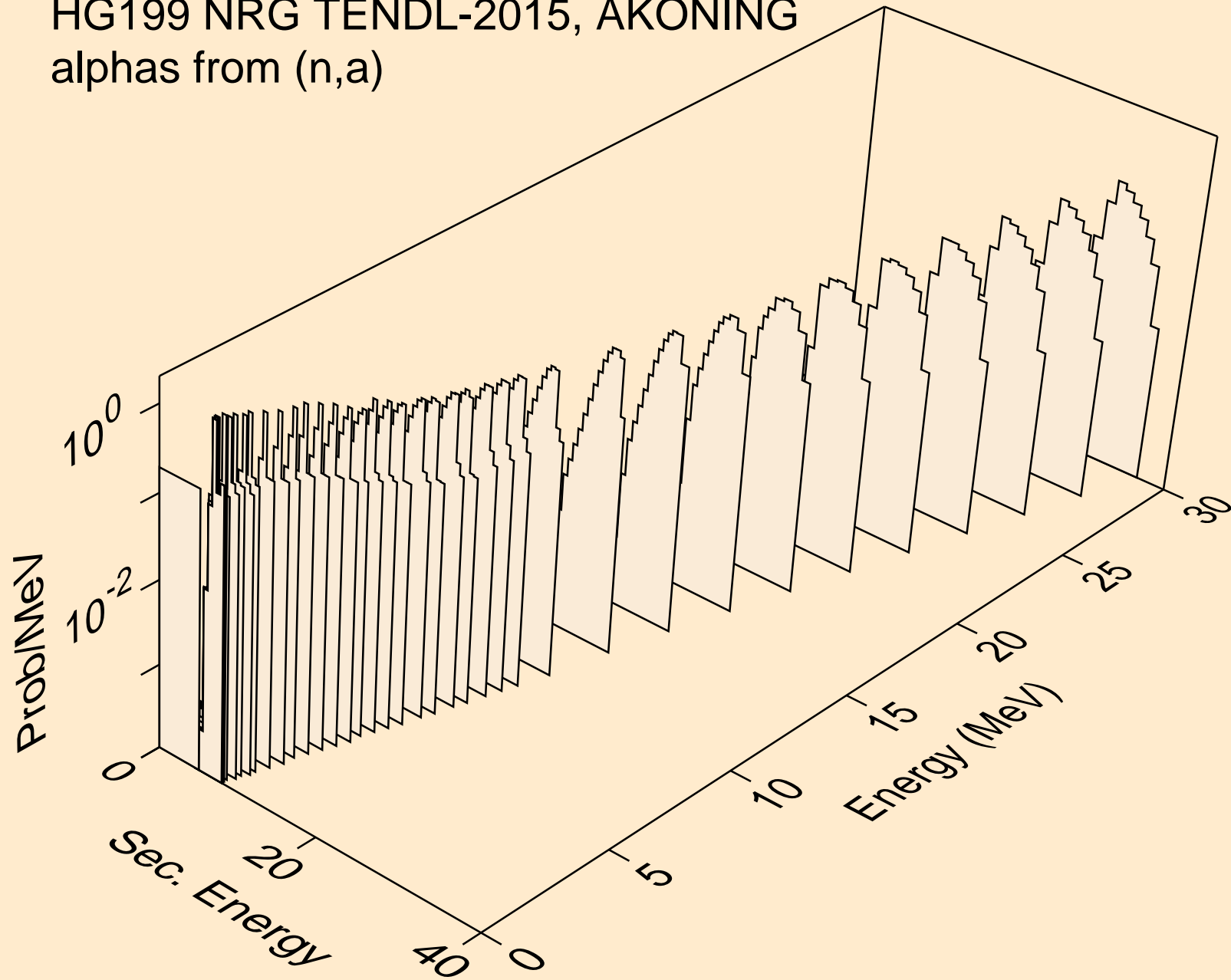

HG199 NRG TENDL-2015, AKONING  
alphas from (n,2a)

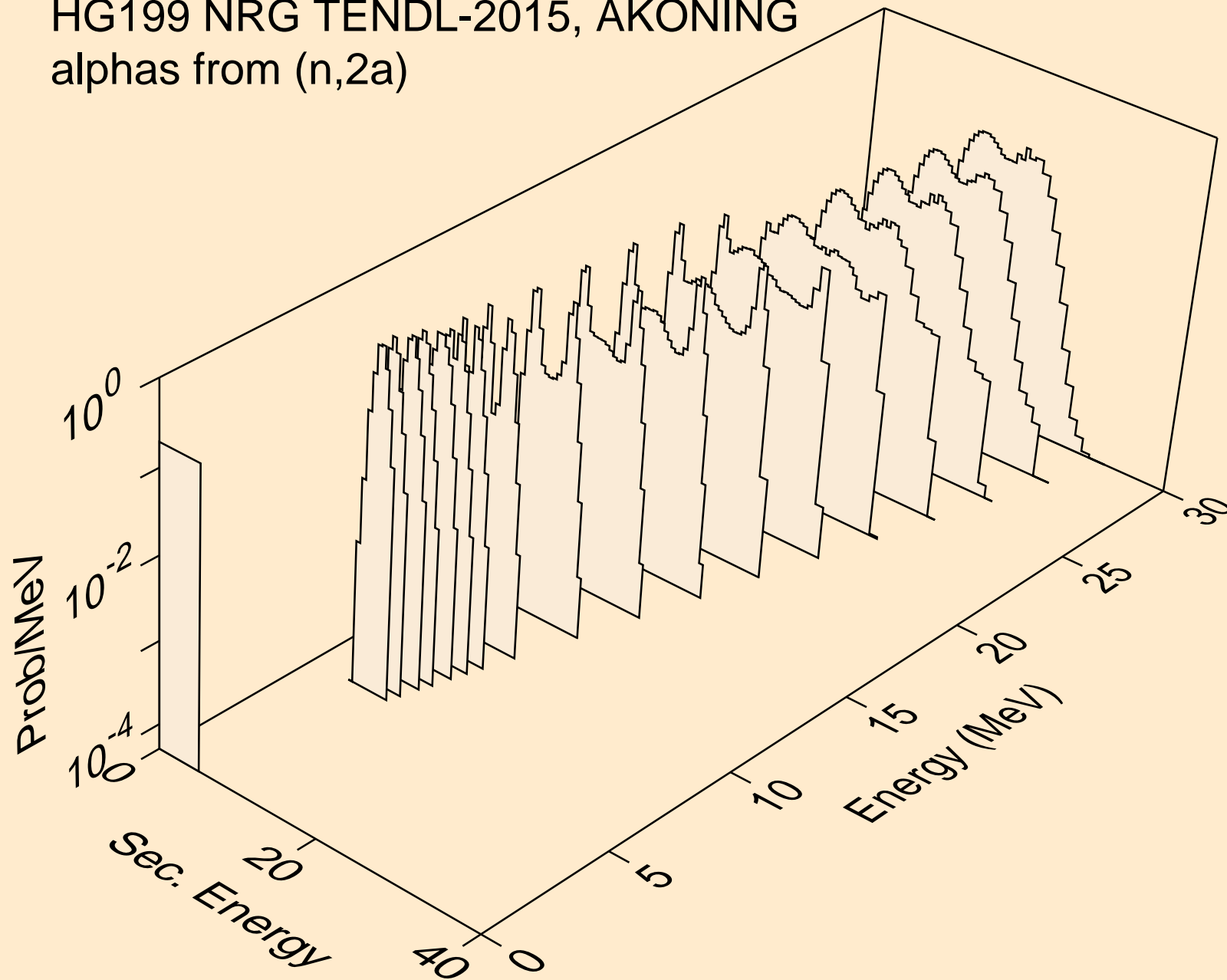

HG199 NRG TENDL-2015, AKONING  
alphas from (n,pa)

