

HO150M NRG TENDL-2015, AKONING

Principal cross sections

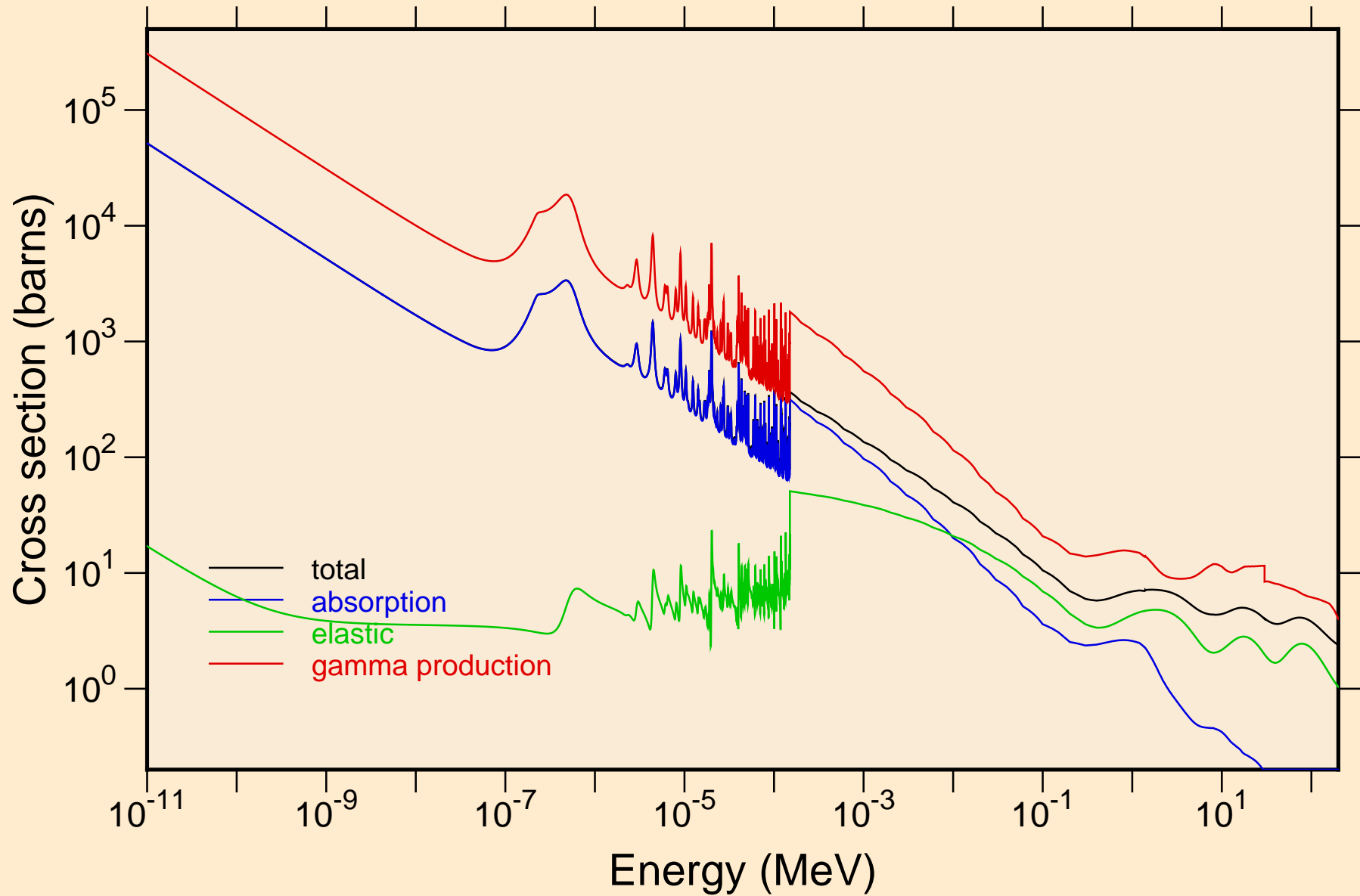

HO150M NRG TENDL-2015, AKONING
resonance total cross section

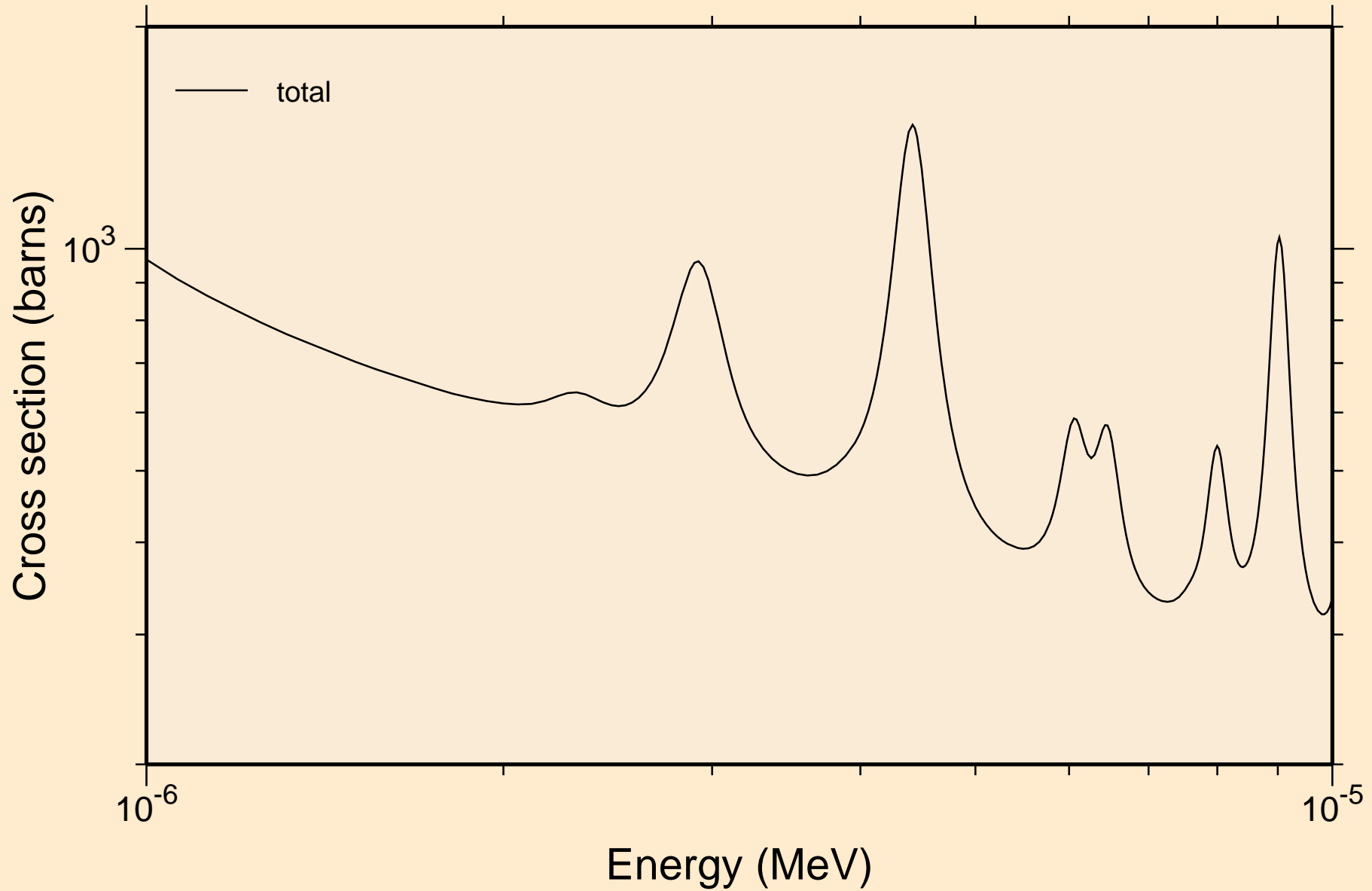

HO150M NRG TENDL-2015, AKONING
resonance total cross section

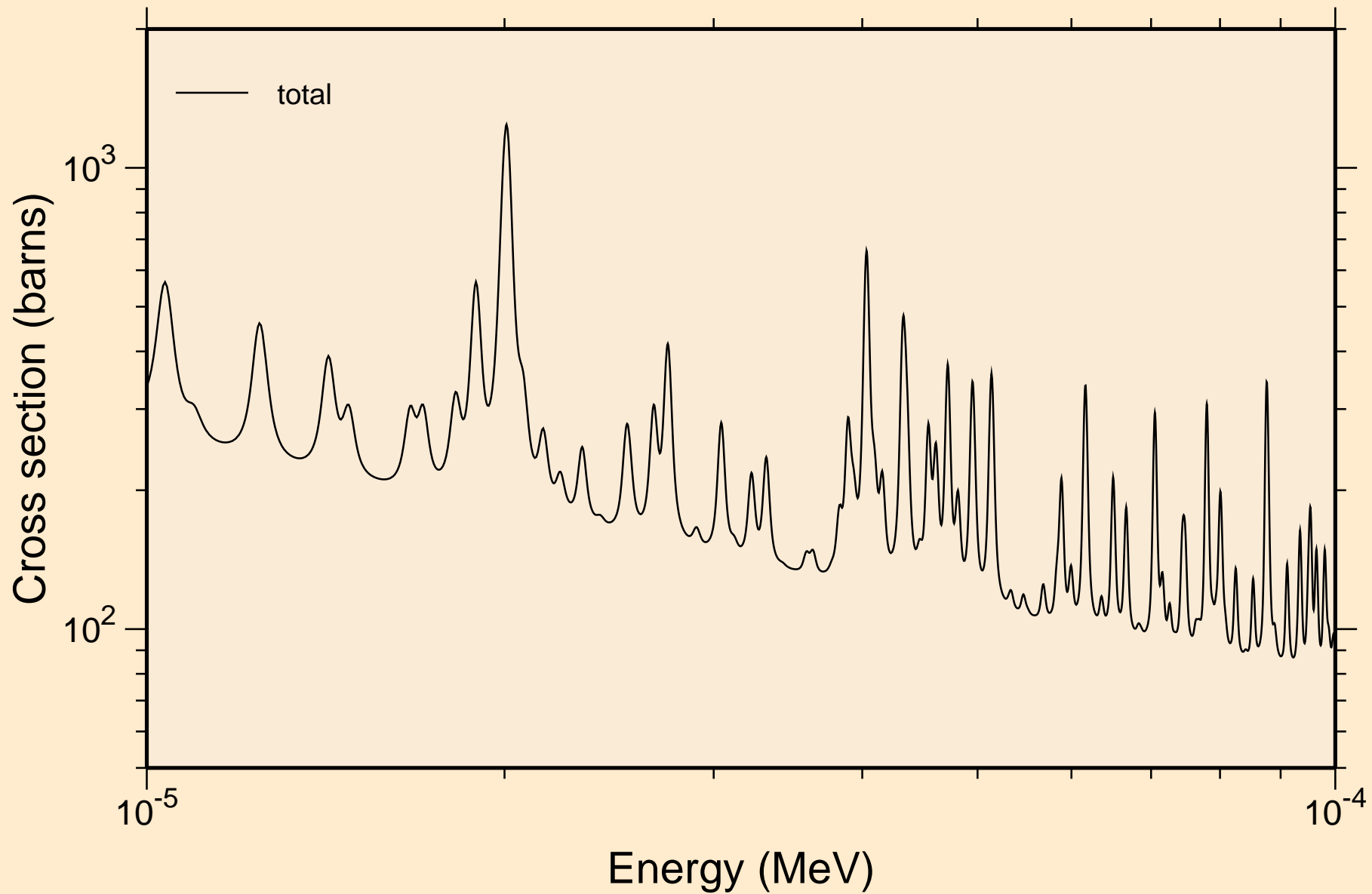

HO150M NRG TENDL-2015, AKONING
resonance total cross section

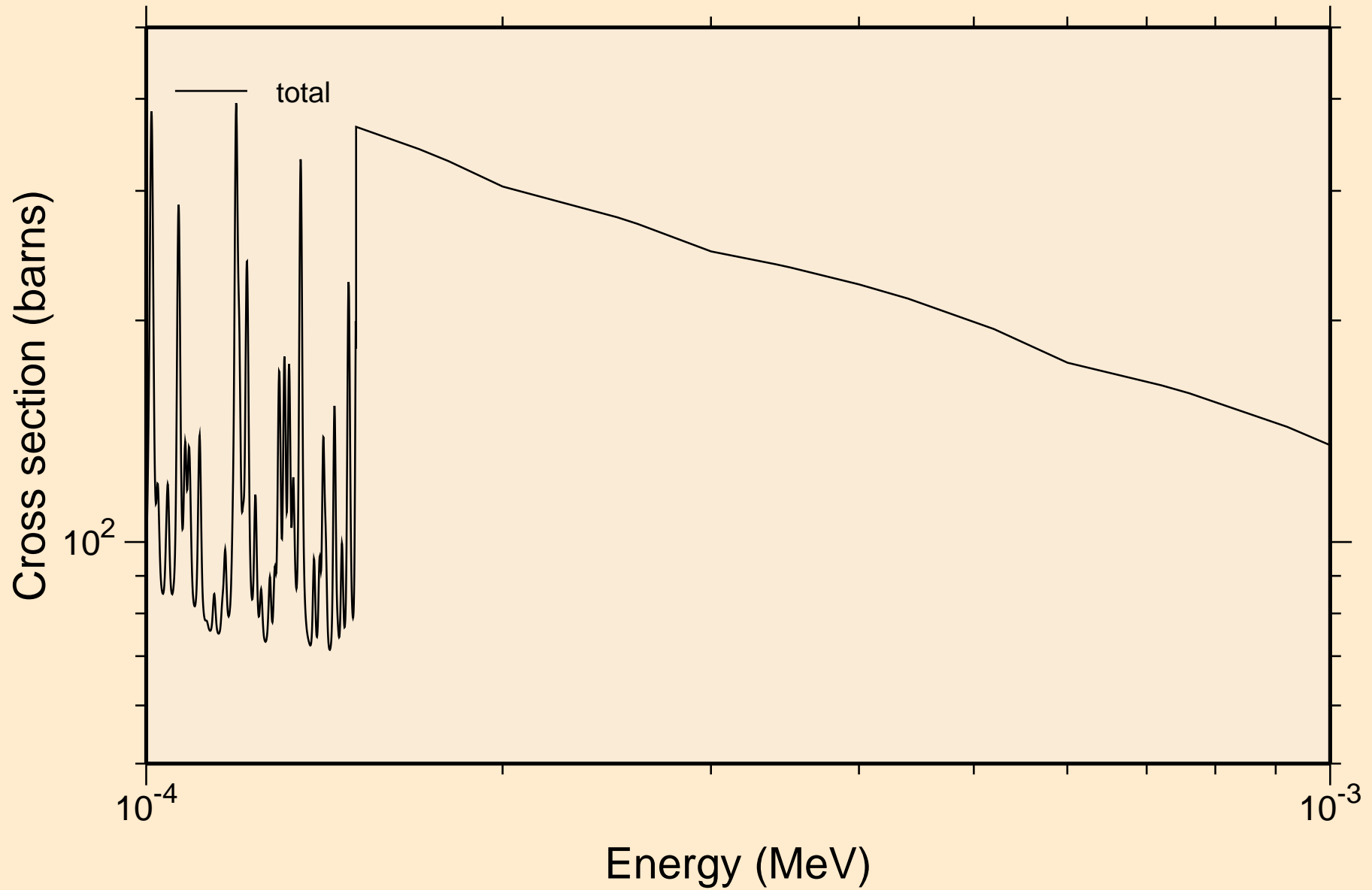

HO150M NRG TENDL-2015, AKONING
resonance total cross section

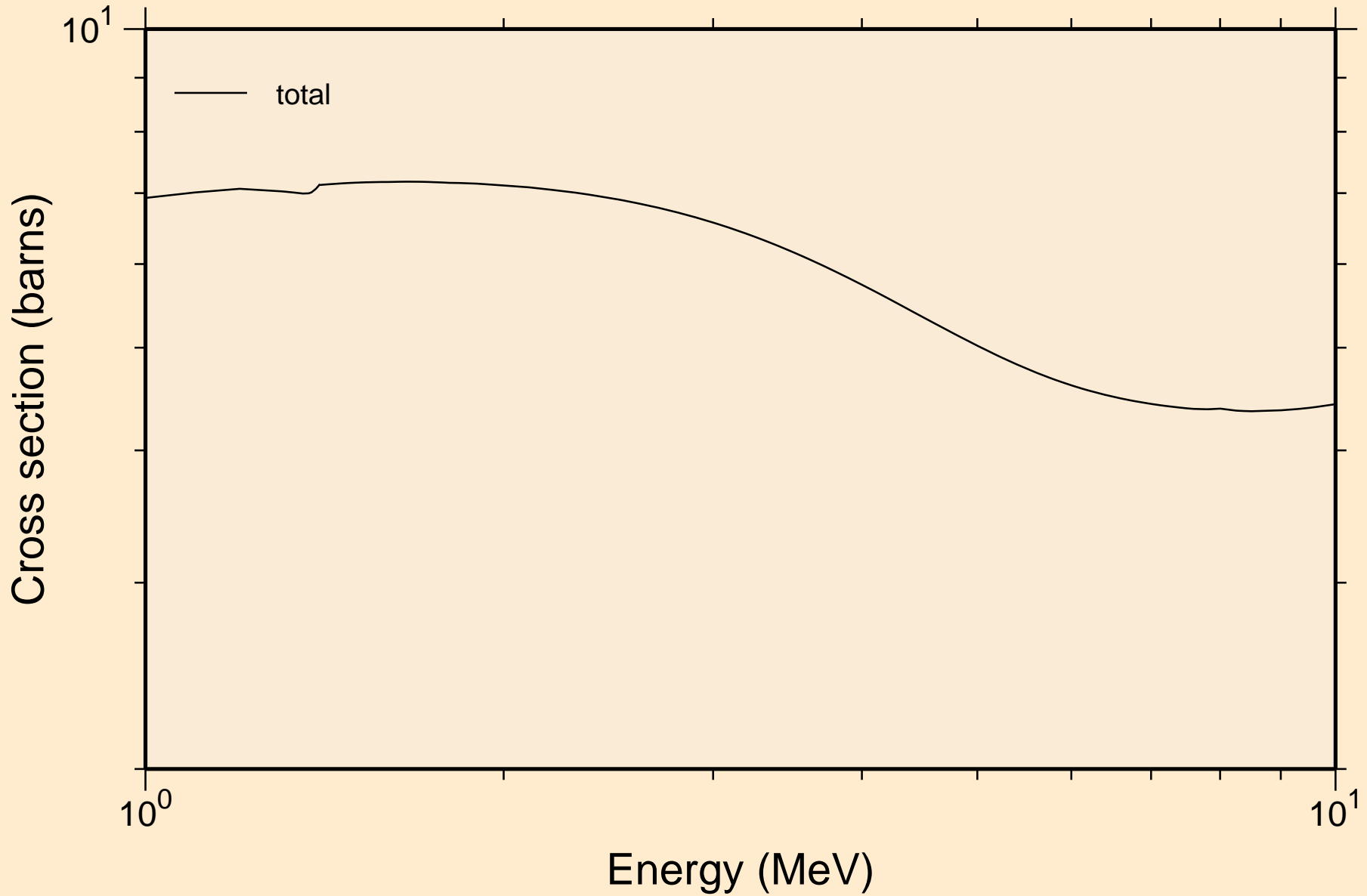

HO150M NRG TENDL-2015, AKONING
resonance absorption cross sections

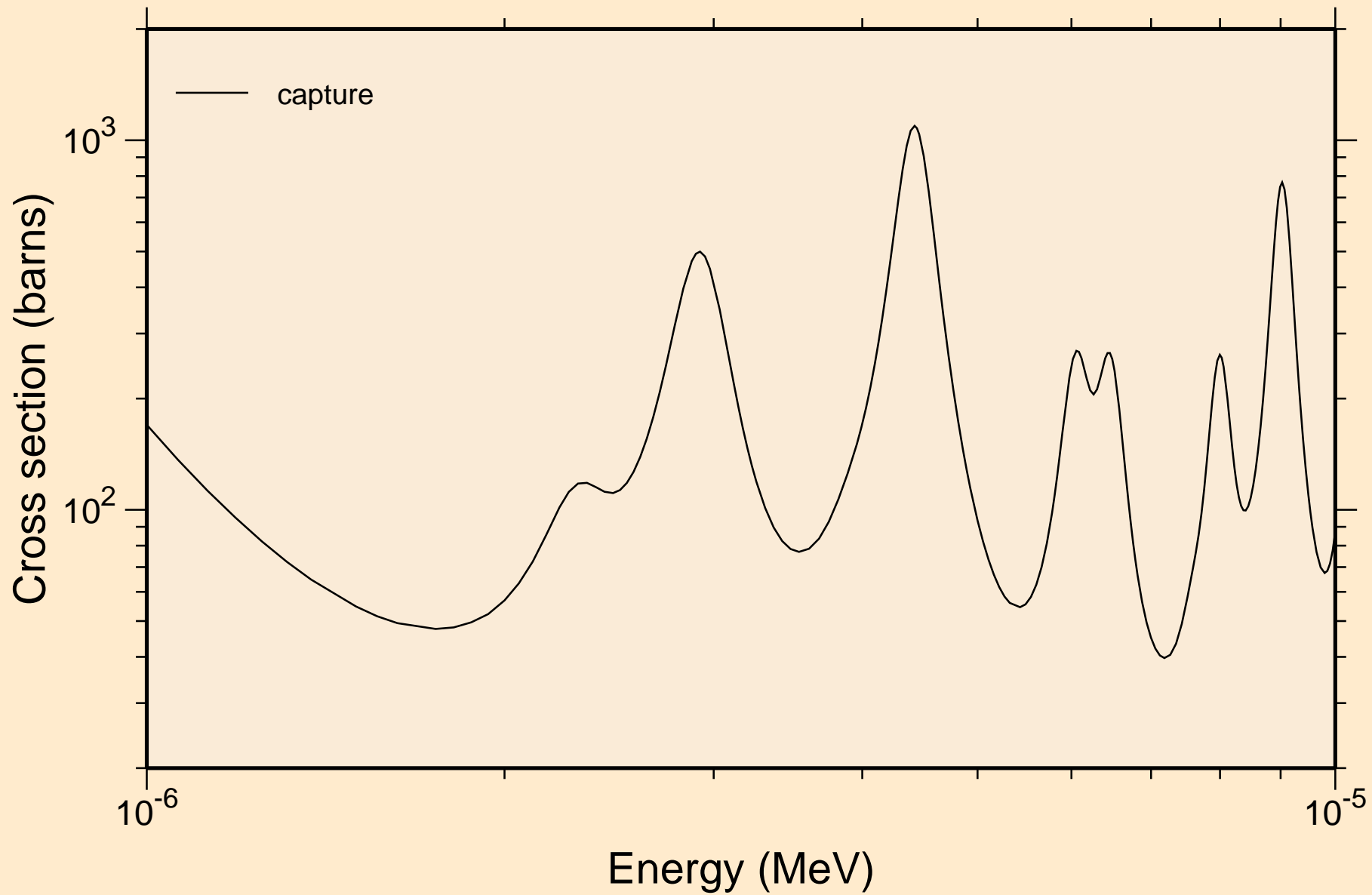

HO150M NRG TENDL-2015, AKONING
resonance absorption cross sections

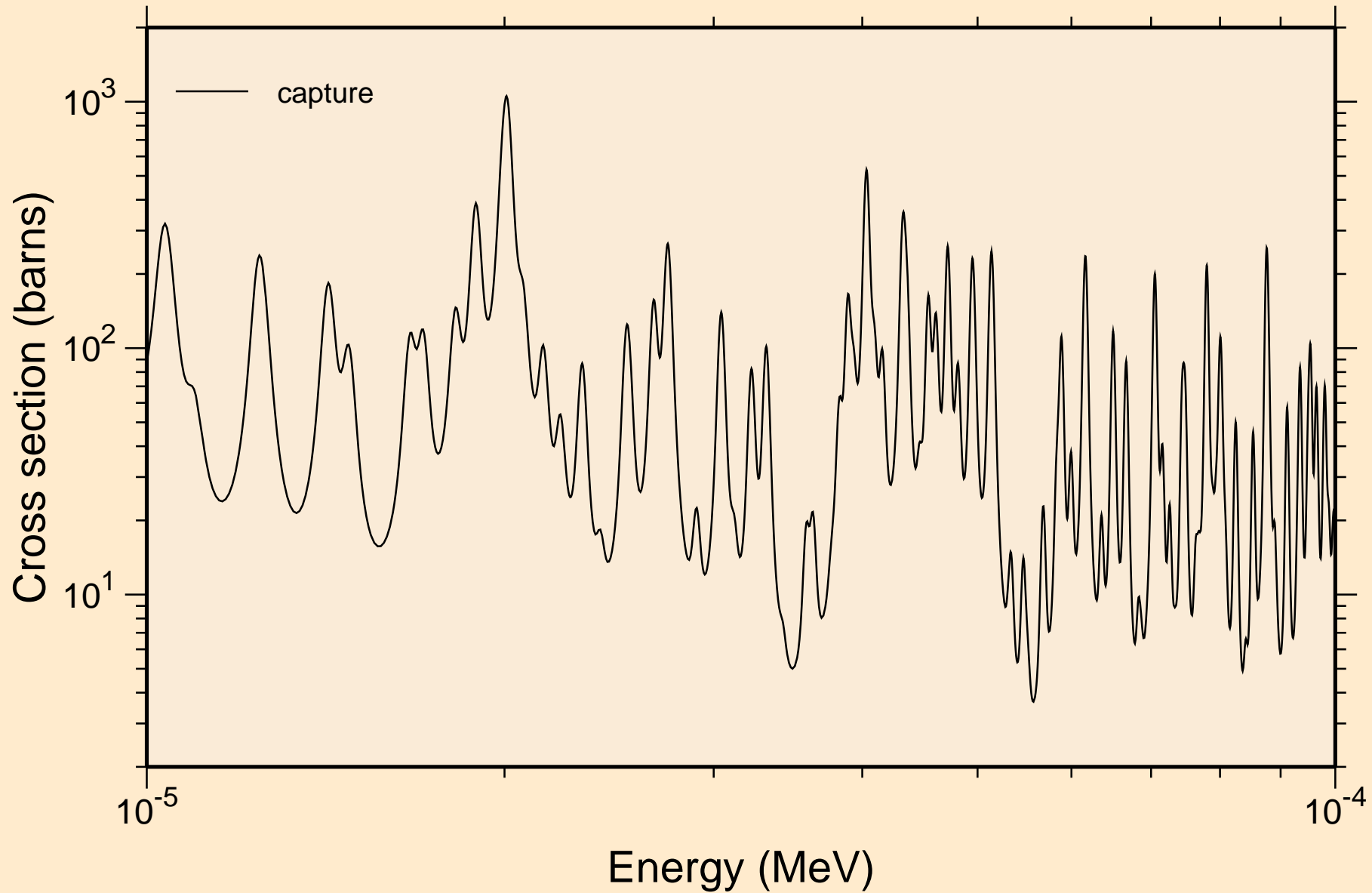

HO150M NRG TENDL-2015, AKONING
resonance absorption cross sections

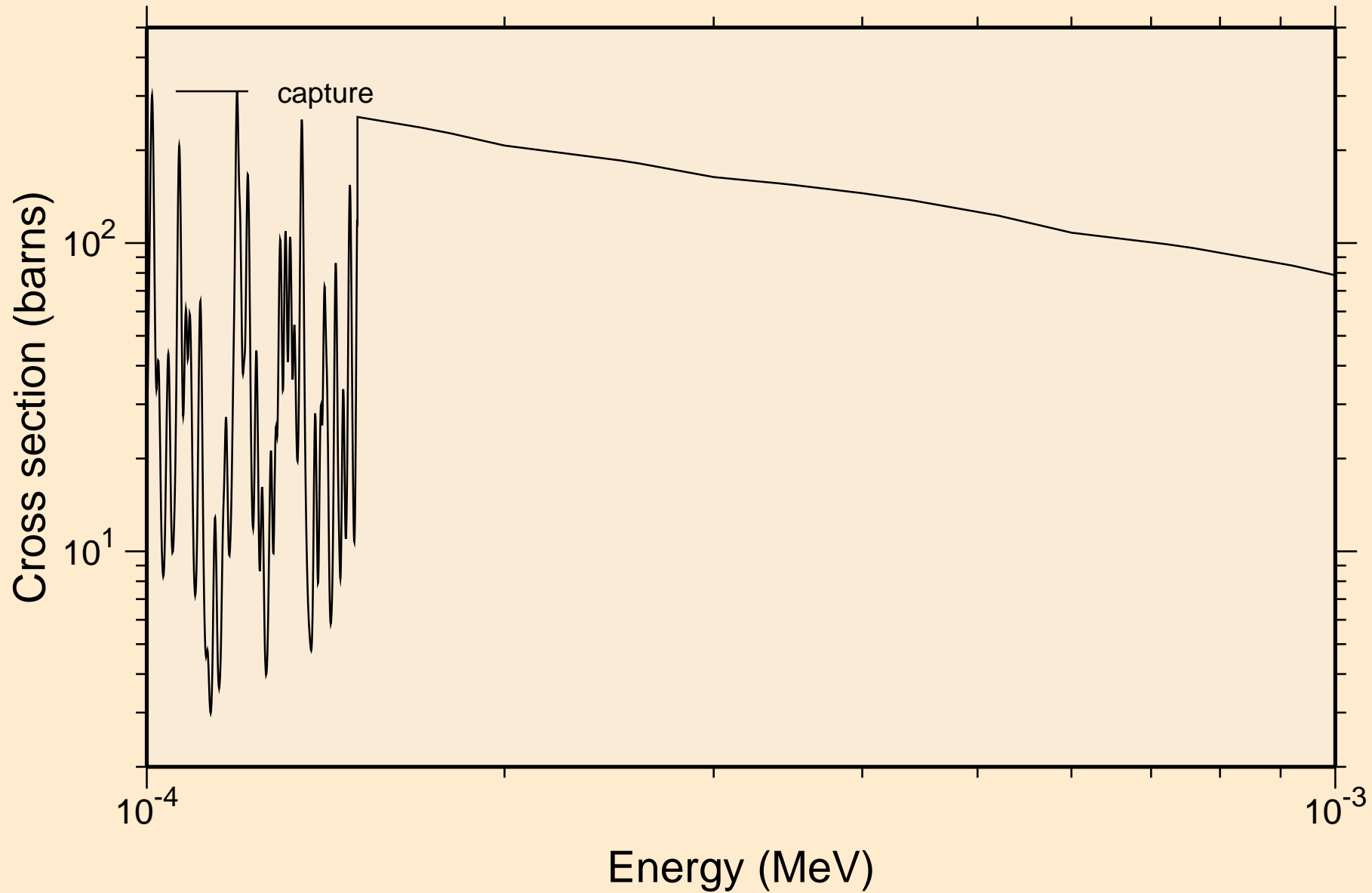

HO150M NRG TENDL-2015, AKONING
resonance absorption cross sections

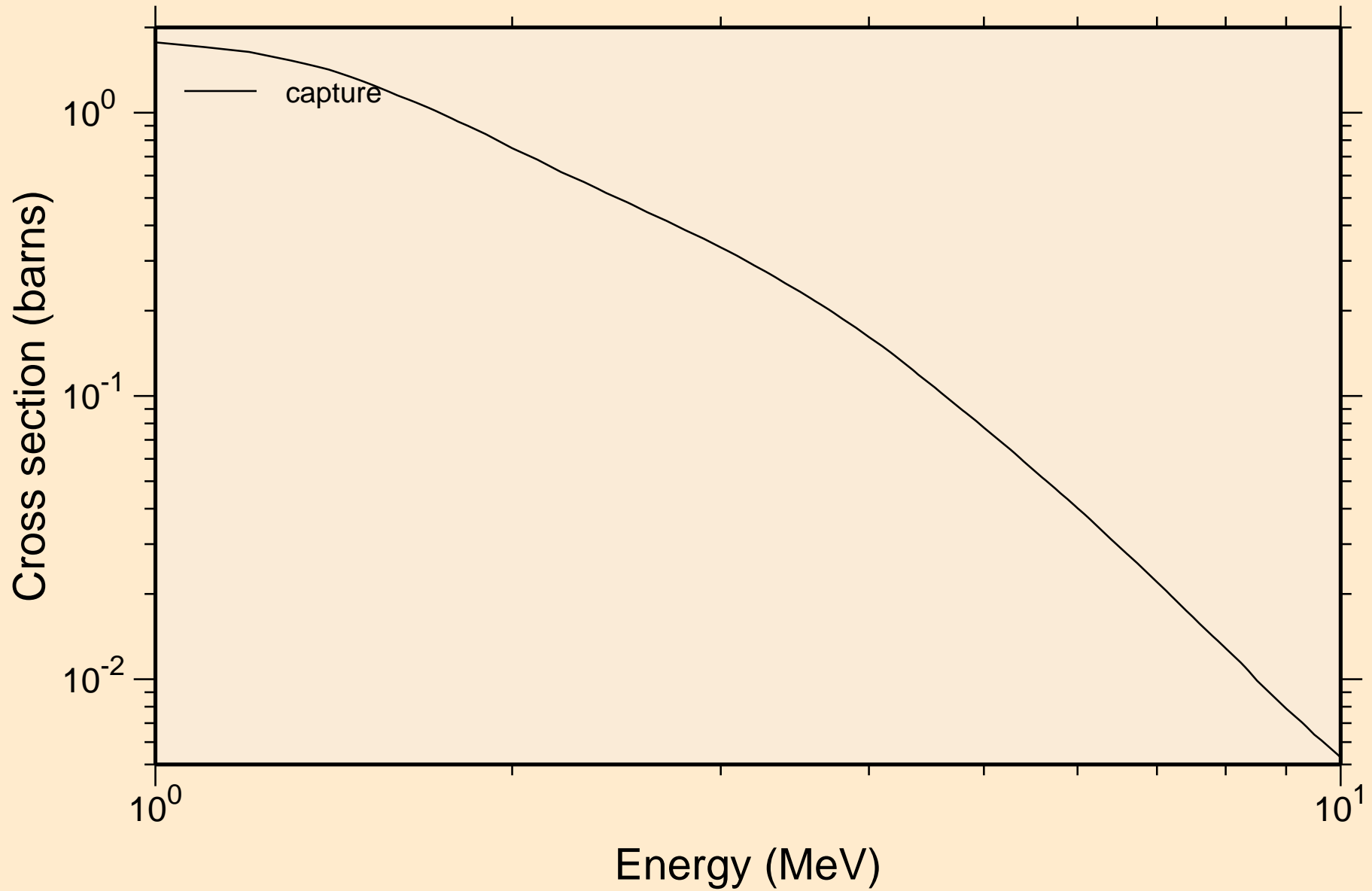

HO150M NRG TENDL-2015, AKONING

Non-threshold reactions

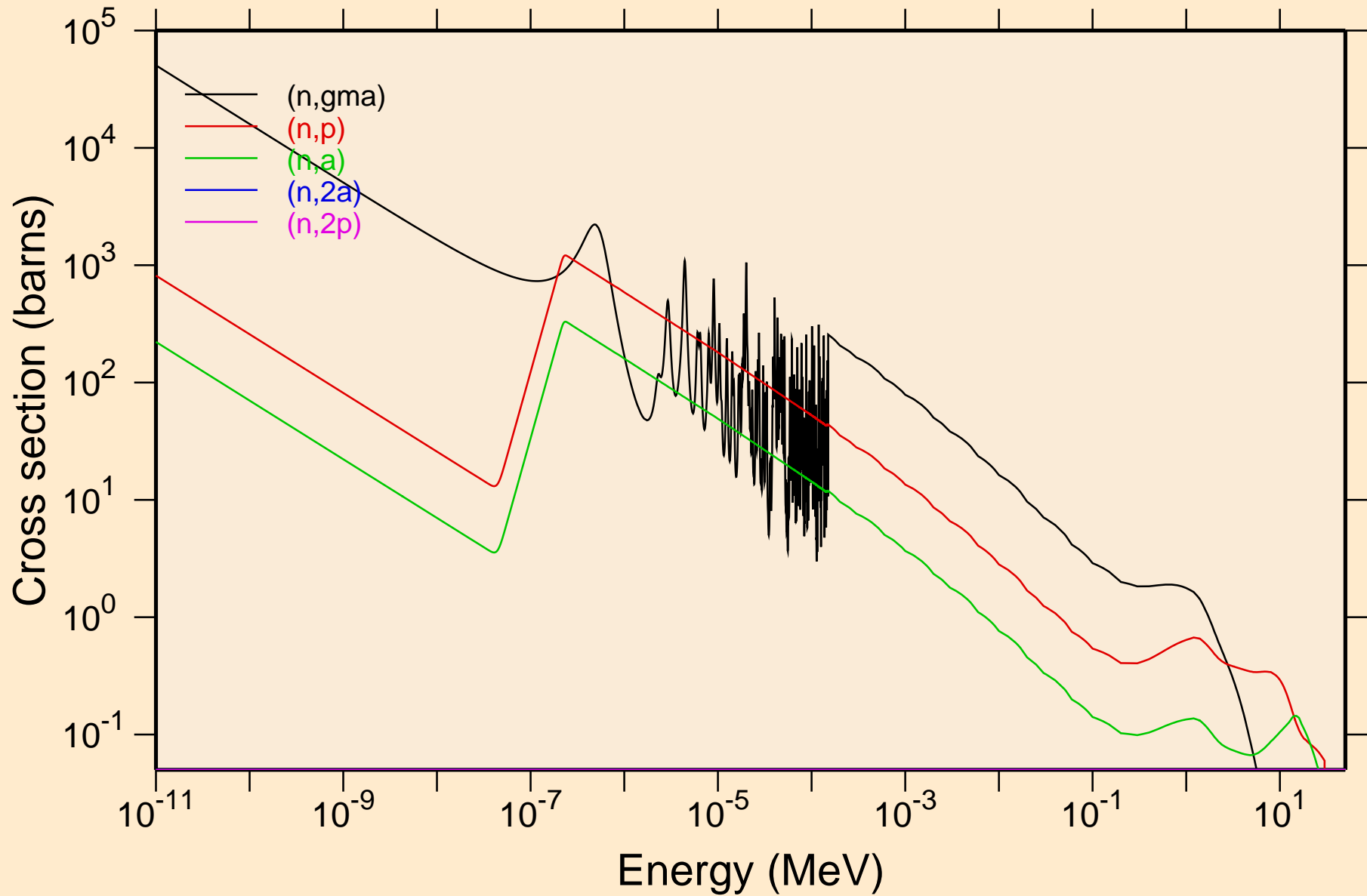

HO150M NRG TENDL-2015, AKONING

Non-threshold reactions

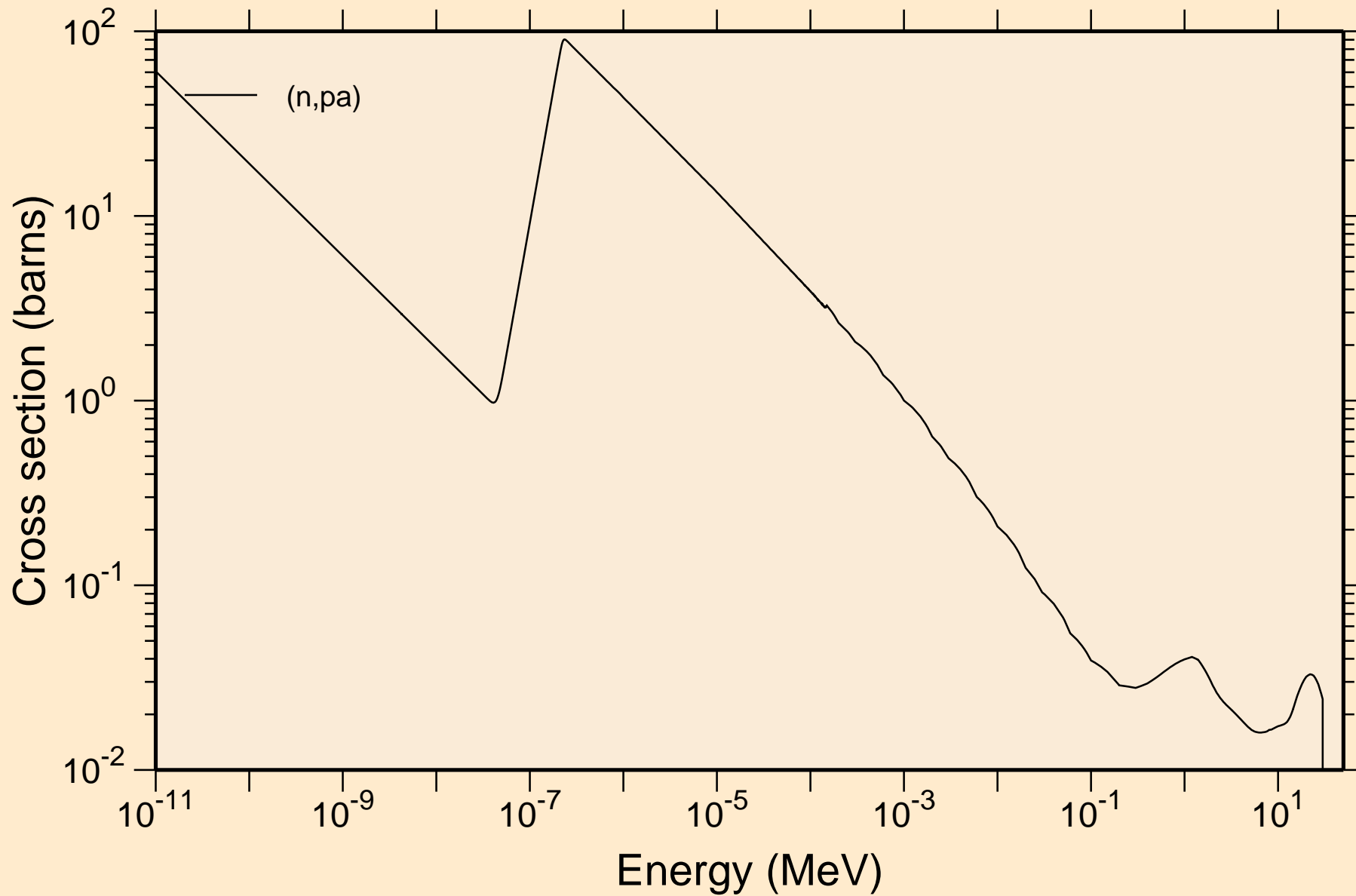

HO150M NRG TENDL-2015, AKONING

Principal cross sections

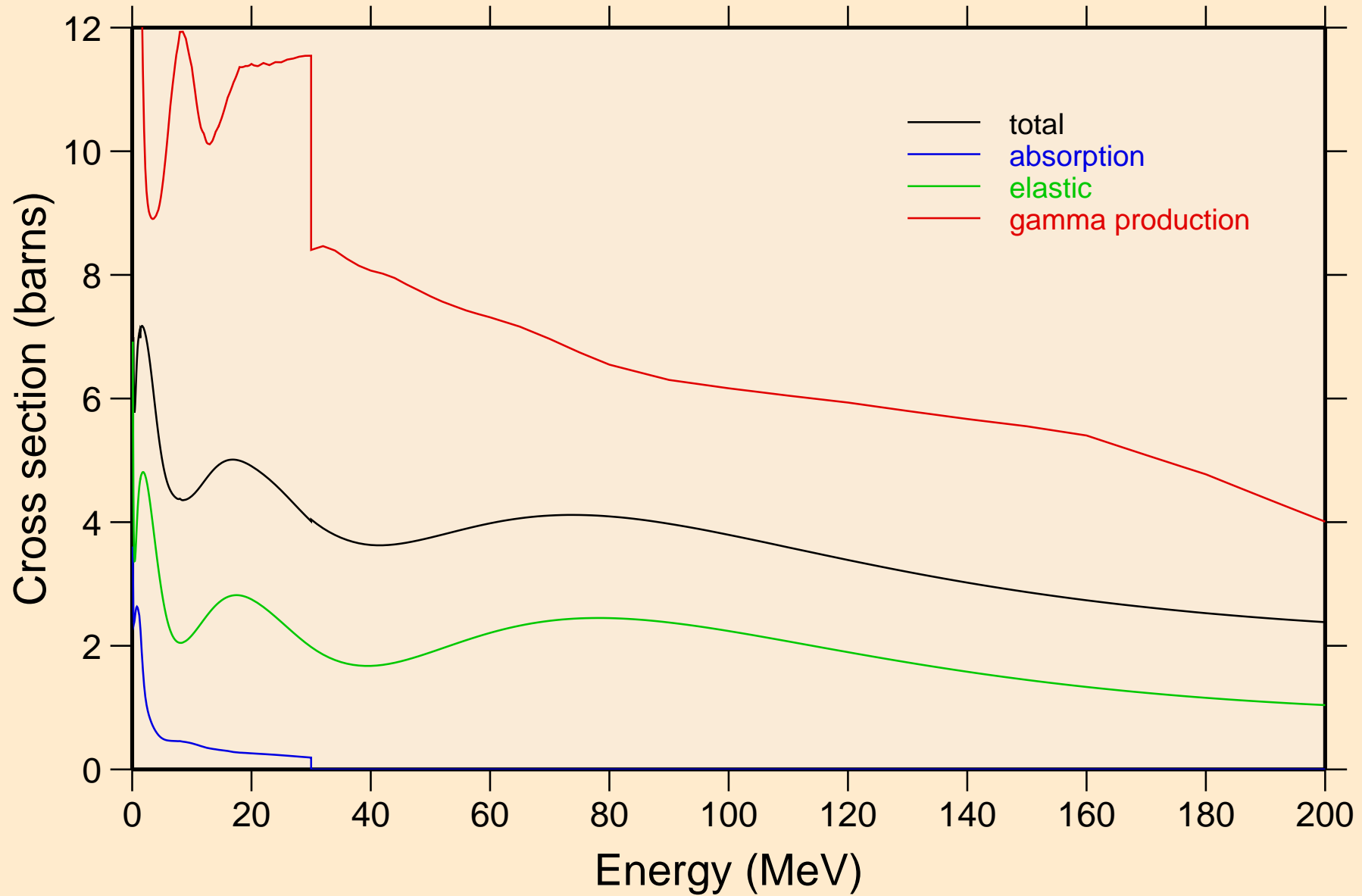

HO150M NRG TENDL-2015, AKONING

Non-threshold reactions

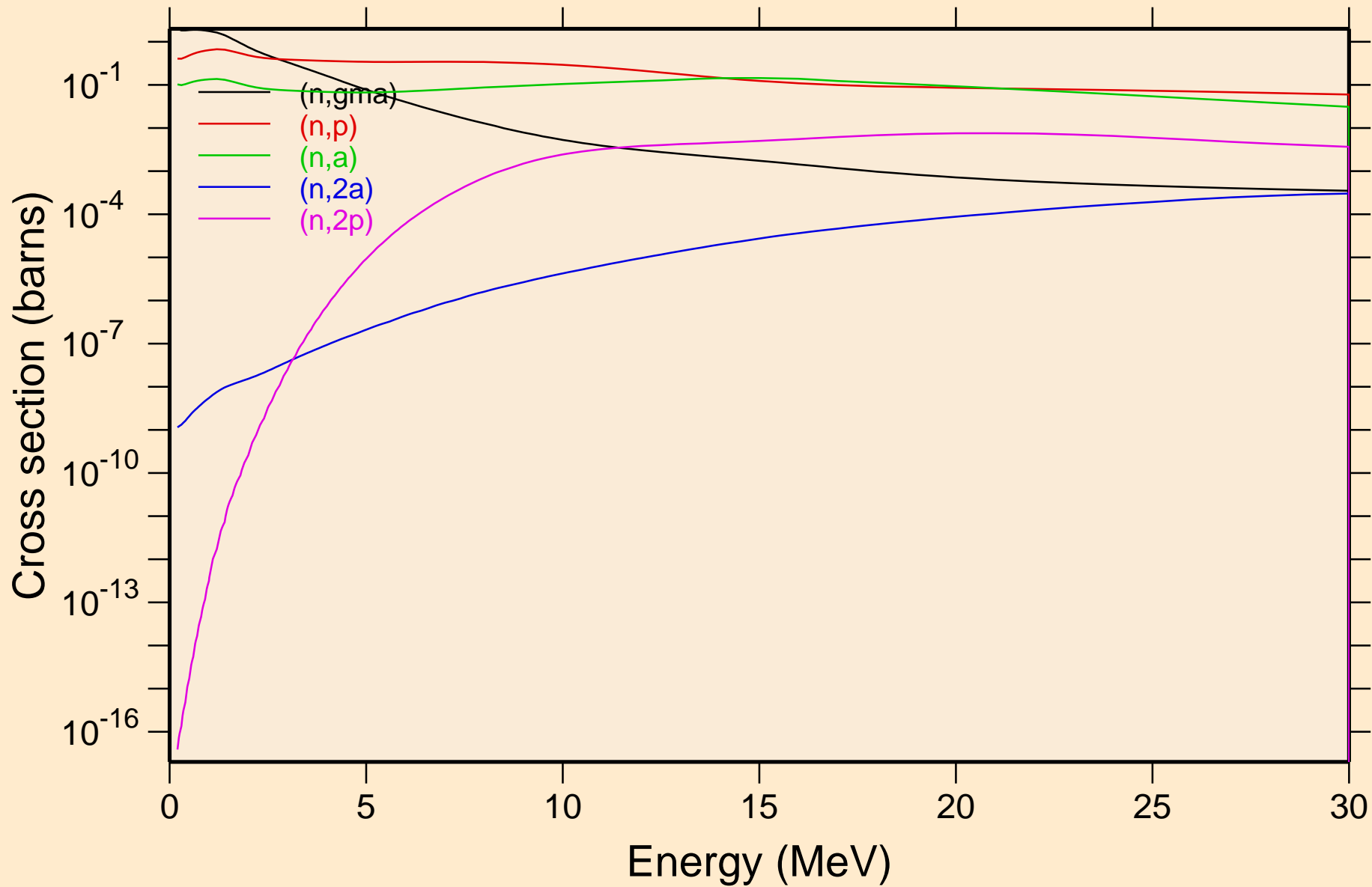

HO150M NRG TENDL-2015, AKONING
Non-threshold reactions

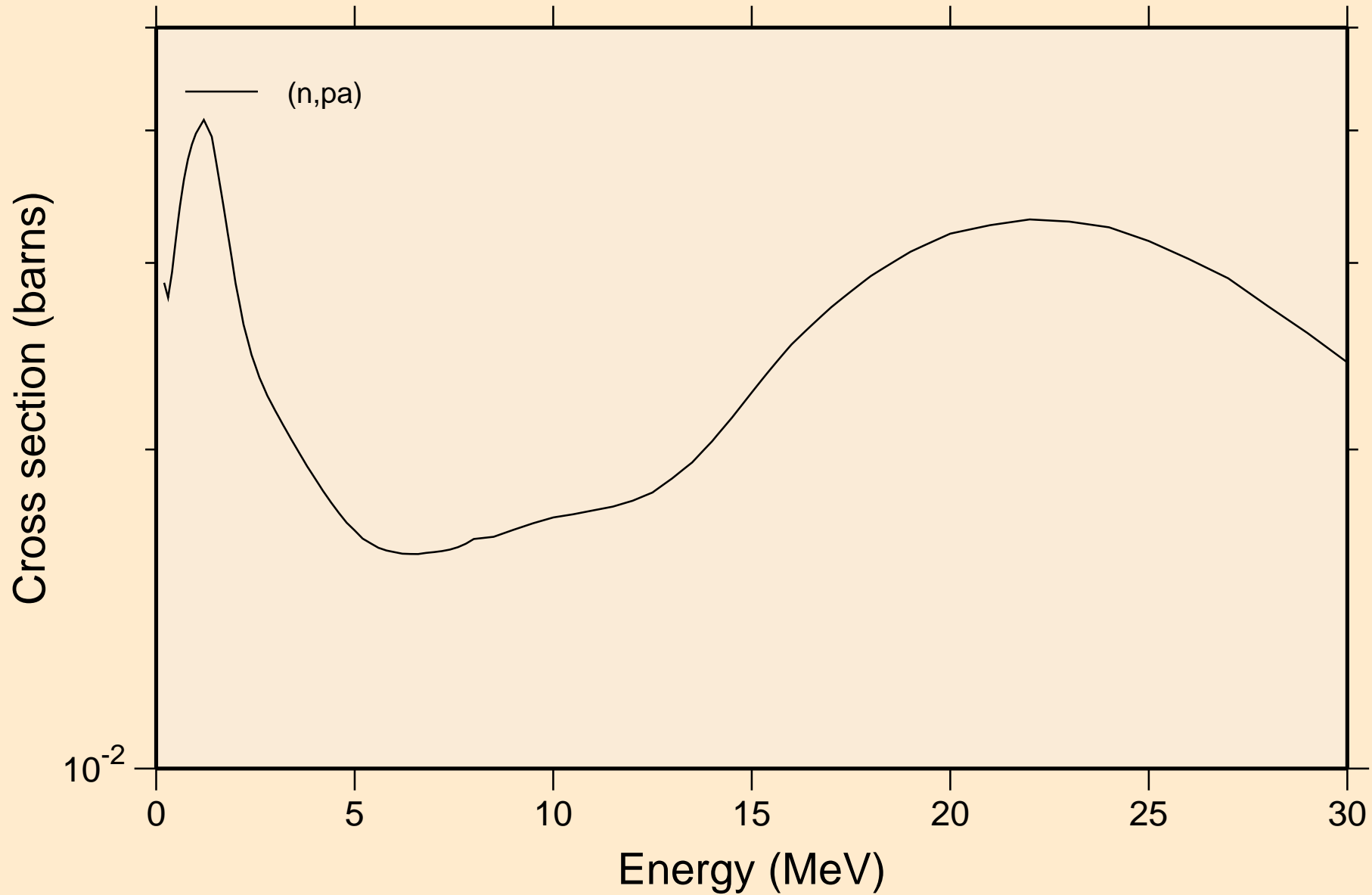

HO150M NRG TENDL-2015, AKONING

Inelastic levels

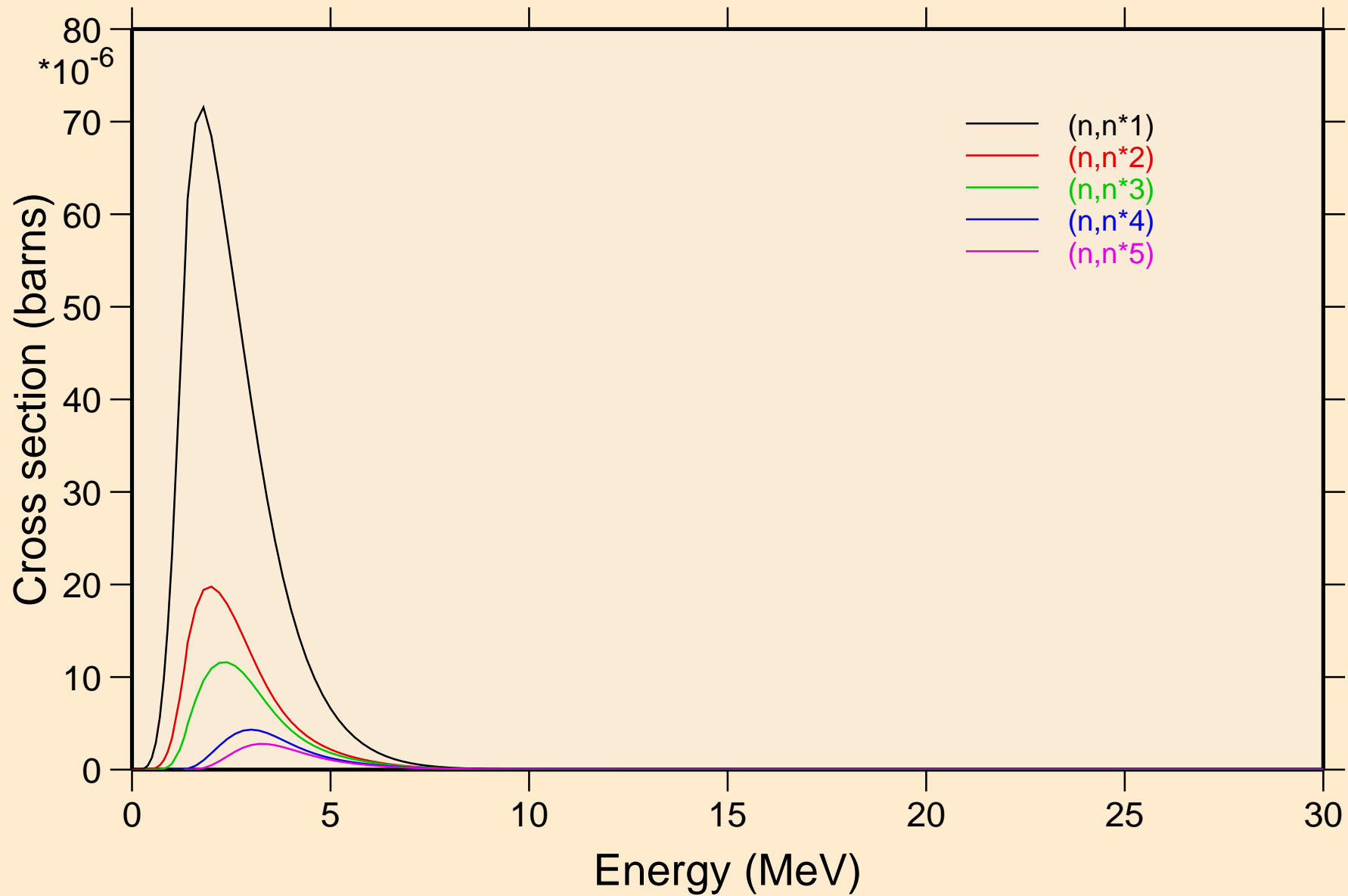

HO150M NRG TENDL-2015, AKONING

Inelastic levels

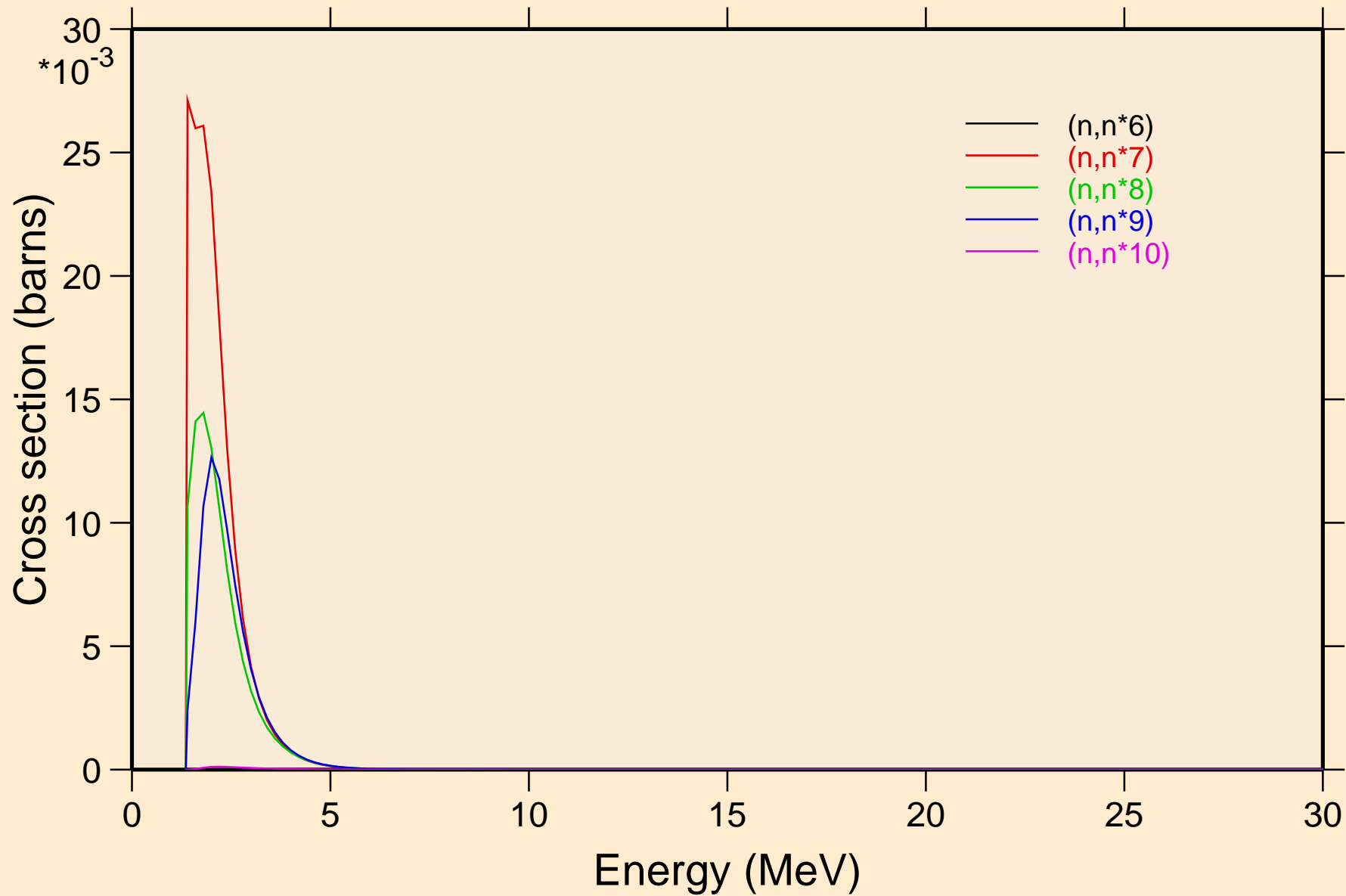

HO150M NRG TENDL-2015, AKONING

Inelastic levels

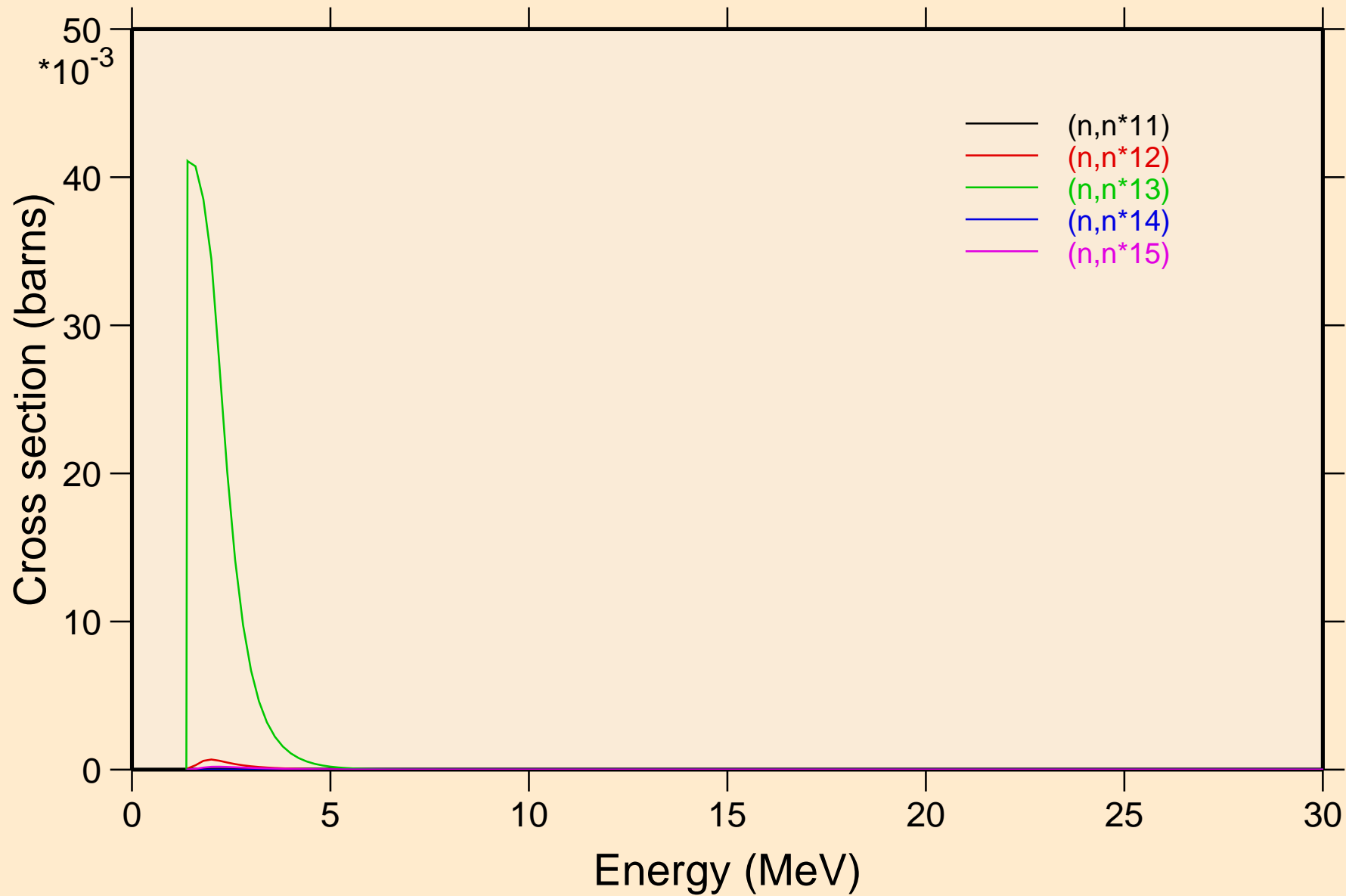

HO150M NRG TENDL-2015, AKONING

Inelastic levels

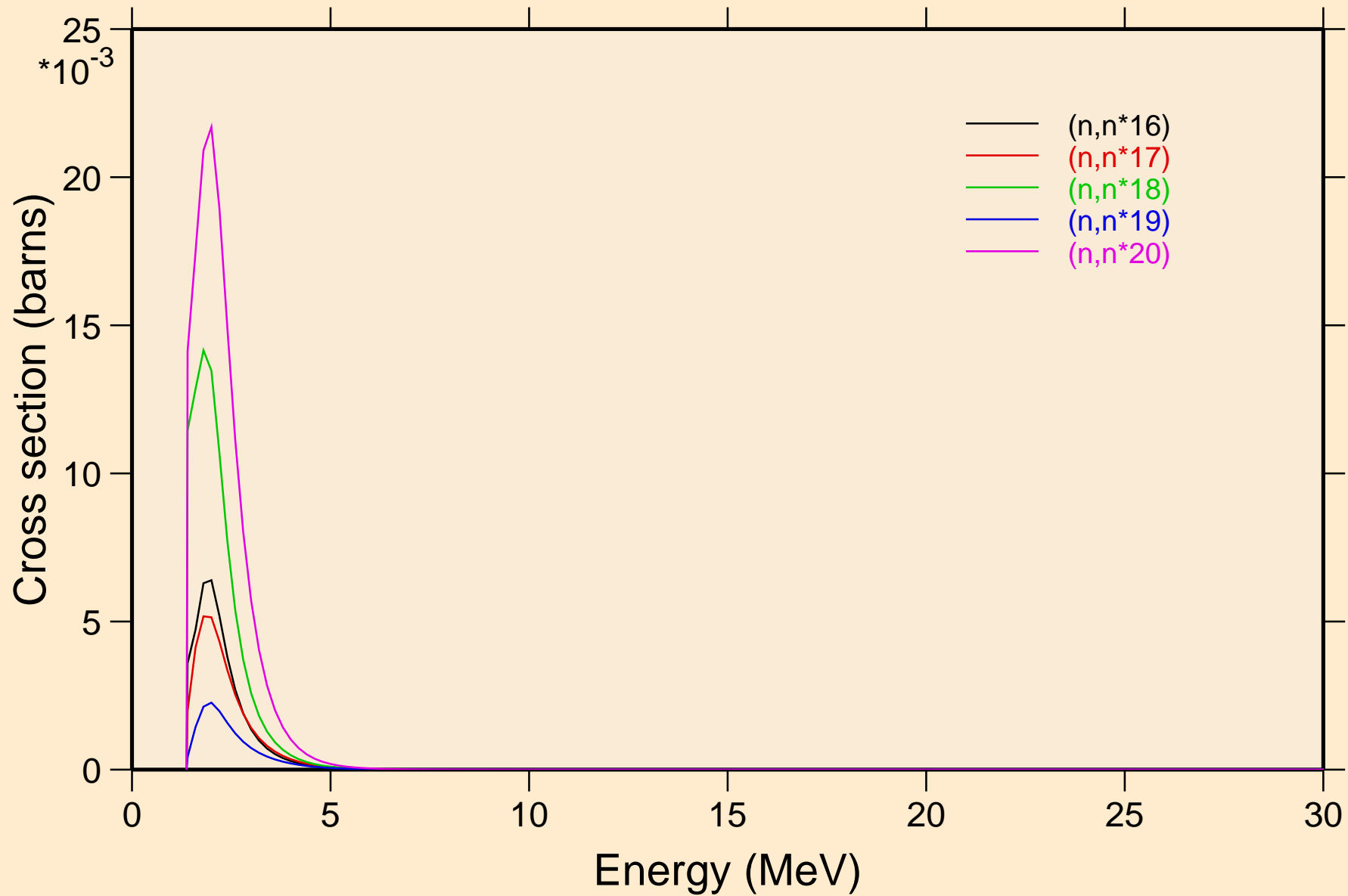

HO150M NRG TENDL-2015, AKONING

Inelastic levels

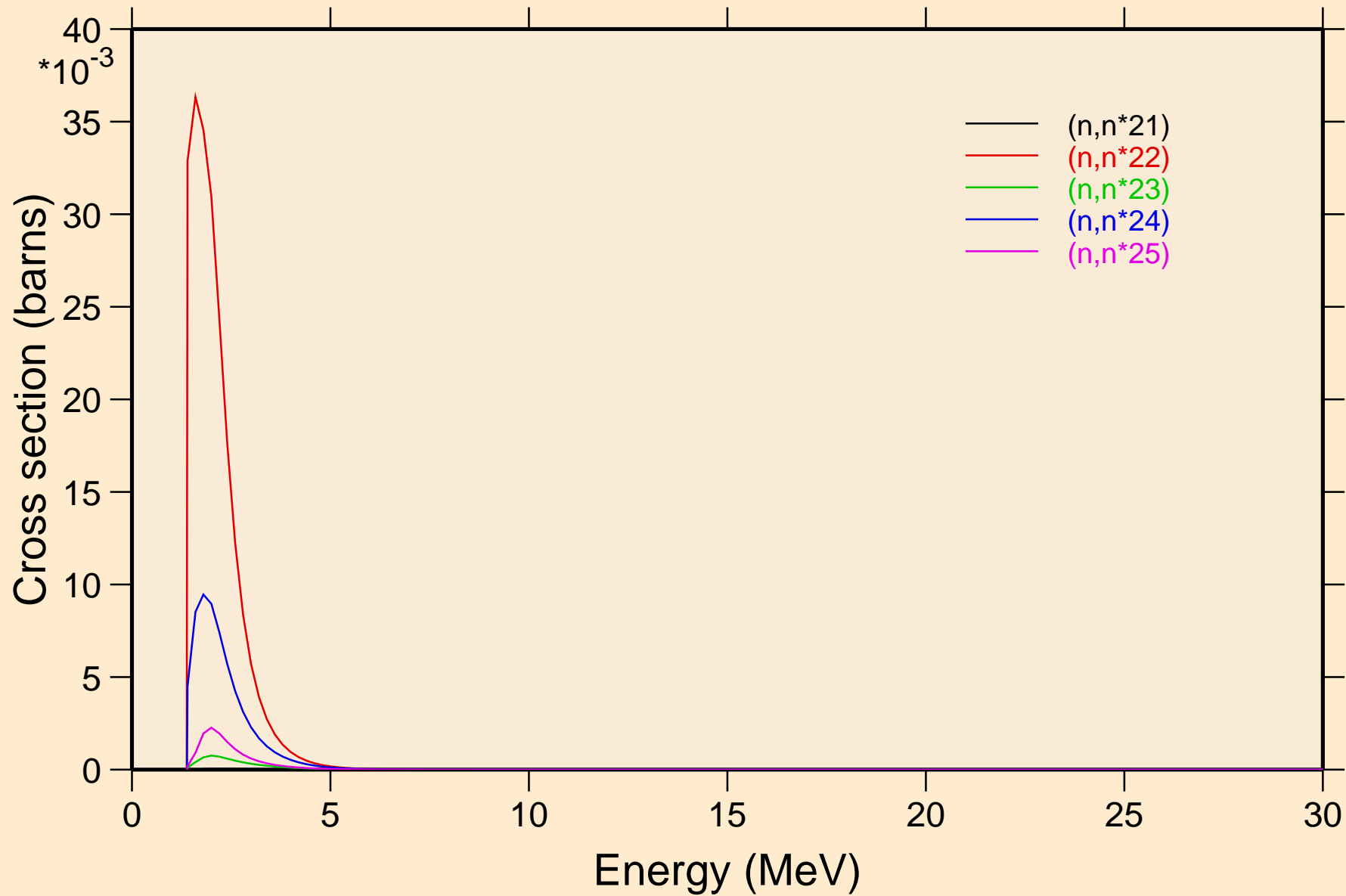

HO150M NRG TENDL-2015, AKONING

Inelastic levels

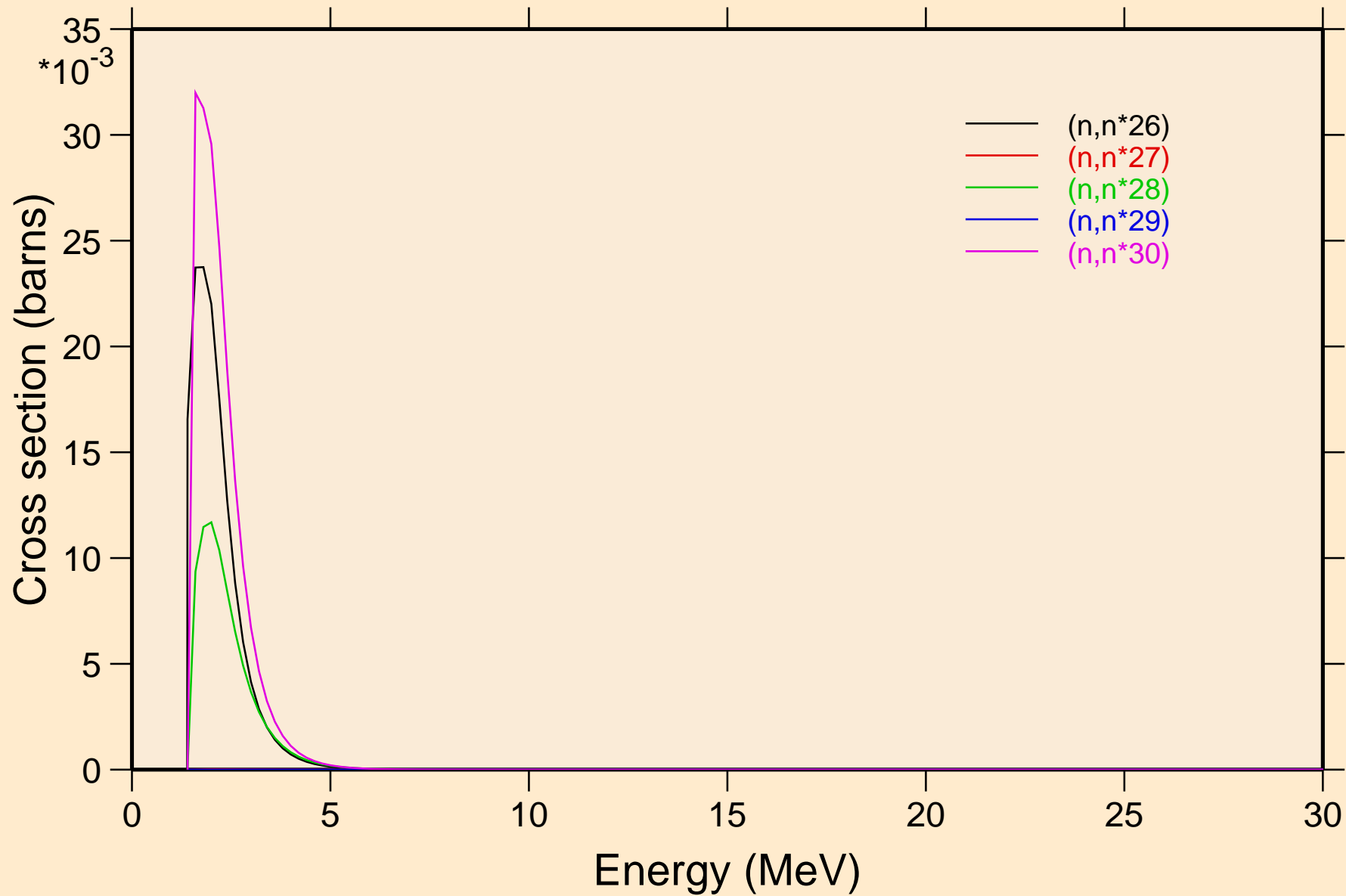

HO150M NRG TENDL-2015, AKONING

Threshold reactions

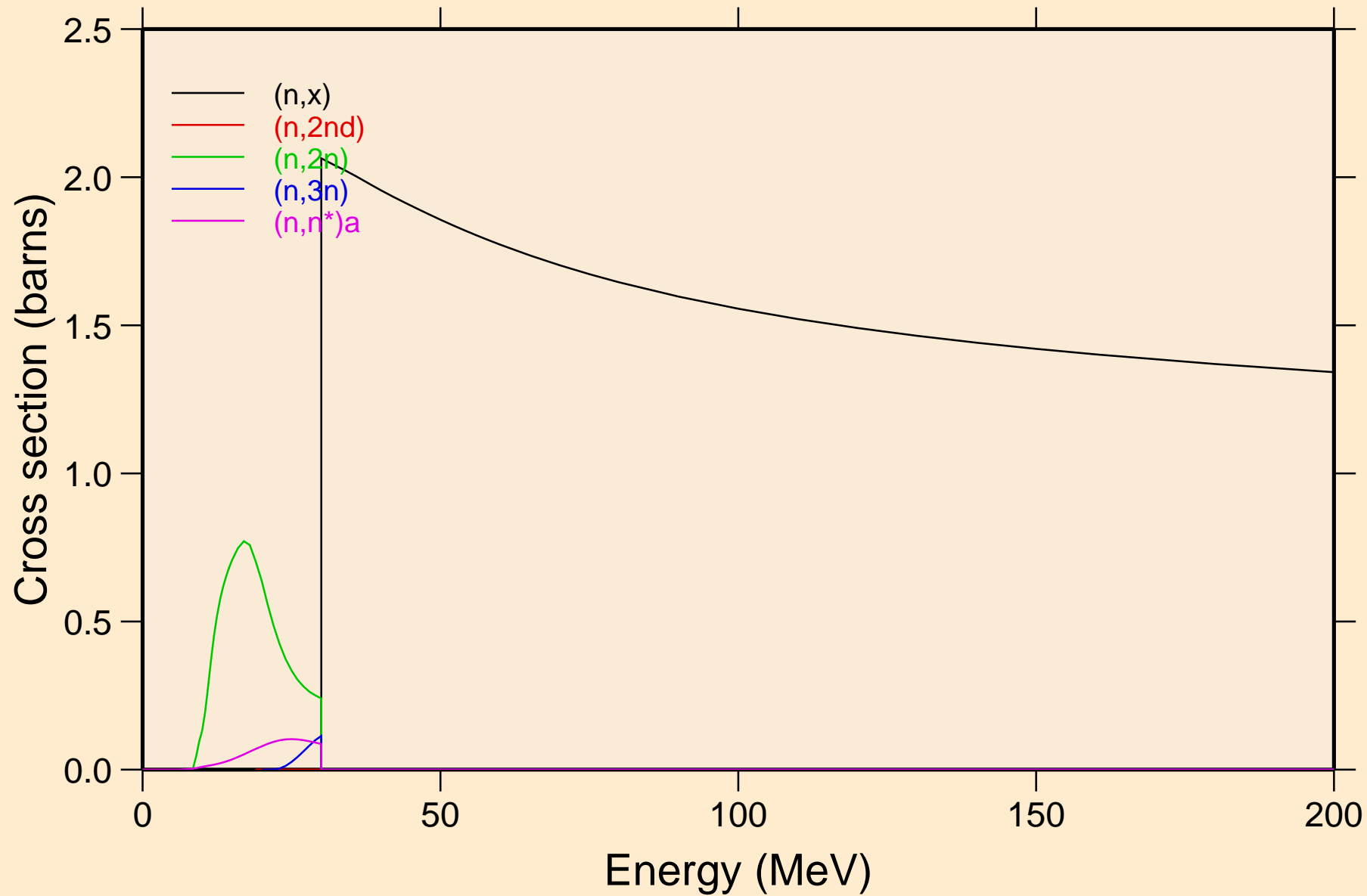

HO150M NRG TENDL-2015, AKONING

Threshold reactions

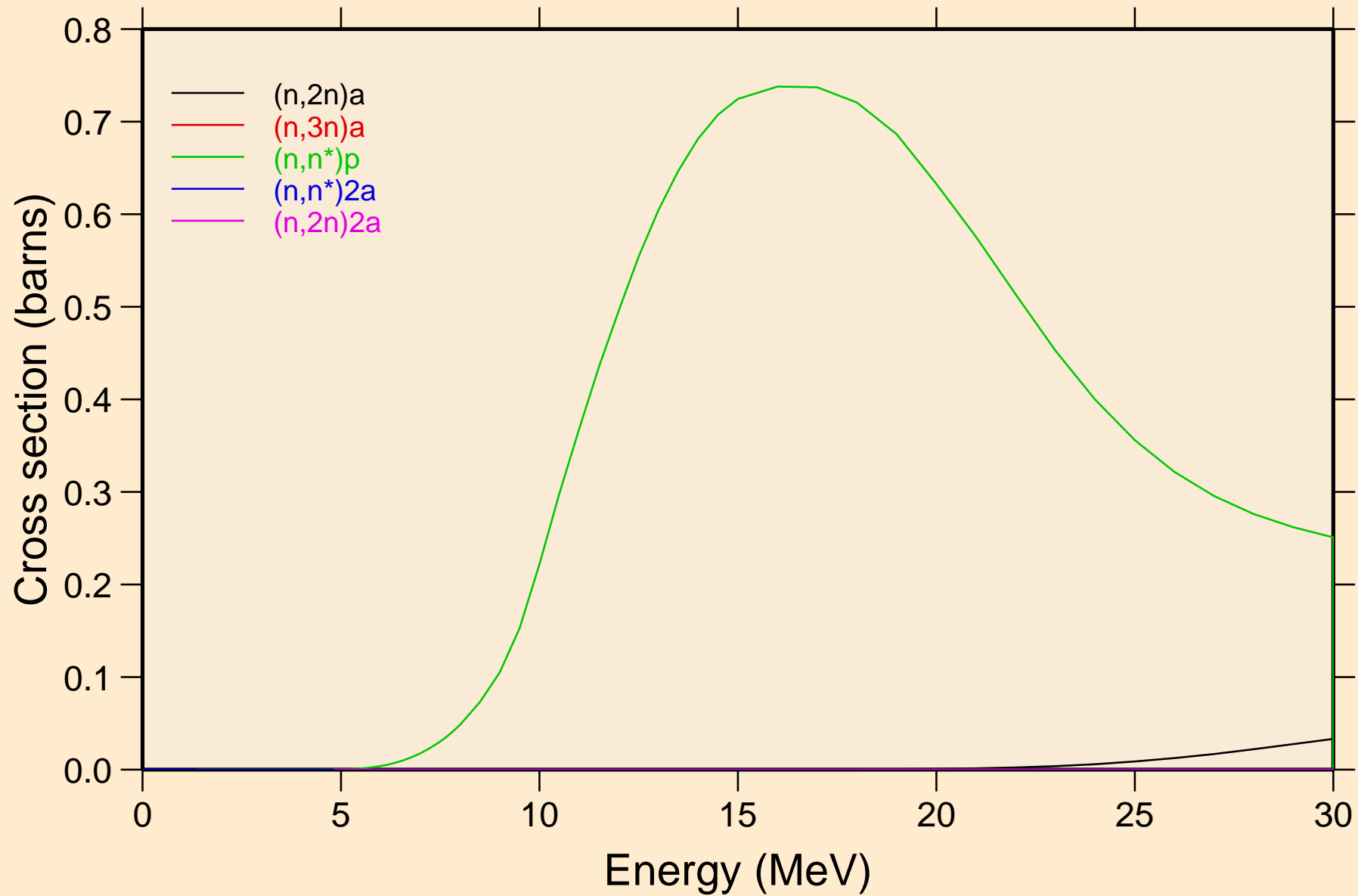

HO150M NRG TENDL-2015, AKONING

Threshold reactions

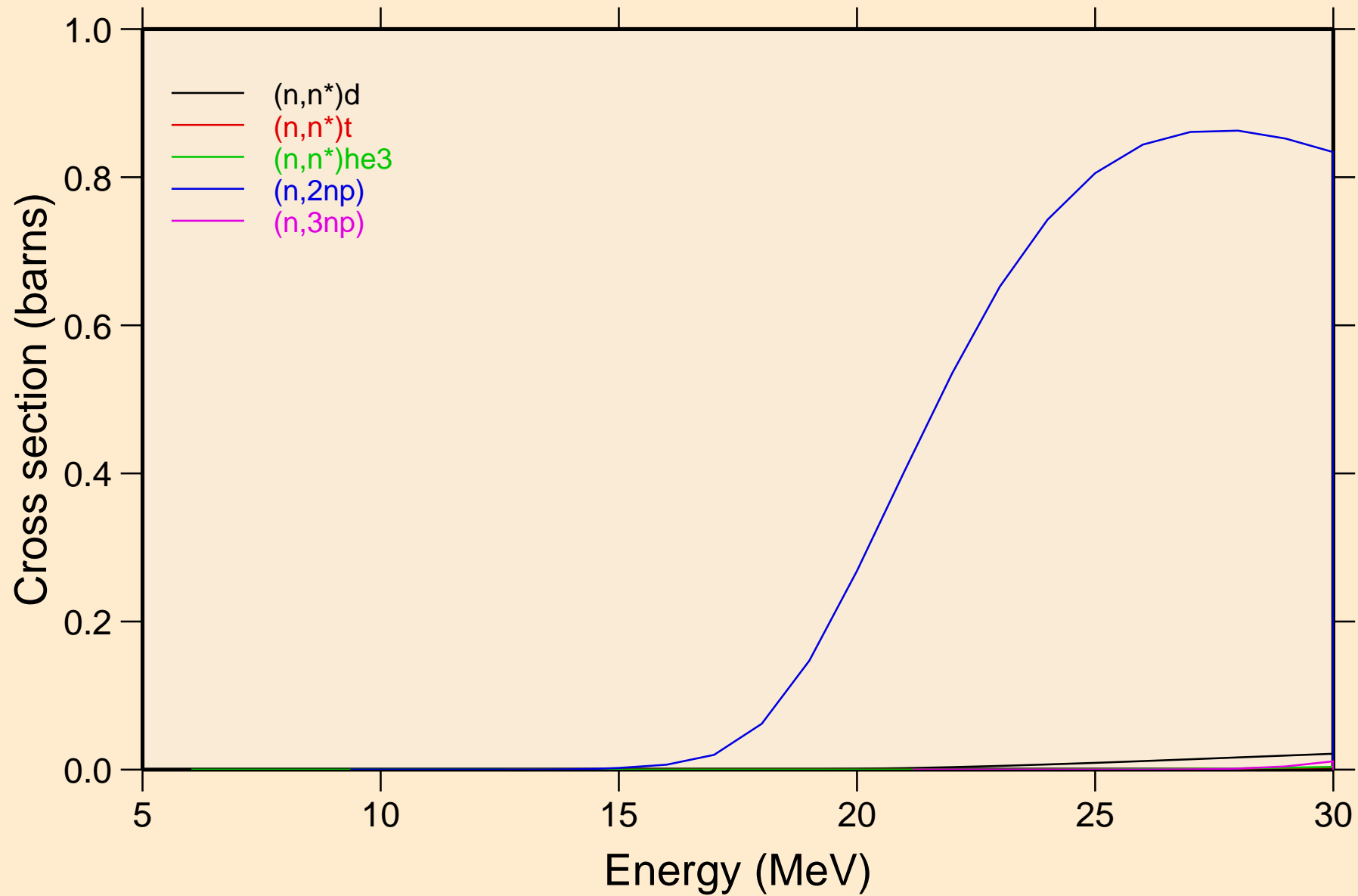

HO150M NRG TENDL-2015, AKONING

Threshold reactions

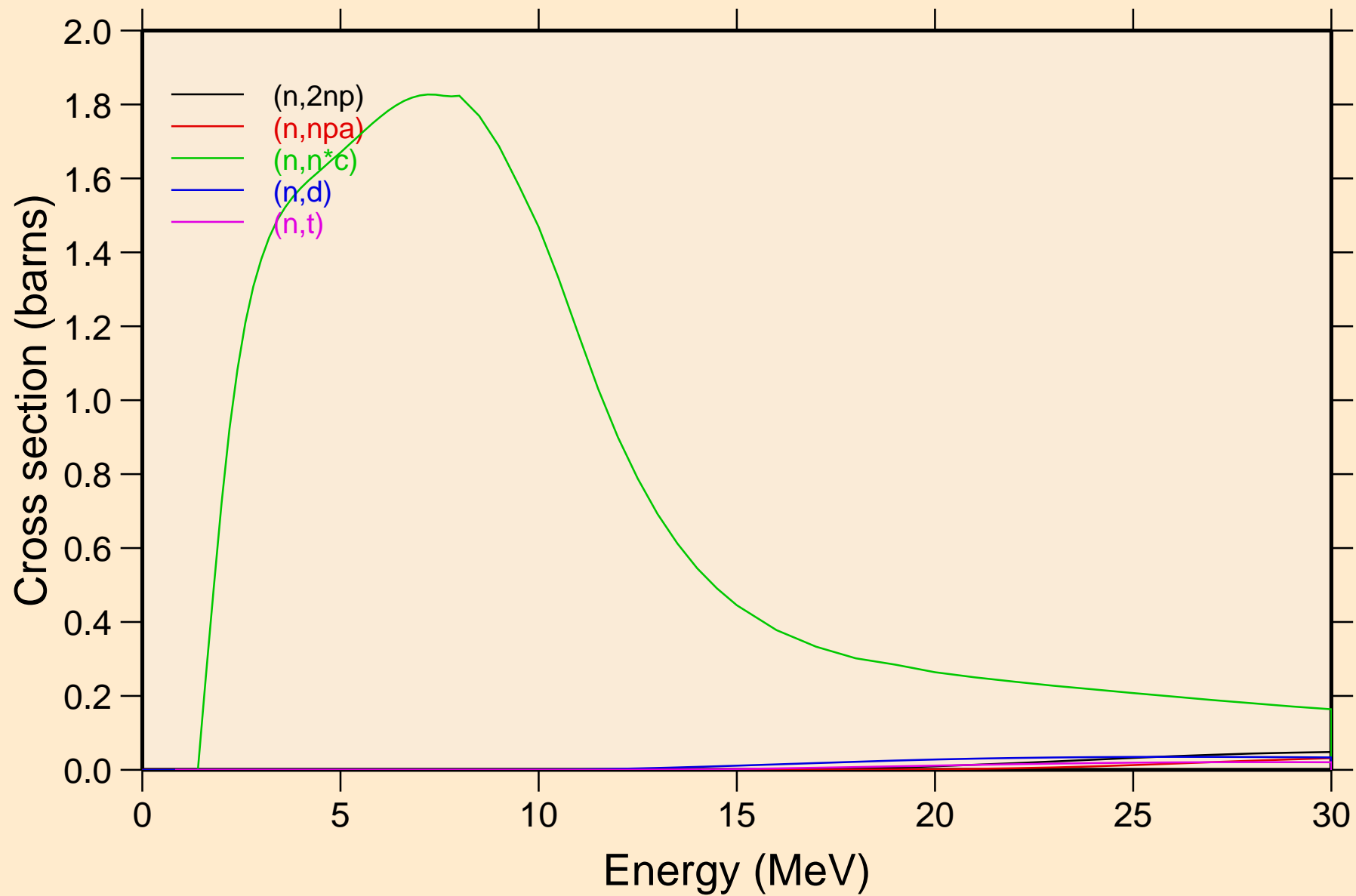

HO150M NRG TENDL-2015, AKONING

Threshold reactions

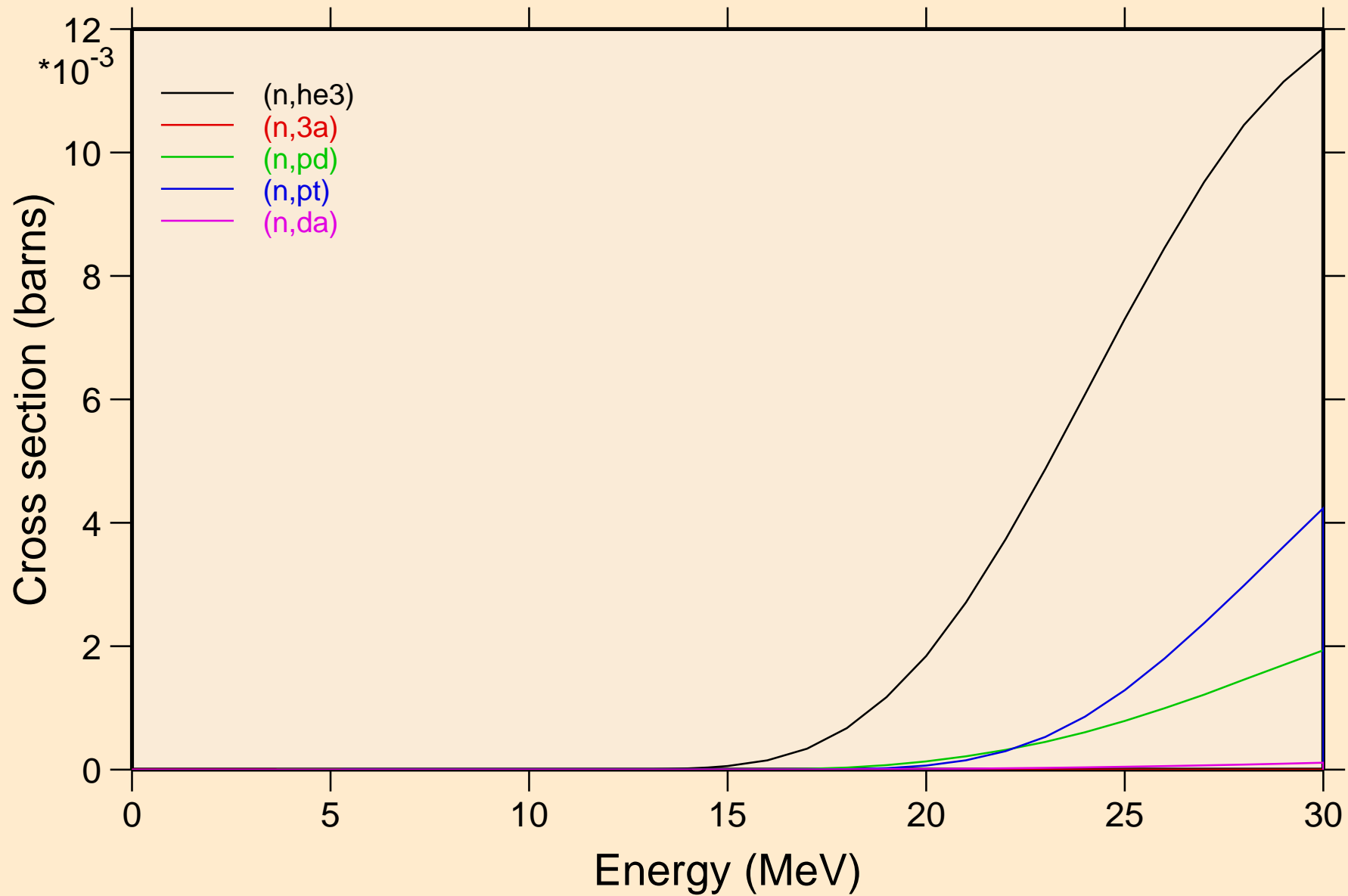

HO150M NRG TENDL-2015, AKONING
angular distribution for elastic

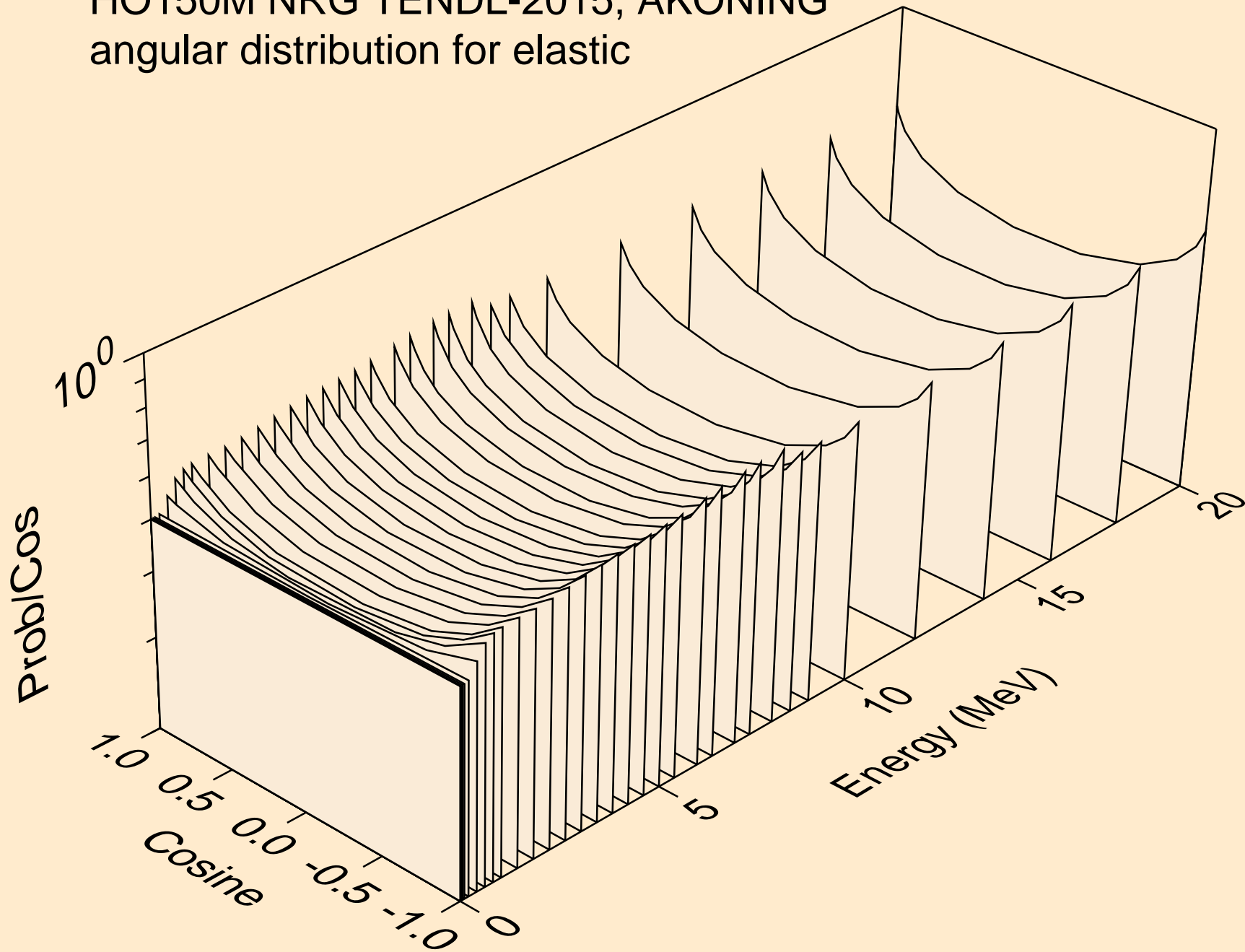

HO150M NRG TENDL-2015, AKONING
angular distribution for elastic

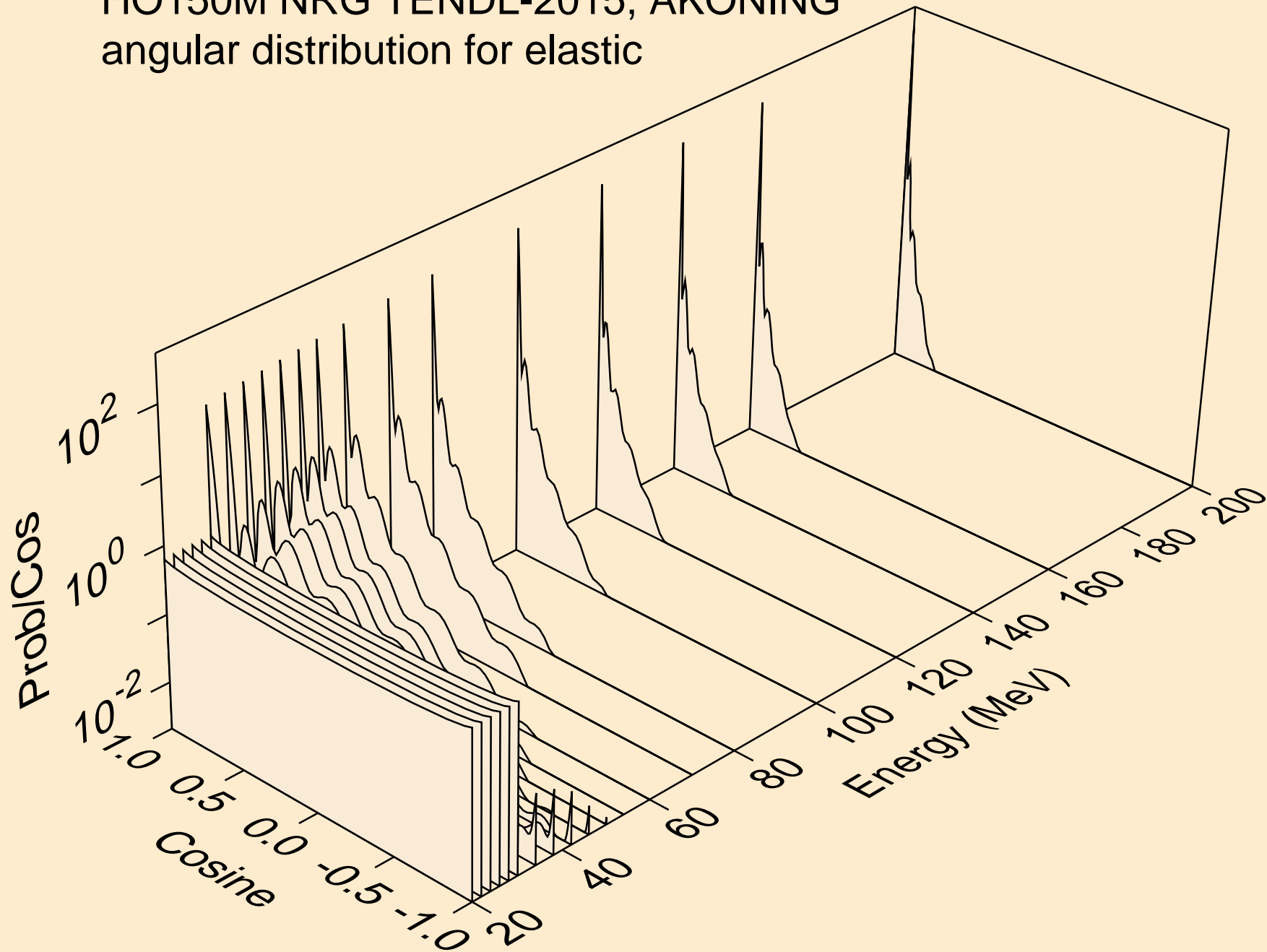

HO150M NRG TENDL-2015, AKONING
angular distribution for (n,n*1)

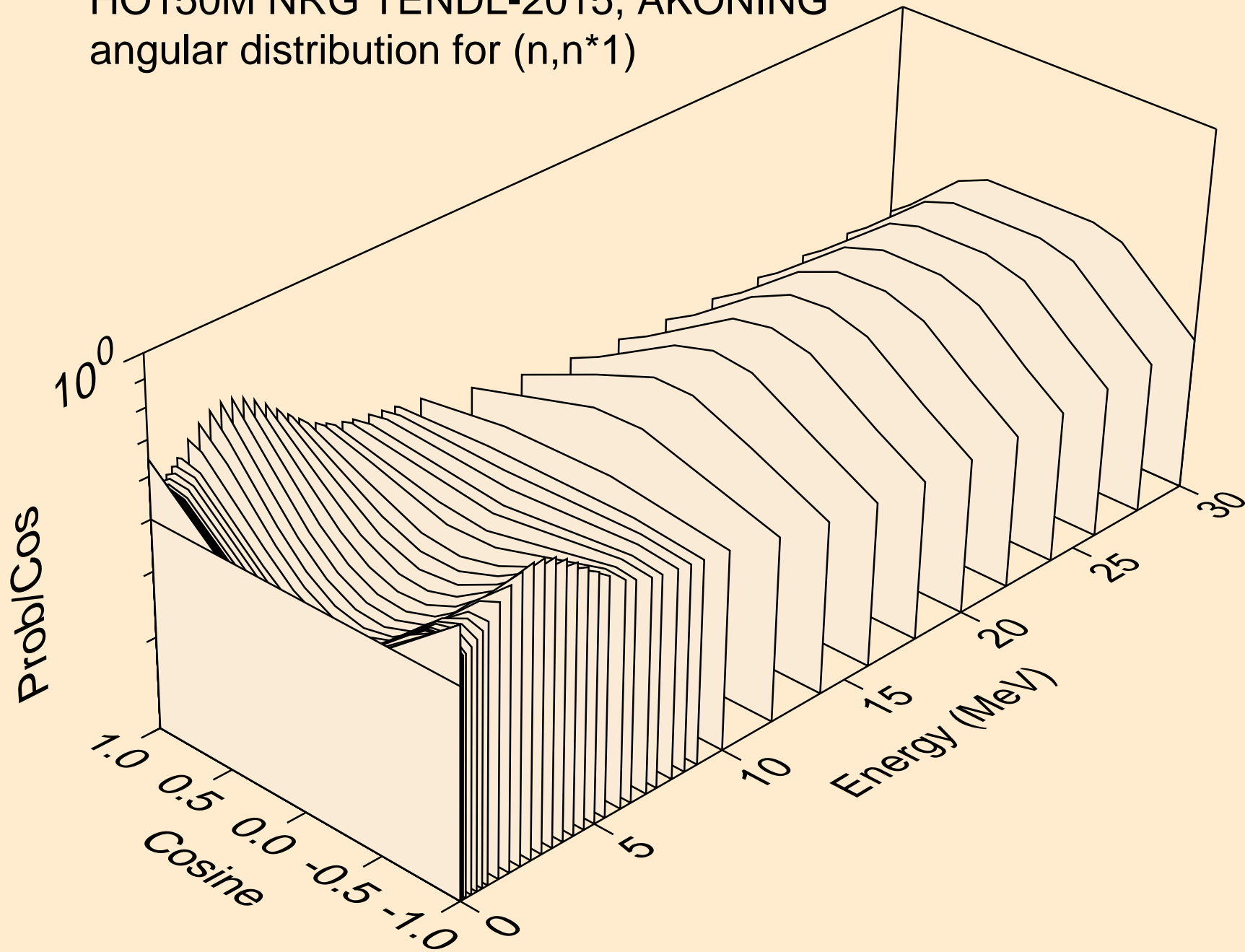

HO150M NRG TENDL-2015, AKONING
angular distribution for (n,n*2)

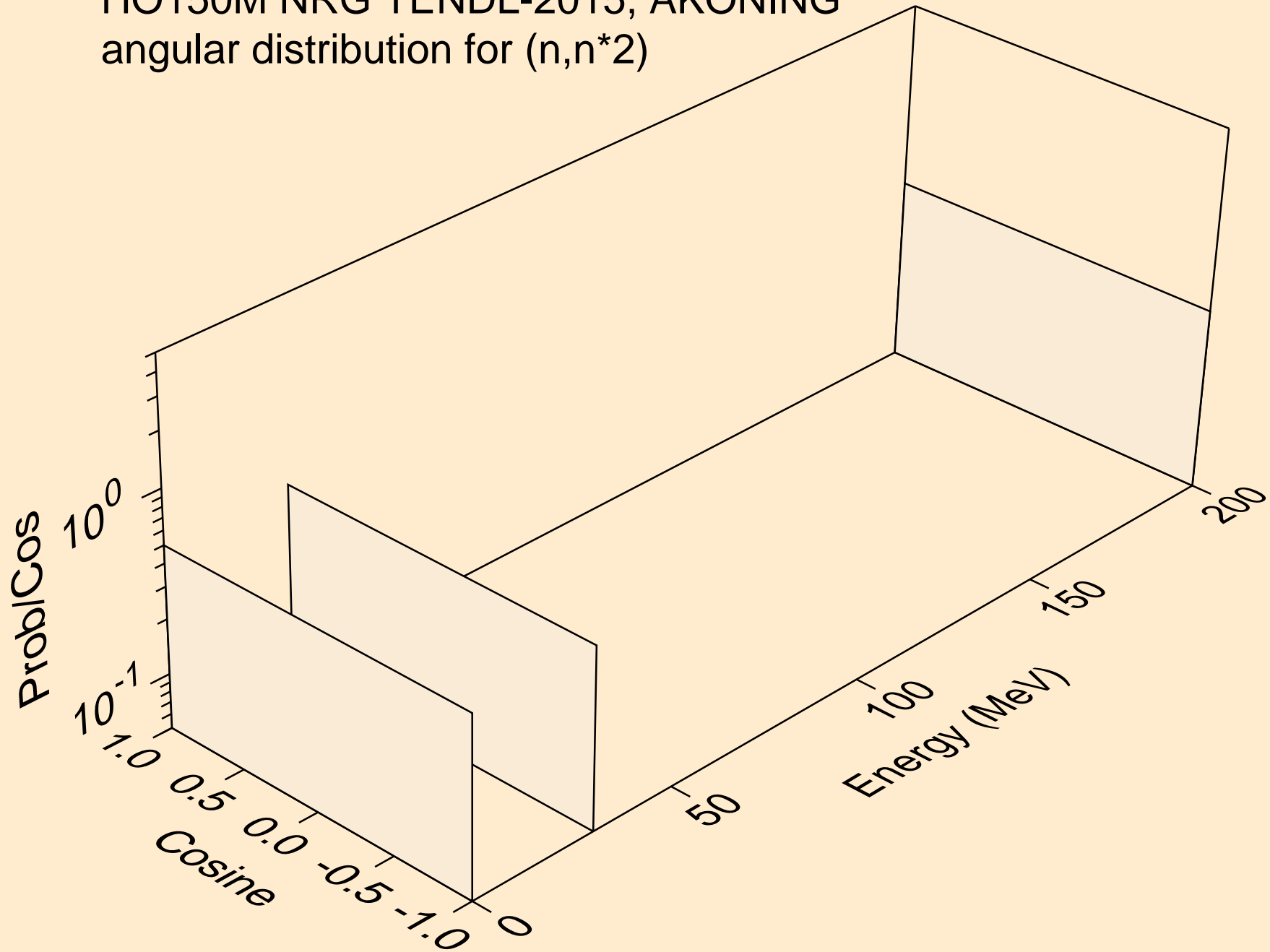

HO150M NRG TENDL-2015, AKONING
angular distribution for (n,n*3)

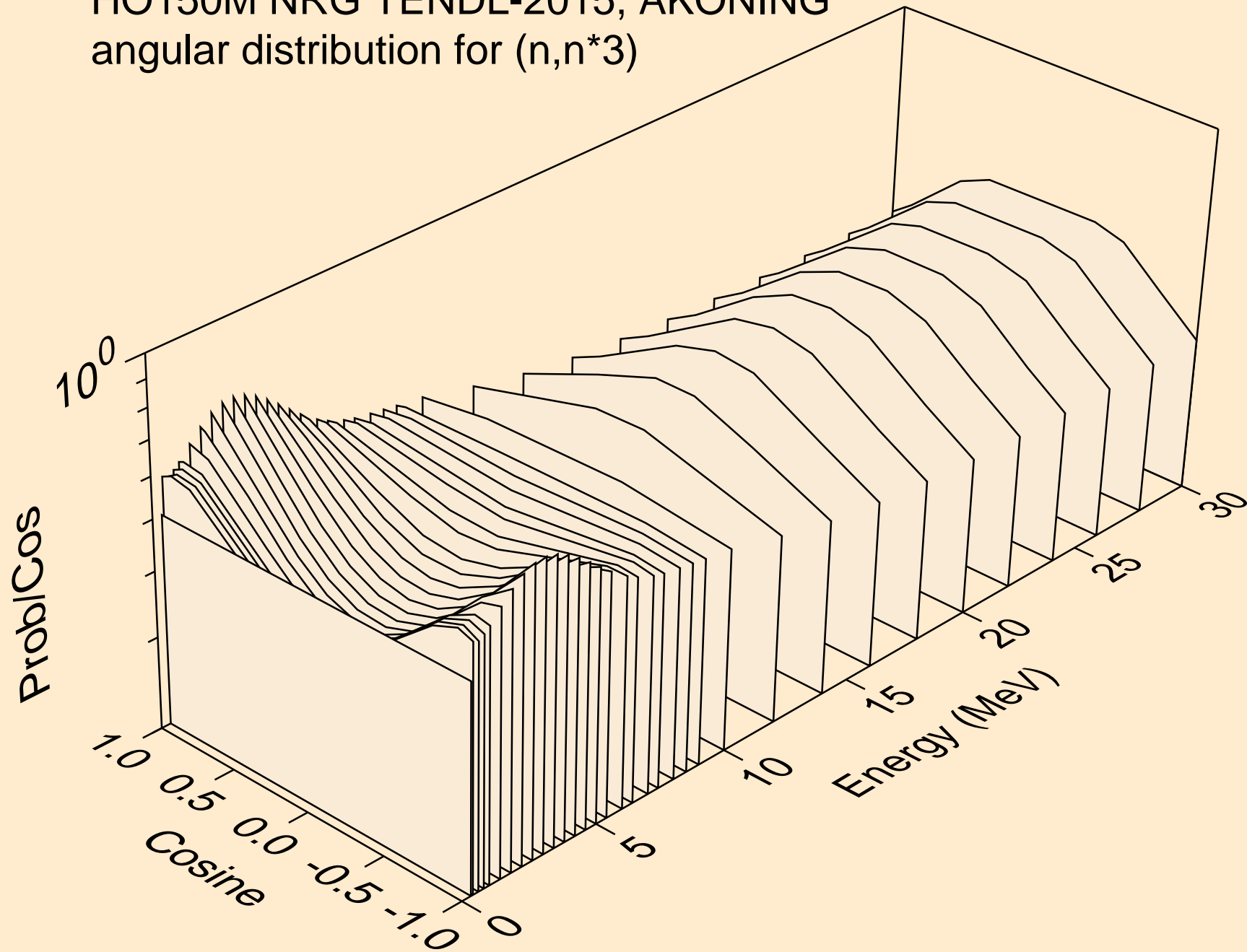

HO150M NRG TENDL-2015, AKONING
angular distribution for (n,n*4)

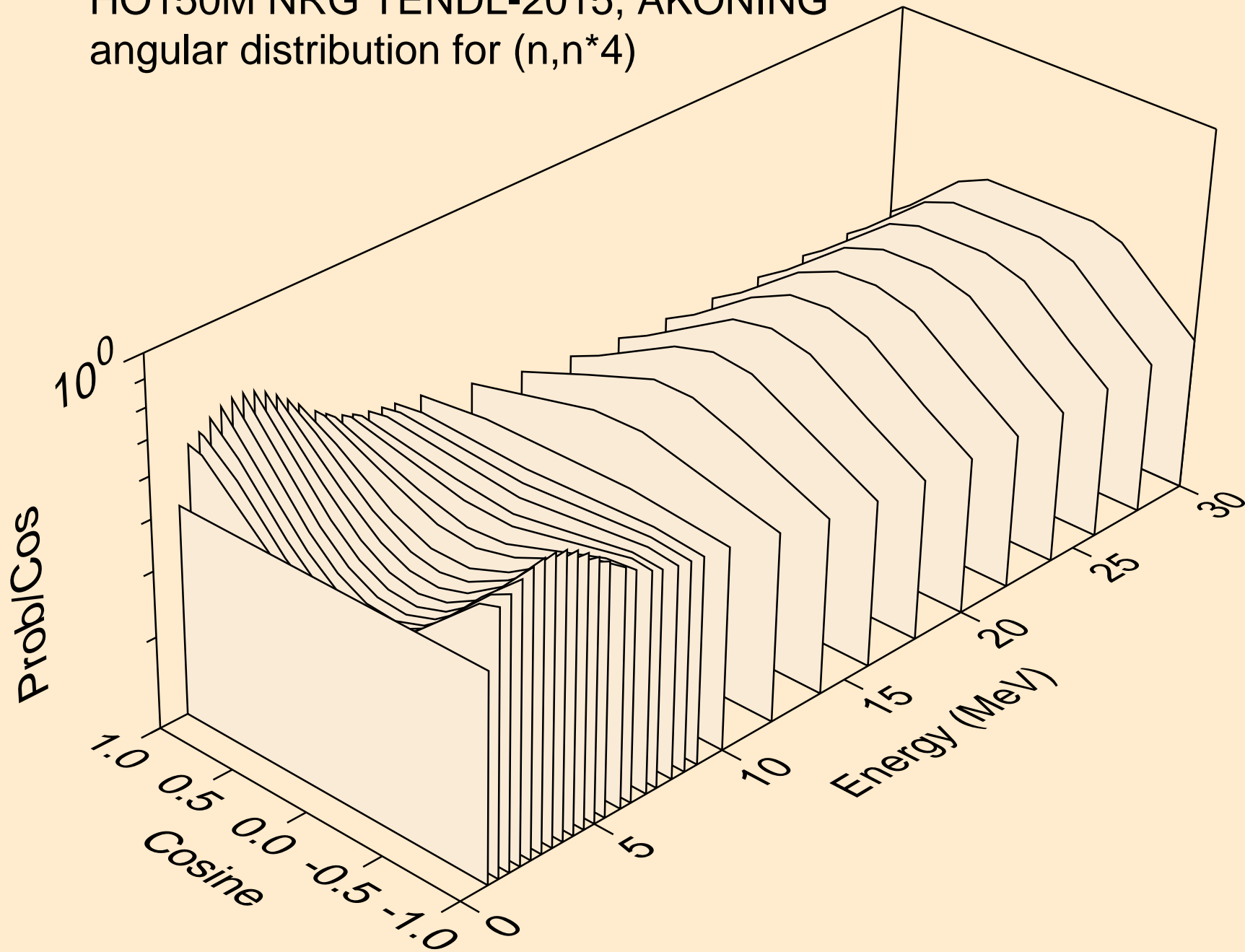

HO150M NRG TENDL-2015, AKONING
angular distribution for (n,n*5)

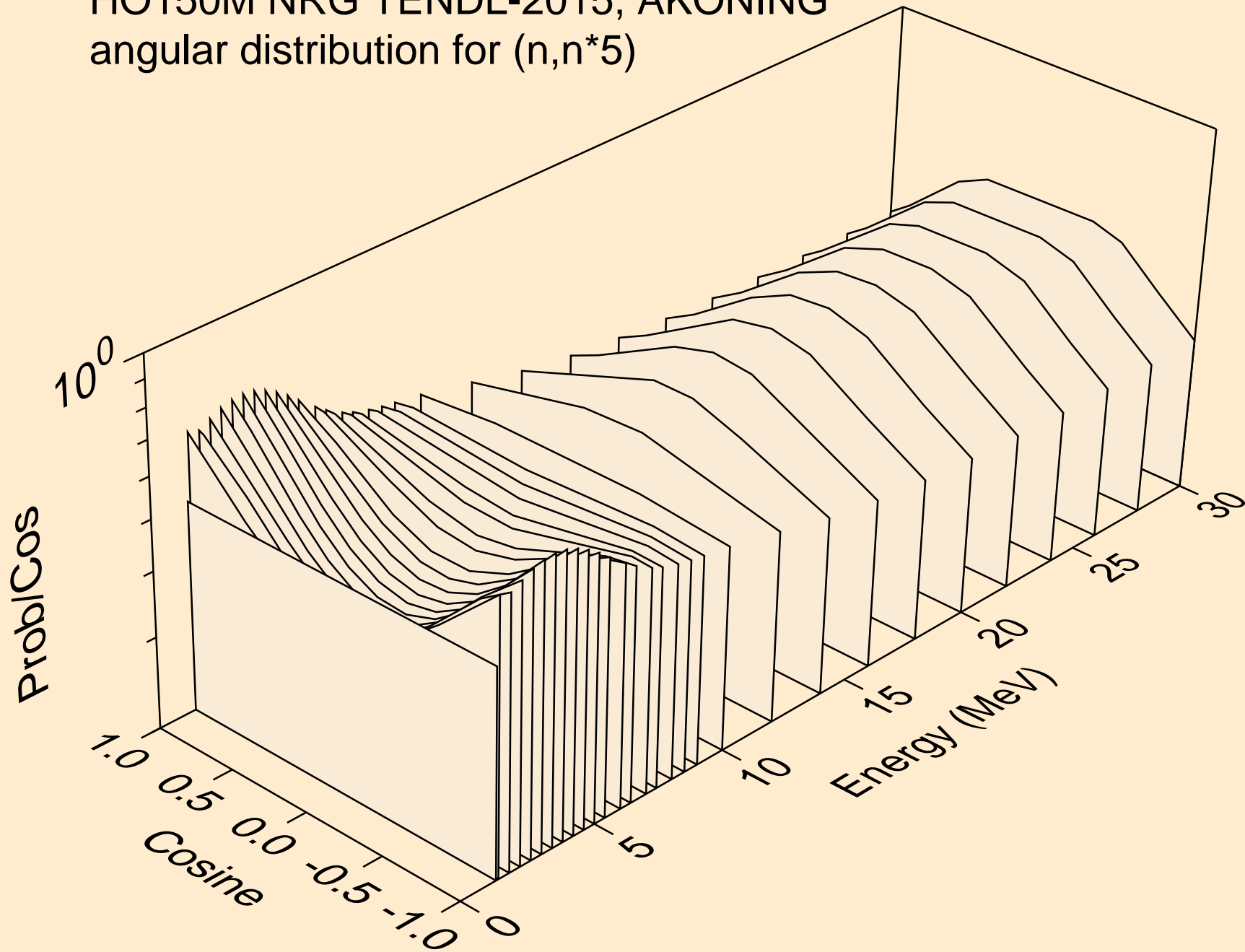

HO150M NRG TENDL-2015, AKONING
angular distribution for (n,n*6)

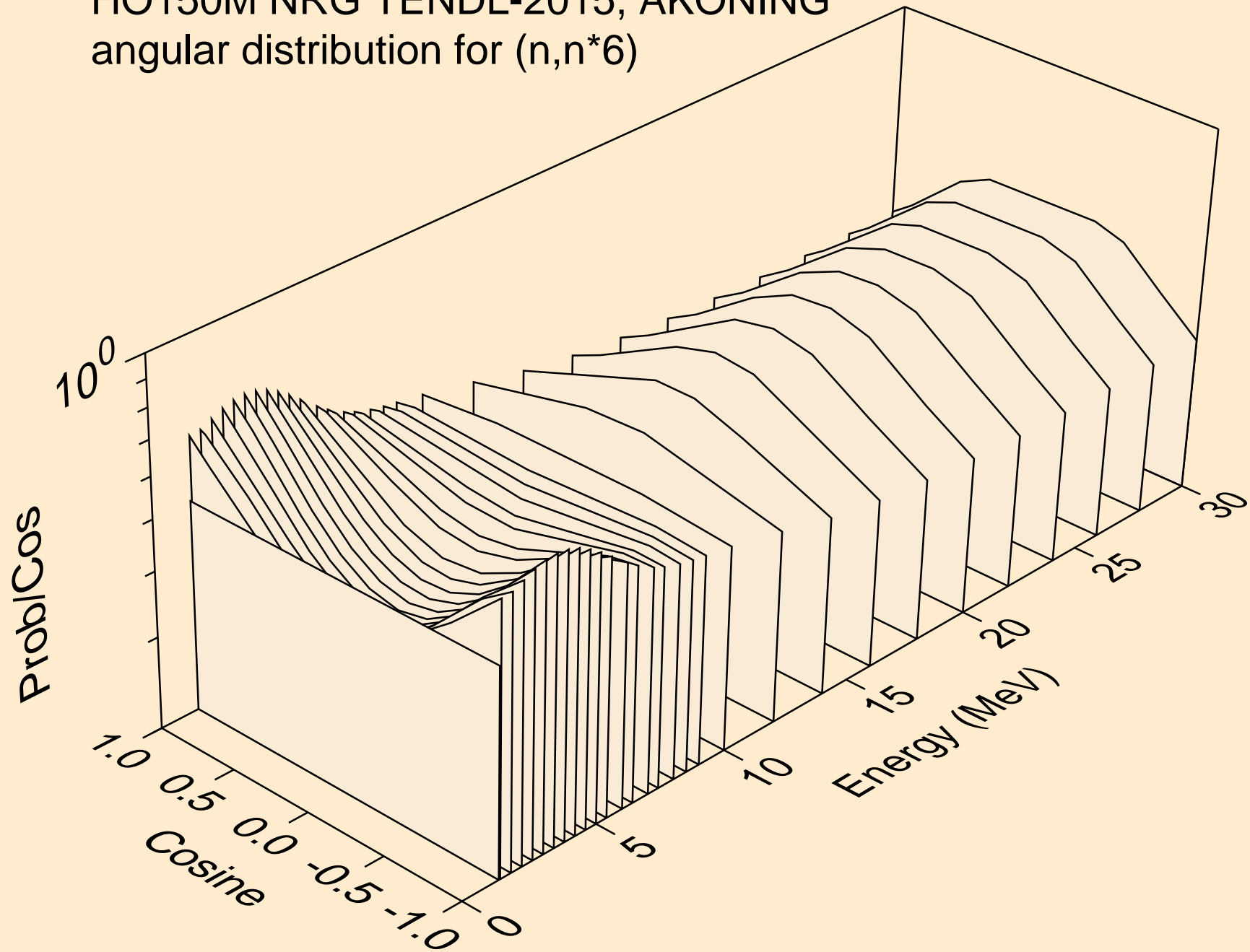

HO150M NRG TENDL-2015, AKONING
angular distribution for (n,n*7)

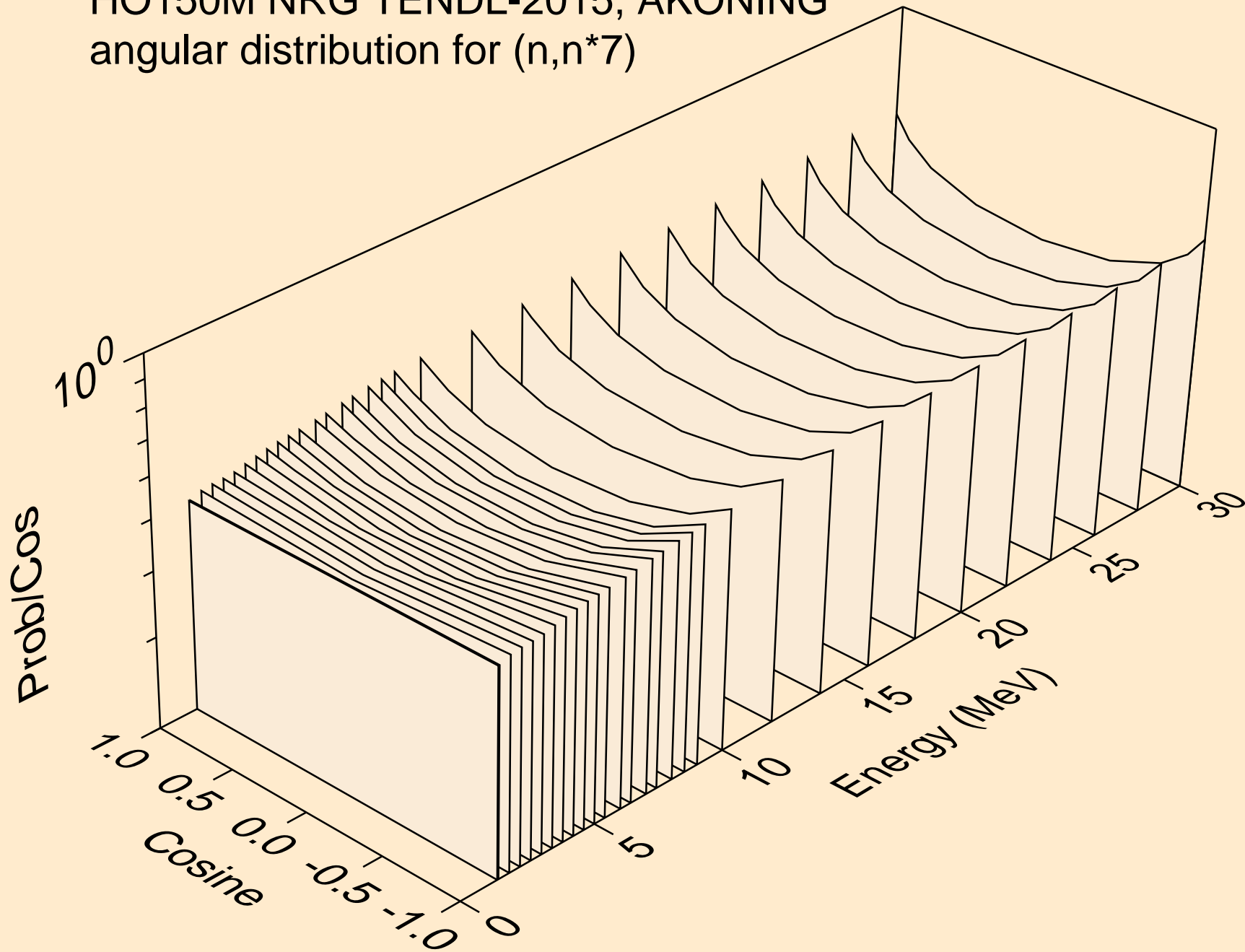

HO150M NRG TENDL-2015, AKONING
angular distribution for (n,n*8)

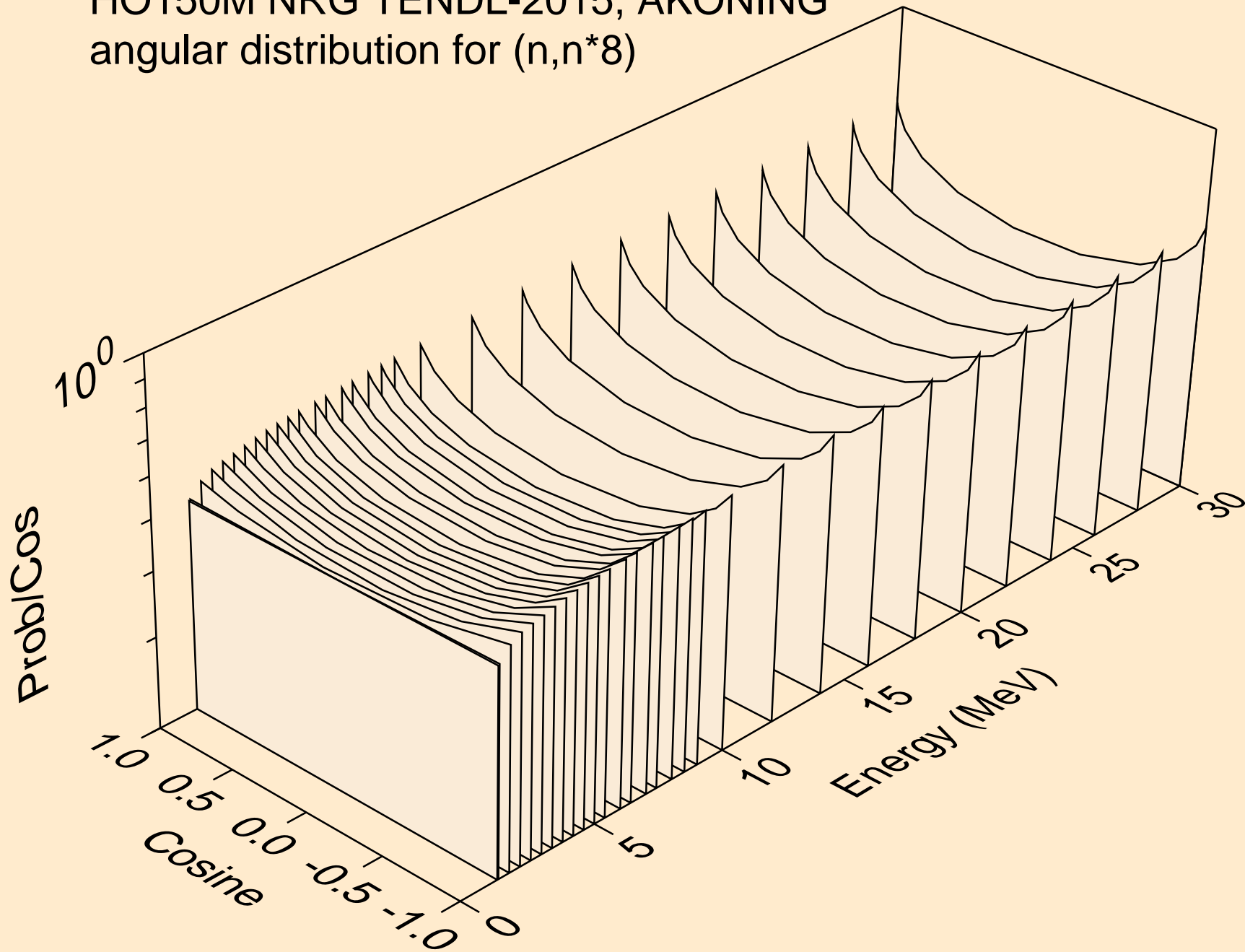

HO150M NRG TENDL-2015, AKONING
angular distribution for (n,n*9)

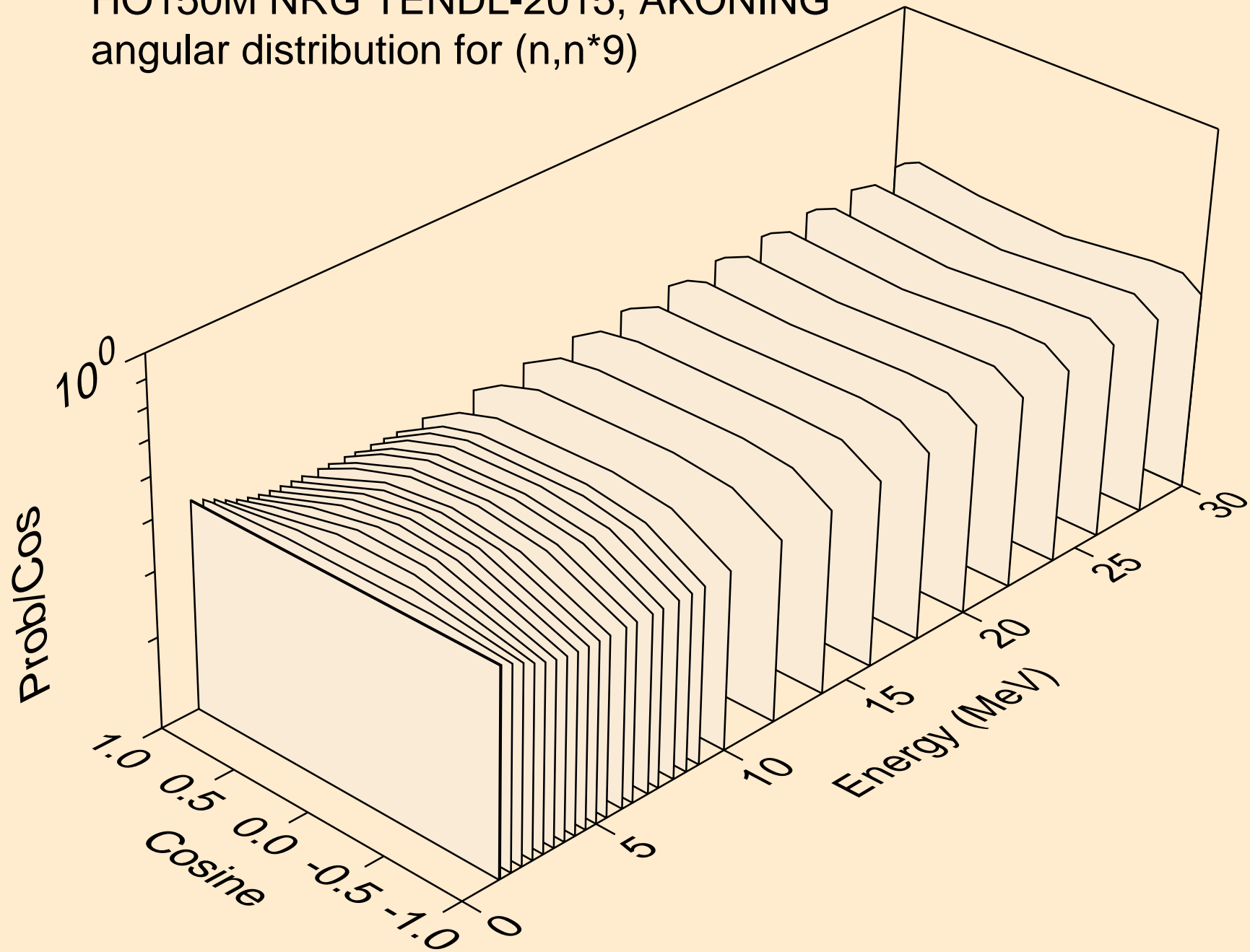

HO150M NRG TENDL-2015, AKONING
angular distribution for (n,n*10)

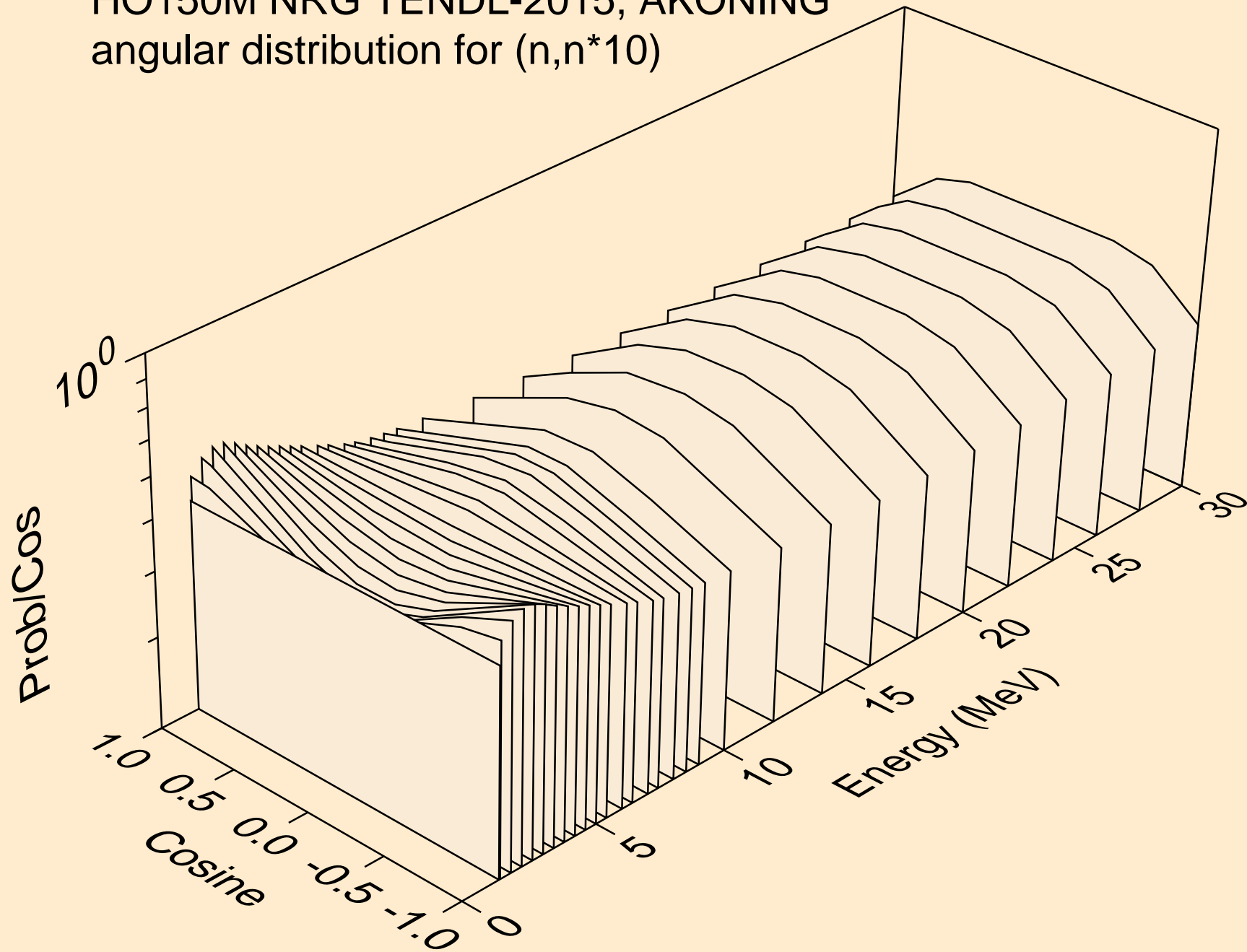

HO150M NRG TENDL-2015, AKONING
angular distribution for (n,n*11)

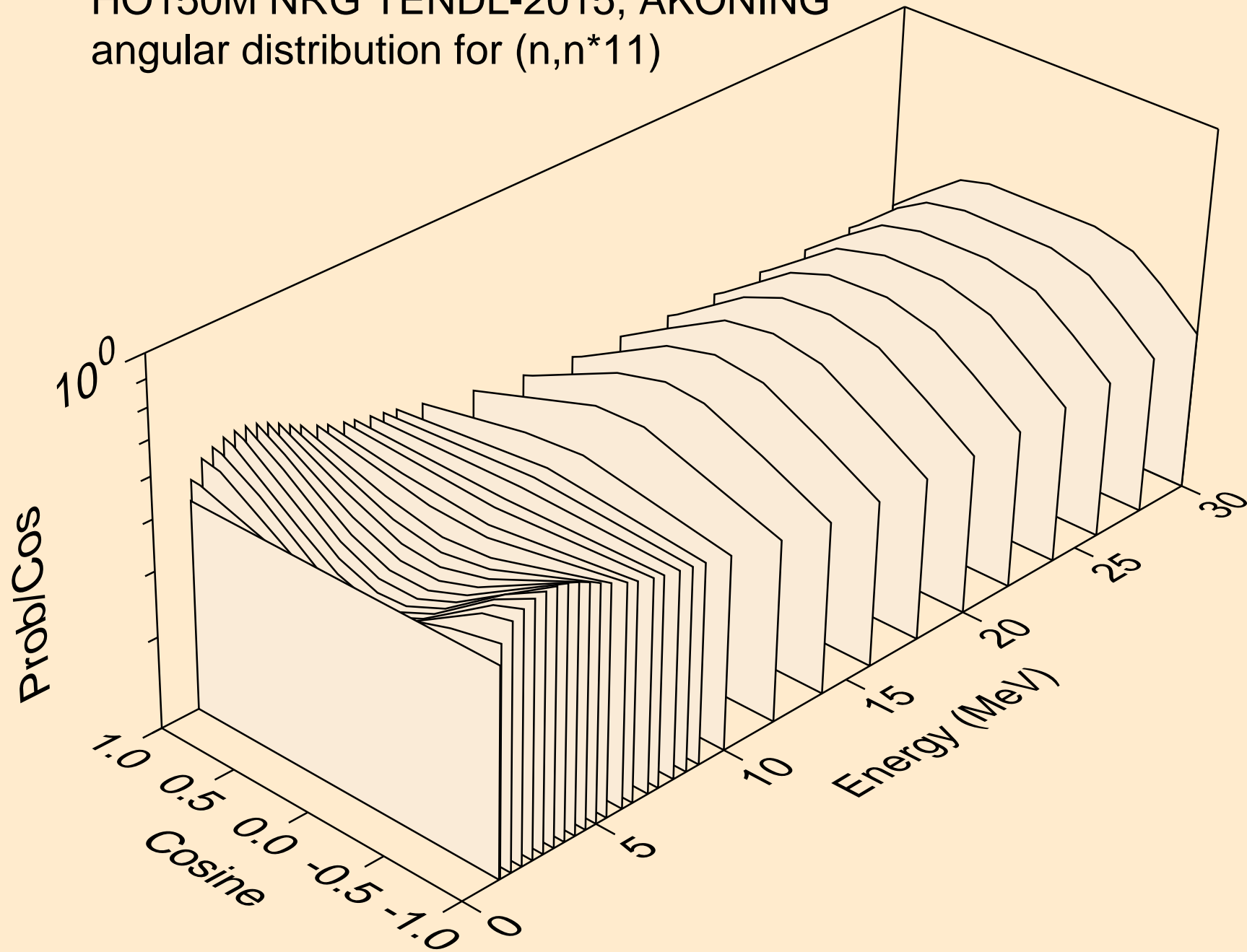

HO150M NRG TENDL-2015, AKONING
angular distribution for (n,n*12)

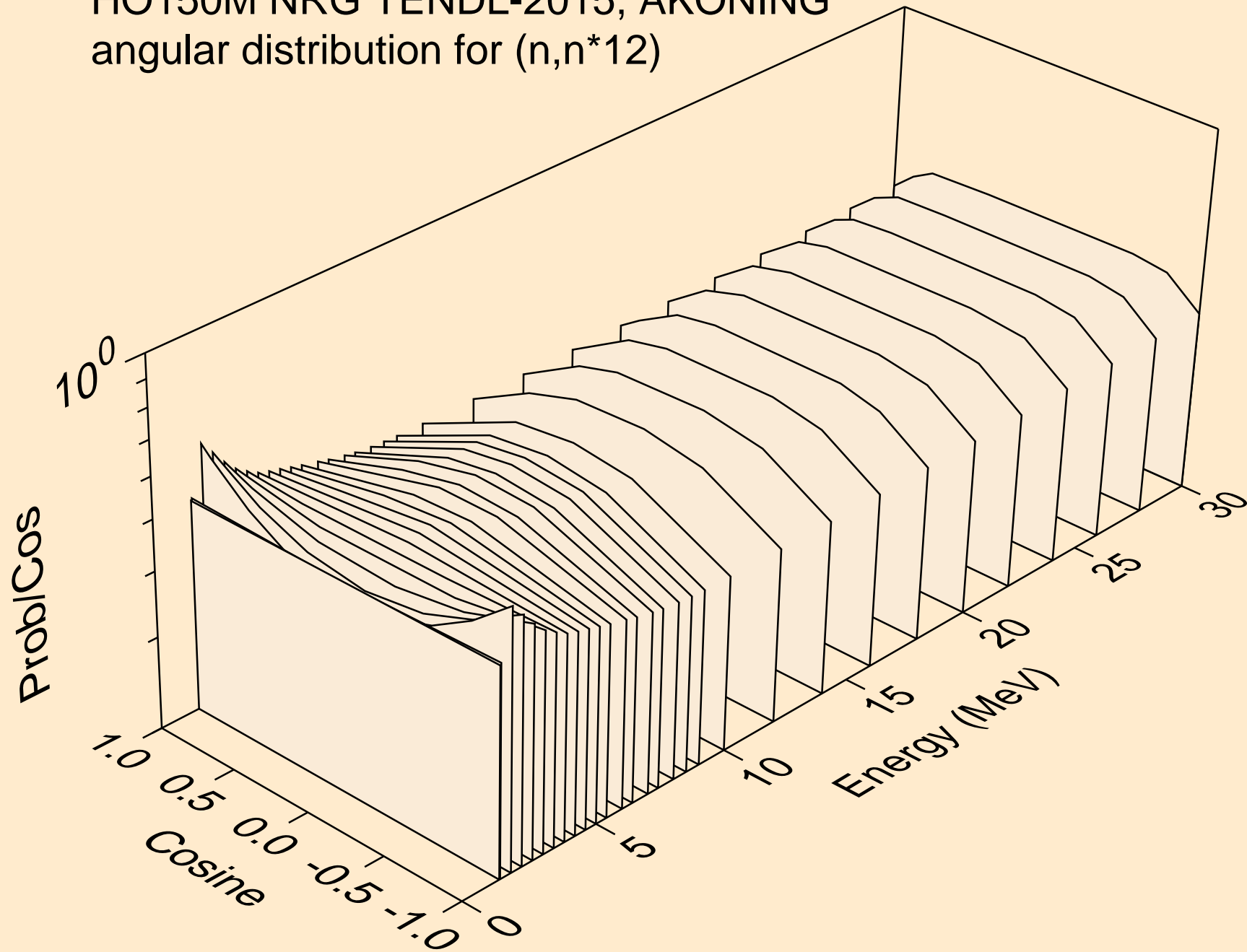

HO150M NRG TENDL-2015, AKONING
angular distribution for (n,n*13)

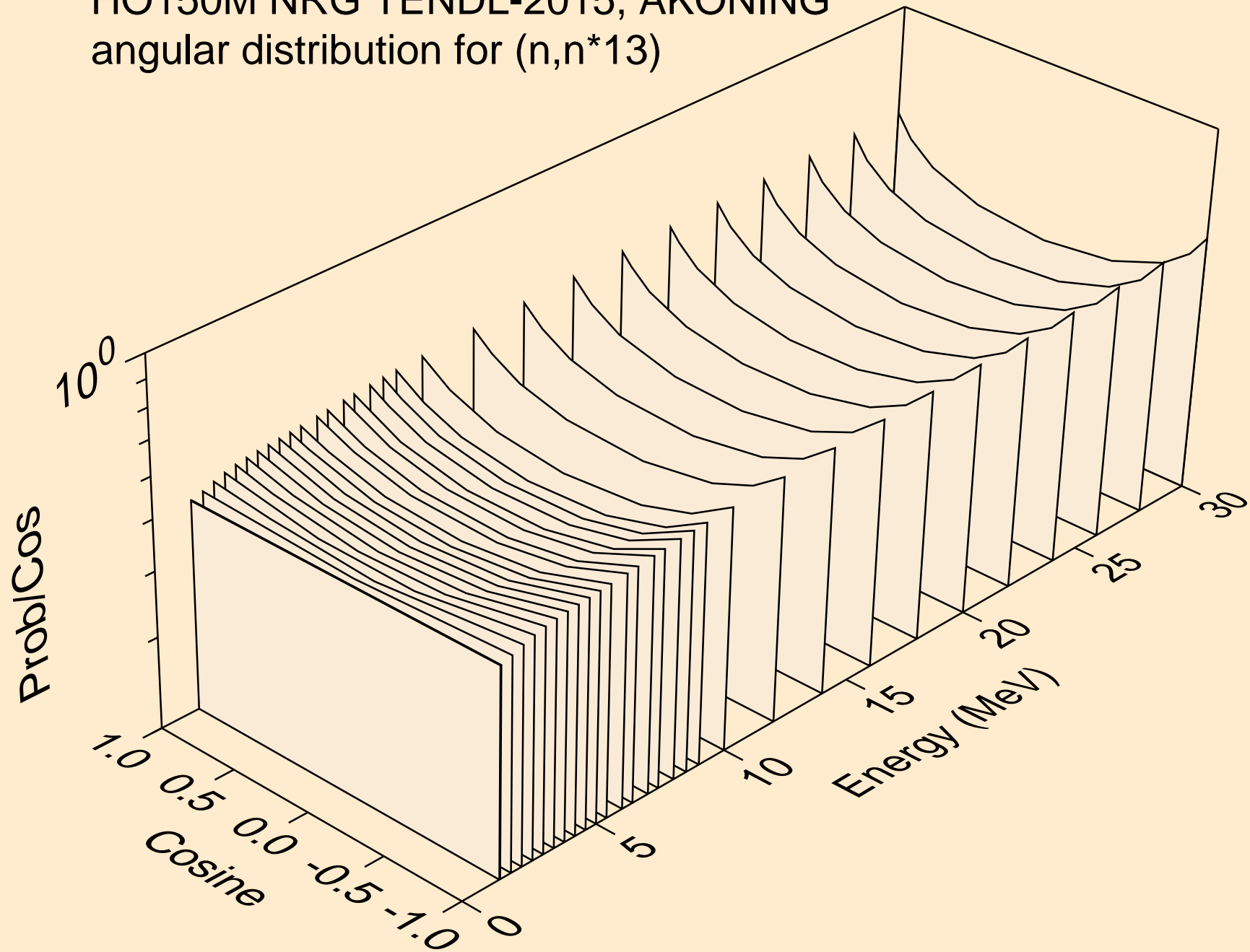

HO150M NRG TENDL-2015, AKONING
angular distribution for (n,n*14)

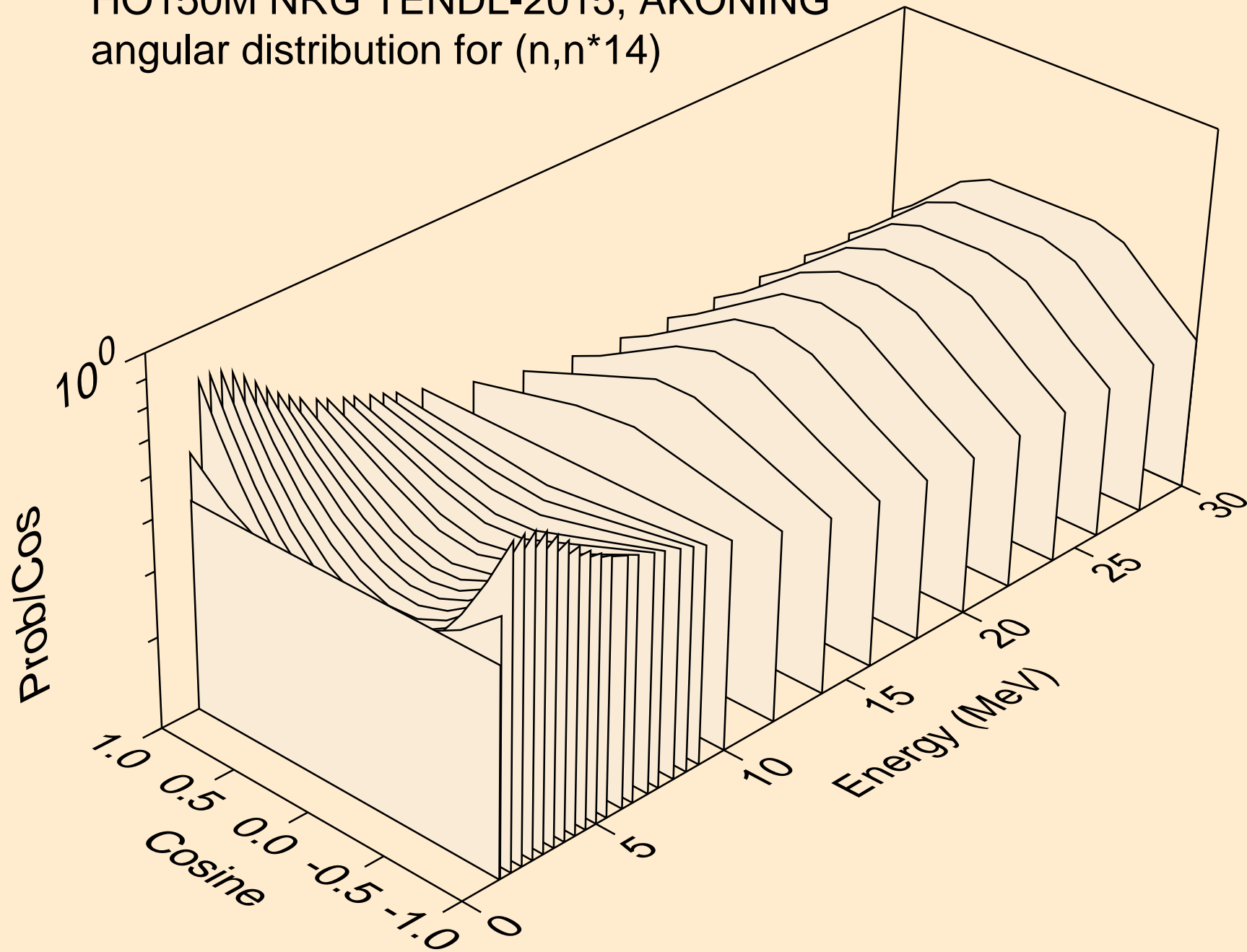

HO150M NRG TENDL-2015, AKONING
angular distribution for (n,n*15)

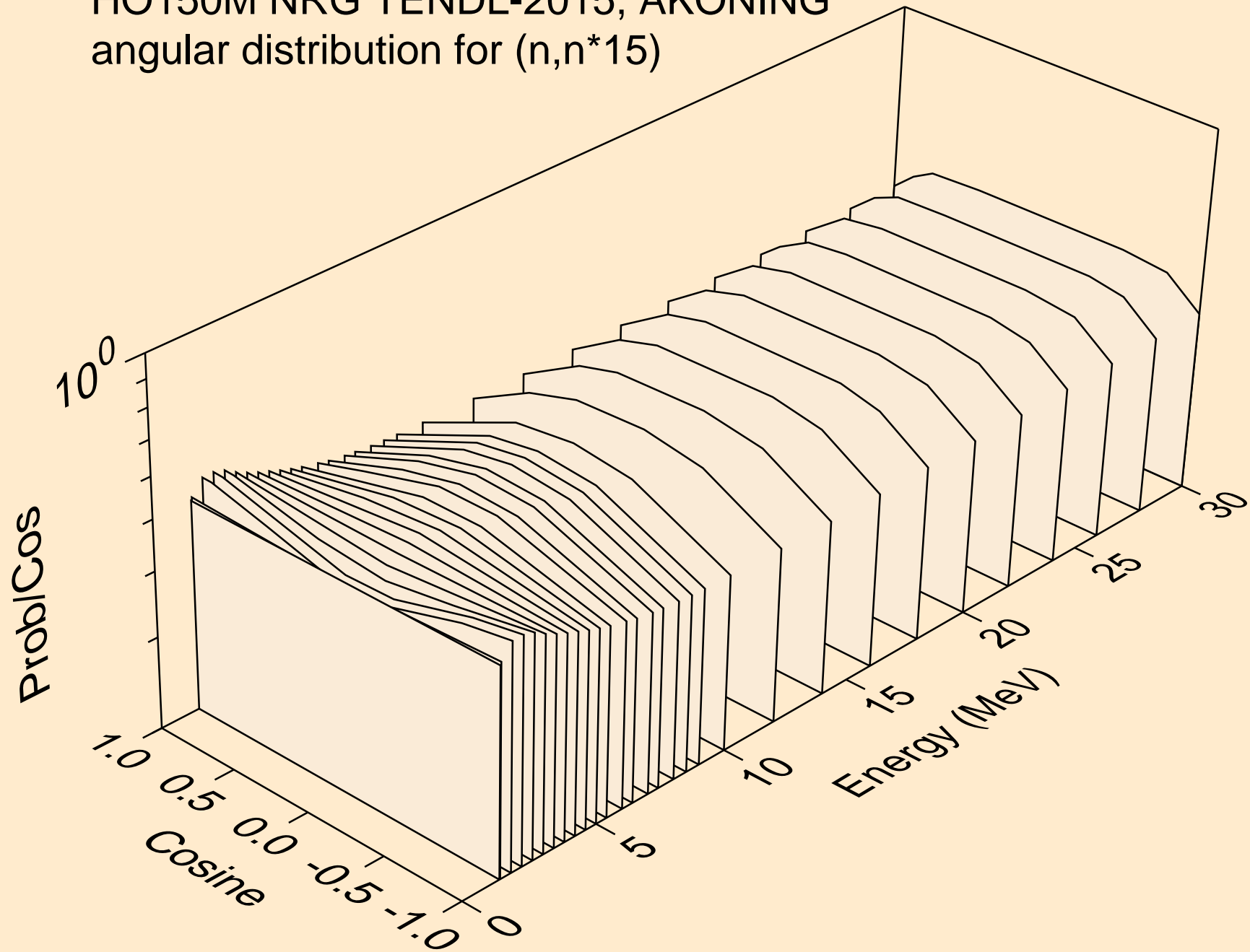

HO150M NRG TENDL-2015, AKONING
angular distribution for (n,n*16)

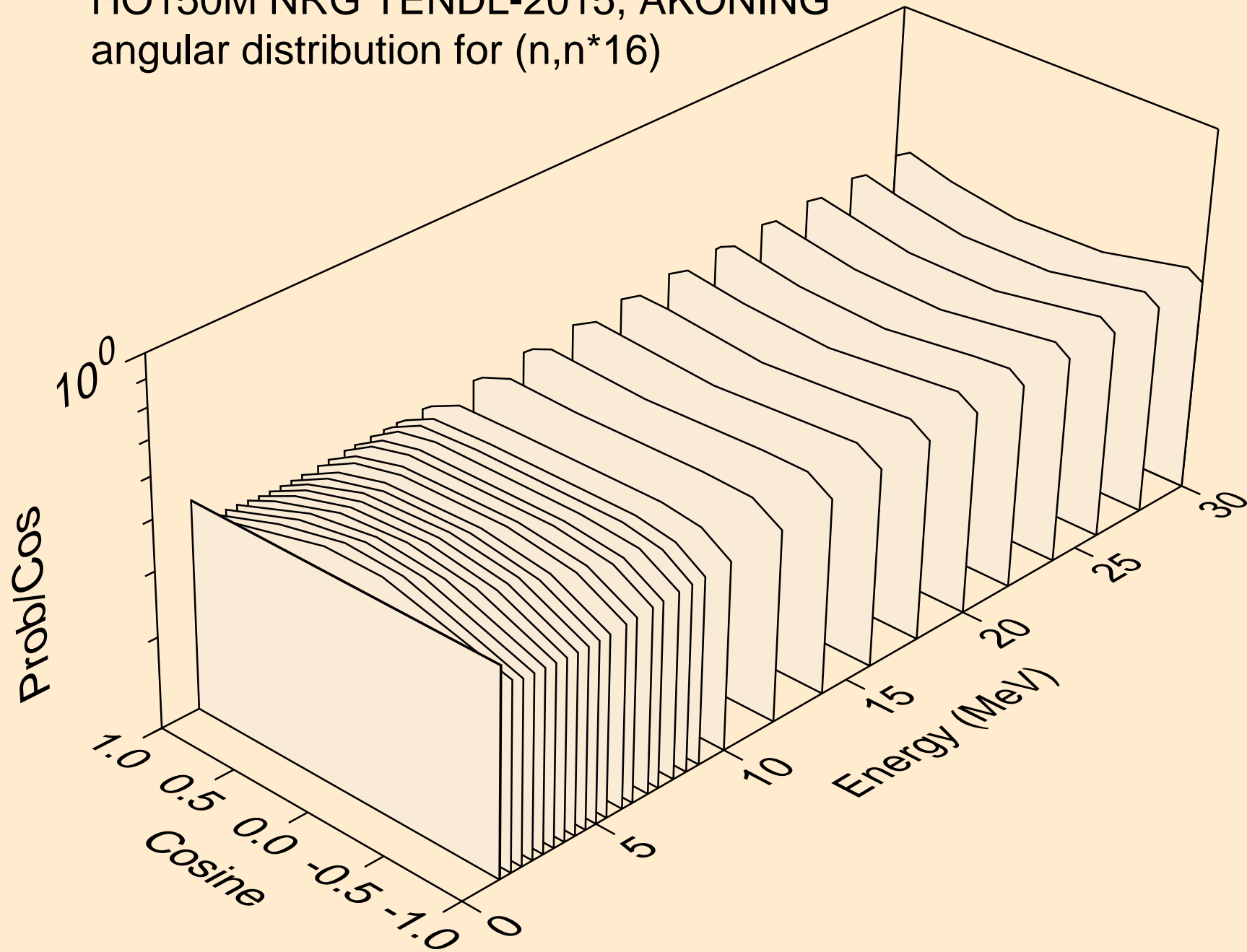

HO150M NRG TENDL-2015, AKONING
angular distribution for (n,n*17)

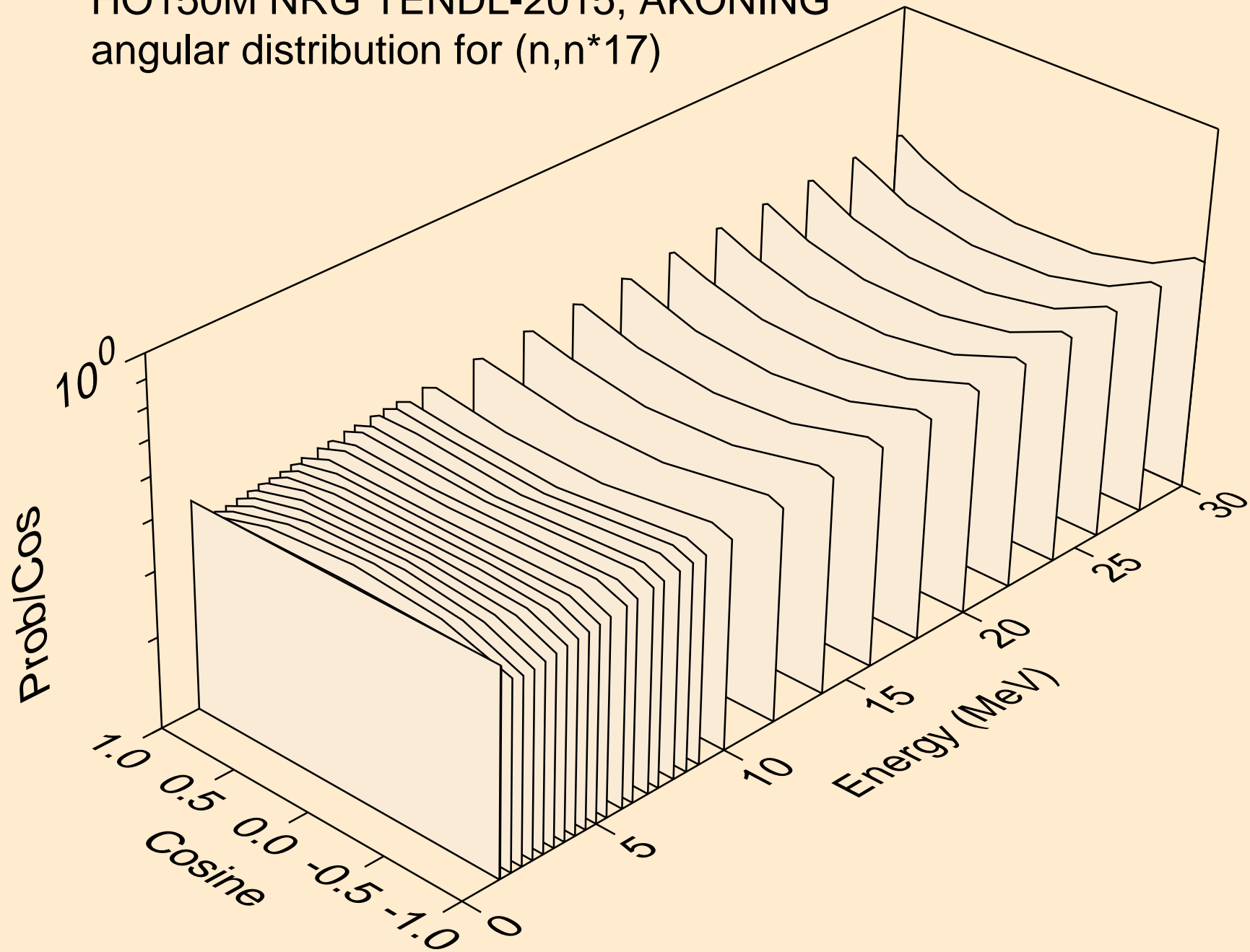

HO150M NRG TENDL-2015, AKONING
angular distribution for (n,n*18)

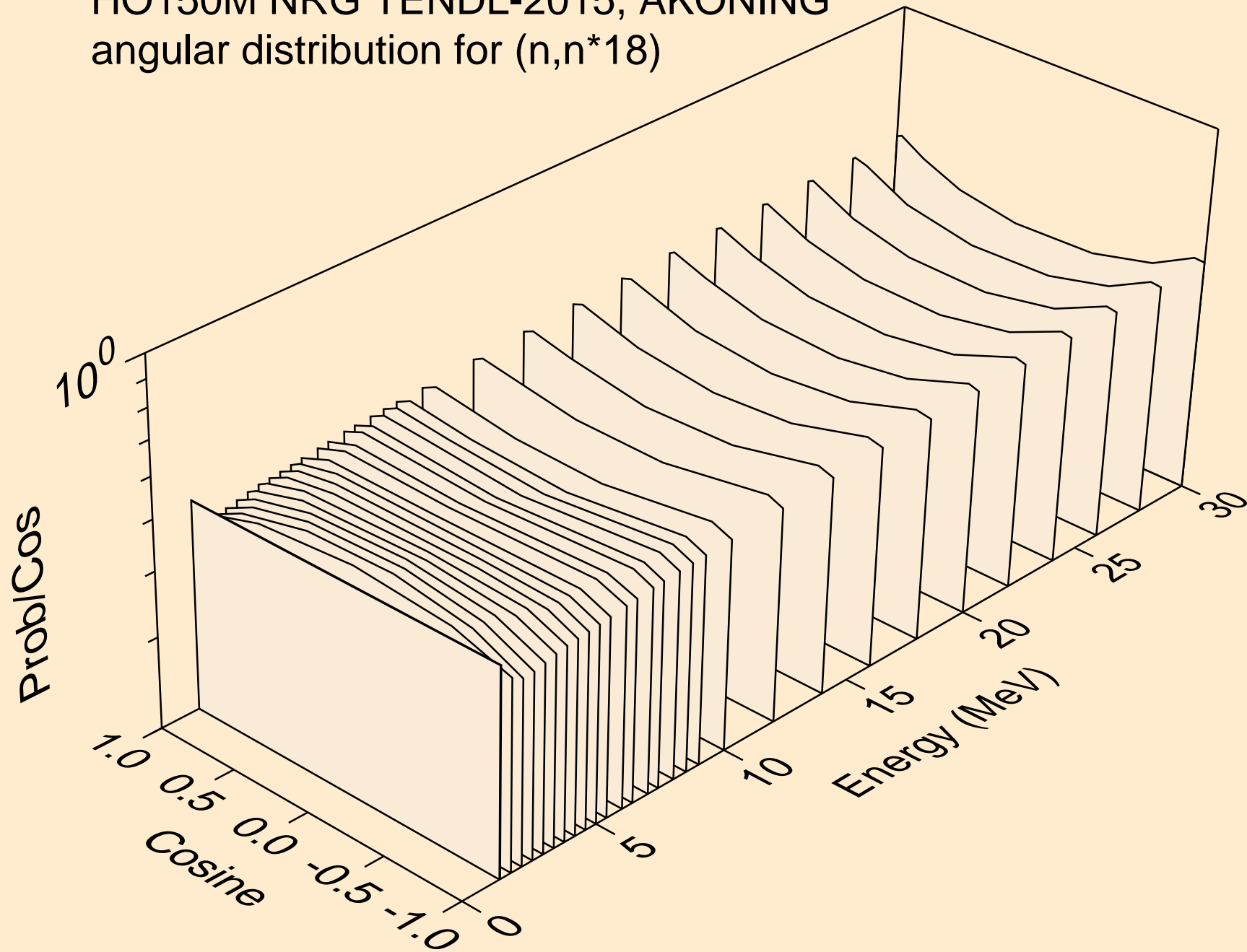

HO150M NRG TENDL-2015, AKONING
angular distribution for (n,n*19)

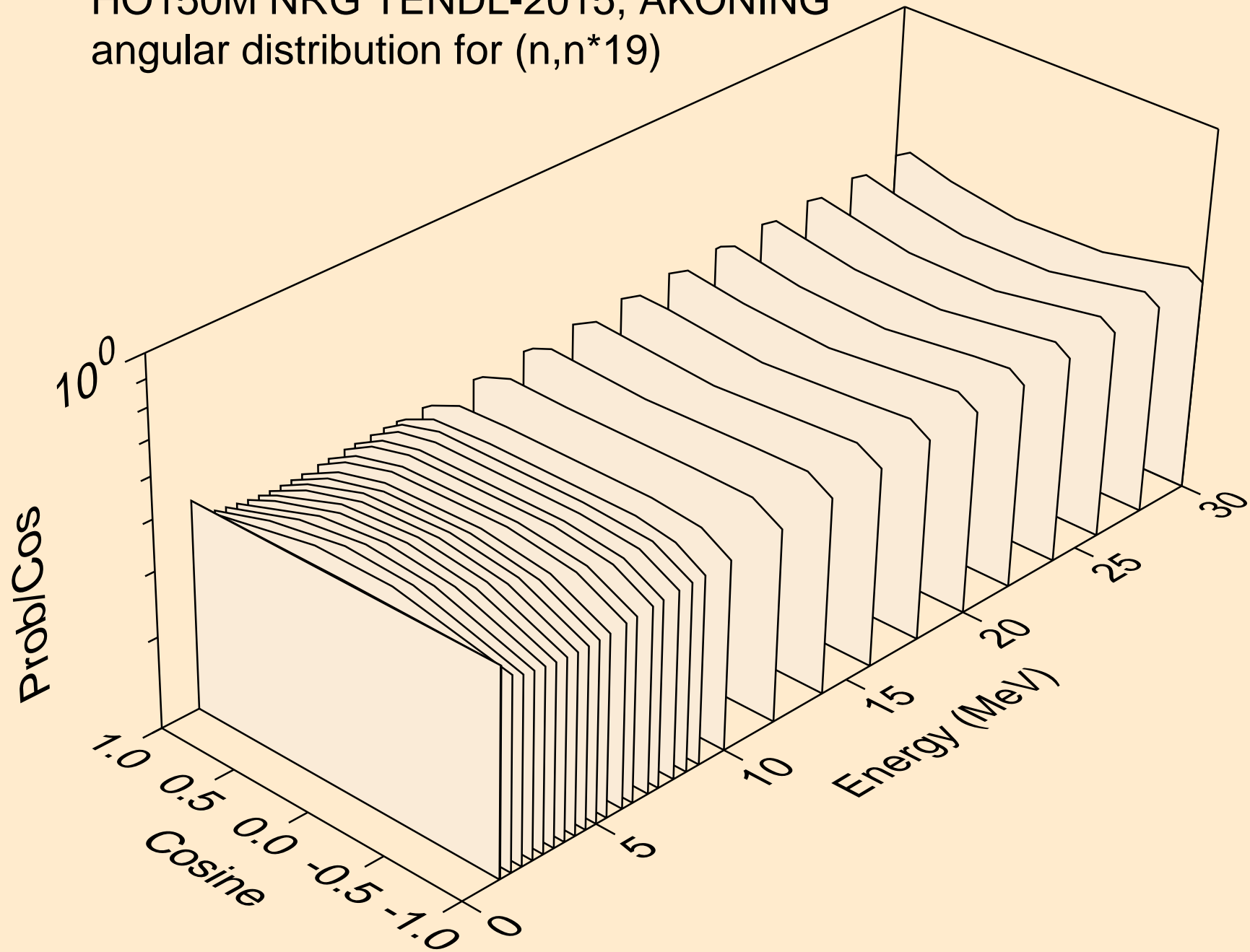

HO150M NRG TENDL-2015, AKONING
angular distribution for (n,n*20)

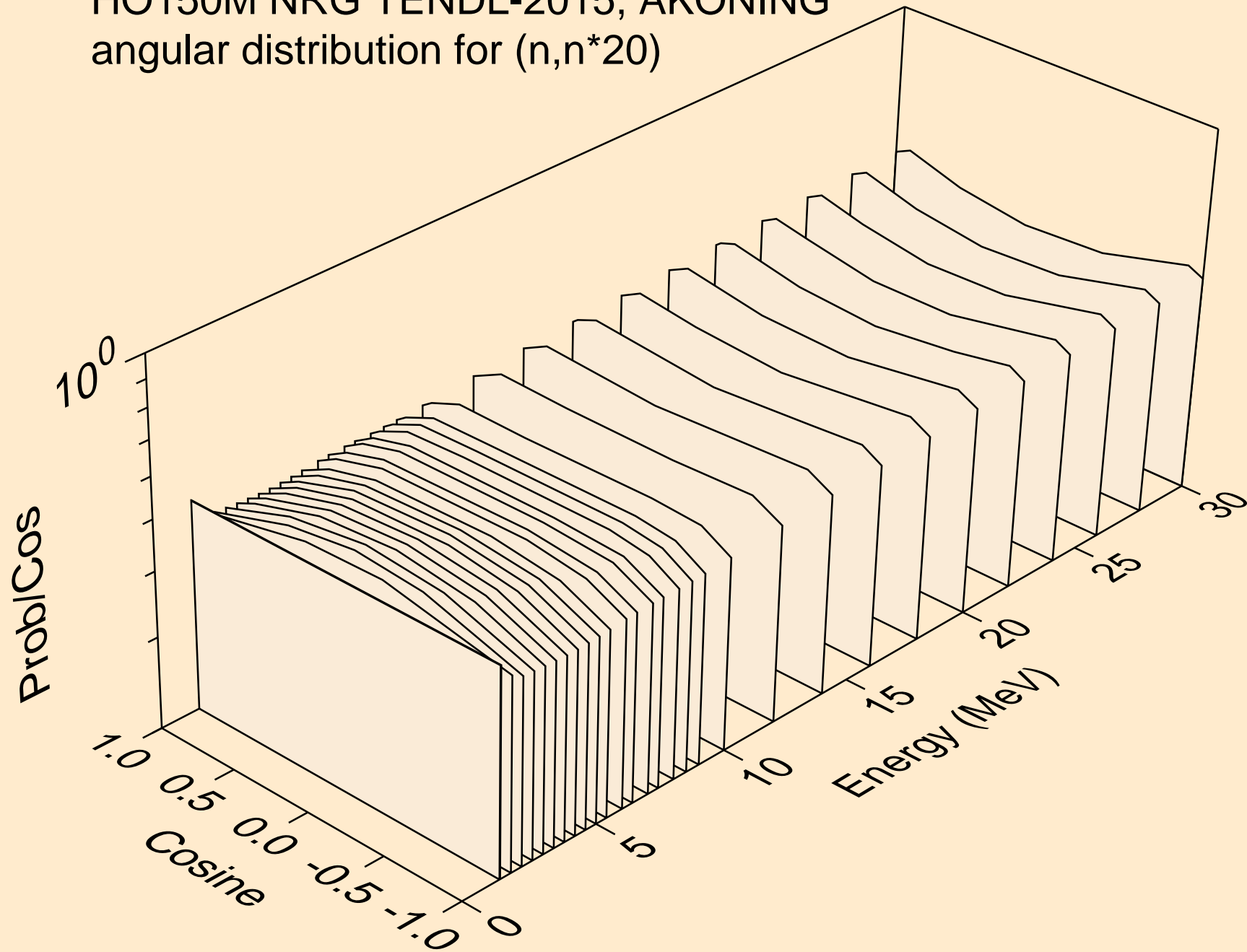

HO150M NRG TENDL-2015, AKONING
angular distribution for (n,n*21)

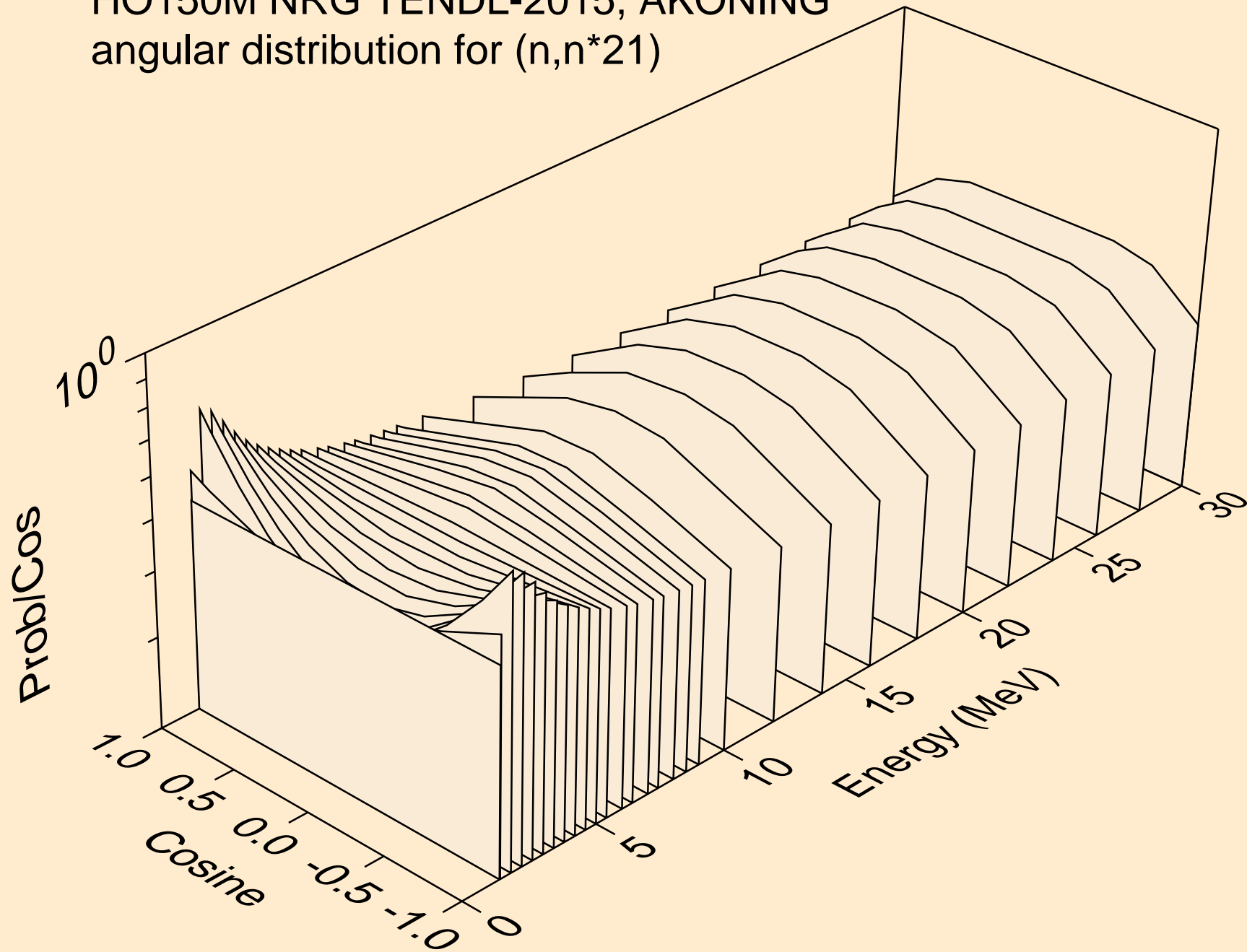

HO150M NRG TENDL-2015, AKONING
angular distribution for (n,n*22)

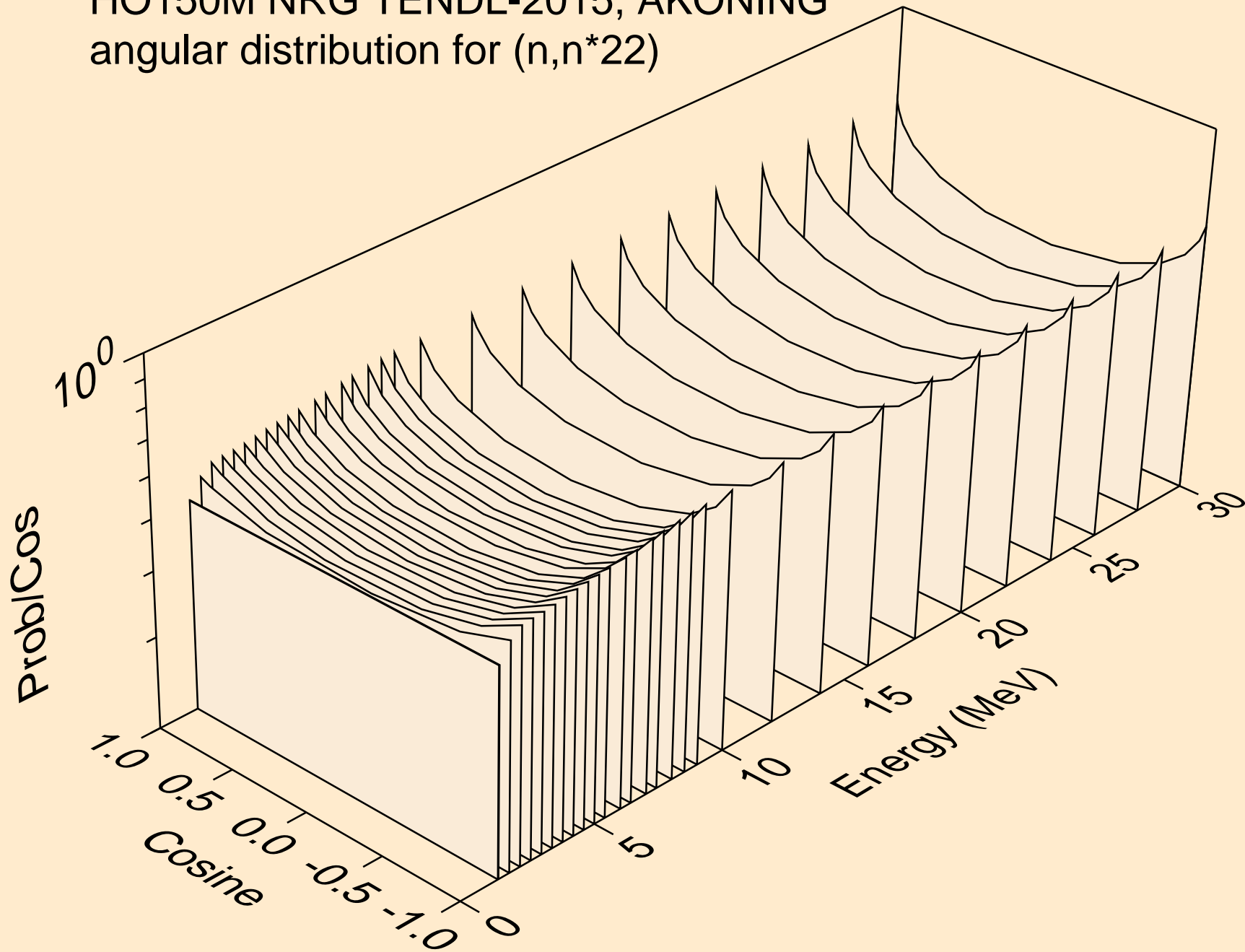

HO150M NRG TENDL-2015, AKONING
angular distribution for (n,n*23)

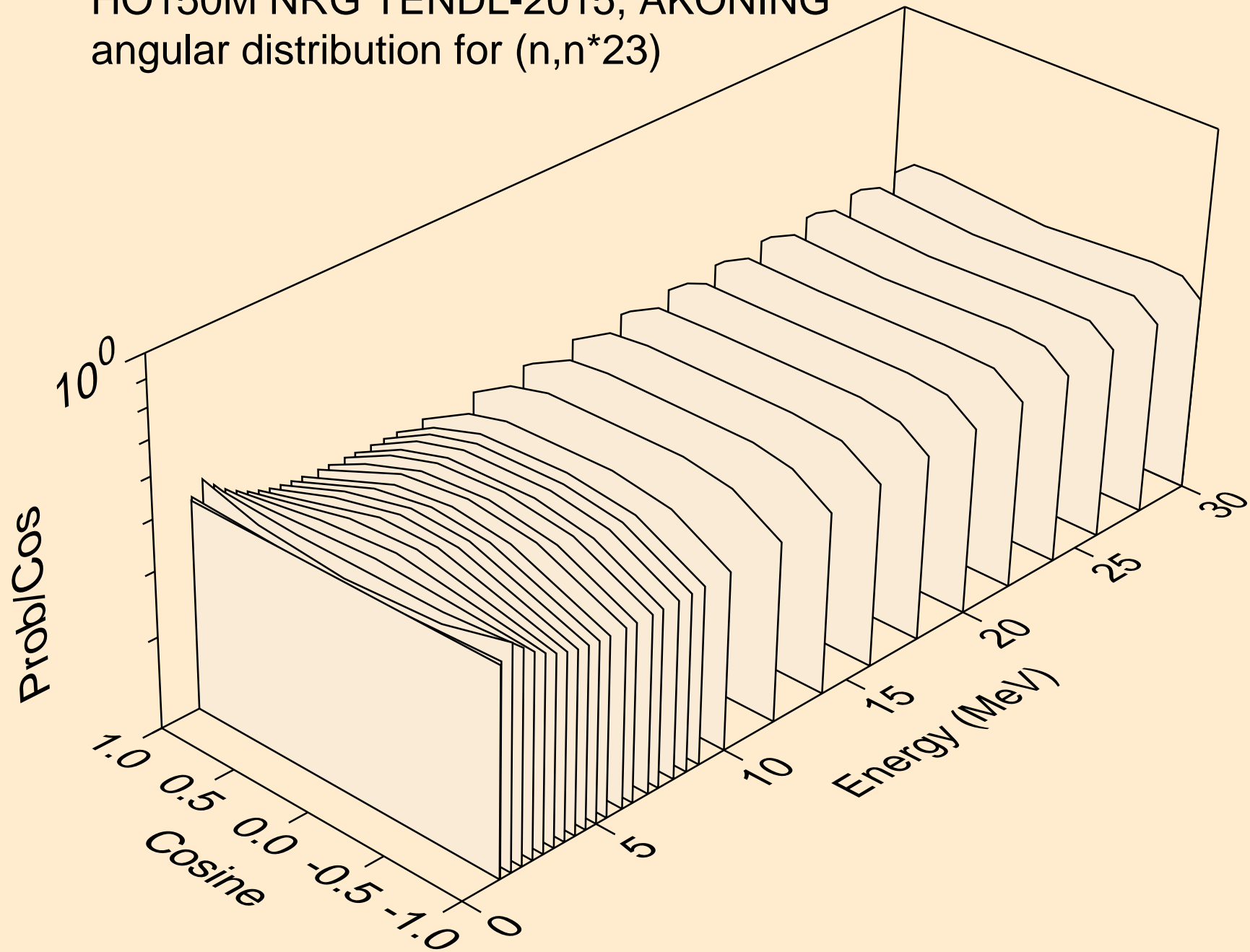

HO150M NRG TENDL-2015, AKONING
angular distribution for (n,n*24)

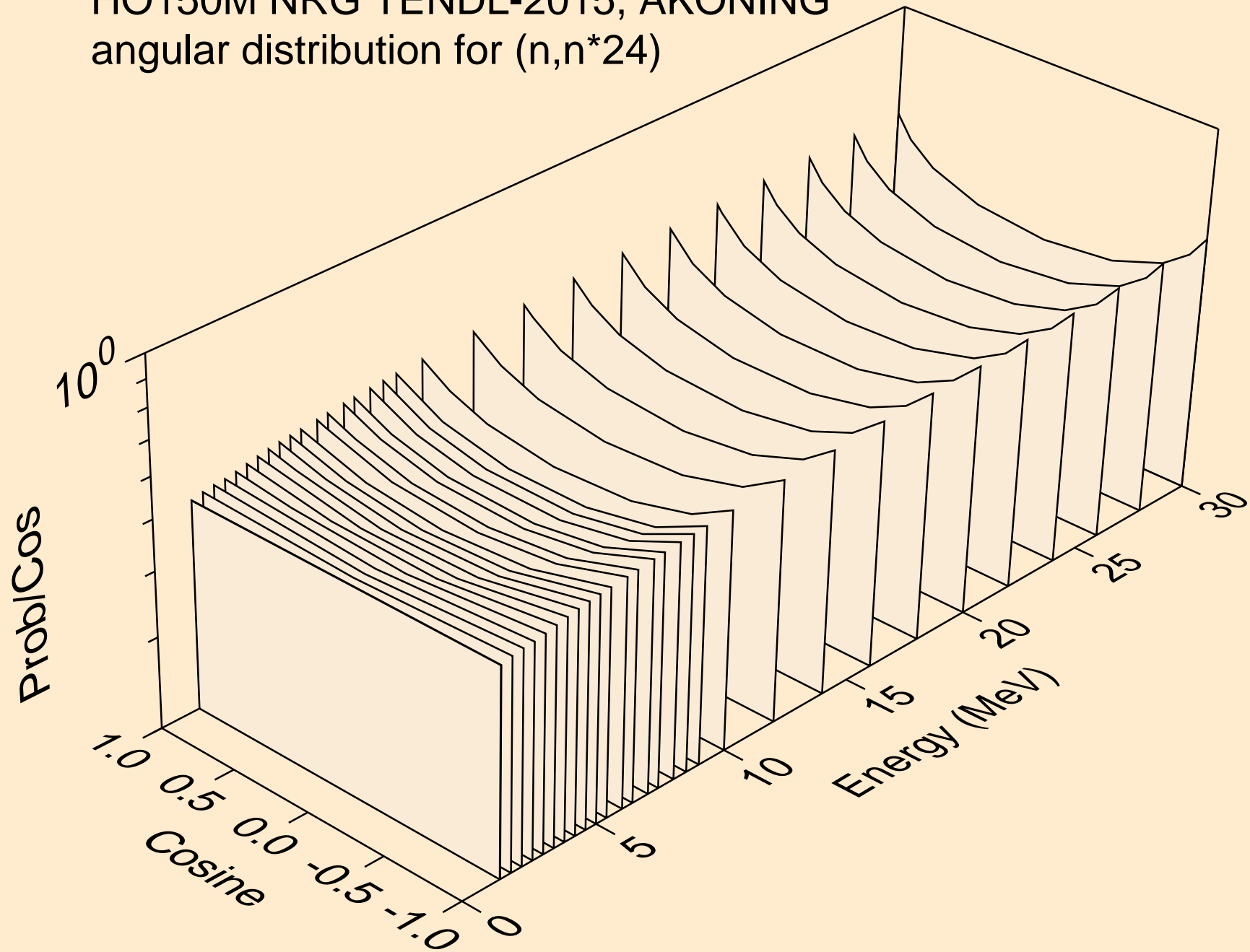

HO150M NRG TENDL-2015, AKONING
angular distribution for (n,n*25)

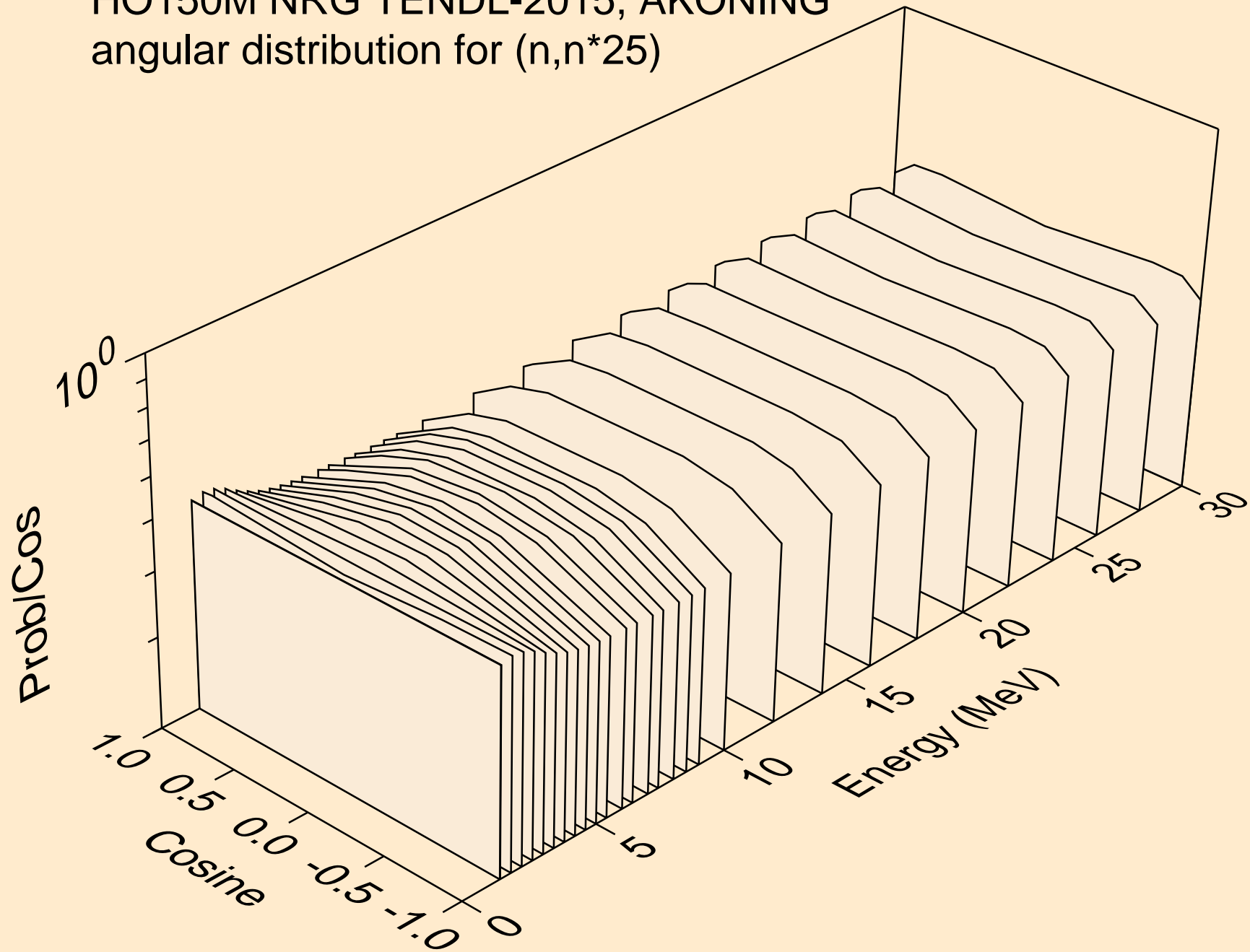

HO150M NRG TENDL-2015, AKONING
angular distribution for (n,n*26)

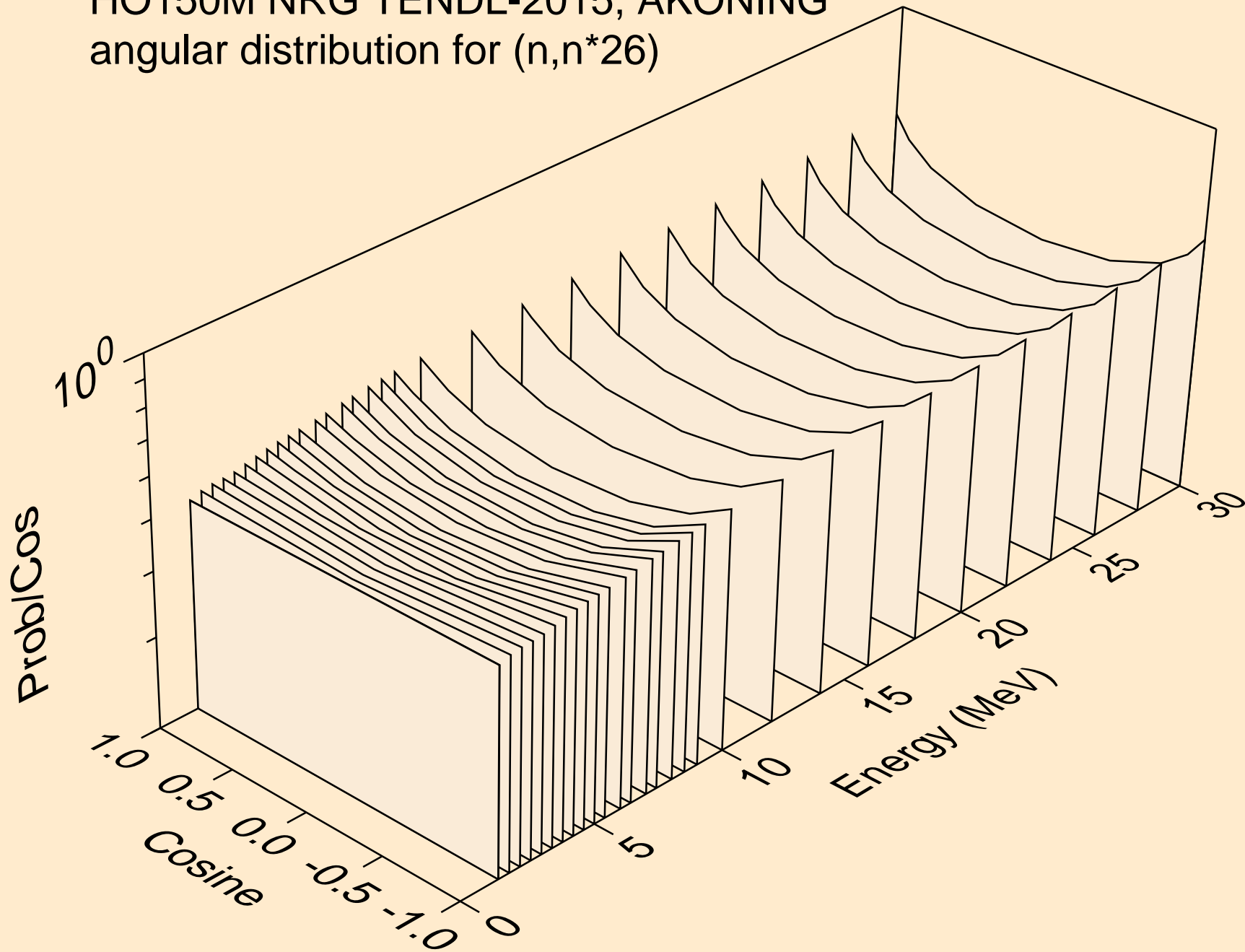

HO150M NRG TENDL-2015, AKONING
angular distribution for (n,n*27)

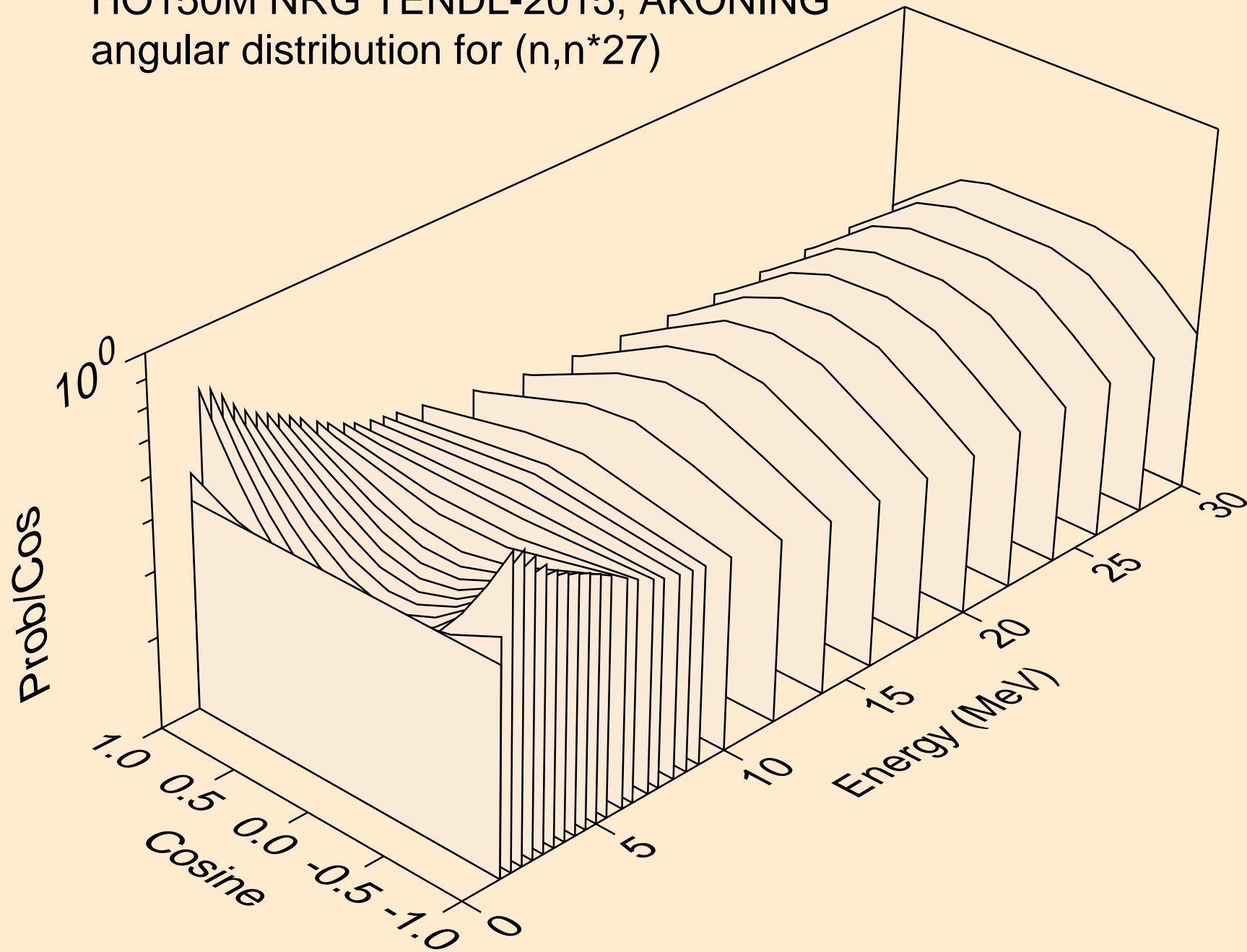

HO150M NRG TENDL-2015, AKONING
angular distribution for (n,n*28)

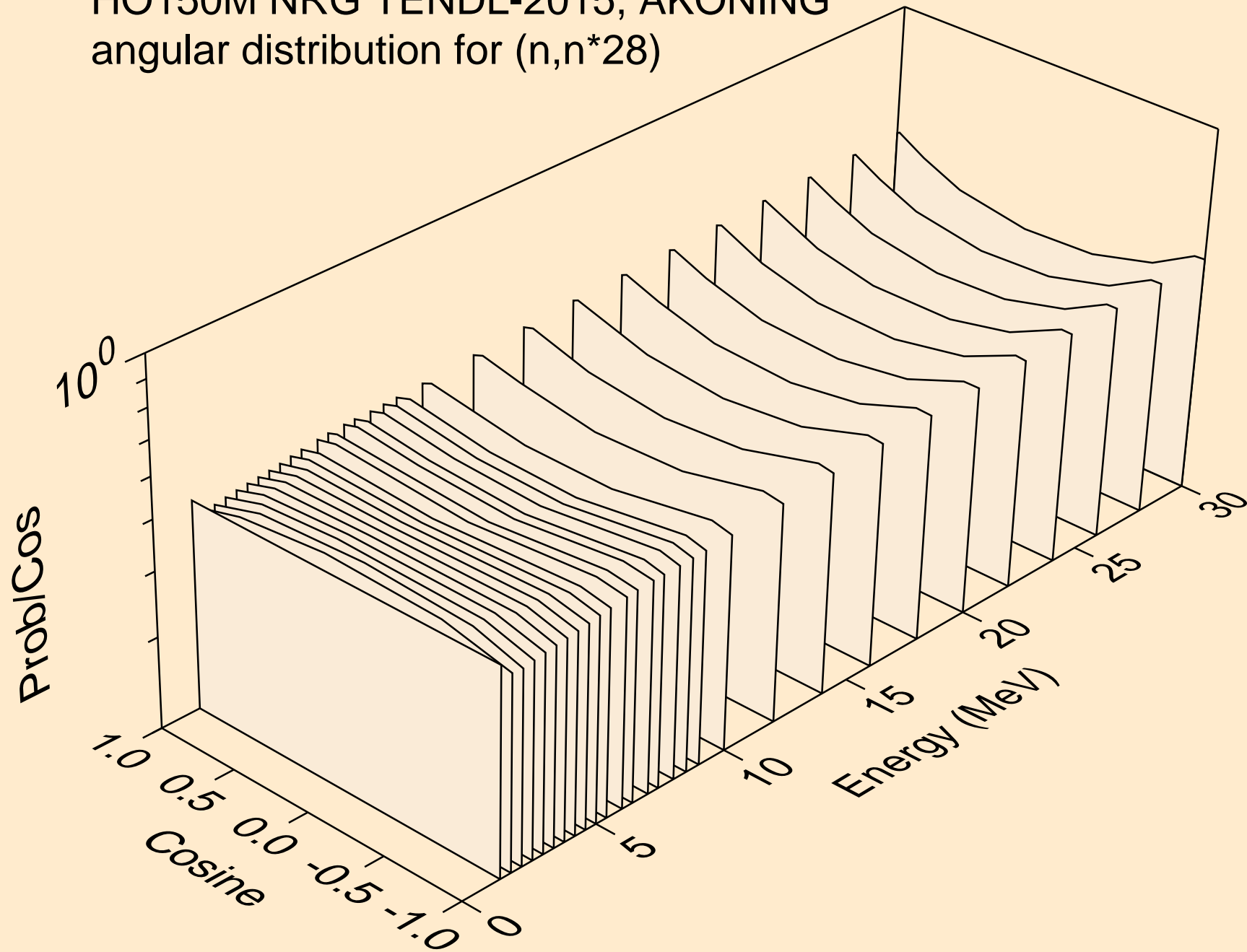

HO150M NRG TENDL-2015, AKONING
angular distribution for (n,n*29)

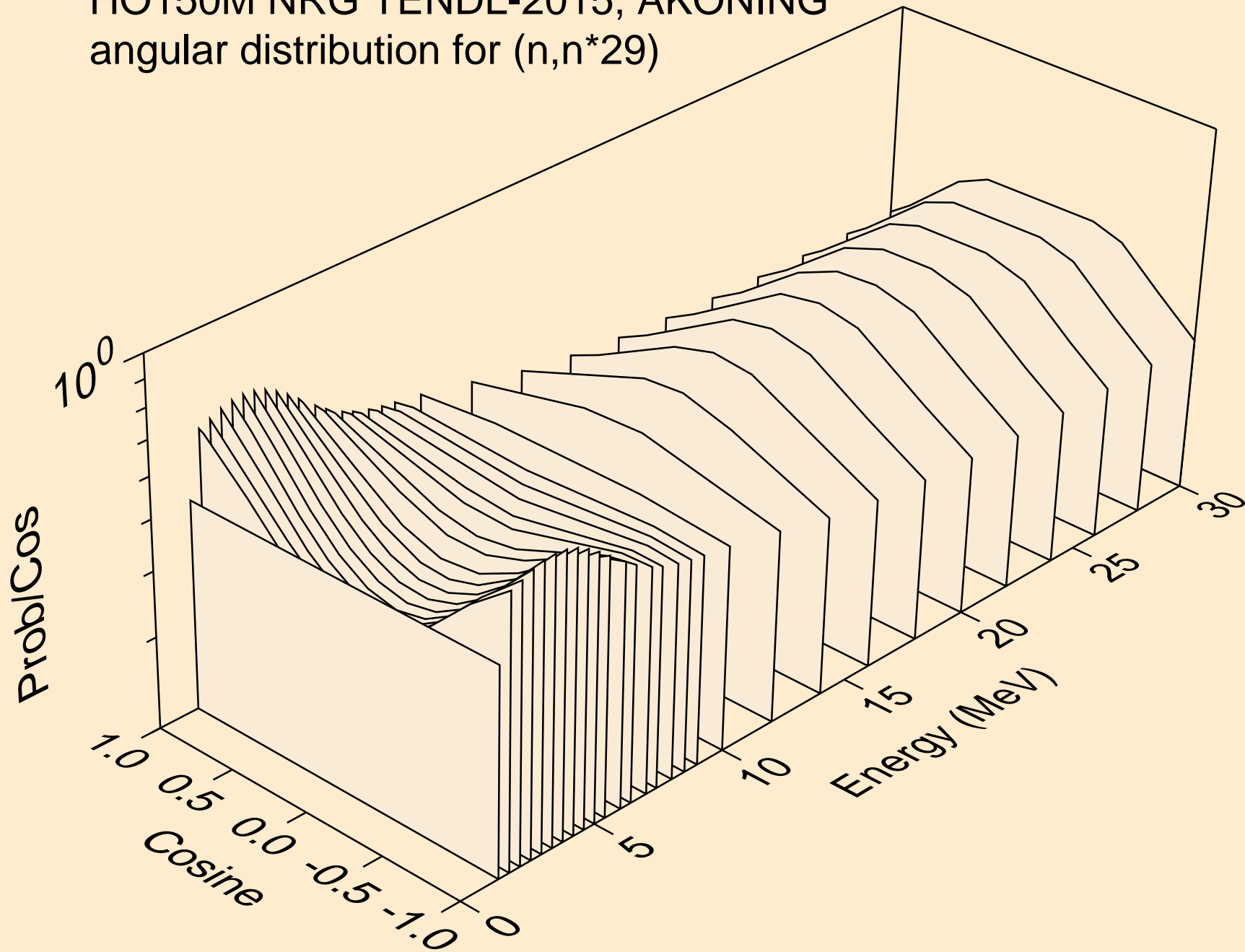

HO150M NRG TENDL-2015, AKONING
angular distribution for (n,n*30)

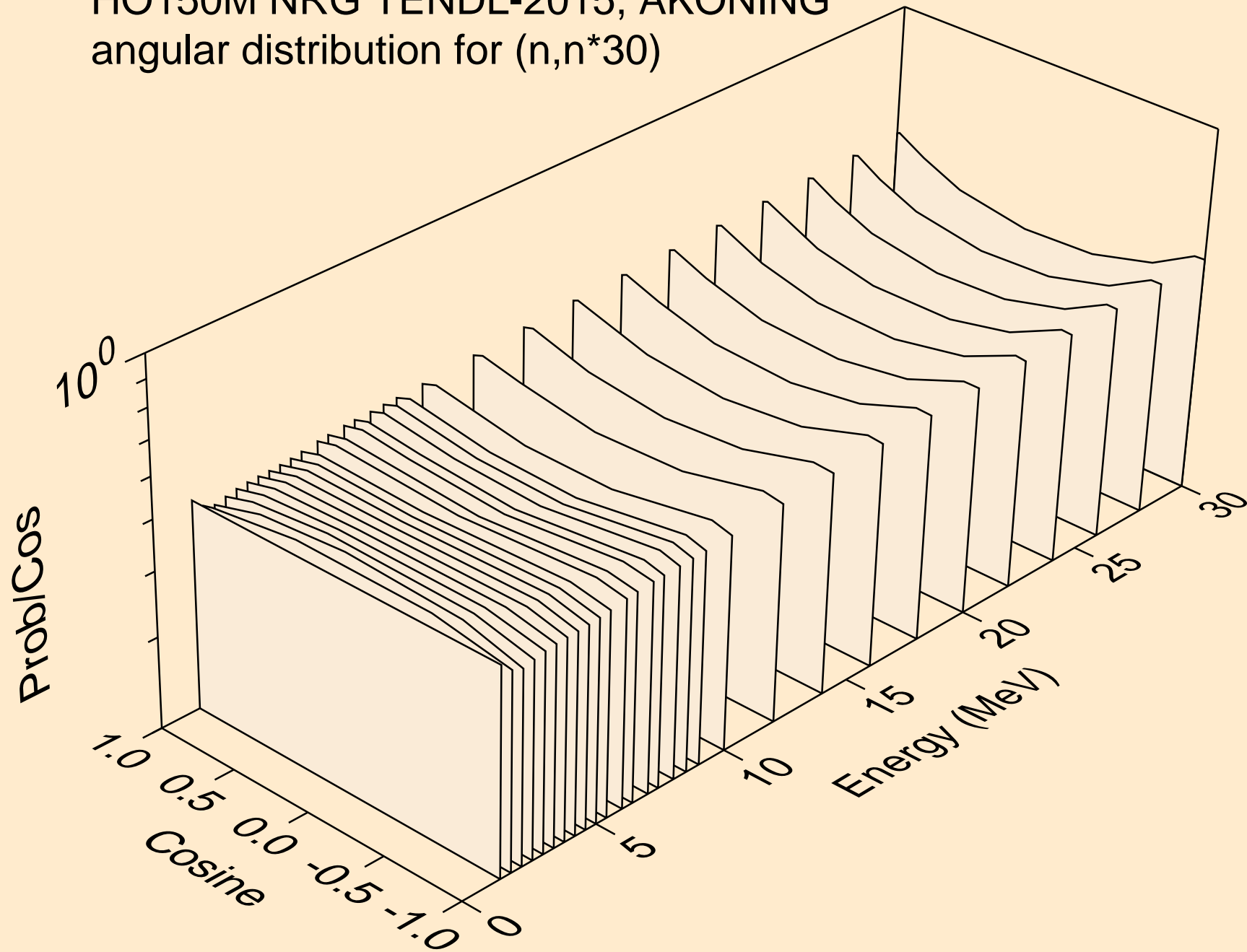

HO150M NRG TENDL-2015, AKONING
Neutron emission for (n,x)

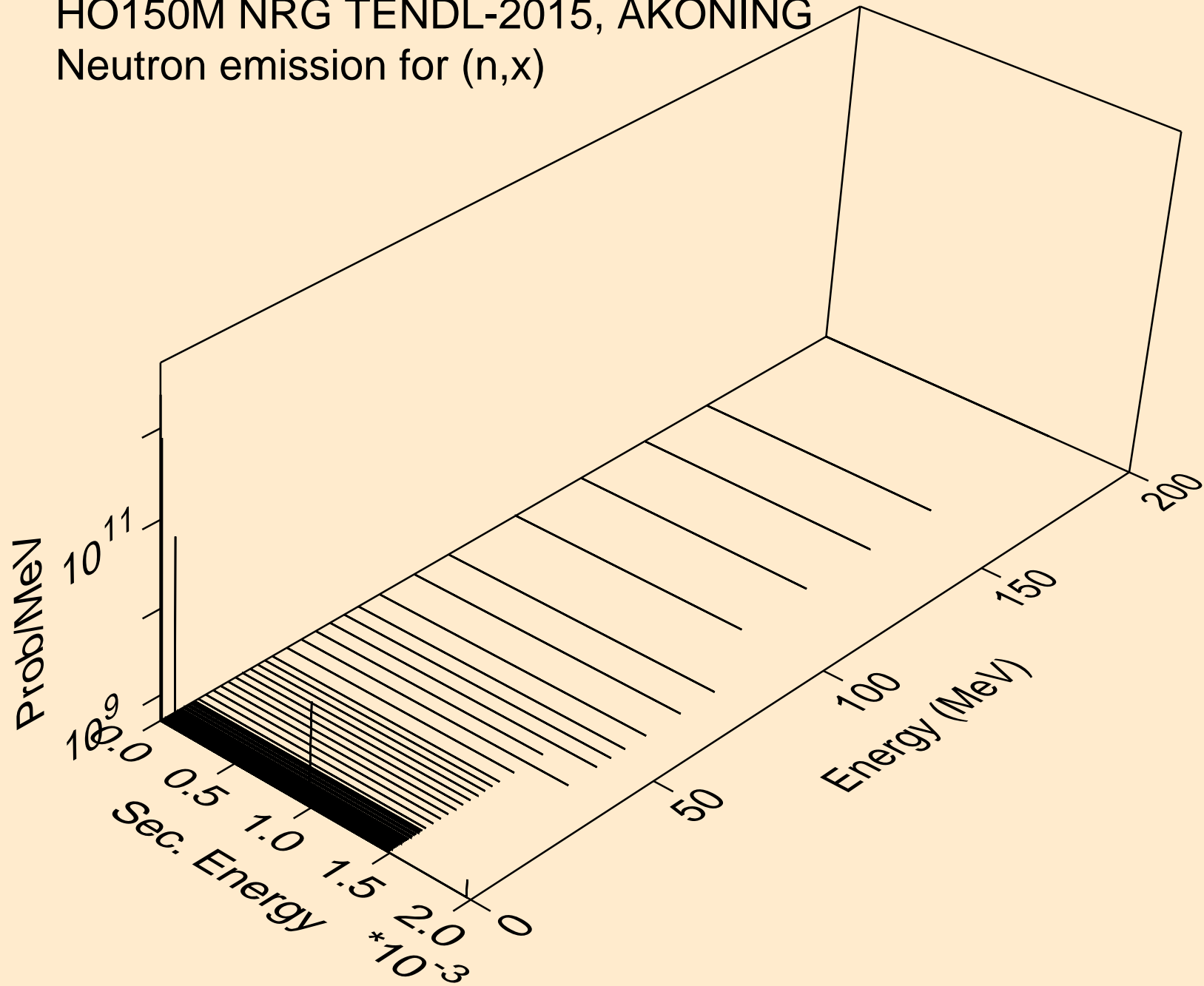

HO150M NRG TENDL-2015, AKONING
Neutron emission for (n,2nd)

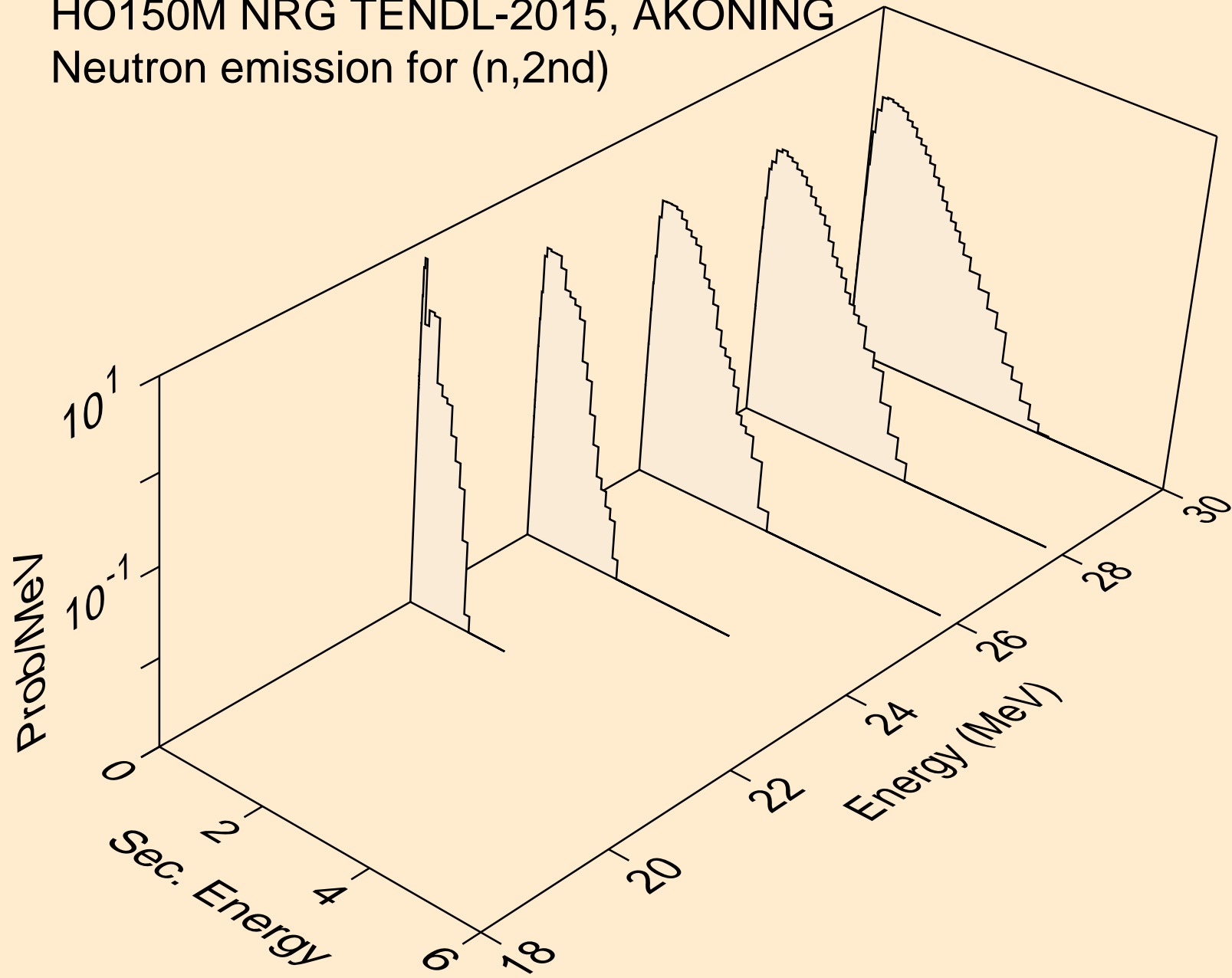

HO150M NRG TENDL-2015, AKONING
Neutron emission for (n,2n)

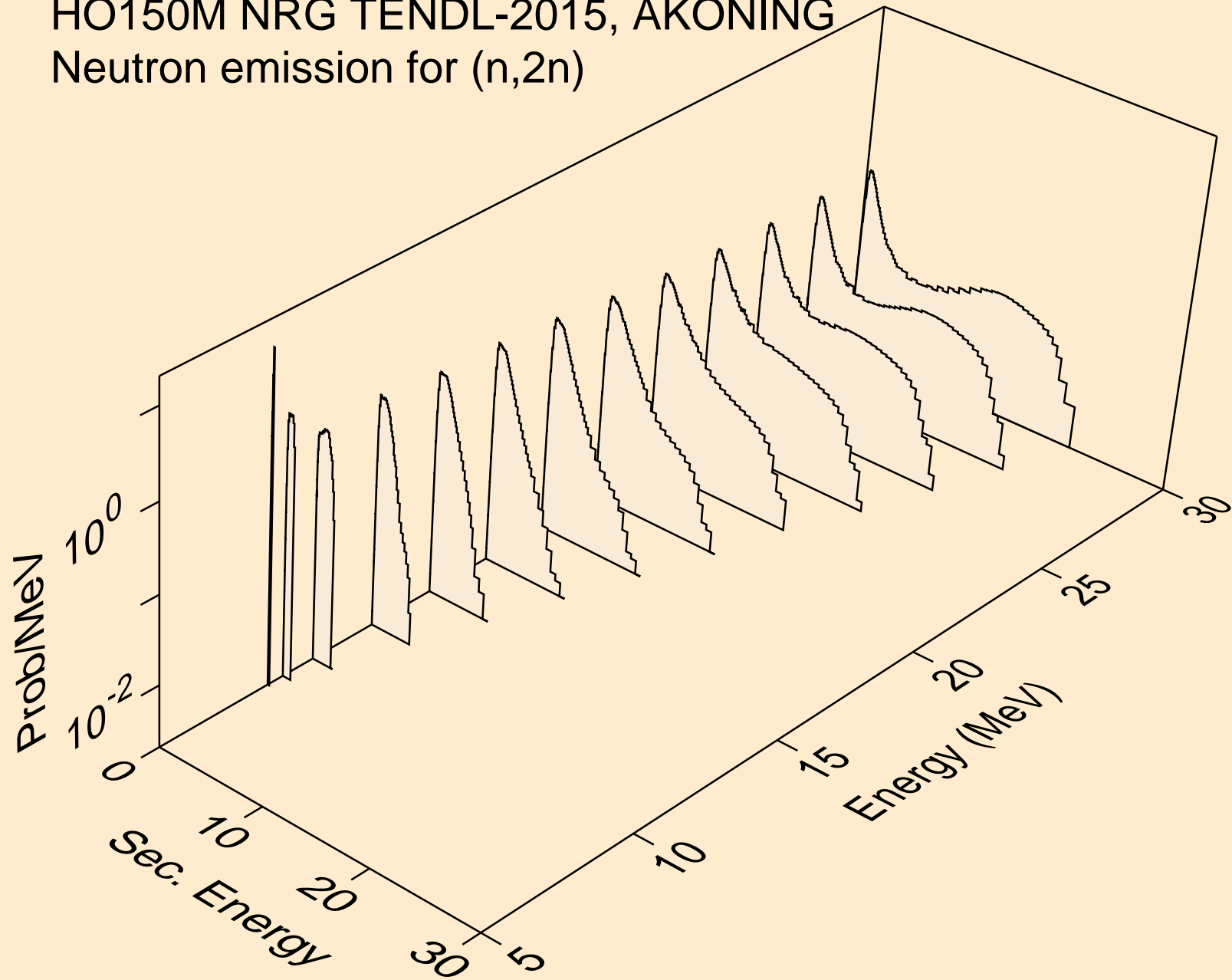

HO150M NRG TENDL-2015, AKONING
Neutron emission for (n,3n)

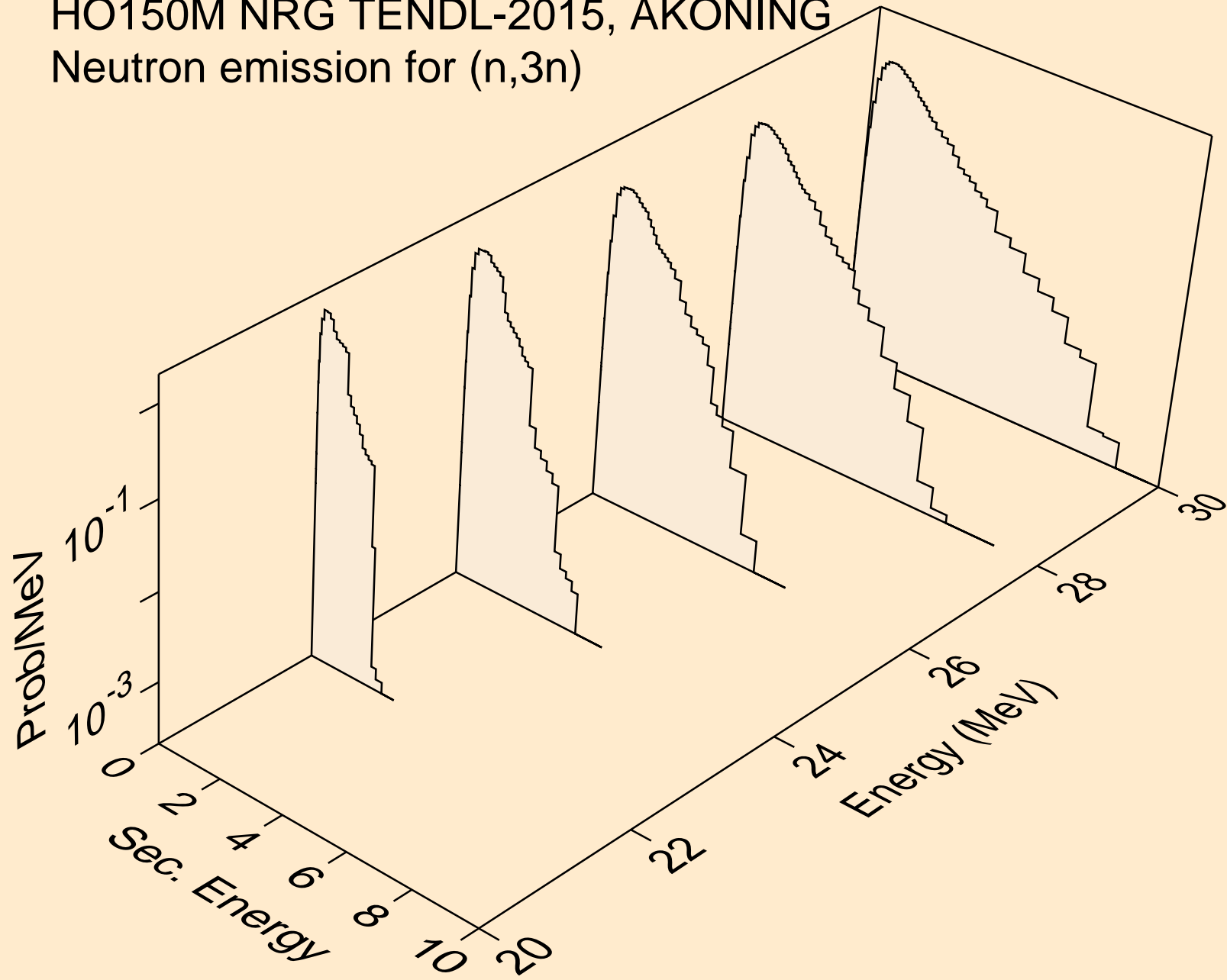

HO150M NRG TENDL-2015, AKONING
Neutron emission for (n,n*)a

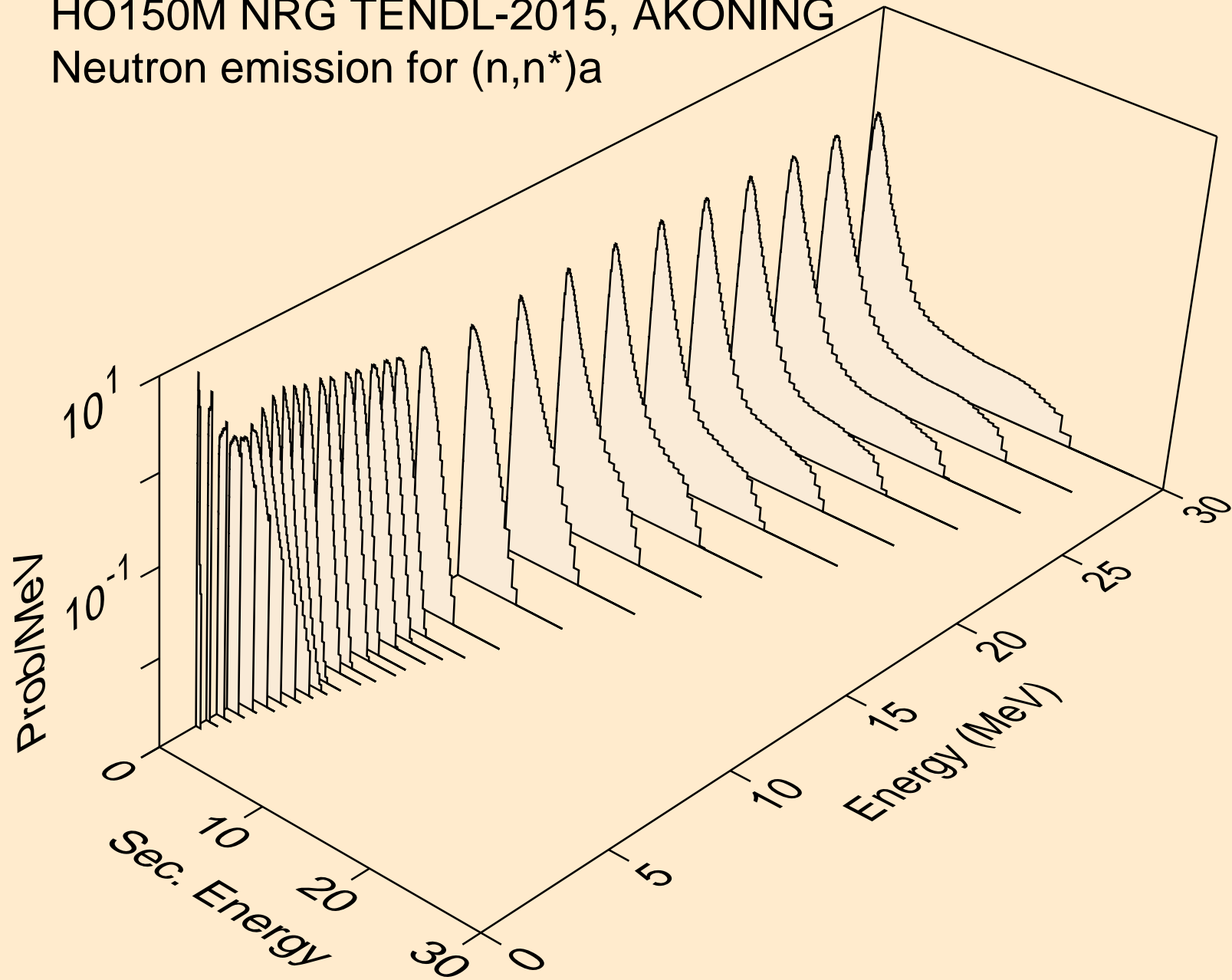

HO150M NRG TENDL-2015, AKONING
Neutron emission for (n,2n)a

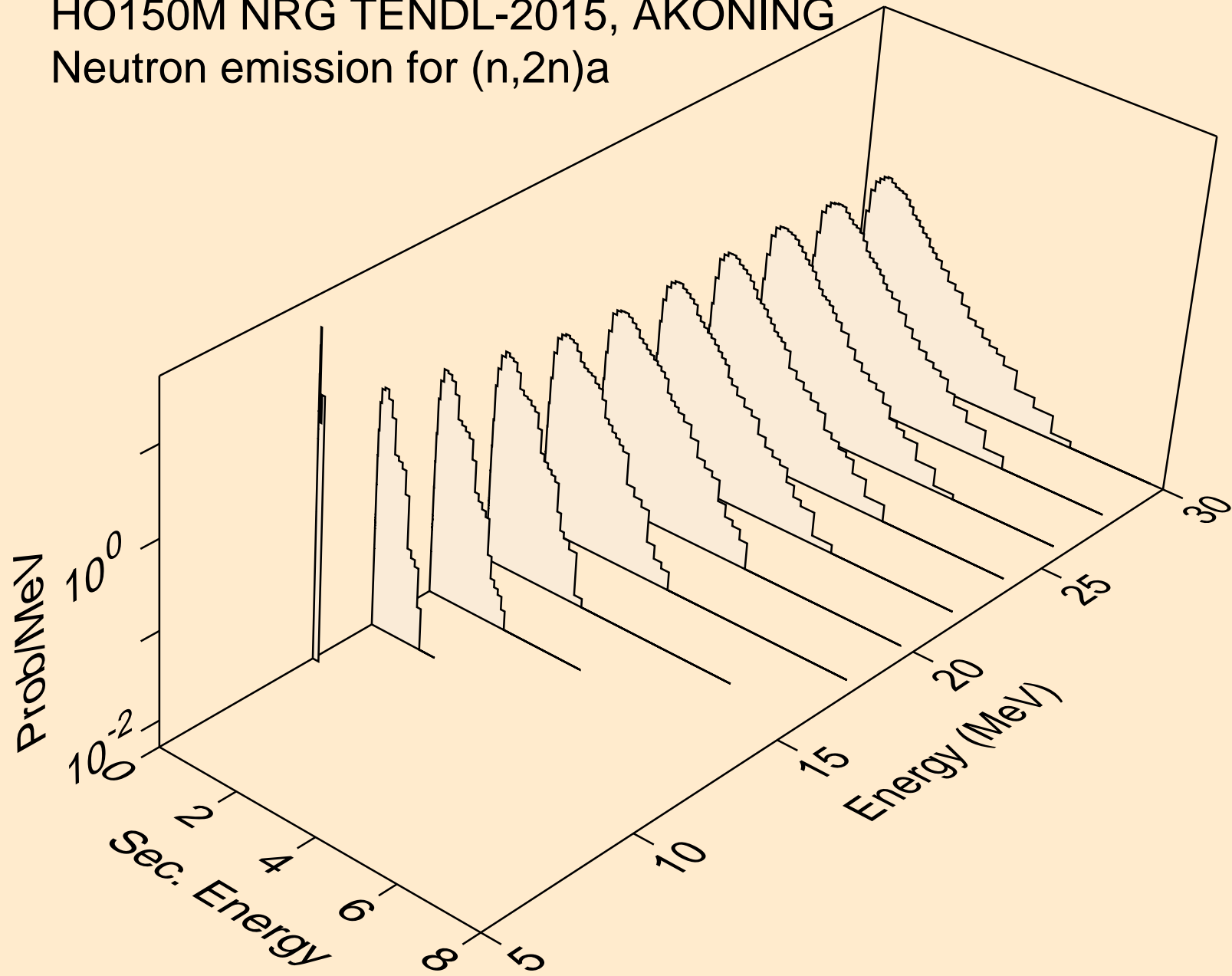

HO150M NRG TENDL-2015, AKONING
Neutron emission for (n,3n)a

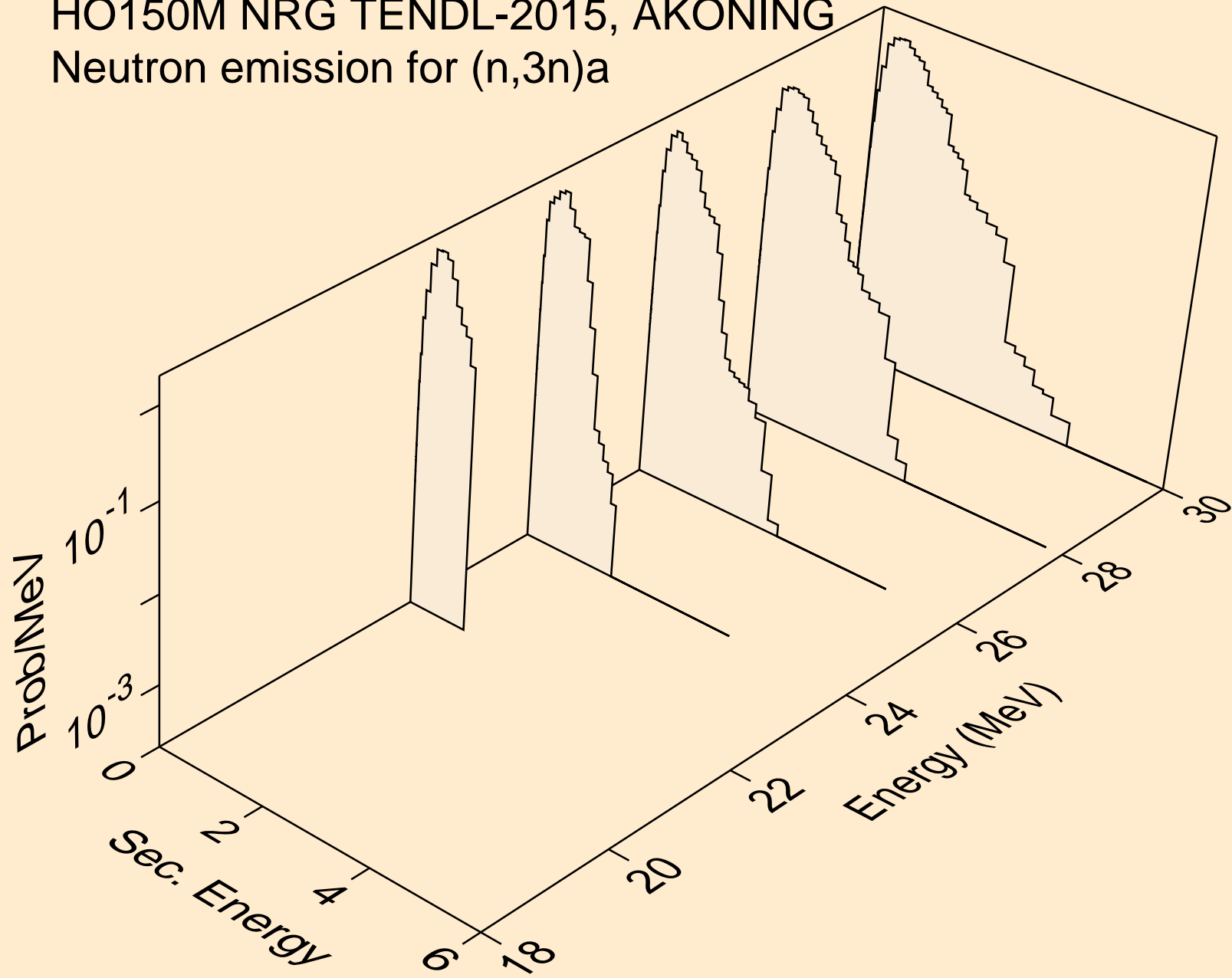

HO150M NRG TENDL-2015, AKONING
Neutron emission for (n,n*)p

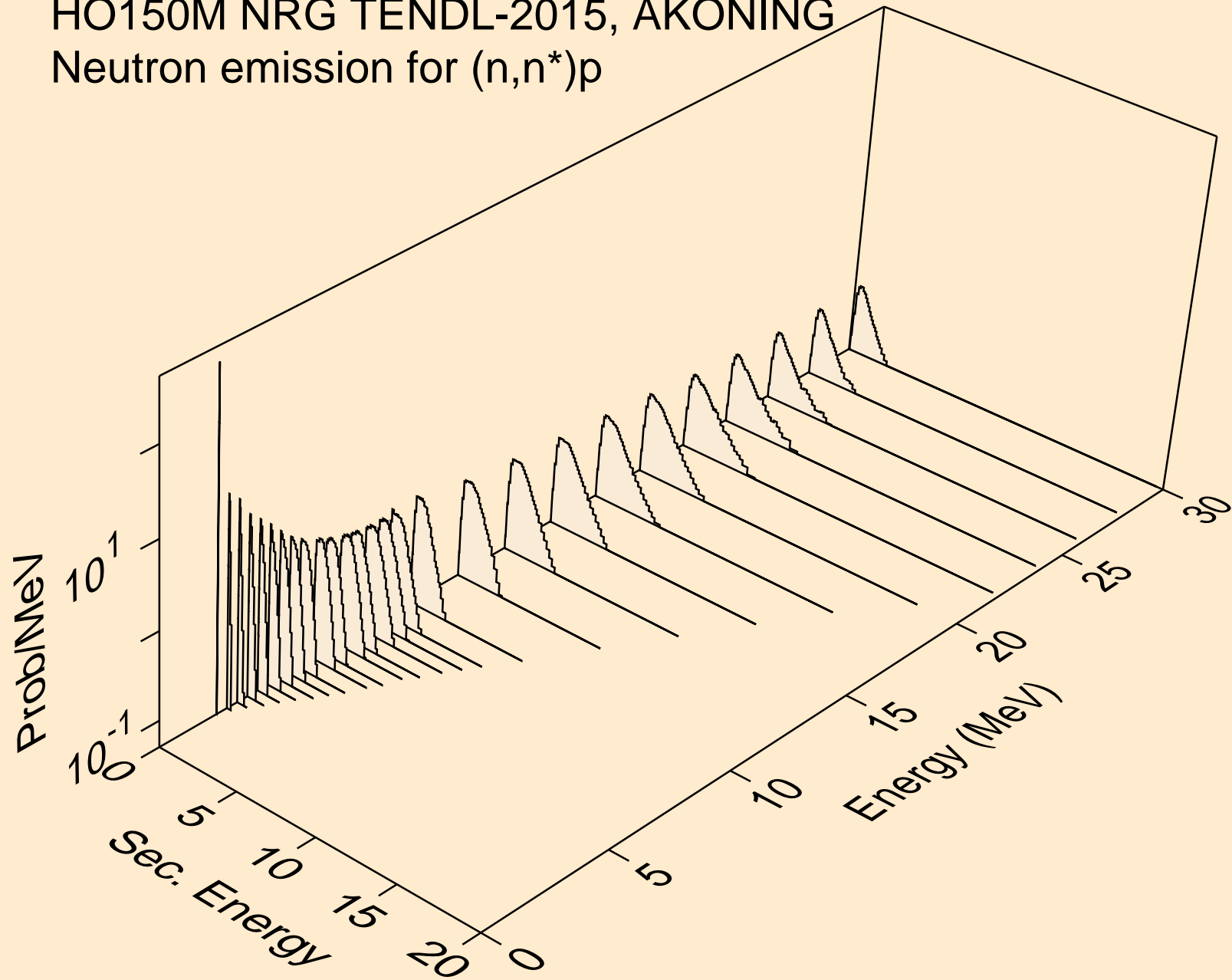

HO150M NRG TENDL-2015, AKONING
Neutron emission for (n,n*)2a

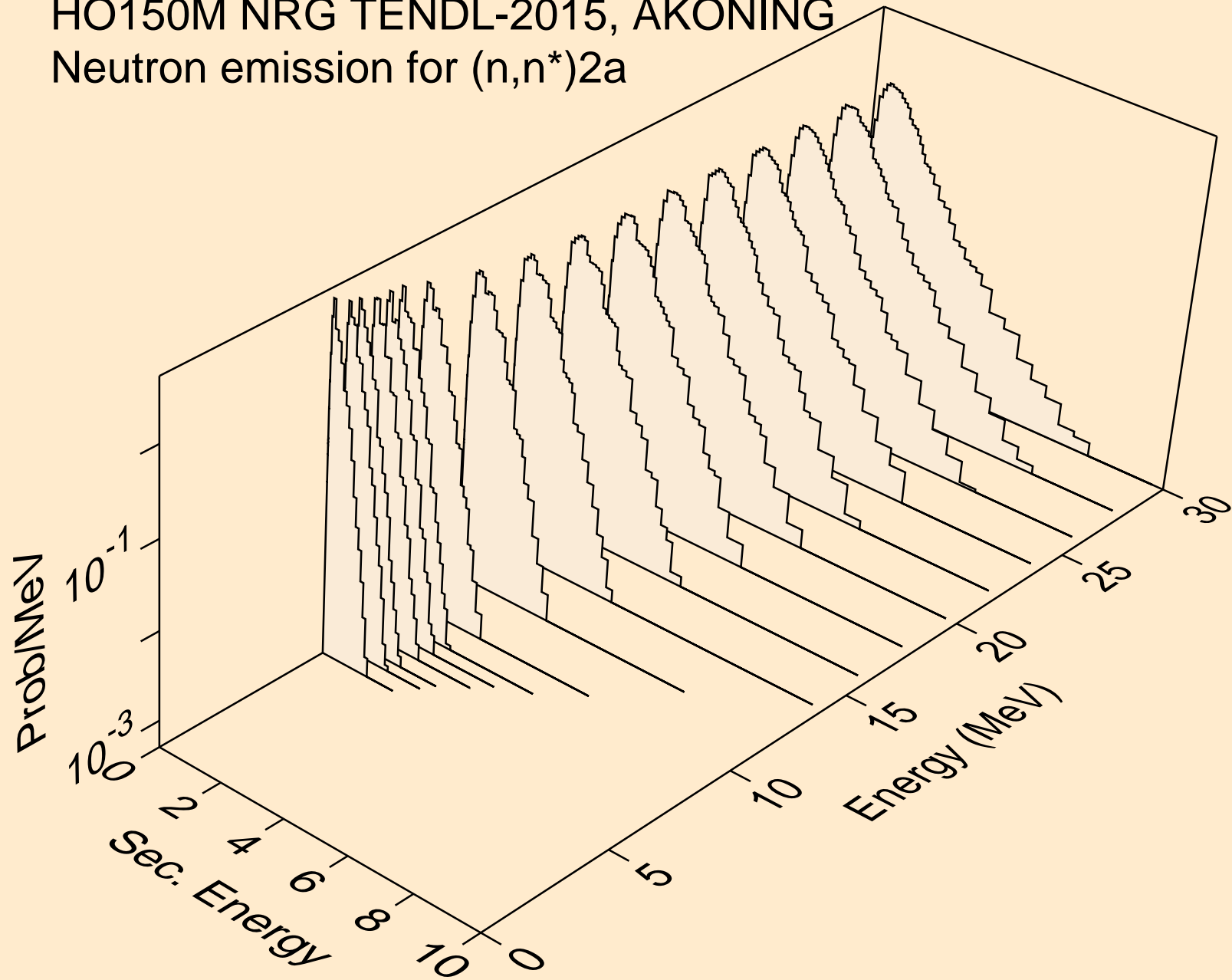

HO150M NRG TENDL-2015, AKONING
Neutron emission for (n,2n)2a

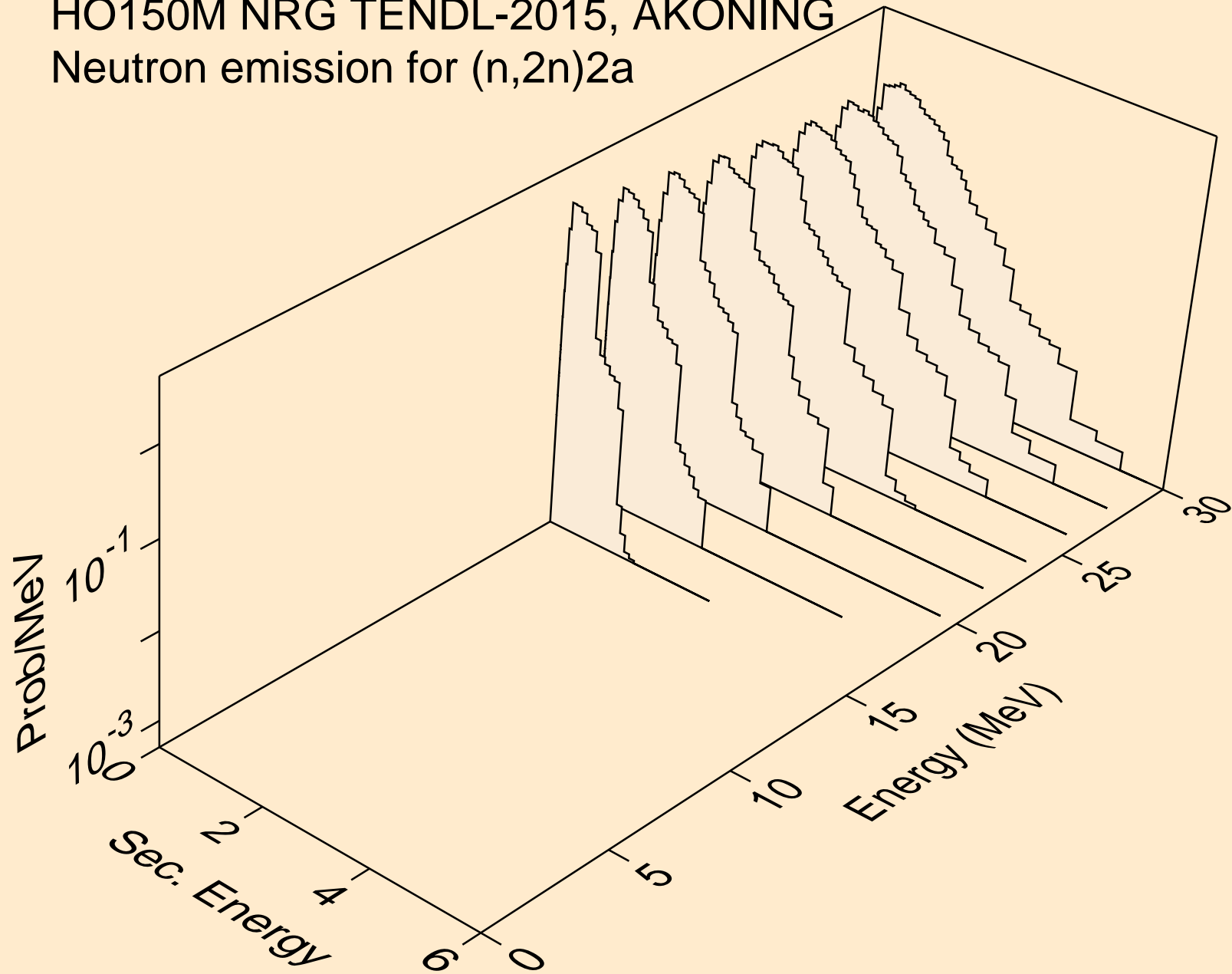

HO150M NRG TENDL-2015, AKONING
Neutron emission for (n,n*)d

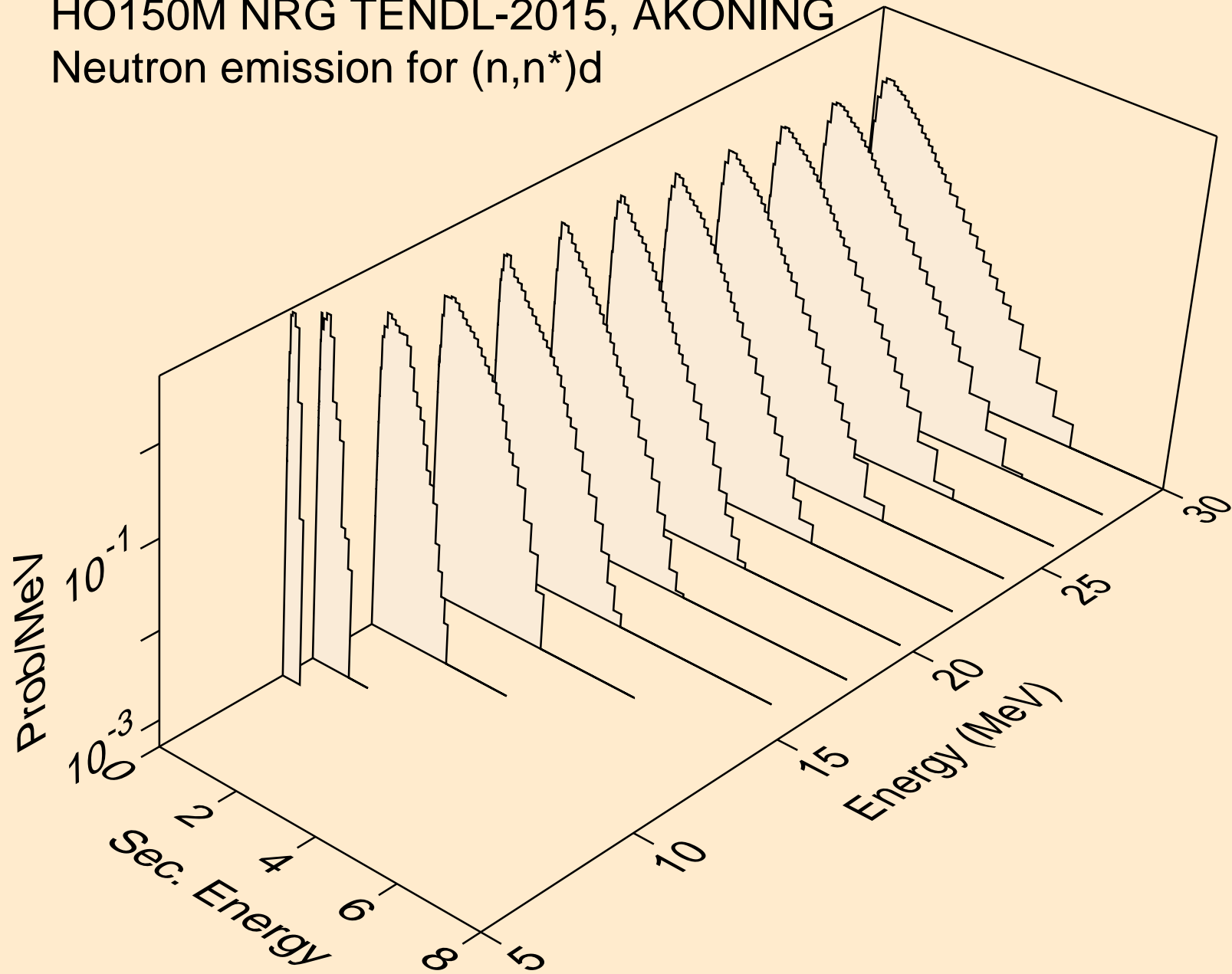

HO150M NRG TENDL-2015, AKONING
Neutron emission for (n,n*)t

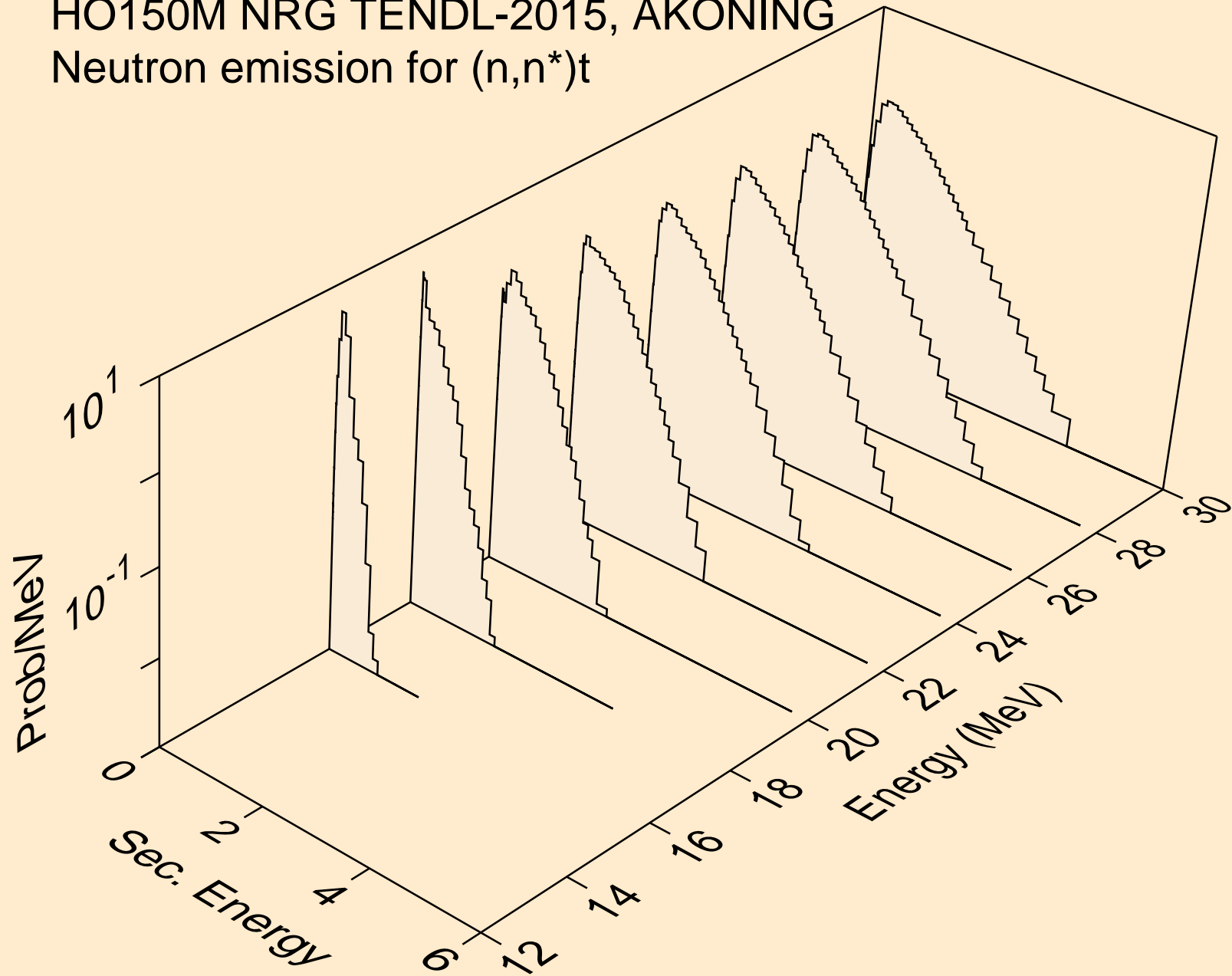

HO150M NRG TENDL-2015, AKONING
Neutron emission for (n,n*)he3

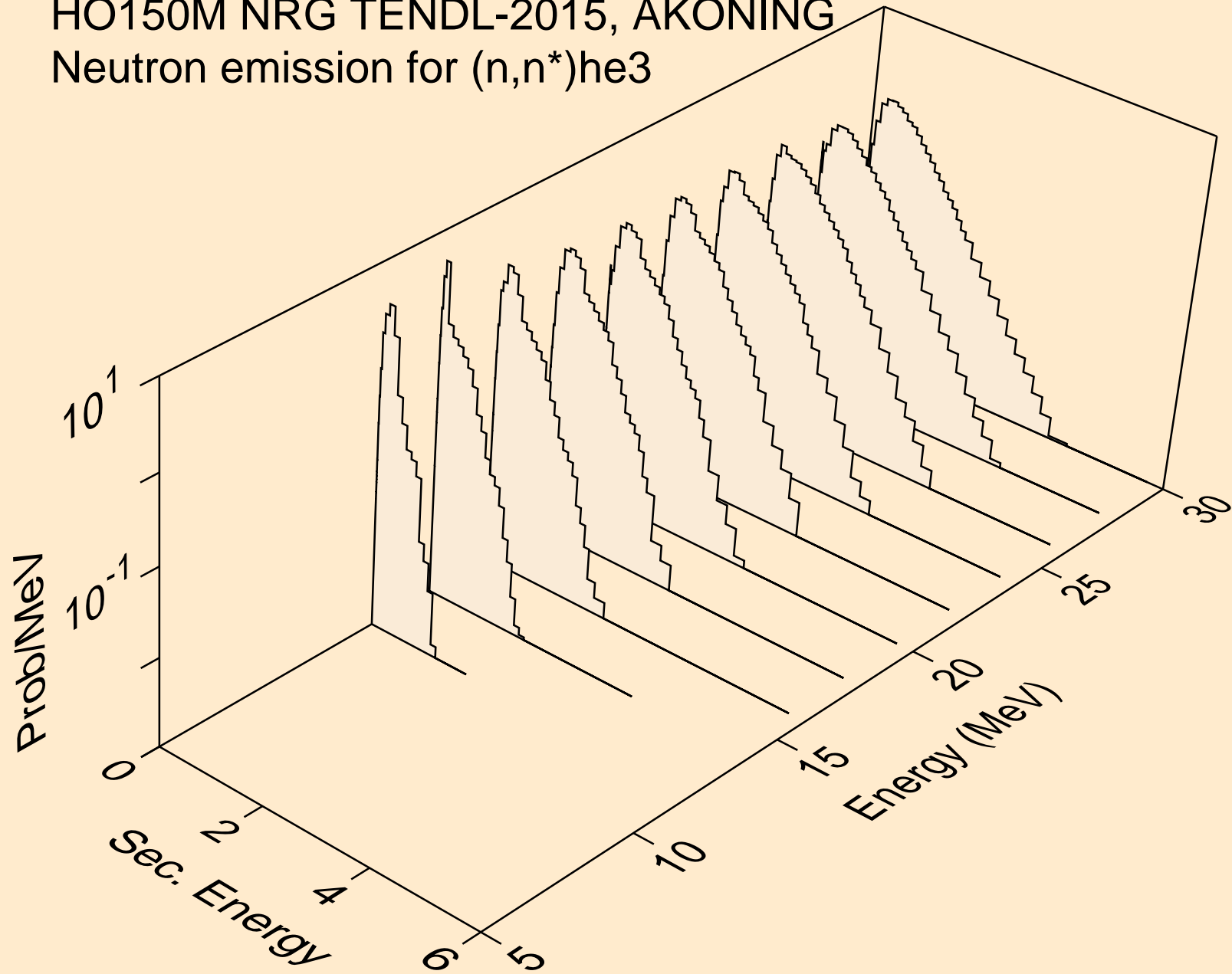

HO150M NRG TENDL-2015, AKONING
Neutron emission for (n,2np)

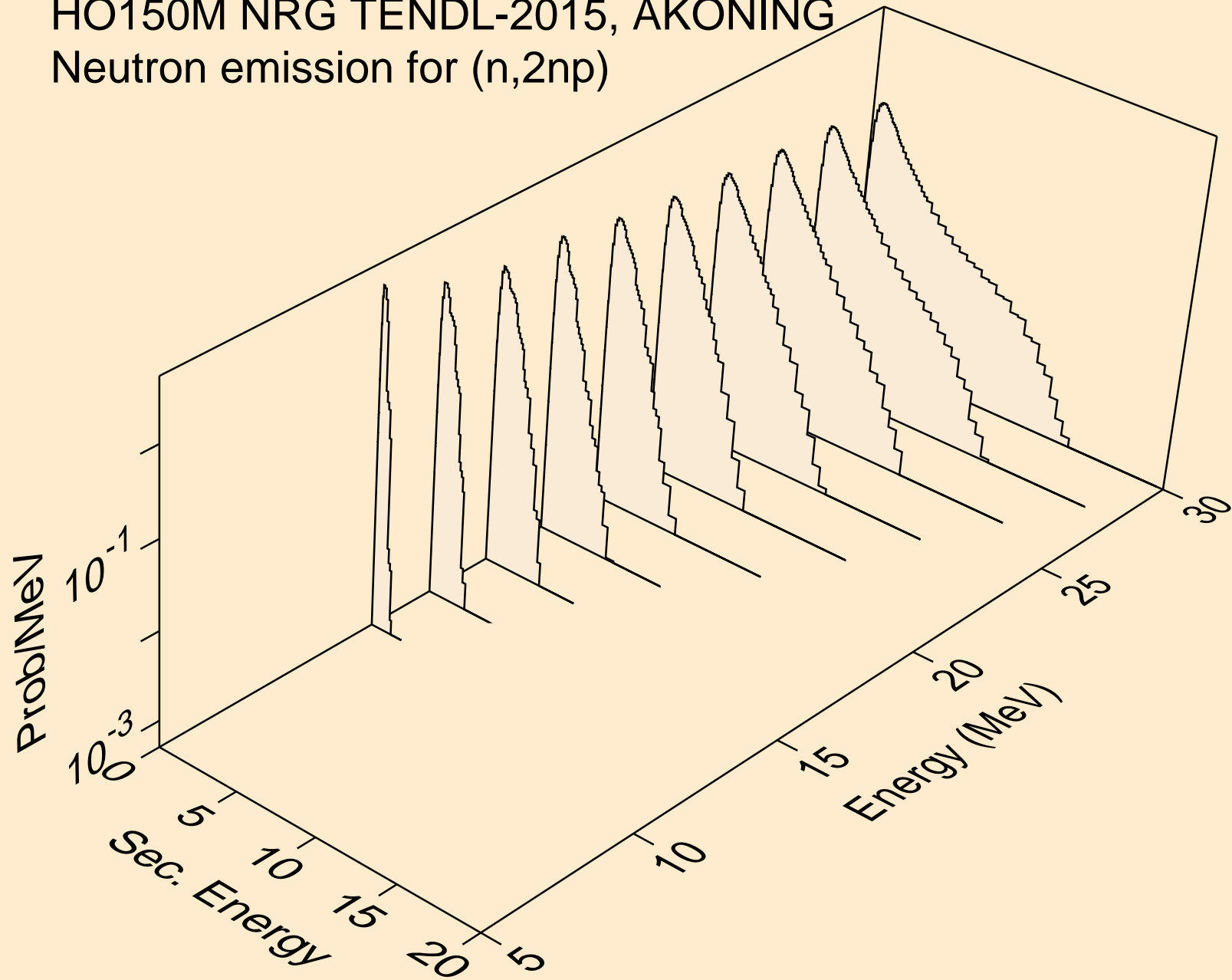

HO150M NRG TENDL-2015, AKONING
Neutron emission for (n,3np)

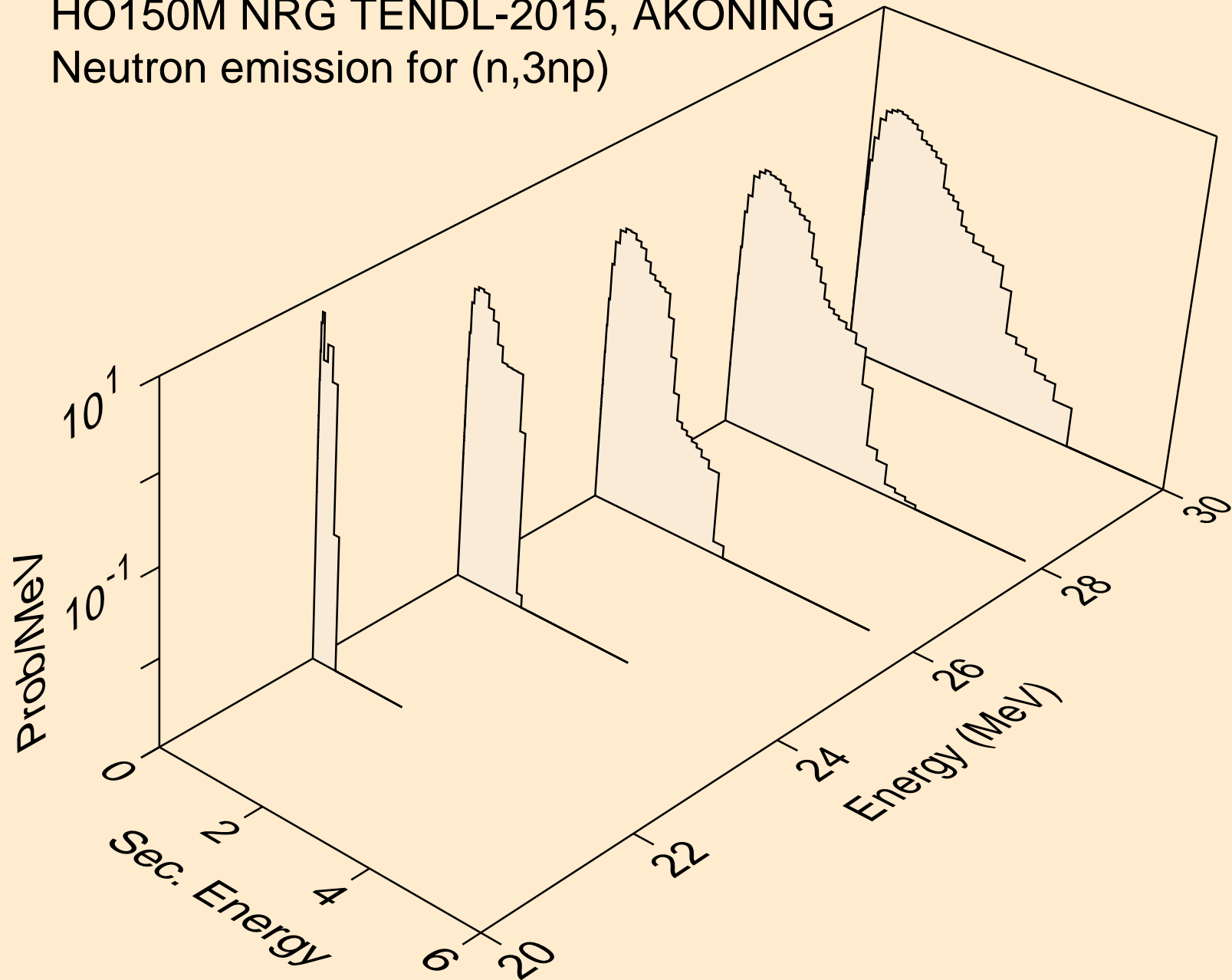

HO150M NRG TENDL-2015, AKONING
Neutron emission for (n,2np)

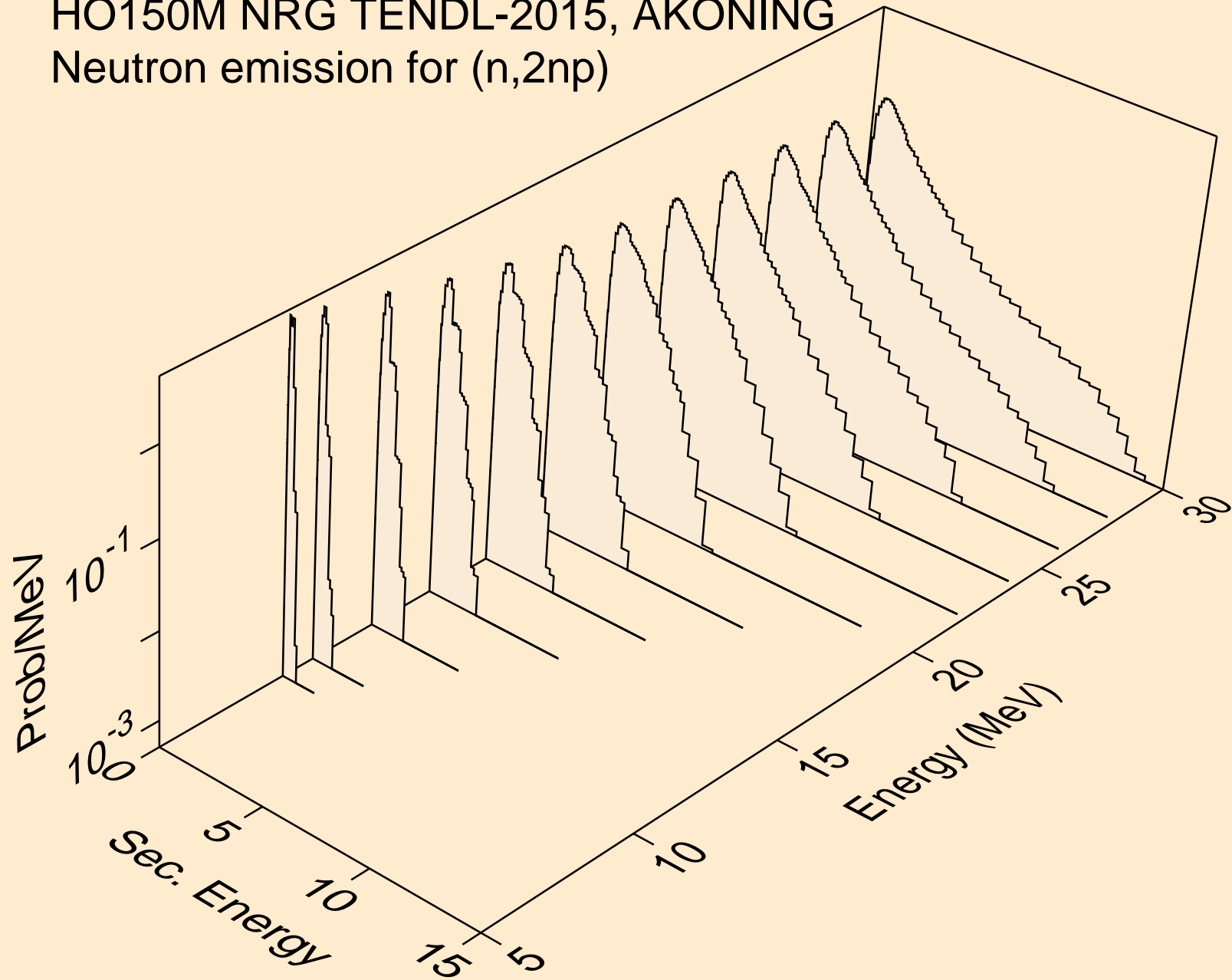

HO150M NRG TENDL-2015, AKONING
Neutron emission for (n,npa)

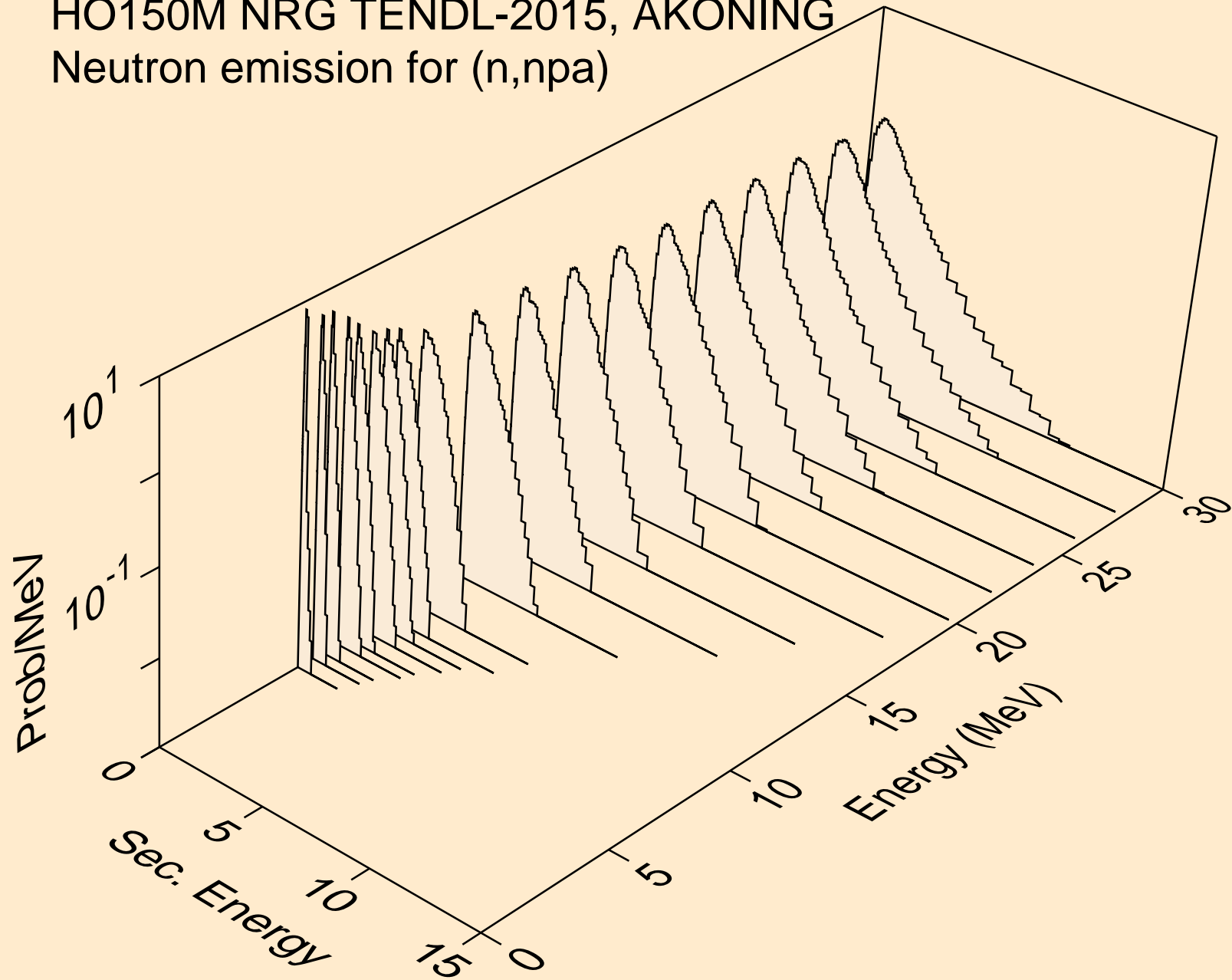

HO150M NRG TENDL-2015, AKONING
Neutron emission for (n,n*c)

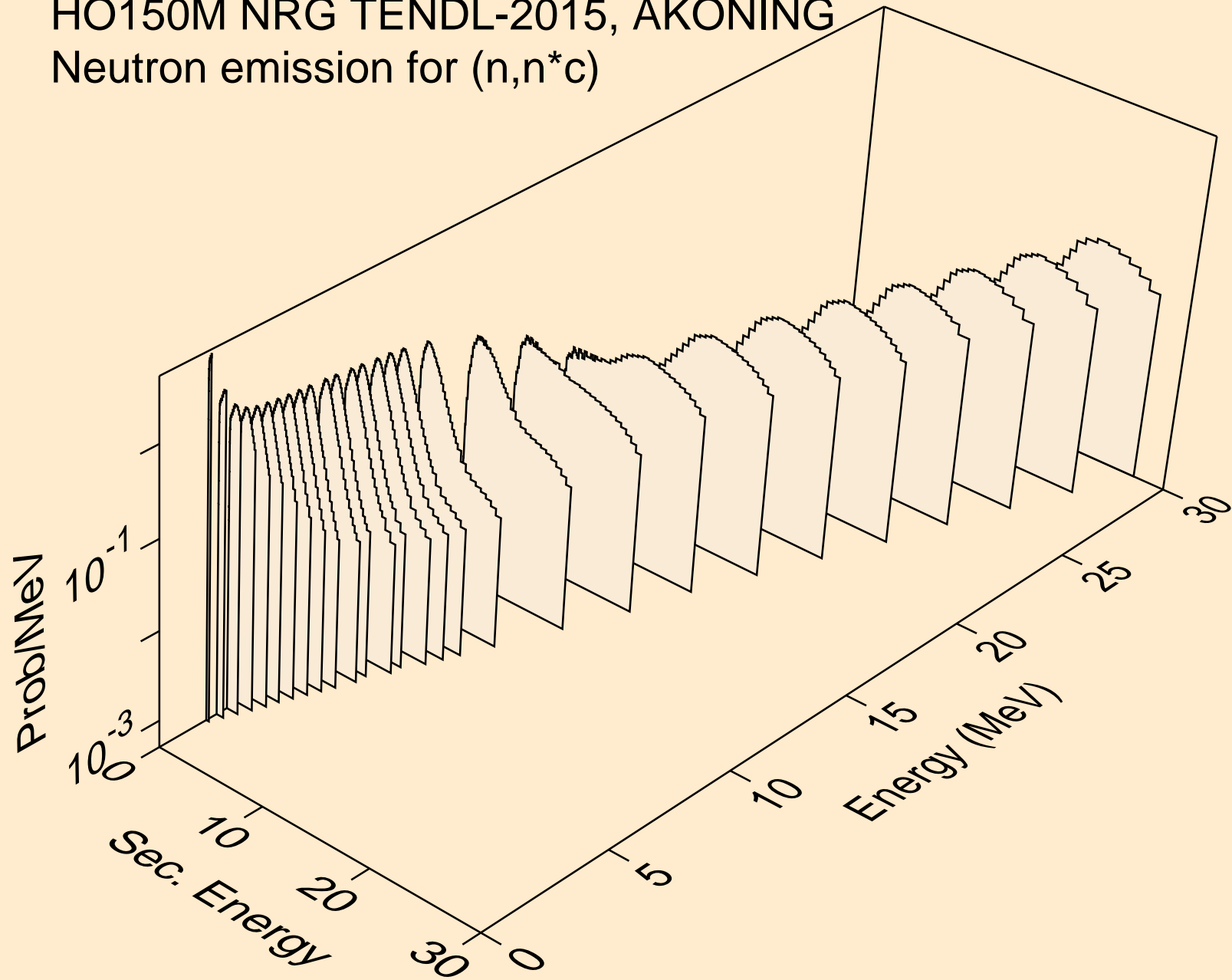

HO150M NRG TENDL-2015, AKONING
Photon emission for (n,x)

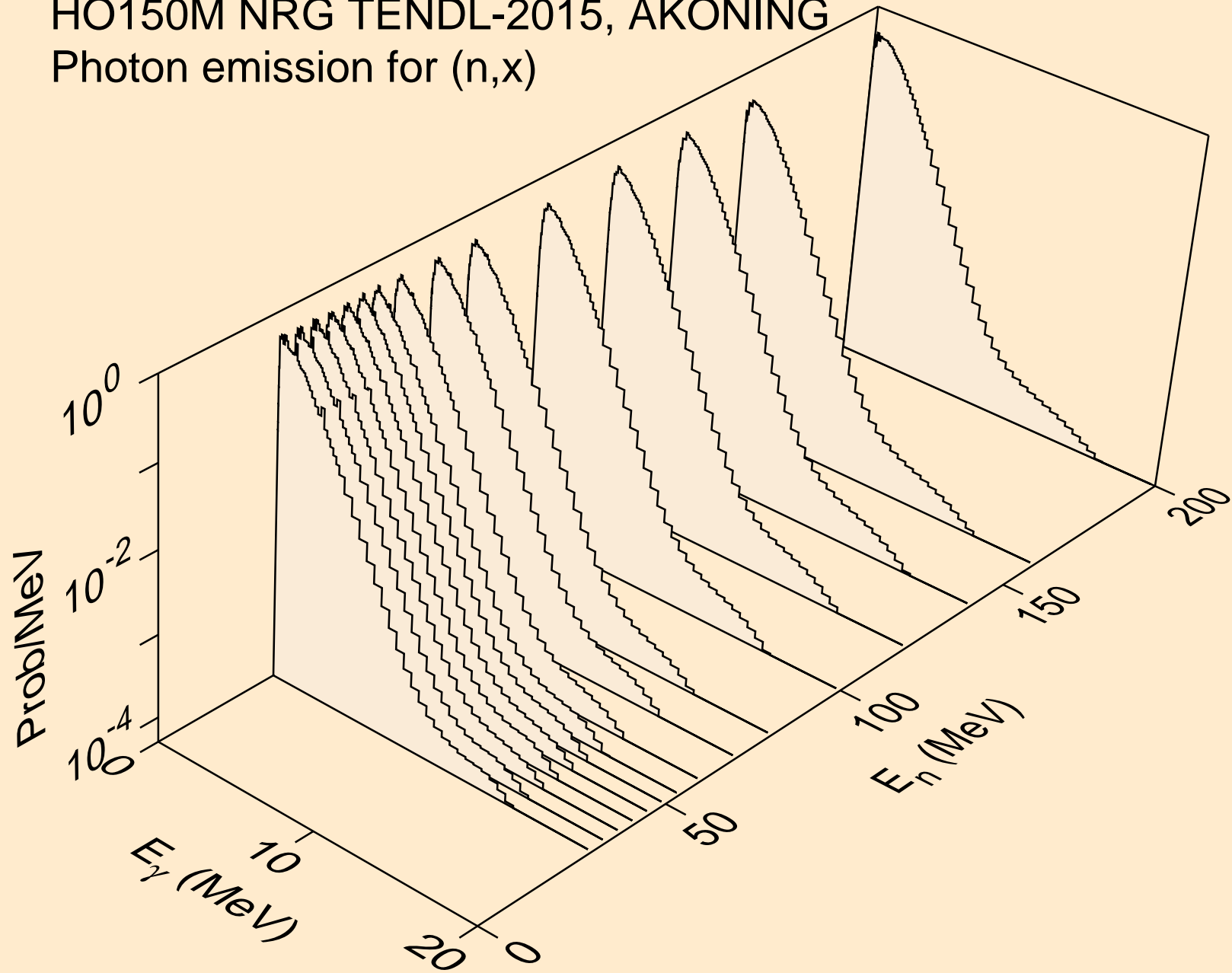

HO150M NRG TENDL-2015, AKONING
Photon emission for (n,2nd)

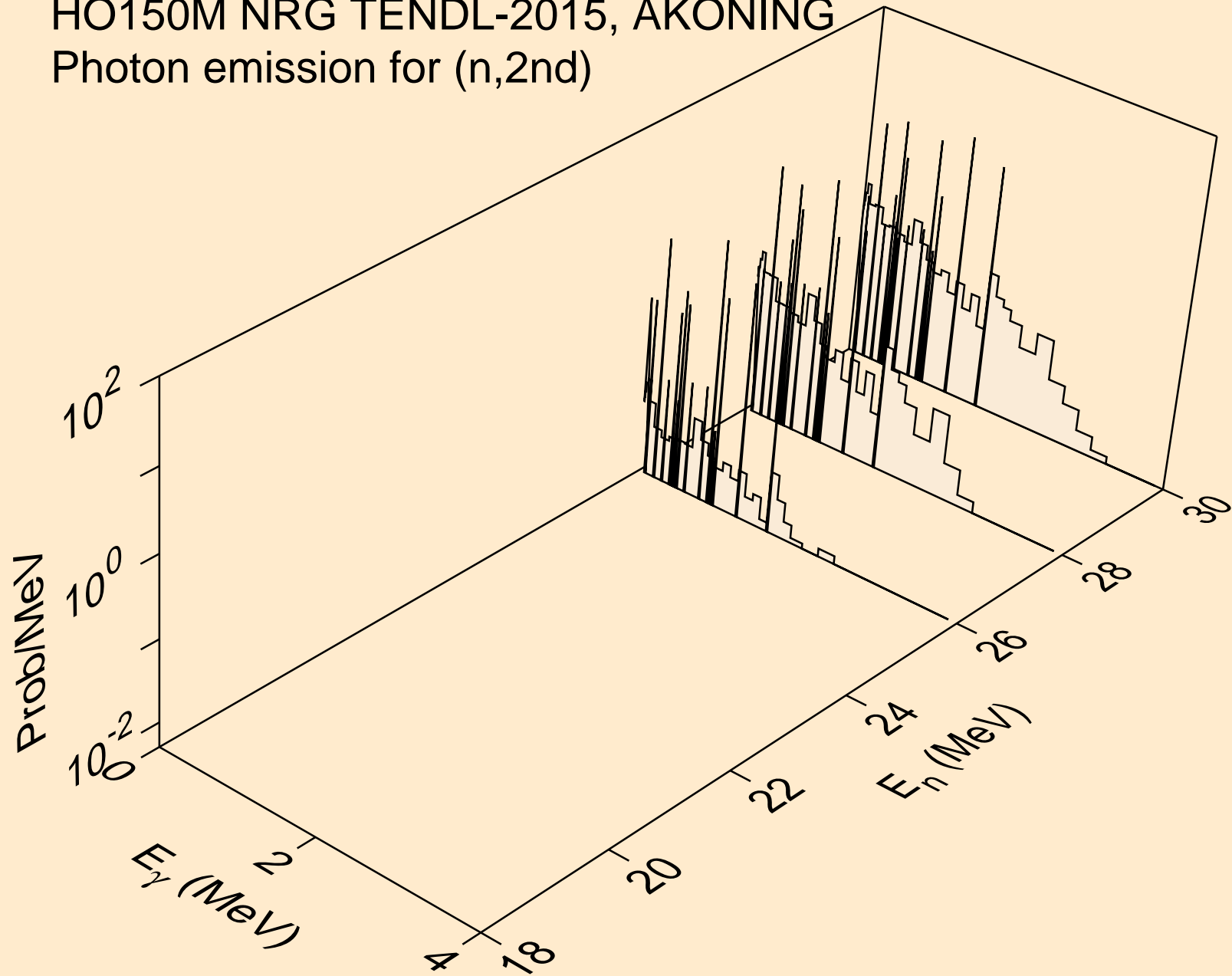

HO150M NRG TENDL-2015, AKONING
Photon emission for (n,2n)

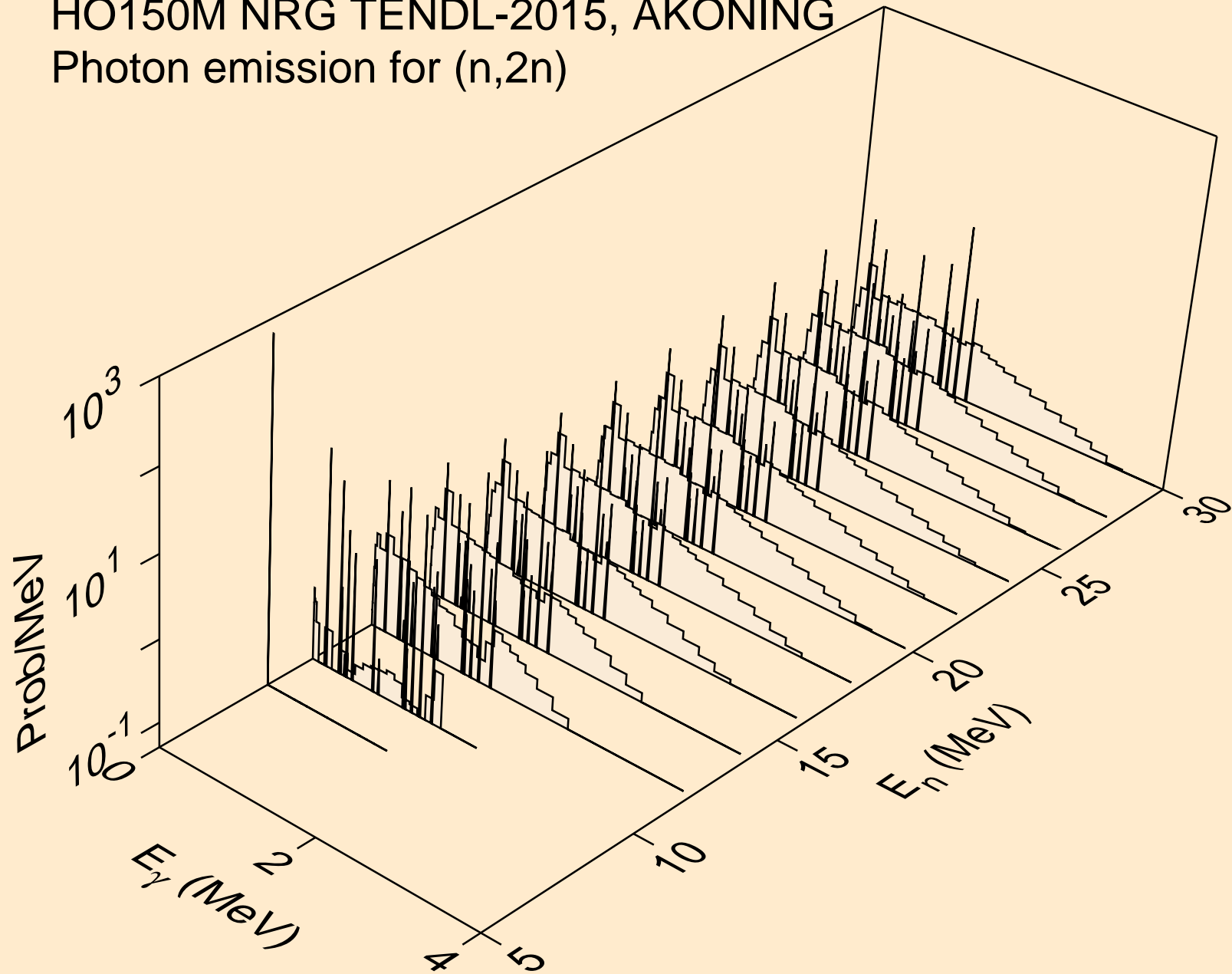

HO150M NRG TENDL-2015, AKONING
Photon emission for (n,3n)

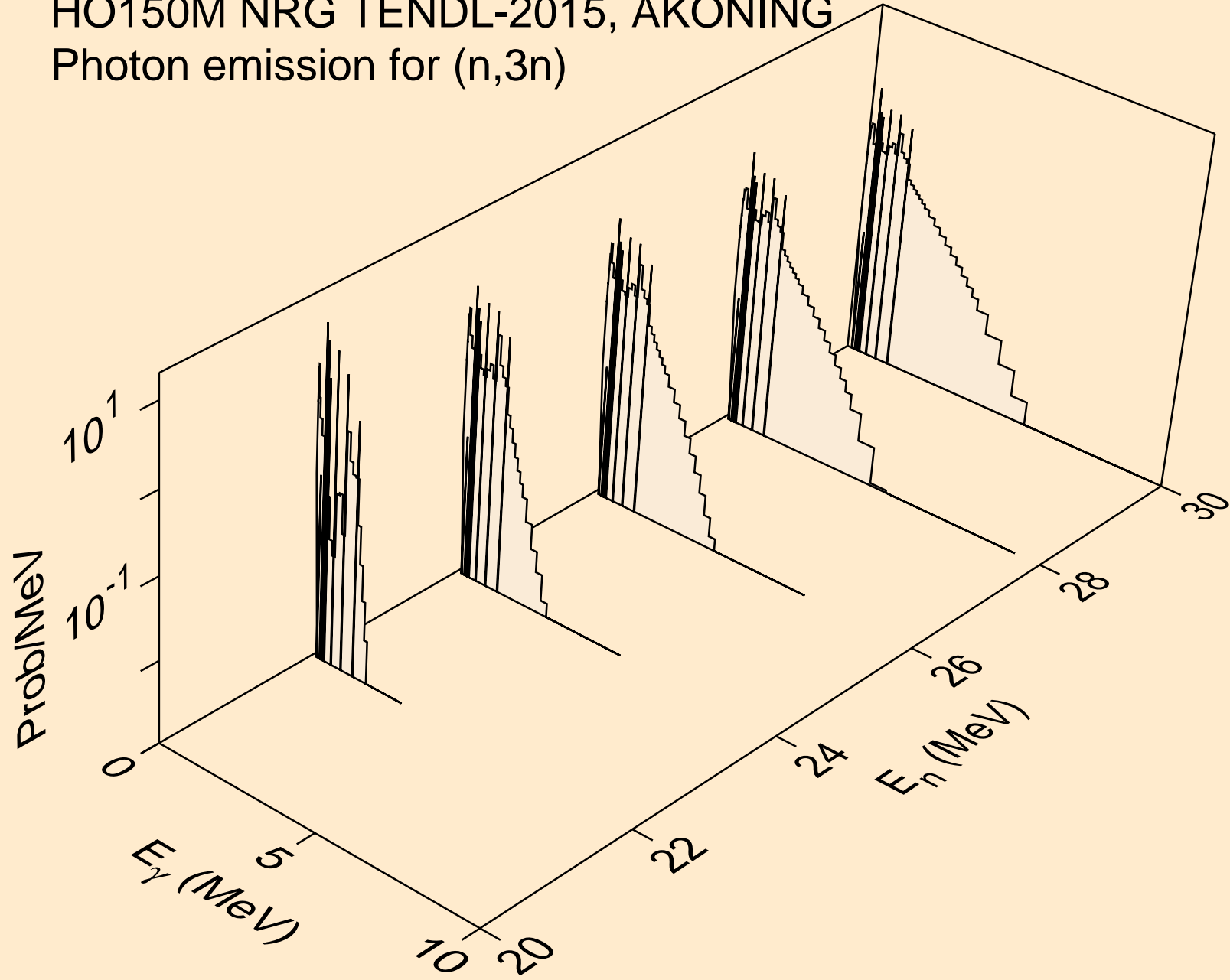

HO150M NRG TENDL-2015, AKONING
Photon emission for (n,n*)a

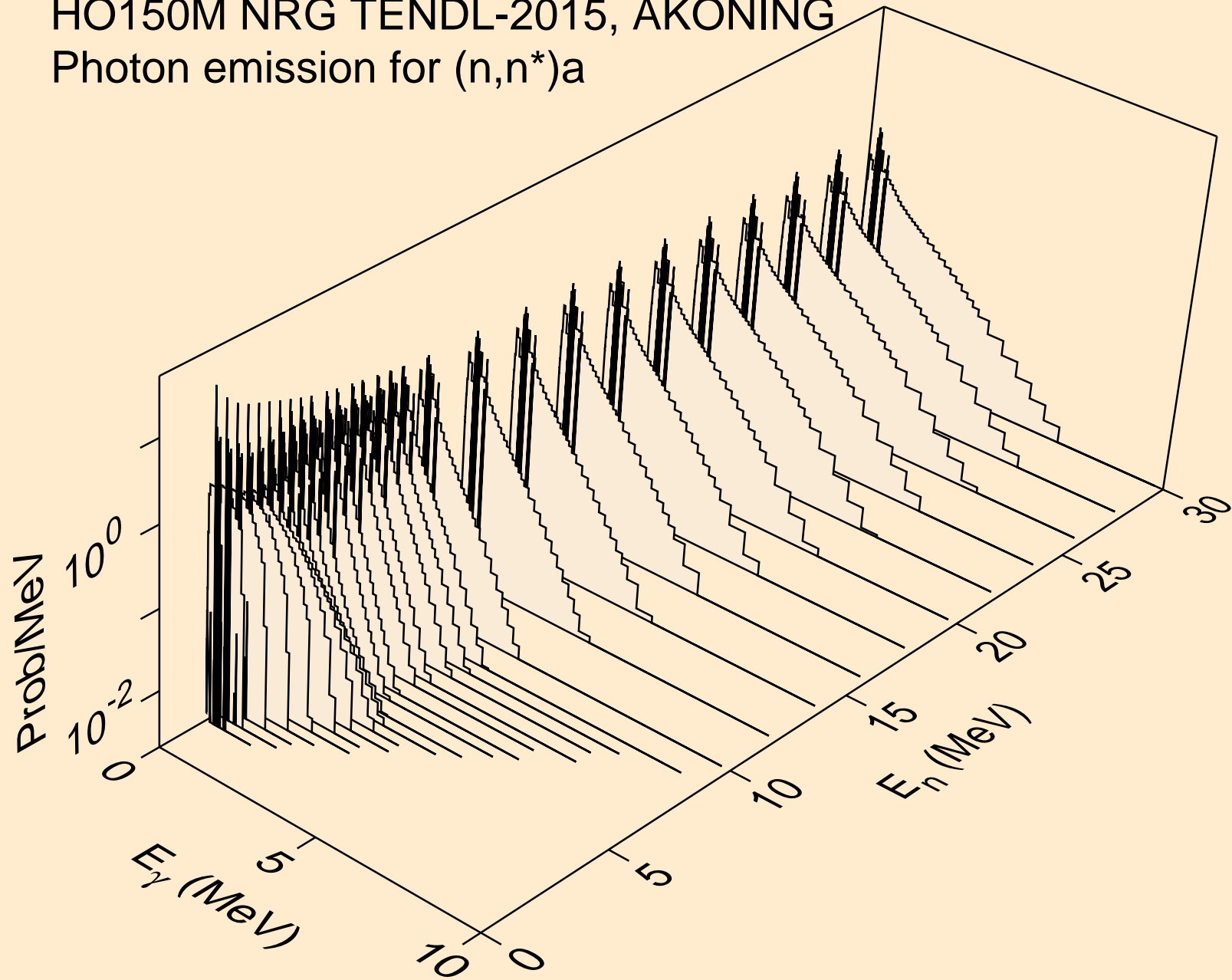

HO150M NRG TENDL-2015, AKONING
Photon emission for (n,2n)a

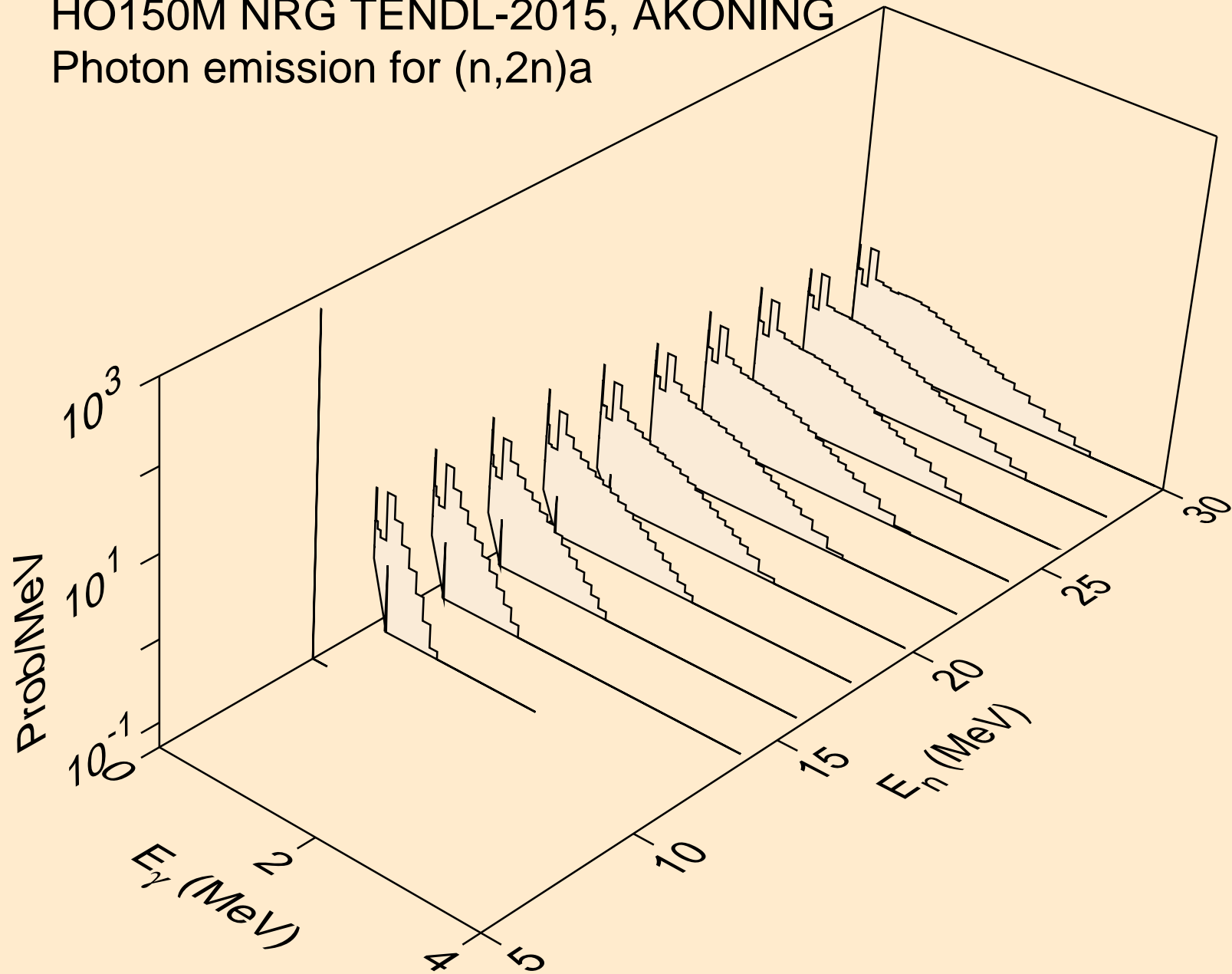

HO150M NRG TENDL-2015, AKONING
Photon emission for (n,3n)a

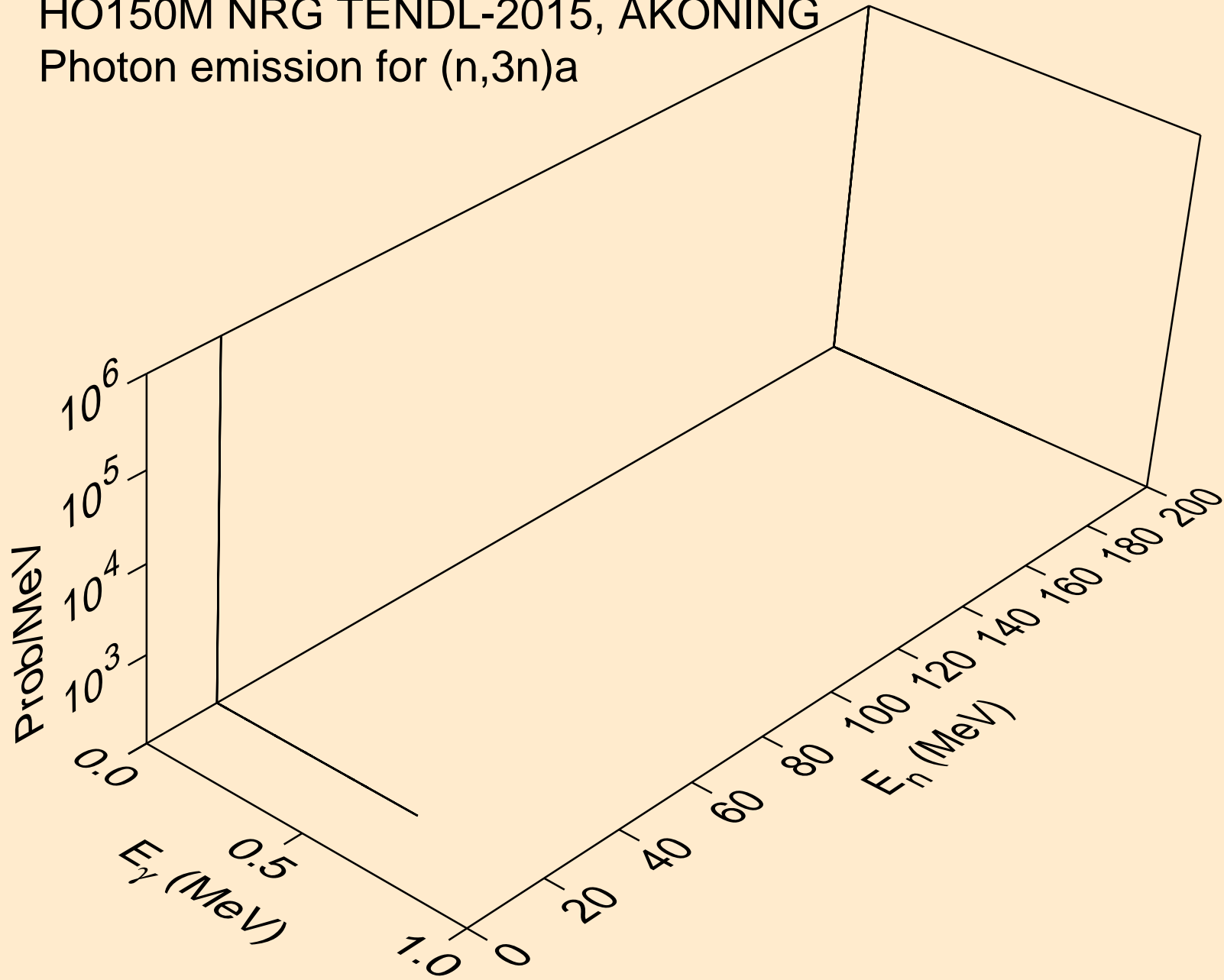

HO150M NRG TENDL-2015, AKONING
Photon emission for (n,n*)p

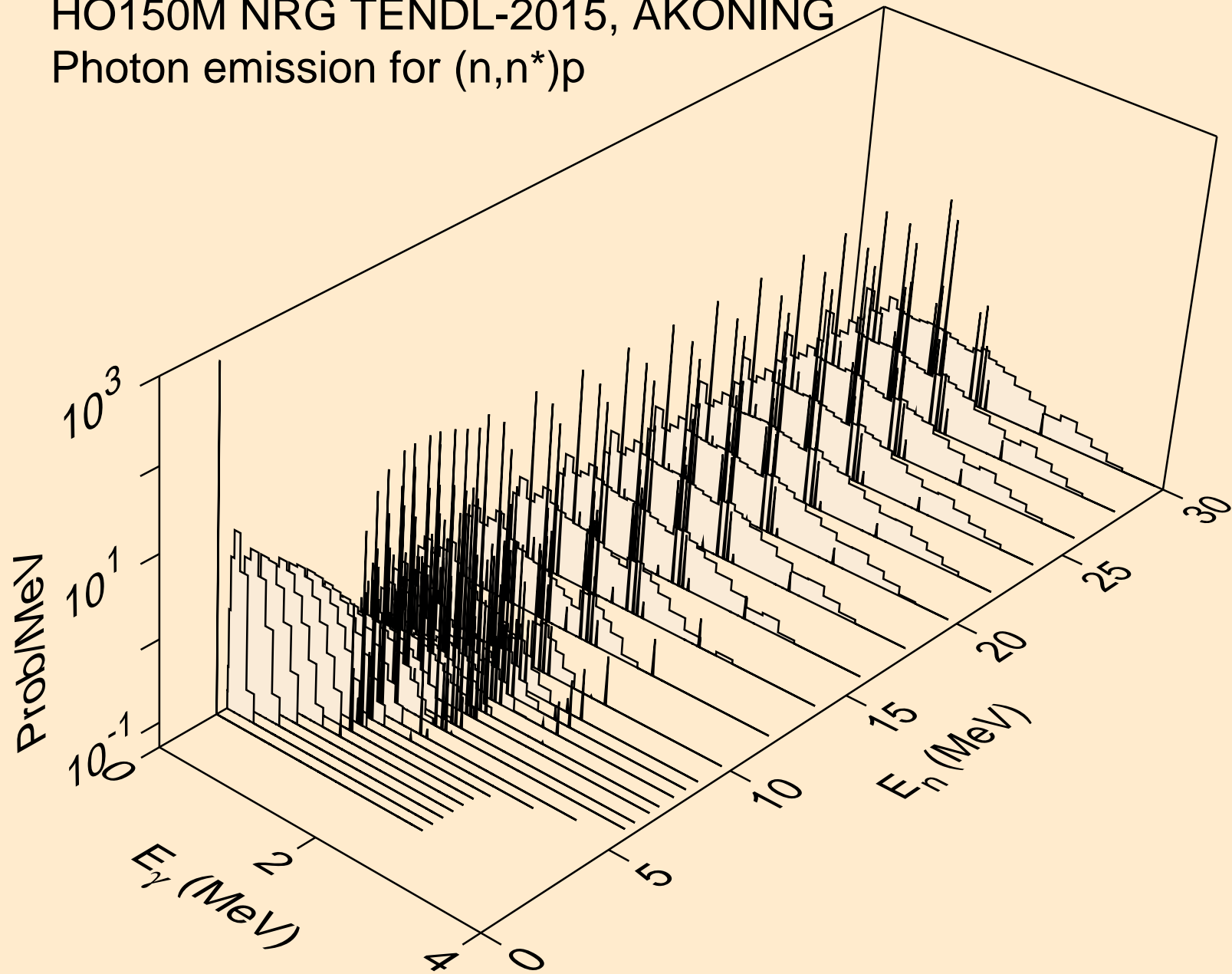

HO150M NRG TENDL-2015, AKONING
Photon emission for (n,n*)2a

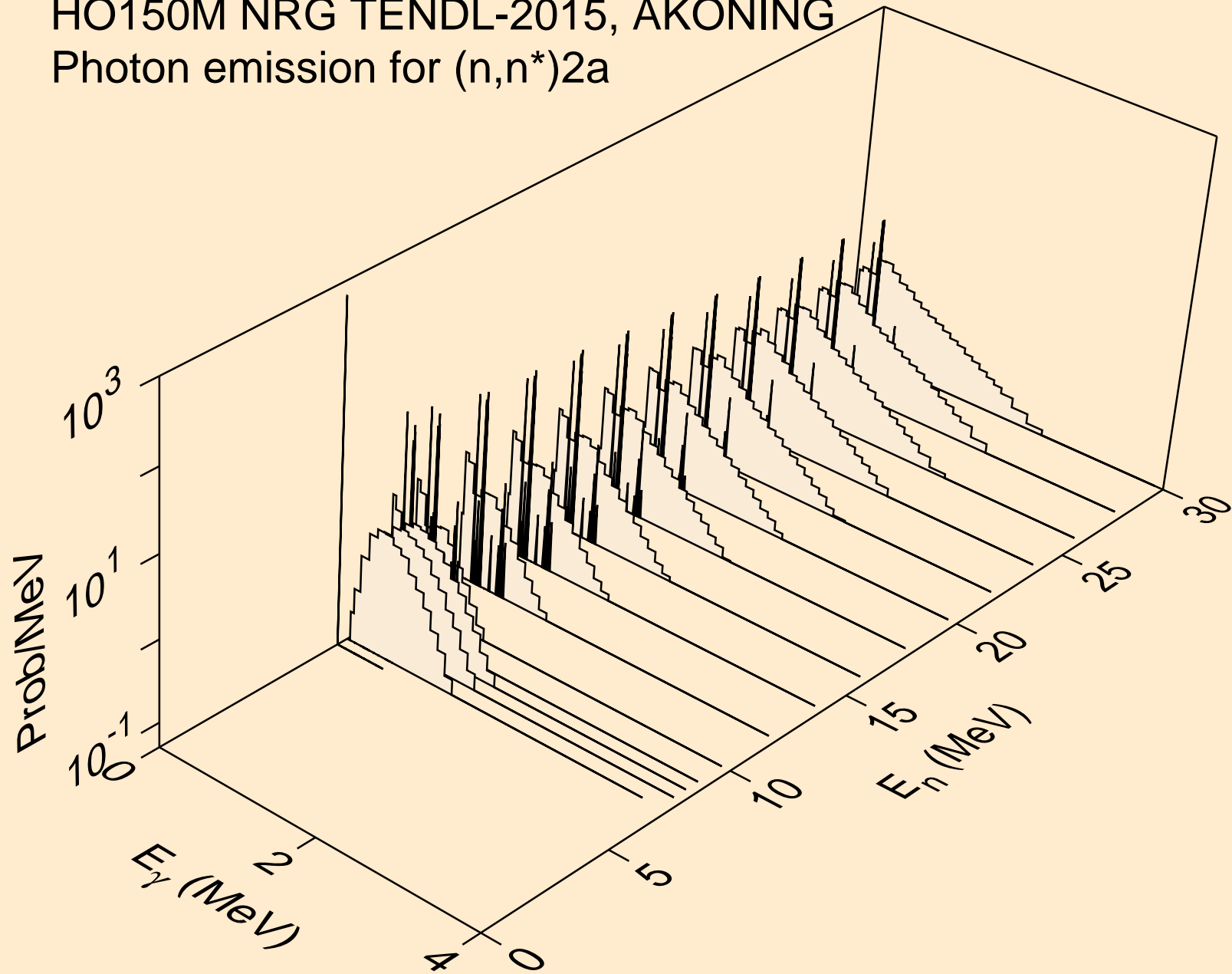

HO150M NRG TENDL-2015, AKONING
Photon emission for (n,2n)2a

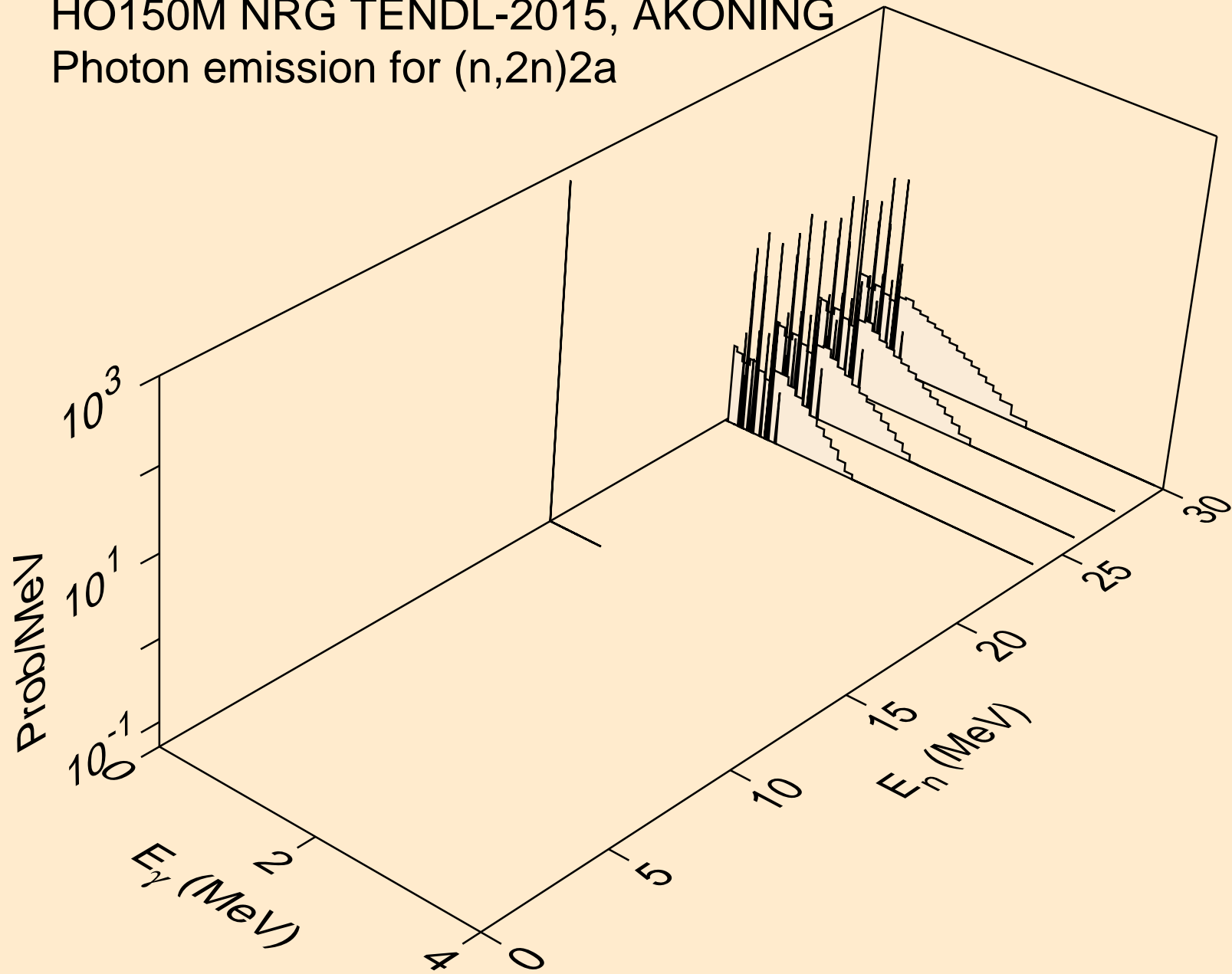

HO150M NRG TENDL-2015, AKONING
Photon emission for (n,n*)d

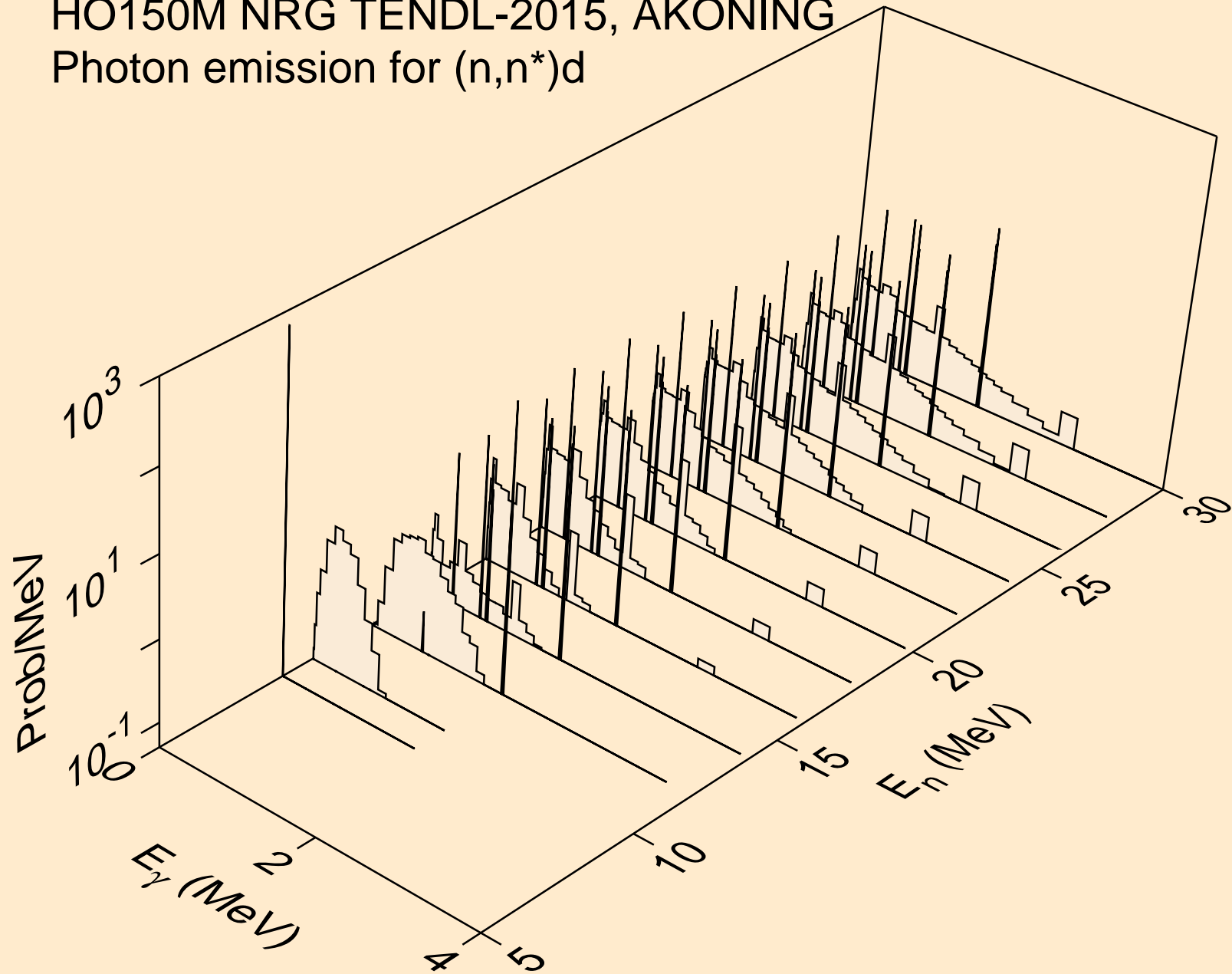

HO150M NRG TENDL-2015, AKONING
Photon emission for (n,n*)t

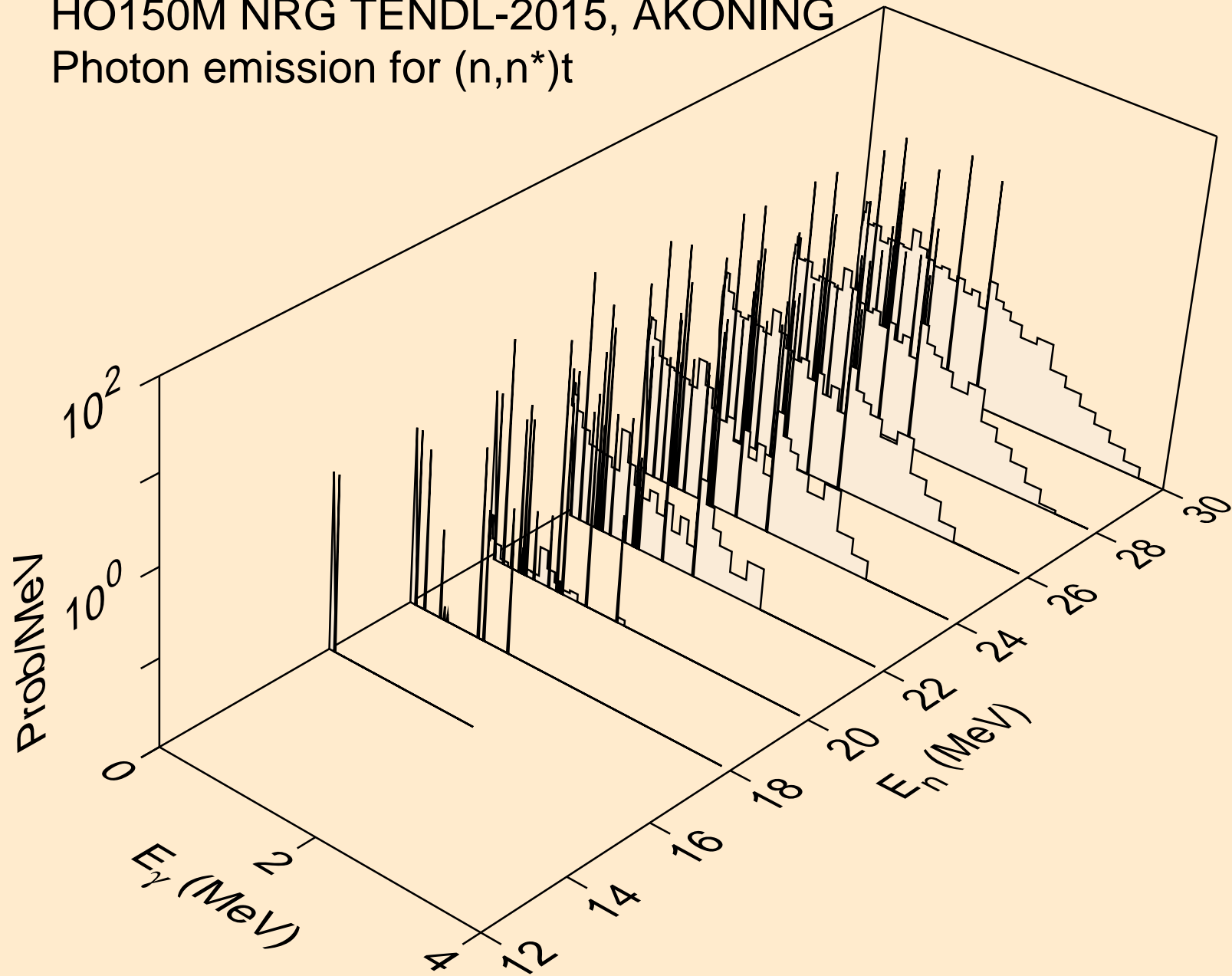

HO150M NRG TENDL-2015, AKONING
Photon emission for (n,n*)he3

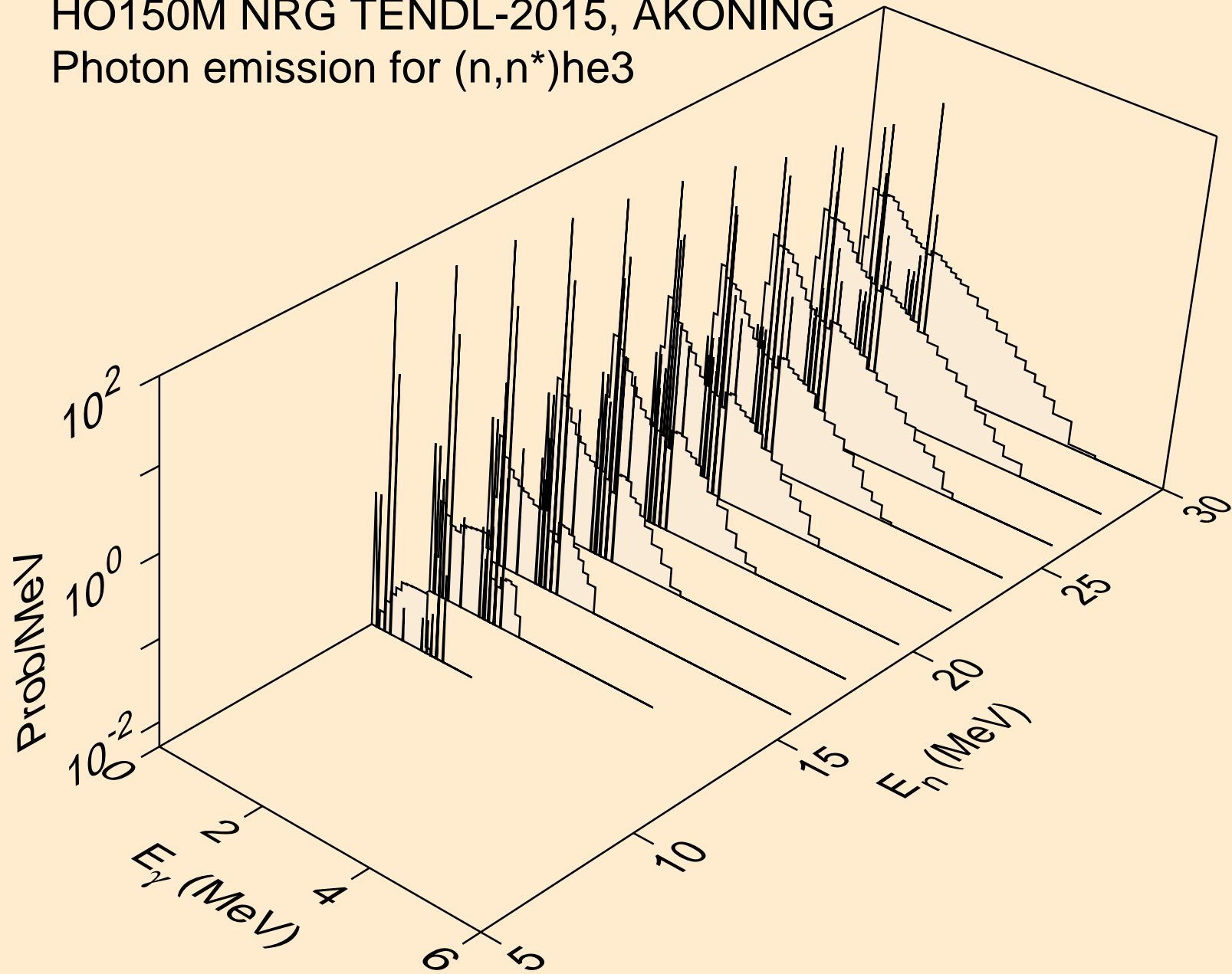

HO150M NRG TENDL-2015, AKONING
Photon emission for (n,2np)

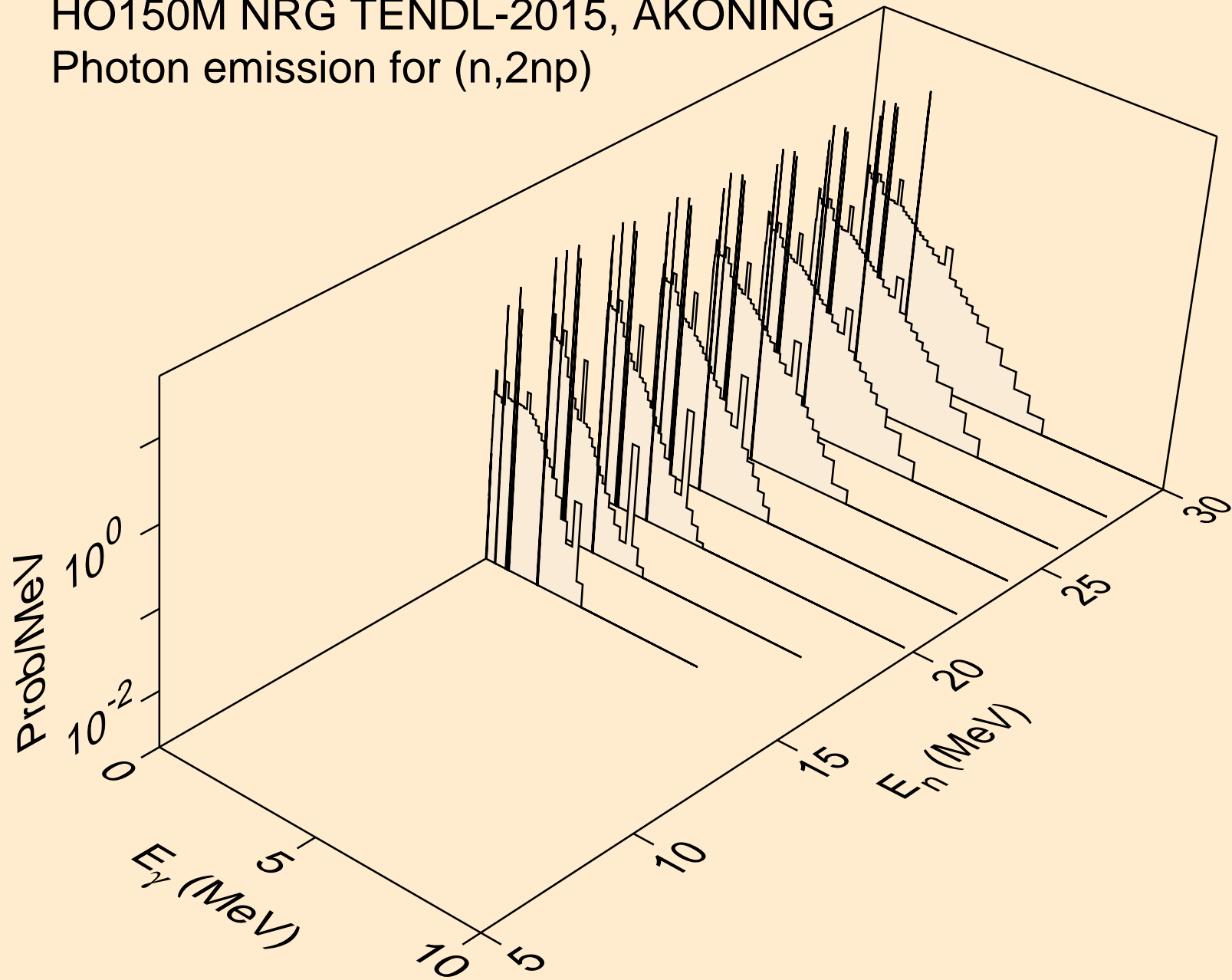

HO150M NRG TENDL-2015, AKONING
Photon emission for (n,3np)

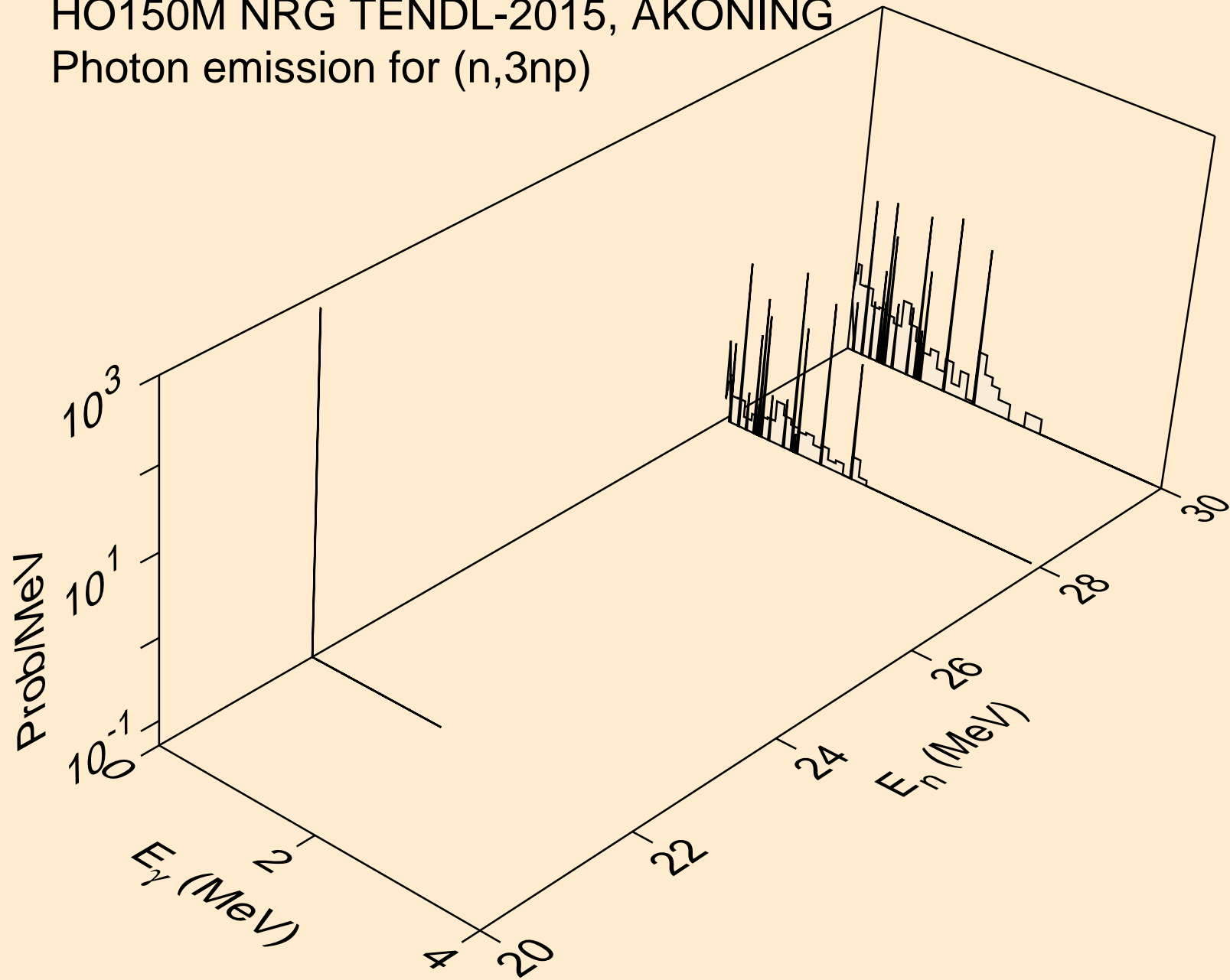

HO150M NRG TENDL-2015, AKONING
Photon emission for (n,2np)

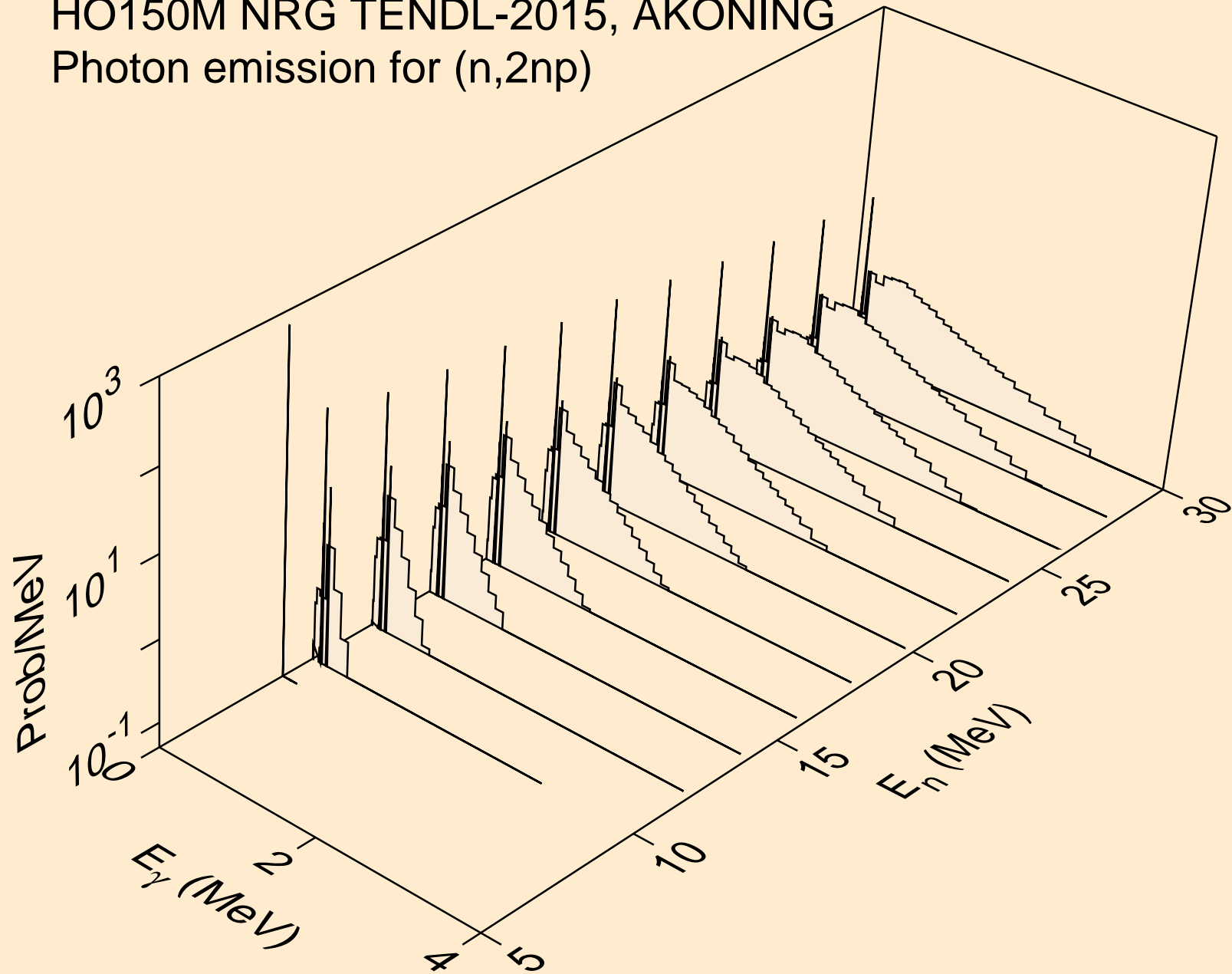

HO150M NRG TENDL-2015, AKONING
Photon emission for (n,npa)

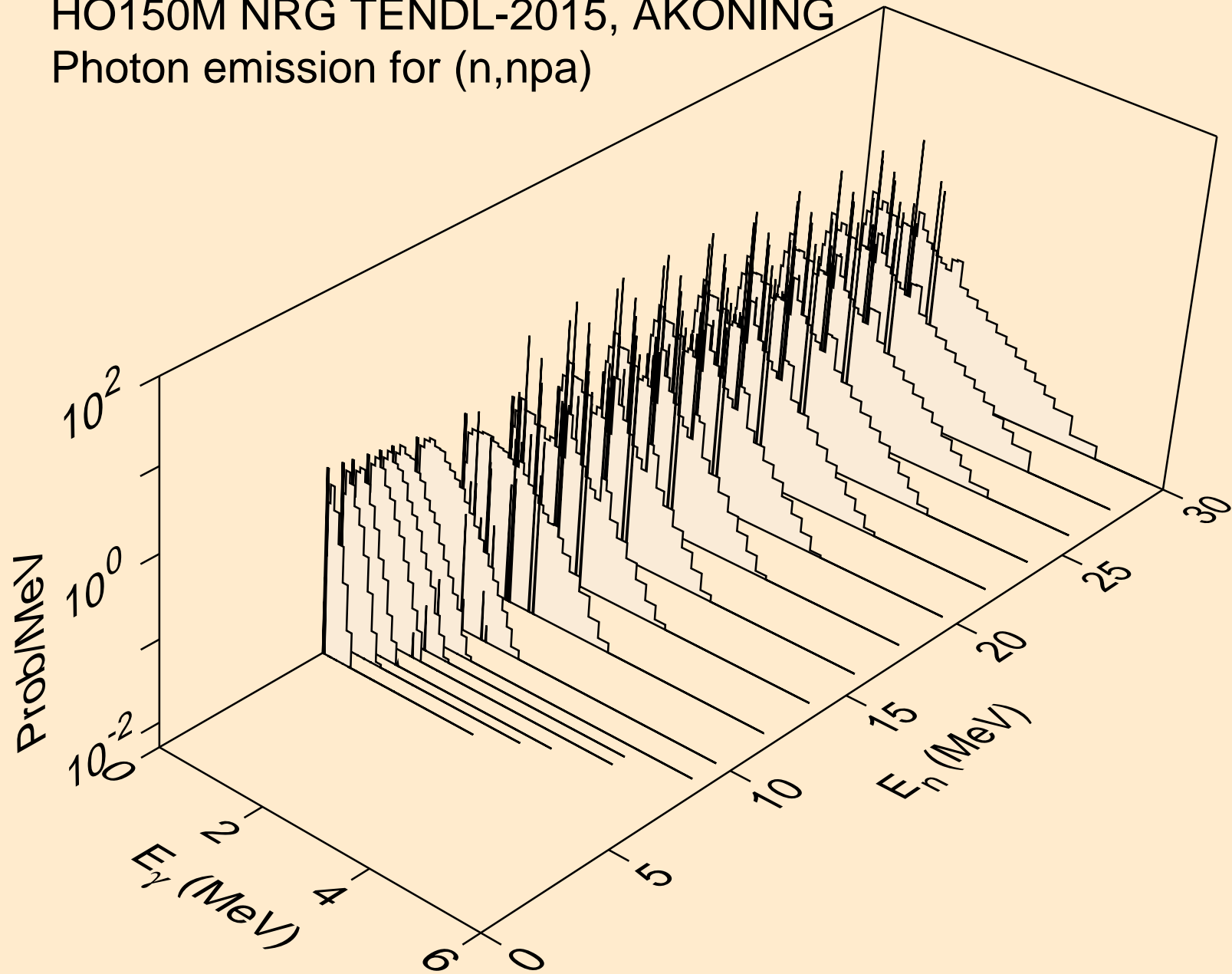

HO150M NRG TENDL-2015, AKONING
Photon emission for (n,n*1)

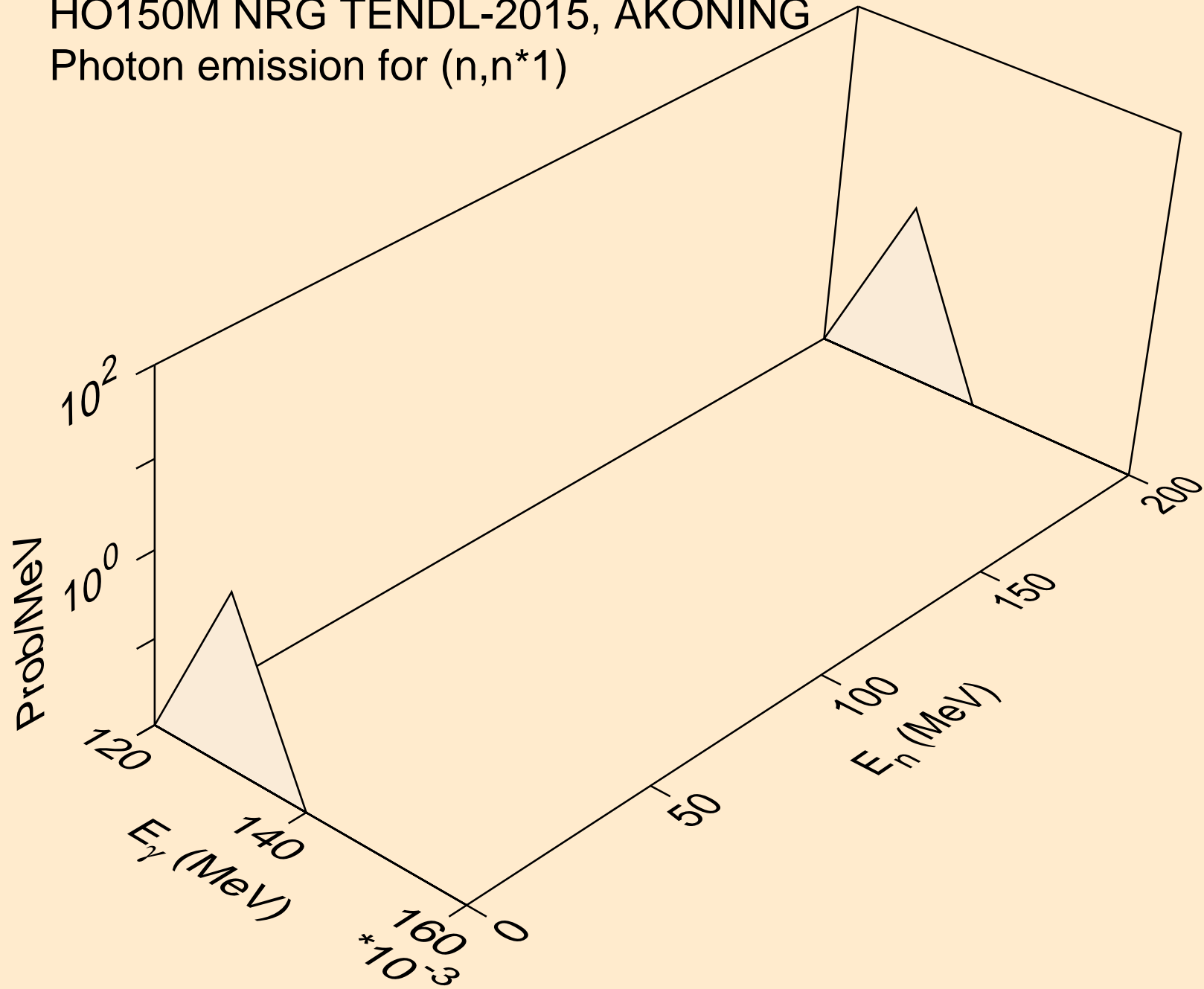

HO150M NRG TENDL-2015, AKONING
Photon emission for (n,n*3)

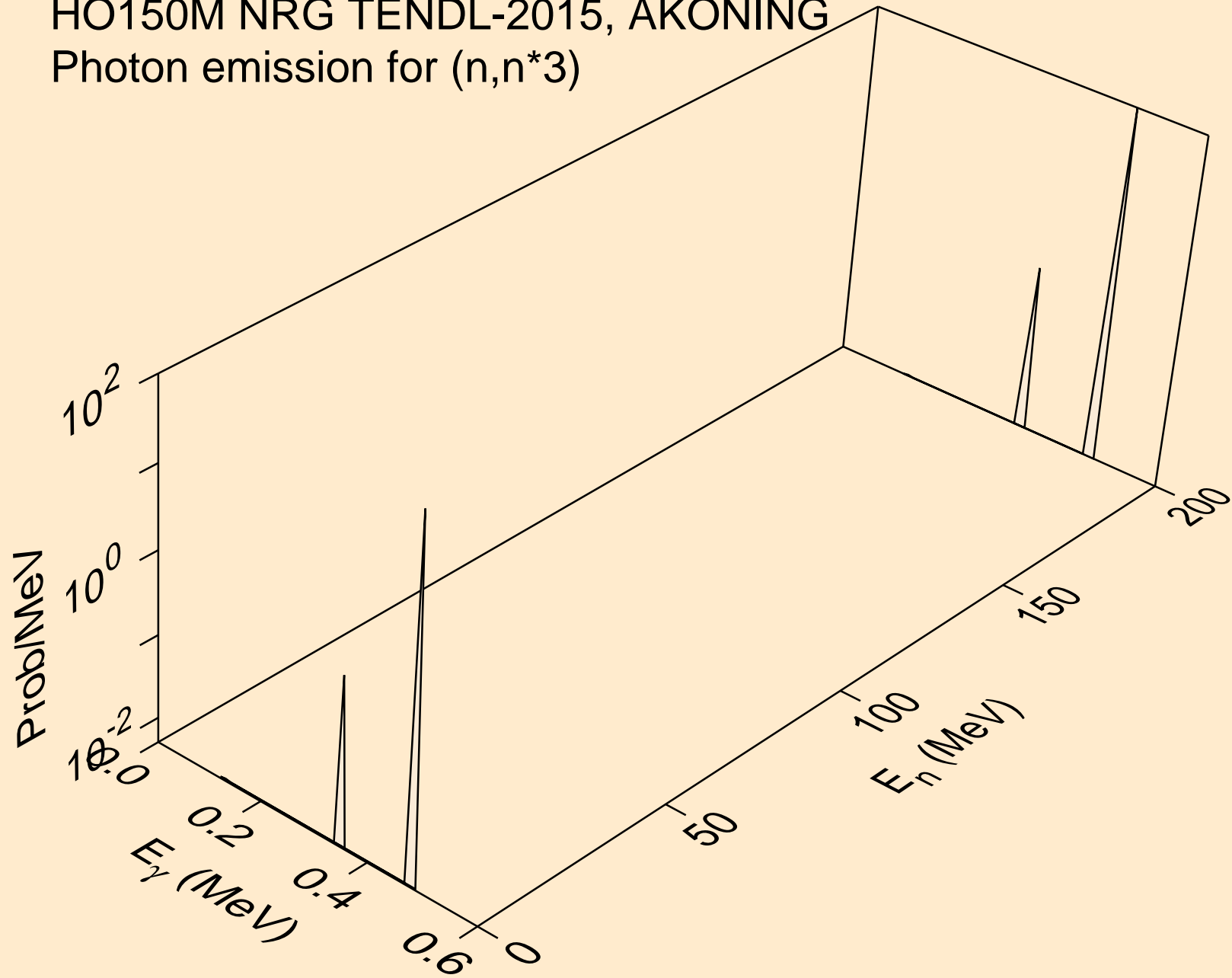

HO150M NRG TENDL-2015, AKONING
Photon emission for (n,n*4)

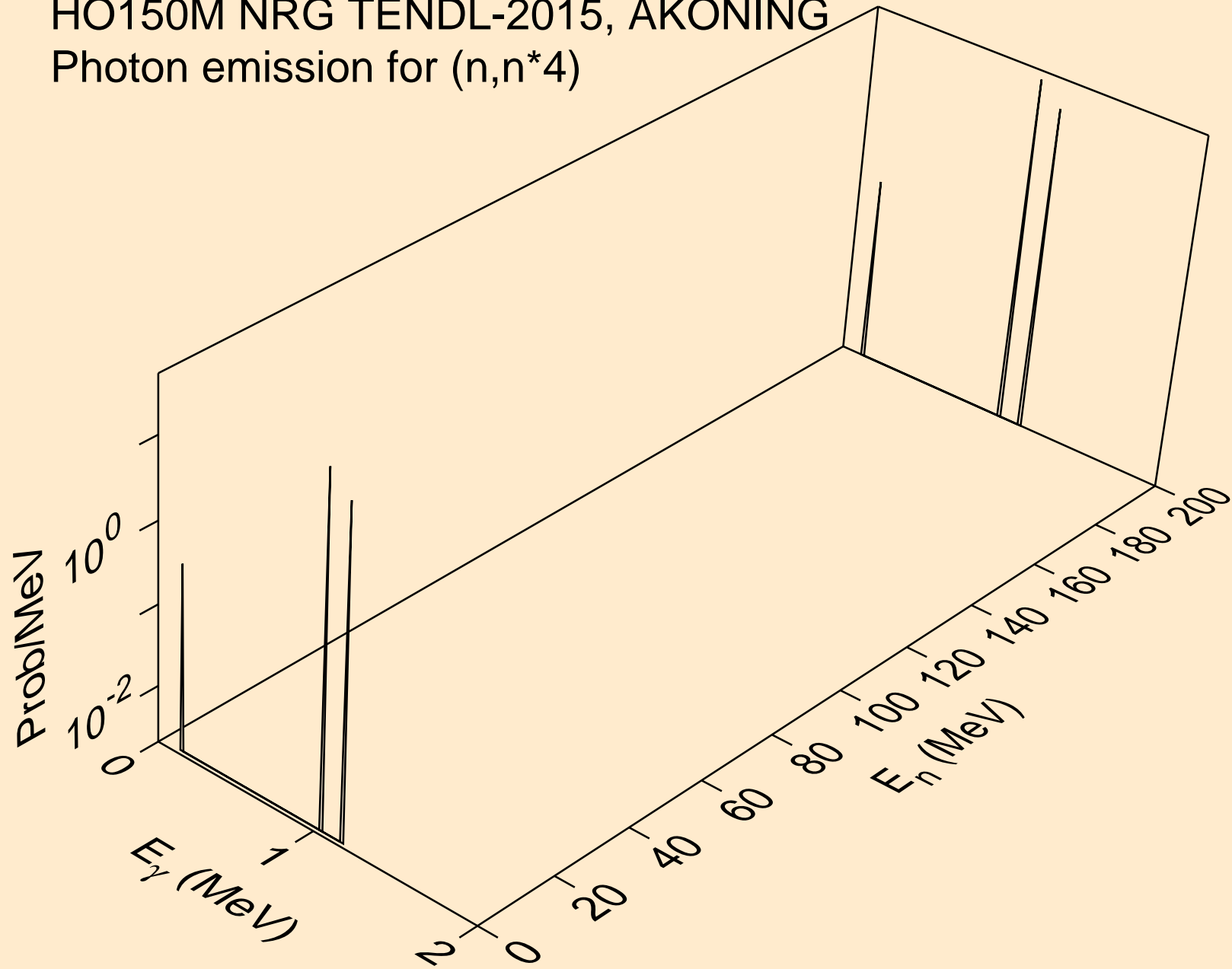

HO150M NRG TENDL-2015, AKONING
Photon emission for (n,n*5)

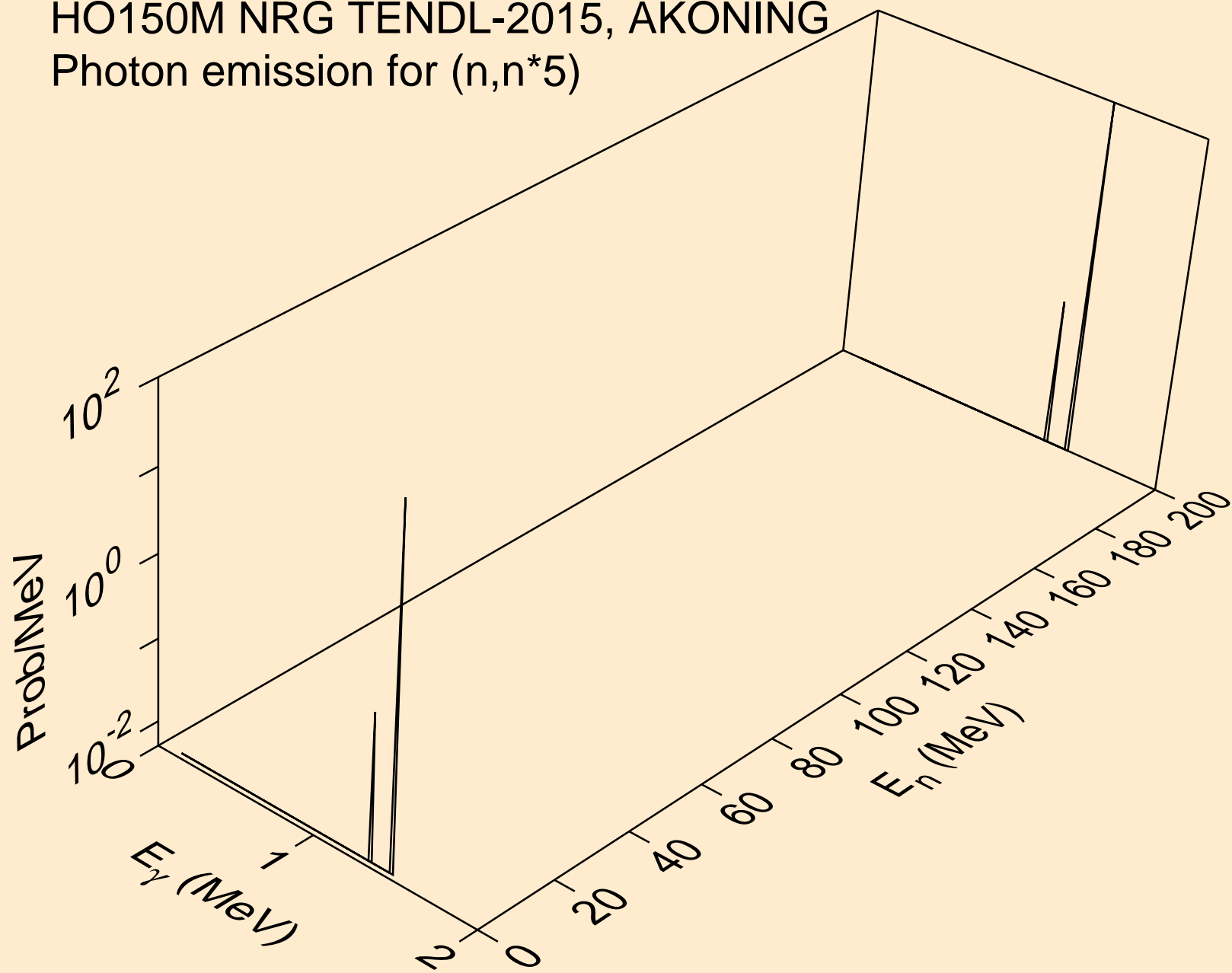

HO150M NRG TENDL-2015, AKONING
Photon emission for (n,n*6)

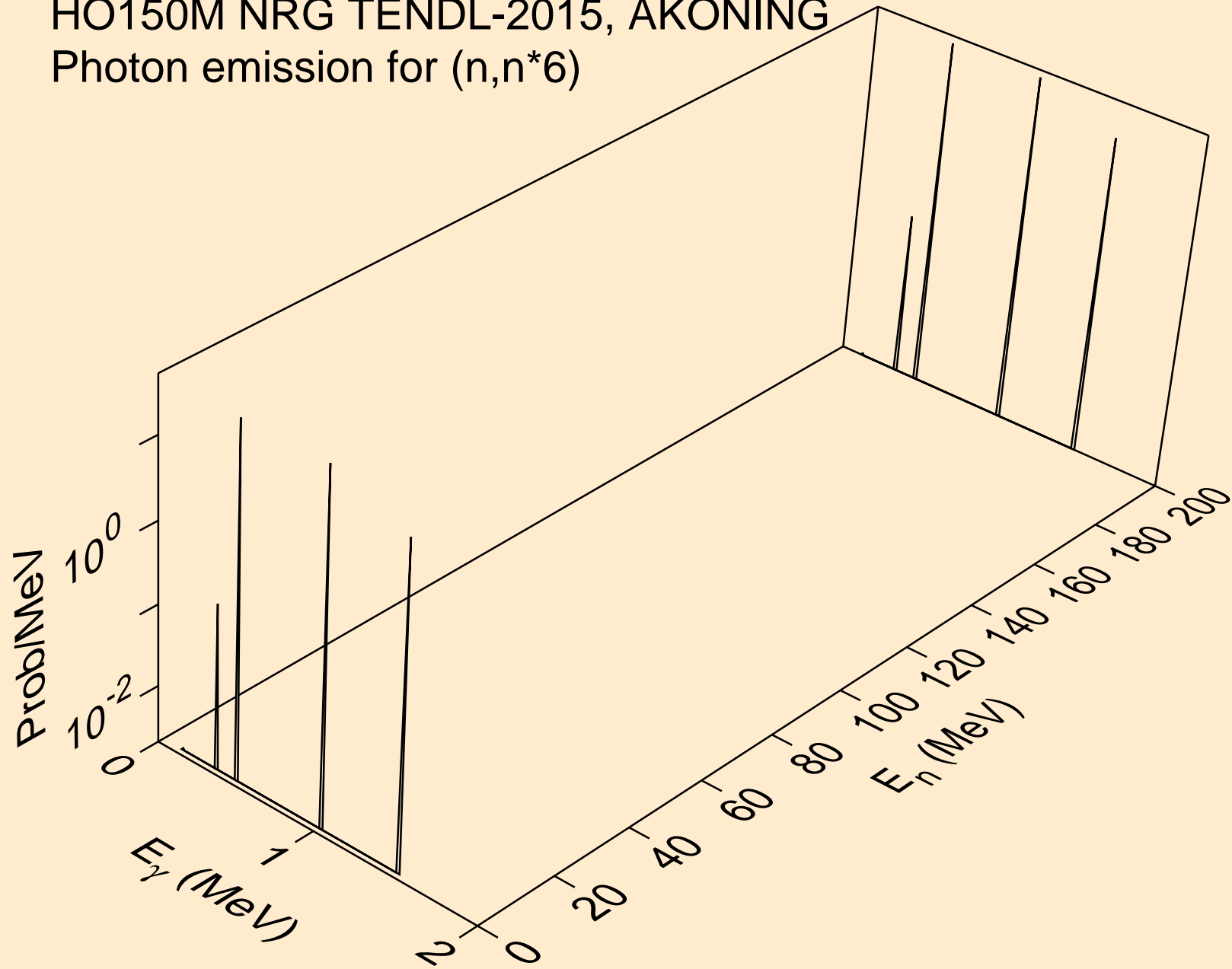

HO150M NRG TENDL-2015, AKONING
Photon emission for (n,n*7)

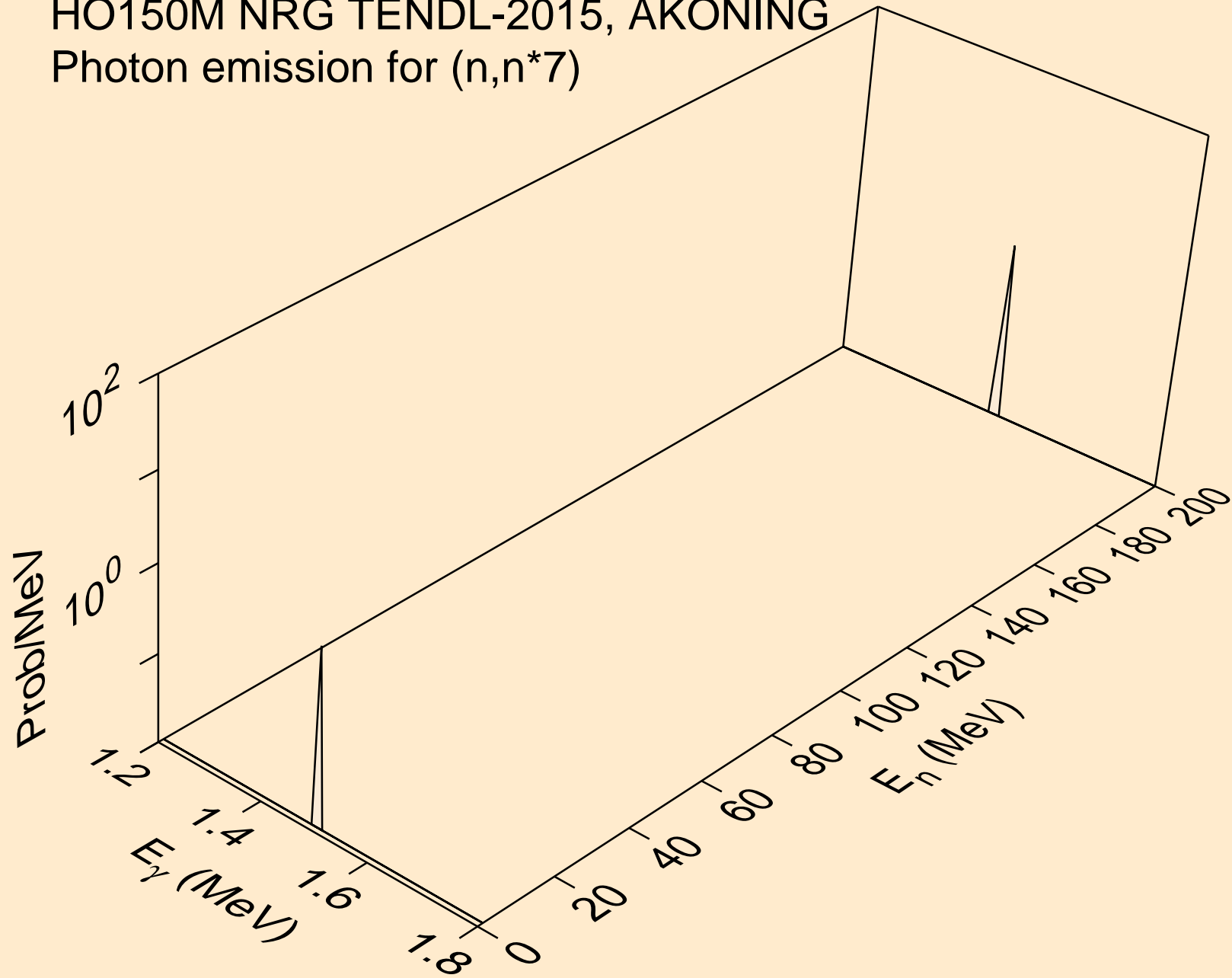

HO150M NRG TENDL-2015, AKONING
Photon emission for (n,n*8)

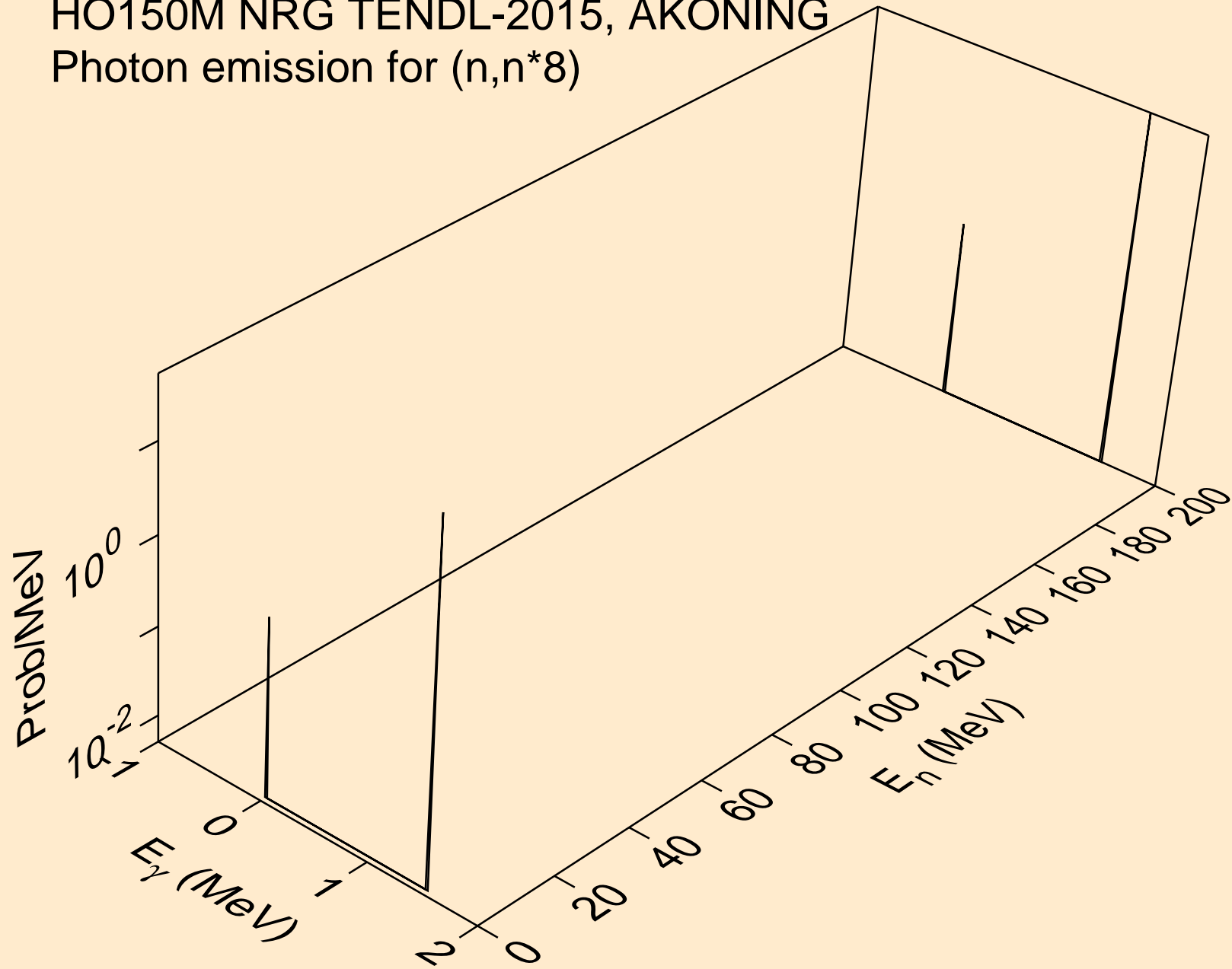

HO150M NRG TENDL-2015, AKONING
Photon emission for (n,n*9)

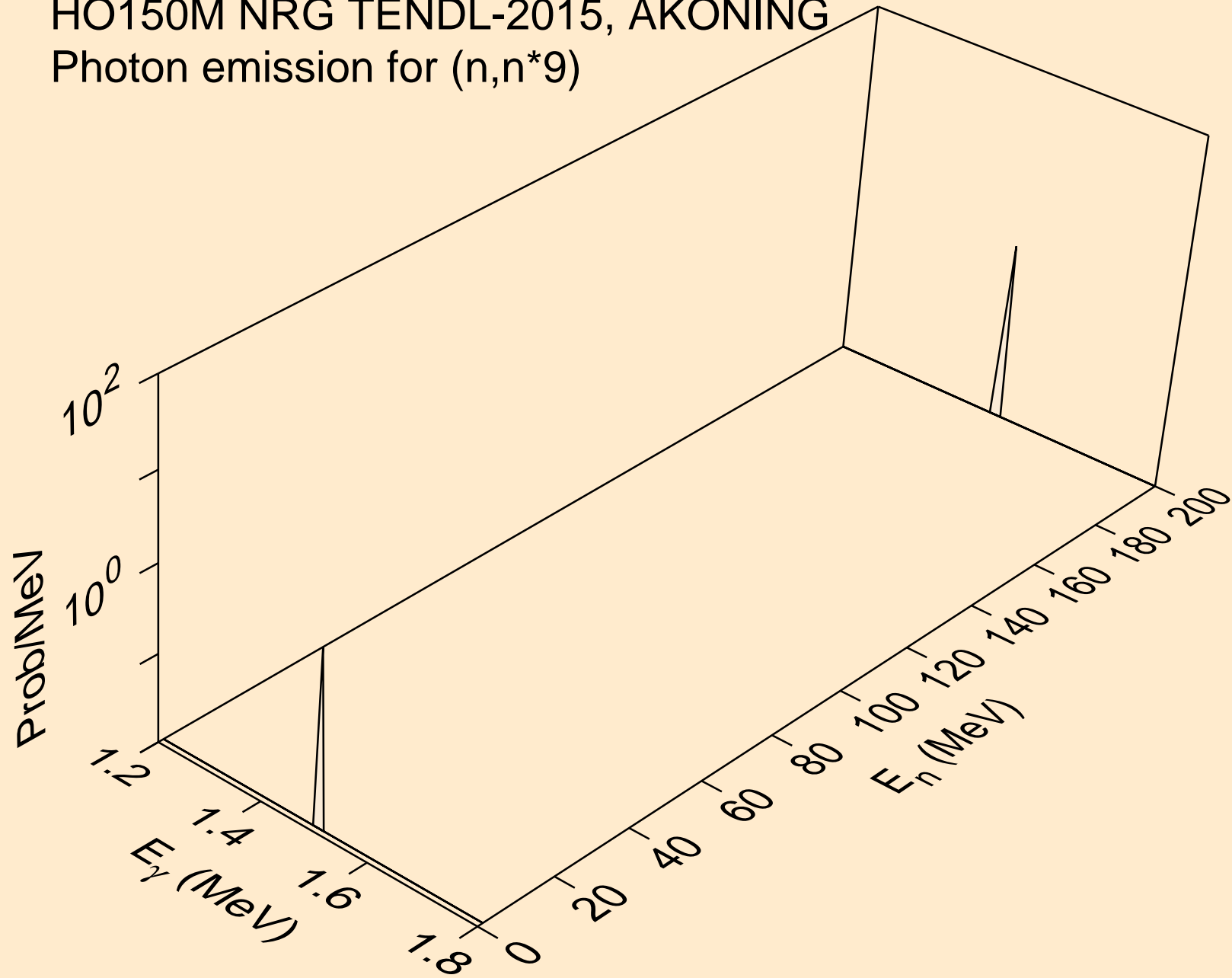

HO150M NRG TENDL-2015, AKONING
Photon emission for (n,n*10)

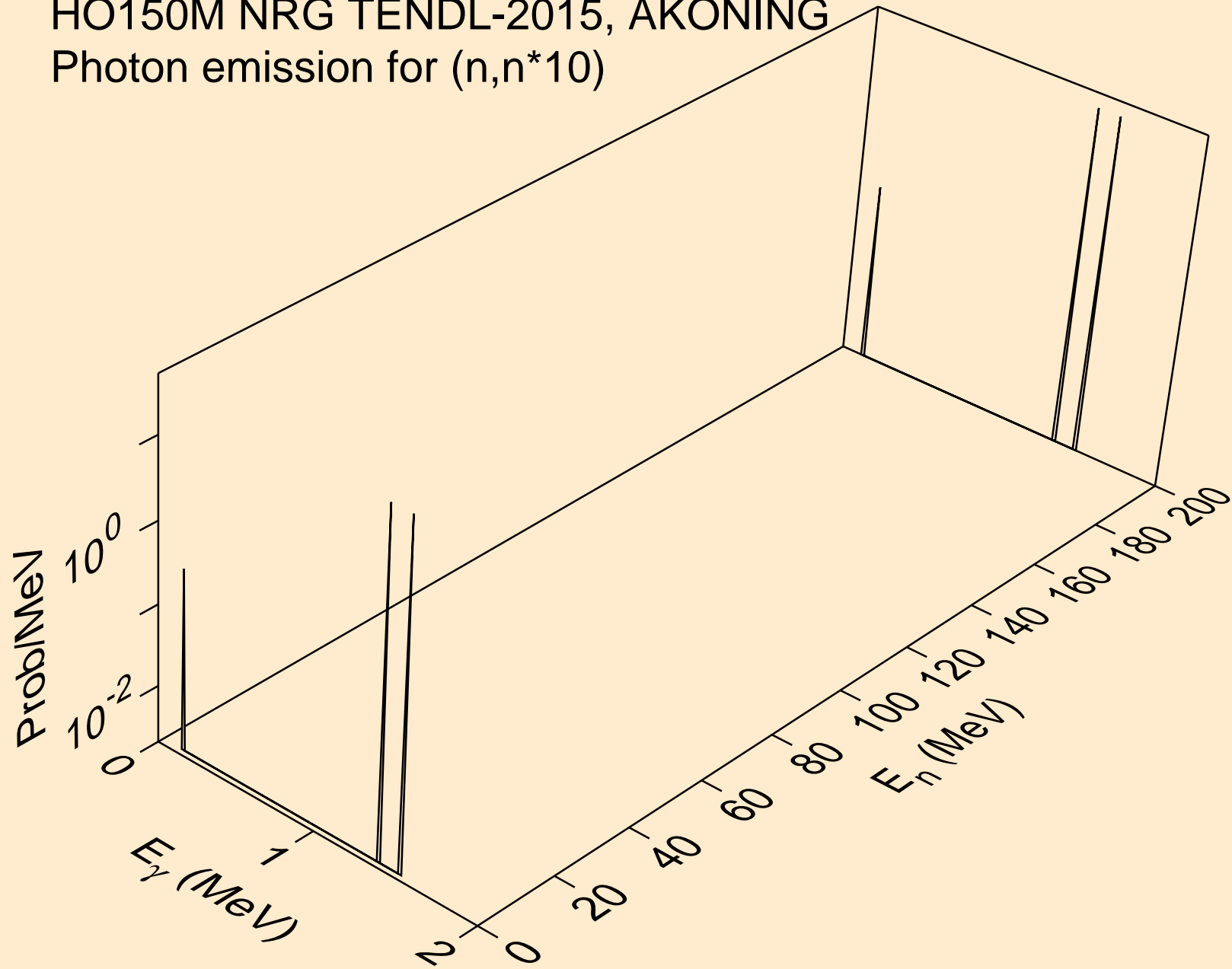

HO150M NRG TENDL-2015, AKONING
Photon emission for (n,n*11)

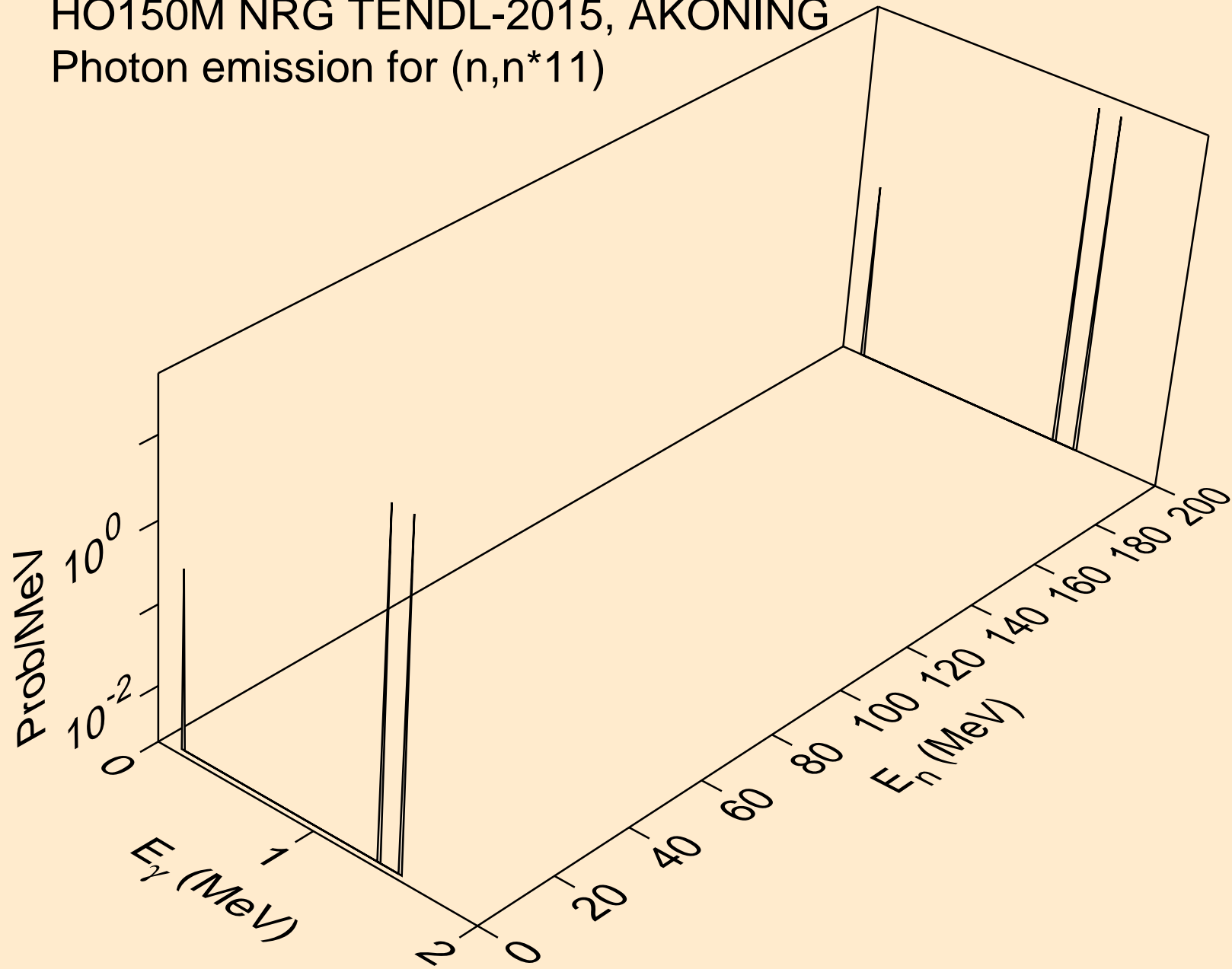

HO150M NRG TENDL-2015, AKONING
Photon emission for (n,n*12)

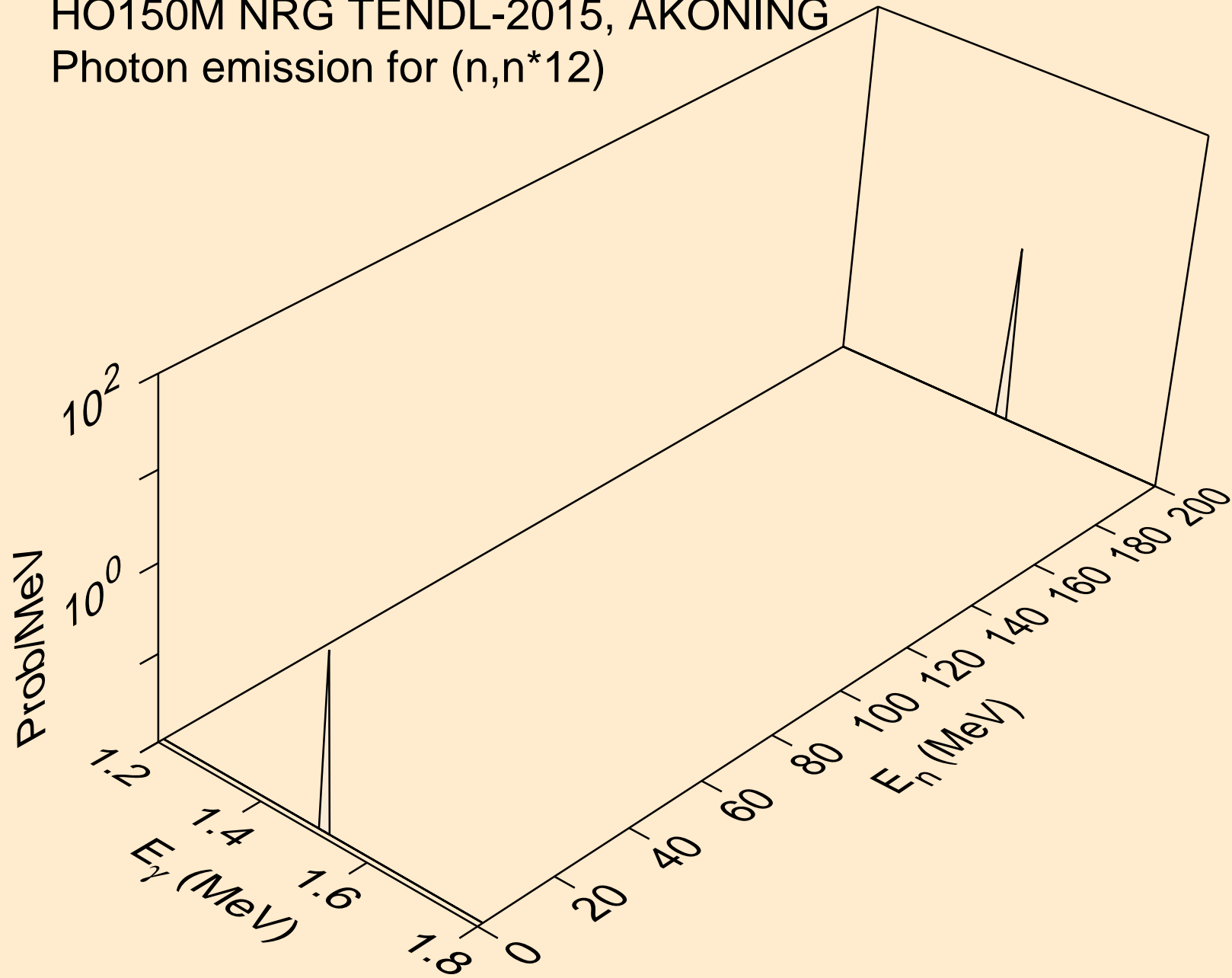

HO150M NRG TENDL-2015, AKONING
Photon emission for (n,n*13)

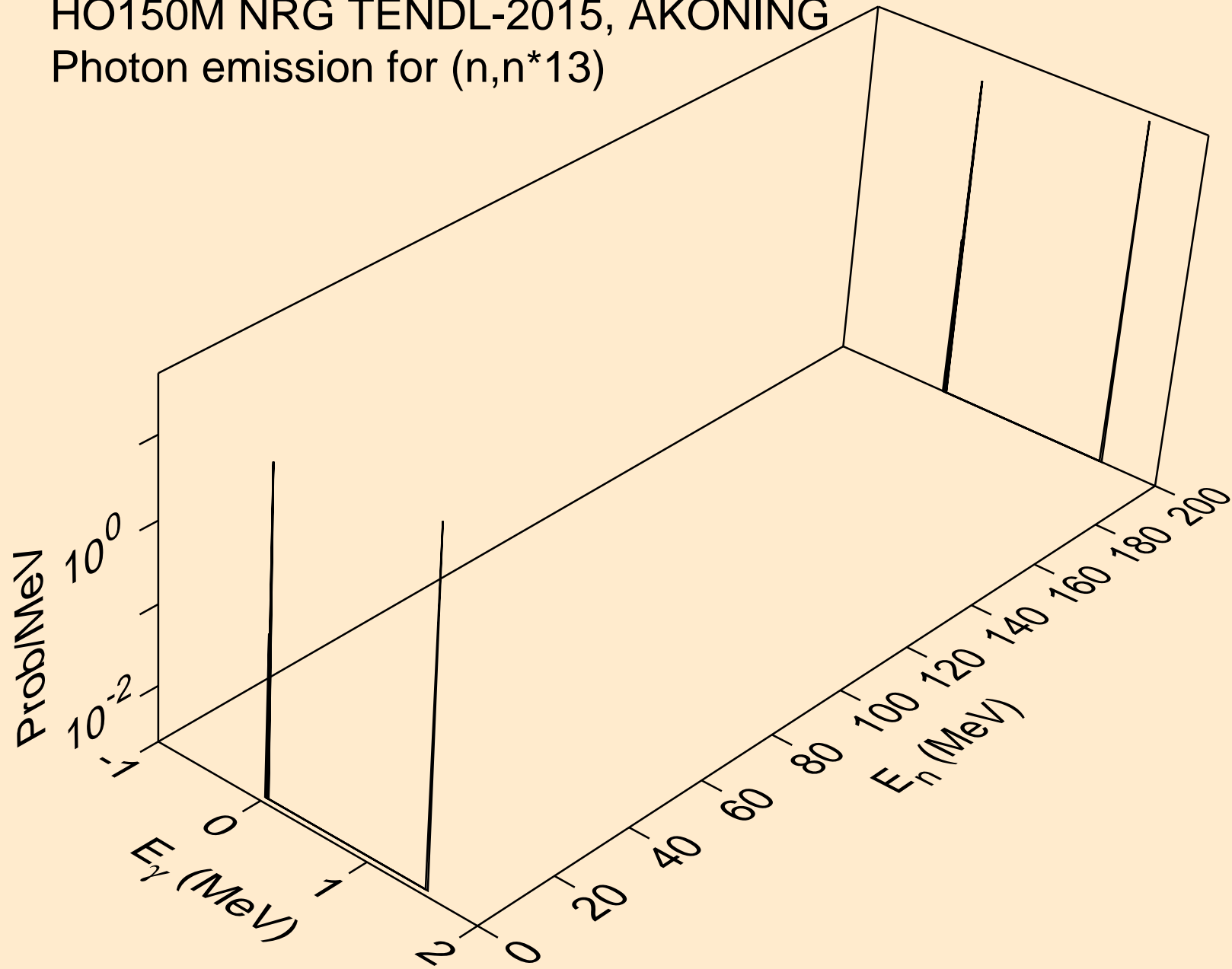

HO150M NRG TENDL-2015, AKONING
Photon emission for (n,n*14)

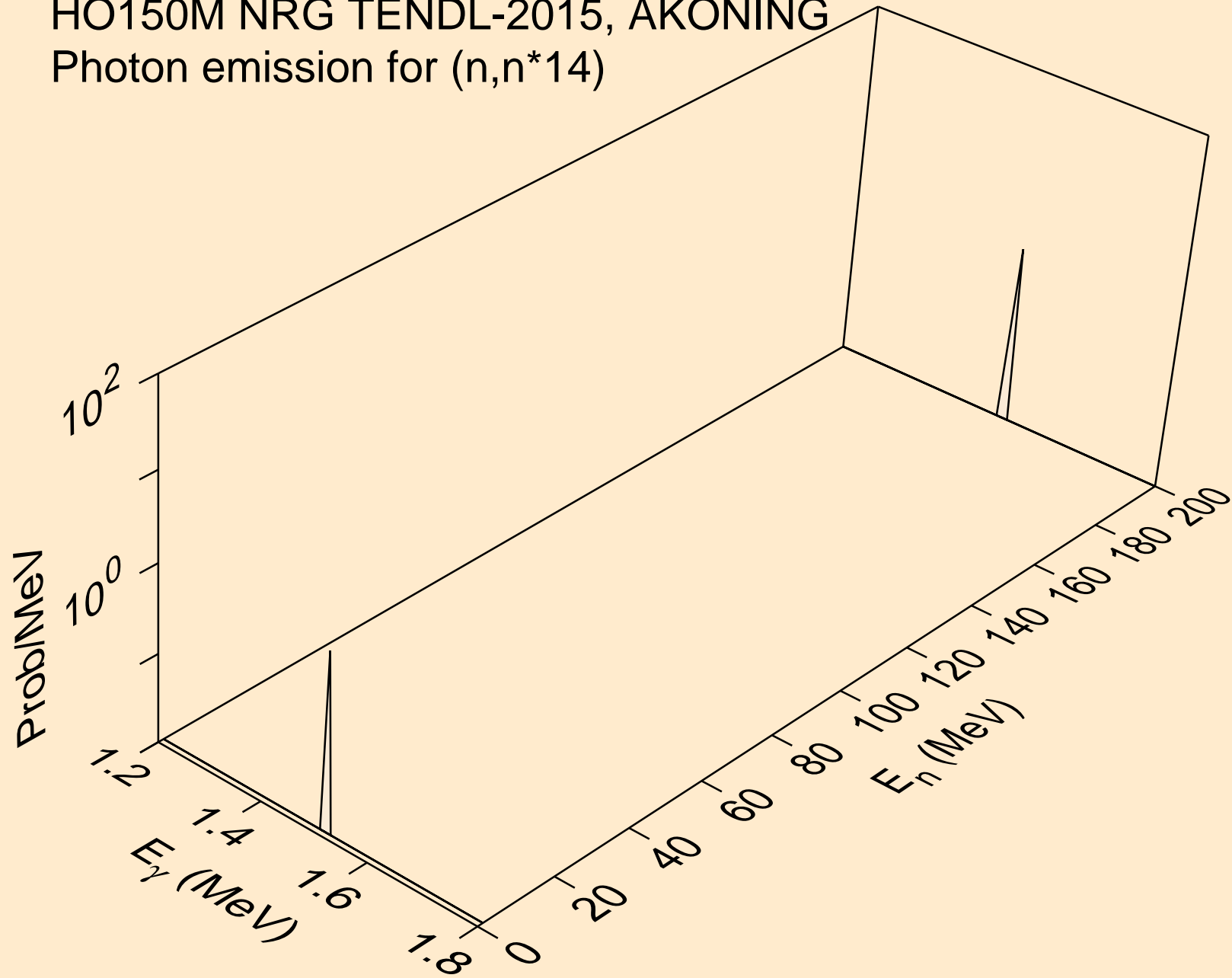

HO150M NRG TENDL-2015, AKONING
Photon emission for (n,n*15)

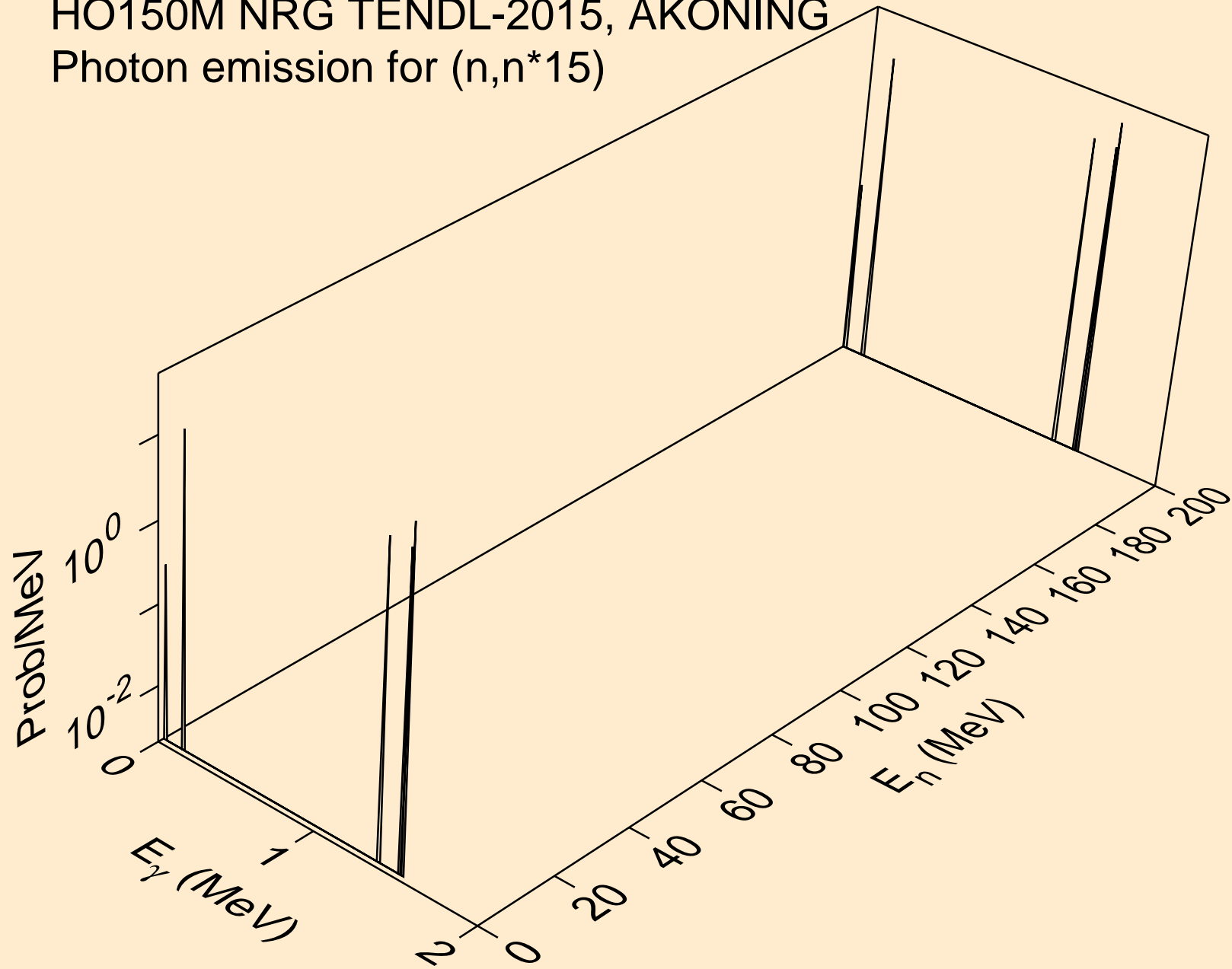

HO150M NRG TENDL-2015, AKONING
Photon emission for (n,n*16)

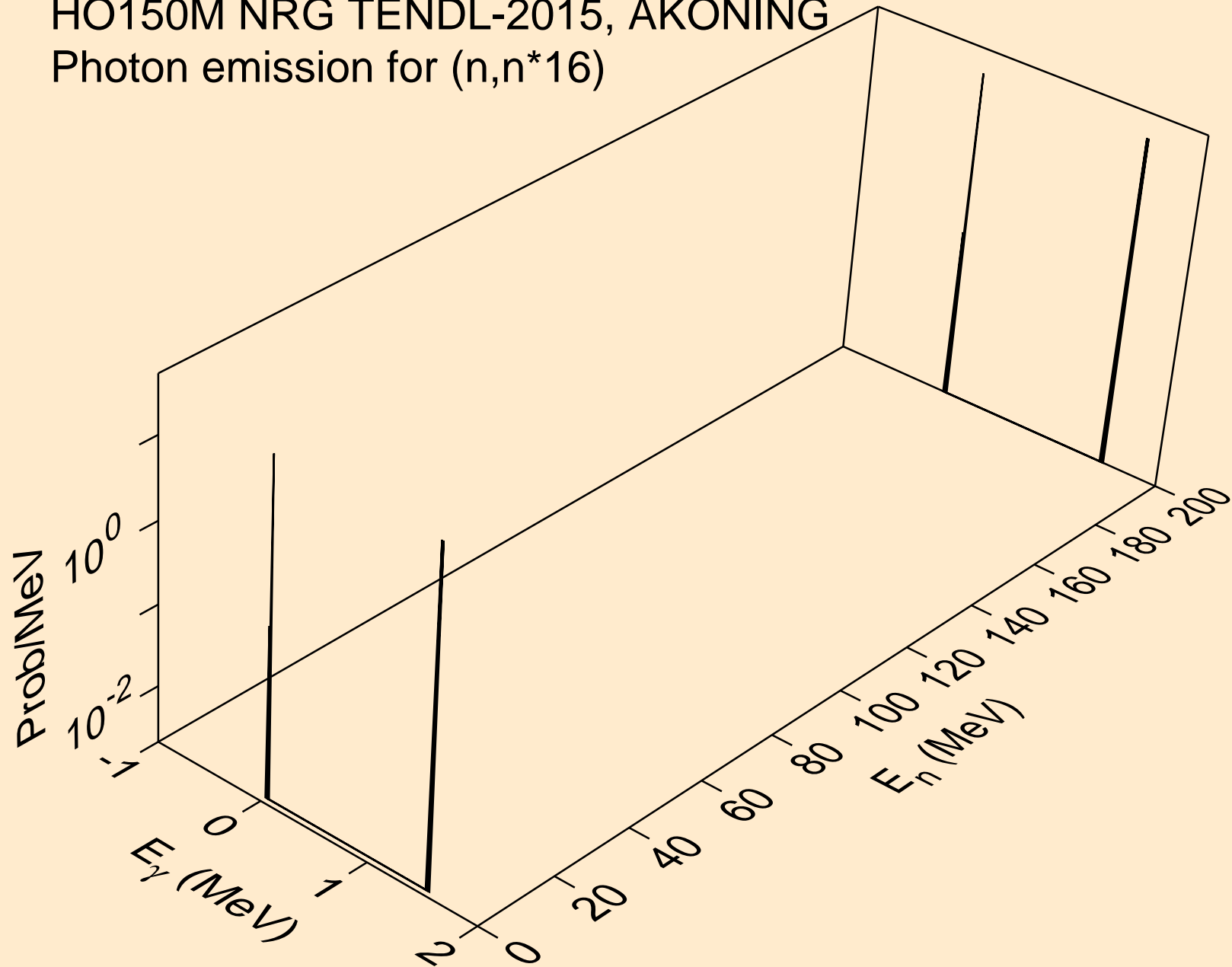

HO150M NRG TENDL-2015, AKONING
Photon emission for (n,n*17)

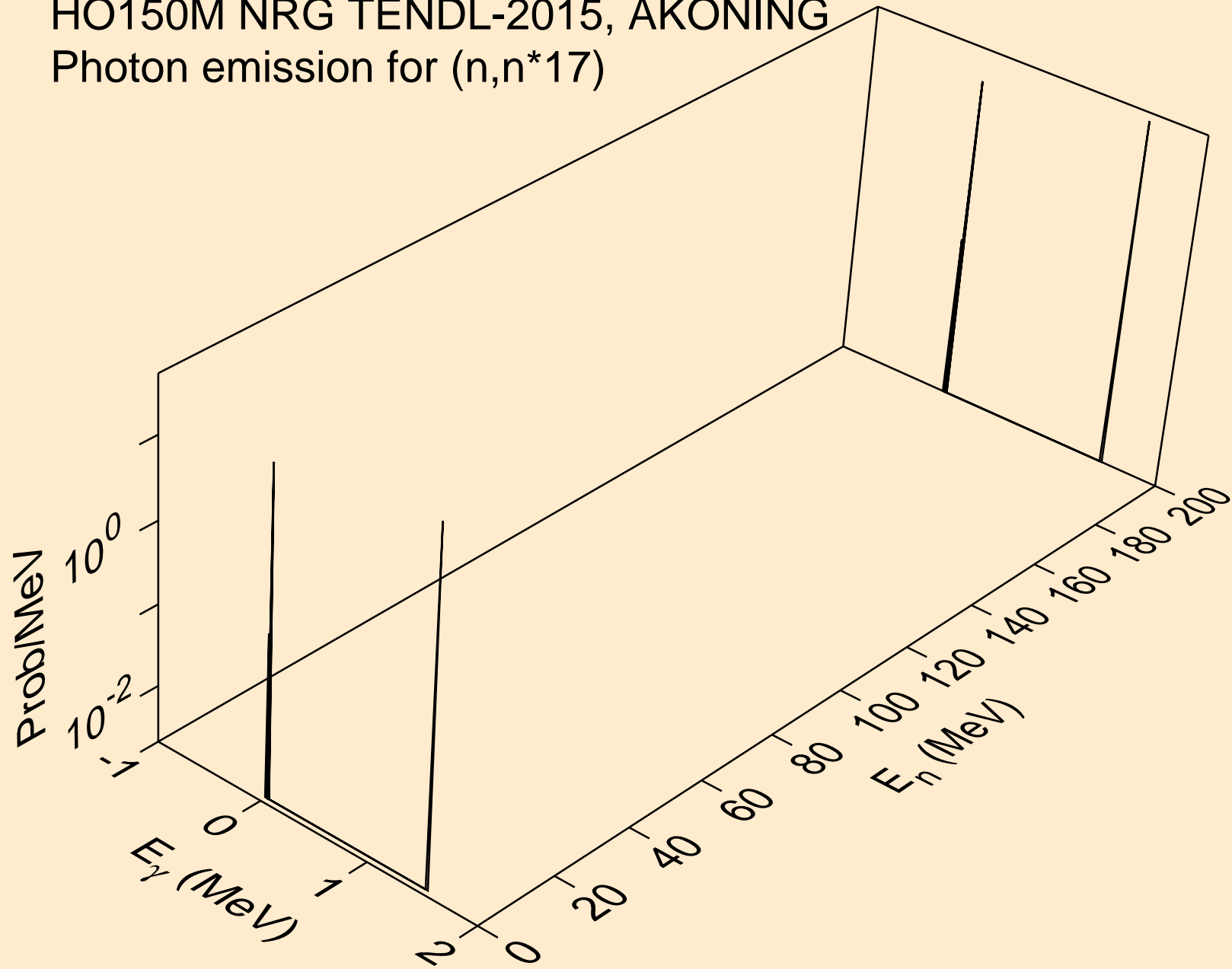

HO150M NRG TENDL-2015, AKONING
Photon emission for (n,n*18)

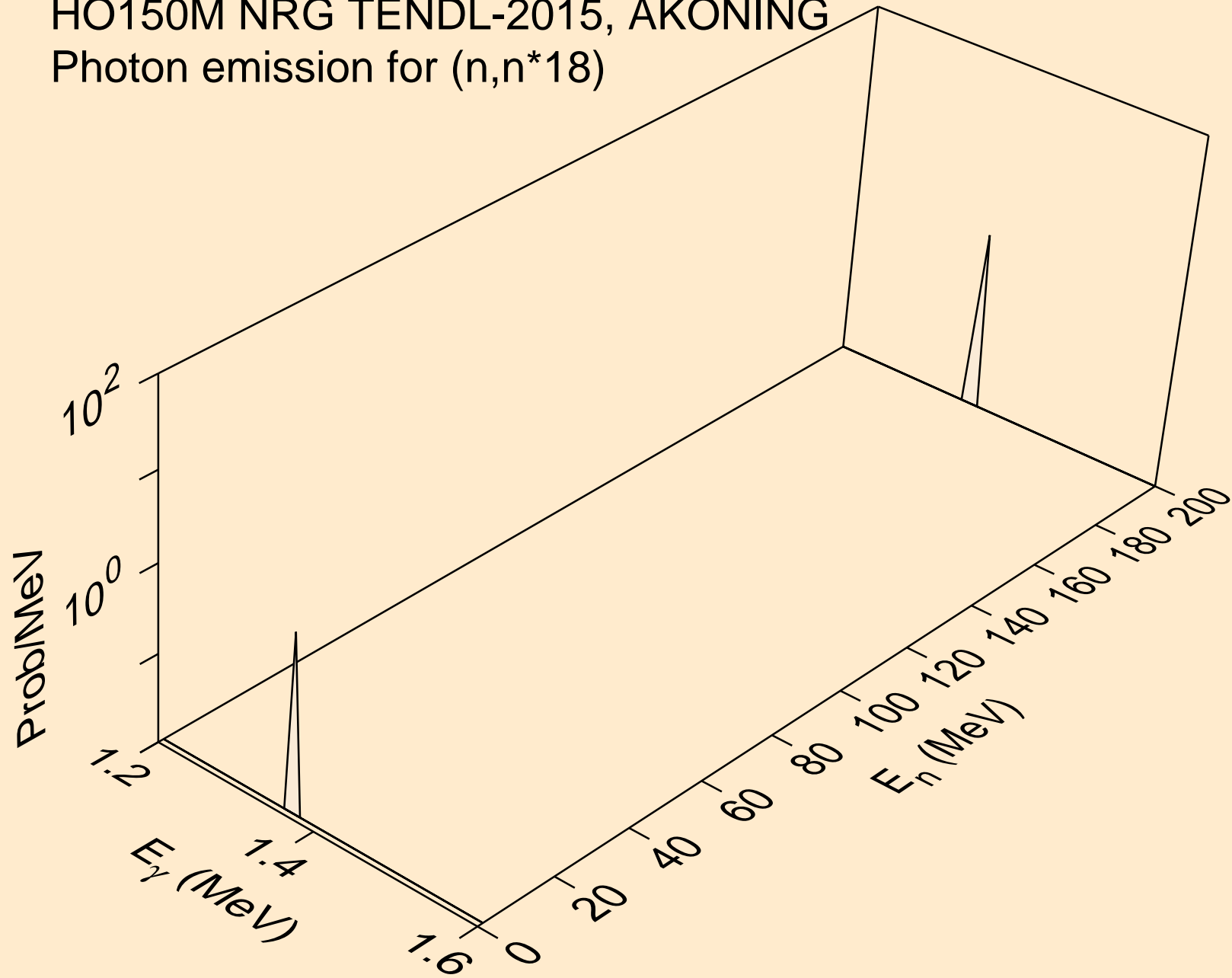

HO150M NRG TENDL-2015, AKONING
Photon emission for (n,n*19)

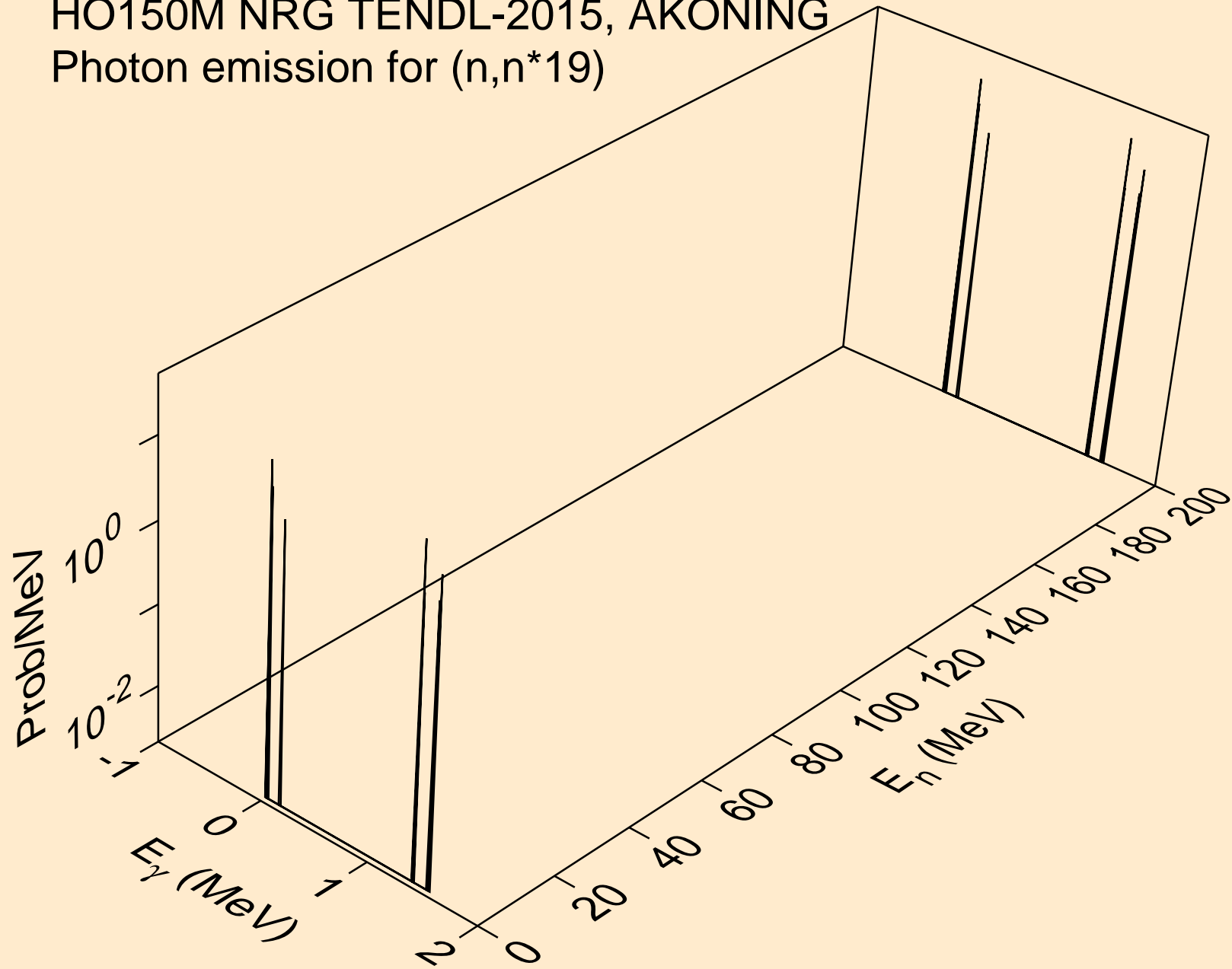

HO150M NRG TENDL-2015, AKONING
Photon emission for (n,n*20)

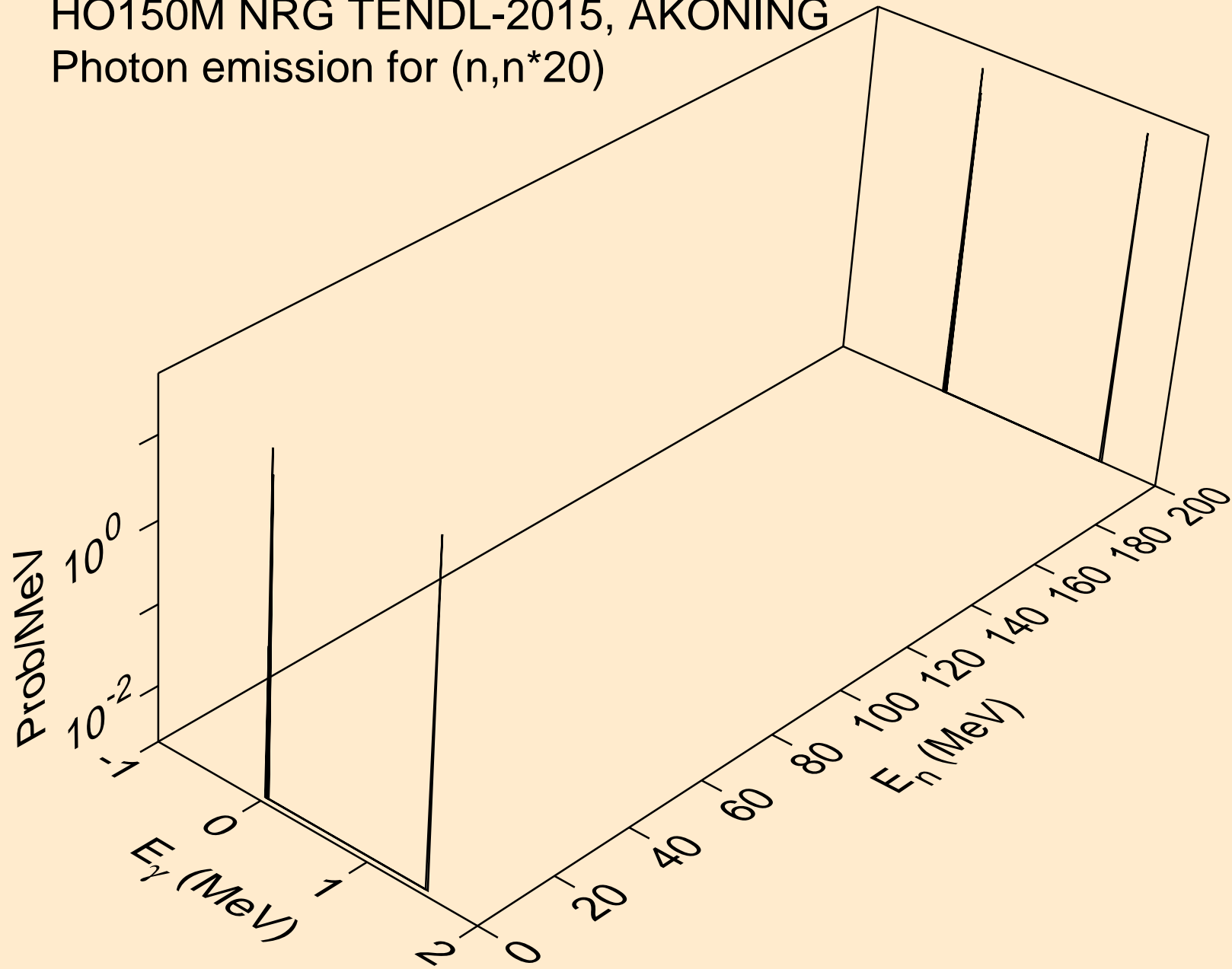

HO150M NRG TENDL-2015, AKONING
Photon emission for (n,n*21)

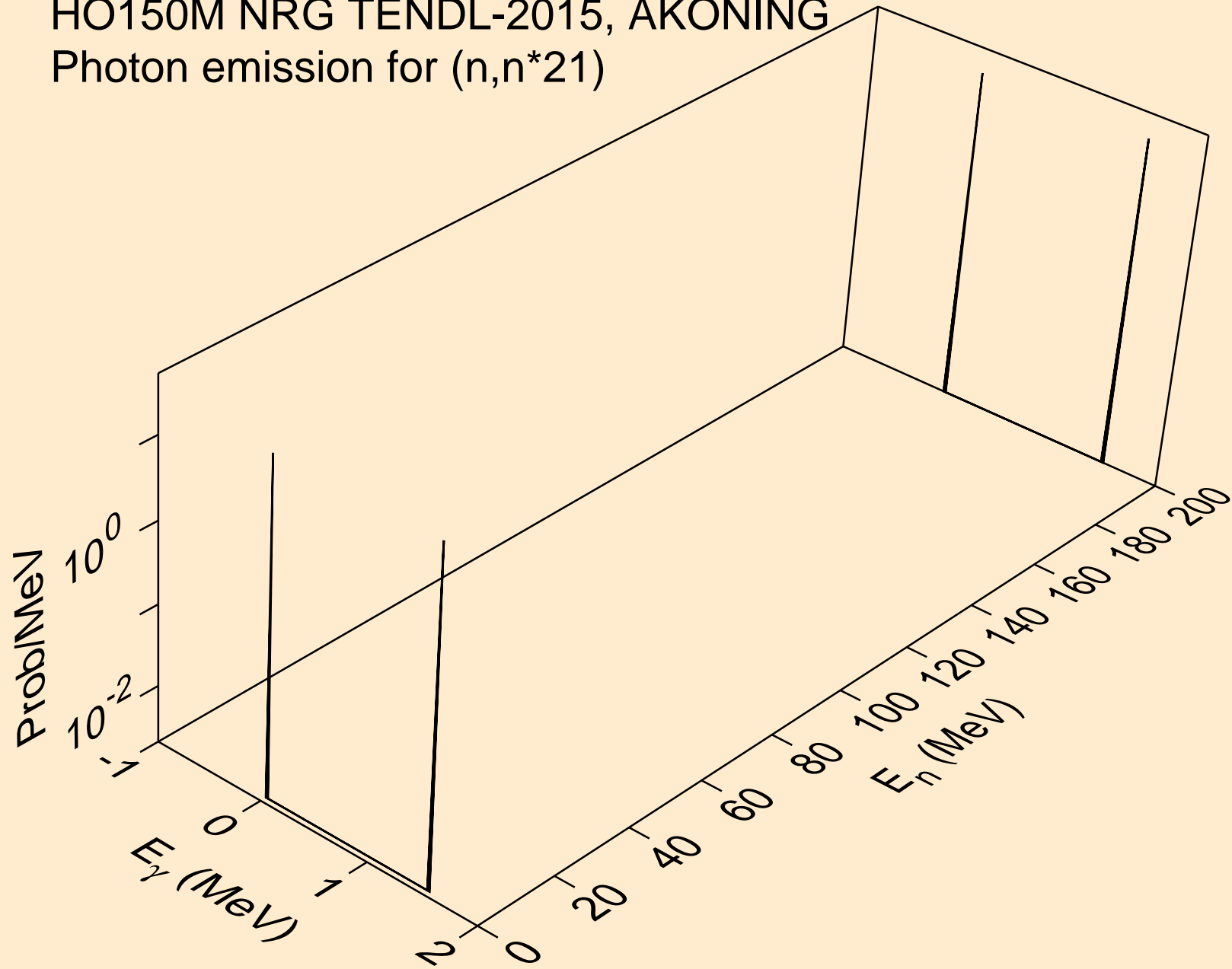

HO150M NRG TENDL-2015, AKONING
Photon emission for (n,n*22)

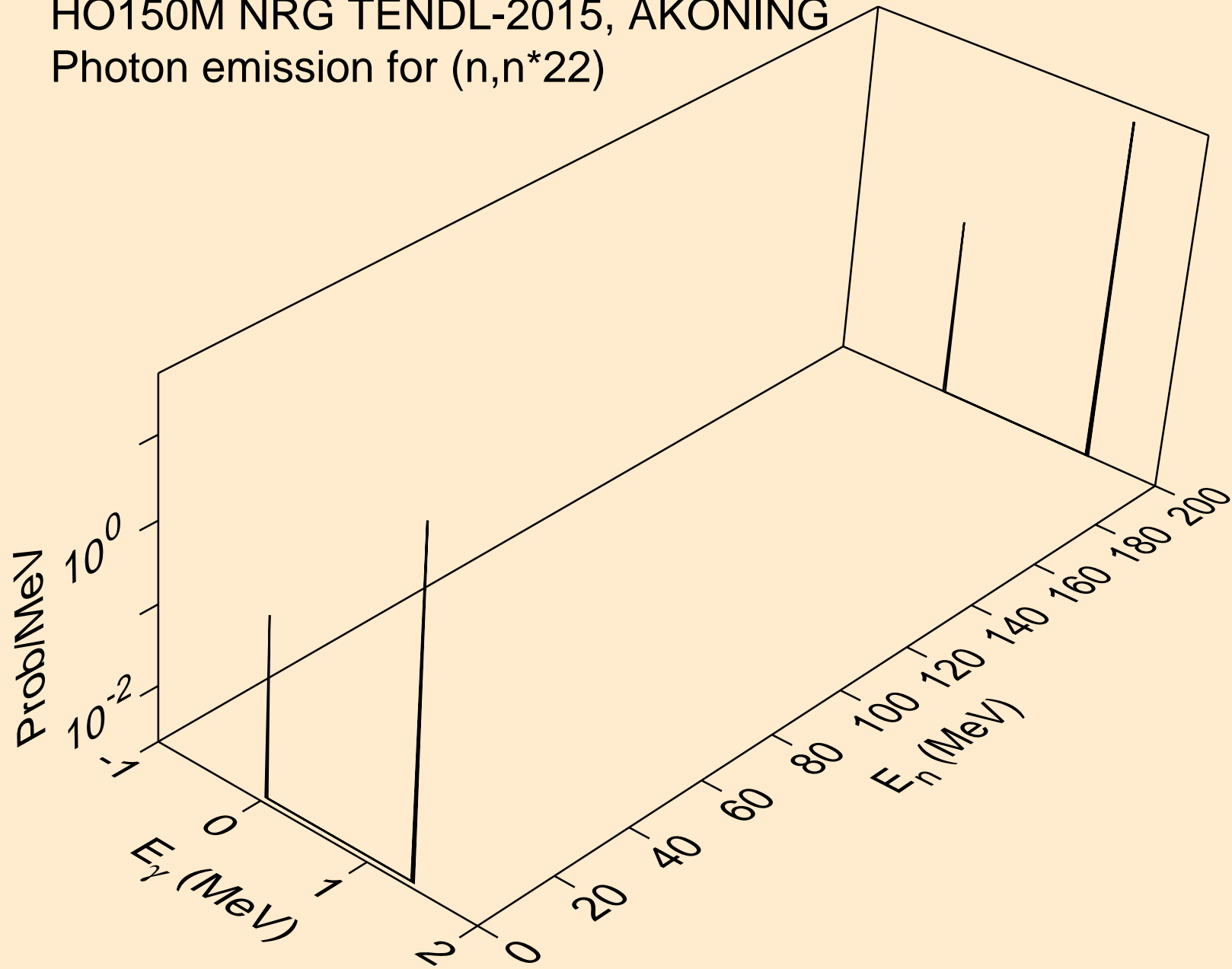

HO150M NRG TENDL-2015, AKONING
Photon emission for (n,n*23)

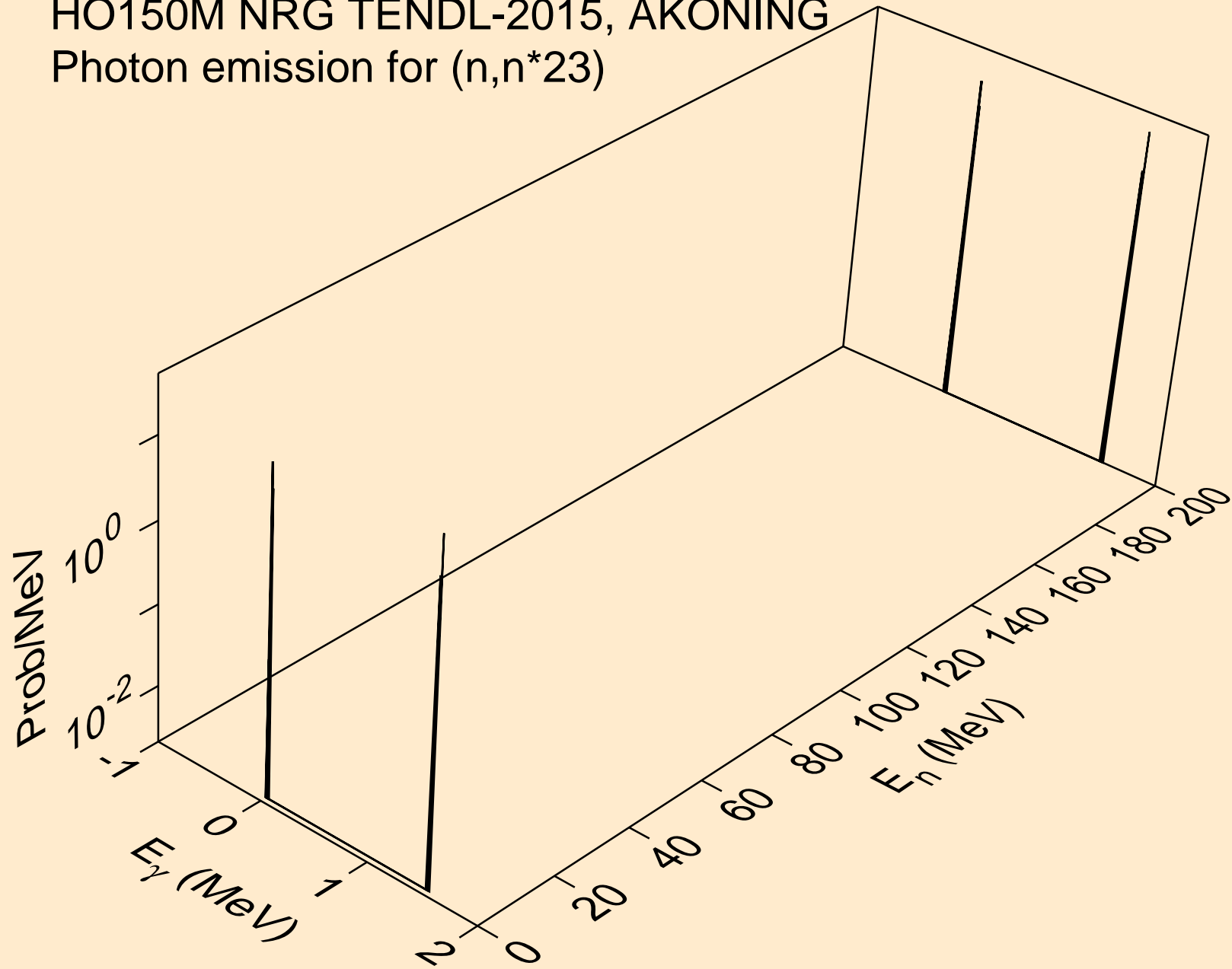

HO150M NRG TENDL-2015, AKONING
Photon emission for (n,n*24)

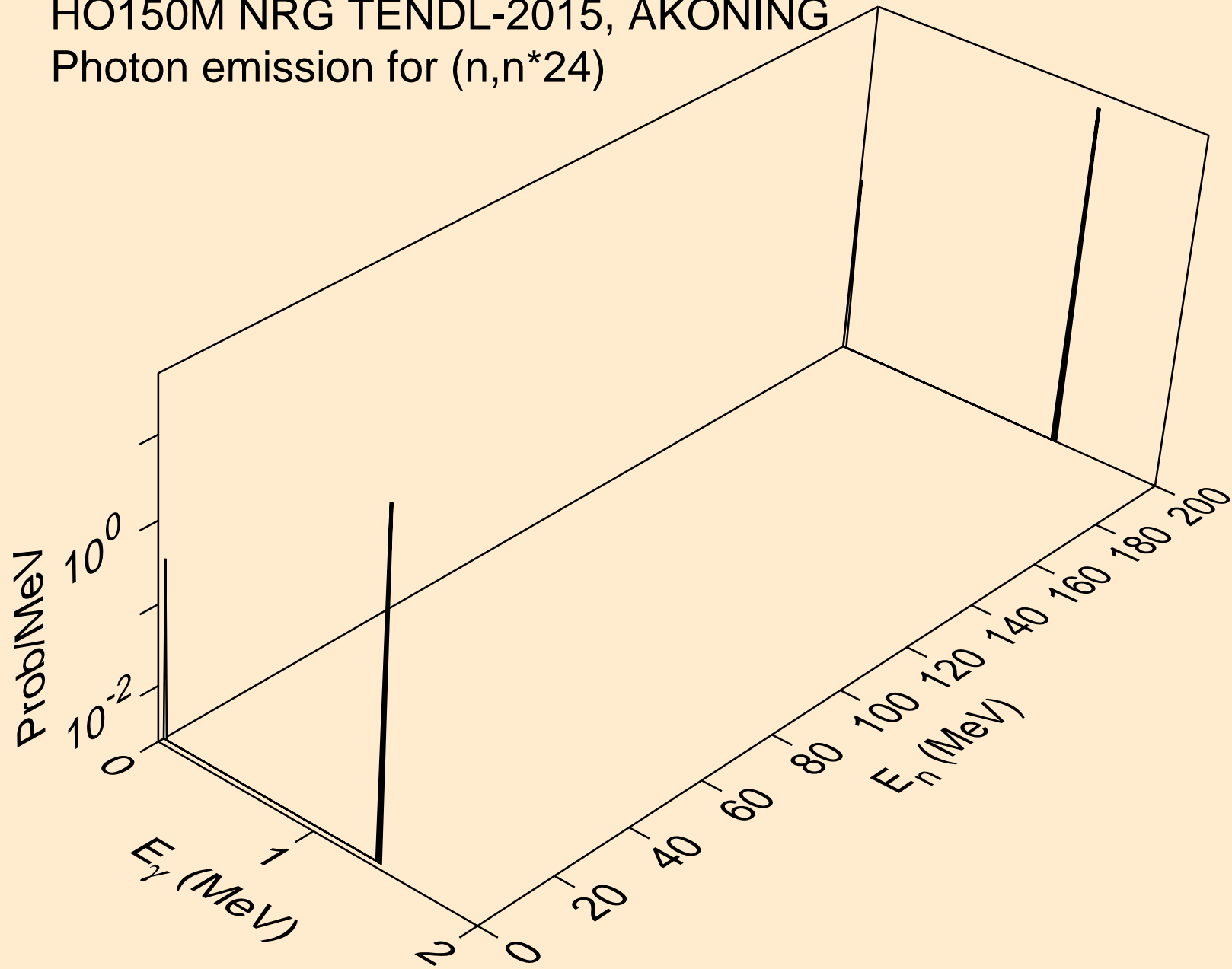

HO150M NRG TENDL-2015, AKONING
Photon emission for (n,n*25)

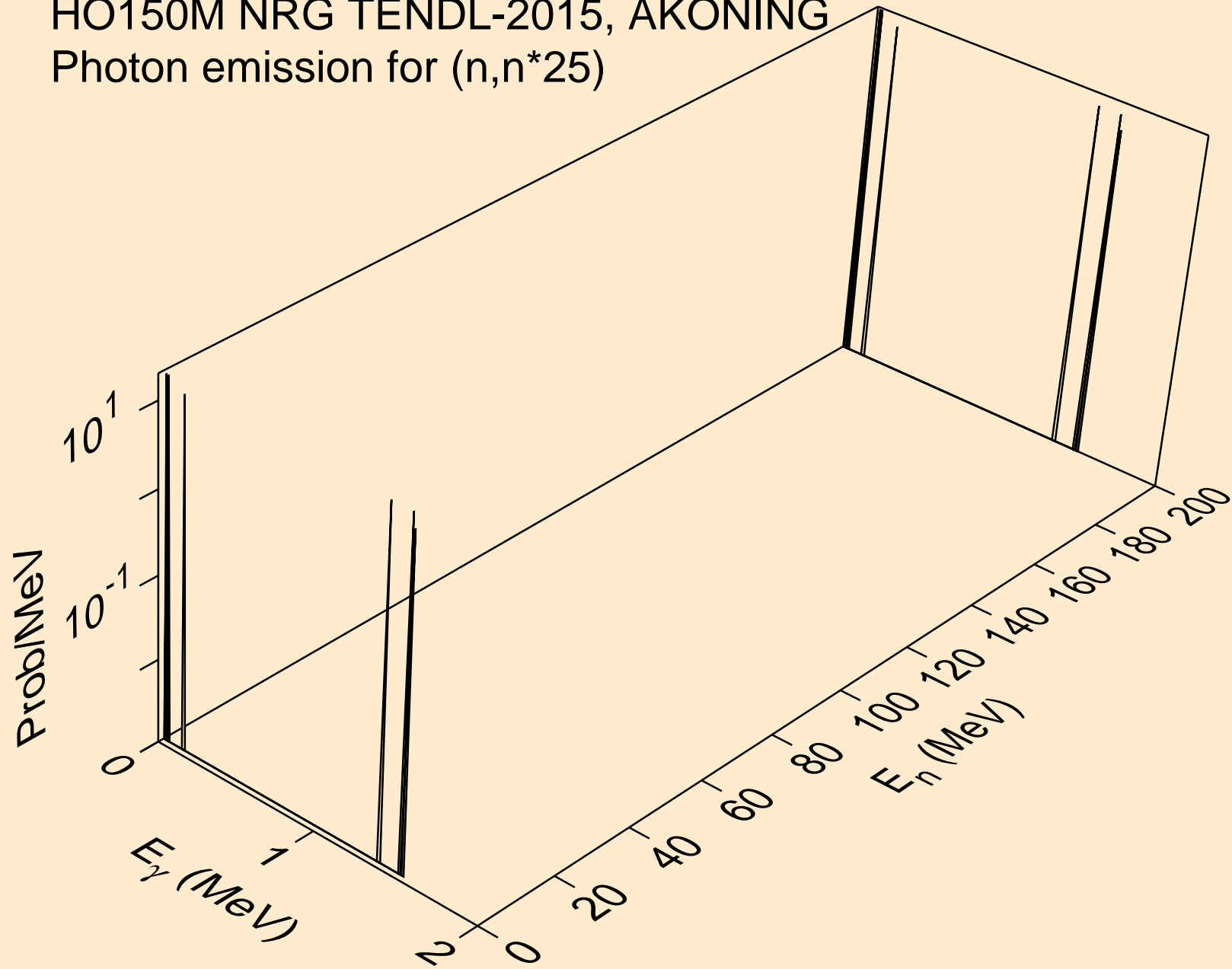

HO150M NRG TENDL-2015, AKONING
Photon emission for (n,n*26)

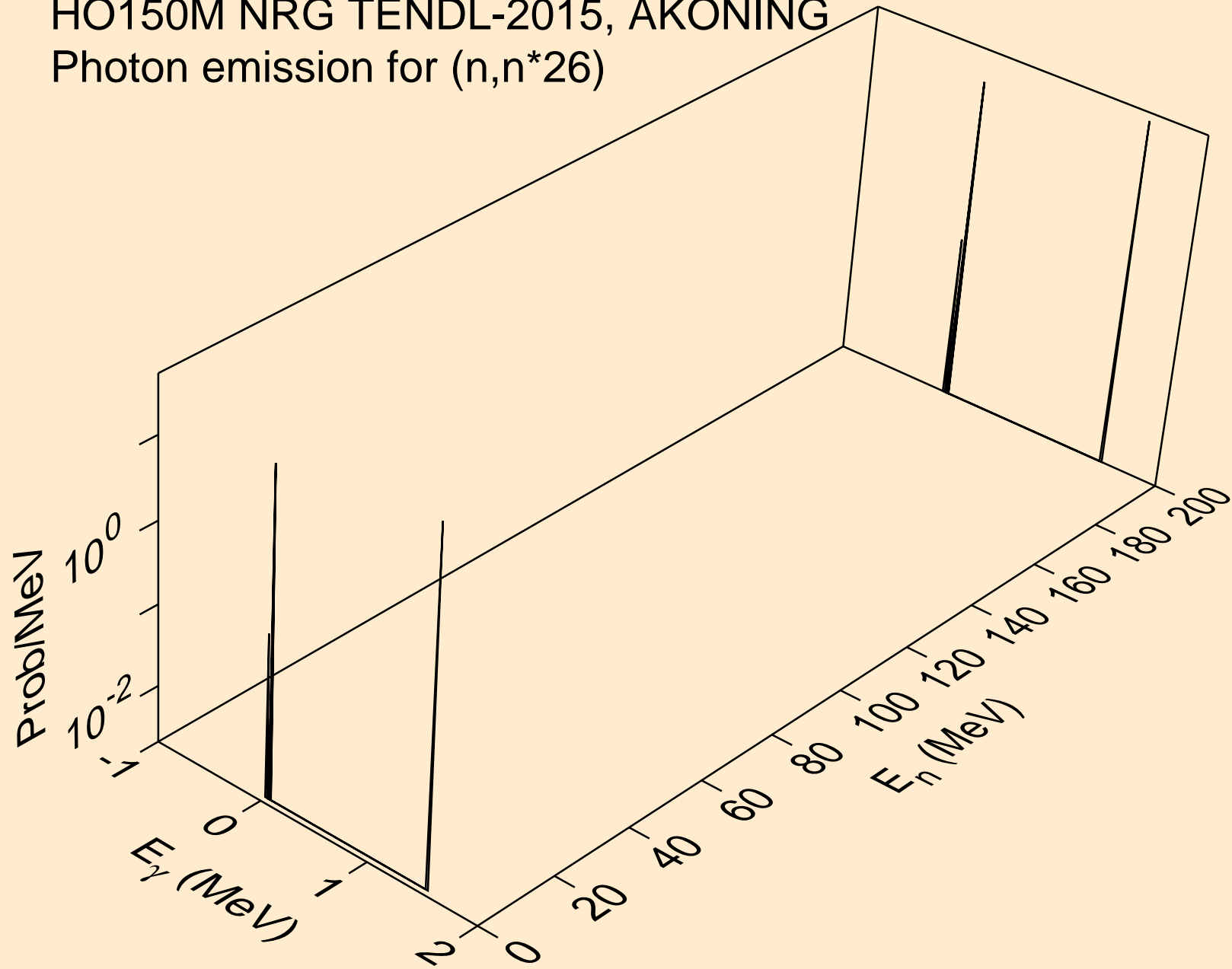

HO150M NRG TENDL-2015, AKONING
Photon emission for (n,n*27)

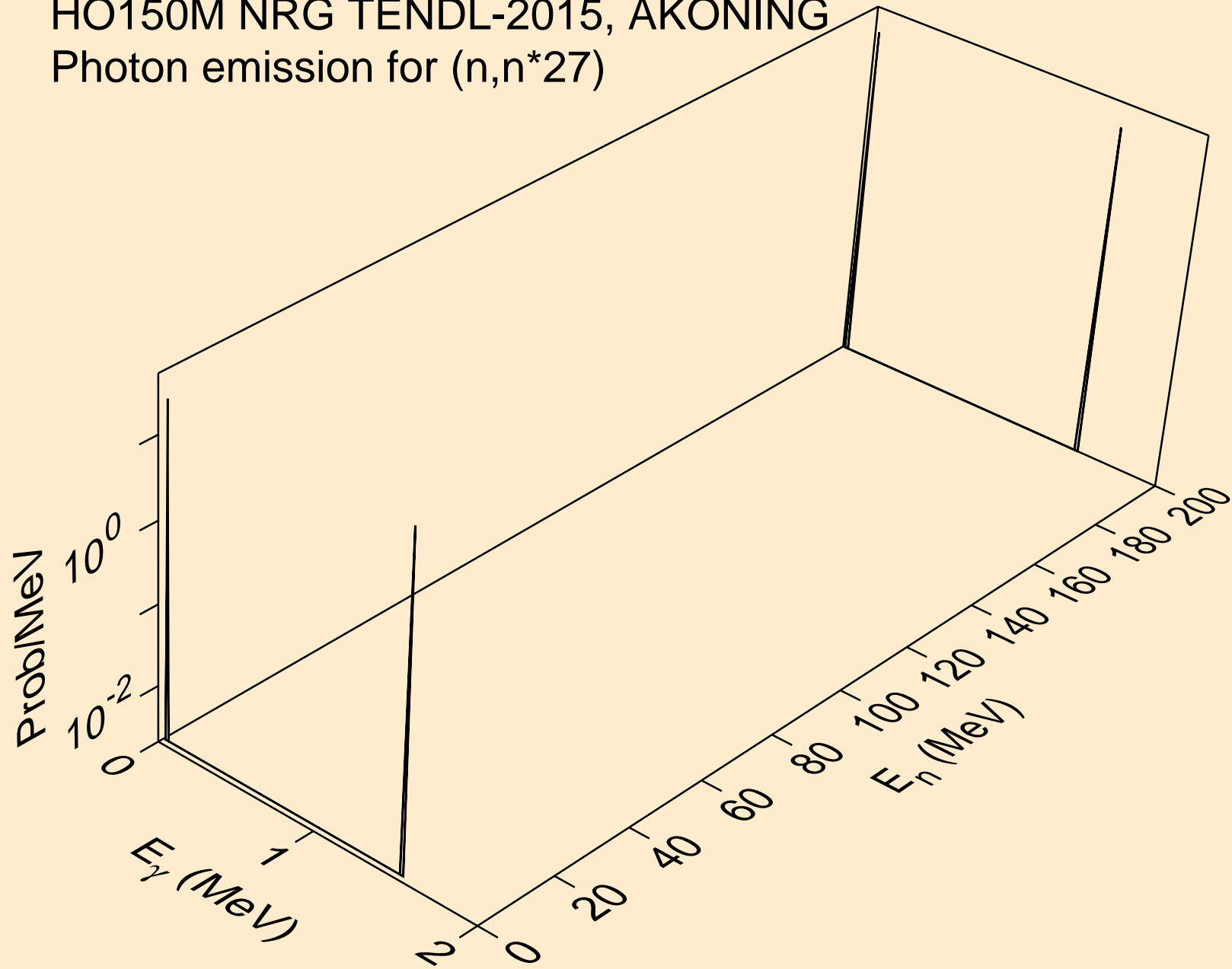

HO150M NRG TENDL-2015, AKONING
Photon emission for (n,n*28)

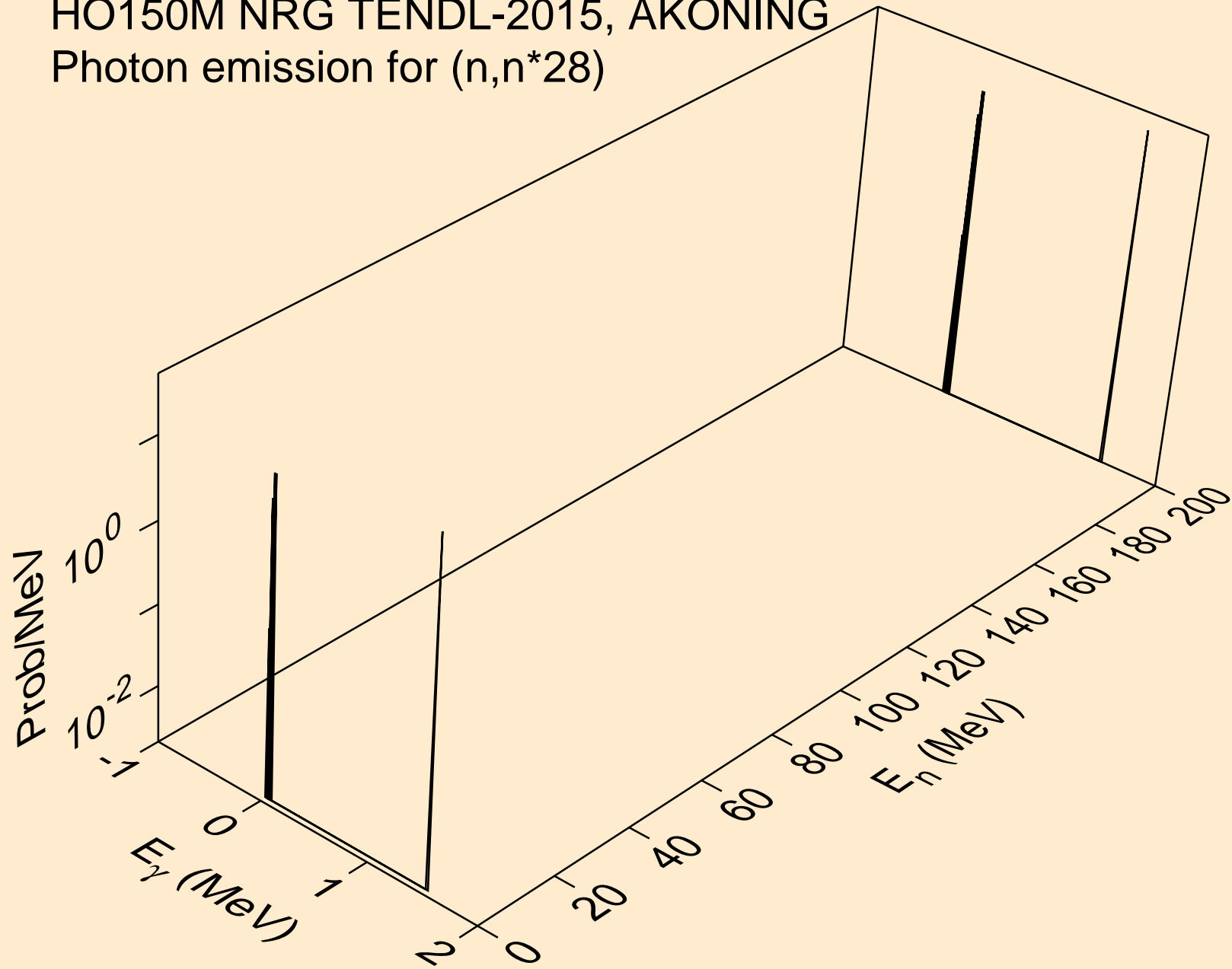

HO150M NRG TENDL-2015, AKONING
Photon emission for (n,n*29)

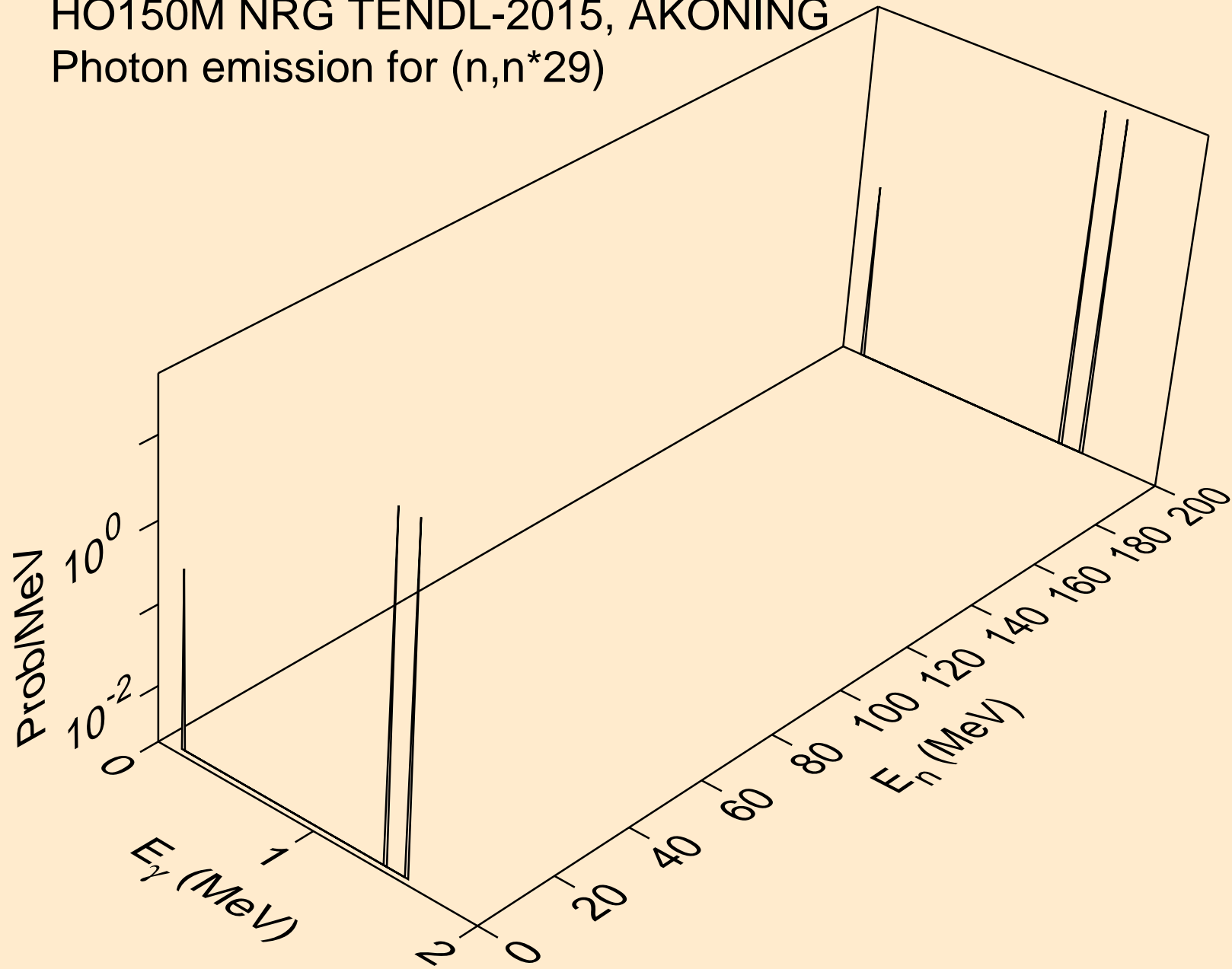

HO150M NRG TENDL-2015, AKONING
Photon emission for (n,n*30)

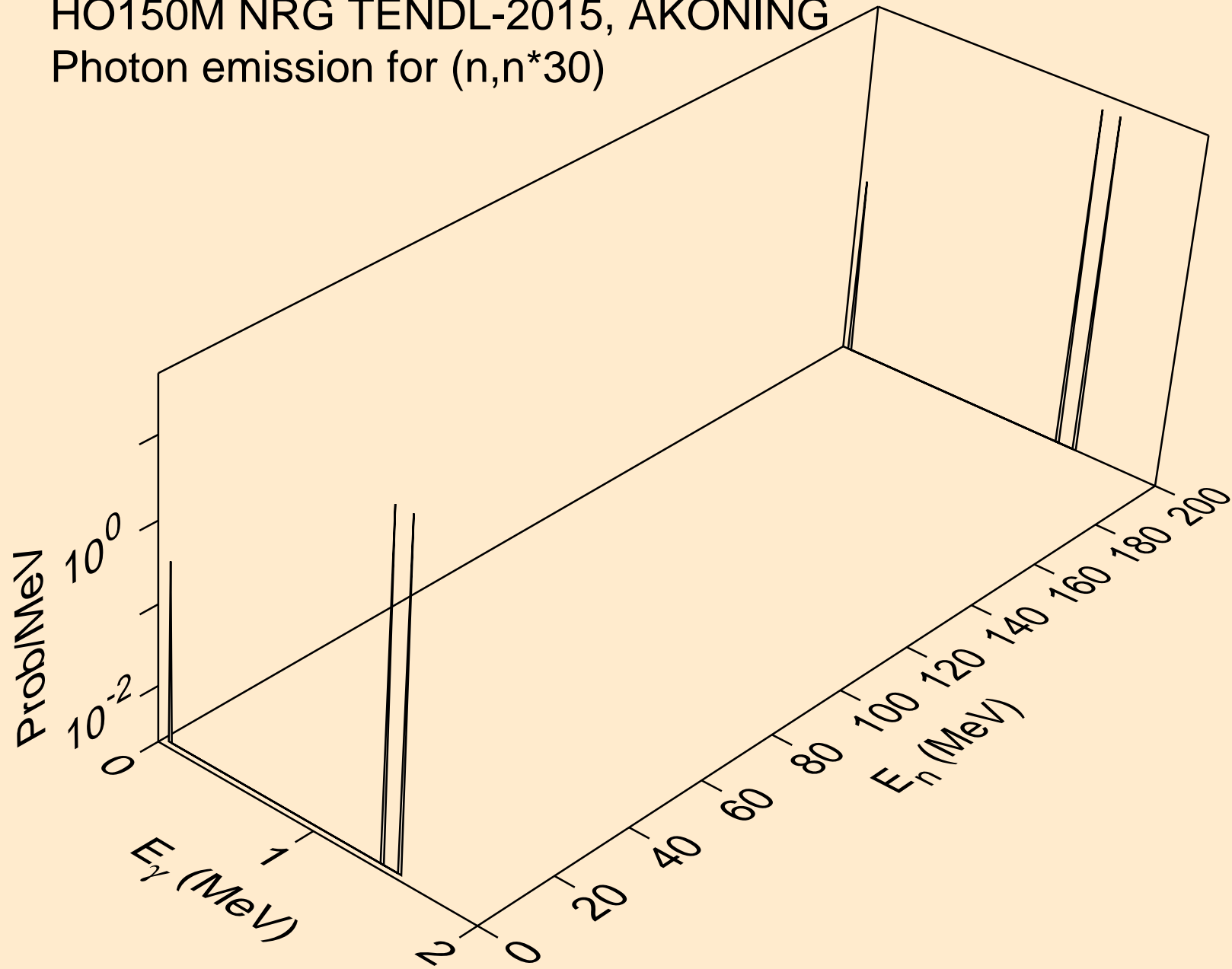

HO150M NRG TENDL-2015, AKONING
Photon emission for (n,n*c)

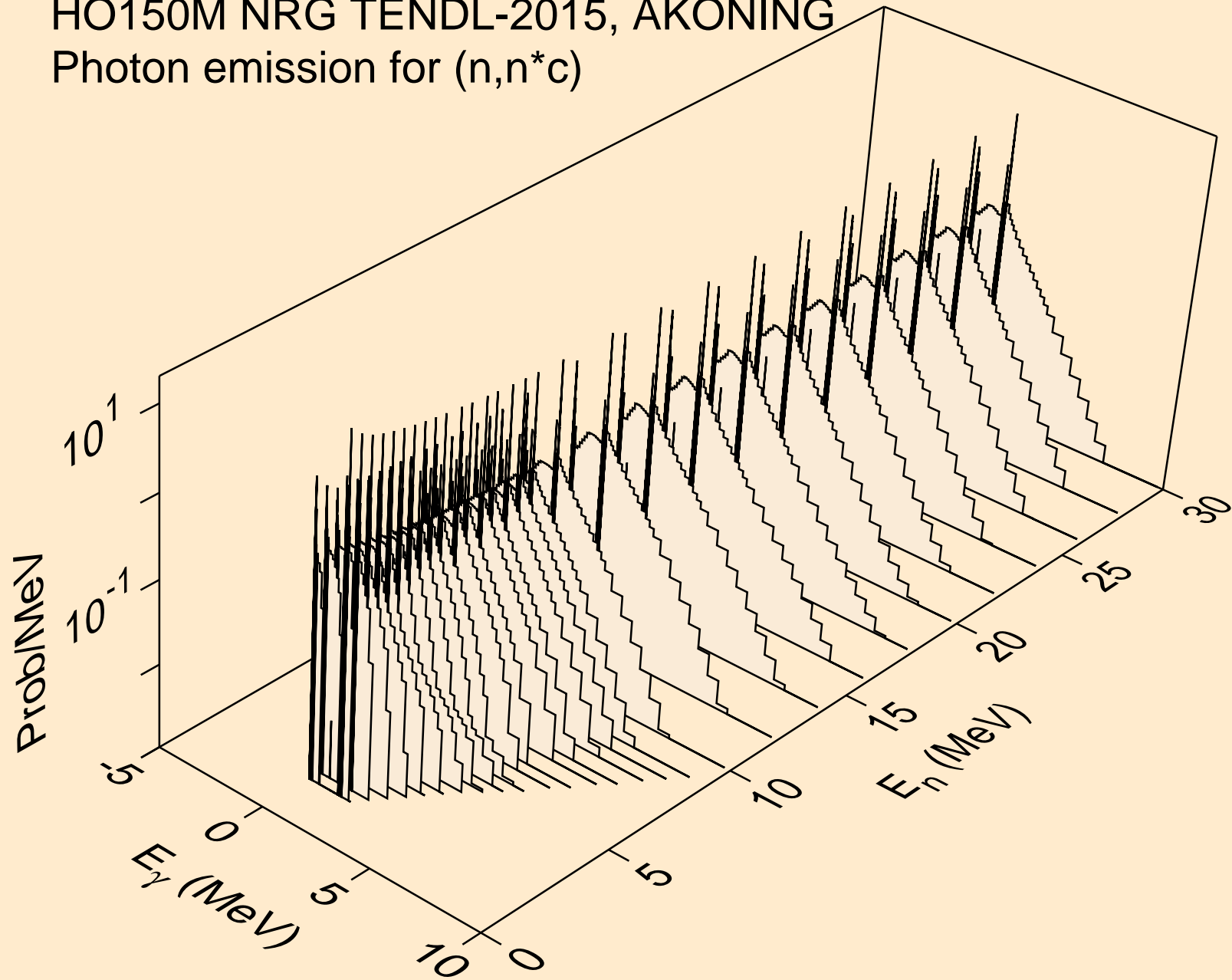

HO150M NRG TENDL-2015, AKONING
Photon emission for (n,gma)

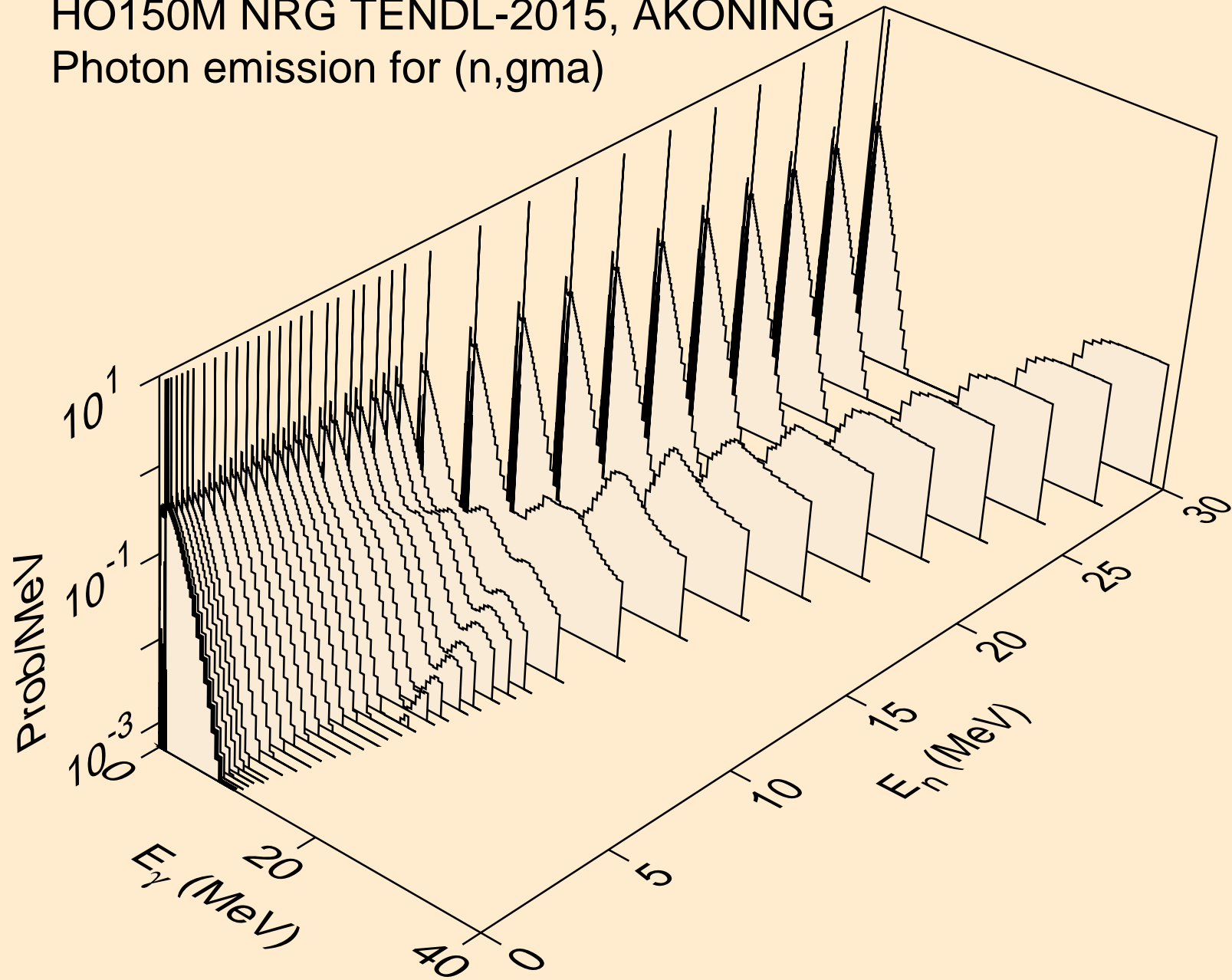

HO150M NRG TENDL-2015, AKONING
Photon emission for (n,p)

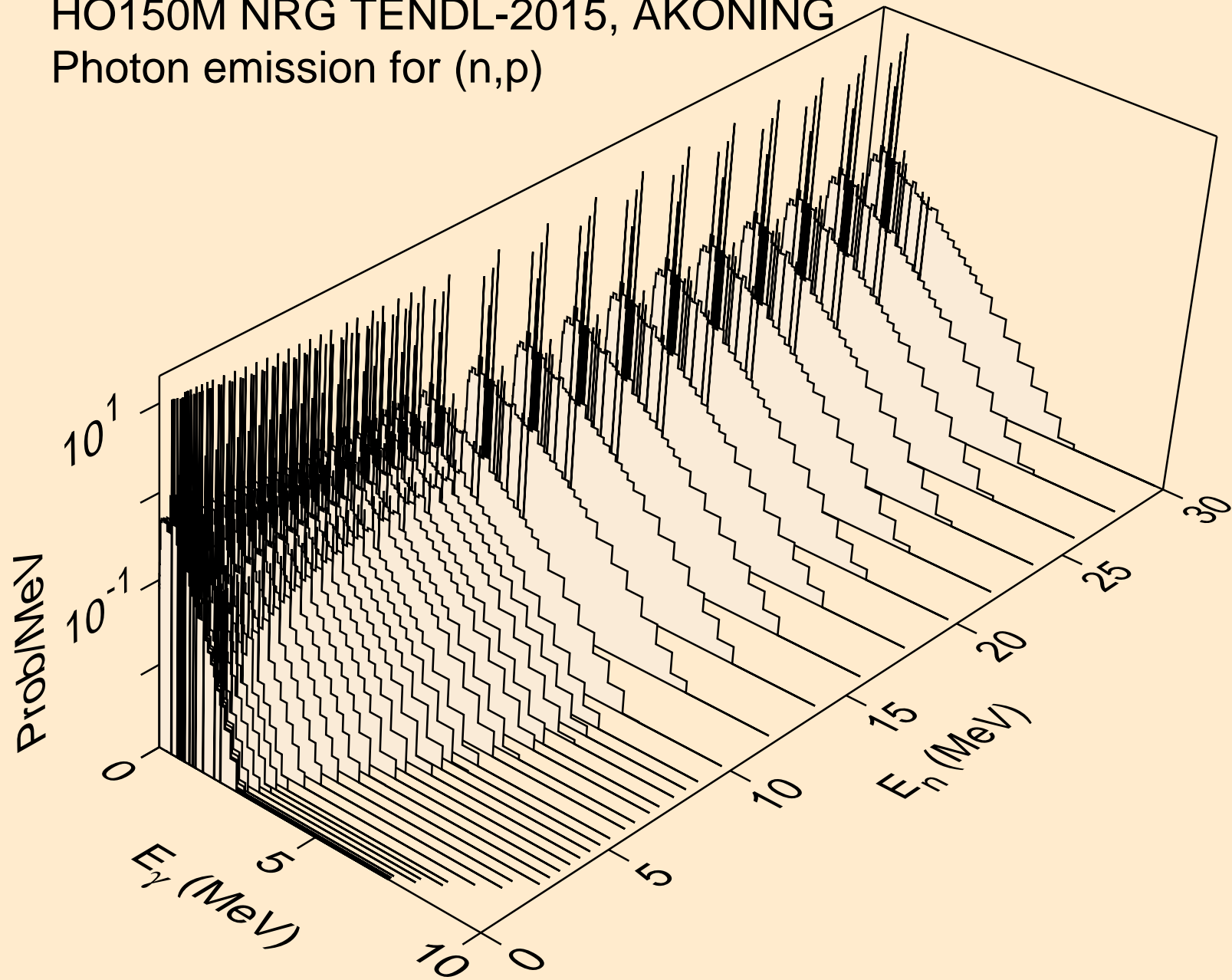

HO150M NRG TENDL-2015, AKONING
Photon emission for (n,d)

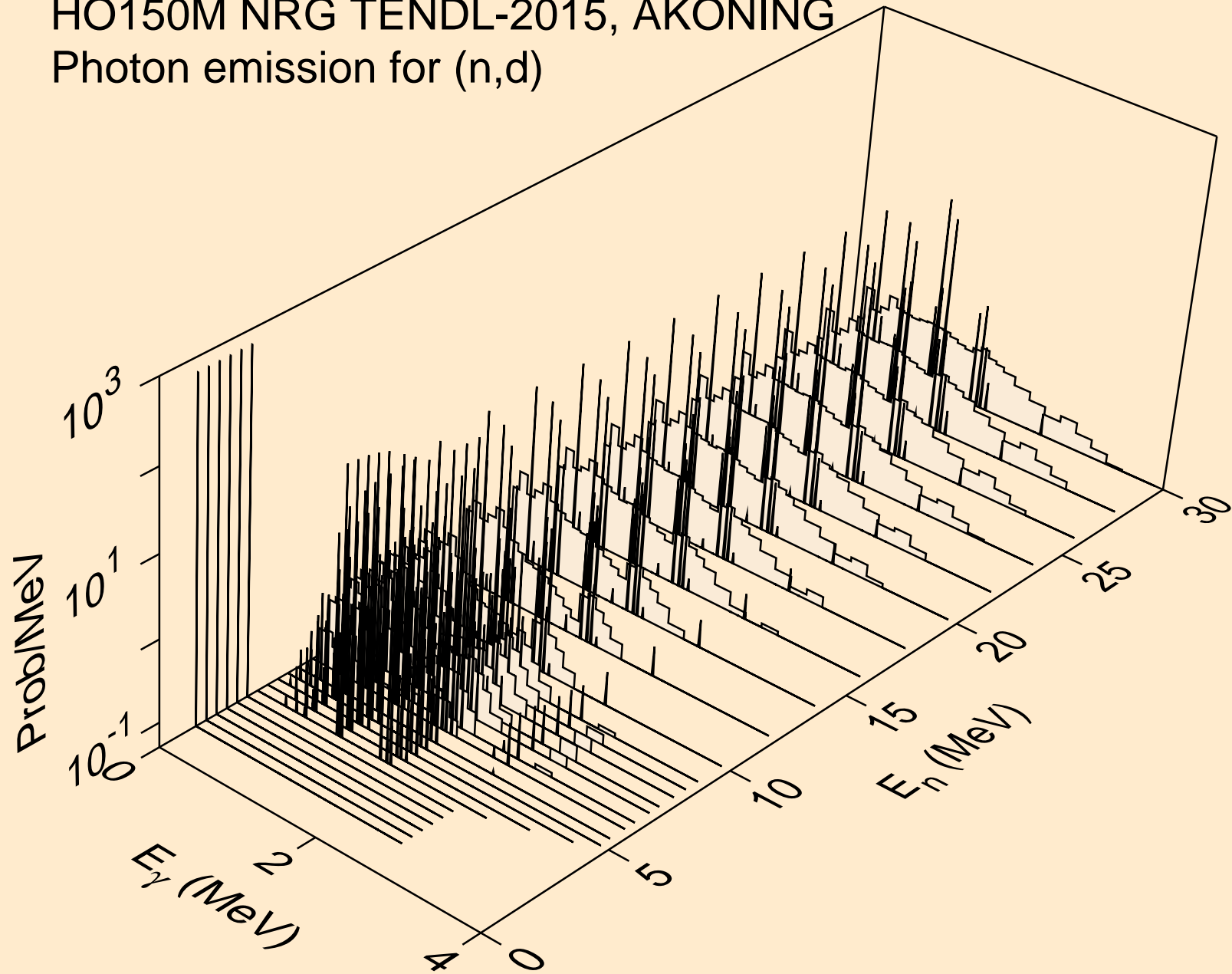

HO150M NRG TENDL-2015, AKONING
Photon emission for (n,t)

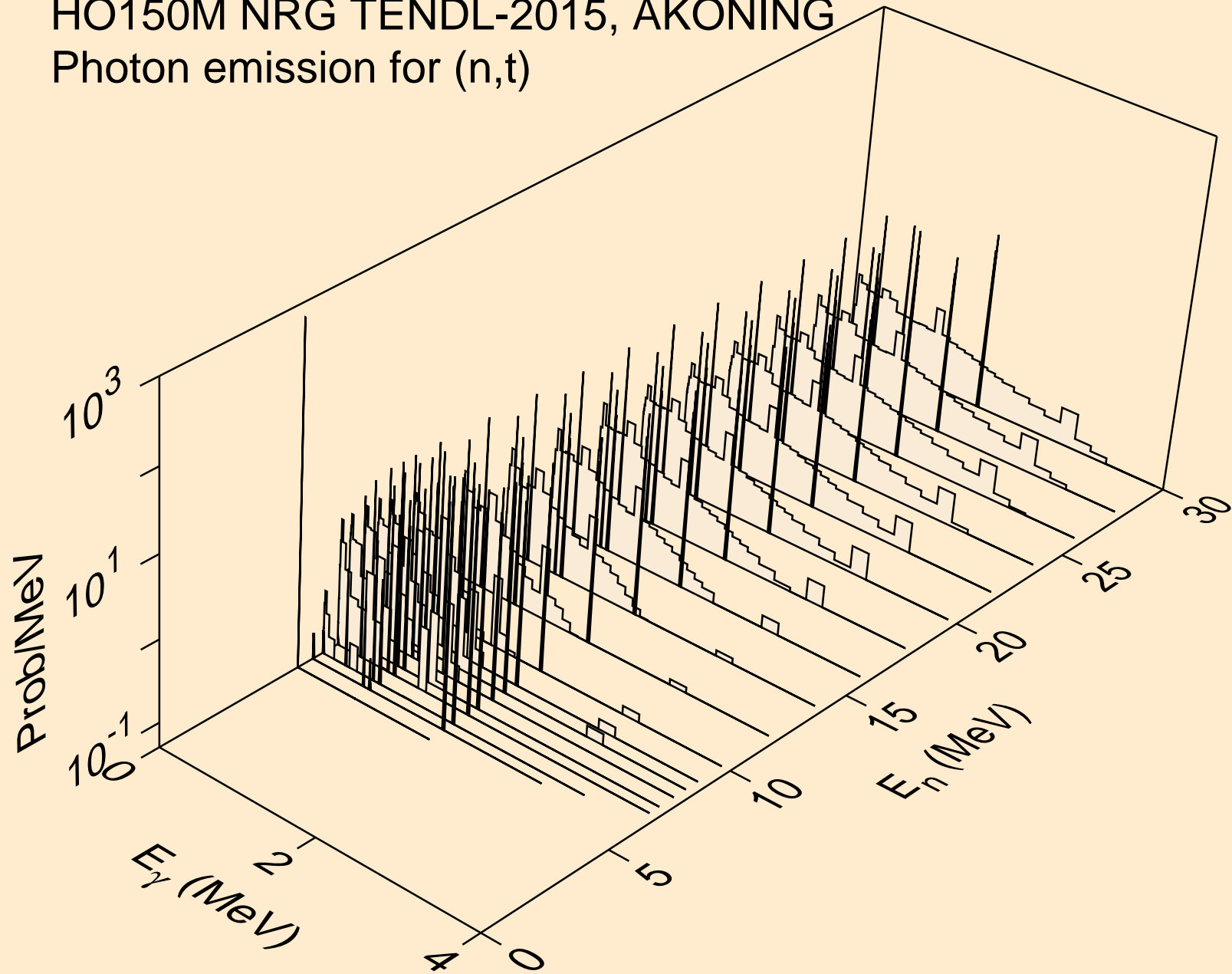

HO150M NRG TENDL-2015, AKONING
Photon emission for (n,he3)

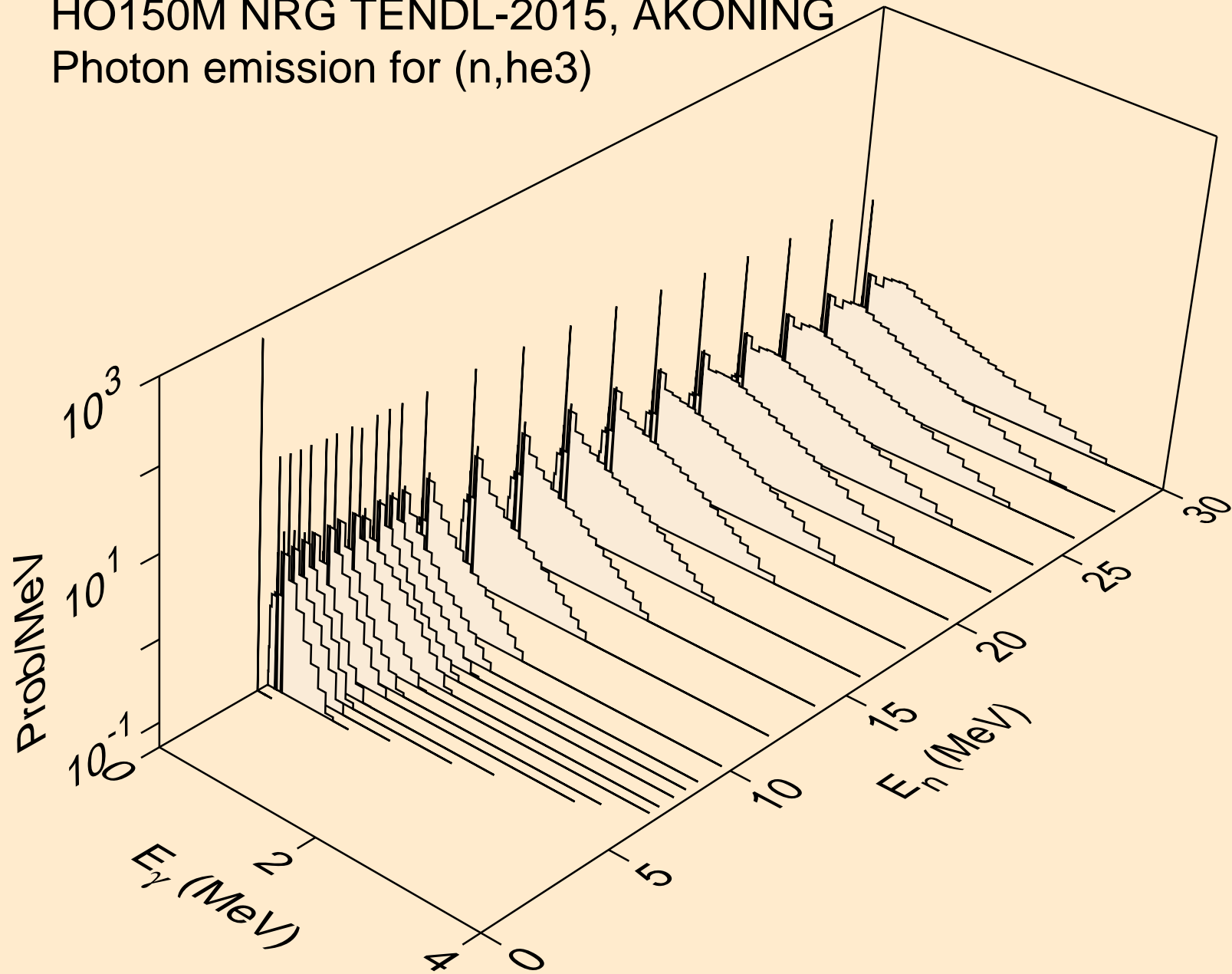

HO150M NRG TENDL-2015, AKONING
Photon emission for (n,a)

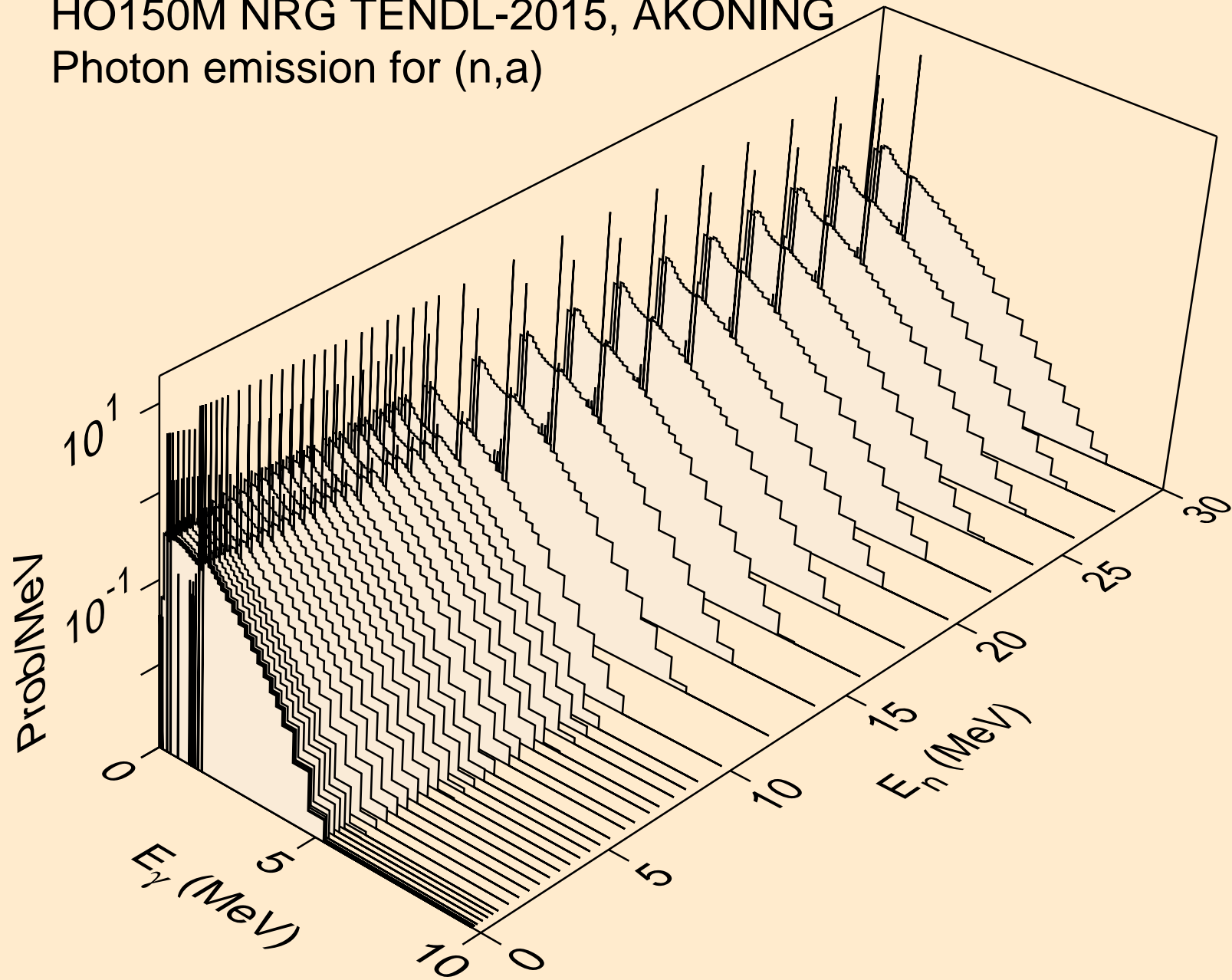

HO150M NRG TENDL-2015, AKONING
Photon emission for (n,2a)

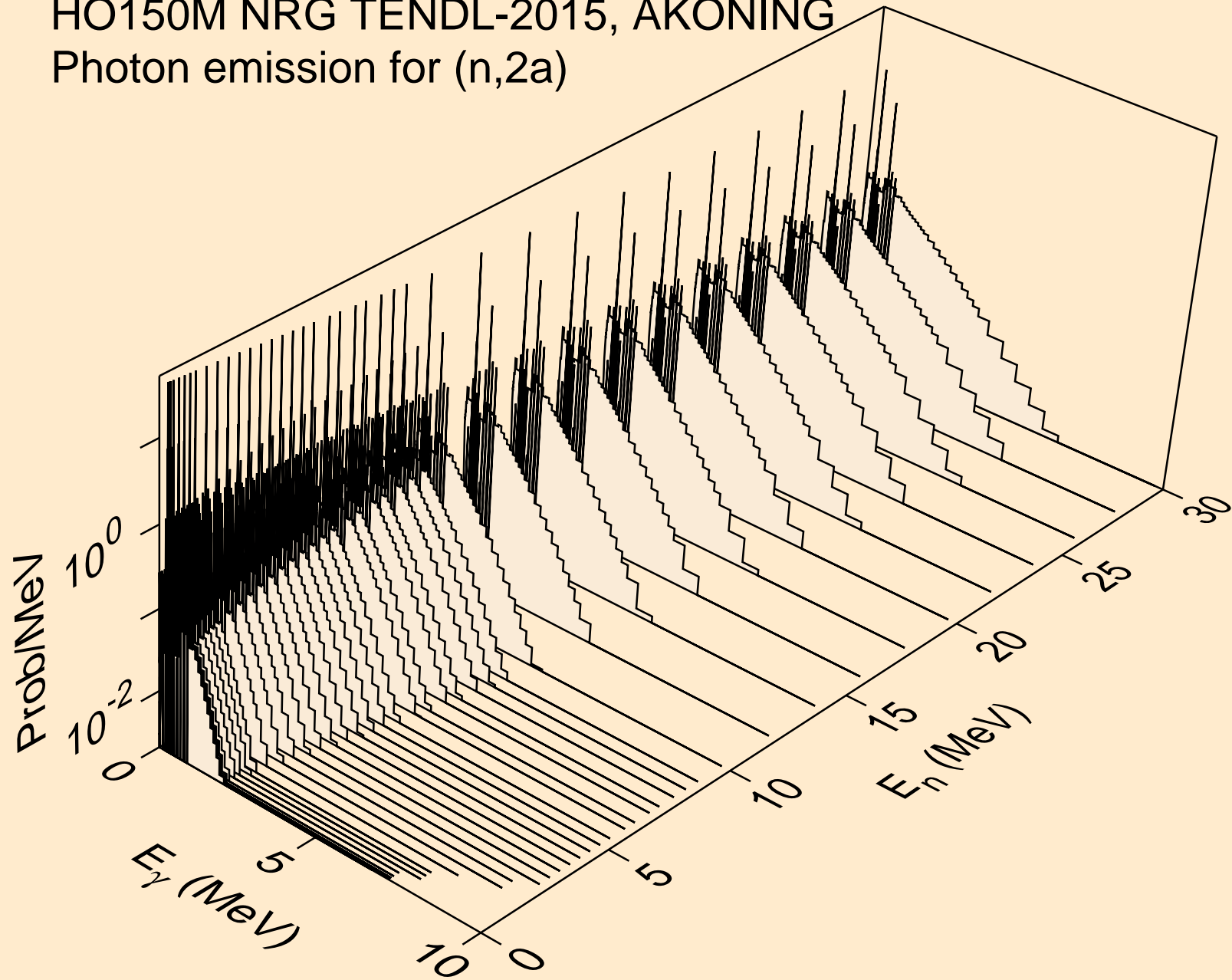

HO150M NRG TENDL-2015, AKONING
Photon emission for (n,3a)

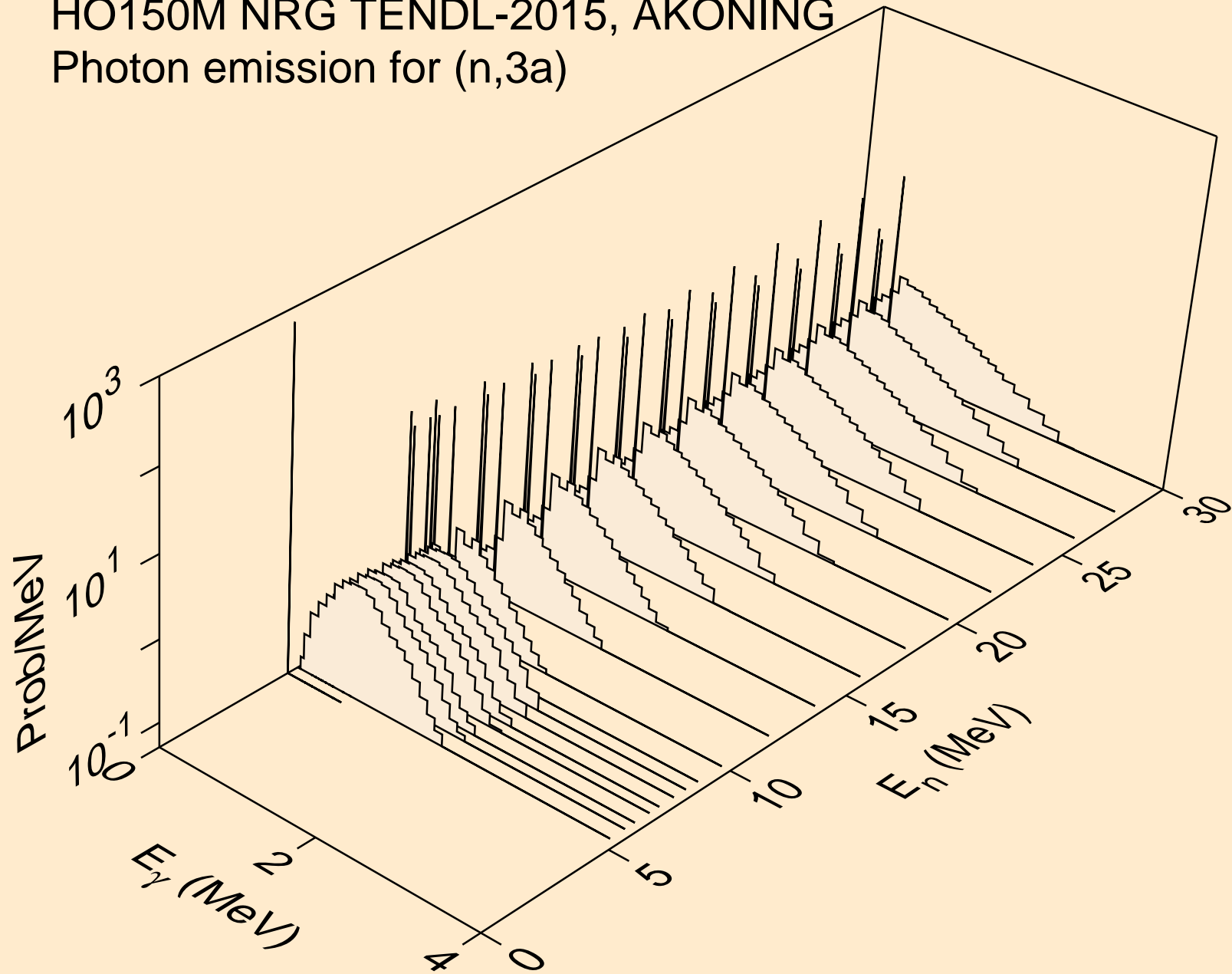

HO150M NRG TENDL-2015, AKONING
Photon emission for (n,2p)

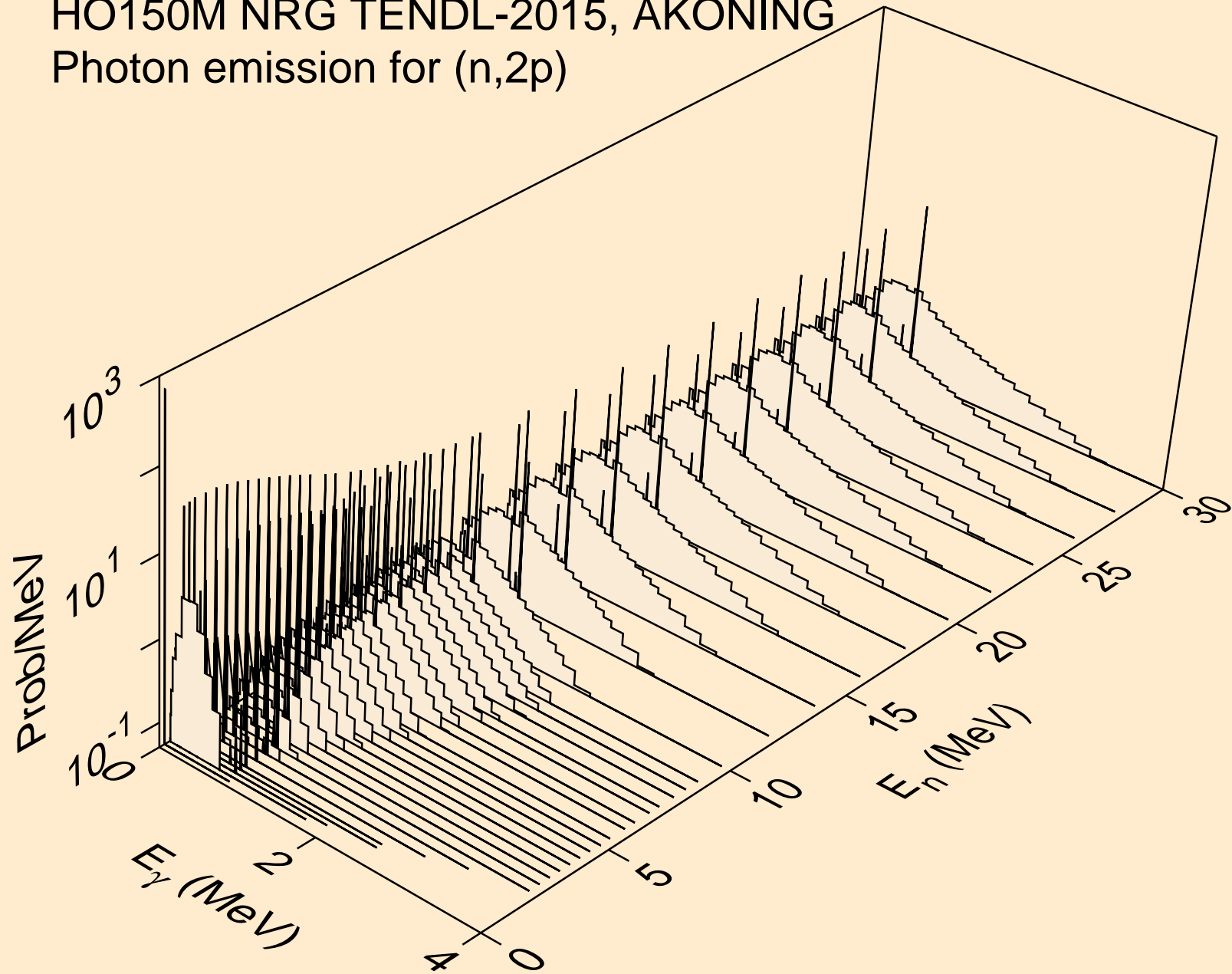

HO150M NRG TENDL-2015, AKONING
Photon emission for (n,p)

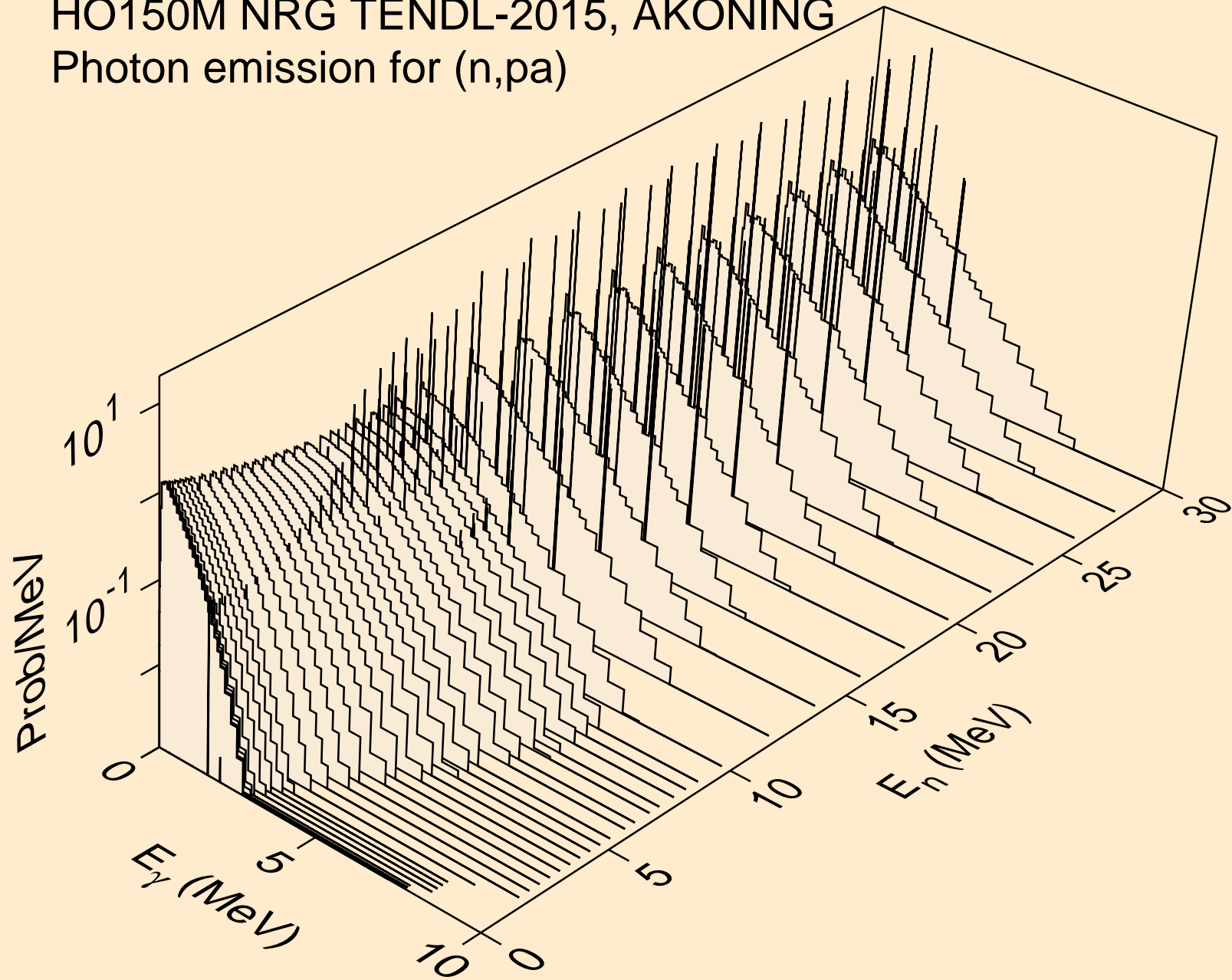

HO150M NRG TENDL-2015, AKONING
Photon emission for (n,pd)

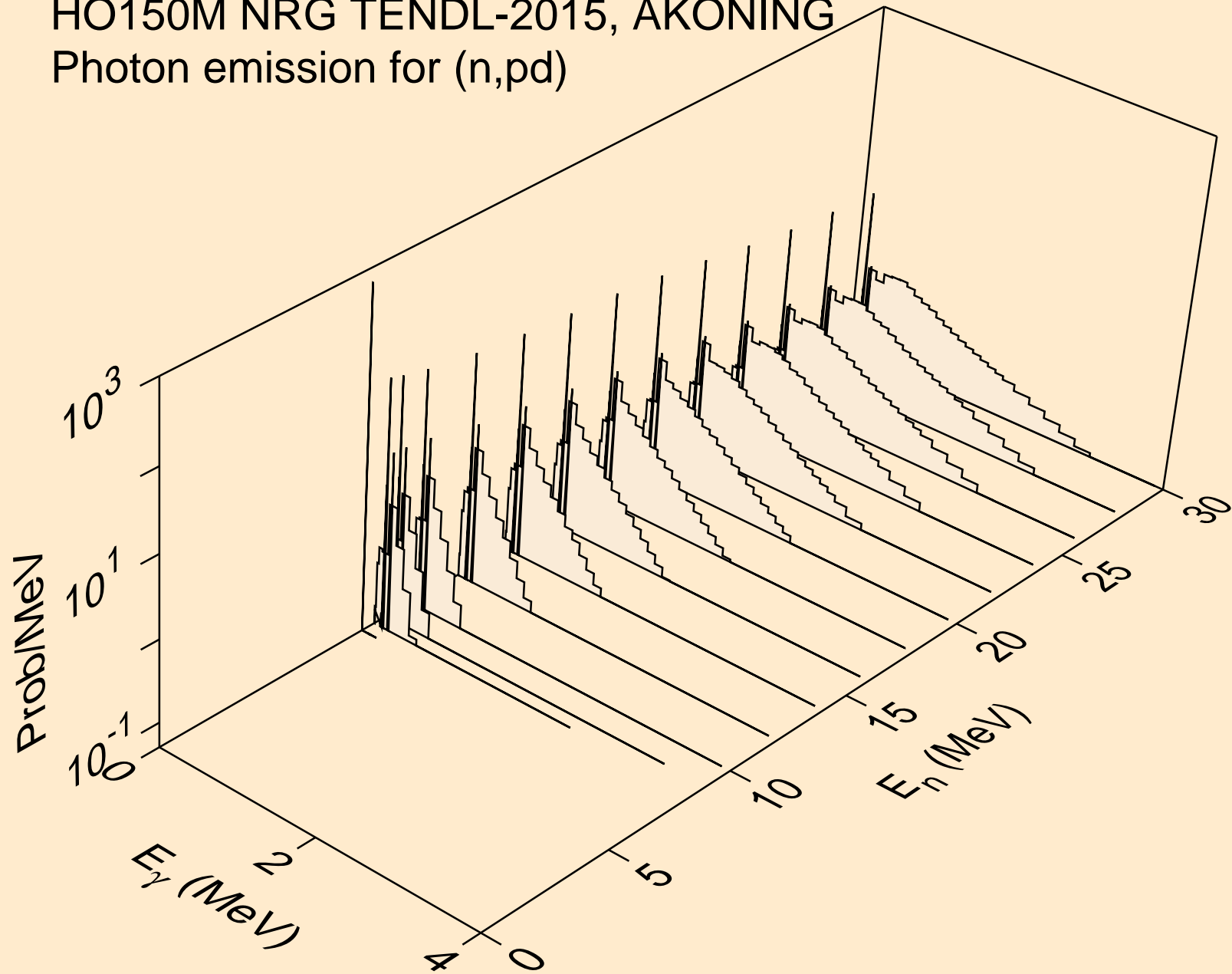

HO150M NRG TENDL-2015, AKONING
Photon emission for (n,pt)

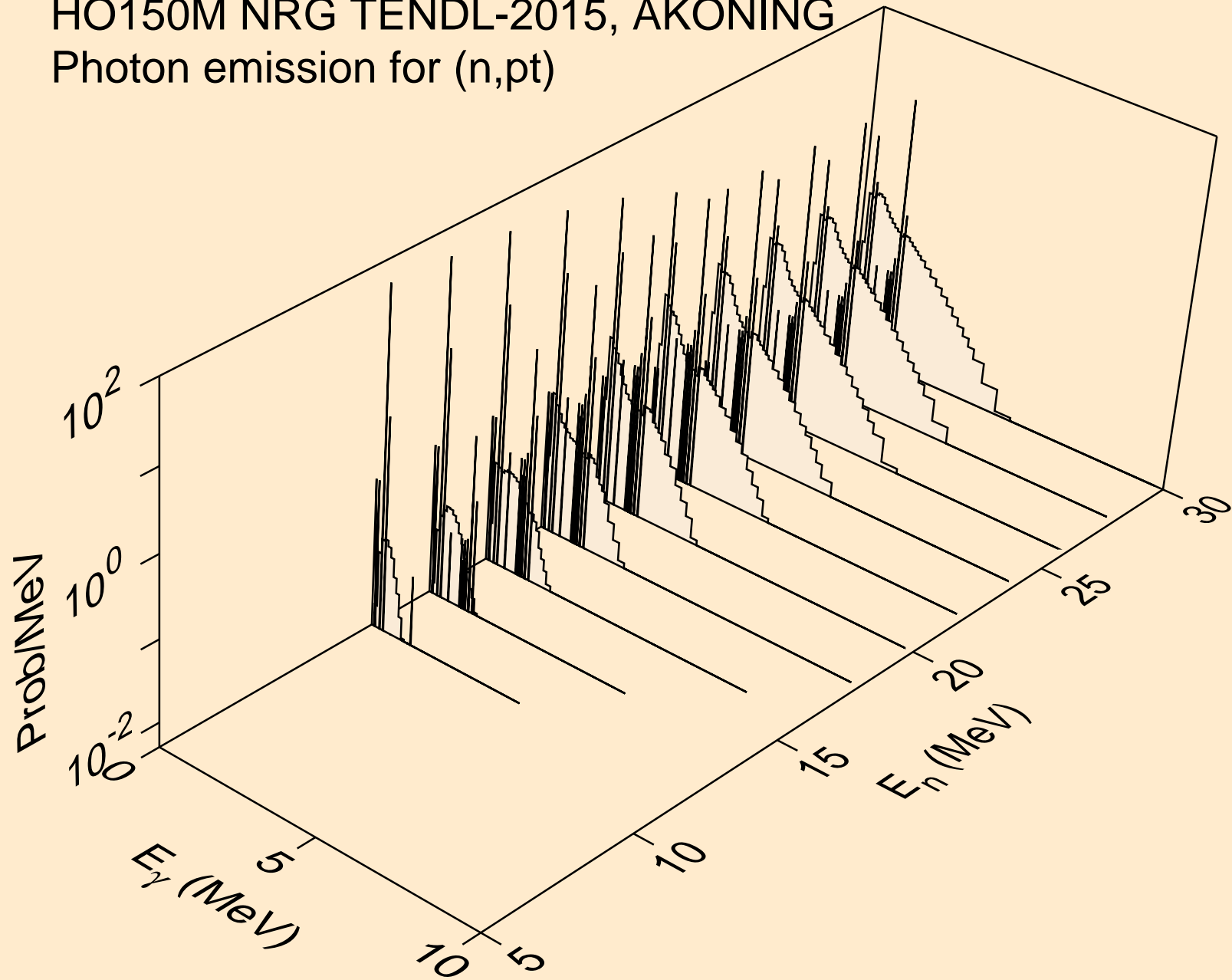

HO150M NRG TENDL-2015, AKONING
Photon emission for (n,da)

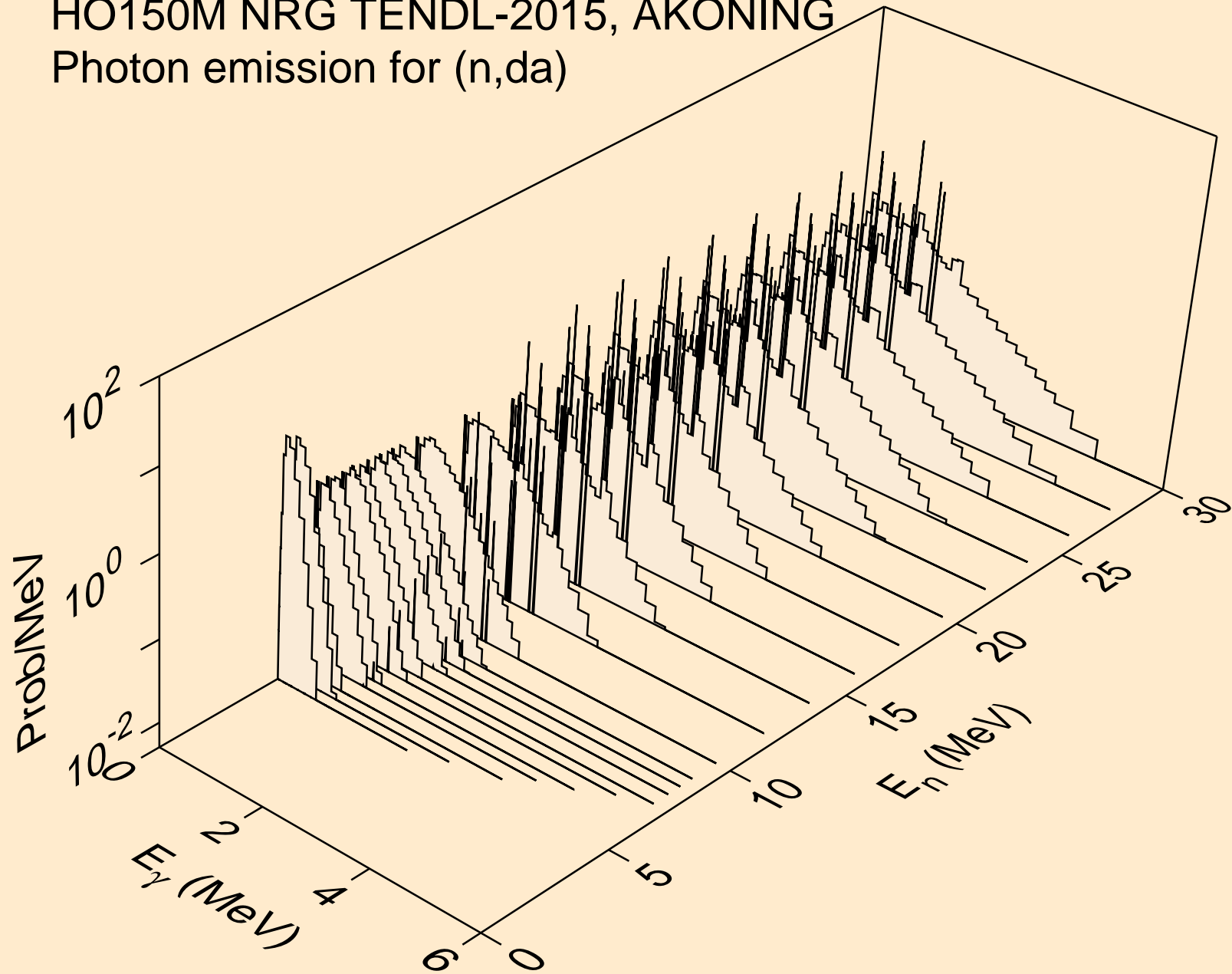

HO150M NRG TENDL-2015, AKONING
thermal capture photon spectrum

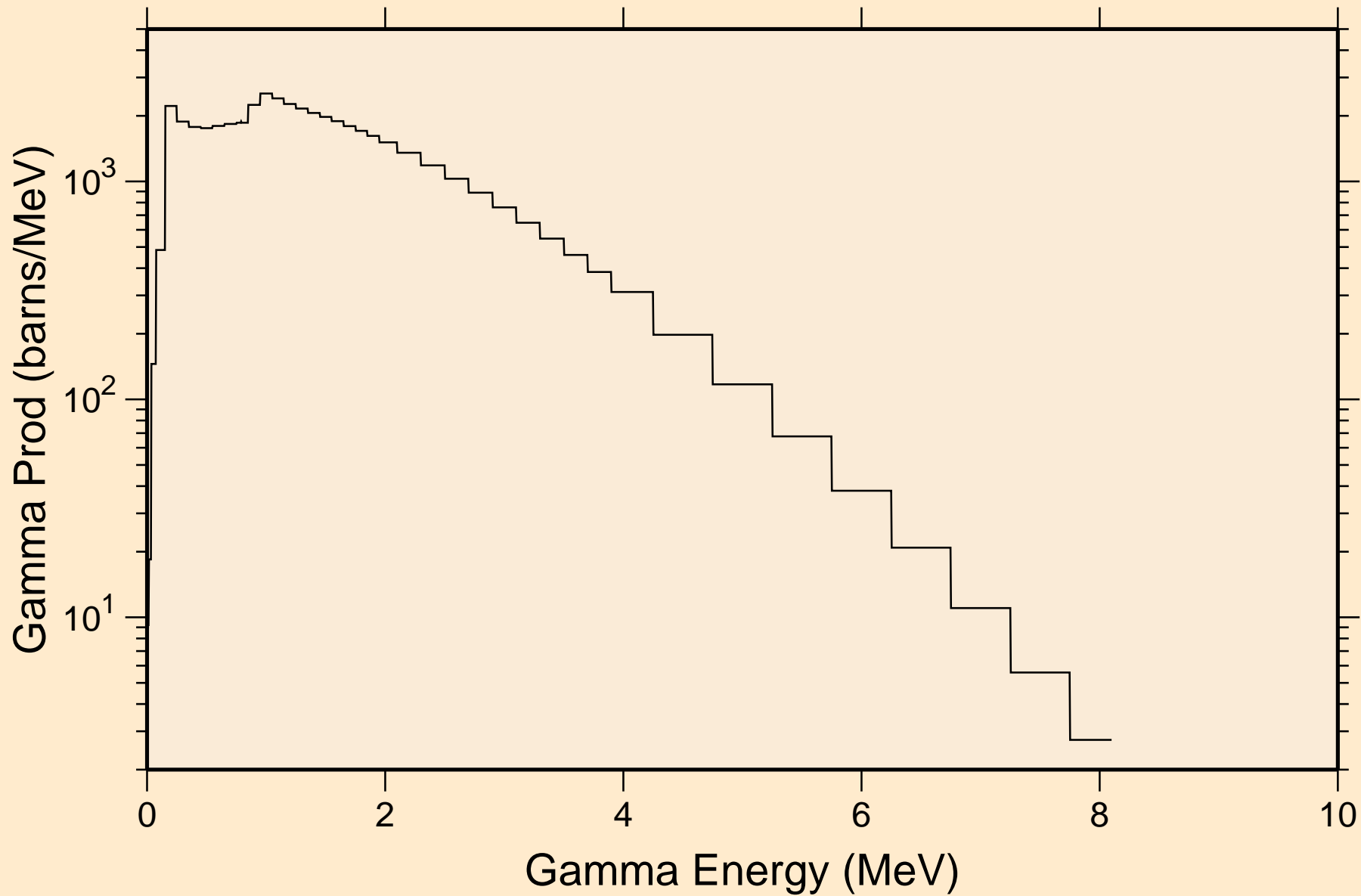

HO150M NRG TENDL-2015, AKONING
14 MeV photon spectrum

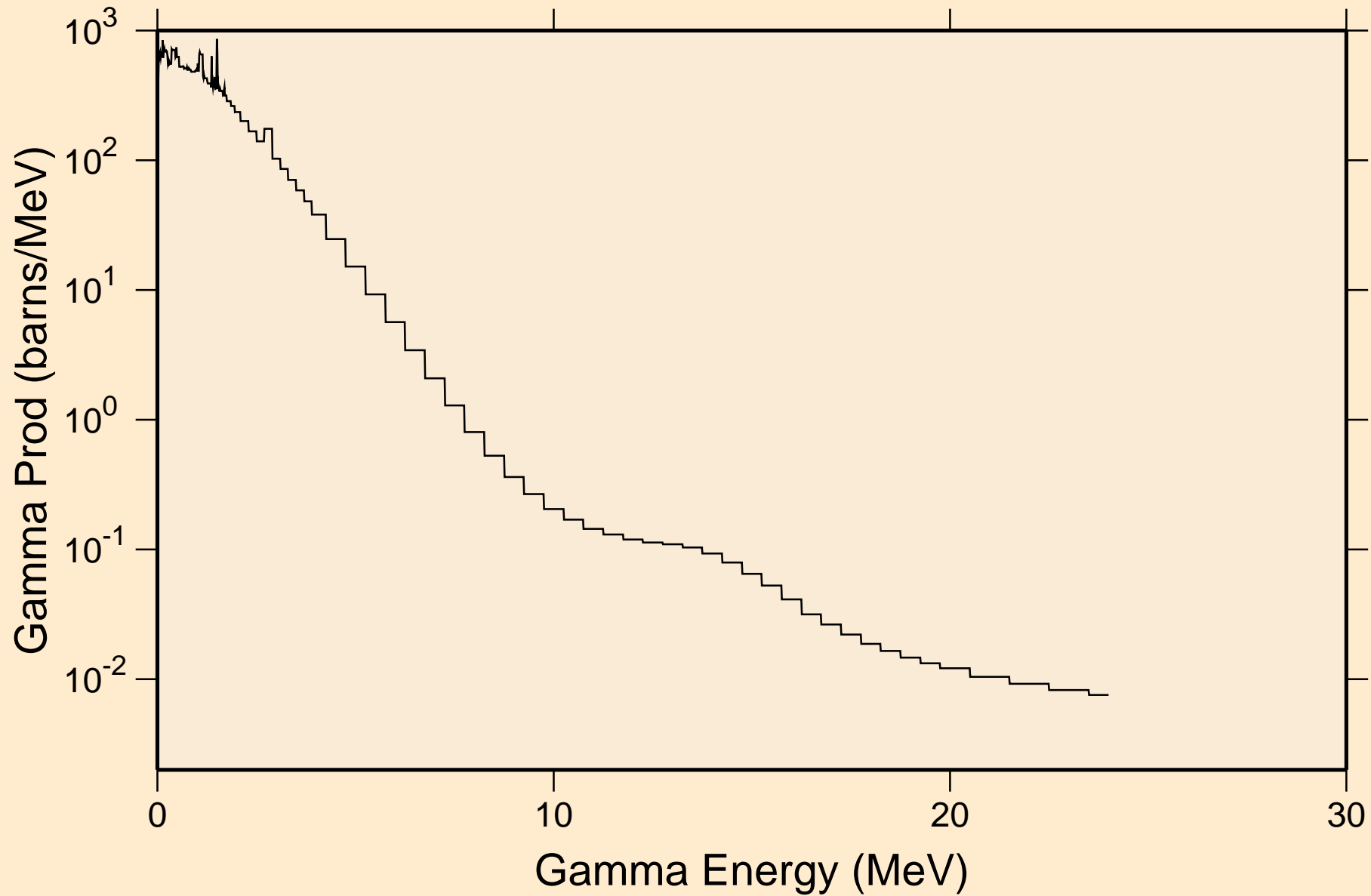

HO150M NRG TENDL-2015, AKONING

Particle heating contributions

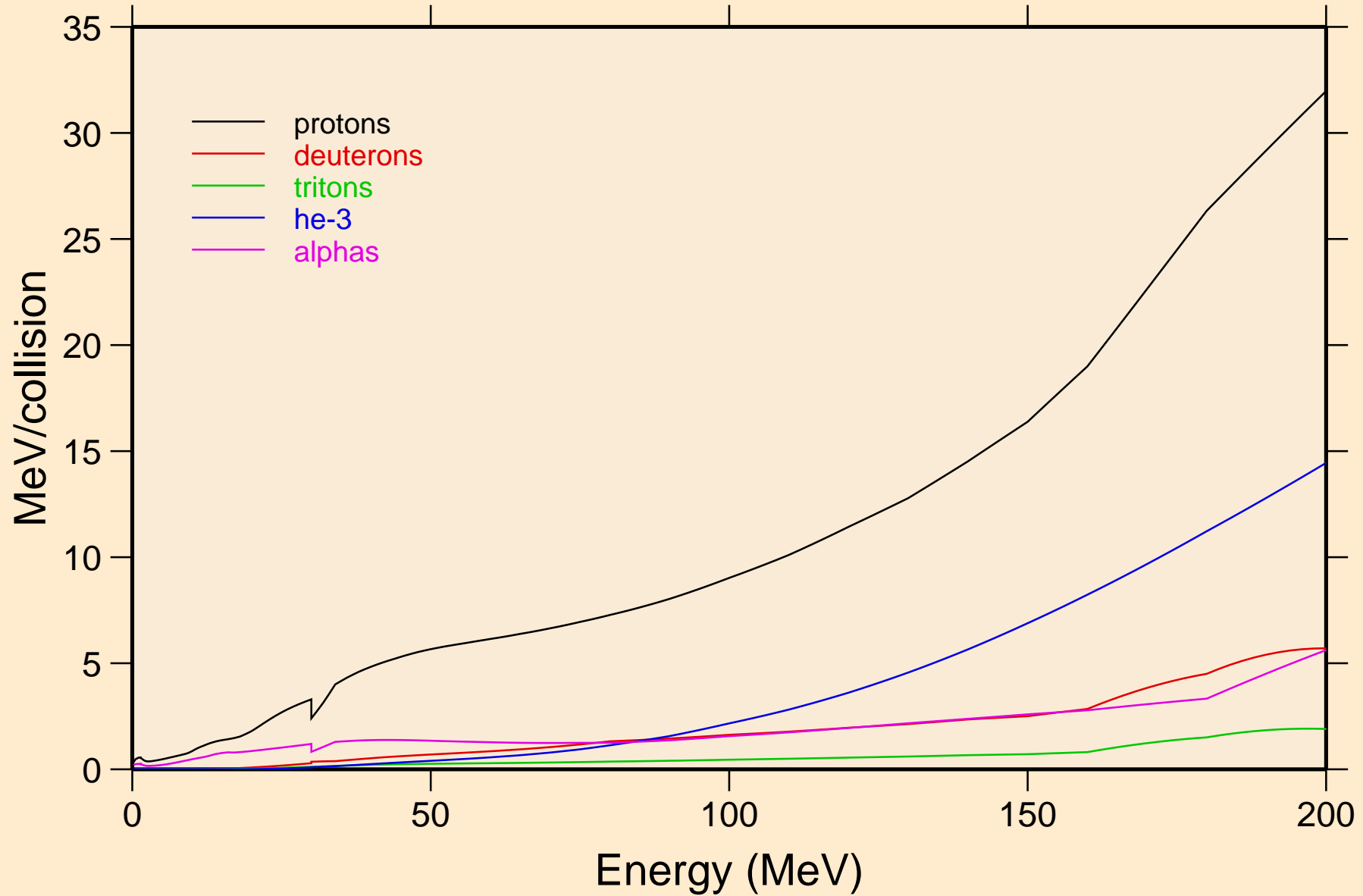

HO150M NRG TENDL-2015, AKONING

Recoil Heating

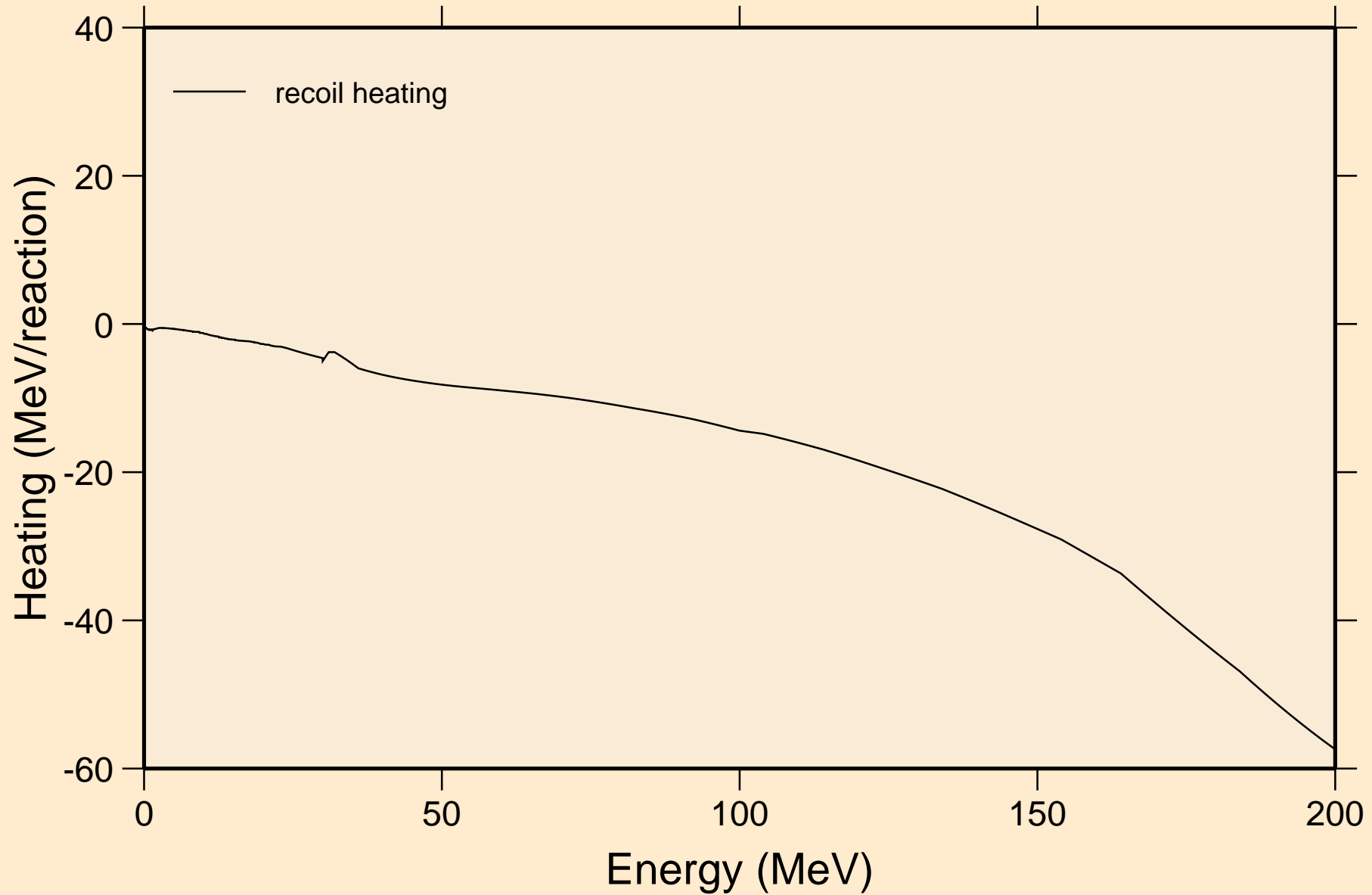

HO150M NRG TENDL-2015, AKONING

Particle production cross sections

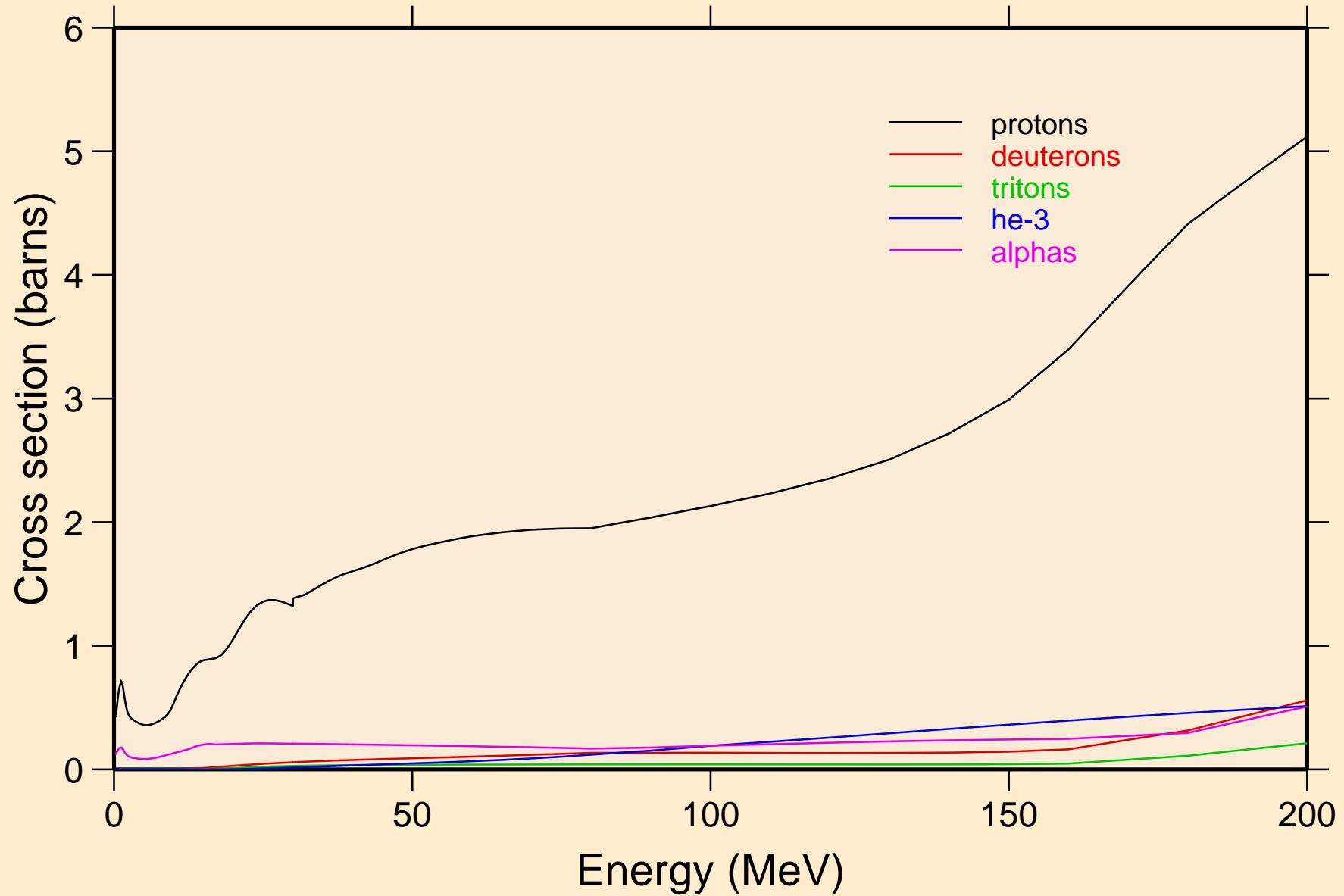

HO150M NRG TENDL-2015, AKONING
protons from (n,x)

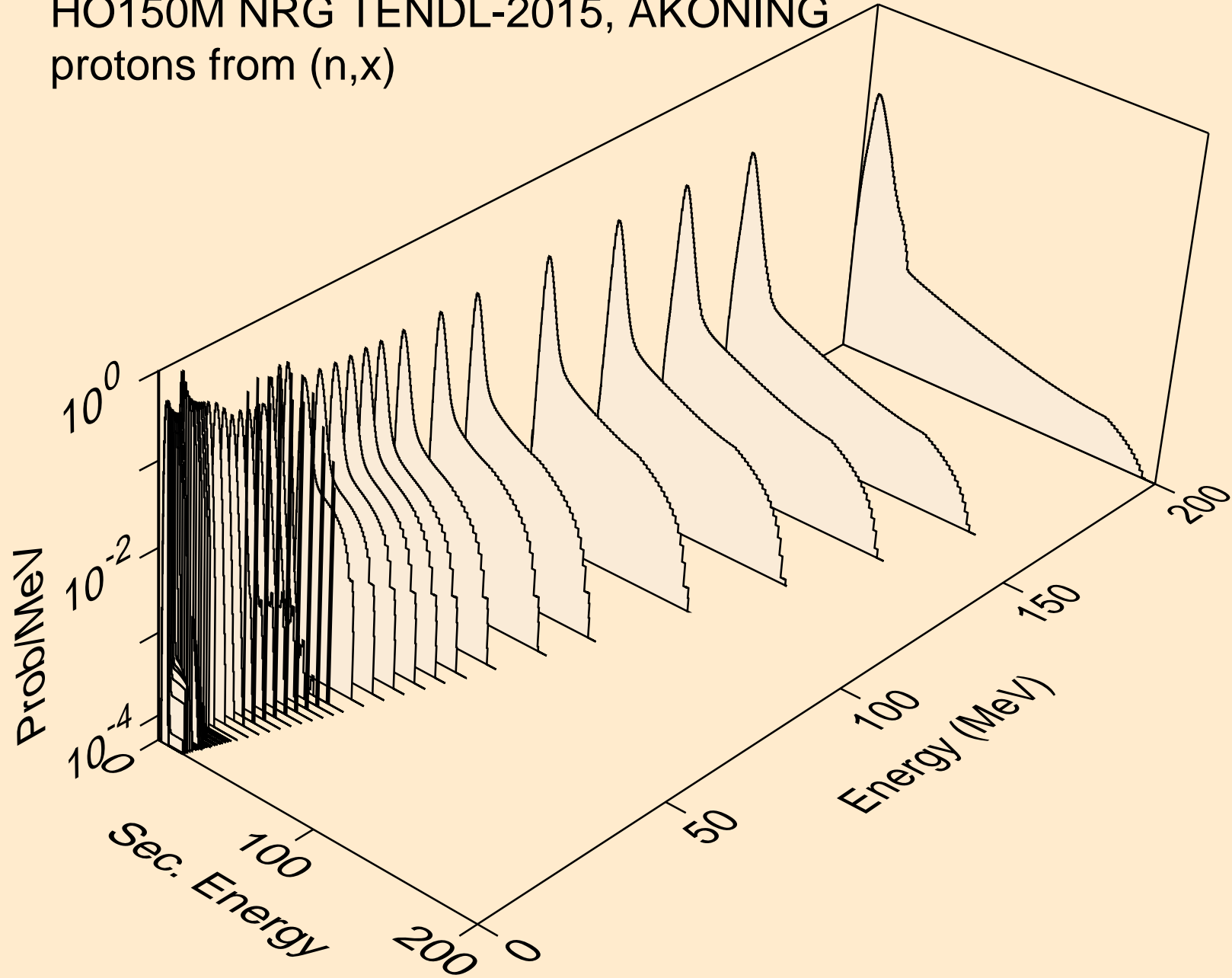

HO150M NRG TENDL-2015, AKONING
protons from (n,n*)p

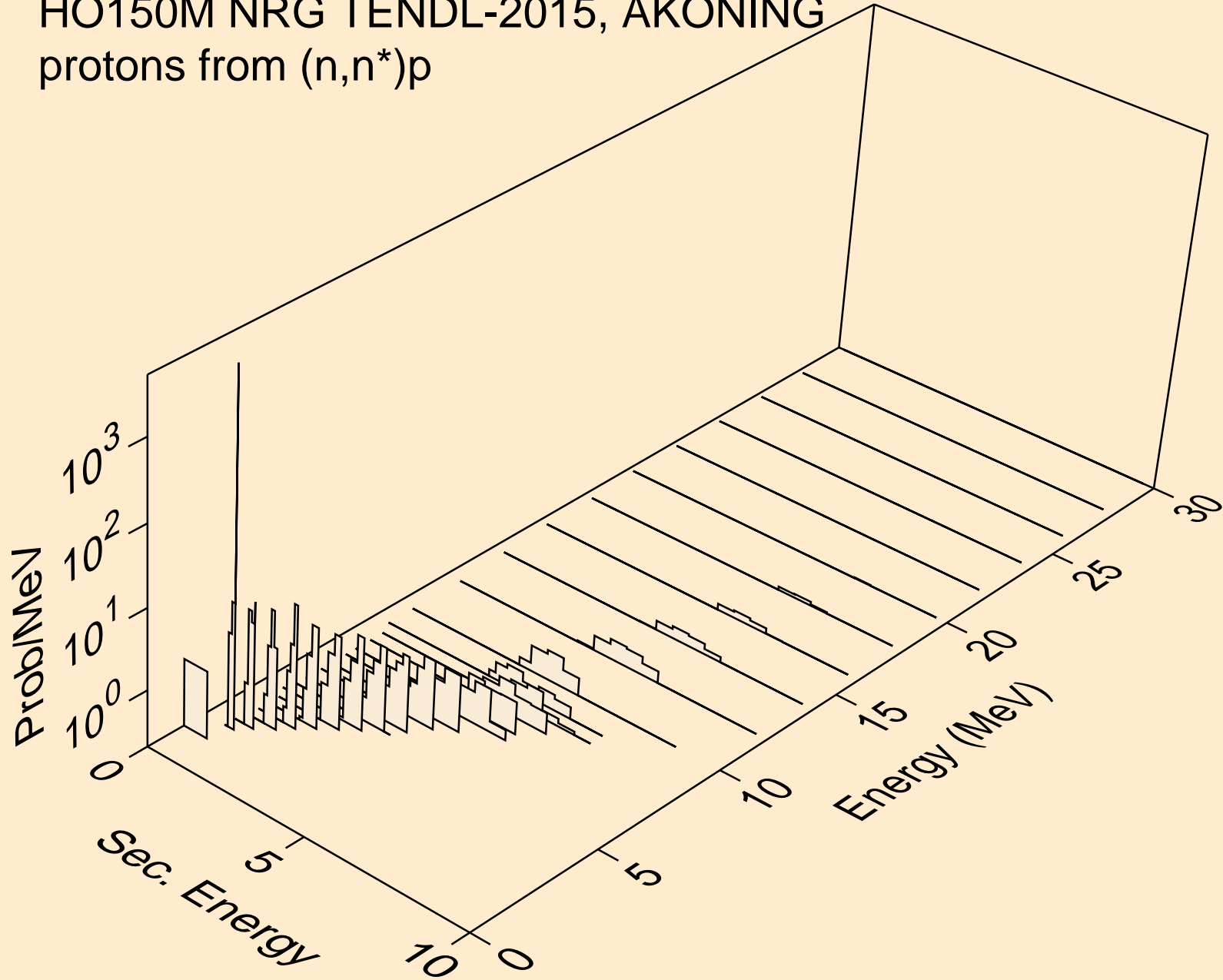

HO150M NRG TENDL-2015, AKONING
protons from (n,2np)

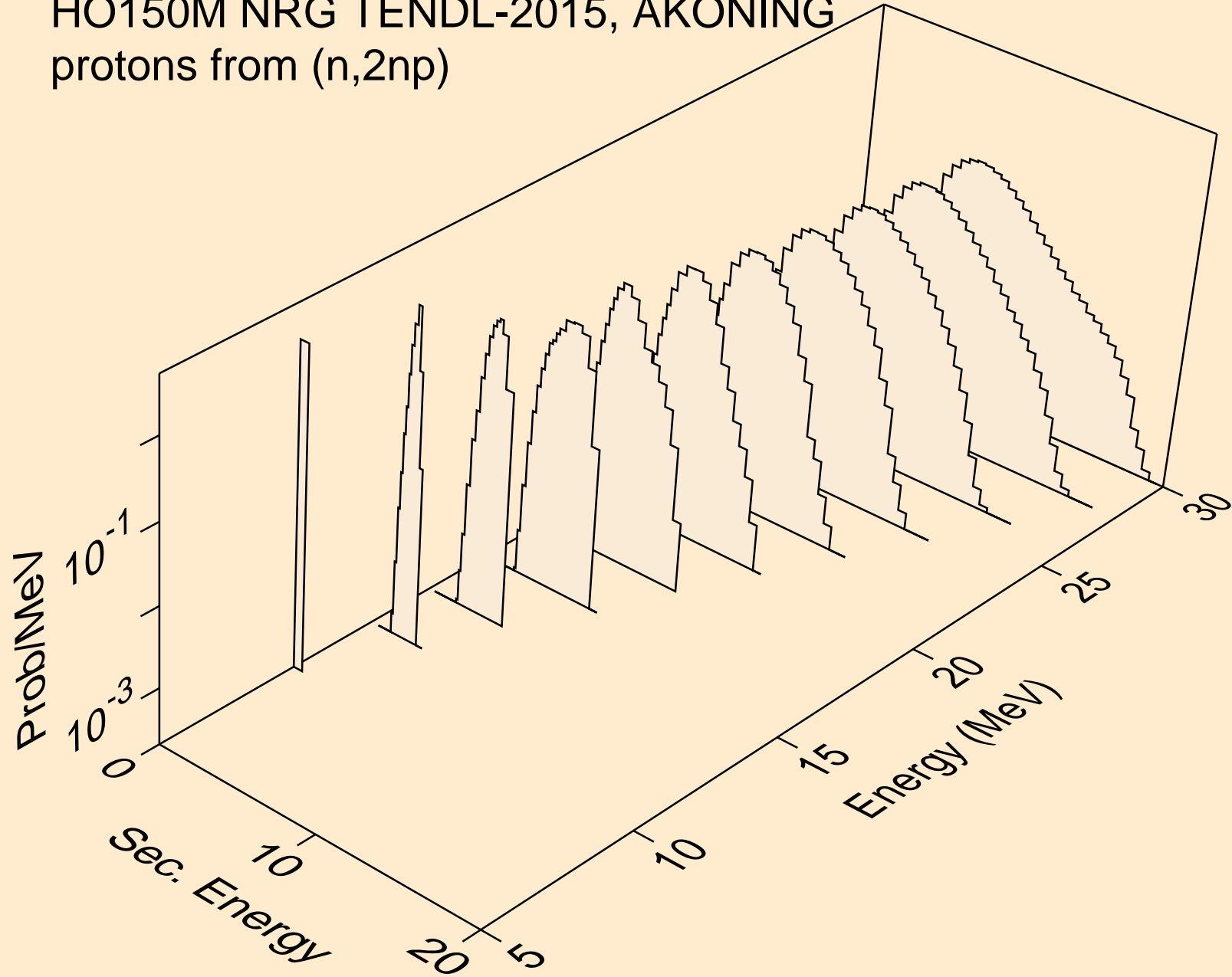

HO150M NRG TENDL-2015, AKONING
protons from (n,3np)

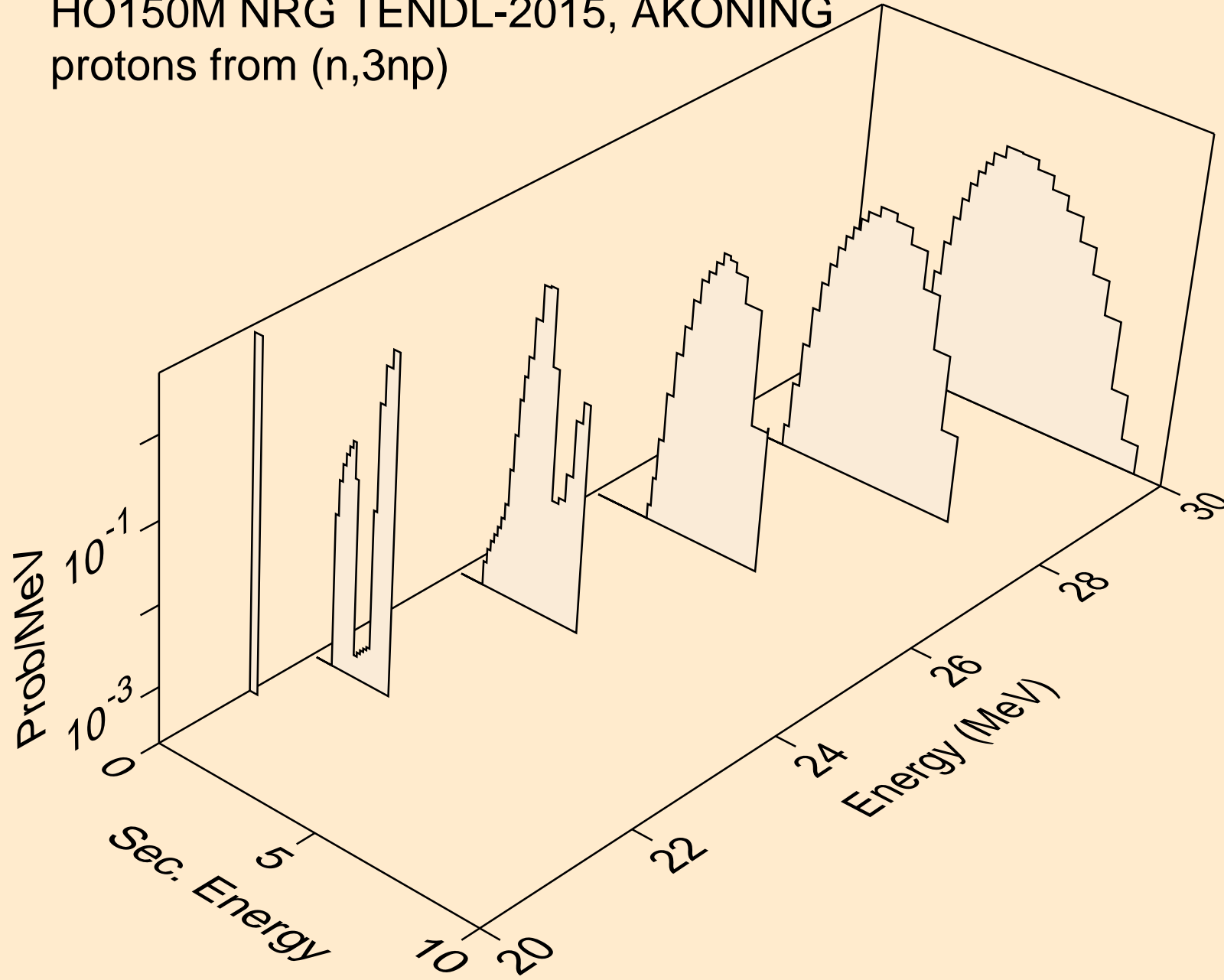

HO150M NRG TENDL-2015, AKONING
protons from (n,2np)

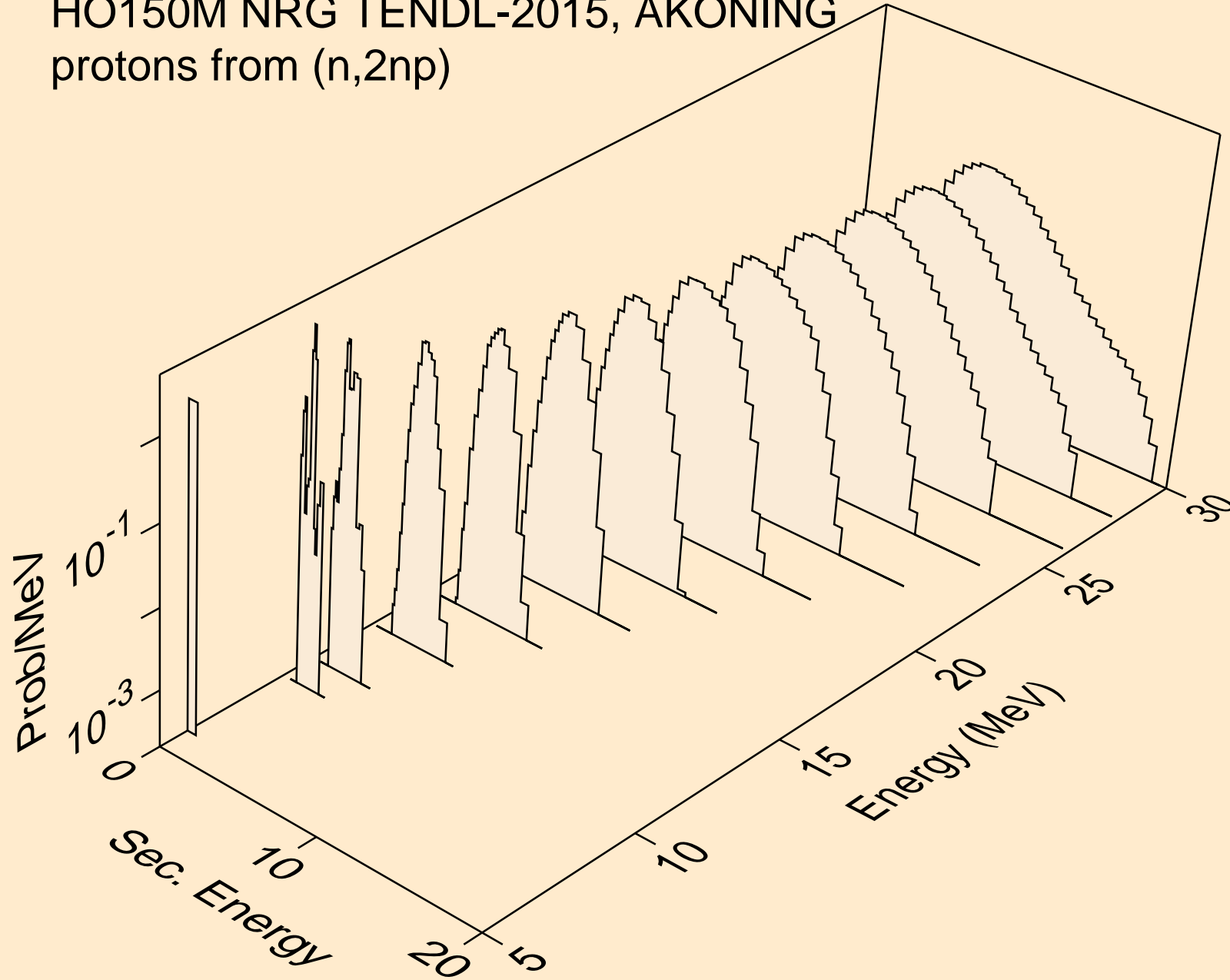

HO150M NRG TENDL-2015, AKONING
protons from (n,npa)

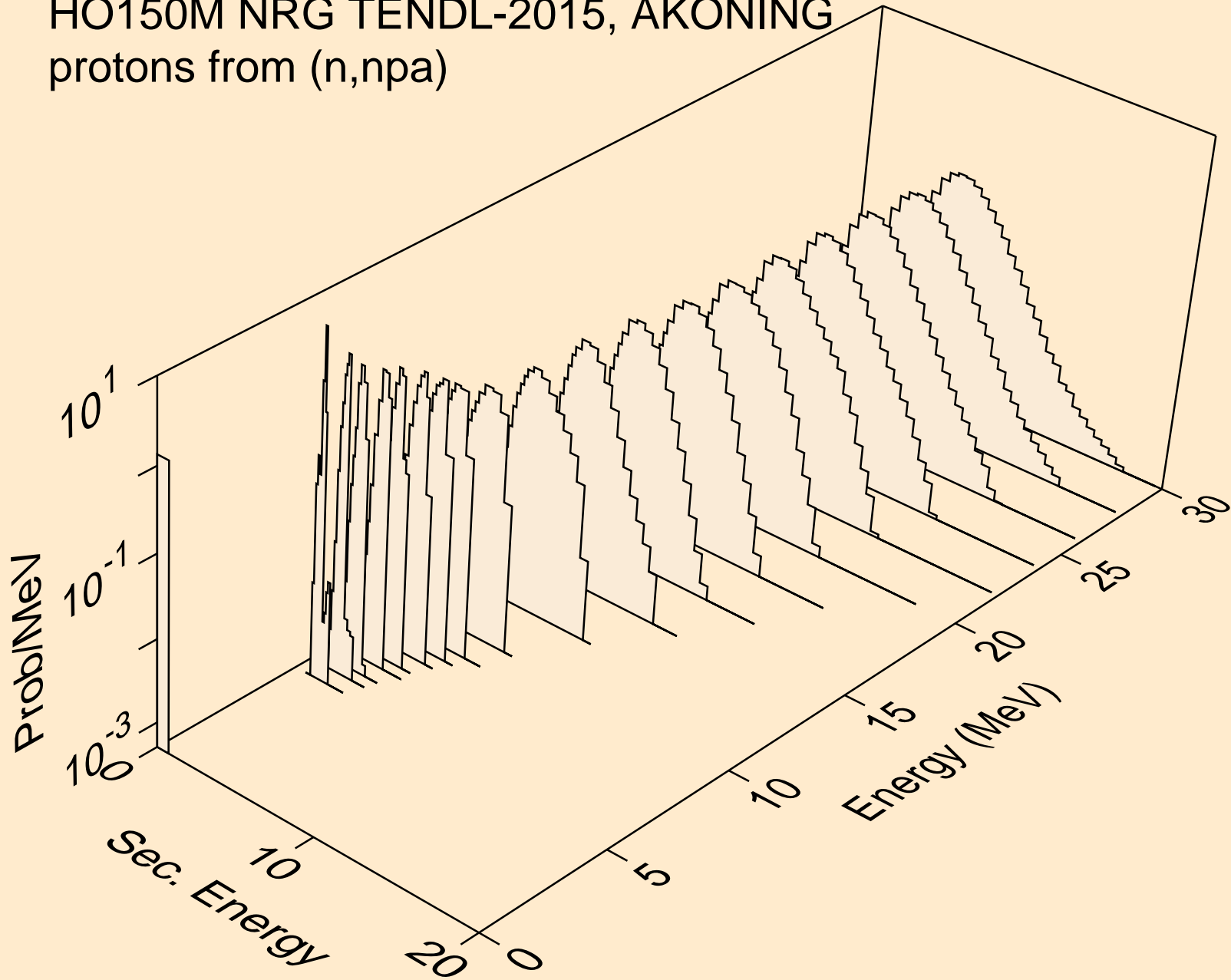

HO150M NRG TENDL-2015, AKONING
protons from (n,p)

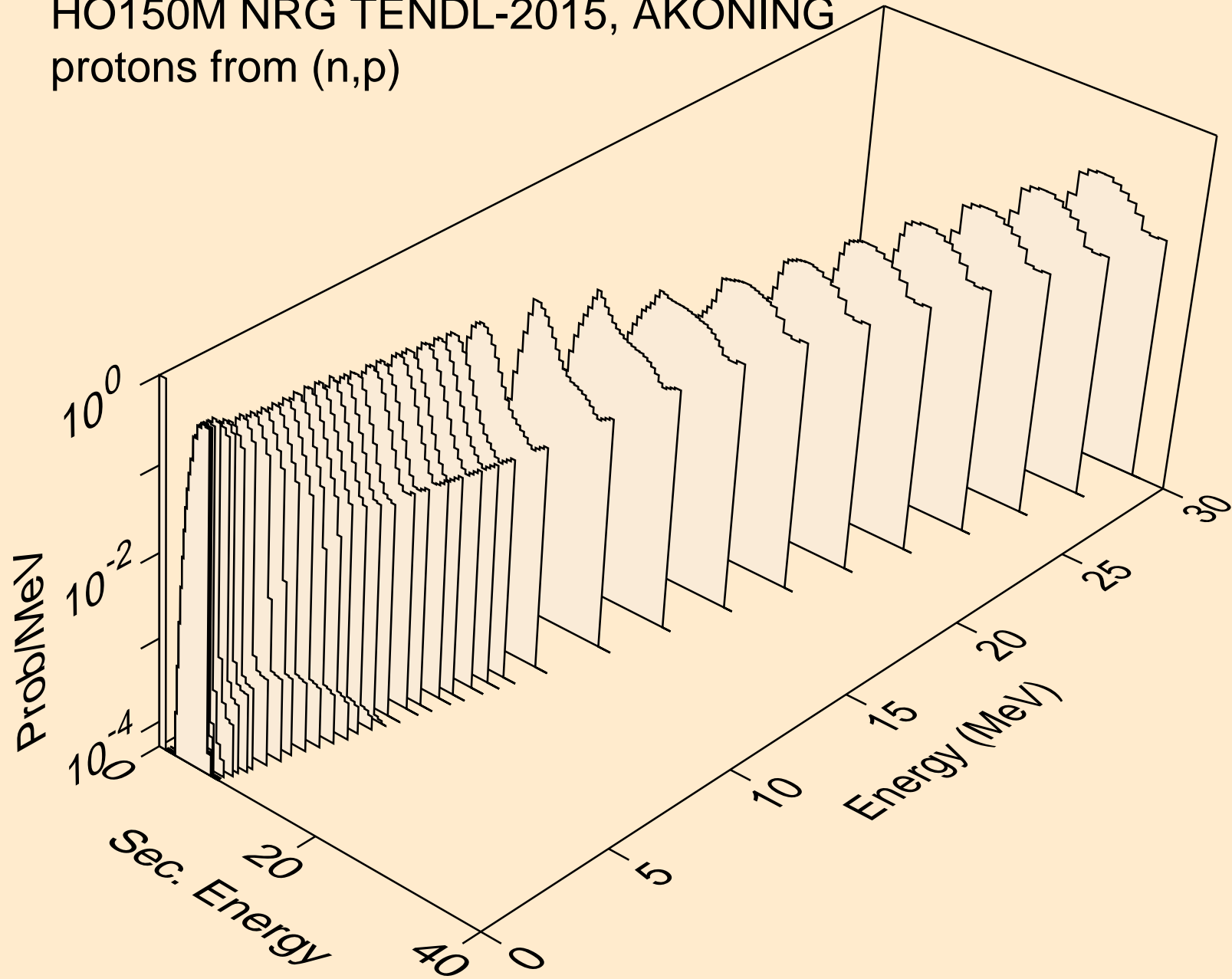

HO150M NRG TENDL-2015, AKONING
protons from (n,2p)

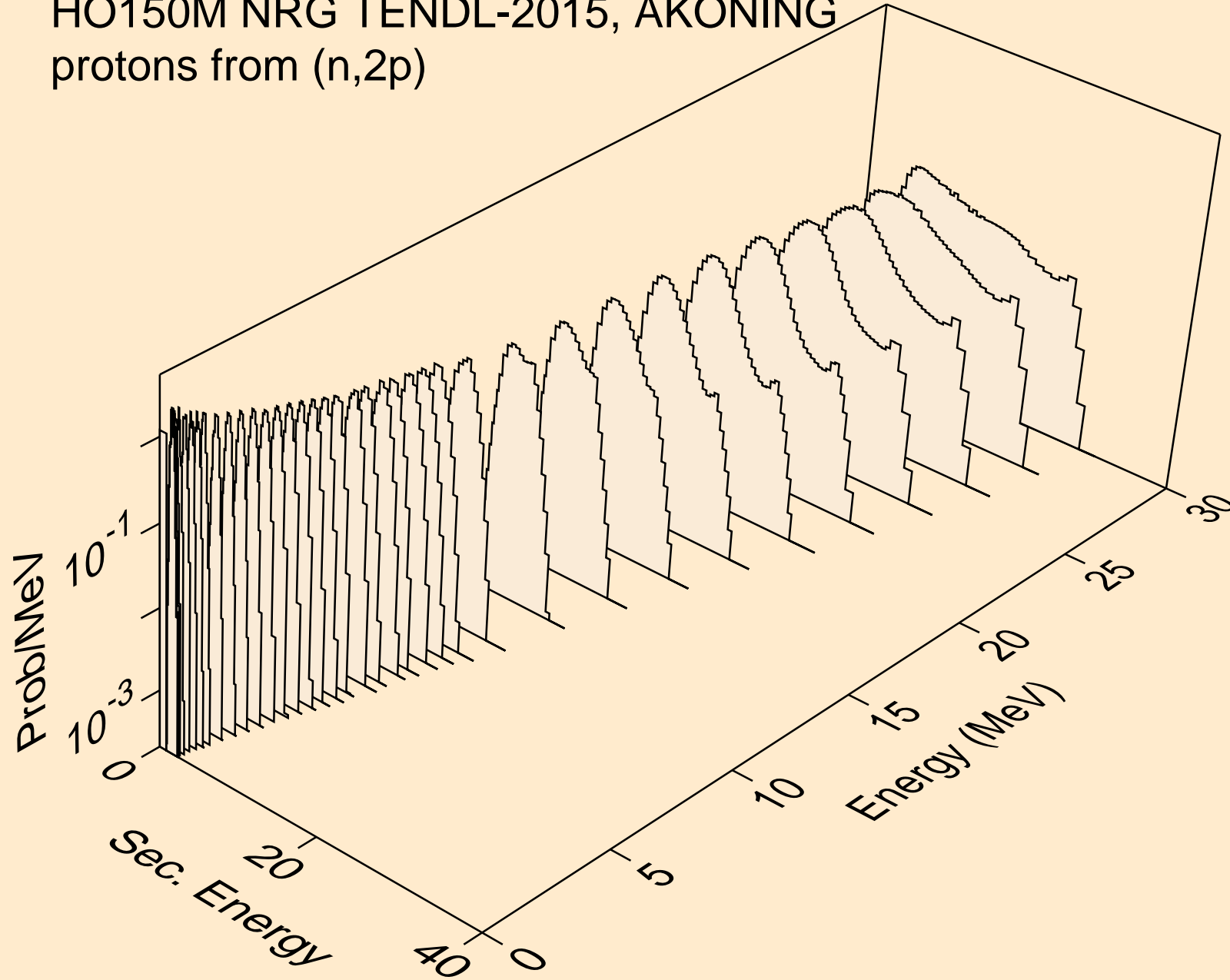

HO150M NRG TENDL-2015, AKONING
protons from (n,pa)

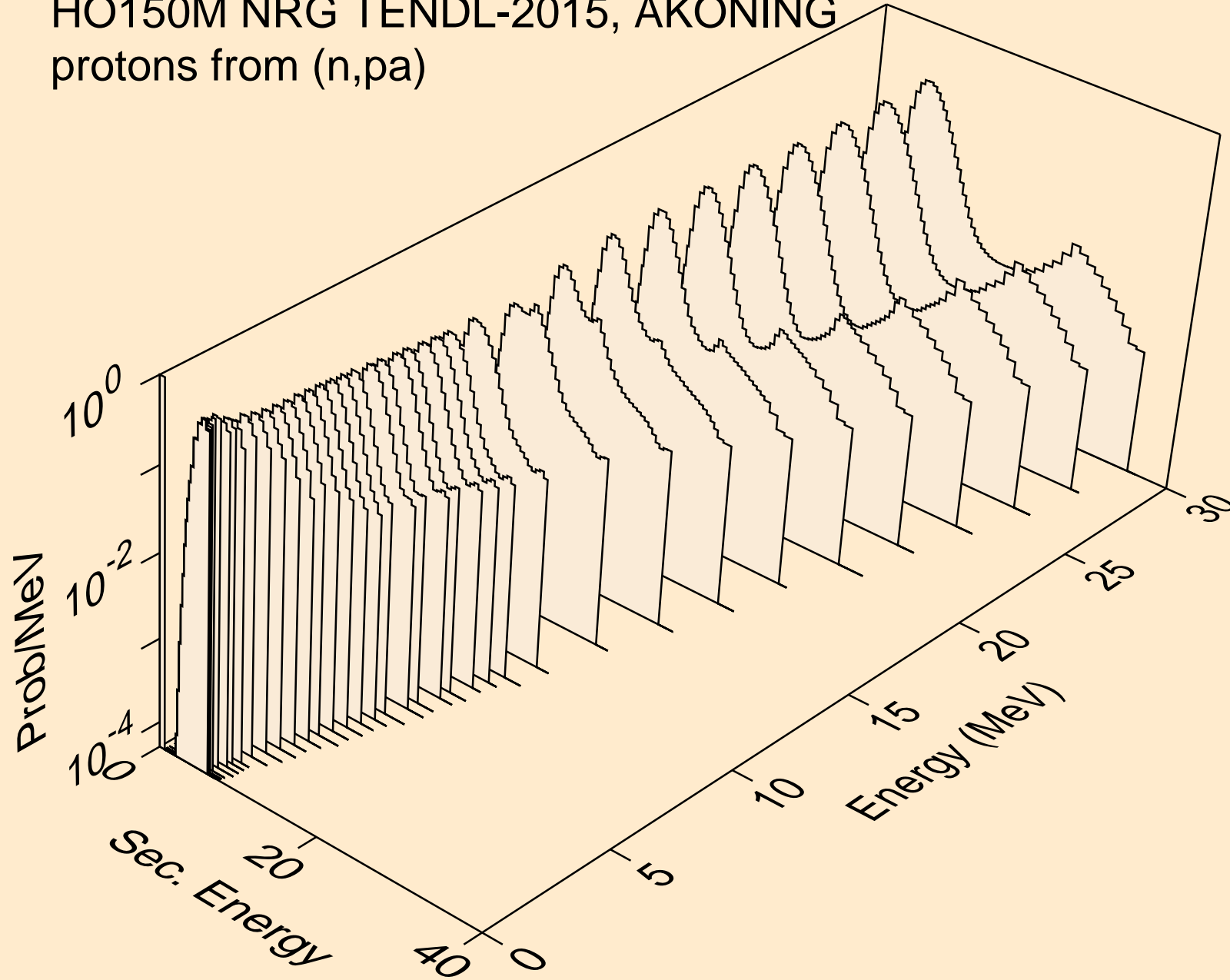

HO150M NRG TENDL-2015, AKONING
protons from (n,pd)

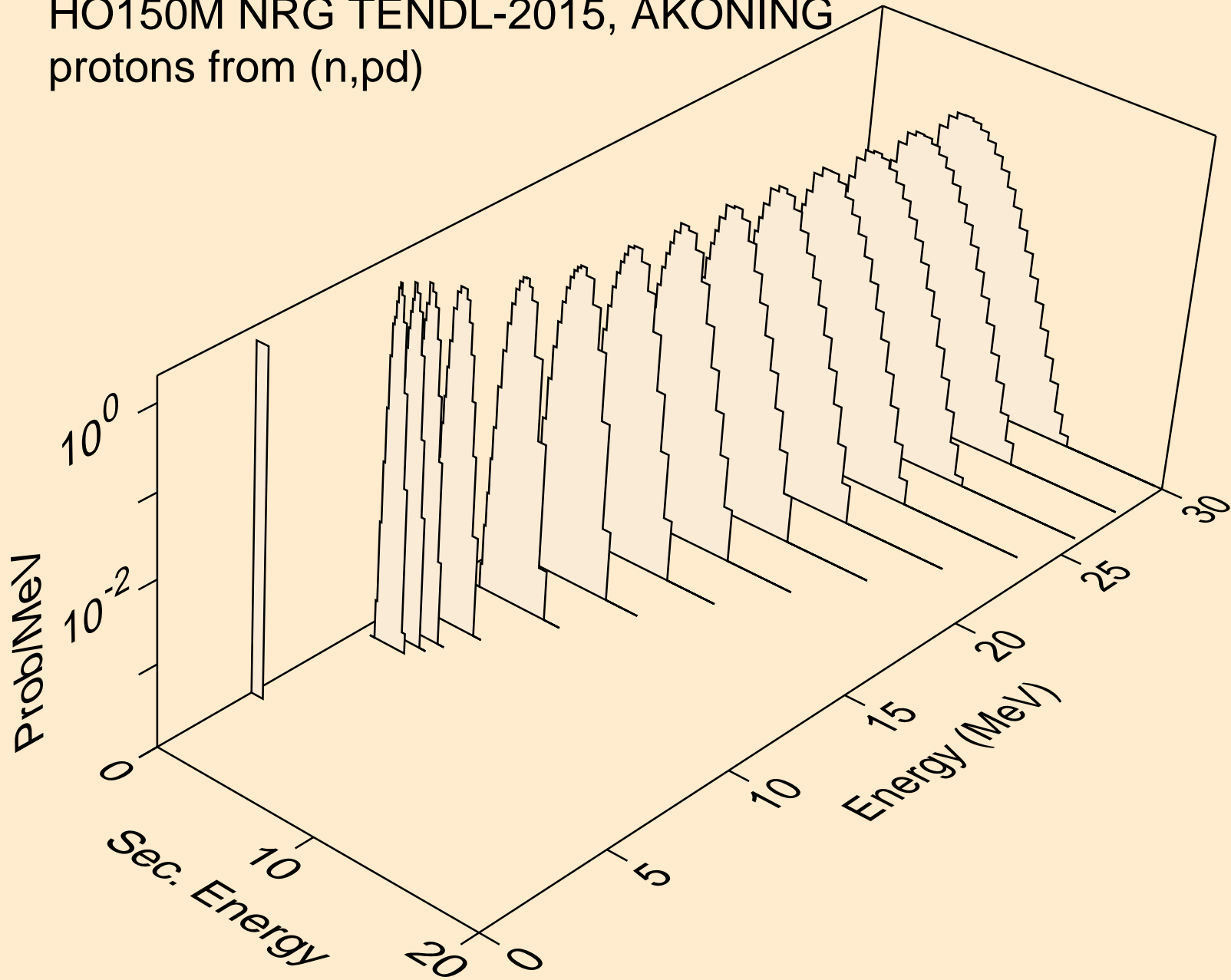

HO150M NRG TENDL-2015, AKONING
protons from (n,pt)

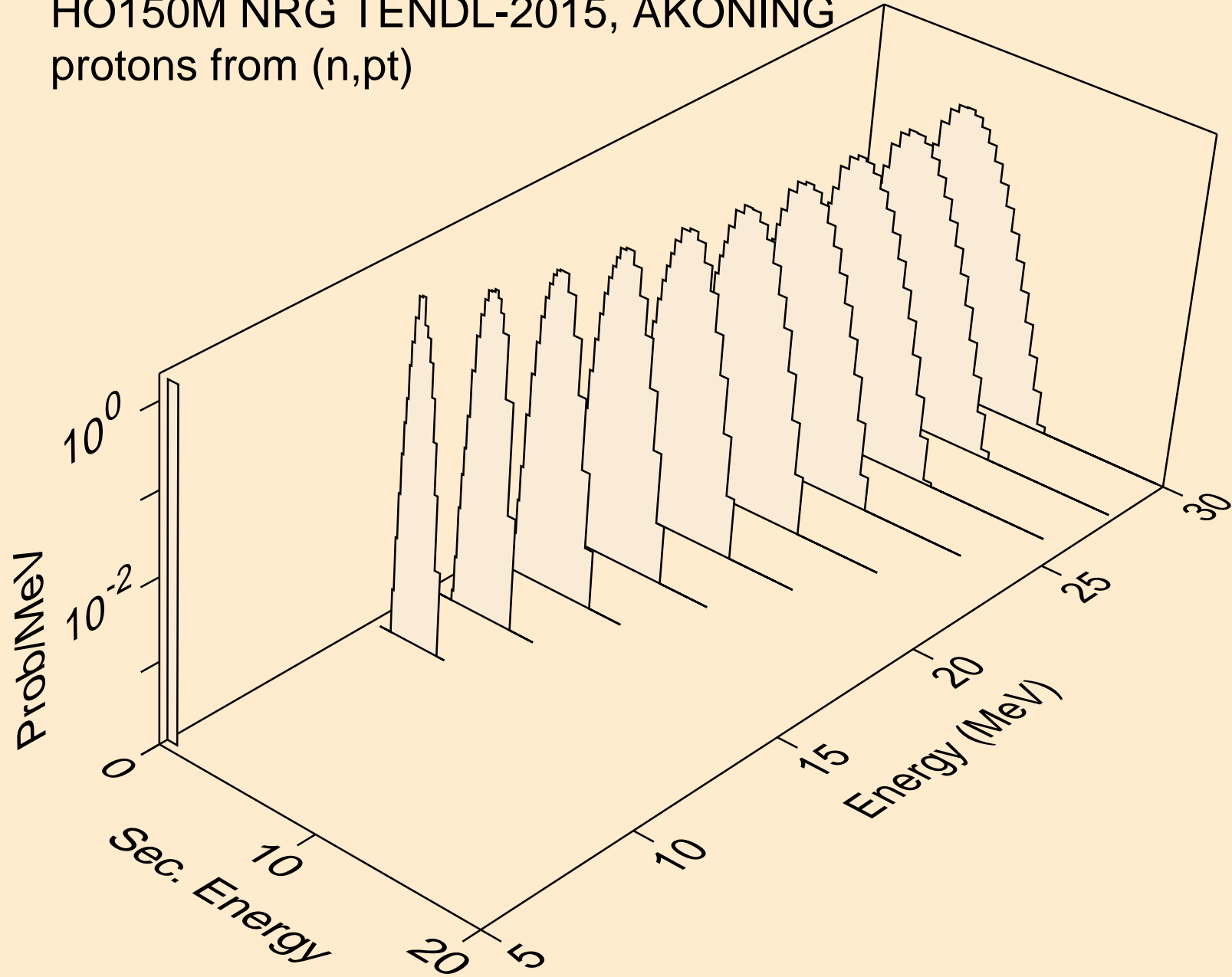

HO150M NRG TENDL-2015, AKONING
deuterons from (n,x)

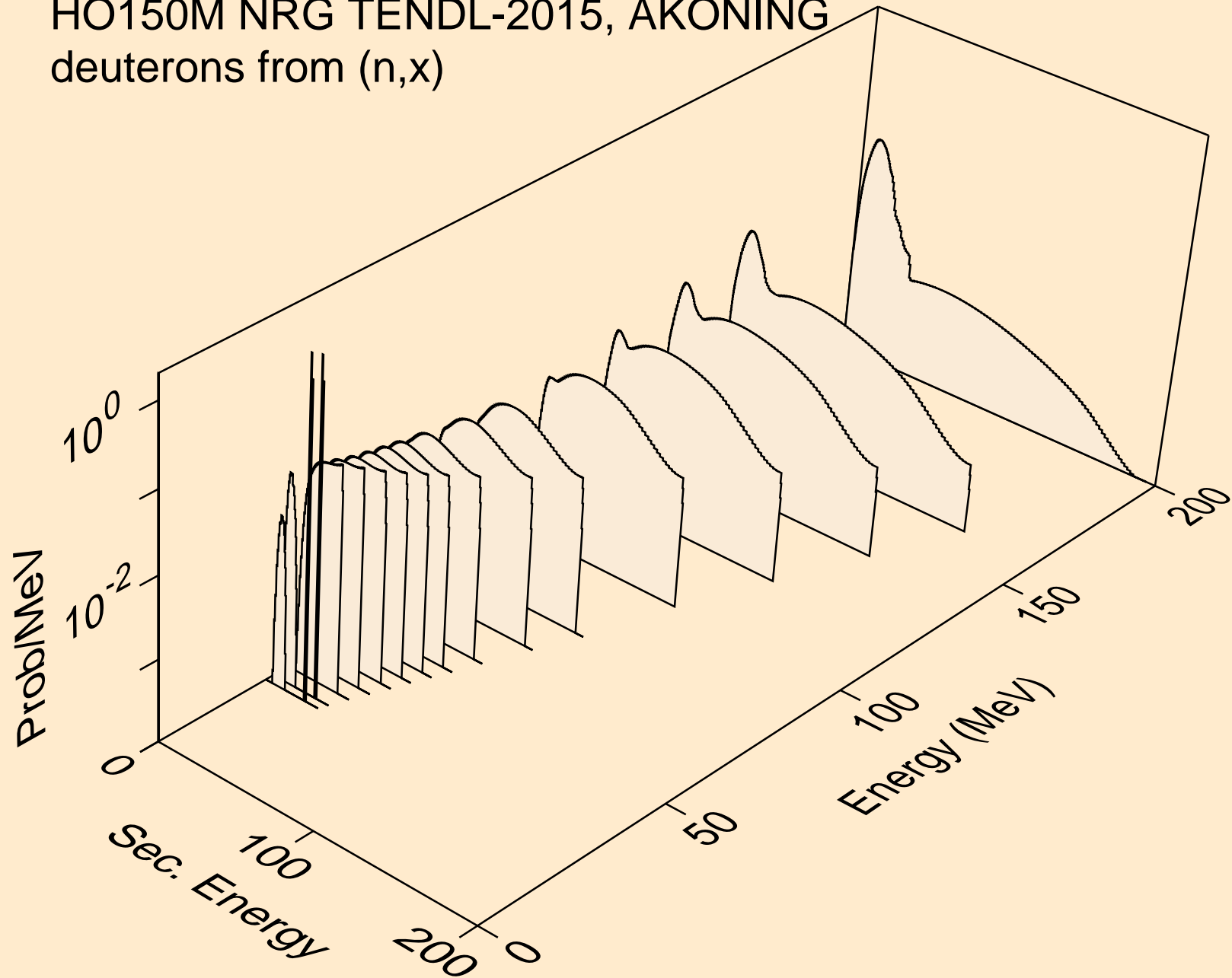

HO150M NRG TENDL-2015, AKONING
deuterons from (n,2nd)

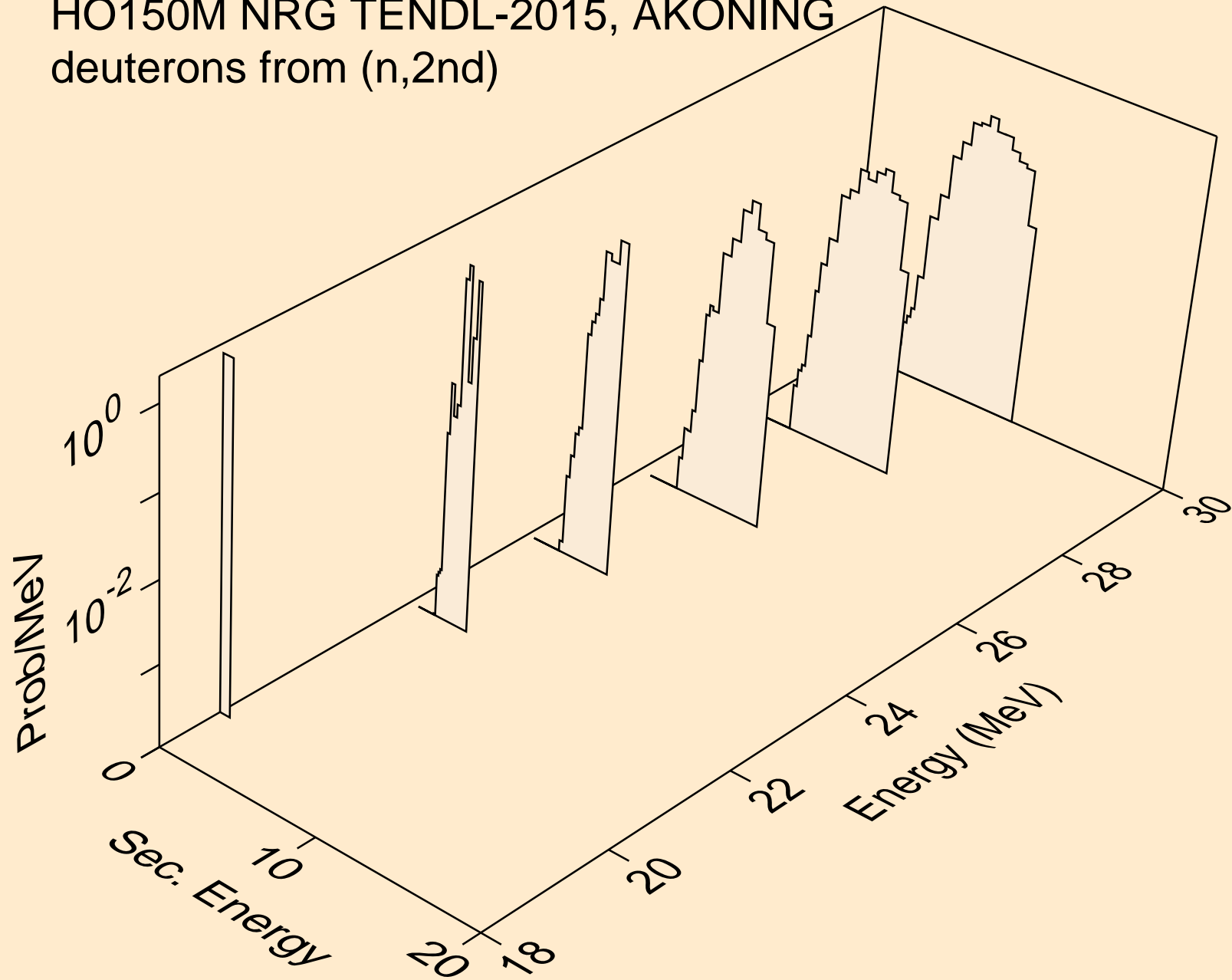

HO150M NRG TENDL-2015, AKONING
deuterons from (n,n*)d

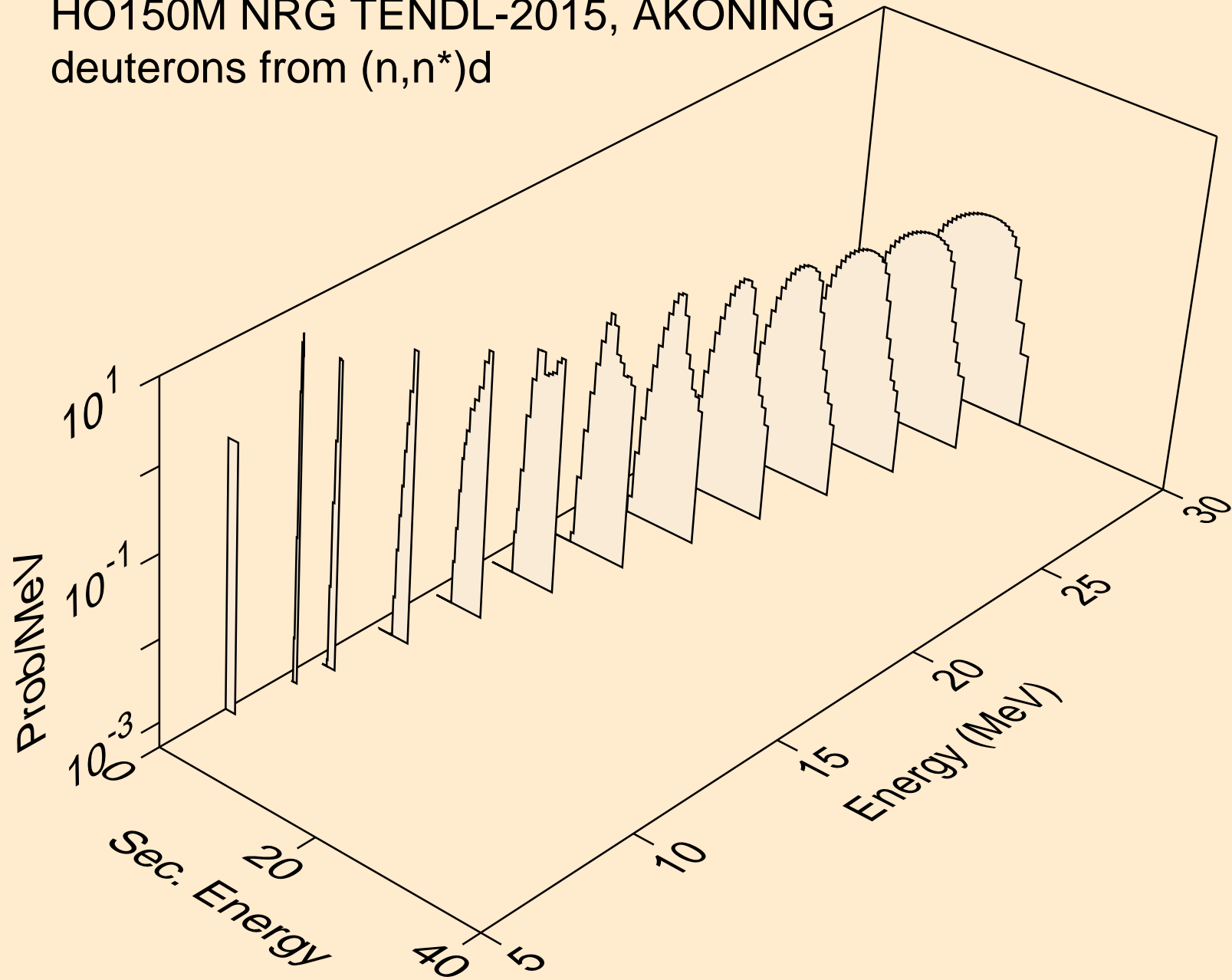

HO150M NRG TENDL-2015, AKONING
deuterons from (n,d)

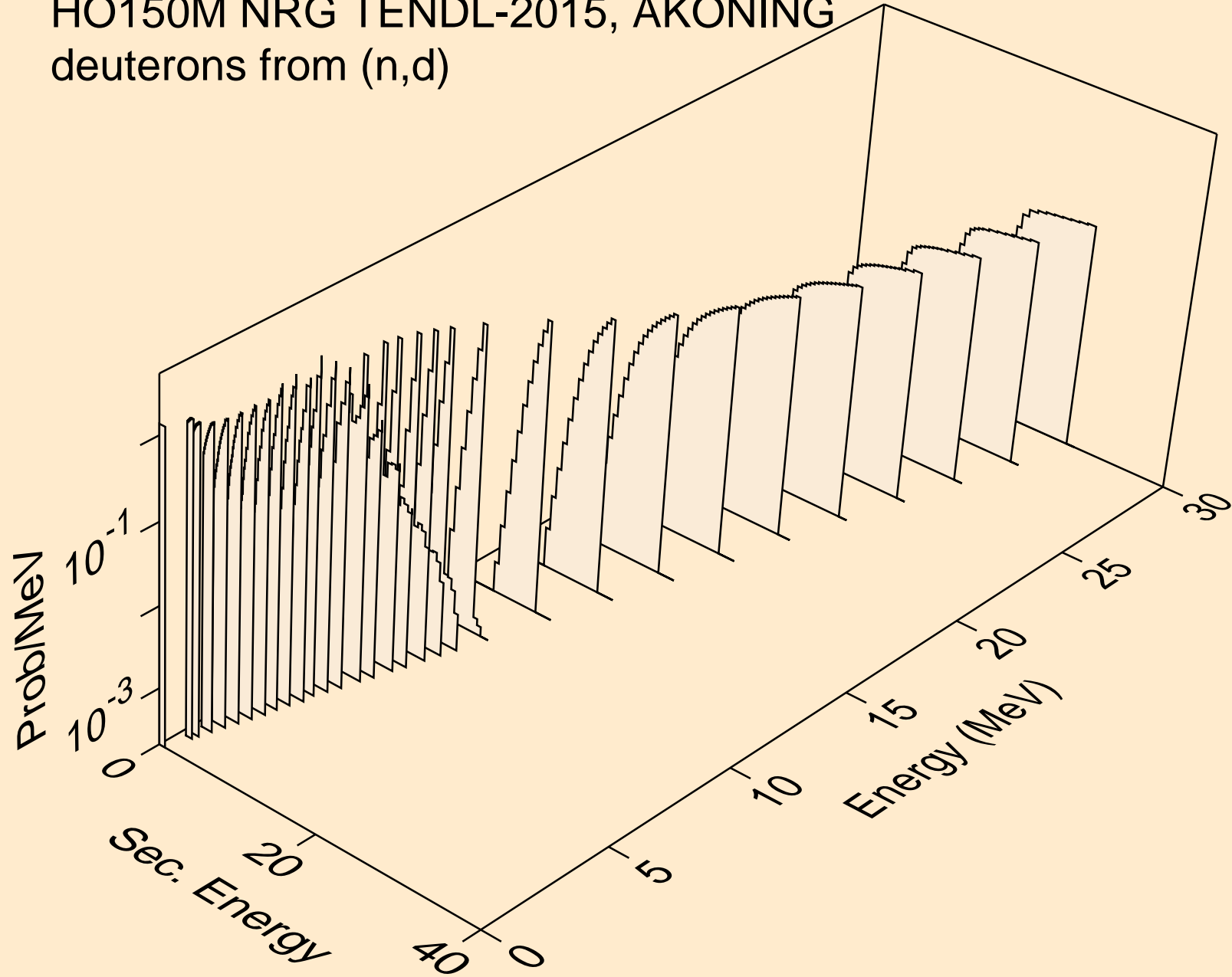

HO150M NRG TENDL-2015, AKONING
deuterons from (n,pd)

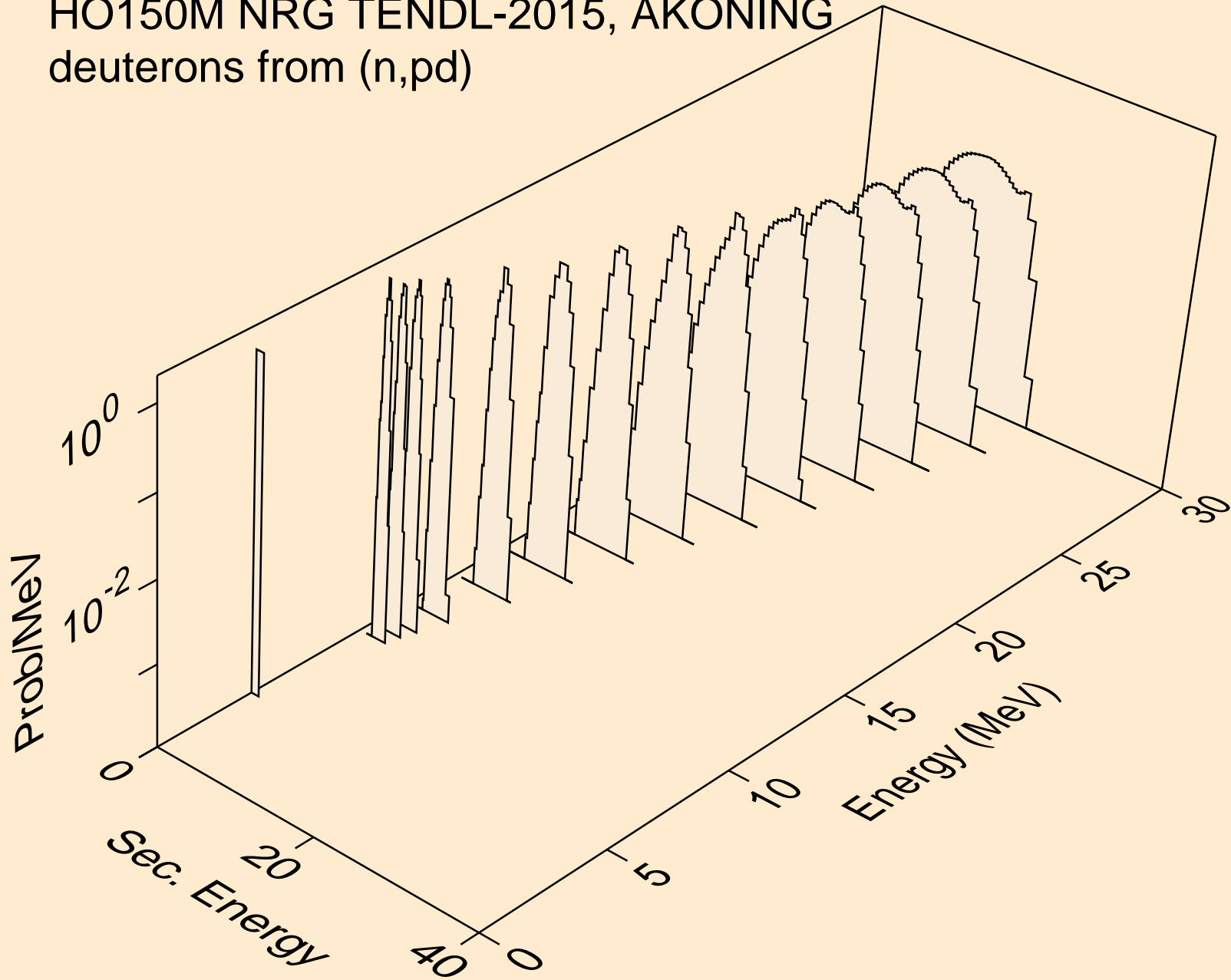

HO150M NRG TENDL-2015, AKONING
deuterons from (n,da)

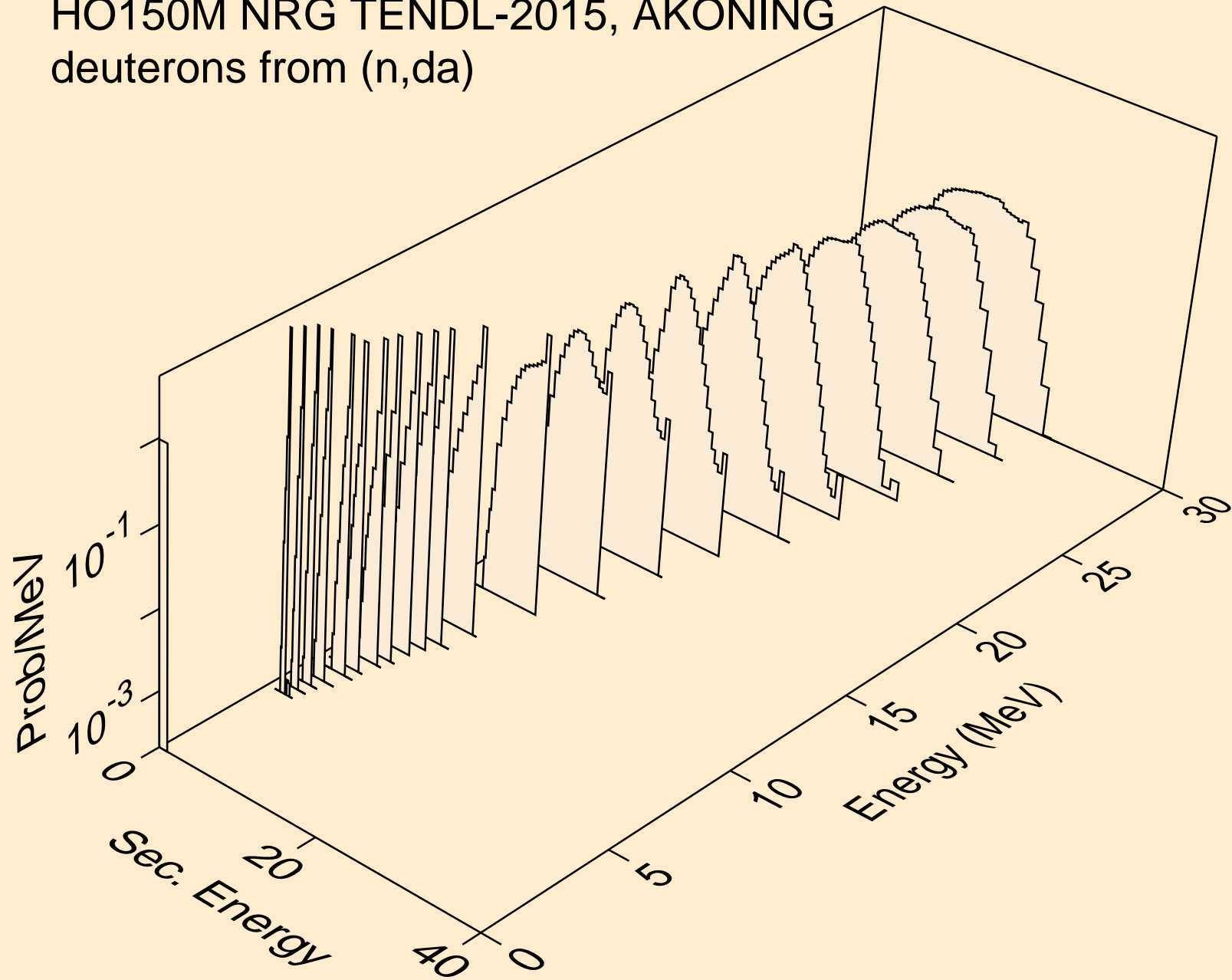

HO150M NRG TENDL-2015, AKONING
tritons from (n,x)

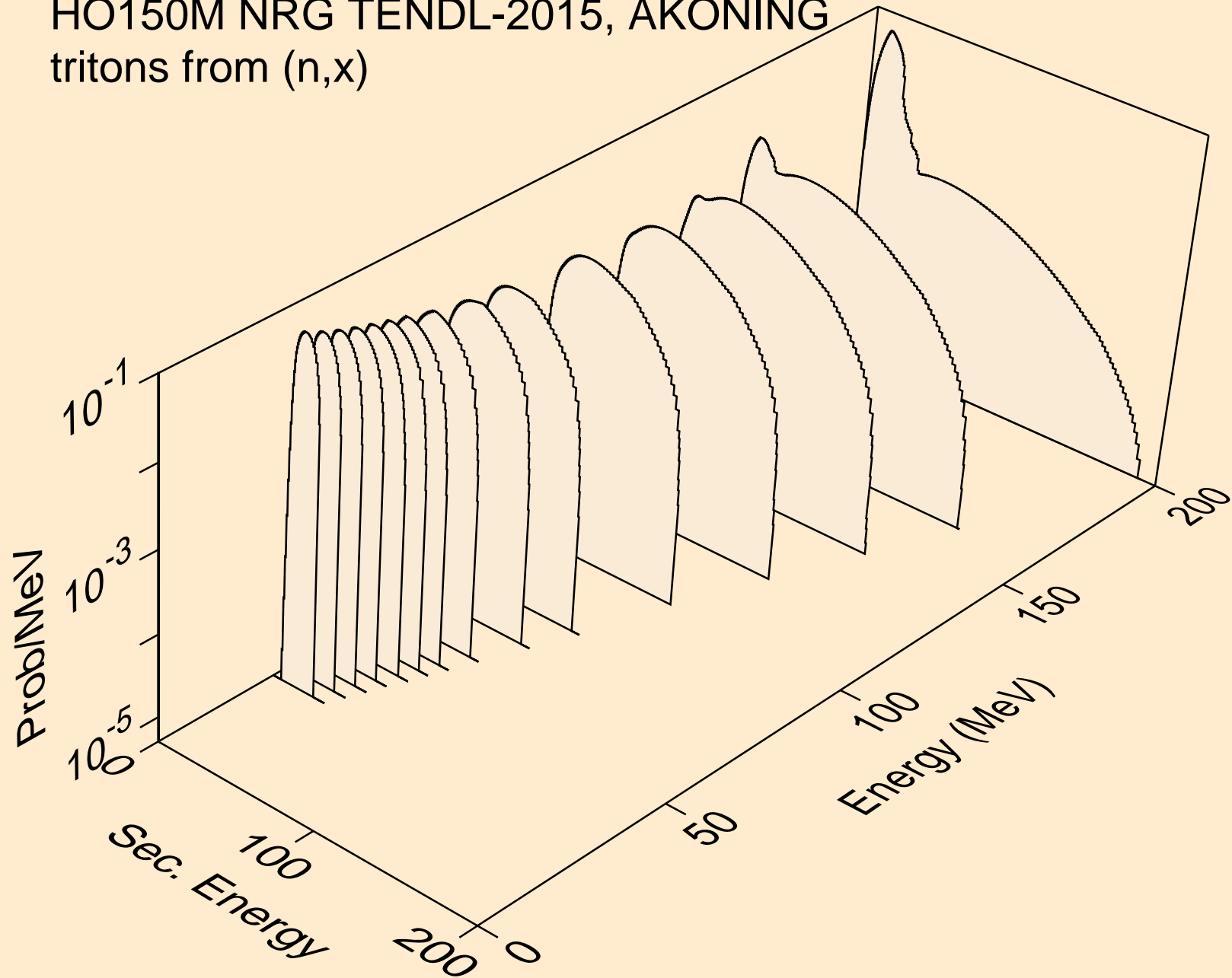

HO150M NRG TENDL-2015, AKONING
tritons from (n,n*)t

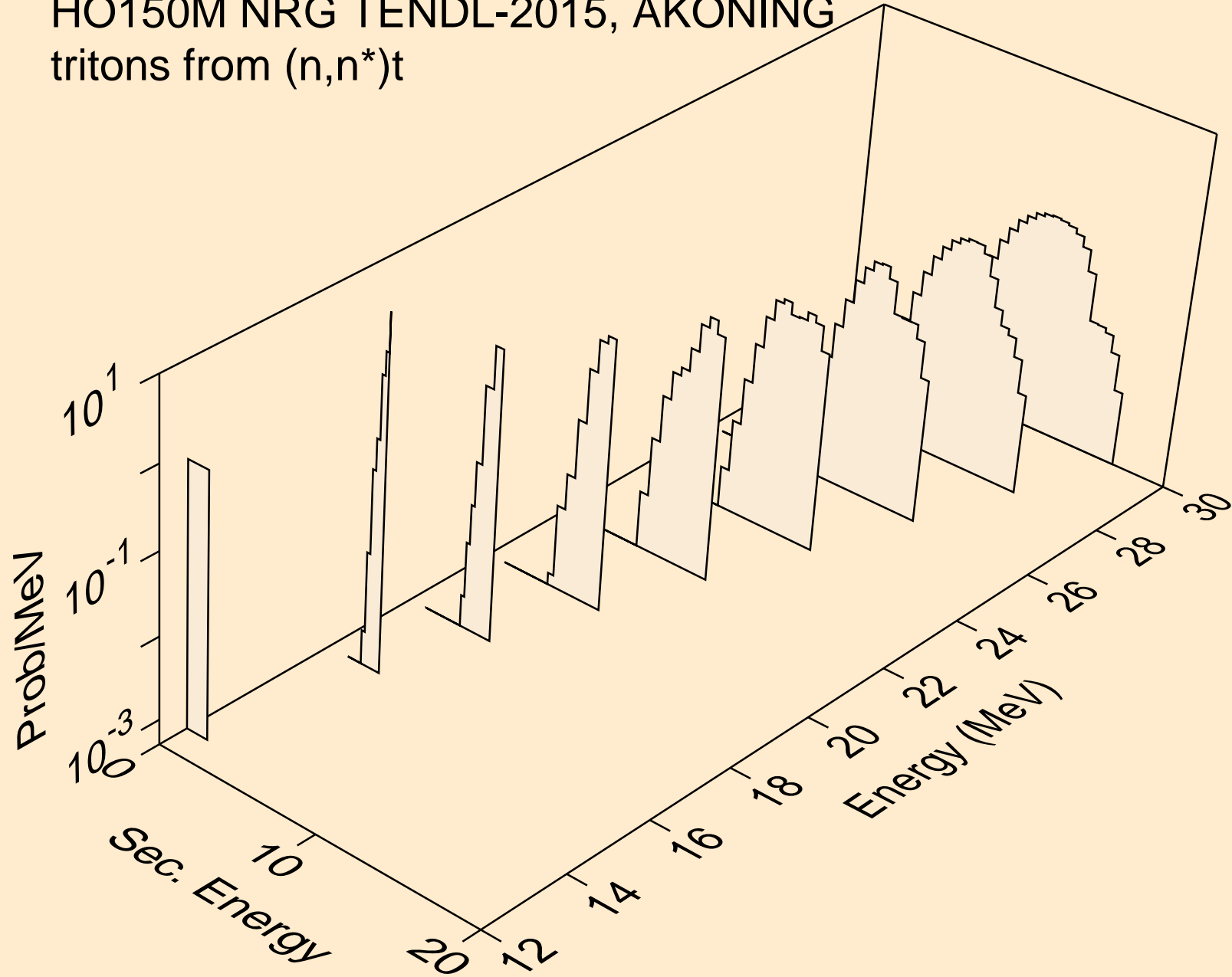

HO150M NRG TENDL-2015, AKONING
tritons from (n,t)

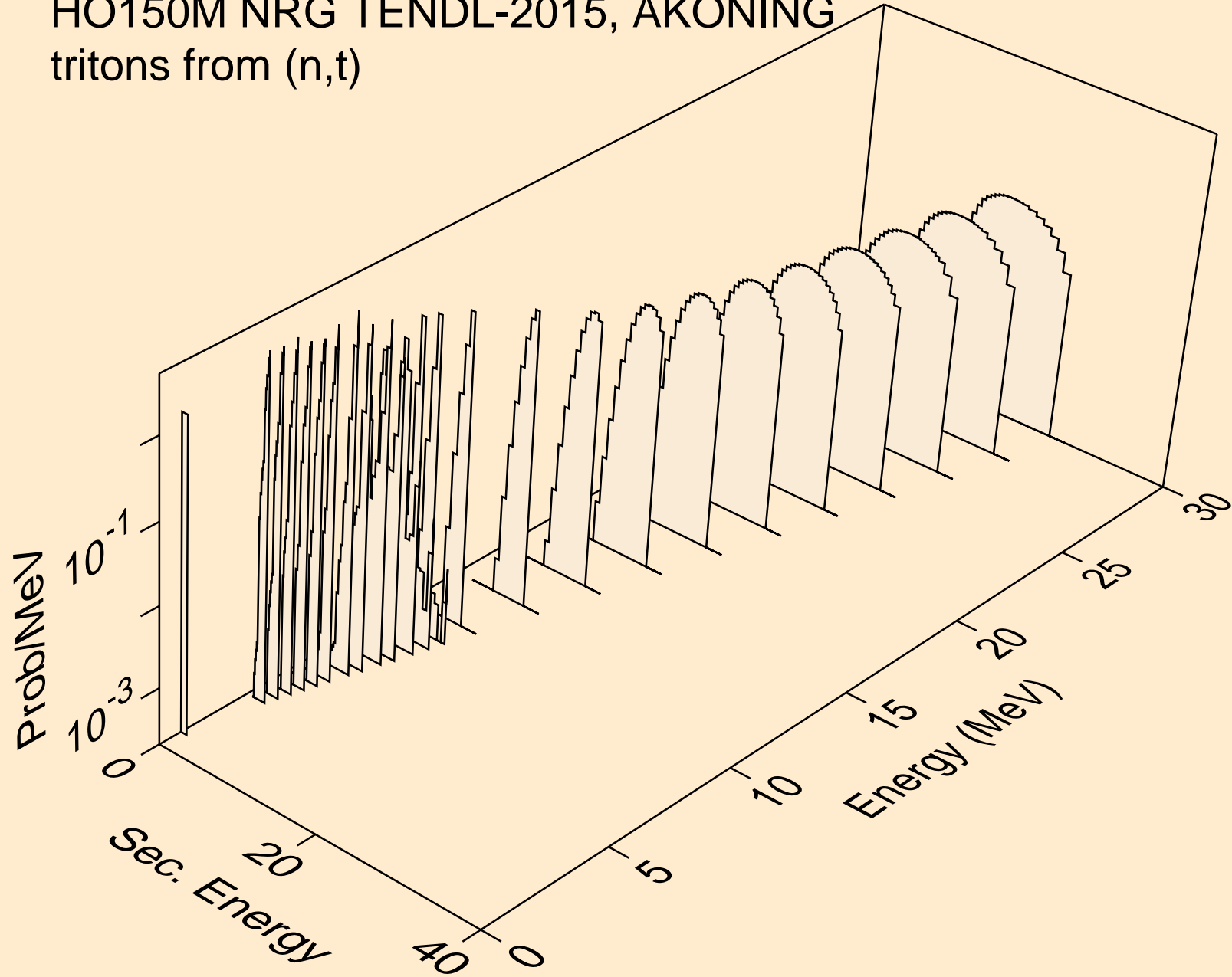

HO150M NRG TENDL-2015, AKONING
tritons from (n,pt)

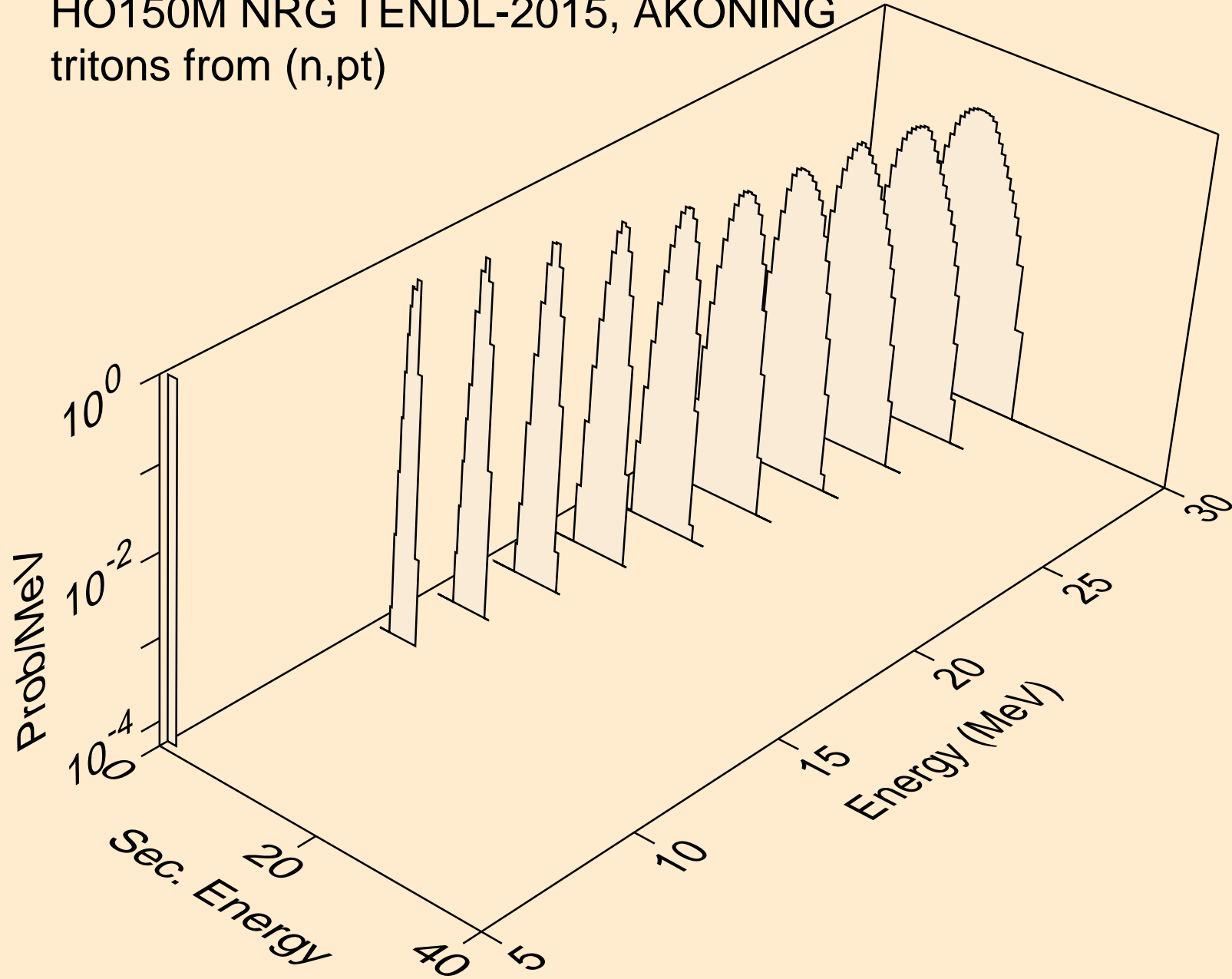

HO150M NRG TENDL-2015, AKONING
he3s from (n,x)

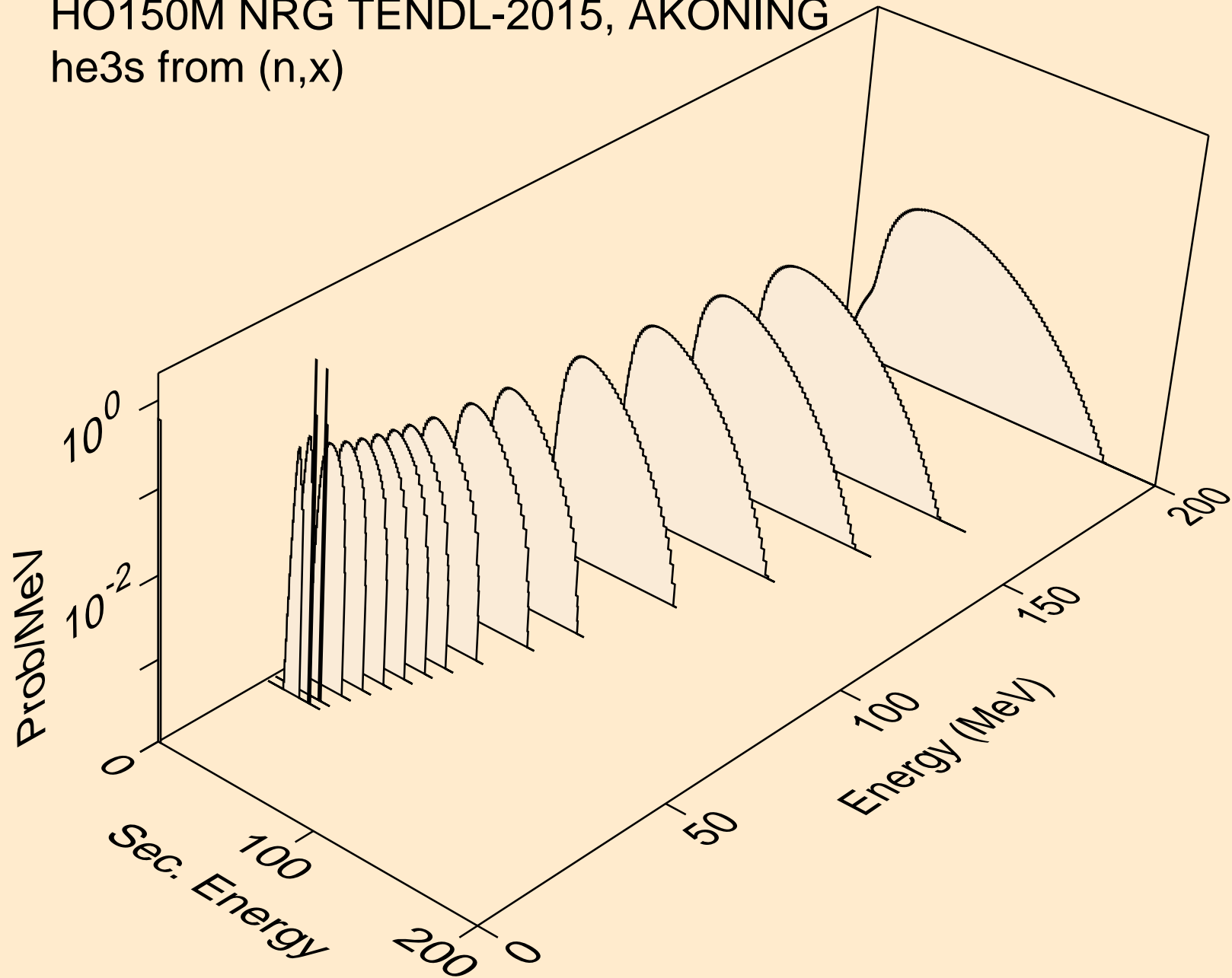

HO150M NRG TENDL-2015, AKONING
he3s from (n,n*)he3

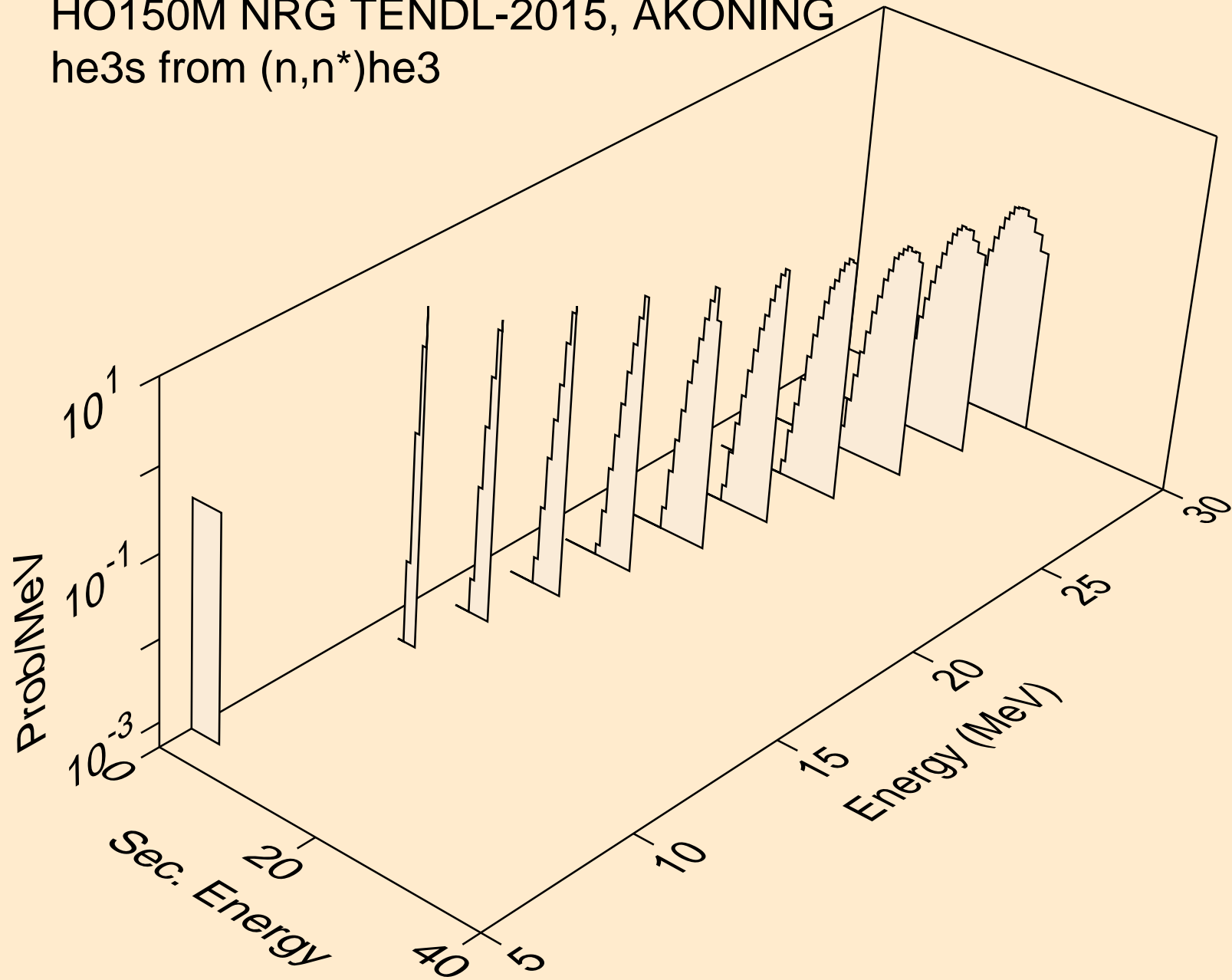

HO150M NRG TENDL-2015, AKONING
he3s from (n,he3)

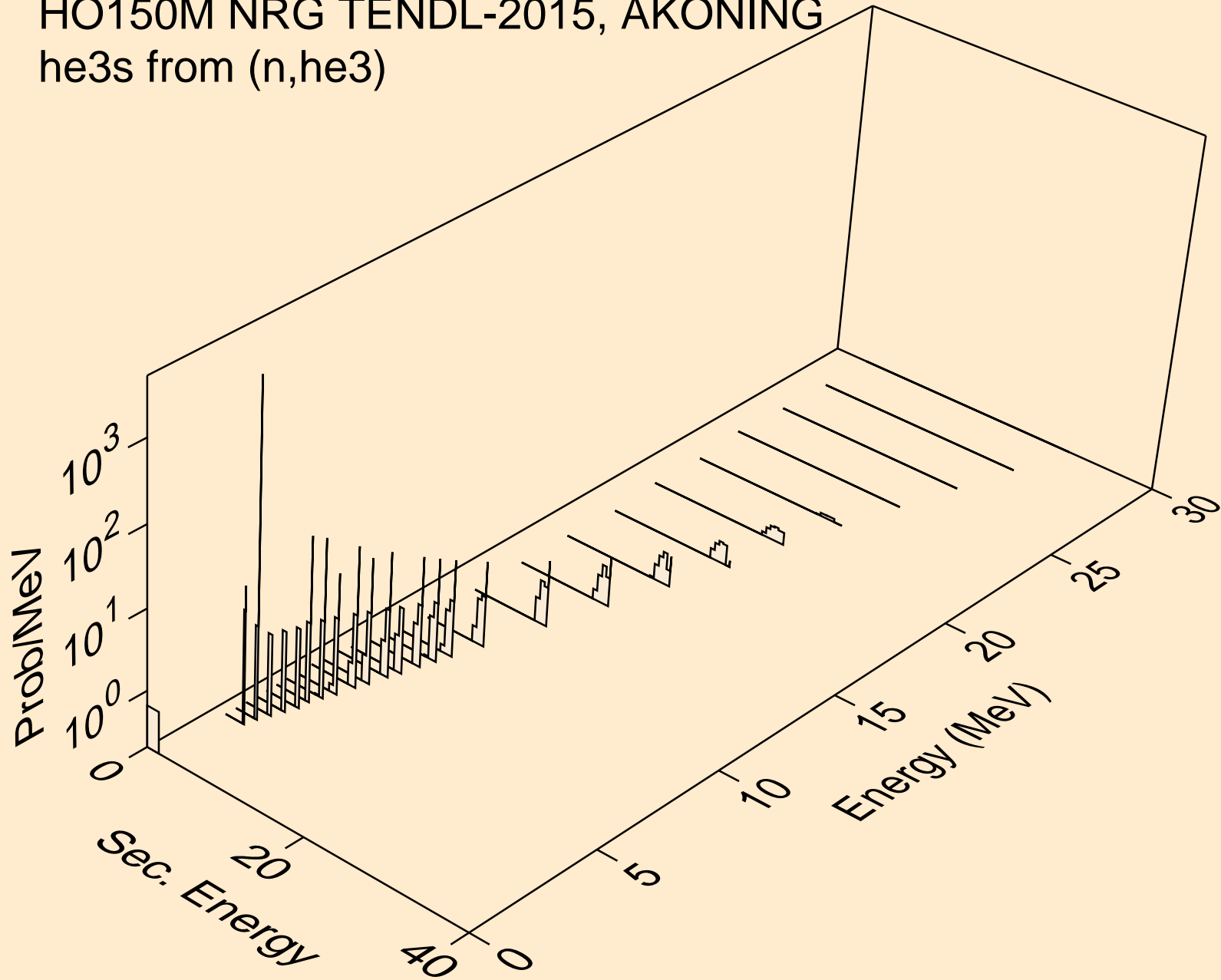

HO150M NRG TENDL-2015, AKONING
alphas from (n,x)

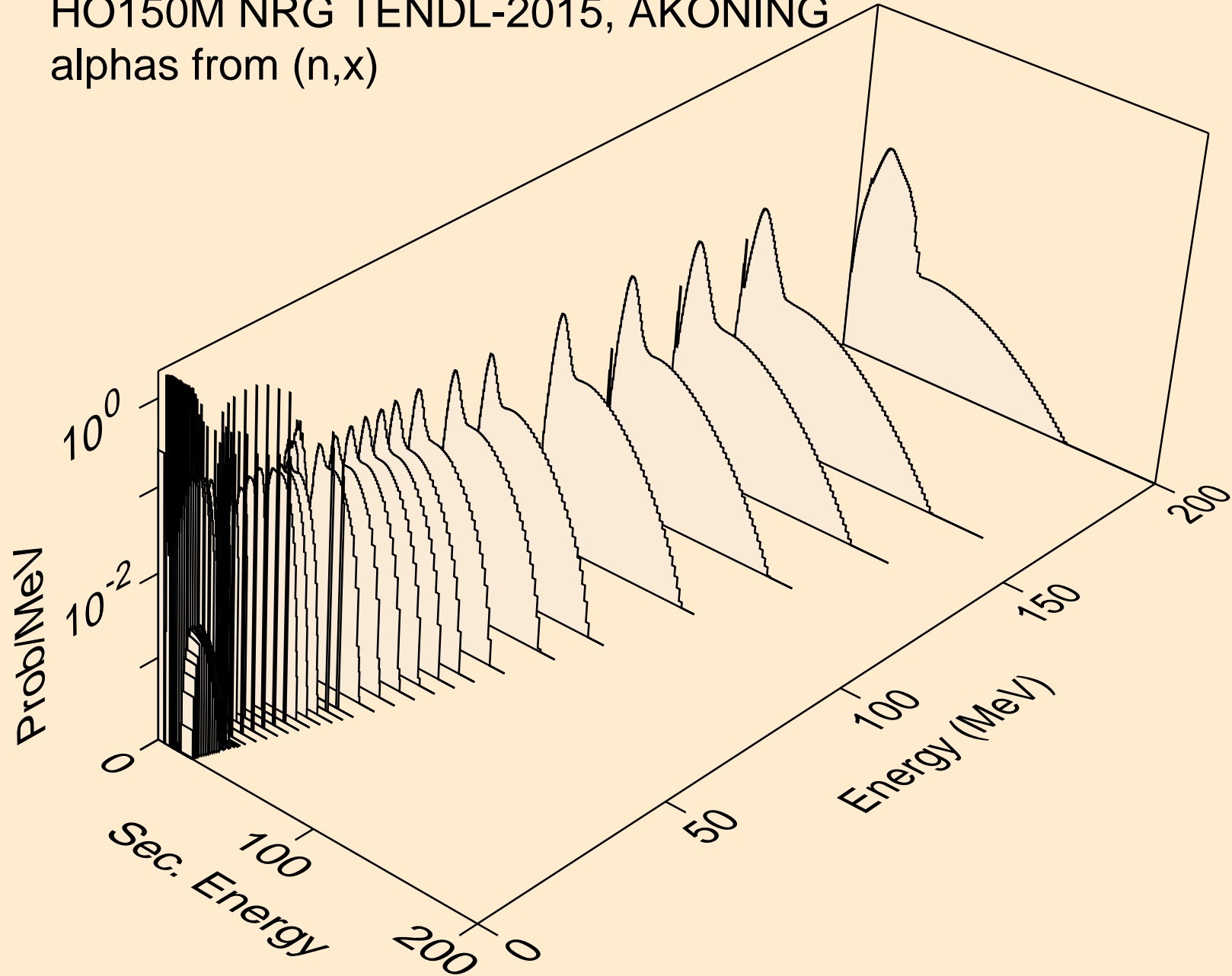

HO150M NRG TENDL-2015, AKONING
alphas from (n,n*)a

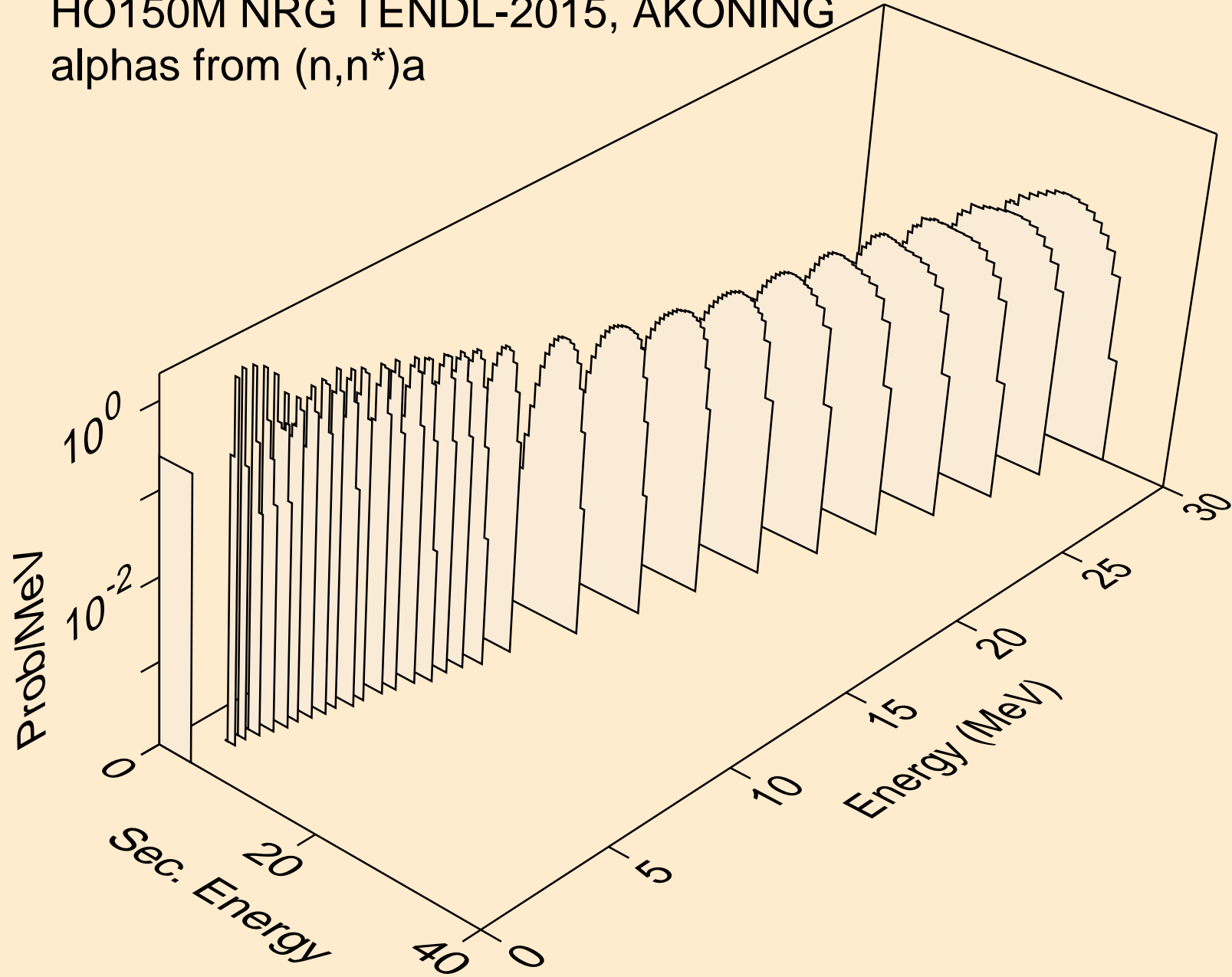

HO150M NRG TENDL-2015, AKONING
alphas from (n,2n)a

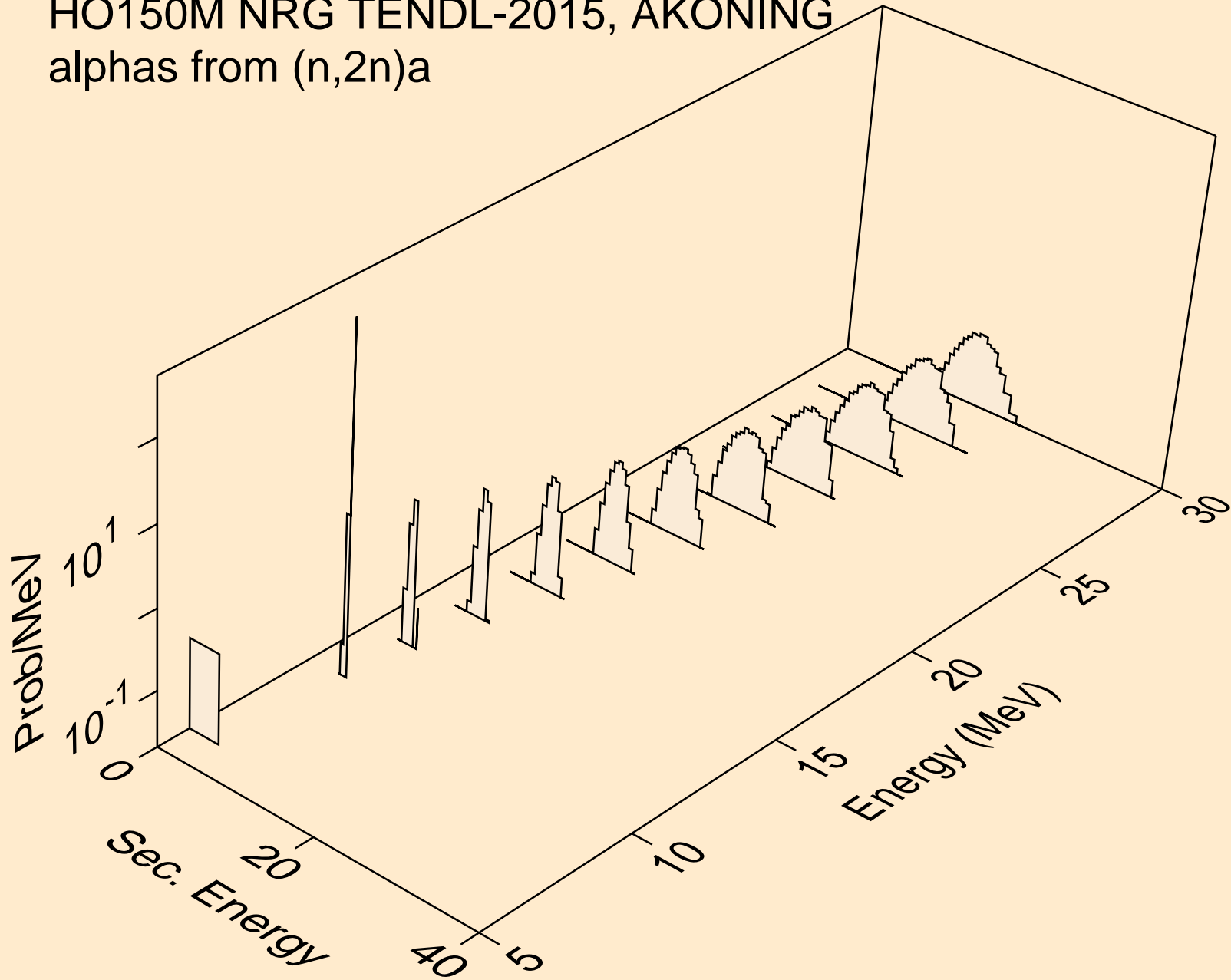

HO150M NRG TENDL-2015, AKONING
alphas from (n,3n)a

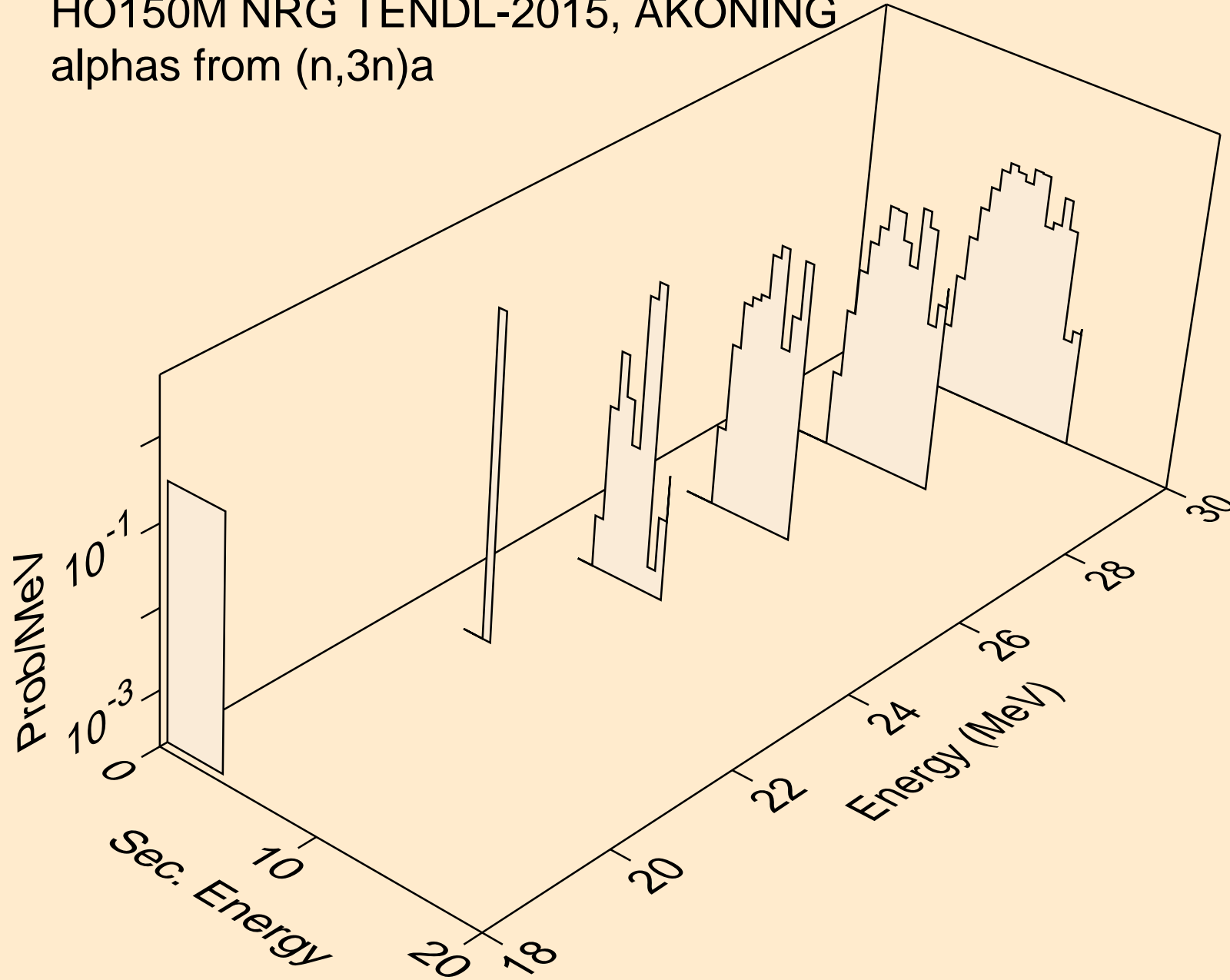

HO150M NRG TENDL-2015, AKONING
alphas from (n,n*)2a

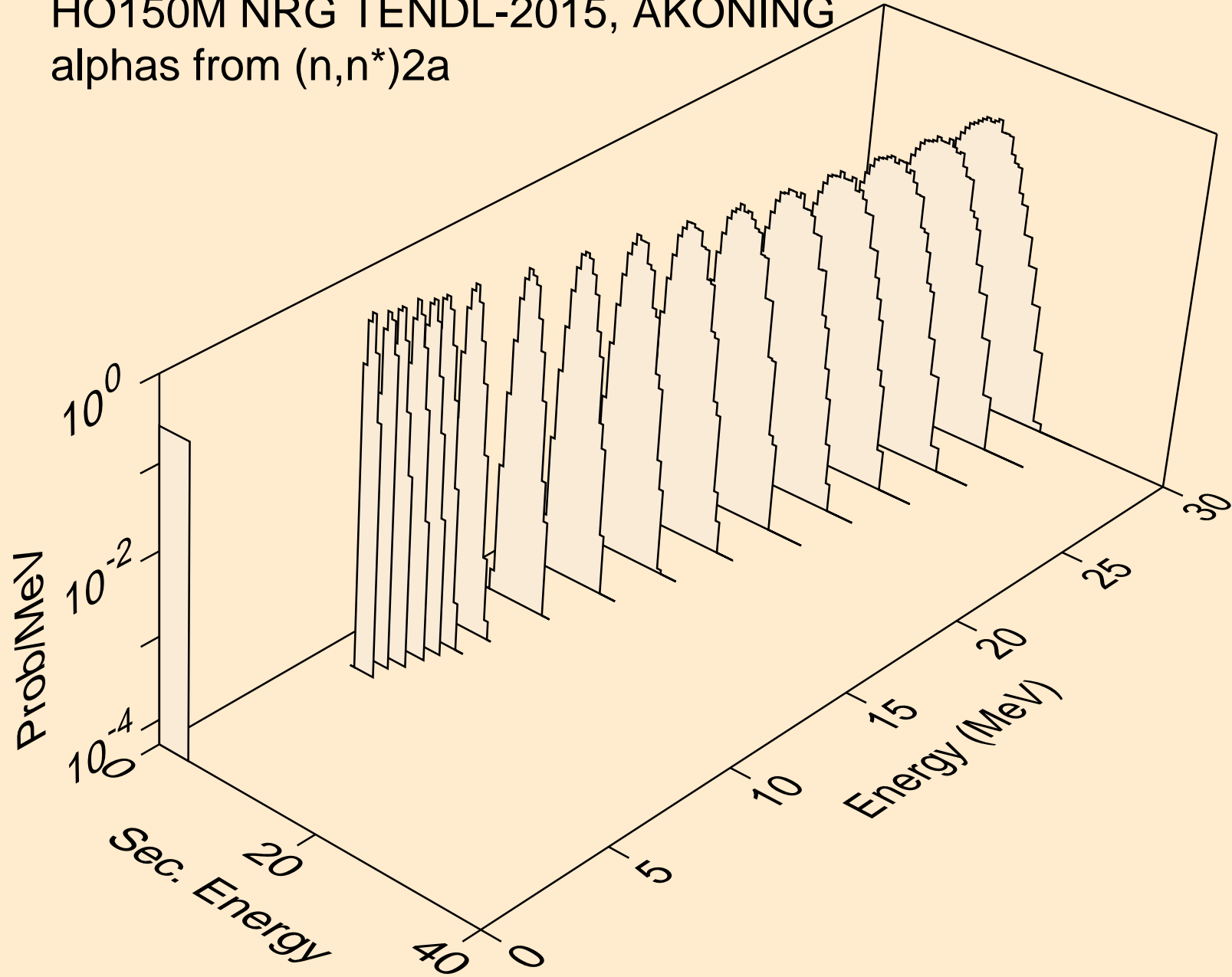

HO150M NRG TENDL-2015, AKONING
alphas from (n,2n)2a

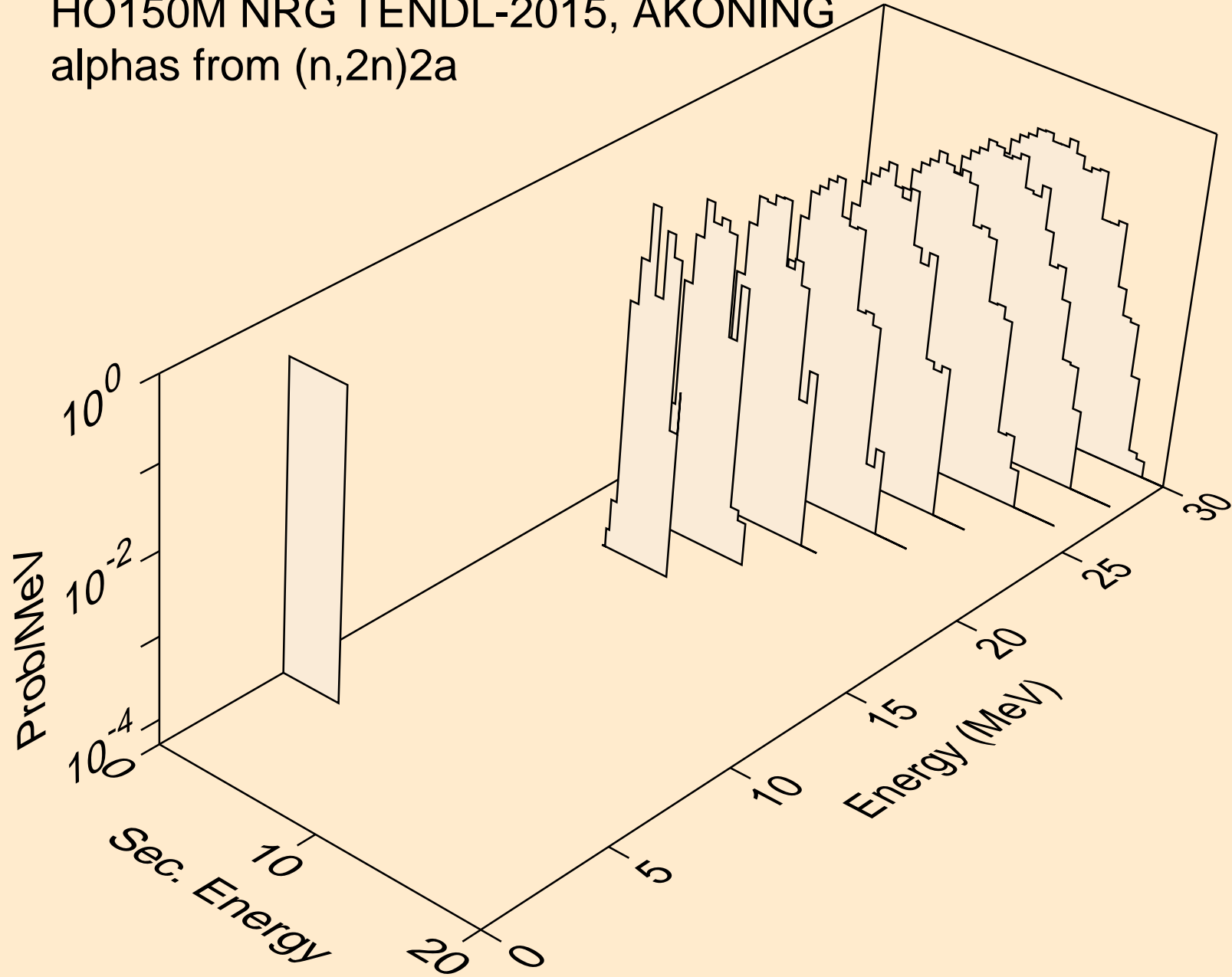

HO150M NRG TENDL-2015, AKONING
alphas from (n,npa)

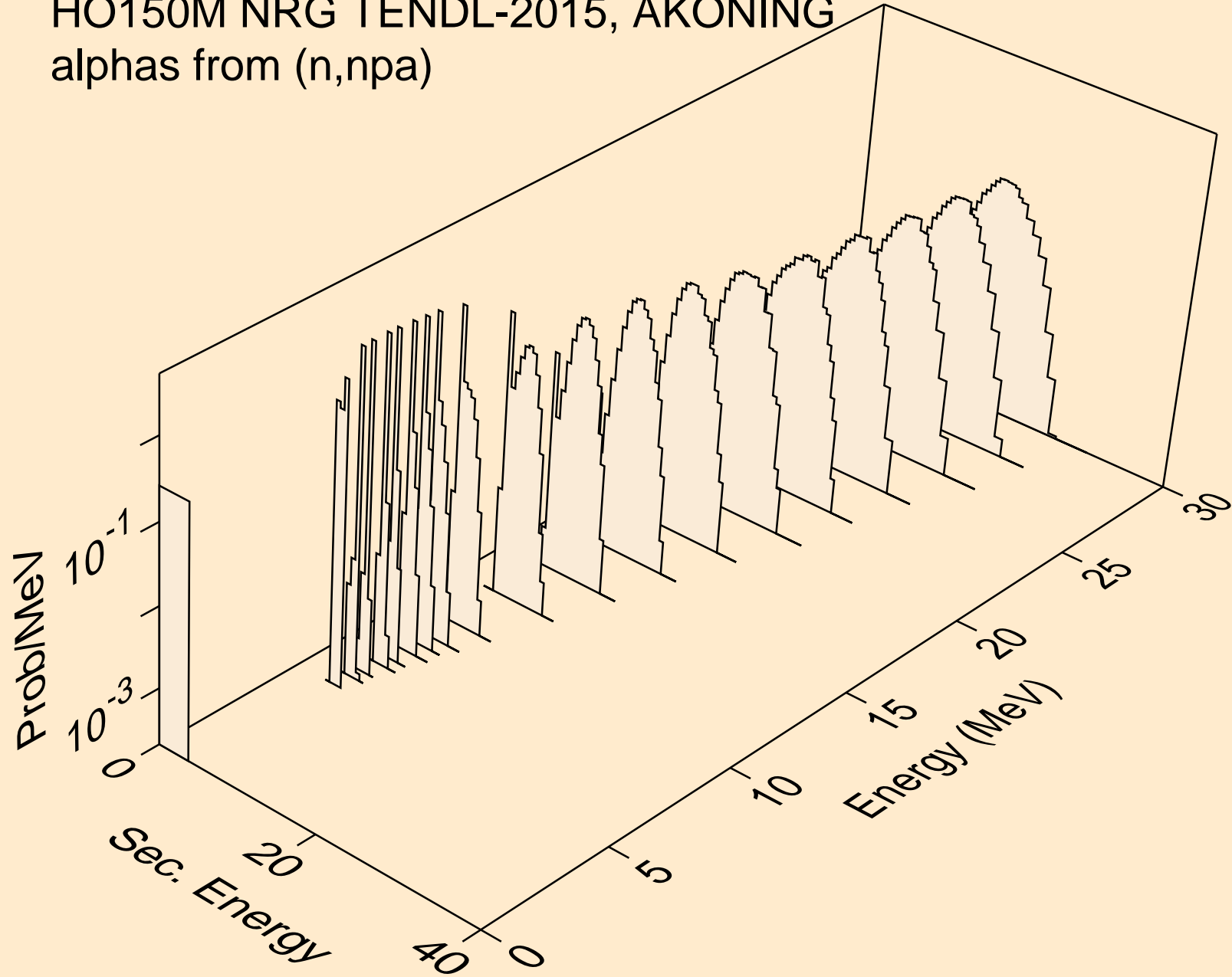

HO150M NRG TENDL-2015, AKONING
alphas from (n,a)

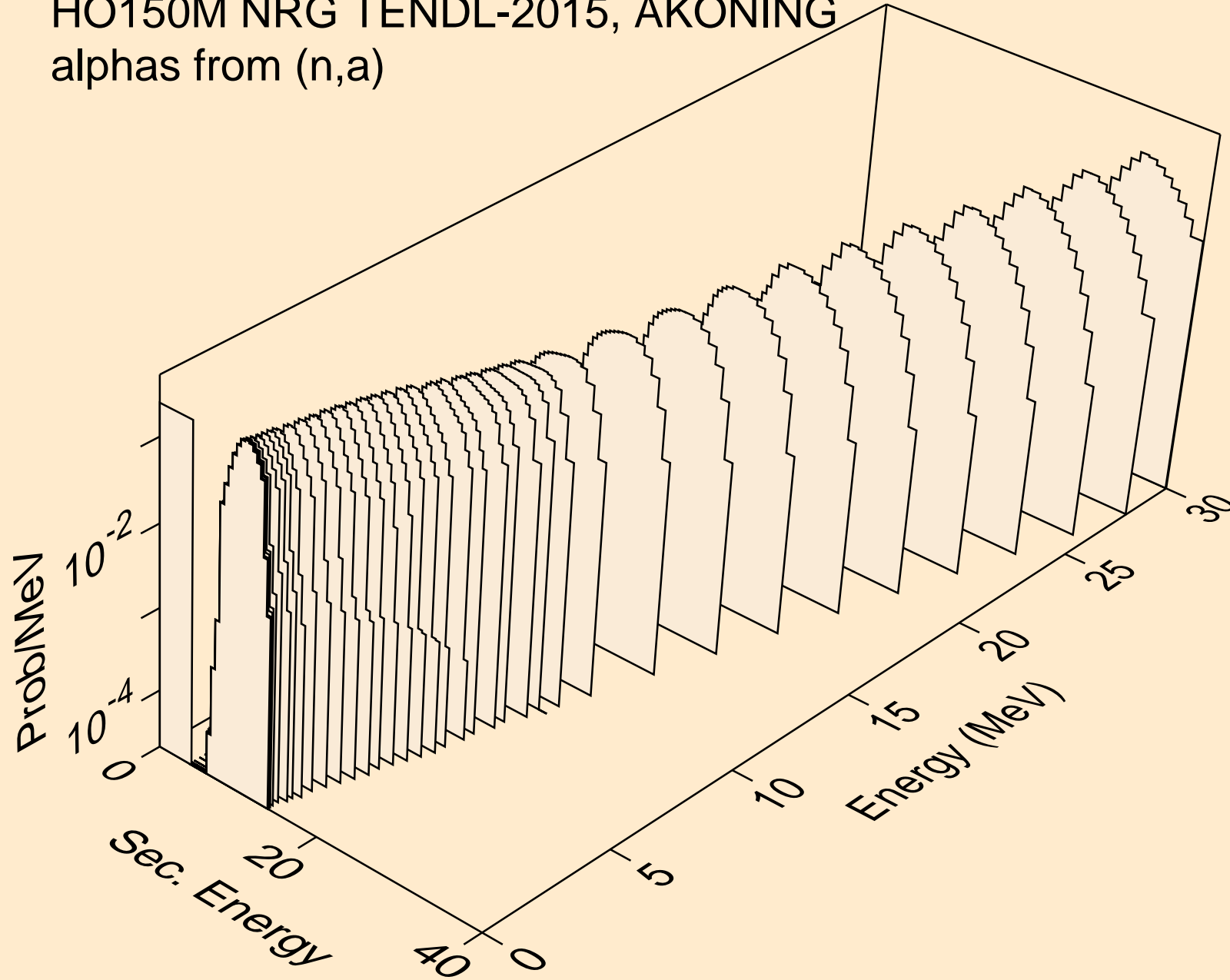

HO150M NRG TENDL-2015, AKONING
alphas from (n,2a)

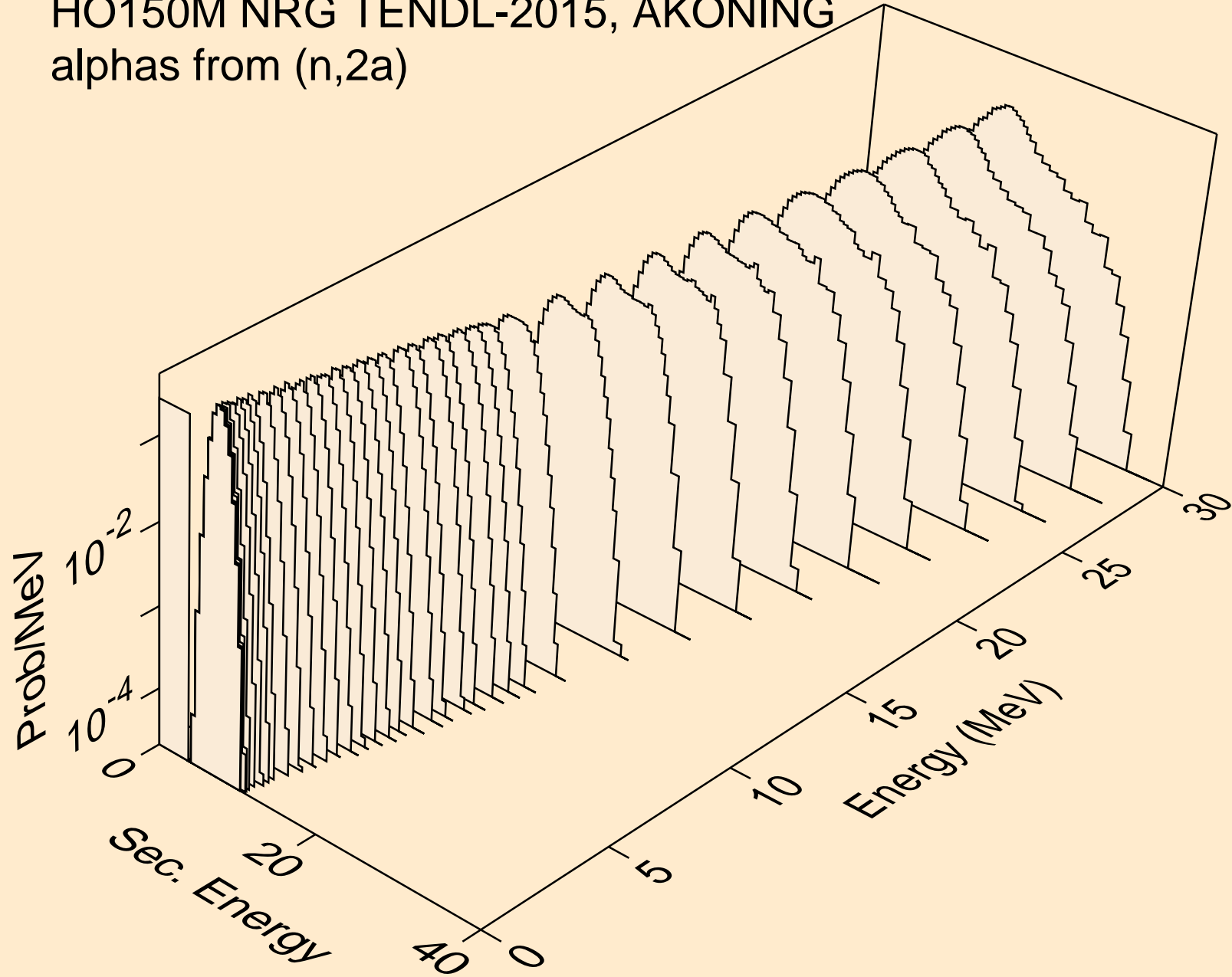

HO150M NRG TENDL-2015, AKONING
alphas from (n,3a)

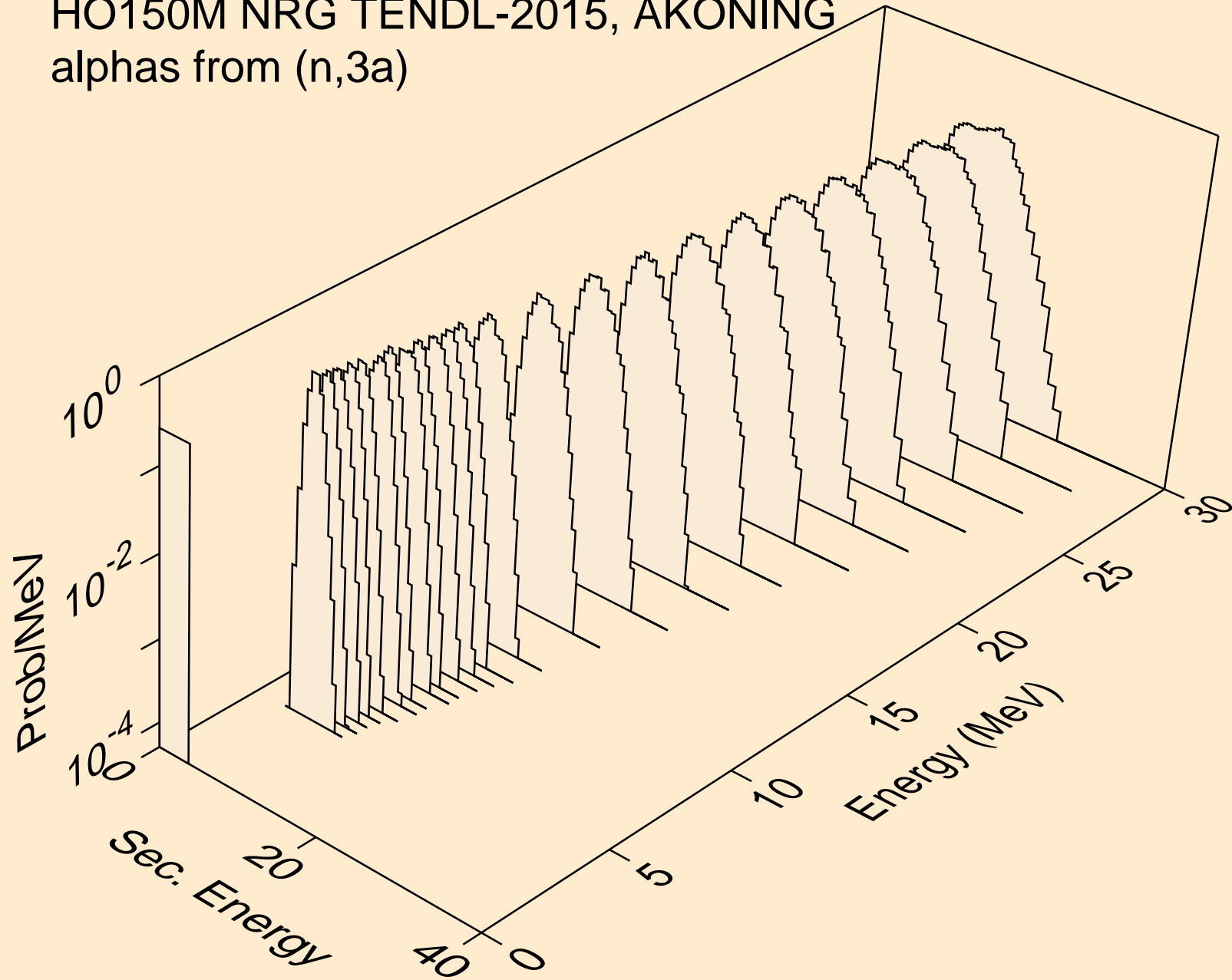

HO150M NRG TENDL-2015, AKONING
alphas from (n,pa)

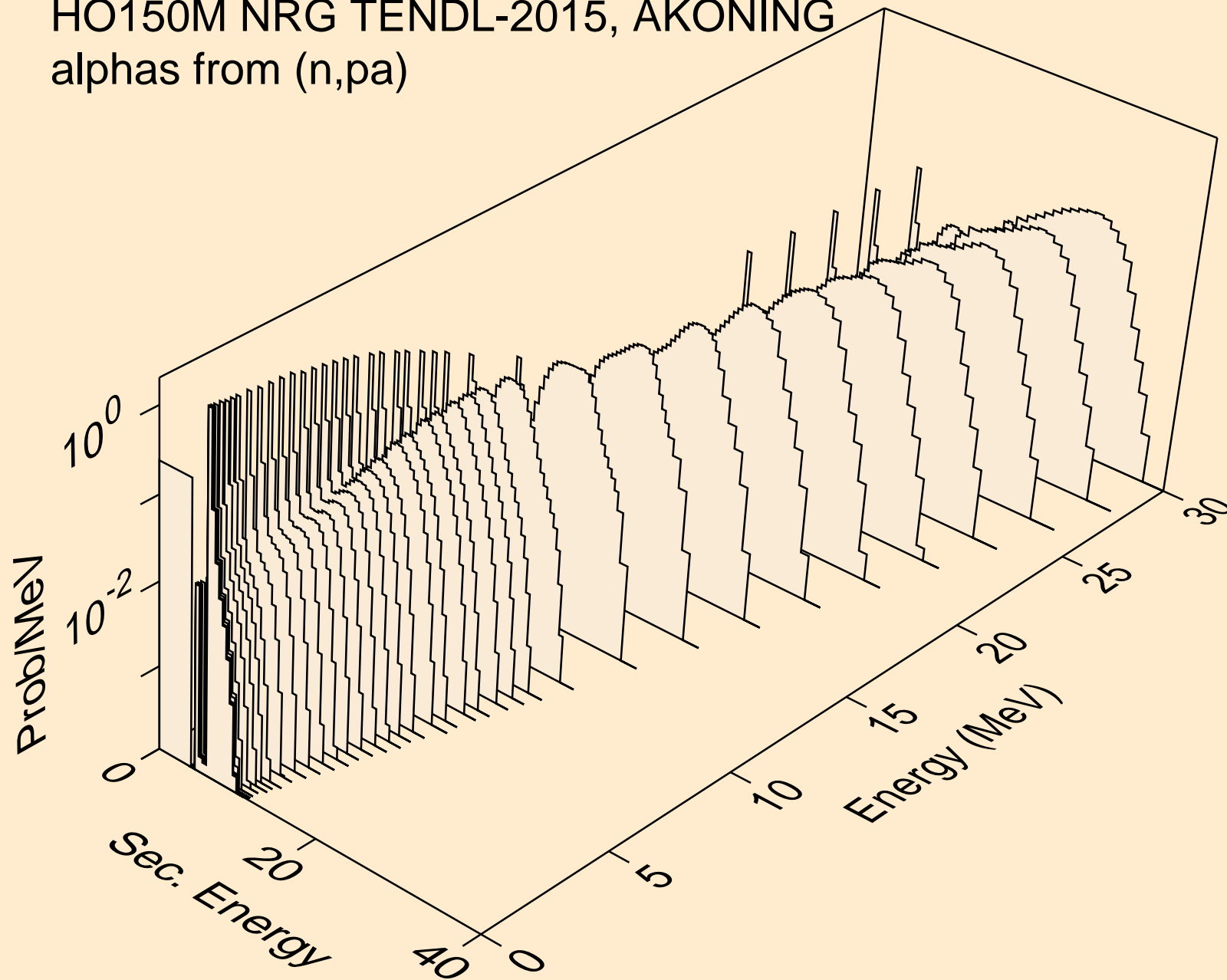

HO150M NRG TENDL-2015, AKONING
alphas from (n,da)

