

# HS268 NRG TENDL-2015, AKONING

## Principal cross sections

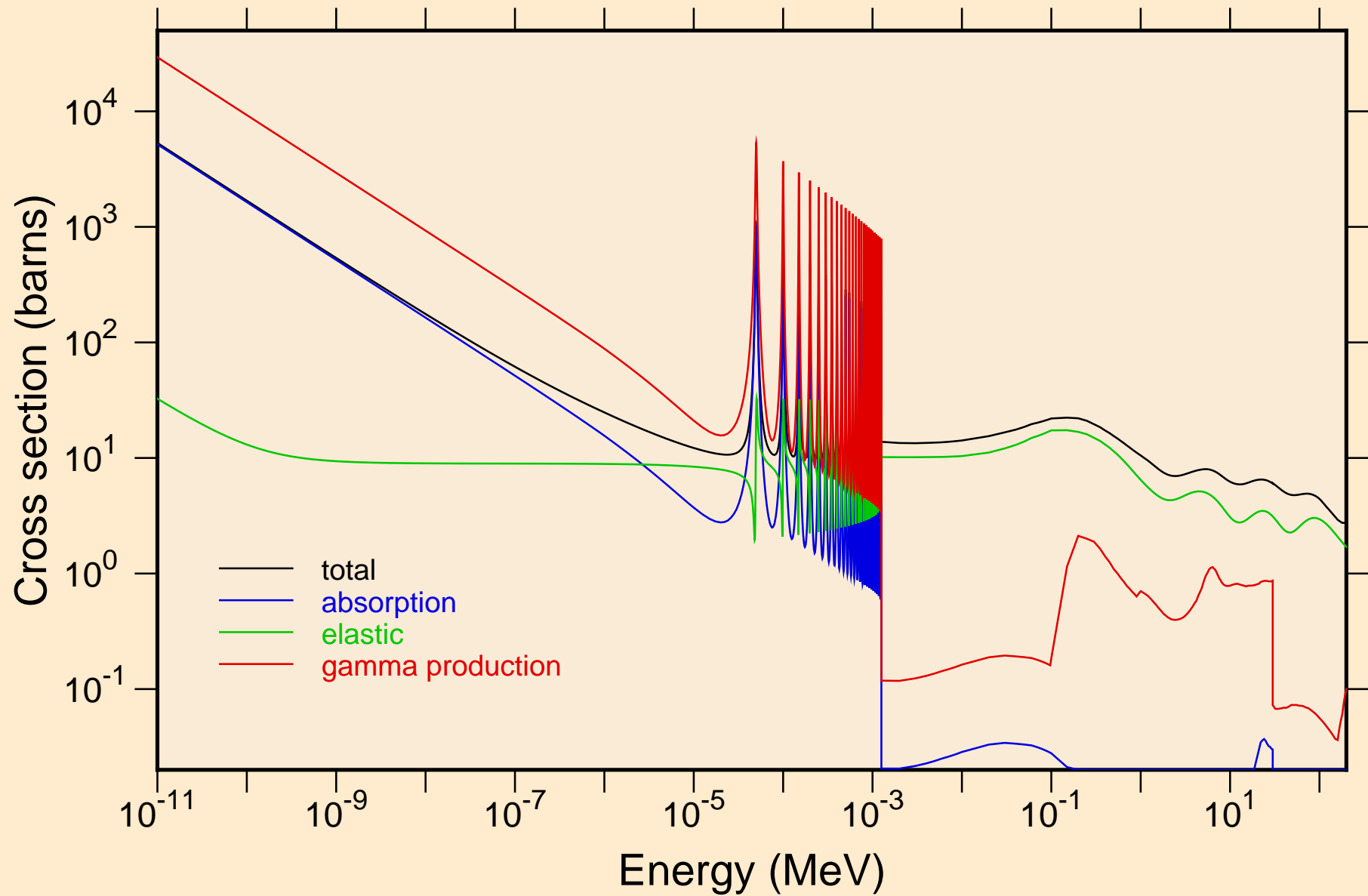

HS268 NRG TENDL-2015, AKONING  
resonance total cross section

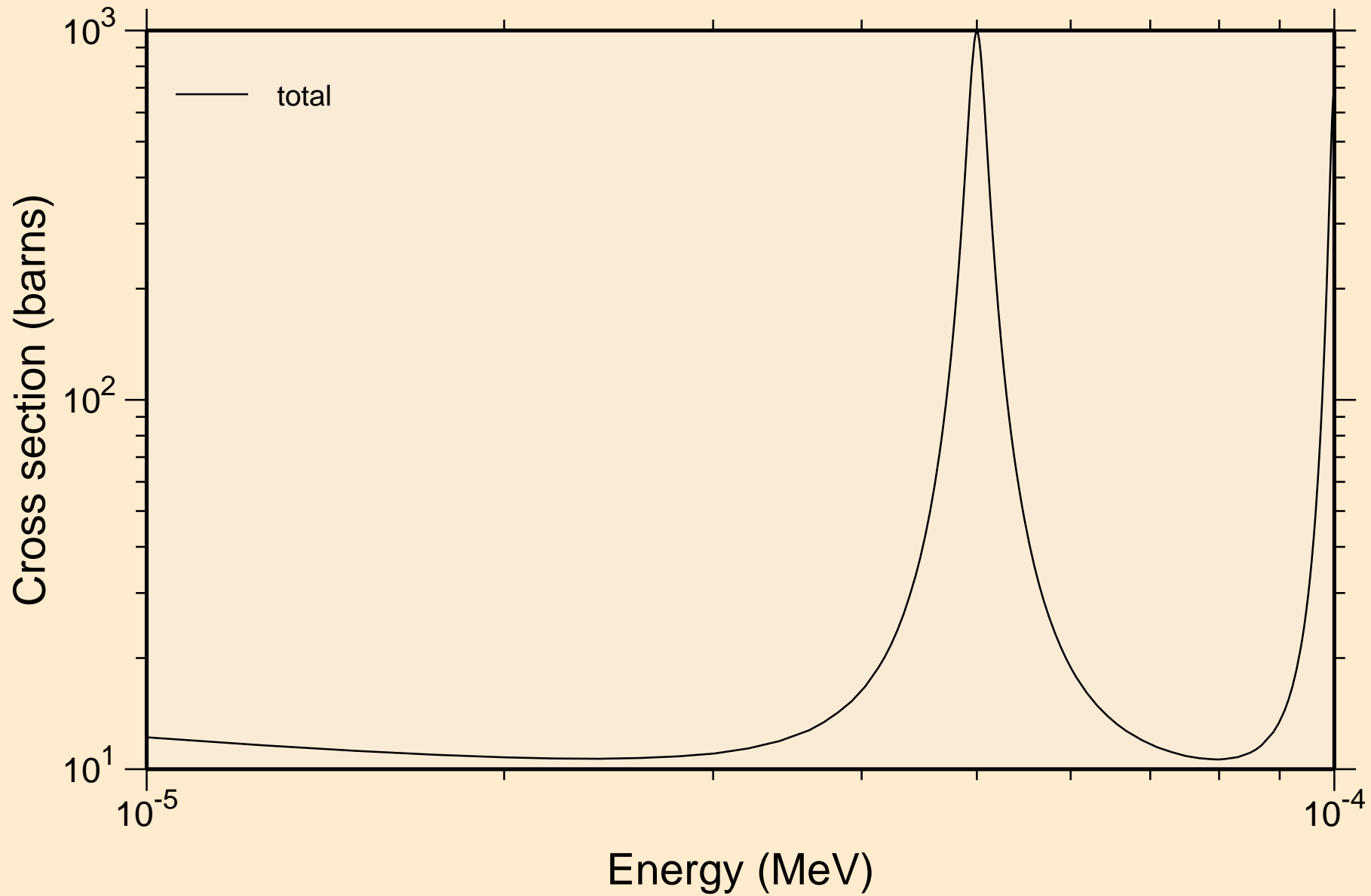

HS268 NRG TENDL-2015, AKONING  
resonance total cross section

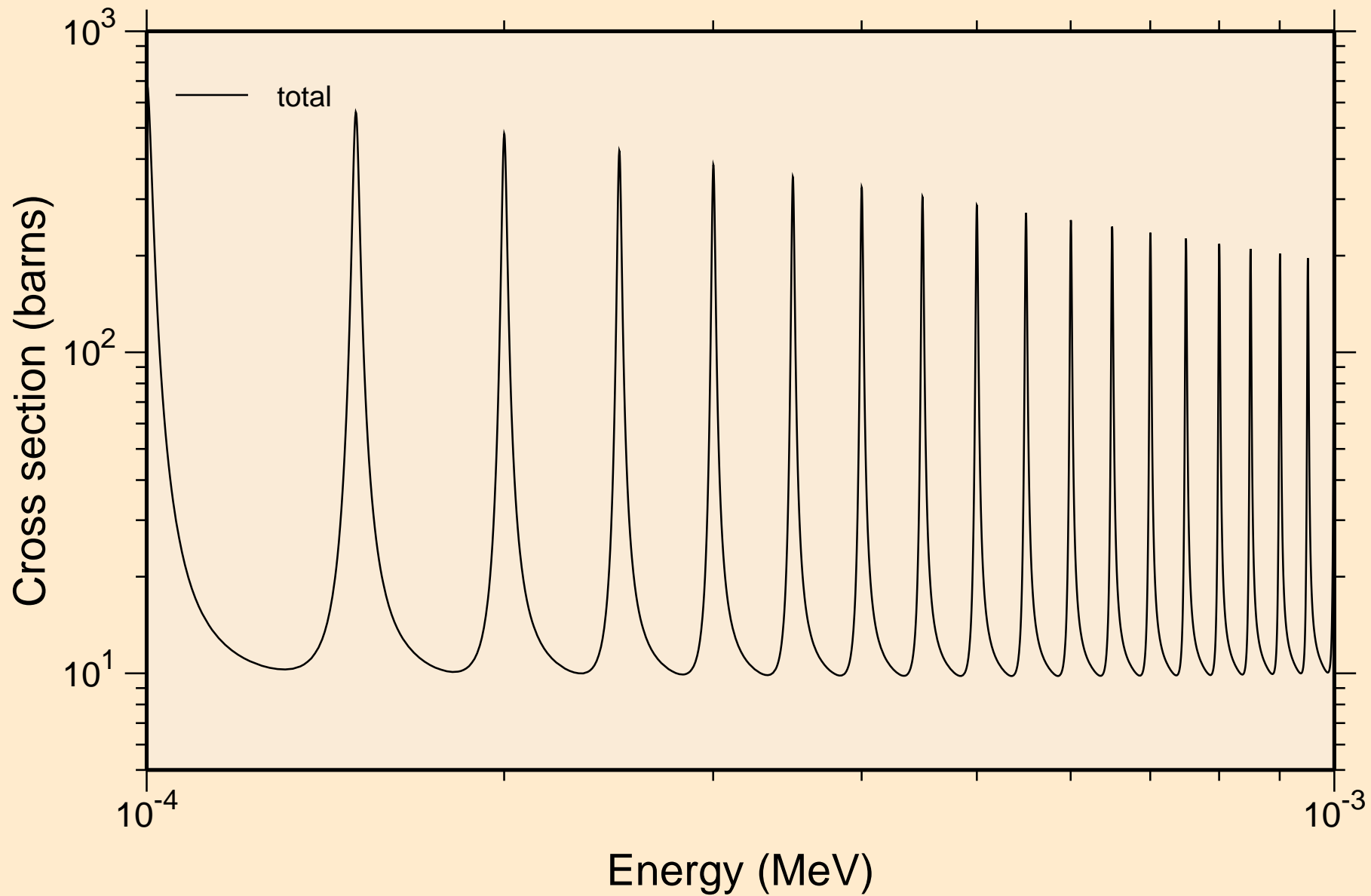

HS268 NRG TENDL-2015, AKONING  
resonance total cross section

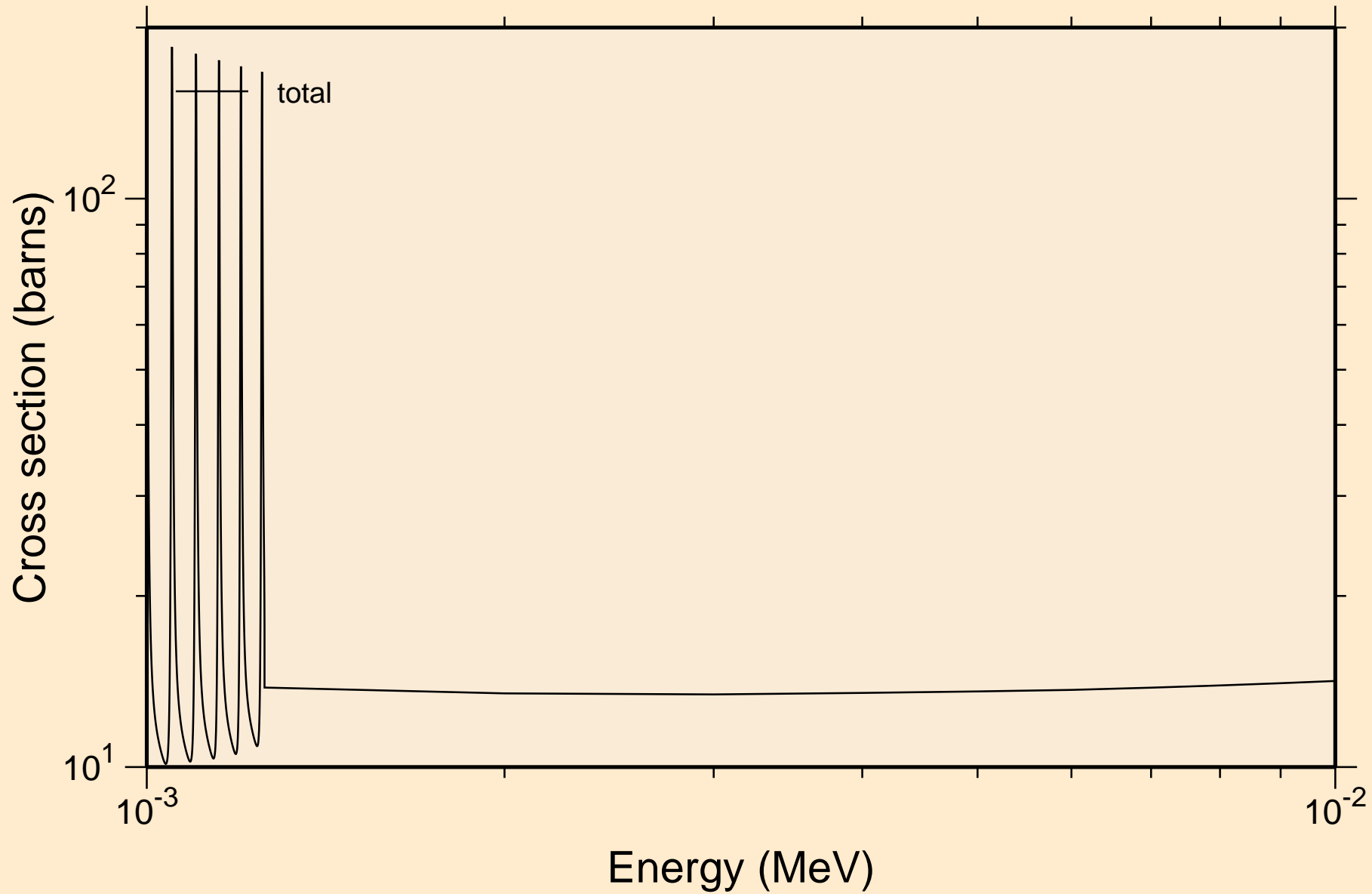

HS268 NRG TENDL-2015, AKONING  
resonance total cross section

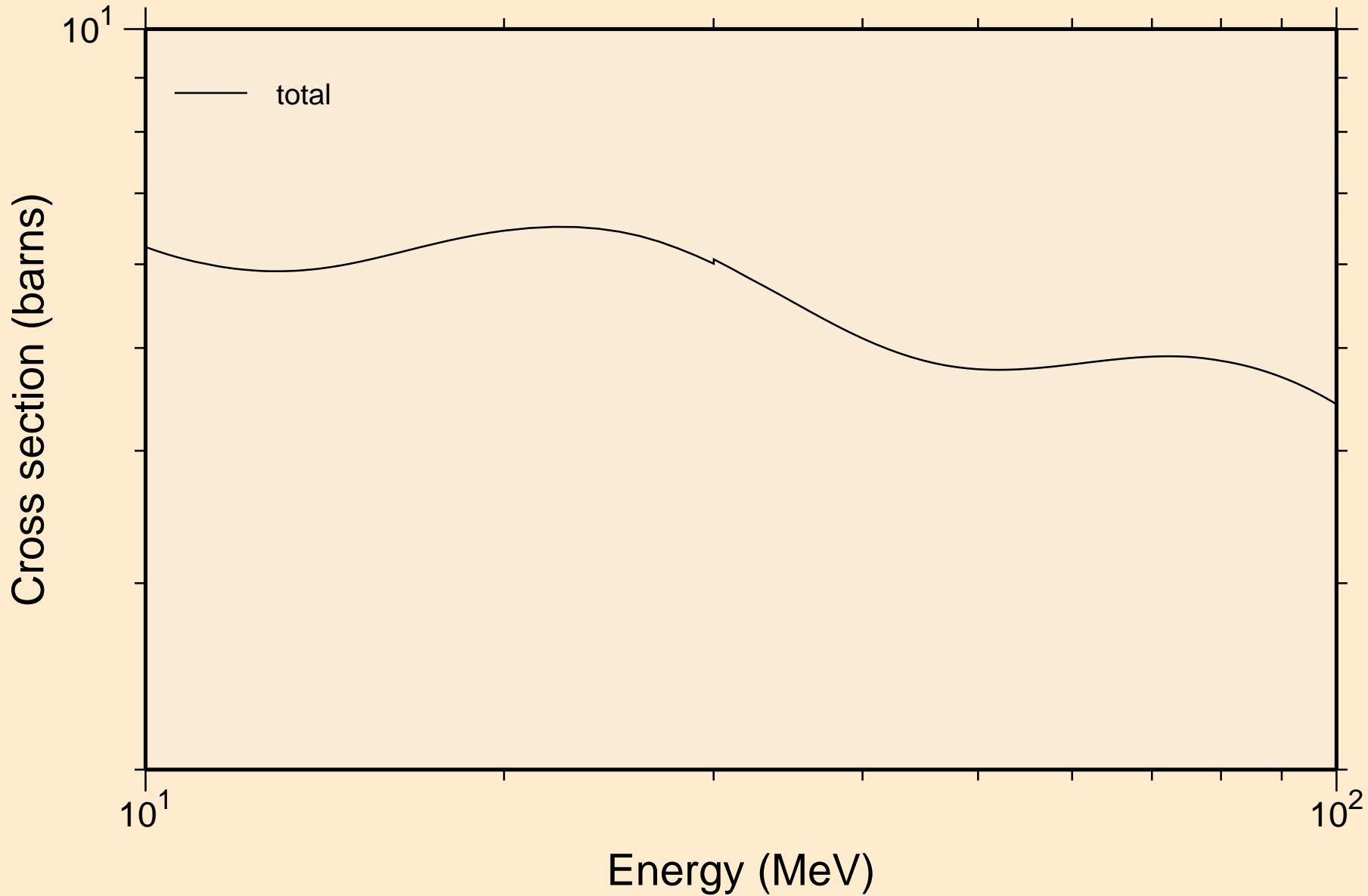

# HS268 NRG TENDL-2015, AKONING

## resonance absorption cross sections

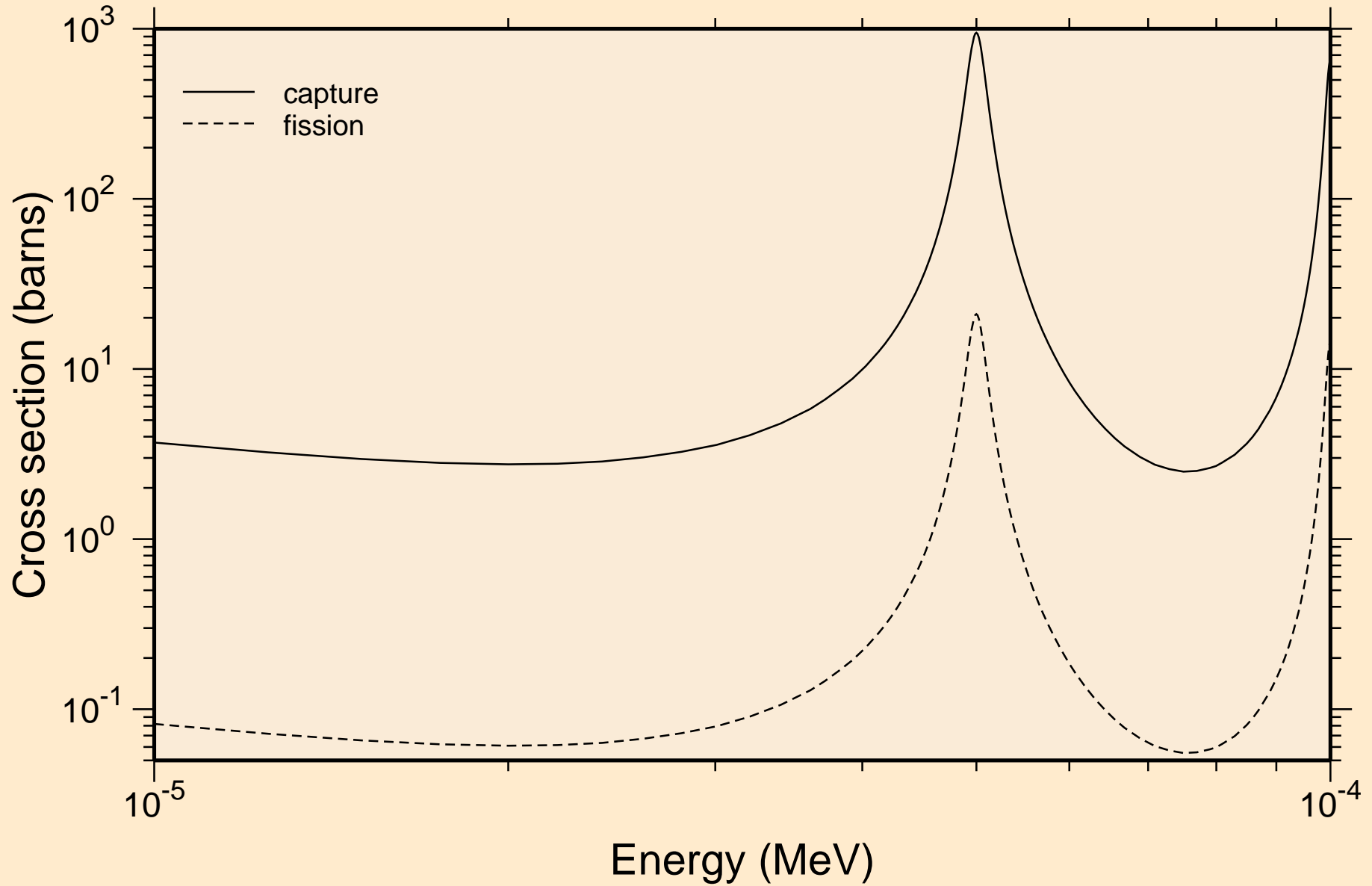

# HS268 NRG TENDL-2015, AKONING

## resonance absorption cross sections

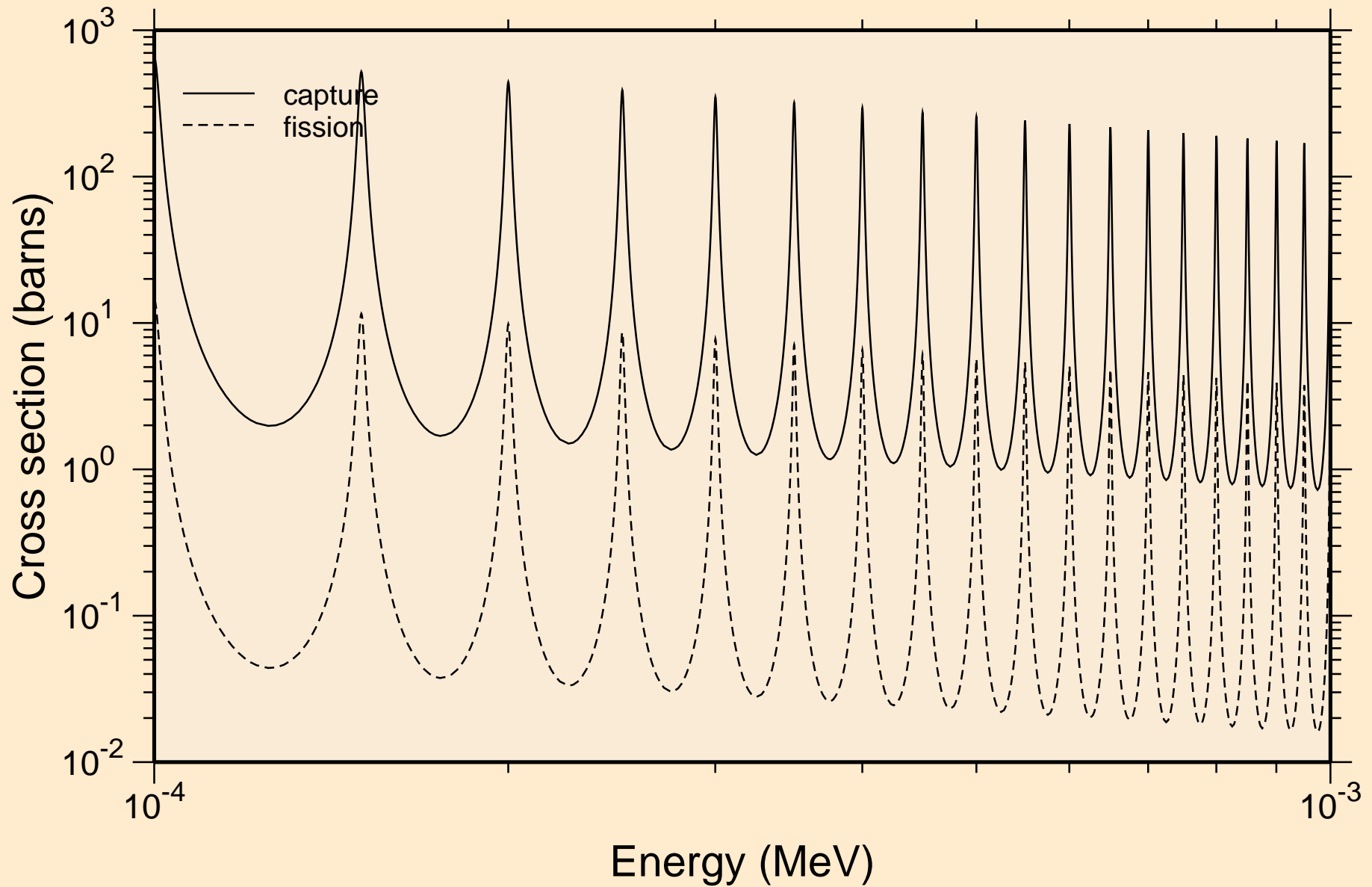

# HS268 NRG TENDL-2015, AKONING resonance absorption cross sections

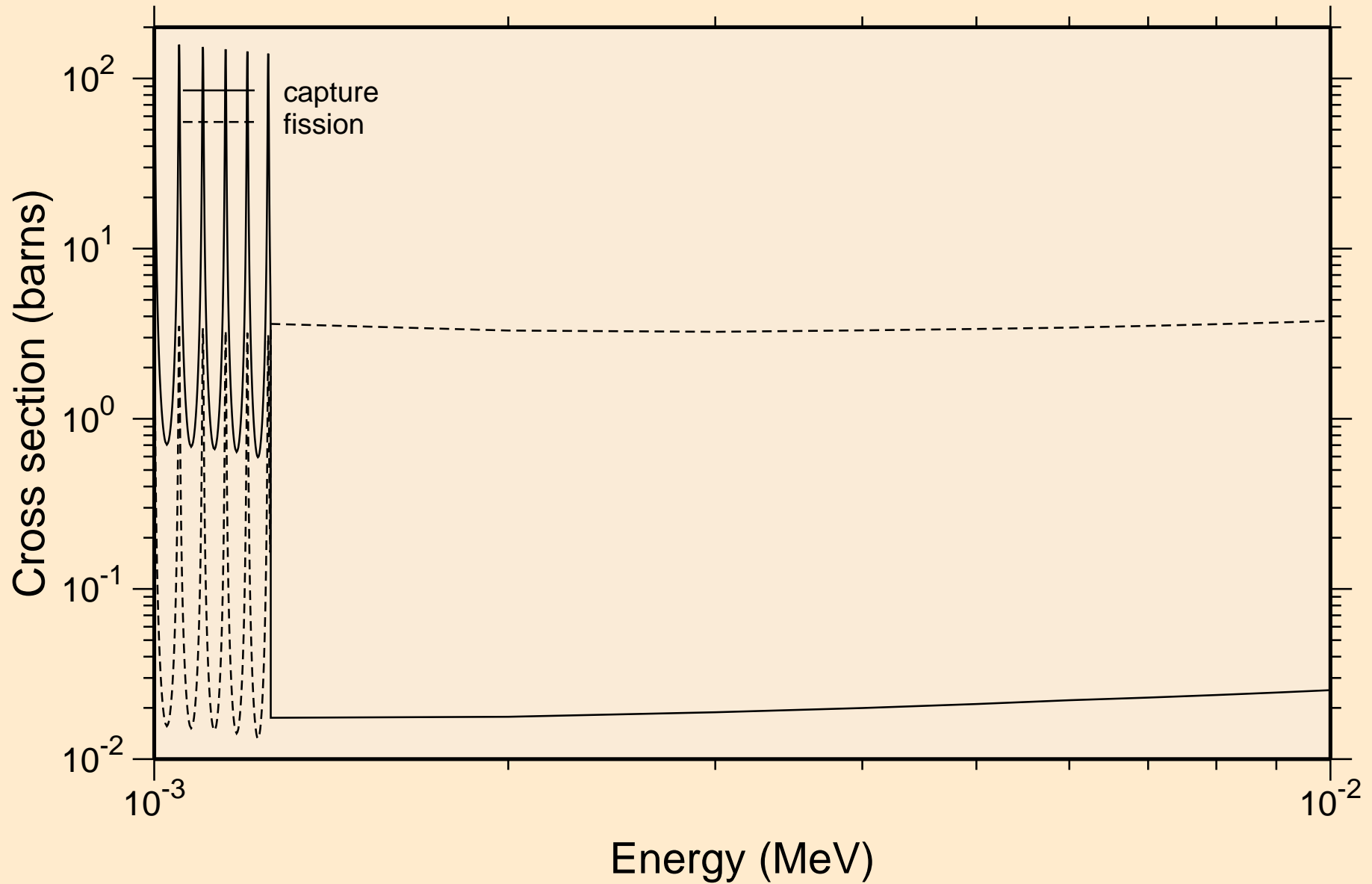



# HS268 NRG TENDL-2015, AKONING

## resonance absorption cross sections

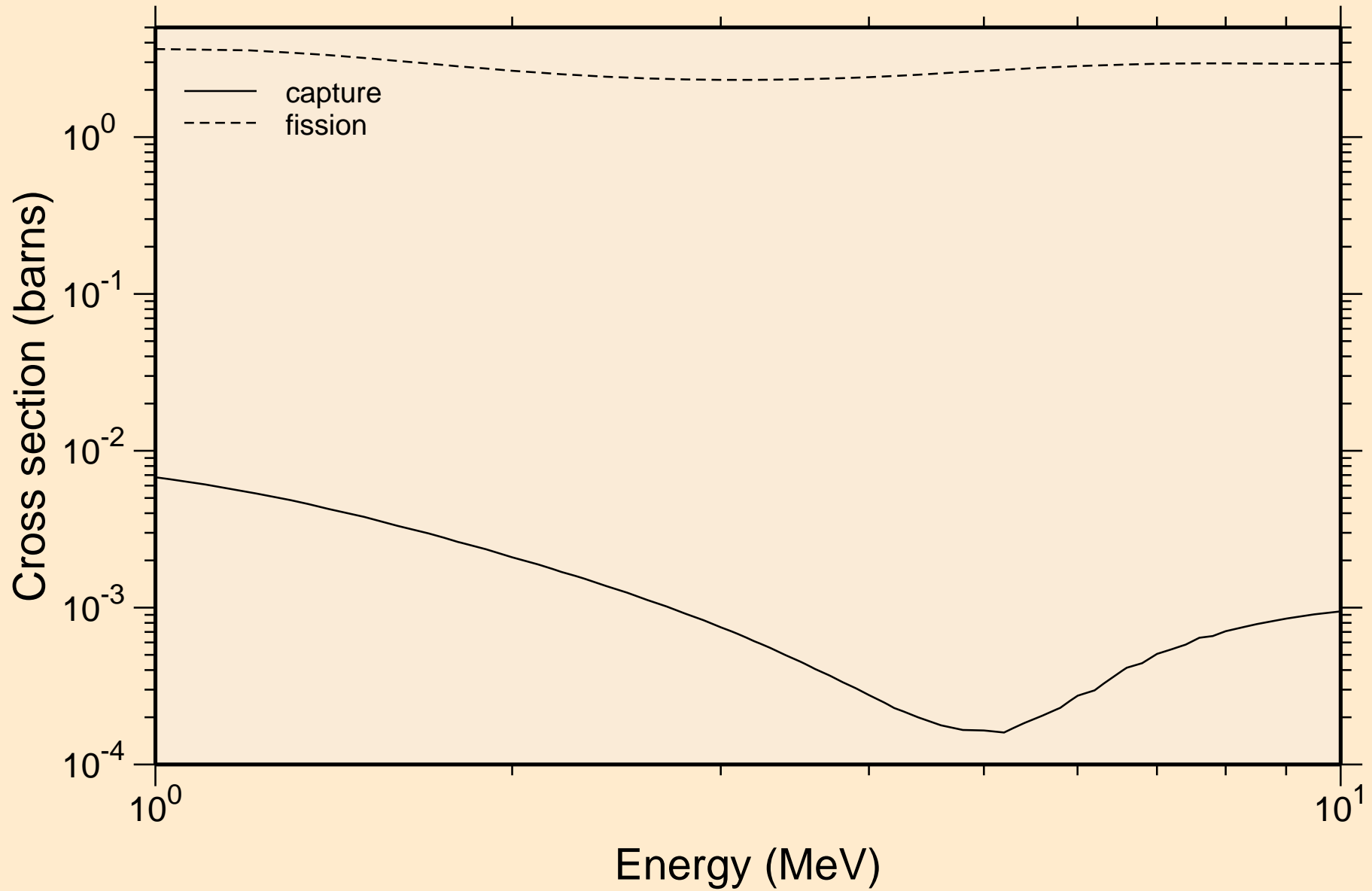

# HS268 NRG TENDL-2015, AKONING

## Non-threshold reactions

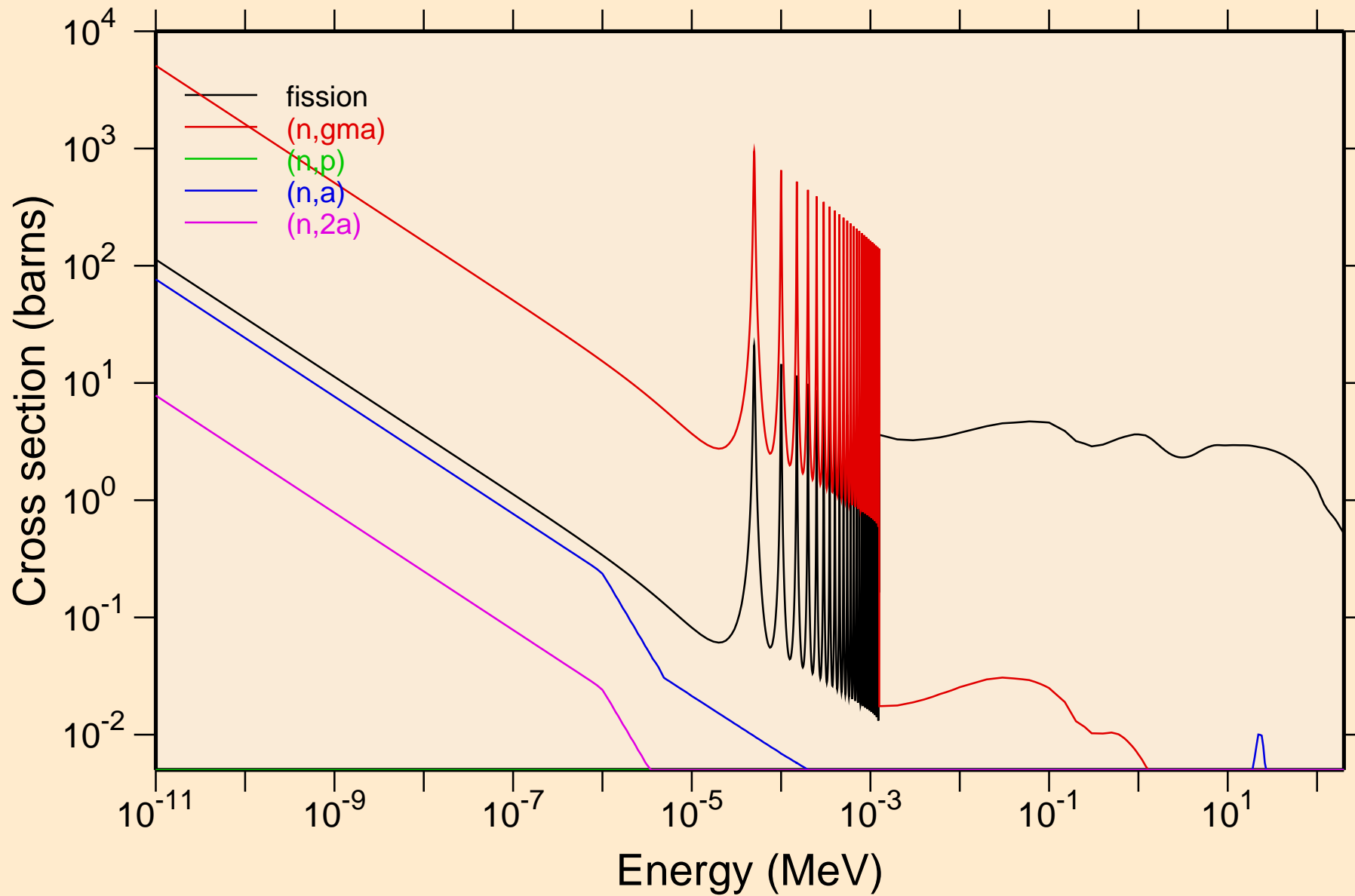

# HS268 NRG TENDL-2015, AKONING

## Non-threshold reactions

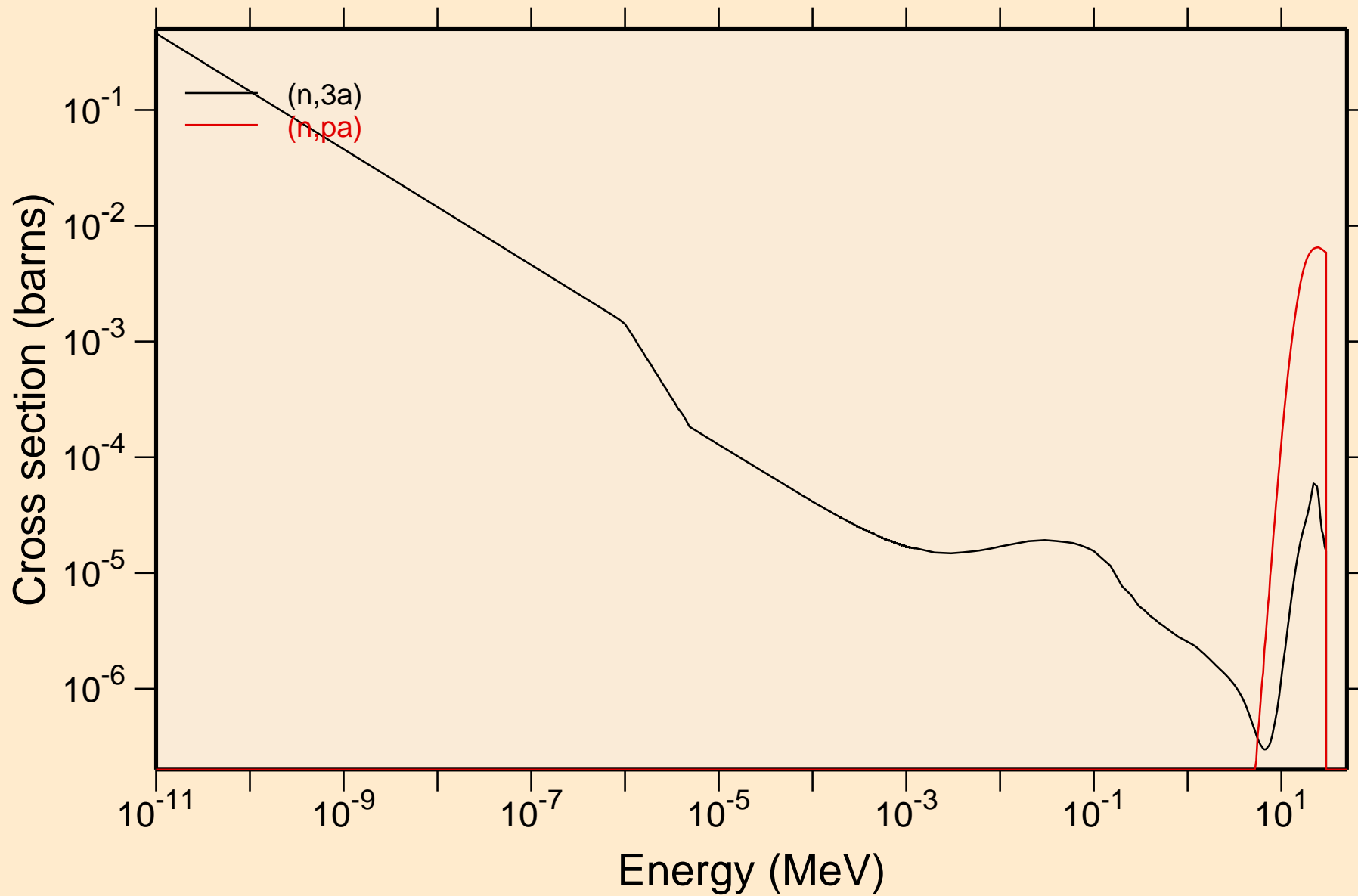

# HS268 NRG TENDL-2015, AKONING

## Principal cross sections

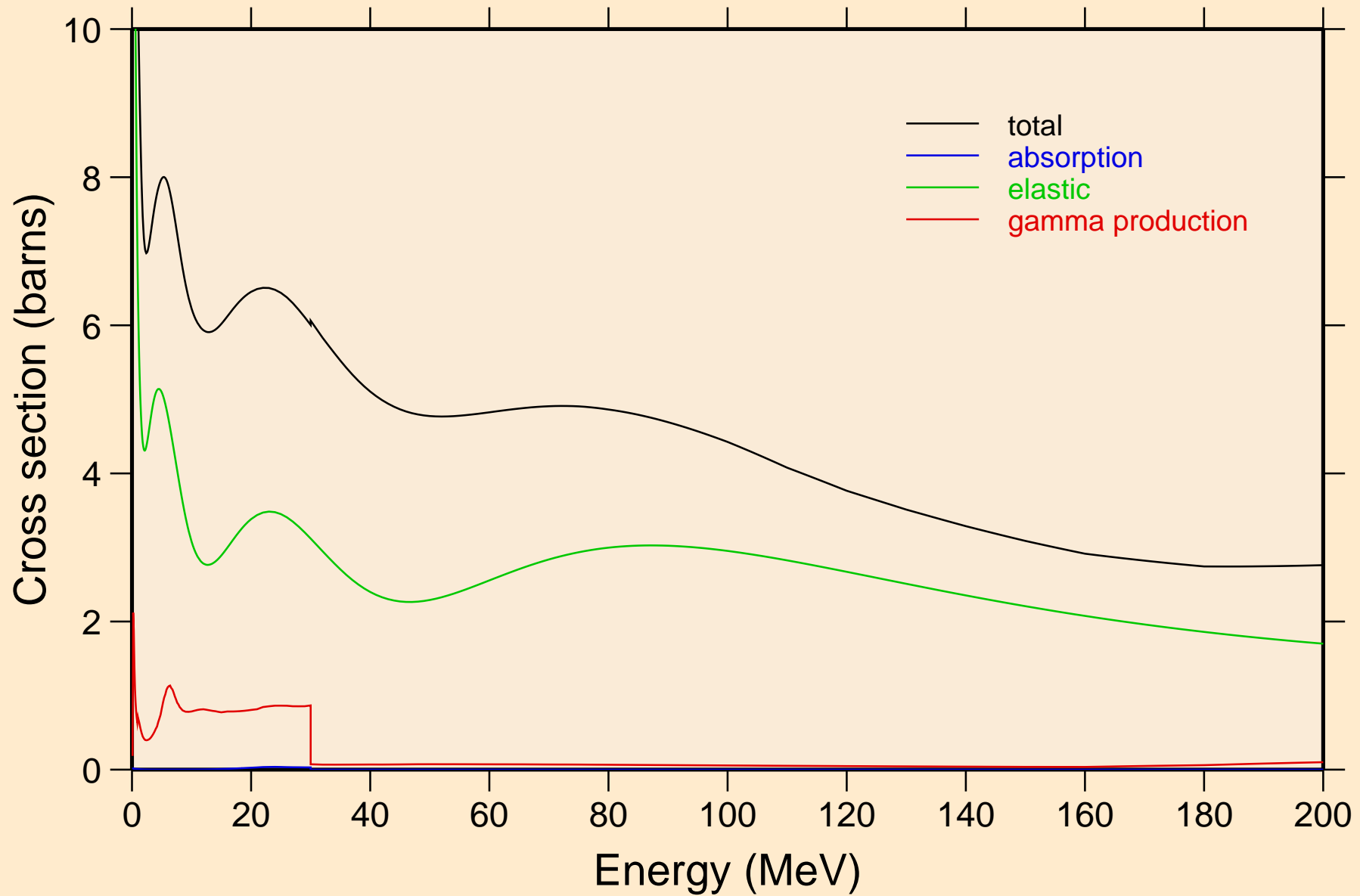

# HS268 NRG TENDL-2015, AKONING

## Non-threshold reactions

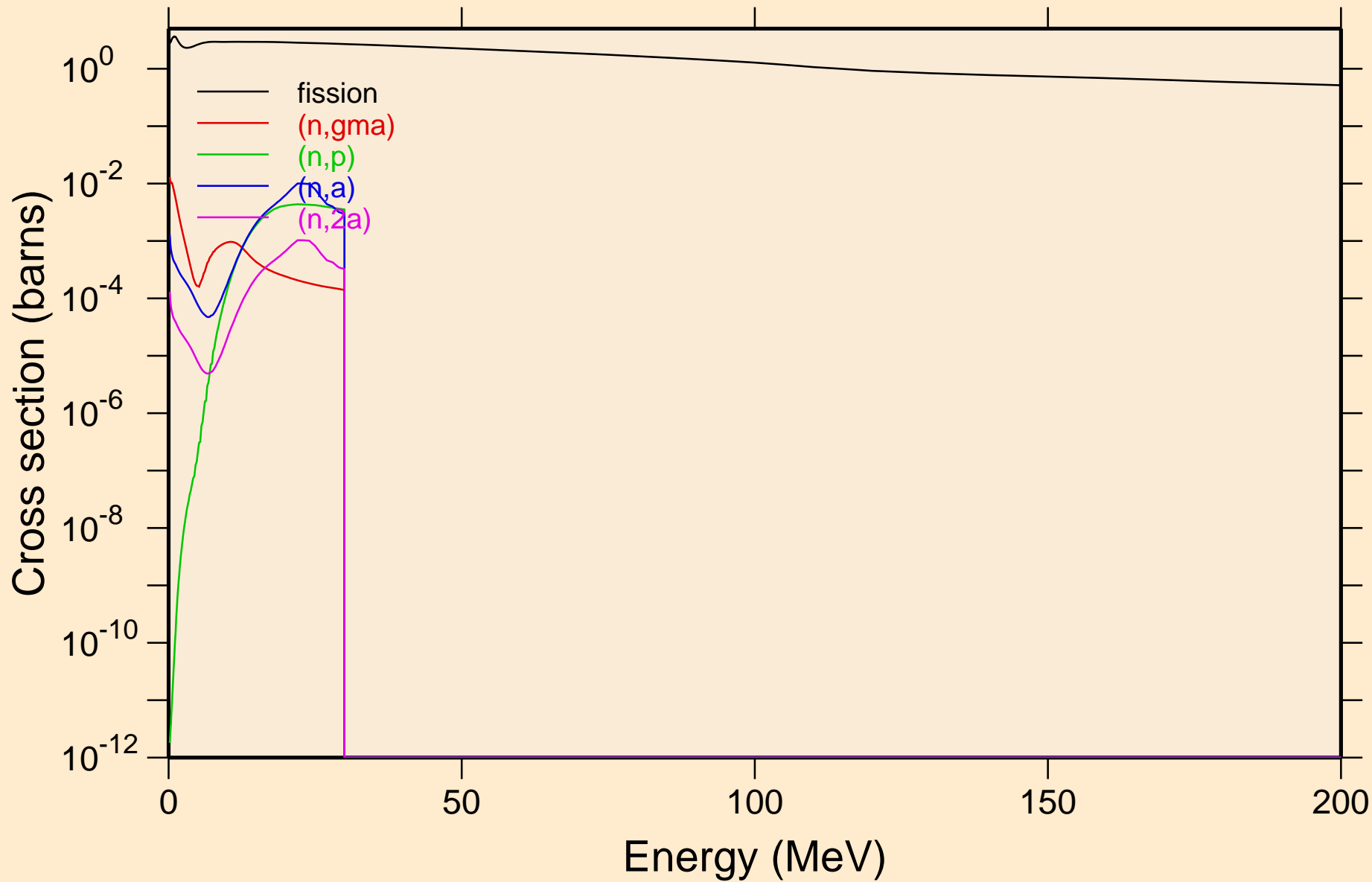

# HS268 NRG TENDL-2015, AKONING

## Non-threshold reactions

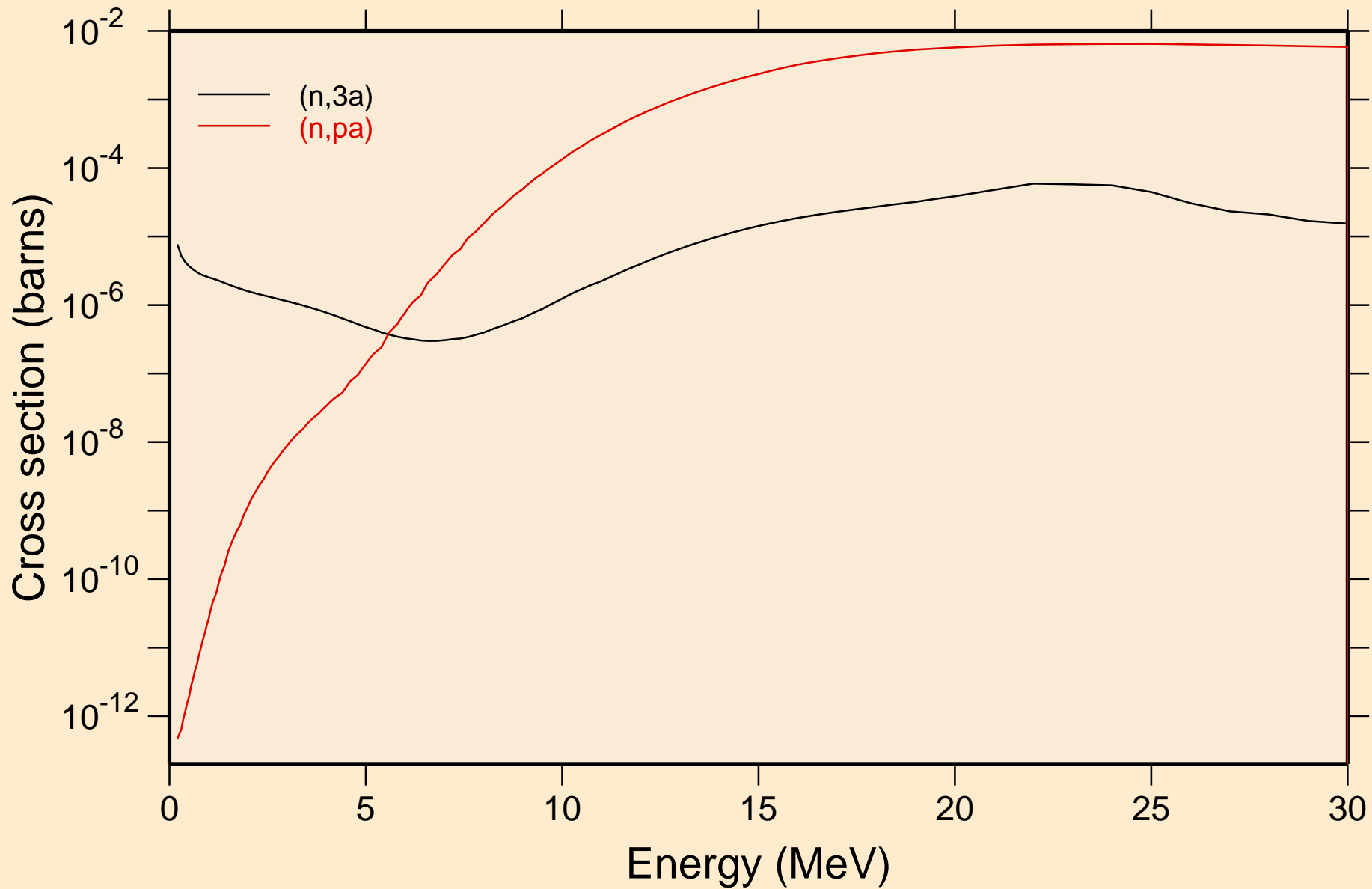

HS268 NRG TENDL-2015, AKONING  
Inelastic levels

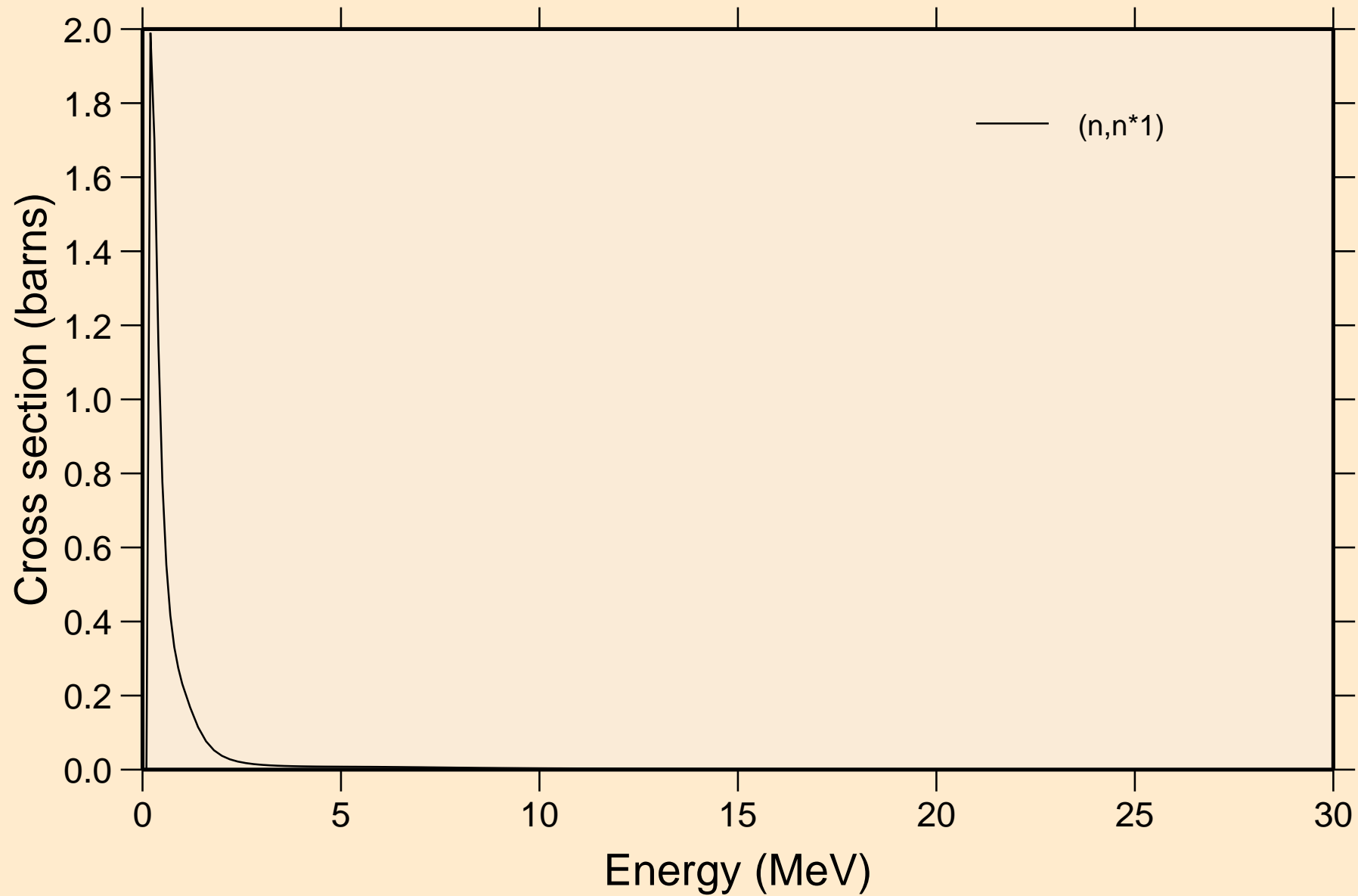

# HS268 NRG TENDL-2015, AKONING

## Threshold reactions

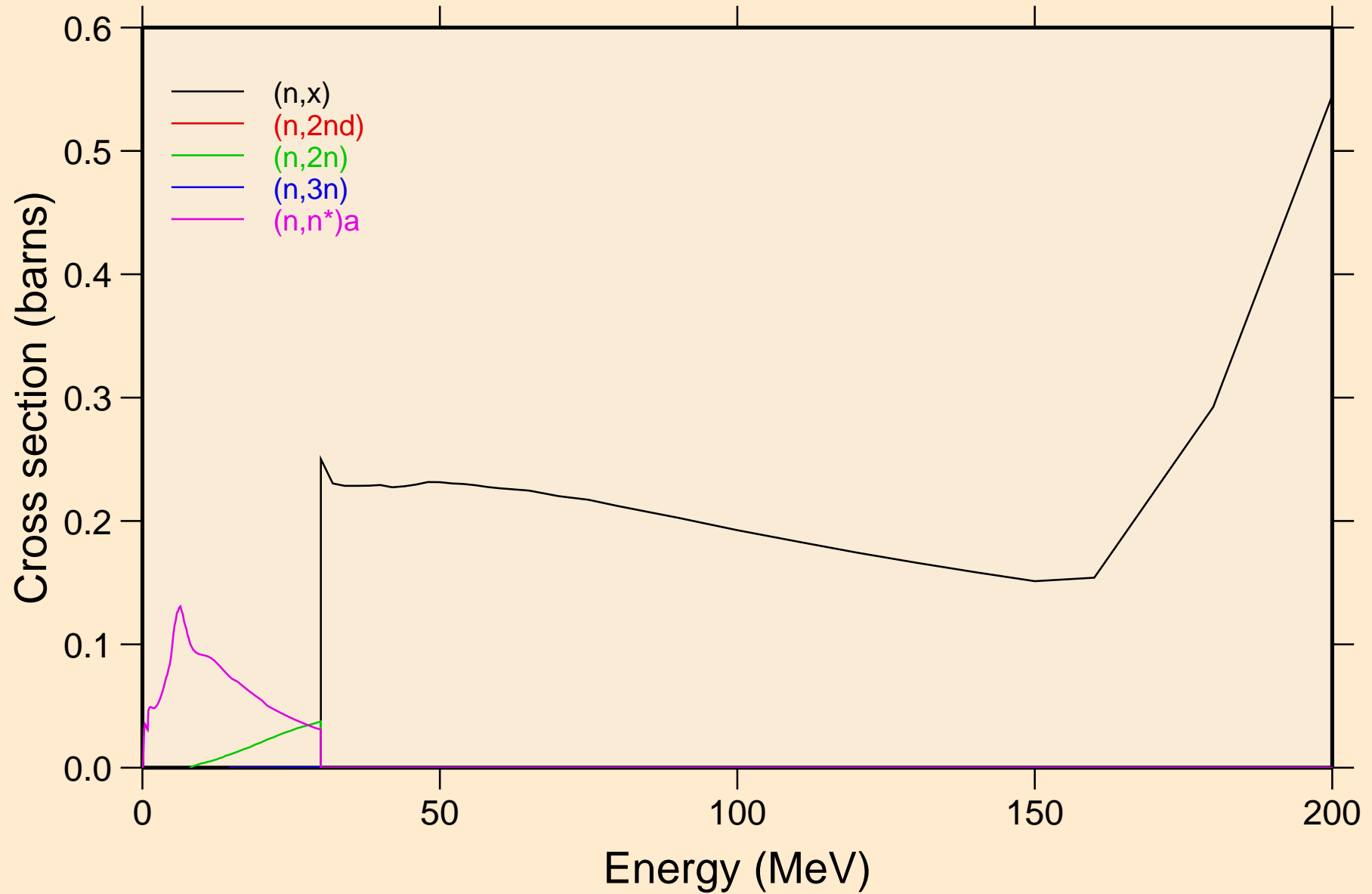



# HS268 NRG TENDL-2015, AKONING

## Threshold reactions

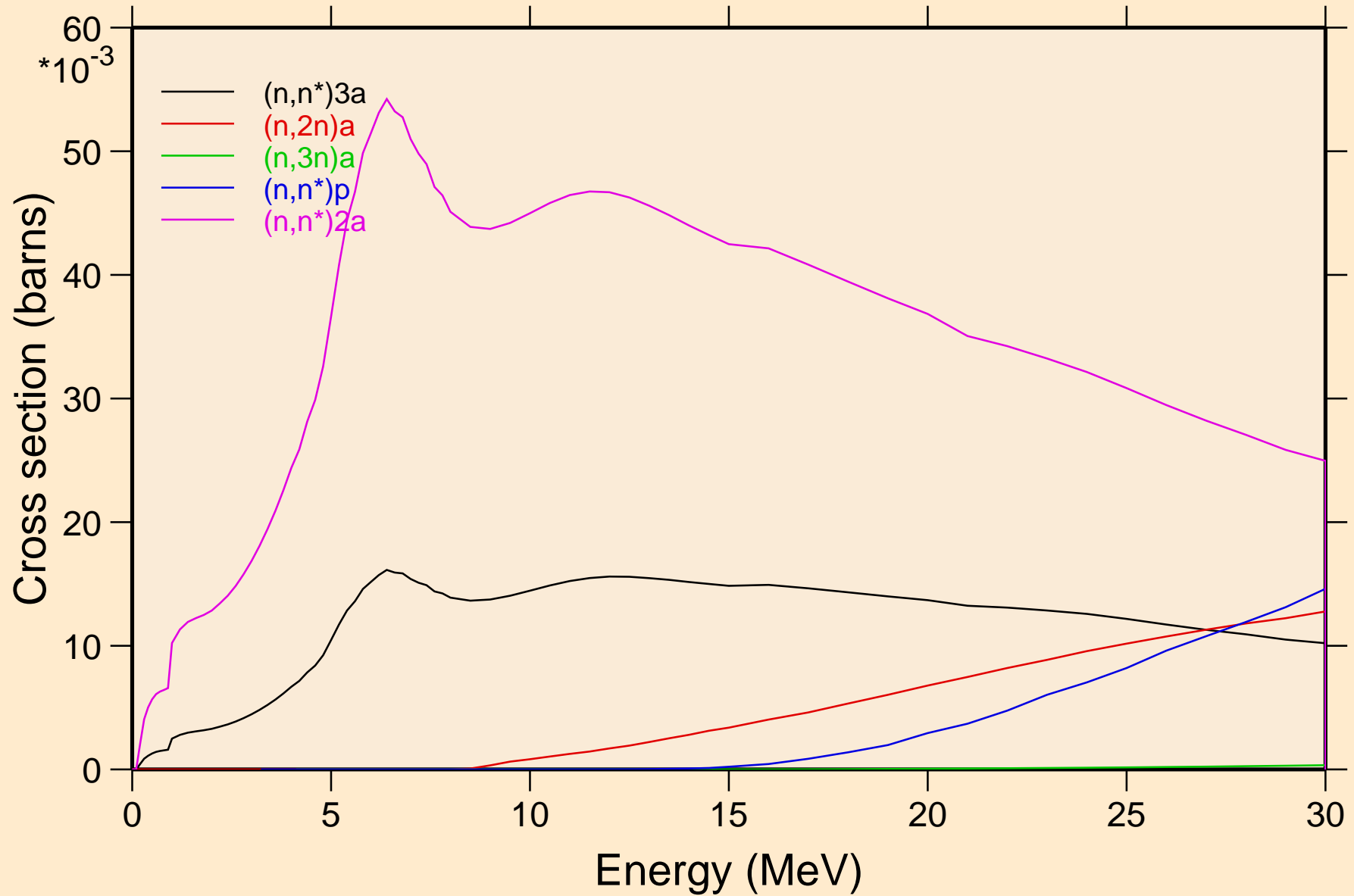

# HS268 NRG TENDL-2015, AKONING

## Threshold reactions

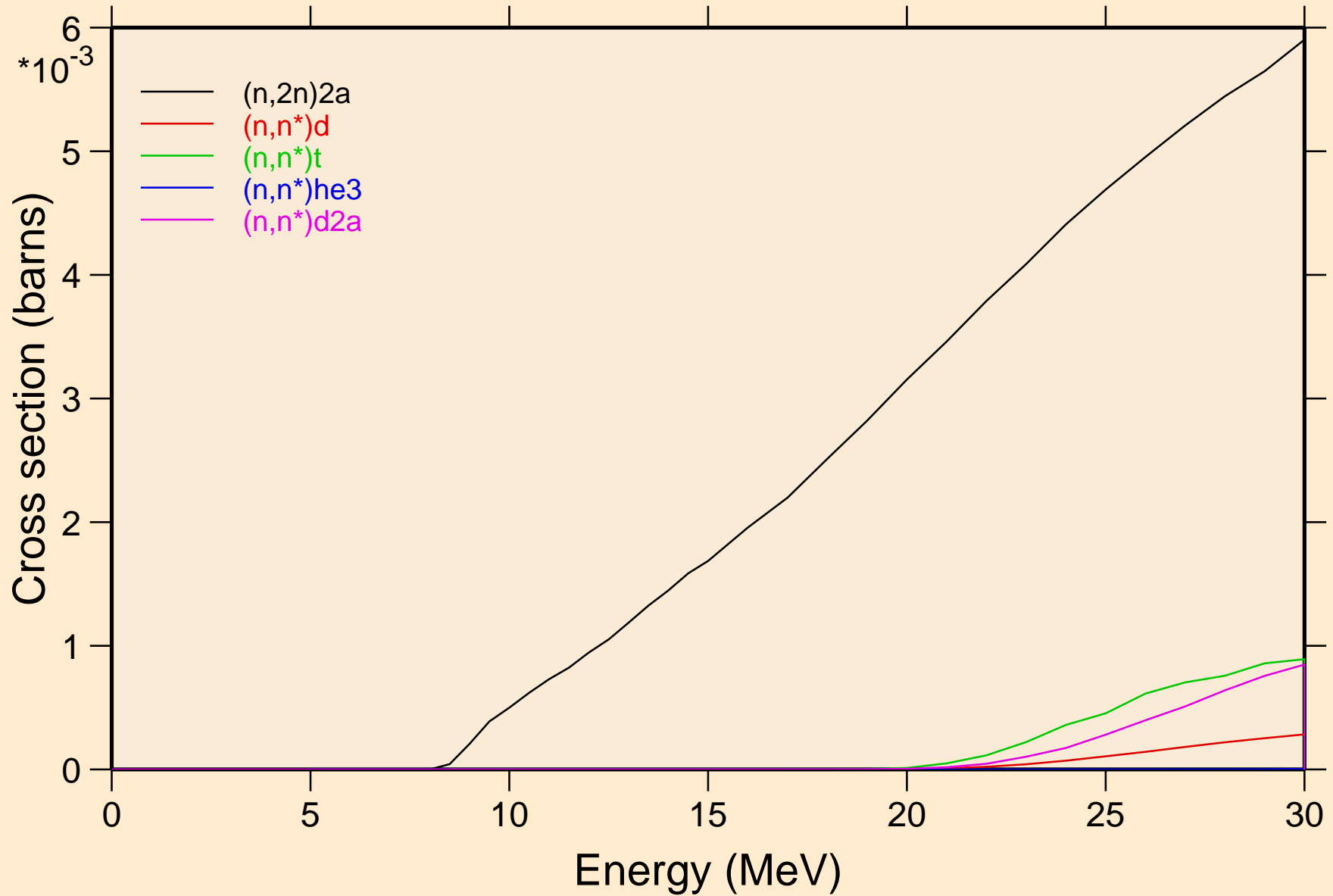

# HS268 NRG TENDL-2015, AKONING

## Threshold reactions

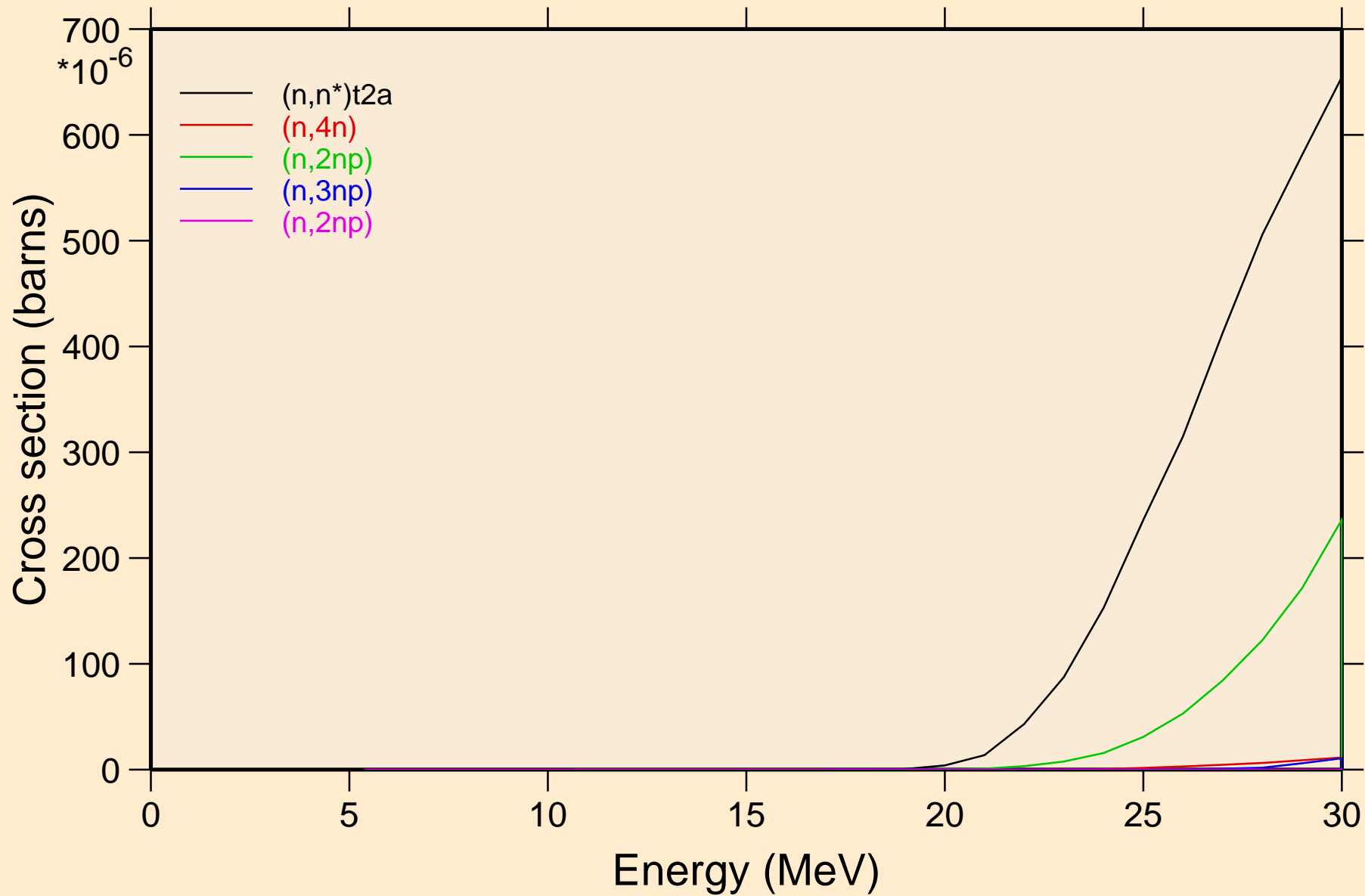

# HS268 NRG TENDL-2015, AKONING

## Threshold reactions

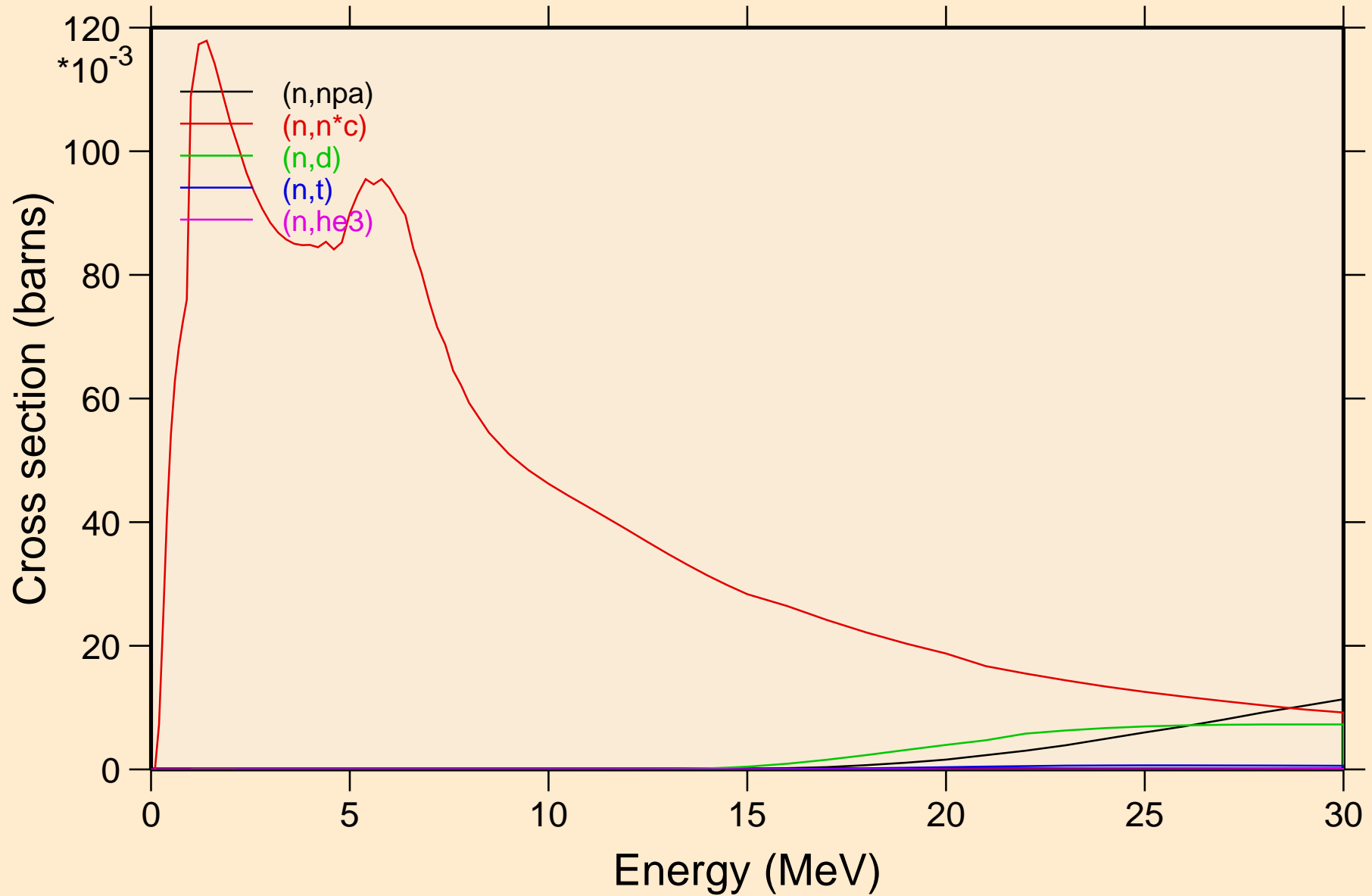

# HS268 NRG TENDL-2015, AKONING

## Threshold reactions

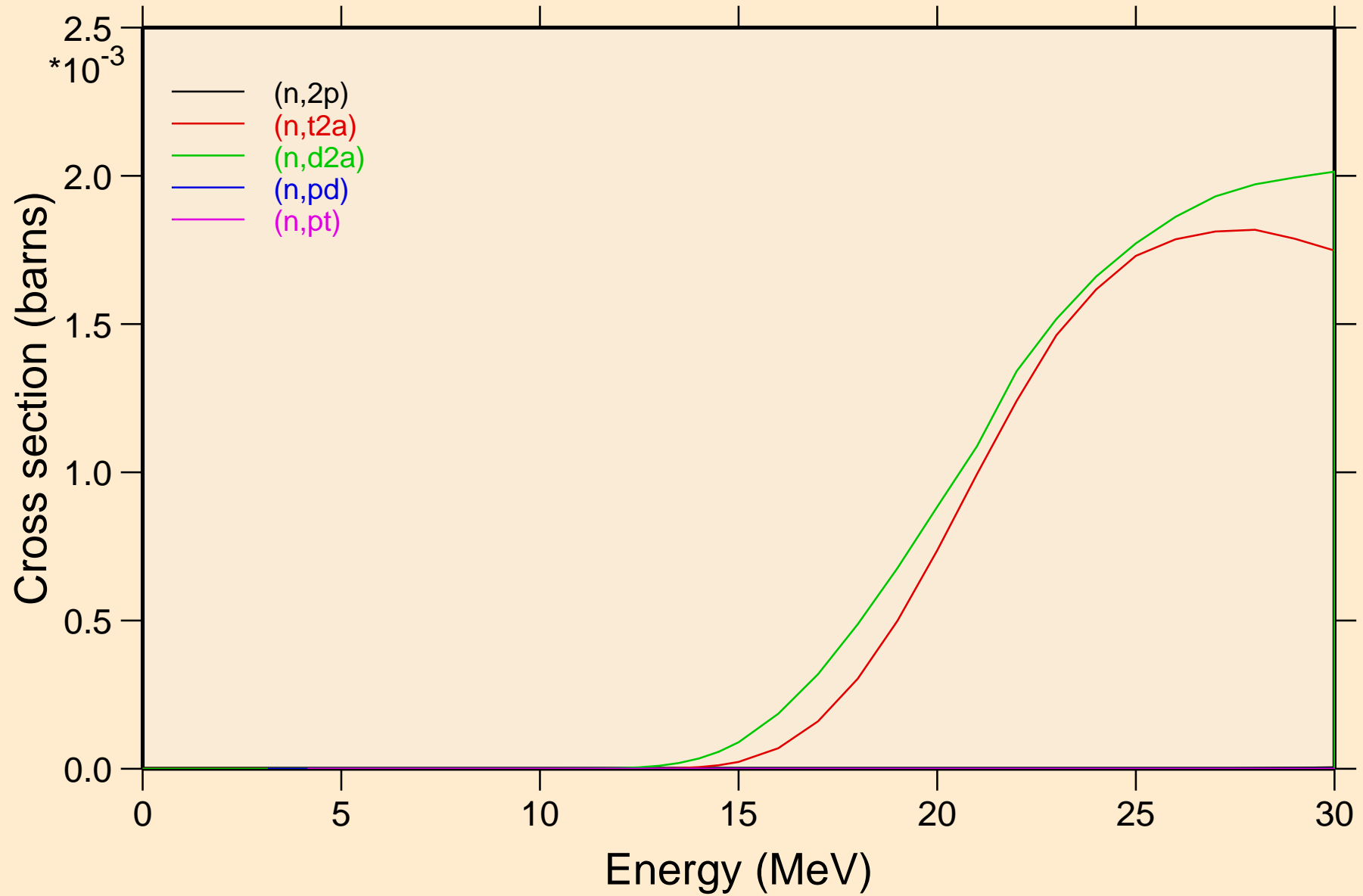

# HS268 NRG TENDL-2015, AKONING

## Threshold reactions

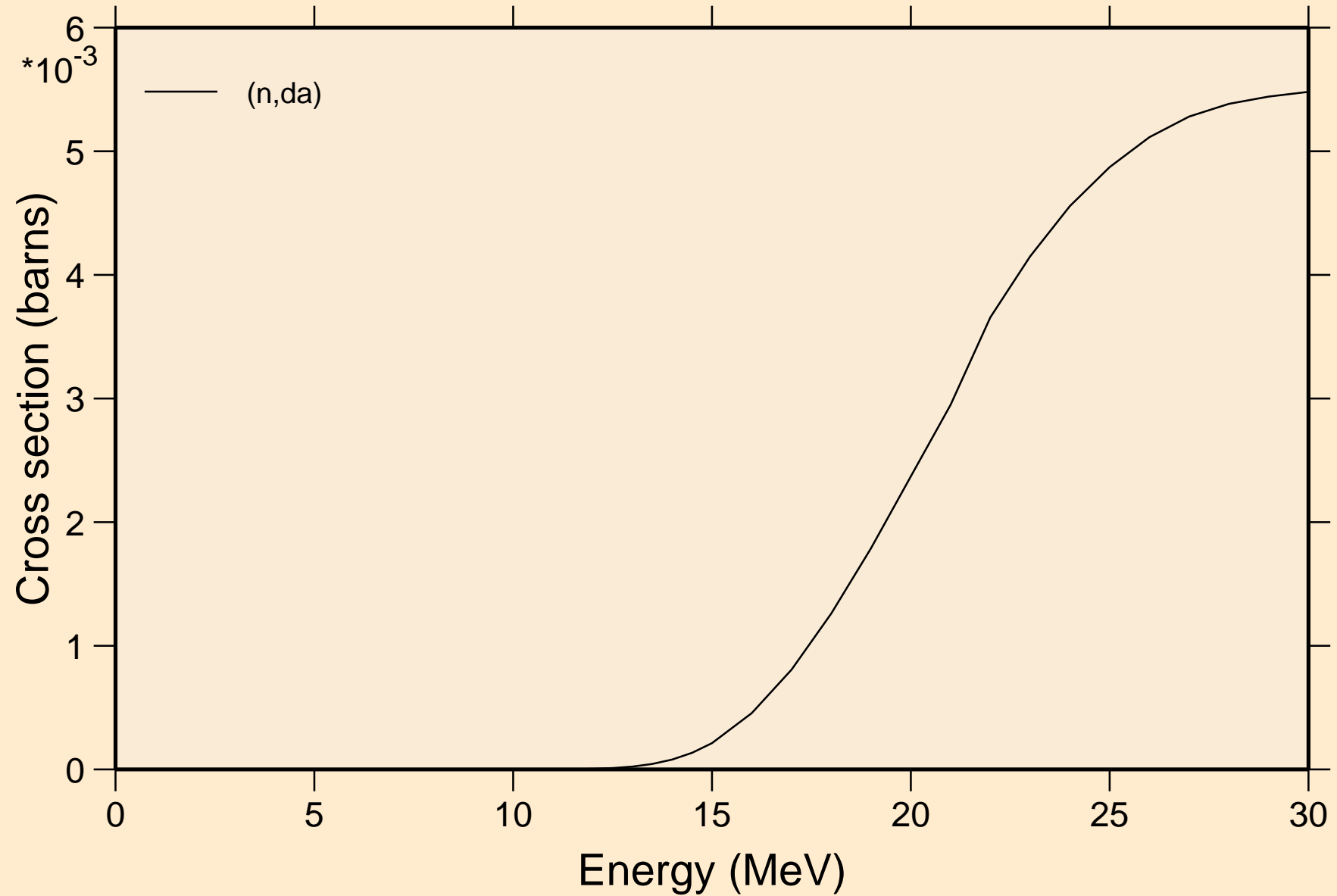

HS268 NRG TENDL-2015, AKONING  
angular distribution for elastic

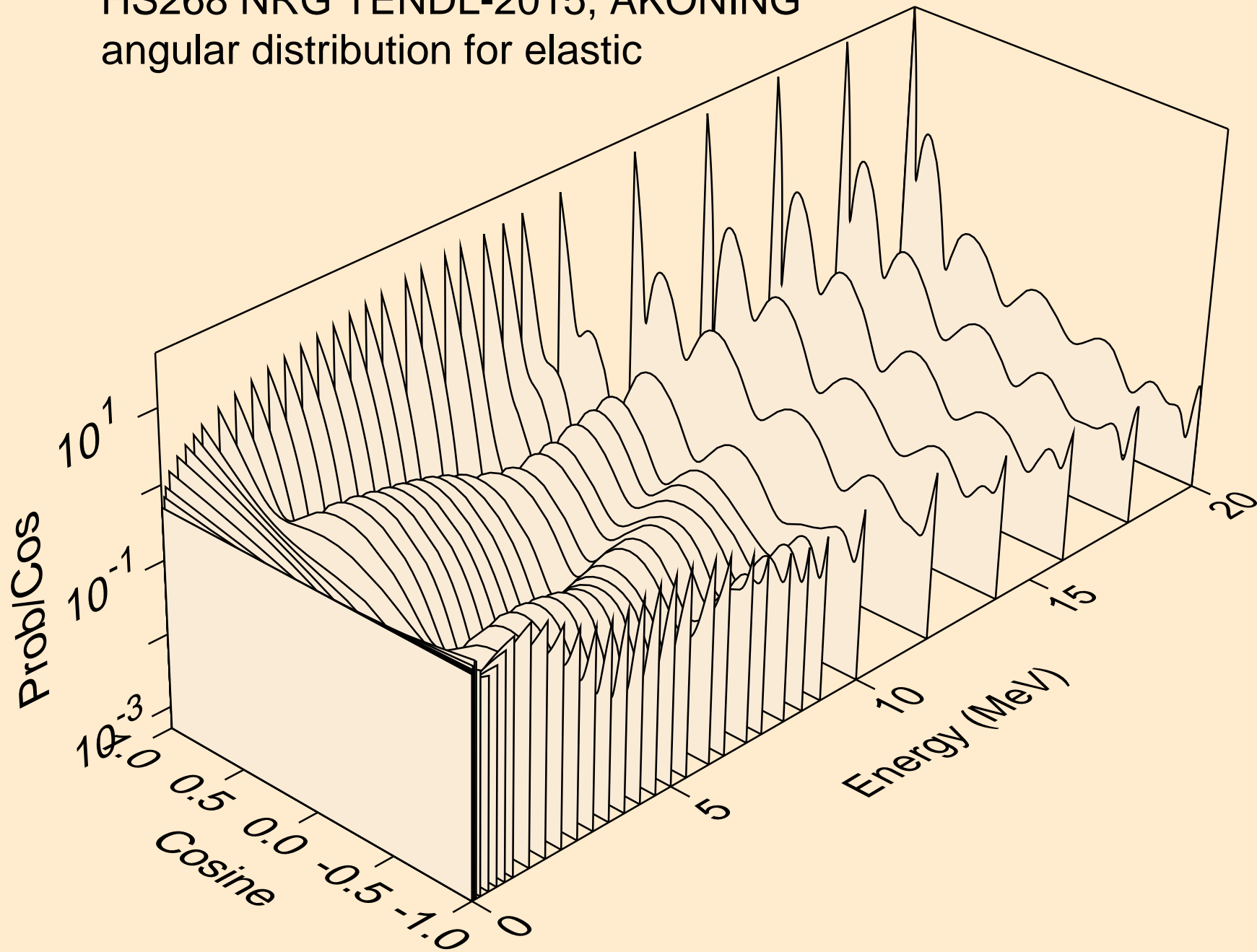

HS268 NRG TENDL-2015, AKONING  
angular distribution for elastic

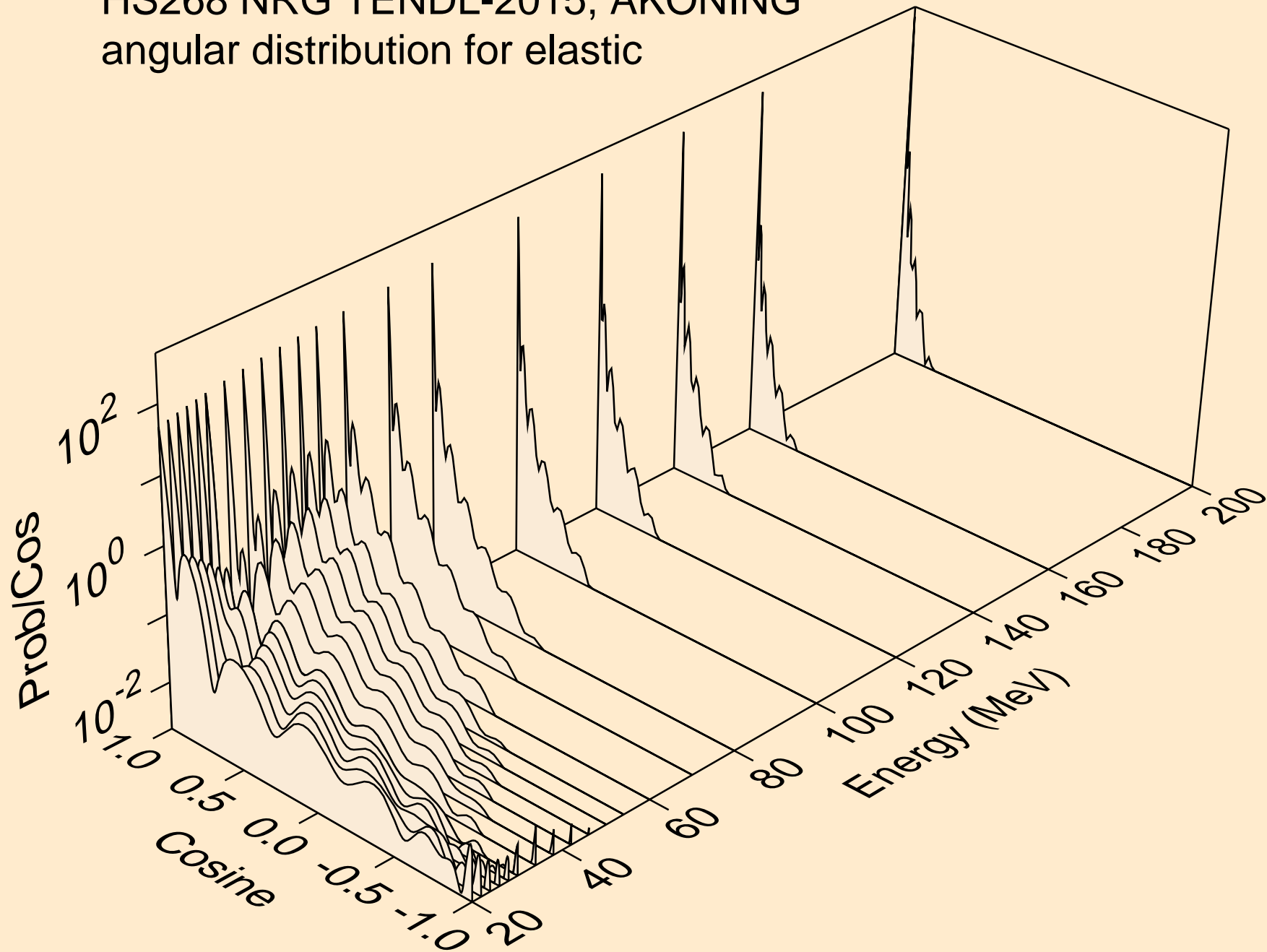



HS268 NRG TENDL-2015, AKONING  
angular distribution for (n,n\*1)

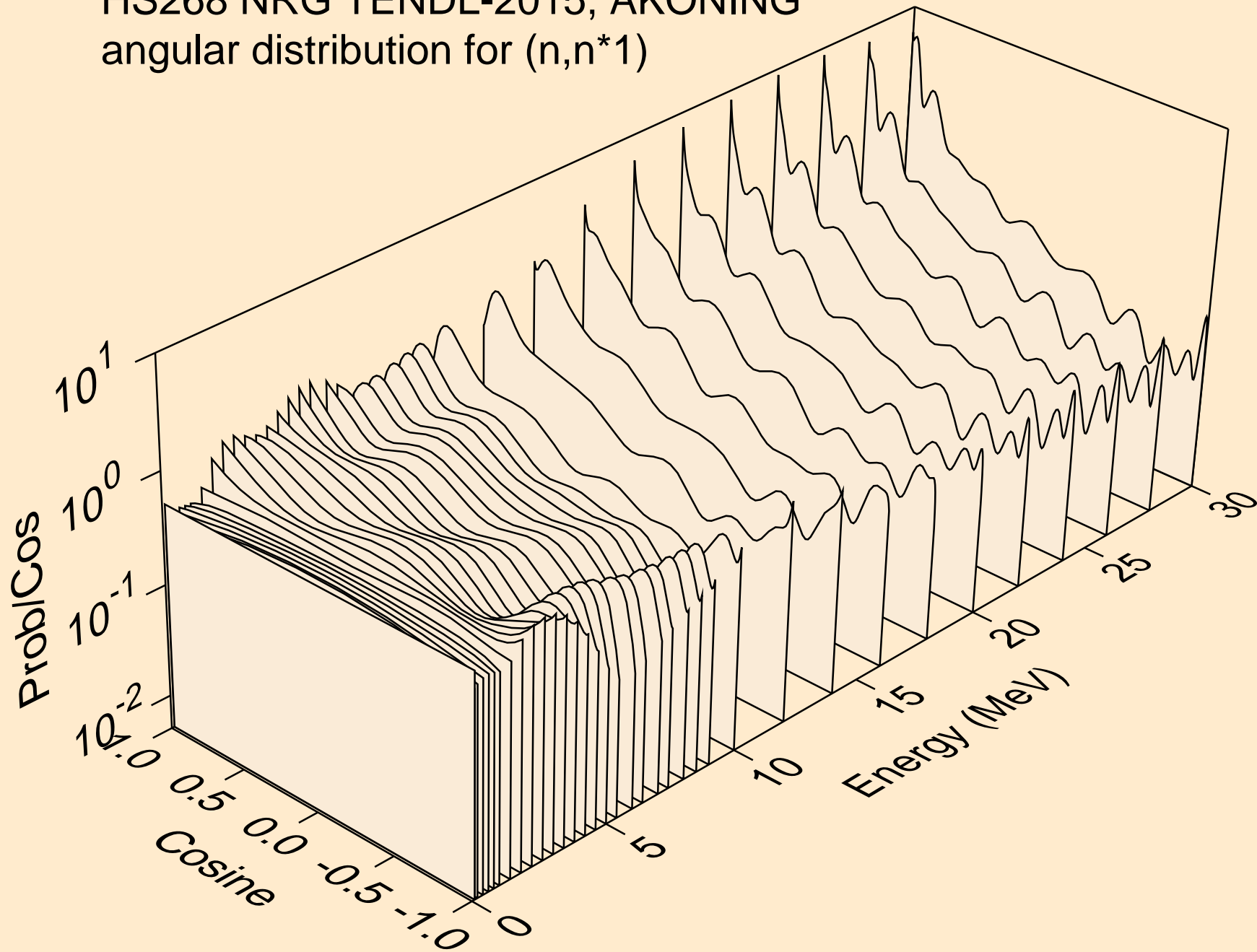

# HS268 NRG TENDL-2015, AKONING

Total fission nubar

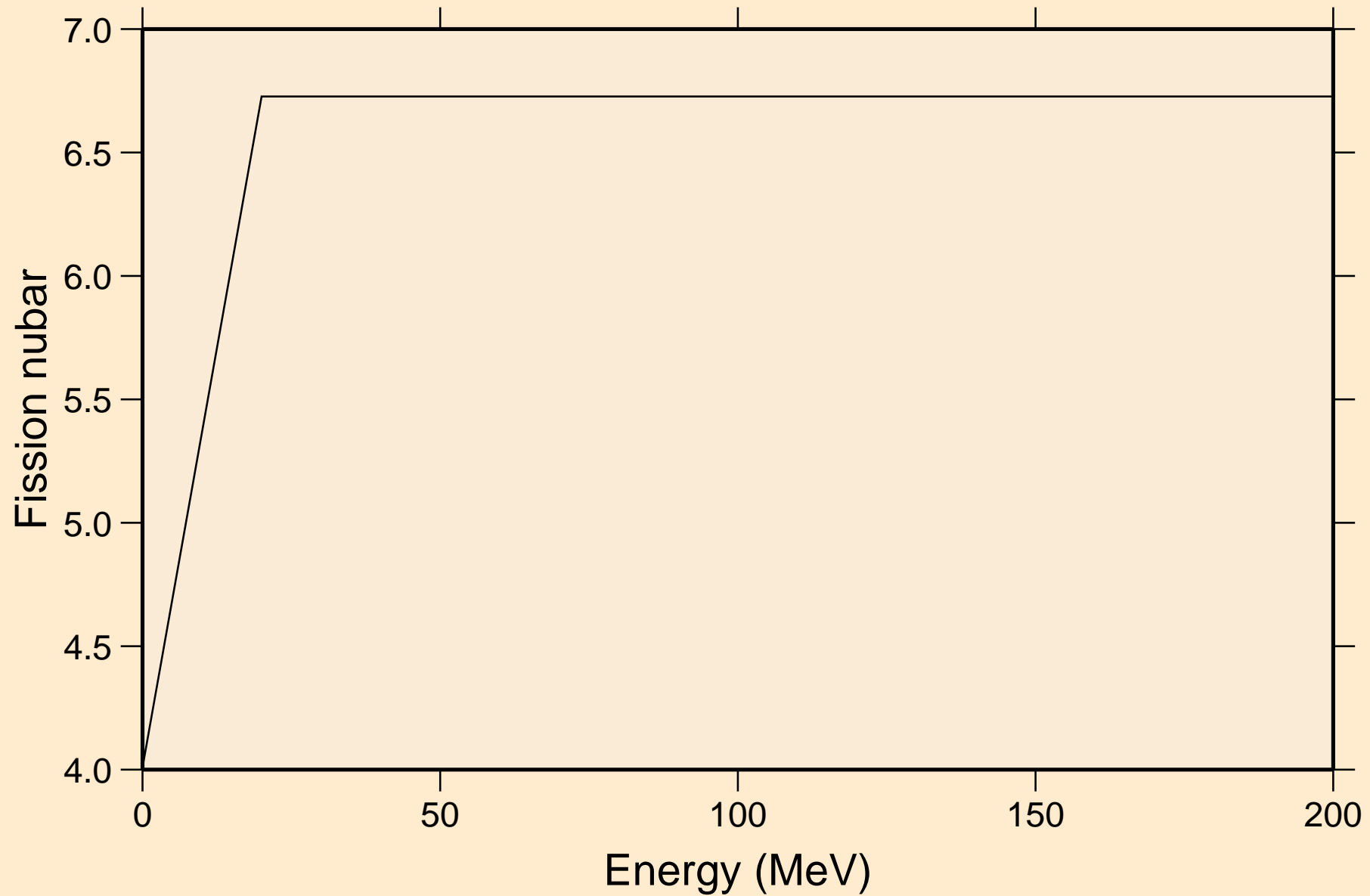

HS268 NRG TENDL-2015, AKONING  
Neutron emission for (n,x)

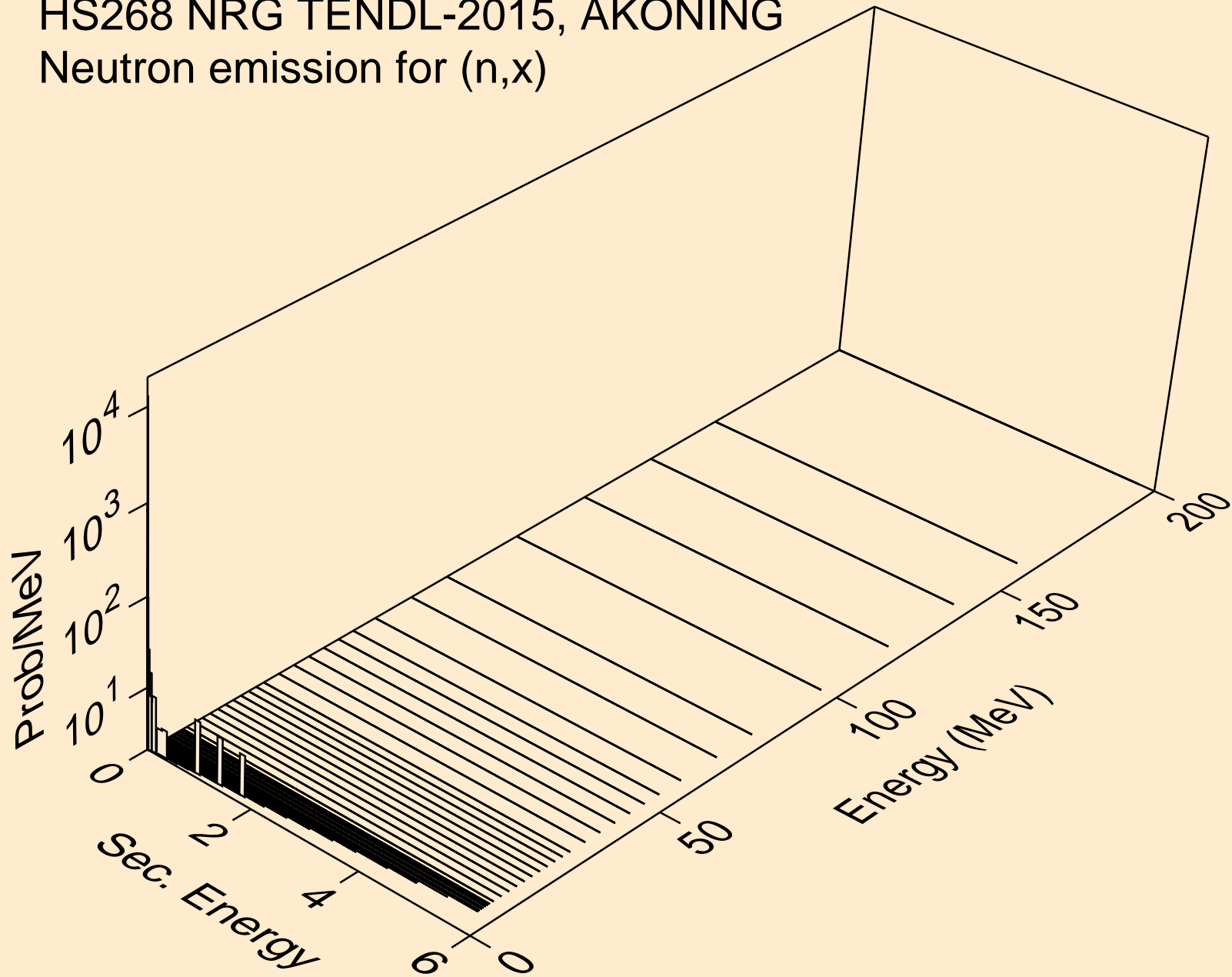

HS268 NRG TENDL-2015, AKONING  
Neutron emission for (n,2nd)

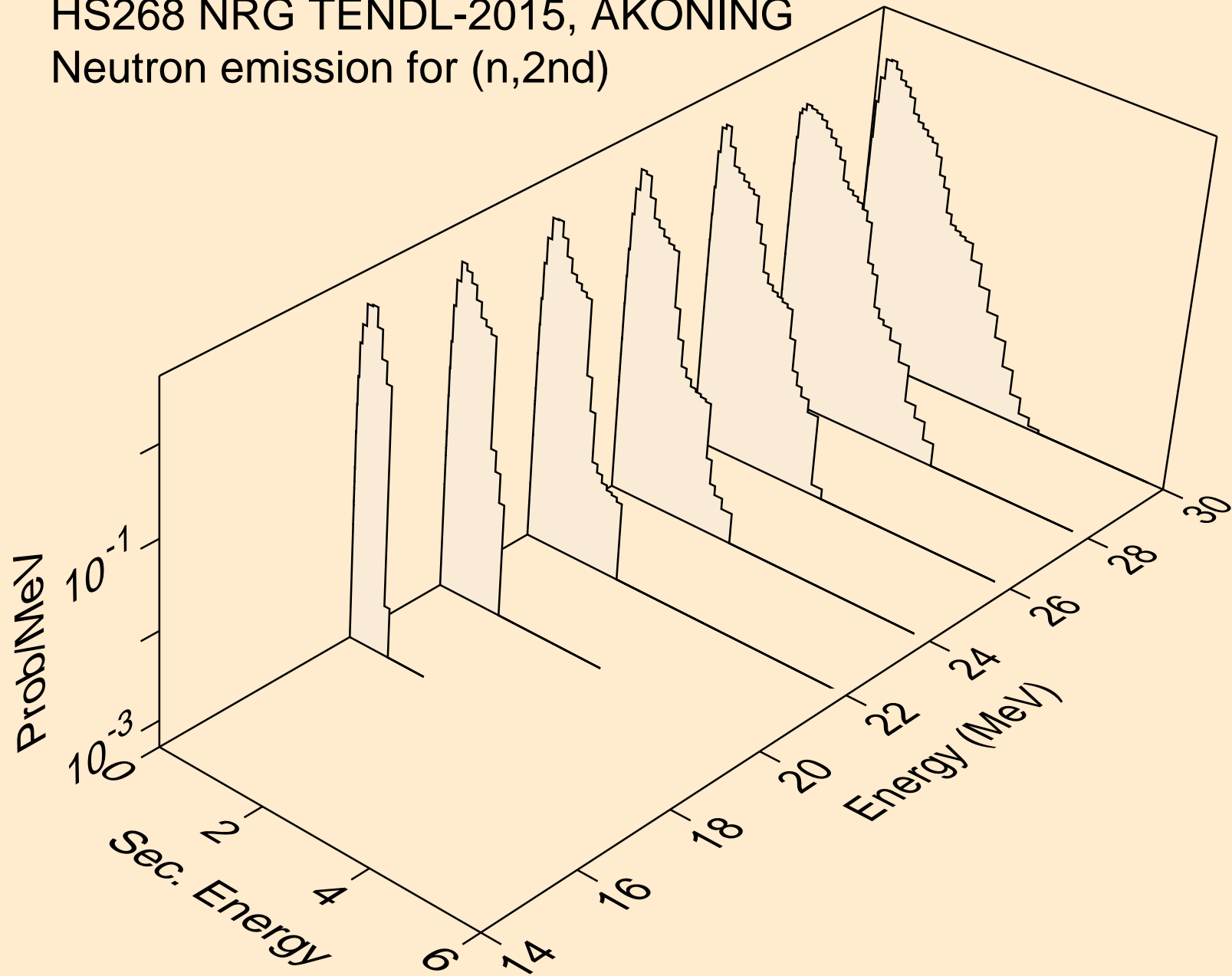

HS268 NRG TENDL-2015, AKONING  
Neutron emission for (n,2n)

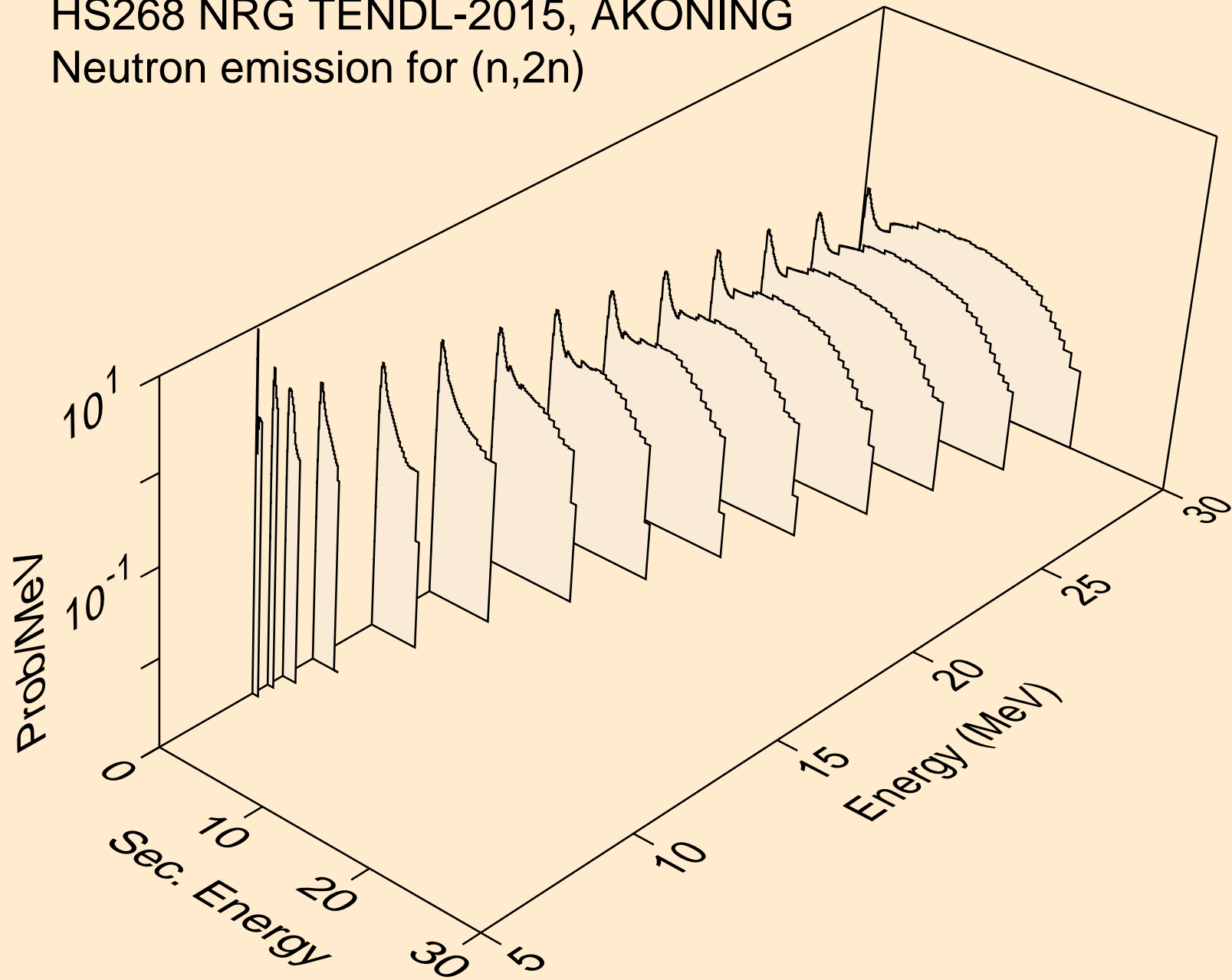

HS268 NRG TENDL-2015, AKONING  
Neutron emission for (n,3n)

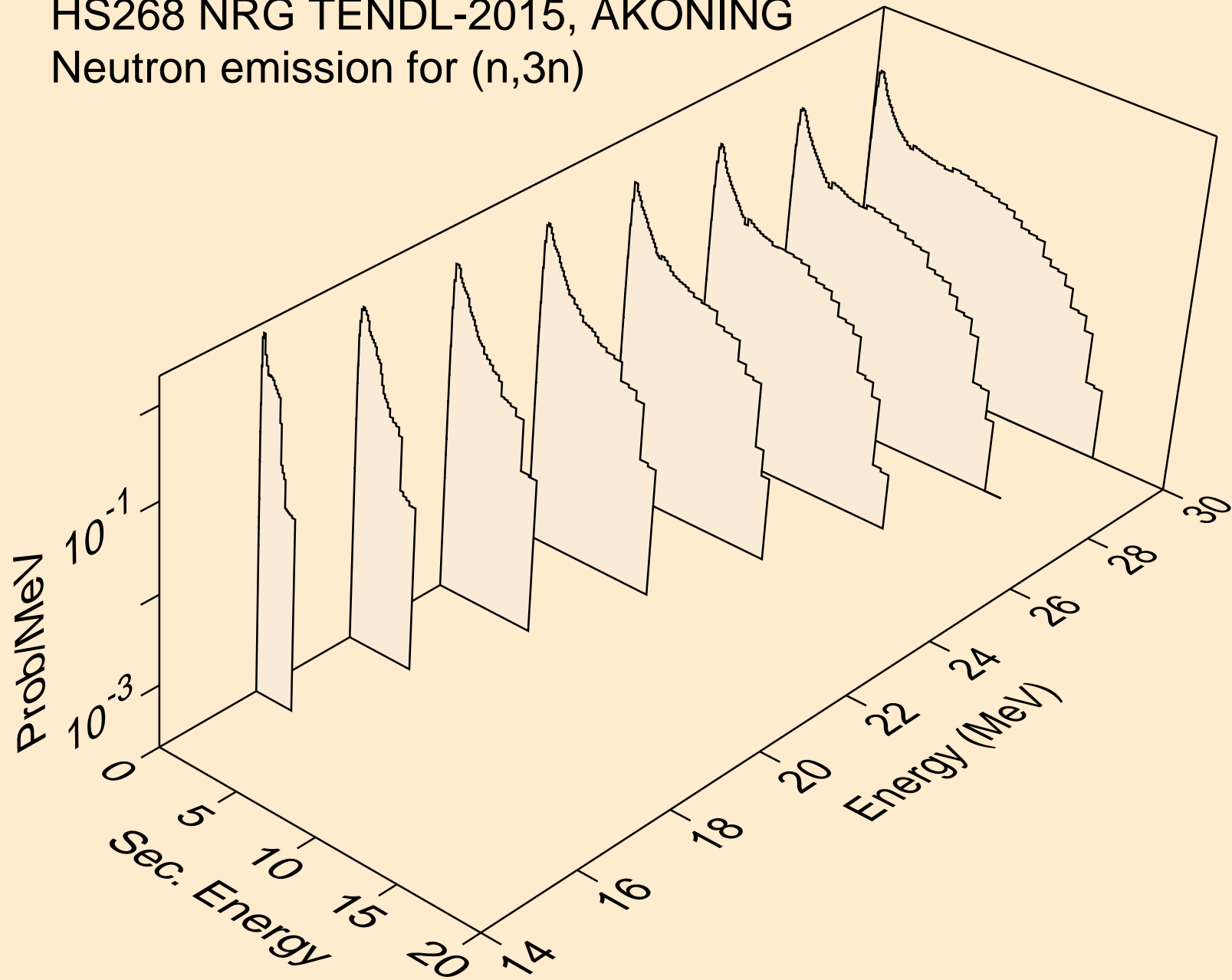

HS268 NRG TENDL-2015, AKONING  
Neutron emission for fission

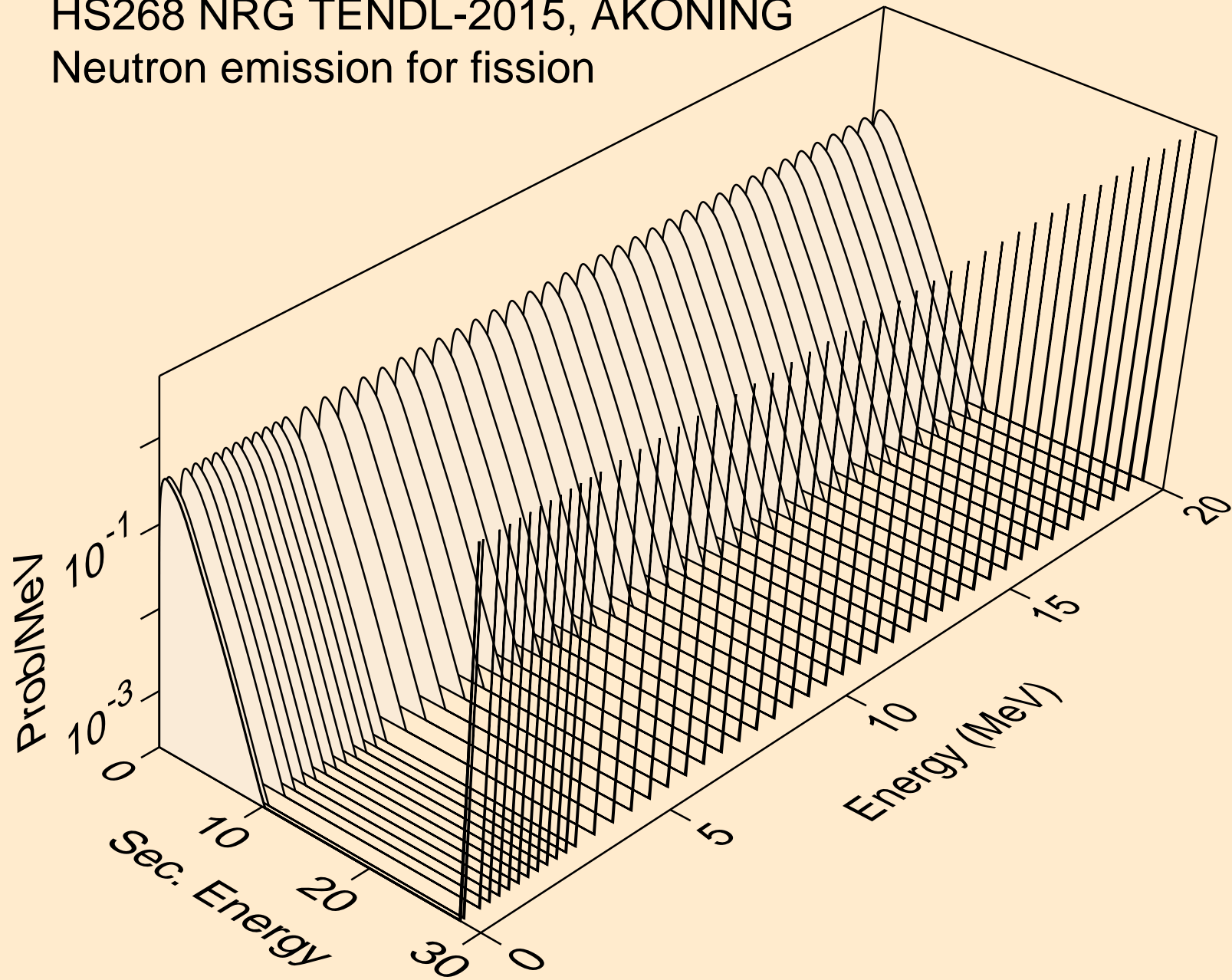

HS268 NRG TENDL-2015, AKONING  
Neutron emission for (n,n\*)a

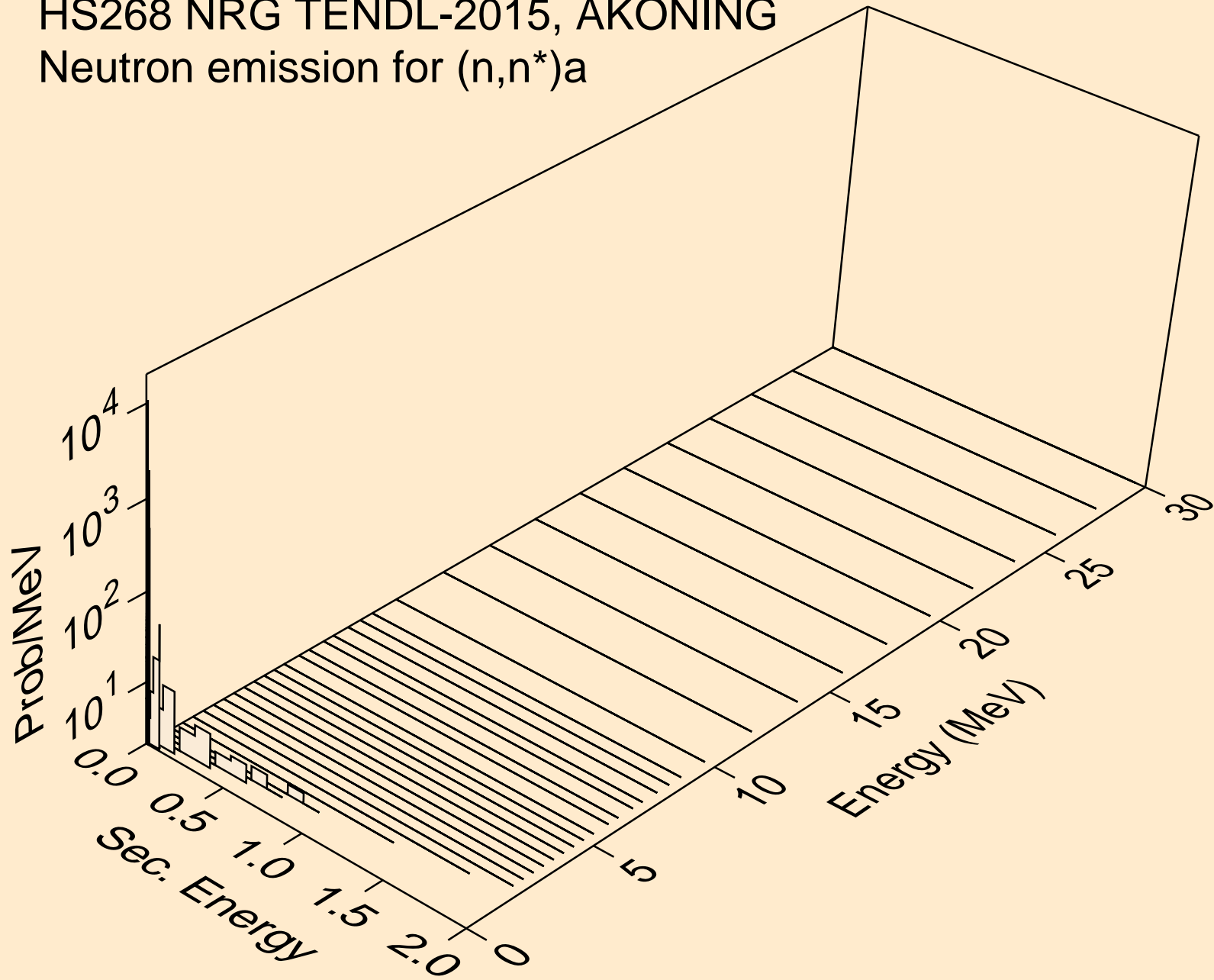



HS268 NRG TENDL-2015, AKONING  
Neutron emission for (n,n\*)3a

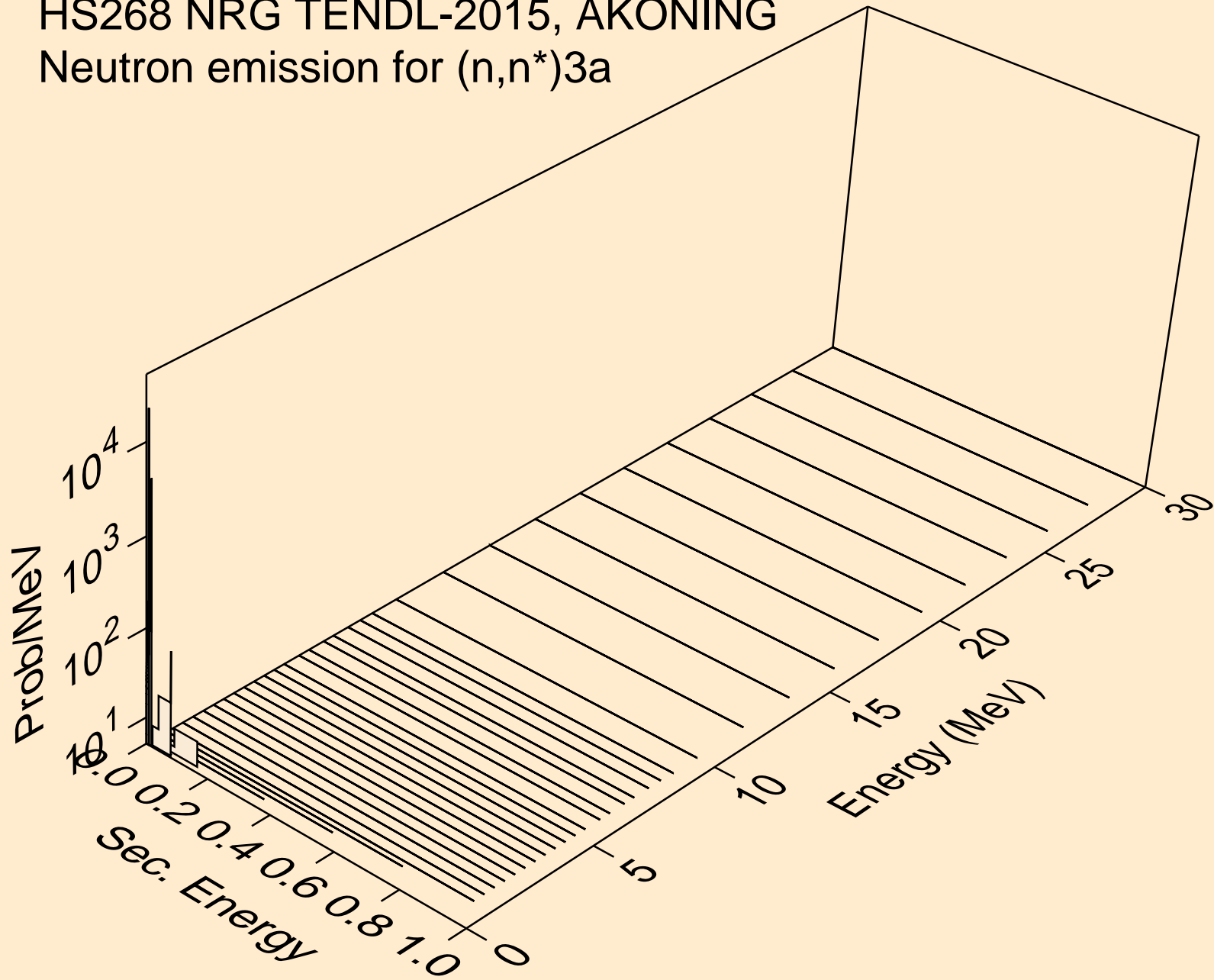

HS268 NRG TENDL-2015, AKONING  
Neutron emission for (n,2n)a

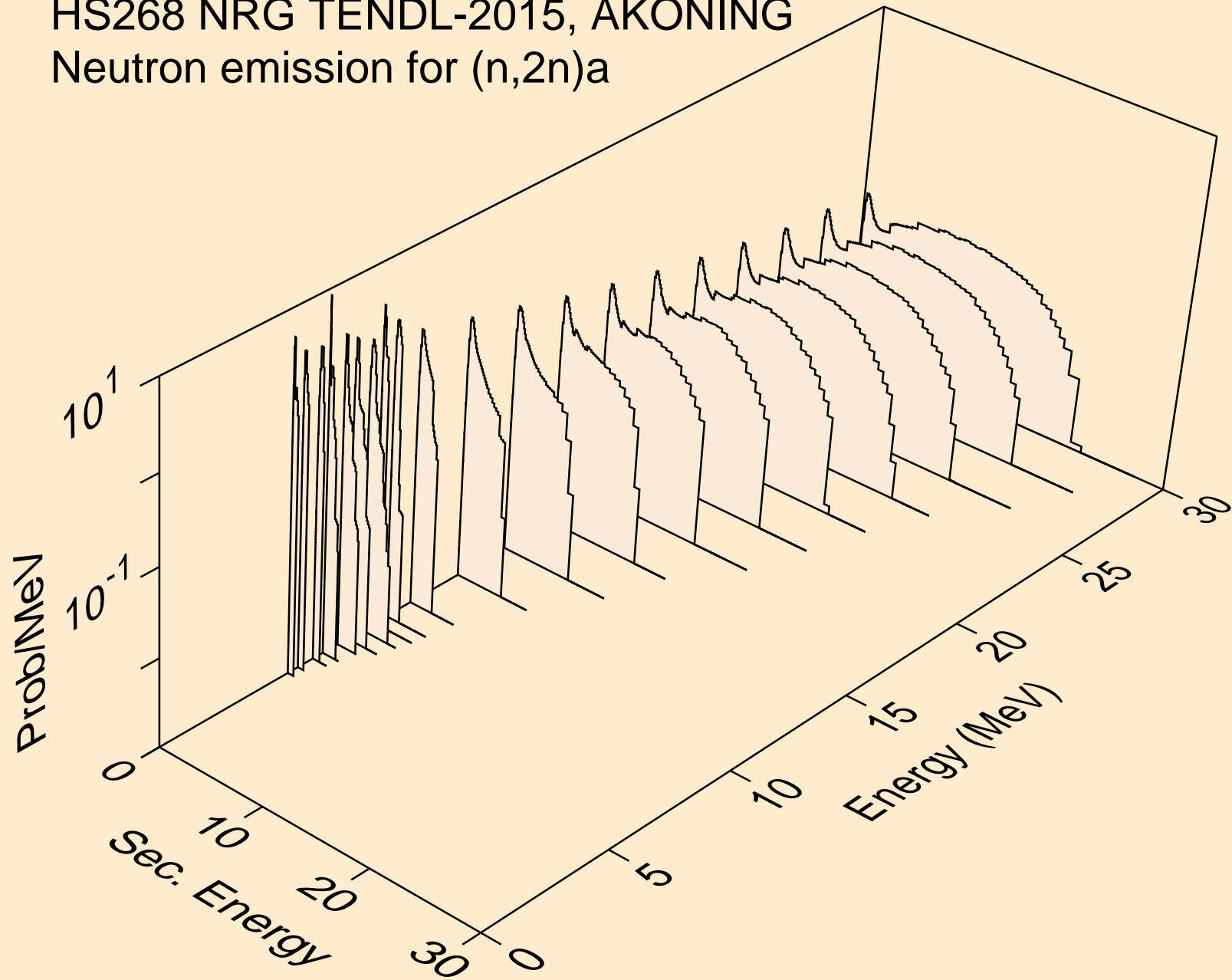

HS268 NRG TENDL-2015, AKONING  
Neutron emission for (n,3n)<sub>a</sub>

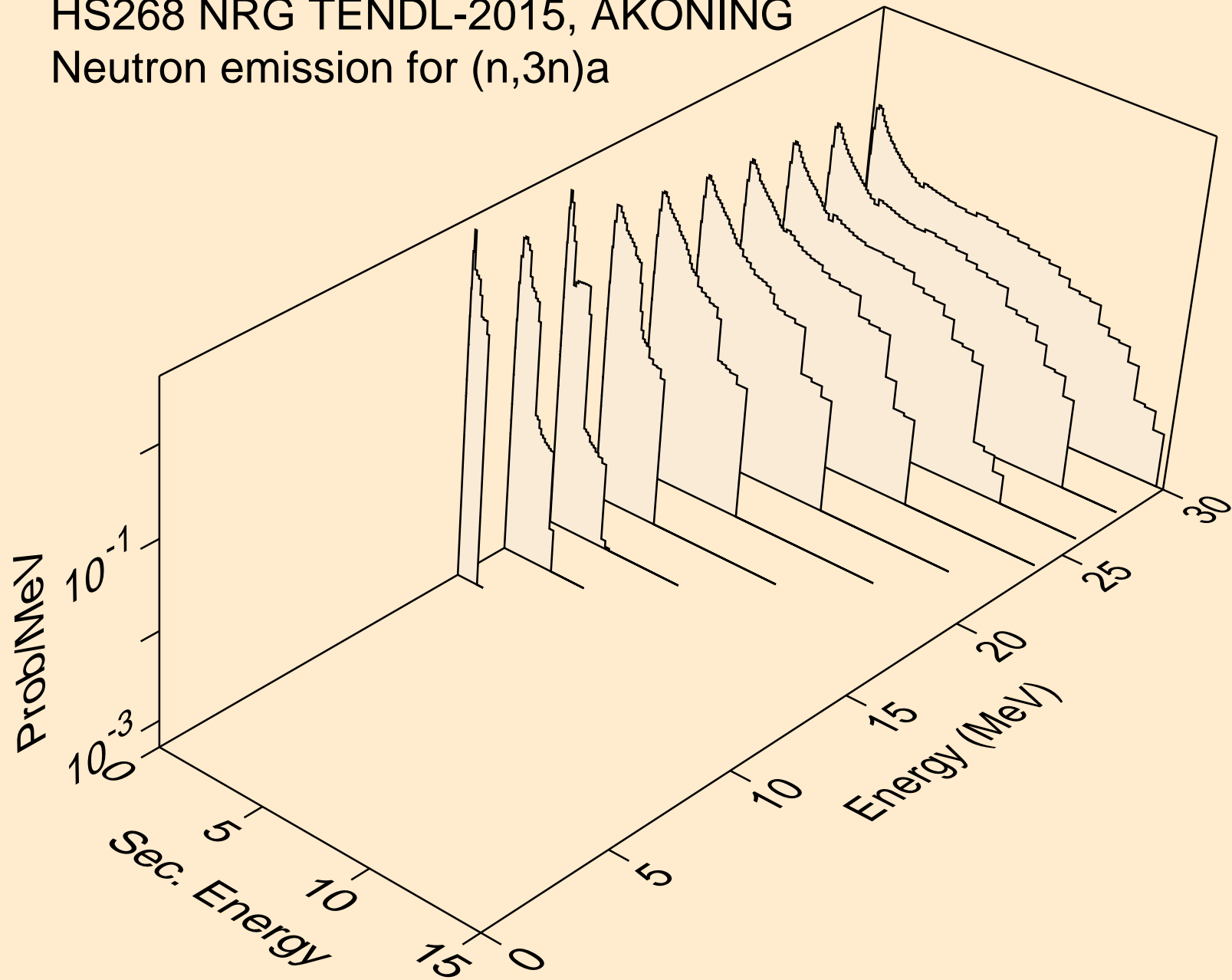

HS268 NRG TENDL-2015, AKONING  
Neutron emission for (n,n\*)p

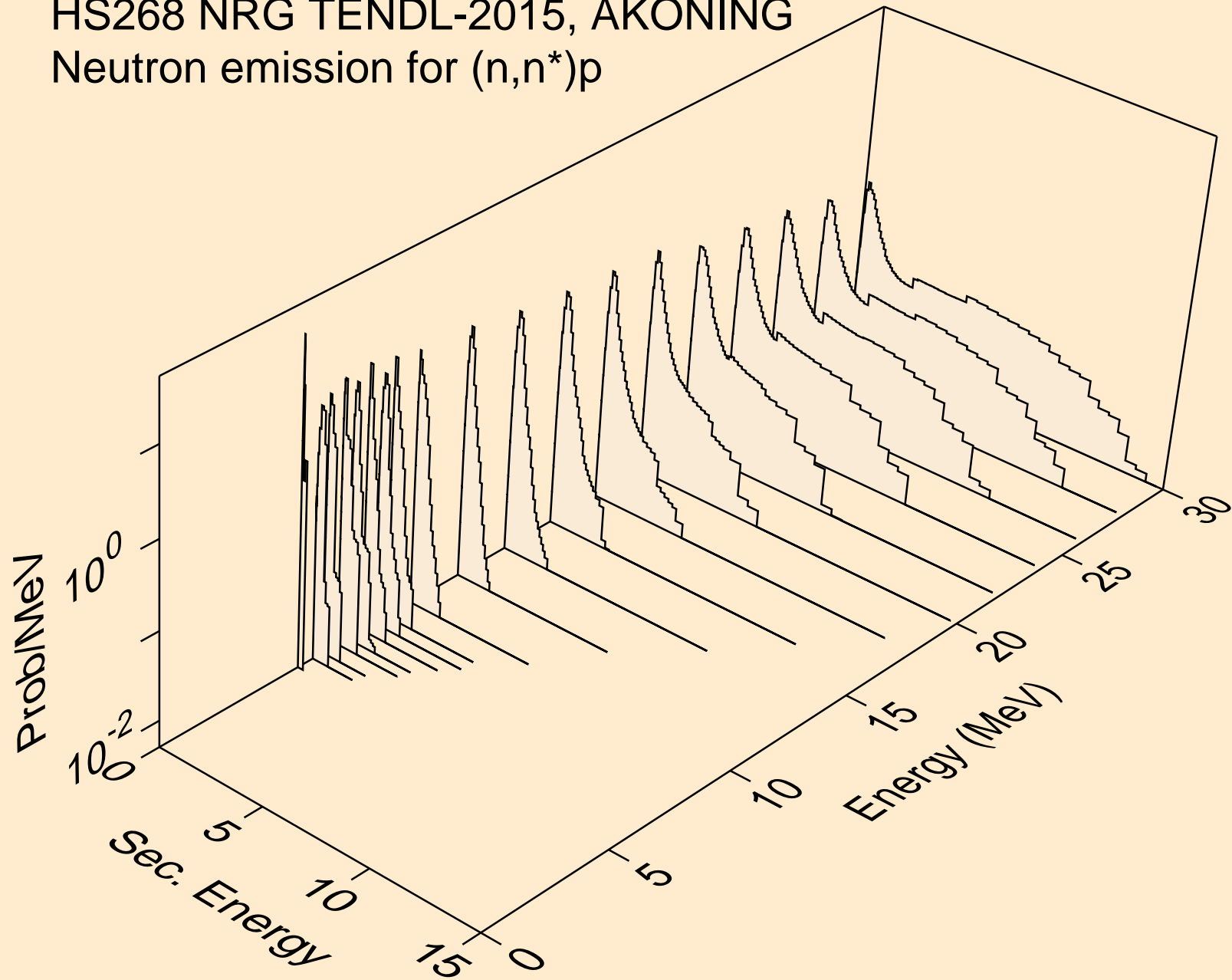

HS268 NRG TENDL-2015, AKONING  
Neutron emission for (n,n\*)2a

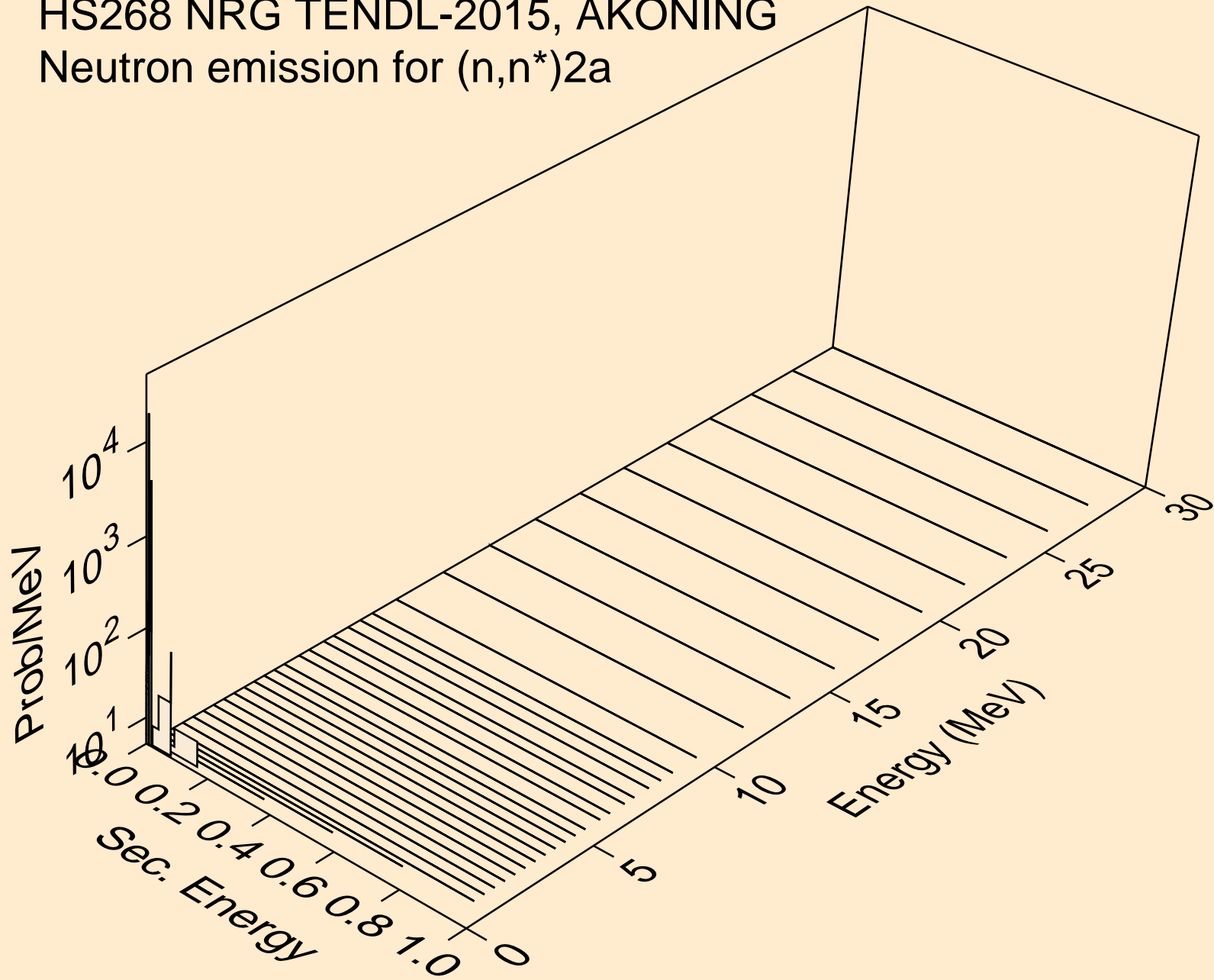

HS268 NRG TENDL-2015, AKONING  
Neutron emission for (n,2n)2a

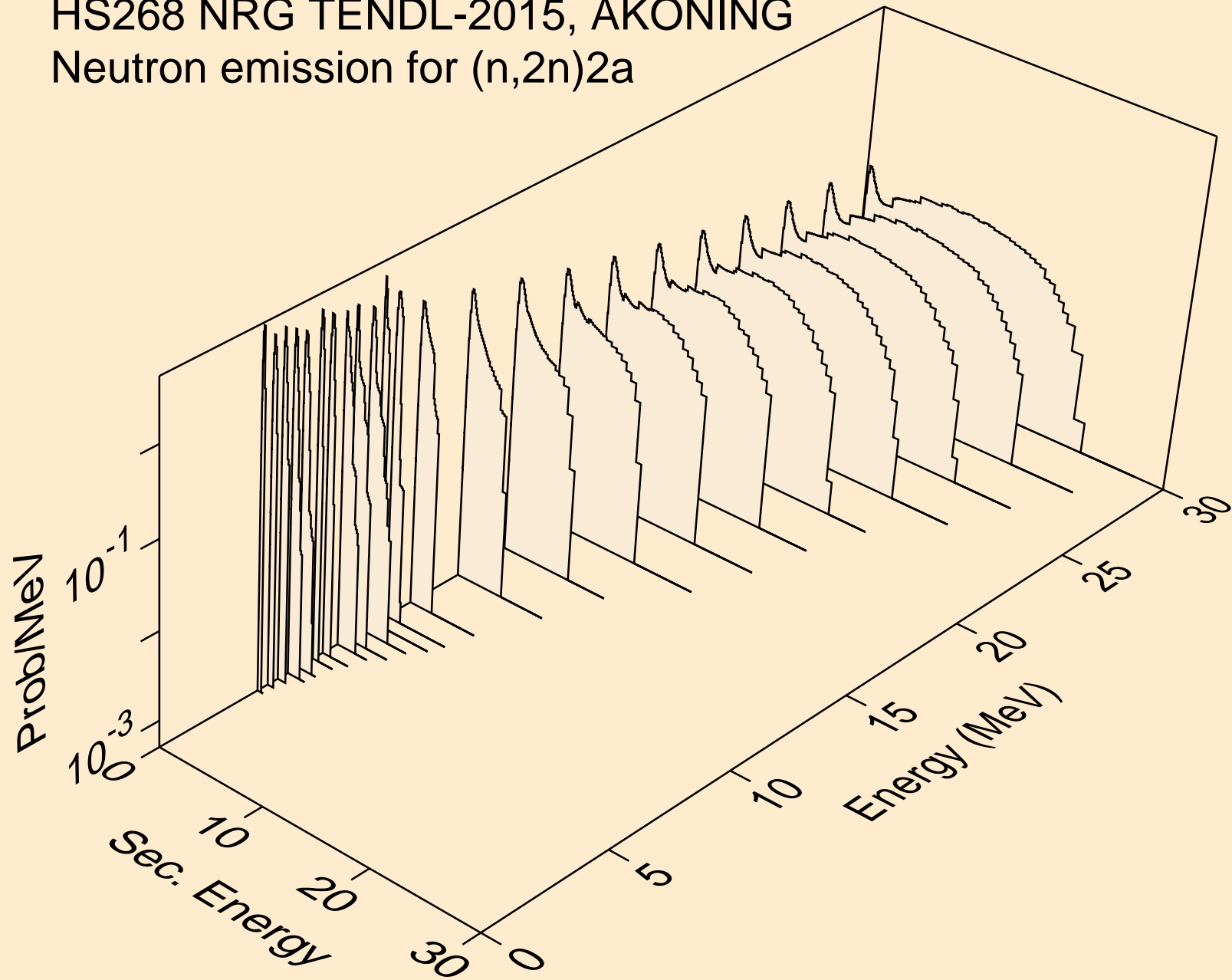

HS268 NRG TENDL-2015, AKONING  
Neutron emission for (n,n\*)d

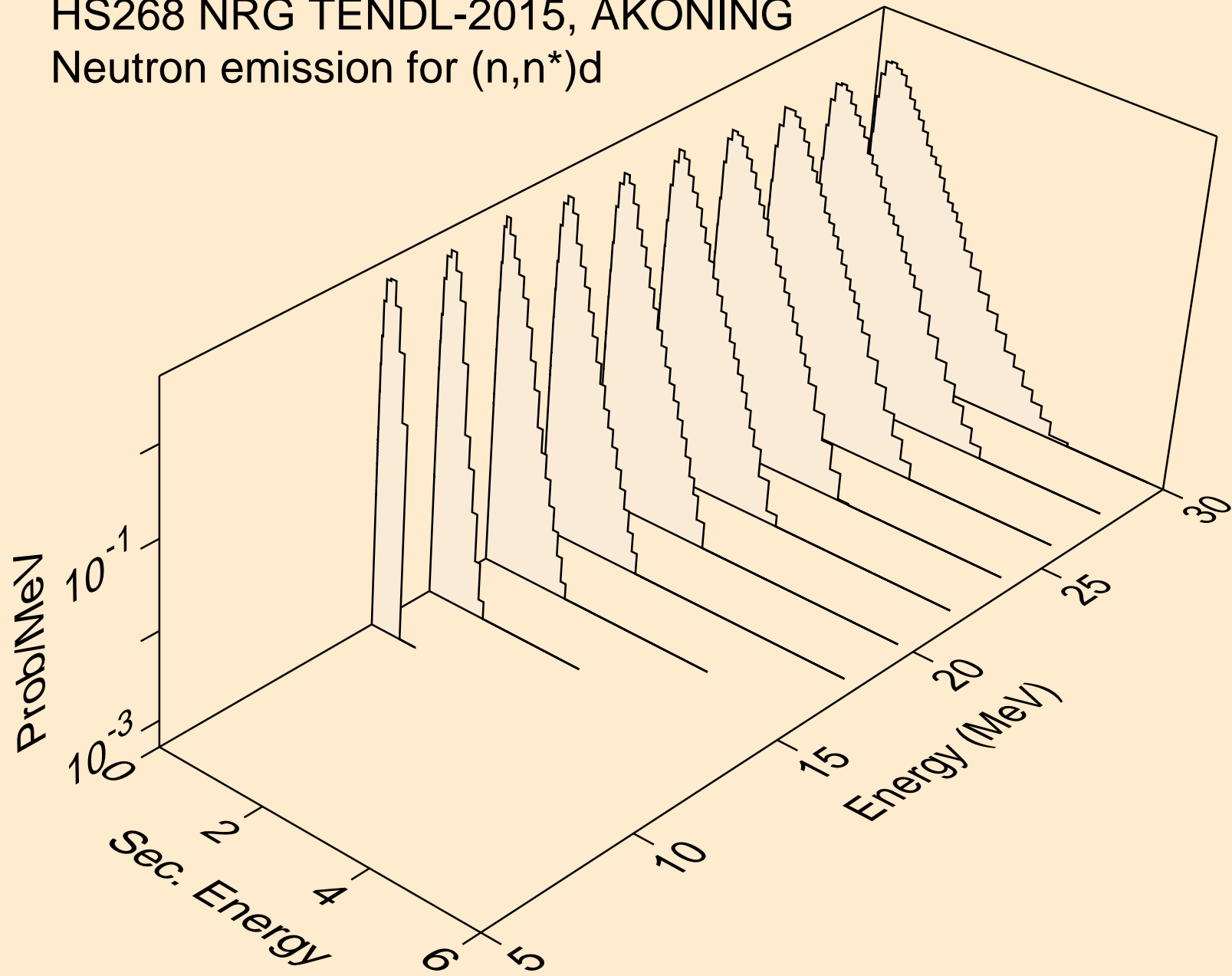

HS268 NRG TENDL-2015, AKONING  
Neutron emission for (n,n\*)t

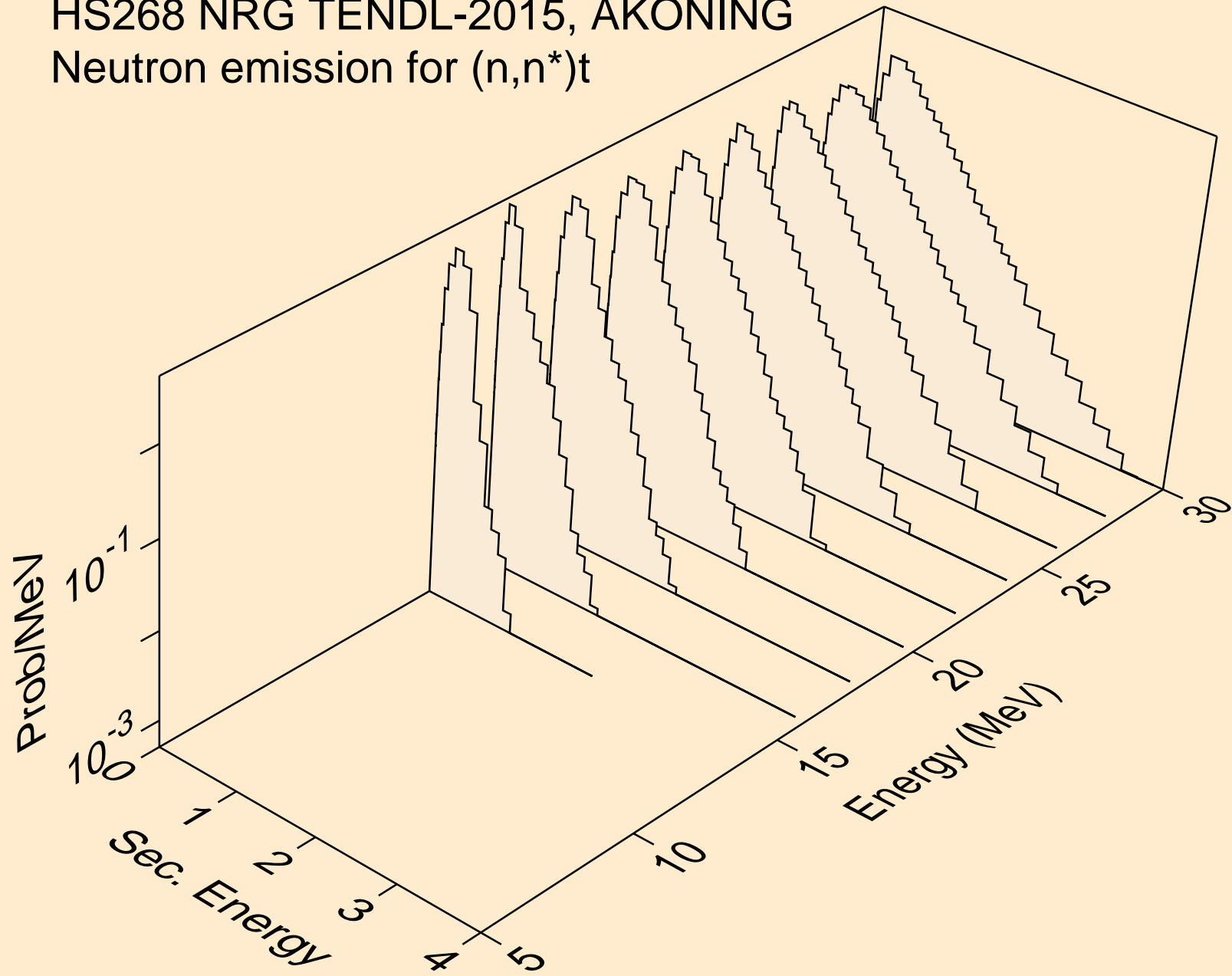



HS268 NRG TENDL-2015, AKONING  
Neutron emission for (n,n\*)he3

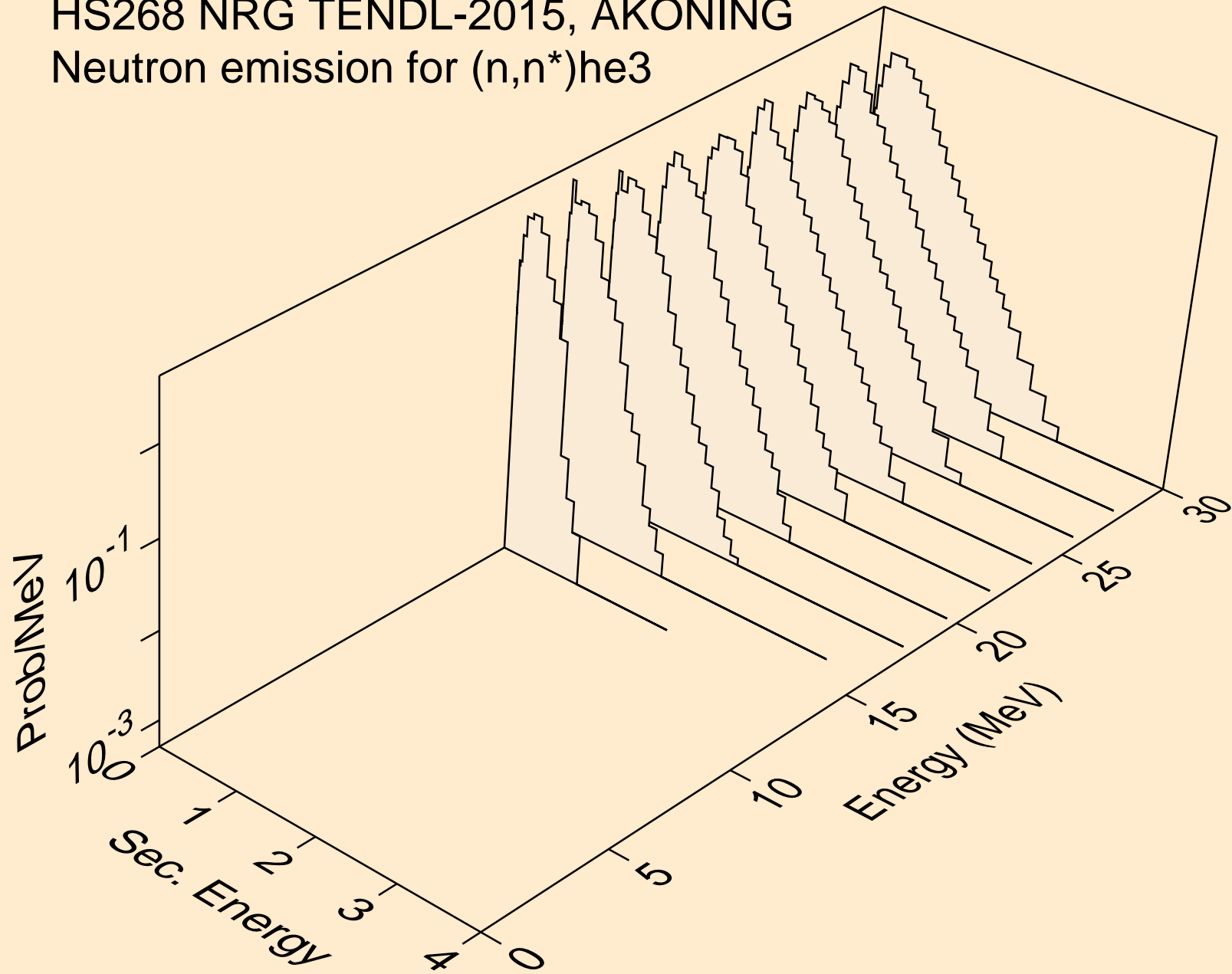

HS268 NRG TENDL-2015, AKONING  
Neutron emission for (n,n\*)d2a

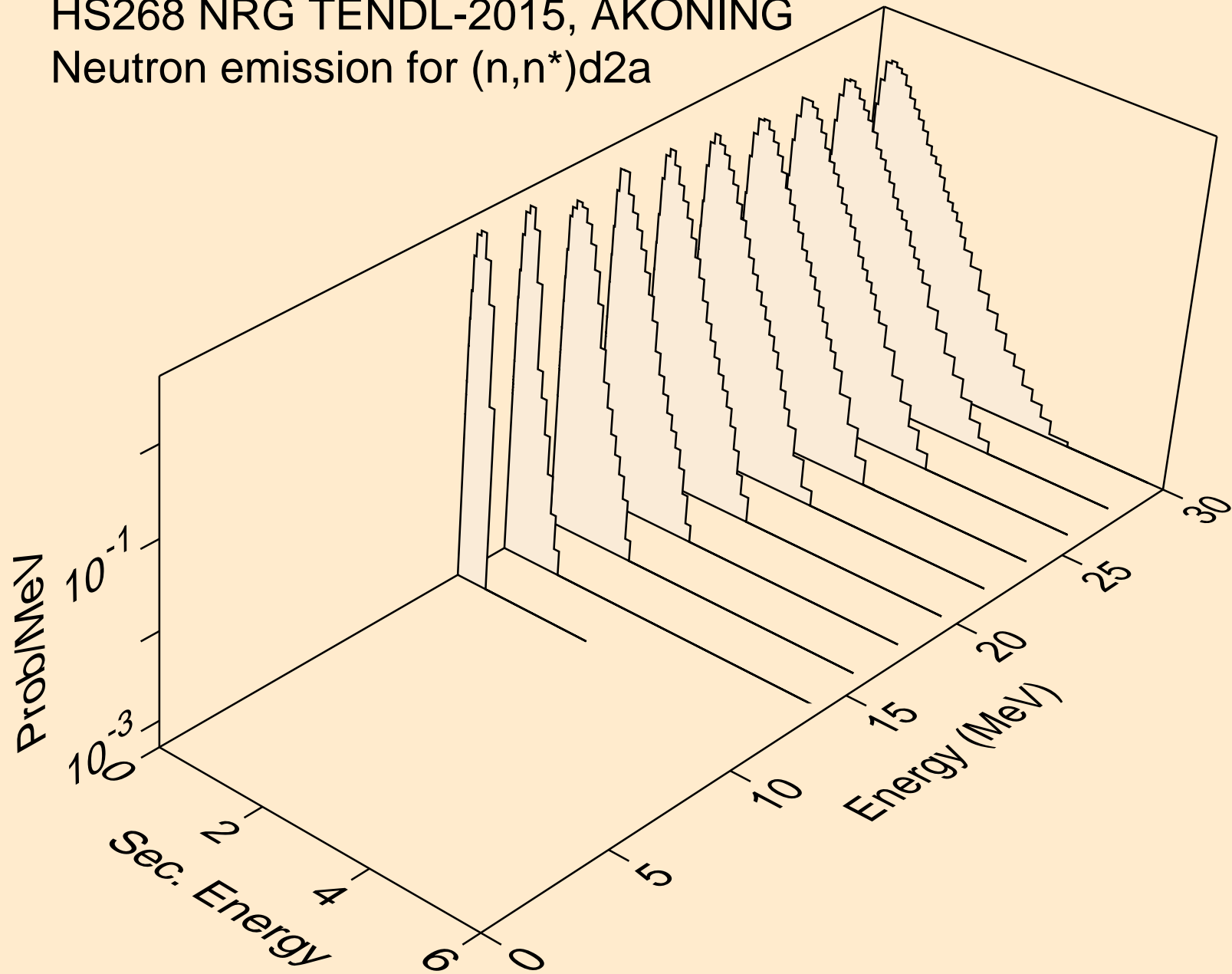

HS268 NRG TENDL-2015, AKONING  
Neutron emission for (n,n\*)t2a

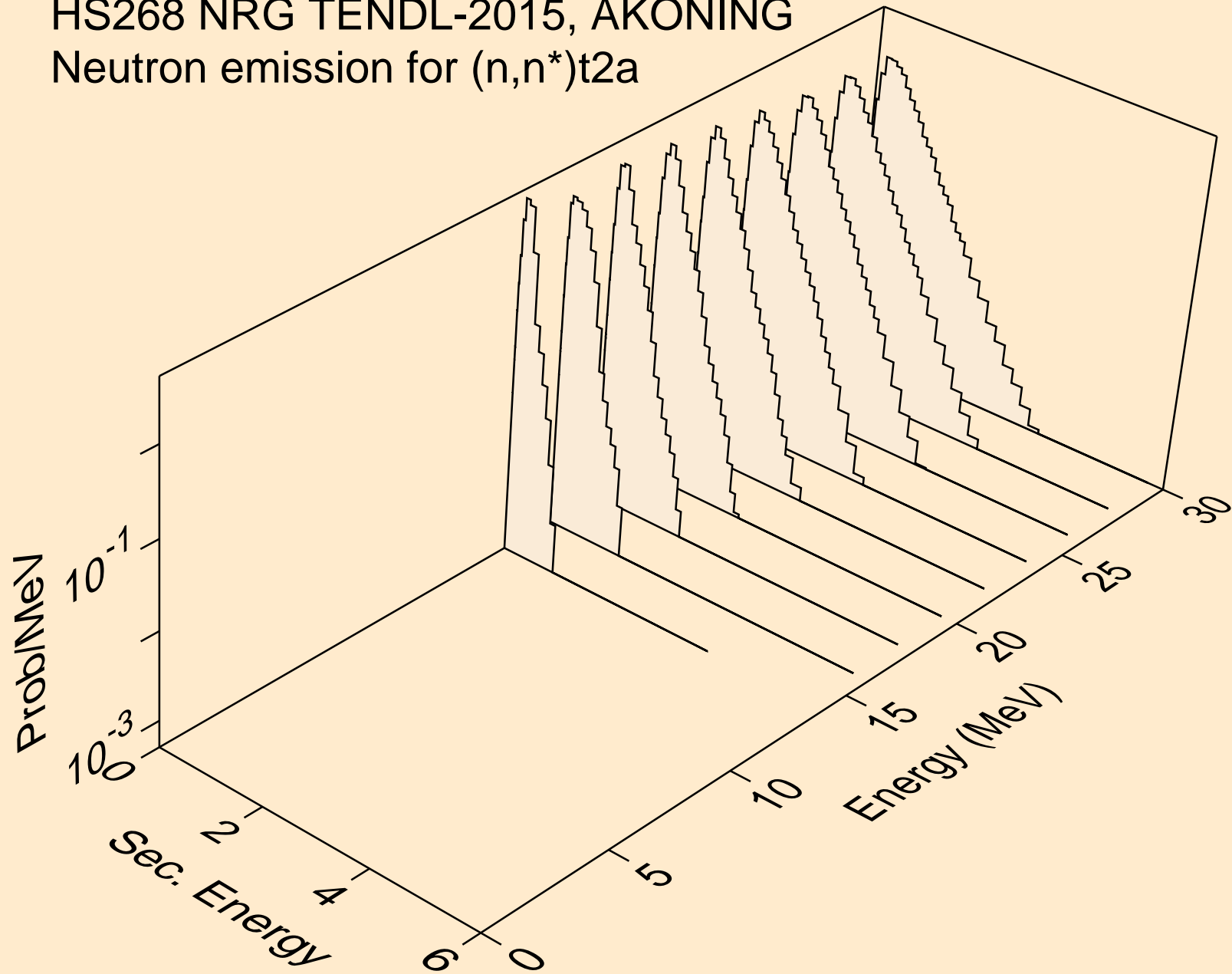

HS268 NRG TENDL-2015, AKONING  
Neutron emission for (n,4n)

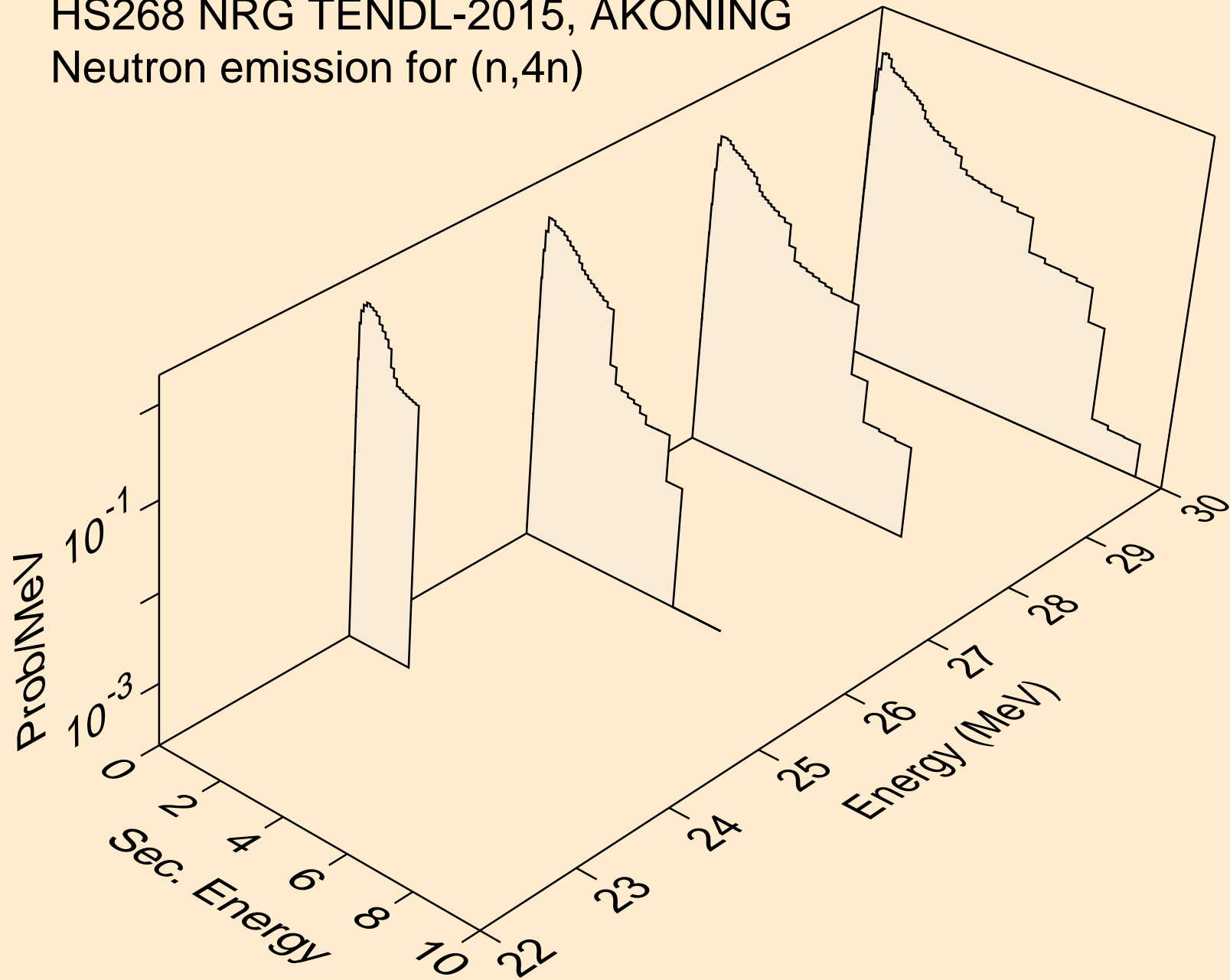

HS268 NRG TENDL-2015, AKONING  
Neutron emission for (n,2np)

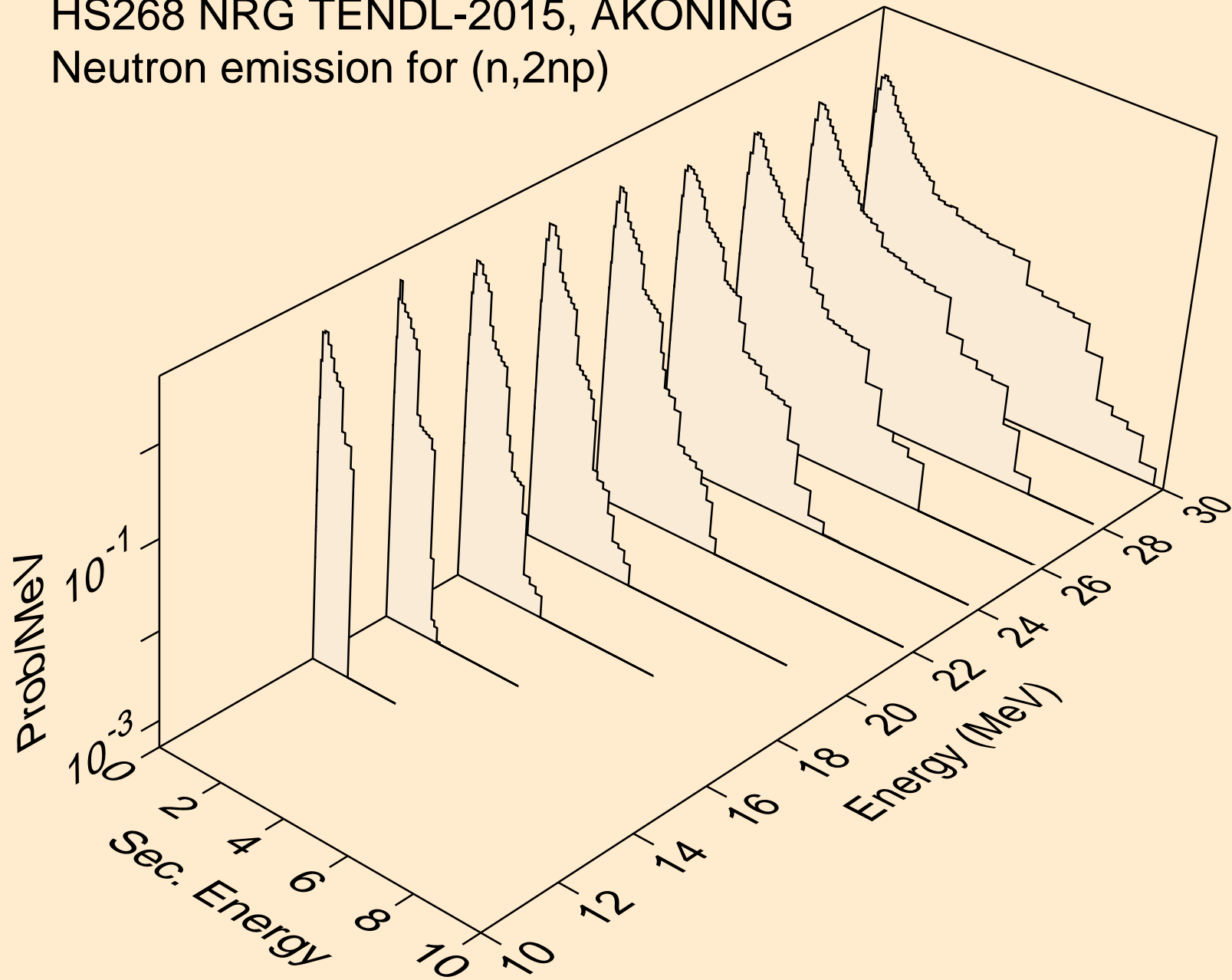

HS268 NRG TENDL-2015, AKONING  
Neutron emission for (n,3np)

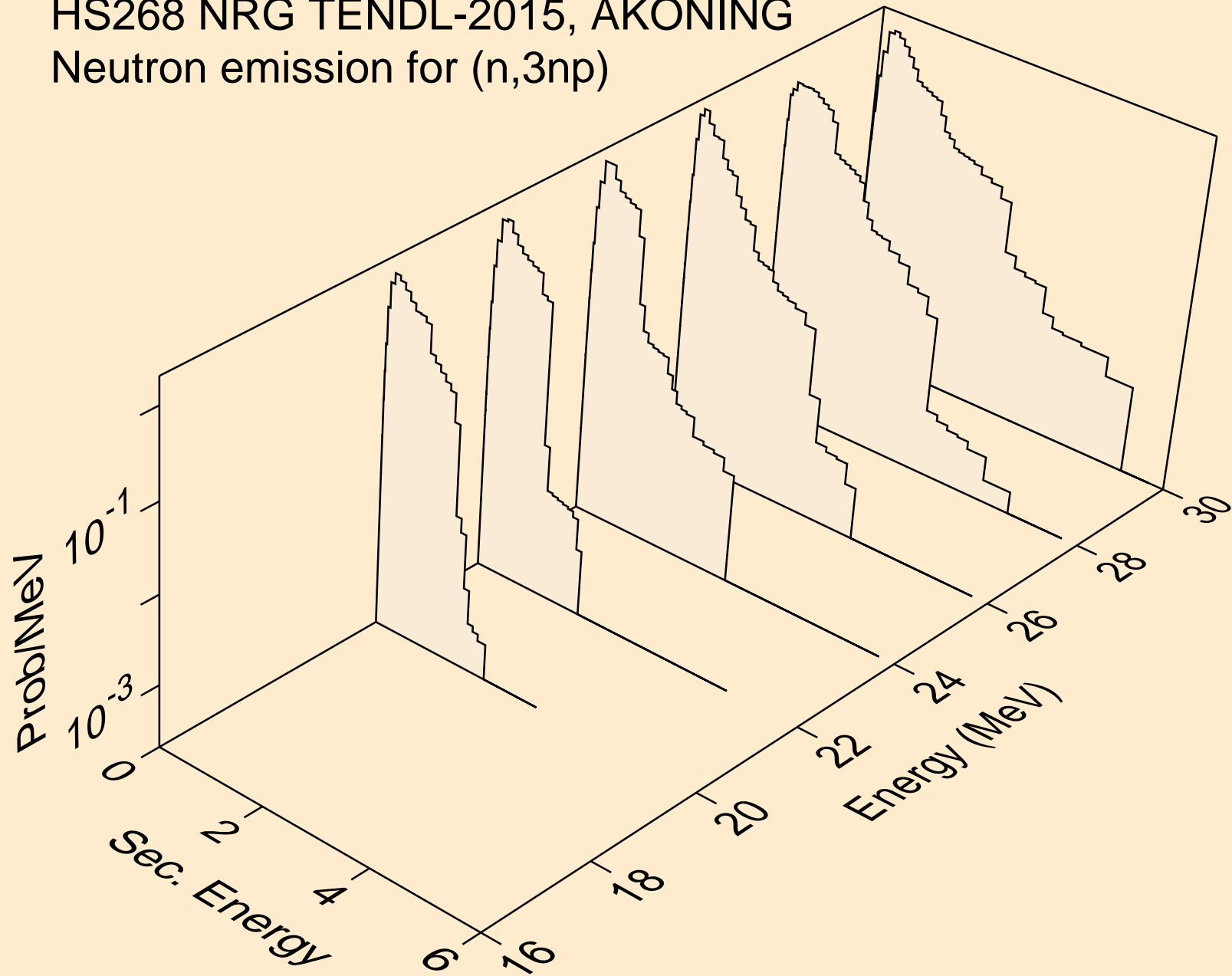

HS268 NRG TENDL-2015, AKONING  
Neutron emission for (n,2np)

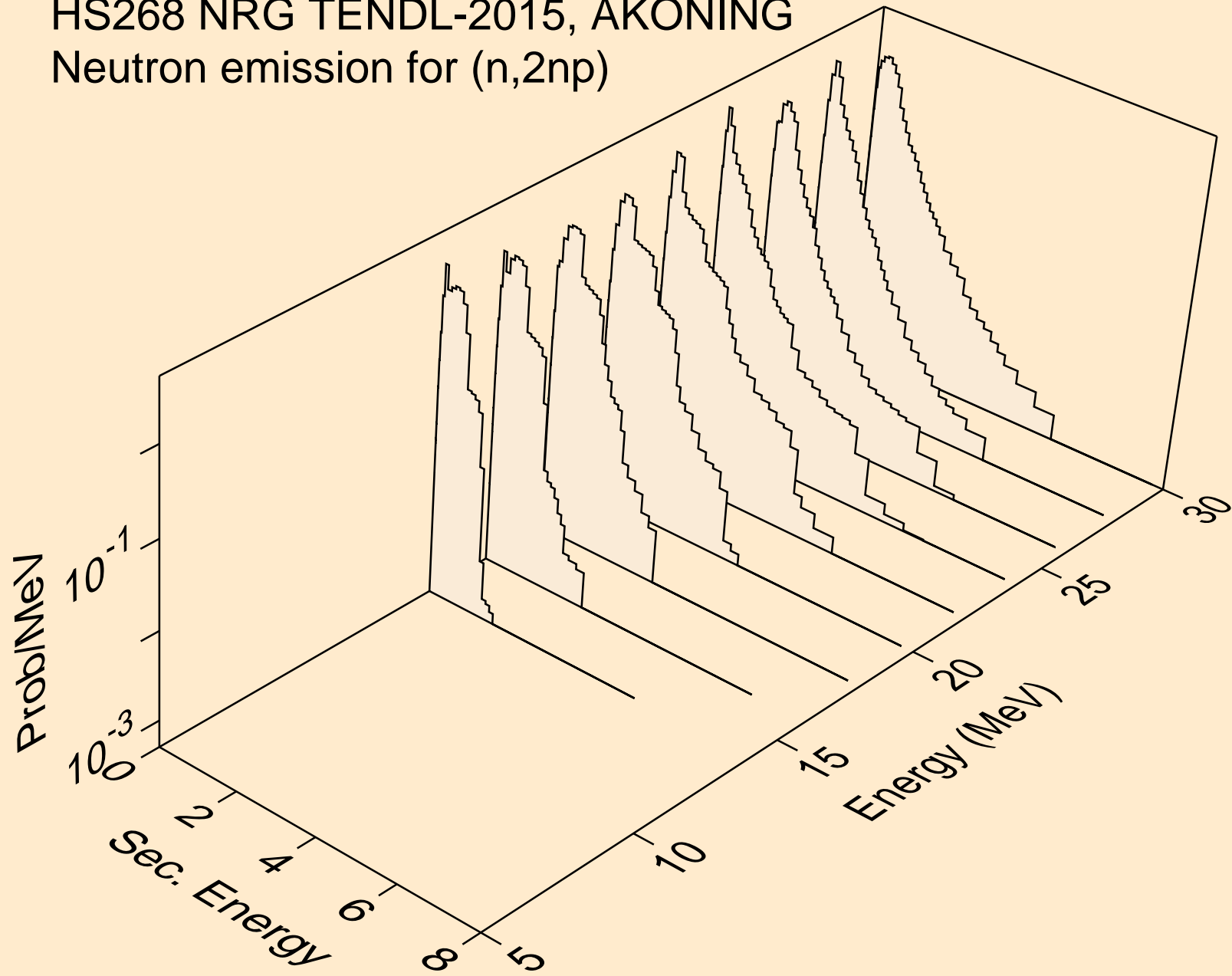

HS268 NRG TENDL-2015, AKONING  
Neutron emission for (n,npa)

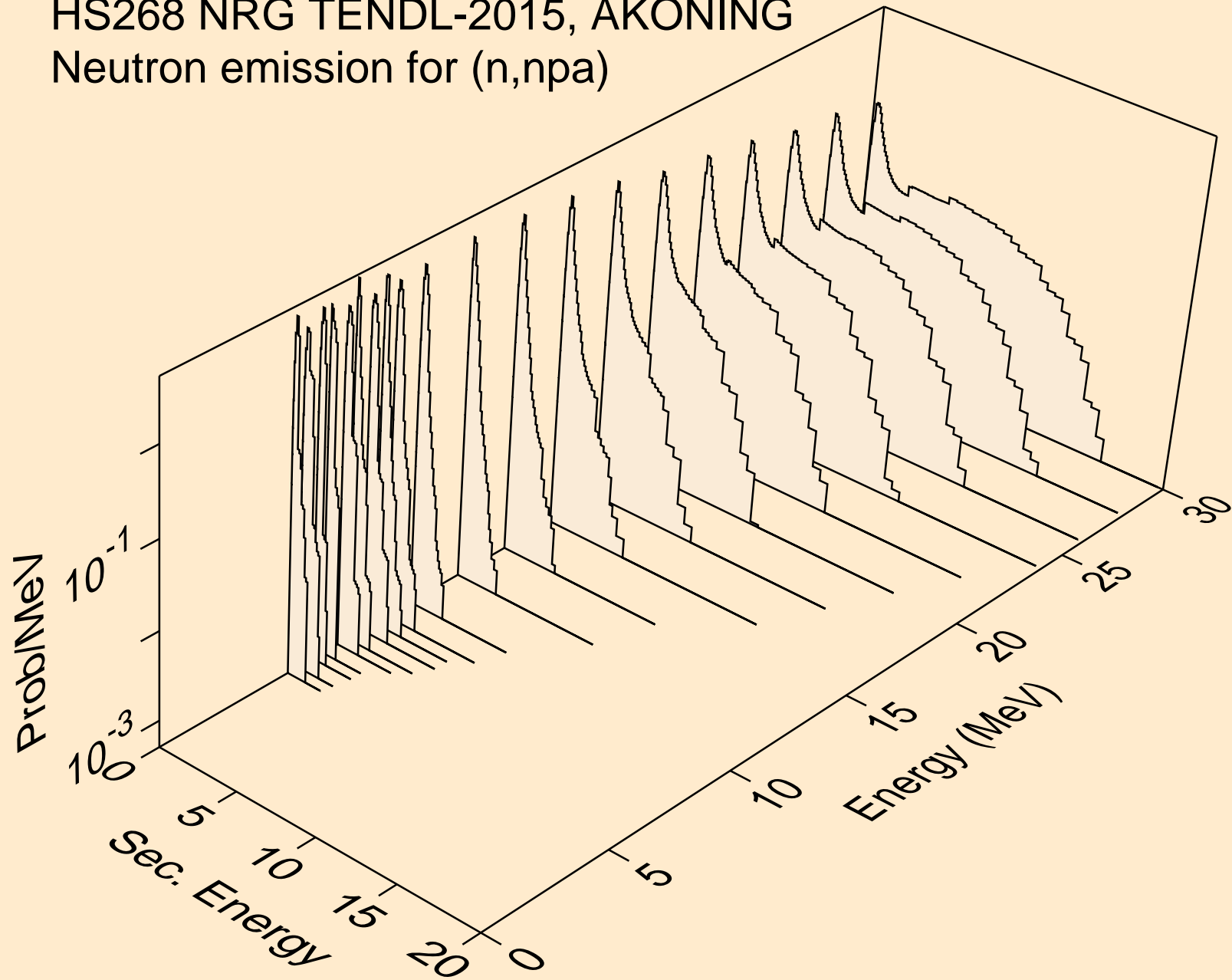



HS268 NRG TENDL-2015, AKONING  
Neutron emission for (n,n\*c)

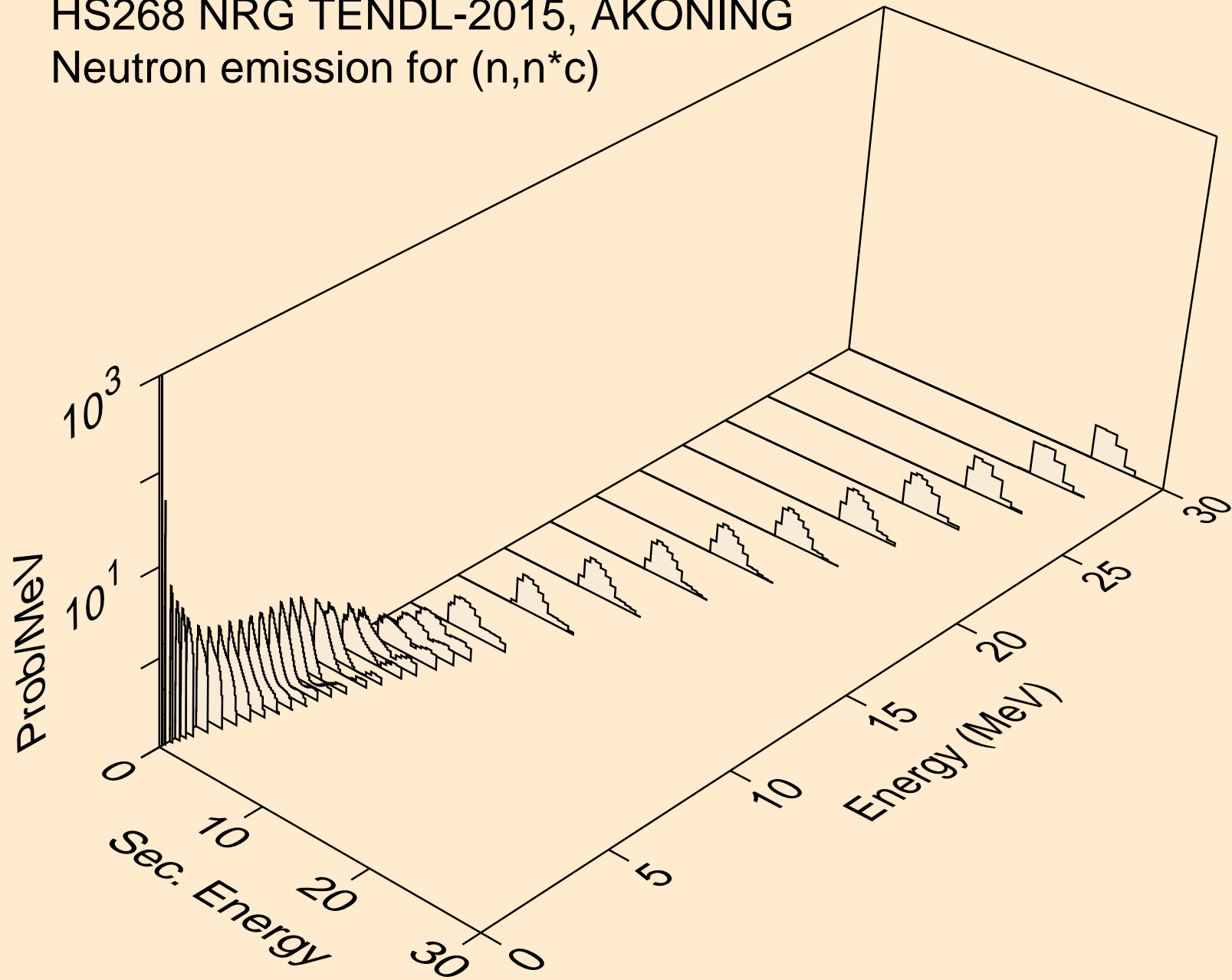

# HS268 NRG TENDL-2015, AKONING

Delayed nubar

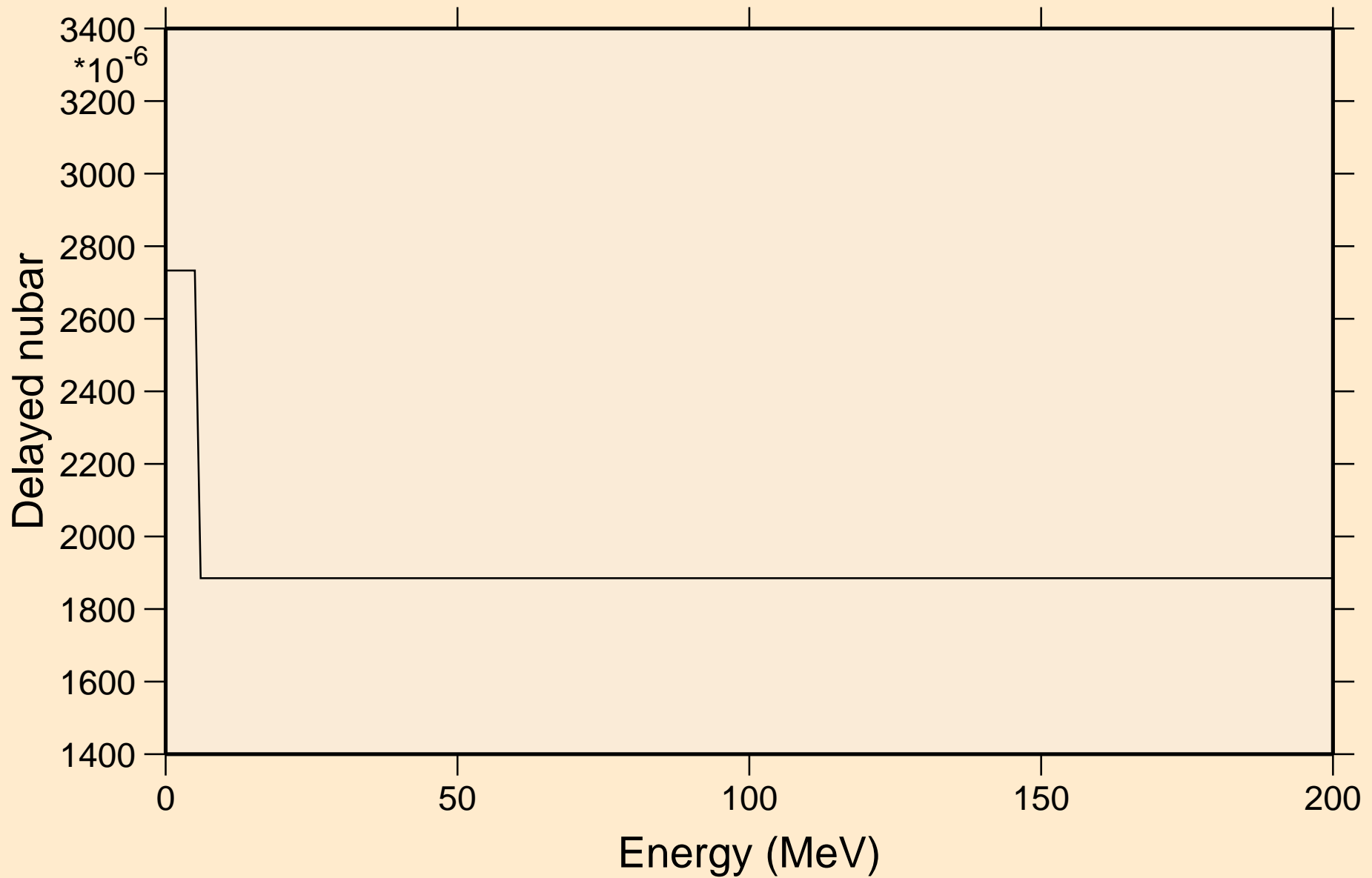

# HS268 NRG TENDL-2015, AKONING

## Delayed neutron spectra

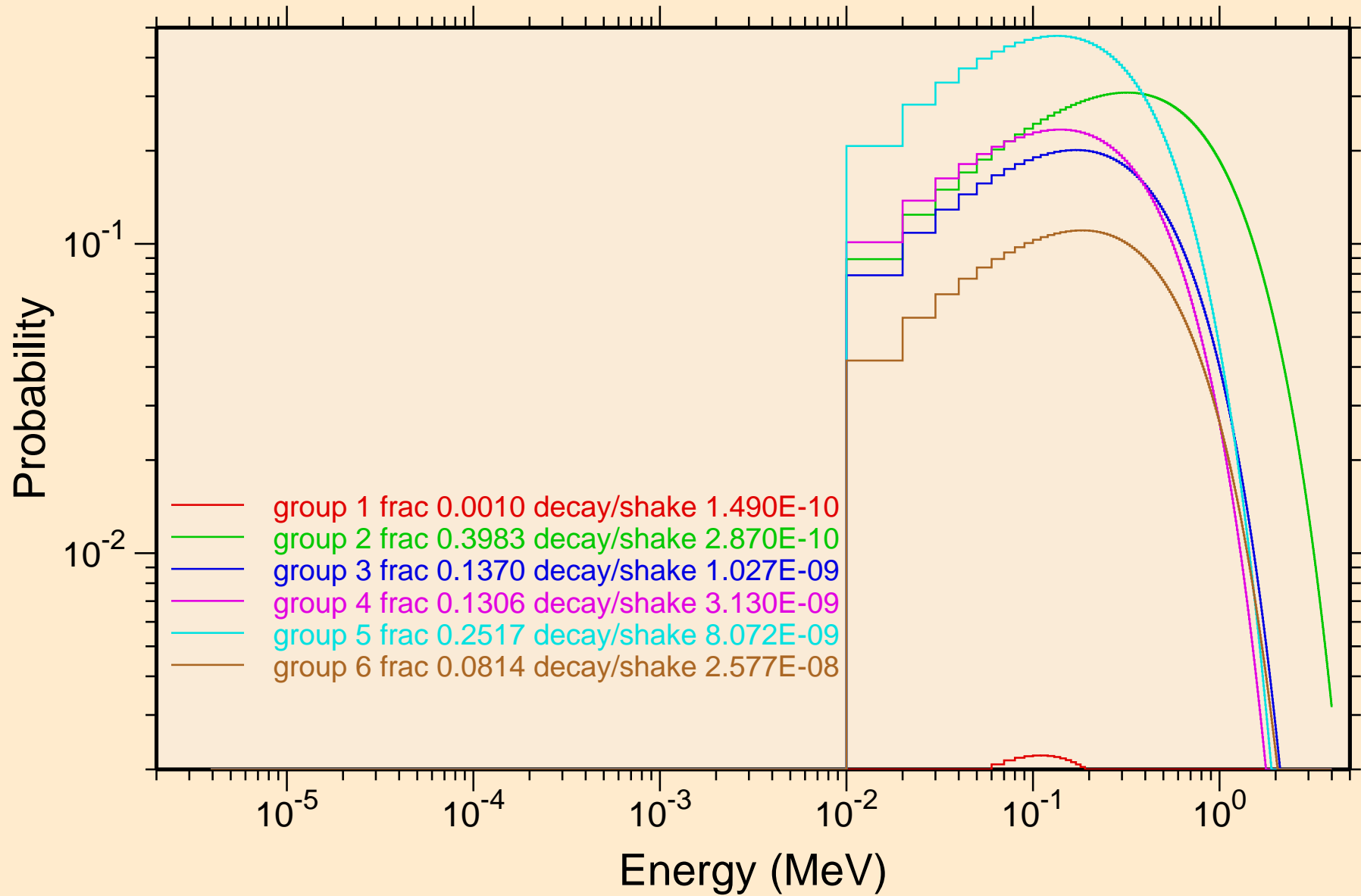

HS268 NRG TENDL-2015, AKONING  
Photon emission for (n,x)

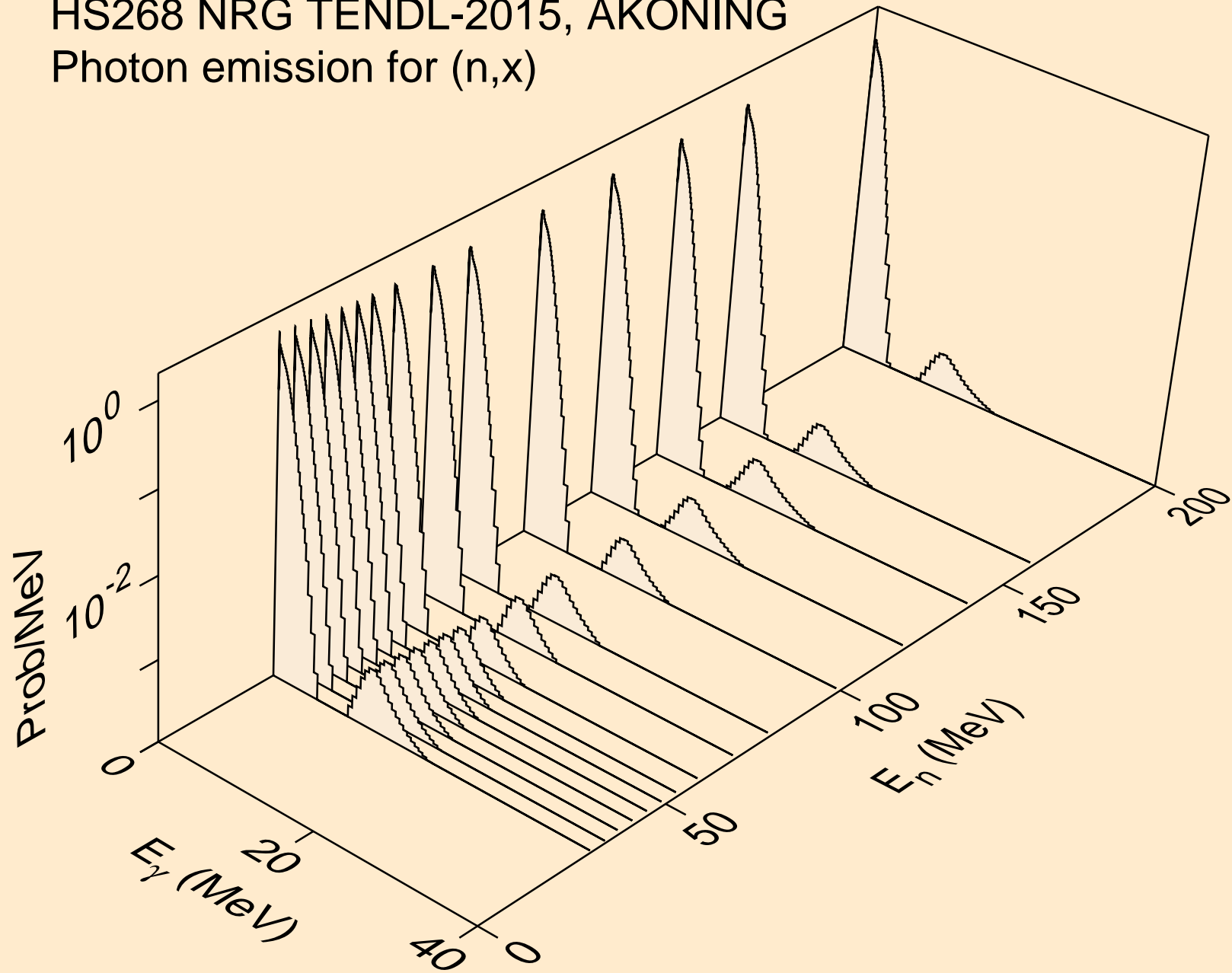

HS268 NRG TENDL-2015, AKONING  
Photon emission for (n,2nd)

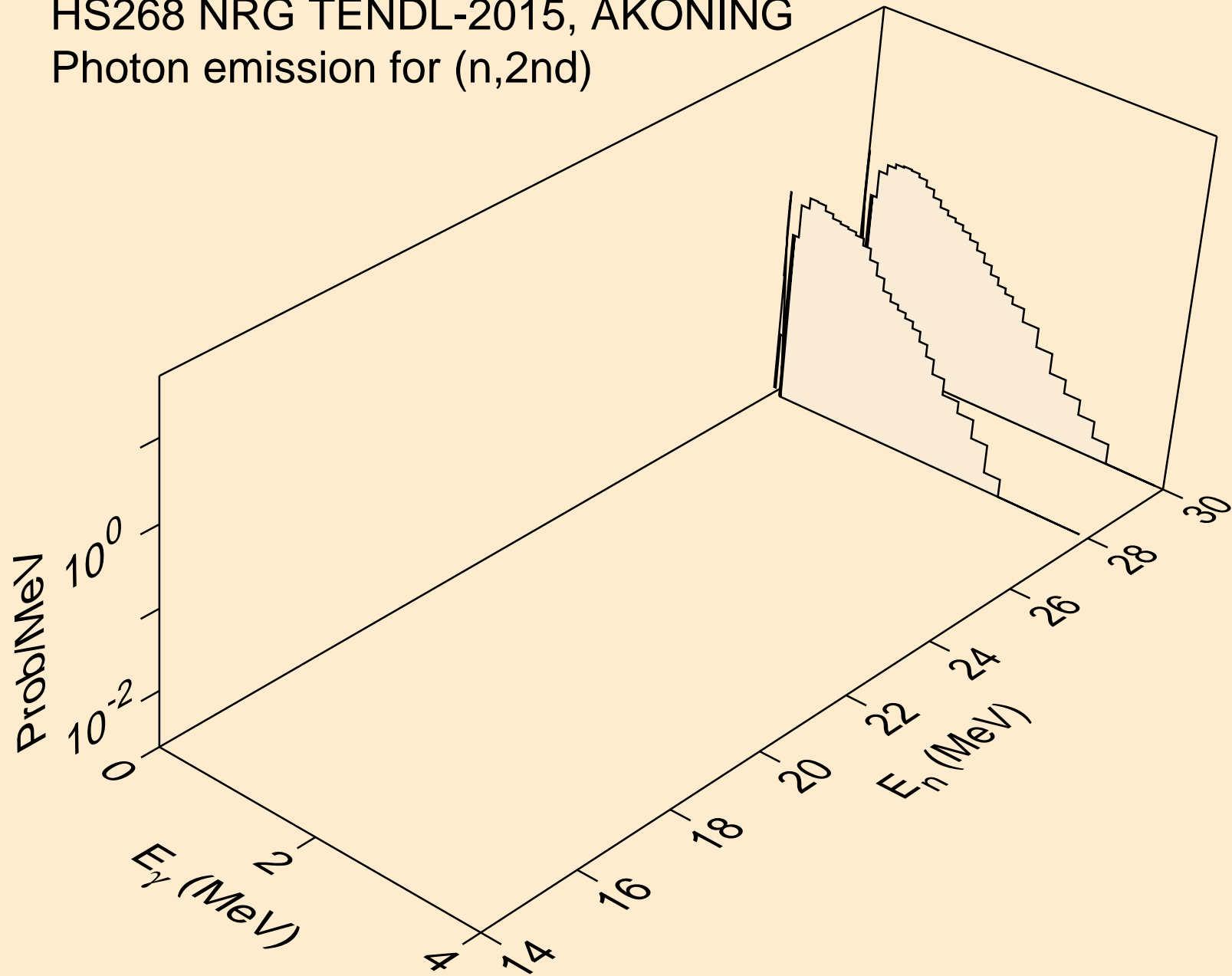

HS268 NRG TENDL-2015, AKONING  
Photon emission for (n,2n)

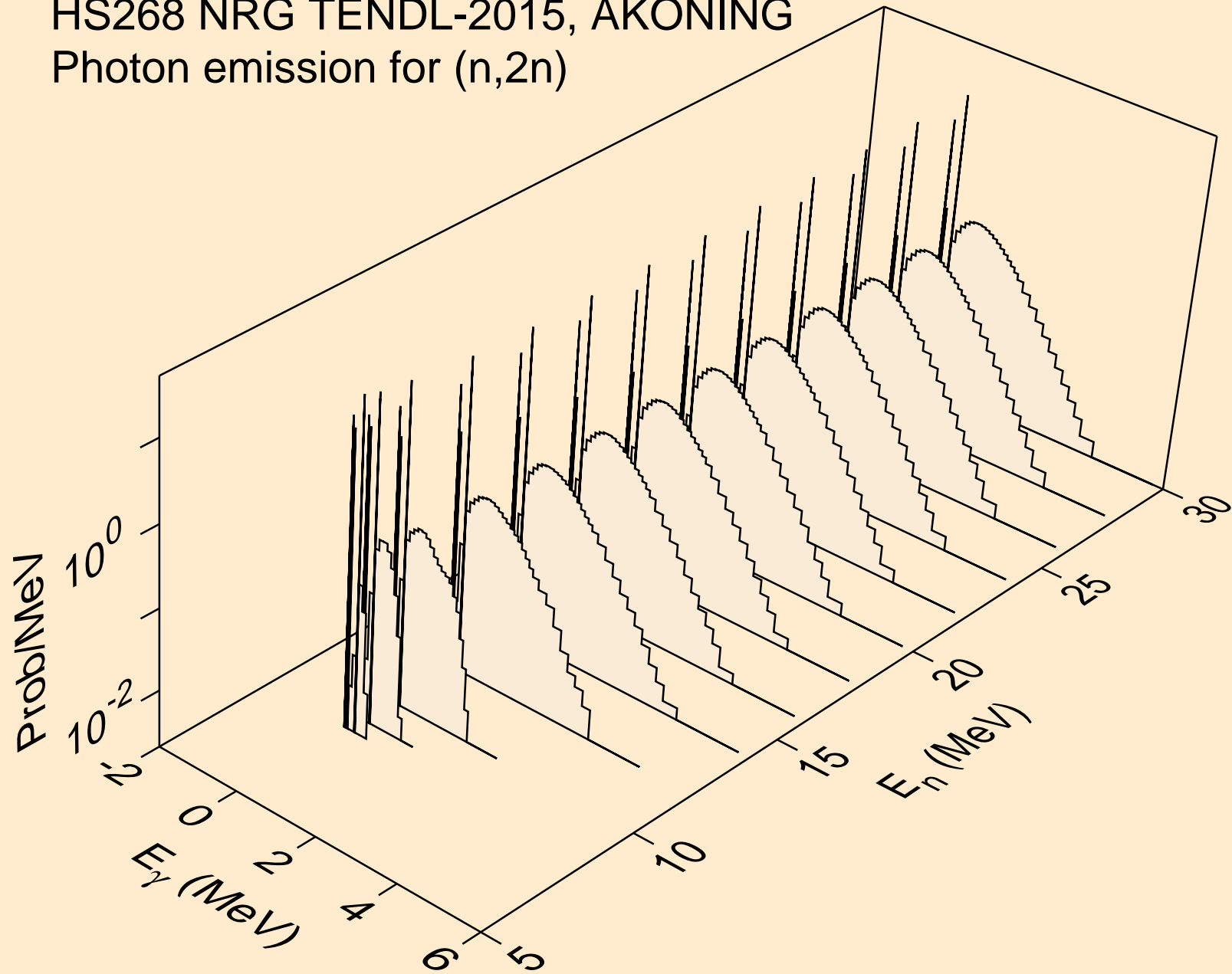

HS268 NRG TENDL-2015, AKONING  
Photon emission for (n,3n)

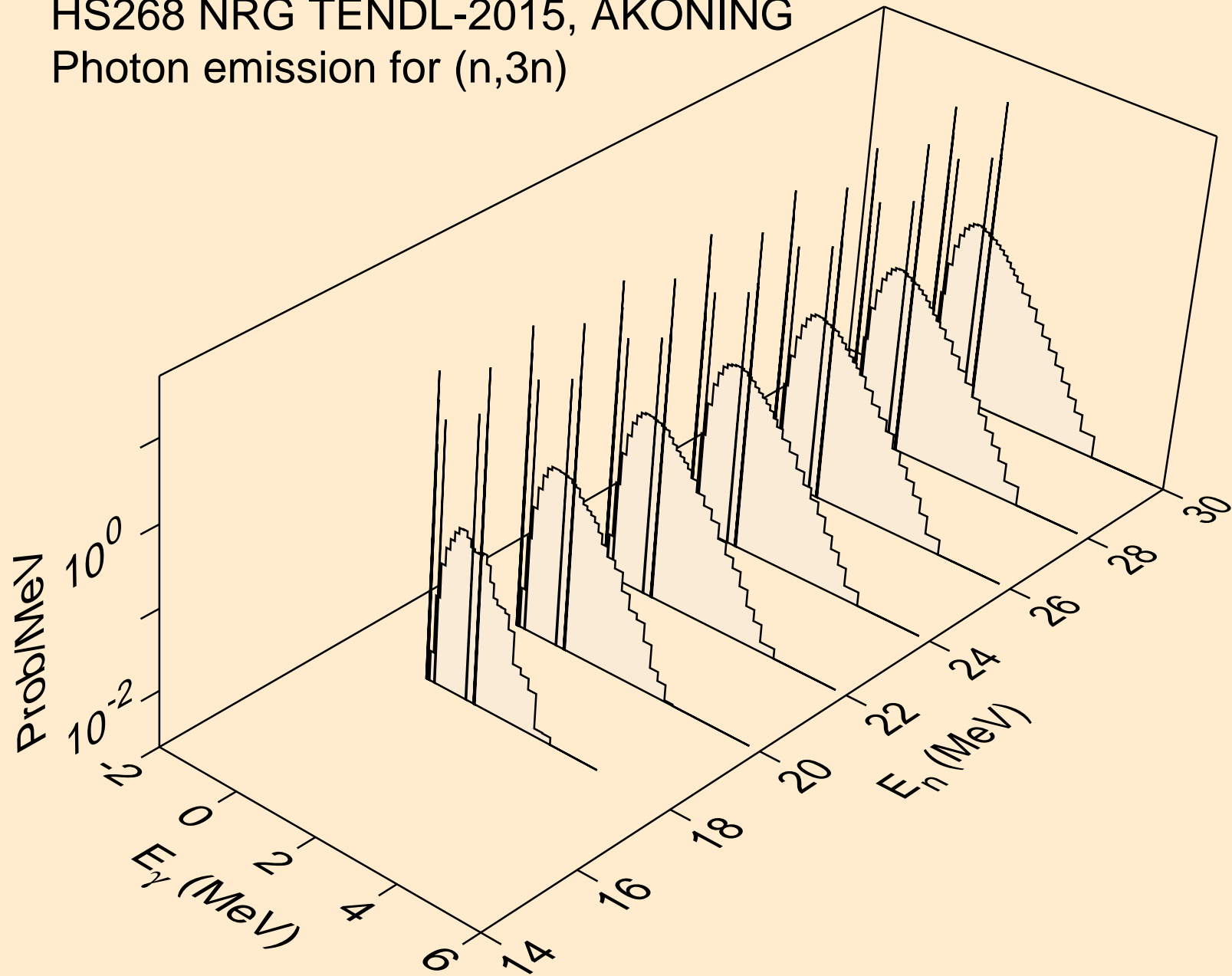

HS268 NRG TENDL-2015, AKONING  
Photon emission for (n,n\*)a

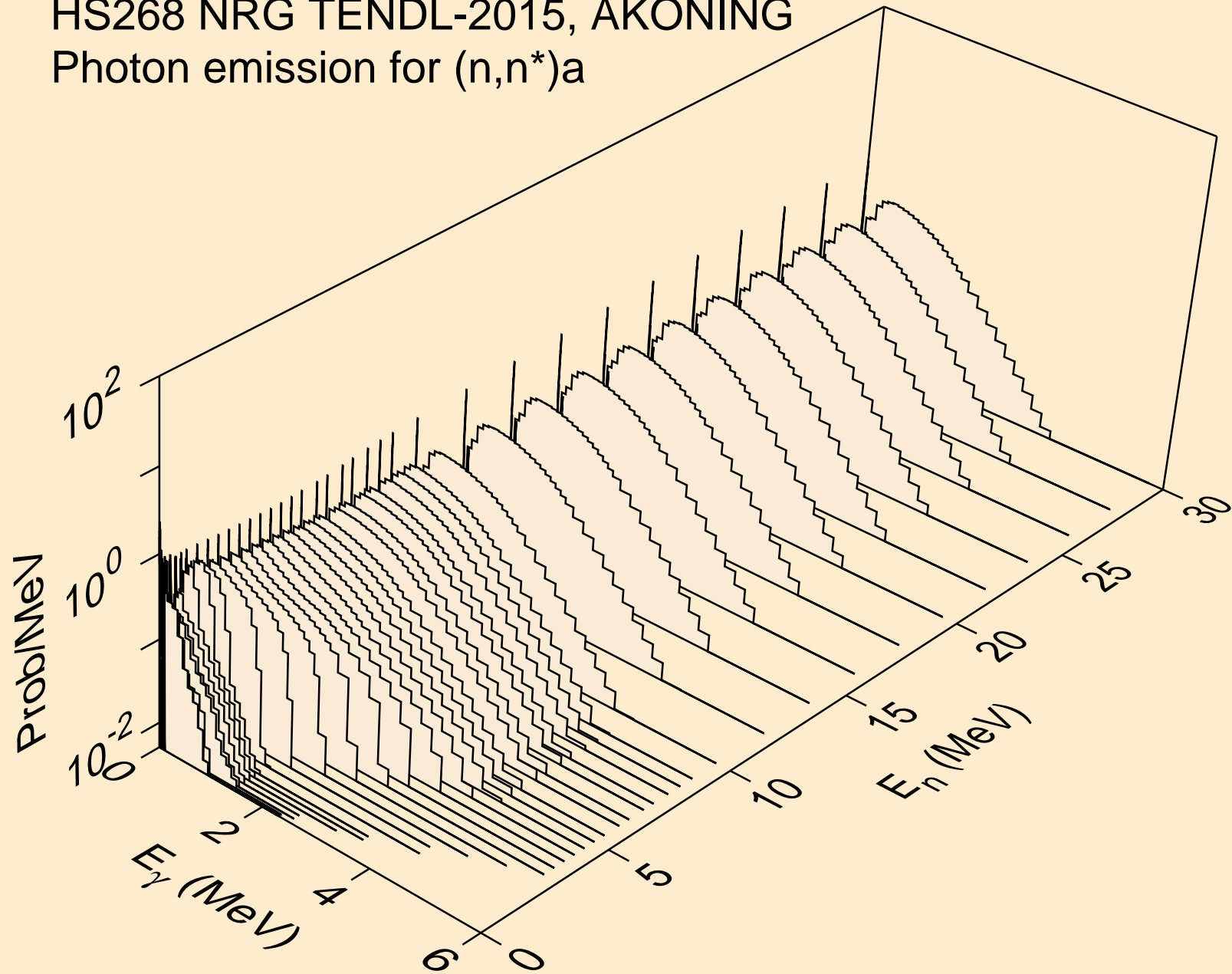



HS268 NRG TENDL-2015, AKONING  
Photon emission for (n,n\*)3a

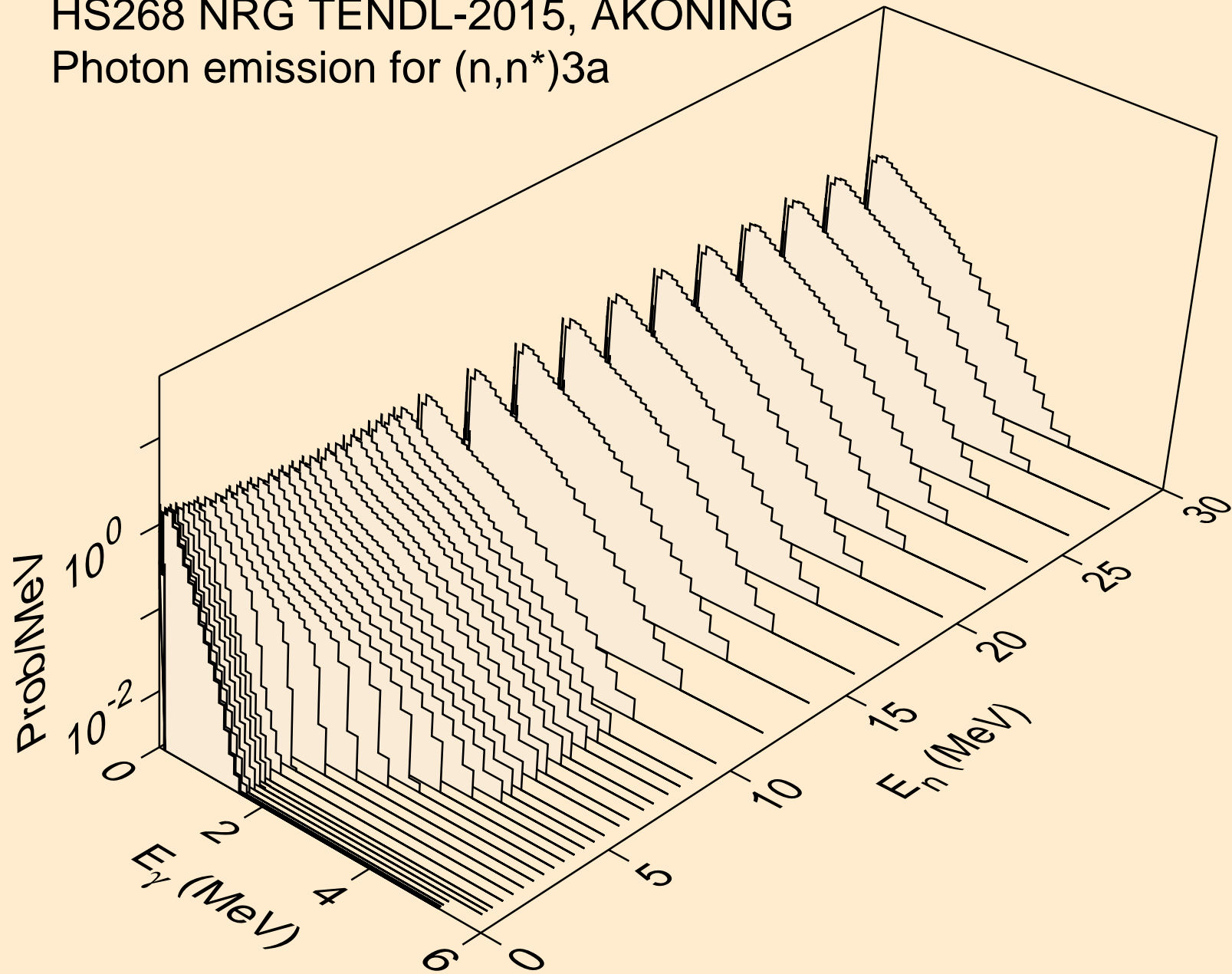

HS268 NRG TENDL-2015, AKONING  
Photon emission for (n,2n)a

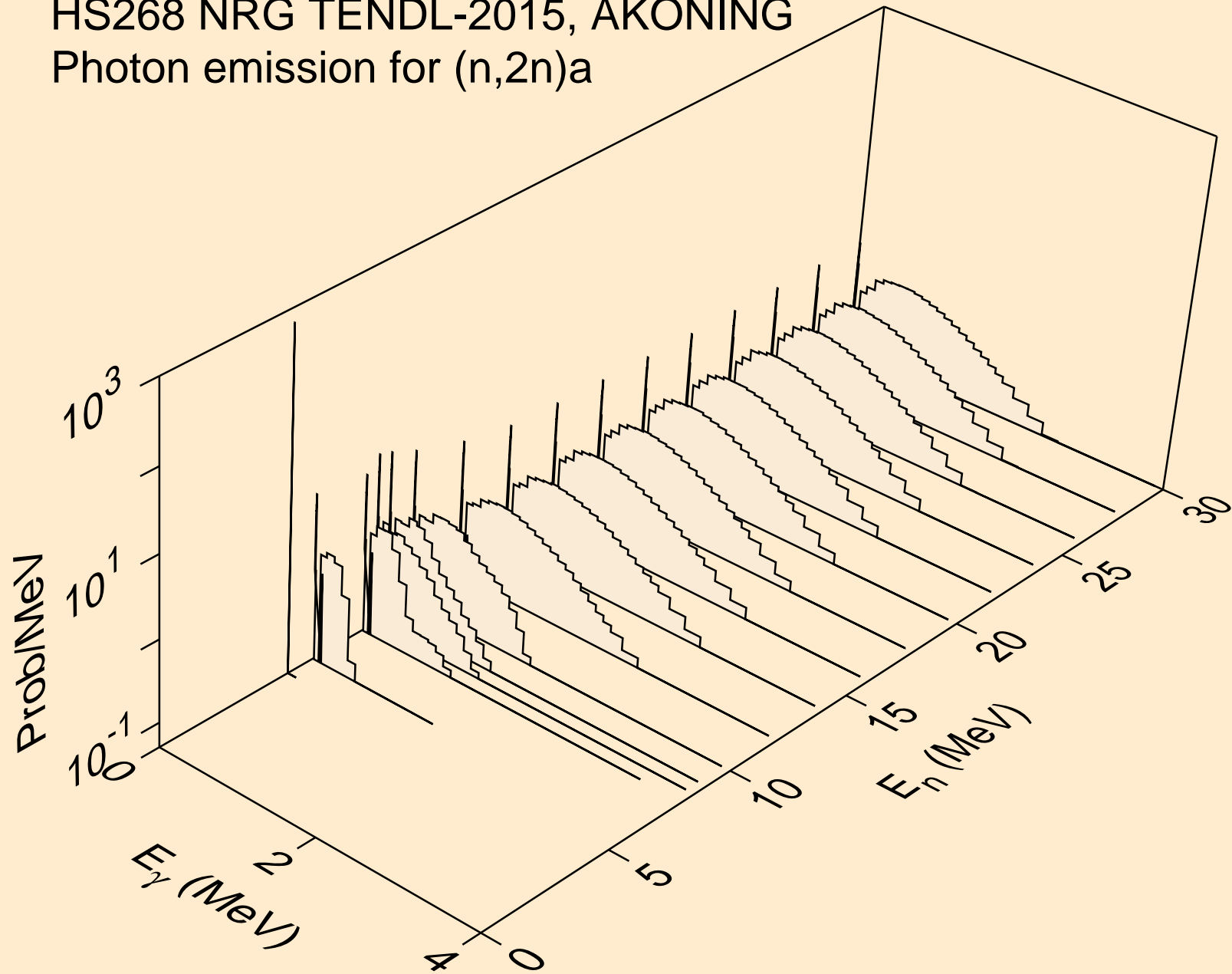

HS268 NRG TENDL-2015, AKONING  
Photon emission for (n,3n)a

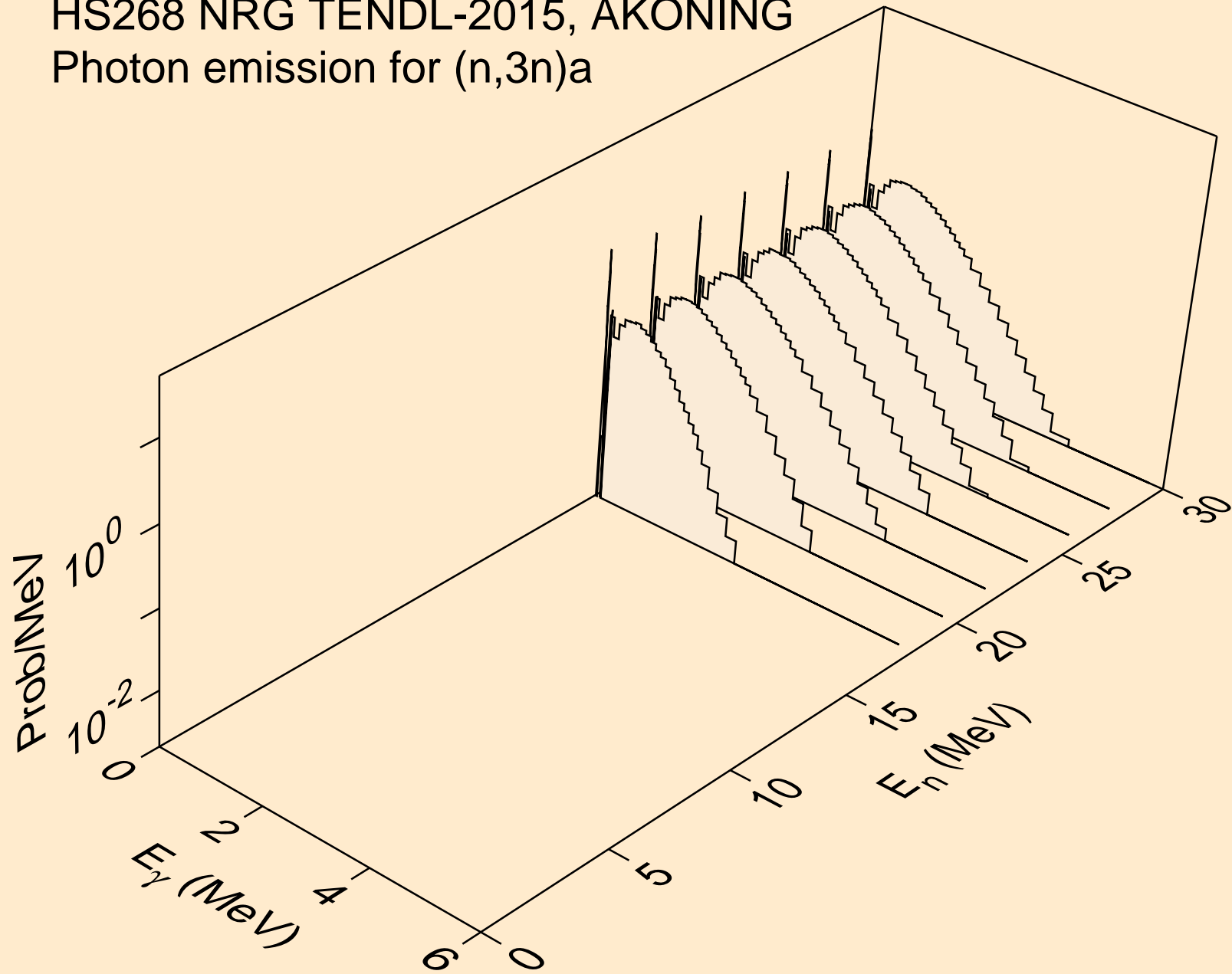

HS268 NRG TENDL-2015, AKONING  
Photon emission for (n,n\*)p

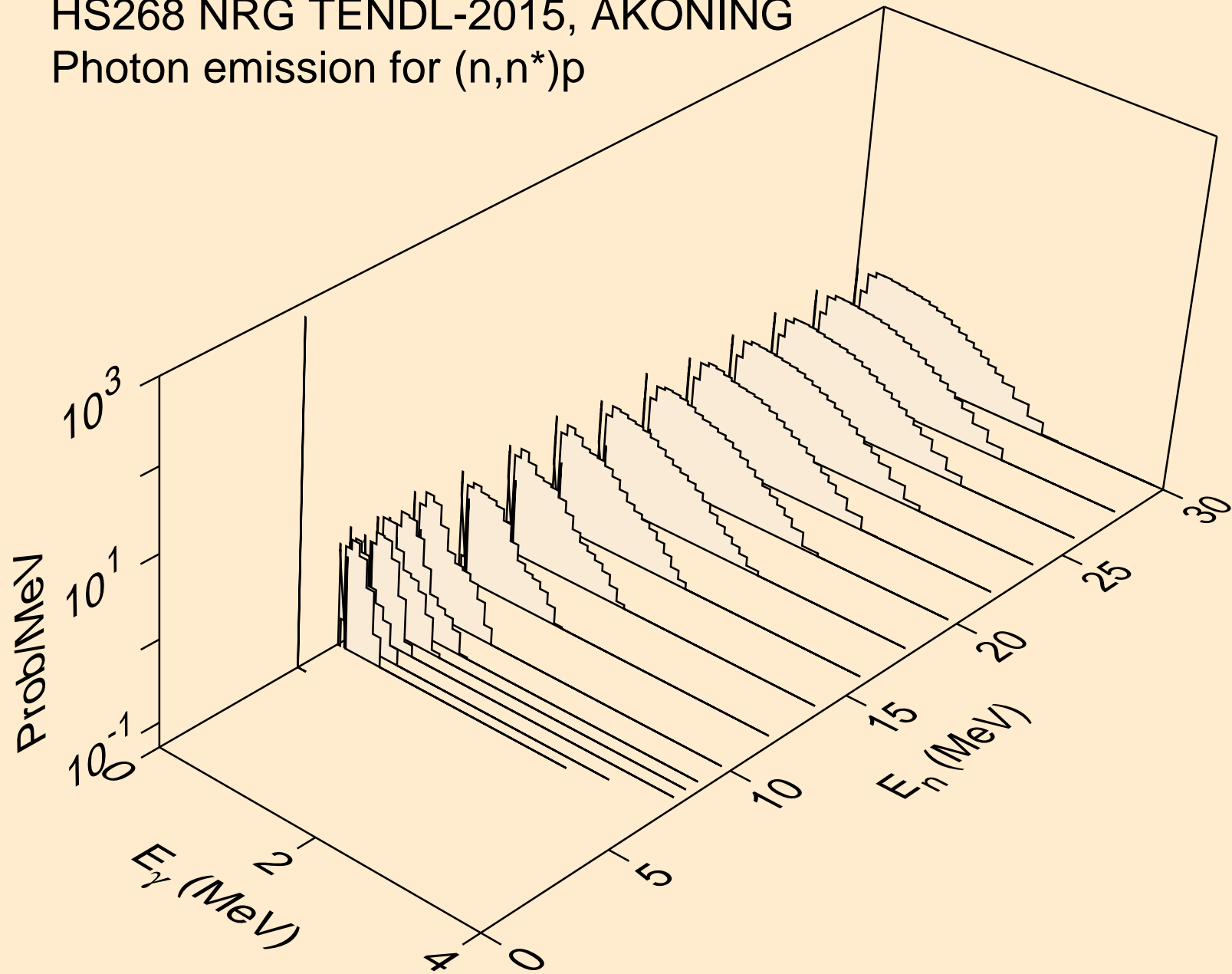

HS268 NRG TENDL-2015, AKONING  
Photon emission for (n,n\*)2a

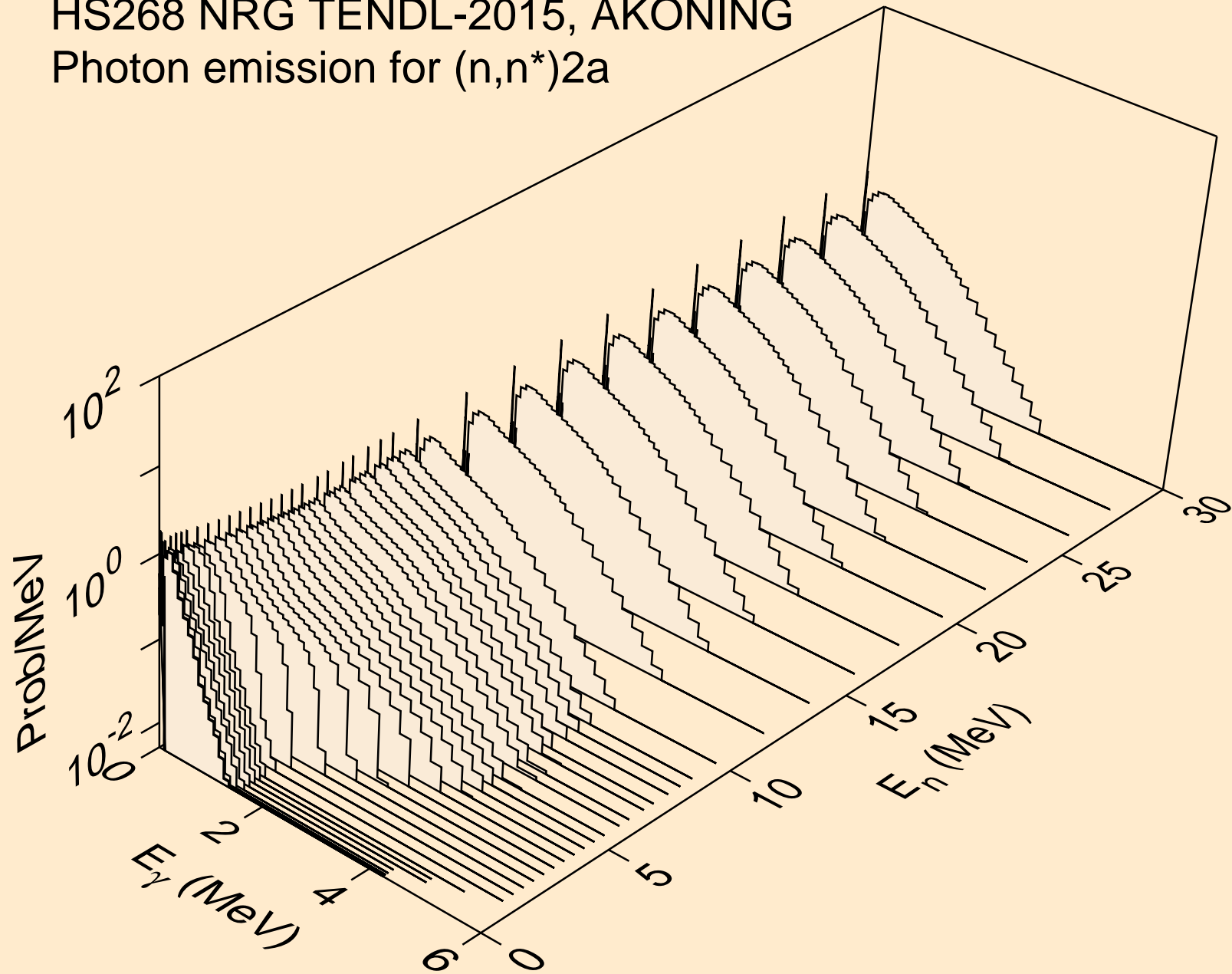

HS268 NRG TENDL-2015, AKONING  
Photon emission for (n,2n)2a

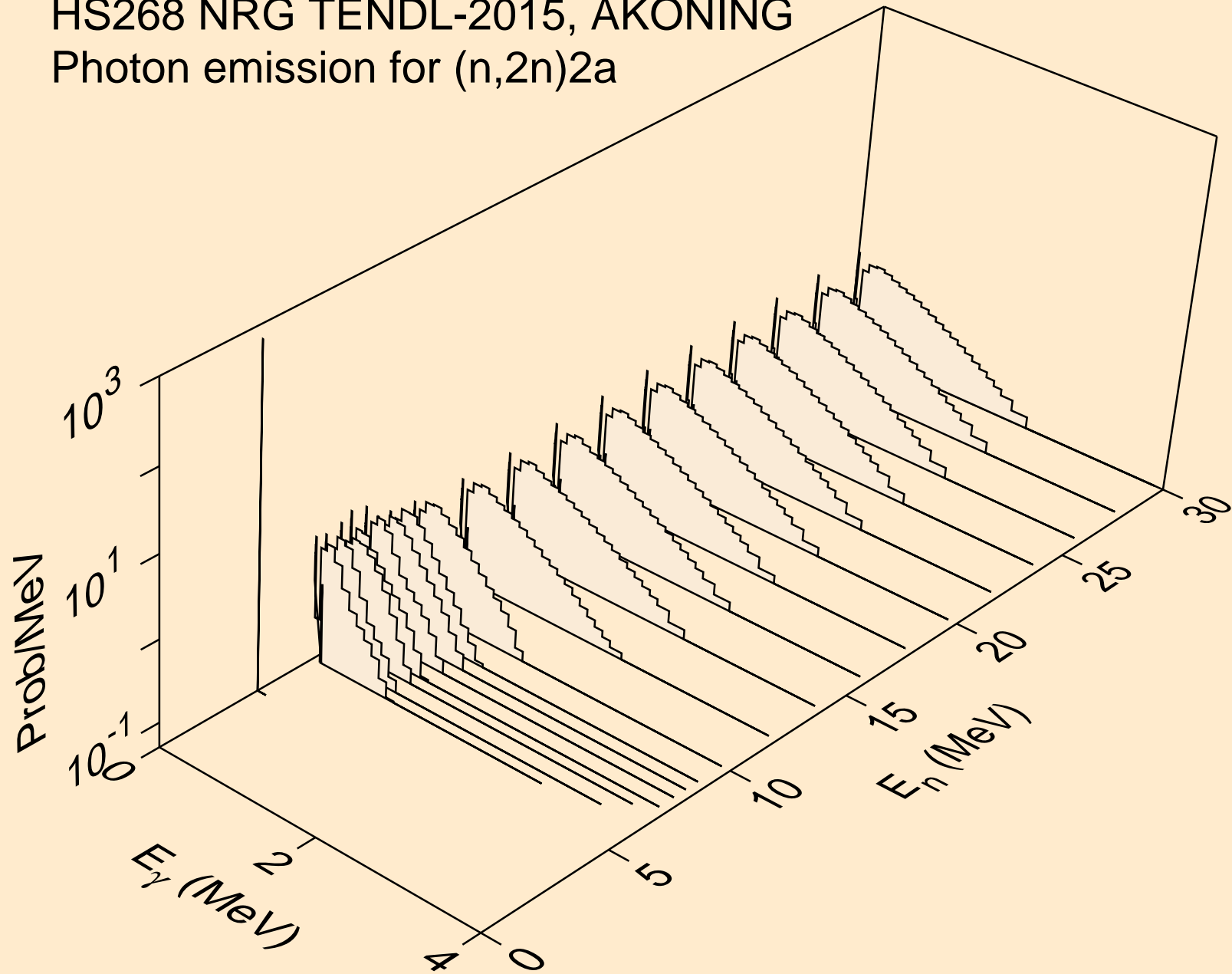

HS268 NRG TENDL-2015, AKONING  
Photon emission for (n,n\*)d

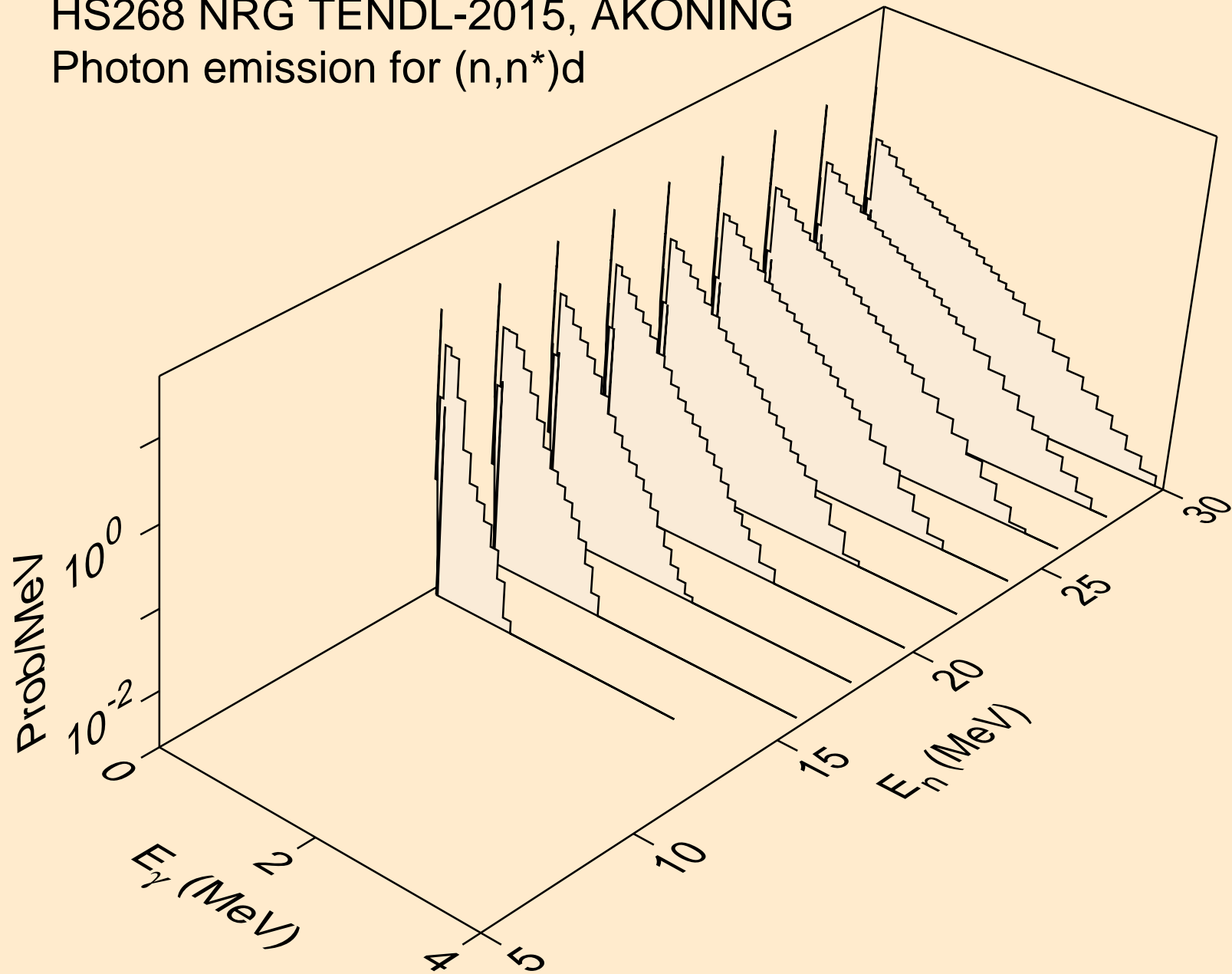

HS268 NRG TENDL-2015, AKONING  
Photon emission for (n,n\*)t

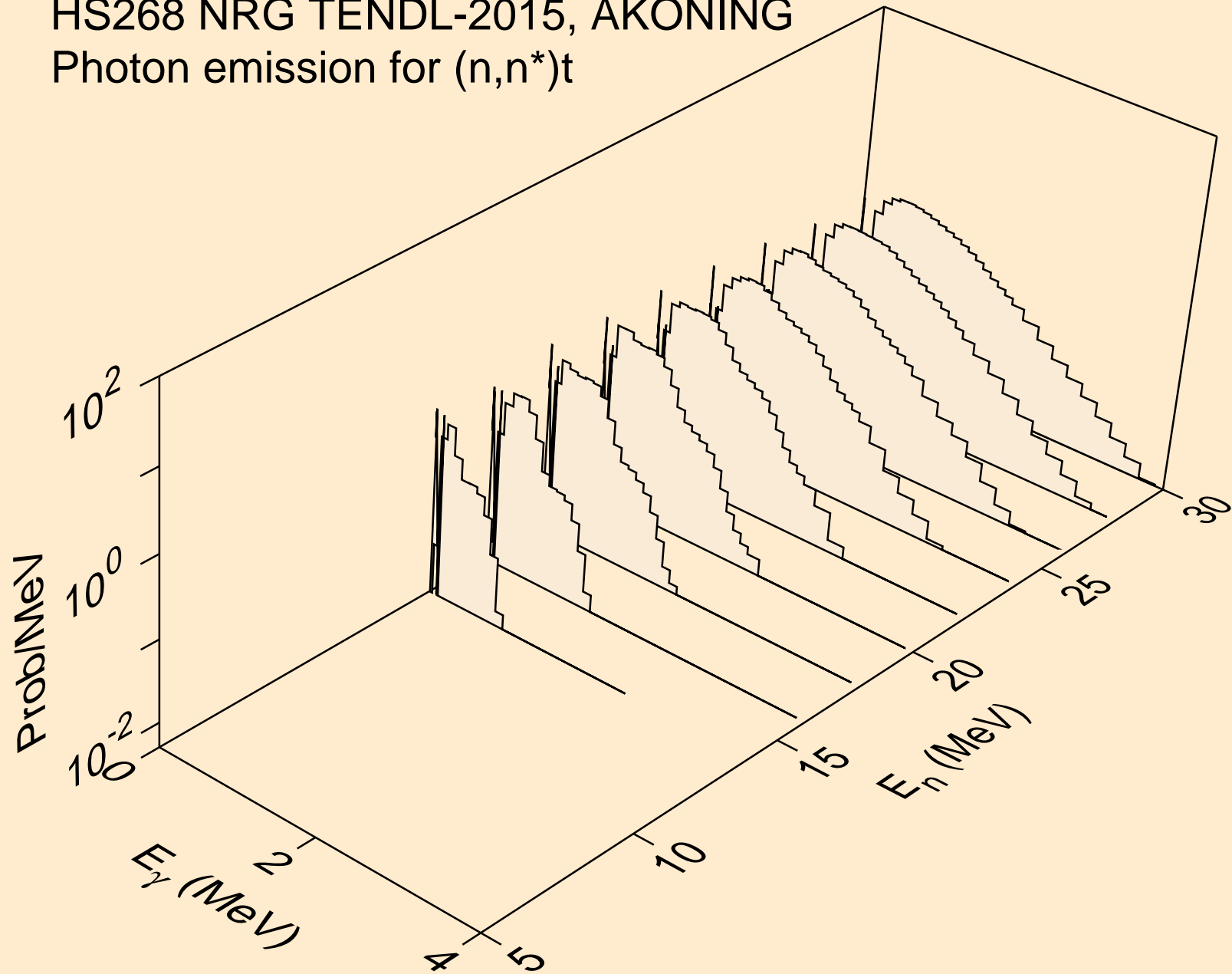



HS268 NRG TENDL-2015, AKONING  
Photon emission for (n,n\*)he3

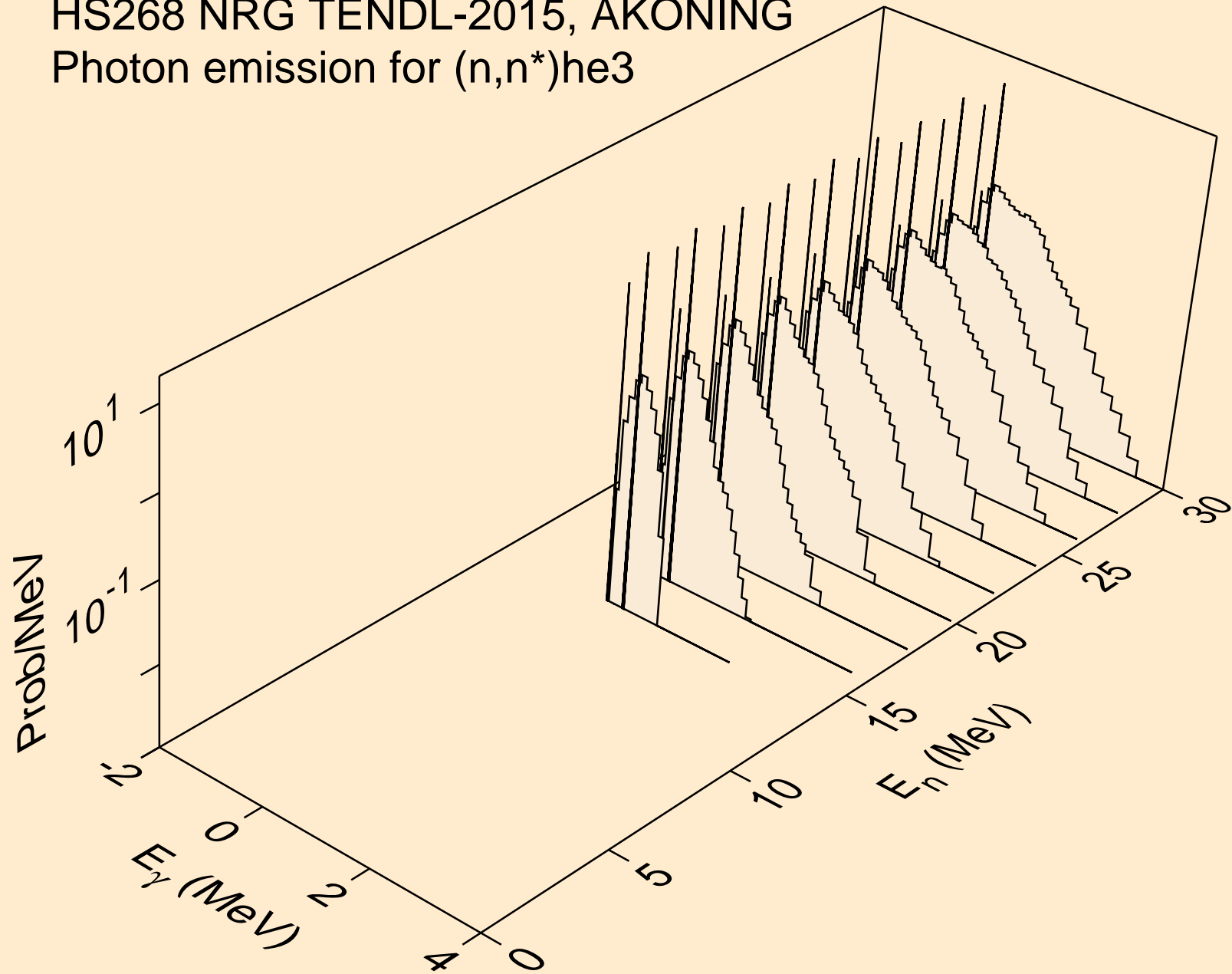

HS268 NRG TENDL-2015, AKONING  
Photon emission for (n,n\*)d2a

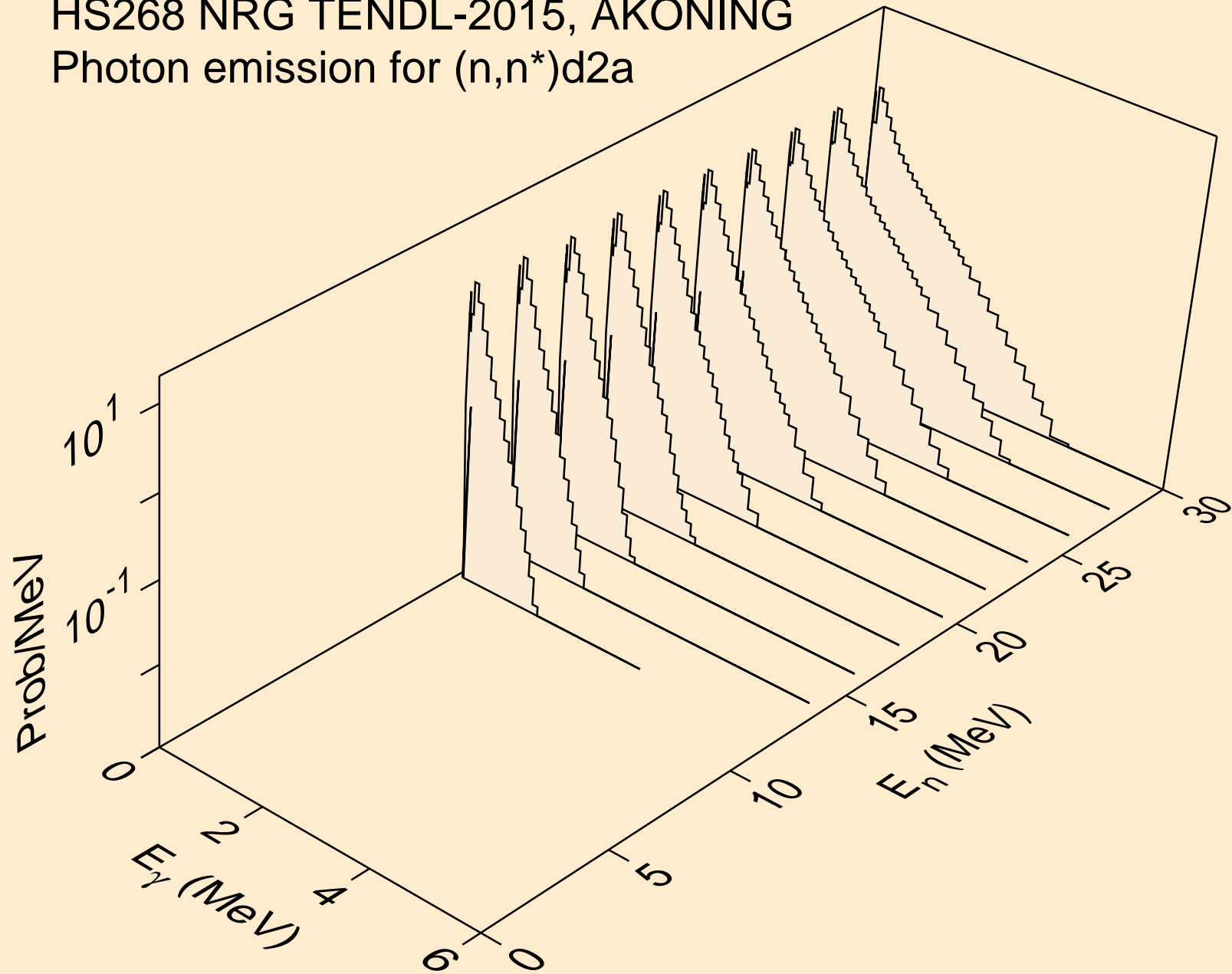

HS268 NRG TENDL-2015, AKONING  
Photon emission for (n,n\*)t2a

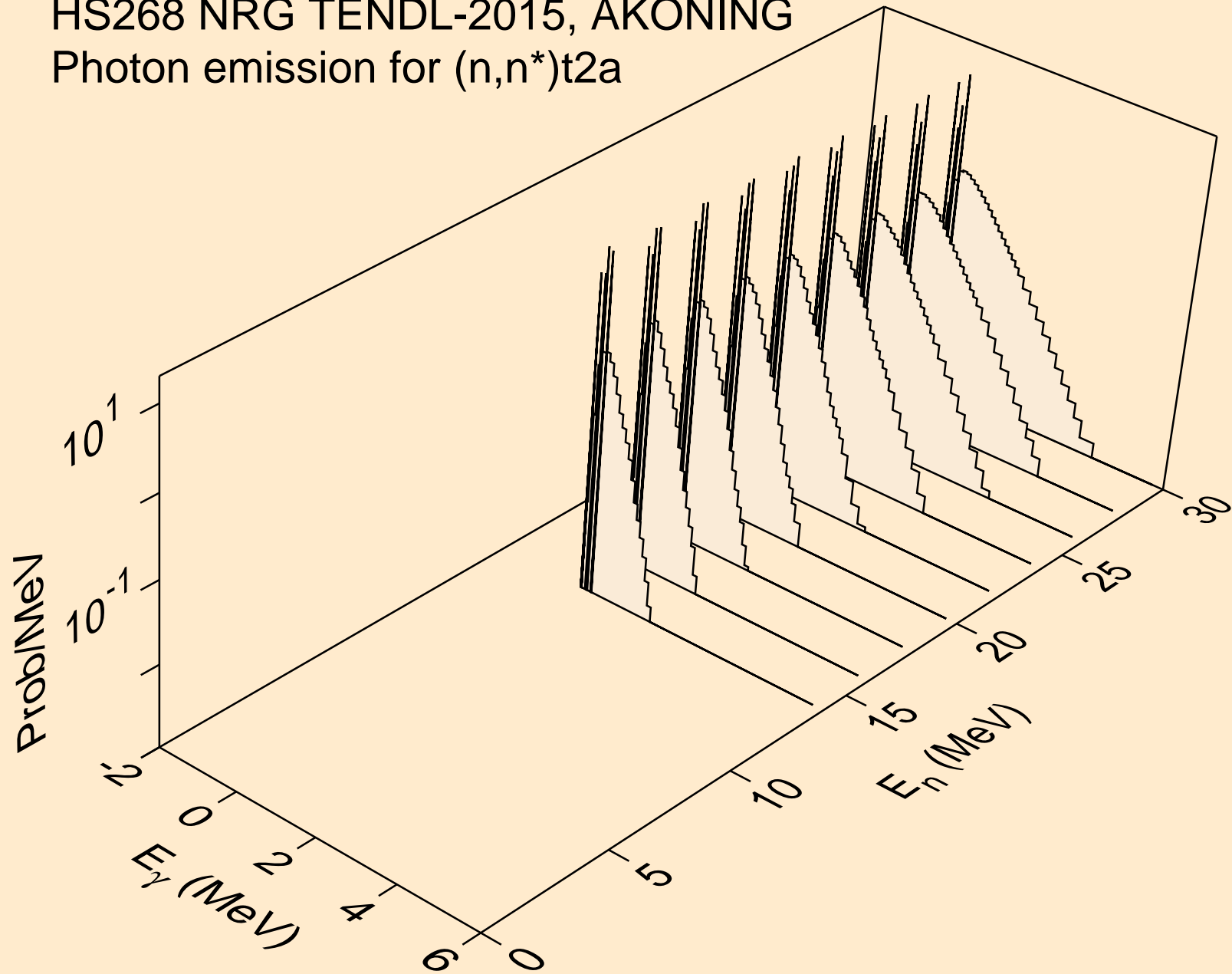

HS268 NRG TENDL-2015, AKONING  
Photon emission for (n,4n)

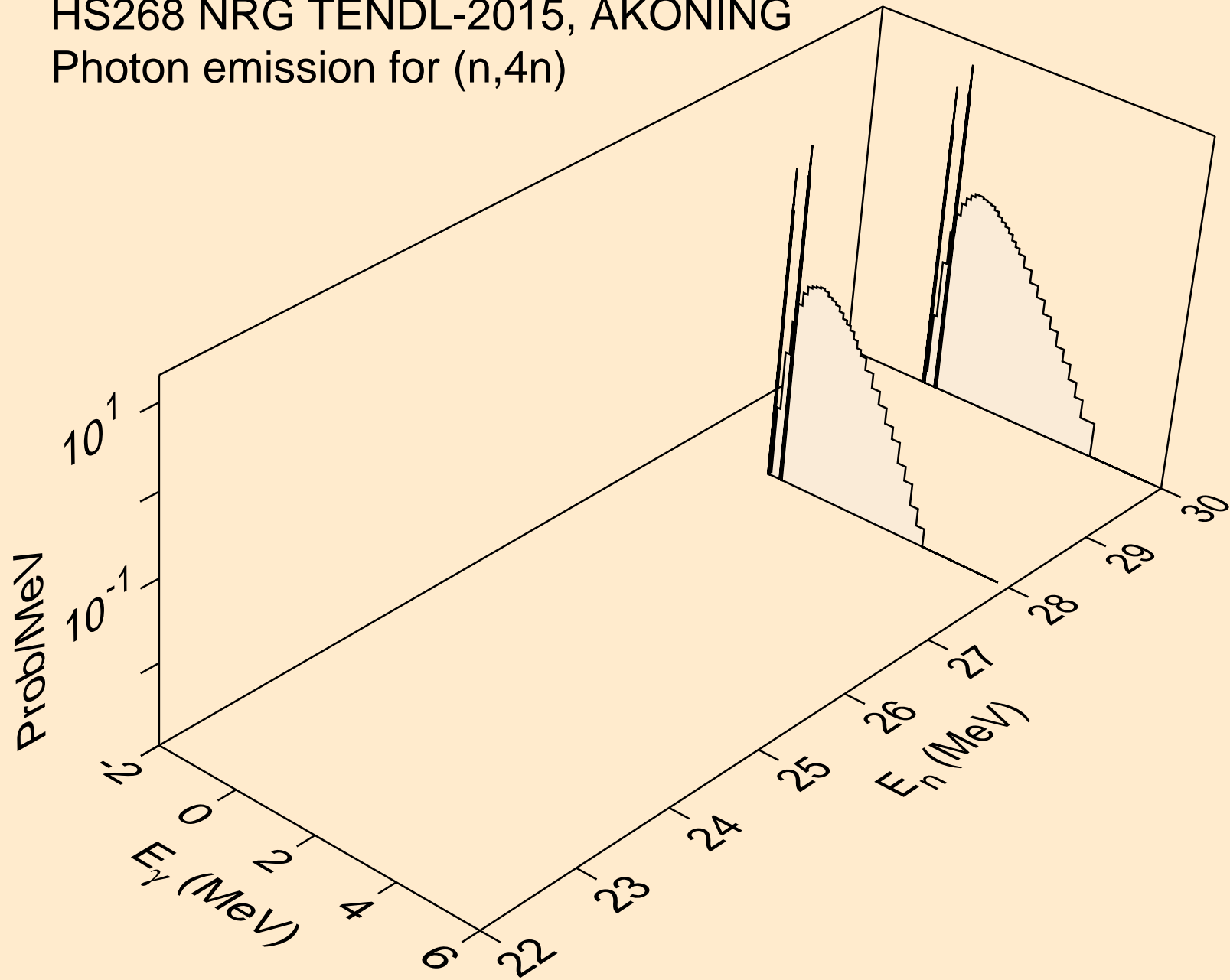

HS268 NRG TENDL-2015, AKONING  
Photon emission for (n,2np)

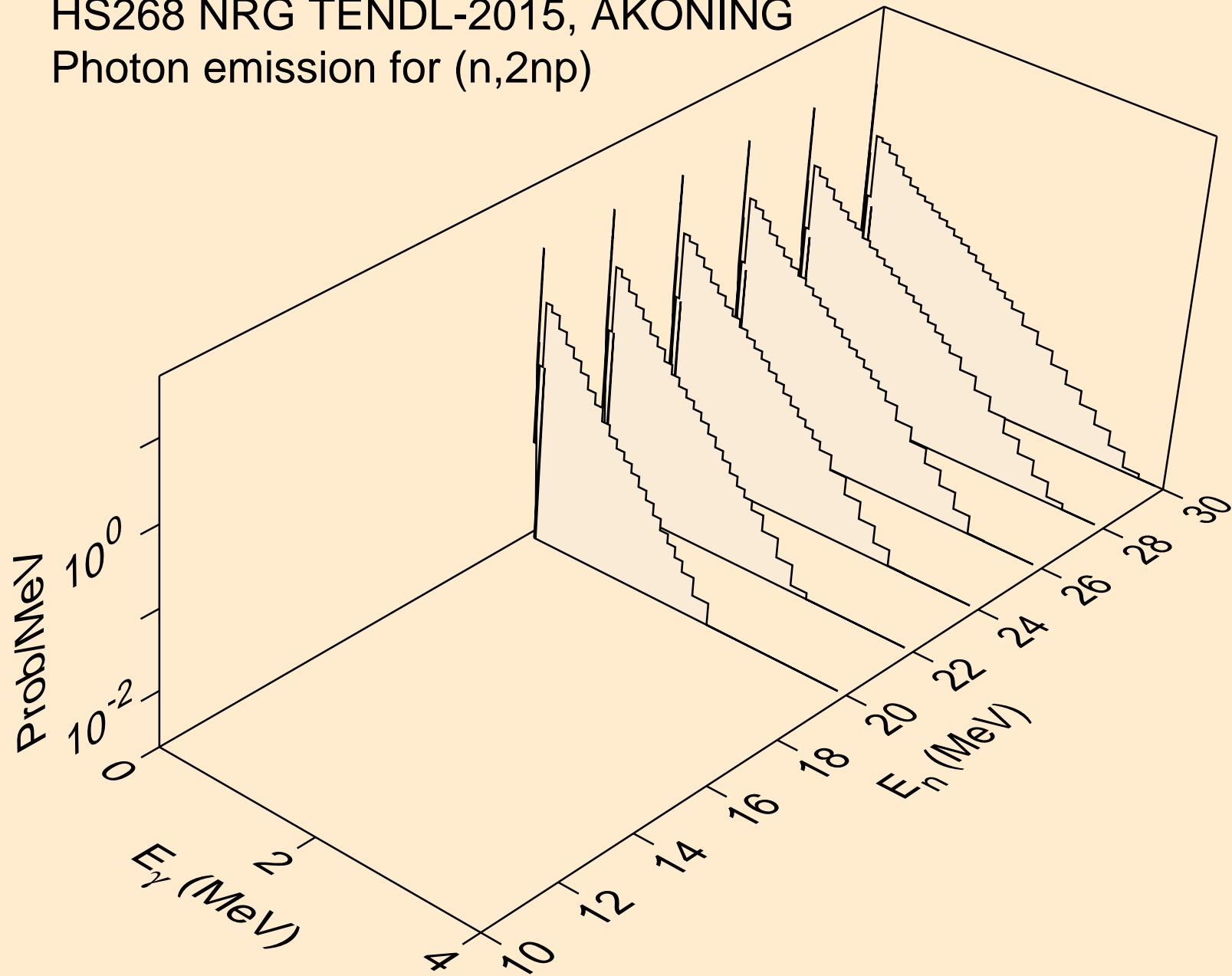

HS268 NRG TENDL-2015, AKONING  
Photon emission for (n,3np)

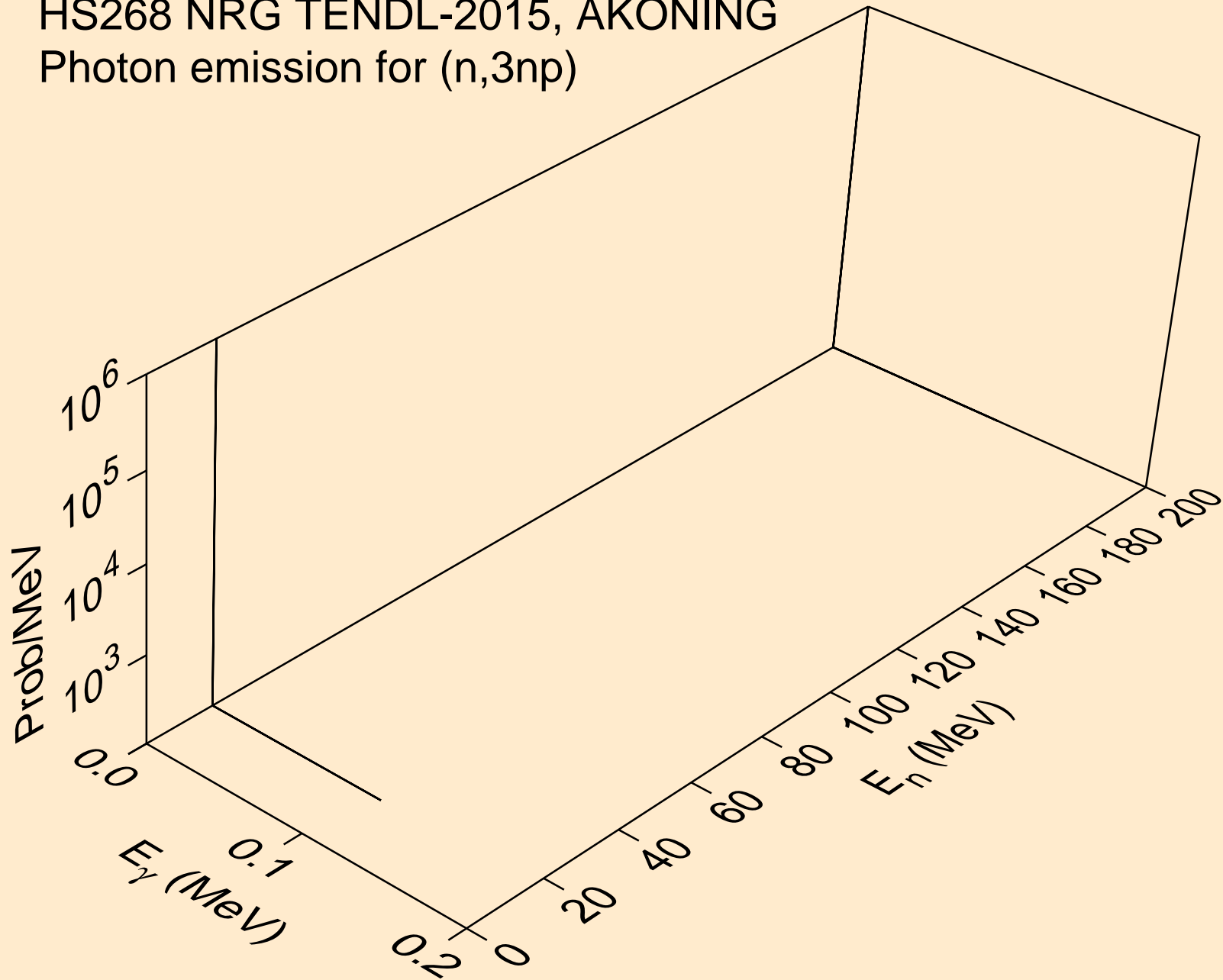

HS268 NRG TENDL-2015, AKONING  
Photon emission for (n,2np)

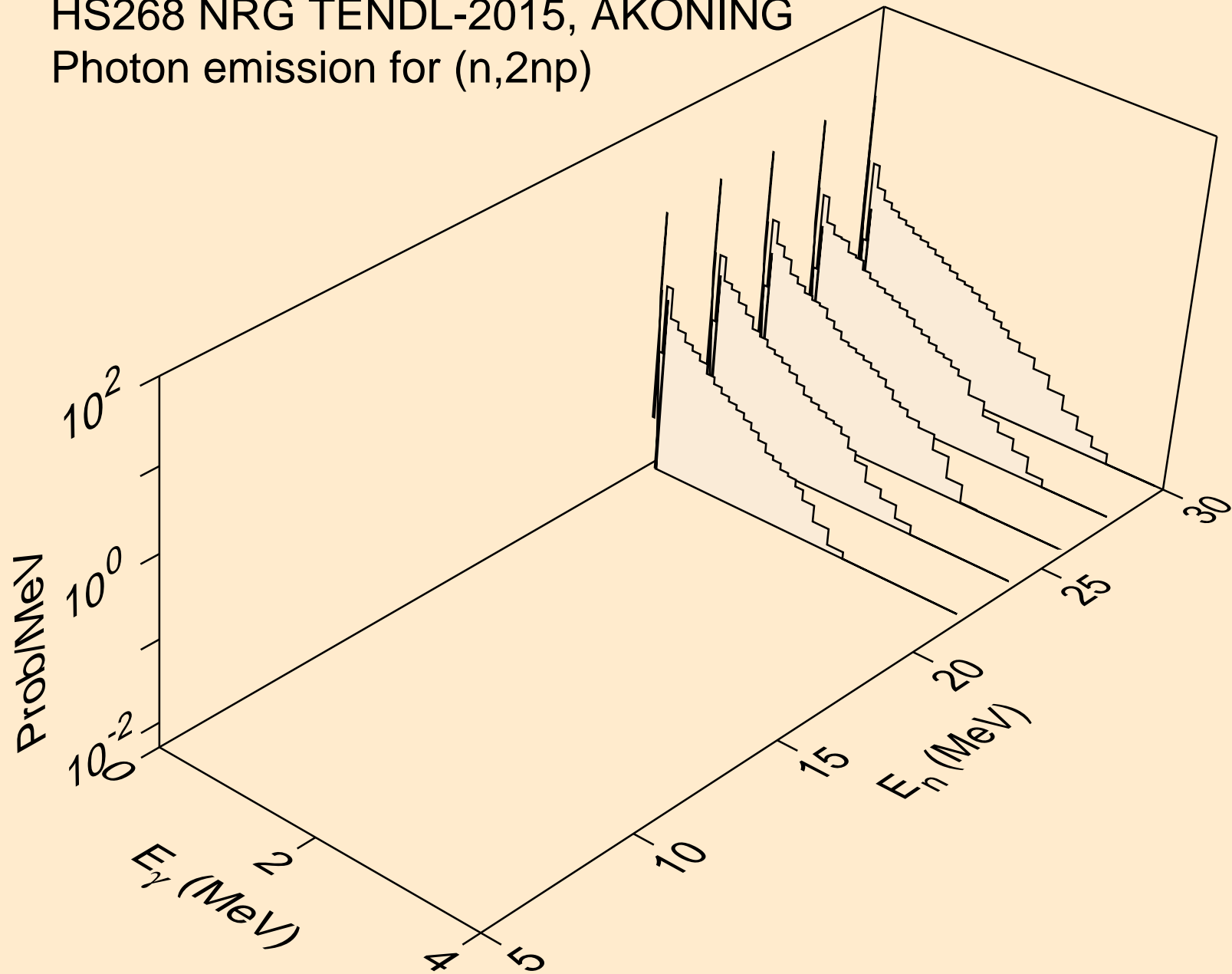

HS268 NRG TENDL-2015, AKONING  
Photon emission for (n,npa)

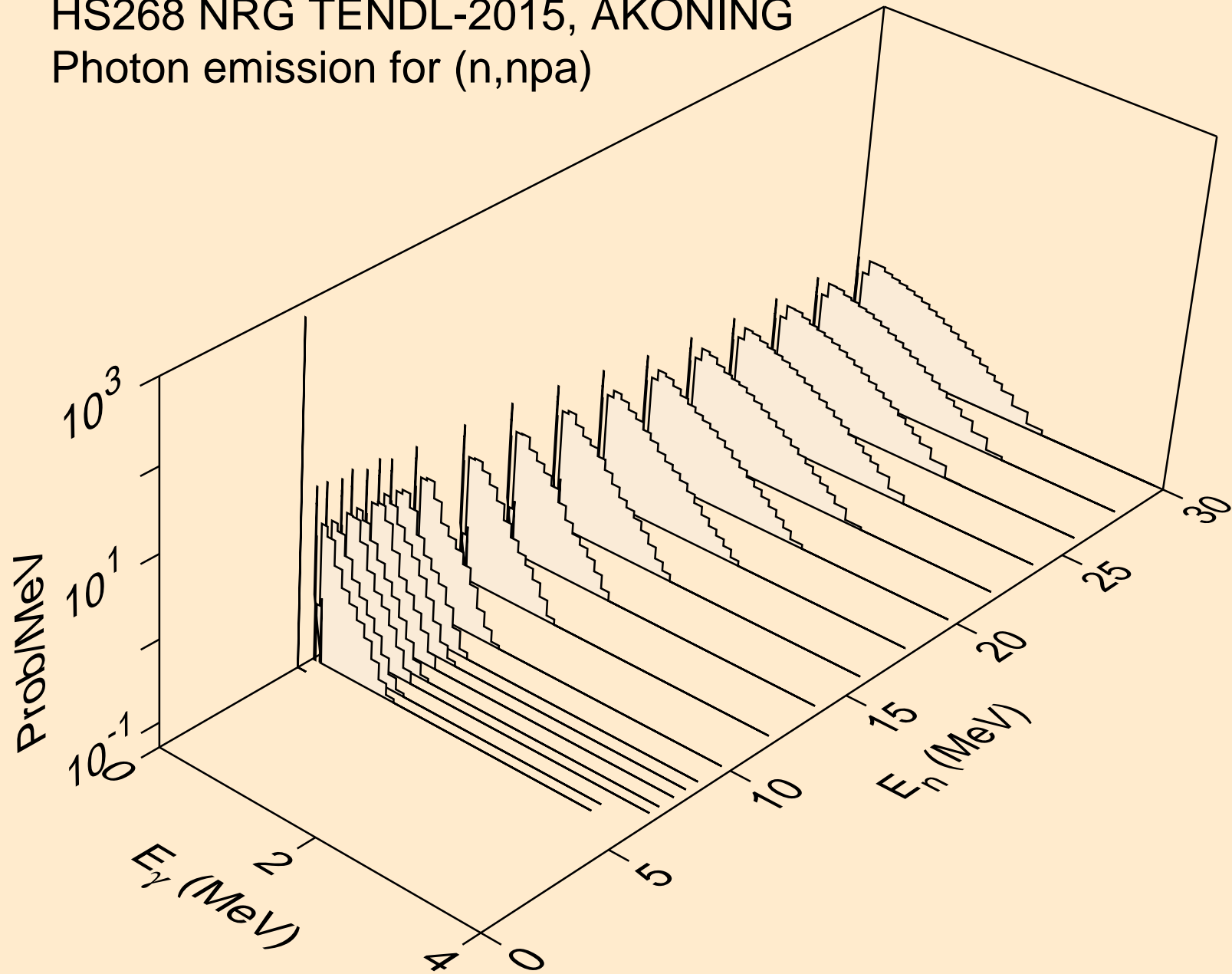



HS268 NRG TENDL-2015, AKONING  
Photon emission for (n,n\*c)

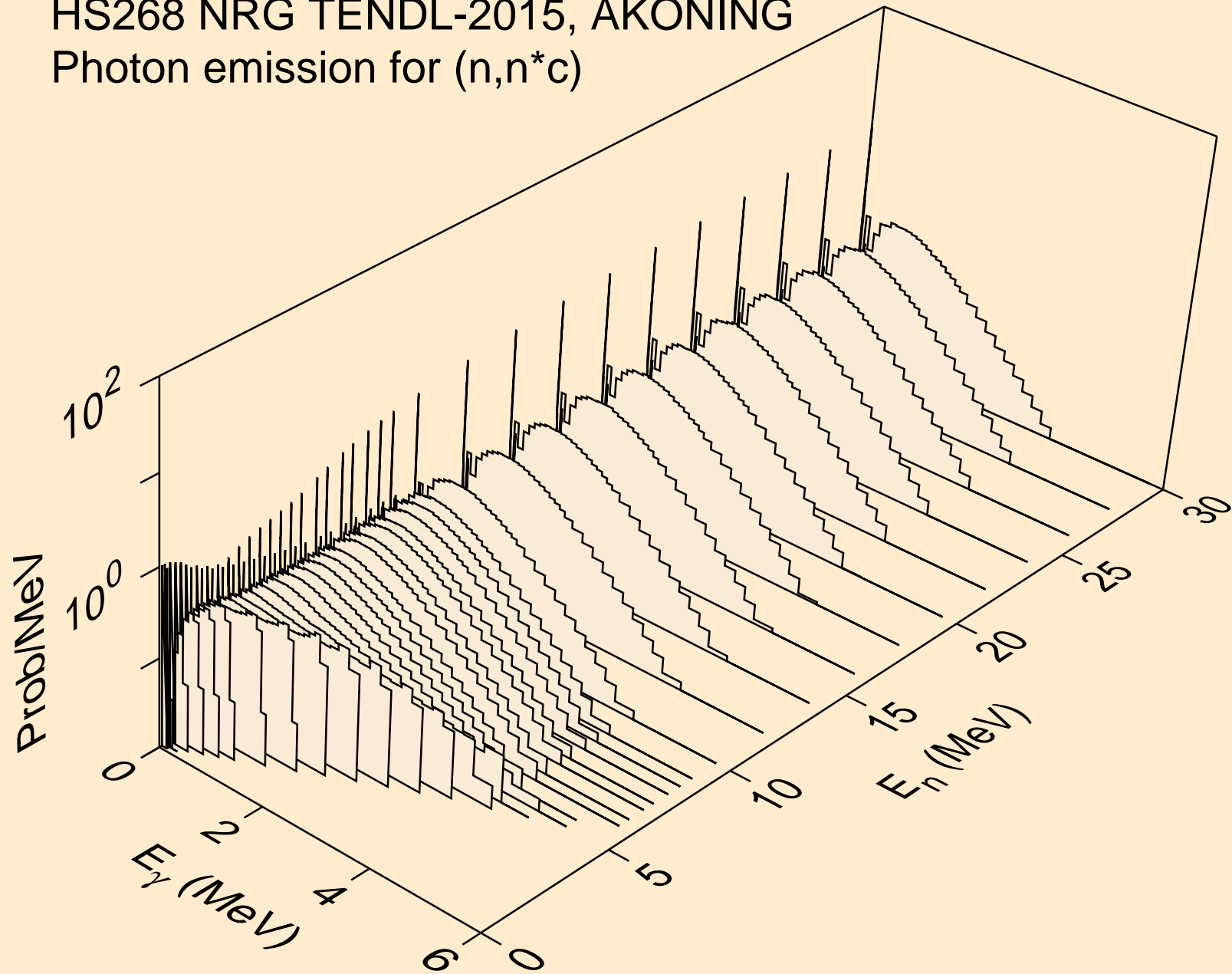

HS268 NRG TENDL-2015, AKONING  
Photon emission for (n,gma)

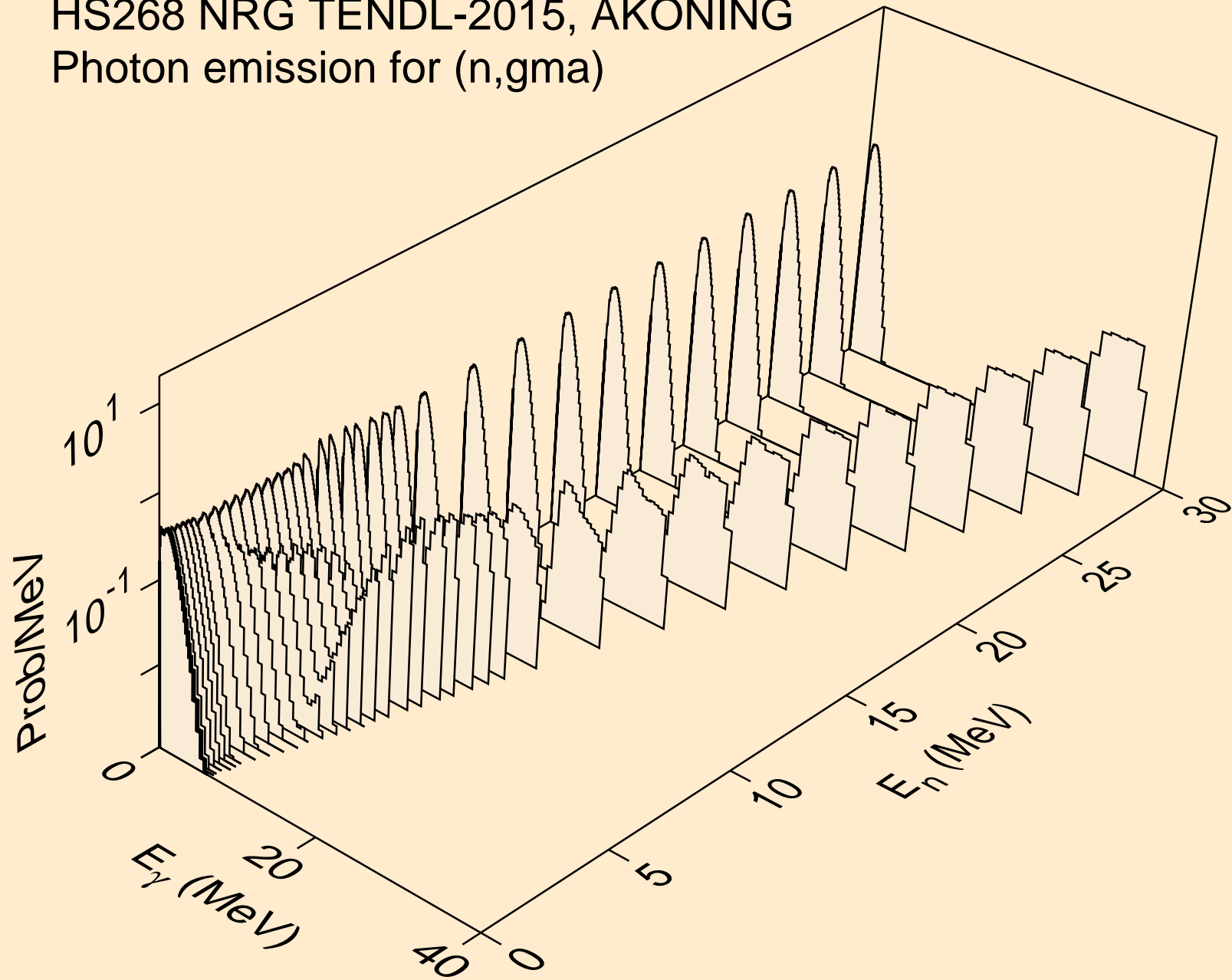

HS268 NRG TENDL-2015, AKONING  
Photon emission for (n,p)

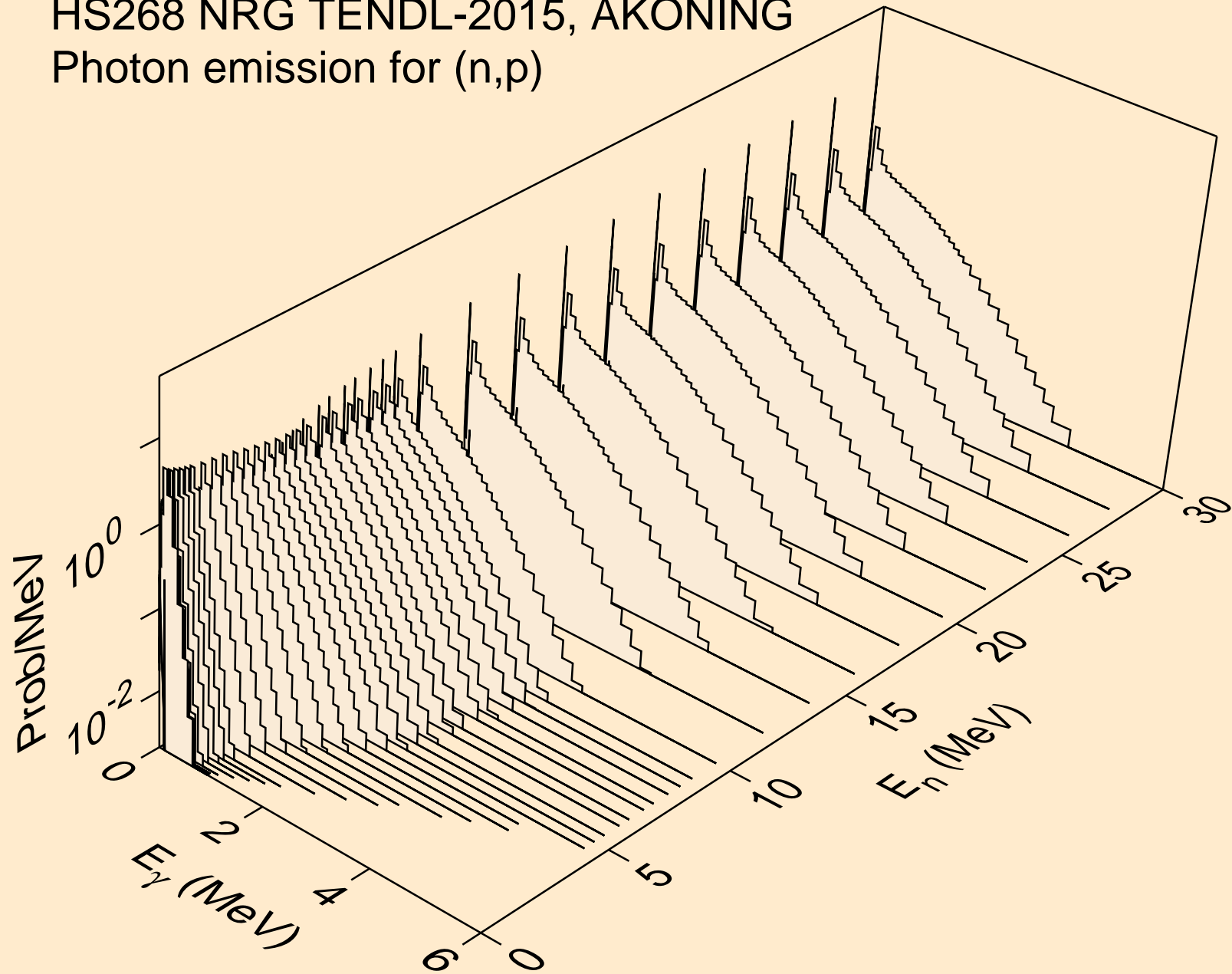

HS268 NRG TENDL-2015, AKONING  
Photon emission for (n,d)

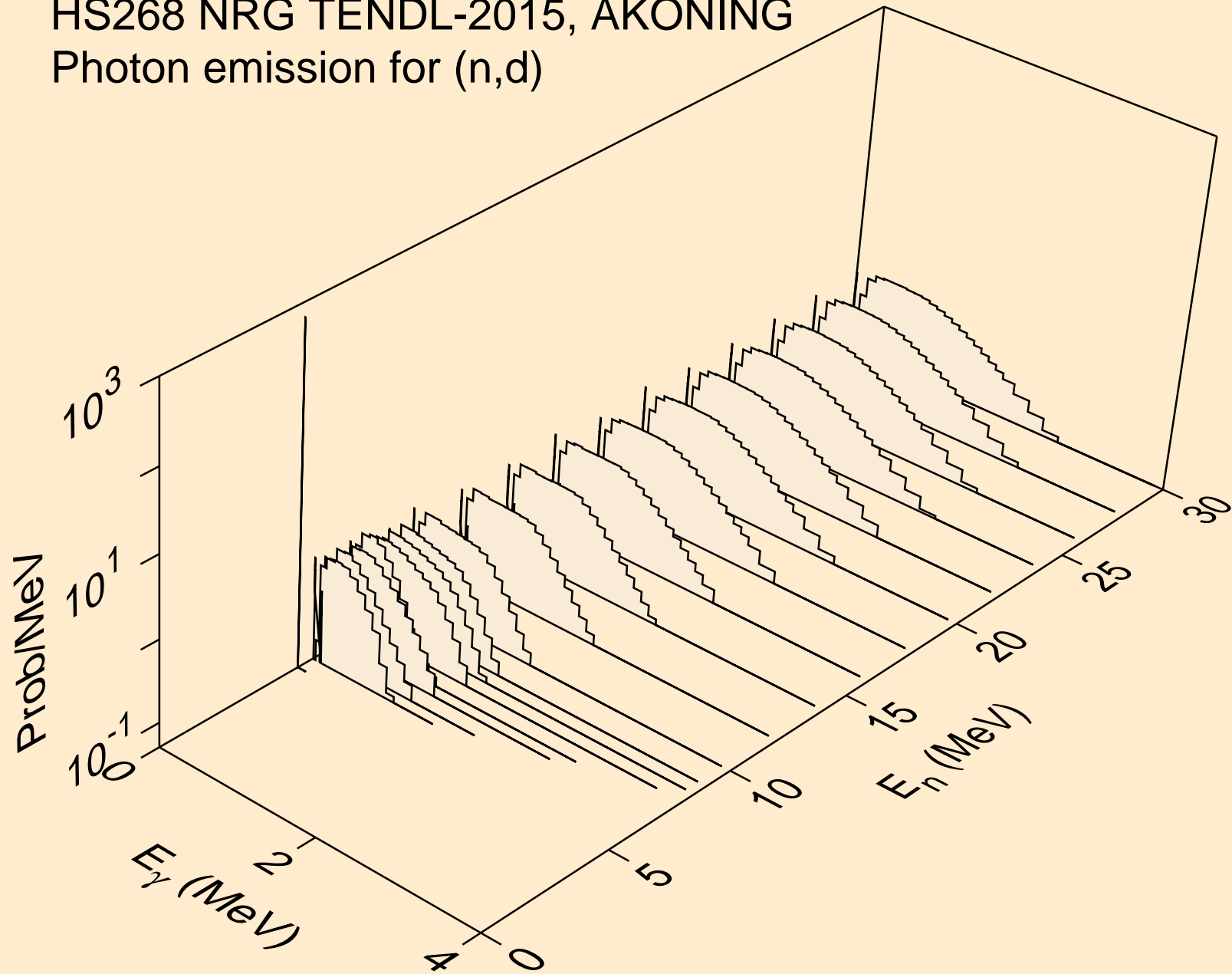

HS268 NRG TENDL-2015, AKONING  
Photon emission for (n,t)

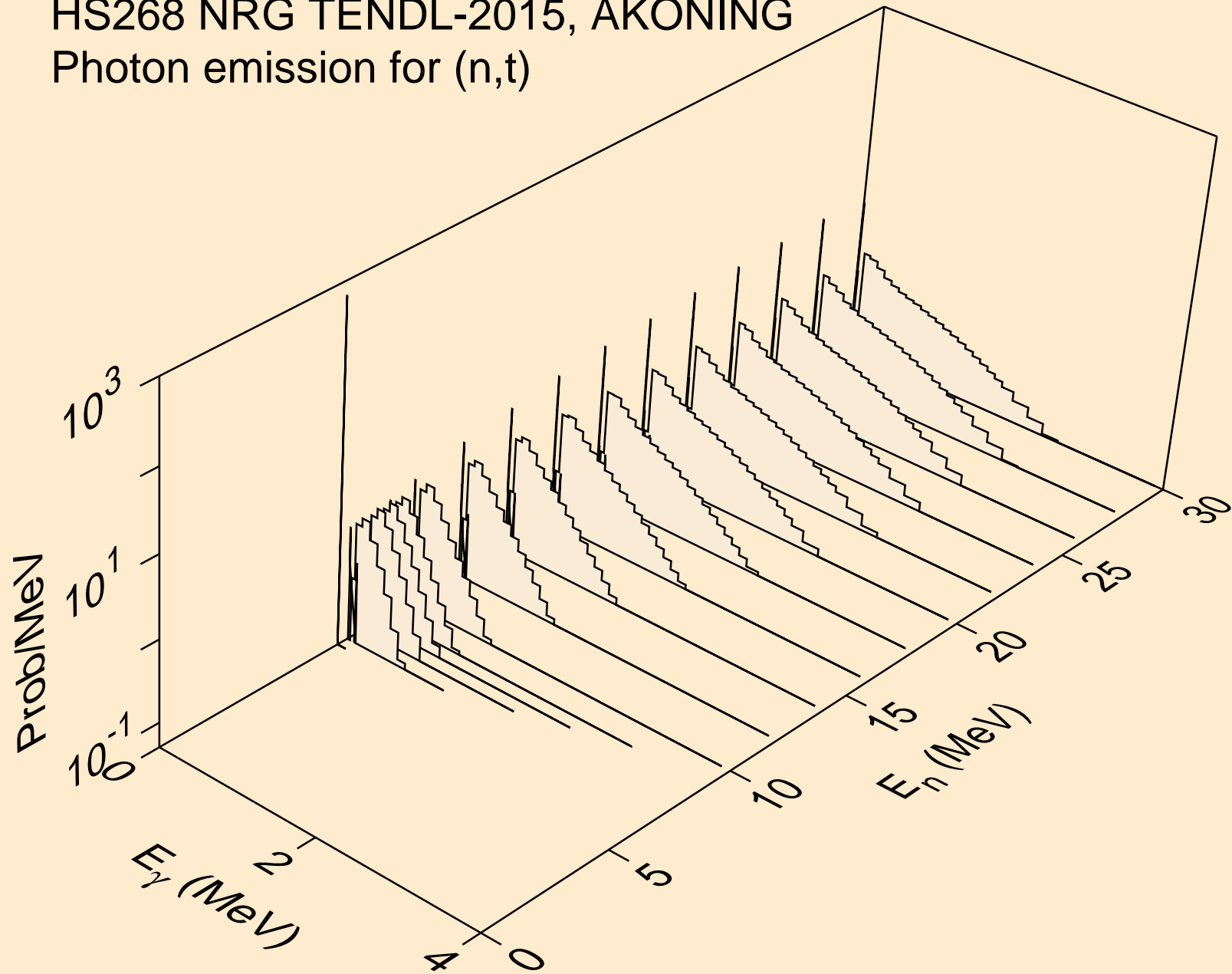

HS268 NRG TENDL-2015, AKONING  
Photon emission for (n,he3)

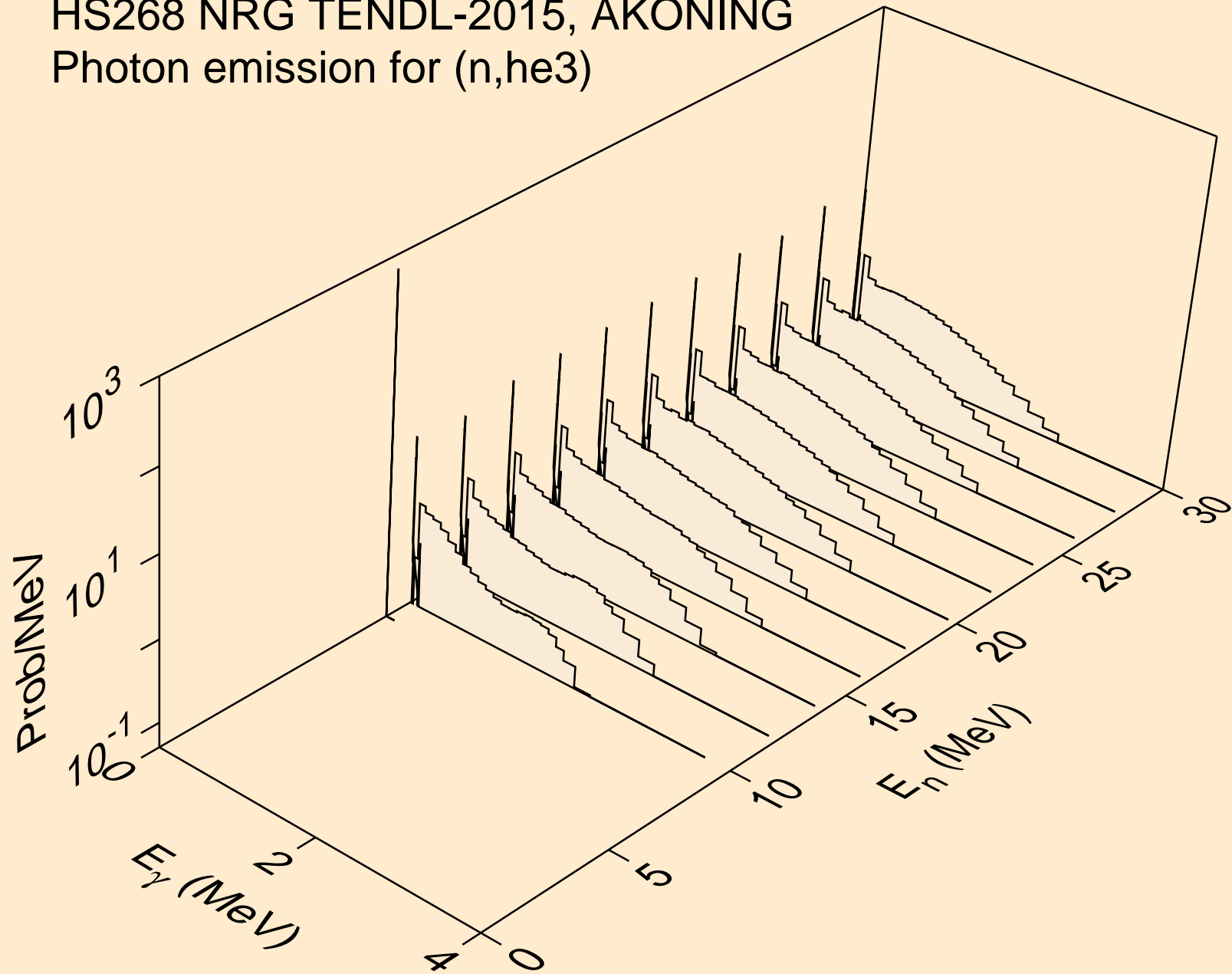

HS268 NRG TENDL-2015, AKONING  
Photon emission for (n,a)

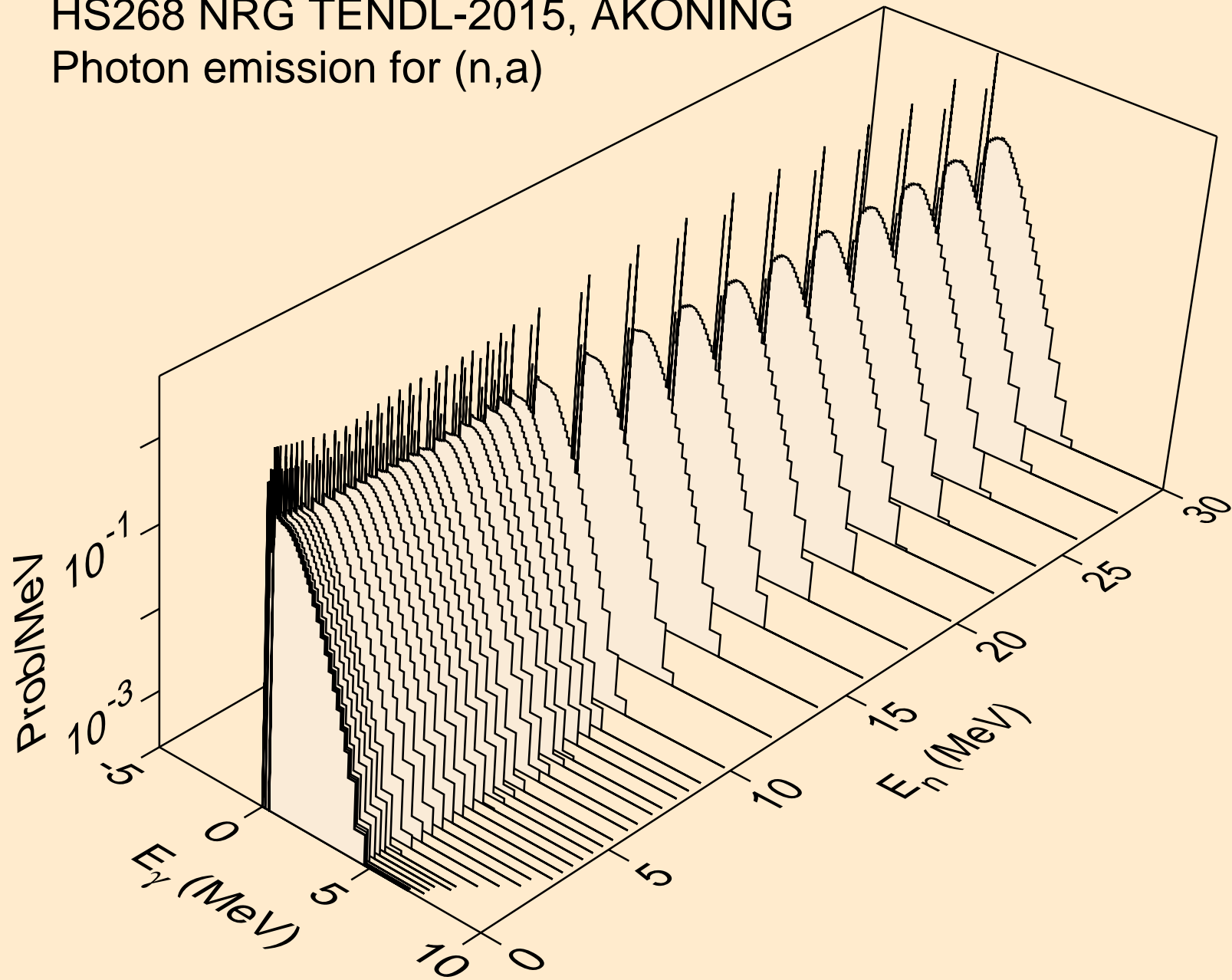

HS268 NRG TENDL-2015, AKONING  
Photon emission for (n,2a)

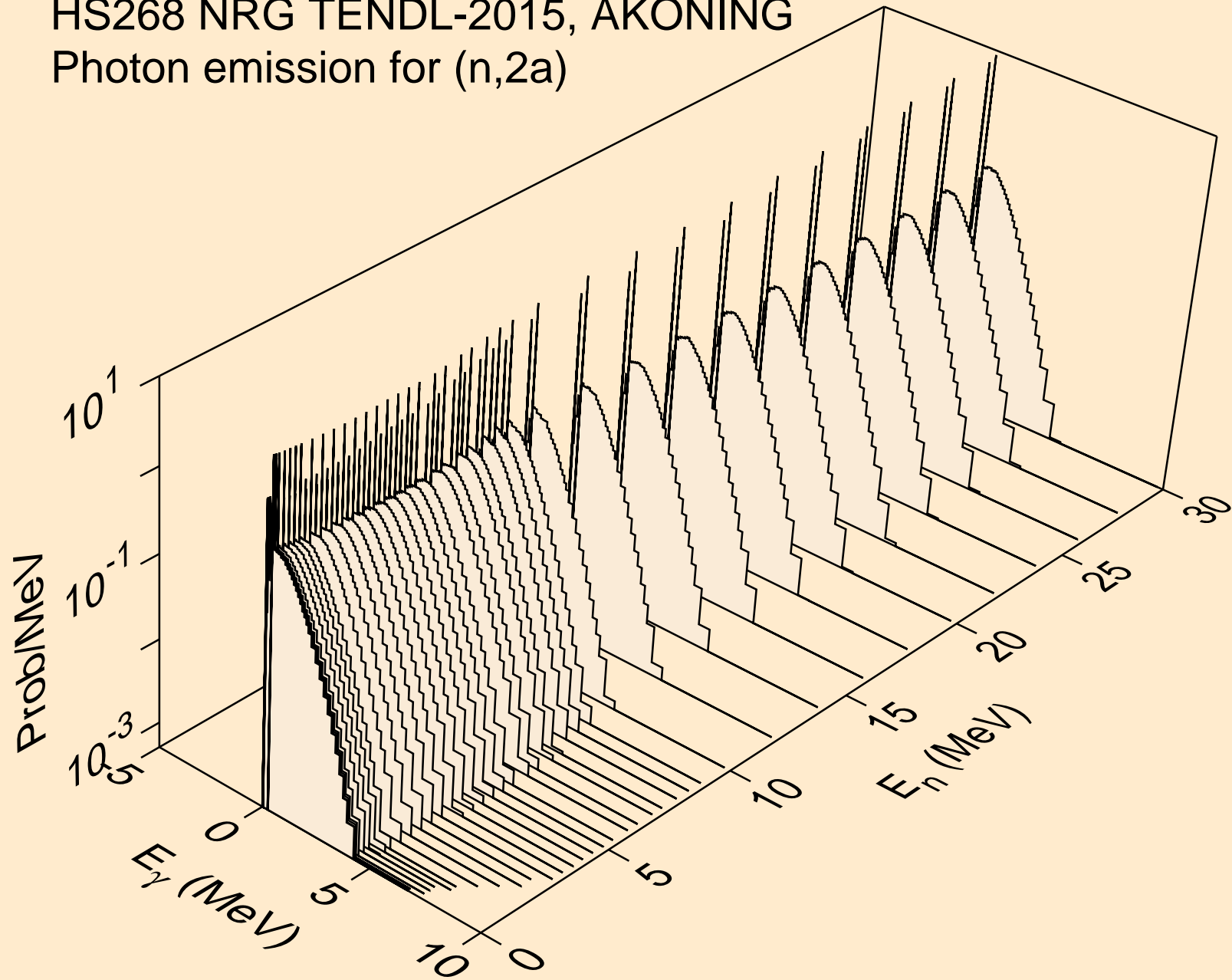



HS268 NRG TENDL-2015, AKONING  
Photon emission for (n,3a)

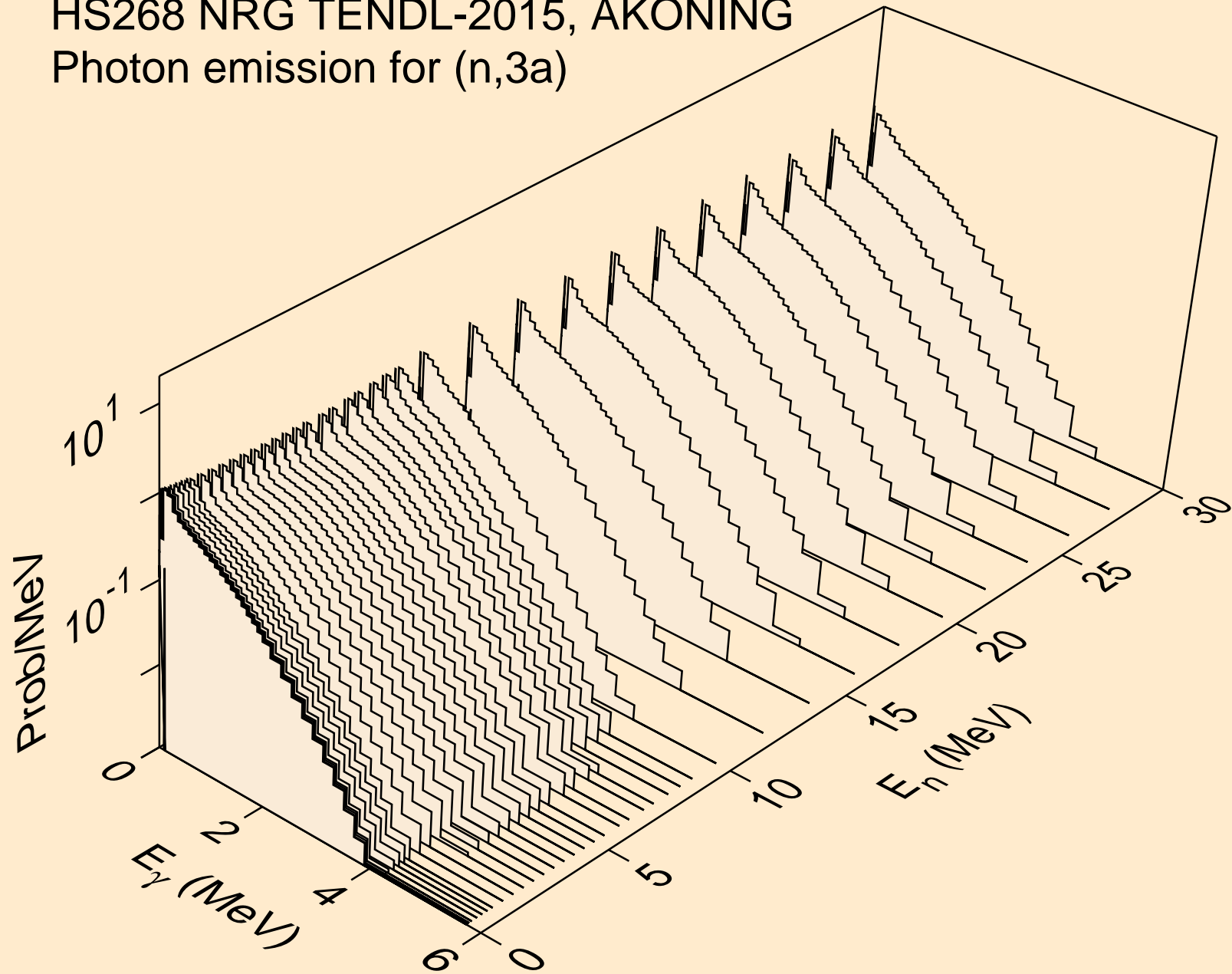

HS268 NRG TENDL-2015, AKONING  
Photon emission for (n,2p)

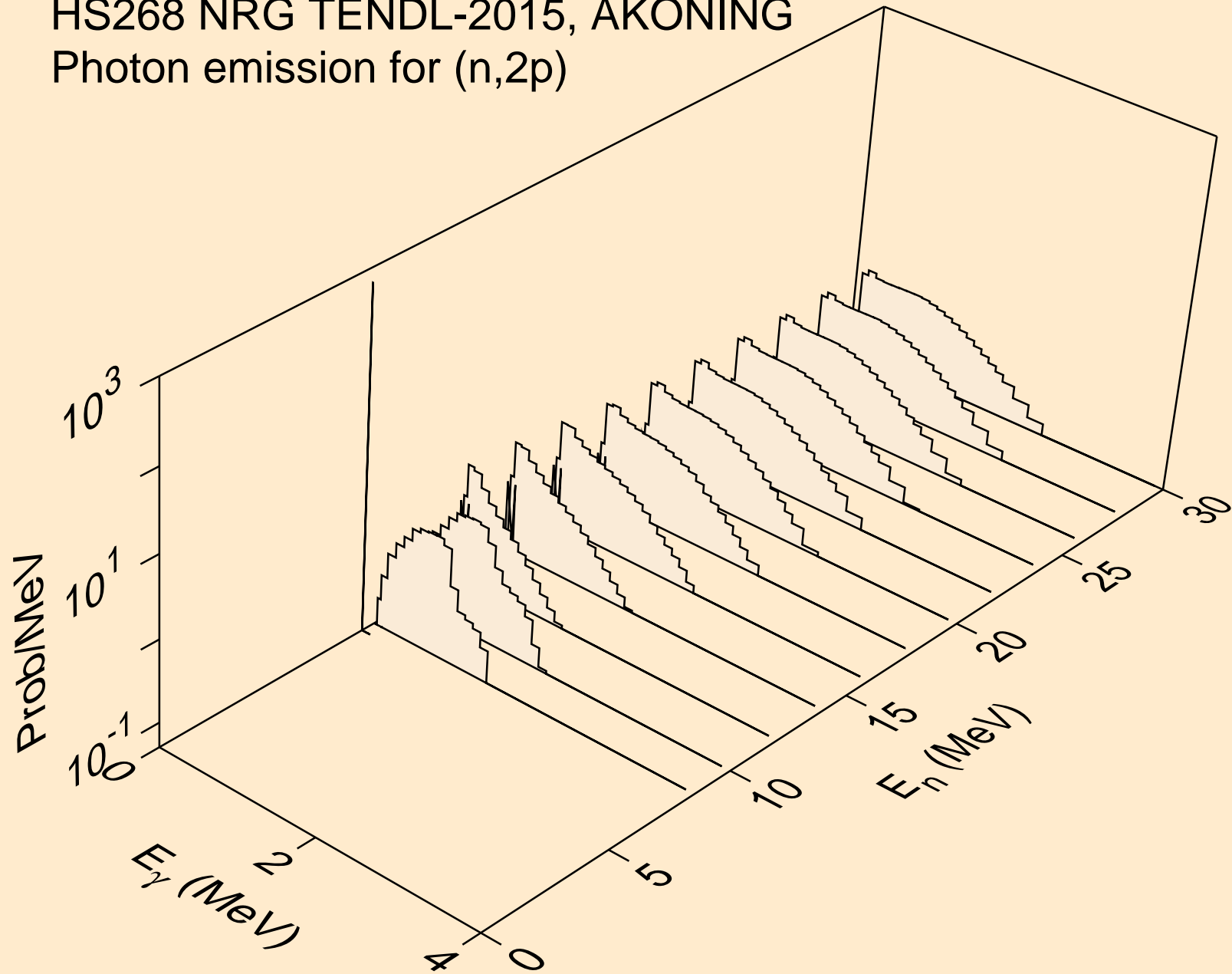

HS268 NRG TENDL-2015, AKONING  
Photon emission for (n,p $\alpha$ )

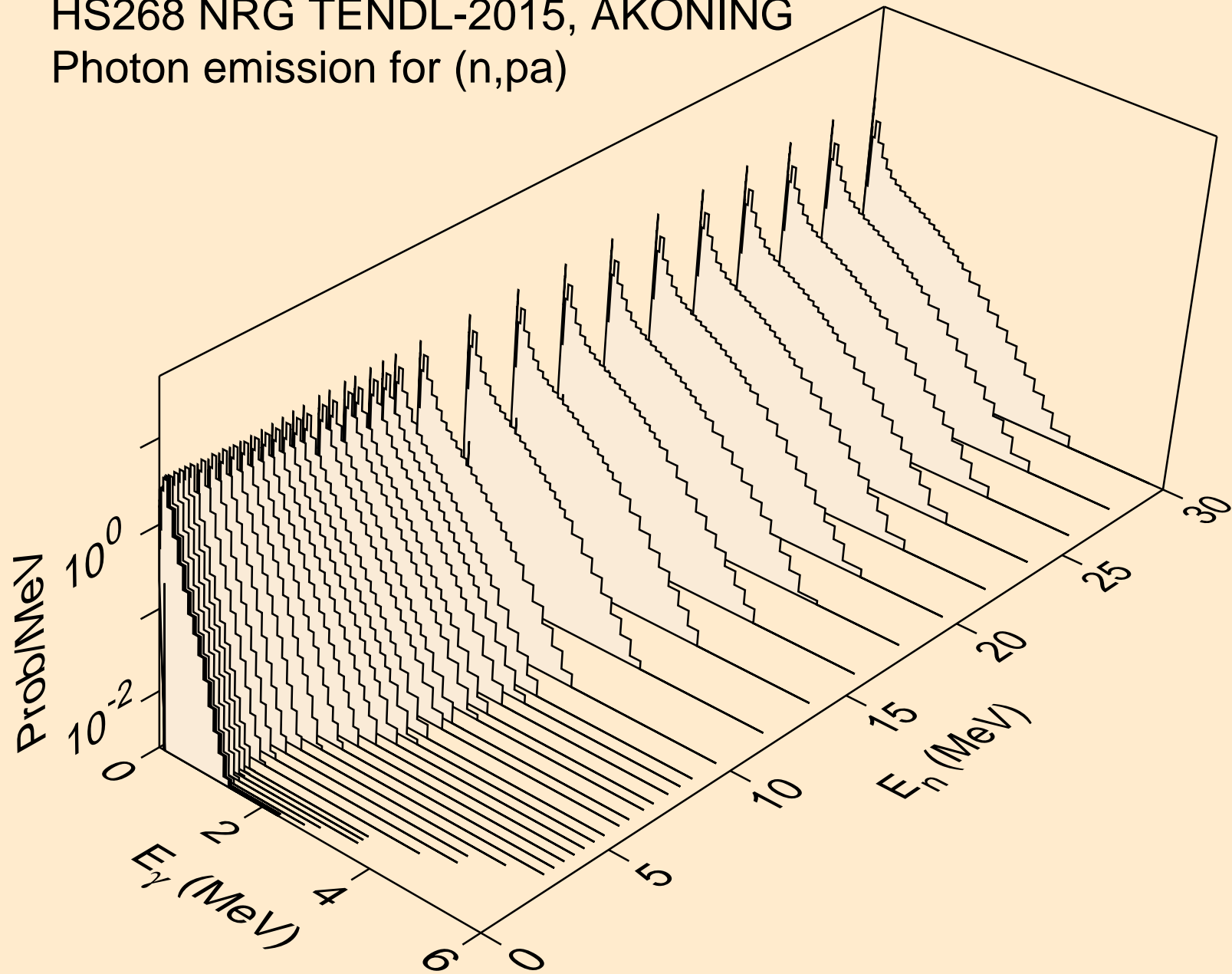

HS268 NRG TENDL-2015, AKONING  
Photon emission for (n,t2a)

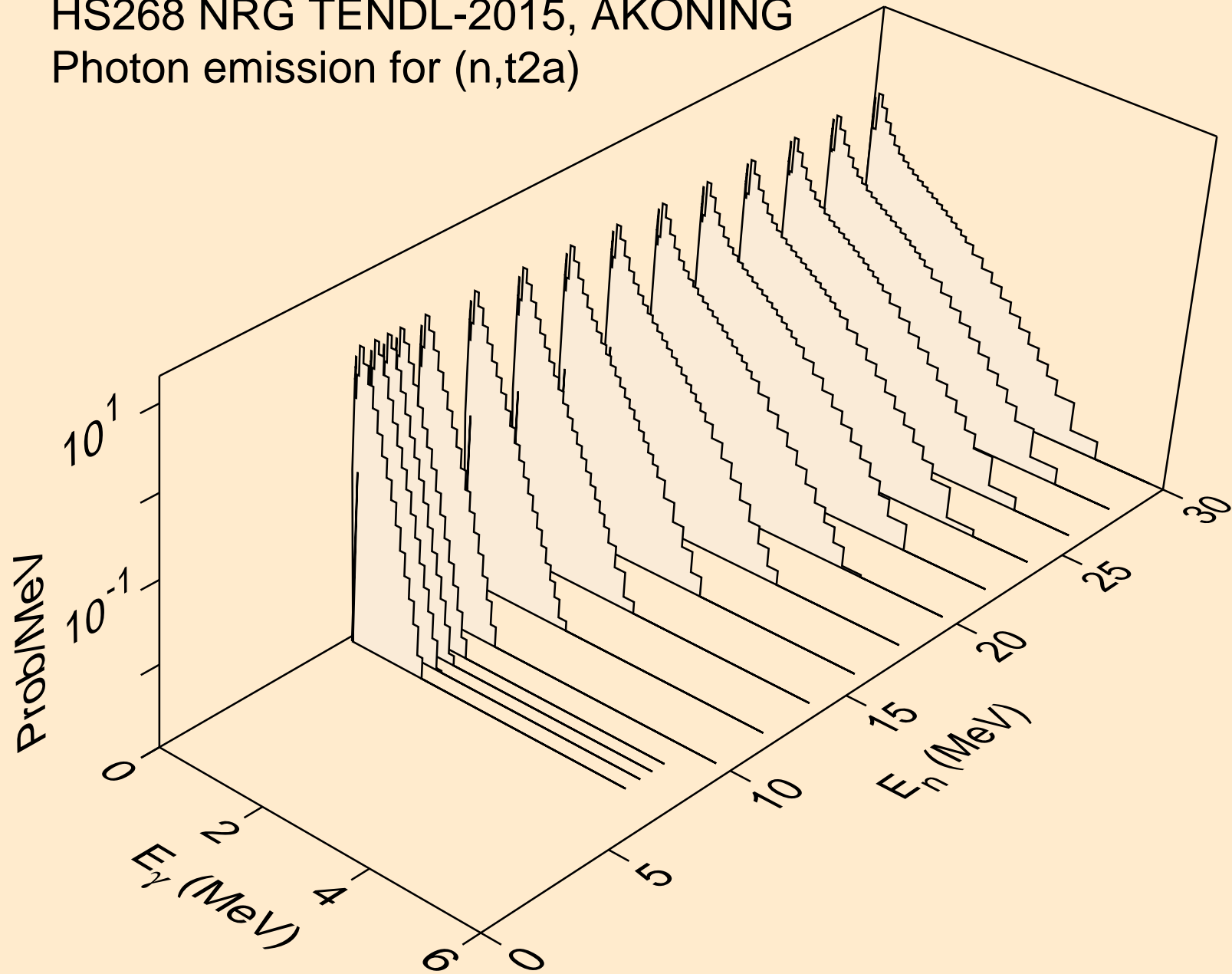

HS268 NRG TENDL-2015, AKONING  
Photon emission for (n,d2a)

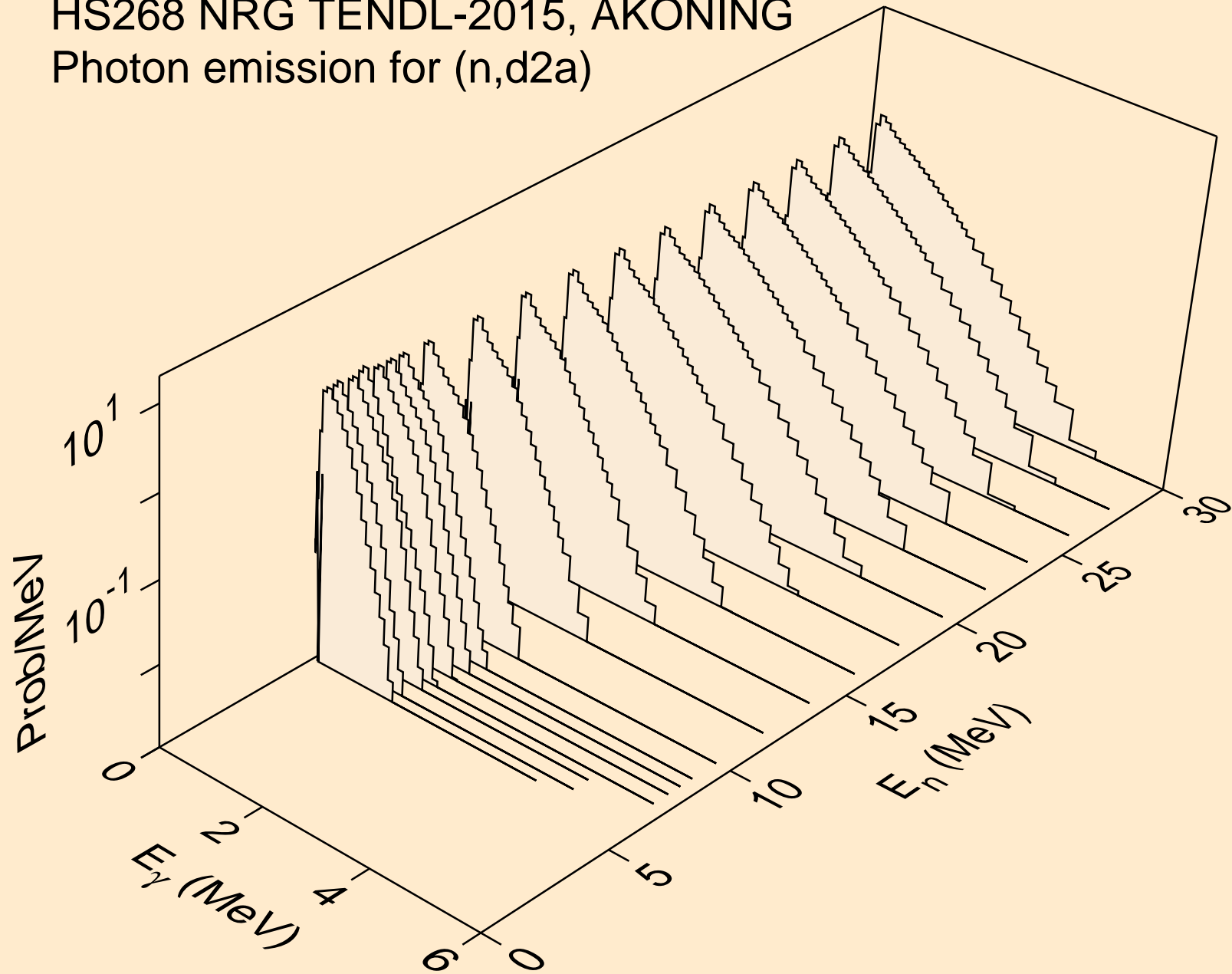

HS268 NRG TENDL-2015, AKONING  
Photon emission for (n,pd)

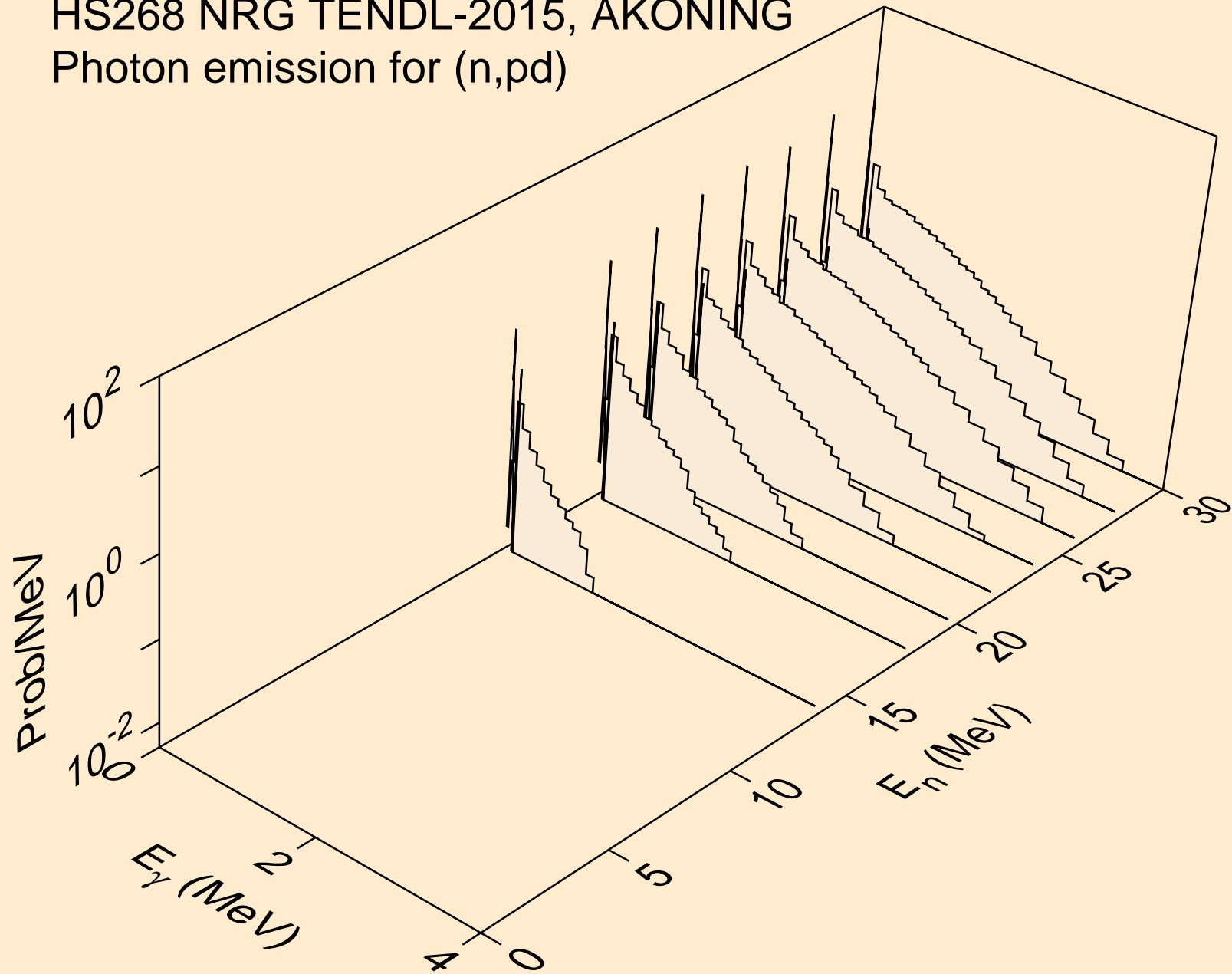

HS268 NRG TENDL-2015, AKONING  
Photon emission for (n,pt)

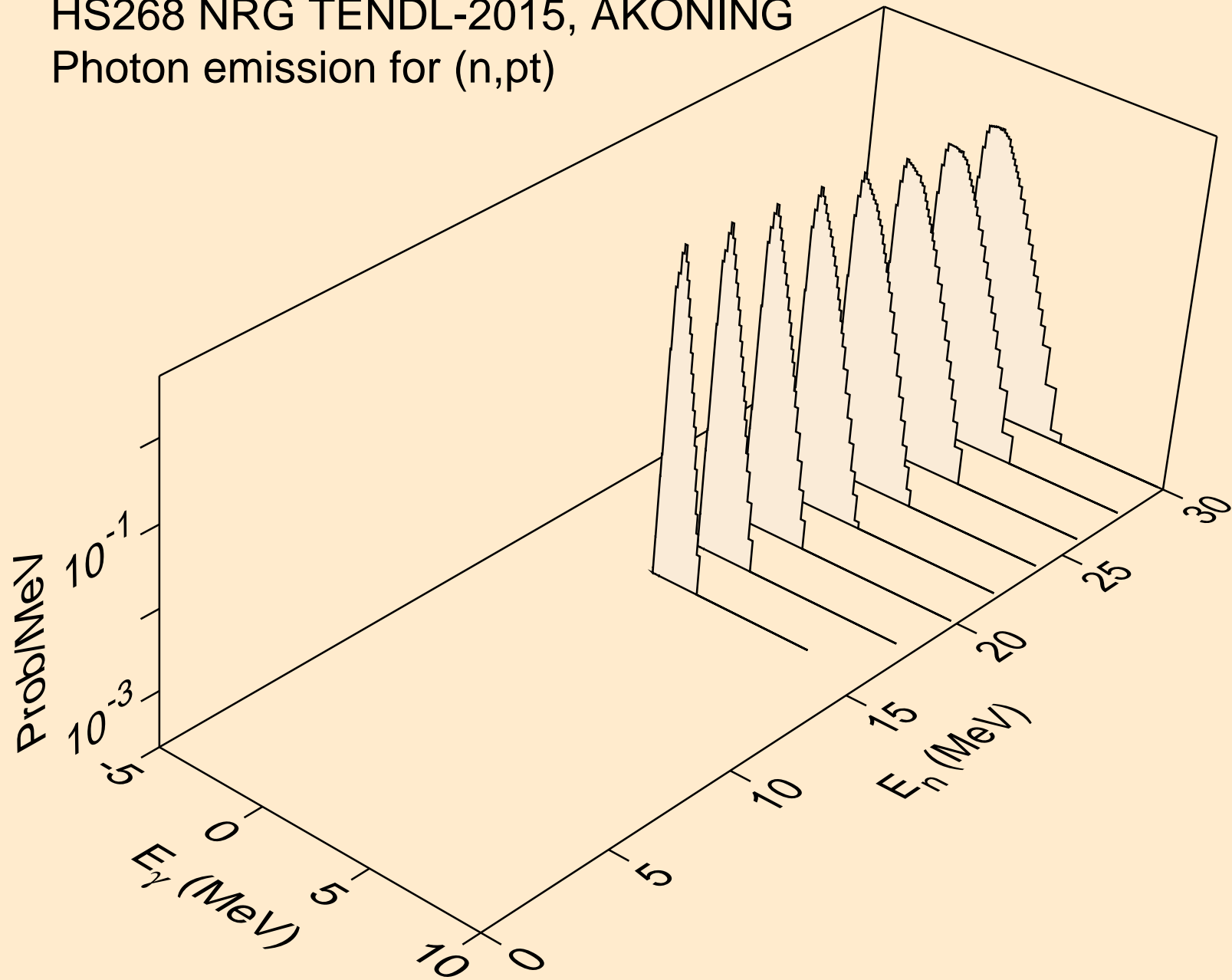

HS268 NRG TENDL-2015, AKONING  
Photon emission for (n,da)

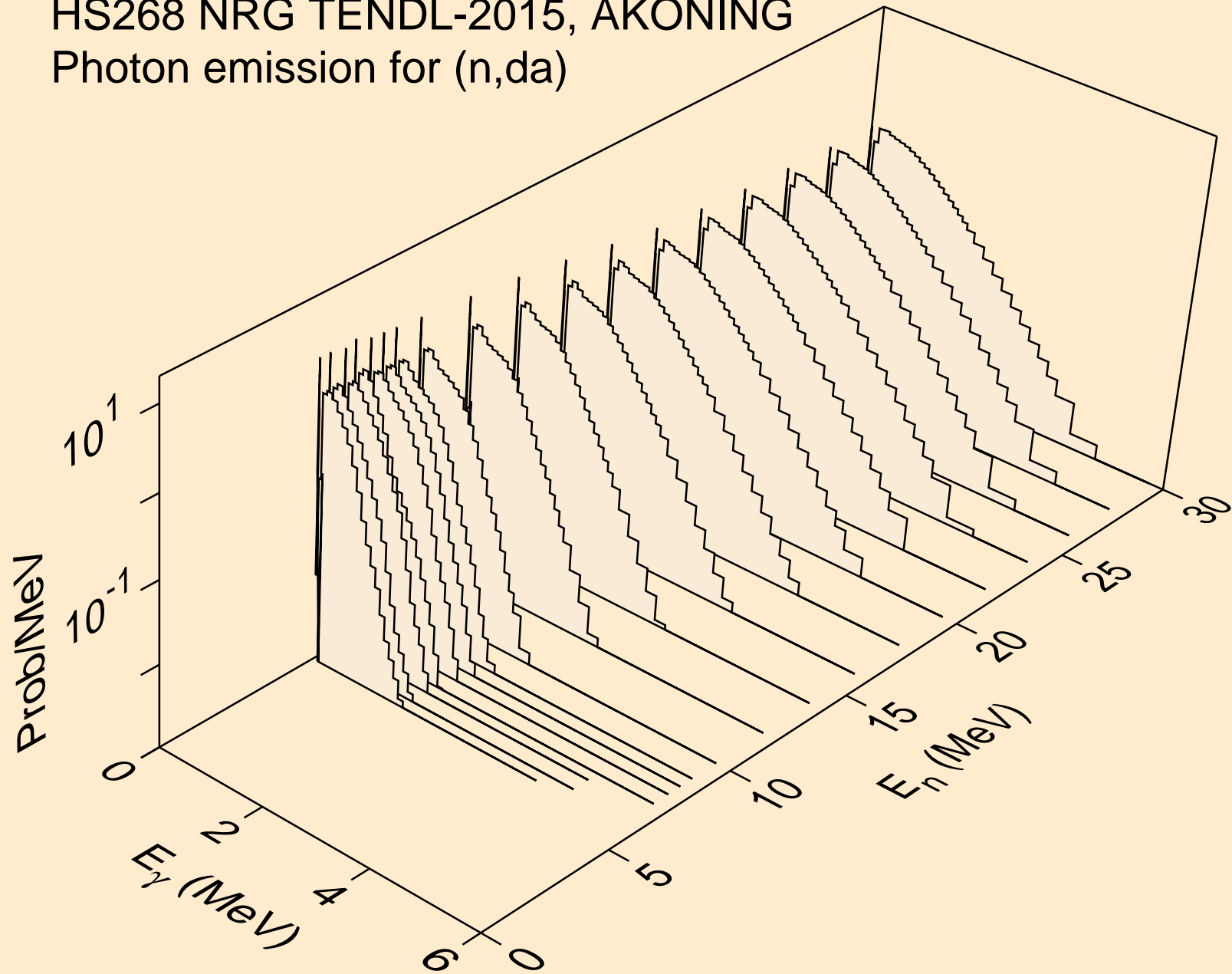



HS268 NRG TENDL-2015, AKONING  
thermal capture photon spectrum

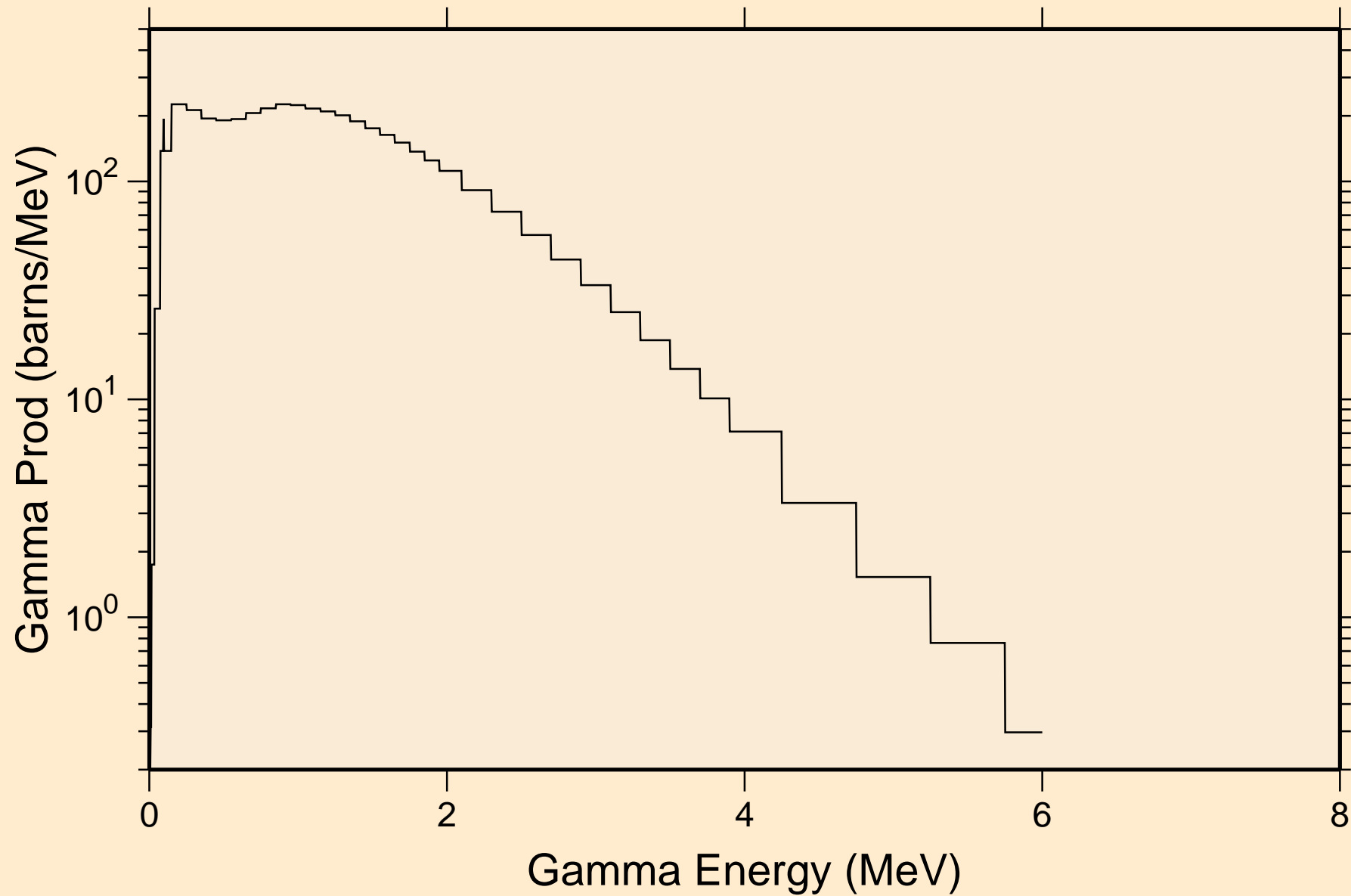

# HS268 NRG TENDL-2015, AKONING

## 14 MeV photon spectrum

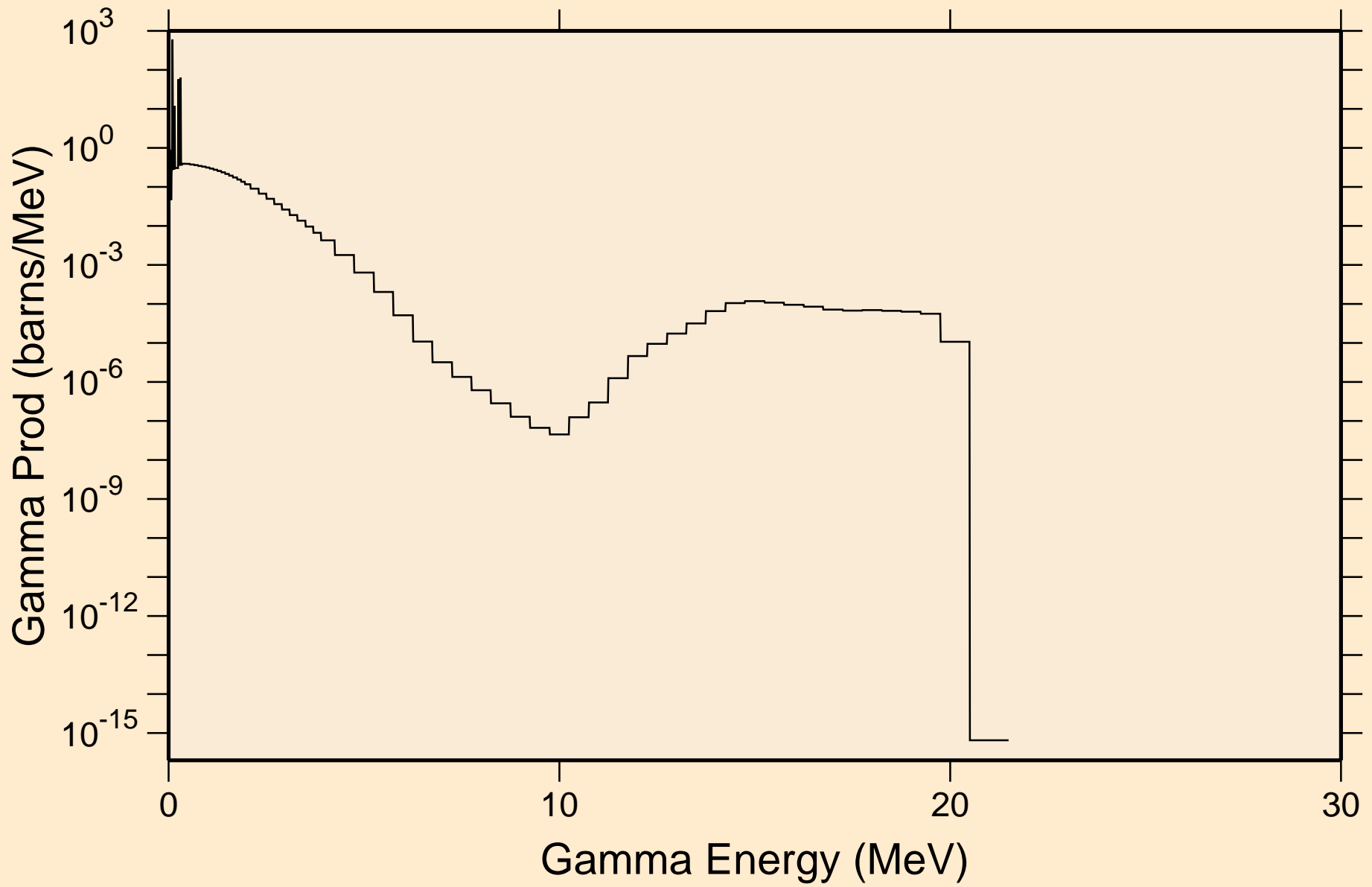

# HS268 NRG TENDL-2015, AKONING

## Particle heating contributions

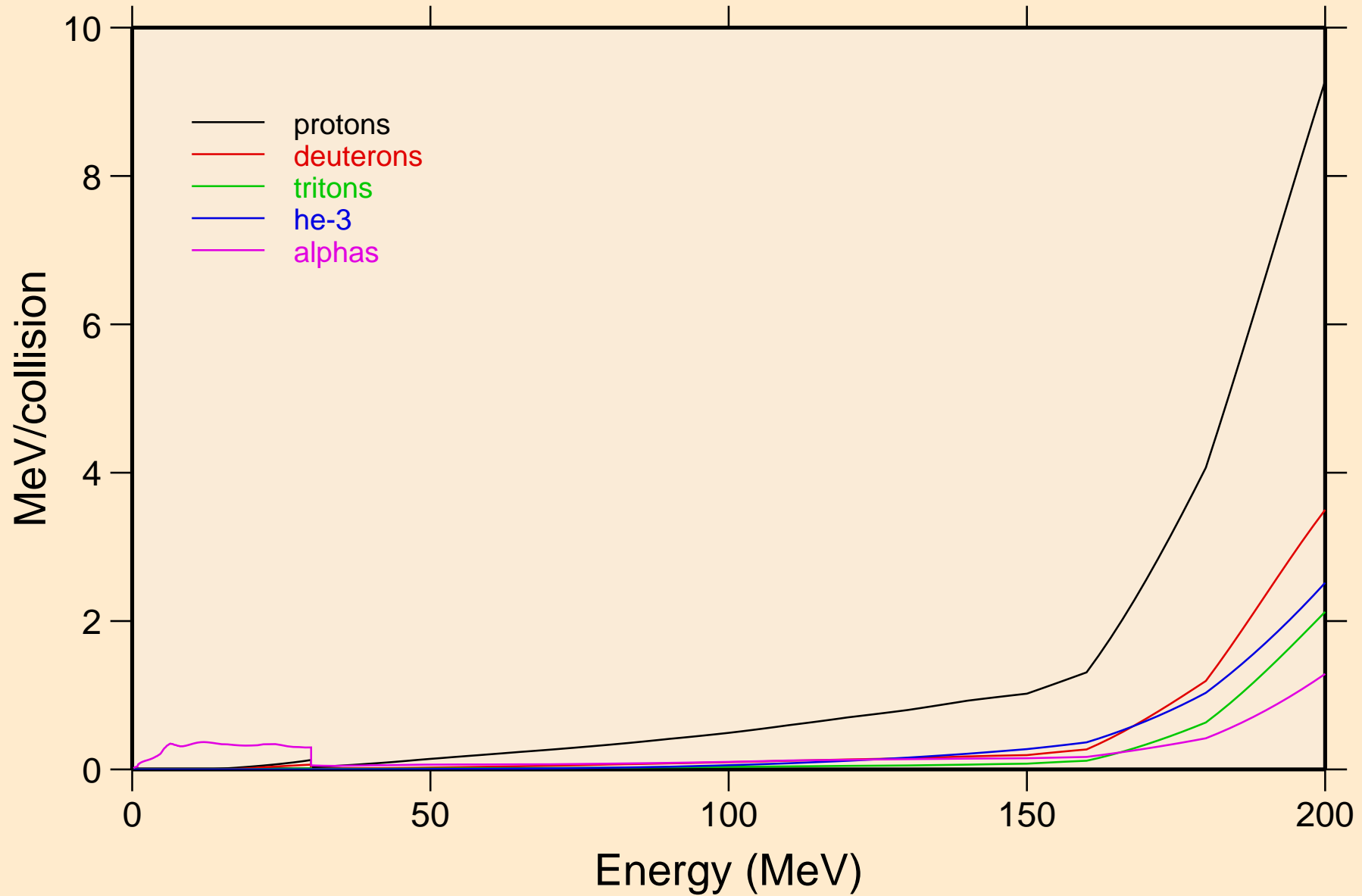

# HS268 NRG TENDL-2015, AKONING

## Recoil Heating

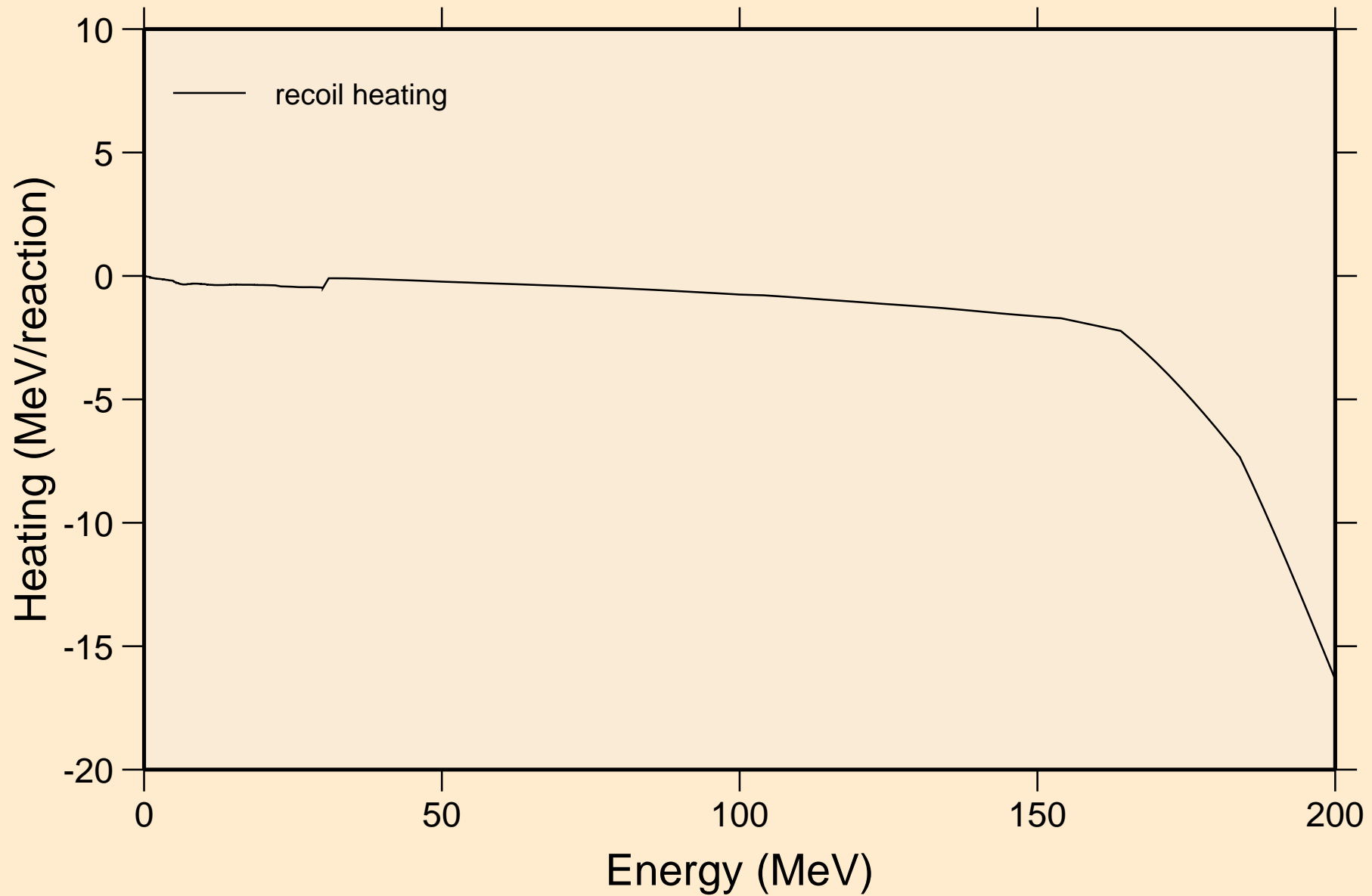

# HS268 NRG TENDL-2015, AKONING

## Particle production cross sections

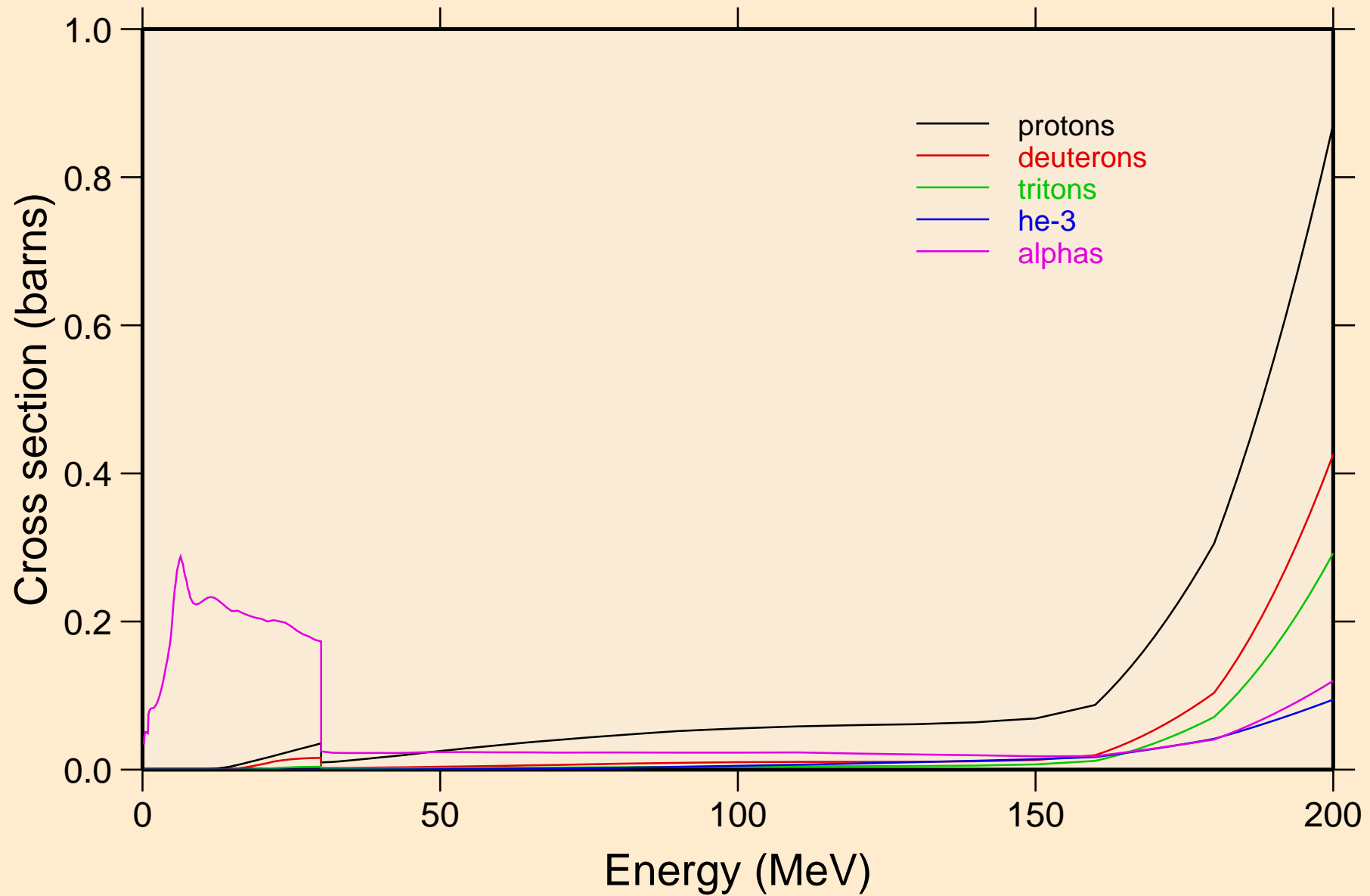

HS268 NRG TENDL-2015, AKONING  
protons from (n,x)

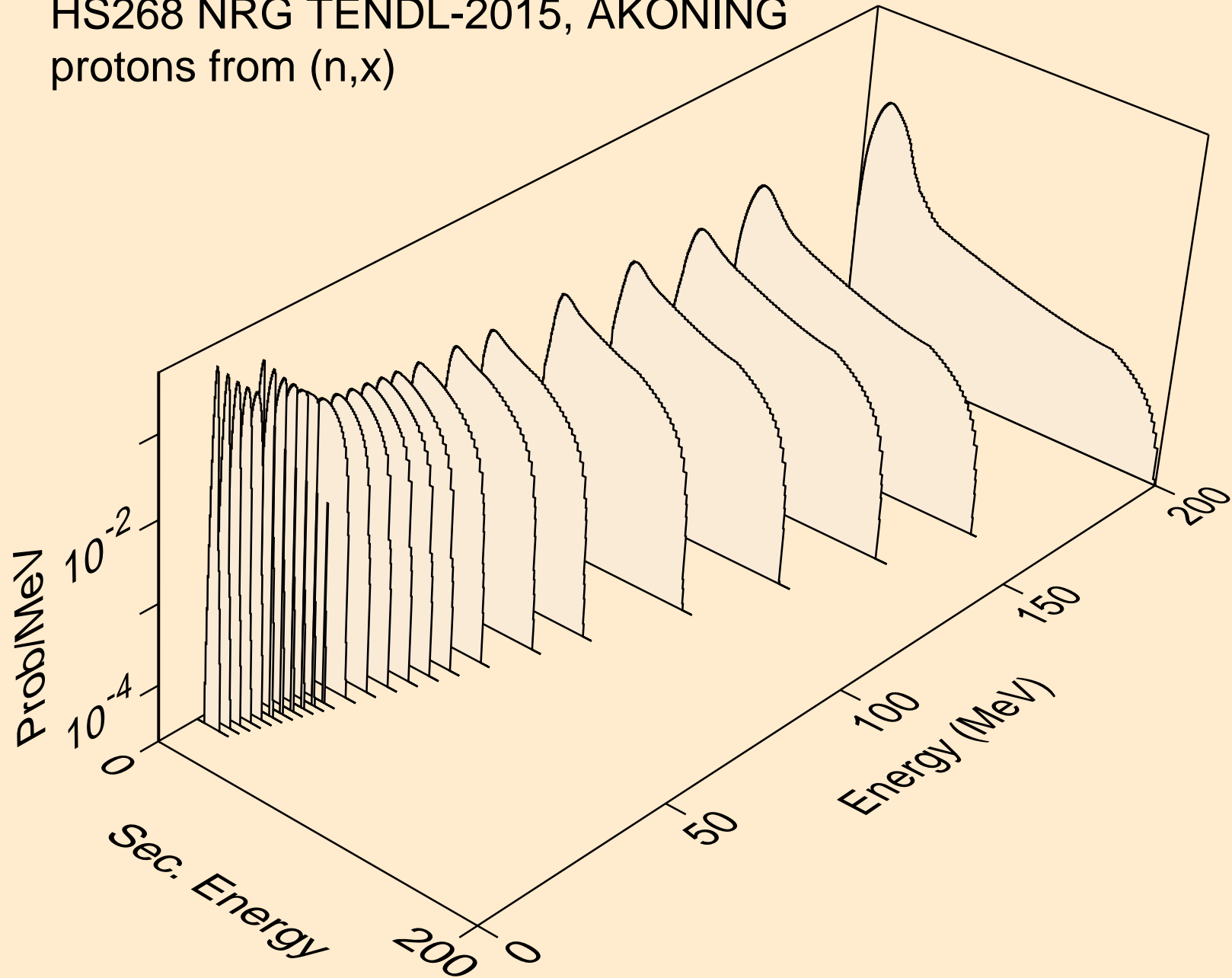

HS268 NRG TENDL-2015, AKONING  
protons from (n,n\*)p

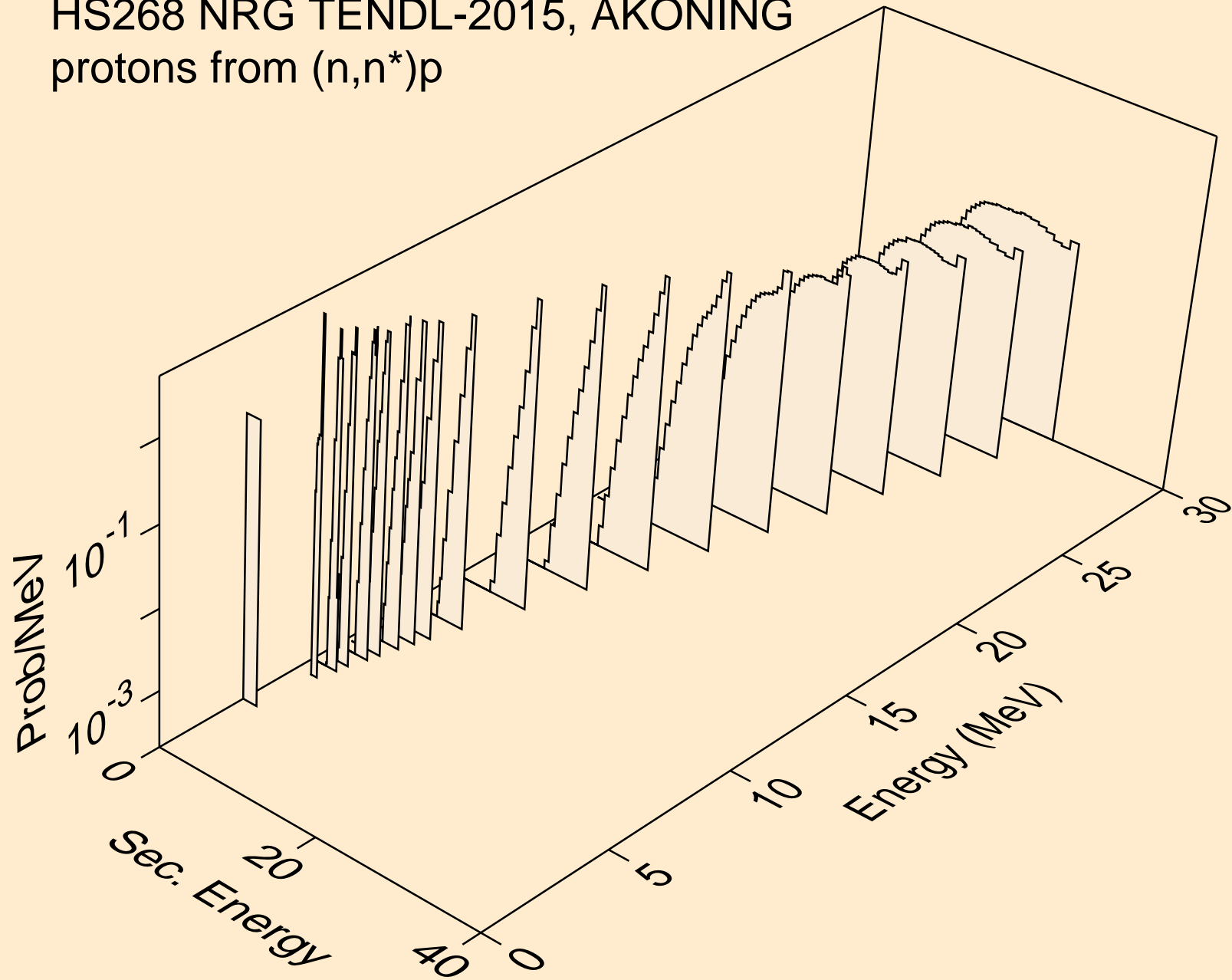

HS268 NRG TENDL-2015, AKONING  
protons from (n,2np)

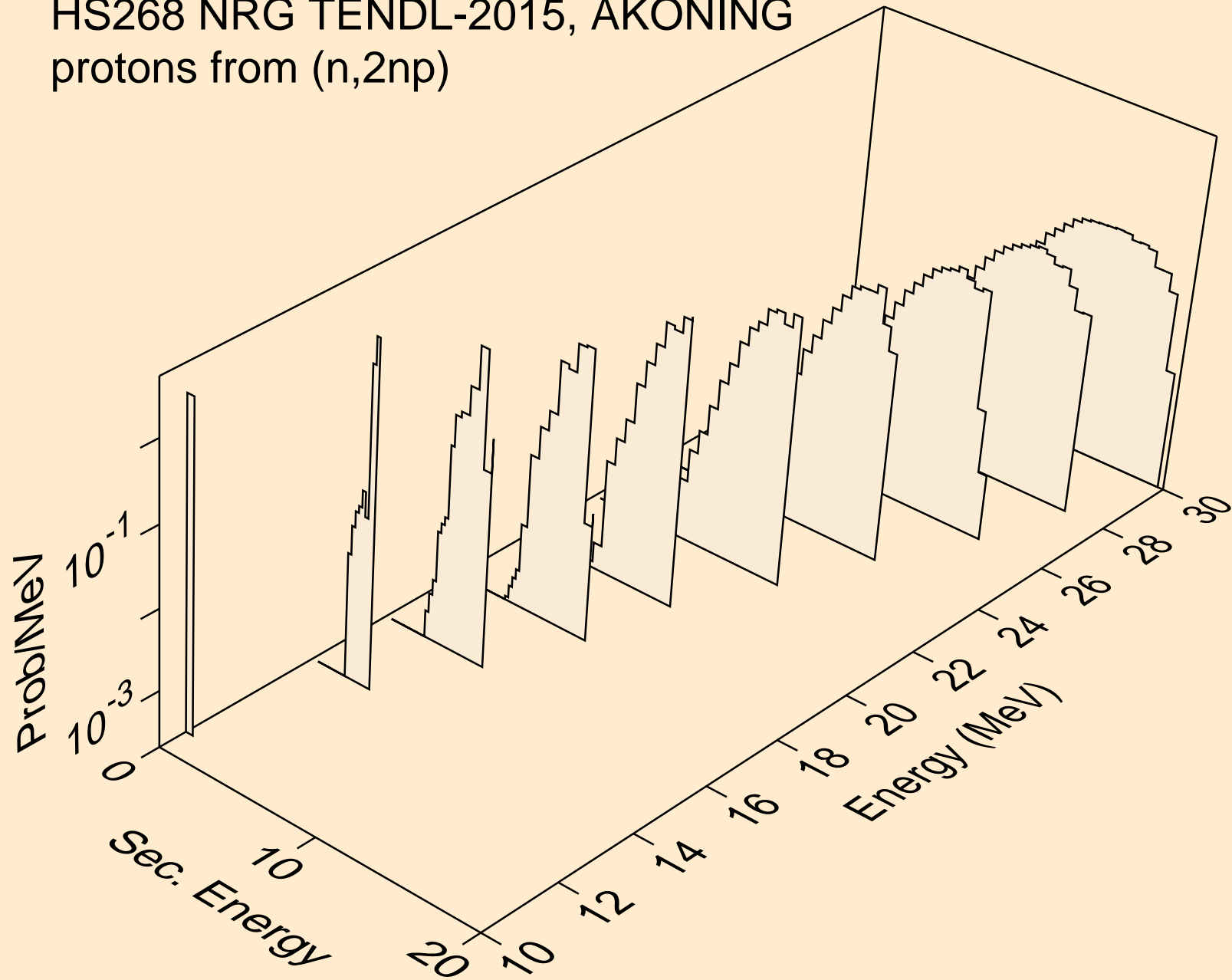



HS268 NRG TENDL-2015, AKONING  
protons from (n,3np)

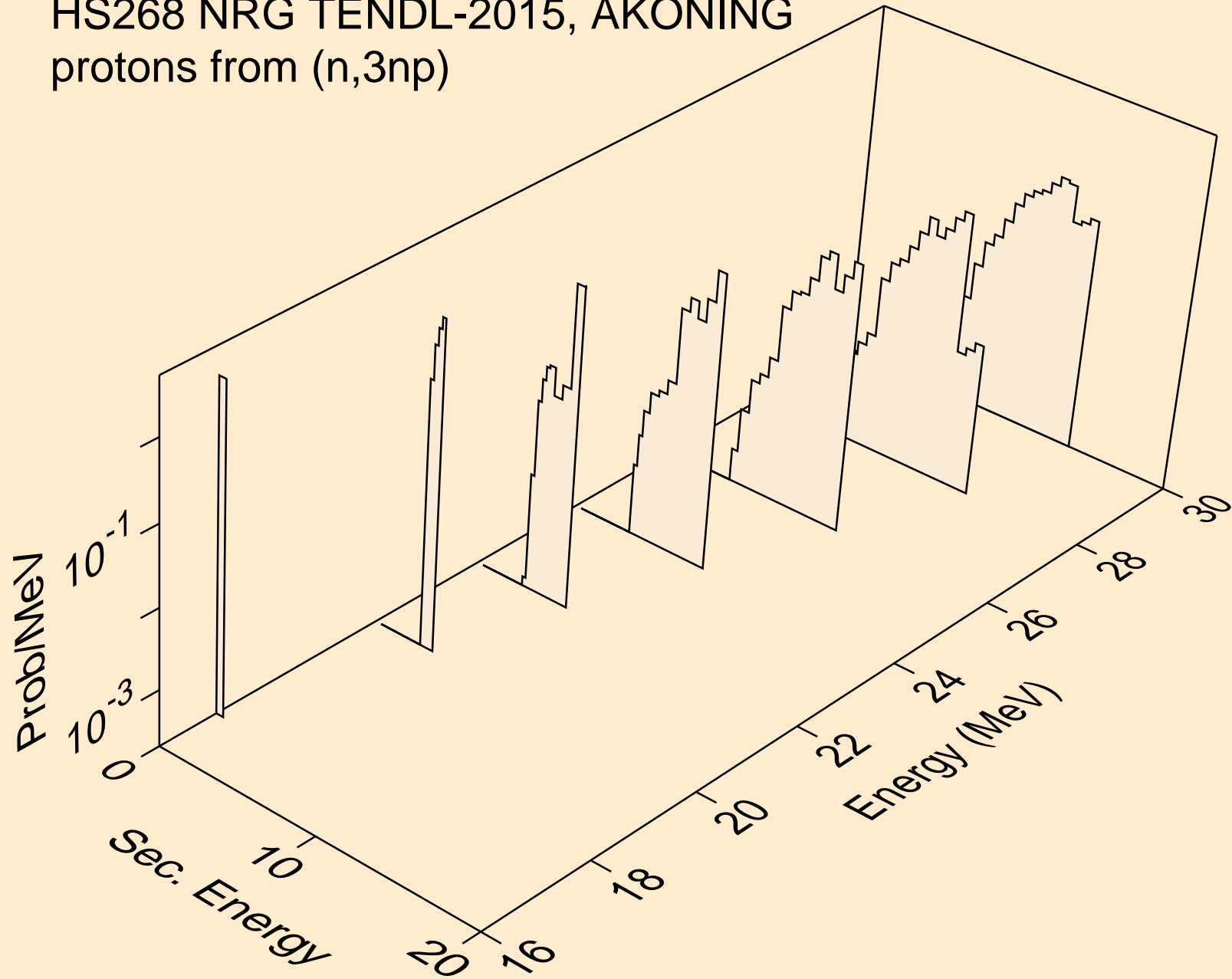

HS268 NRG TENDL-2015, AKONING  
protons from (n,2np)

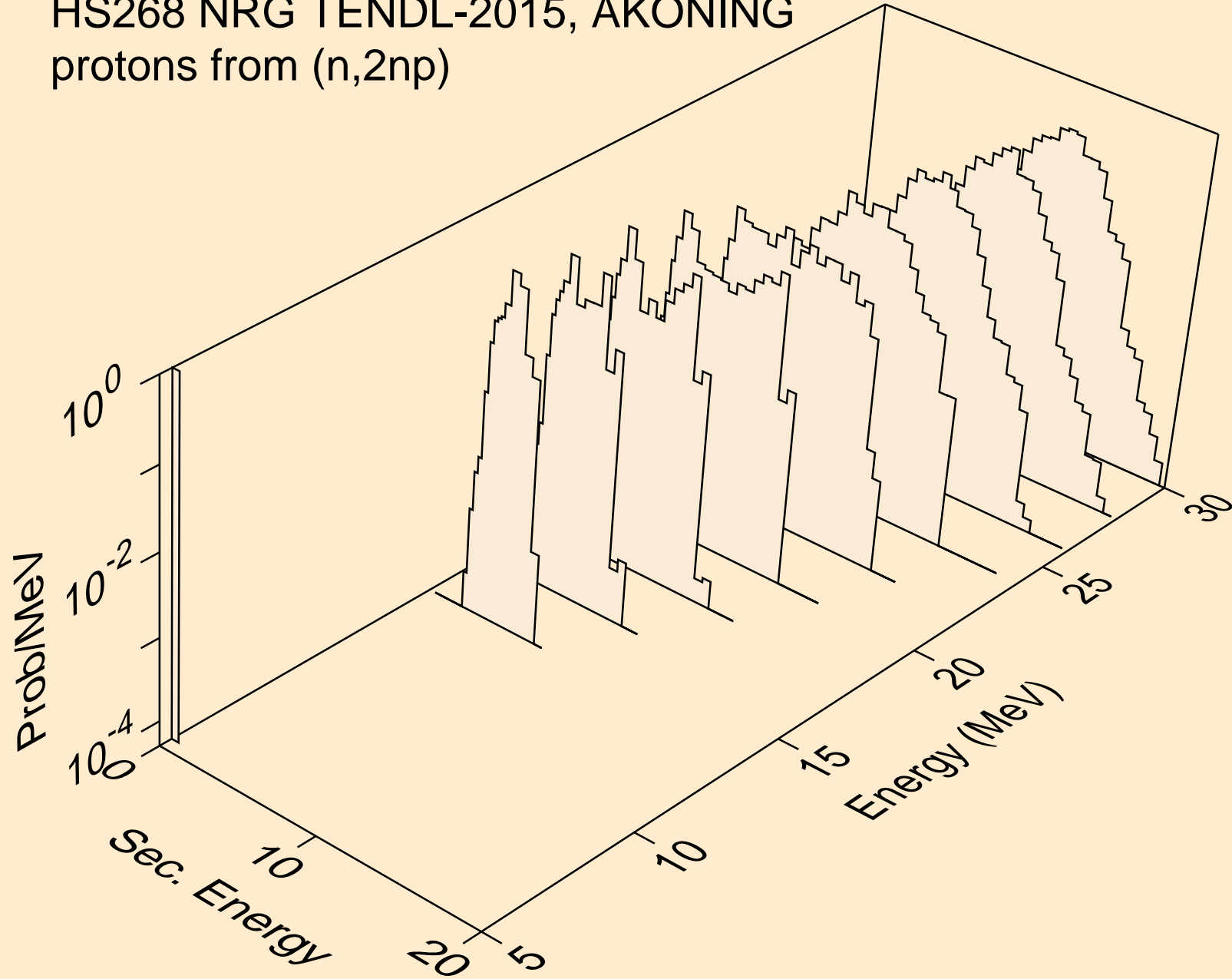

HS268 NRG TENDL-2015, AKONING  
protons from (n,npa)

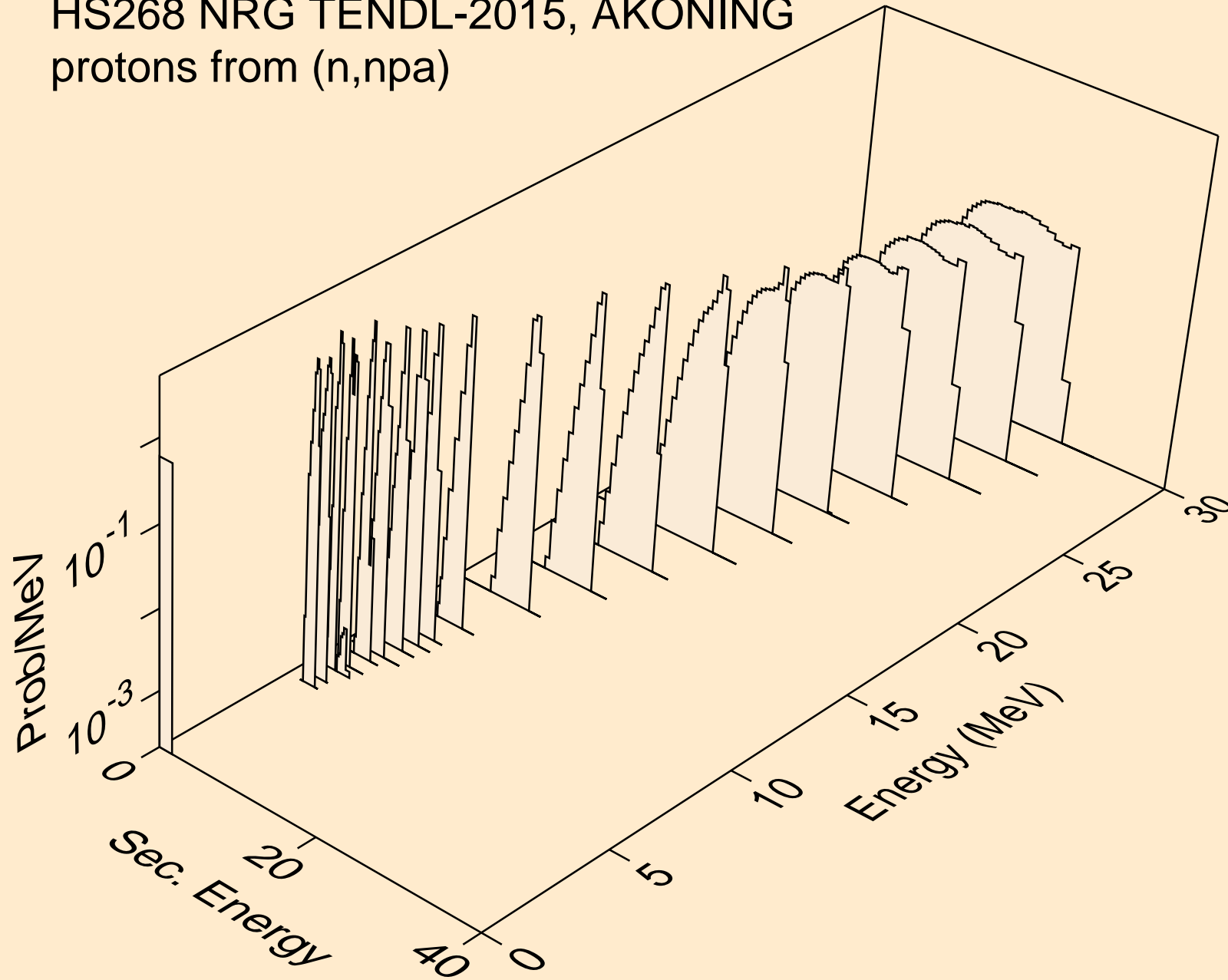

HS268 NRG TENDL-2015, AKONING  
protons from (n,p)

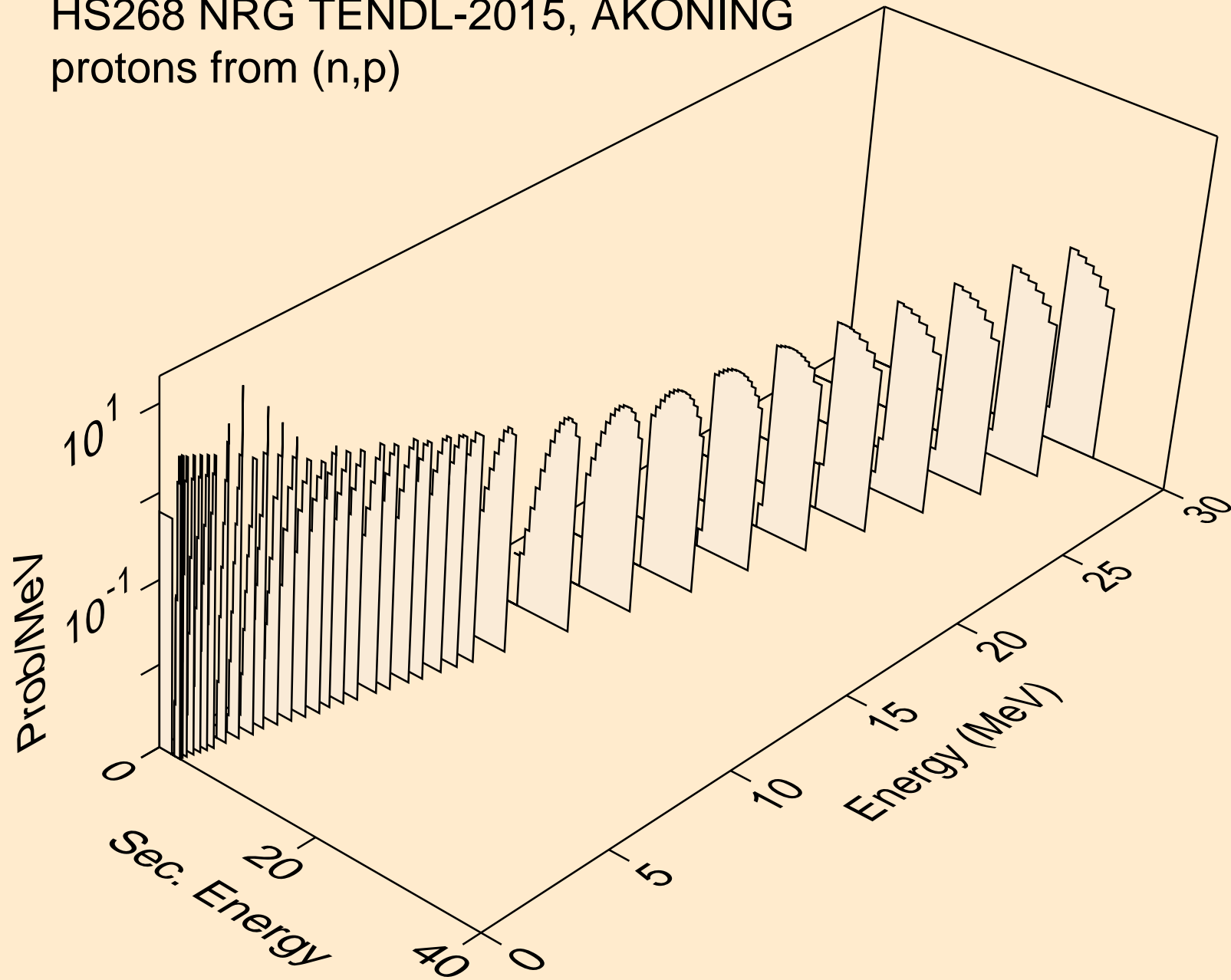

HS268 NRG TENDL-2015, AKONING  
protons from (n,2p)

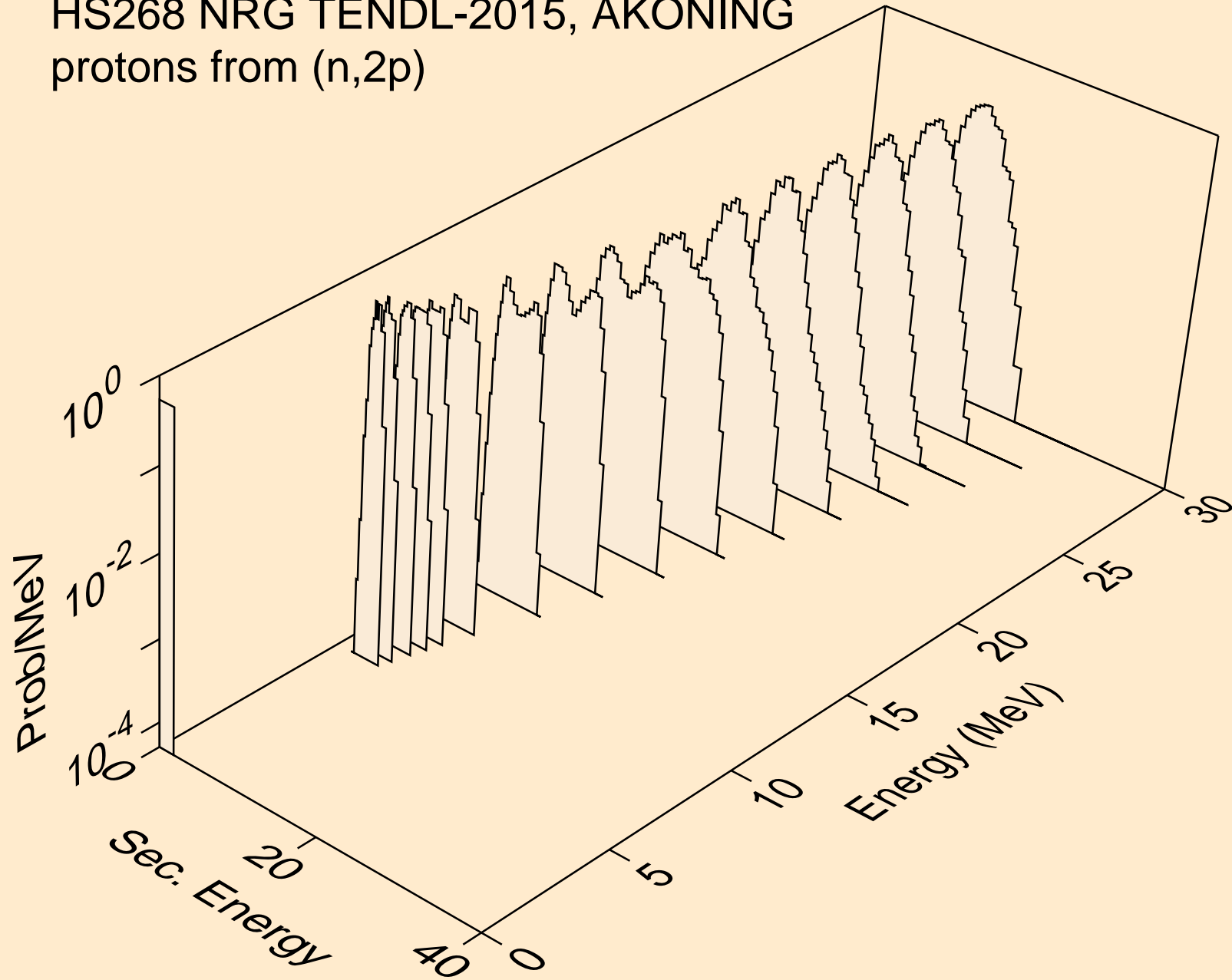

HS268 NRG TENDL-2015, AKONING  
protons from (n,pa)

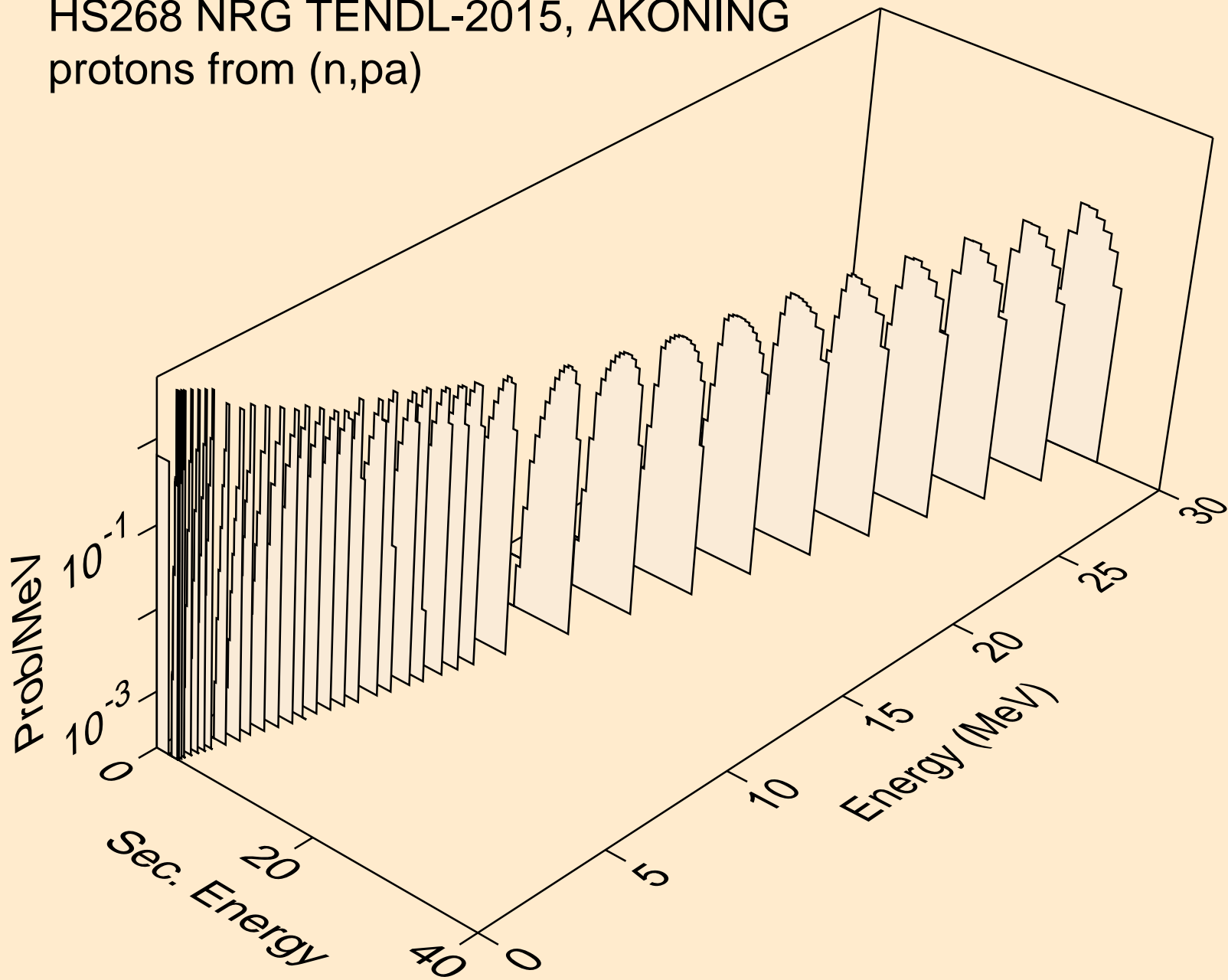

HS268 NRG TENDL-2015, AKONING  
protons from (n,pd)

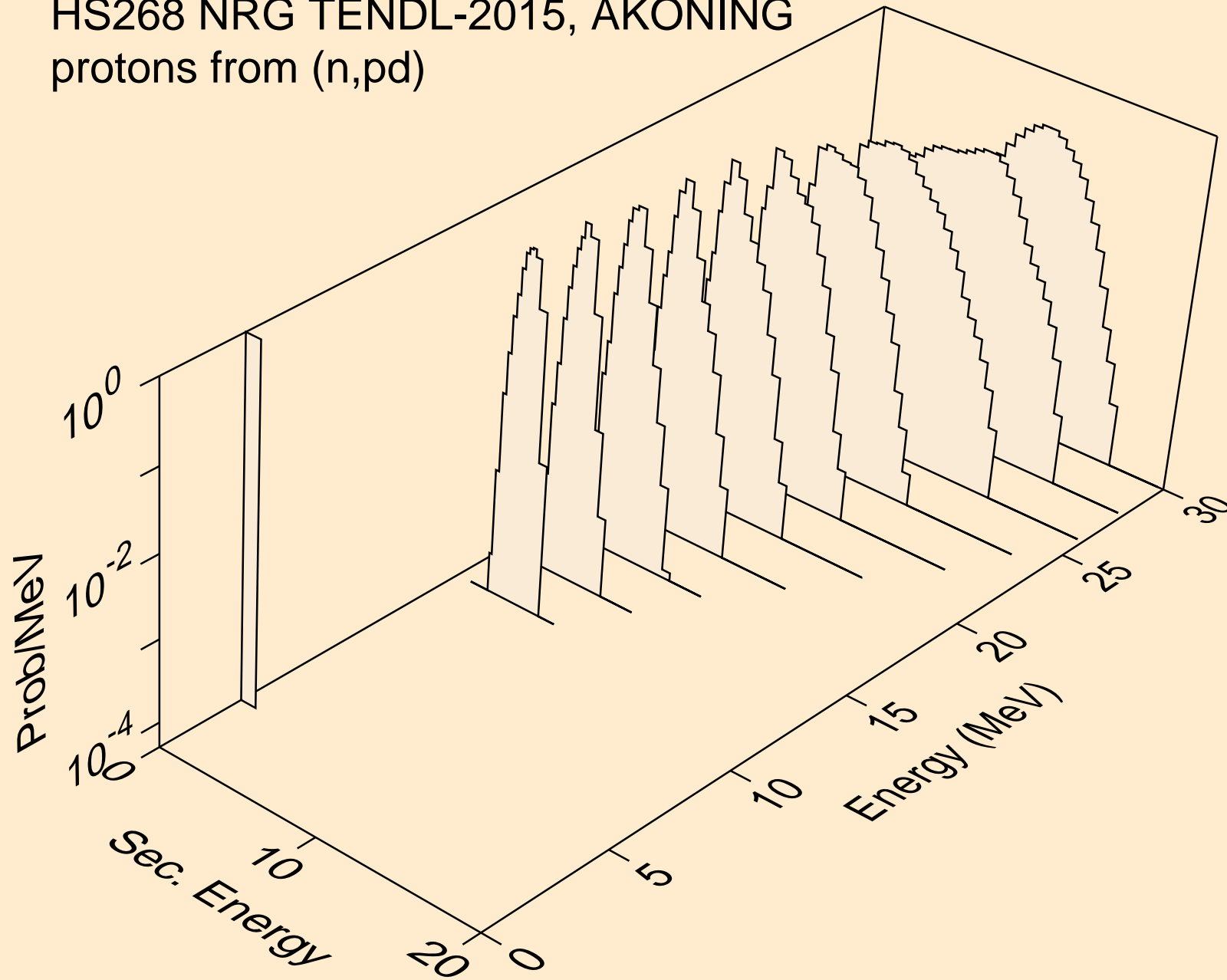

HS268 NRG TENDL-2015, AKONING  
protons from (n,pt)

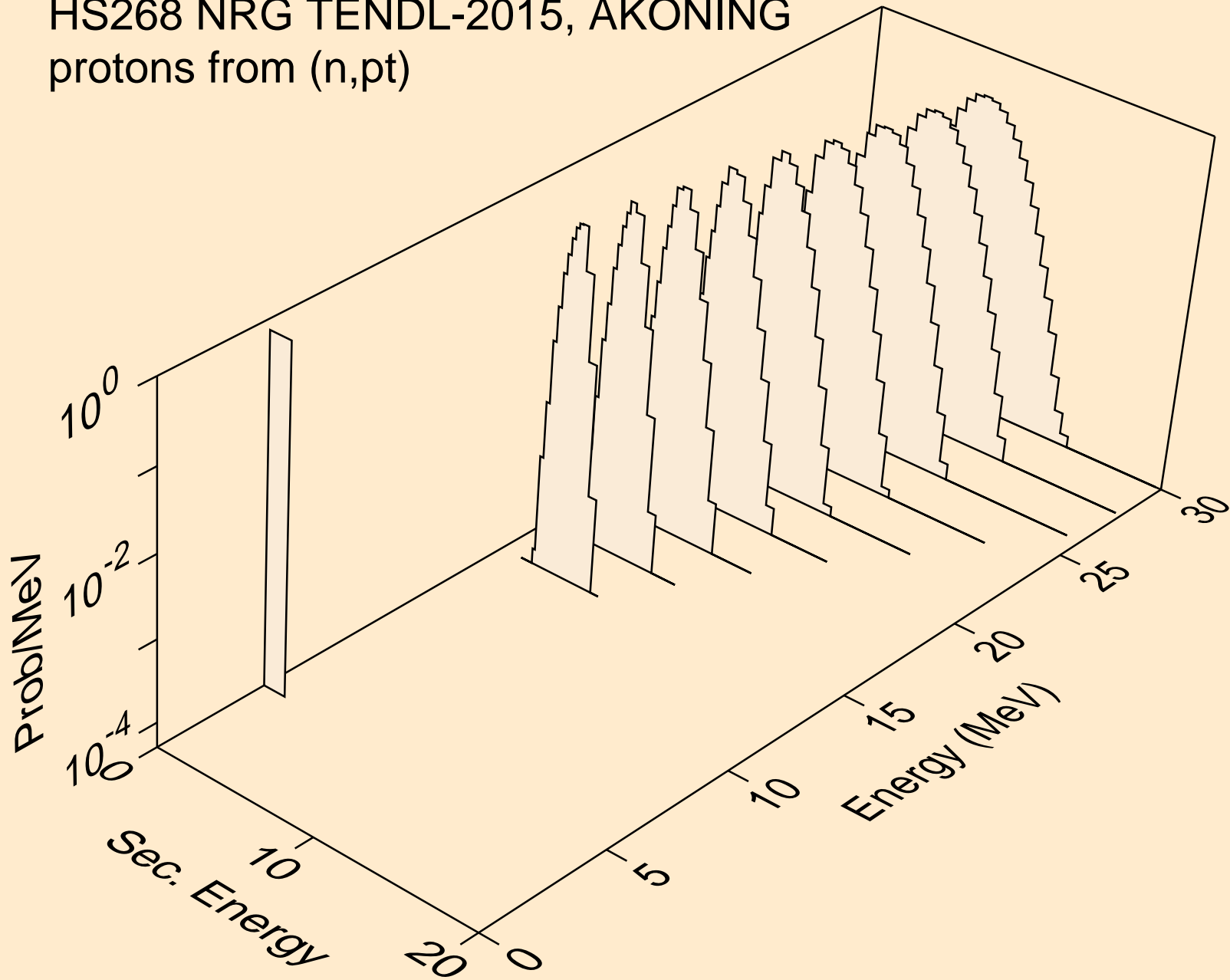



HS268 NRG TENDL-2015, AKONING  
deuterons from (n,x)

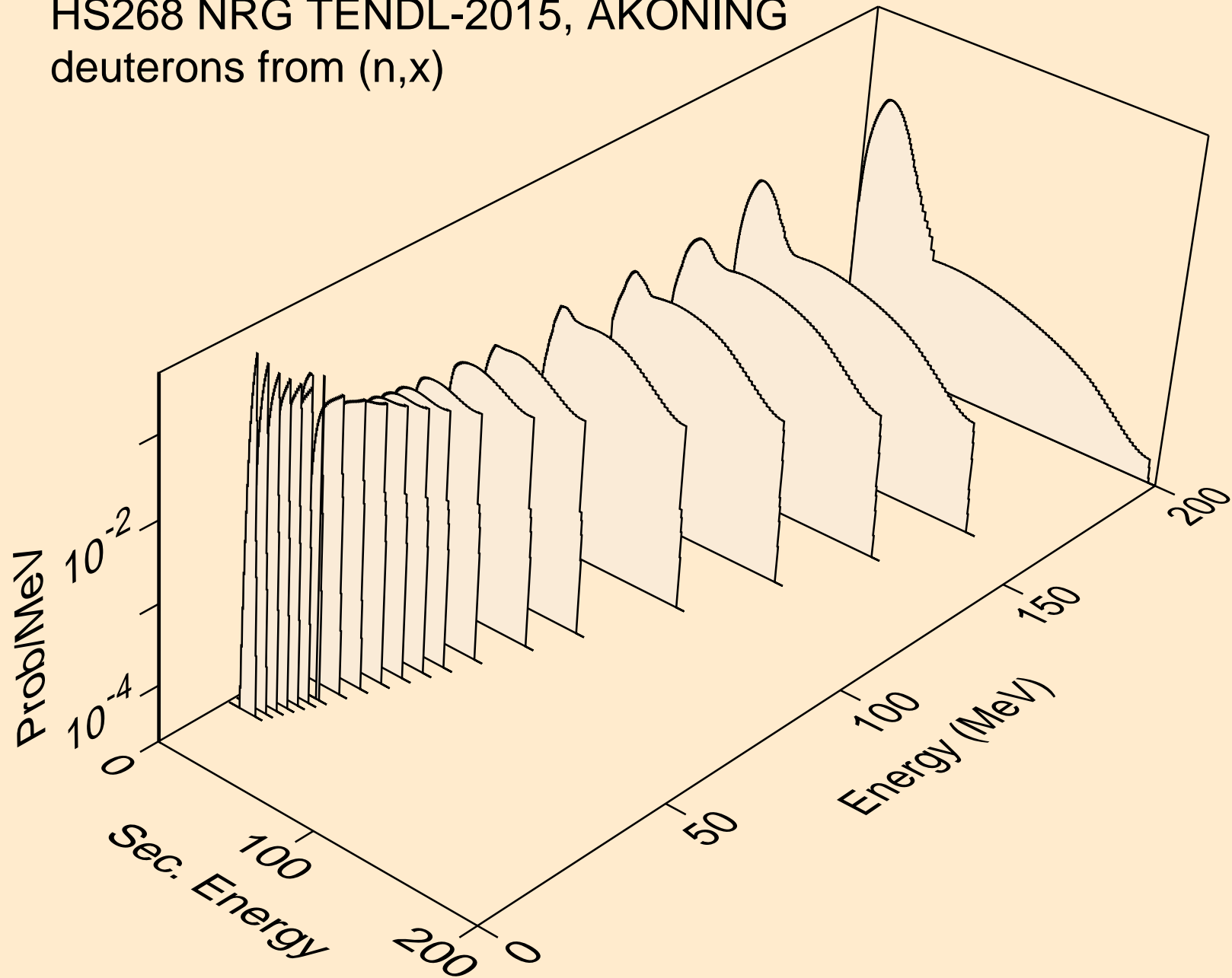

HS268 NRG TENDL-2015, AKONING  
deuterons from (n,2nd)

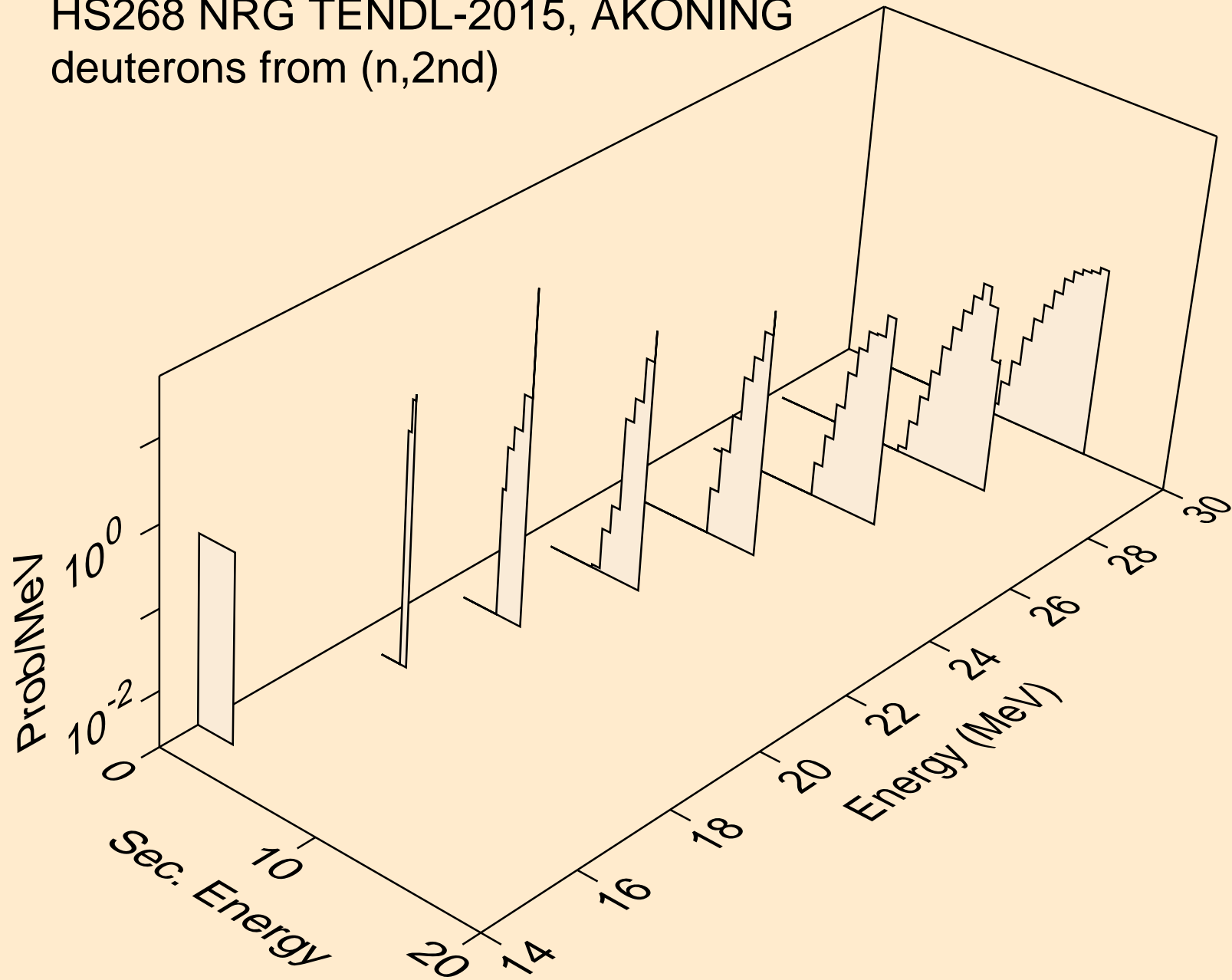

HS268 NRG TENDL-2015, AKONING  
deuterons from (n,n\*)d

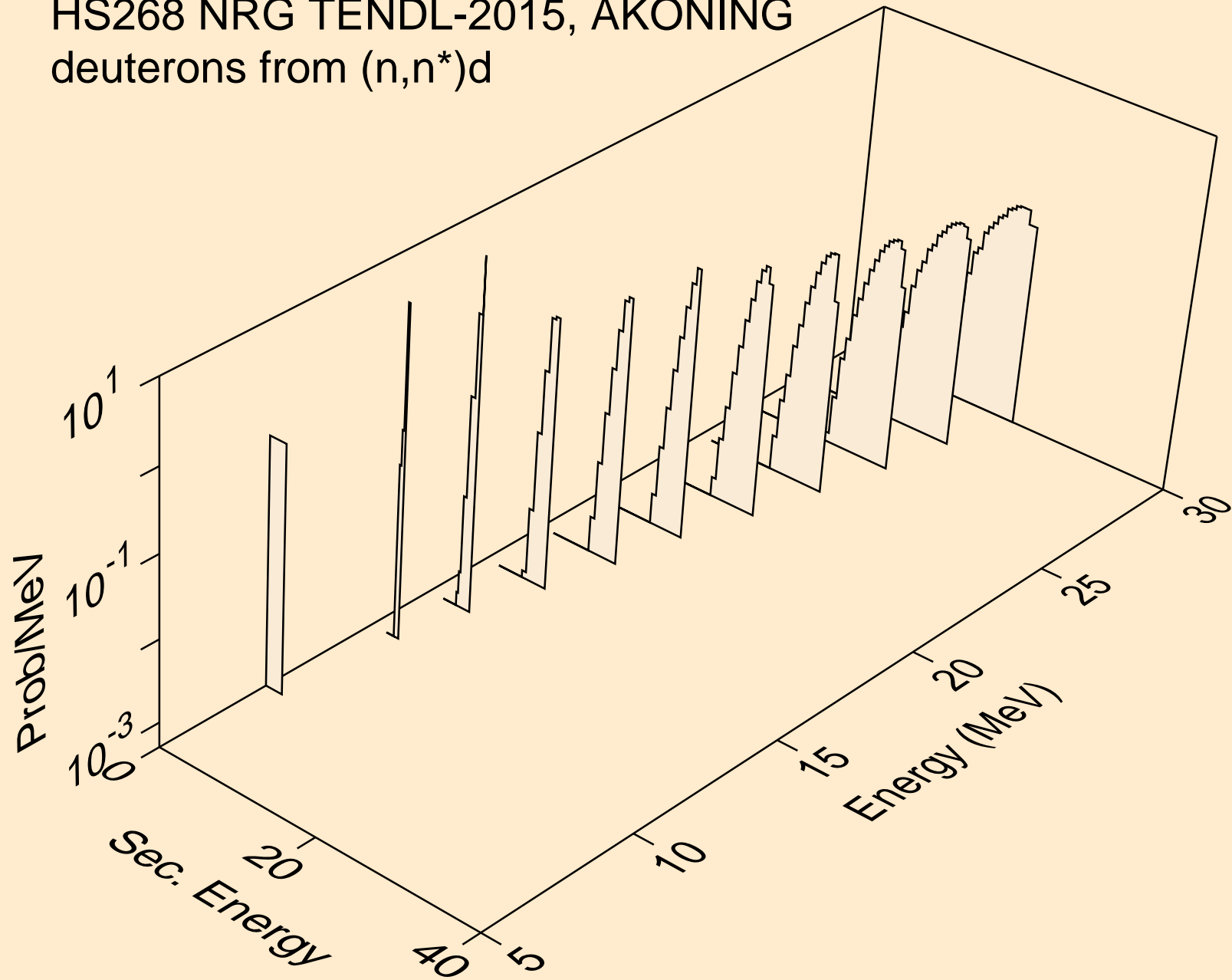

HS268 NRG TENDL-2015, AKONING  
deuterons from (n,n\*)d2a

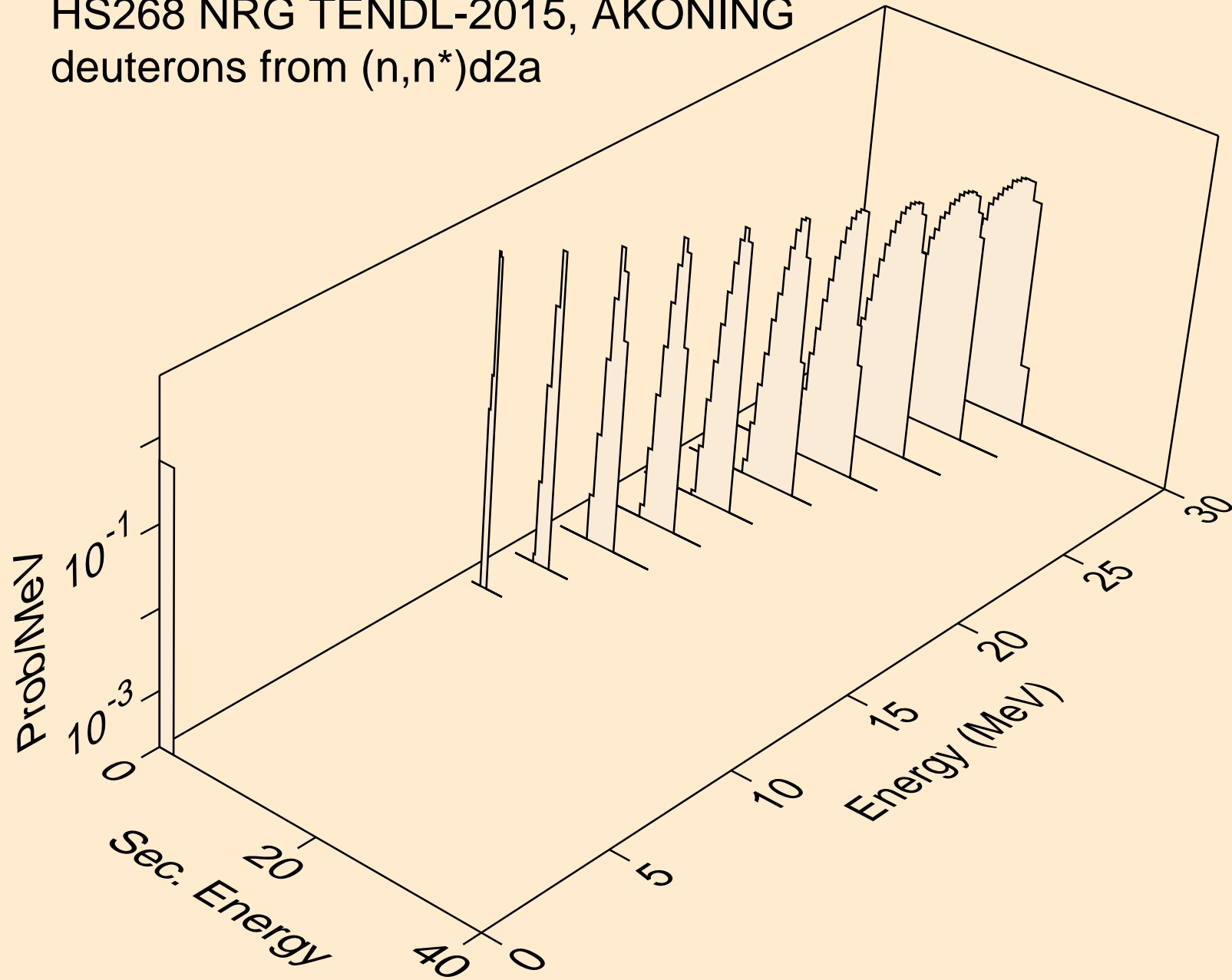

HS268 NRG TENDL-2015, AKONING  
deuterons from (n,d)

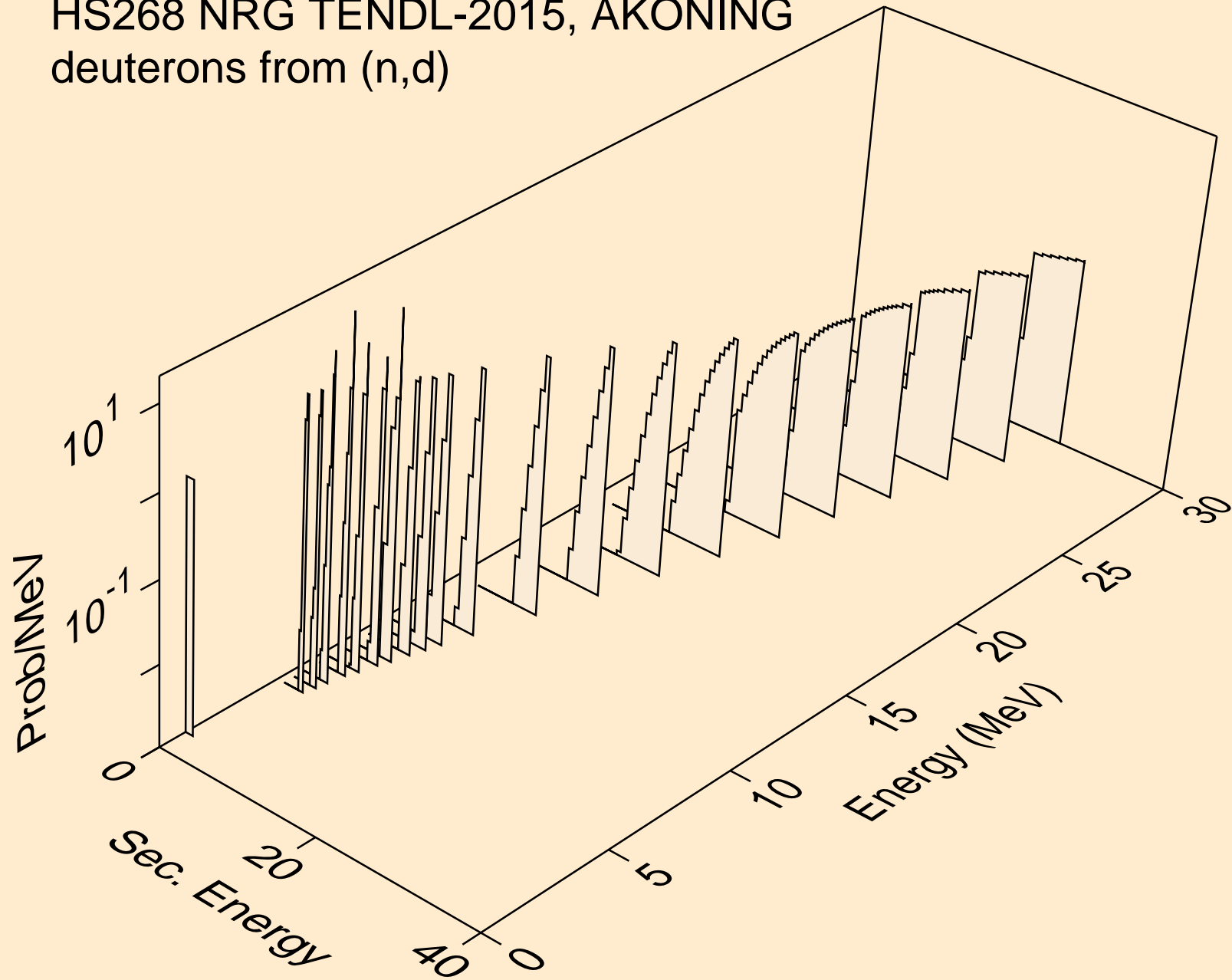

HS268 NRG TENDL-2015, AKONING  
deuterons from (n,d2a)

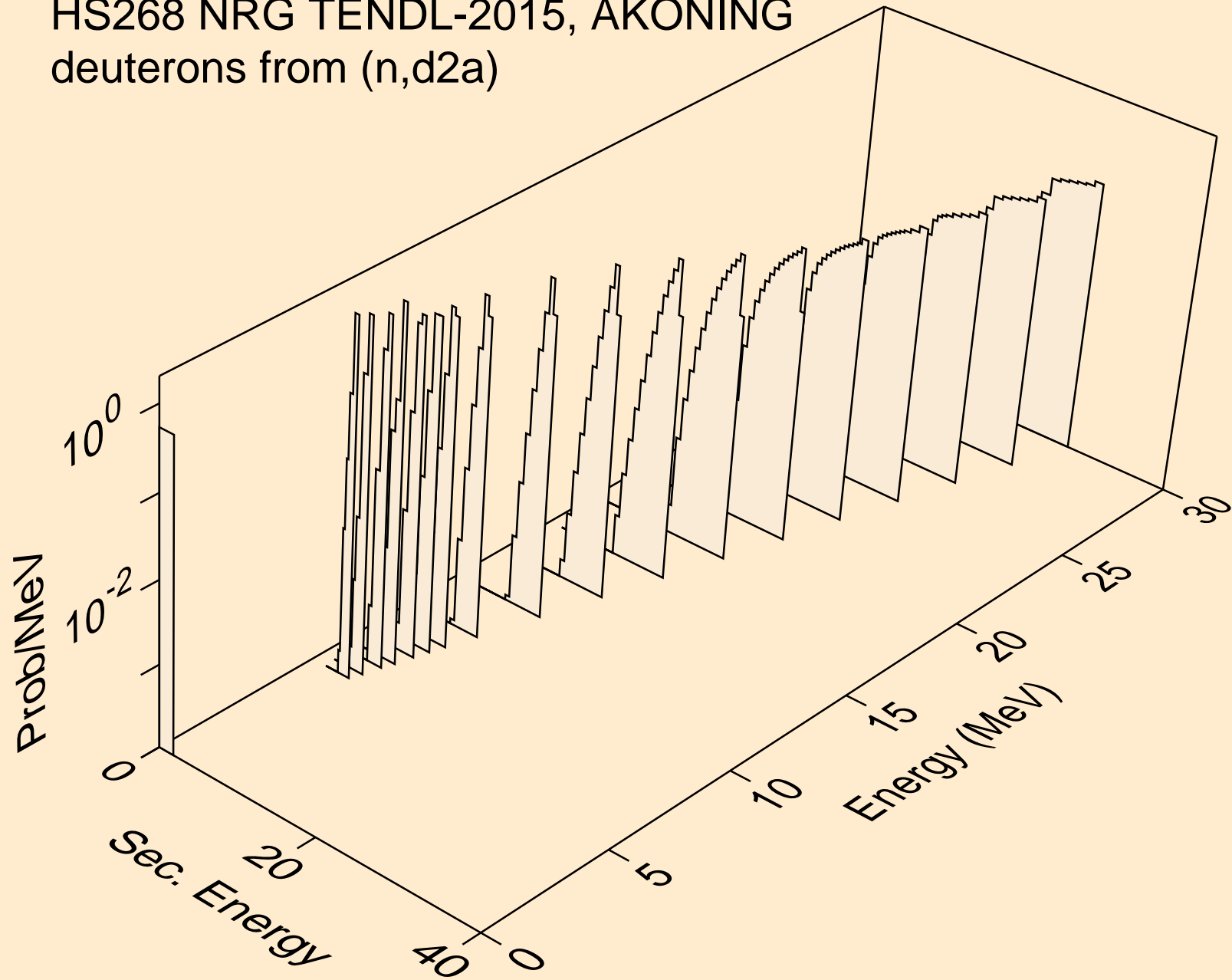

HS268 NRG TENDL-2015, AKONING  
deuterons from (n,pd)

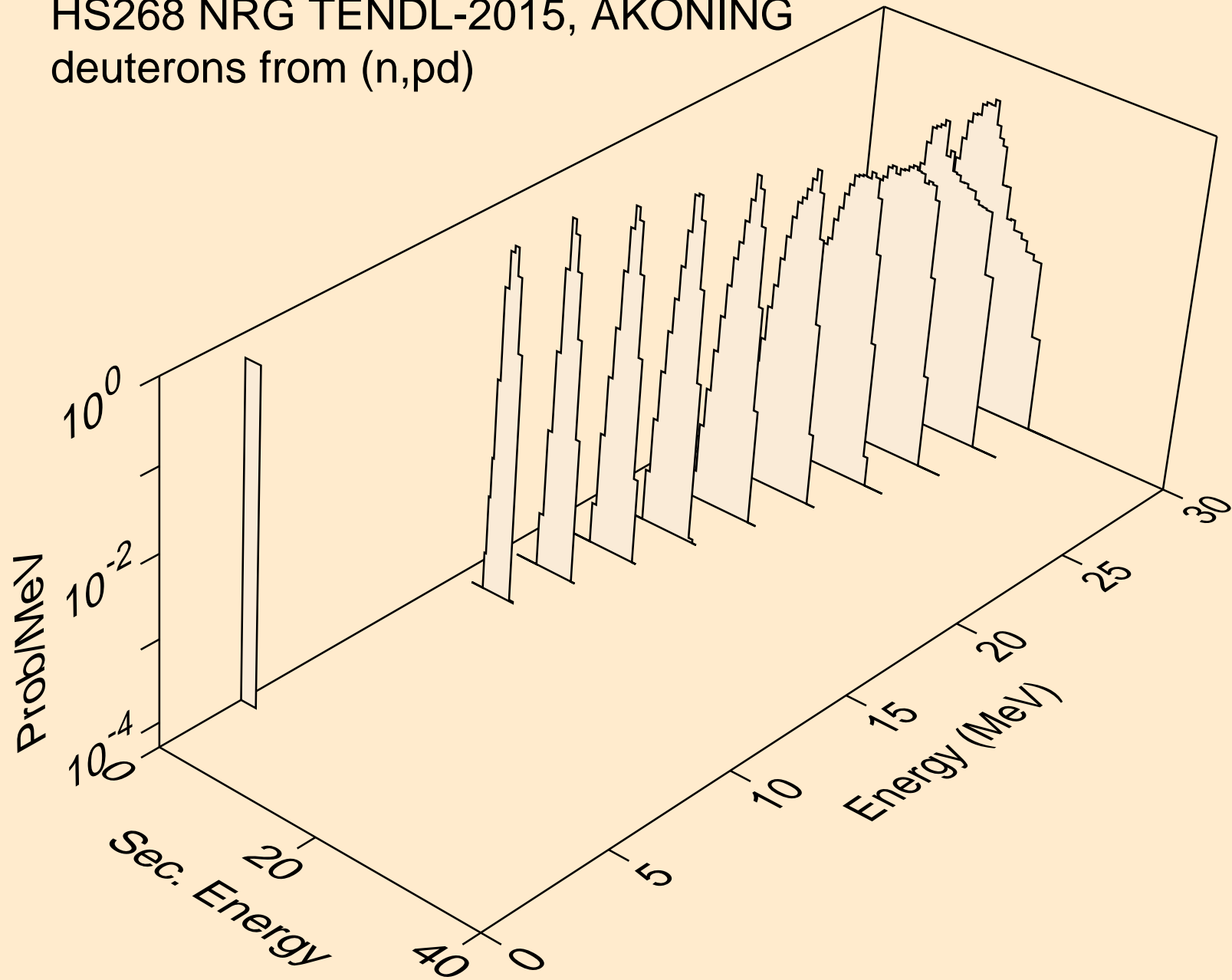

HS268 NRG TENDL-2015, AKONING  
deuterons from (n,da)

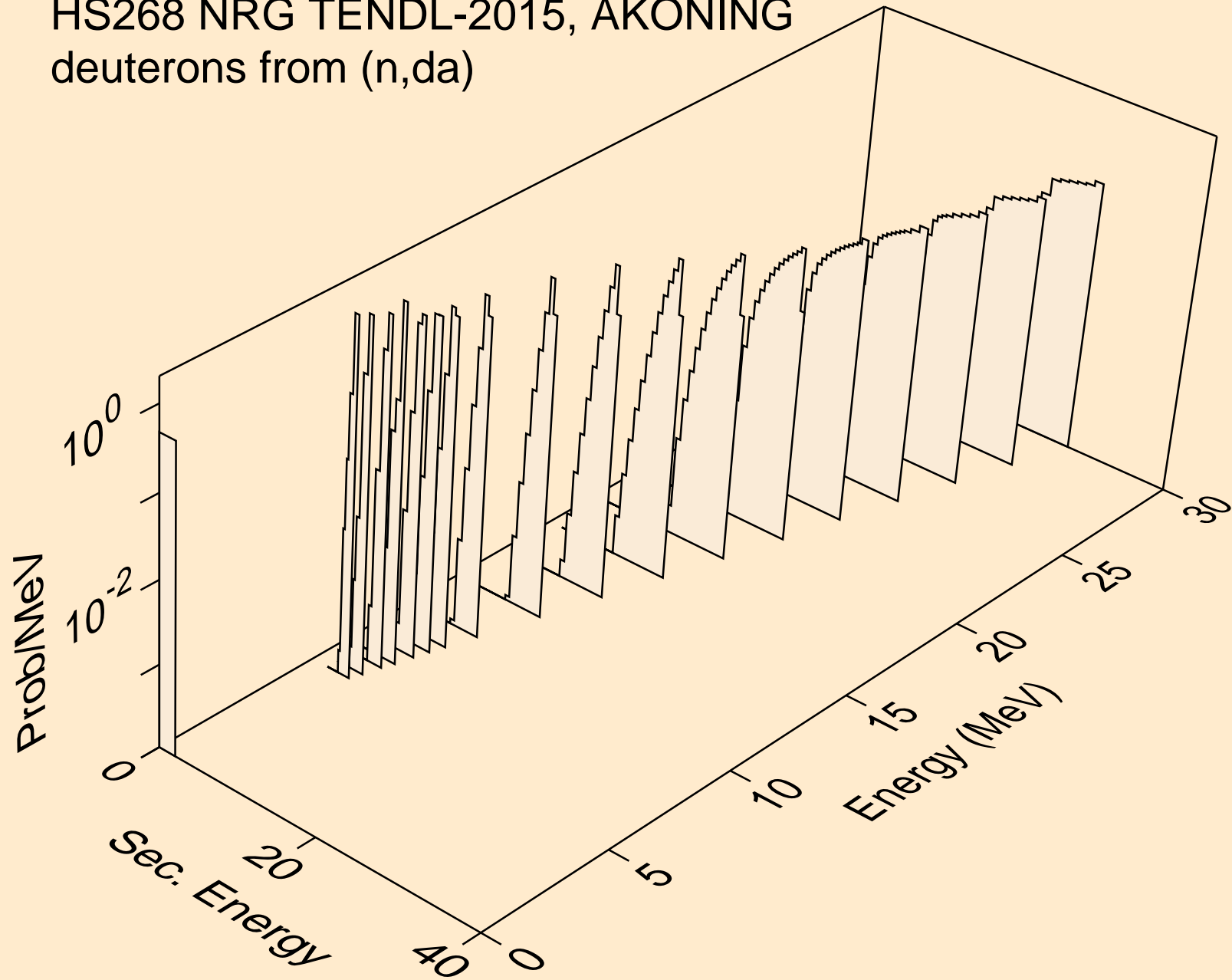



HS268 NRG TENDL-2015, AKONING  
tritons from (n,x)

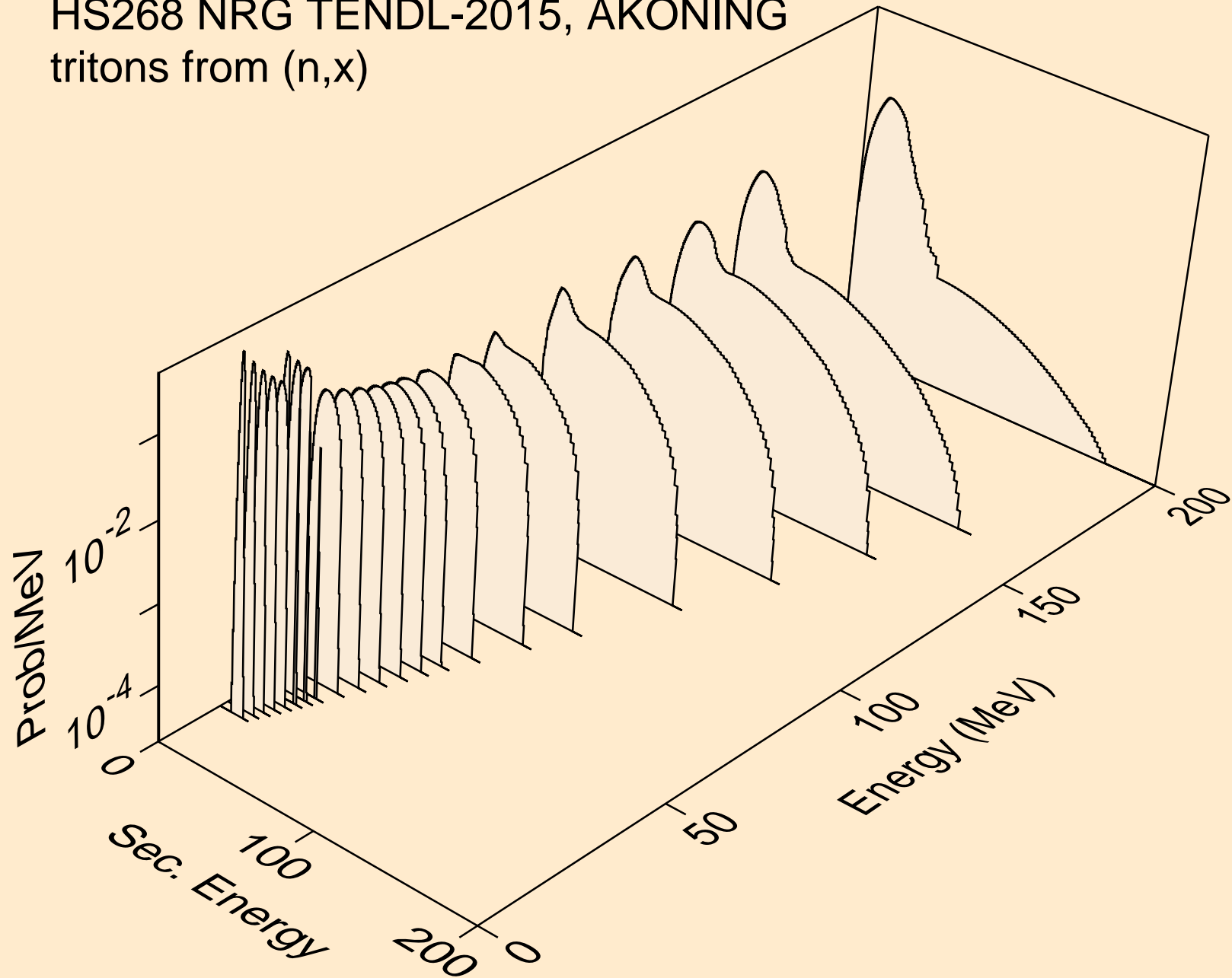

HS268 NRG TENDL-2015, AKONING  
tritons from (n,n\*)t

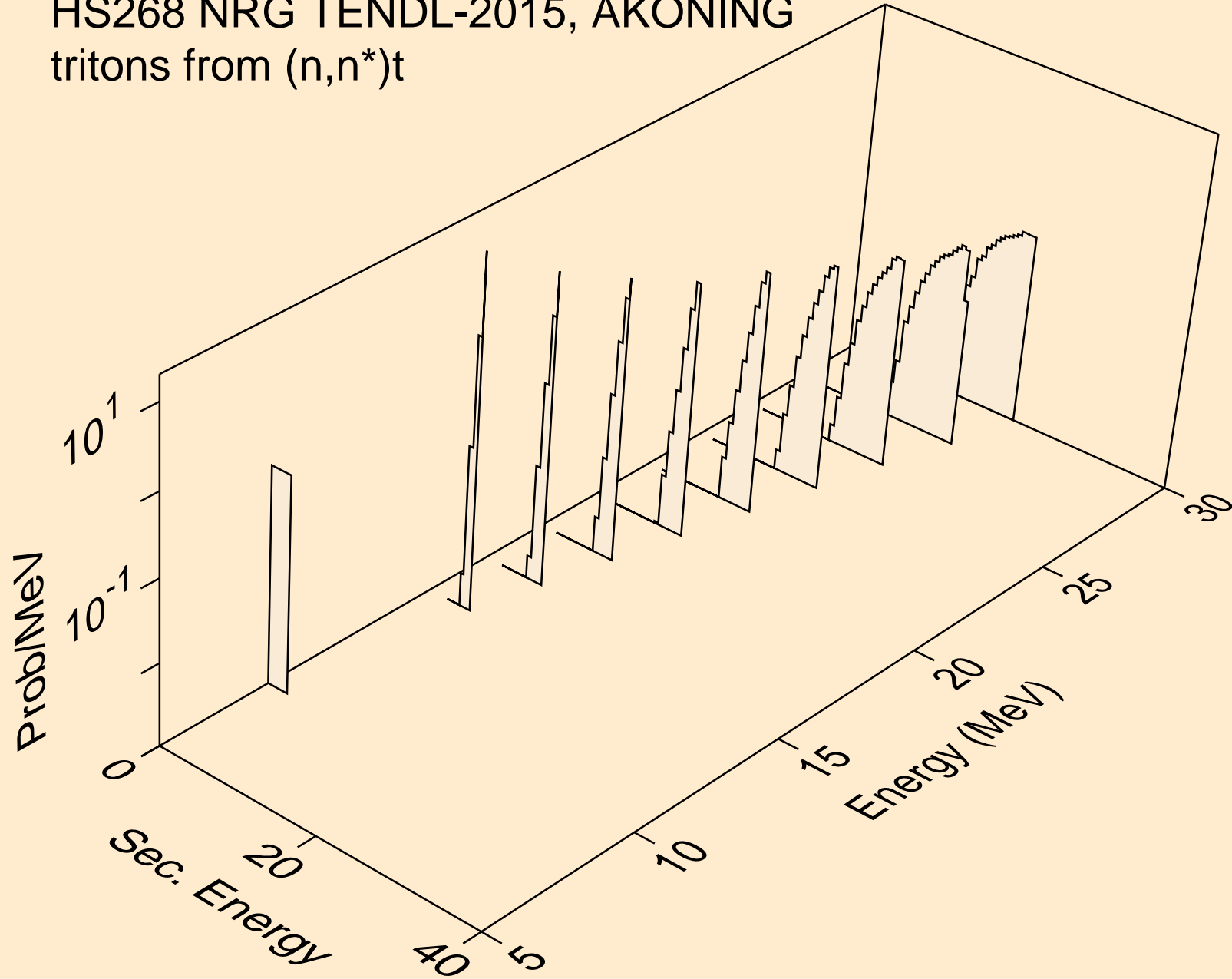

HS268 NRG TENDL-2015, AKONING  
tritons from (n,n\*)t2a

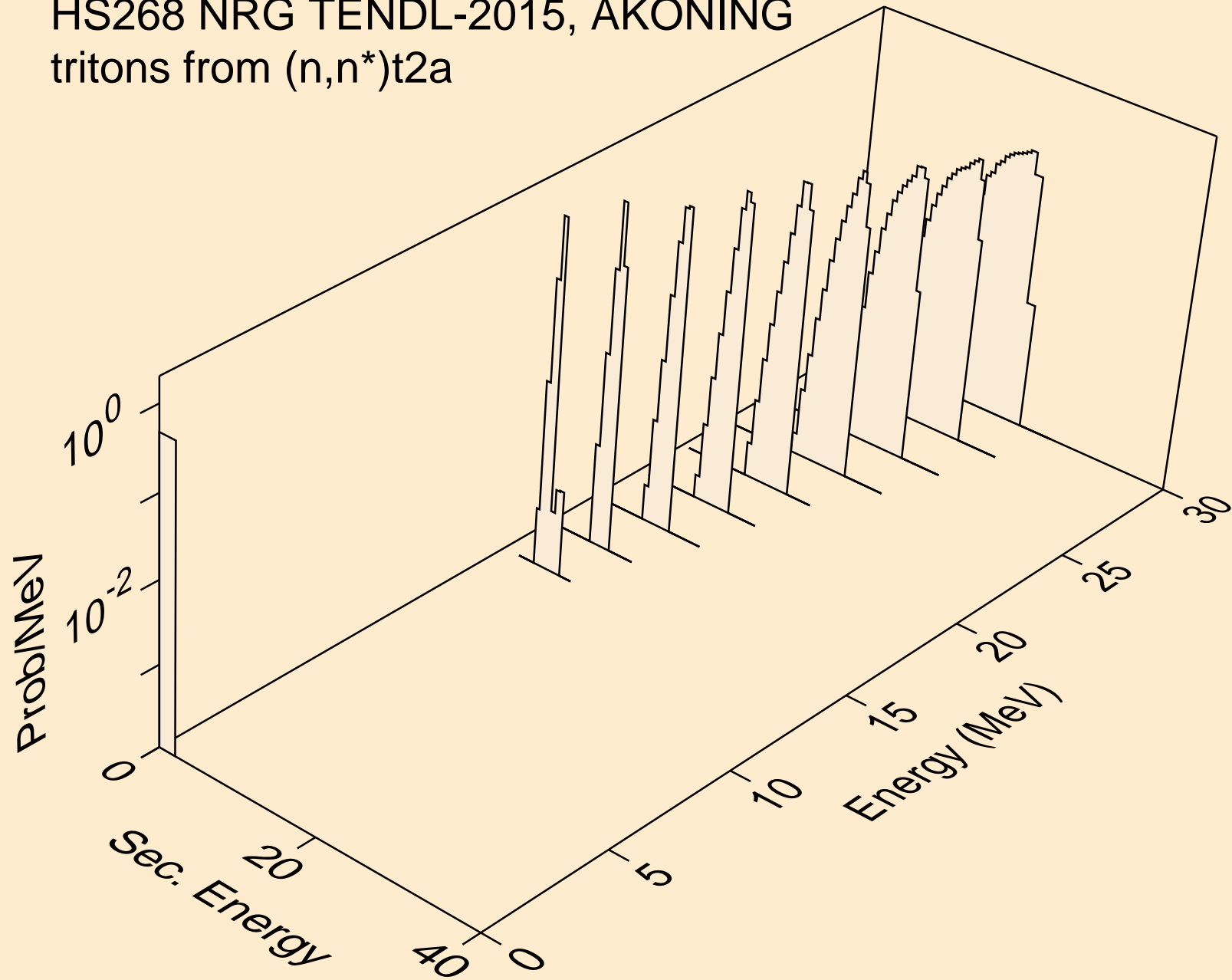

HS268 NRG TENDL-2015, AKONING  
tritons from (n,t)

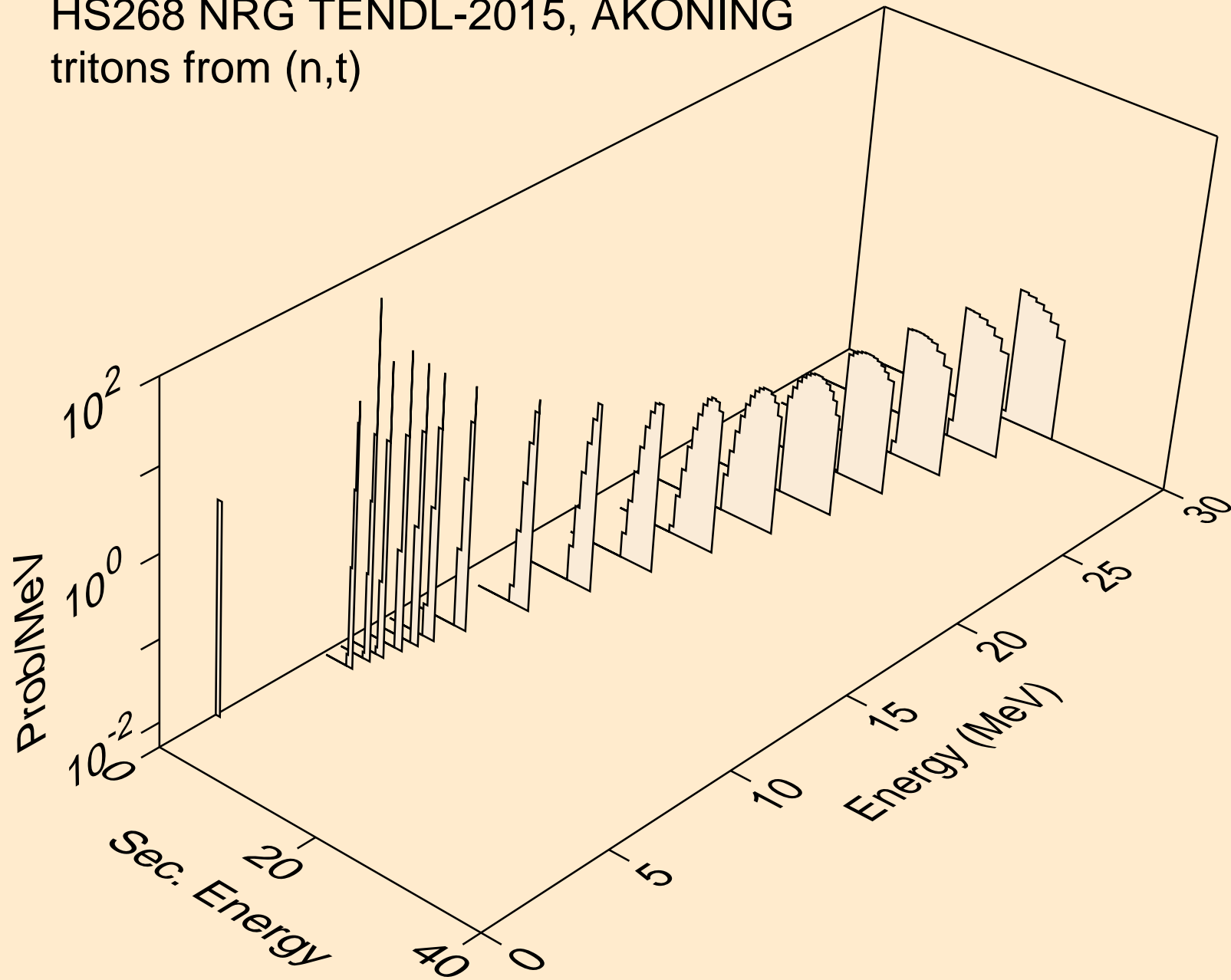

HS268 NRG TENDL-2015, AKONING  
tritons from (n,t2a)

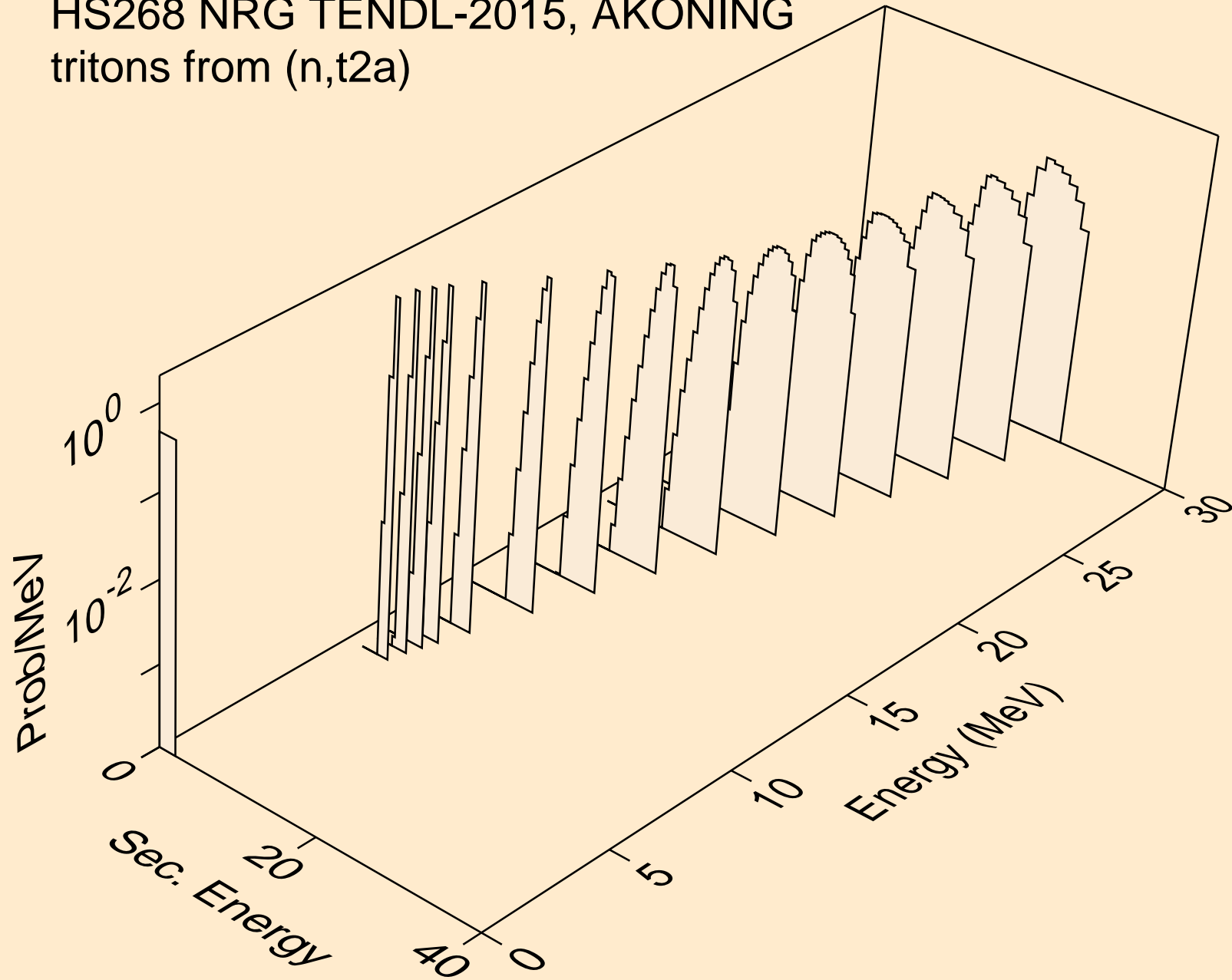

HS268 NRG TENDL-2015, AKONING  
tritons from (n,pt)

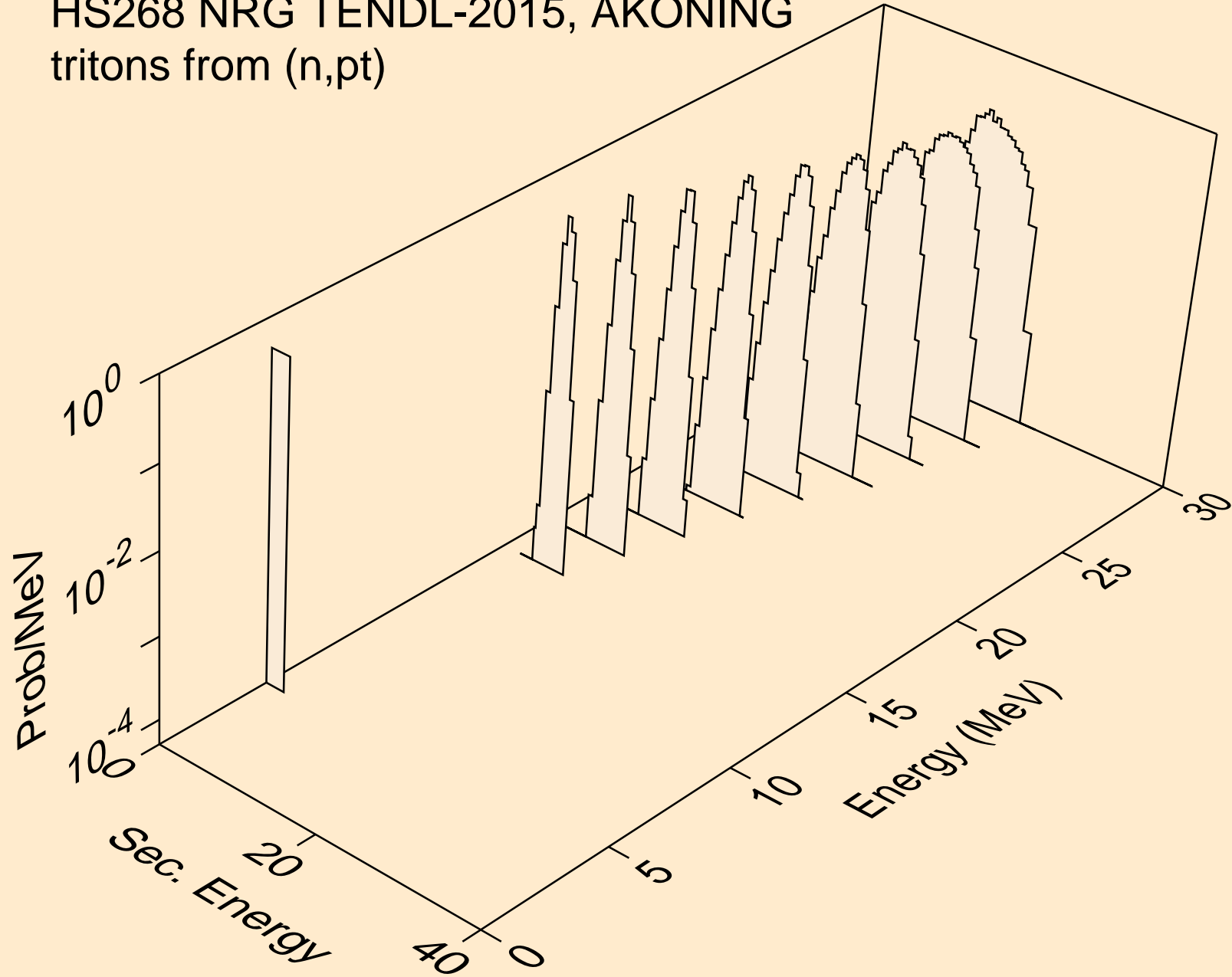

HS268 NRG TENDL-2015, AKONING  
he3s from (n,x)

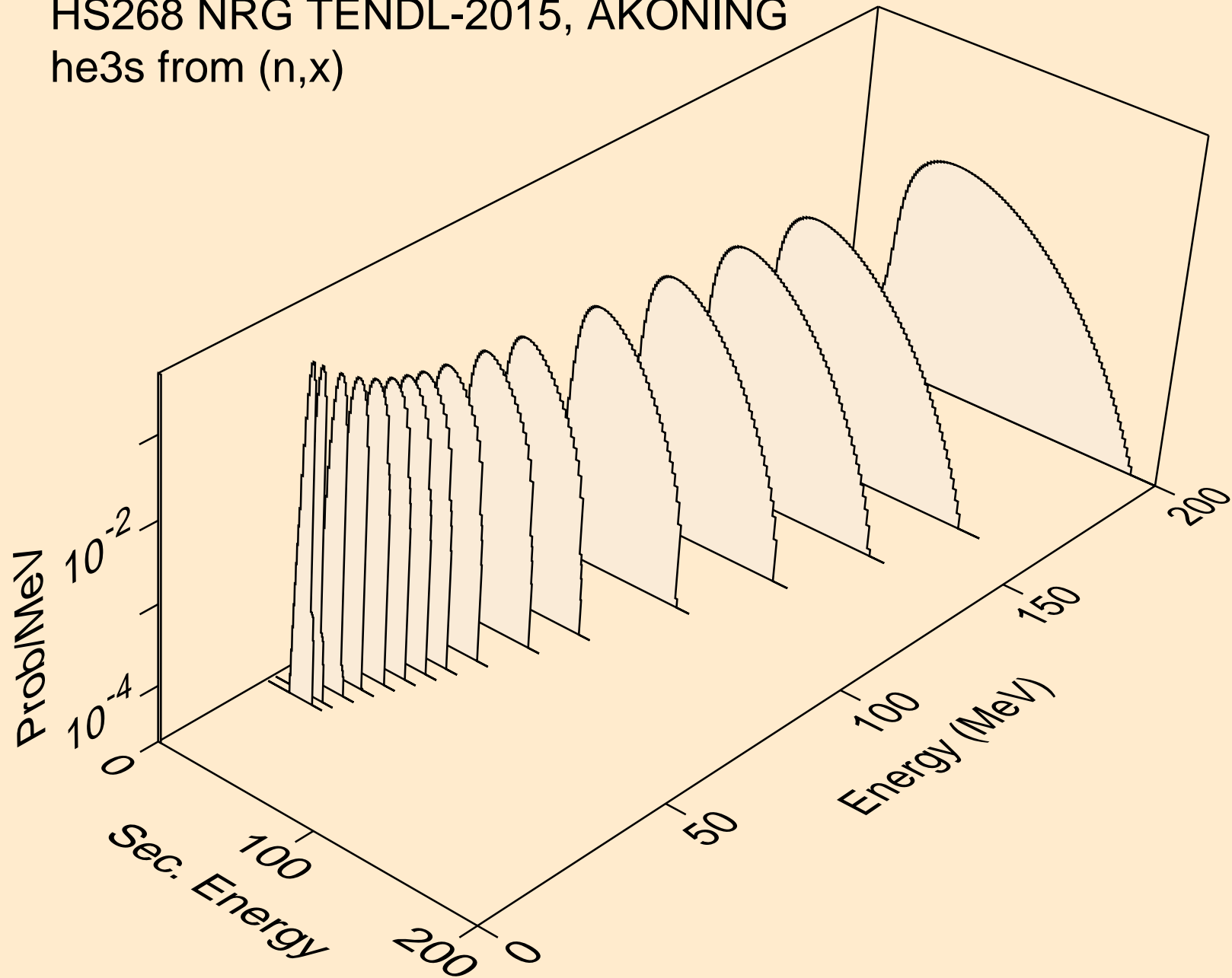

HS268 NRG TENDL-2015, AKONING  
he3s from (n,n\*)he3

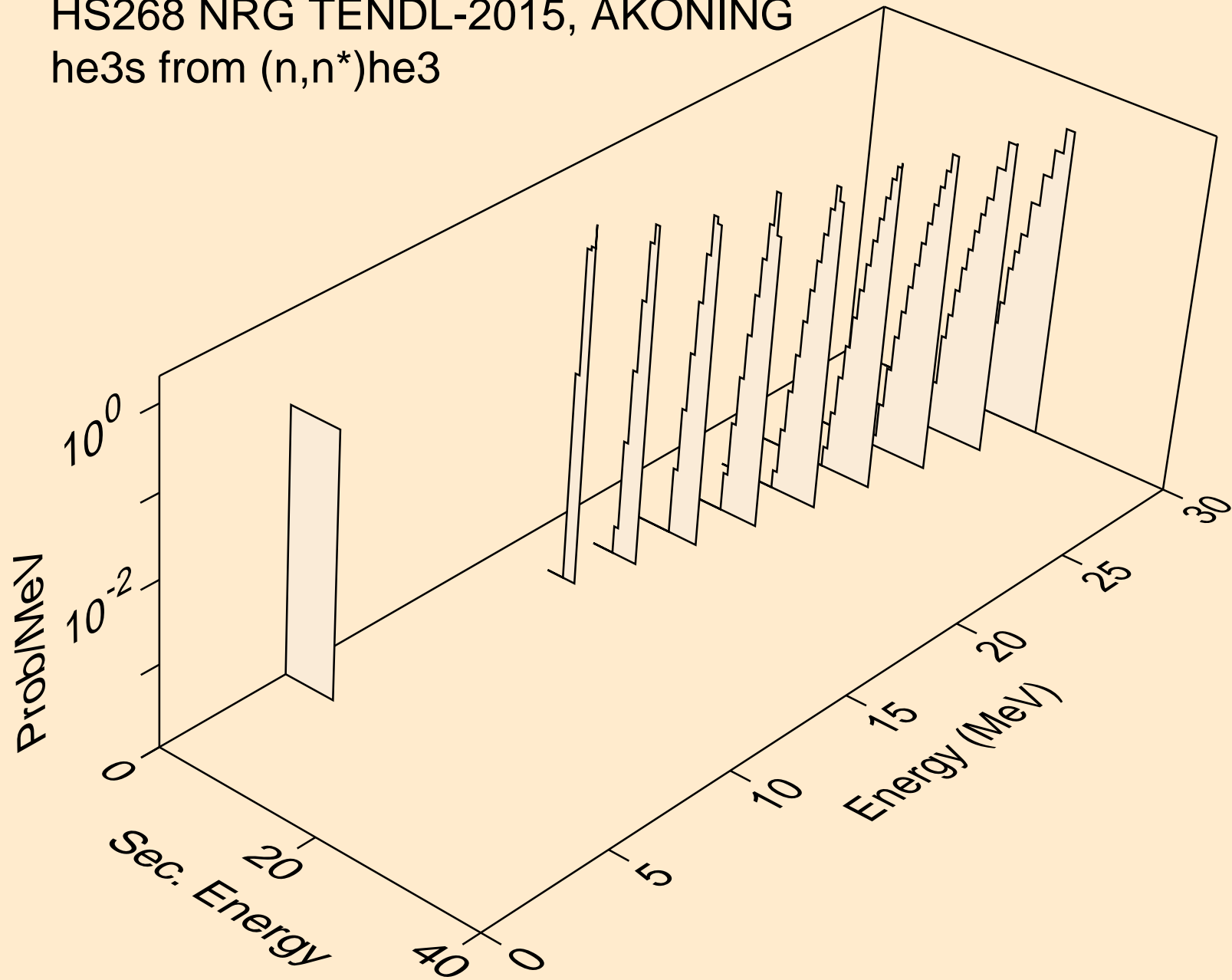



HS268 NRG TENDL-2015, AKONING  
he3s from (n,he3)

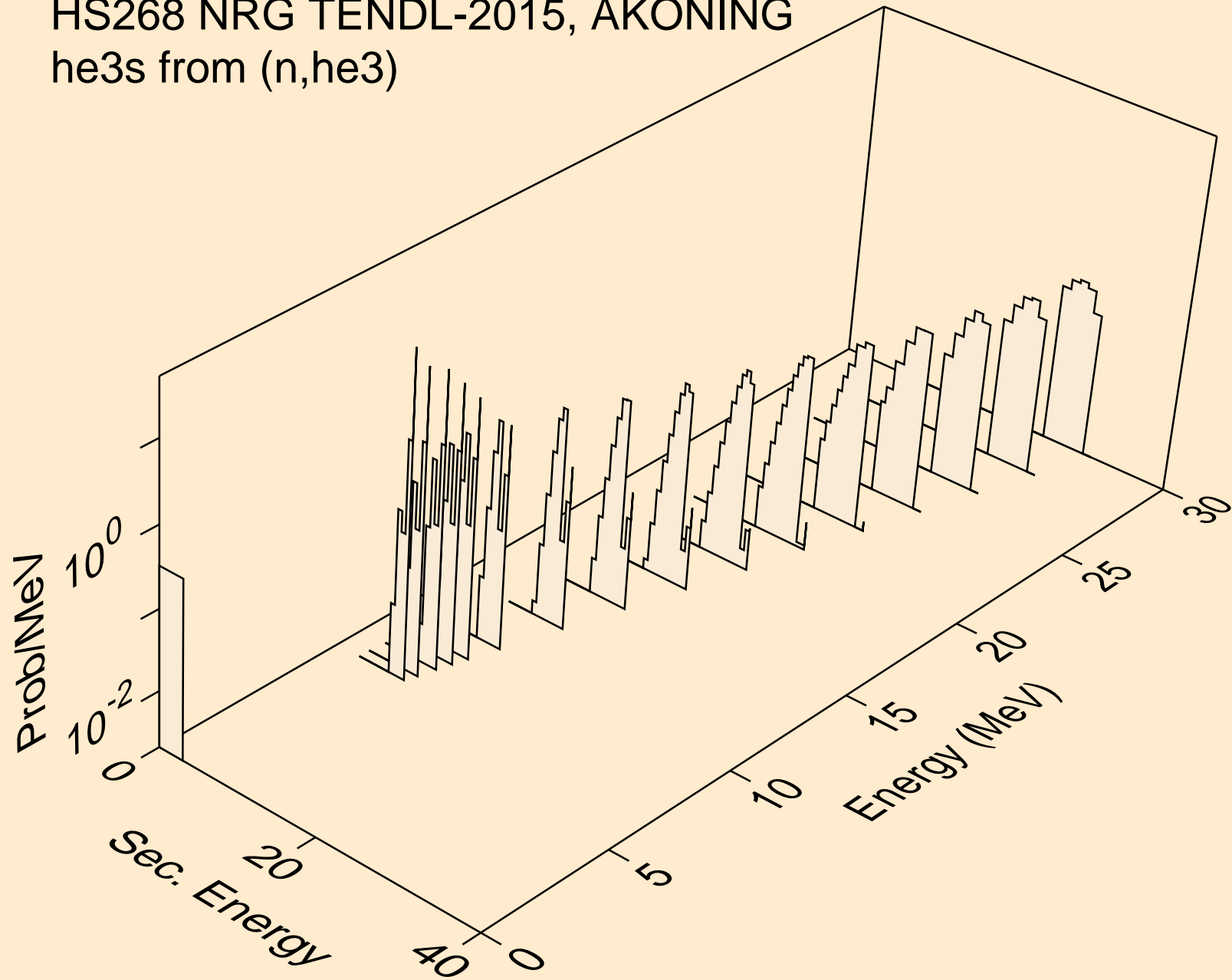

HS268 NRG TENDL-2015, AKONING  
alphas from (n,x)

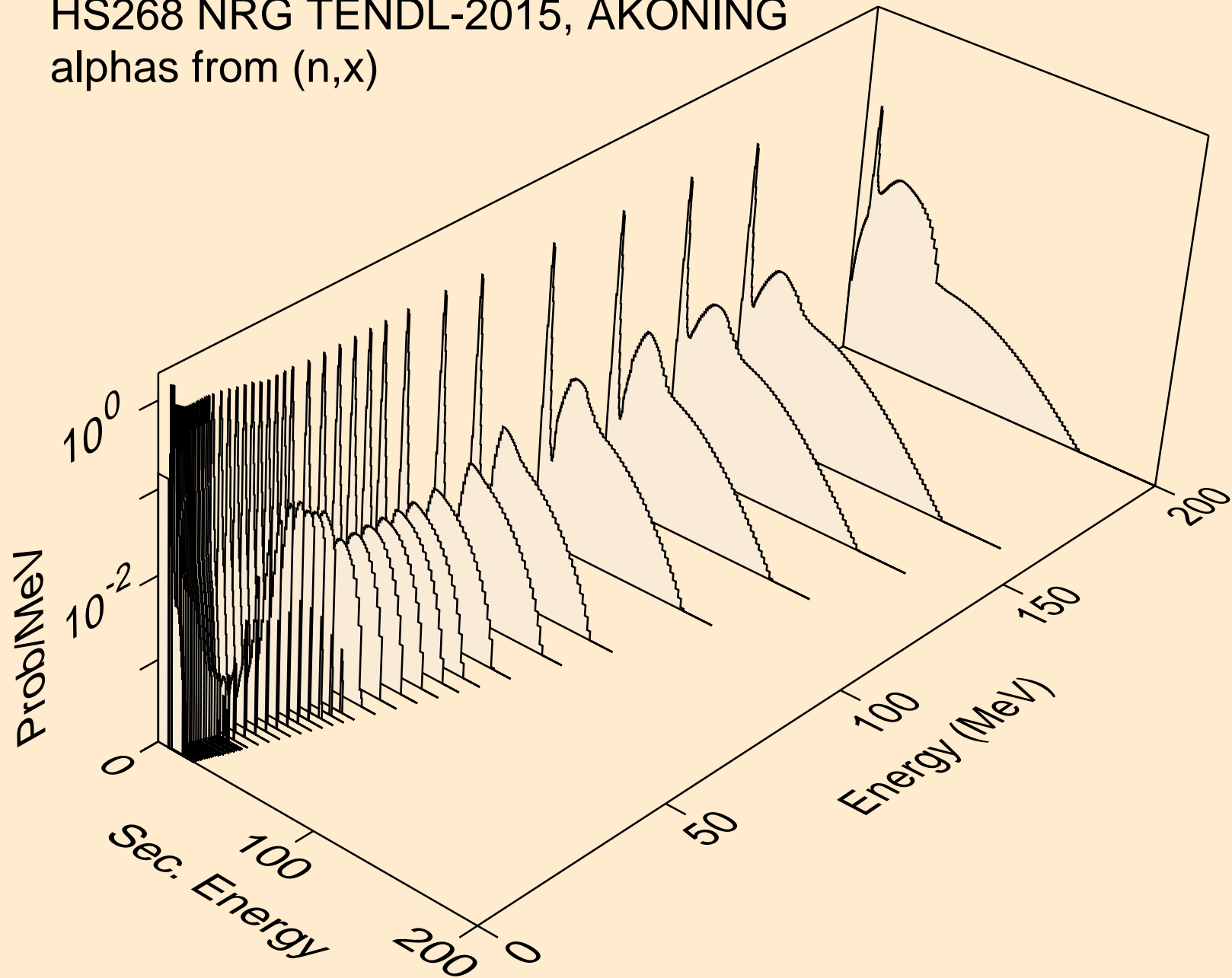

HS268 NRG TENDL-2015, AKONING  
alphas from (n,n\*)a

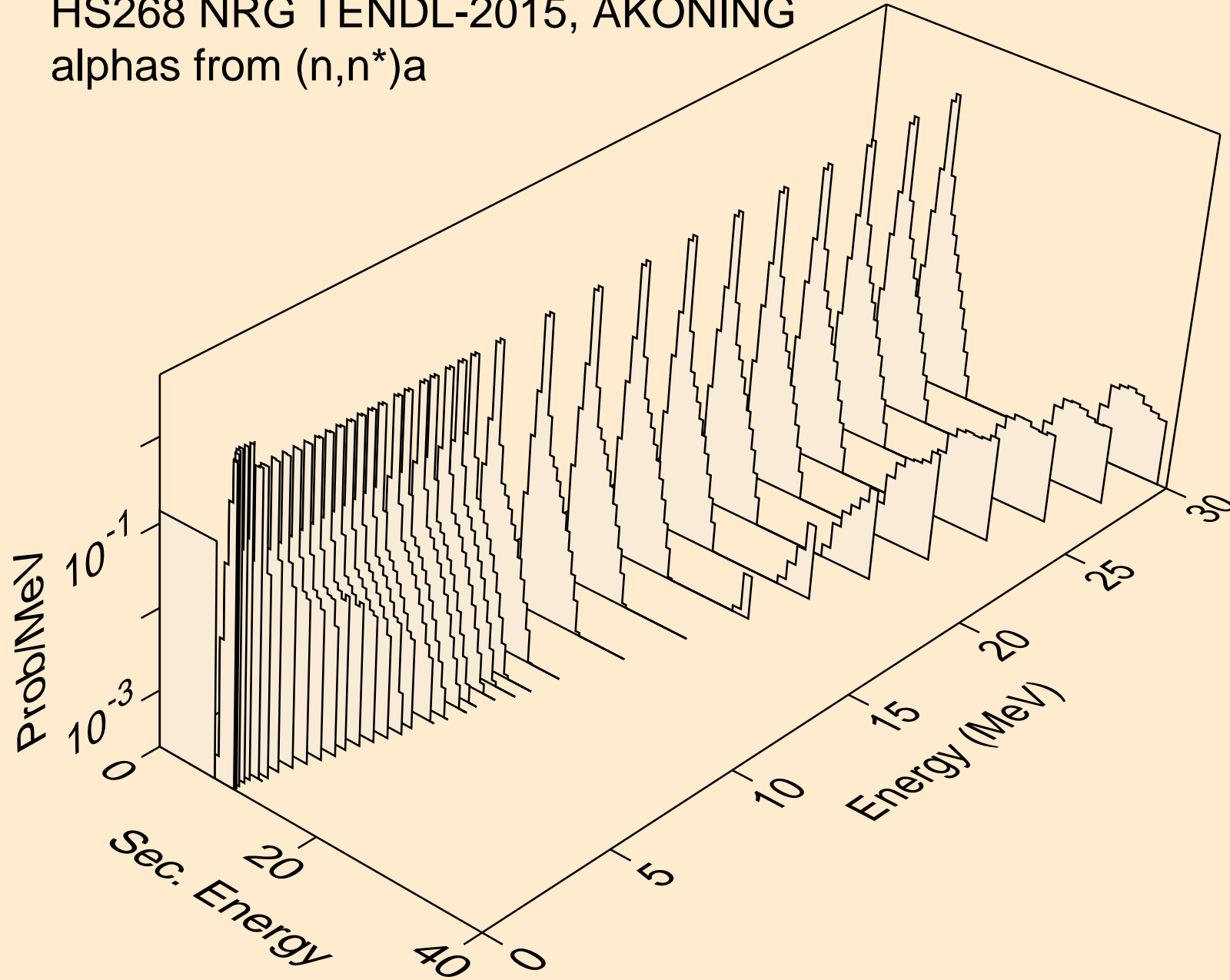

HS268 NRG TENDL-2015, AKONING  
alphas from (n,n\*)3a

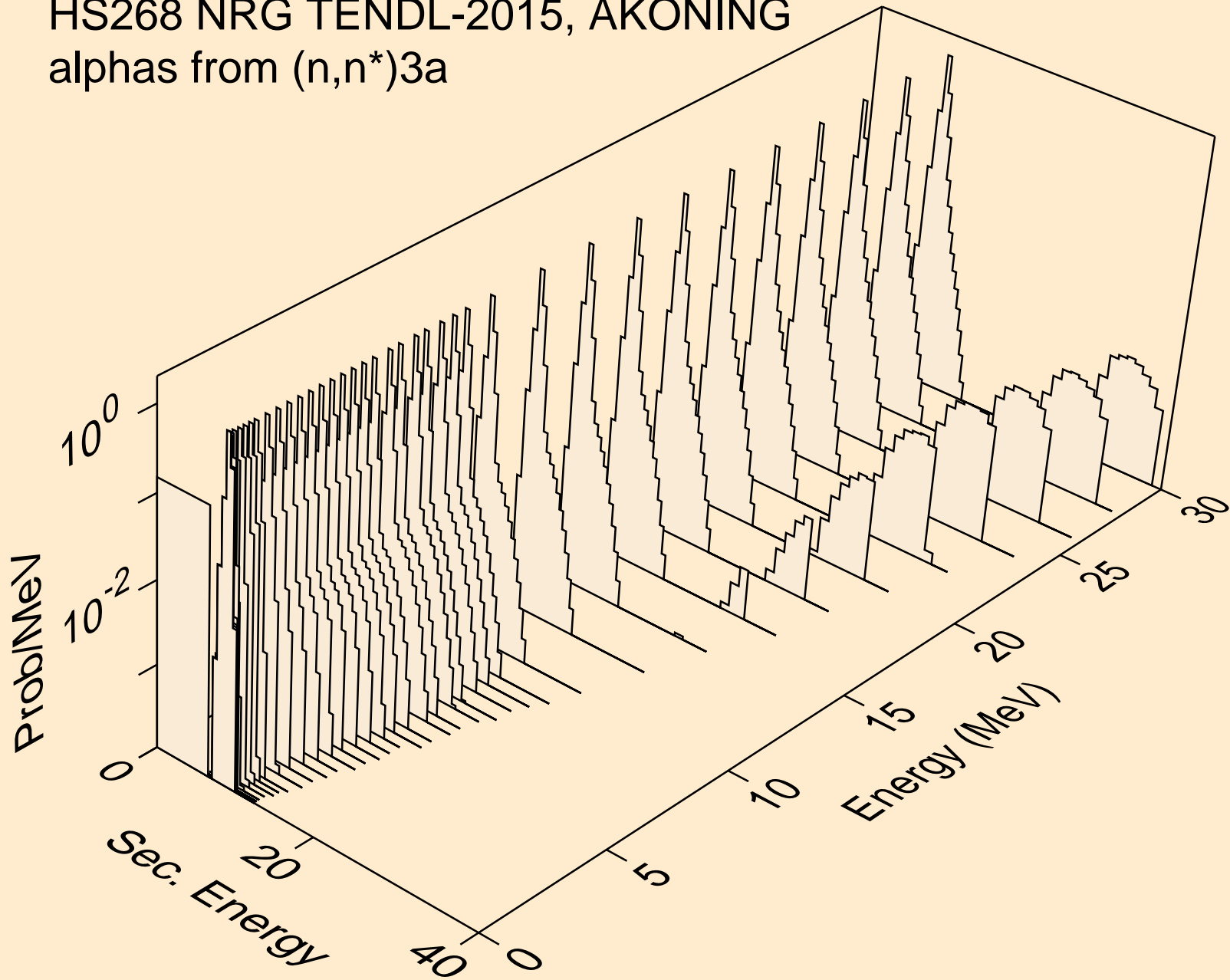

HS268 NRG TENDL-2015, AKONING  
alphas from (n,2n)a

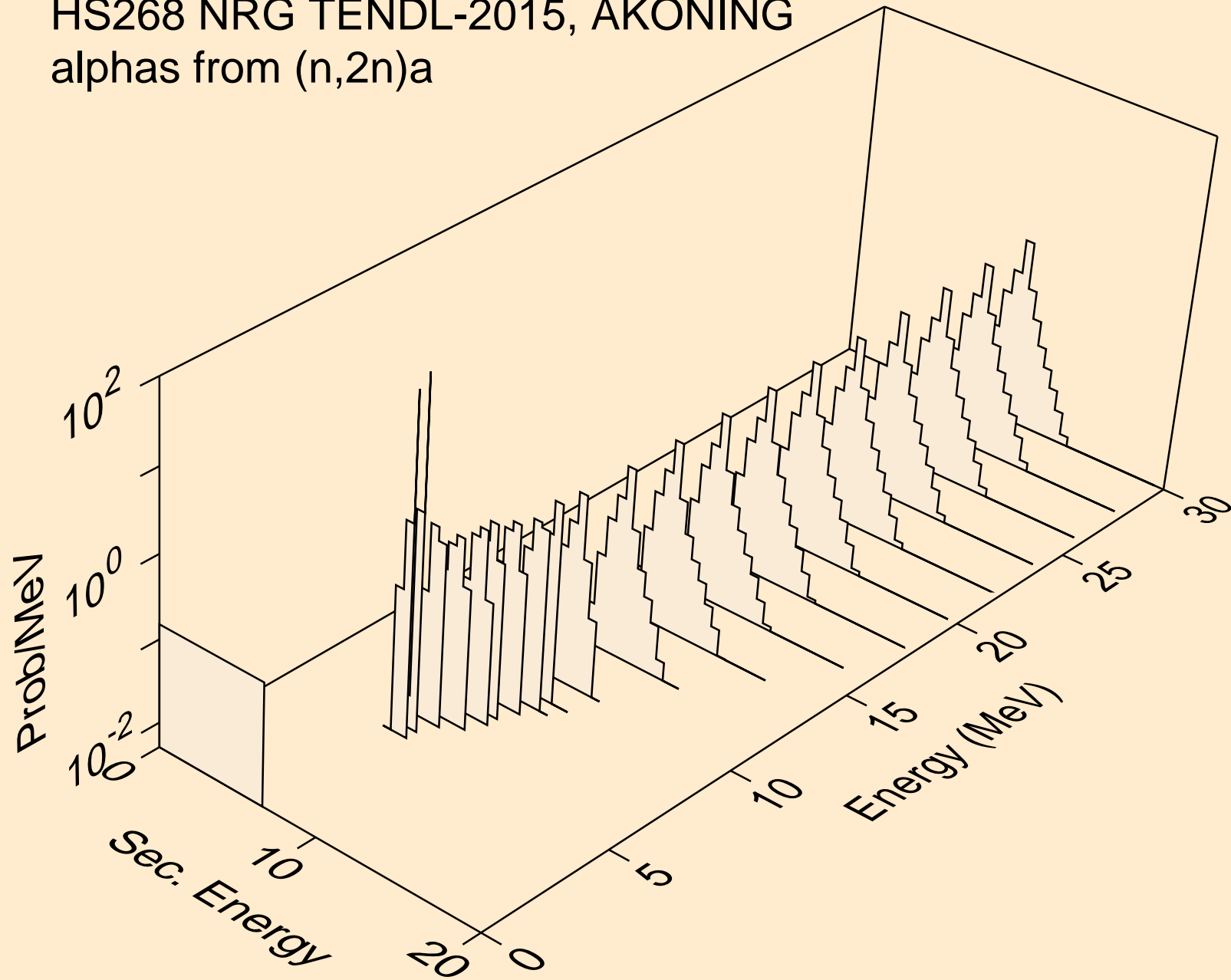

HS268 NRG TENDL-2015, AKONING  
alphas from (n,3n)a

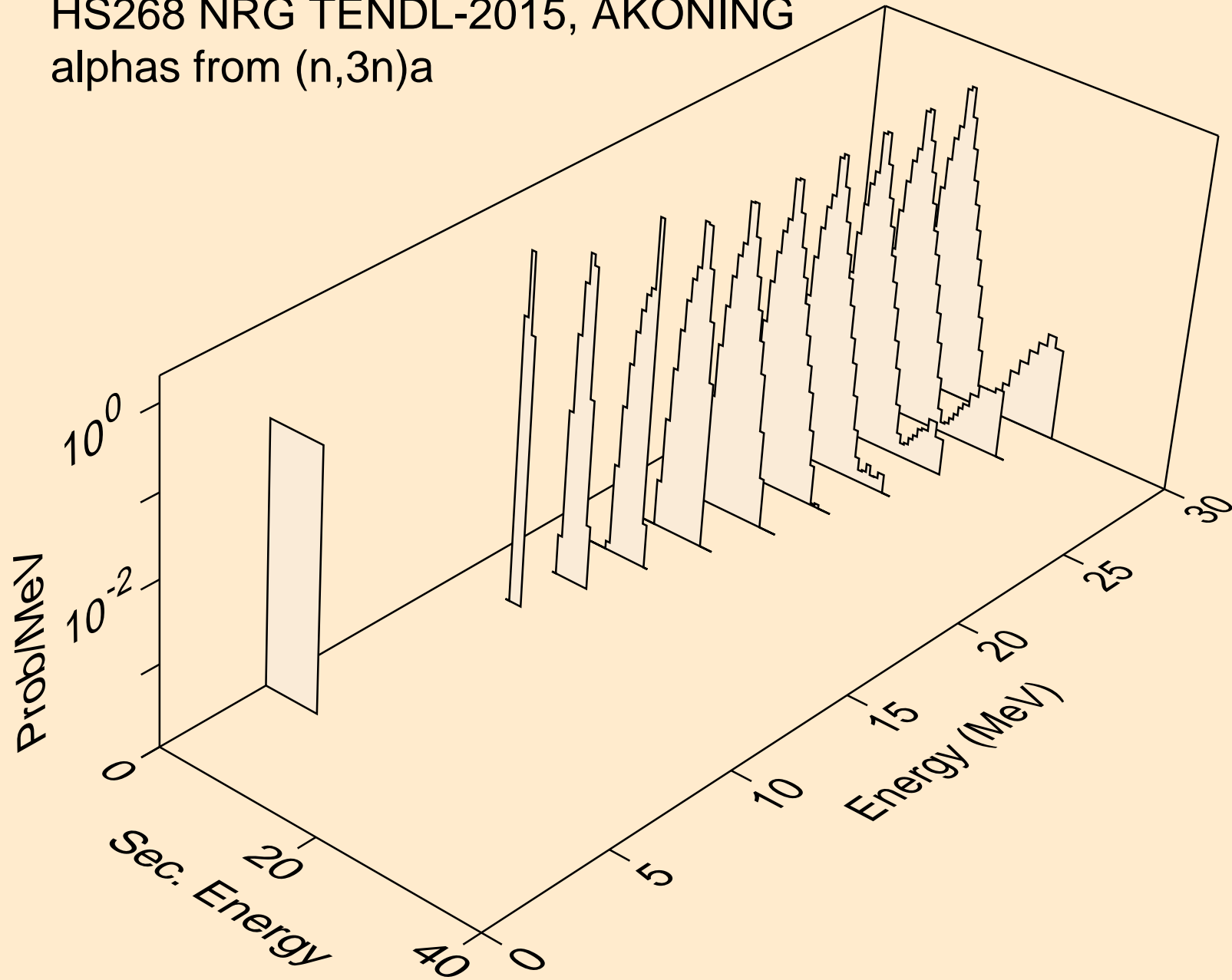

HS268 NRG TENDL-2015, AKONING  
alphas from (n,n\*)2a

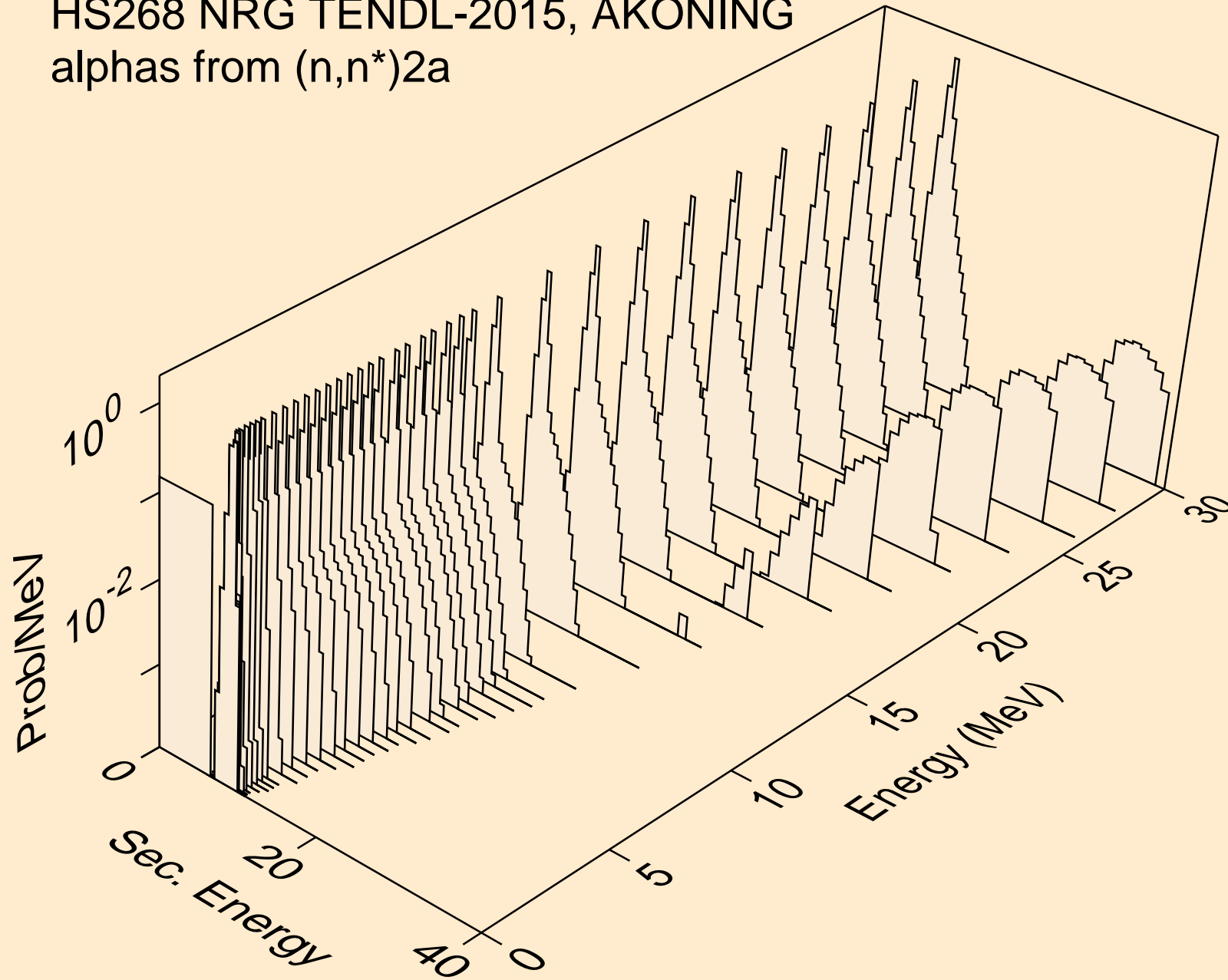

HS268 NRG TENDL-2015, AKONING  
alphas from (n,2n)2a

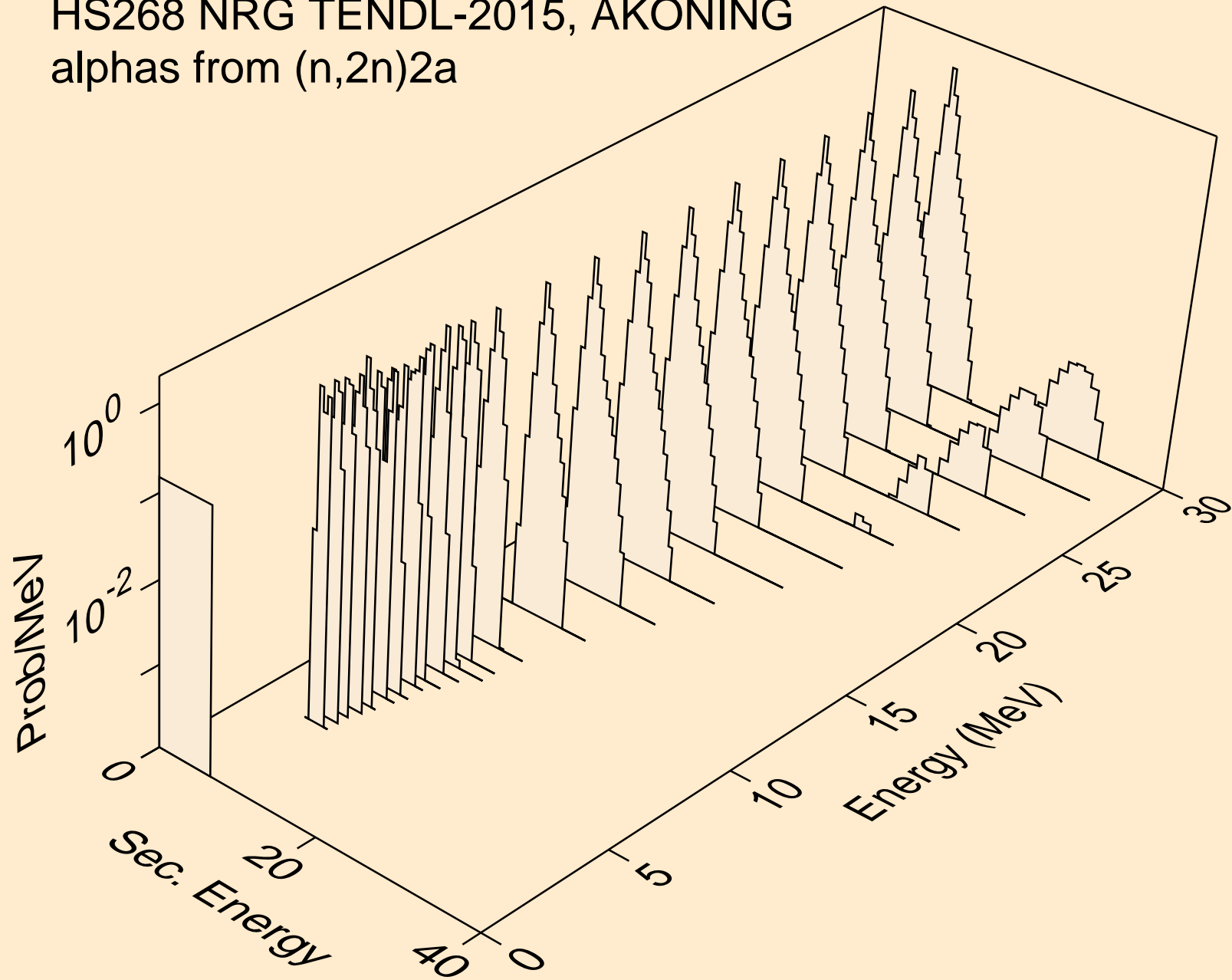



HS268 NRG TENDL-2015, AKONING  
alphas from (n,n\*)d2a

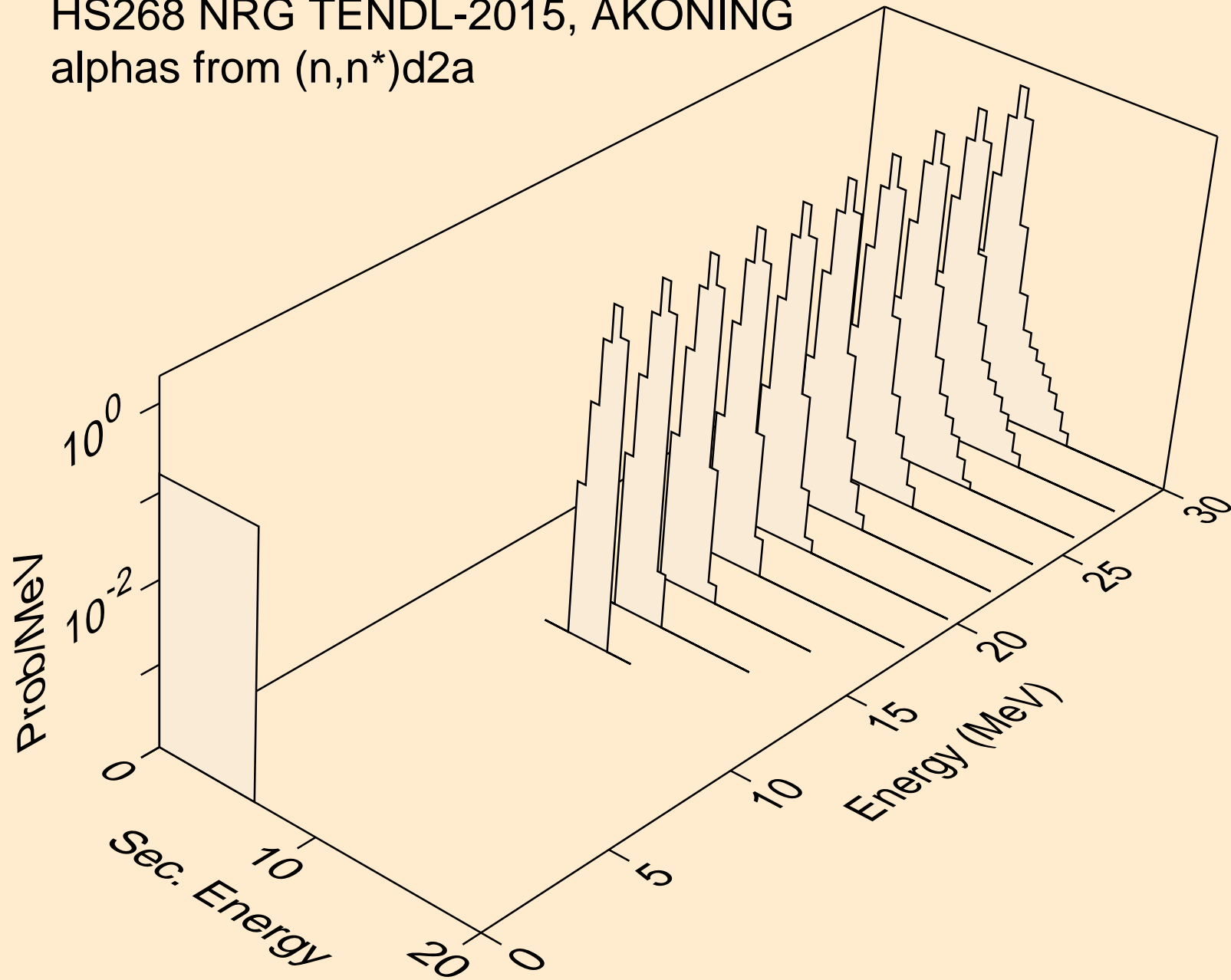

HS268 NRG TENDL-2015, AKONING  
alphas from (n,n\*)t2a

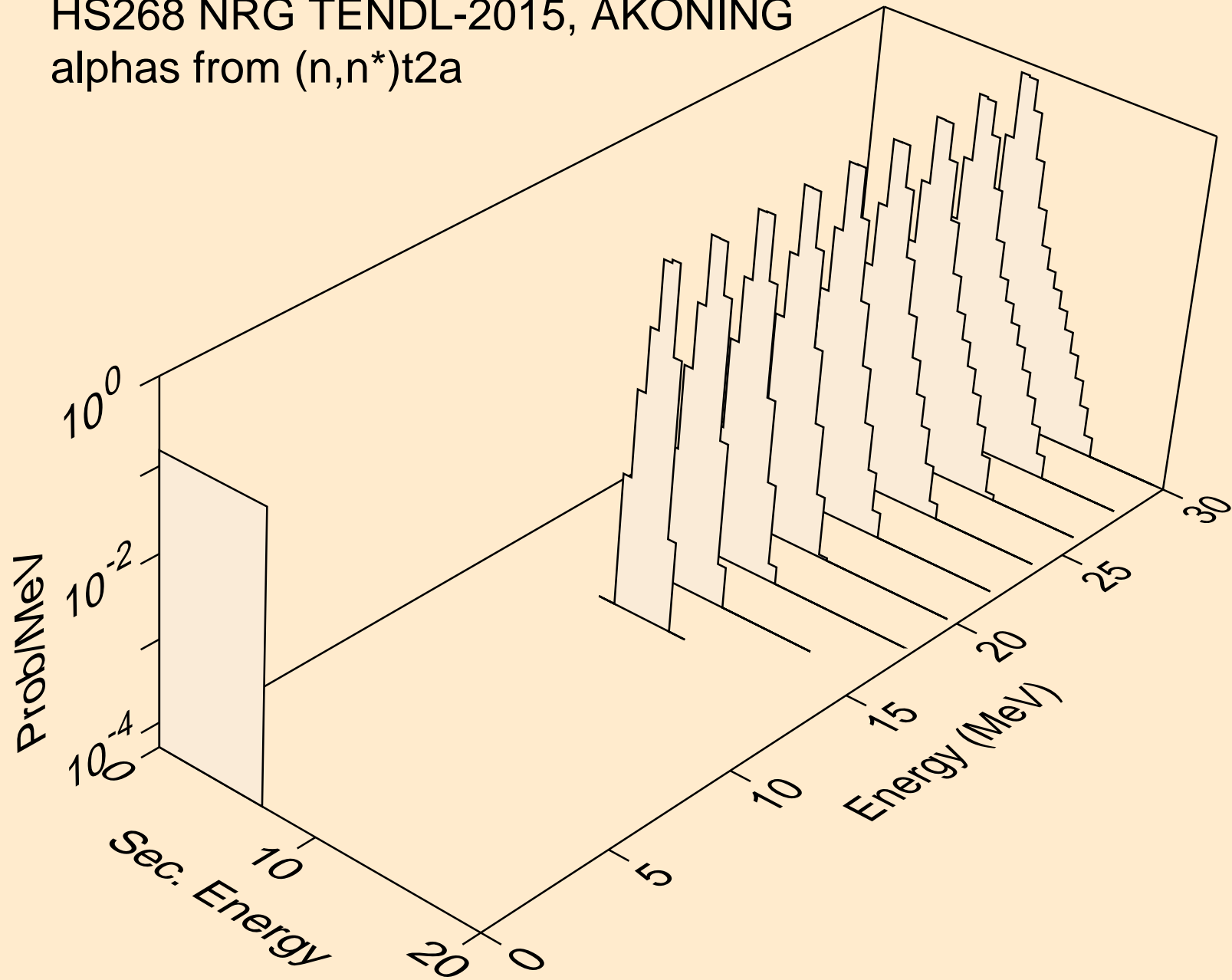

HS268 NRG TENDL-2015, AKONING  
alphas from (n,npa)

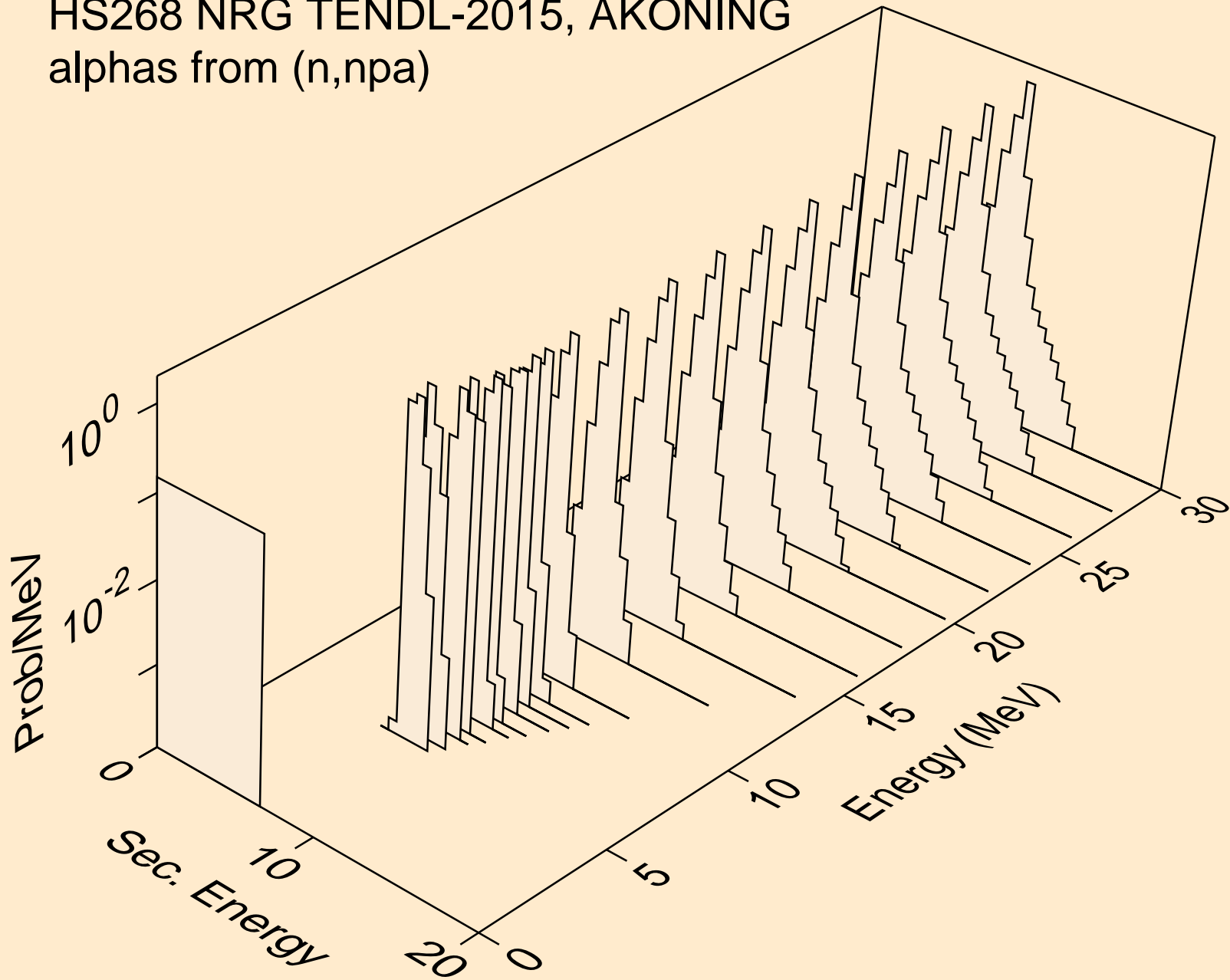

HS268 NRG TENDL-2015, AKONING  
alphas from (n,a)

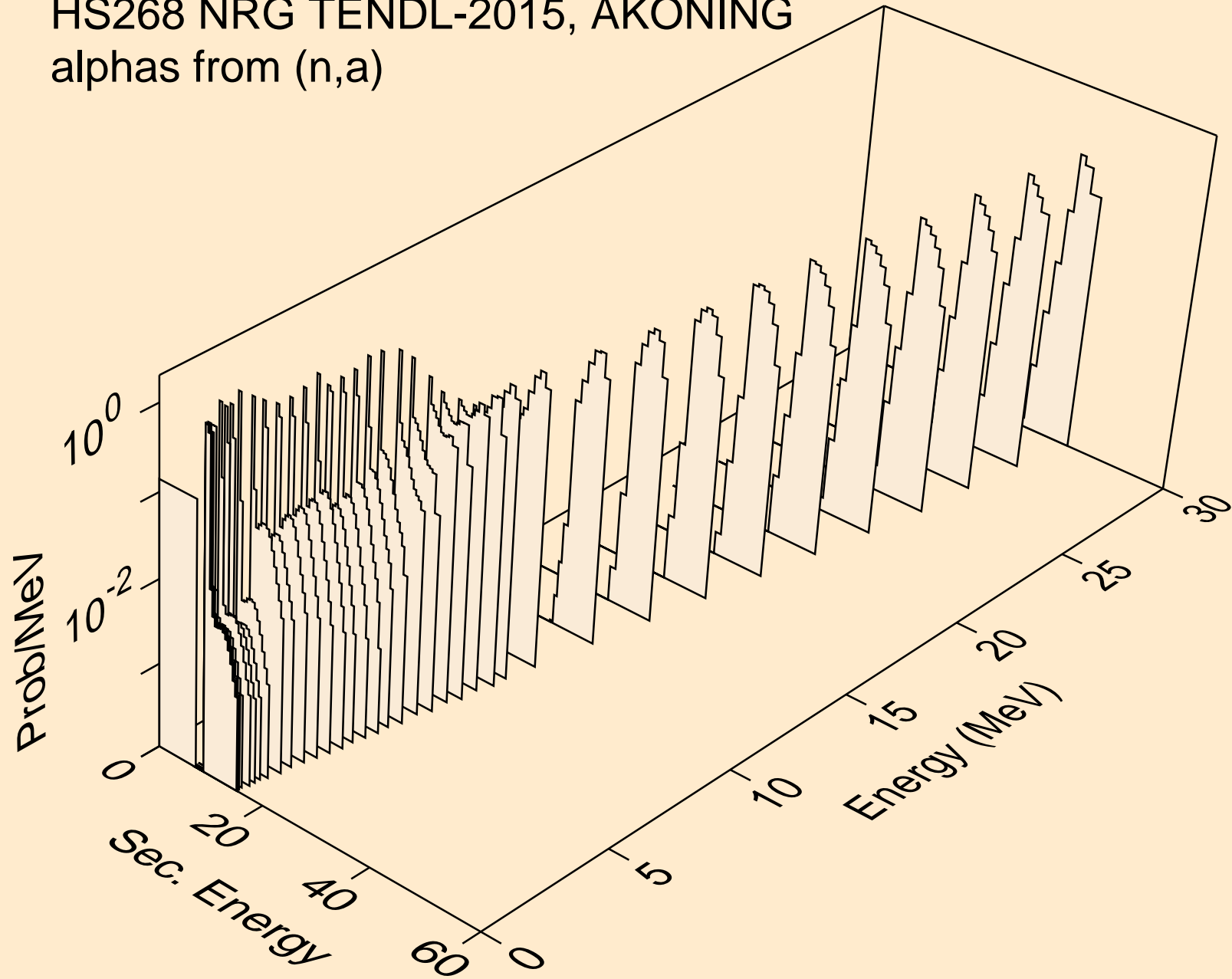

HS268 NRG TENDL-2015, AKONING  
alphas from (n,2a)

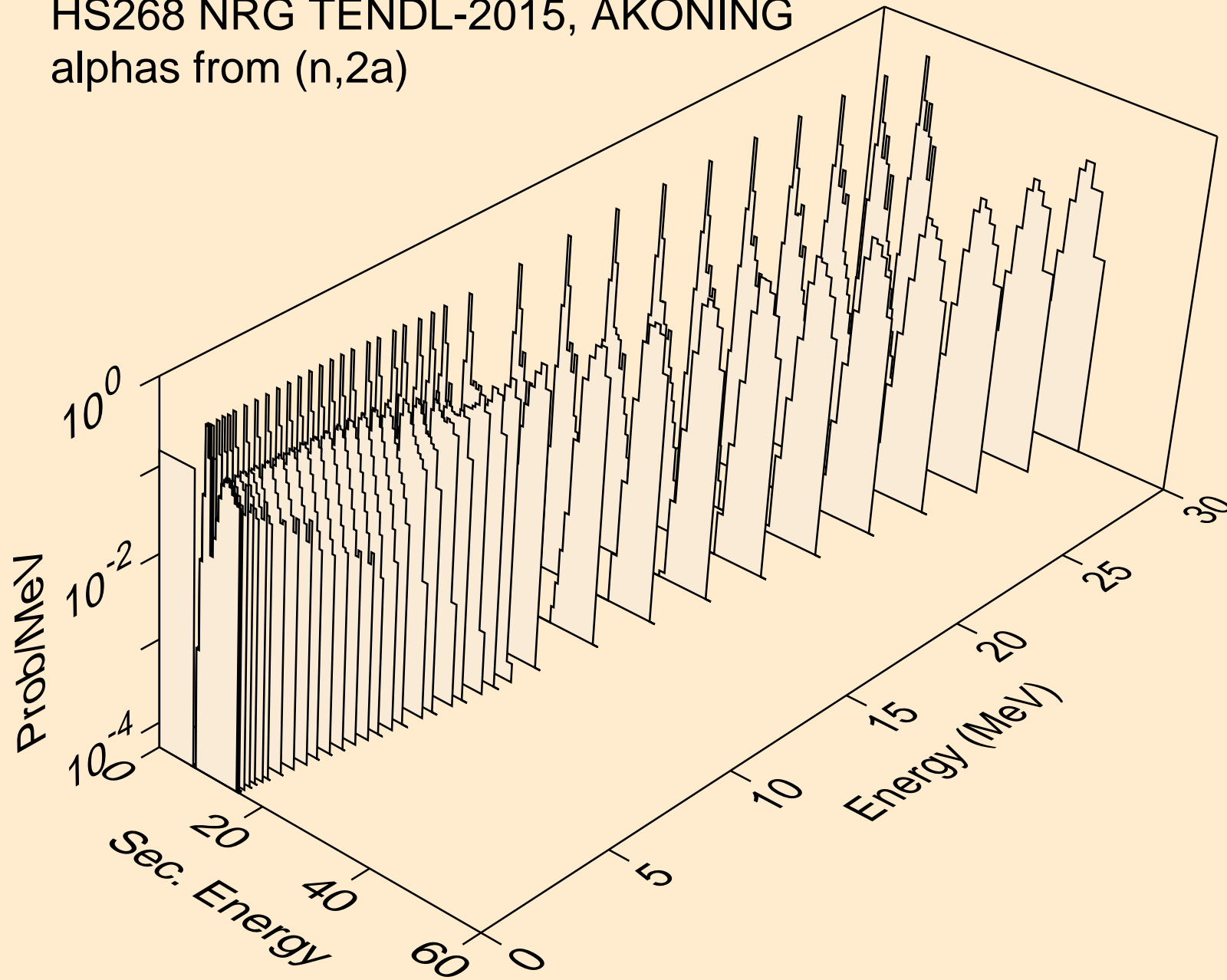

HS268 NRG TENDL-2015, AKONING  
alphas from (n,3a)

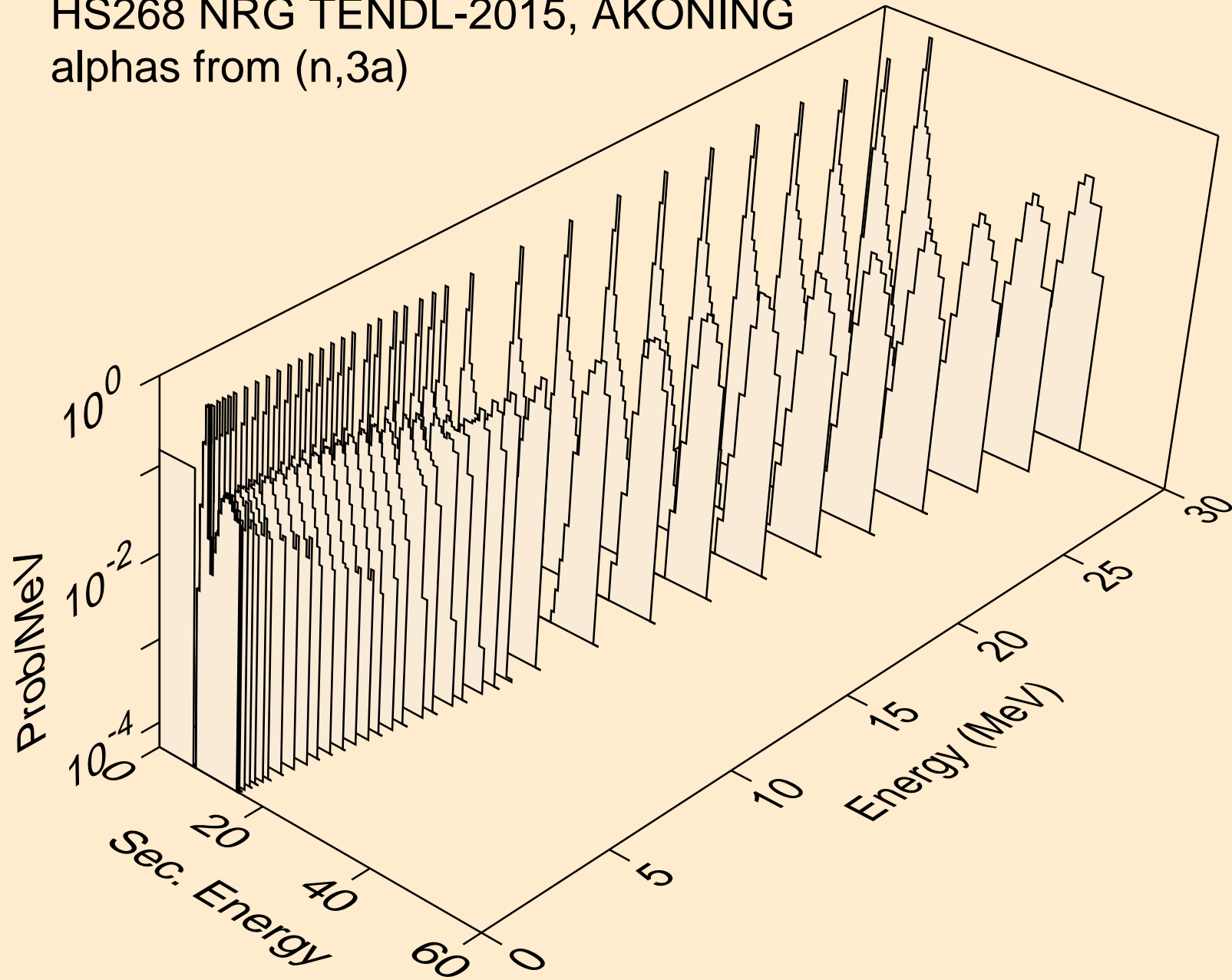

HS268 NRG TENDL-2015, AKONING  
alphas from (n,pa)

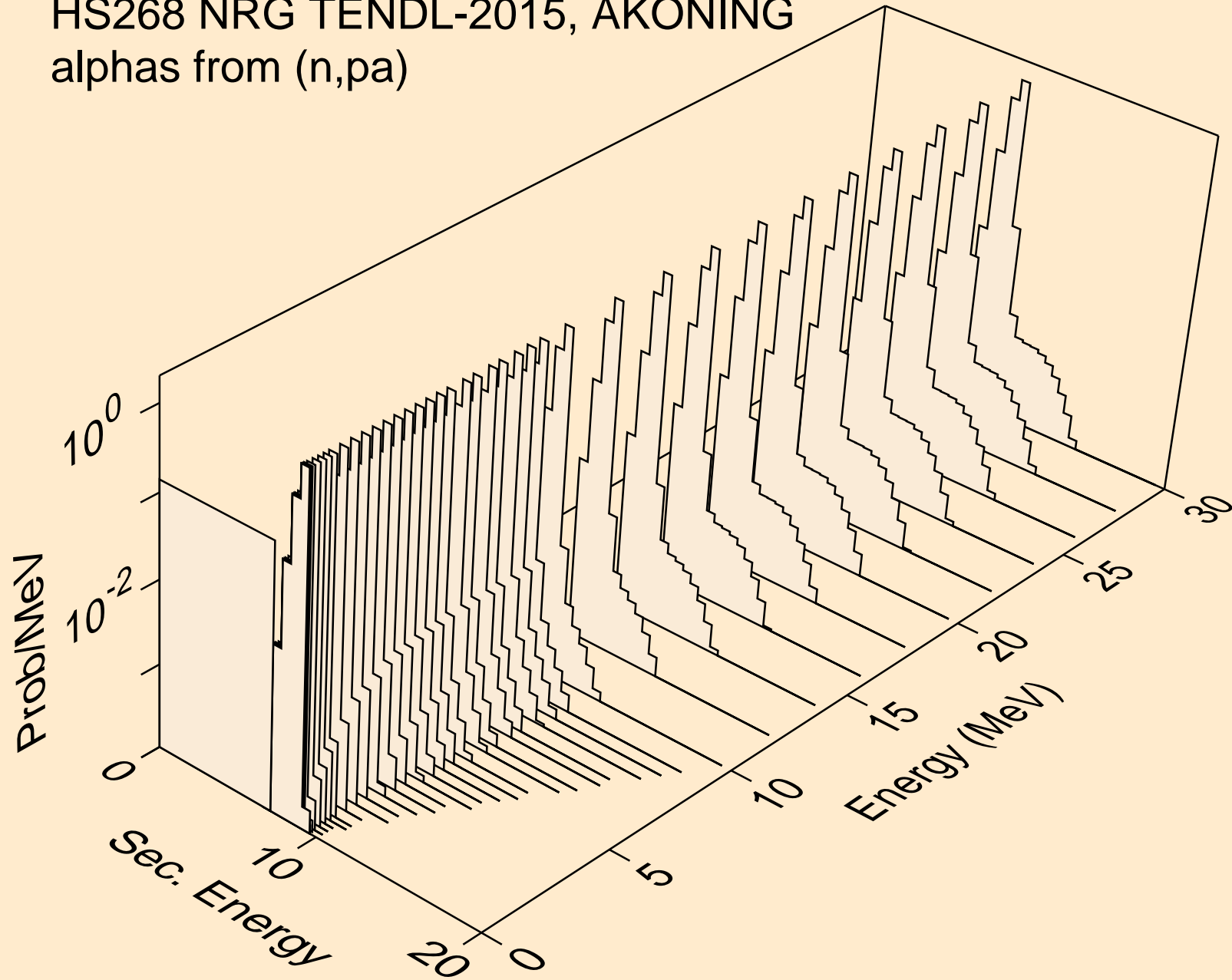

HS268 NRG TENDL-2015, AKONING  
alphas from (n,t2a)

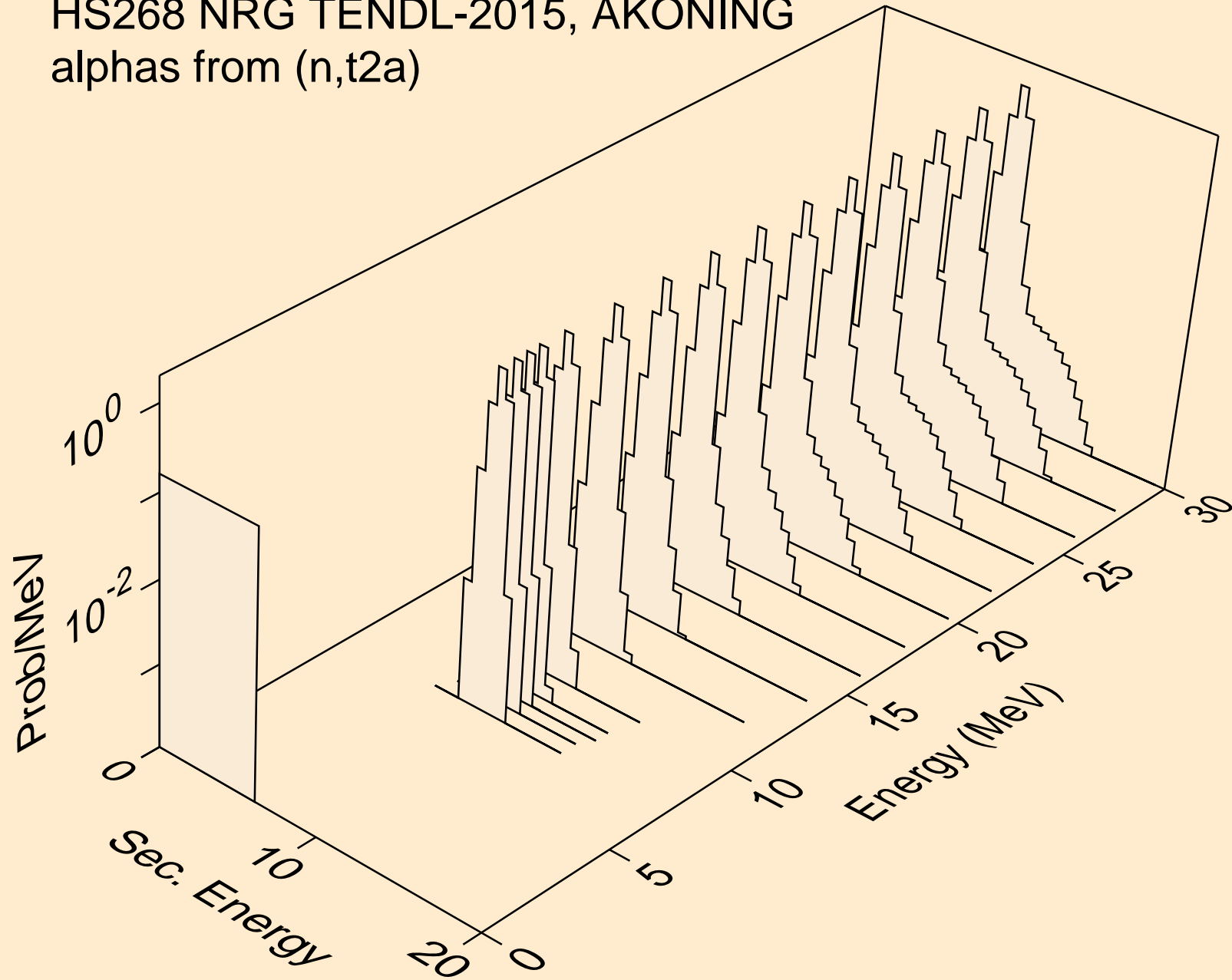



HS268 NRG TENDL-2015, AKONING  
alphas from (n,d2a)

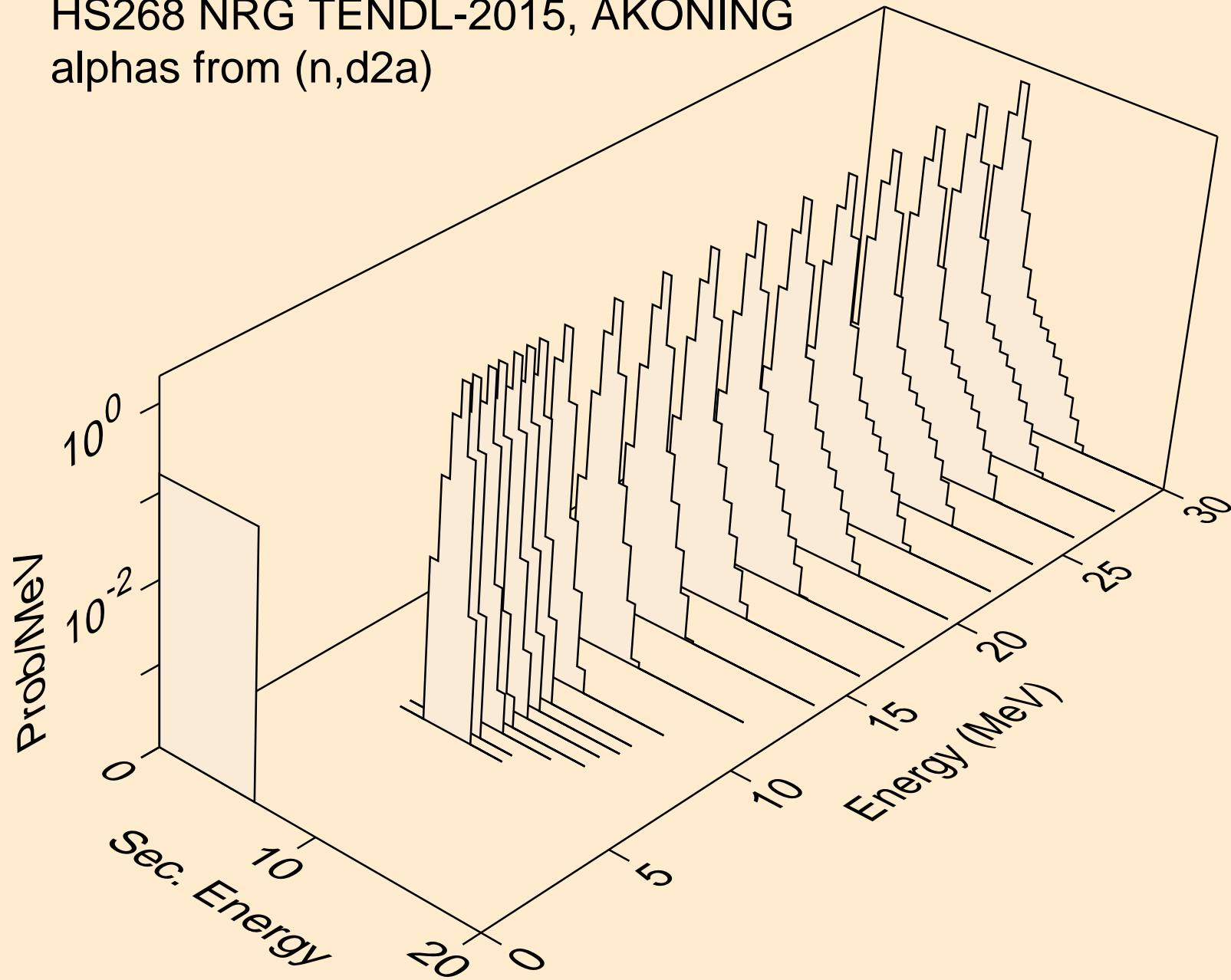

HS268 NRG TENDL-2015, AKONING  
alphas from (n,da)

