

HS272 NRG TENDL-2015, AKONING

Principal cross sections

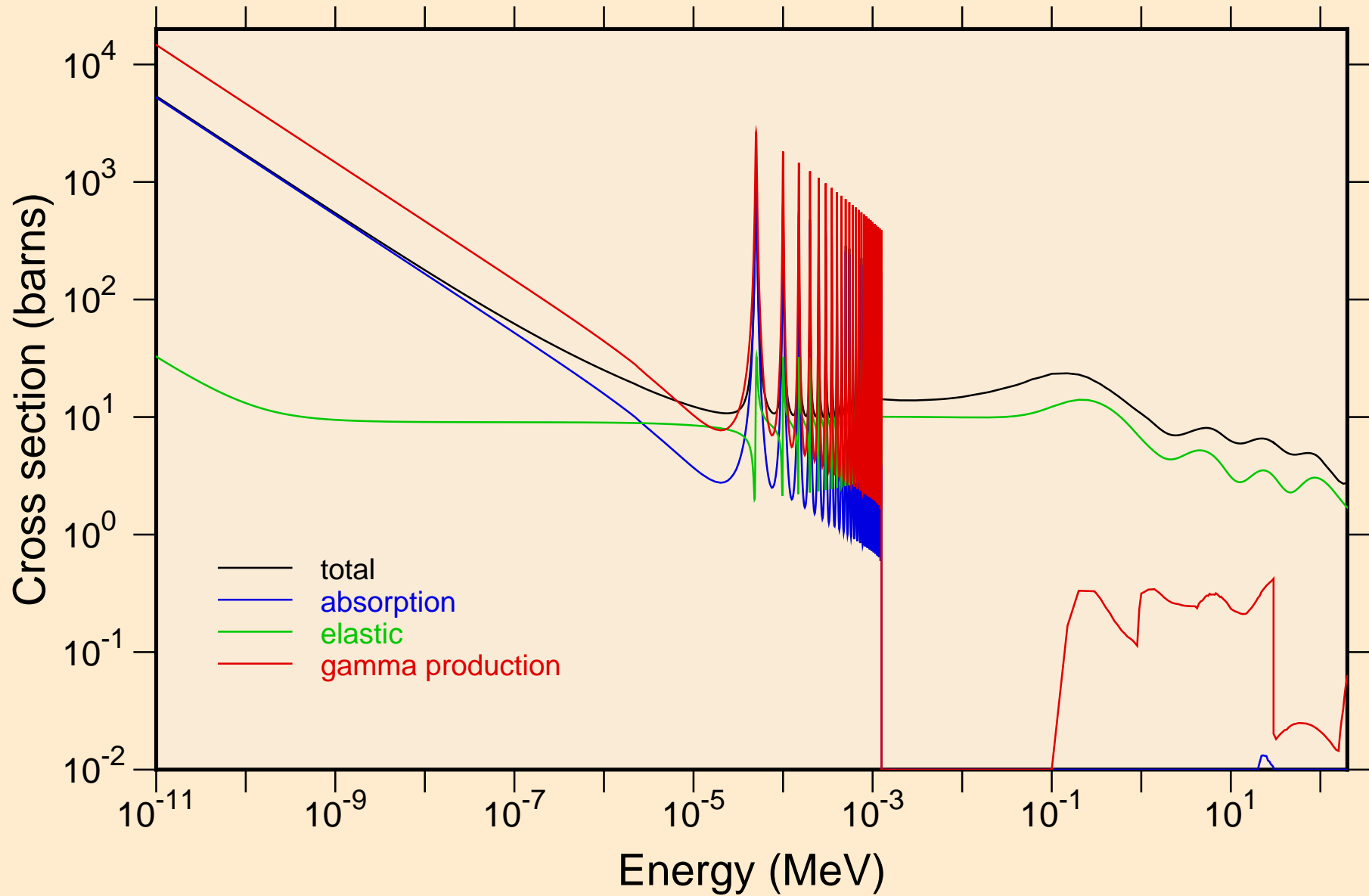

HS272 NRG TENDL-2015, AKONING
resonance total cross section

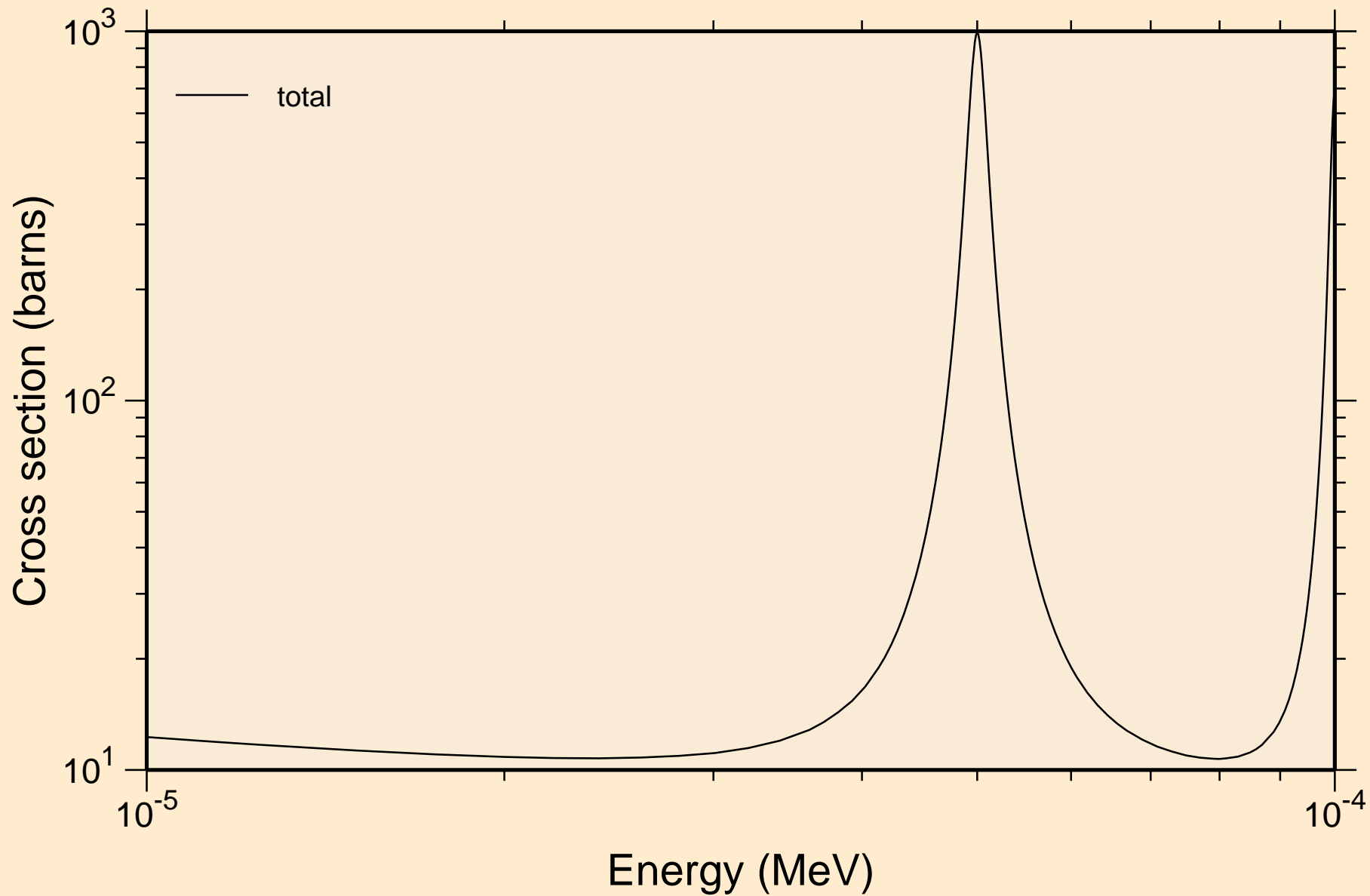

HS272 NRG TENDL-2015, AKONING
resonance total cross section

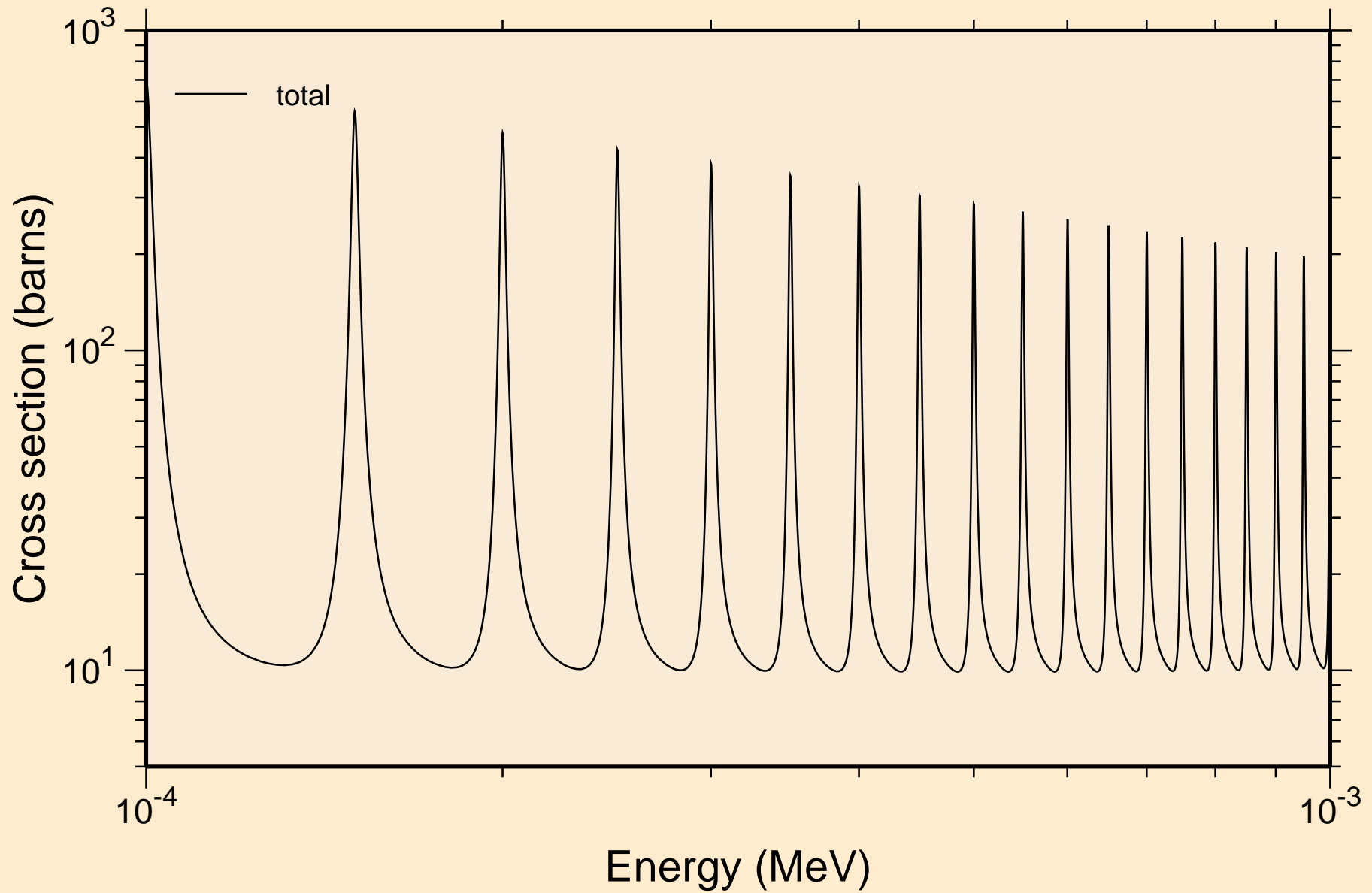

HS272 NRG TENDL-2015, AKONING
resonance total cross section

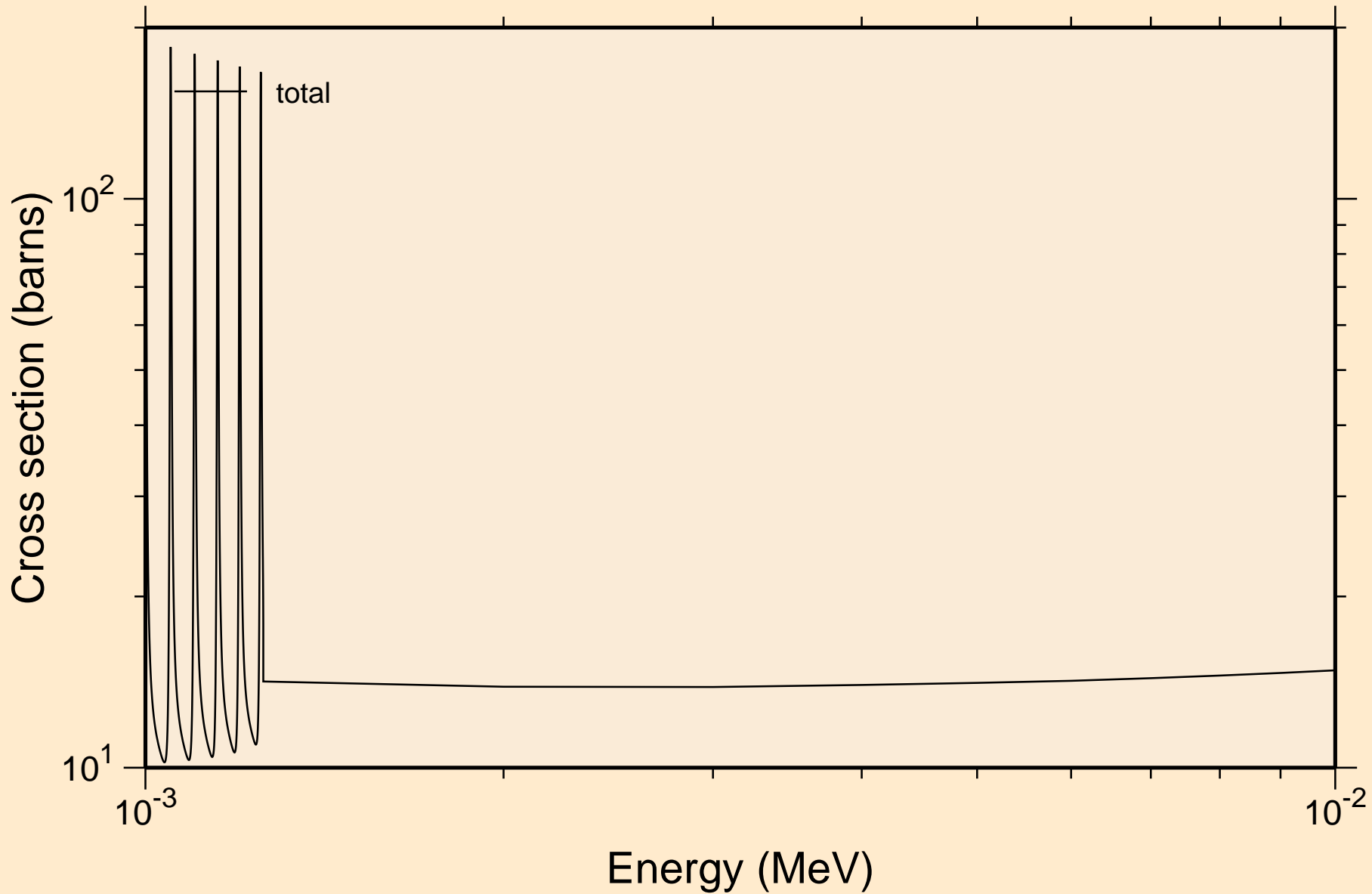

HS272 NRG TENDL-2015, AKONING
resonance total cross section

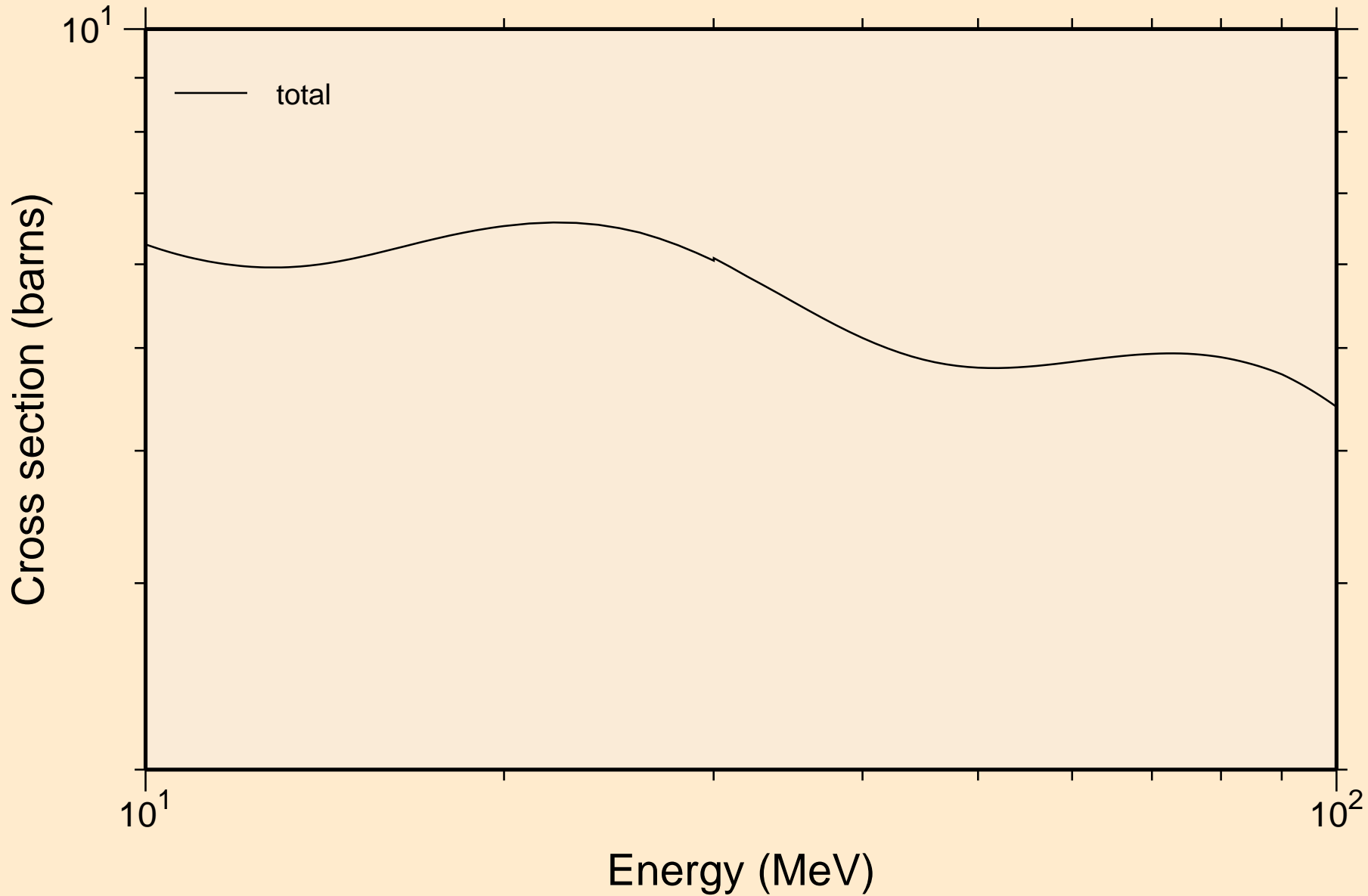

HS272 NRG TENDL-2015, AKONING

resonance absorption cross sections

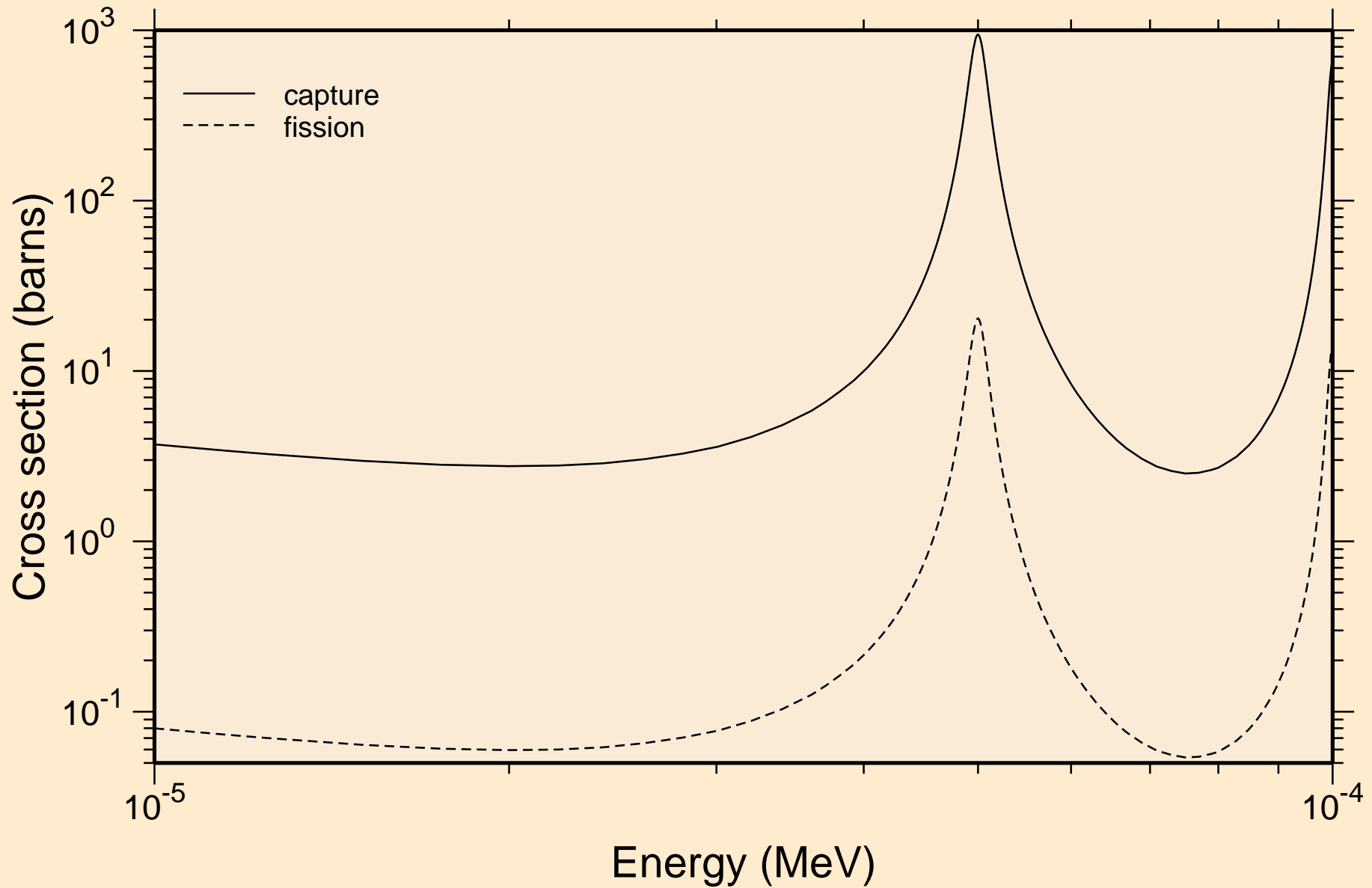

HS272 NRG TENDL-2015, AKONING

resonance absorption cross sections

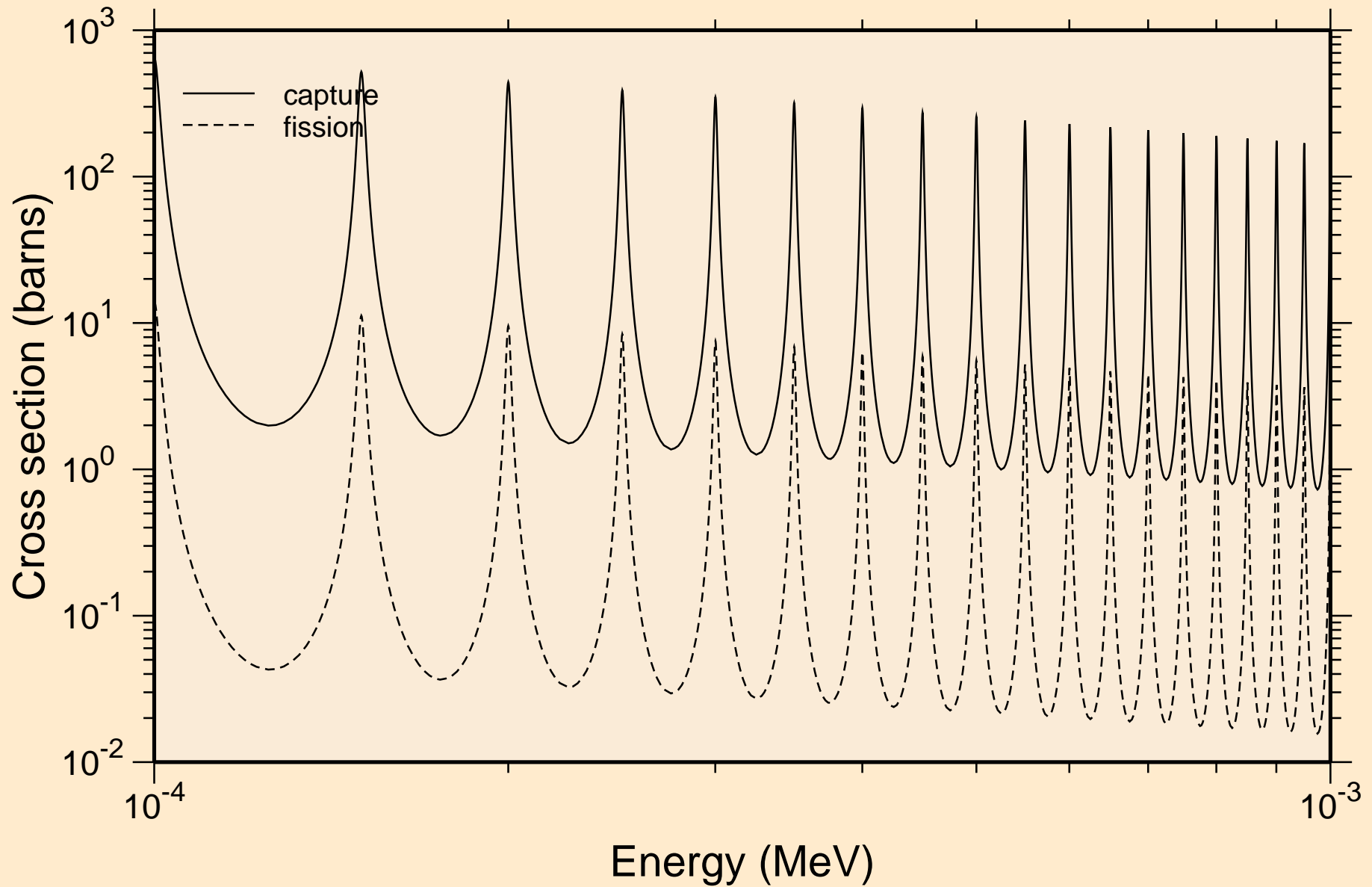

HS272 NRG TENDL-2015, AKONING resonance absorption cross sections

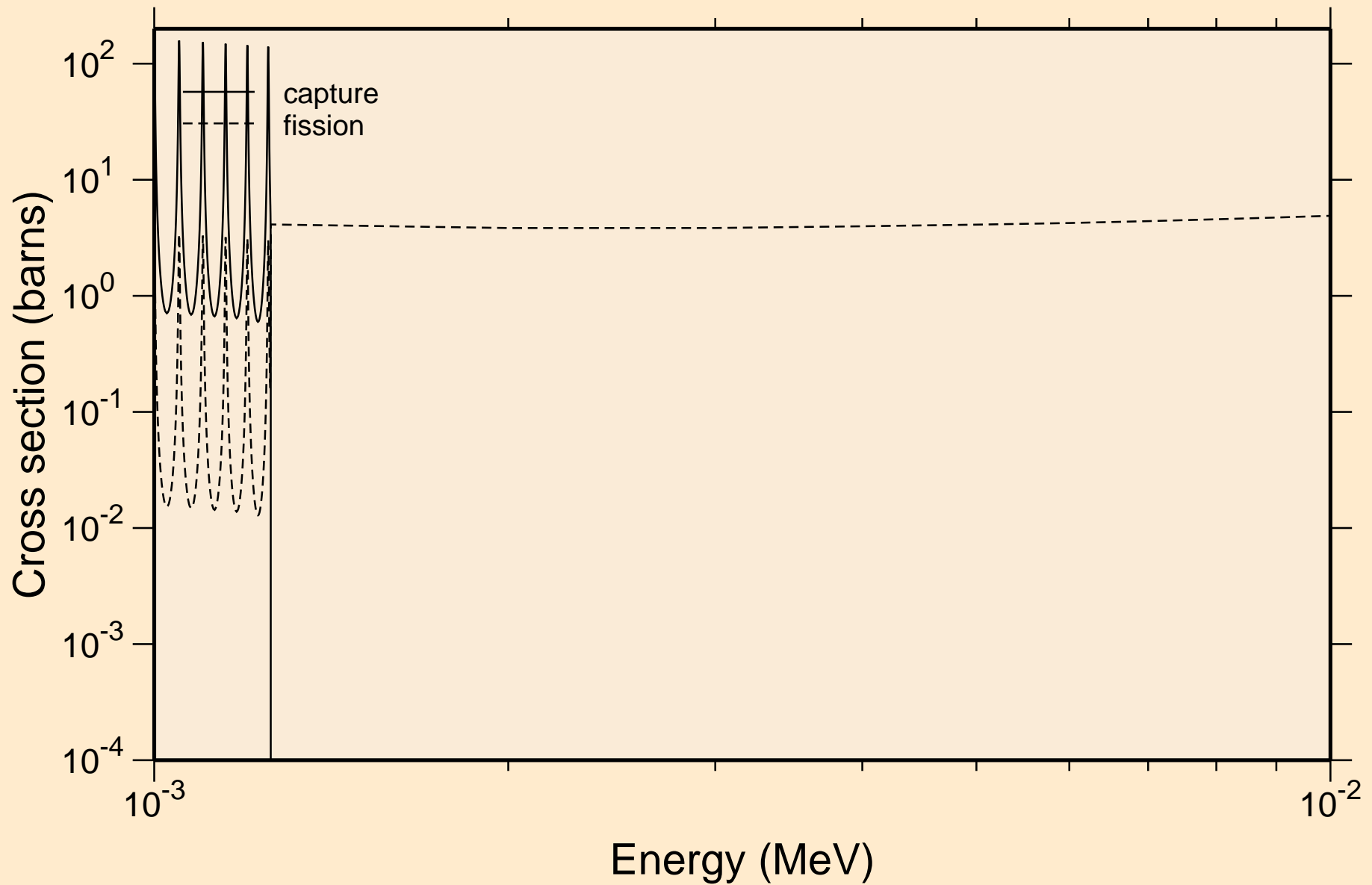

HS272 NRG TENDL-2015, AKONING

resonance absorption cross sections

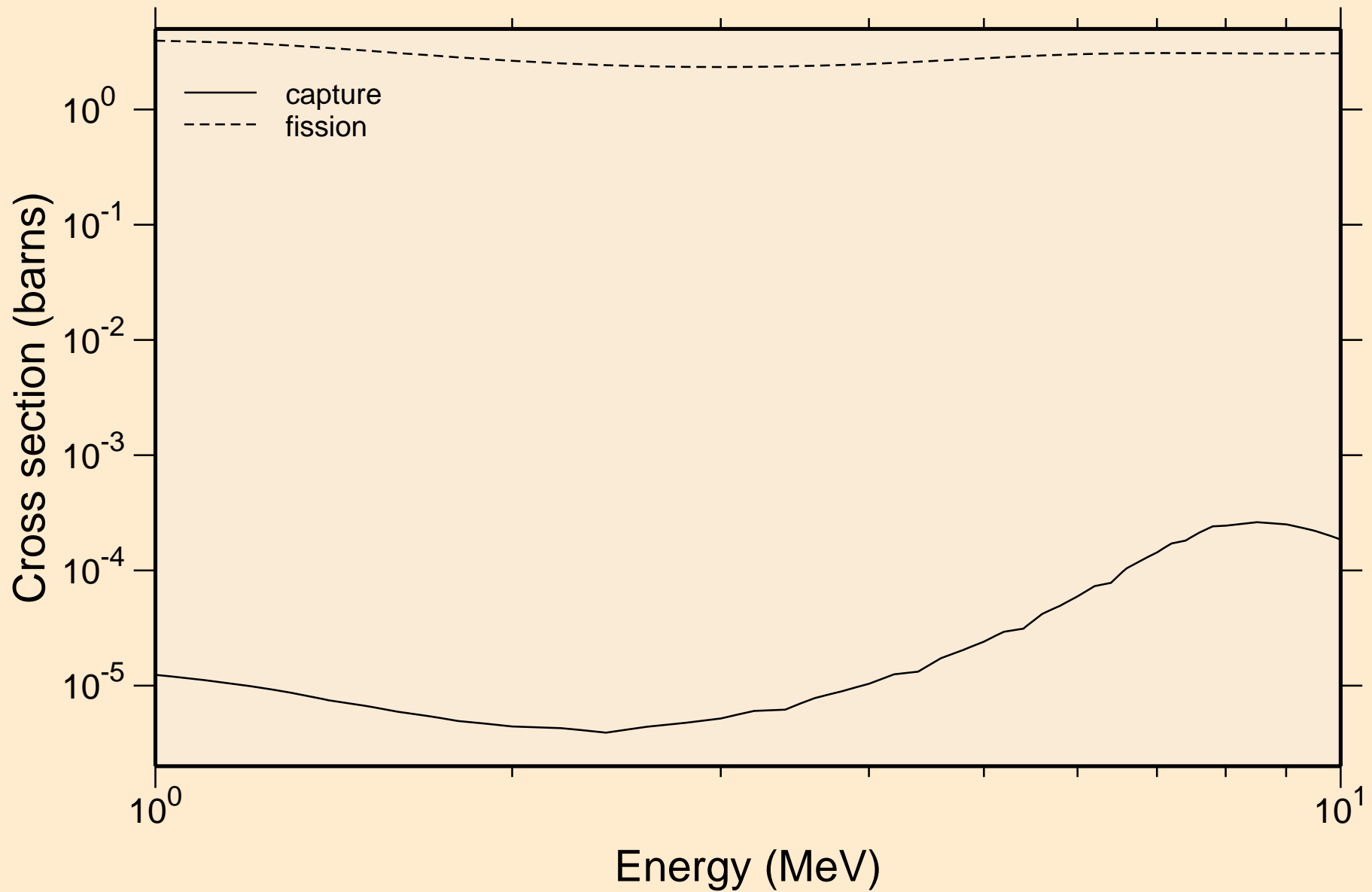

HS272 NRG TENDL-2015, AKONING

Non-threshold reactions

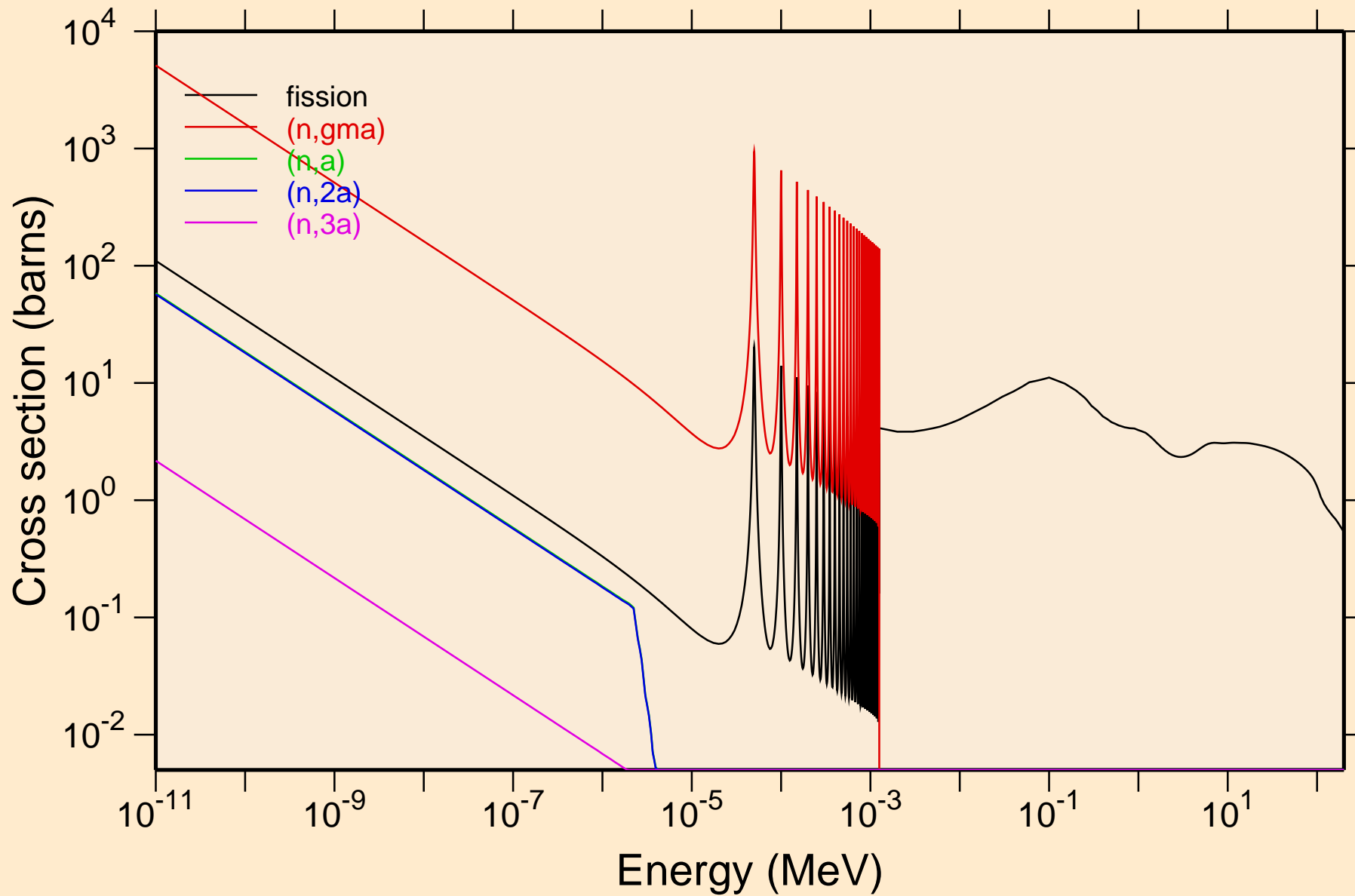

HS272 NRG TENDL-2015, AKONING

Principal cross sections

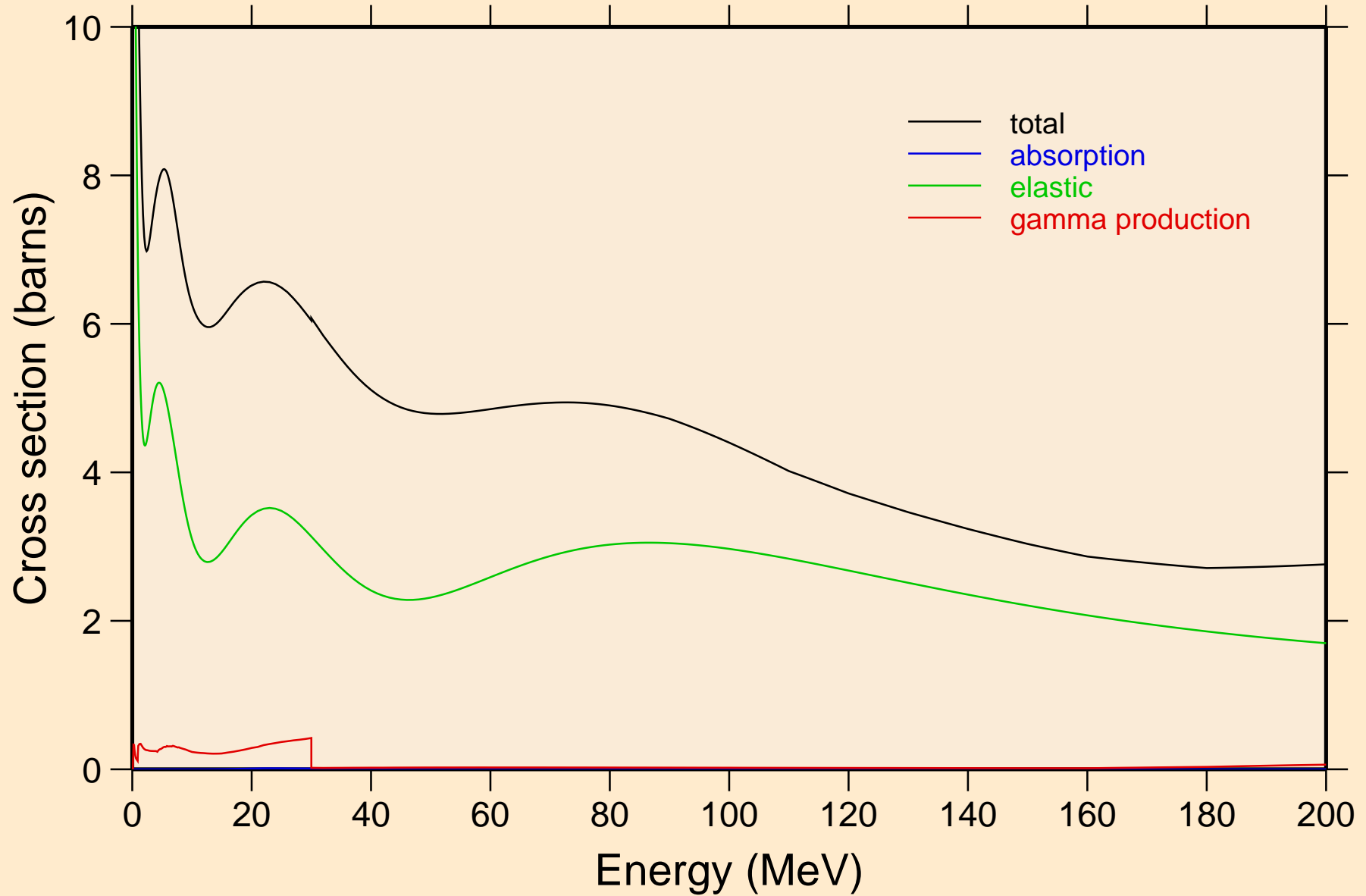

HS272 NRG TENDL-2015, AKONING

Non-threshold reactions

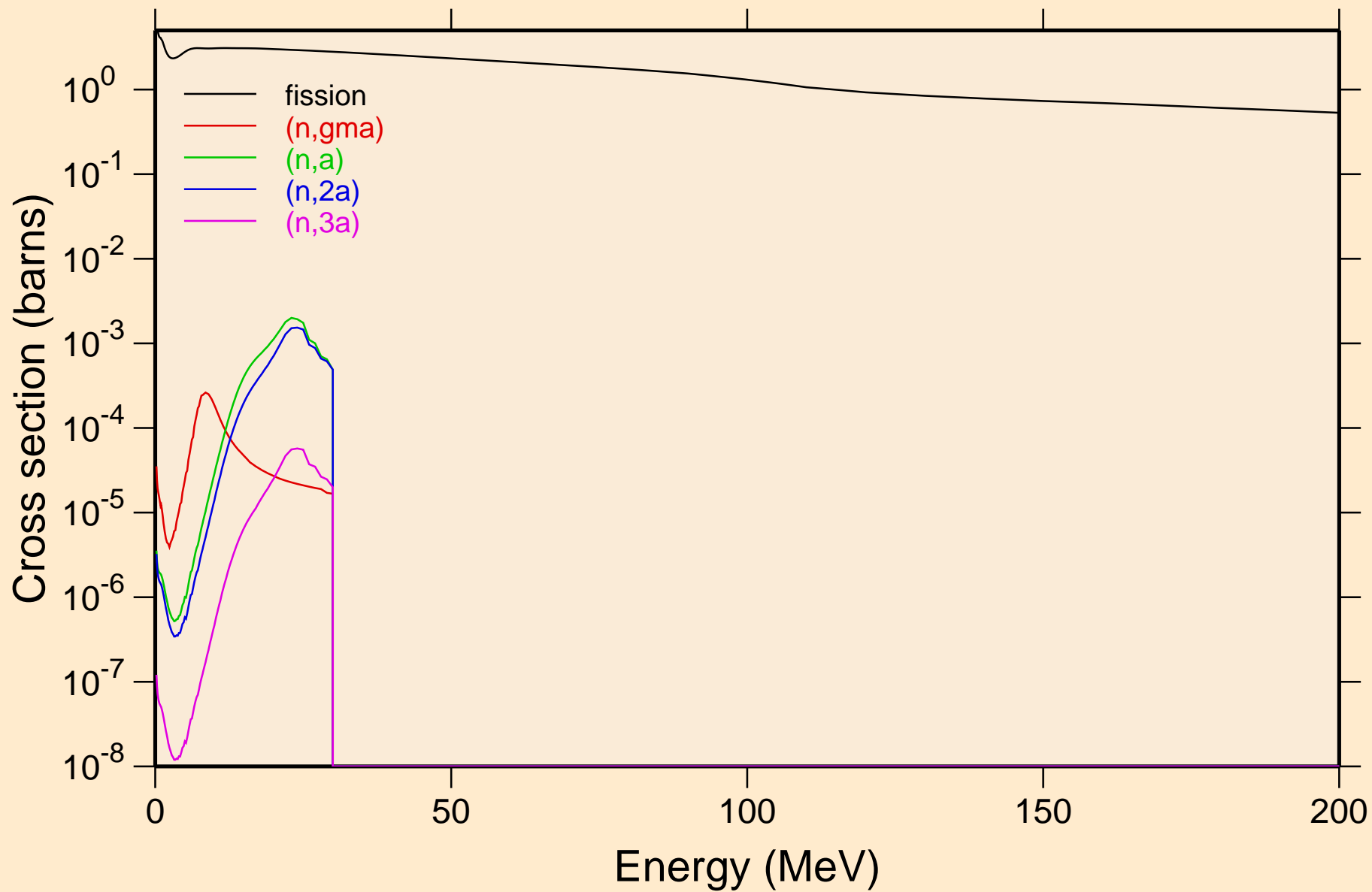

HS272 NRG TENDL-2015, AKONING

Inelastic levels

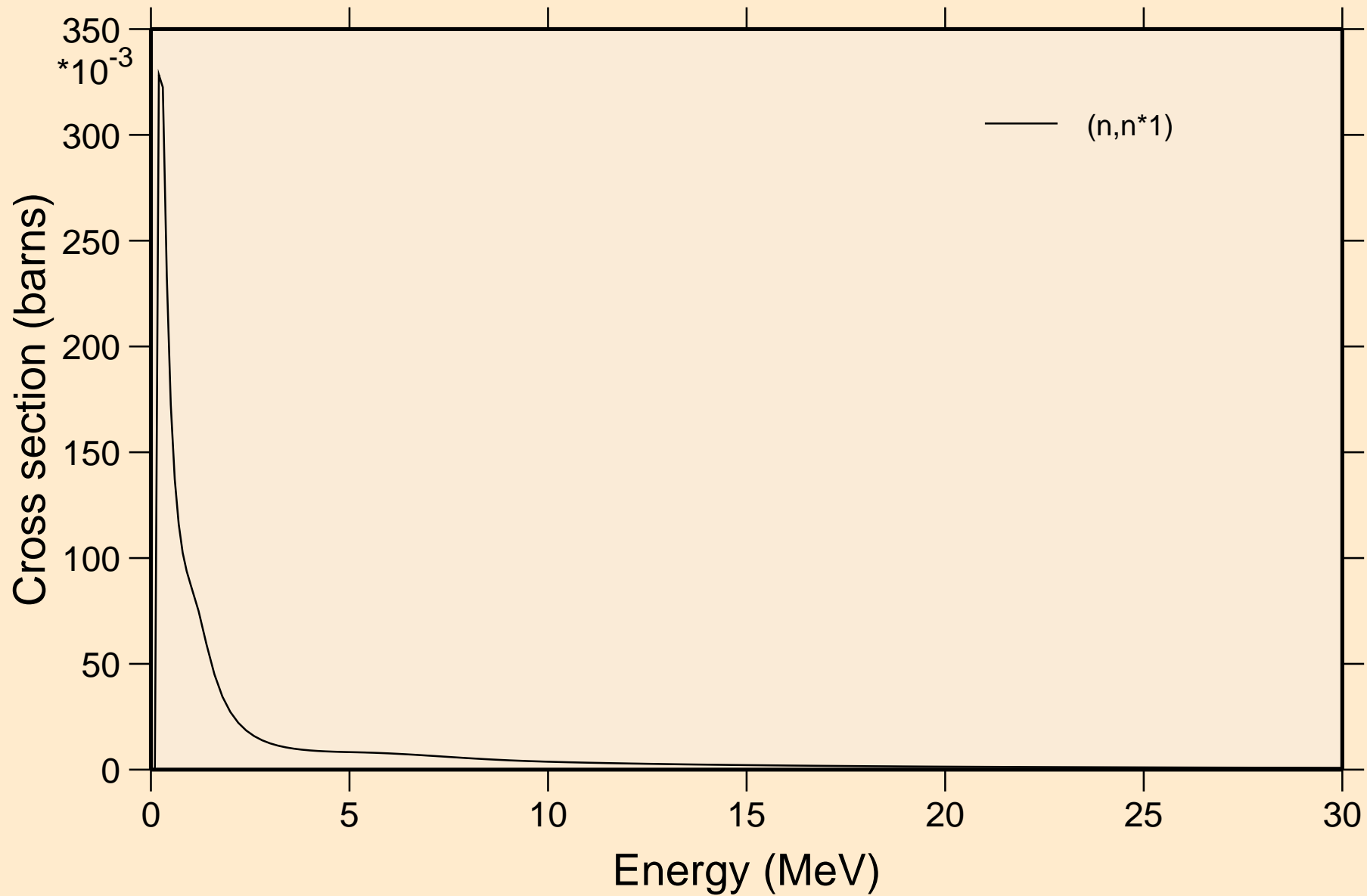

HS272 NRG TENDL-2015, AKONING

Threshold reactions

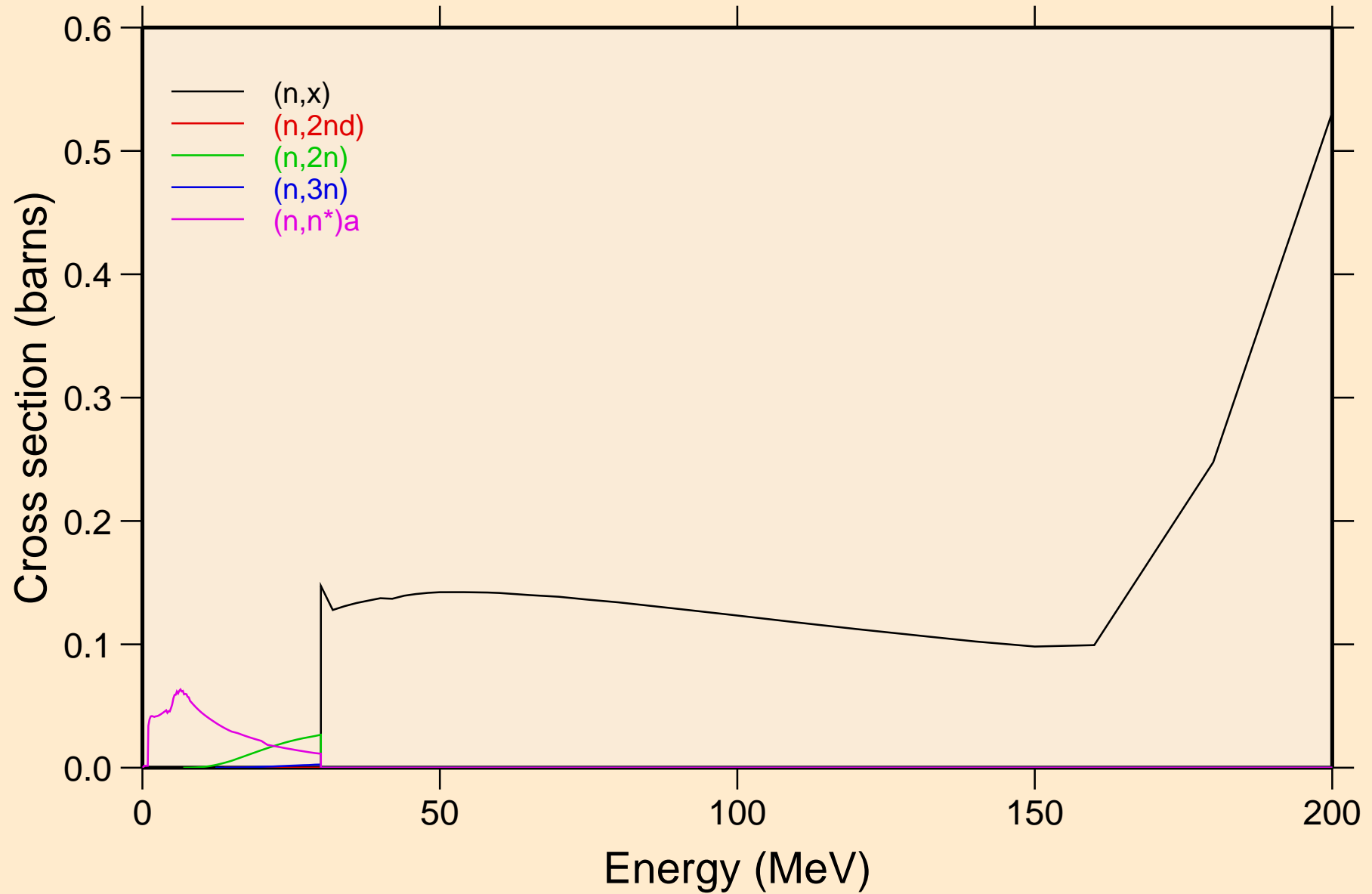

HS272 NRG TENDL-2015, AKONING

Threshold reactions

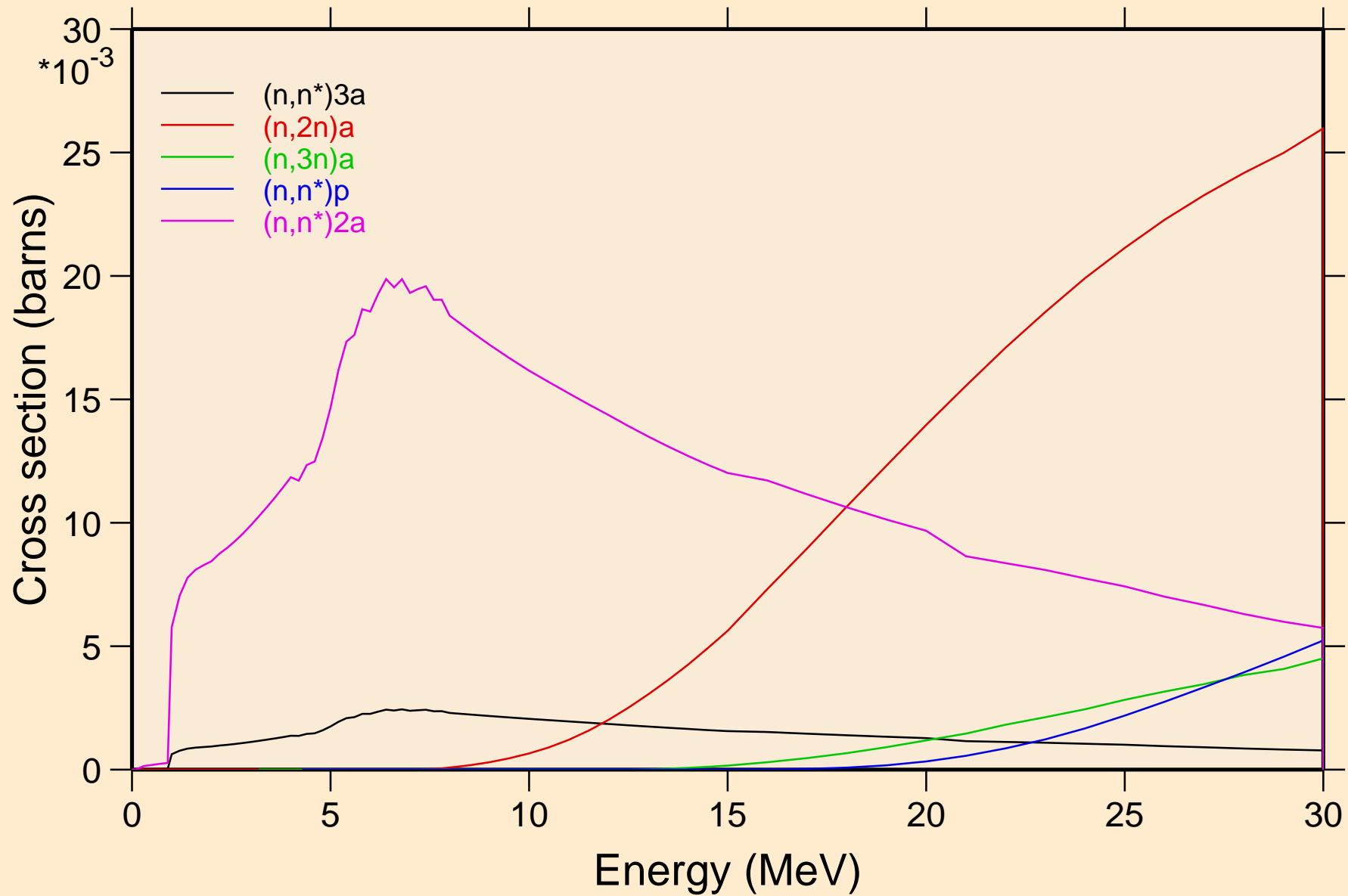

HS272 NRG TENDL-2015, AKONING

Threshold reactions

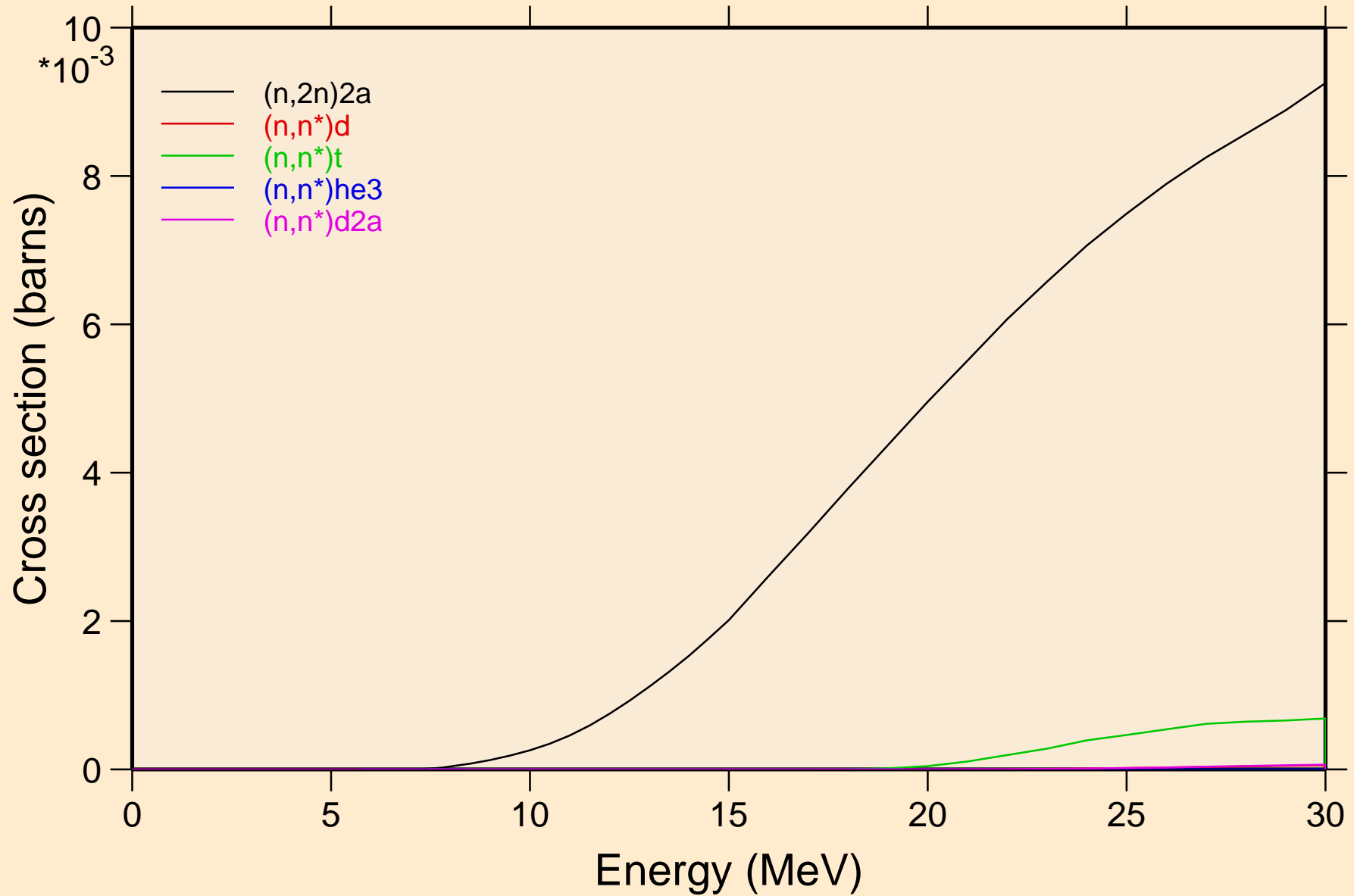

HS272 NRG TENDL-2015, AKONING

Threshold reactions

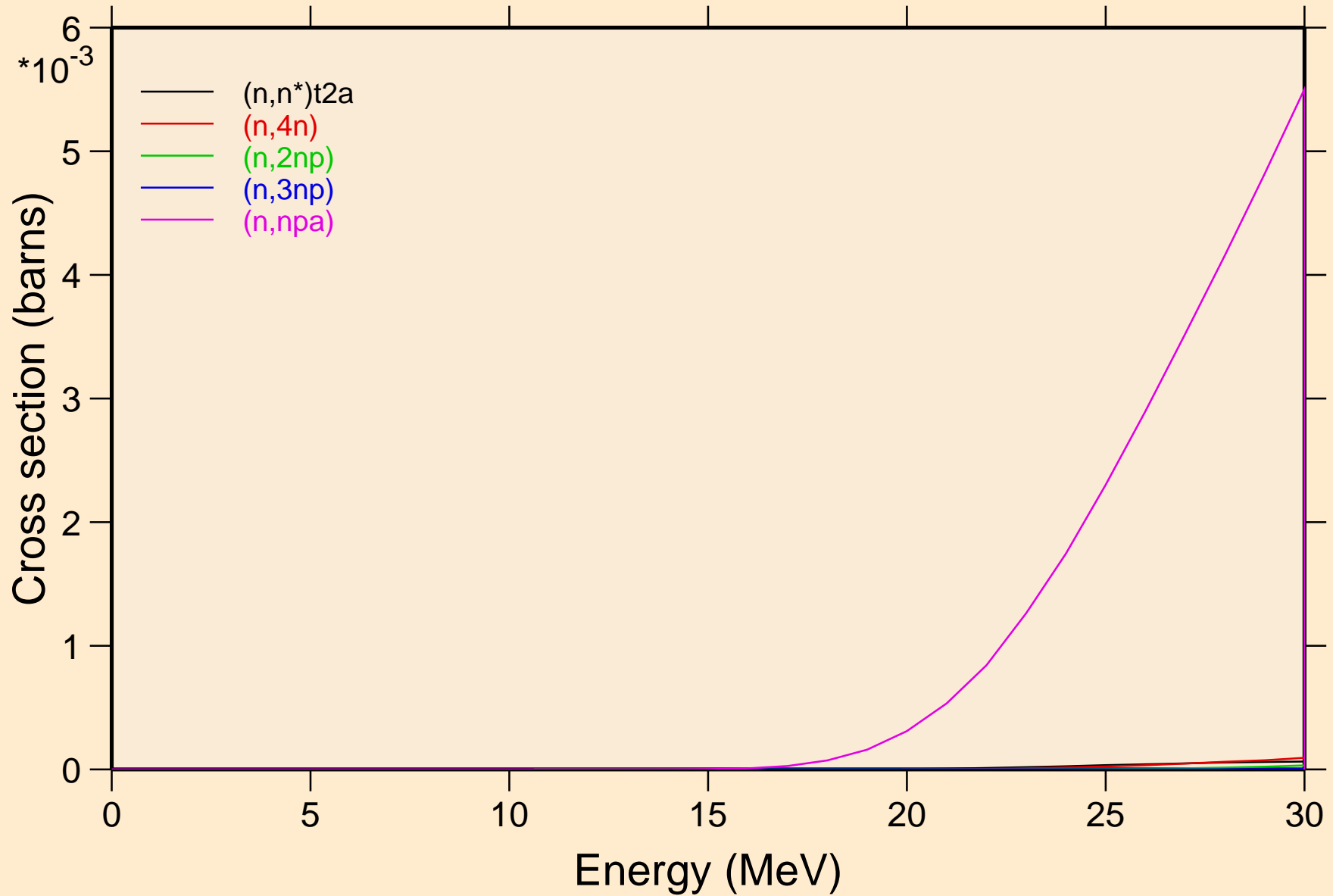

HS272 NRG TENDL-2015, AKONING

Threshold reactions

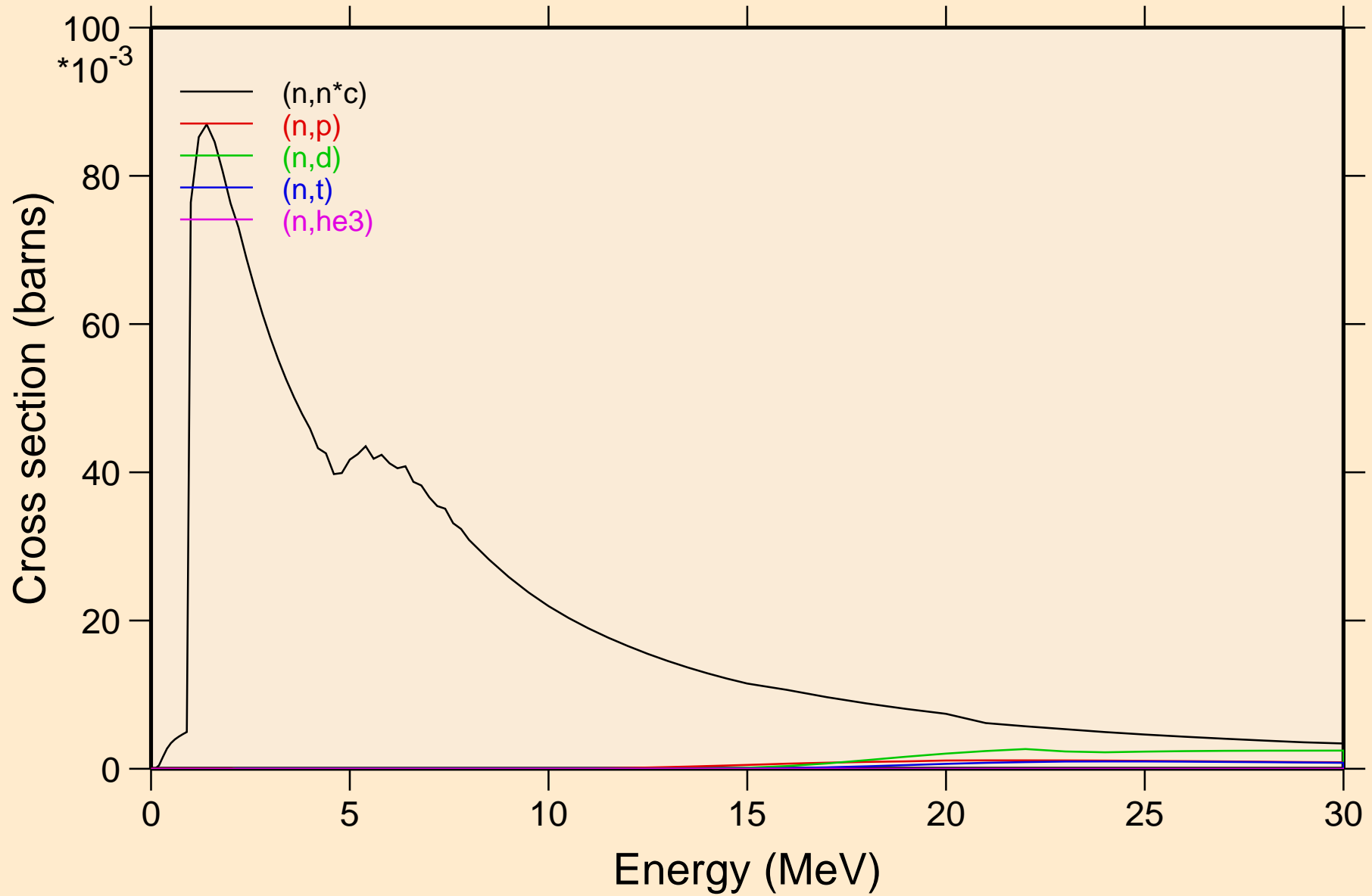

HS272 NRG TENDL-2015, AKONING

Threshold reactions

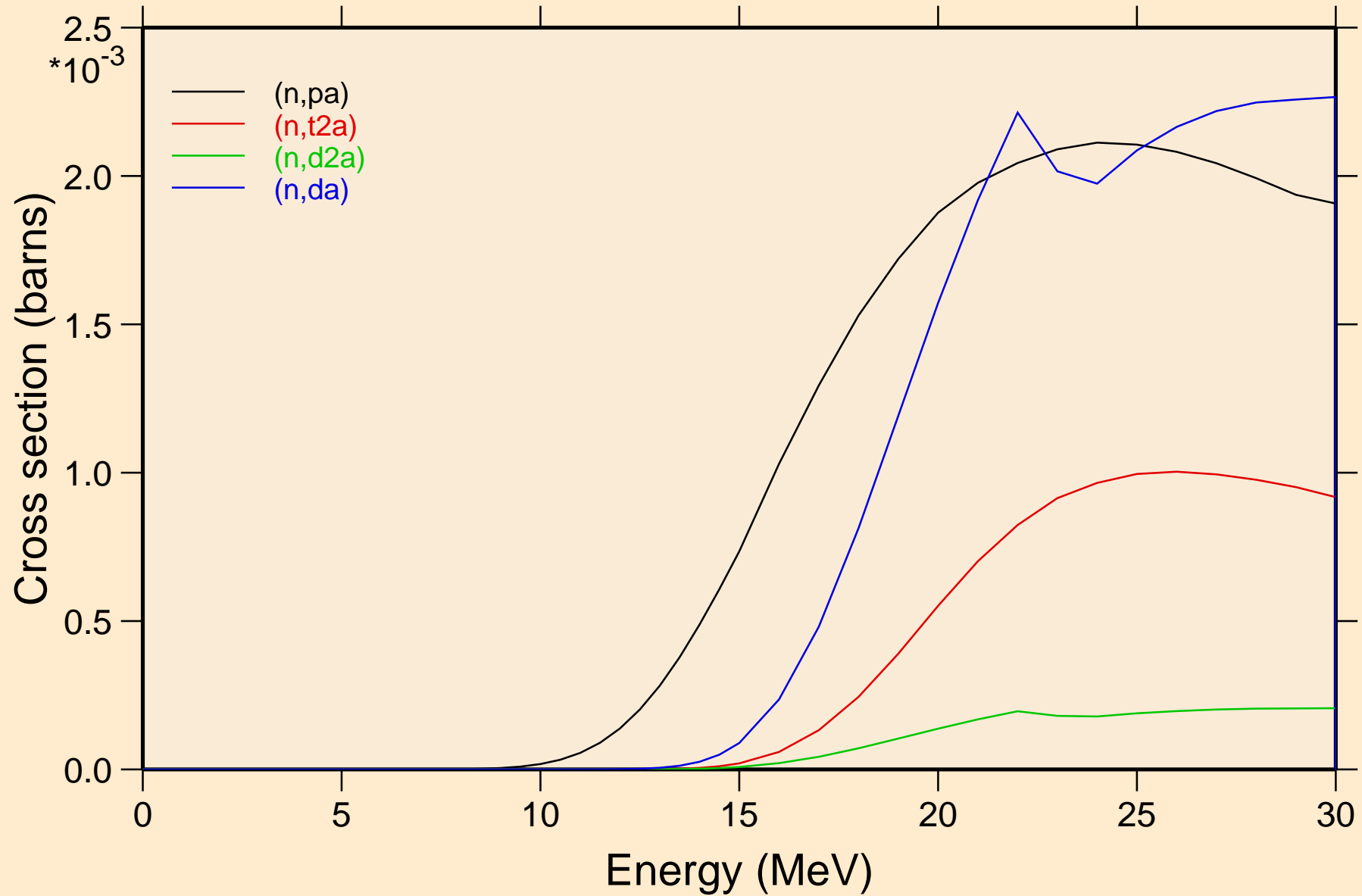

HS272 NRG TENDL-2015, AKONING
angular distribution for elastic

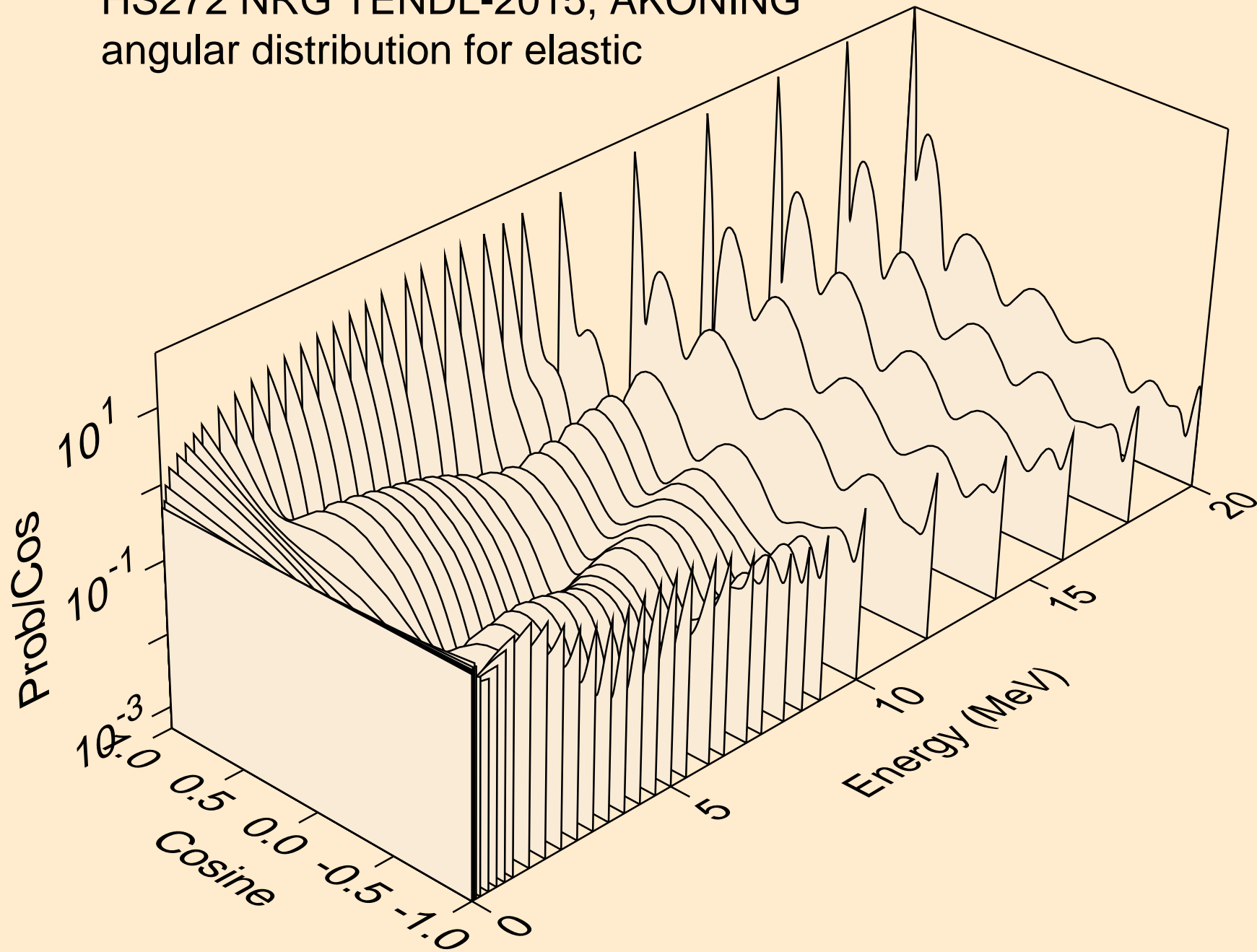

HS272 NRG TENDL-2015, AKONING
angular distribution for elastic

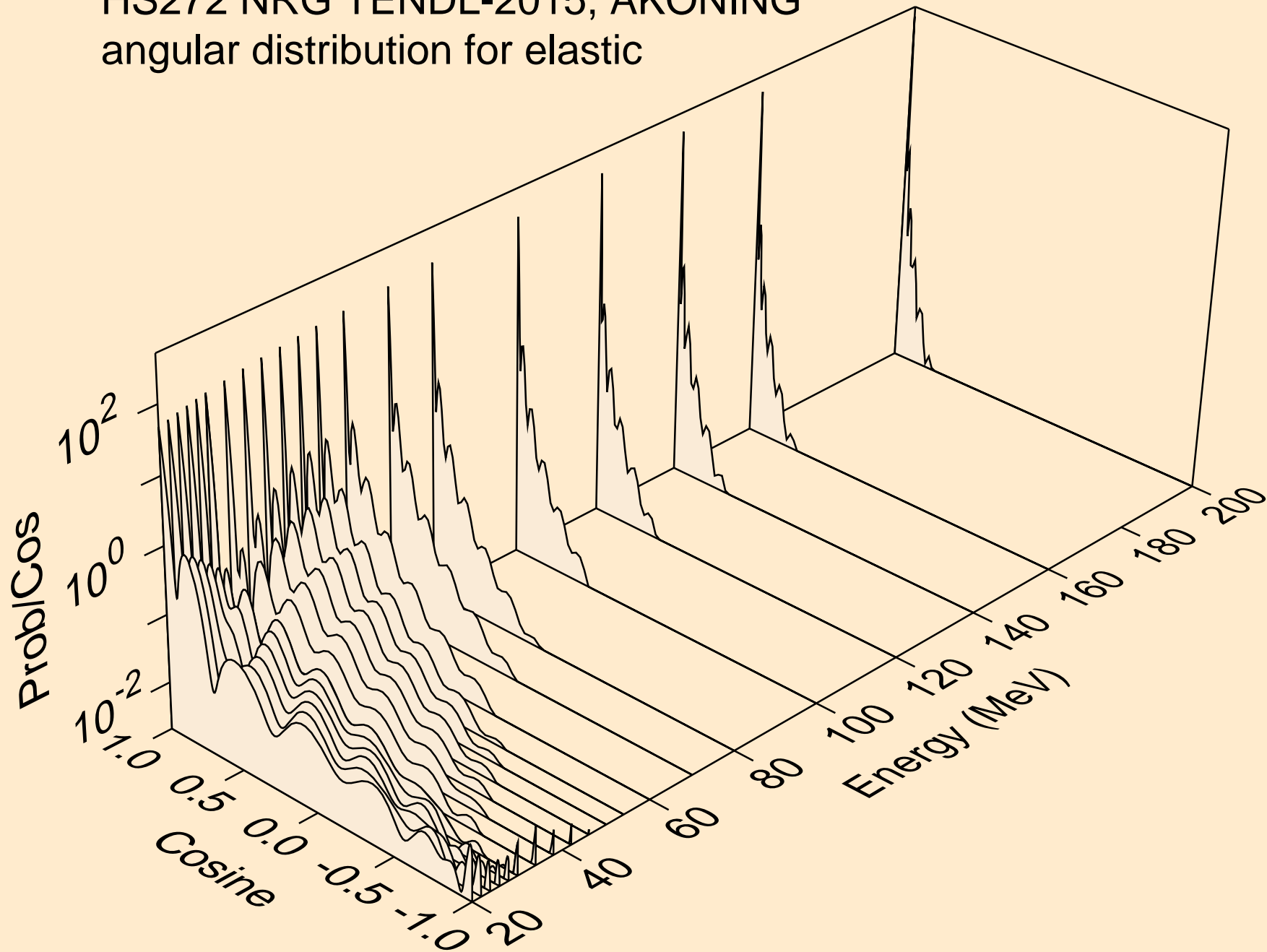

HS272 NRG TENDL-2015, AKONING
angular distribution for (n,n*1)

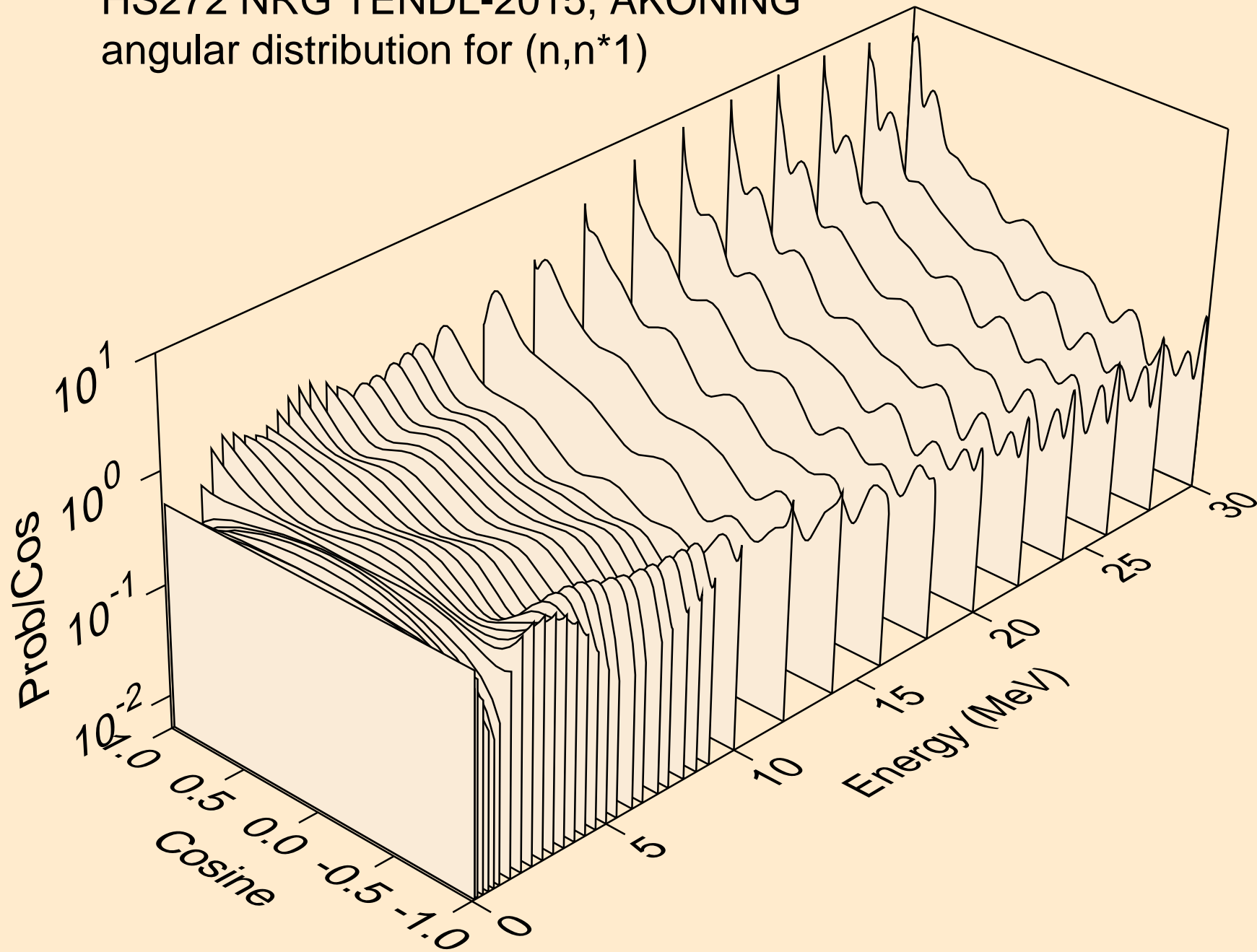

HS272 NRG TENDL-2015, AKONING

Total fission nubar

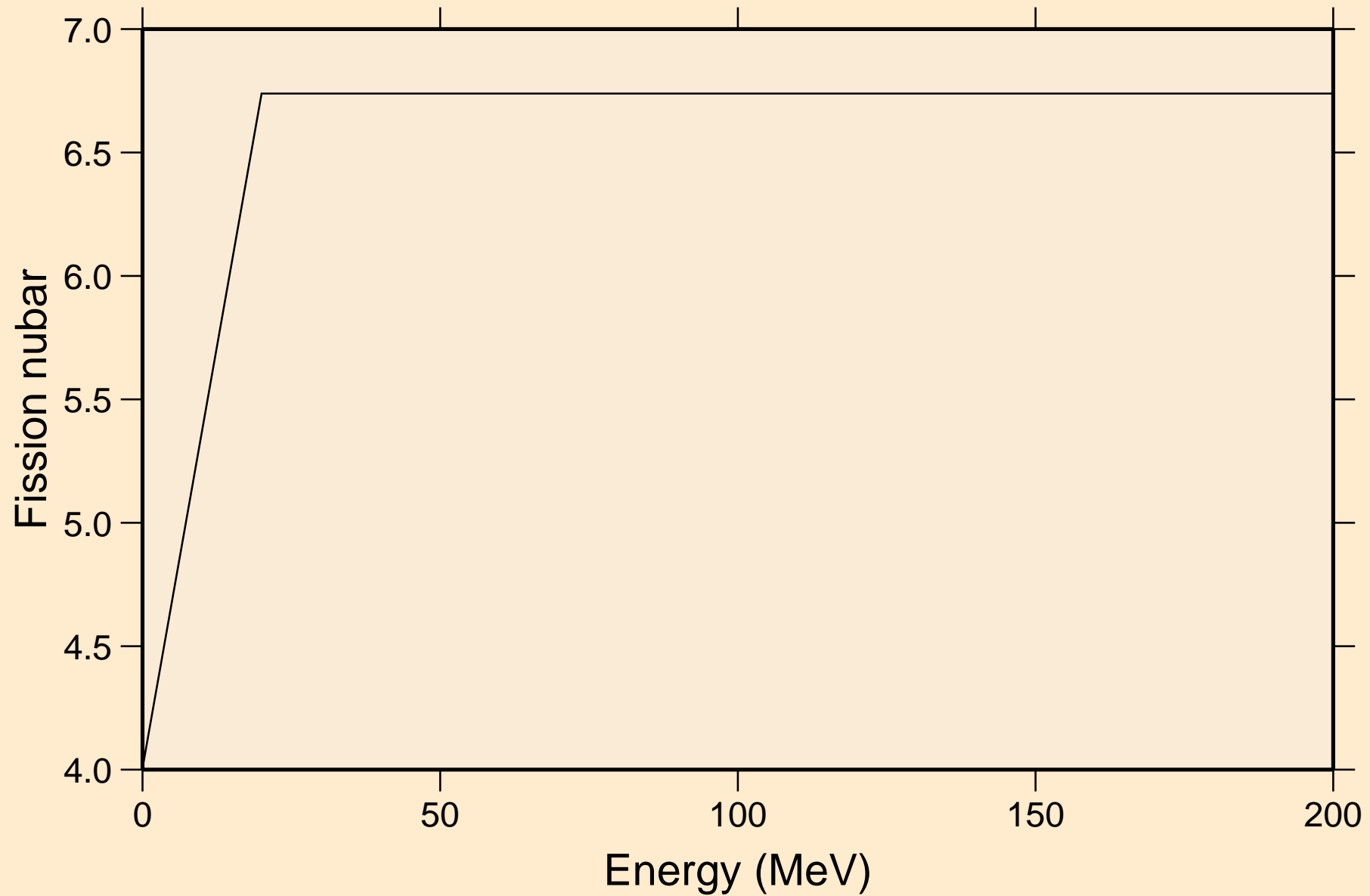

HS272 NRG TENDL-2015, AKONING
Neutron emission for (n,x)

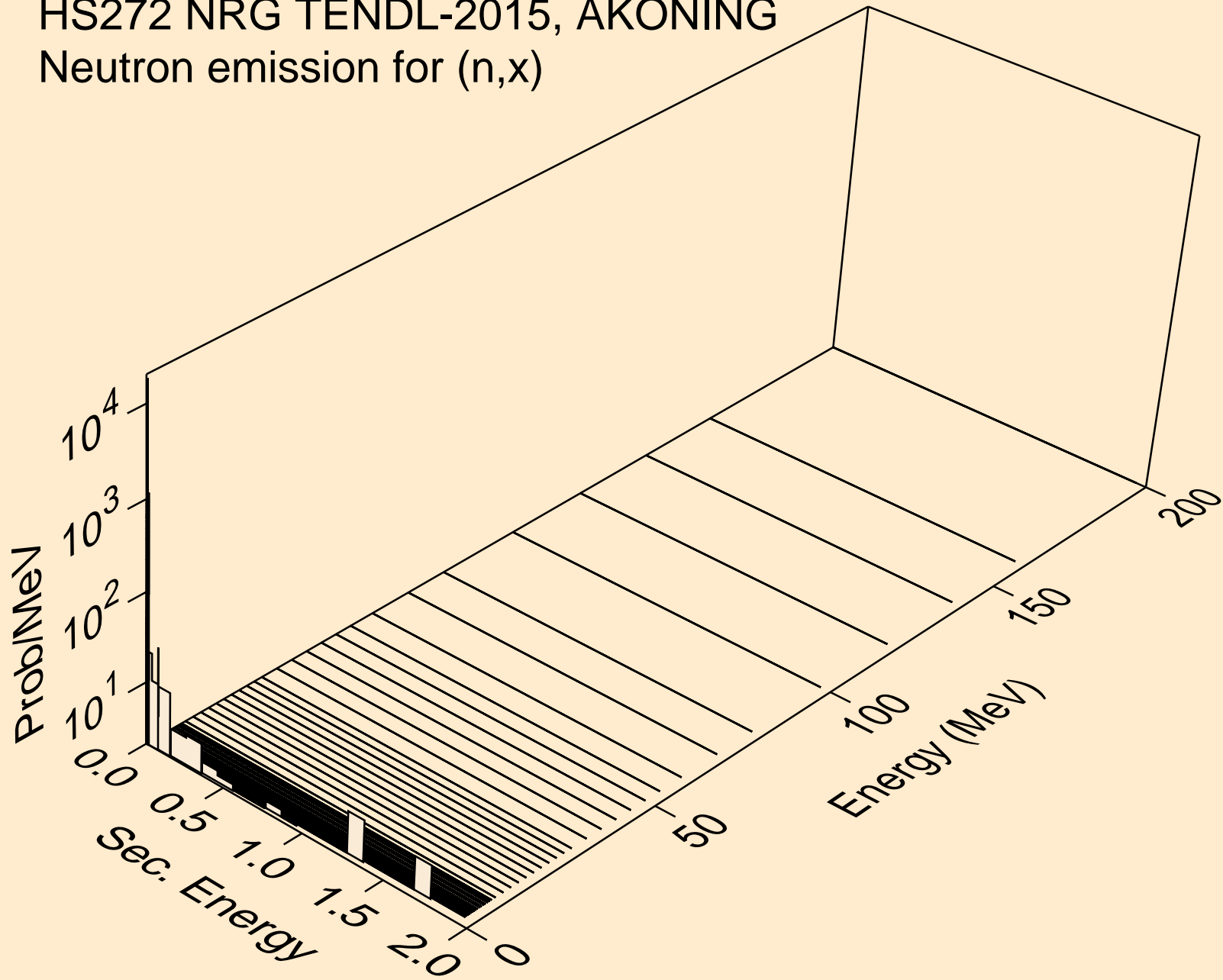

HS272 NRG TENDL-2015, AKONING
Neutron emission for (n,2nd)

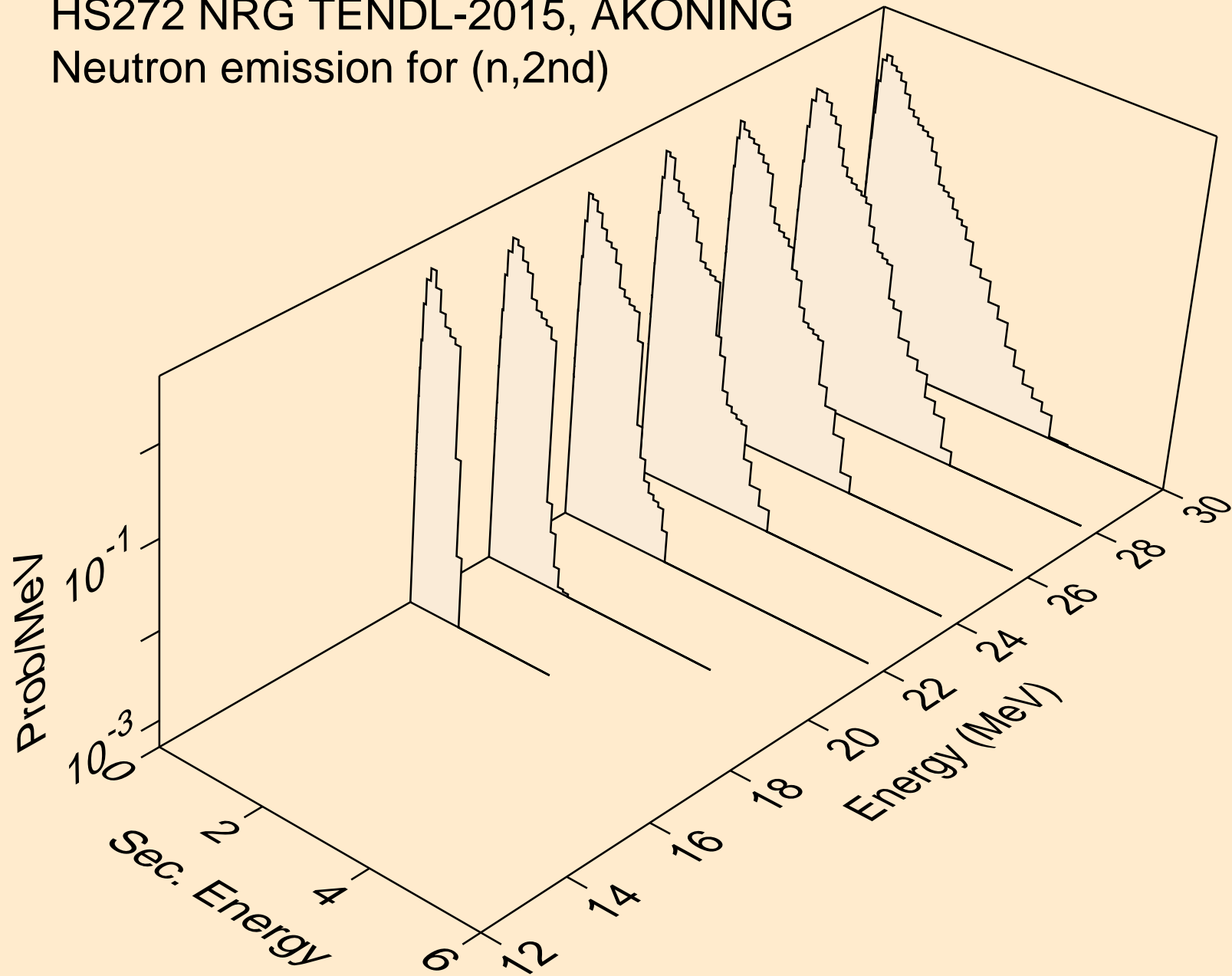

HS272 NRG TENDL-2015, AKONING
Neutron emission for (n,2n)

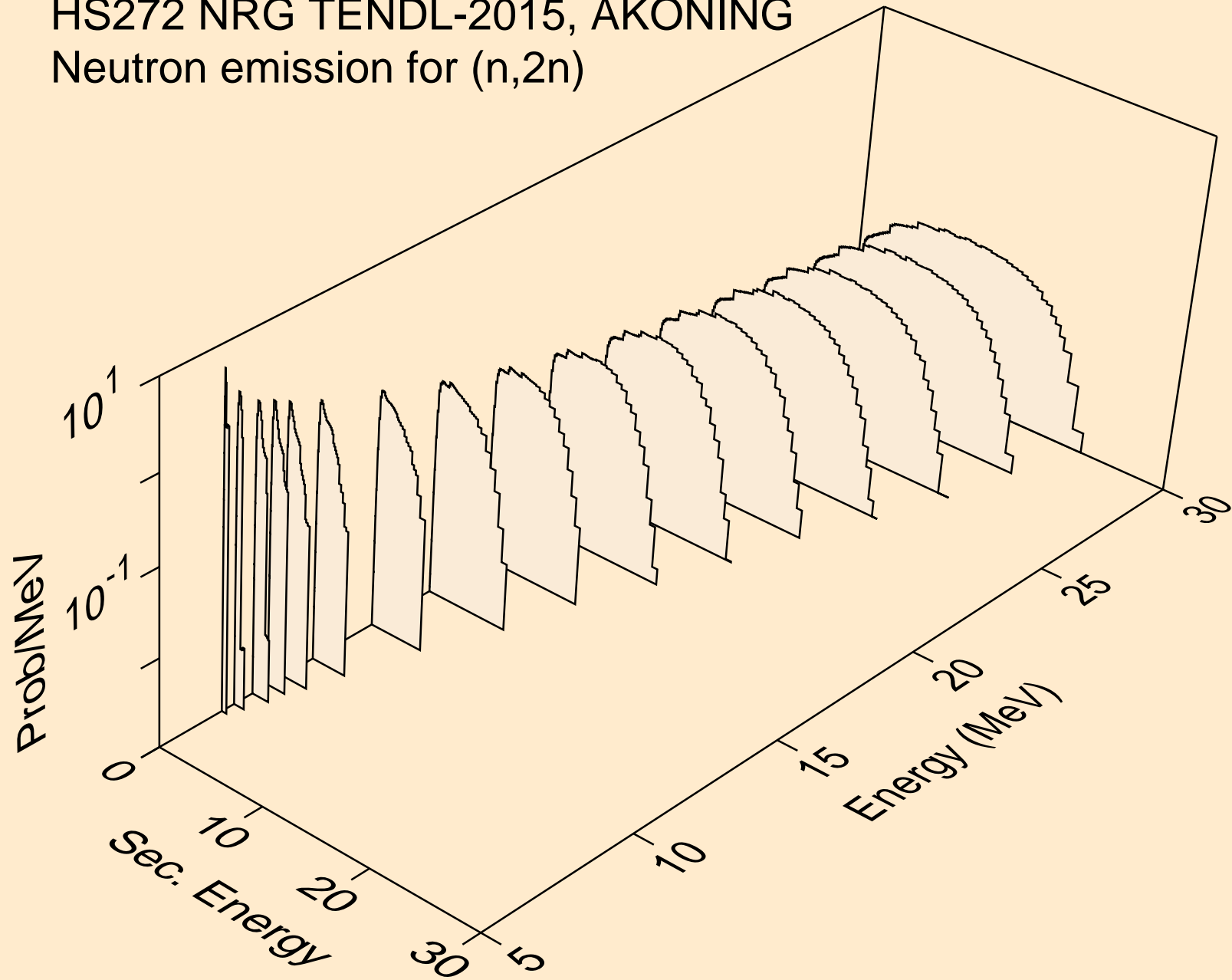

HS272 NRG TENDL-2015, AKONING
Neutron emission for (n,3n)

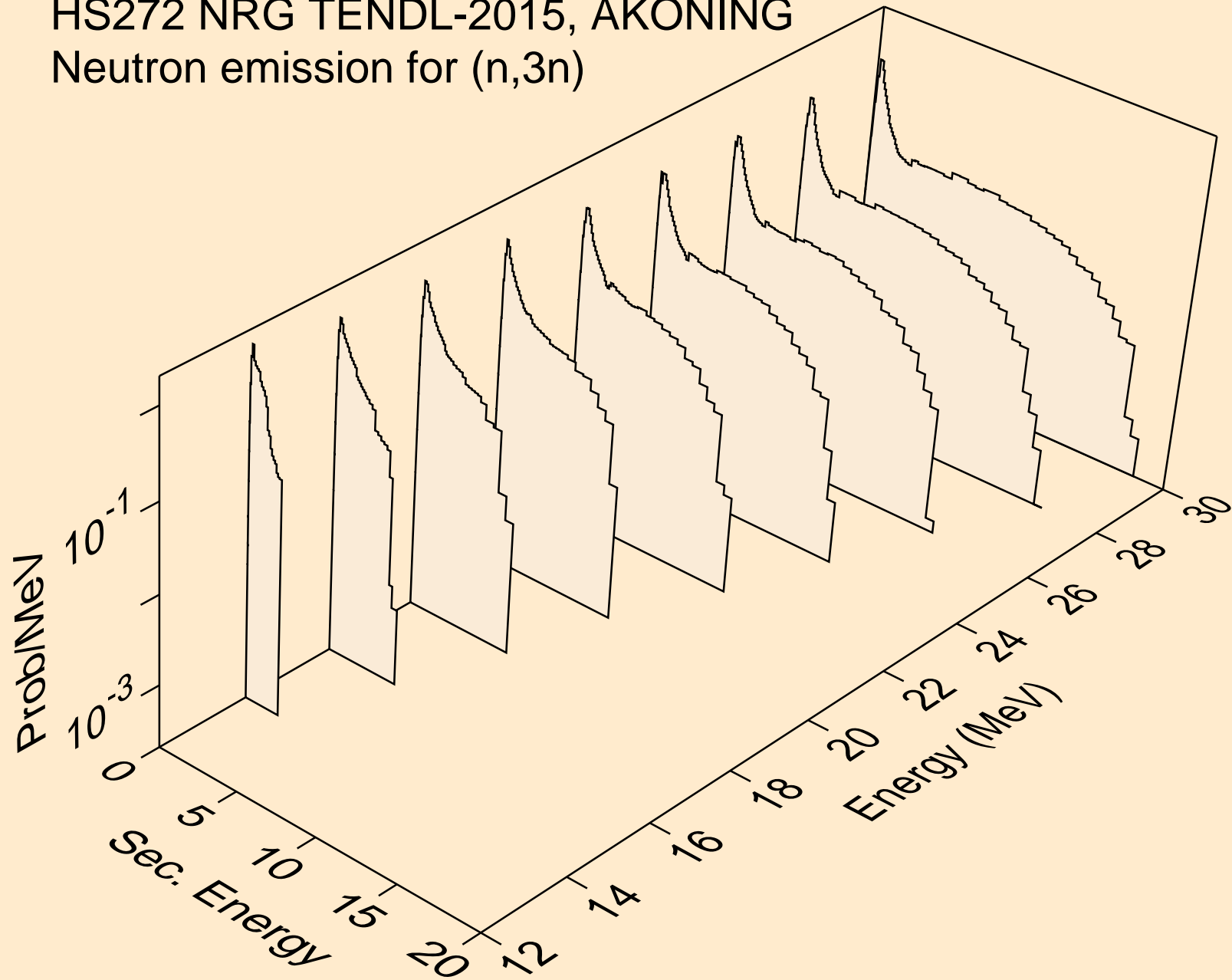

HS272 NRG TENDL-2015, AKONING
Neutron emission for fission

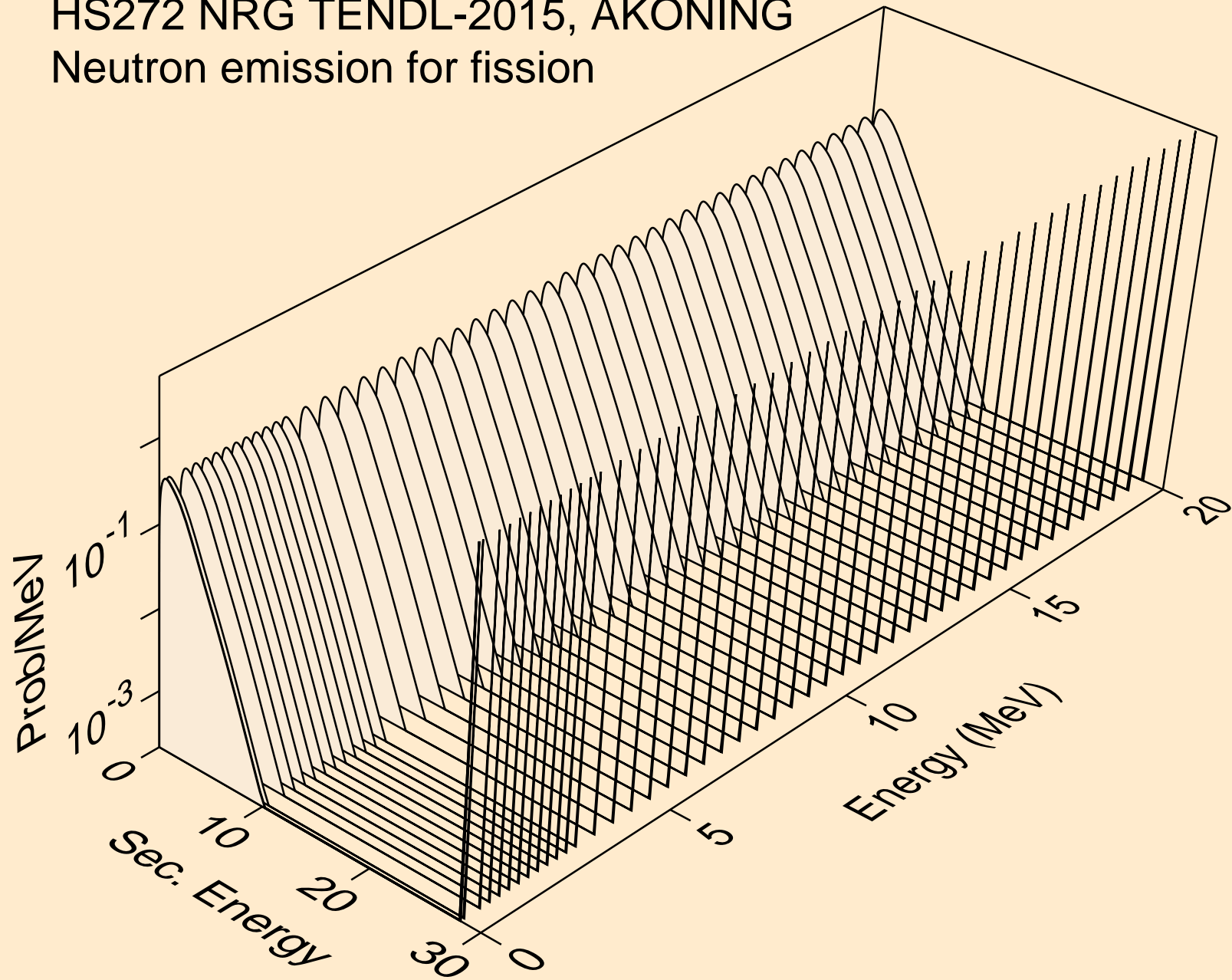

HS272 NRG TENDL-2015, AKONING
Neutron emission for (n,n*)a

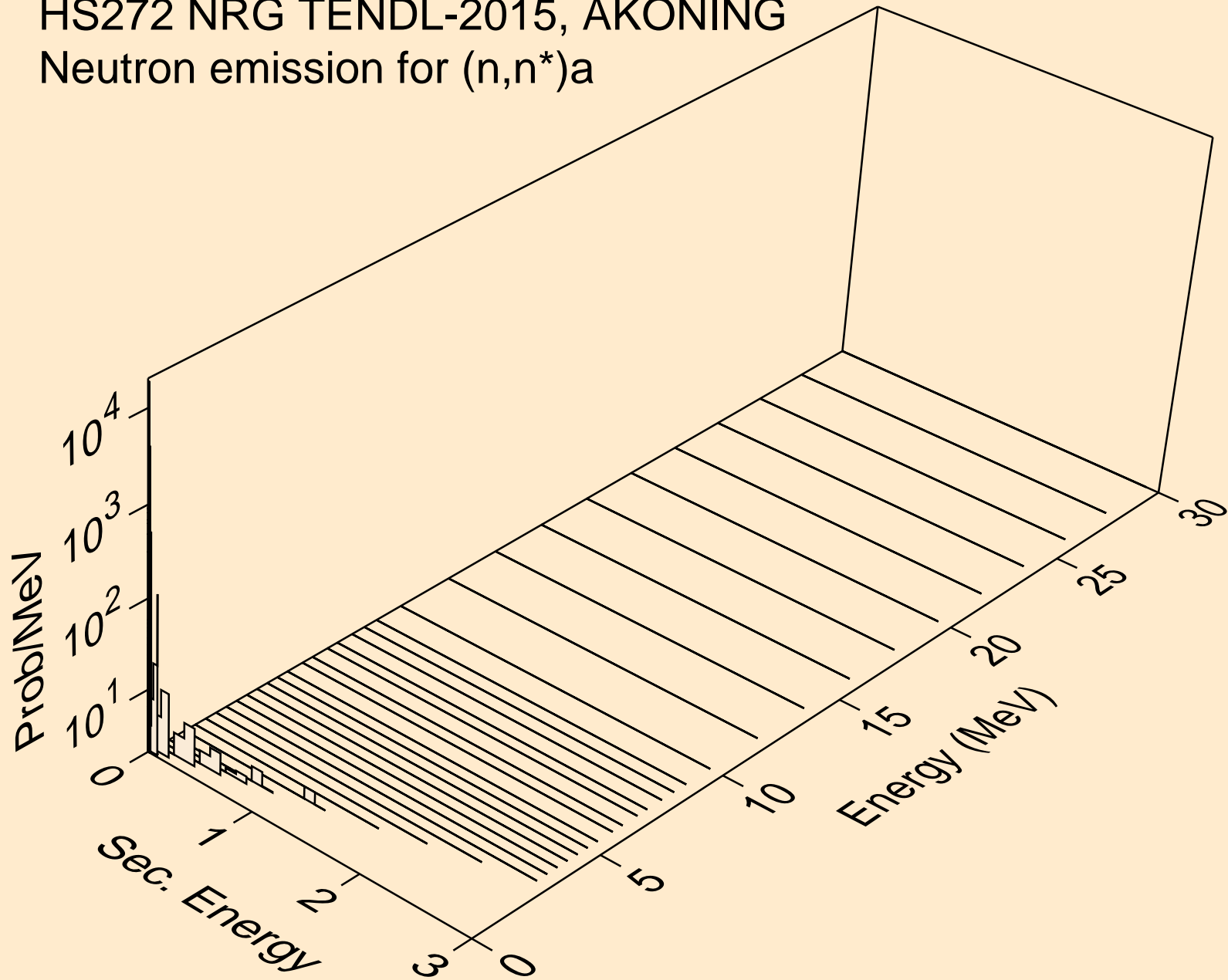

HS272 NRG TENDL-2015, AKONING
Neutron emission for (n,n*)3a

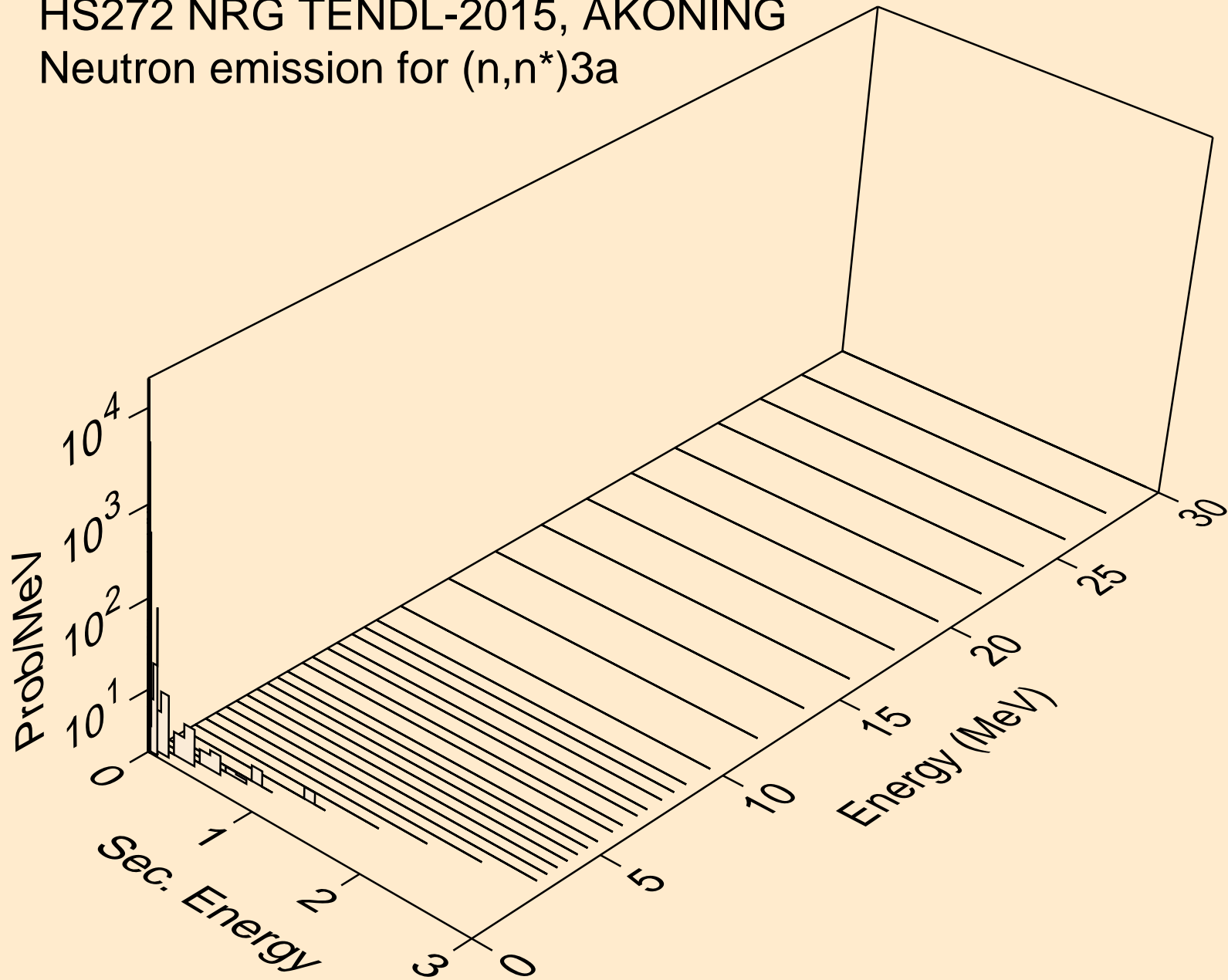

HS272 NRG TENDL-2015, AKONING
Neutron emission for (n,2n)a

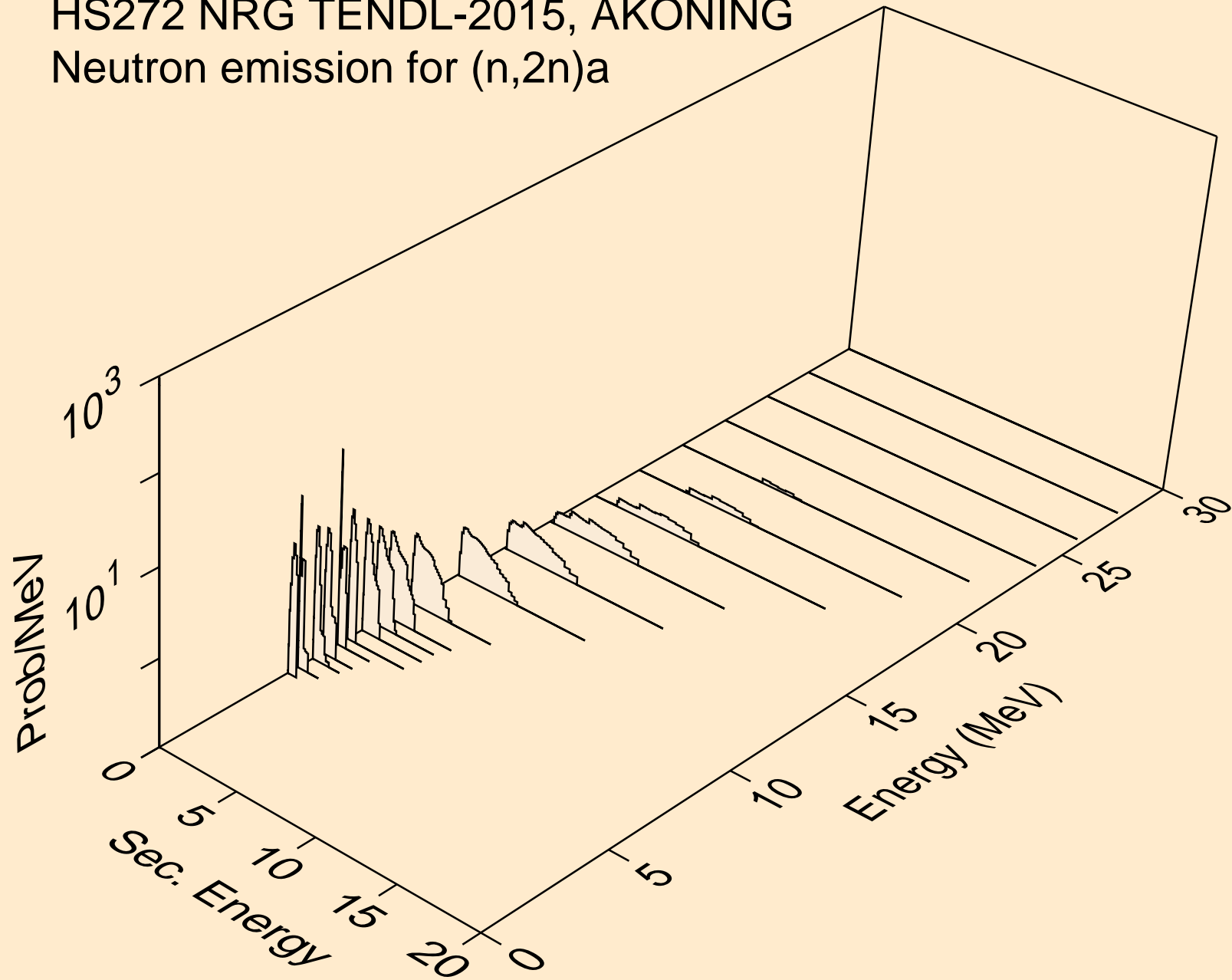

HS272 NRG TENDL-2015, AKONING
Neutron emission for (n,3n)a

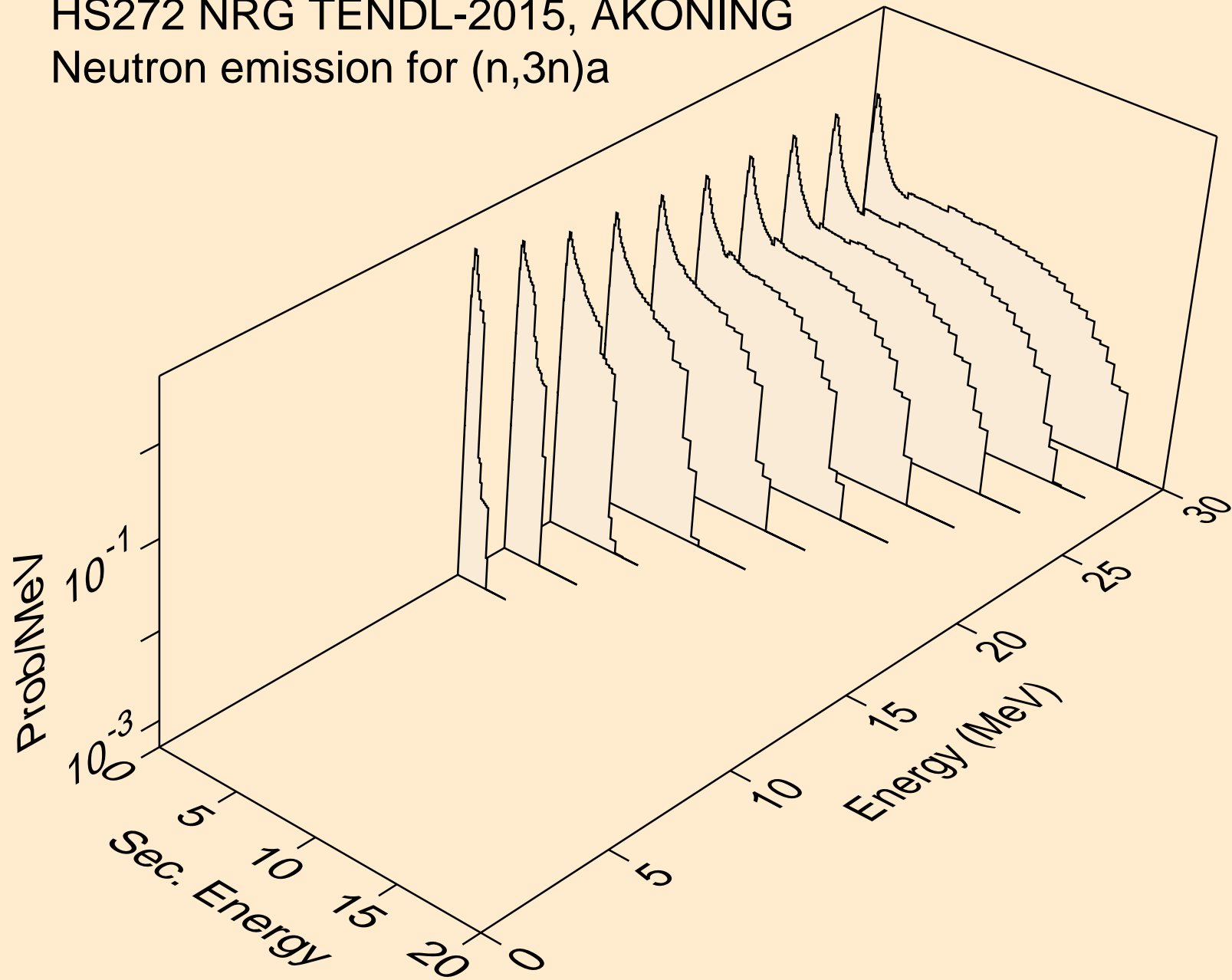

HS272 NRG TENDL-2015, AKONING
Neutron emission for (n,n*)p

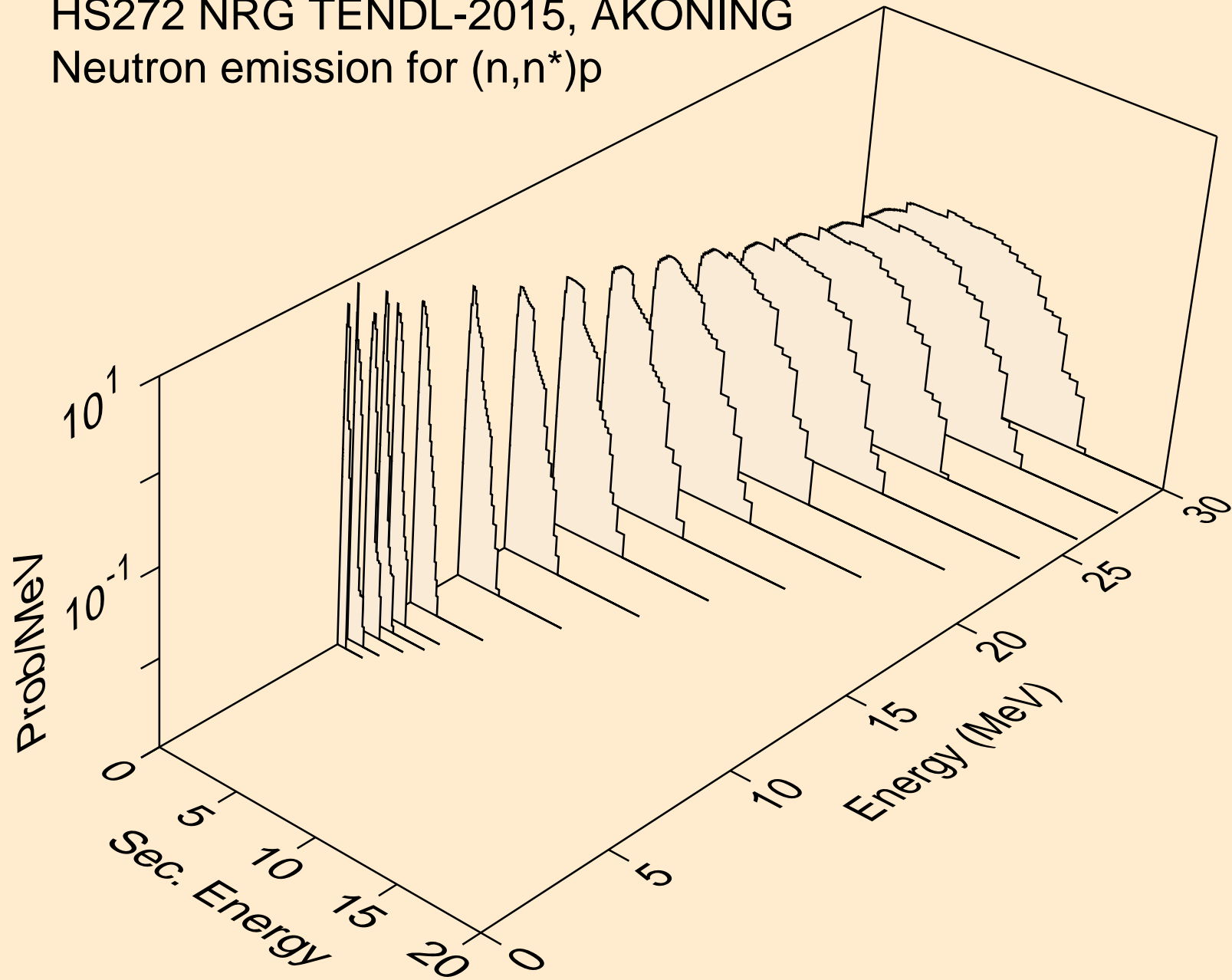

HS272 NRG TENDL-2015, AKONING
Neutron emission for (n,n*)2a

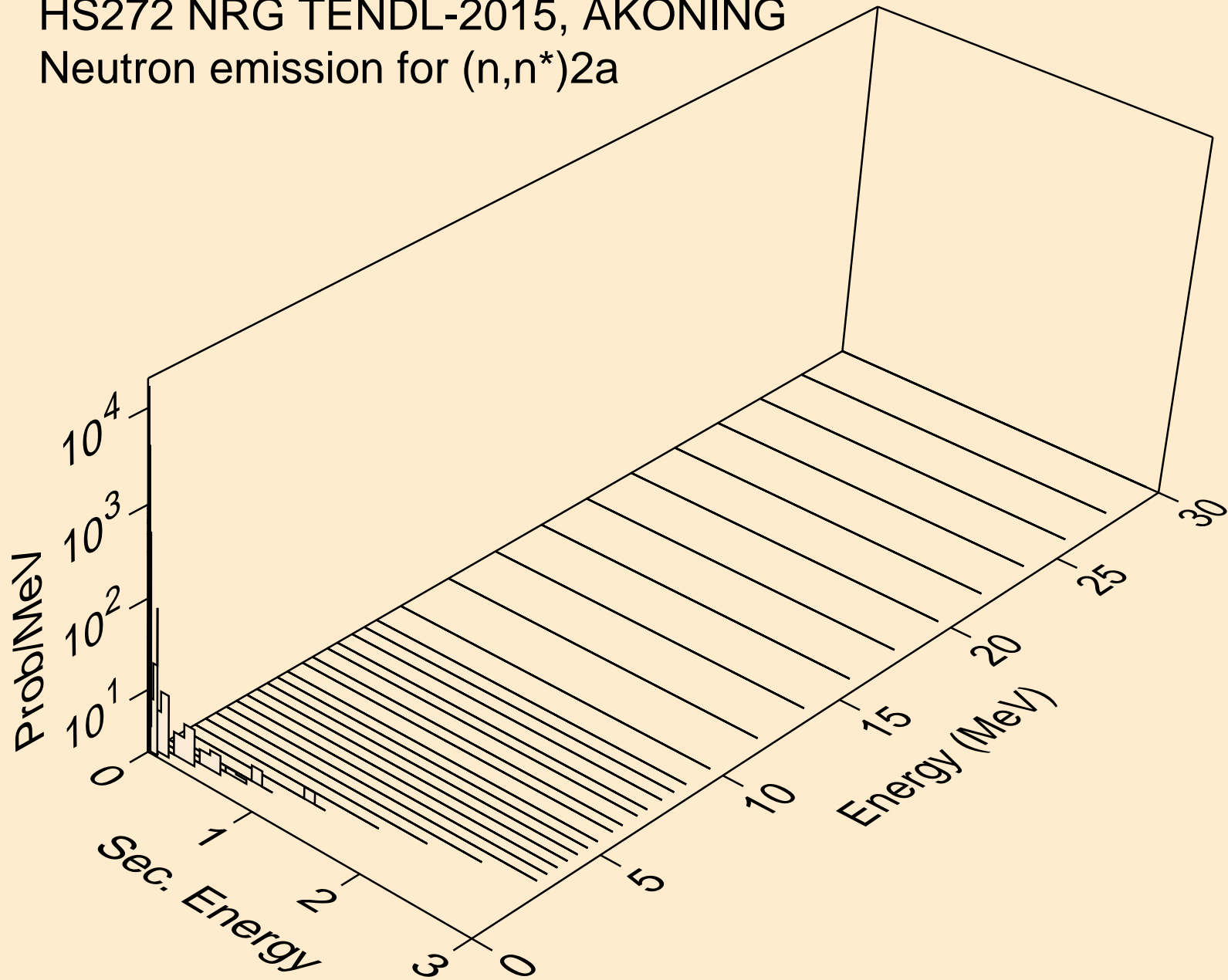

HS272 NRG TENDL-2015, AKONING
Neutron emission for (n,2n)2a

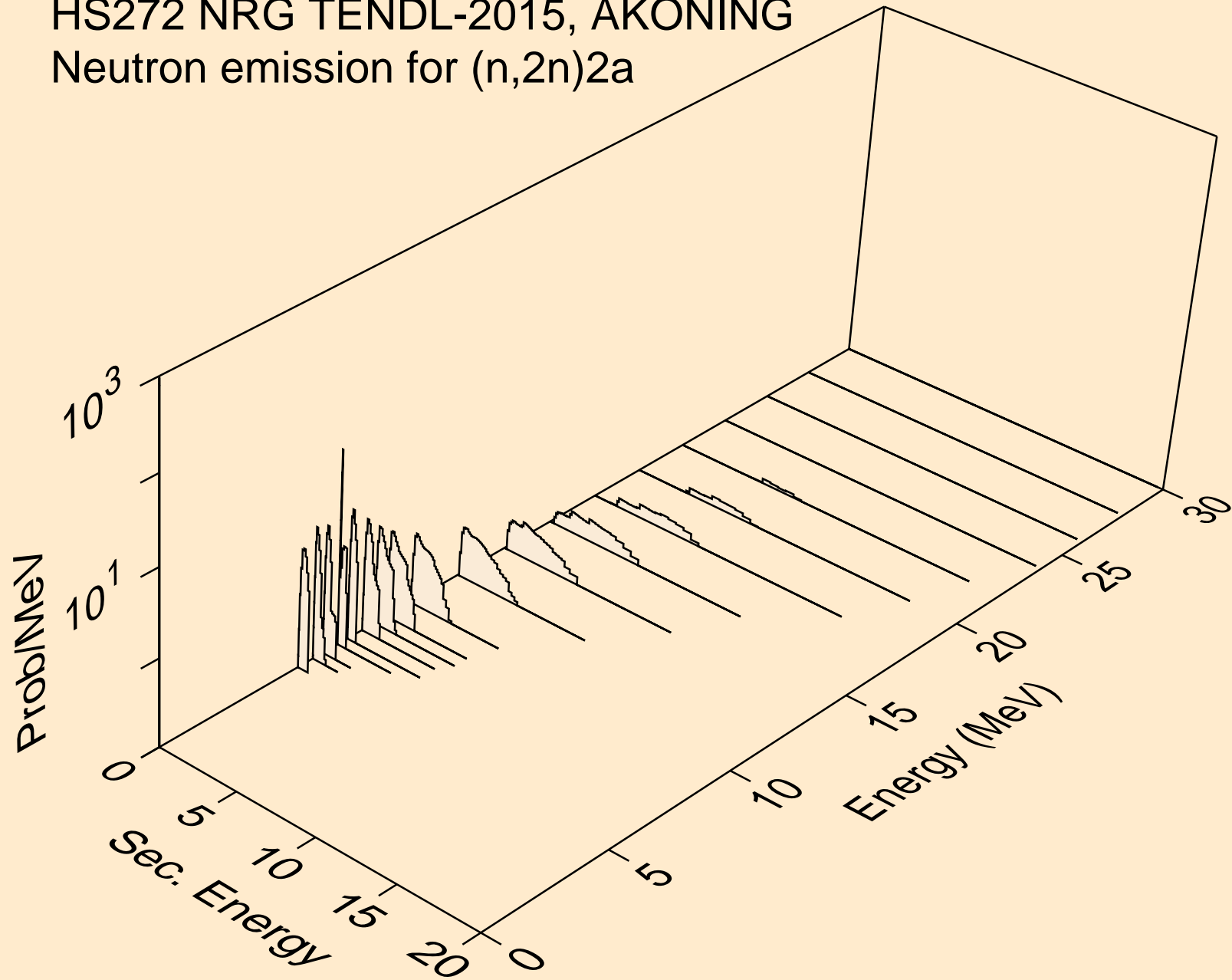

HS272 NRG TENDL-2015, AKONING
Neutron emission for (n,n*)d

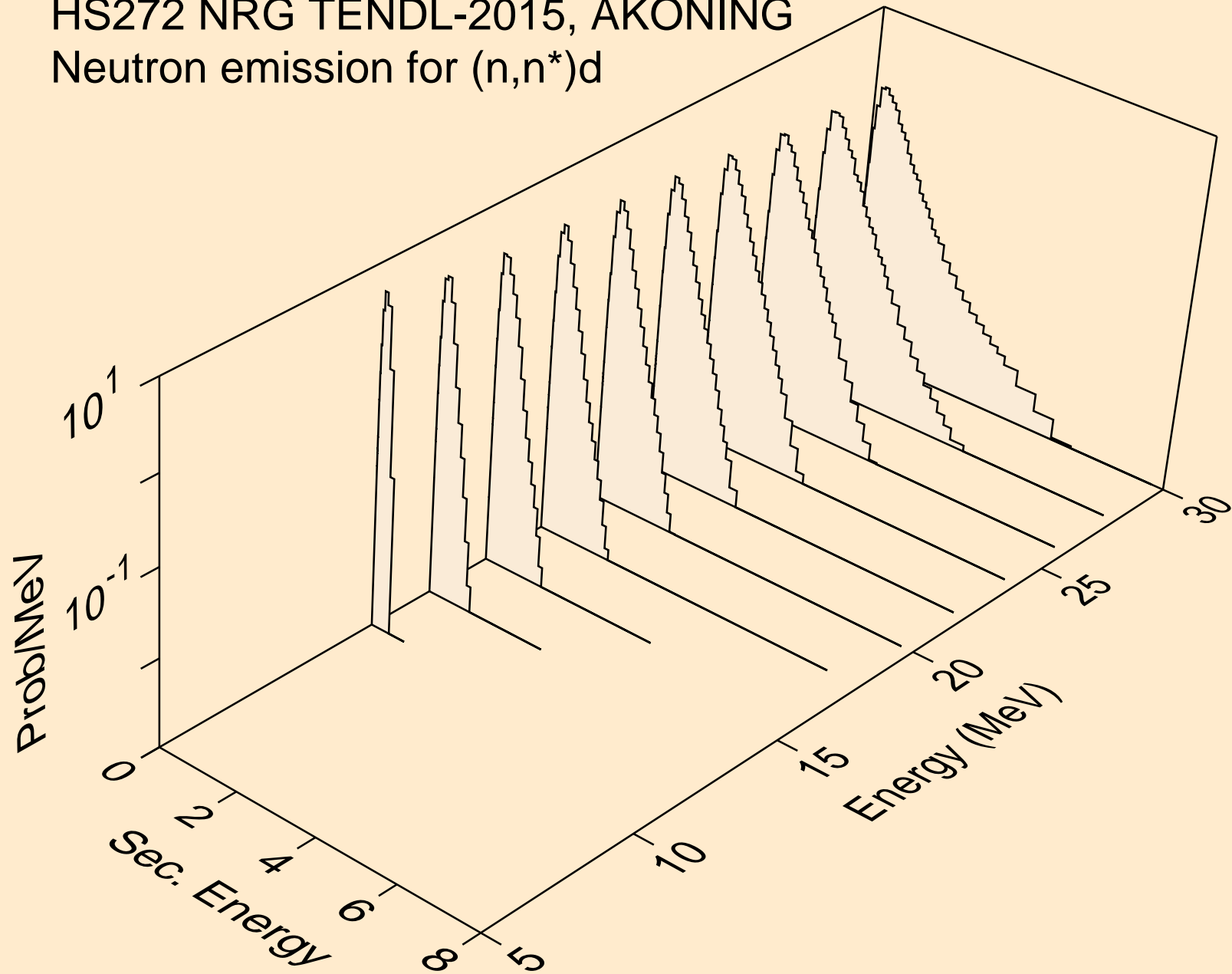

HS272 NRG TENDL-2015, AKONING
Neutron emission for (n,n*)t

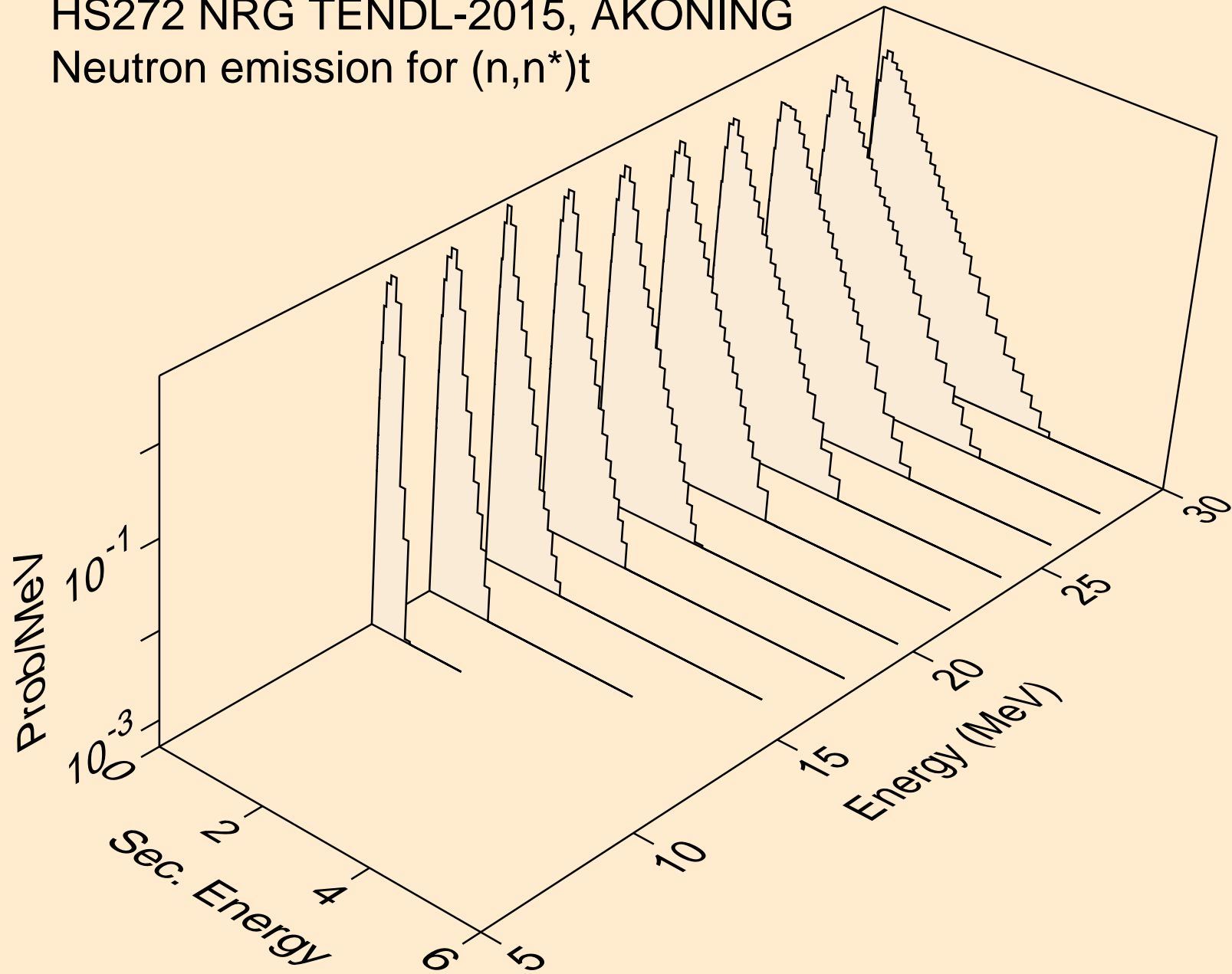

HS272 NRG TENDL-2015, AKONING
Neutron emission for (n,n*)he3

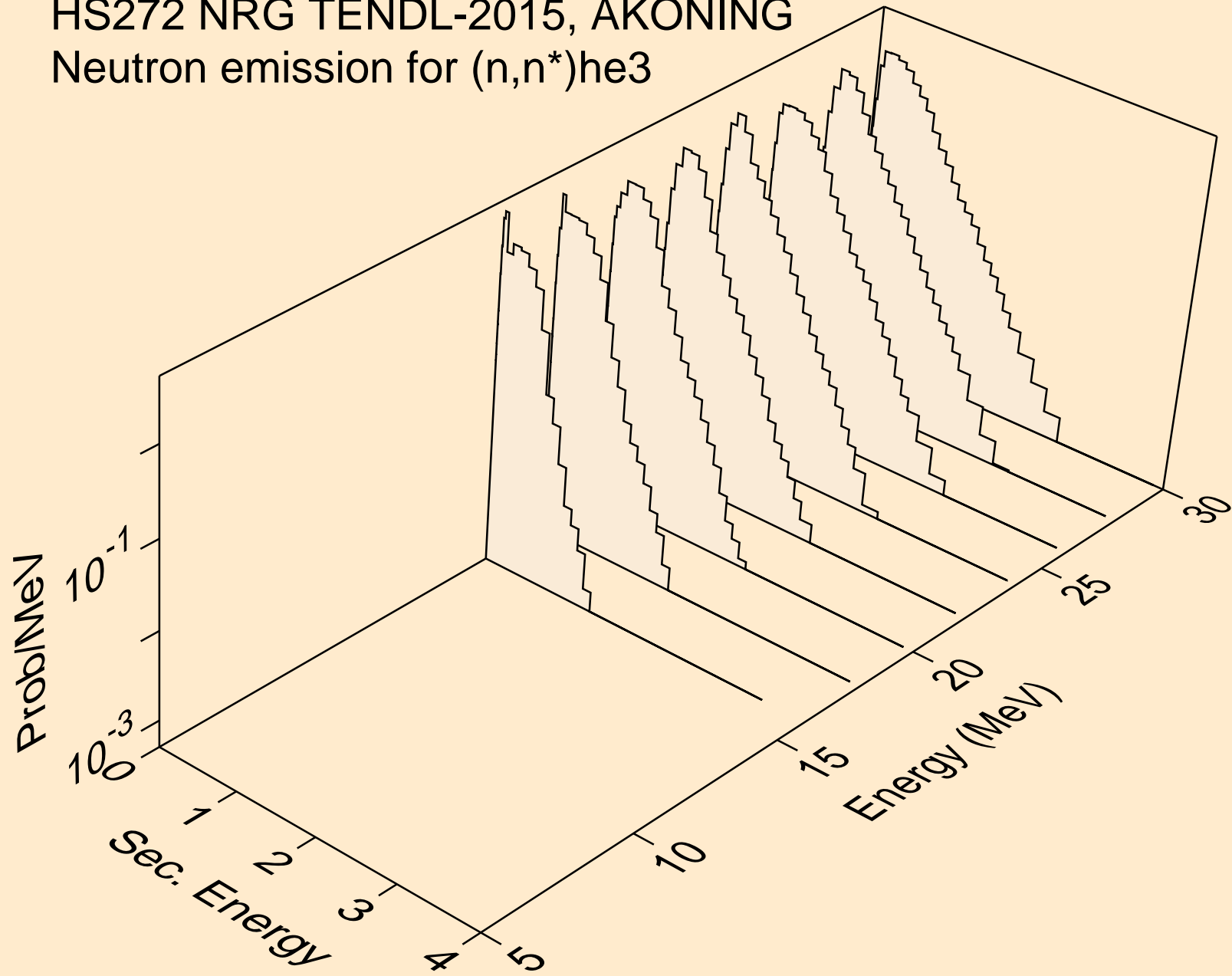

HS272 NRG TENDL-2015, AKONING
Neutron emission for (n,n*)d2a

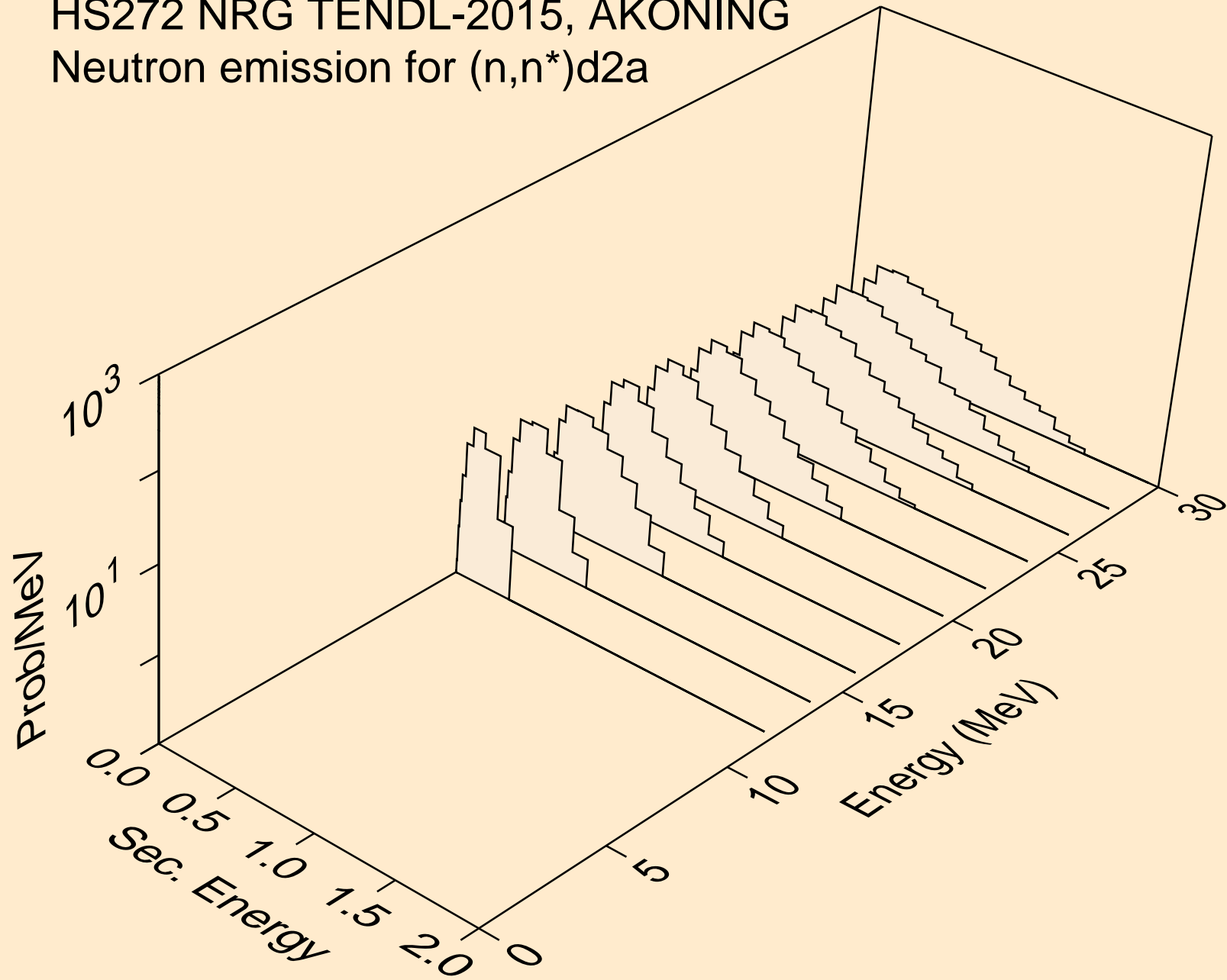

HS272 NRG TENDL-2015, AKONING
Neutron emission for (n,n*)t2a

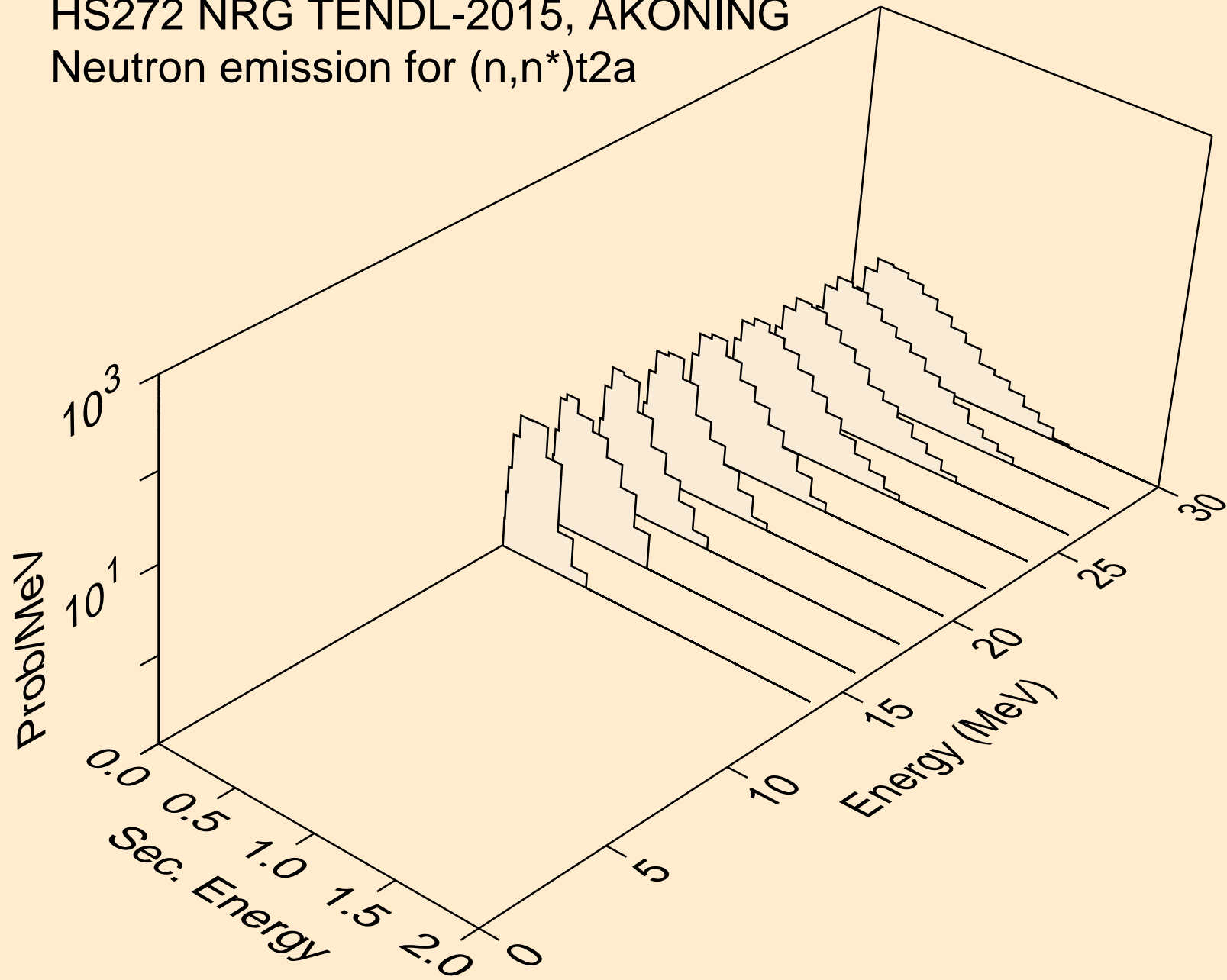

HS272 NRG TENDL-2015, AKONING
Neutron emission for (n,4n)

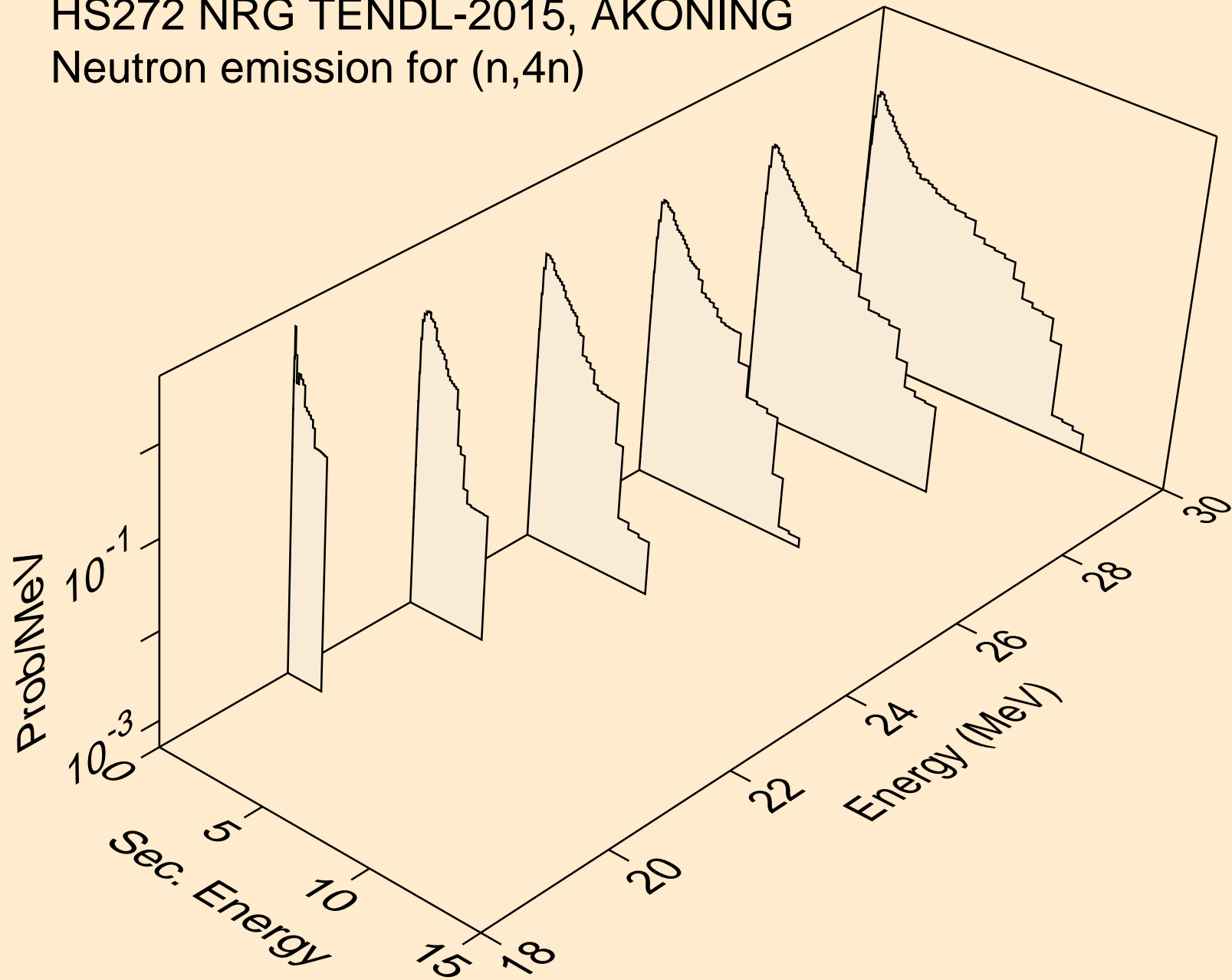

HS272 NRG TENDL-2015, AKONING
Neutron emission for (n,2np)

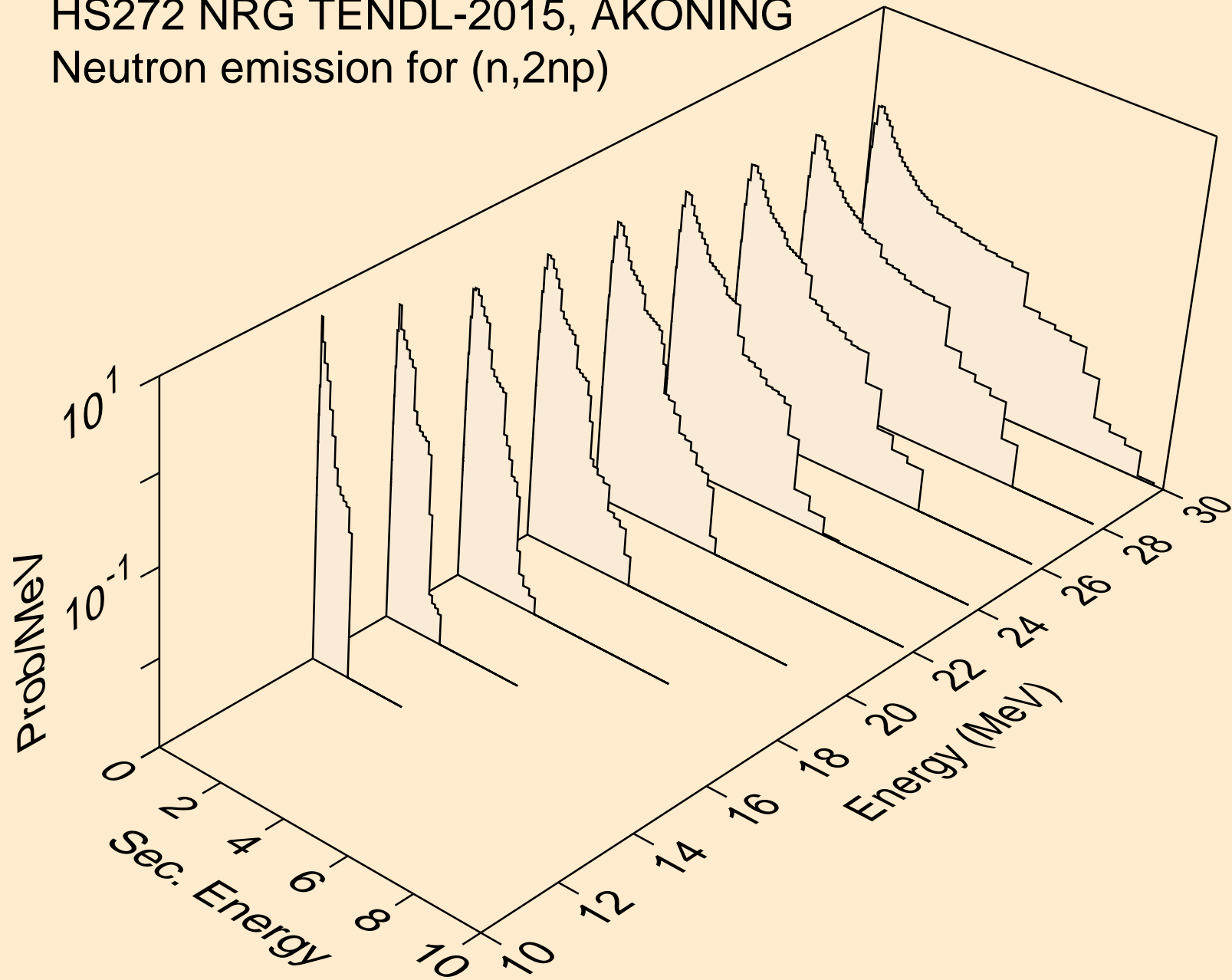

HS272 NRG TENDL-2015, AKONING
Neutron emission for (n,3np)

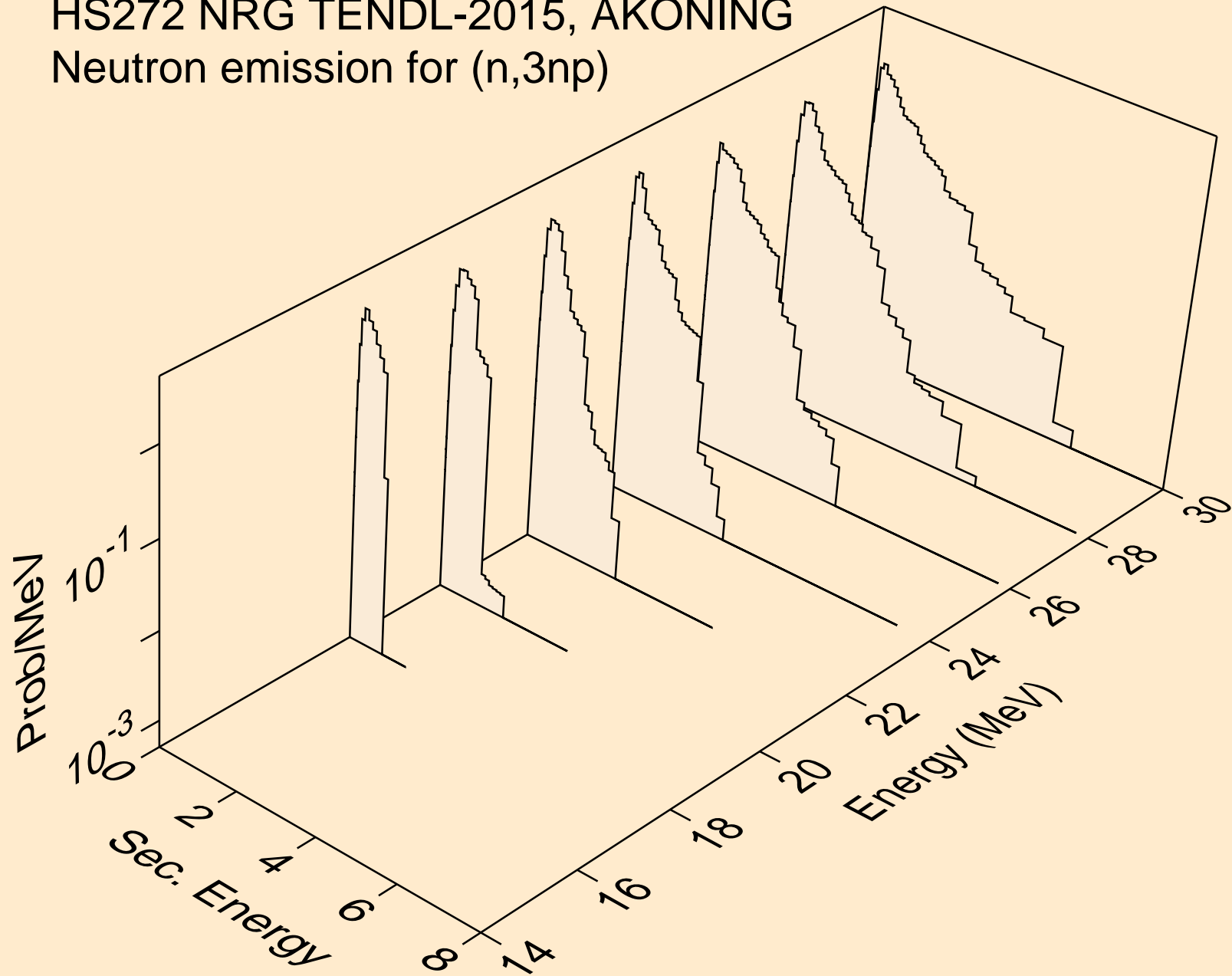

HS272 NRG TENDL-2015, AKONING
Neutron emission for (n,npa)

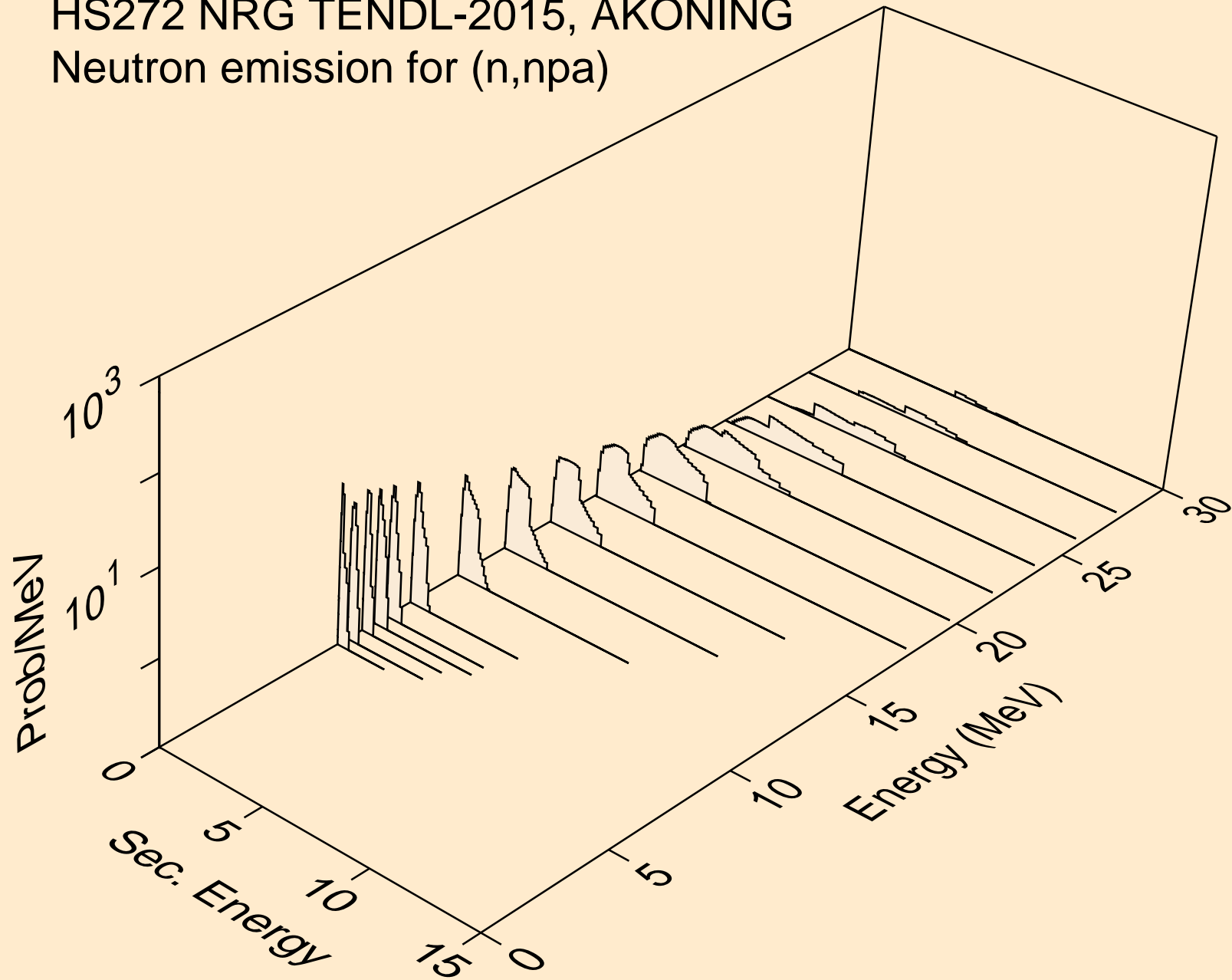

HS272 NRG TENDL-2015, AKONING
Neutron emission for (n,n*c)

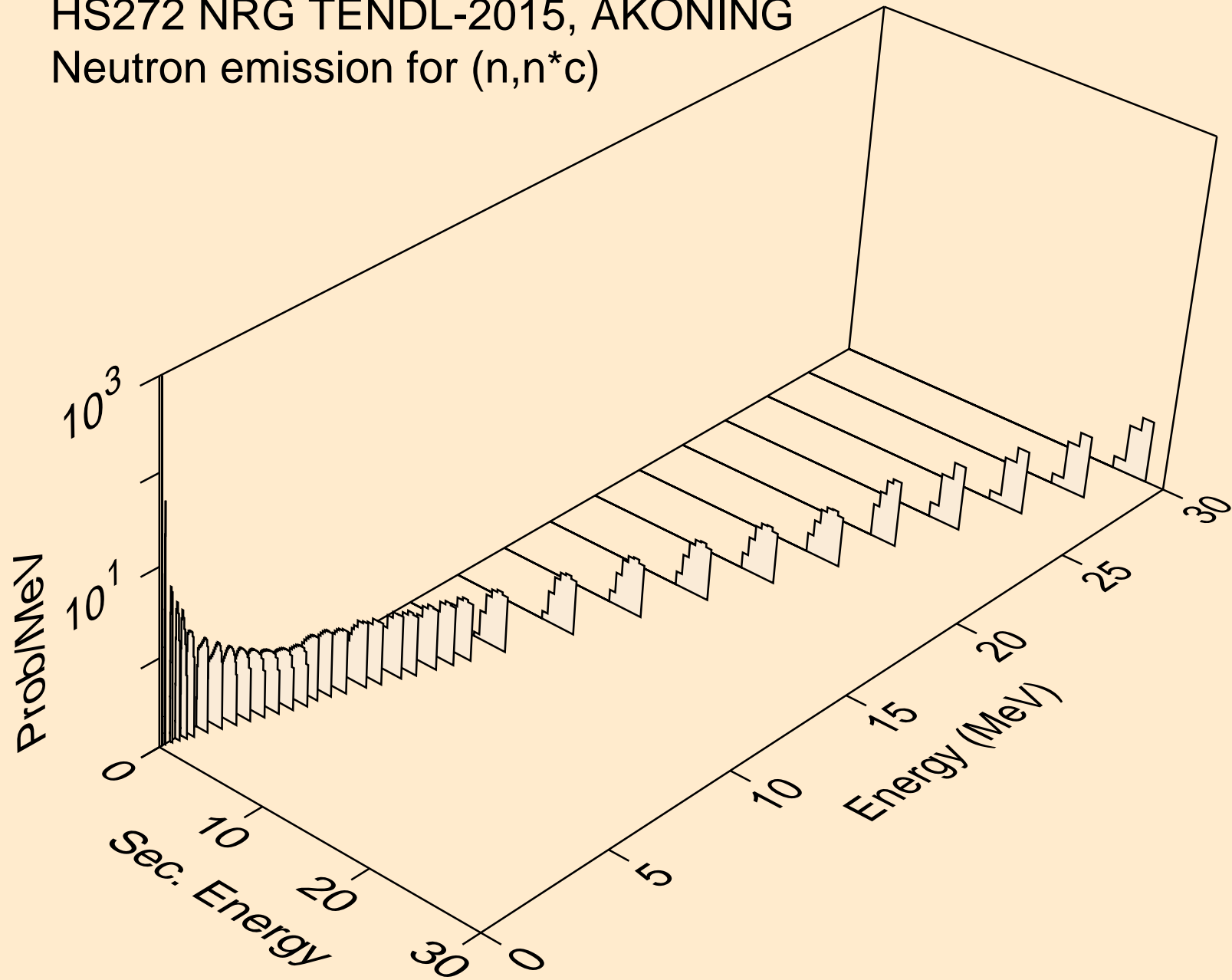

HS272 NRG TENDL-2015, AKONING

Delayed nubar

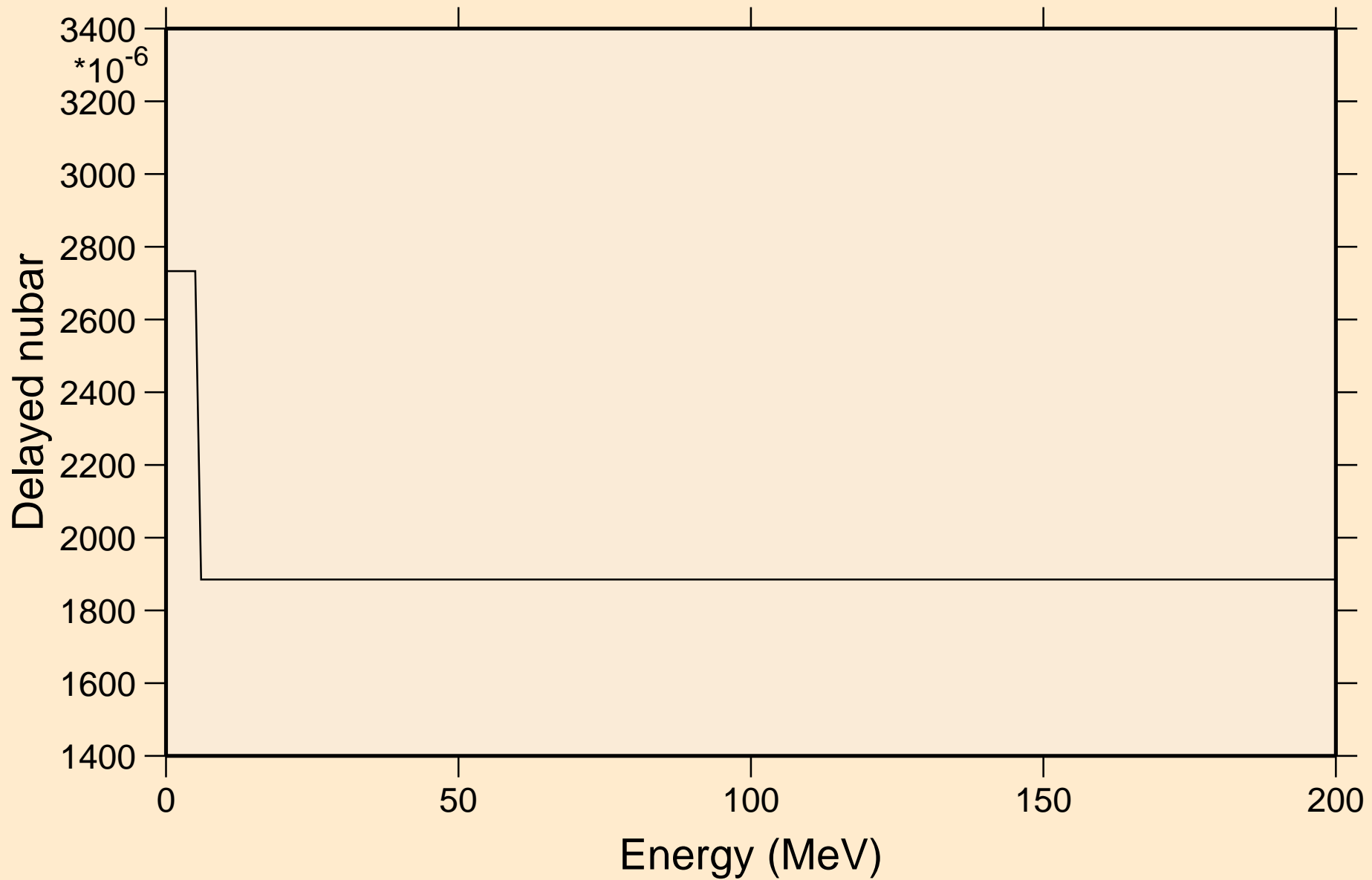

HS272 NRG TENDL-2015, AKONING

Delayed neutron spectra

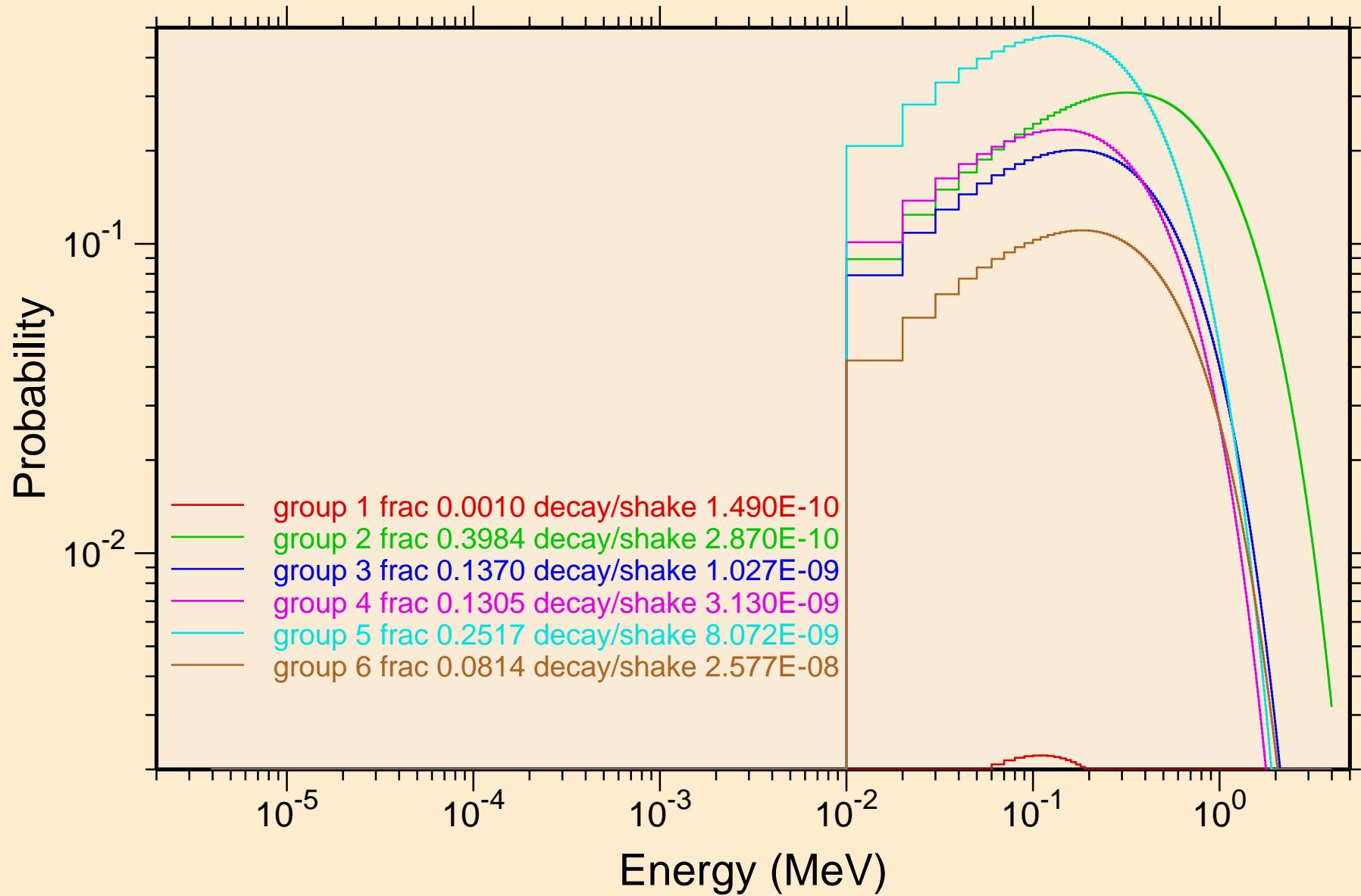

HS272 NRG TENDL-2015, AKONING
Photon emission for (n,x)

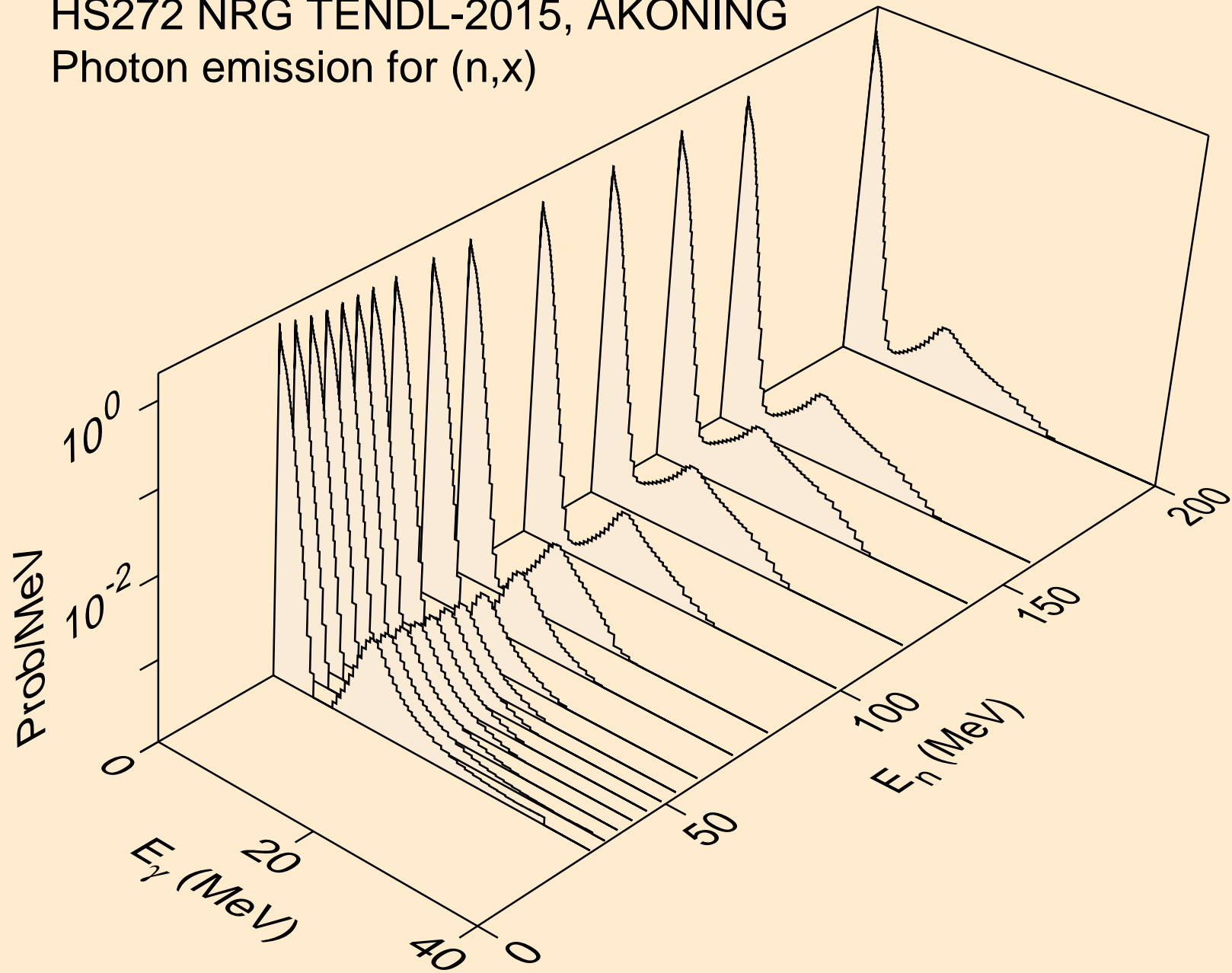

HS272 NRG TENDL-2015, AKONING
Photon emission for (n,2nd)

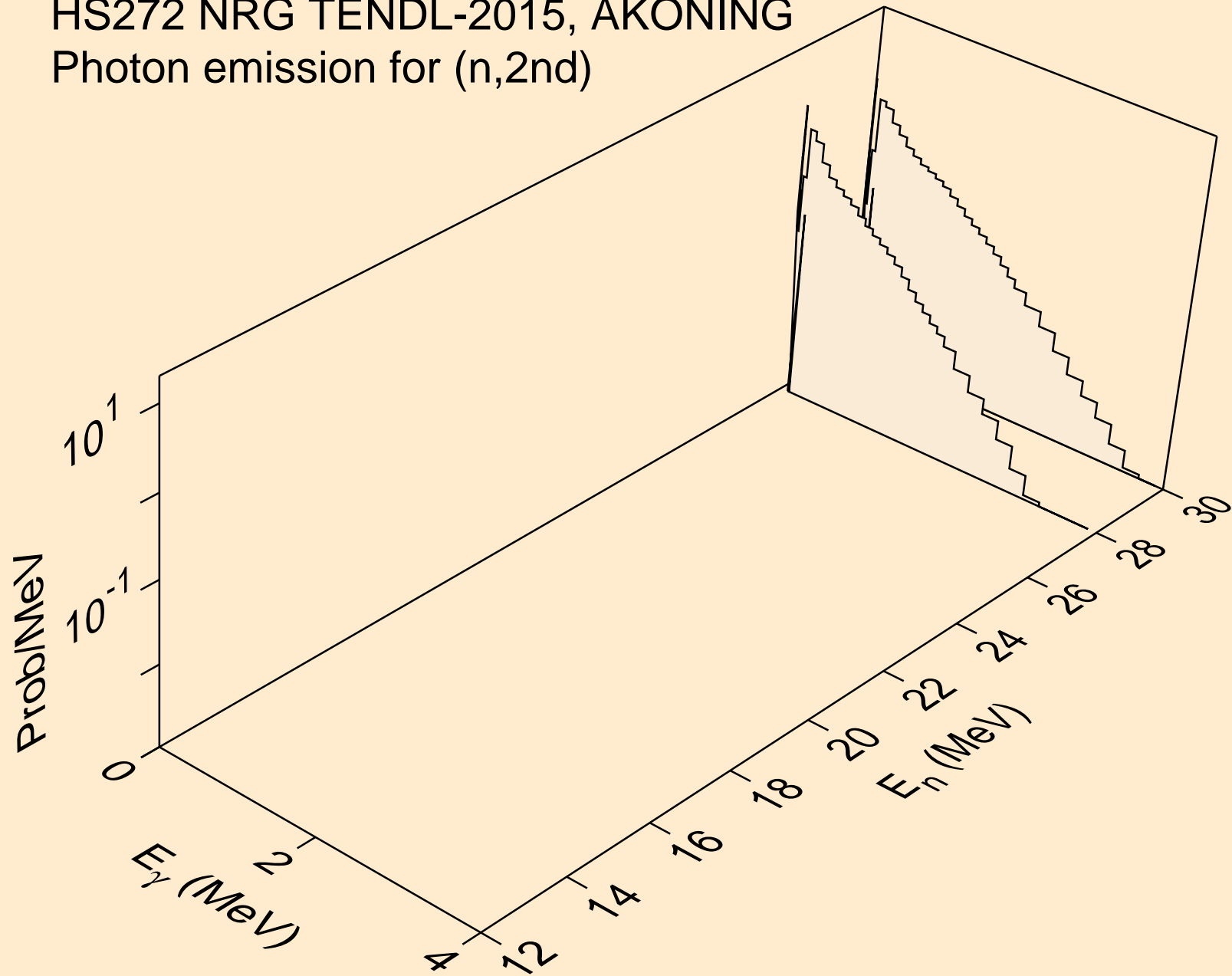

HS272 NRG TENDL-2015, AKONING
Photon emission for (n,2n)

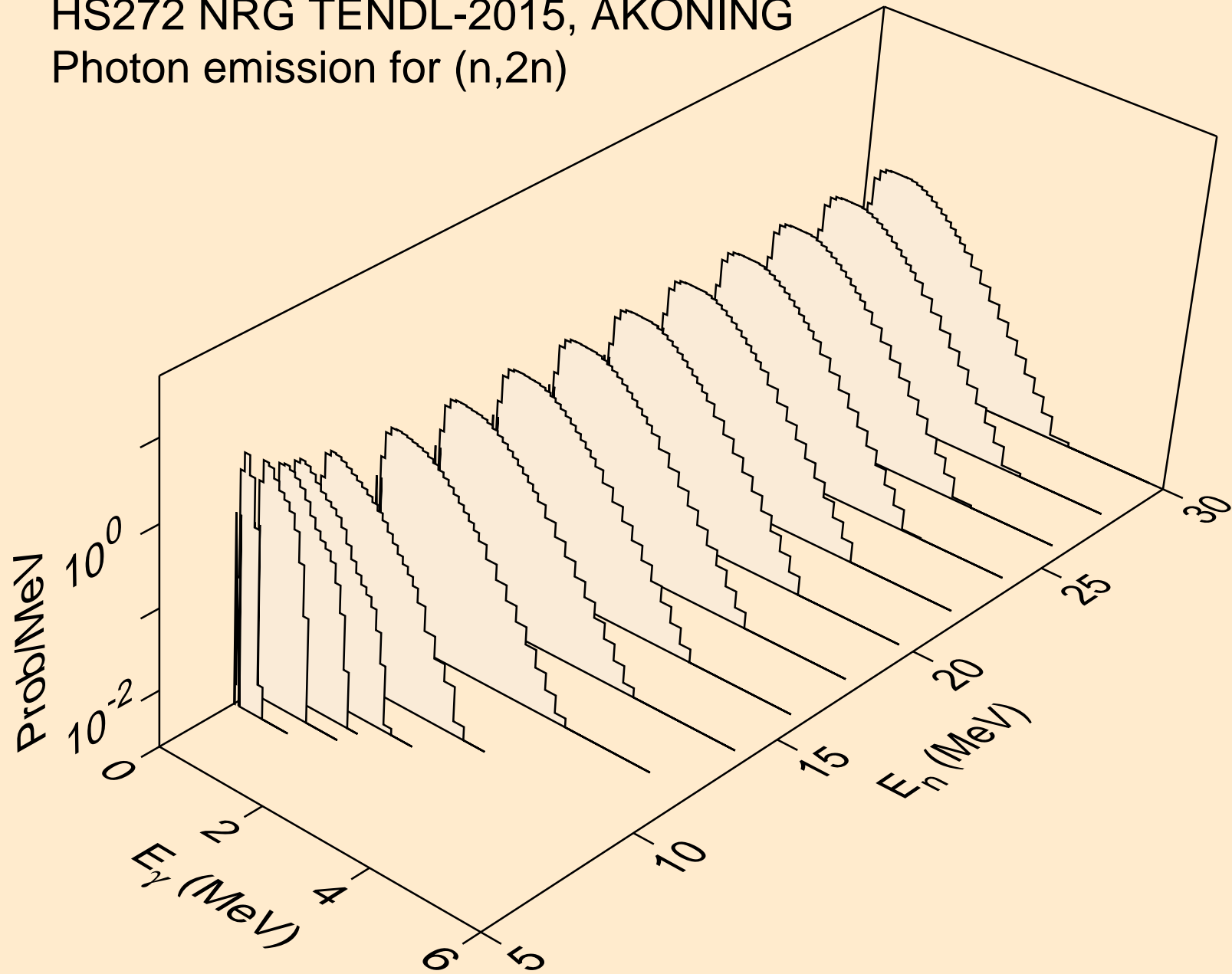

HS272 NRG TENDL-2015, AKONING
Photon emission for (n,3n)

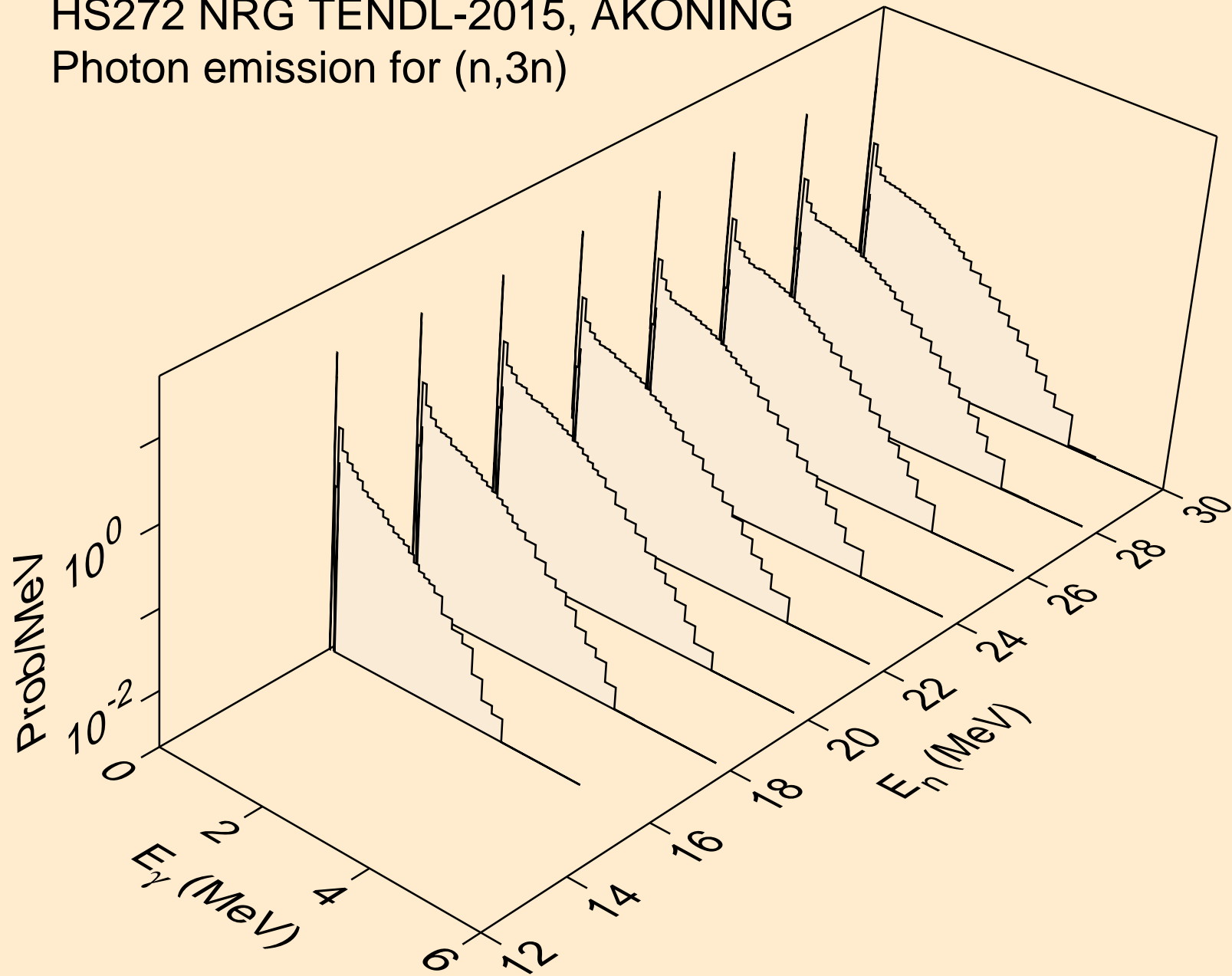

HS272 NRG TENDL-2015, AKONING
Photon emission for (n,n*)a

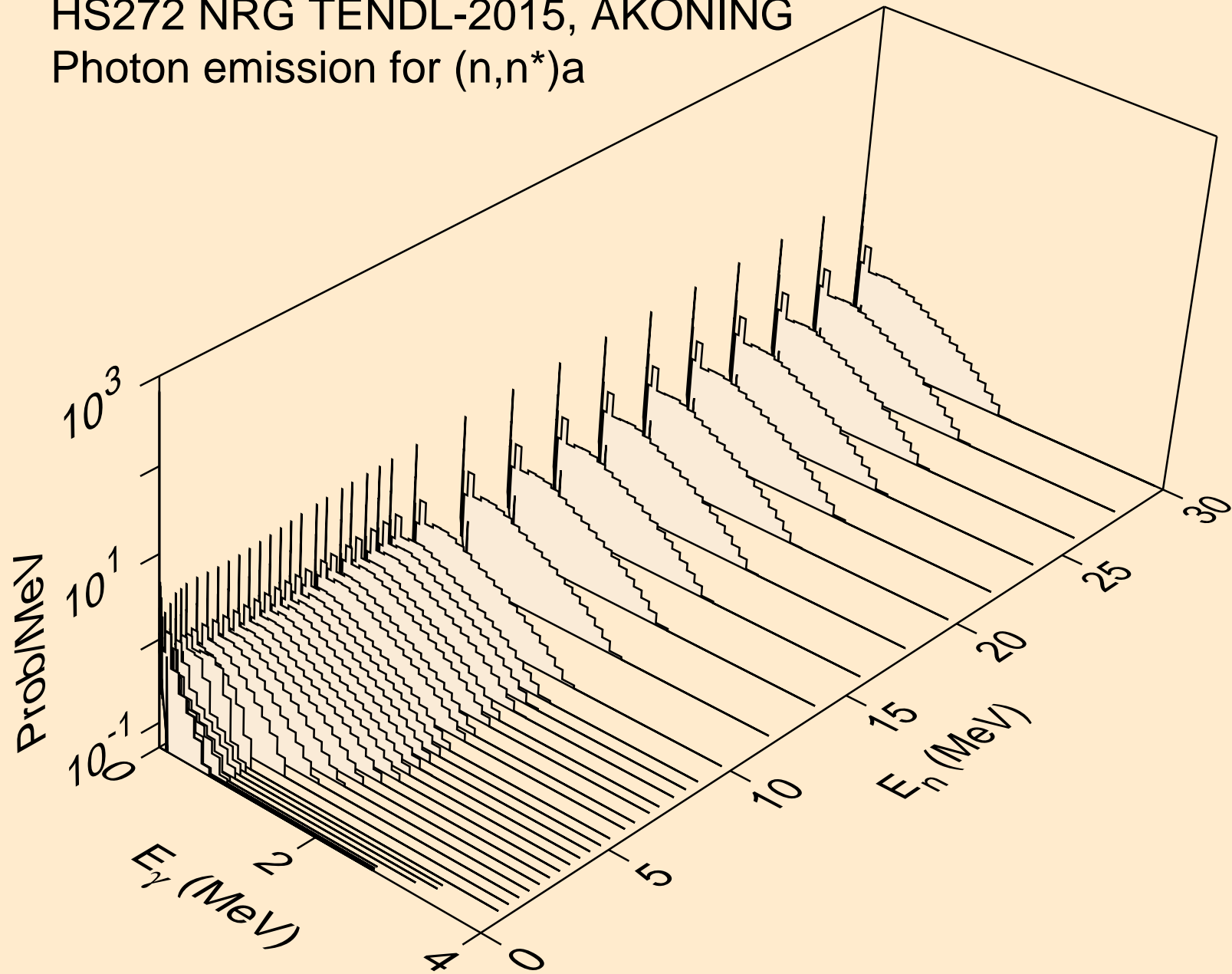

HS272 NRG TENDL-2015, AKONING
Photon emission for (n,n*)3a

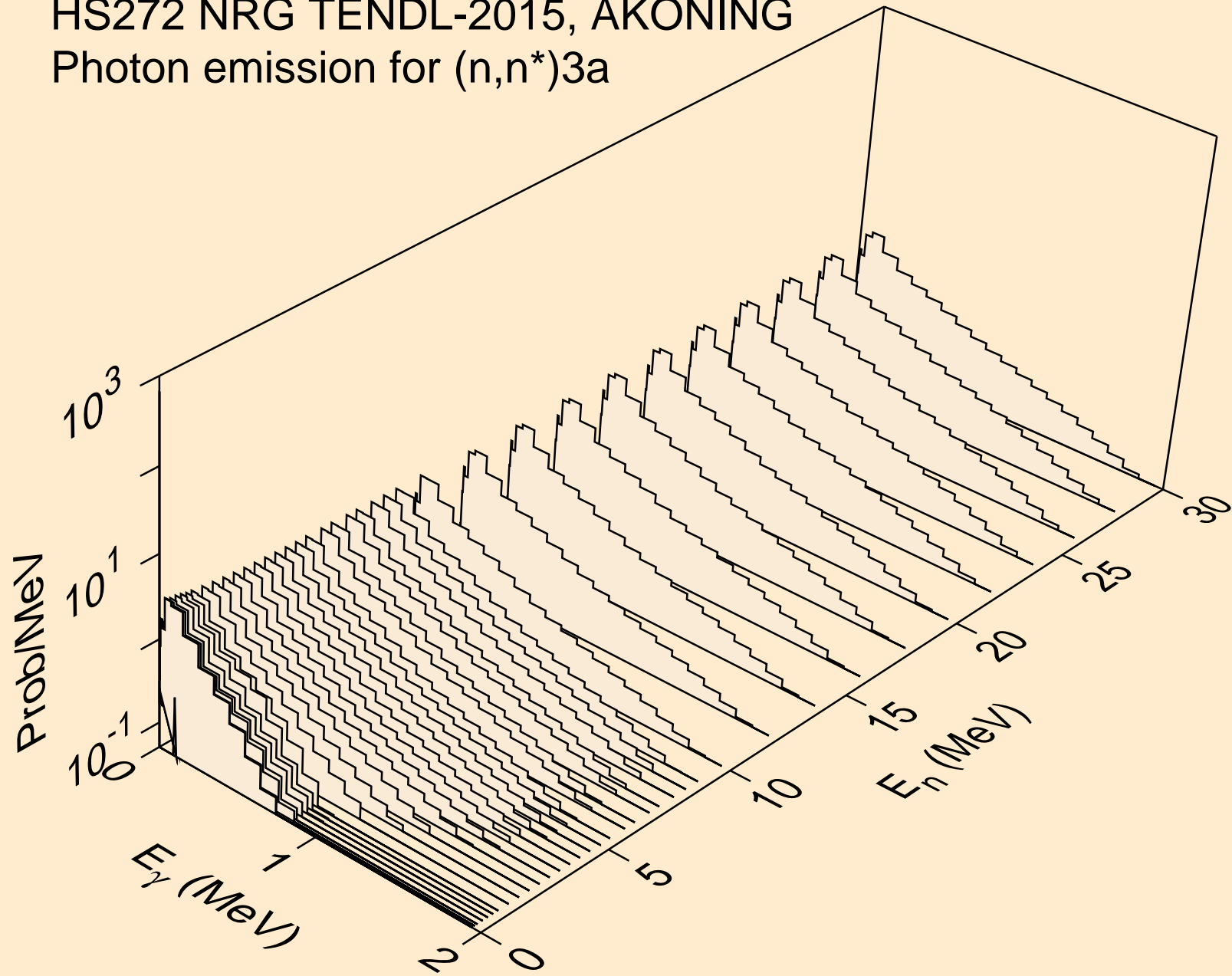

HS272 NRG TENDL-2015, AKONING
Photon emission for (n,2n)a

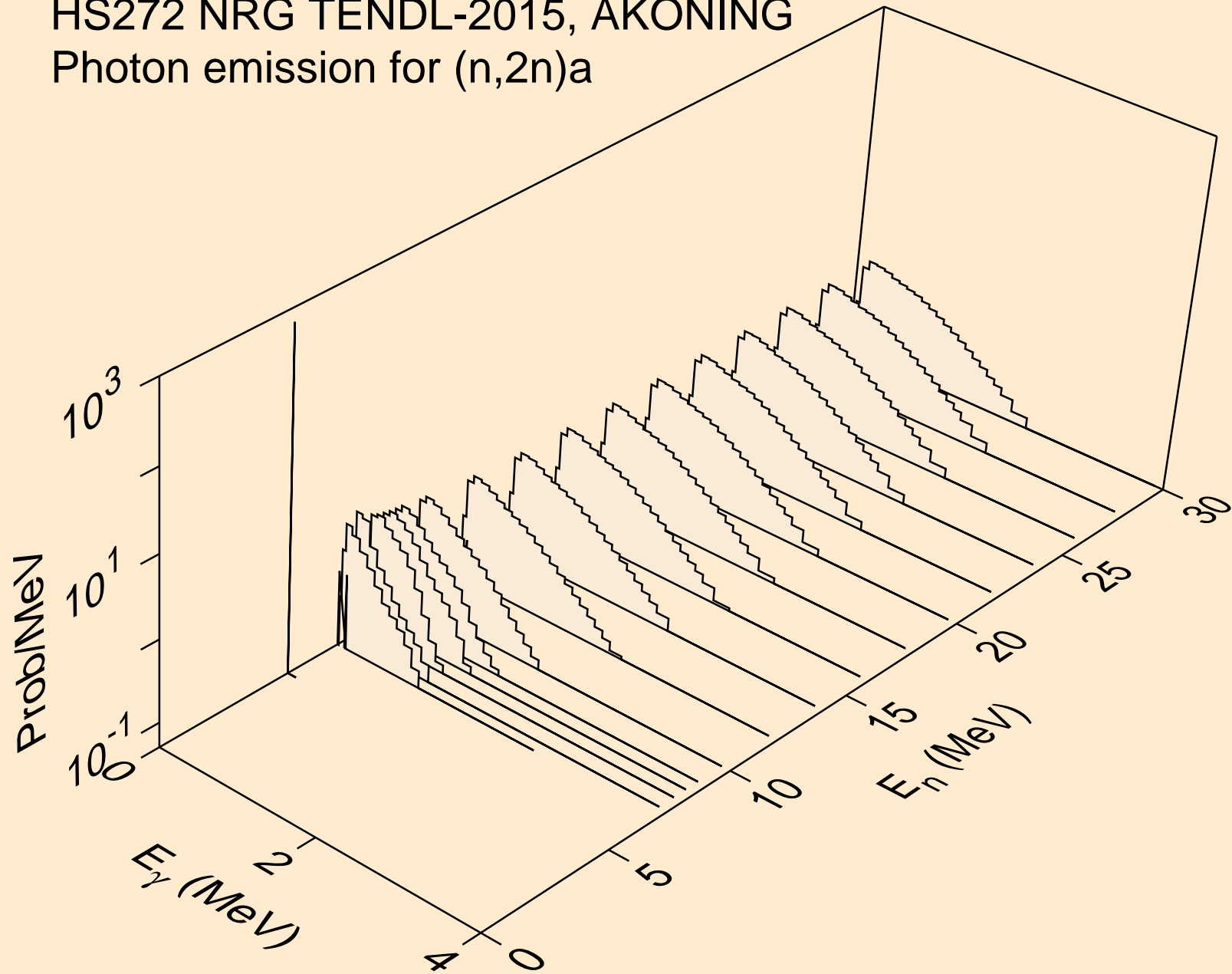

HS272 NRG TENDL-2015, AKONING
Photon emission for (n,3n)a

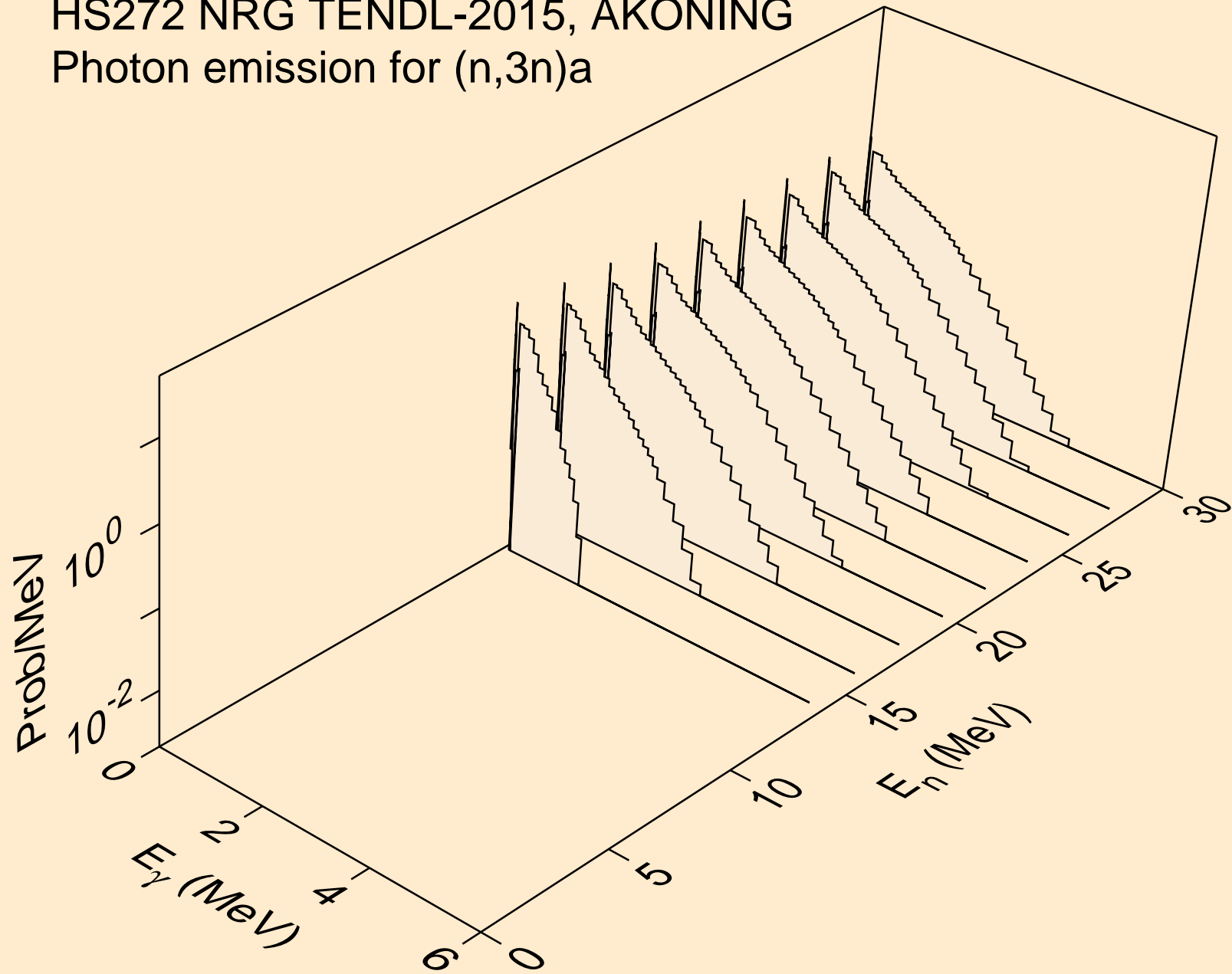

HS272 NRG TENDL-2015, AKONING
Photon emission for (n,n*)p

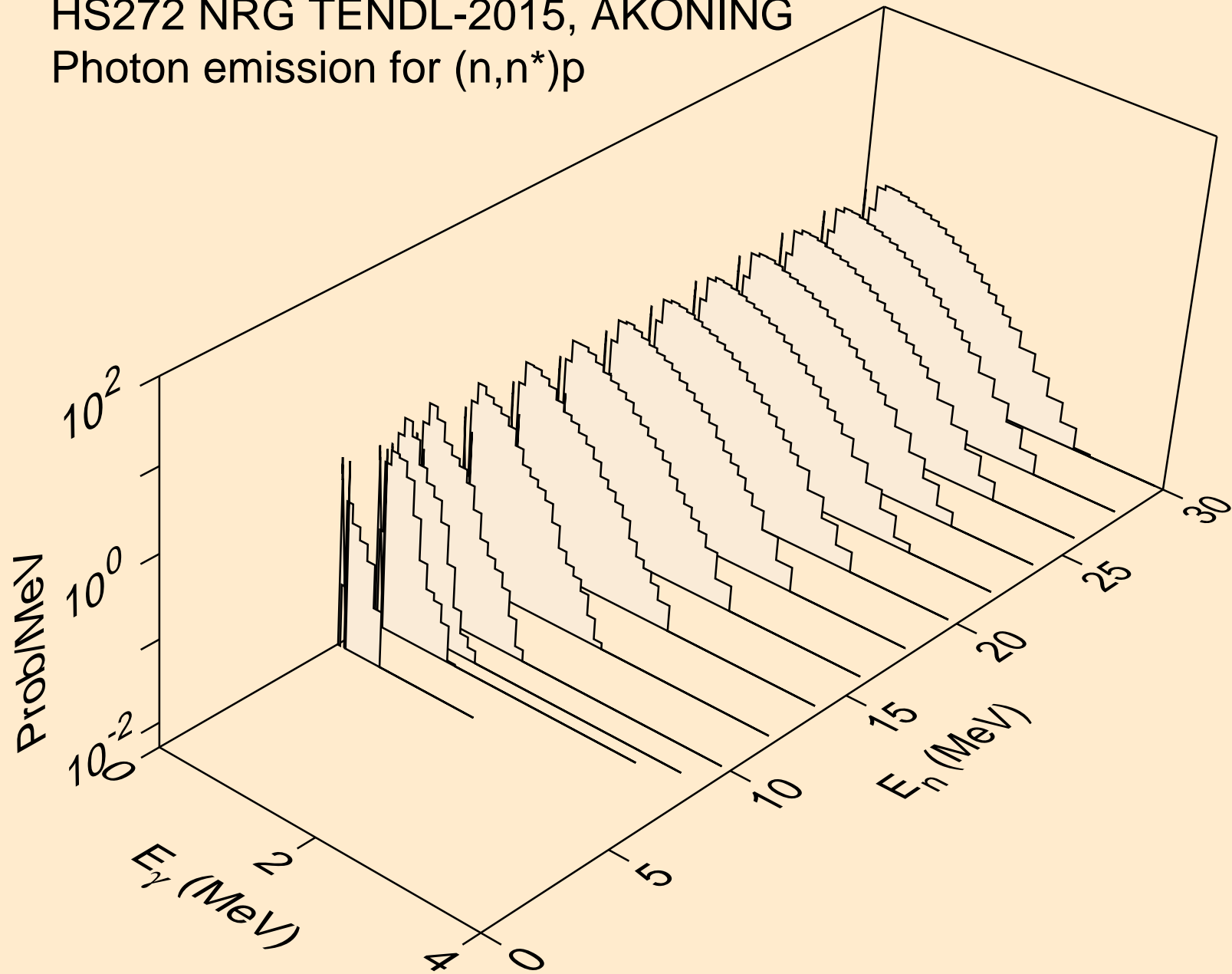

HS272 NRG TENDL-2015, AKONING
Photon emission for (n,n*)2a

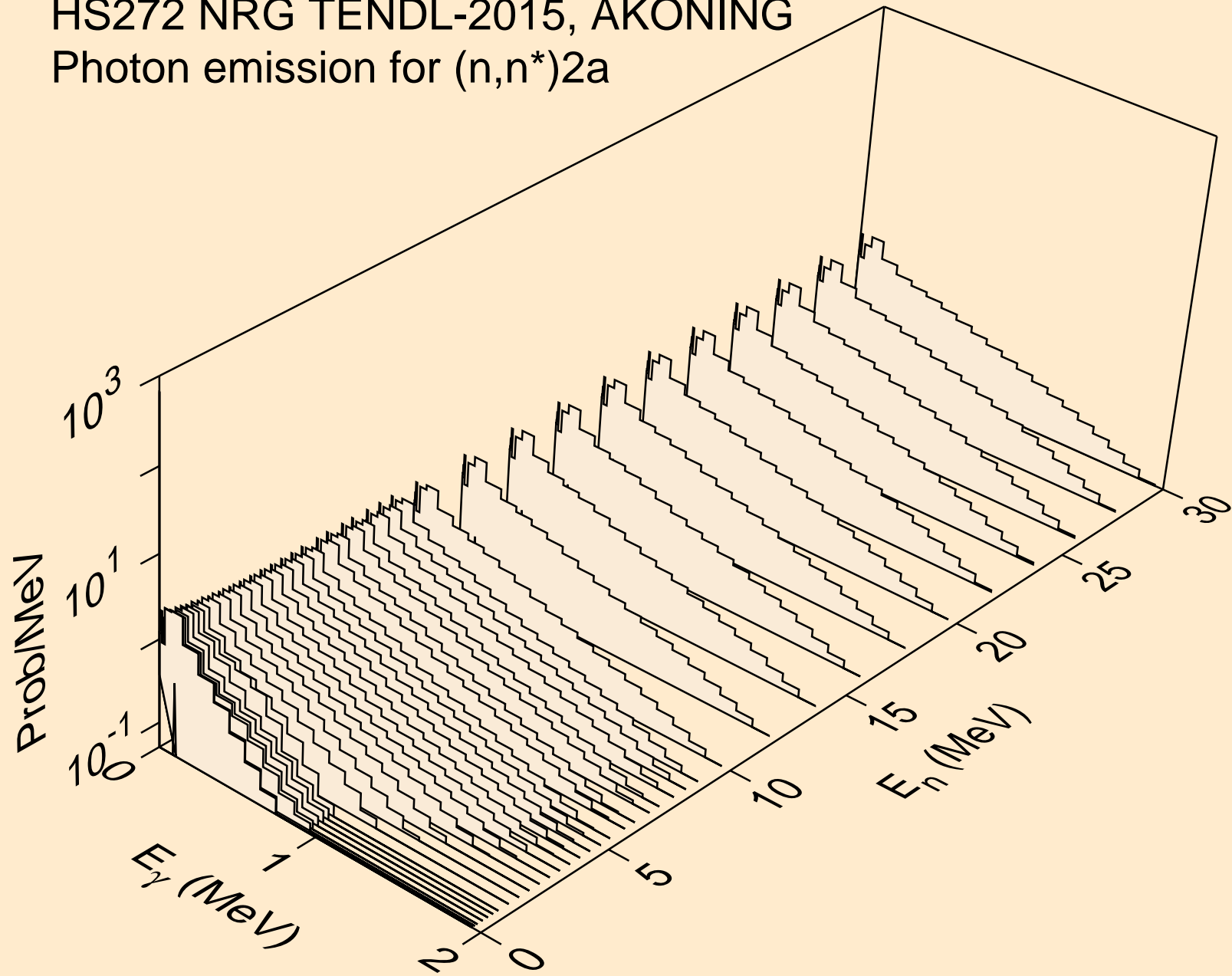

HS272 NRG TENDL-2015, AKONING
Photon emission for (n,2n)2a

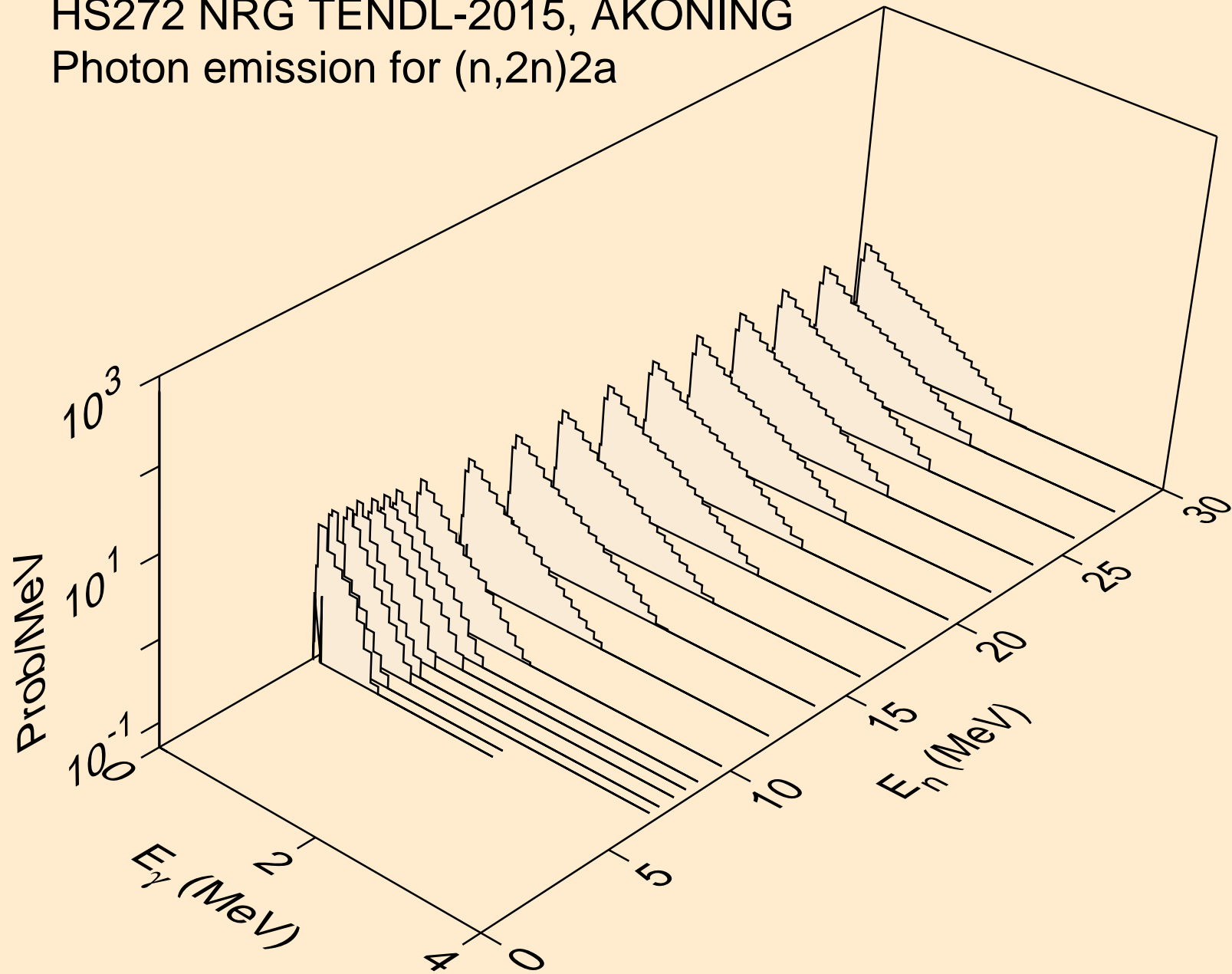

HS272 NRG TENDL-2015, AKONING
Photon emission for (n,n*)d

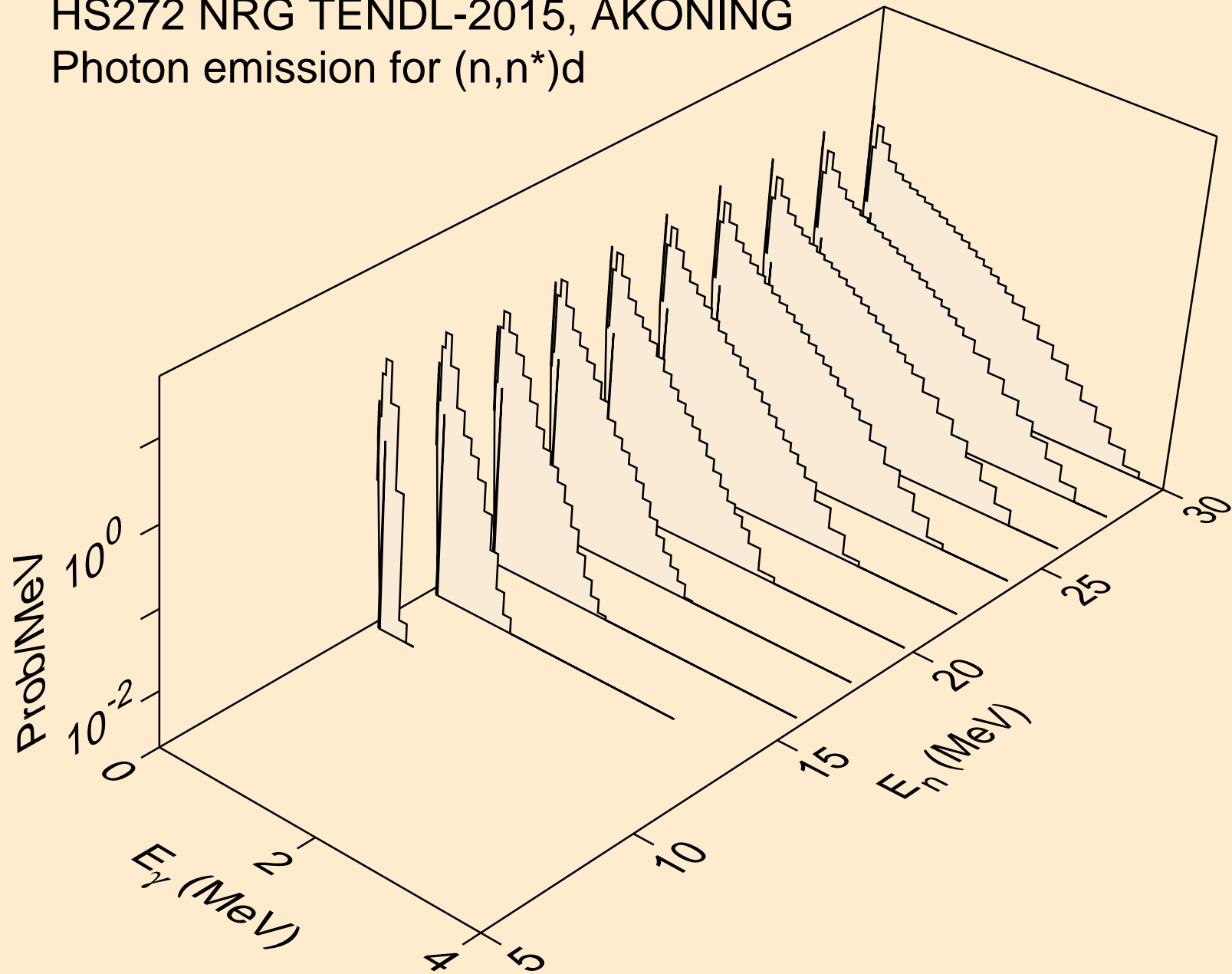

HS272 NRG TENDL-2015, AKONING
Photon emission for (n,n*)t

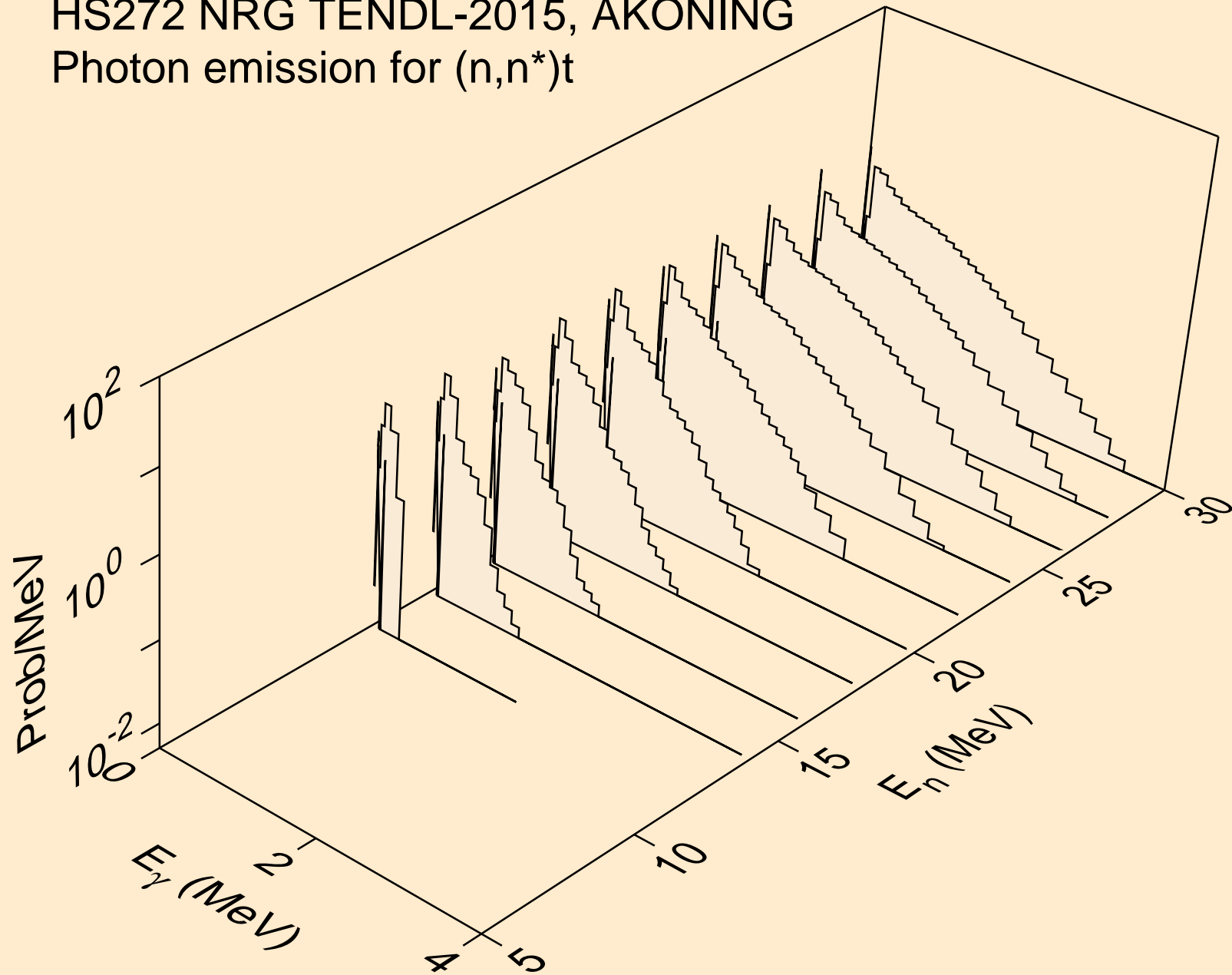

HS272 NRG TENDL-2015, AKONING
Photon emission for (n,n*)he3

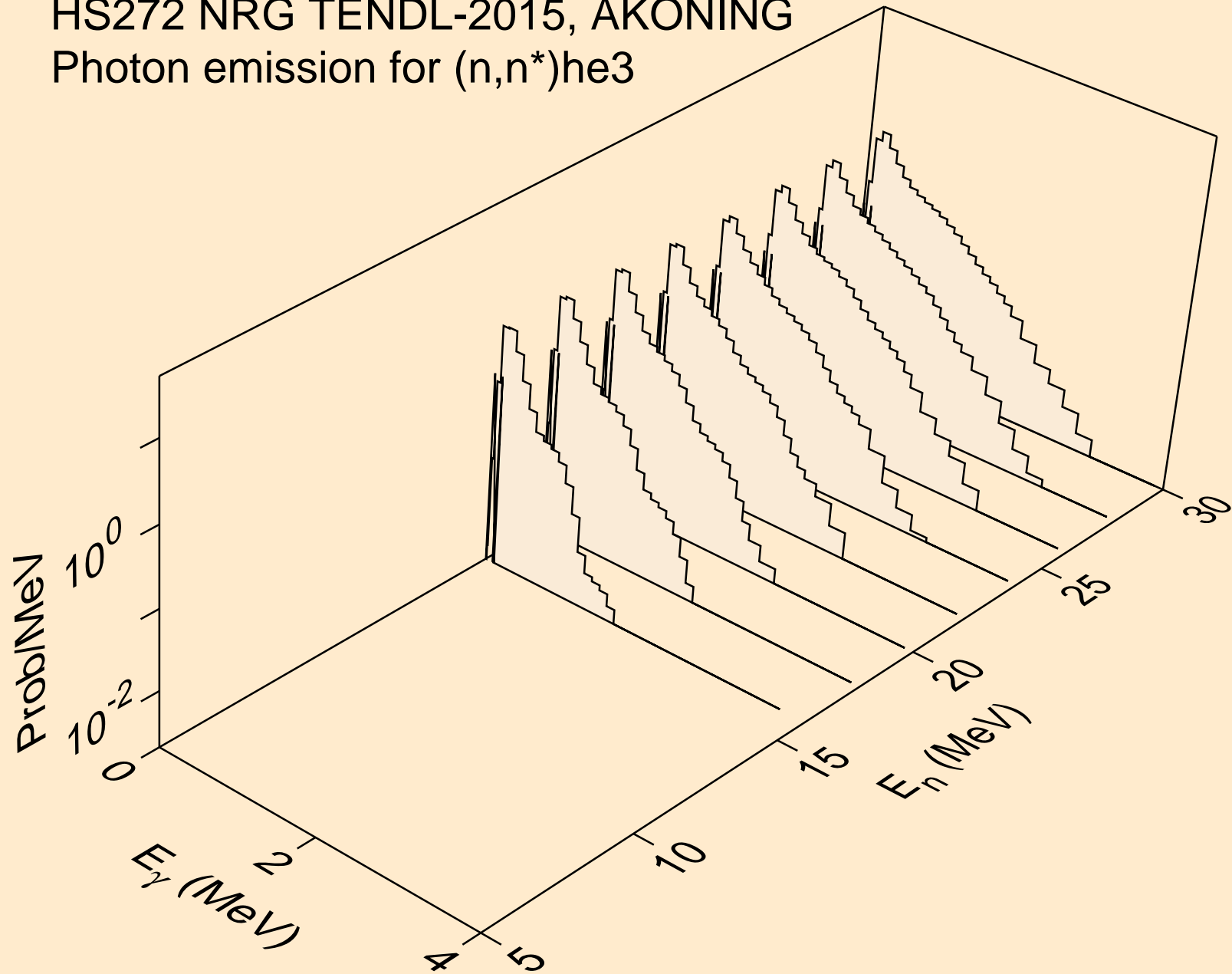

HS272 NRG TENDL-2015, AKONING
Photon emission for (n,n*)d2a

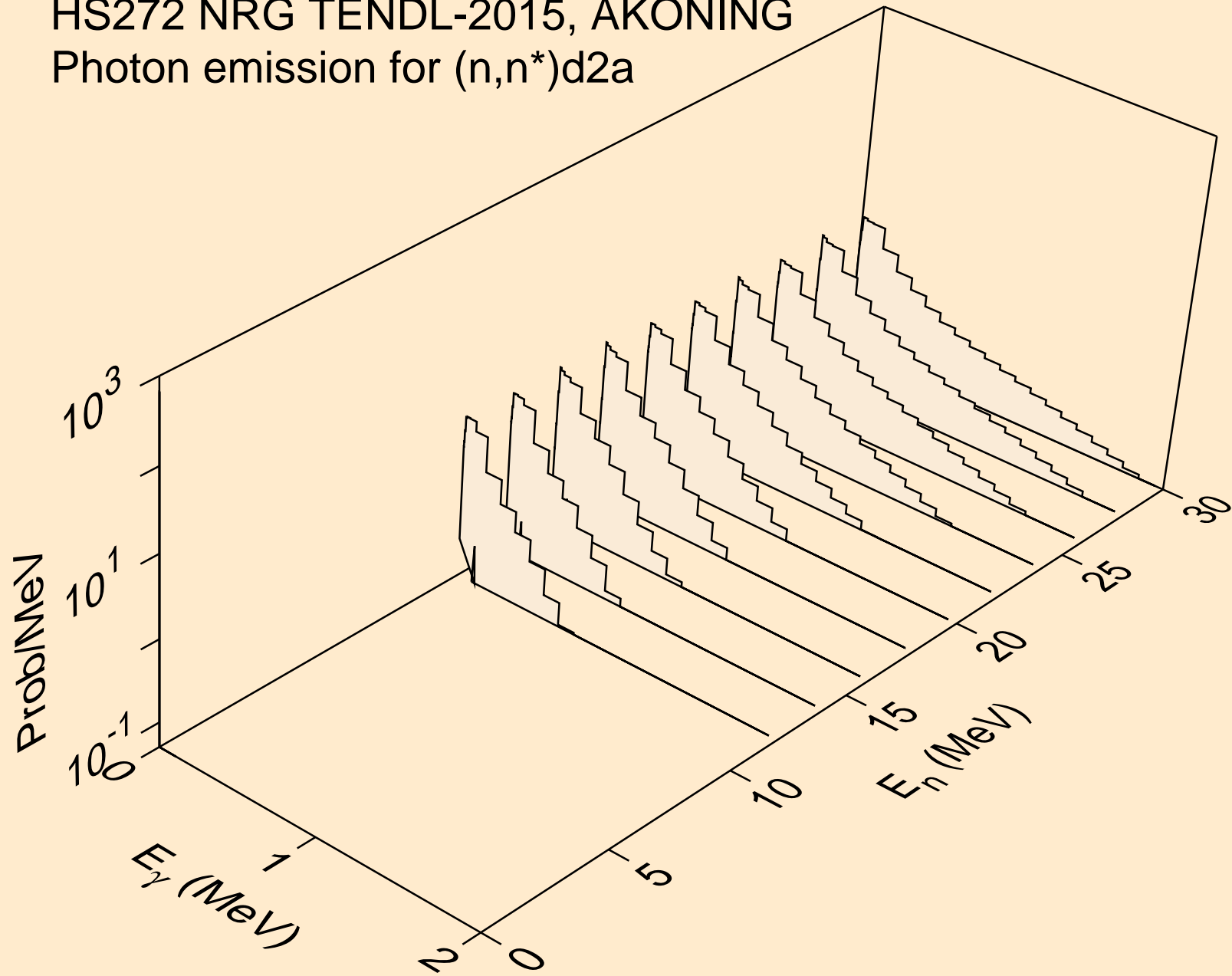

HS272 NRG TENDL-2015, AKONING
Photon emission for (n,n*)t2a

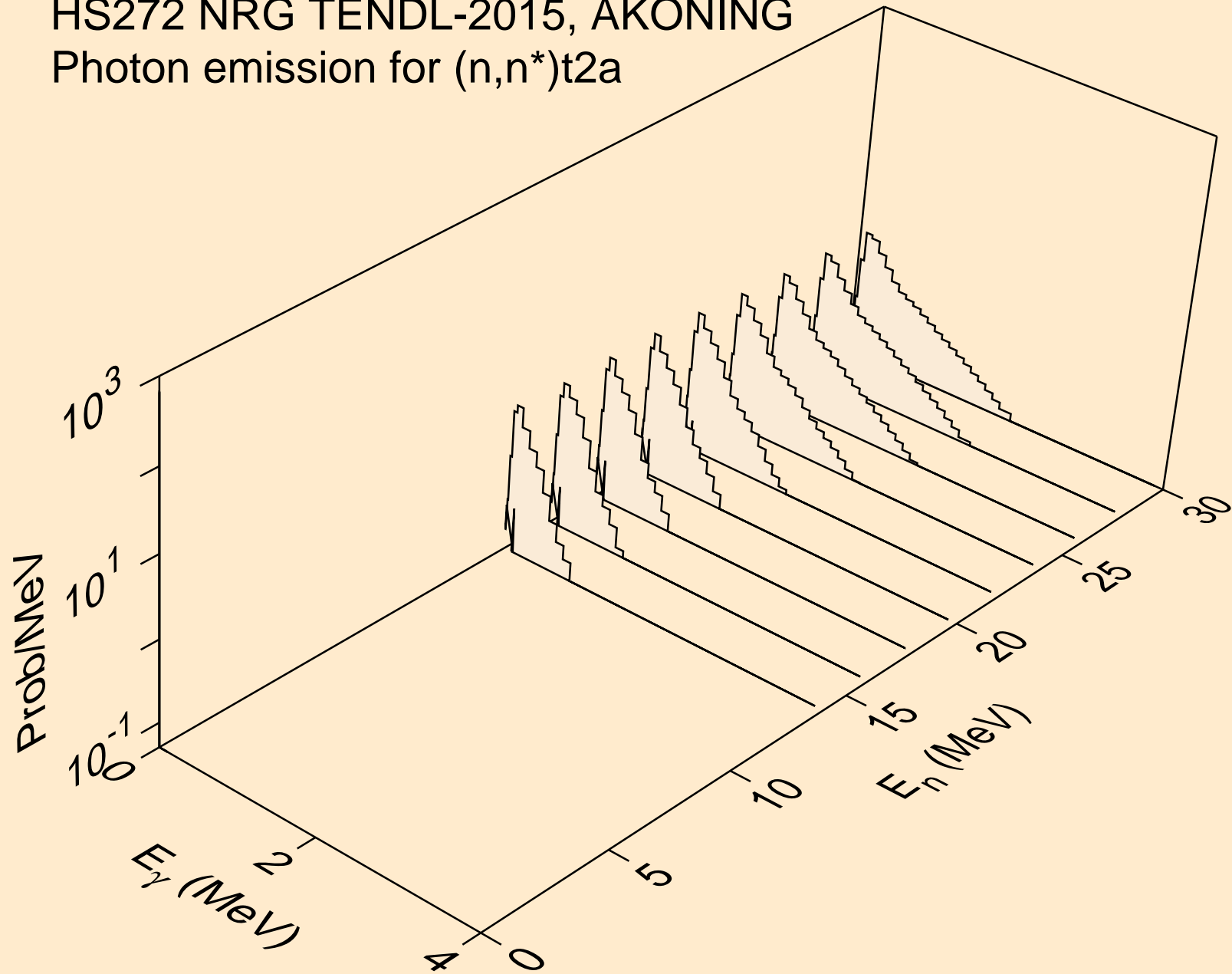

HS272 NRG TENDL-2015, AKONING
Photon emission for (n,4n)

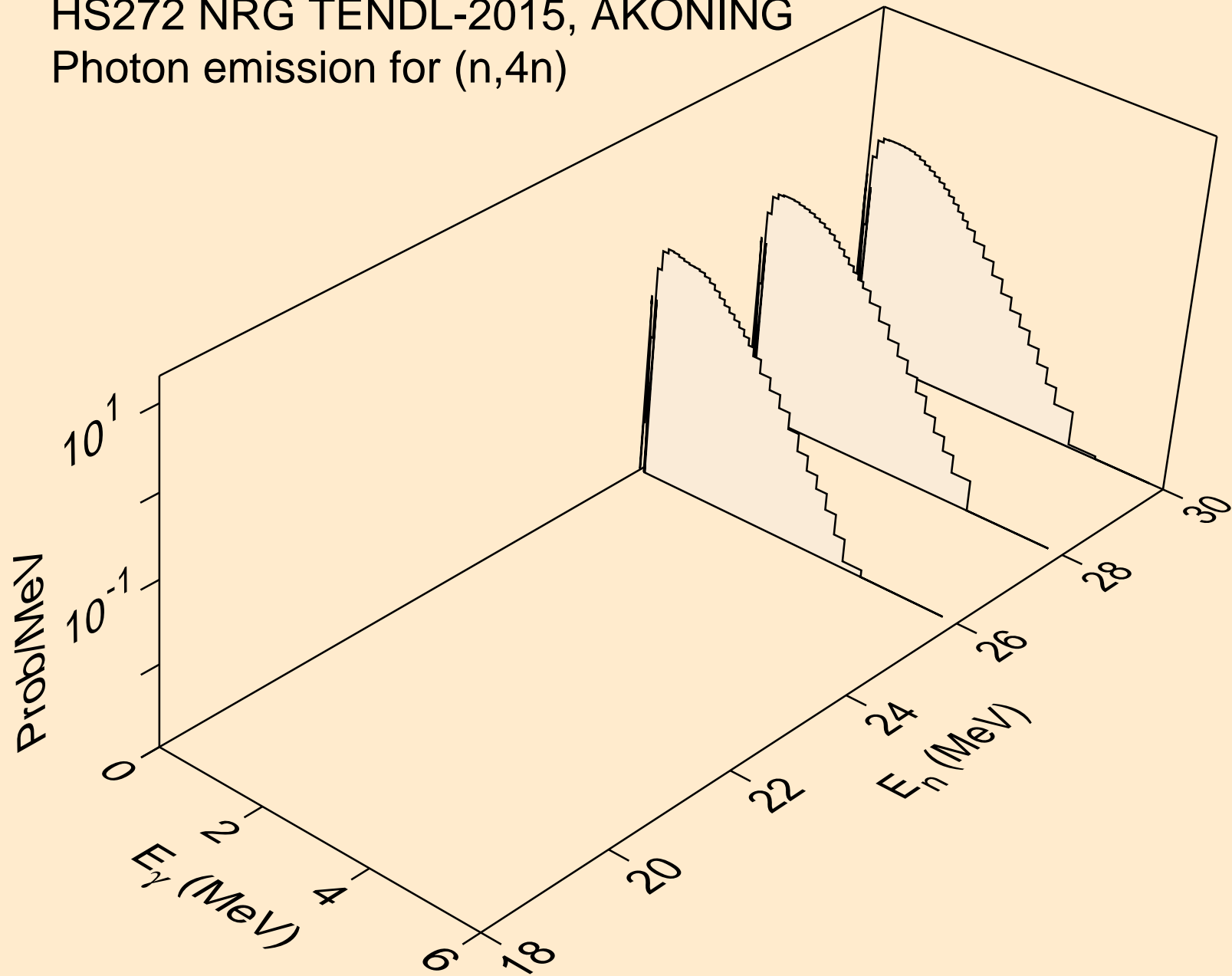

HS272 NRG TENDL-2015, AKONING
Photon emission for (n,2np)

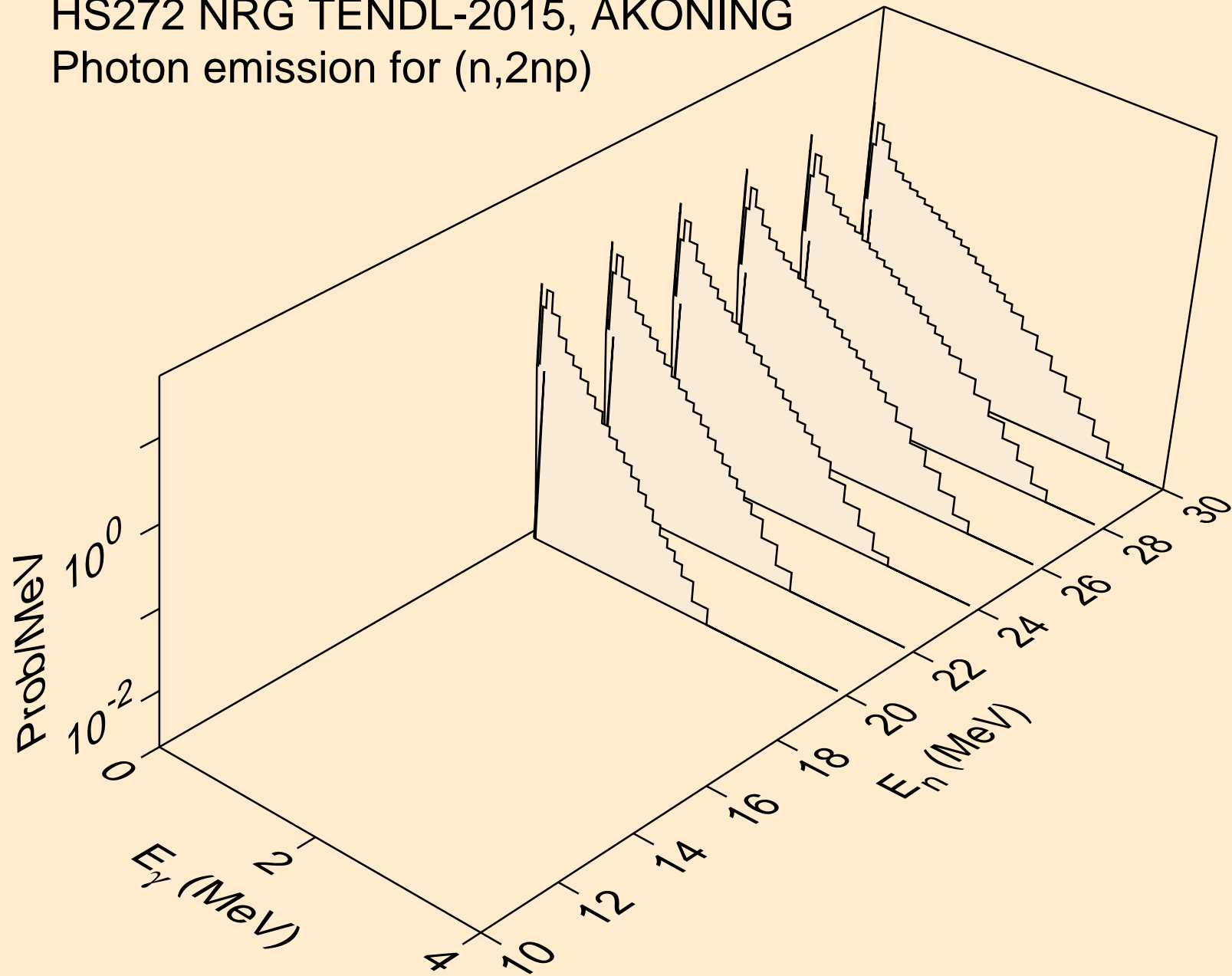

HS272 NRG TENDL-2015, AKONING
Photon emission for (n,3np)

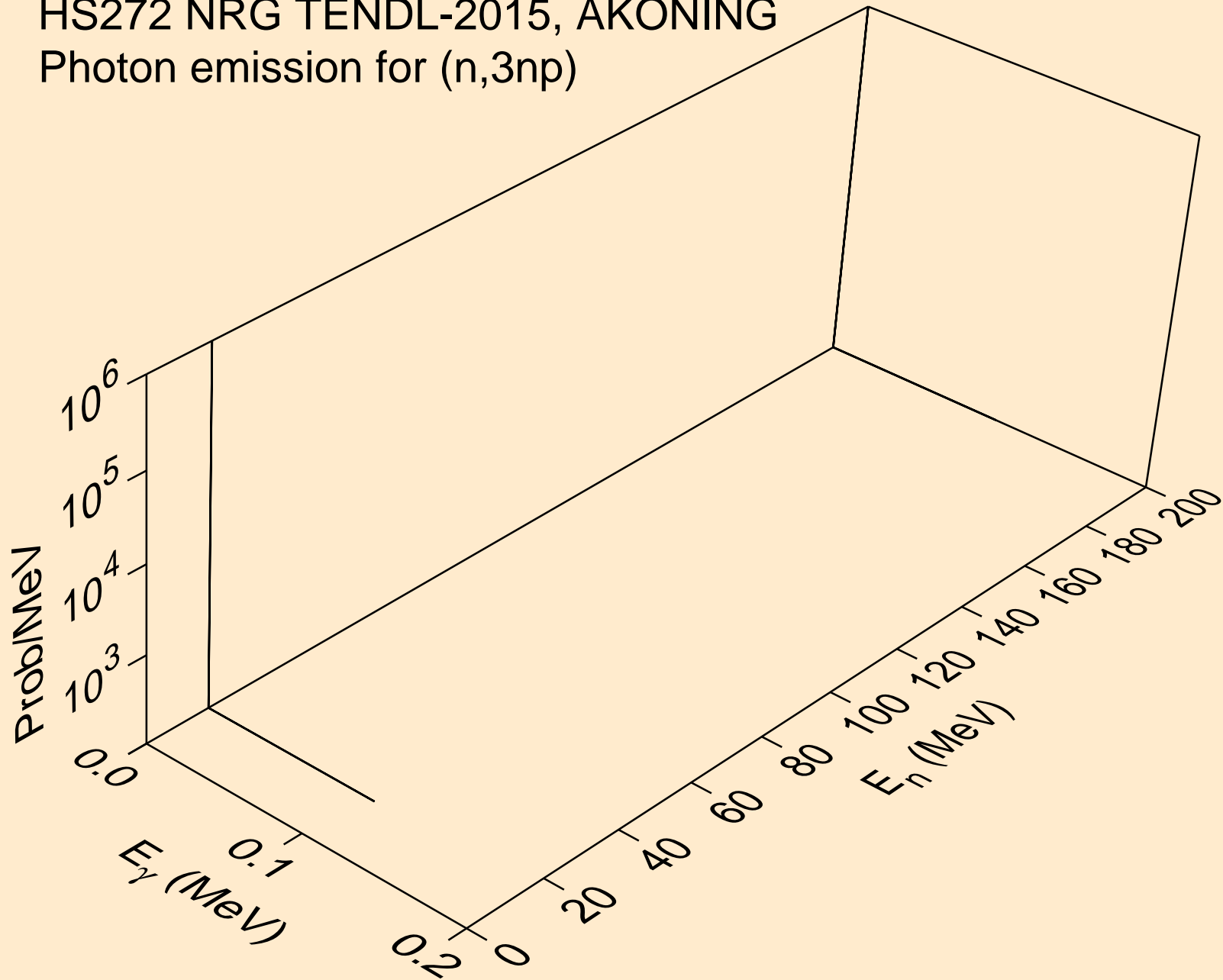

HS272 NRG TENDL-2015, AKONING
Photon emission for (n,npa)

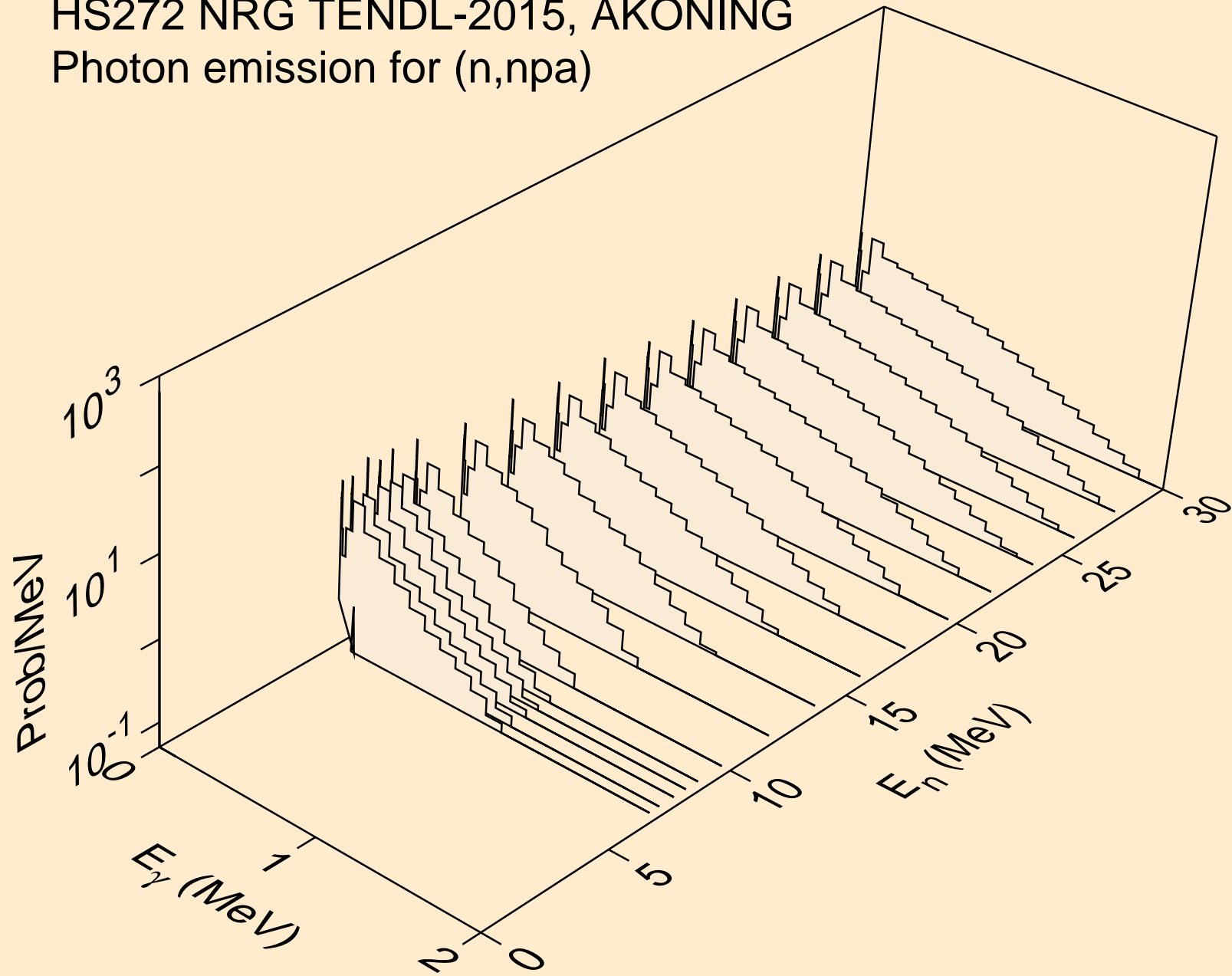

HS272 NRG TENDL-2015, AKONING
Photon emission for (n,n*c)

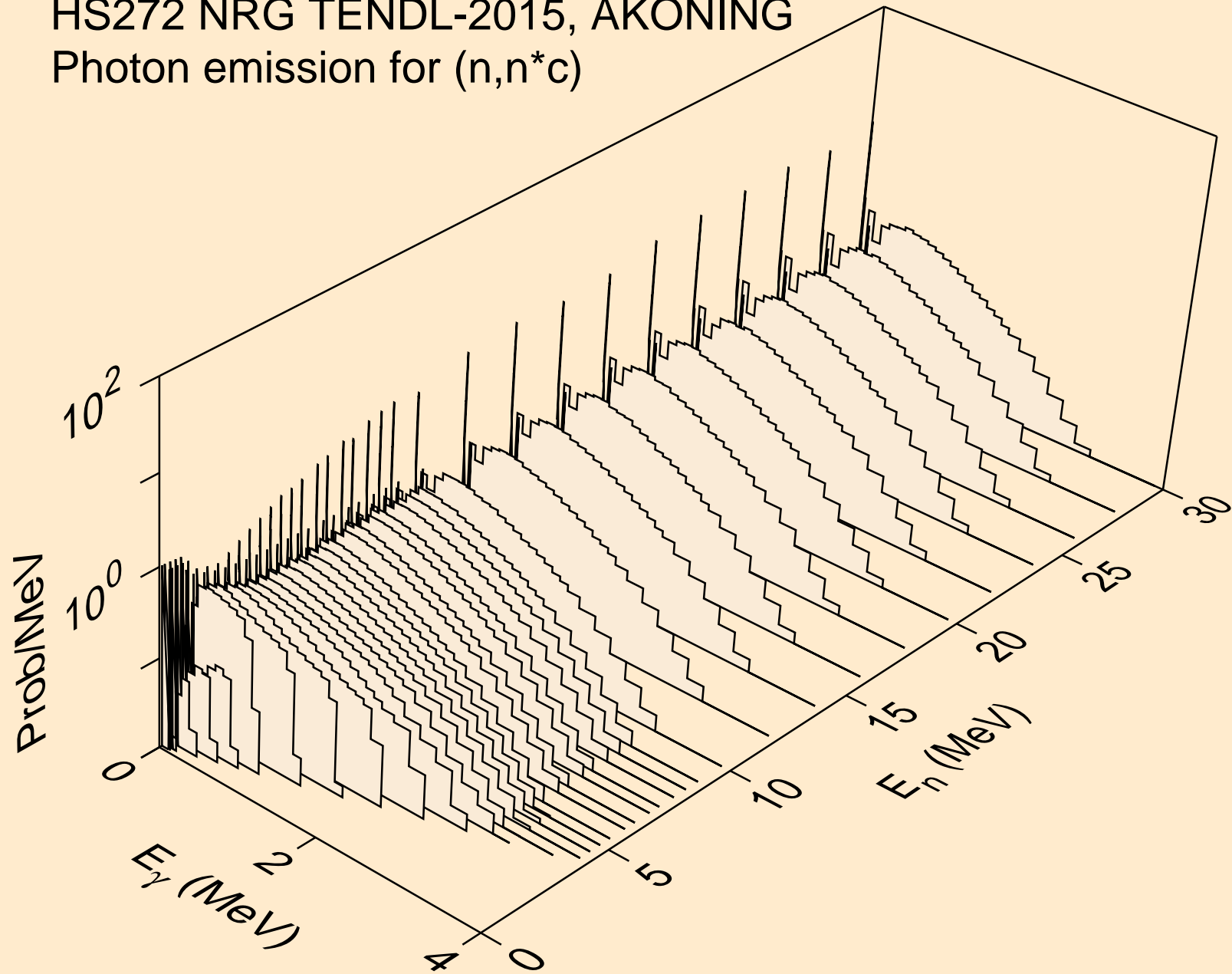

HS272 NRG TENDL-2015, AKONING
Photon emission for (n,gma)

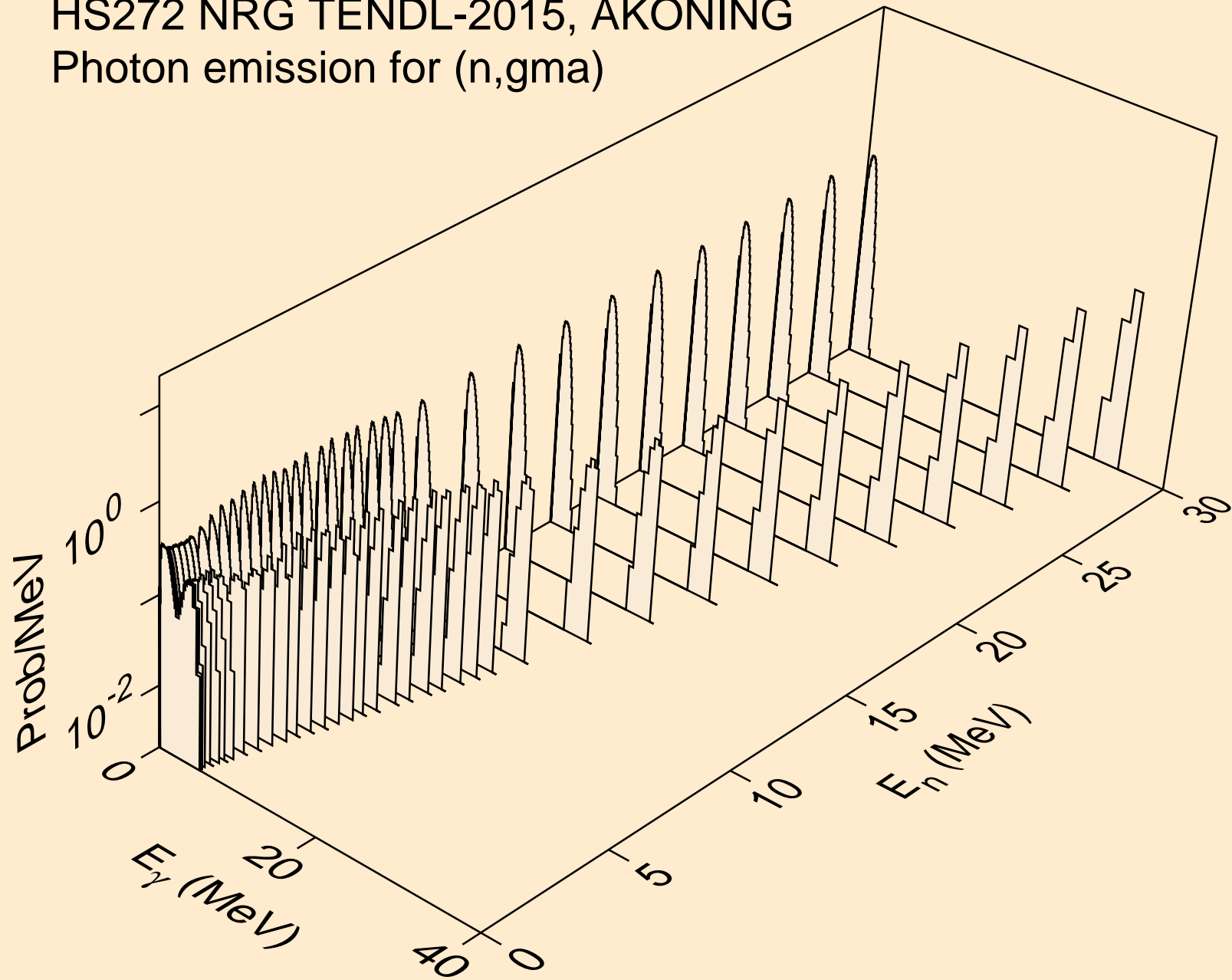

HS272 NRG TENDL-2015, AKONING
Photon emission for (n,p)

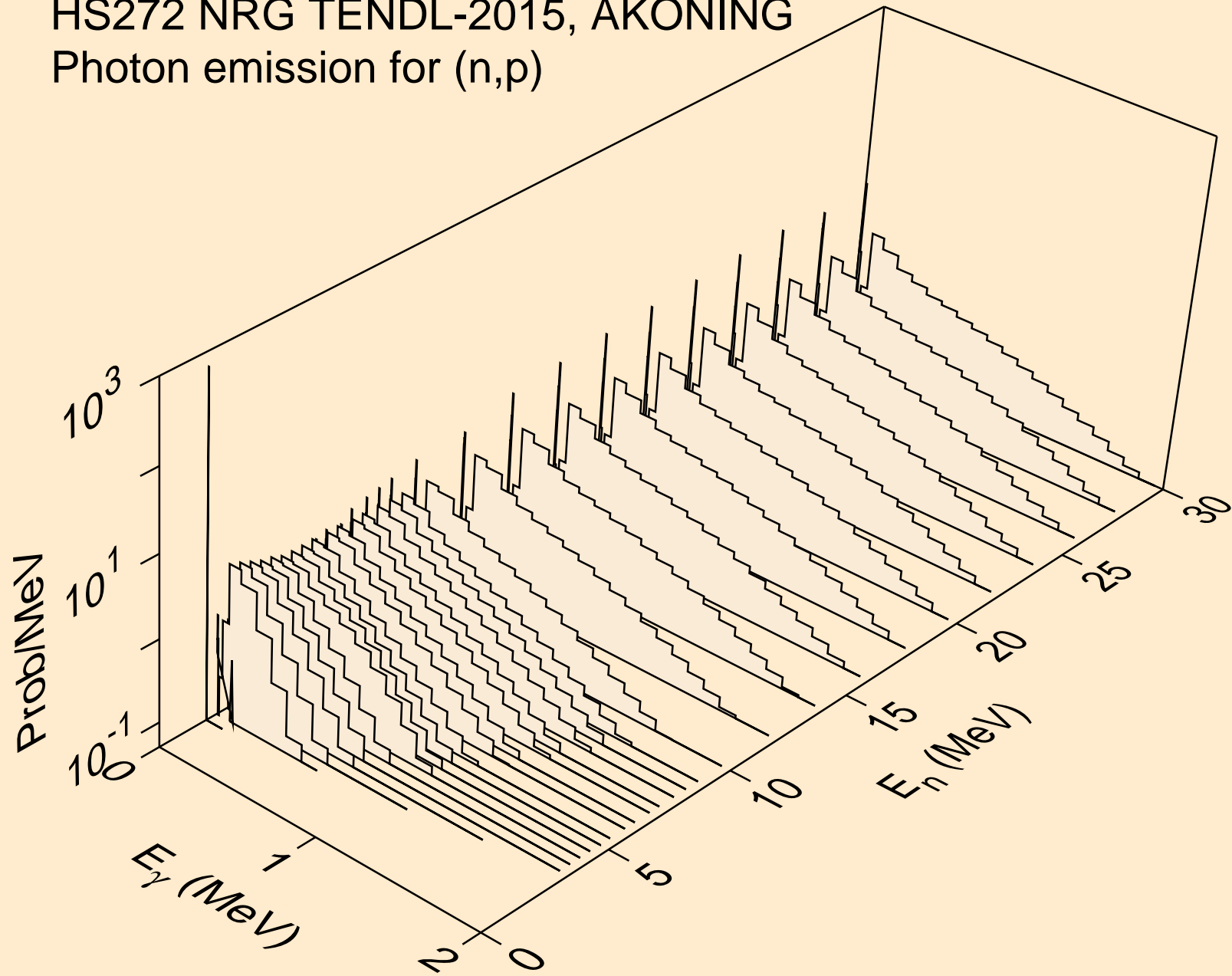

HS272 NRG TENDL-2015, AKONING
Photon emission for (n,d)

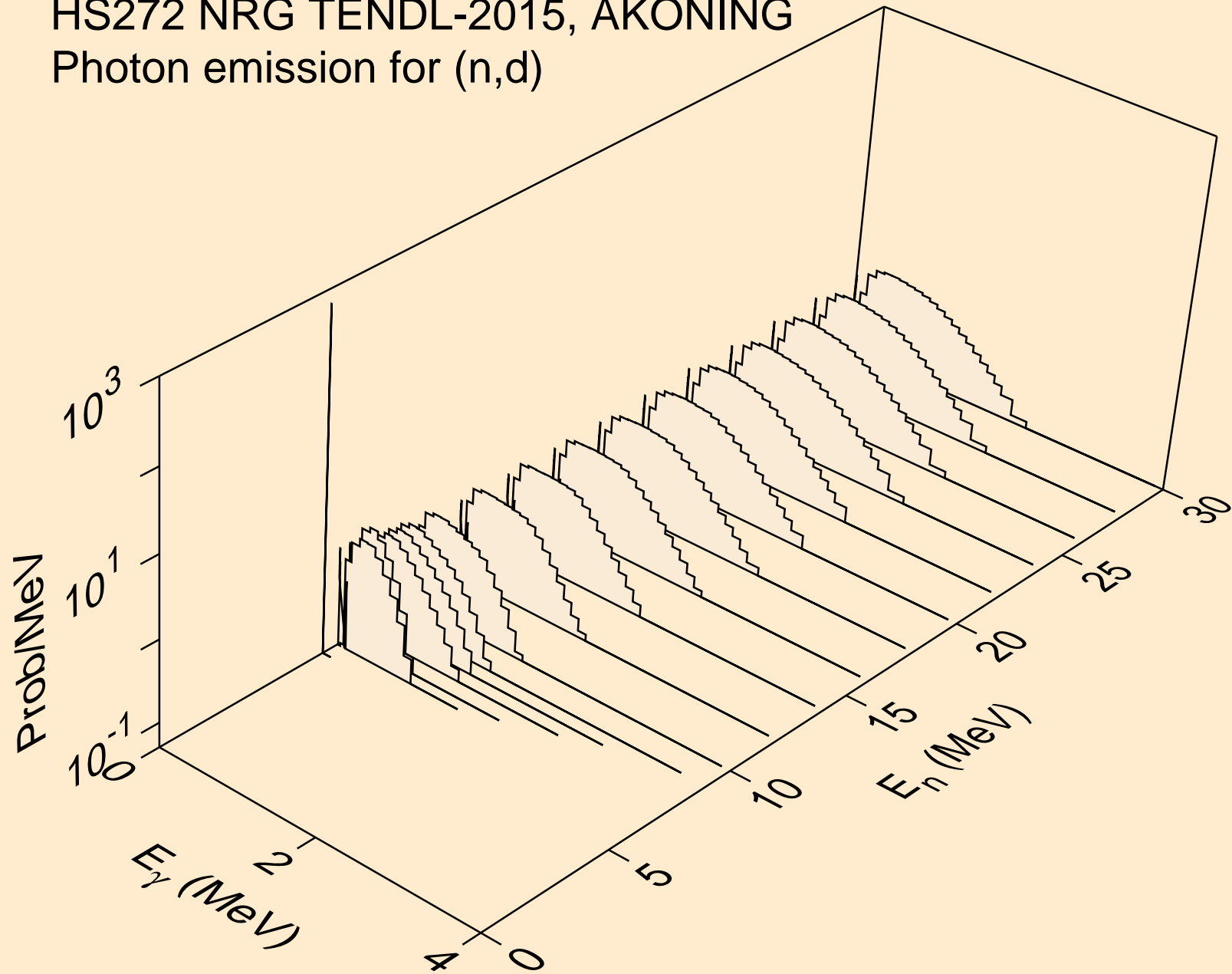

HS272 NRG TENDL-2015, AKONING
Photon emission for (n,t)

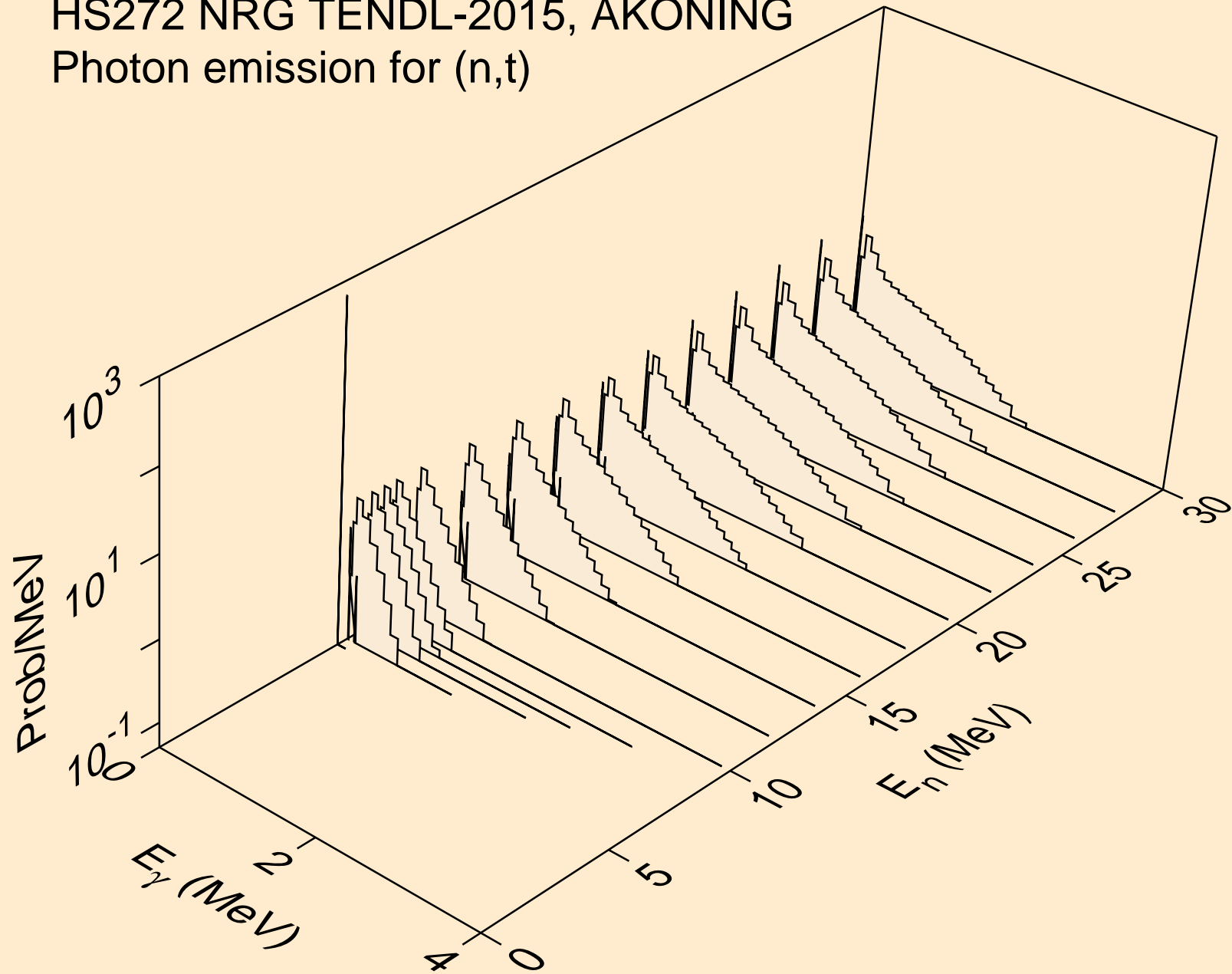

HS272 NRG TENDL-2015, AKONING
Photon emission for (n,he3)

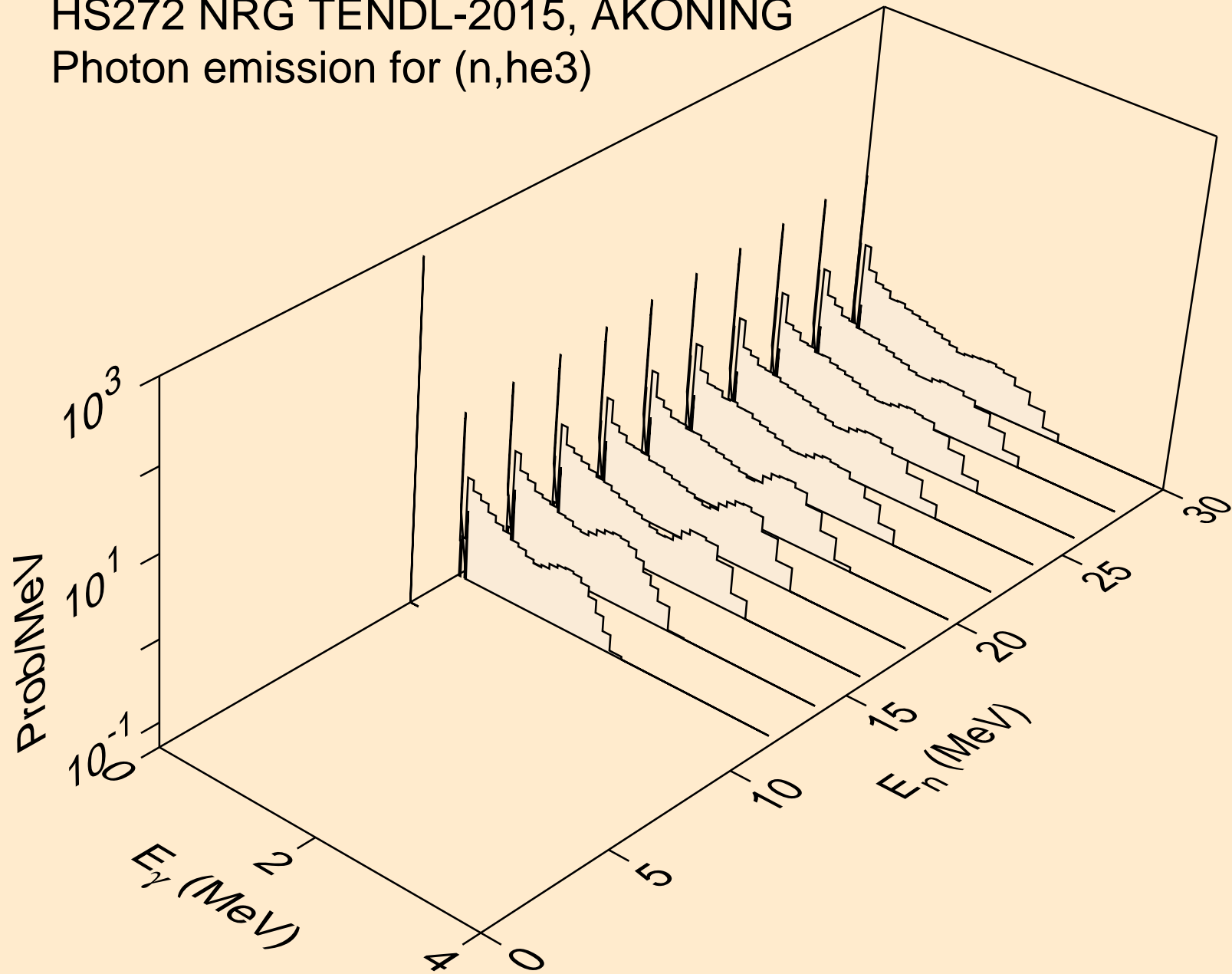

HS272 NRG TENDL-2015, AKONING
Photon emission for (n,a)

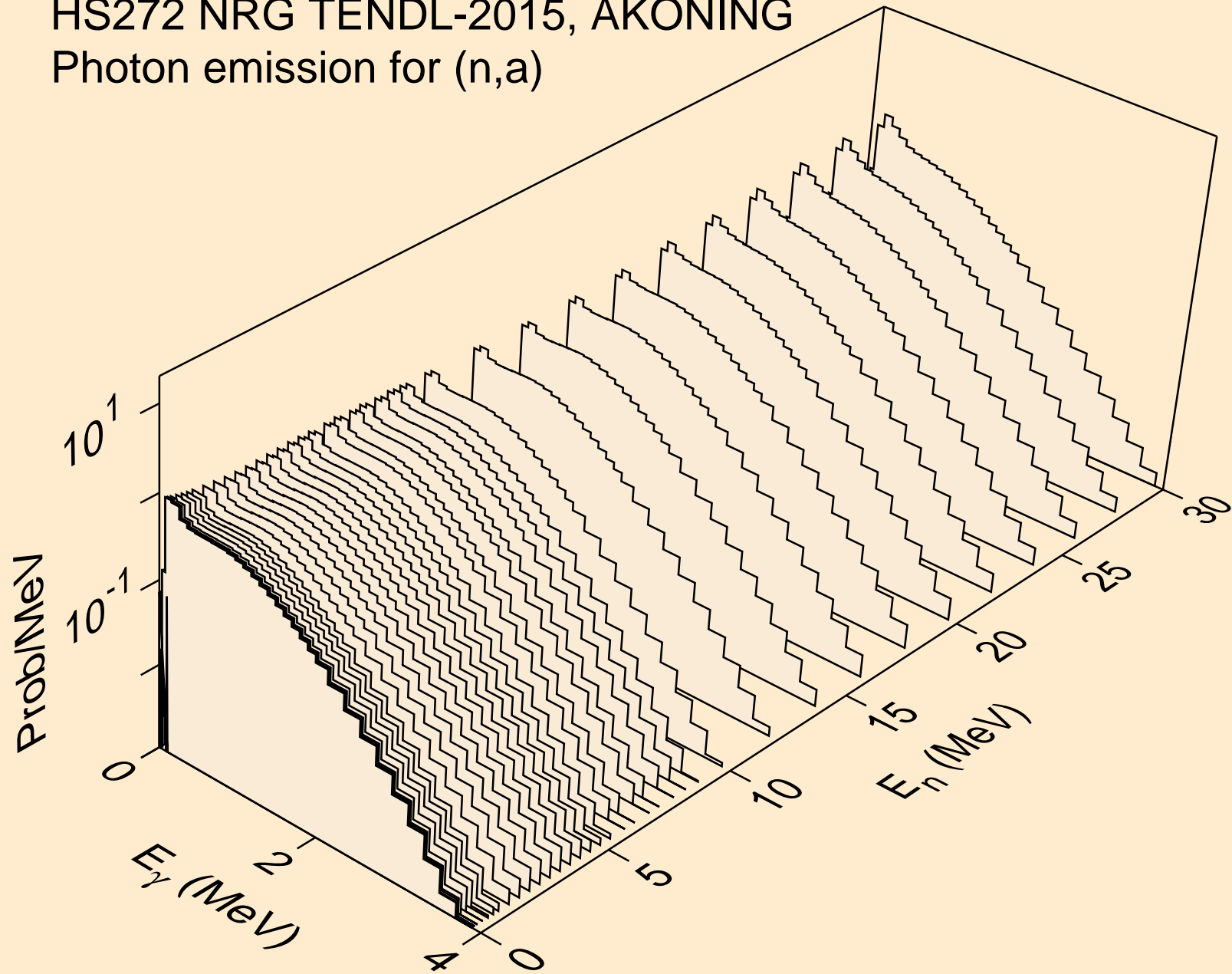

HS272 NRG TENDL-2015, AKONING
Photon emission for (n,2a)

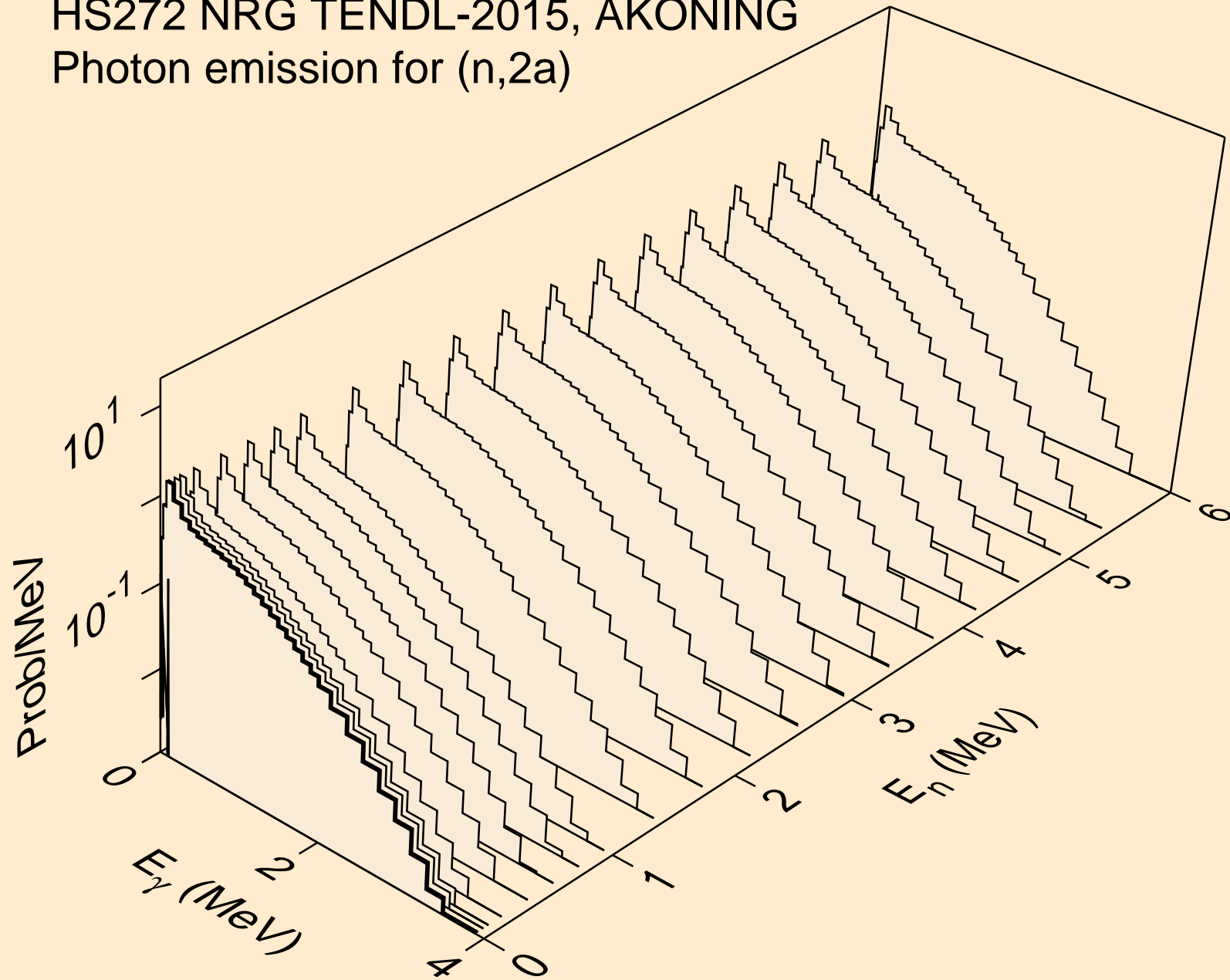

HS272 NRG TENDL-2015, AKONING
Photon emission for (n,3a)

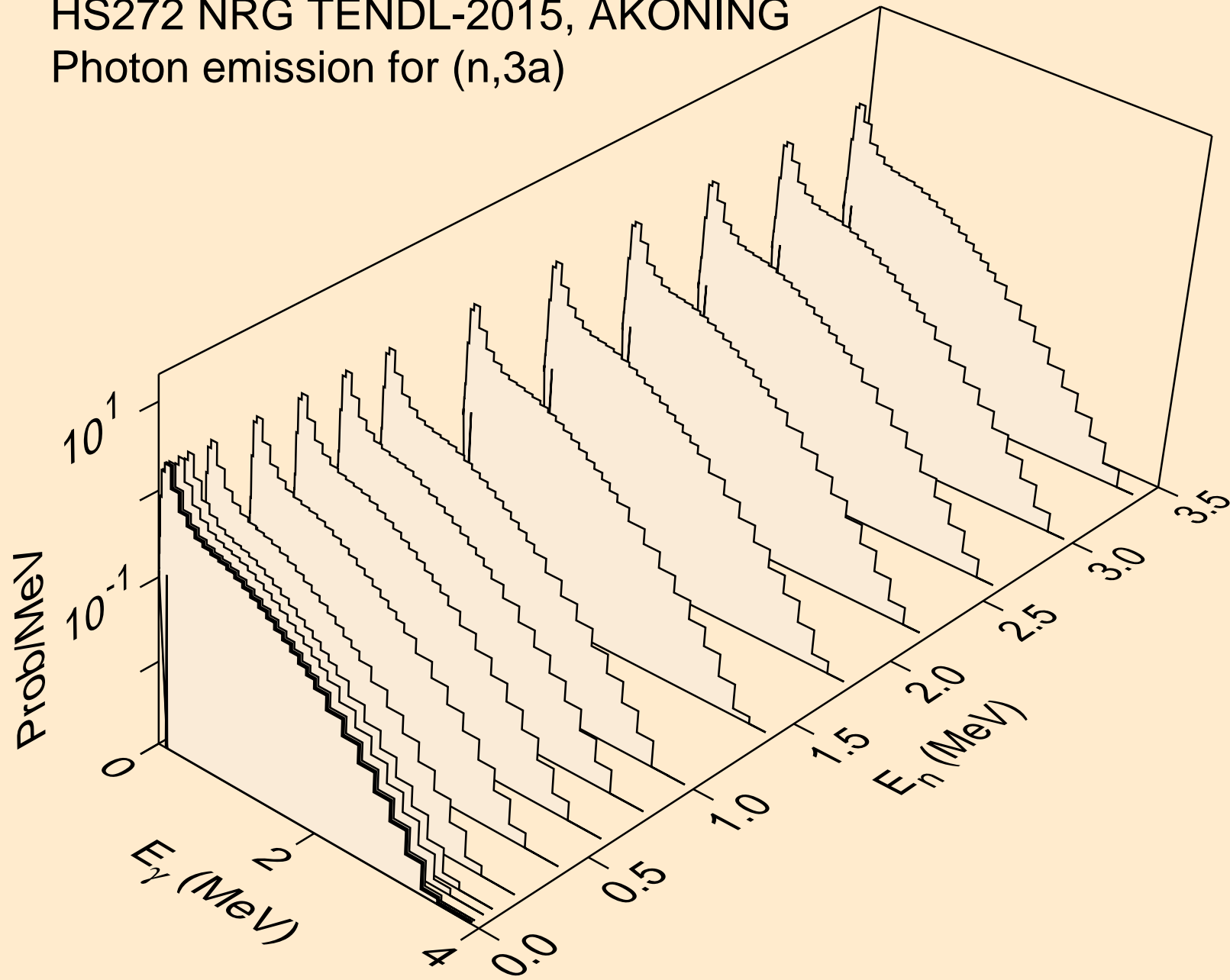

HS272 NRG TENDL-2015, AKONING
Photon emission for (n,p)

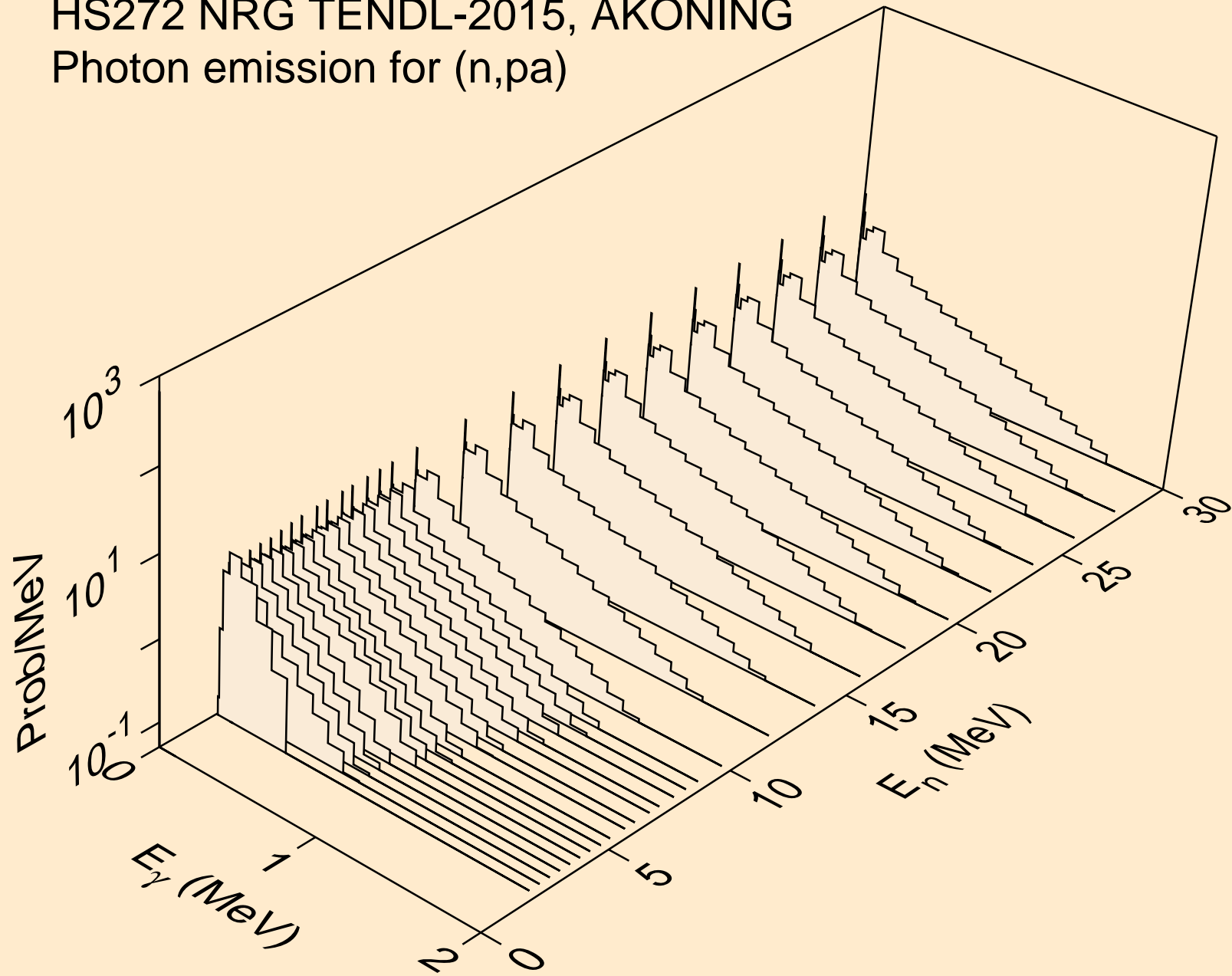

HS272 NRG TENDL-2015, AKONING
Photon emission for (n,t2a)

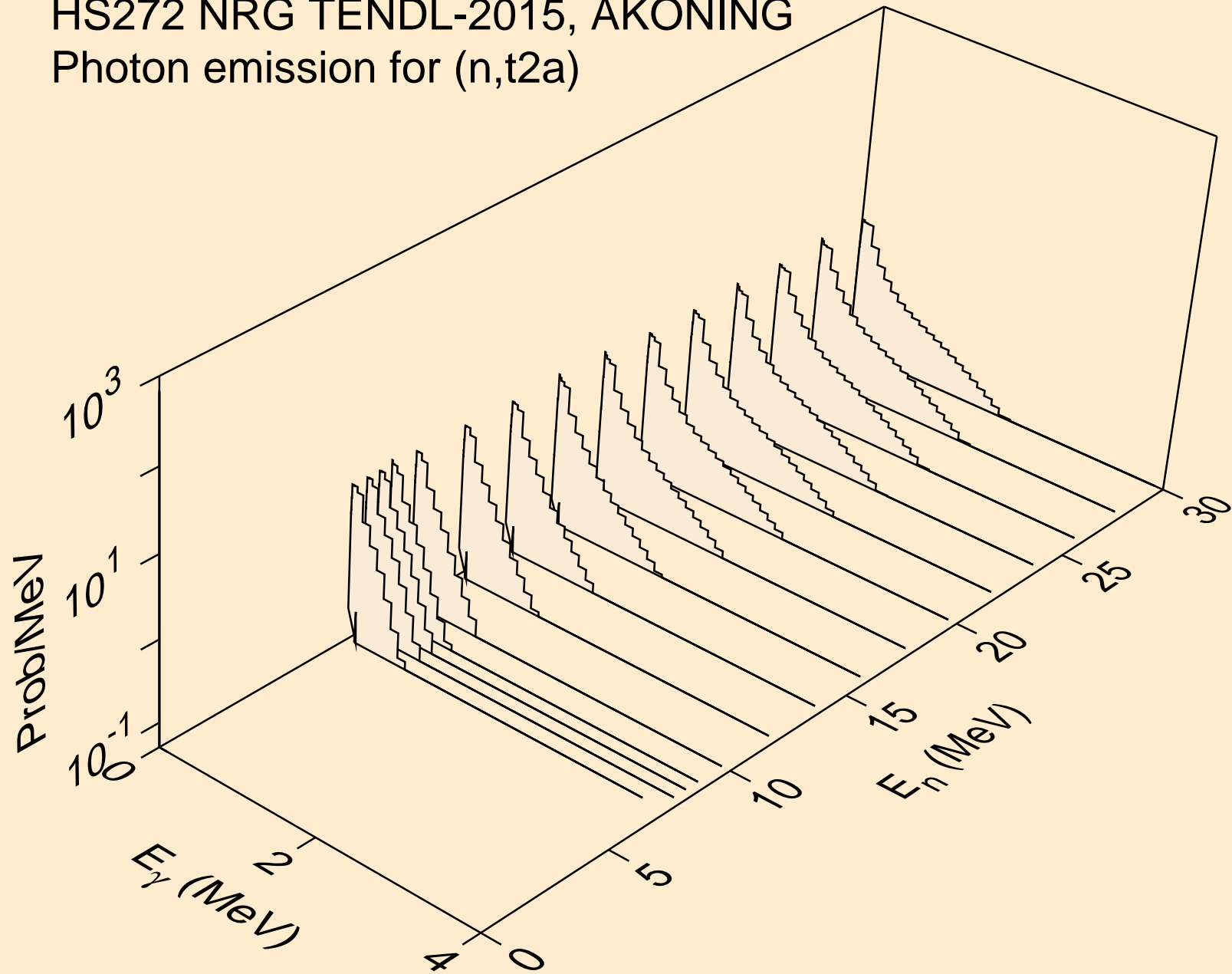

HS272 NRG TENDL-2015, AKONING
Photon emission for (n,d2a)

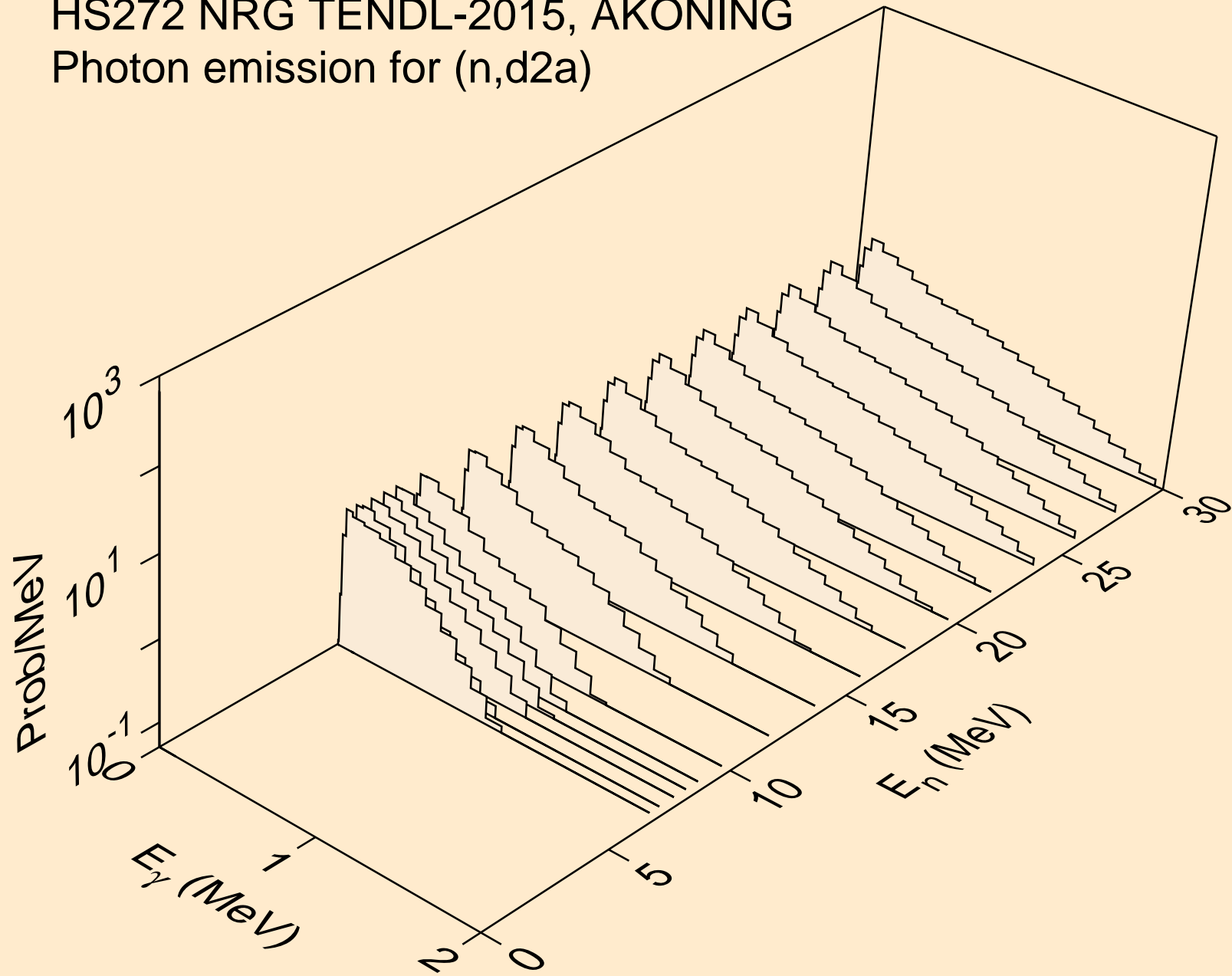

HS272 NRG TENDL-2015, AKONING
Photon emission for (n,da)

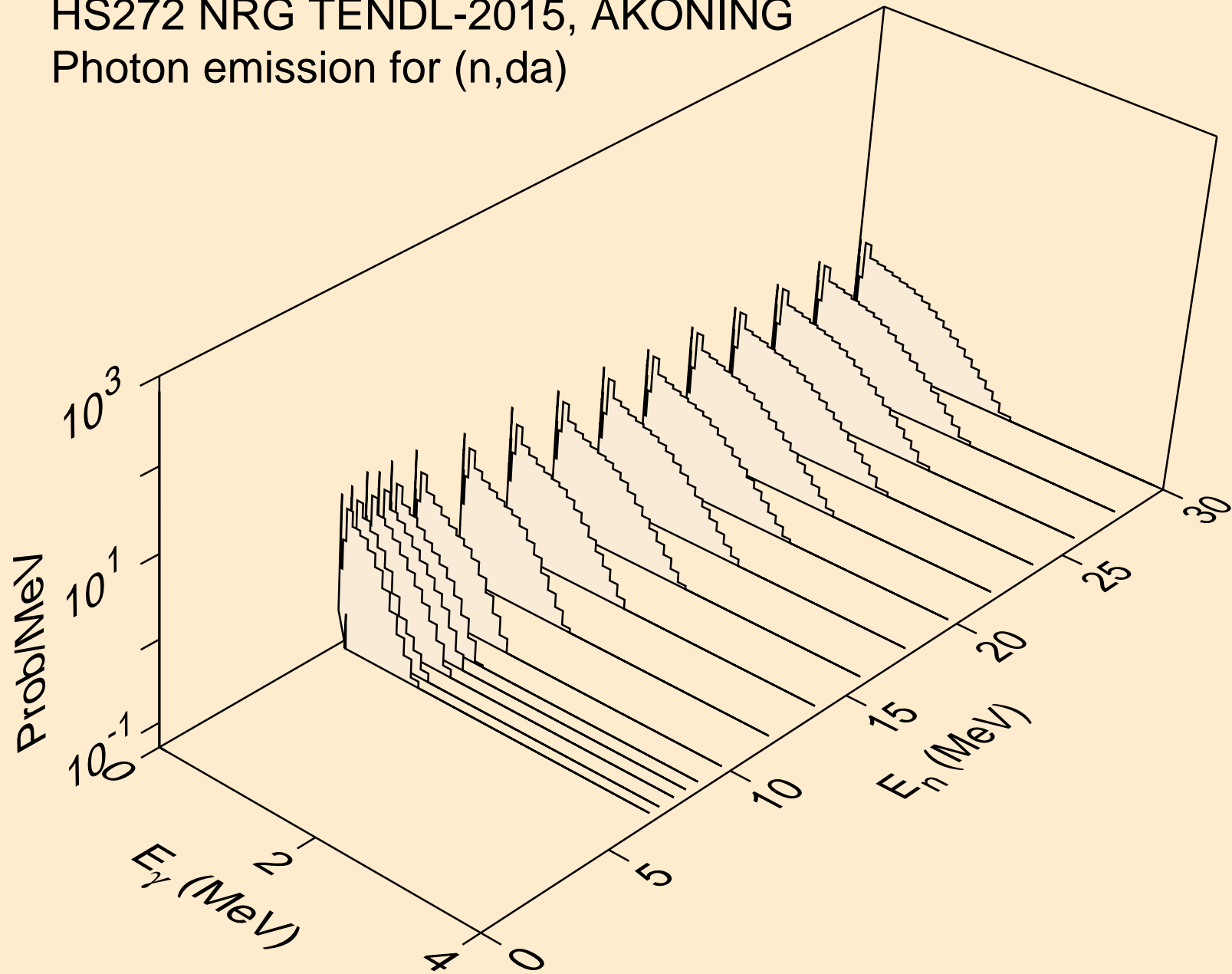

HS272 NRG TENDL-2015, AKONING
thermal capture photon spectrum

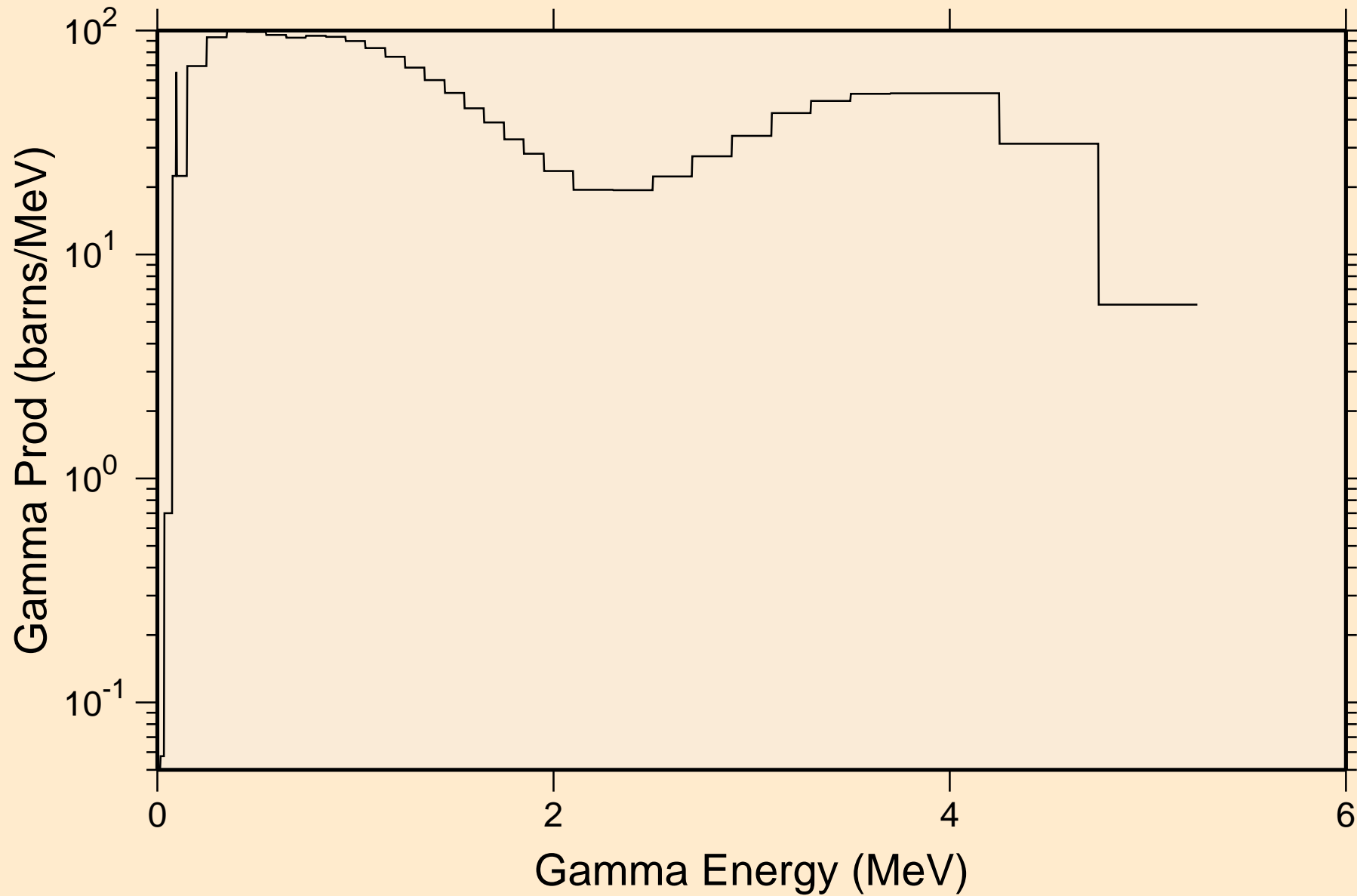

HS272 NRG TENDL-2015, AKONING

14 MeV photon spectrum

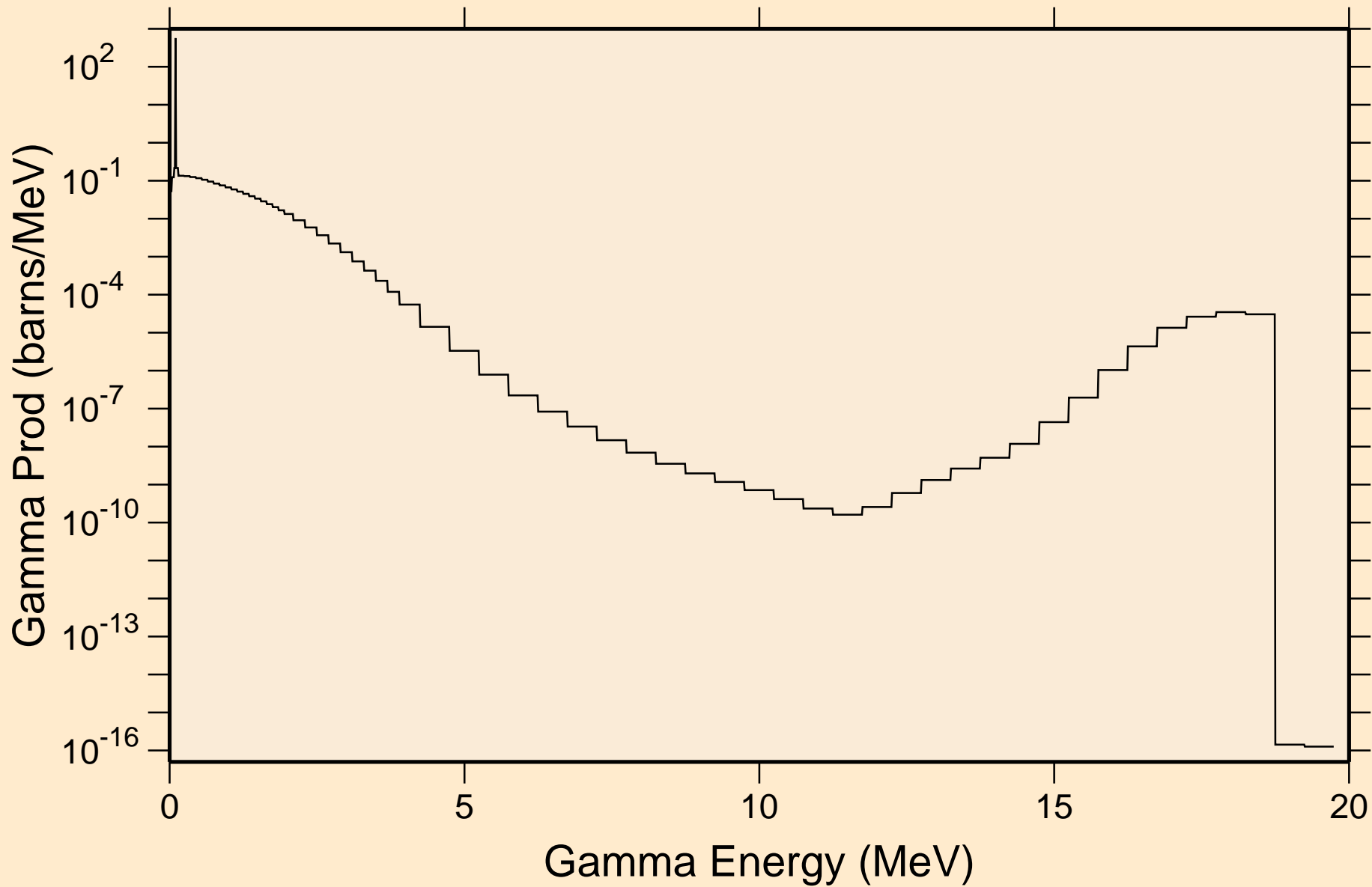

HS272 NRG TENDL-2015, AKONING

Particle heating contributions

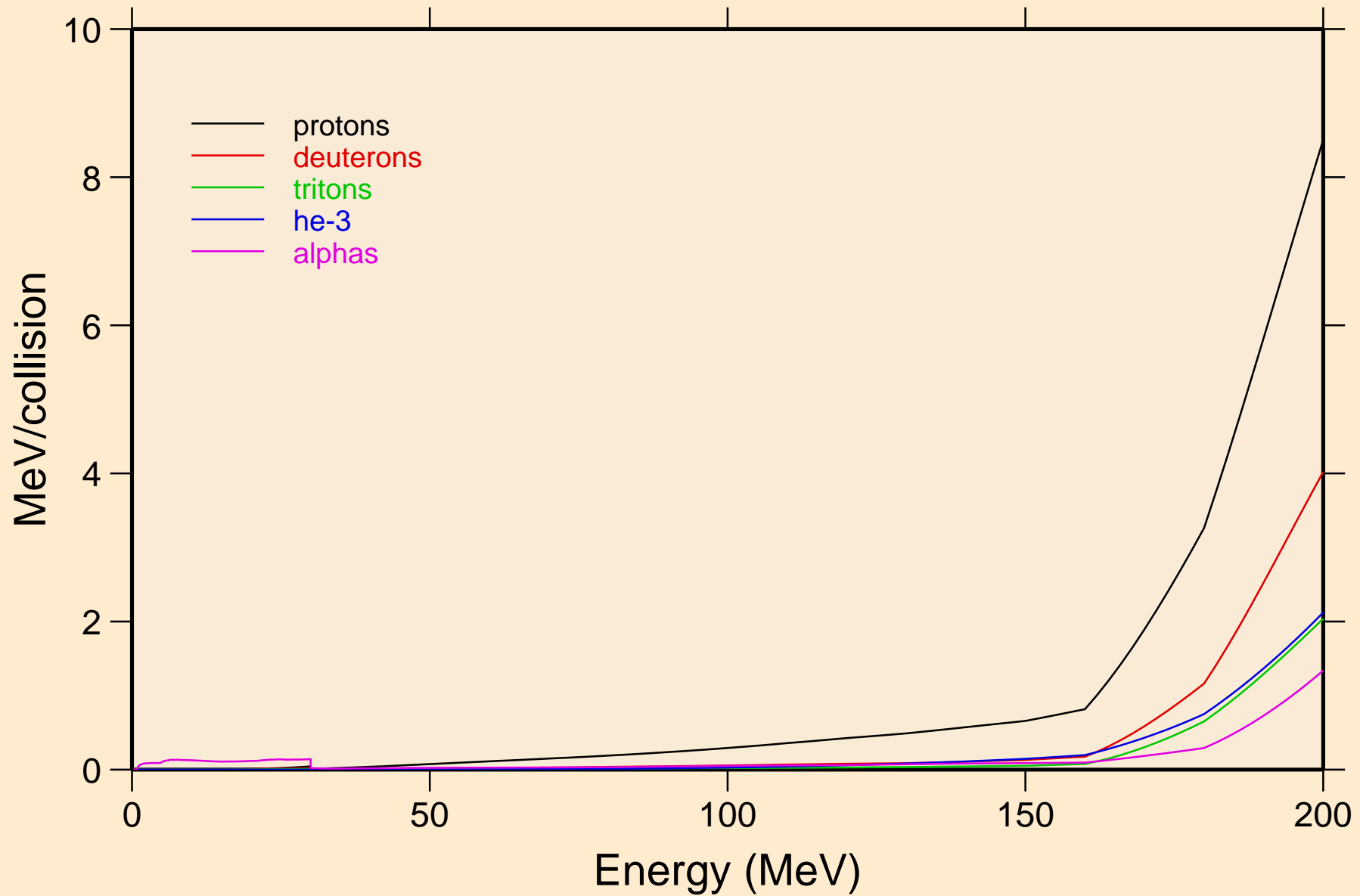

HS272 NRG TENDL-2015, AKONING

Recoil Heating

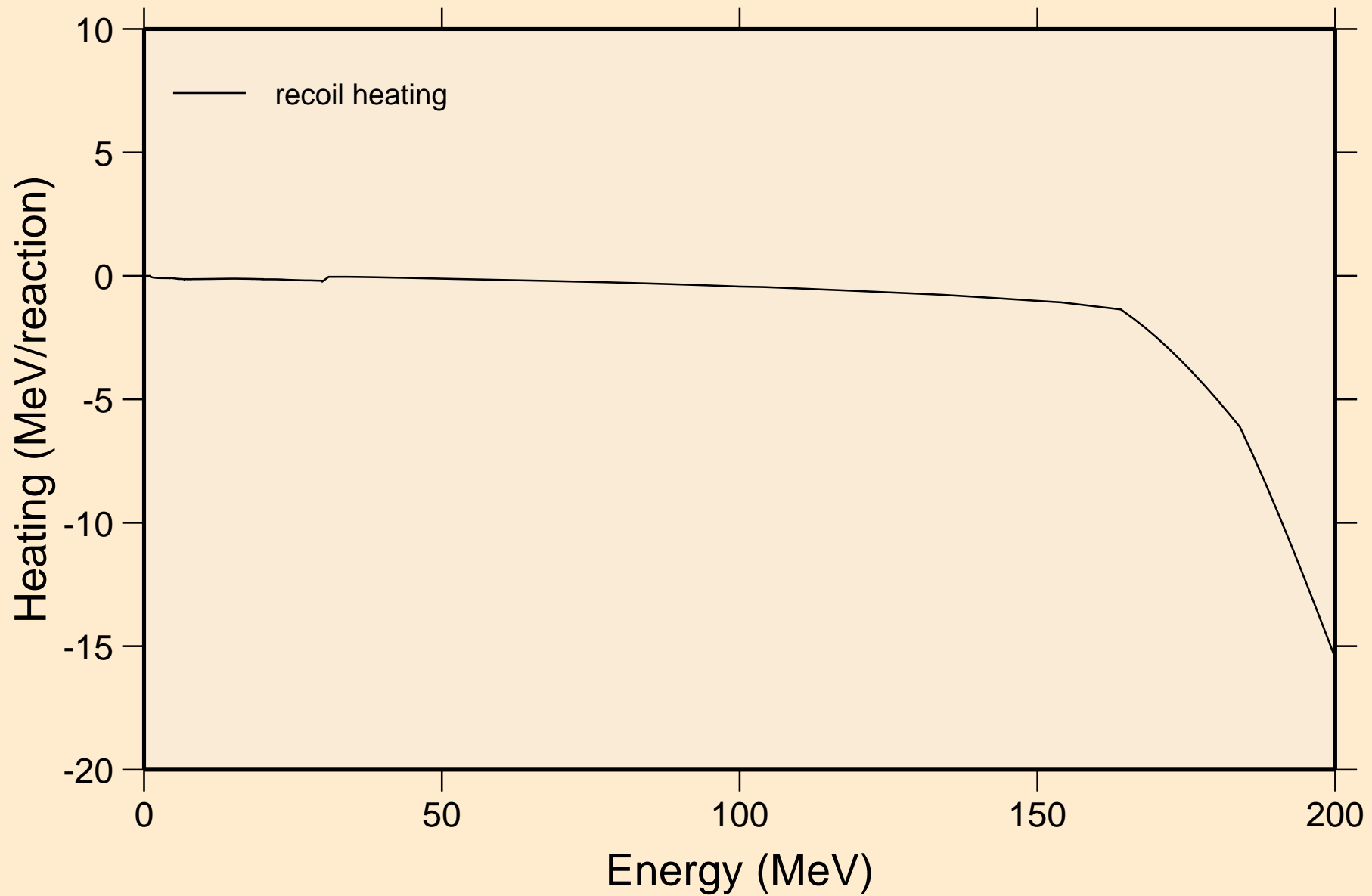

HS272 NRG TENDL-2015, AKONING

Particle production cross sections

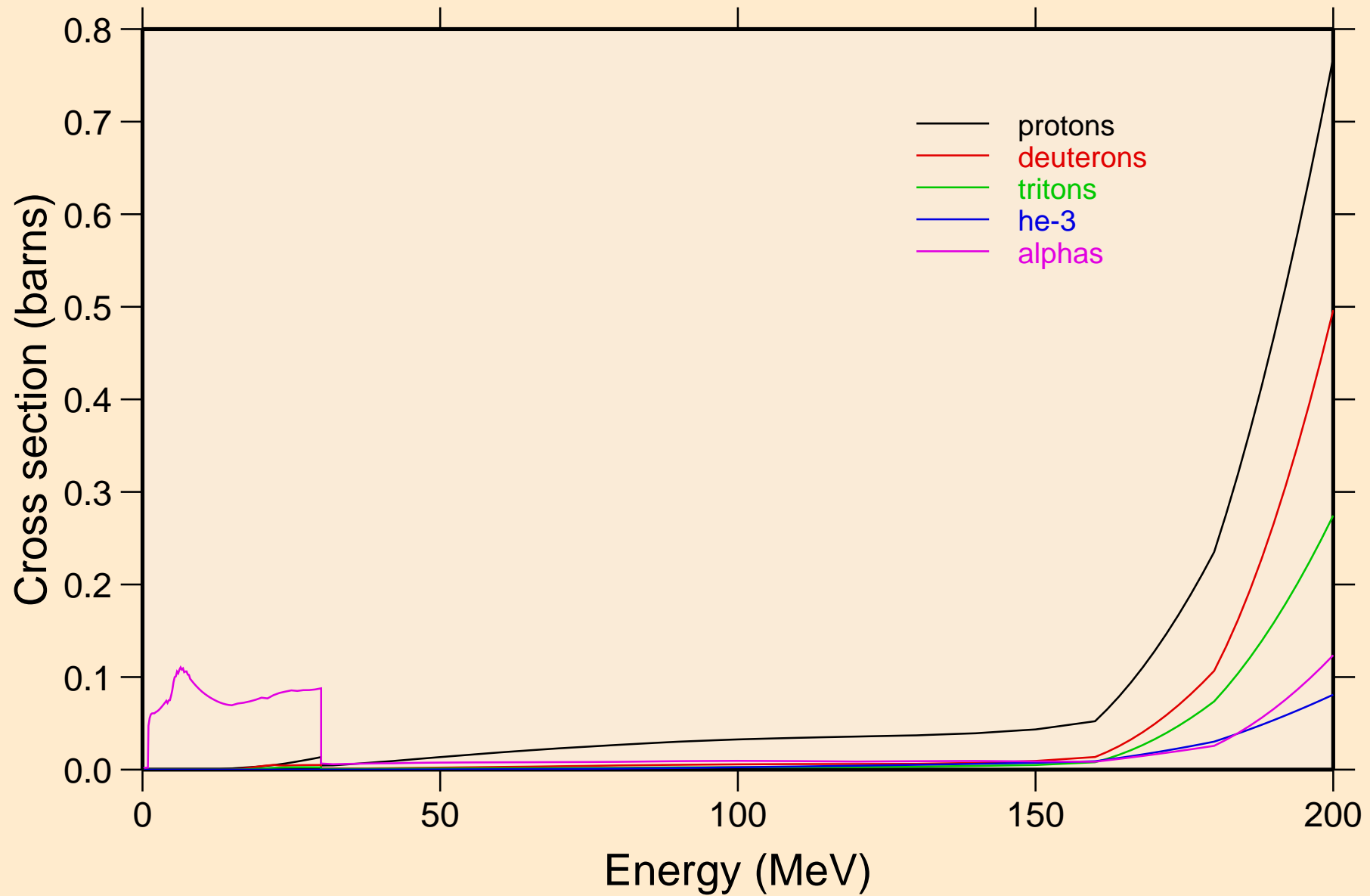

HS272 NRG TENDL-2015, AKONING
protons from (n,x)

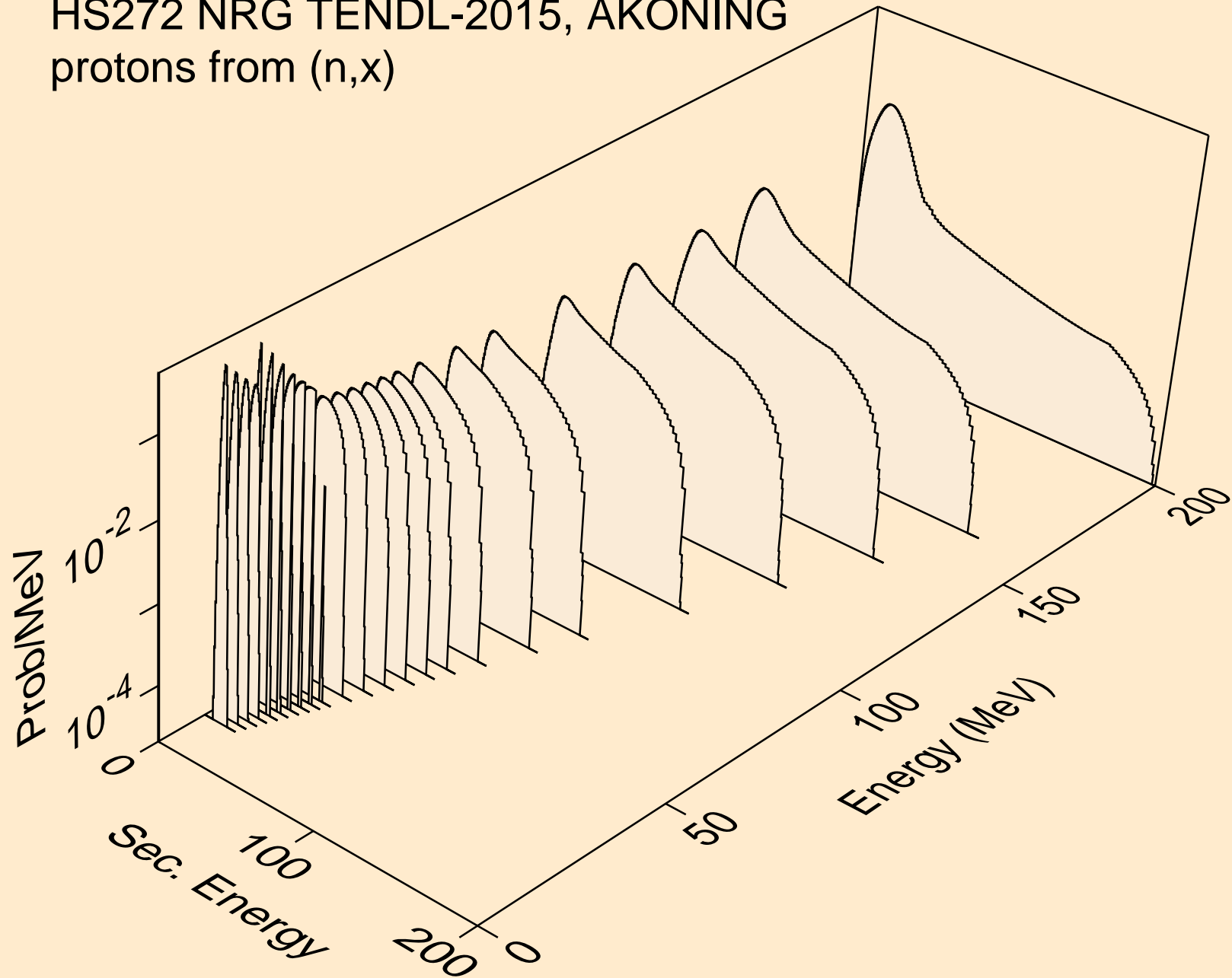

HS272 NRG TENDL-2015, AKONING
protons from (n,n*)p

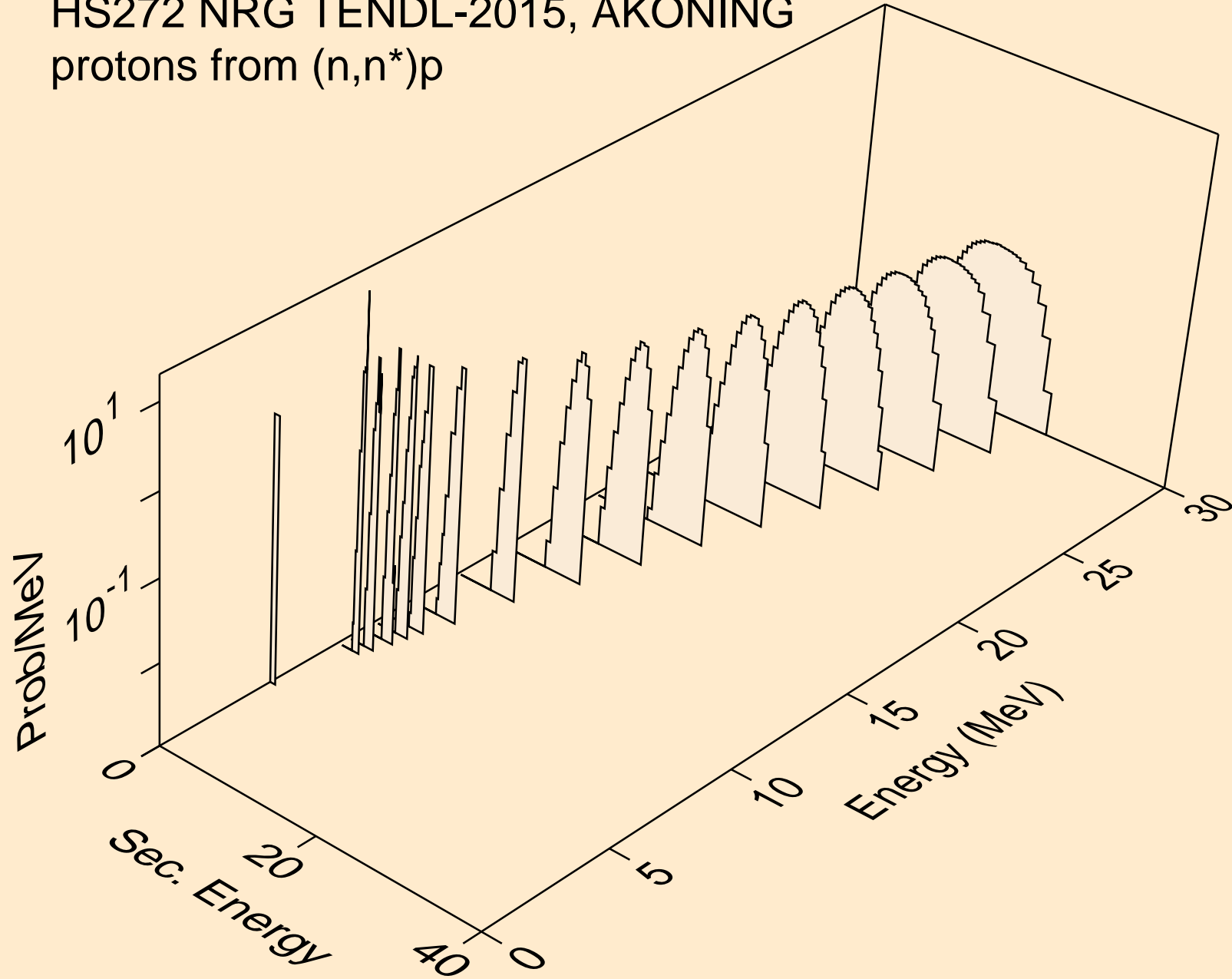

HS272 NRG TENDL-2015, AKONING
protons from (n,2np)

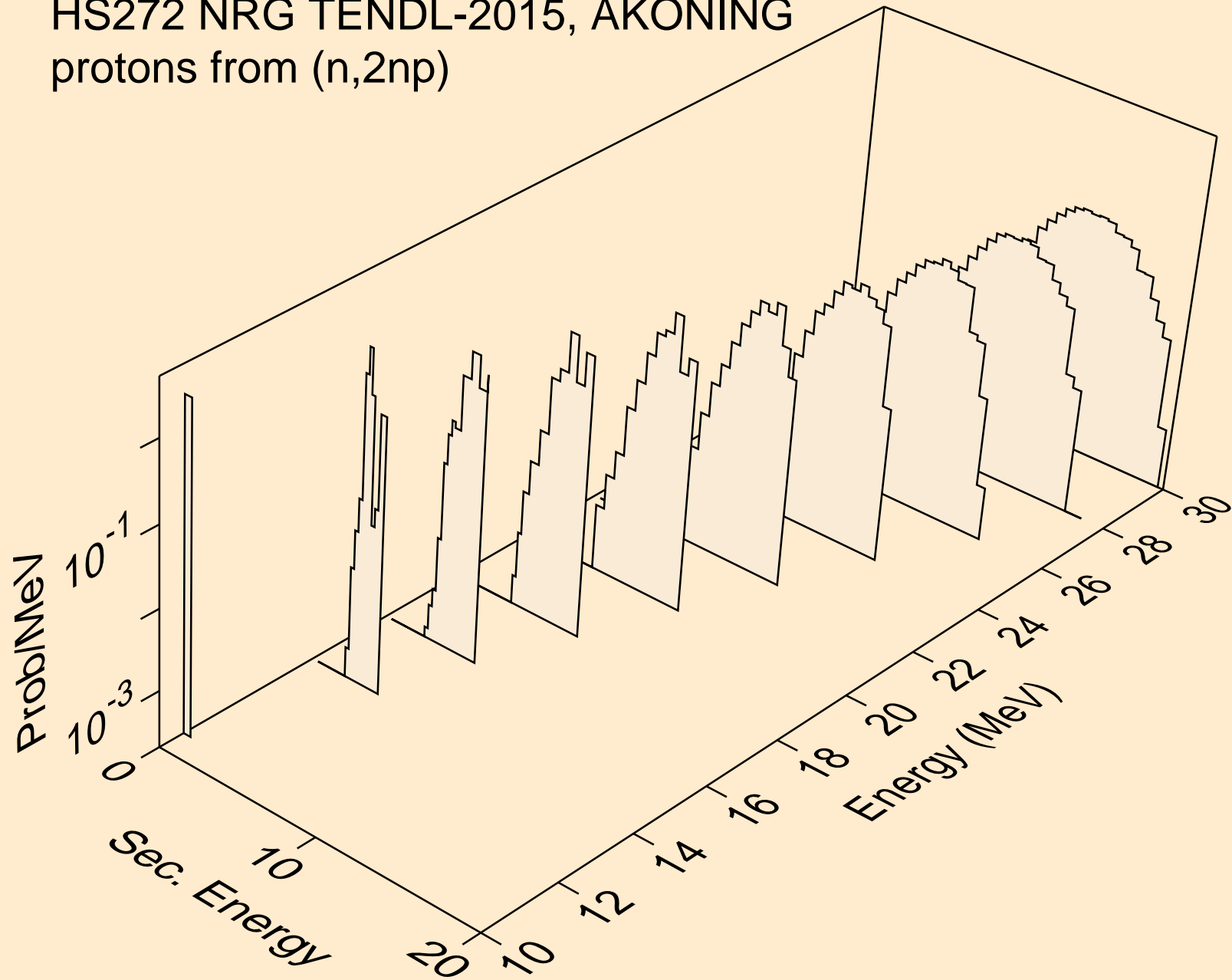

HS272 NRG TENDL-2015, AKONING
protons from (n,3np)

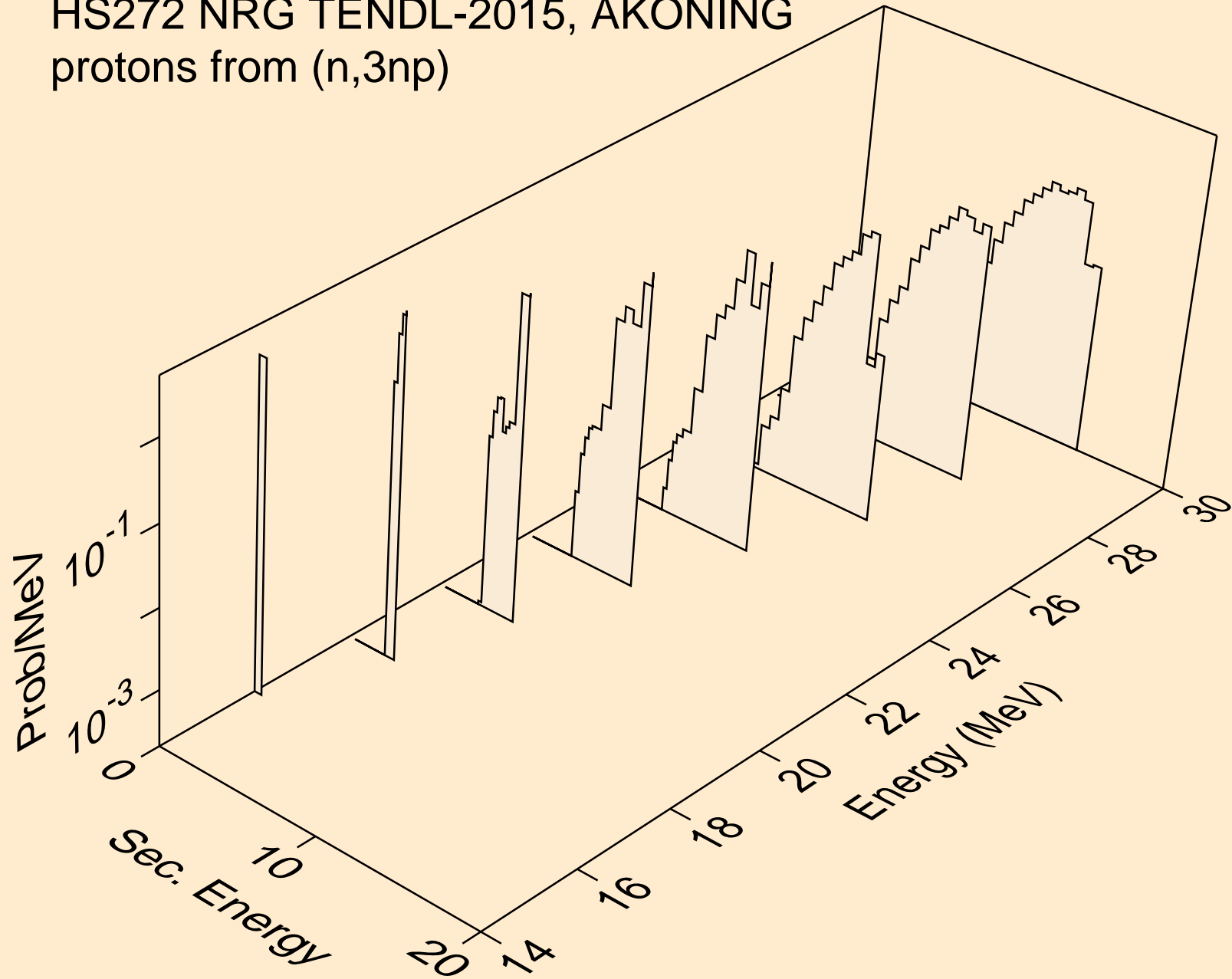

HS272 NRG TENDL-2015, AKONING
protons from (n,npa)

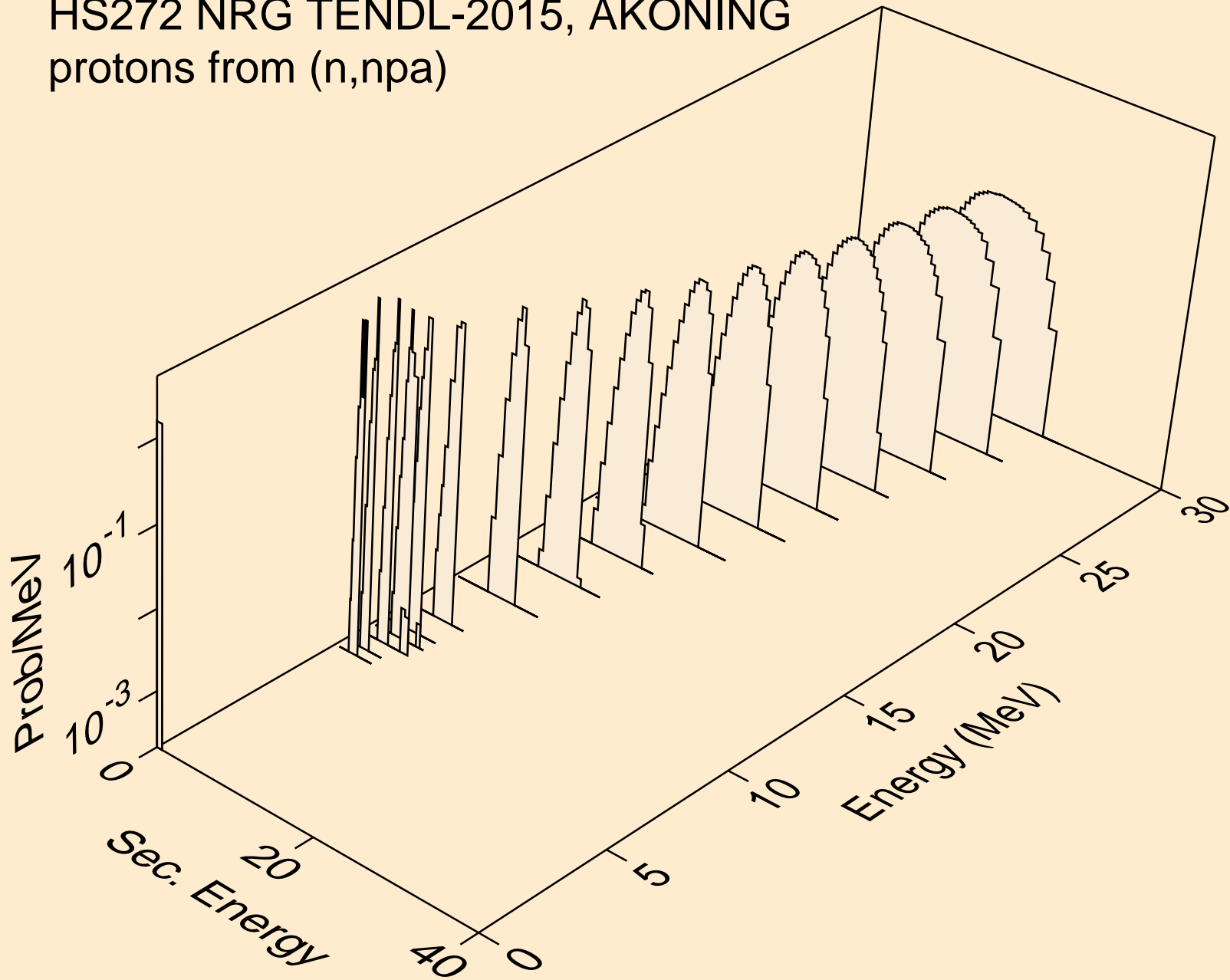

HS272 NRG TENDL-2015, AKONING
protons from (n,p)

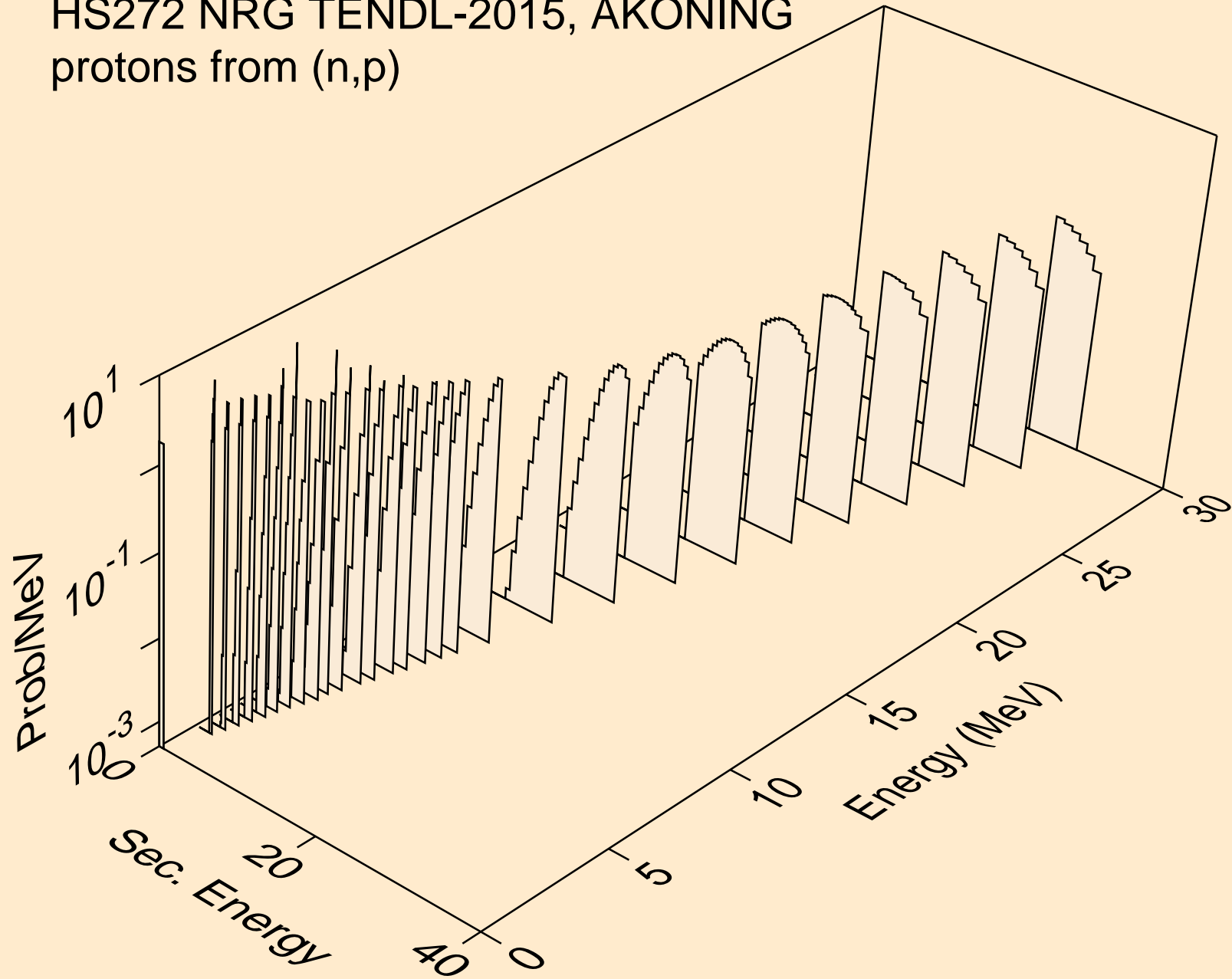

HS272 NRG TENDL-2015, AKONING
protons from (n,pa)

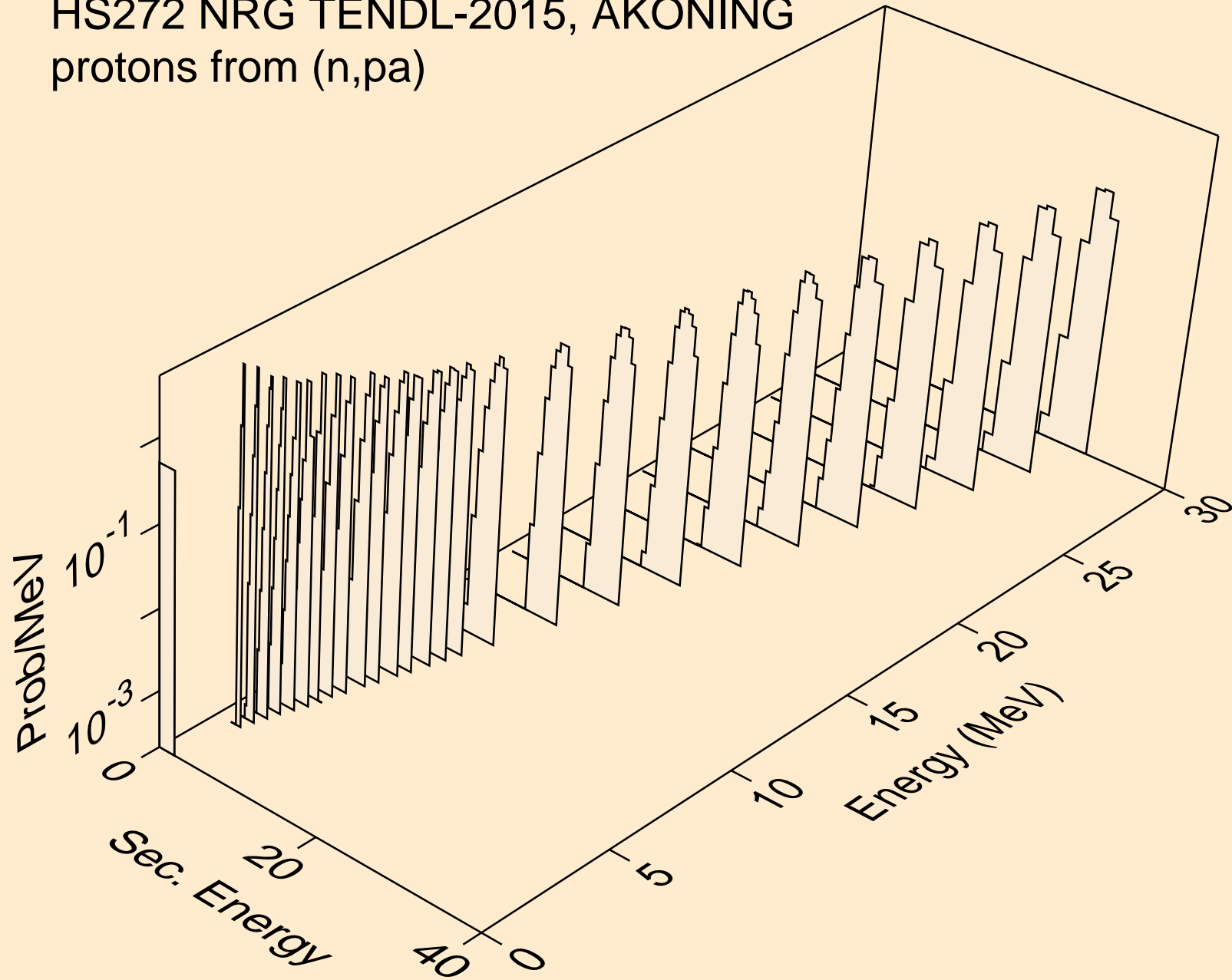

HS272 NRG TENDL-2015, AKONING
deuterons from (n,x)

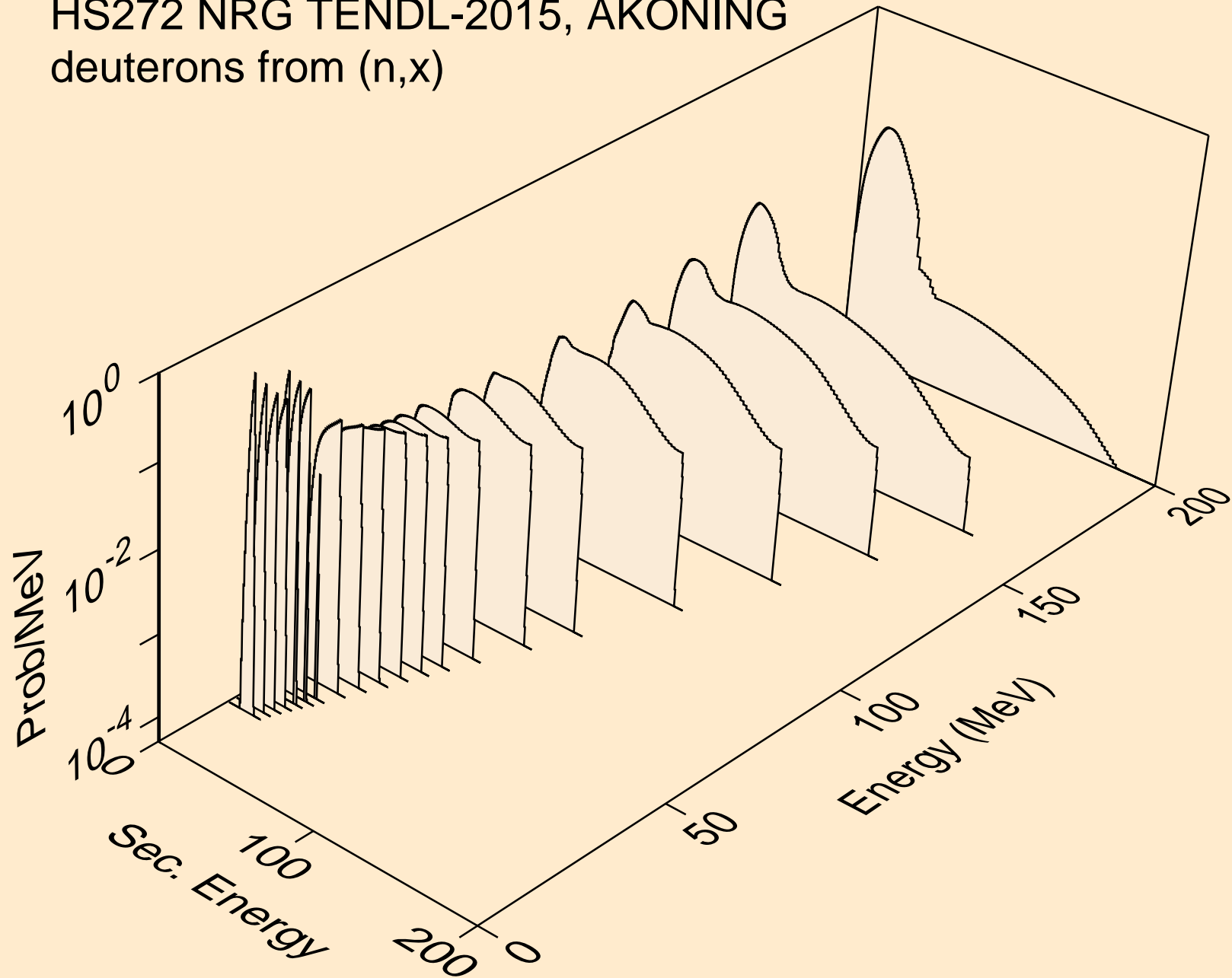

HS272 NRG TENDL-2015, AKONING
deuterons from (n,2nd)

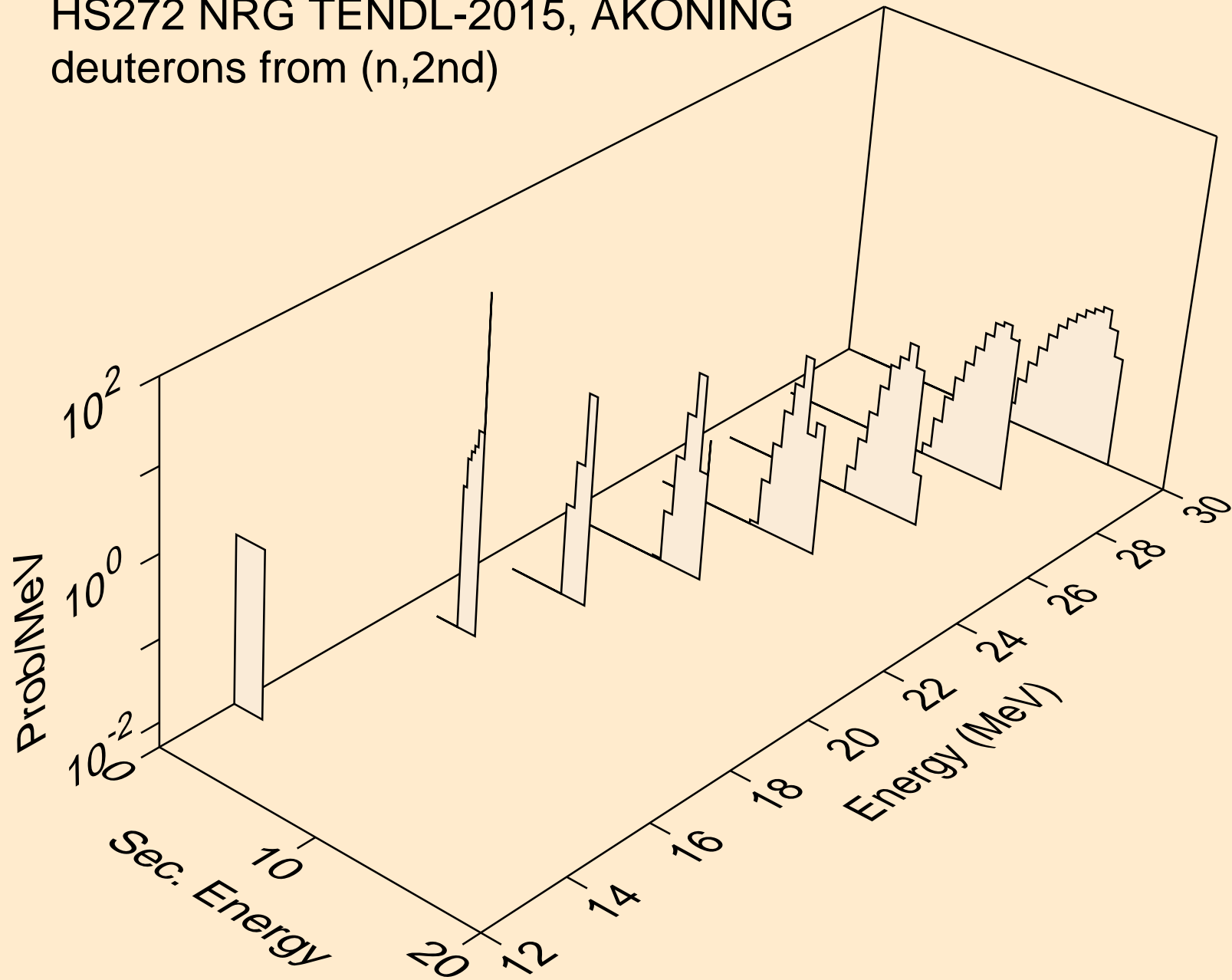

HS272 NRG TENDL-2015, AKONING
deuterons from (n,n*)d

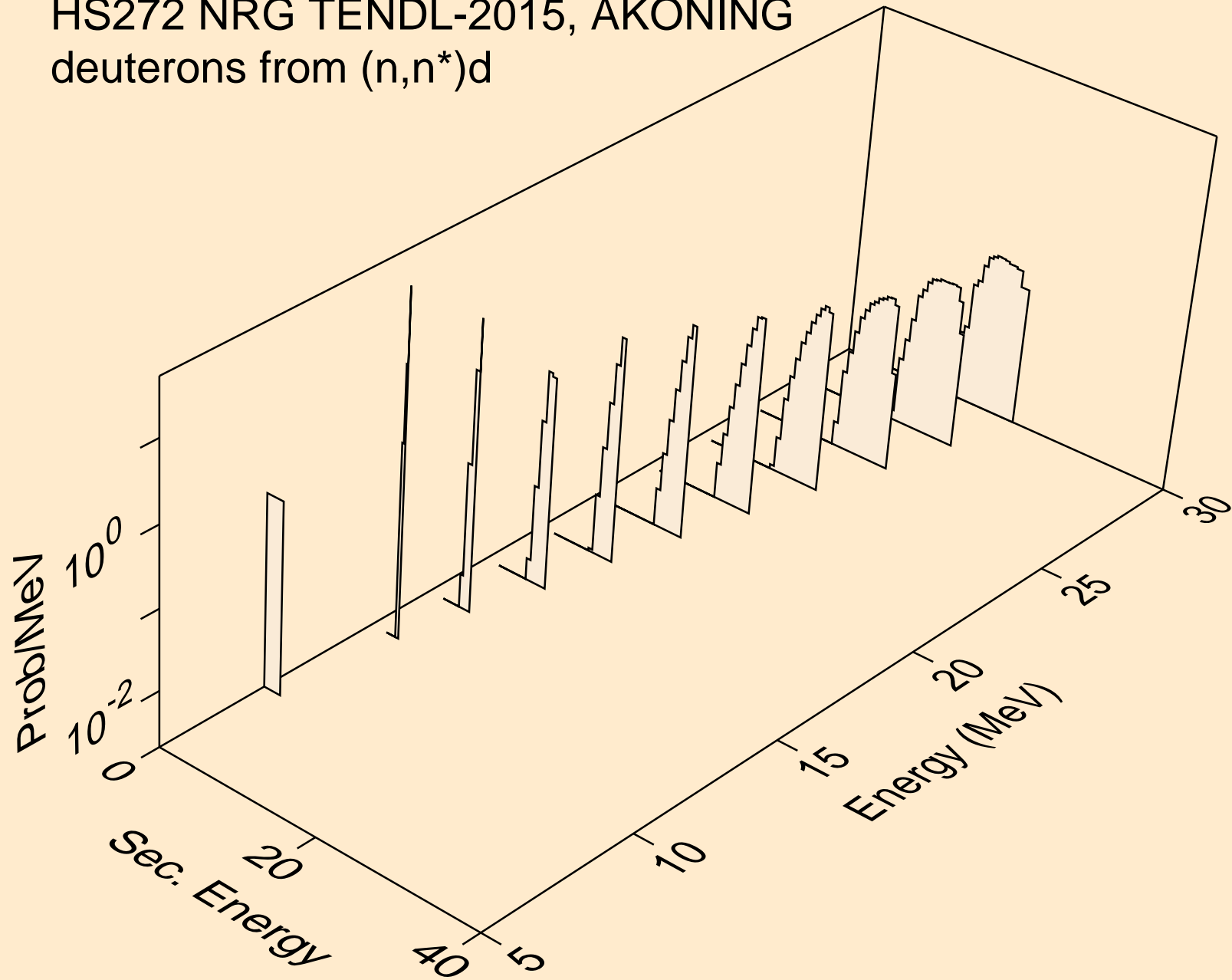

HS272 NRG TENDL-2015, AKONING
deuterons from (n,n*)d2a

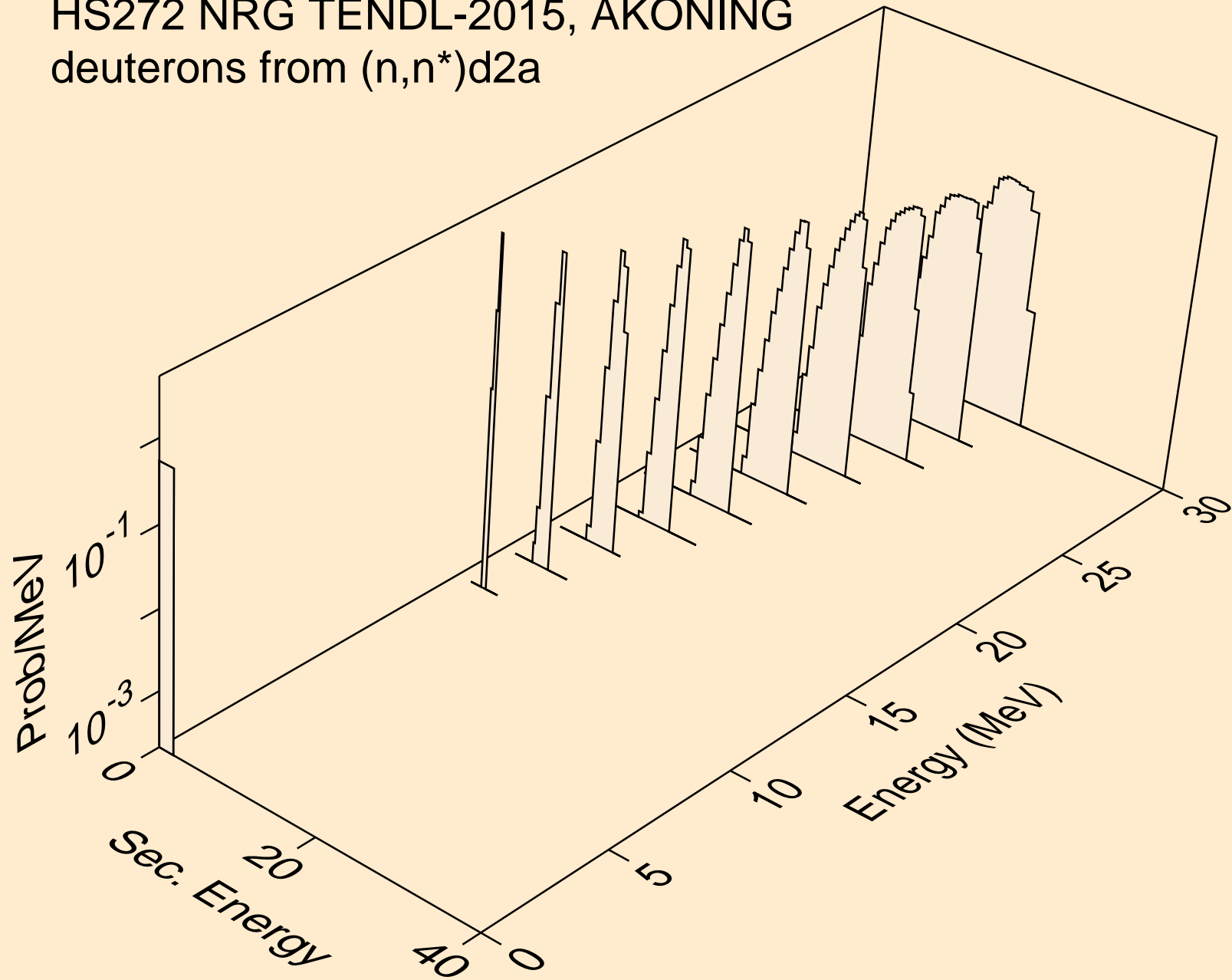

HS272 NRG TENDL-2015, AKONING
deuterons from (n,d)

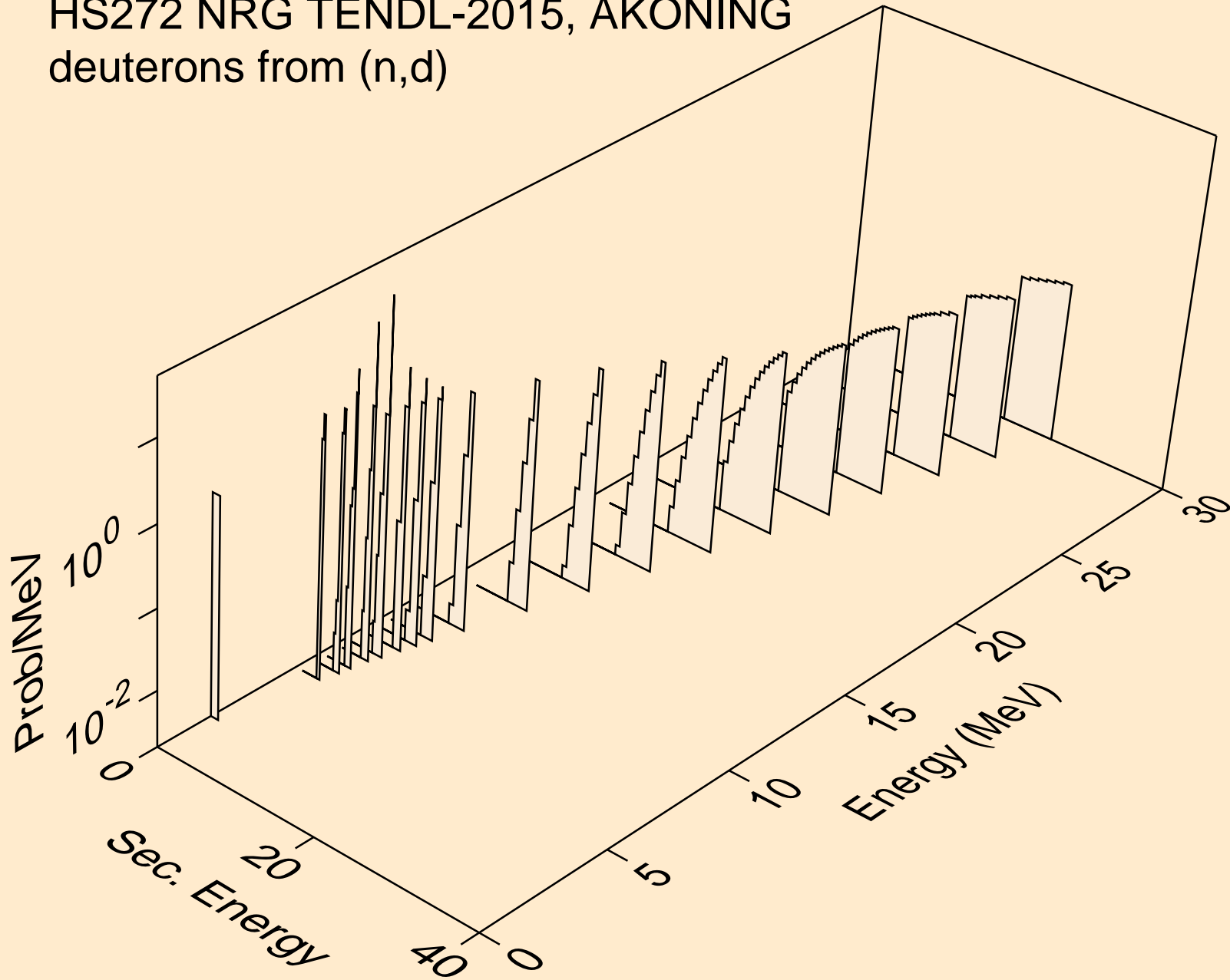

HS272 NRG TENDL-2015, AKONING
deuterons from (n,d2a)

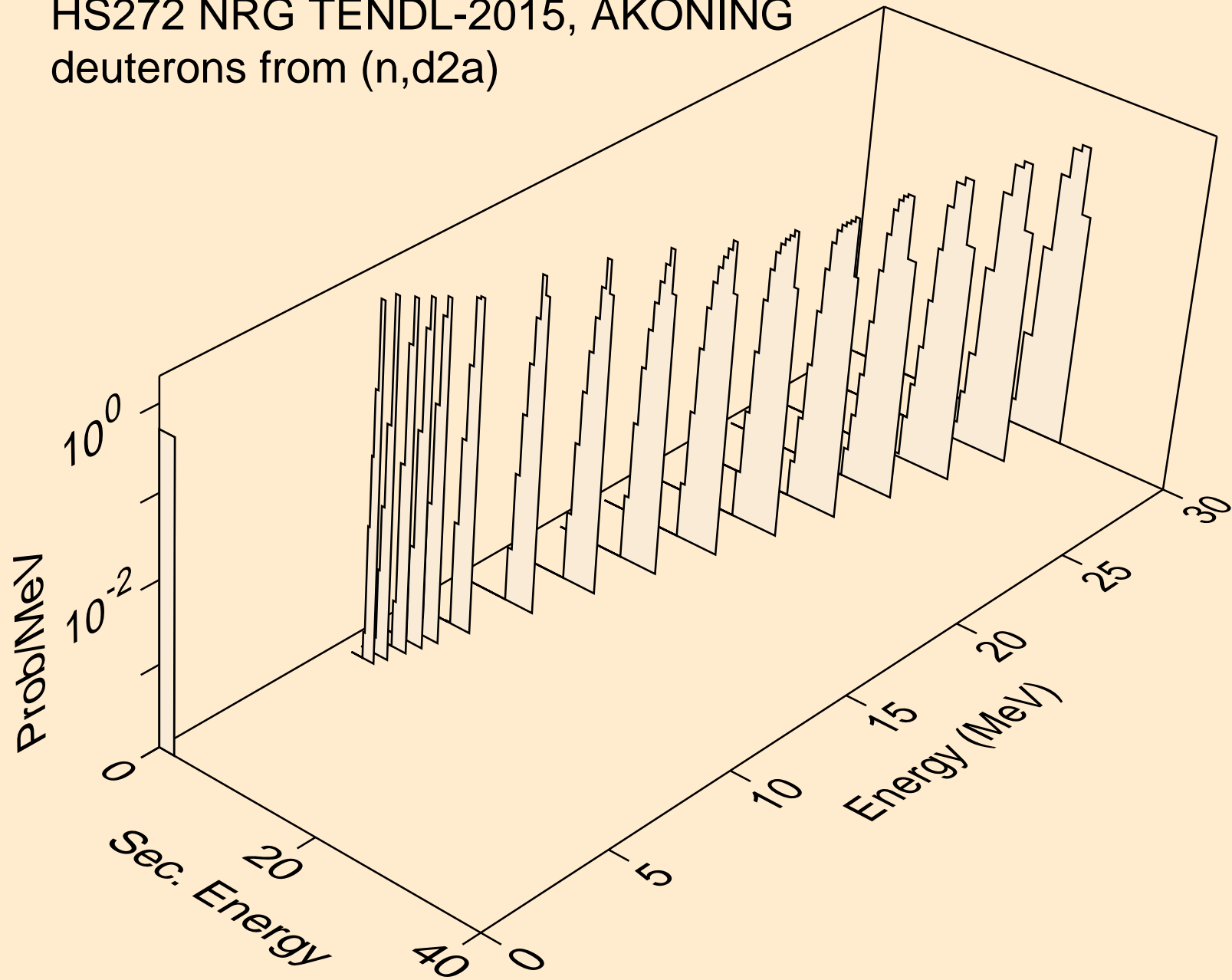

HS272 NRG TENDL-2015, AKONING
deuterons from (n,da)

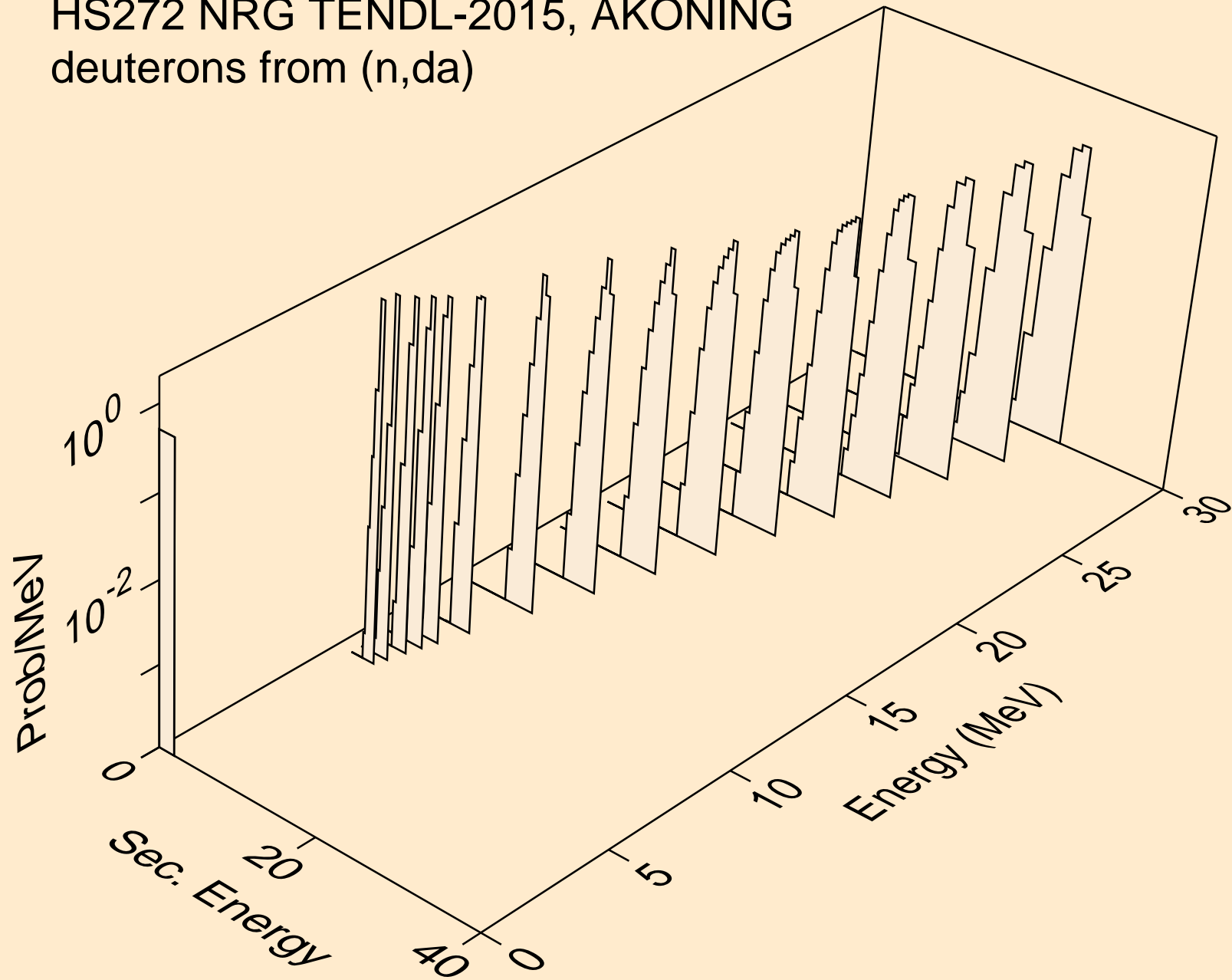

HS272 NRG TENDL-2015, AKONING
tritons from (n,x)

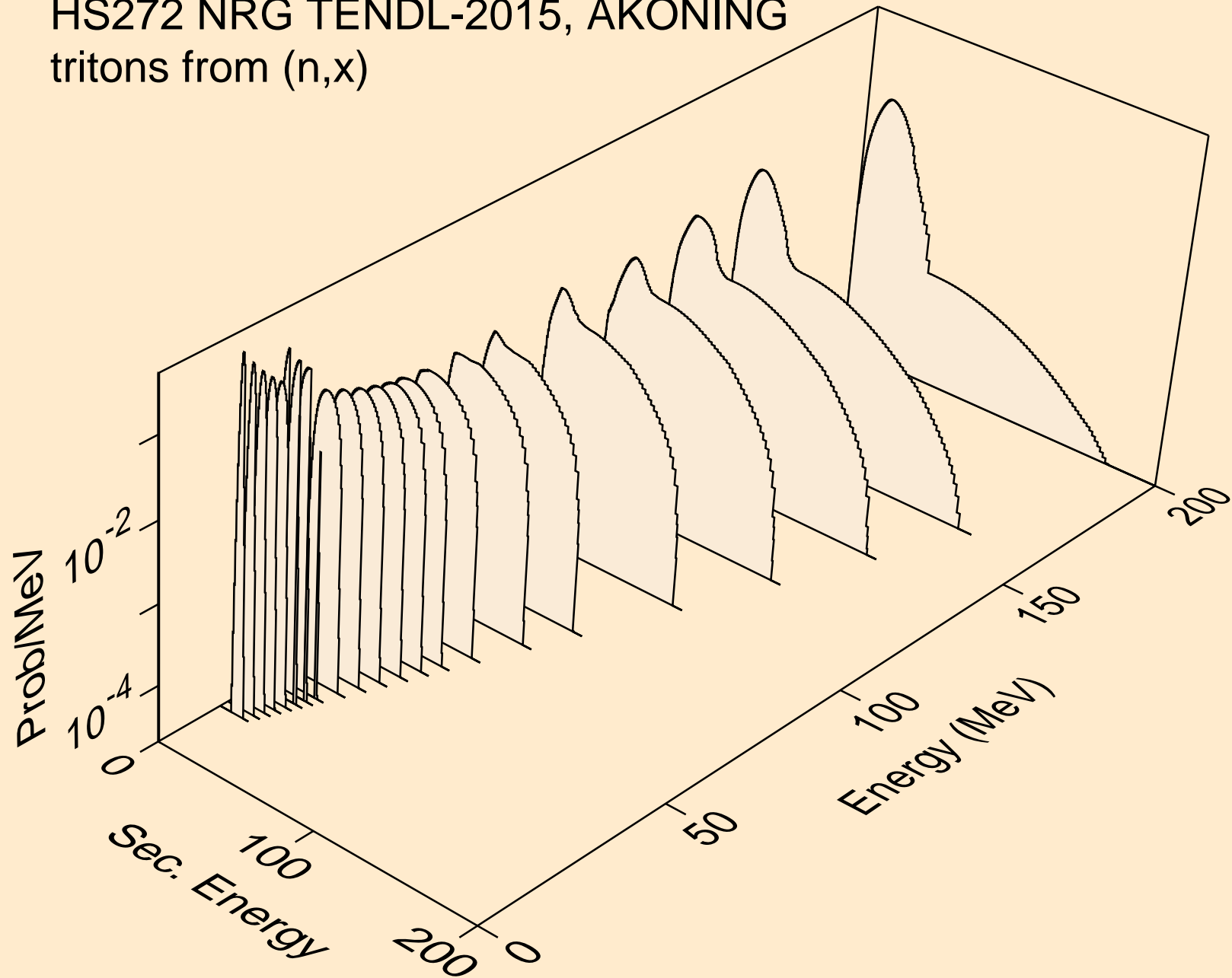

HS272 NRG TENDL-2015, AKONING
tritons from (n,n*)t

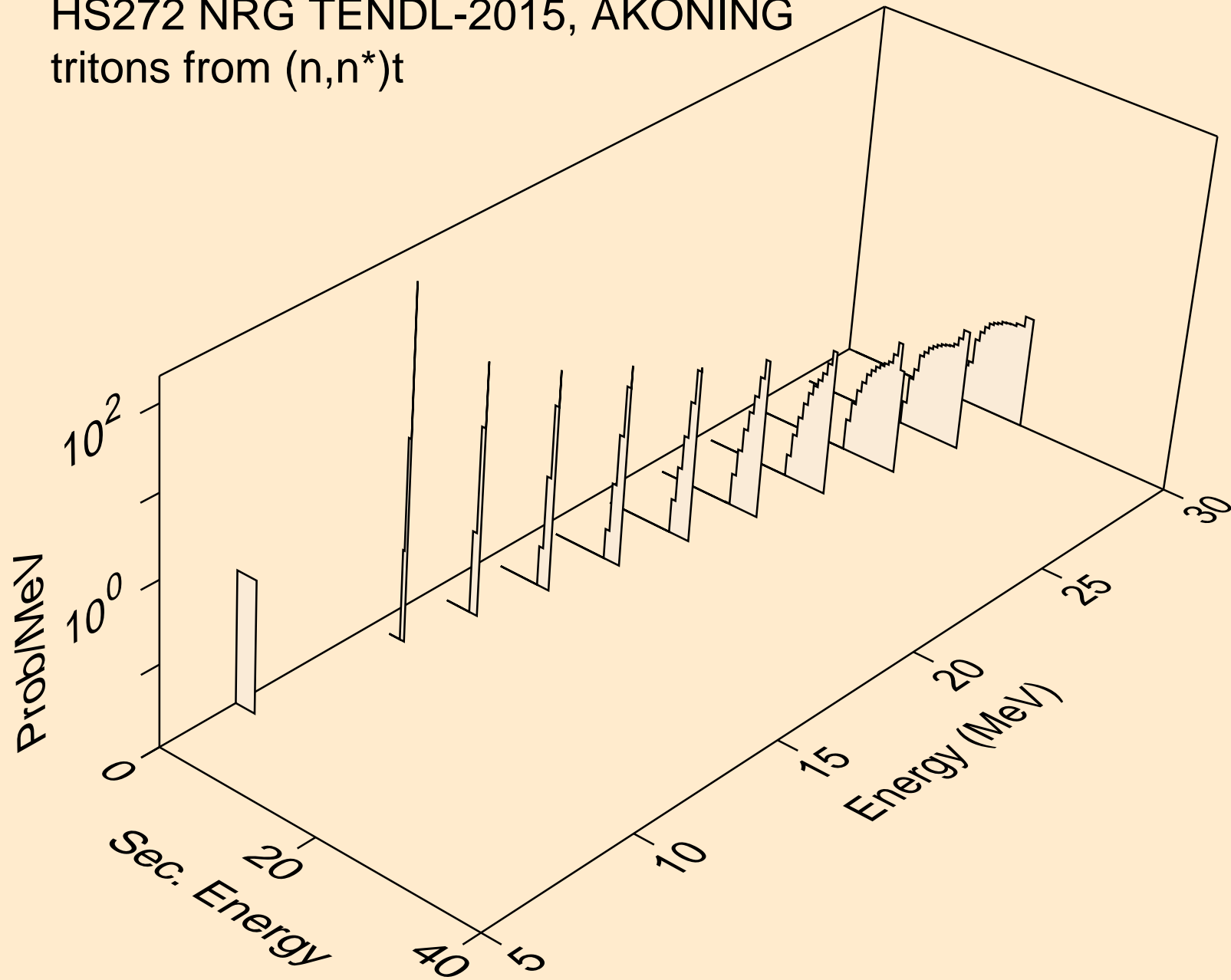

HS272 NRG TENDL-2015, AKONING
tritons from (n,n*)t2a

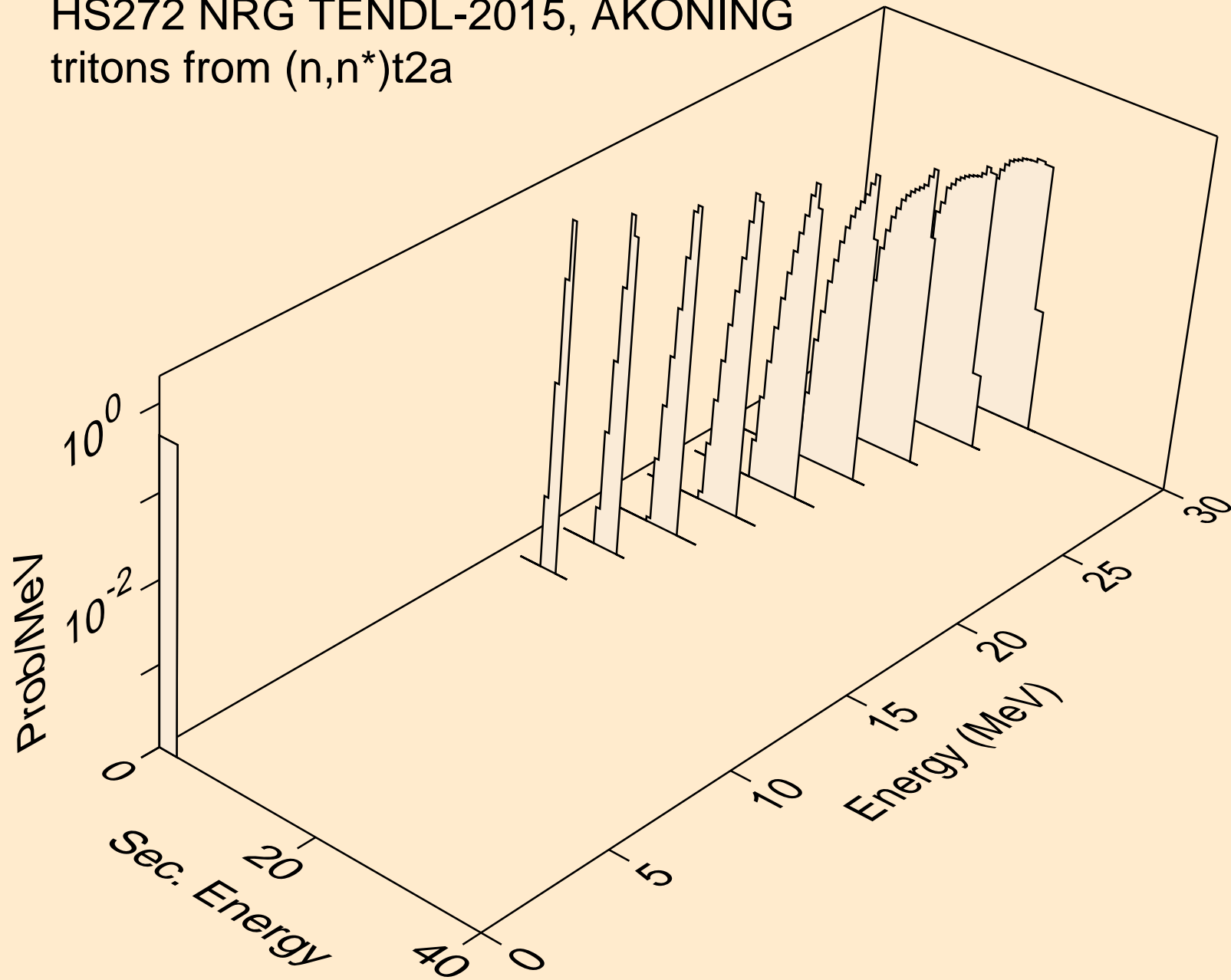

HS272 NRG TENDL-2015, AKONING
tritons from (n,t)

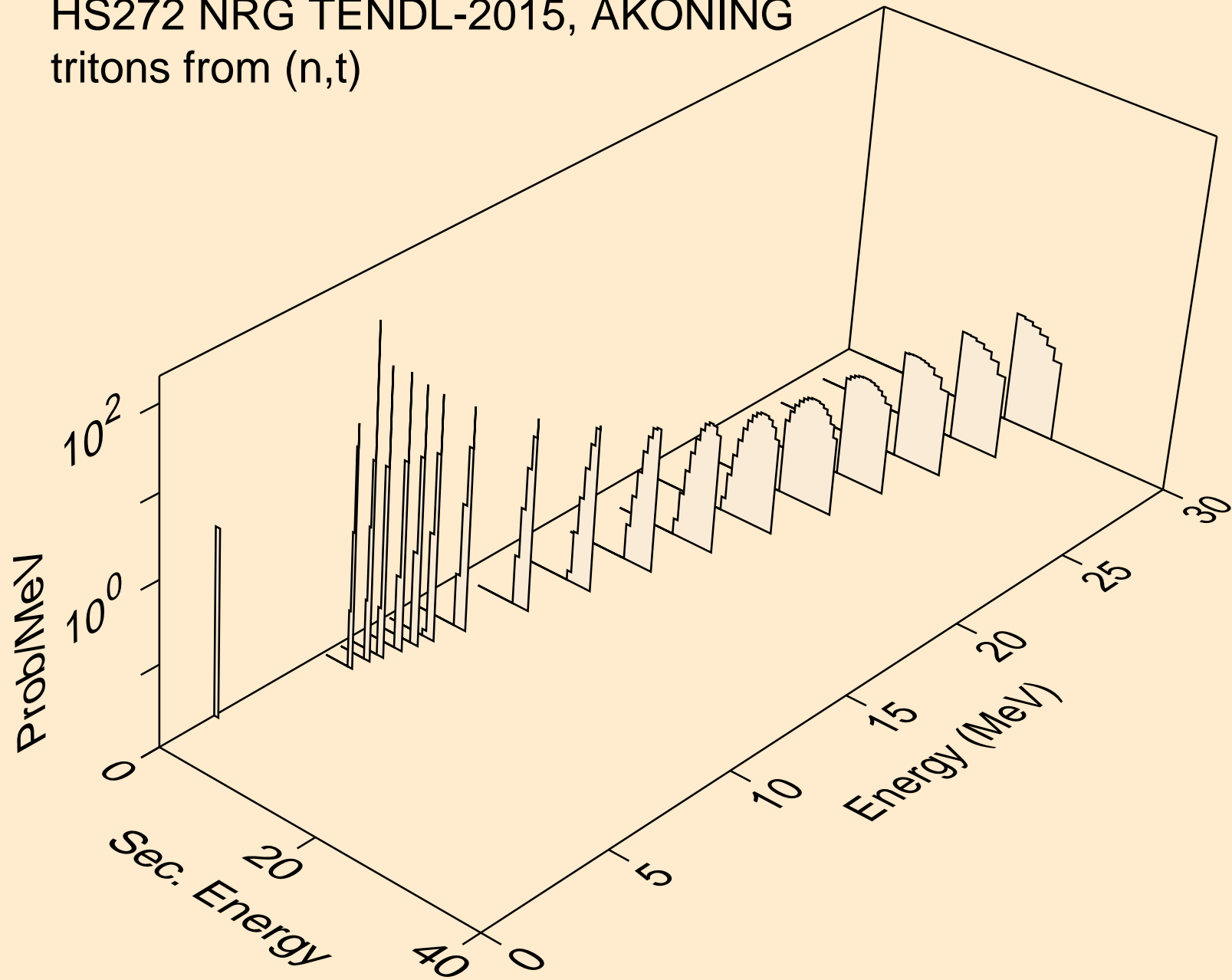

HS272 NRG TENDL-2015, AKONING
tritons from (n,t2a)

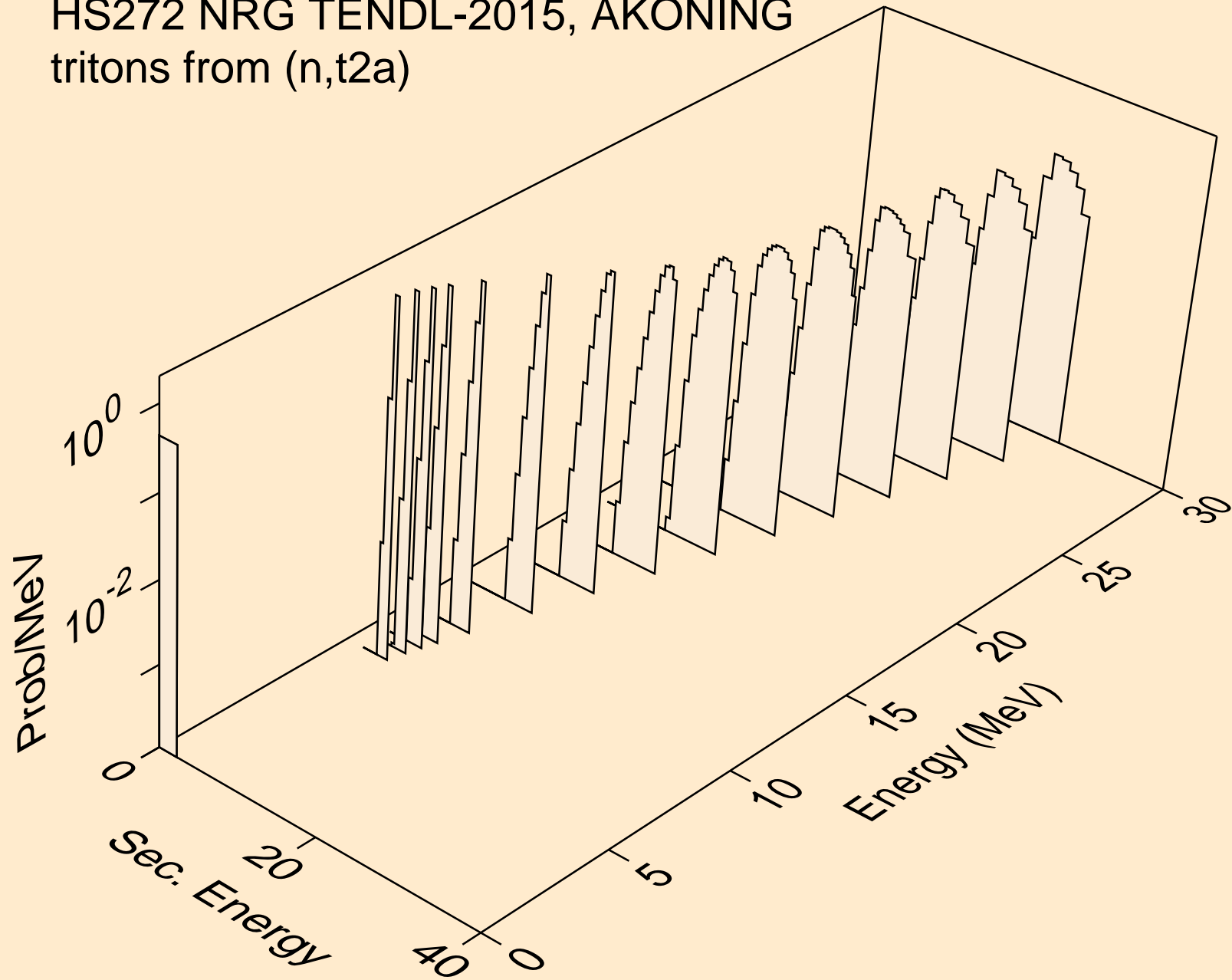

HS272 NRG TENDL-2015, AKONING
he3s from (n,x)

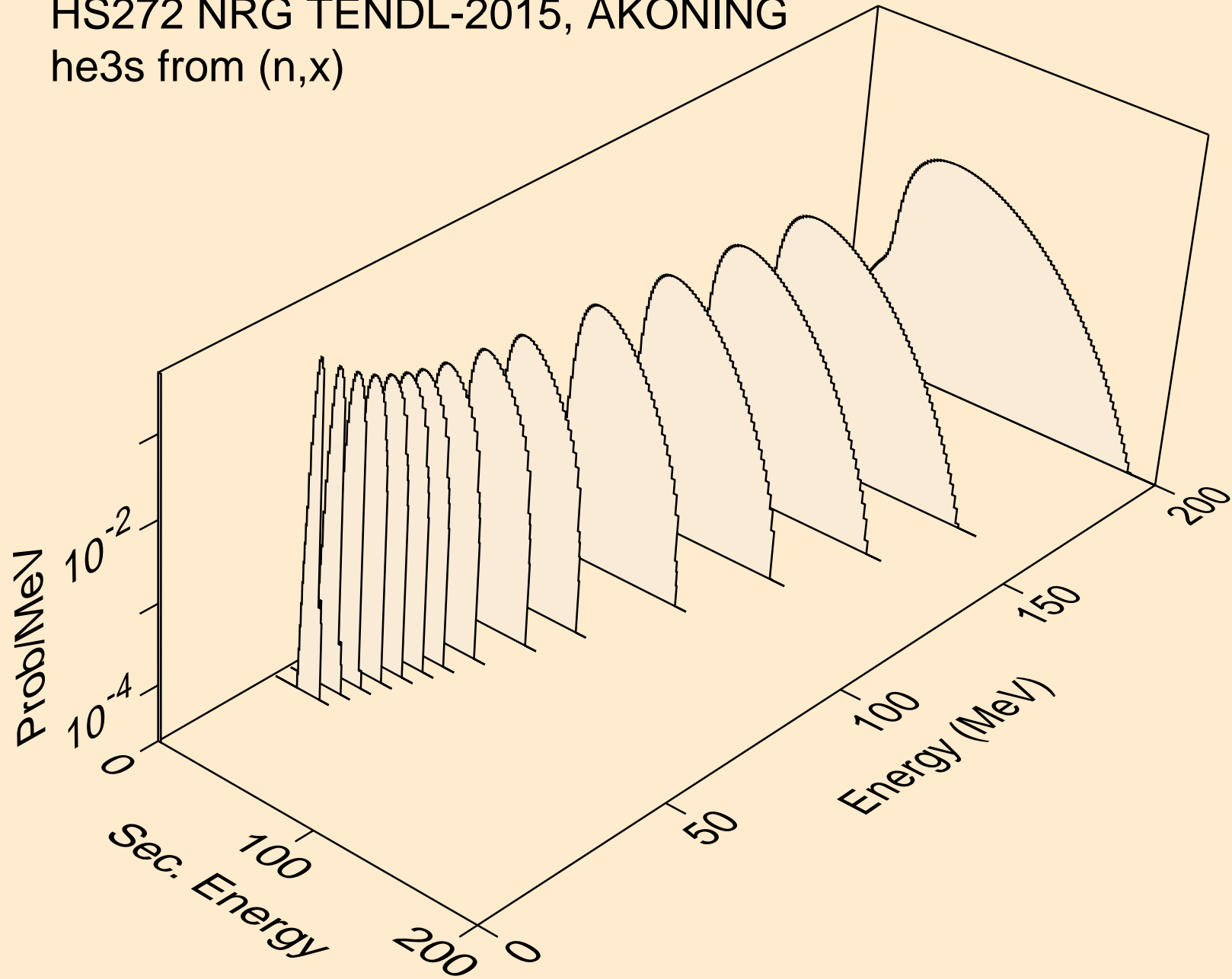

HS272 NRG TENDL-2015, AKONING
he3s from (n,n*)he3

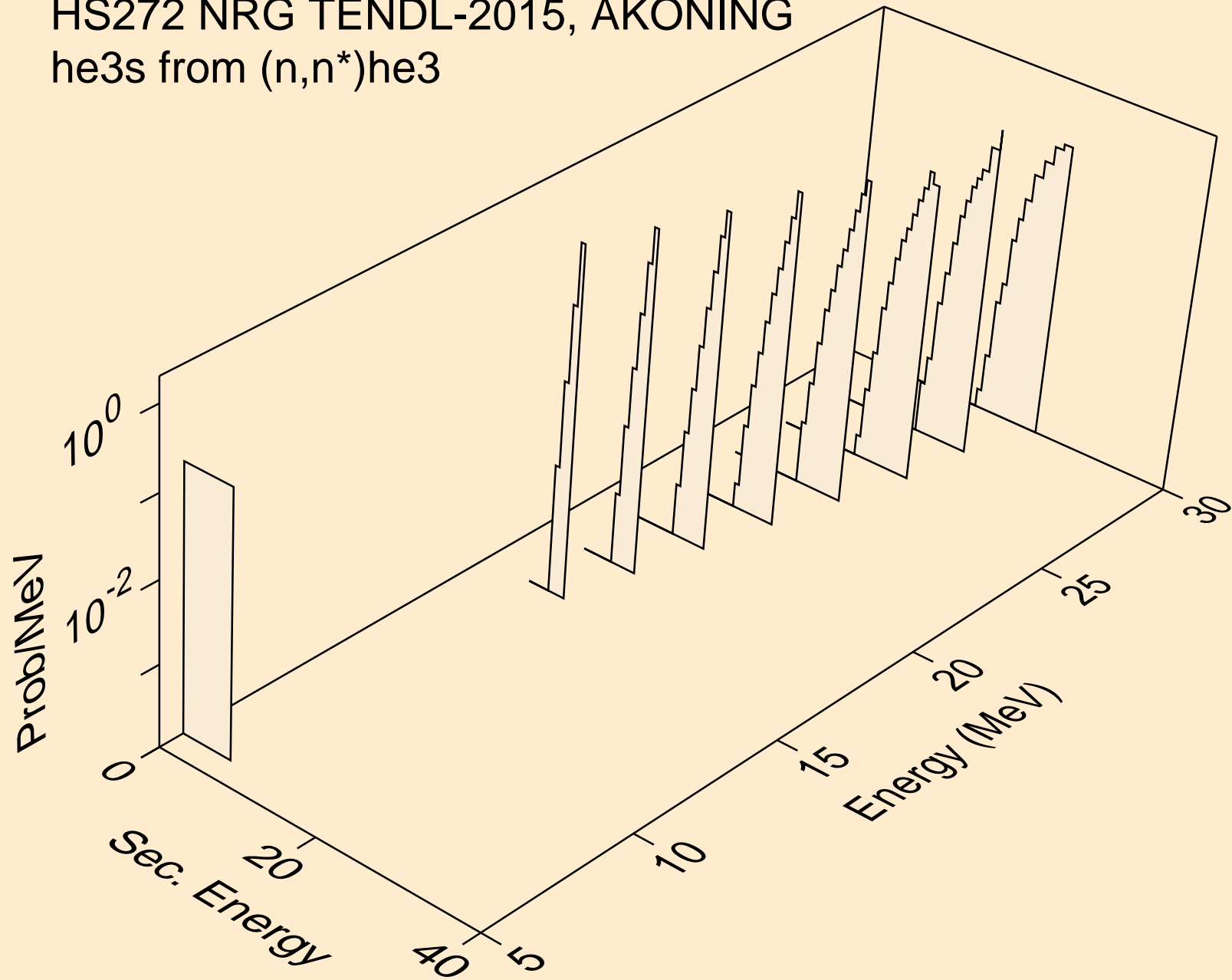

HS272 NRG TENDL-2015, AKONING
he3s from (n,he3)

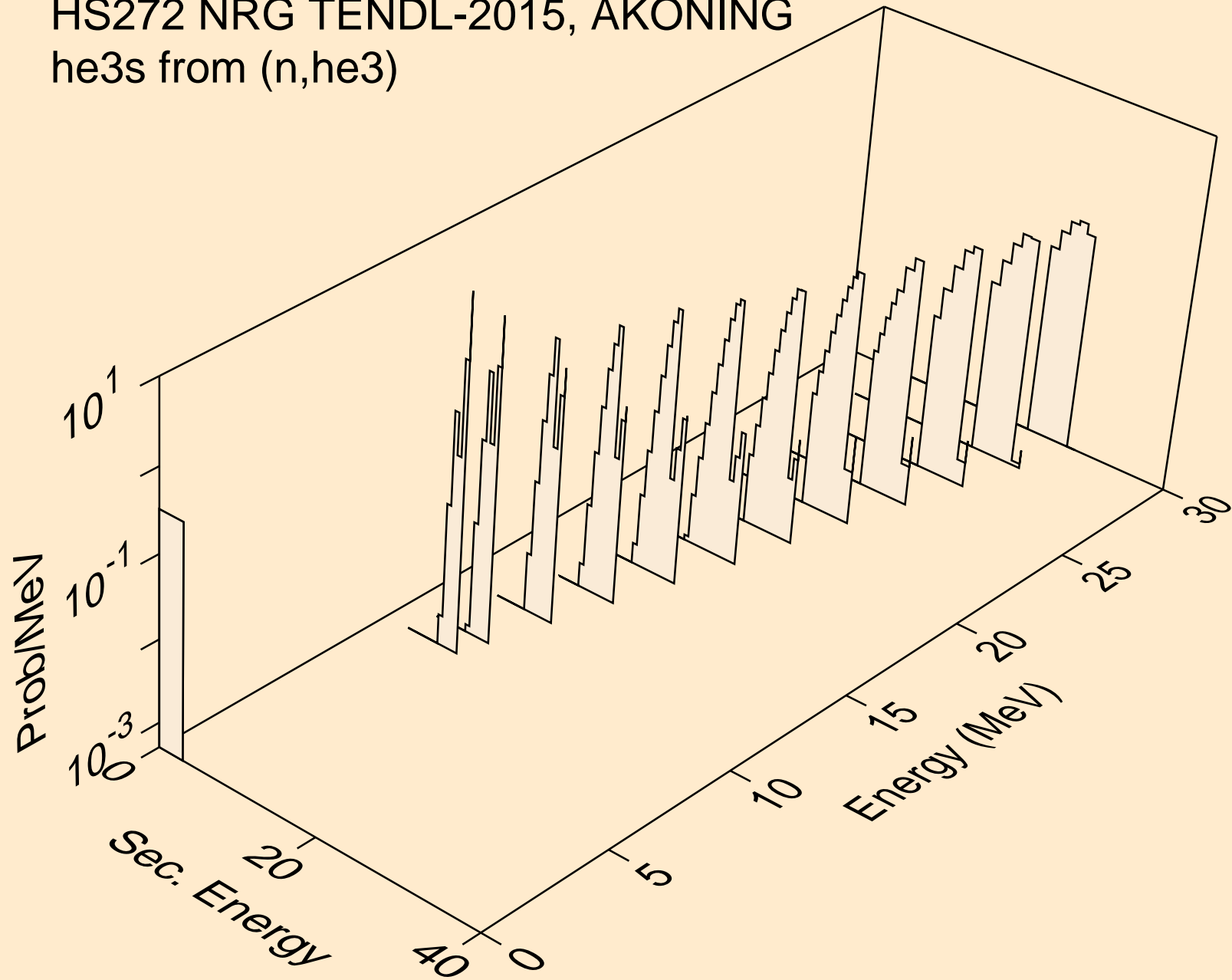

HS272 NRG TENDL-2015, AKONING
alphas from (n,x)

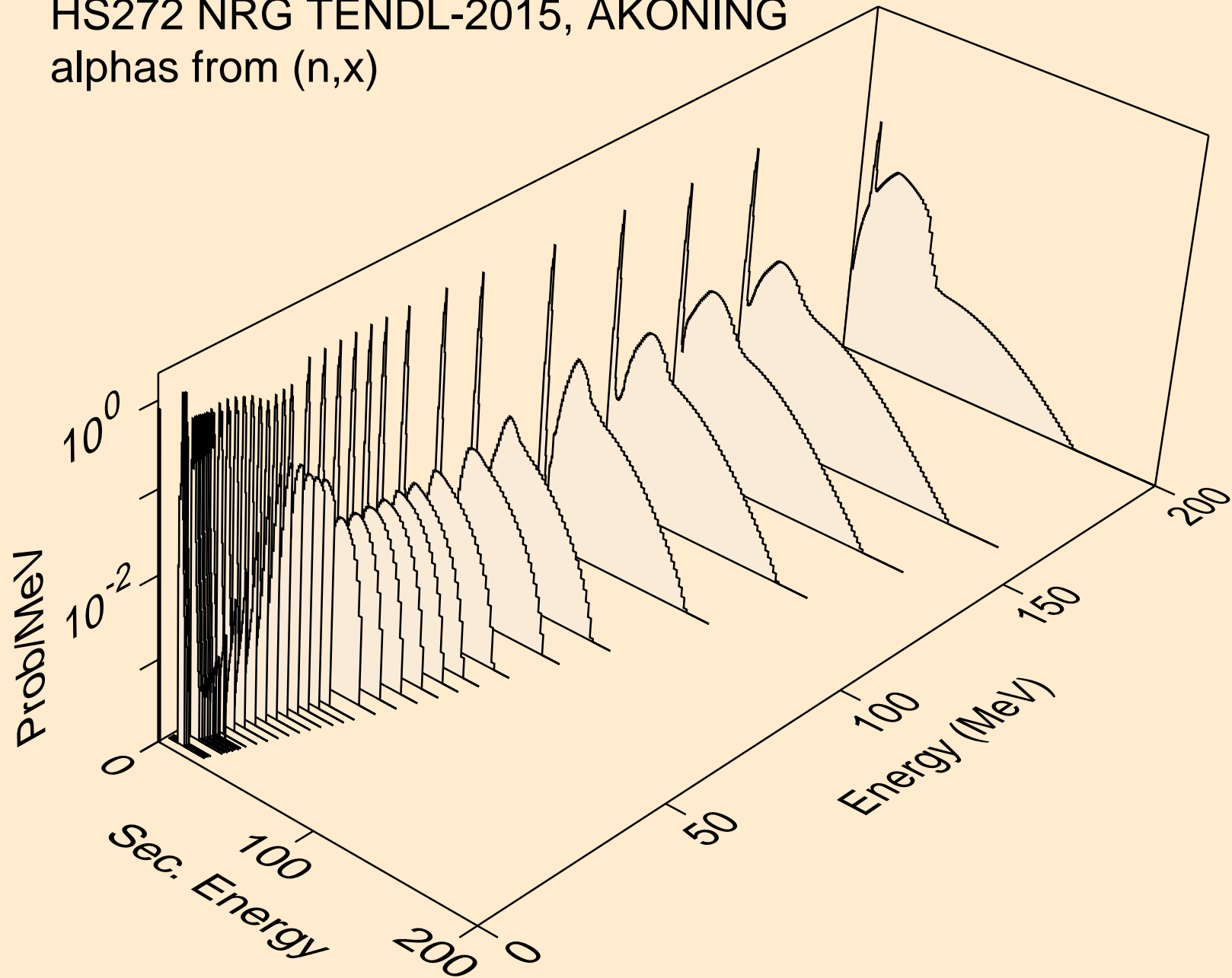

HS272 NRG TENDL-2015, AKONING
alphas from (n,n*)a

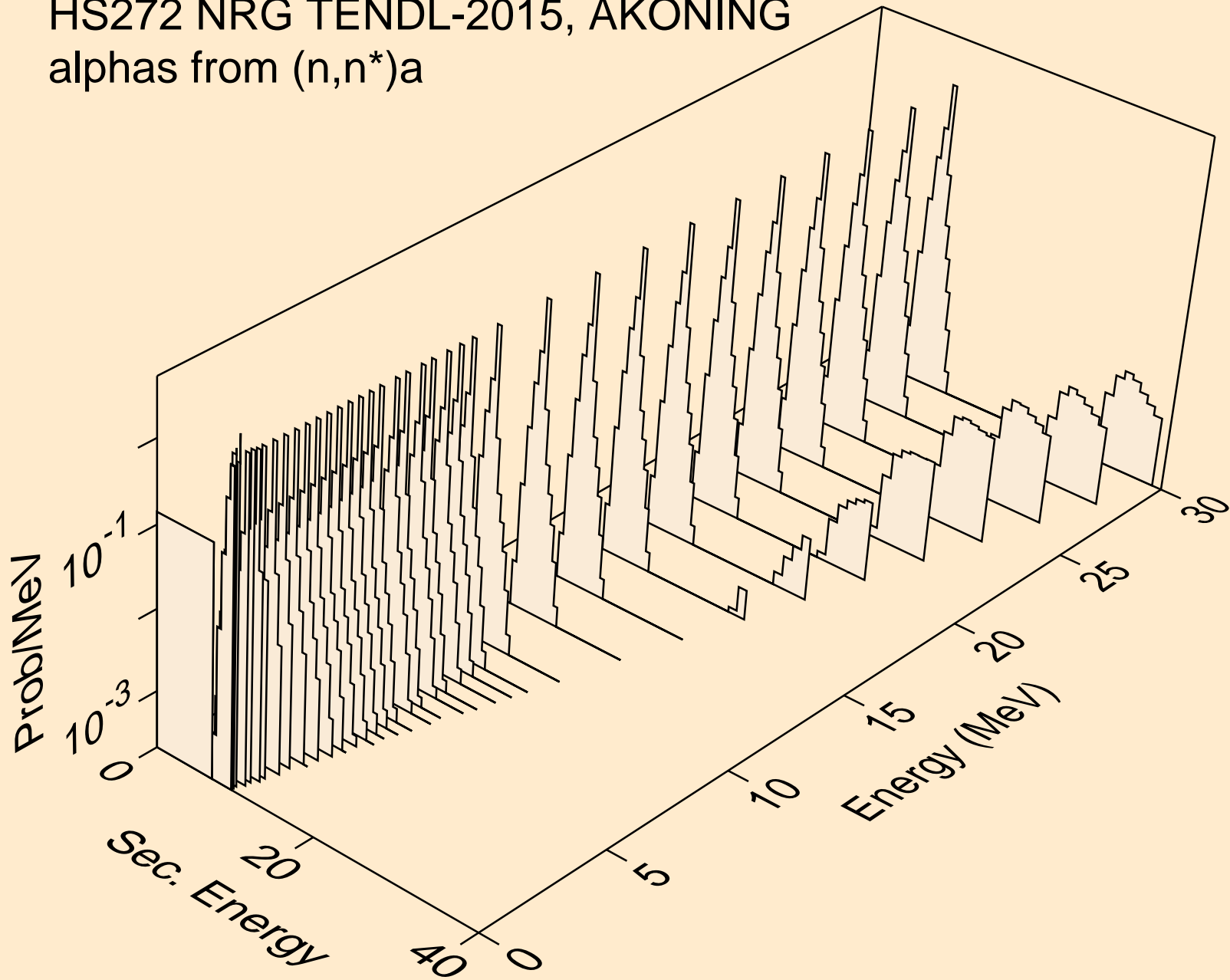

HS272 NRG TENDL-2015, AKONING
alphas from (n,n*)3a

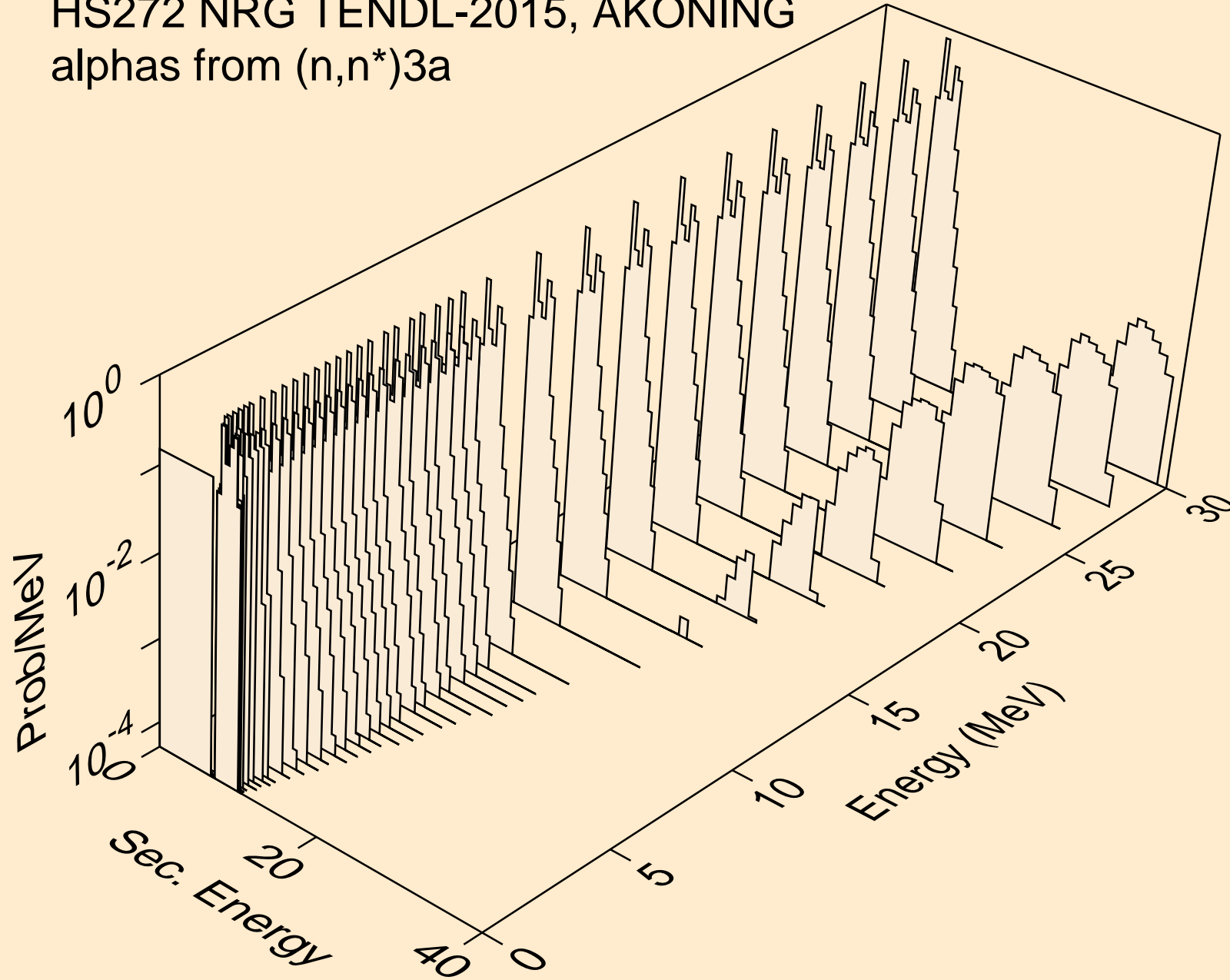

HS272 NRG TENDL-2015, AKONING
alphas from (n,2n)a

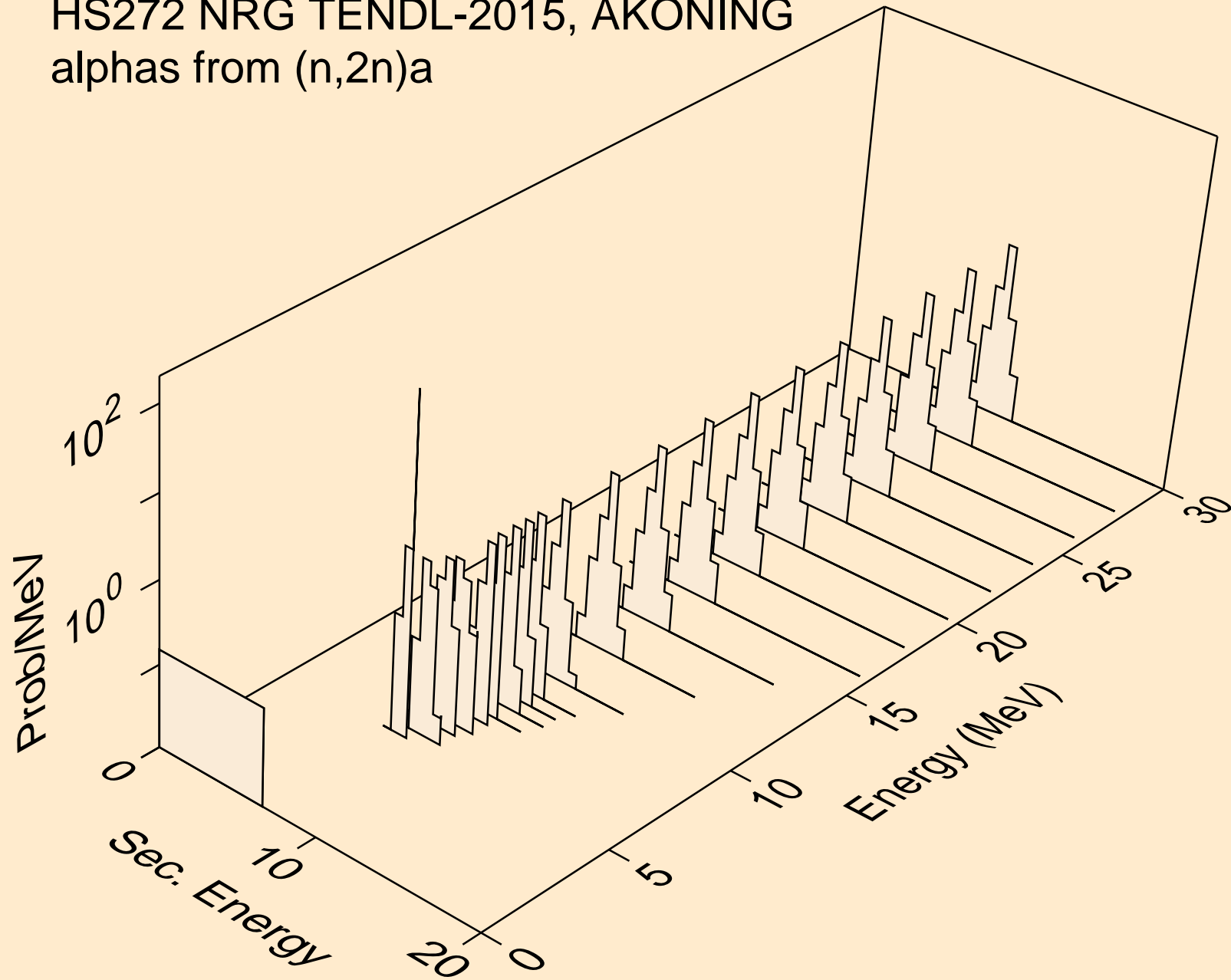

HS272 NRG TENDL-2015, AKONING
alphas from (n,3n)a

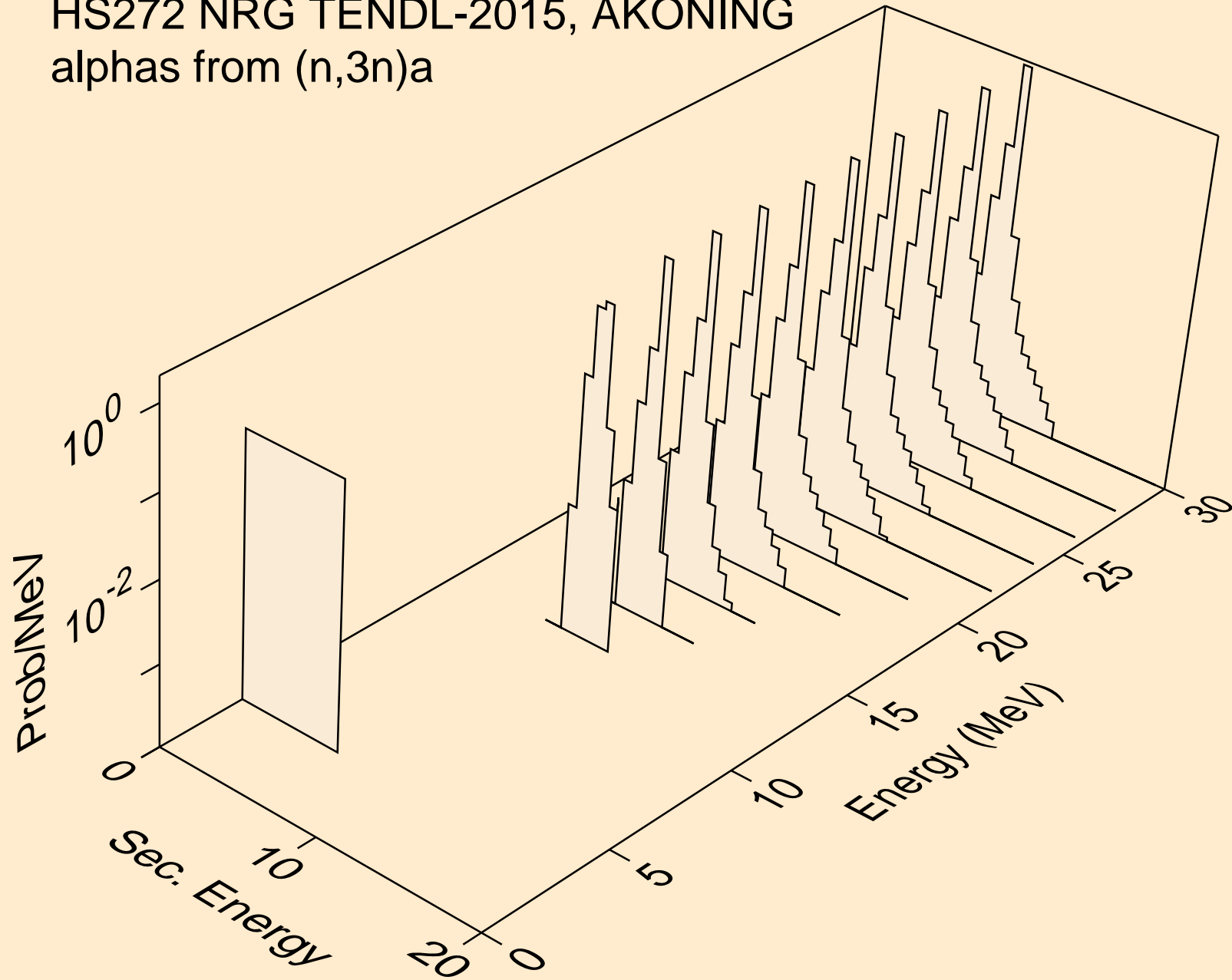

HS272 NRG TENDL-2015, AKONING
alphas from (n,n*)2a

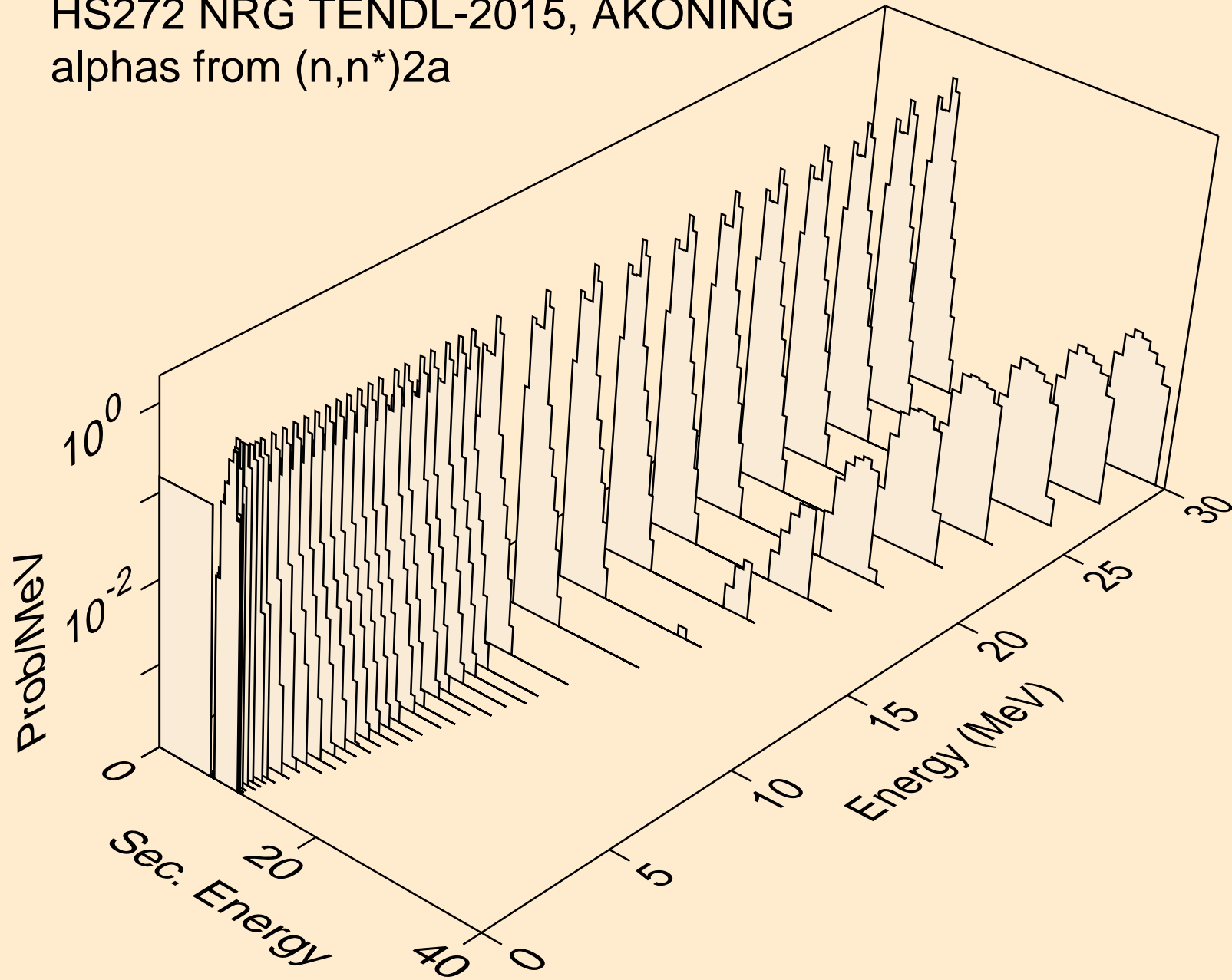

HS272 NRG TENDL-2015, AKONING
alphas from (n,2n)2a

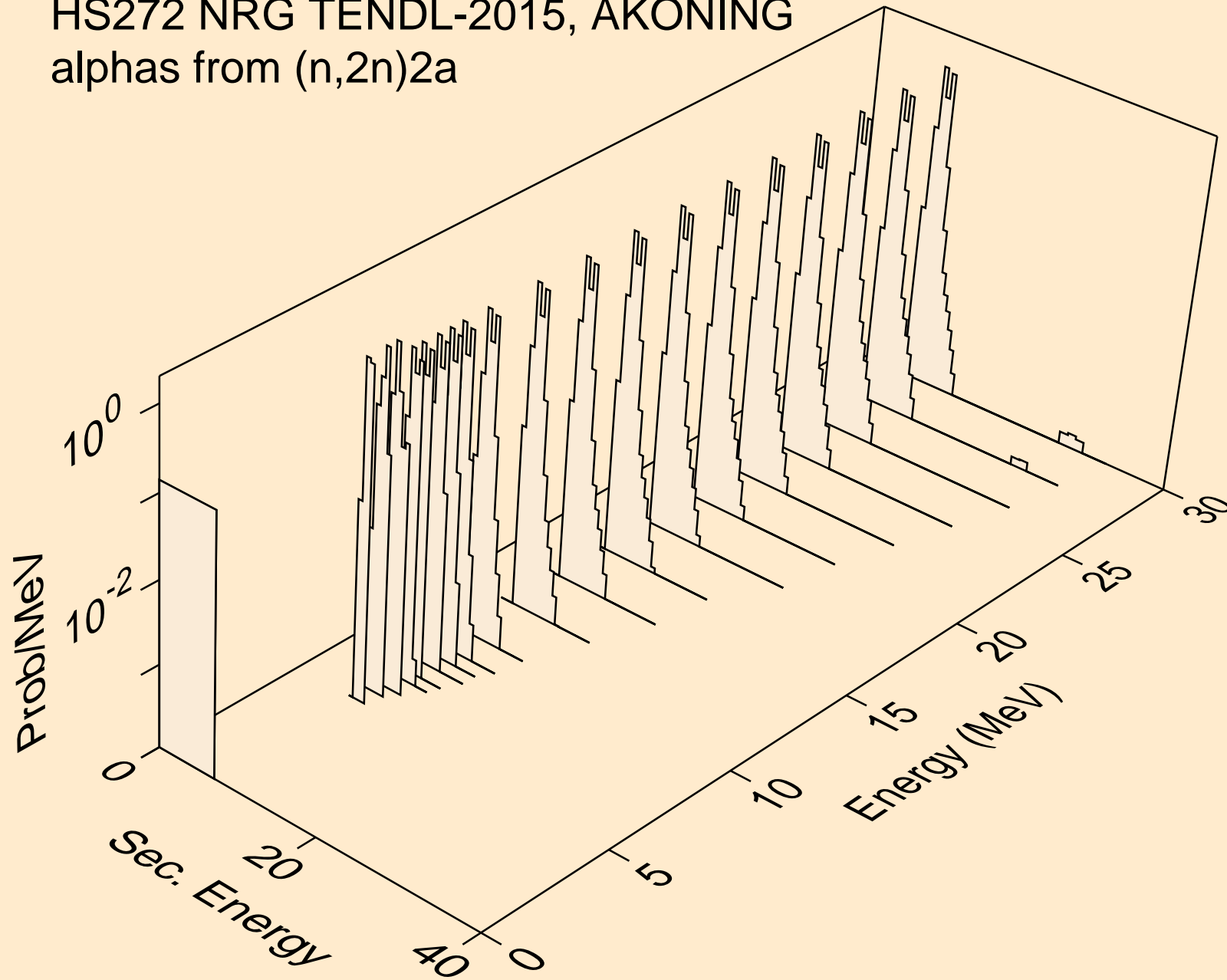

HS272 NRG TENDL-2015, AKONING
alphas from (n,n*)d2a

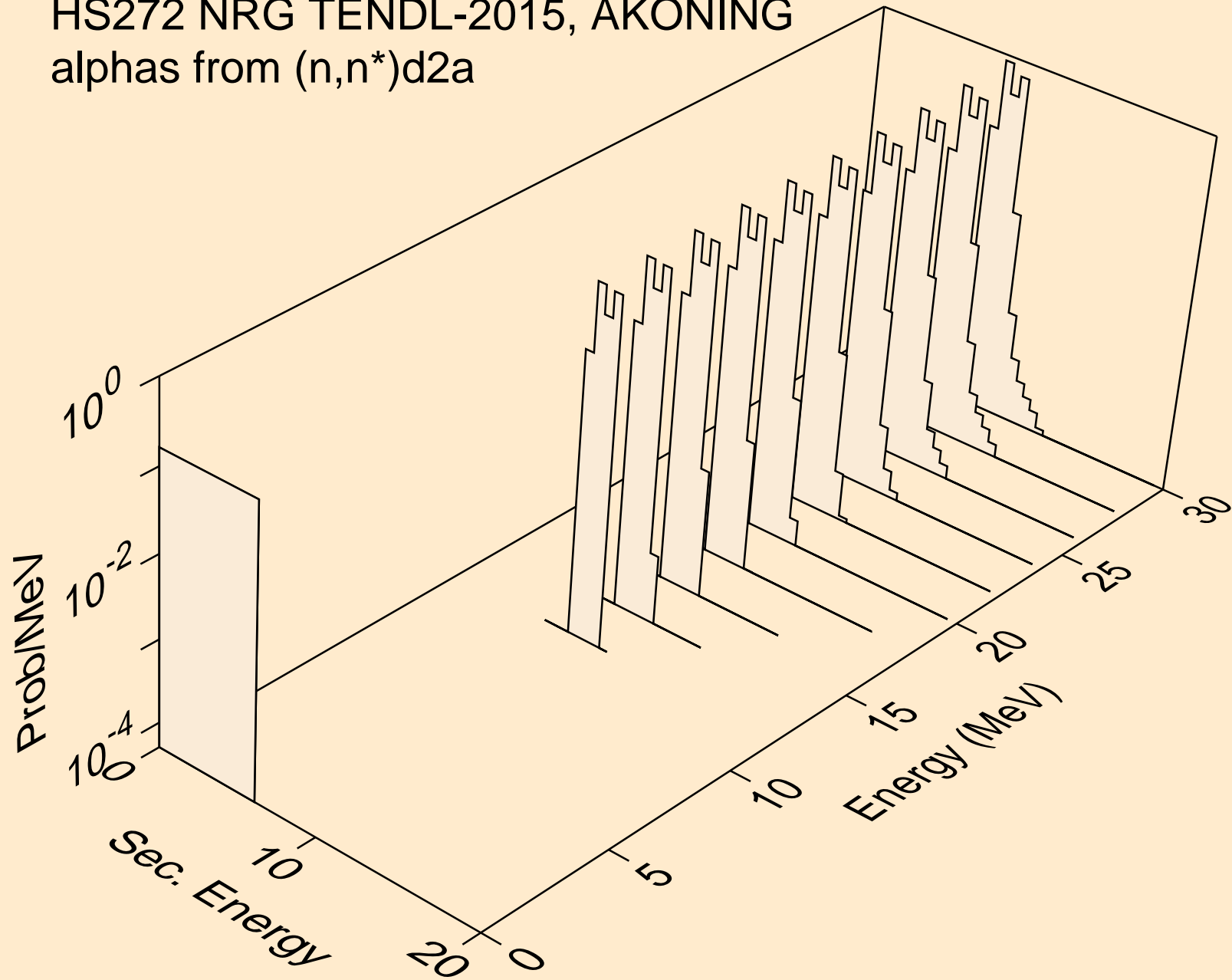

HS272 NRG TENDL-2015, AKONING
alphas from (n,n*)t2a

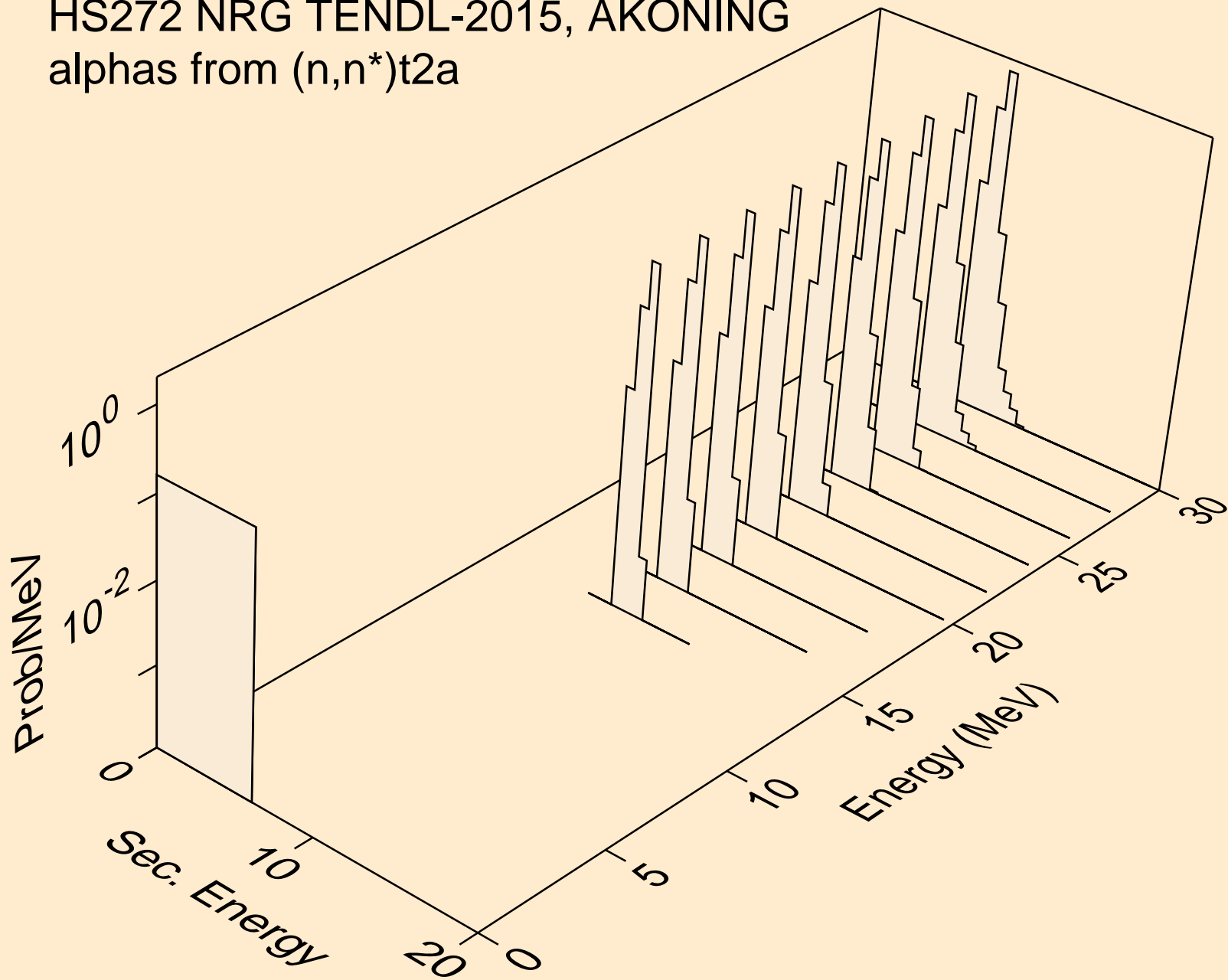

HS272 NRG TENDL-2015, AKONING
alphas from (n,npa)

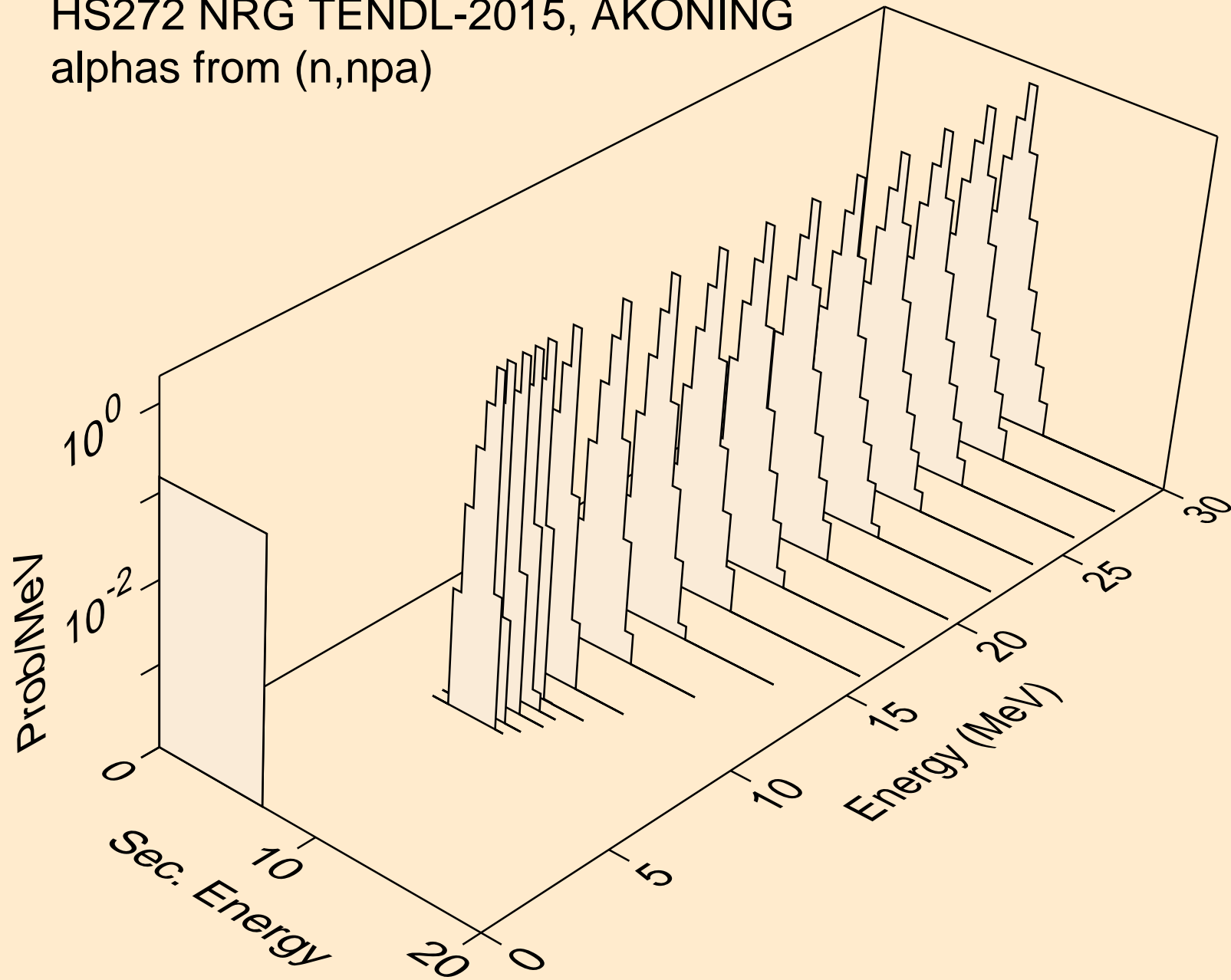

HS272 NRG TENDL-2015, AKONING
alphas from (n,a)

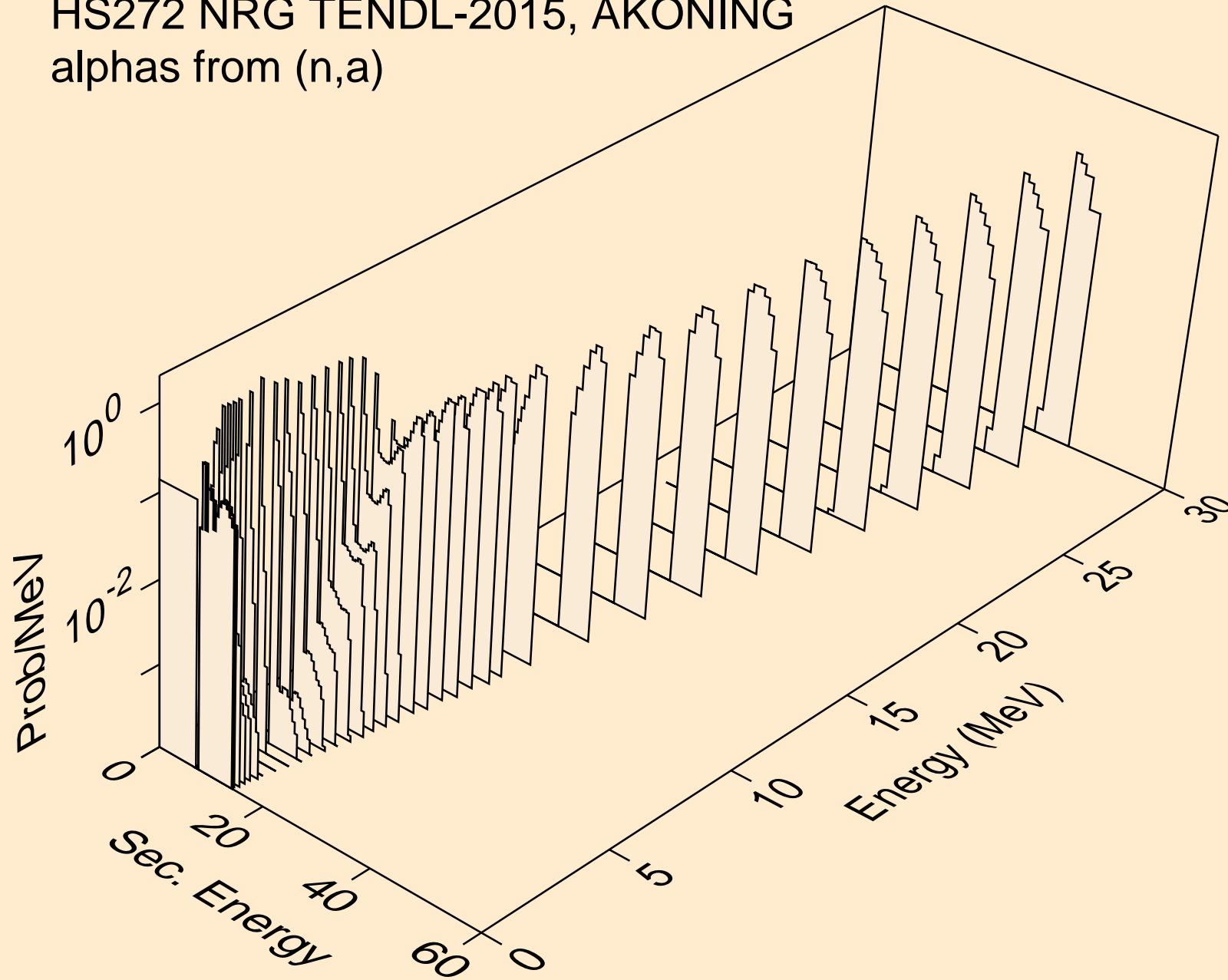

HS272 NRG TENDL-2015, AKONING
alphas from (n,2a)

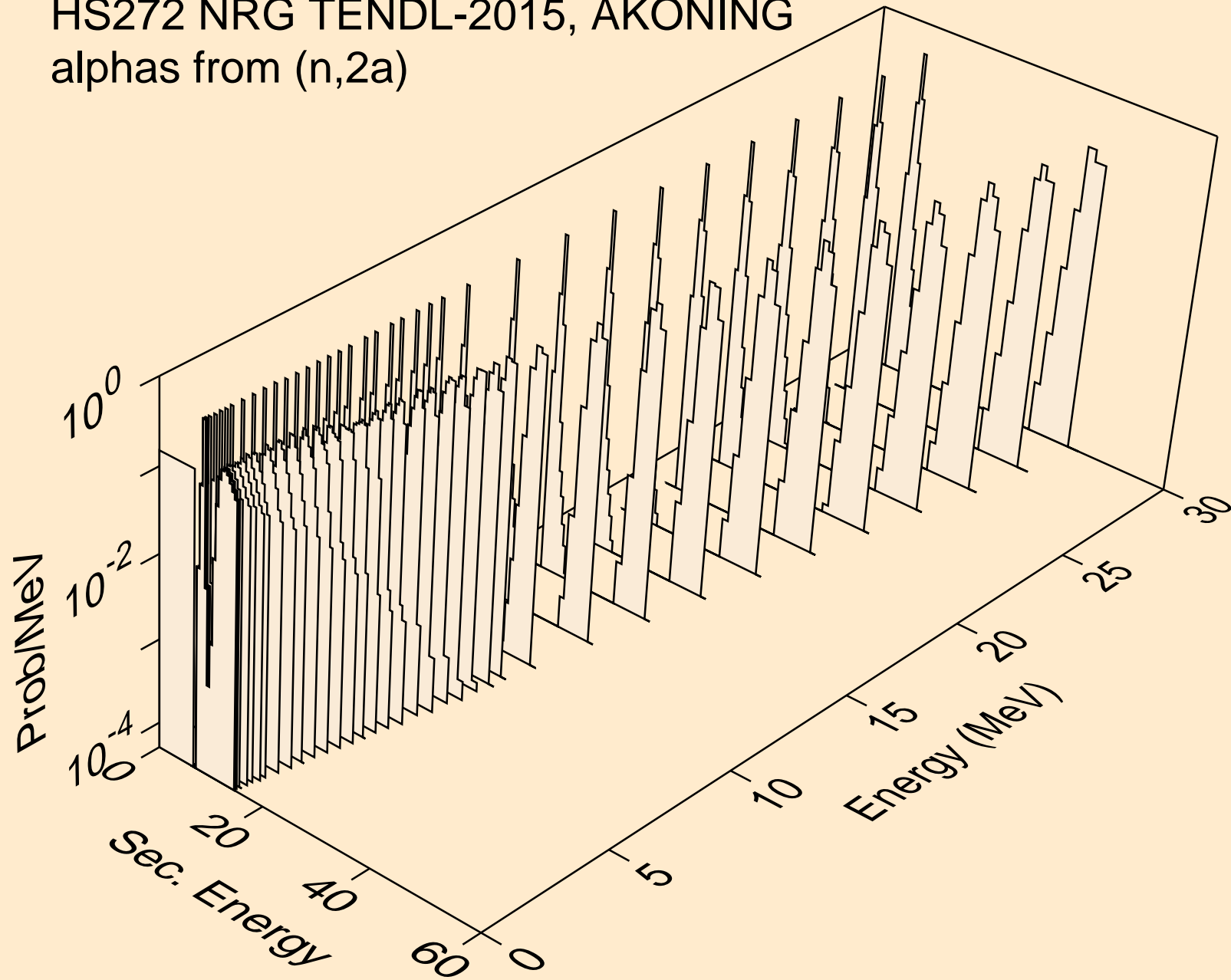

HS272 NRG TENDL-2015, AKONING
alphas from (n,3a)

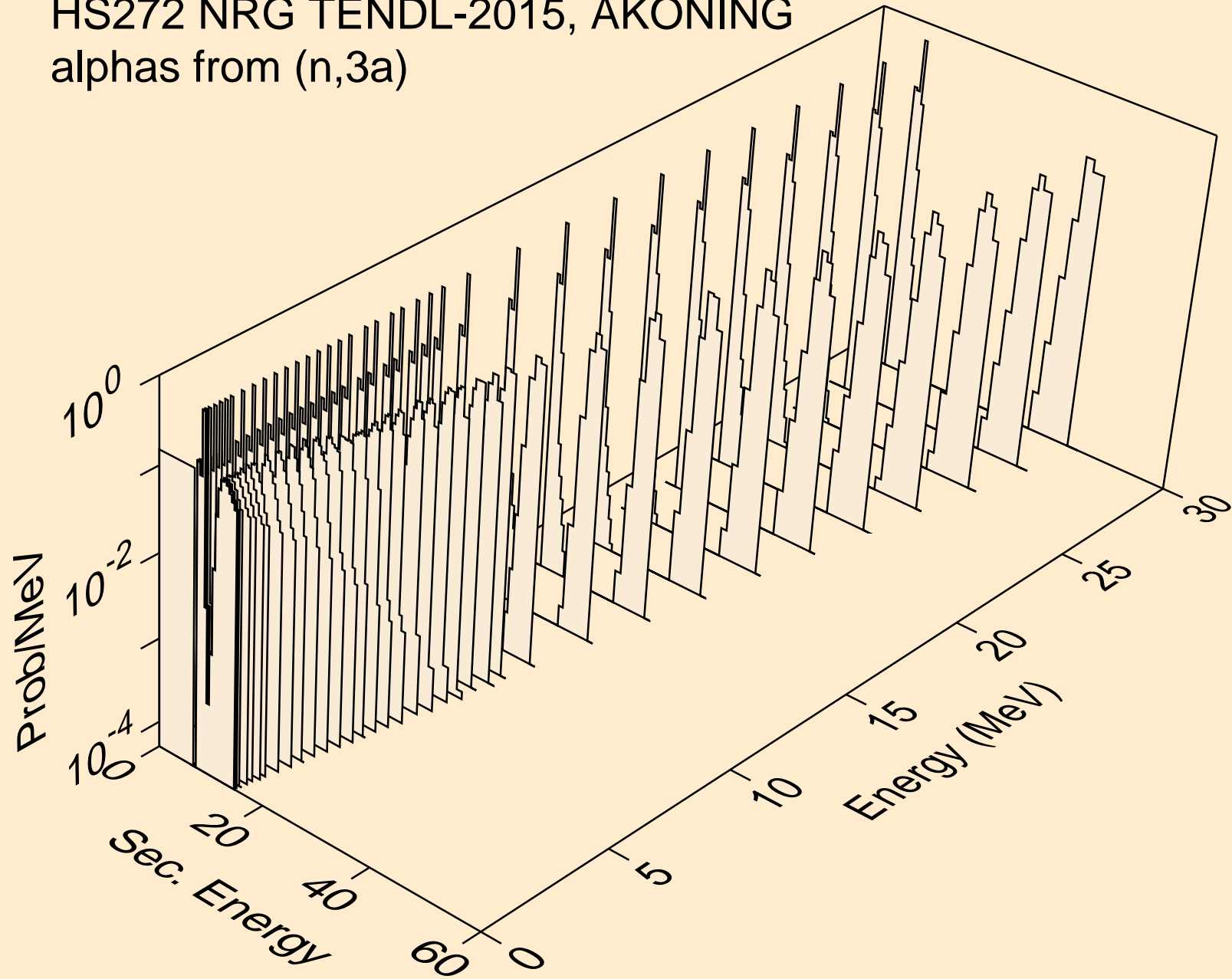

HS272 NRG TENDL-2015, AKONING
alphas from (n,pa)

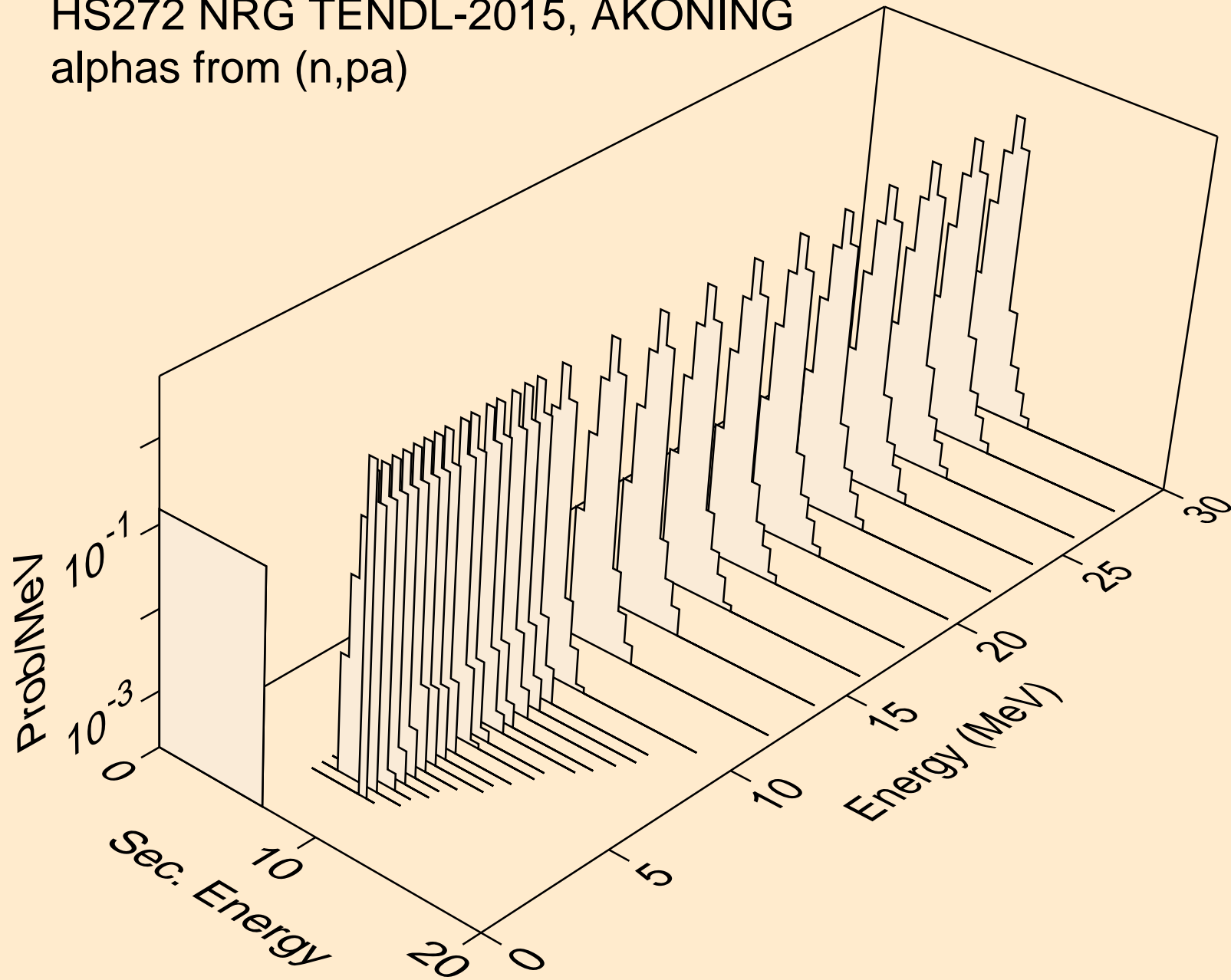

HS272 NRG TENDL-2015, AKONING
alphas from (n,t2a)

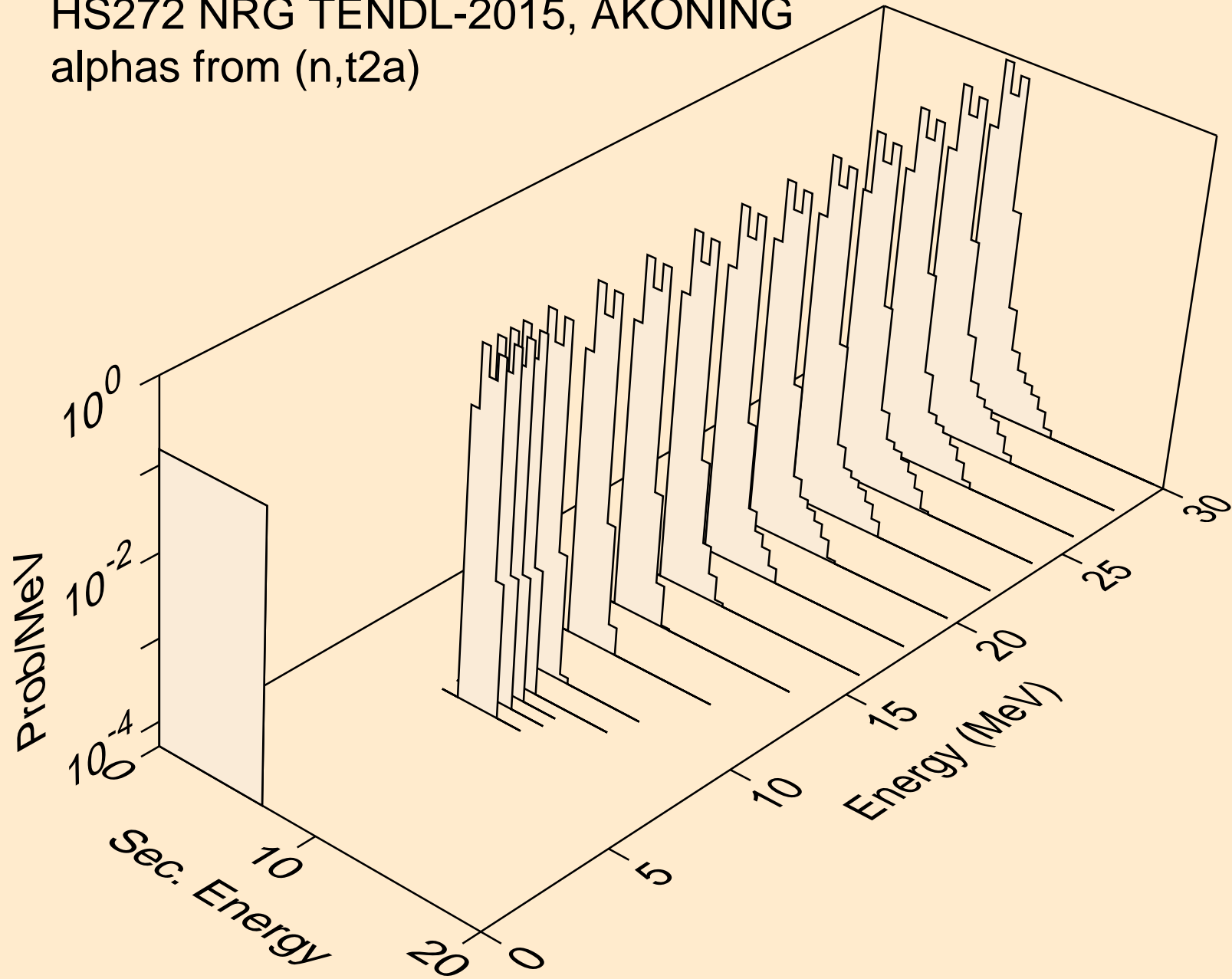

HS272 NRG TENDL-2015, AKONING
alphas from (n,d2a)

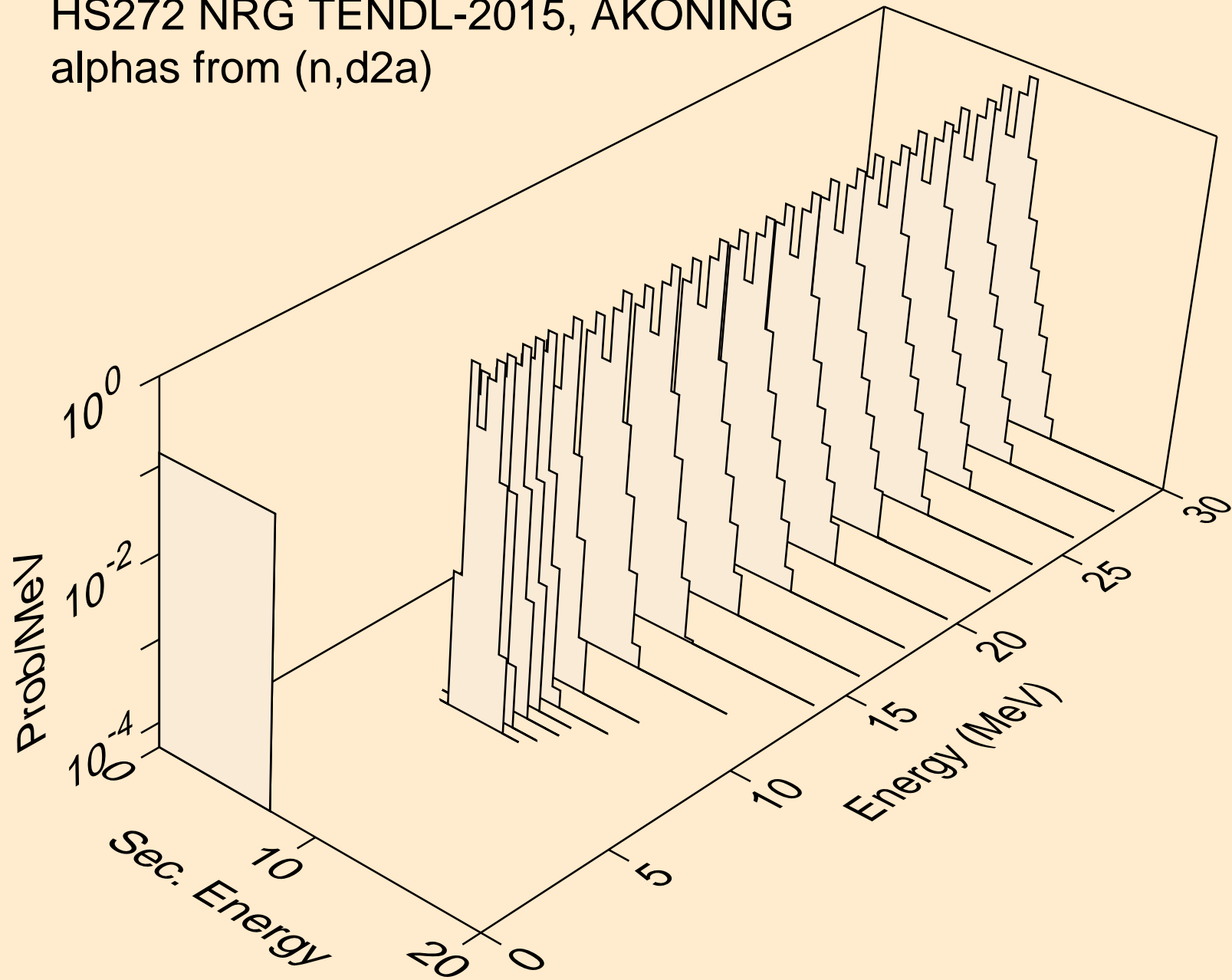

HS272 NRG TENDL-2015, AKONING
alphas from (n,da)

