

IN120N NRG TENDL-2015, AKONING

Principal cross sections

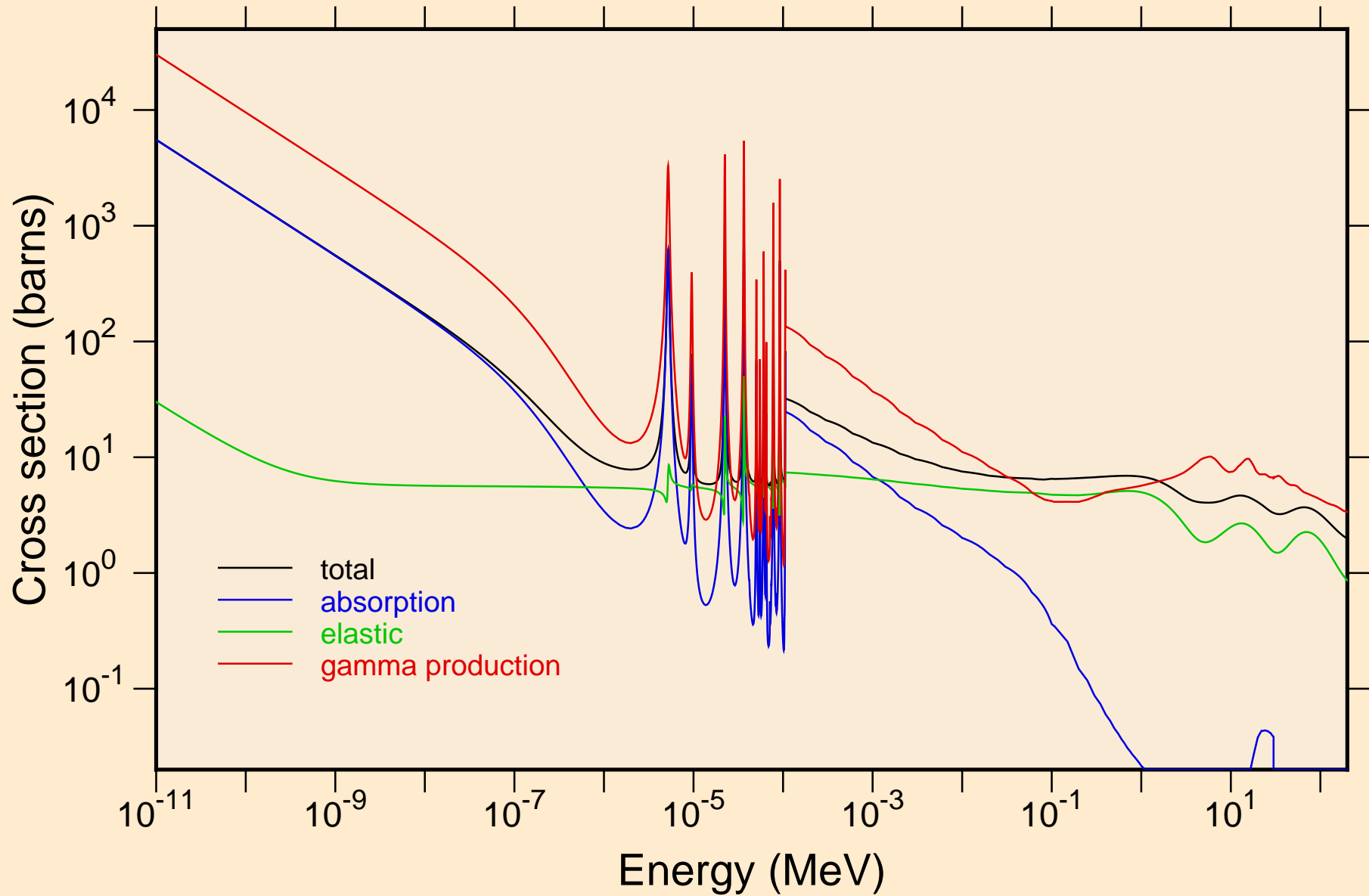

IN120N NRG TENDL-2015, AKONING
Non-threshold reactions

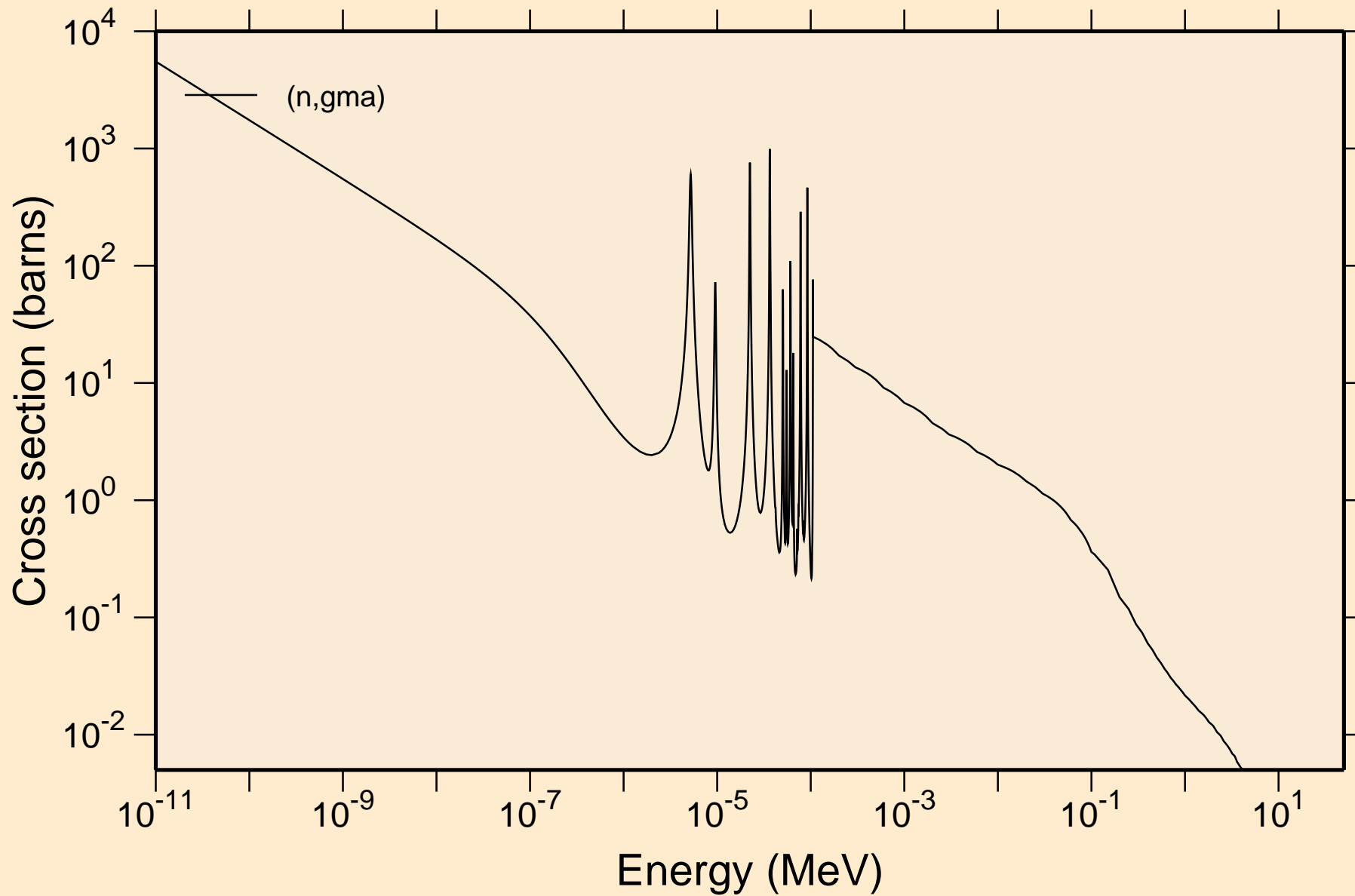

IN120N NRG TENDL-2015, AKONING

Principal cross sections

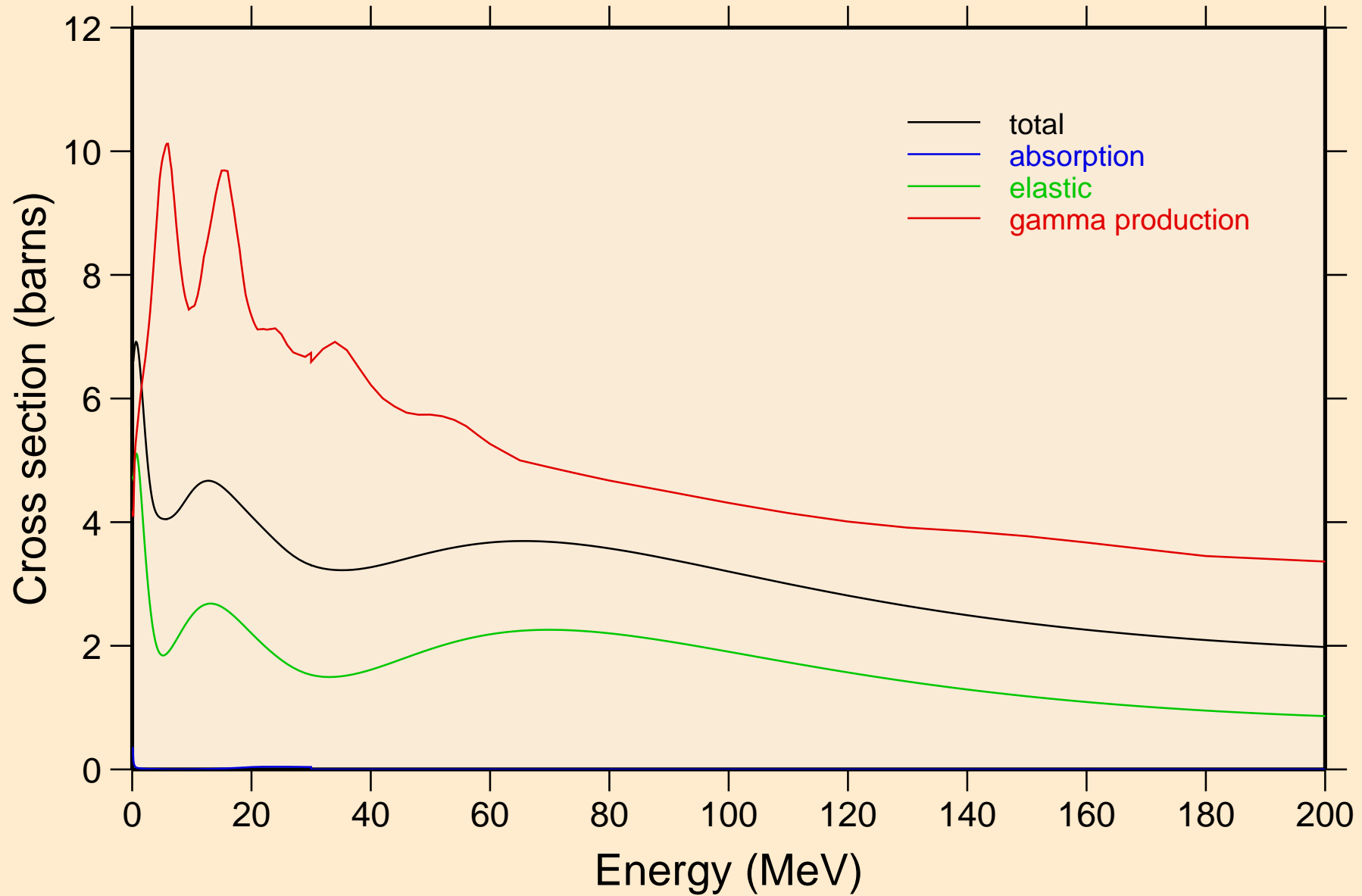

IN120N NRG TENDL-2015, AKONING
Non-threshold reactions

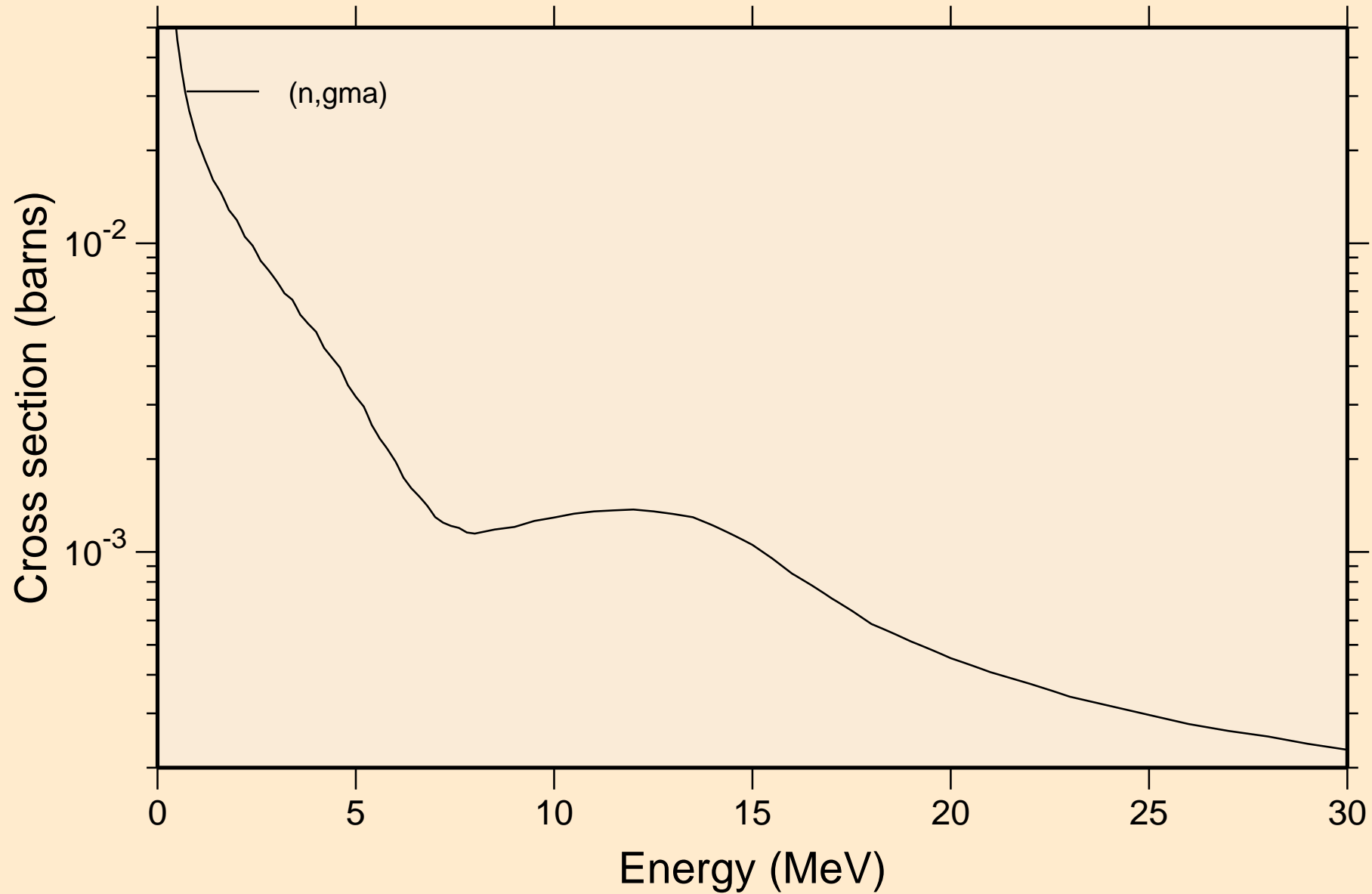

IN120N NRG TENDL-2015, AKONING

Inelastic levels

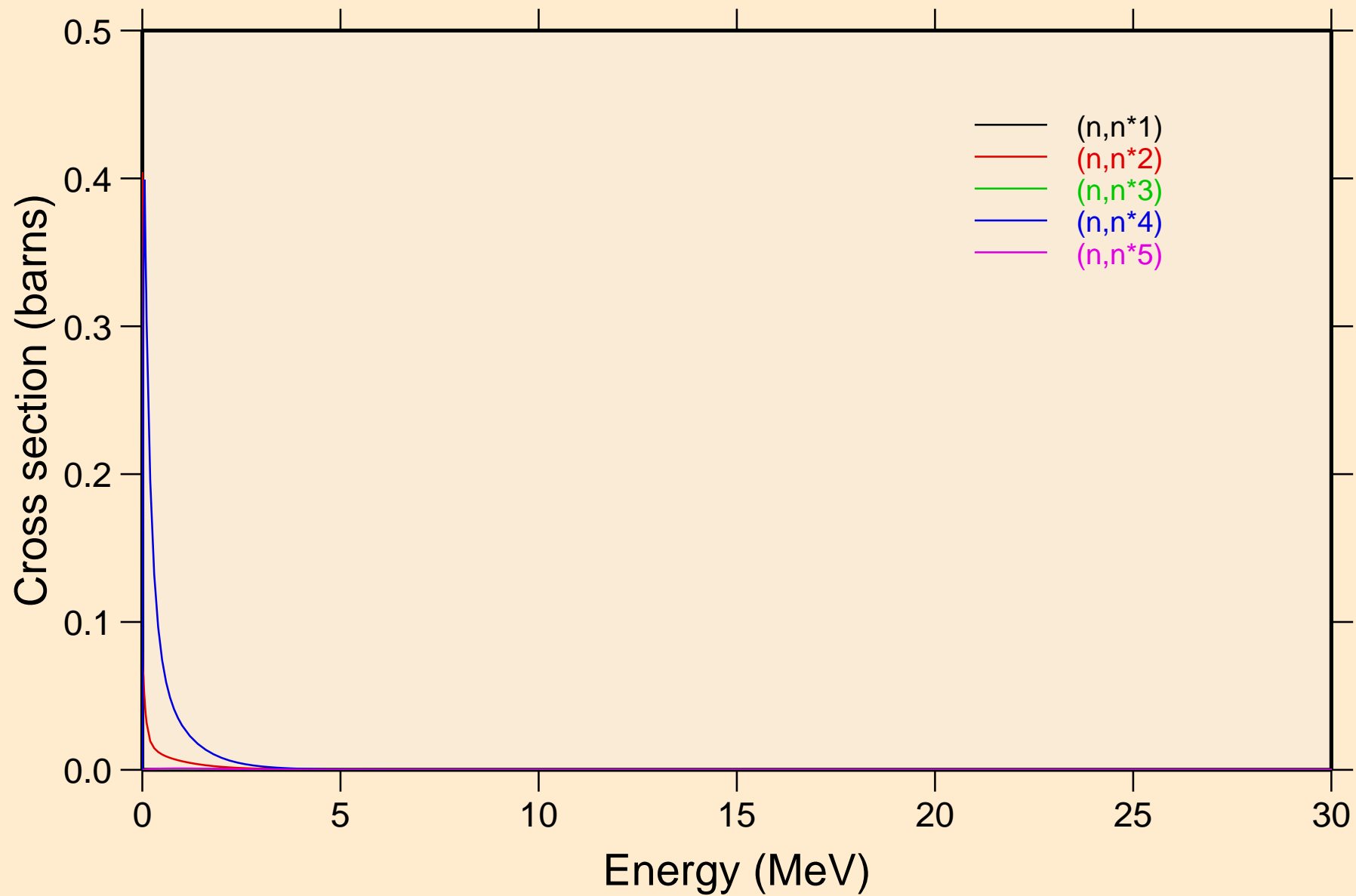

IN120N NRG TENDL-2015, AKONING

Inelastic levels

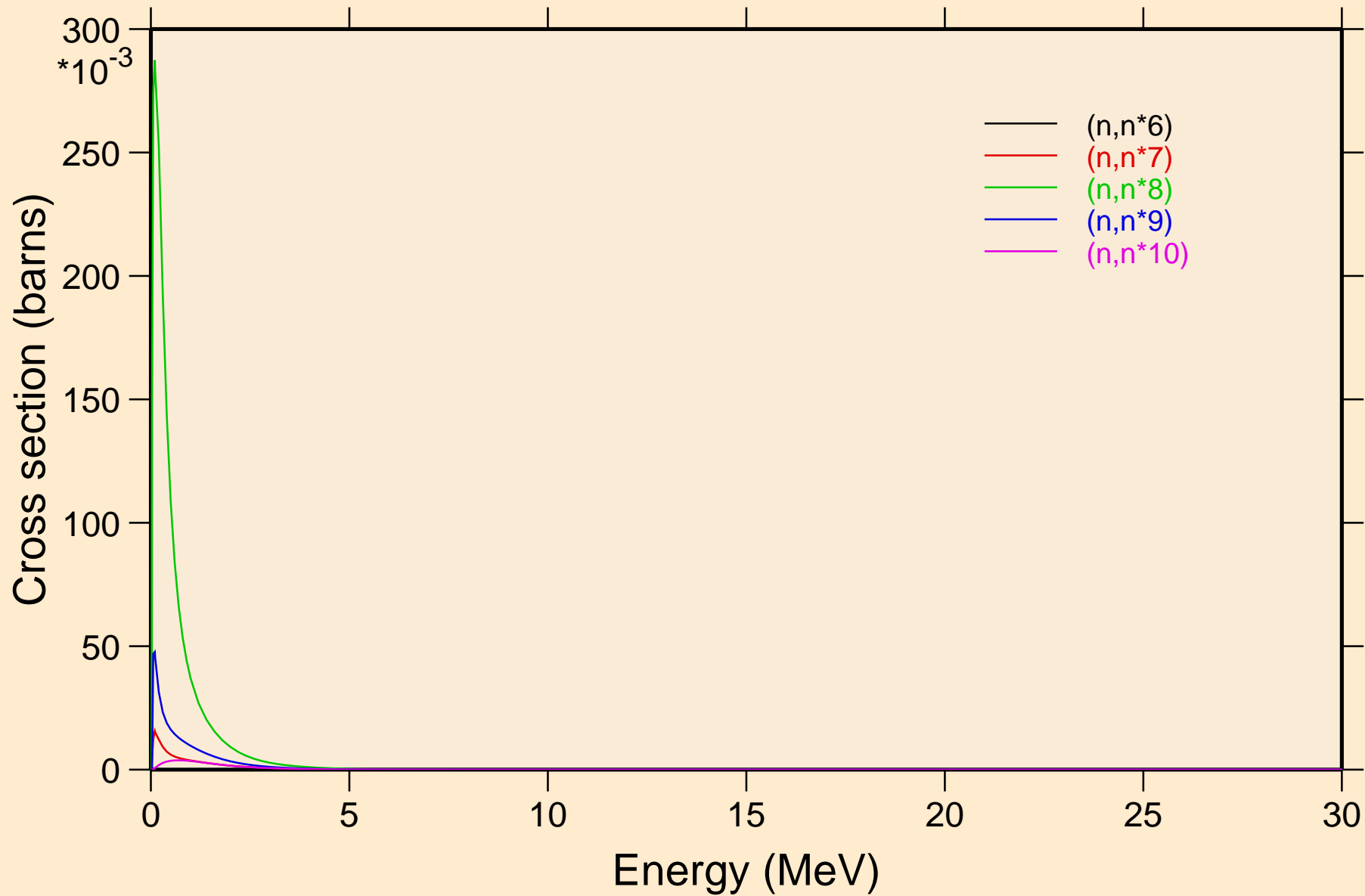

IN120N NRG TENDL-2015, AKONING

Inelastic levels

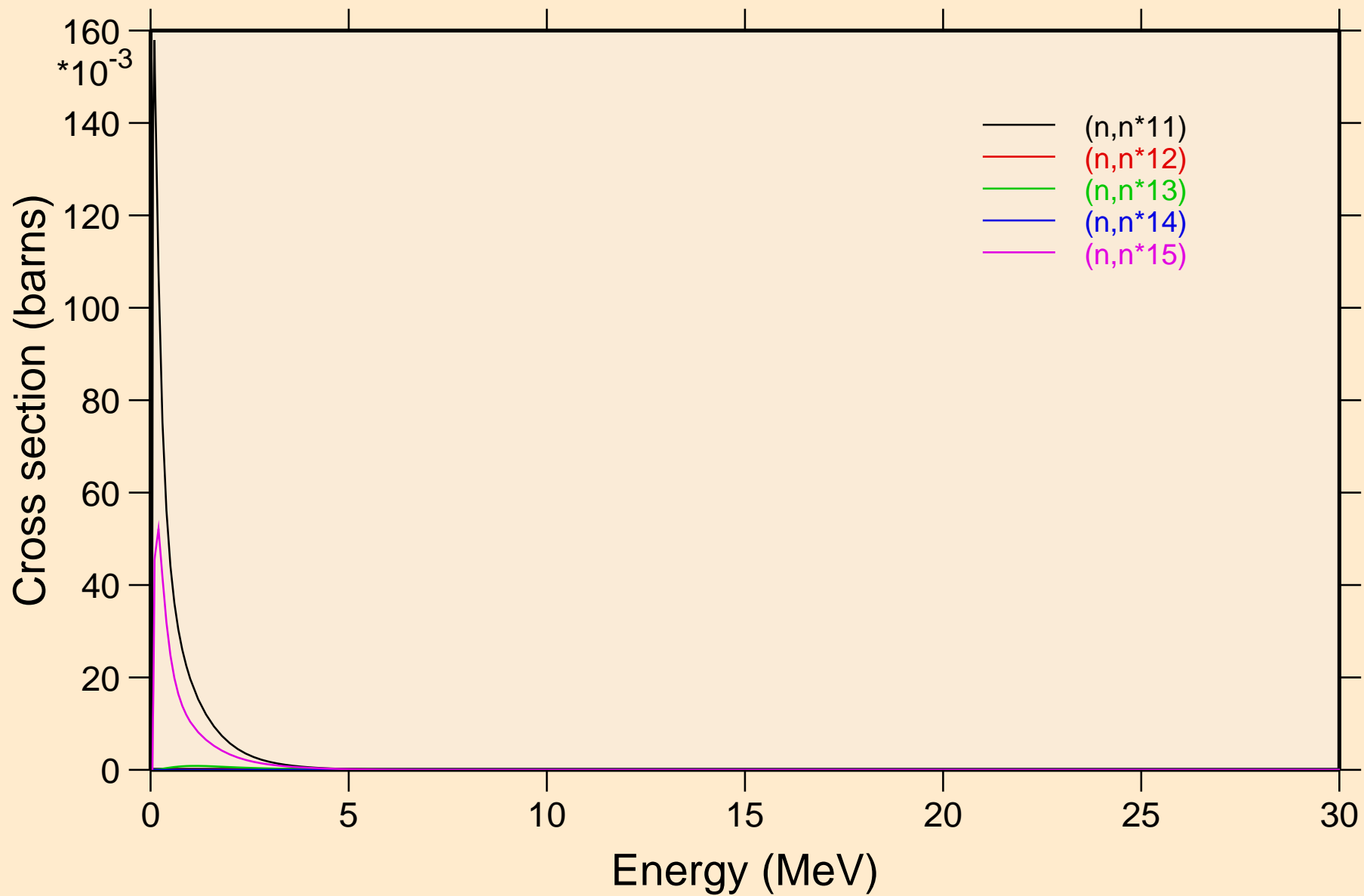

IN120N NRG TENDL-2015, AKONING

Inelastic levels

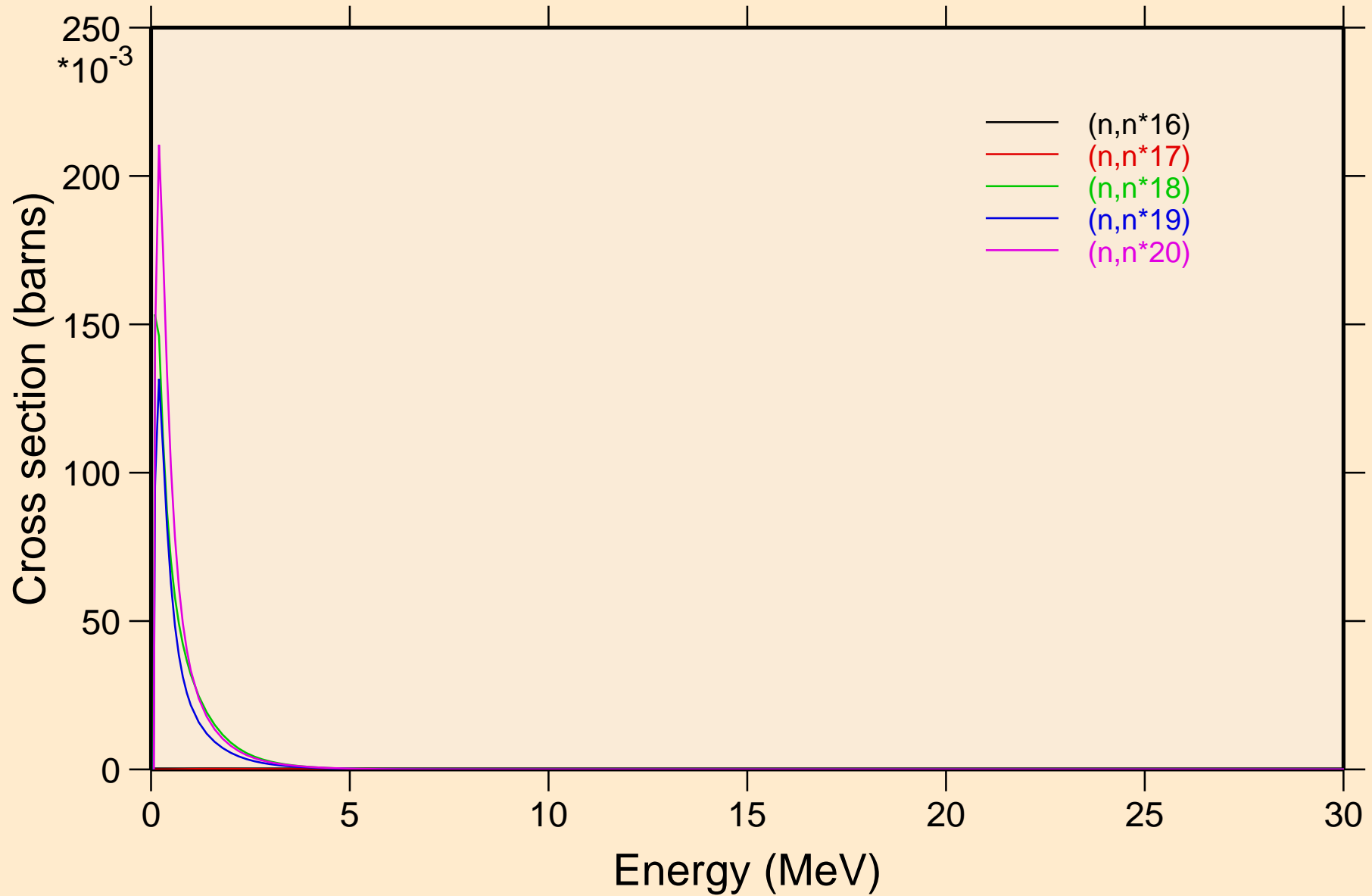

IN120N NRG TENDL-2015, AKONING

Inelastic levels

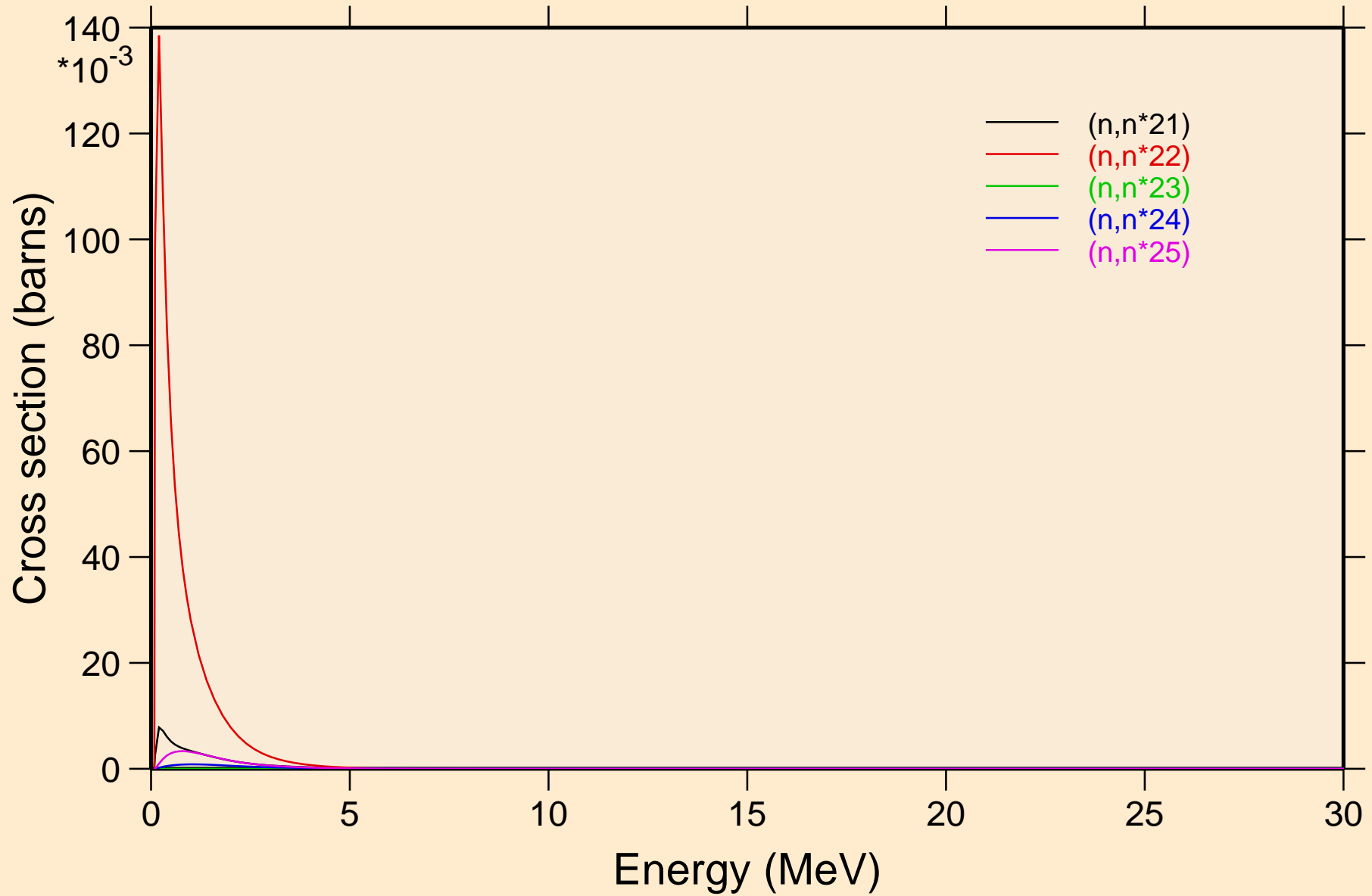

IN120N NRG TENDL-2015, AKONING

Inelastic levels

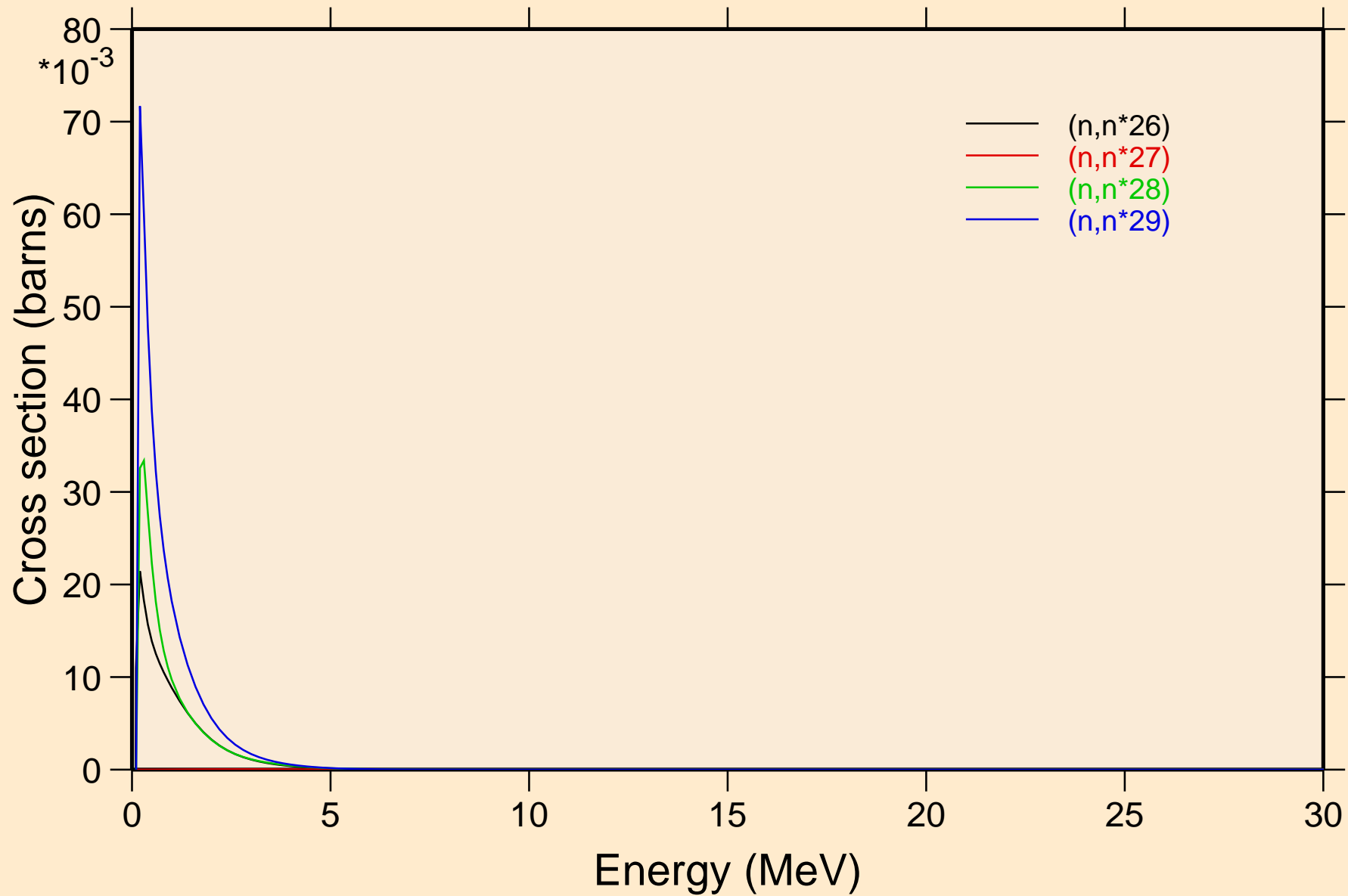

IN120N NRG TENDL-2015, AKONING

Threshold reactions

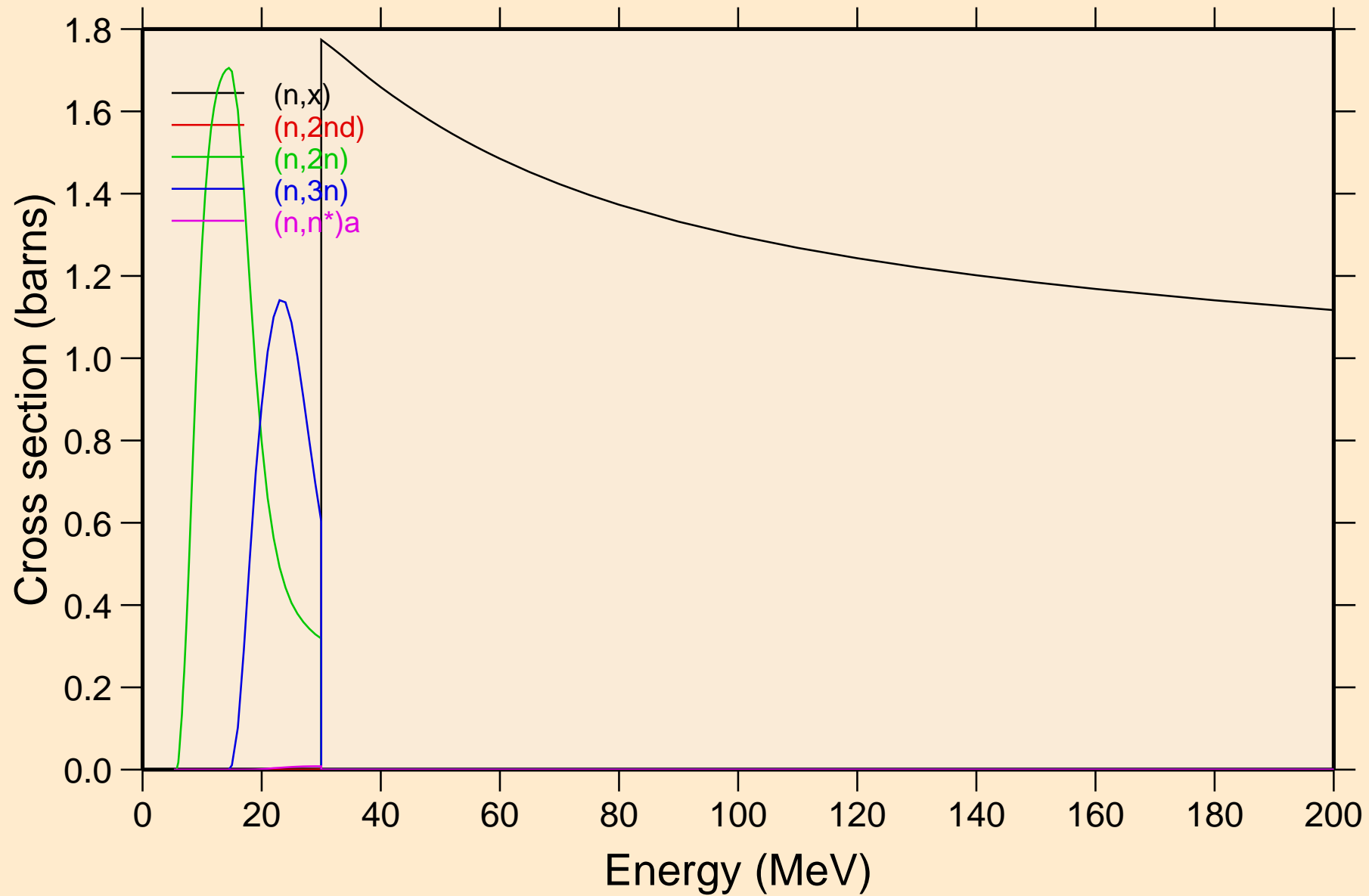

IN120N NRG TENDL-2015, AKONING

Threshold reactions

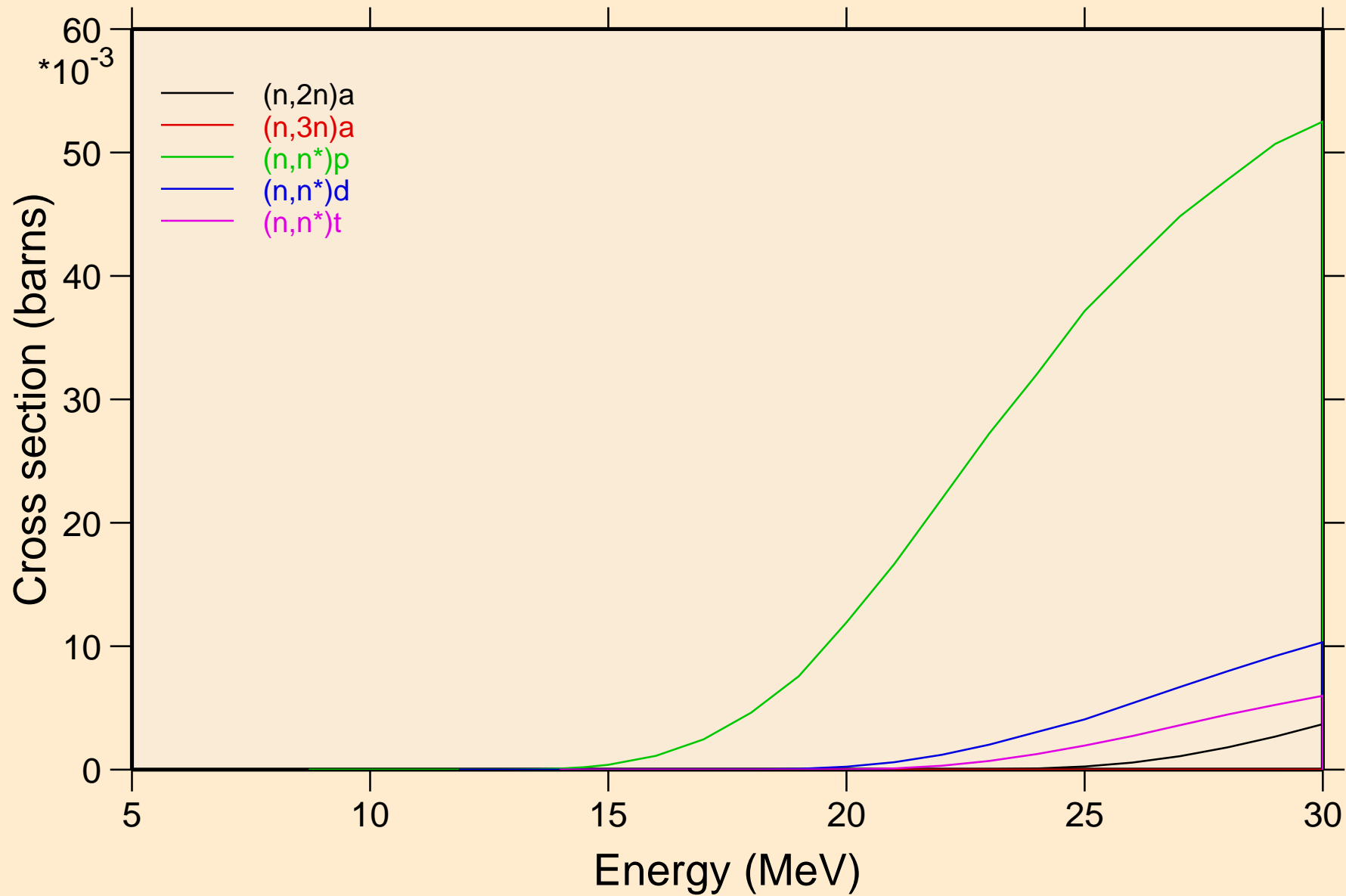

IN120N NRG TENDL-2015, AKONING

Threshold reactions

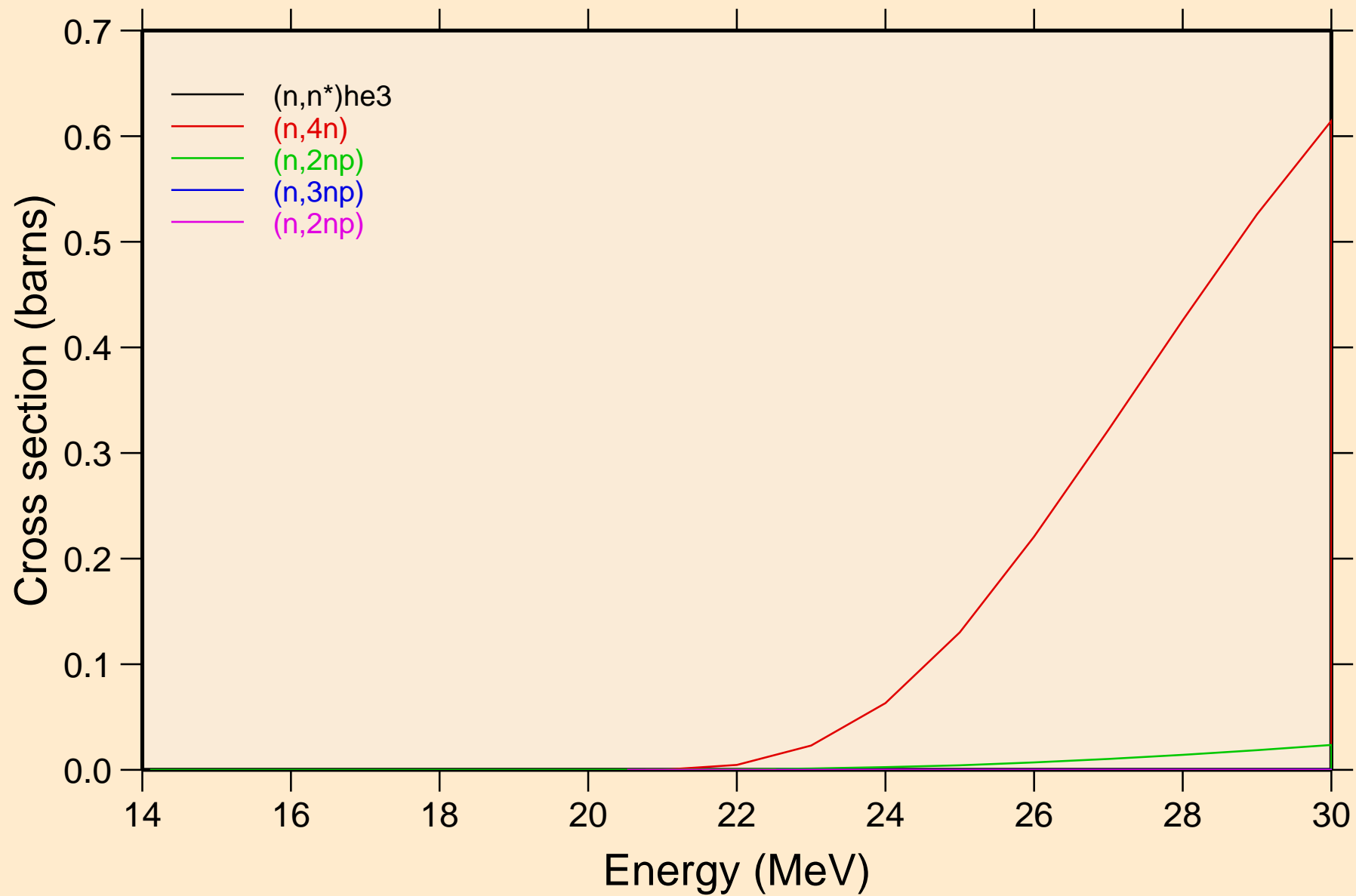

IN120N NRG TENDL-2015, AKONING

Threshold reactions

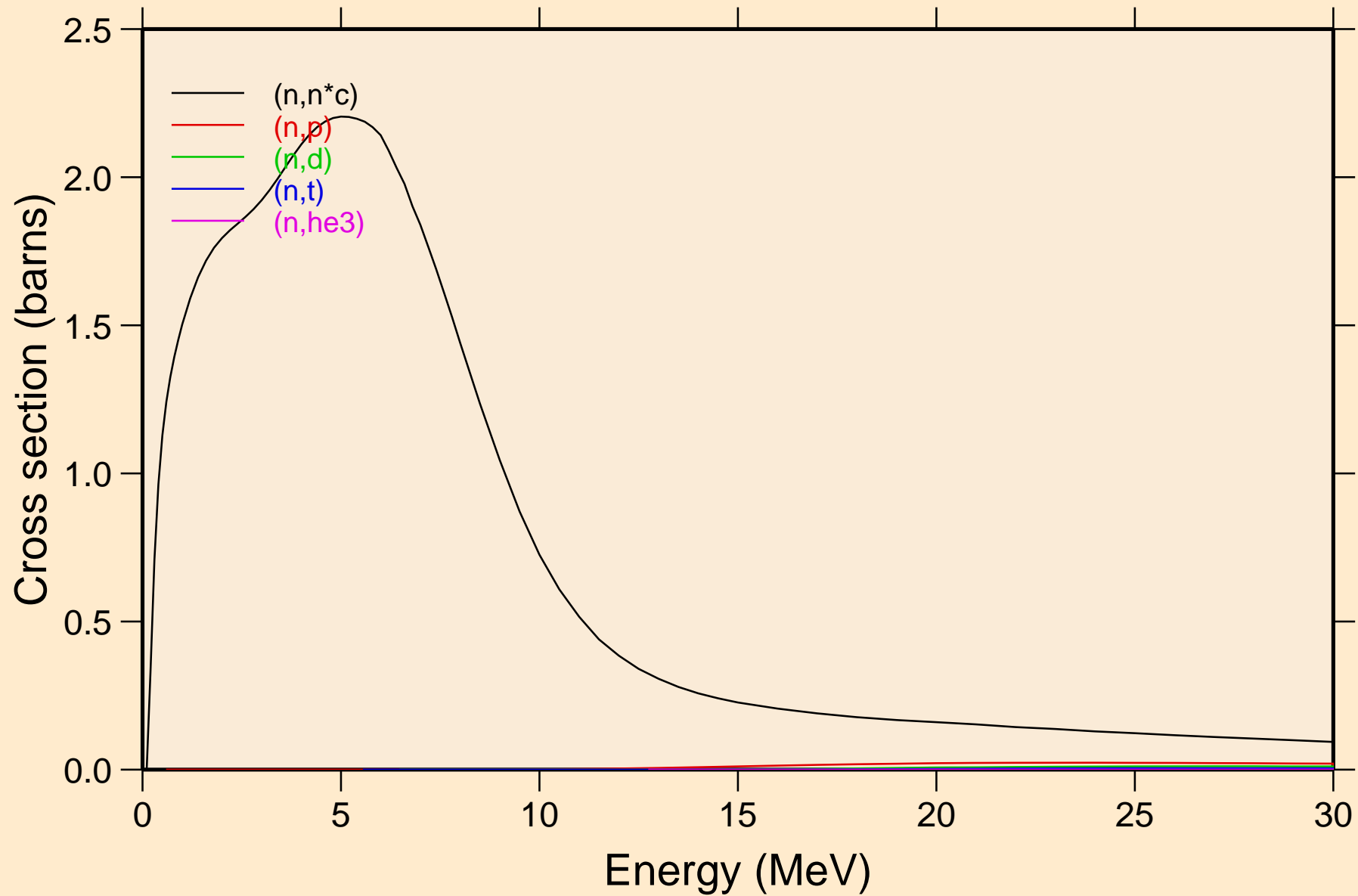

IN120N NRG TENDL-2015, AKONING

Threshold reactions

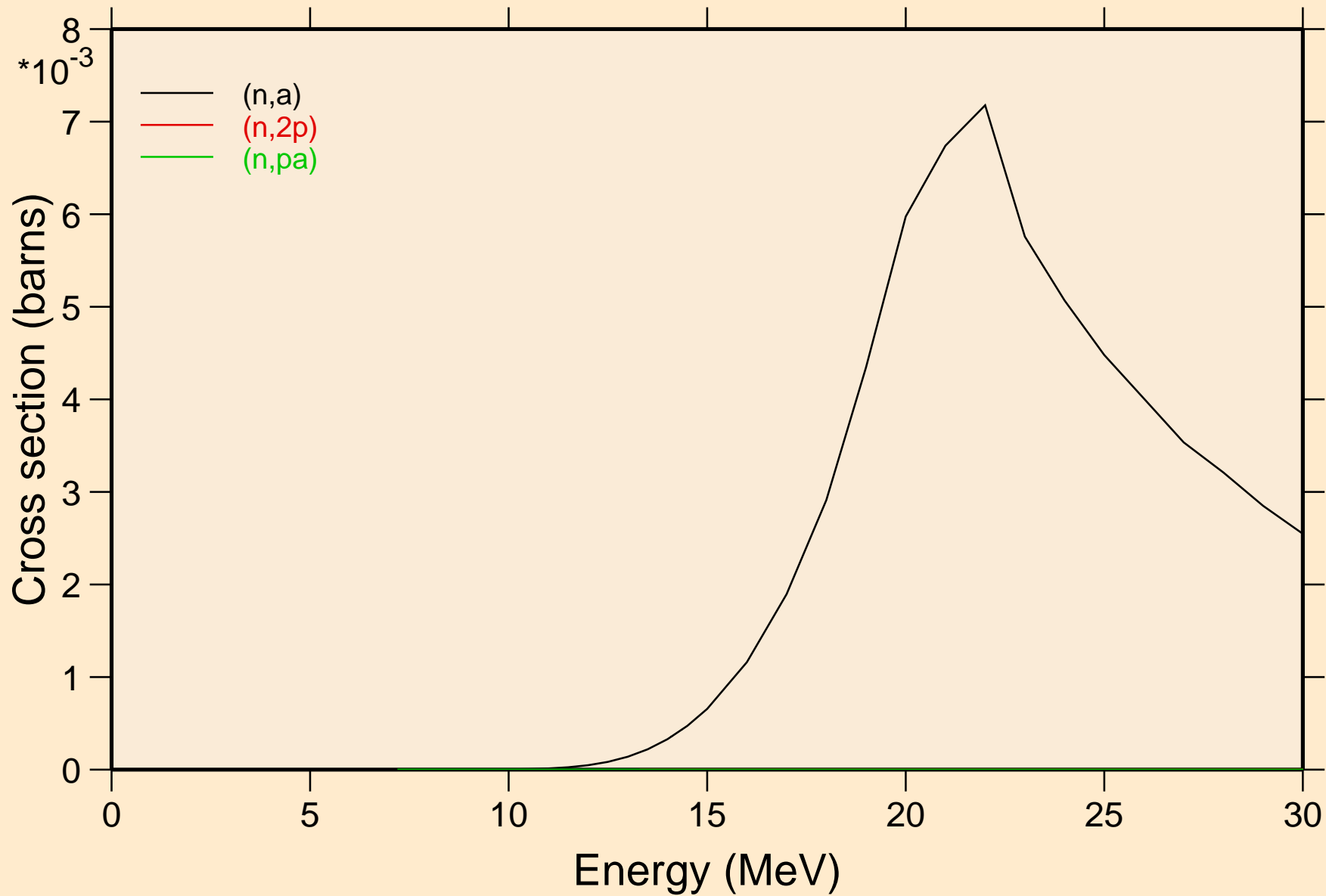

IN120N NRG TENDL-2015, AKONING
angular distribution for elastic

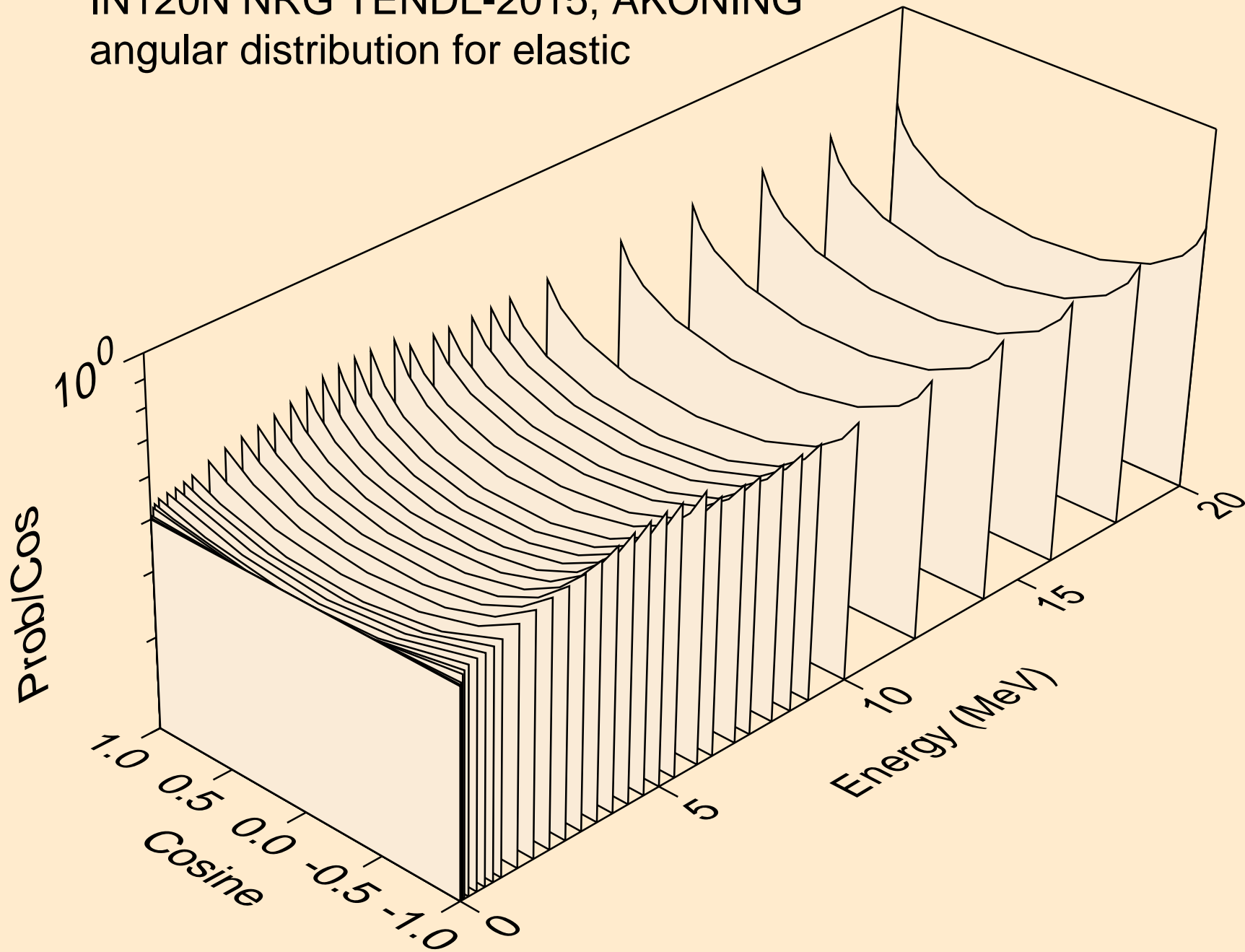

IN120N NRG TENDL-2015, AKONING
angular distribution for elastic

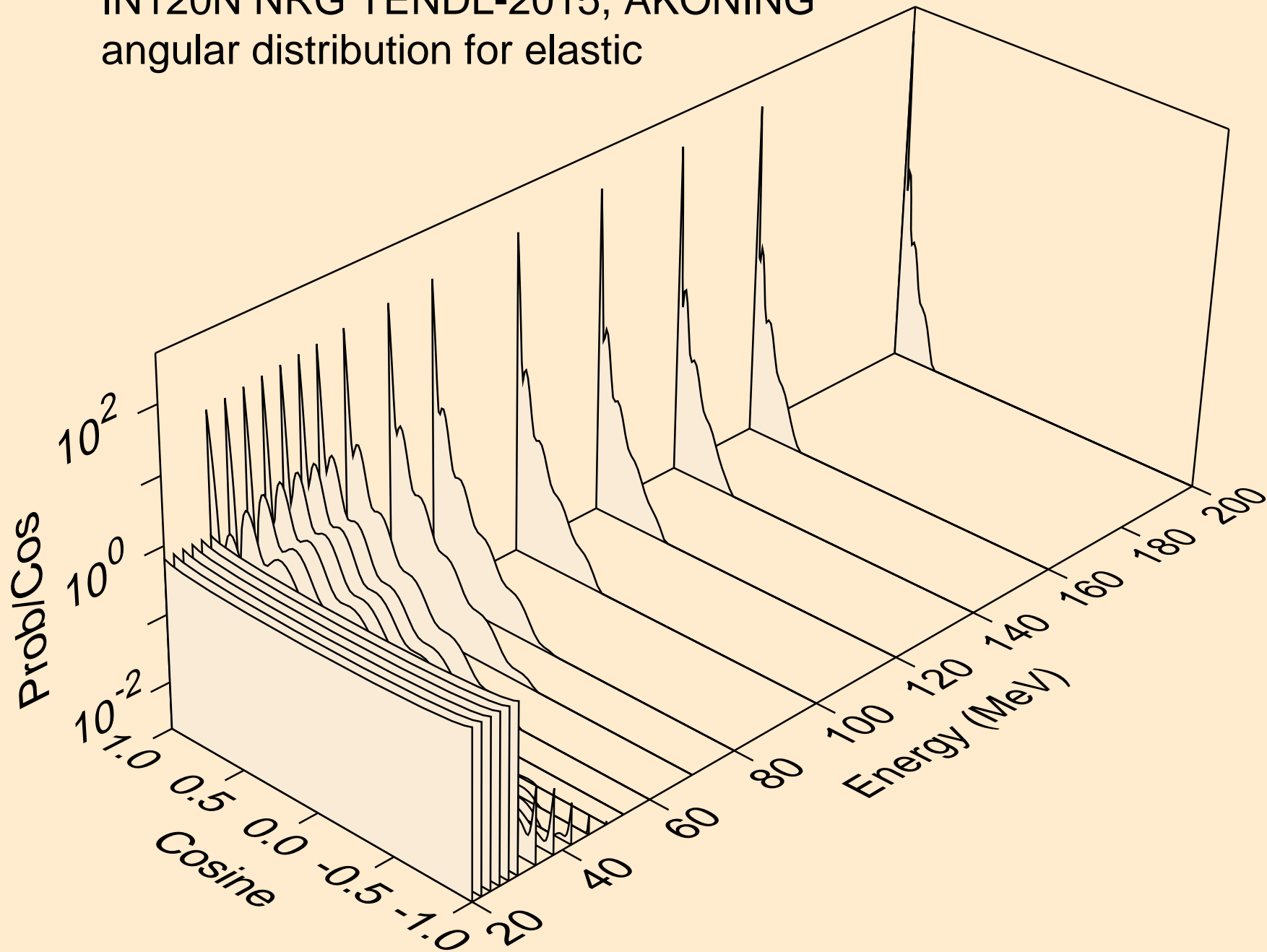

IN120N NRG TENDL-2015, AKONING
angular distribution for (n,n*1)

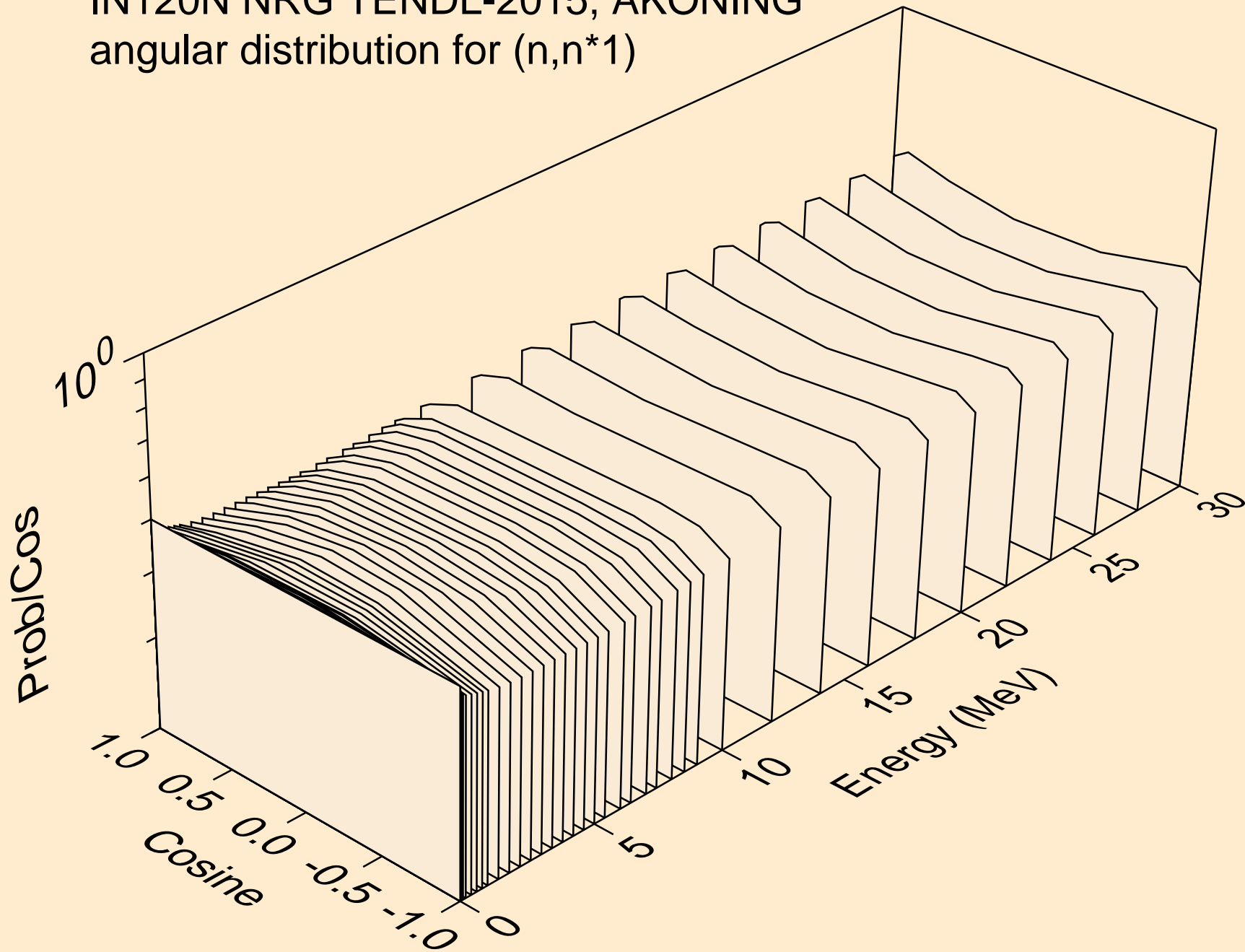

IN120N NRG TENDL-2015, AKONING
angular distribution for (n,n*2)

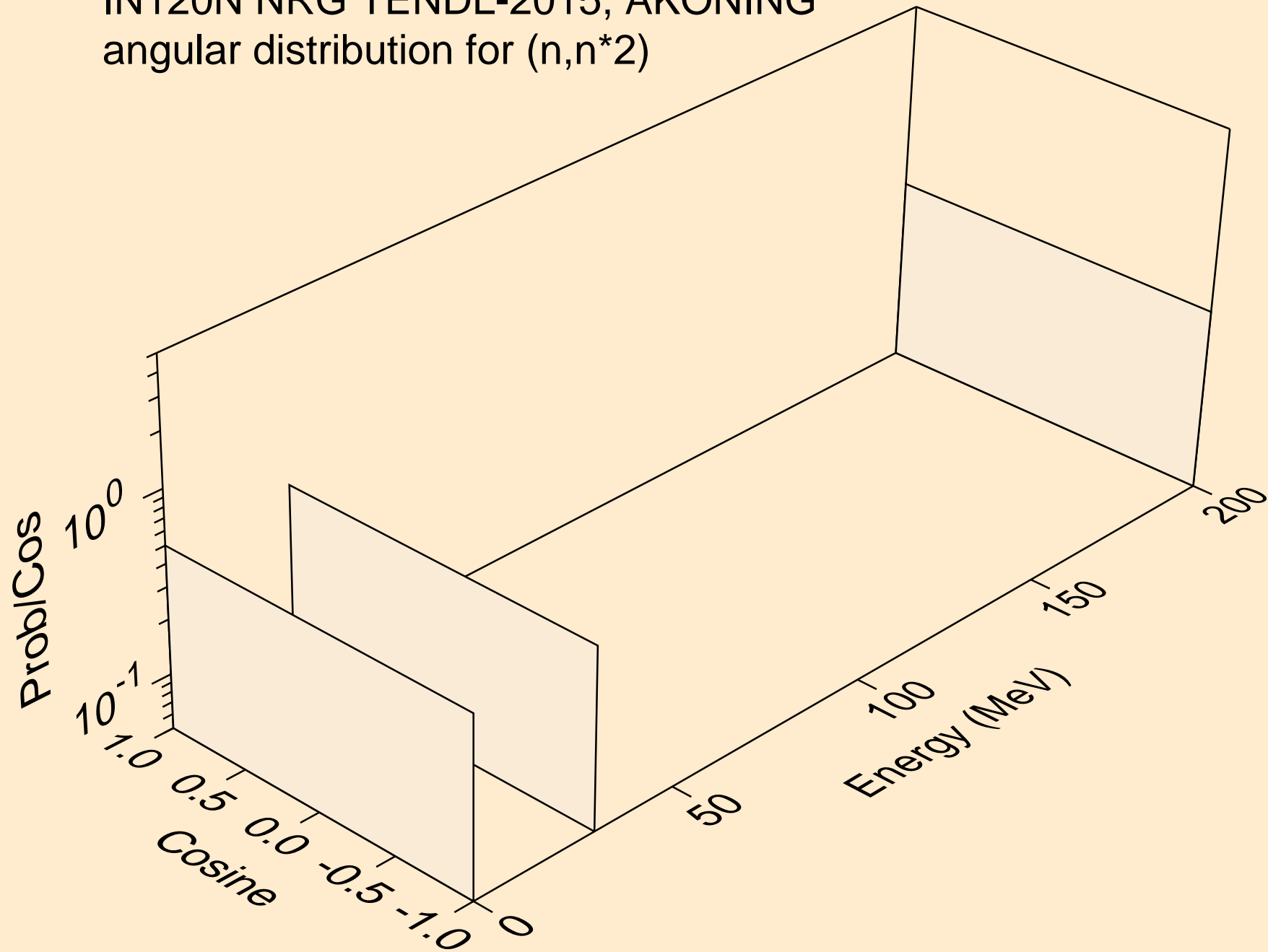

IN120N NRG TENDL-2015, AKONING
angular distribution for (n,n*3)

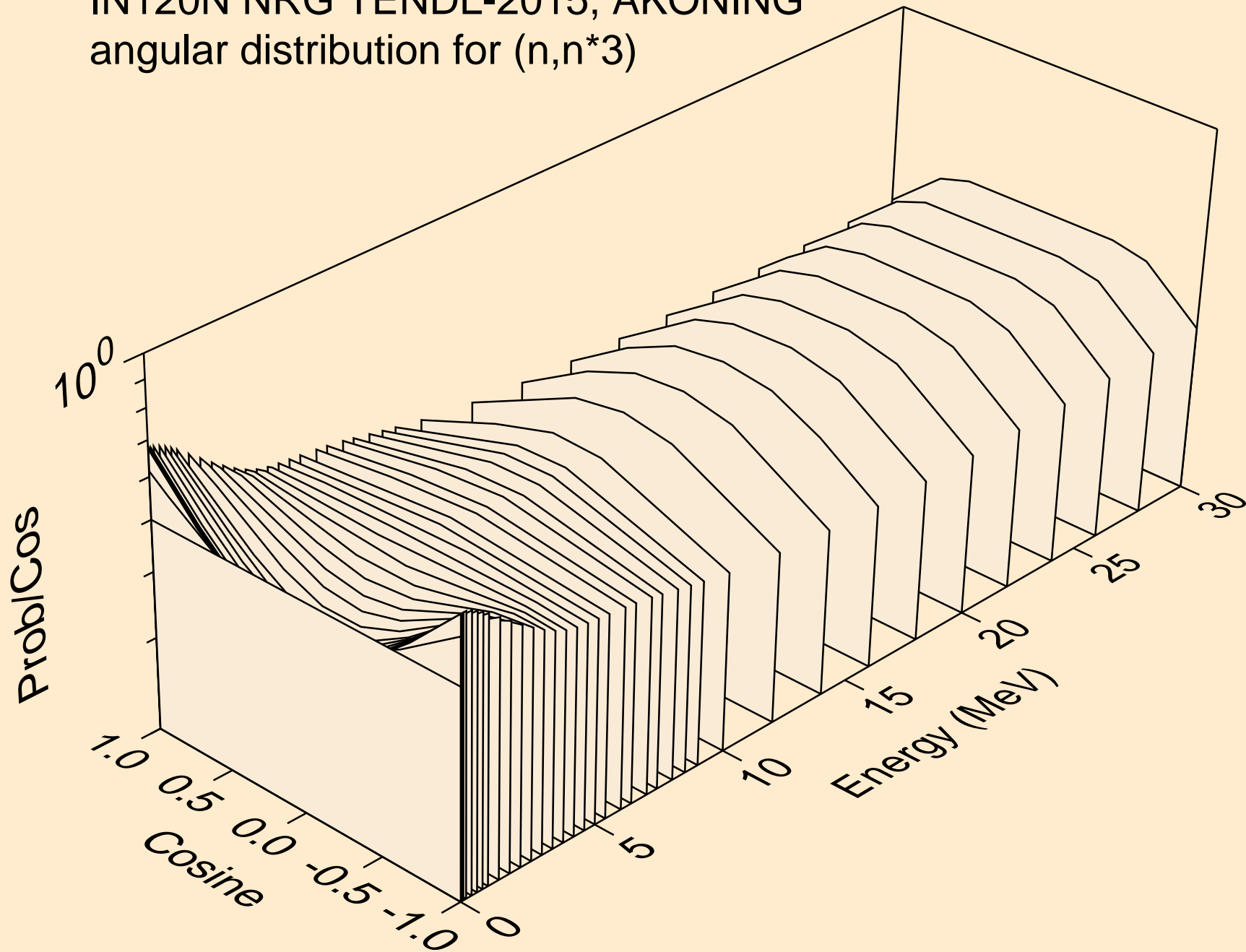

IN120N NRG TENDL-2015, AKONING
angular distribution for (n,n*4)

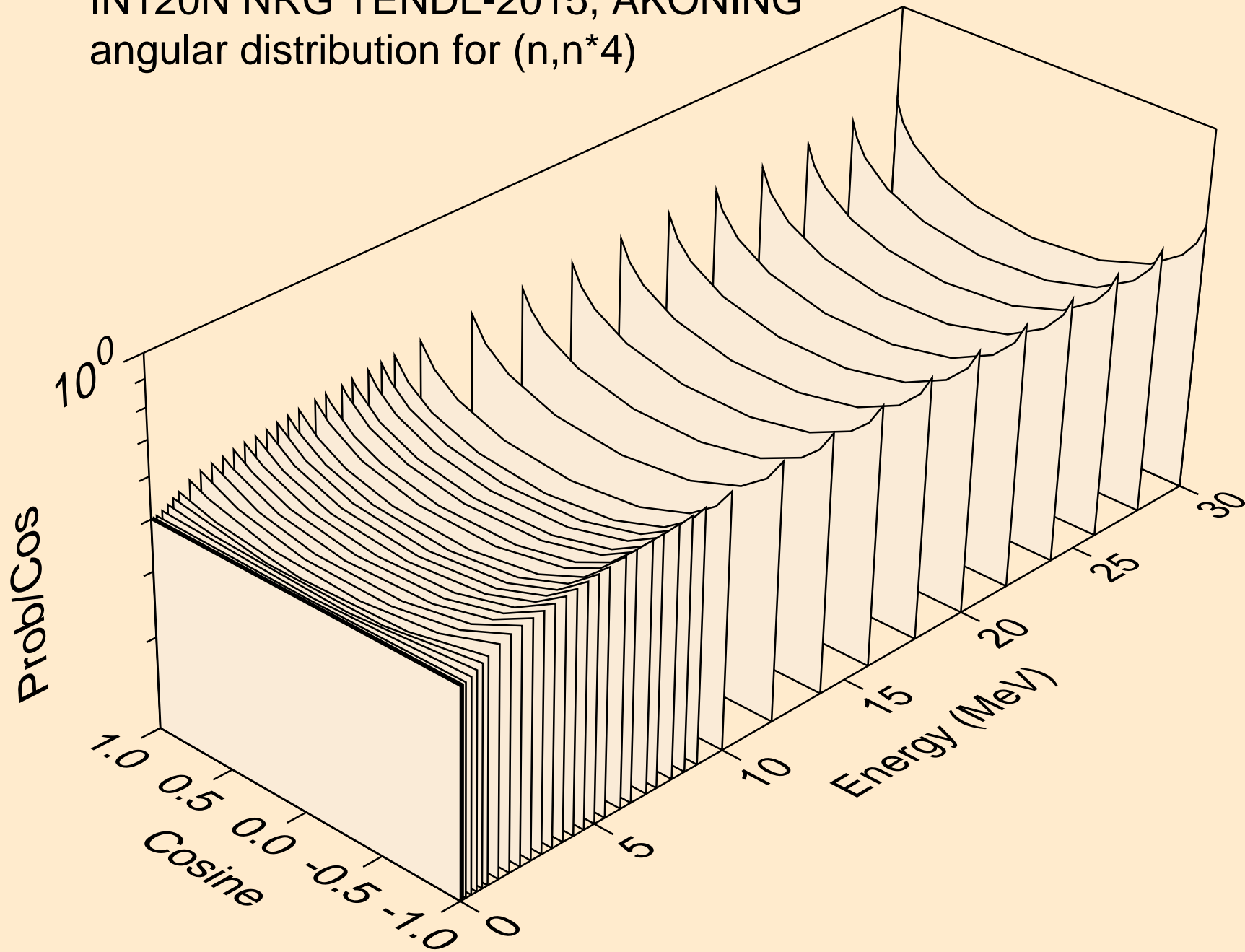

IN120N NRG TENDL-2015, AKONING
angular distribution for (n,n*5)

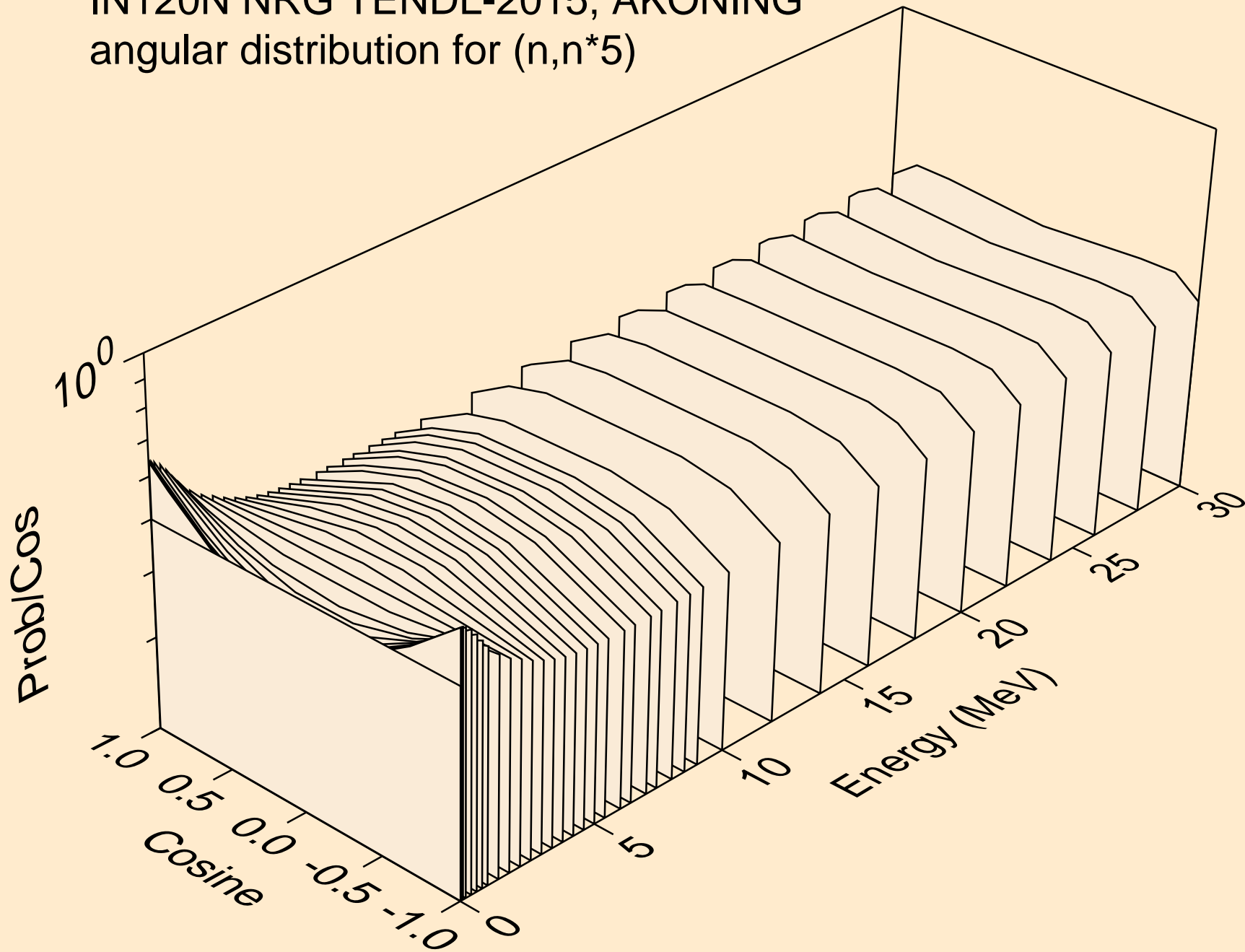

IN120N NRG TENDL-2015, AKONING
angular distribution for (n,n*6)

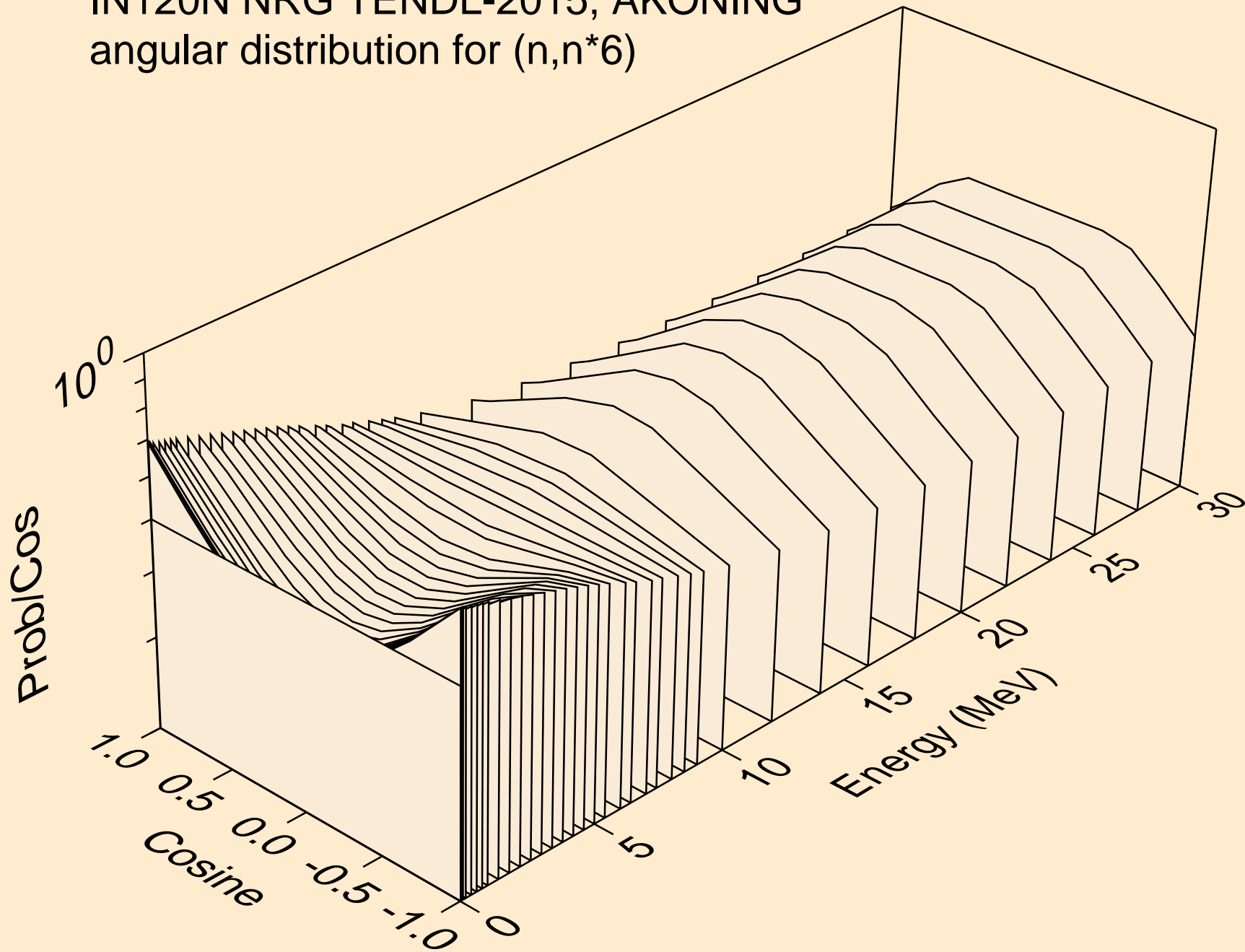

IN120N NRG TENDL-2015, AKONING
angular distribution for (n,n*7)

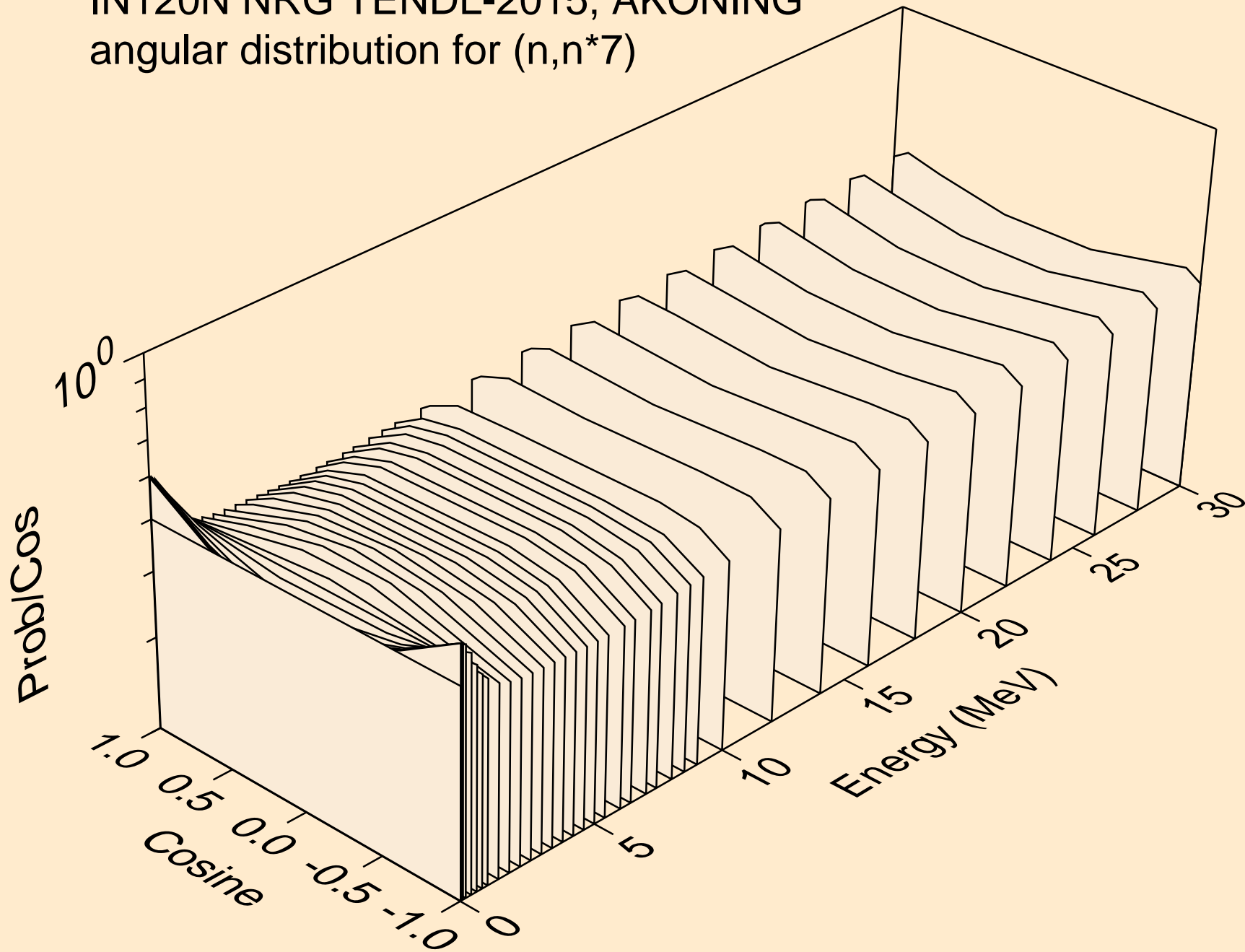

IN120N NRG TENDL-2015, AKONING
angular distribution for (n,n*8)

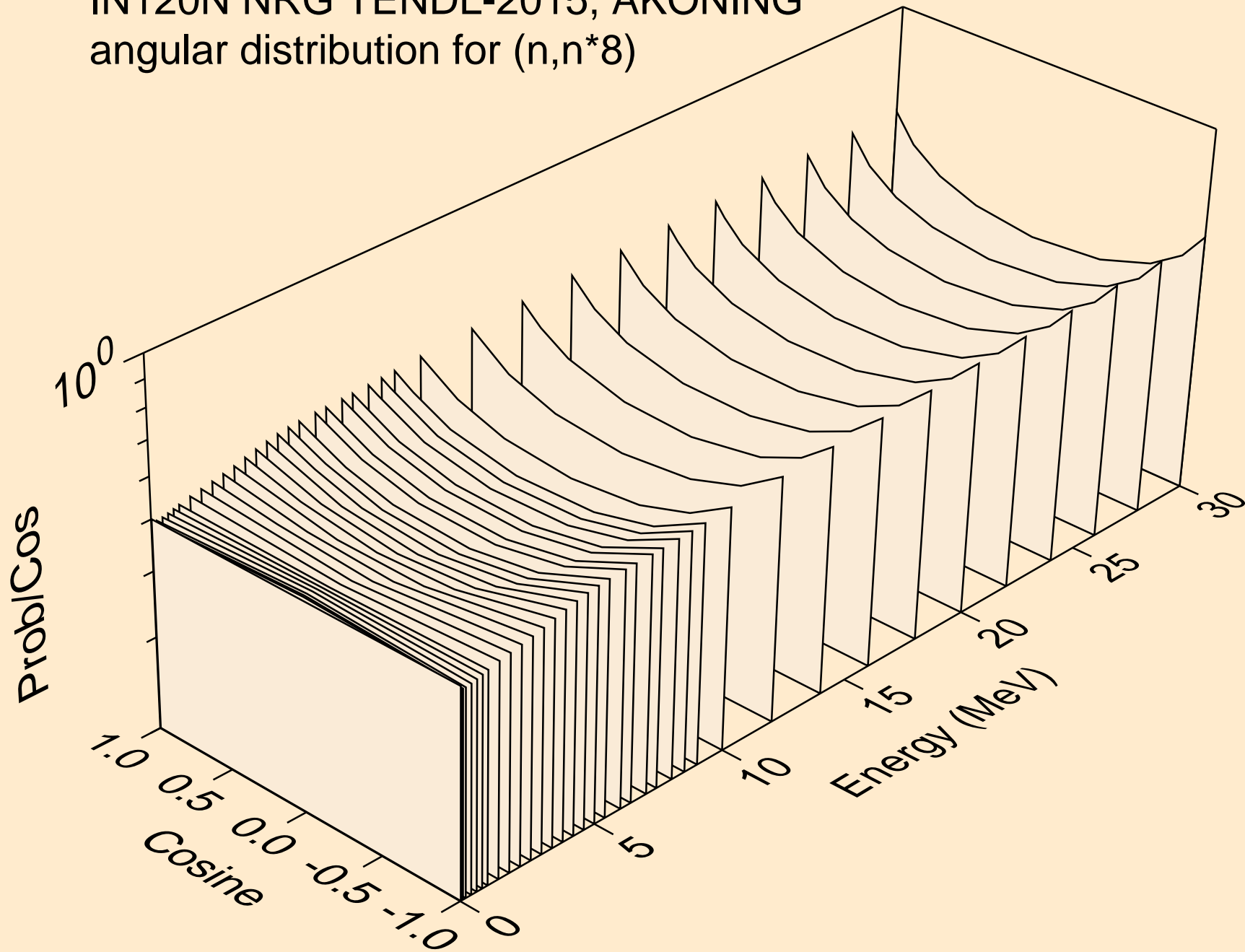

IN120N NRG TENDL-2015, AKONING
angular distribution for (n,n*9)

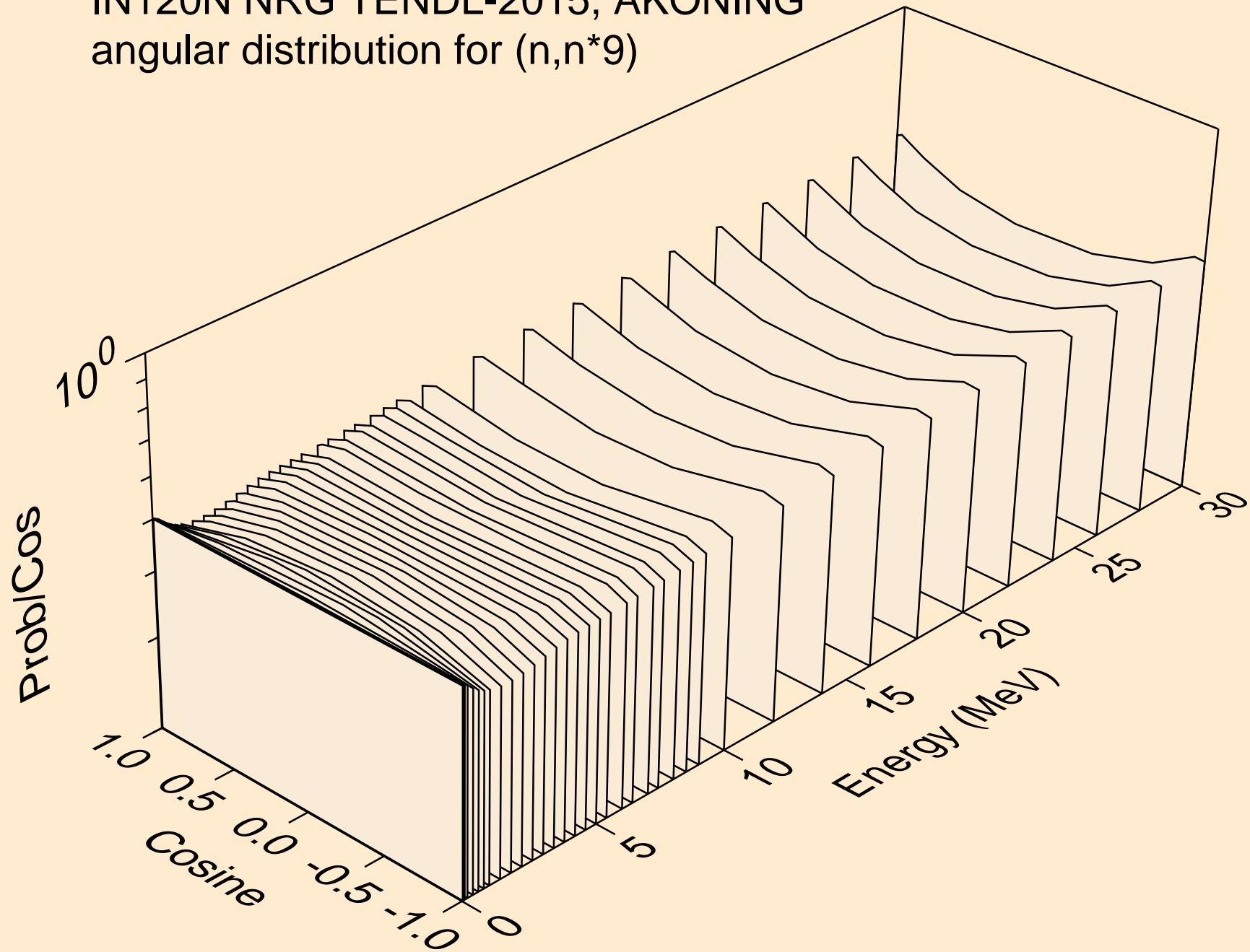

IN120N NRG TENDL-2015, AKONING
angular distribution for (n,n*10)

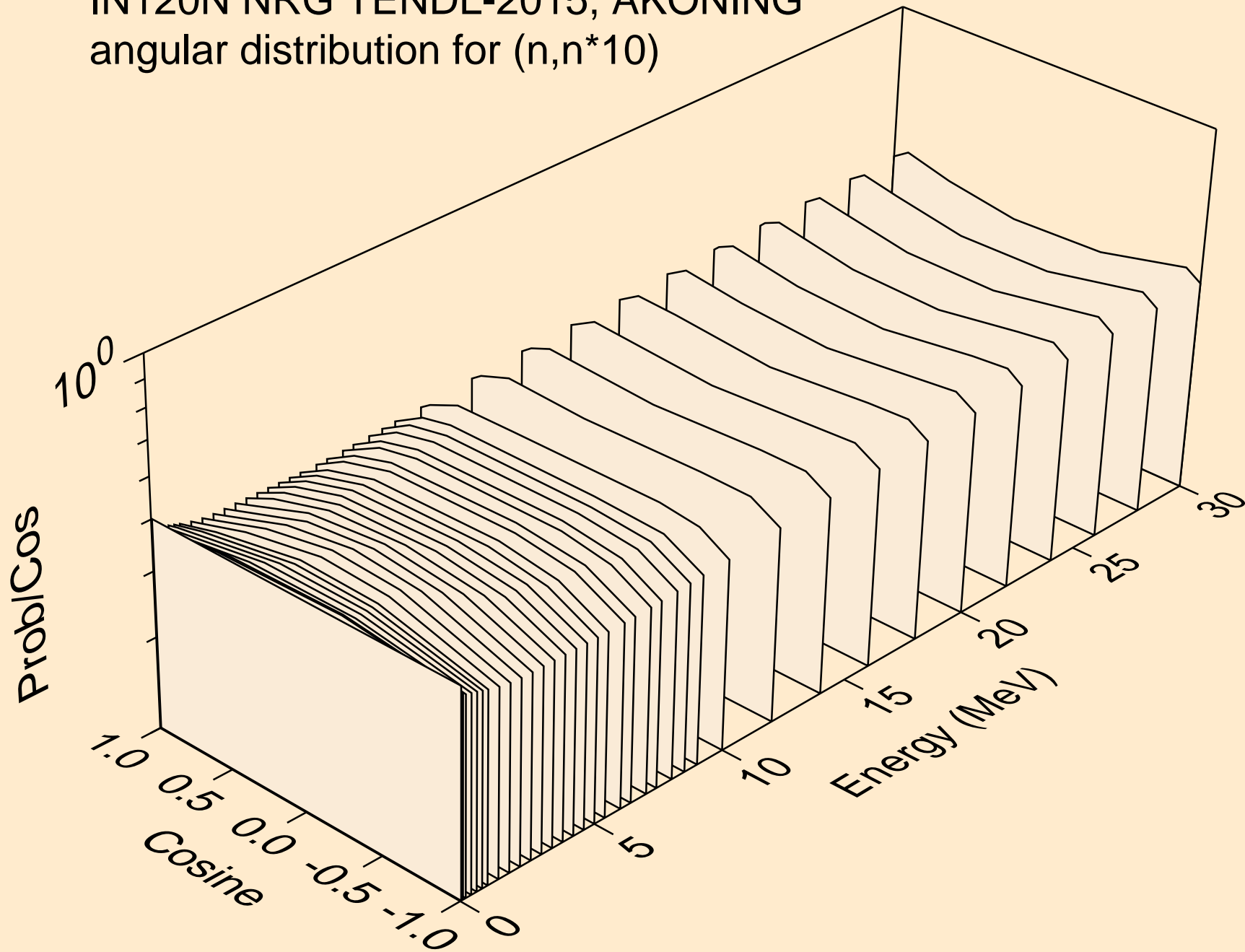

IN120N NRG TENDL-2015, AKONING
angular distribution for (n,n*11)

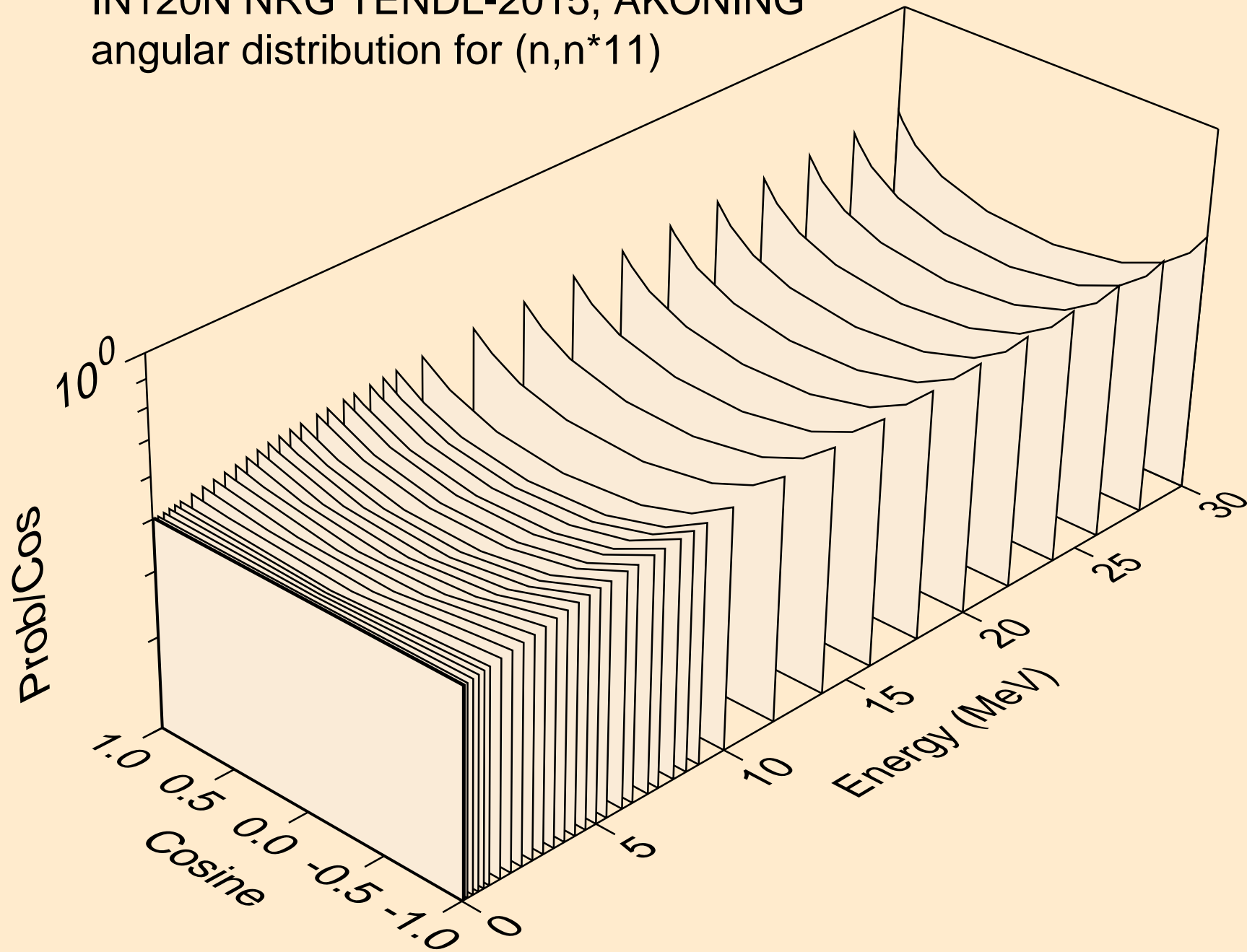

IN120N NRG TENDL-2015, AKONING
angular distribution for (n,n*12)

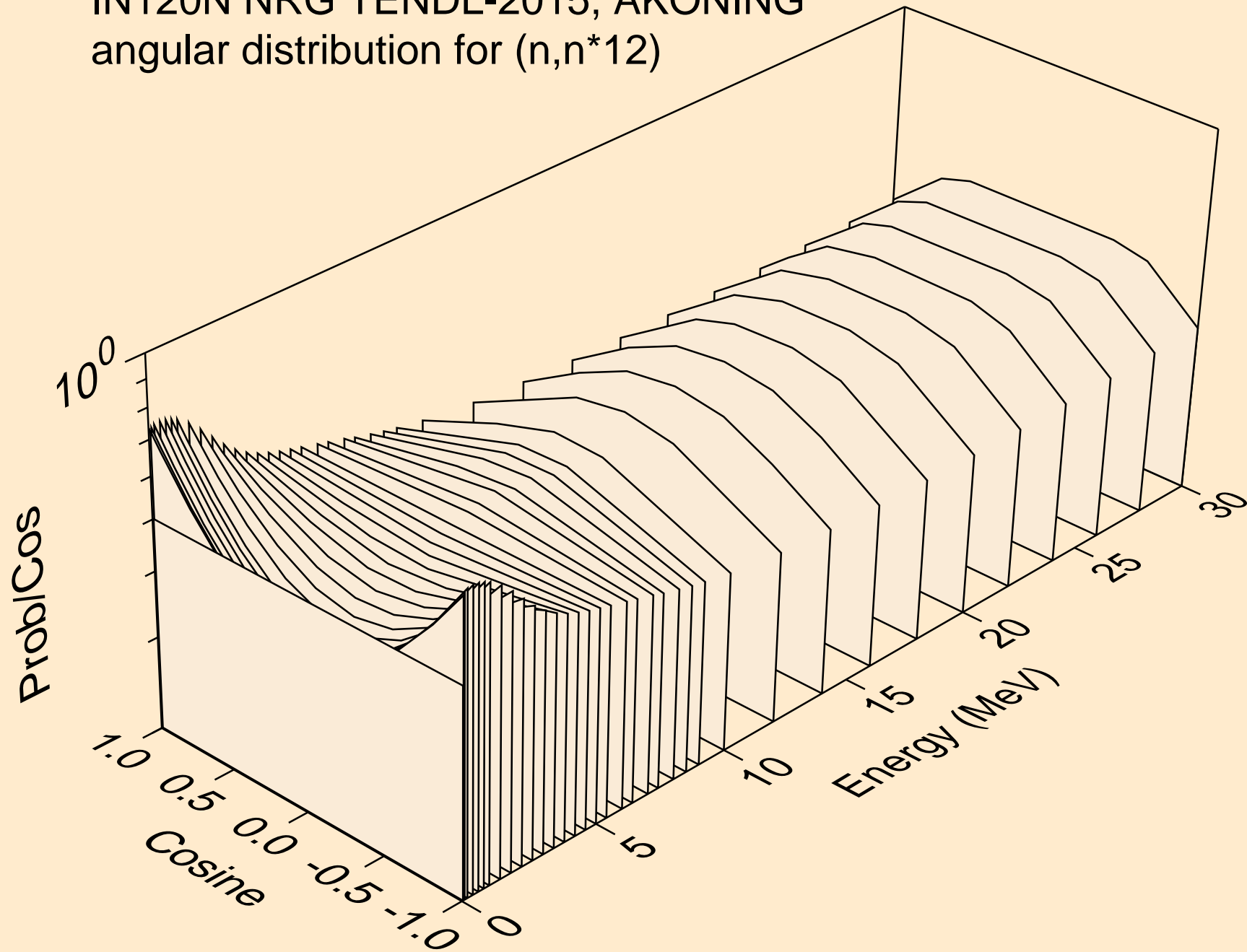

IN120N NRG TENDL-2015, AKONING
angular distribution for (n,n*13)

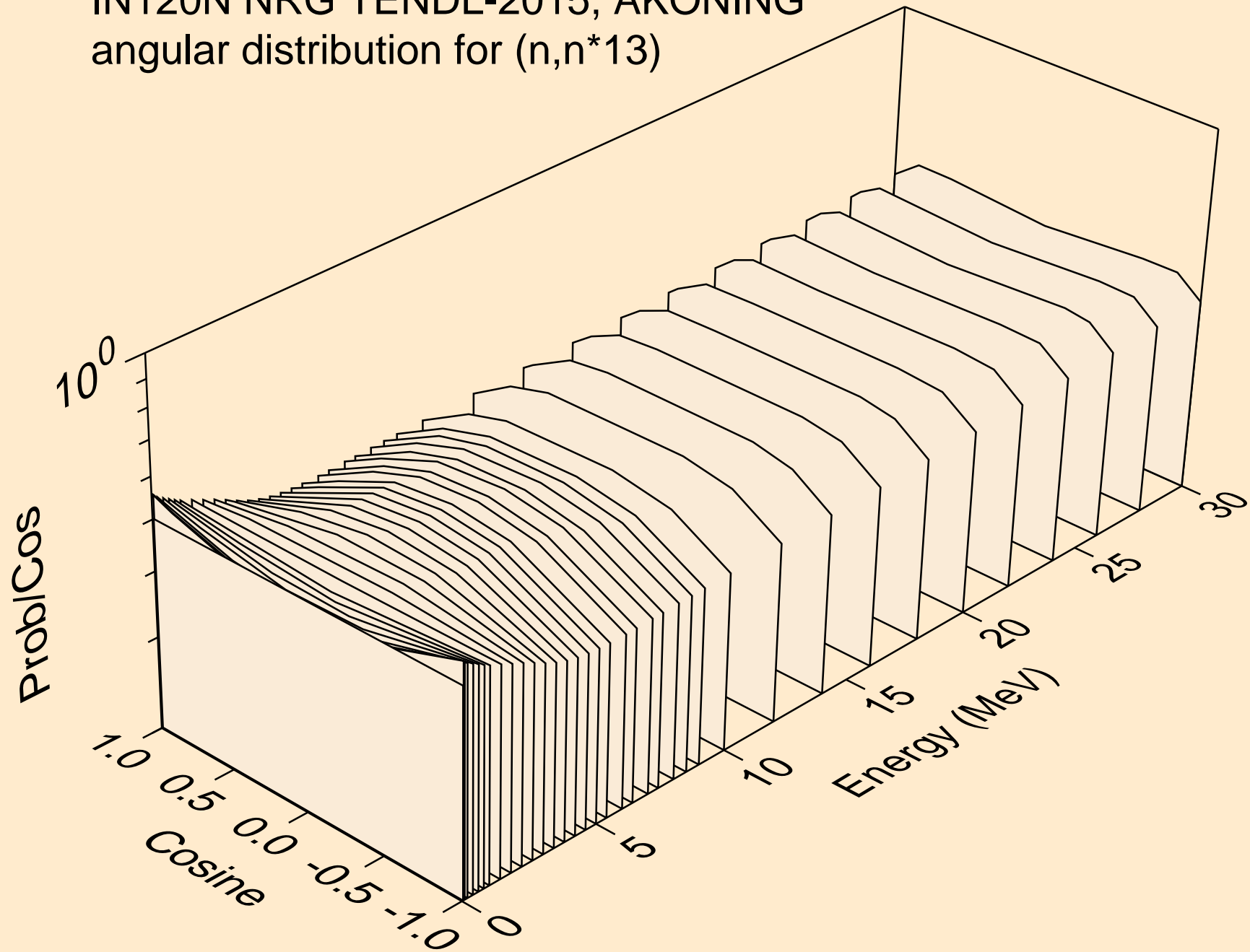

IN120N NRG TENDL-2015, AKONING
angular distribution for (n,n*14)

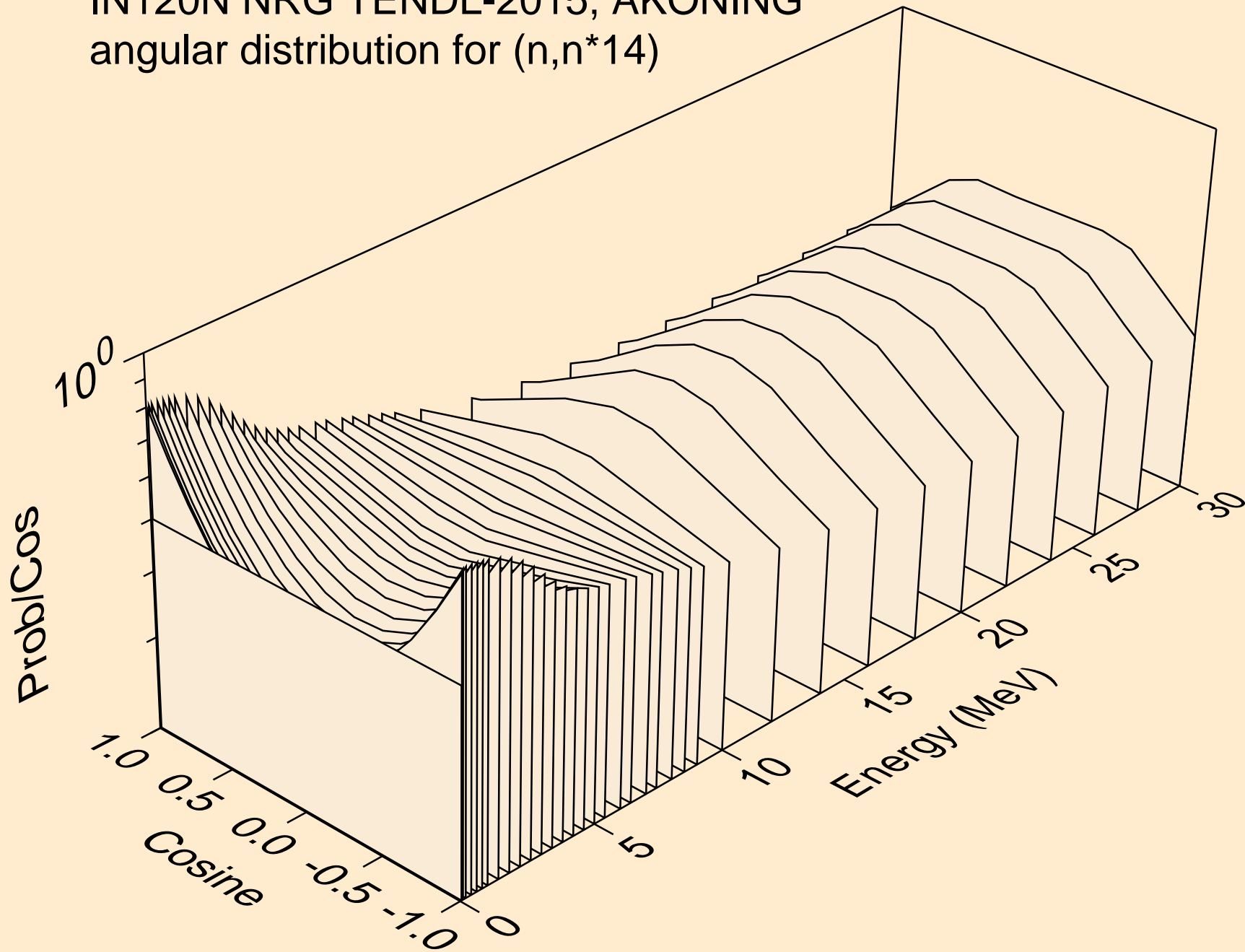

IN120N NRG TENDL-2015, AKONING
angular distribution for (n,n*15)

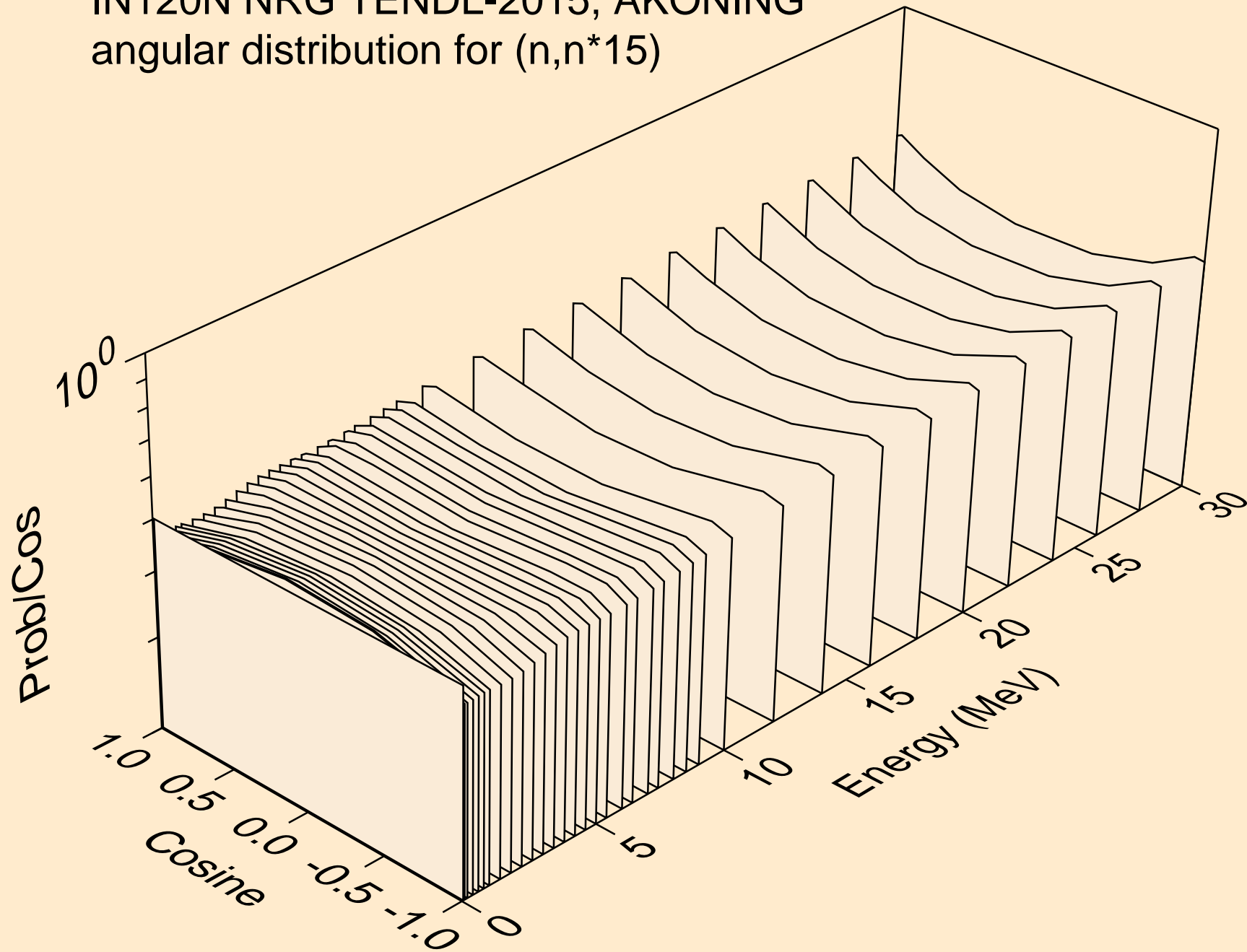

IN120N NRG TENDL-2015, AKONING
angular distribution for (n,n*16)

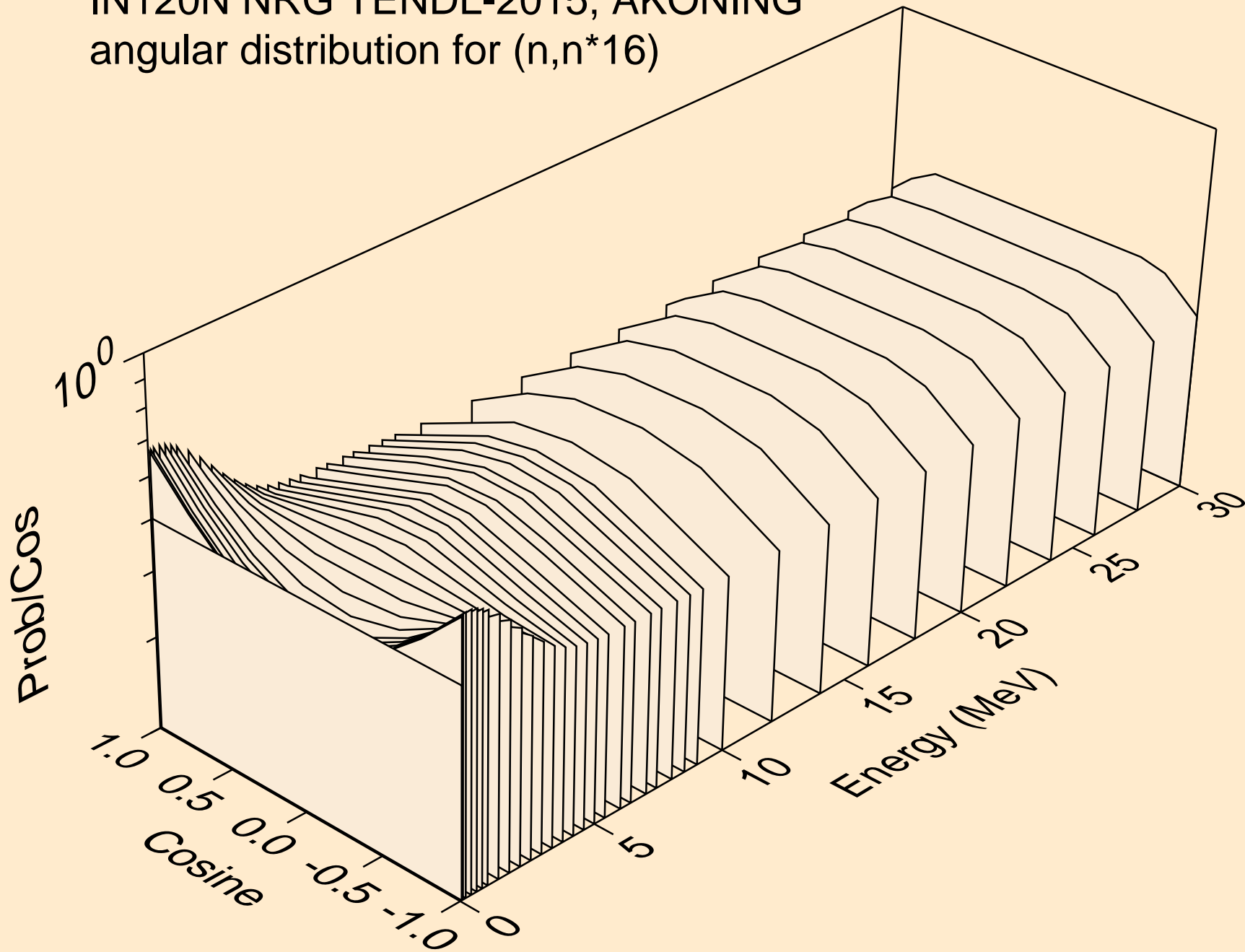

IN120N NRG TENDL-2015, AKONING
angular distribution for (n,n*17)

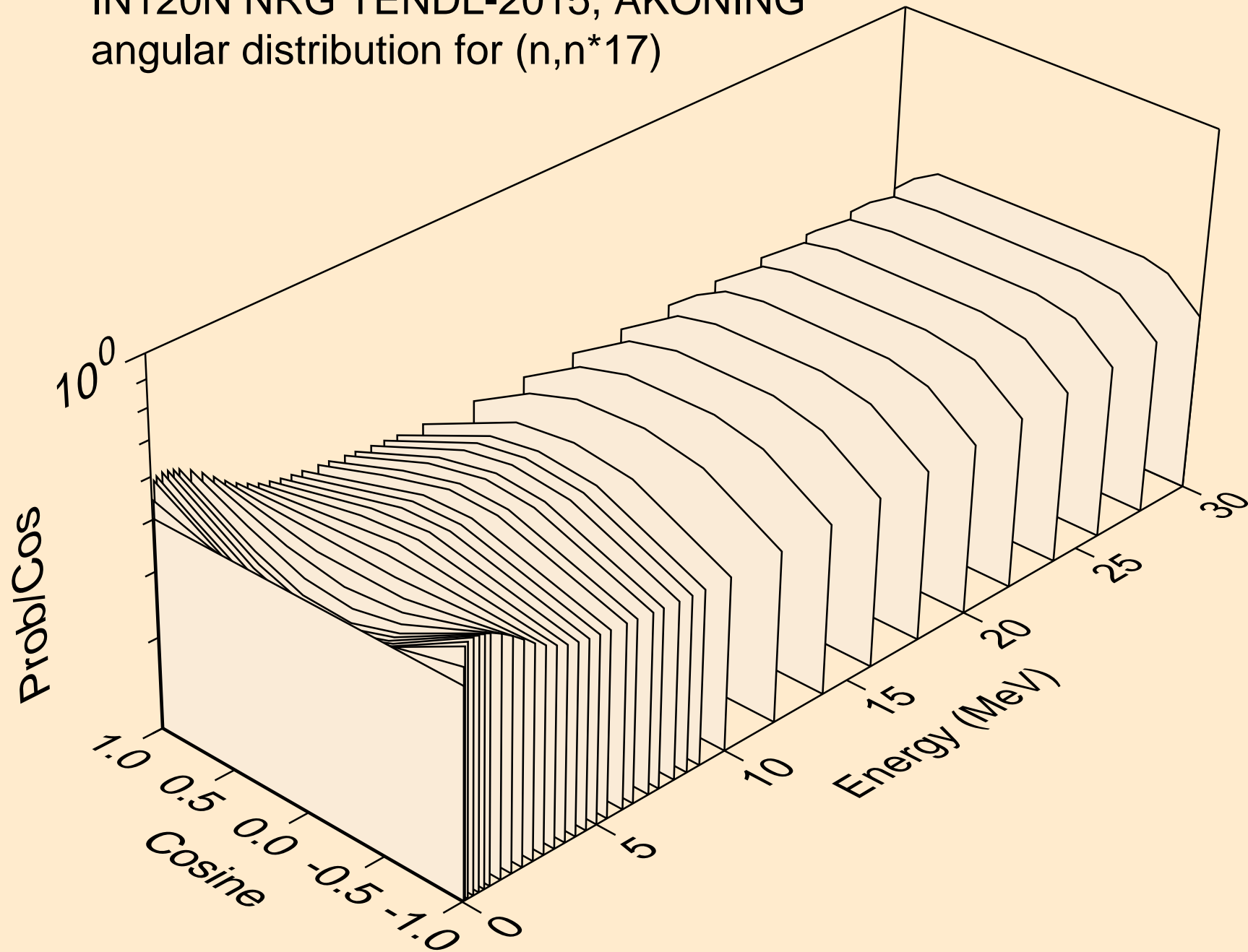

IN120N NRG TENDL-2015, AKONING
angular distribution for (n,n*18)

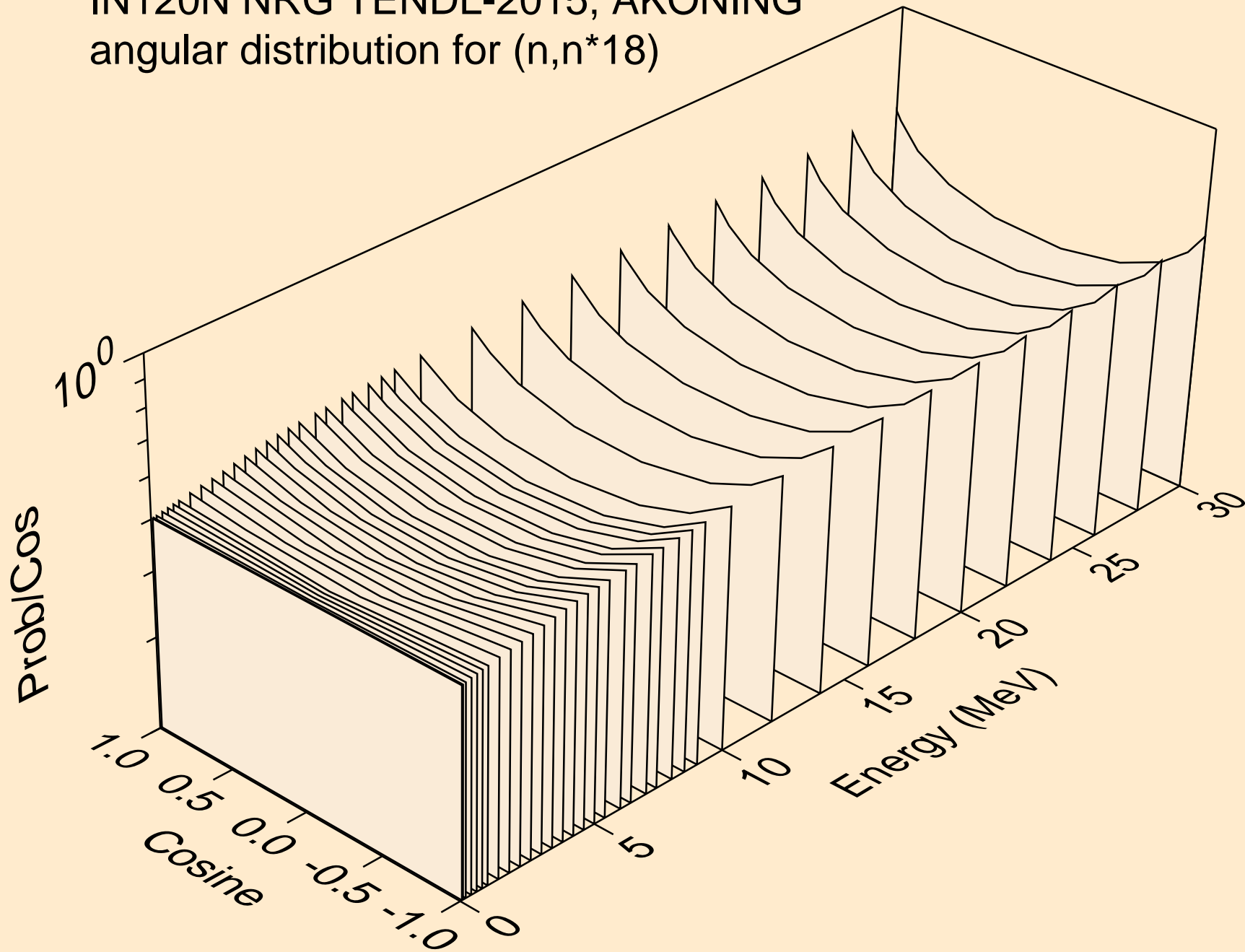

IN120N NRG TENDL-2015, AKONING
angular distribution for (n,n*19)

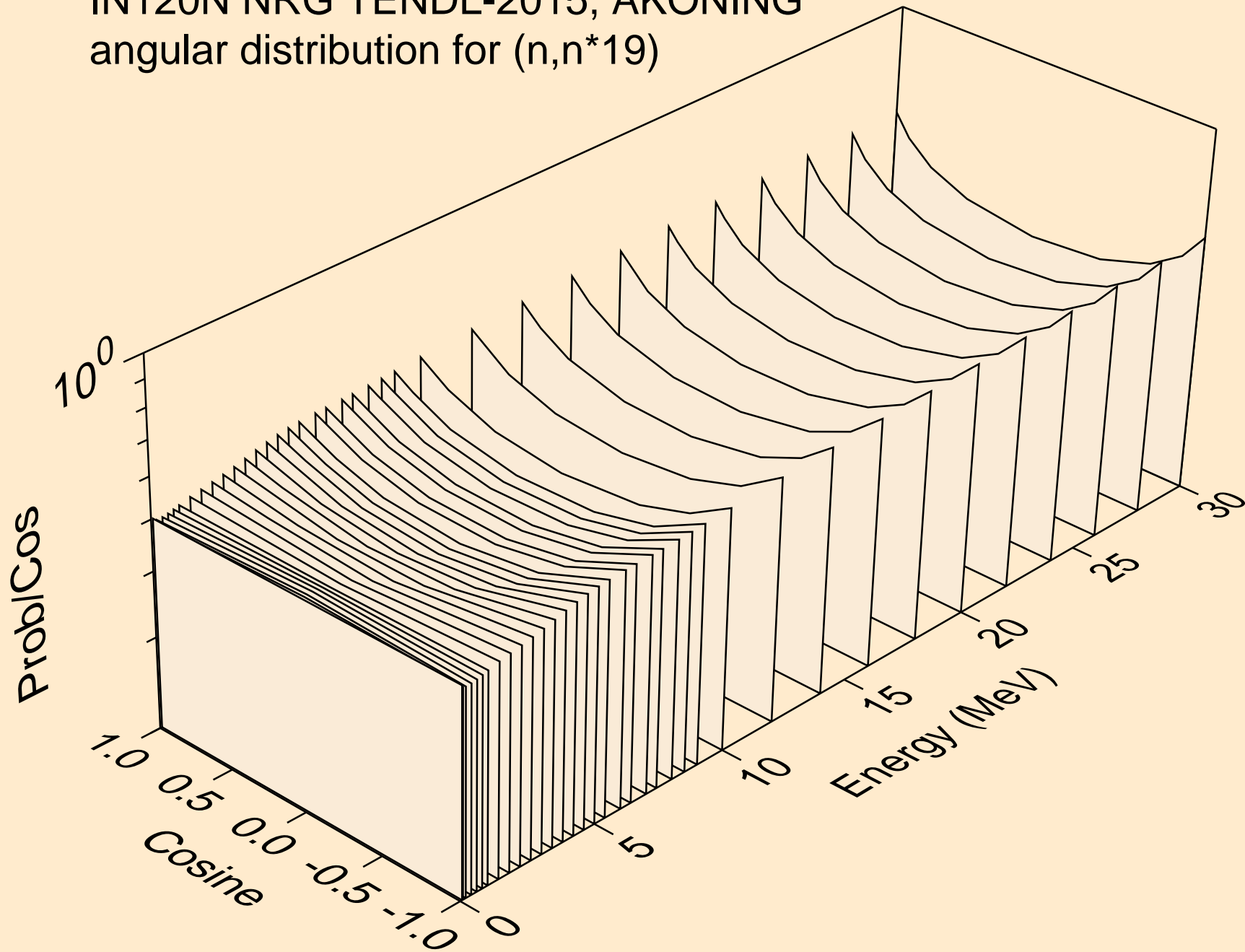

IN120N NRG TENDL-2015, AKONING
angular distribution for (n,n*20)

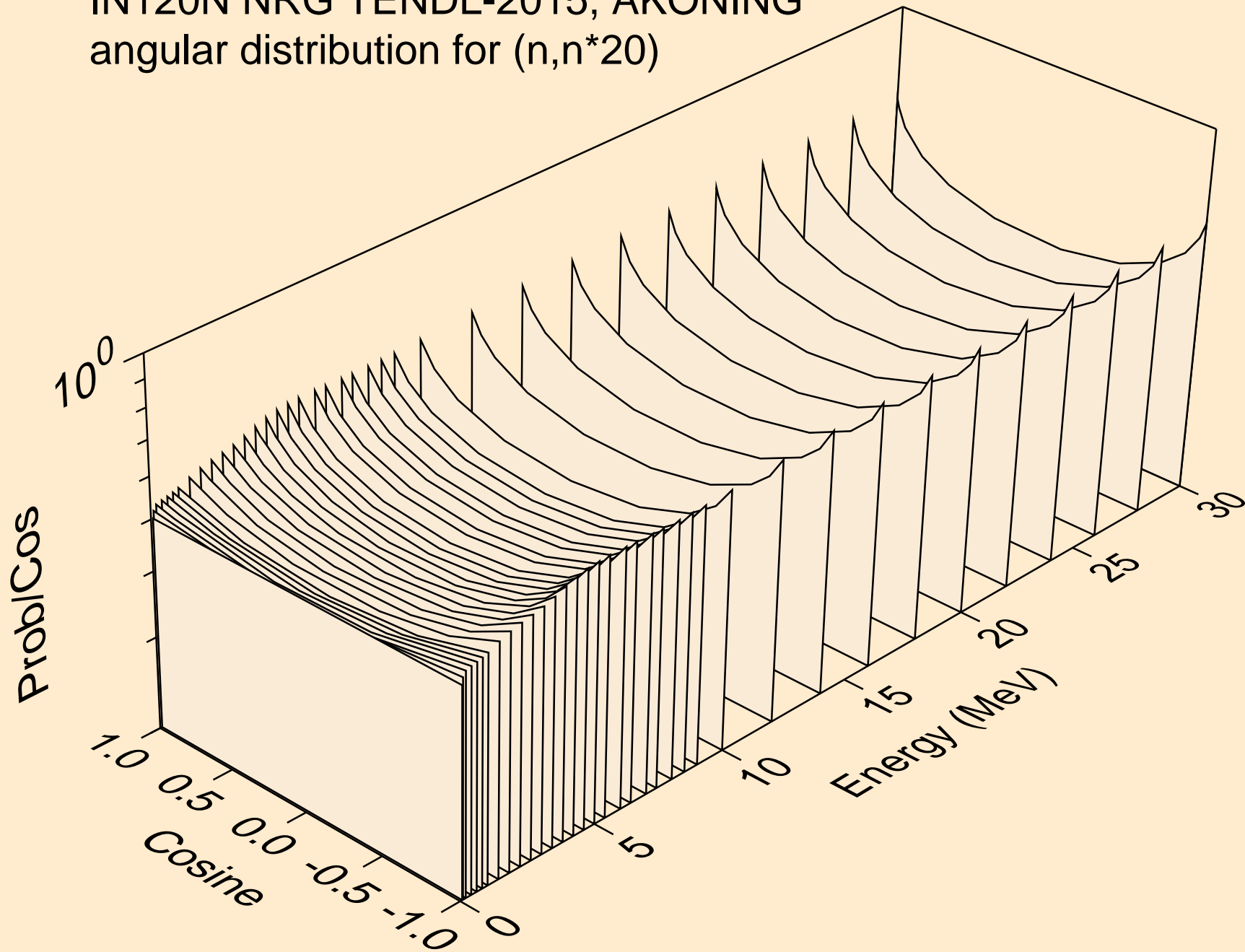

IN120N NRG TENDL-2015, AKONING
angular distribution for (n,n*21)

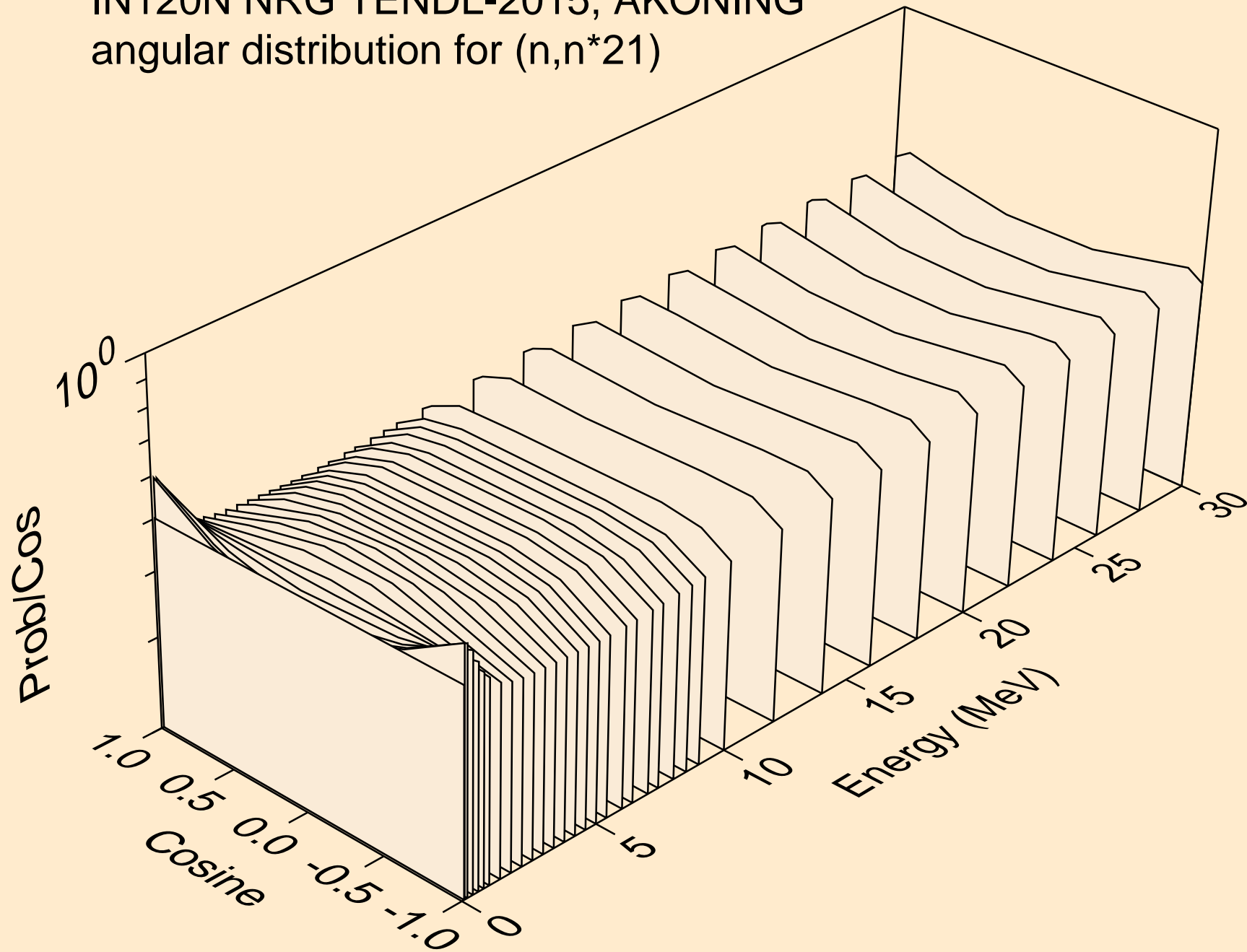

IN120N NRG TENDL-2015, AKONING
angular distribution for (n,n*22)

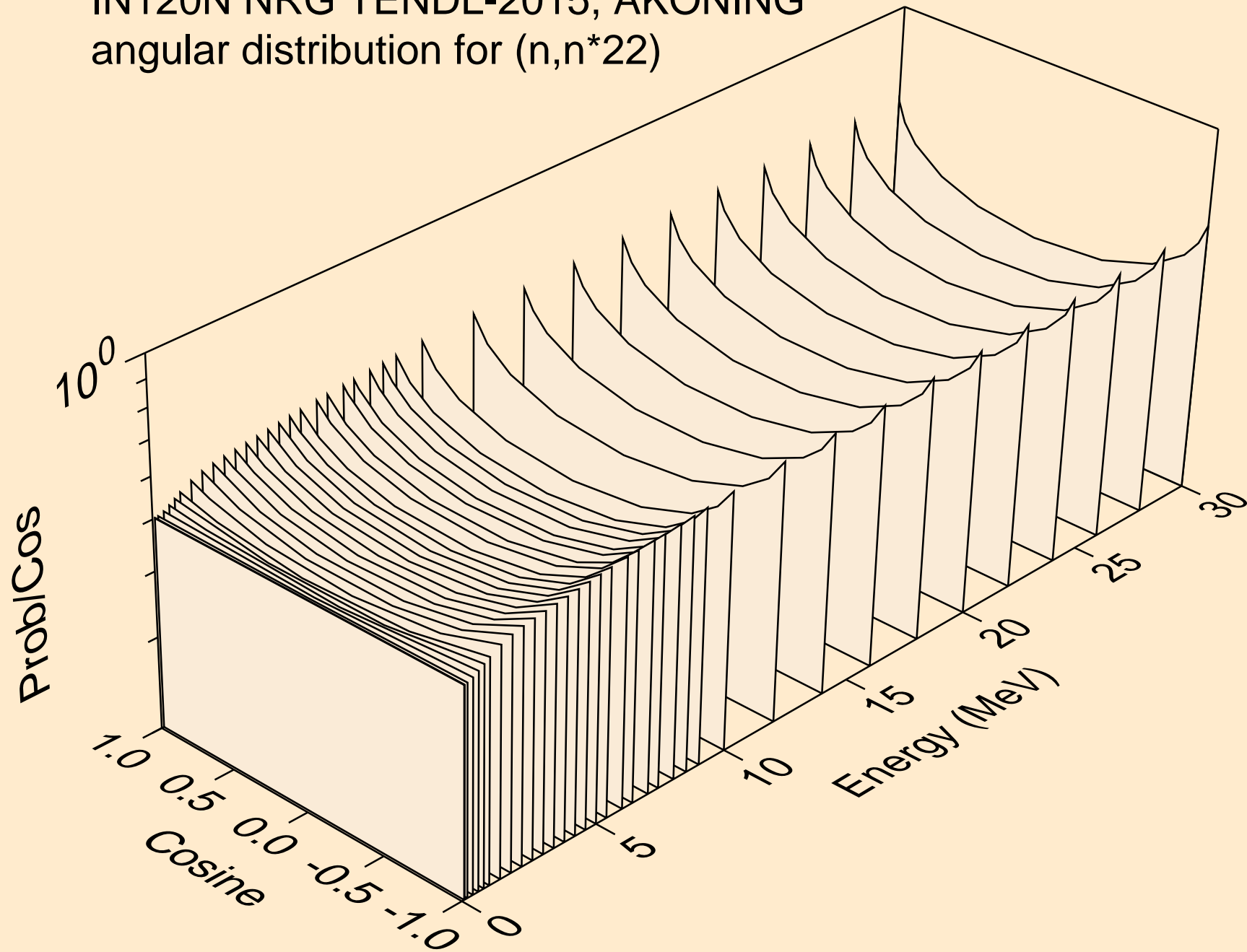

IN120N NRG TENDL-2015, AKONING
angular distribution for (n,n*23)

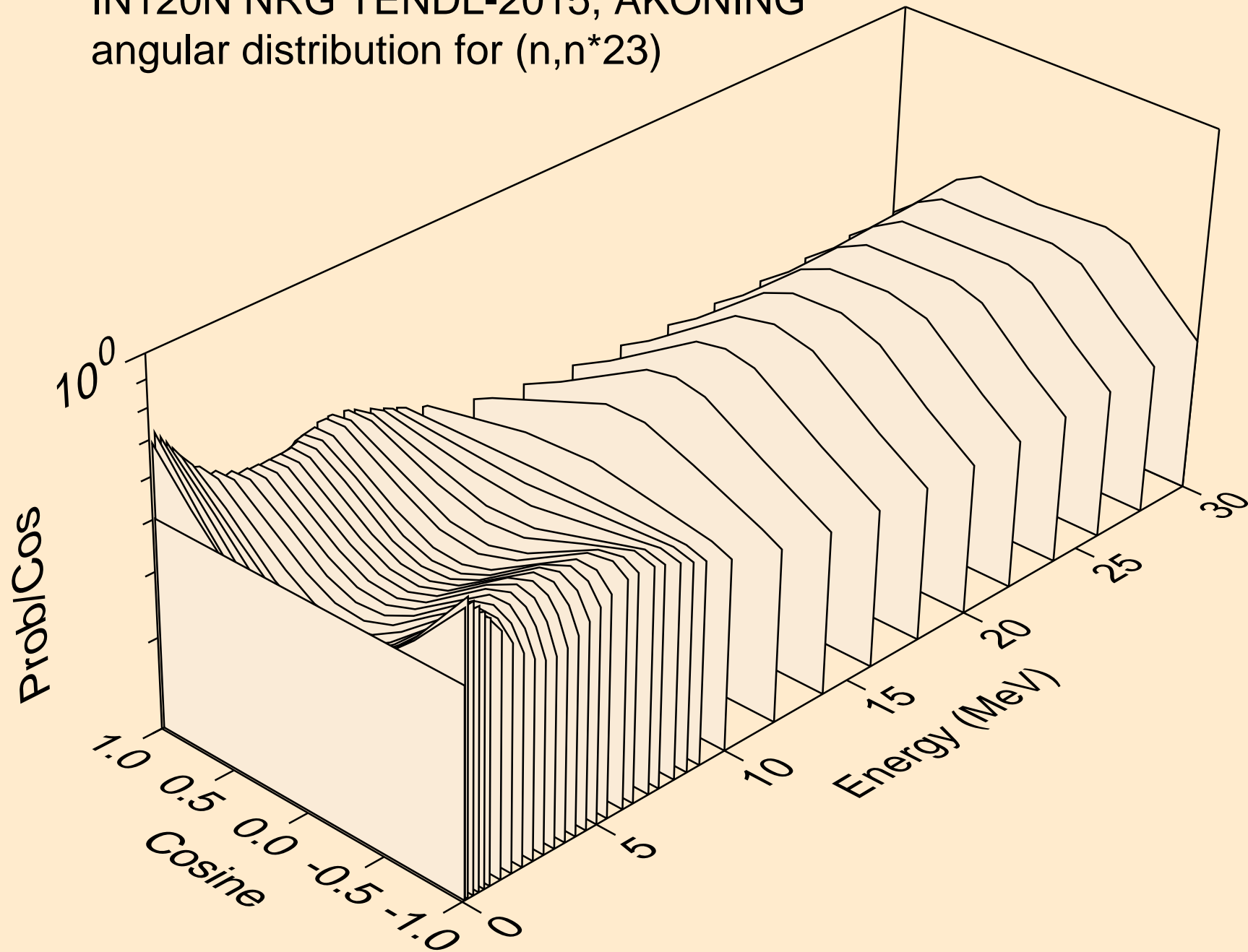

IN120N NRG TENDL-2015, AKONING
angular distribution for (n,n*24)

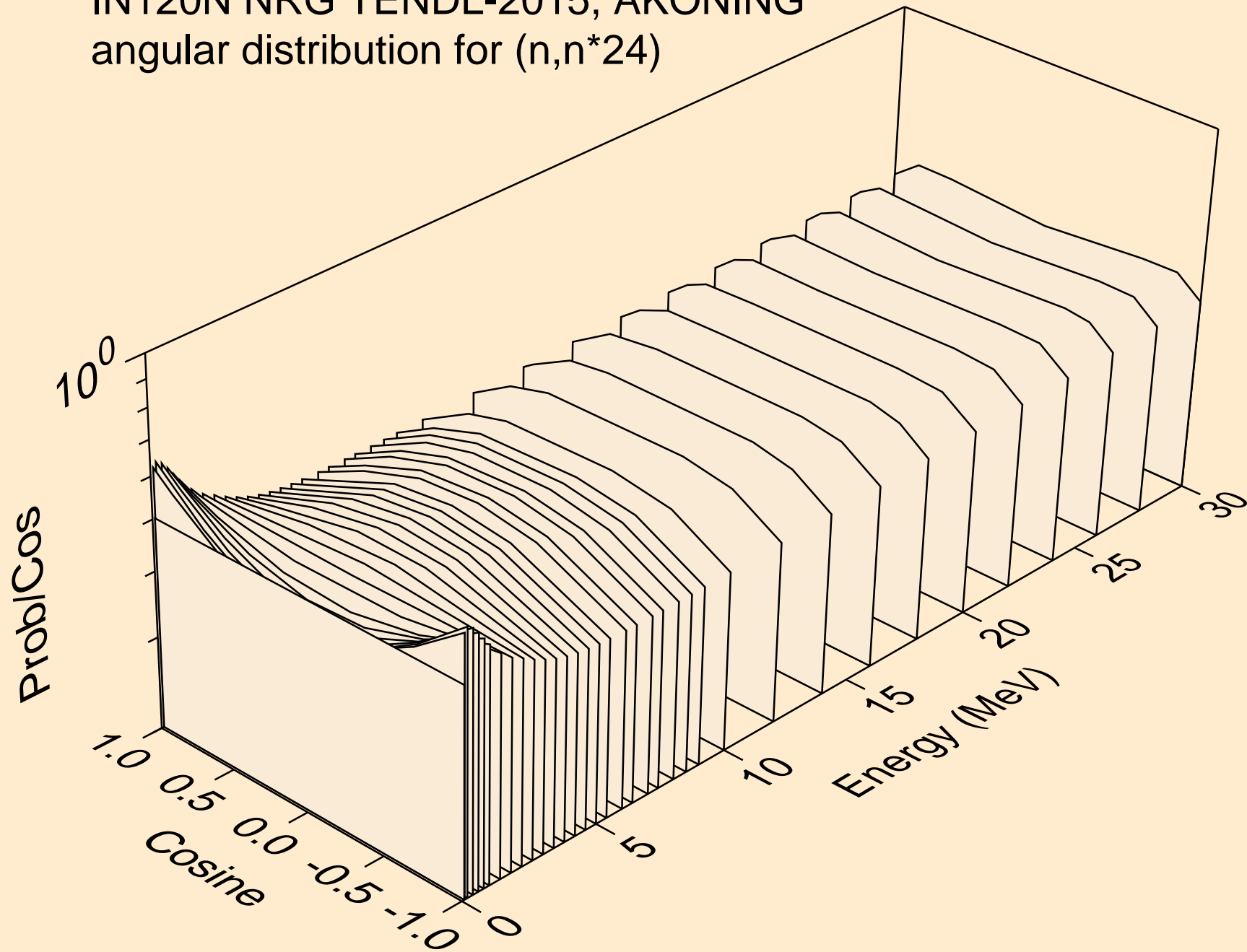

IN120N NRG TENDL-2015, AKONING
angular distribution for (n,n*25)

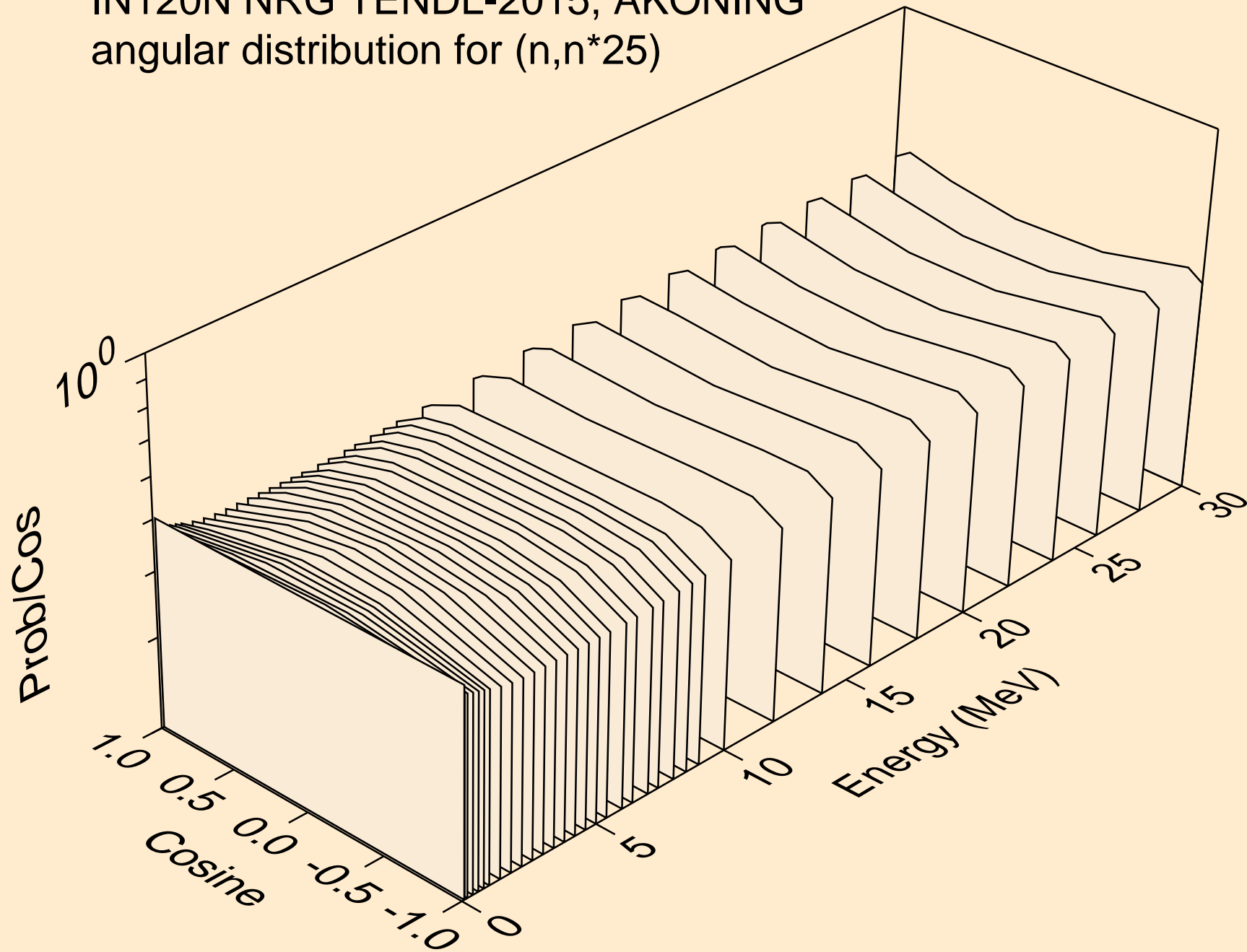

IN120N NRG TENDL-2015, AKONING
angular distribution for (n,n*26)

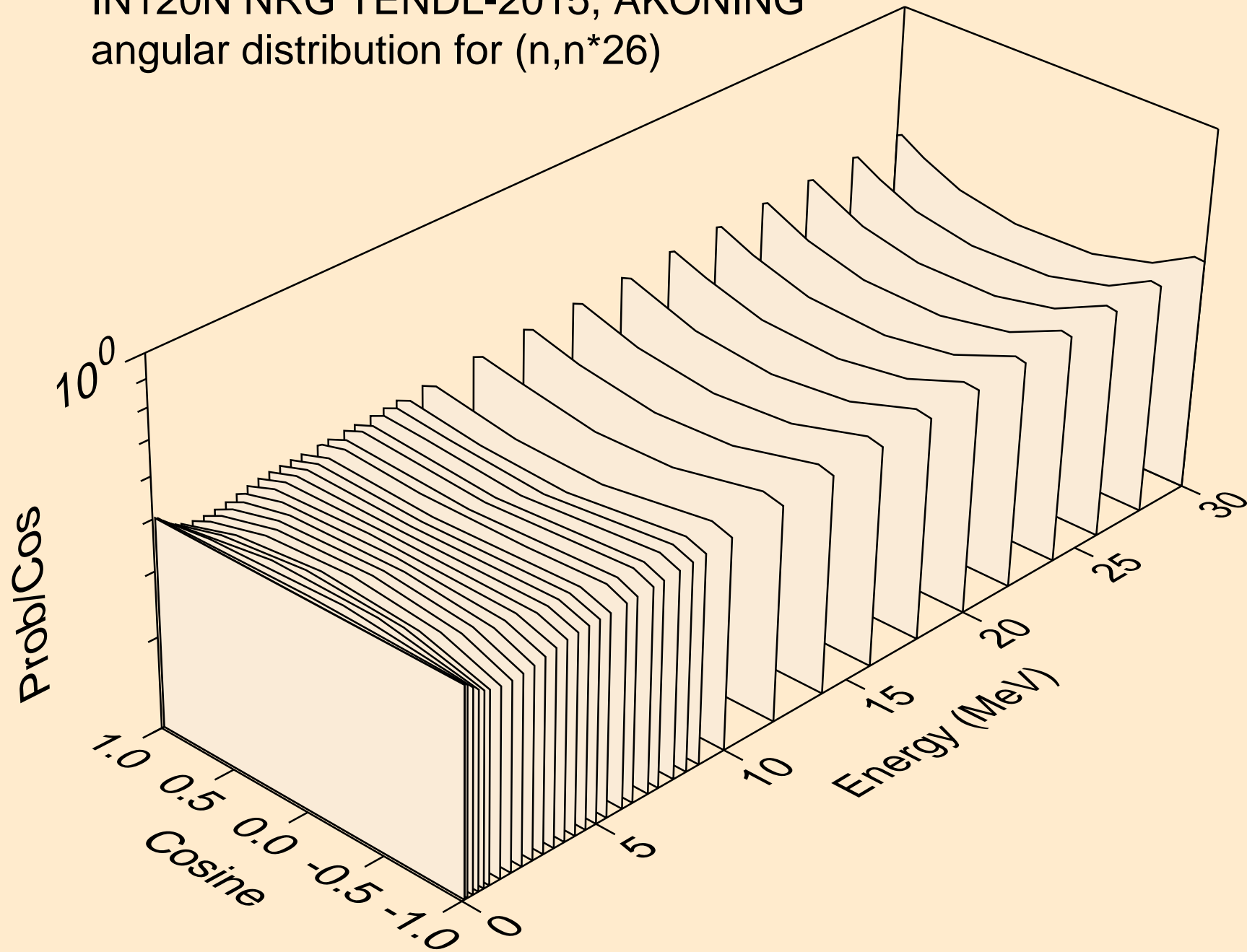

IN120N NRG TENDL-2015, AKONING
angular distribution for (n,n*27)

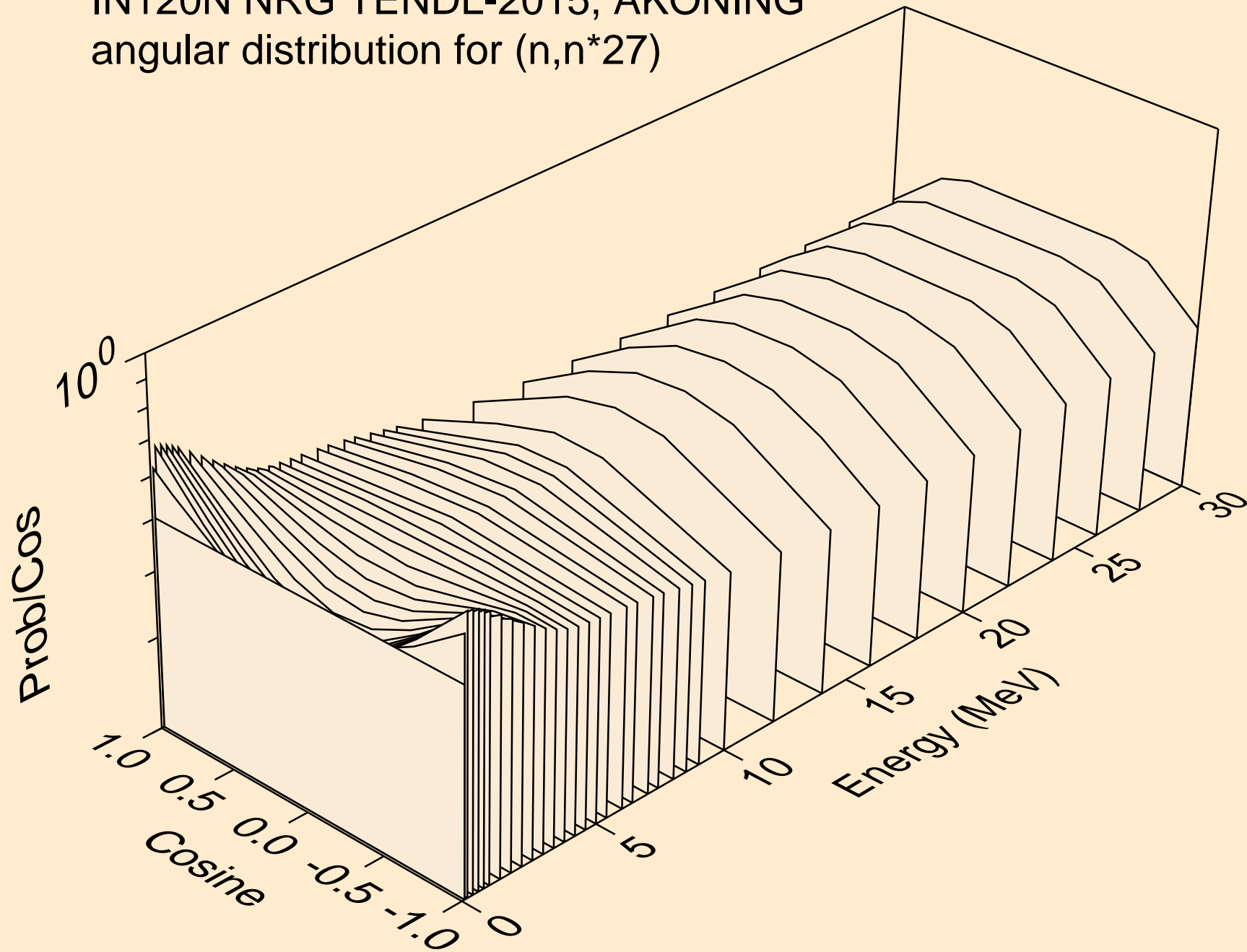

IN120N NRG TENDL-2015, AKONING
angular distribution for (n,n*28)

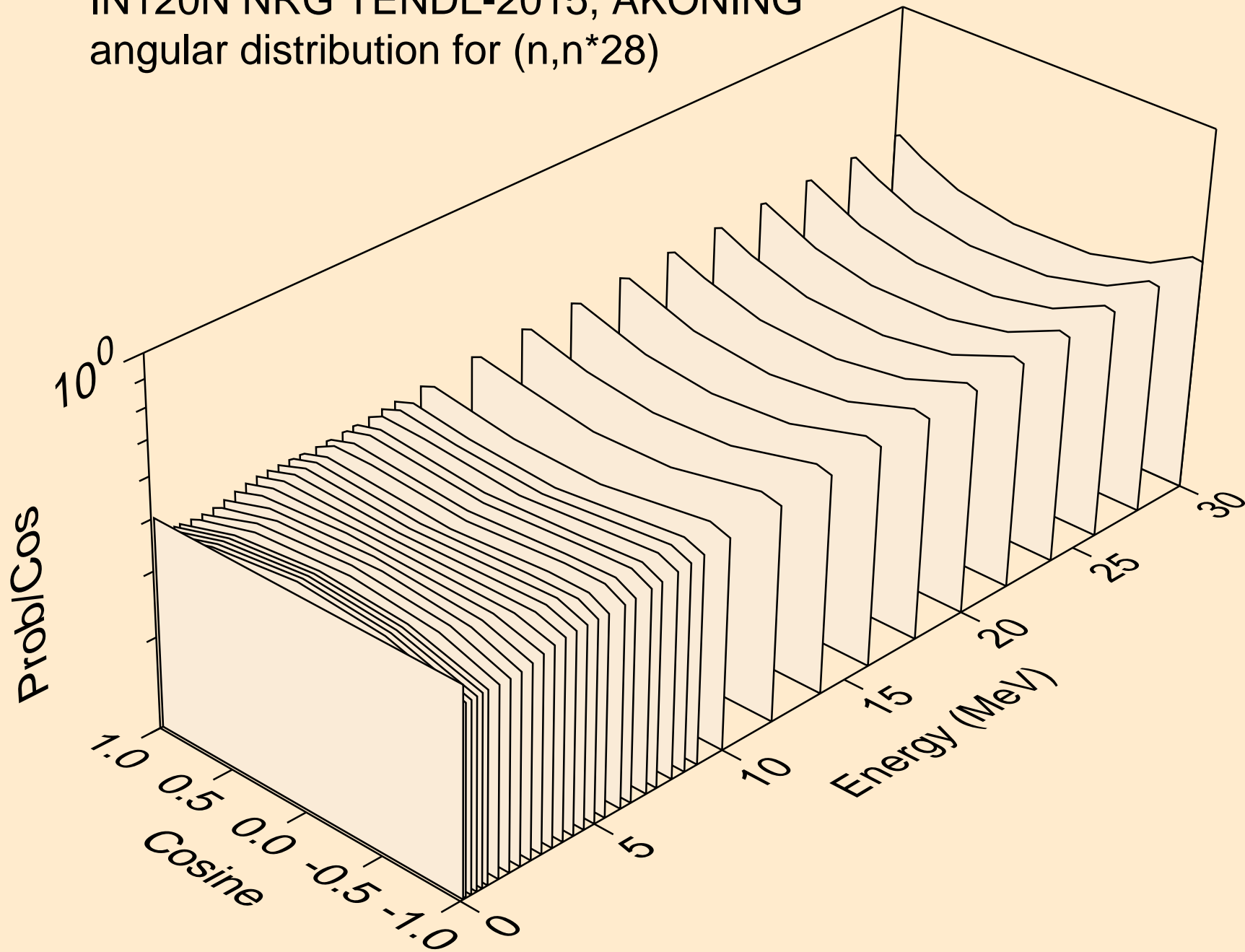

IN120N NRG TENDL-2015, AKONING
angular distribution for (n,n*29)

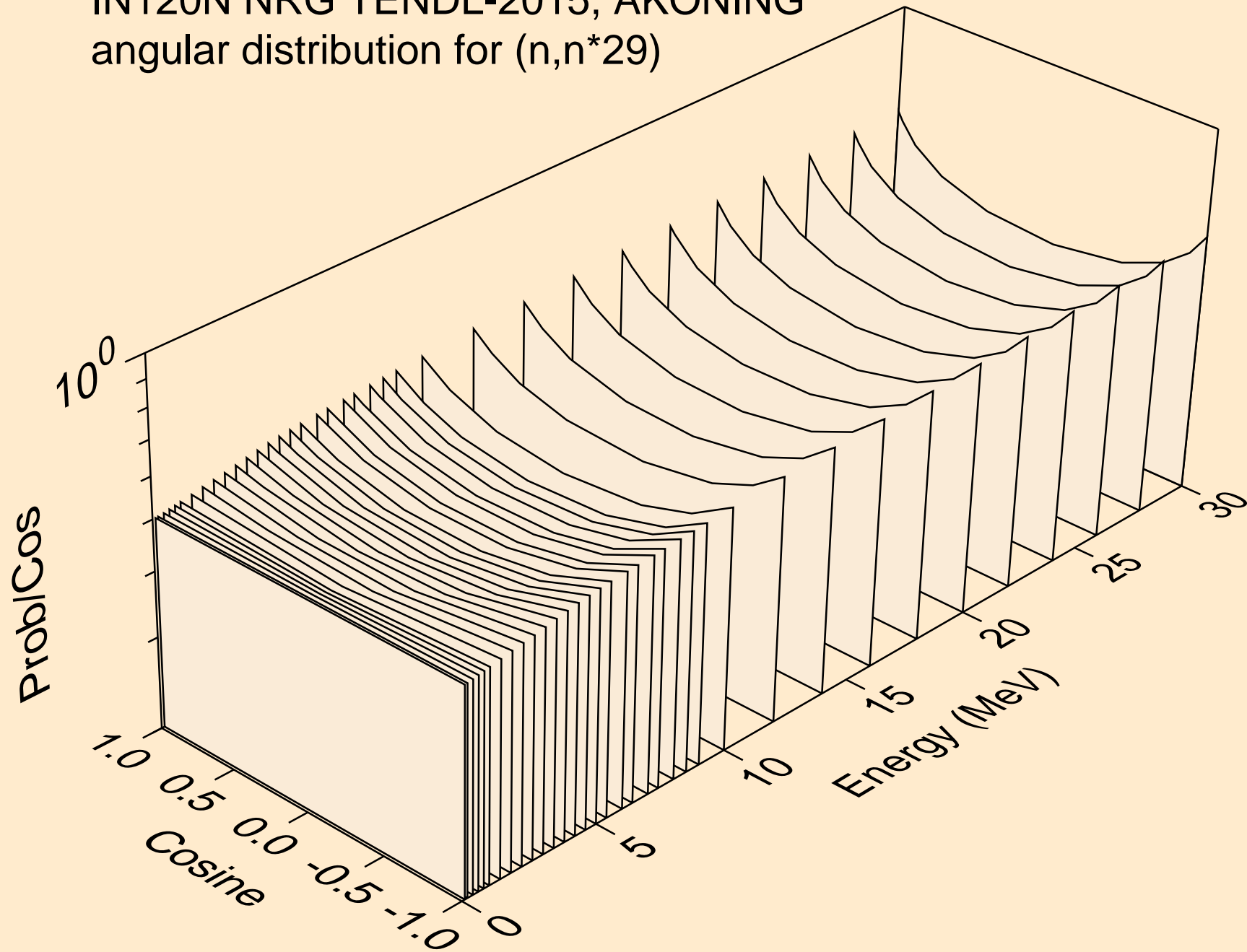

IN120N NRG TENDL-2015, AKONING
Neutron emission for (n,x)

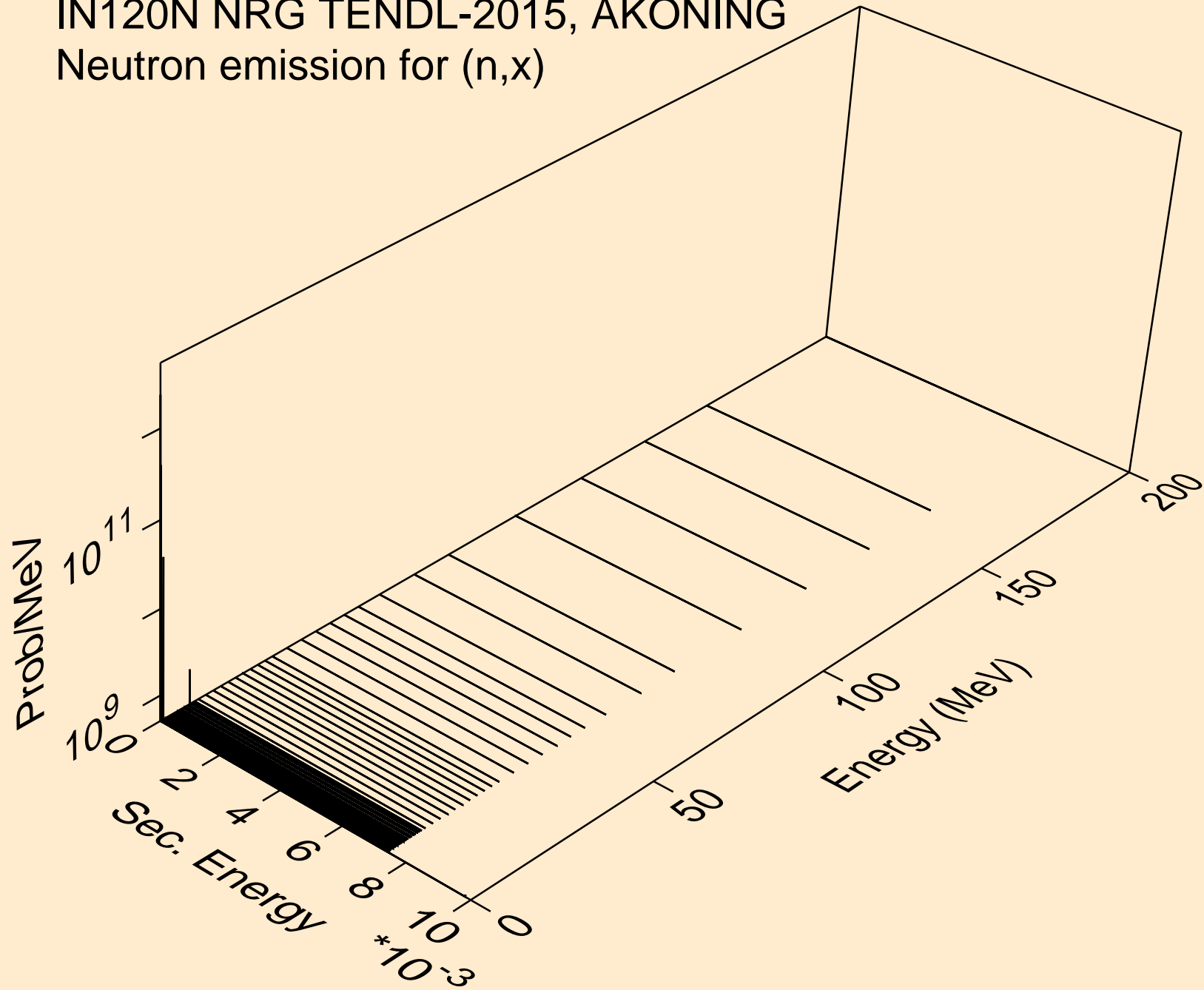

IN120N NRG TENDL-2015, AKONING
Neutron emission for (n,2nd)

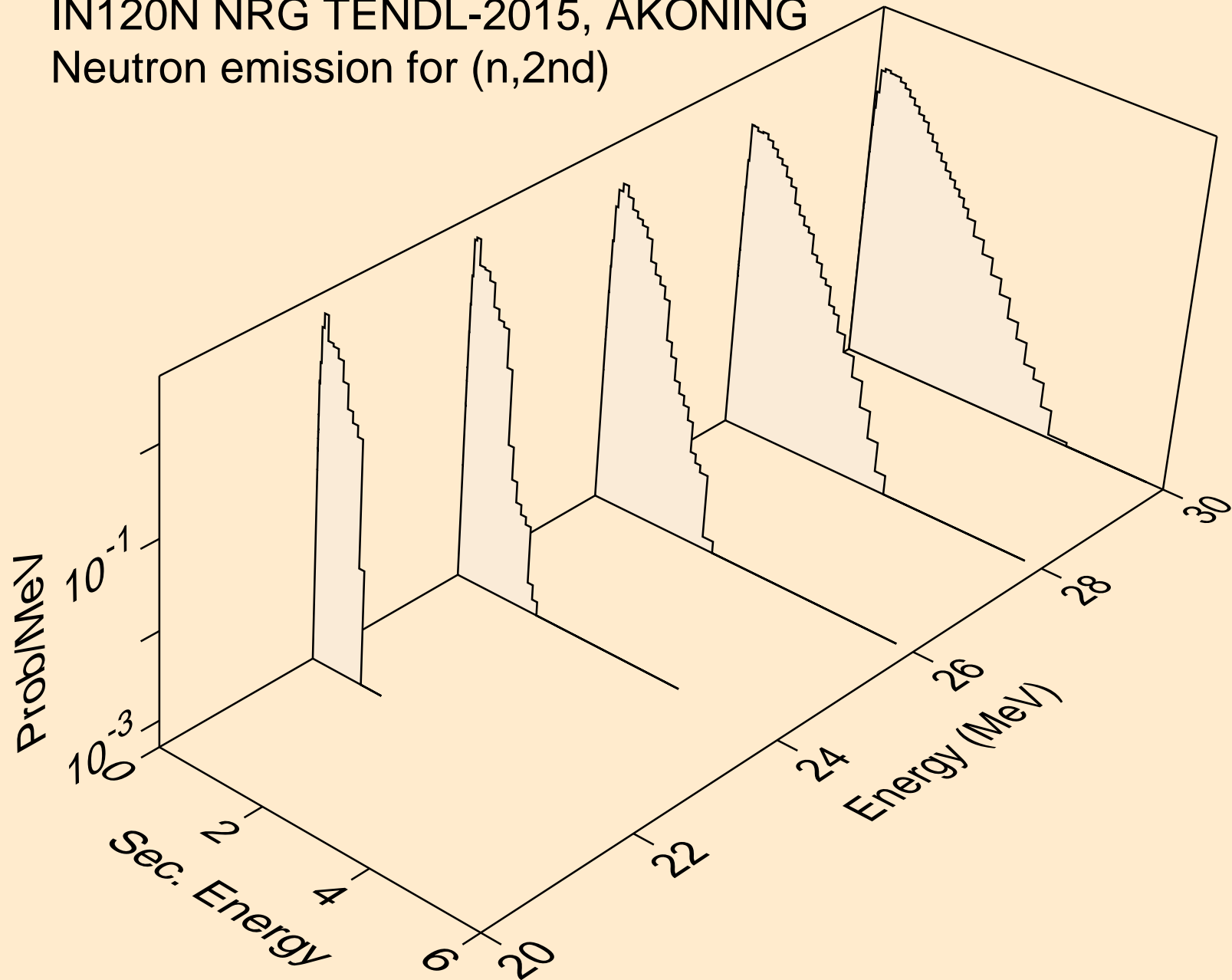

IN120N NRG TENDL-2015, AKONING
Neutron emission for (n,2n)

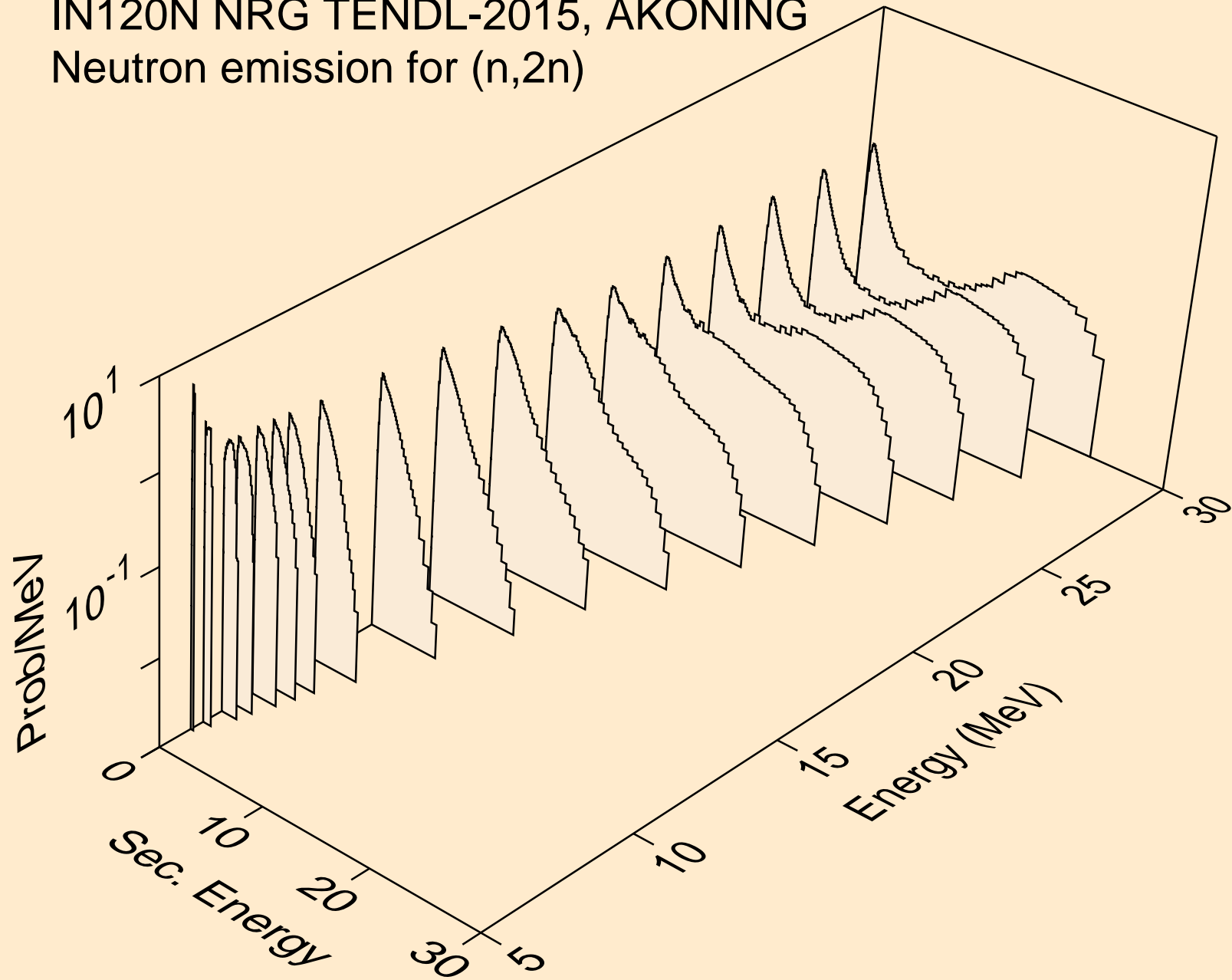

IN120N NRG TENDL-2015, AKONING
Neutron emission for (n,3n)

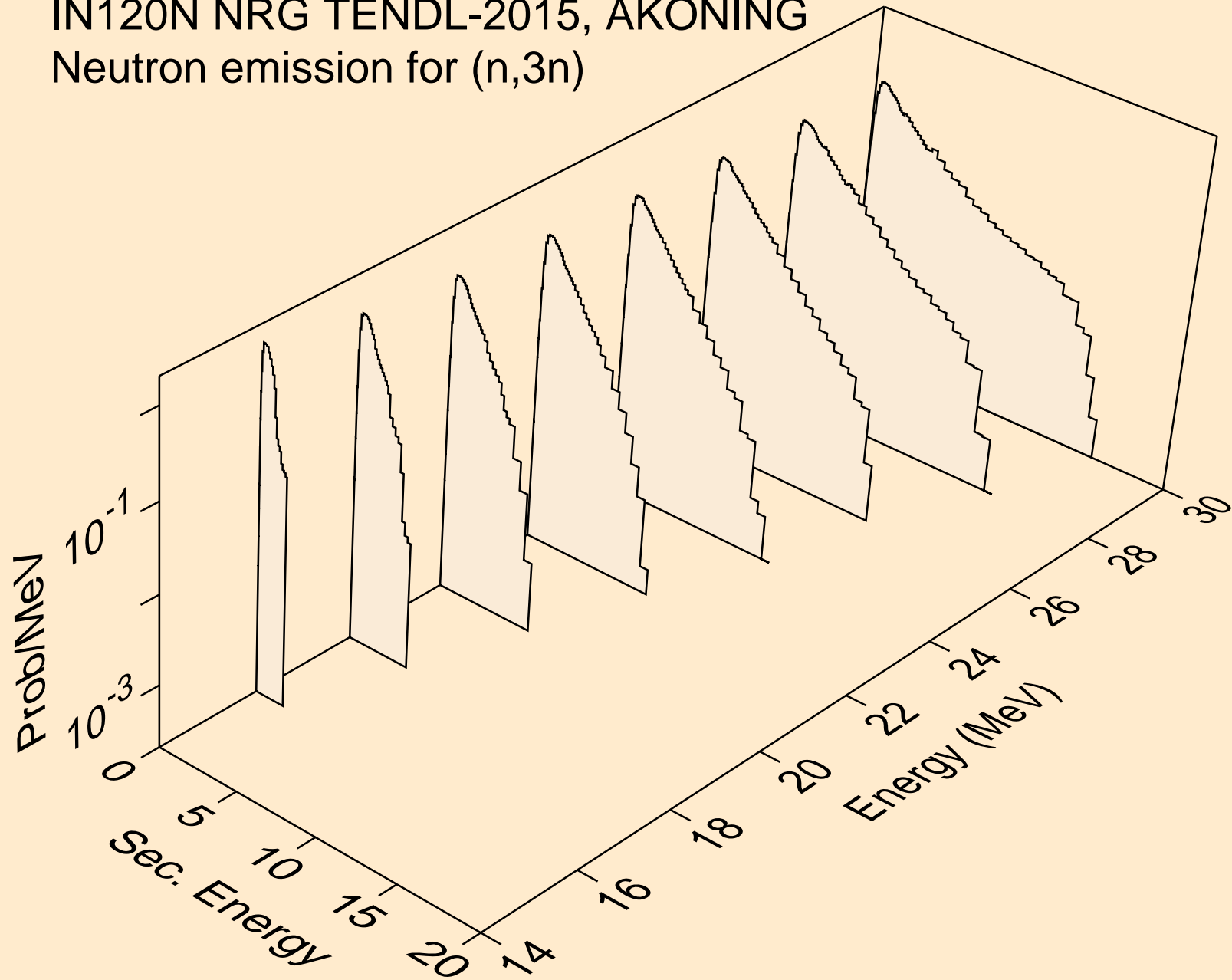

IN120N NRG TENDL-2015, AKONING
Neutron emission for (n,n*)a

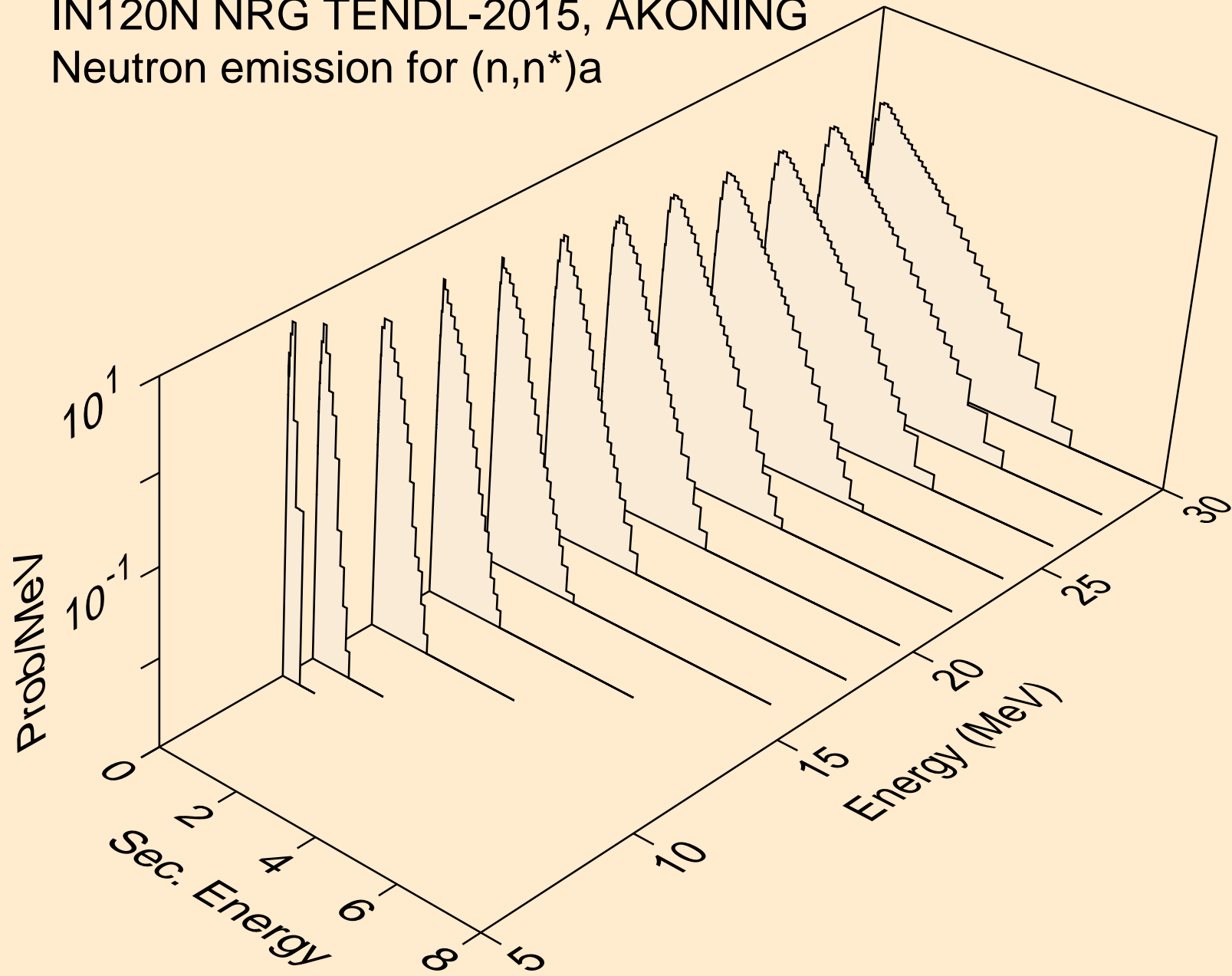

IN120N NRG TENDL-2015, AKONING
Neutron emission for (n,2n)_a

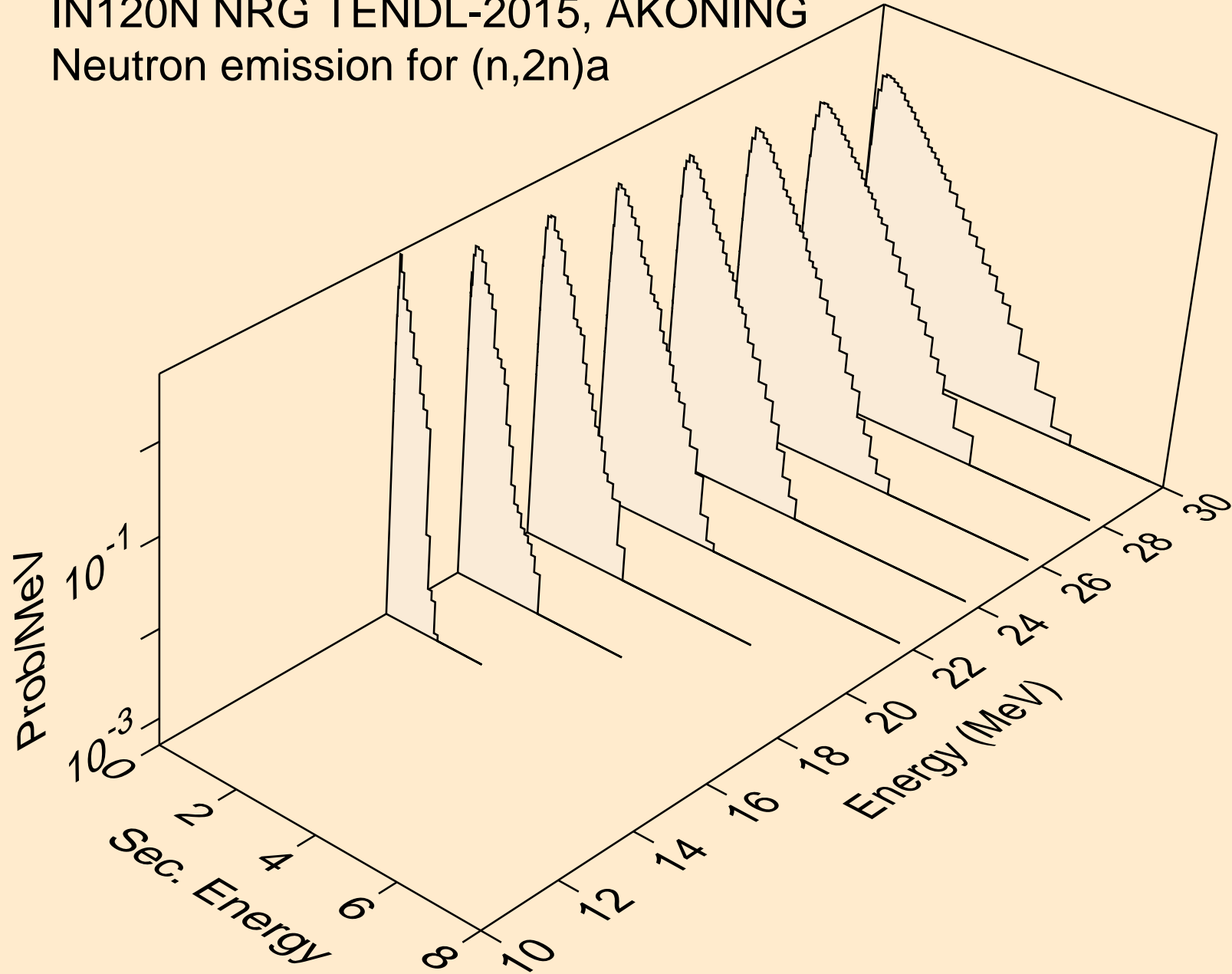

IN120N NRG TENDL-2015, AKONING
Neutron emission for (n,3n)a

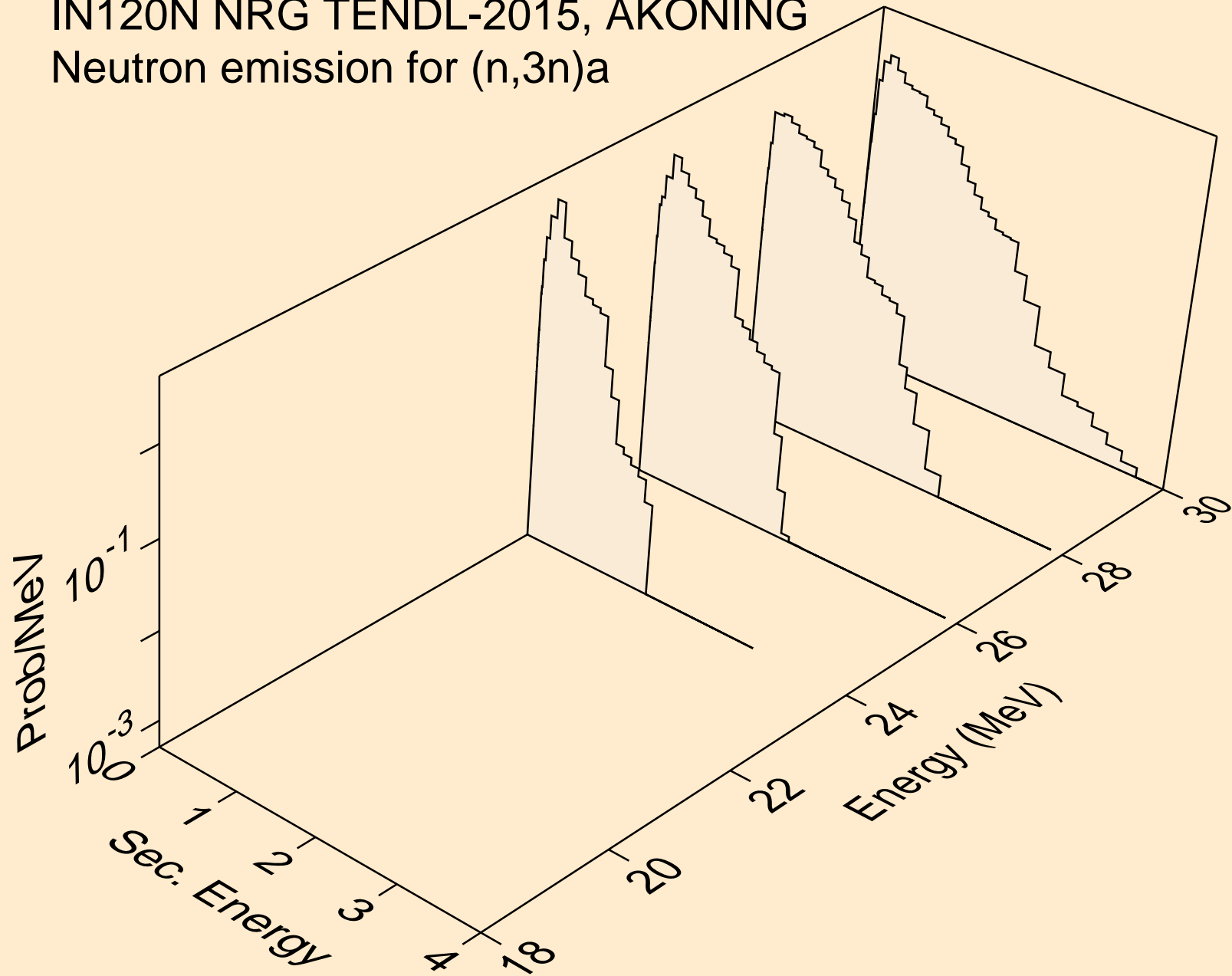

IN120N NRG TENDL-2015, AKONING
Neutron emission for (n,n*)p

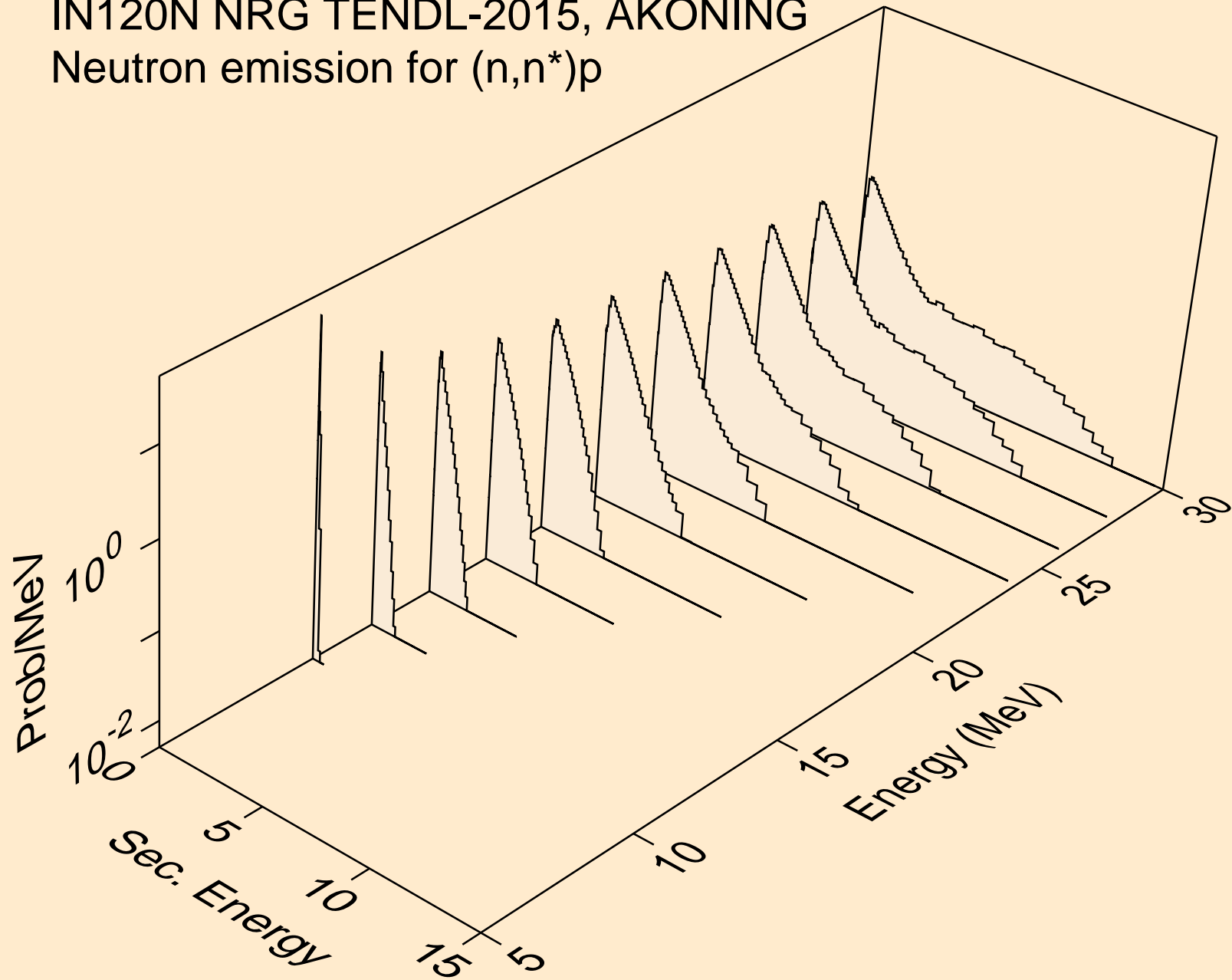

IN120N NRG TENDL-2015, AKONING
Neutron emission for (n,n*)d

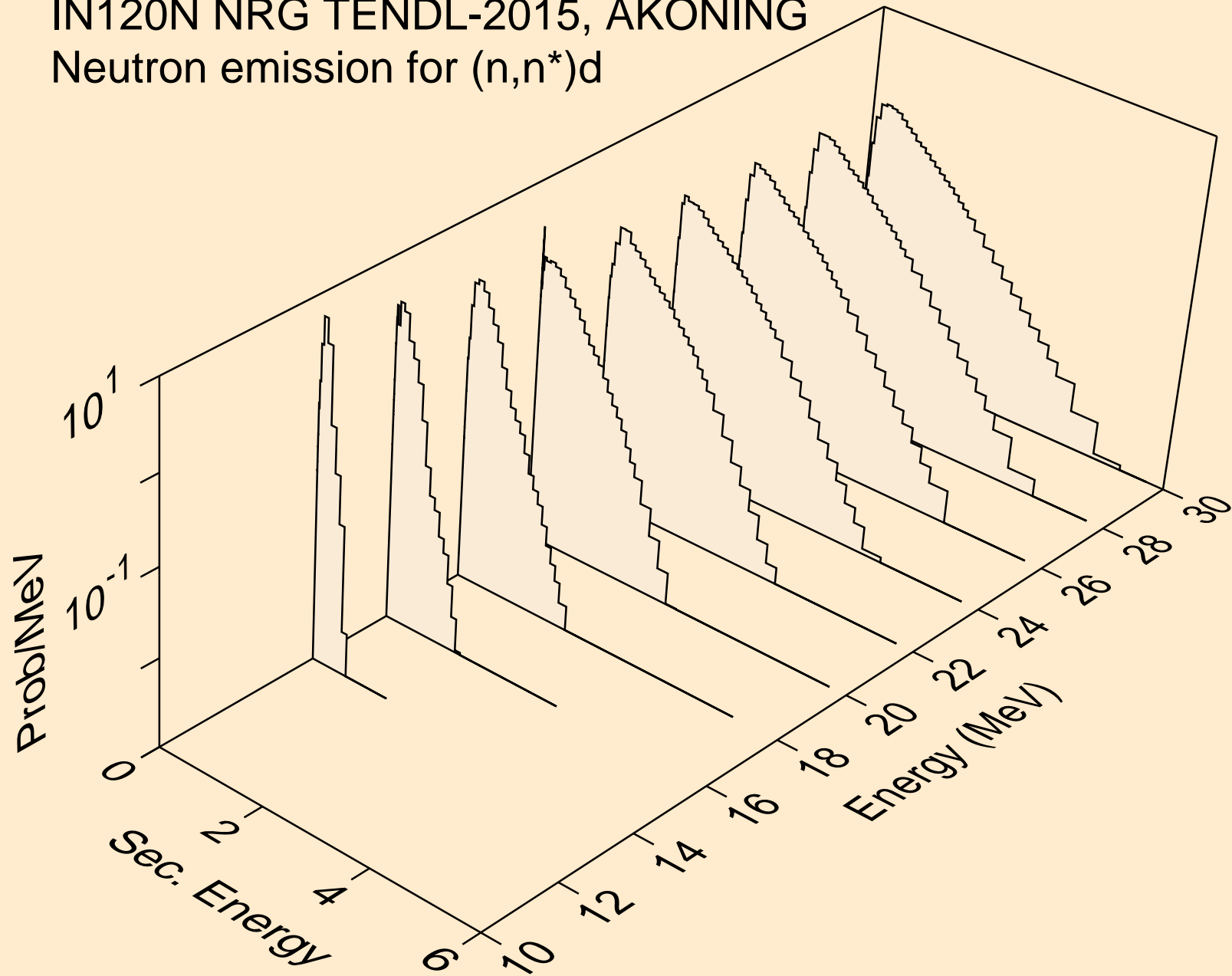

IN120N NRG TENDL-2015, AKONING
Neutron emission for (n,n*)t

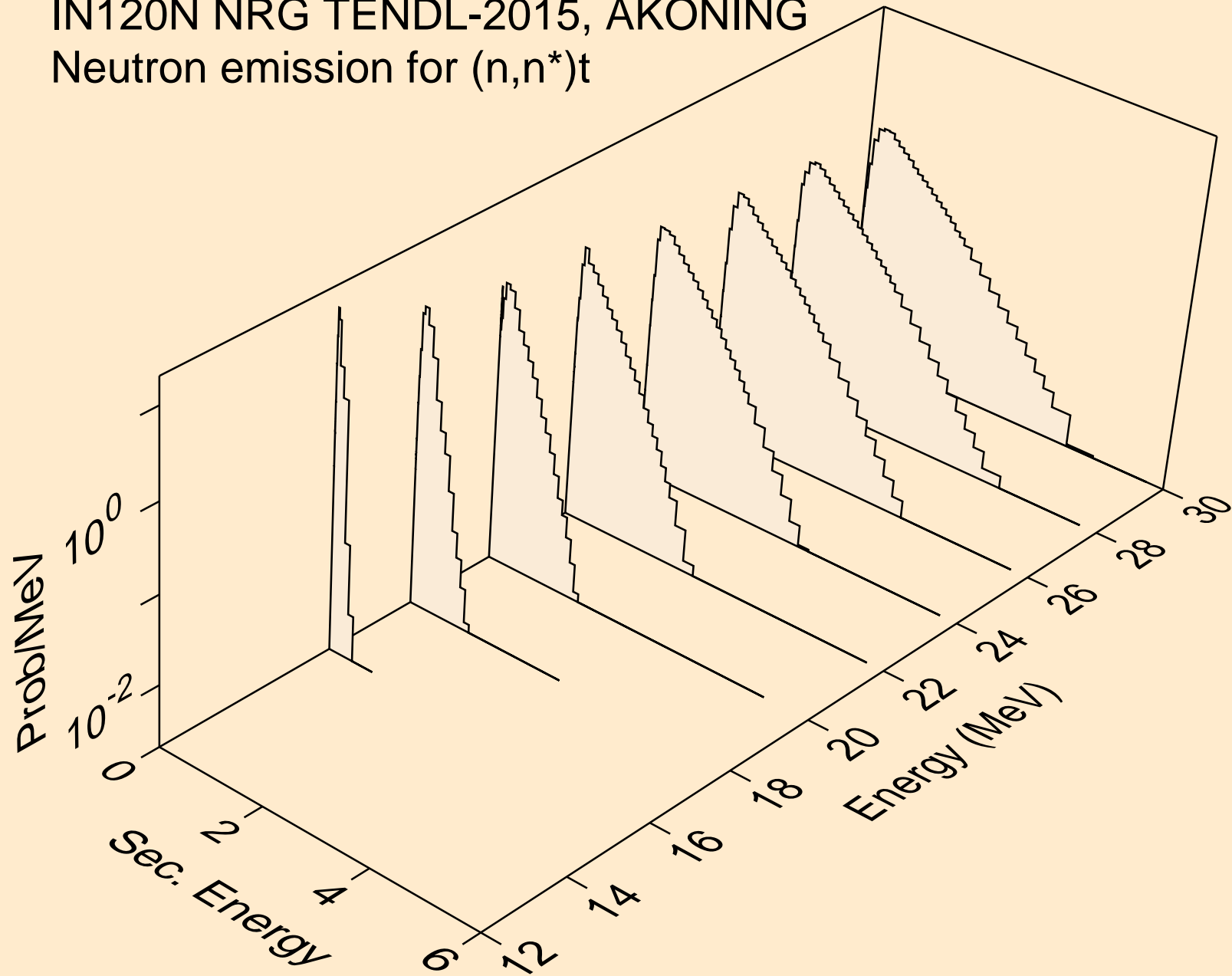

IN120N NRG TENDL-2015, AKONING
Neutron emission for (n,n*)he3

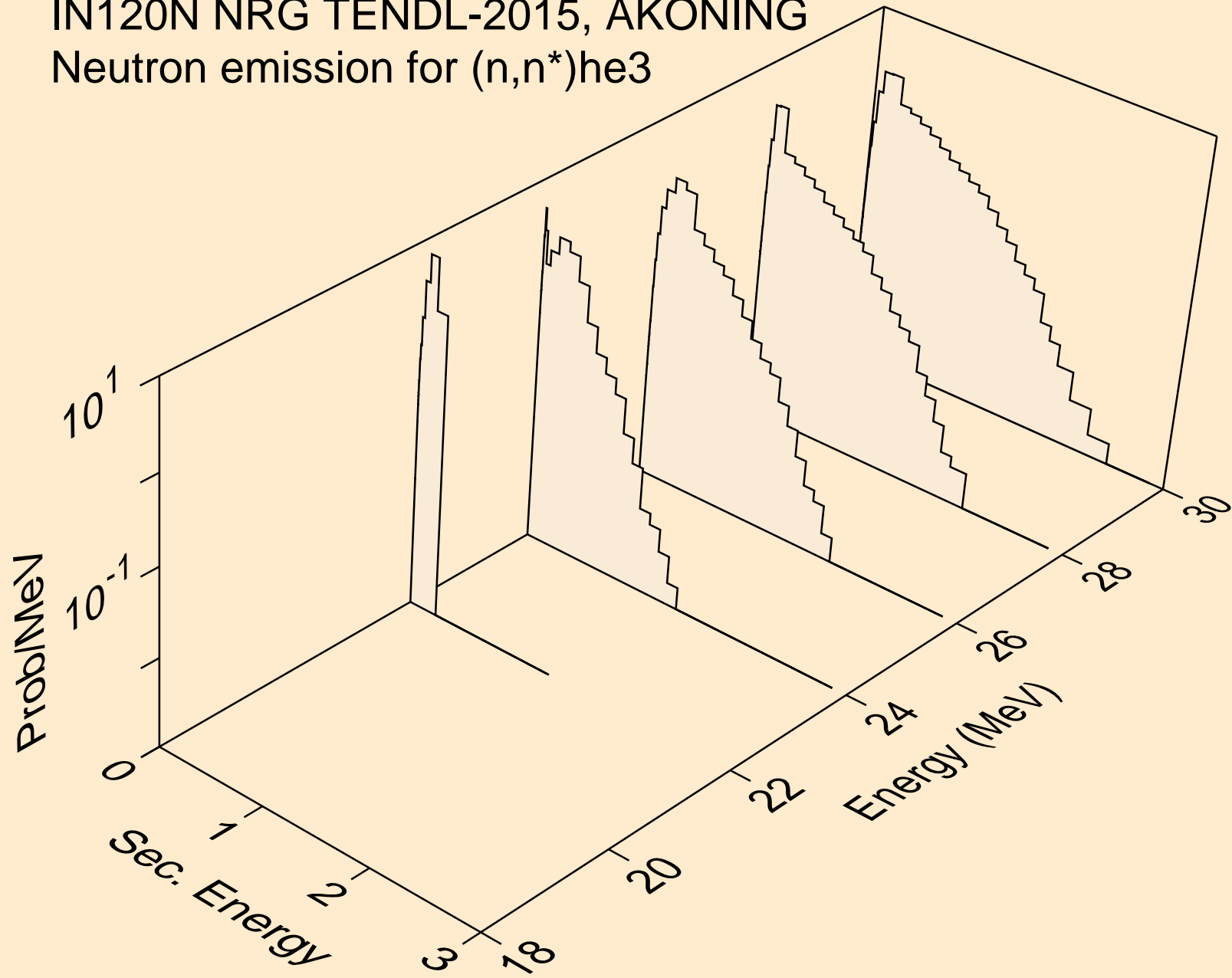

IN120N NRG TENDL-2015, AKONING
Neutron emission for (n,4n)

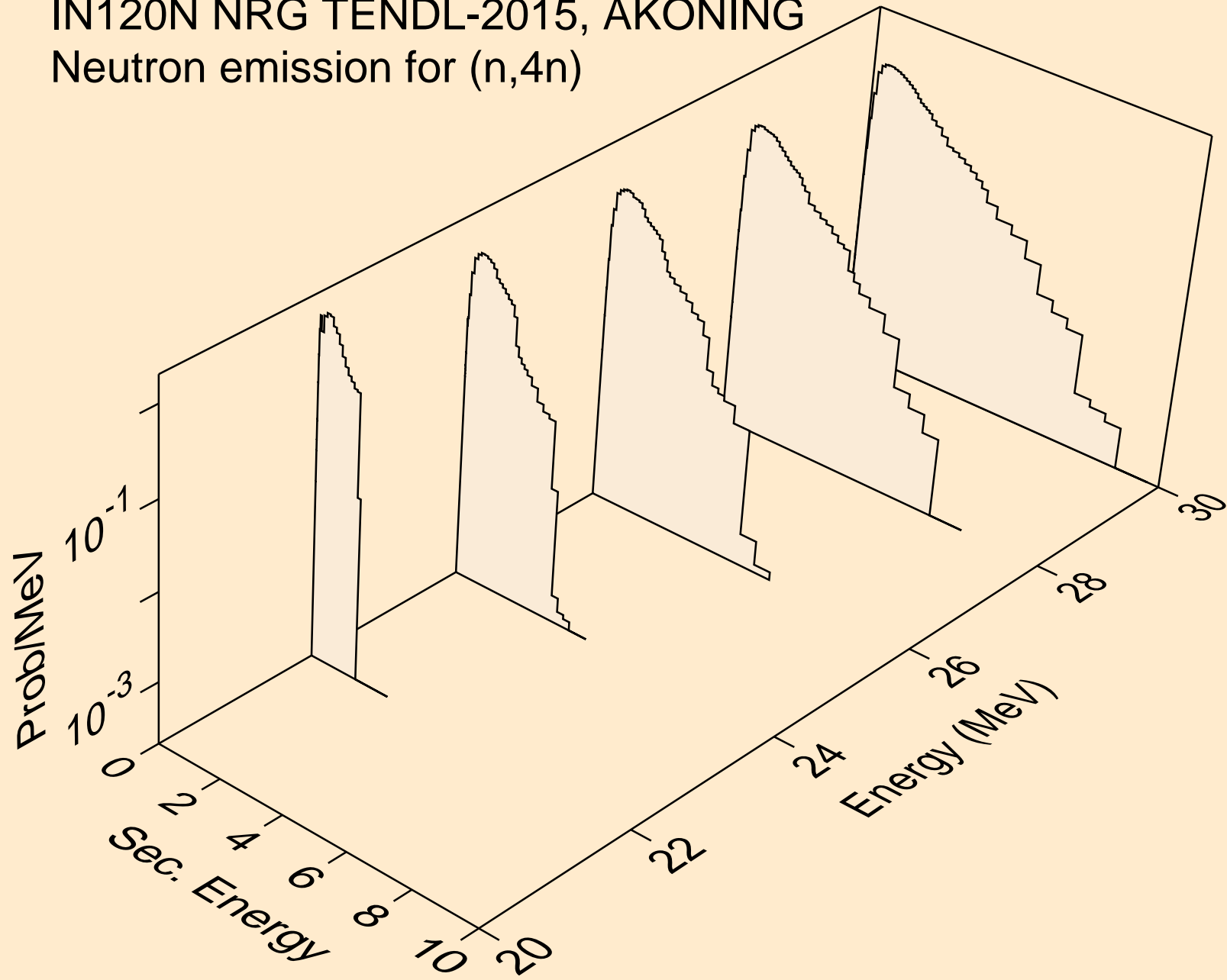

IN120N NRG TENDL-2015, AKONING
Neutron emission for (n,2np)

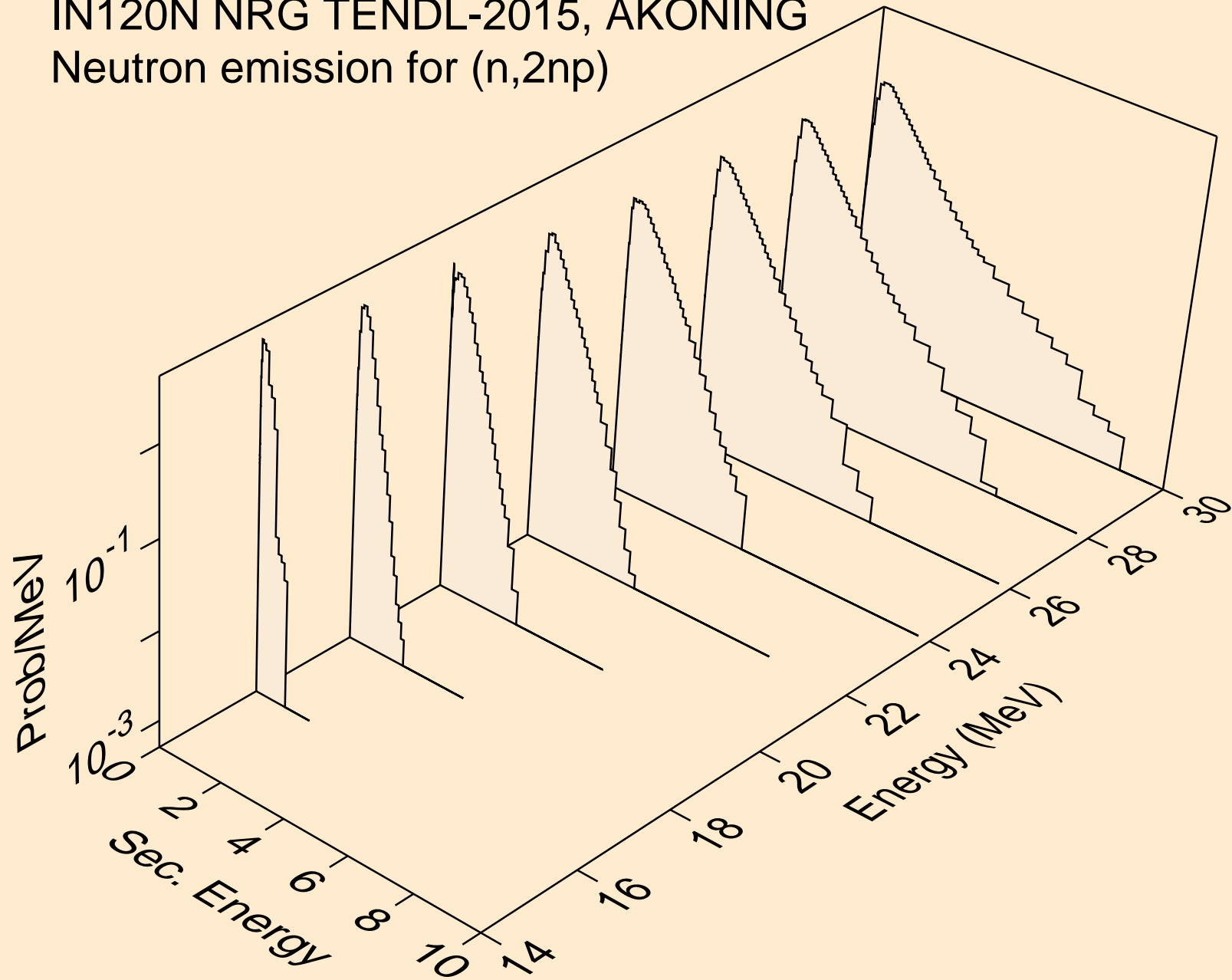

IN120N NRG TENDL-2015, AKONING
Neutron emission for (n,3np)

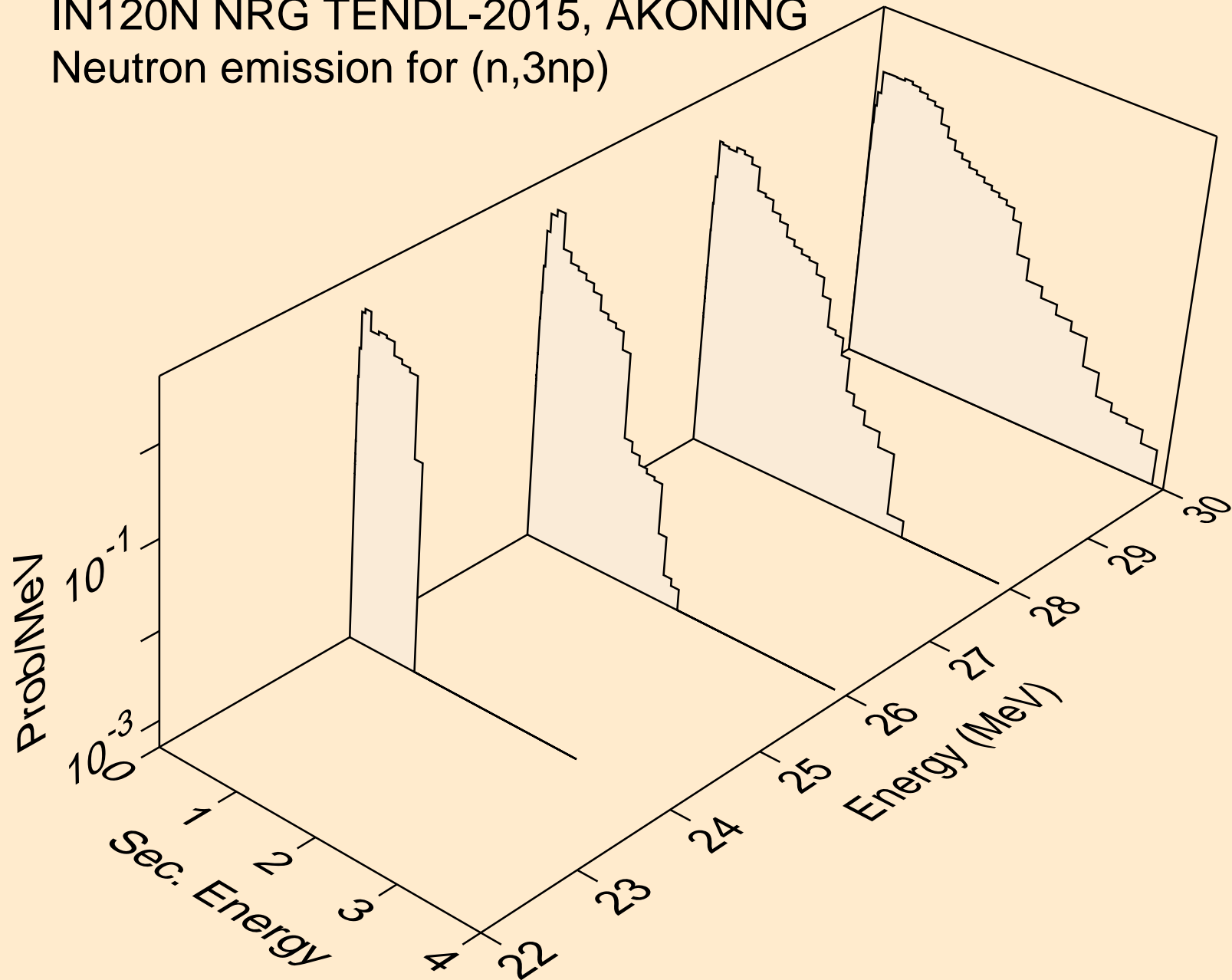

IN120N NRG TENDL-2015, AKONING
Neutron emission for (n,2np)

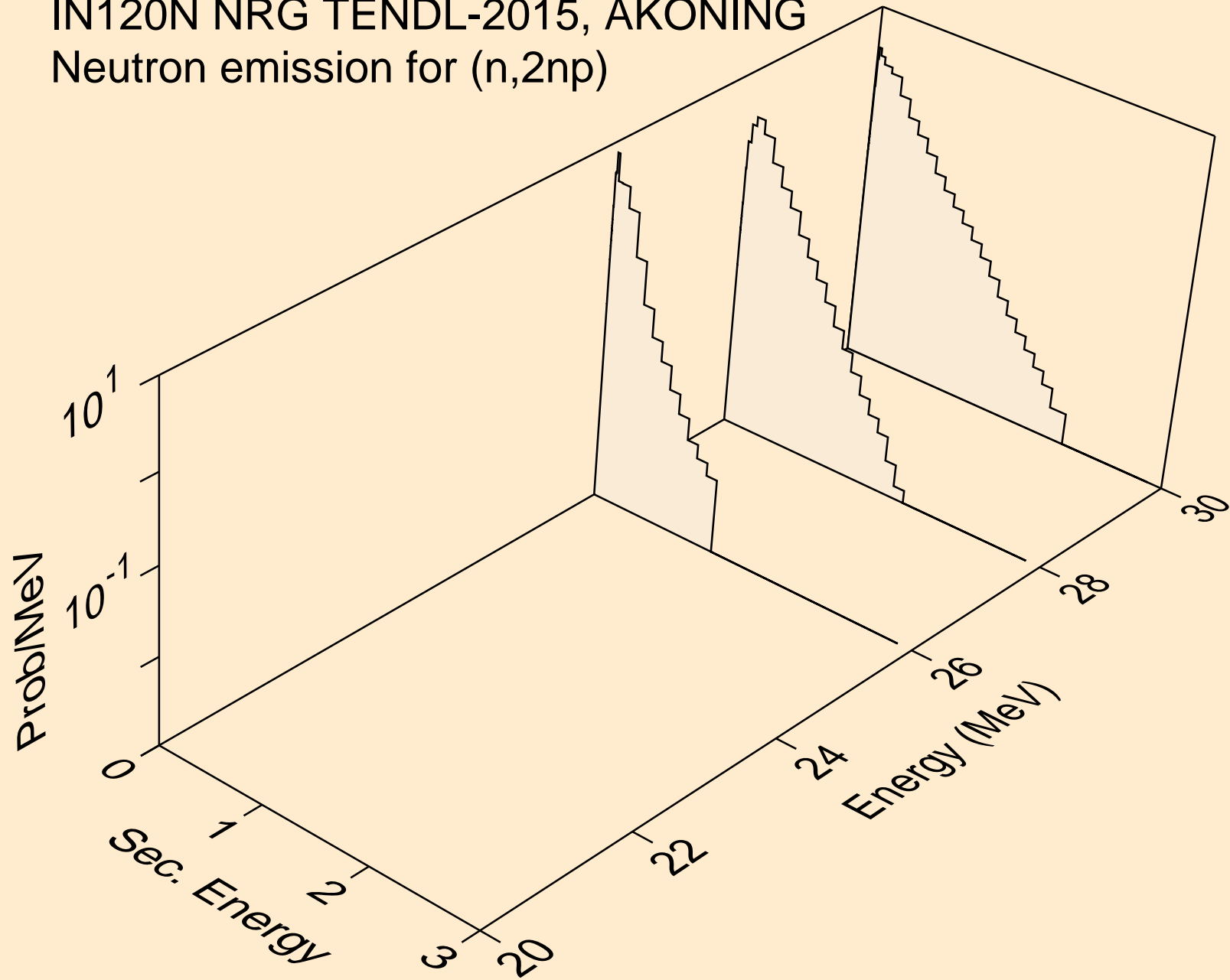

IN120N NRG TENDL-2015, AKONING
Neutron emission for (n,n*c)

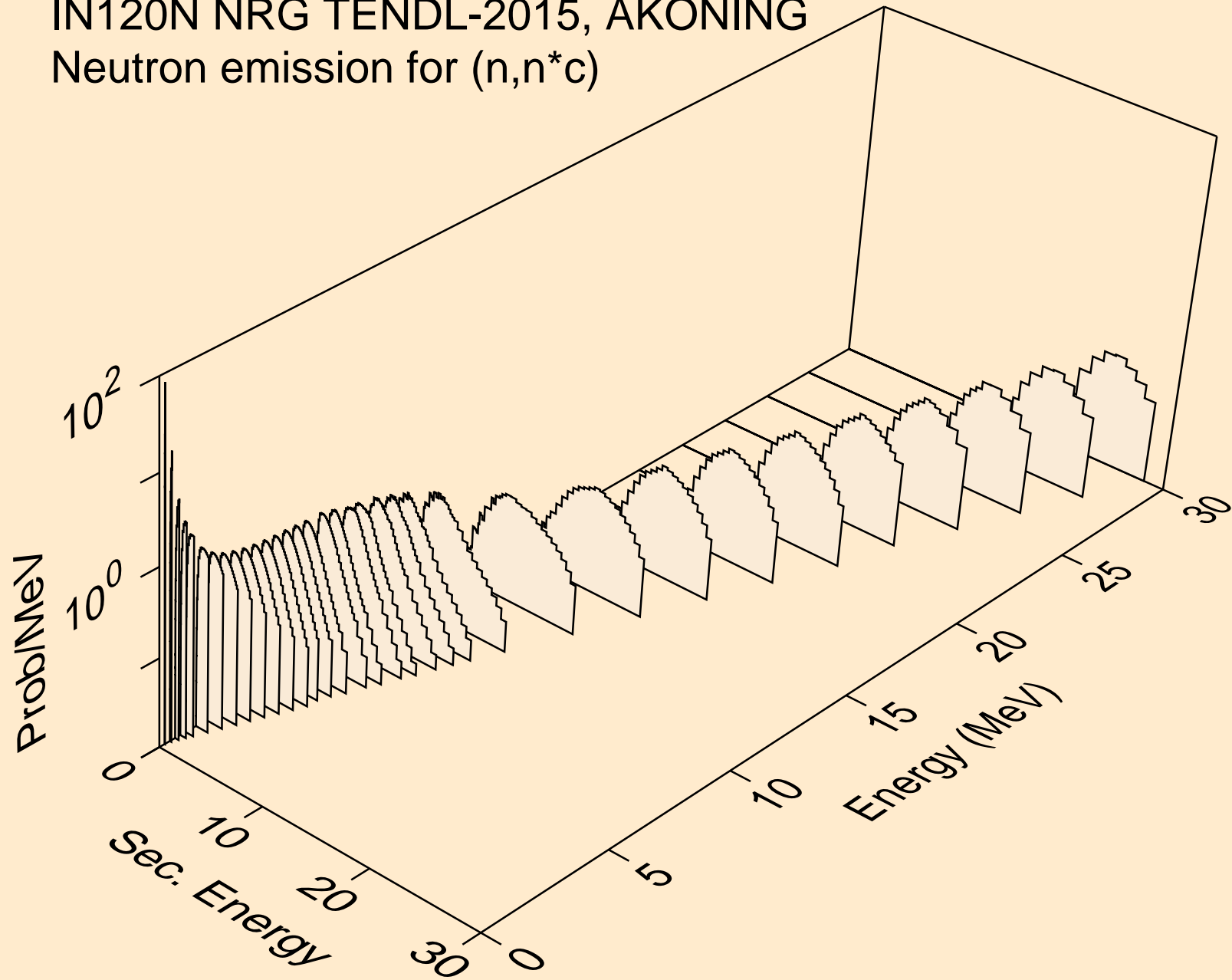

IN120N NRG TENDL-2015, AKONING
Photon emission for (n,x)

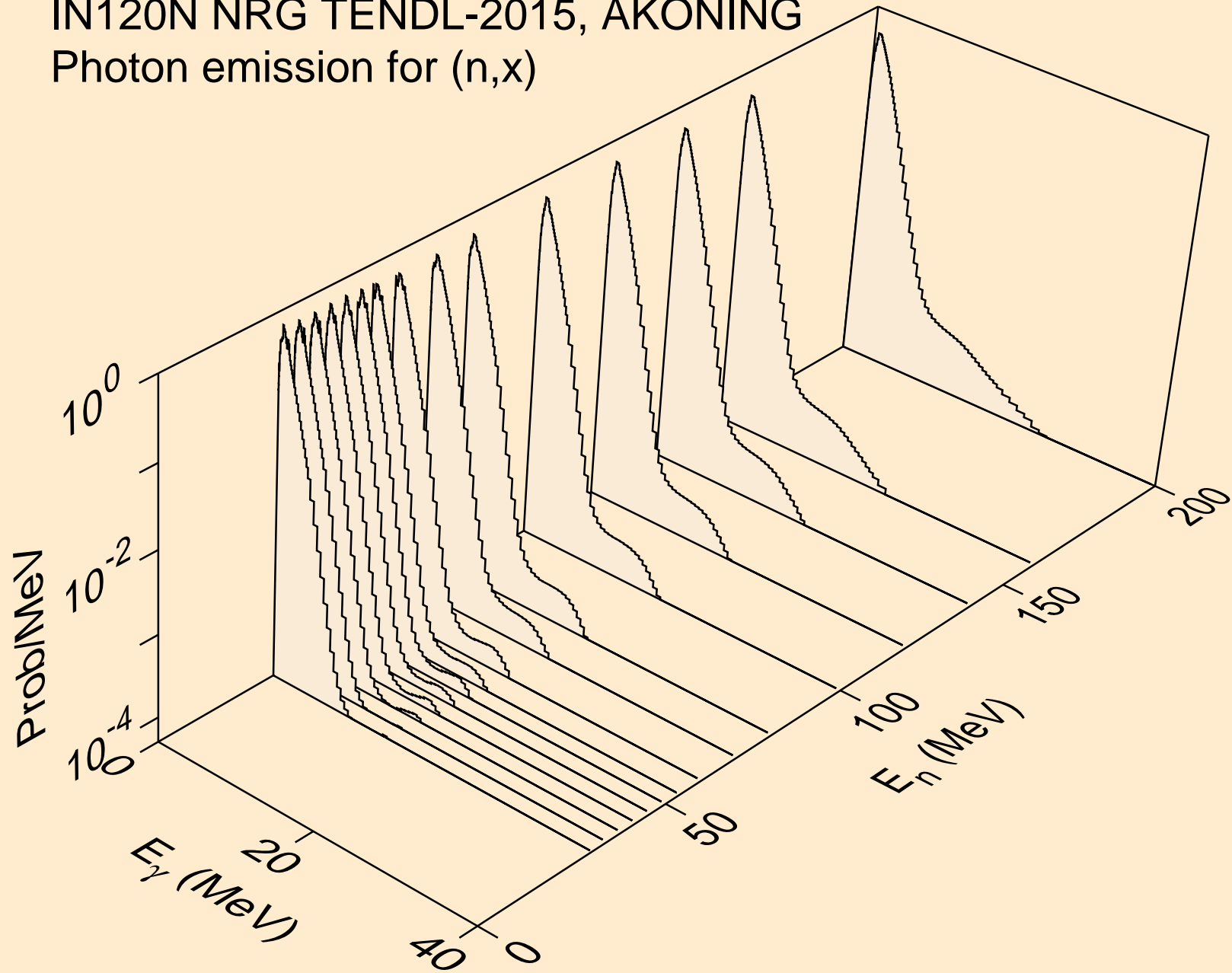

IN120N NRG TENDL-2015, AKONING
Photon emission for (n,2nd)

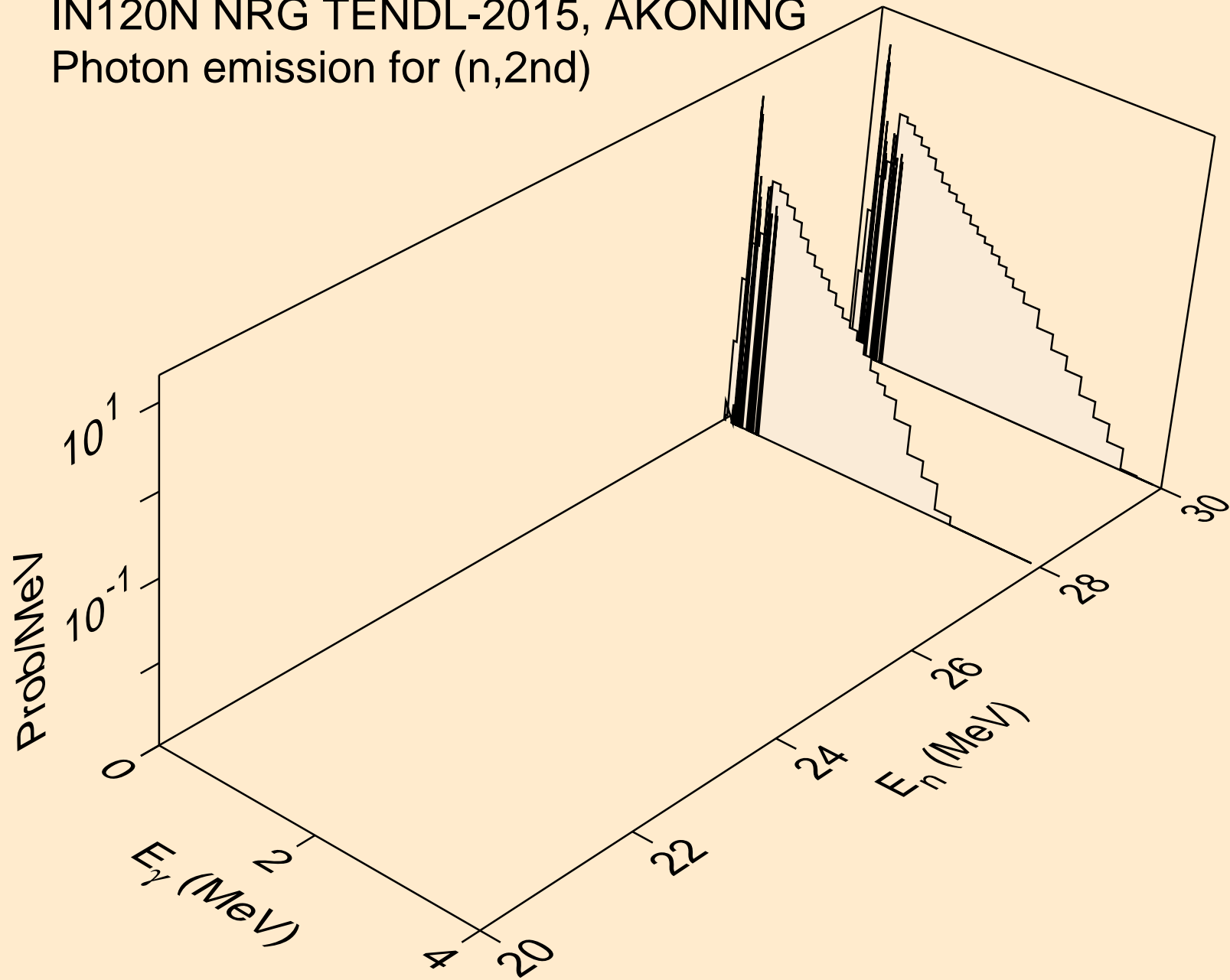

IN120N NRG TENDL-2015, AKONING
Photon emission for (n,2n)

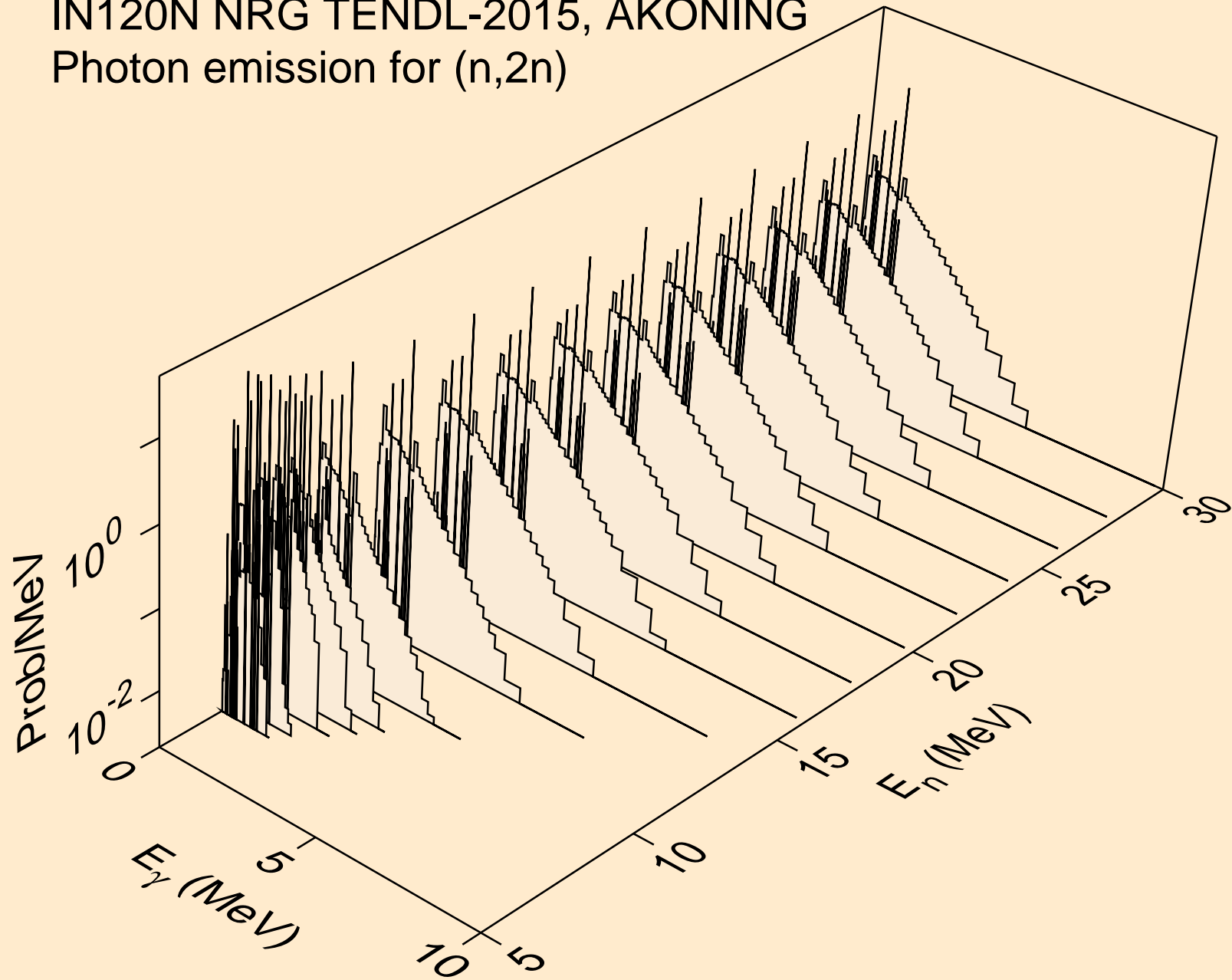

IN120N NRG TENDL-2015, AKONING
Photon emission for (n,3n)

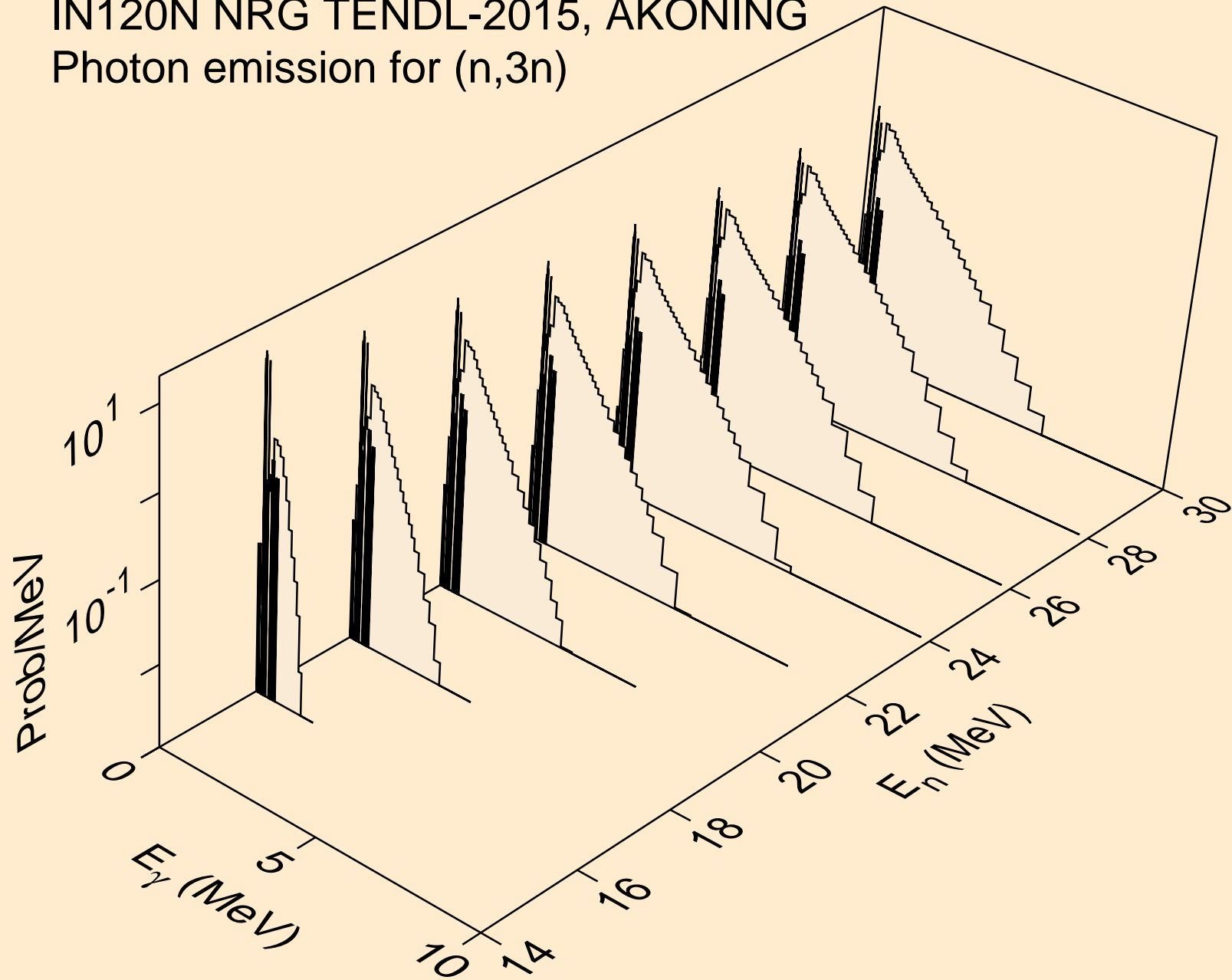

IN120N NRG TENDL-2015, AKONING
Photon emission for (n,n*)a

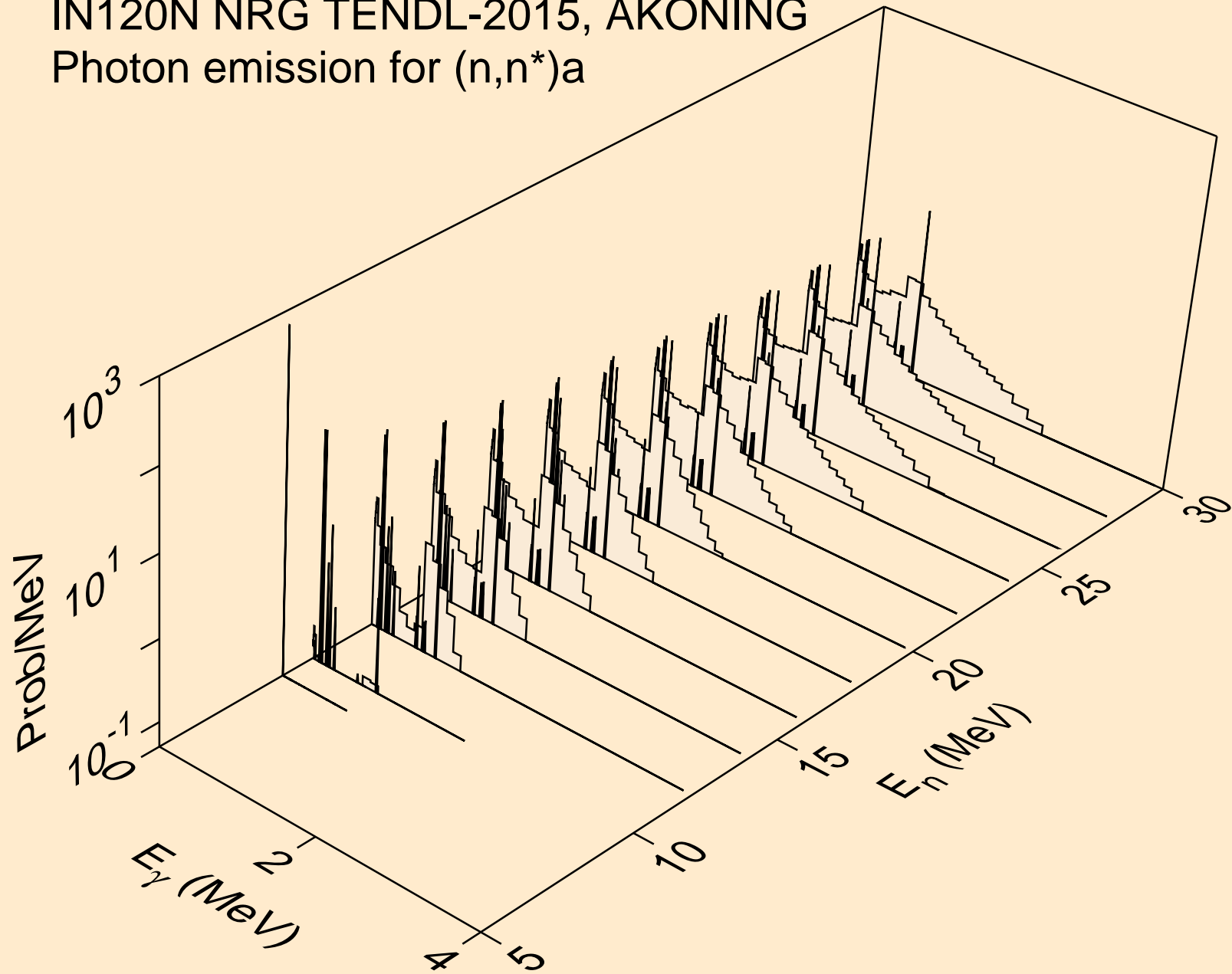

IN120N NRG TENDL-2015, AKONING
Photon emission for (n,2n)a

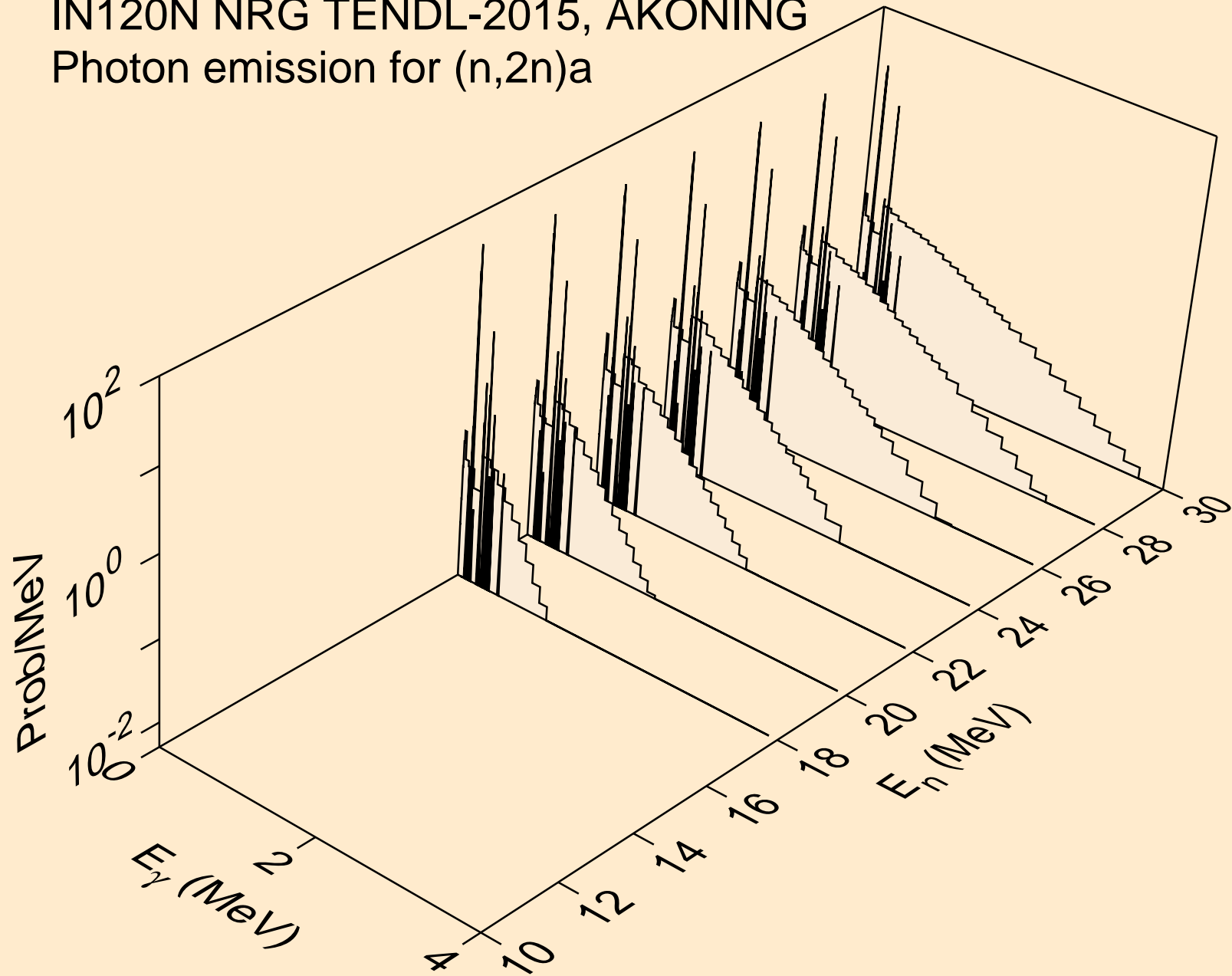

IN120N NRG TENDL-2015, AKONING
Photon emission for (n,3n)a

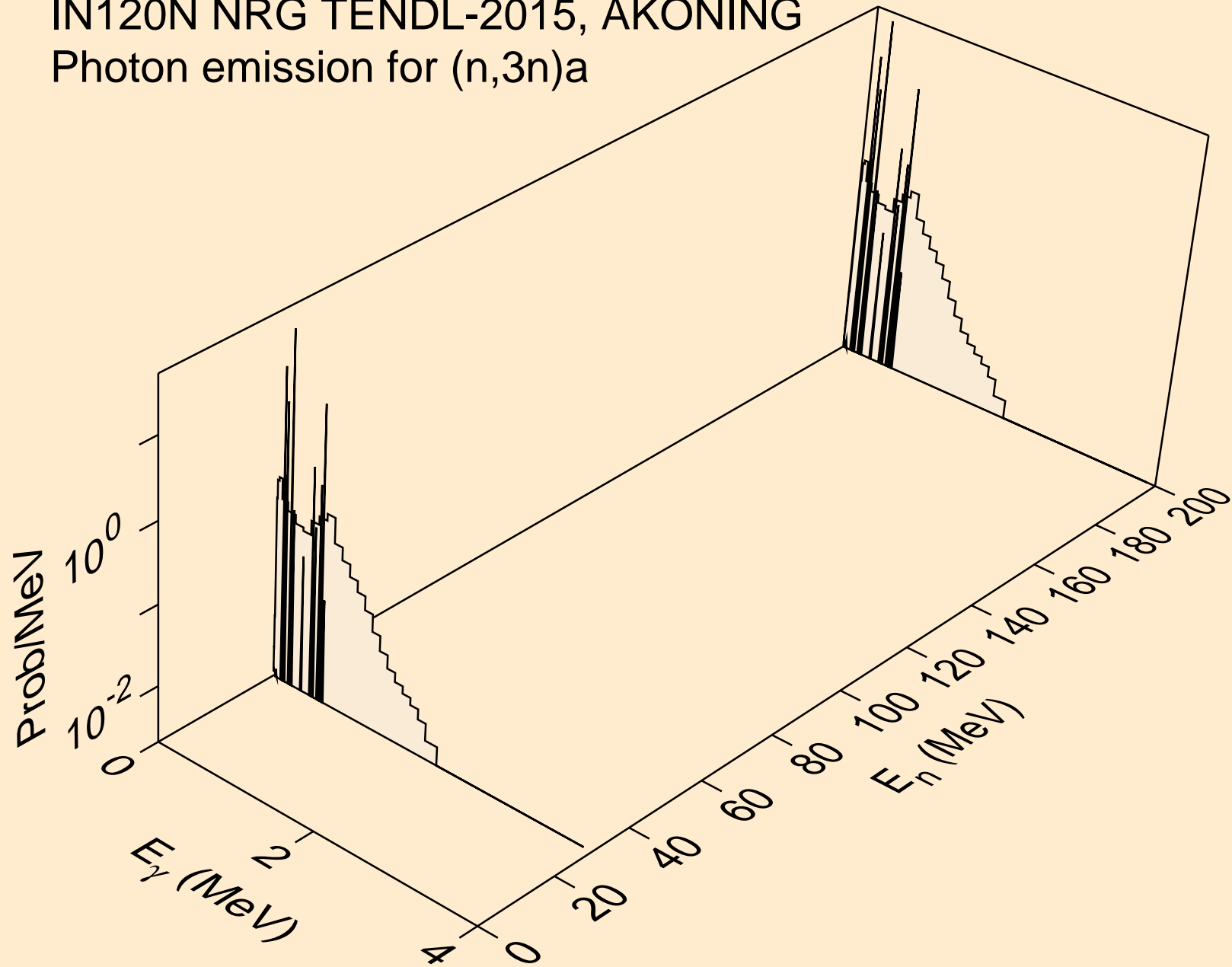

IN120N NRG TENDL-2015, AKONING
Photon emission for (n,n*)p

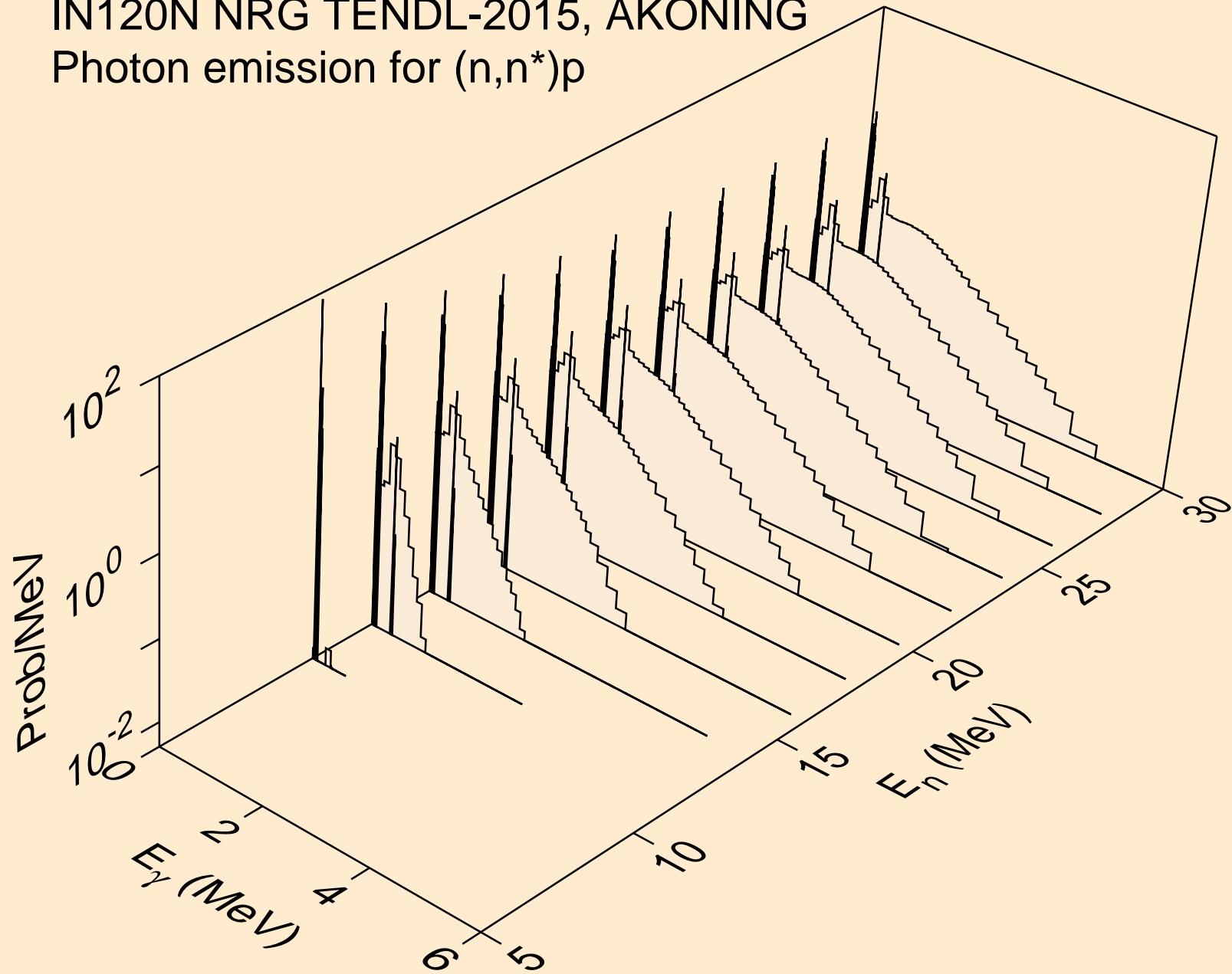

IN120N NRG TENDL-2015, AKONING
Photon emission for (n,n*)d

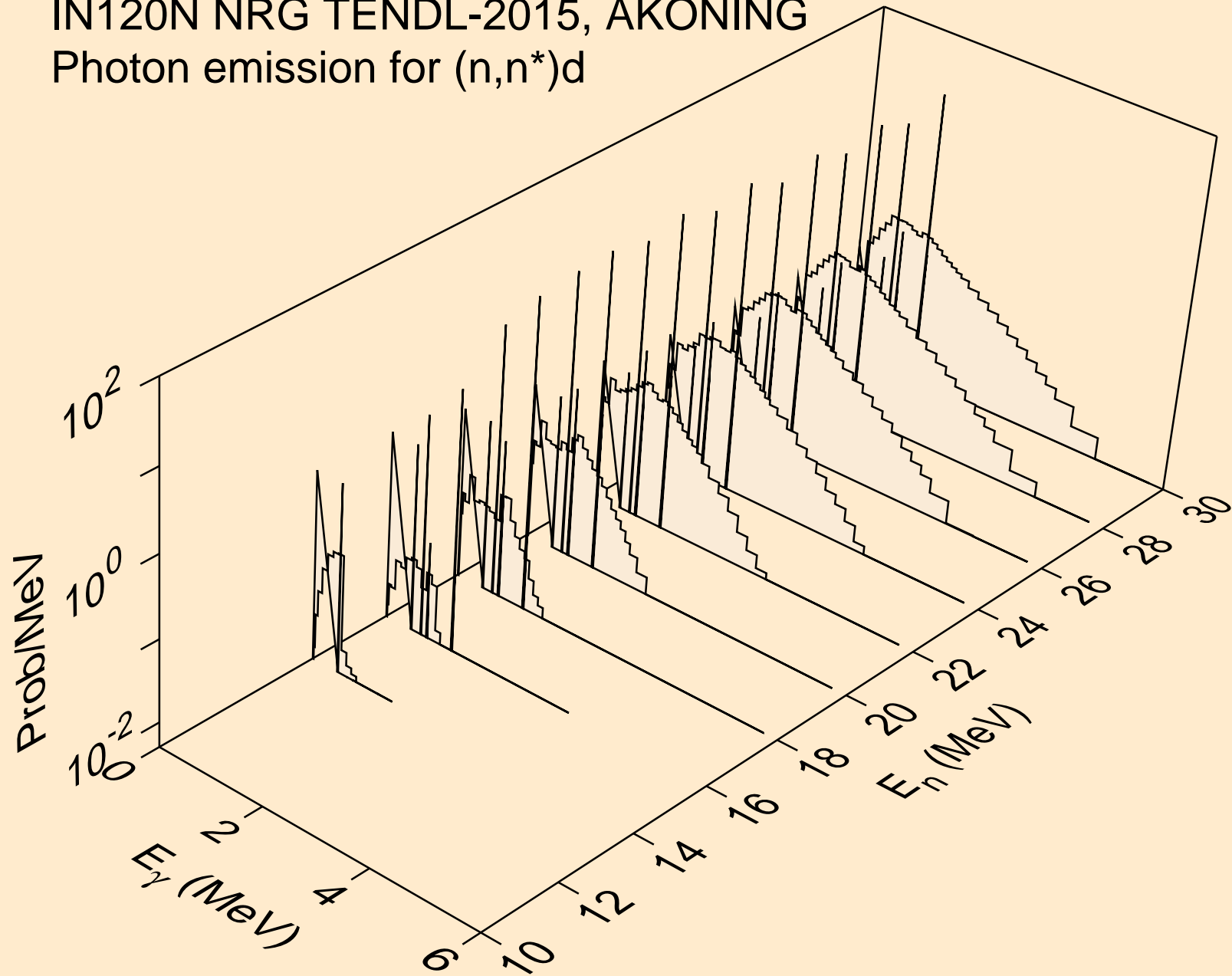

IN120N NRG TENDL-2015, AKONING
Photon emission for (n,n*)t

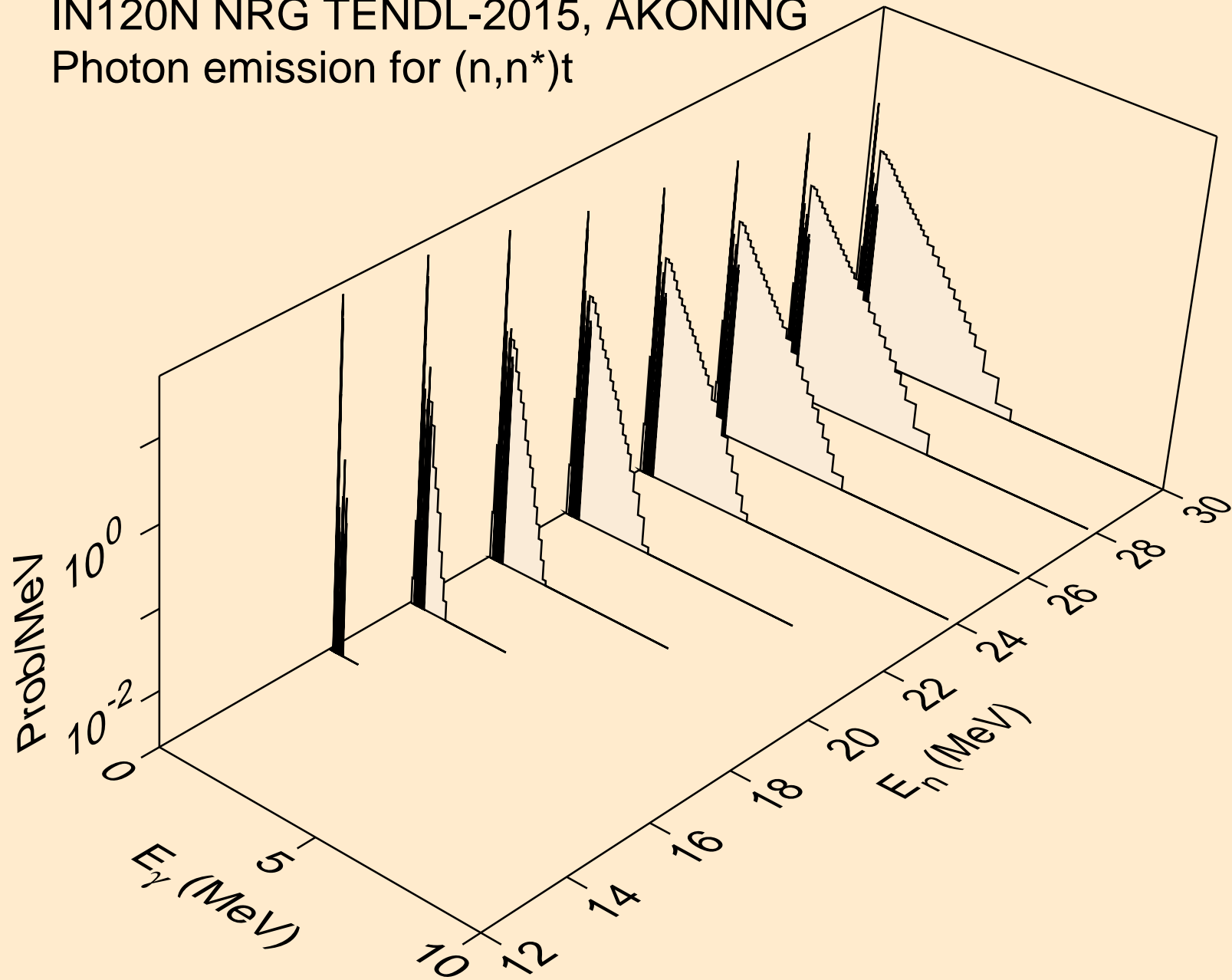

IN120N NRG TENDL-2015, AKONING
Photon emission for (n,n*)he3

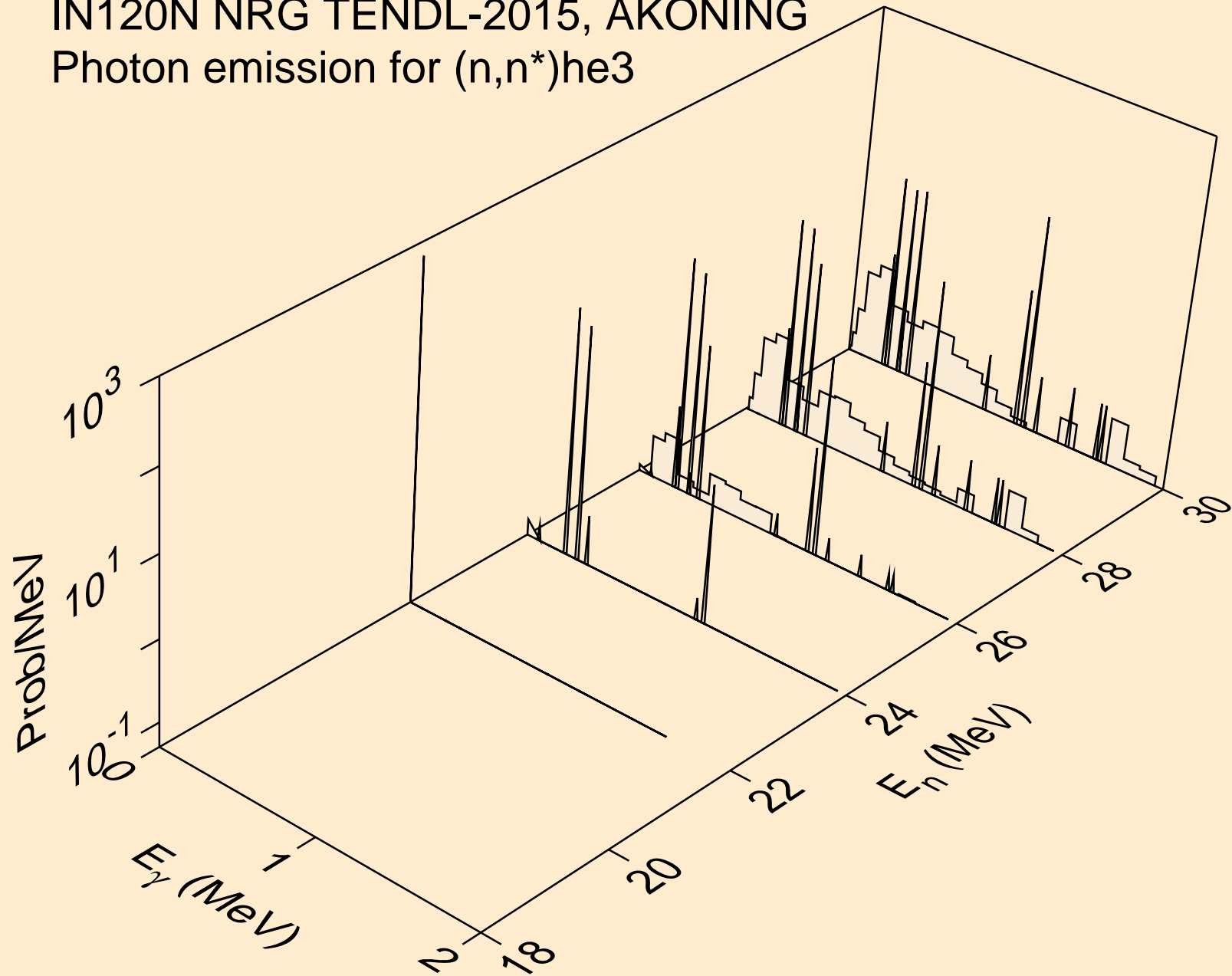

IN120N NRG TENDL-2015, AKONING
Photon emission for (n,4n)

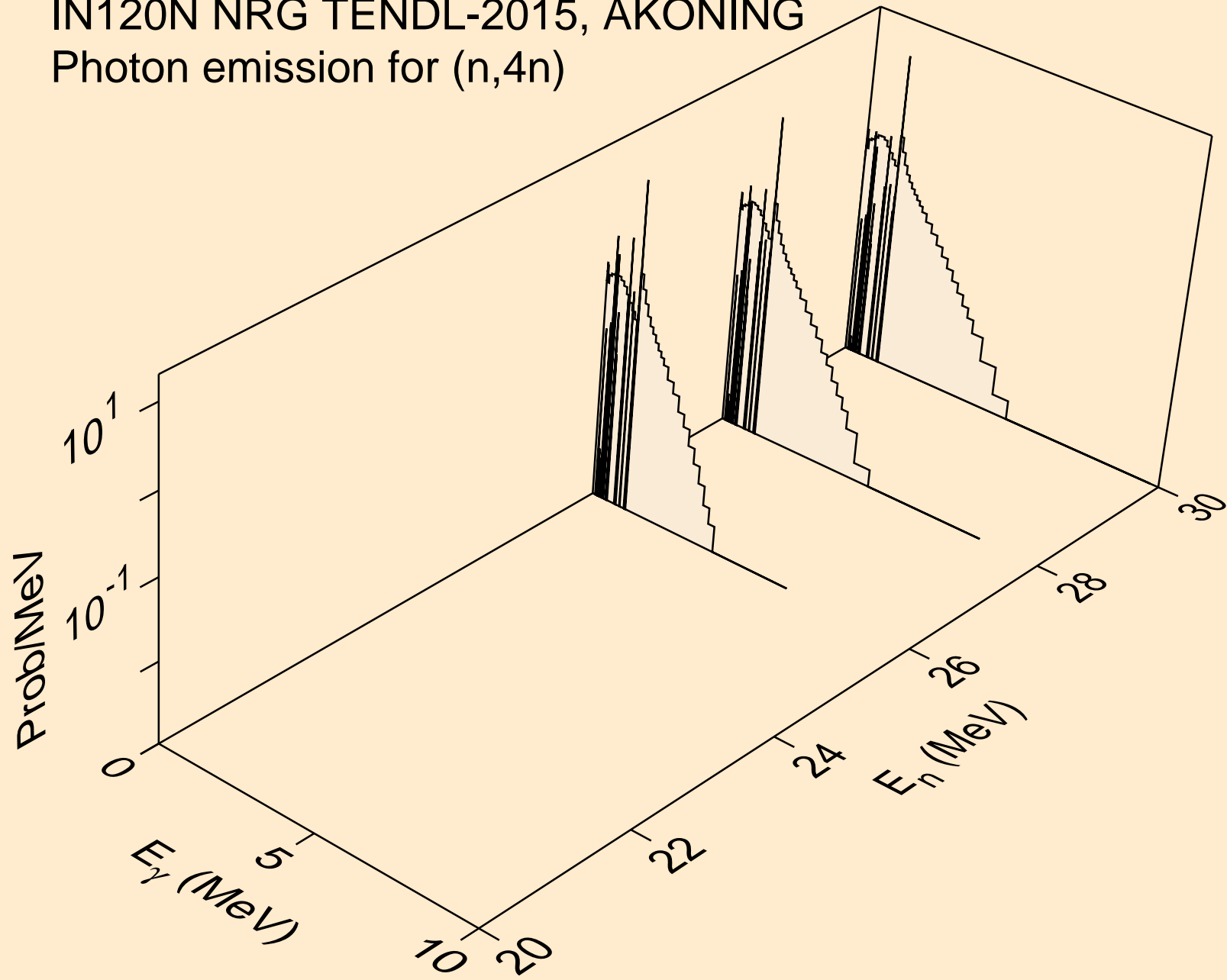

IN120N NRG TENDL-2015, AKONING
Photon emission for (n,2np)

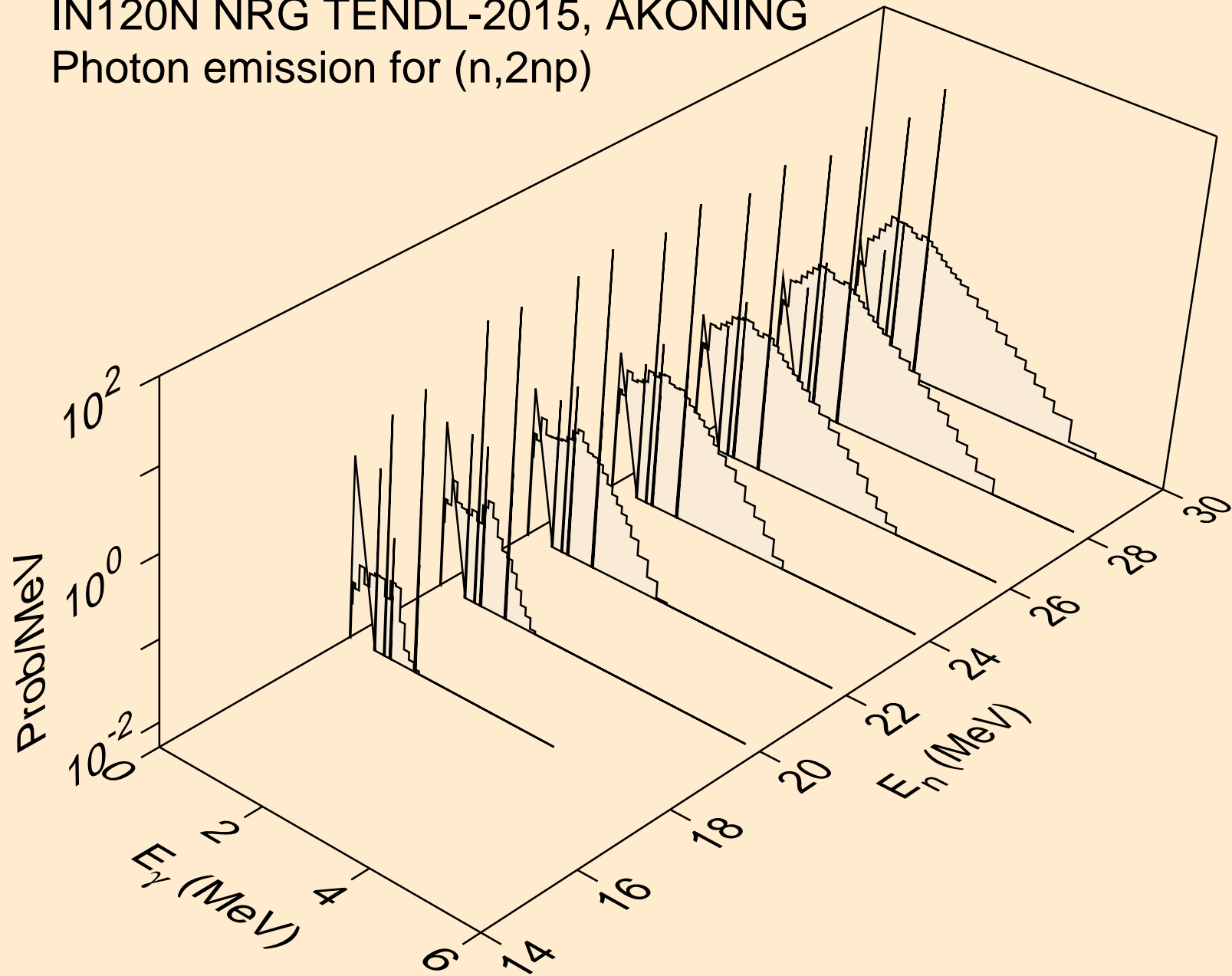

IN120N NRG TENDL-2015, AKONING
Photon emission for (n,3np)

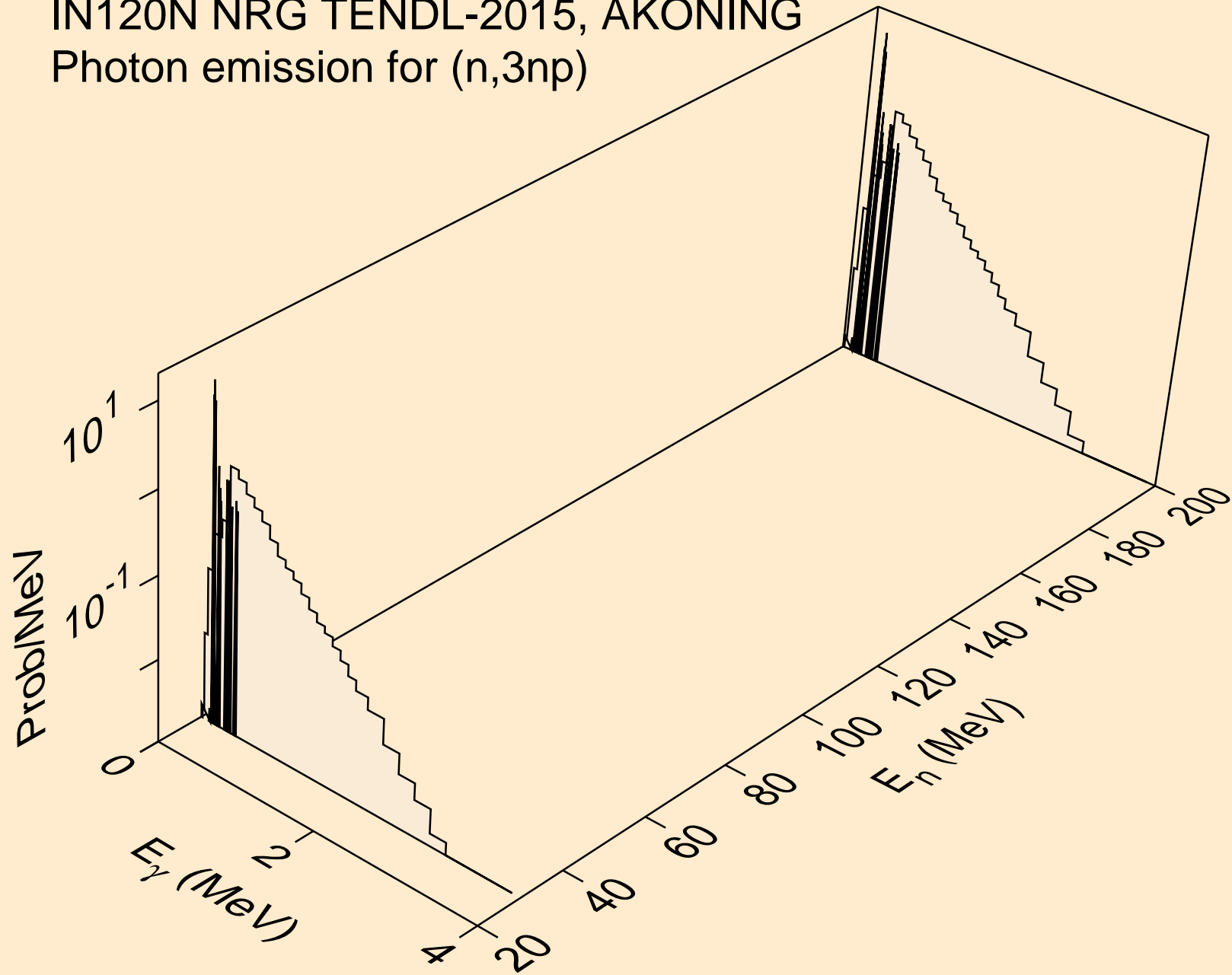

IN120N NRG TENDL-2015, AKONING
Photon emission for (n,2np)

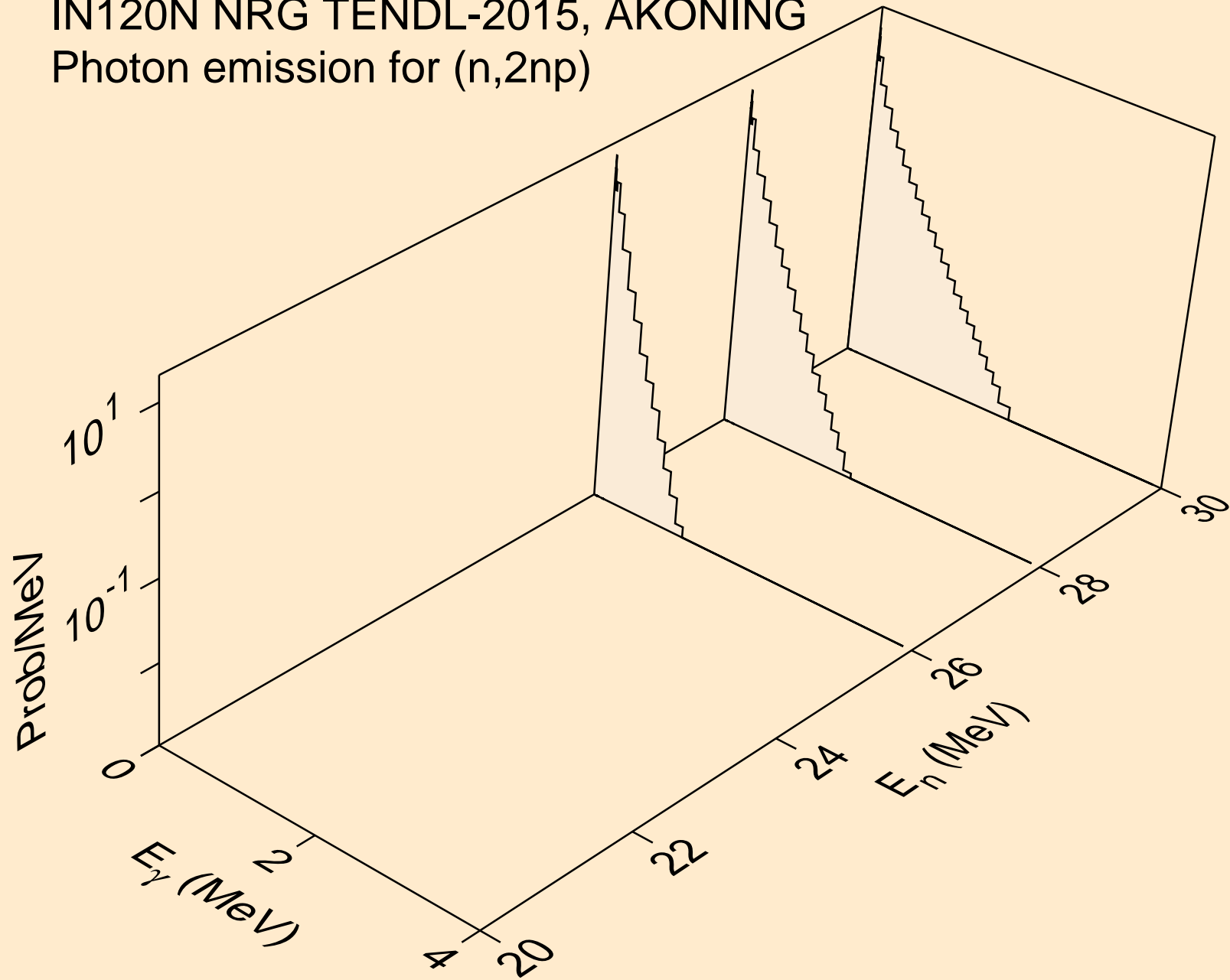

IN120N NRG TENDL-2015, AKONING
Photon emission for (n,n*3)

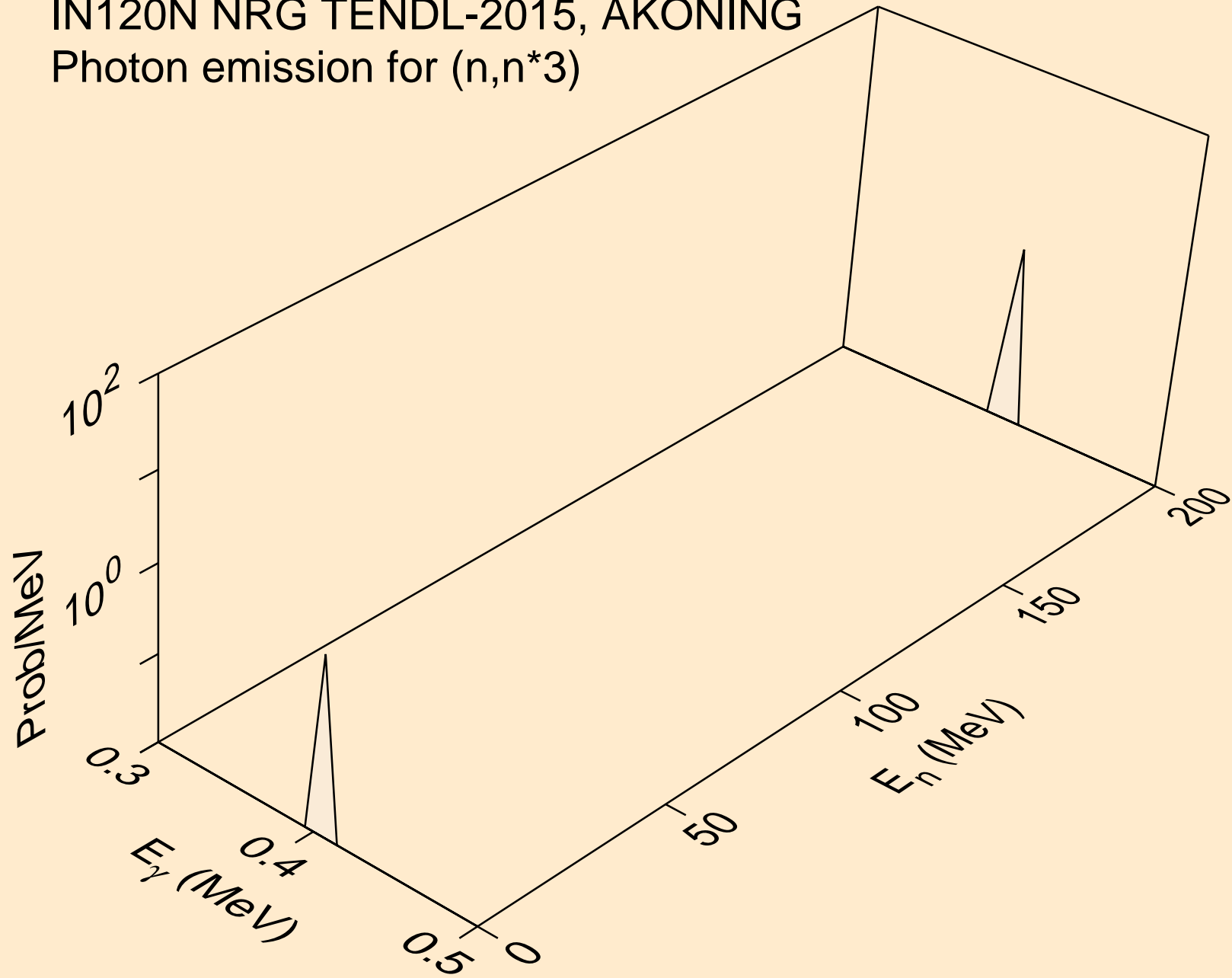

IN120N NRG TENDL-2015, AKONING
Photon emission for (n,n*4)

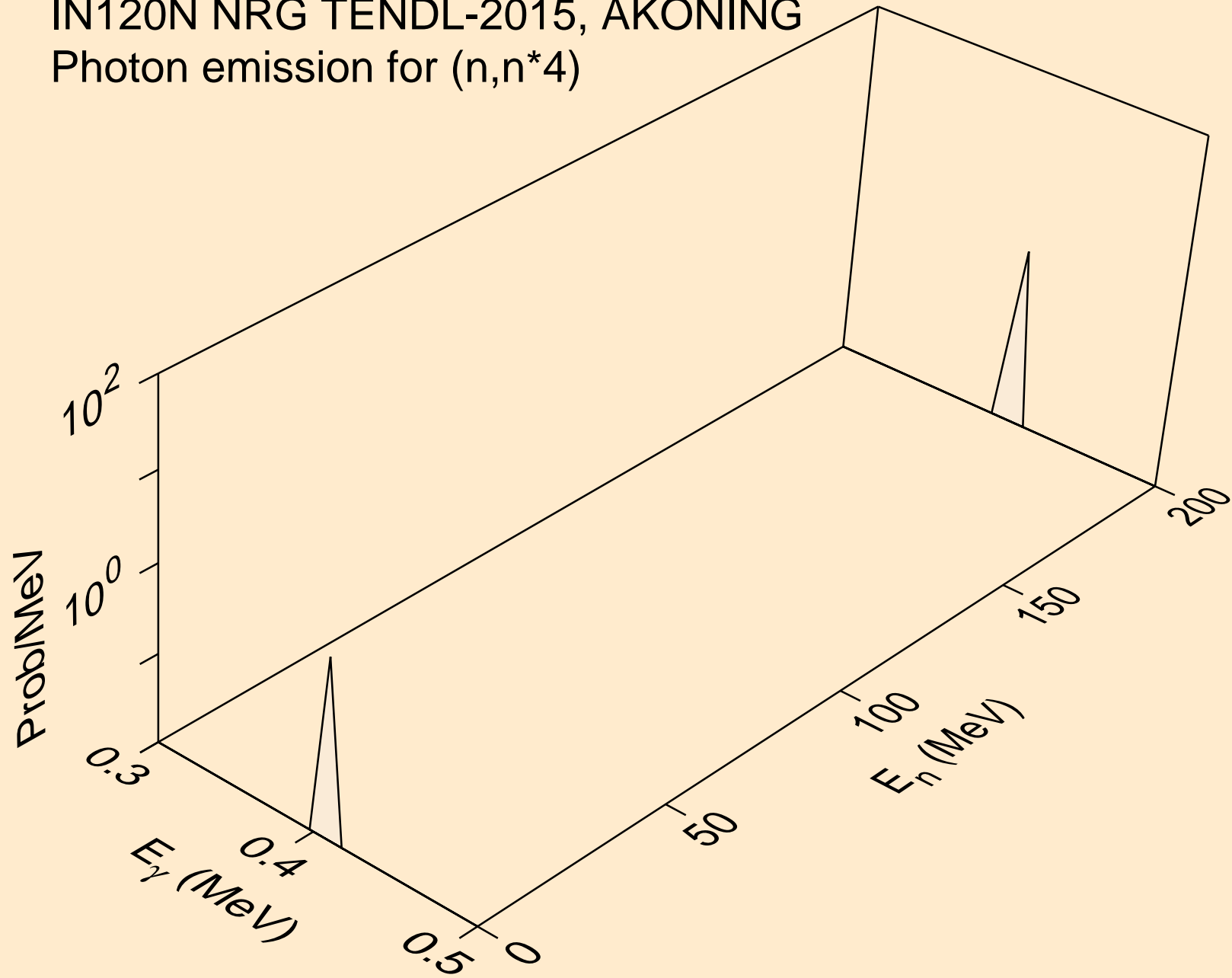

IN120N NRG TENDL-2015, AKONING
Photon emission for (n,n*5)

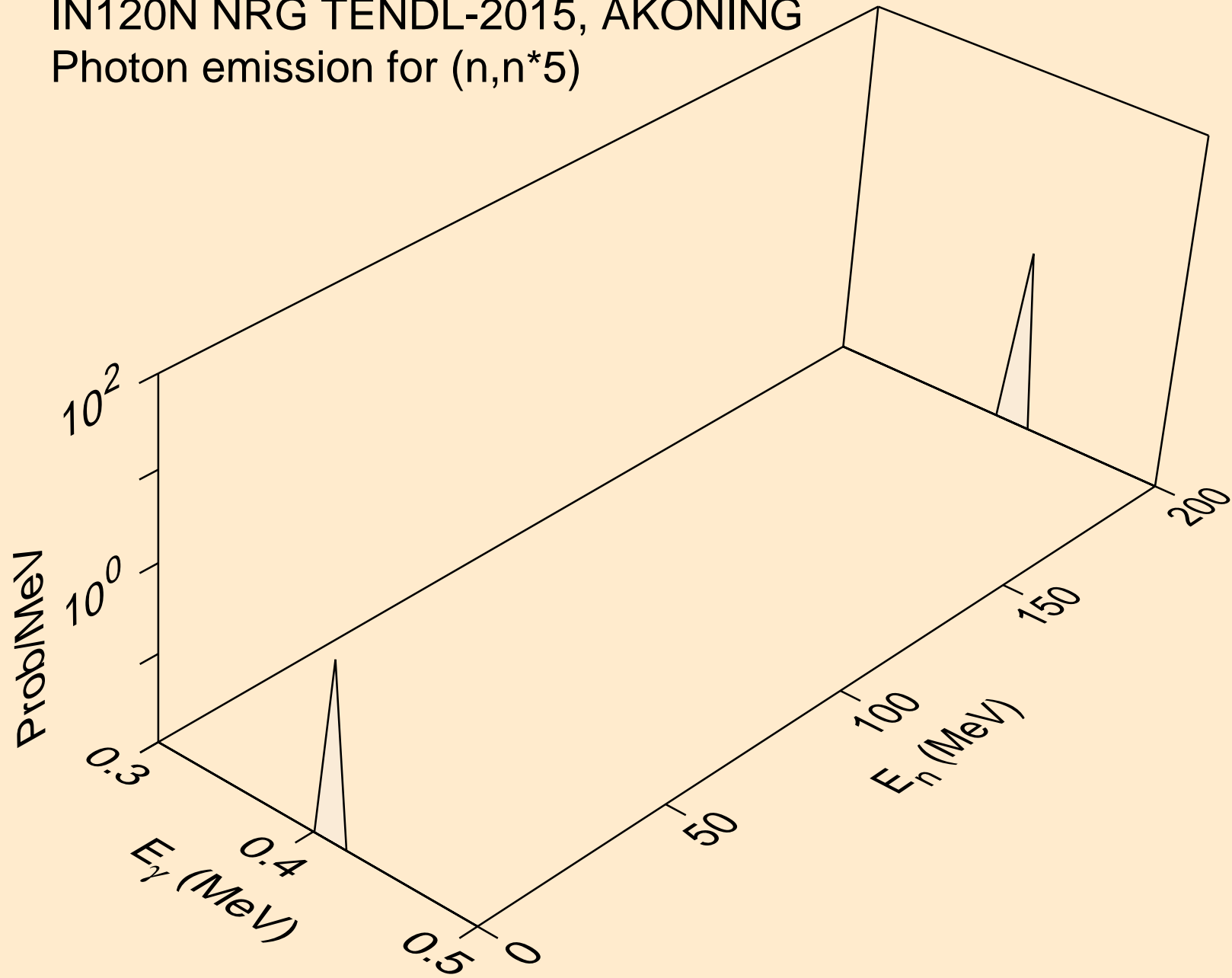

IN120N NRG TENDL-2015, AKONING
Photon emission for (n,n*6)

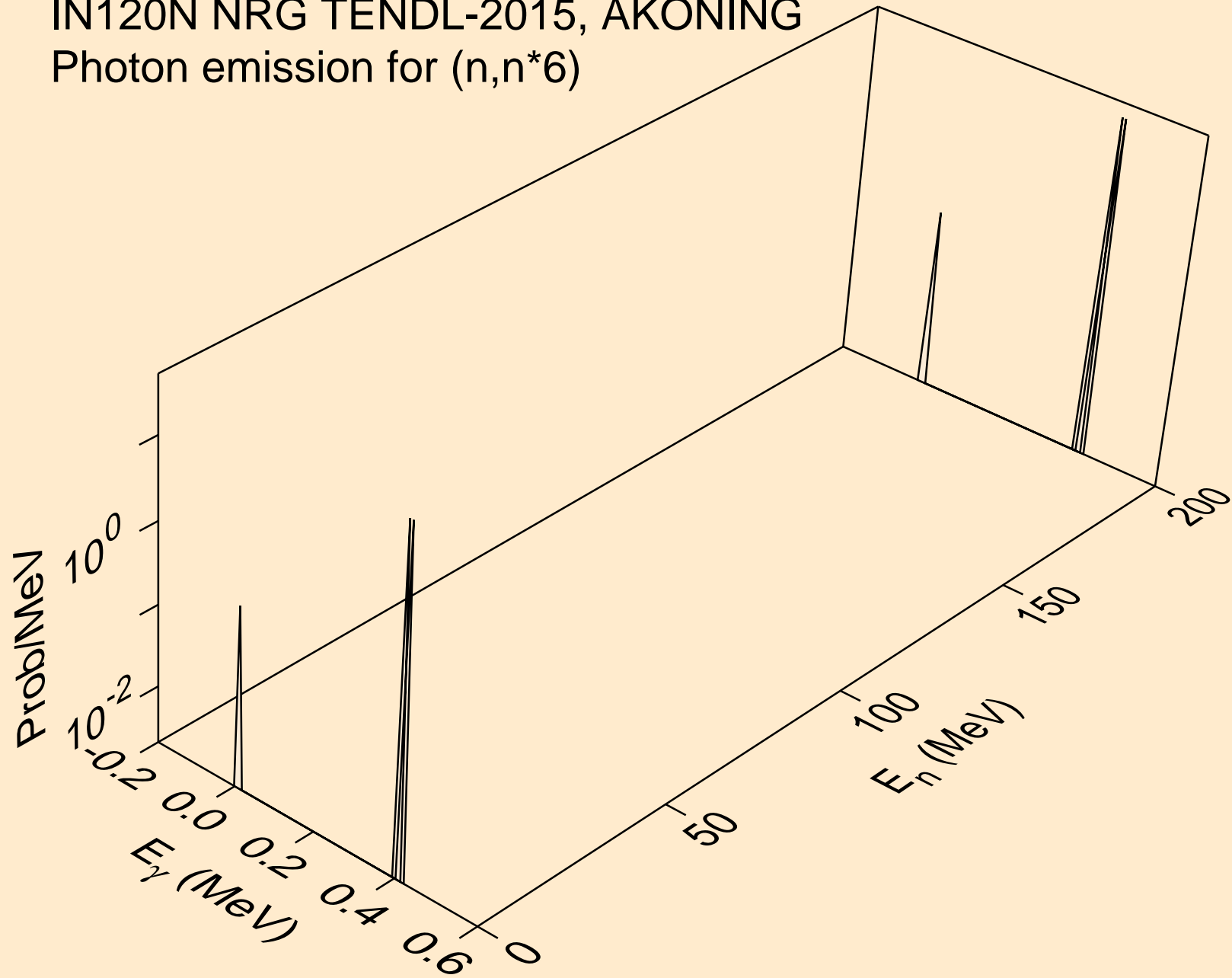

IN120N NRG TENDL-2015, AKONING
Photon emission for (n,n*7)

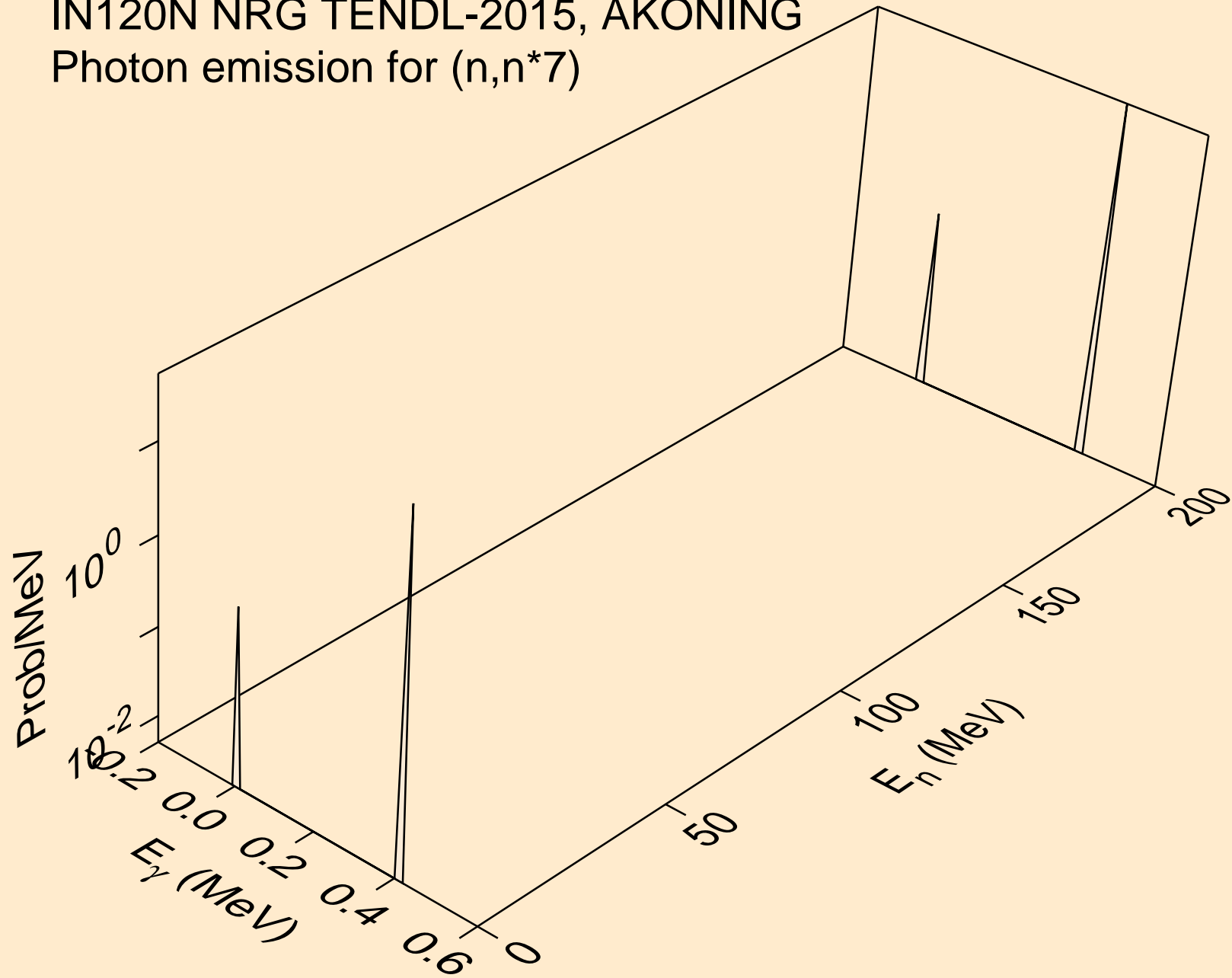

IN120N NRG TENDL-2015, AKONING
Photon emission for (n,n*8)

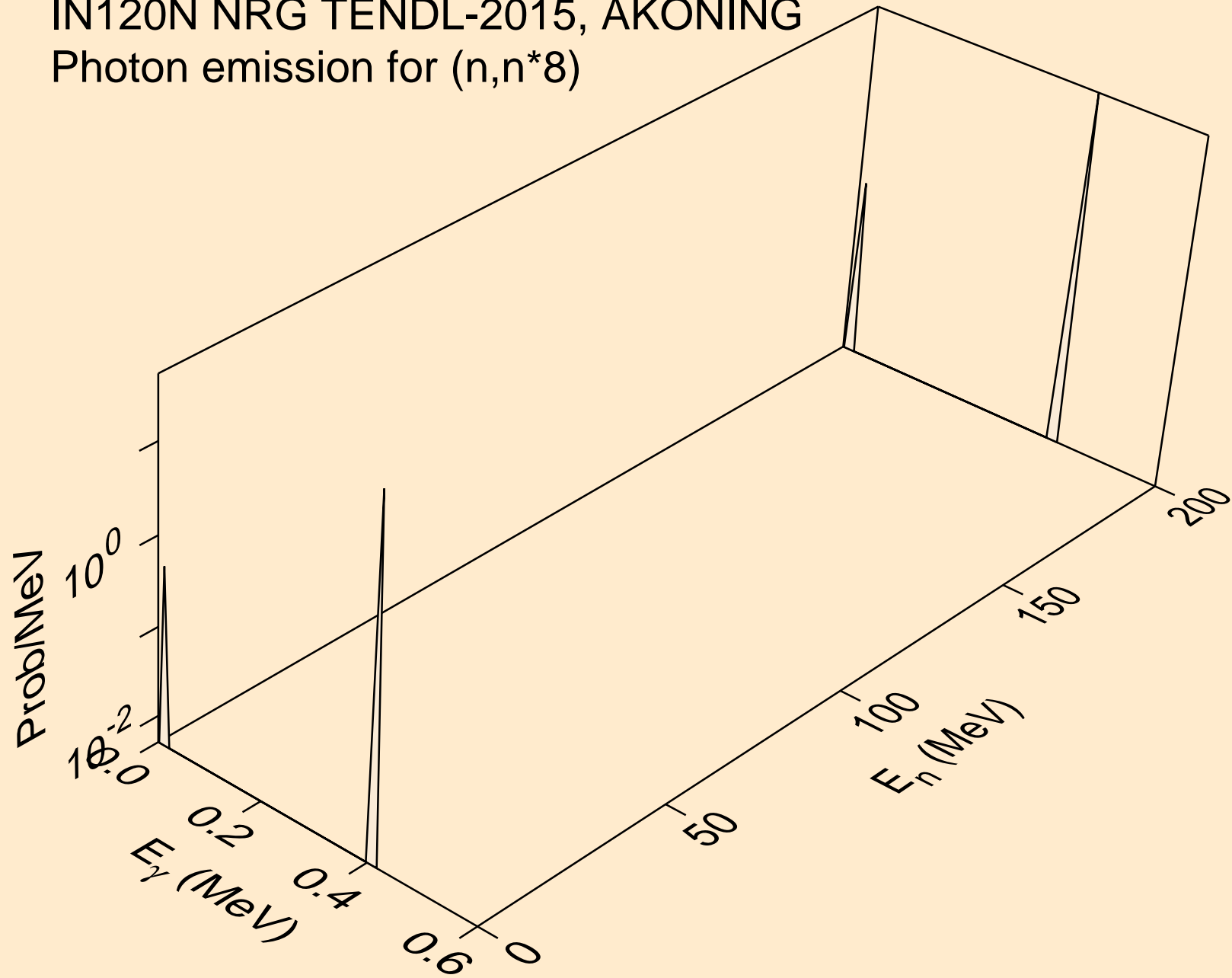

IN120N NRG TENDL-2015, AKONING
Photon emission for (n,n*9)

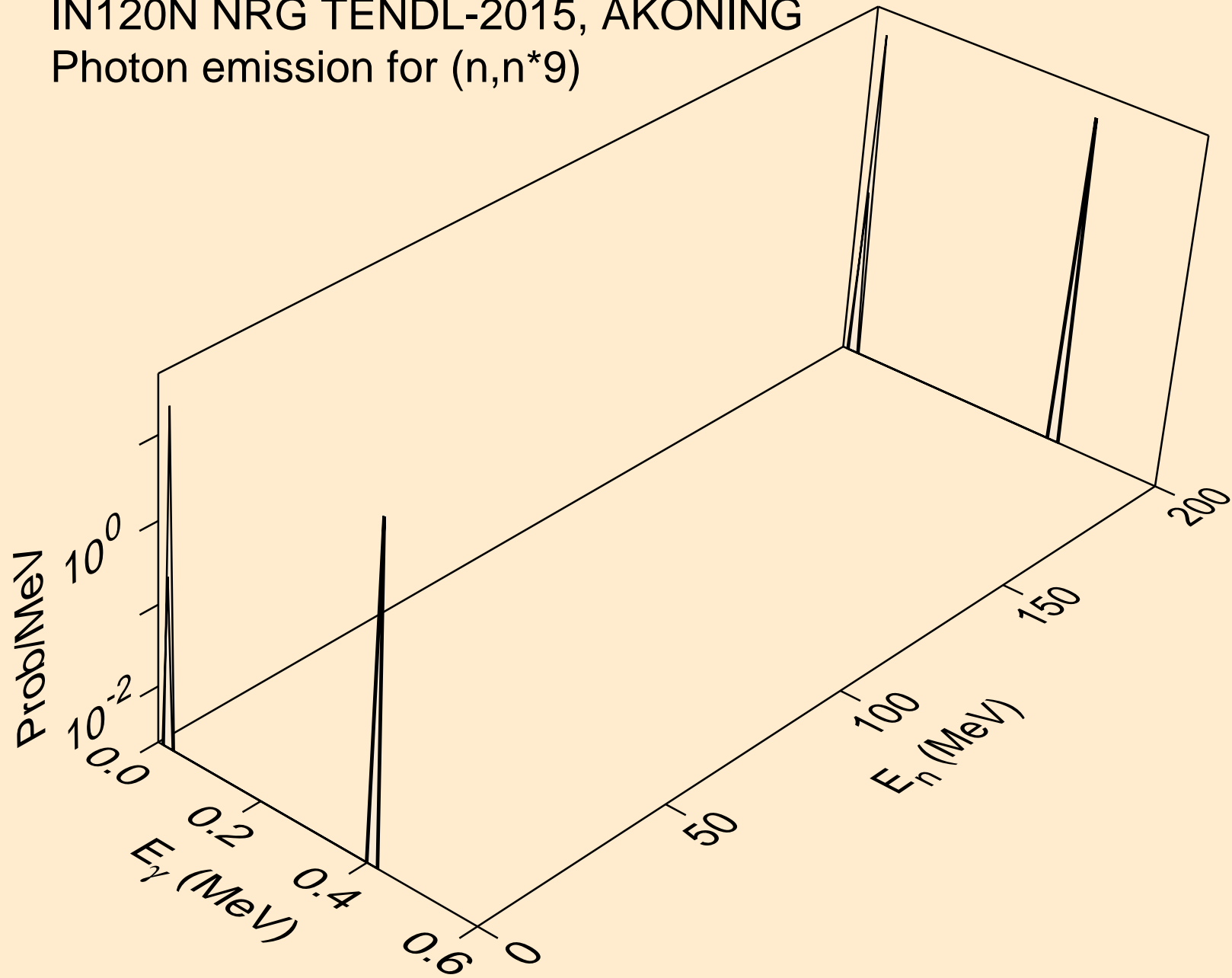

IN120N NRG TENDL-2015, AKONING
Photon emission for (n,n*10)

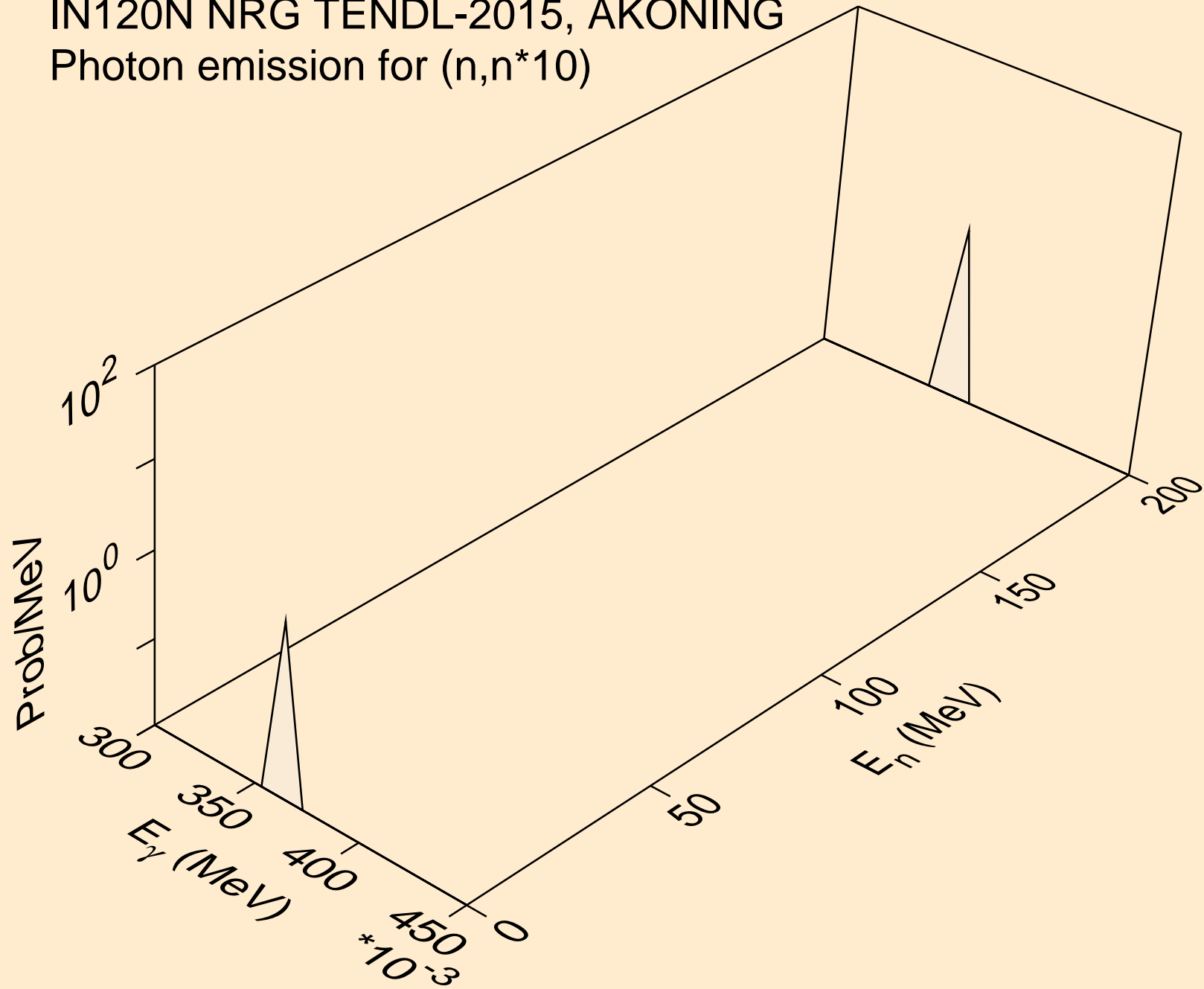

IN120N NRG TENDL-2015, AKONING
Photon emission for (n,n*11)

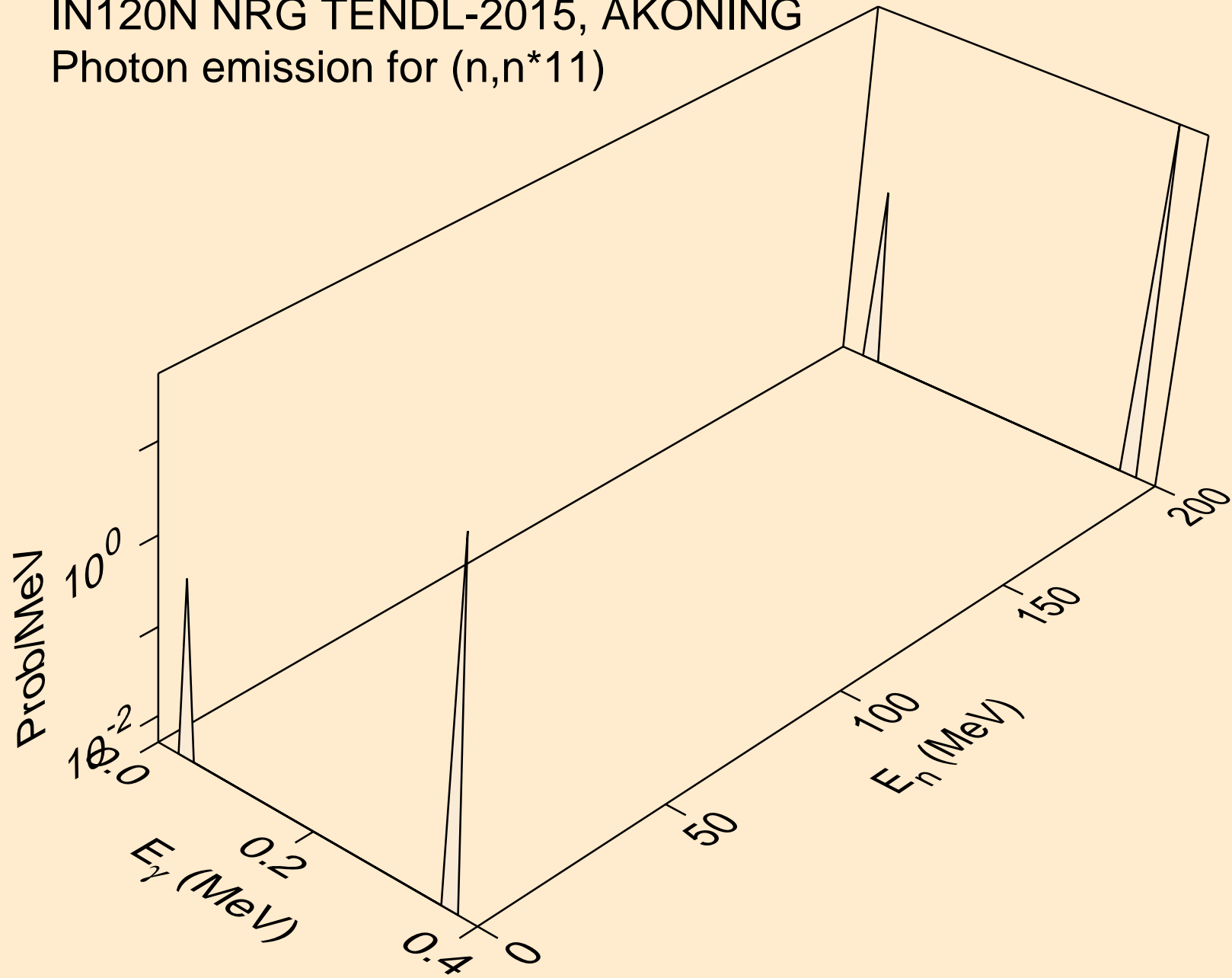

IN120N NRG TENDL-2015, AKONING
Photon emission for (n,n*12)

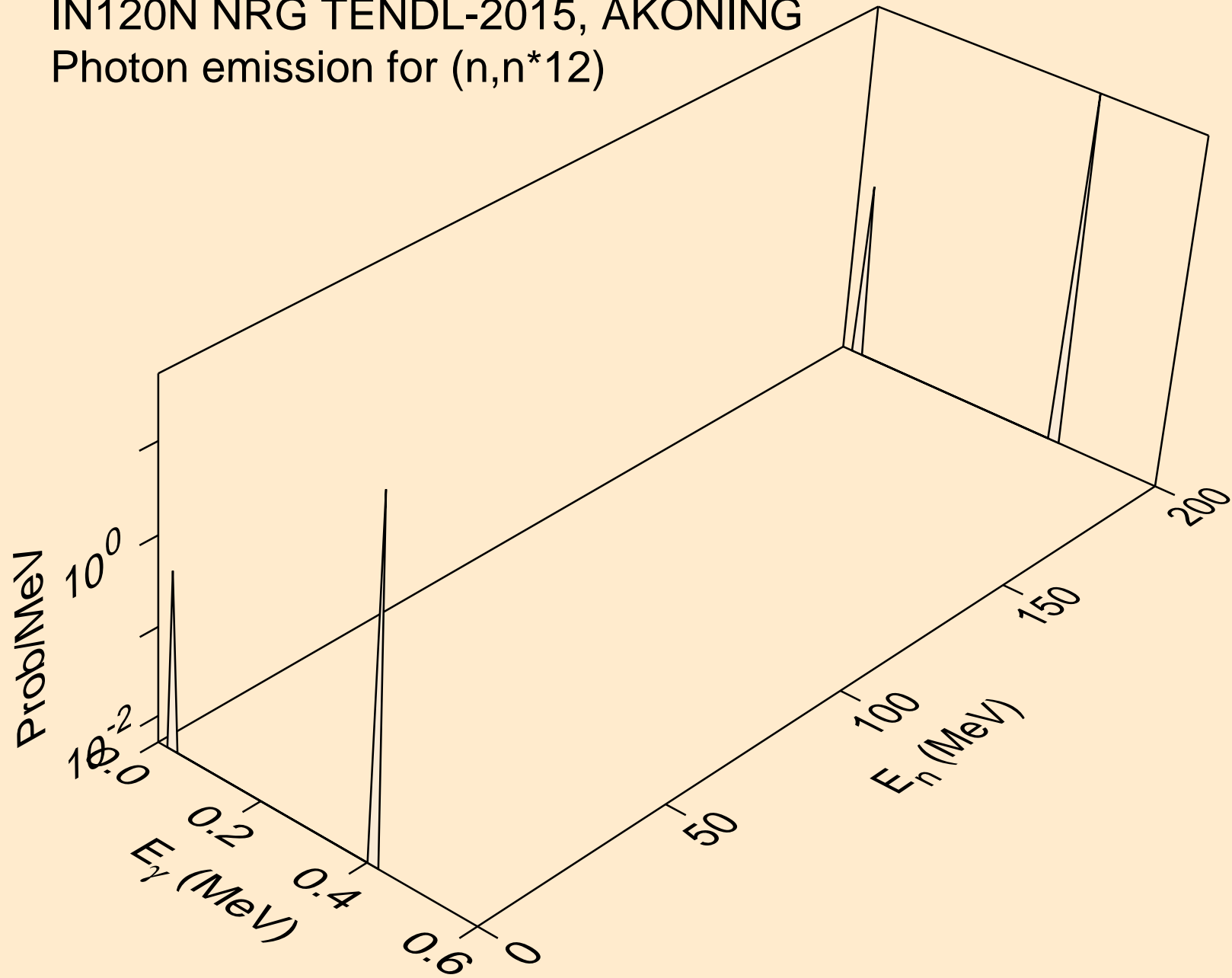

IN120N NRG TENDL-2015, AKONING
Photon emission for (n,n*13)

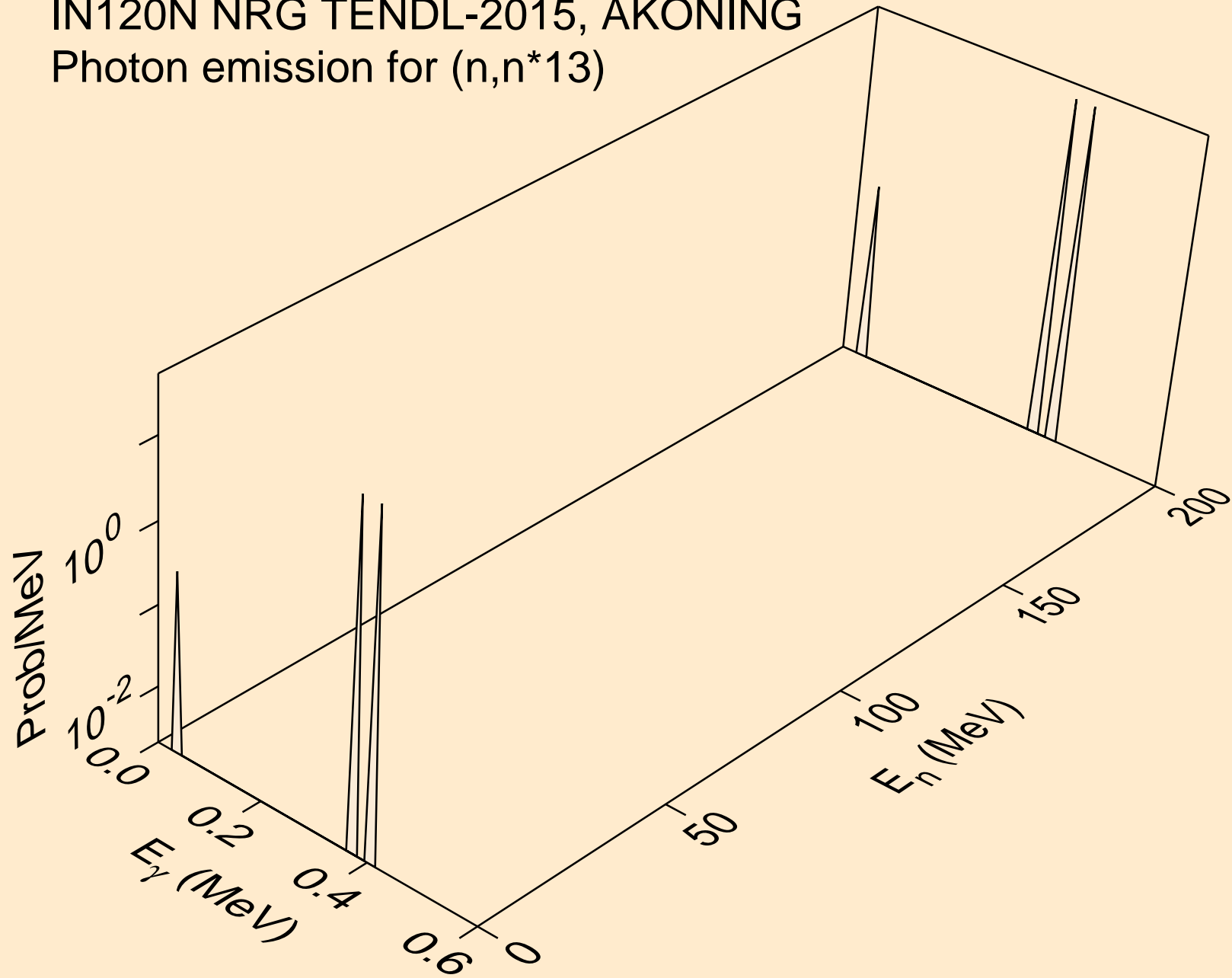

IN120N NRG TENDL-2015, AKONING
Photon emission for (n,n*14)

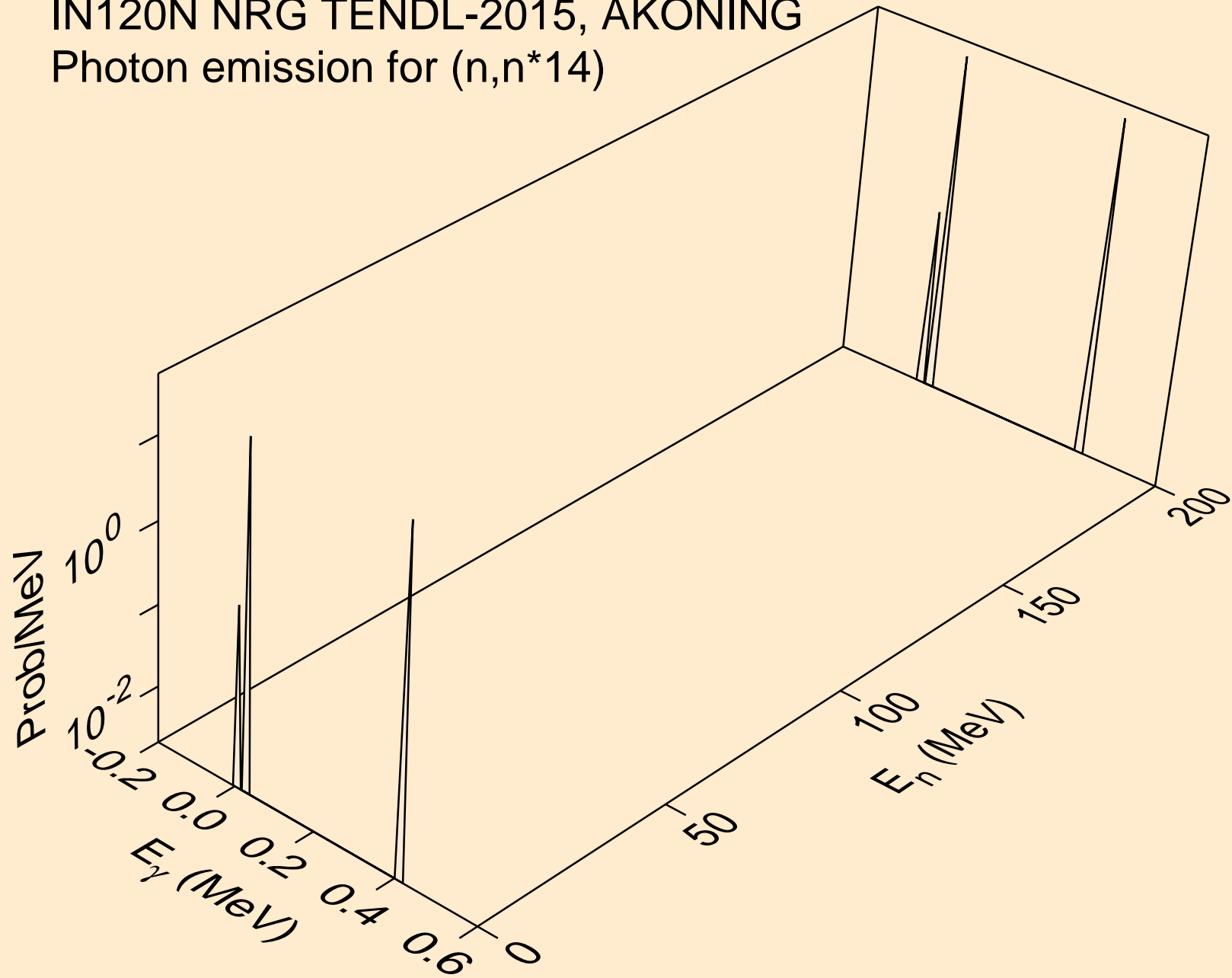

IN120N NRG TENDL-2015, AKONING
Photon emission for (n,n*15)

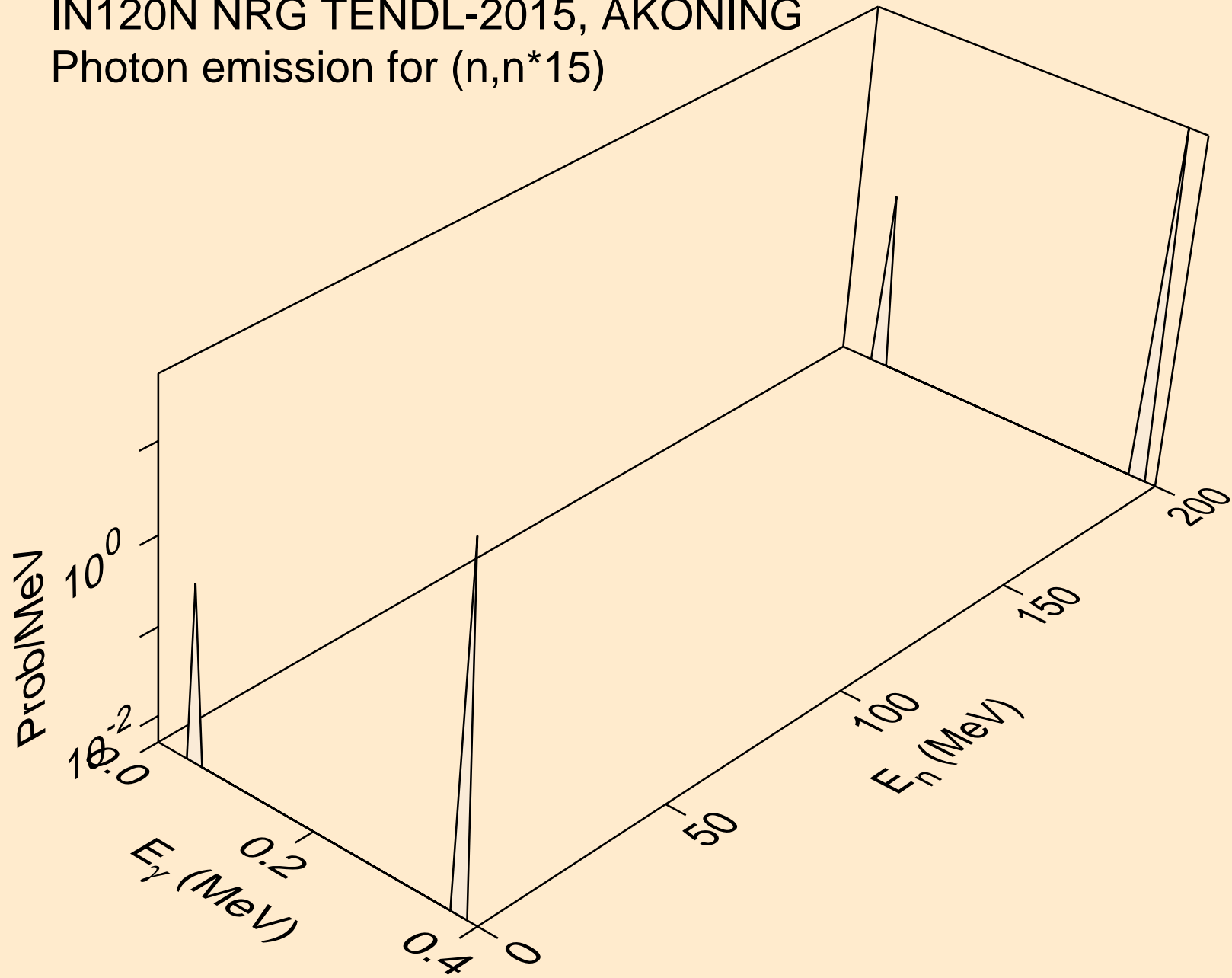

IN120N NRG TENDL-2015, AKONING
Photon emission for (n,n*16)

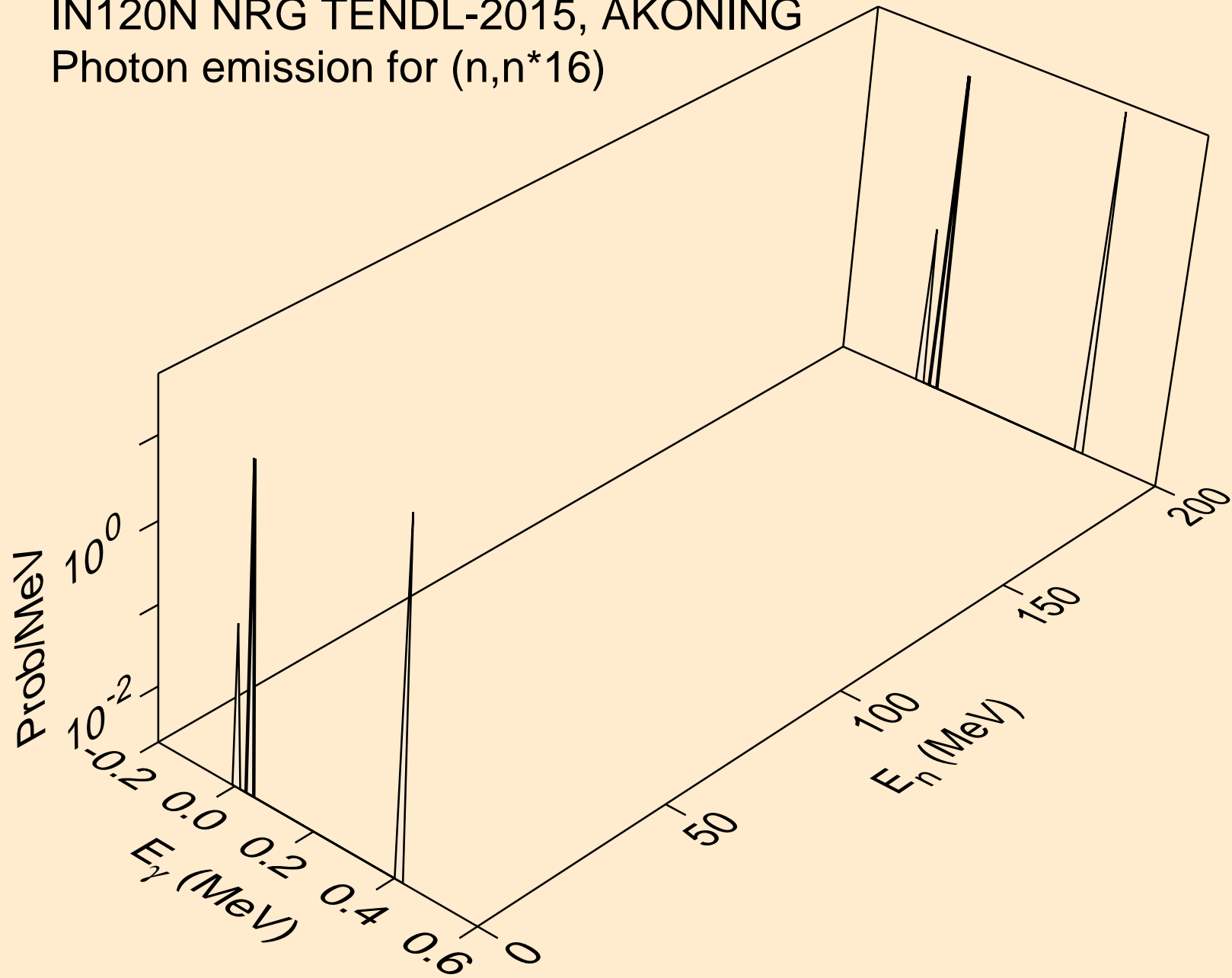

IN120N NRG TENDL-2015, AKONING
Photon emission for (n,n*17)

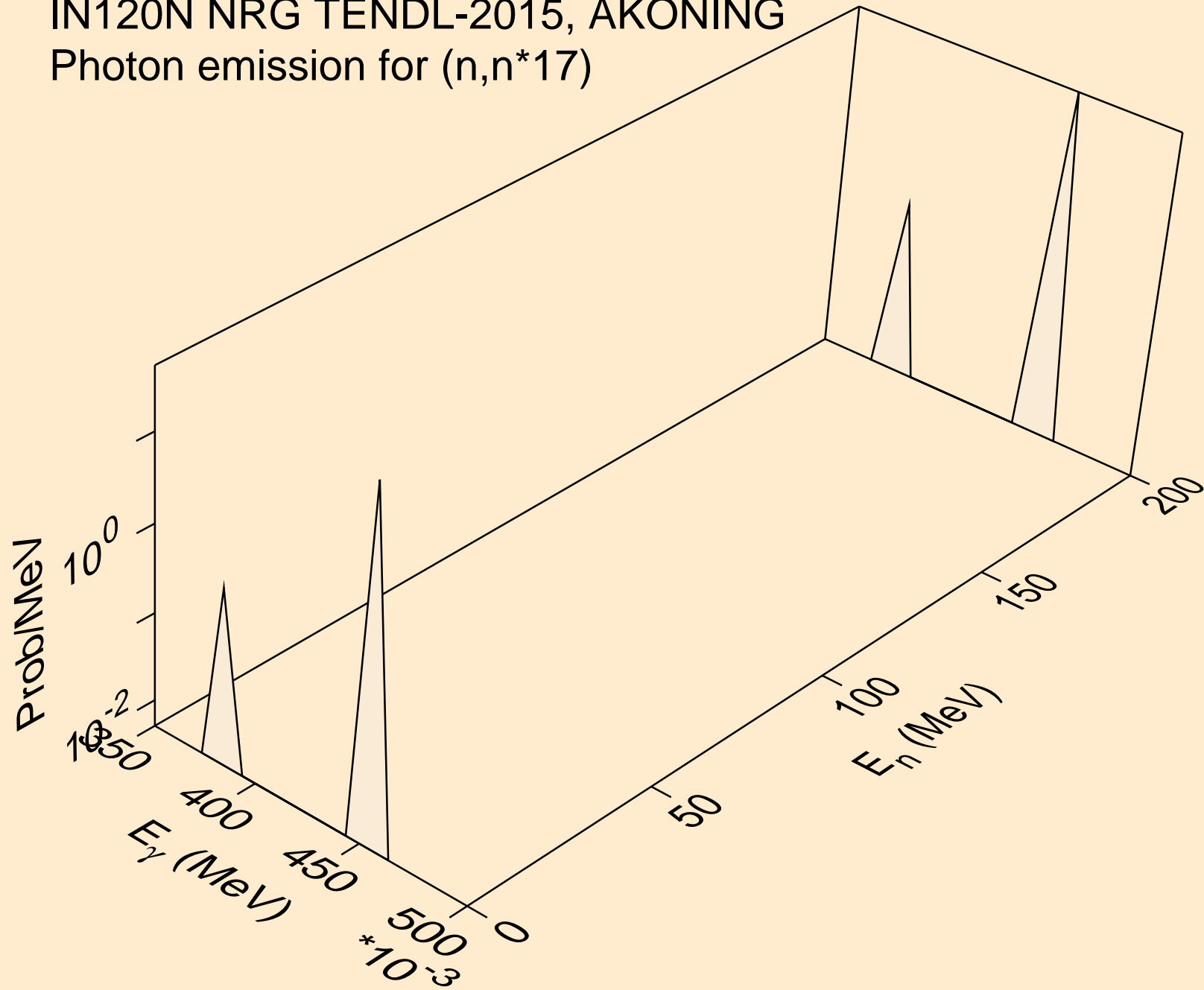

IN120N NRG TENDL-2015, AKONING
Photon emission for (n,n*18)

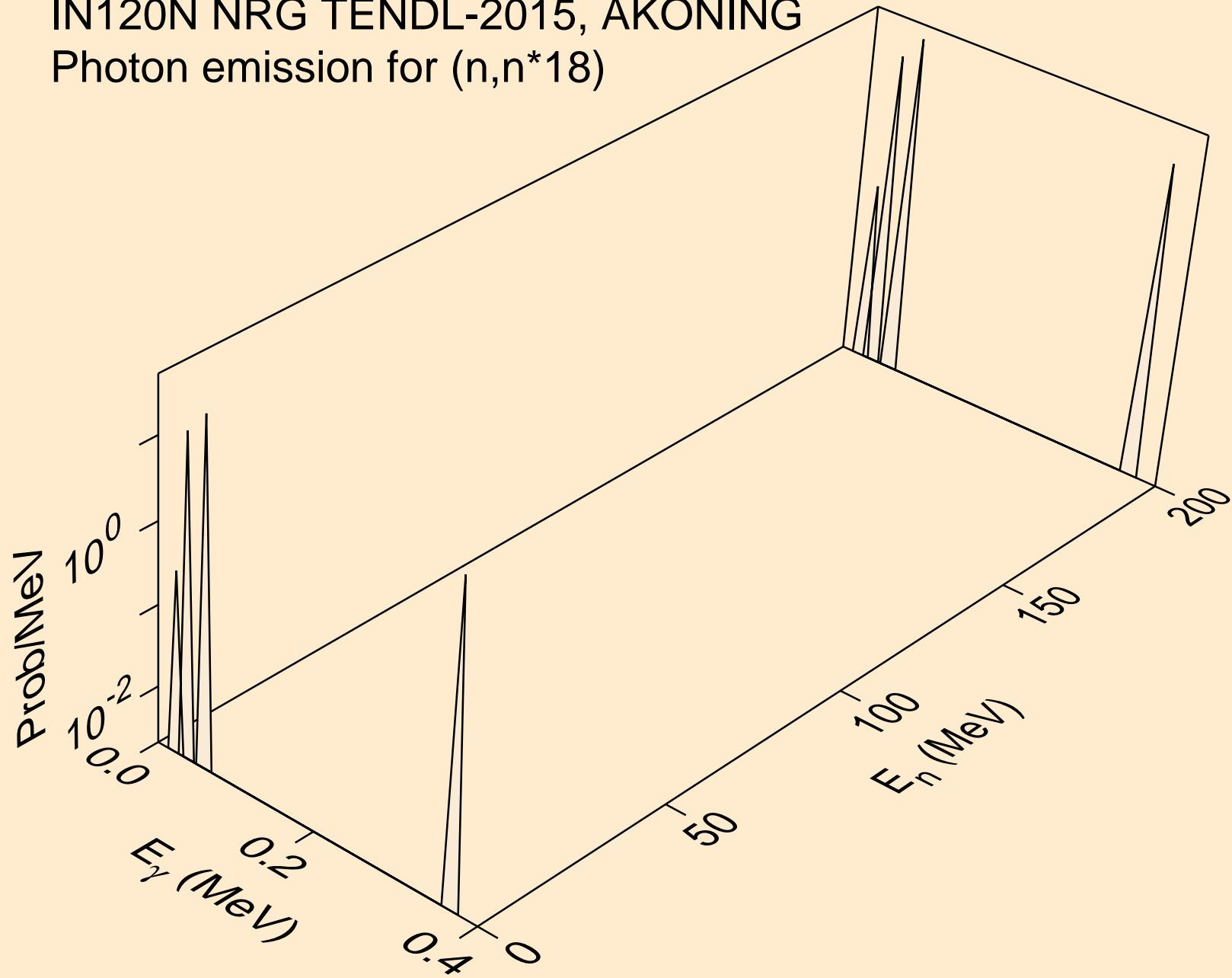

IN120N NRG TENDL-2015, AKONING
Photon emission for (n,n*19)

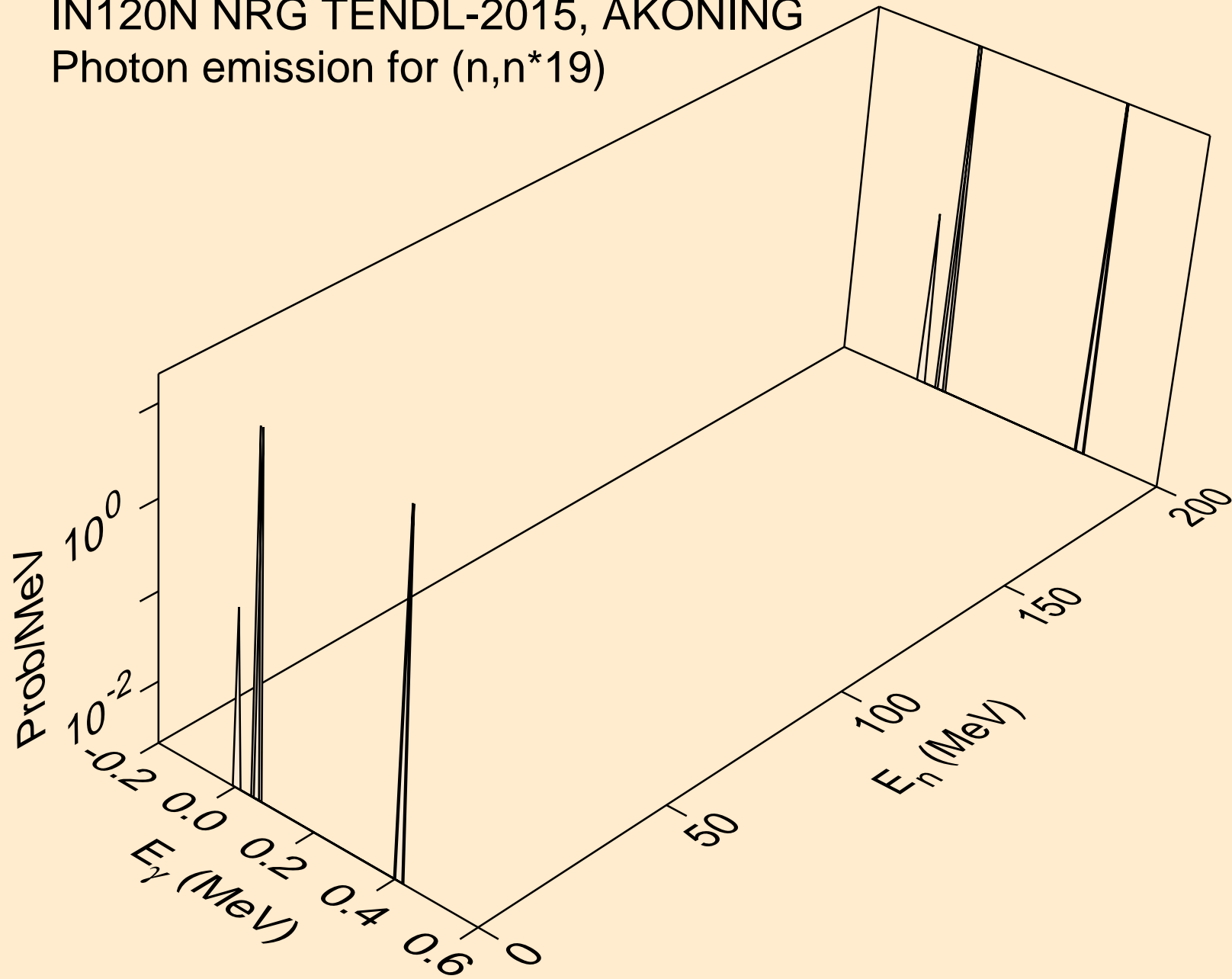

IN120N NRG TENDL-2015, AKONING
Photon emission for (n,n*20)

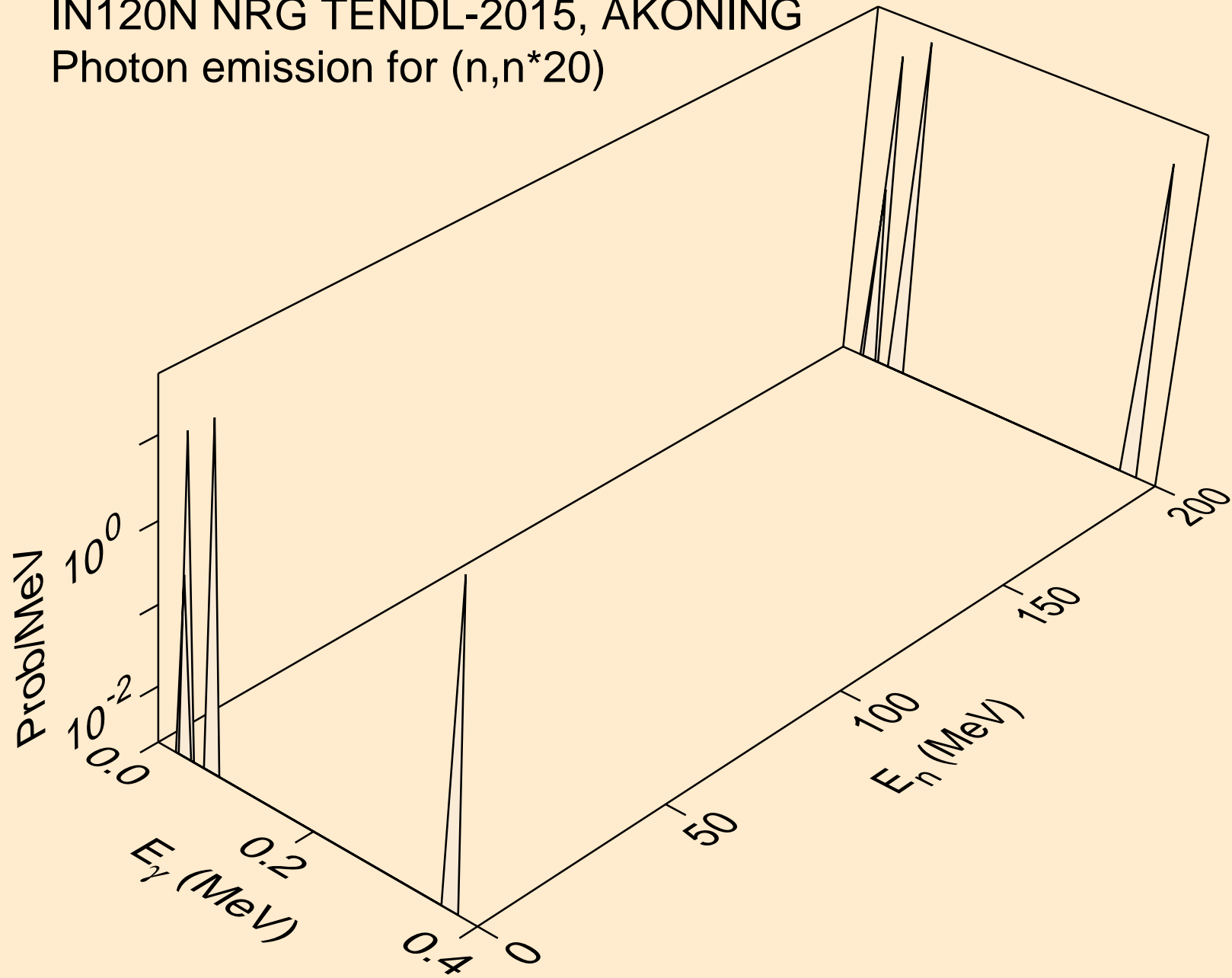

IN120N NRG TENDL-2015, AKONING
Photon emission for (n,n*21)

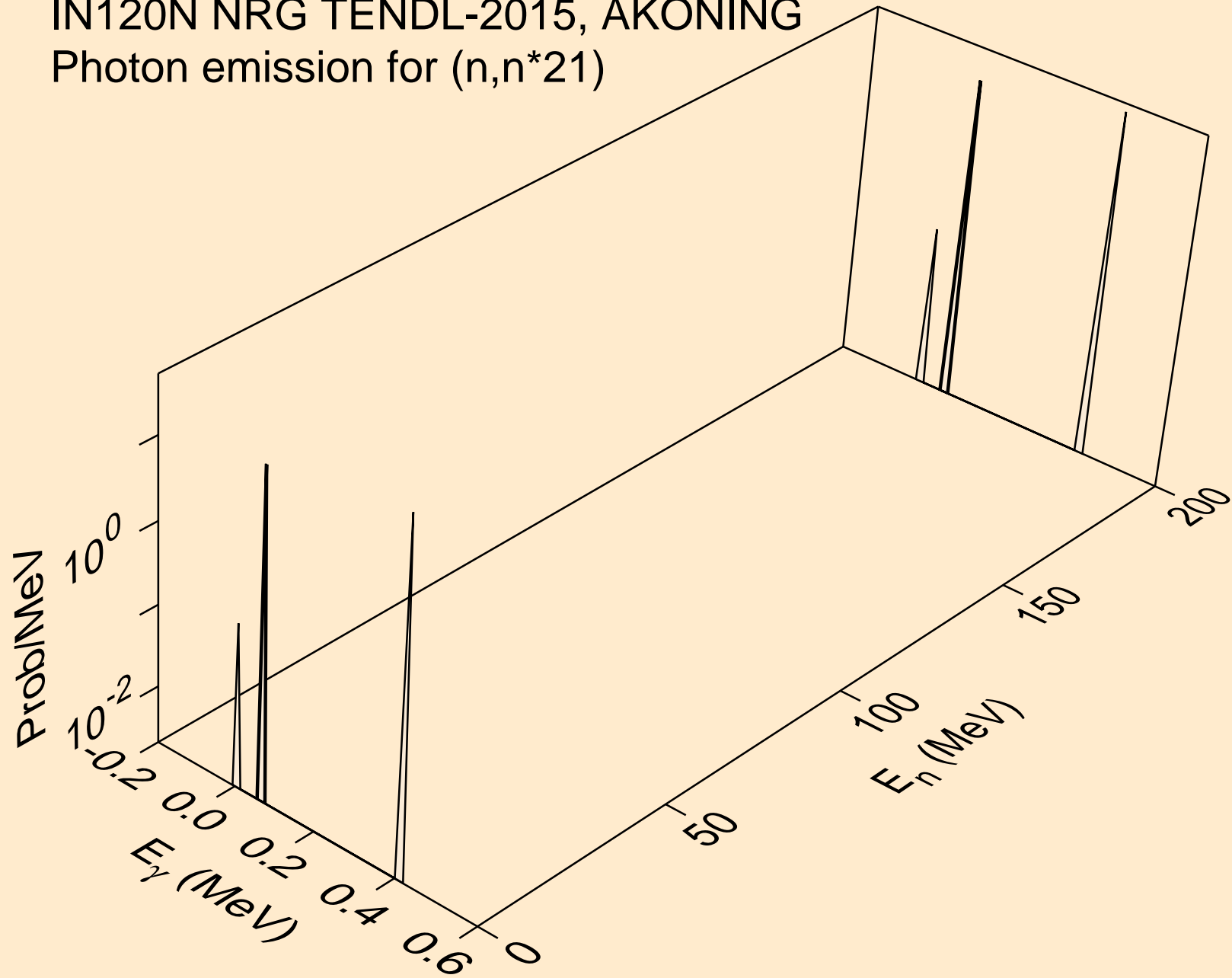

IN120N NRG TENDL-2015, AKONING
Photon emission for (n,n*22)

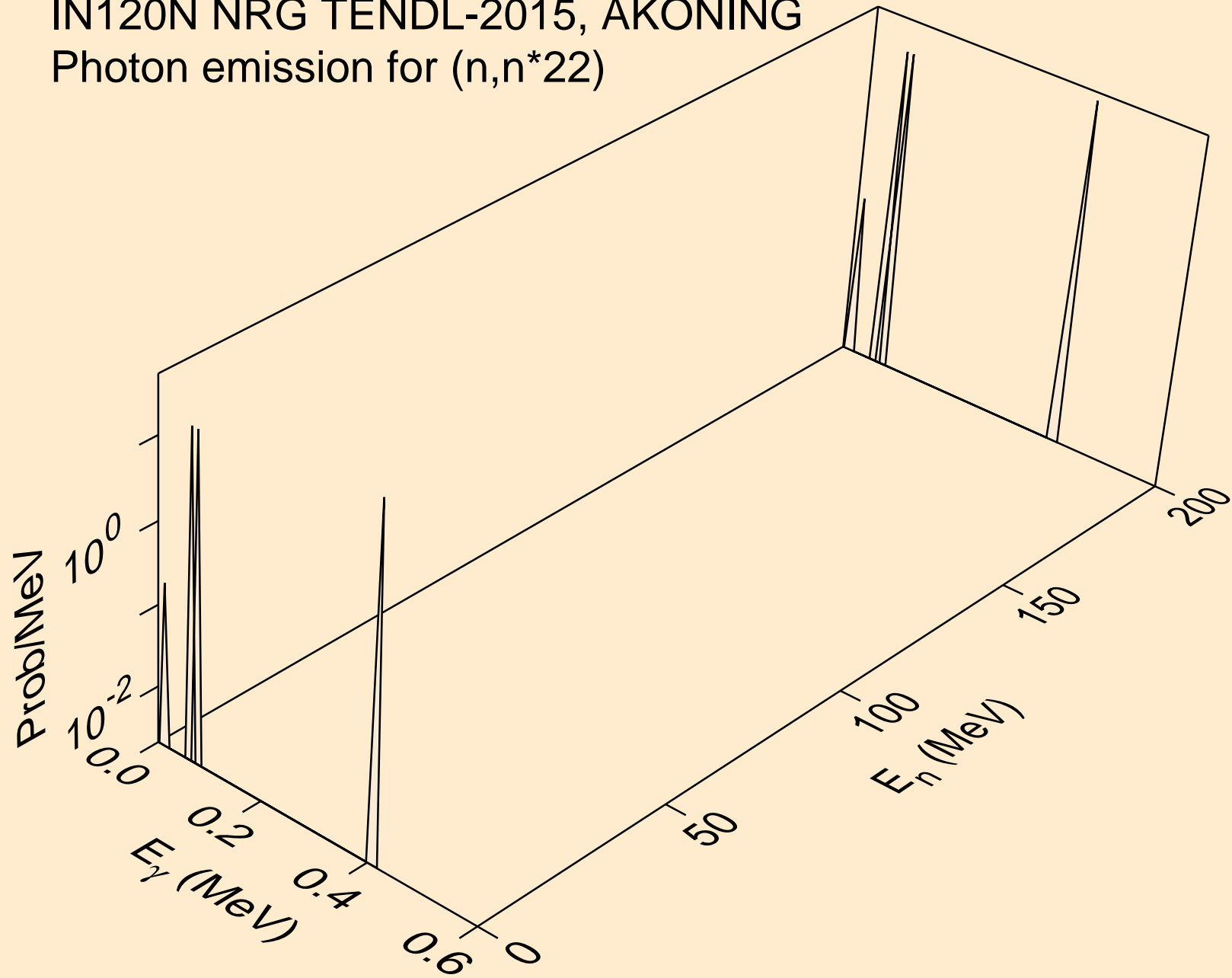

IN120N NRG TENDL-2015, AKONING
Photon emission for (n,n*23)

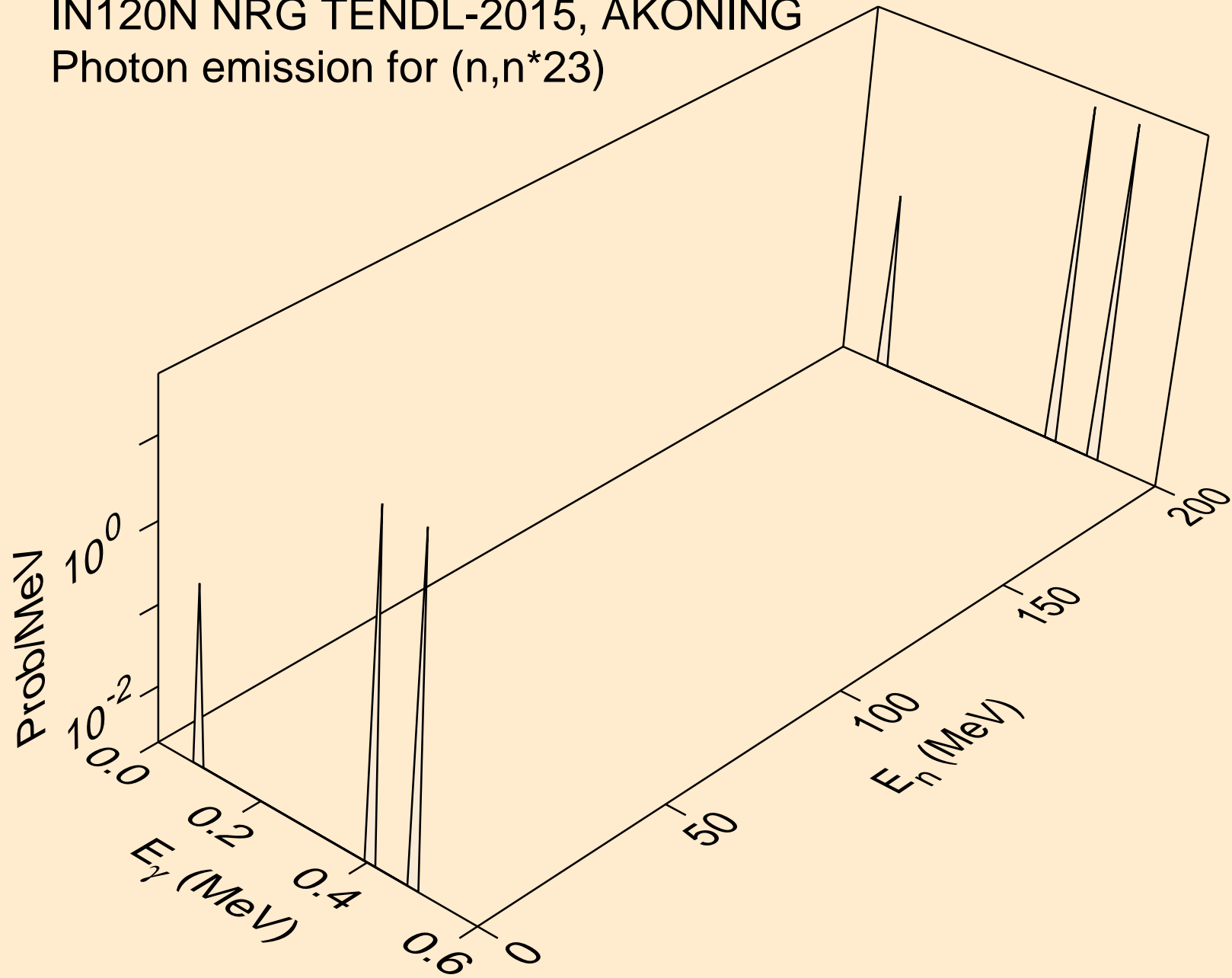

IN120N NRG TENDL-2015, AKONING
Photon emission for (n,n*24)

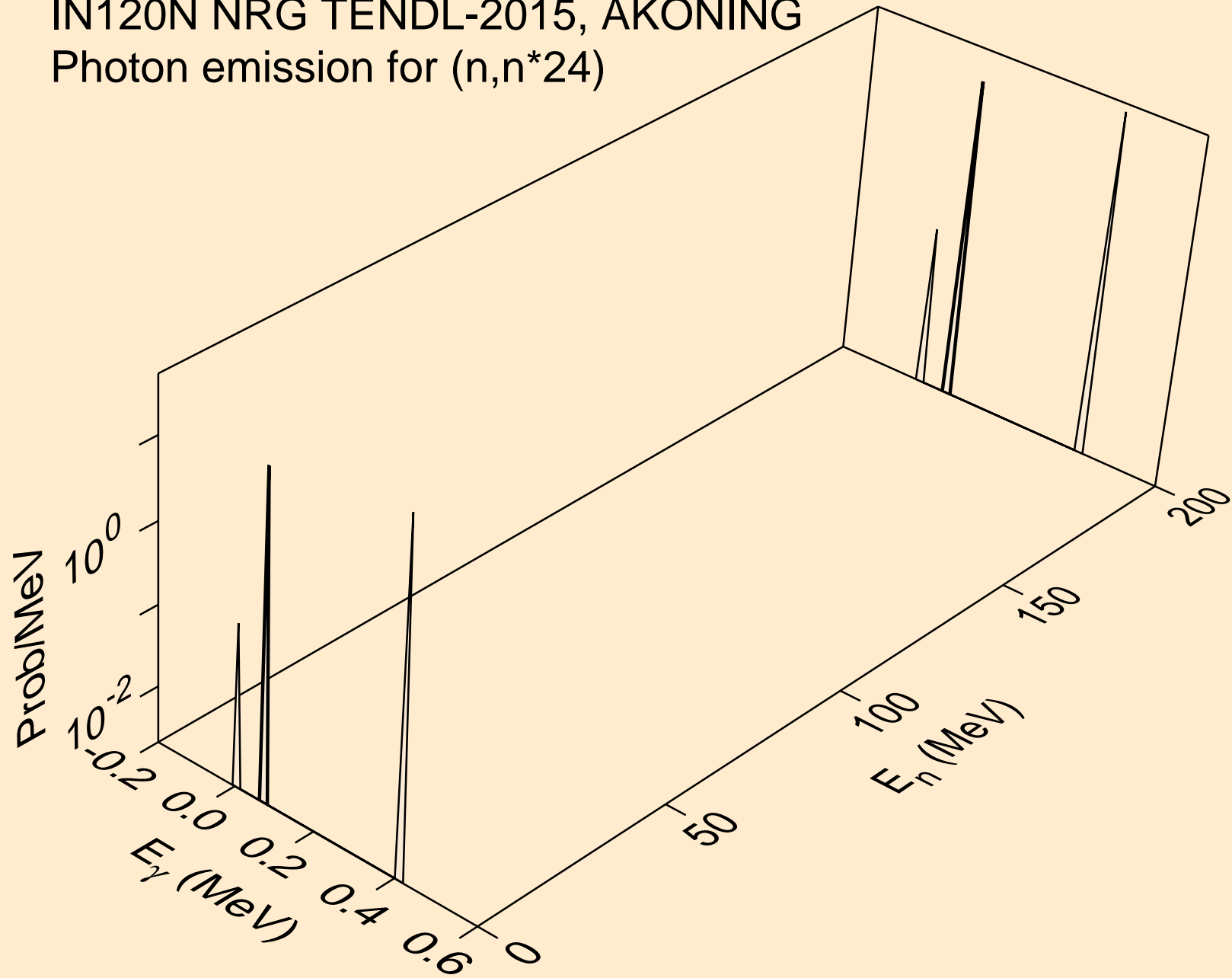

IN120N NRG TENDL-2015, AKONING
Photon emission for (n,n*25)

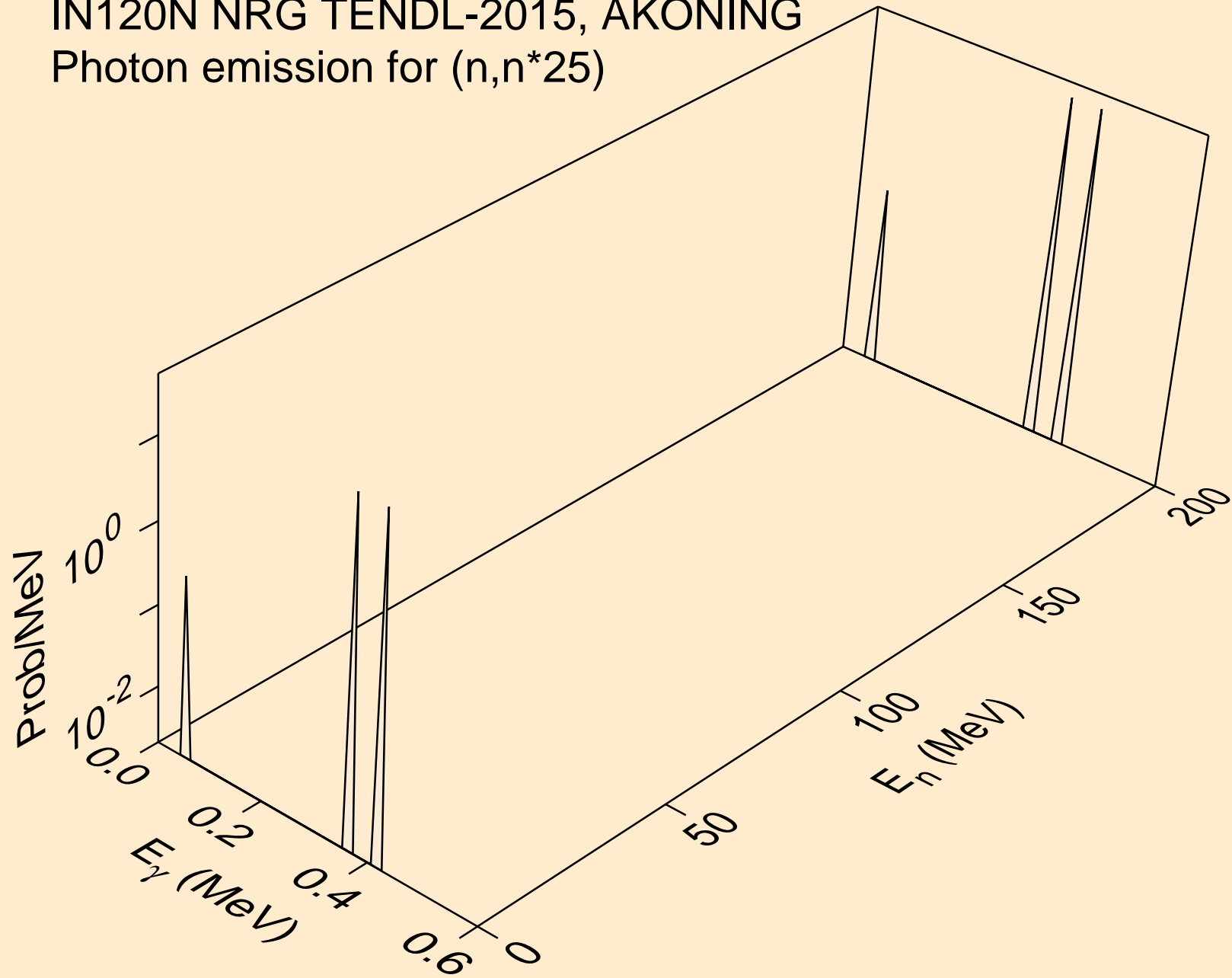

IN120N NRG TENDL-2015, AKONING
Photon emission for (n,n*26)

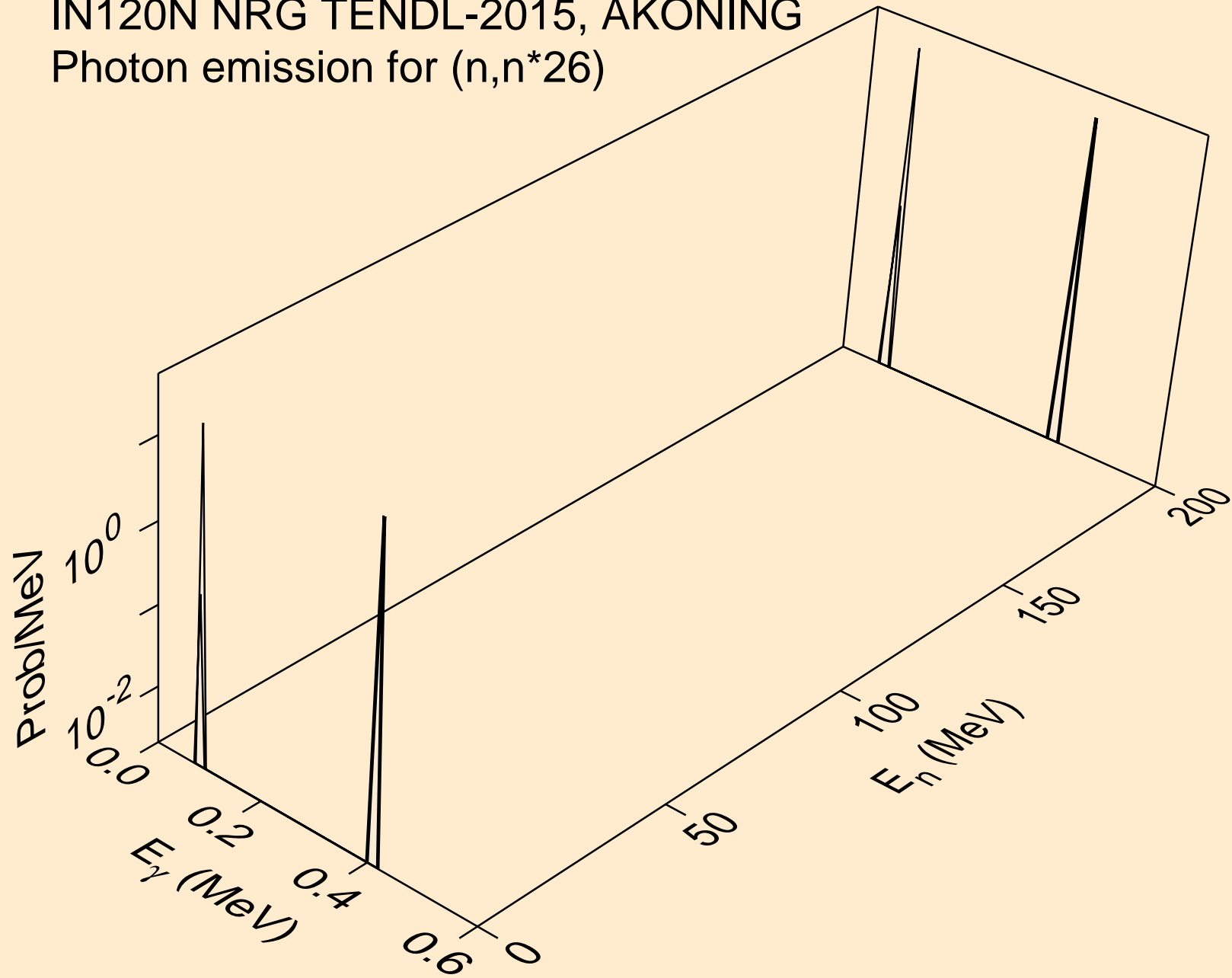

IN120N NRG TENDL-2015, AKONING
Photon emission for (n,n*27)

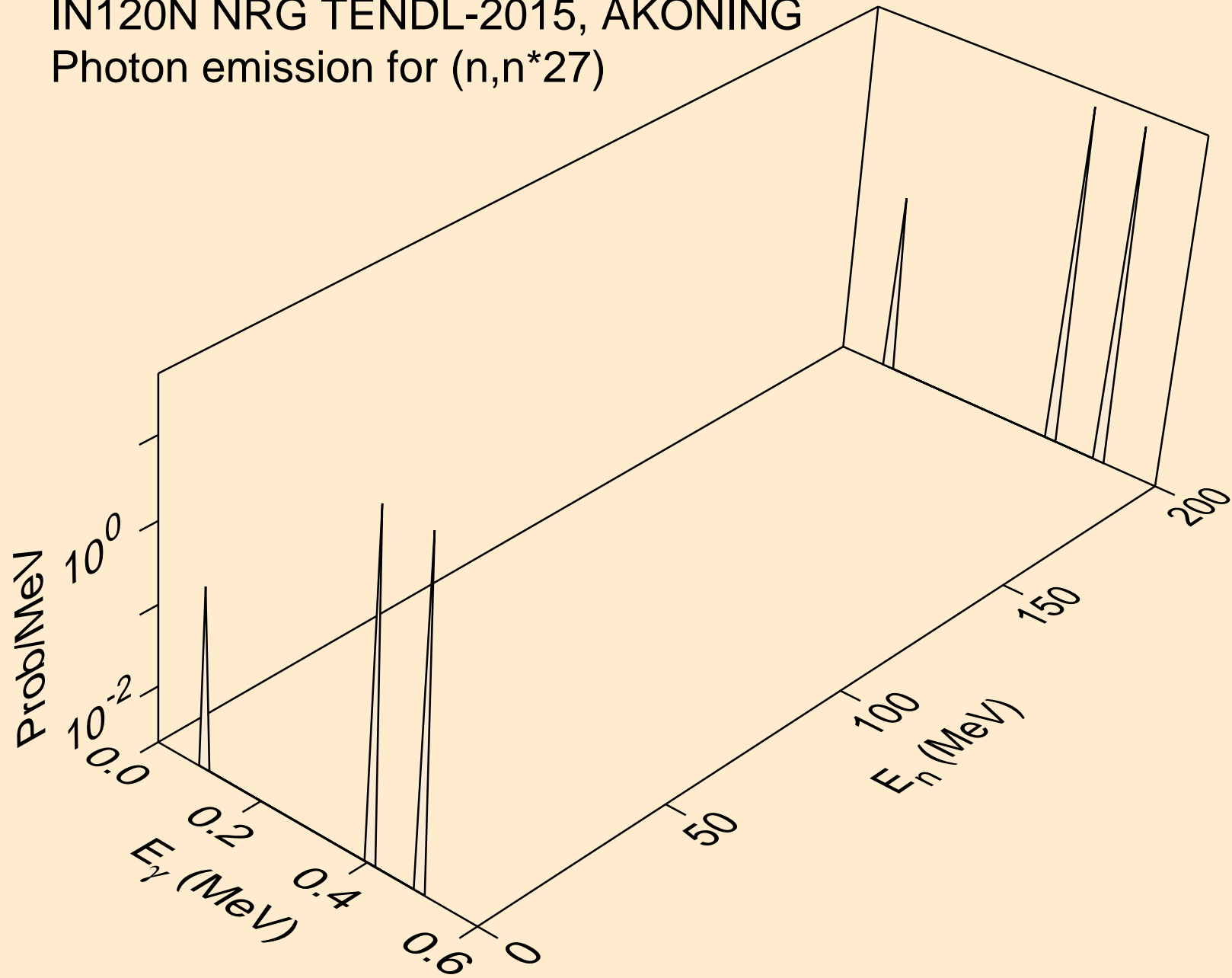

IN120N NRG TENDL-2015, AKONING
Photon emission for (n,n*28)

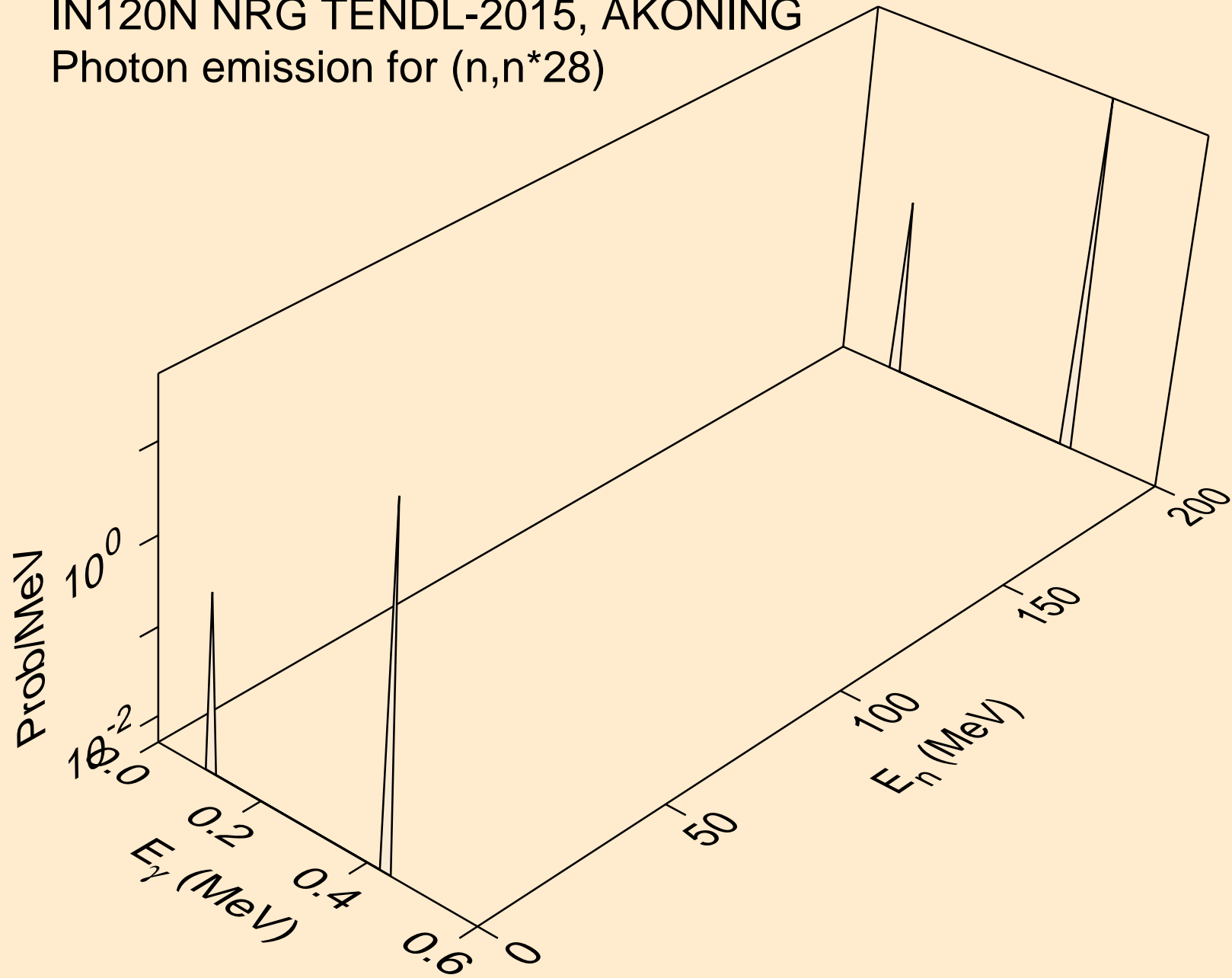

IN120N NRG TENDL-2015, AKONING
Photon emission for (n,n*29)

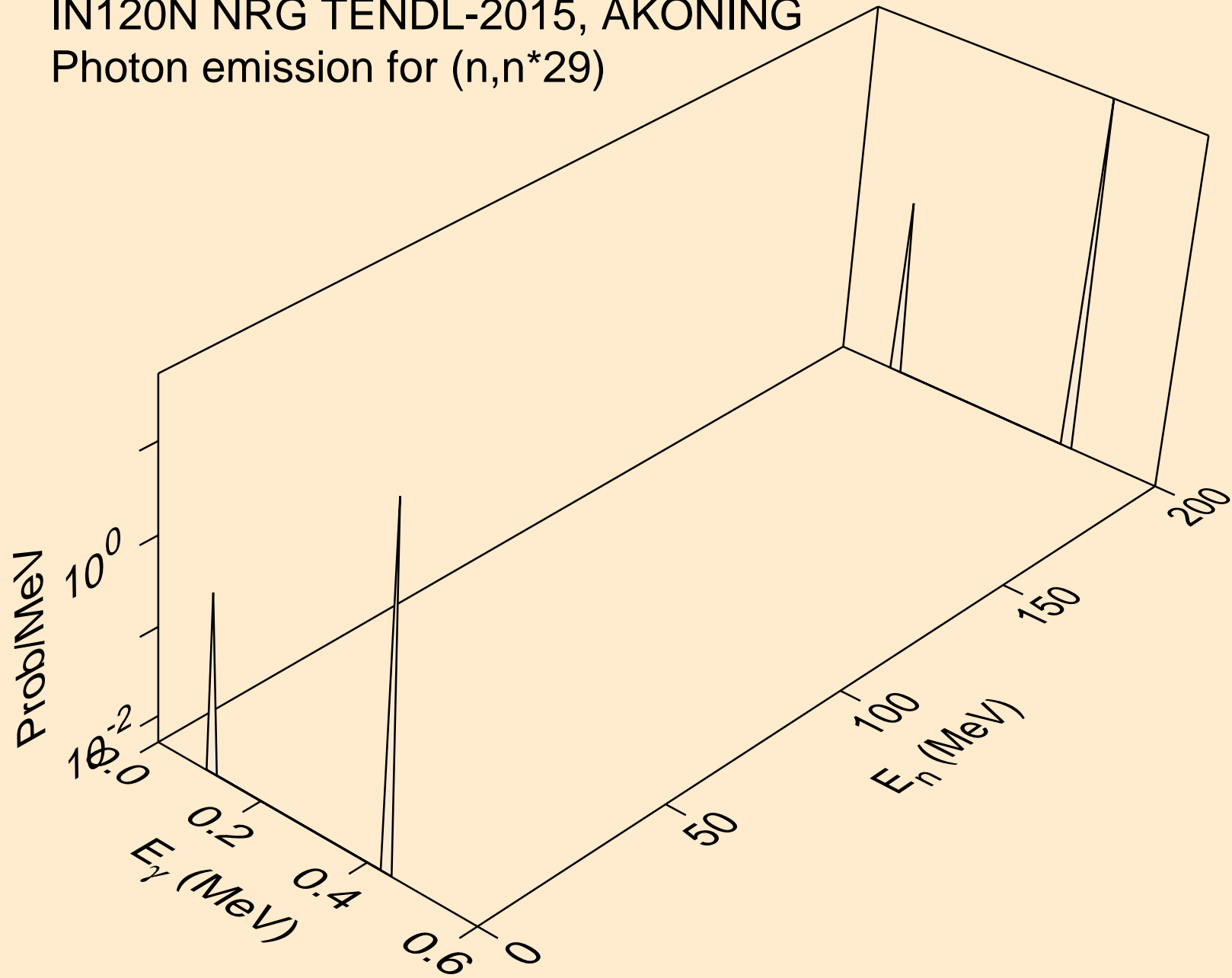

IN120N NRG TENDL-2015, AKONING
Photon emission for (n,n*c)

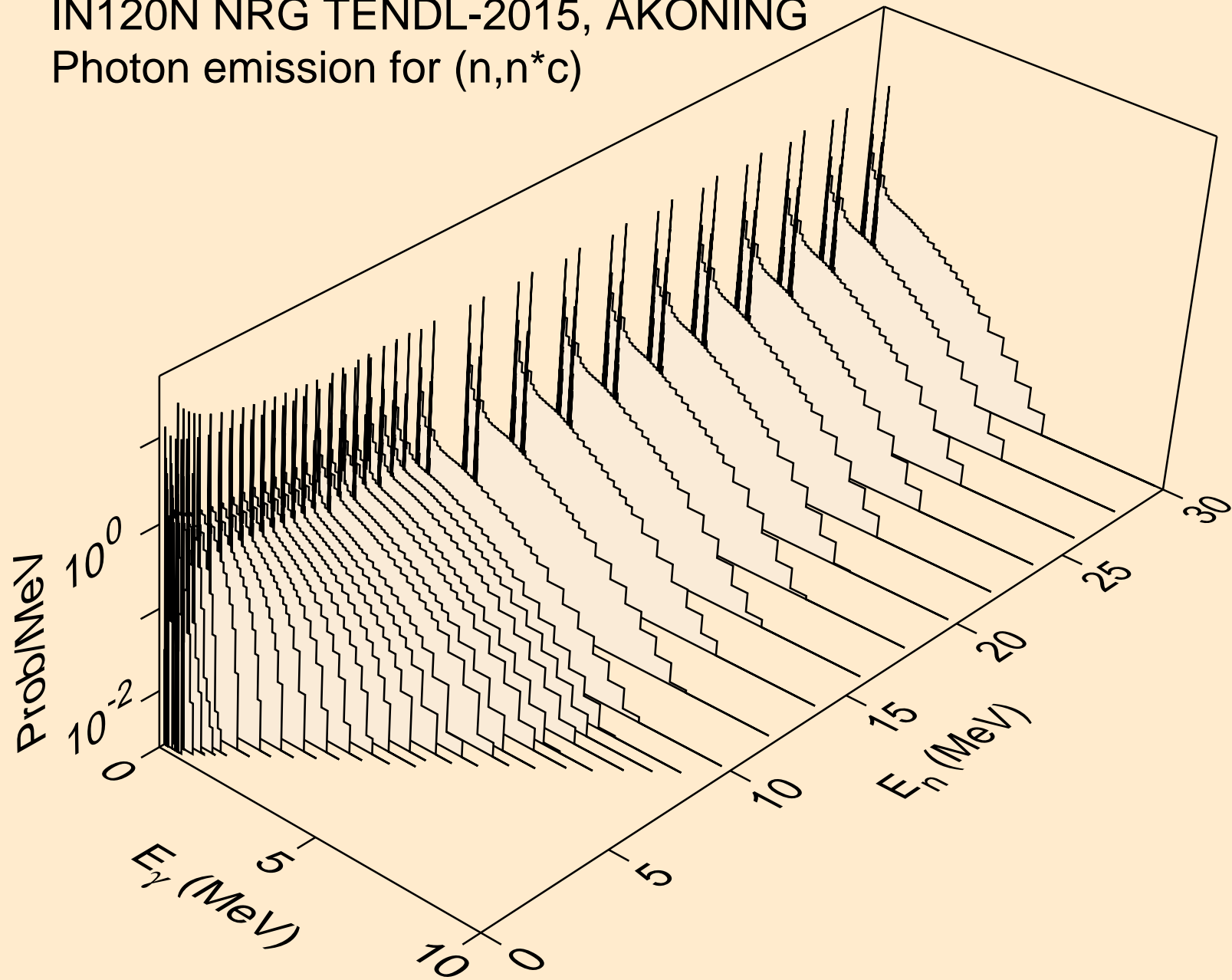

IN120N NRG TENDL-2015, AKONING
Photon emission for (n,gma)

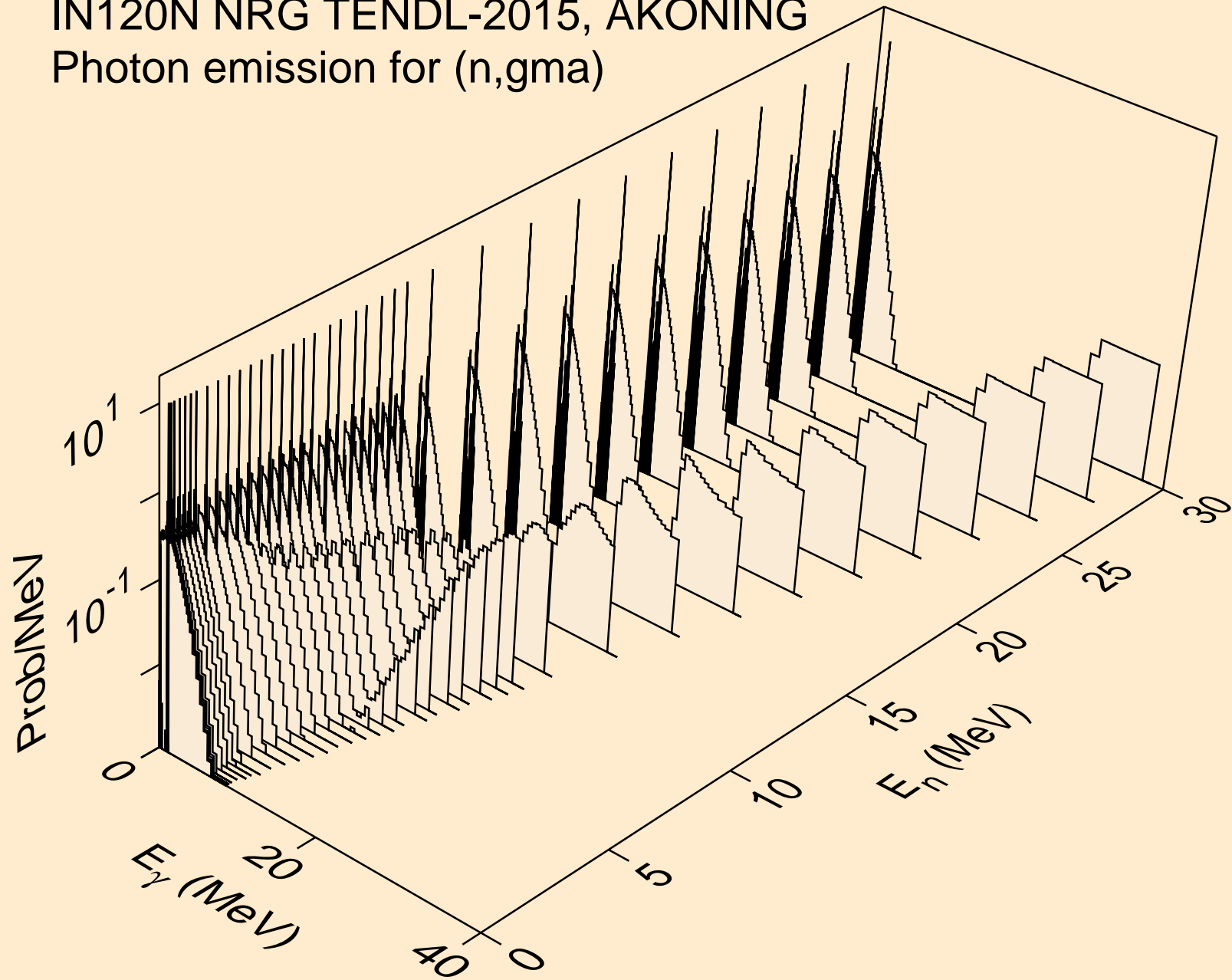

IN120N NRG TENDL-2015, AKONING
Photon emission for (n,p)

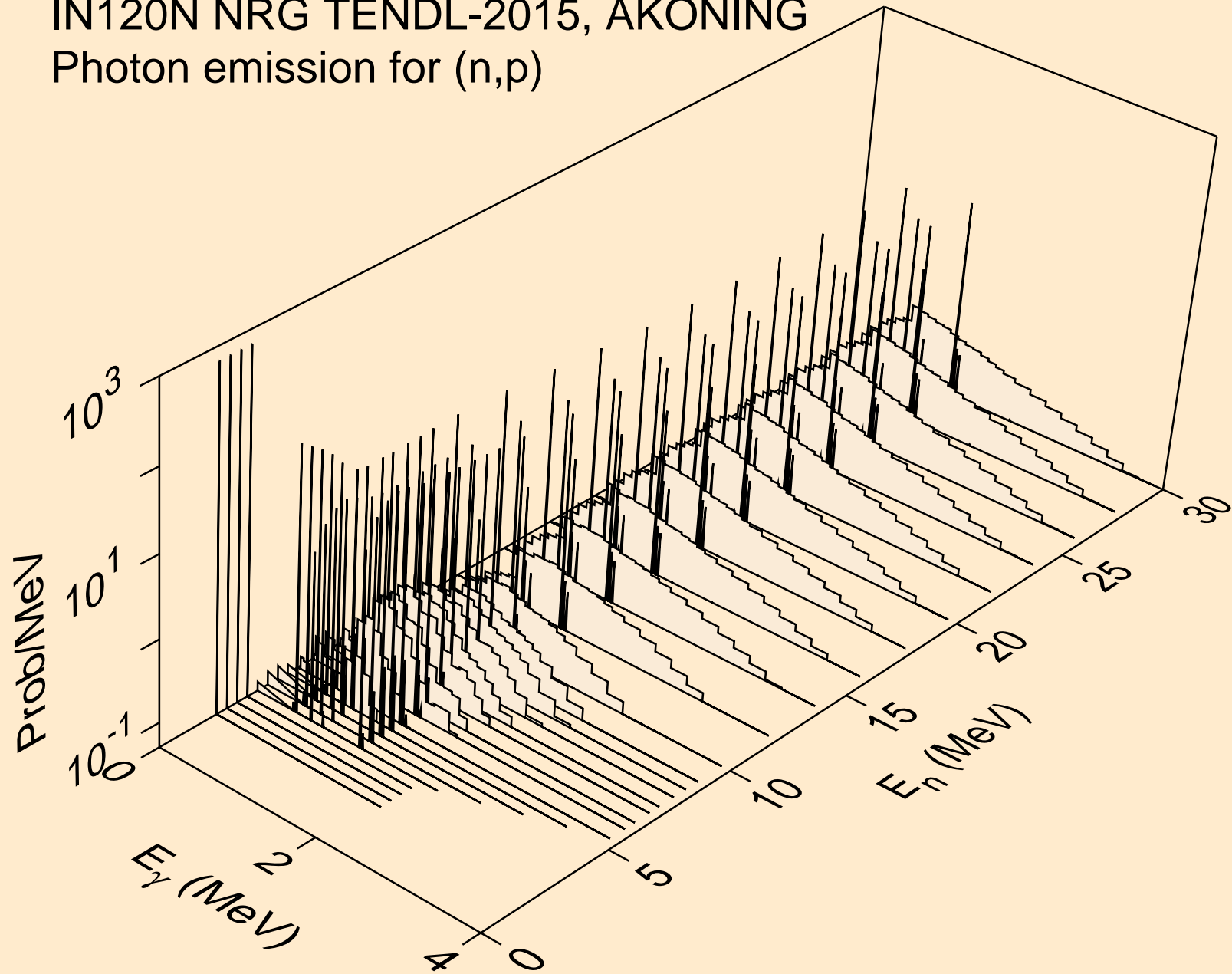

IN120N NRG TENDL-2015, AKONING
Photon emission for (n,d)

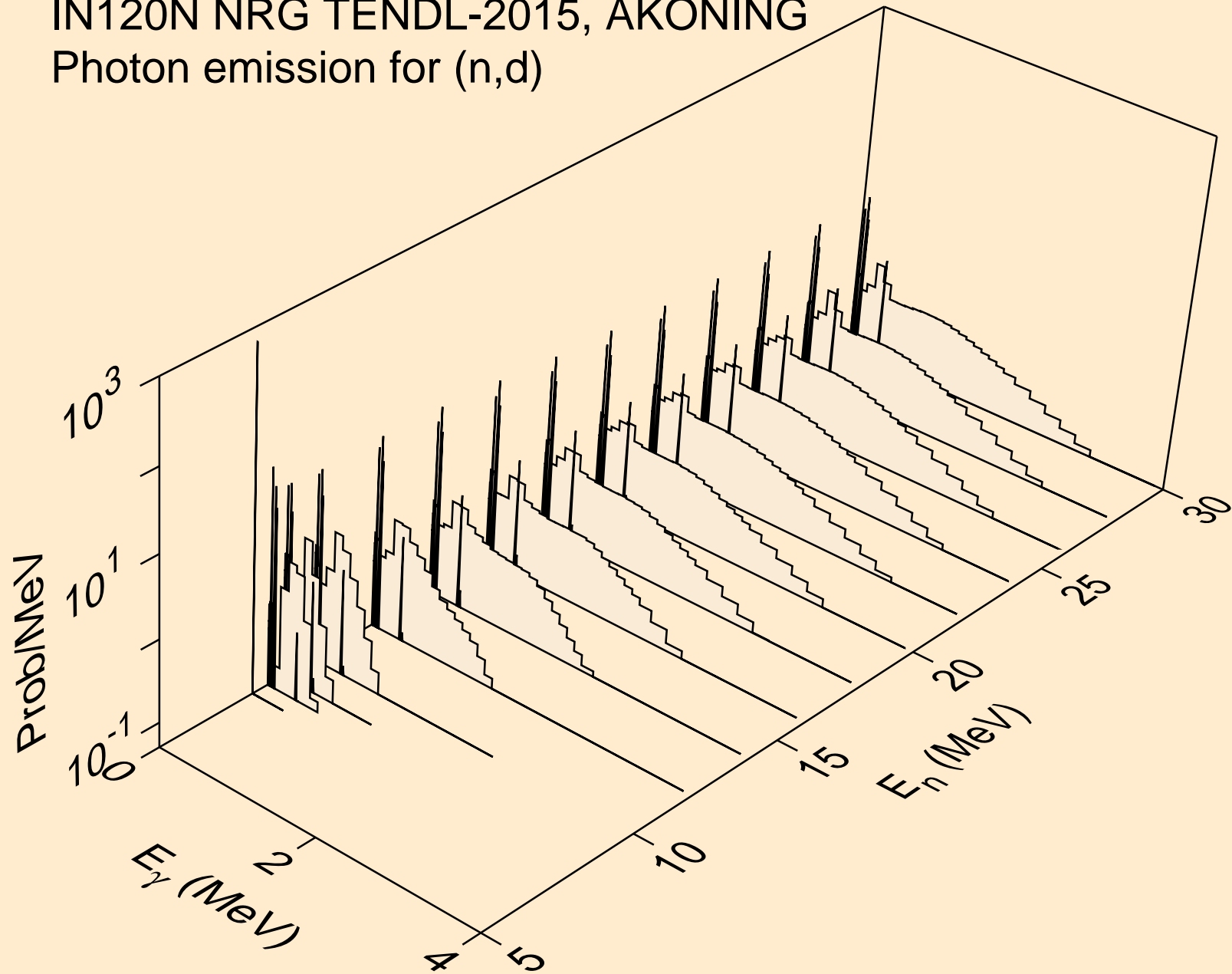

IN120N NRG TENDL-2015, AKONING
Photon emission for (n,t)

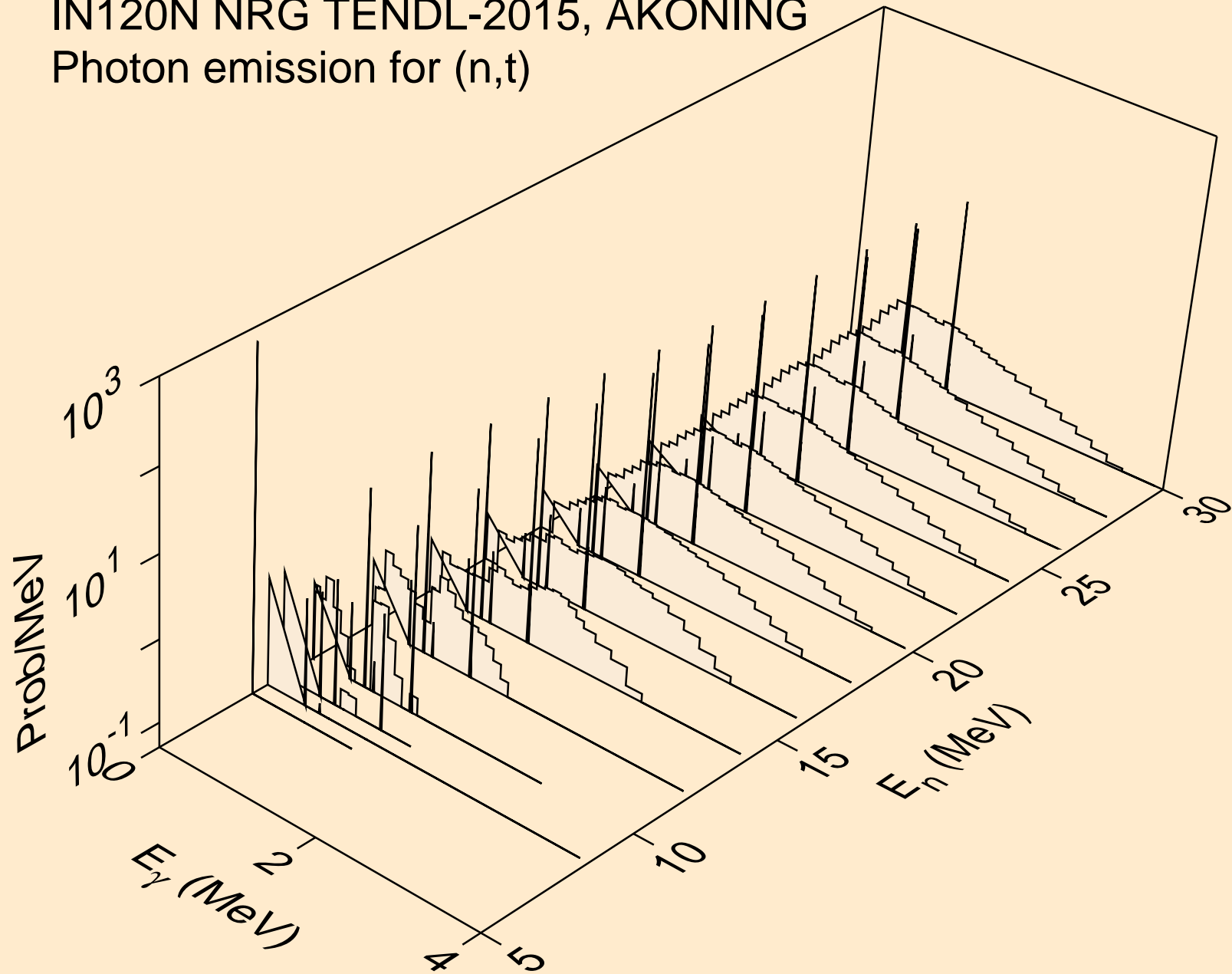

IN120N NRG TENDL-2015, AKONING
Photon emission for (n,he3)

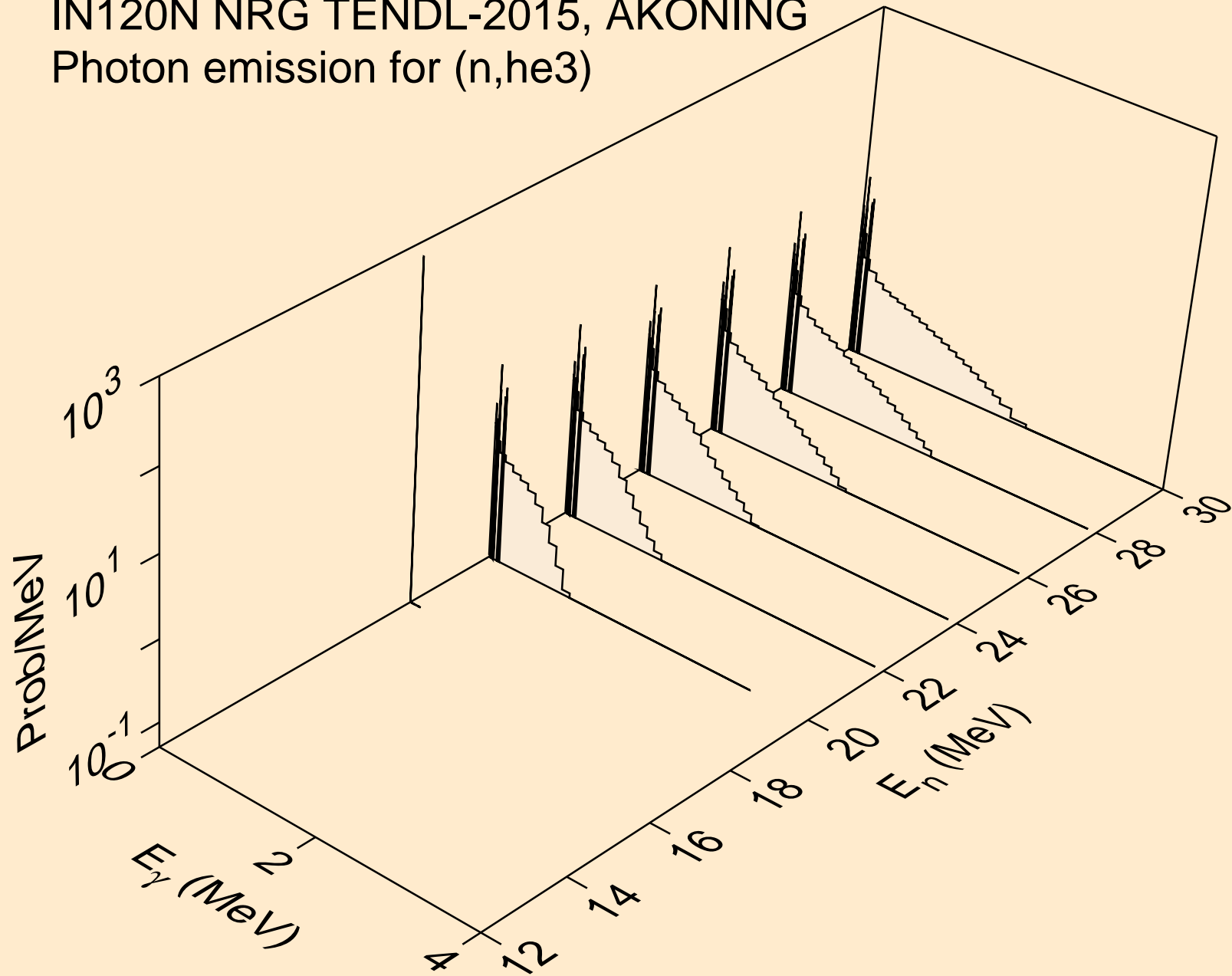

IN120N NRG TENDL-2015, AKONING
Photon emission for (n,a)

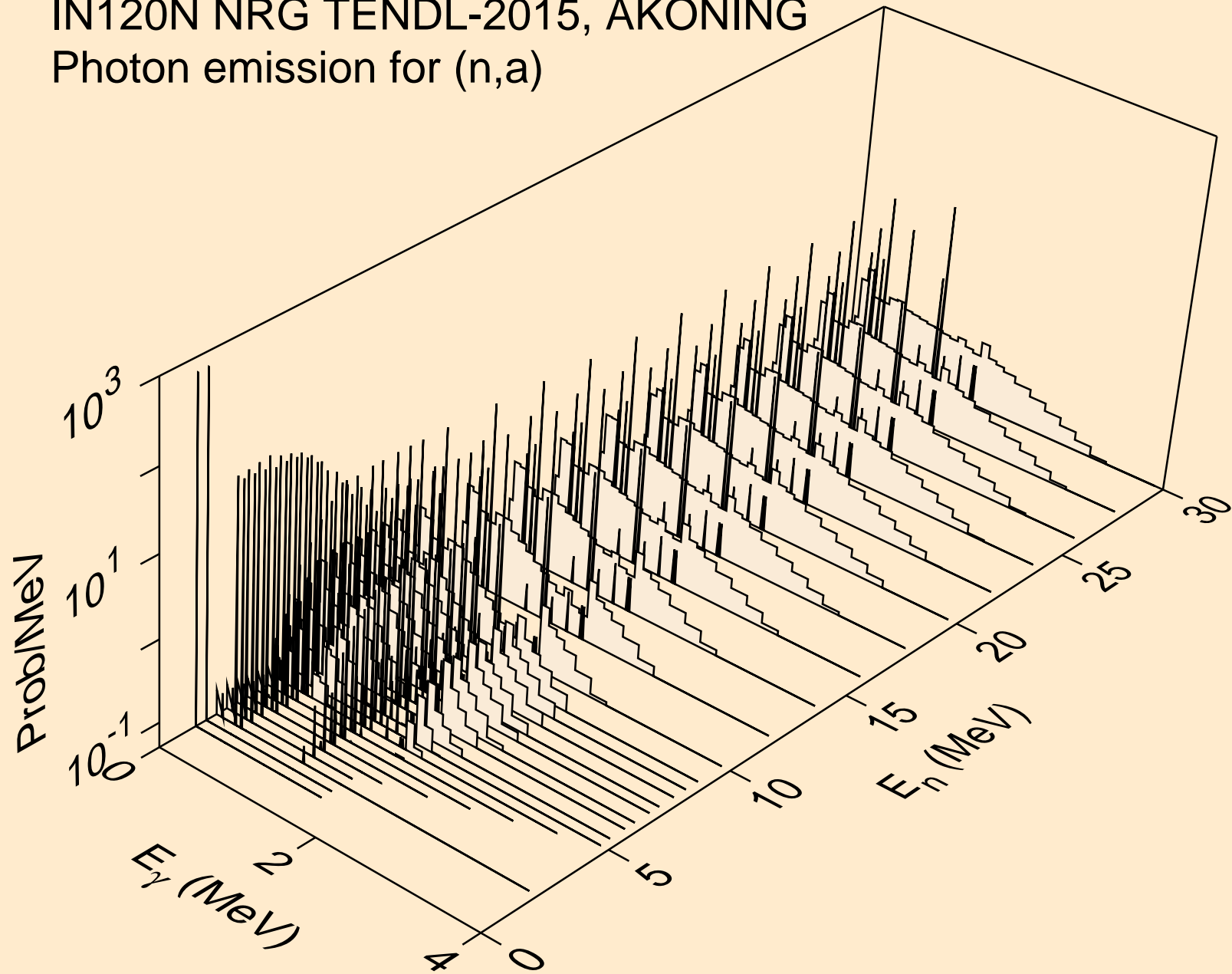

IN120N NRG TENDL-2015, AKONING
Photon emission for (n,2p)

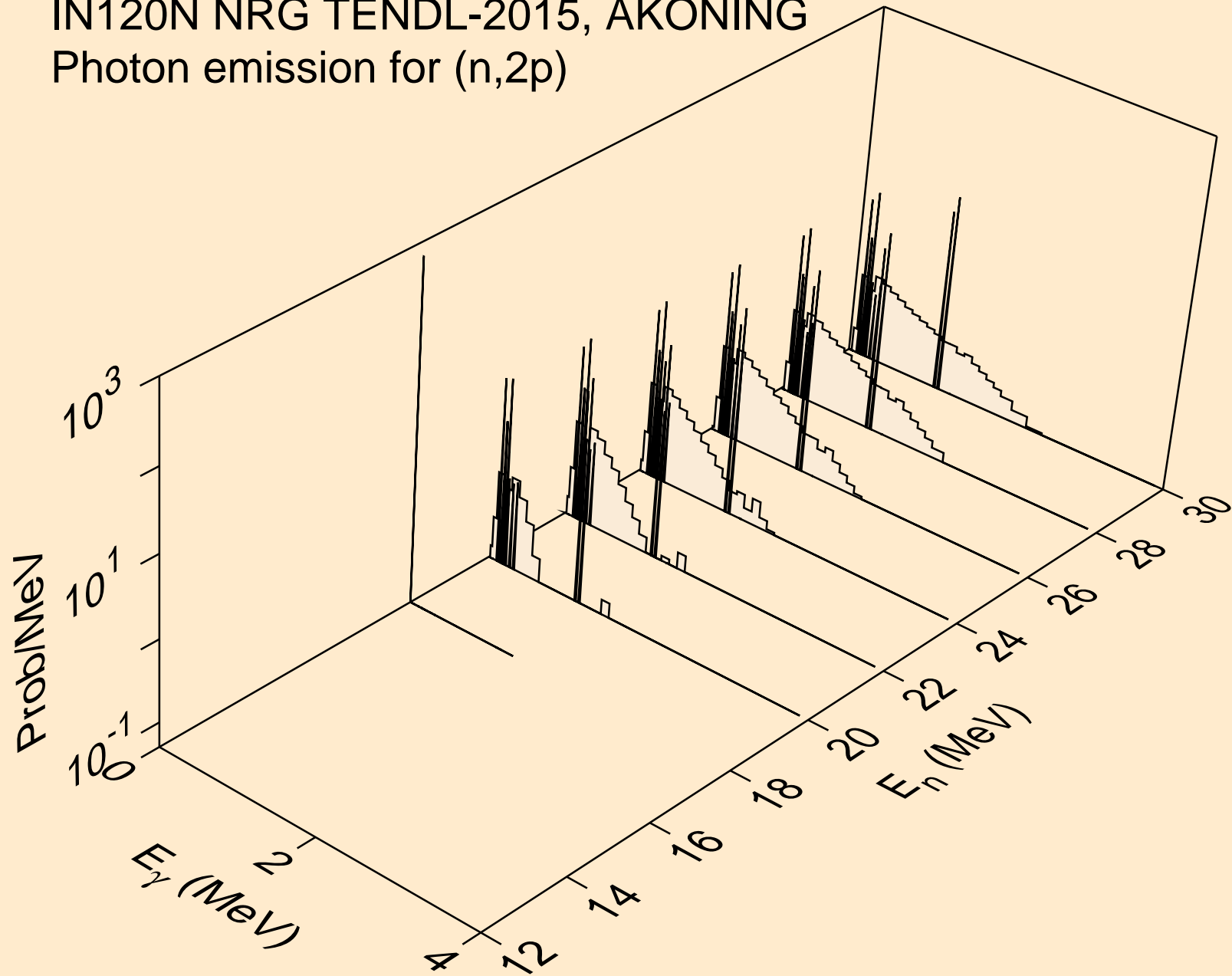

IN120N NRG TENDL-2015, AKONING
Photon emission for (n,pa)

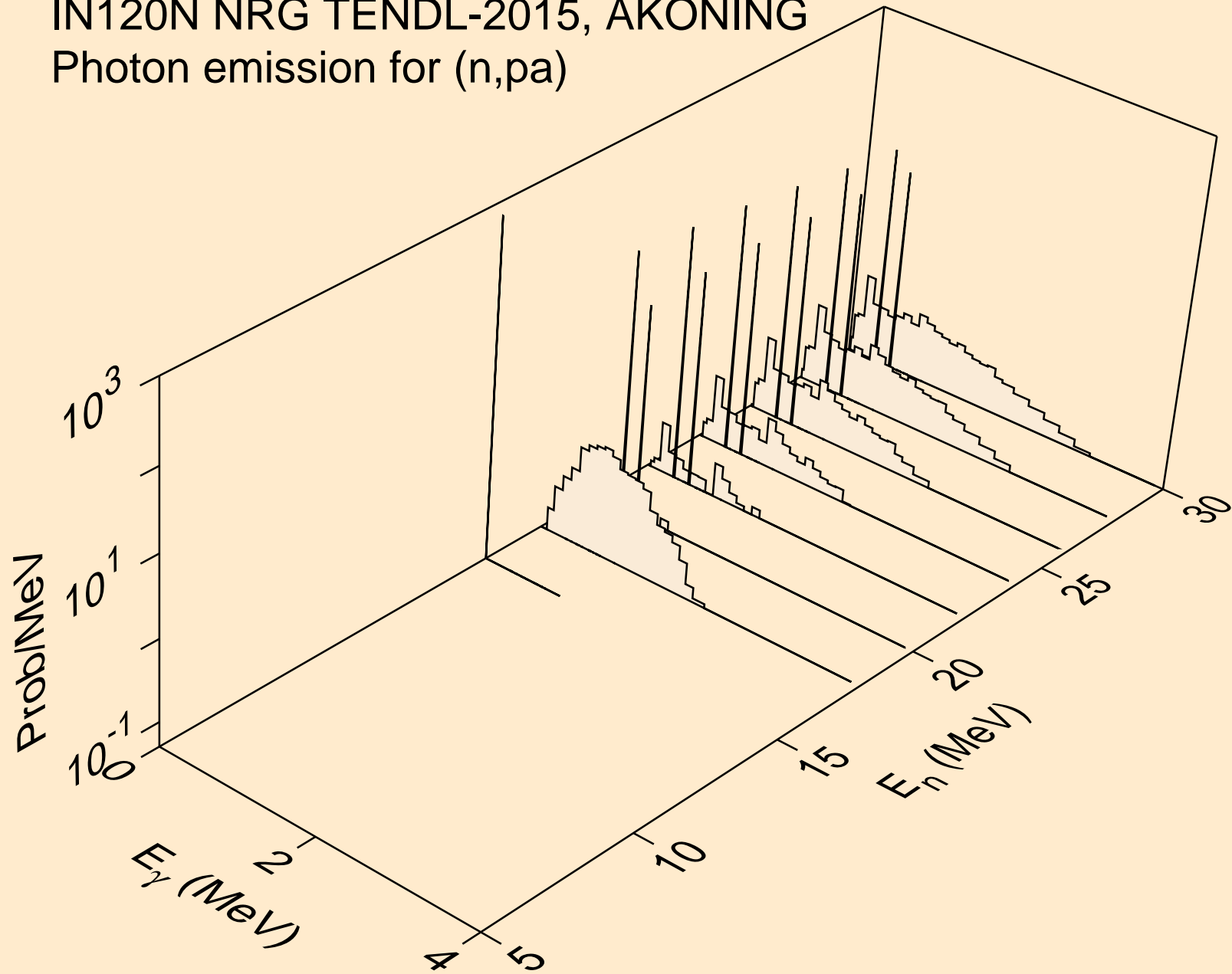

IN120N NRG TENDL-2015, AKONING
thermal capture photon spectrum

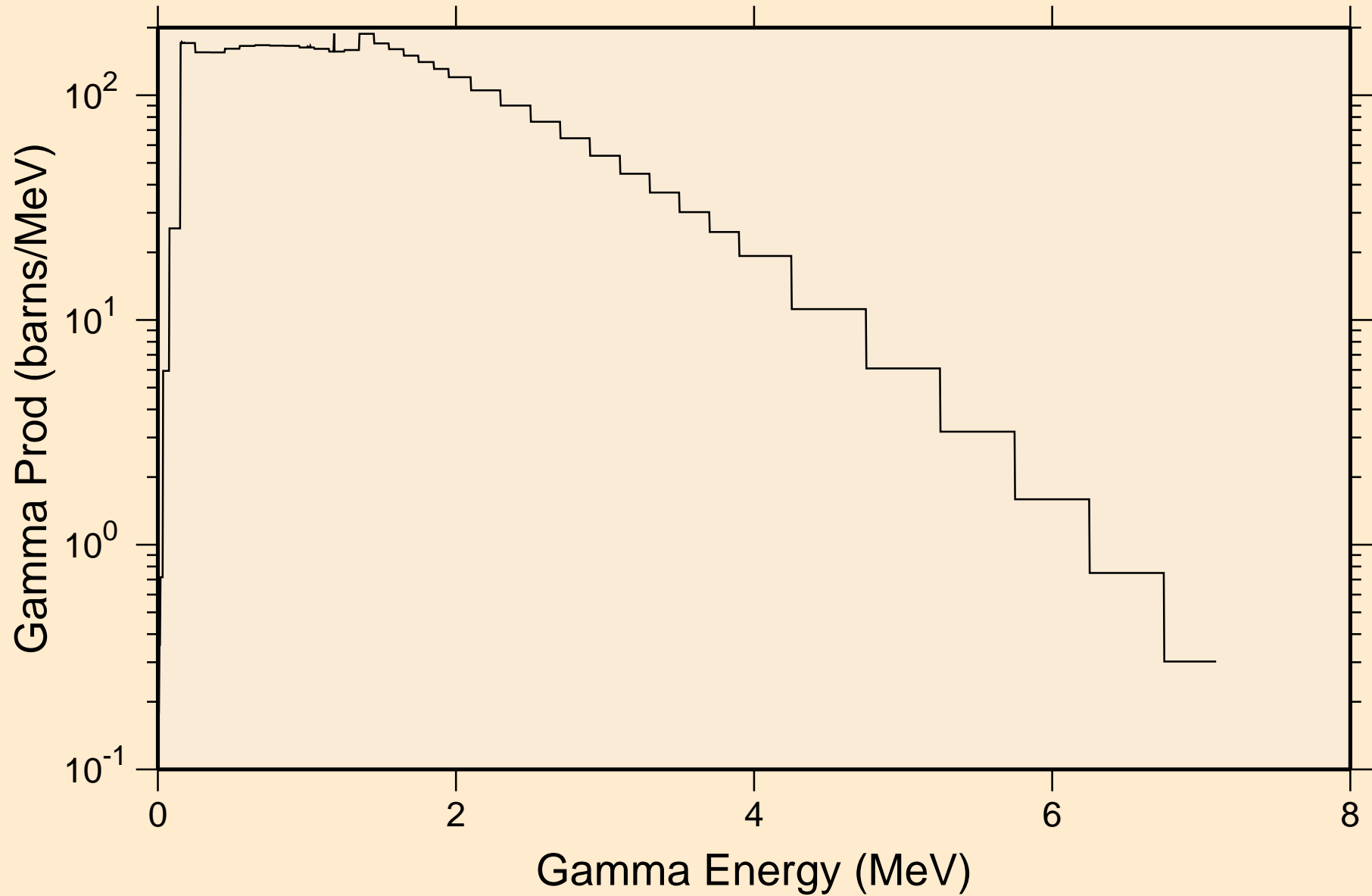

IN120N NRG TENDL-2015, AKONING
14 MeV photon spectrum

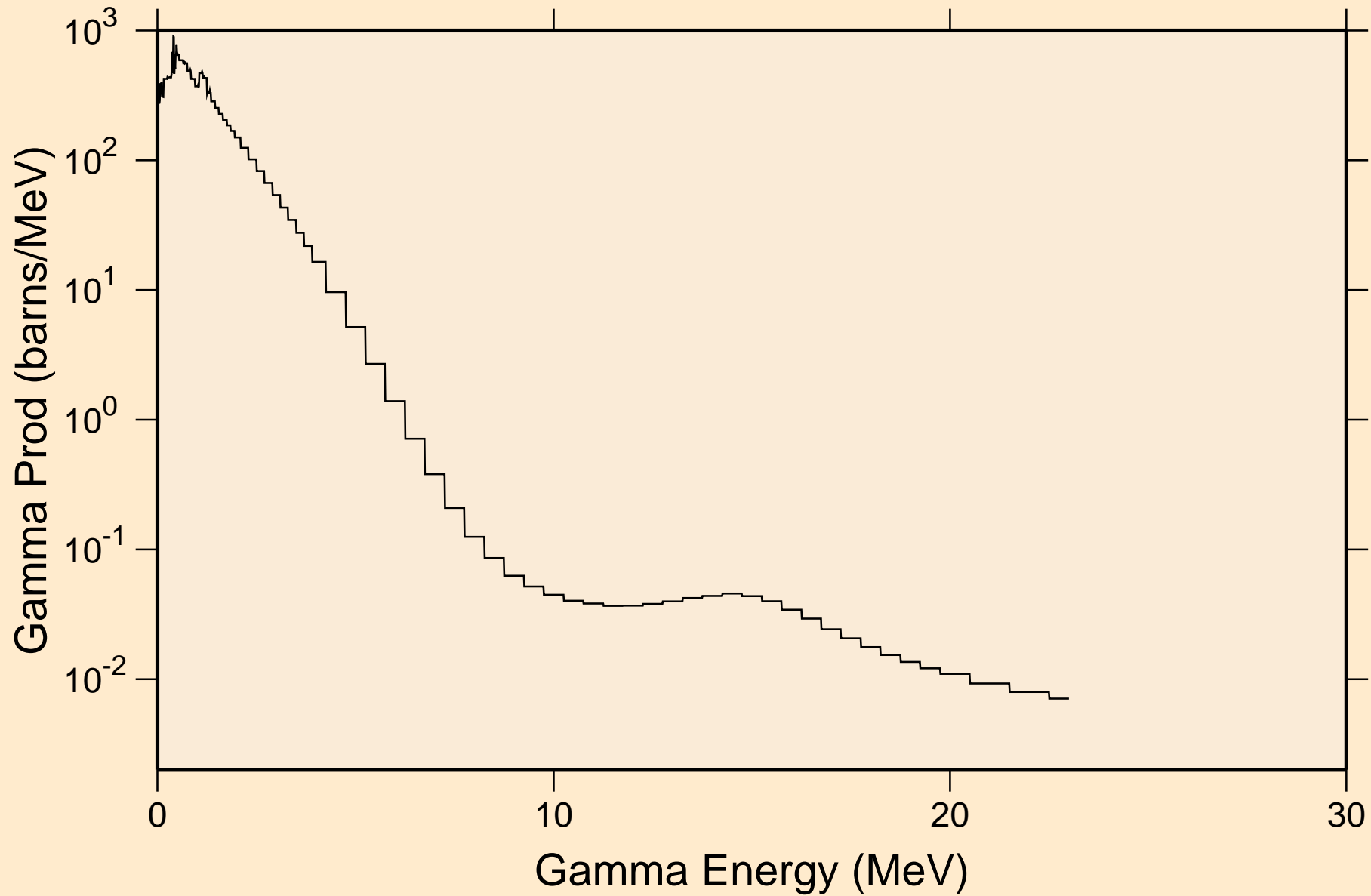

IN120N NRG TENDL-2015, AKONING

Particle heating contributions

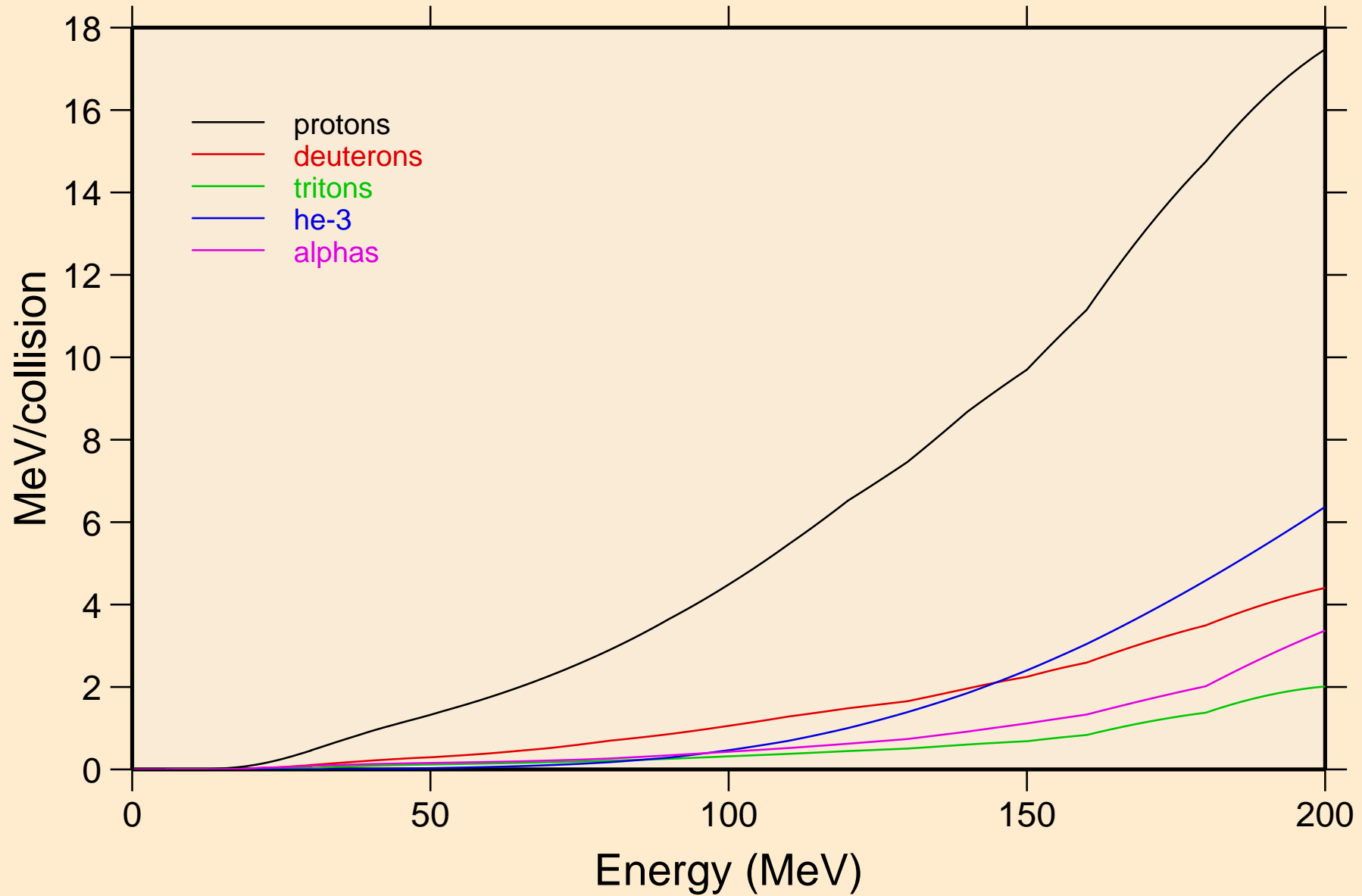

IN120N NRG TENDL-2015, AKONING

Recoil Heating

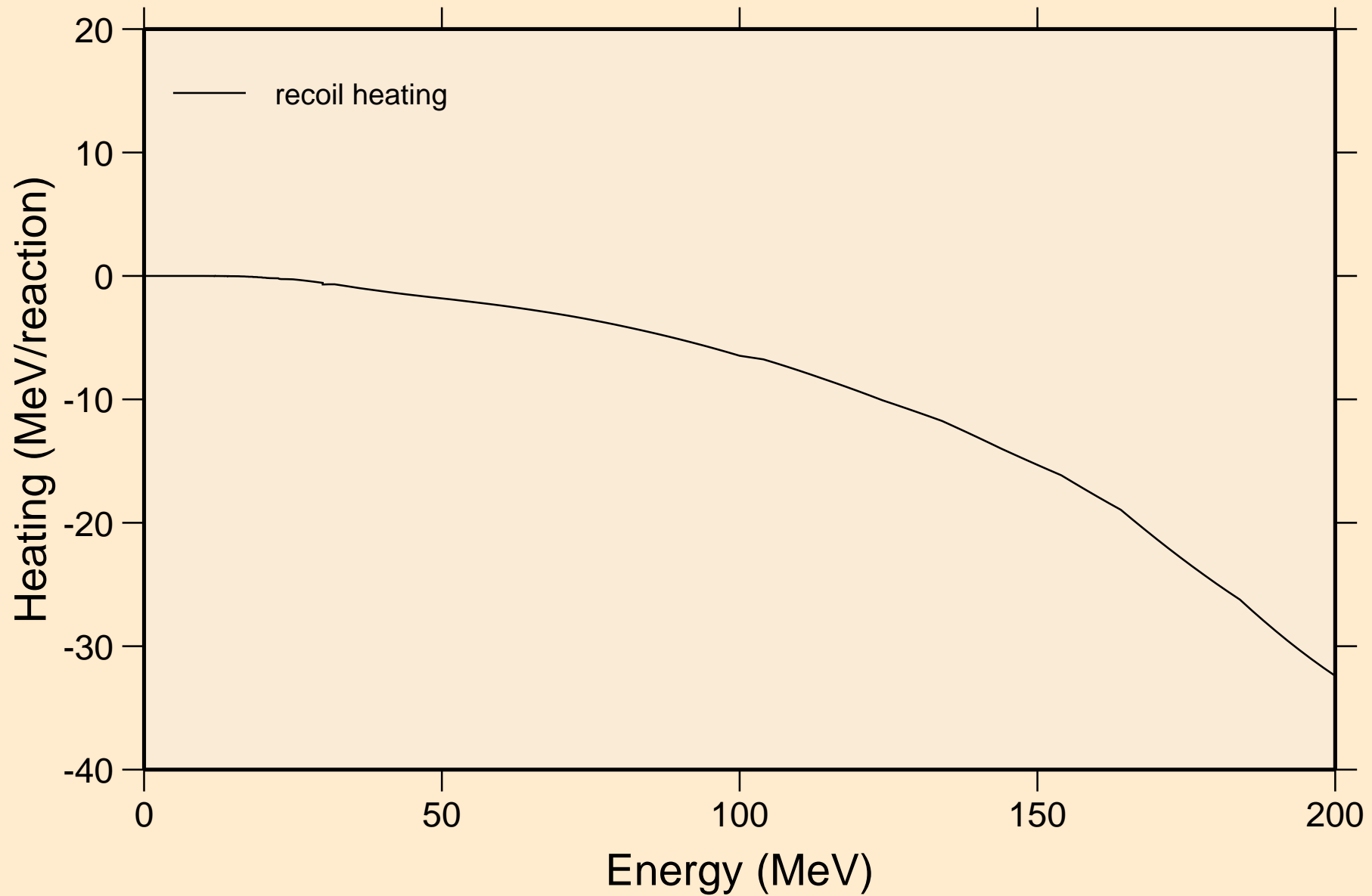

IN120N NRG TENDL-2015, AKONING

Particle production cross sections

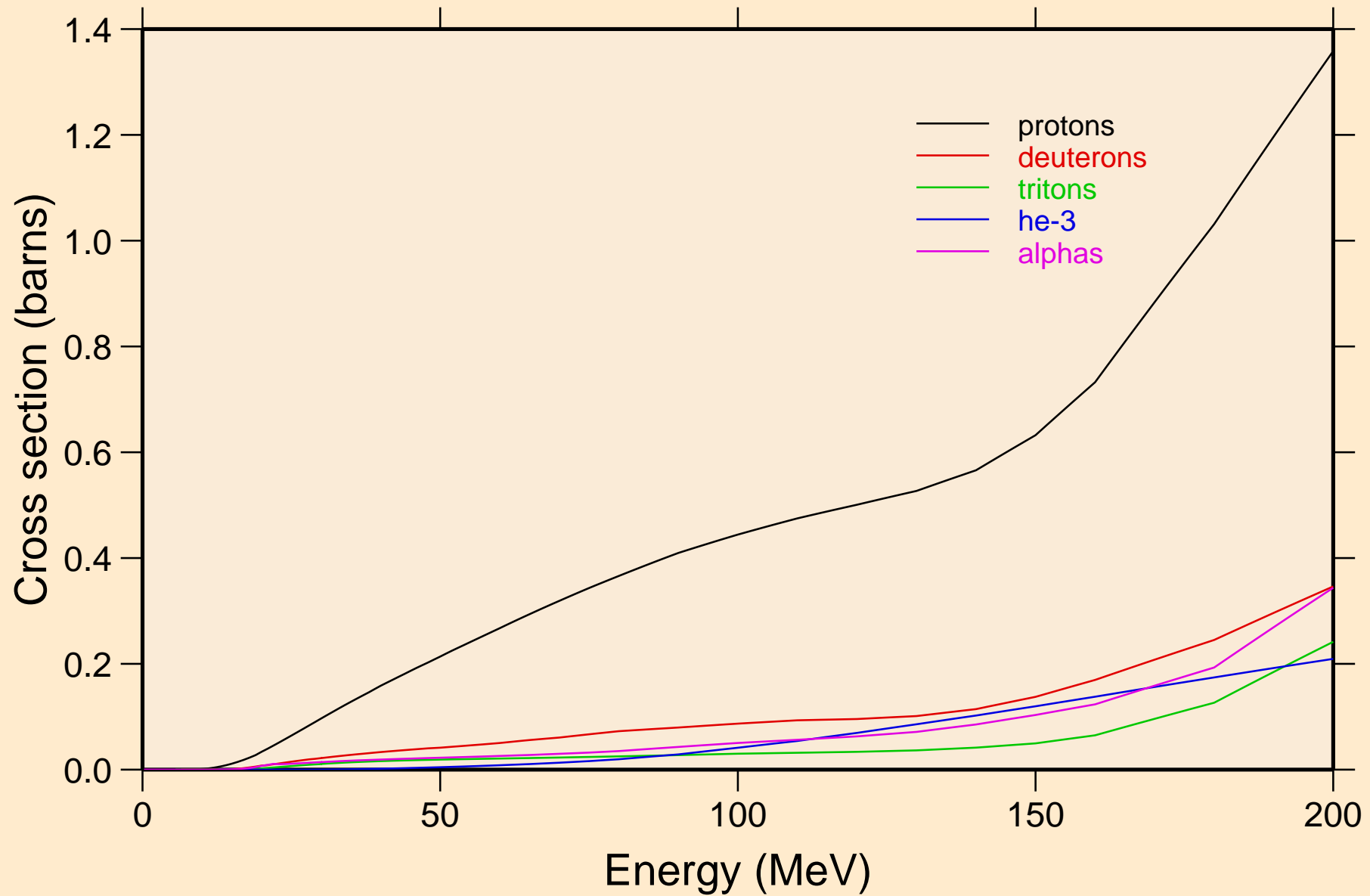

IN120N NRG TENDL-2015, AKONING
protons from (n,x)

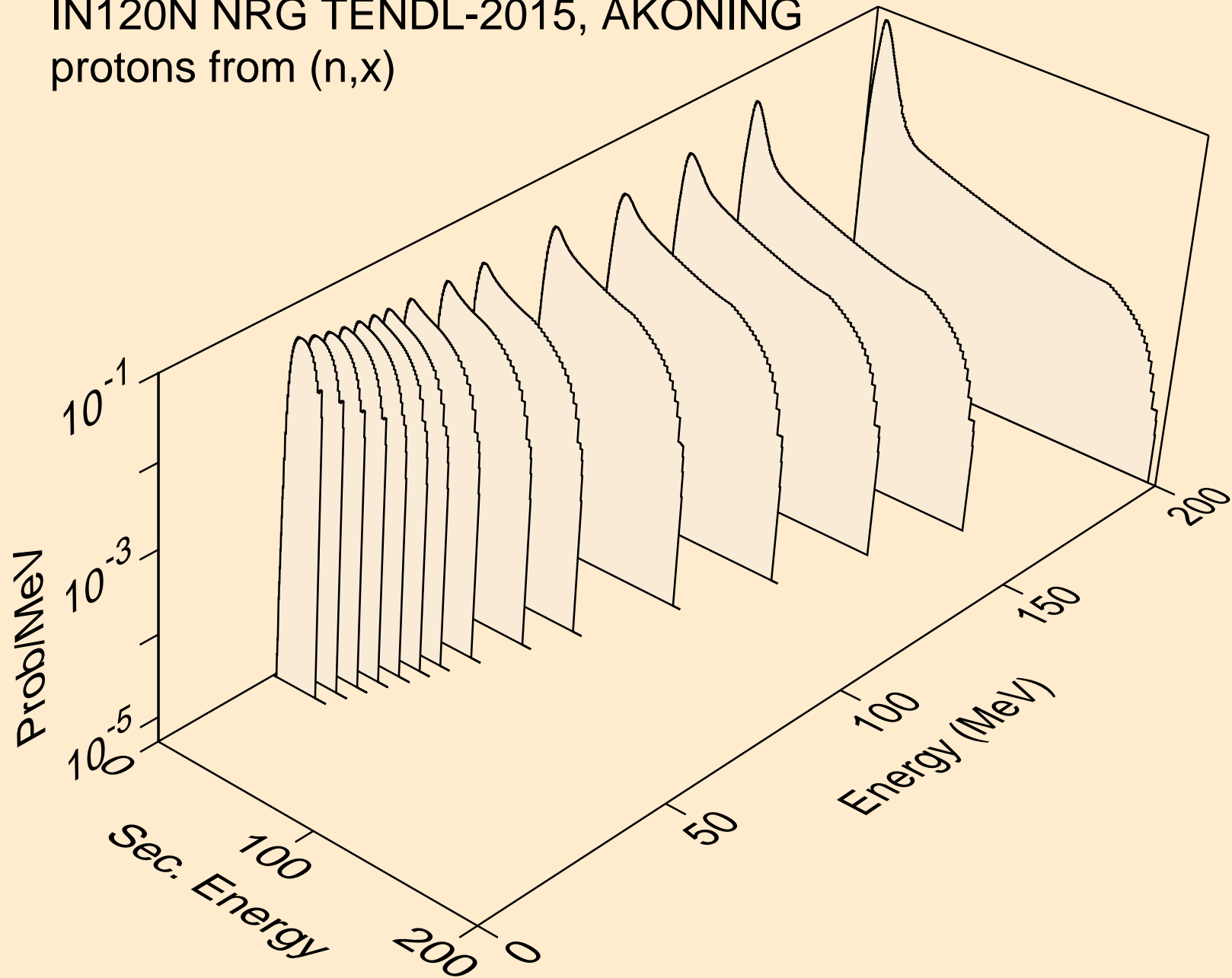

IN120N NRG TENDL-2015, AKONING
protons from (n,n*)p

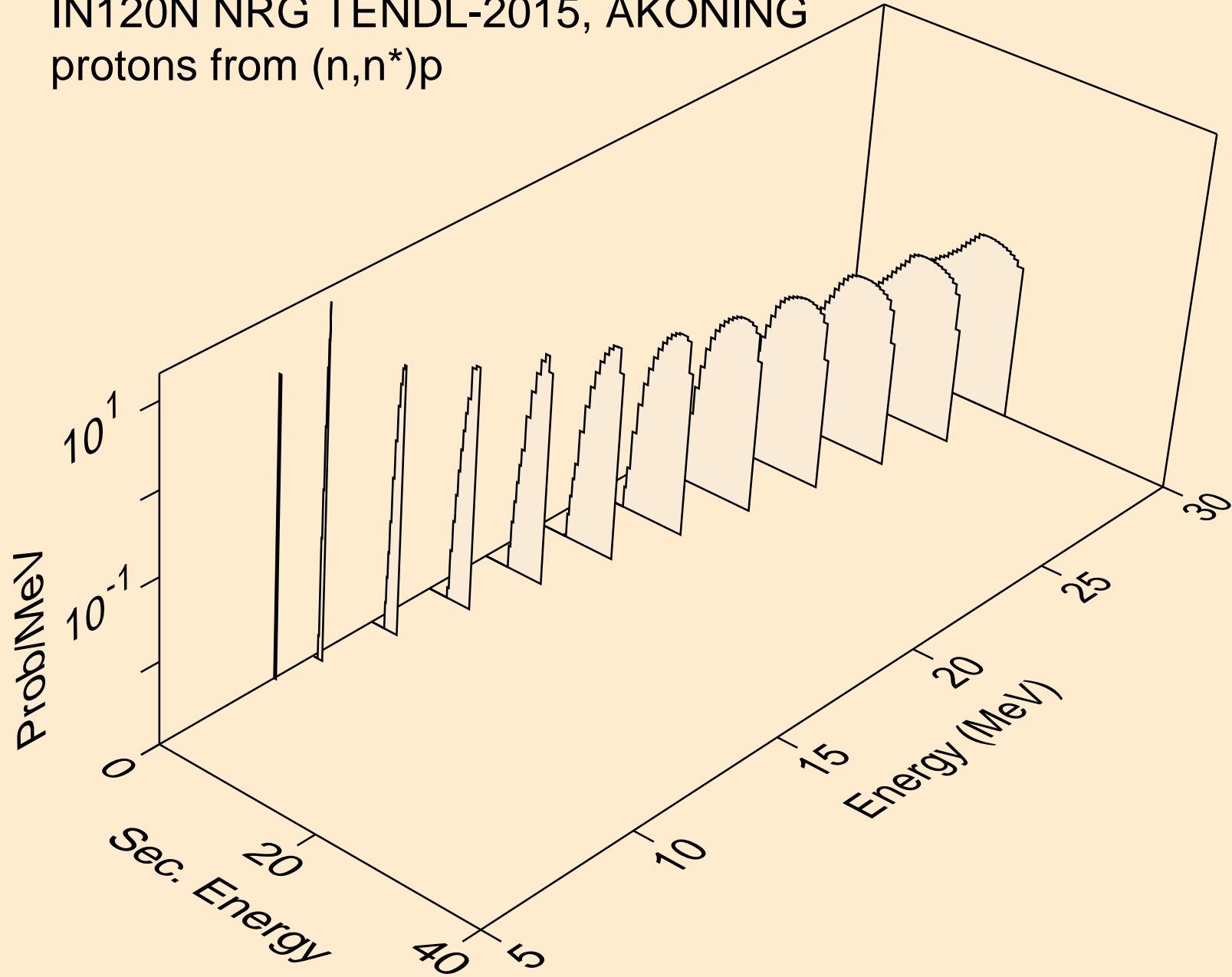

IN120N NRG TENDL-2015, AKONING
protons from (n,2np)

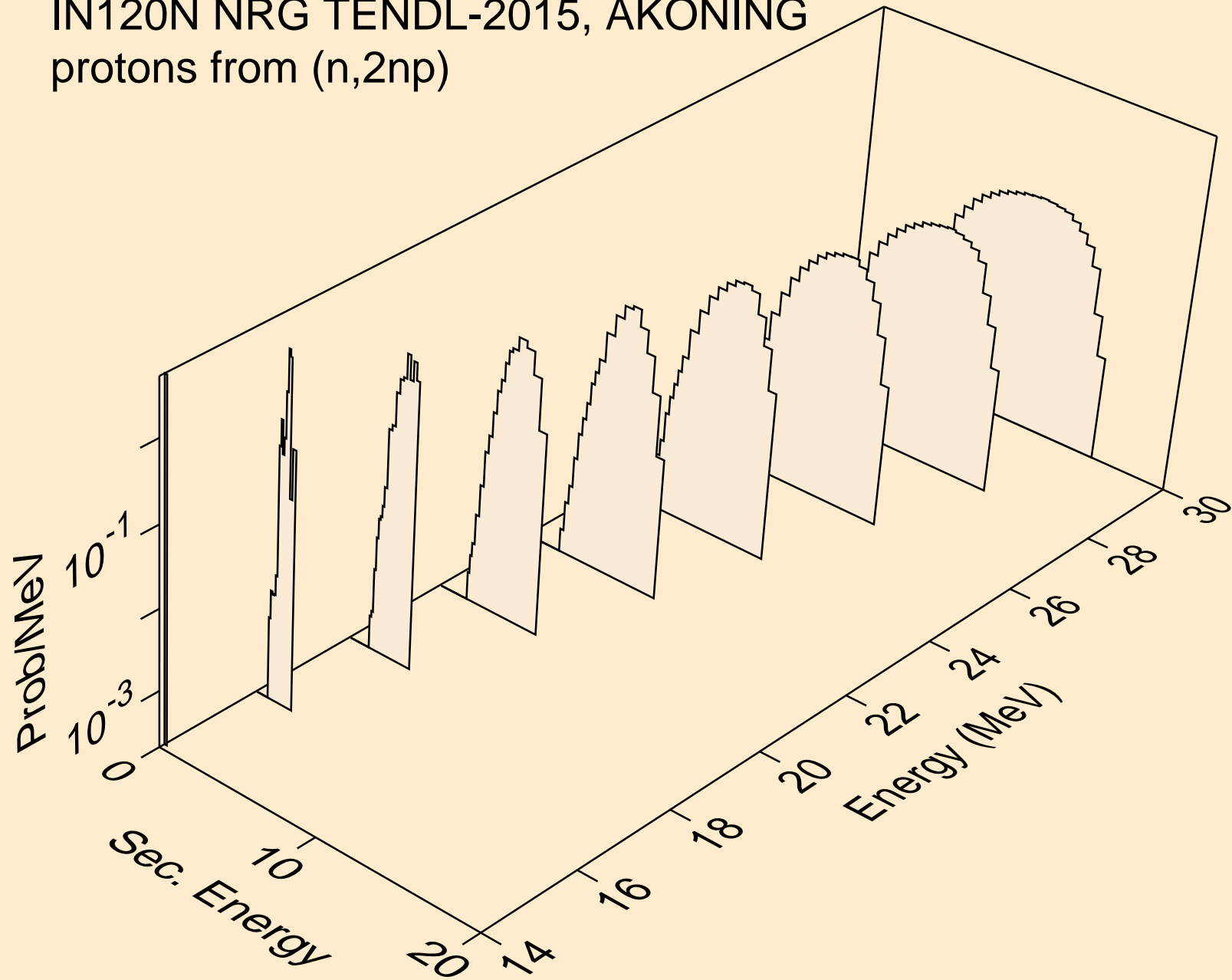

IN120N NRG TENDL-2015, AKONING
protons from (n,3np)

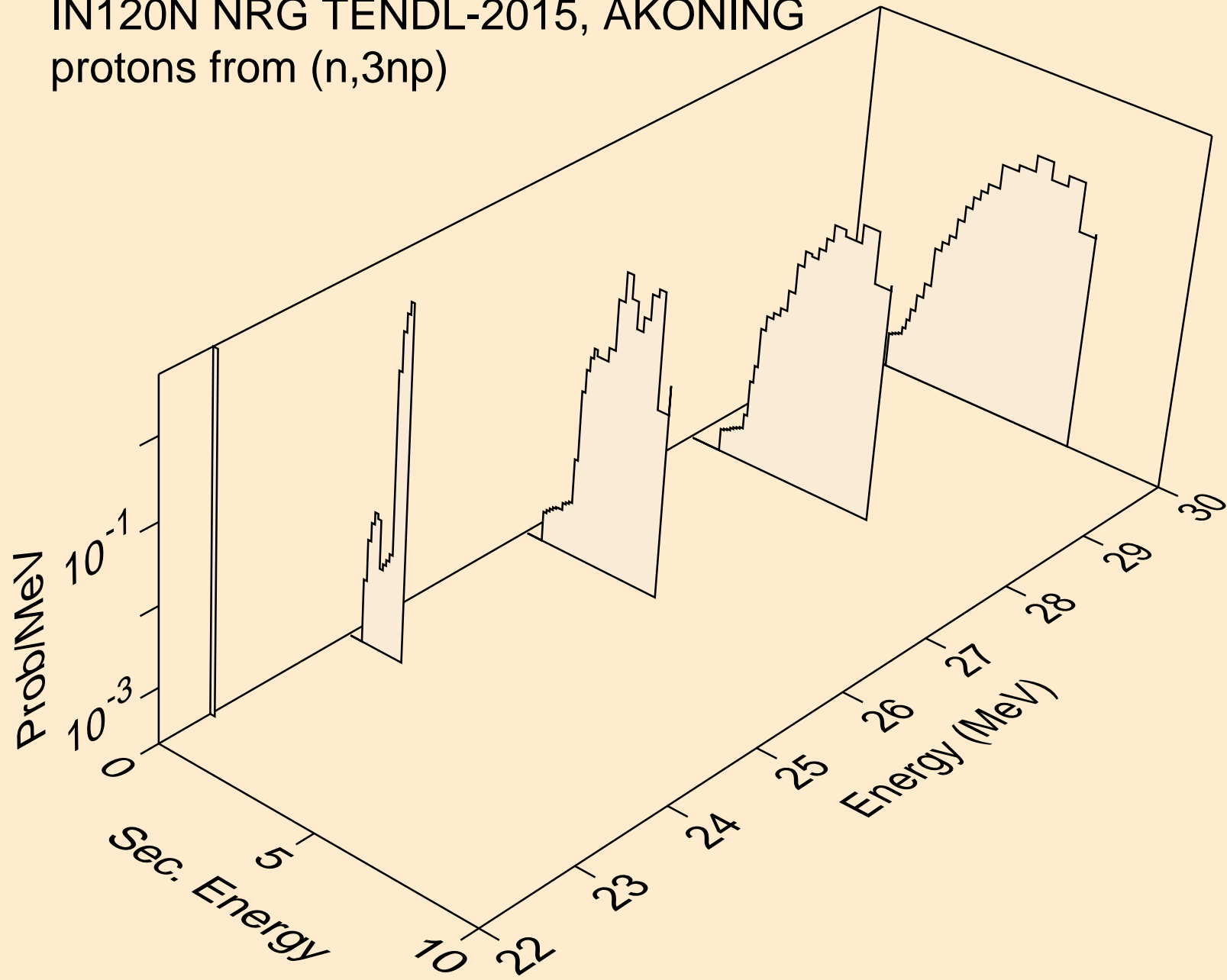

IN120N NRG TENDL-2015, AKONING
protons from (n,2np)

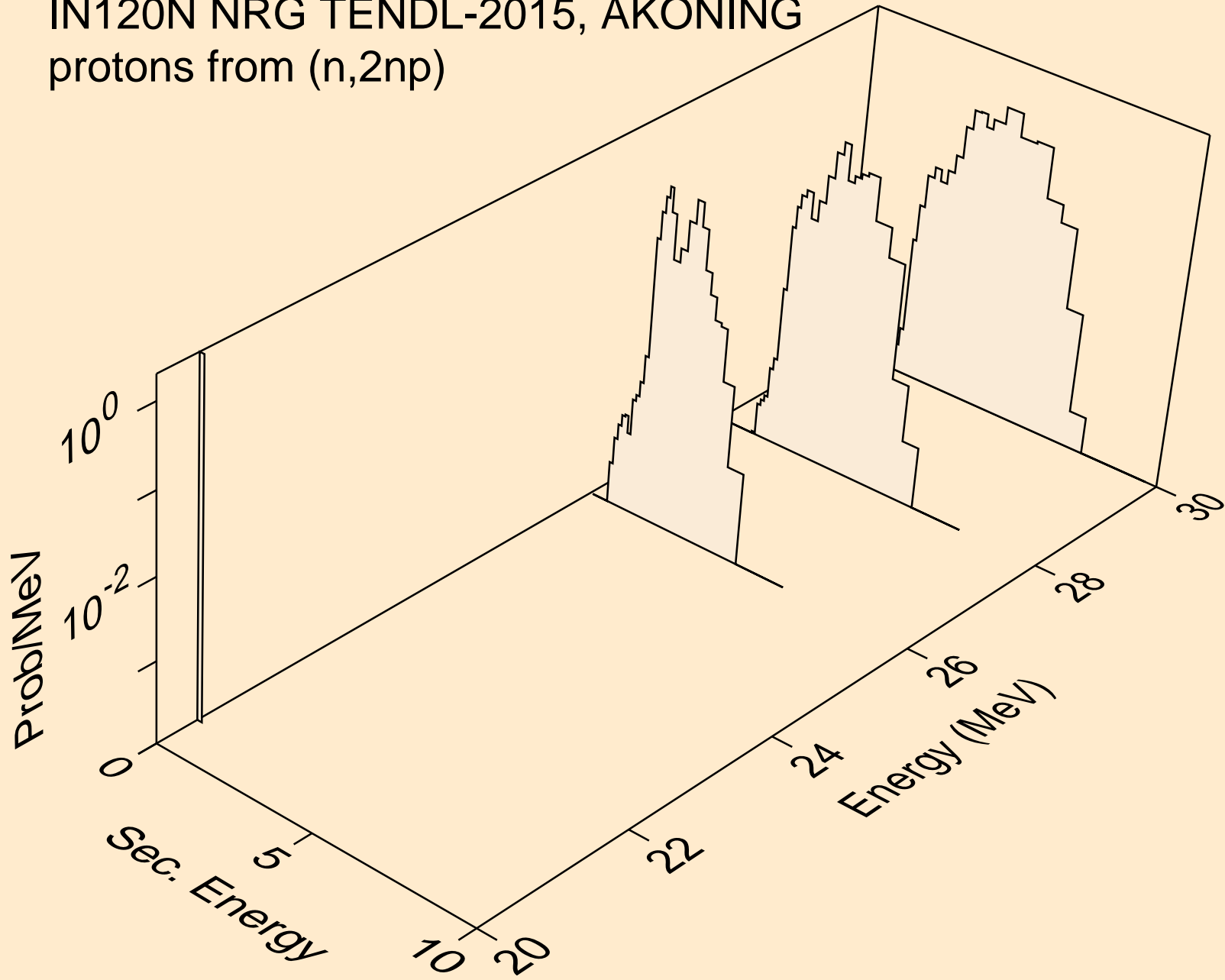

IN120N NRG TENDL-2015, AKONING
protons from (n,p)

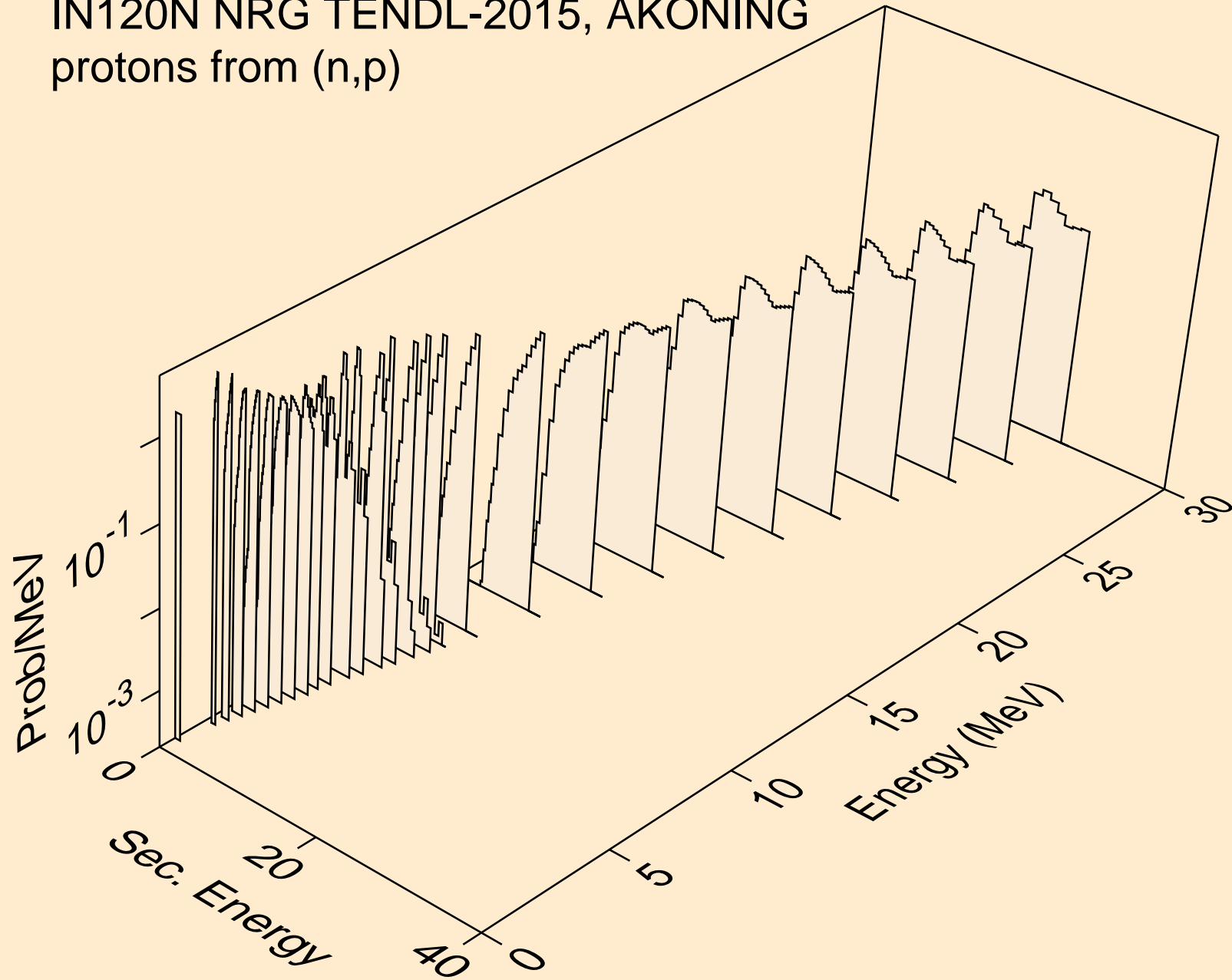

IN120N NRG TENDL-2015, AKONING
protons from (n,2p)

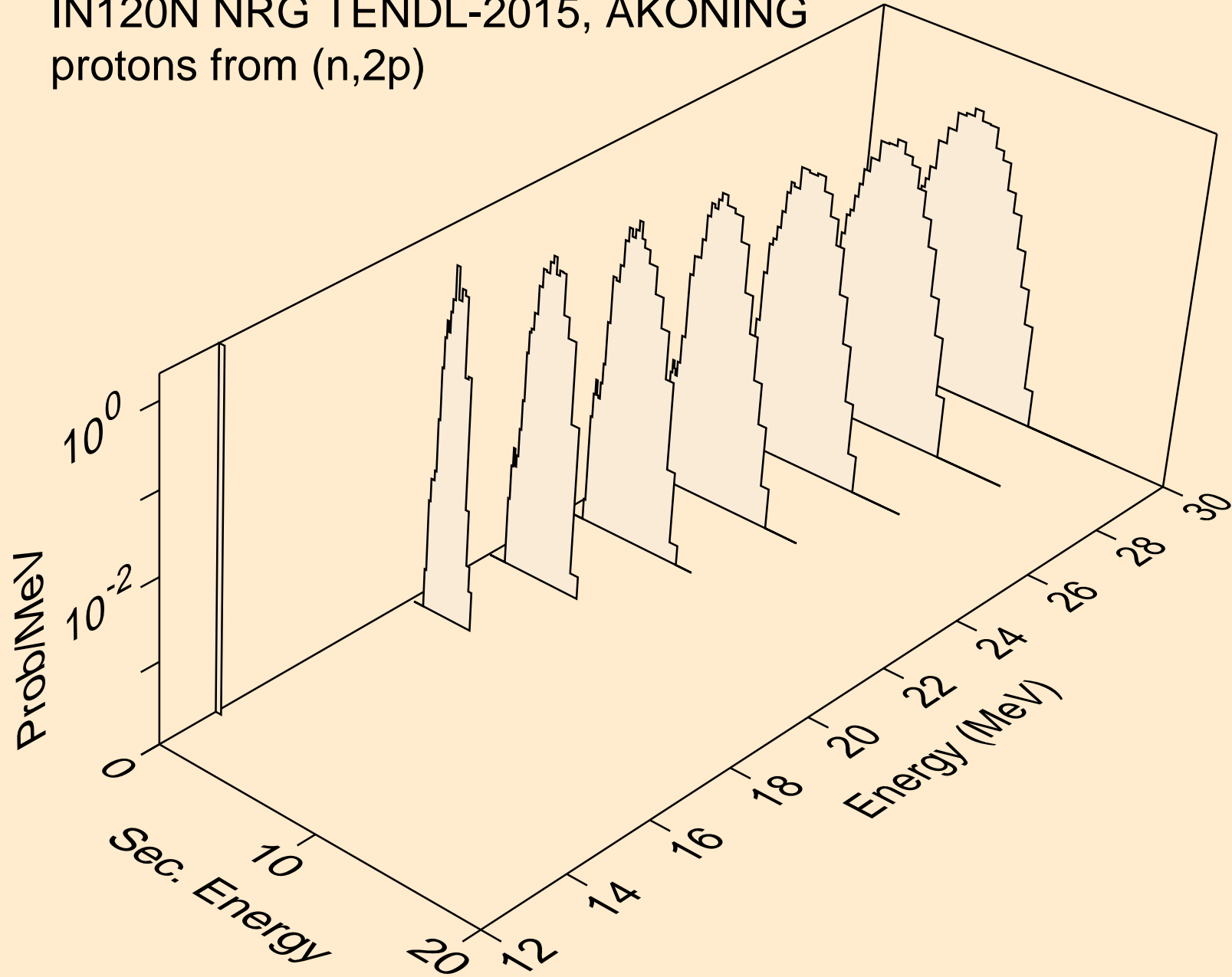

IN120N NRG TENDL-2015, AKONING
protons from (n,pa)

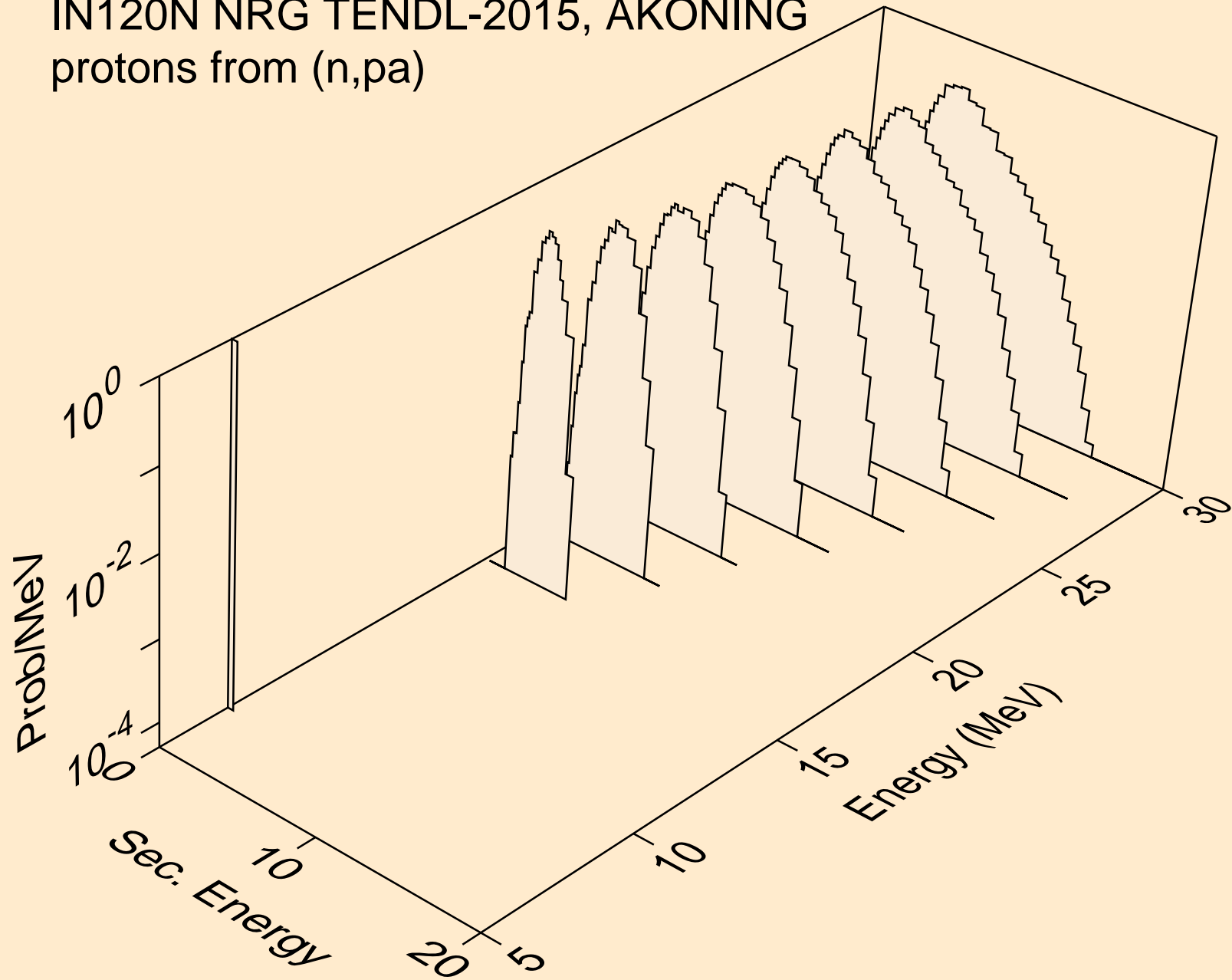

IN120N NRG TENDL-2015, AKONING
deuterons from (n,x)

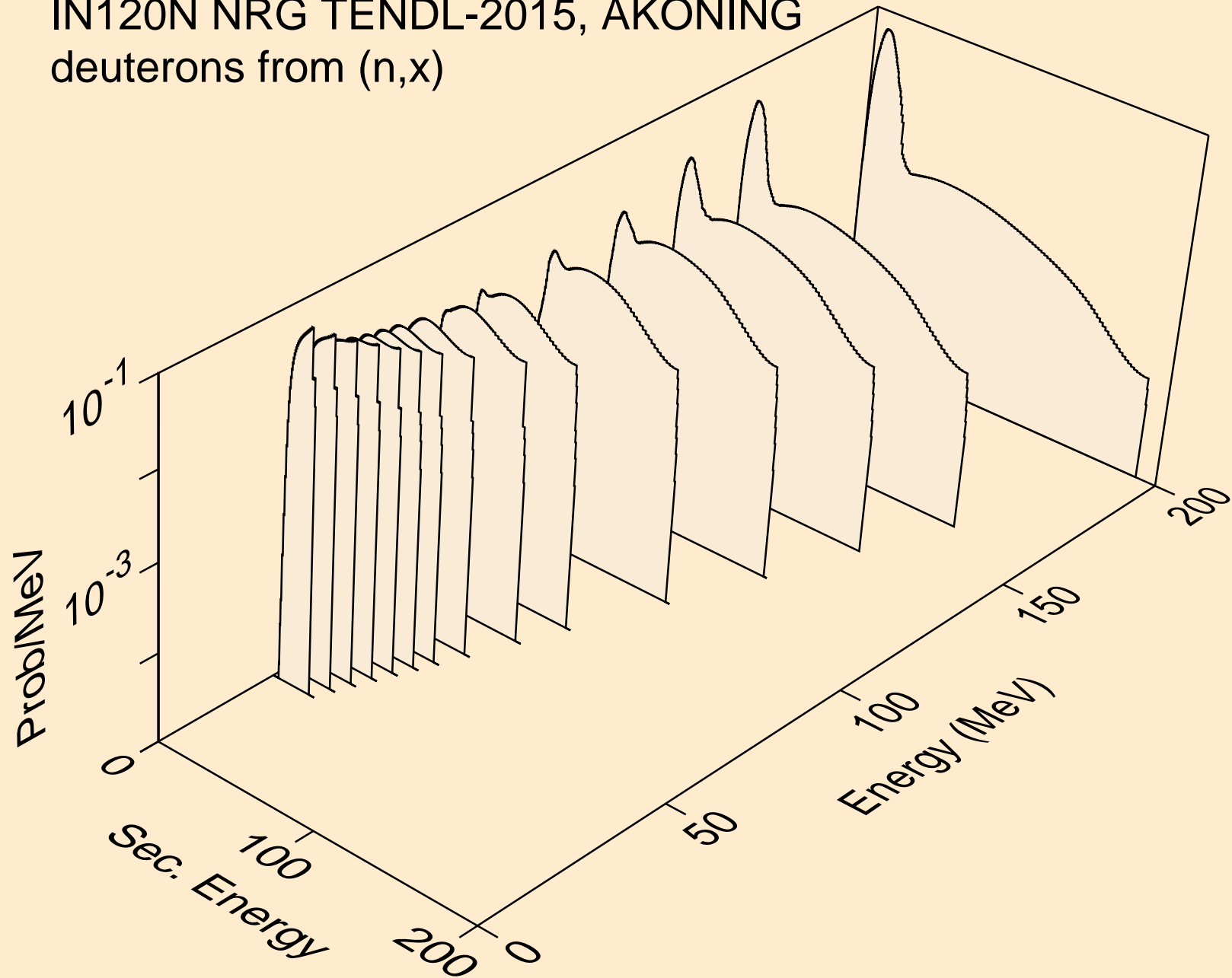

IN120N NRG TENDL-2015, AKONING
deuterons from (n,2nd)

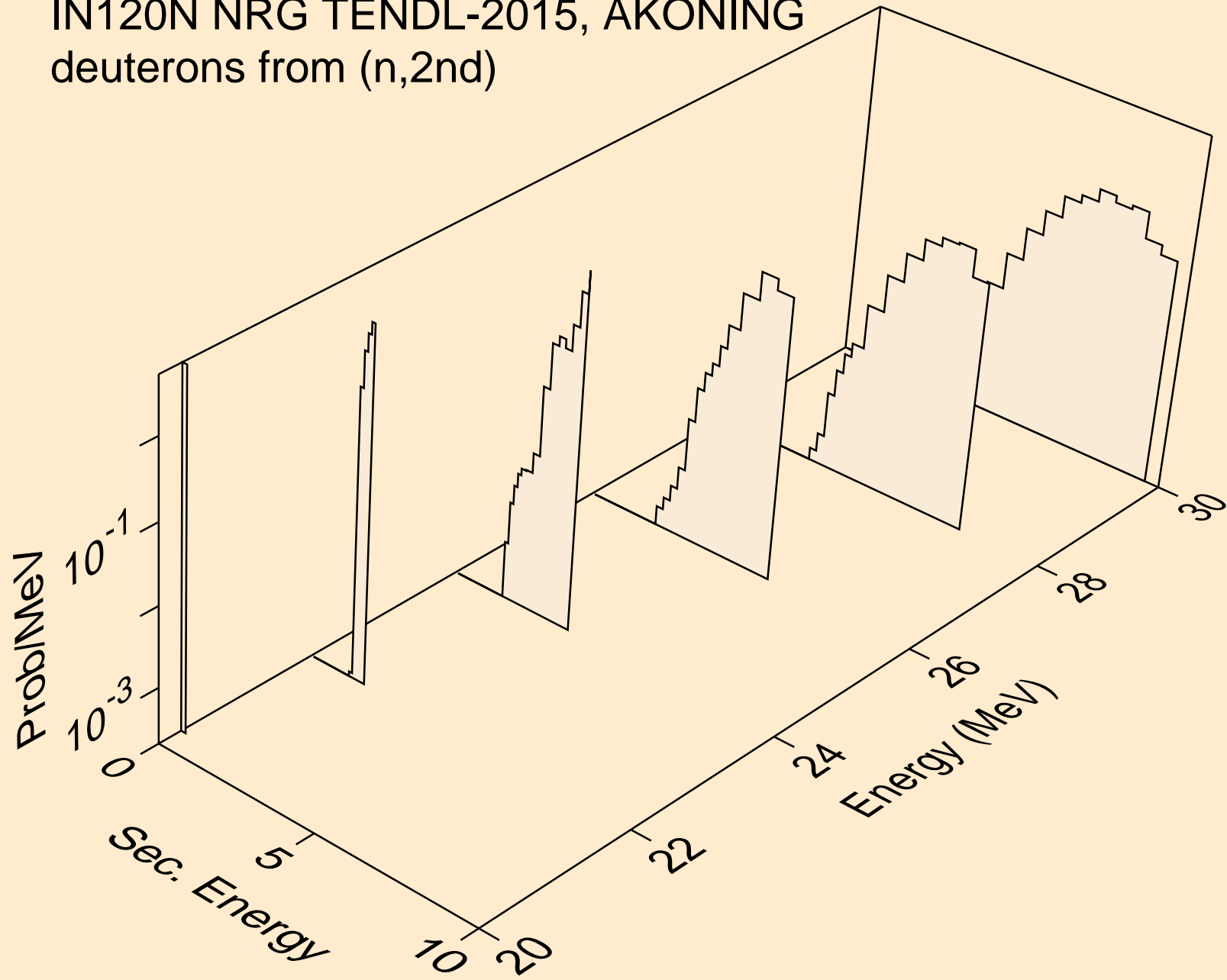

IN120N NRG TENDL-2015, AKONING
deuterons from (n,n*)d

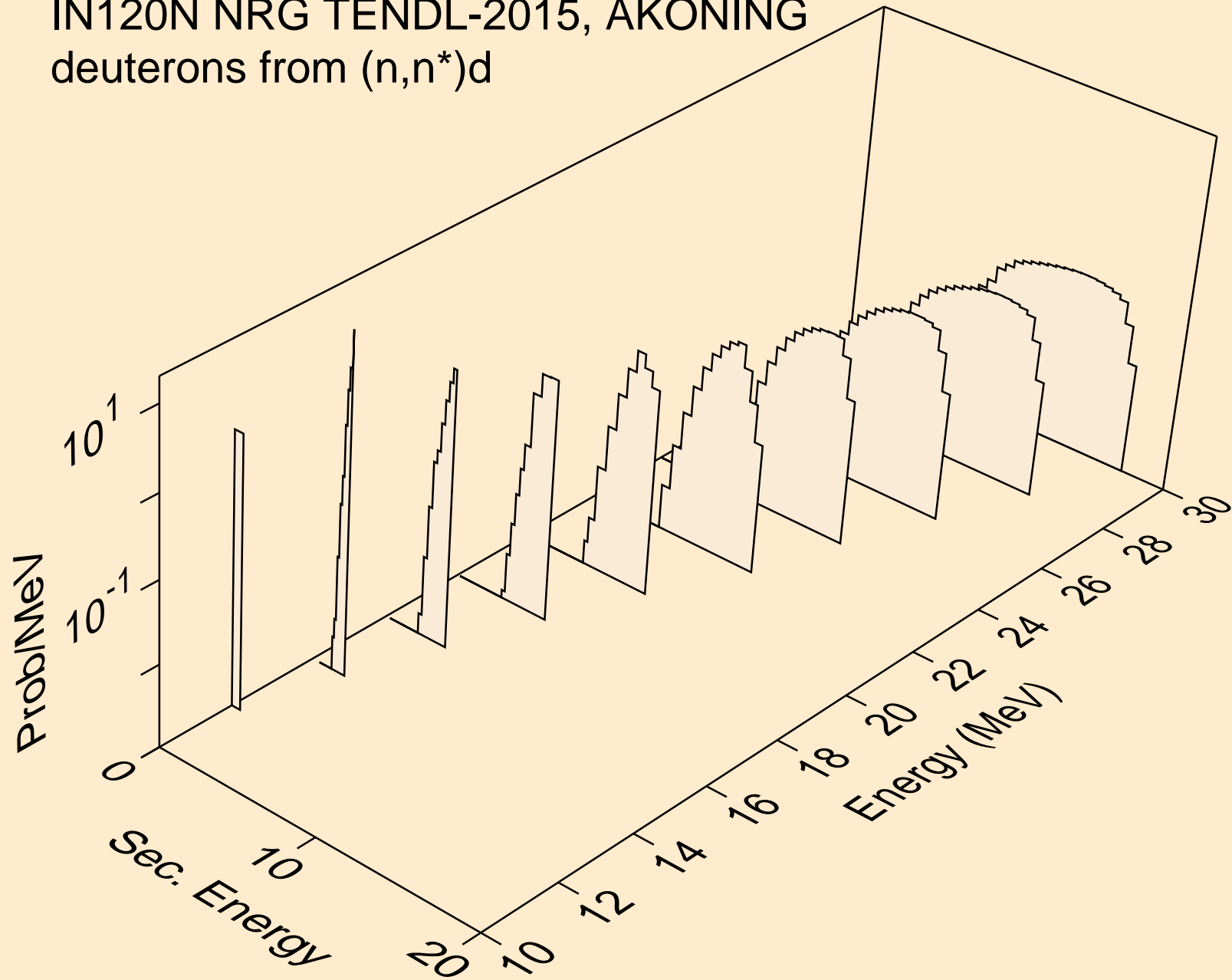

IN120N NRG TENDL-2015, AKONING
deuterons from (n,d)

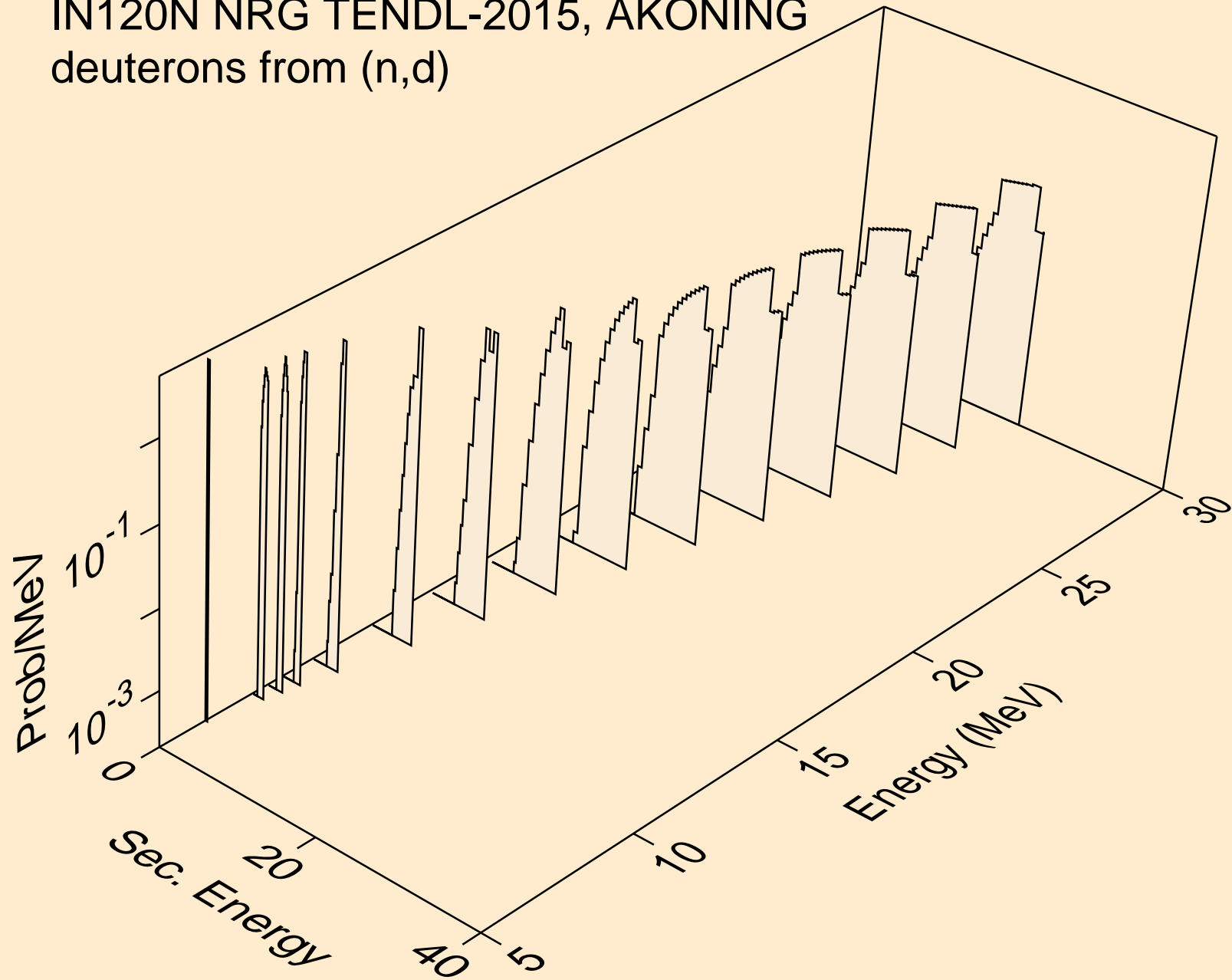

IN120N NRG TENDL-2015, AKONING
tritons from (n,x)

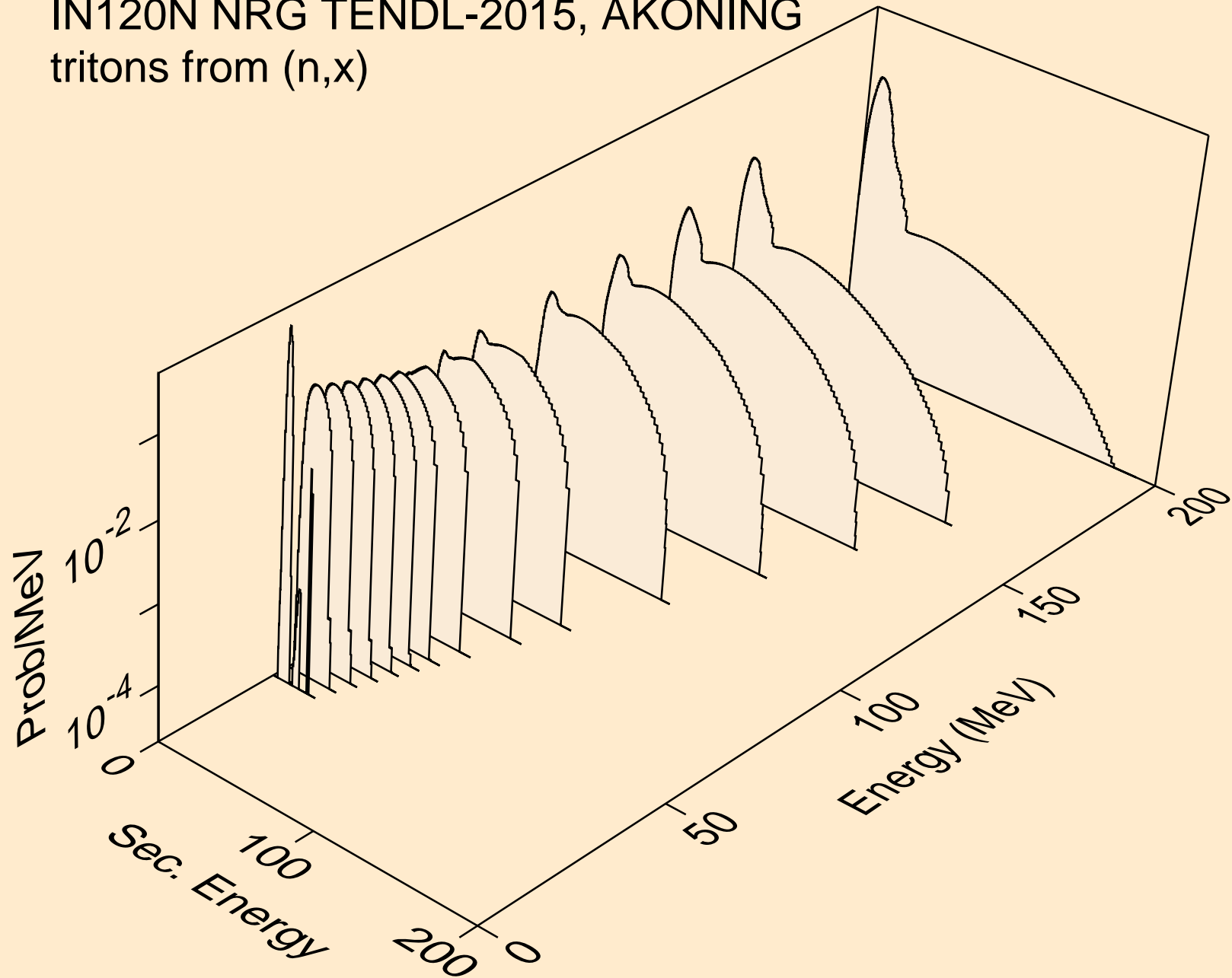

IN120N NRG TENDL-2015, AKONING
tritons from (n,n*)t

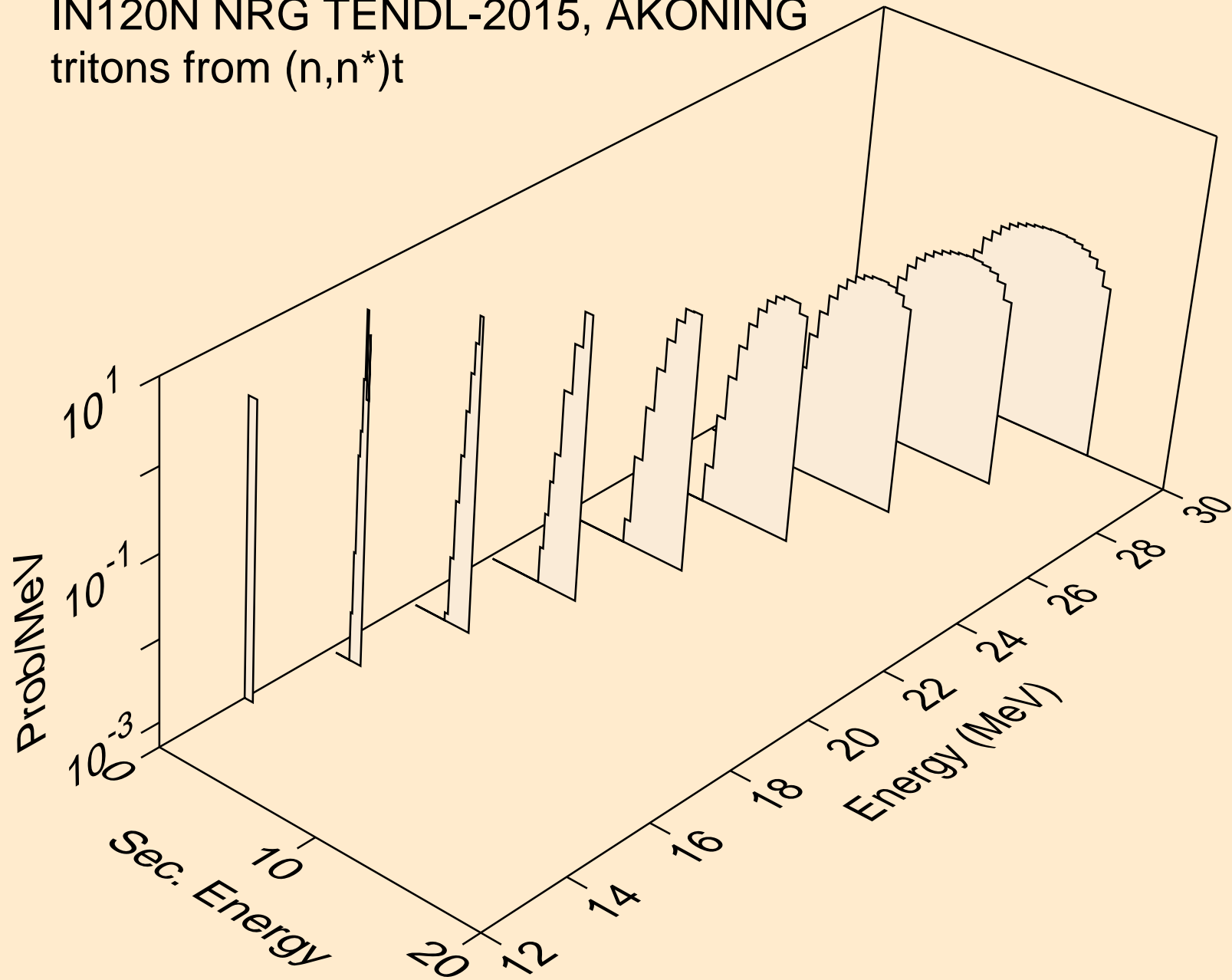

IN120N NRG TENDL-2015, AKONING
tritons from (n,t)

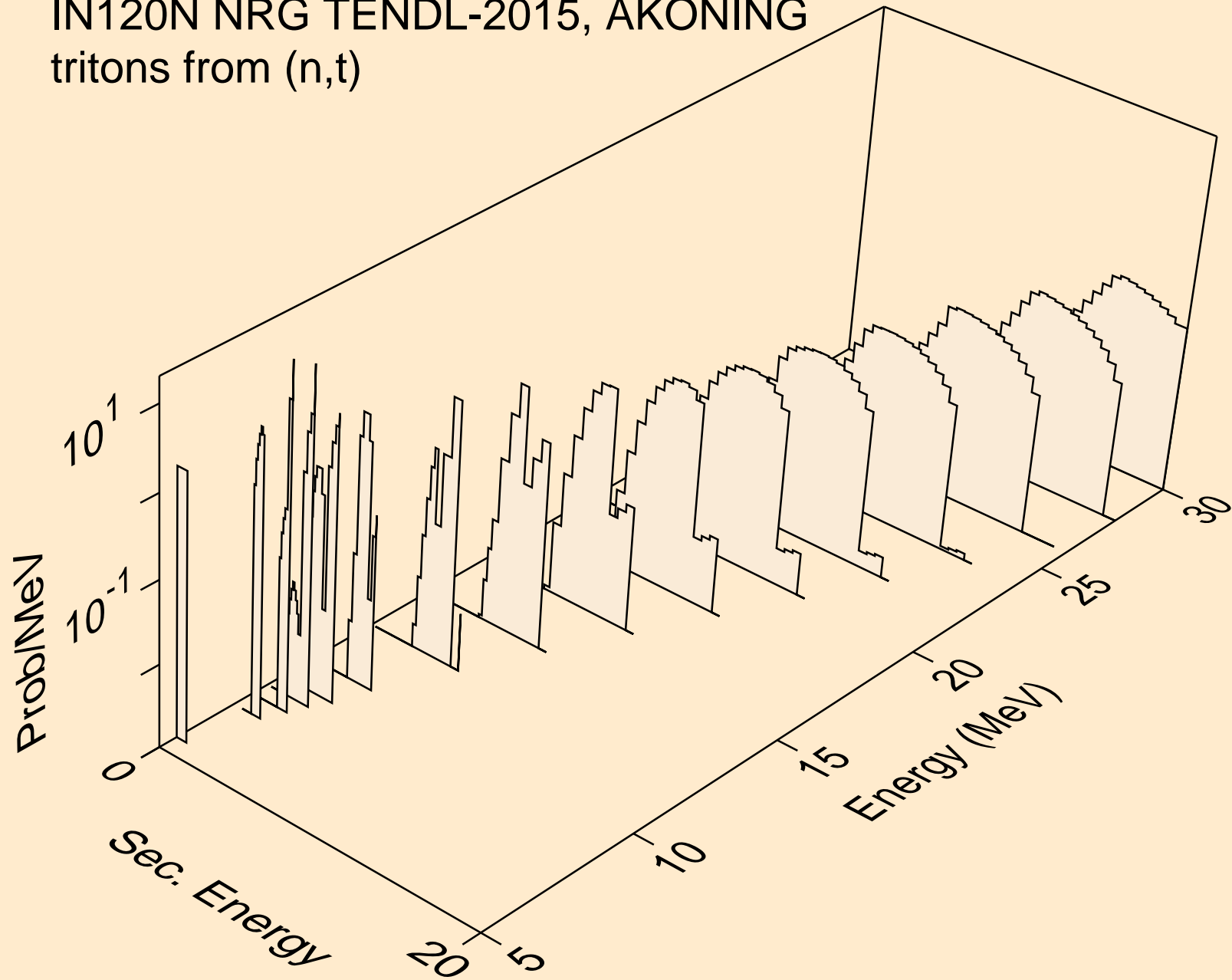

IN120N NRG TENDL-2015, AKONING
he3s from (n,x)

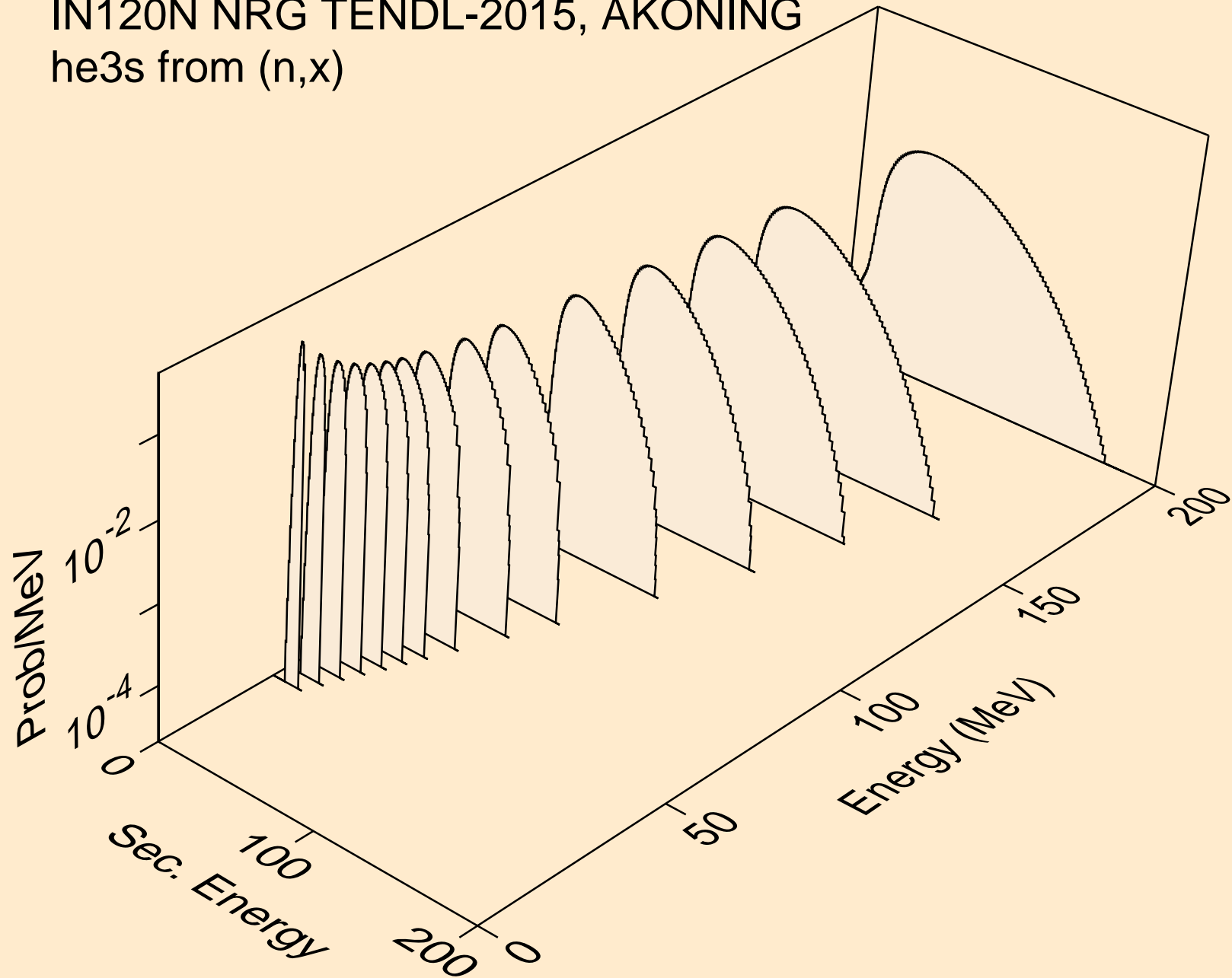

IN120N NRG TENDL-2015, AKONING
he3s from (n,n*)he3

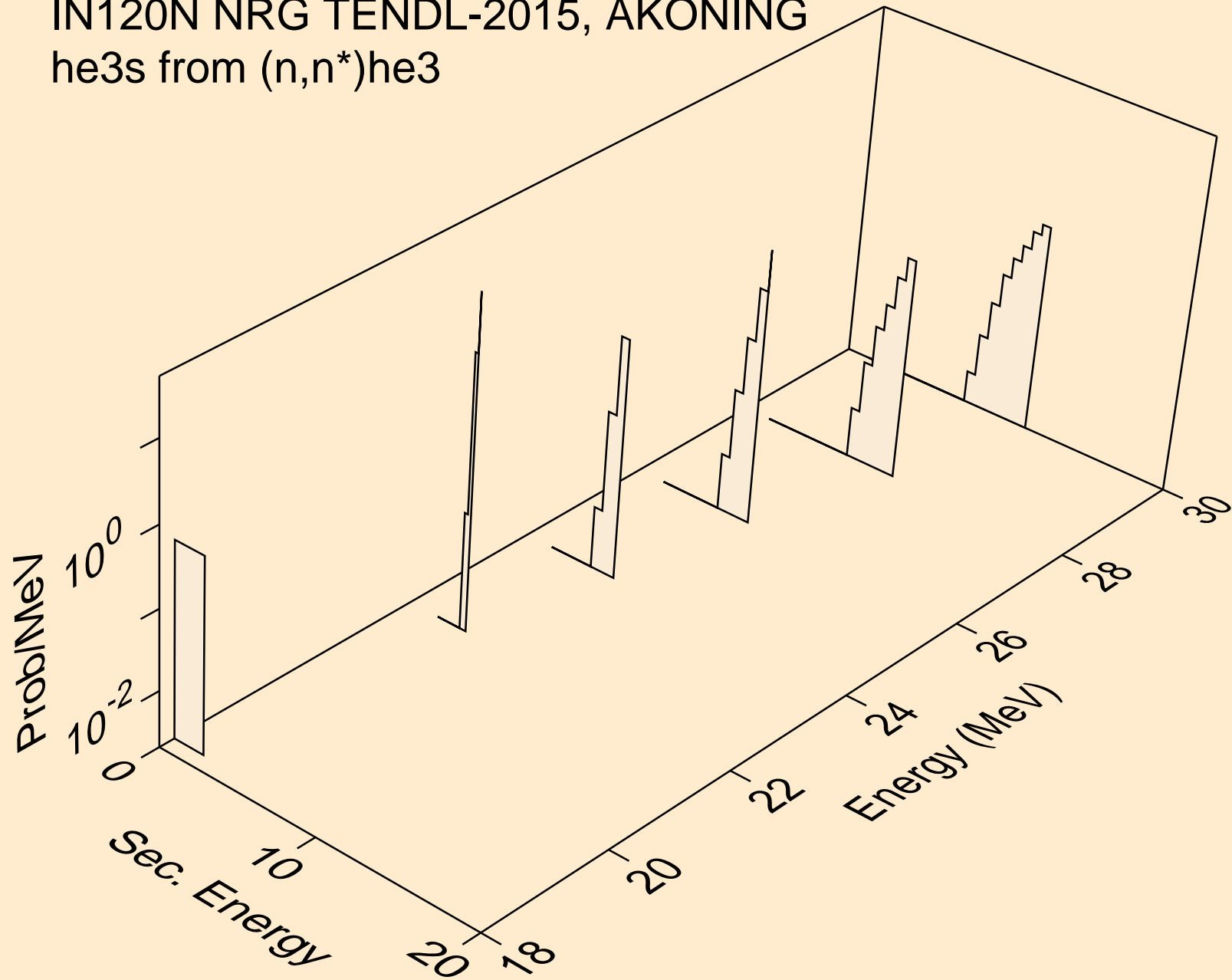

IN120N NRG TENDL-2015, AKONING
he3s from (n,he3)

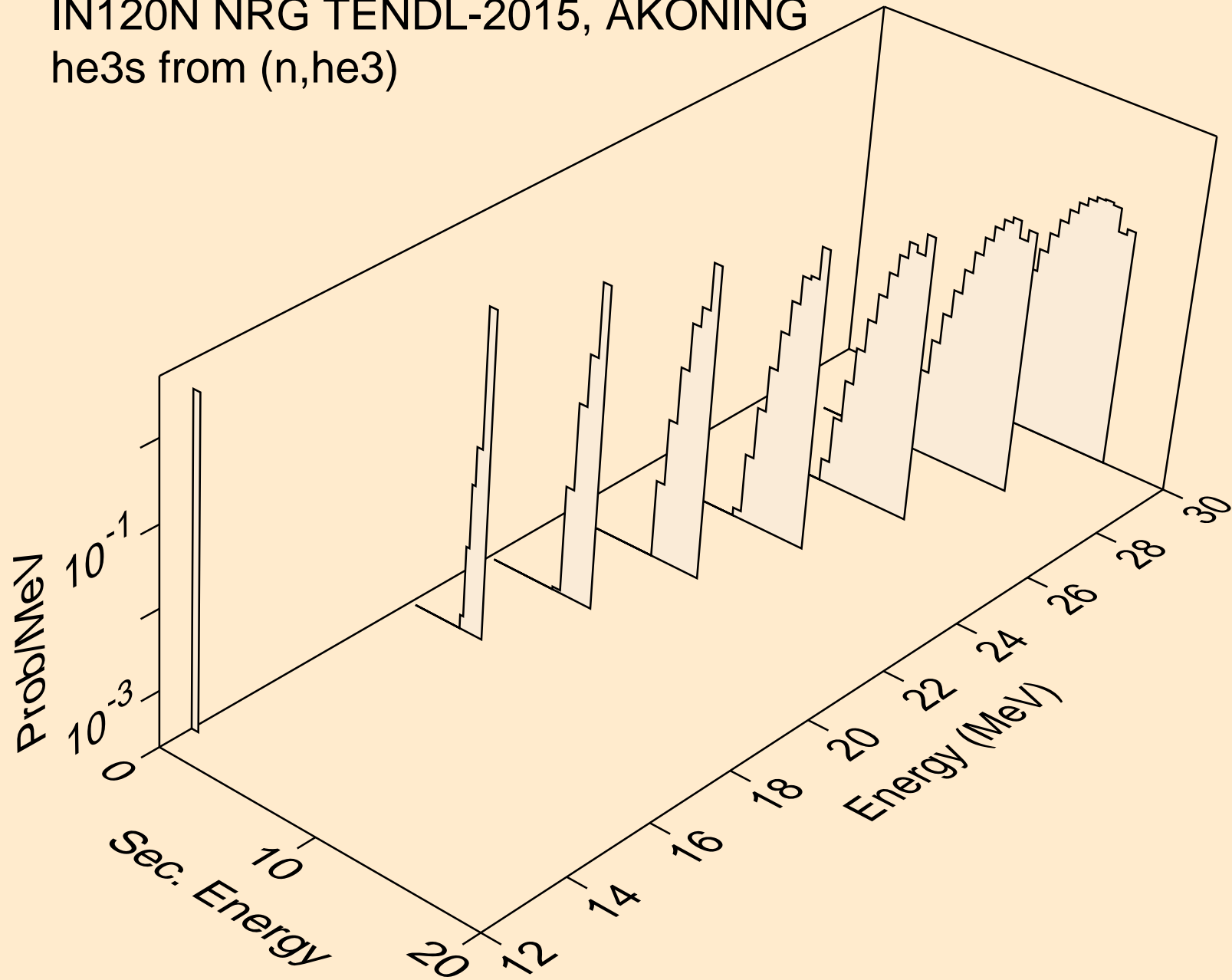

IN120N NRG TENDL-2015, AKONING
alphas from (n,x)

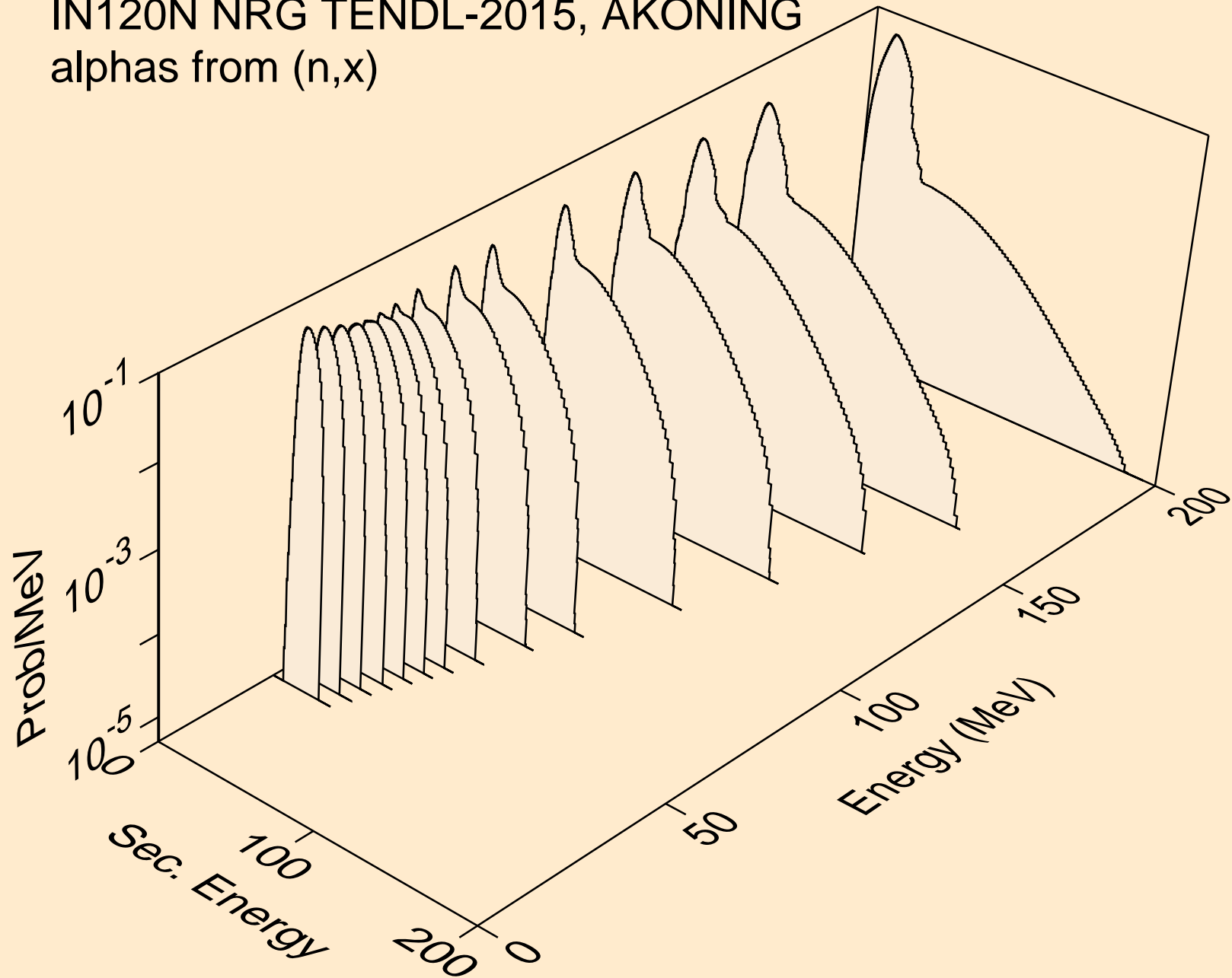

IN120N NRG TENDL-2015, AKONING
alphas from (n,n*)a

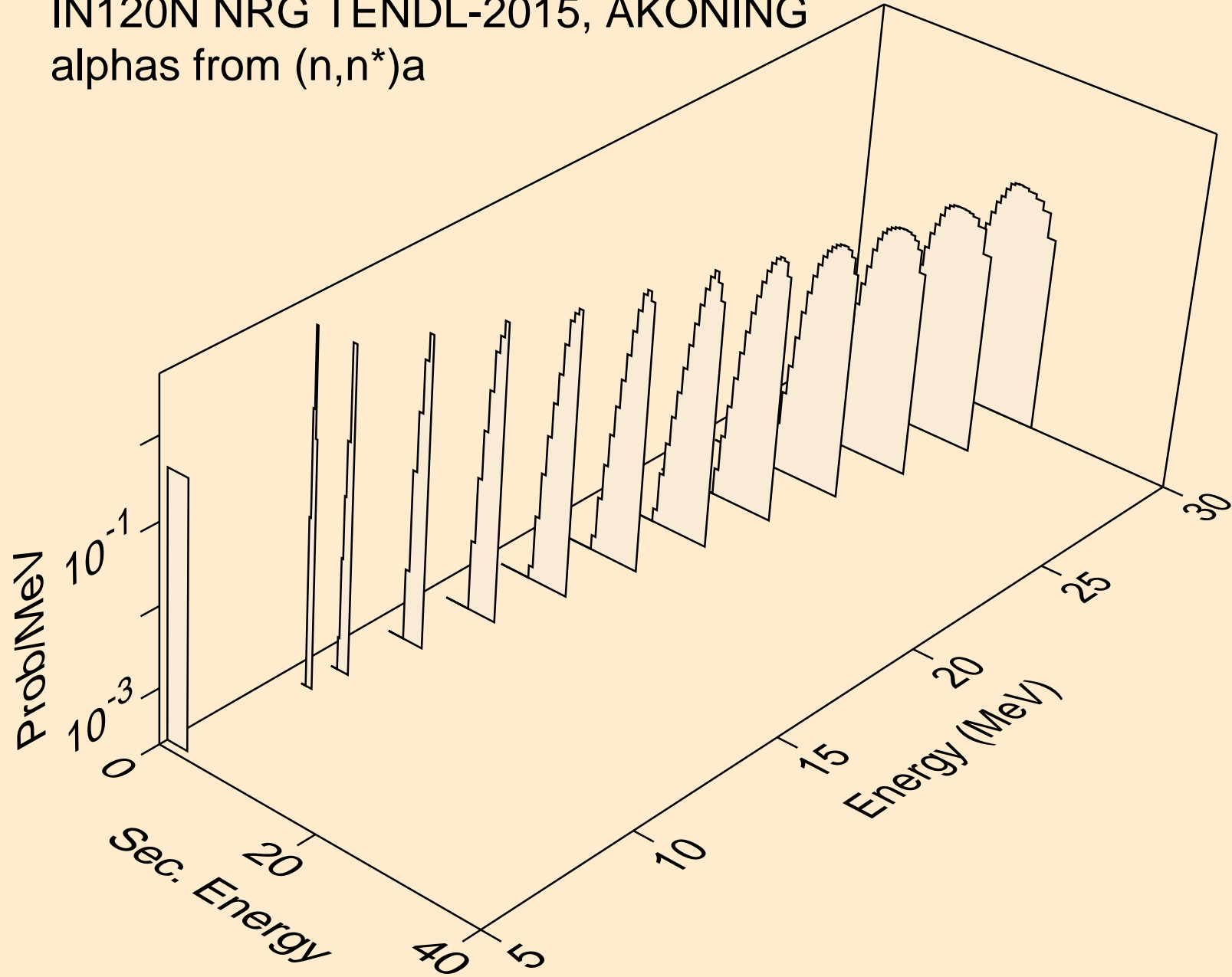

IN120N NRG TENDL-2015, AKONING
alphas from (n,2n)a

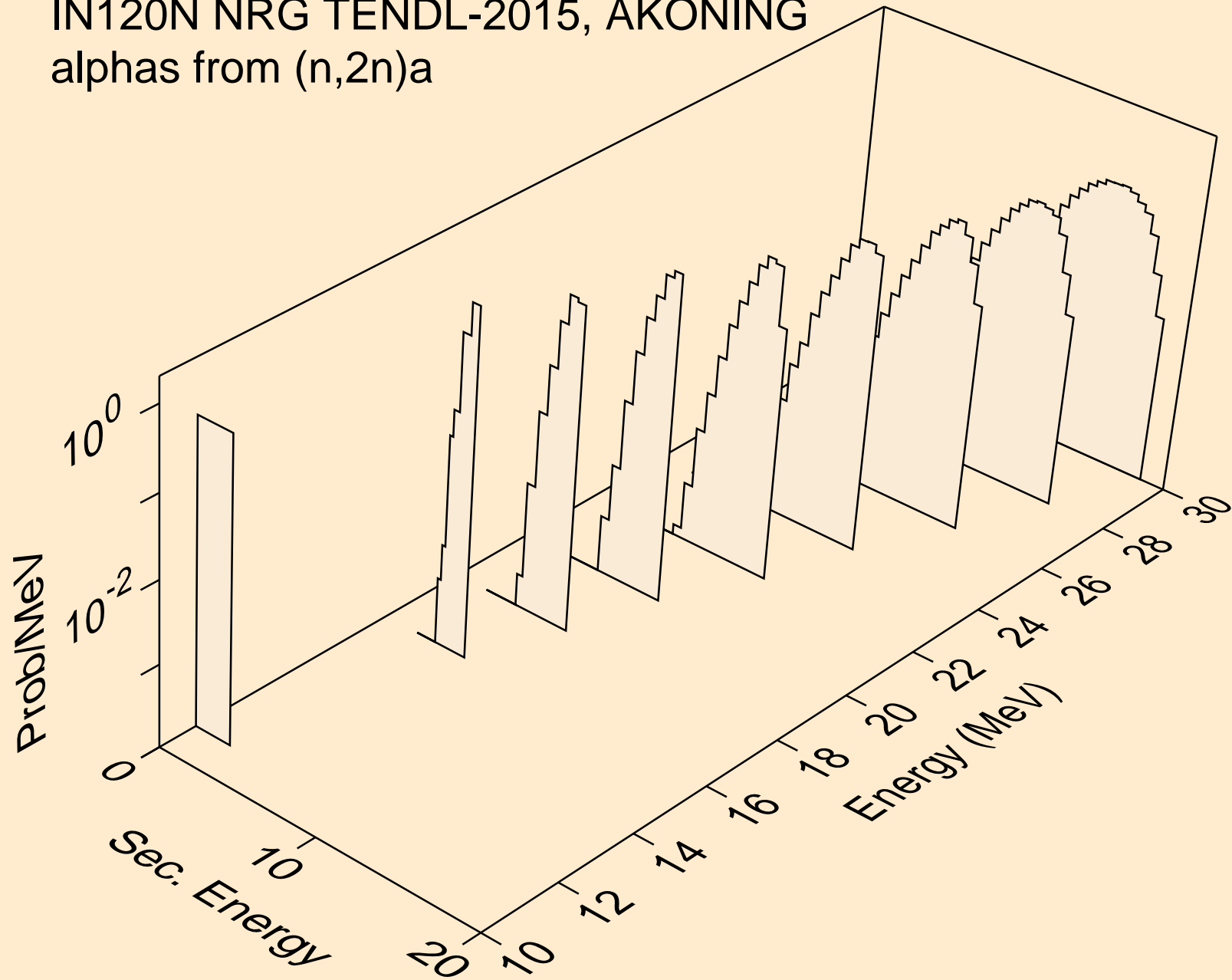

IN120N NRG TENDL-2015, AKONING
alphas from (n,3n)a

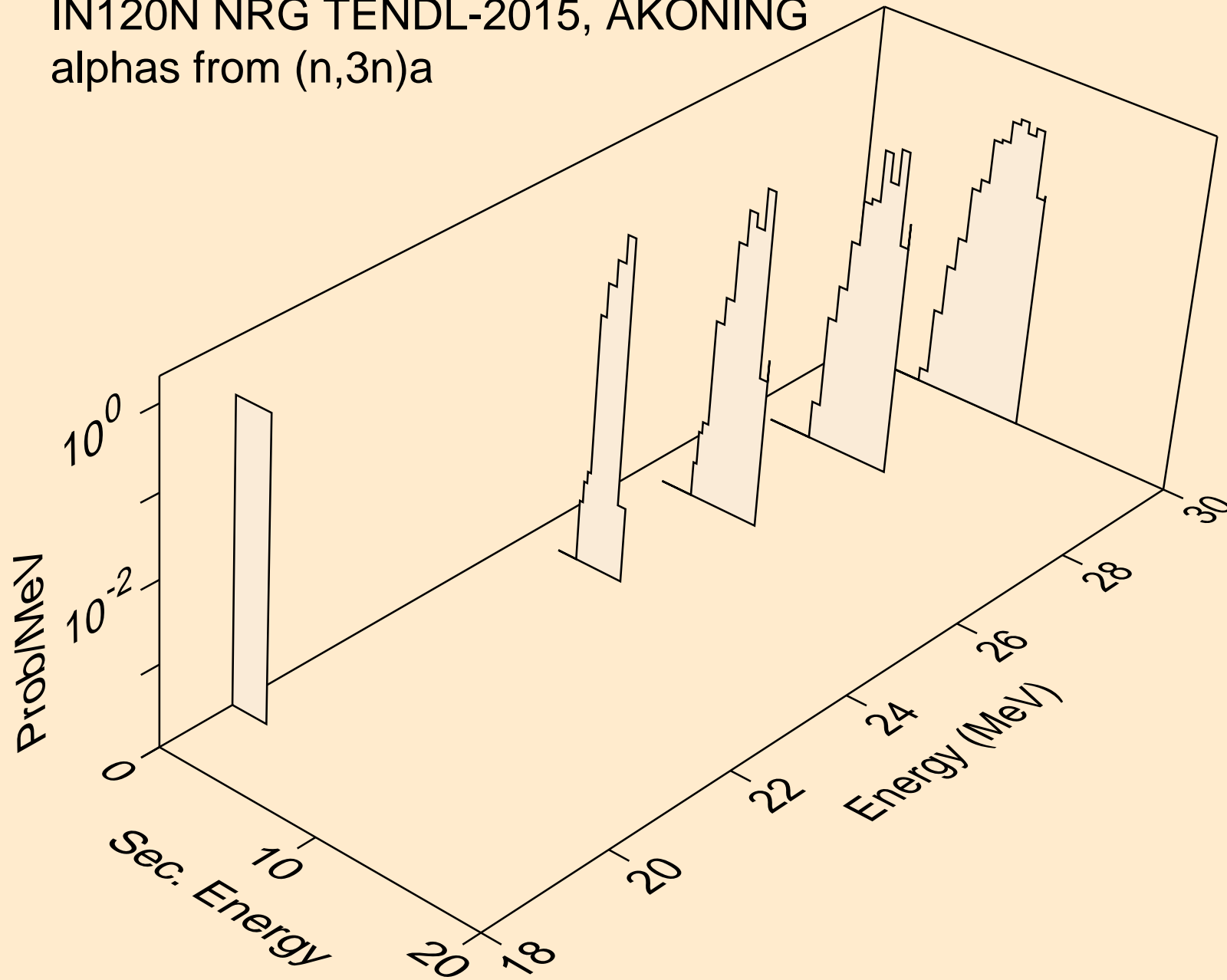

IN120N NRG TENDL-2015, AKONING
alphas from (n,a)

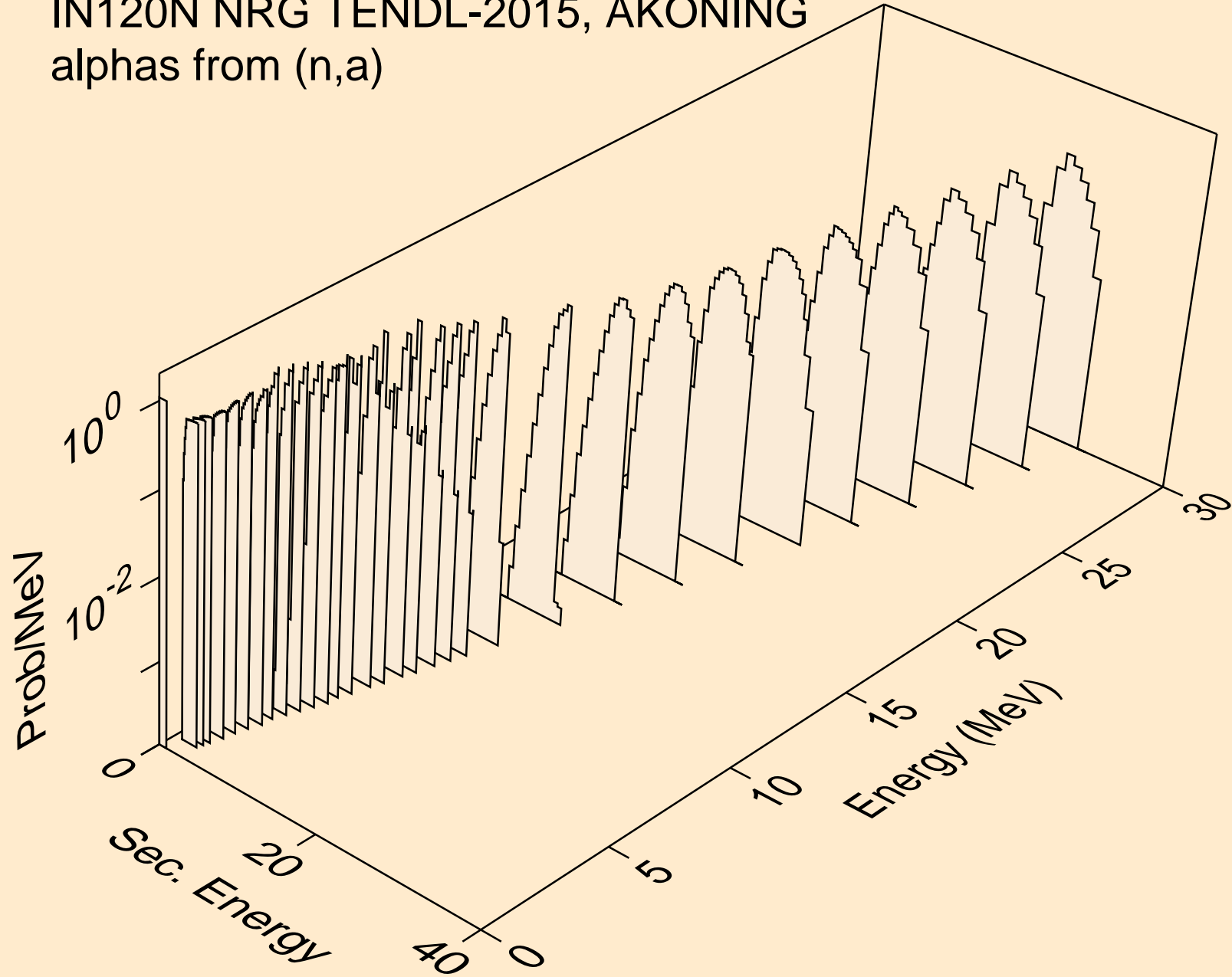

IN120N NRG TENDL-2015, AKONING
alphas from (n,pa)

