

# IR171 NRG TENDL-2015, AKONING

## Principal cross sections

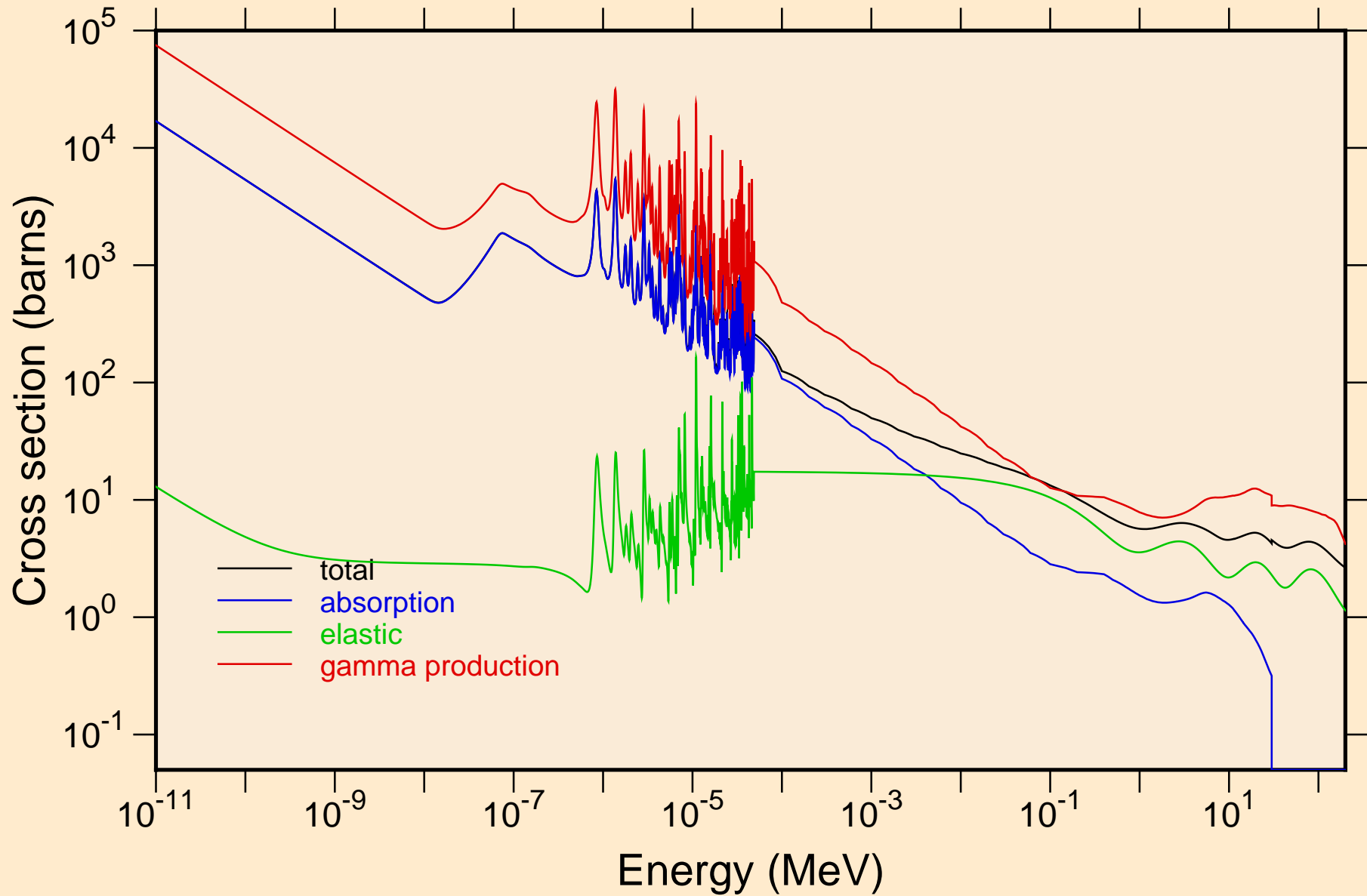

IR171 NRG TENDL-2015, AKONING  
resonance total cross section

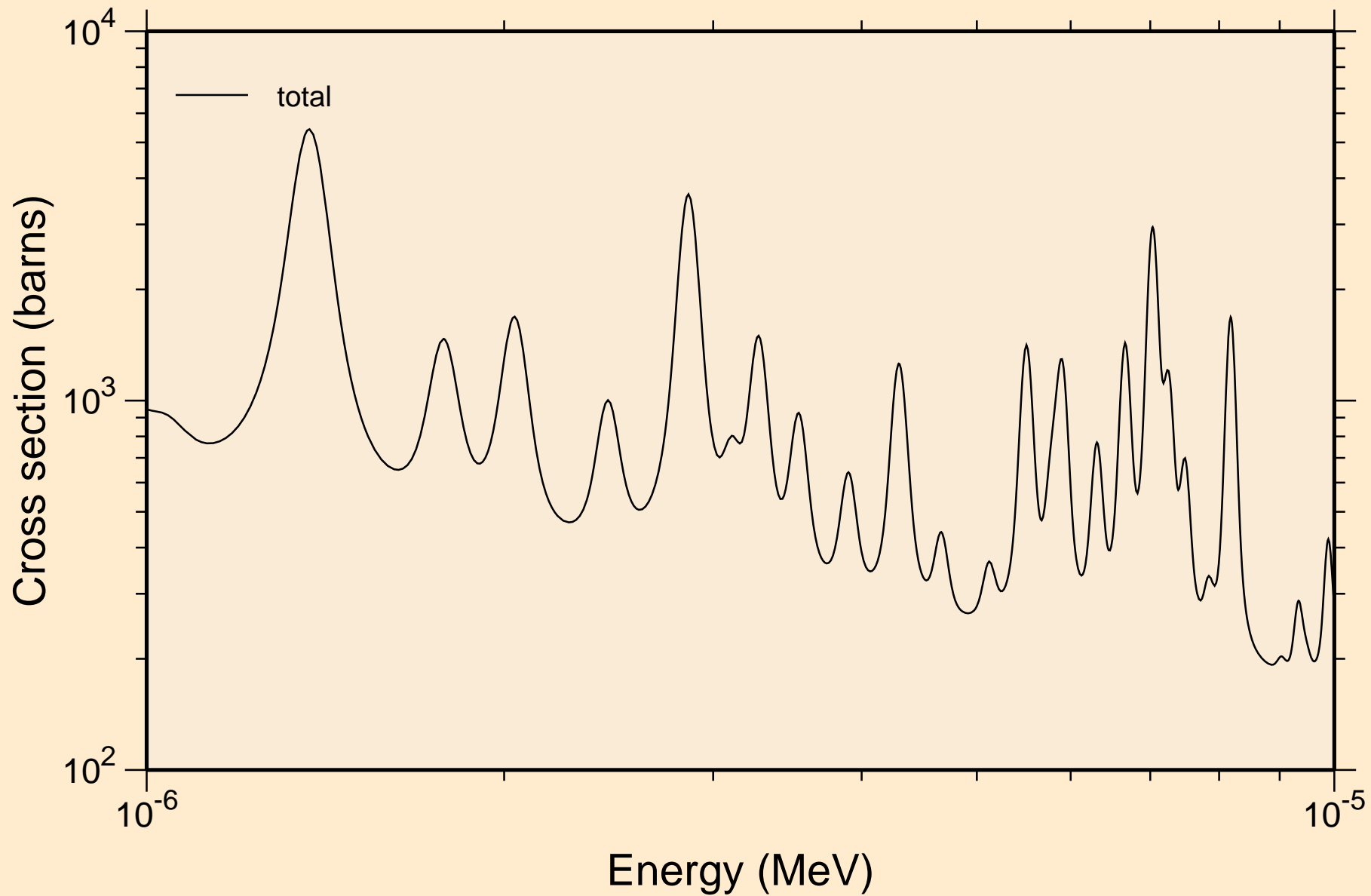

IR171 NRG TENDL-2015, AKONING  
resonance total cross section

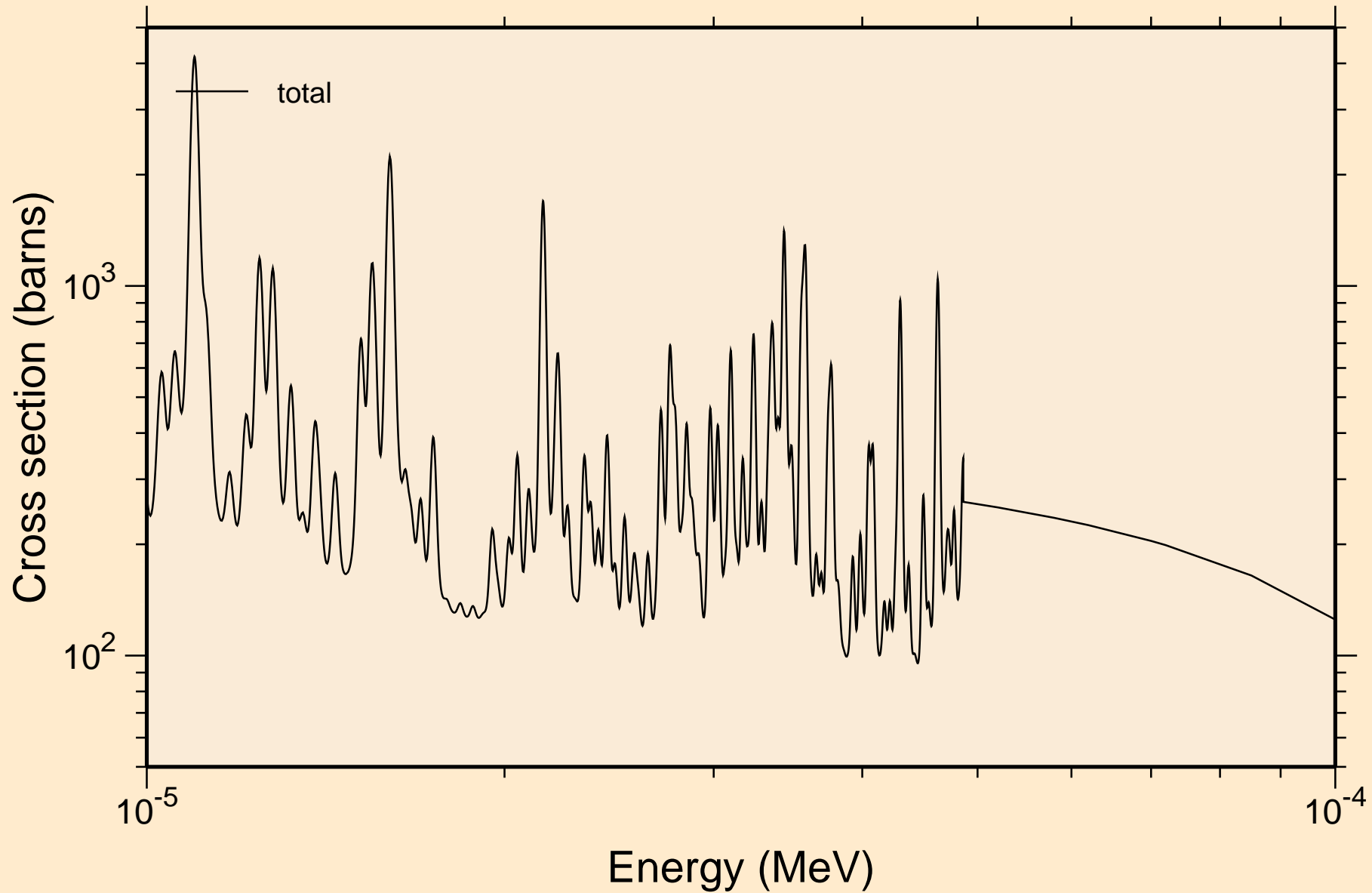

IR171 NRG TENDL-2015, AKONING  
resonance total cross section

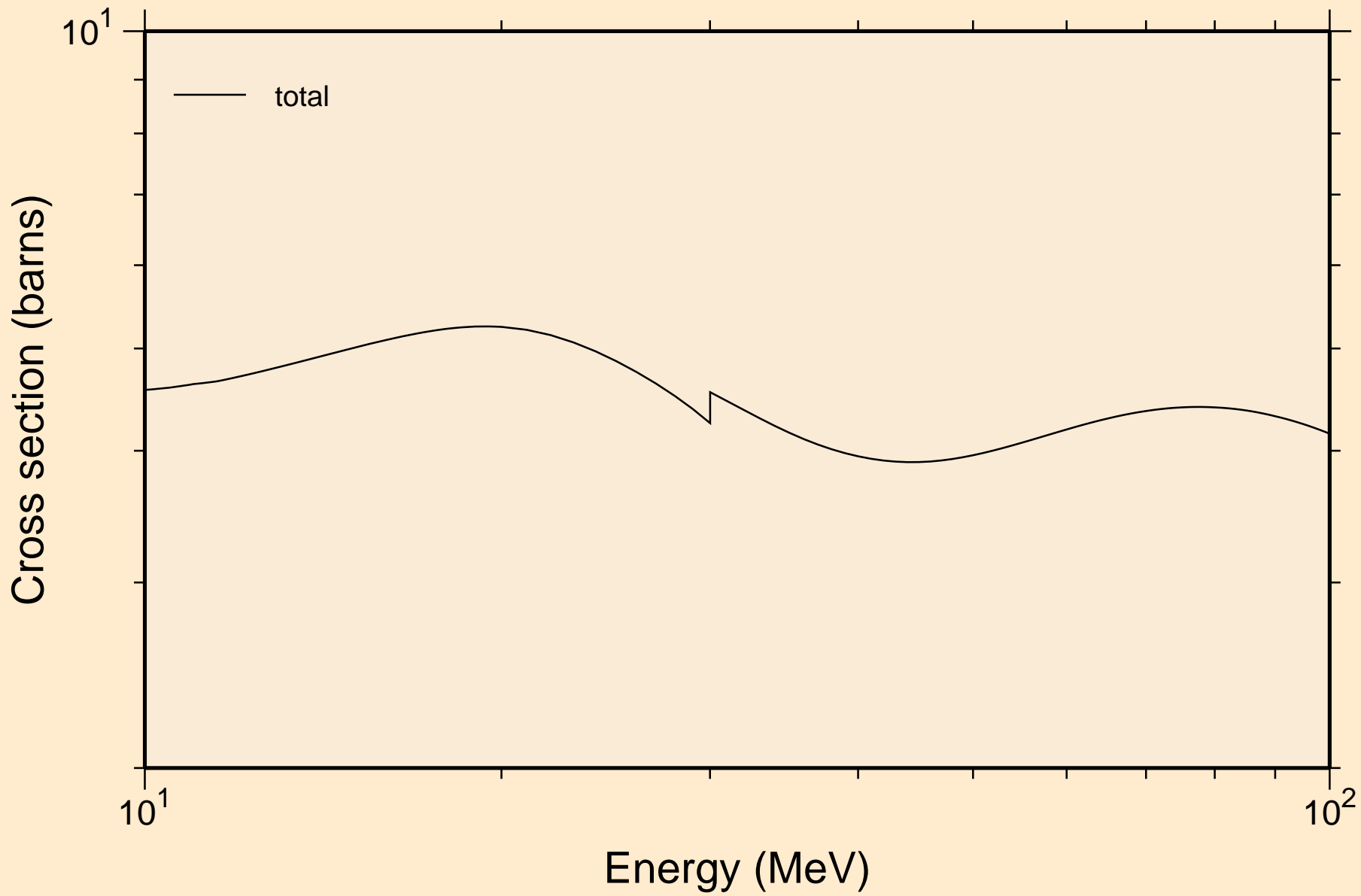

IR171 NRG TENDL-2015, AKONING  
resonance absorption cross sections

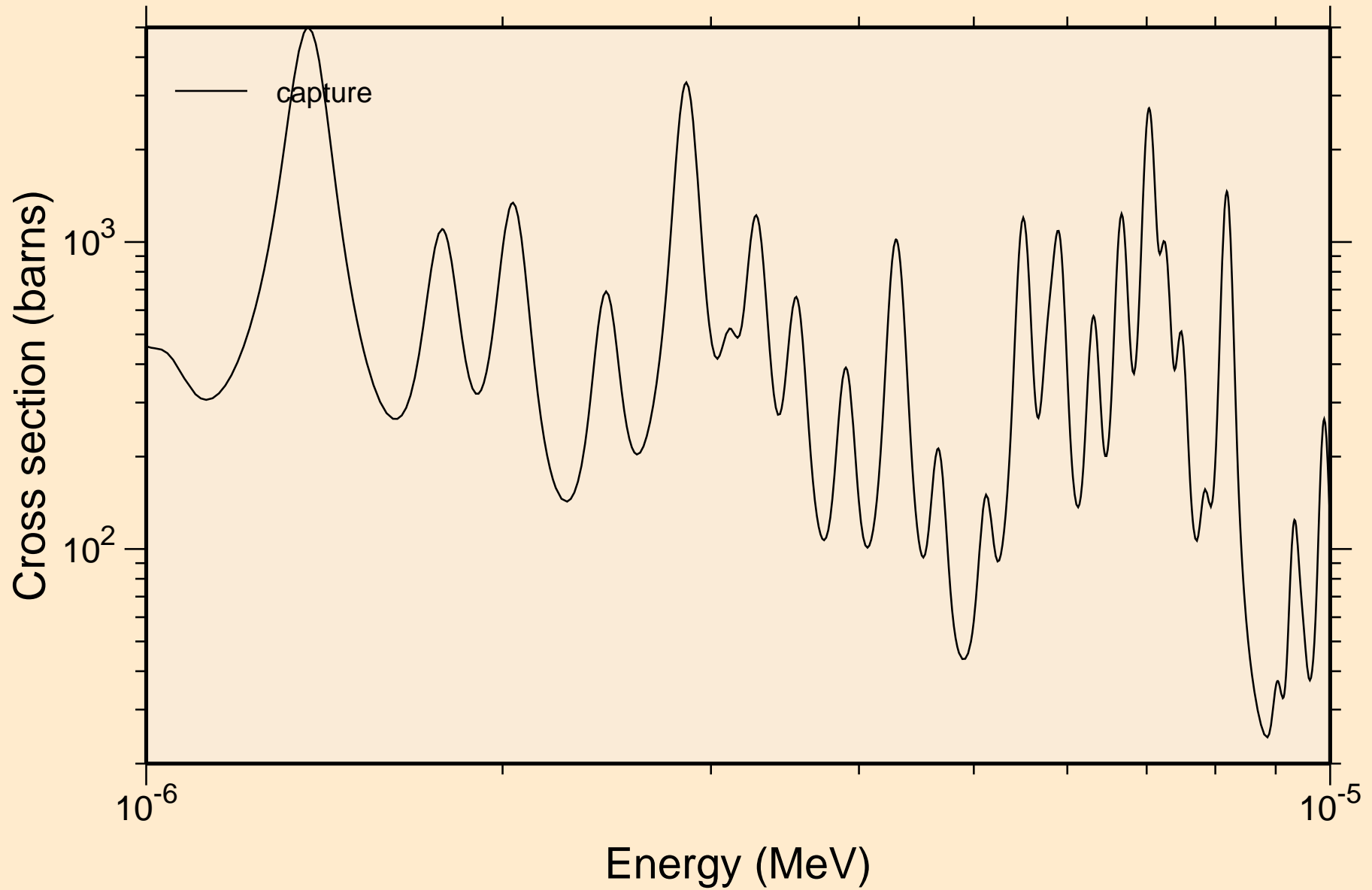

# IR171 NRG TENDL-2015, AKONING resonance absorption cross sections

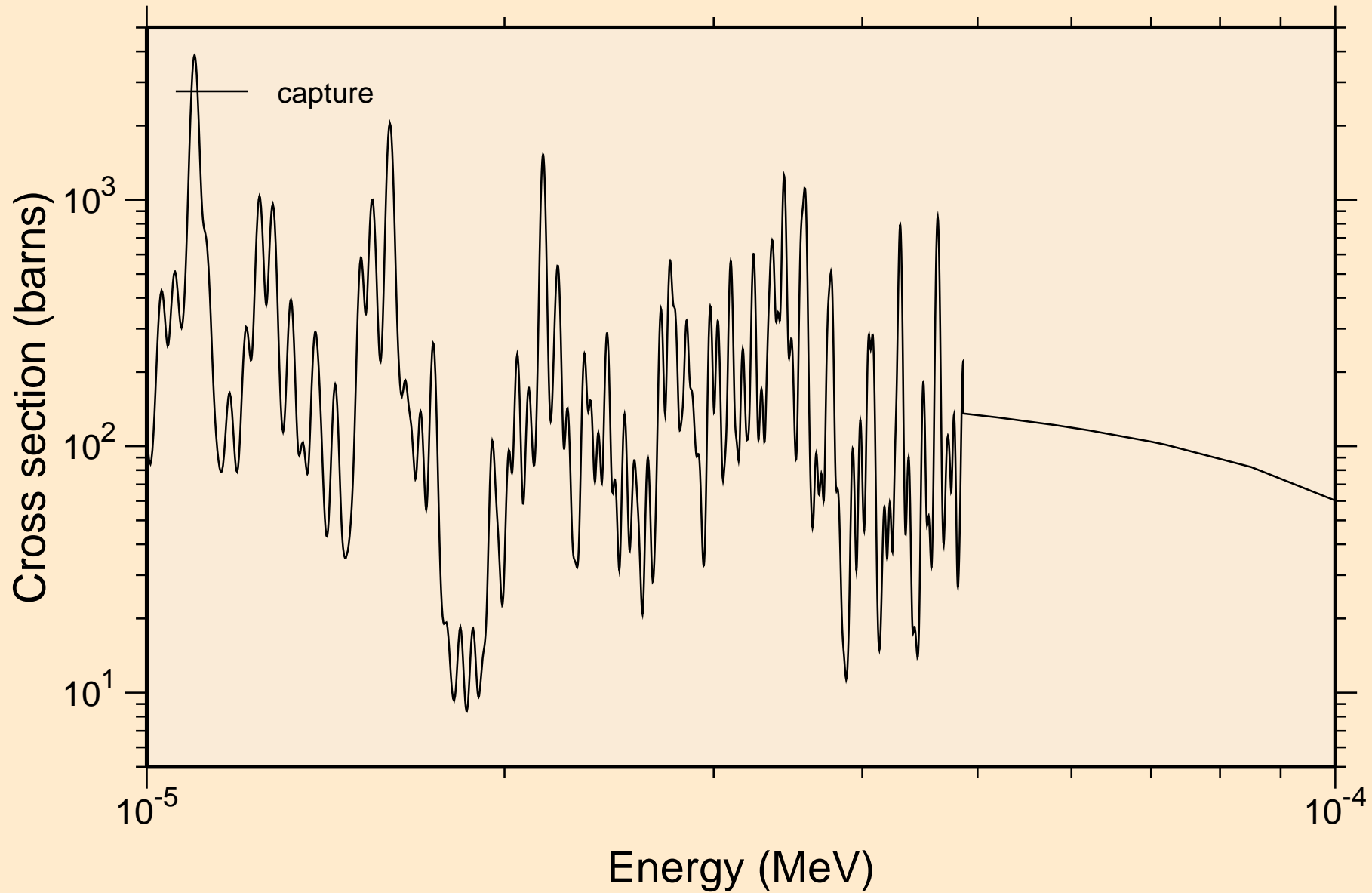

IR171 NRG TENDL-2015, AKONING  
resonance absorption cross sections

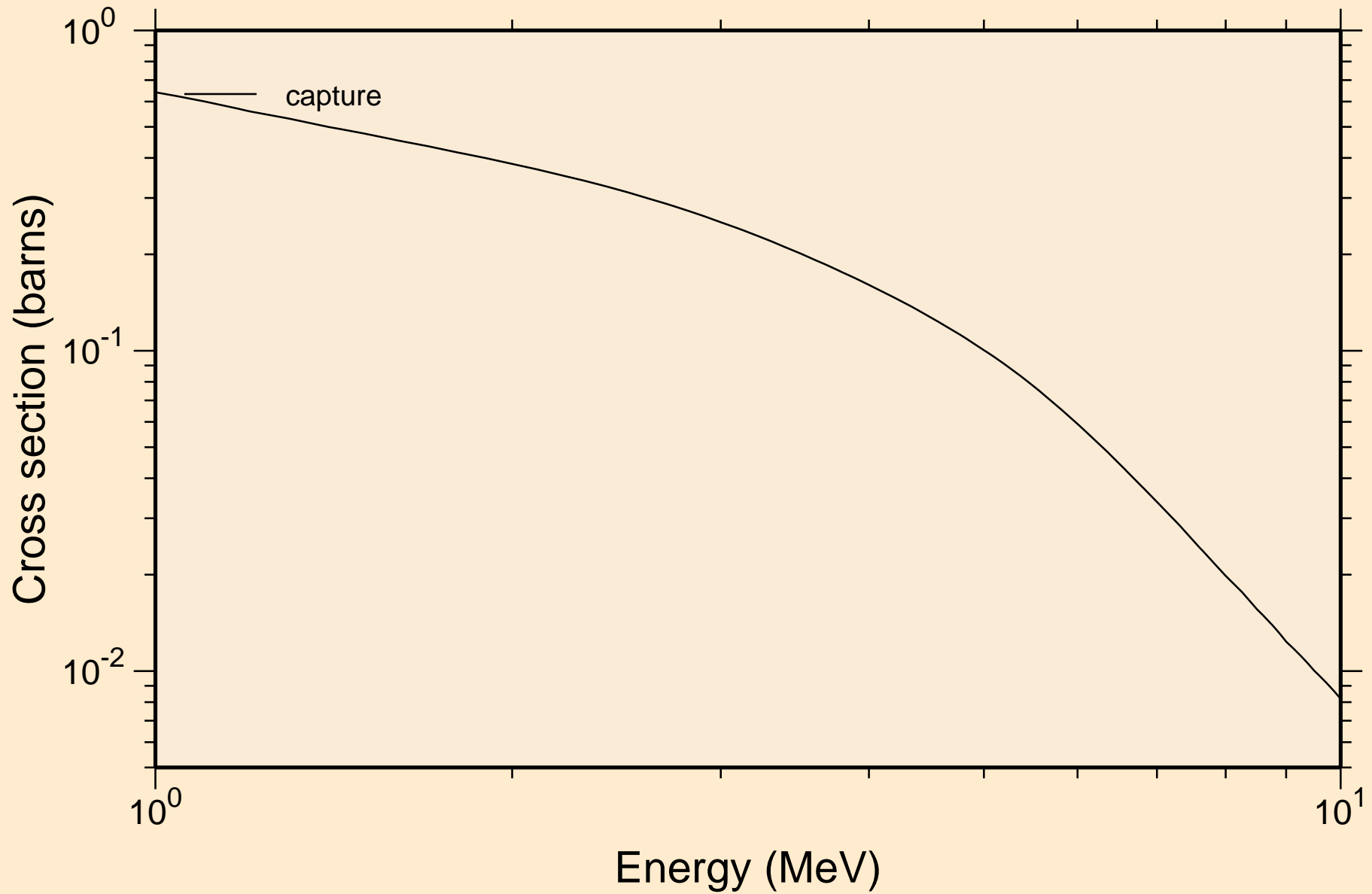

# IR171 NRG TENDL-2015, AKONING

## Non-threshold reactions

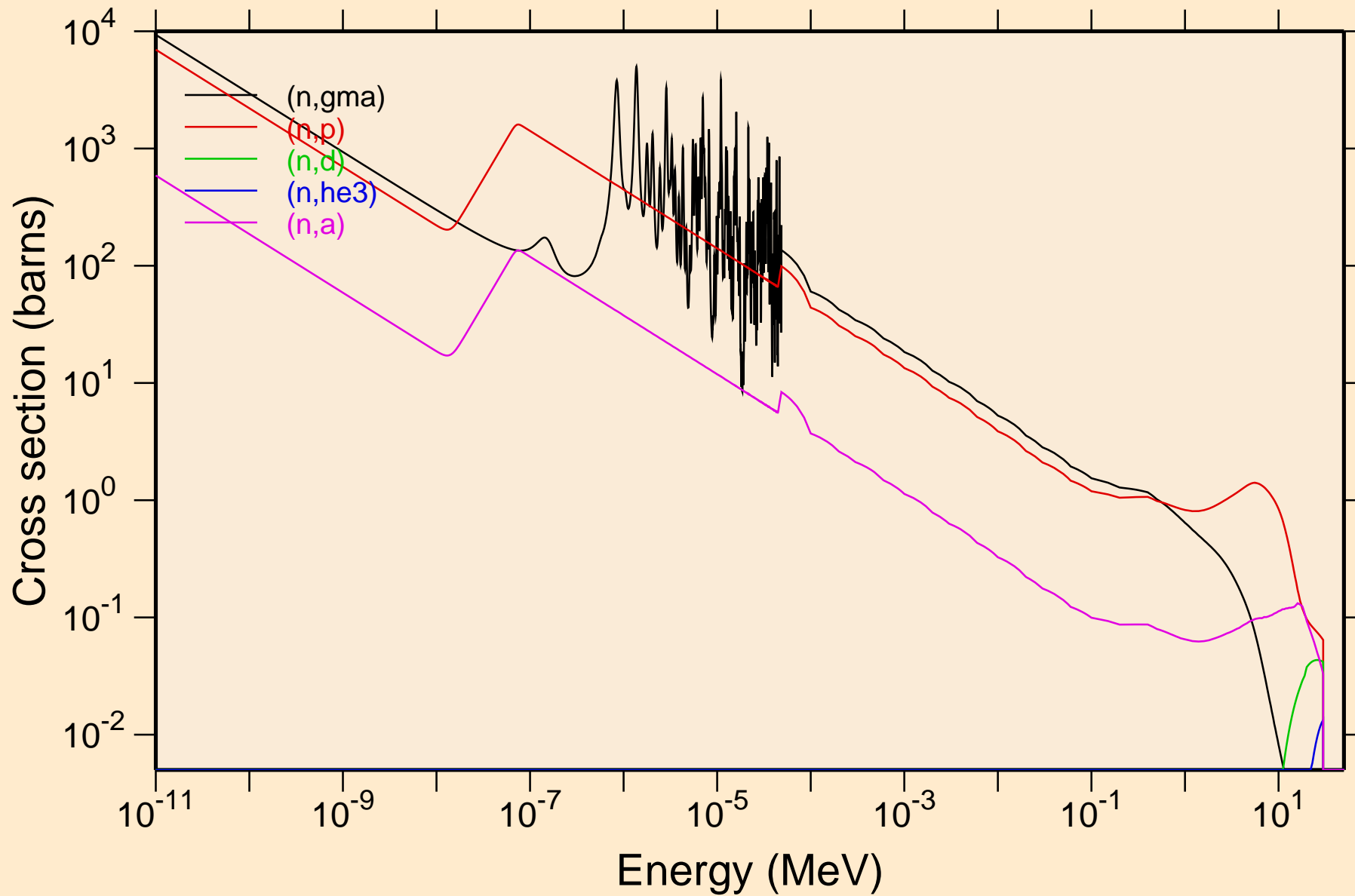



# IR171 NRG TENDL-2015, AKONING

## Non-threshold reactions

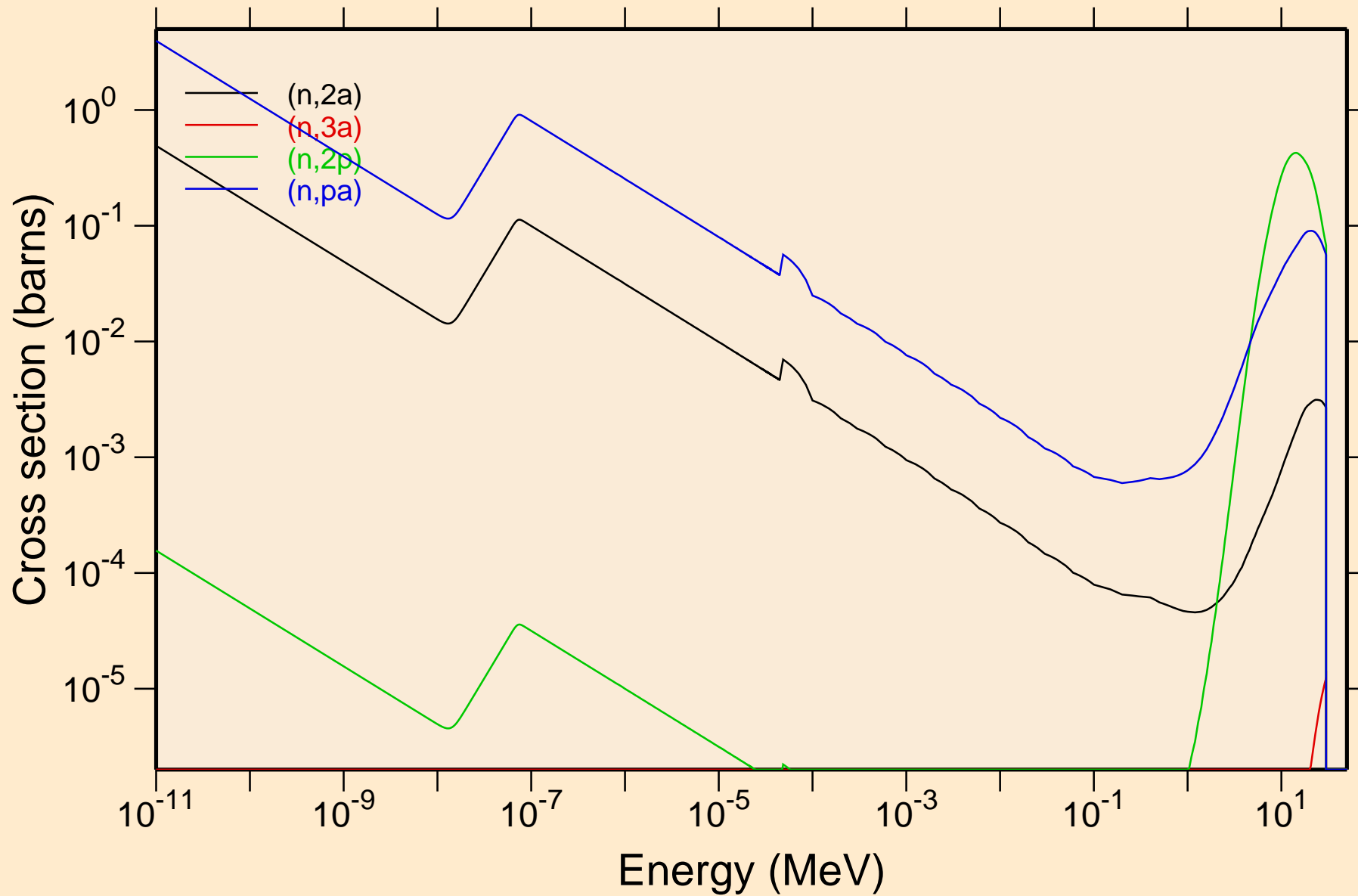

# IR171 NRG TENDL-2015, AKONING

## Principal cross sections

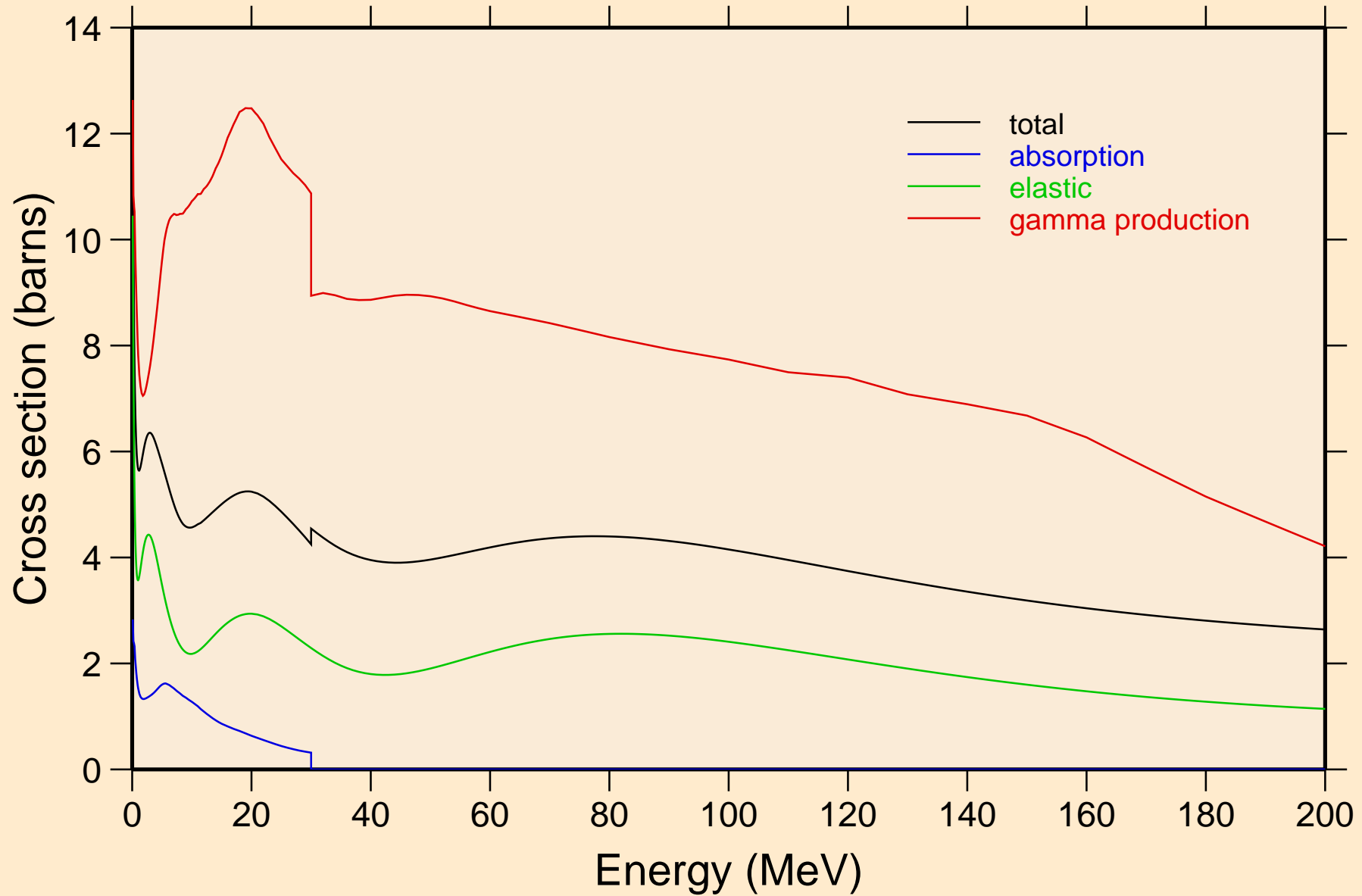

# IR171 NRG TENDL-2015, AKONING

## Non-threshold reactions

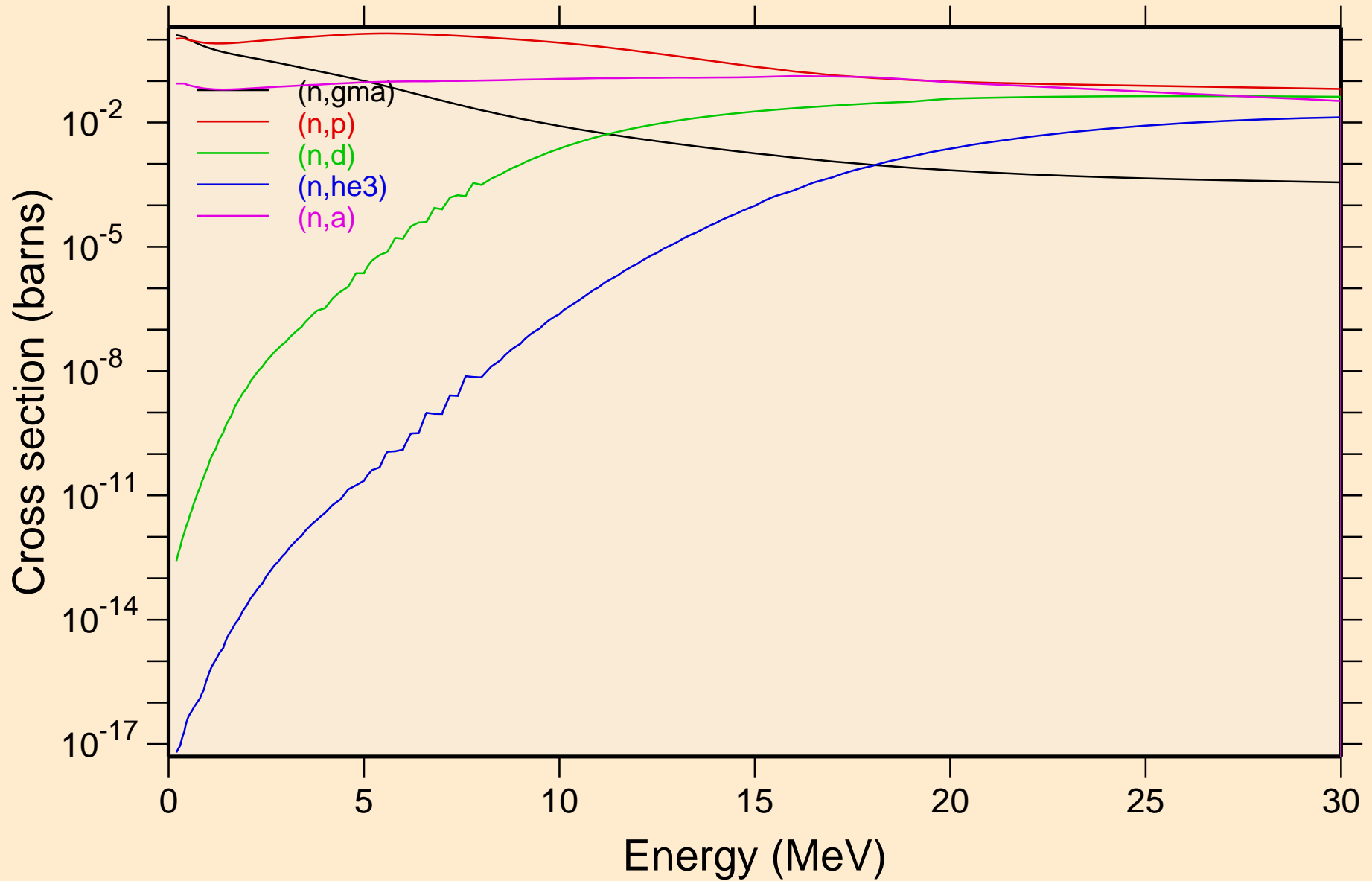

# IR171 NRG TENDL-2015, AKONING

## Non-threshold reactions

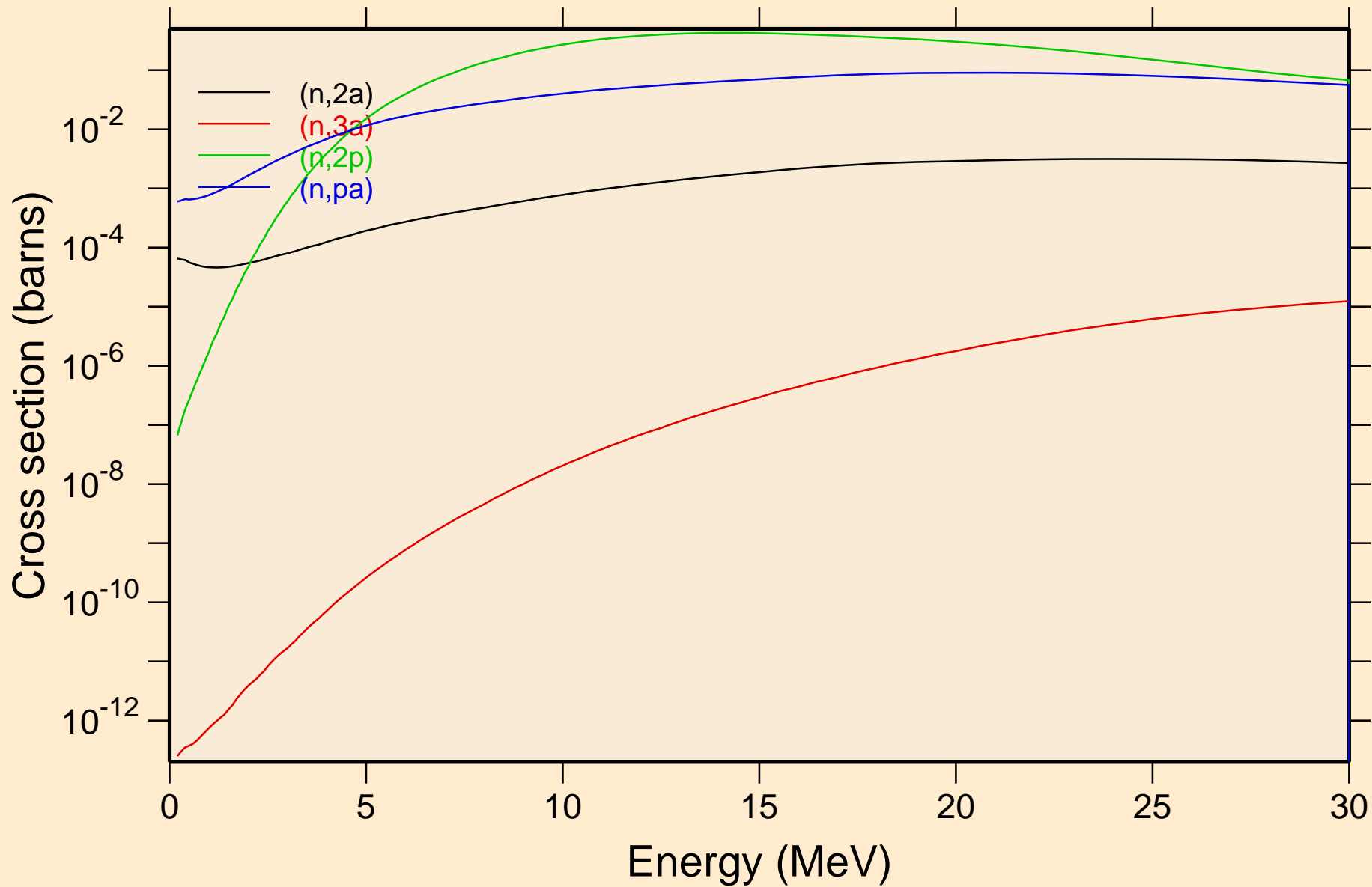

# IR171 NRG TENDL-2015, AKONING

## Inelastic levels

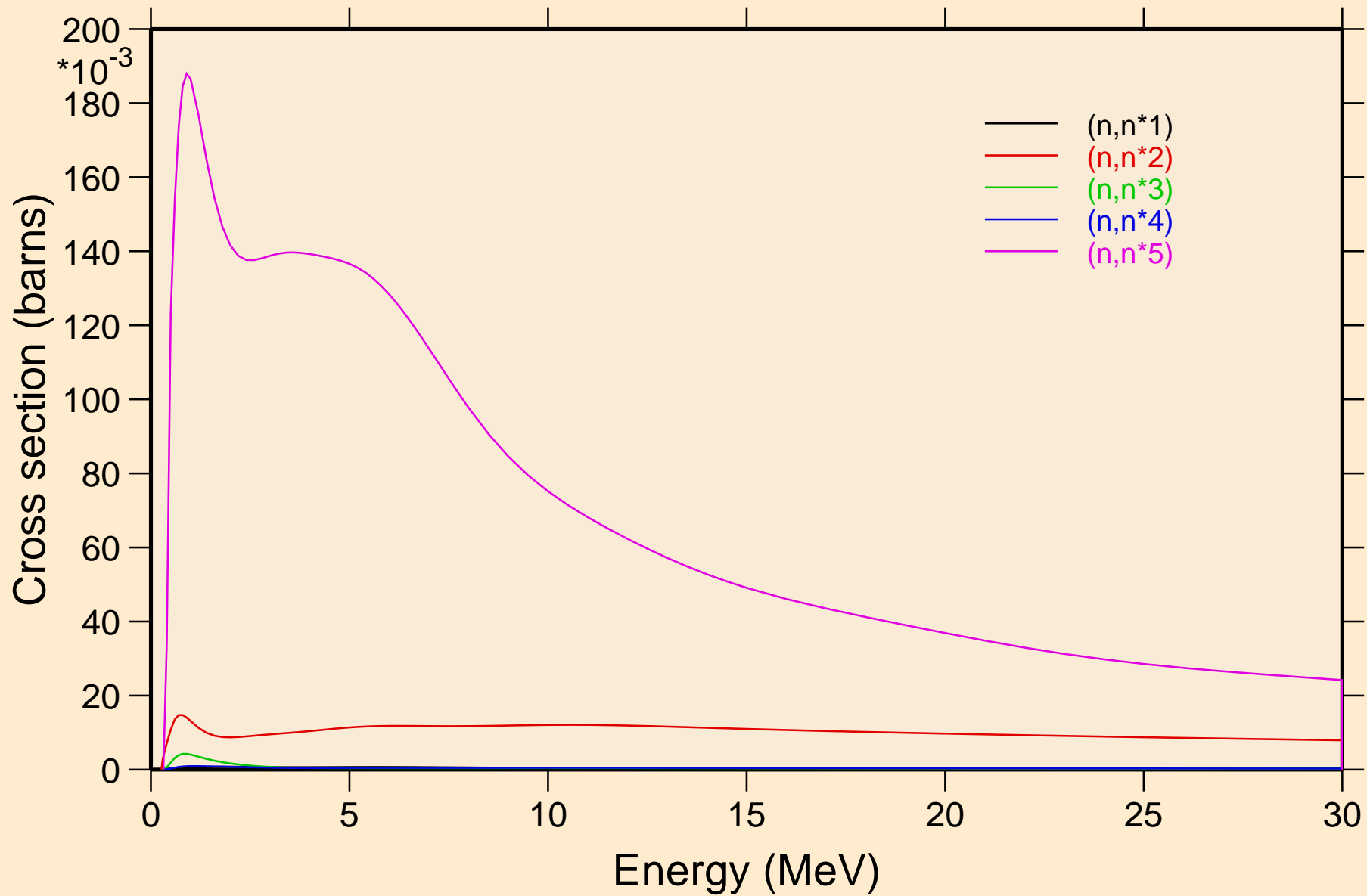

# IR171 NRG TENDL-2015, AKONING

## Inelastic levels

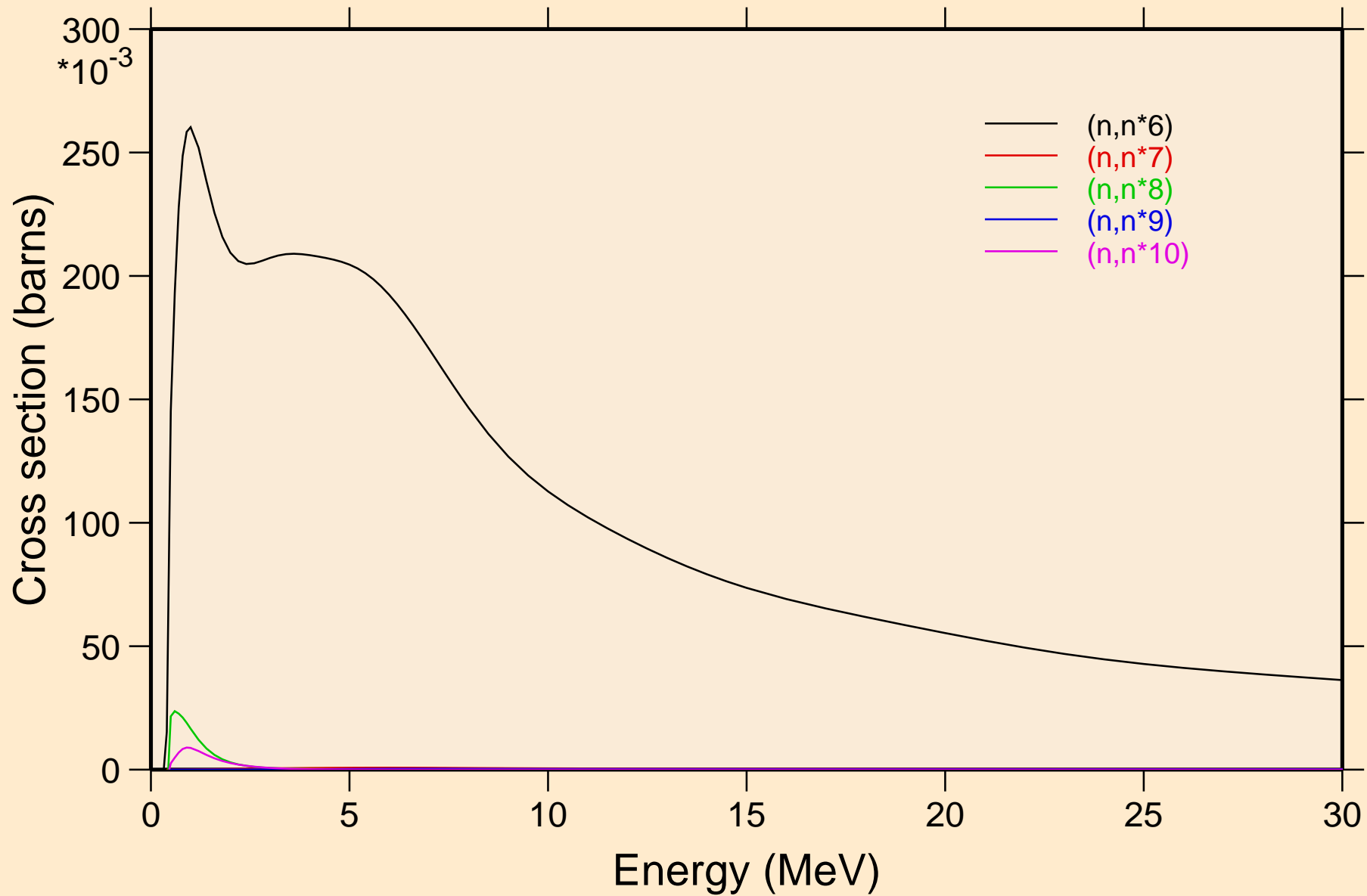

# IR171 NRG TENDL-2015, AKONING

## Inelastic levels

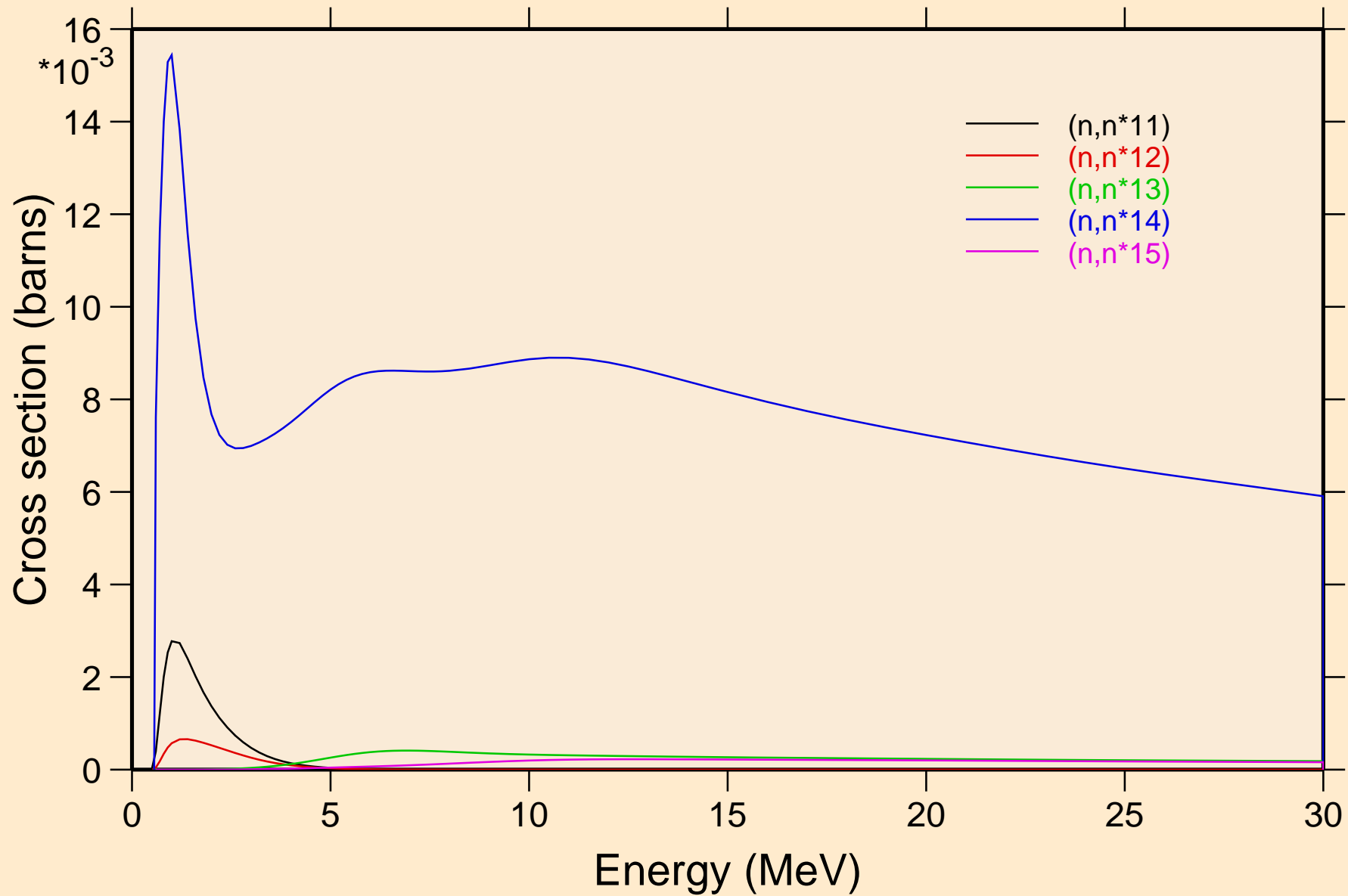

# IR171 NRG TENDL-2015, AKONING

## Inelastic levels

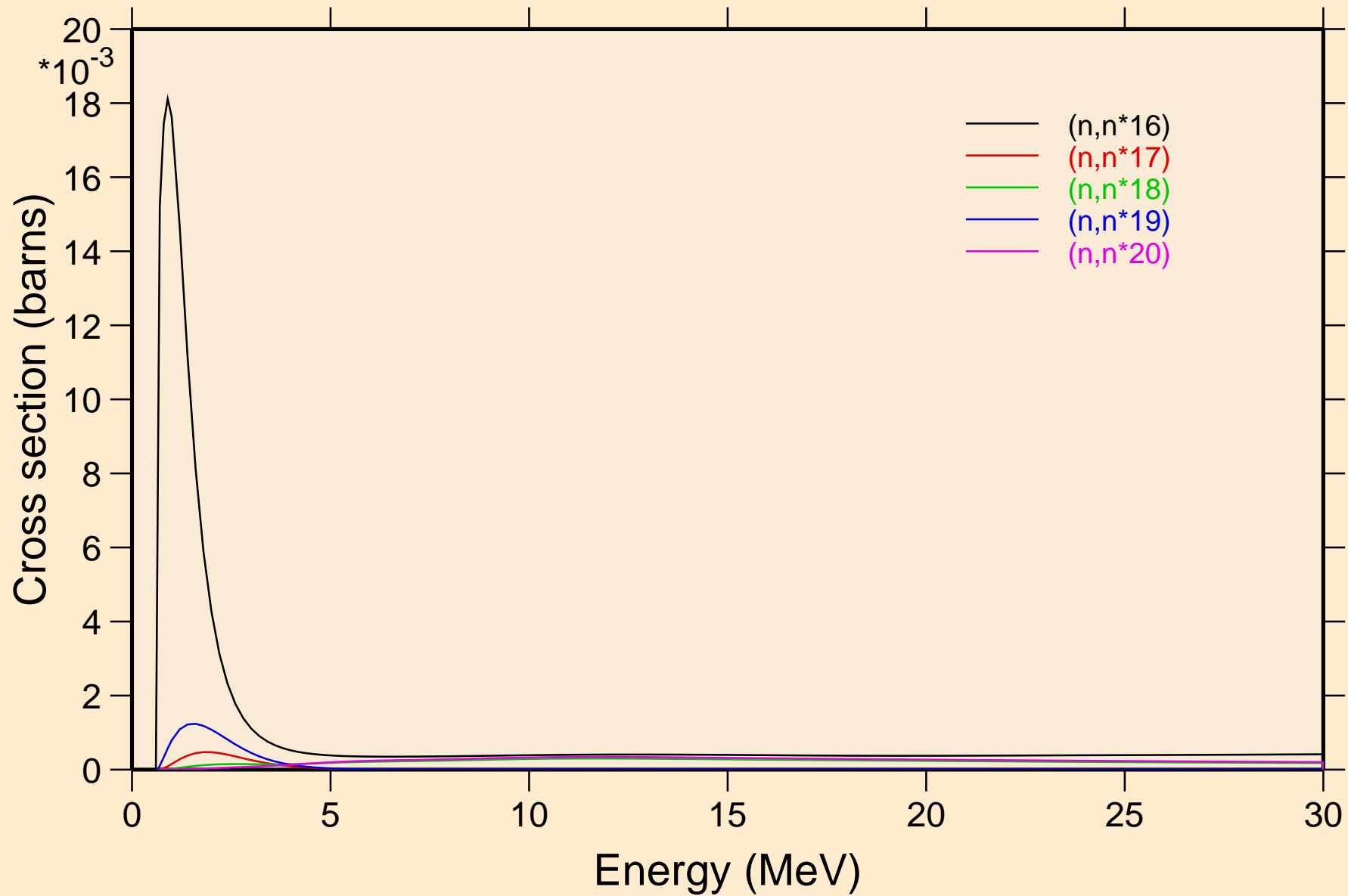



# IR171 NRG TENDL-2015, AKONING

## Inelastic levels

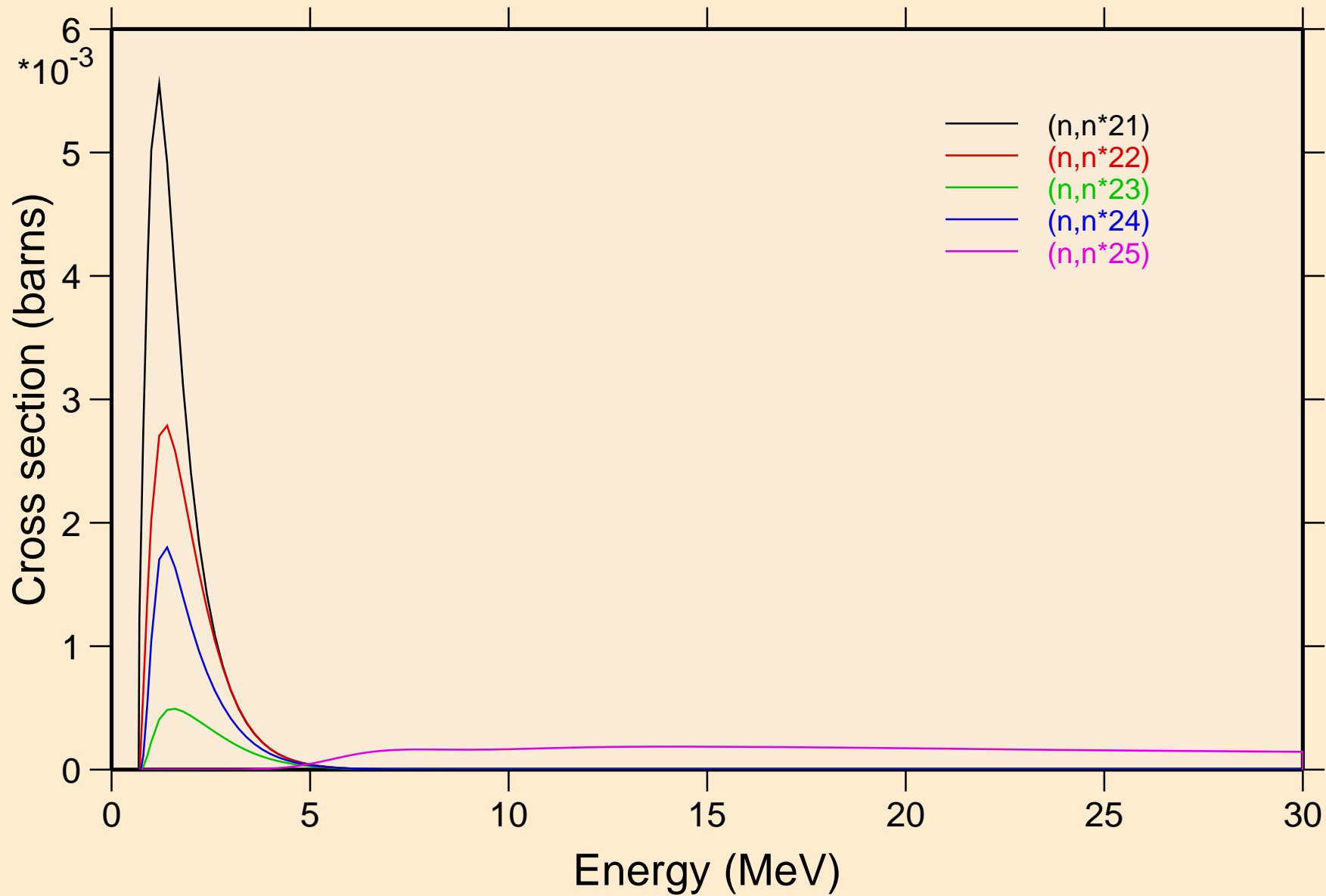

# IR171 NRG TENDL-2015, AKONING

## Inelastic levels

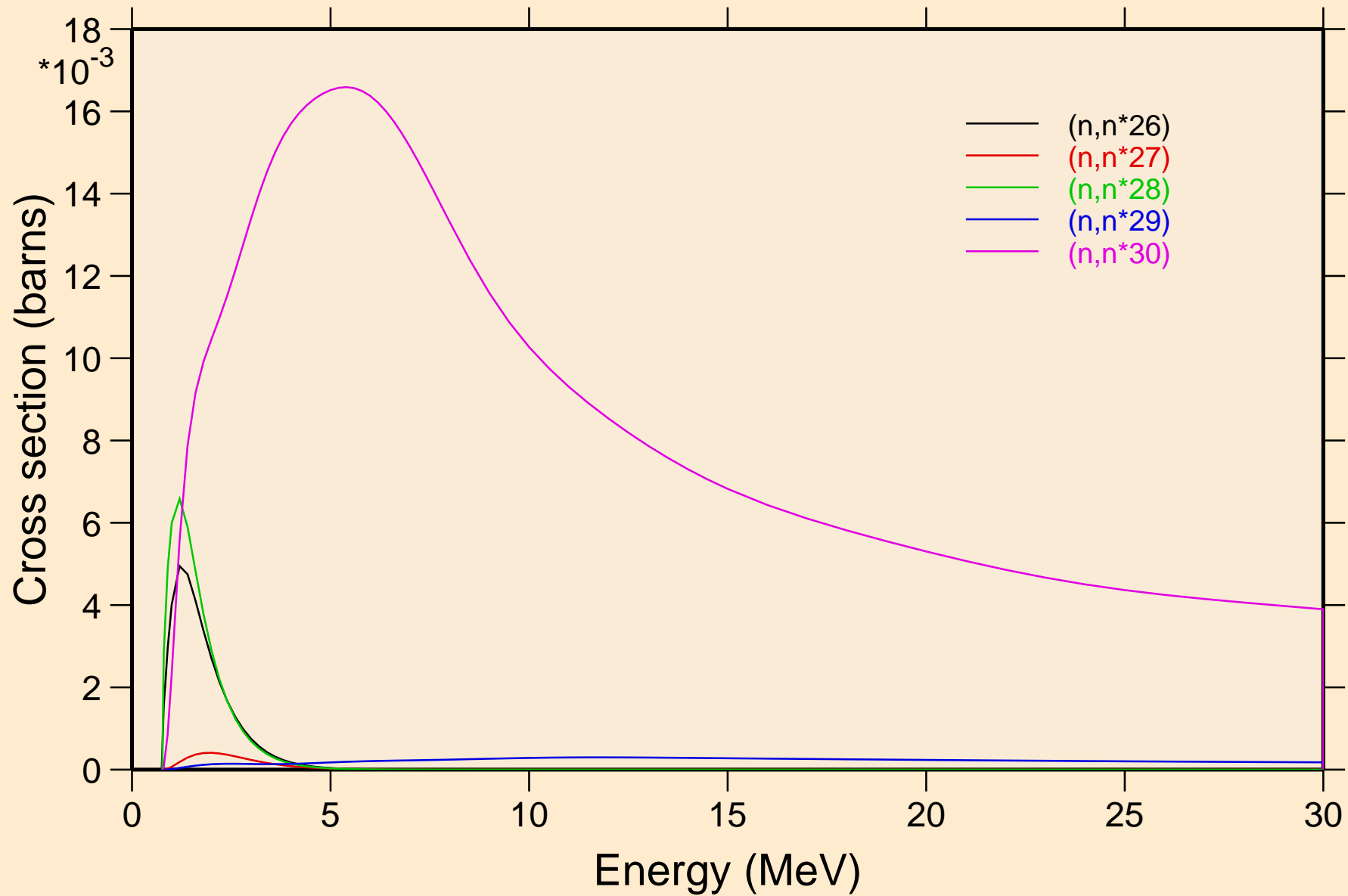

# IR171 NRG TENDL-2015, AKONING

## Threshold reactions

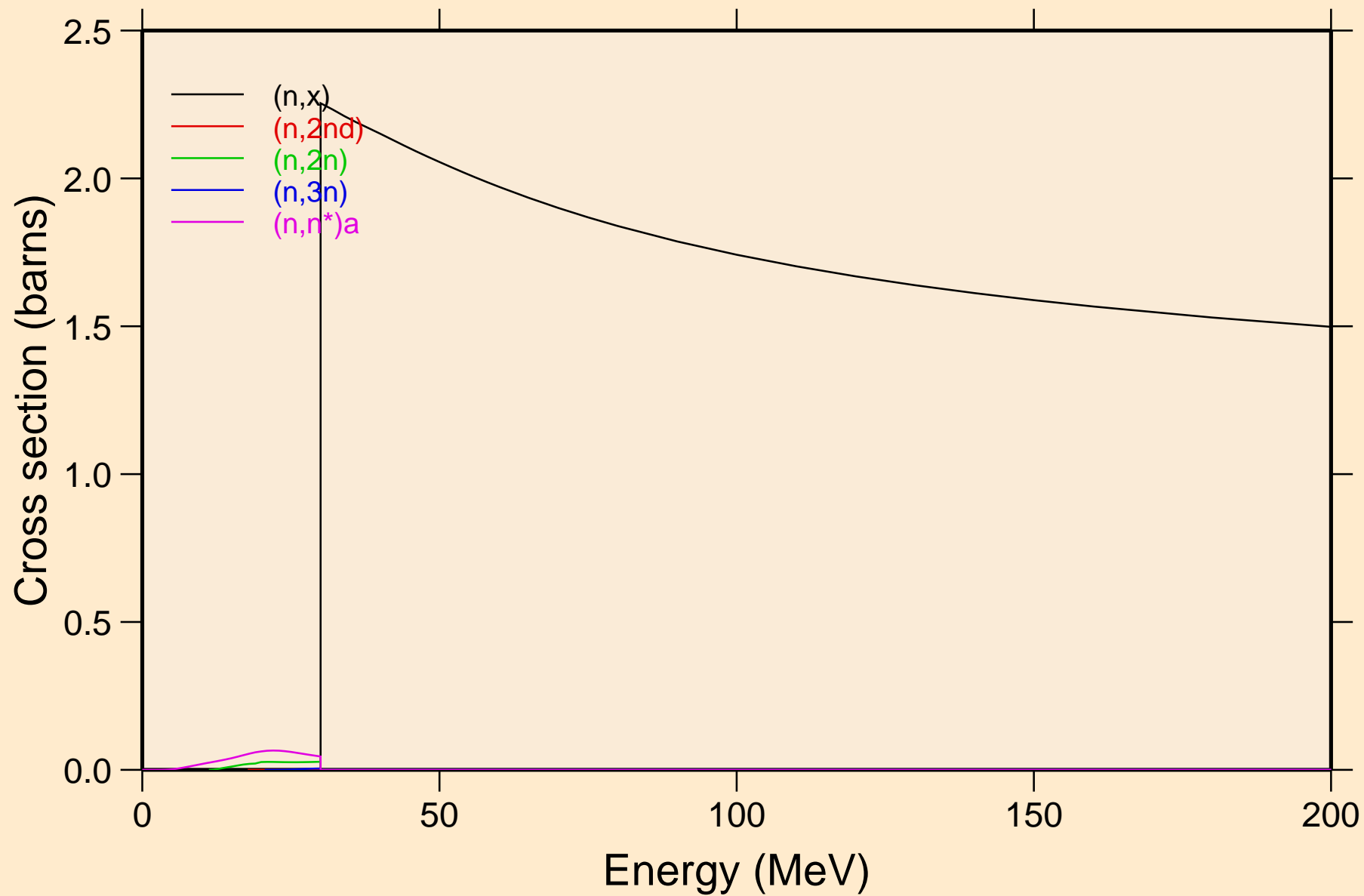

# IR171 NRG TENDL-2015, AKONING

## Threshold reactions

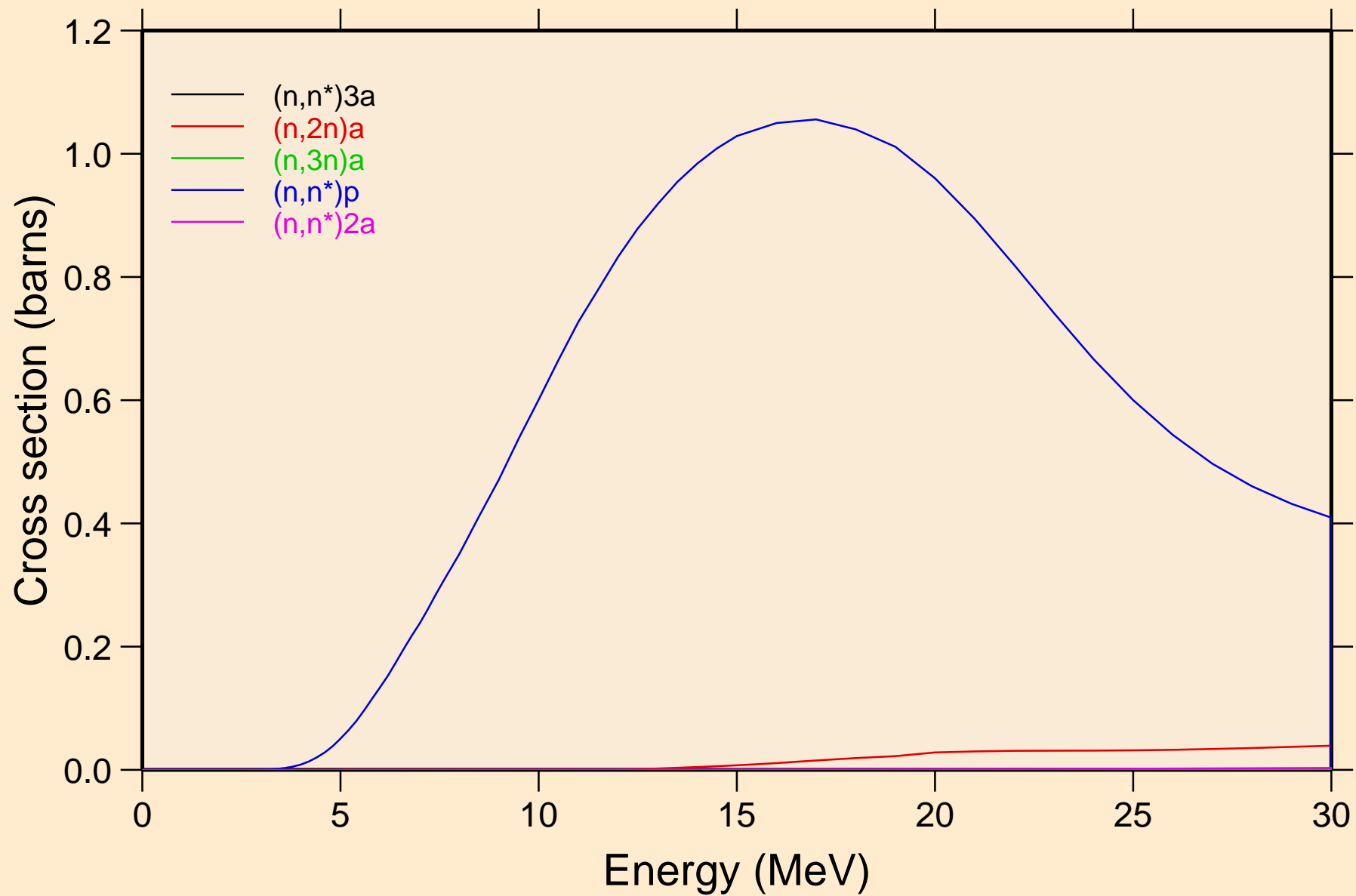

# IR171 NRG TENDL-2015, AKONING

## Threshold reactions

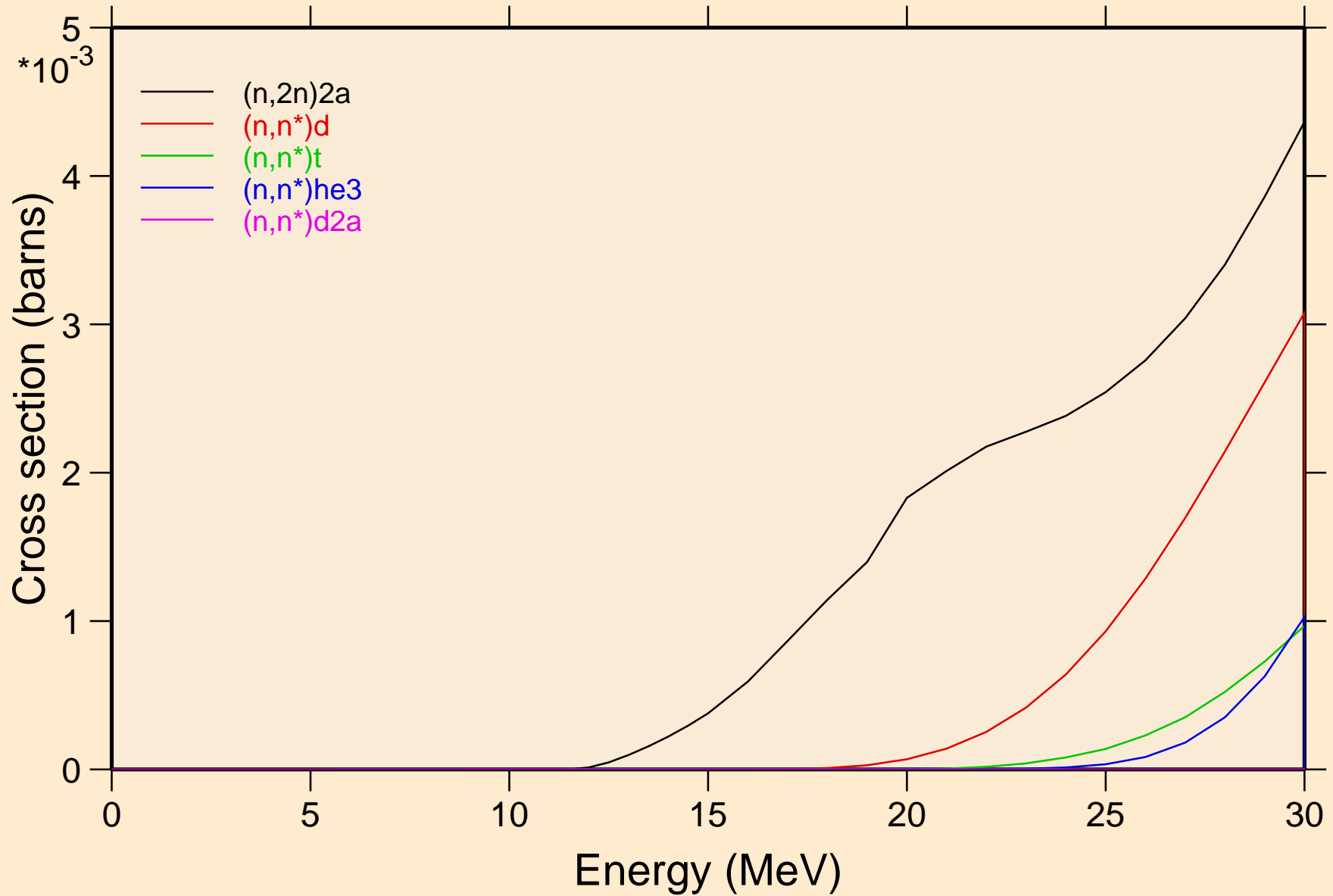

# IR171 NRG TENDL-2015, AKONING

## Threshold reactions

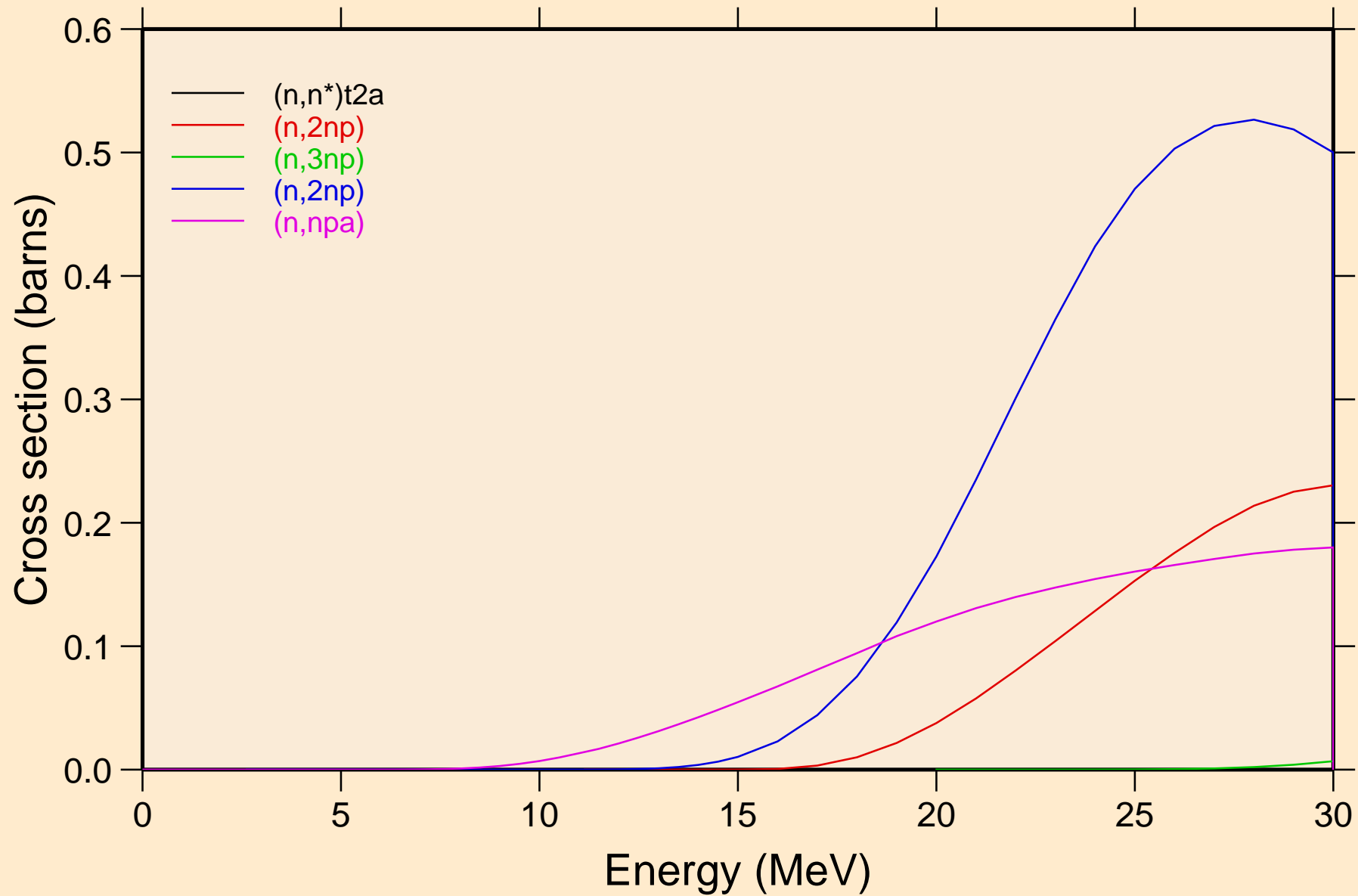

# IR171 NRG TENDL-2015, AKONING

## Threshold reactions

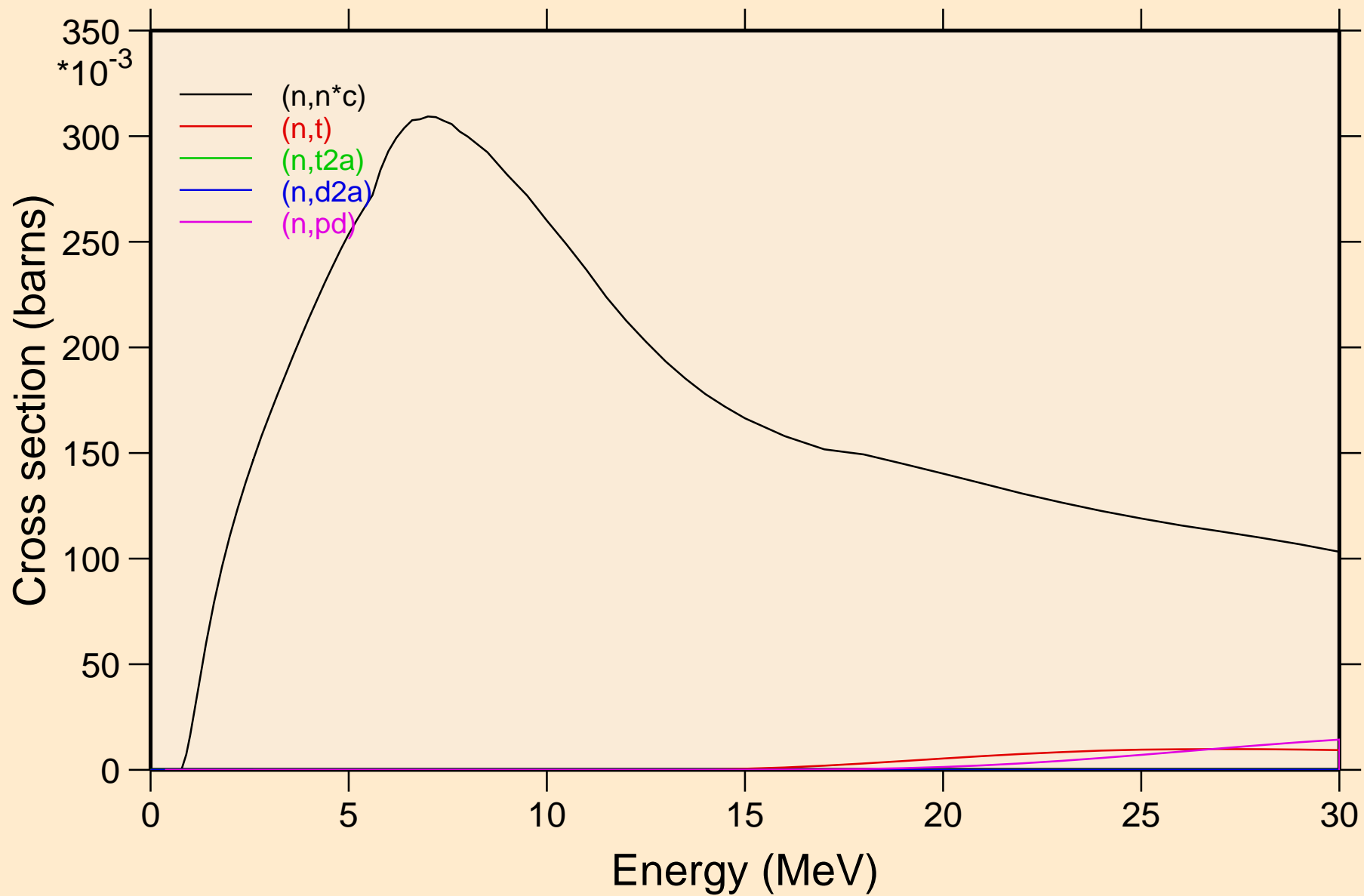

# IR171 NRG TENDL-2015, AKONING

## Threshold reactions

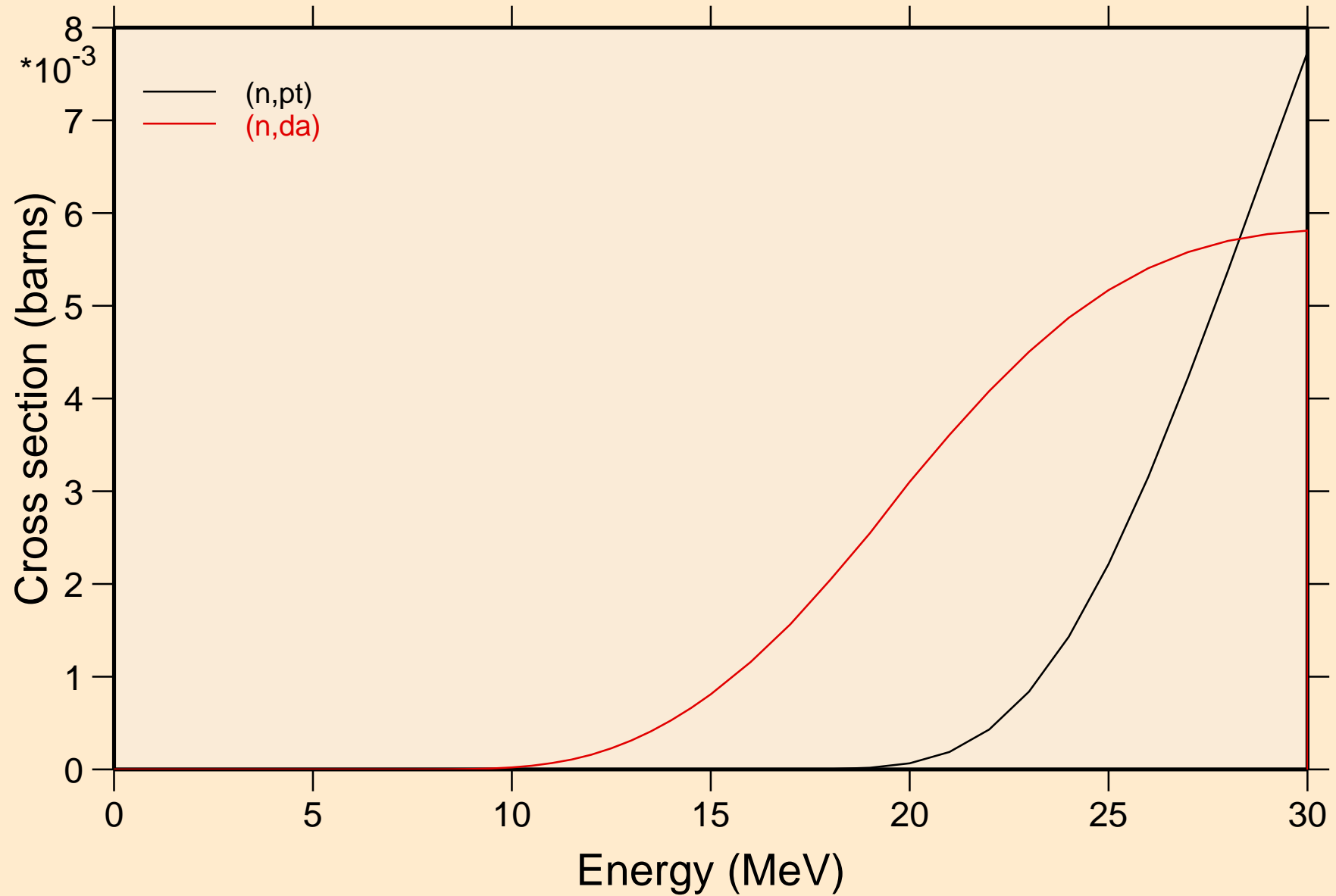



IR171 NRG TENDL-2015, AKONING  
angular distribution for elastic

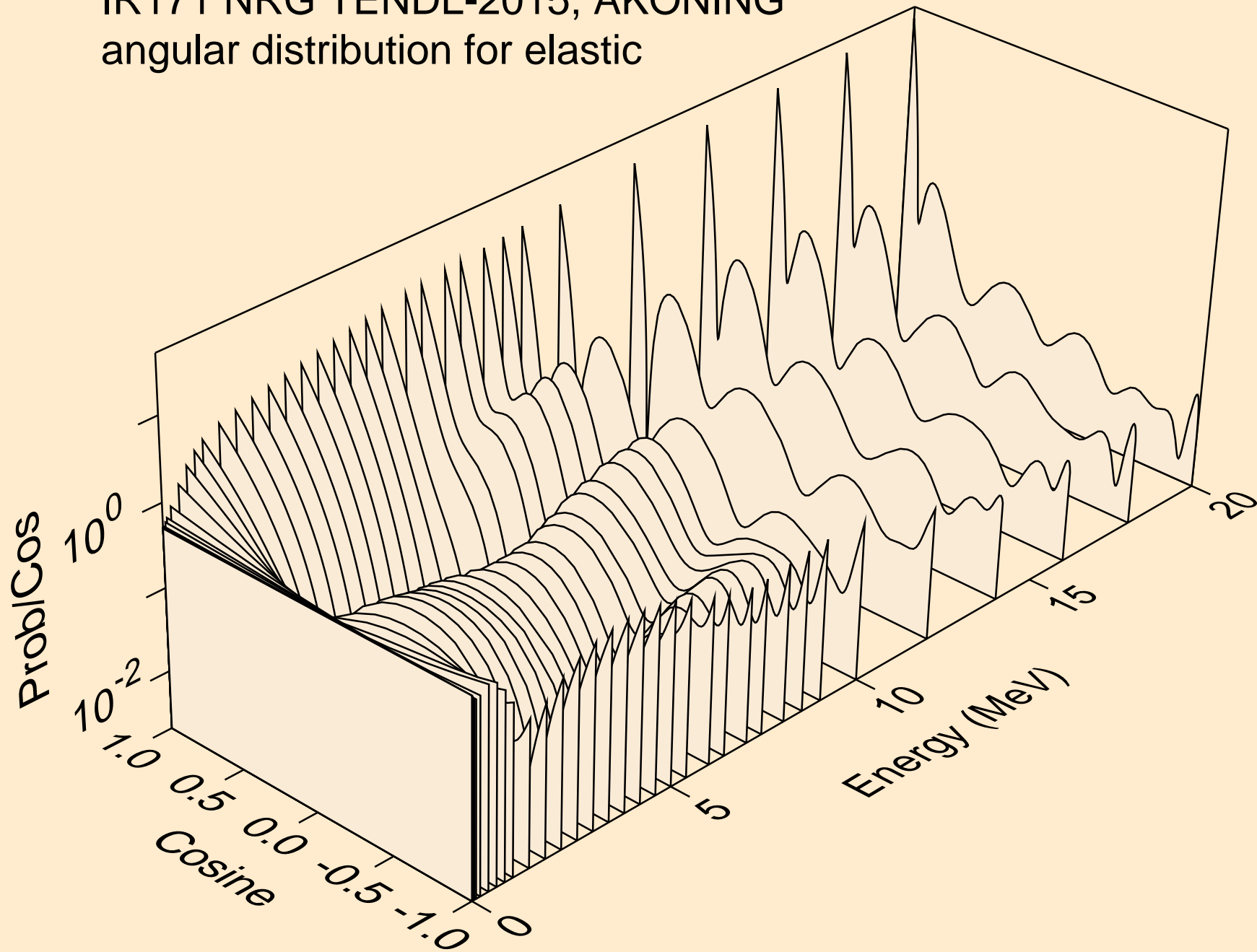

IR171 NRG TENDL-2015, AKONING  
angular distribution for elastic

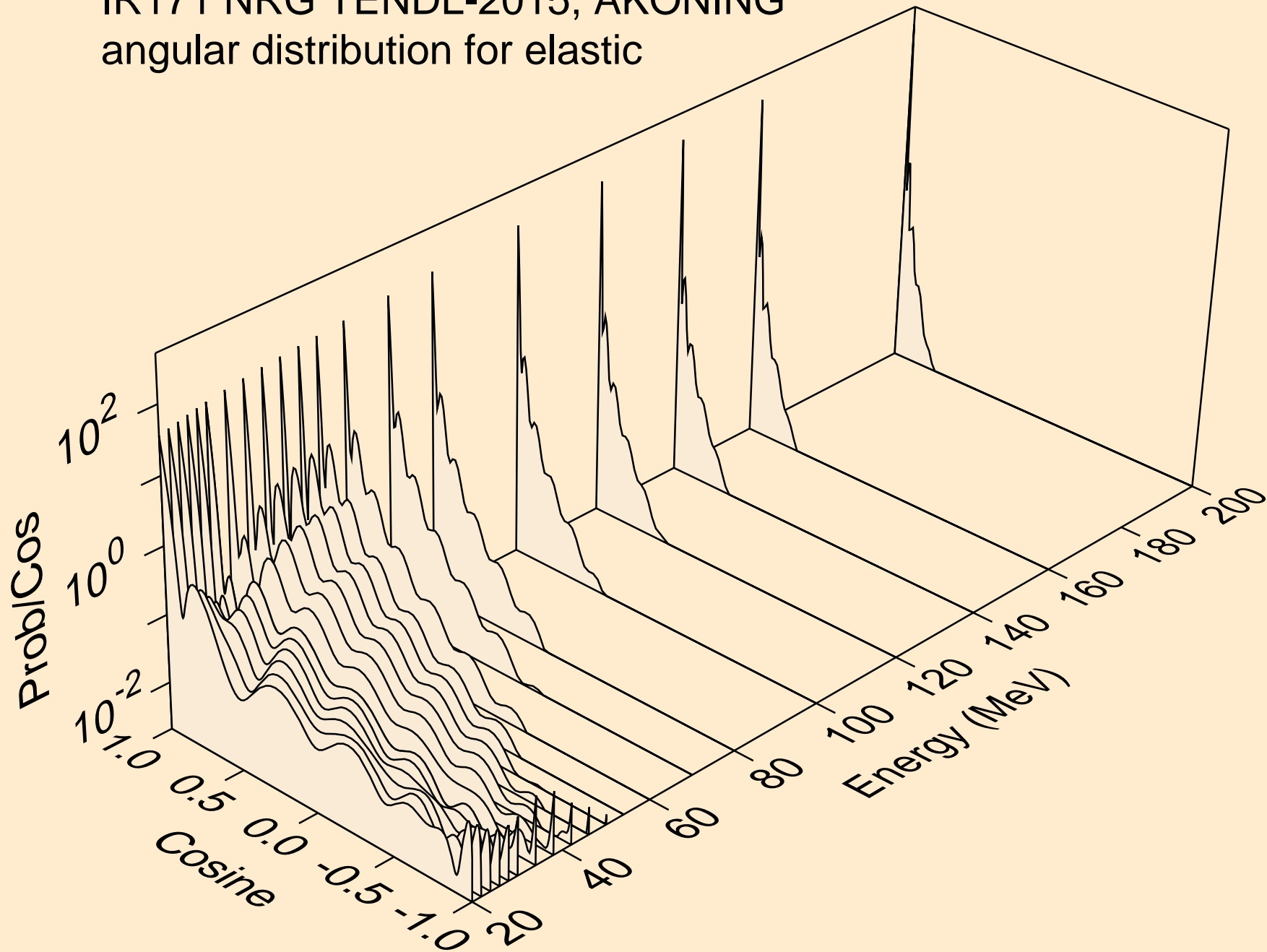

IR171 NRG TENDL-2015, AKONING  
angular distribution for (n,n\*1)

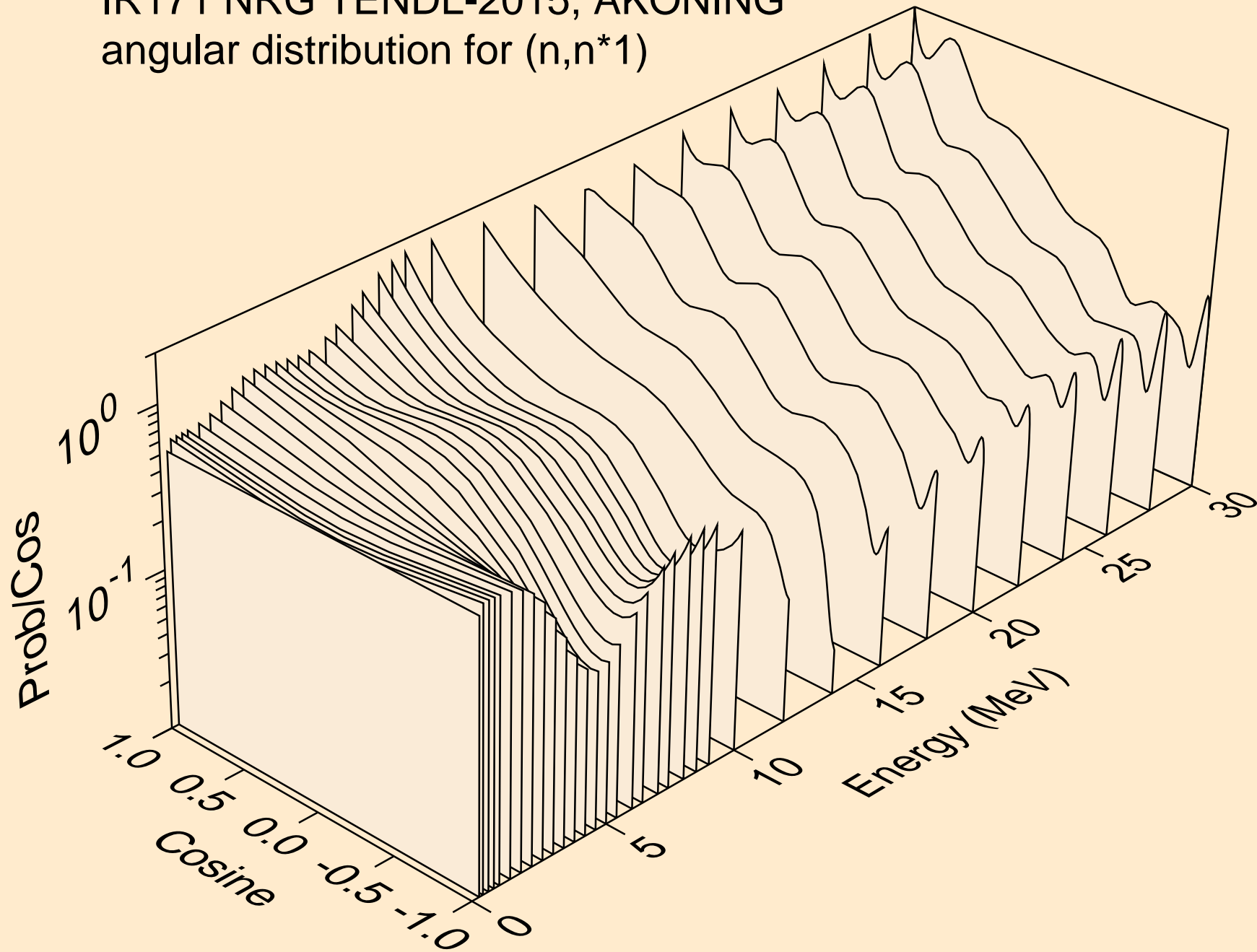

IR171 NRG TENDL-2015, AKONING  
angular distribution for (n,n\*2)

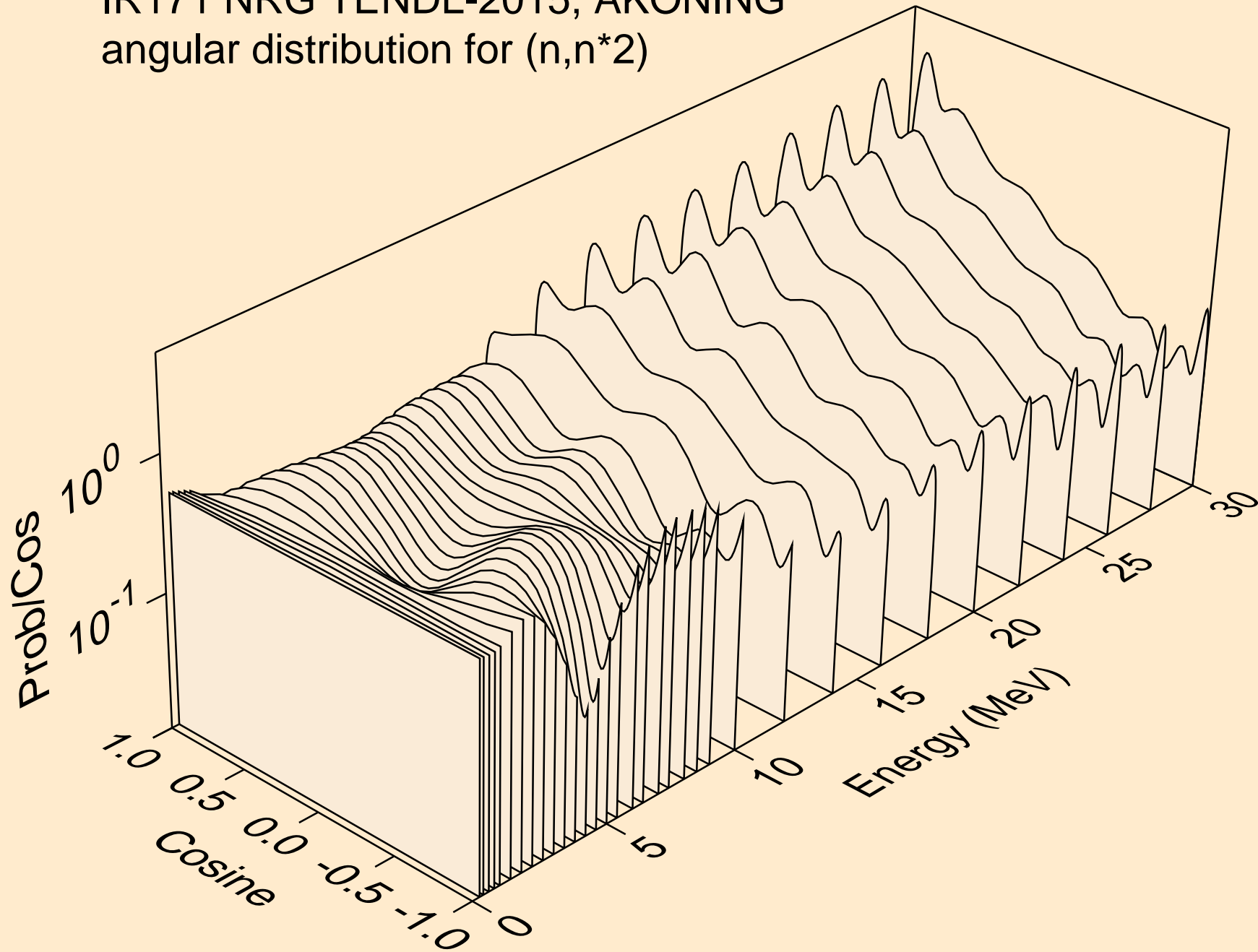

IR171 NRG TENDL-2015, AKONING  
angular distribution for (n,n\*3)

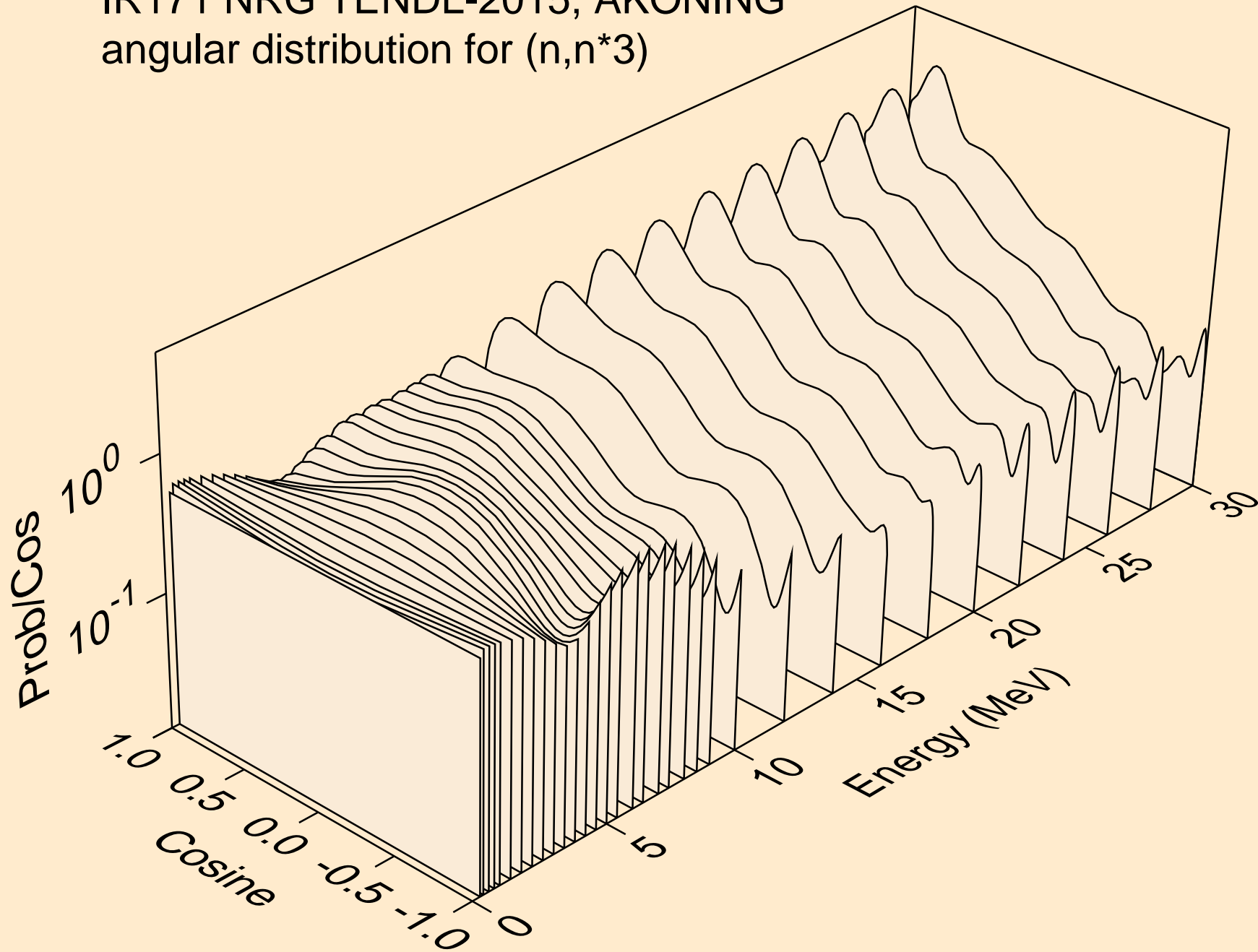

IR171 NRG TENDL-2015, AKONING  
angular distribution for (n,n\*4)

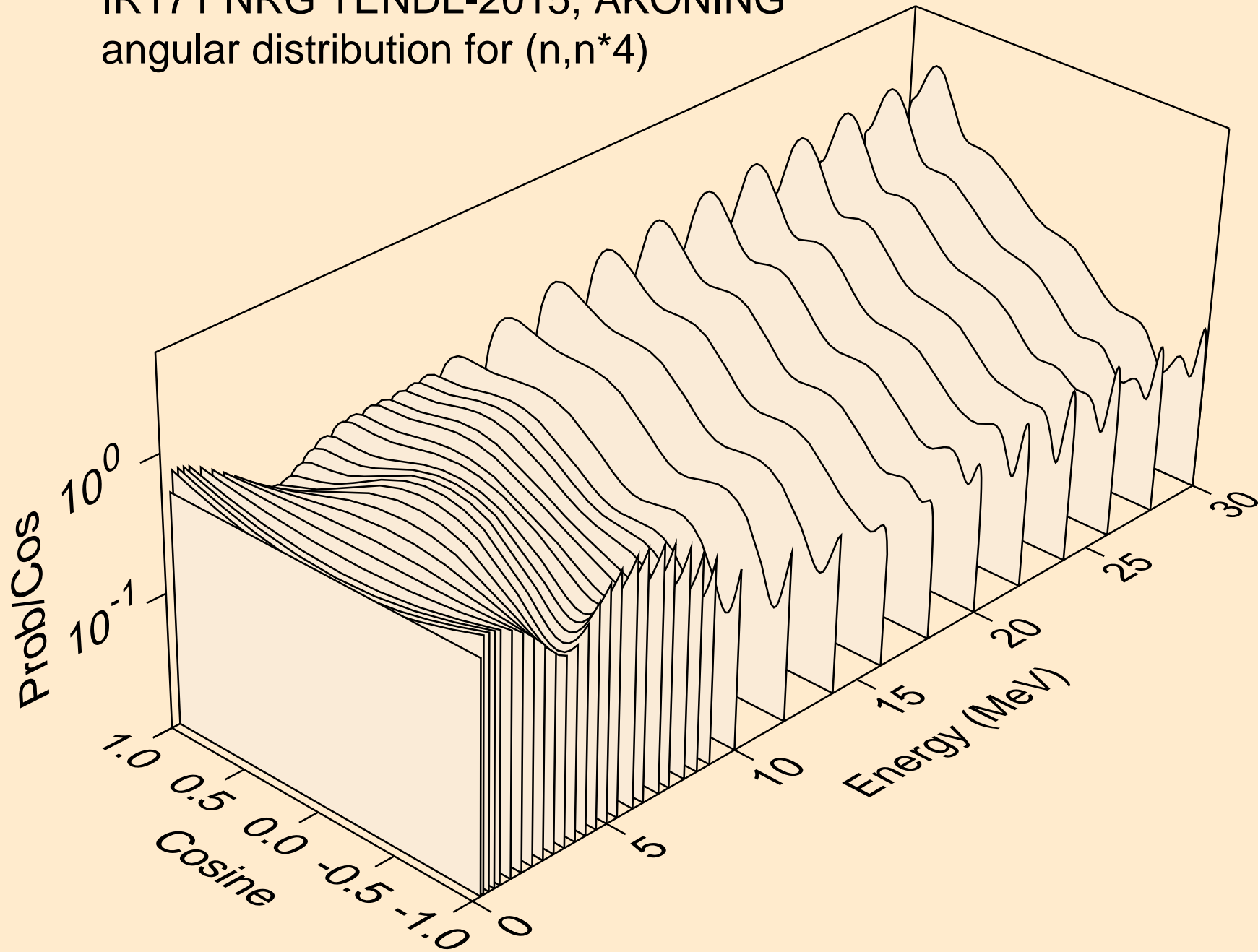

IR171 NRG TENDL-2015, AKONING  
angular distribution for (n,n\*5)

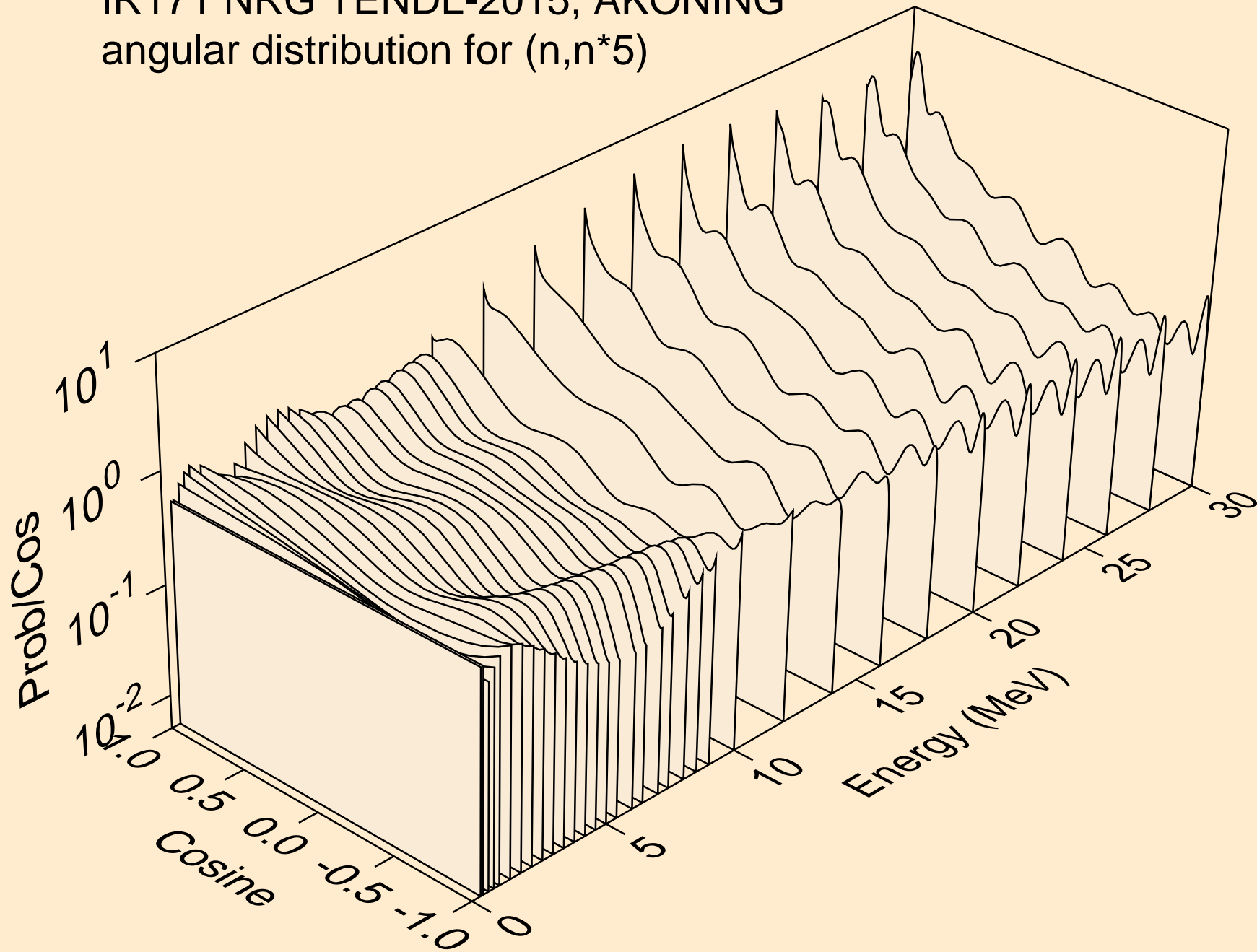

IR171 NRG TENDL-2015, AKONING  
angular distribution for (n,n\*6)

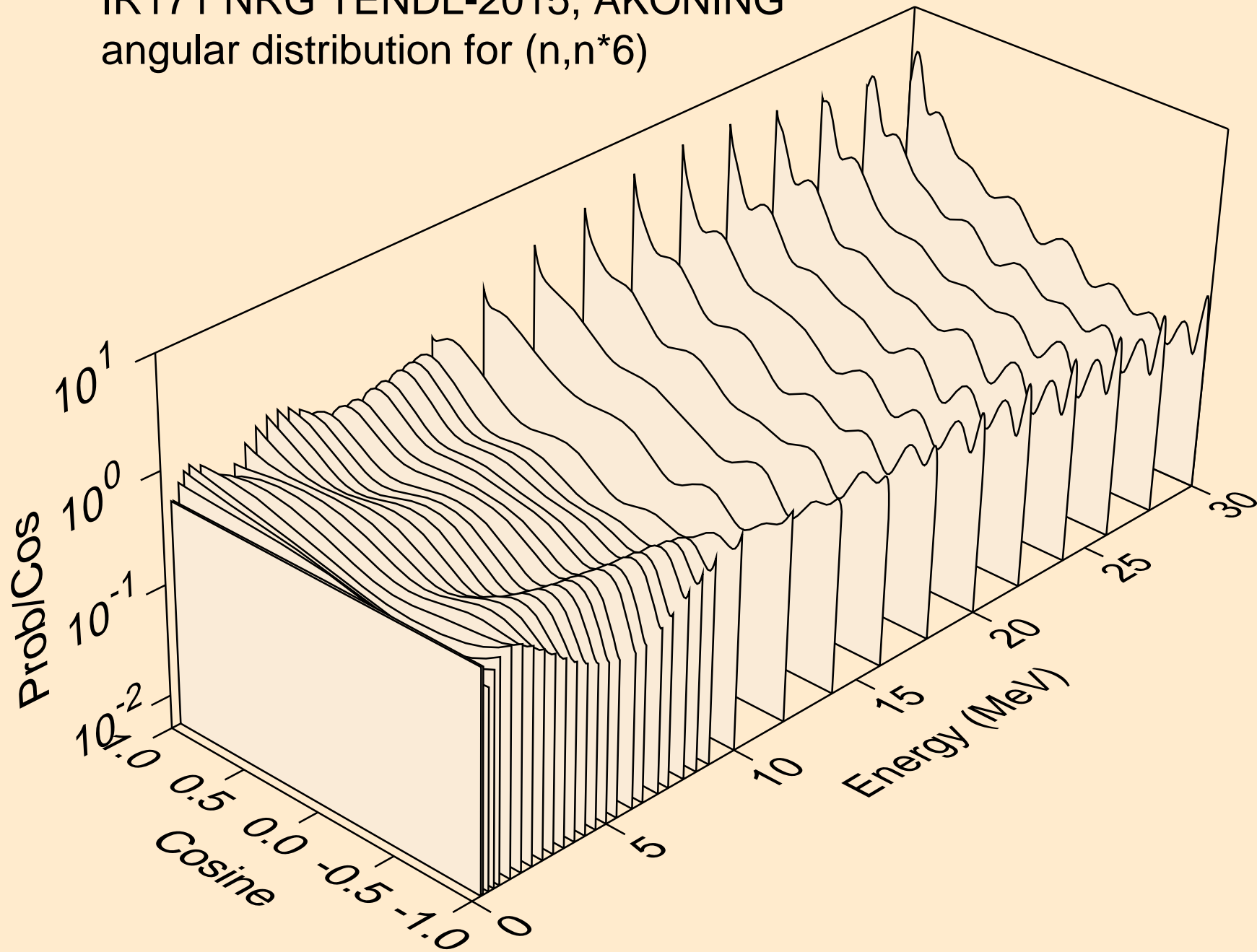



IR171 NRG TENDL-2015, AKONING  
angular distribution for (n,n\*7)

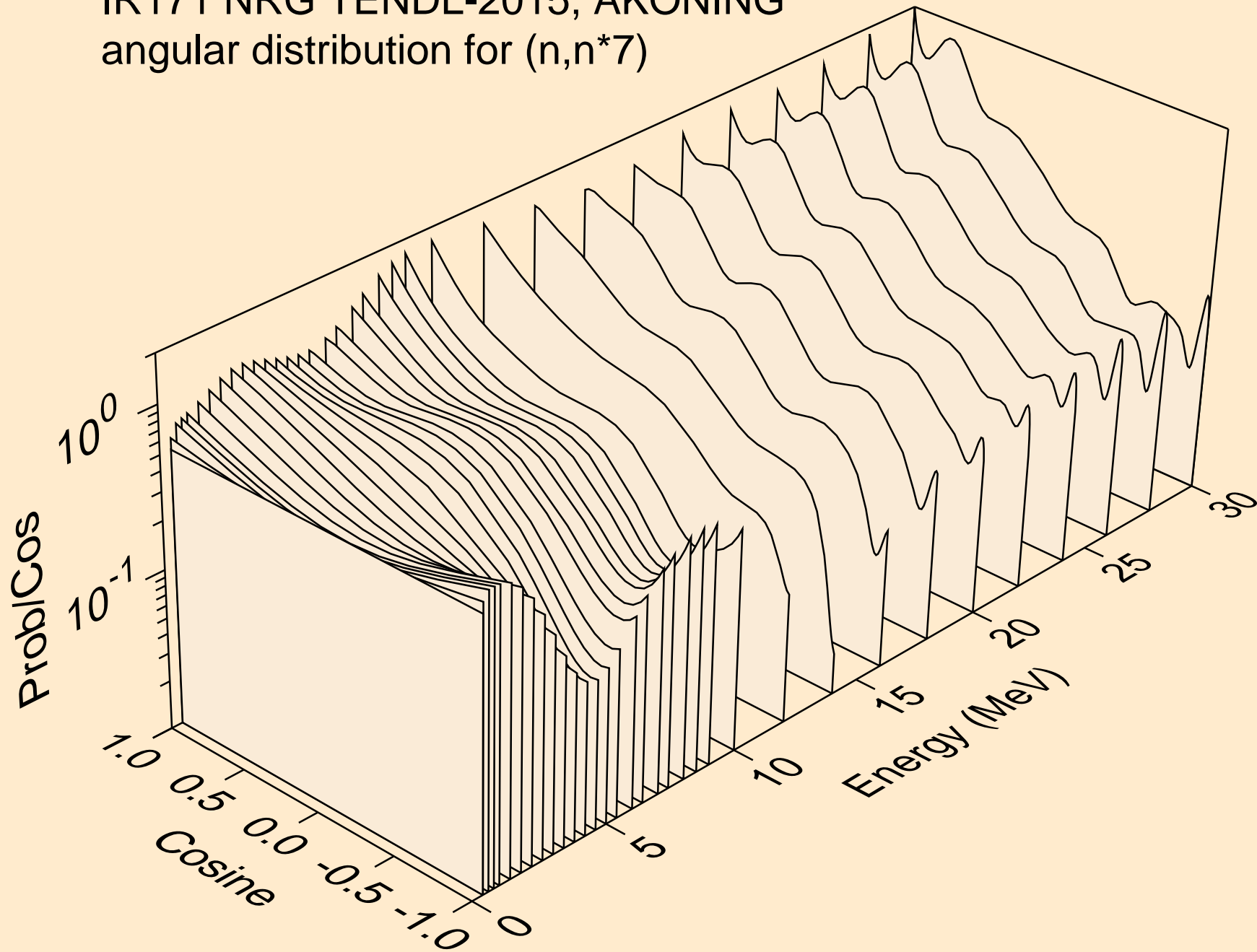

IR171 NRG TENDL-2015, AKONING  
angular distribution for (n,n\*8)

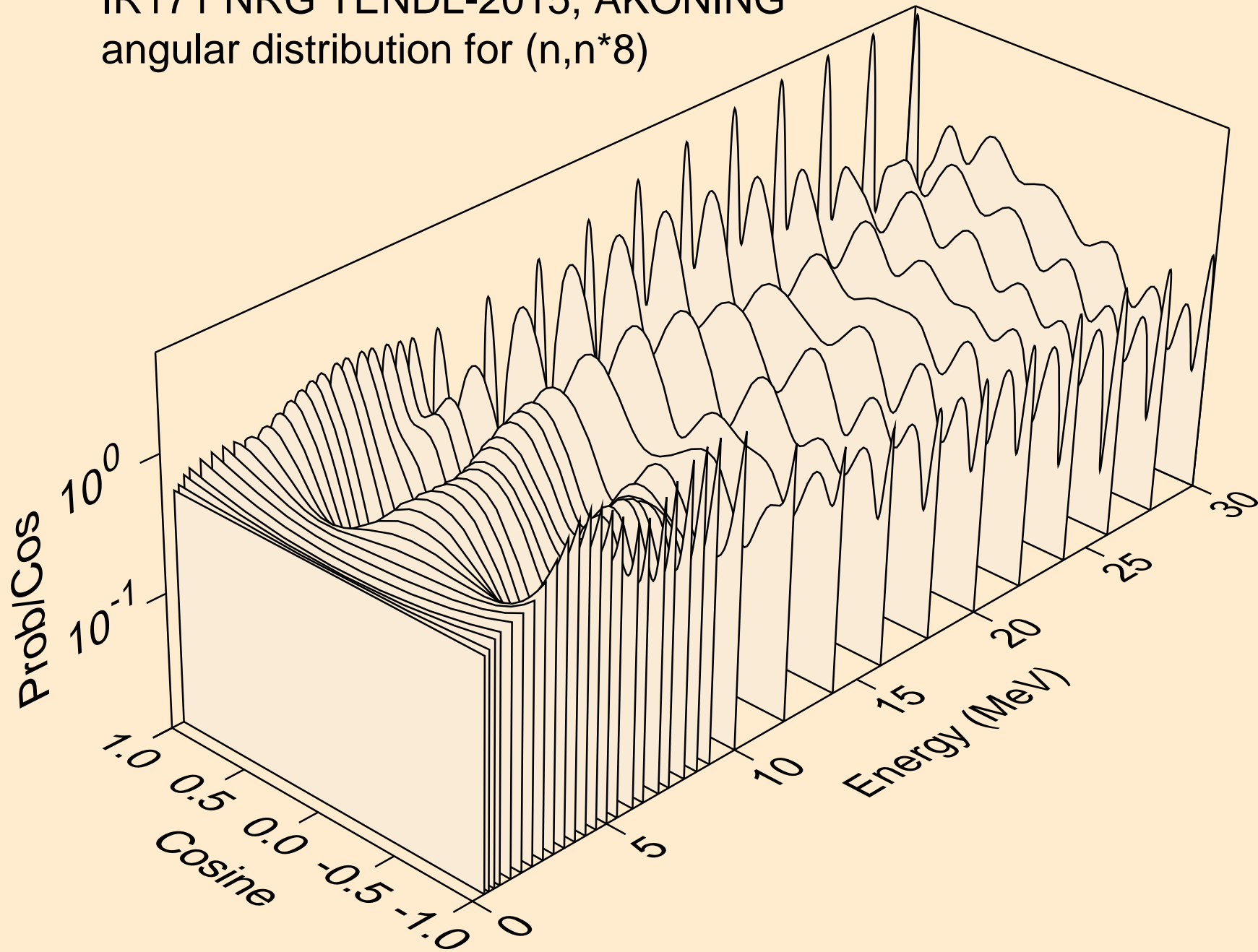

IR171 NRG TENDL-2015, AKONING  
angular distribution for (n,n\*9)

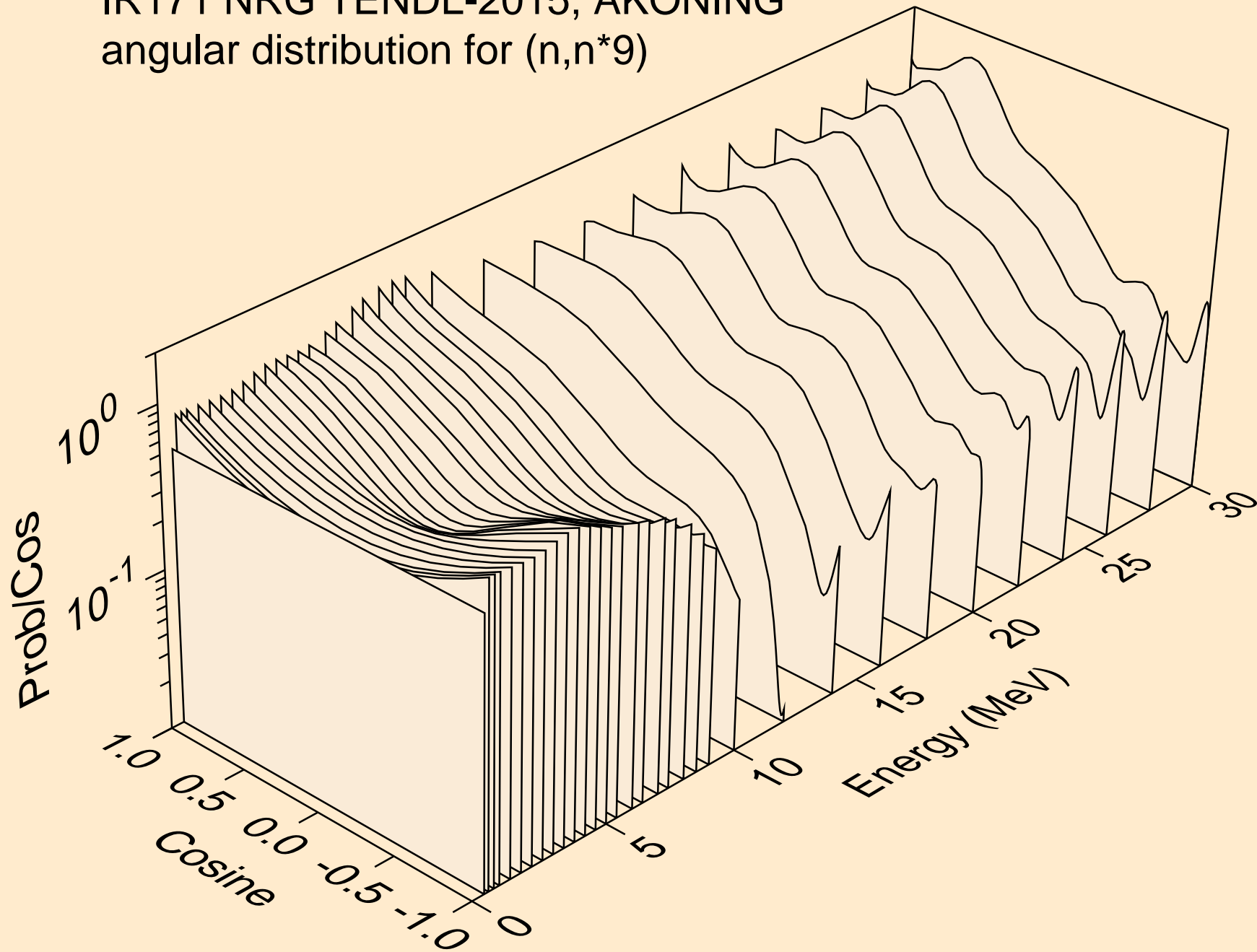

IR171 NRG TENDL-2015, AKONING  
angular distribution for (n,n\*10)

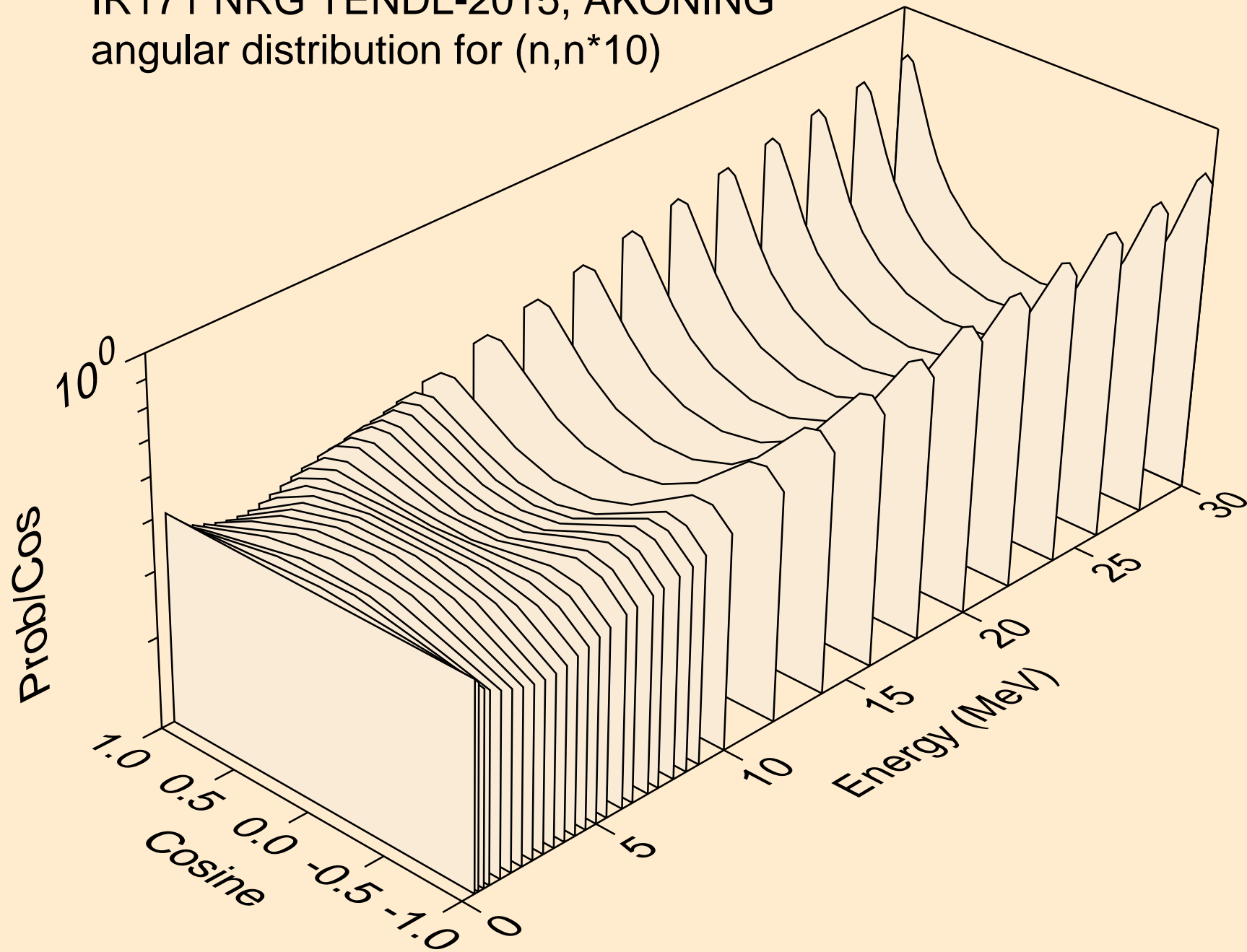

IR171 NRG TENDL-2015, AKONING  
angular distribution for (n,n\*11)

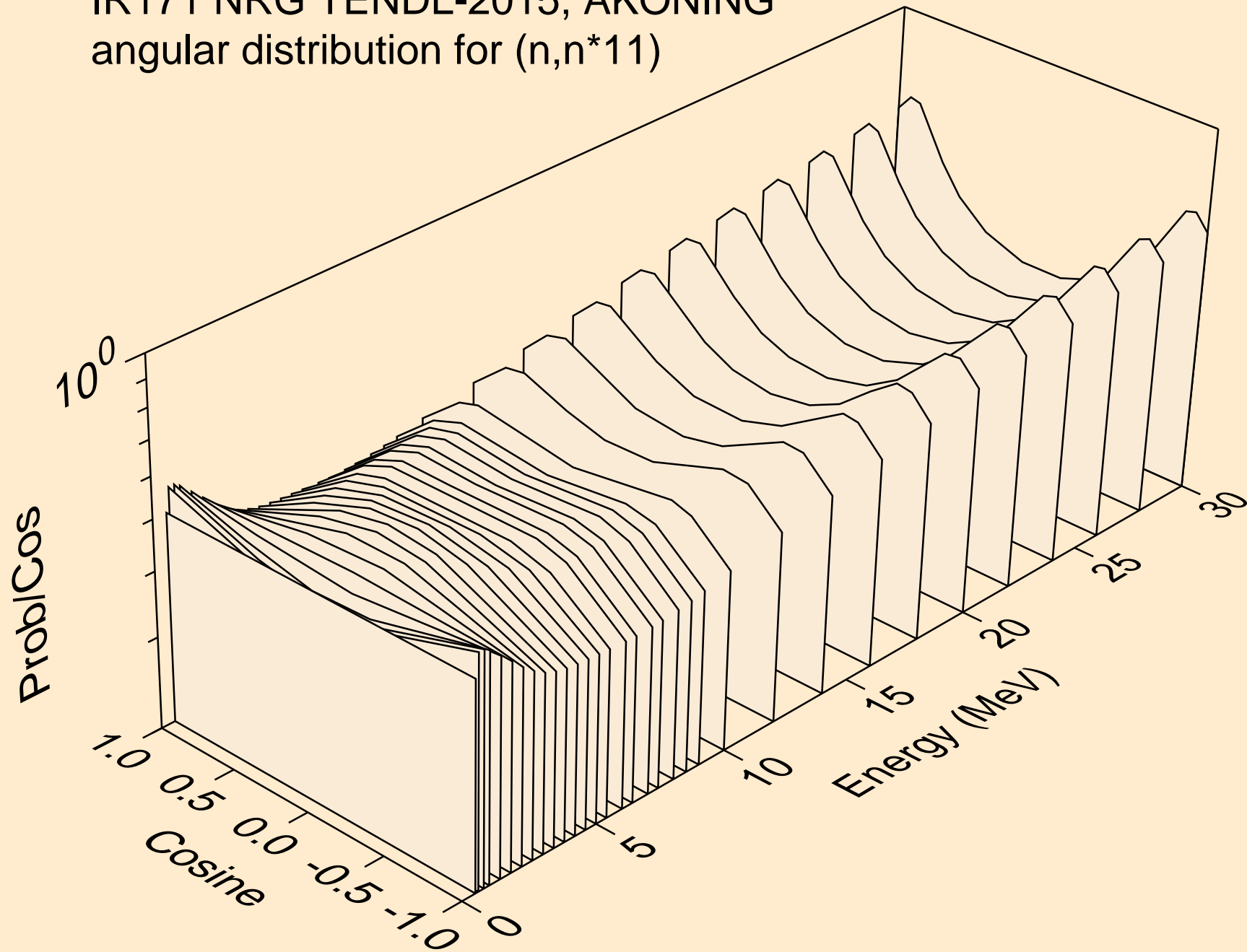

IR171 NRG TENDL-2015, AKONING  
angular distribution for (n,n\*12)

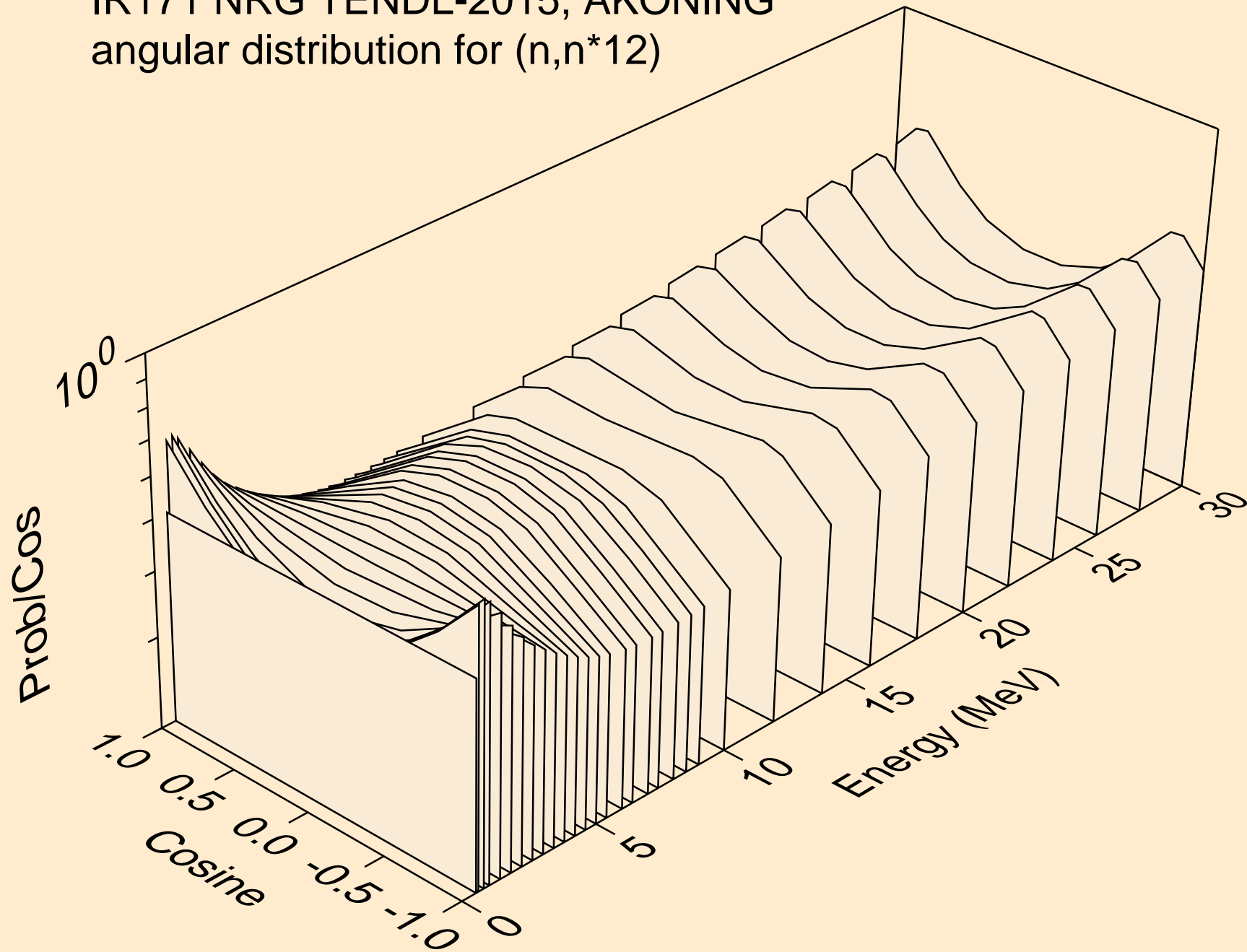

IR171 NRG TENDL-2015, AKONING  
angular distribution for (n,n\*13)

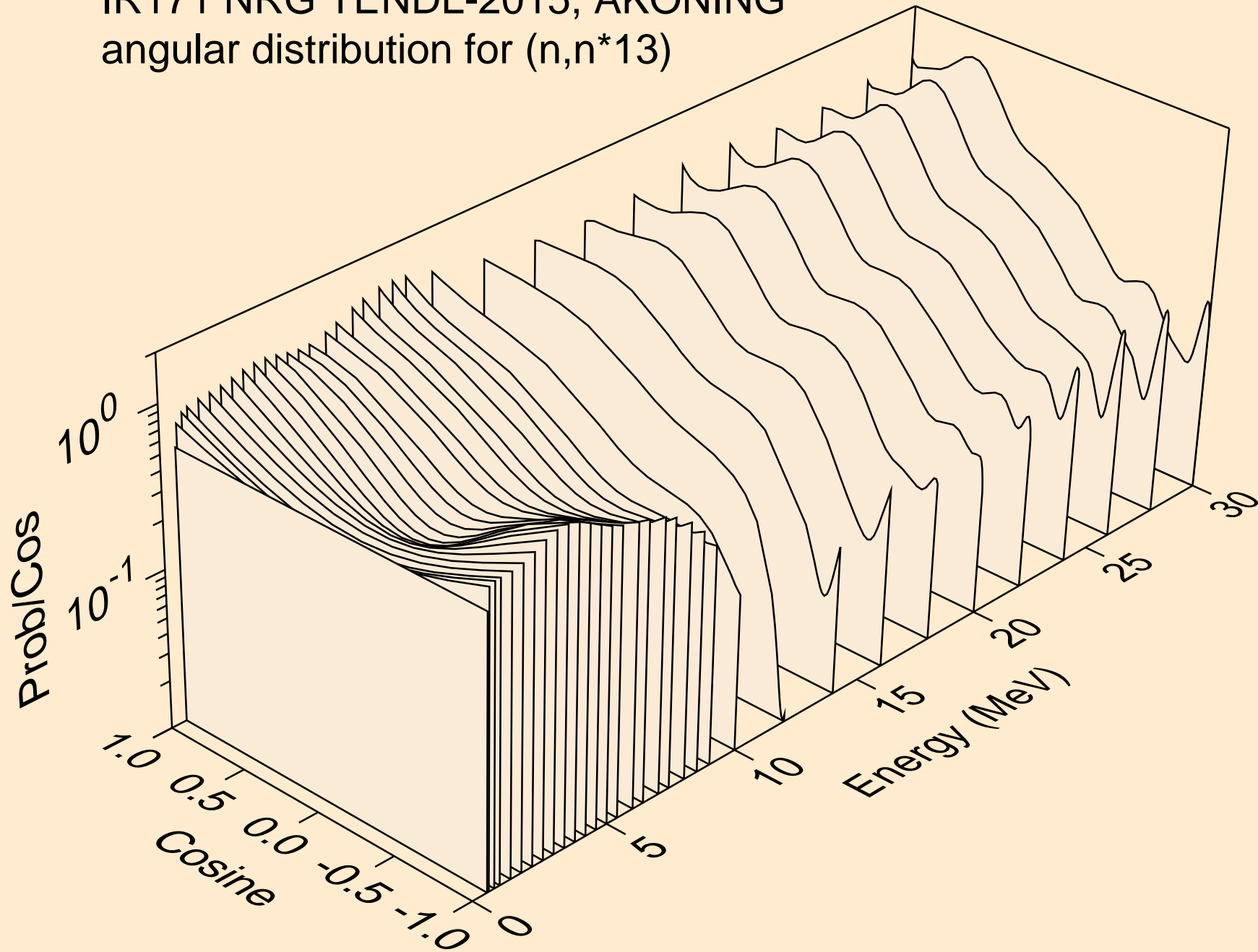

IR171 NRG TENDL-2015, AKONING  
angular distribution for (n,n\*14)

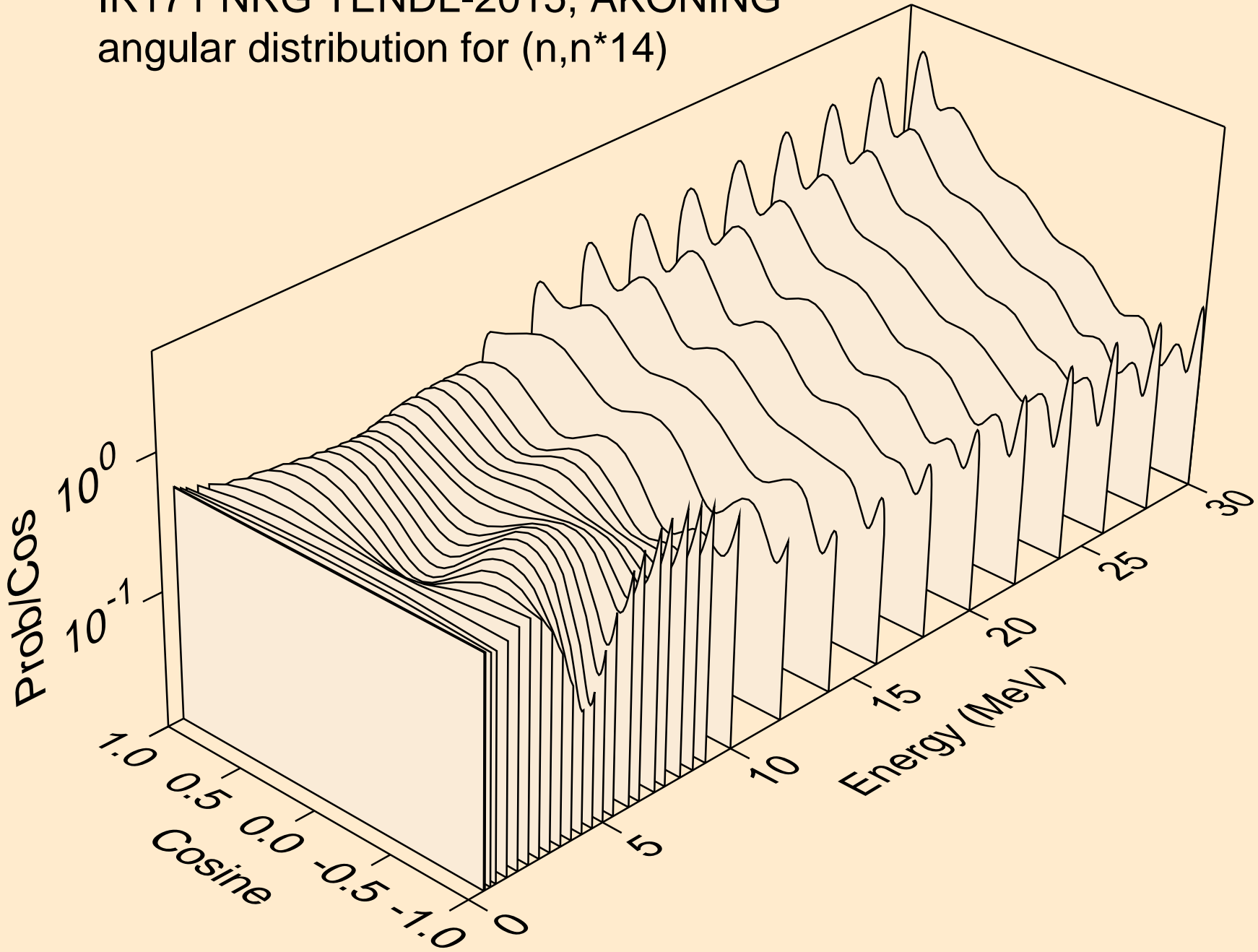



IR171 NRG TENDL-2015, AKONING  
angular distribution for (n,n\*15)

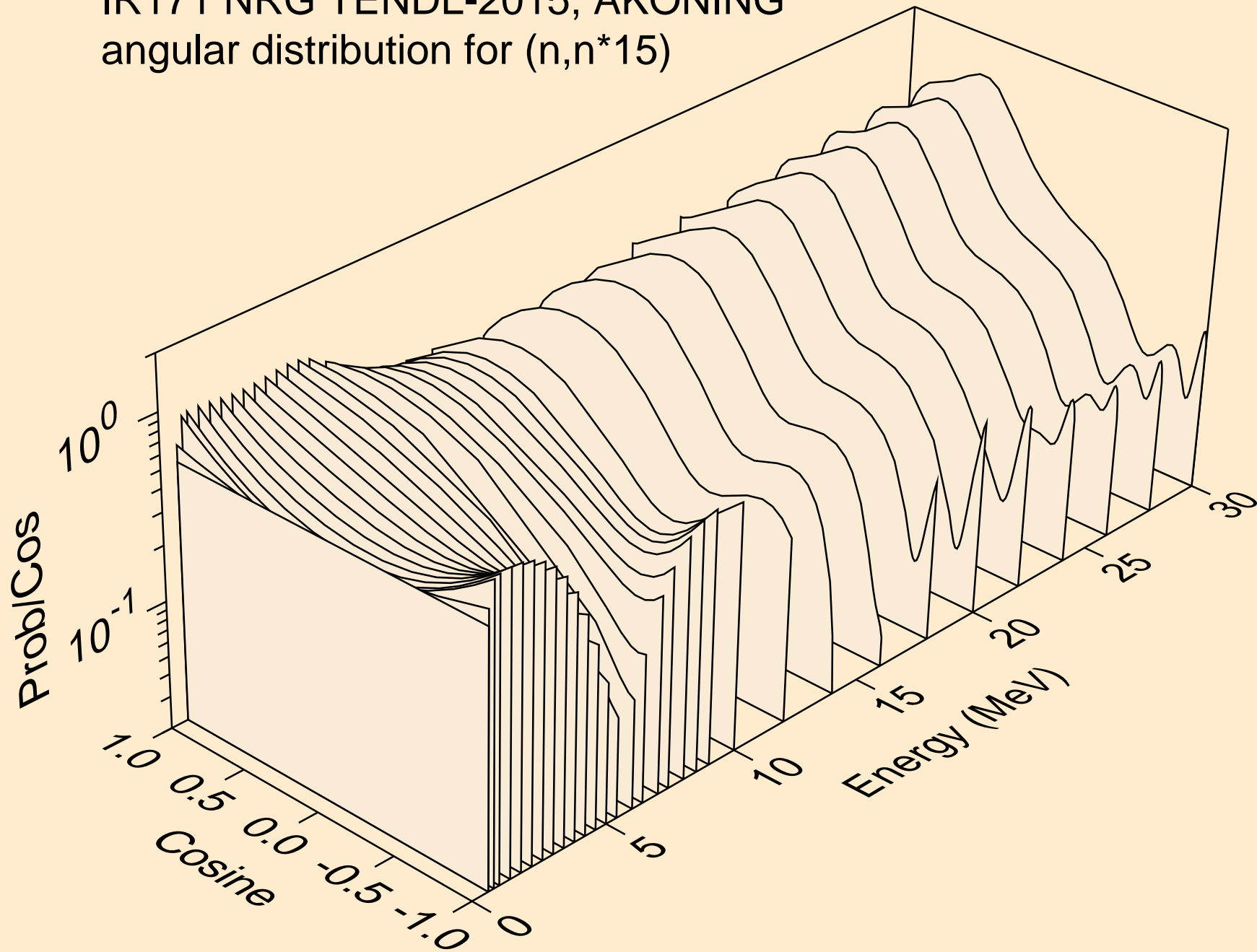

IR171 NRG TENDL-2015, AKONING  
angular distribution for (n,n\*16)

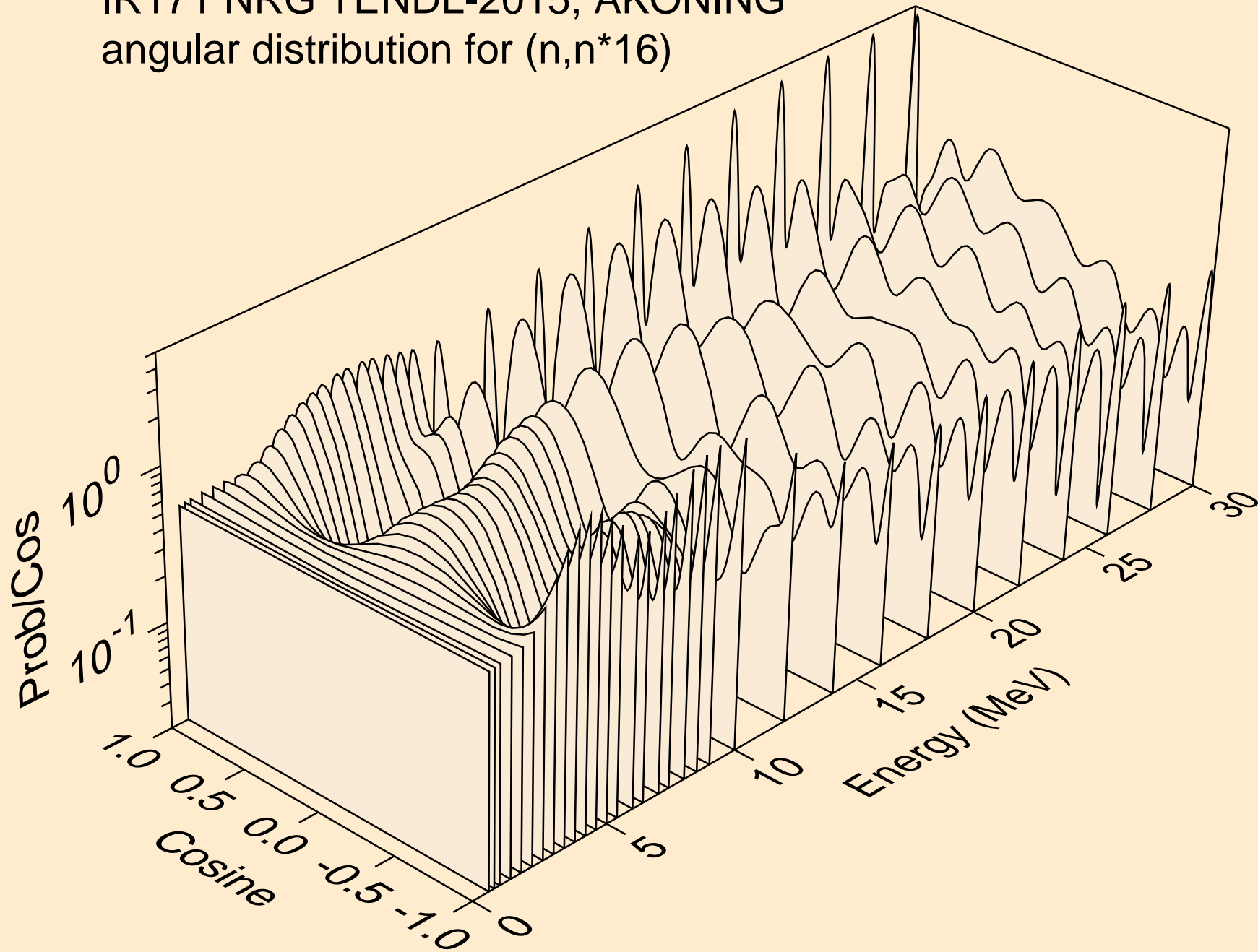

IR171 NRG TENDL-2015, AKONING  
angular distribution for (n,n\*17)

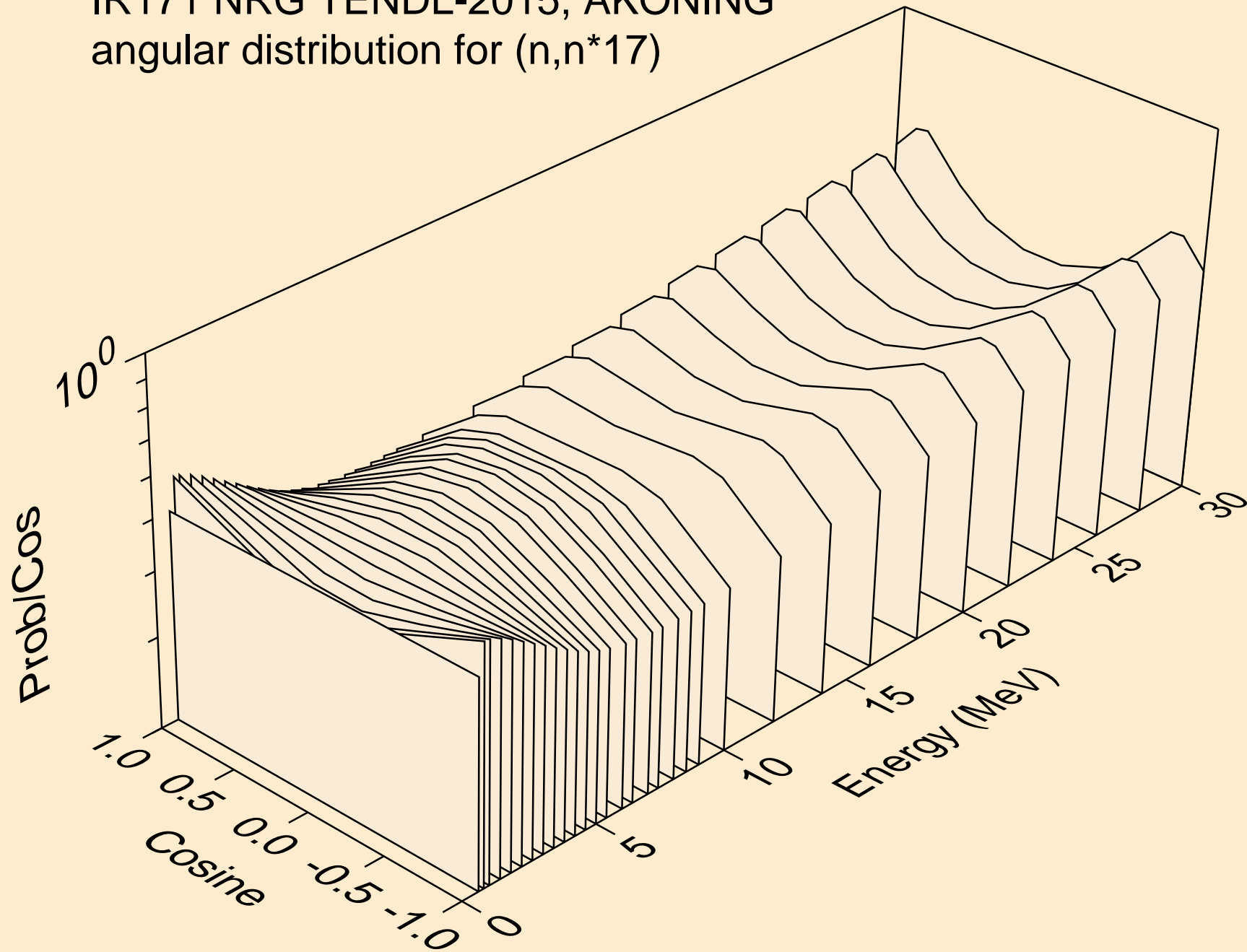

IR171 NRG TENDL-2015, AKONING  
angular distribution for (n,n\*18)

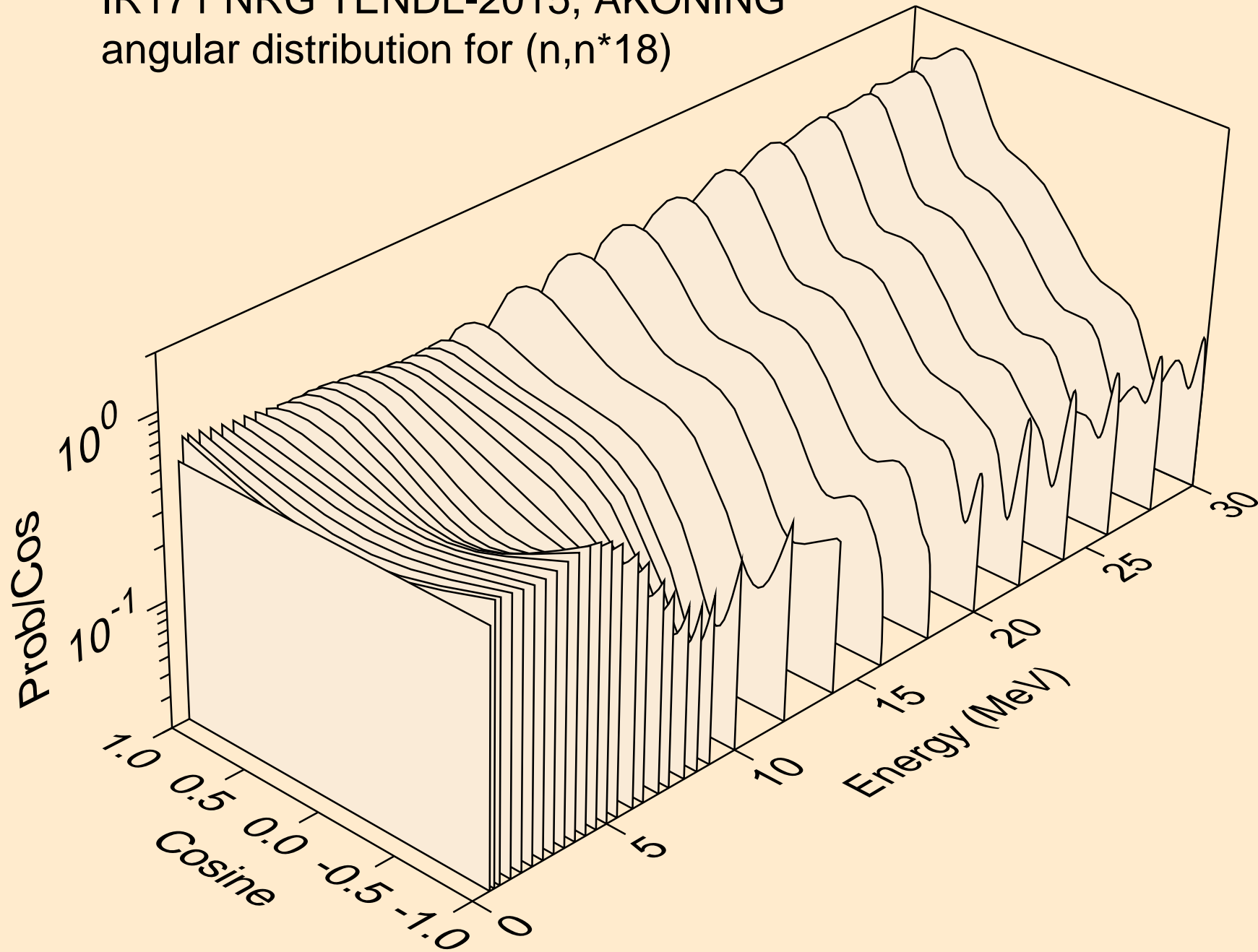

IR171 NRG TENDL-2015, AKONING  
angular distribution for (n,n\*19)

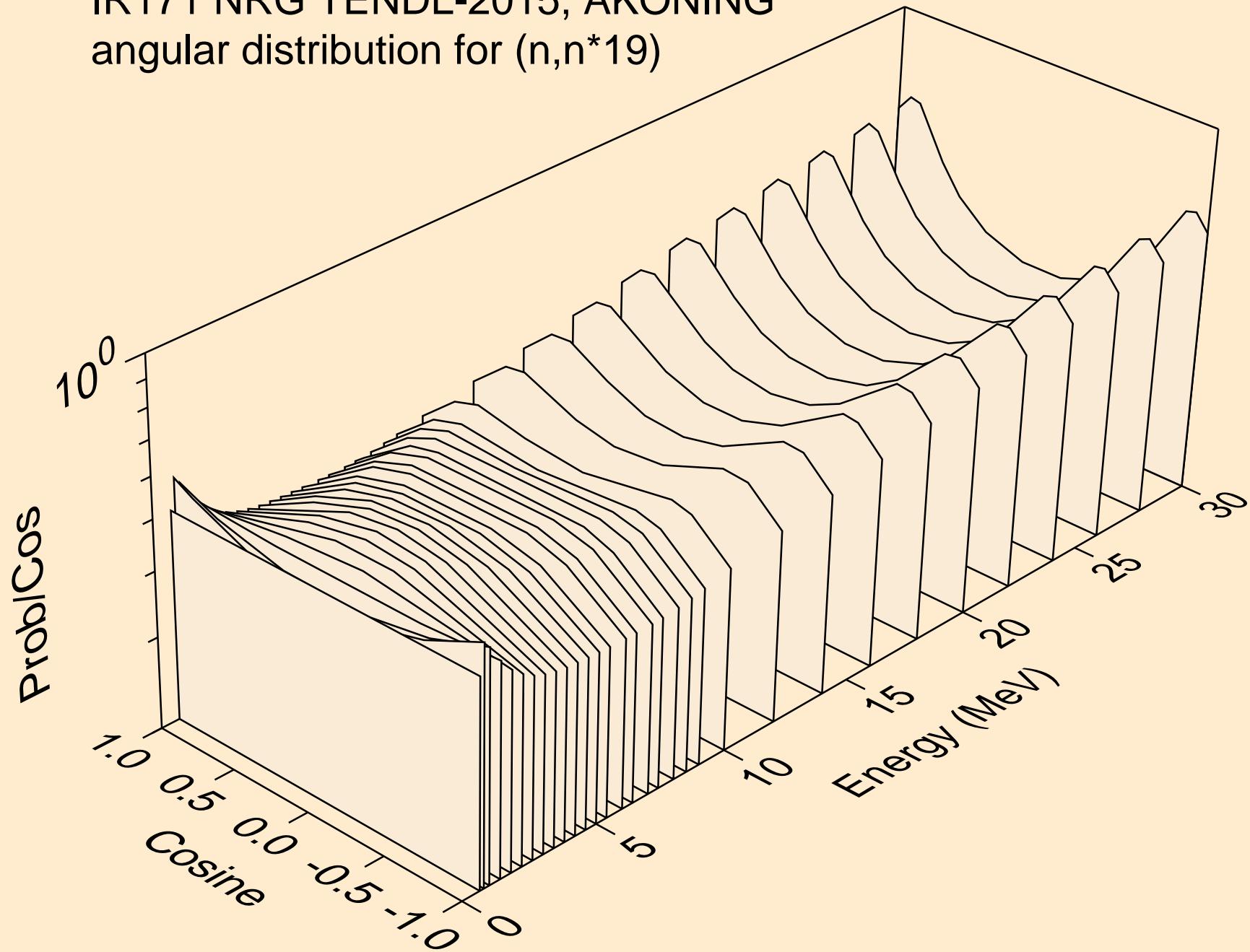

IR171 NRG TENDL-2015, AKONING  
angular distribution for (n,n\*20)

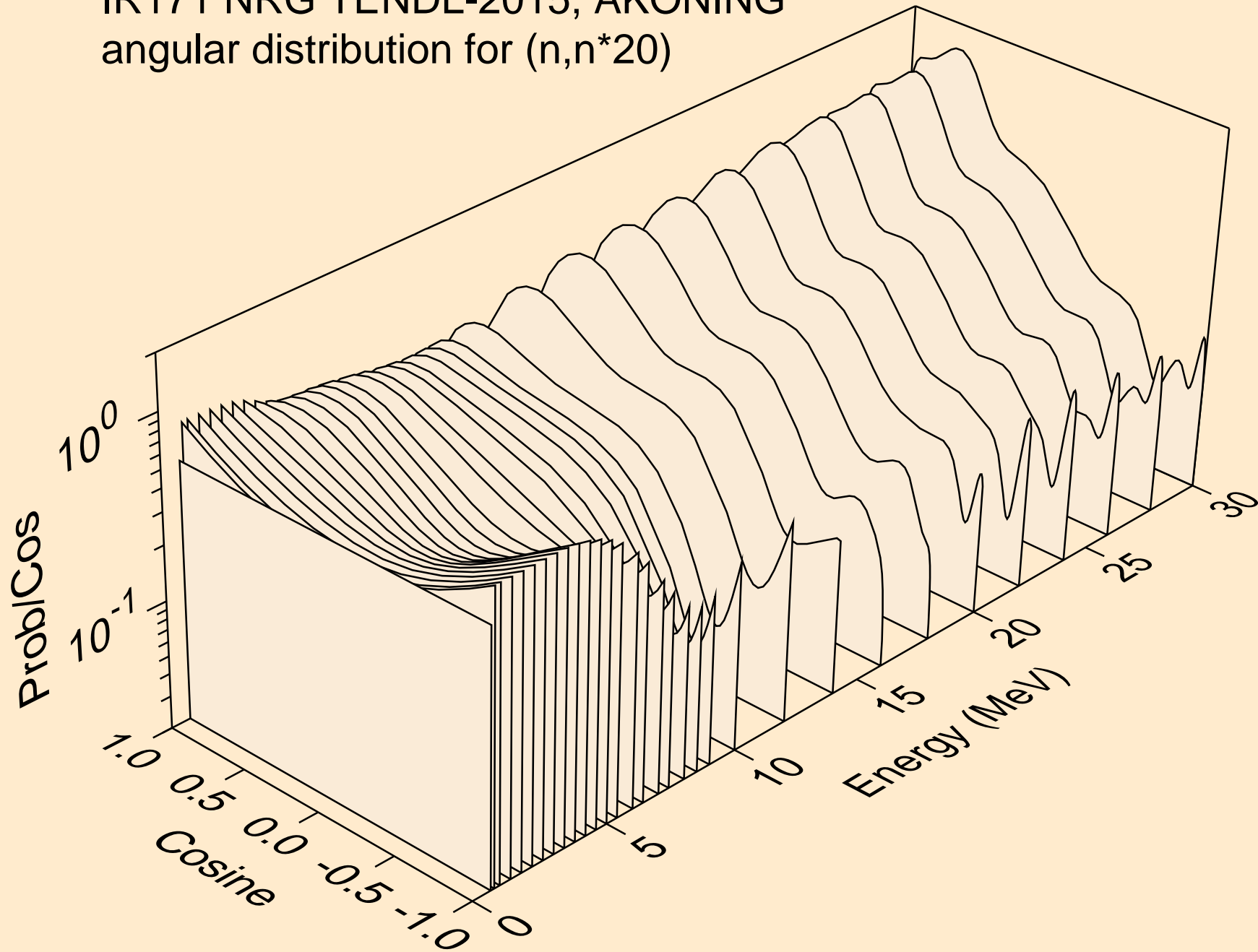

IR171 NRG TENDL-2015, AKONING  
angular distribution for (n,n\*21)

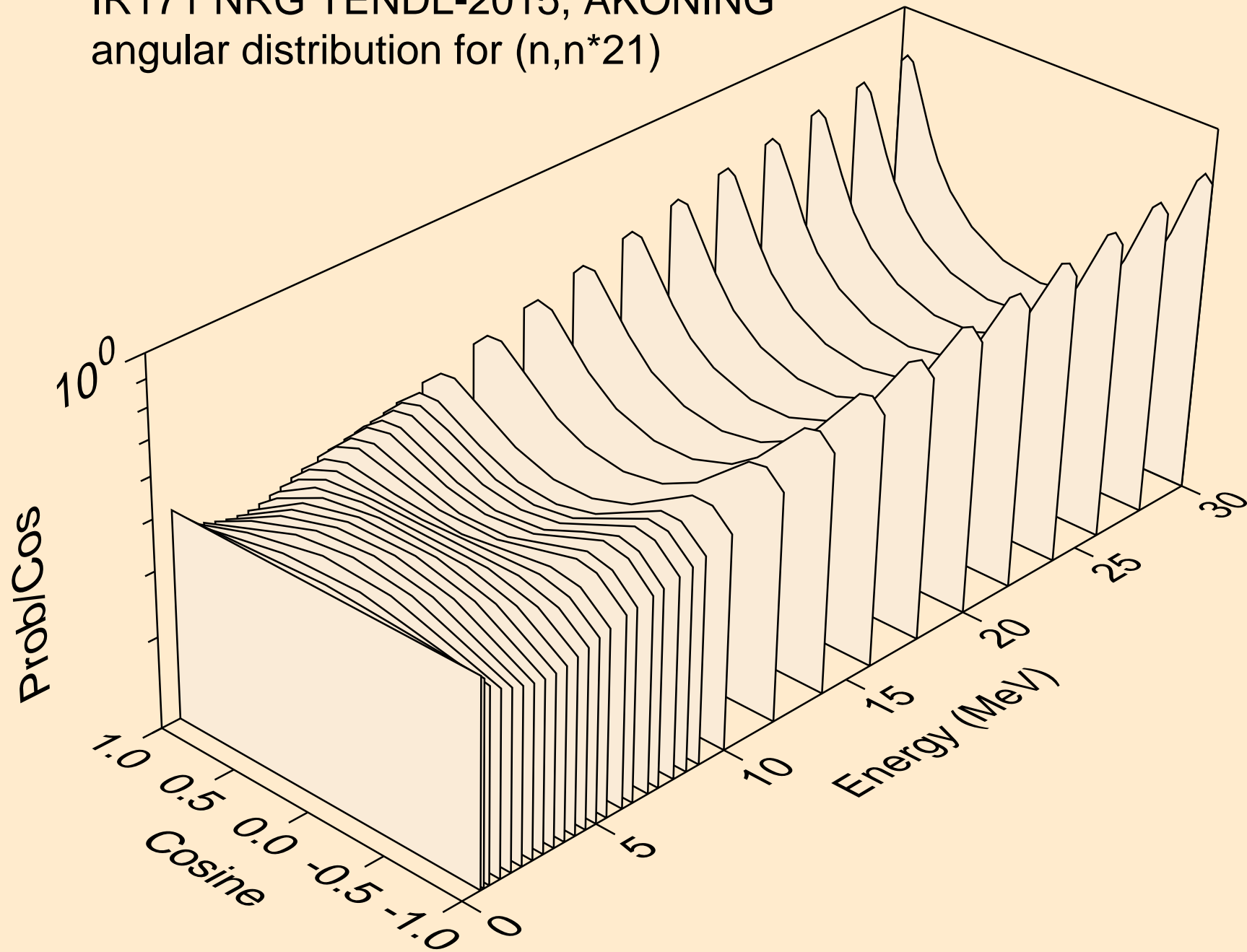

IR171 NRG TENDL-2015, AKONING  
angular distribution for (n,n\*22)

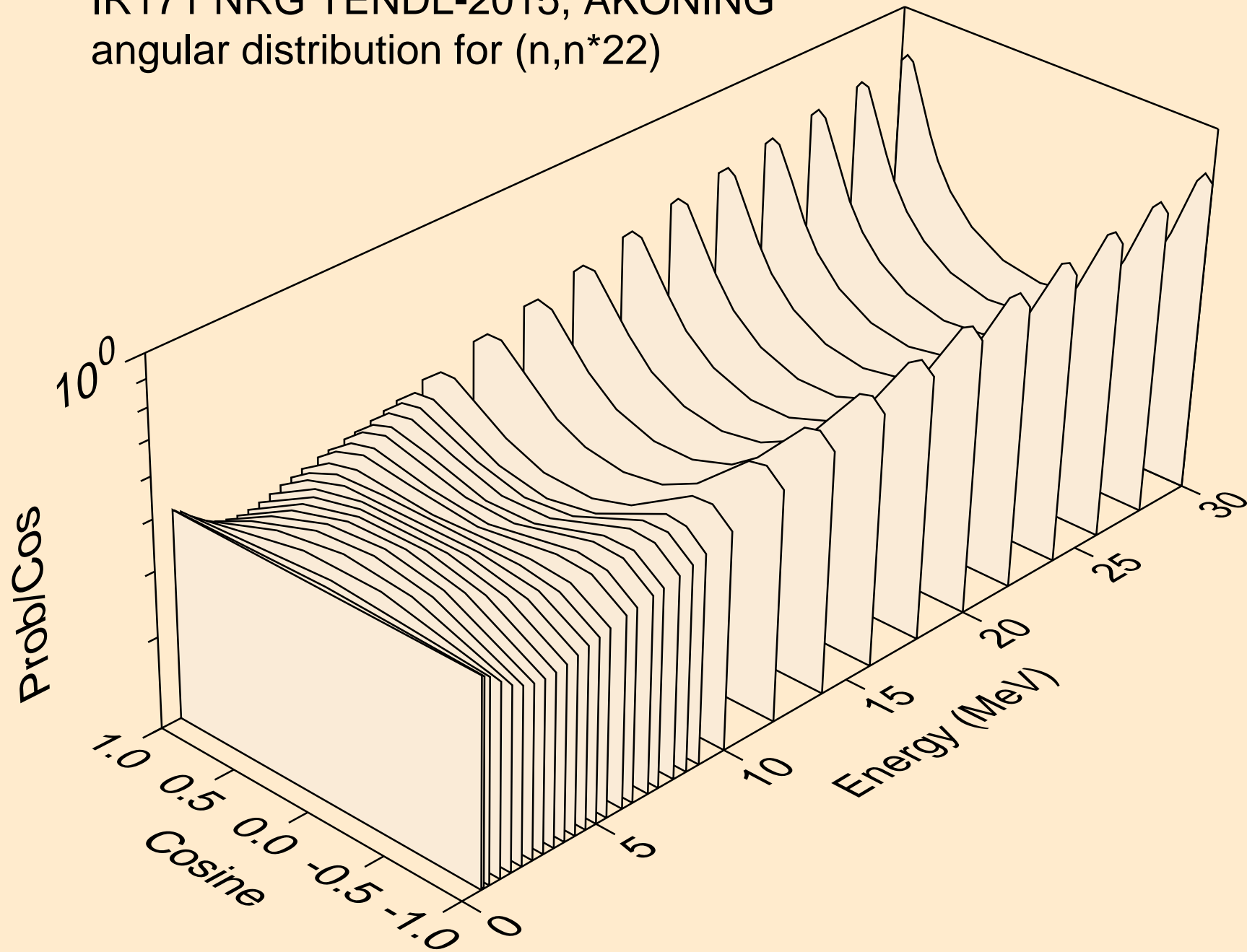



IR171 NRG TENDL-2015, AKONING  
angular distribution for (n,n\*23)

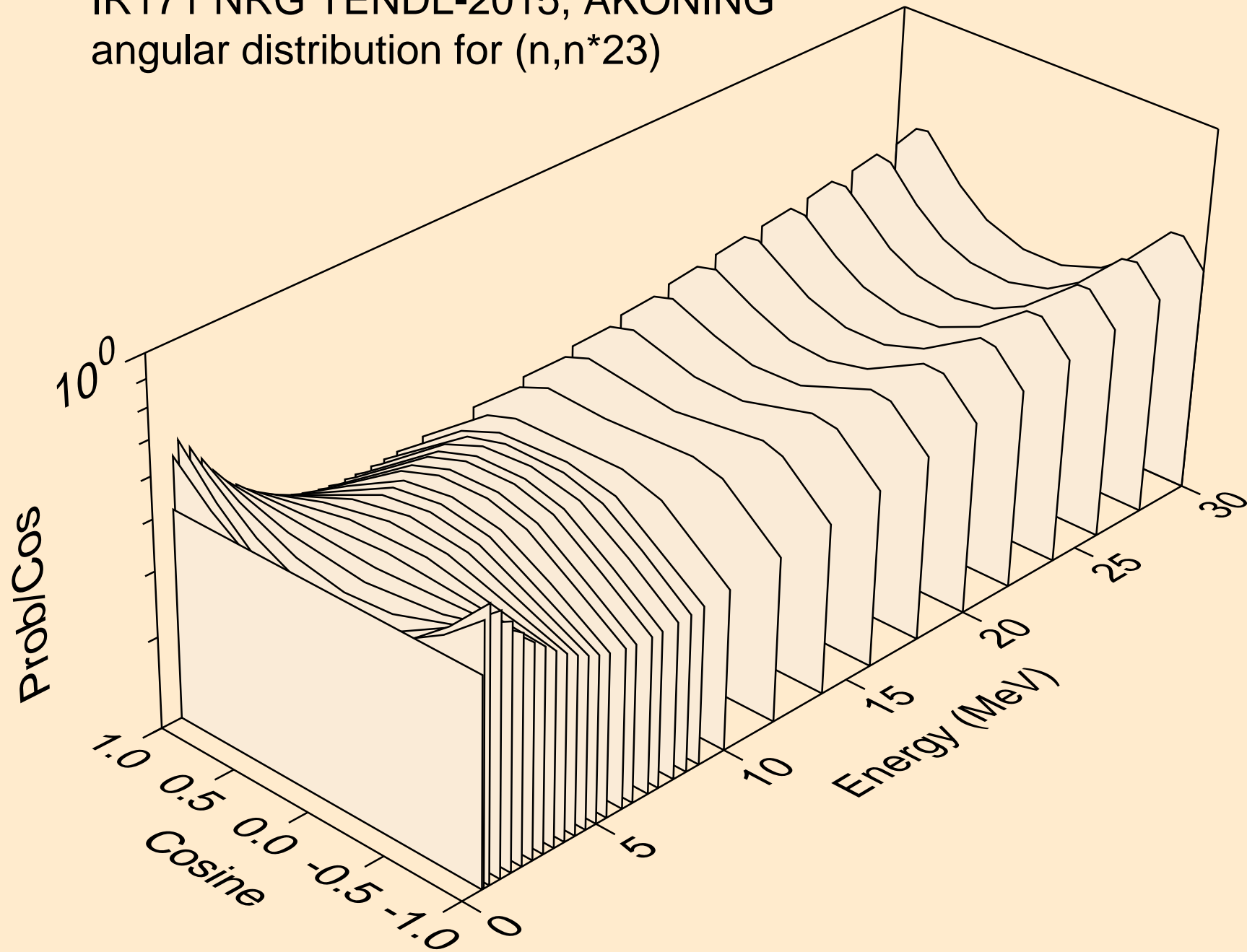

IR171 NRG TENDL-2015, AKONING  
angular distribution for (n,n\*24)

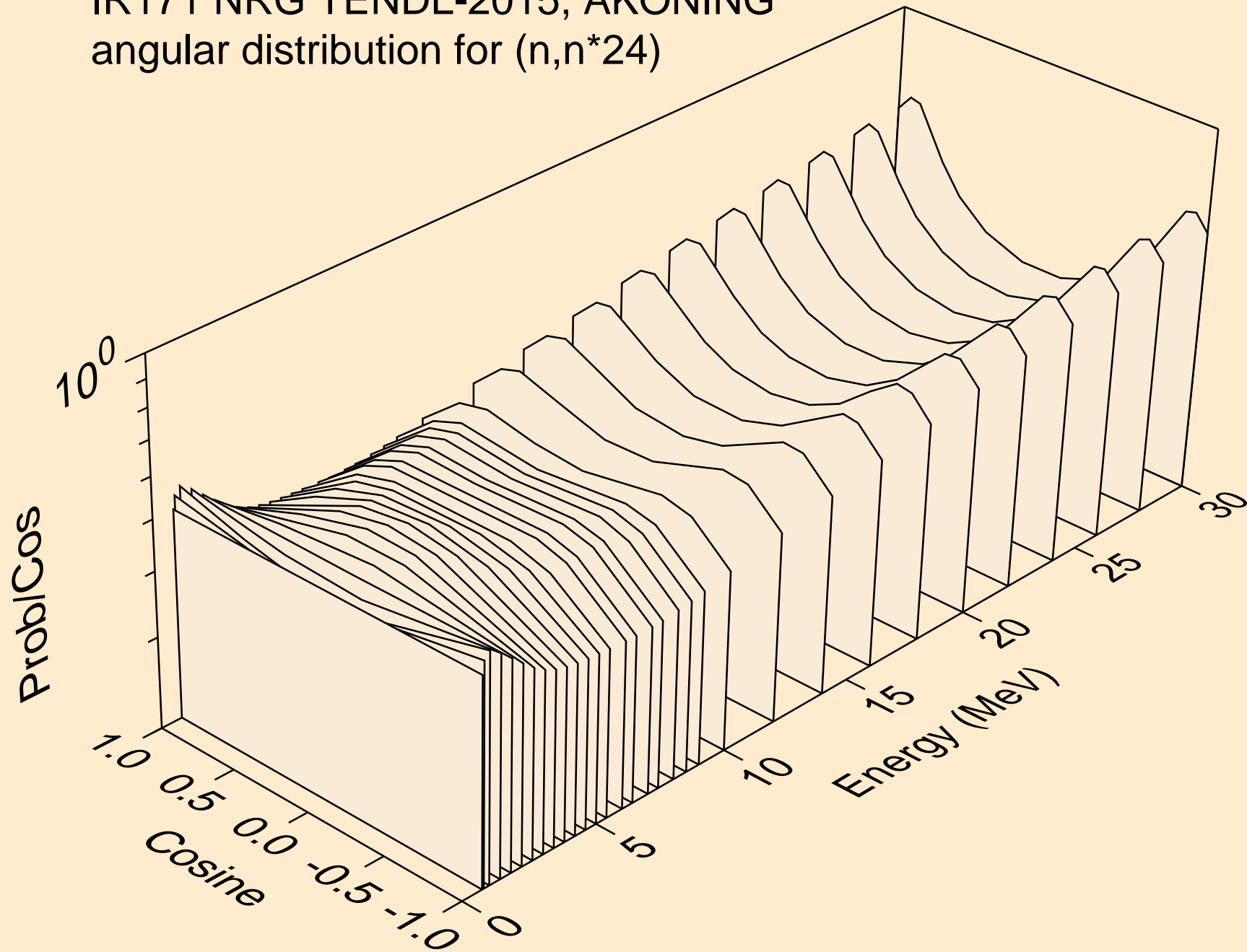

IR171 NRG TENDL-2015, AKONING  
angular distribution for (n,n\*25)

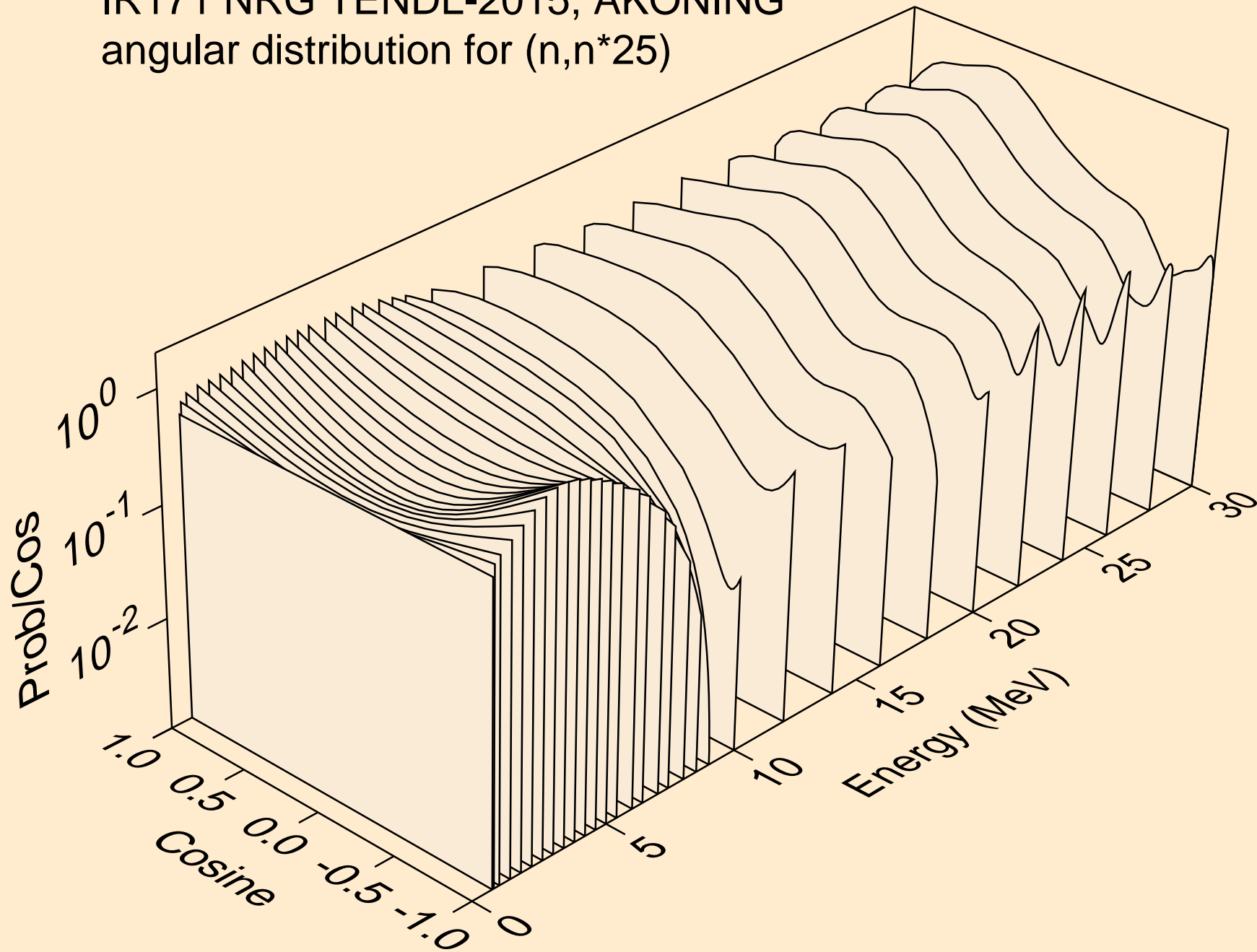

IR171 NRG TENDL-2015, AKONING  
angular distribution for (n,n\*26)

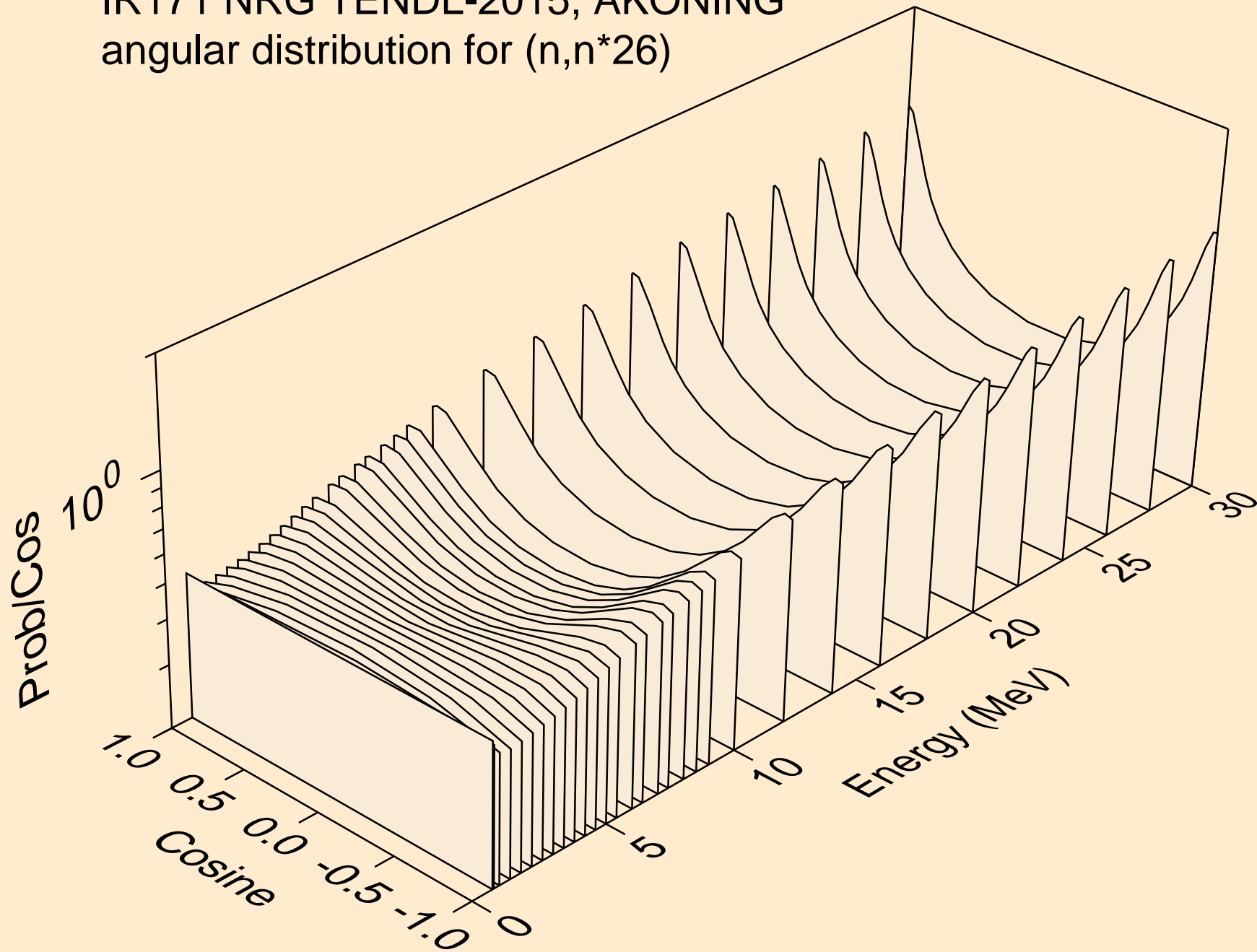

IR171 NRG TENDL-2015, AKONING  
angular distribution for (n,n\*27)

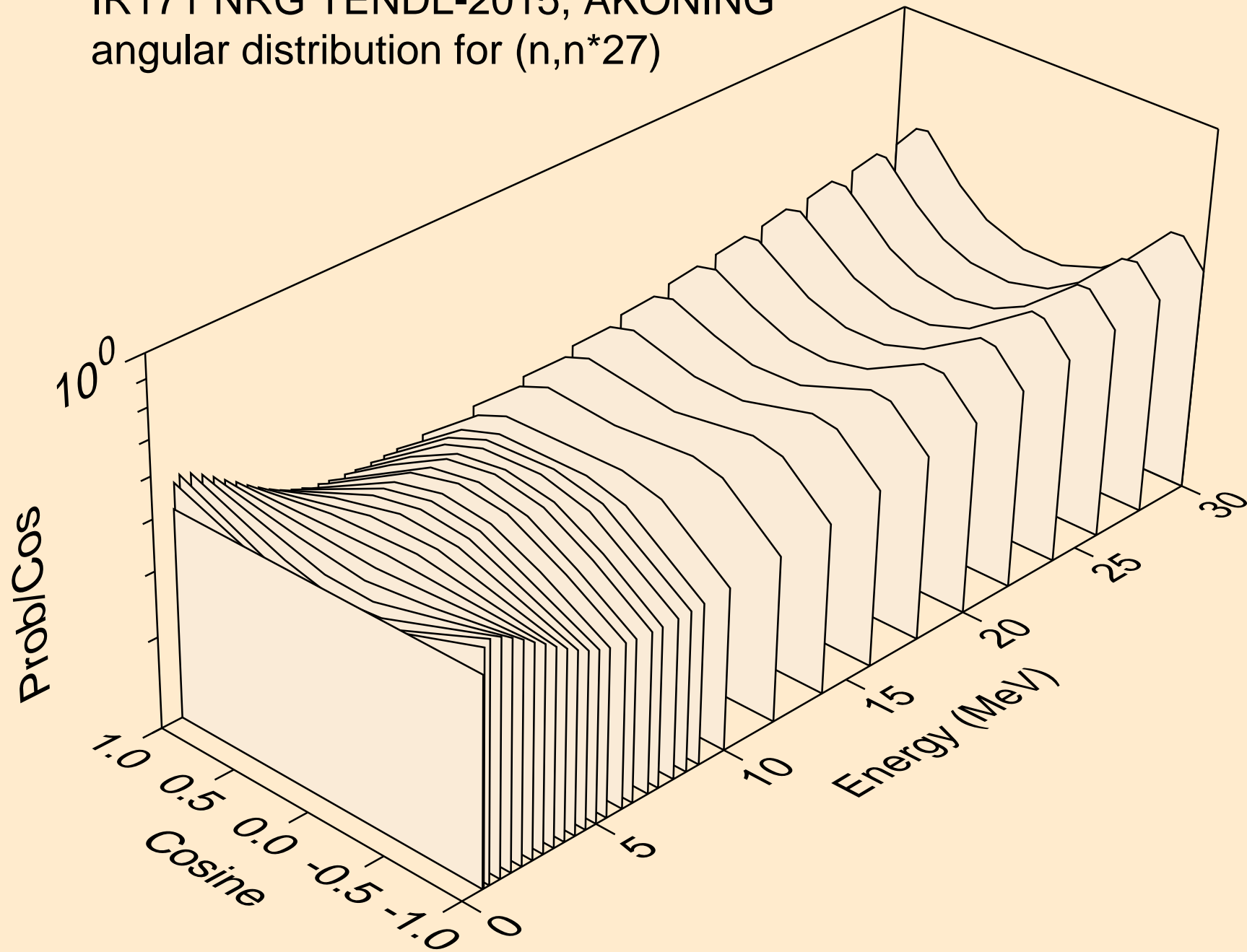

IR171 NRG TENDL-2015, AKONING  
angular distribution for (n,n\*28)

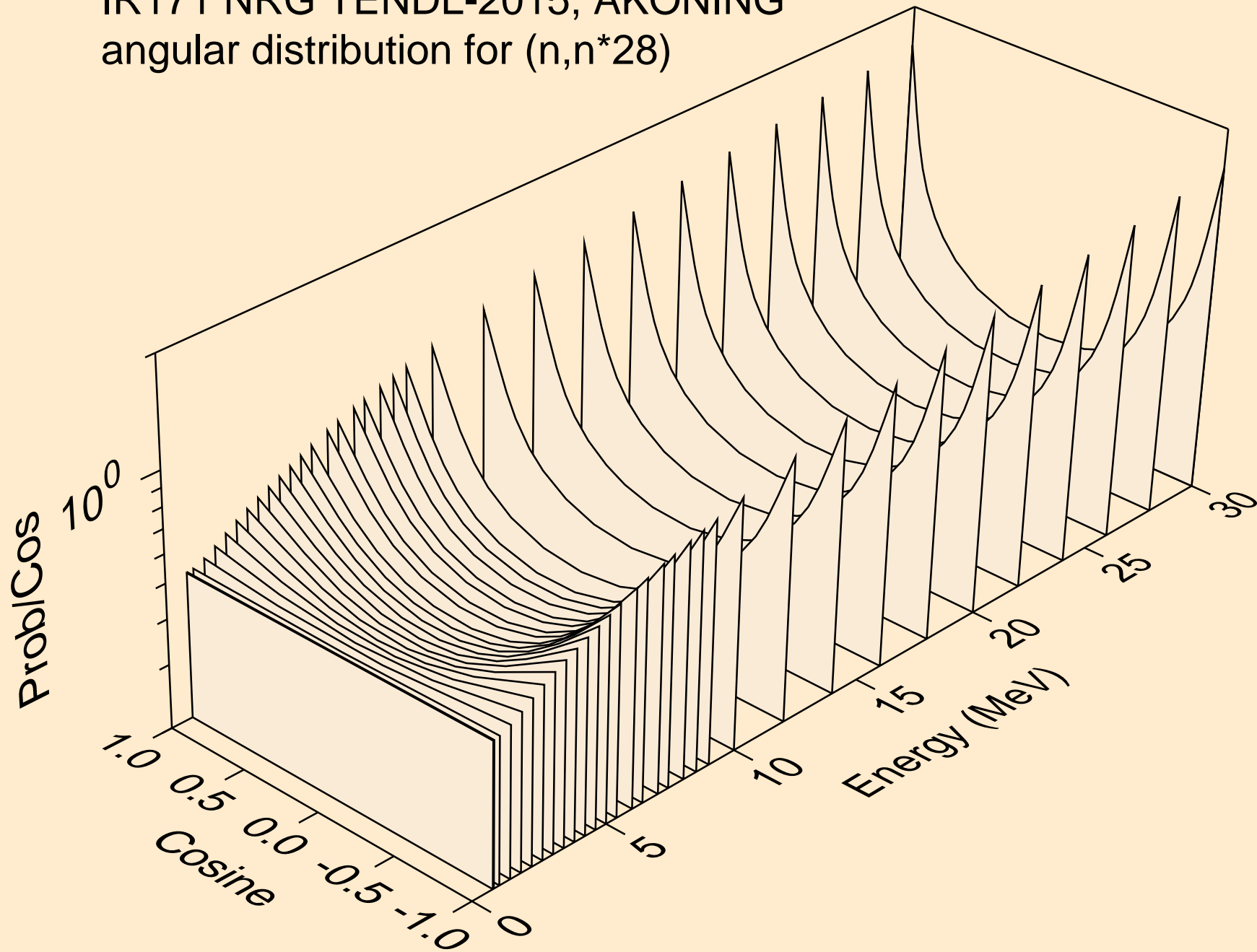

IR171 NRG TENDL-2015, AKONING  
angular distribution for (n,n\*29)

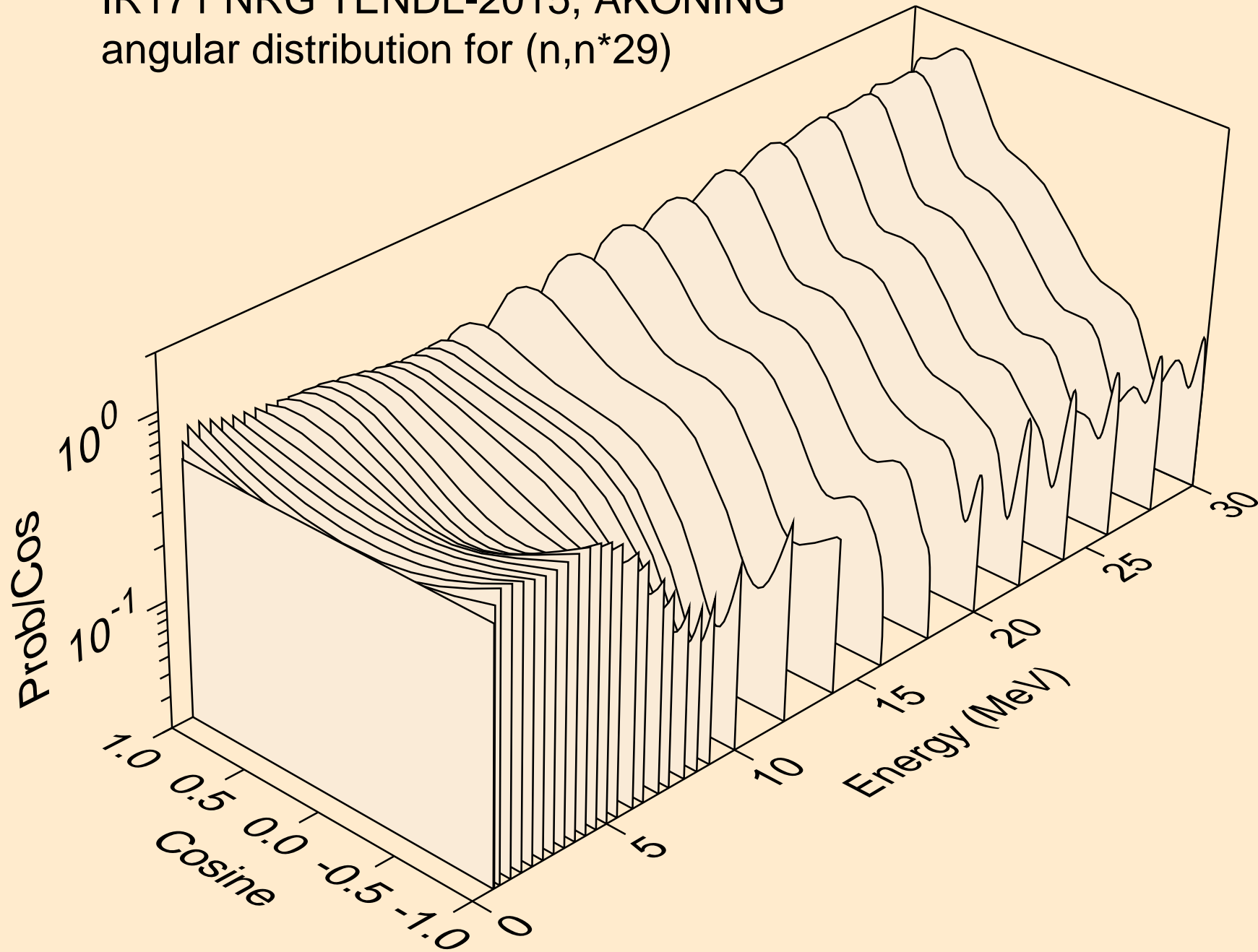

IR171 NRG TENDL-2015, AKONING  
angular distribution for (n,n\*30)

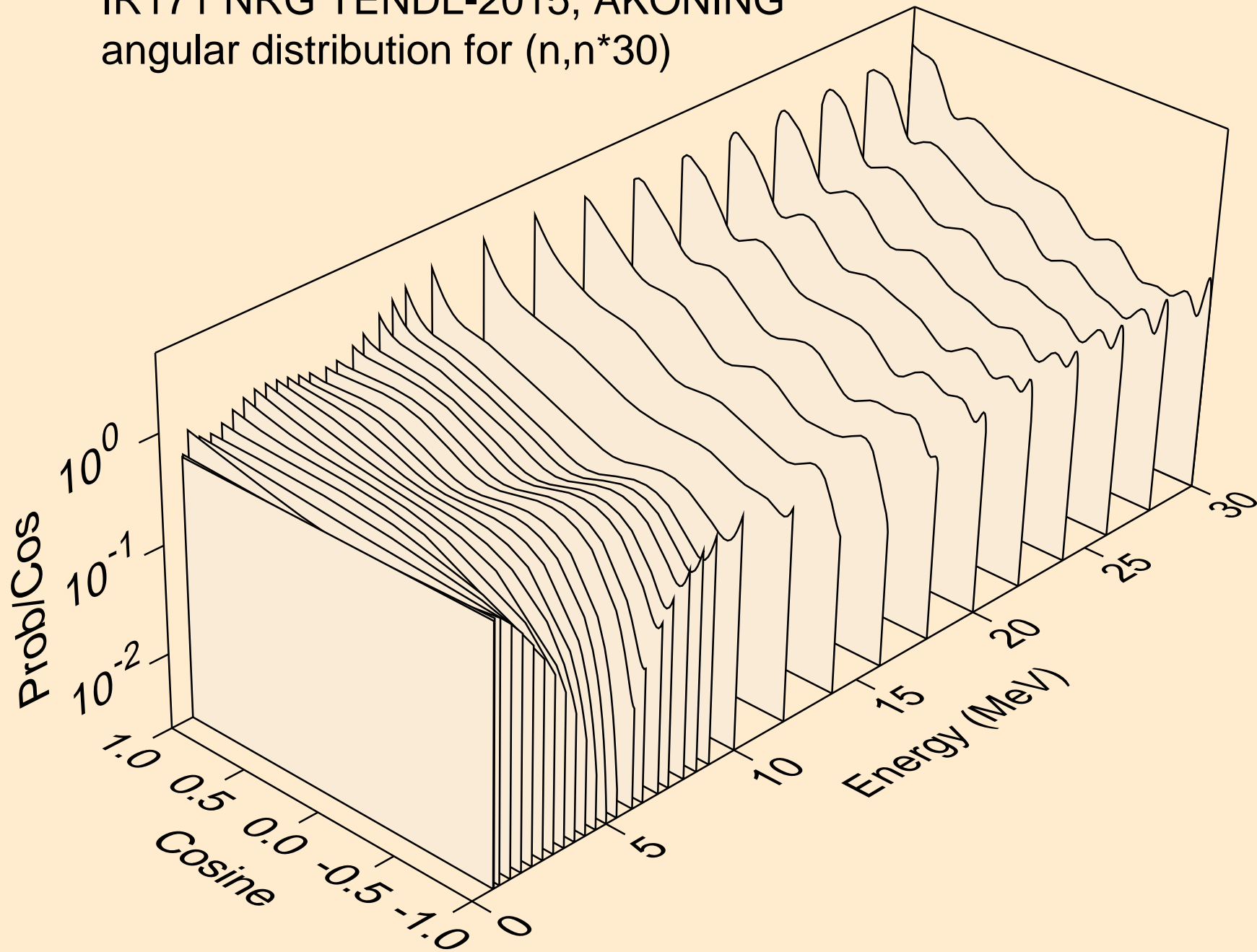



IR171 NRG TENDL-2015, AKONING  
Neutron emission for (n,x)

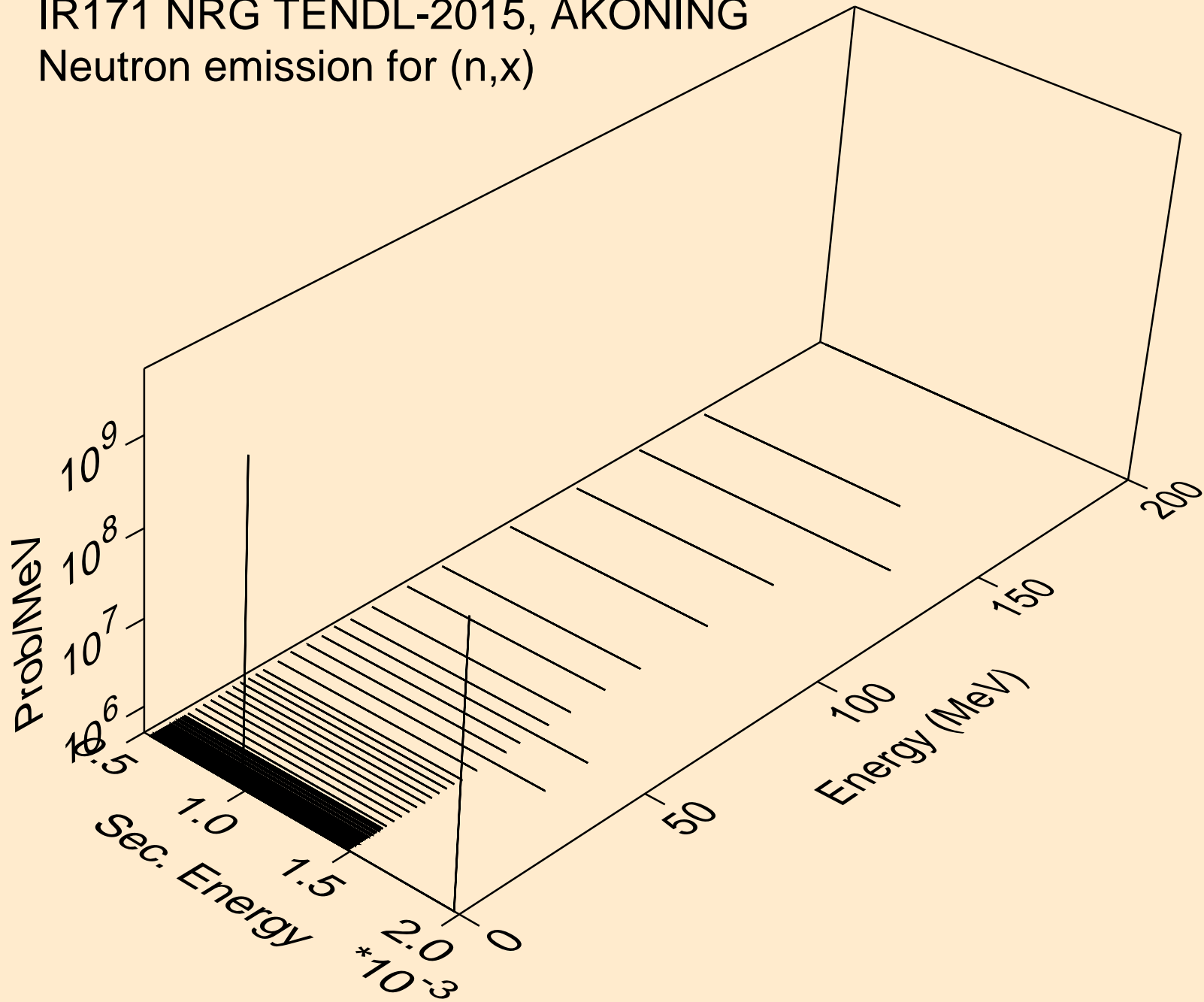

IR171 NRG TENDL-2015, AKONING  
Neutron emission for (n,2nd)

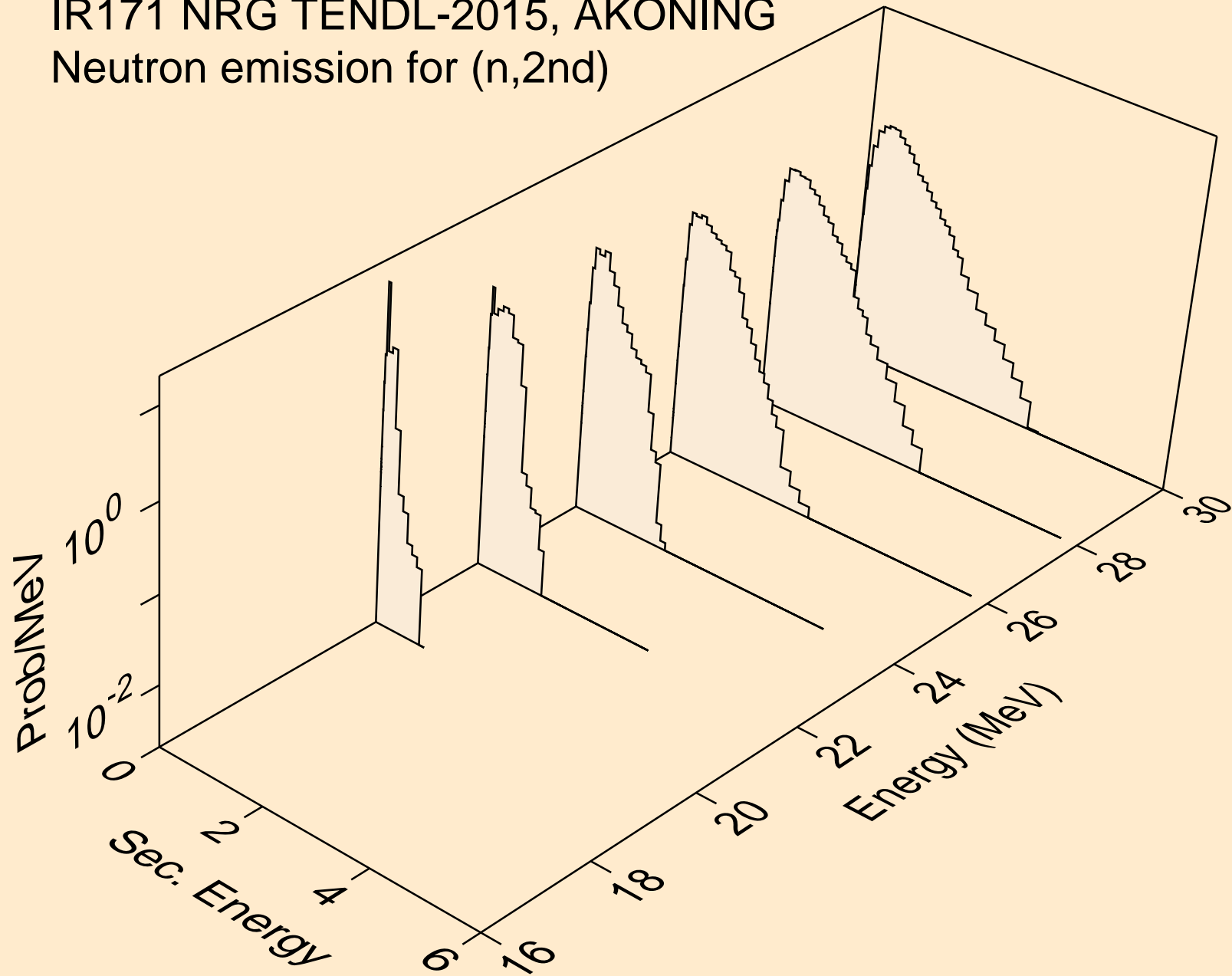

IR171 NRG TENDL-2015, AKONING  
Neutron emission for (n,2n)

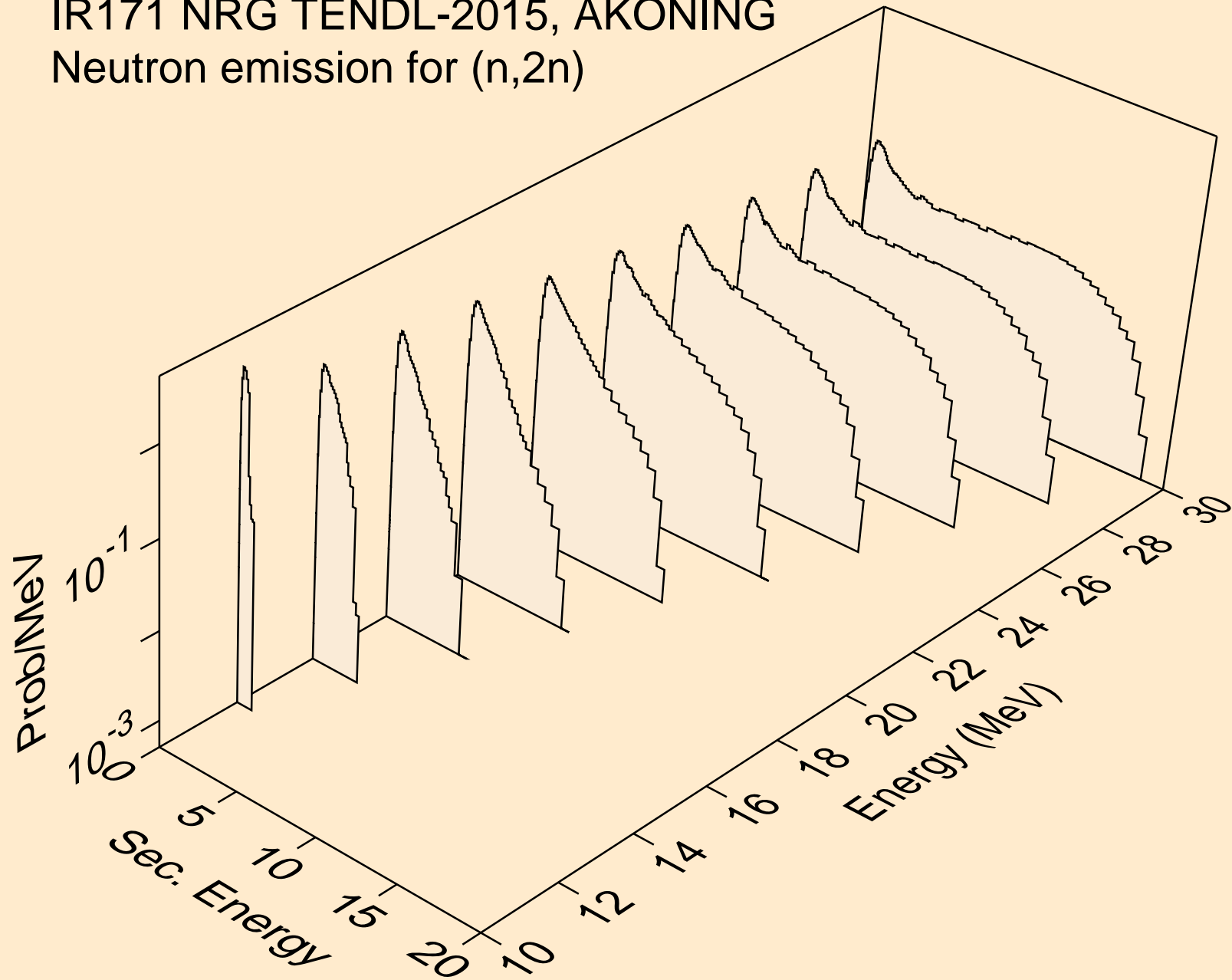

IR171 NRG TENDL-2015, AKONING  
Neutron emission for (n,3n)

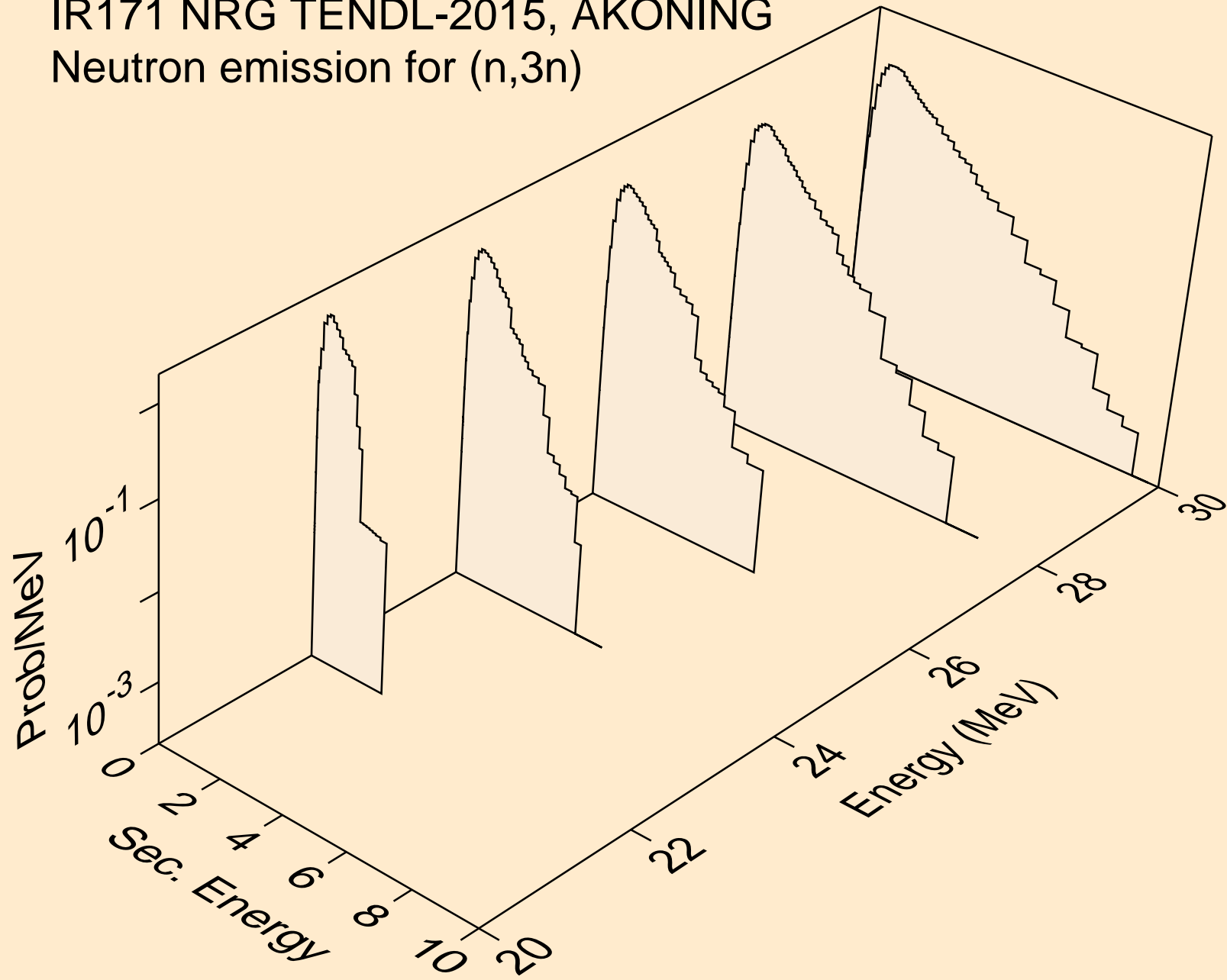

IR171 NRG TENDL-2015, AKONING  
Neutron emission for (n,n\*)a

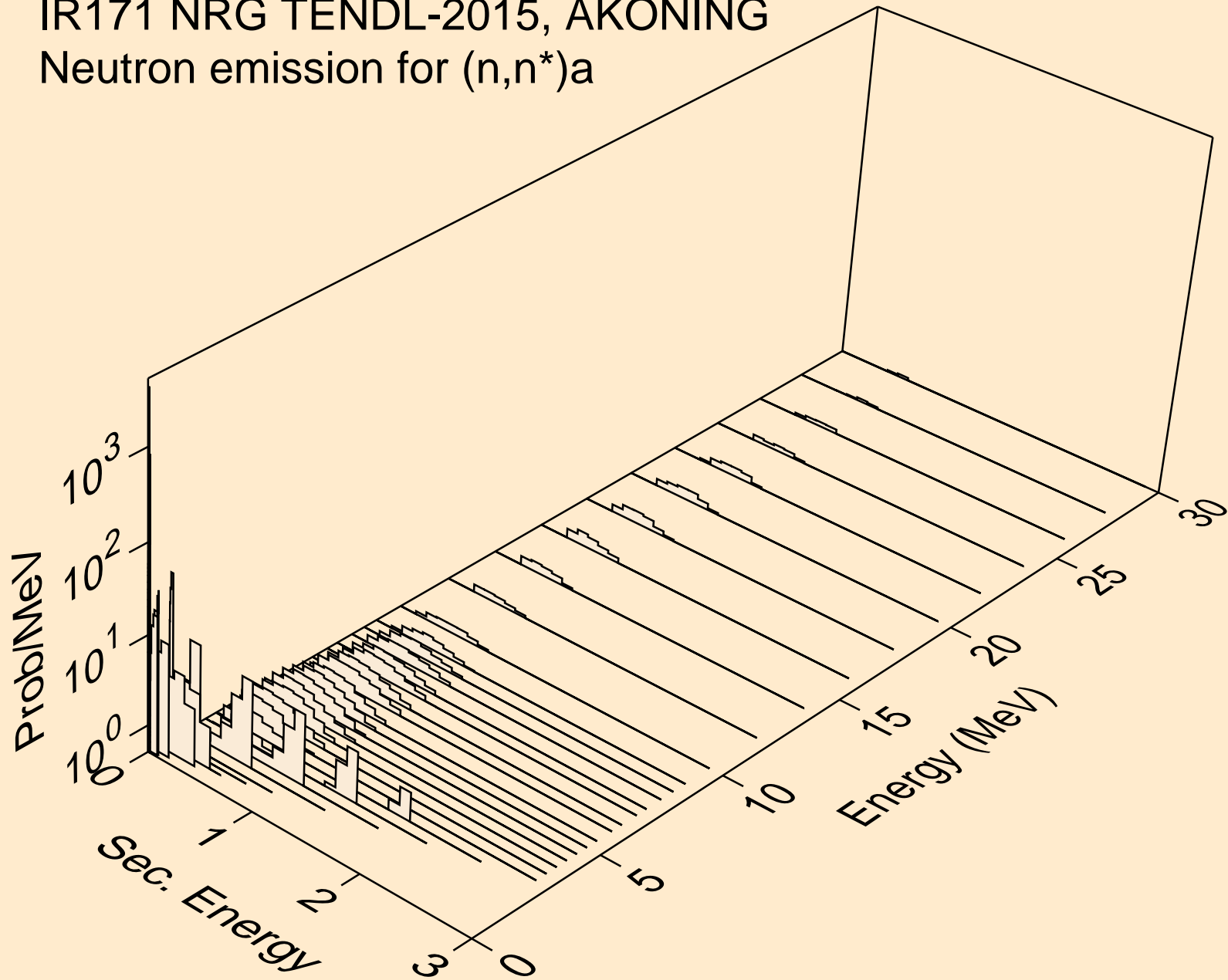

IR171 NRG TENDL-2015, AKONING  
Neutron emission for (n,n\*)3a

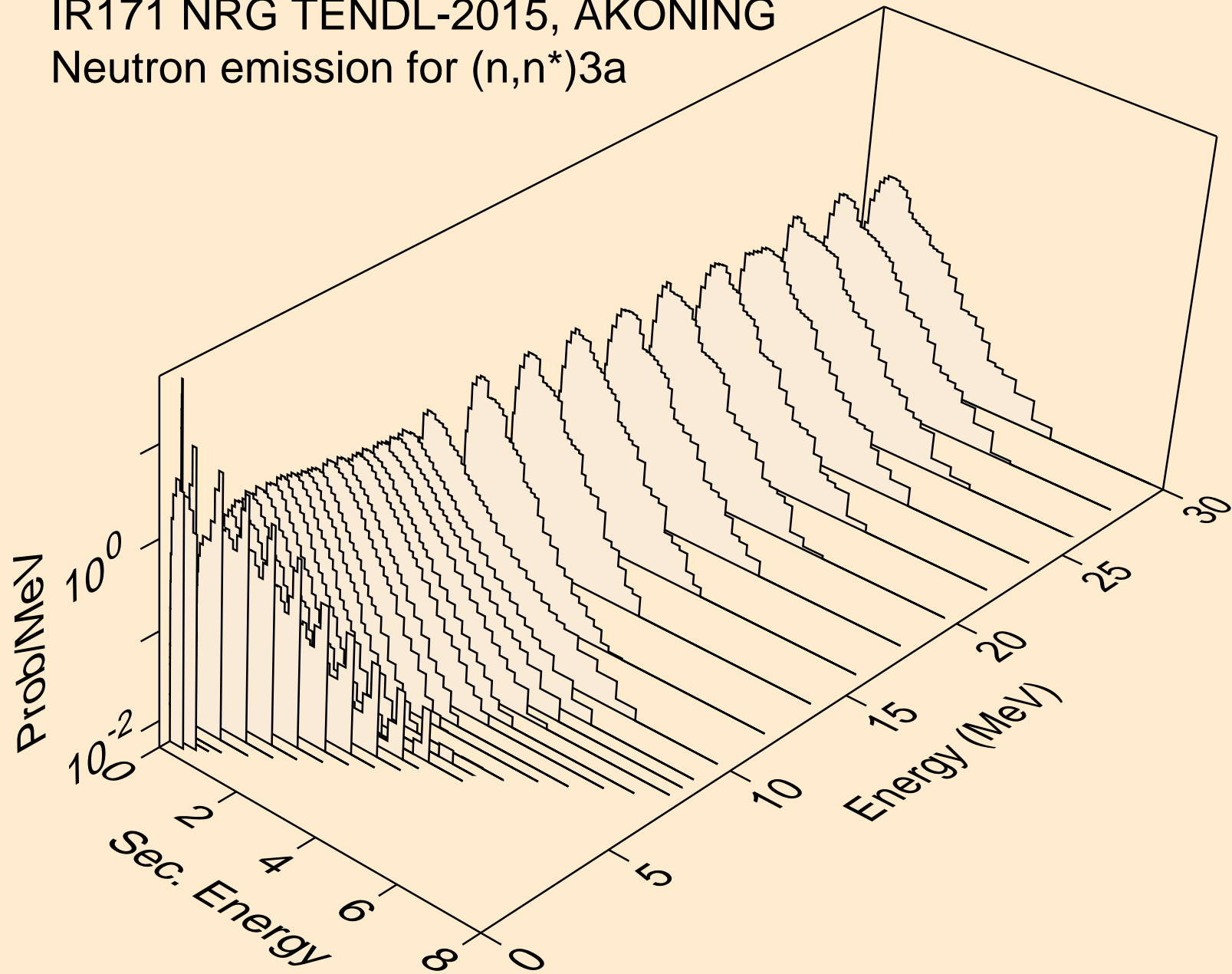

IR171 NRG TENDL-2015, AKONING  
Neutron emission for (n,2n)a

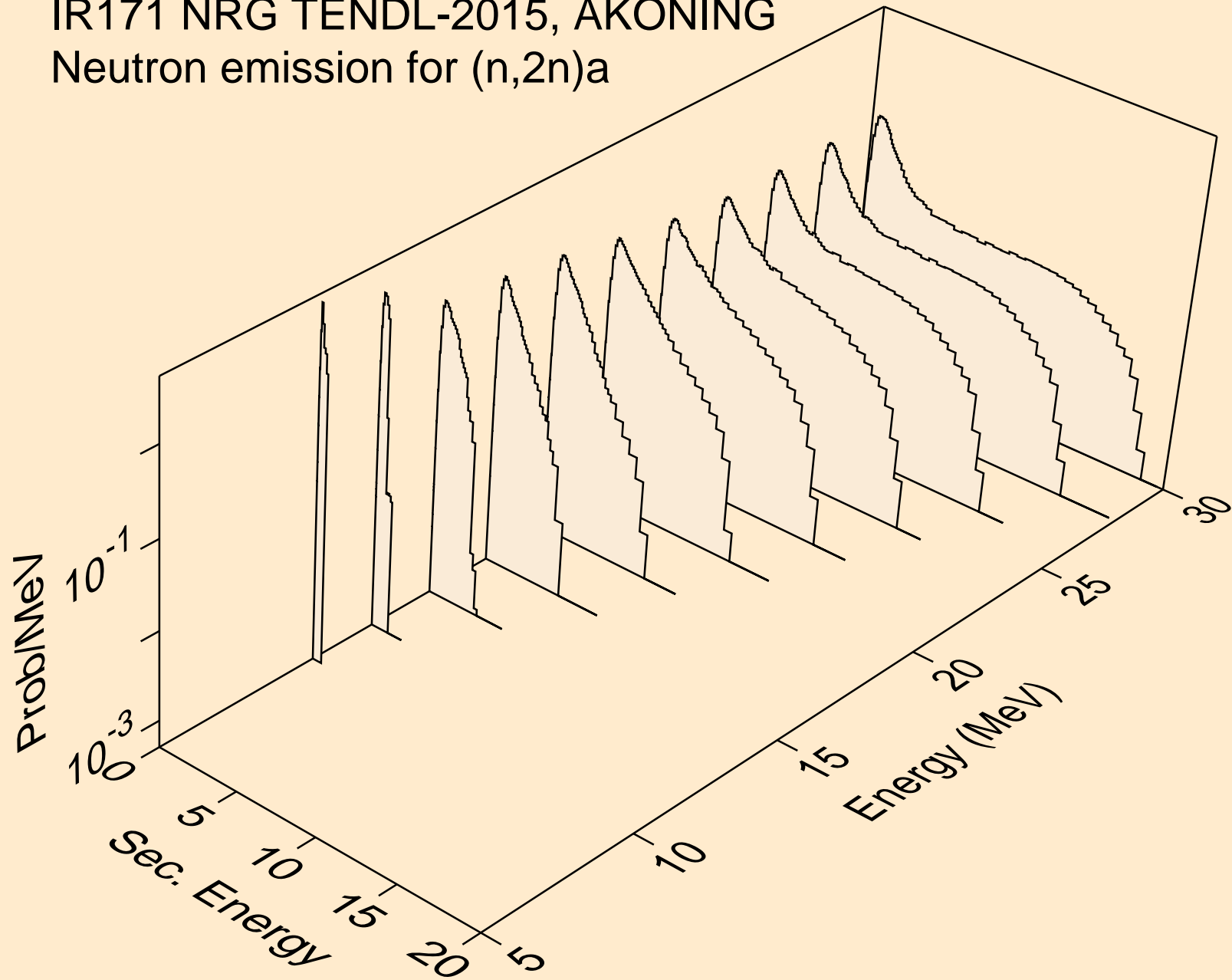

IR171 NRG TENDL-2015, AKONING  
Neutron emission for (n,3n)a

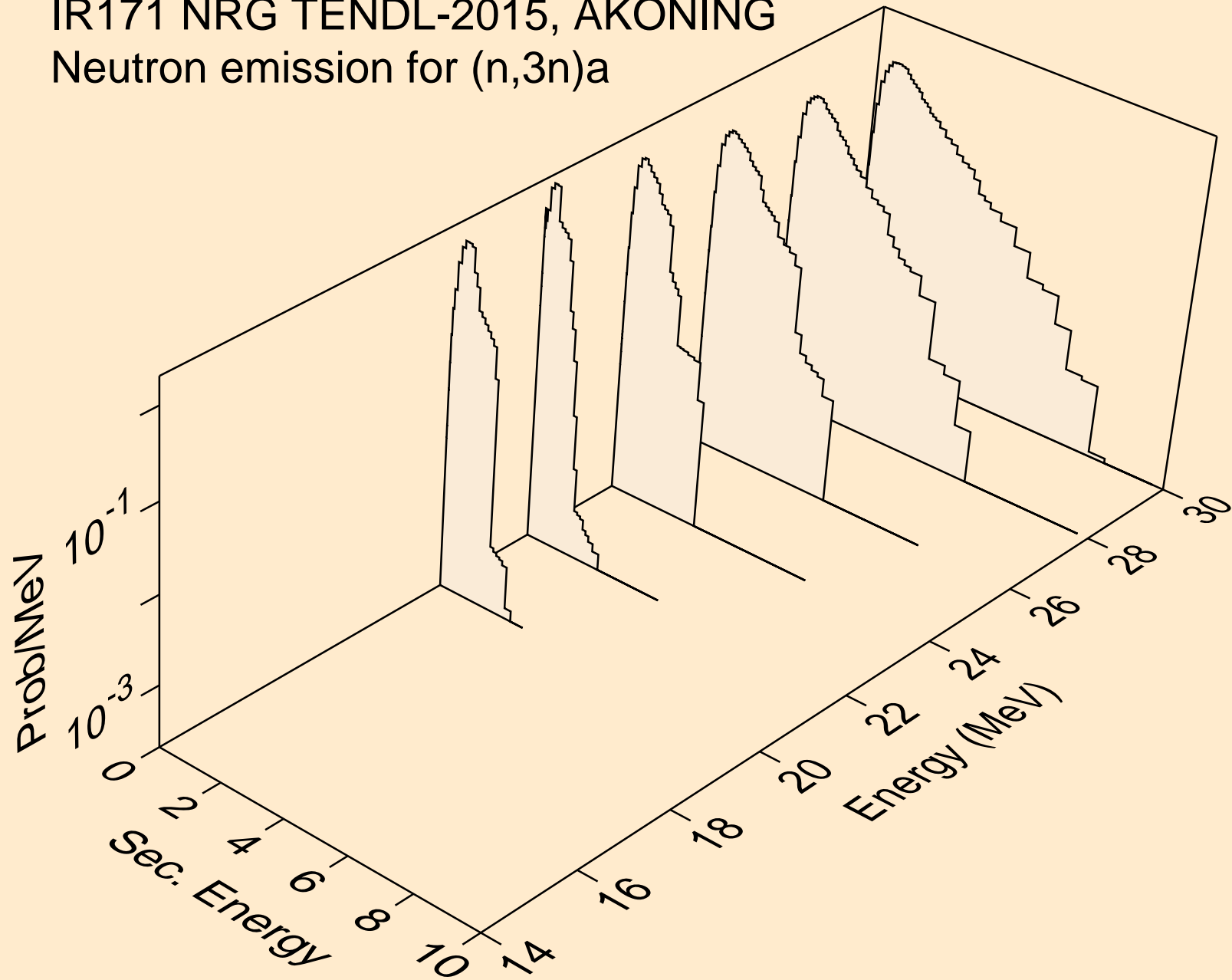



IR171 NRG TENDL-2015, AKONING  
Neutron emission for (n,n\*)p

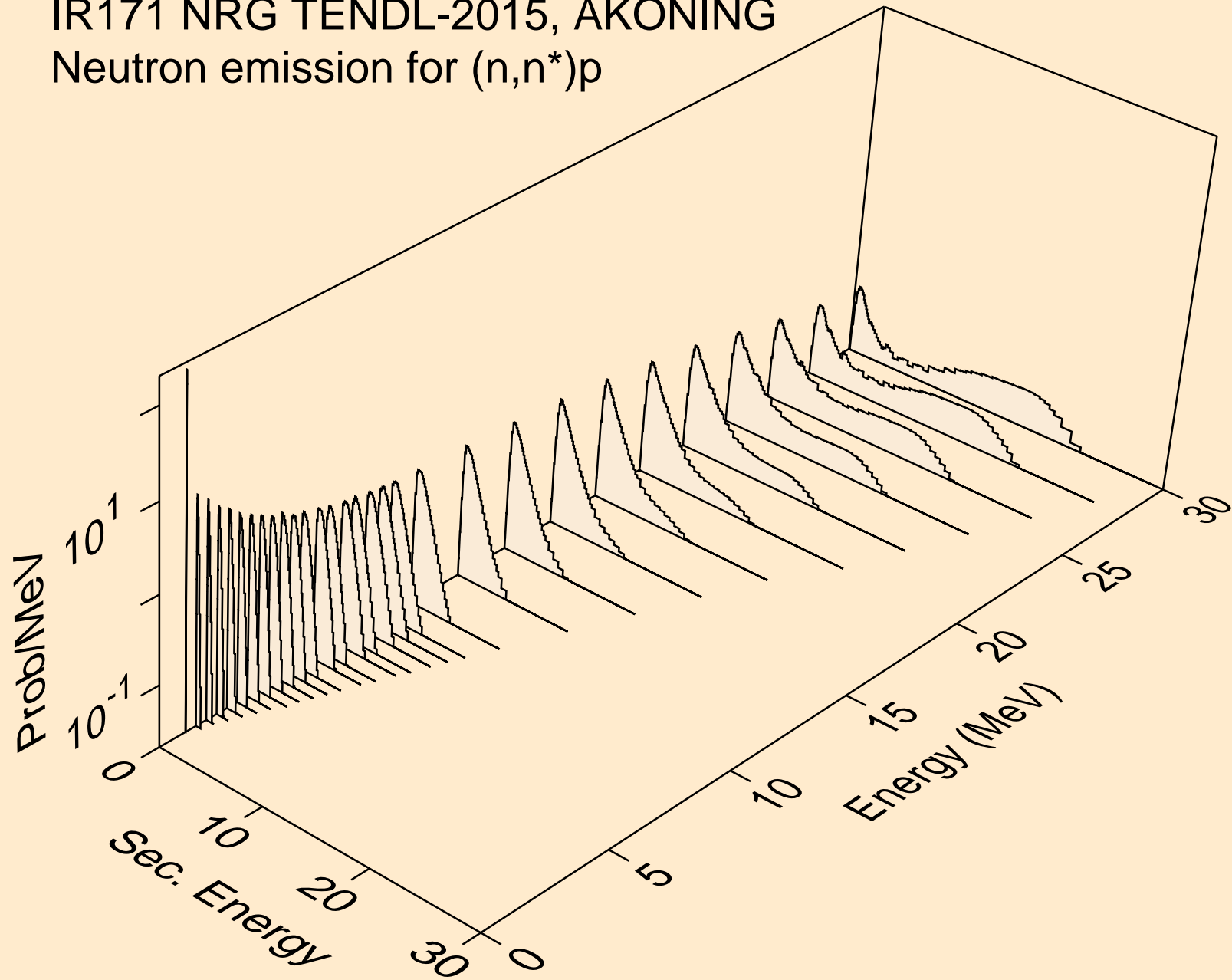

IR171 NRG TENDL-2015, AKONING  
Neutron emission for (n,n\*)2a

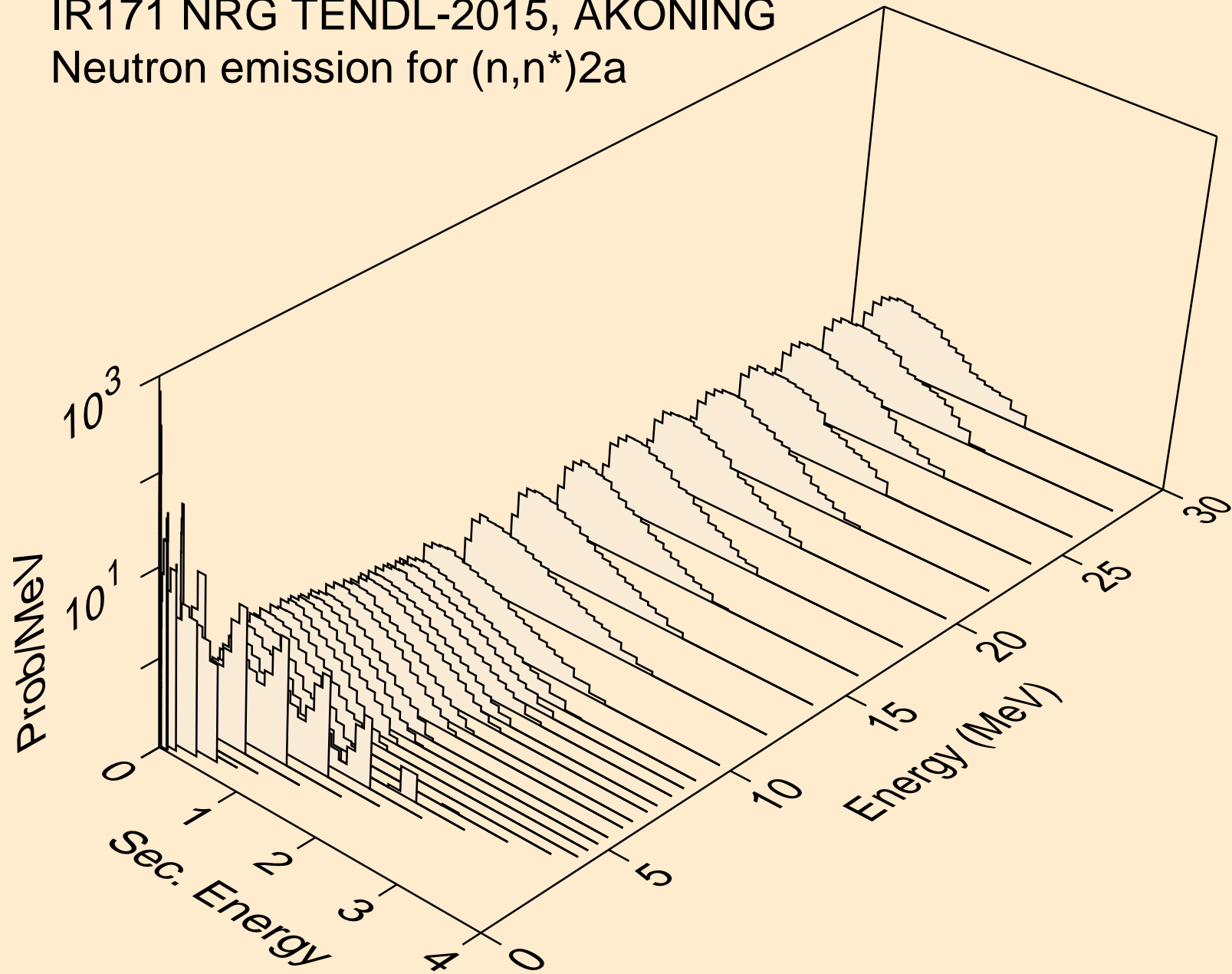

IR171 NRG TENDL-2015, AKONING  
Neutron emission for (n,2n)2a

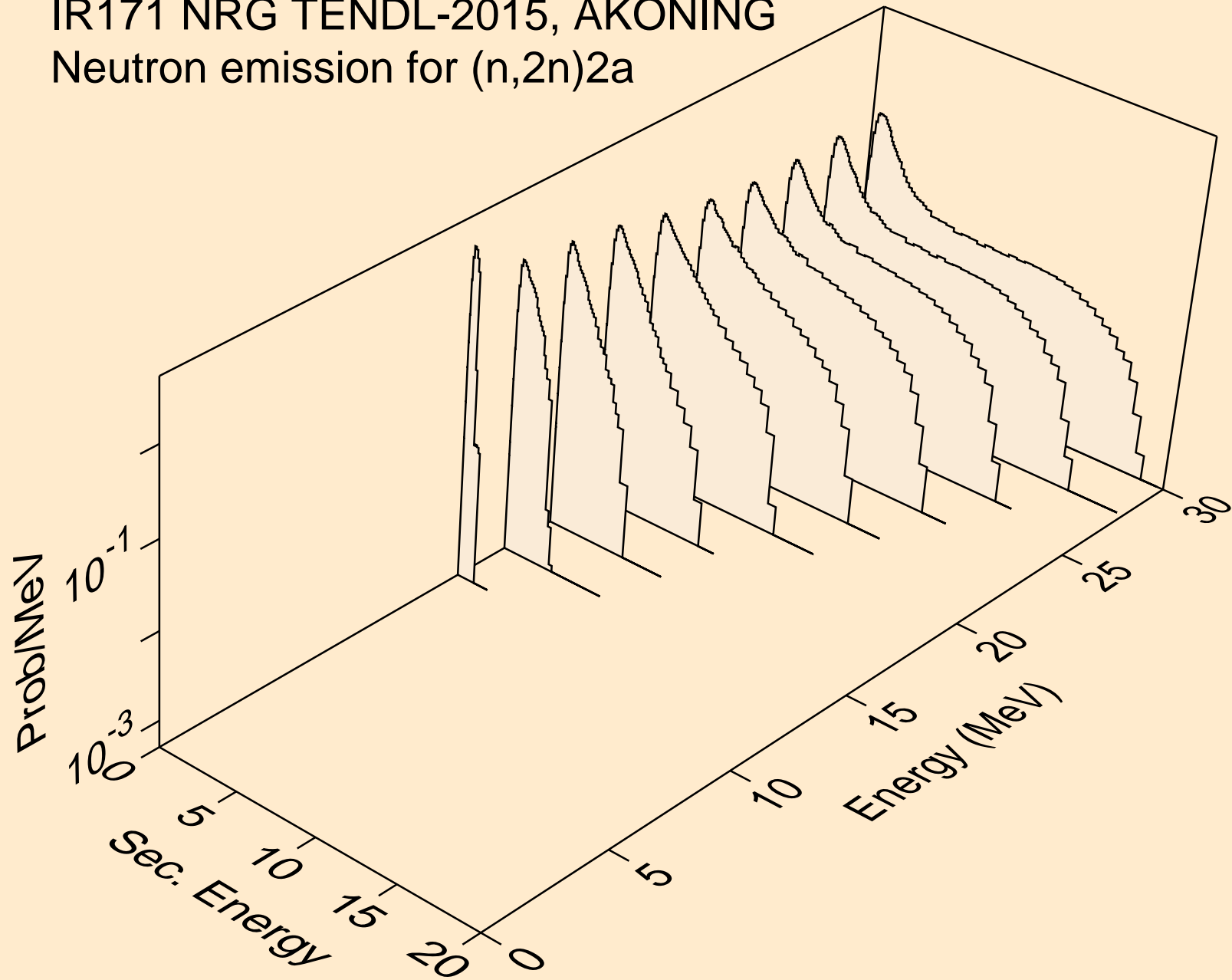

IR171 NRG TENDL-2015, AKONING  
Neutron emission for (n,n\*)d

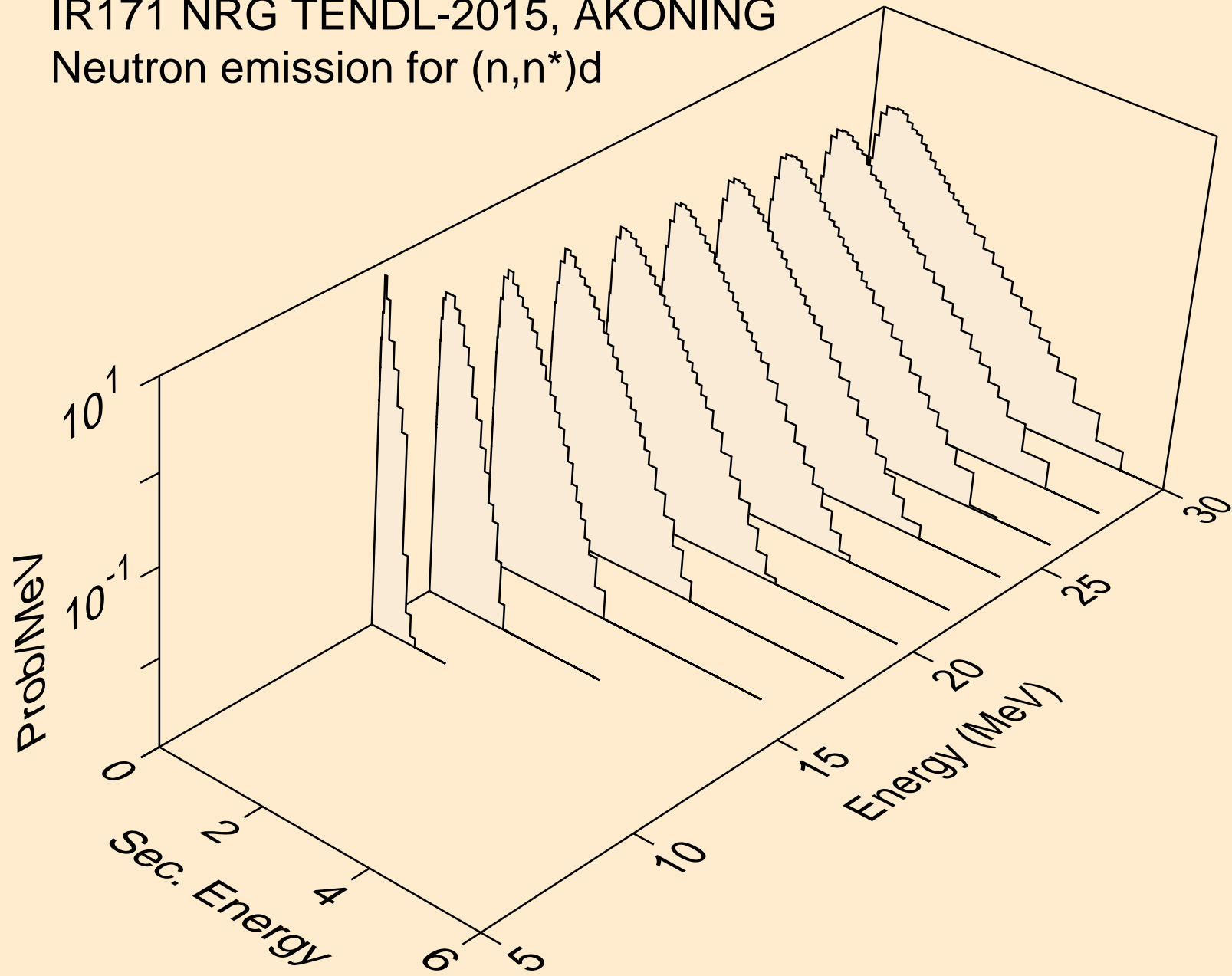

IR171 NRG TENDL-2015, AKONING  
Neutron emission for (n,n\*)t

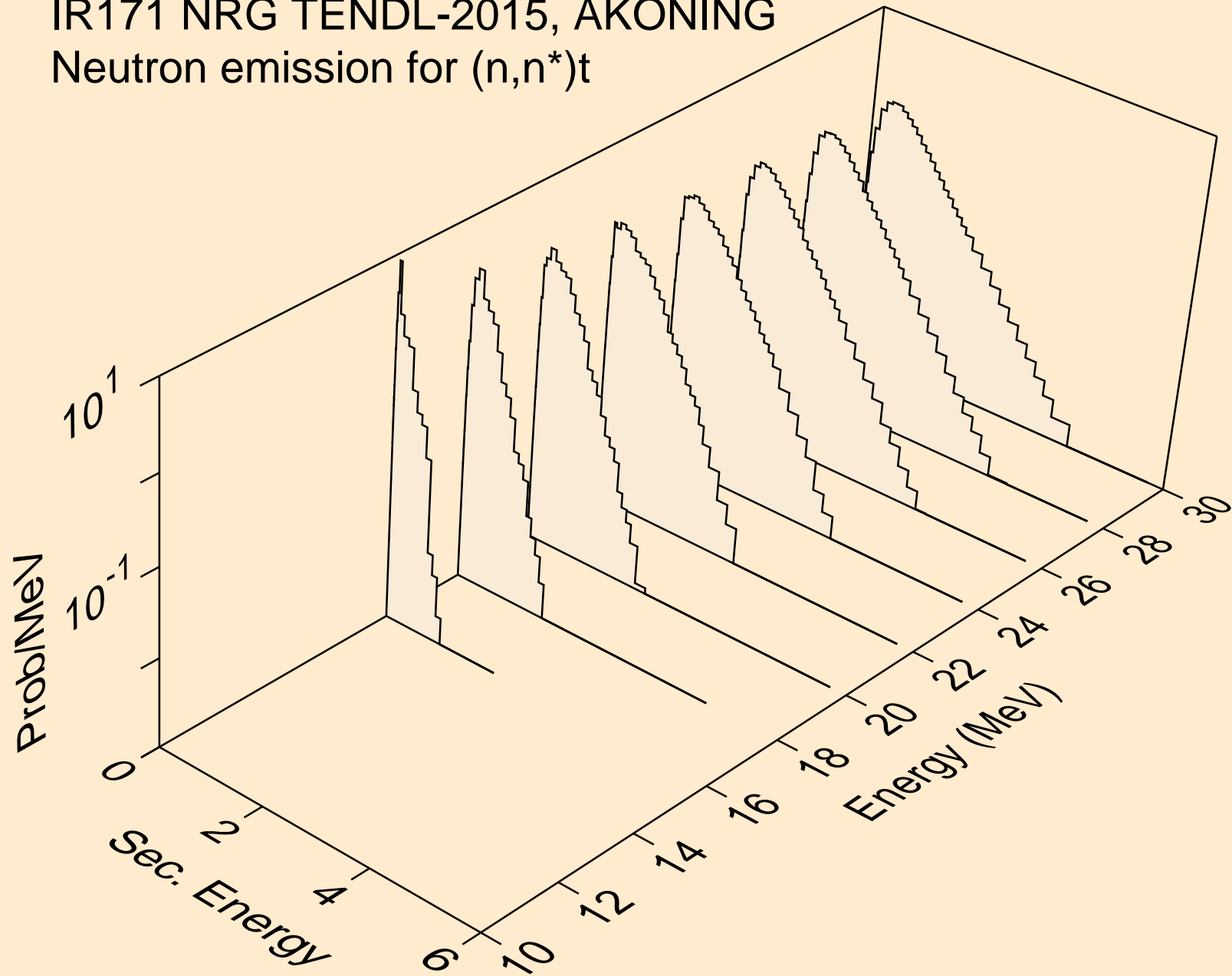

IR171 NRG TENDL-2015, AKONING  
Neutron emission for (n,n\*)he3

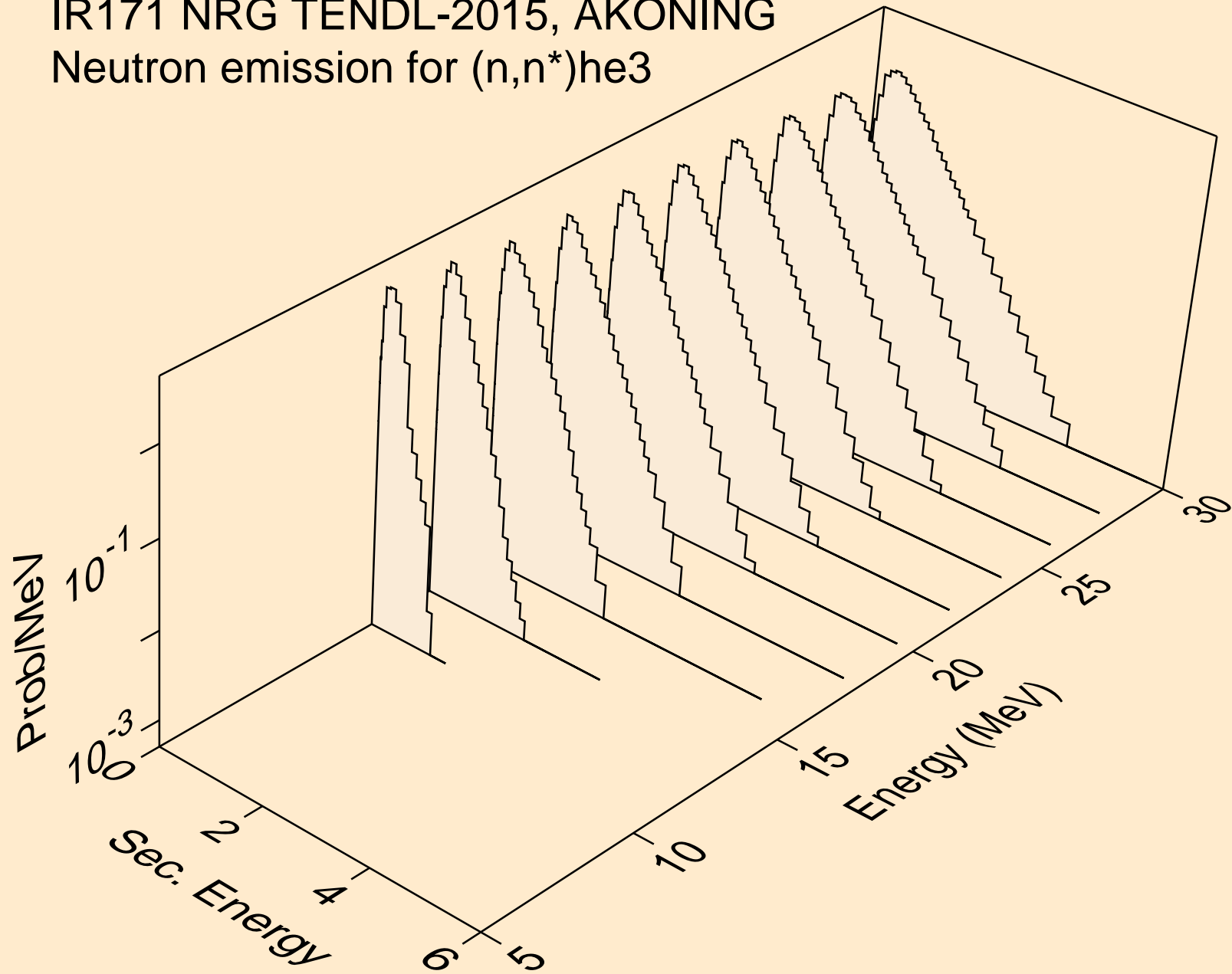

IR171 NRG TENDL-2015, AKONING  
Neutron emission for (n,n\*)d2a

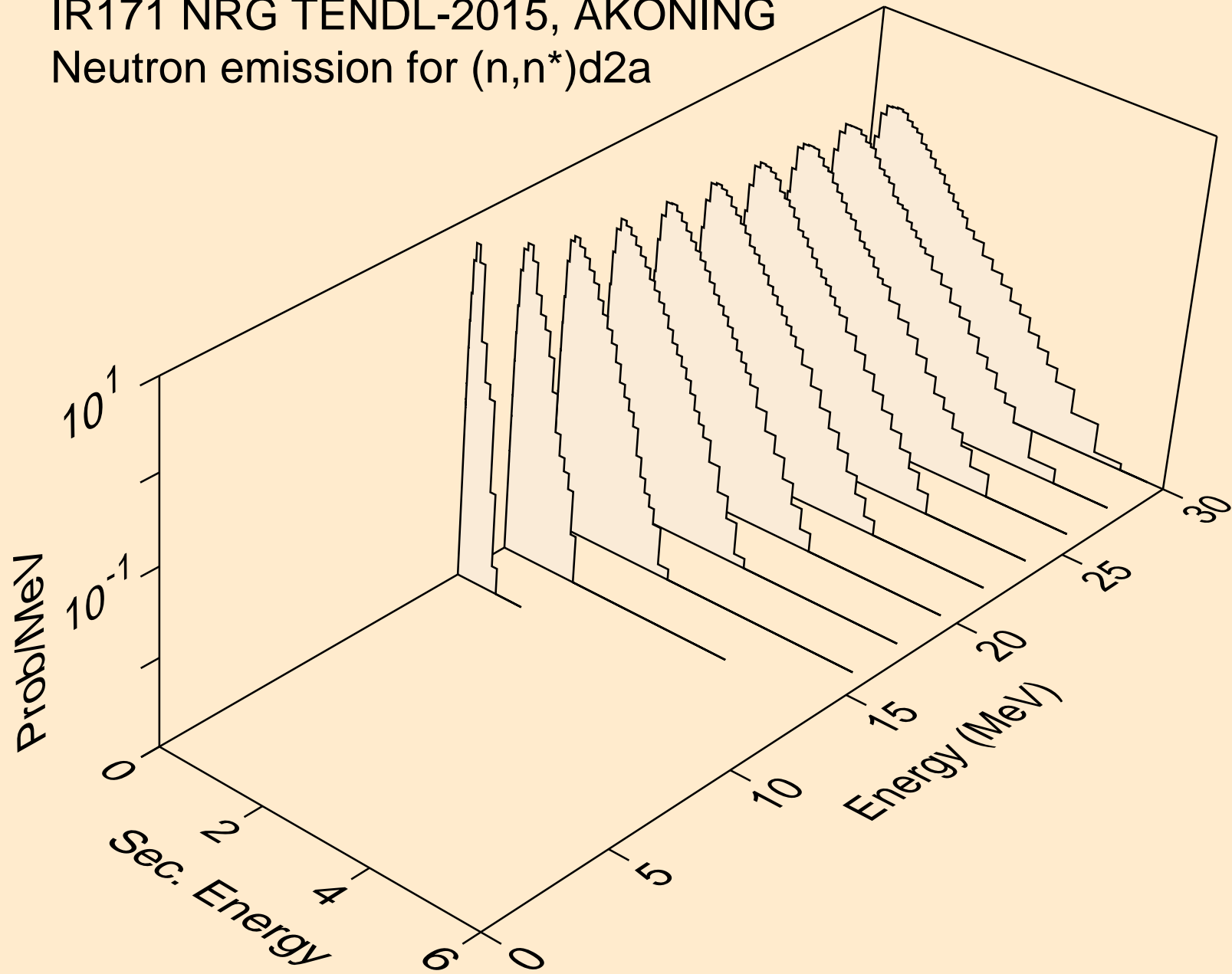

IR171 NRG TENDL-2015, AKONING  
Neutron emission for (n,n\*)t2a

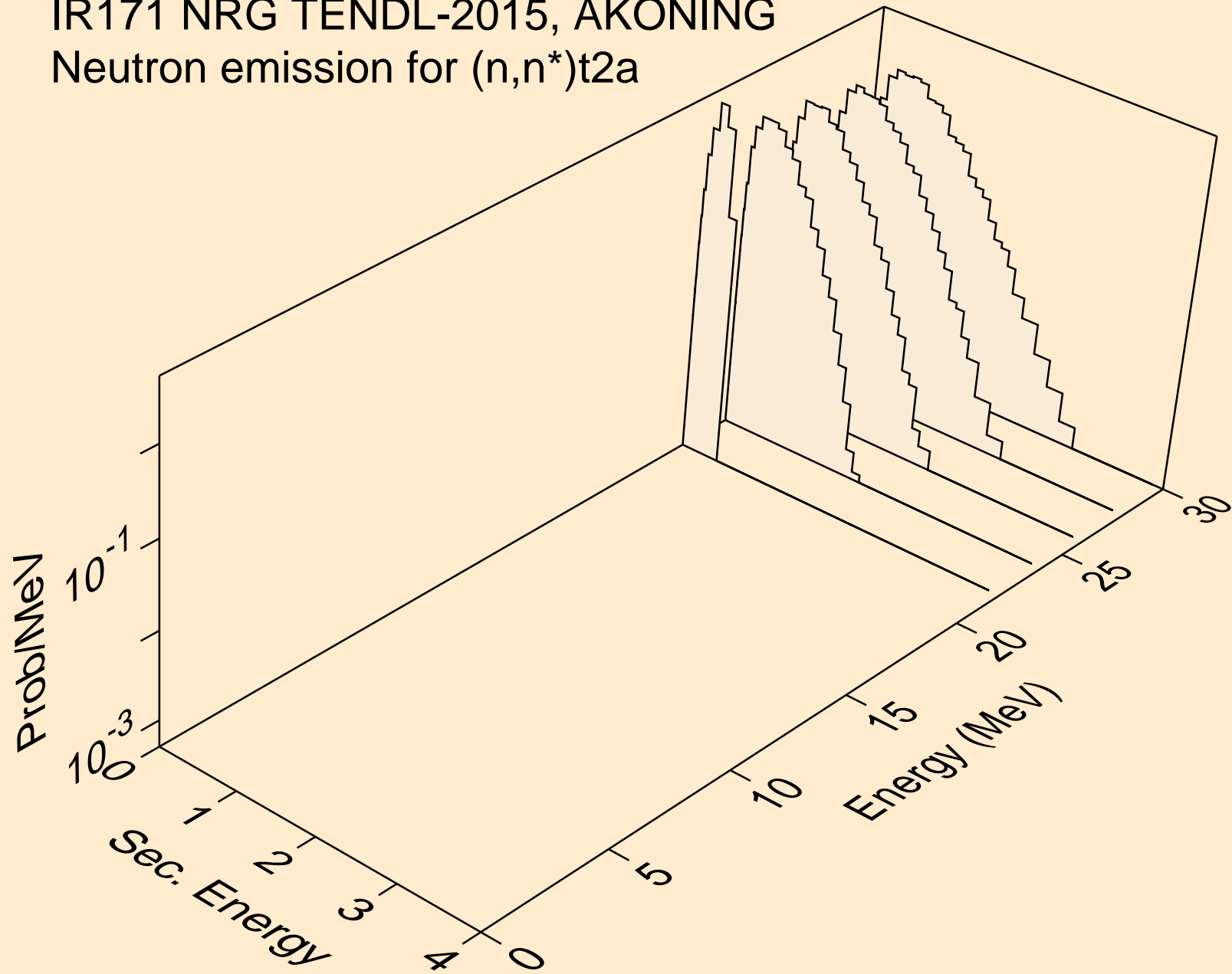



IR171 NRG TENDL-2015, AKONING  
Neutron emission for (n,2np)

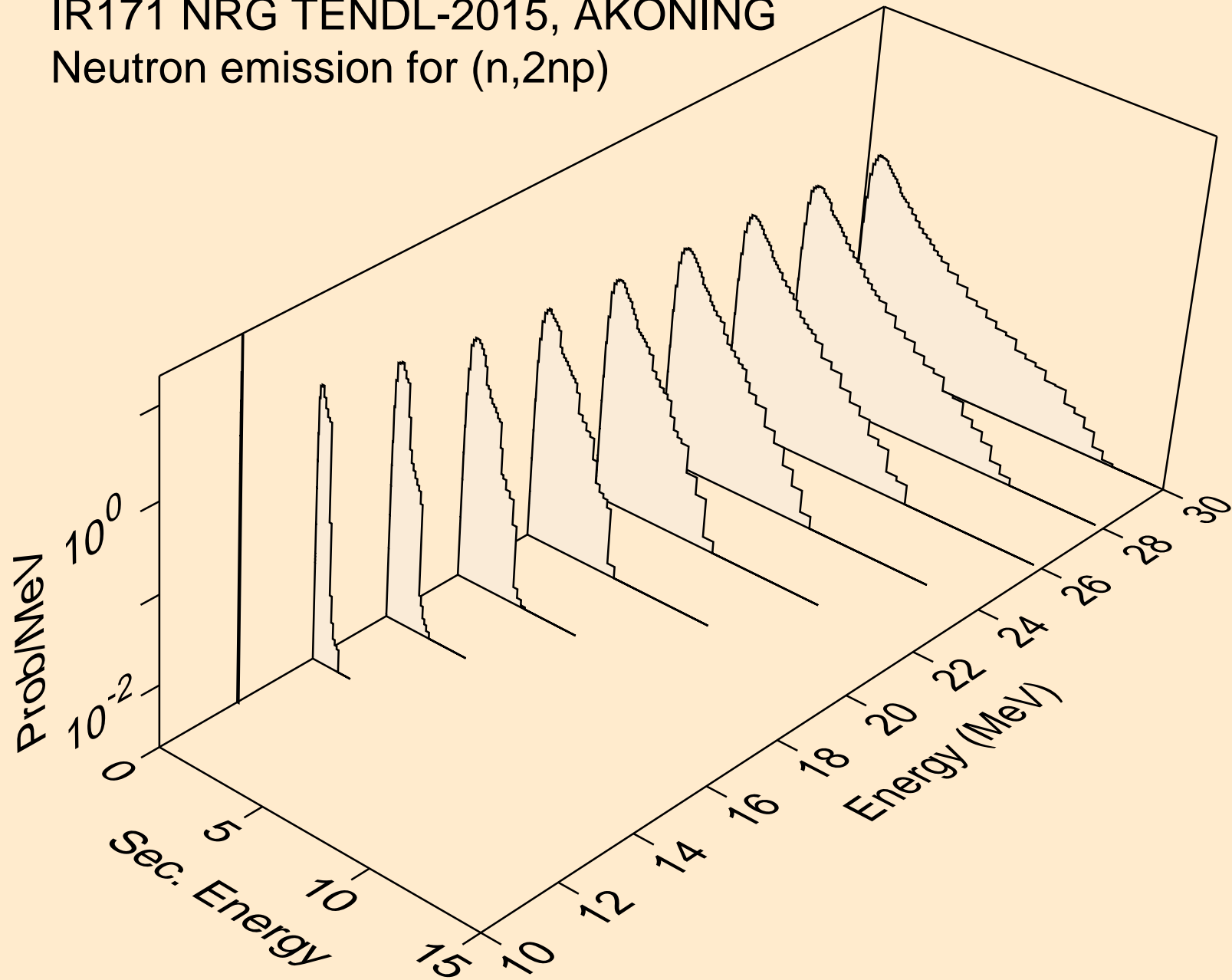

IR171 NRG TENDL-2015, AKONING  
Neutron emission for (n,3np)

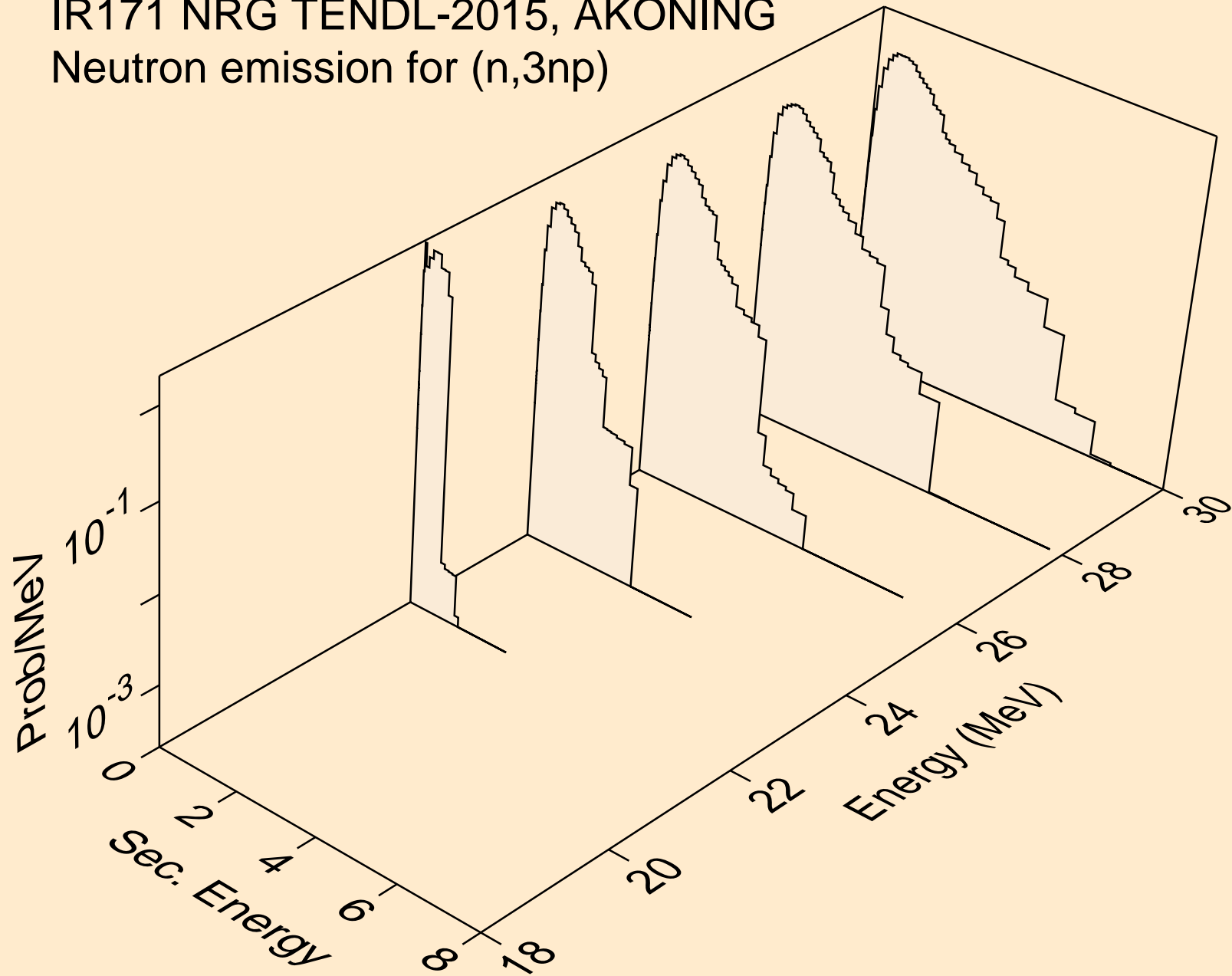

IR171 NRG TENDL-2015, AKONING  
Neutron emission for (n,2np)

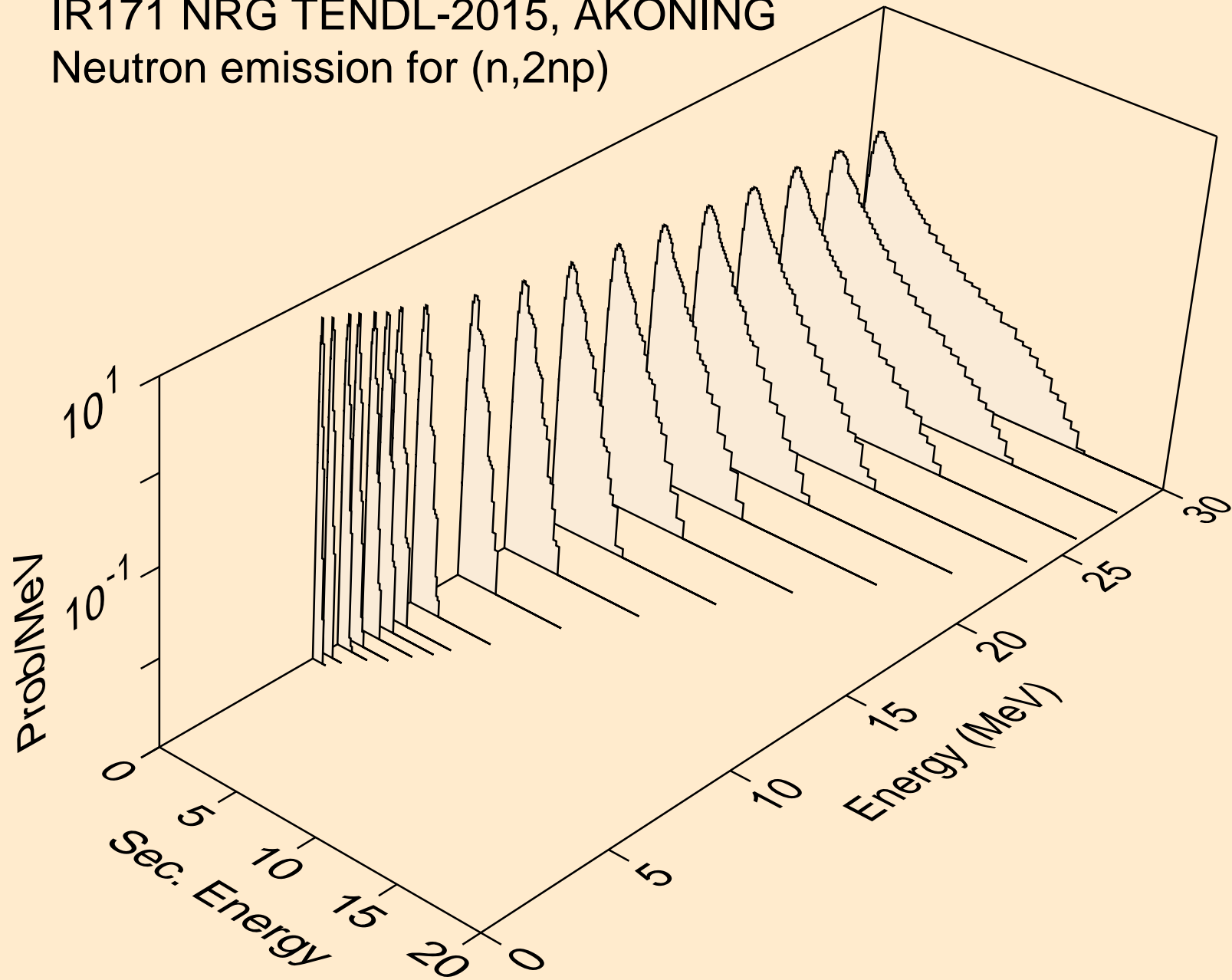

IR171 NRG TENDL-2015, AKONING  
Neutron emission for (n,npa)

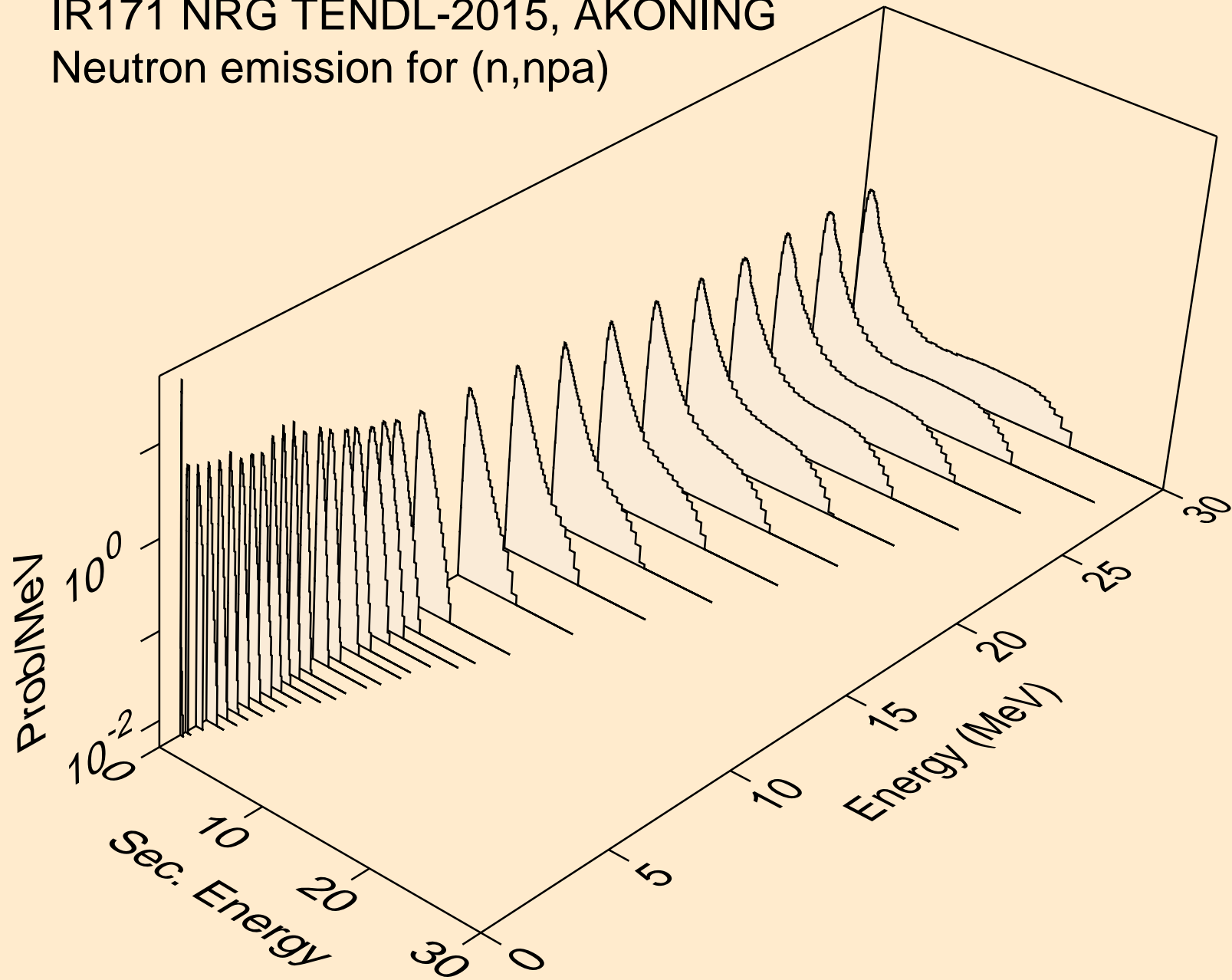

IR171 NRG TENDL-2015, AKONING  
Neutron emission for (n,n\*c)

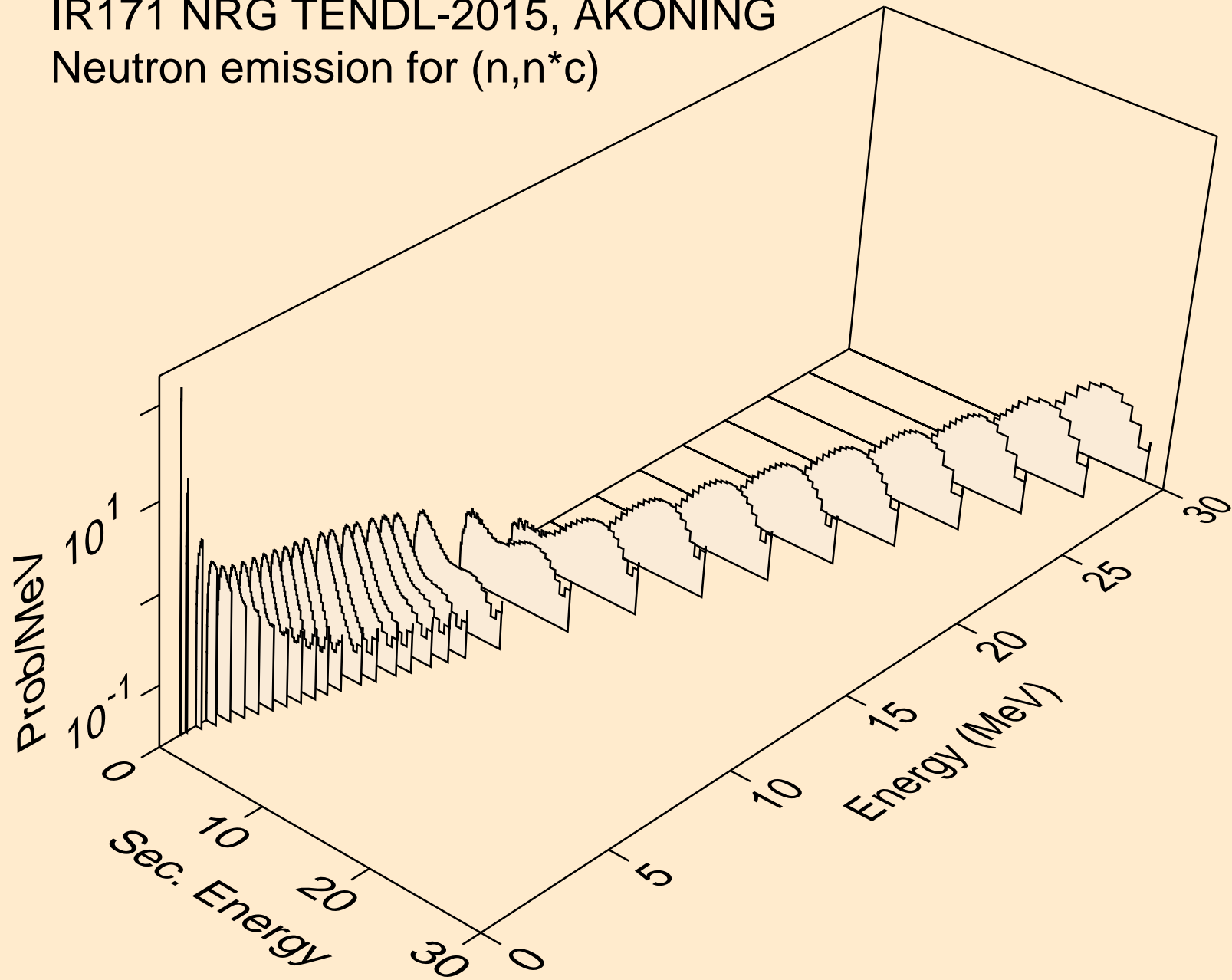

IR171 NRG TENDL-2015, AKONING  
Photon emission for (n,x)

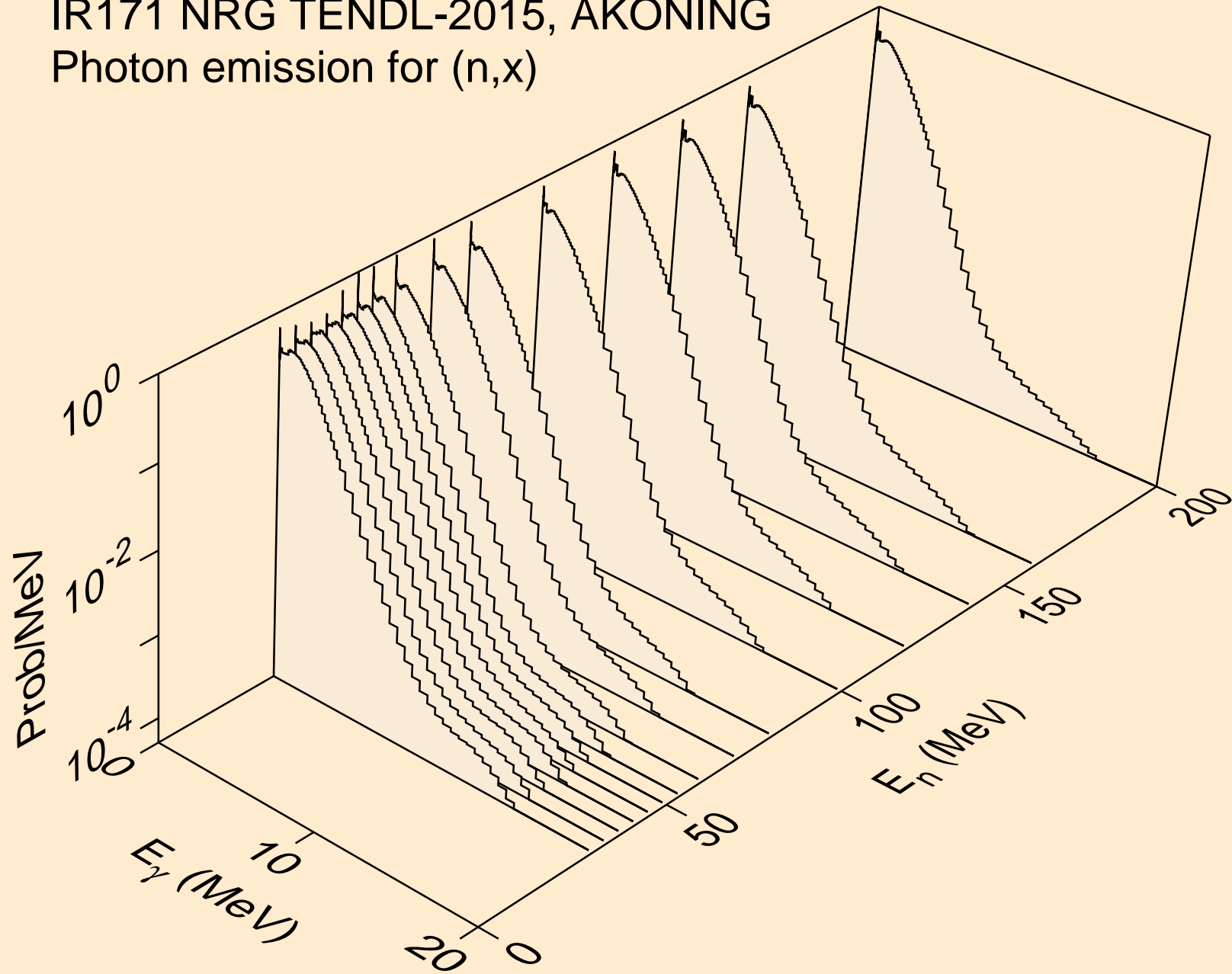

IR171 NRG TENDL-2015, AKONING  
Photon emission for (n,2nd)

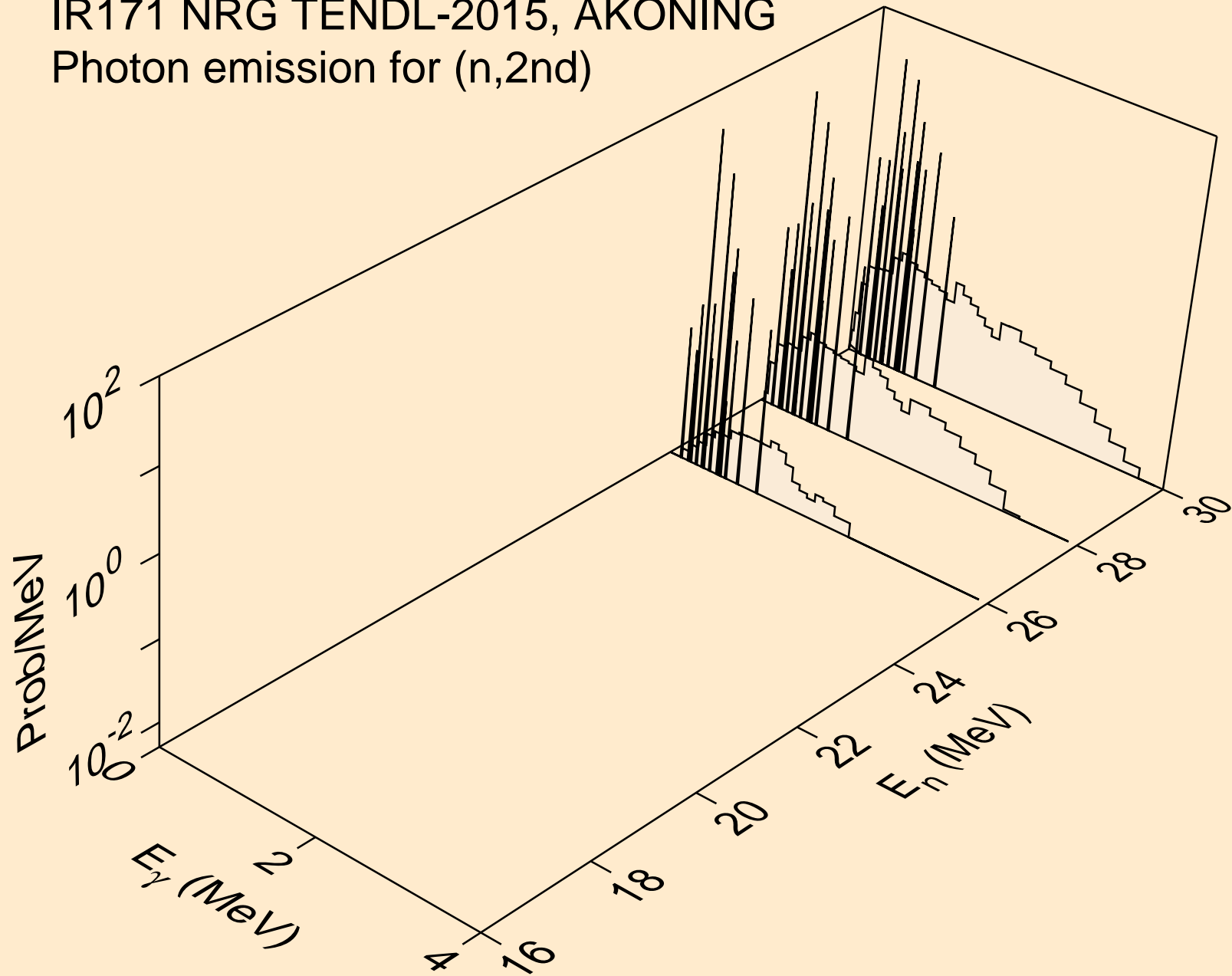

IR171 NRG TENDL-2015, AKONING  
Photon emission for (n,2n)

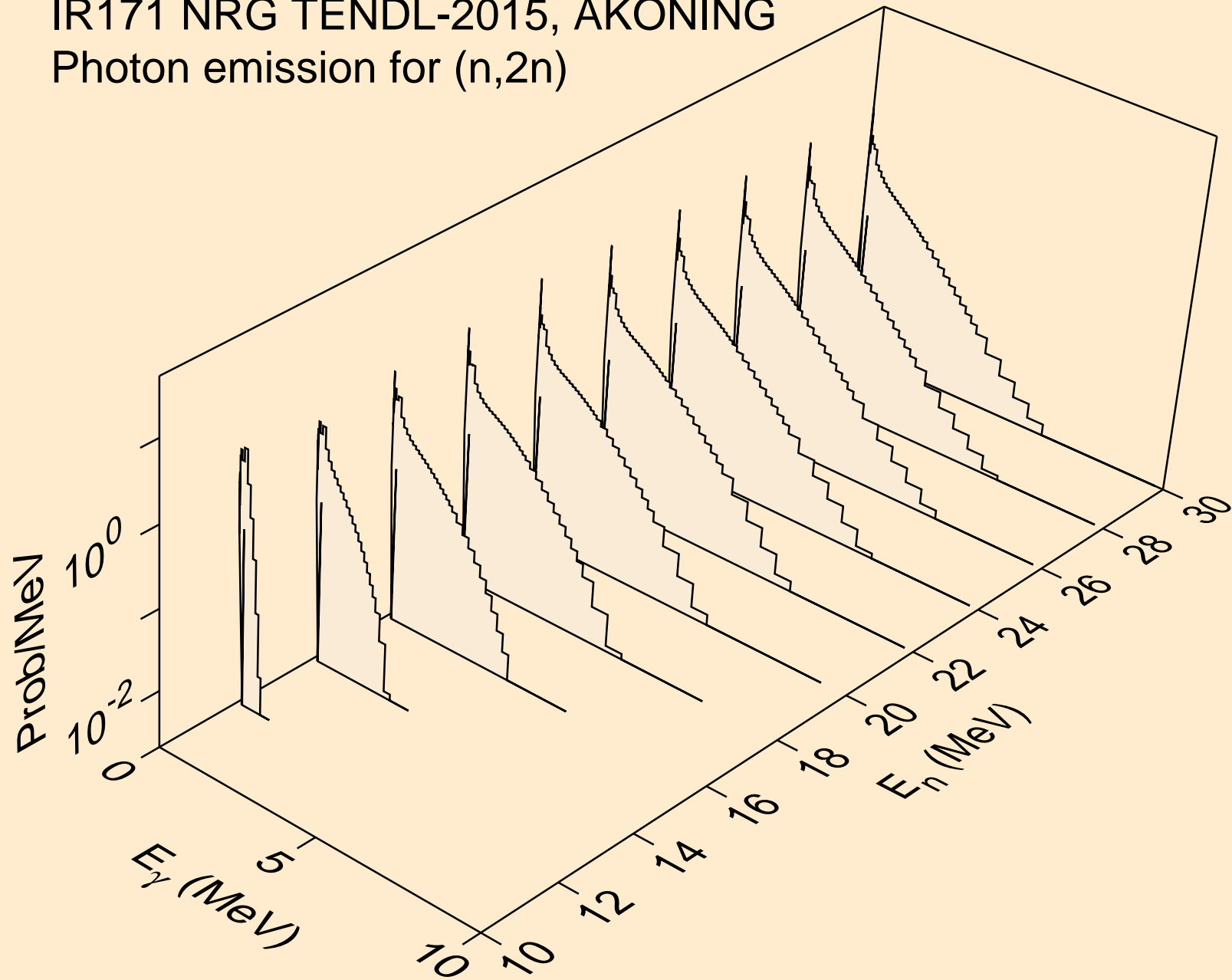



IR171 NRG TENDL-2015, AKONING  
Photon emission for (n,3n)

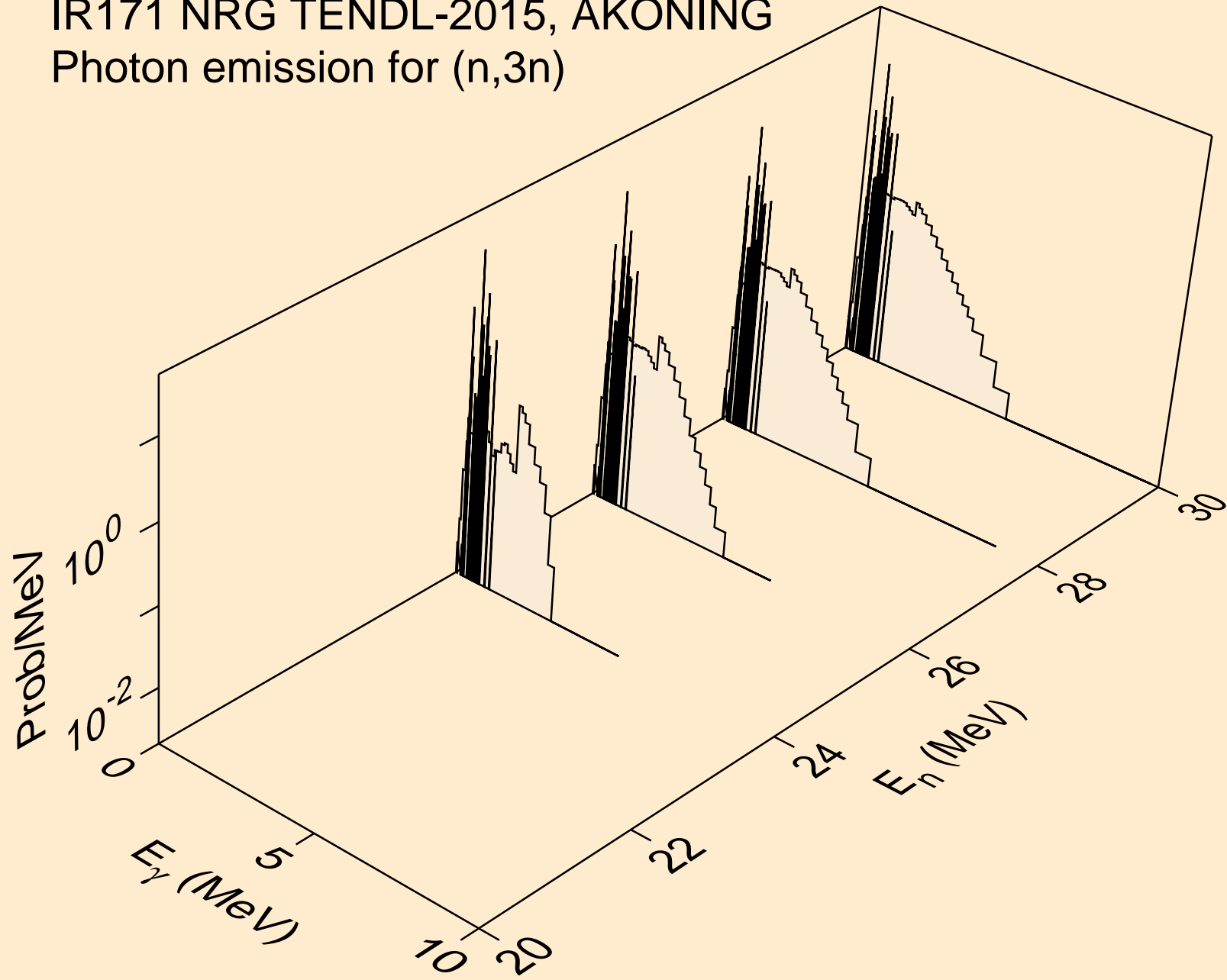

IR171 NRG TENDL-2015, AKONING  
Photon emission for (n,n\*)a

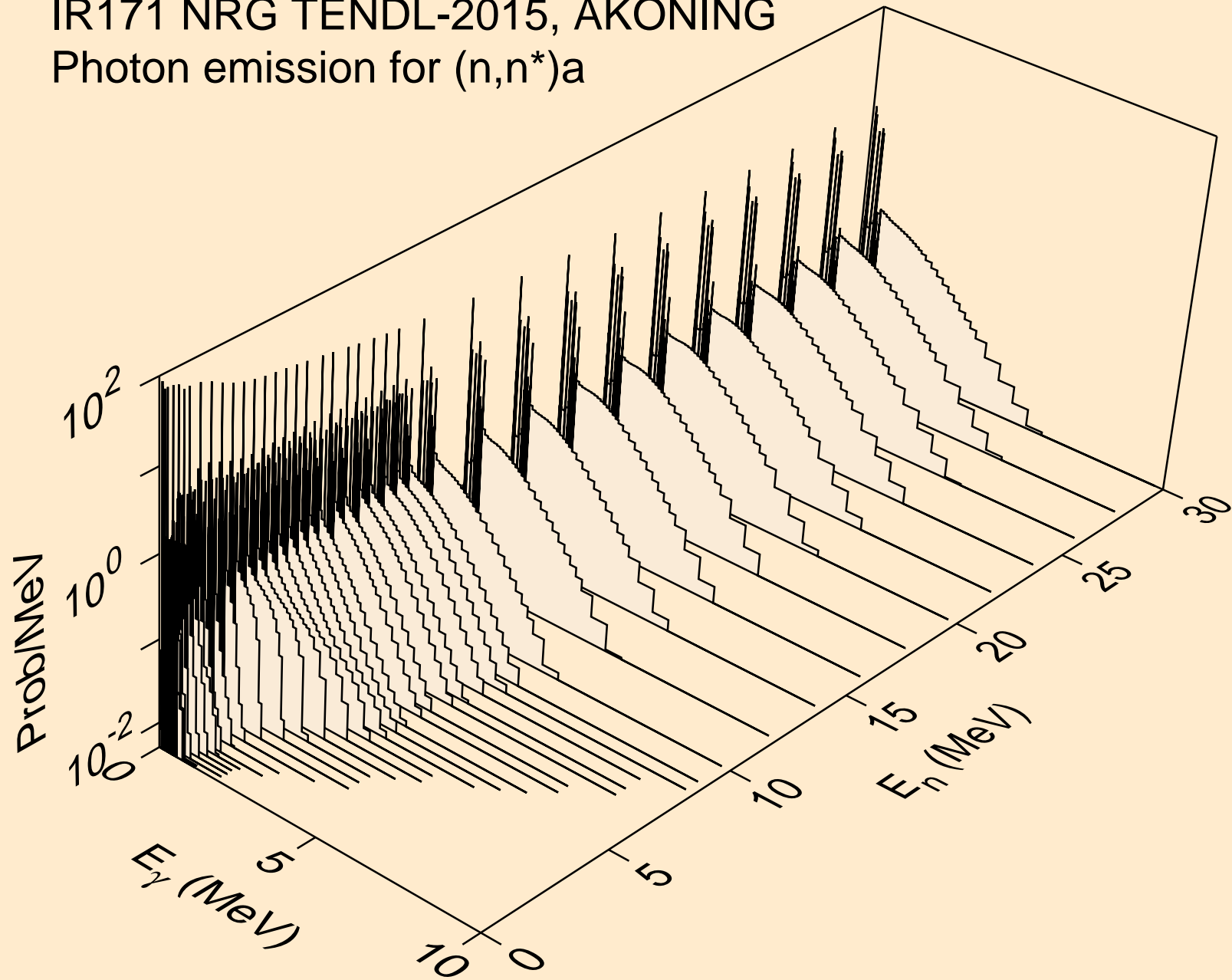

IR171 NRG TENDL-2015, AKONING  
Photon emission for (n,n\*)3a

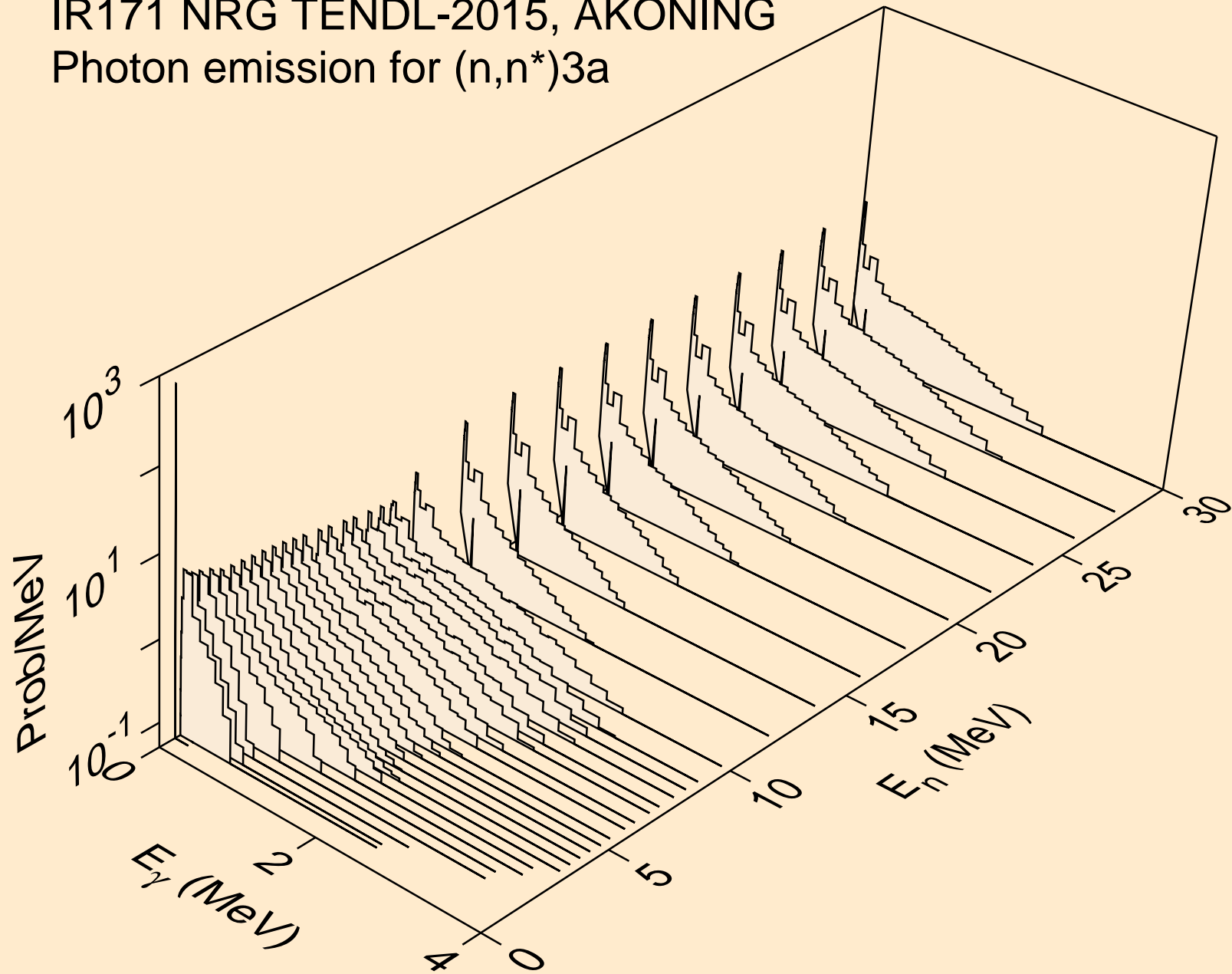

IR171 NRG TENDL-2015, AKONING  
Photon emission for (n,2n)a

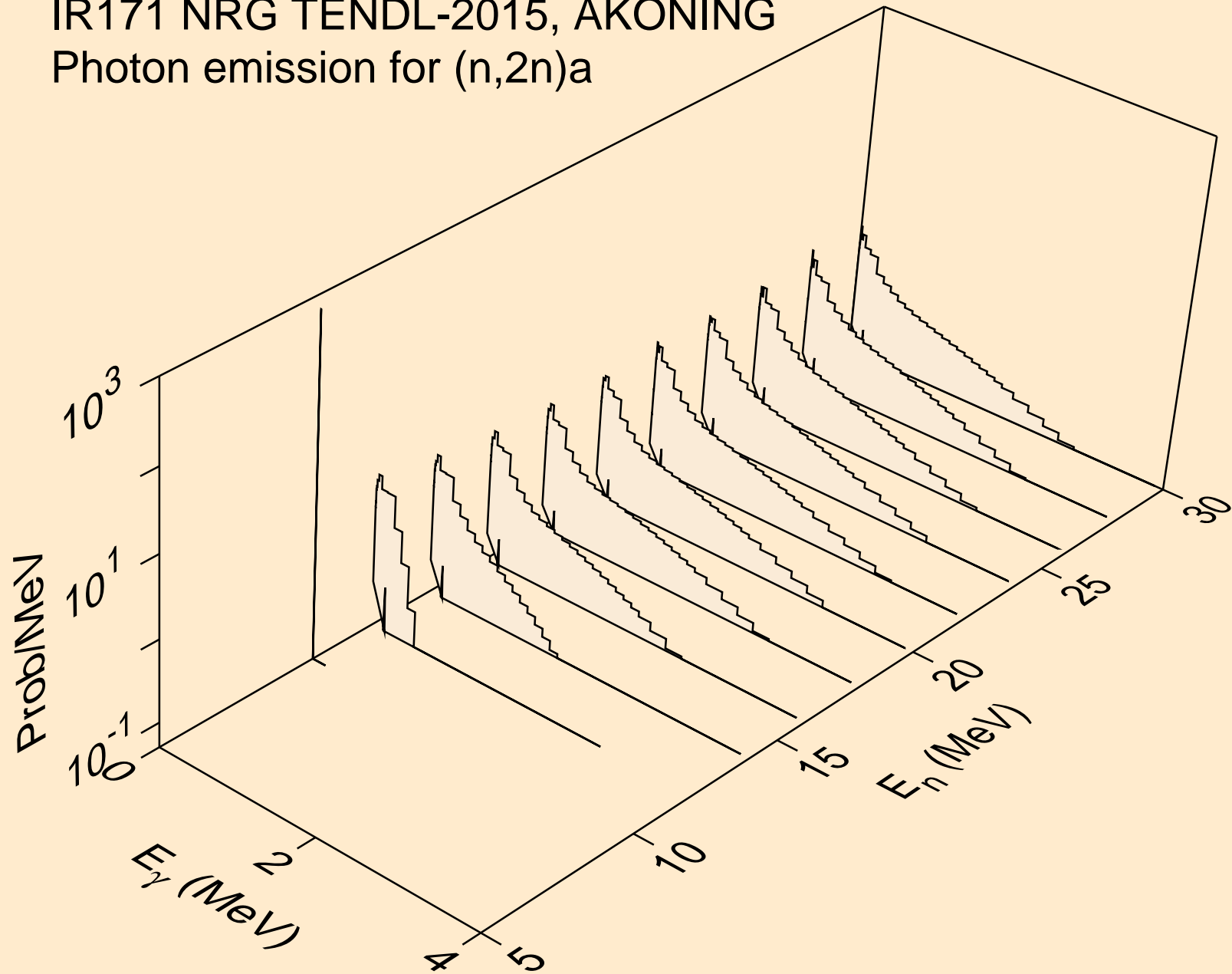

IR171 NRG TENDL-2015, AKONING  
Photon emission for (n,3n)a

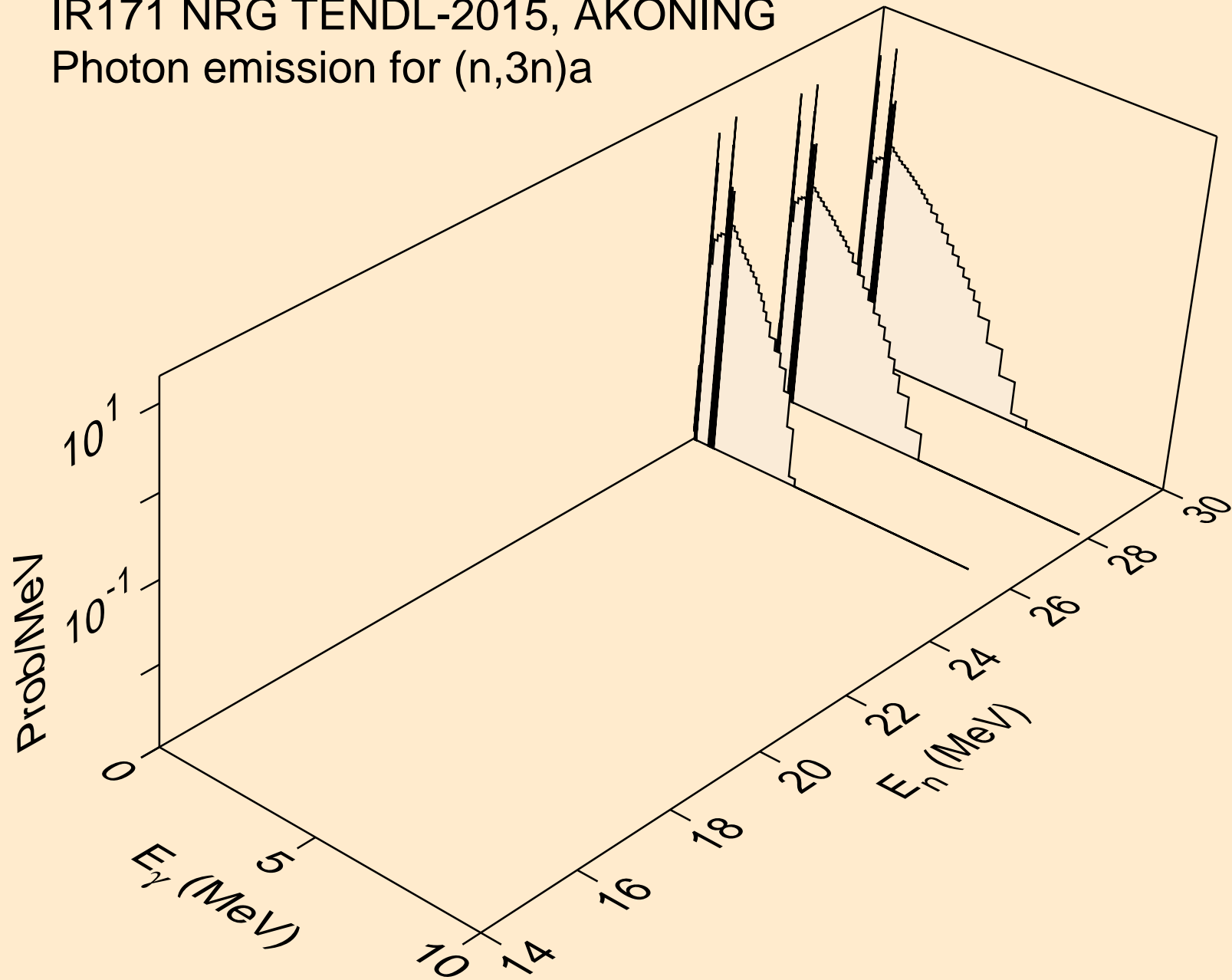

IR171 NRG TENDL-2015, AKONING  
Photon emission for (n,n\*)p

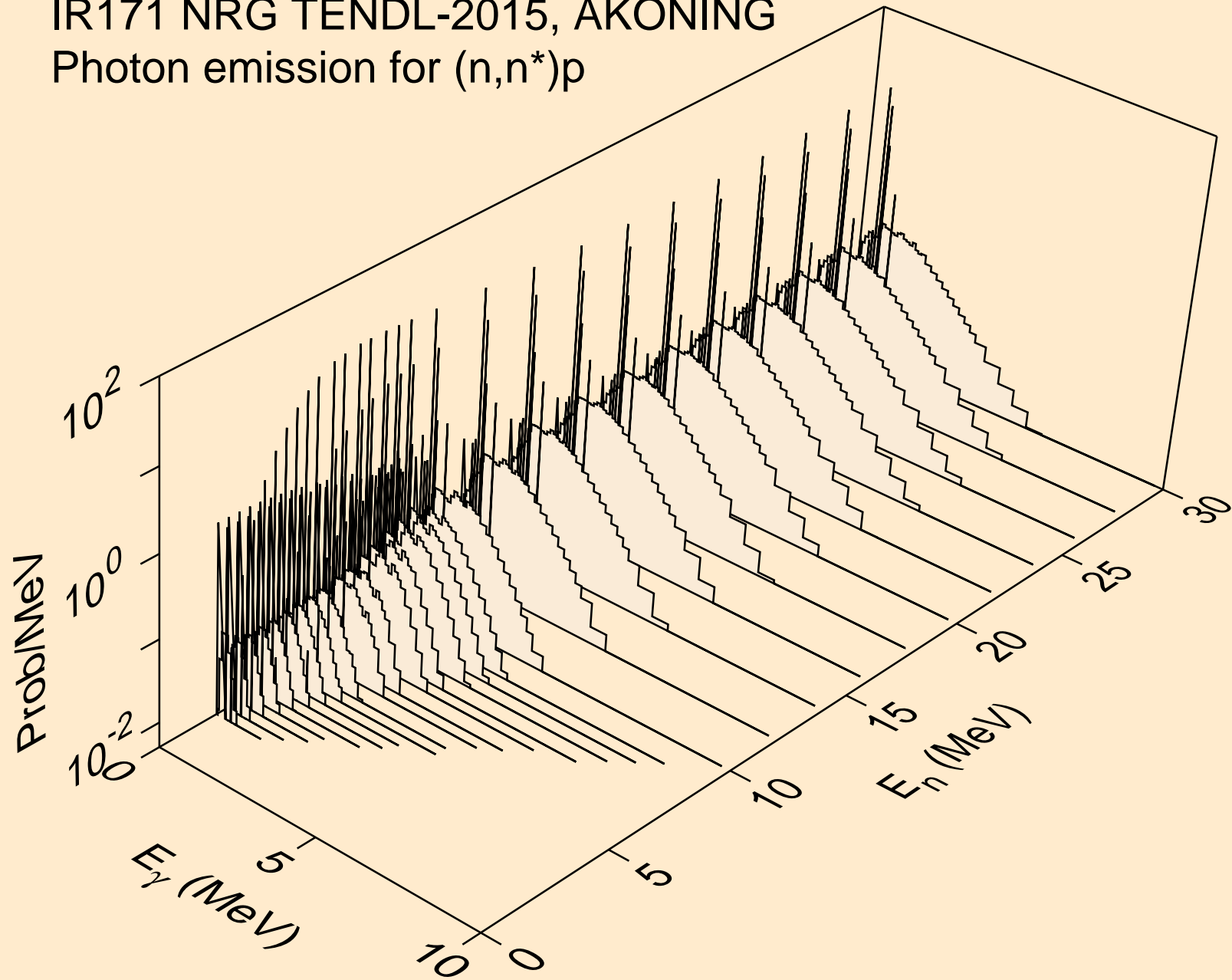

IR171 NRG TENDL-2015, AKONING  
Photon emission for (n,n\*)2a

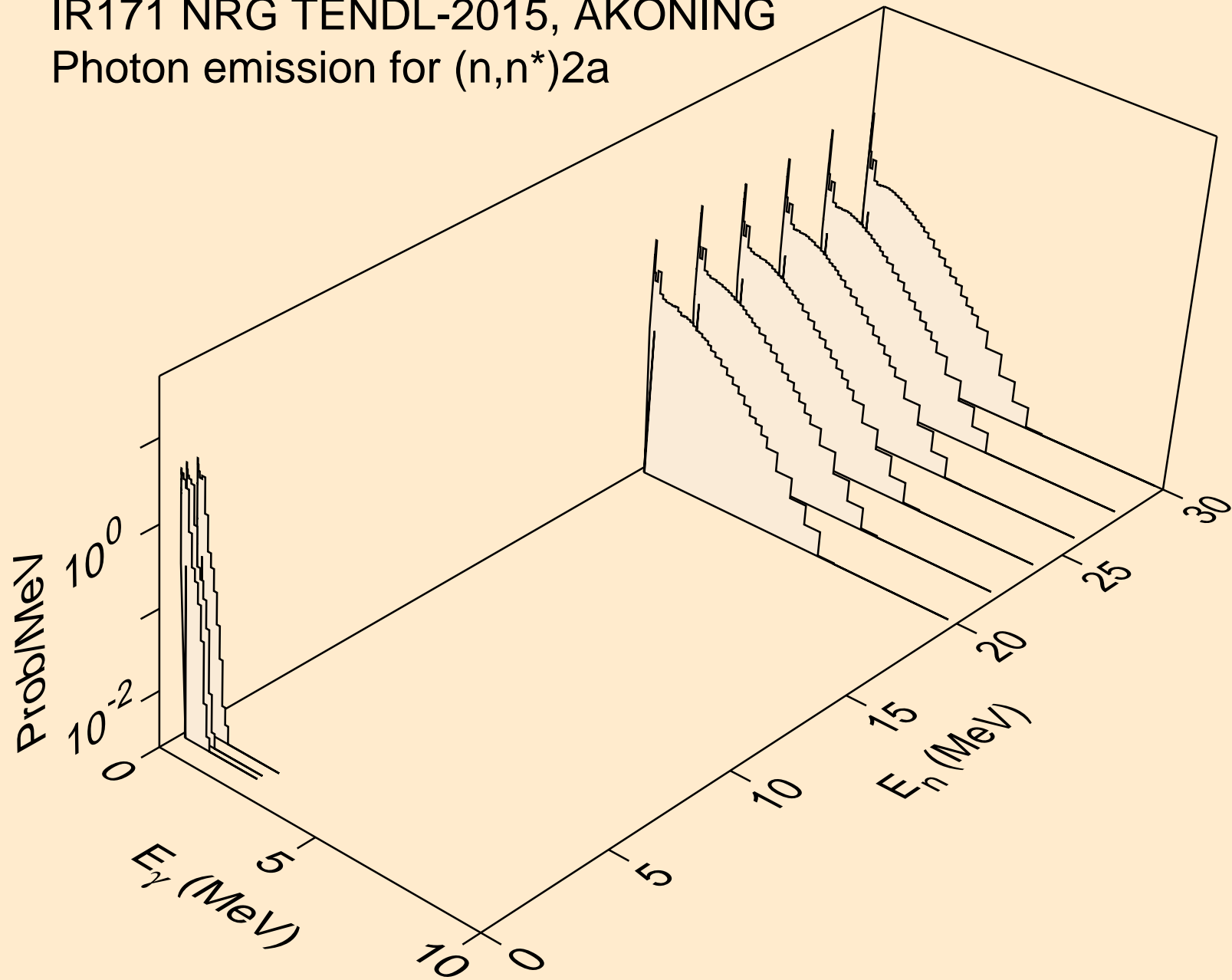

IR171 NRG TENDL-2015, AKONING  
Photon emission for (n,2n)2a

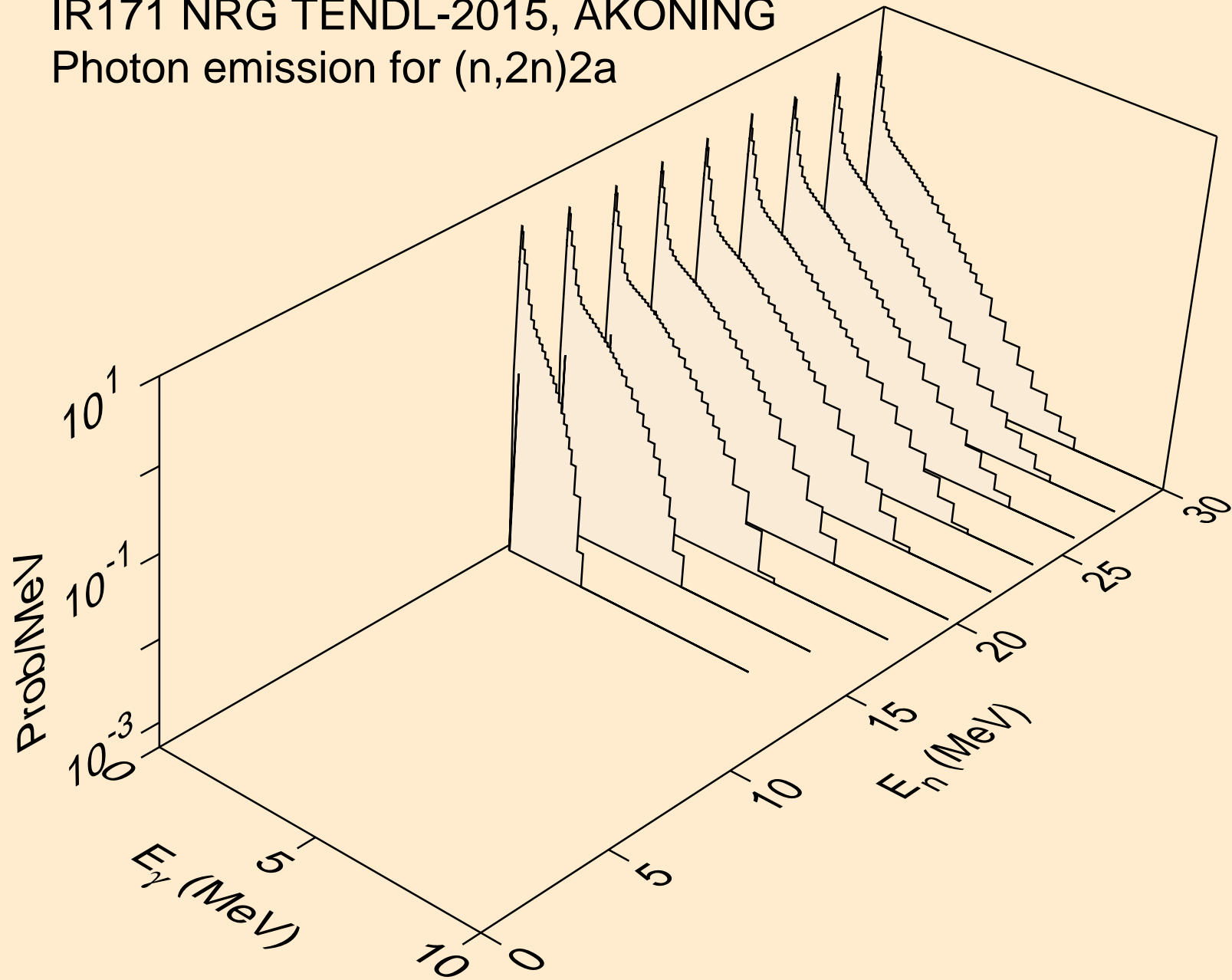



IR171 NRG TENDL-2015, AKONING  
Photon emission for (n,n\*)d

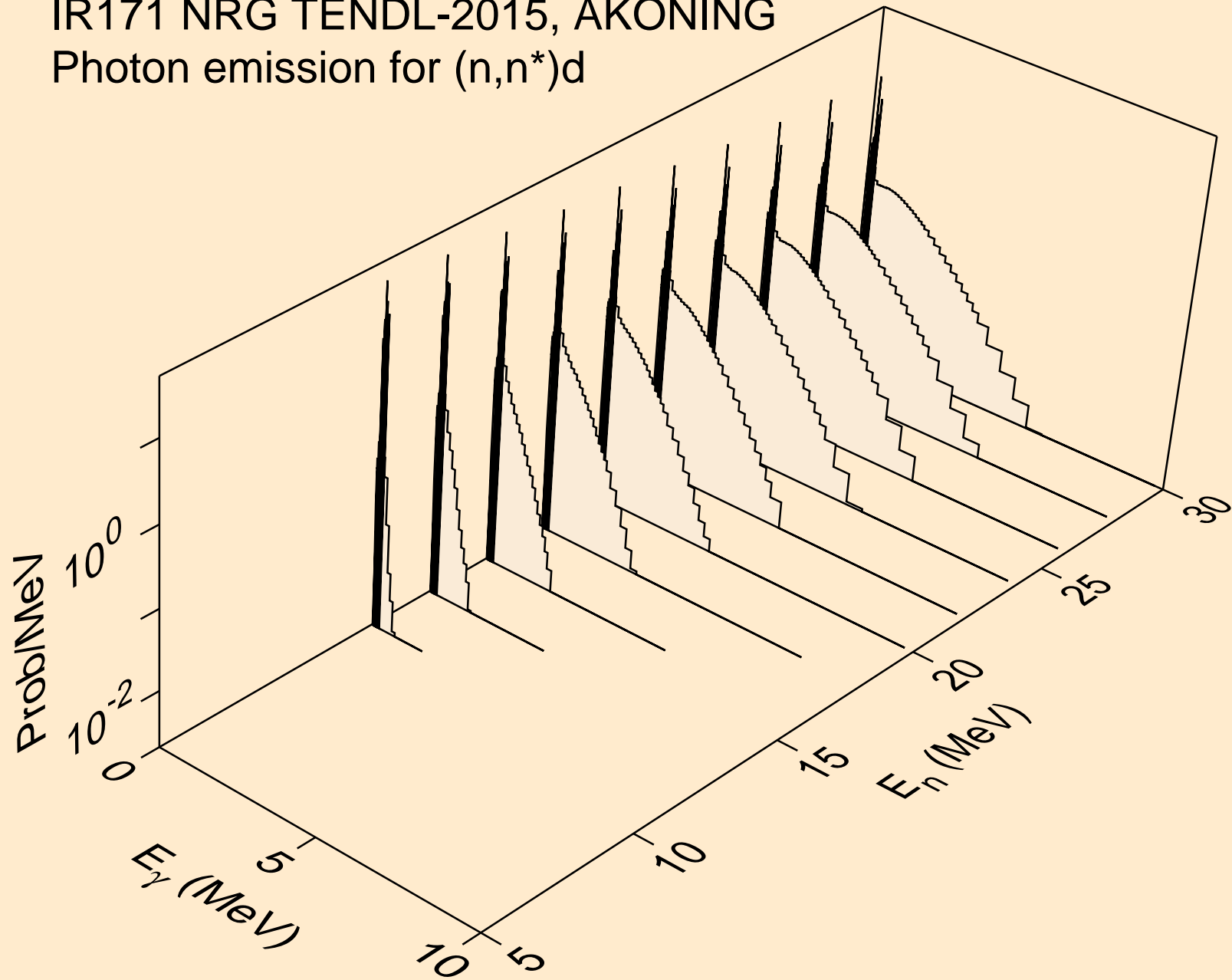

IR171 NRG TENDL-2015, AKONING  
Photon emission for (n,n\*)t

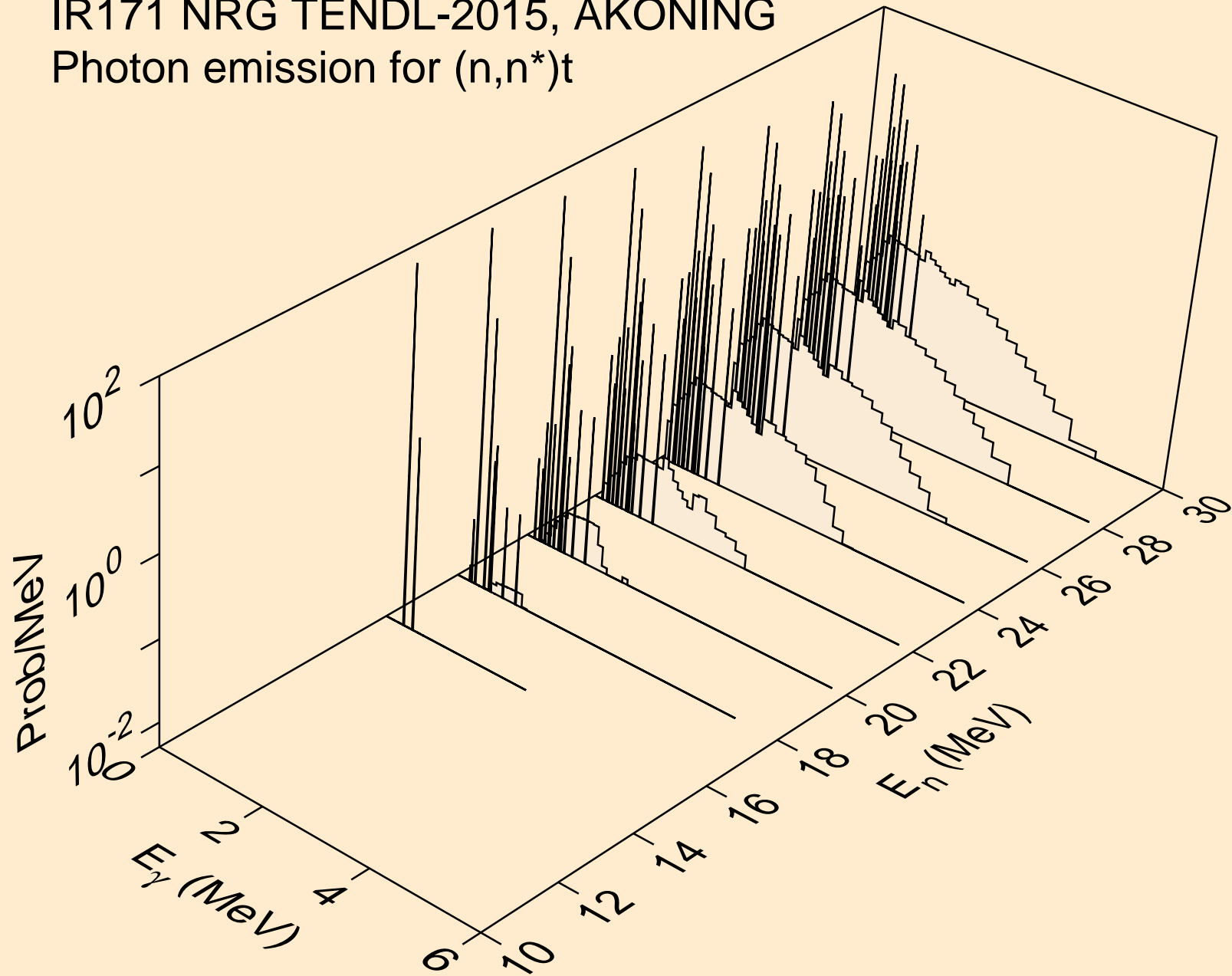

IR171 NRG TENDL-2015, AKONING  
Photon emission for (n,n\*)he3

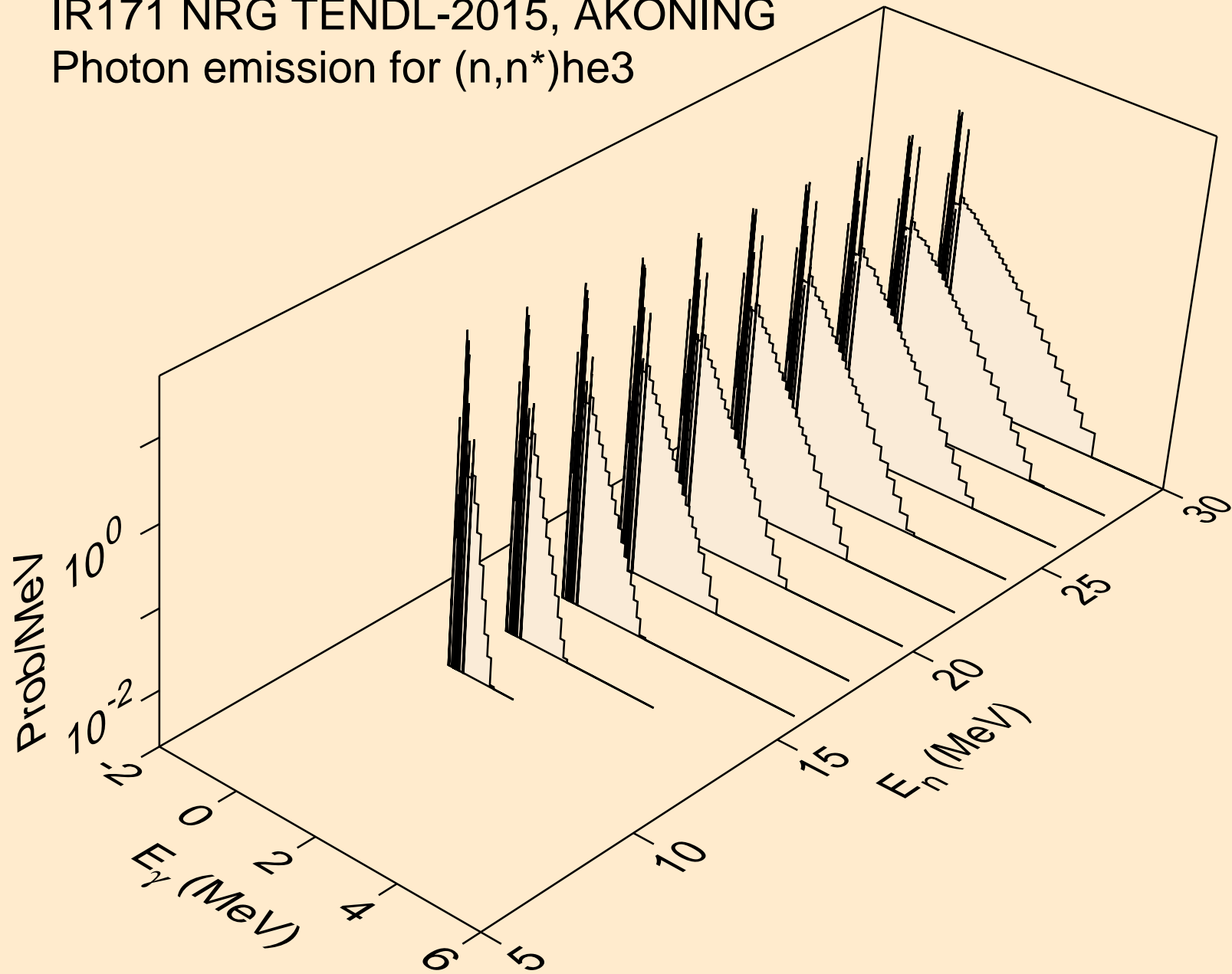

IR171 NRG TENDL-2015, AKONING  
Photon emission for (n,n\*)d2a

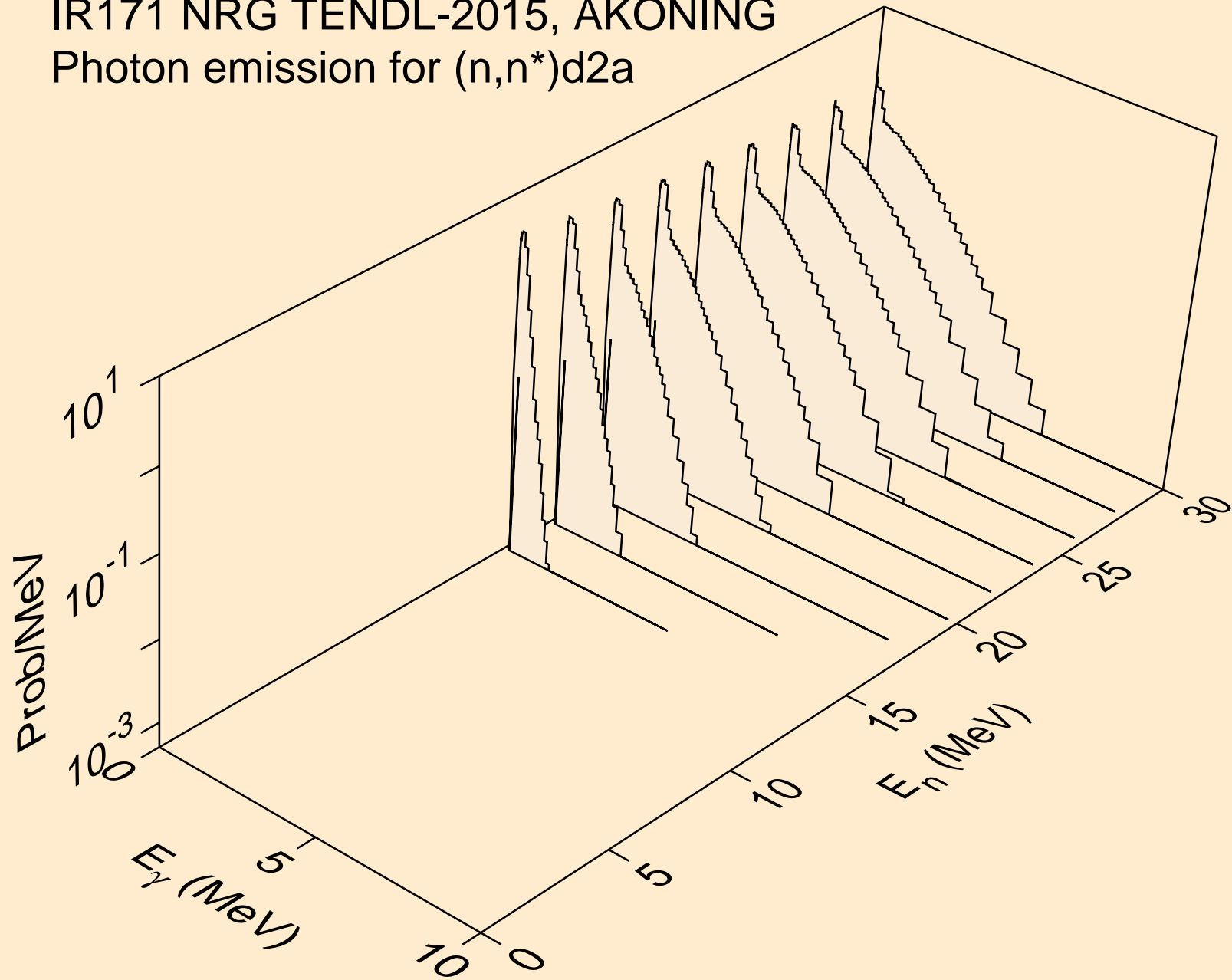

IR171 NRG TENDL-2015, AKONING  
Photon emission for (n,n\*)t2a

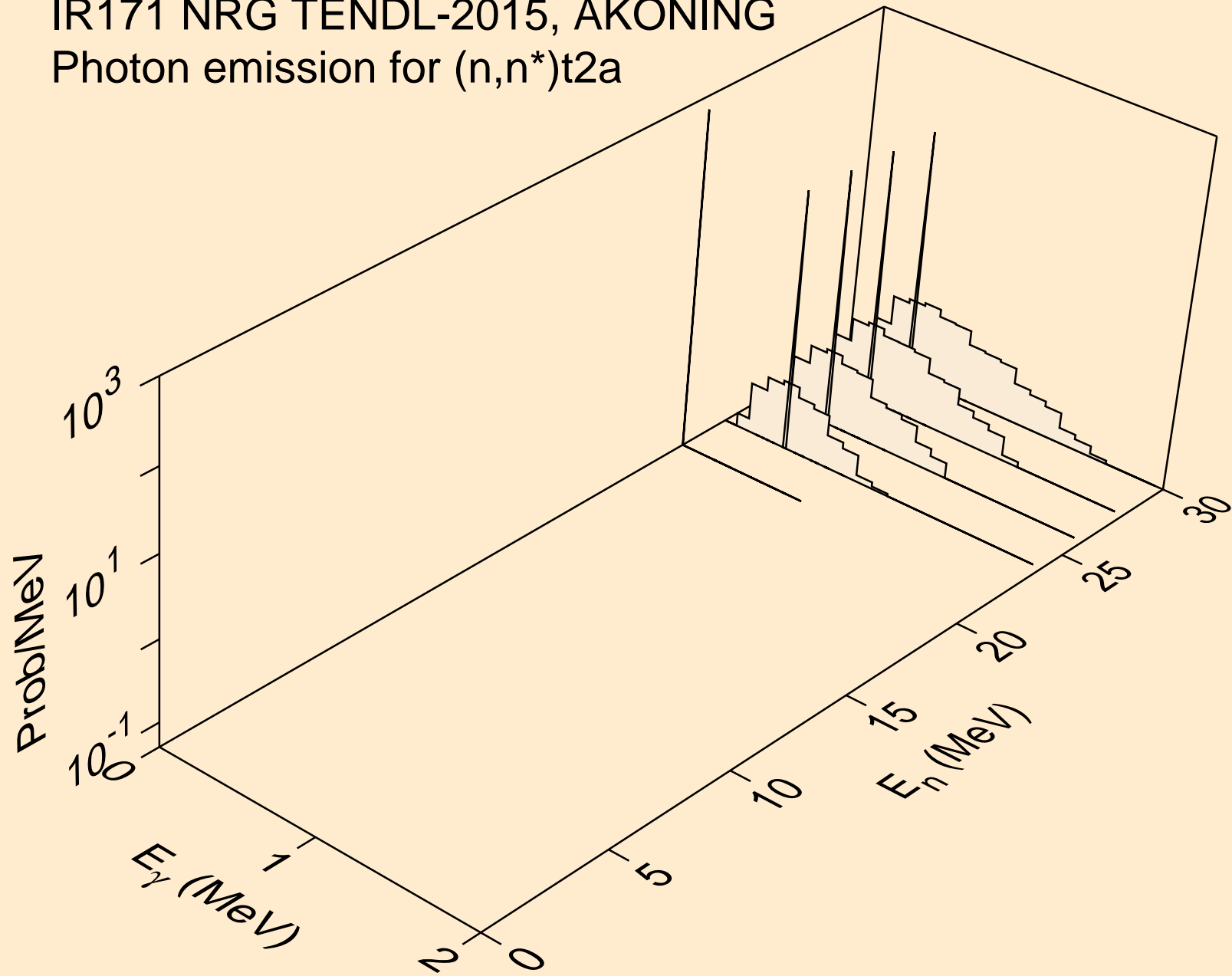

IR171 NRG TENDL-2015, AKONING  
Photon emission for (n,2np)

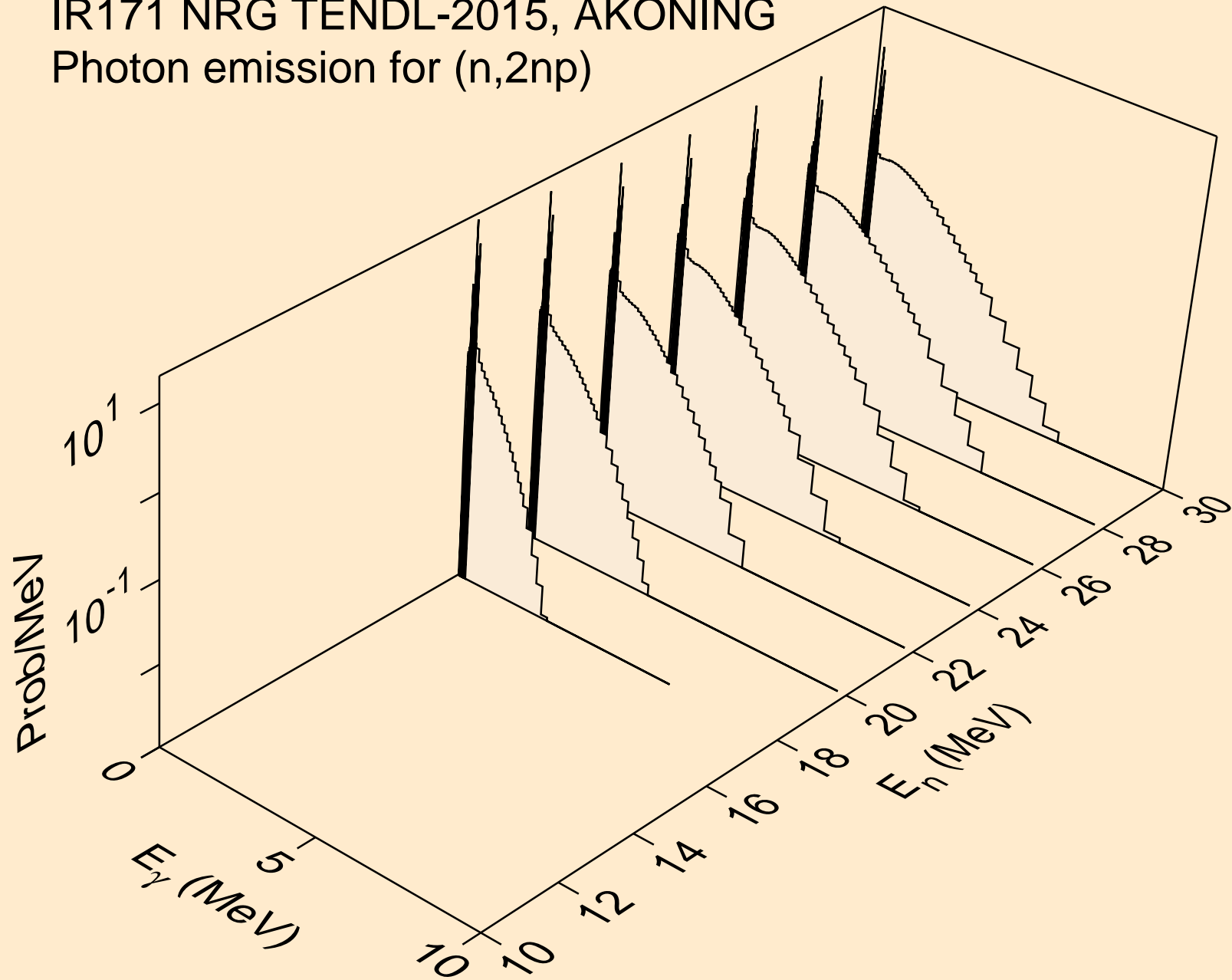

IR171 NRG TENDL-2015, AKONING  
Photon emission for (n,3np)

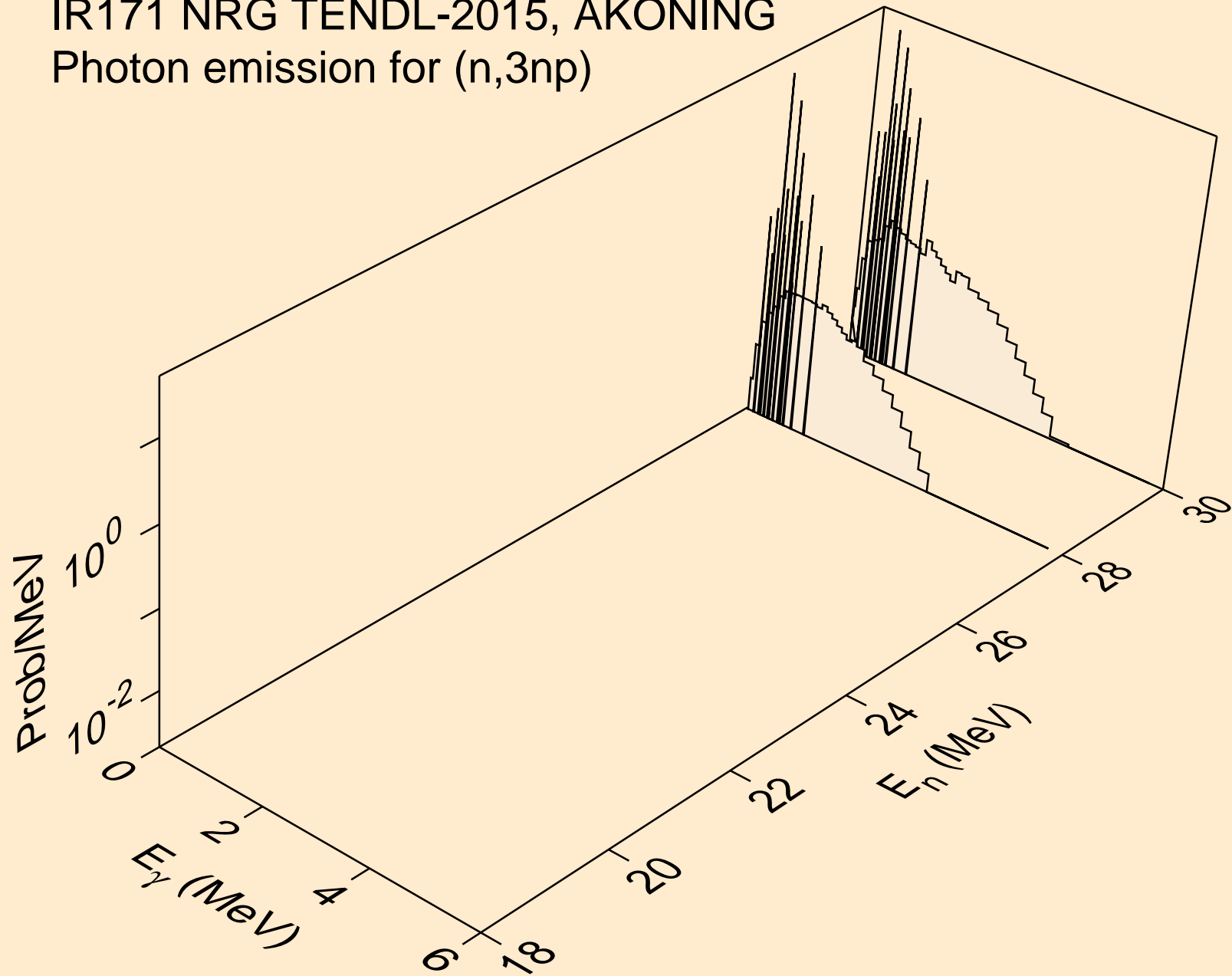

IR171 NRG TENDL-2015, AKONING  
Photon emission for (n,2np)

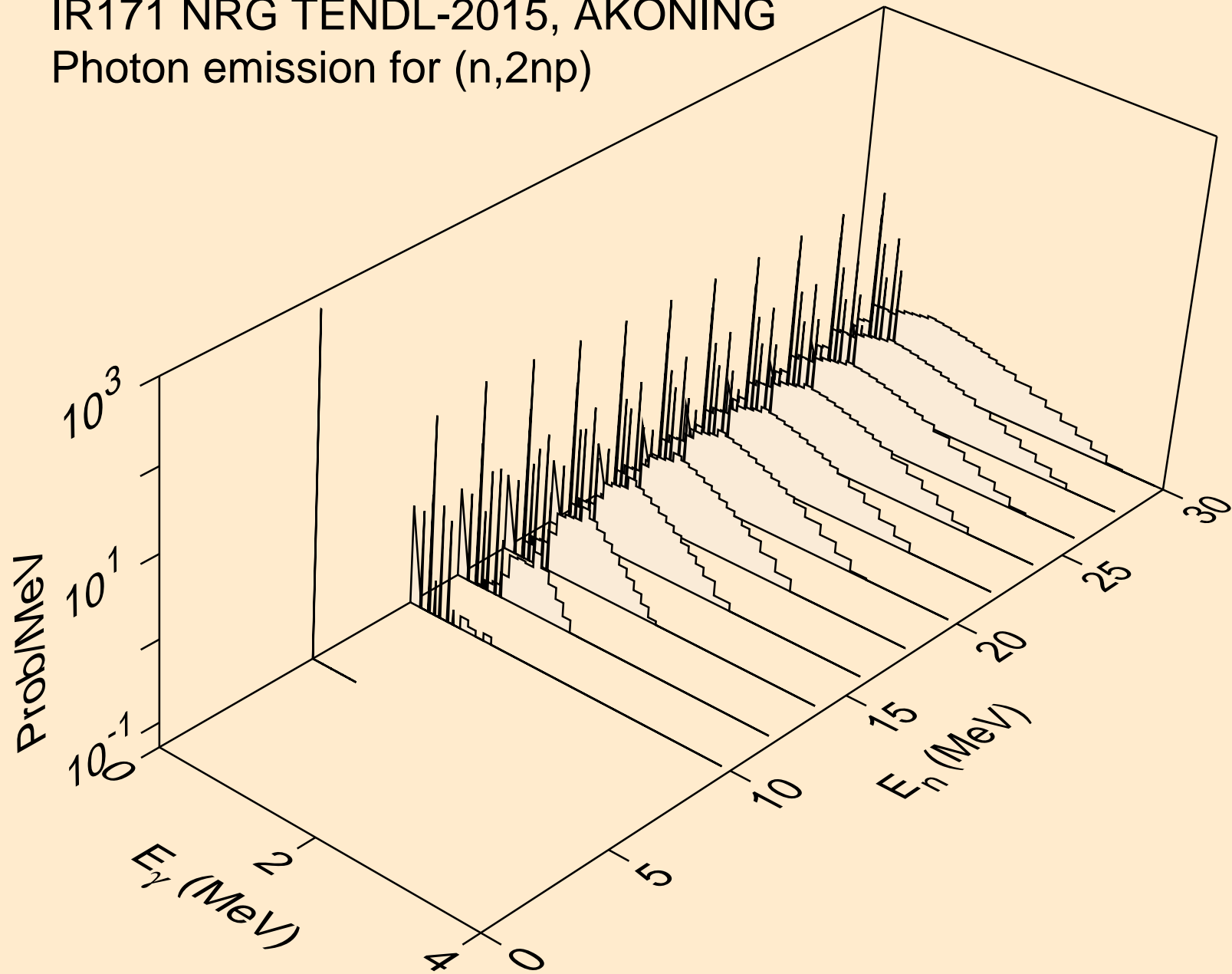



IR171 NRG TENDL-2015, AKONING  
Photon emission for (n,npa)

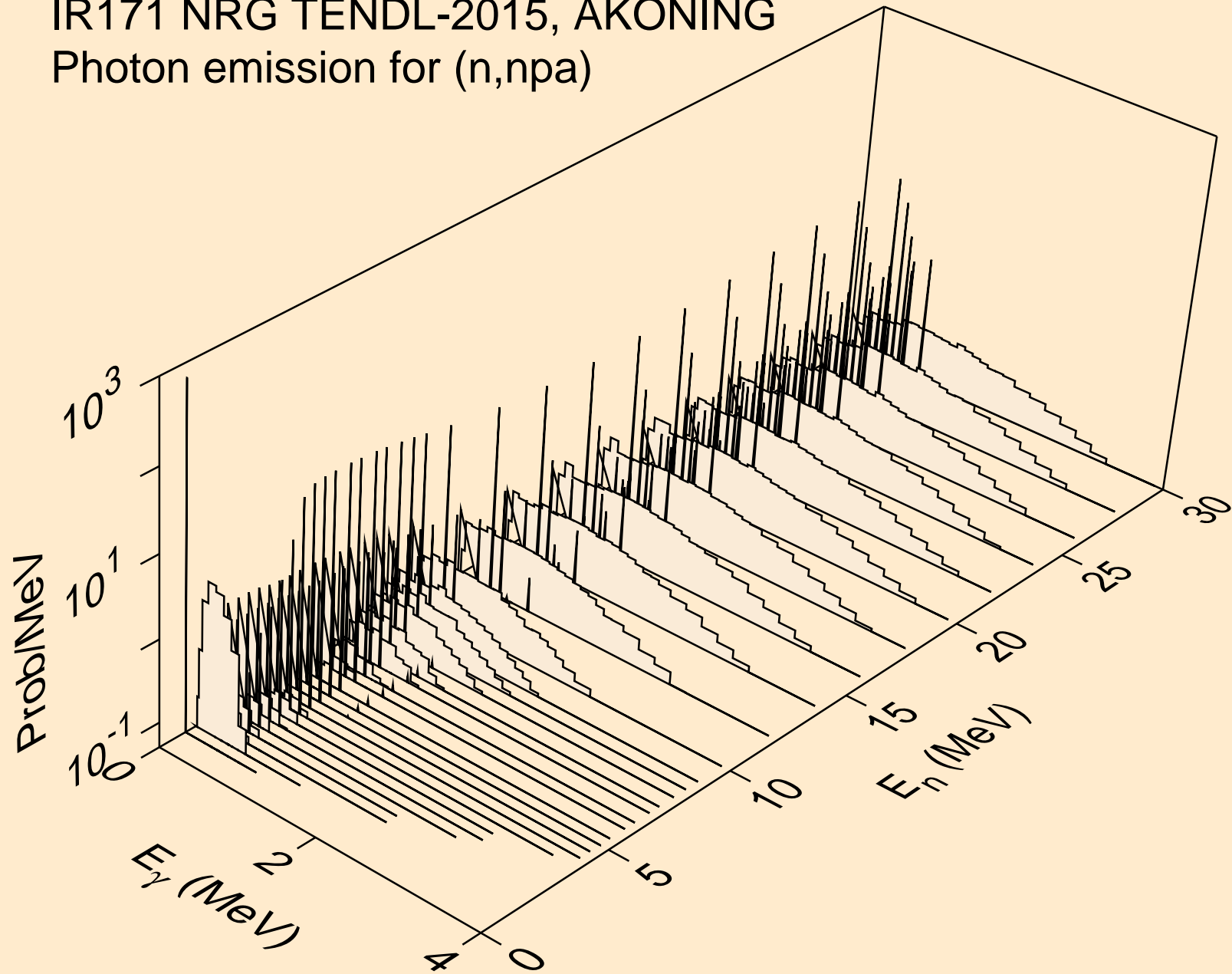

IR171 NRG TENDL-2015, AKONING  
Photon emission for (n,n\*c)

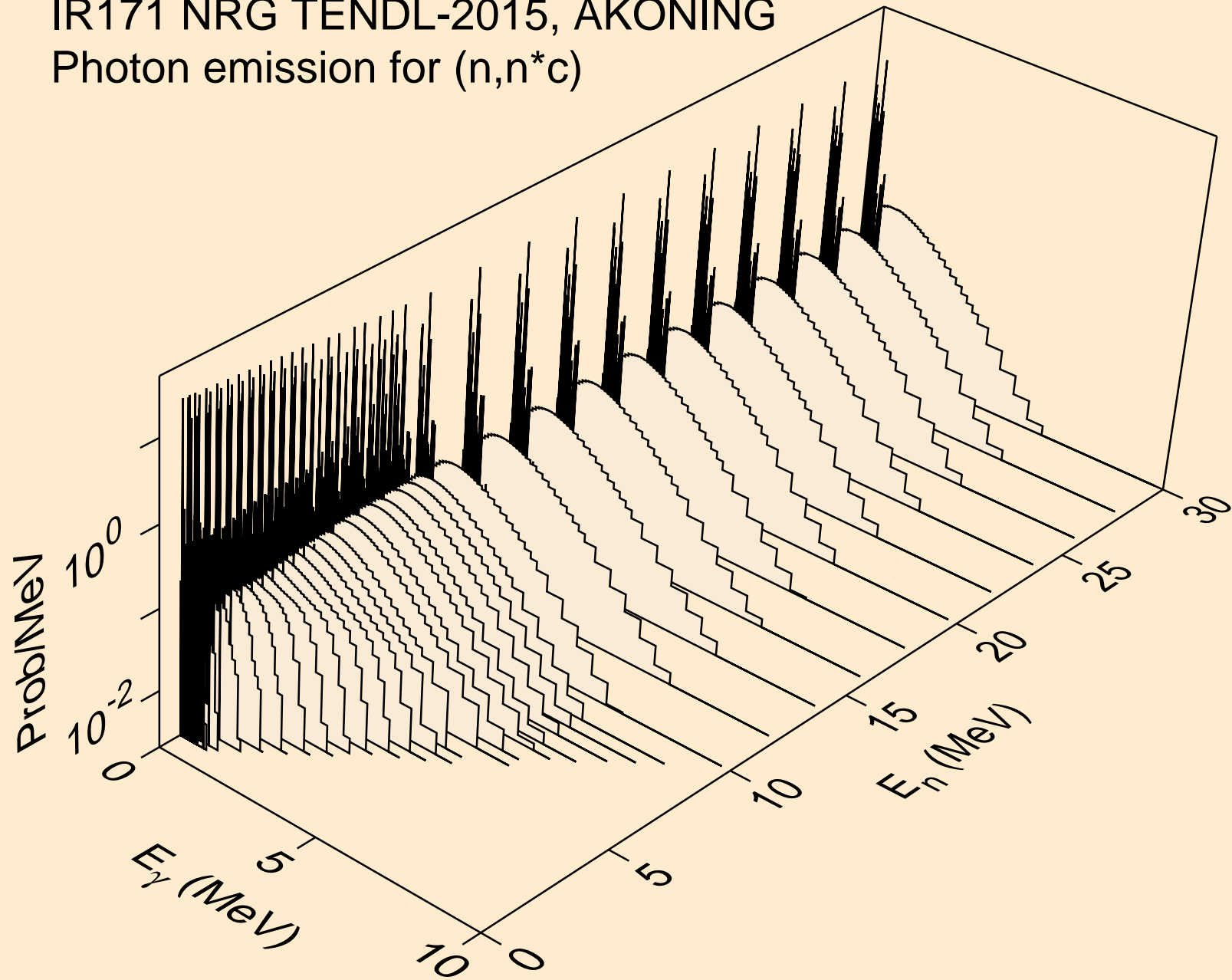

IR171 NRG TENDL-2015, AKONING  
Photon emission for (n,gma)

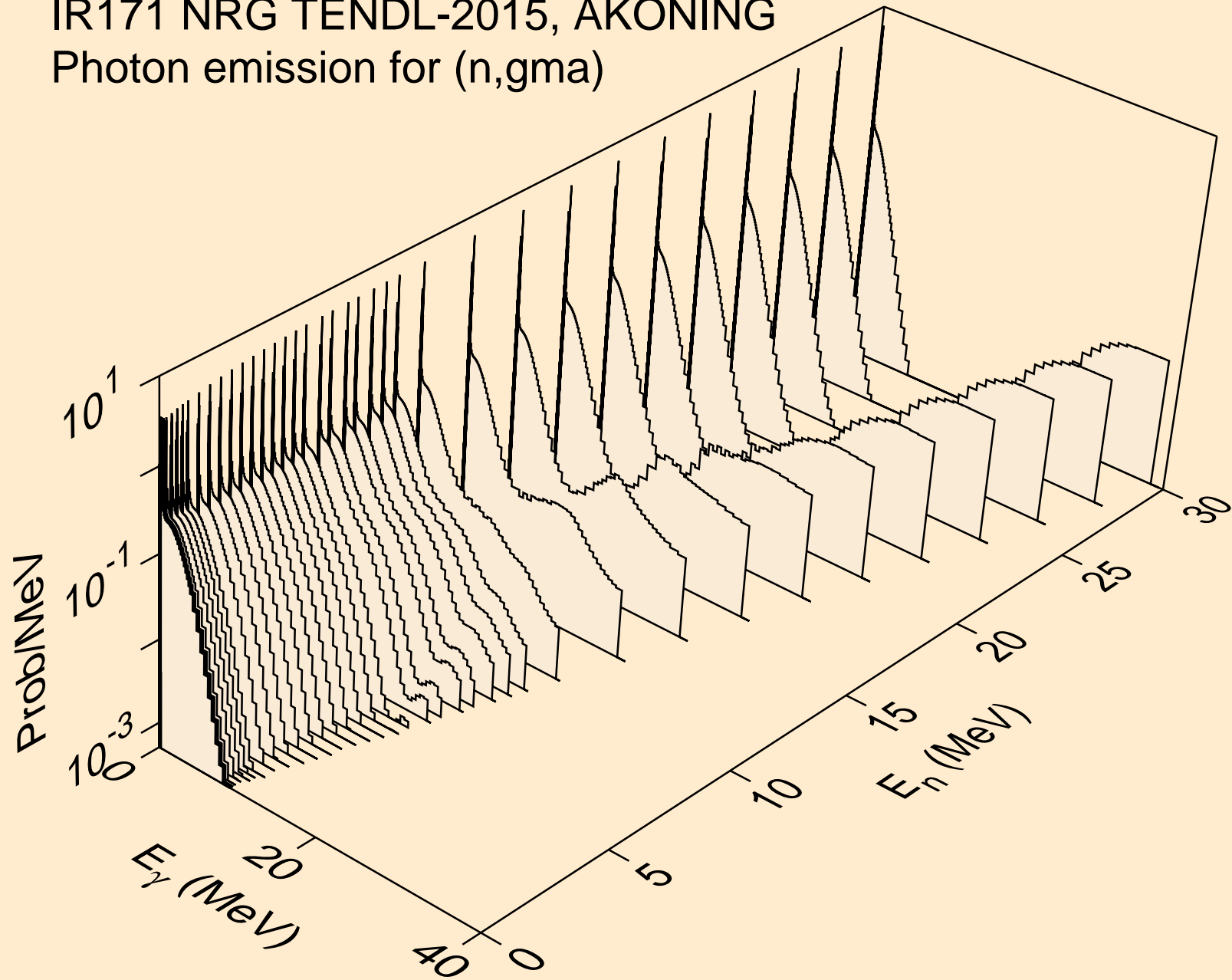

IR171 NRG TENDL-2015, AKONING  
Photon emission for (n,p)

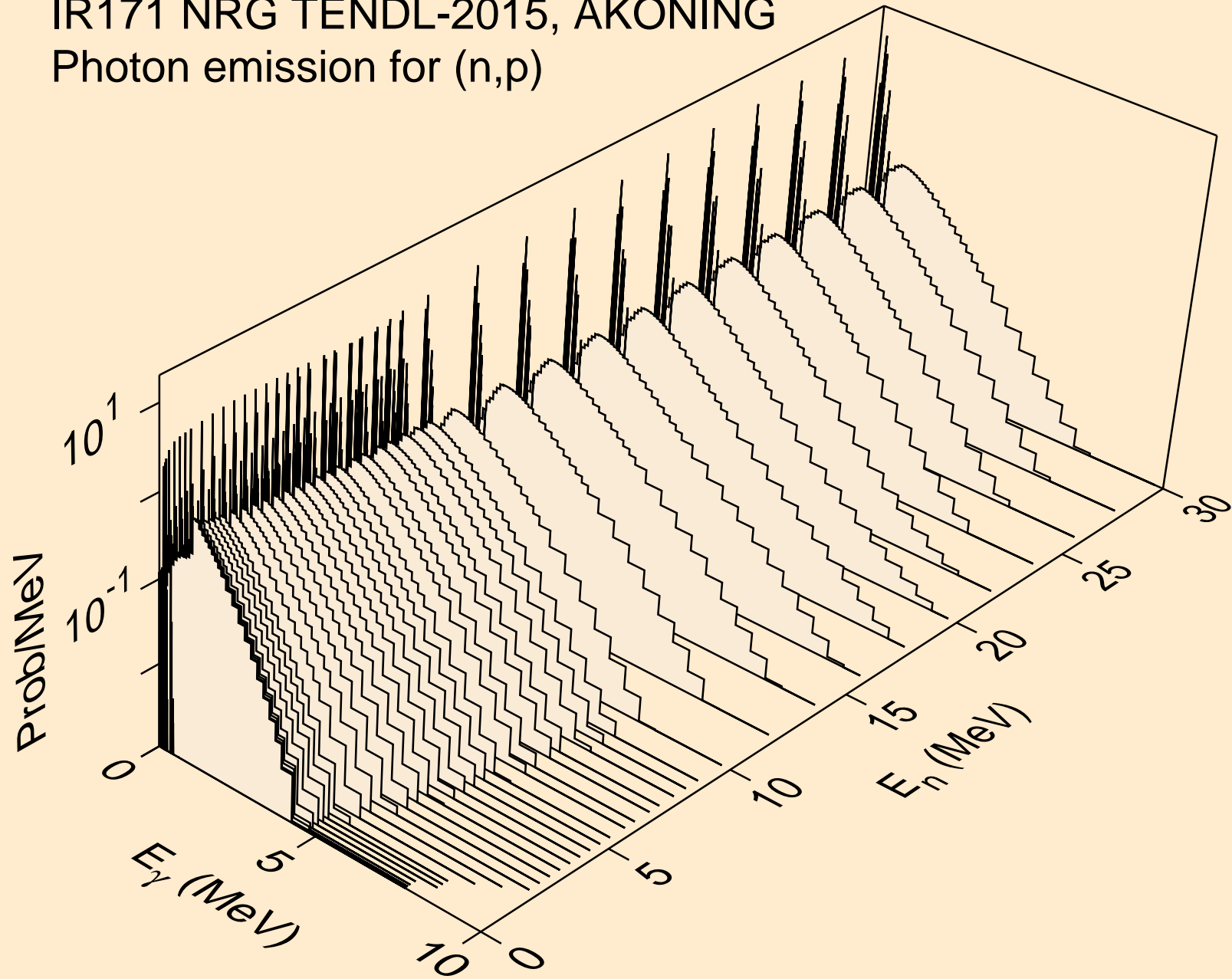

IR171 NRG TENDL-2015, AKONING  
Photon emission for (n,d)

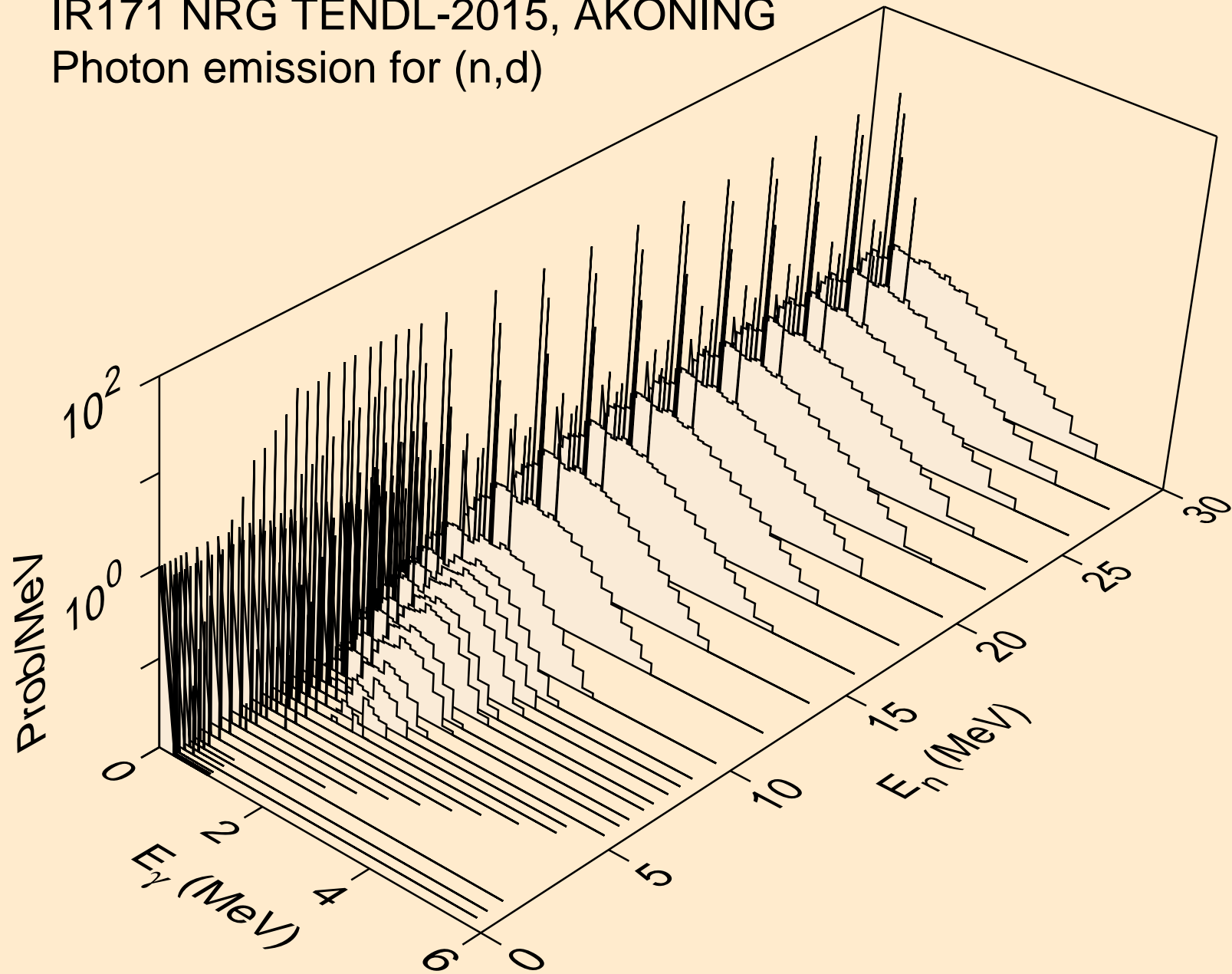

IR171 NRG TENDL-2015, AKONING  
Photon emission for (n,t)

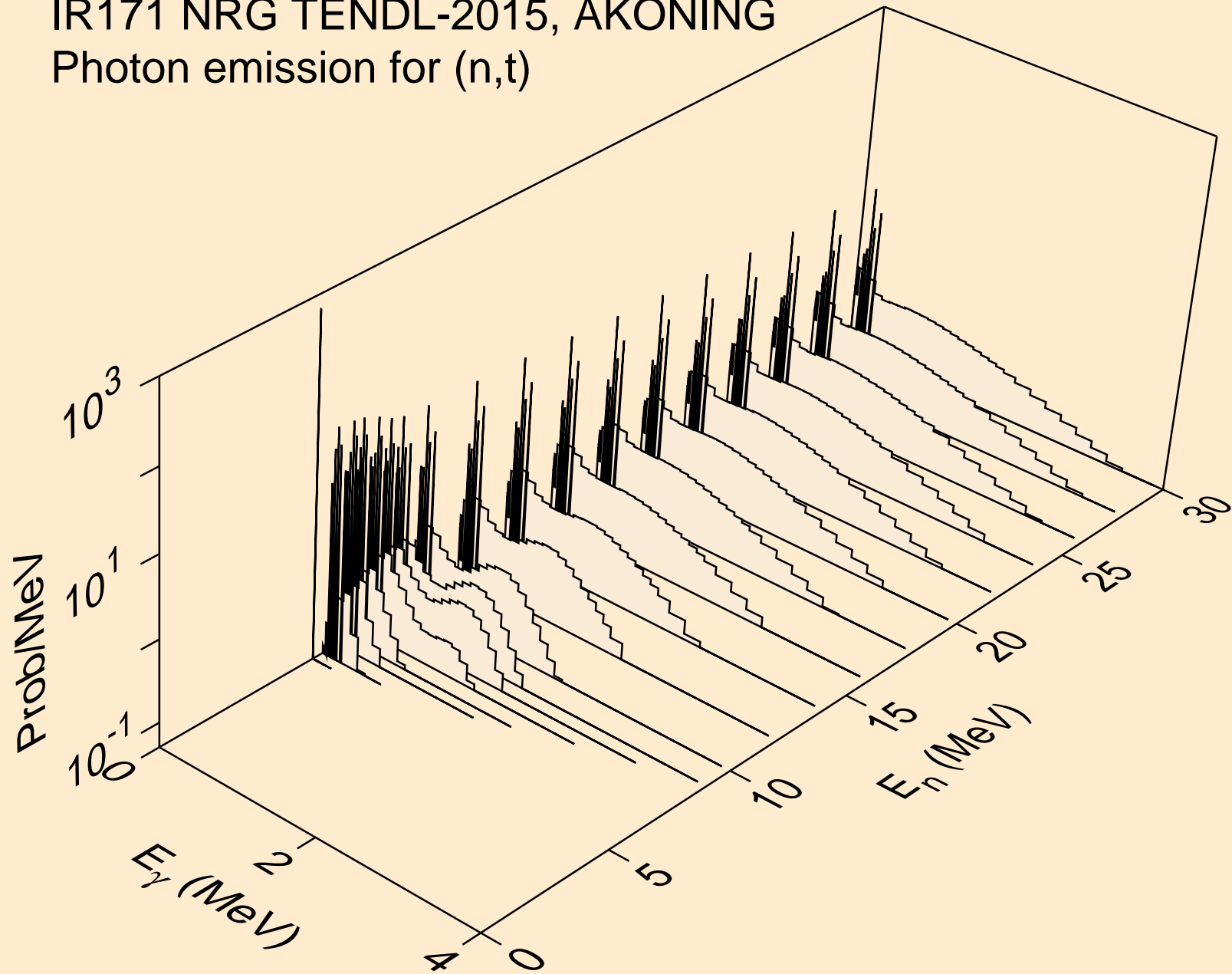

IR171 NRG TENDL-2015, AKONING  
Photon emission for (n,he3)

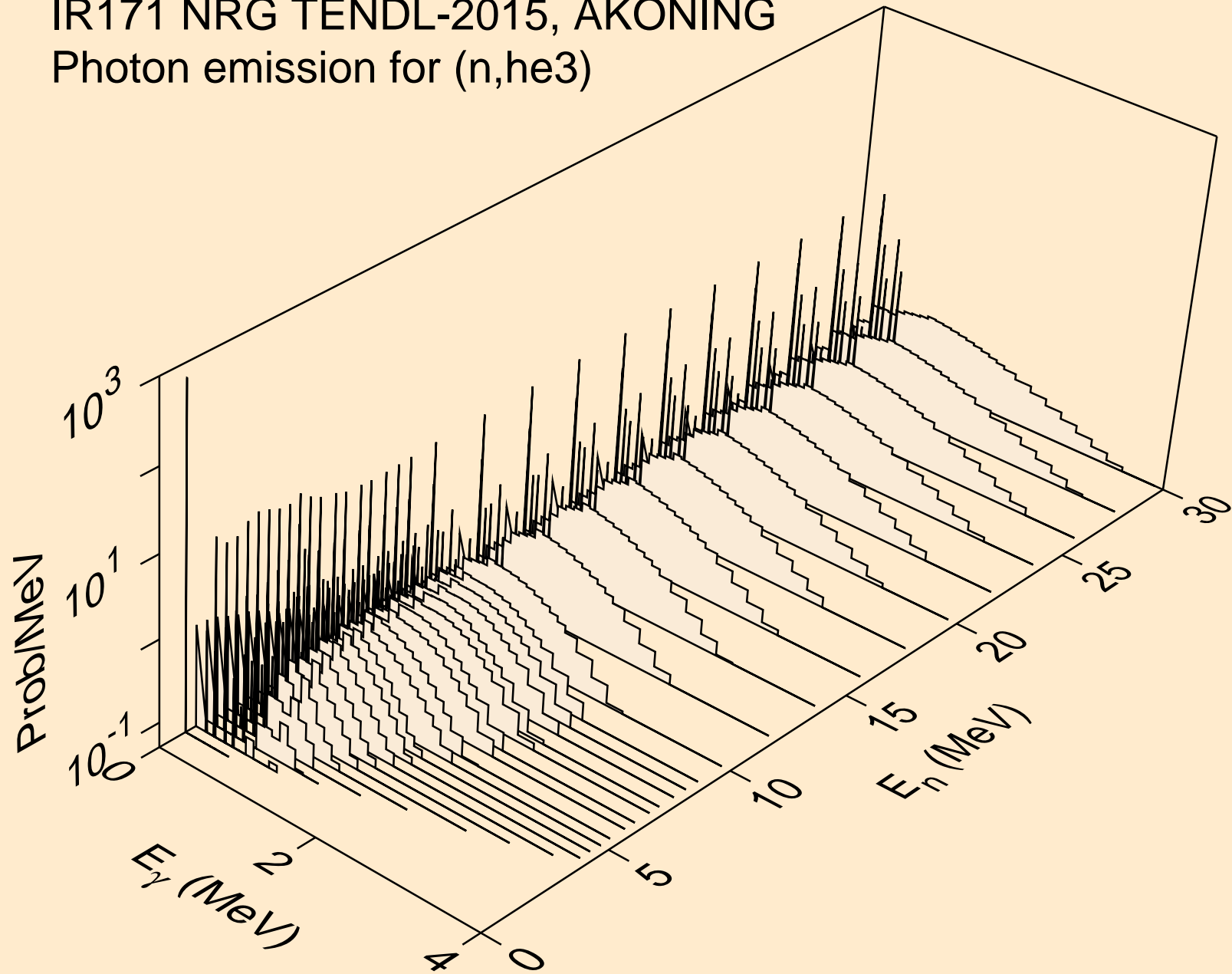

IR171 NRG TENDL-2015, AKONING  
Photon emission for (n,a)

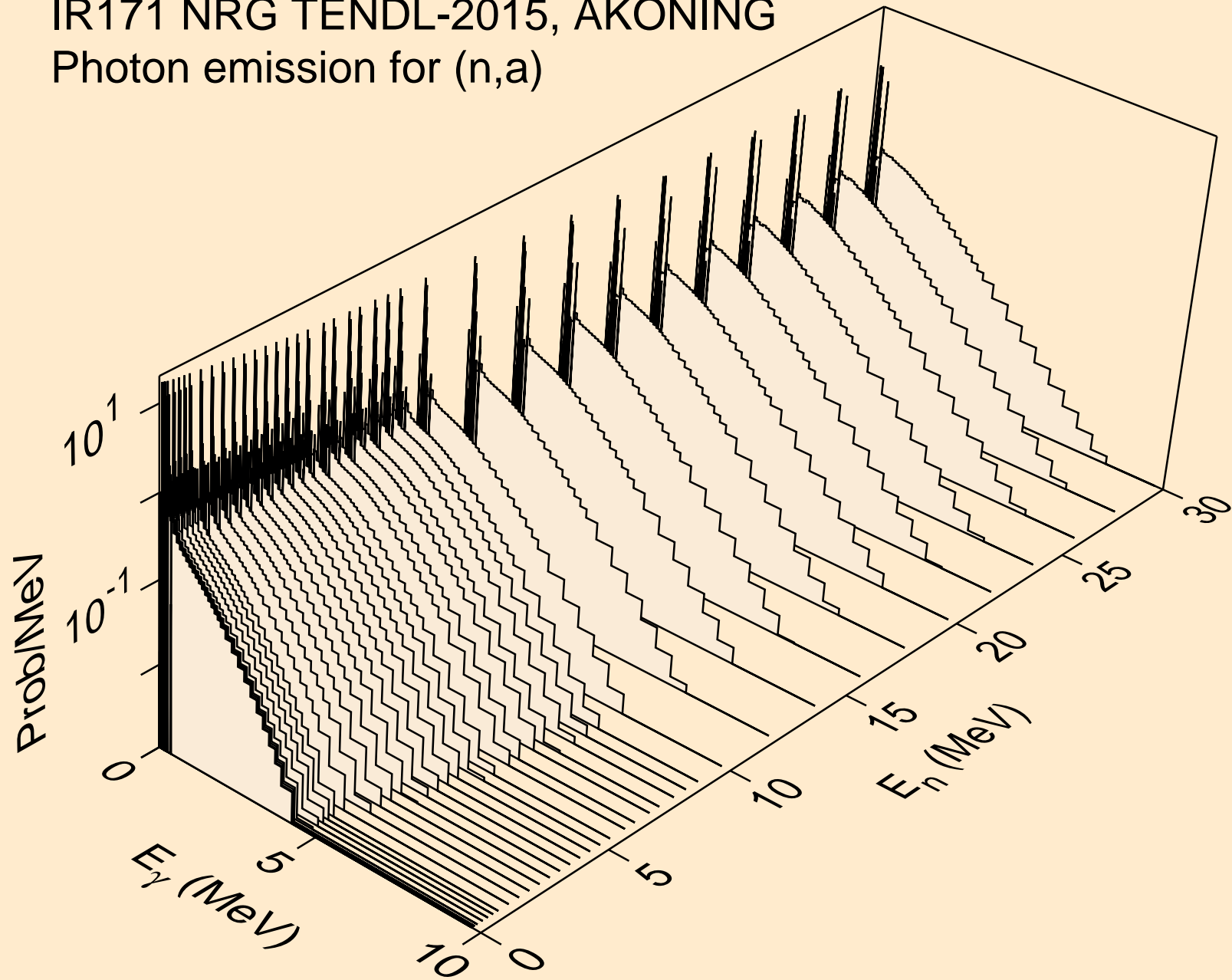



IR171 NRG TENDL-2015, AKONING  
Photon emission for (n,2a)

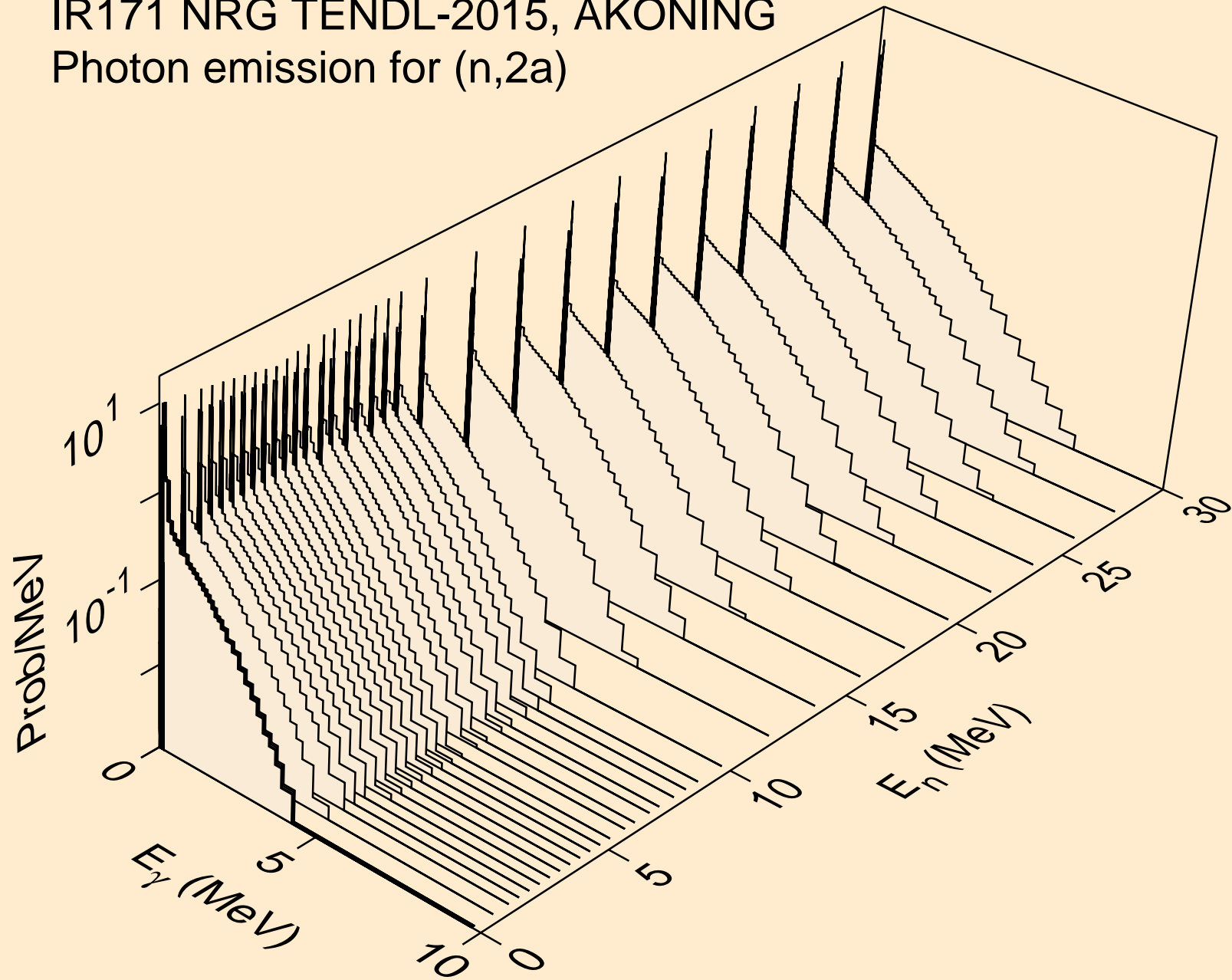

IR171 NRG TENDL-2015, AKONING  
Photon emission for (n,3a)

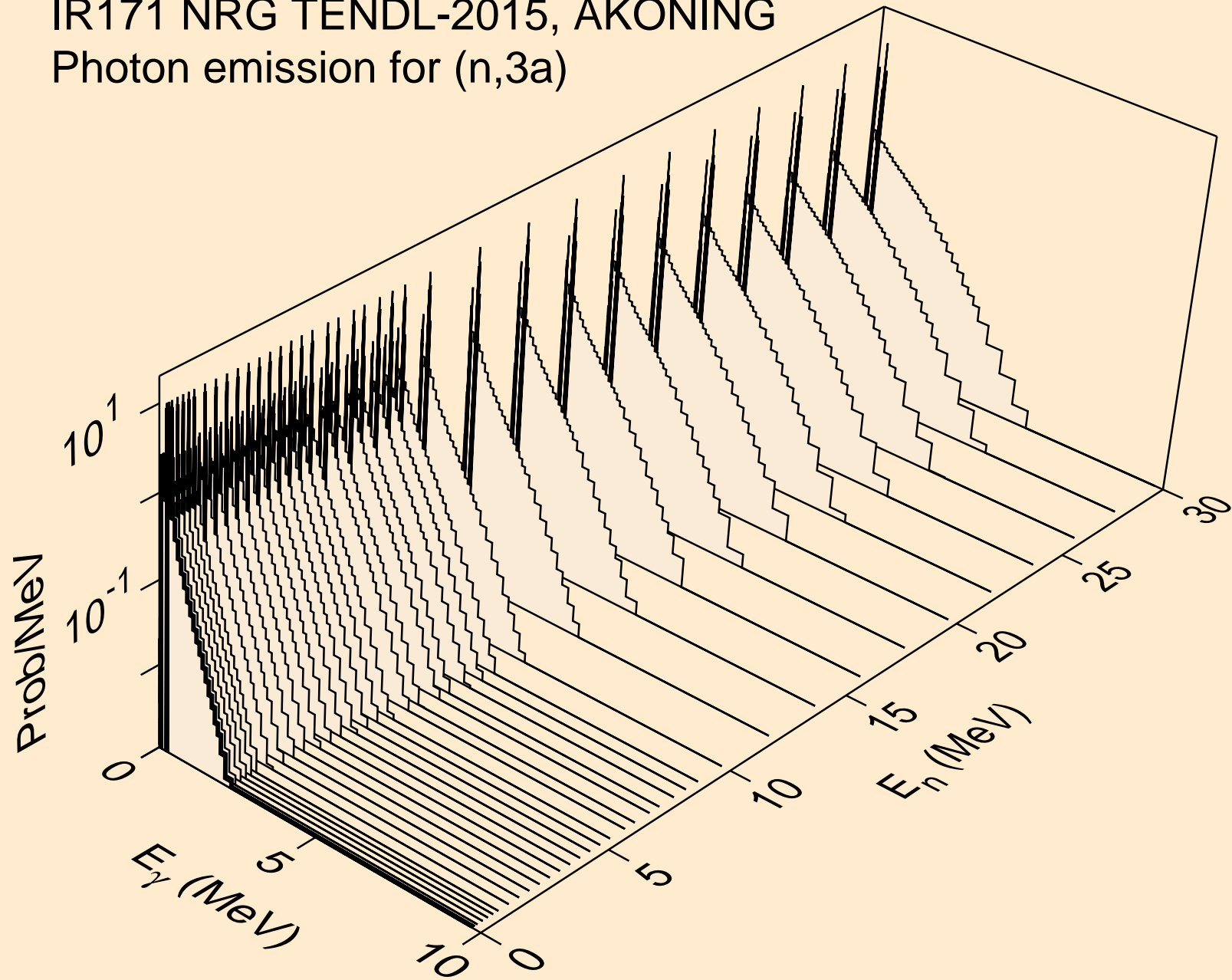

IR171 NRG TENDL-2015, AKONING  
Photon emission for (n,2p)

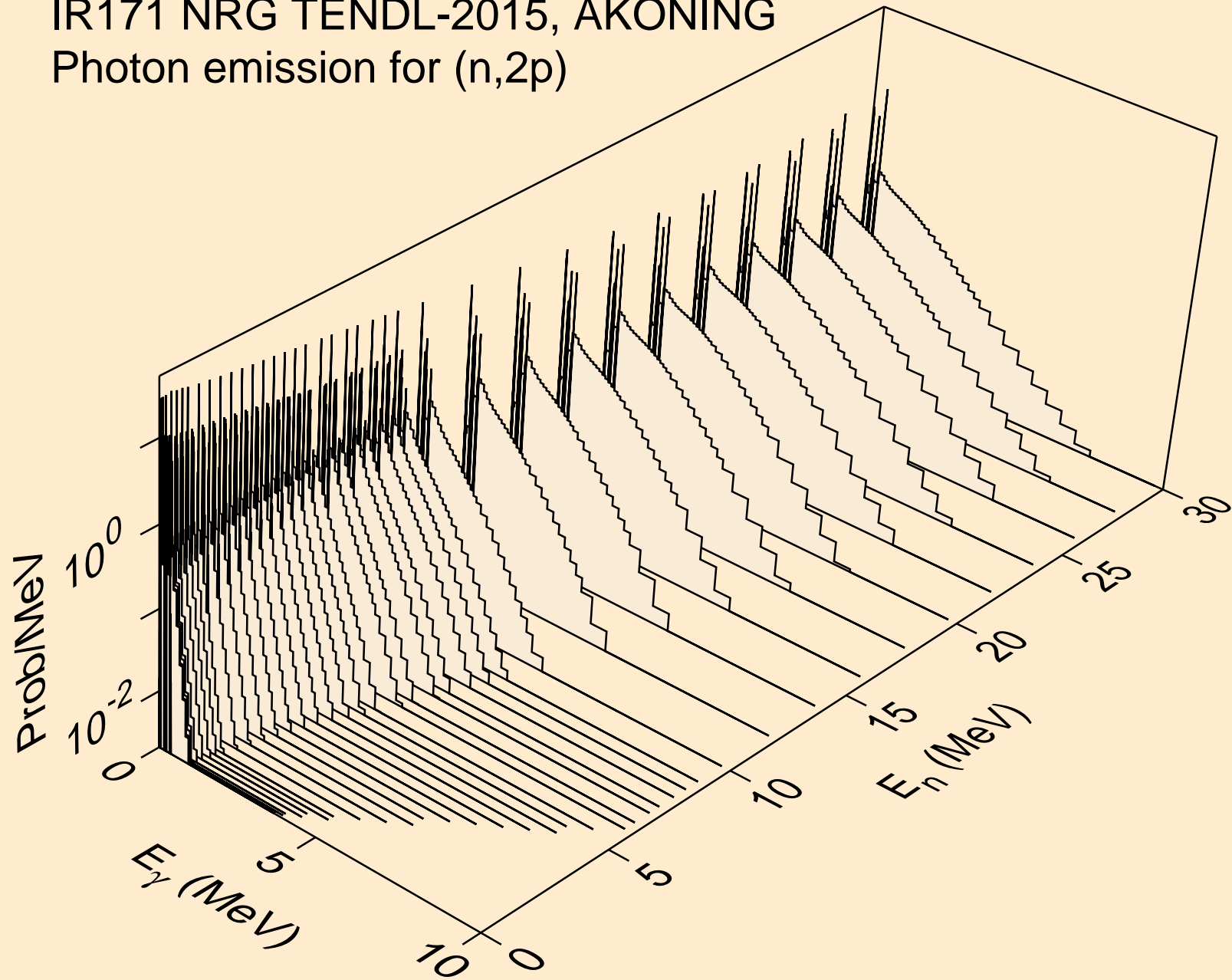

IR171 NRG TENDL-2015, AKONING  
Photon emission for (n,p $\alpha$ )

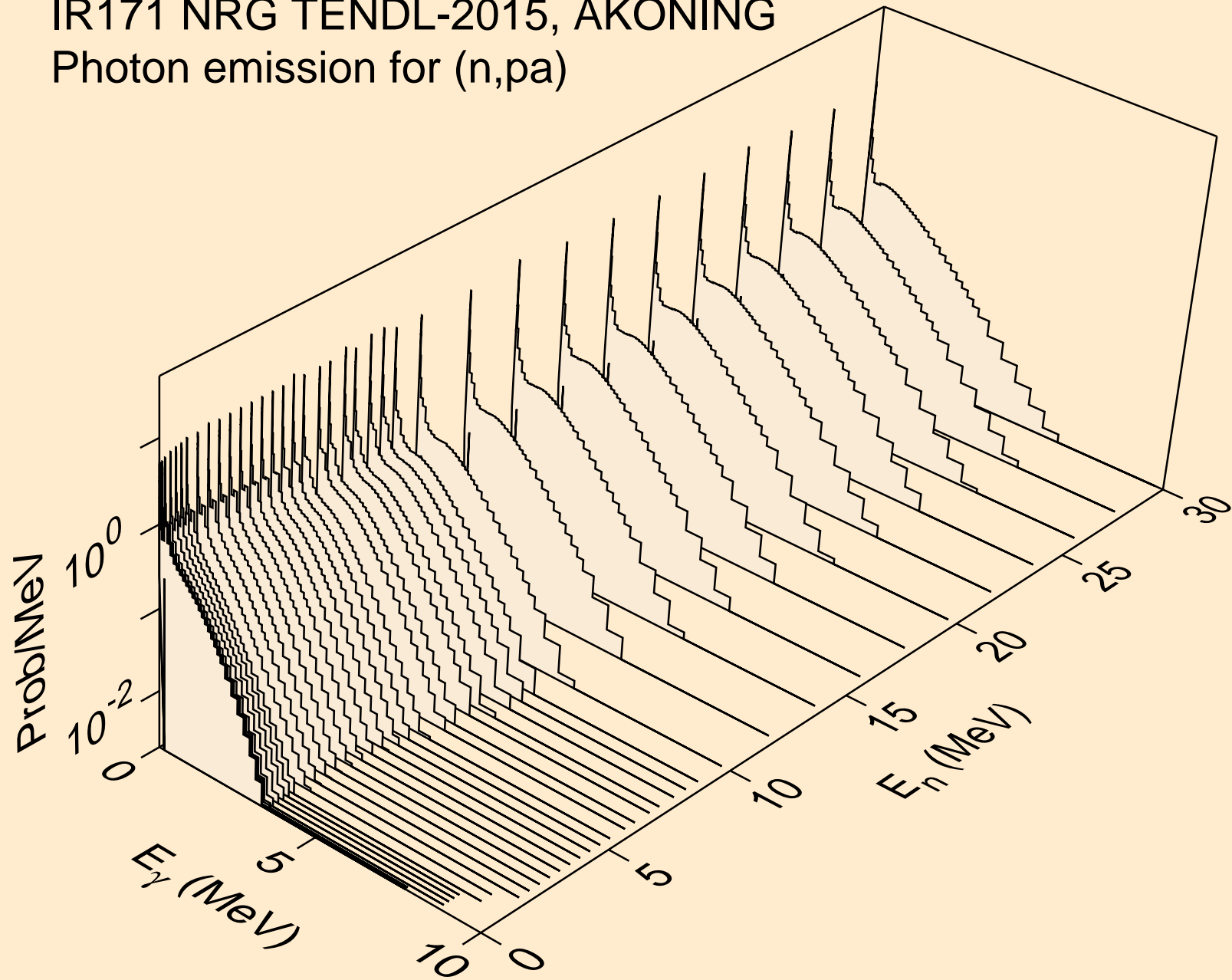

IR171 NRG TENDL-2015, AKONING  
Photon emission for (n,t2a)

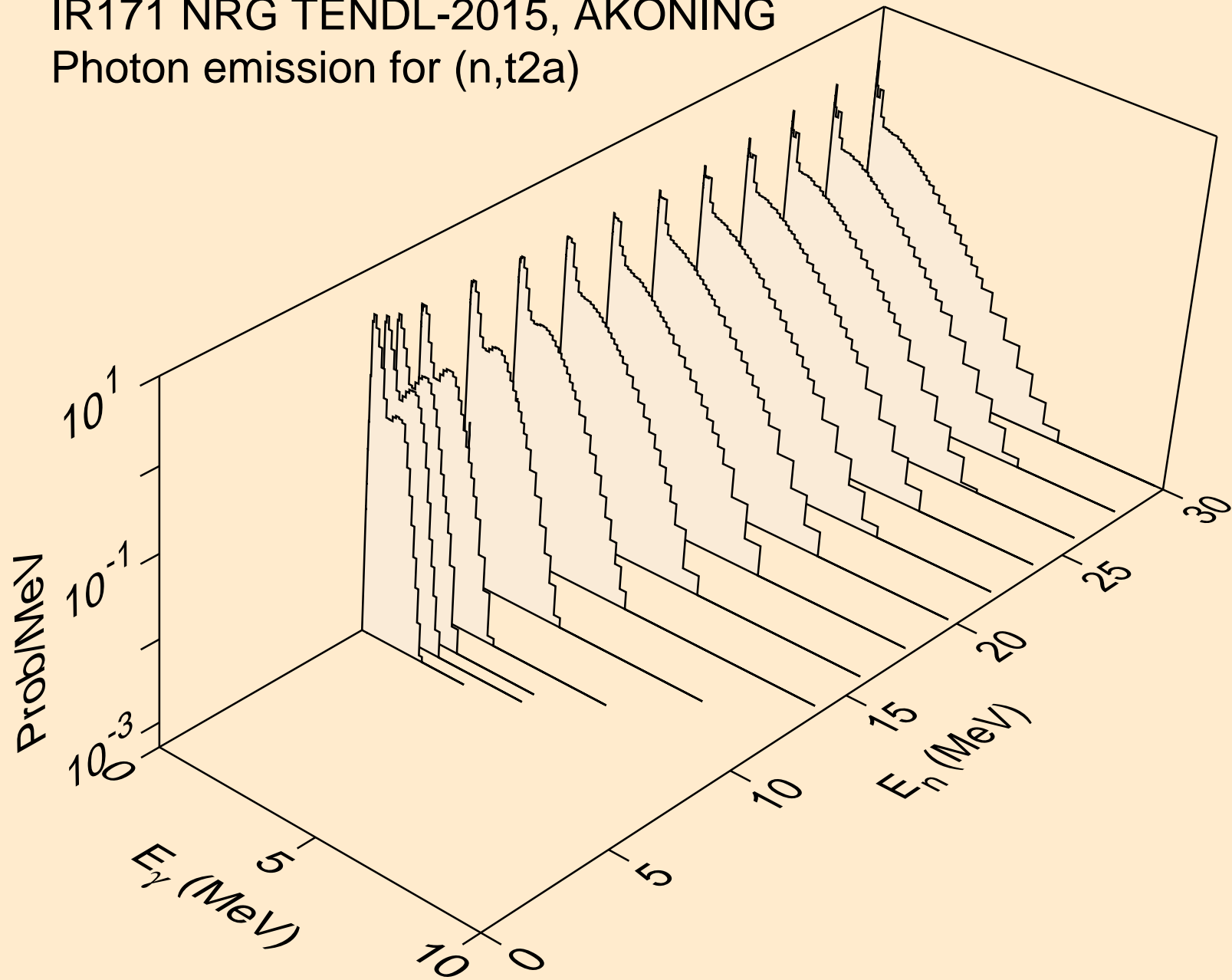

IR171 NRG TENDL-2015, AKONING  
Photon emission for (n,d2a)

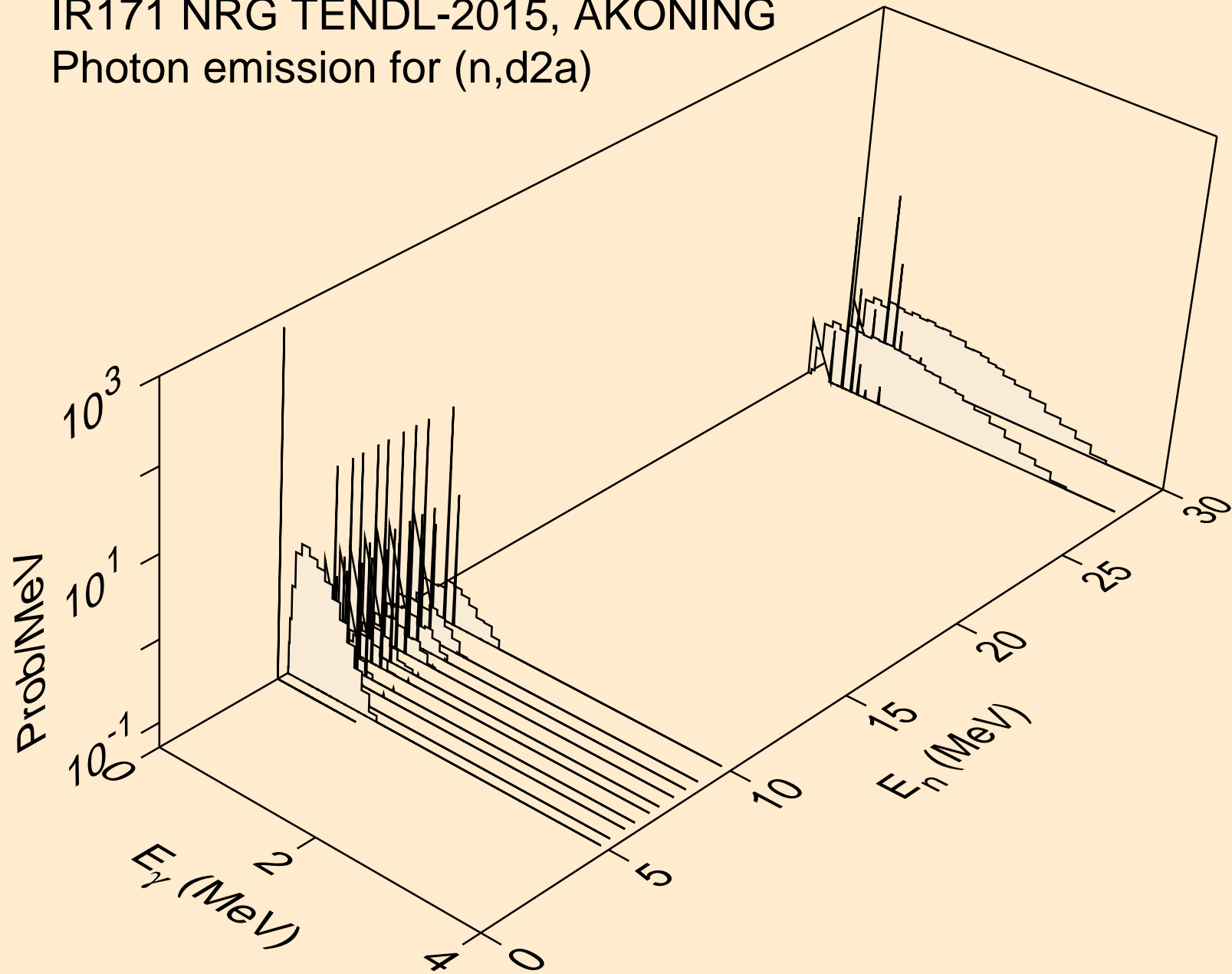

IR171 NRG TENDL-2015, AKONING  
Photon emission for (n,pd)

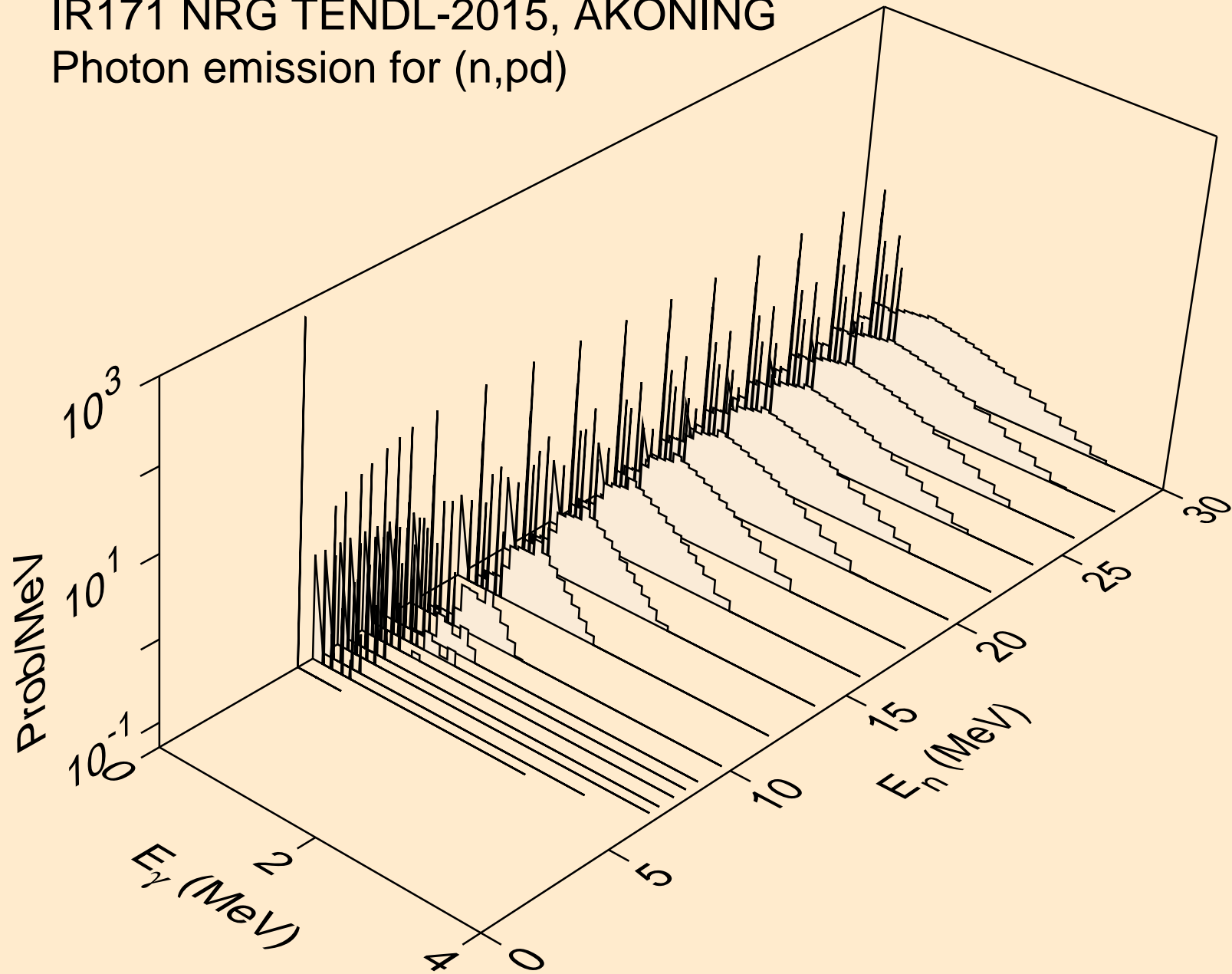

IR171 NRG TENDL-2015, AKONING  
Photon emission for (n,pt)

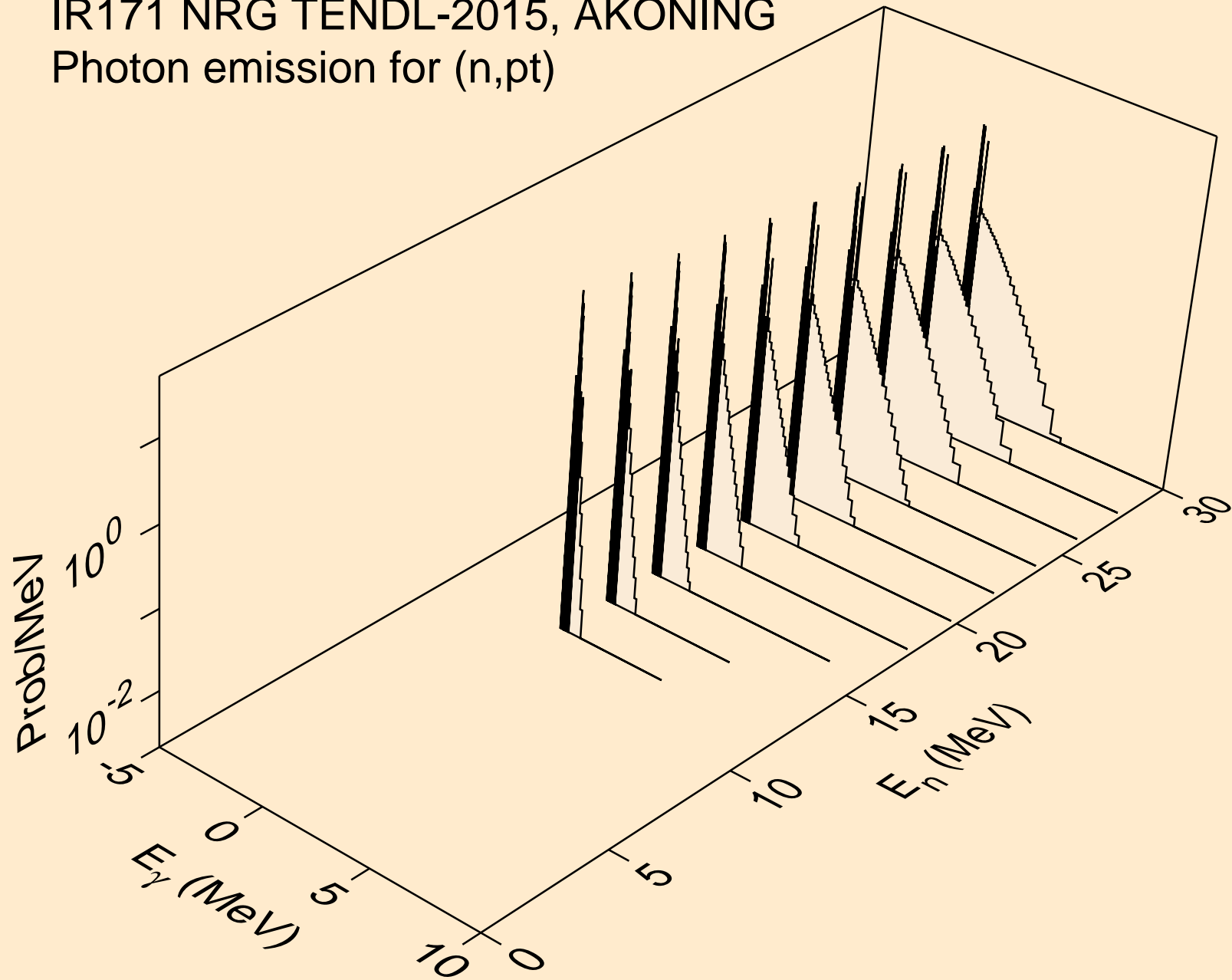



IR171 NRG TENDL-2015, AKONING  
Photon emission for (n,da)

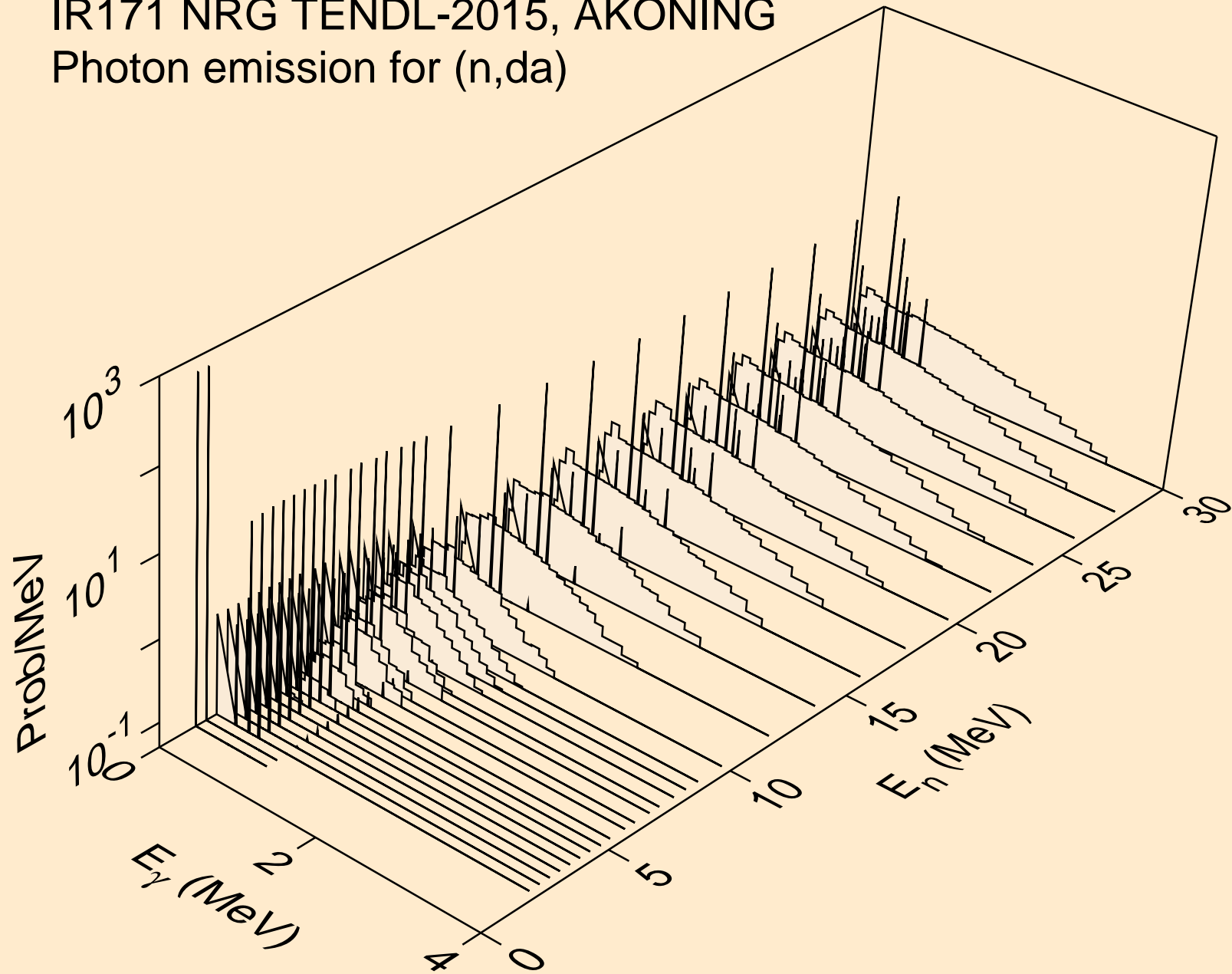

IR171 NRG TENDL-2015, AKONING  
thermal capture photon spectrum

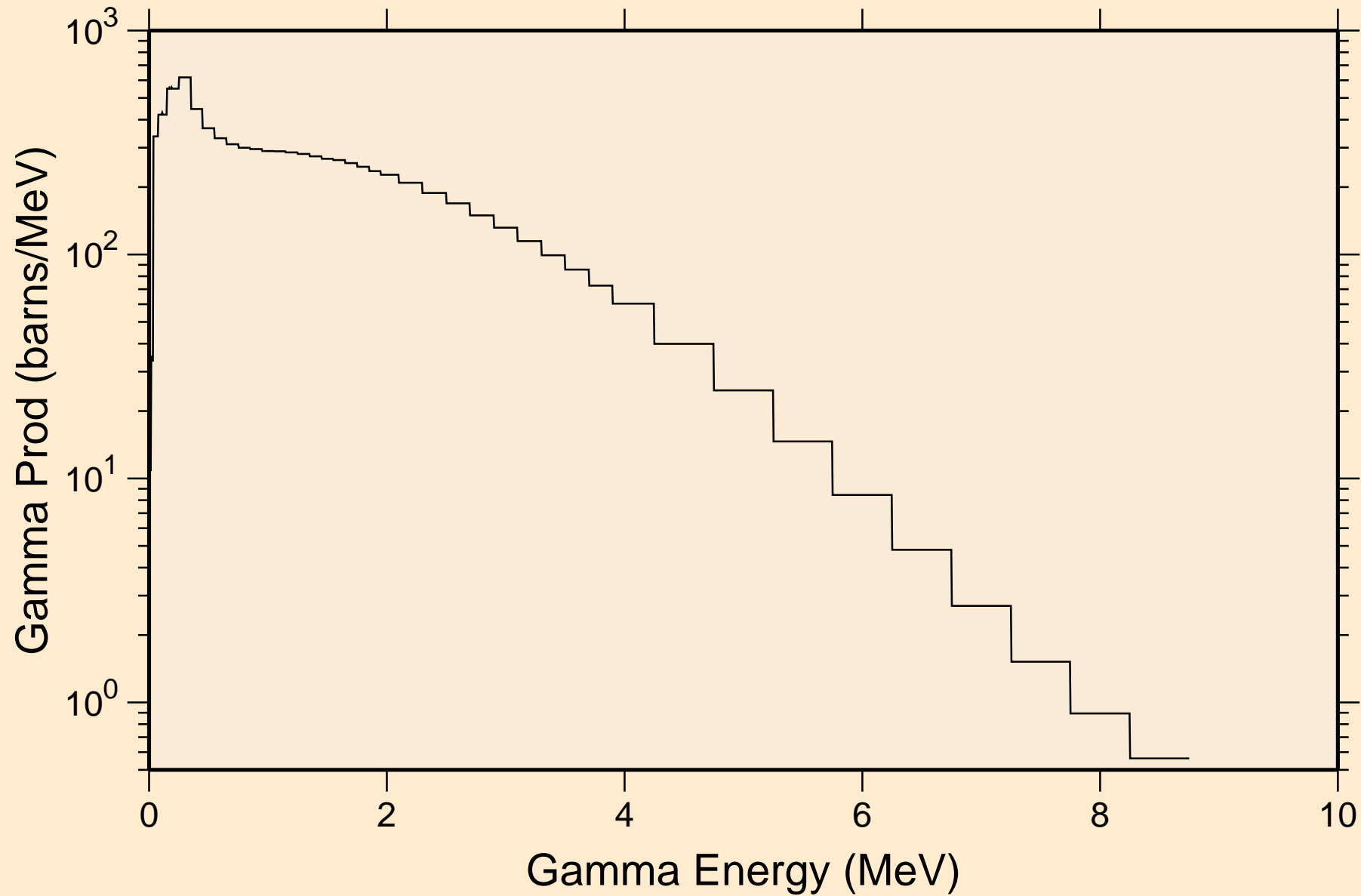

IR171 NRG TENDL-2015, AKONING  
14 MeV photon spectrum

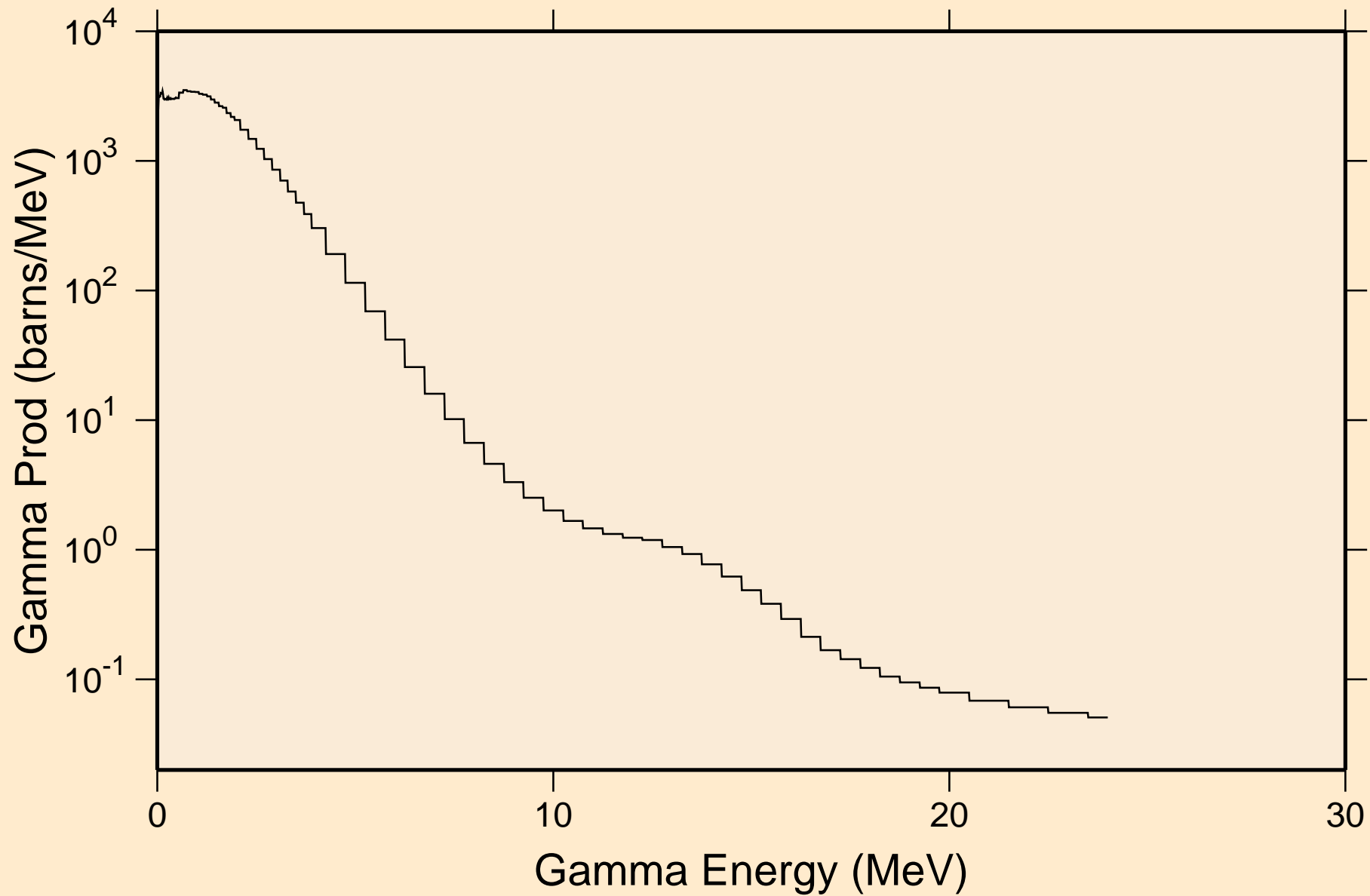

# IR171 NRG TENDL-2015, AKONING

## Particle heating contributions

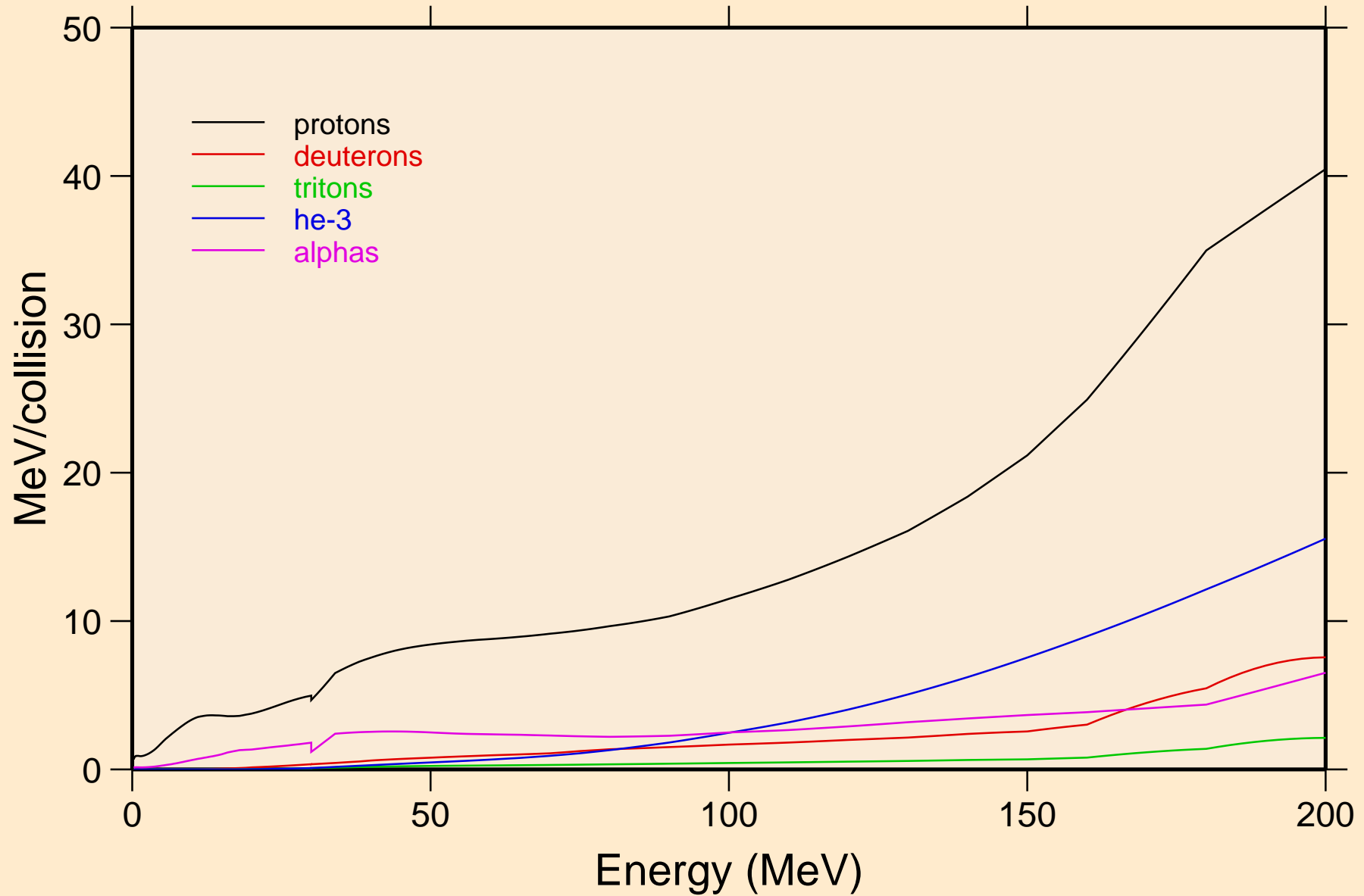

# IR171 NRG TENDL-2015, AKONING

## Recoil Heating

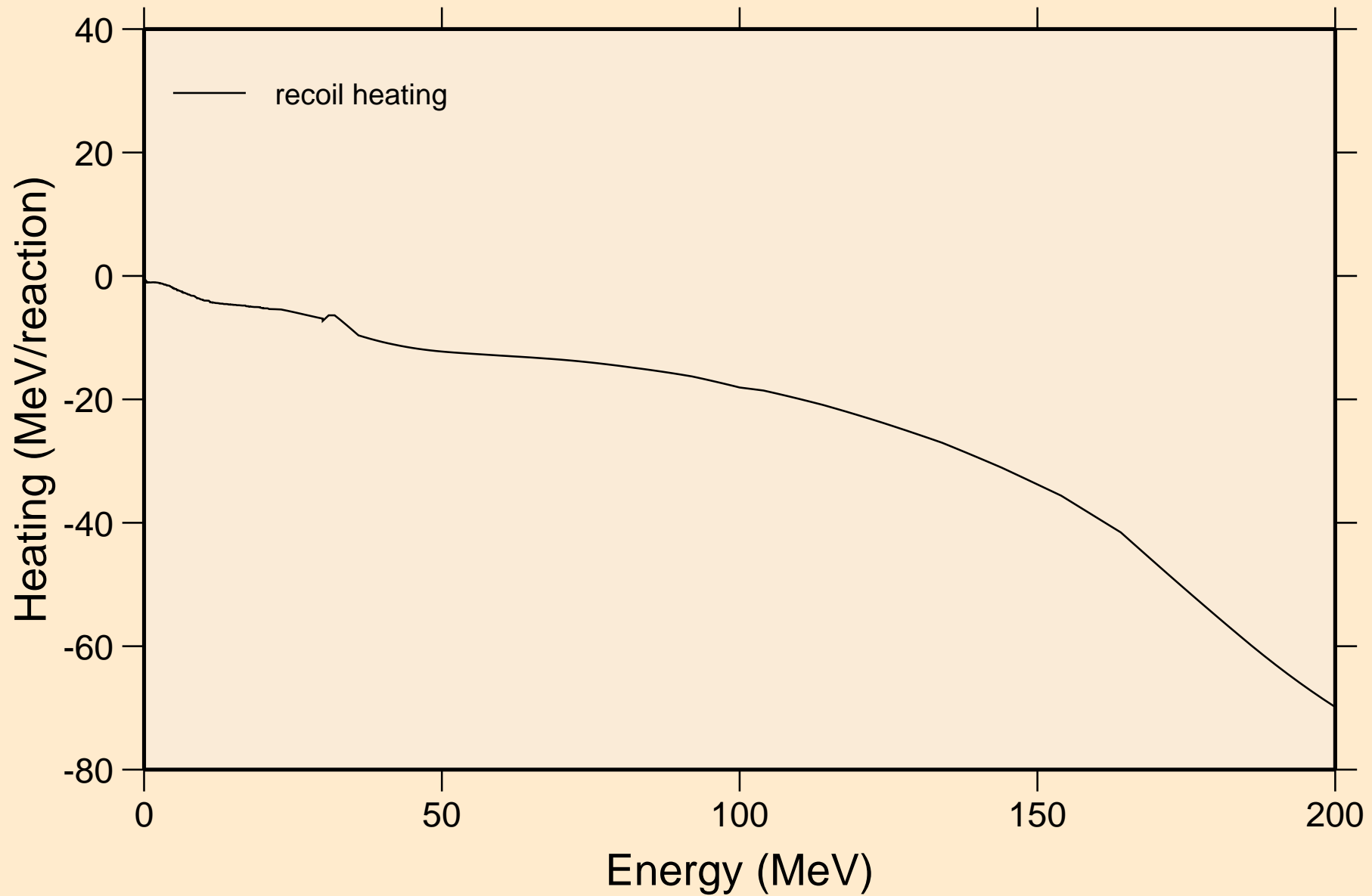

# IR171 NRG TENDL-2015, AKONING

## Particle production cross sections

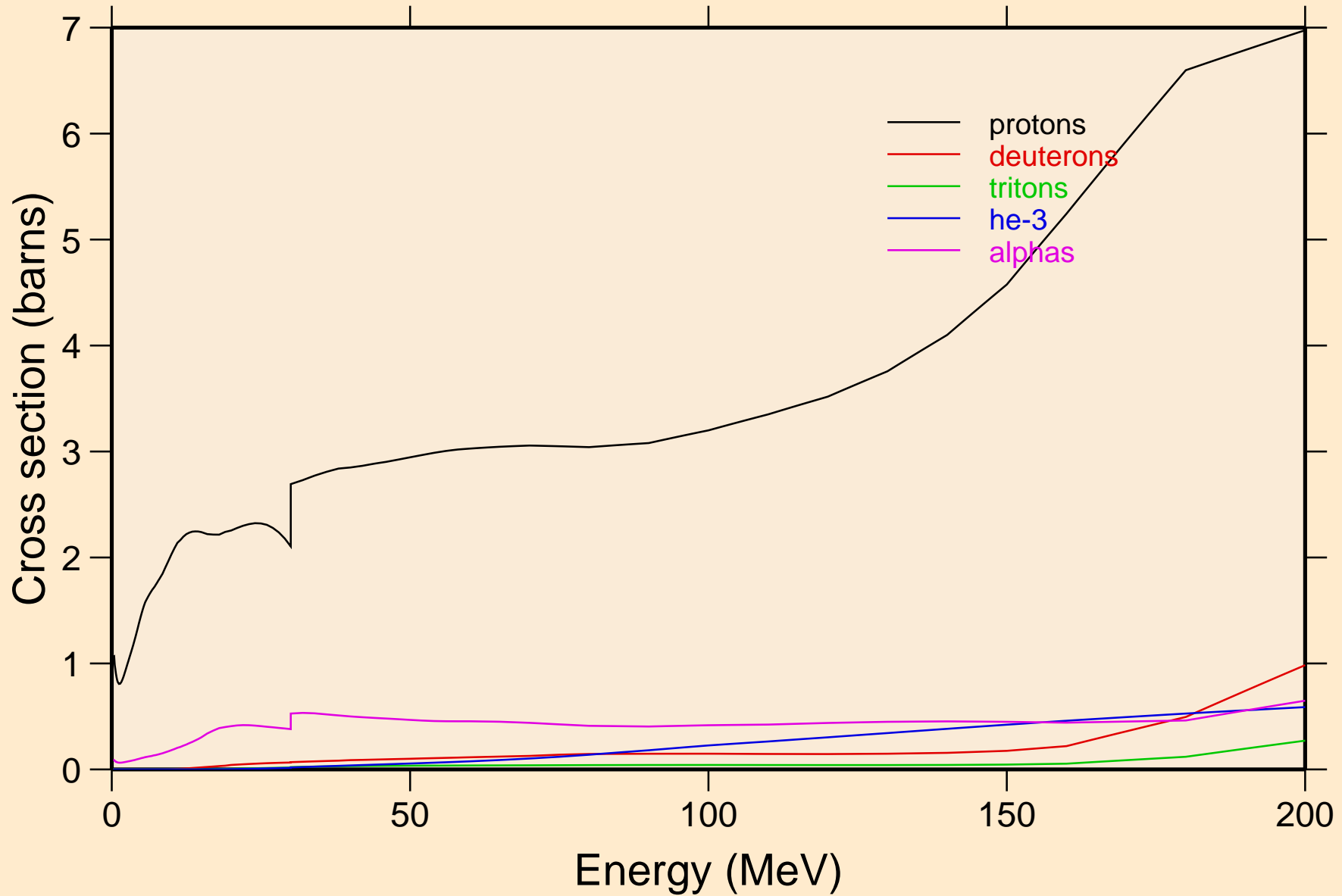

IR171 NRG TENDL-2015, AKONING  
protons from (n,x)

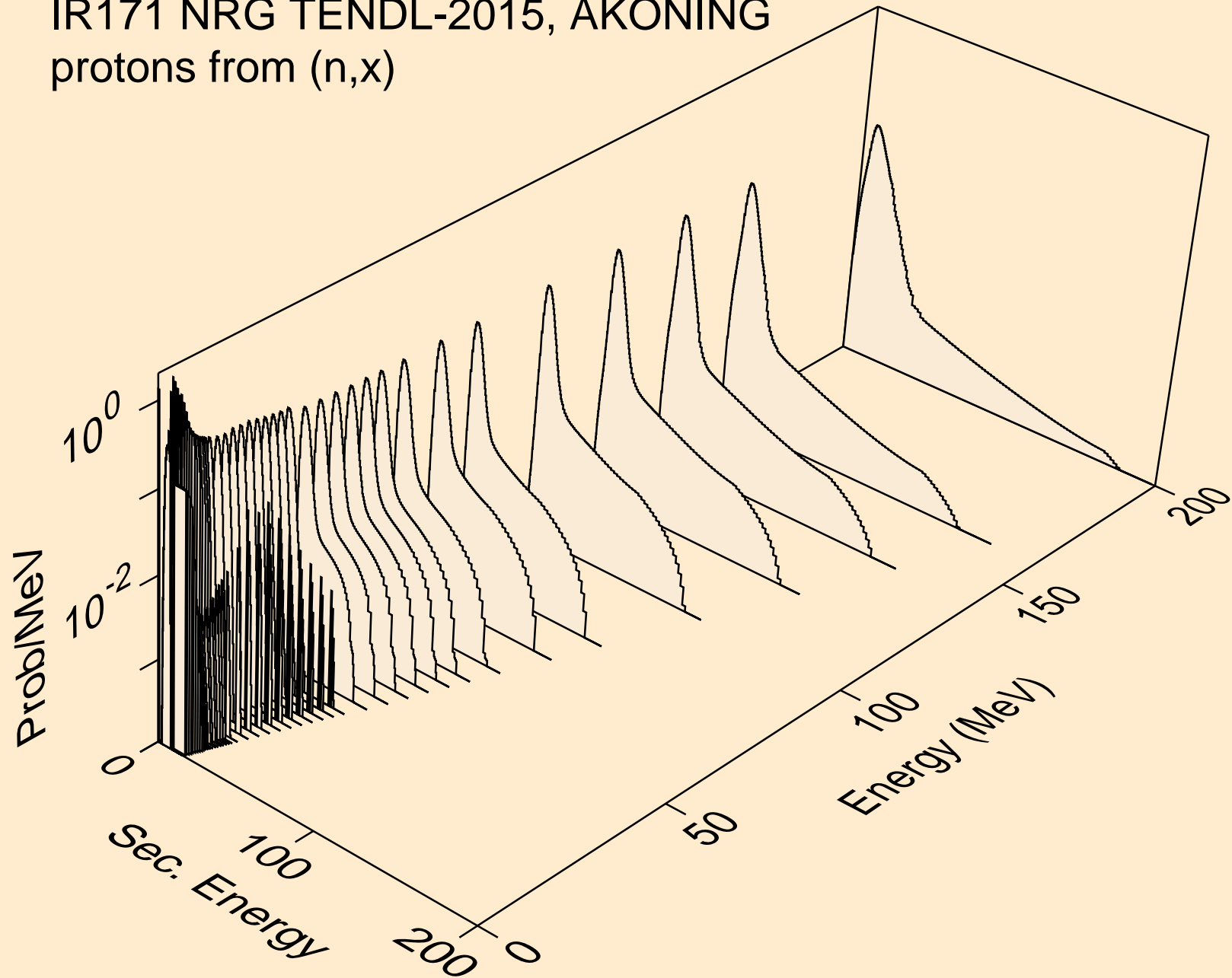

IR171 NRG TENDL-2015, AKONING  
protons from (n,n\*)p

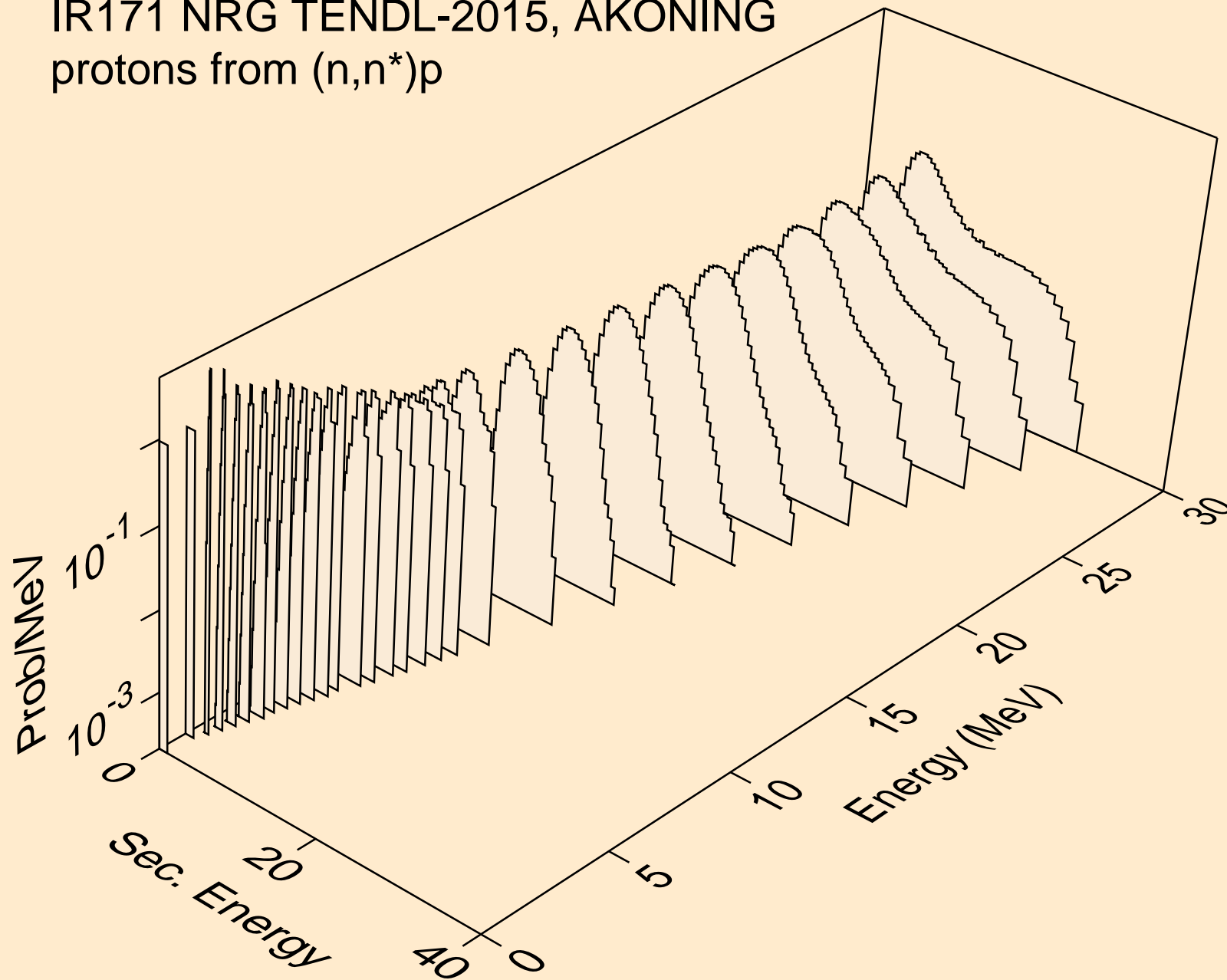



IR171 NRG TENDL-2015, AKONING  
protons from (n,2np)

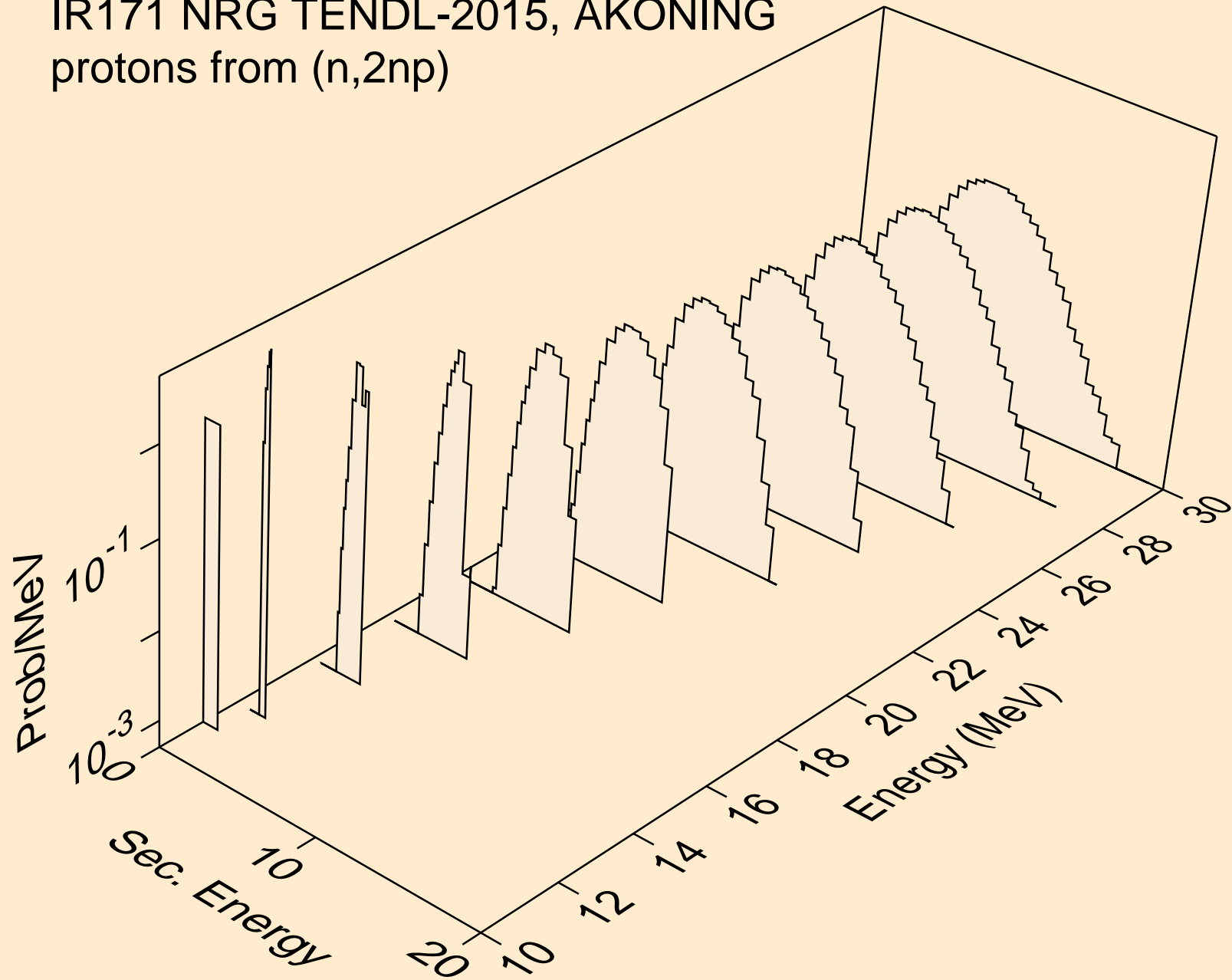

IR171 NRG TENDL-2015, AKONING  
protons from (n,3np)

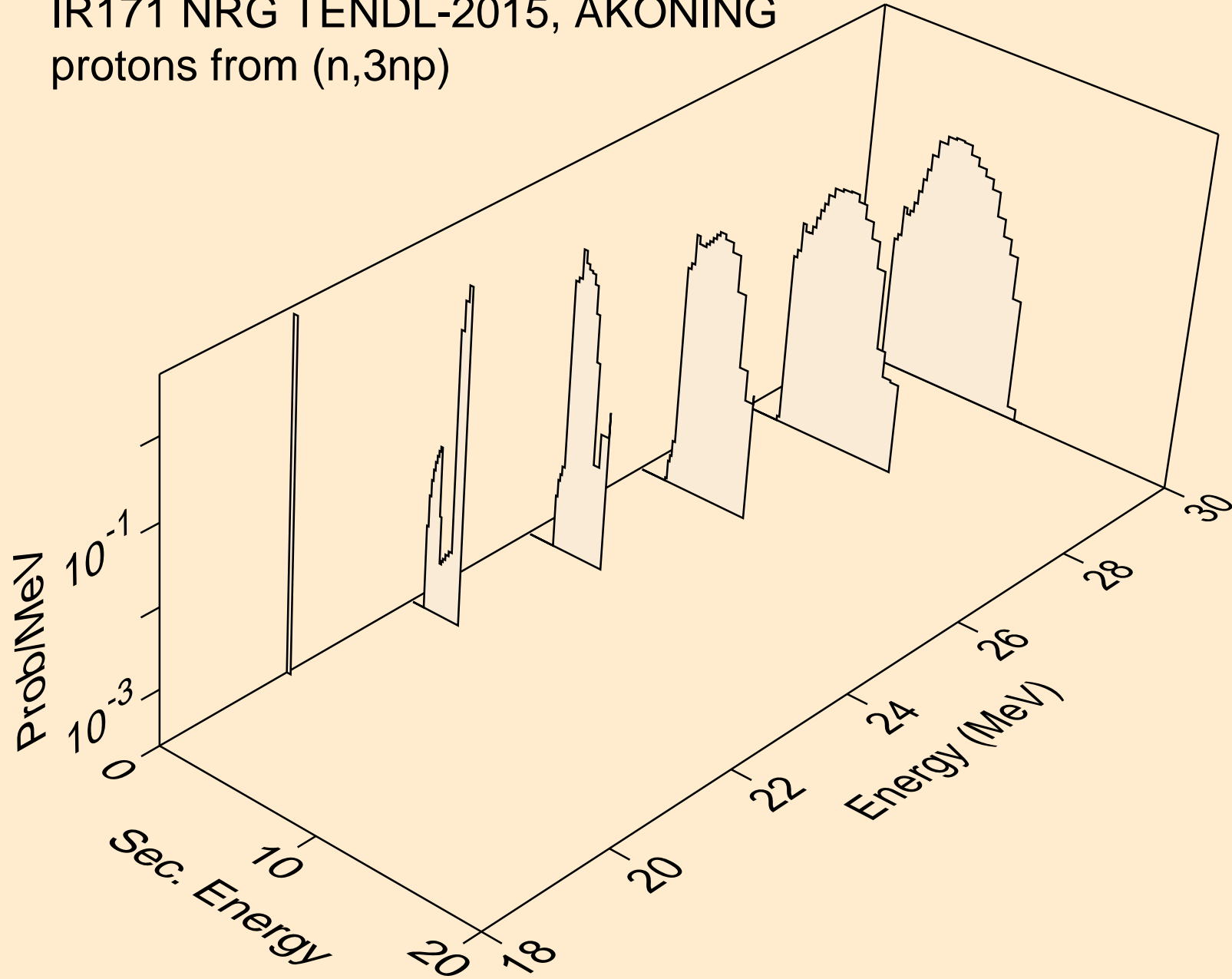

IR171 NRG TENDL-2015, AKONING  
protons from (n,2np)

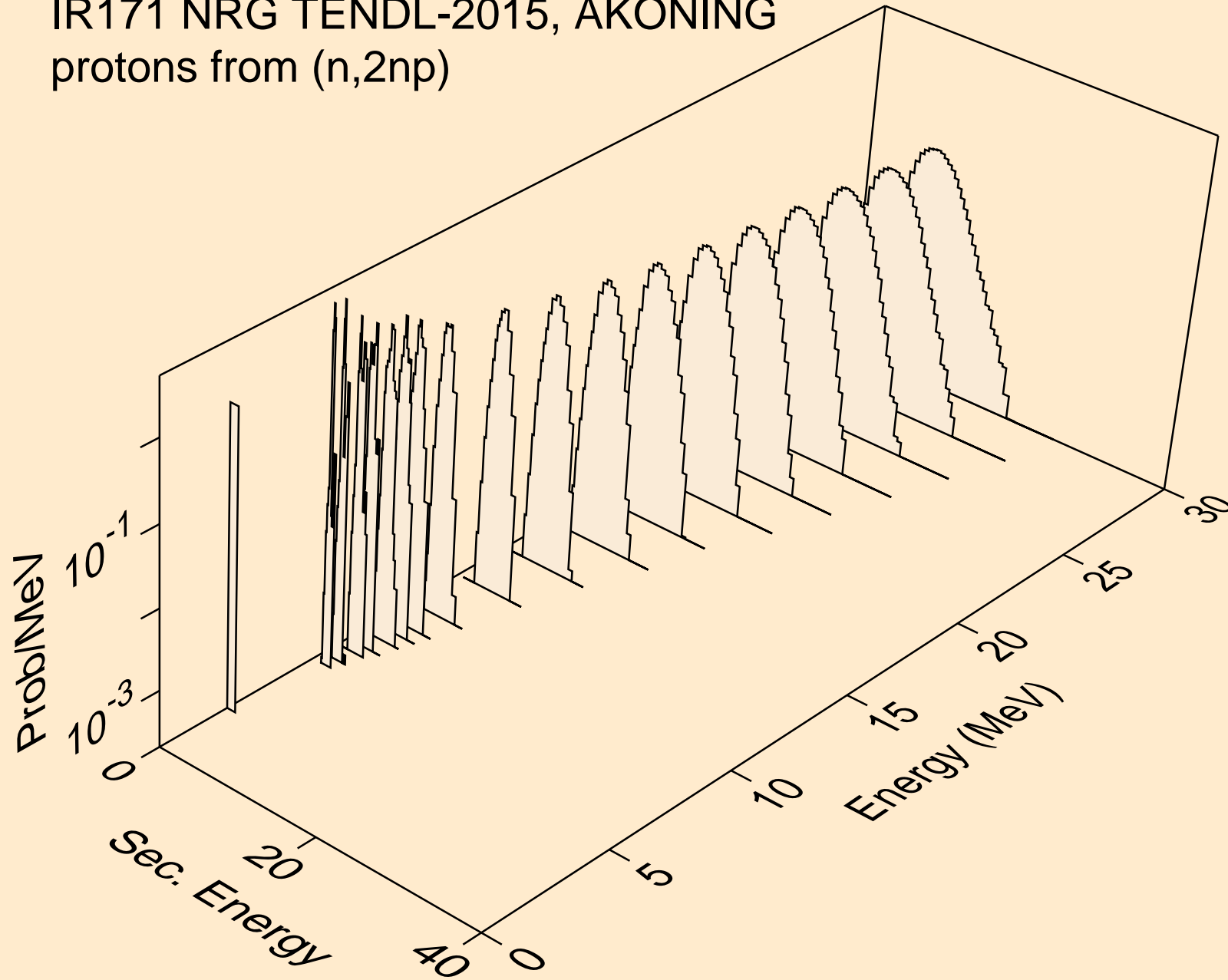

IR171 NRG TENDL-2015, AKONING  
protons from (n,npa)

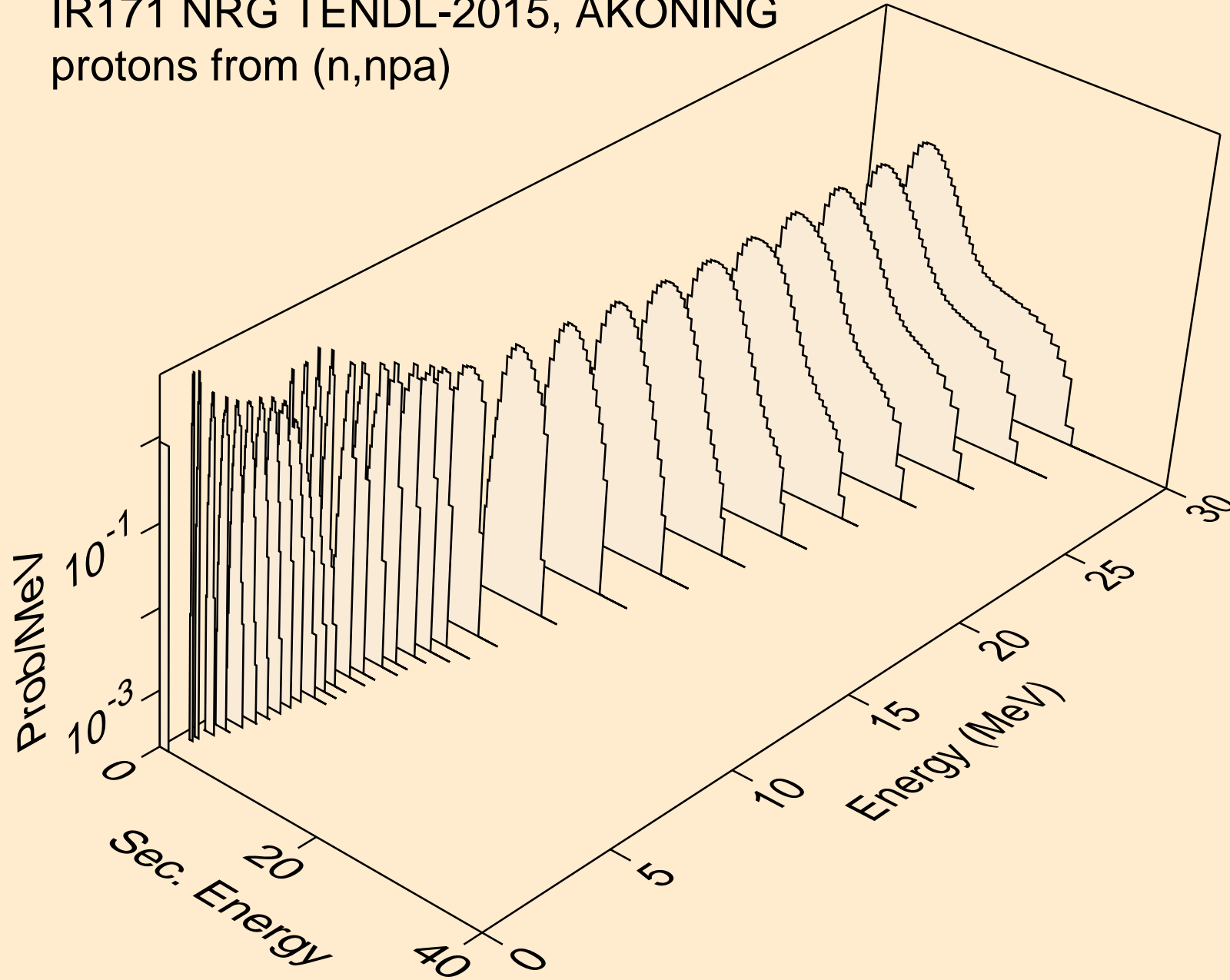

IR171 NRG TENDL-2015, AKONING  
protons from (n,p)

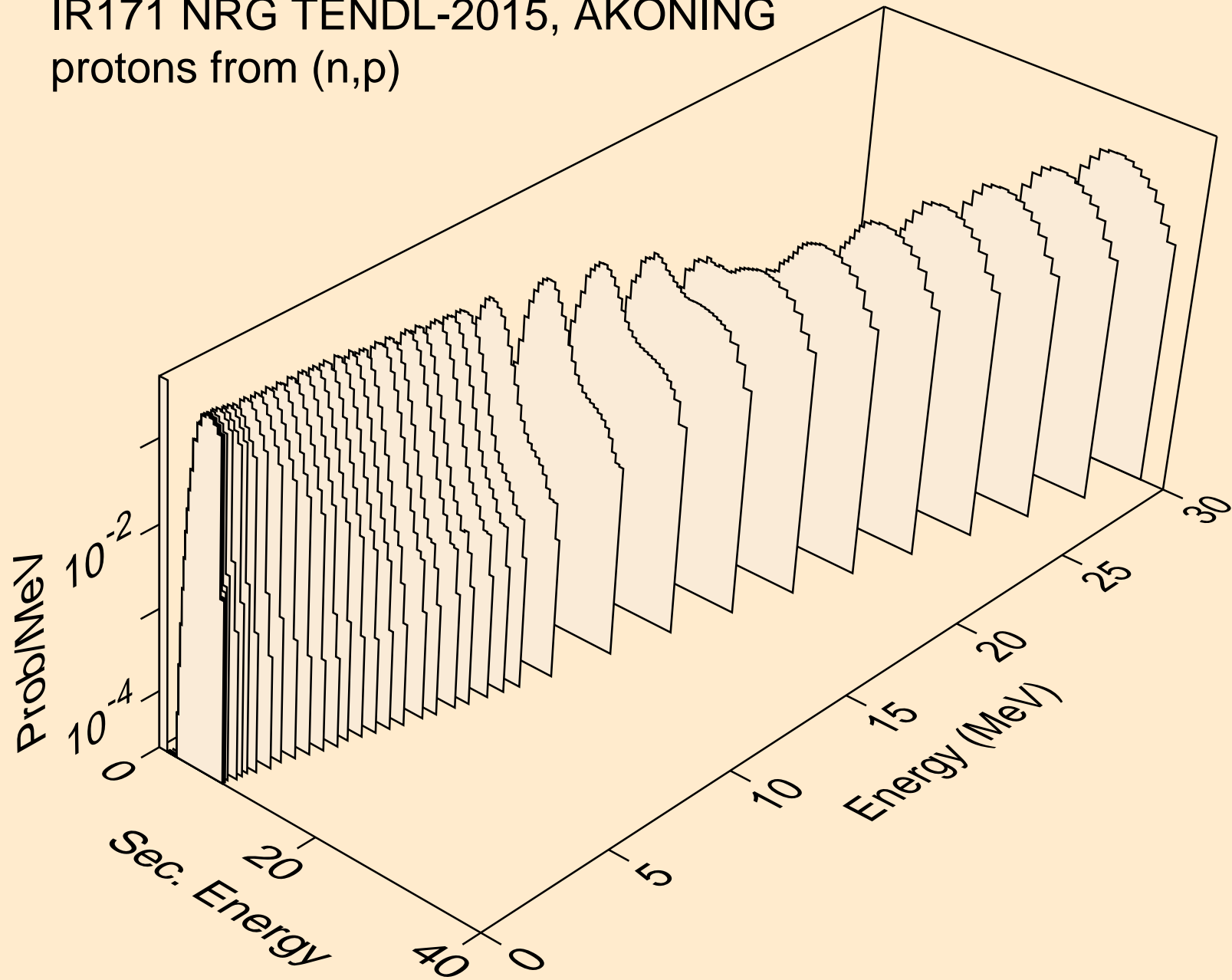

IR171 NRG TENDL-2015, AKONING  
protons from (n,2p)

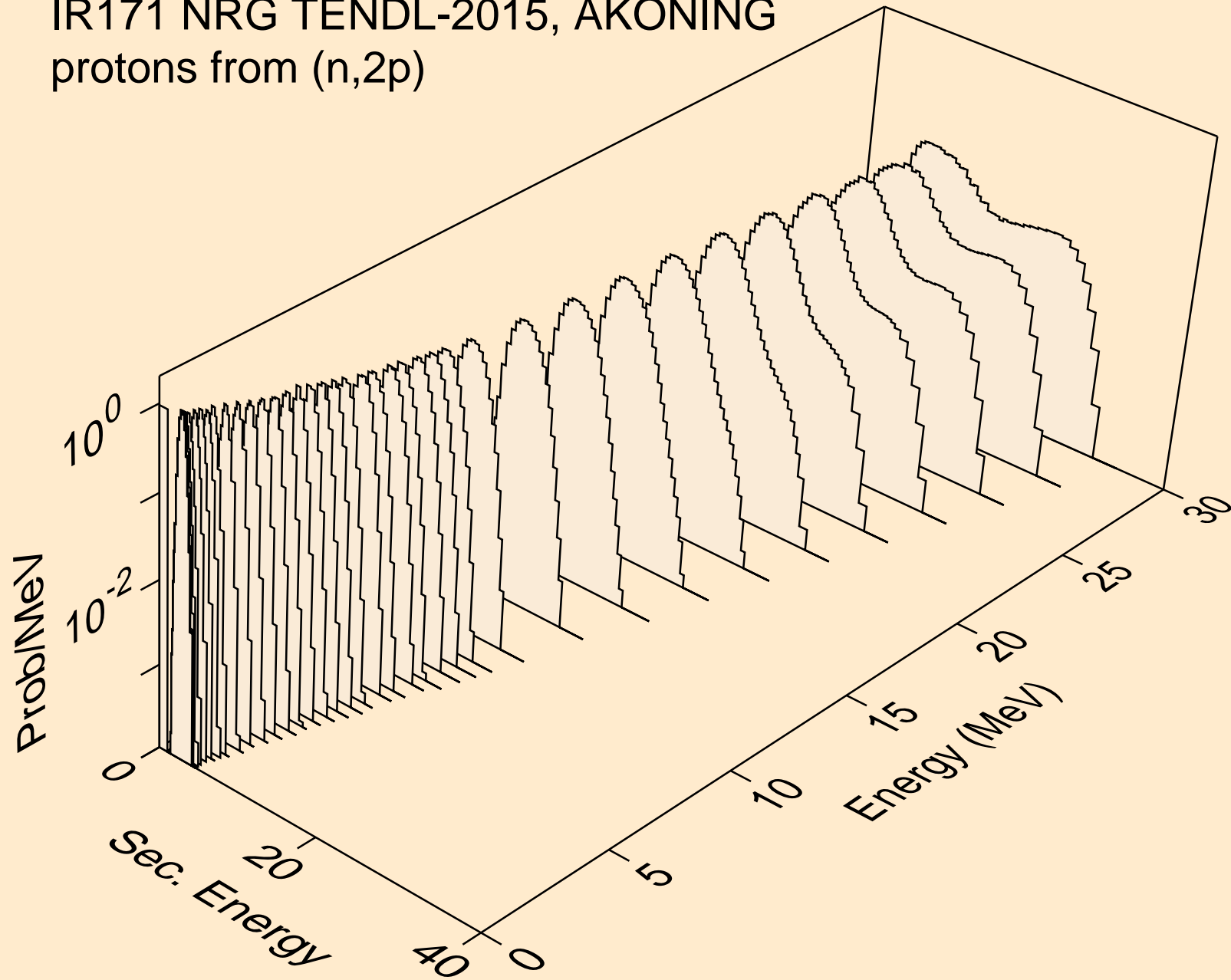

IR171 NRG TENDL-2015, AKONING  
protons from (n,pa)

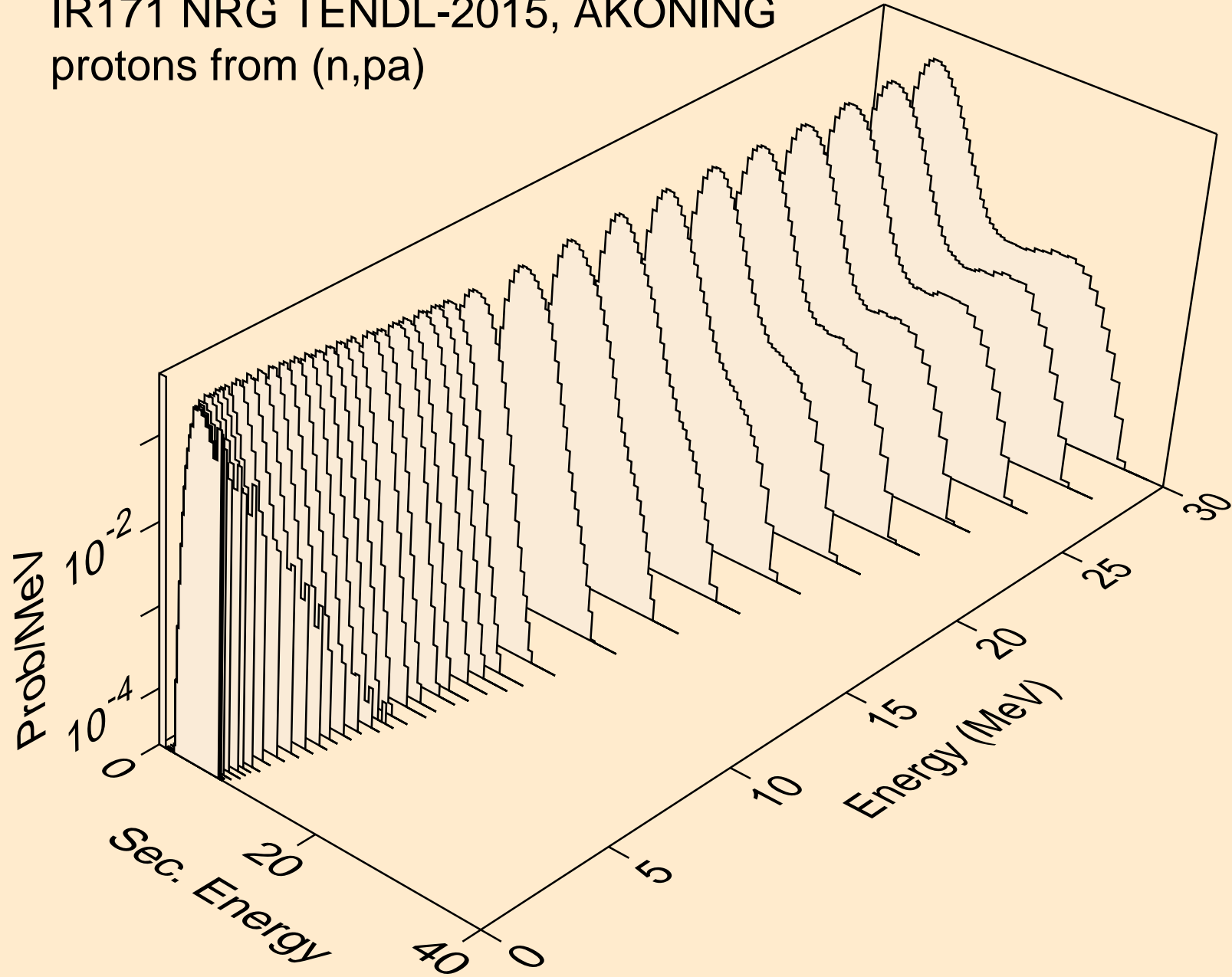

IR171 NRG TENDL-2015, AKONING  
protons from (n,pd)

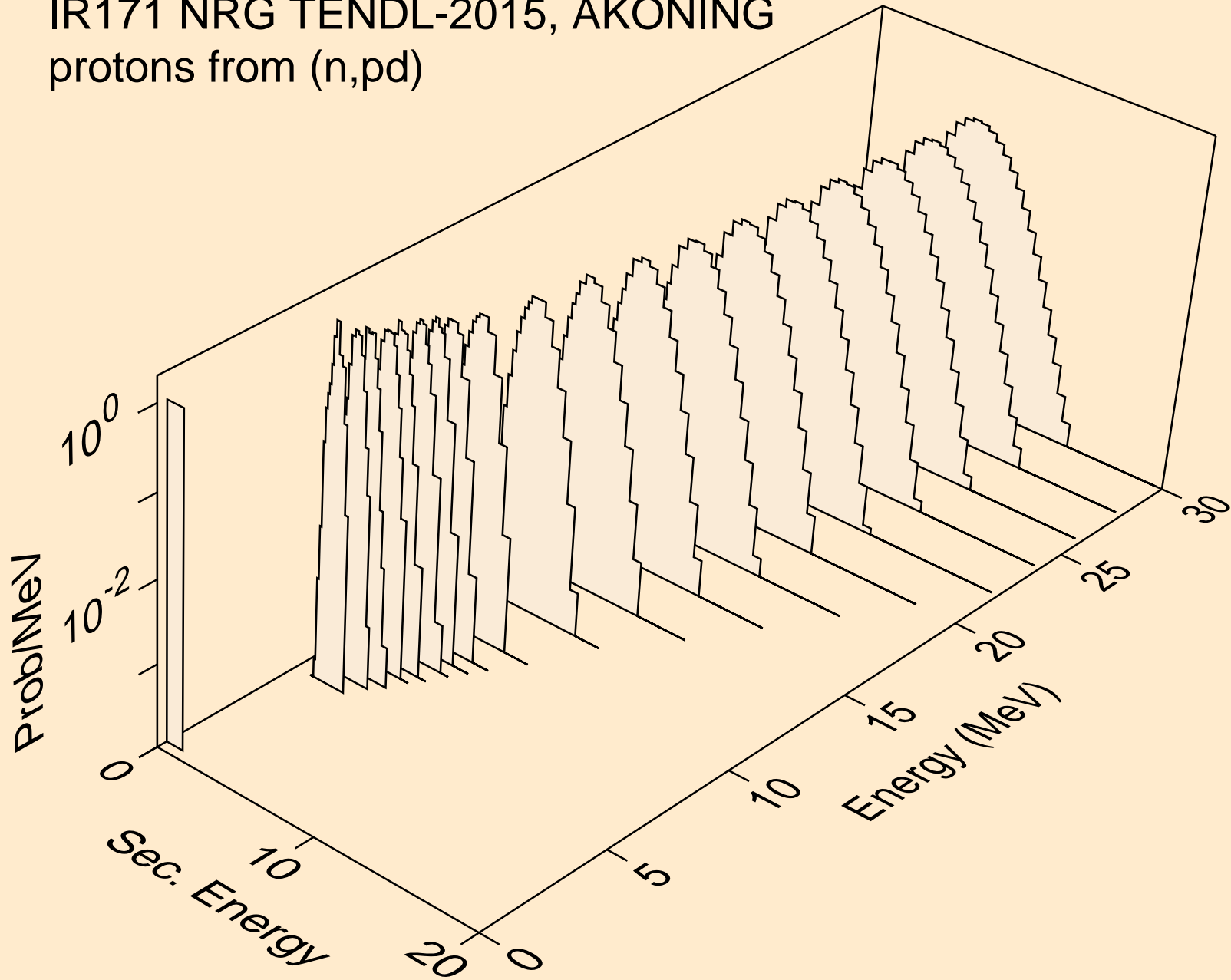



IR171 NRG TENDL-2015, AKONING  
protons from (n,pt)

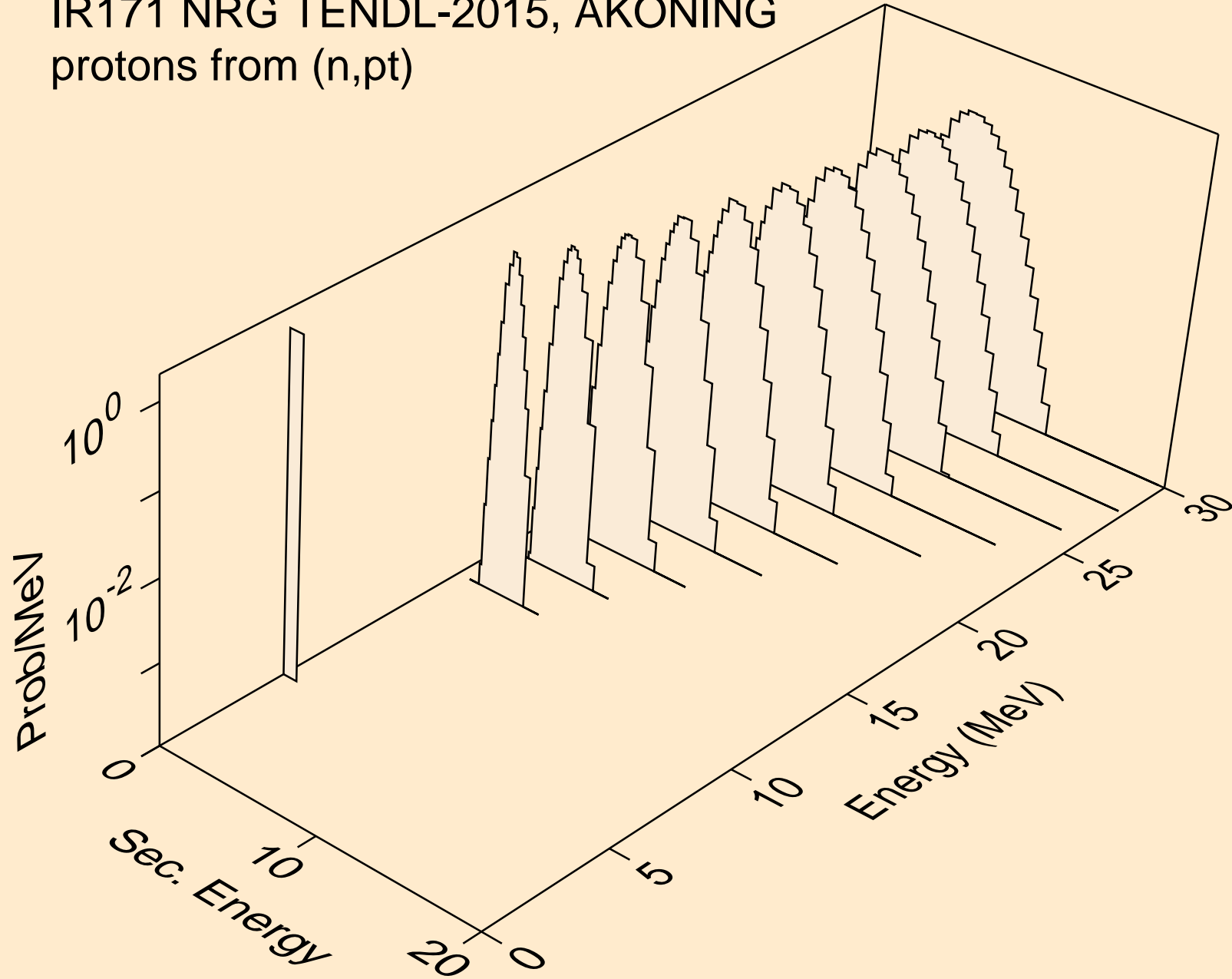

IR171 NRG TENDL-2015, AKONING  
deuterons from (n,x)

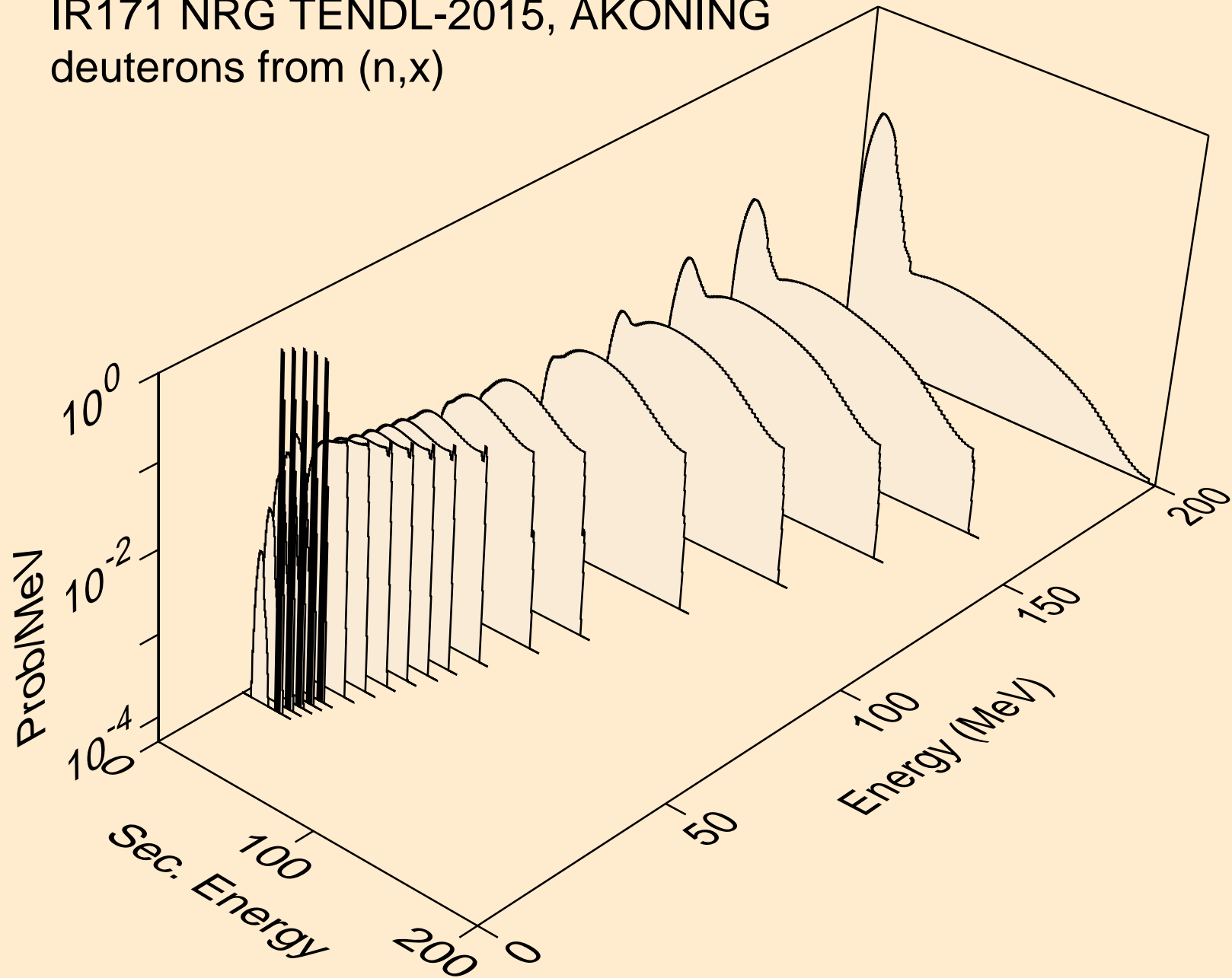

IR171 NRG TENDL-2015, AKONING  
deuterons from (n,2nd)

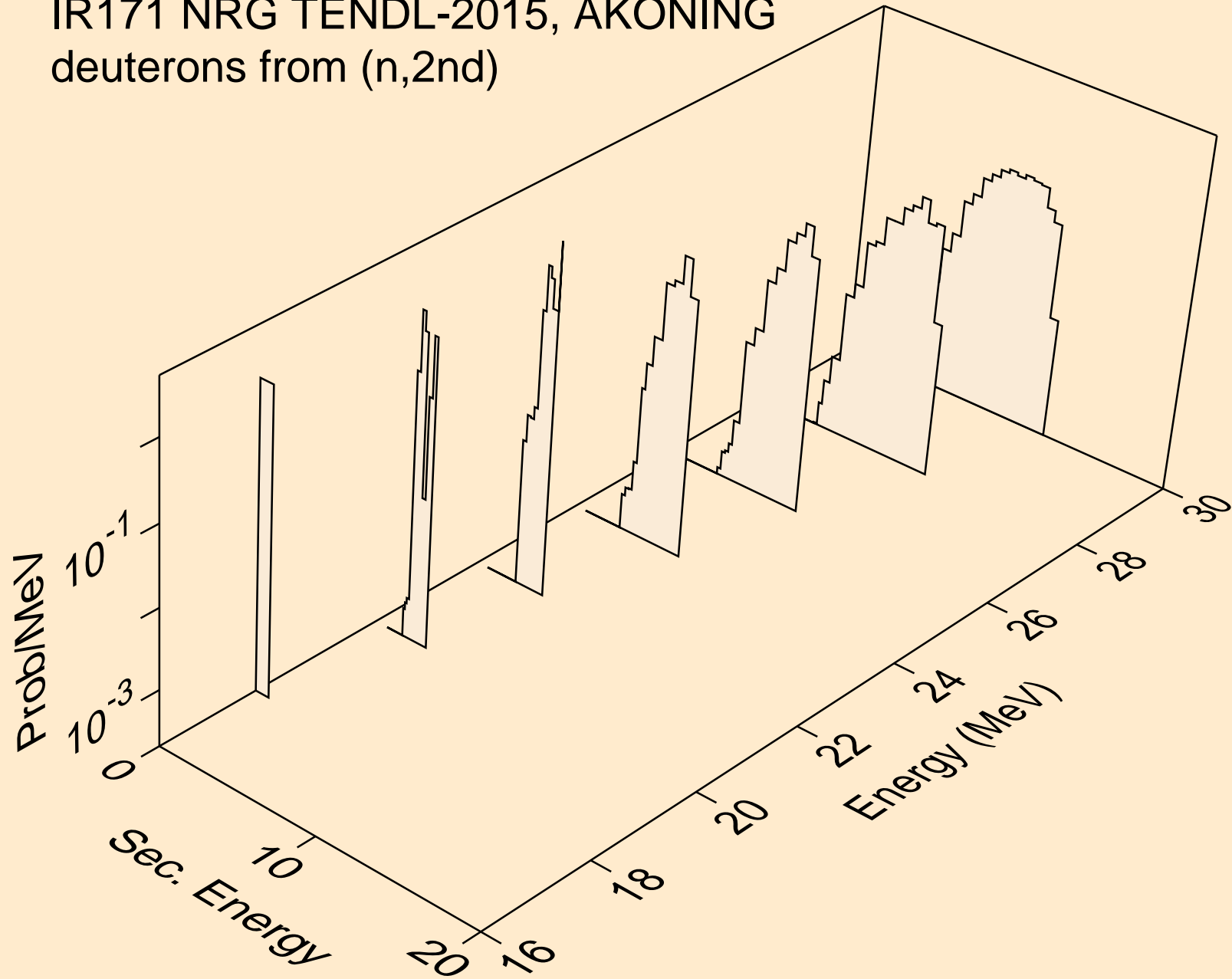

IR171 NRG TENDL-2015, AKONING  
deuterons from (n,n\*)d

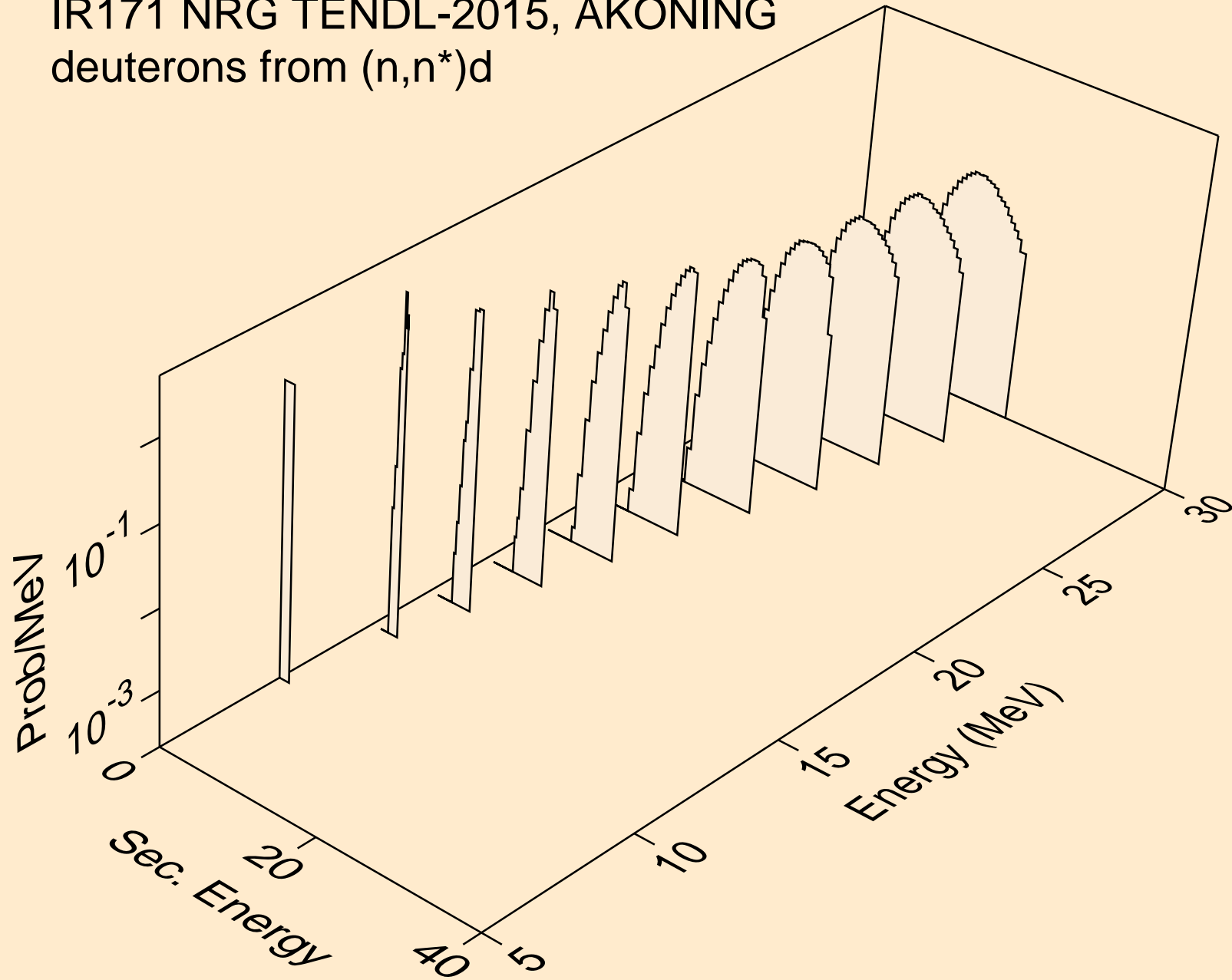

IR171 NRG TENDL-2015, AKONING  
deuterons from (n,n\*)d2a

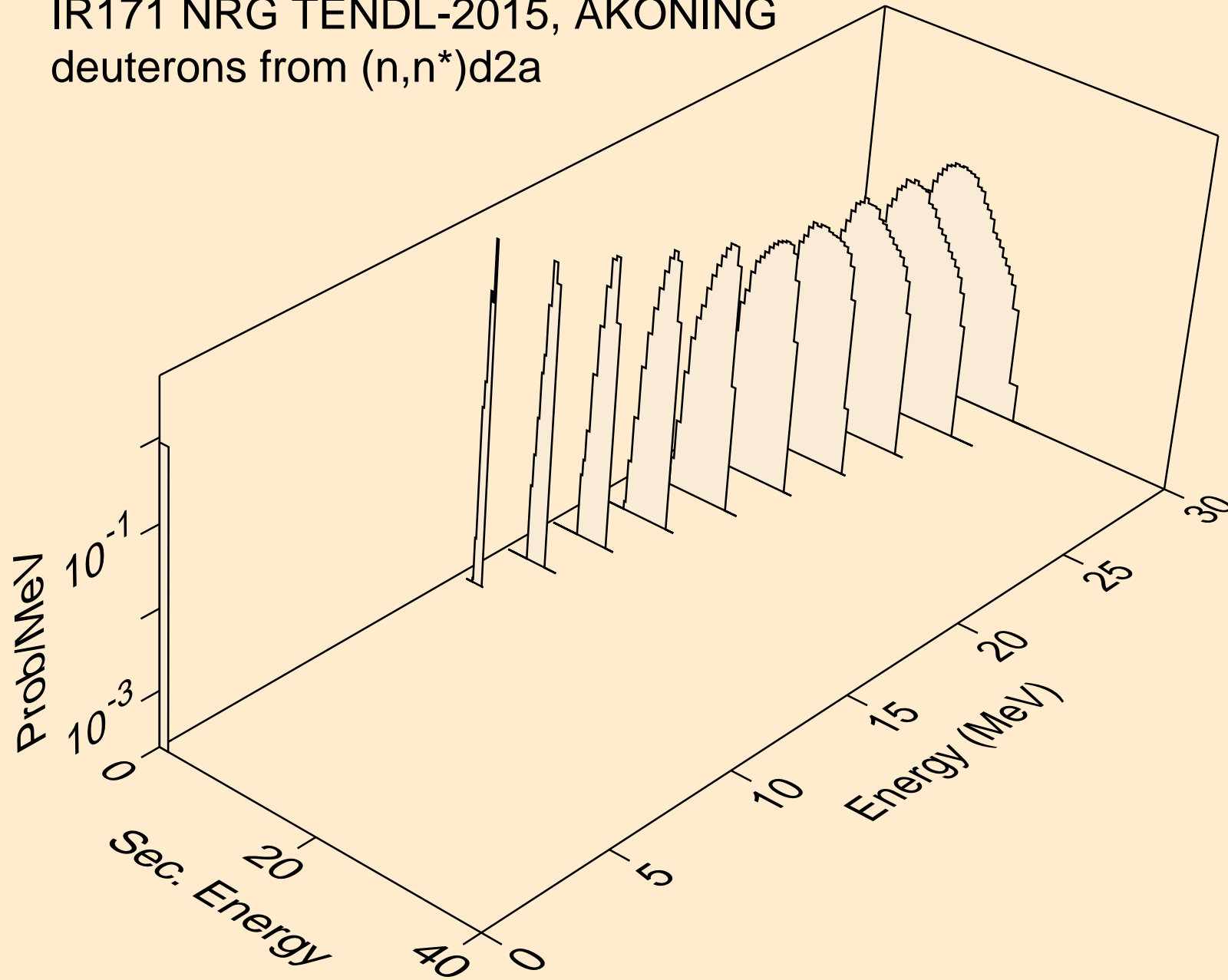

IR171 NRG TENDL-2015, AKONING  
deuterons from (n,d)

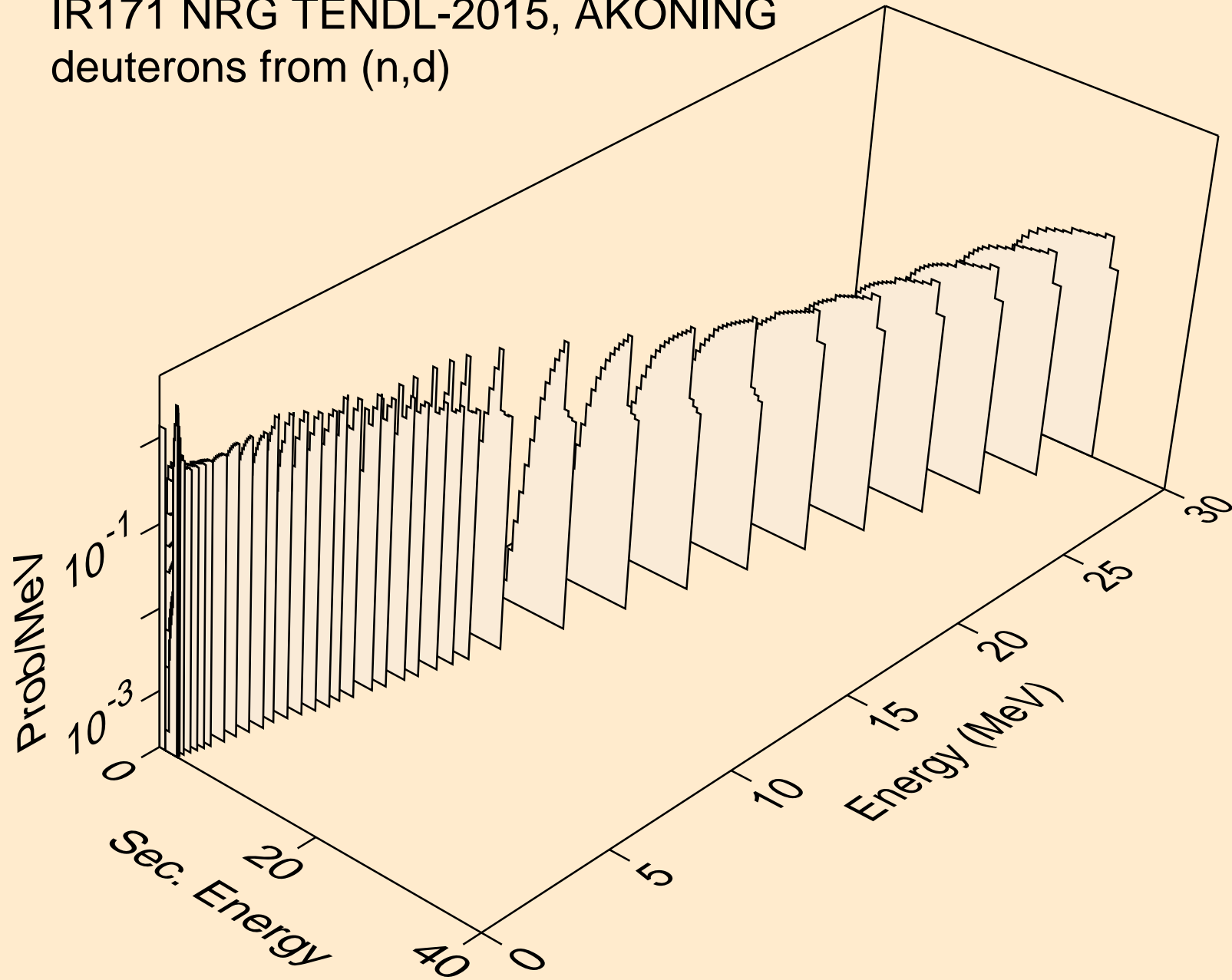

IR171 NRG TENDL-2015, AKONING  
deuterons from (n,d2a)

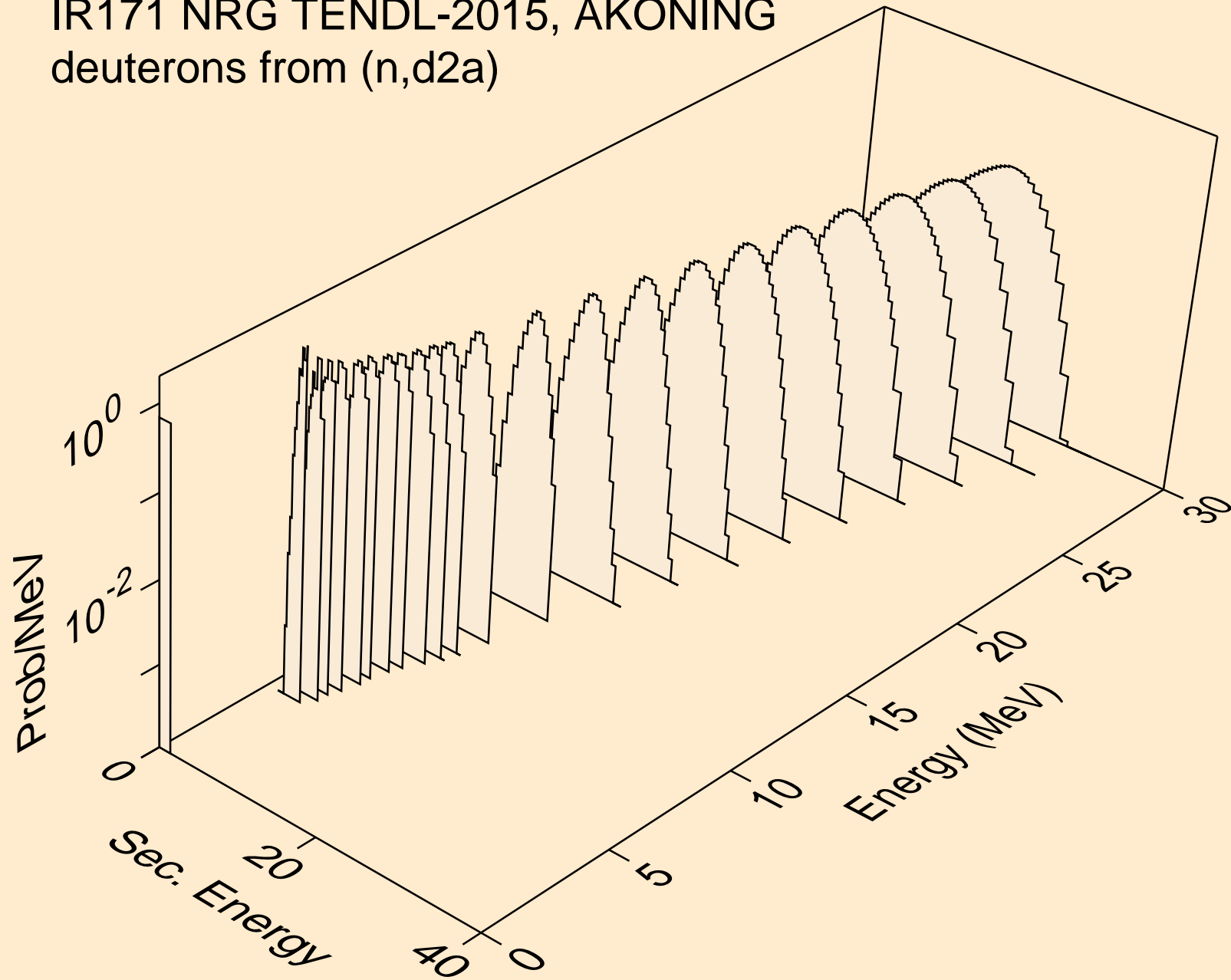

IR171 NRG TENDL-2015, AKONING  
deuterons from (n,pd)

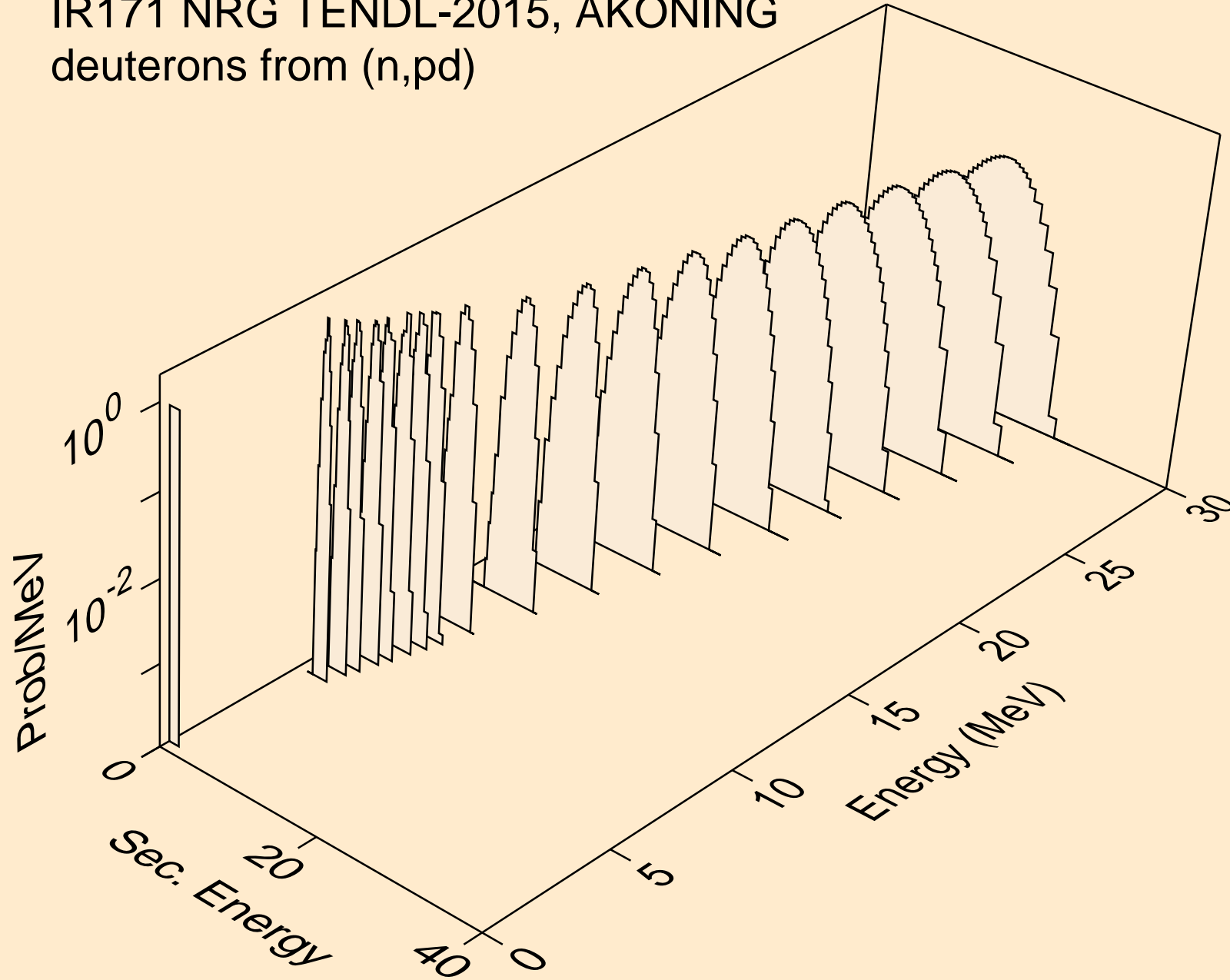



IR171 NRG TENDL-2015, AKONING  
deuterons from (n,da)

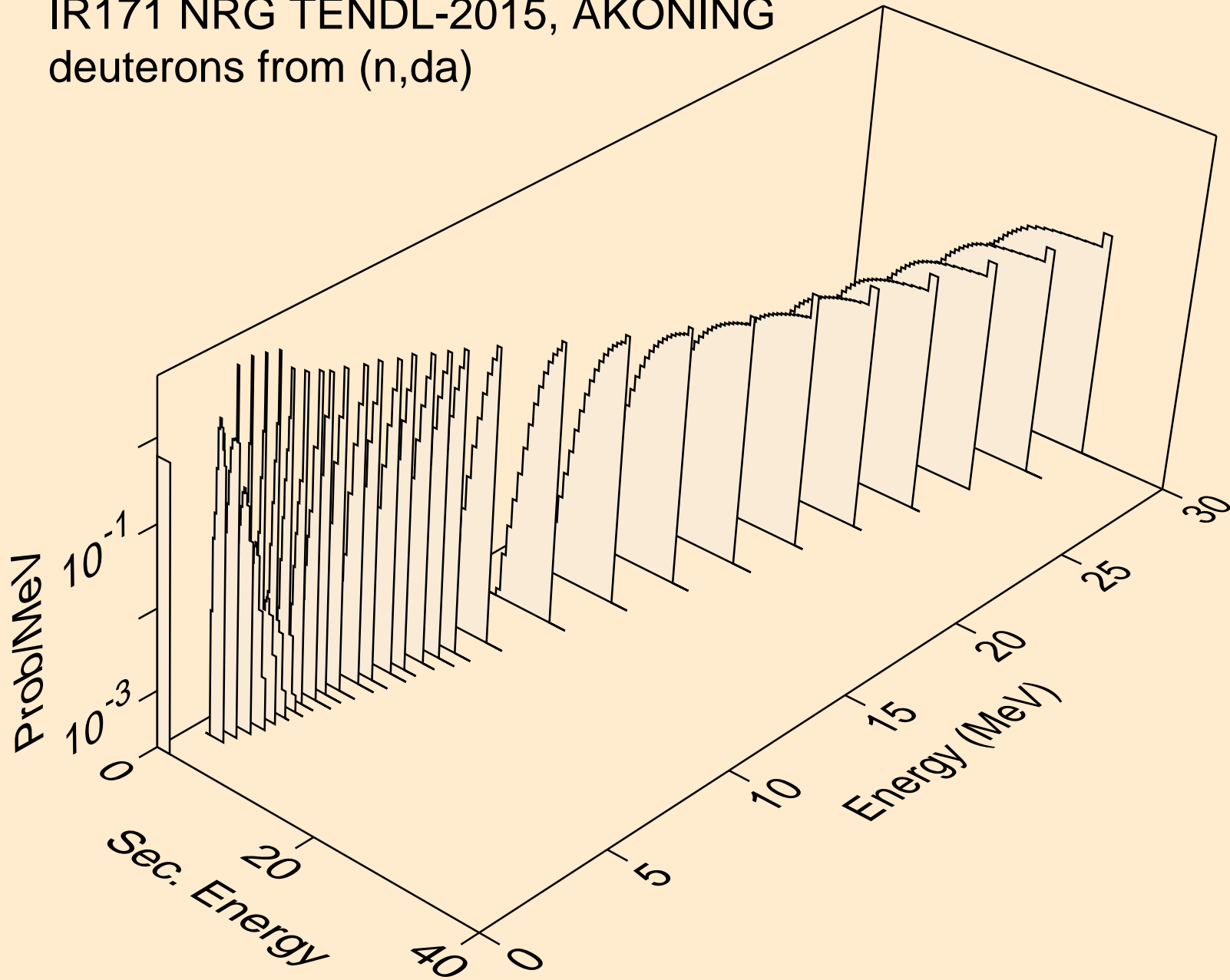

IR171 NRG TENDL-2015, AKONING  
tritons from (n,x)

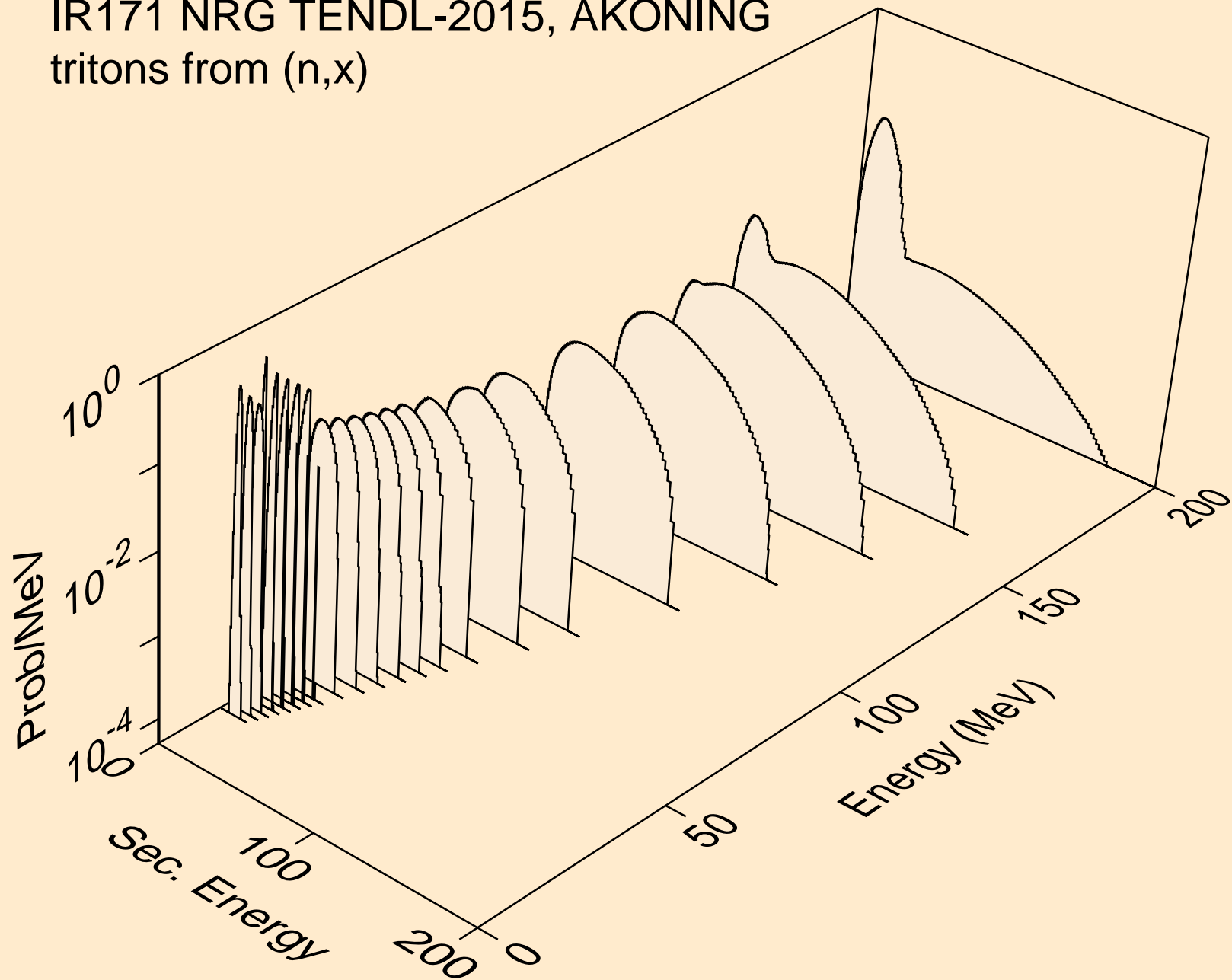

IR171 NRG TENDL-2015, AKONING  
tritons from (n,n\*)t

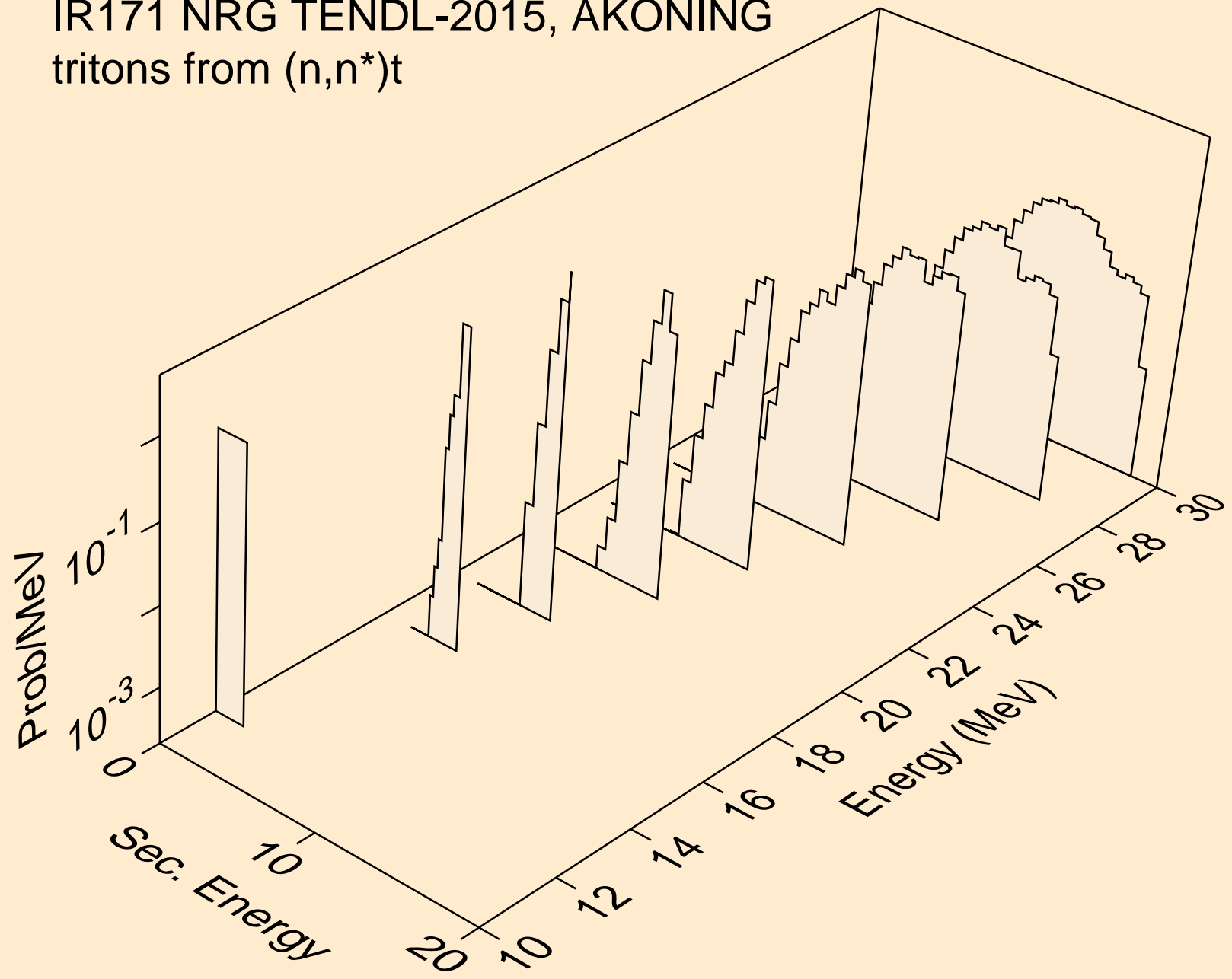

IR171 NRG TENDL-2015, AKONING  
tritons from (n,n\*)t2a

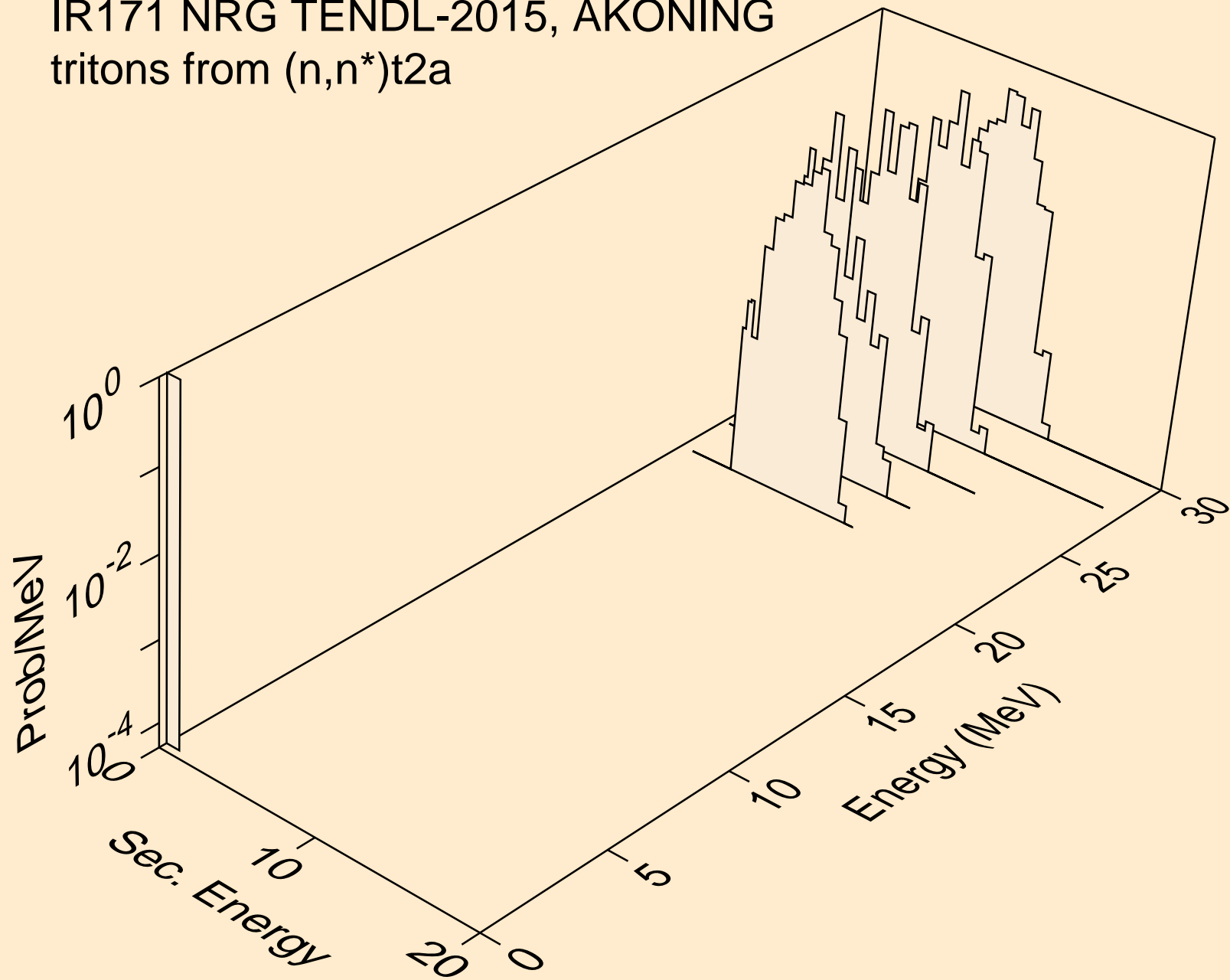

IR171 NRG TENDL-2015, AKONING  
tritons from (n,t)

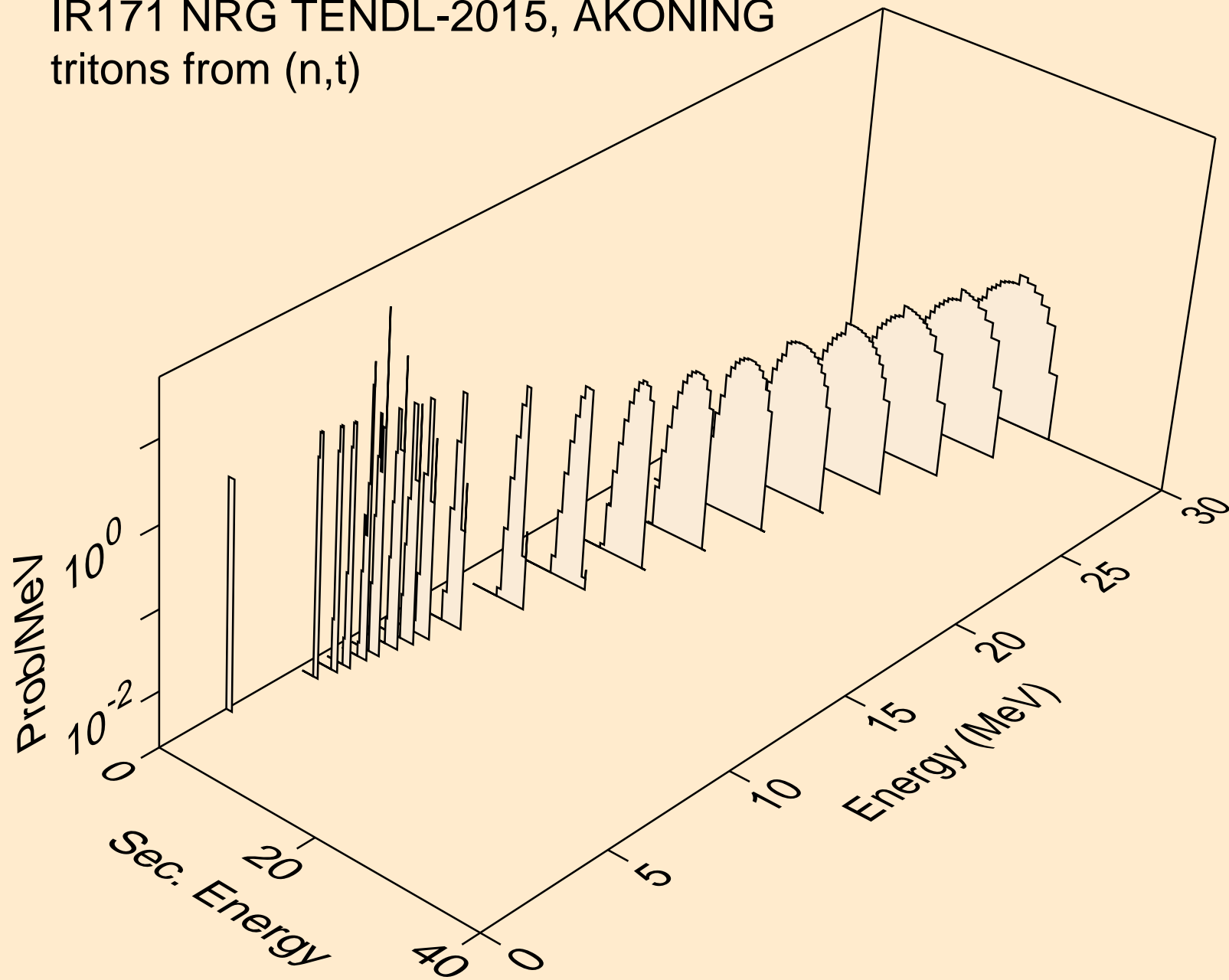

IR171 NRG TENDL-2015, AKONING  
tritons from (n,t2a)

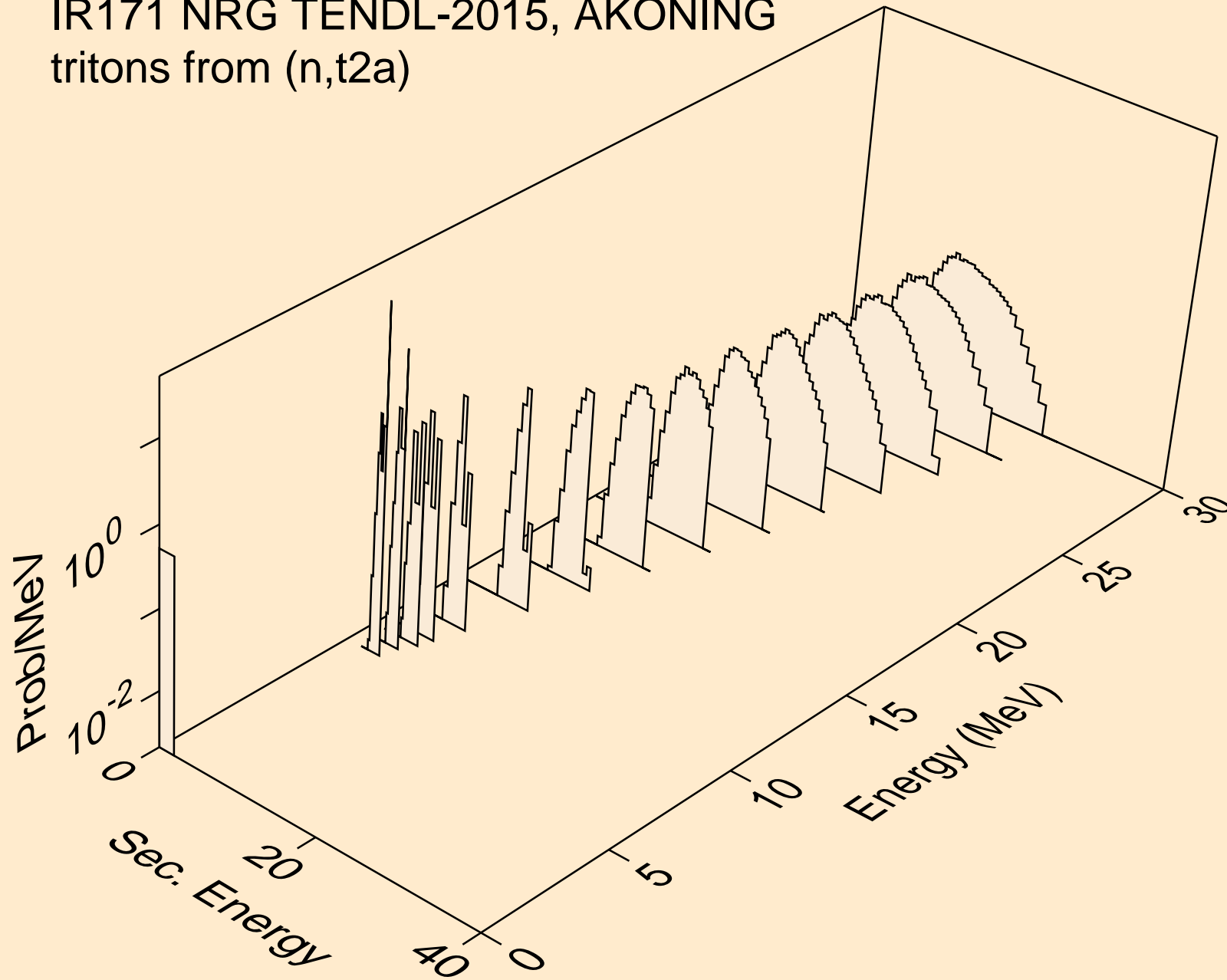

IR171 NRG TENDL-2015, AKONING  
tritons from (n,pt)

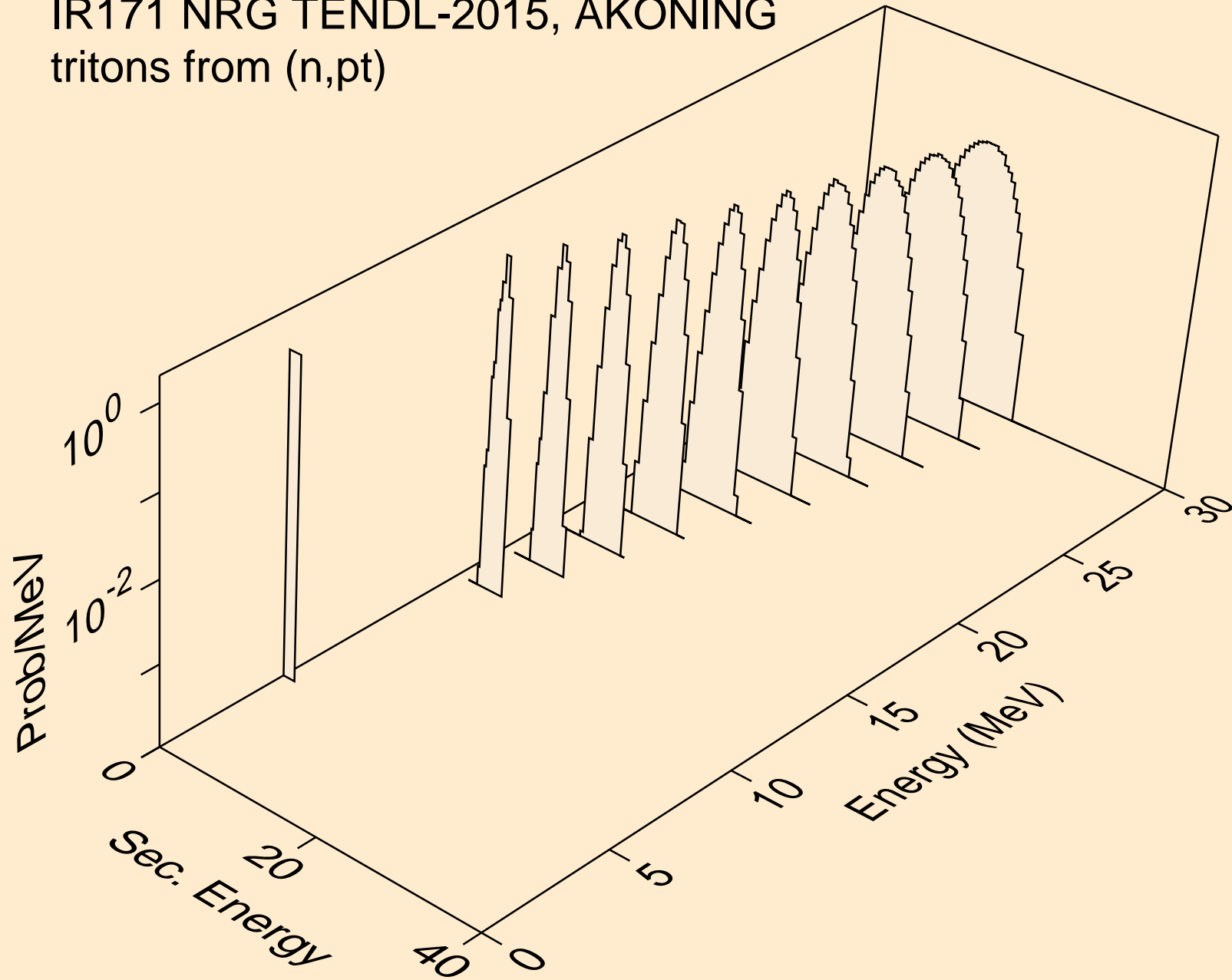

IR171 NRG TENDL-2015, AKONING  
he3s from (n,x)

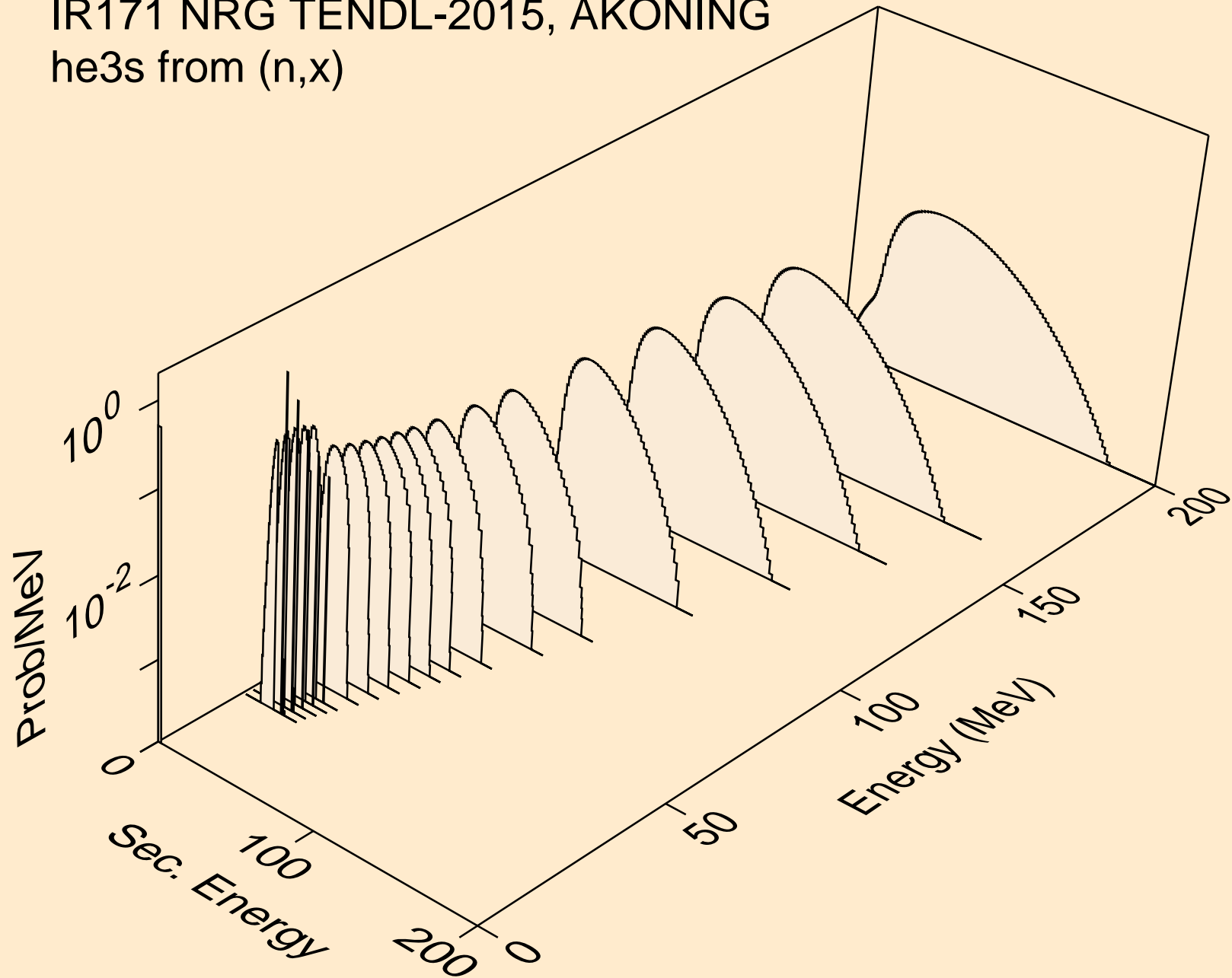



IR171 NRG TENDL-2015, AKONING  
he3s from (n,n\*)he3

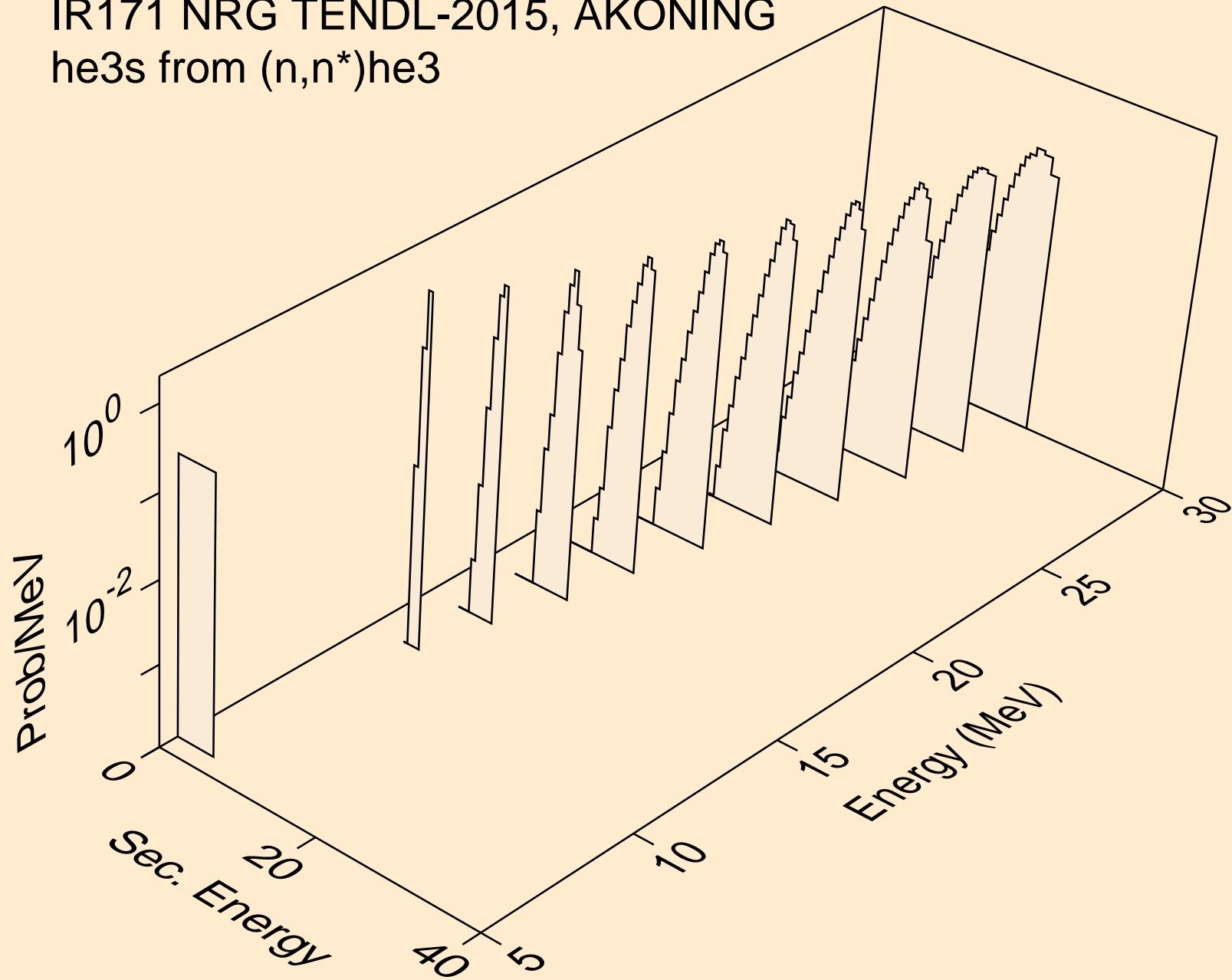

IR171 NRG TENDL-2015, AKONING  
he3s from (n,he3)

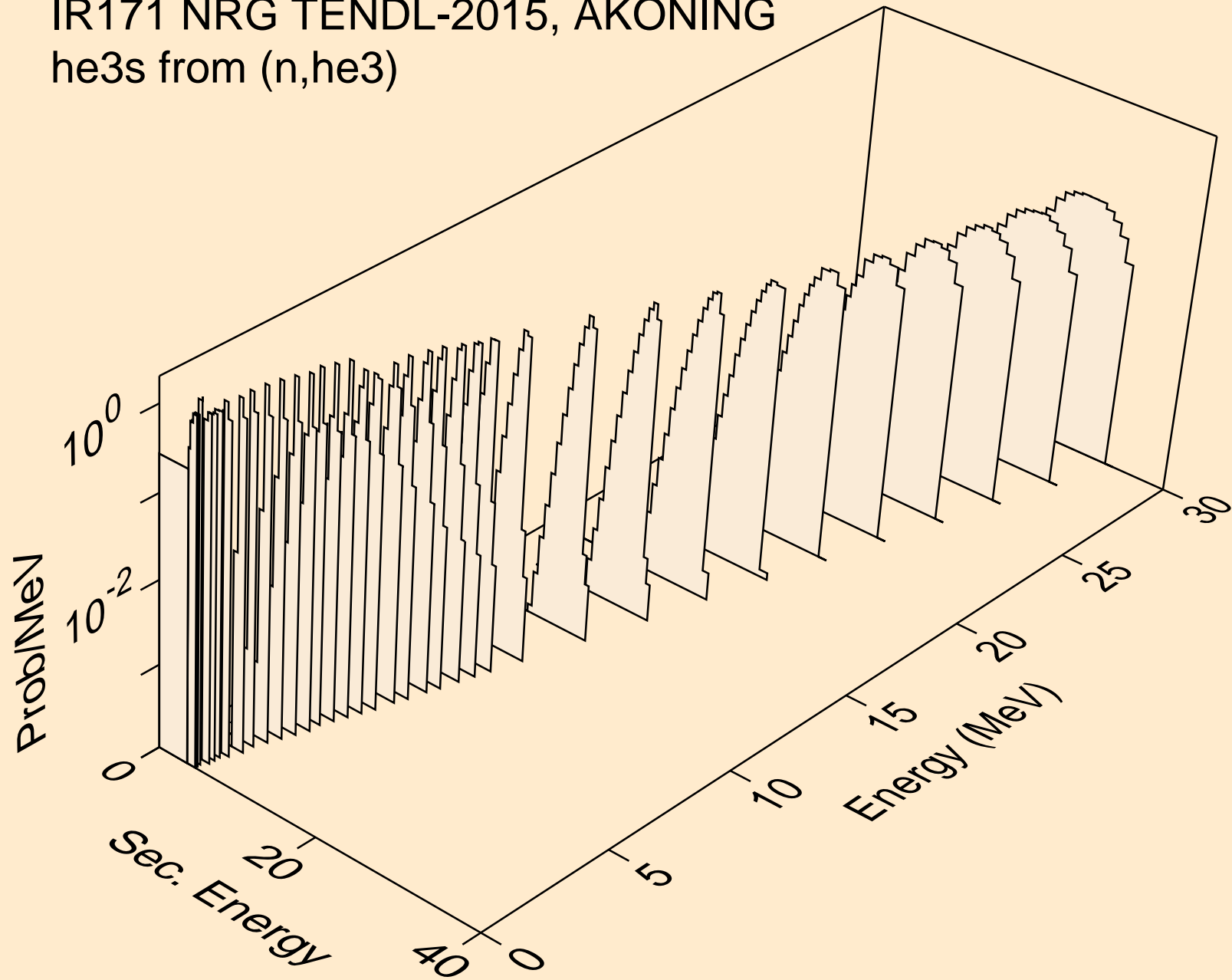

IR171 NRG TENDL-2015, AKONING  
alphas from (n,x)

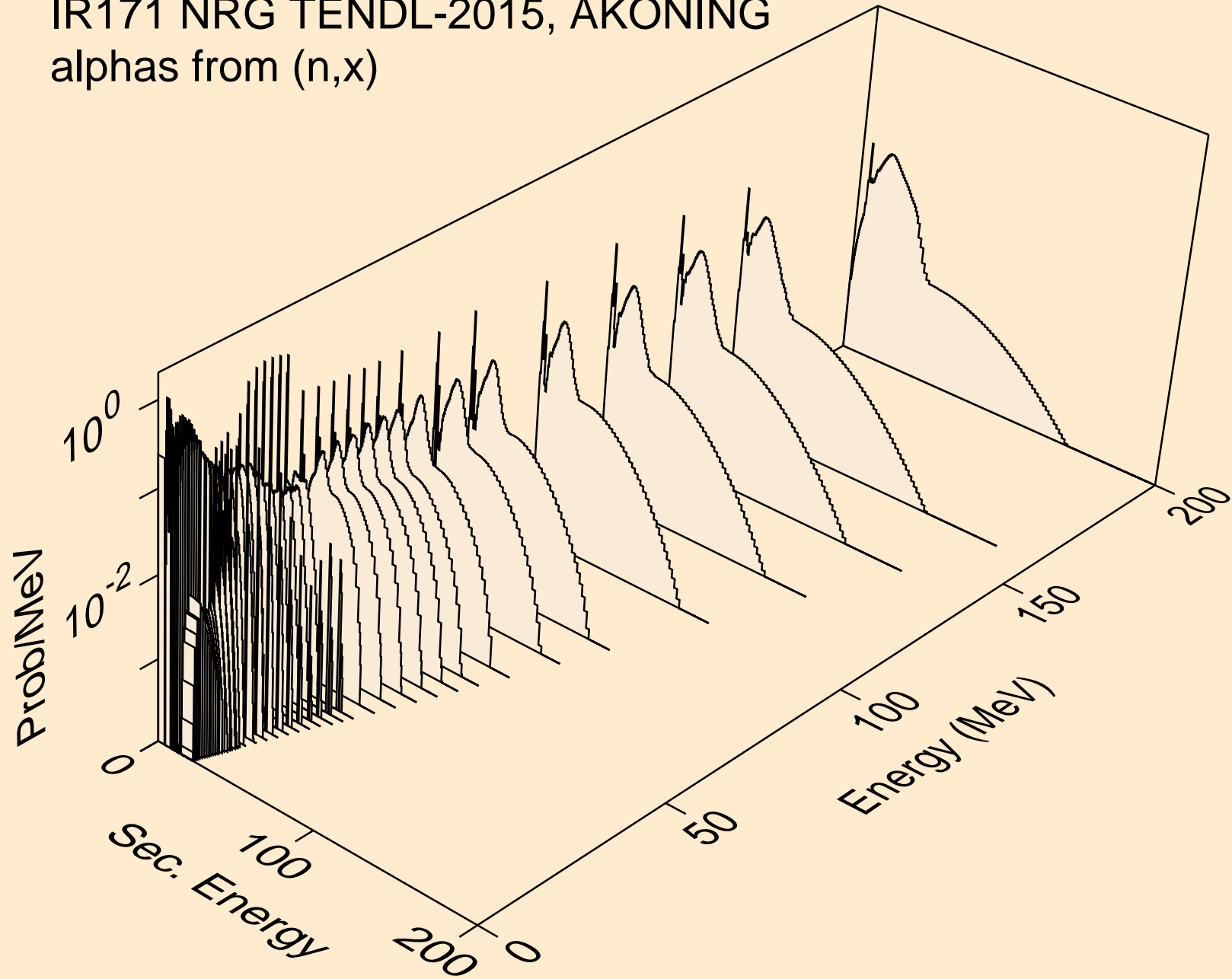

IR171 NRG TENDL-2015, AKONING  
alphas from (n,n\*)a

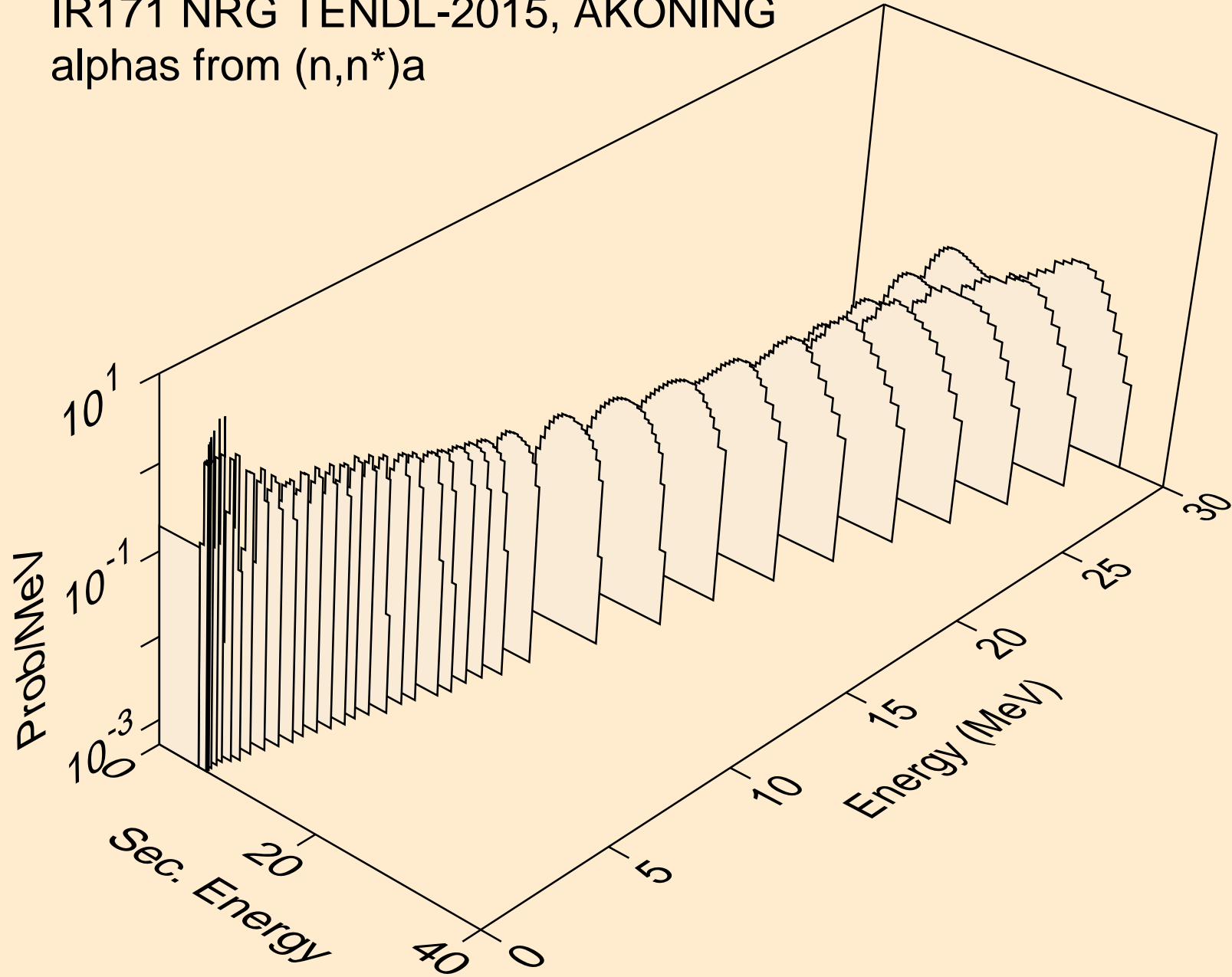

IR171 NRG TENDL-2015, AKONING  
alphas from (n,n\*)3a

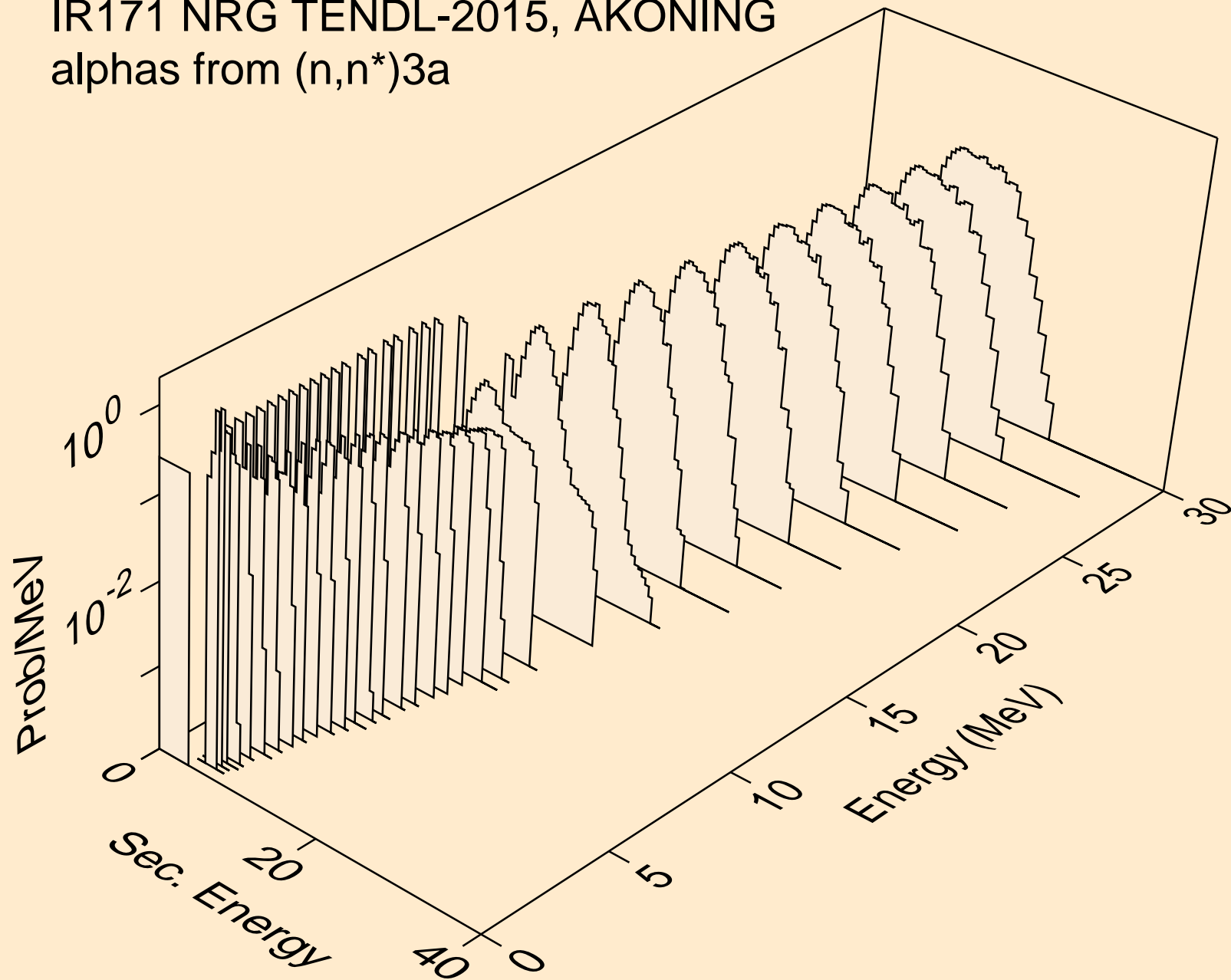

IR171 NRG TENDL-2015, AKONING  
alphas from (n,2n)a

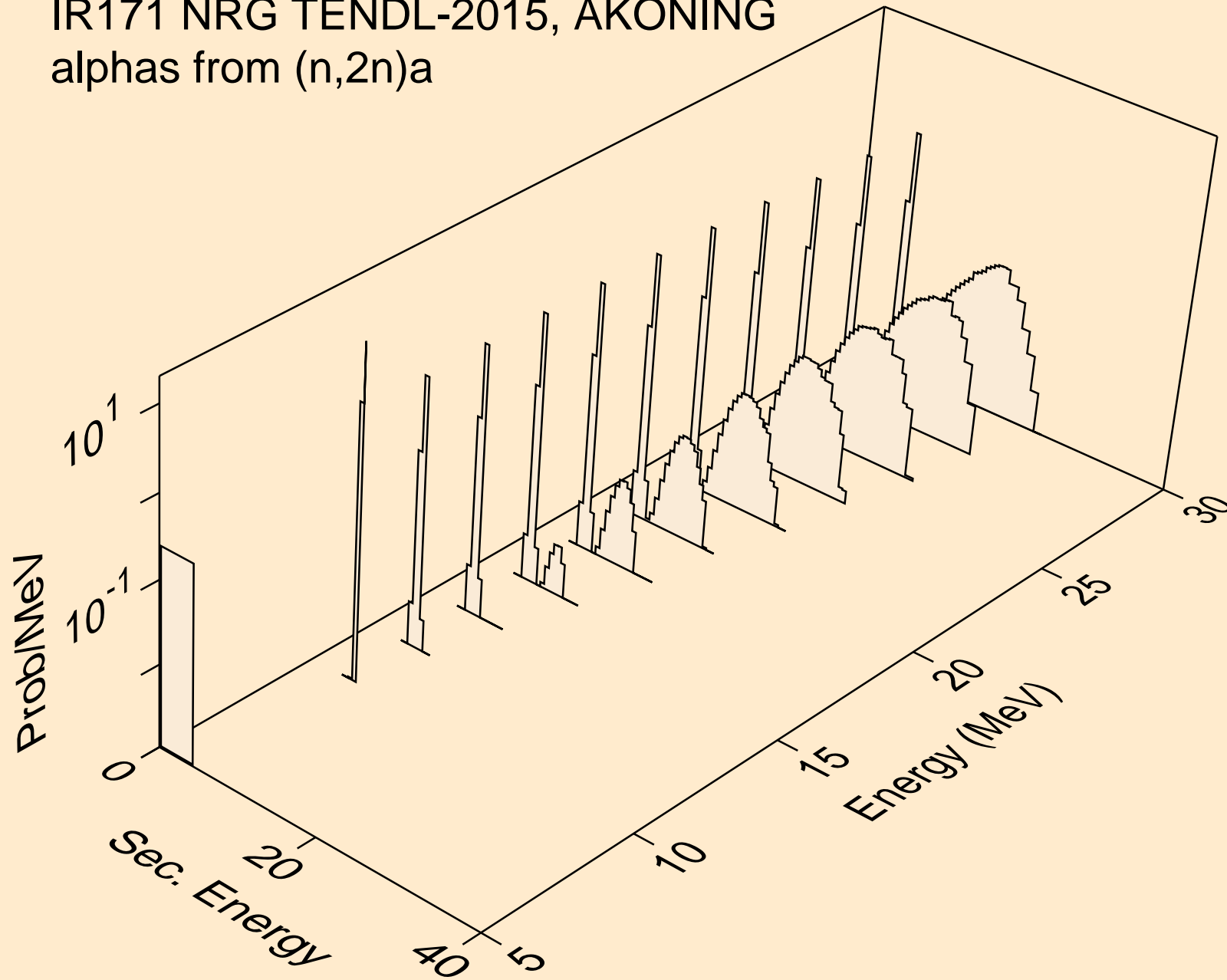

IR171 NRG TENDL-2015, AKONING  
alphas from (n,3n)a

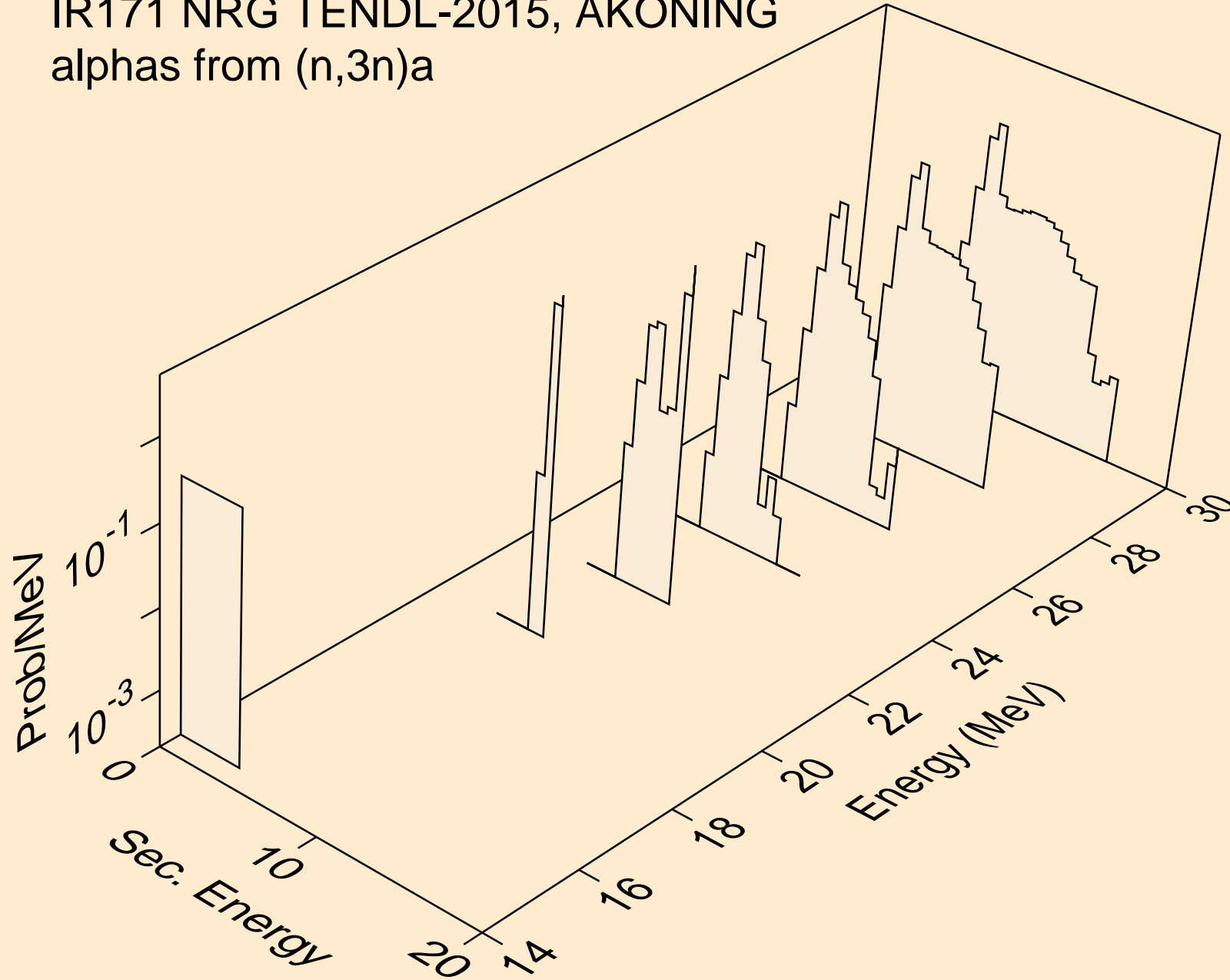

IR171 NRG TENDL-2015, AKONING  
alphas from (n,n\*)2a

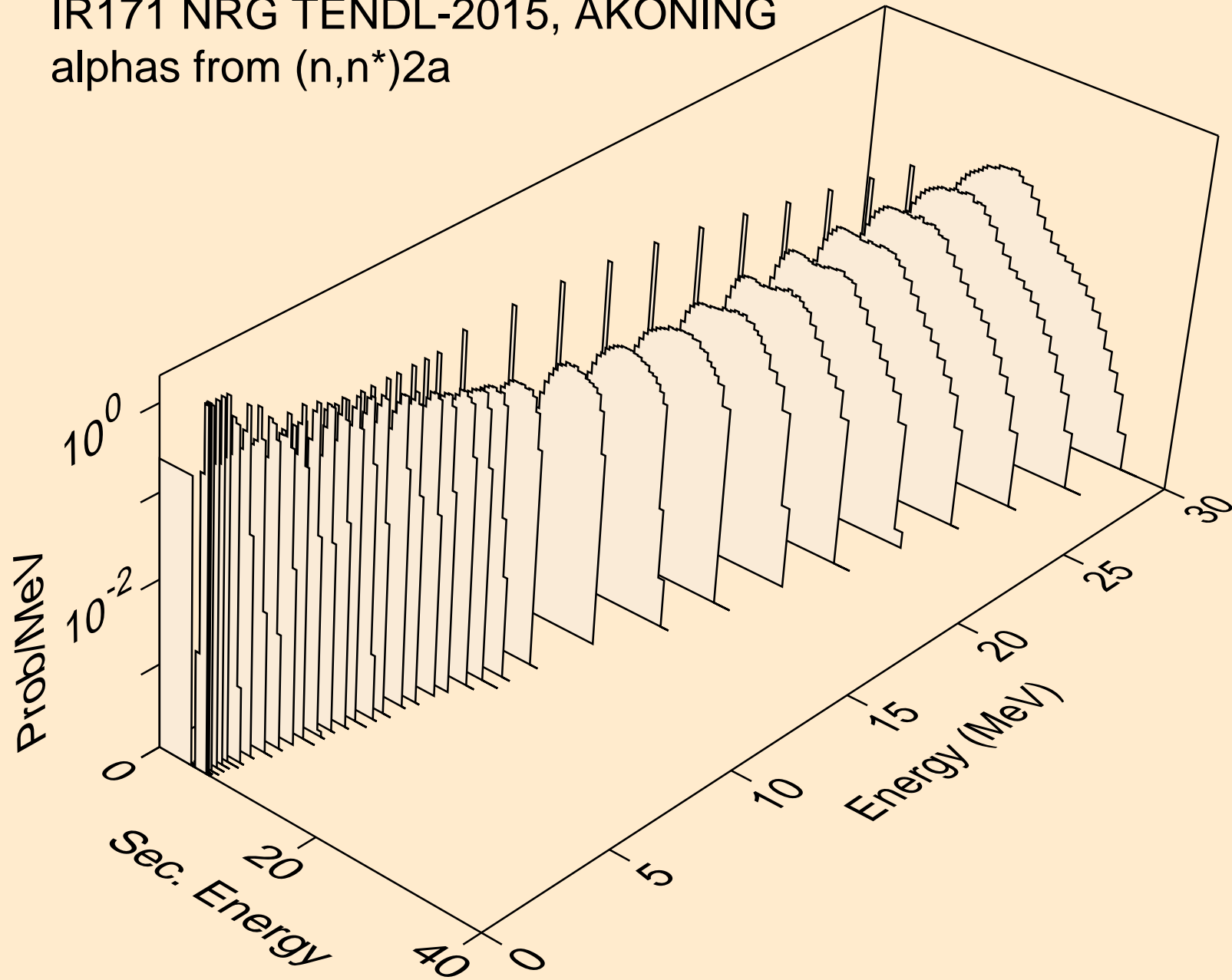



IR171 NRG TENDL-2015, AKONING  
alphas from (n,2n)2a

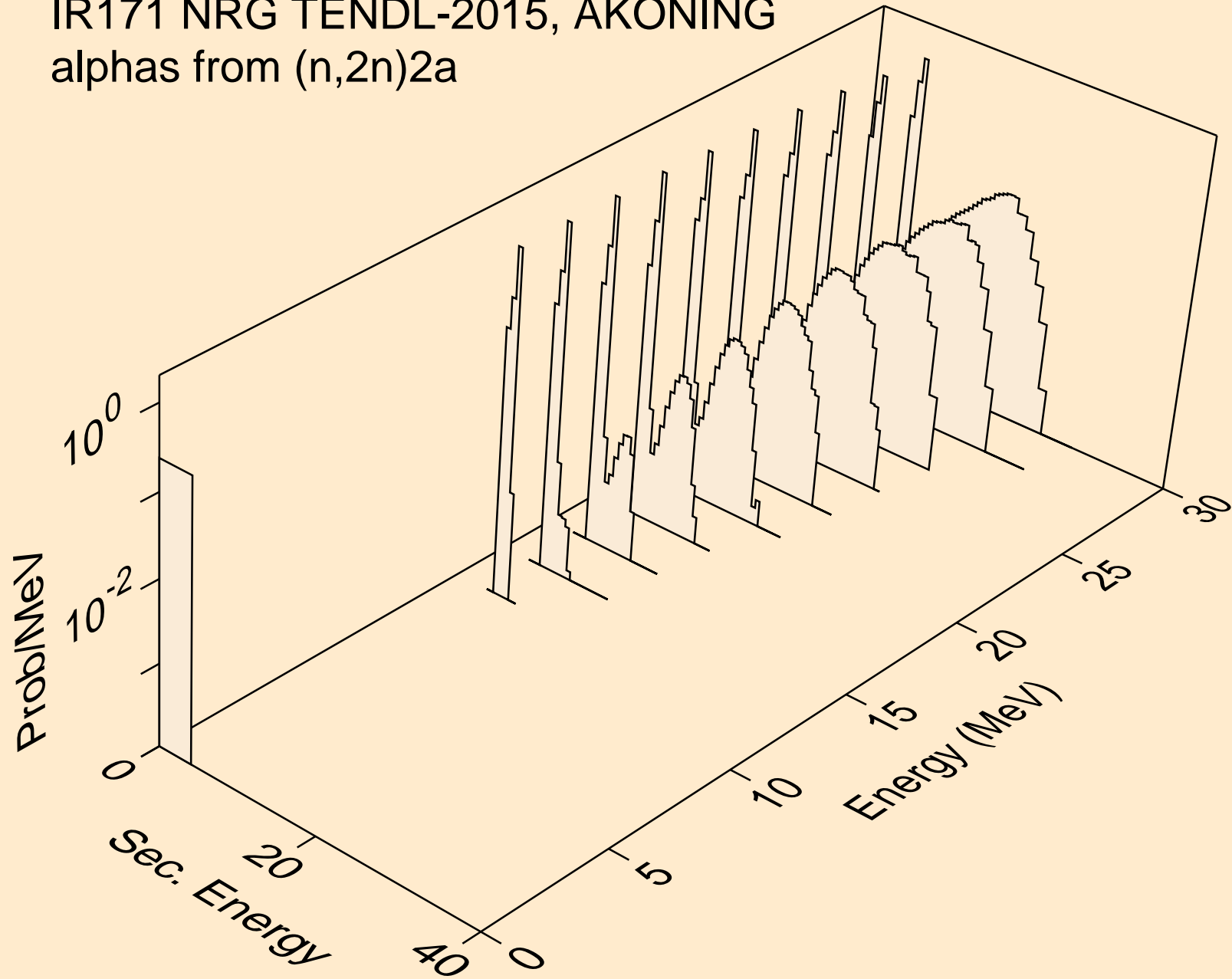

IR171 NRG TENDL-2015, AKONING  
alphas from (n,n\*)d2a

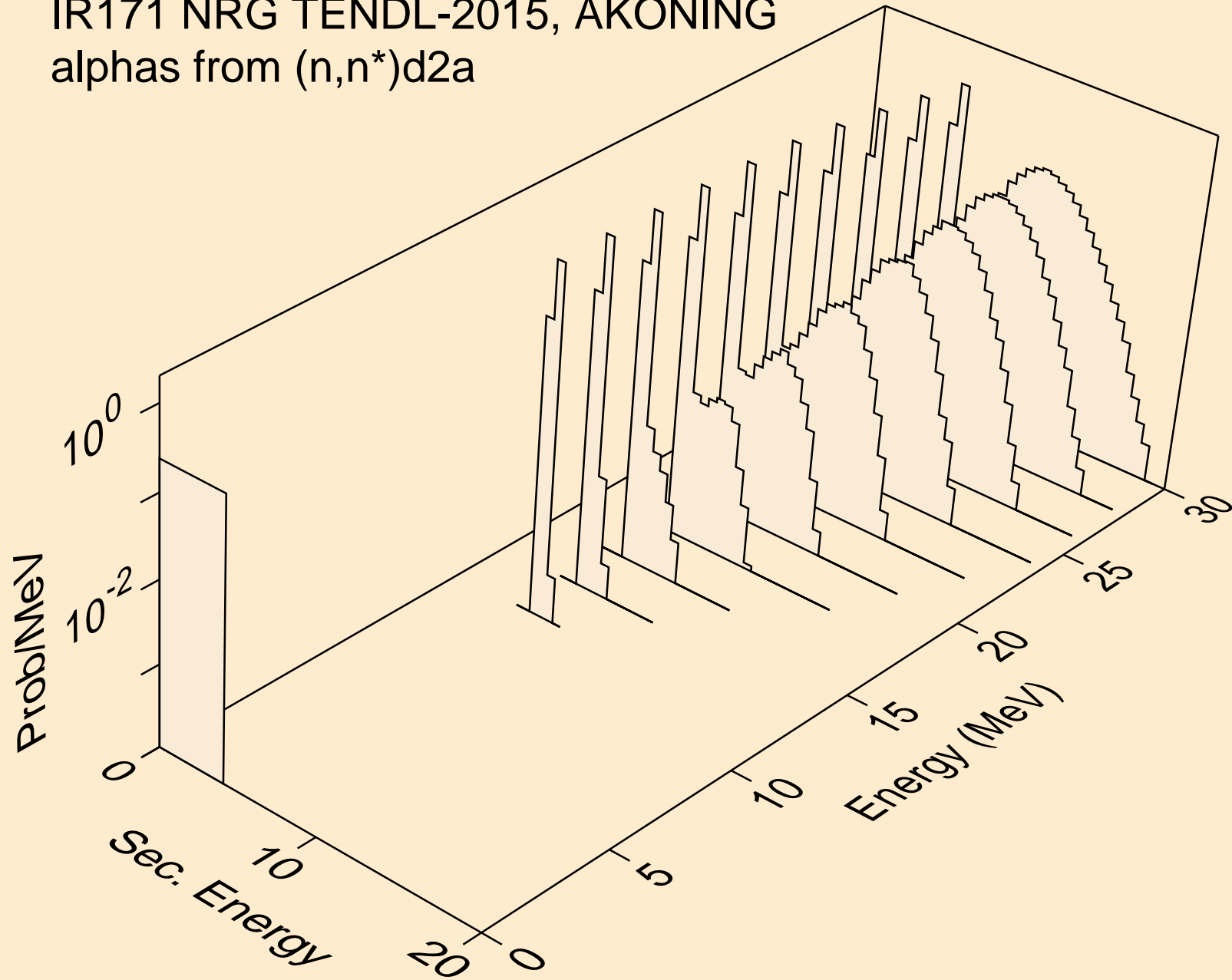

IR171 NRG TENDL-2015, AKONING  
alphas from (n,n\*)t2a

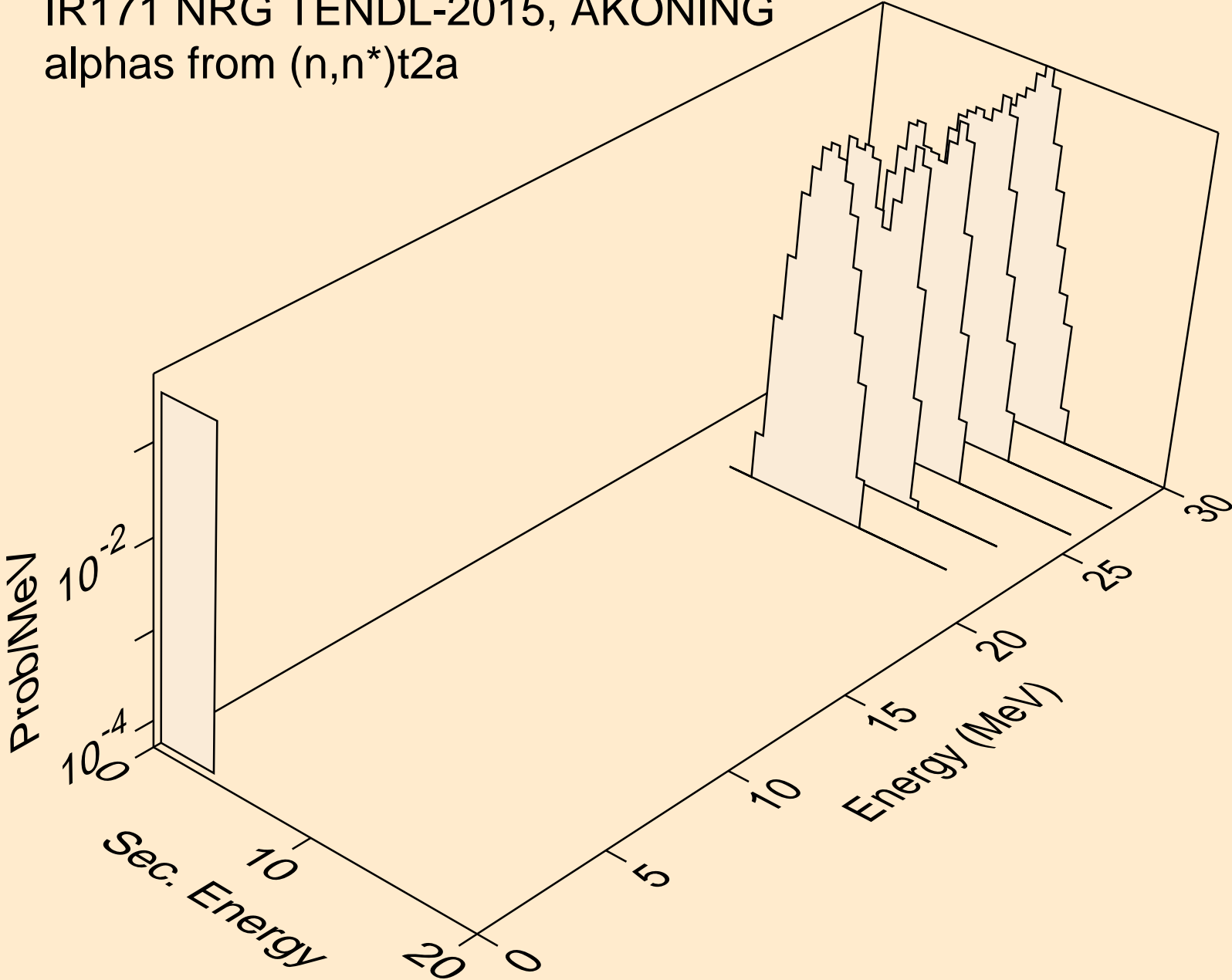

IR171 NRG TENDL-2015, AKONING  
alphas from (n,npa)

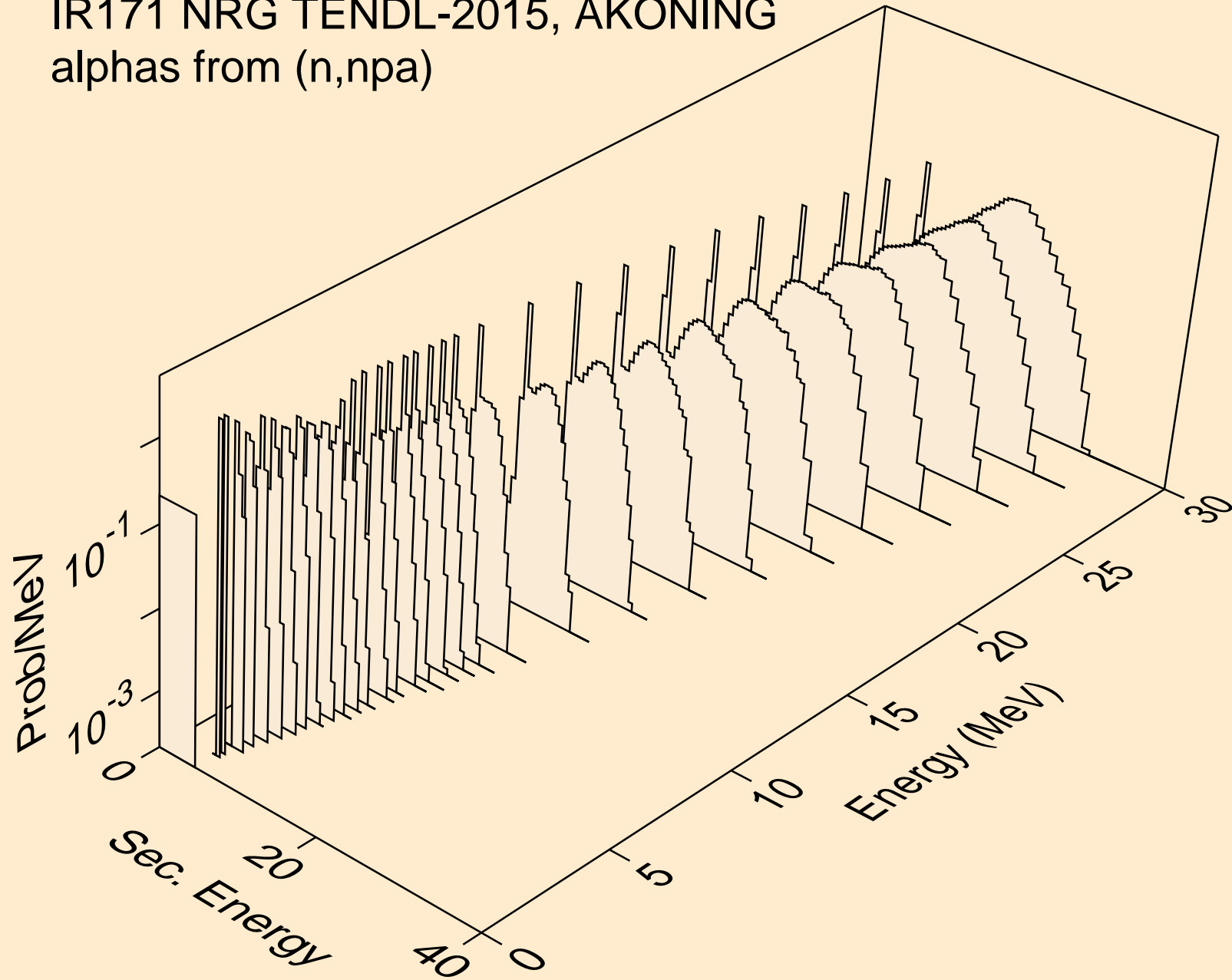

IR171 NRG TENDL-2015, AKONING  
alphas from (n,a)

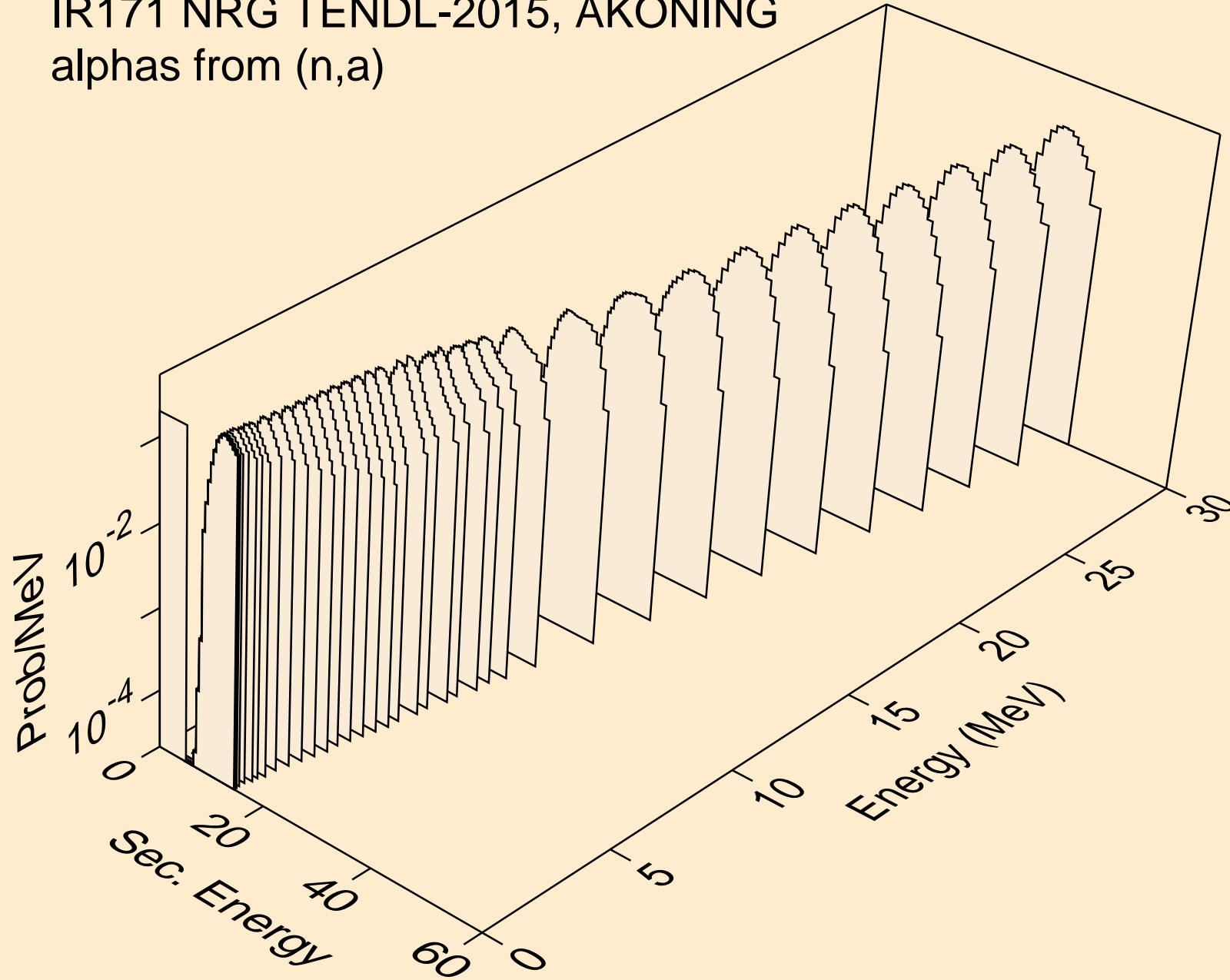

IR171 NRG TENDL-2015, AKONING  
alphas from (n,2a)

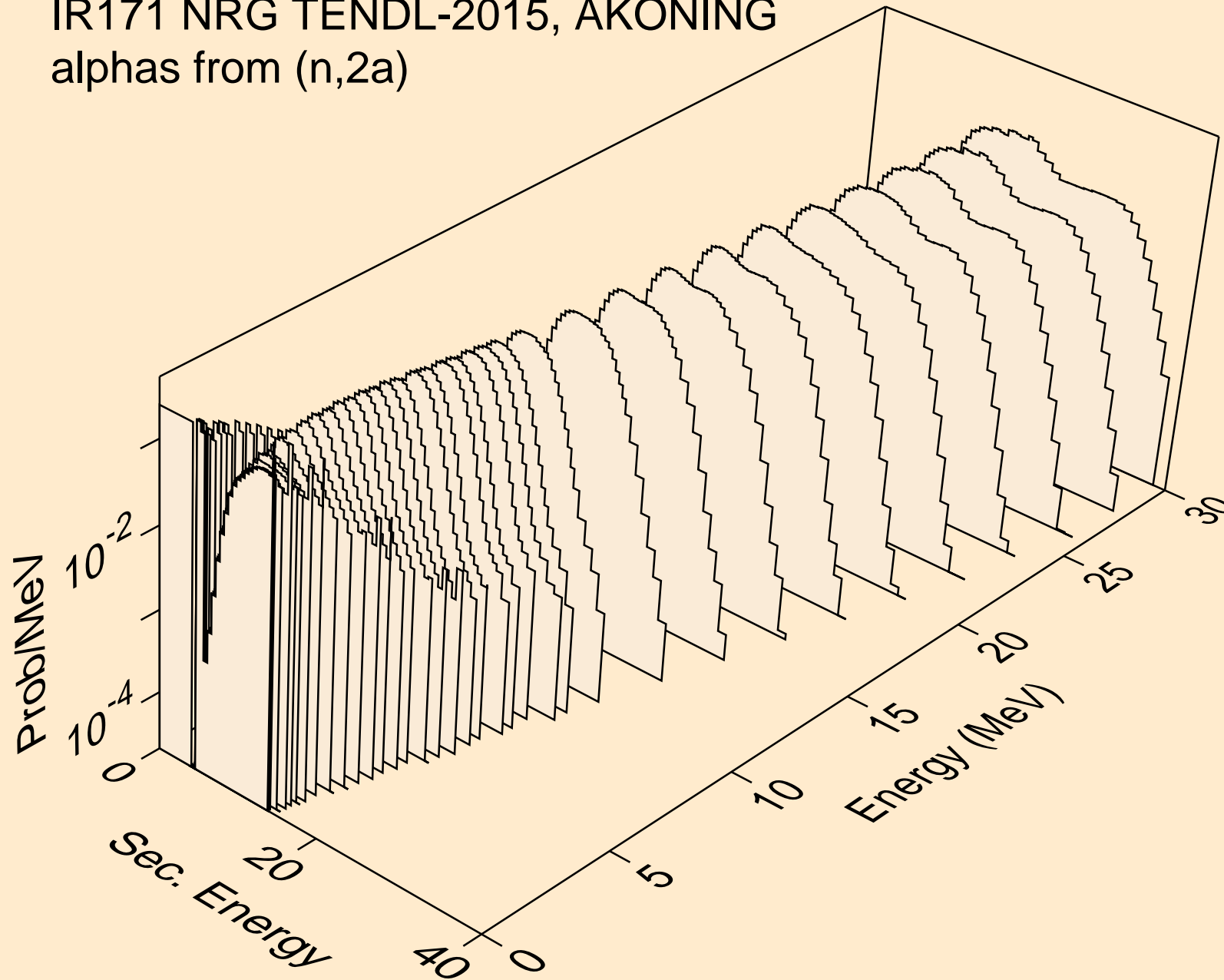

IR171 NRG TENDL-2015, AKONING  
alphas from (n,3a)

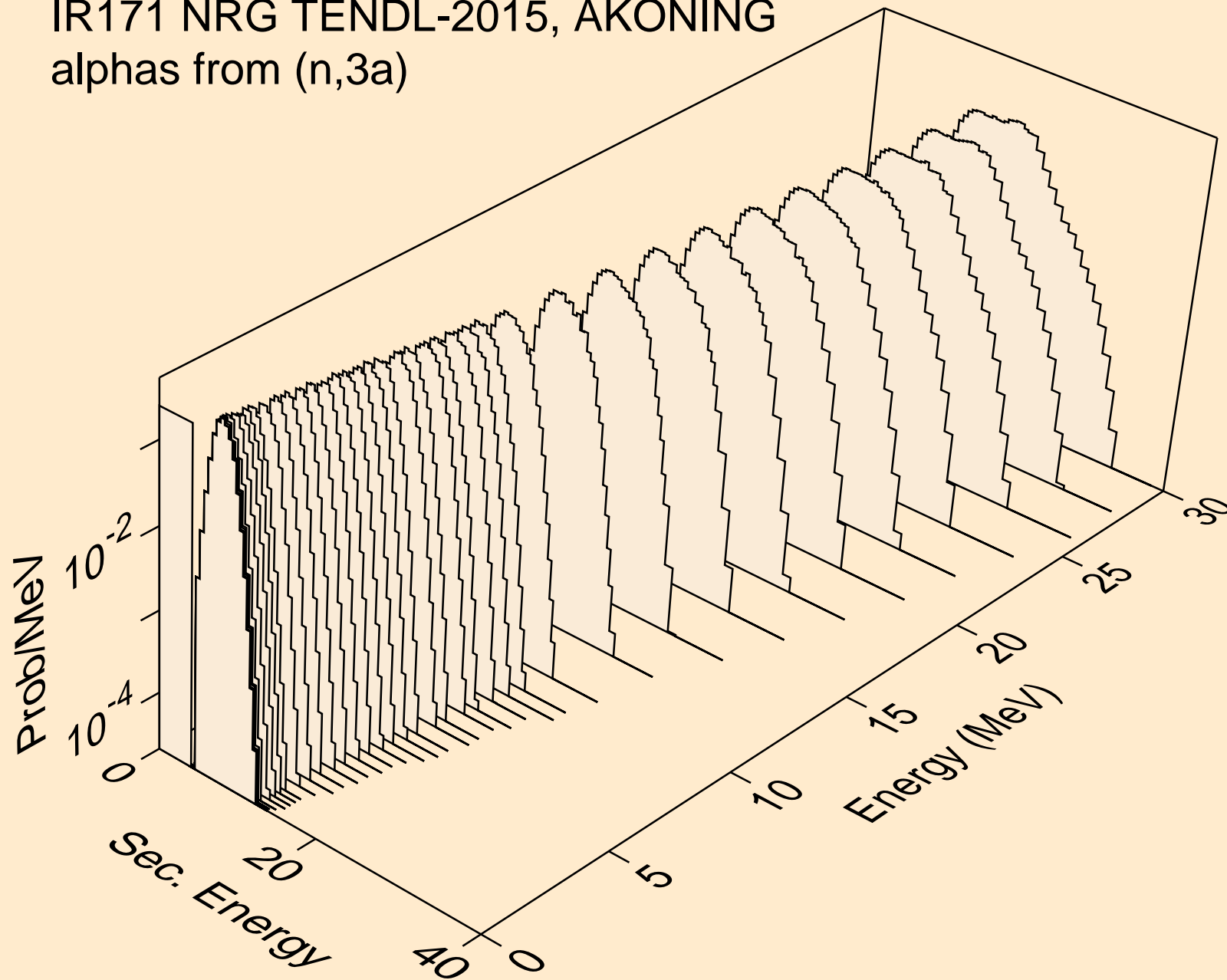

IR171 NRG TENDL-2015, AKONING  
alphas from (n,pa)

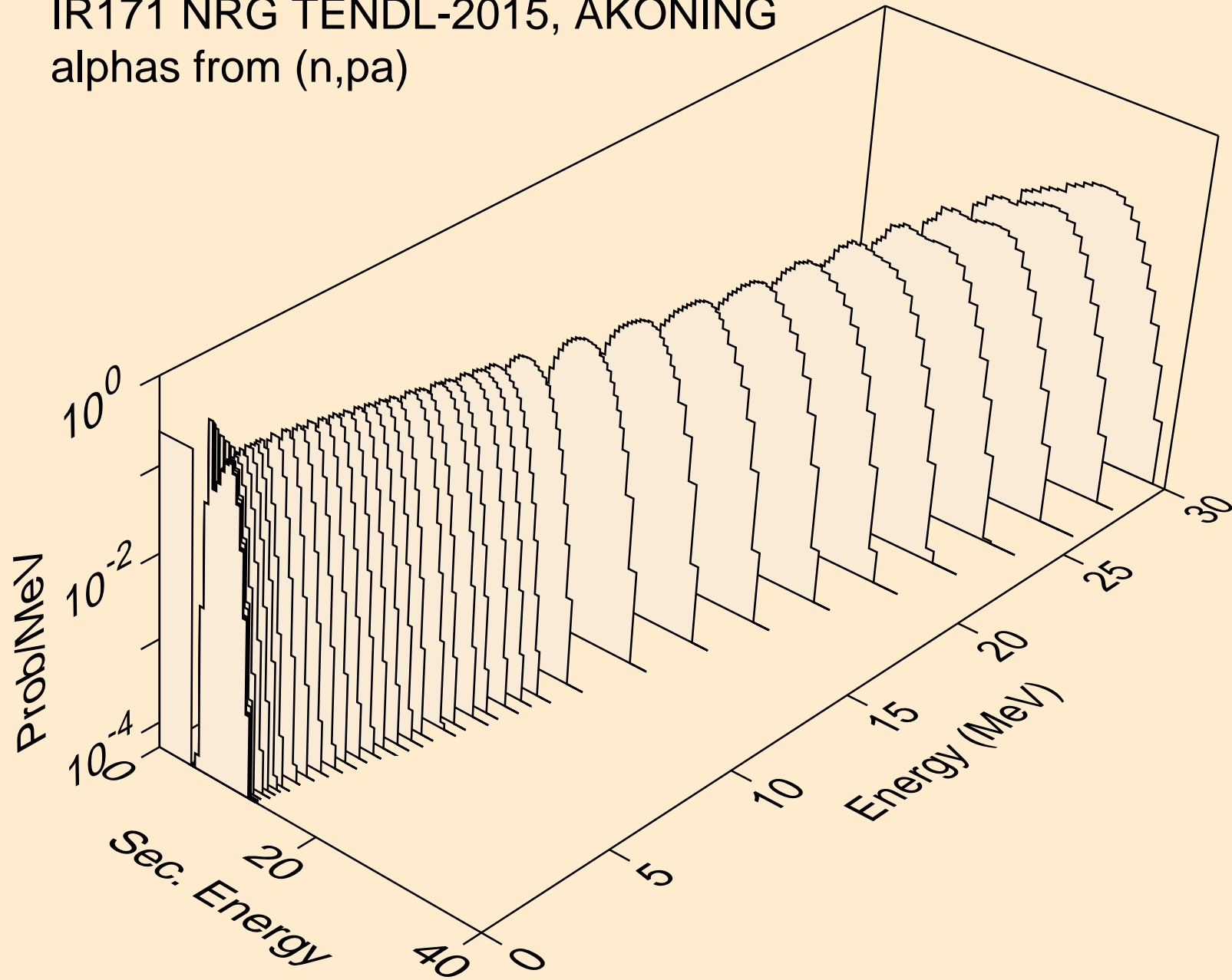



IR171 NRG TENDL-2015, AKONING  
alphas from (n,t2a)

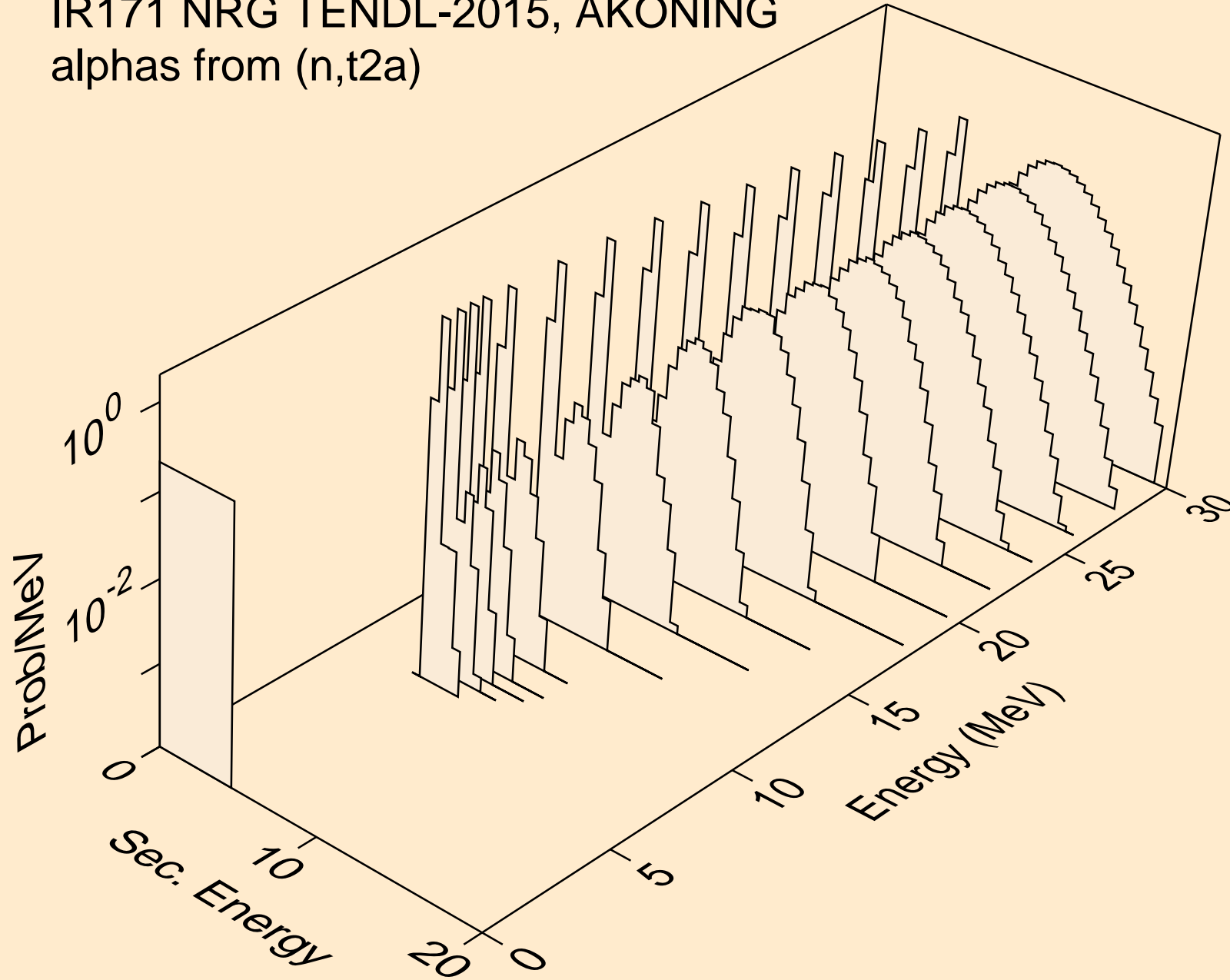

IR171 NRG TENDL-2015, AKONING  
alphas from (n,d2a)

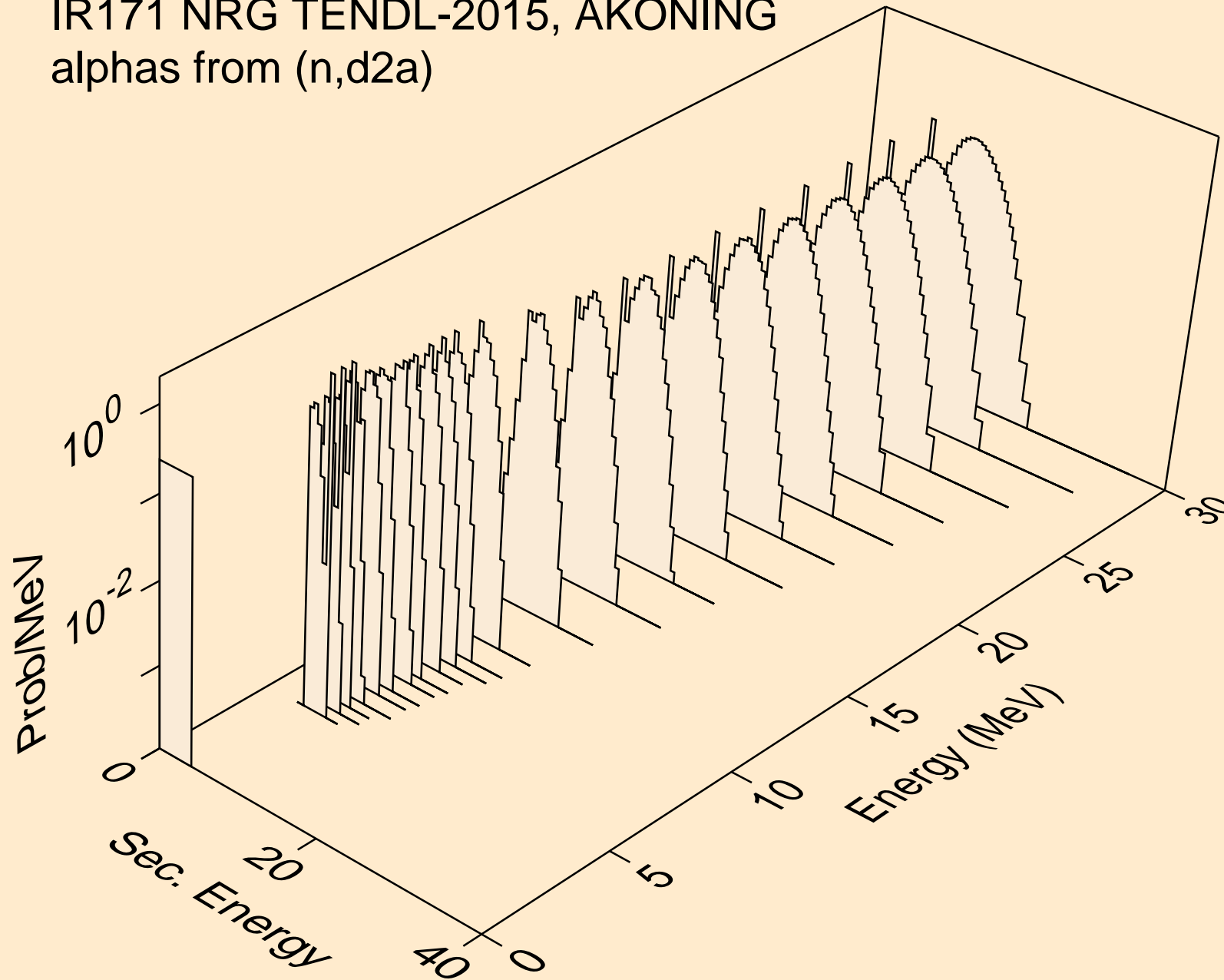

IR171 NRG TENDL-2015, AKONING  
alphas from (n,da)

