

# IR171M NRG TENDL-2015, AKONING

## Principal cross sections

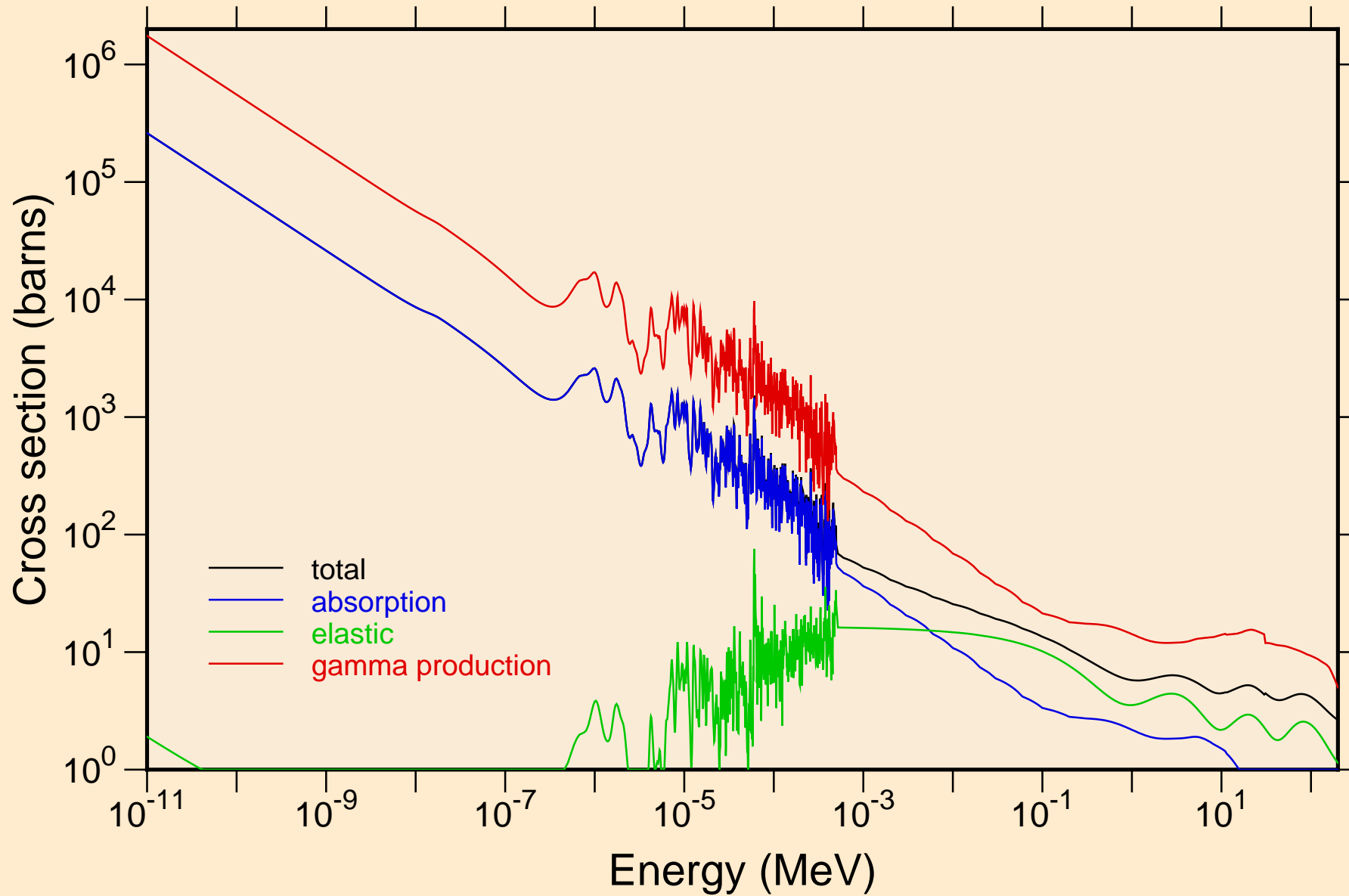

IR171M NRG TENDL-2015, AKONING  
resonance total cross section

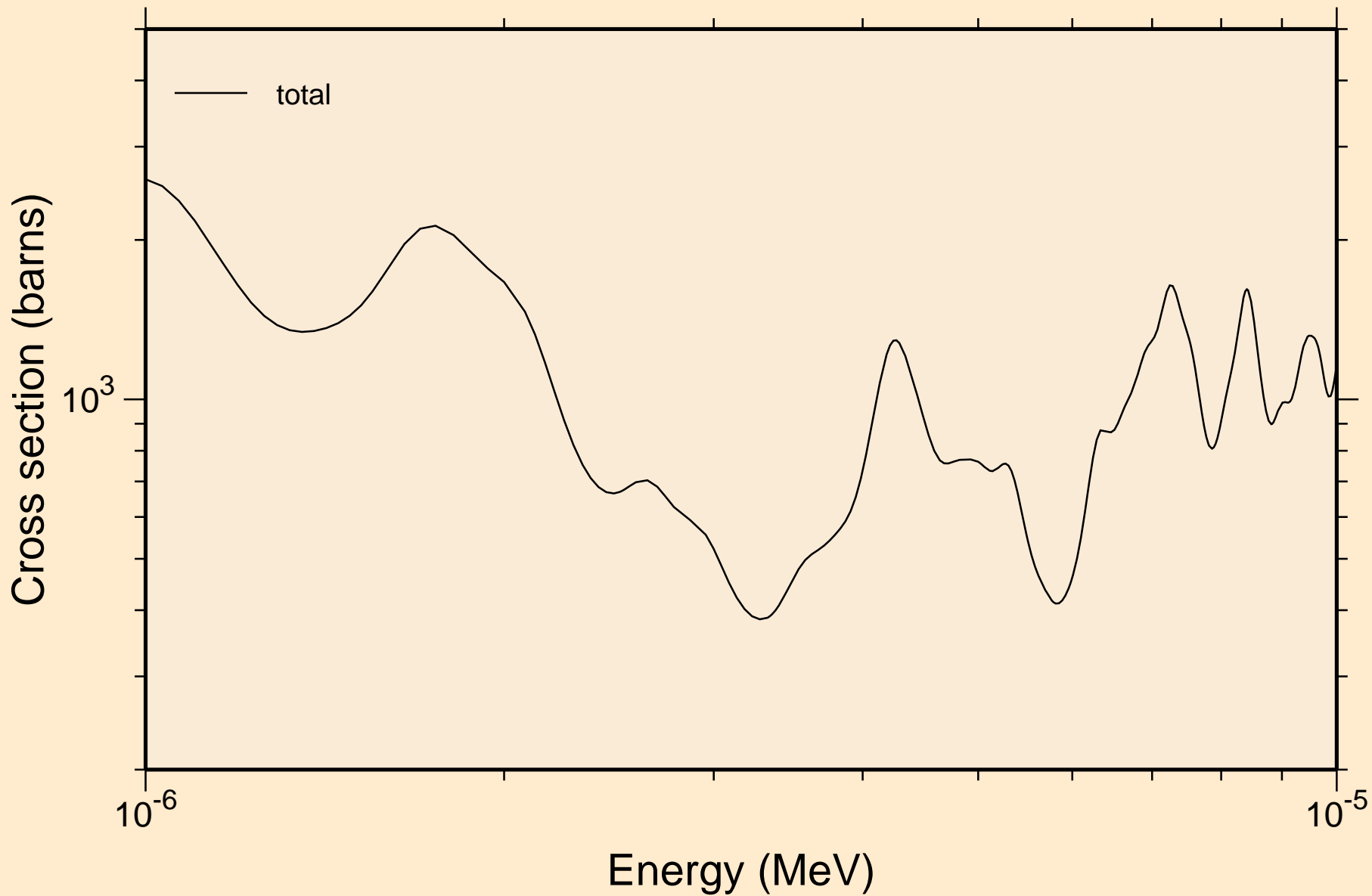

IR171M NRG TENDL-2015, AKONING  
resonance total cross section

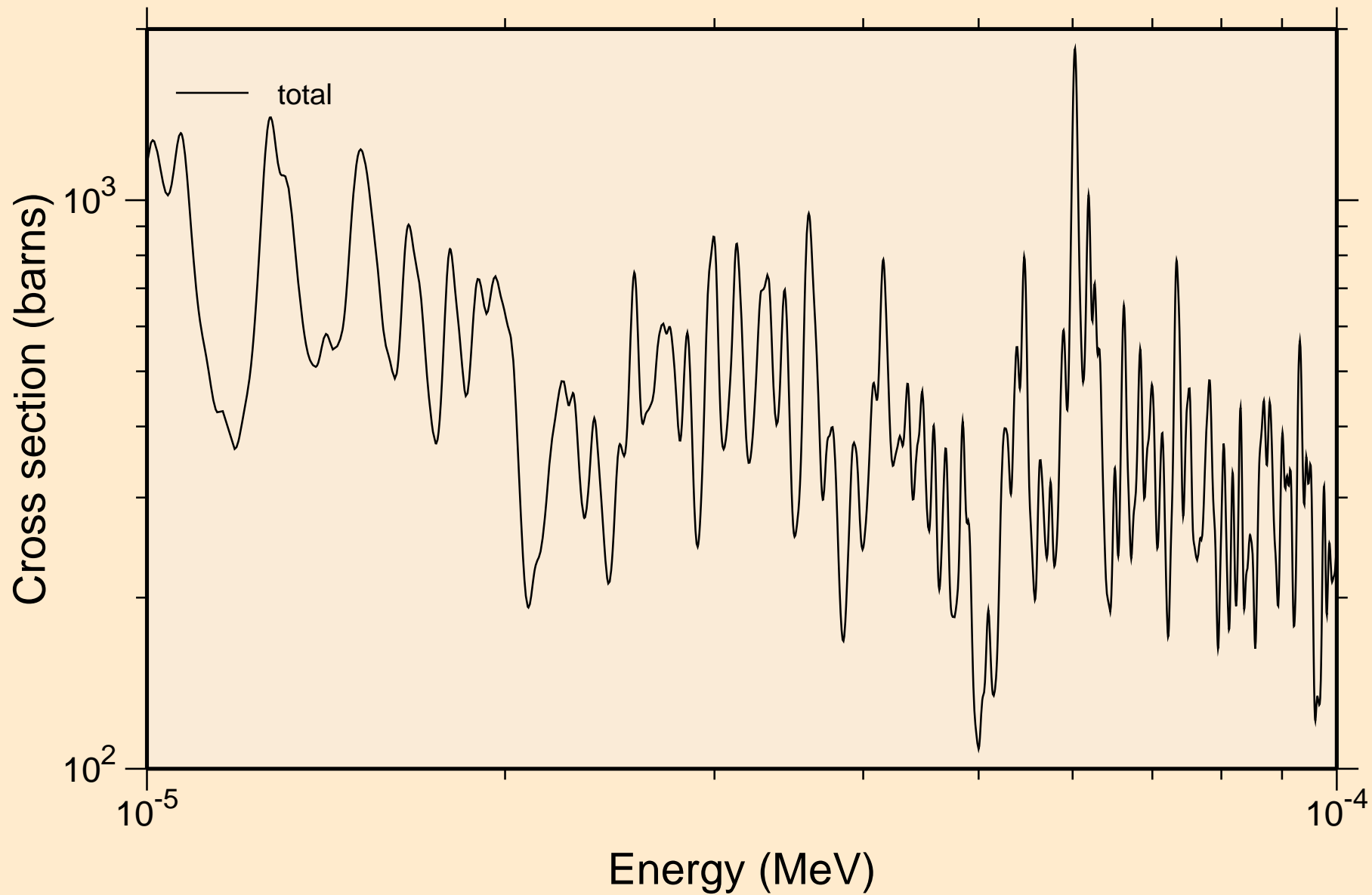

IR171M NRG TENDL-2015, AKONING  
resonance total cross section

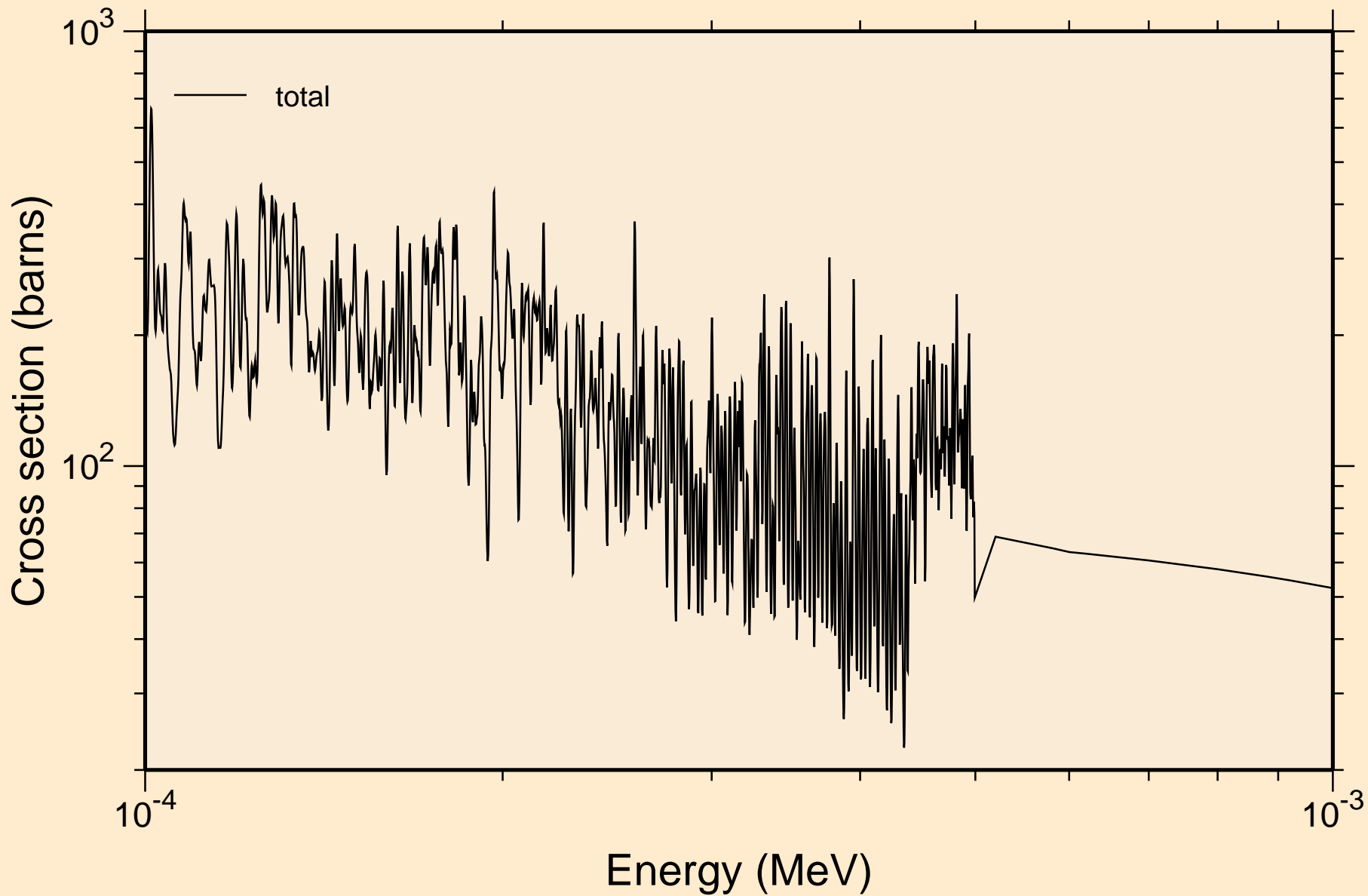

IR171M NRG TENDL-2015, AKONING  
resonance total cross section

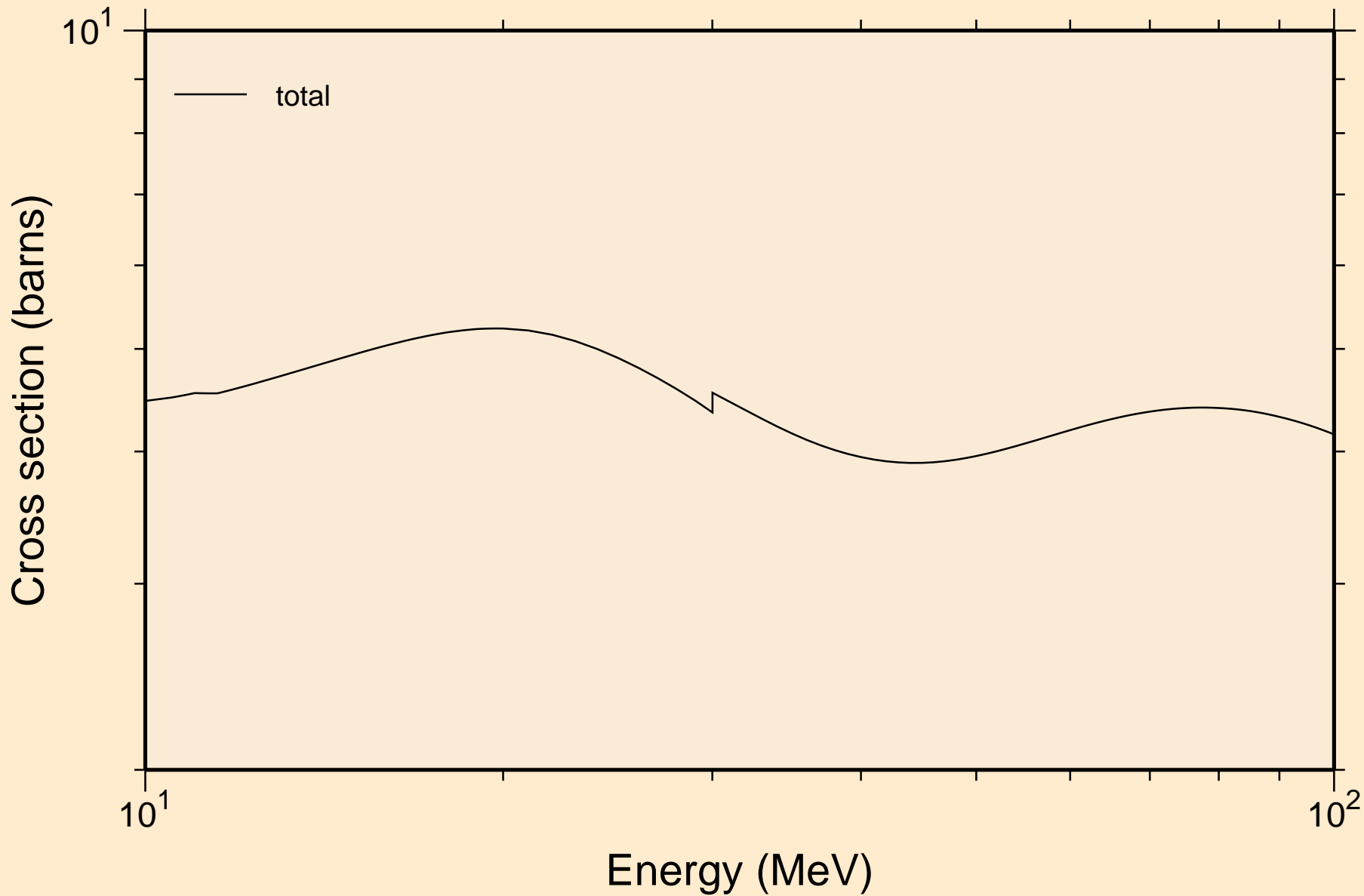

IR171M NRG TENDL-2015, AKONING  
resonance absorption cross sections

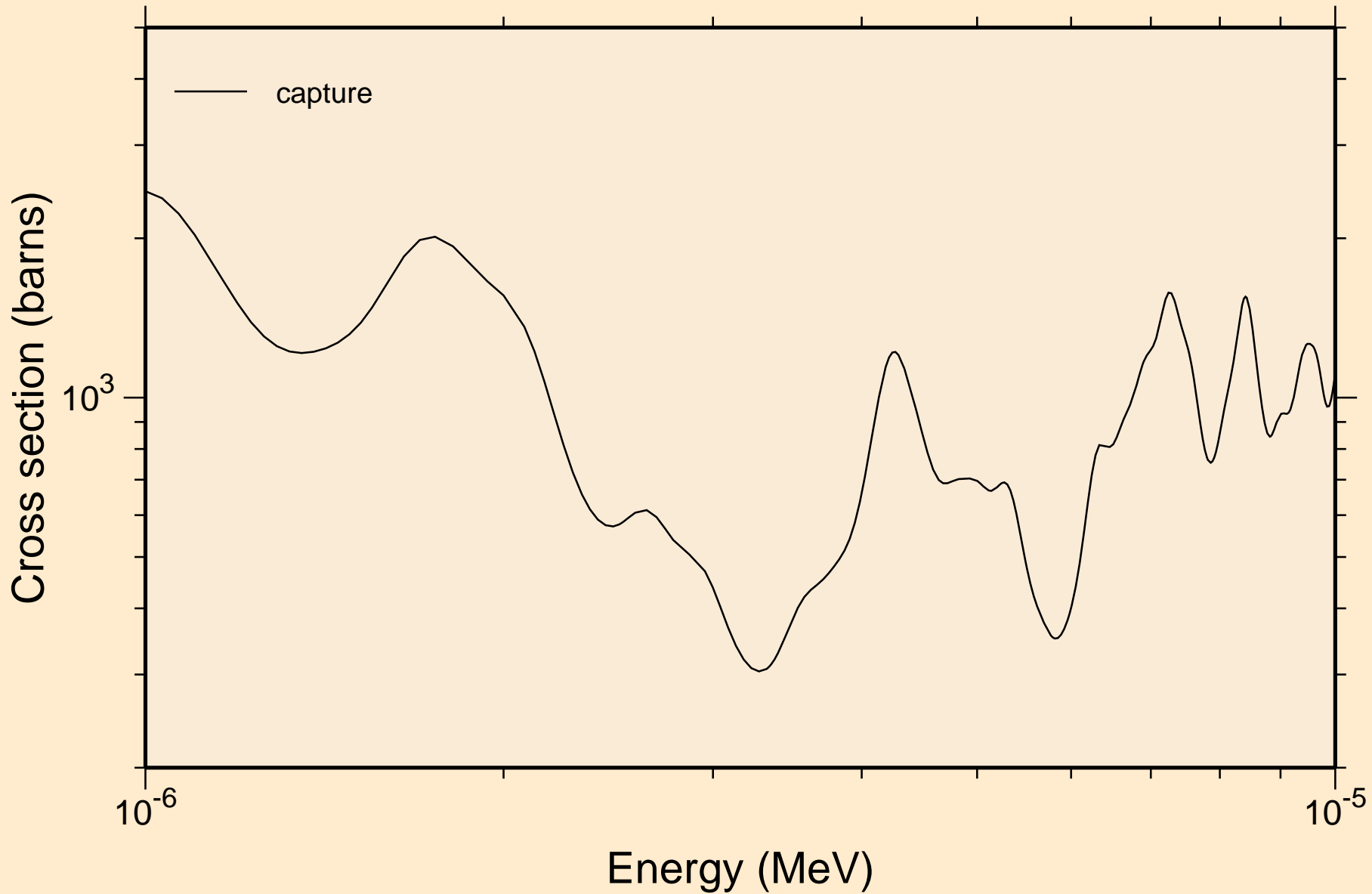

IR171M NRG TENDL-2015, AKONING  
resonance absorption cross sections

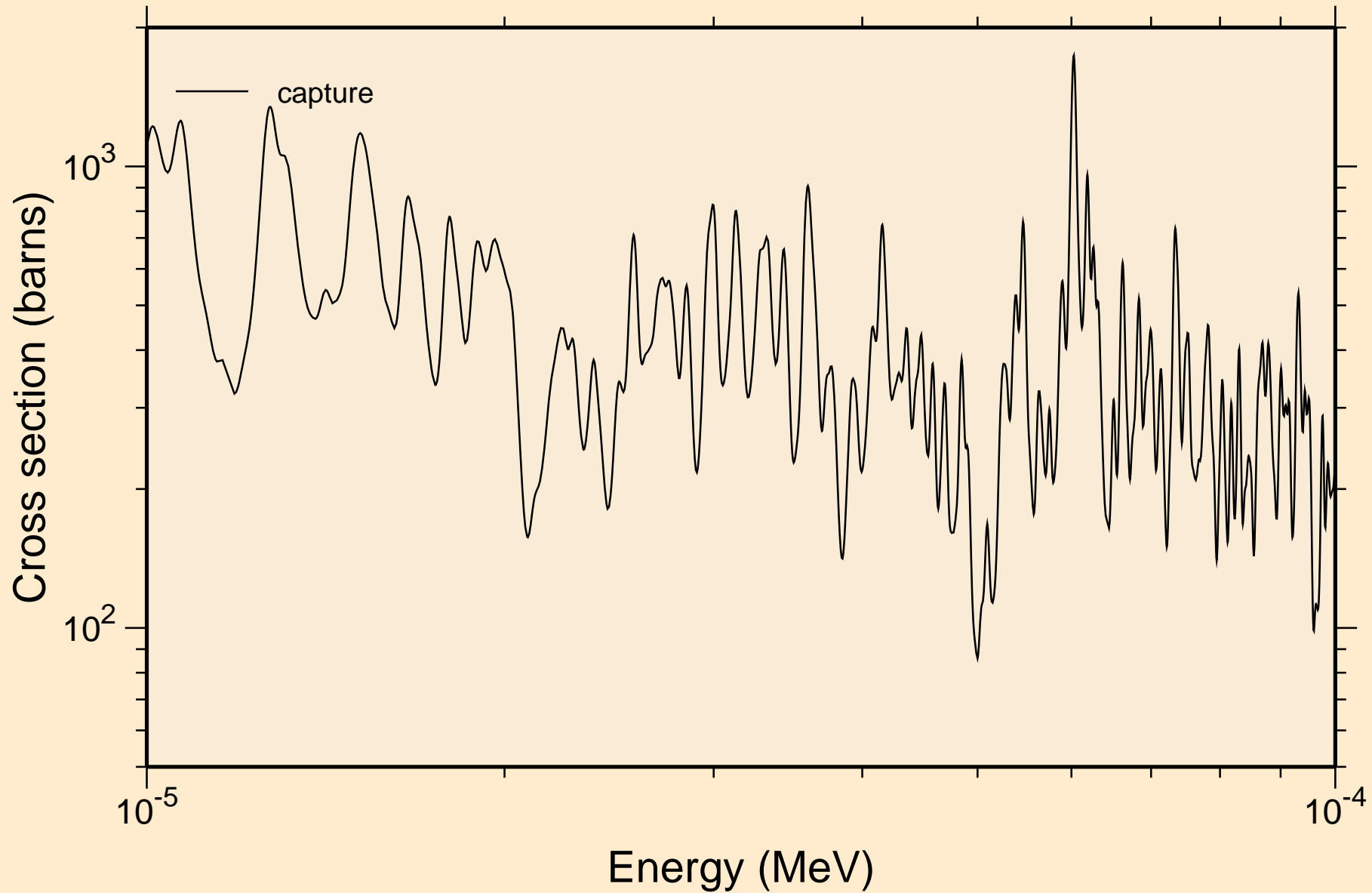

IR171M NRG TENDL-2015, AKONING  
resonance absorption cross sections

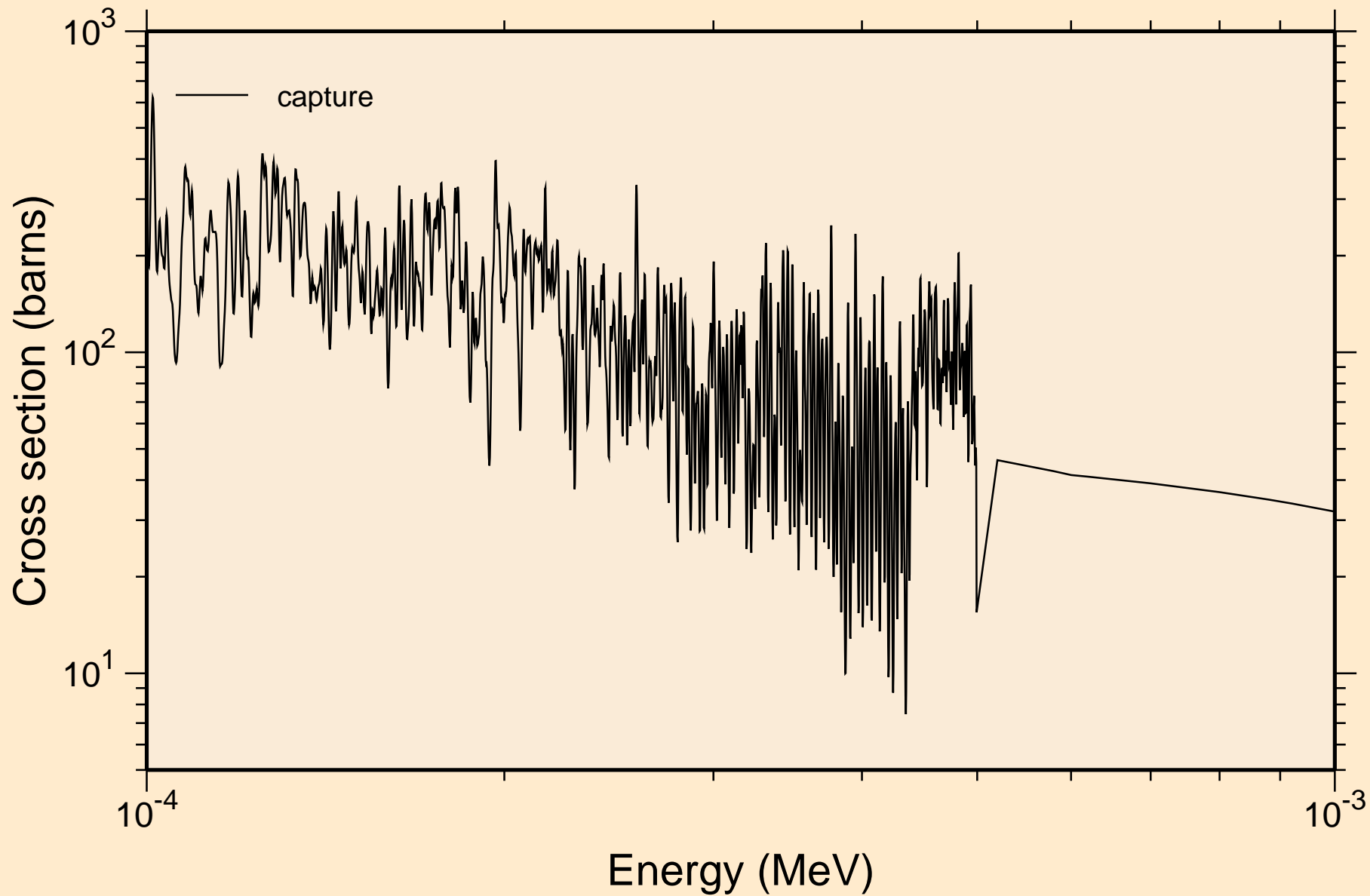



IR171M NRG TENDL-2015, AKONING  
resonance absorption cross sections

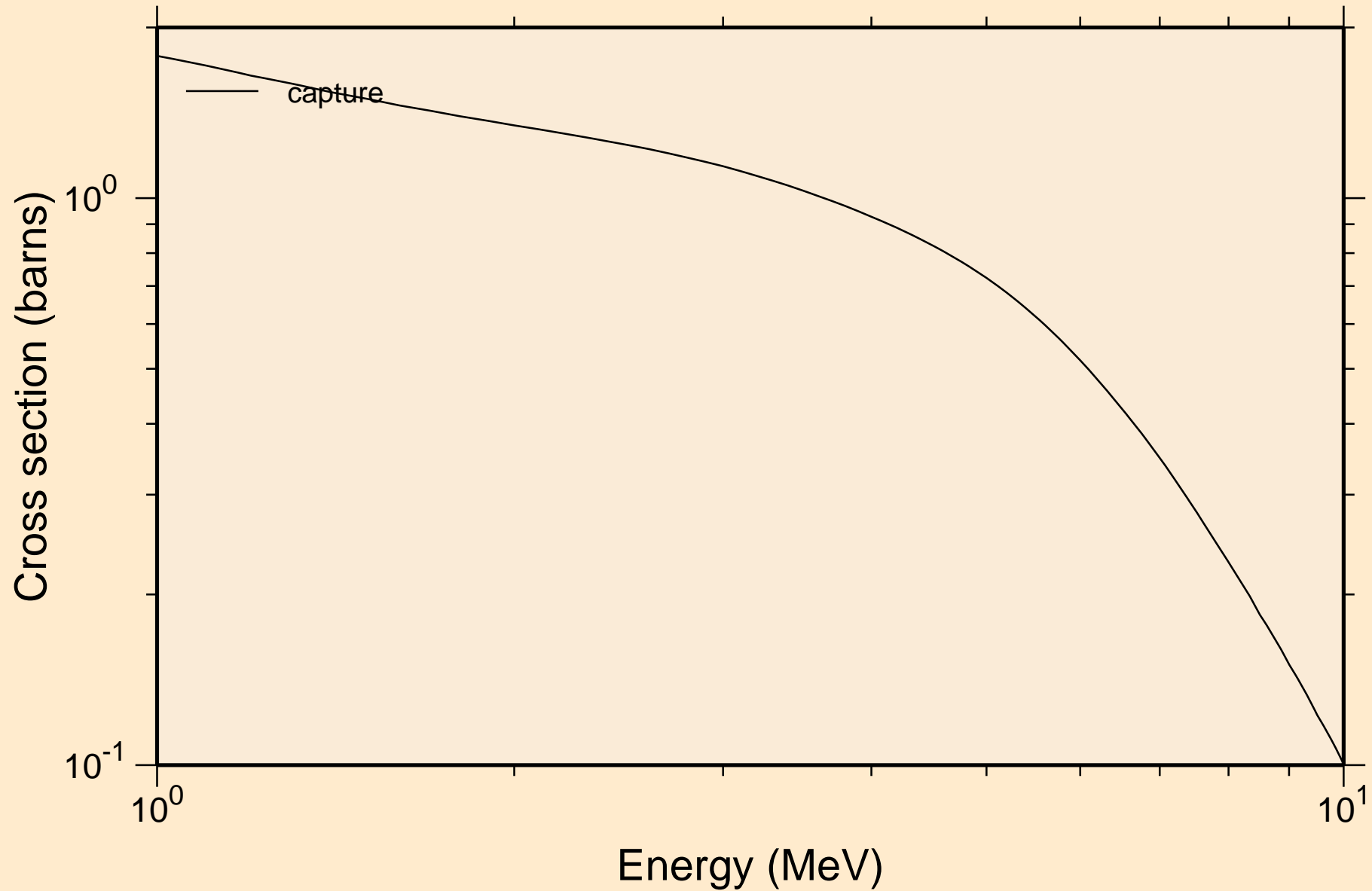

IR171M NRG TENDL-2015, AKONING  
Non-threshold reactions

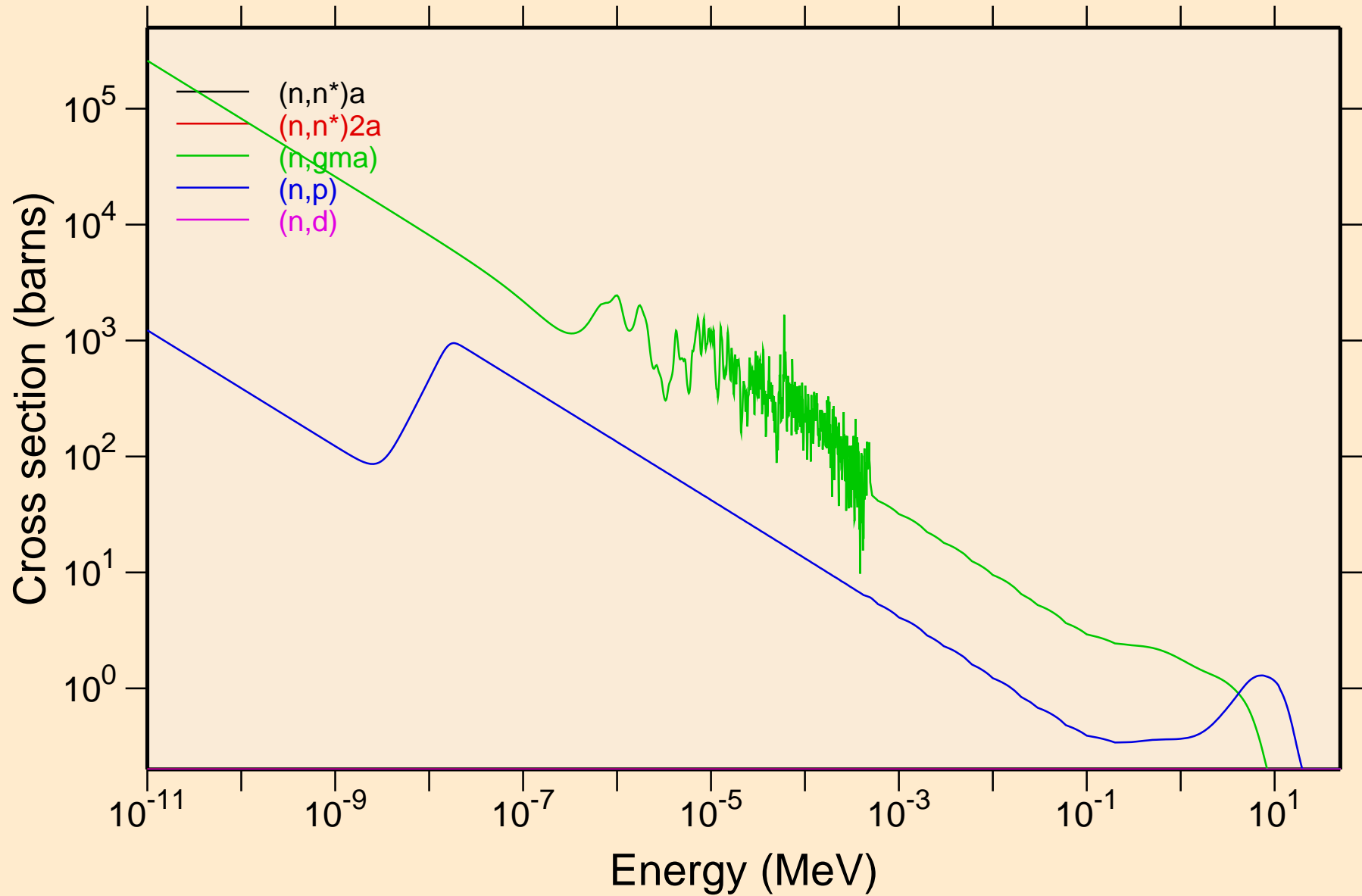

# IR171M NRG TENDL-2015, AKONING

## Non-threshold reactions

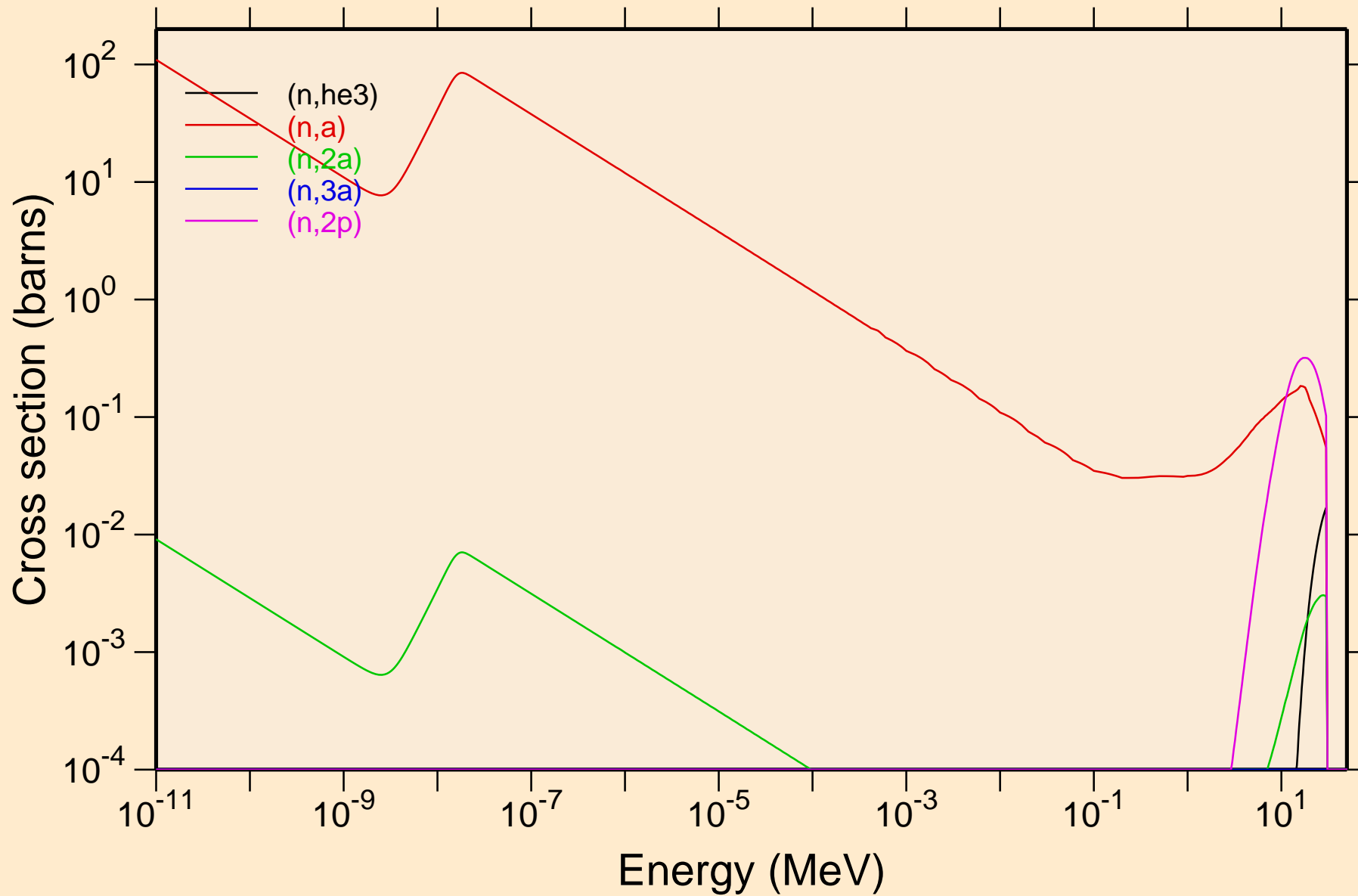

IR171M NRG TENDL-2015, AKONING  
Non-threshold reactions

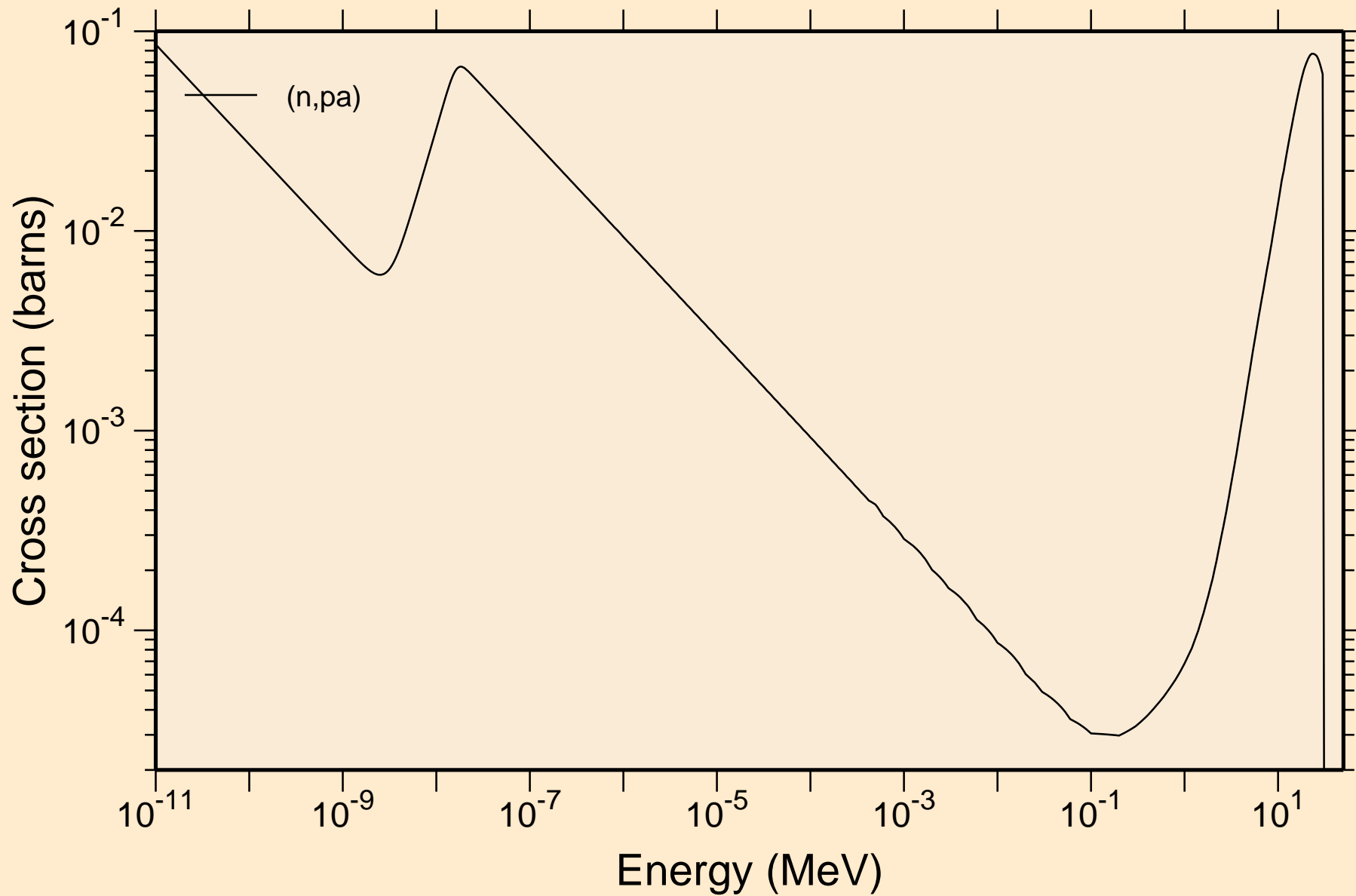

# IR171M NRG TENDL-2015, AKONING

## Principal cross sections

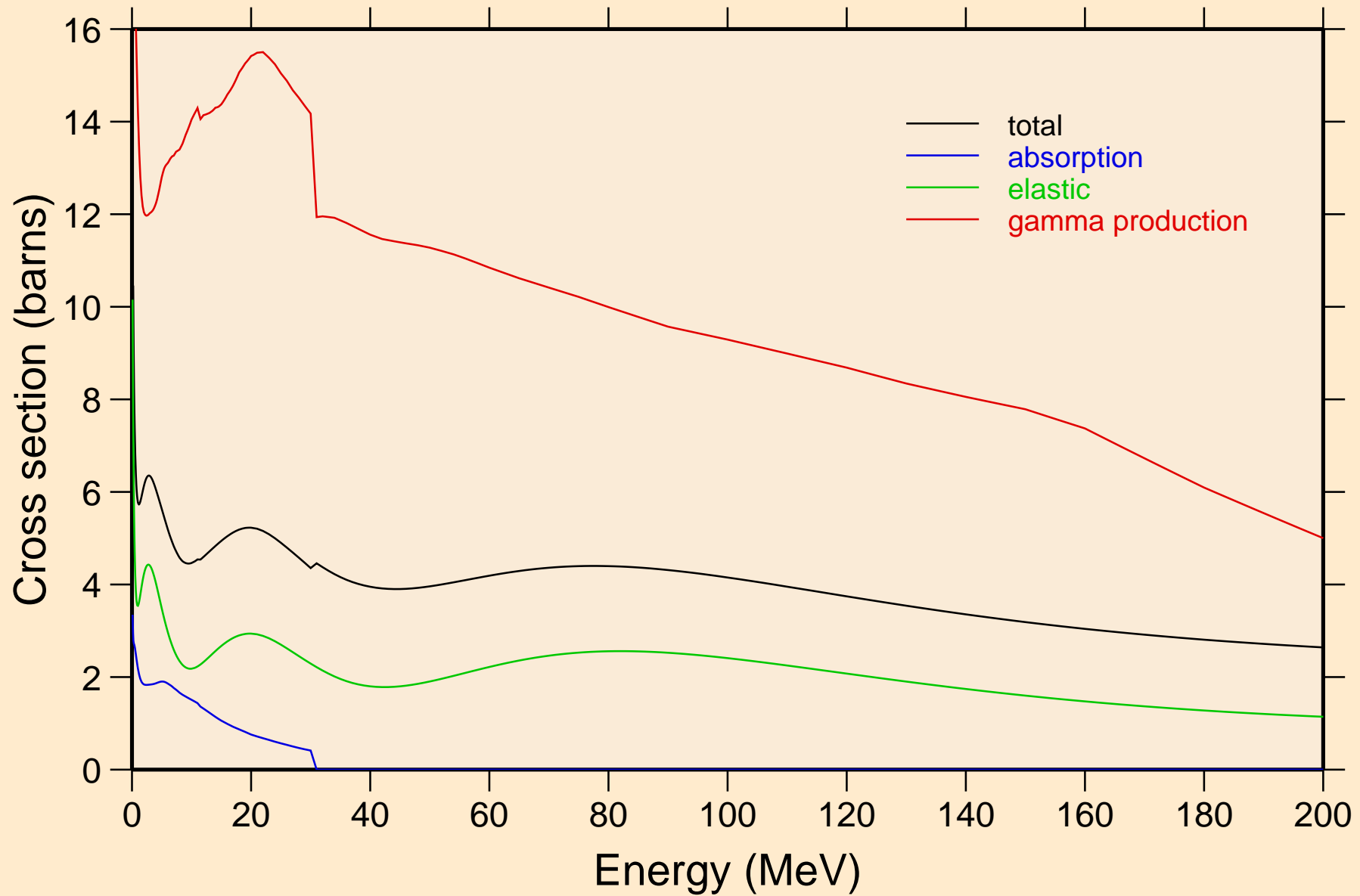

# IR171M NRG TENDL-2015, AKONING

## Non-threshold reactions

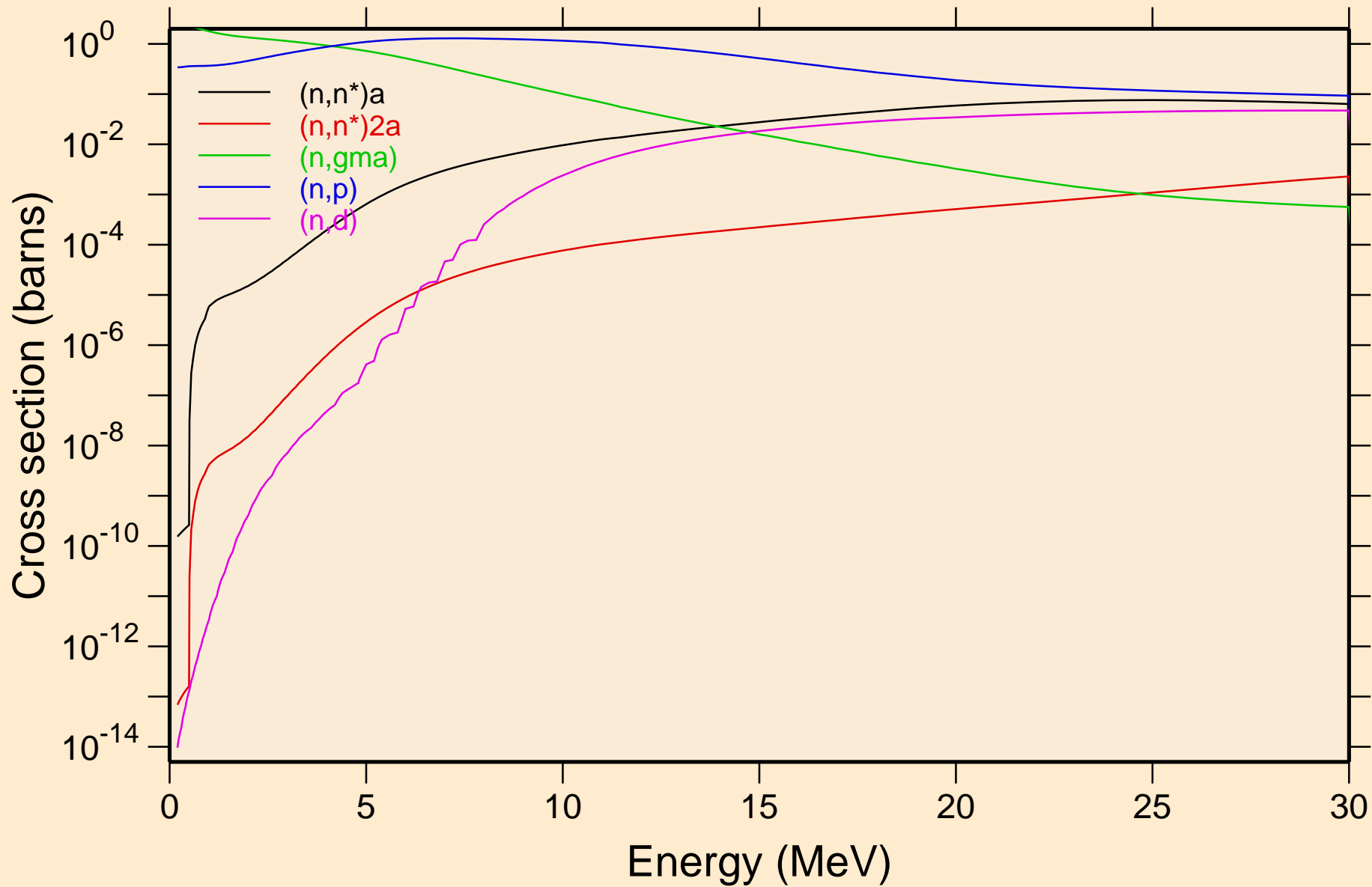

# IR171M NRG TENDL-2015, AKONING

## Non-threshold reactions

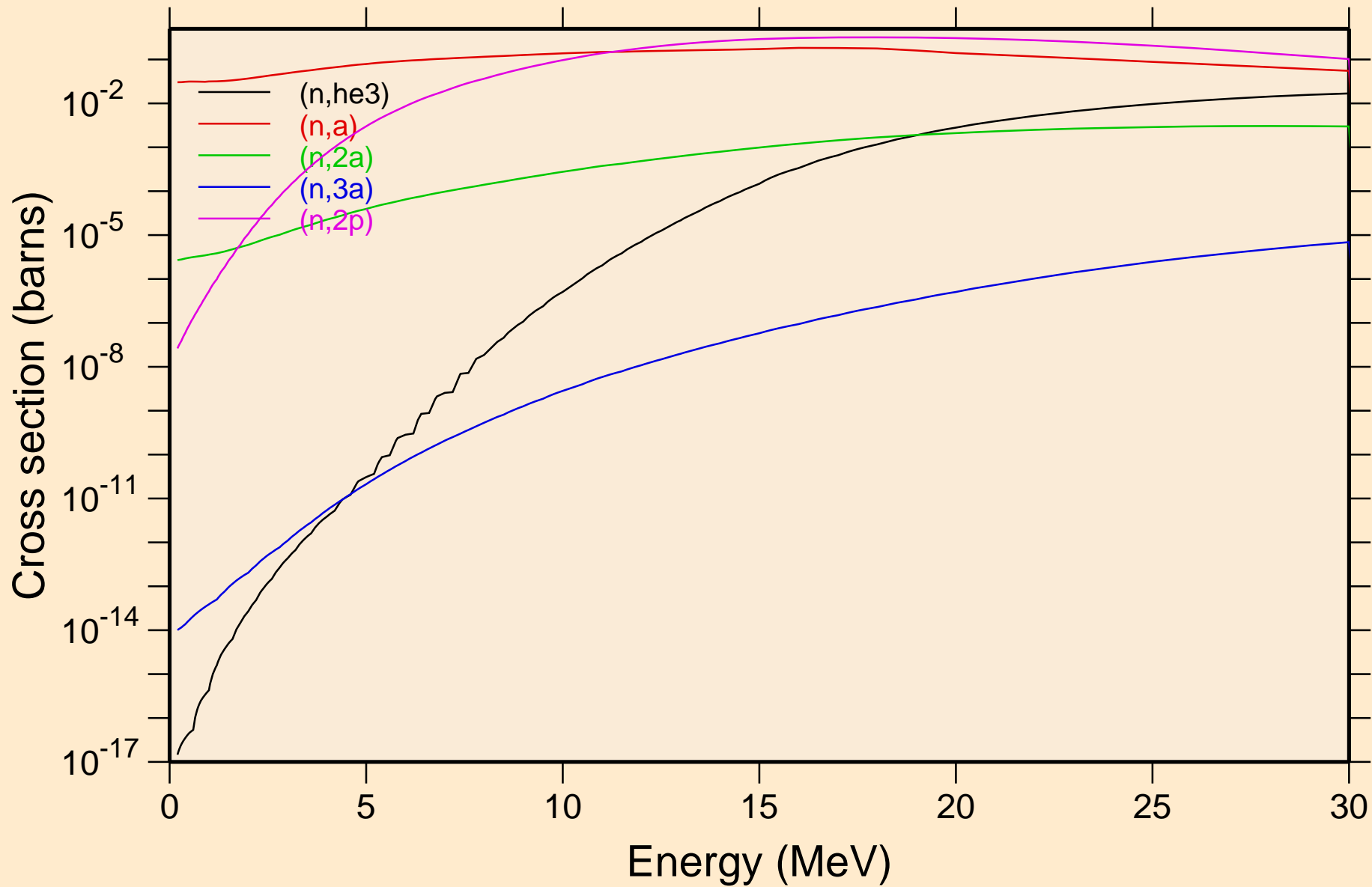

IR171M NRG TENDL-2015, AKONING  
Non-threshold reactions

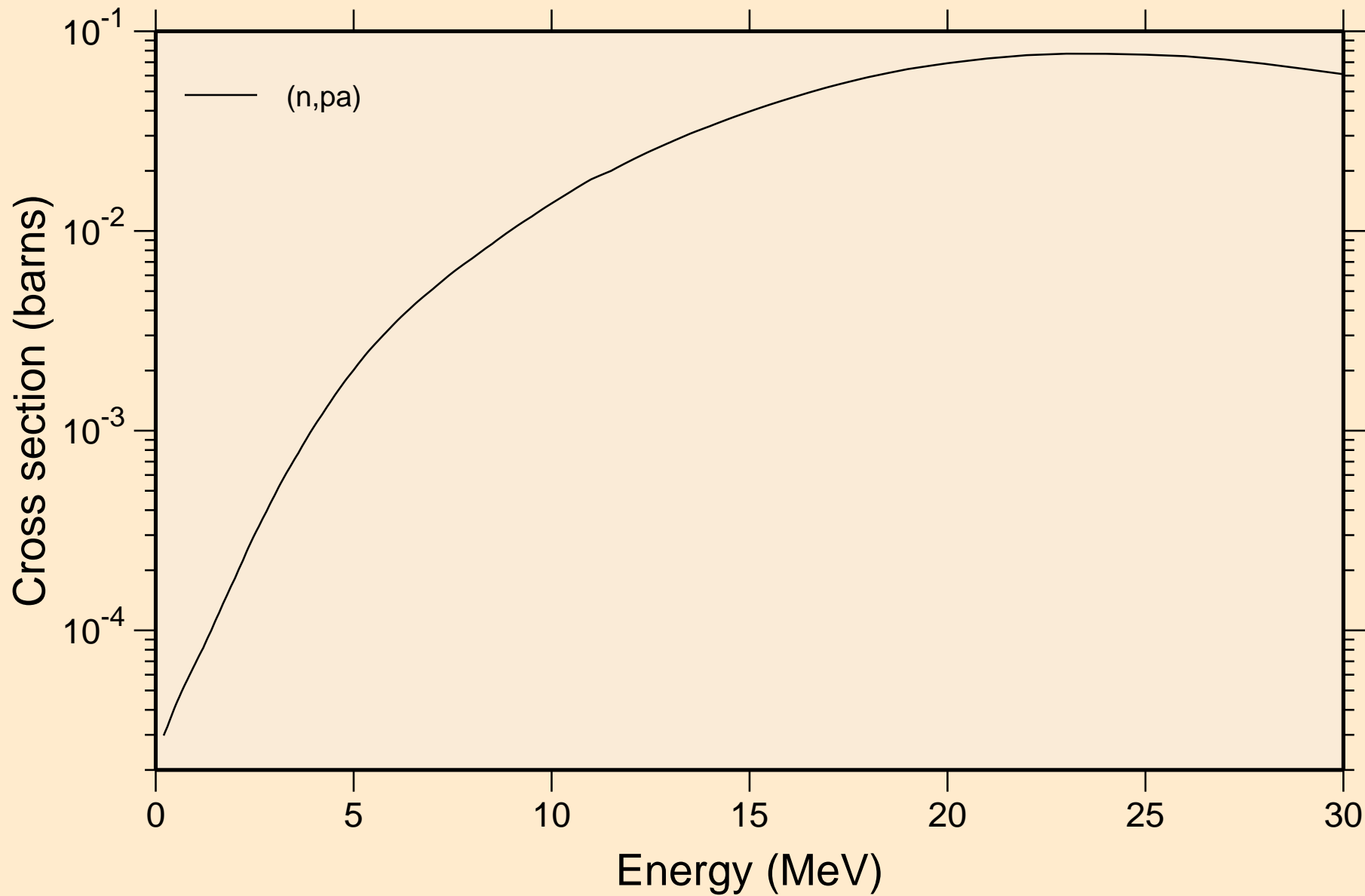



# IR171M NRG TENDL-2015, AKONING

## Inelastic levels

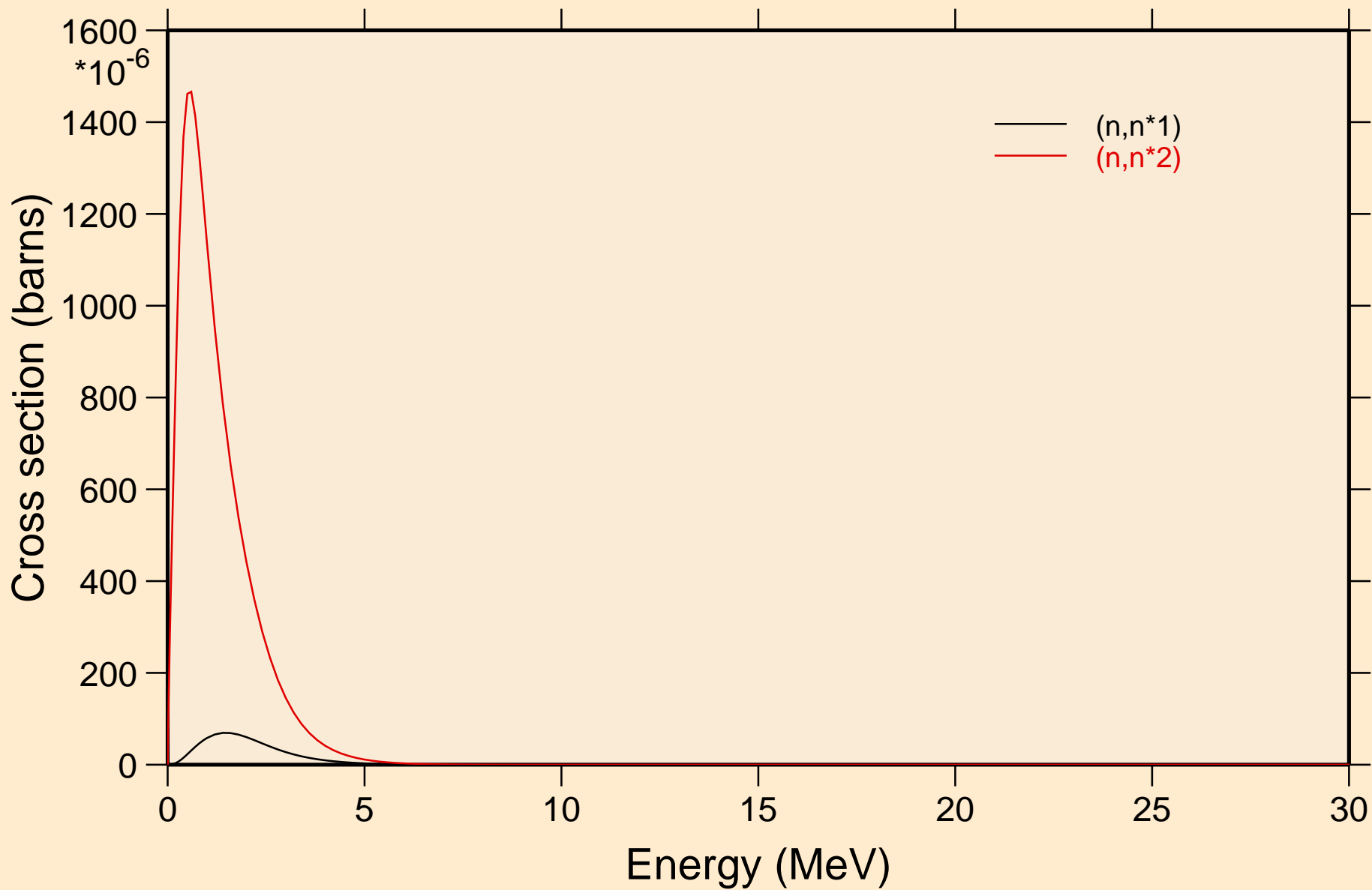

# IR171M NRG TENDL-2015, AKONING

## Threshold reactions

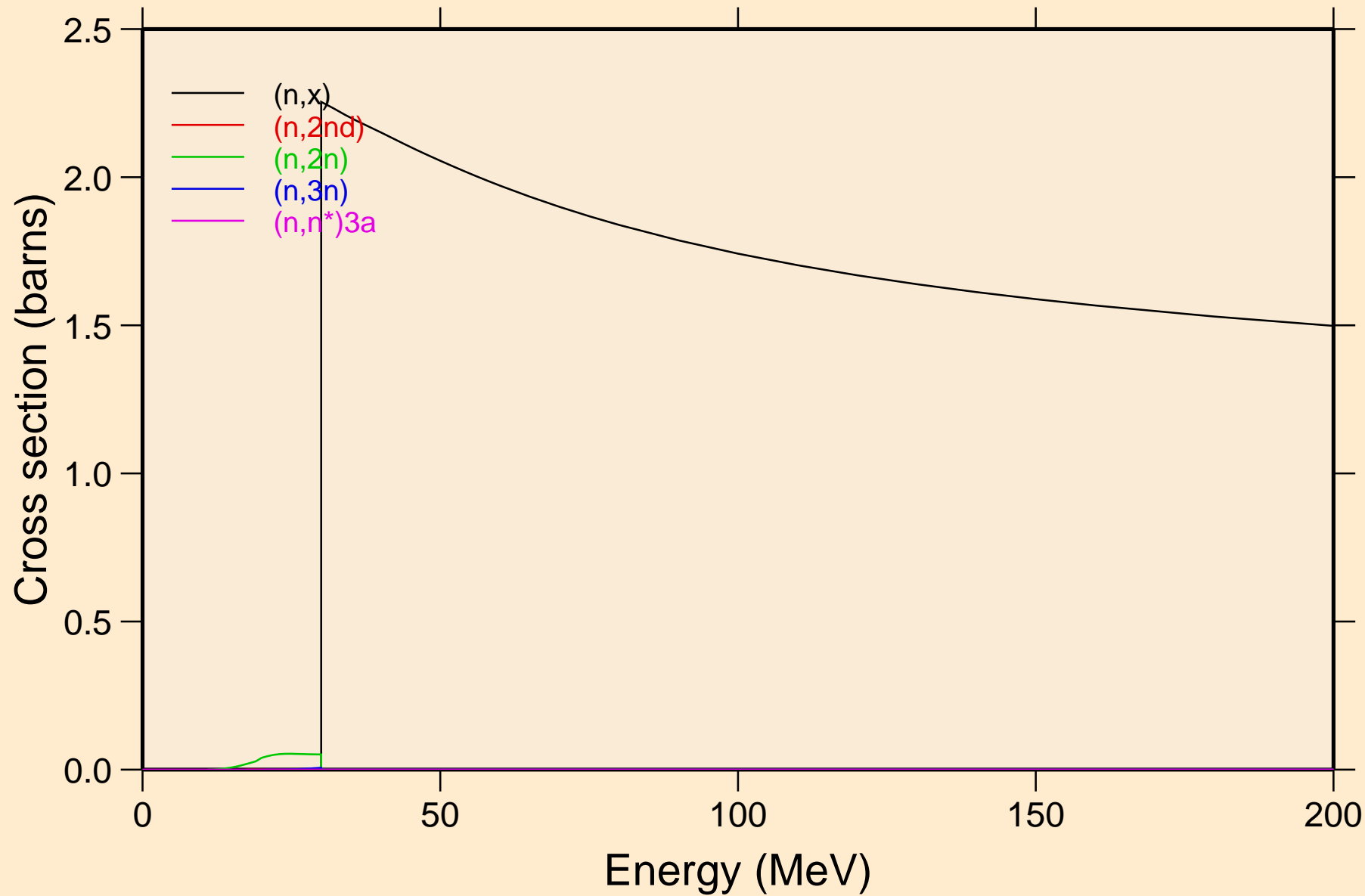

# IR171M NRG TENDL-2015, AKONING

## Threshold reactions

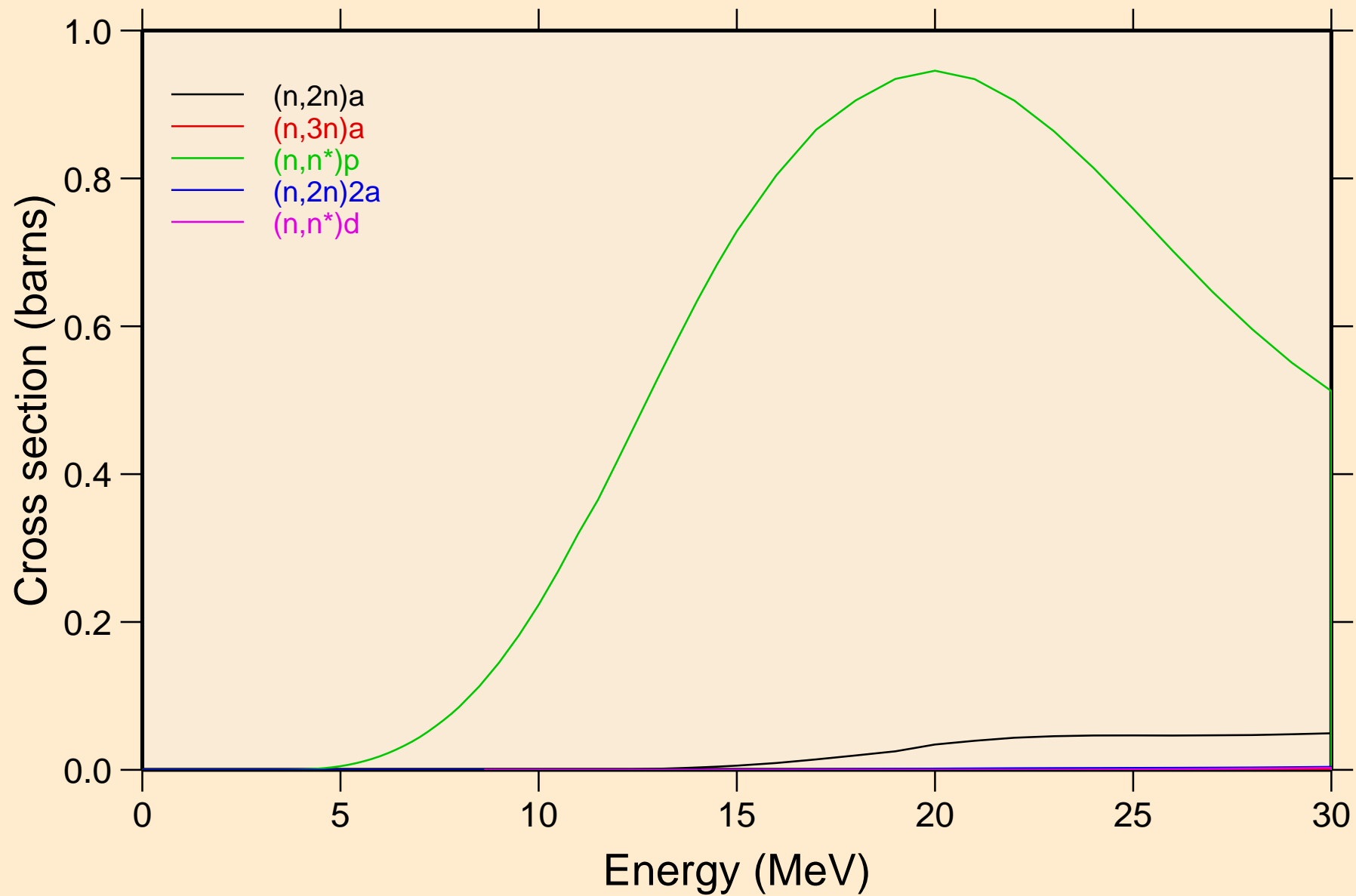

# IR171M NRG TENDL-2015, AKONING

## Threshold reactions

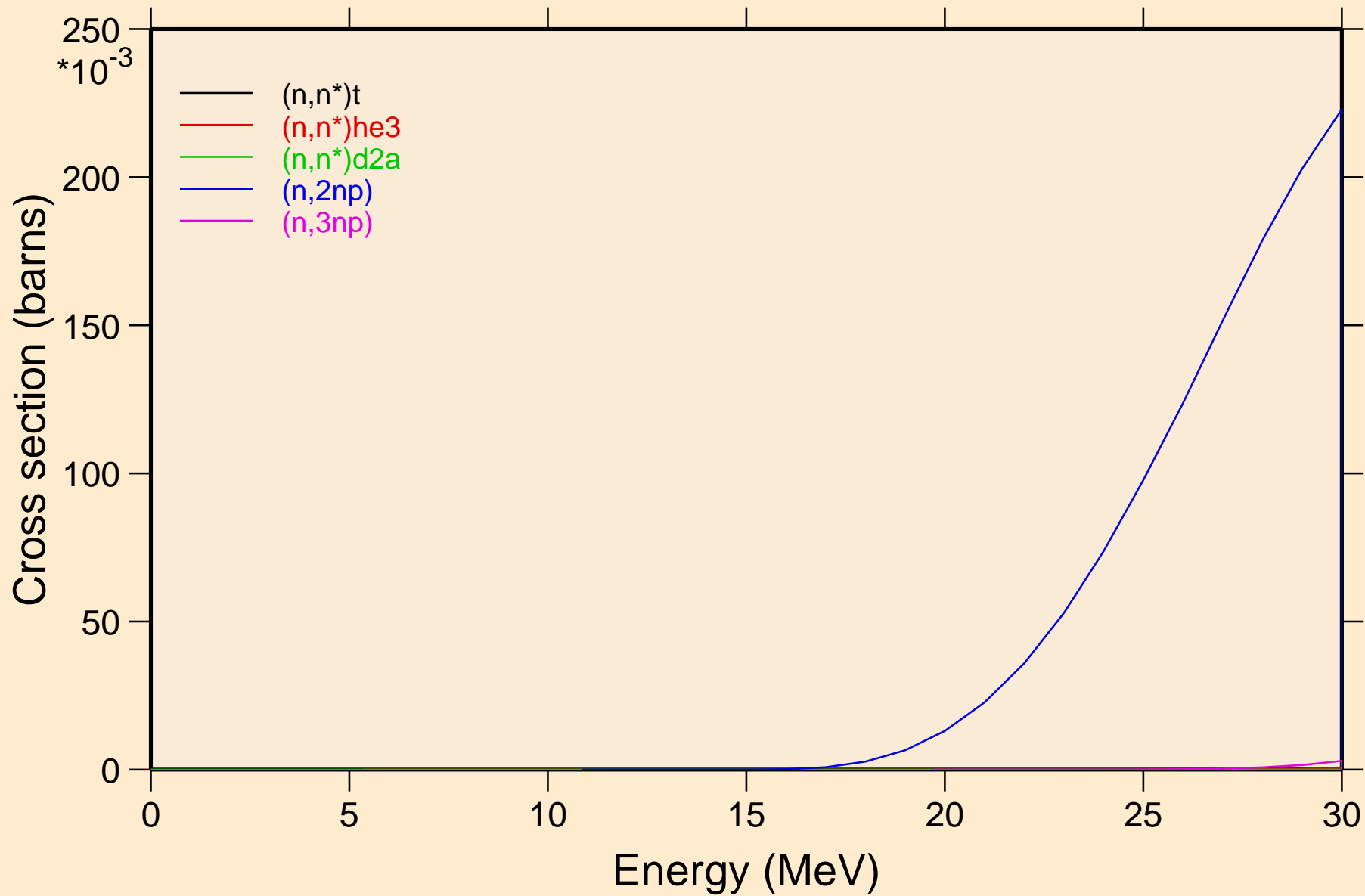

# IR171M NRG TENDL-2015, AKONING

## Threshold reactions

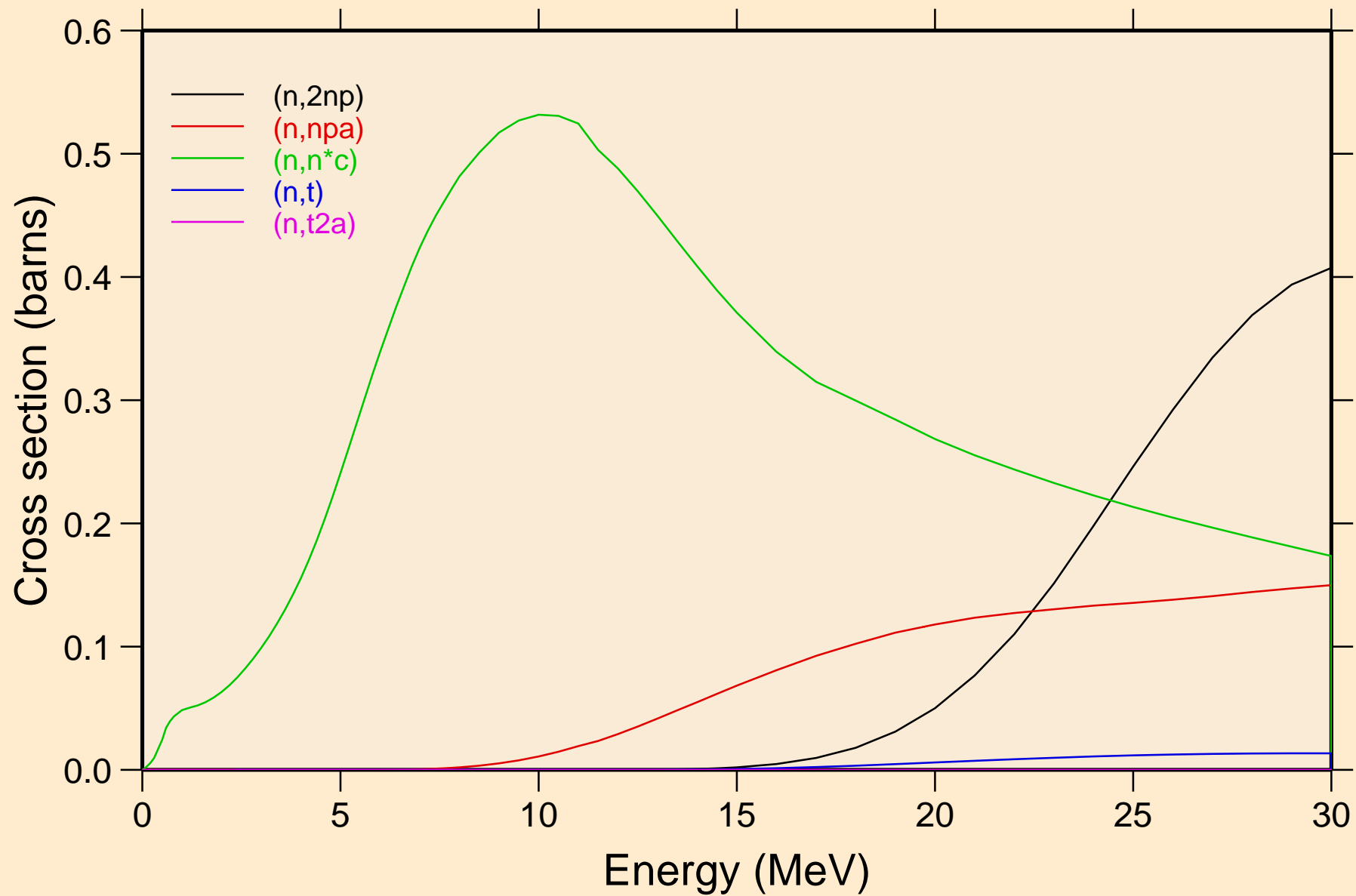

# IR171M NRG TENDL-2015, AKONING

## Threshold reactions

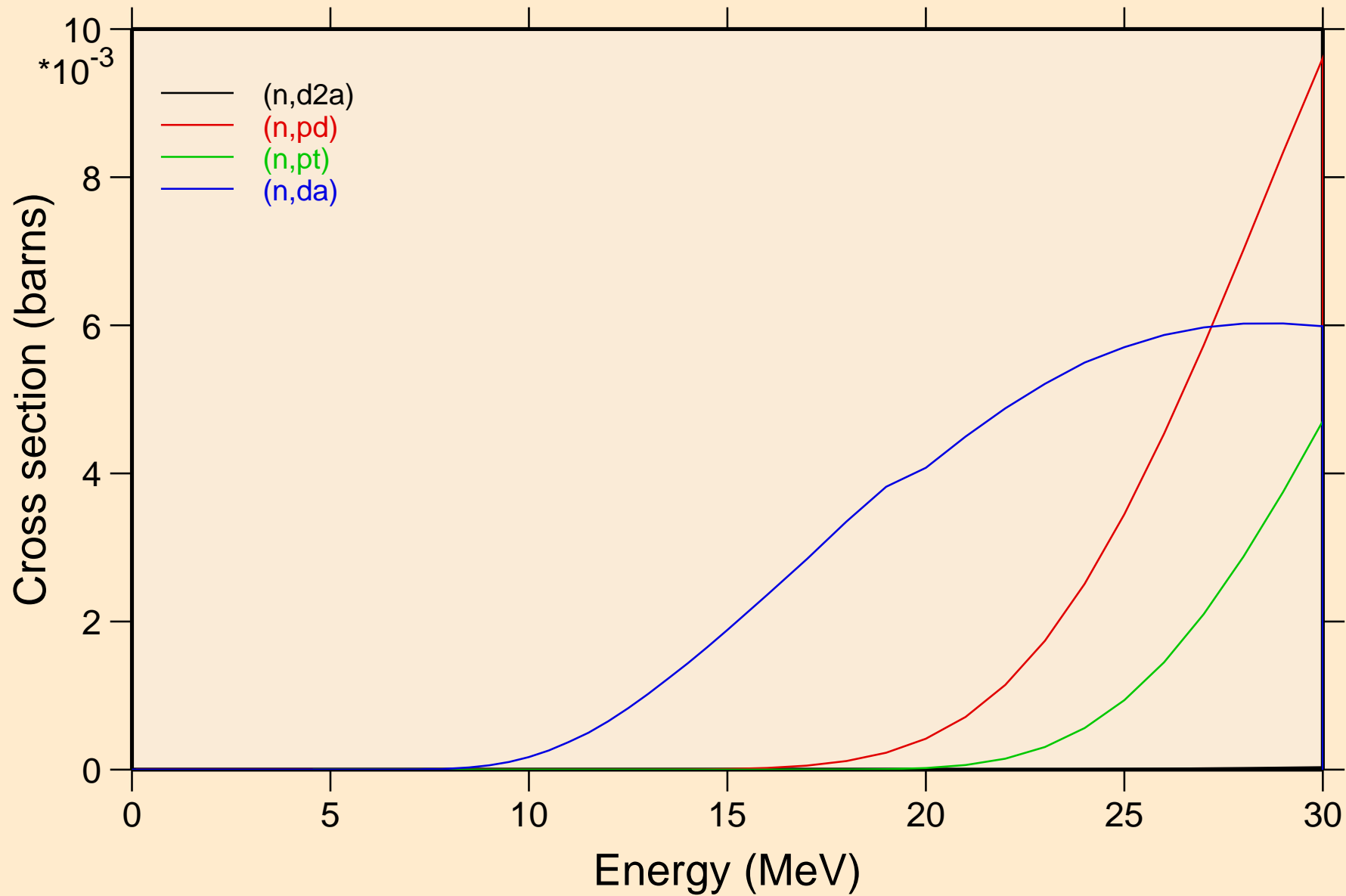

IR171M NRG TENDL-2015, AKONING  
angular distribution for elastic

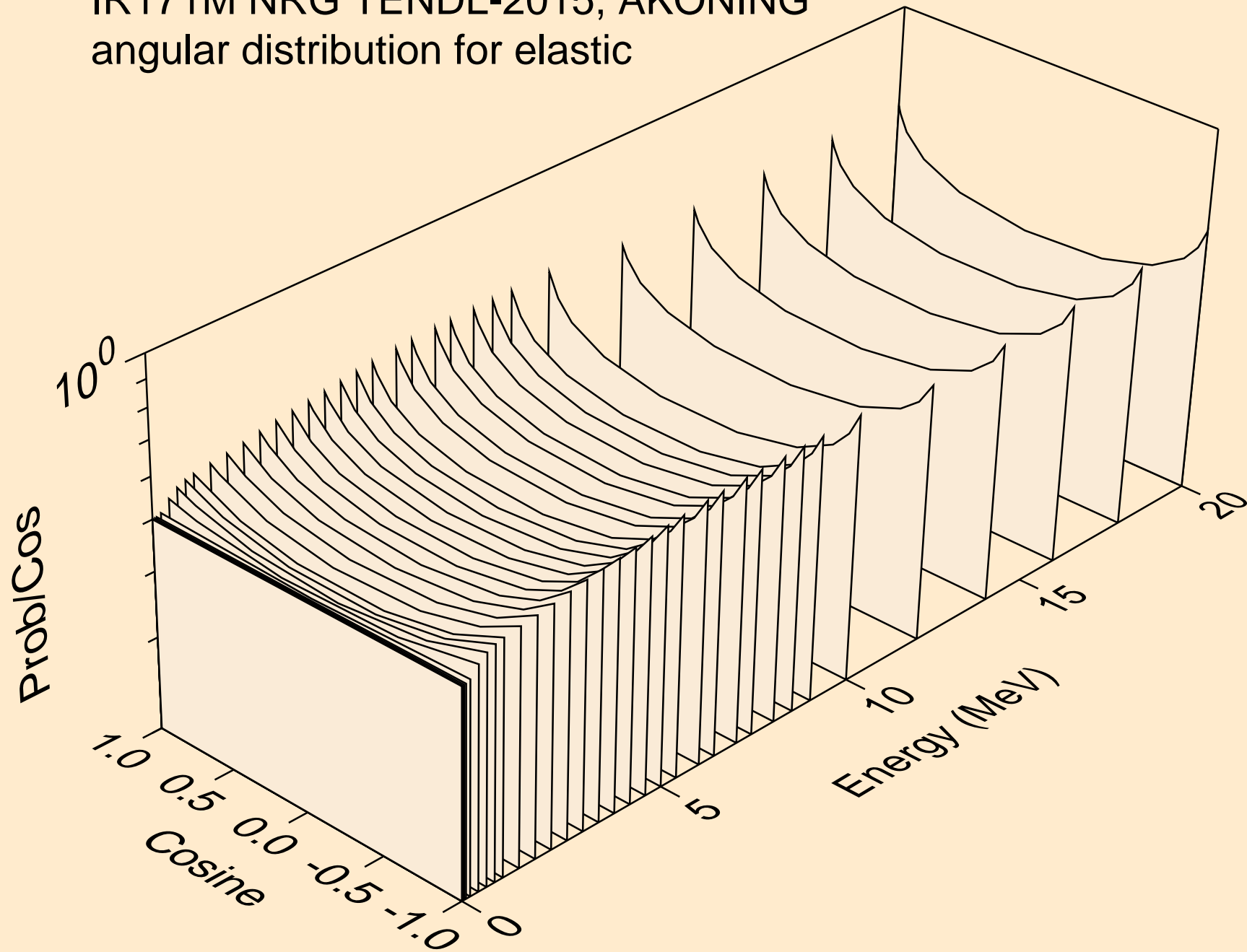

IR171M NRG TENDL-2015, AKONING  
angular distribution for elastic

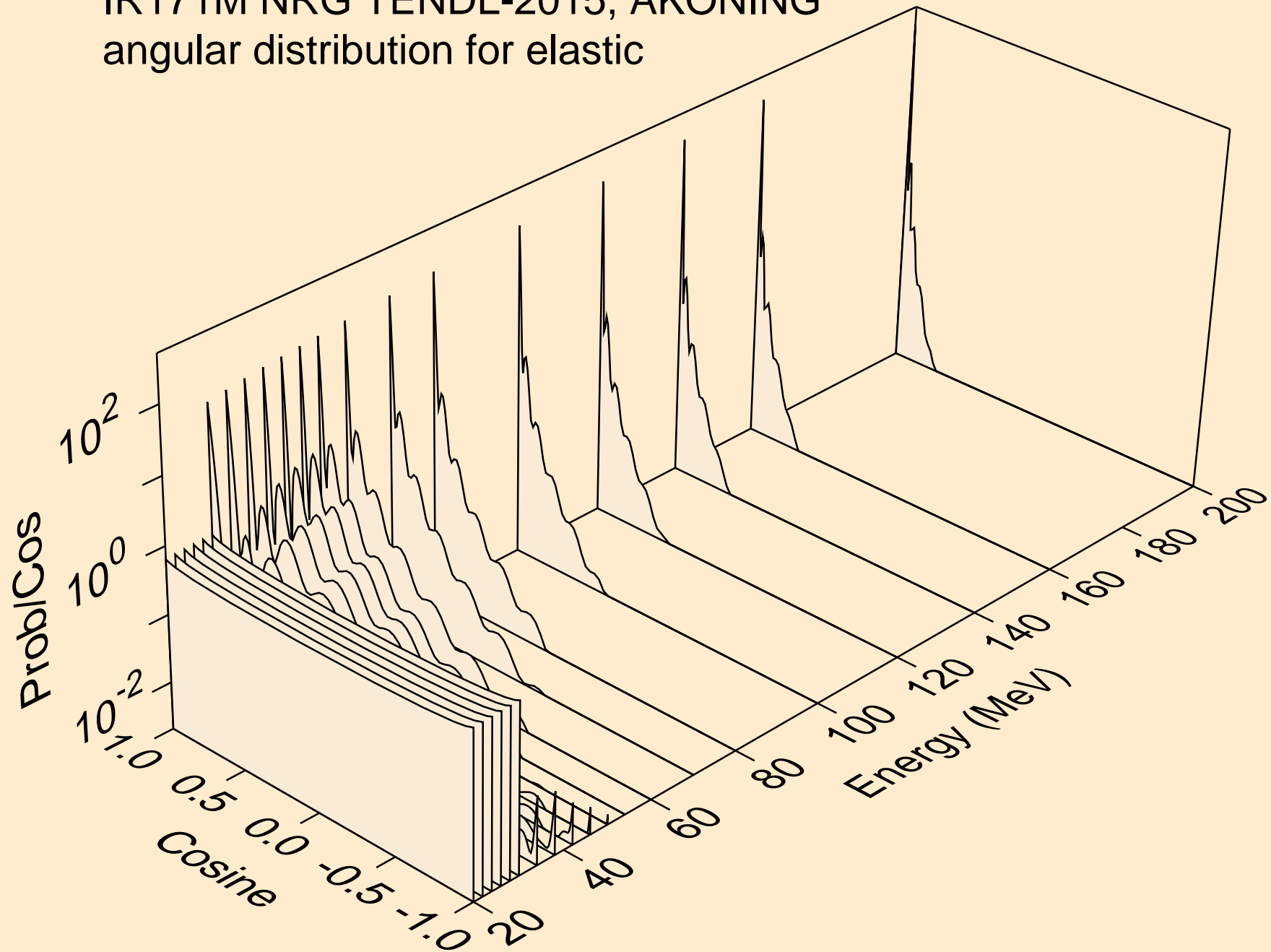



IR171M NRG TENDL-2015, AKONING  
angular distribution for (n,n\*1)

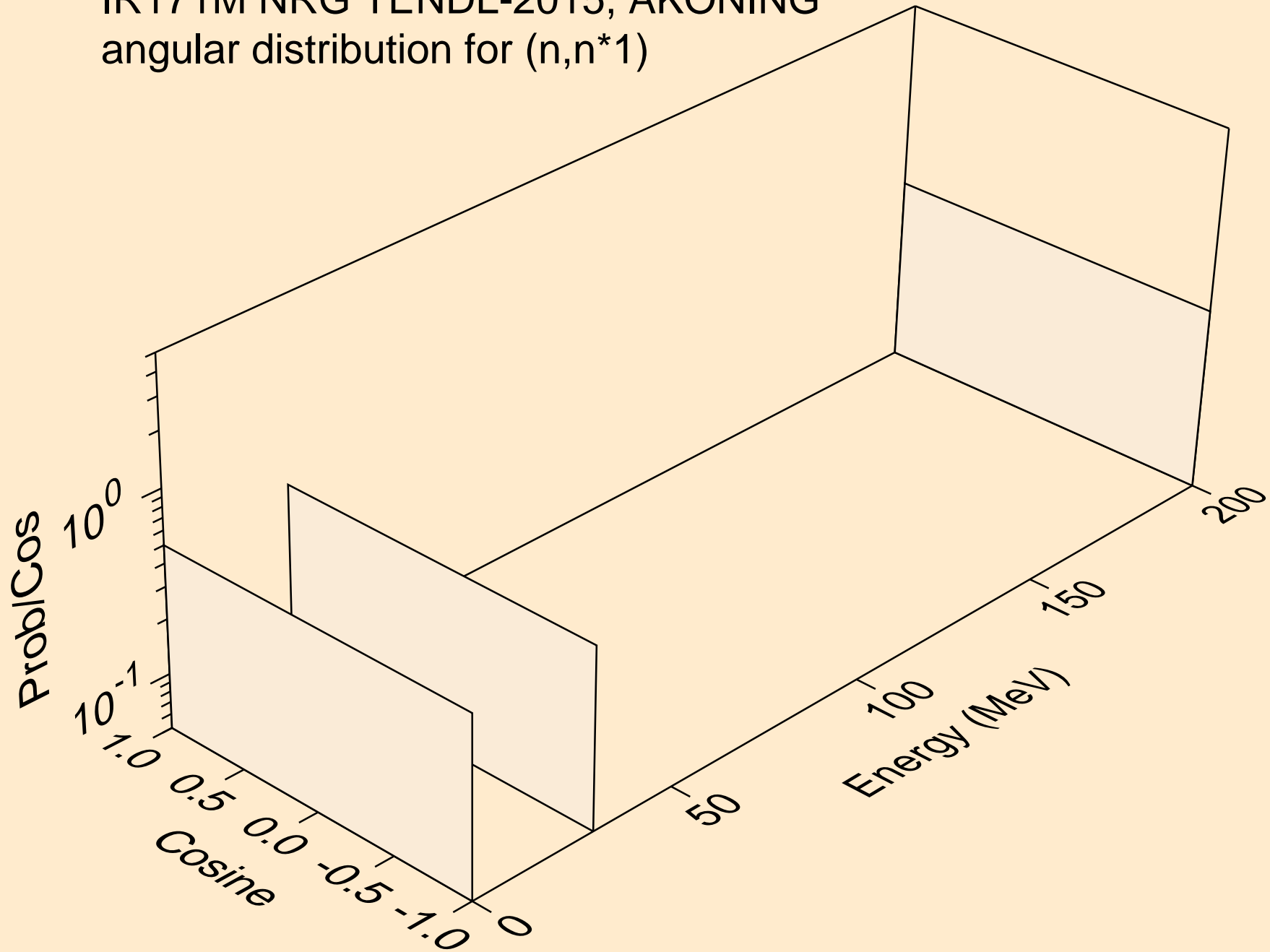

IR171M NRG TENDL-2015, AKONING  
angular distribution for (n,n\*2)

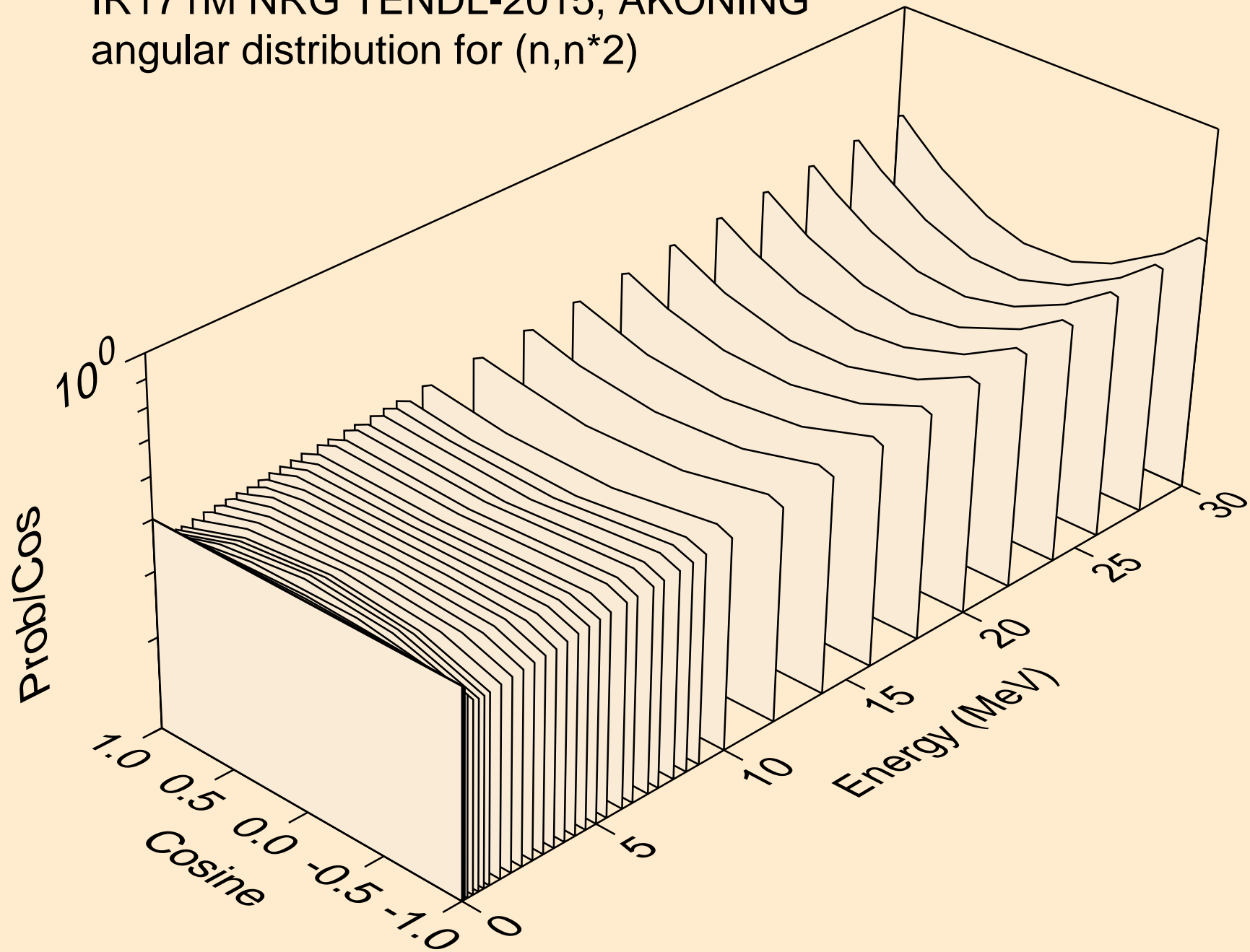

IR171M NRG TENDL-2015, AKONING  
Neutron emission for (n,x)

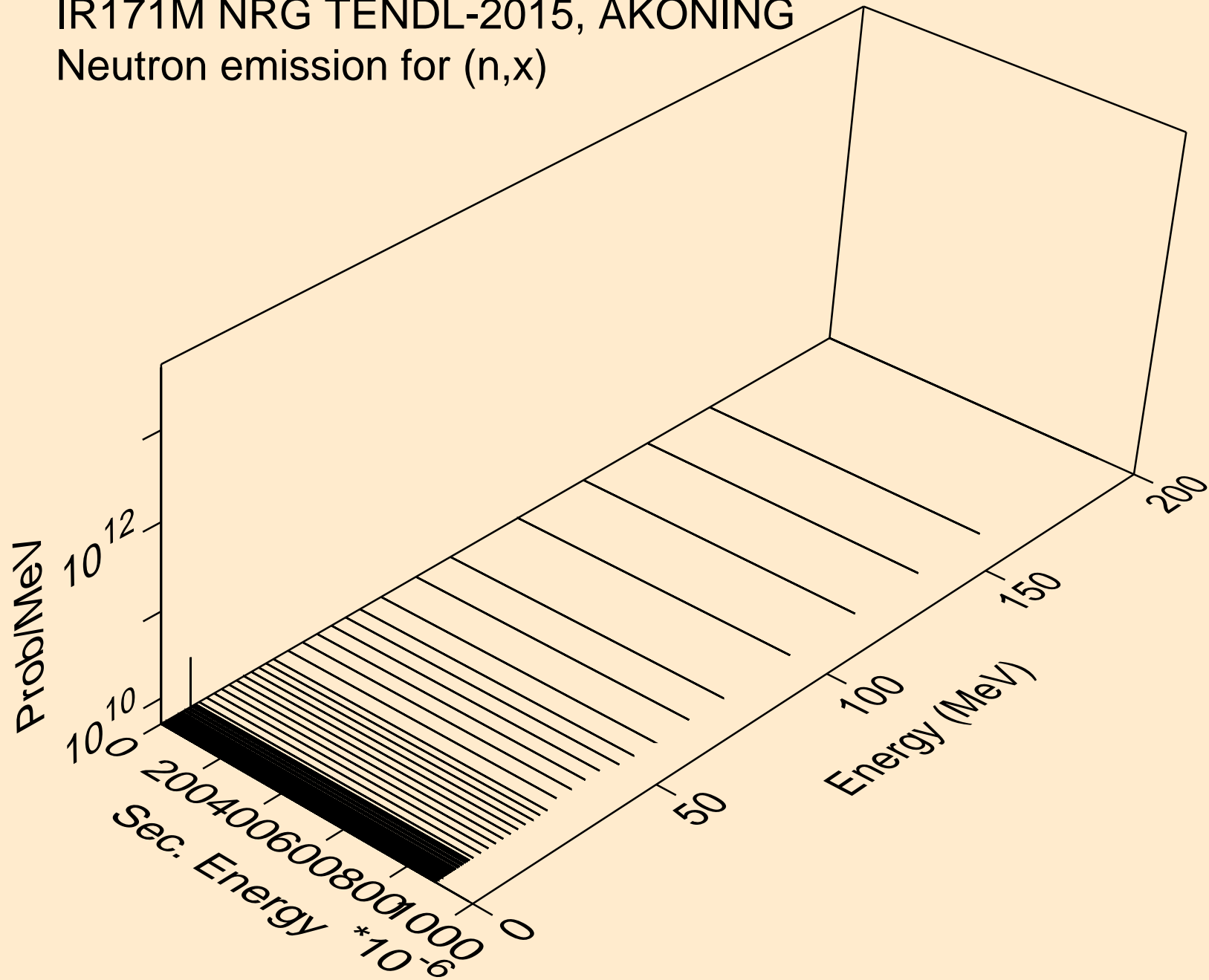

IR171M NRG TENDL-2015, AKONING  
Neutron emission for (n,2nd)

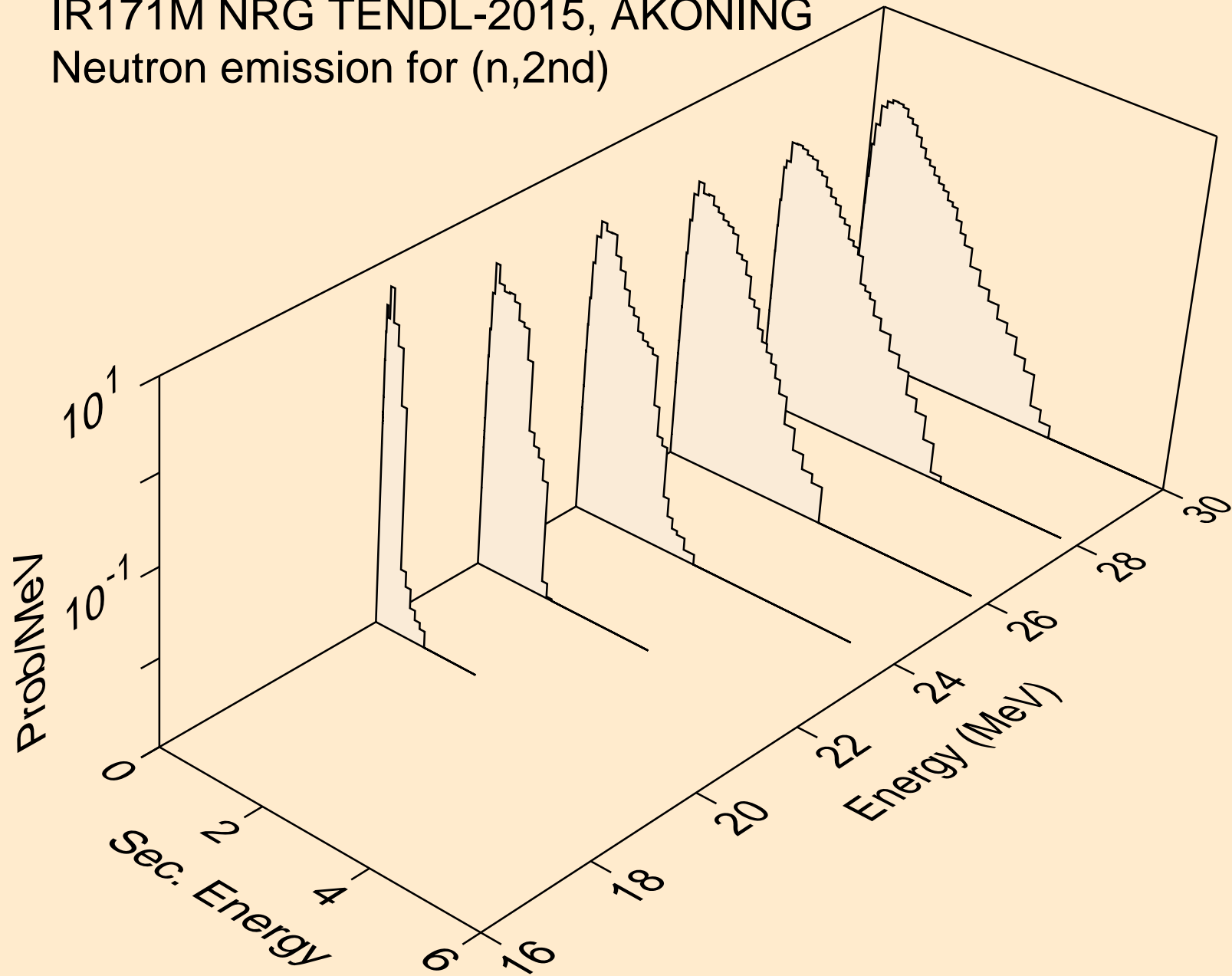

IR171M NRG TENDL-2015, AKONING  
Neutron emission for (n,2n)

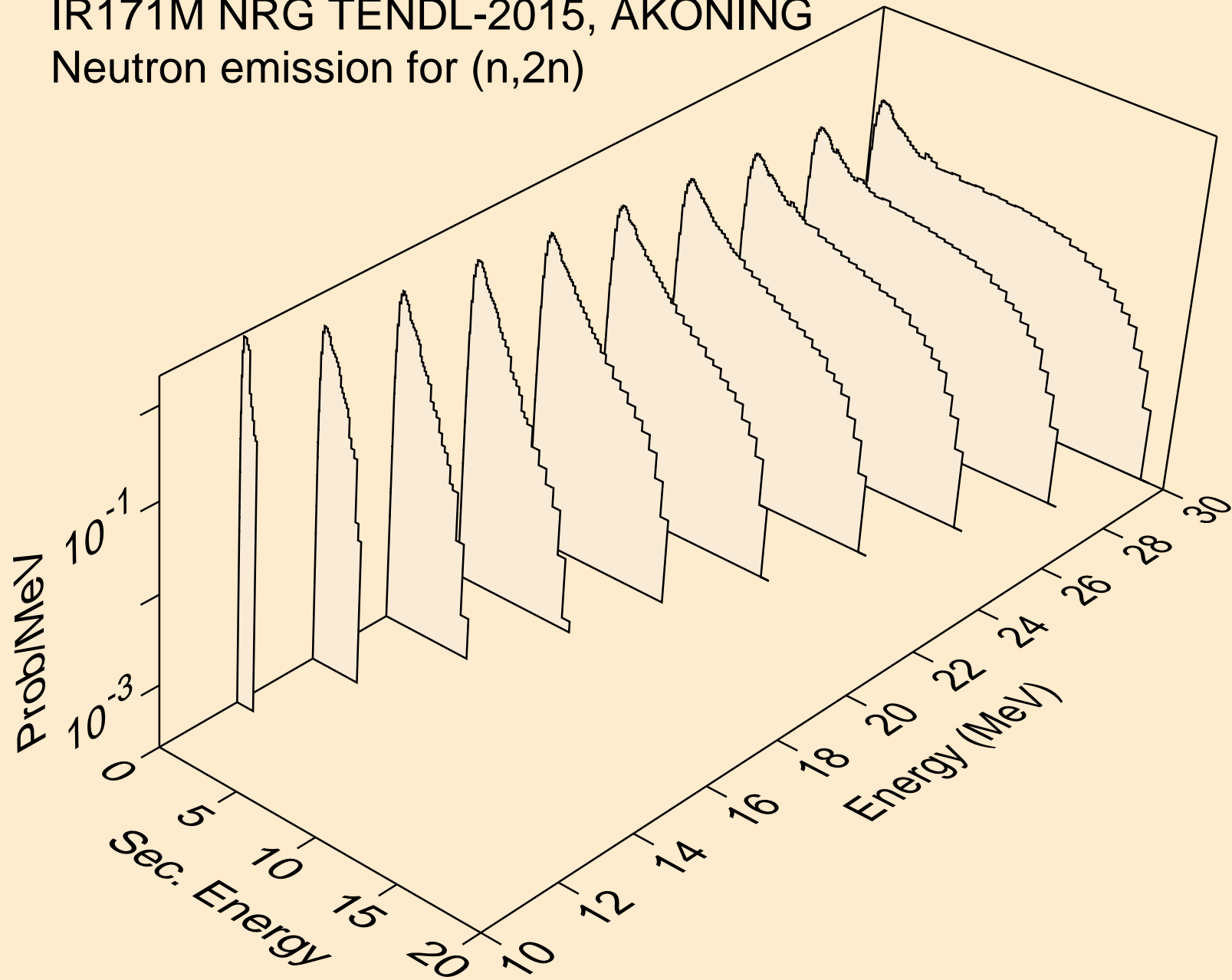

IR171M NRG TENDL-2015, AKONING  
Neutron emission for (n,3n)

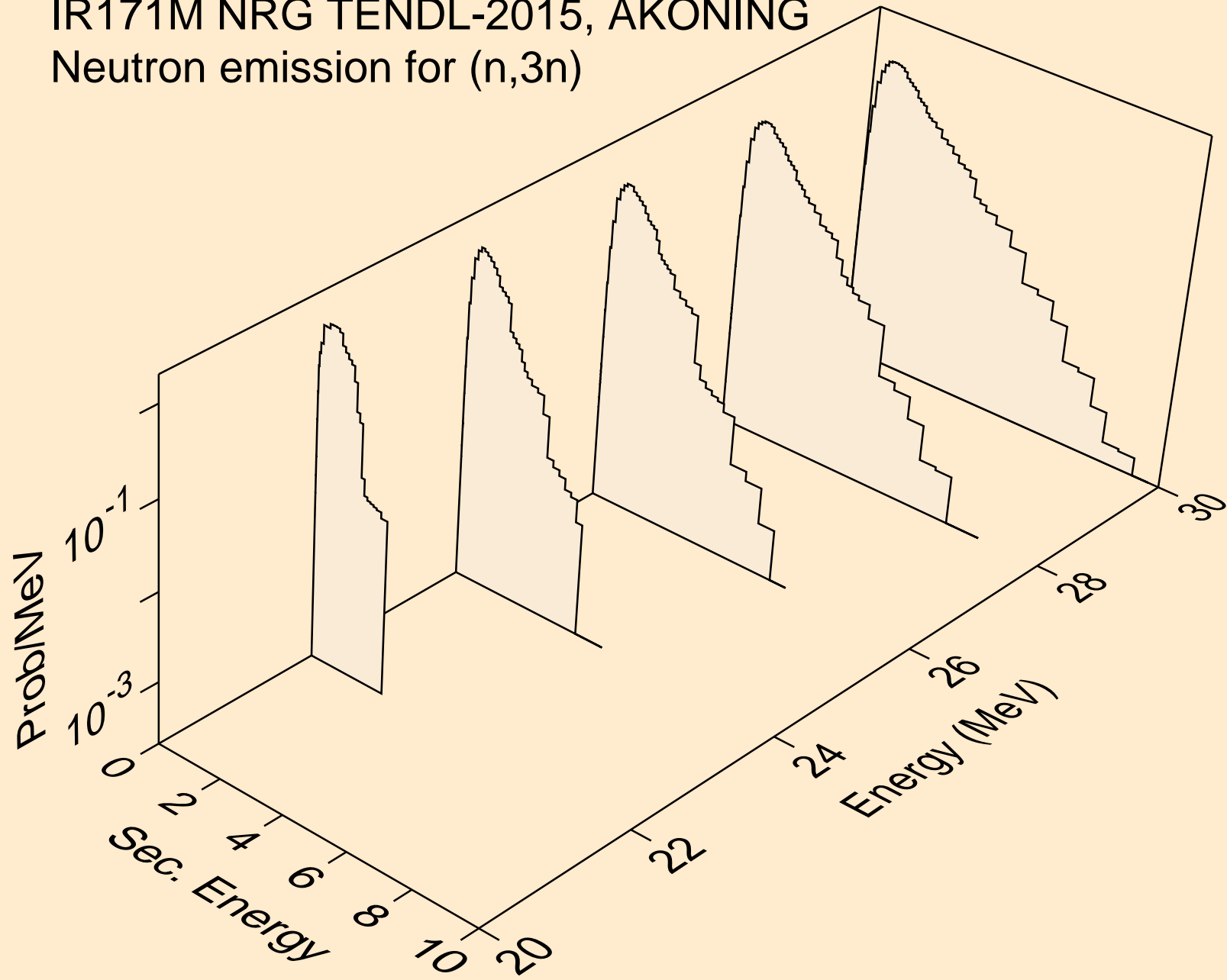

IR171M NRG TENDL-2015, AKONING  
Neutron emission for (n,n\*)a

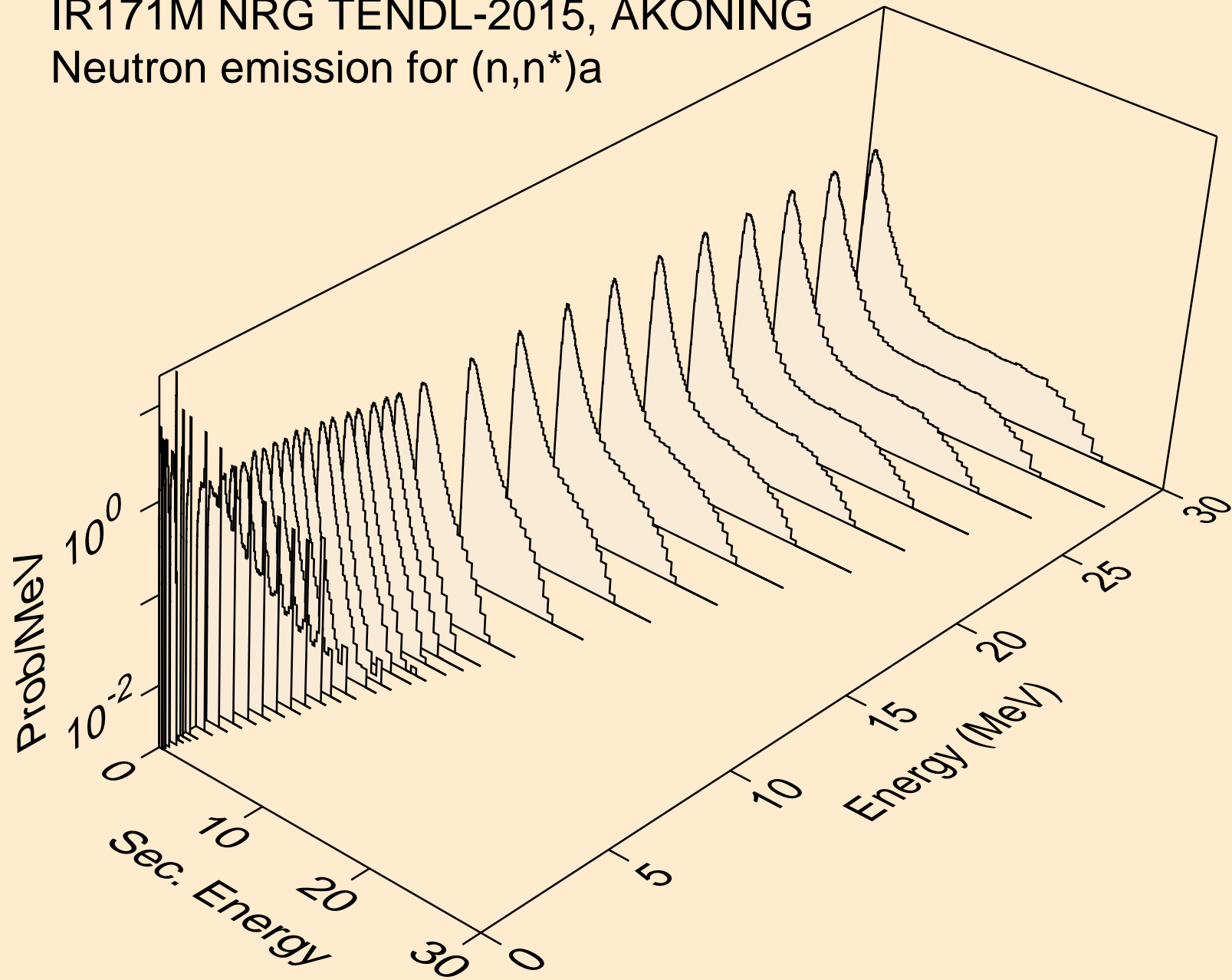

IR171M NRG TENDL-2015, AKONING  
Neutron emission for (n,n\*)3a

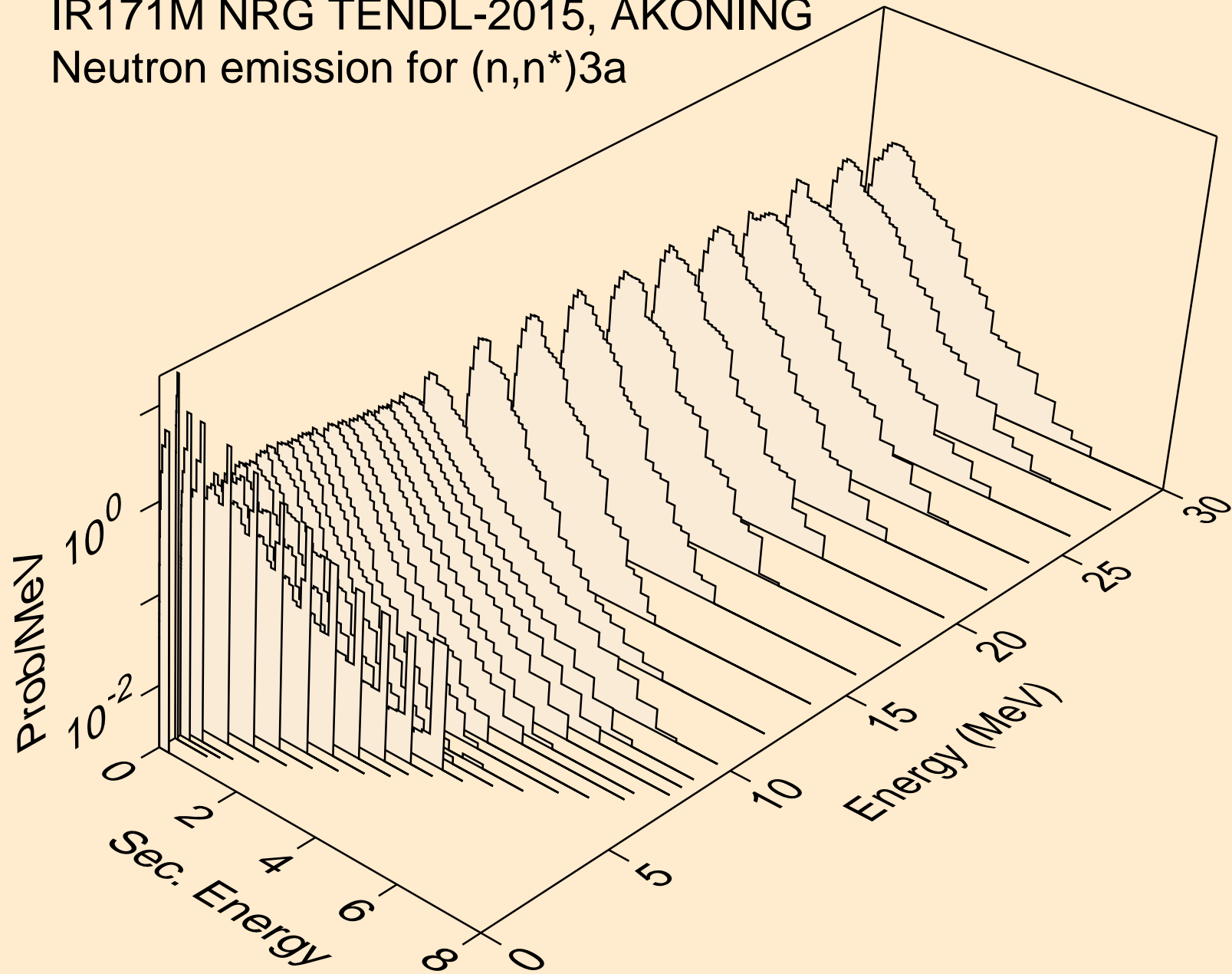



IR171M NRG TENDL-2015, AKONING  
Neutron emission for (n,2n)a

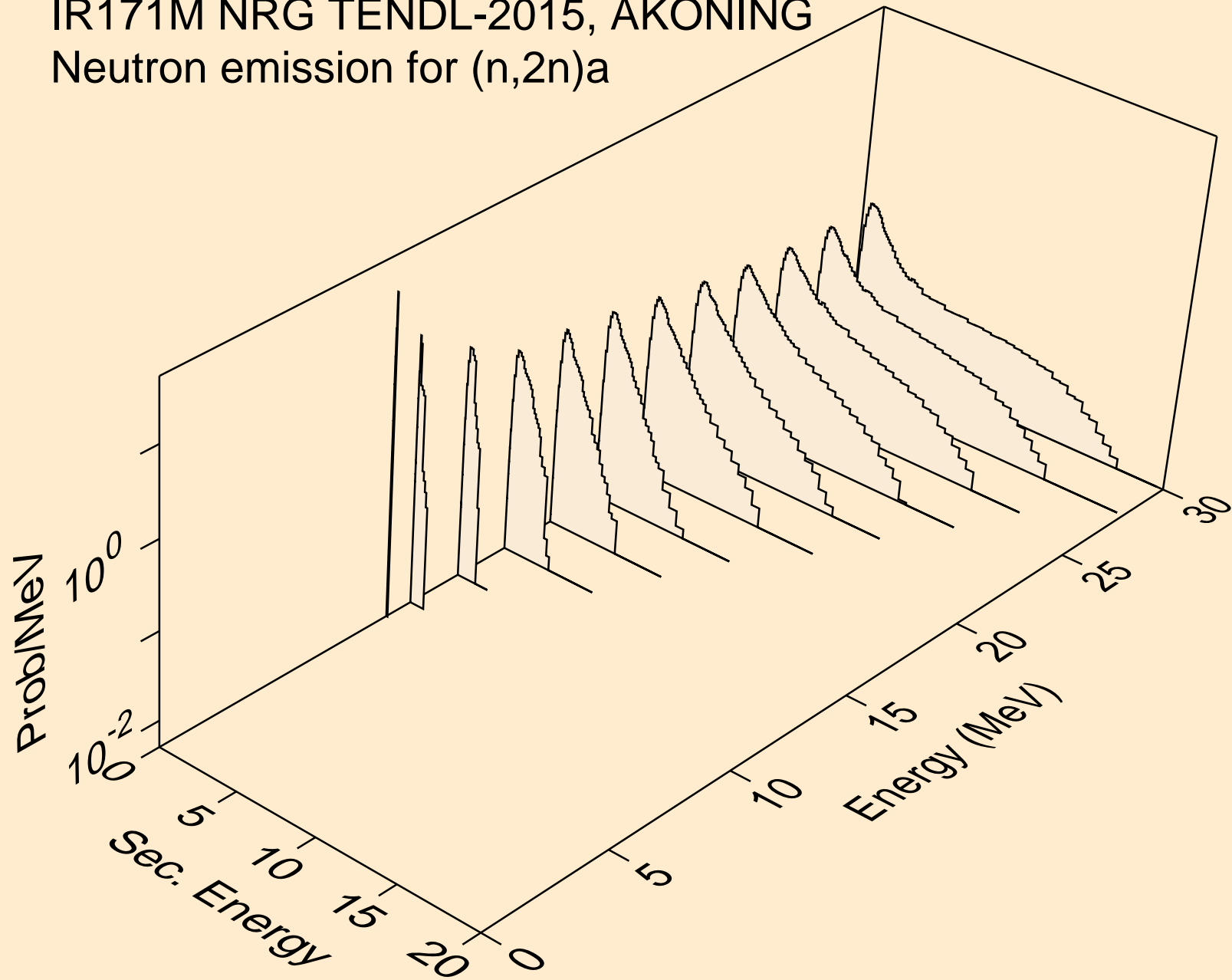

IR171M NRG TENDL-2015, AKONING  
Neutron emission for (n,3n)a

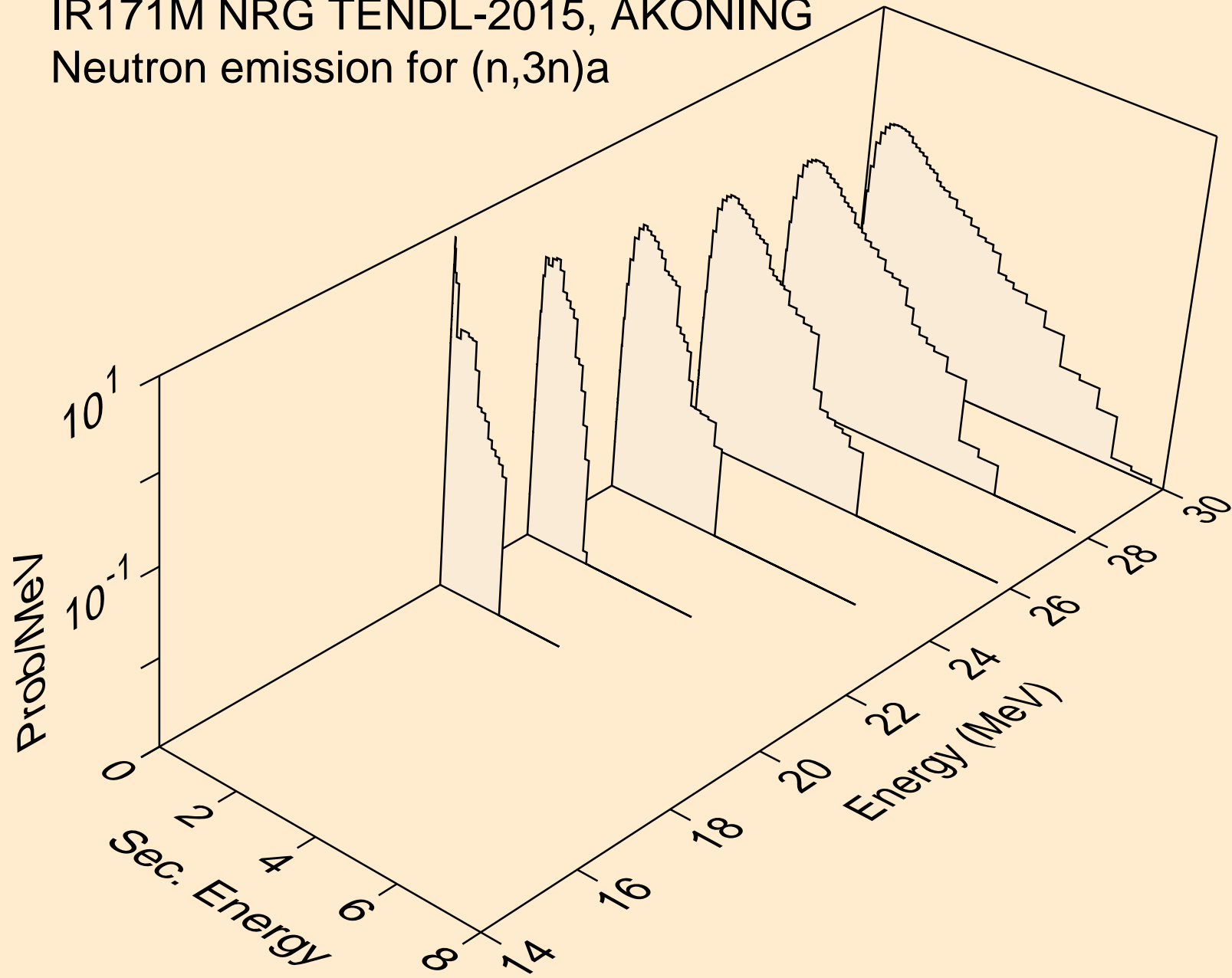

IR171M NRG TENDL-2015, AKONING  
Neutron emission for (n,n\*)p

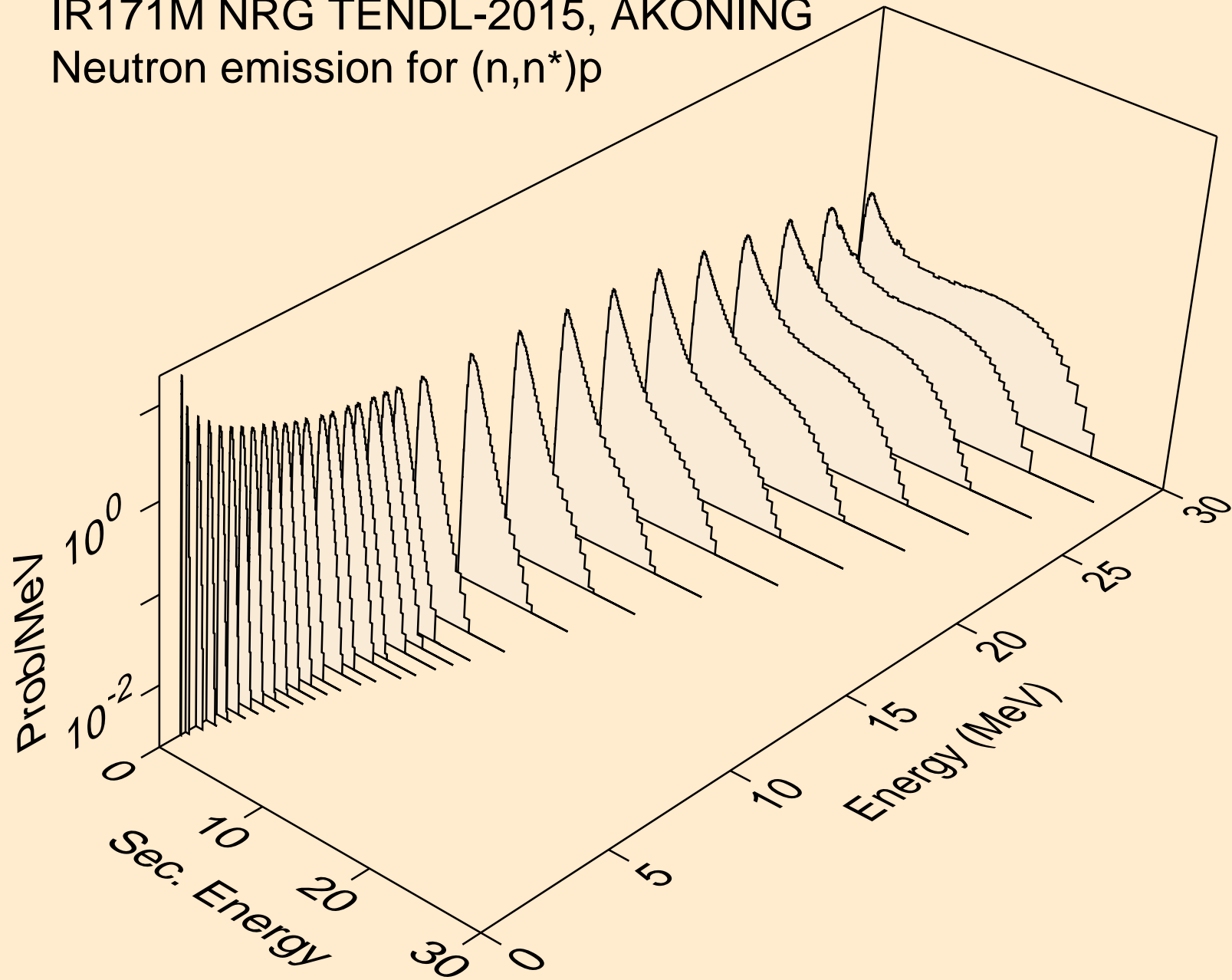

IR171M NRG TENDL-2015, AKONING  
Neutron emission for (n,n\*)2a

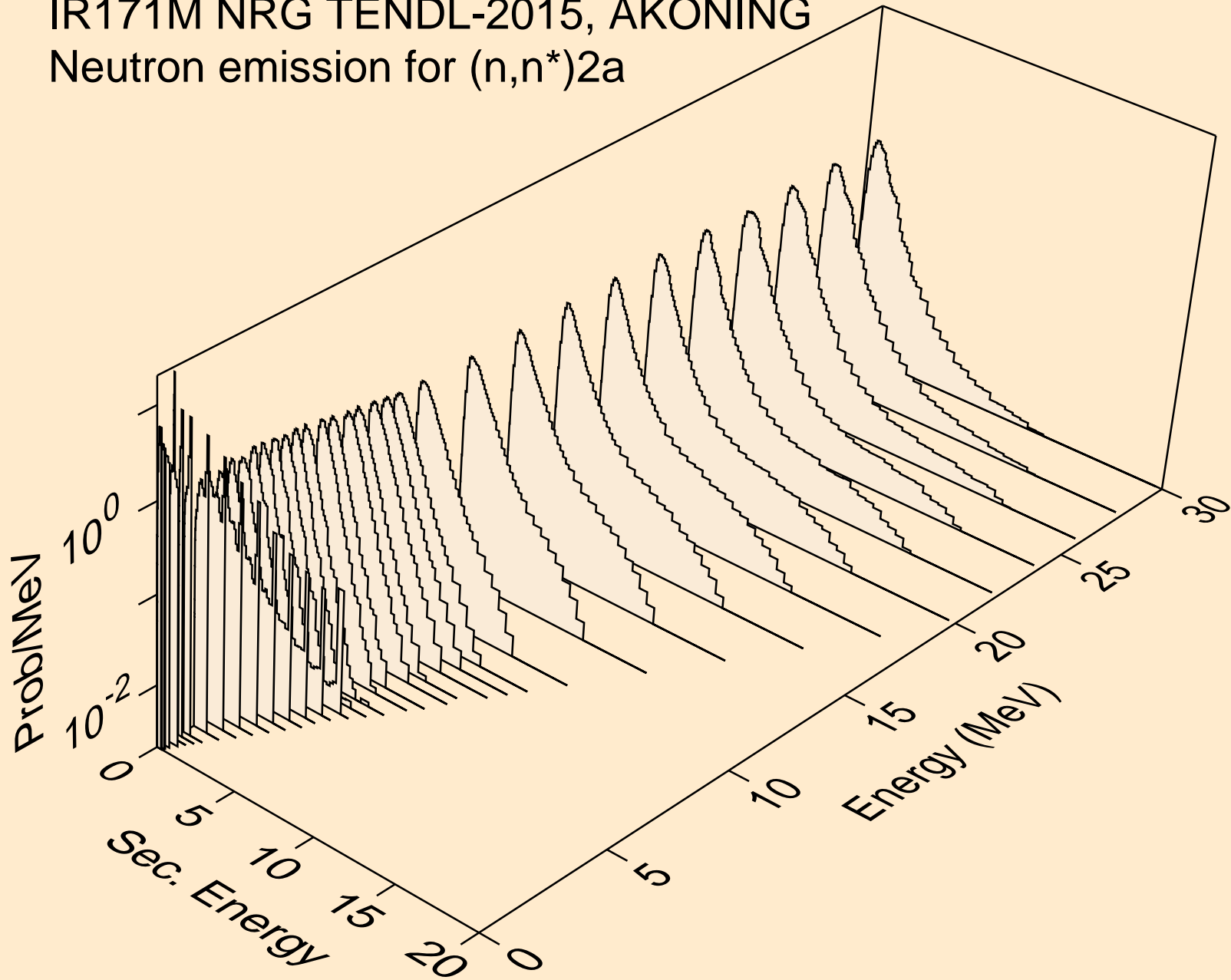

IR171M NRG TENDL-2015, AKONING  
Neutron emission for (n,2n)2a

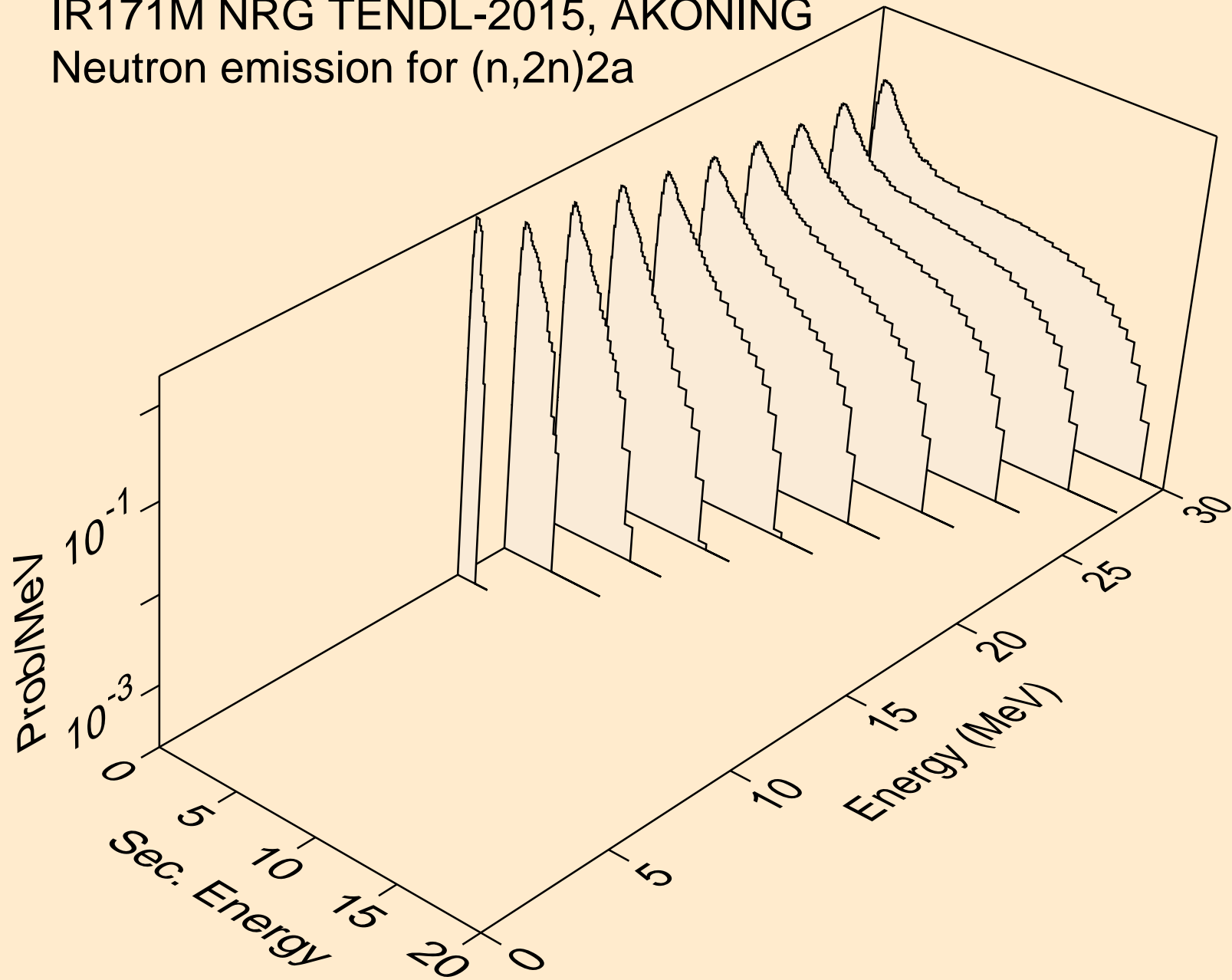

IR171M NRG TENDL-2015, AKONING  
Neutron emission for (n,n\*)d

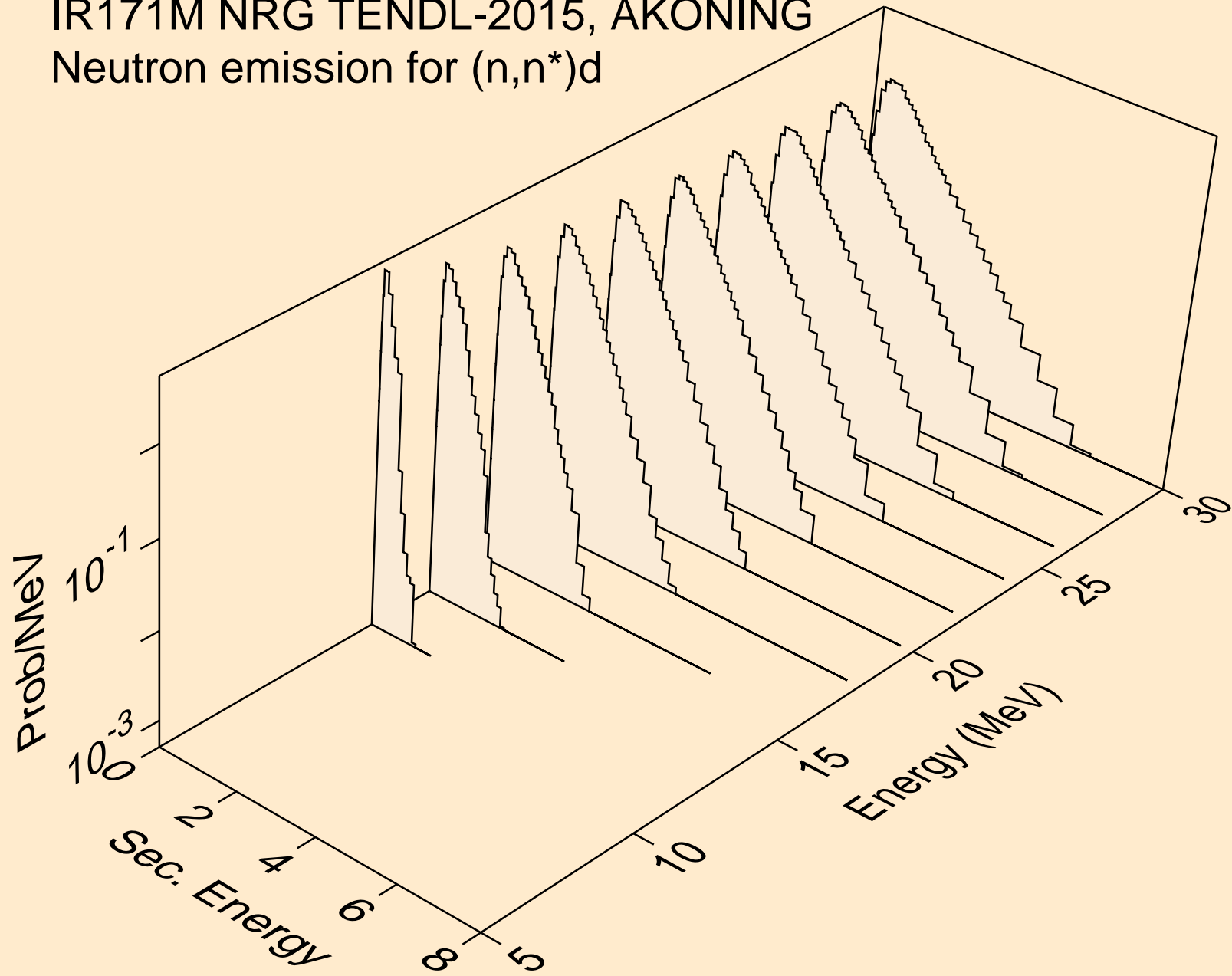

IR171M NRG TENDL-2015, AKONING  
Neutron emission for (n,n\*)t

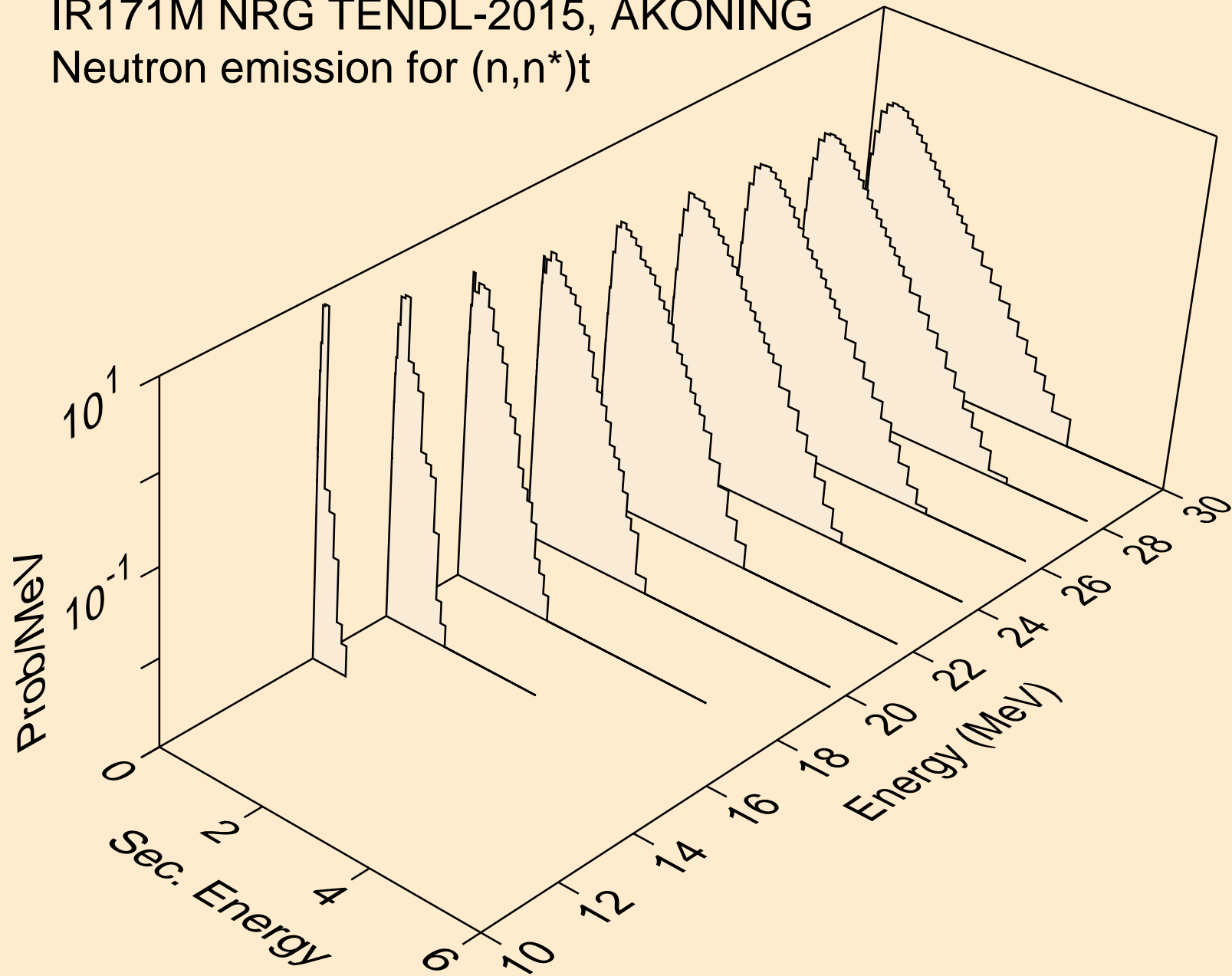

IR171M NRG TENDL-2015, AKONING  
Neutron emission for (n,n\*)he3

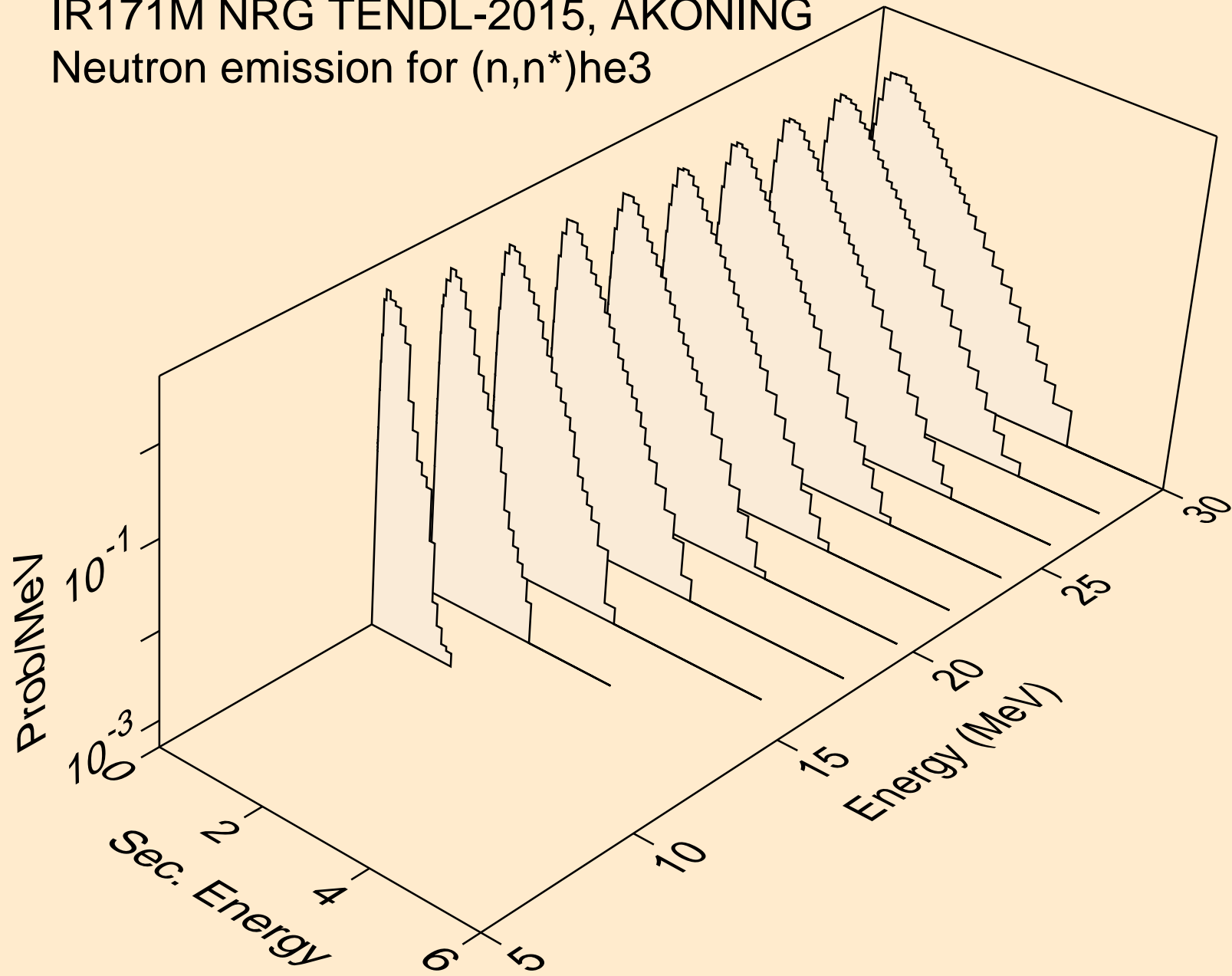



IR171M NRG TENDL-2015, AKONING  
Neutron emission for (n,n\*)d2a

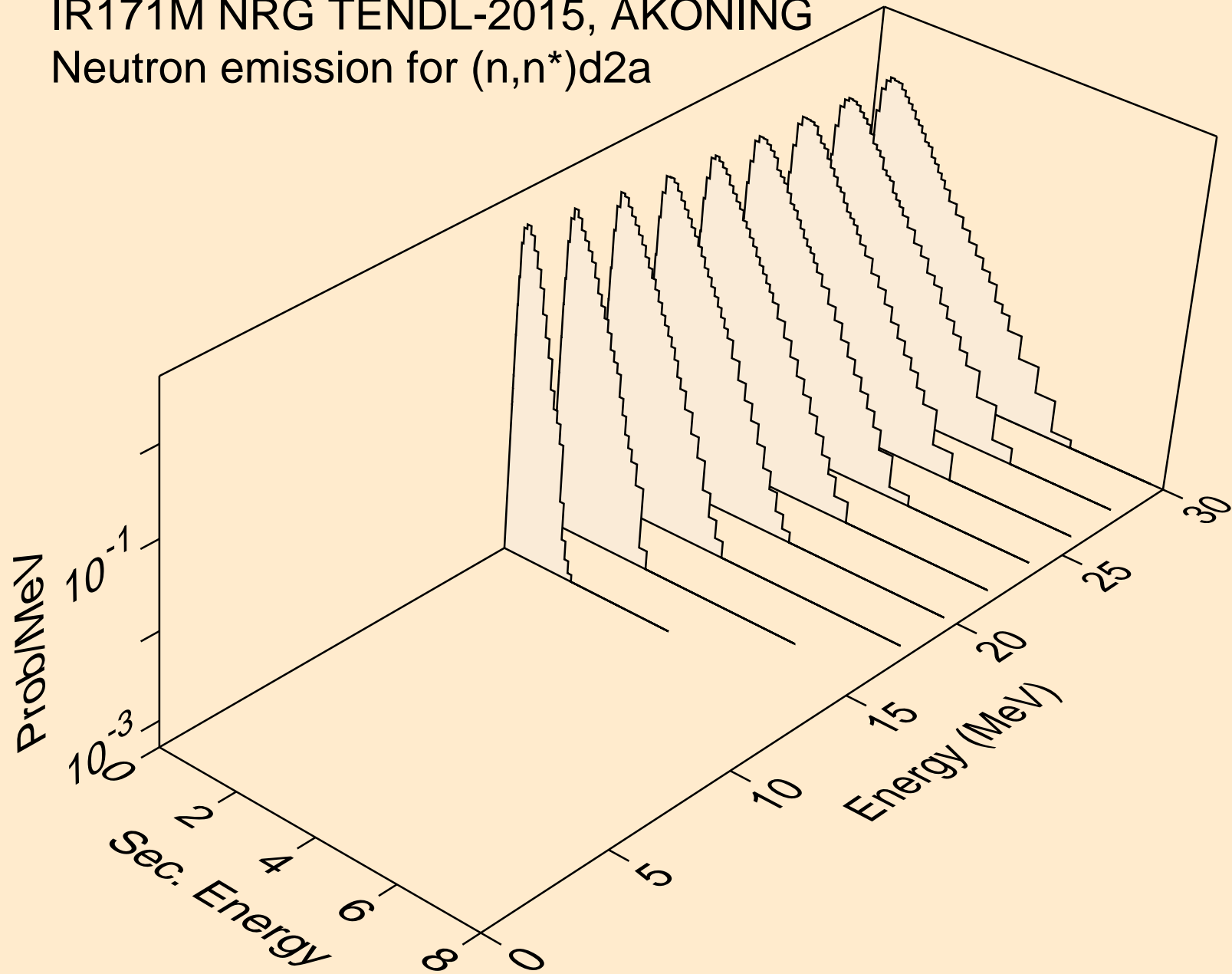

IR171M NRG TENDL-2015, AKONING  
Neutron emission for (n,2np)

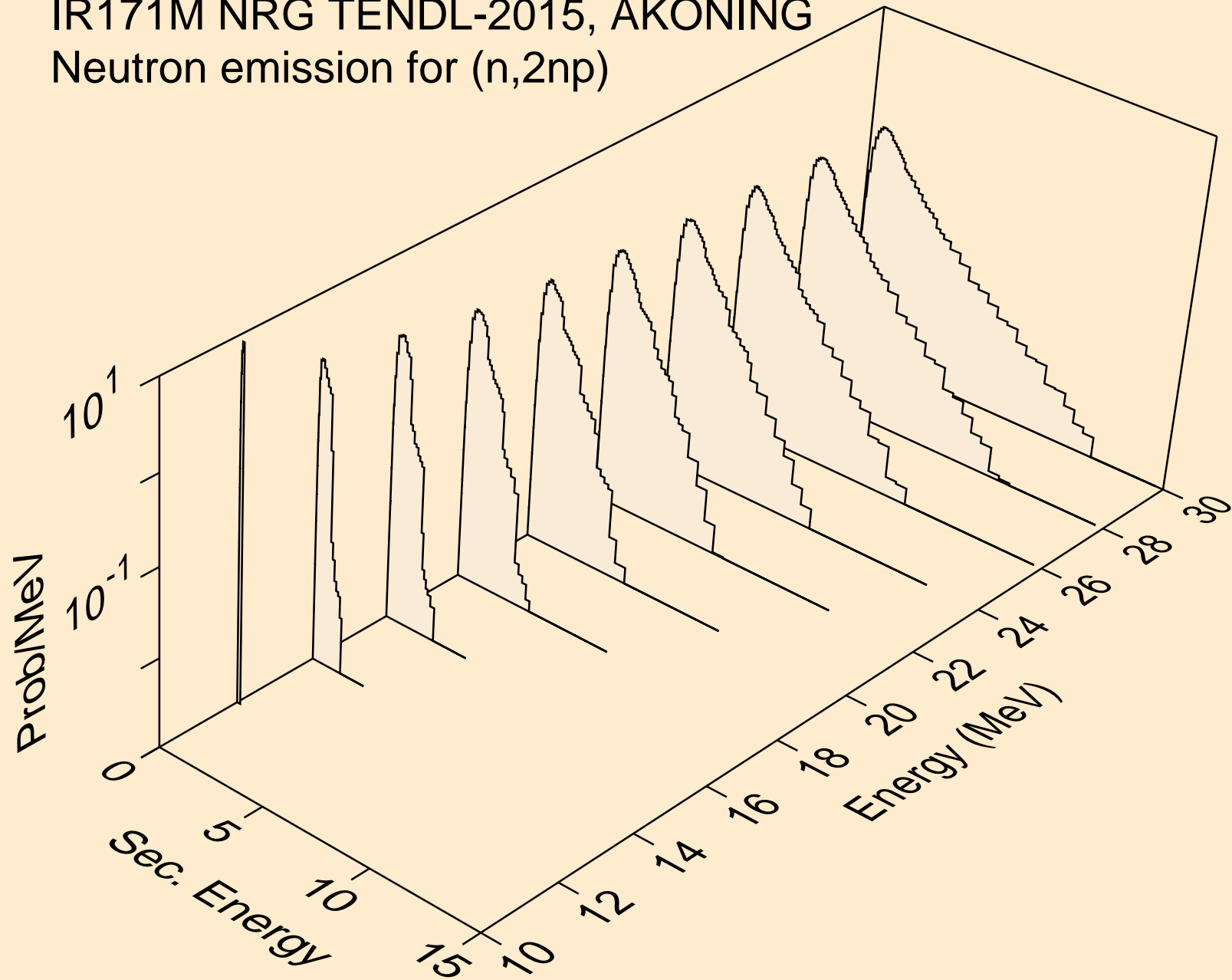

IR171M NRG TENDL-2015, AKONING  
Neutron emission for (n,3np)

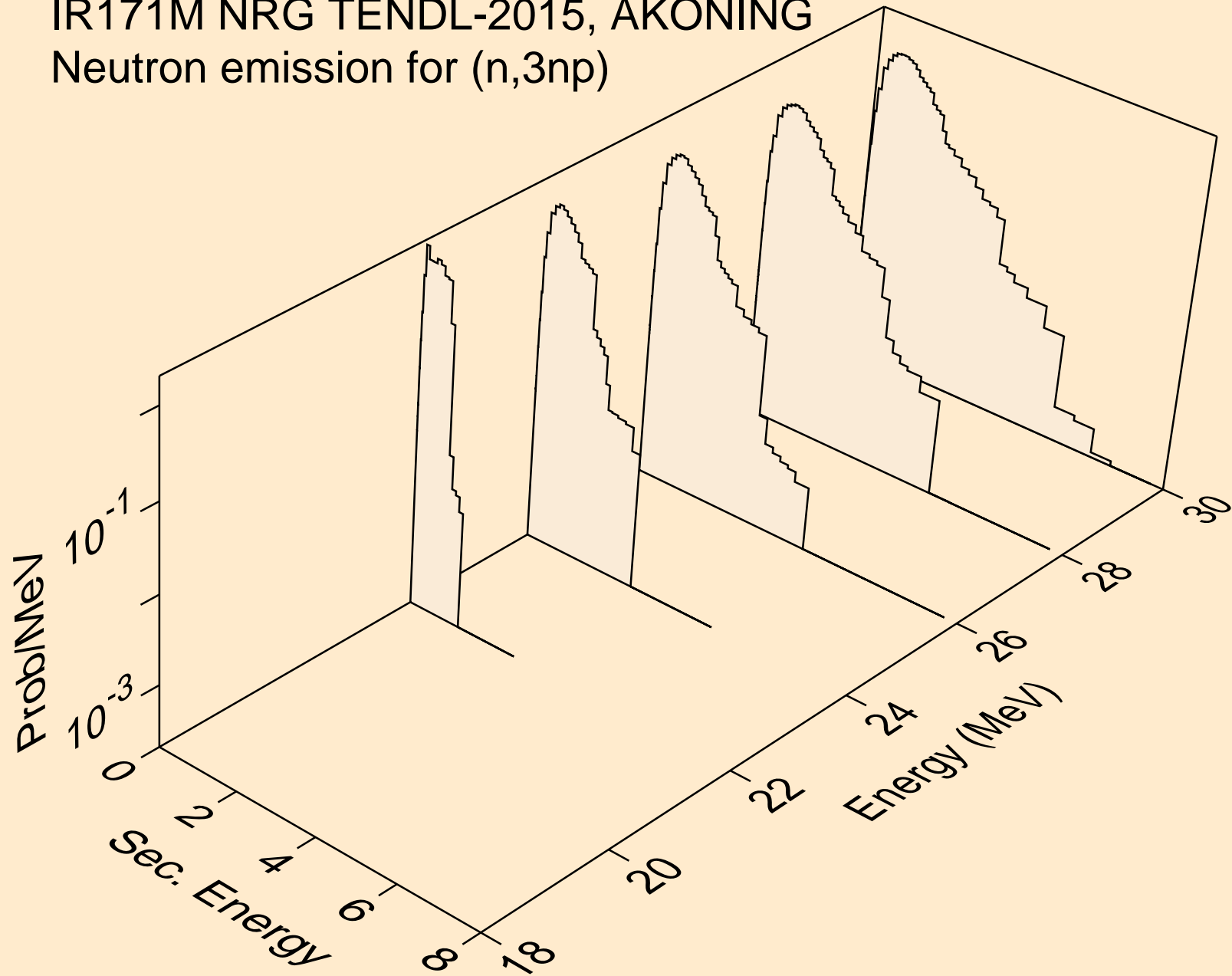

IR171M NRG TENDL-2015, AKONING  
Neutron emission for (n,2np)

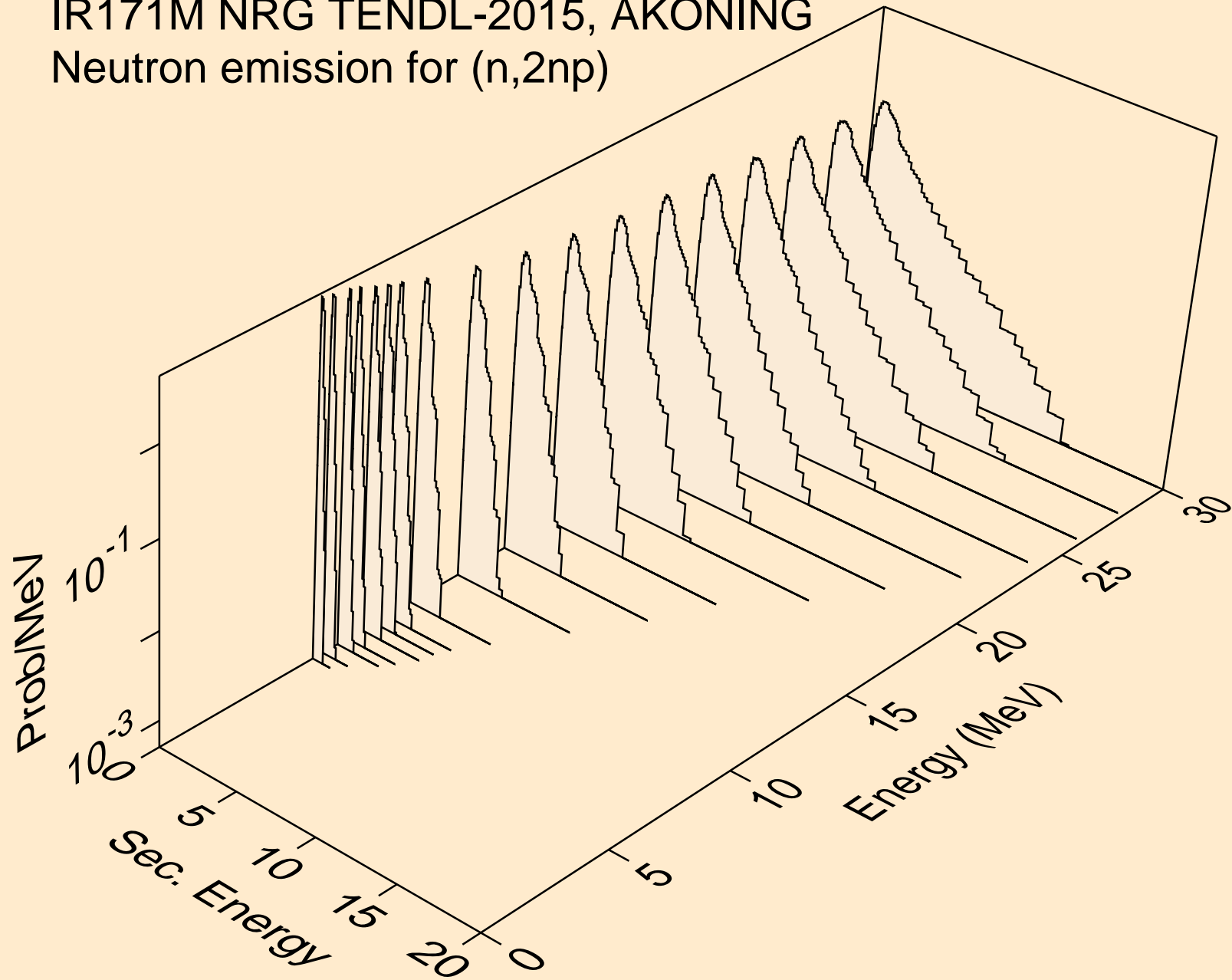

IR171M NRG TENDL-2015, AKONING  
Neutron emission for (n,npa)

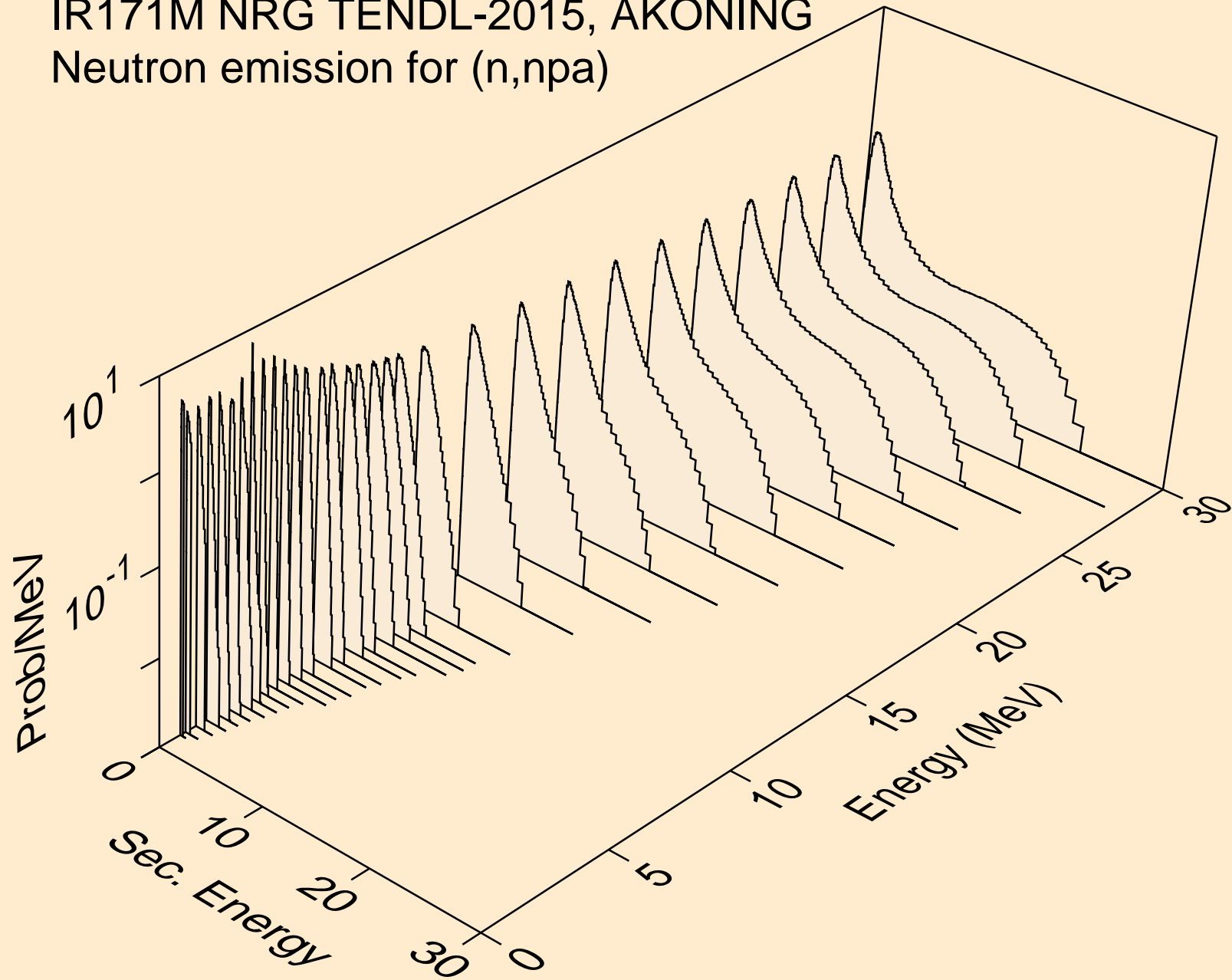

IR171M NRG TENDL-2015, AKONING  
Neutron emission for (n,n\*c)

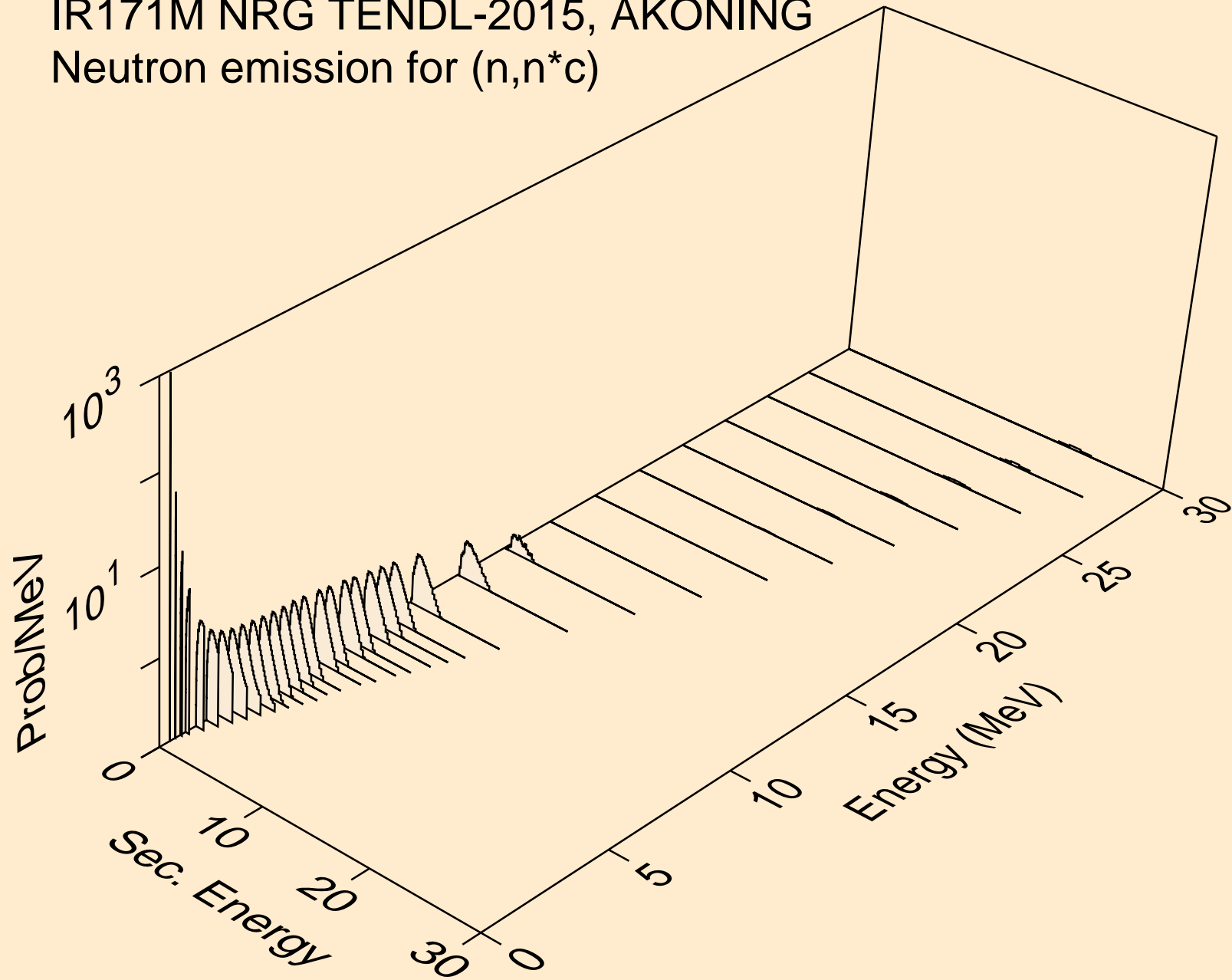

IR171M NRG TENDL-2015, AKONING  
Photon emission for (n,x)

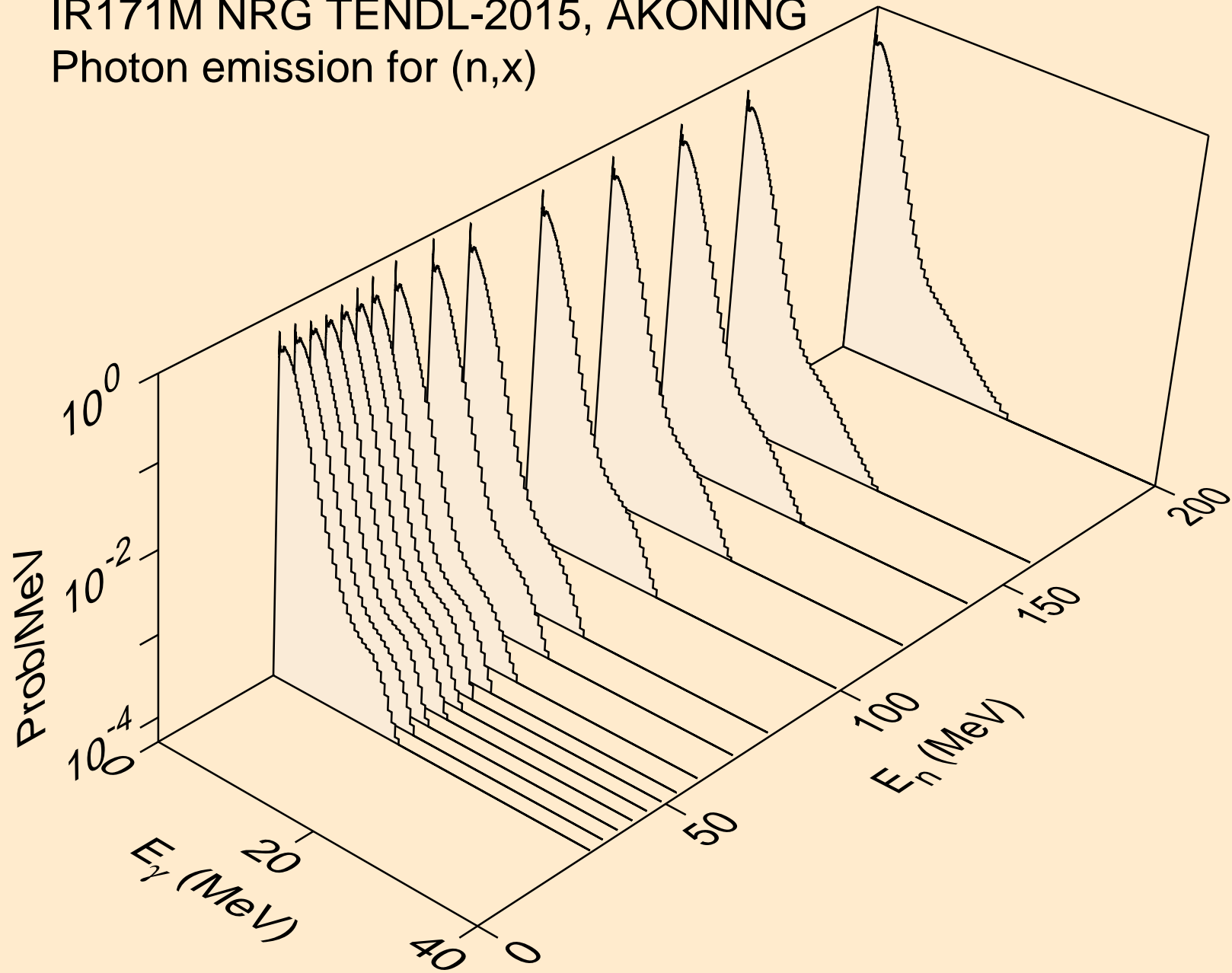

IR171M NRG TENDL-2015, AKONING  
Photon emission for (n,2nd)

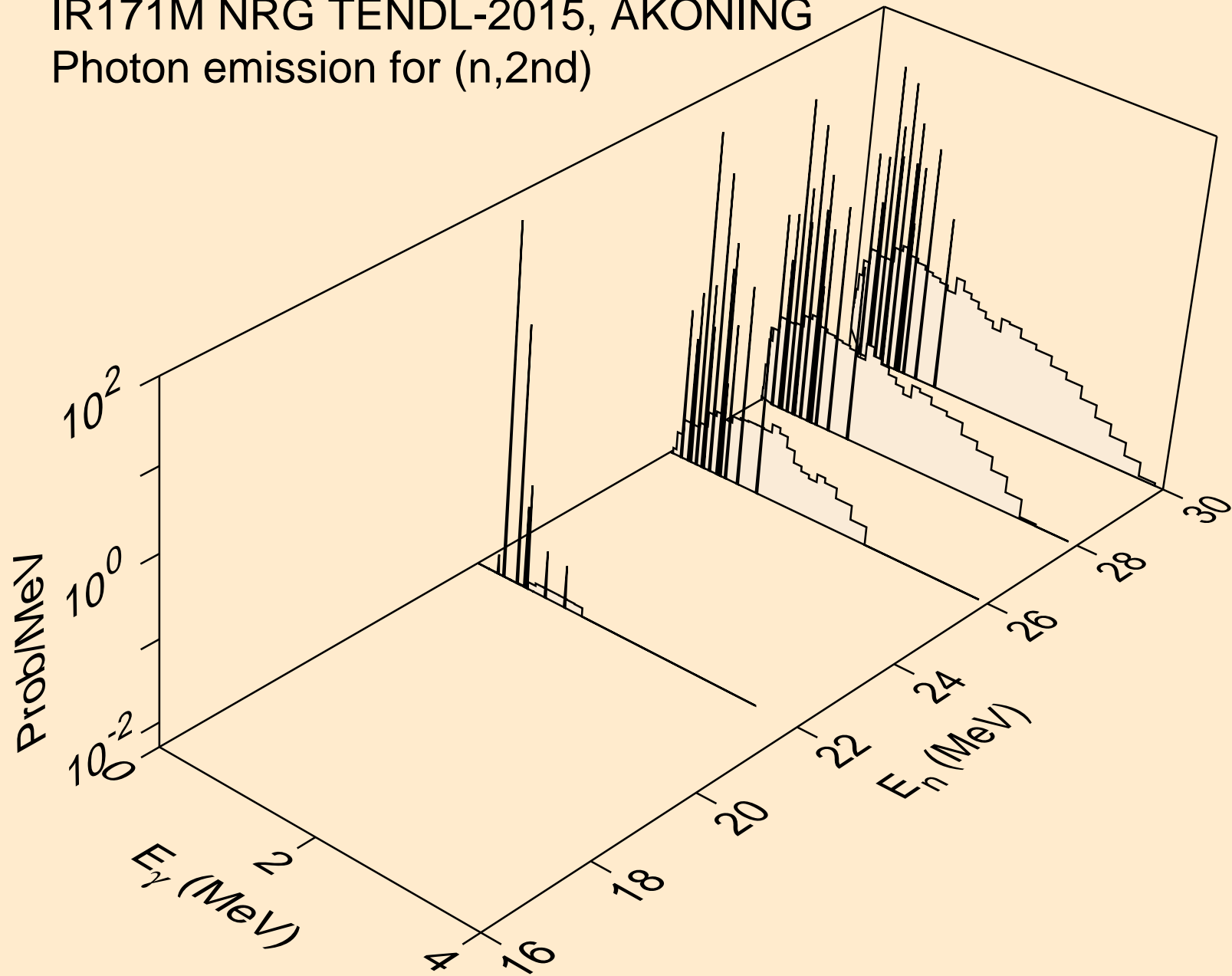



IR171M NRG TENDL-2015, AKONING  
Photon emission for (n,2n)

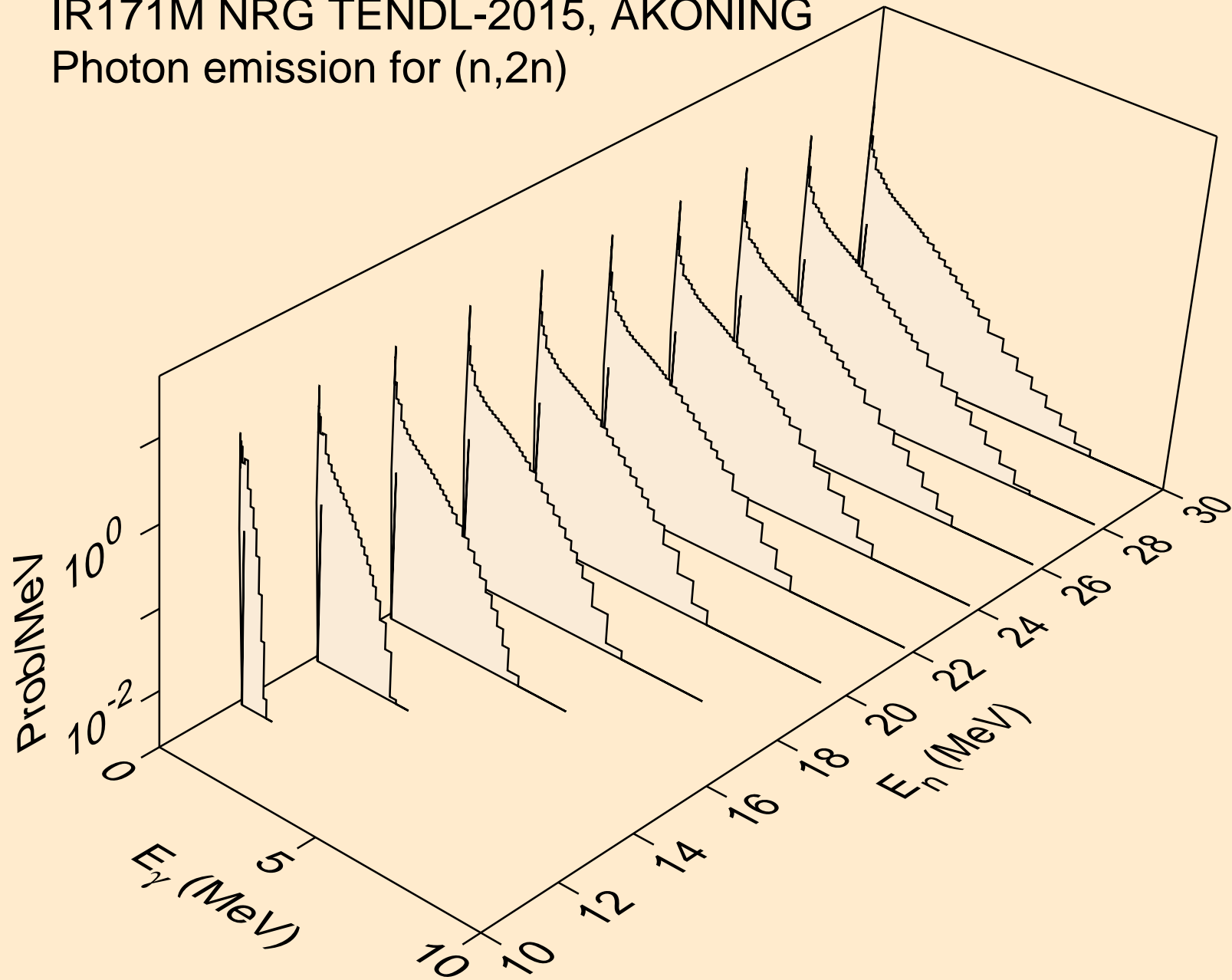

IR171M NRG TENDL-2015, AKONING  
Photon emission for (n,3n)

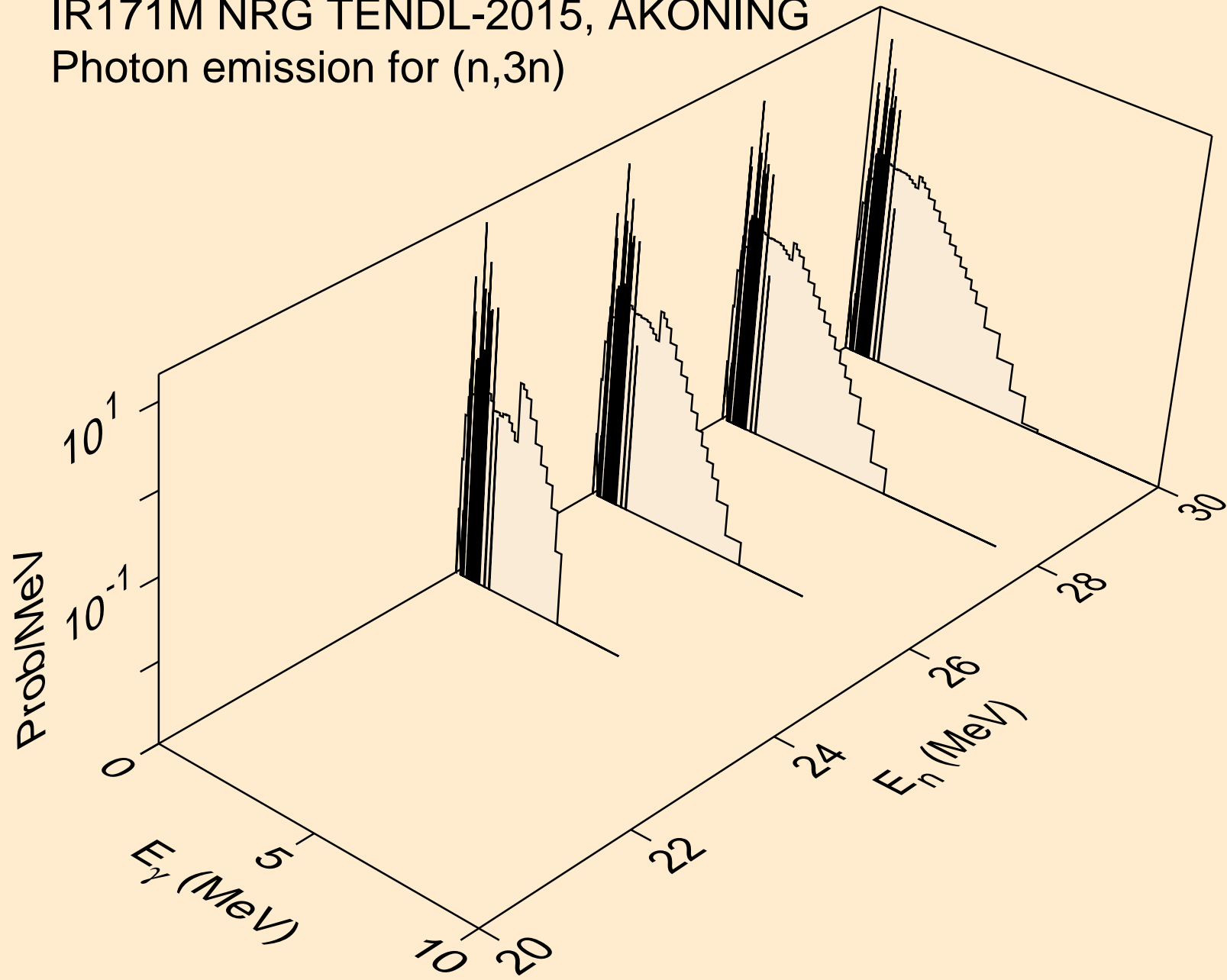

IR171M NRG TENDL-2015, AKONING  
Photon emission for (n,n\*)a

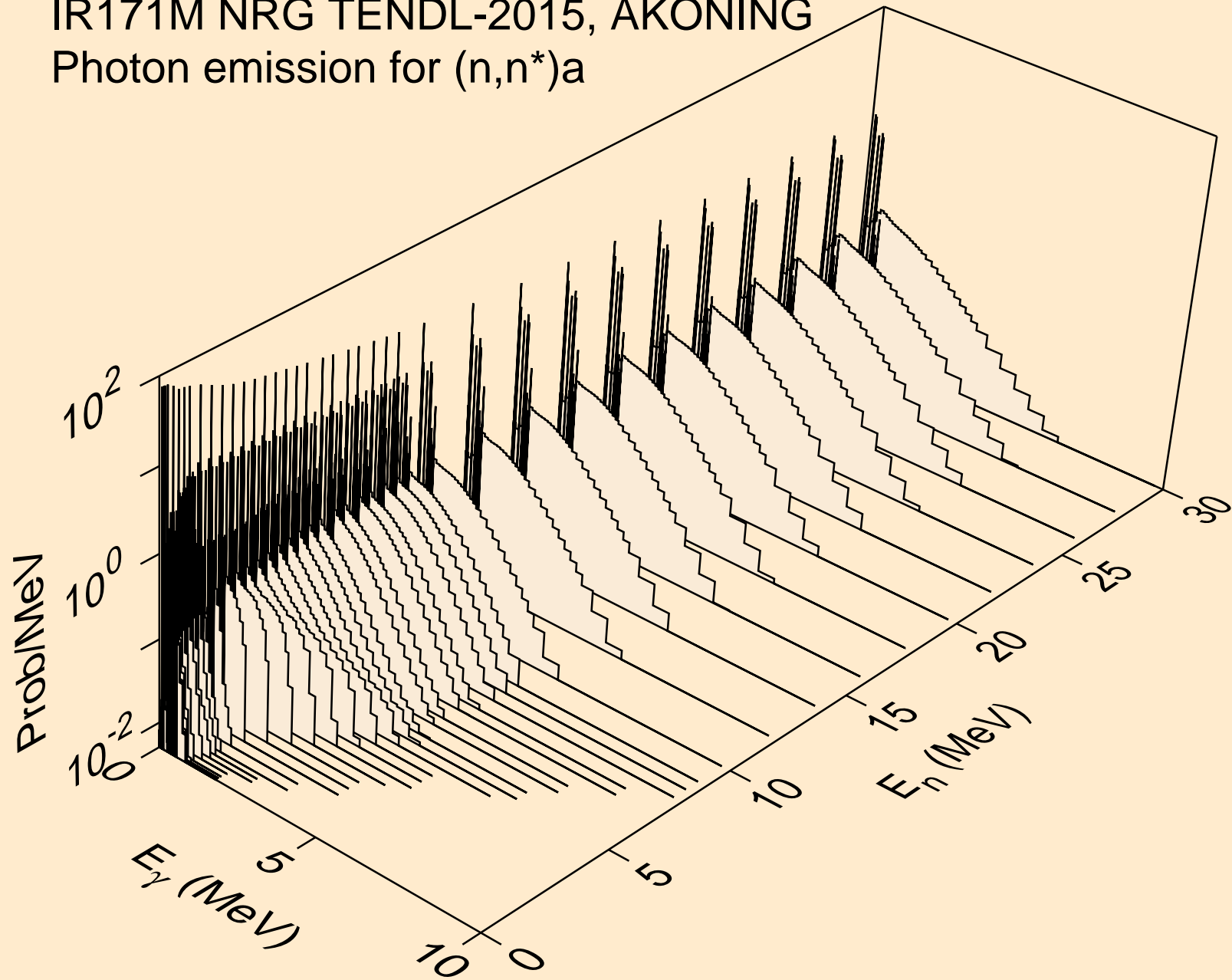

IR171M NRG TENDL-2015, AKONING  
Photon emission for (n,n\*)3a

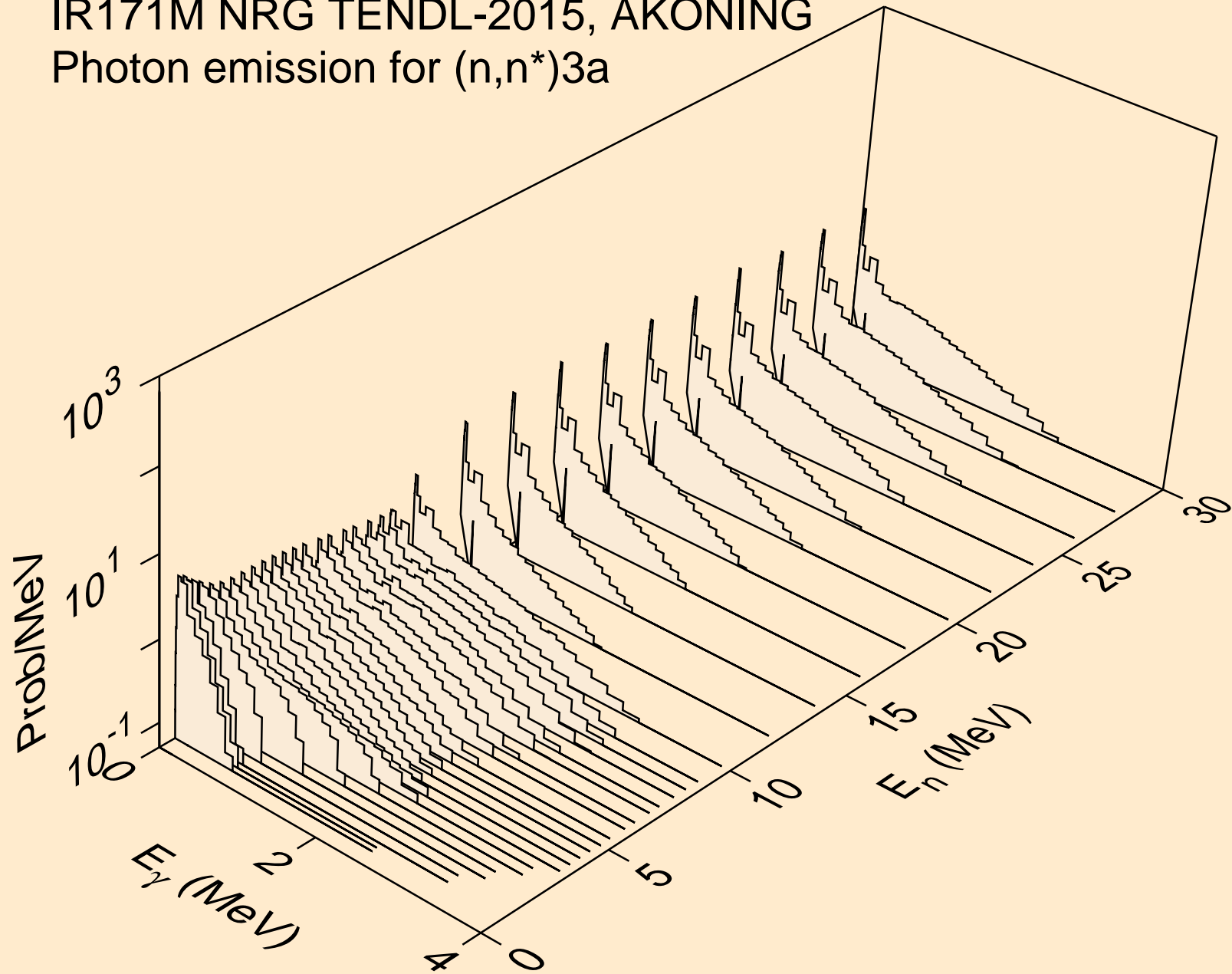

IR171M NRG TENDL-2015, AKONING  
Photon emission for (n,2n)a

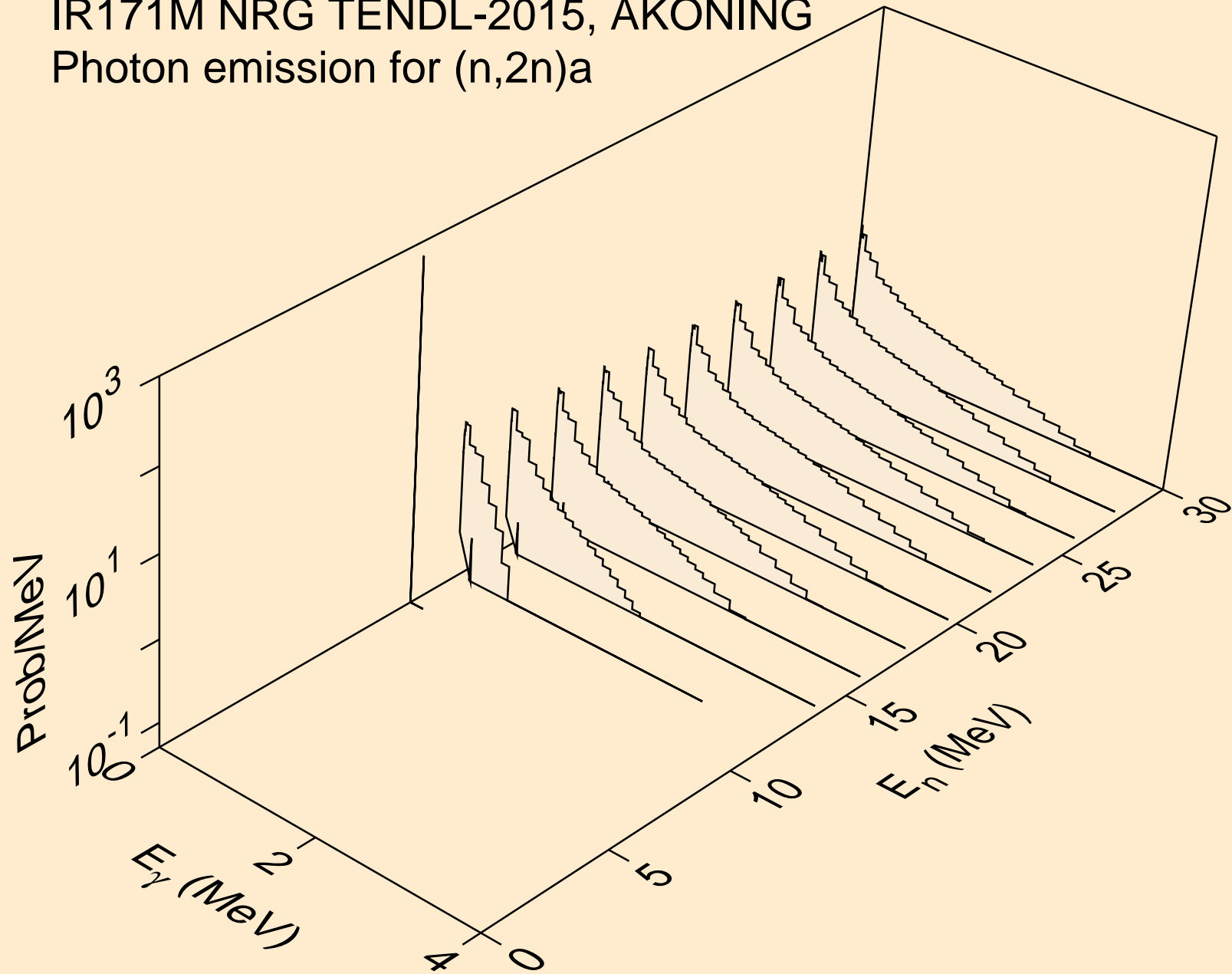

IR171M NRG TENDL-2015, AKONING  
Photon emission for (n,3n)a

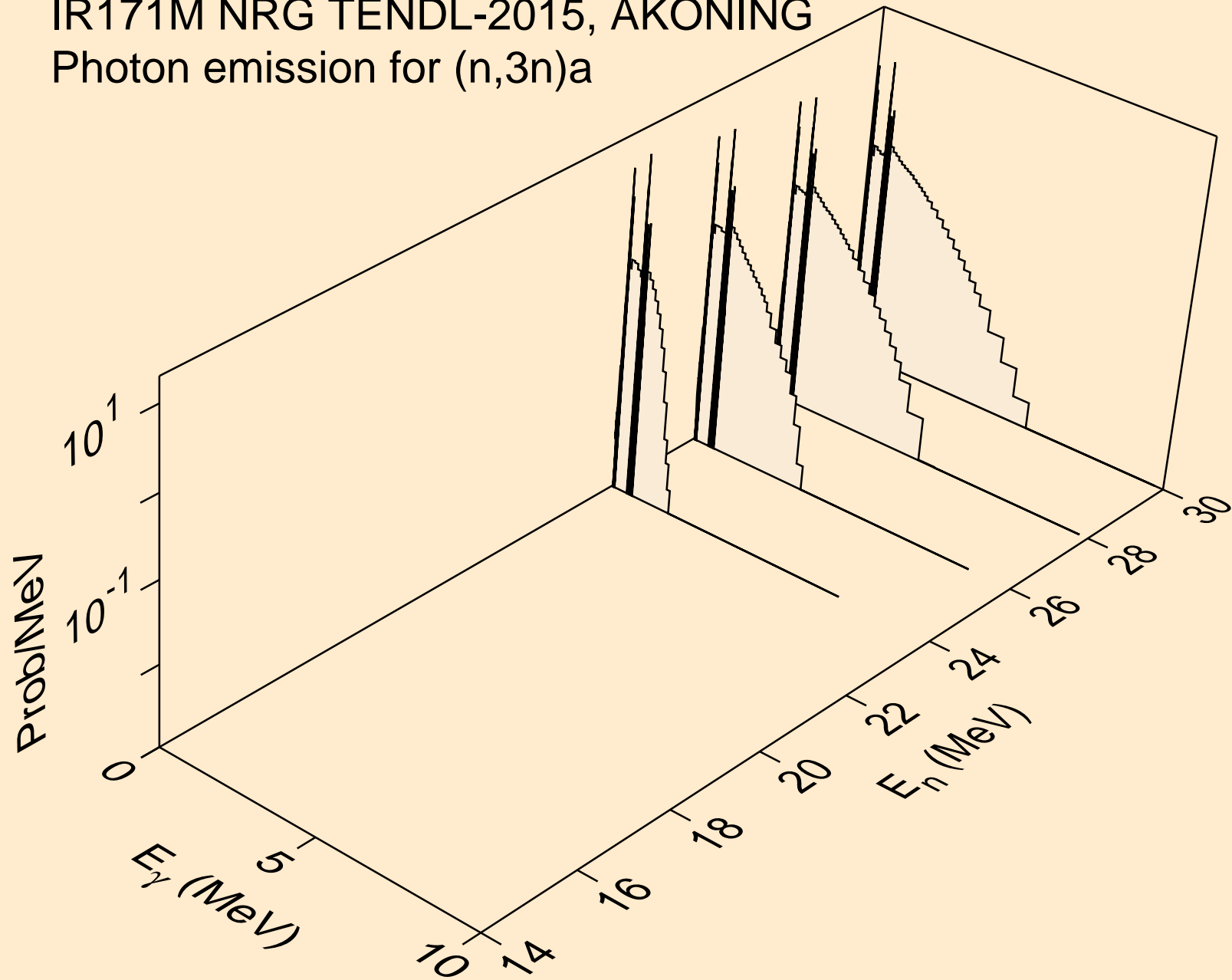

IR171M NRG TENDL-2015, AKONING  
Photon emission for (n,n\*)p

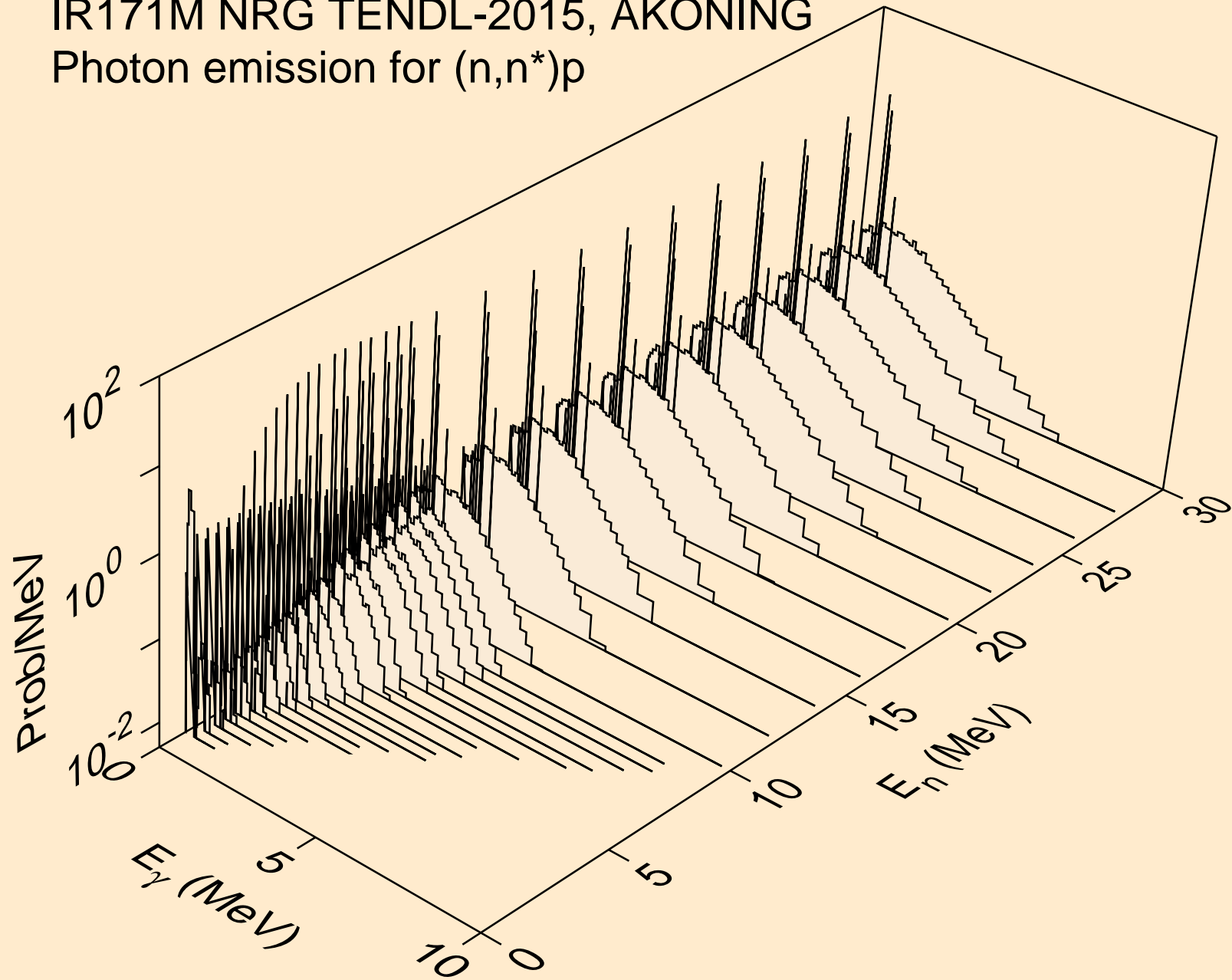

IR171M NRG TENDL-2015, AKONING  
Photon emission for (n,n\*)2a

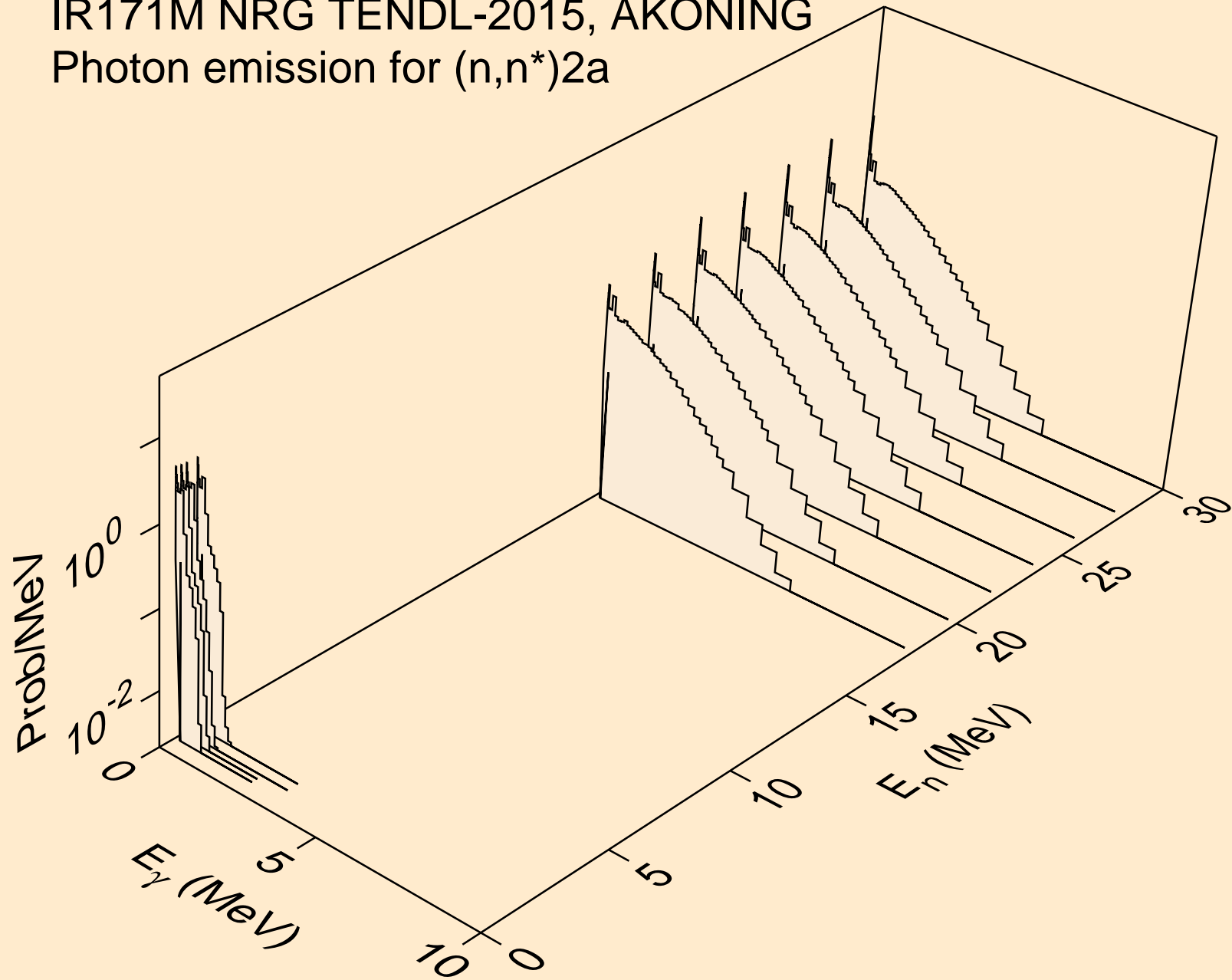



IR171M NRG TENDL-2015, AKONING  
Photon emission for (n,2n)2a

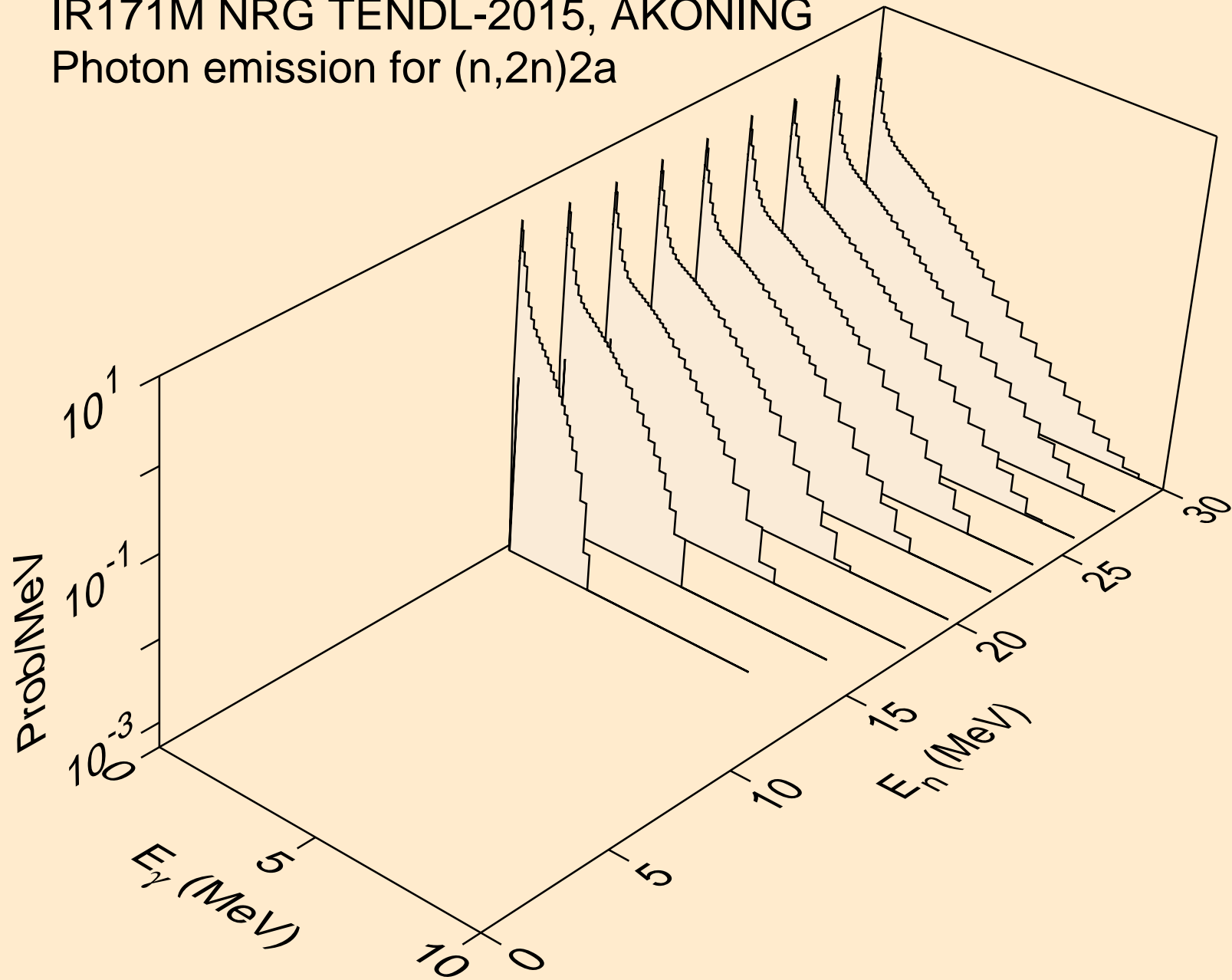

IR171M NRG TENDL-2015, AKONING  
Photon emission for (n,n\*)d

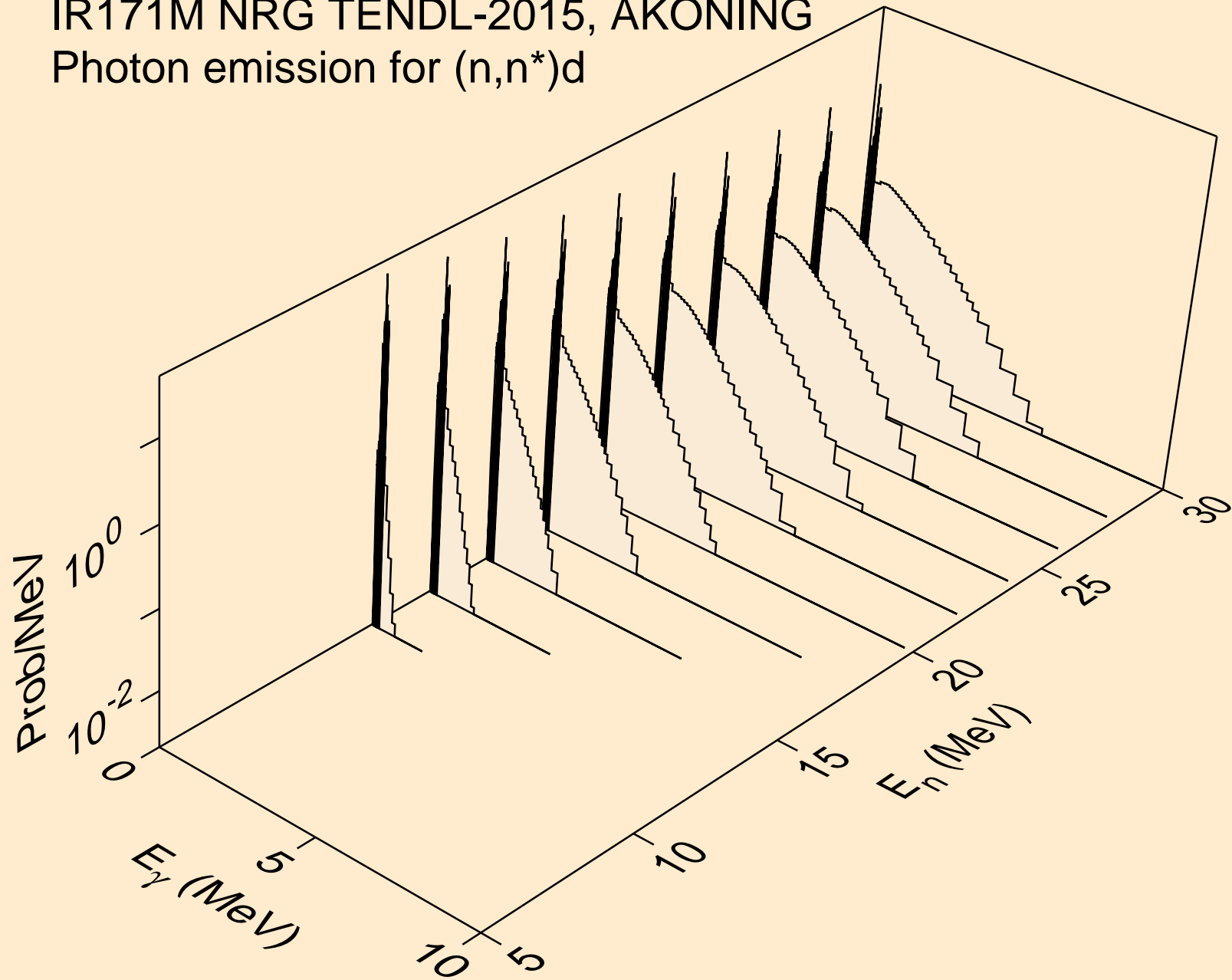

IR171M NRG TENDL-2015, AKONING  
Photon emission for (n,n\*)t

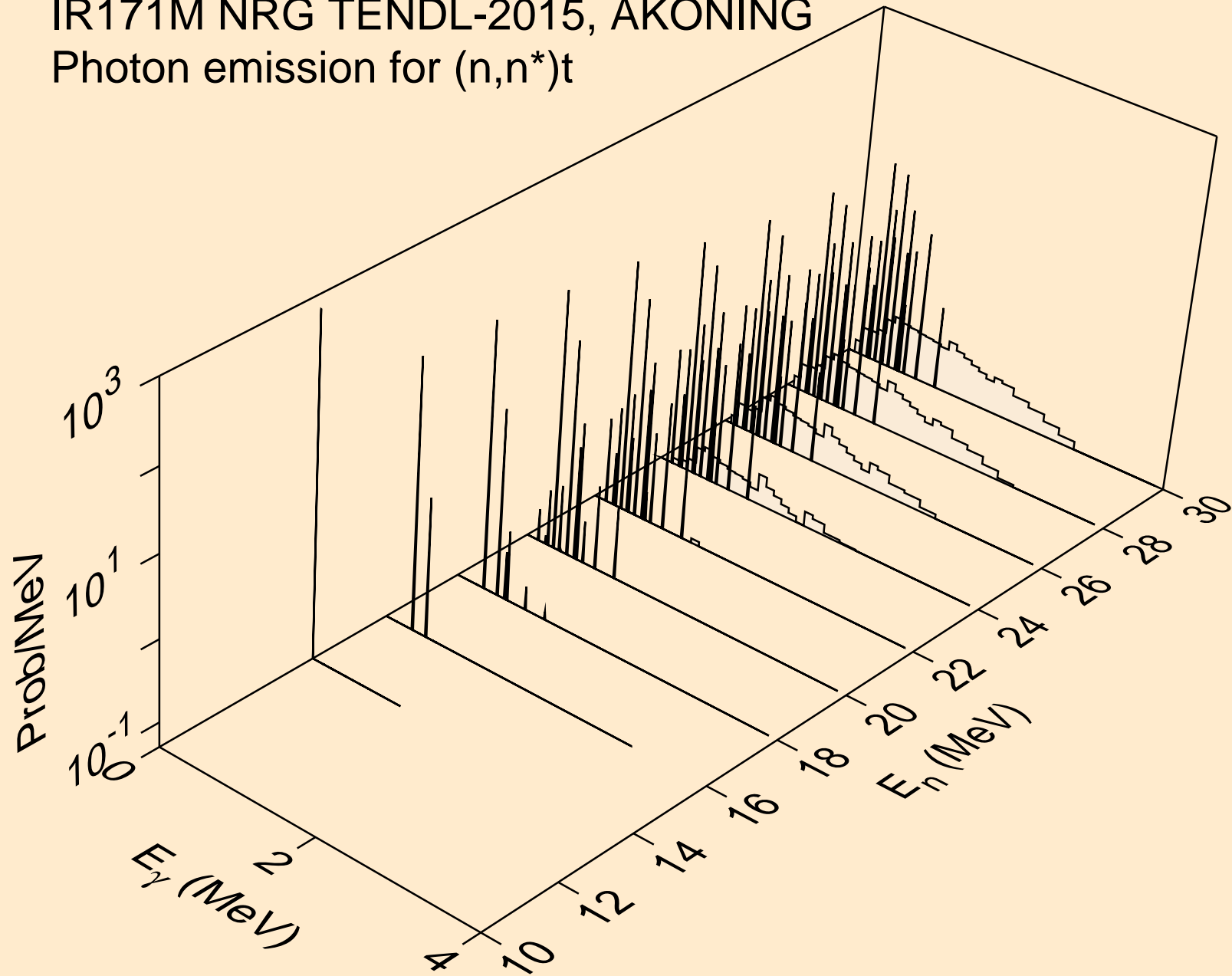

IR171M NRG TENDL-2015, AKONING  
Photon emission for (n,n\*)he3

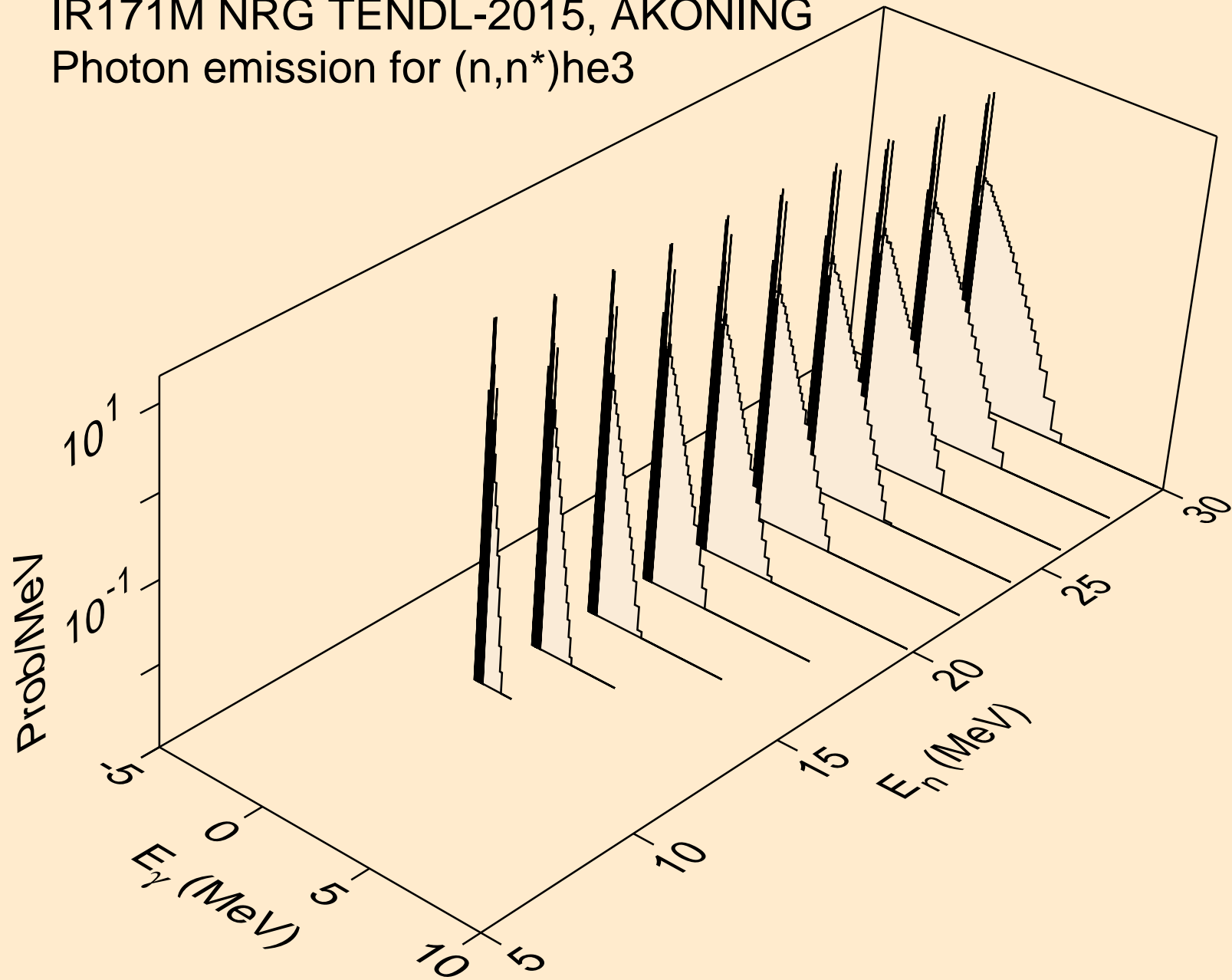

IR171M NRG TENDL-2015, AKONING  
Photon emission for (n,n\*)d2a

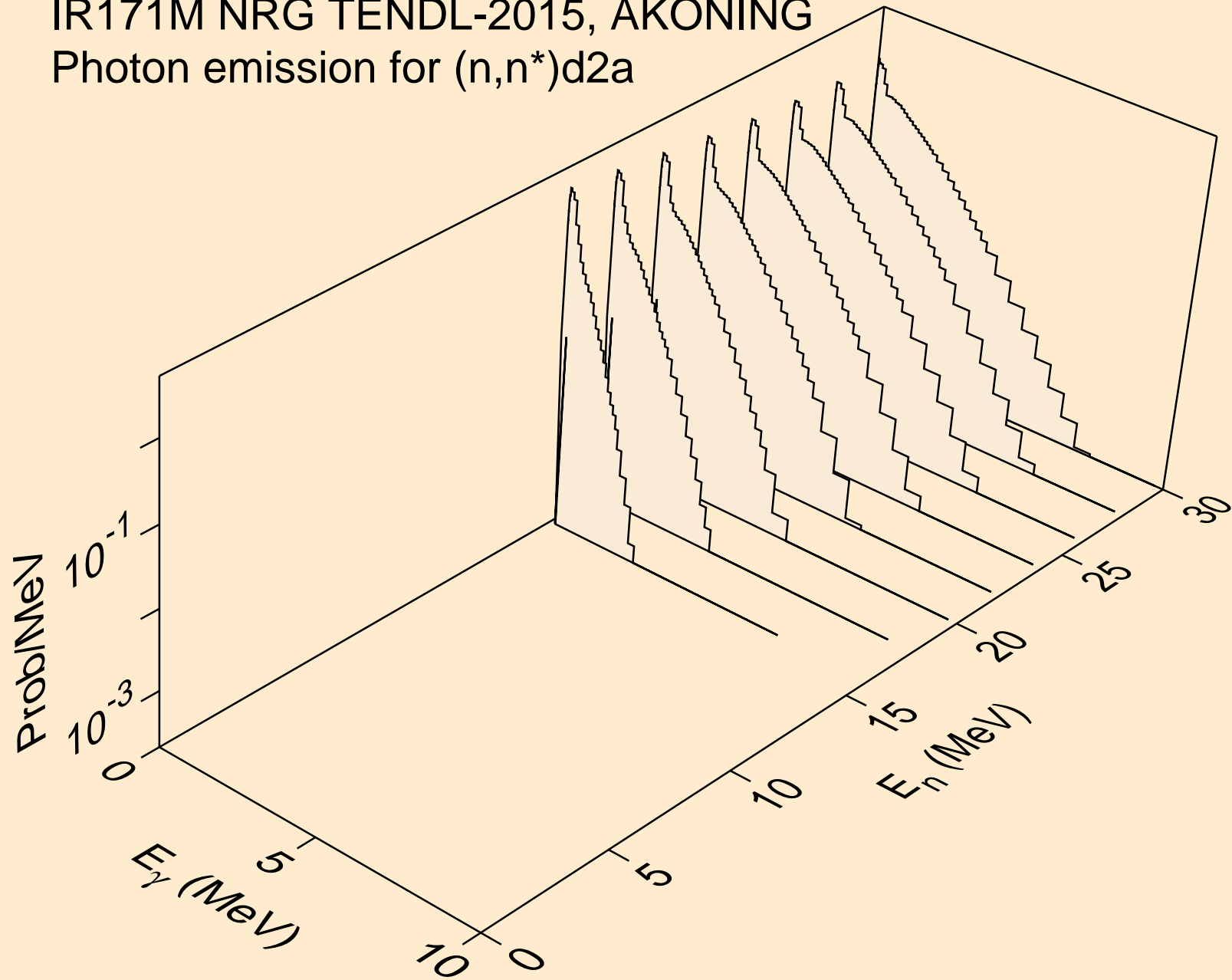

IR171M NRG TENDL-2015, AKONING  
Photon emission for (n,2np)

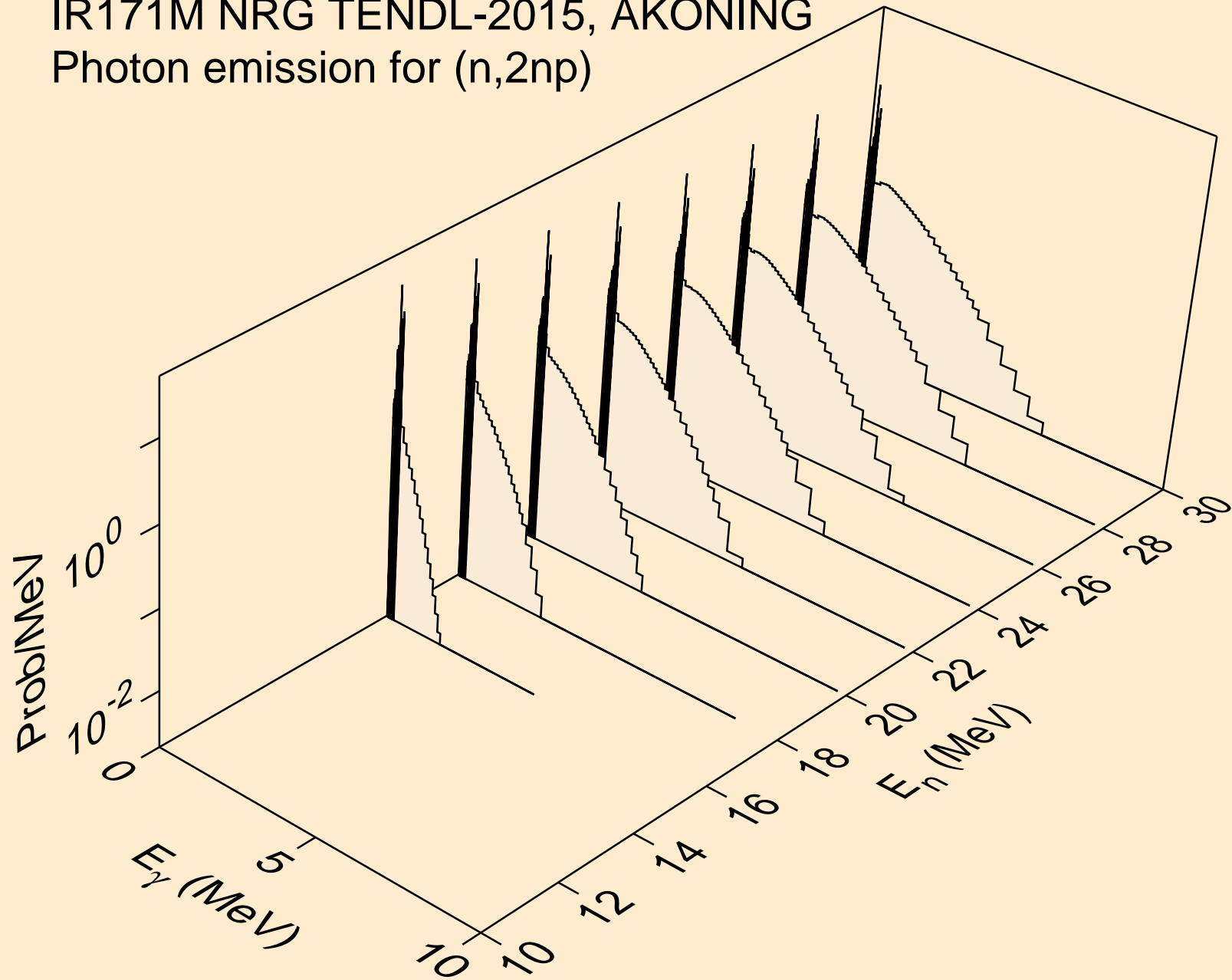

IR171M NRG TENDL-2015, AKONING  
Photon emission for (n,3np)

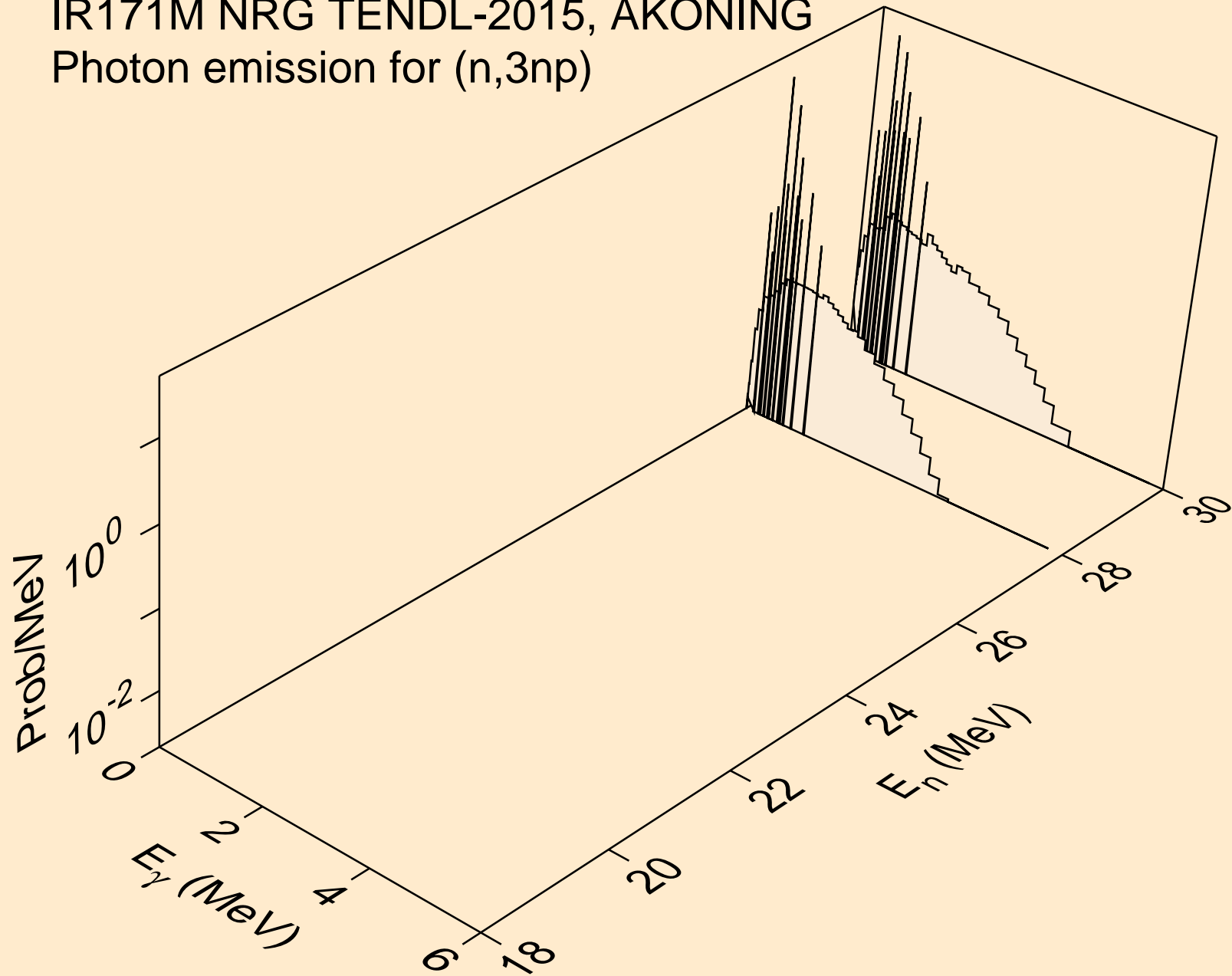

IR171M NRG TENDL-2015, AKONING  
Photon emission for (n,2np)

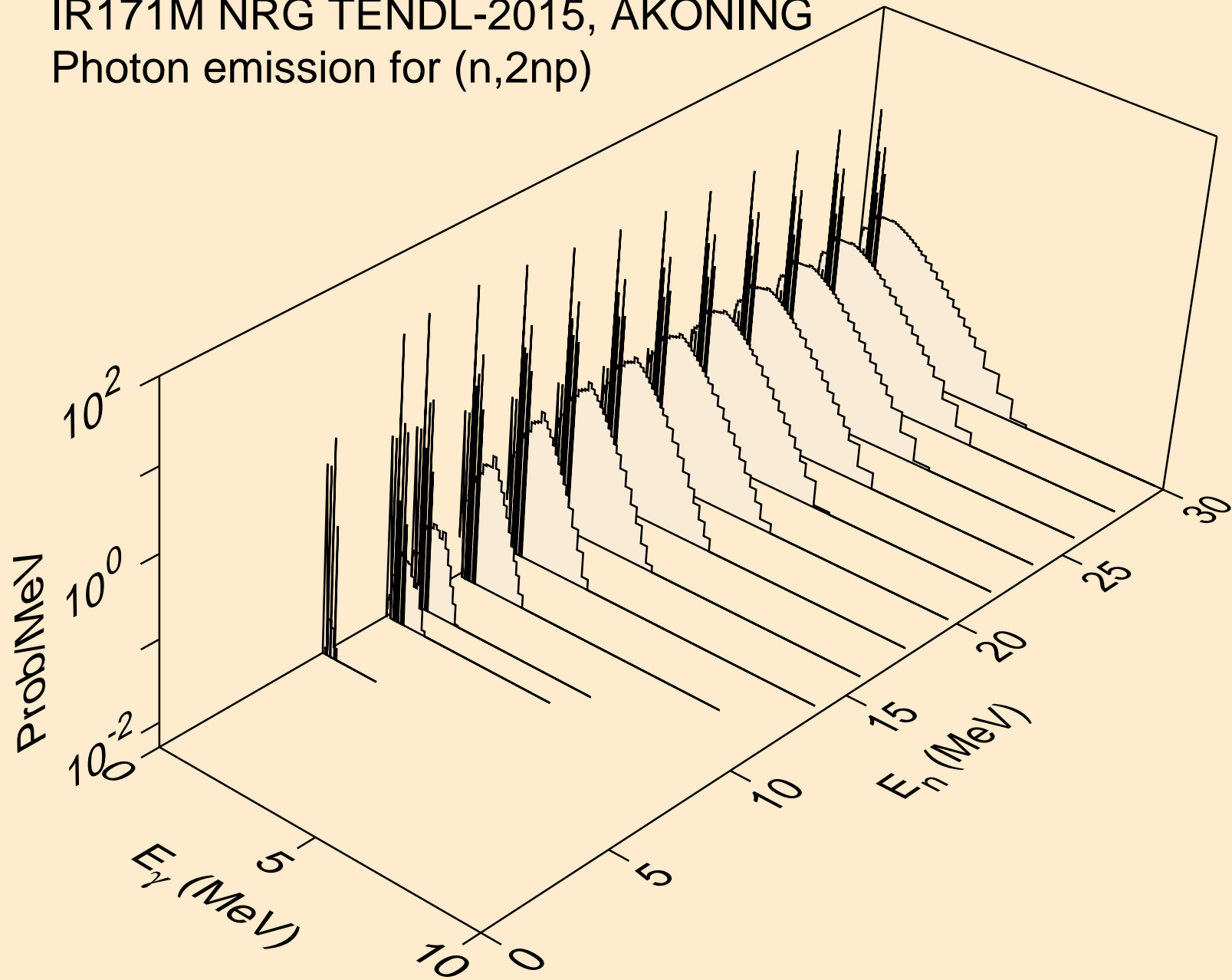



IR171M NRG TENDL-2015, AKONING  
Photon emission for (n,npa)

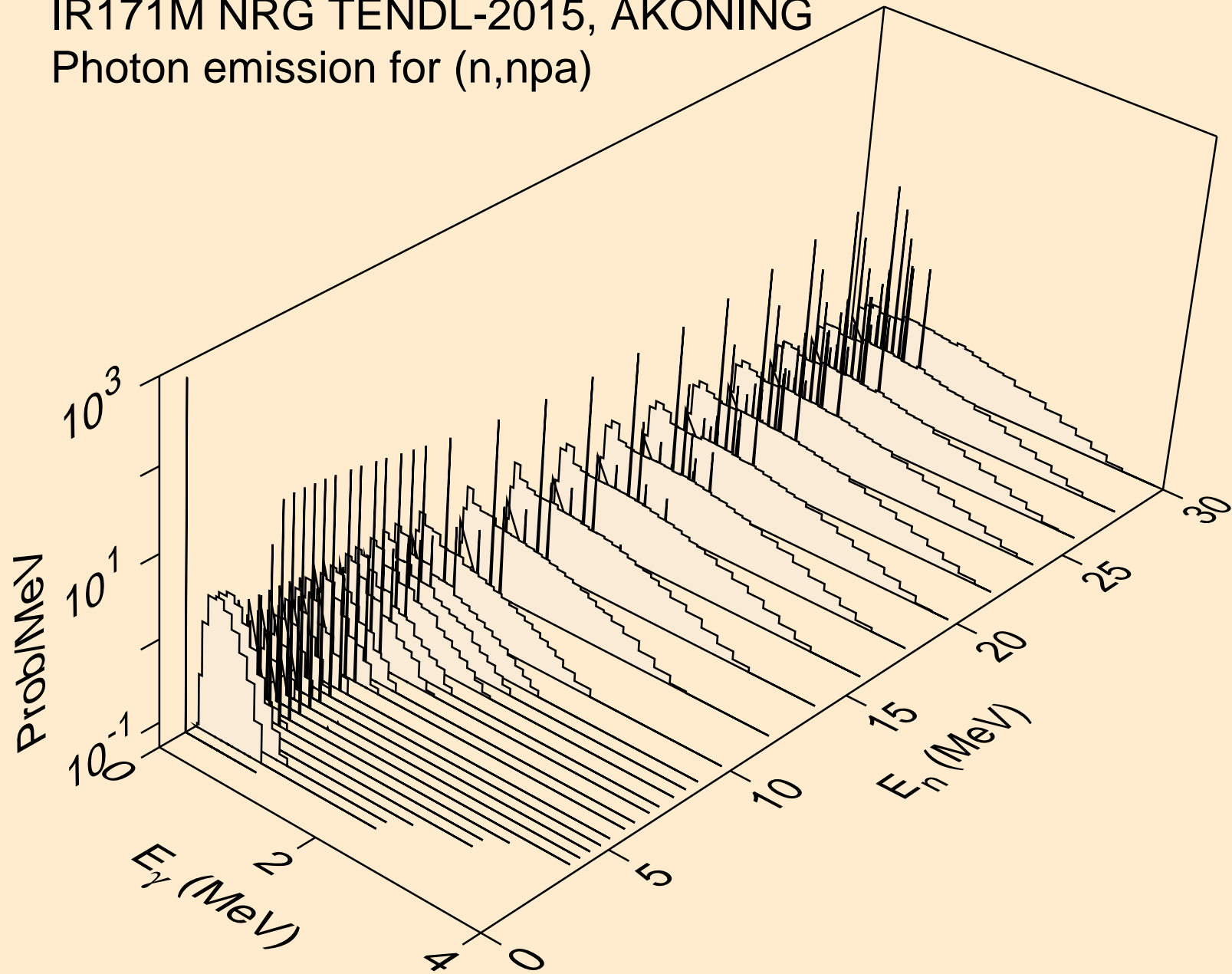

IR171M NRG TENDL-2015, AKONING  
Photon emission for (n,n\*2)

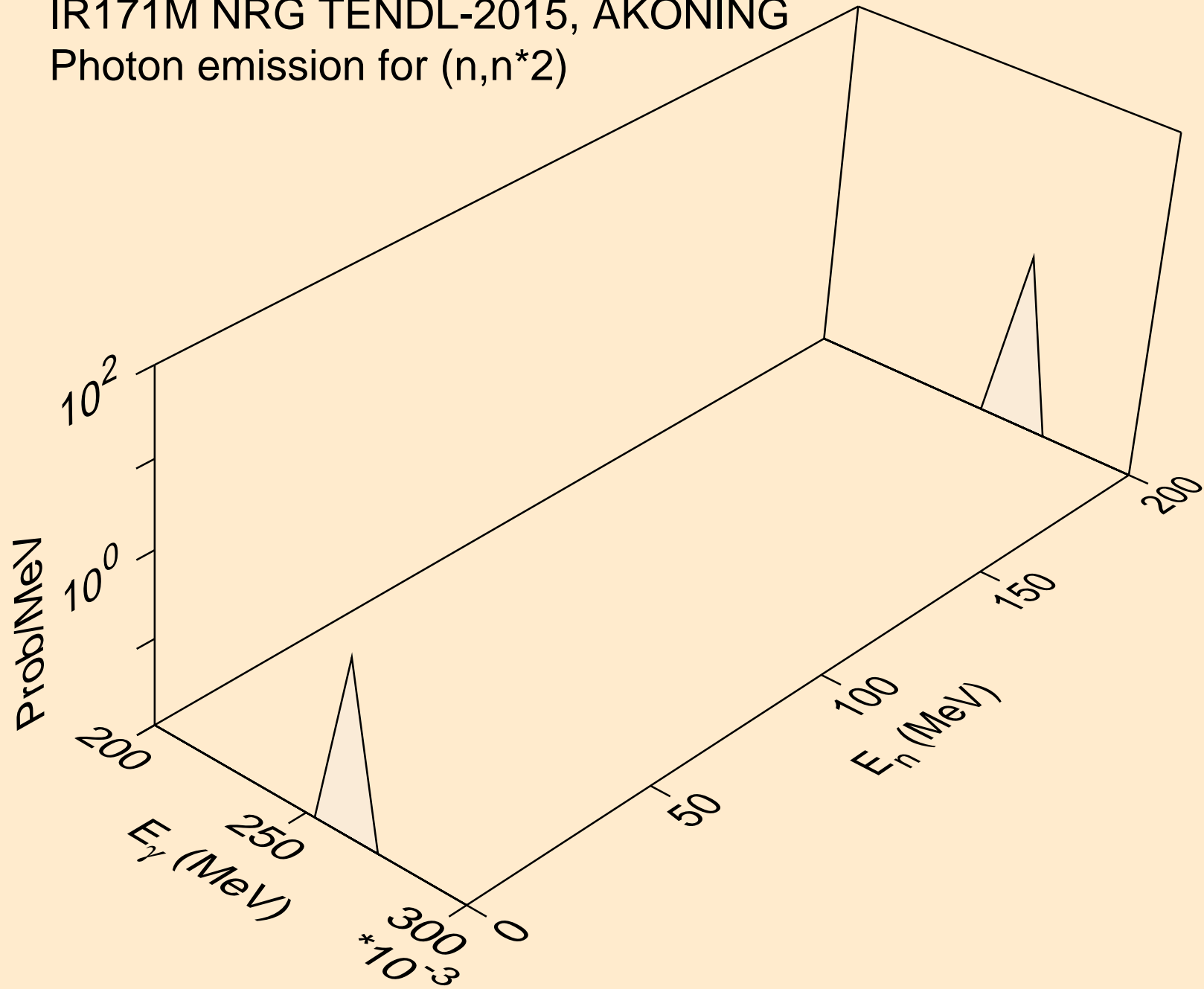

IR171M NRG TENDL-2015, AKONING  
Photon emission for (n,n\*c)

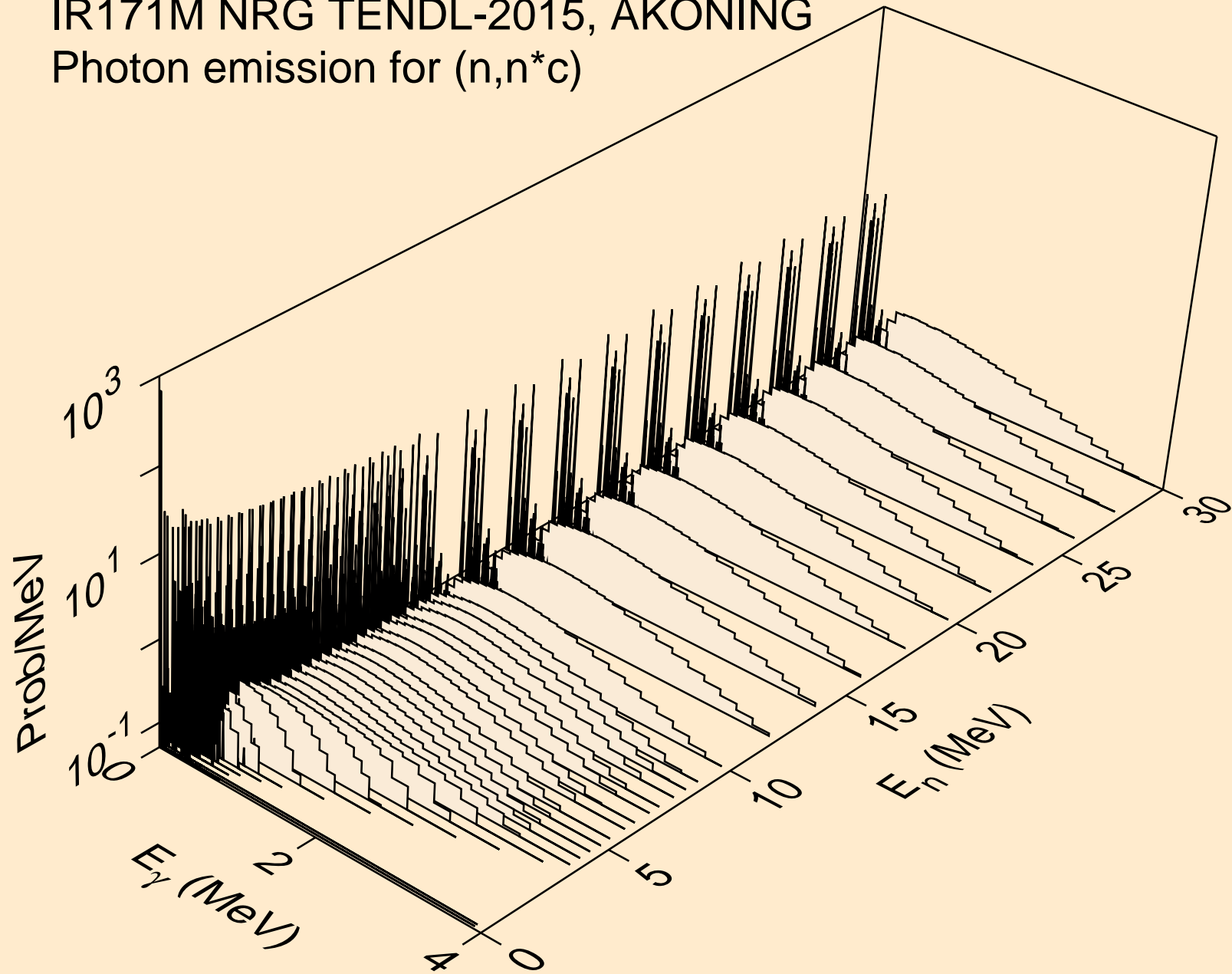

IR171M NRG TENDL-2015, AKONING  
Photon emission for (n,gma)

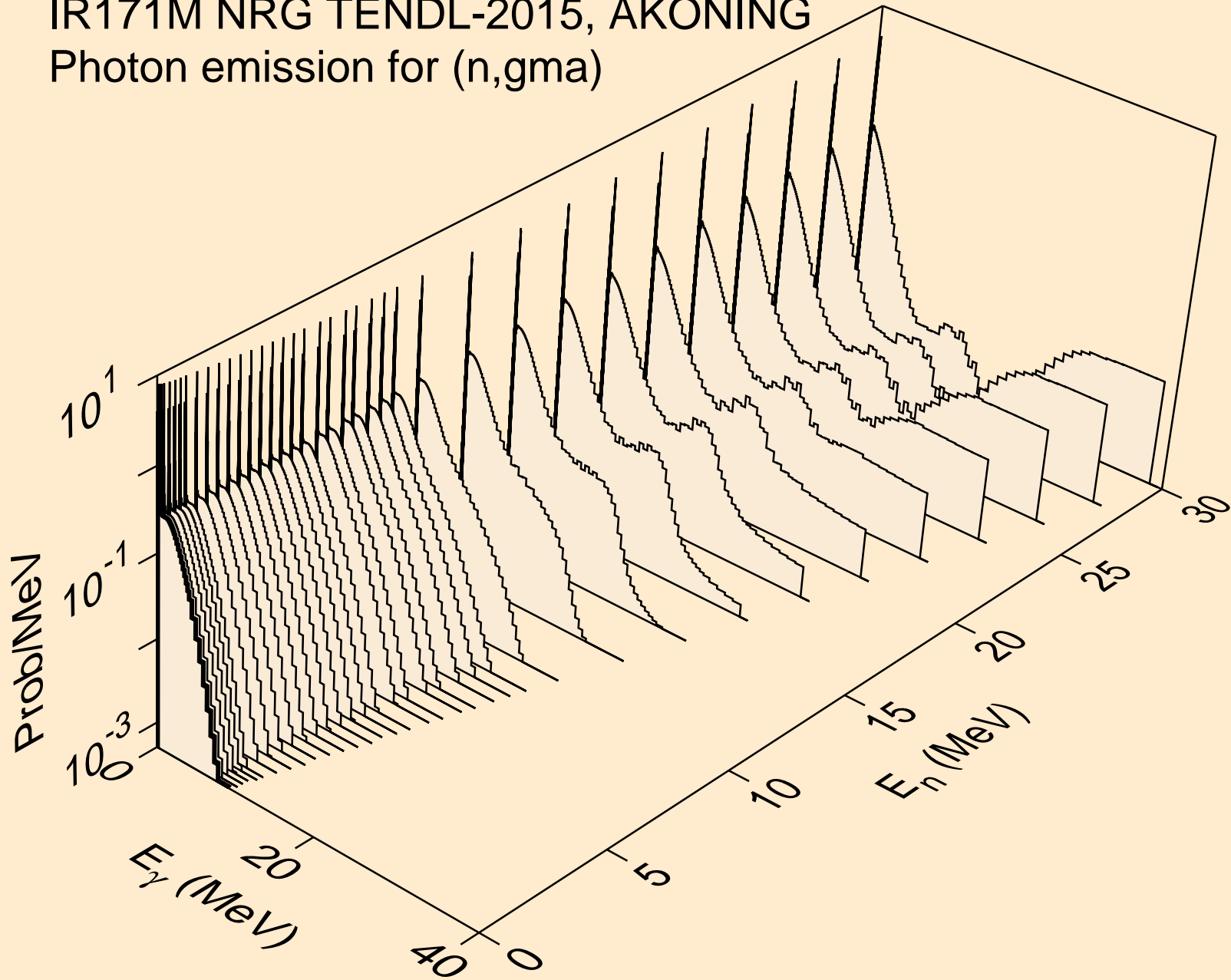

IR171M NRG TENDL-2015, AKONING  
Photon emission for (n,p)

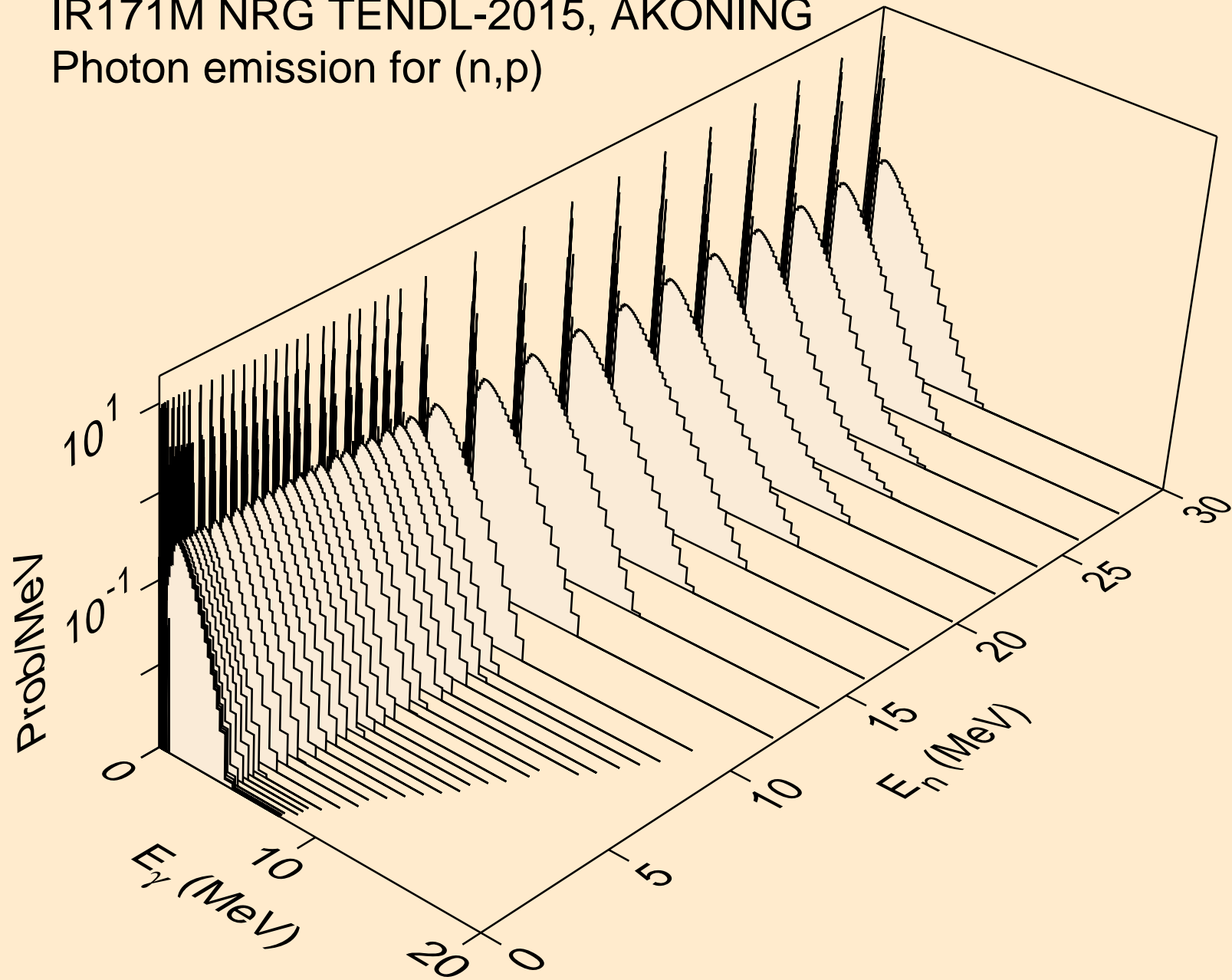

IR171M NRG TENDL-2015, AKONING  
Photon emission for (n,d)

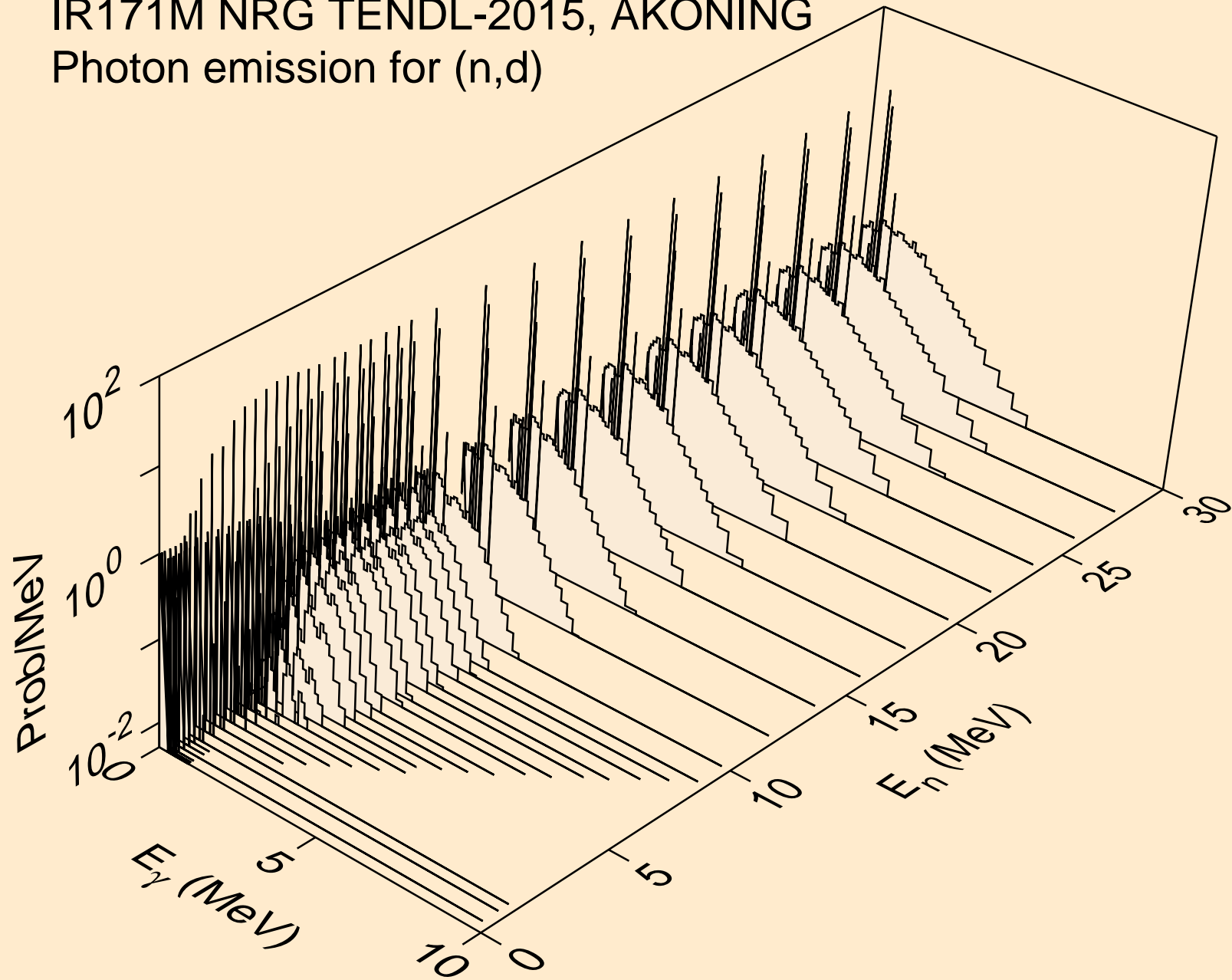

IR171M NRG TENDL-2015, AKONING  
Photon emission for (n,t)

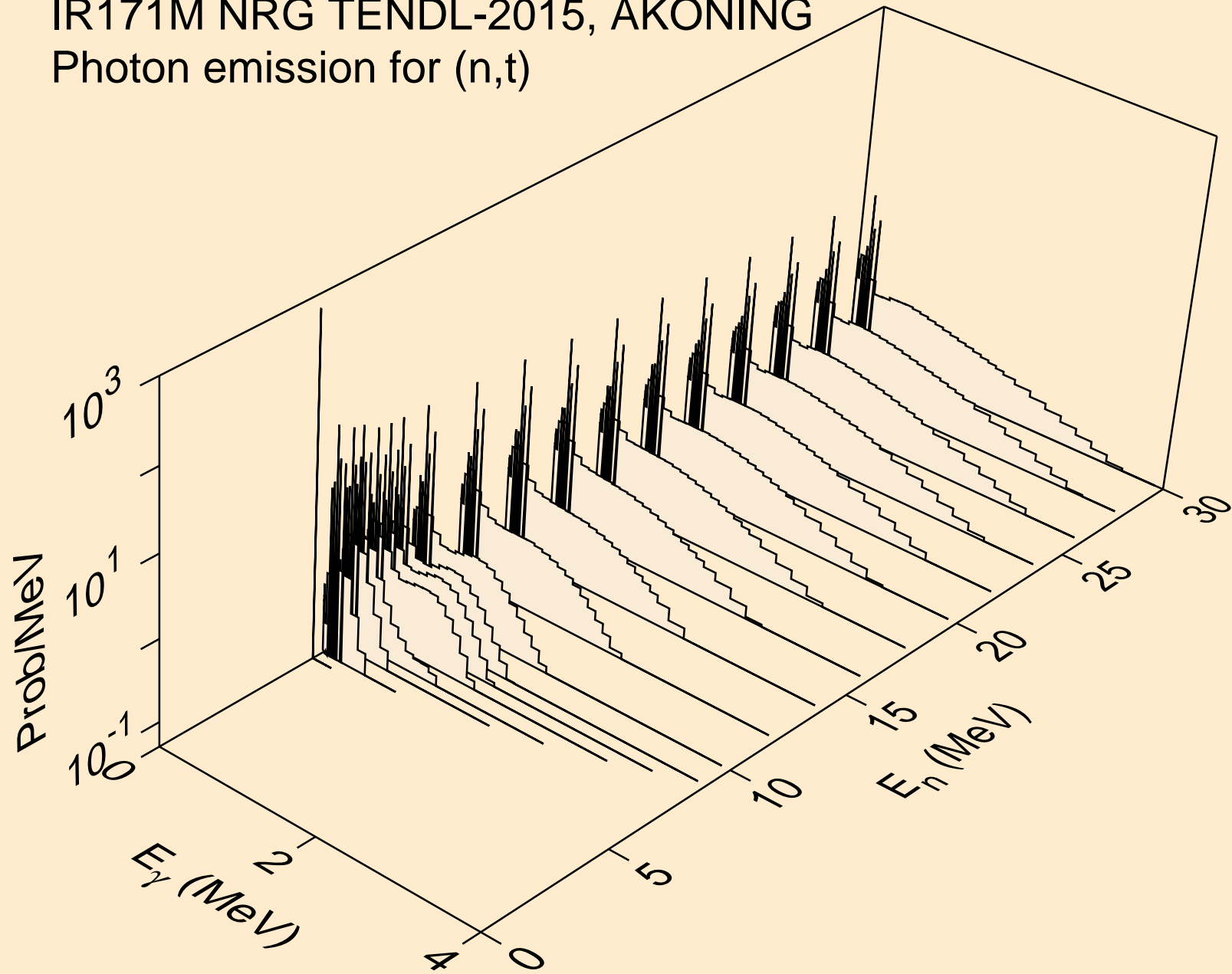

IR171M NRG TENDL-2015, AKONING  
Photon emission for (n,he3)

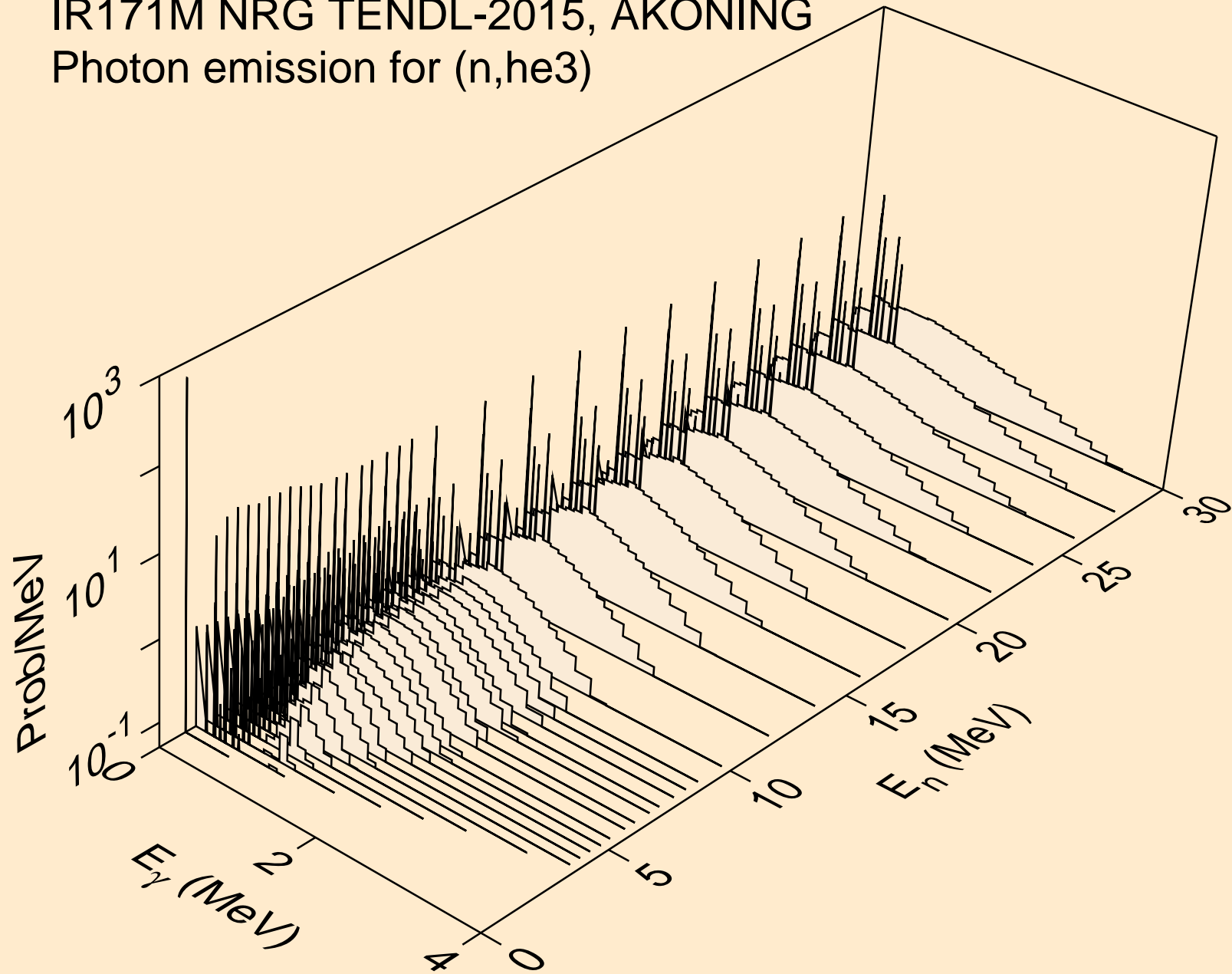



IR171M NRG TENDL-2015, AKONING  
Photon emission for (n,a)

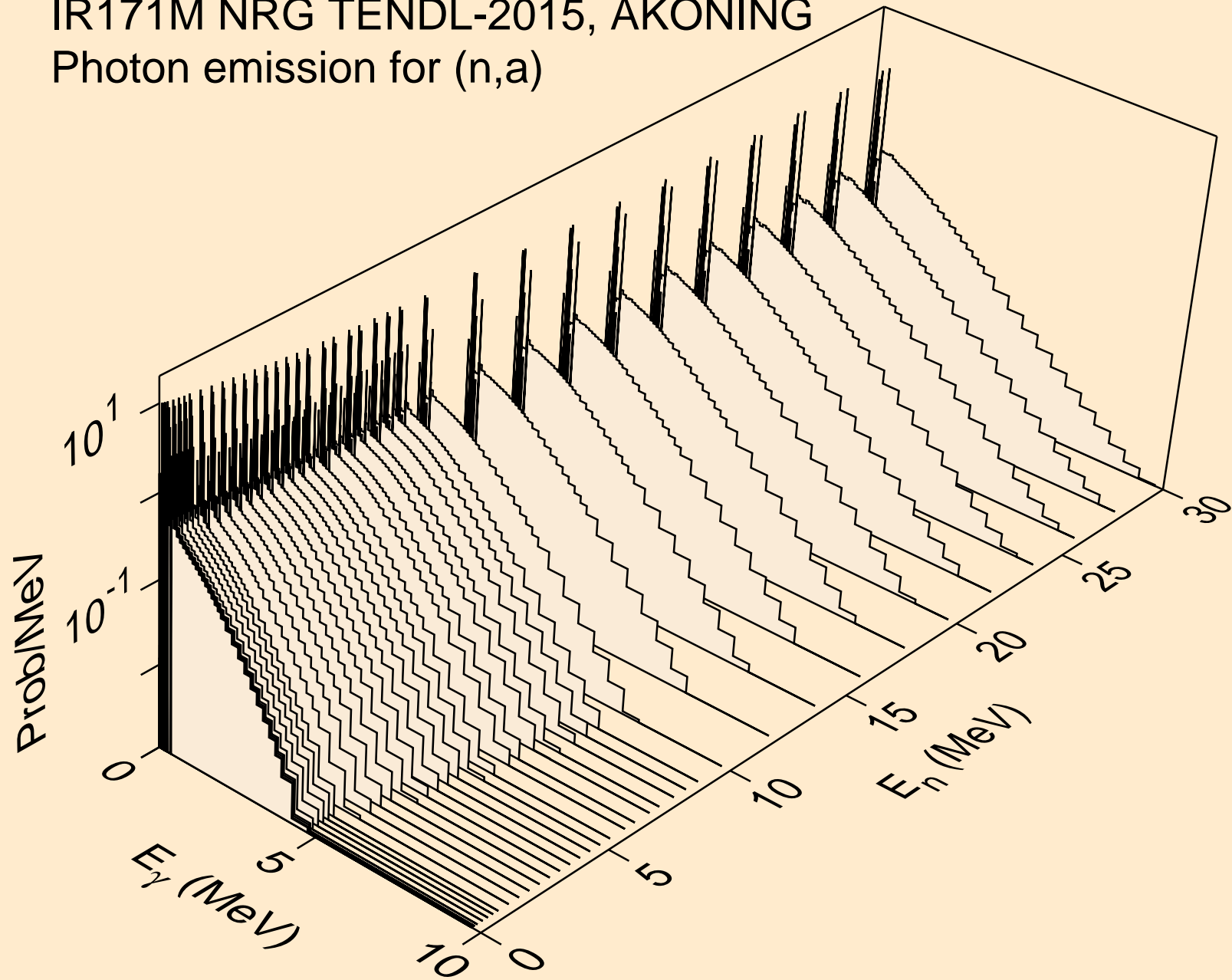

IR171M NRG TENDL-2015, AKONING  
Photon emission for (n,2a)

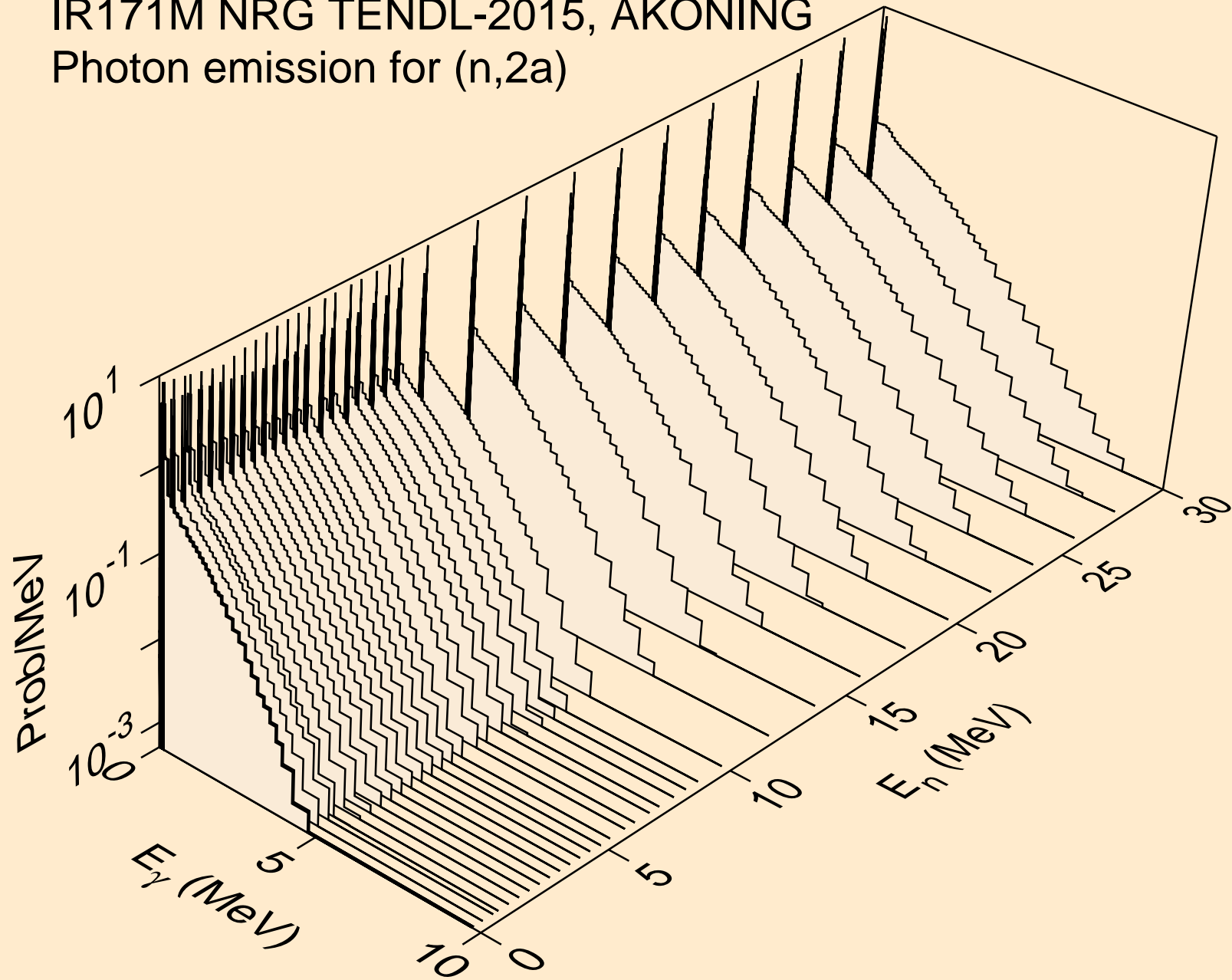

IR171M NRG TENDL-2015, AKONING  
Photon emission for (n,3a)

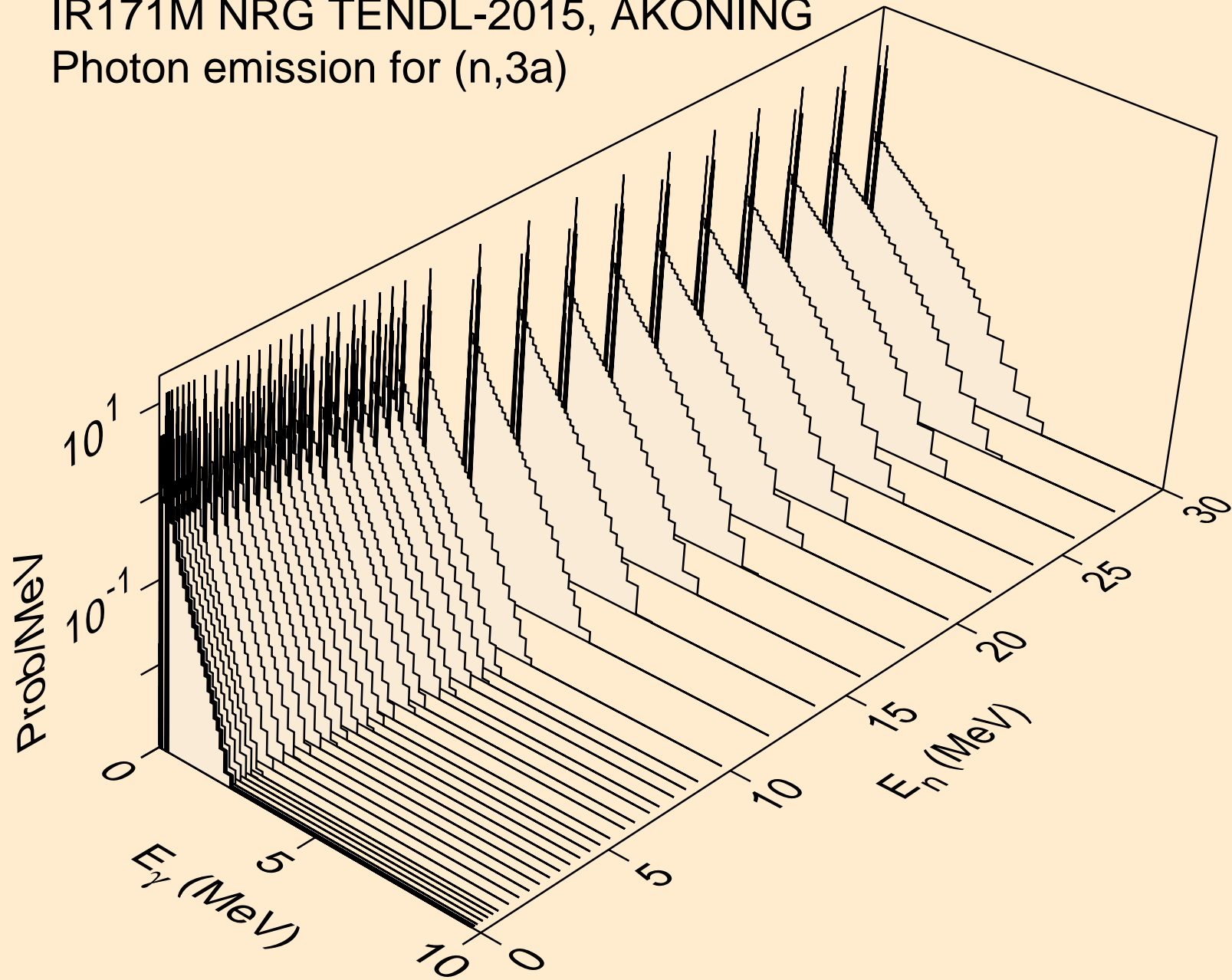

IR171M NRG TENDL-2015, AKONING  
Photon emission for (n,2p)

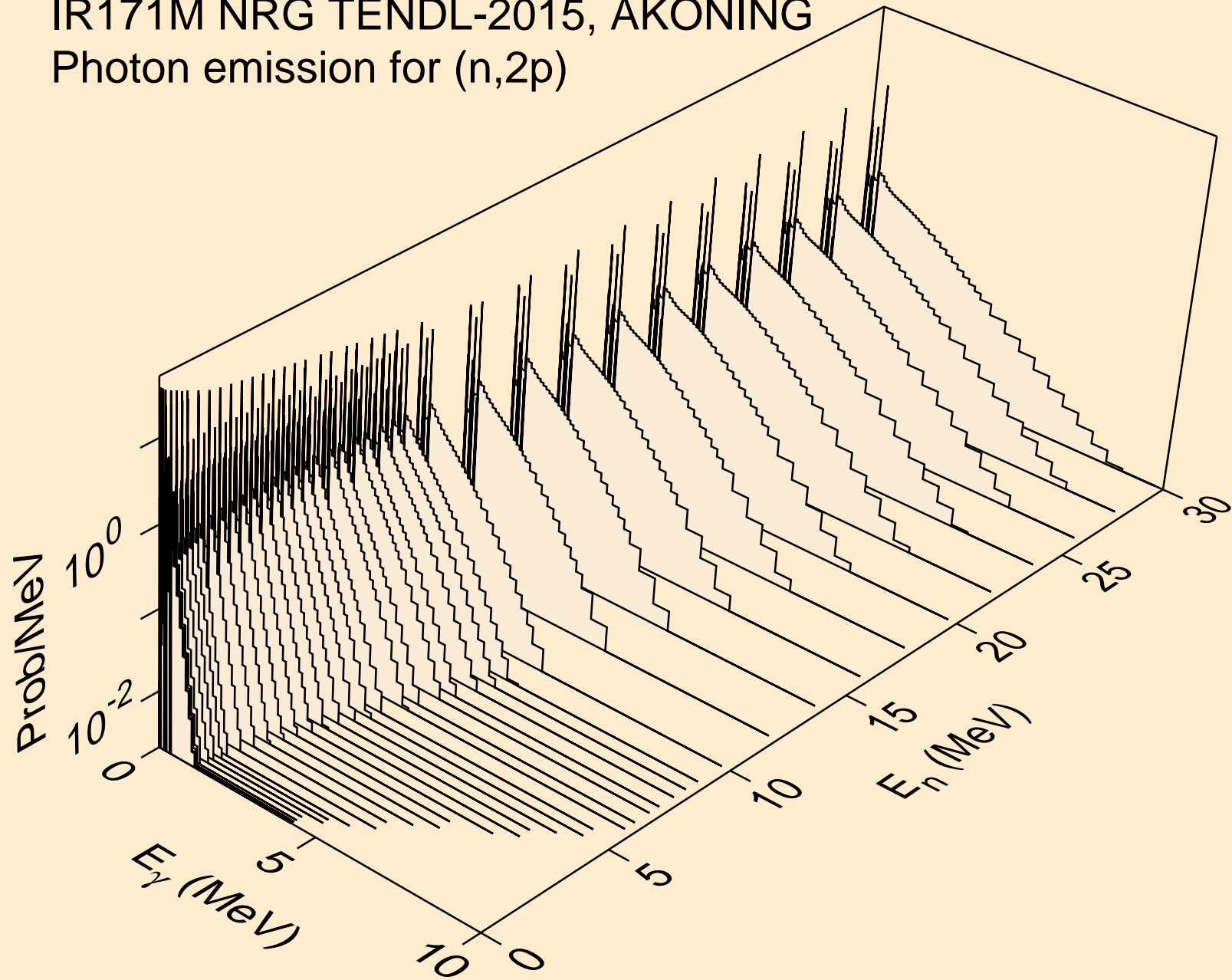

IR171M NRG TENDL-2015, AKONING  
Photon emission for (n,p $\alpha$ )

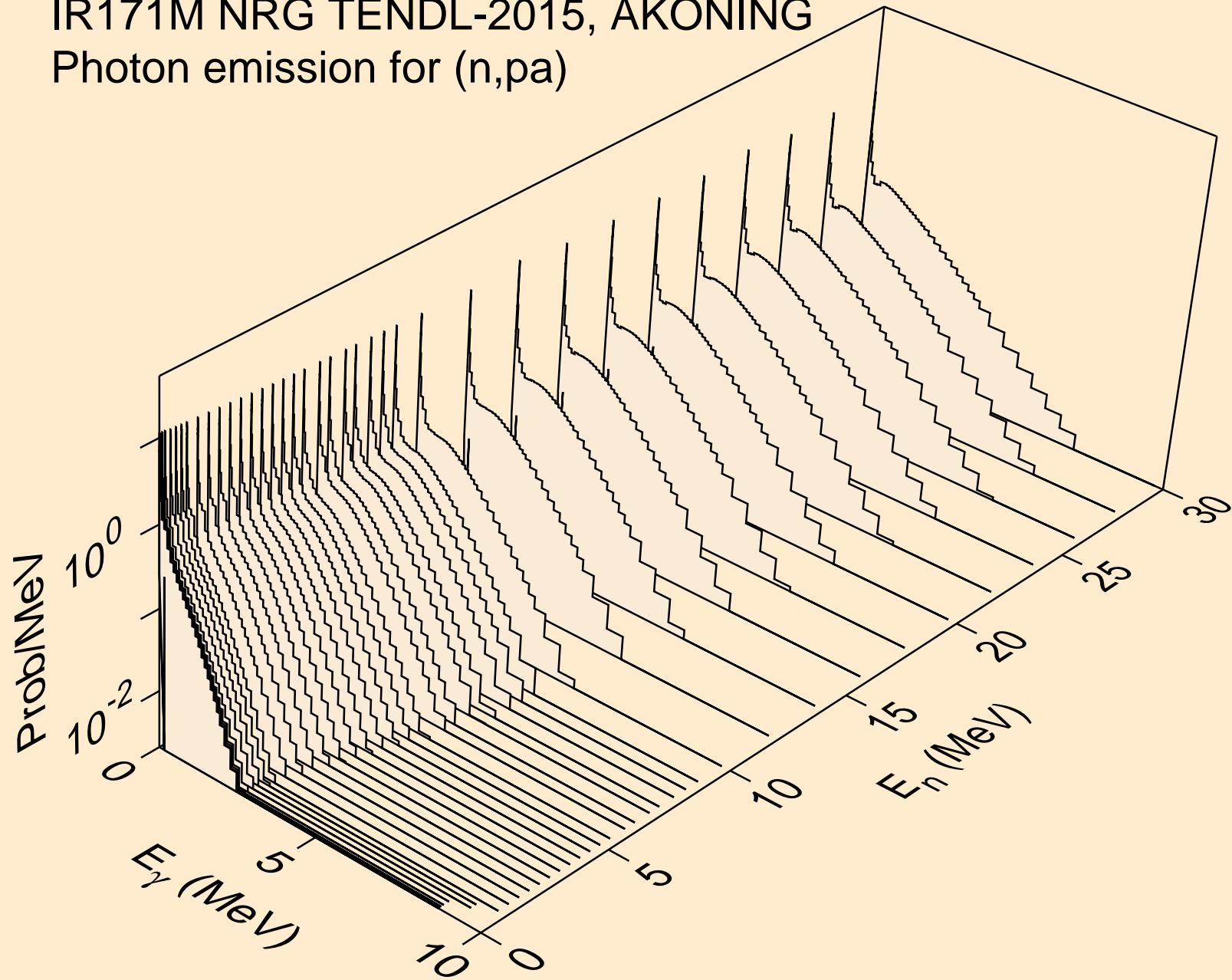

IR171M NRG TENDL-2015, AKONING  
Photon emission for (n,t2a)

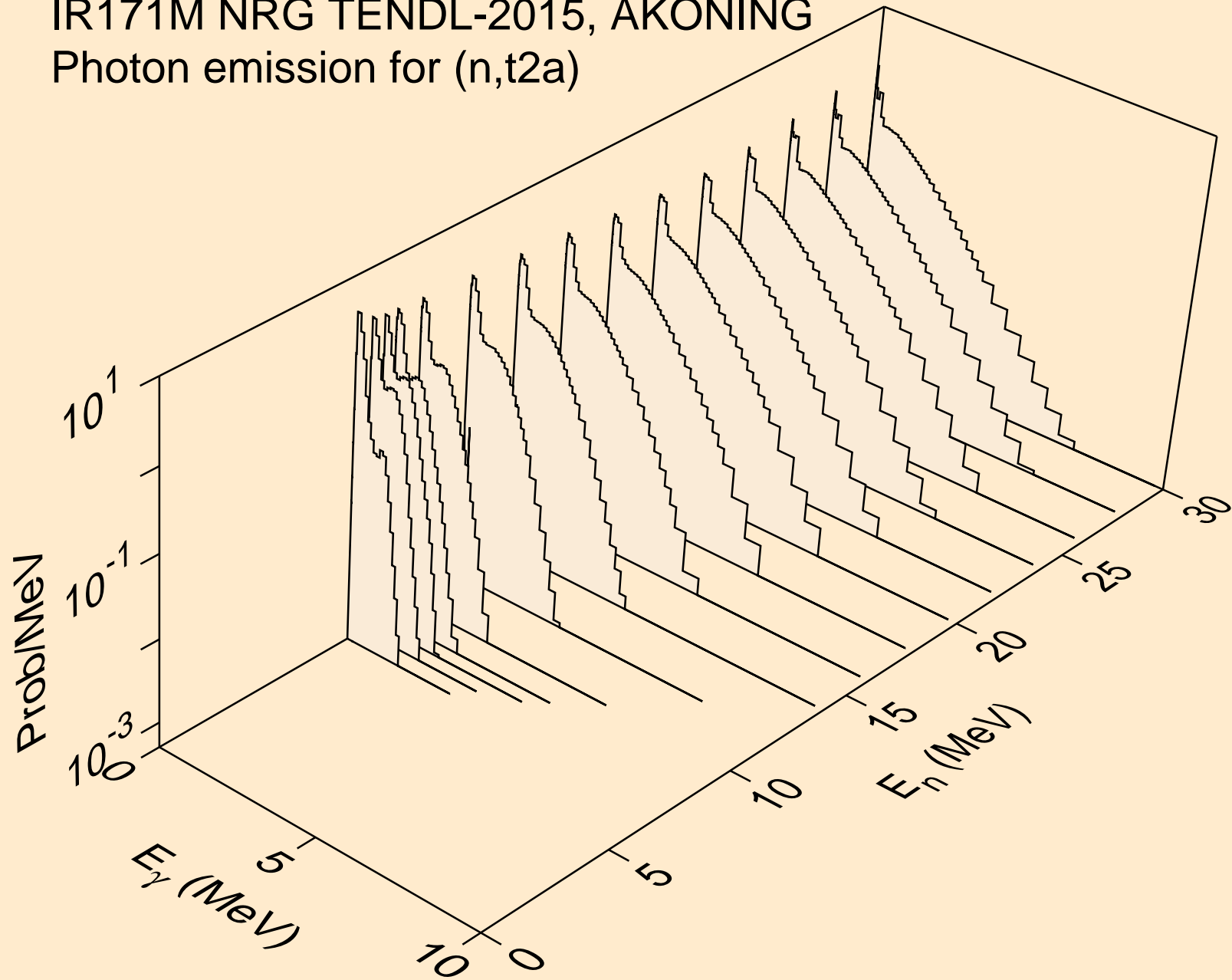

IR171M NRG TENDL-2015, AKONING  
Photon emission for (n,d2a)

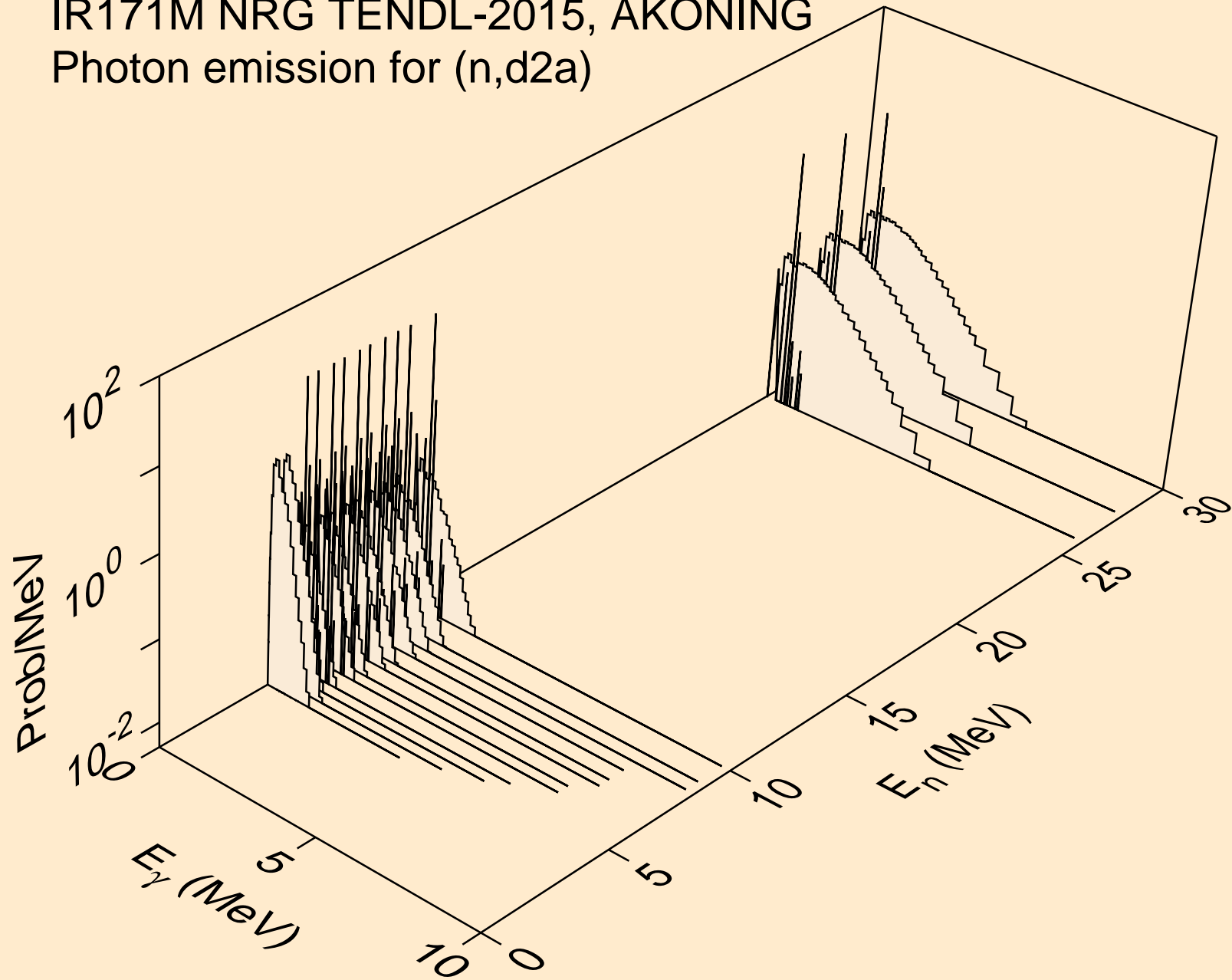

IR171M NRG TENDL-2015, AKONING  
Photon emission for (n,pd)

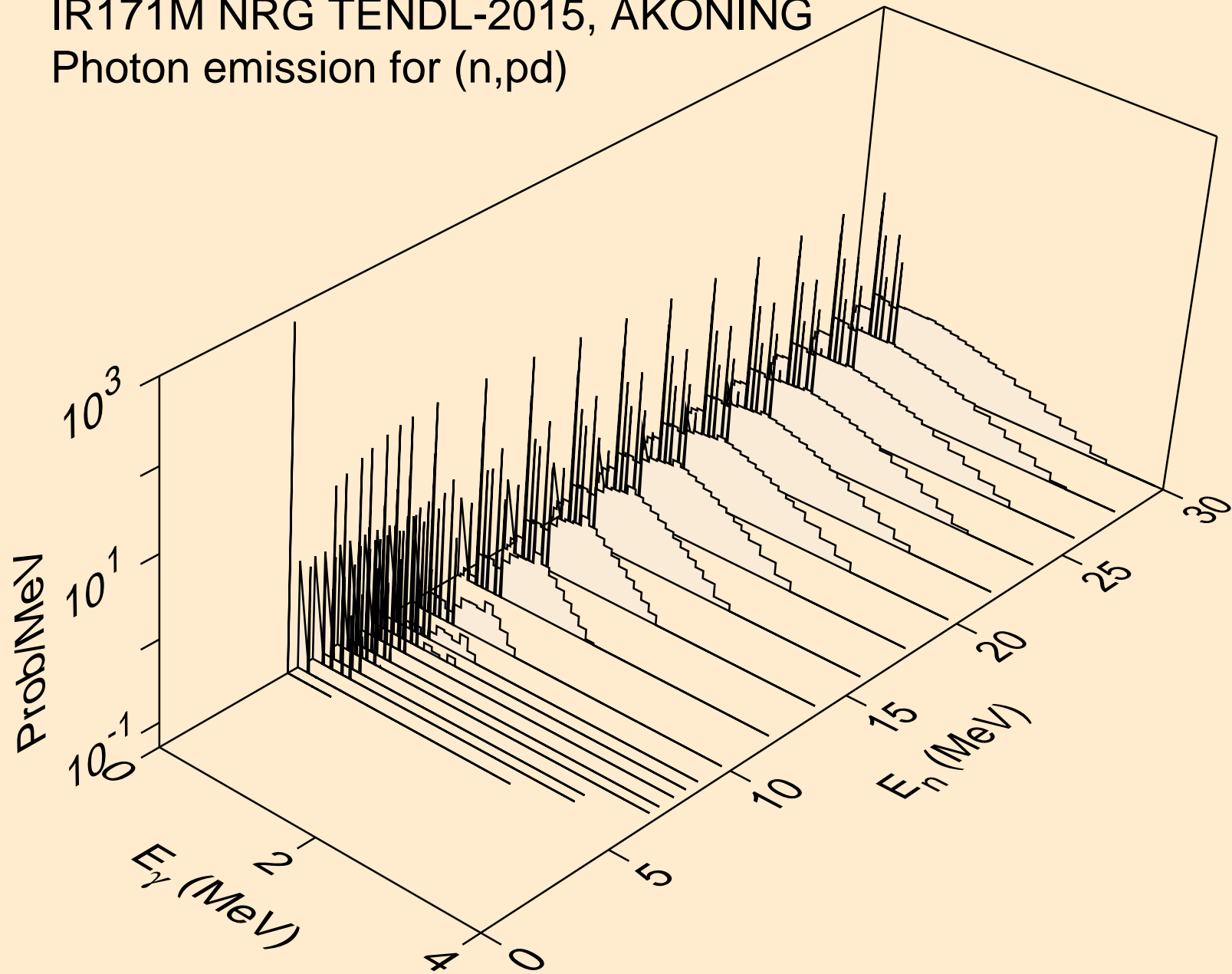



IR171M NRG TENDL-2015, AKONING  
Photon emission for (n,pt)

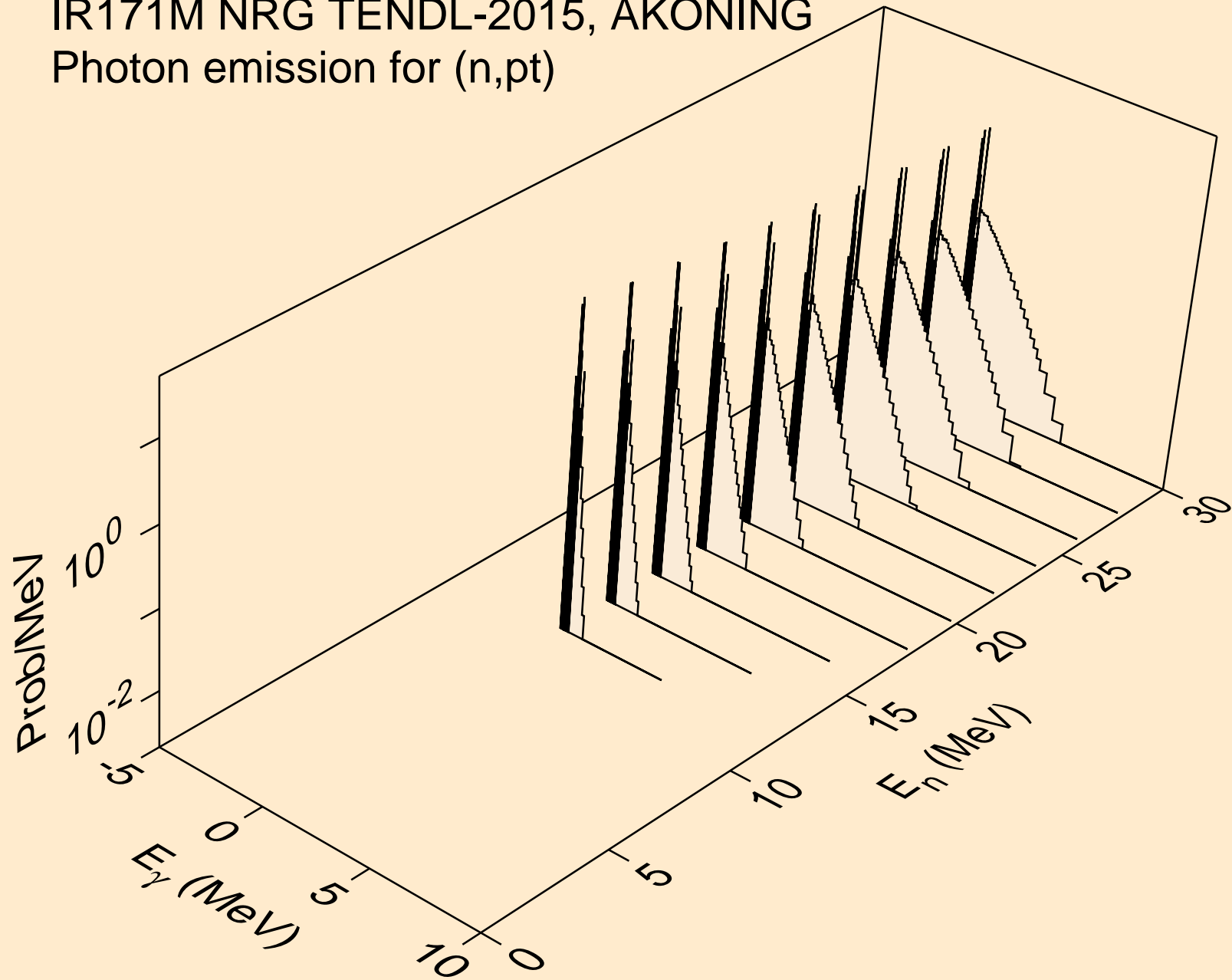

IR171M NRG TENDL-2015, AKONING  
Photon emission for (n,da)

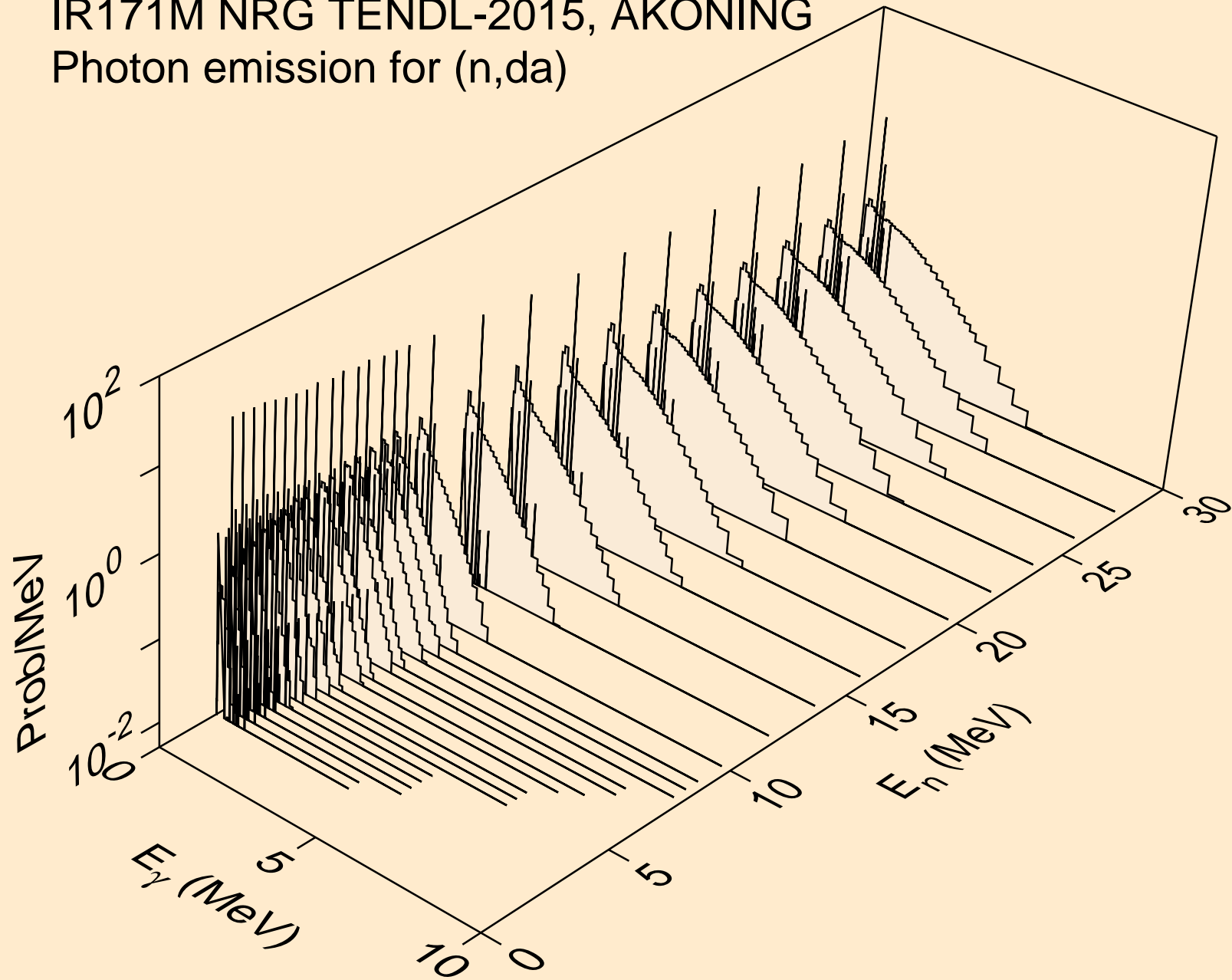

IR171M NRG TENDL-2015, AKONING  
thermal capture photon spectrum

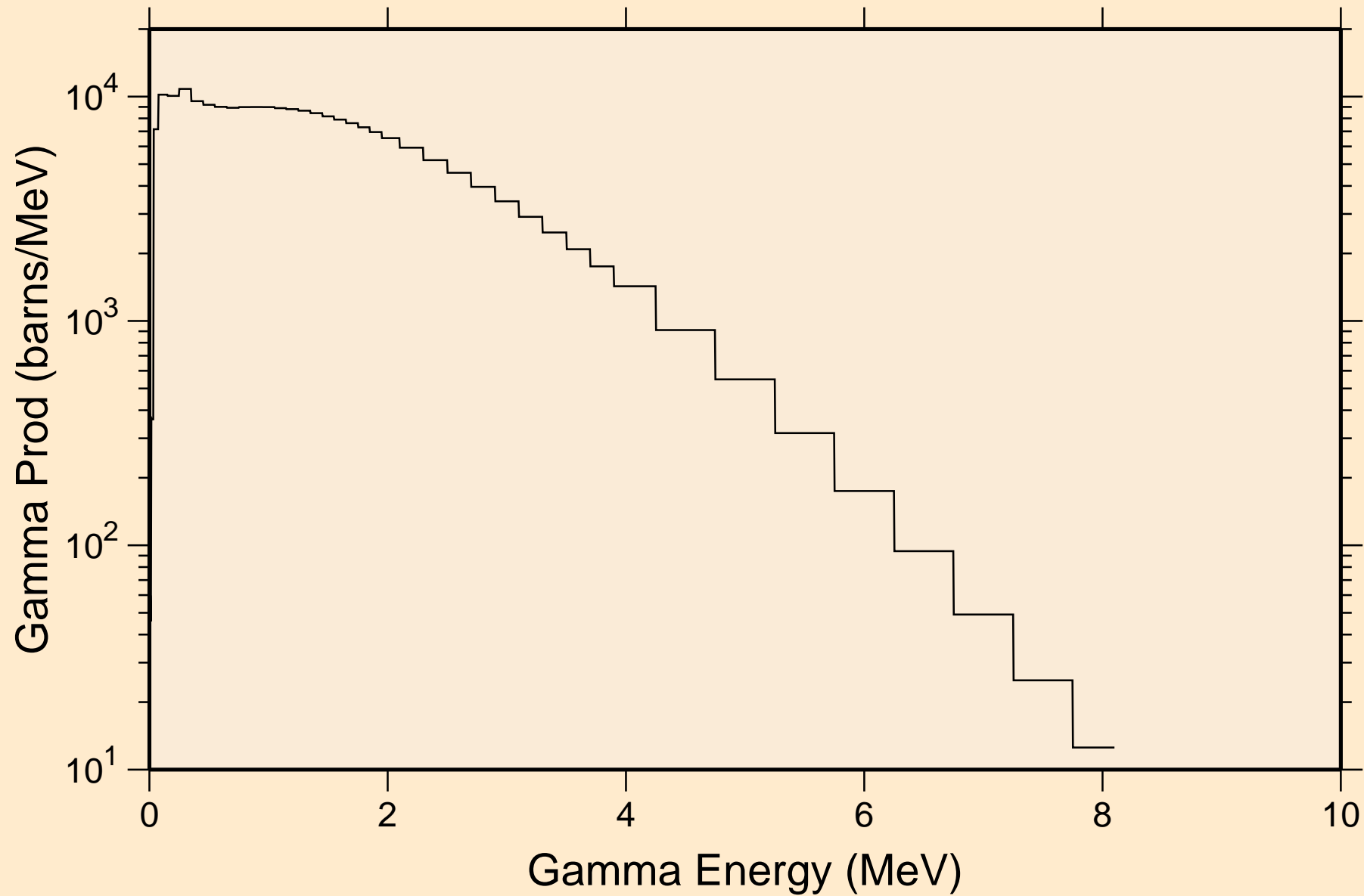

IR171M NRG TENDL-2015, AKONING  
14 MeV photon spectrum

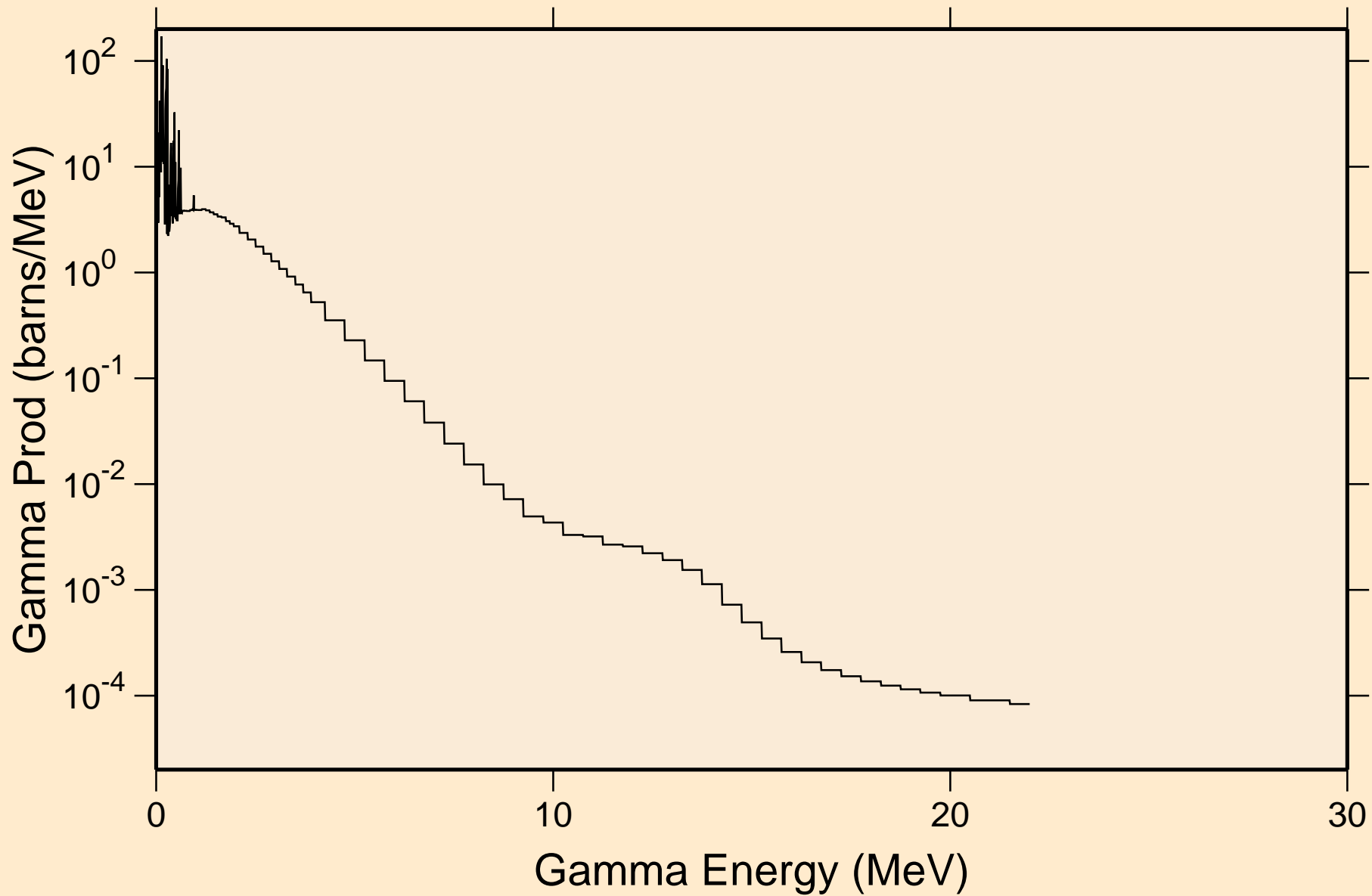

# IR171M NRG TENDL-2015, AKONING

## Particle heating contributions

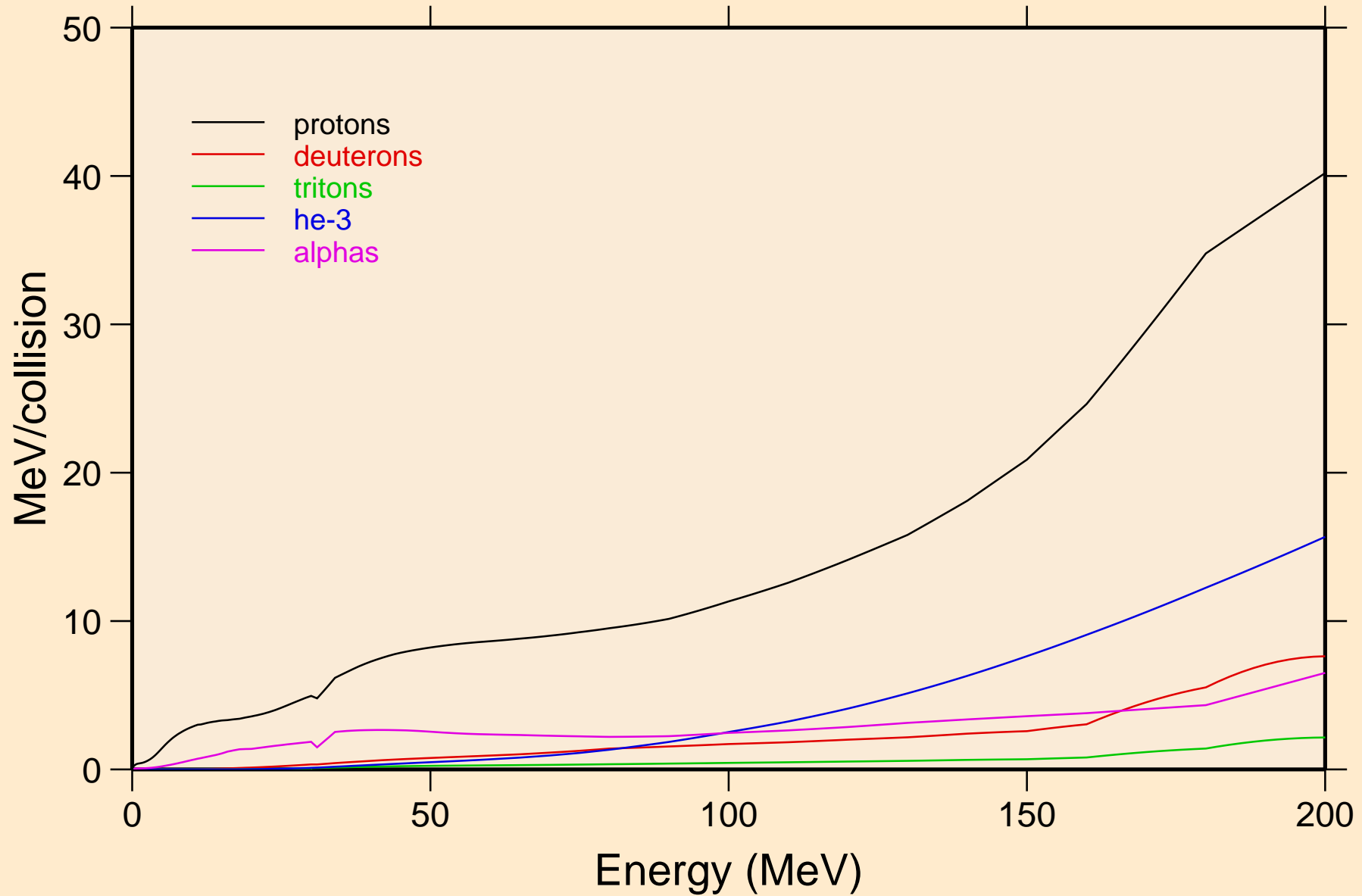

# IR171M NRG TENDL-2015, AKONING

## Recoil Heating

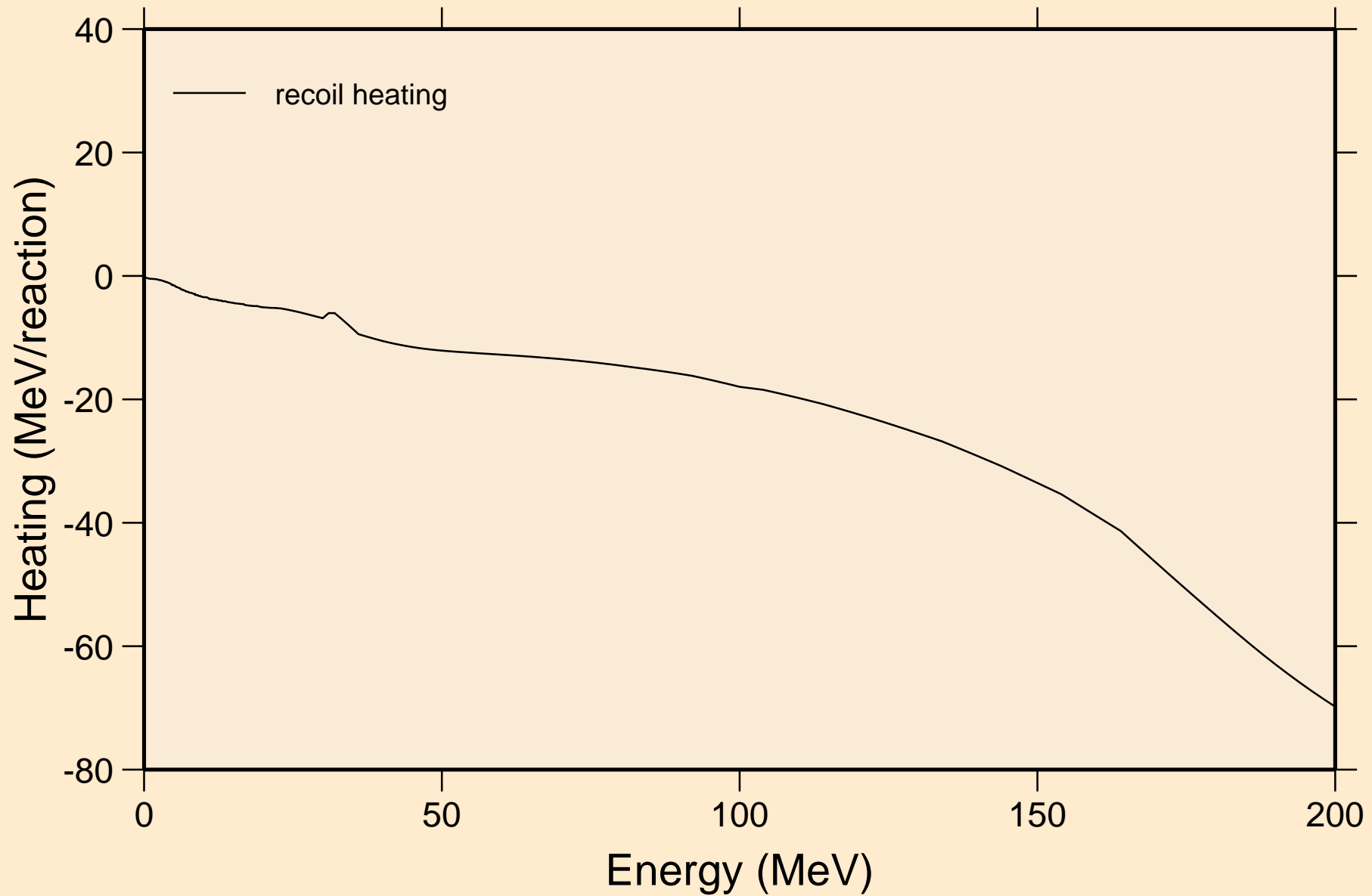

# IR171M NRG TENDL-2015, AKONING

## Particle production cross sections

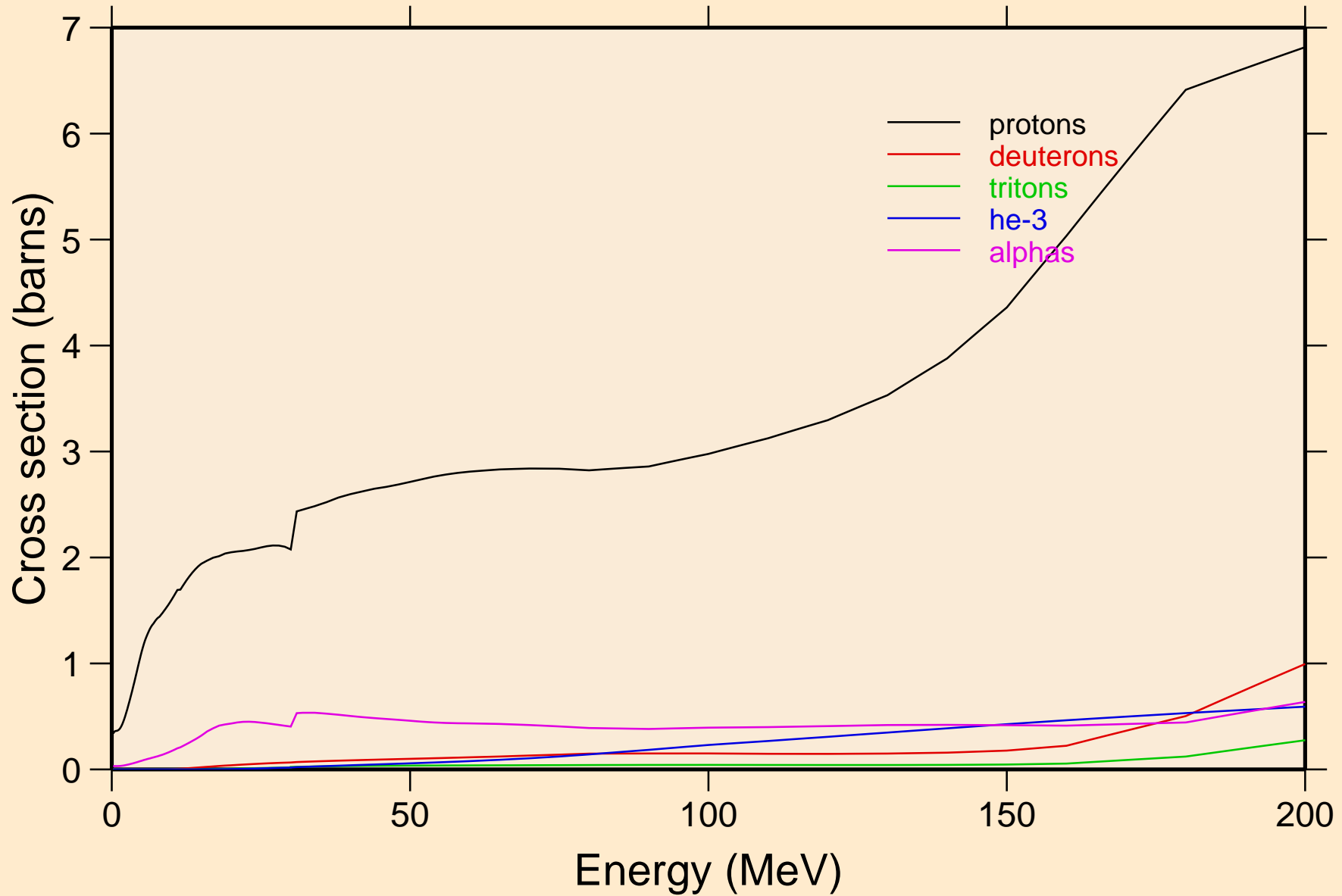

IR171M NRG TENDL-2015, AKONING  
protons from (n,x)

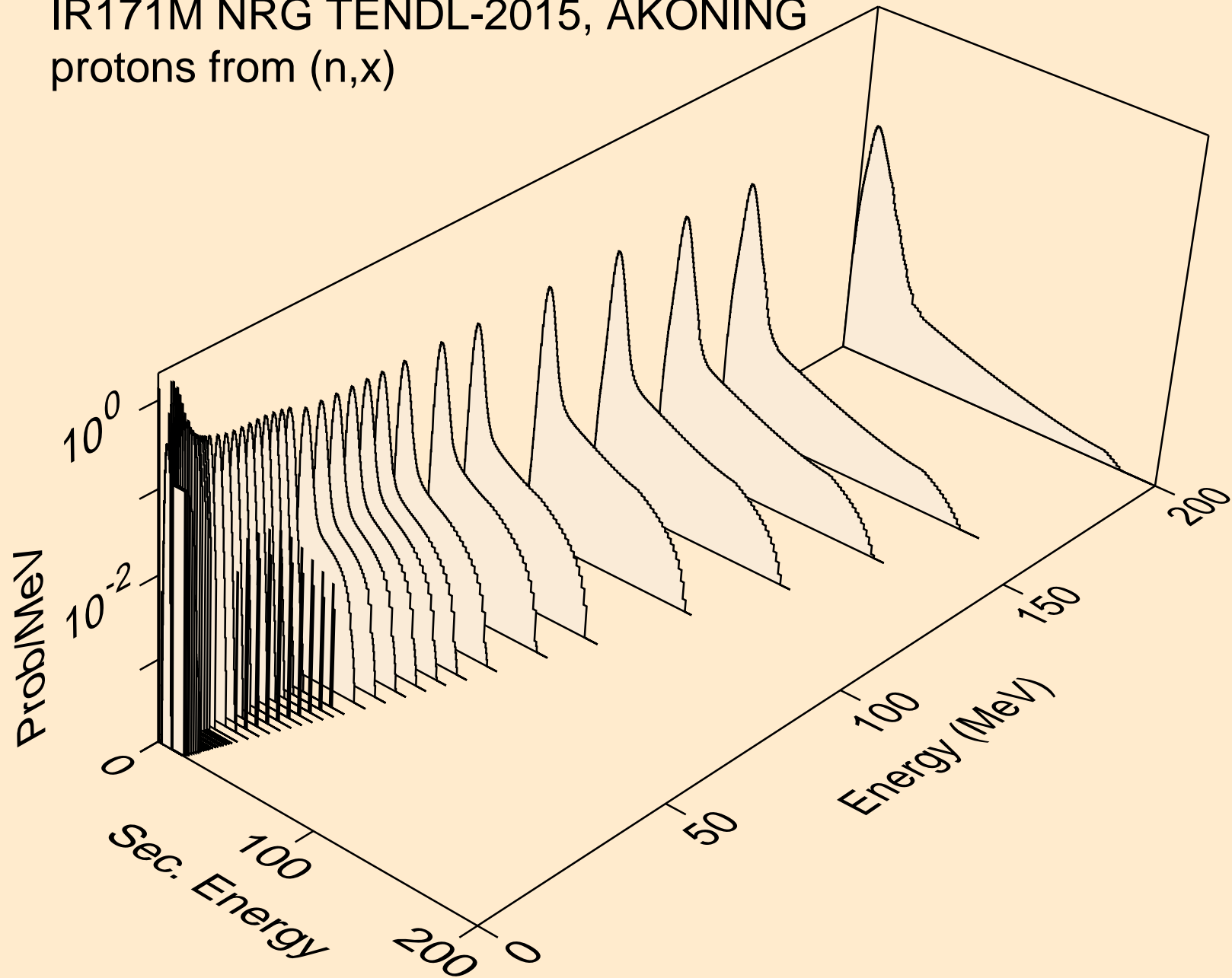



IR171M NRG TENDL-2015, AKONING  
protons from (n,n\*)p

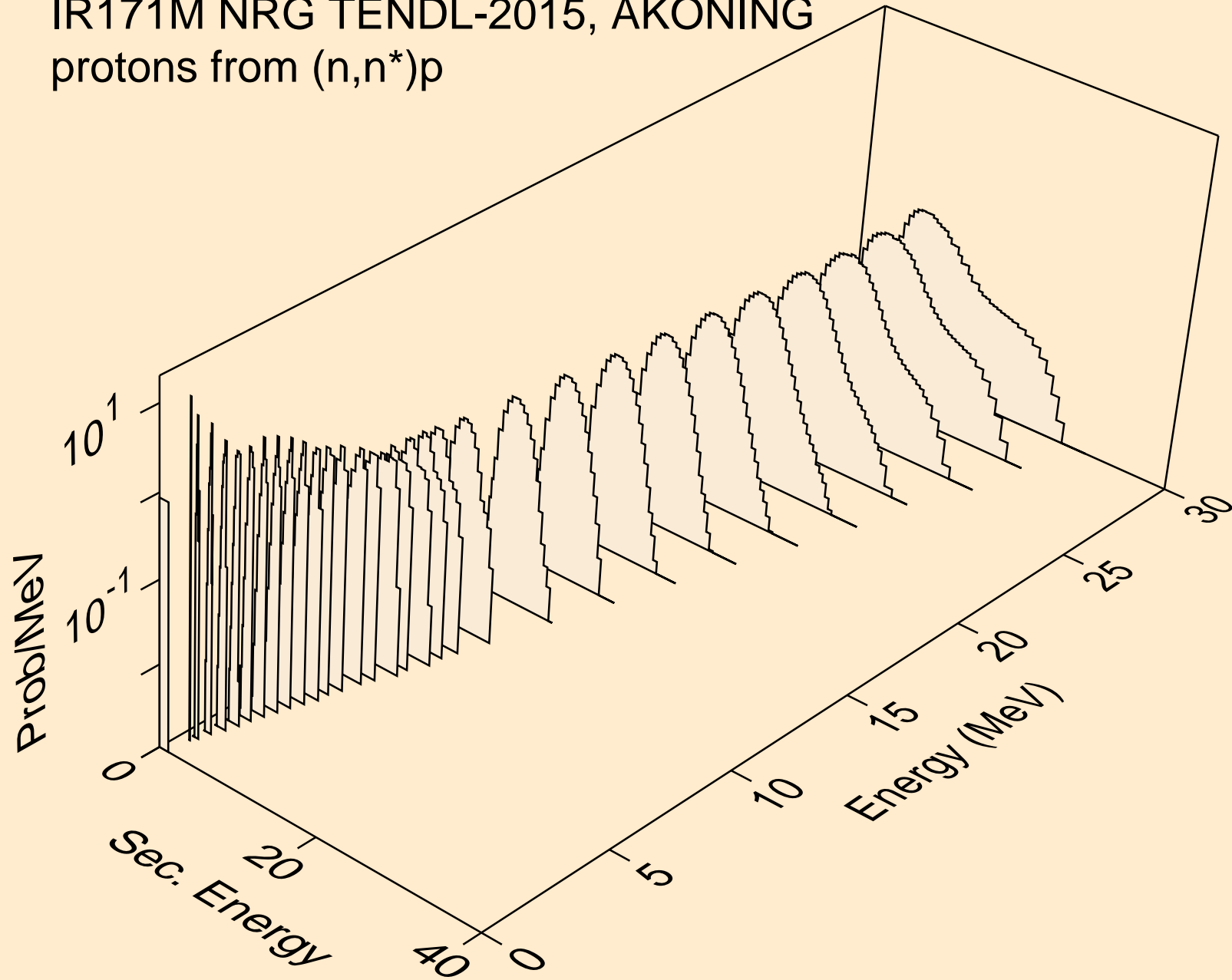

IR171M NRG TENDL-2015, AKONING  
protons from (n,2np)

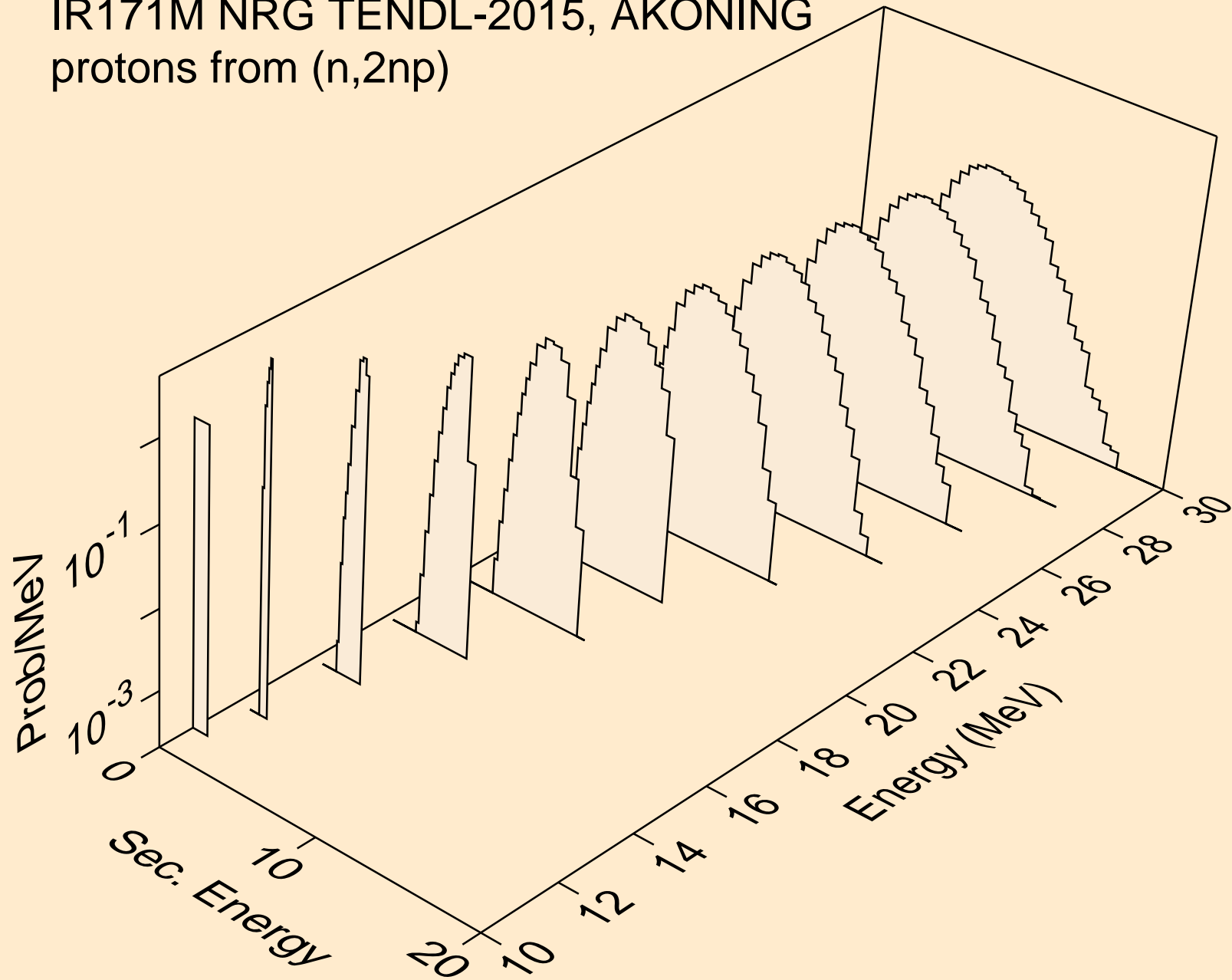

IR171M NRG TENDL-2015, AKONING  
protons from (n,3np)

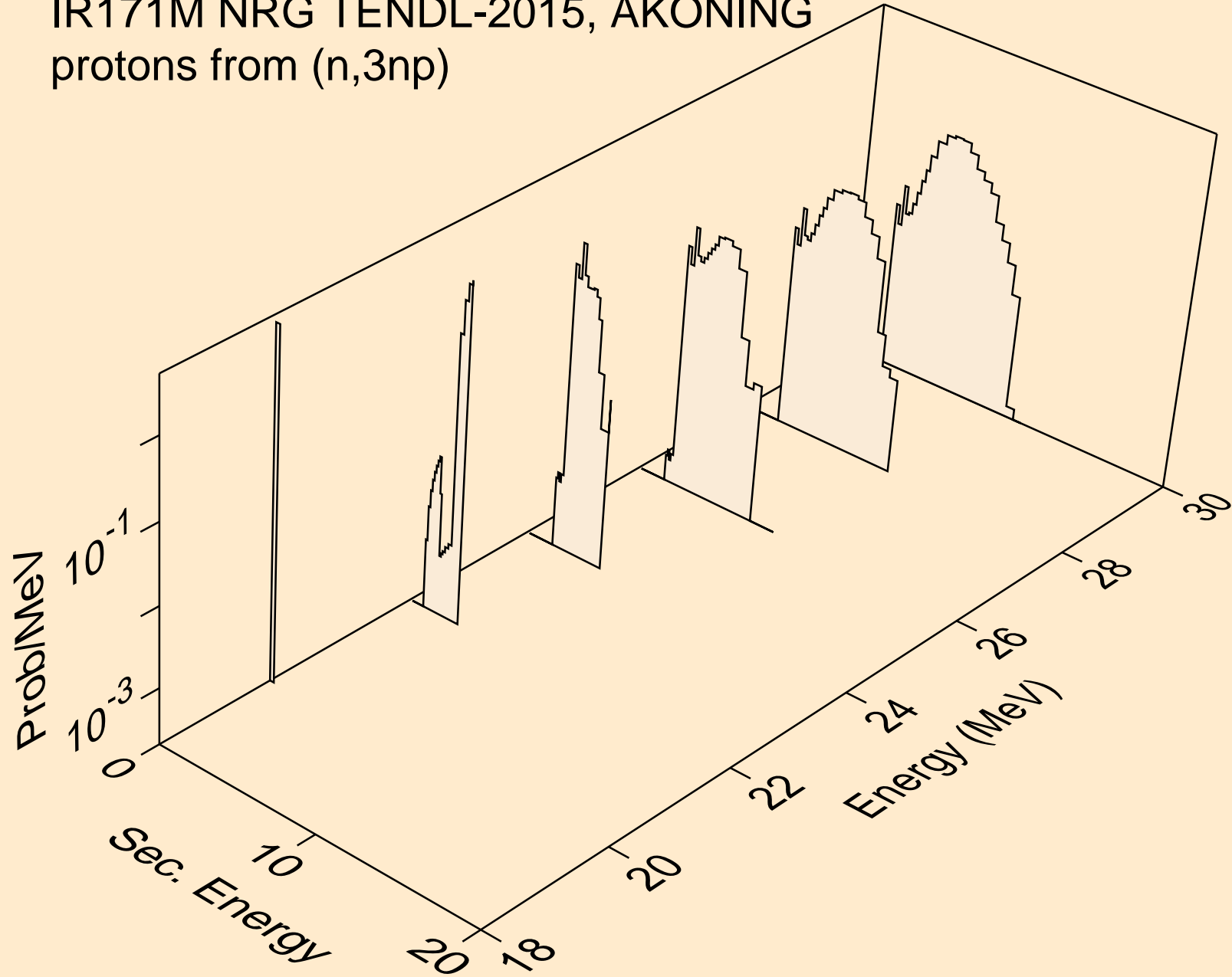

IR171M NRG TENDL-2015, AKONING  
protons from (n,2np)

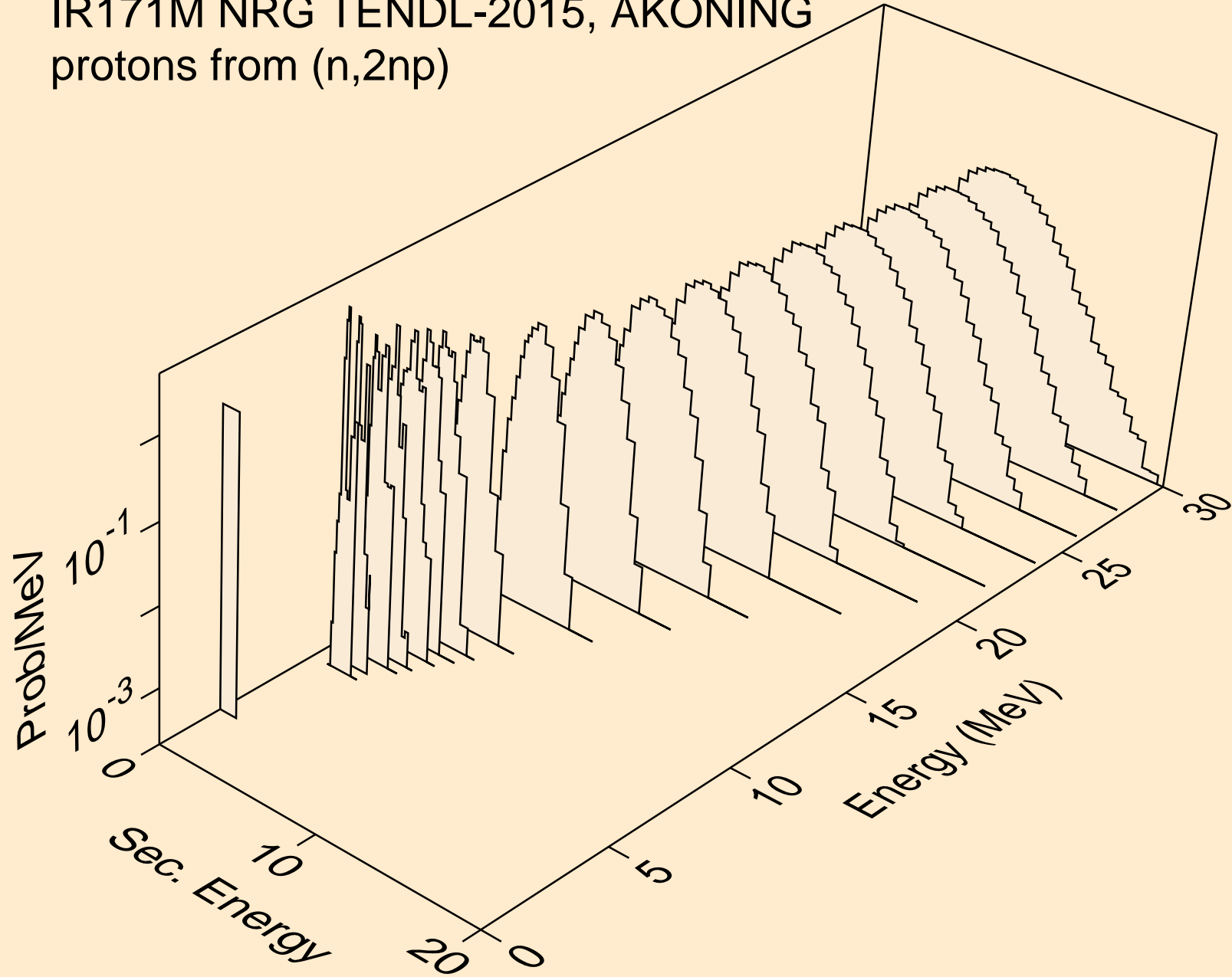

IR171M NRG TENDL-2015, AKONING  
protons from (n,npa)

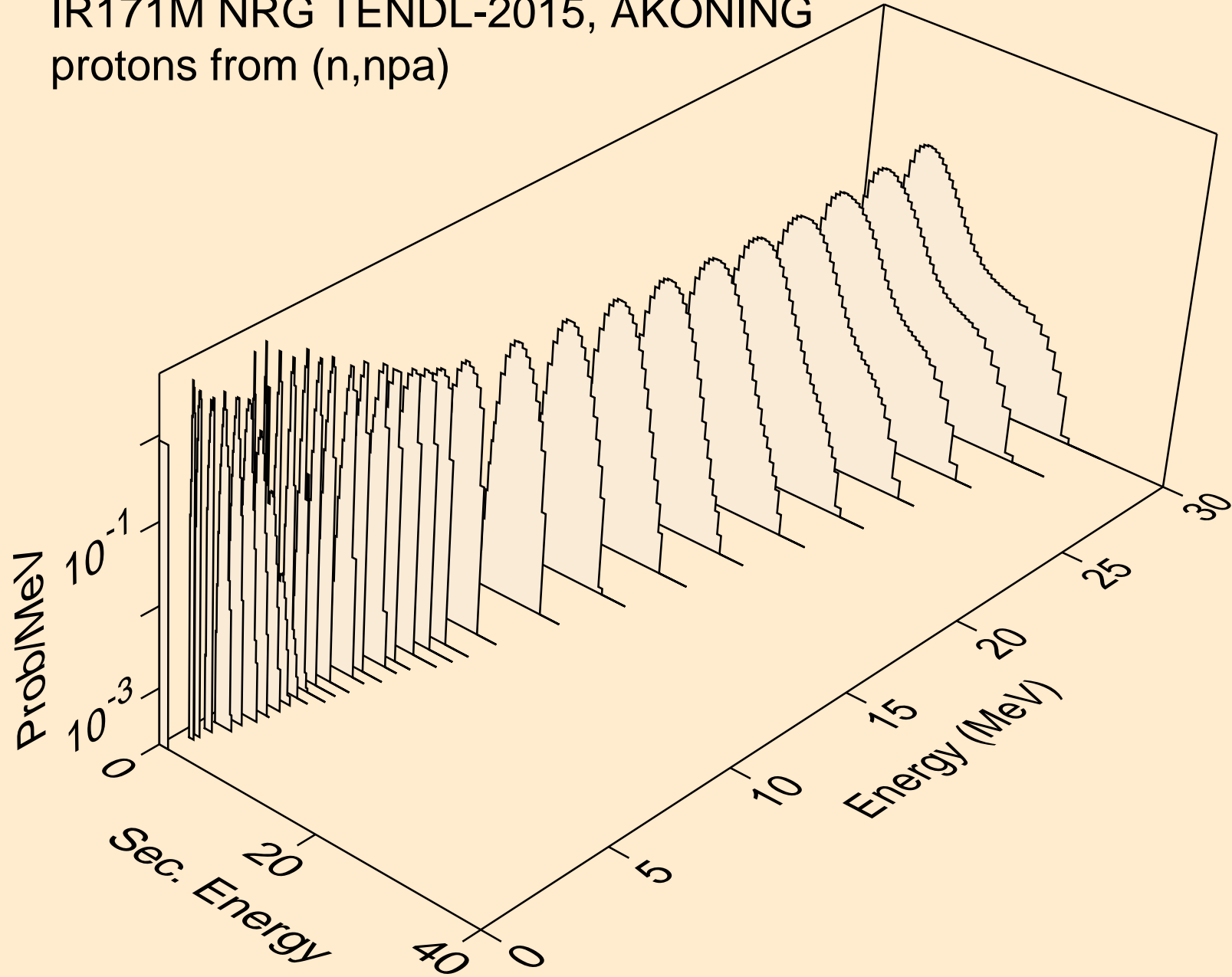

IR171M NRG TENDL-2015, AKONING  
protons from (n,p)

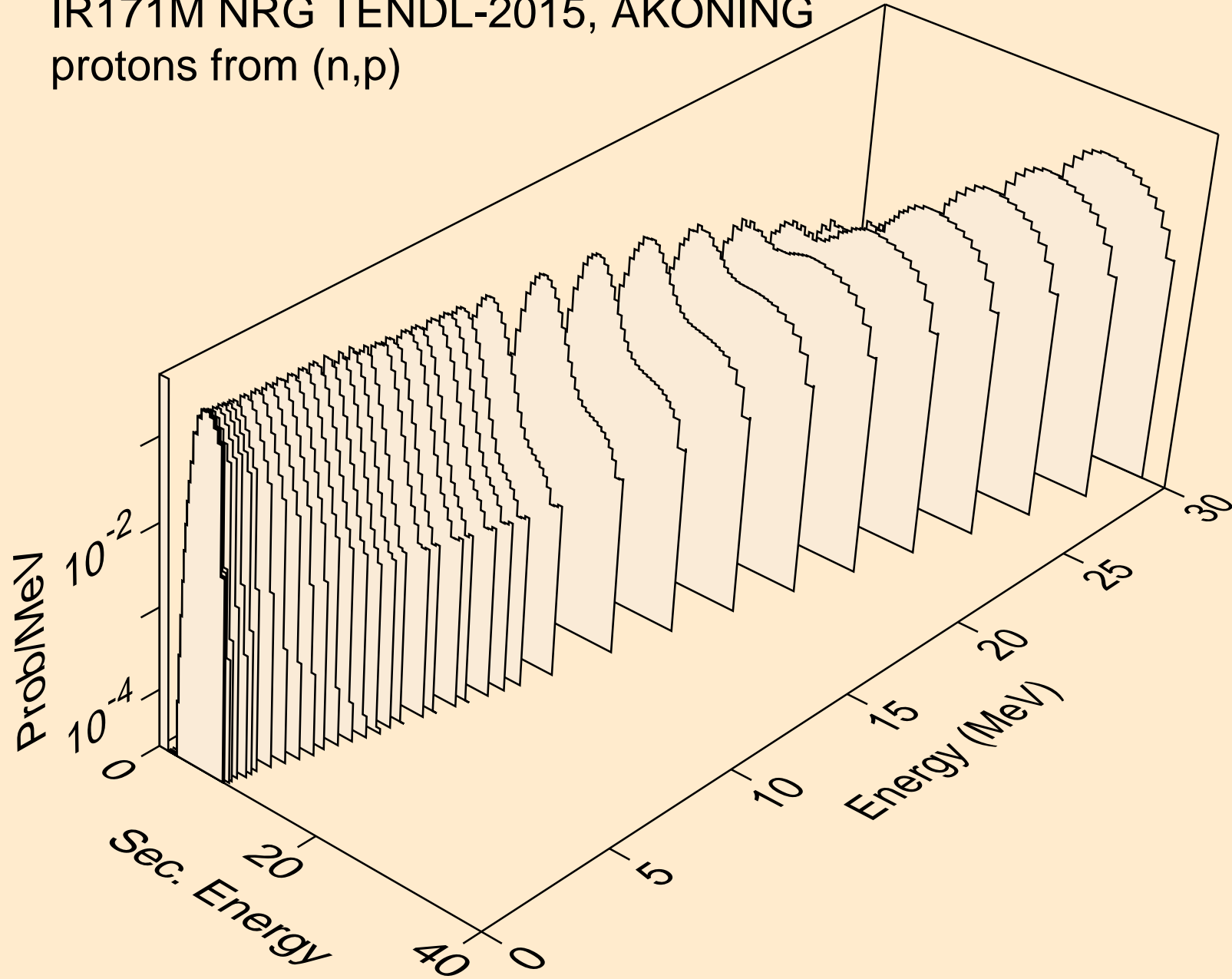

IR171M NRG TENDL-2015, AKONING  
protons from (n,2p)

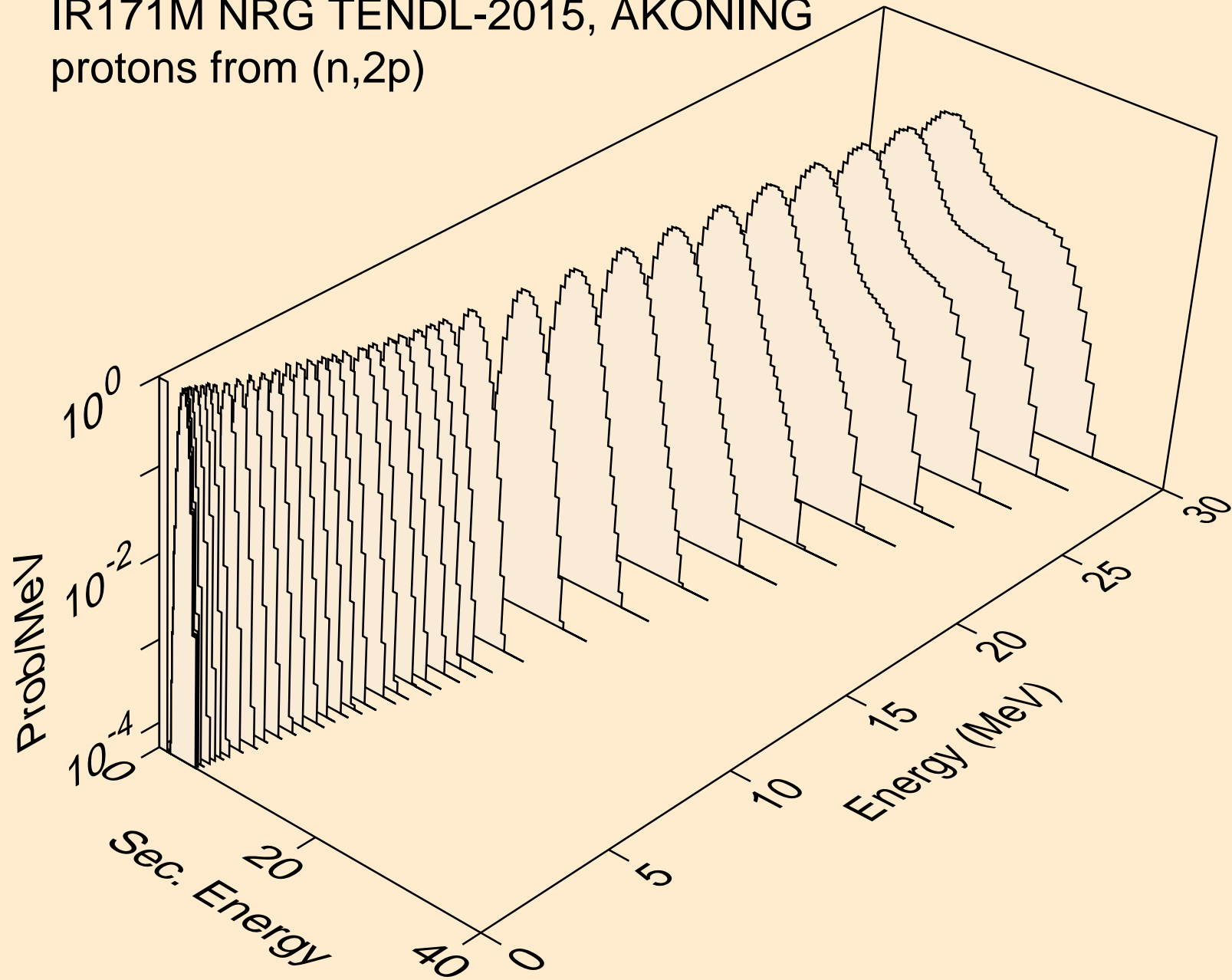

IR171M NRG TENDL-2015, AKONING  
protons from (n,pa)

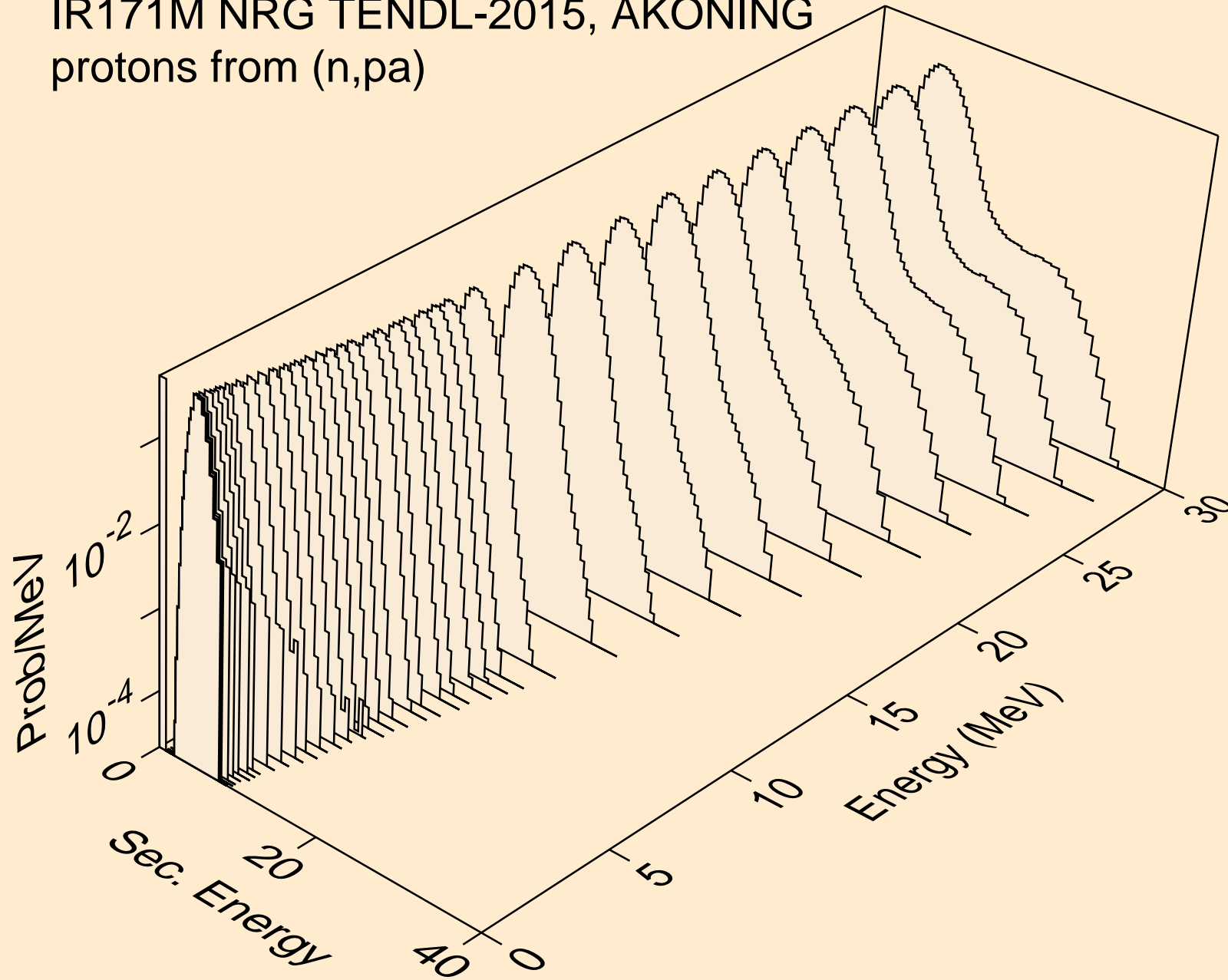



IR171M NRG TENDL-2015, AKONING  
protons from (n,pd)

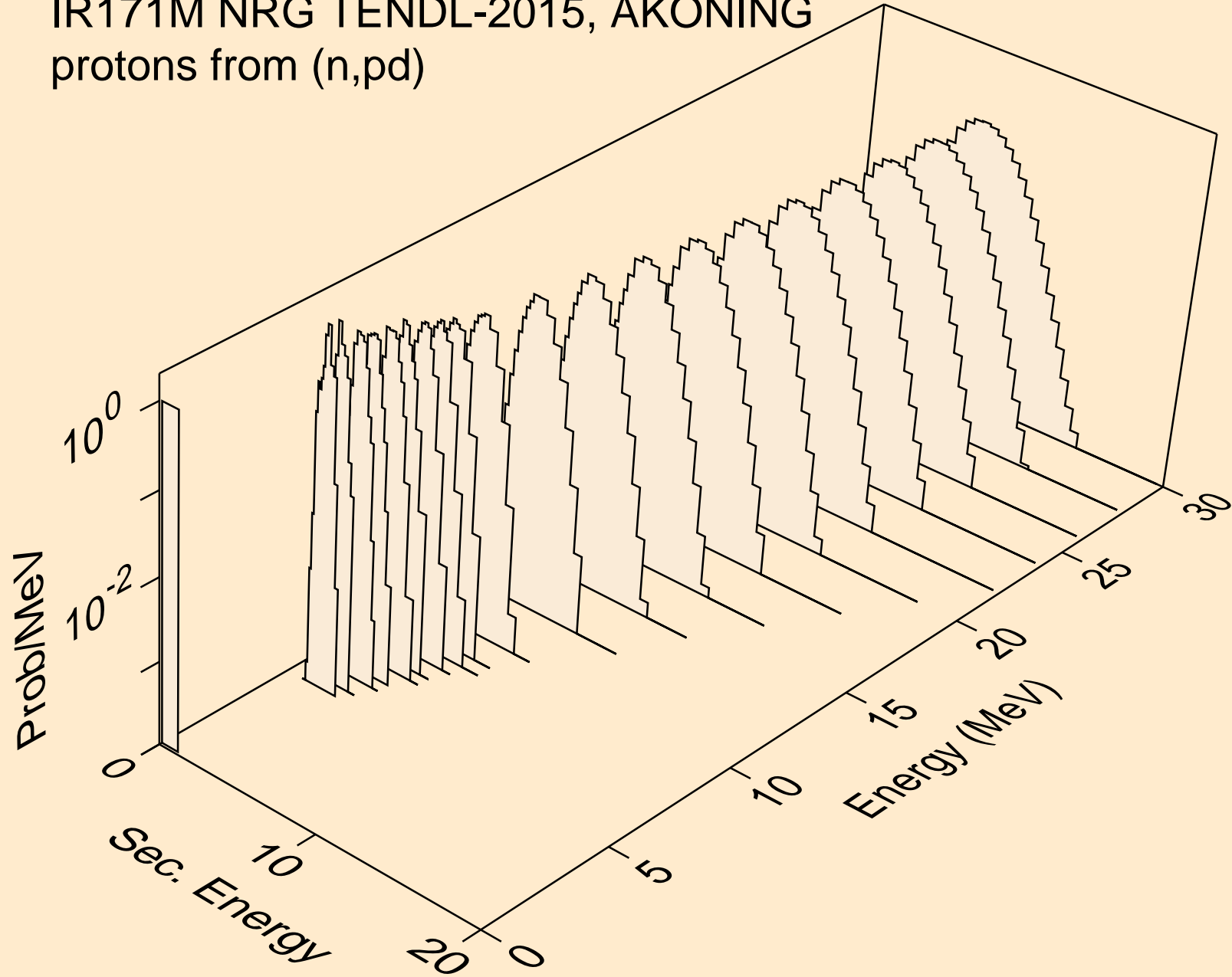

IR171M NRG TENDL-2015, AKONING  
protons from (n,pt)

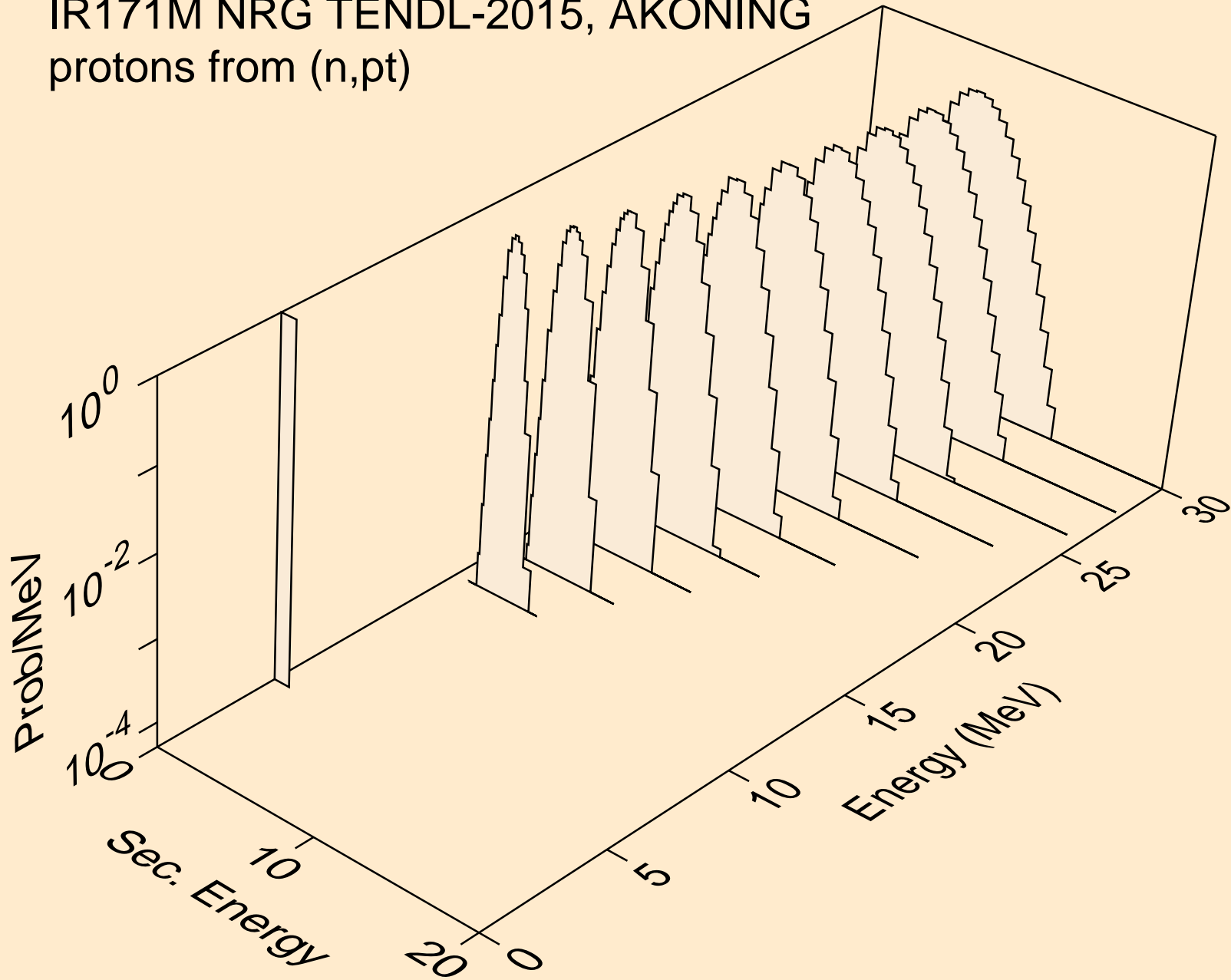

IR171M NRG TENDL-2015, AKONING  
deuterons from (n,x)

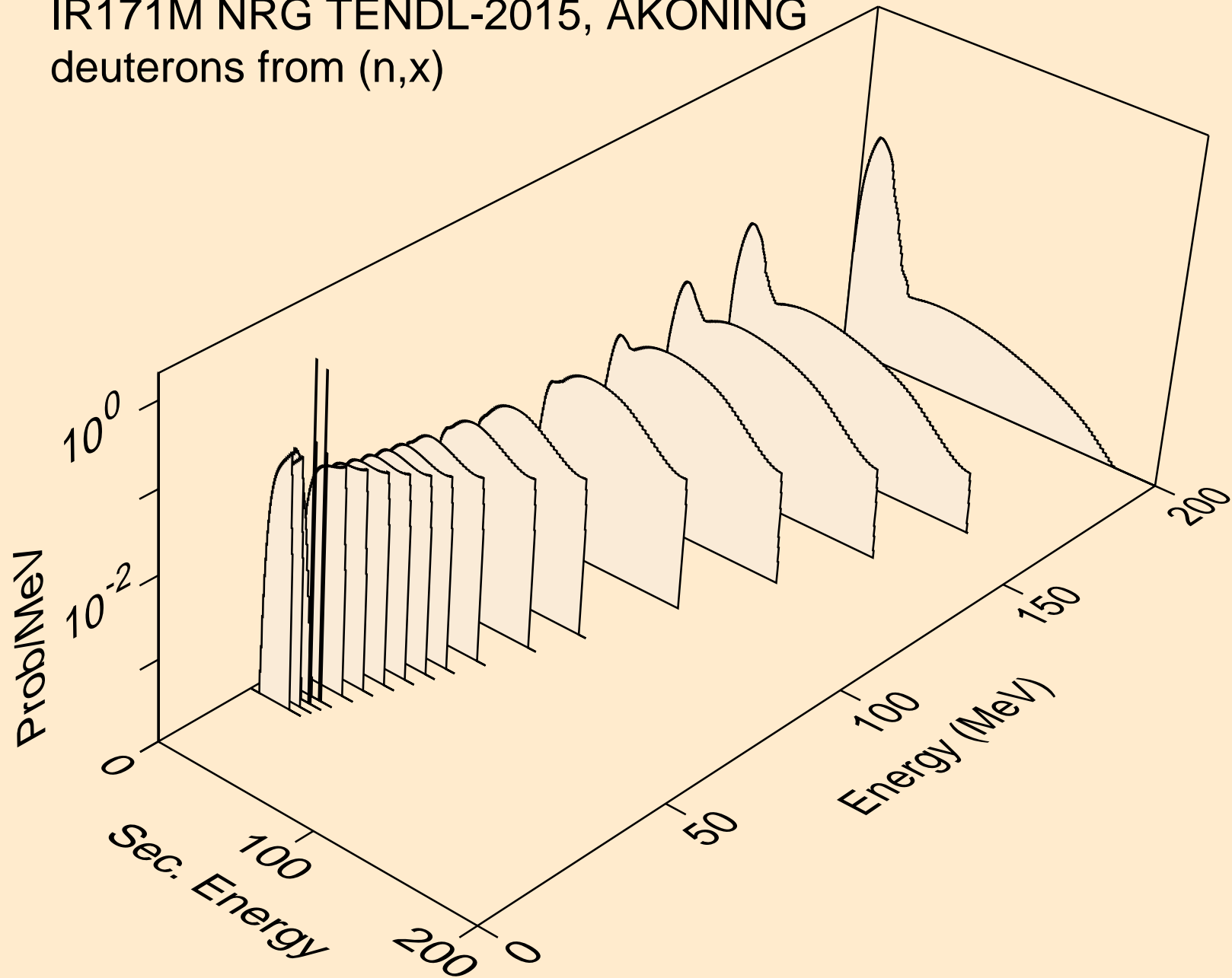

IR171M NRG TENDL-2015, AKONING  
deuterons from (n,2nd)

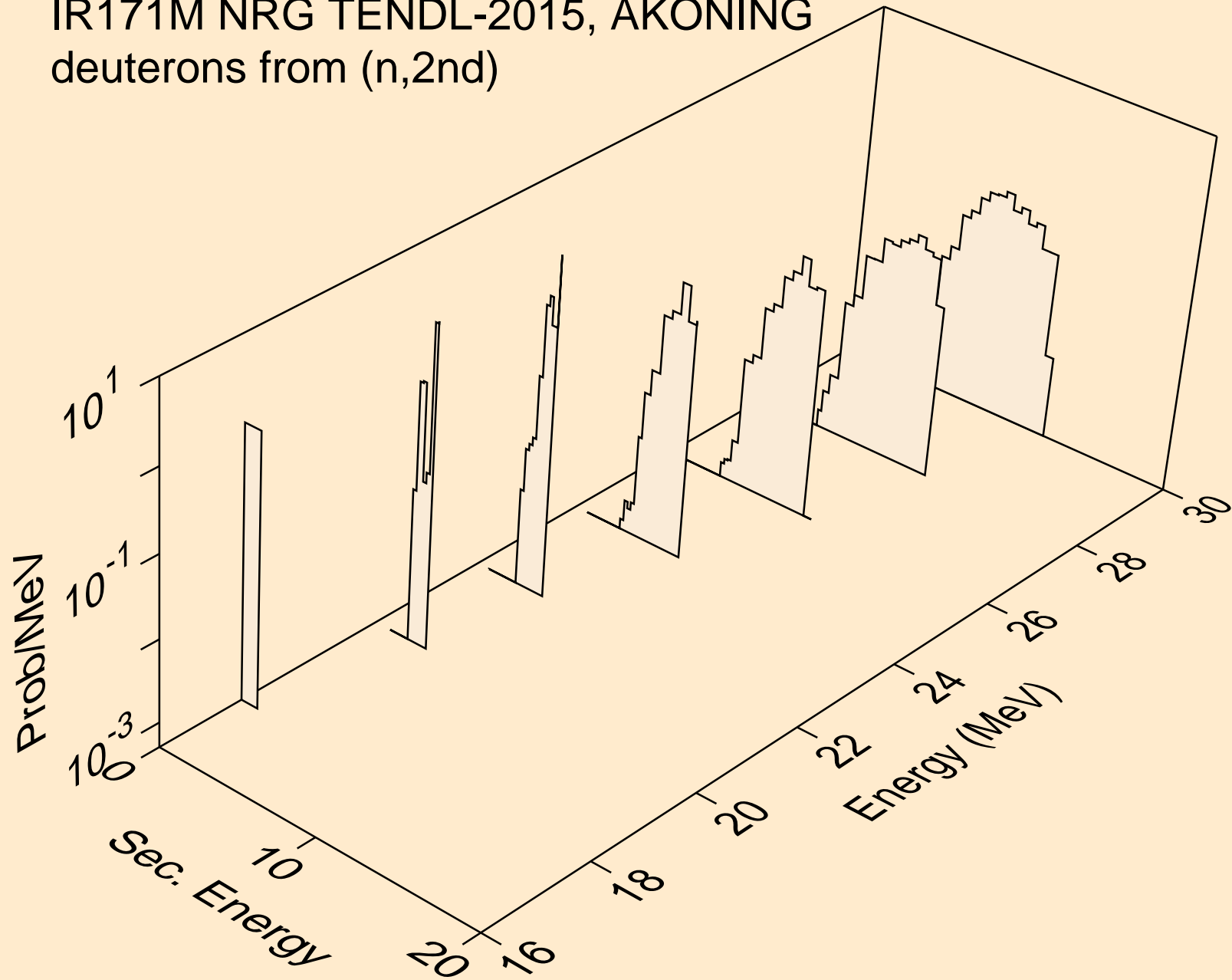

IR171M NRG TENDL-2015, AKONING  
deuterons from (n,n\*)d

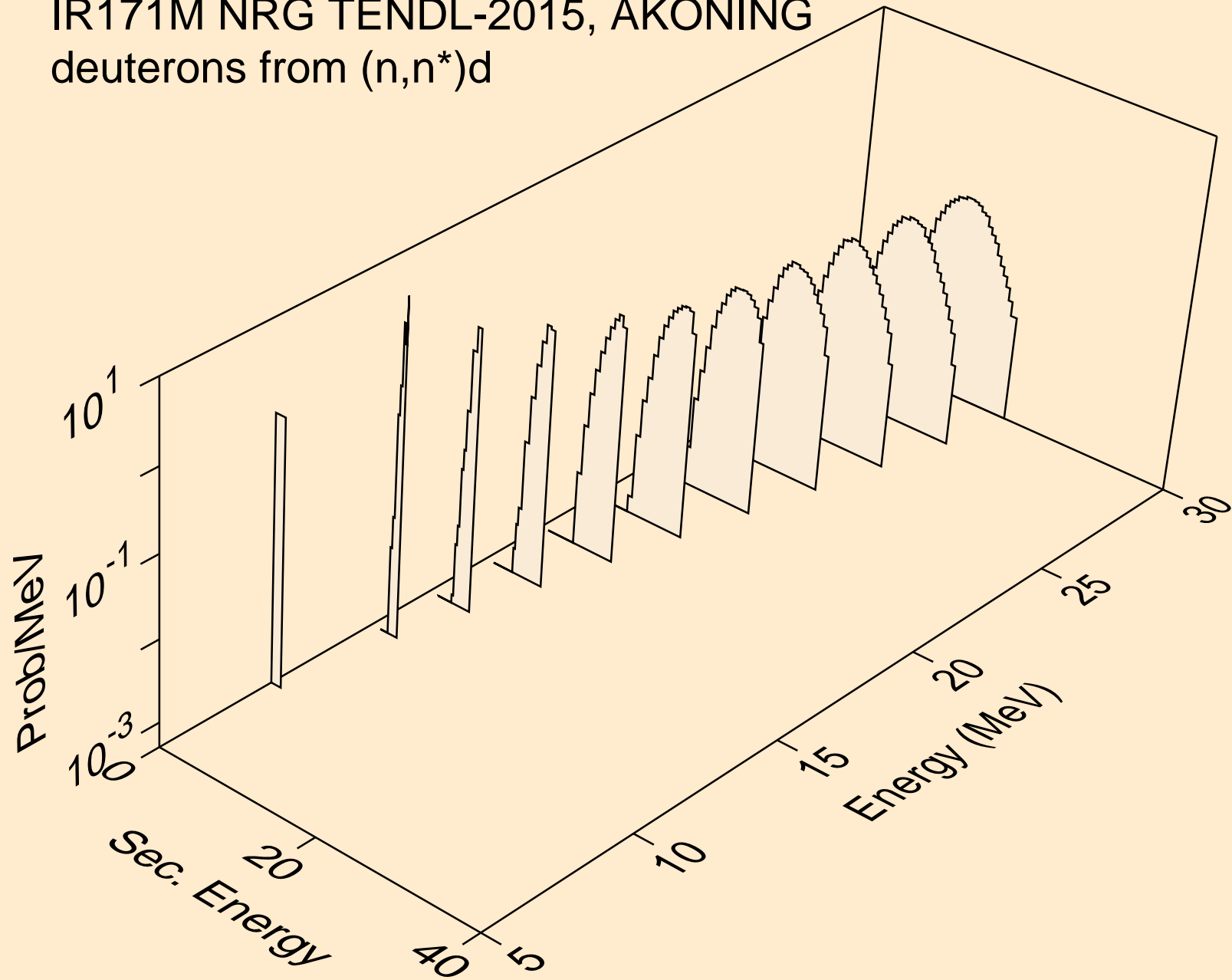

IR171M NRG TENDL-2015, AKONING  
deuterons from (n,n\*)d2a

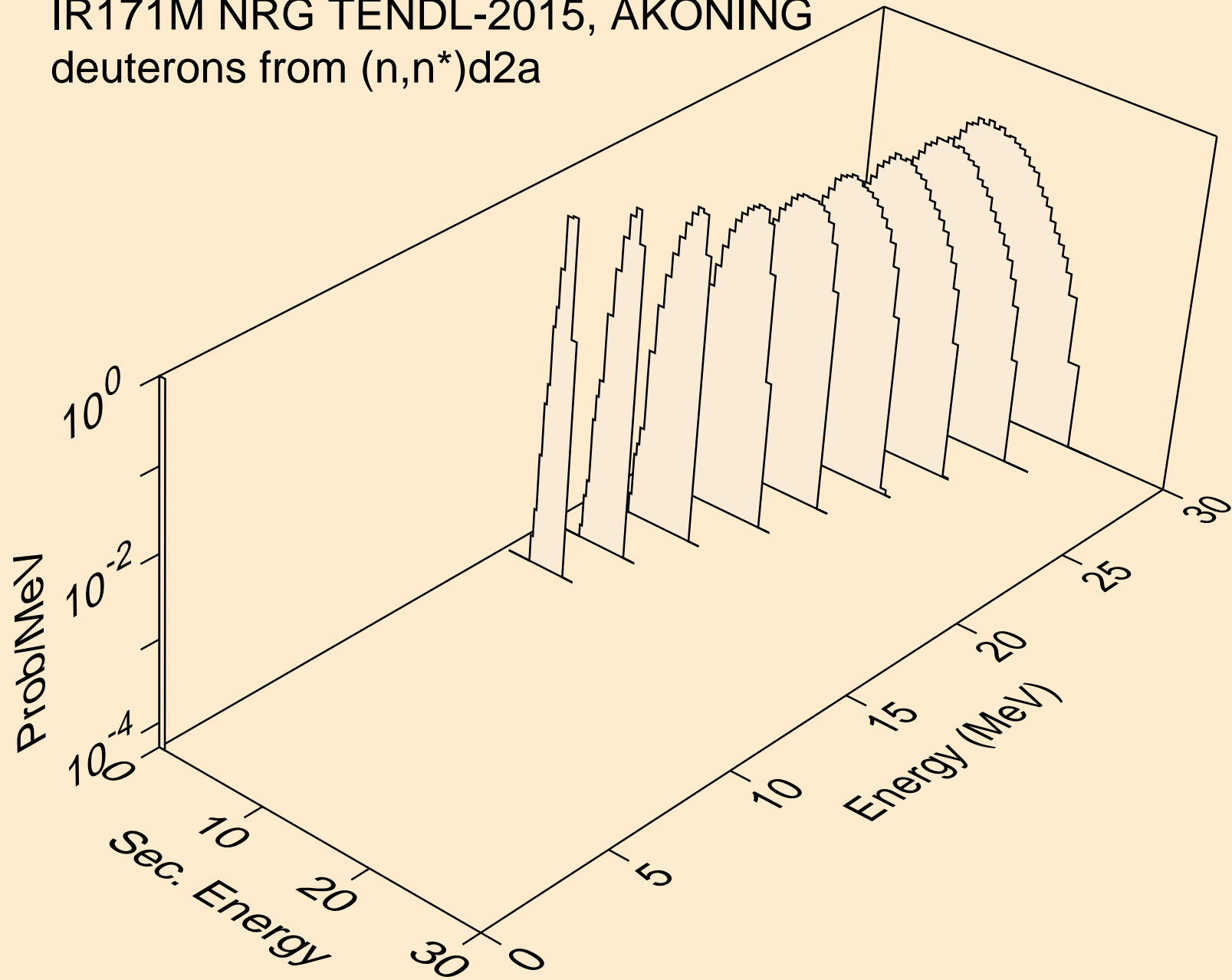

IR171M NRG TENDL-2015, AKONING  
deuterons from (n,d)

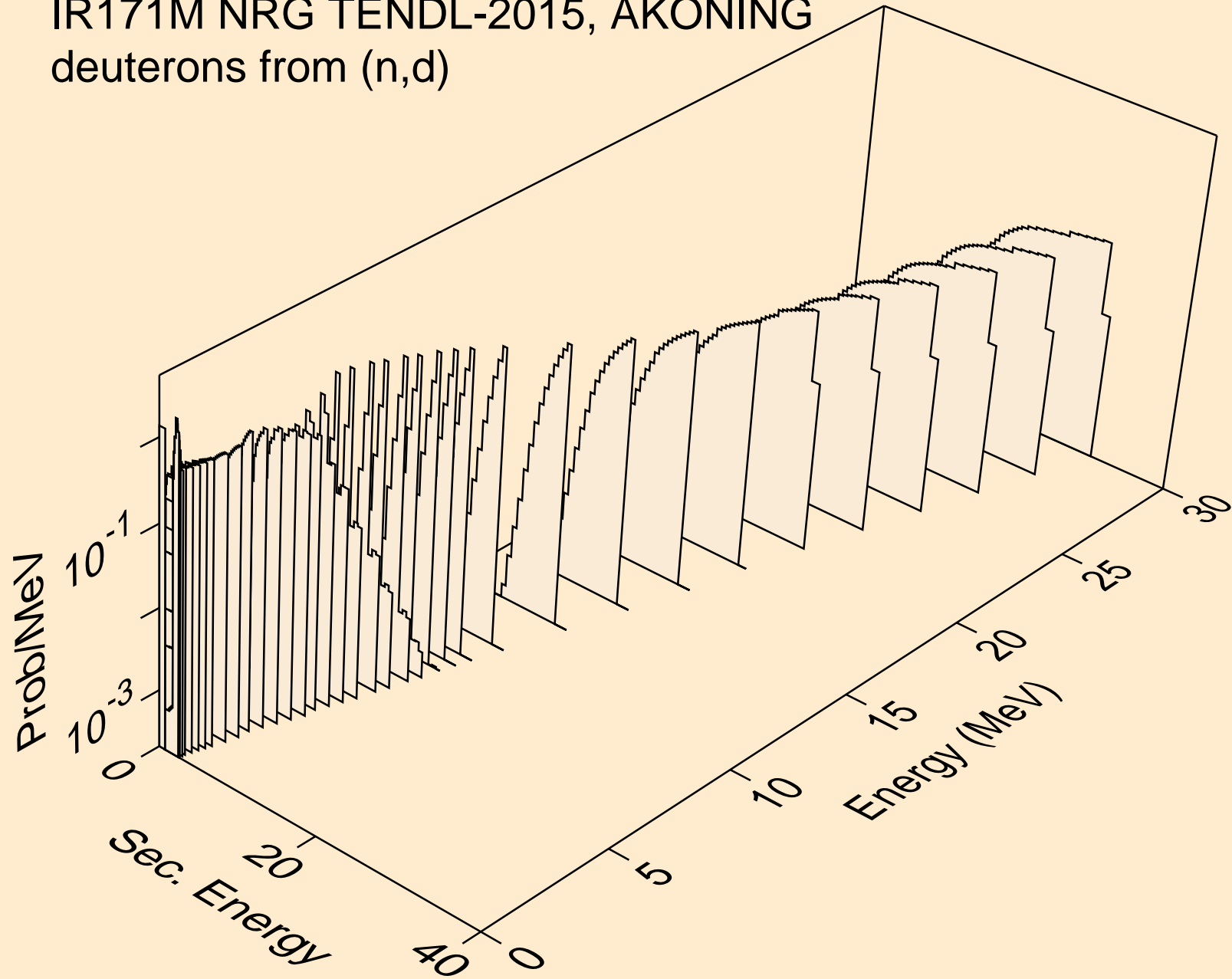

IR171M NRG TENDL-2015, AKONING  
deuterons from (n,d2a)

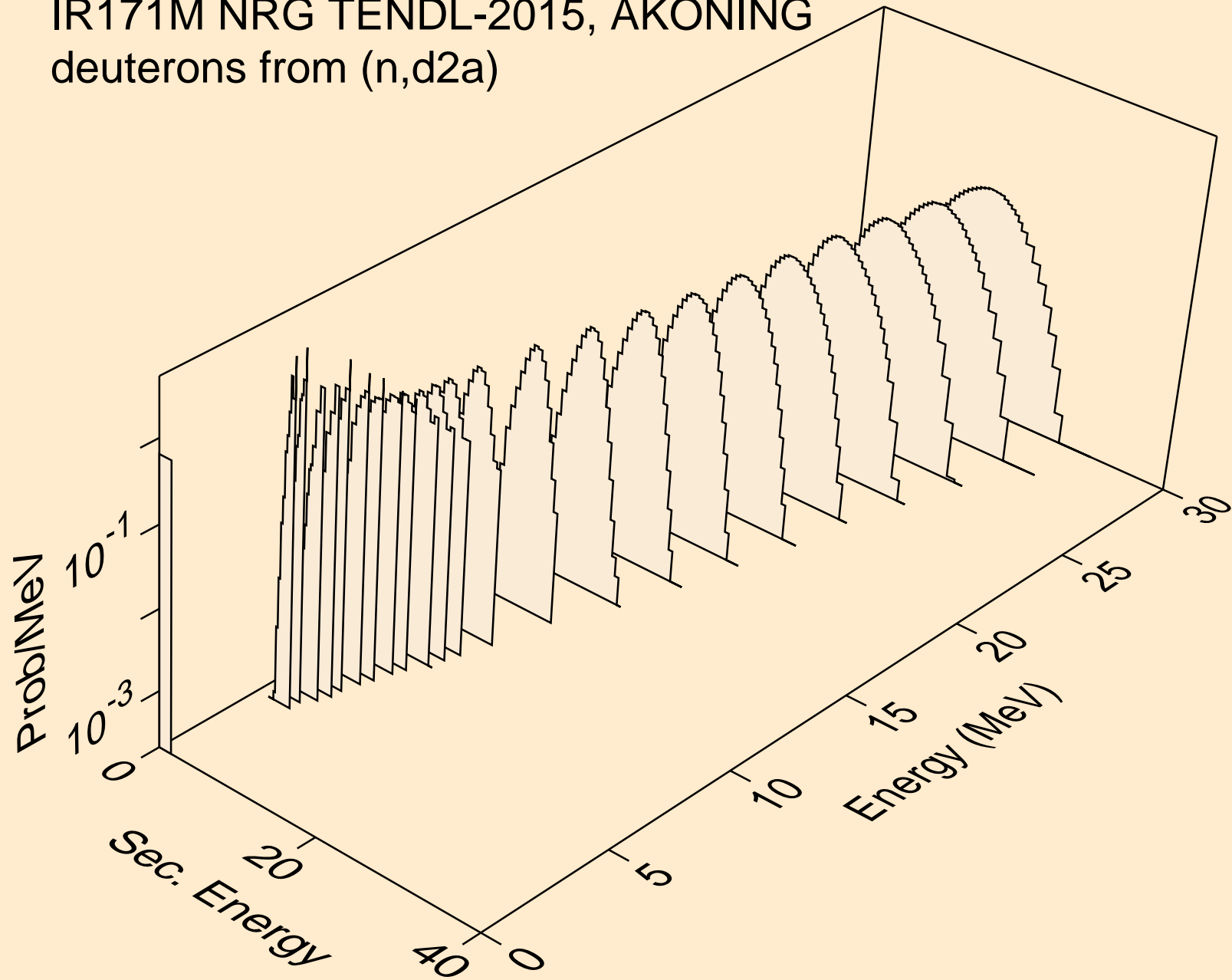



IR171M NRG TENDL-2015, AKONING  
deuterons from (n,pd)

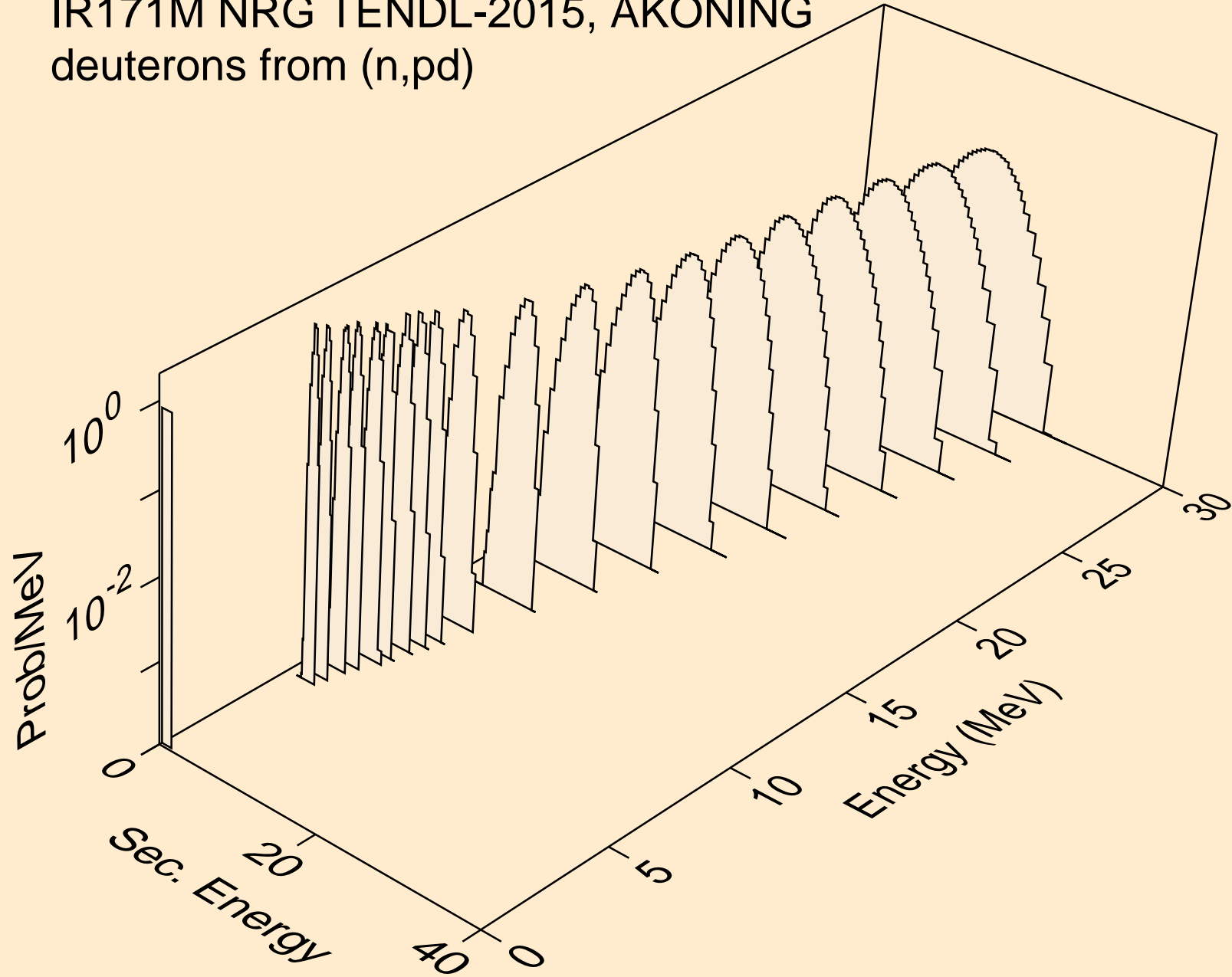

IR171M NRG TENDL-2015, AKONING  
deuterons from (n,da)

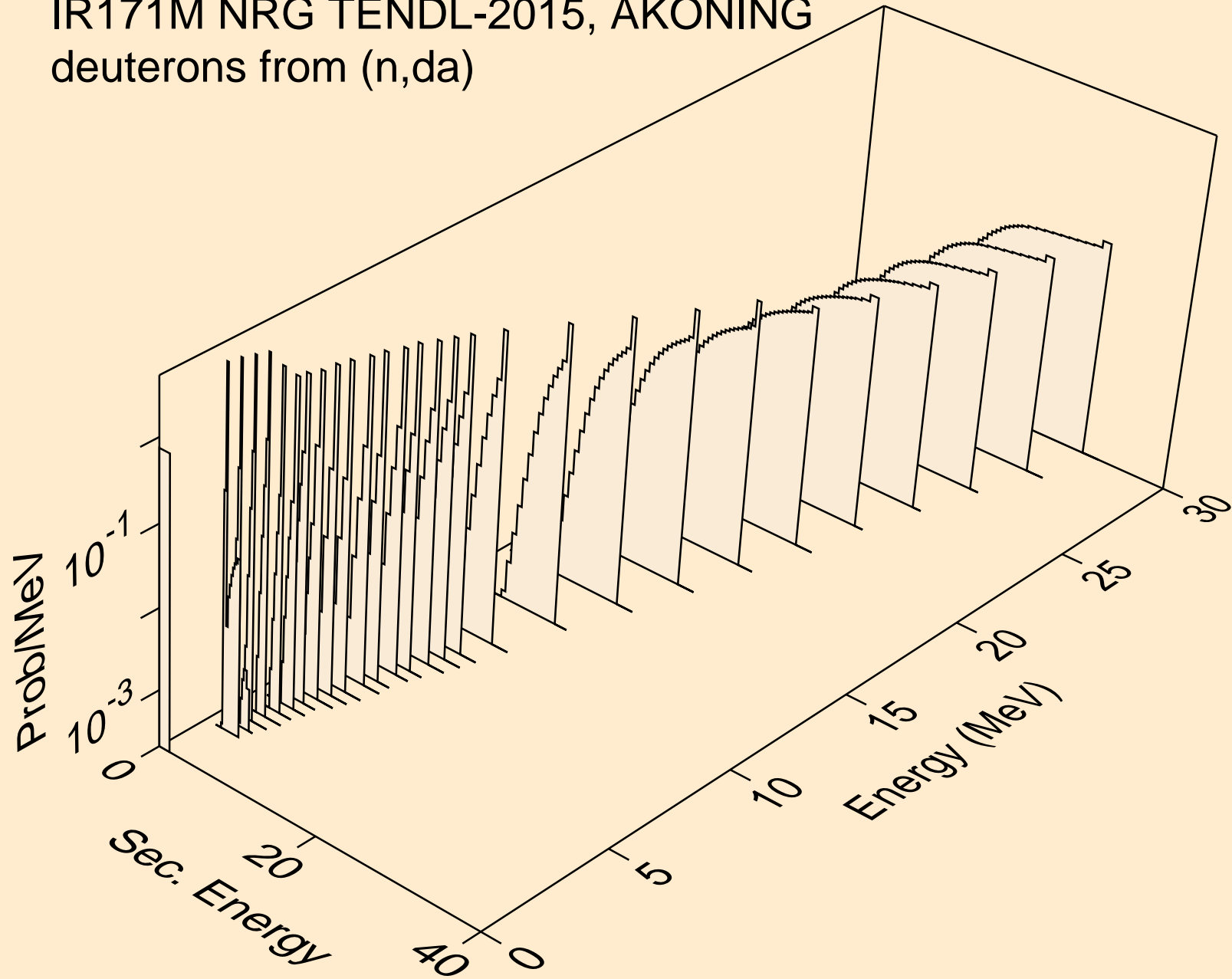

IR171M NRG TENDL-2015, AKONING  
tritons from (n,x)

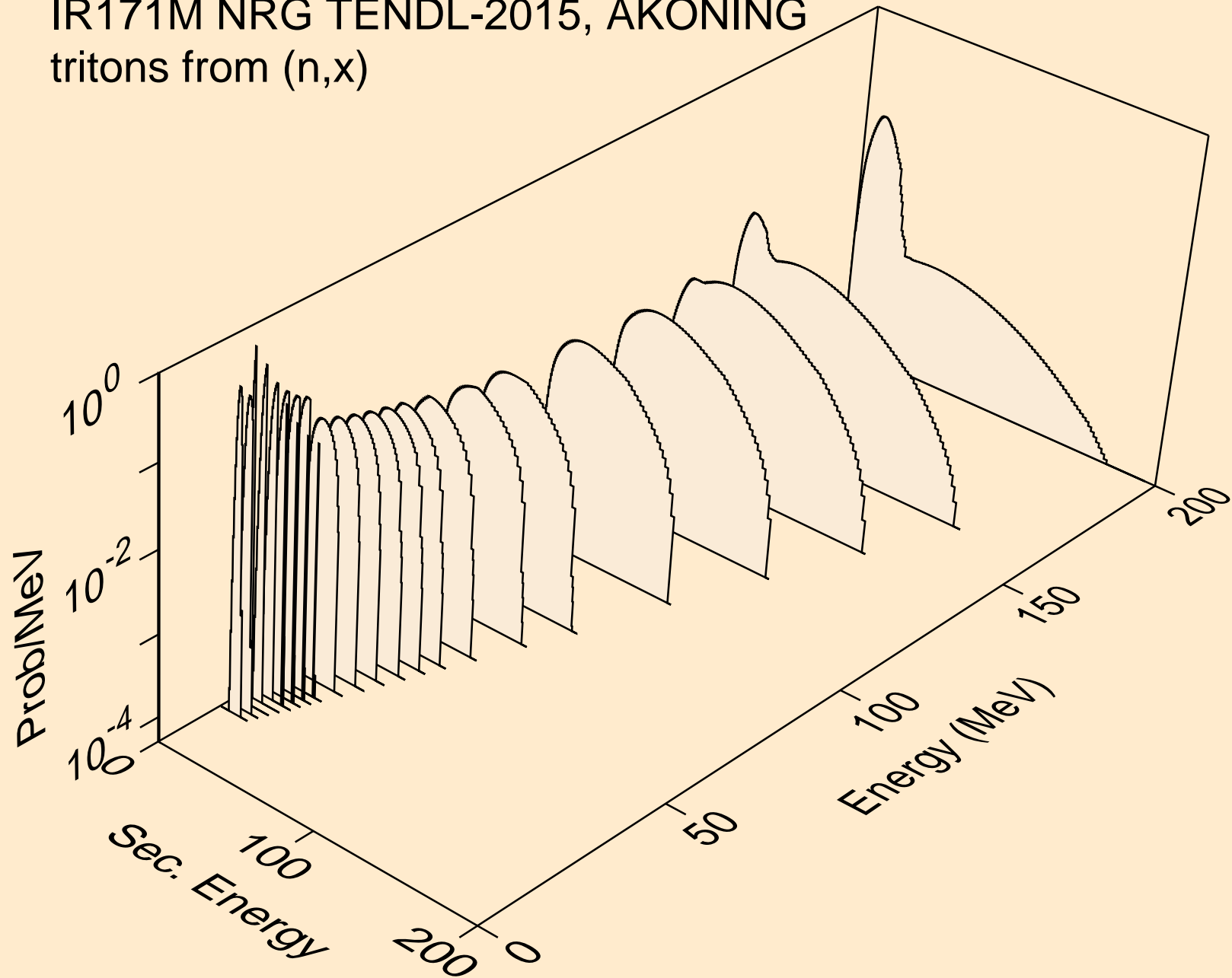

IR171M NRG TENDL-2015, AKONING  
tritons from (n,n\*)t

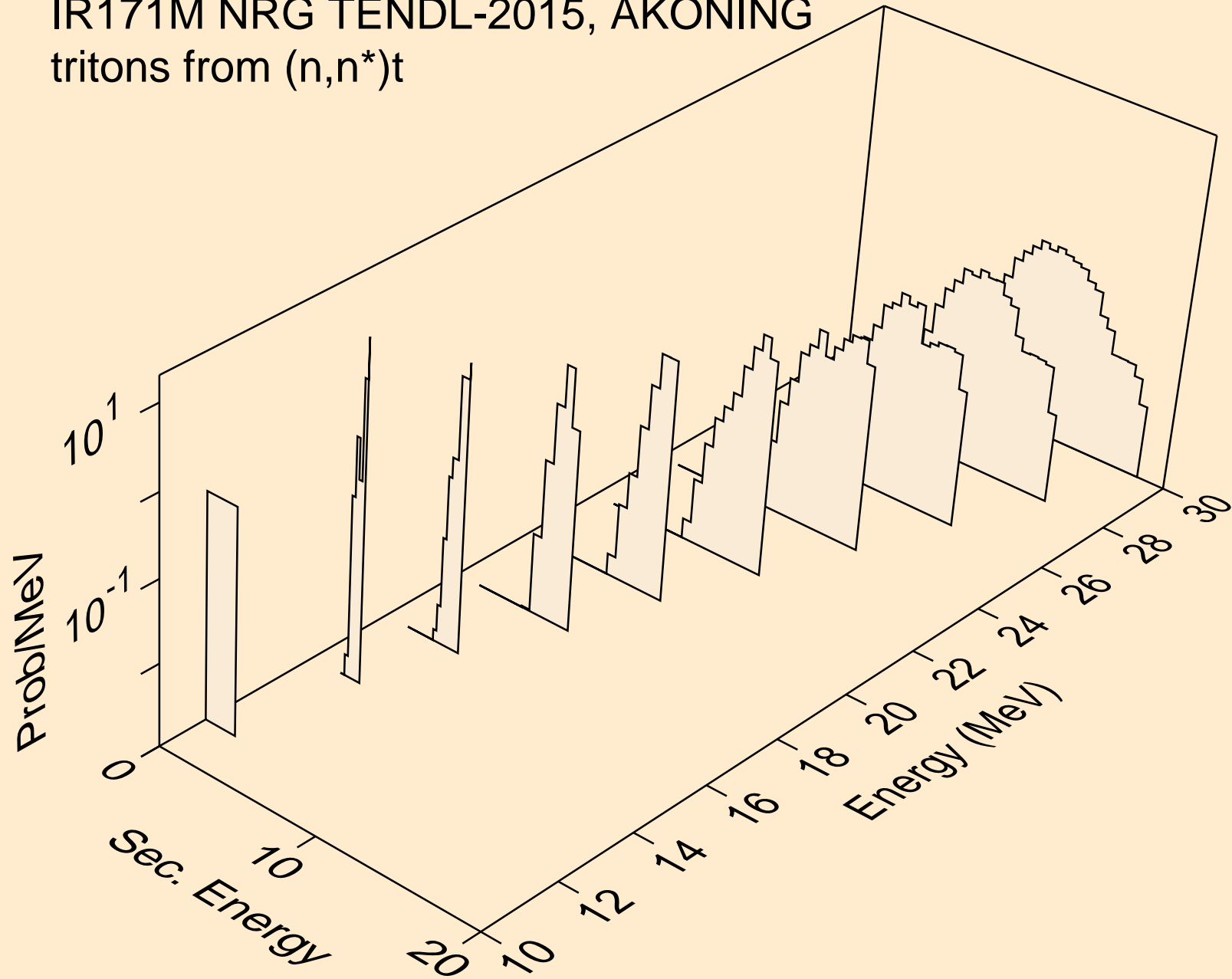

IR171M NRG TENDL-2015, AKONING  
tritons from (n,t)

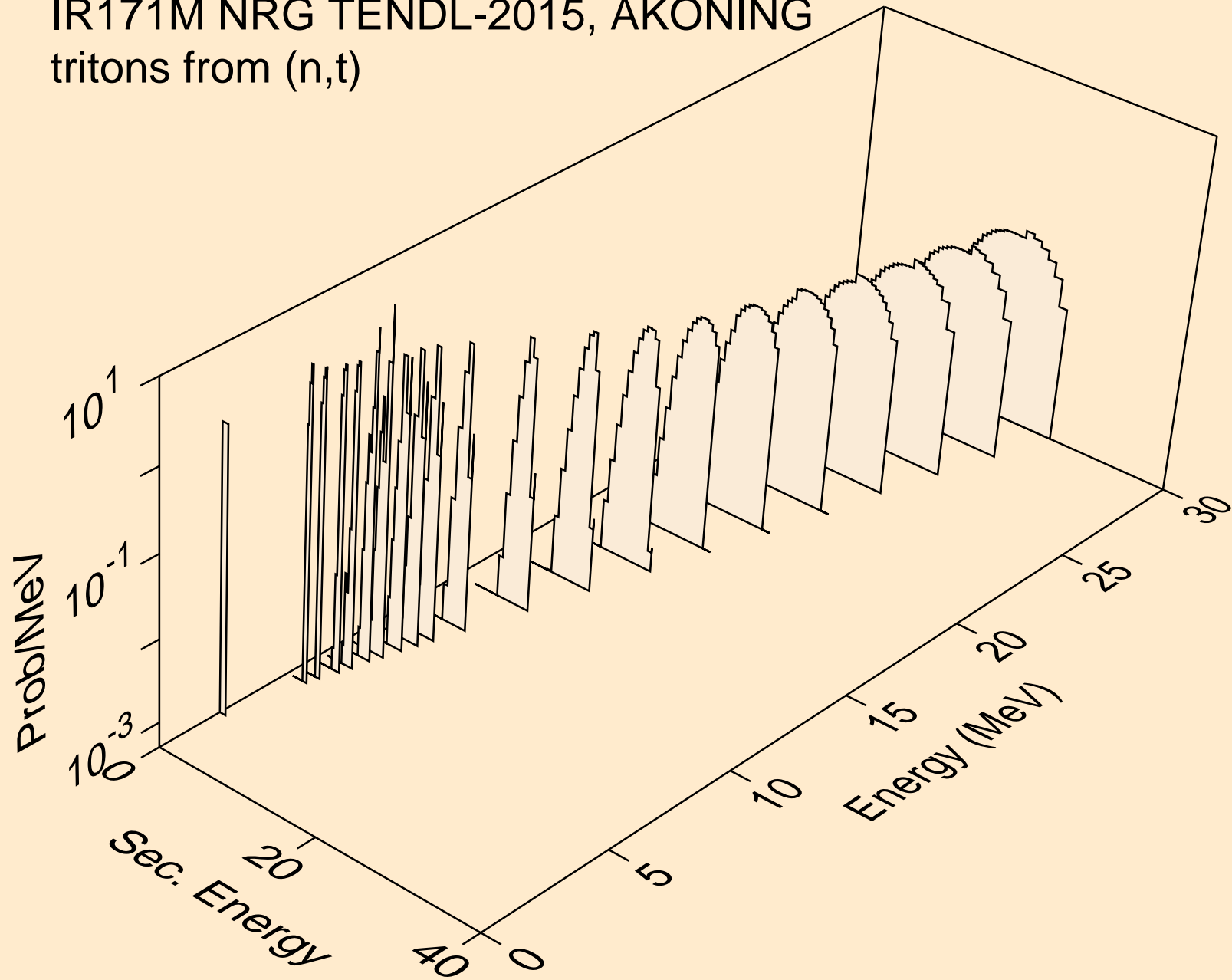

IR171M NRG TENDL-2015, AKONING  
tritons from (n,t2a)

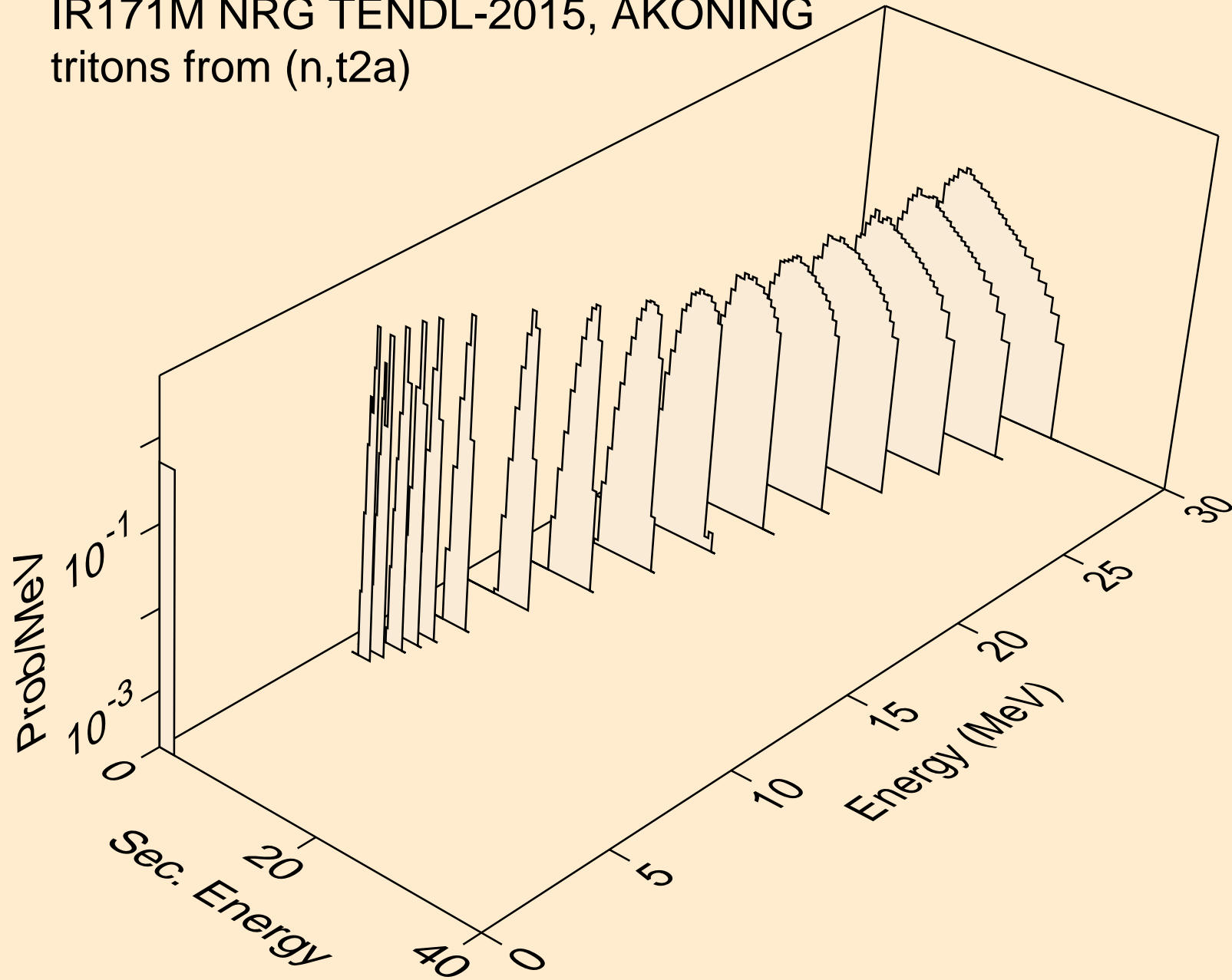

IR171M NRG TENDL-2015, AKONING  
tritons from (n,pt)

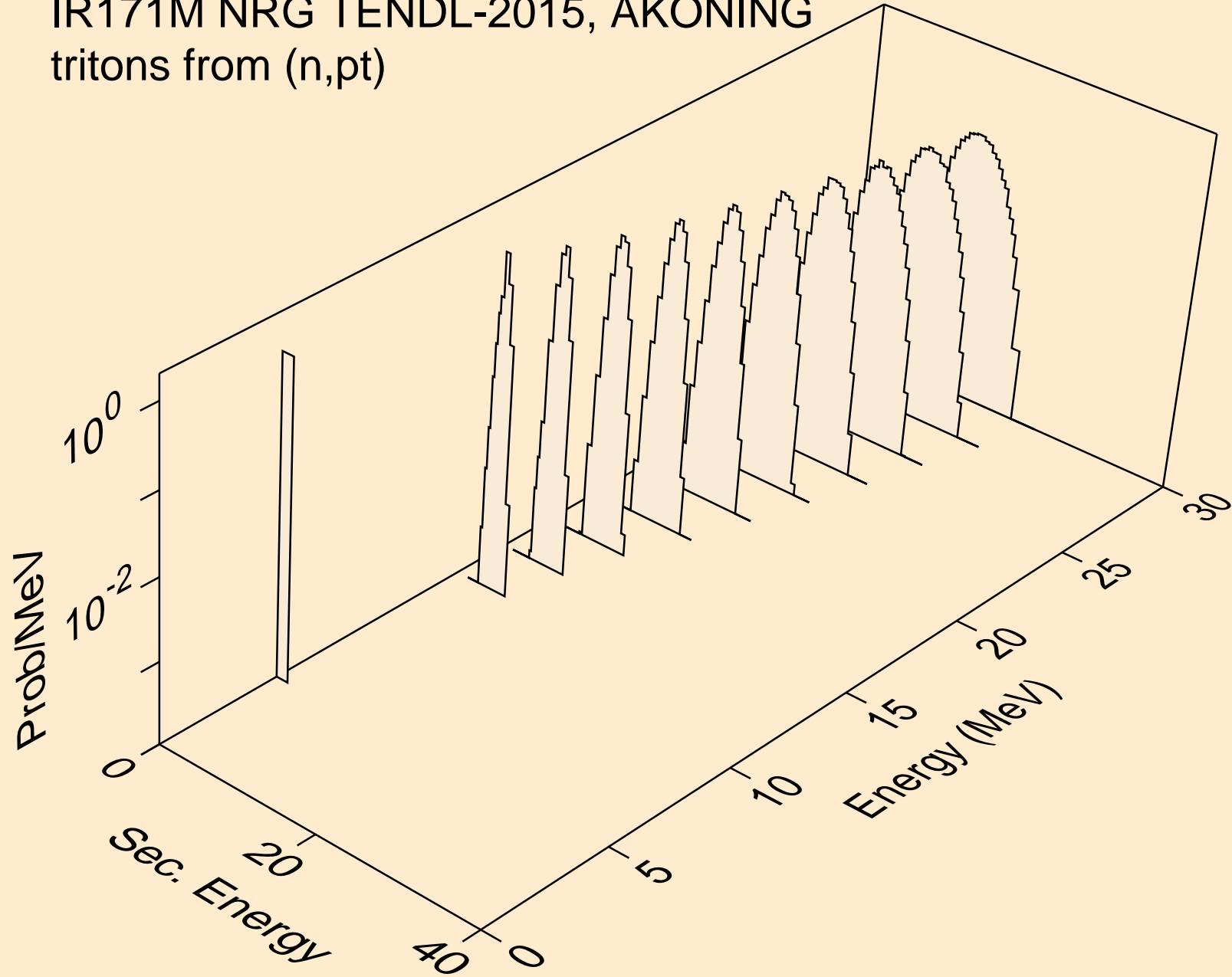

IR171M NRG TENDL-2015, AKONING  
he3s from (n,x)

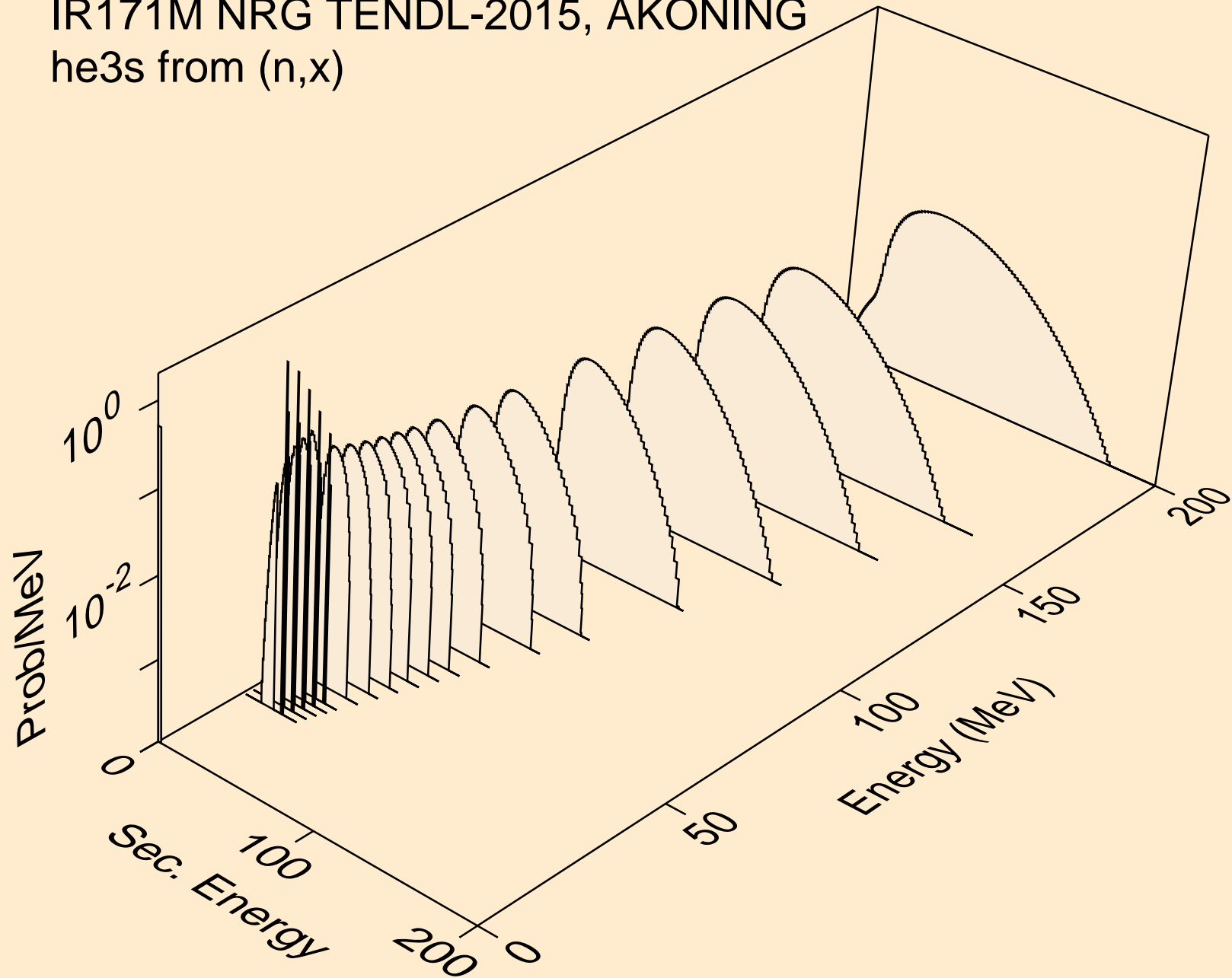



IR171M NRG TENDL-2015, AKONING  
he3s from (n,n\*)he3

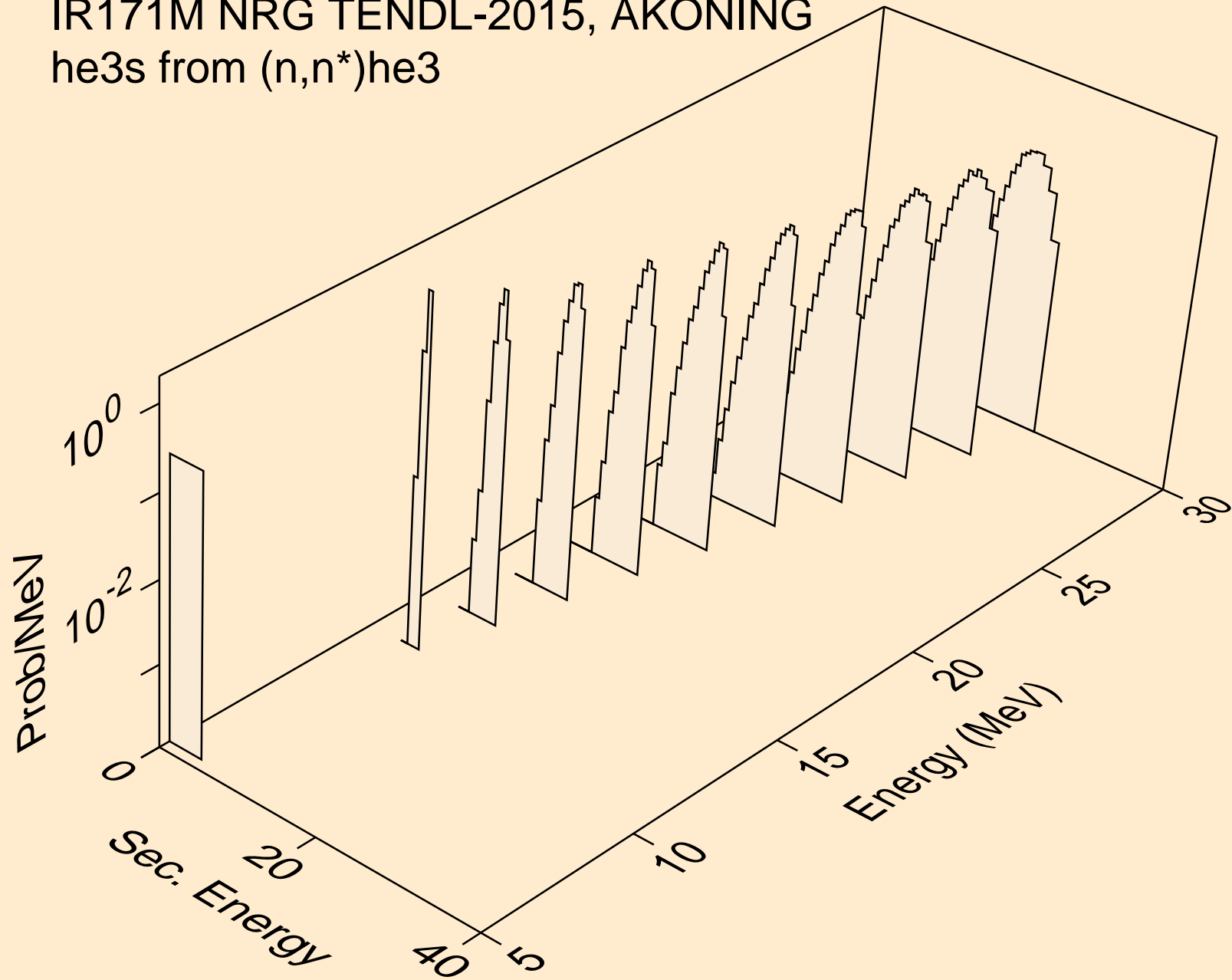

IR171M NRG TENDL-2015, AKONING  
he3s from (n,he3)

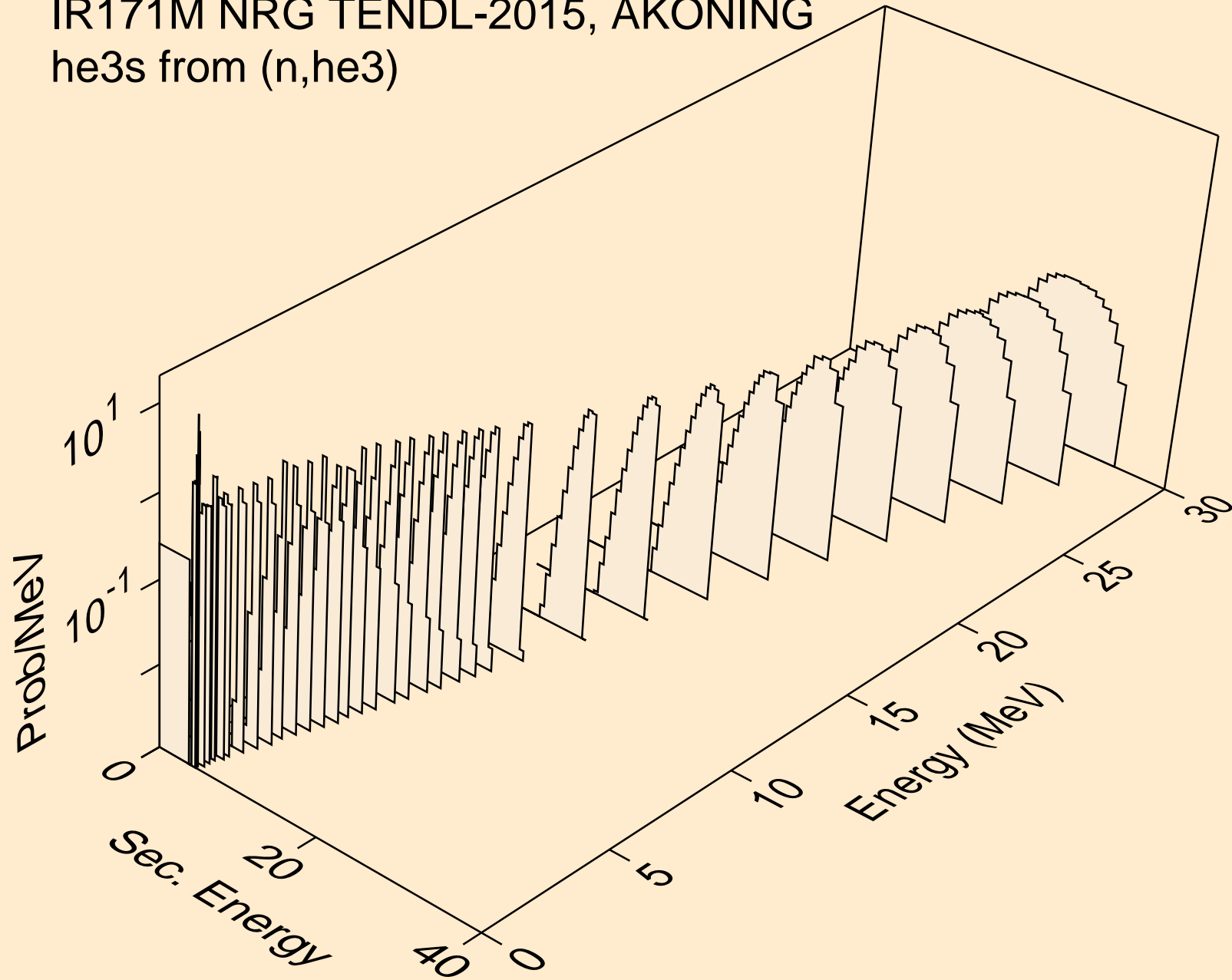

IR171M NRG TENDL-2015, AKONING  
alphas from (n,x)

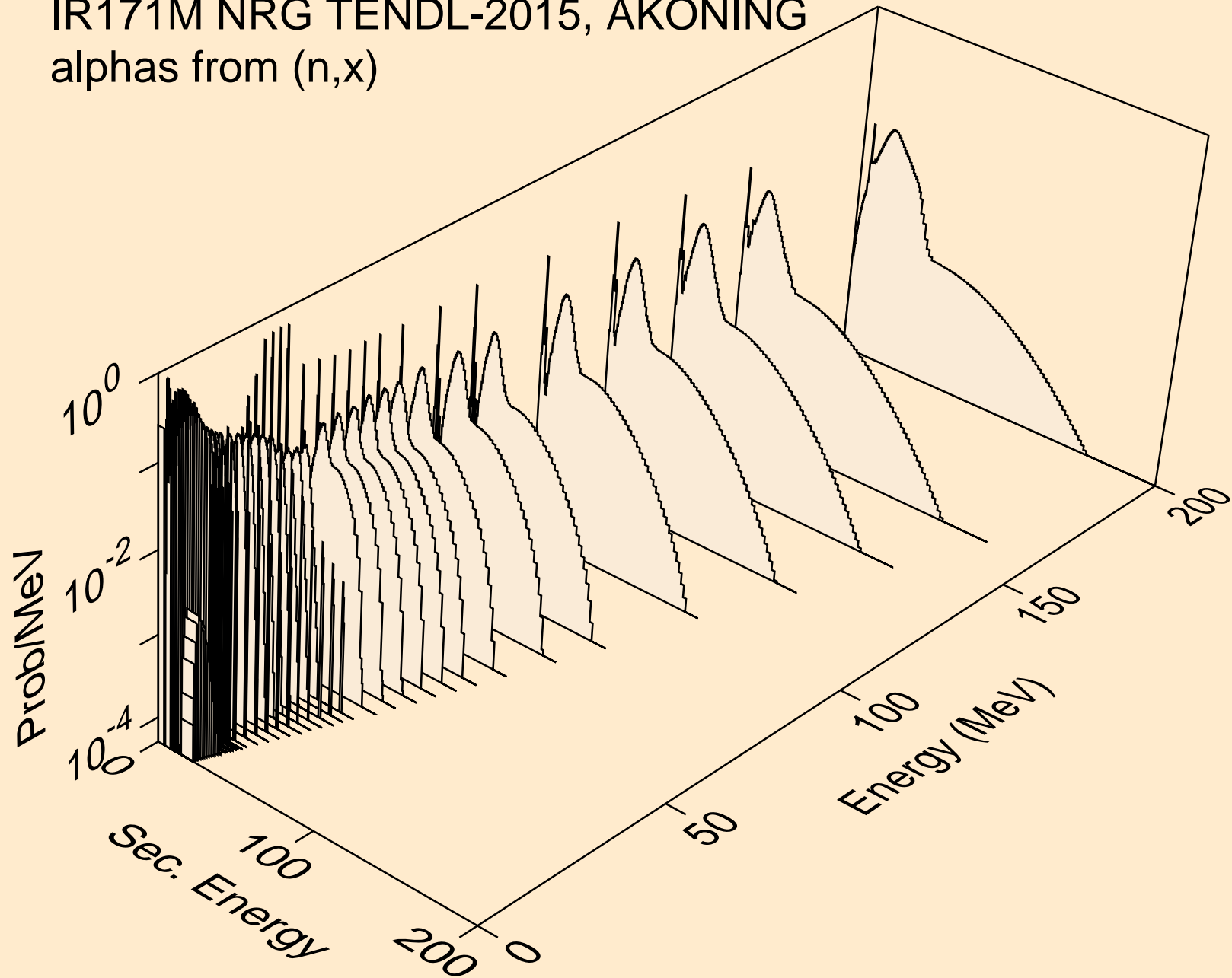

IR171M NRG TENDL-2015, AKONING  
alphas from (n,n\*)a

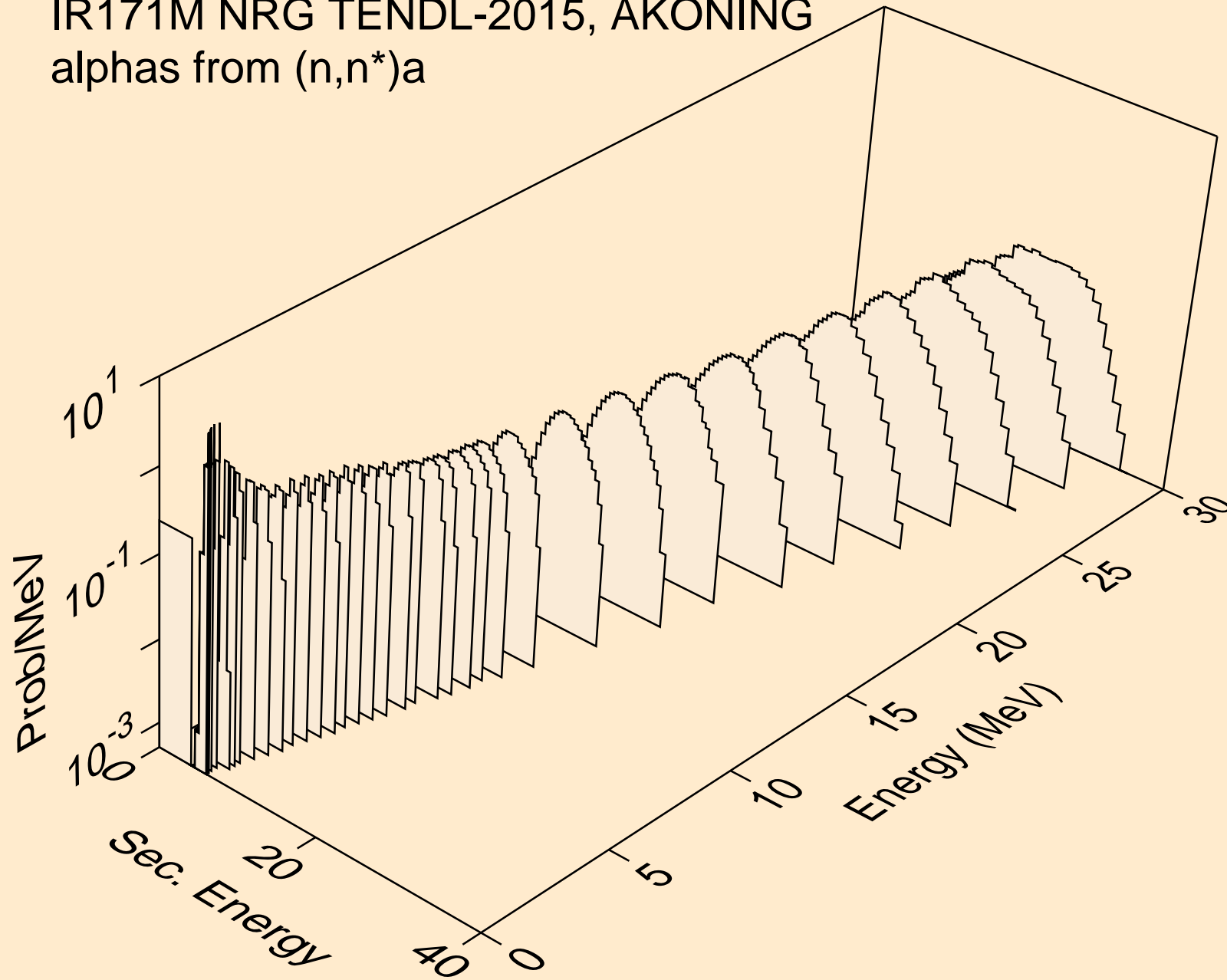

IR171M NRG TENDL-2015, AKONING  
alphas from (n,n\*)3a

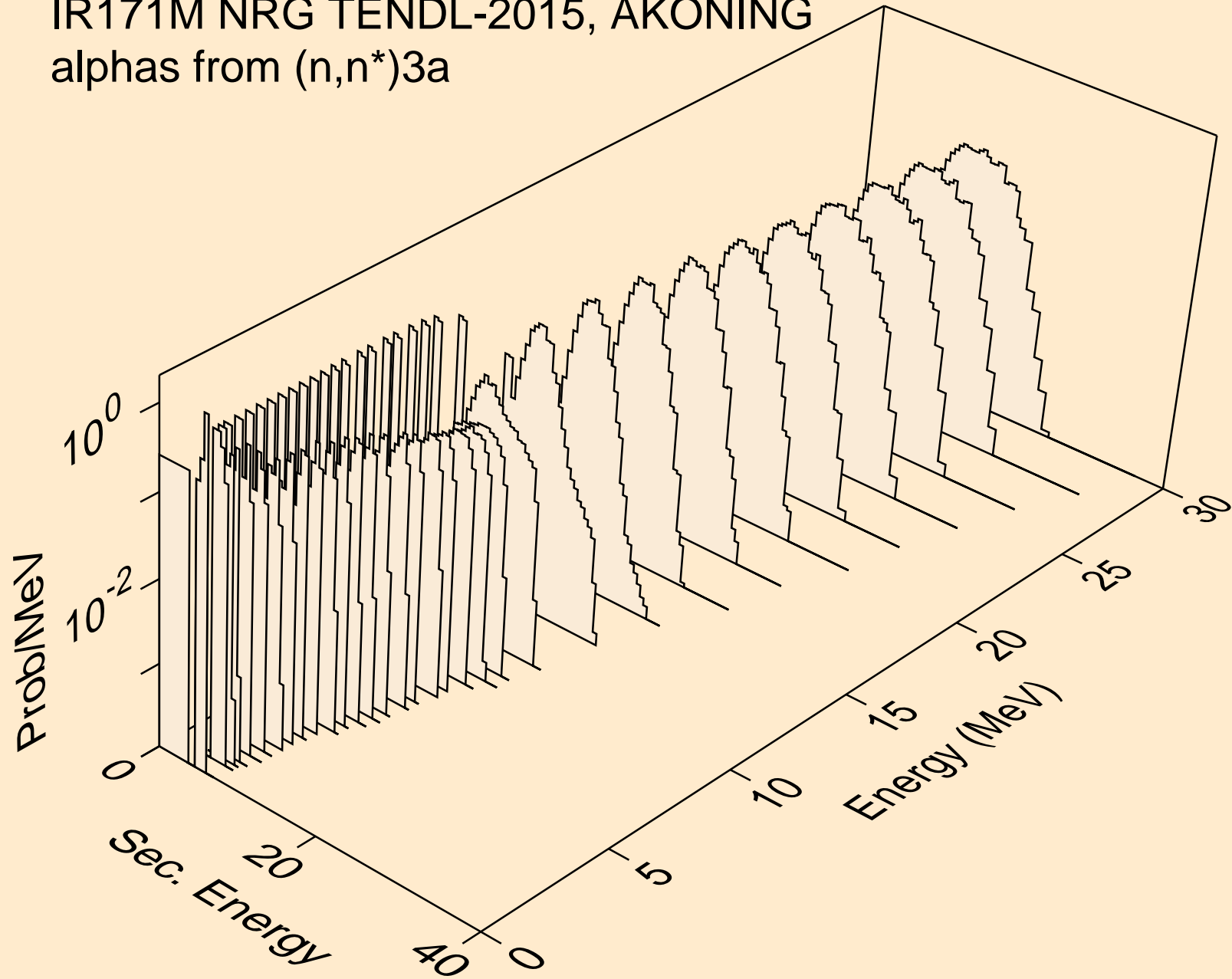

IR171M NRG TENDL-2015, AKONING  
alphas from (n,2n)a

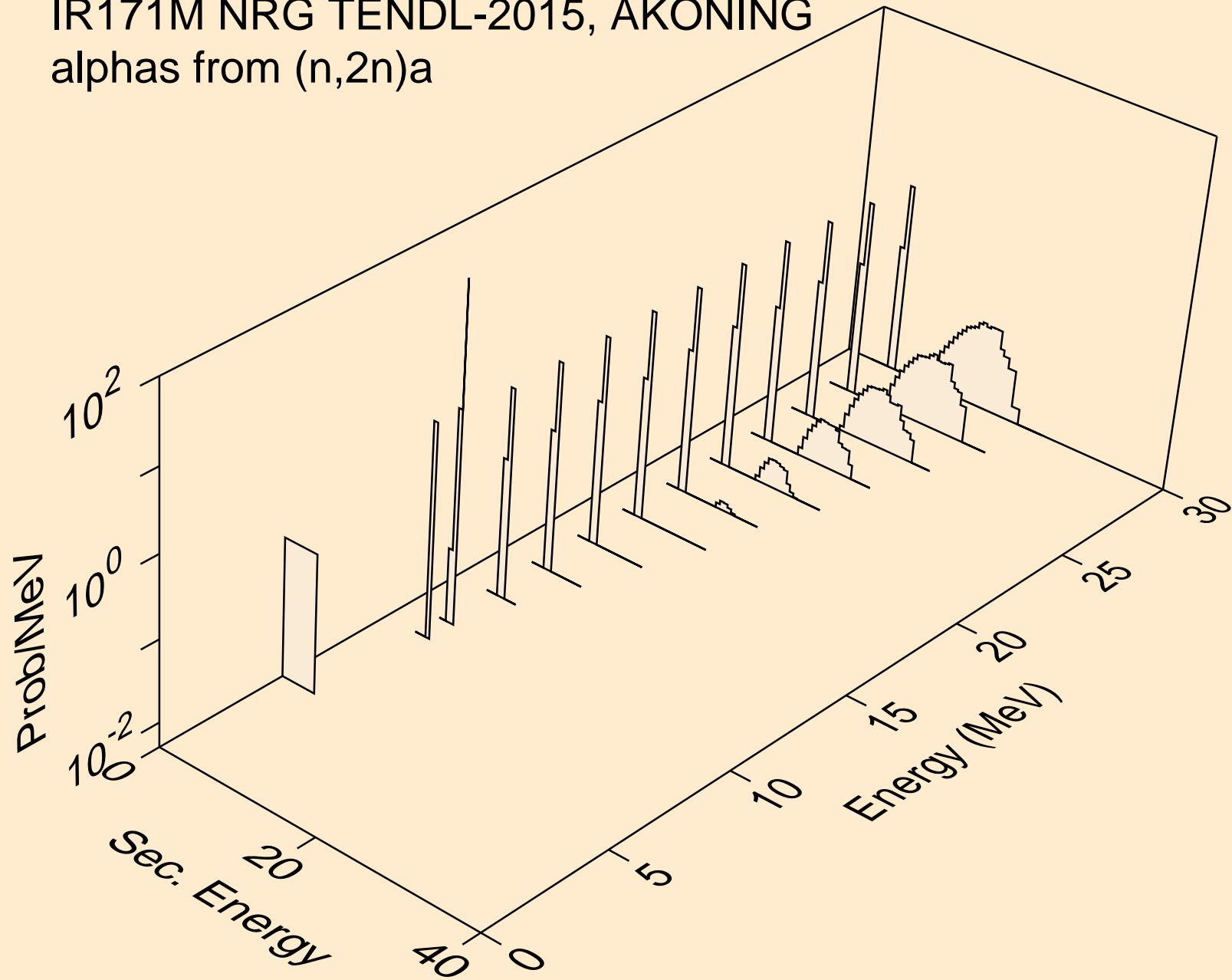

IR171M NRG TENDL-2015, AKONING  
alphas from (n,3n)a

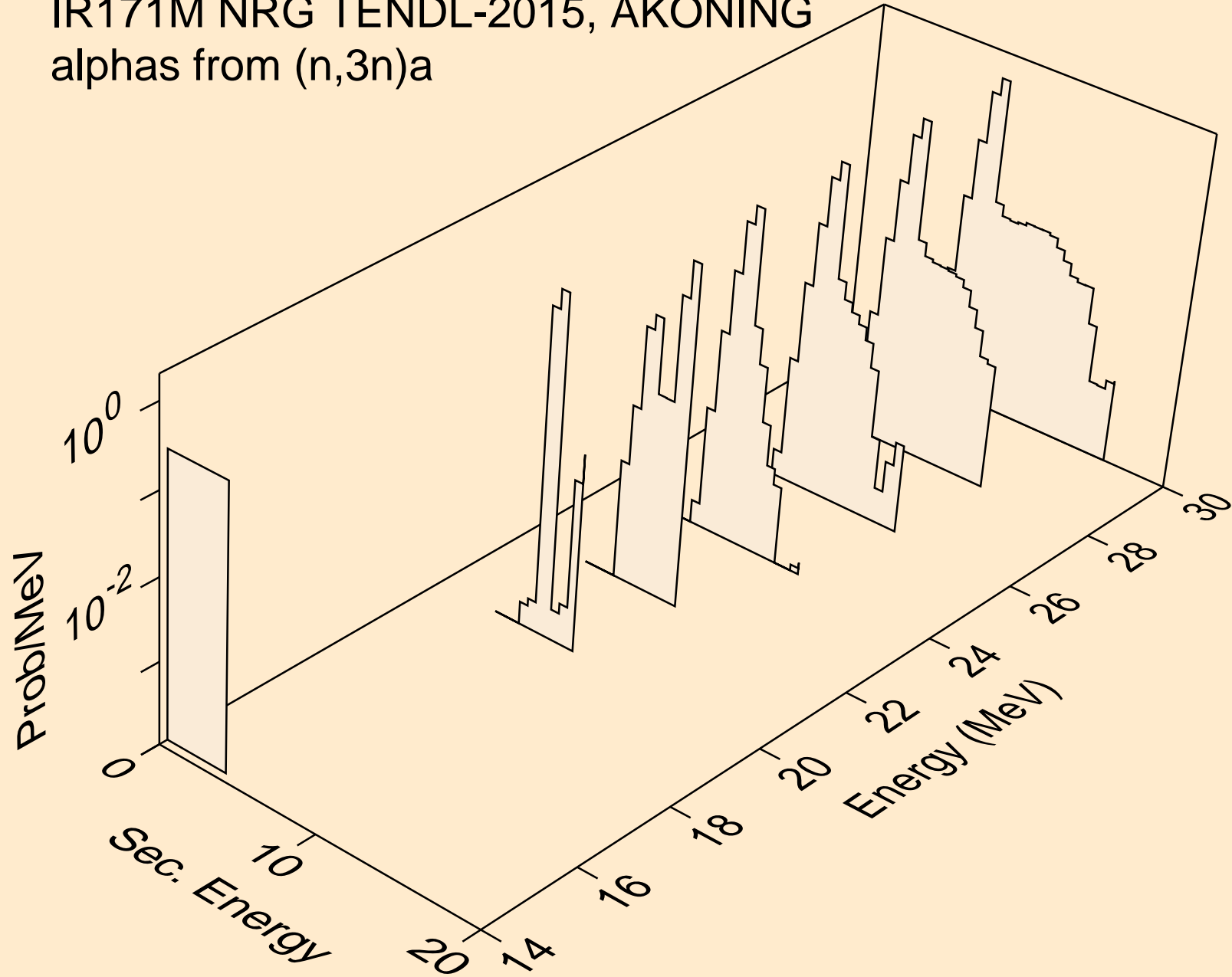

IR171M NRG TENDL-2015, AKONING  
alphas from (n,n\*)2a

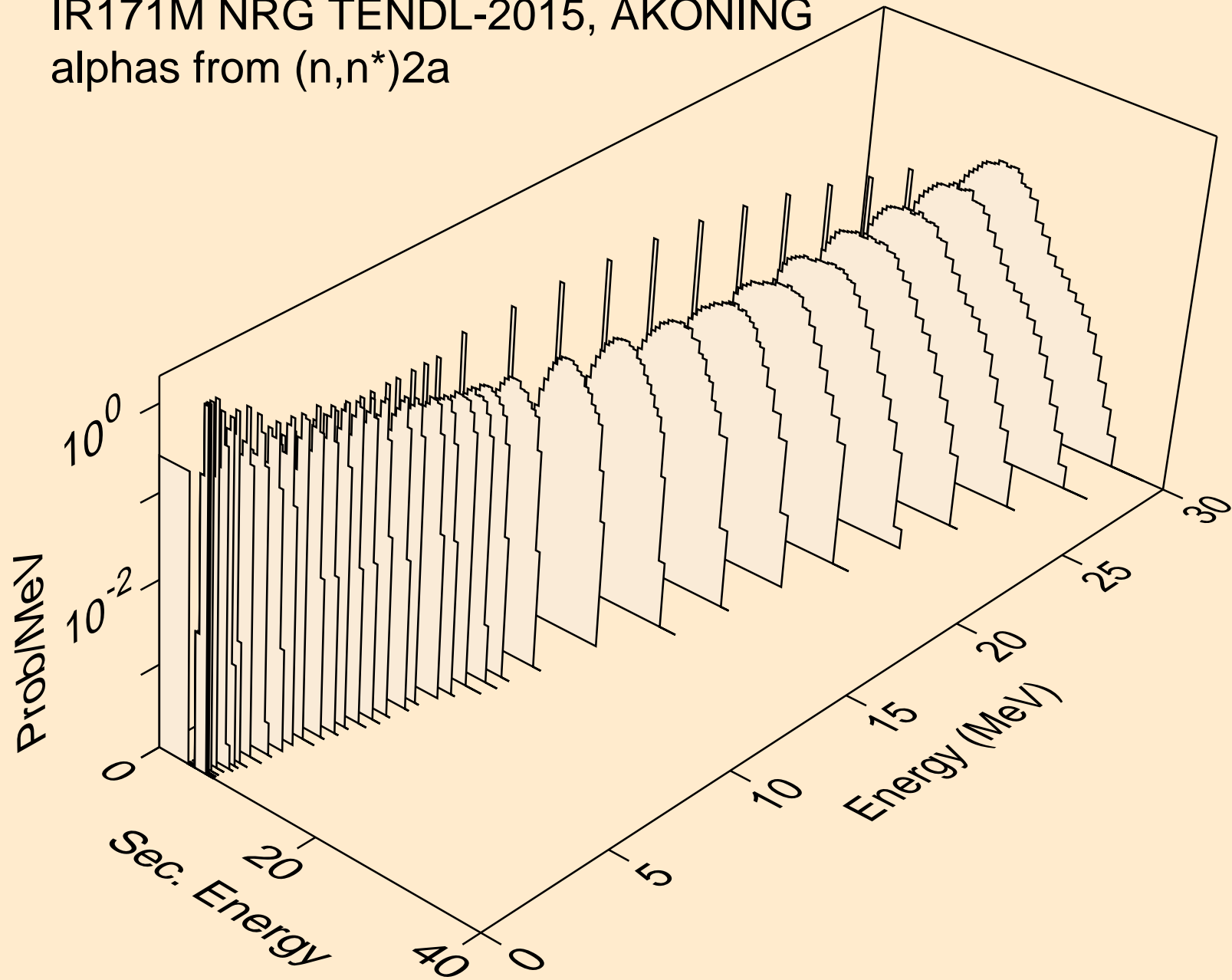



IR171M NRG TENDL-2015, AKONING  
alphas from (n,2n)2a

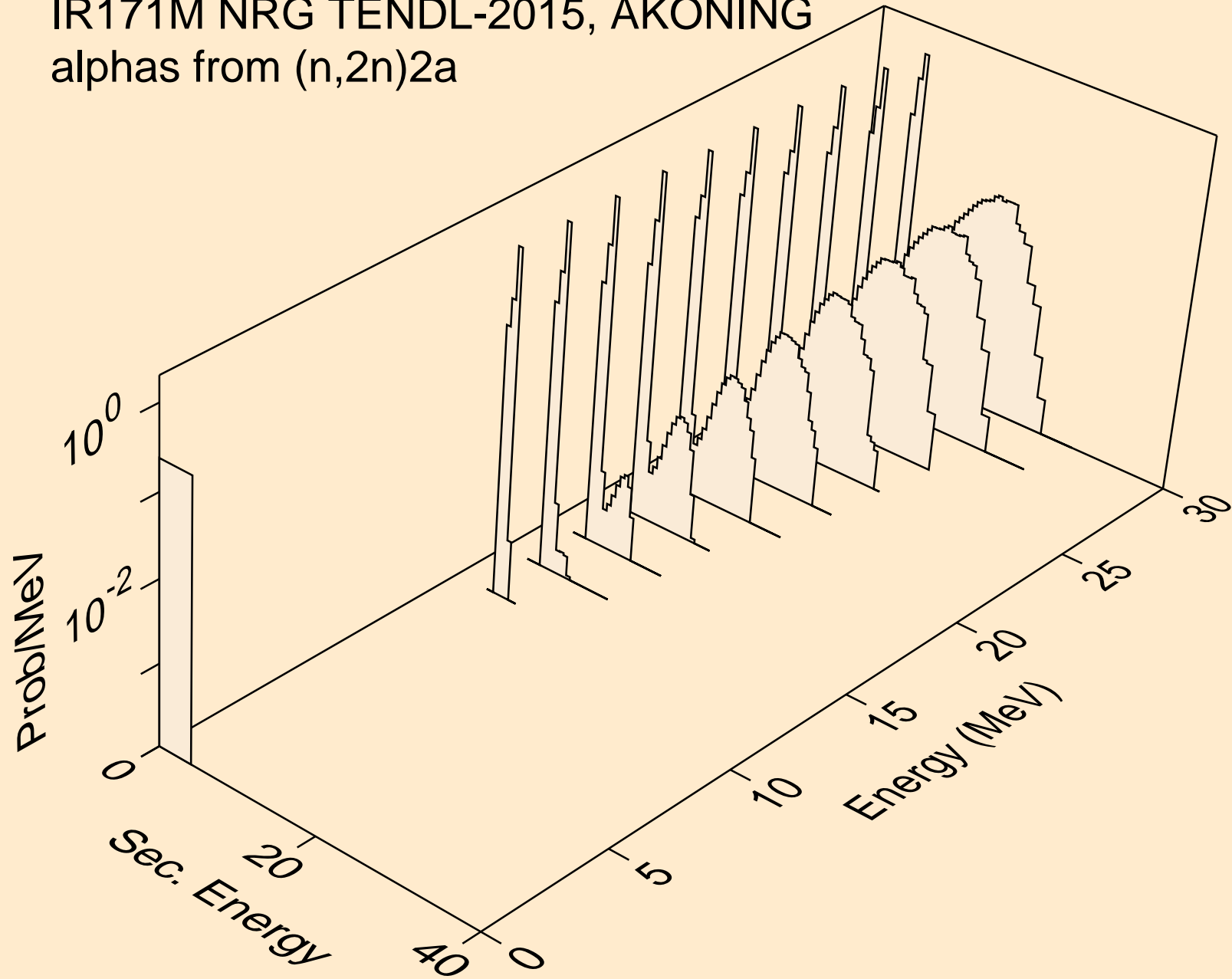

IR171M NRG TENDL-2015, AKONING  
alphas from (n,n\*)d2a

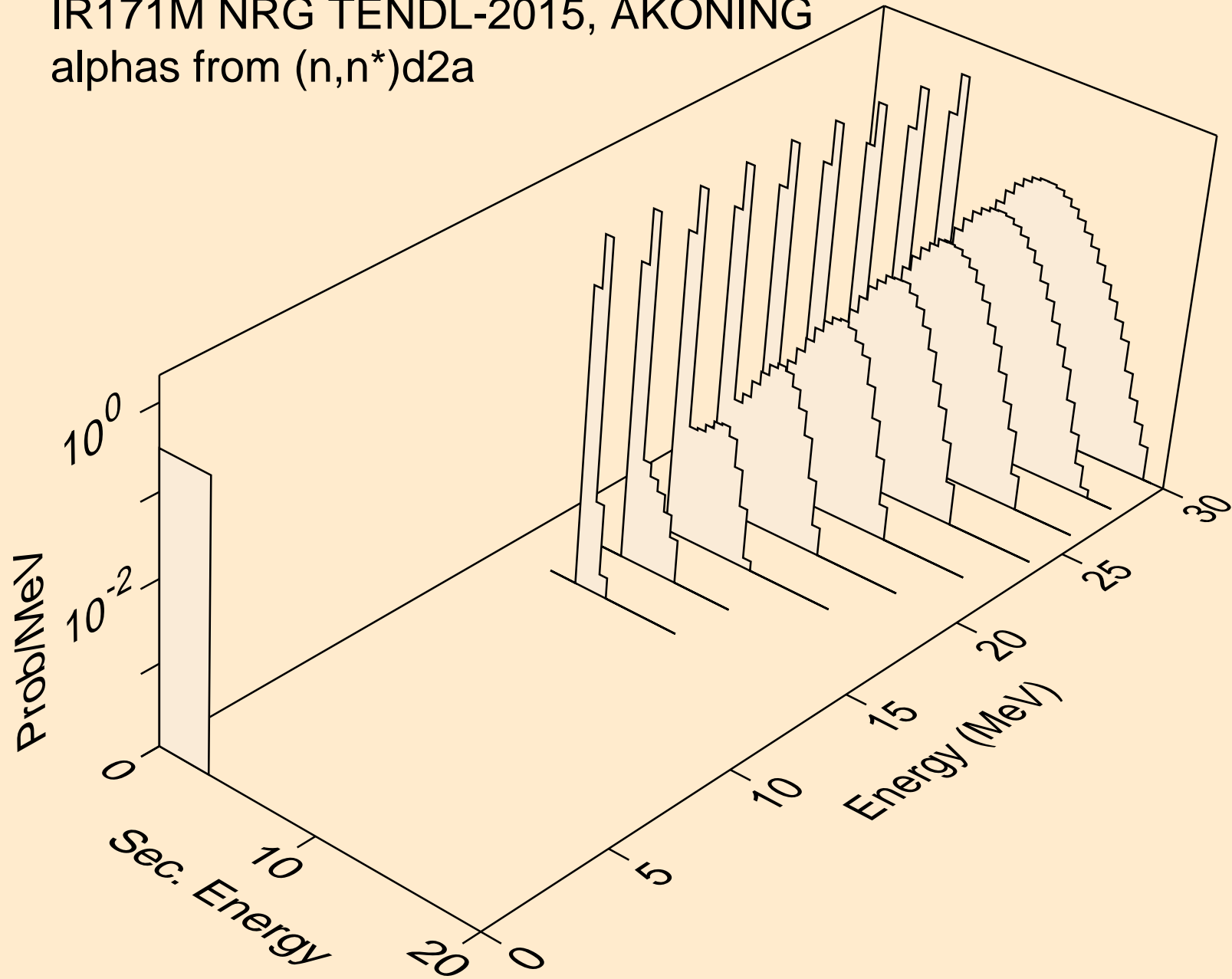

IR171M NRG TENDL-2015, AKONING  
alphas from (n,npa)

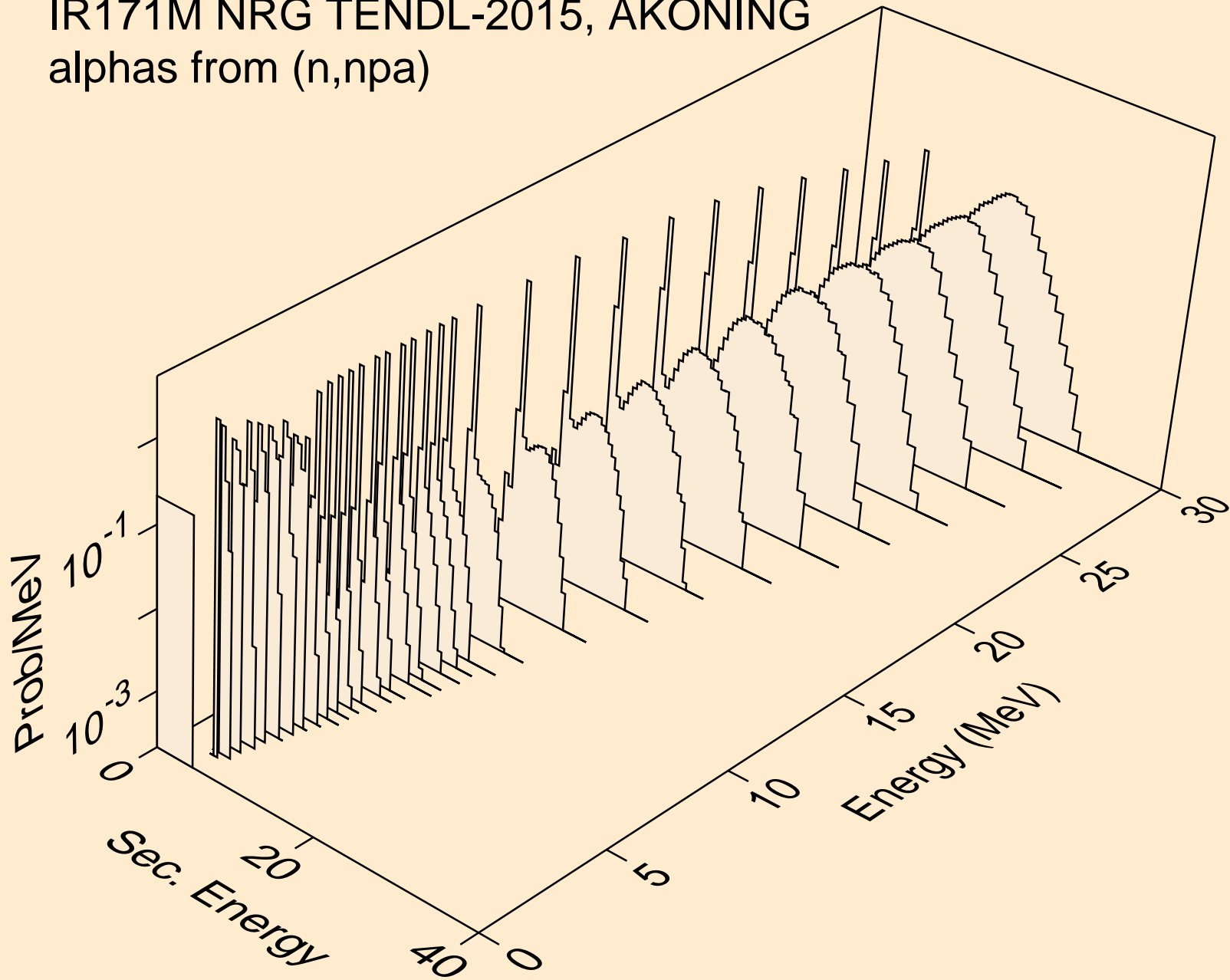

IR171M NRG TENDL-2015, AKONING  
alphas from (n,a)

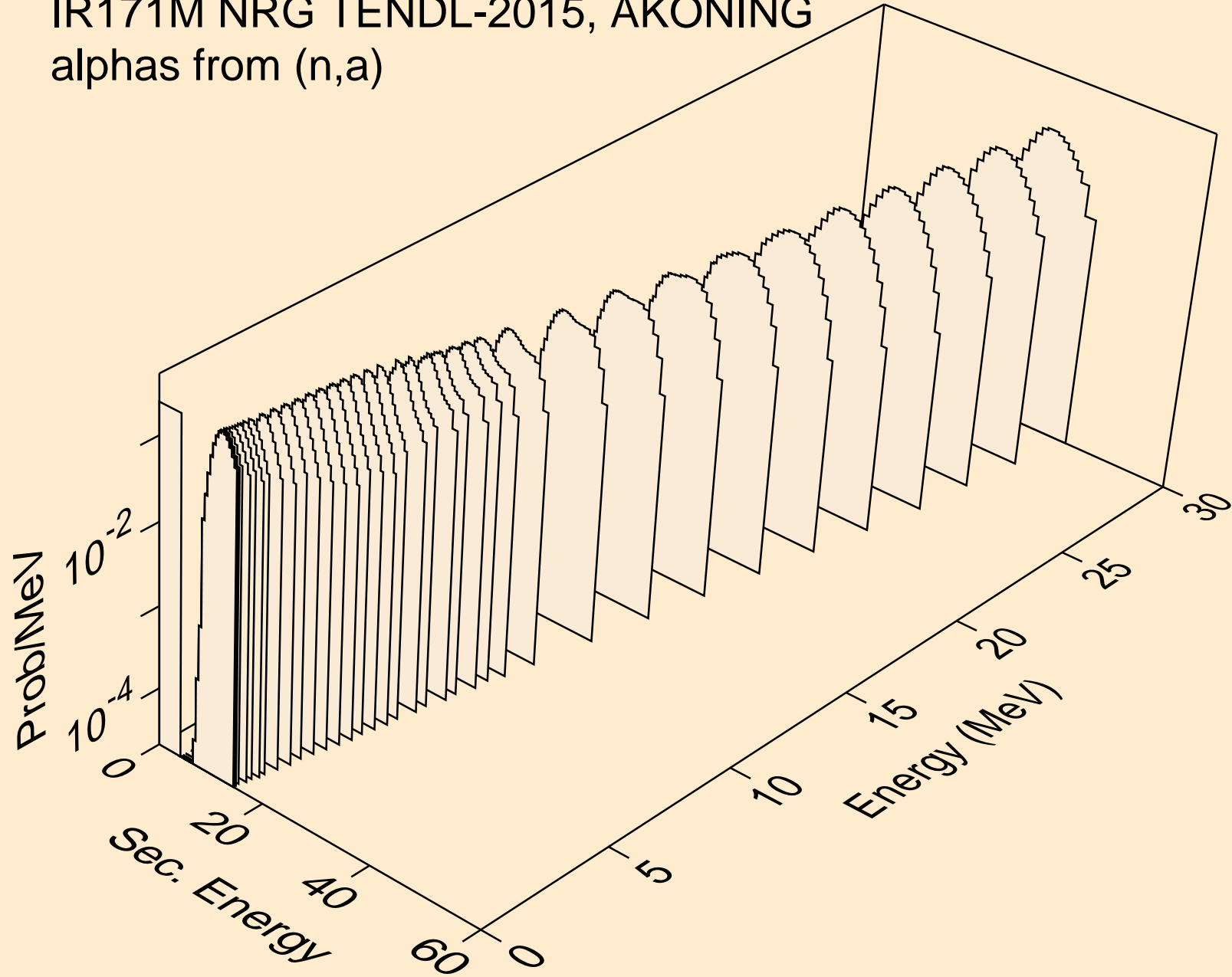

IR171M NRG TENDL-2015, AKONING  
alphas from (n,2a)

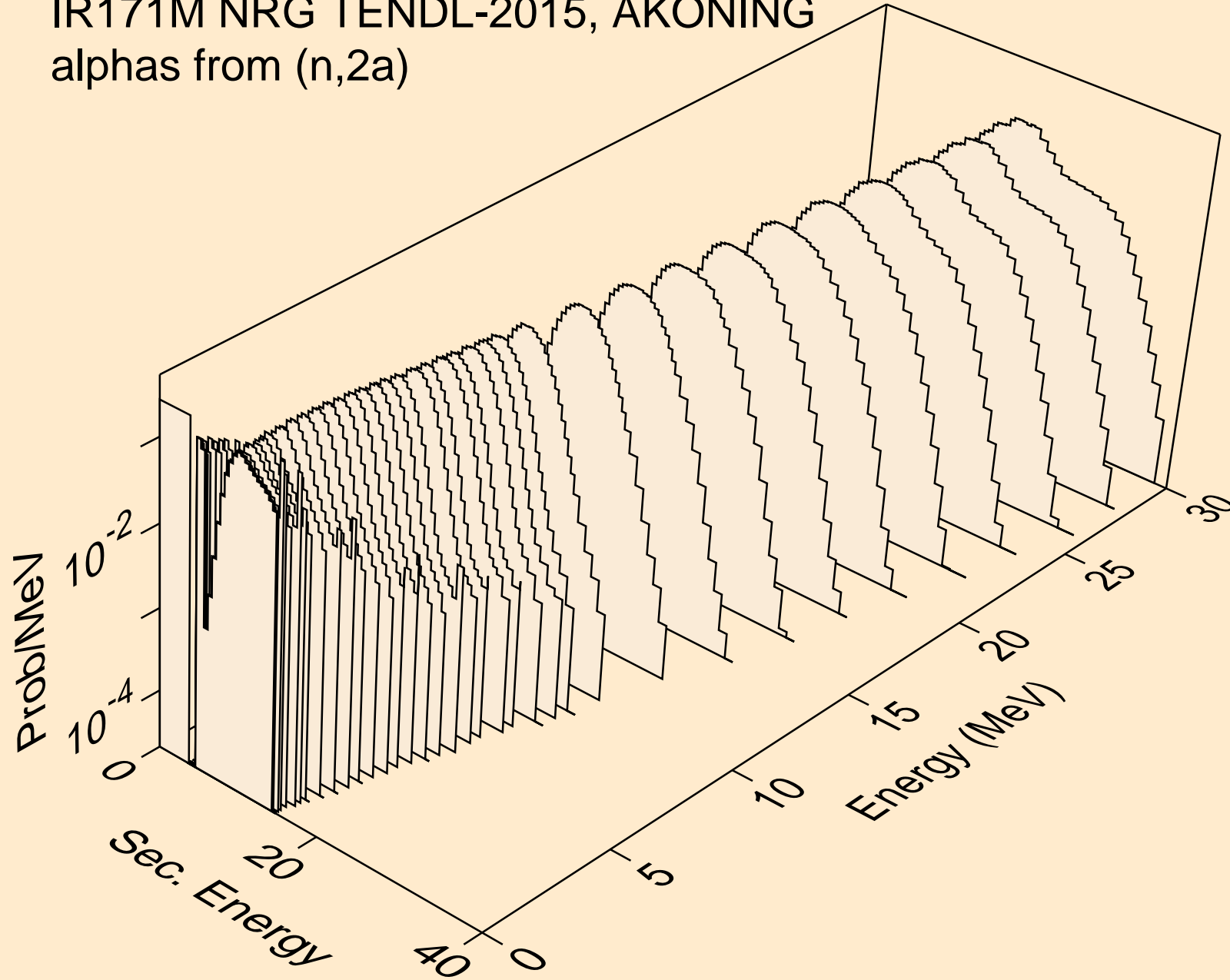

IR171M NRG TENDL-2015, AKONING  
alphas from (n,3a)

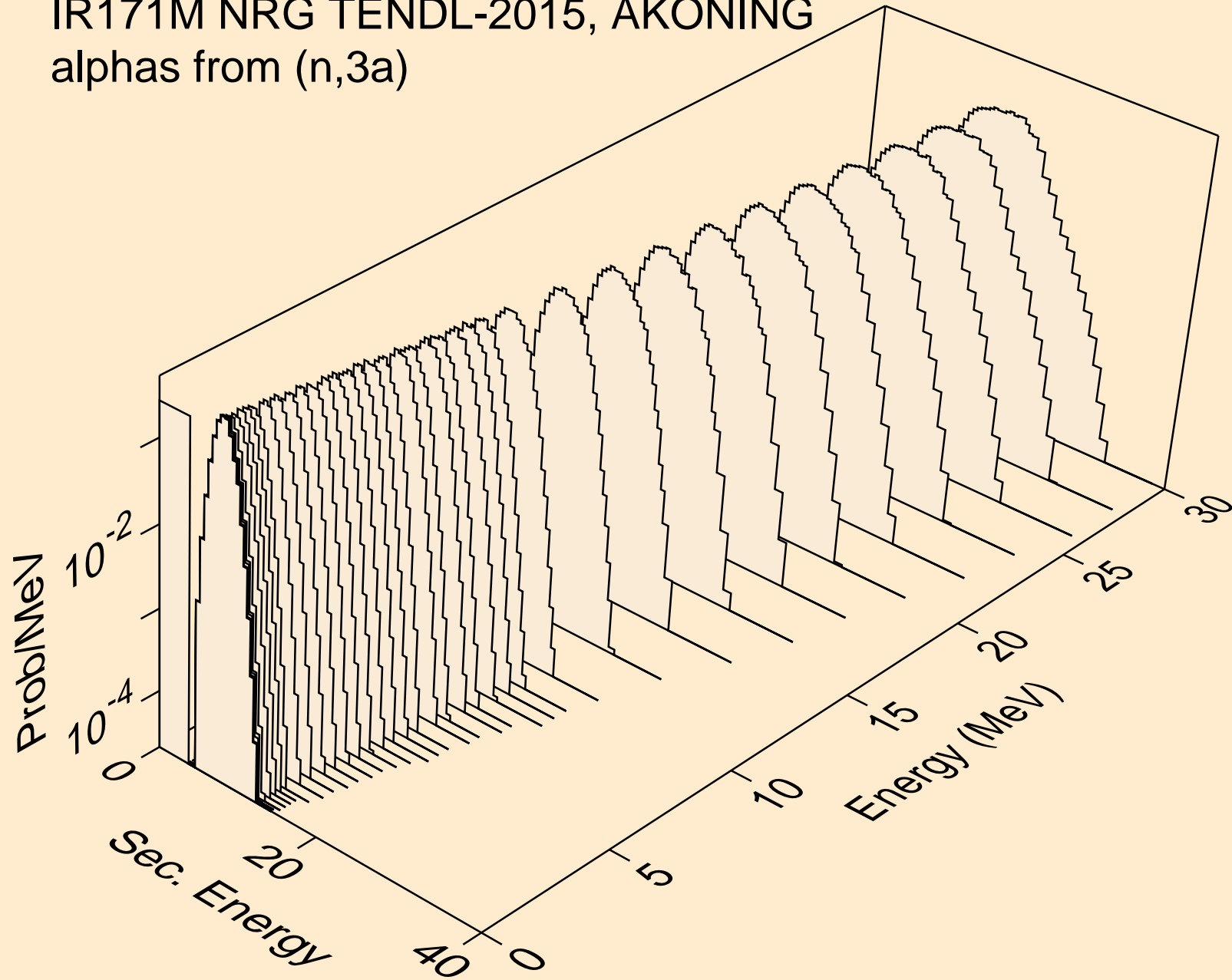

IR171M NRG TENDL-2015, AKONING  
alphas from (n,pa)

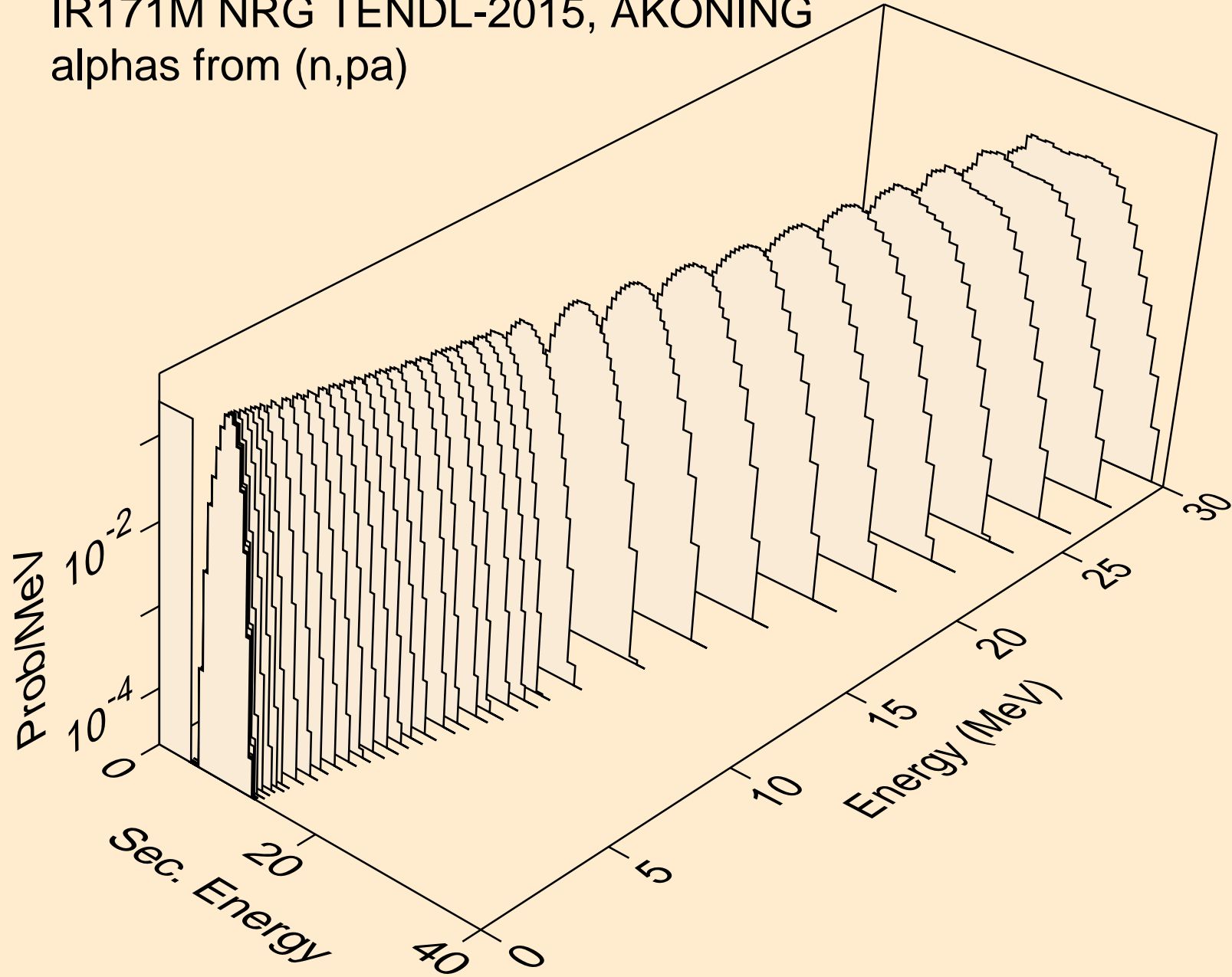

IR171M NRG TENDL-2015, AKONING  
alphas from (n,t2a)

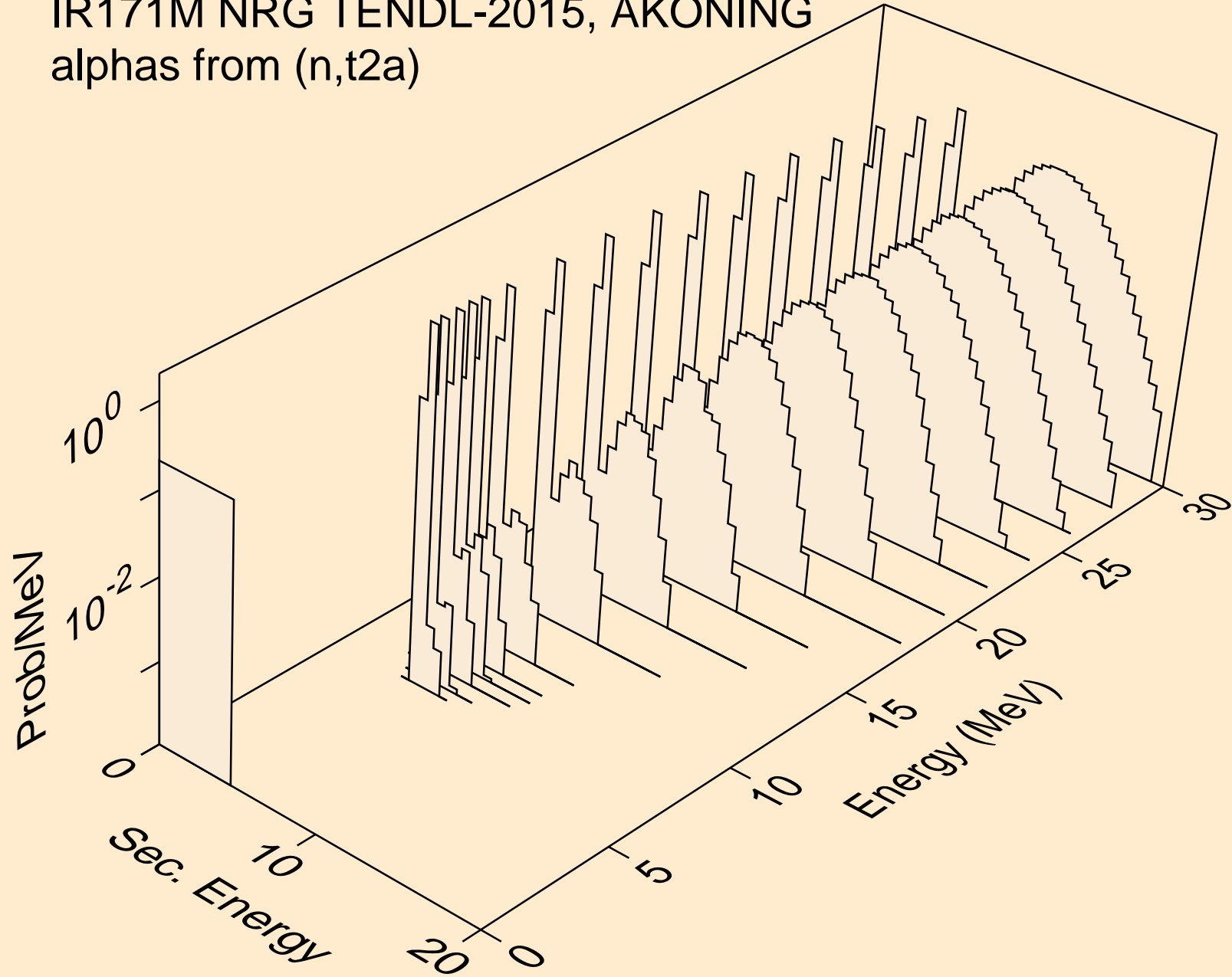



IR171M NRG TENDL-2015, AKONING  
alphas from (n,d2a)

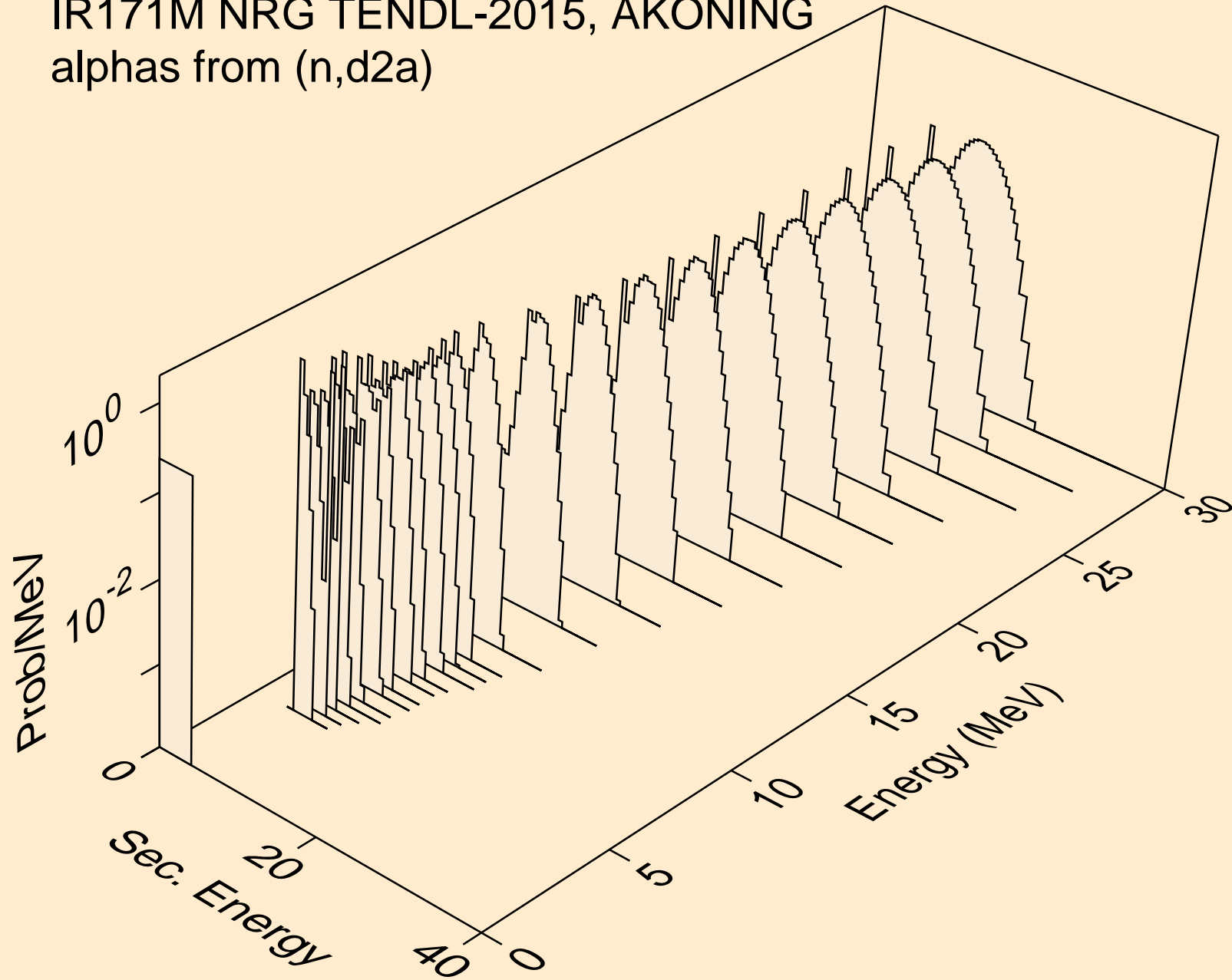

IR171M NRG TENDL-2015, AKONING  
alphas from (n,da)

