

IR172 NRG TENDL-2015, AKONING

Principal cross sections

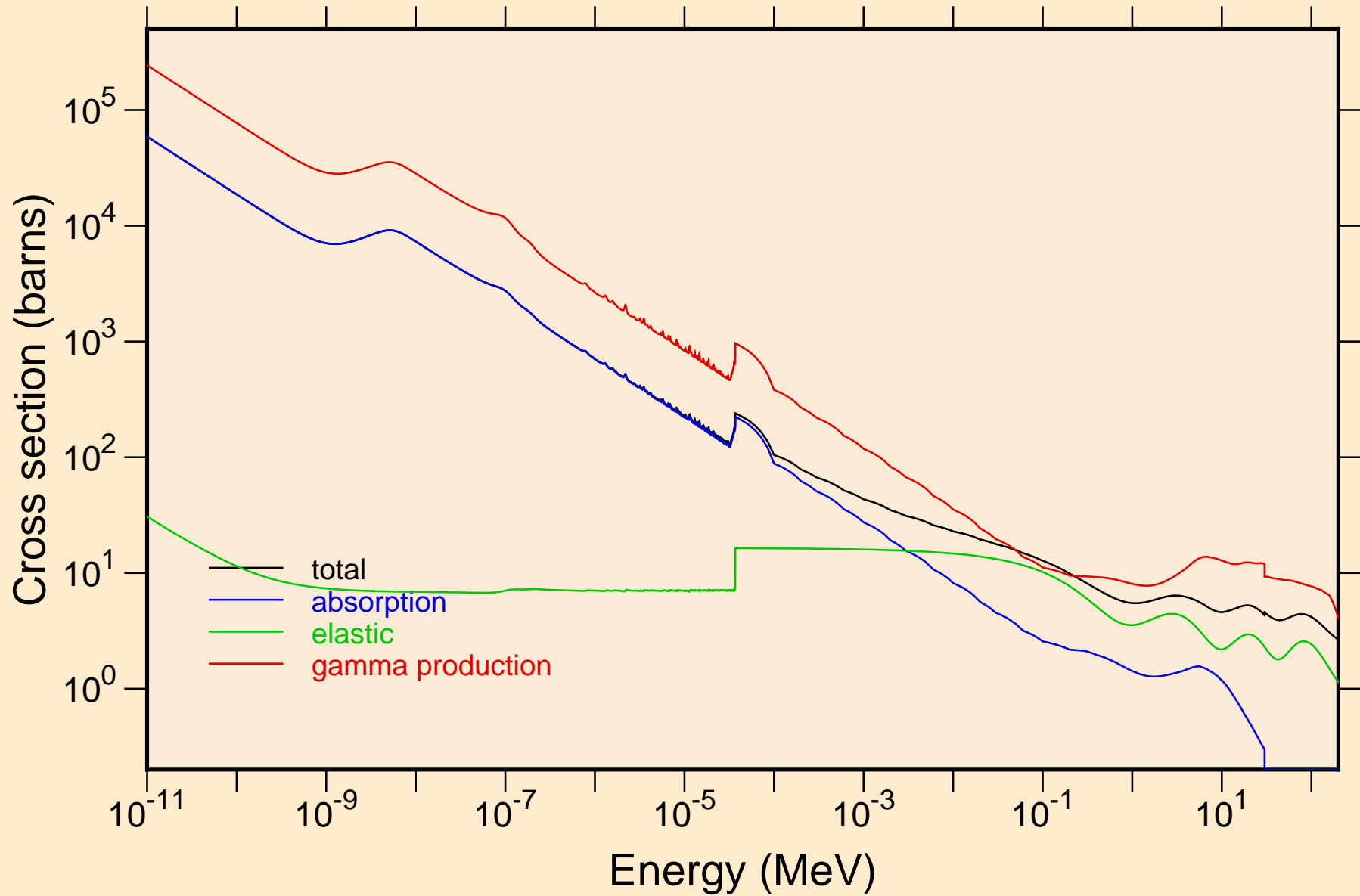

IR172 NRG TENDL-2015, AKONING
resonance total cross section

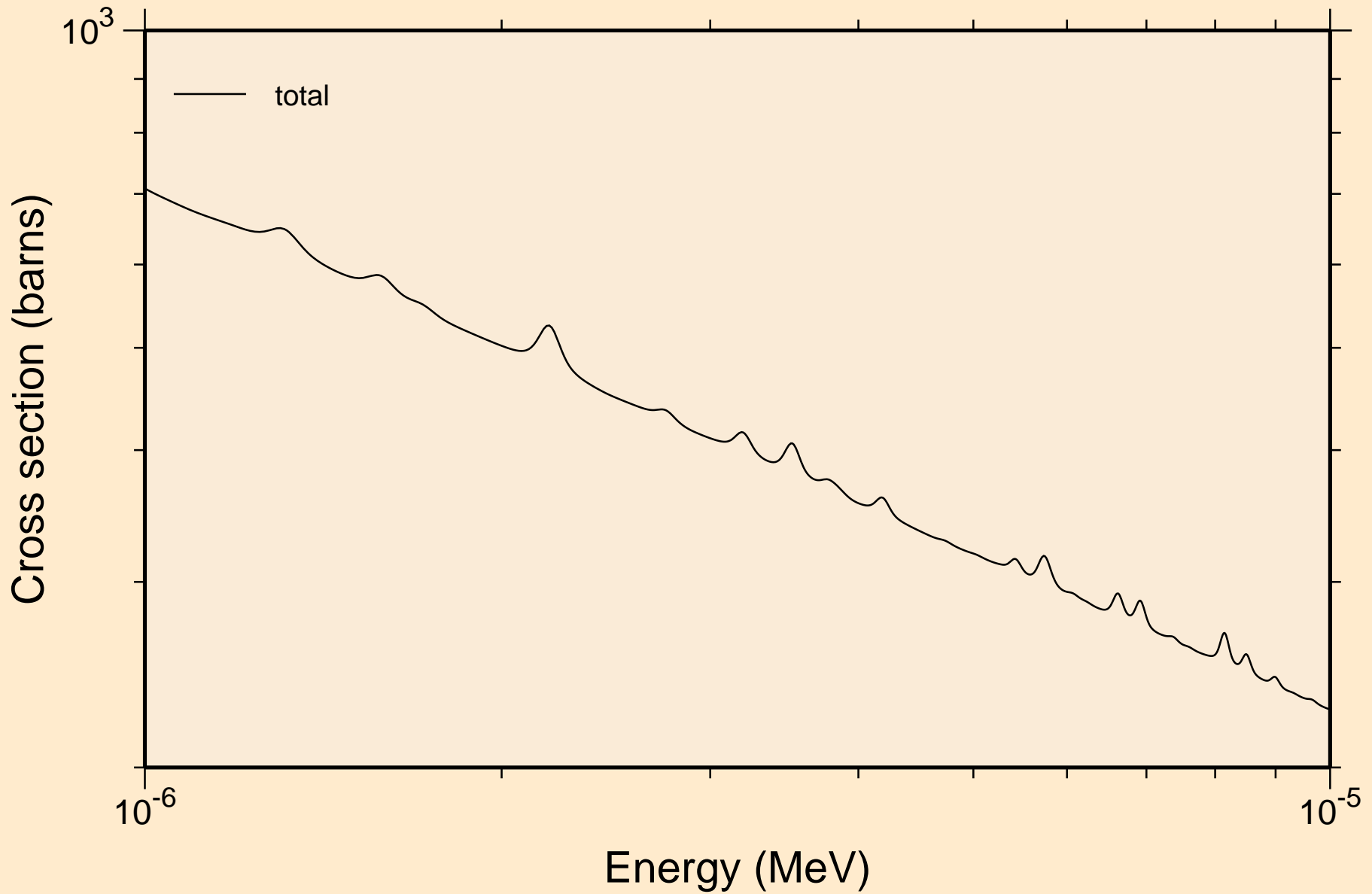

IR172 NRG TENDL-2015, AKONING
resonance total cross section

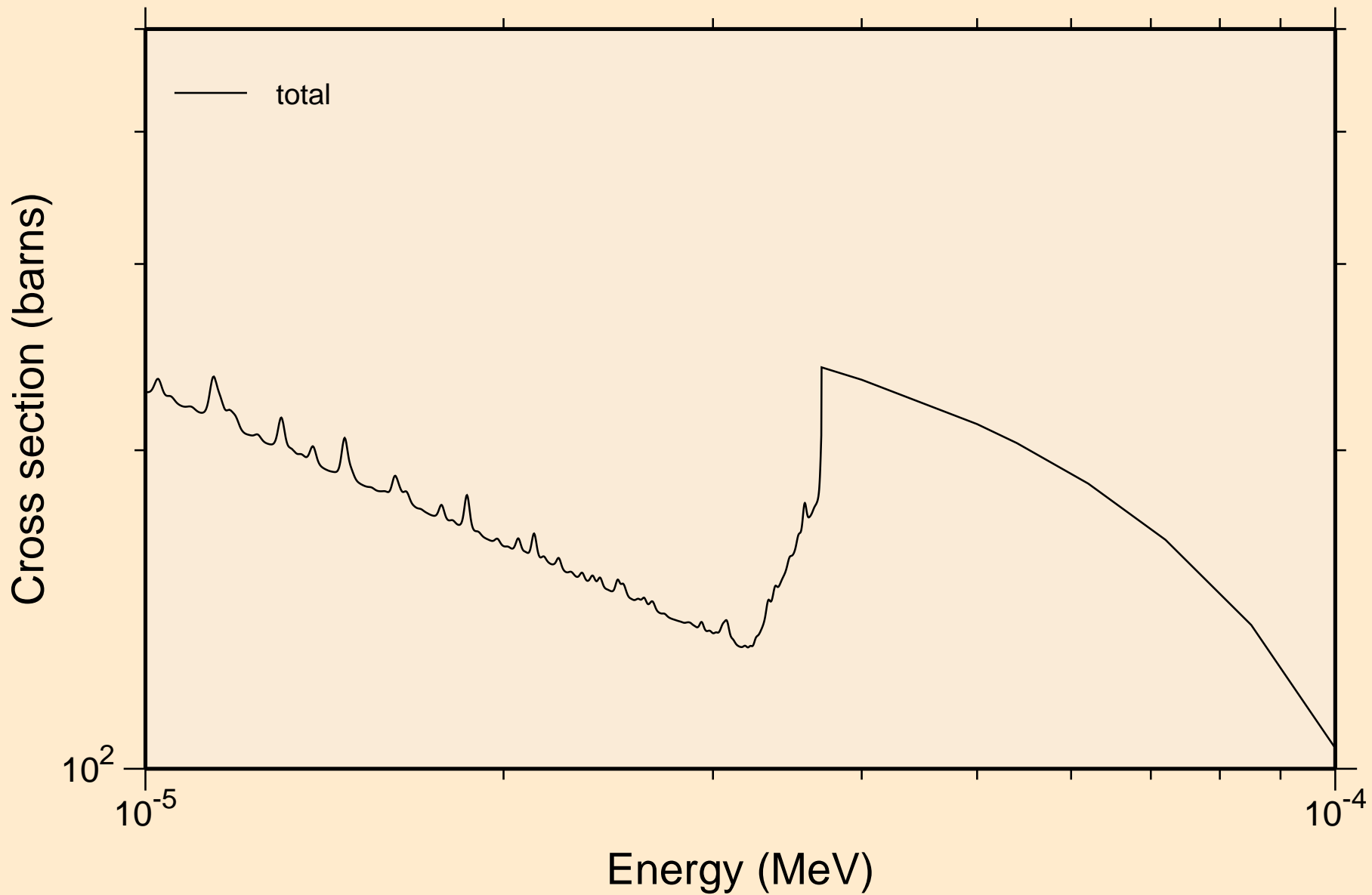

IR172 NRG TENDL-2015, AKONING
resonance total cross section

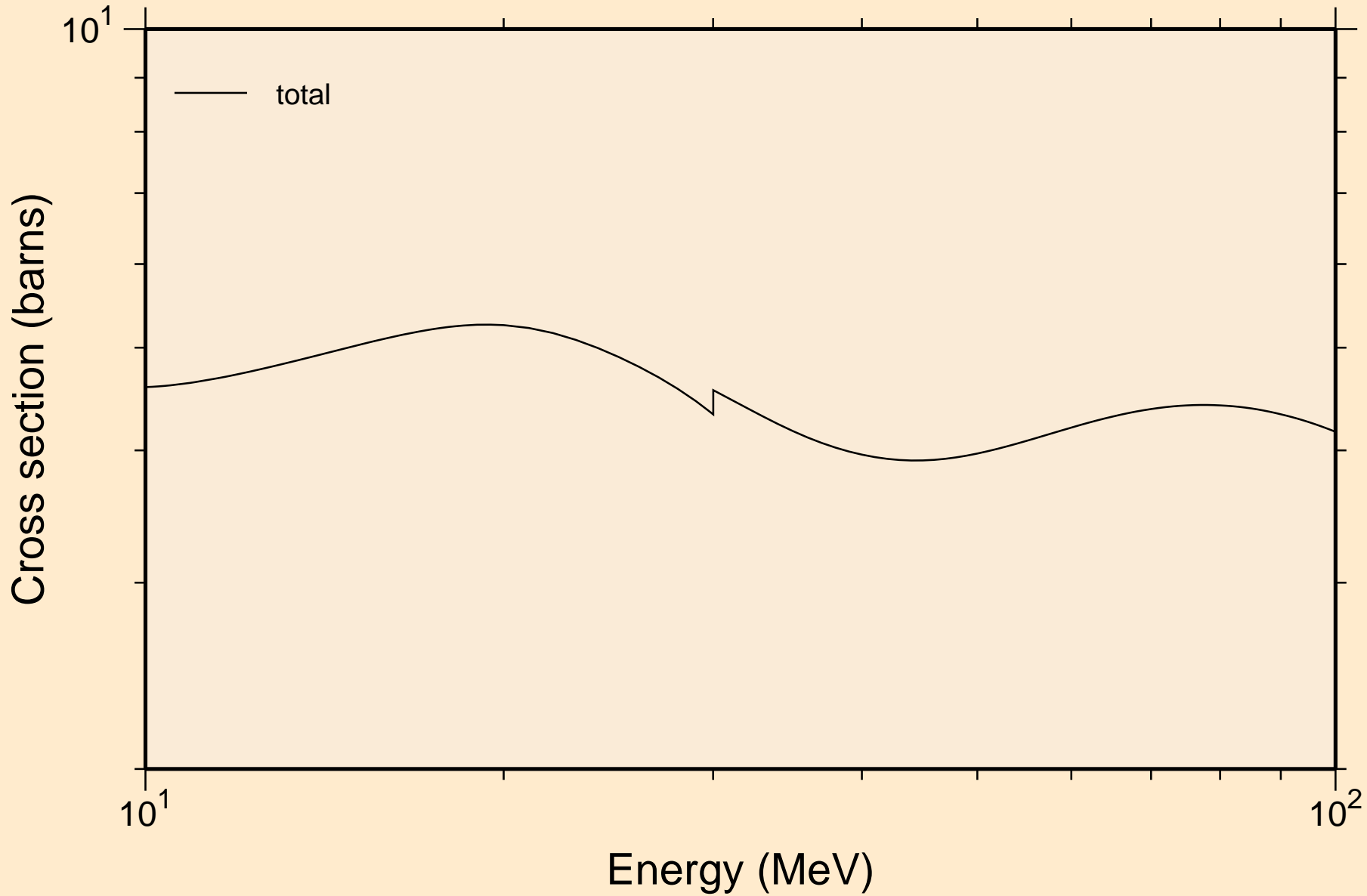

IR172 NRG TENDL-2015, AKONING
resonance absorption cross sections

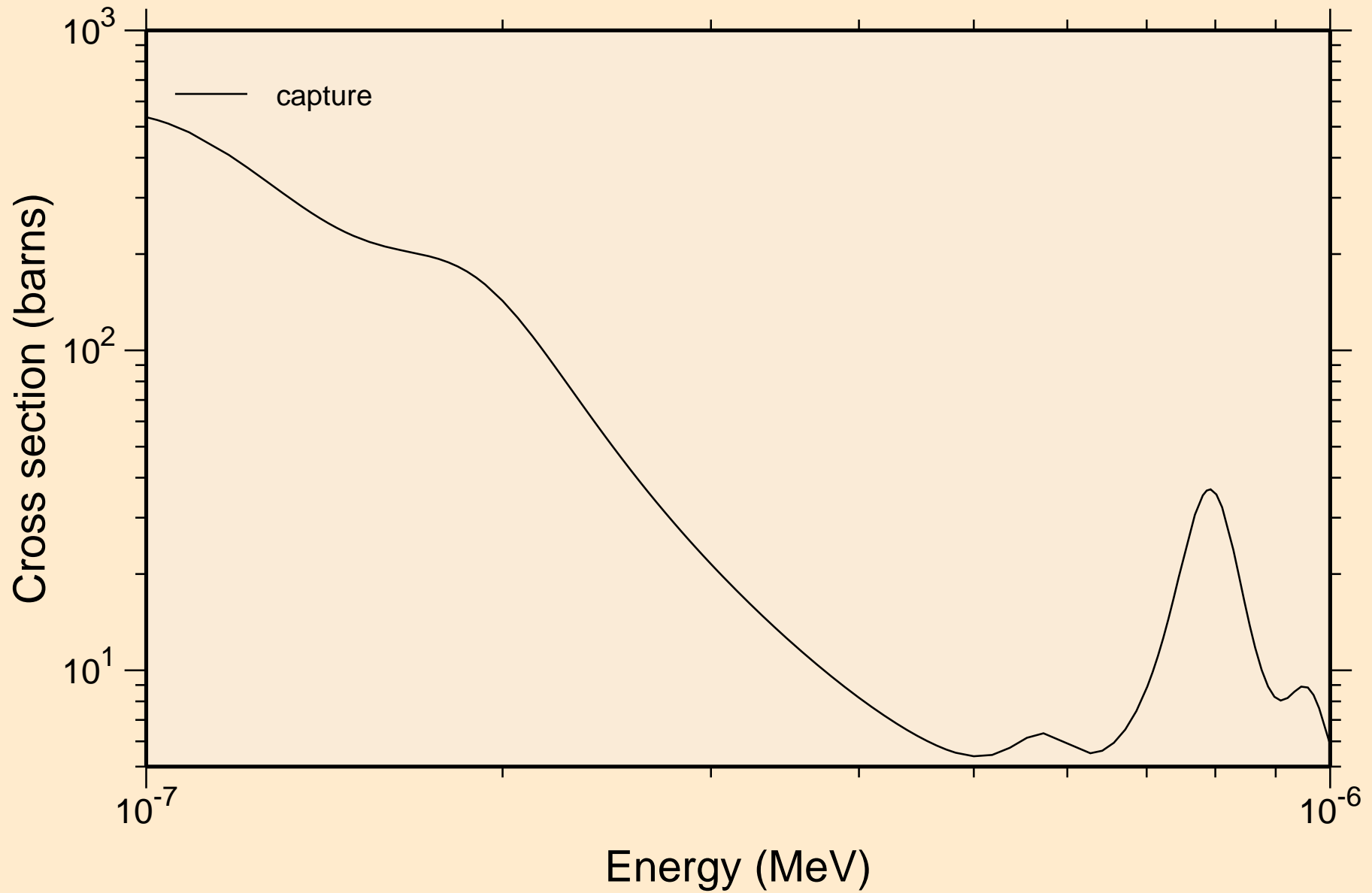

IR172 NRG TENDL-2015, AKONING
resonance absorption cross sections

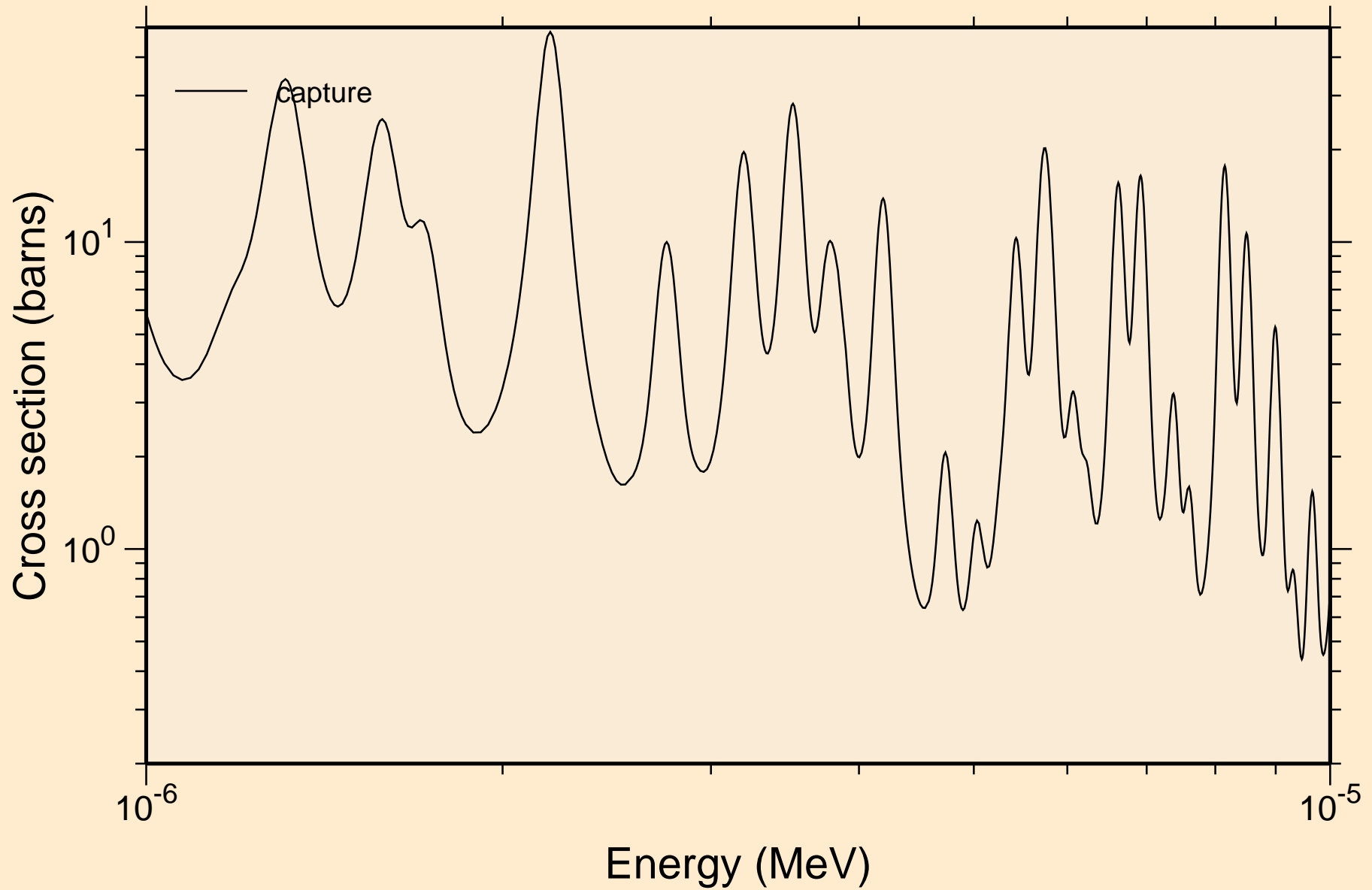

IR172 NRG TENDL-2015, AKONING
resonance absorption cross sections

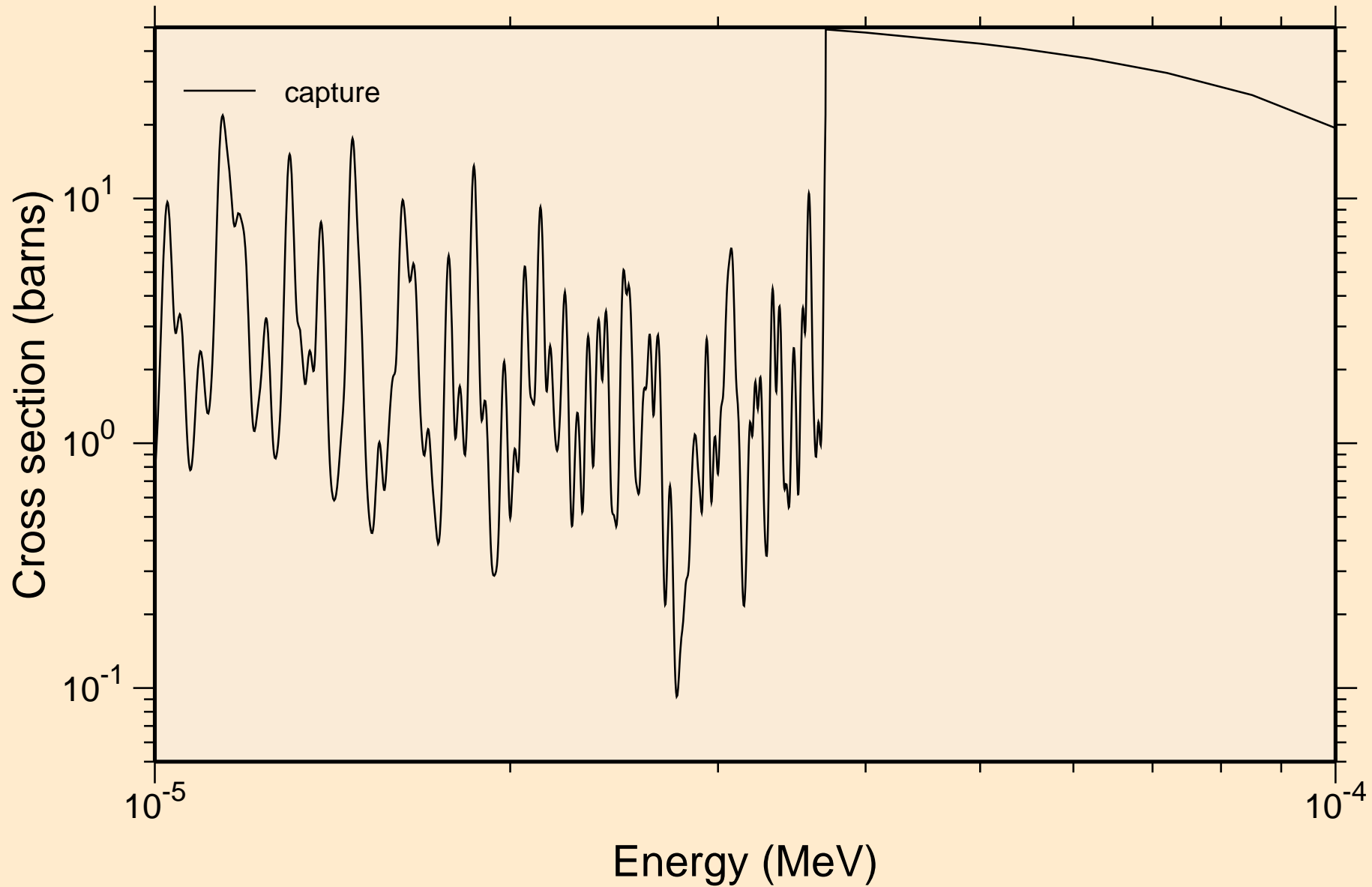

IR172 NRG TENDL-2015, AKONING
resonance absorption cross sections

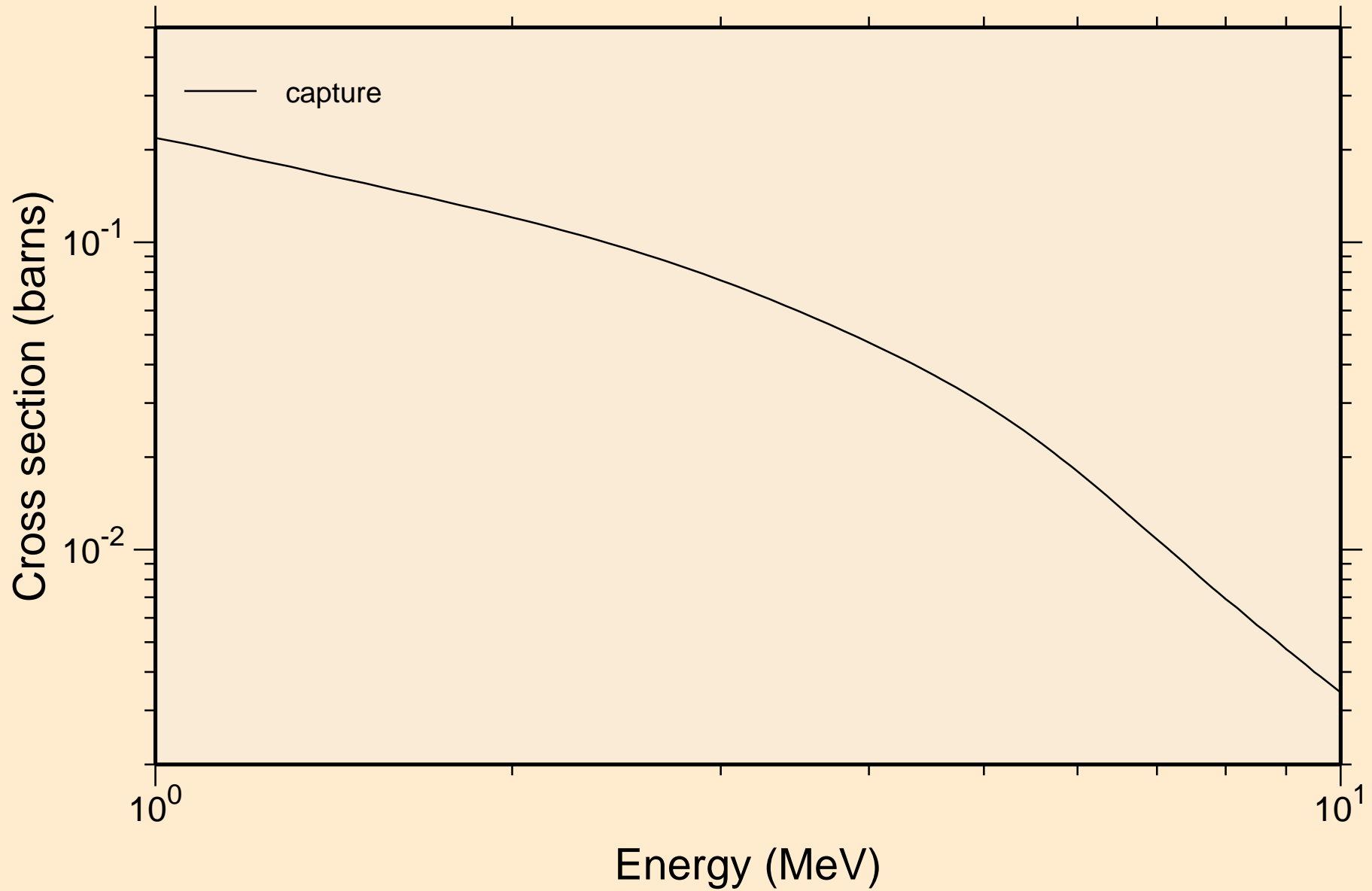

IR172 NRG TENDL-2015, AKONING

Non-threshold reactions

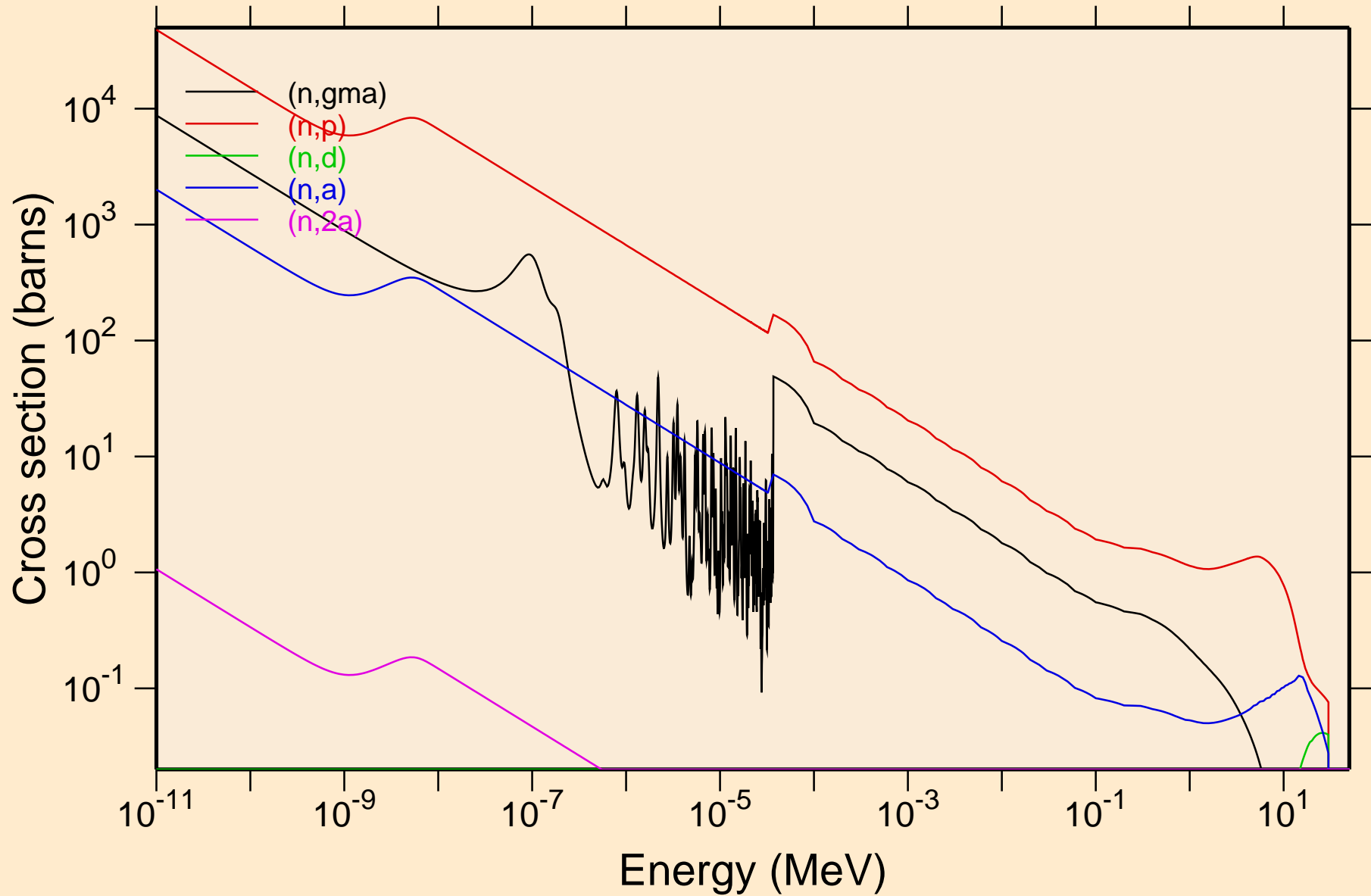

IR172 NRG TENDL-2015, AKONING
Non-threshold reactions

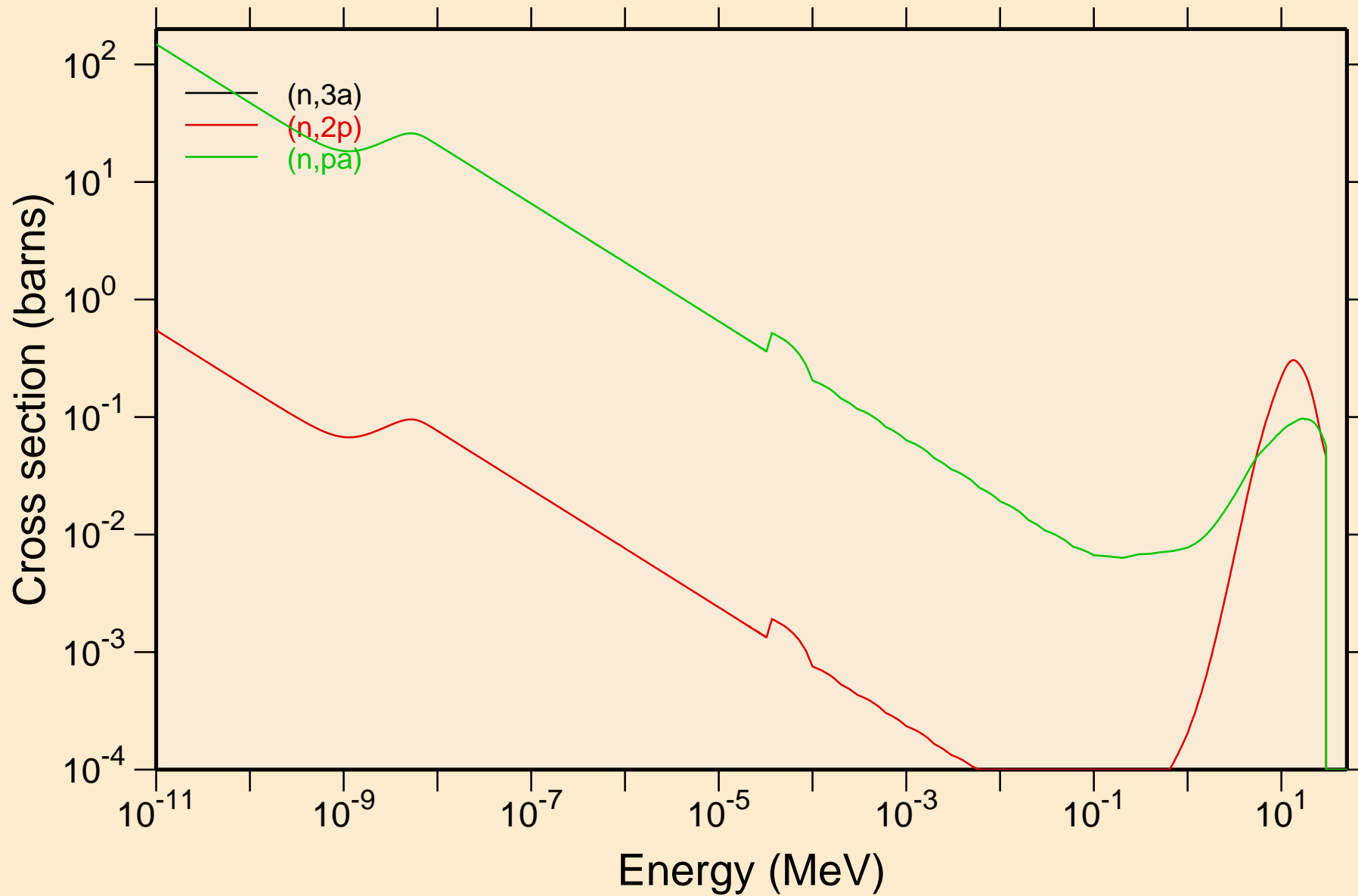

IR172 NRG TENDL-2015, AKONING

Principal cross sections

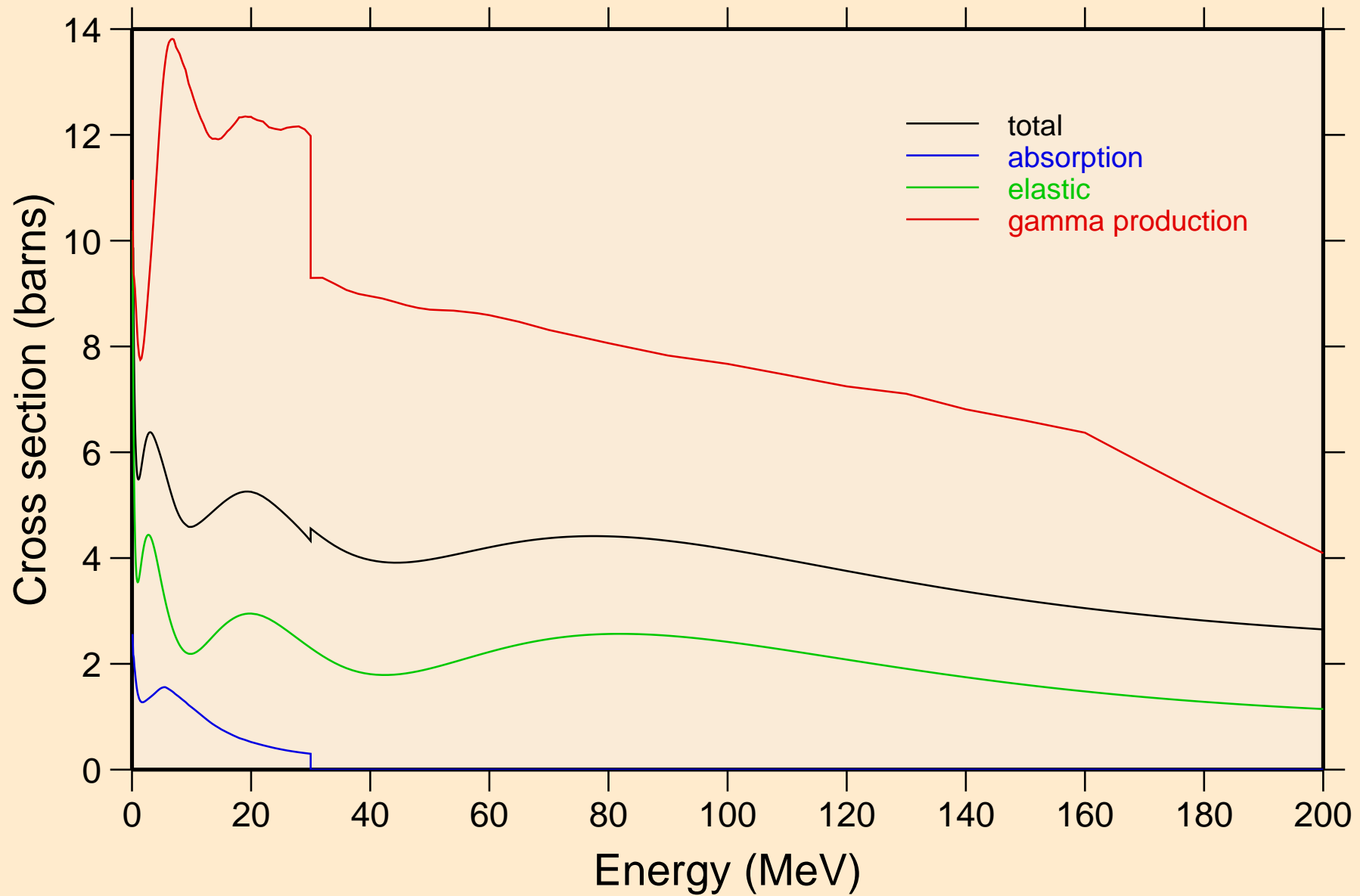

IR172 NRG TENDL-2015, AKONING

Non-threshold reactions

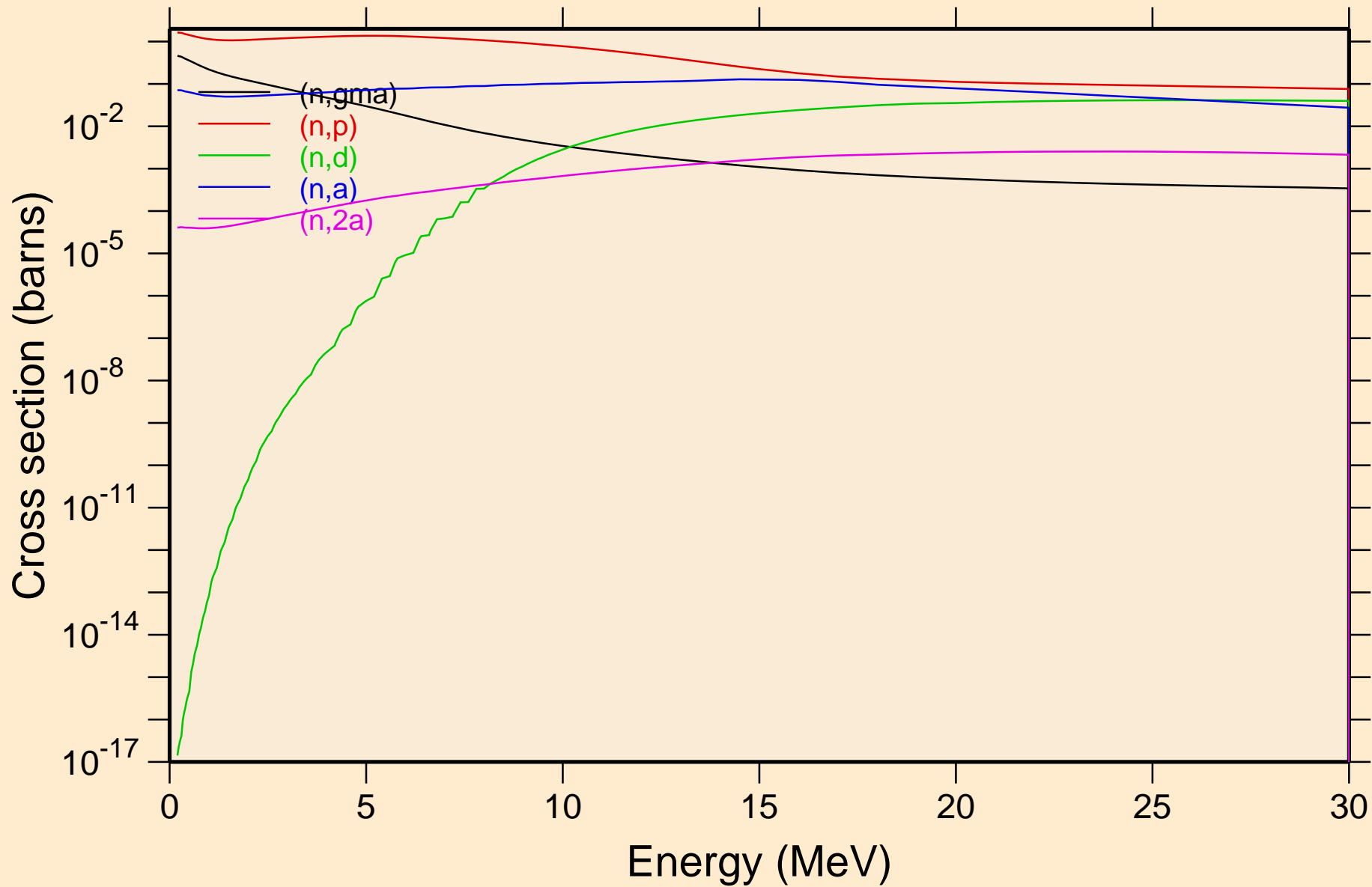

IR172 NRG TENDL-2015, AKONING

Non-threshold reactions

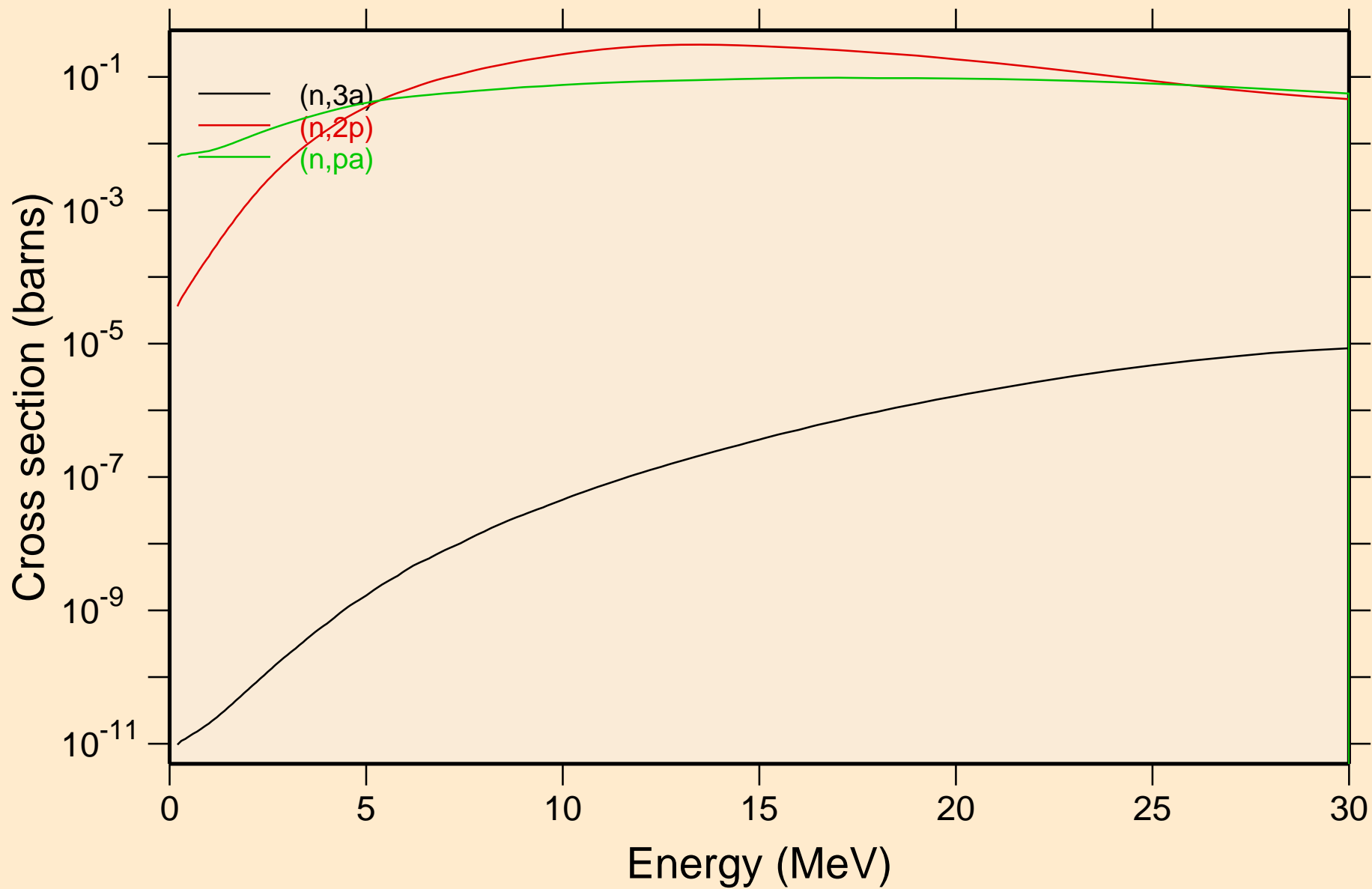

IR172 NRG TENDL-2015, AKONING

Inelastic levels

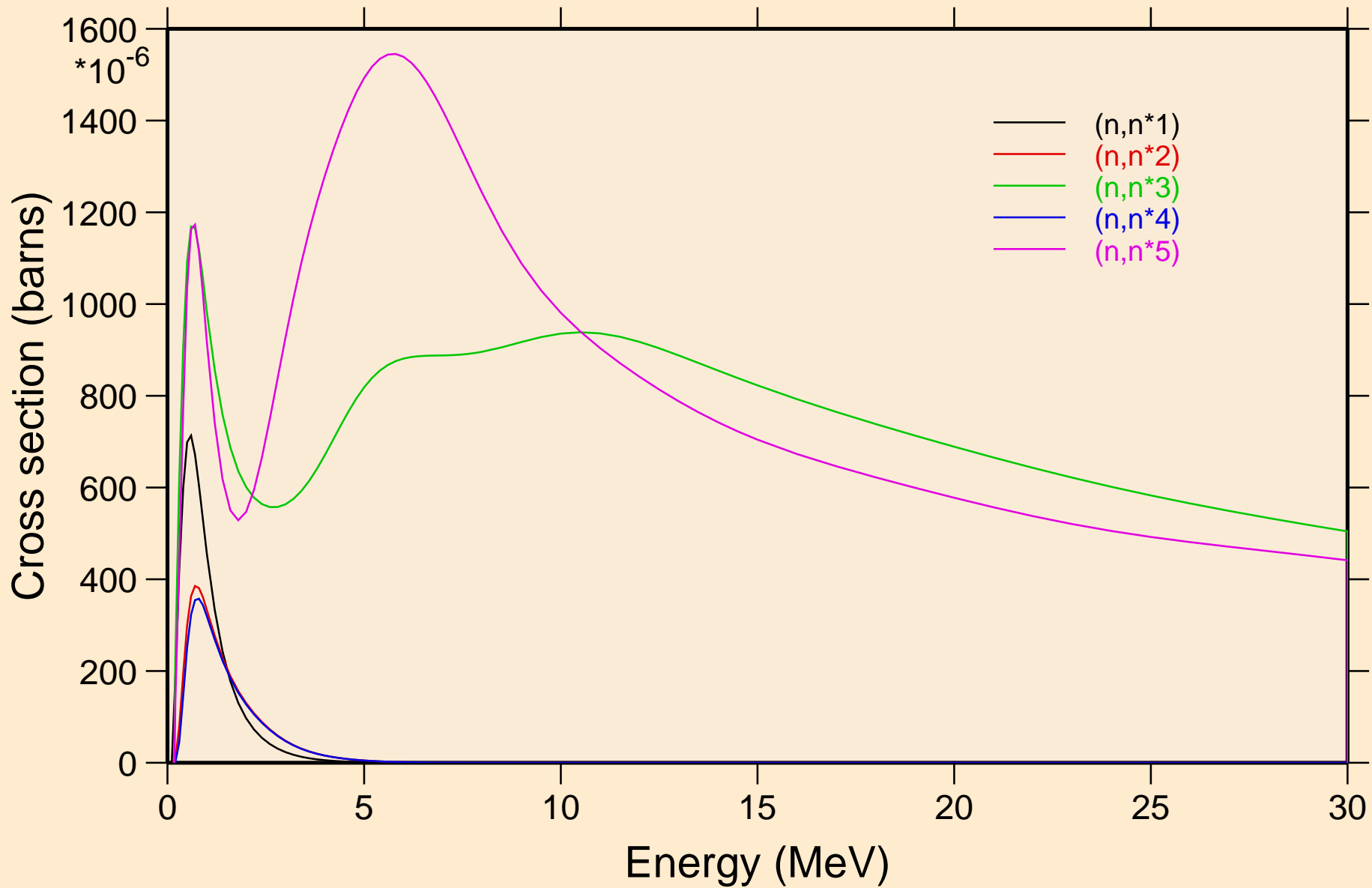

IR172 NRG TENDL-2015, AKONING

Inelastic levels

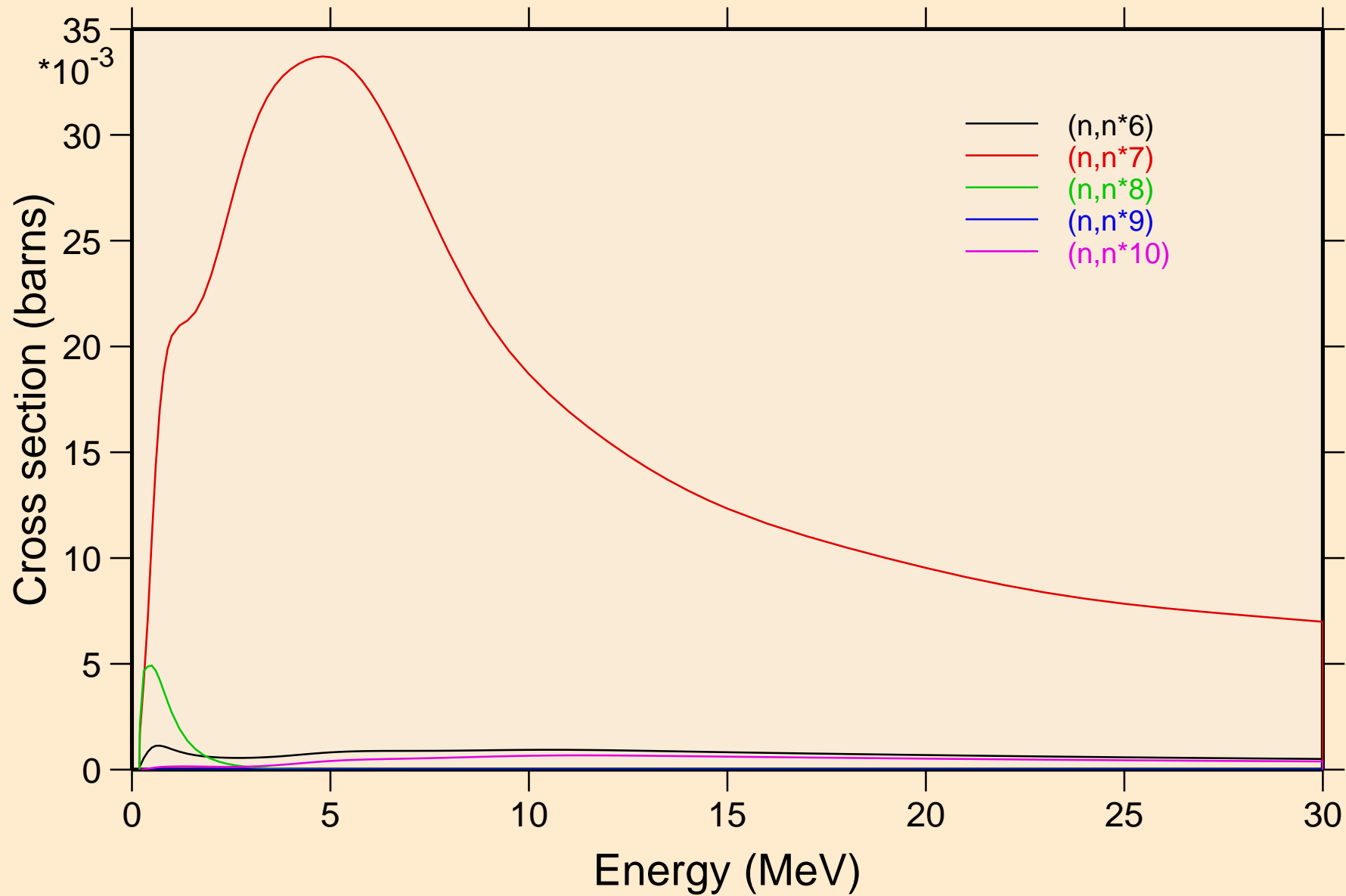

IR172 NRG TENDL-2015, AKONING

Inelastic levels

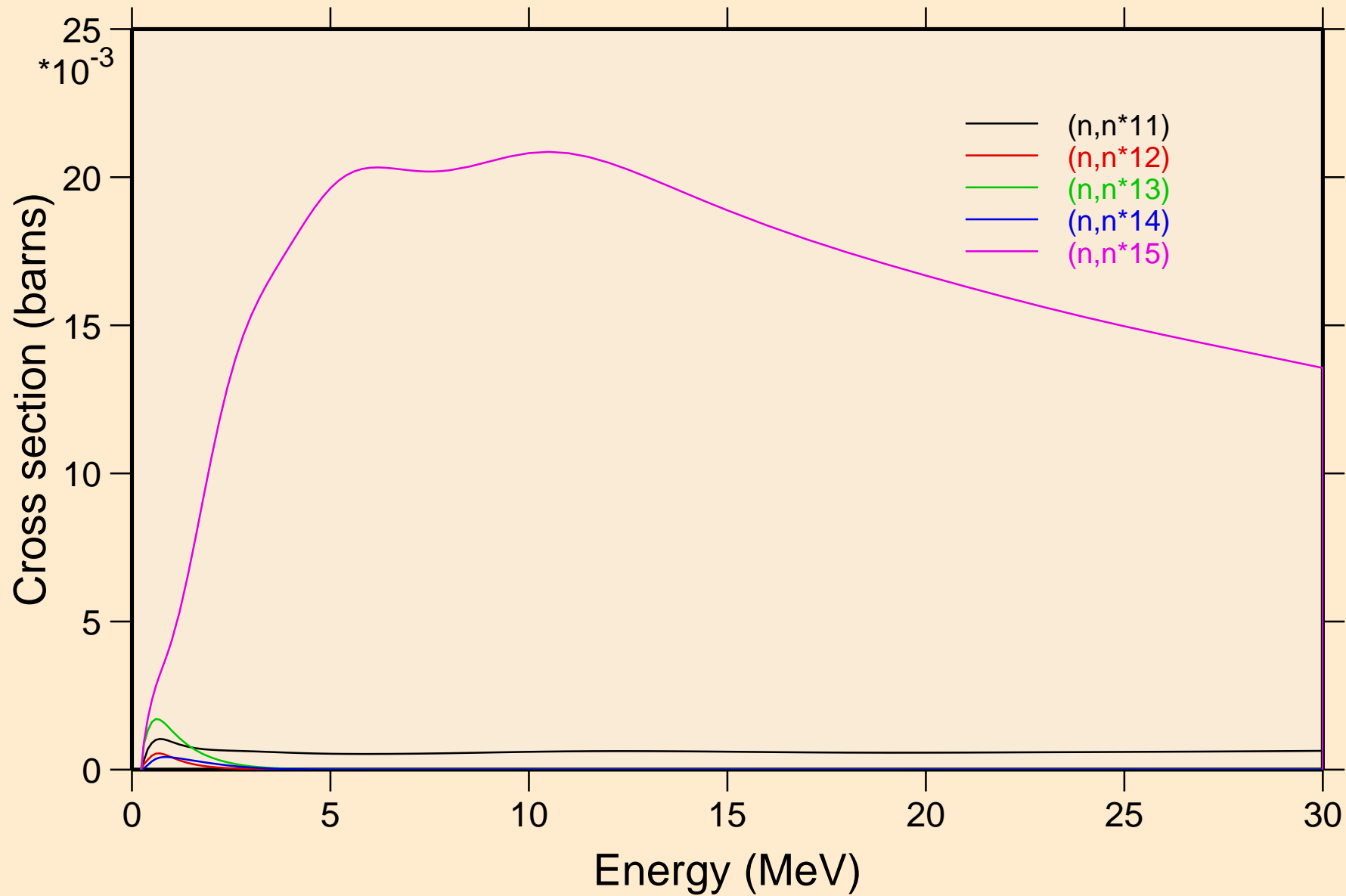

IR172 NRG TENDL-2015, AKONING

Inelastic levels

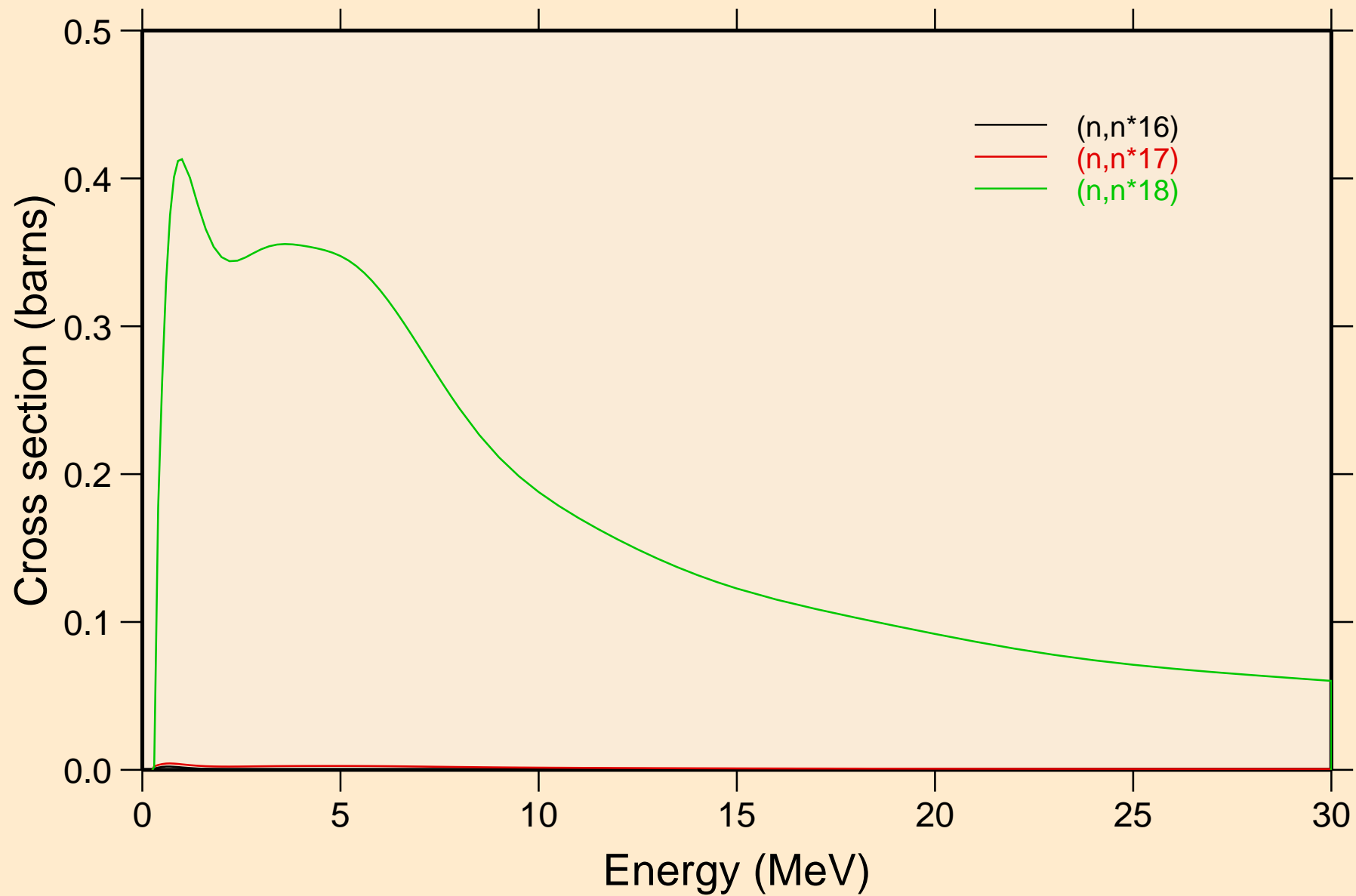

IR172 NRG TENDL-2015, AKONING

Threshold reactions

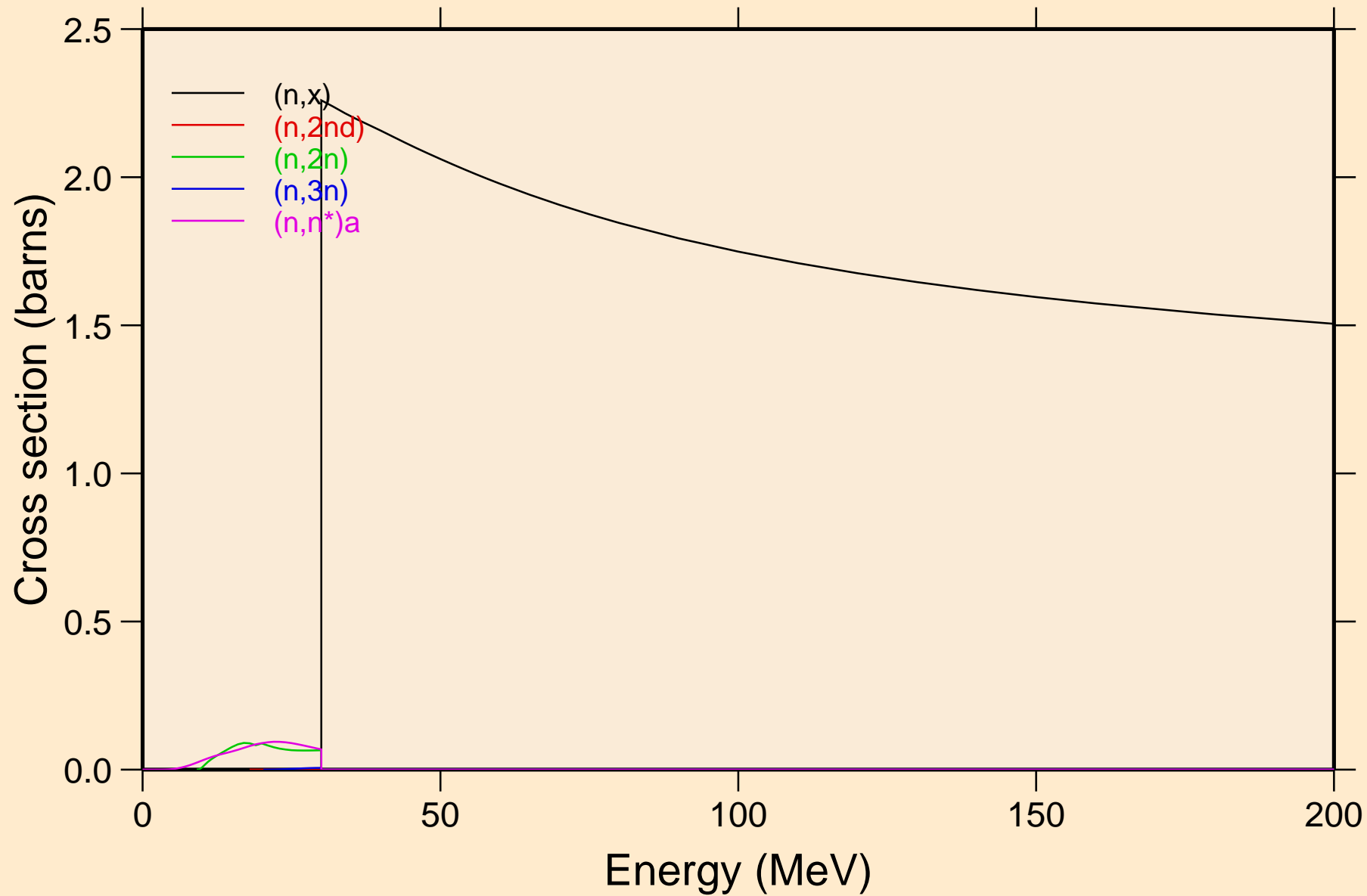

IR172 NRG TENDL-2015, AKONING

Threshold reactions

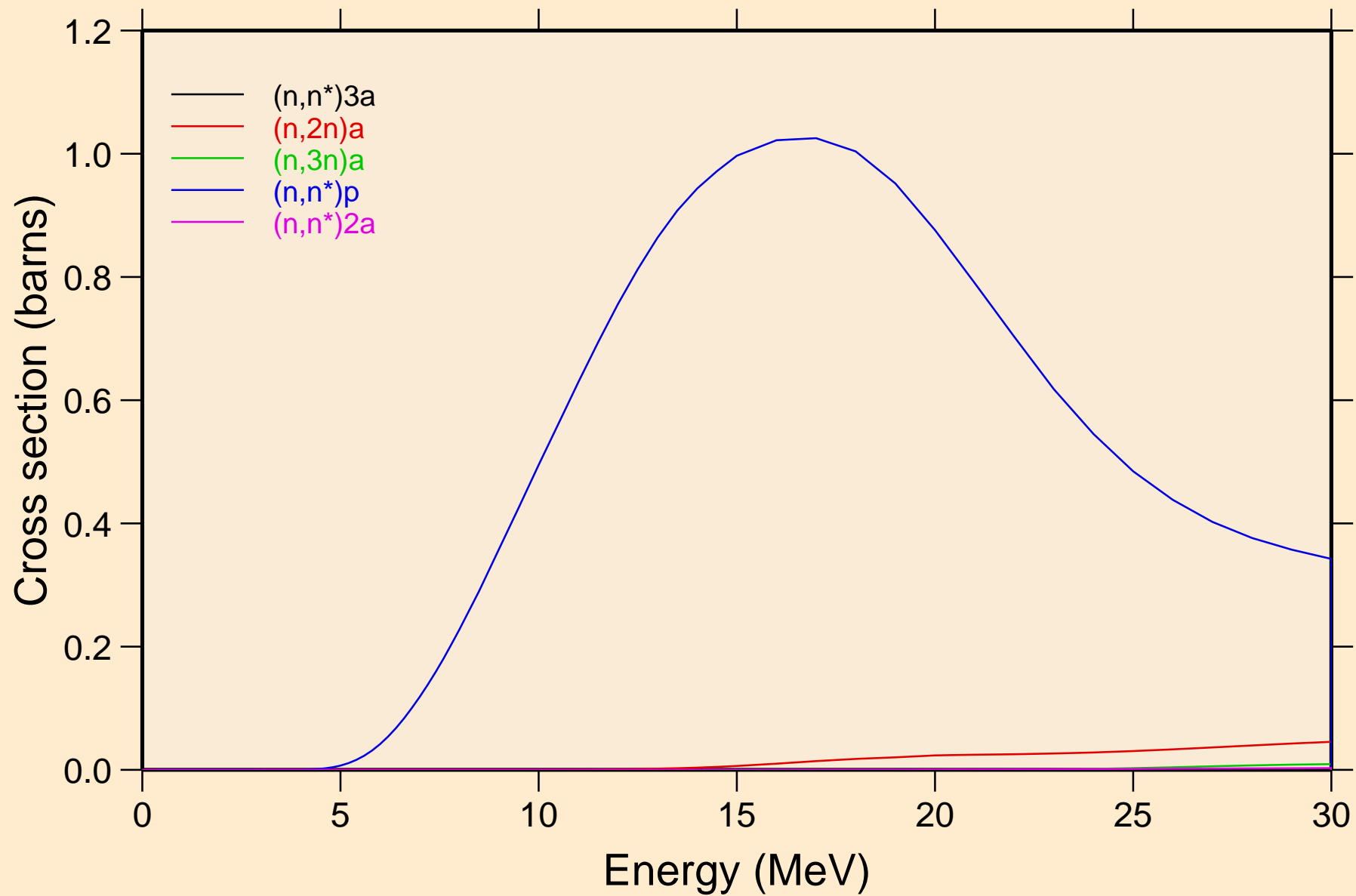

IR172 NRG TENDL-2015, AKONING

Threshold reactions

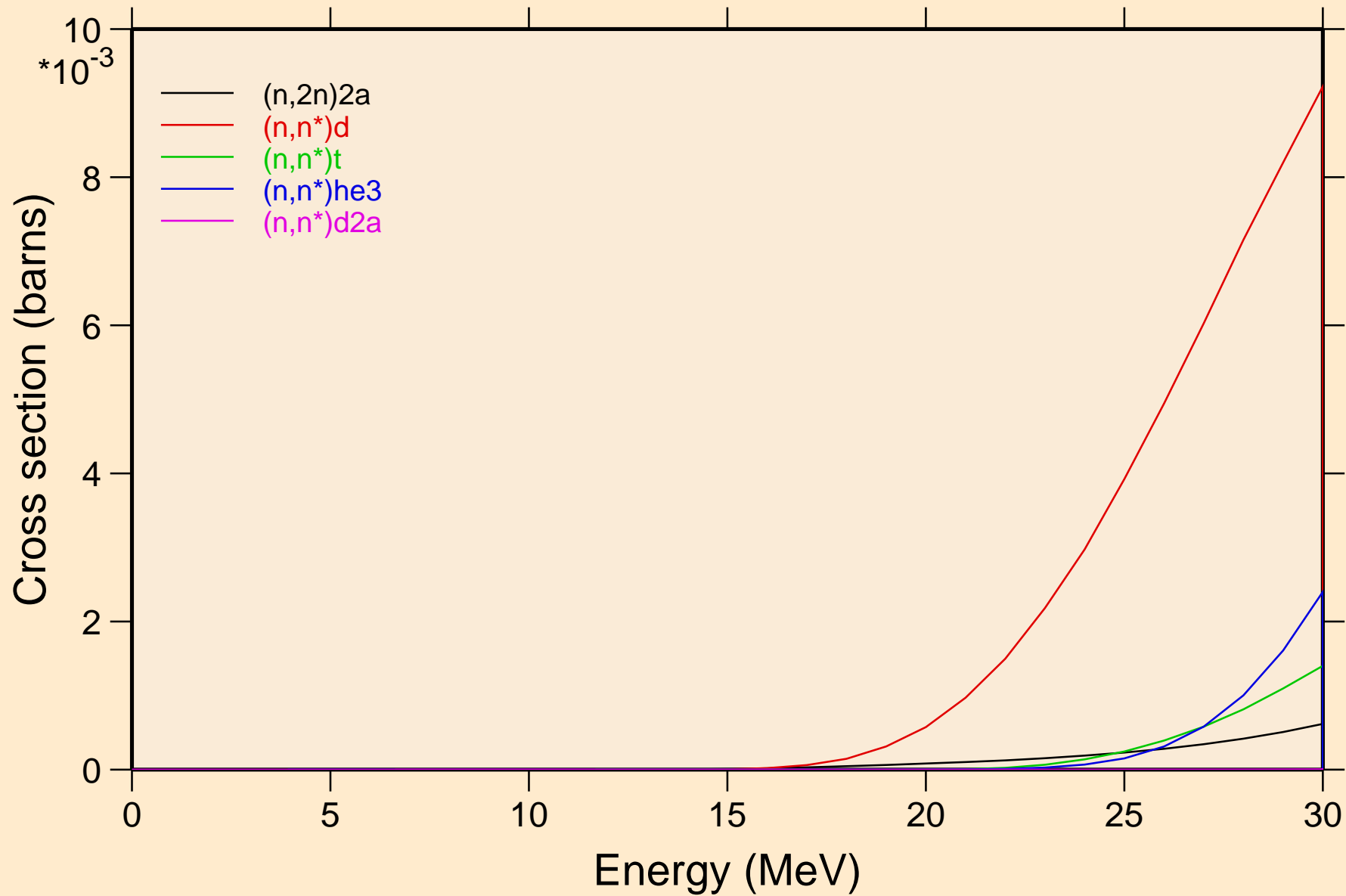

IR172 NRG TENDL-2015, AKONING

Threshold reactions

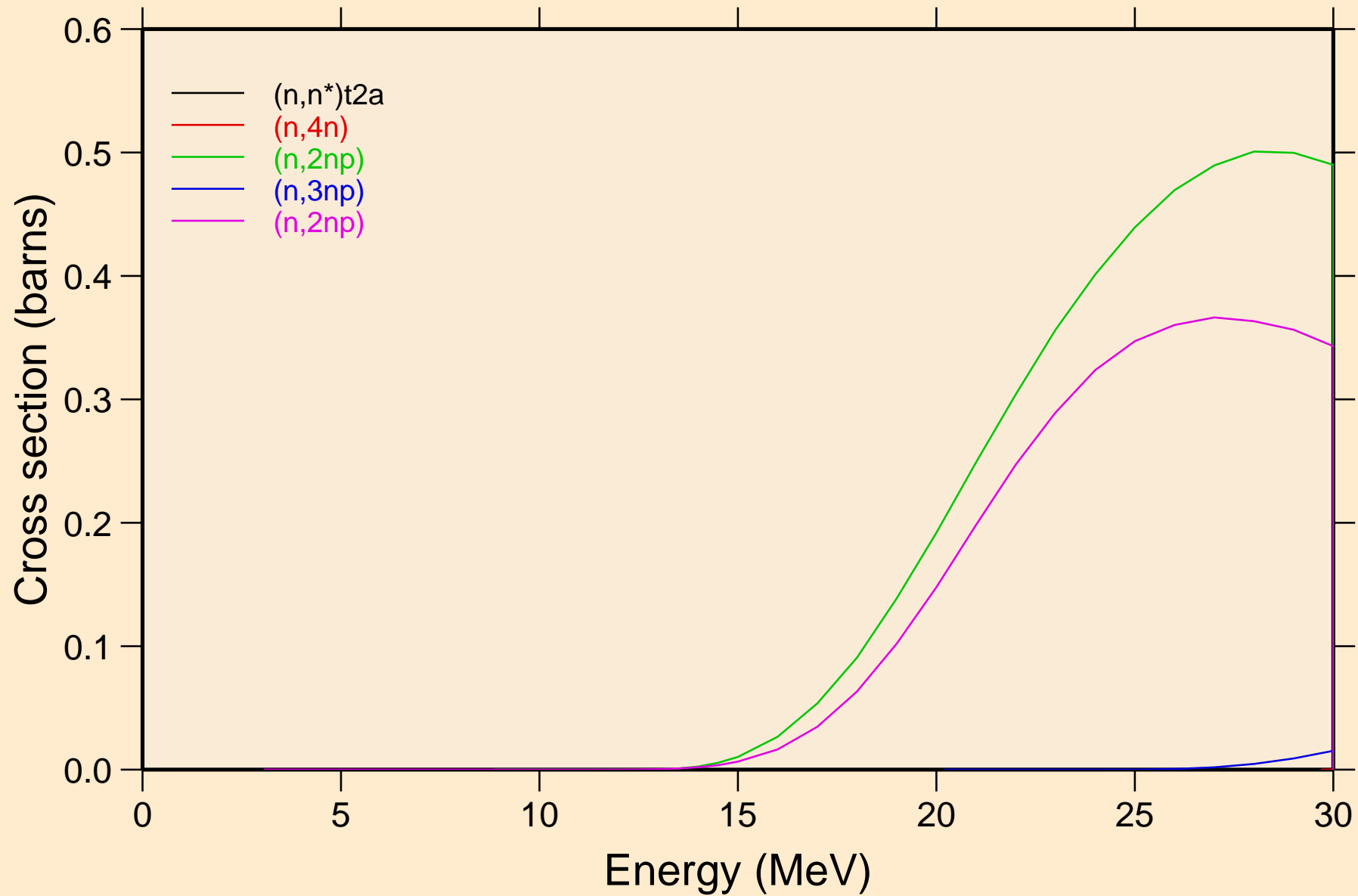

IR172 NRG TENDL-2015, AKONING

Threshold reactions

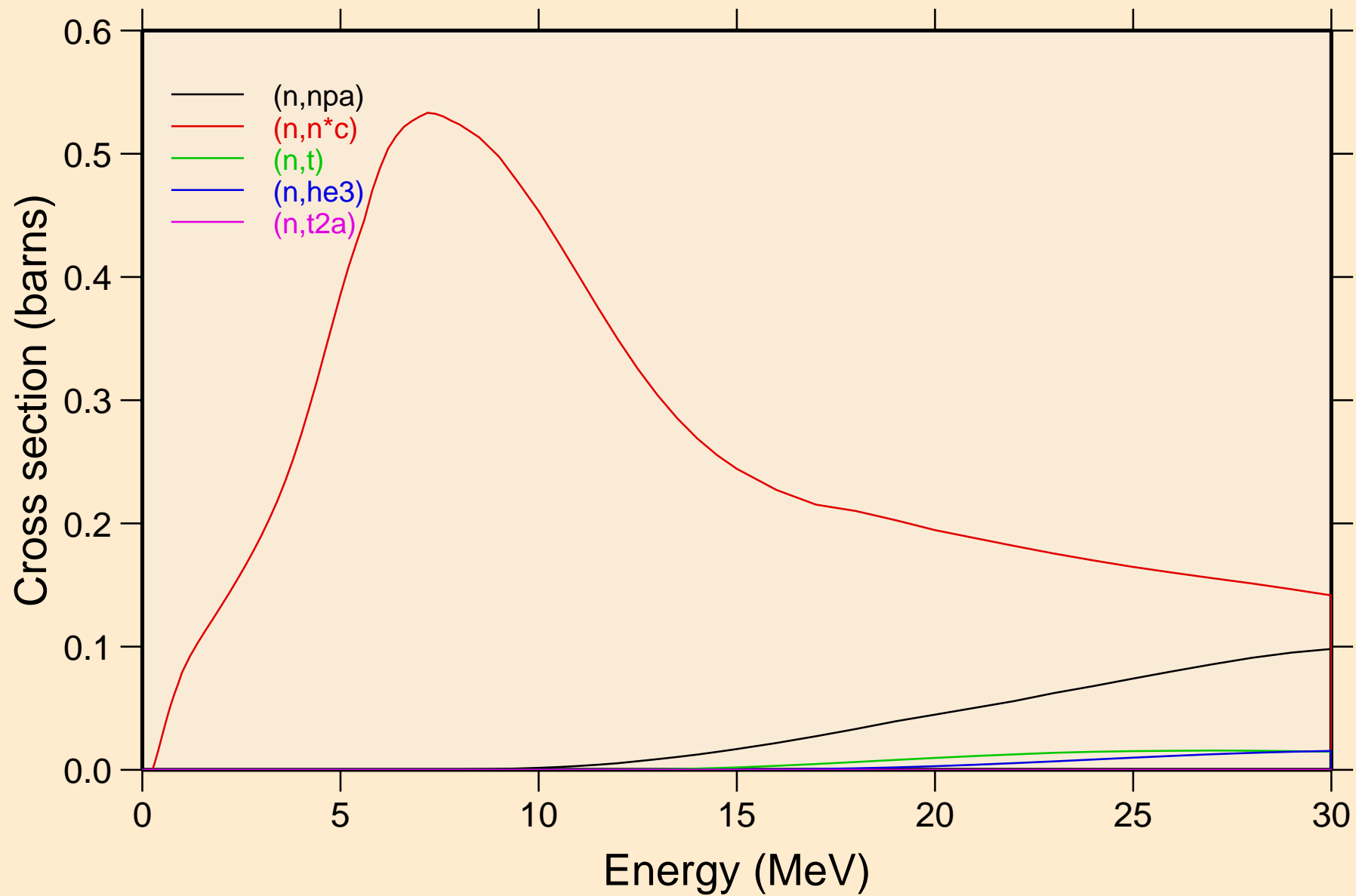

IR172 NRG TENDL-2015, AKONING

Threshold reactions

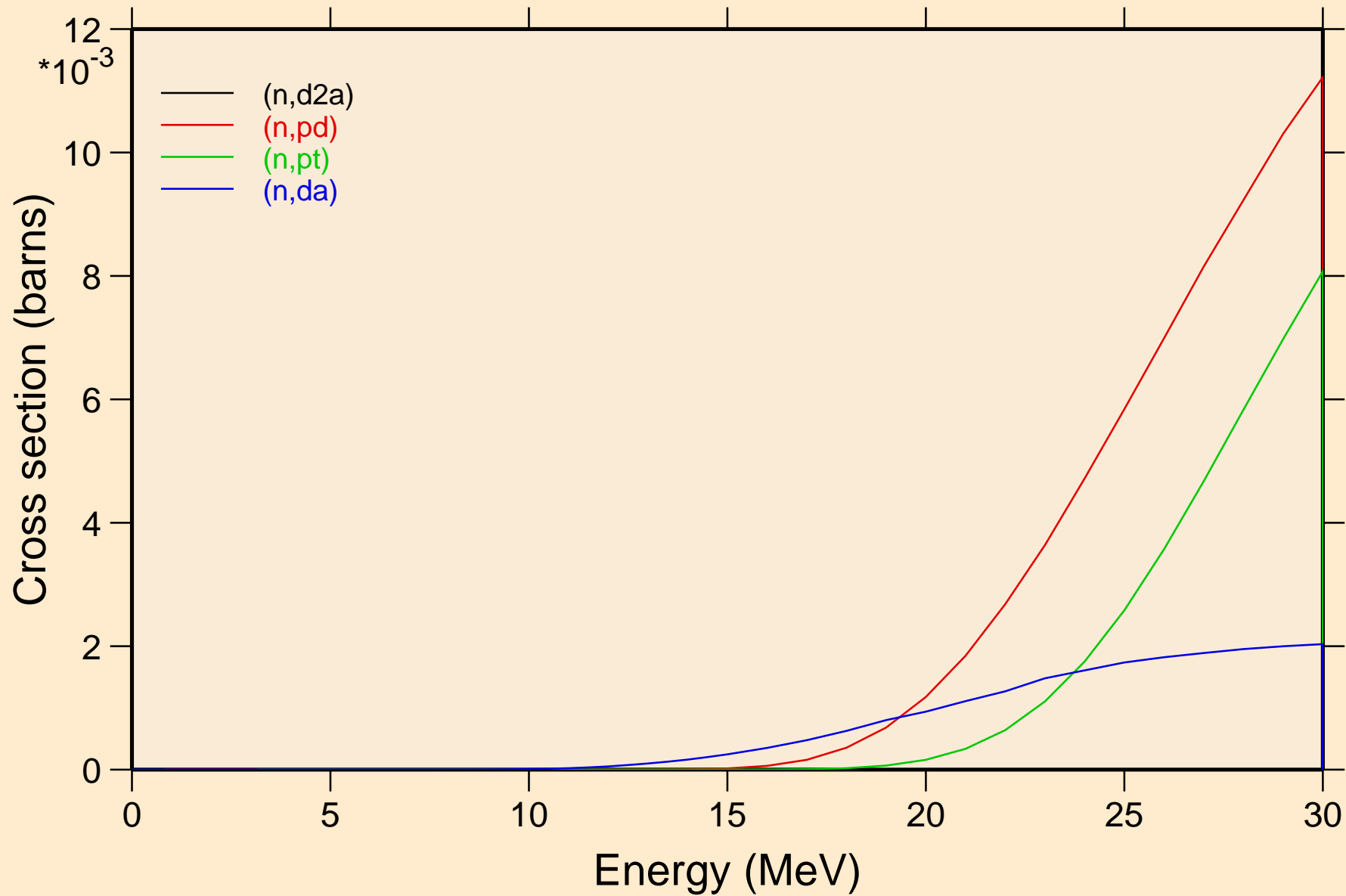

IR172 NRG TENDL-2015, AKONING
angular distribution for elastic

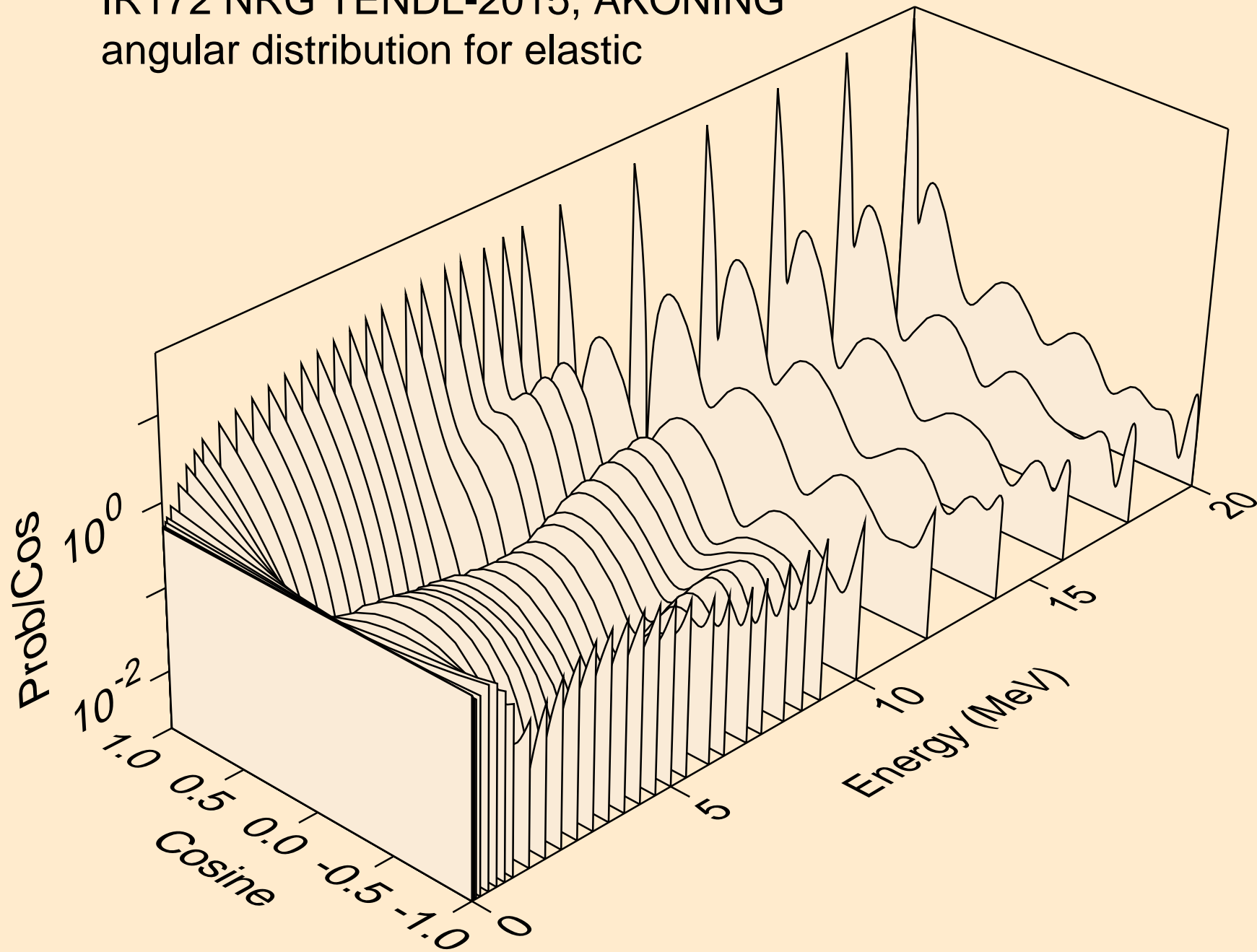

IR172 NRG TENDL-2015, AKONING
angular distribution for elastic

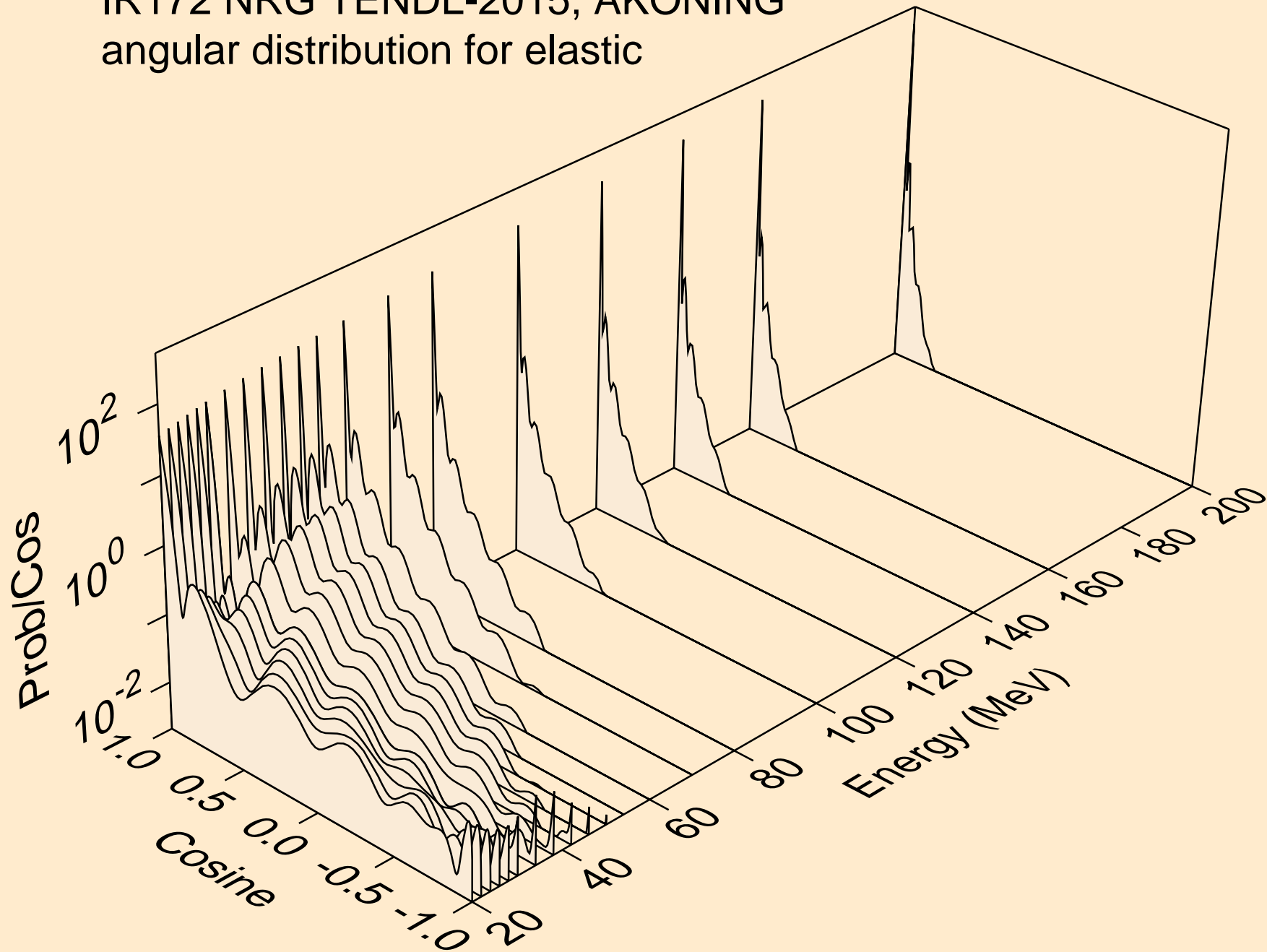

IR172 NRG TENDL-2015, AKONING
angular distribution for (n,n*1)

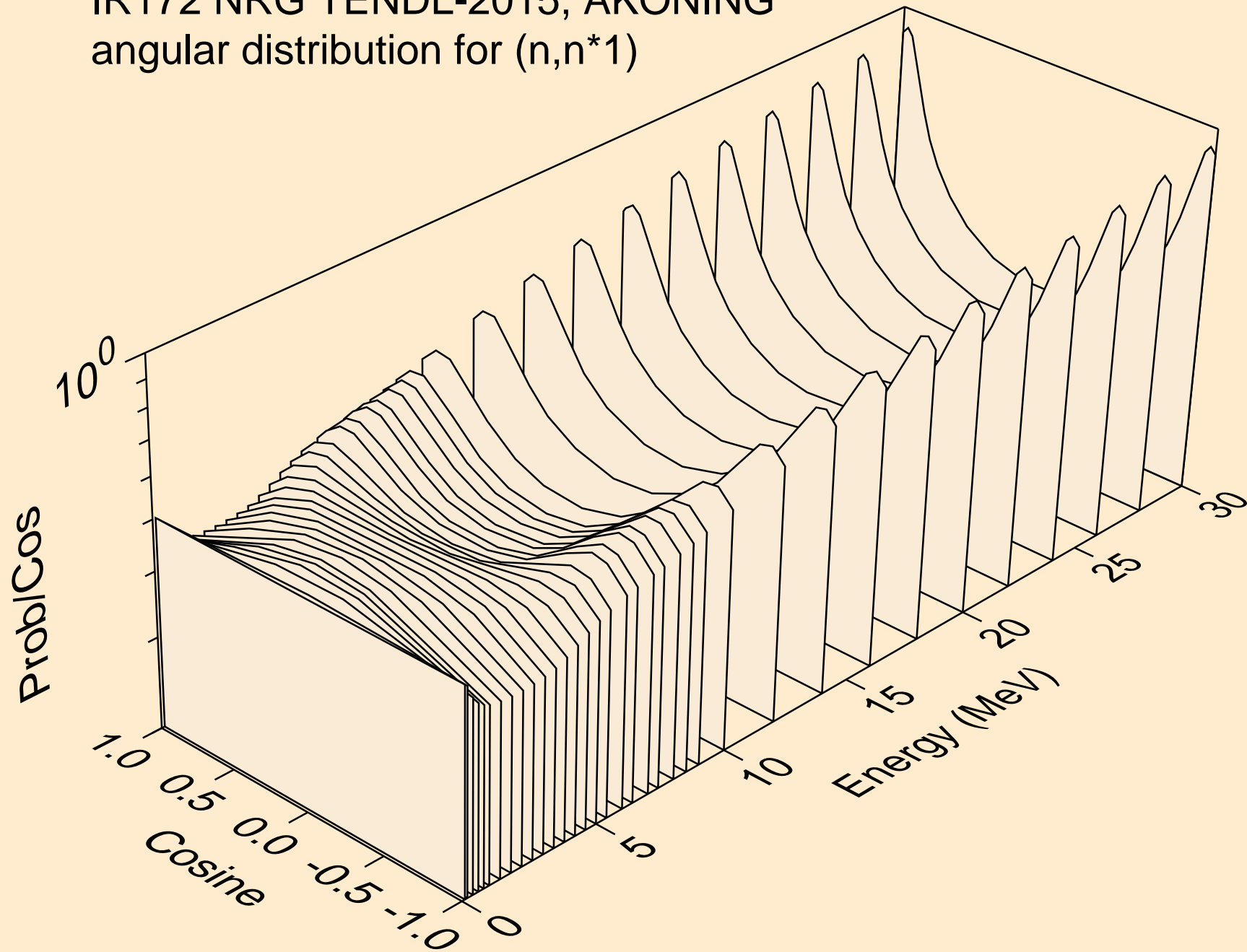

IR172 NRG TENDL-2015, AKONING
angular distribution for (n,n*2)

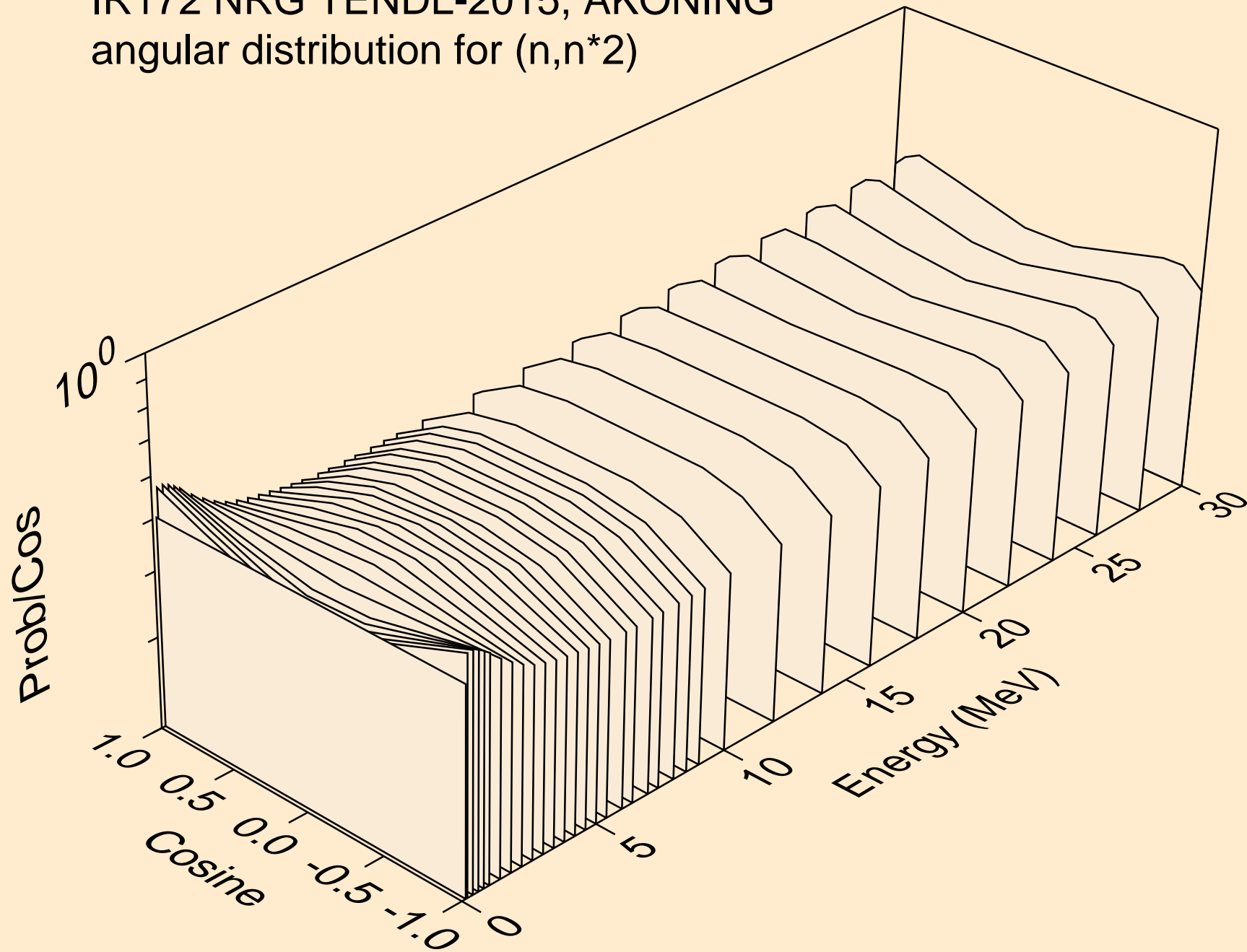

IR172 NRG TENDL-2015, AKONING
angular distribution for (n,n*3)

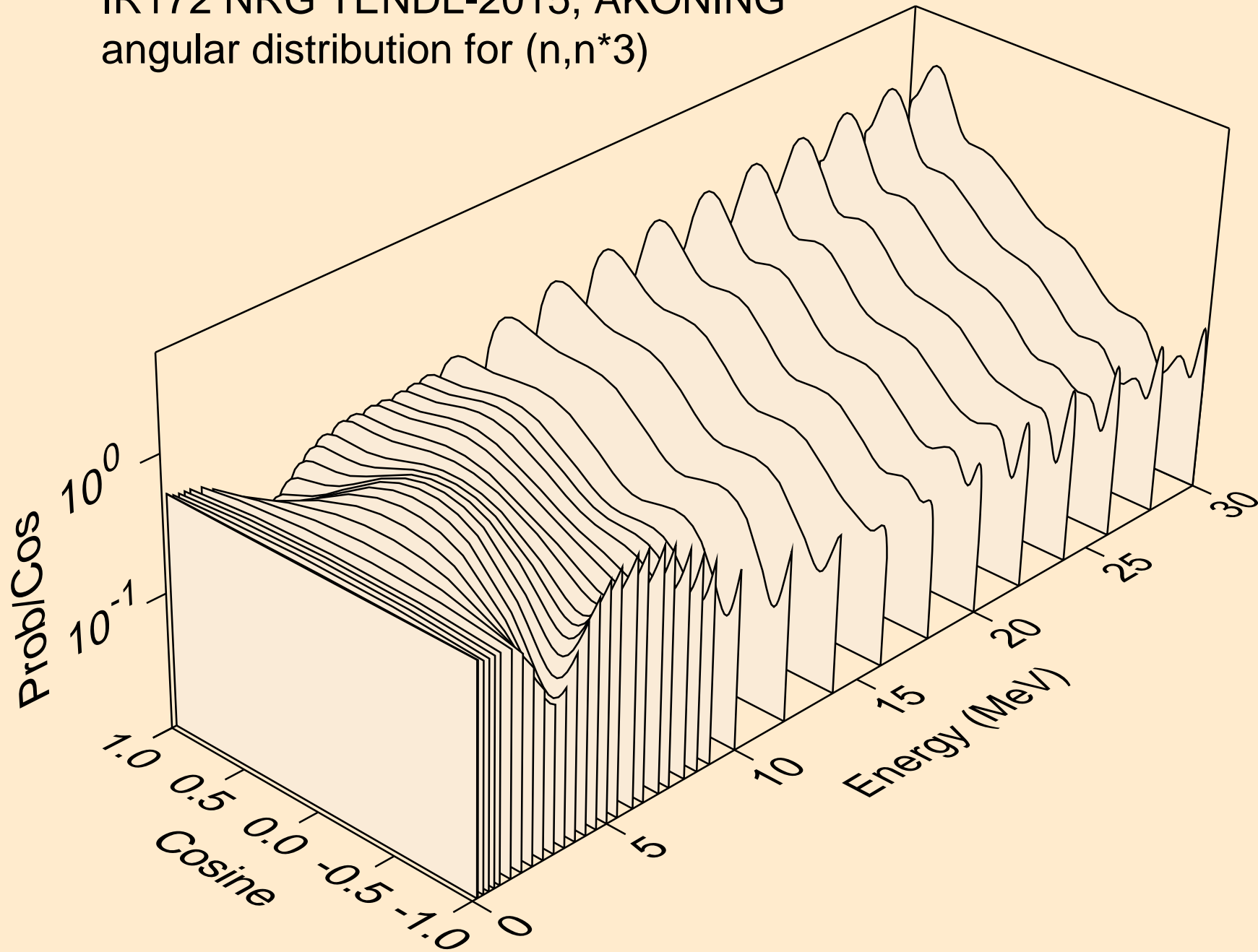

IR172 NRG TENDL-2015, AKONING
angular distribution for (n,n*4)

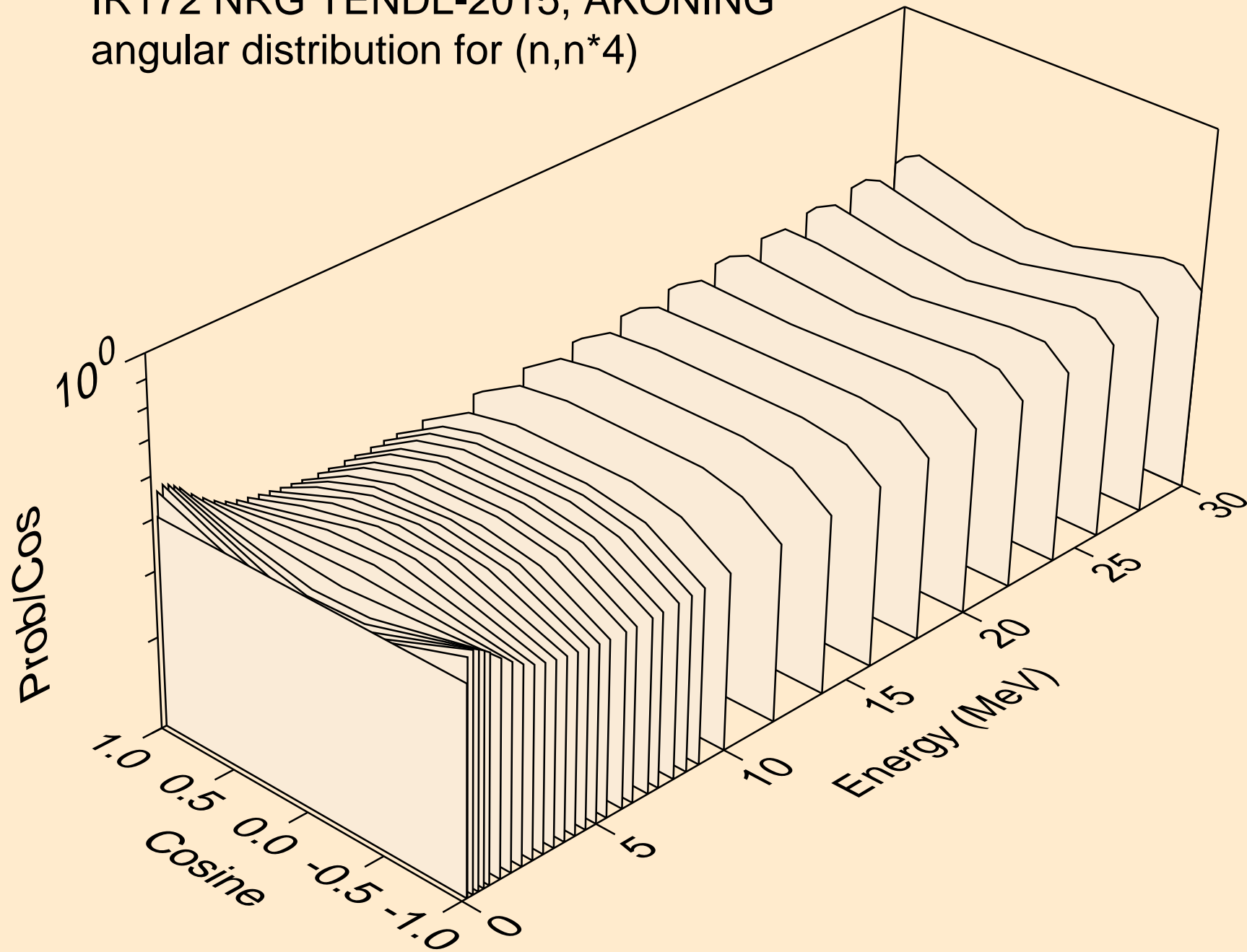

IR172 NRG TENDL-2015, AKONING
angular distribution for (n,n*5)

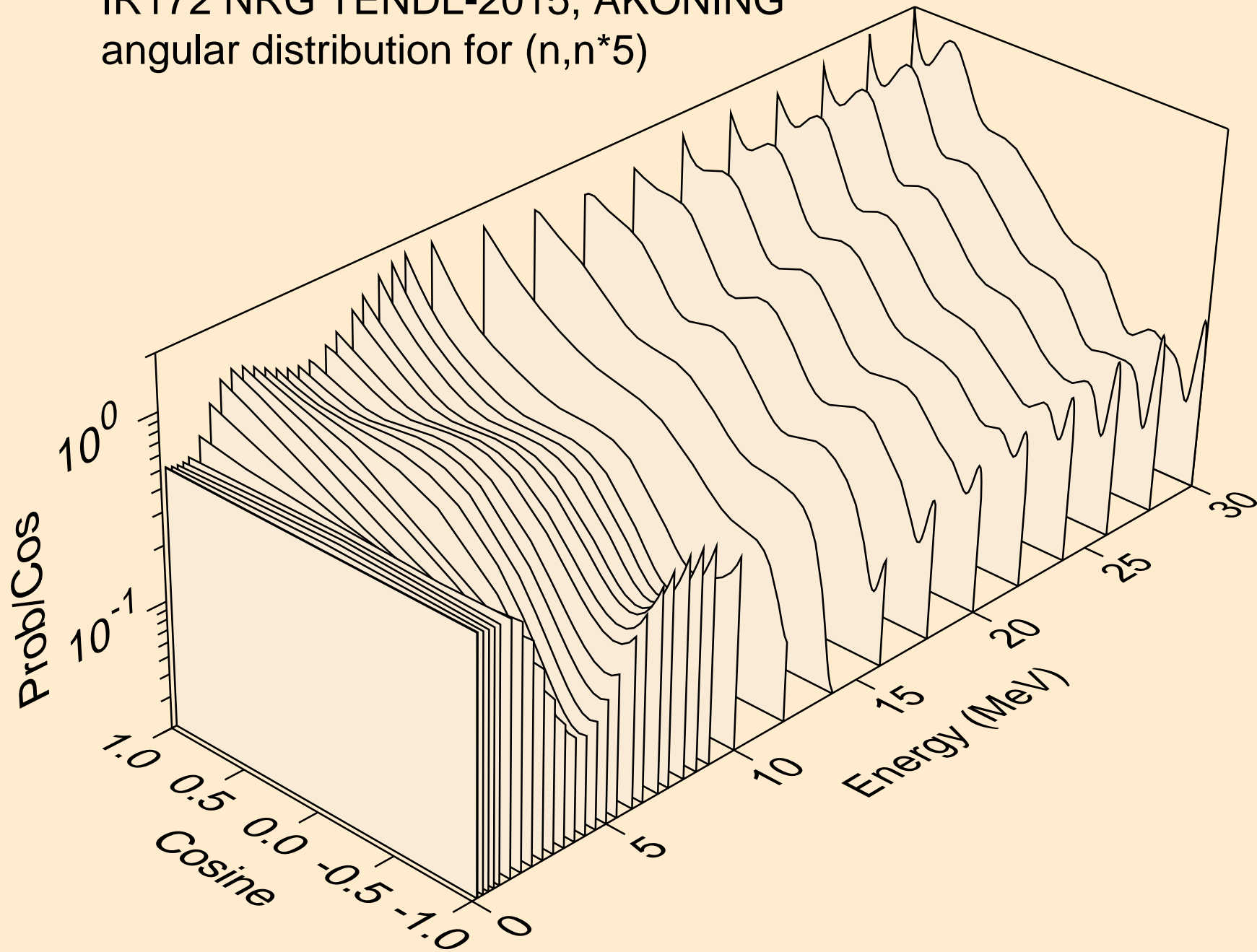

IR172 NRG TENDL-2015, AKONING
angular distribution for (n,n*6)

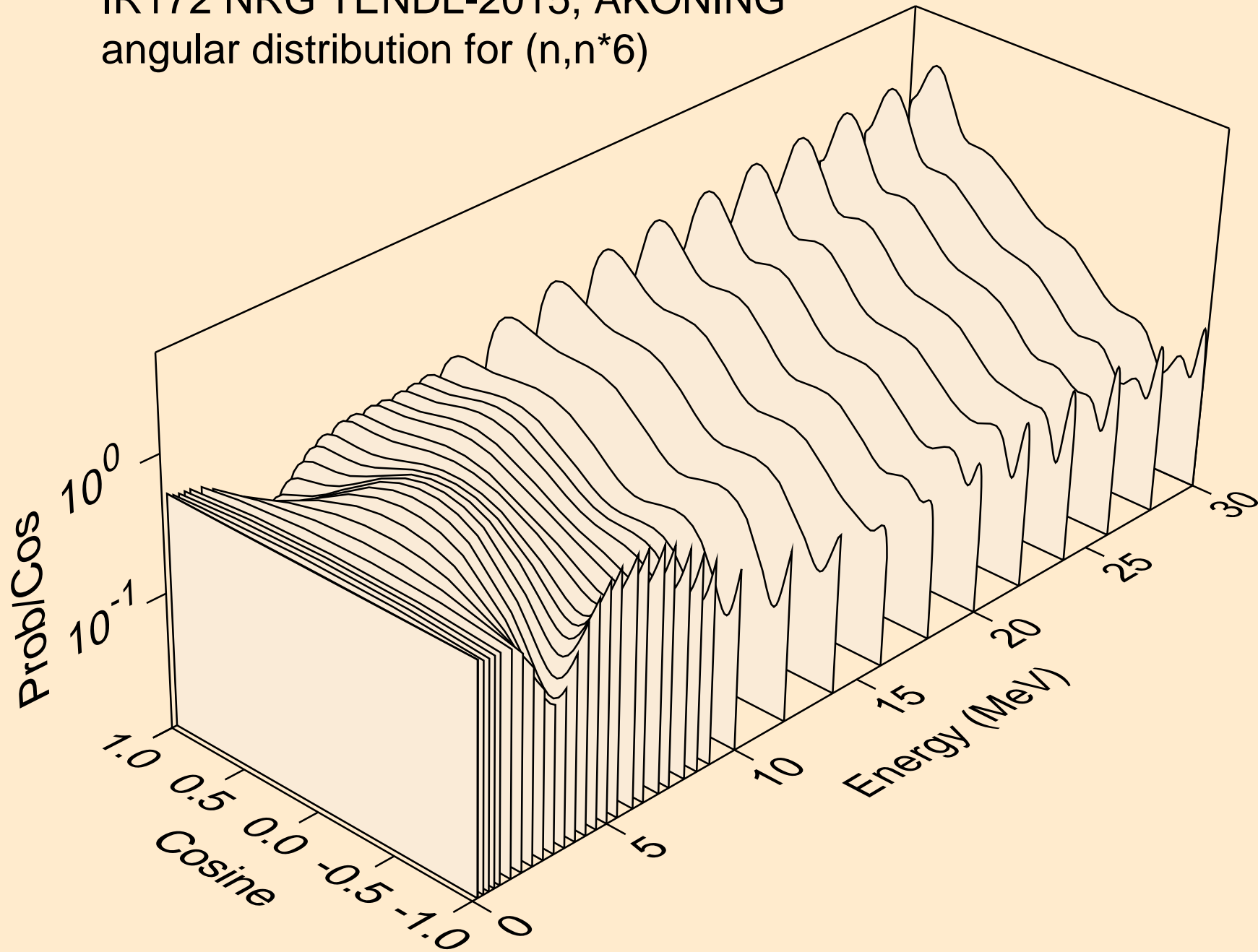

IR172 NRG TENDL-2015, AKONING
angular distribution for (n,n*7)

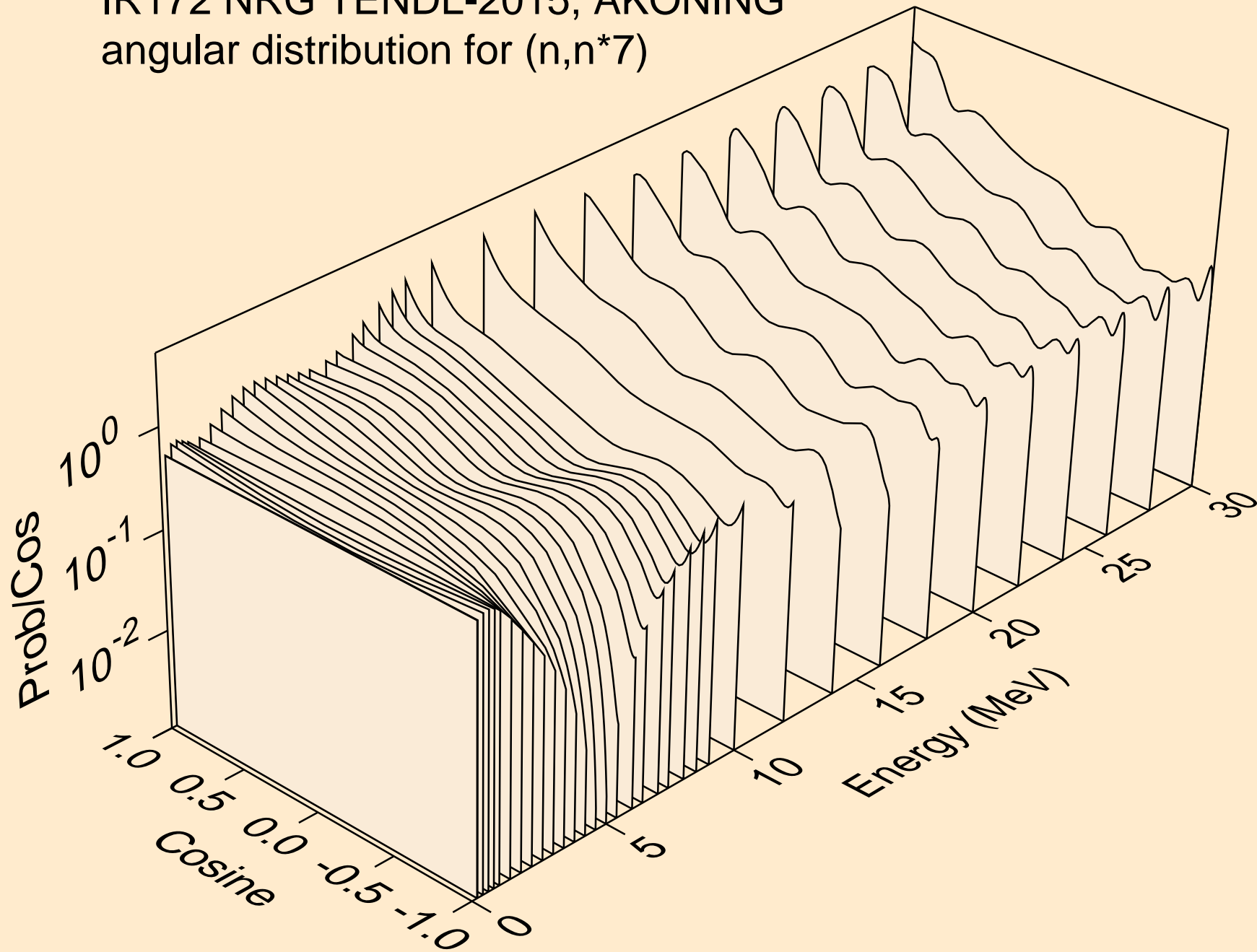

IR172 NRG TENDL-2015, AKONING
angular distribution for (n,n*8)

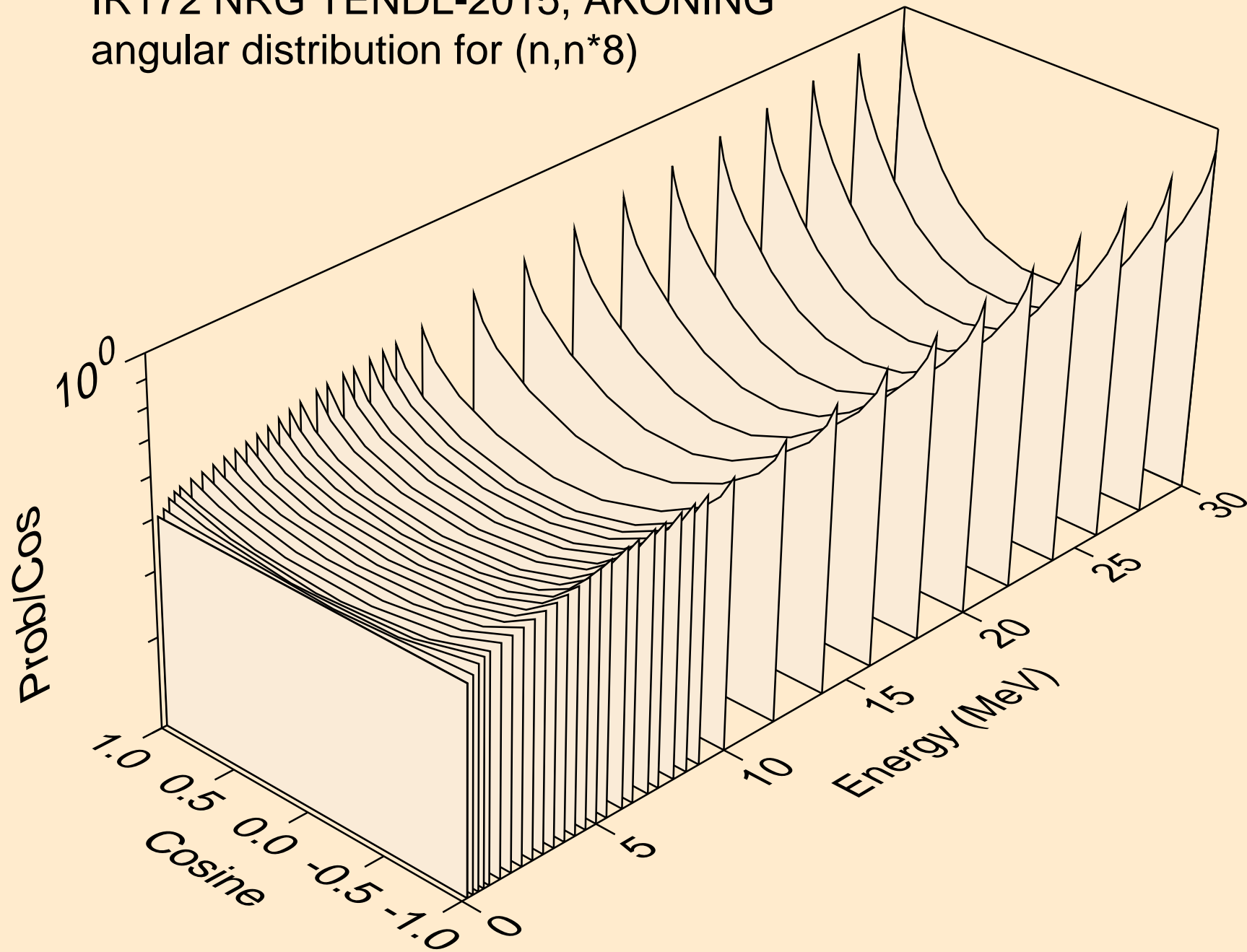

IR172 NRG TENDL-2015, AKONING
angular distribution for (n,n*9)

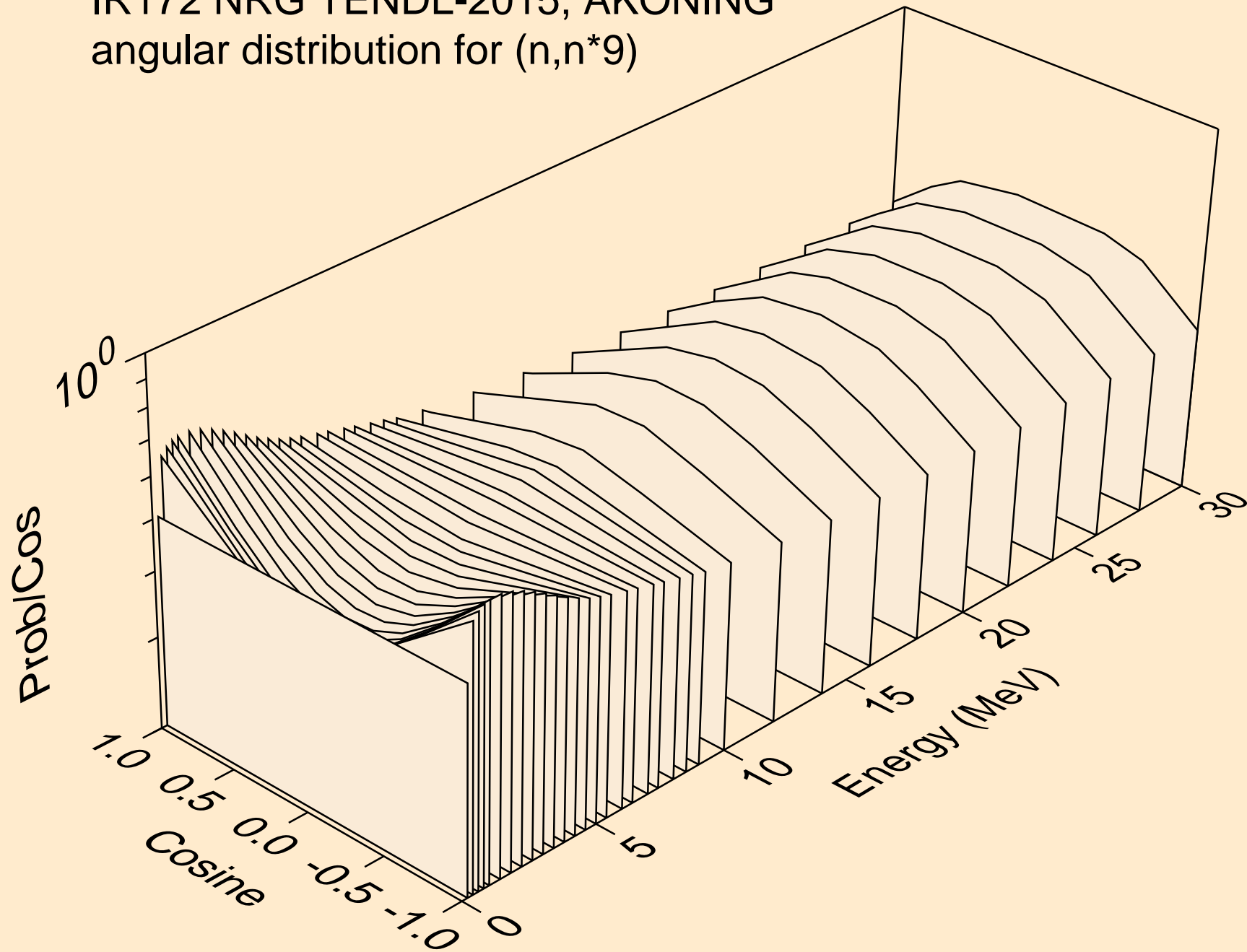

IR172 NRG TENDL-2015, AKONING
angular distribution for (n,n*10)

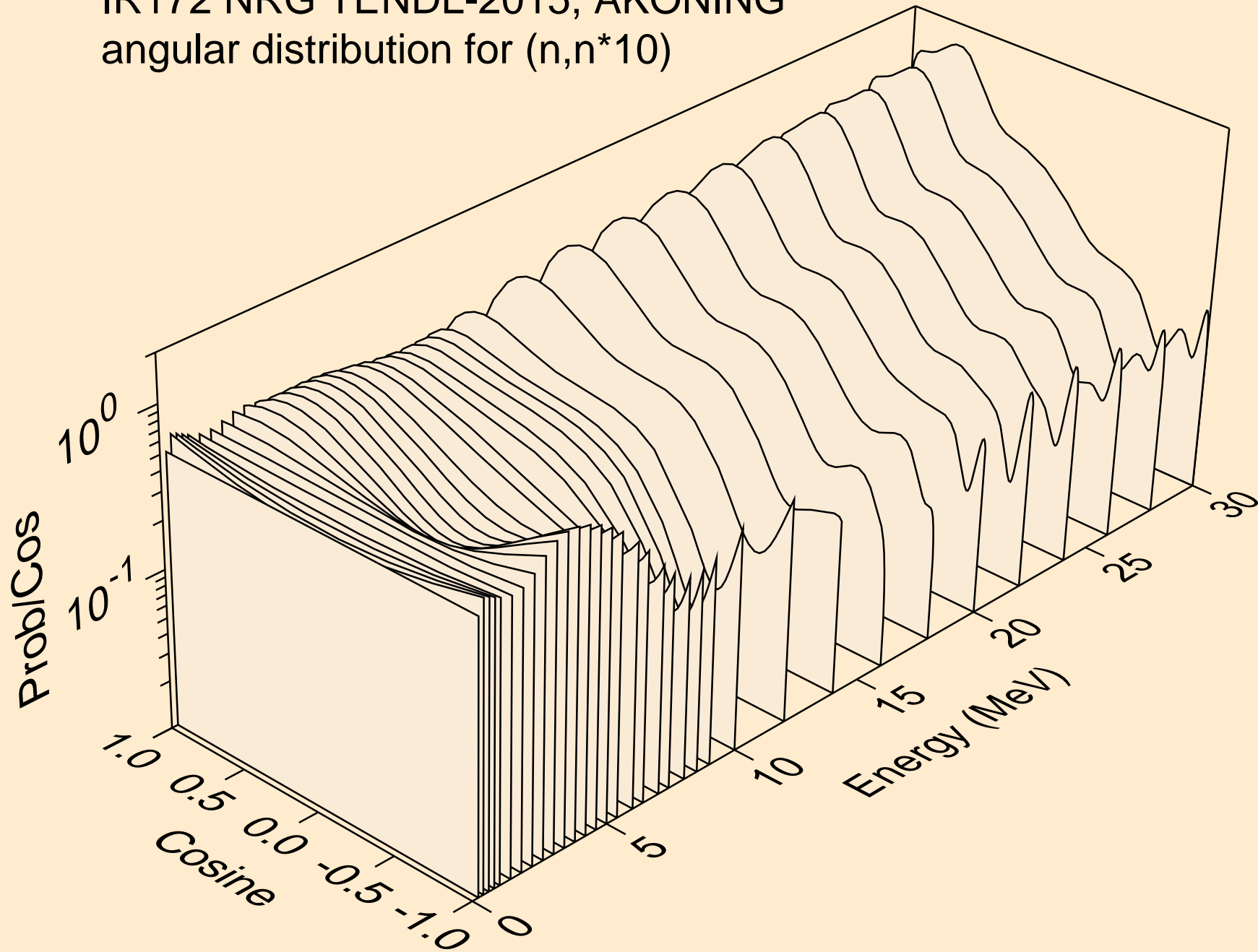

IR172 NRG TENDL-2015, AKONING
angular distribution for (n,n*11)

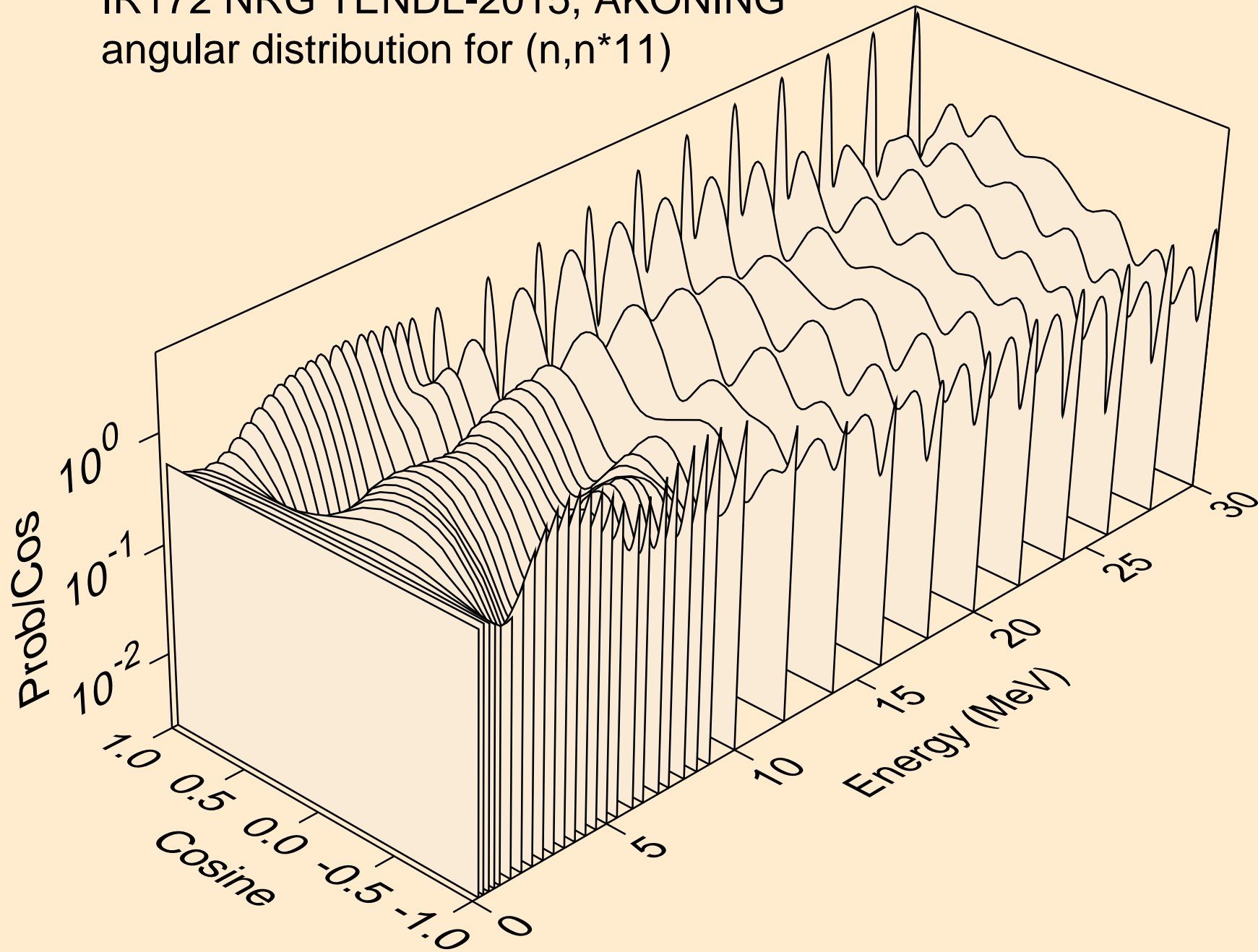

IR172 NRG TENDL-2015, AKONING
angular distribution for (n,n*12)

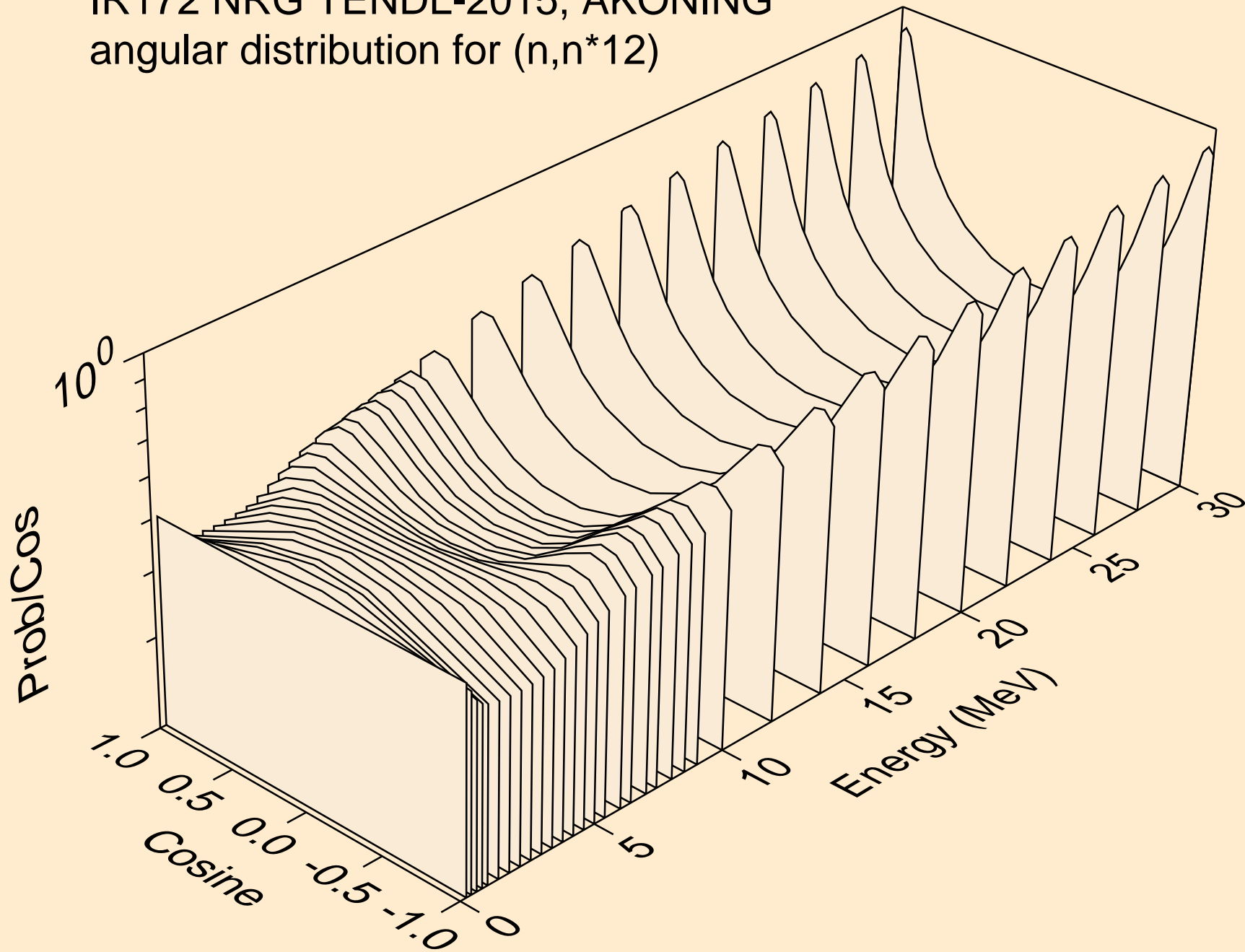

IR172 NRG TENDL-2015, AKONING
angular distribution for (n,n*13)

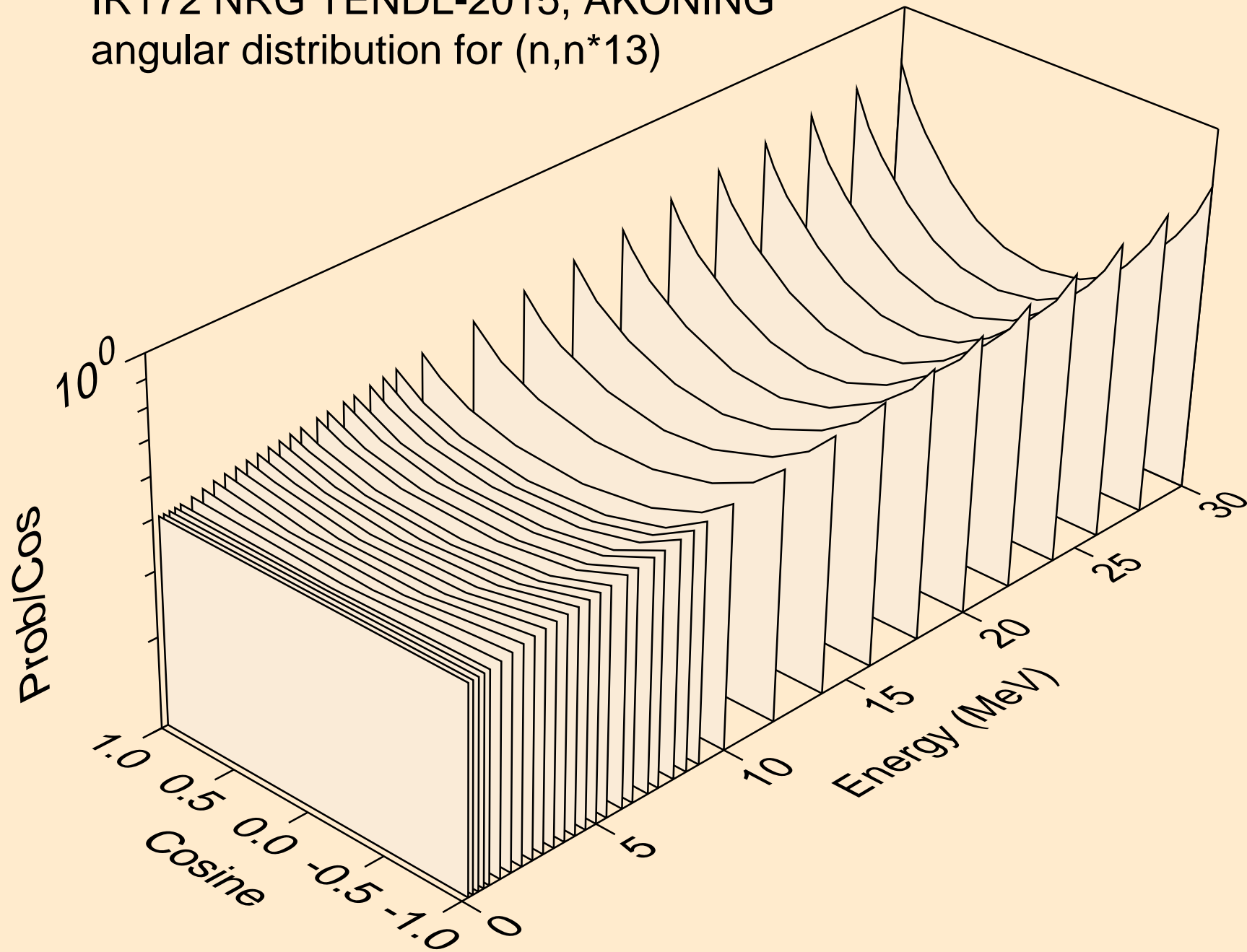

IR172 NRG TENDL-2015, AKONING
angular distribution for (n,n*14)

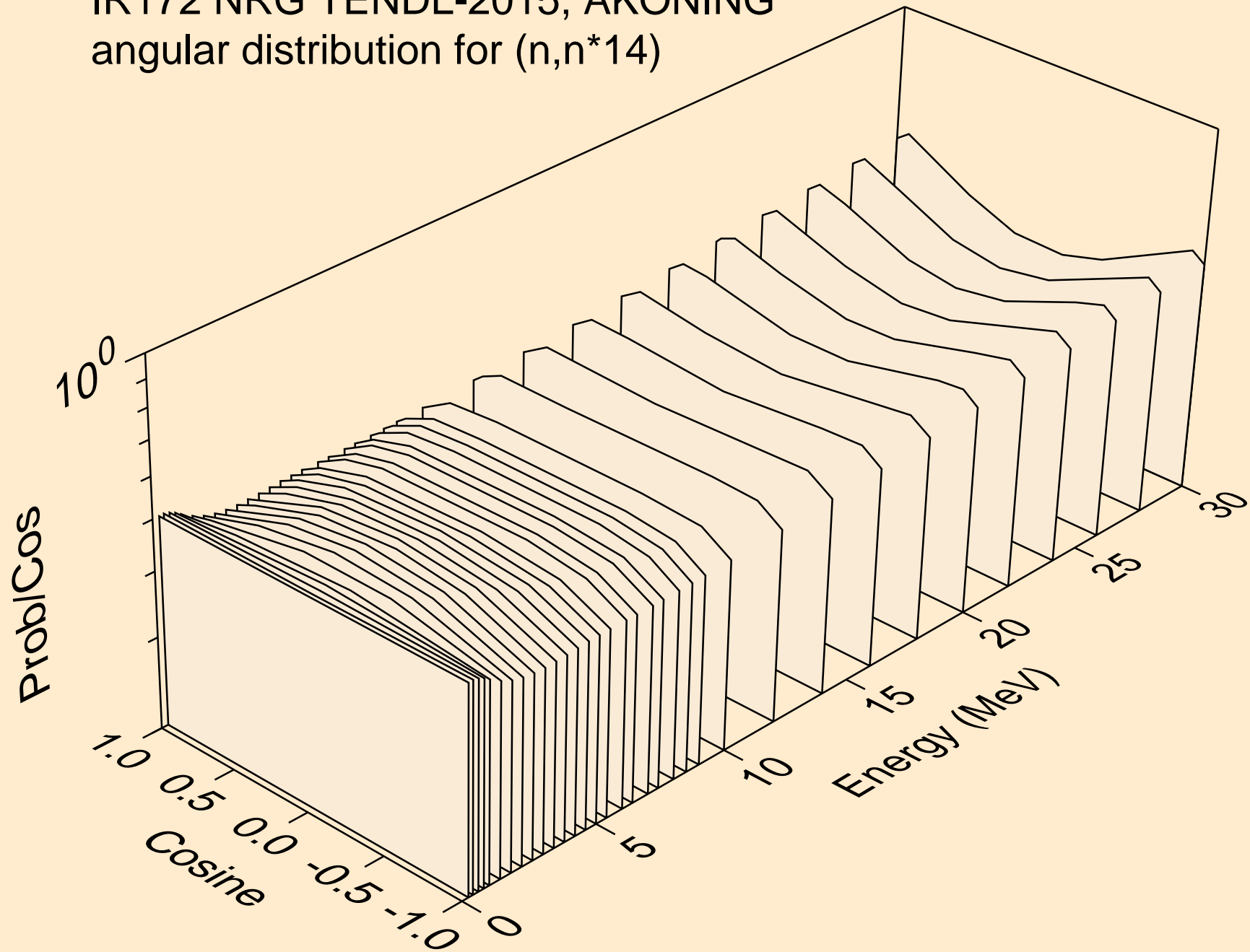

IR172 NRG TENDL-2015, AKONING
angular distribution for (n,n*15)

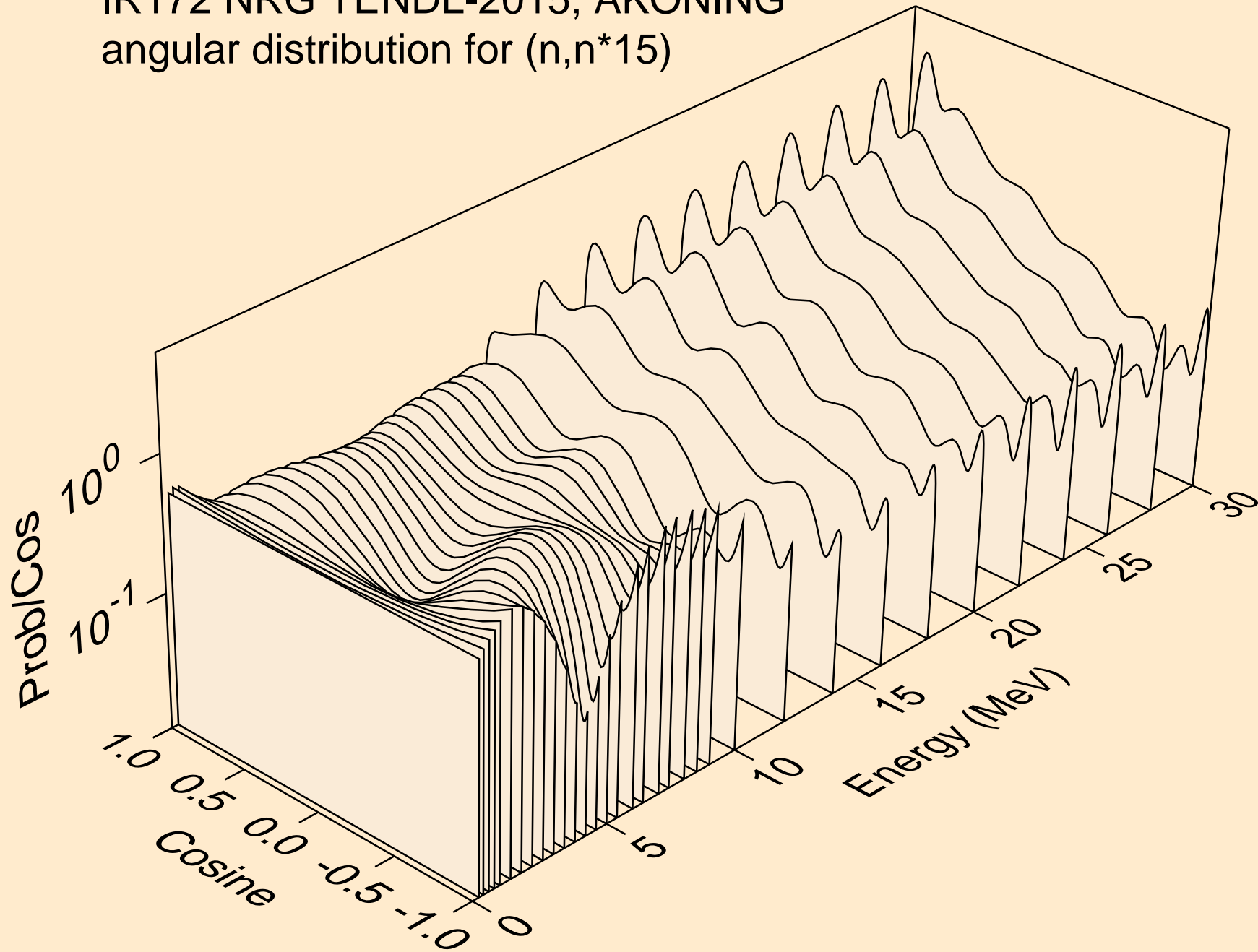

IR172 NRG TENDL-2015, AKONING
angular distribution for (n,n*16)

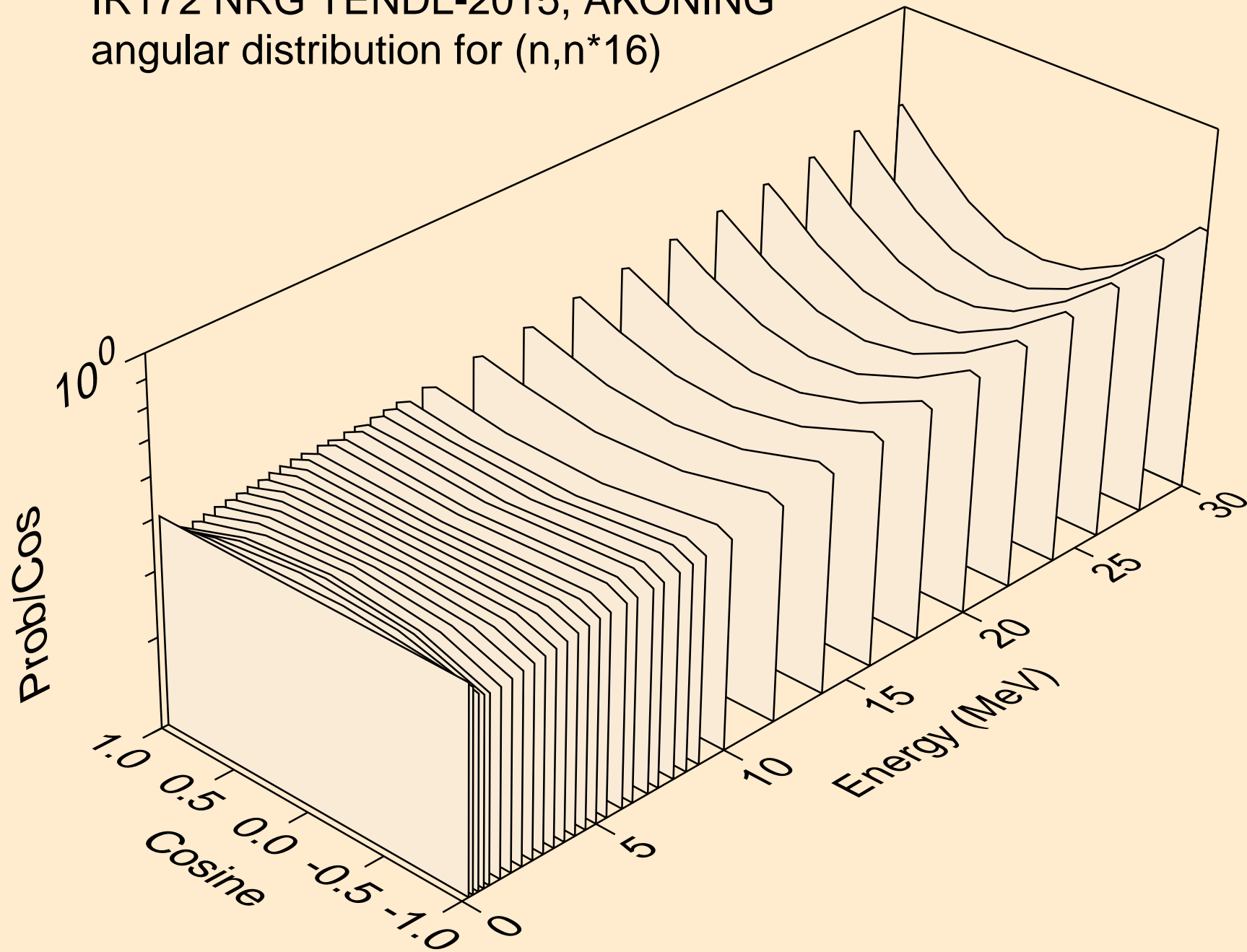

IR172 NRG TENDL-2015, AKONING
angular distribution for (n,n*17)

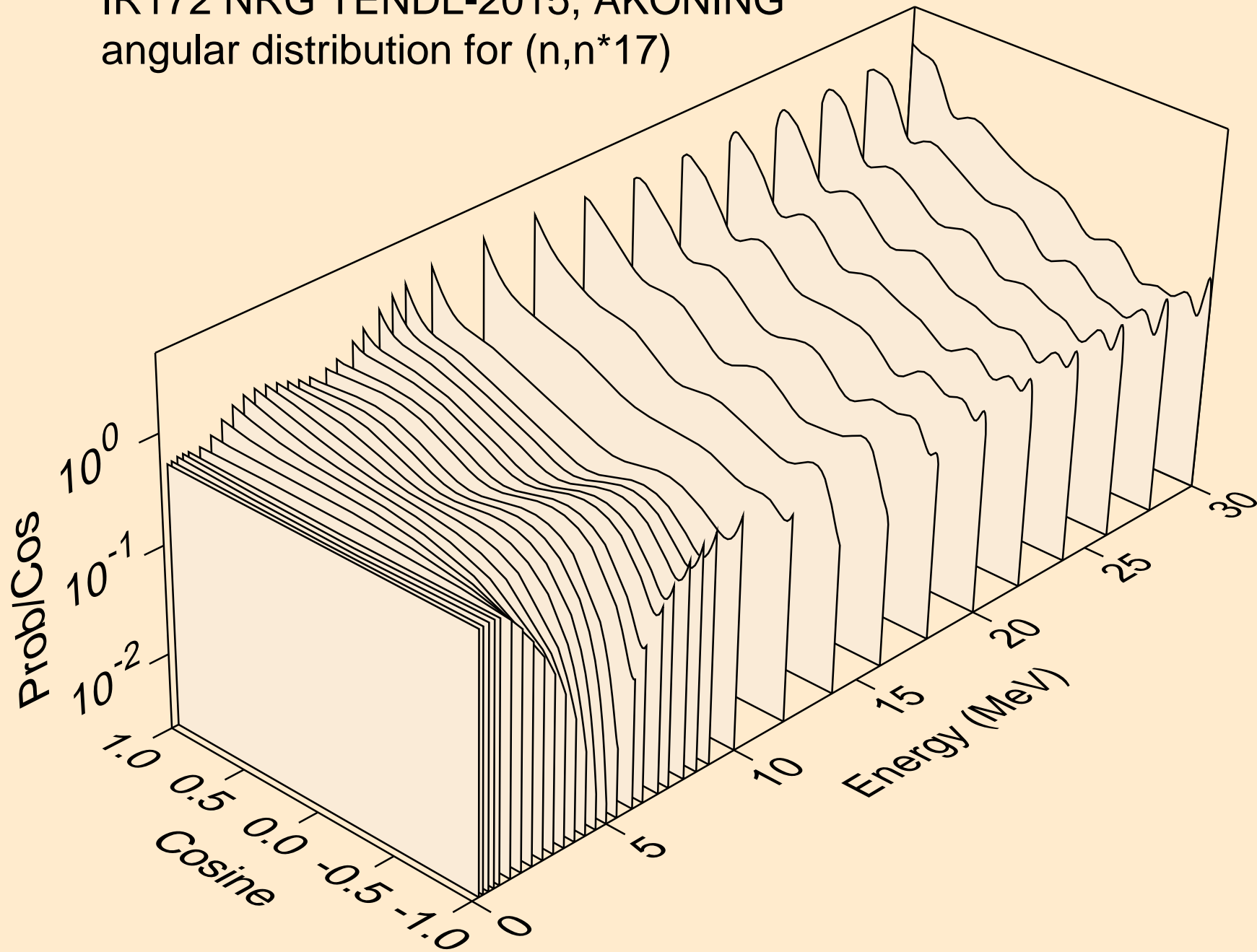

IR172 NRG TENDL-2015, AKONING
angular distribution for (n,n*18)

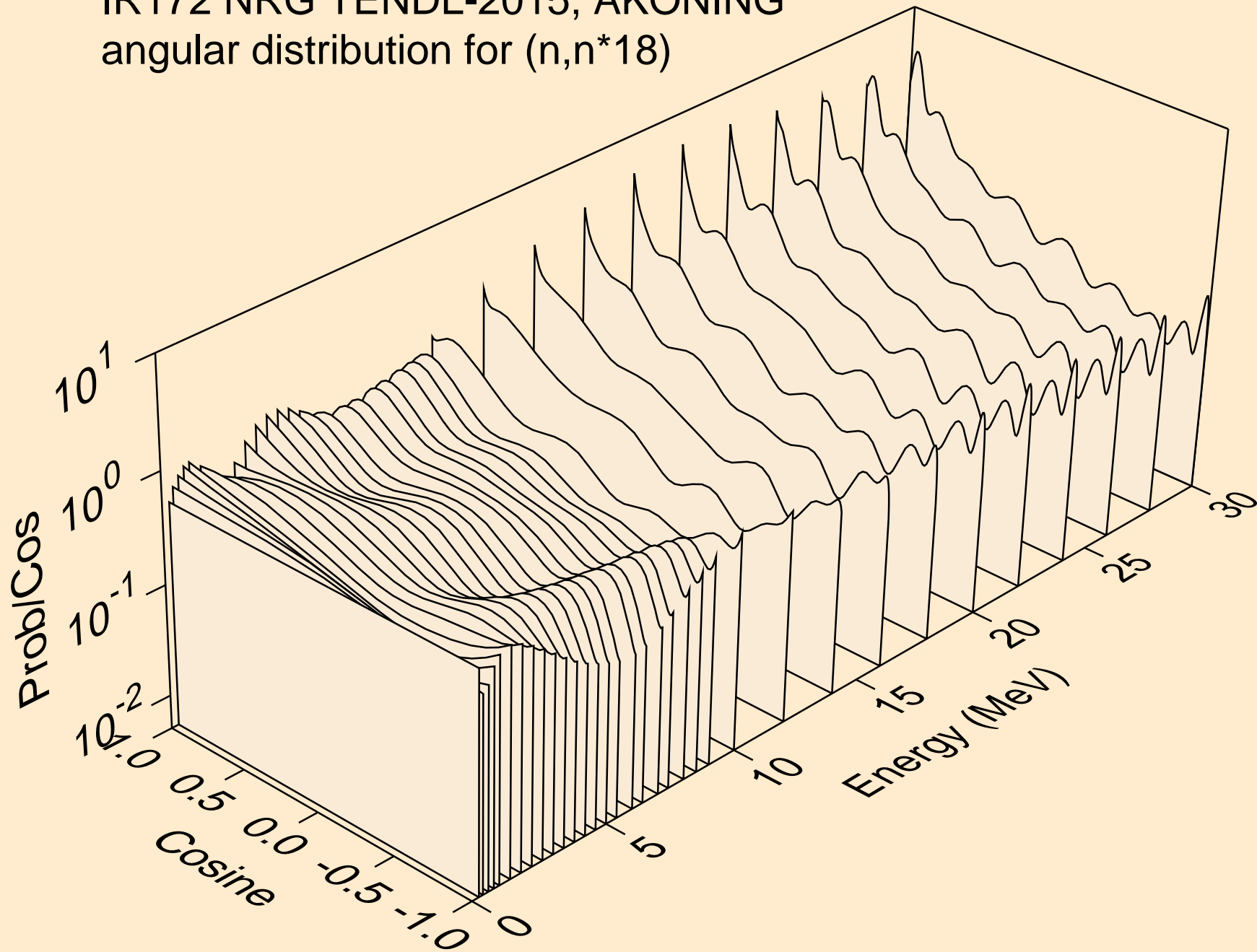

IR172 NRG TENDL-2015, AKONING
Neutron emission for (n,x)

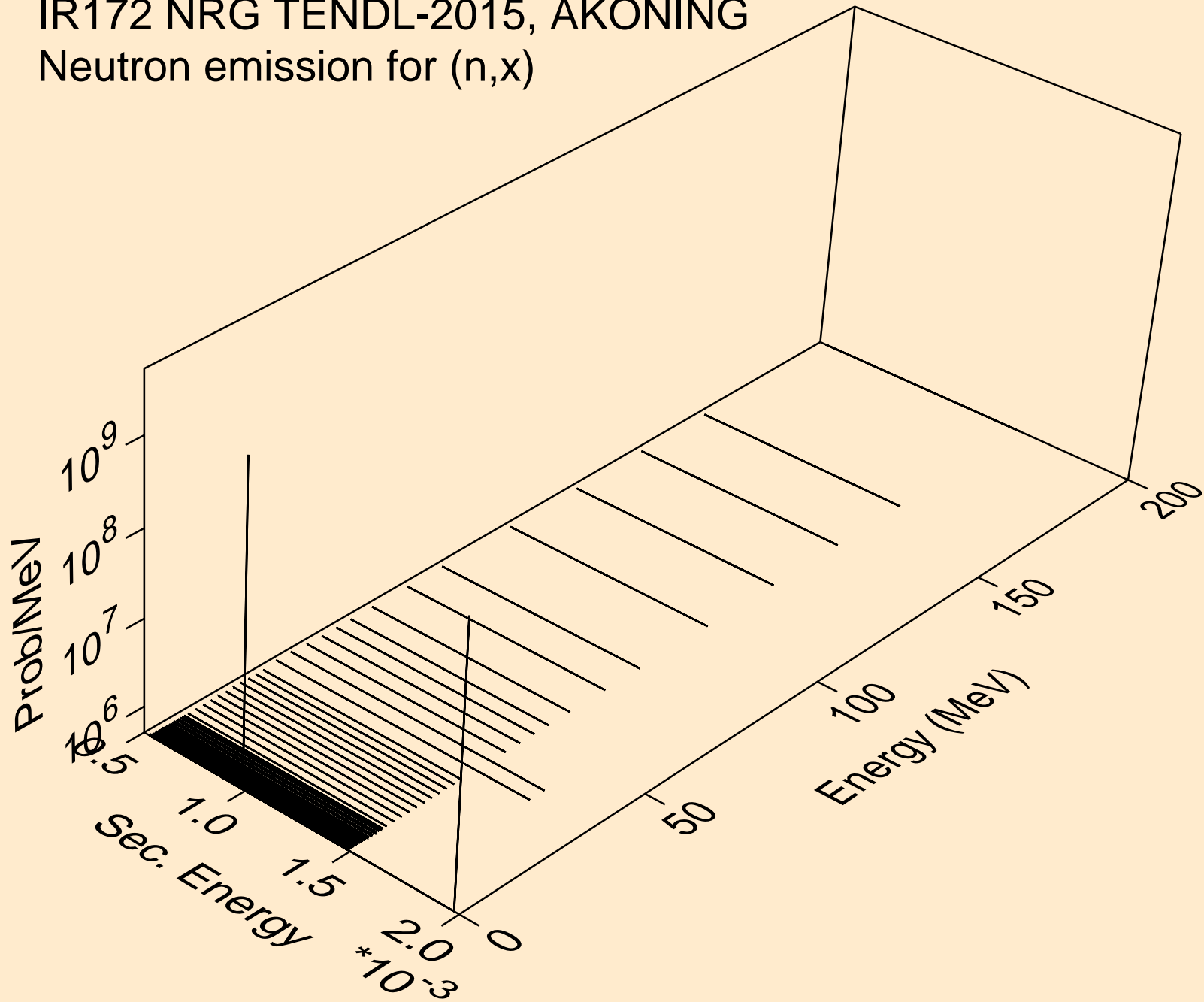

IR172 NRG TENDL-2015, AKONING
Neutron emission for (n,2nd)

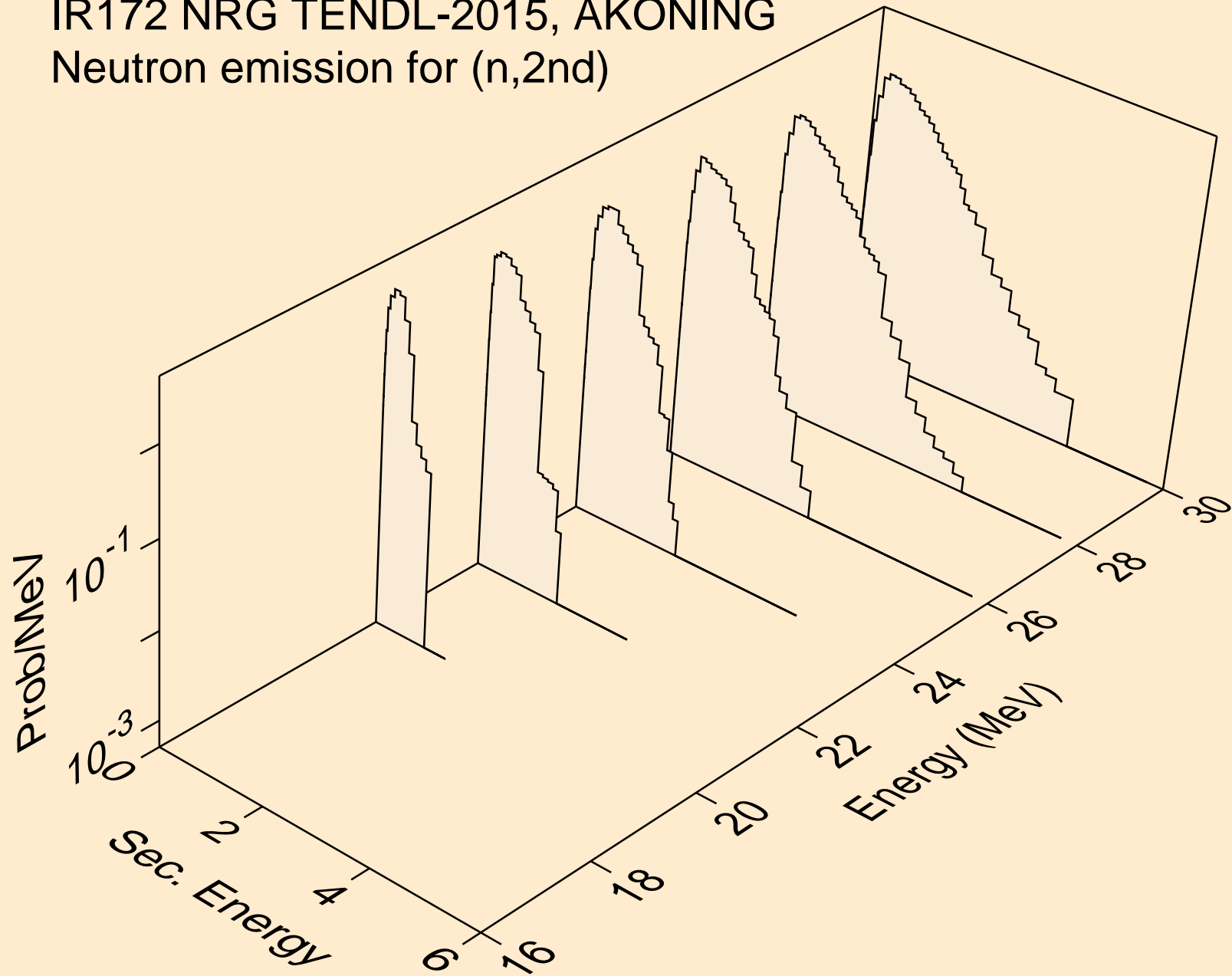

IR172 NRG TENDL-2015, AKONING
Neutron emission for (n,2n)

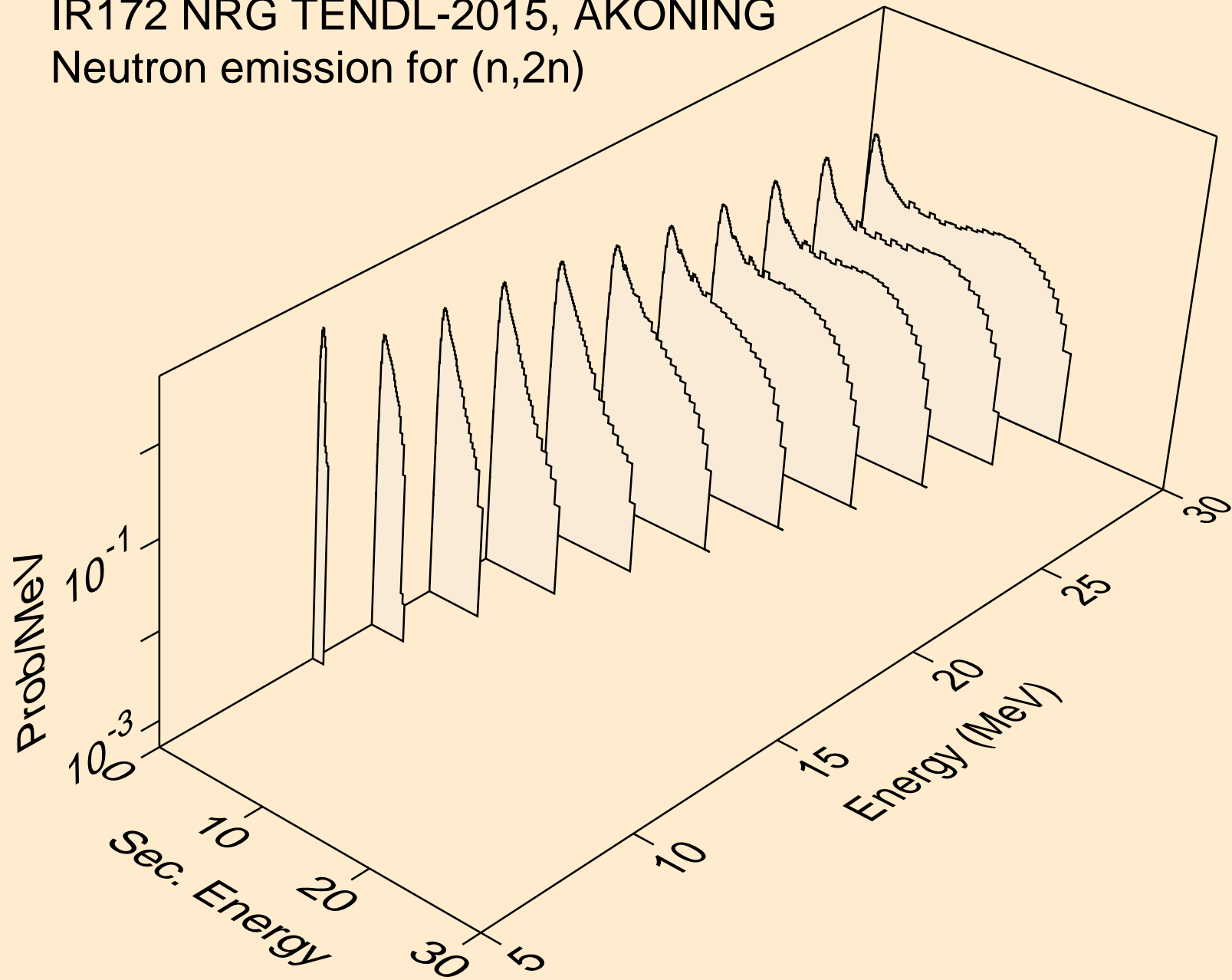

IR172 NRG TENDL-2015, AKONING
Neutron emission for (n,3n)

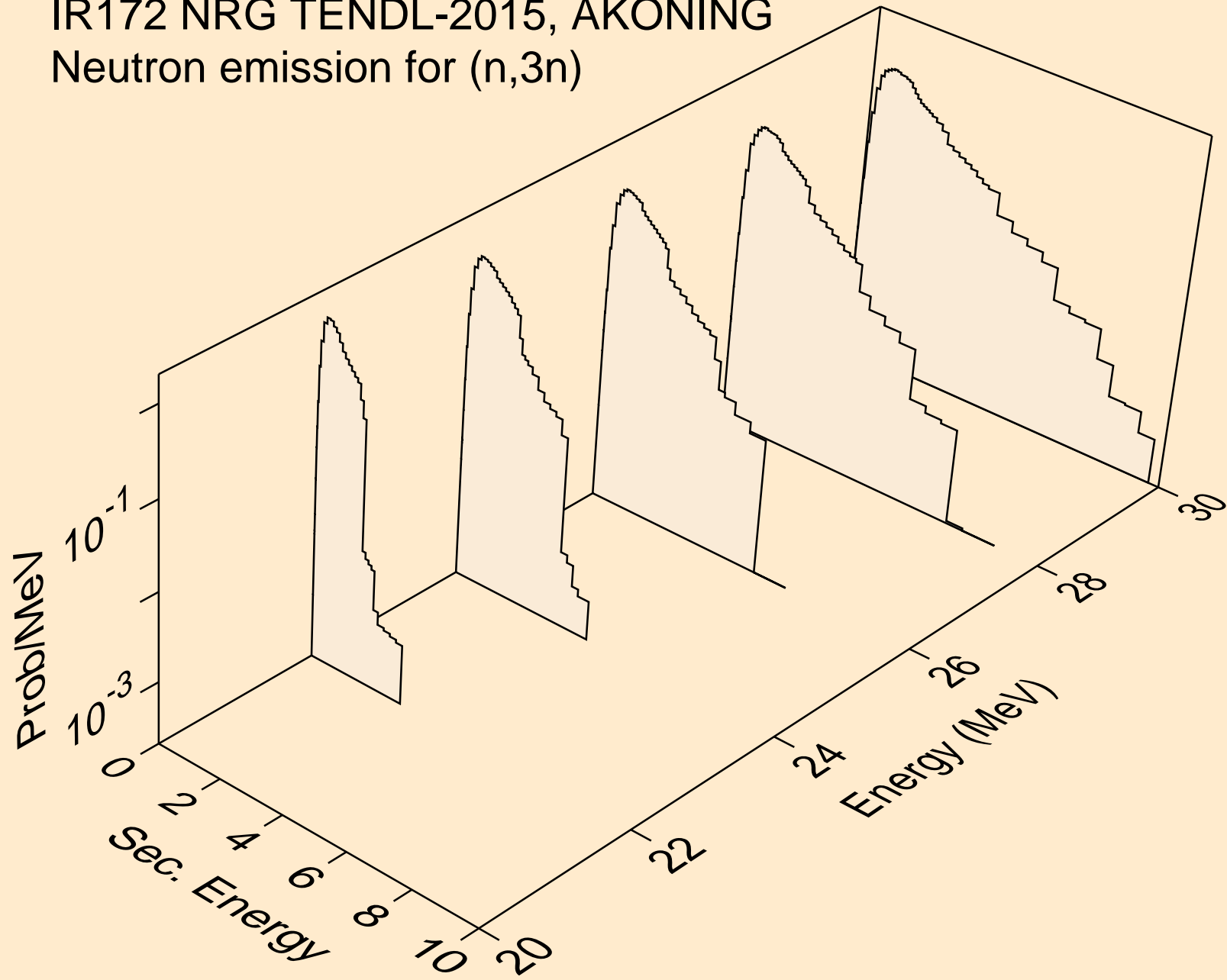

IR172 NRG TENDL-2015, AKONING
Neutron emission for (n,n*)a

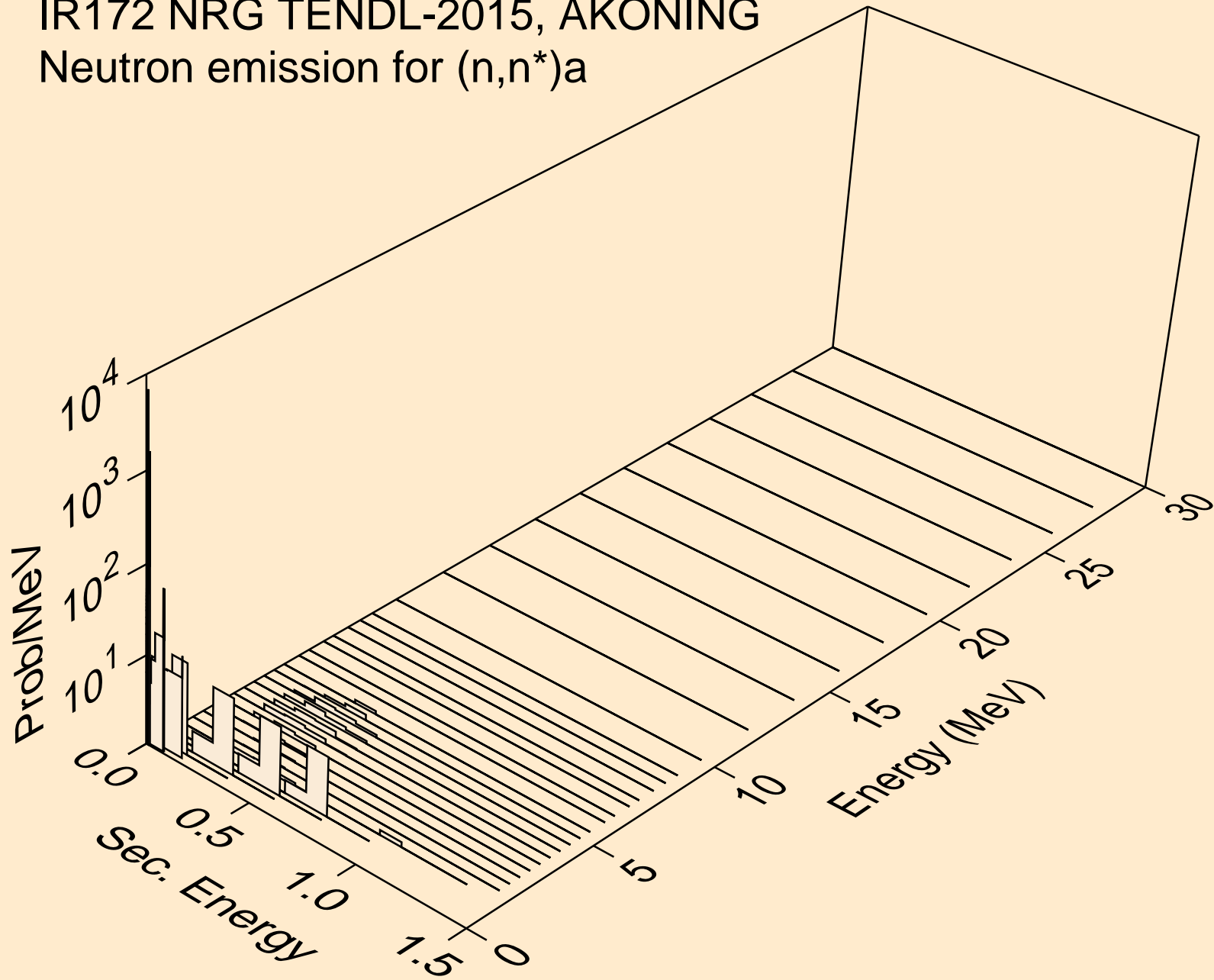

IR172 NRG TENDL-2015, AKONING
Neutron emission for (n,n*)3a

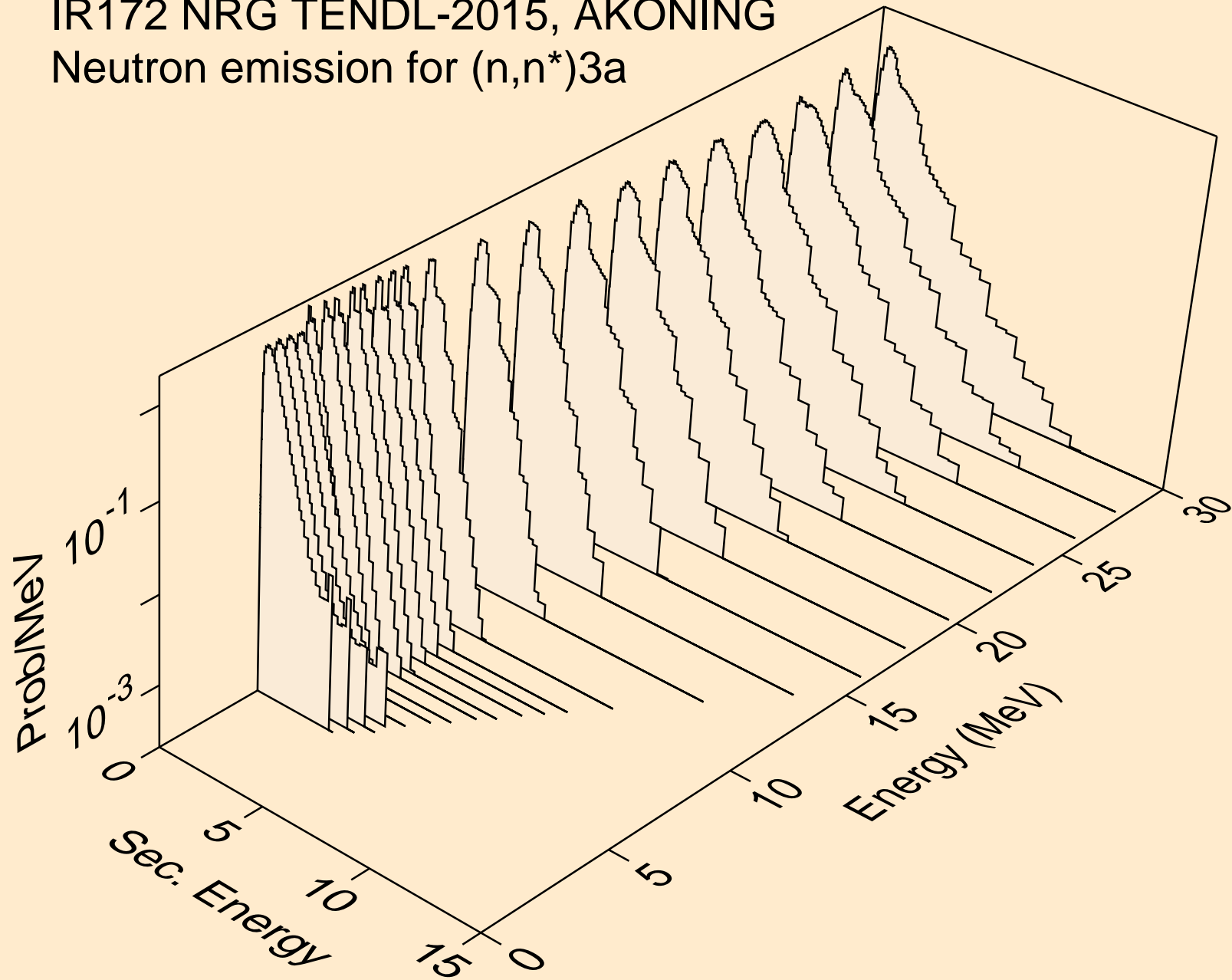

IR172 NRG TENDL-2015, AKONING
Neutron emission for (n,2n)a

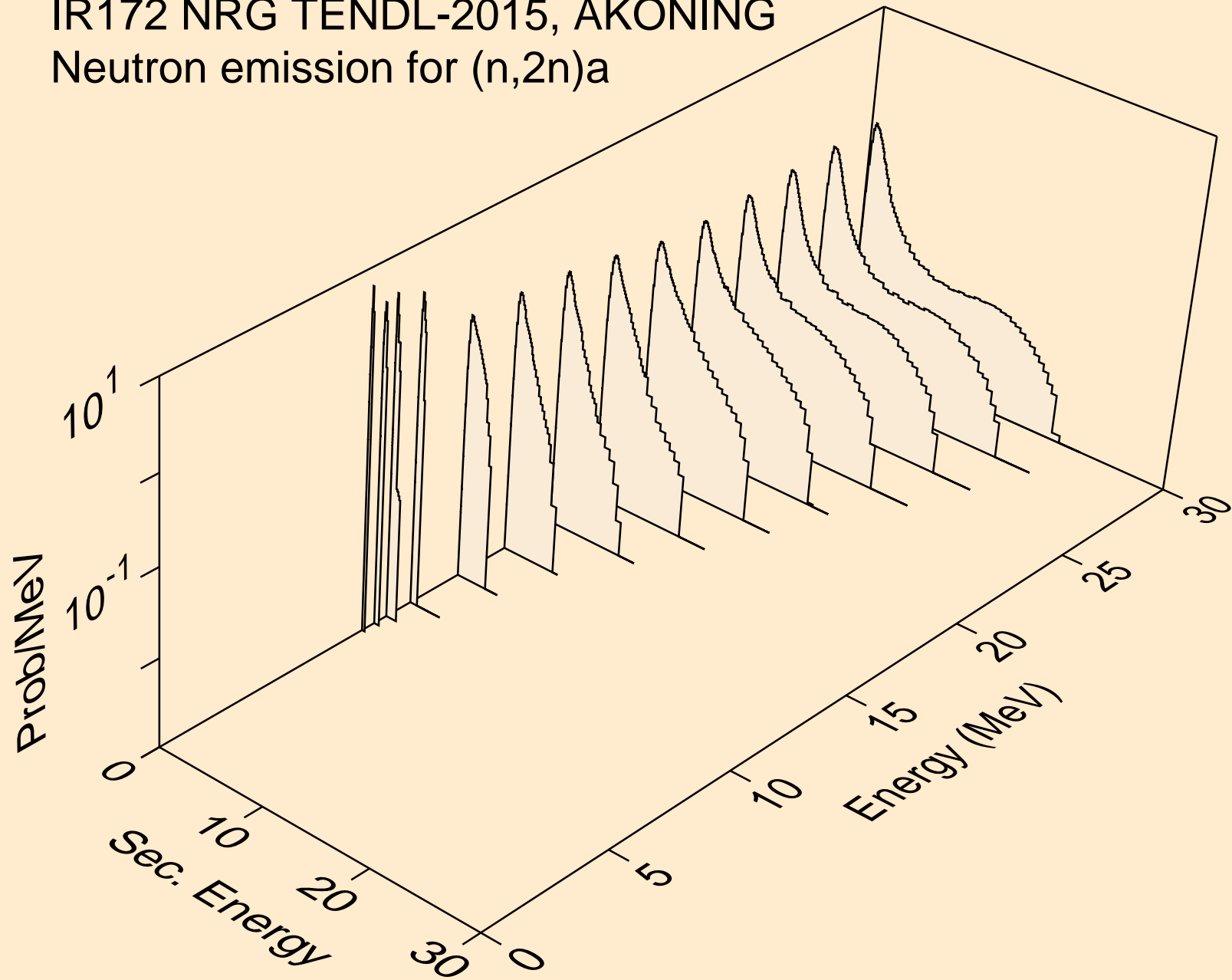

IR172 NRG TENDL-2015, AKONING
Neutron emission for (n,3n)a

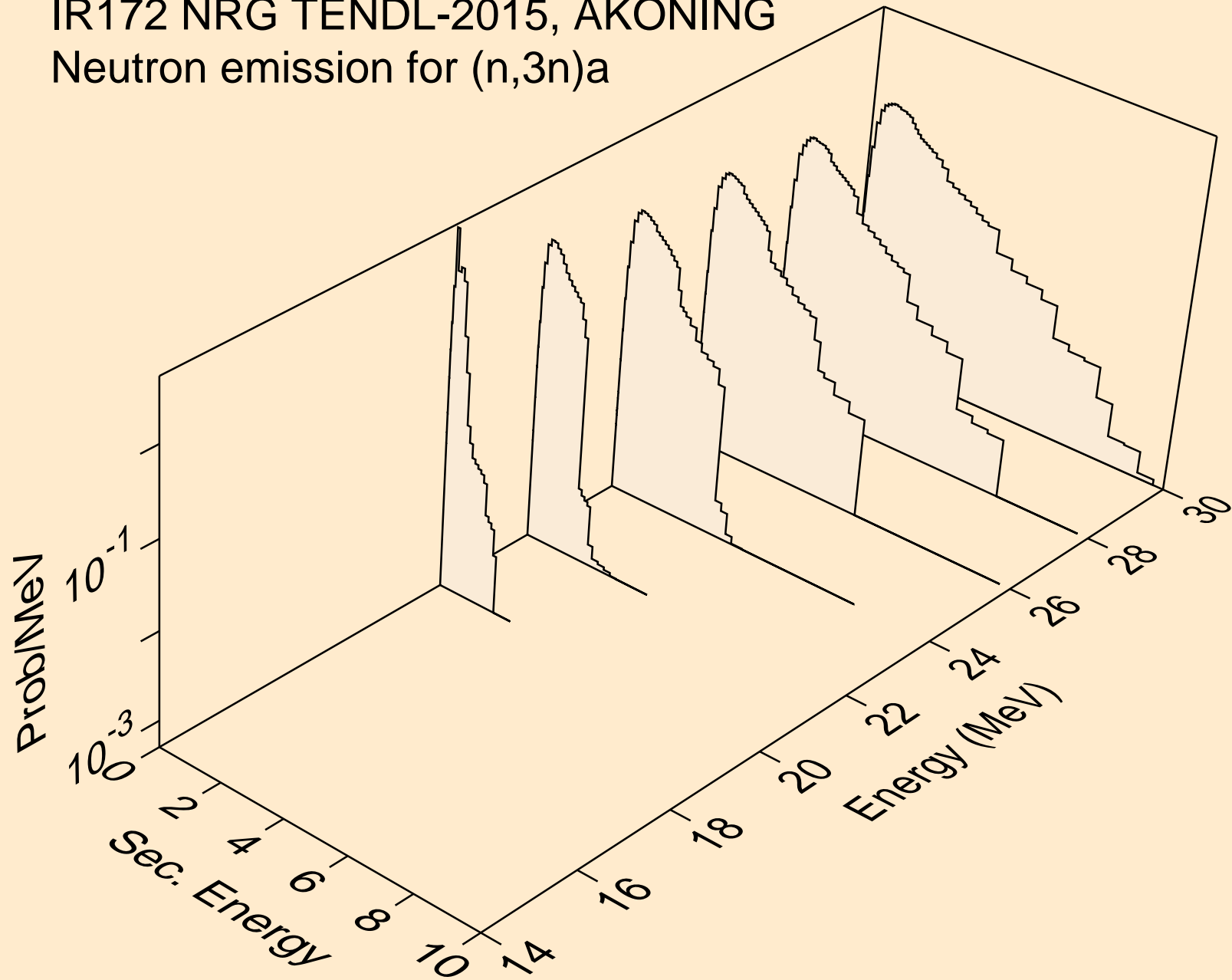

IR172 NRG TENDL-2015, AKONING
Neutron emission for (n,n*)p

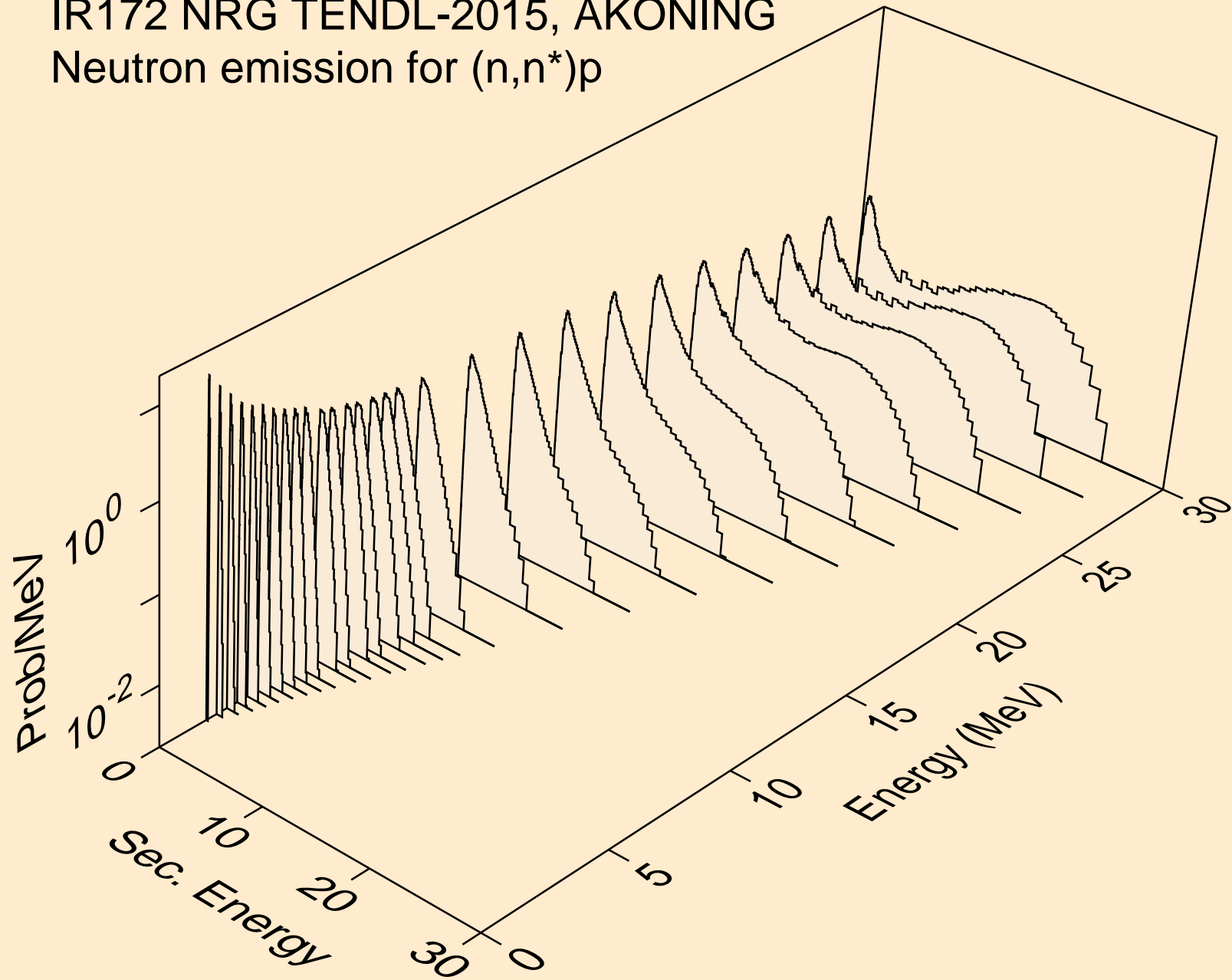

IR172 NRG TENDL-2015, AKONING
Neutron emission for (n,n*)2a

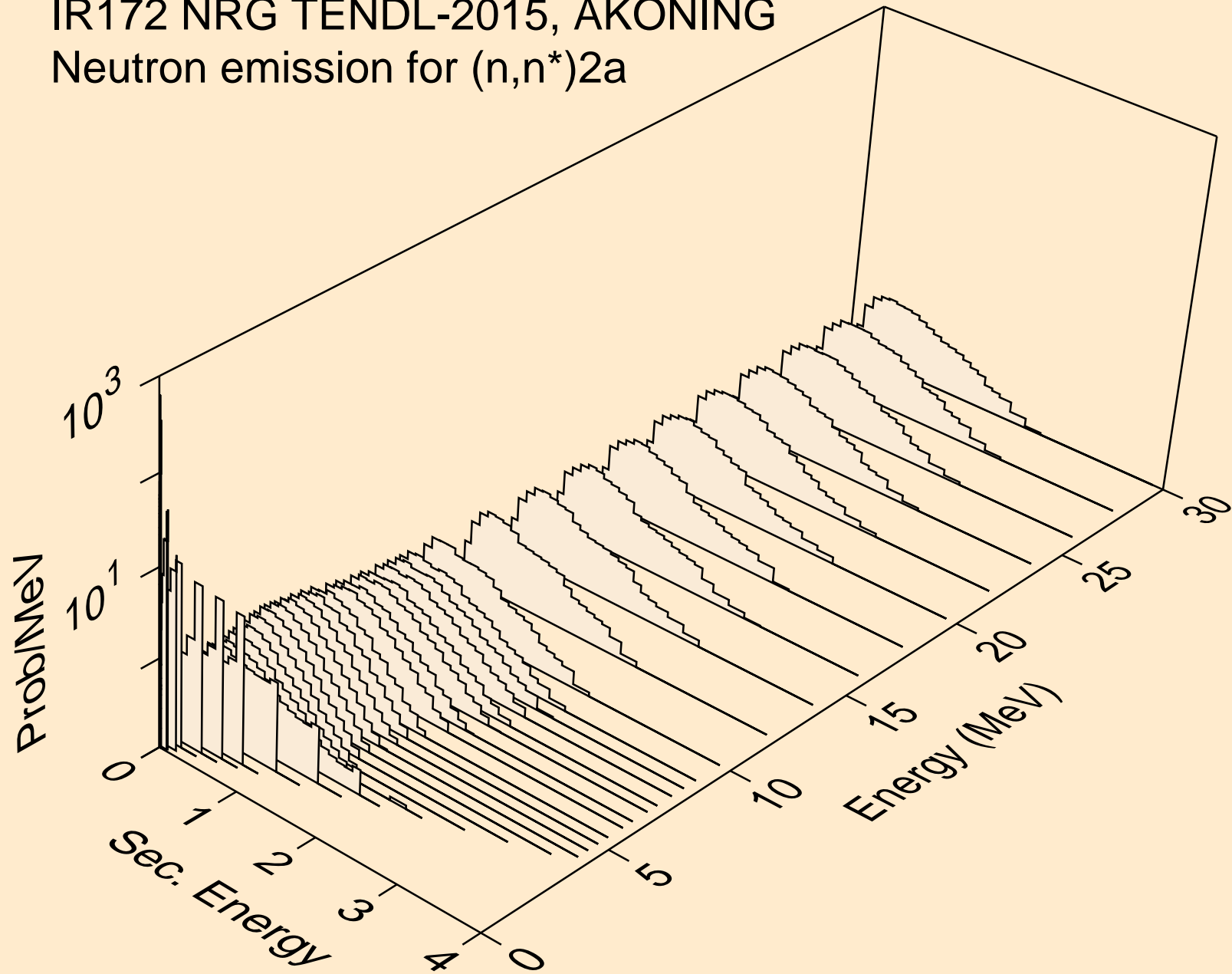

IR172 NRG TENDL-2015, AKONING
Neutron emission for (n,2n)_{2a}

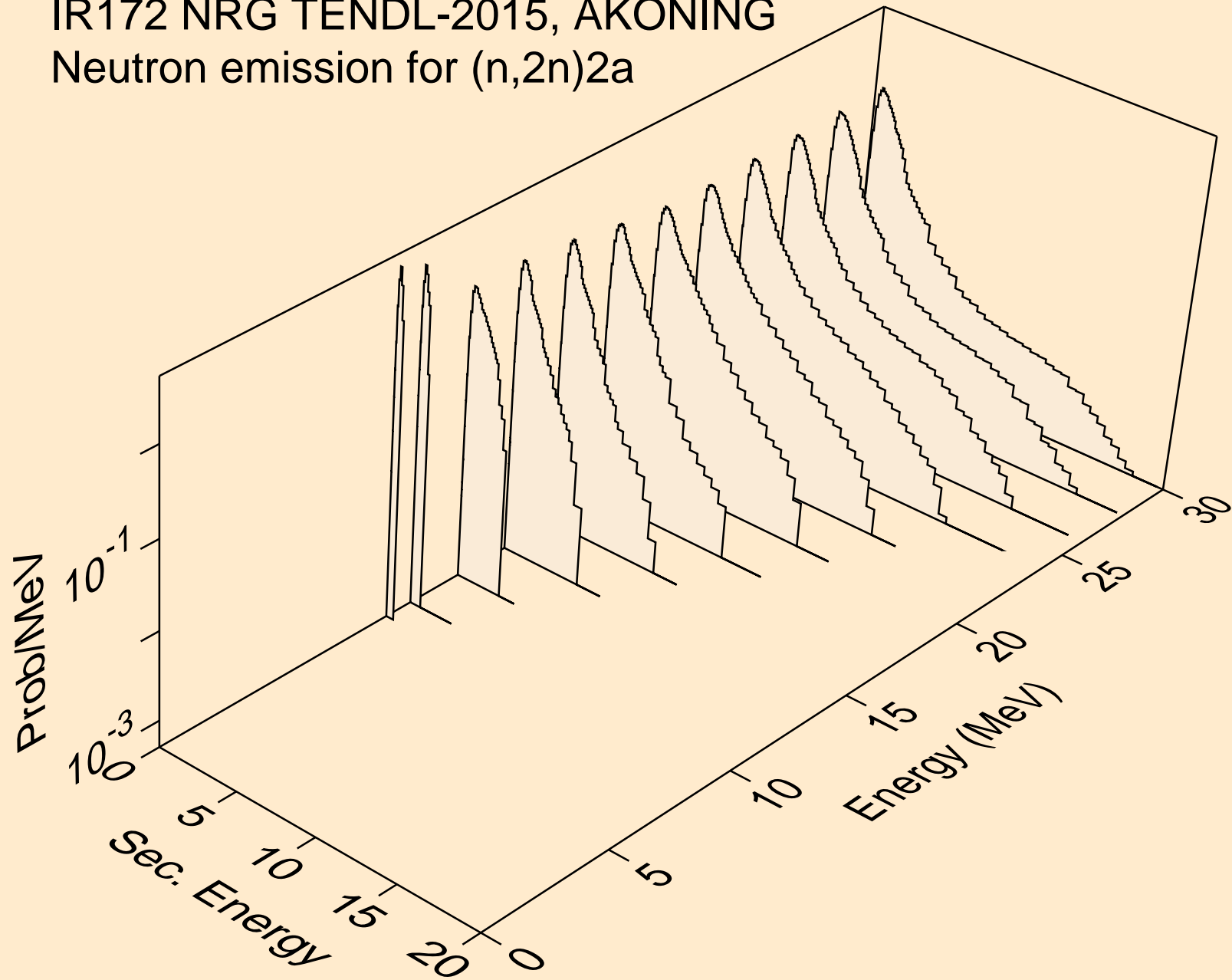

IR172 NRG TENDL-2015, AKONING
Neutron emission for (n,n*)d

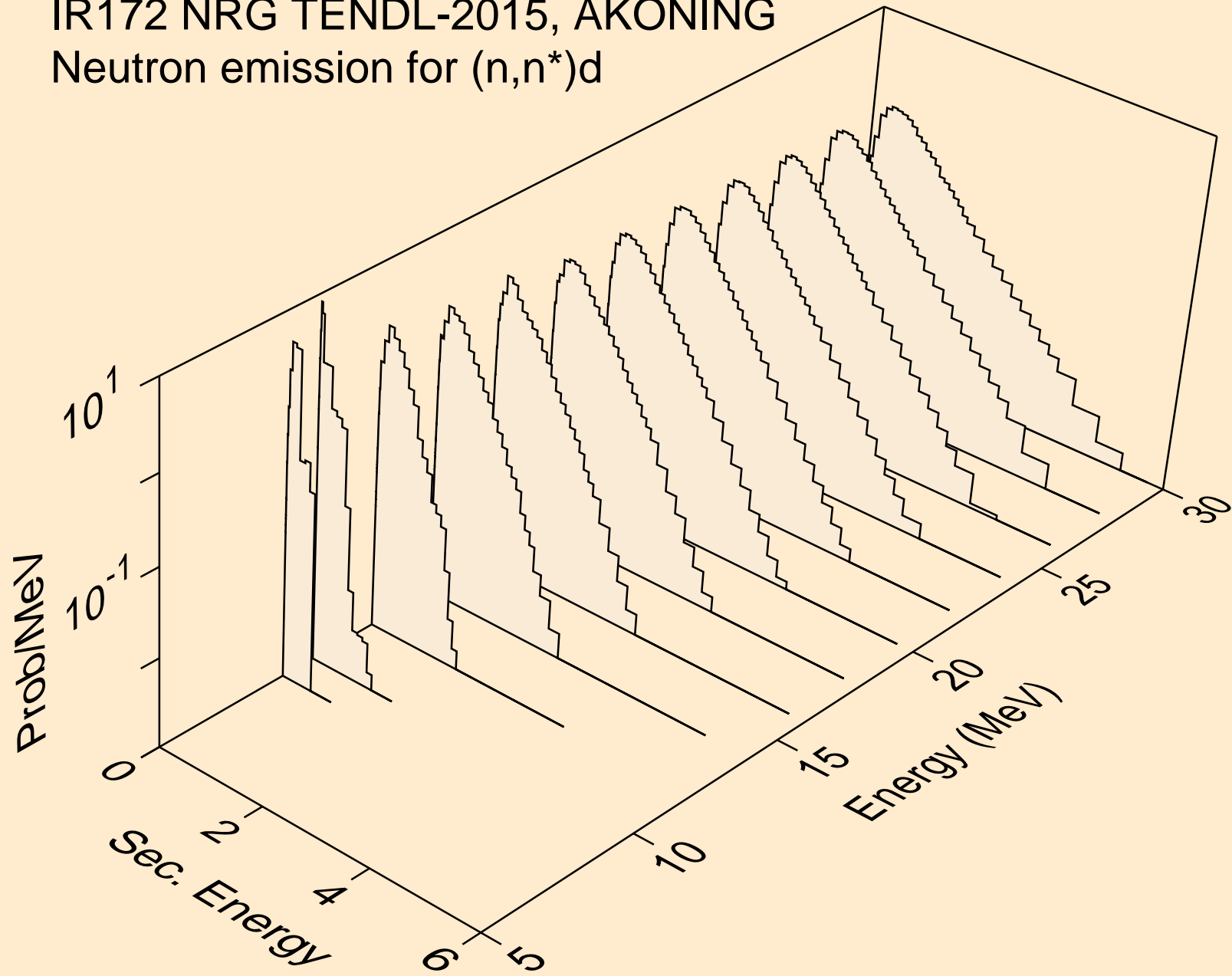

IR172 NRG TENDL-2015, AKONING
Neutron emission for (n,n*)t

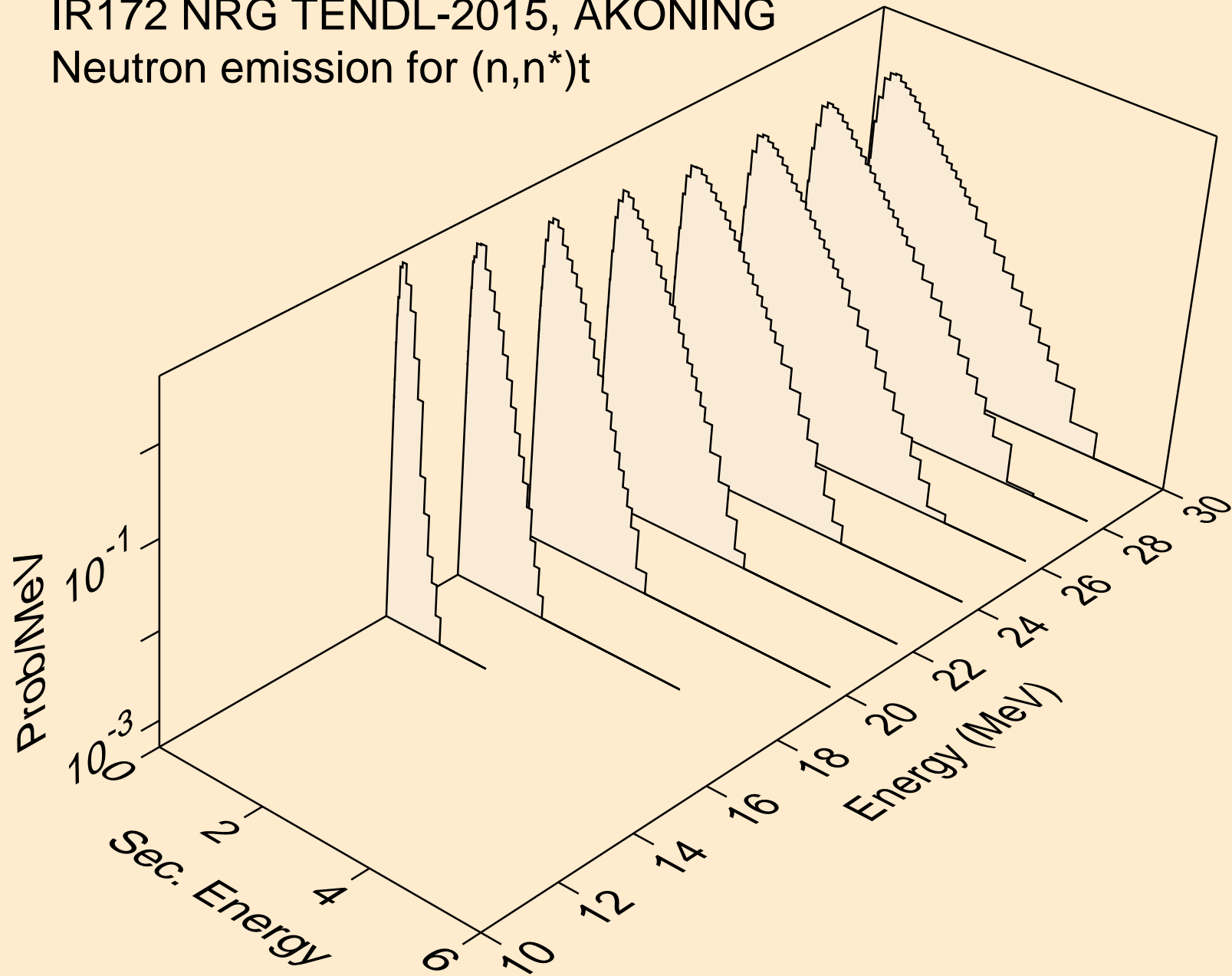

IR172 NRG TENDL-2015, AKONING
Neutron emission for (n,n*)he3

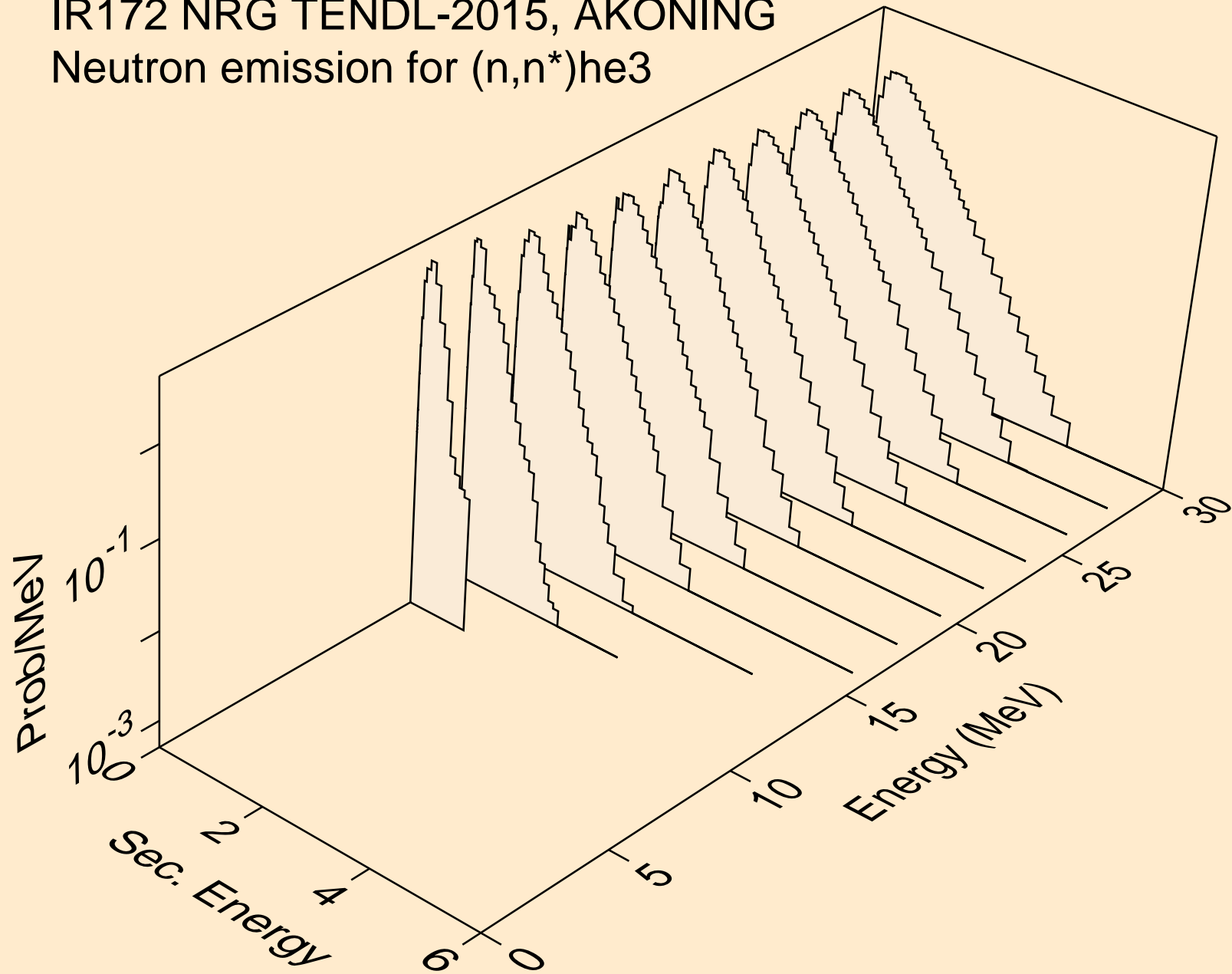

IR172 NRG TENDL-2015, AKONING
Neutron emission for (n,n*)d2a

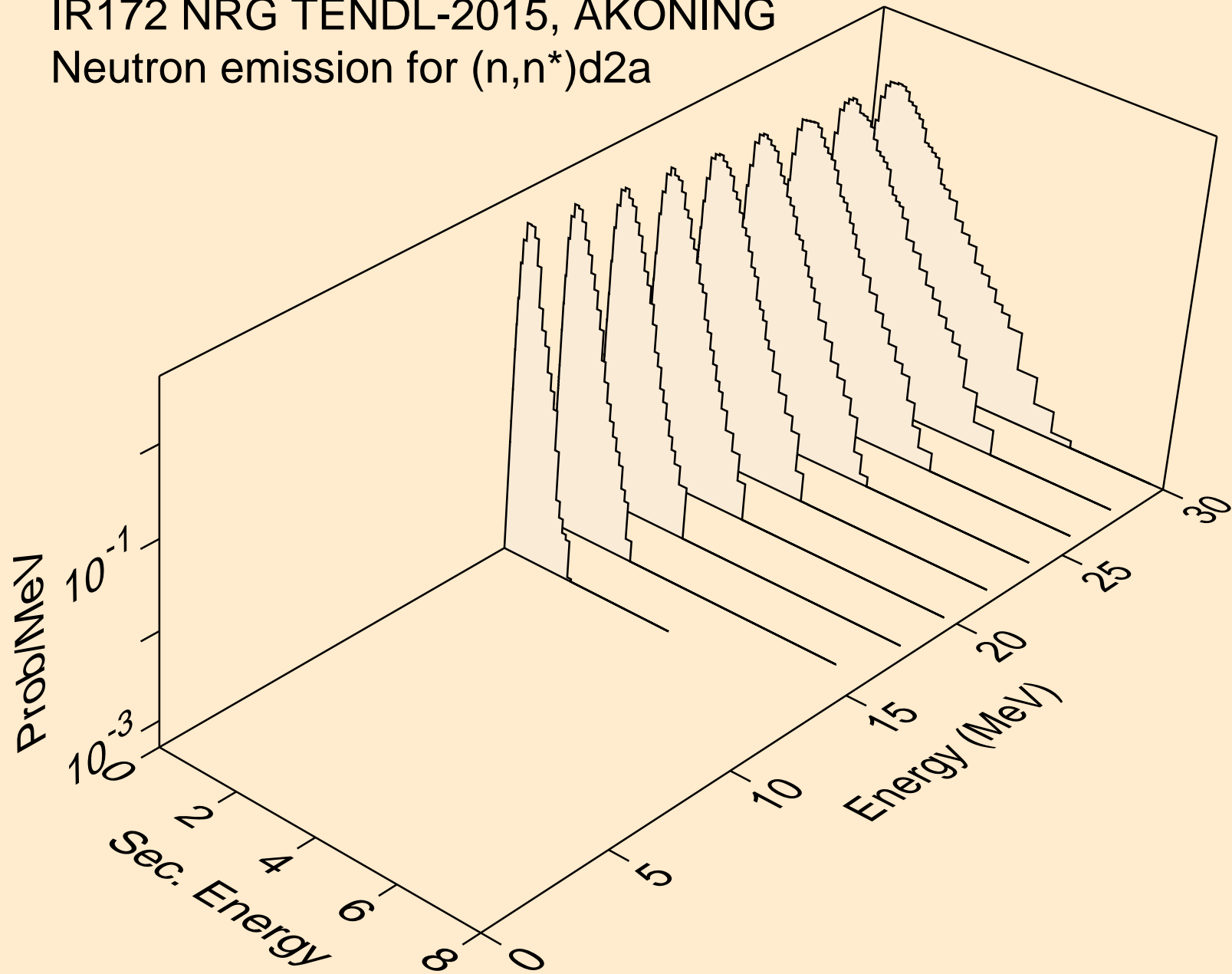

IR172 NRG TENDL-2015, AKONING
Neutron emission for (n,n*)t2a

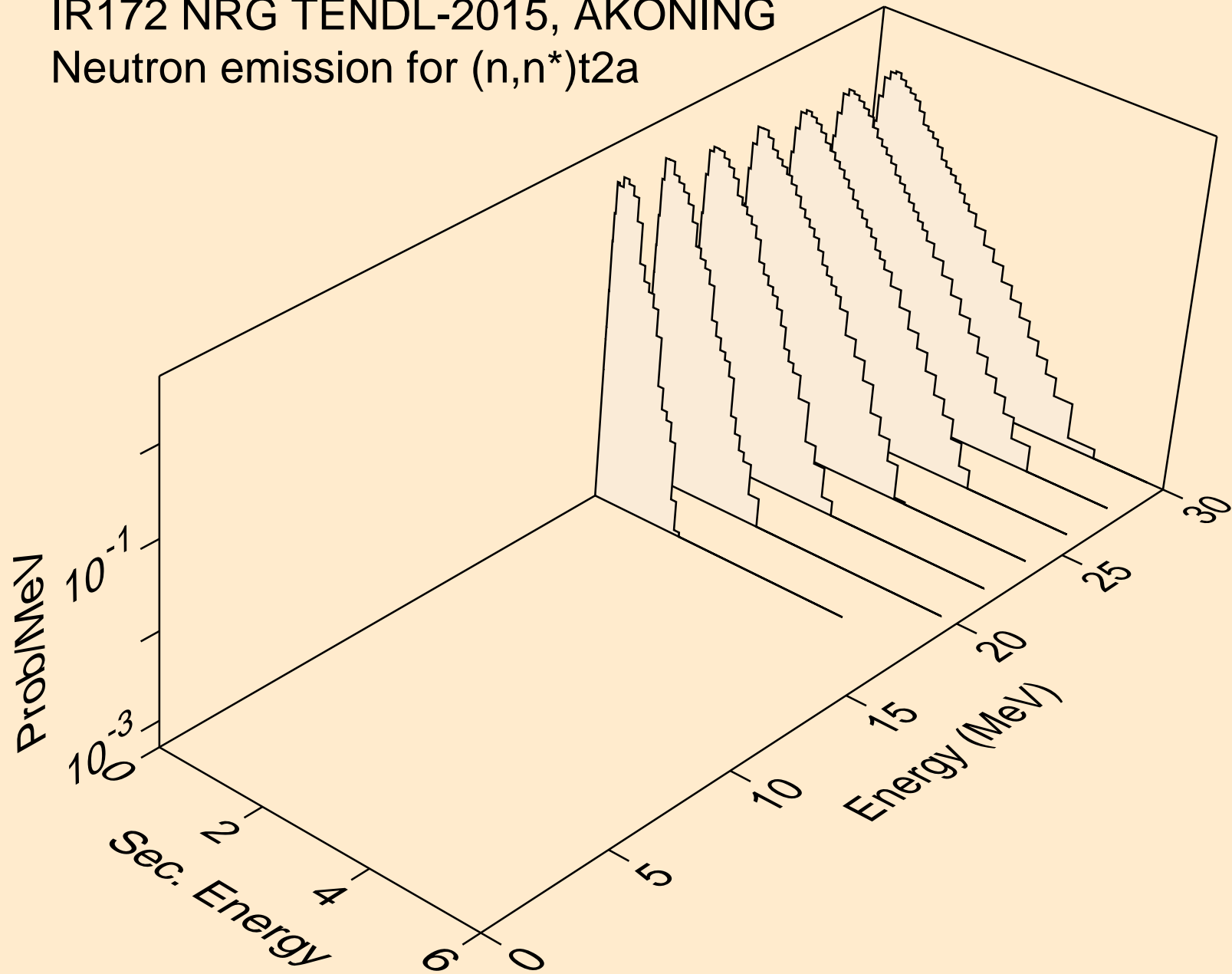

IR172 NRG TENDL-2015, AKONING
Neutron emission for (n,4n)

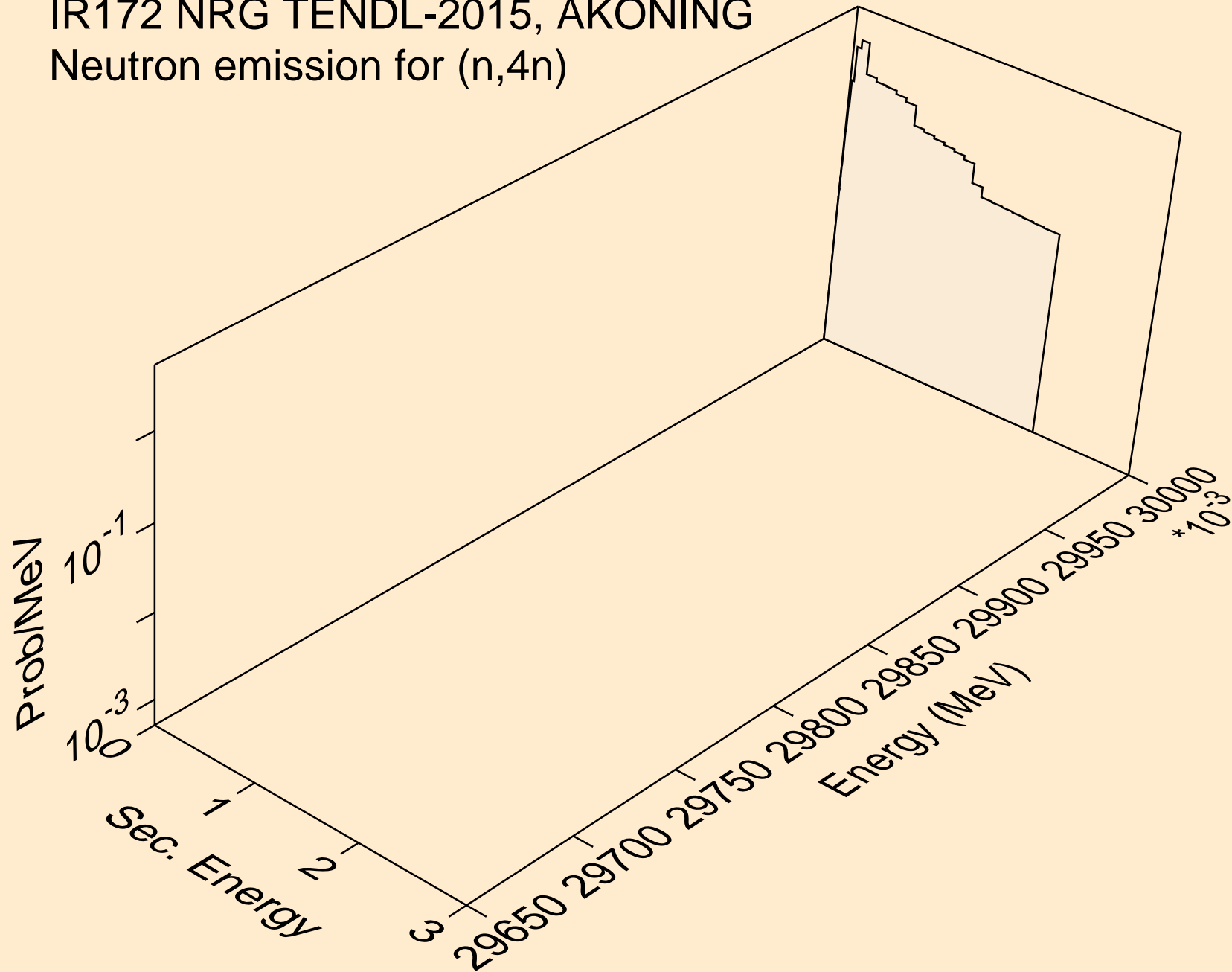

IR172 NRG TENDL-2015, AKONING
Neutron emission for (n,2np)

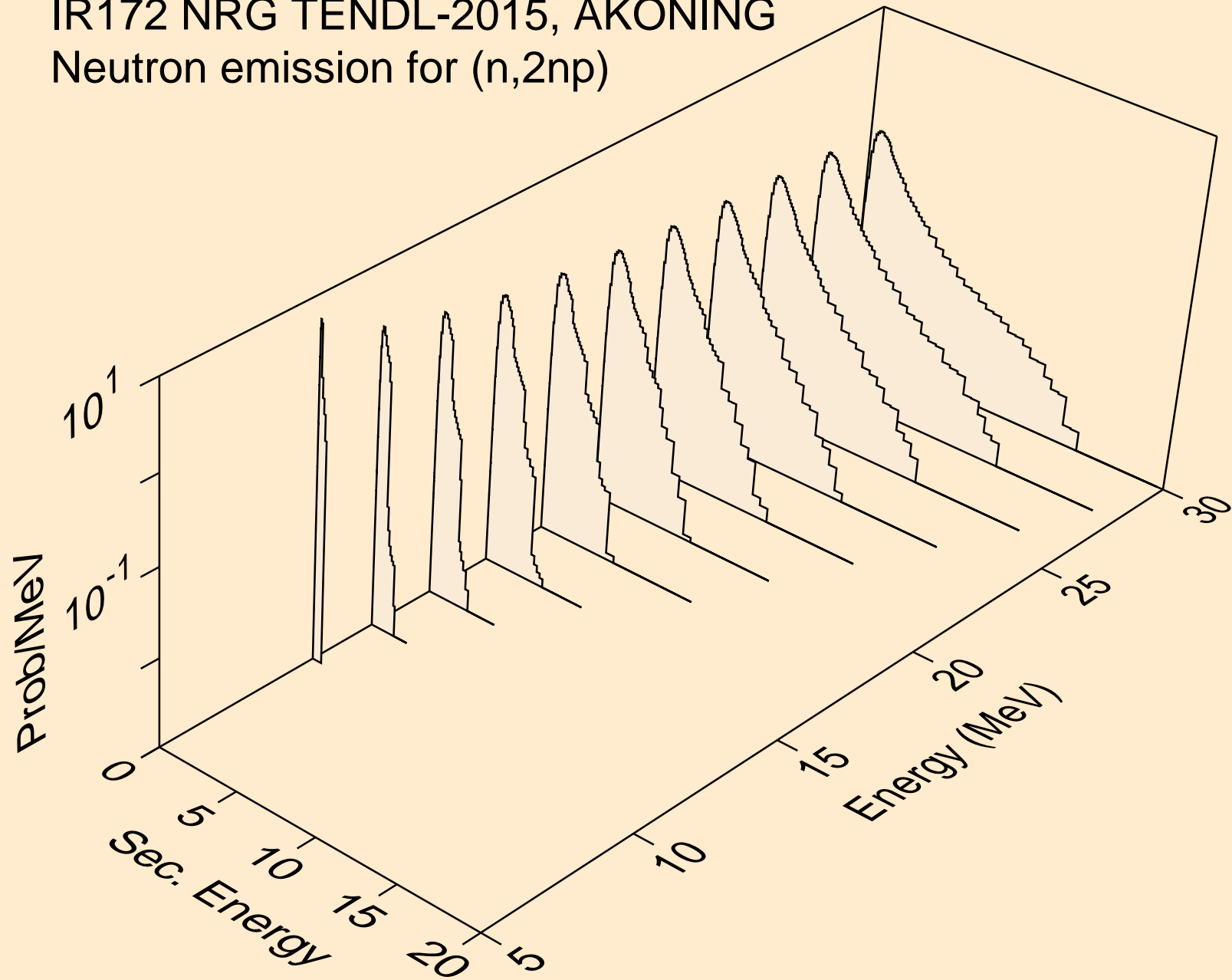

IR172 NRG TENDL-2015, AKONING
Neutron emission for (n,3np)

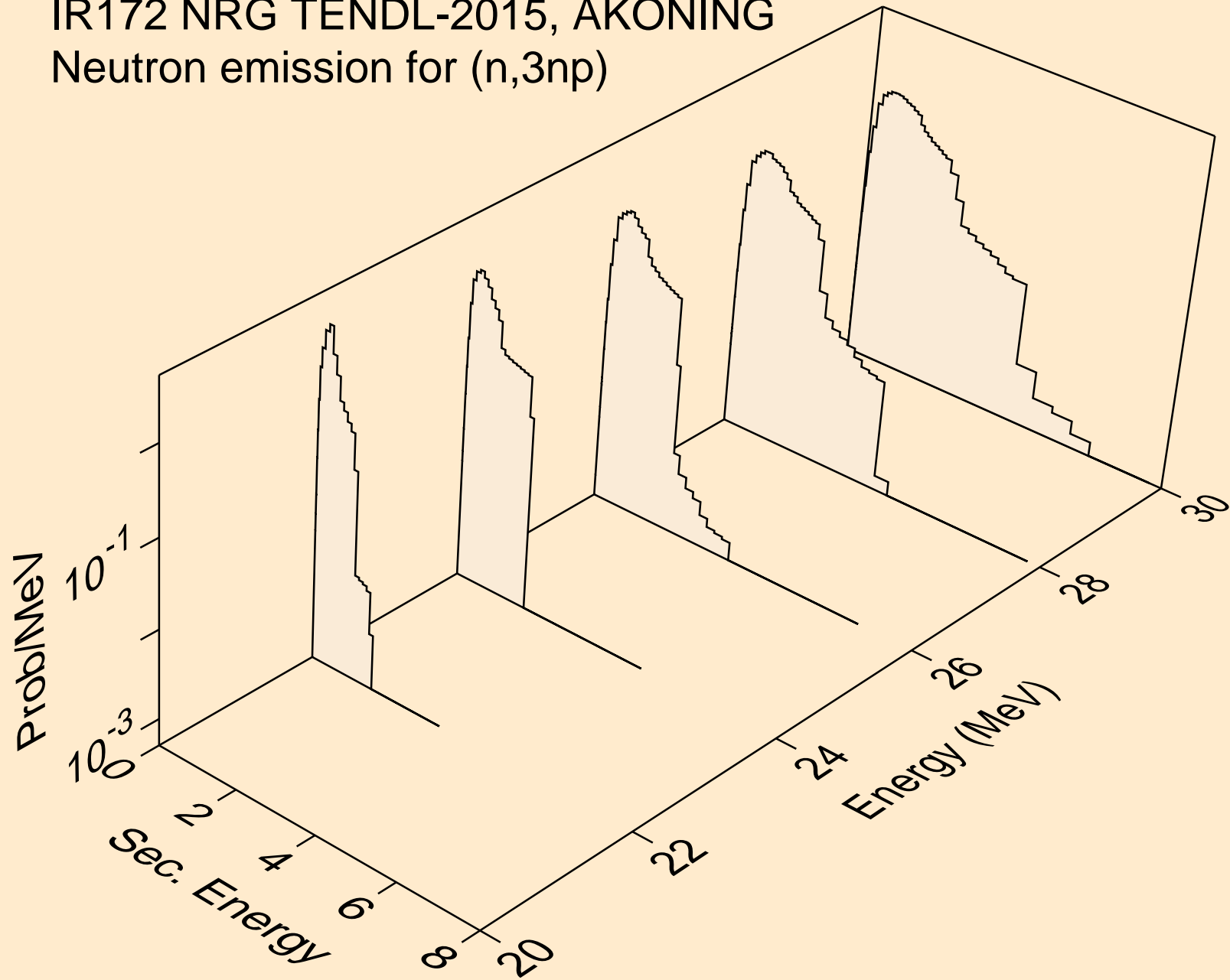

IR172 NRG TENDL-2015, AKONING
Neutron emission for (n,2np)

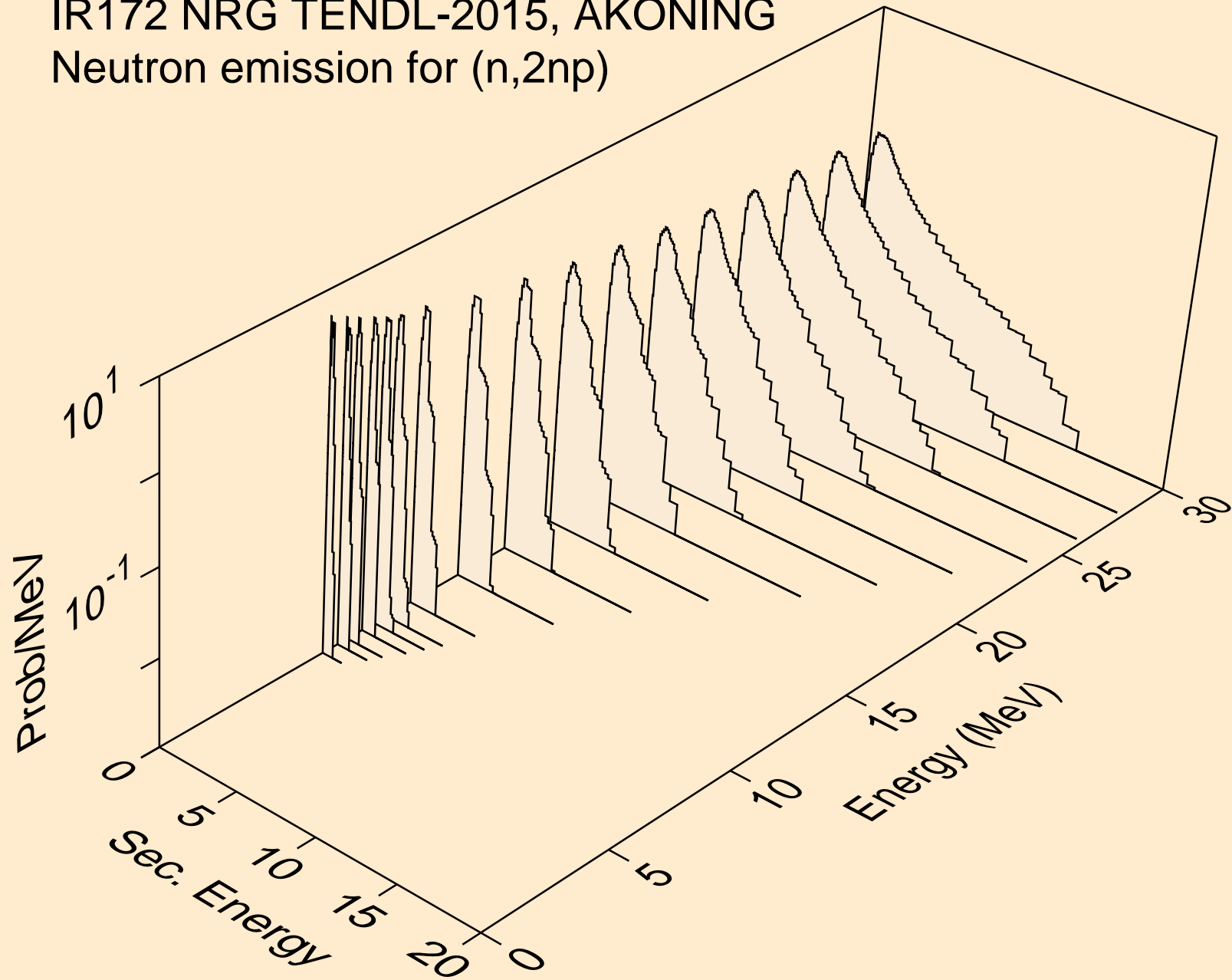

IR172 NRG TENDL-2015, AKONING
Neutron emission for (n,npa)

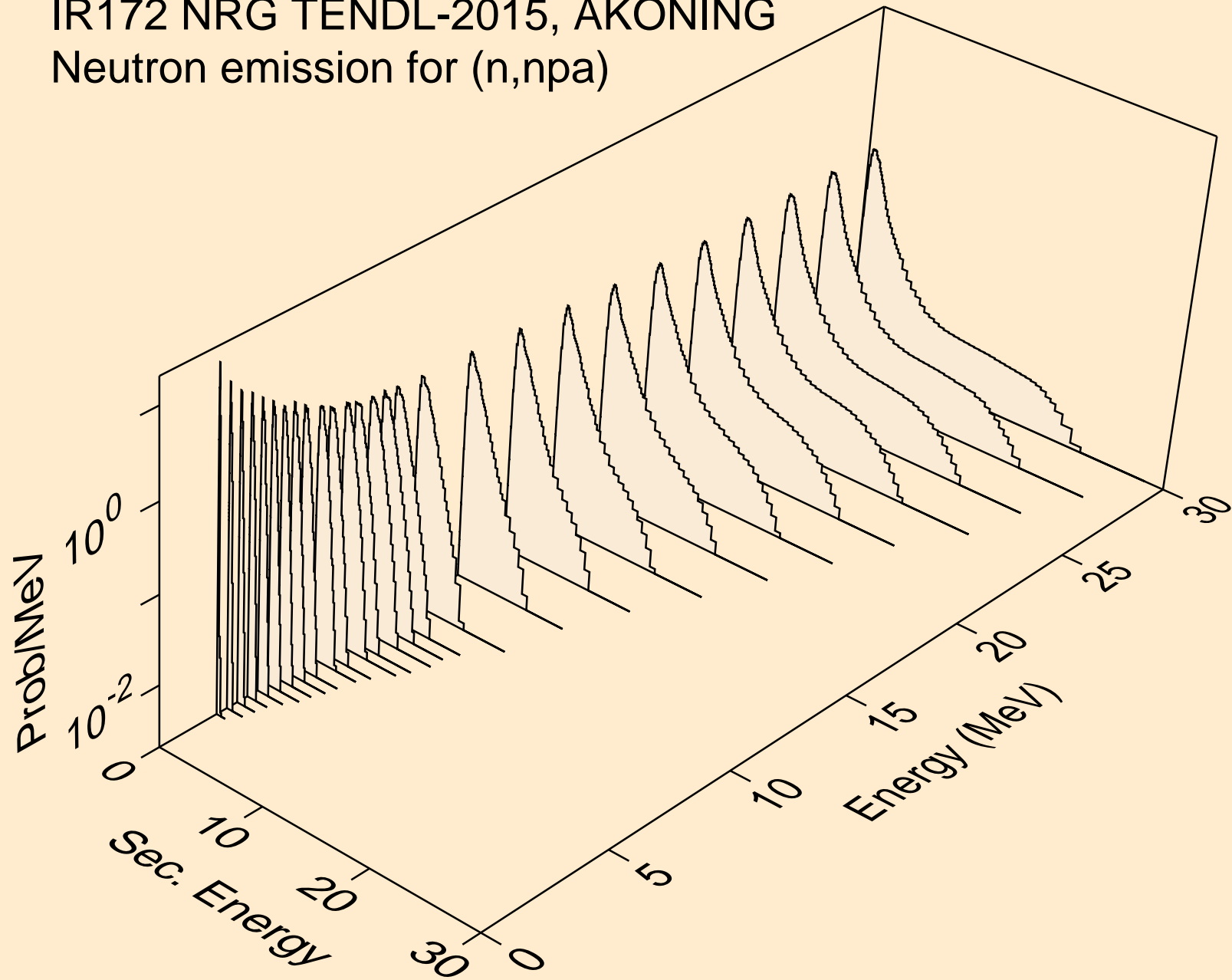

IR172 NRG TENDL-2015, AKONING
Neutron emission for (n,n*c)

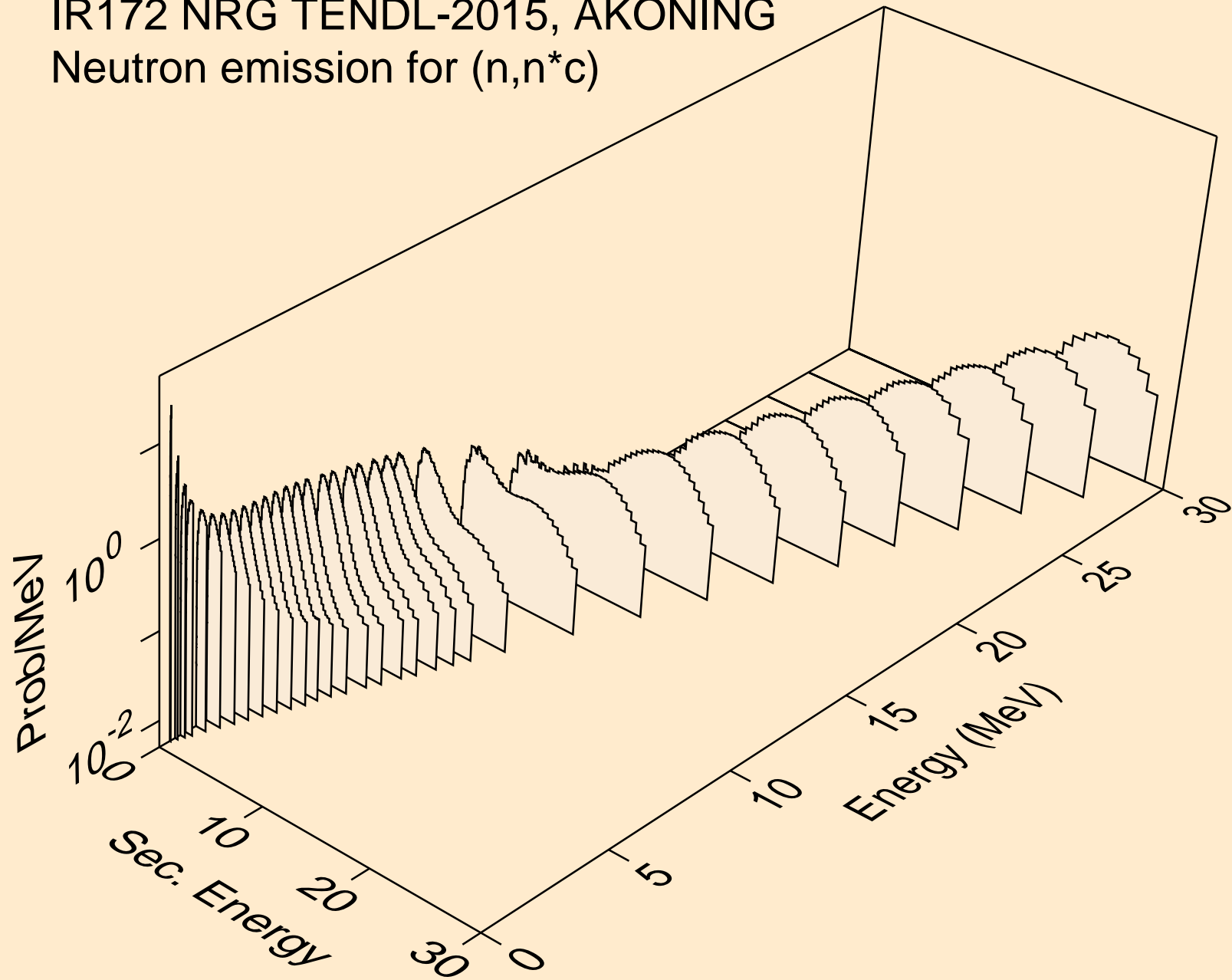

IR172 NRG TENDL-2015, AKONING
Photon emission for (n,x)

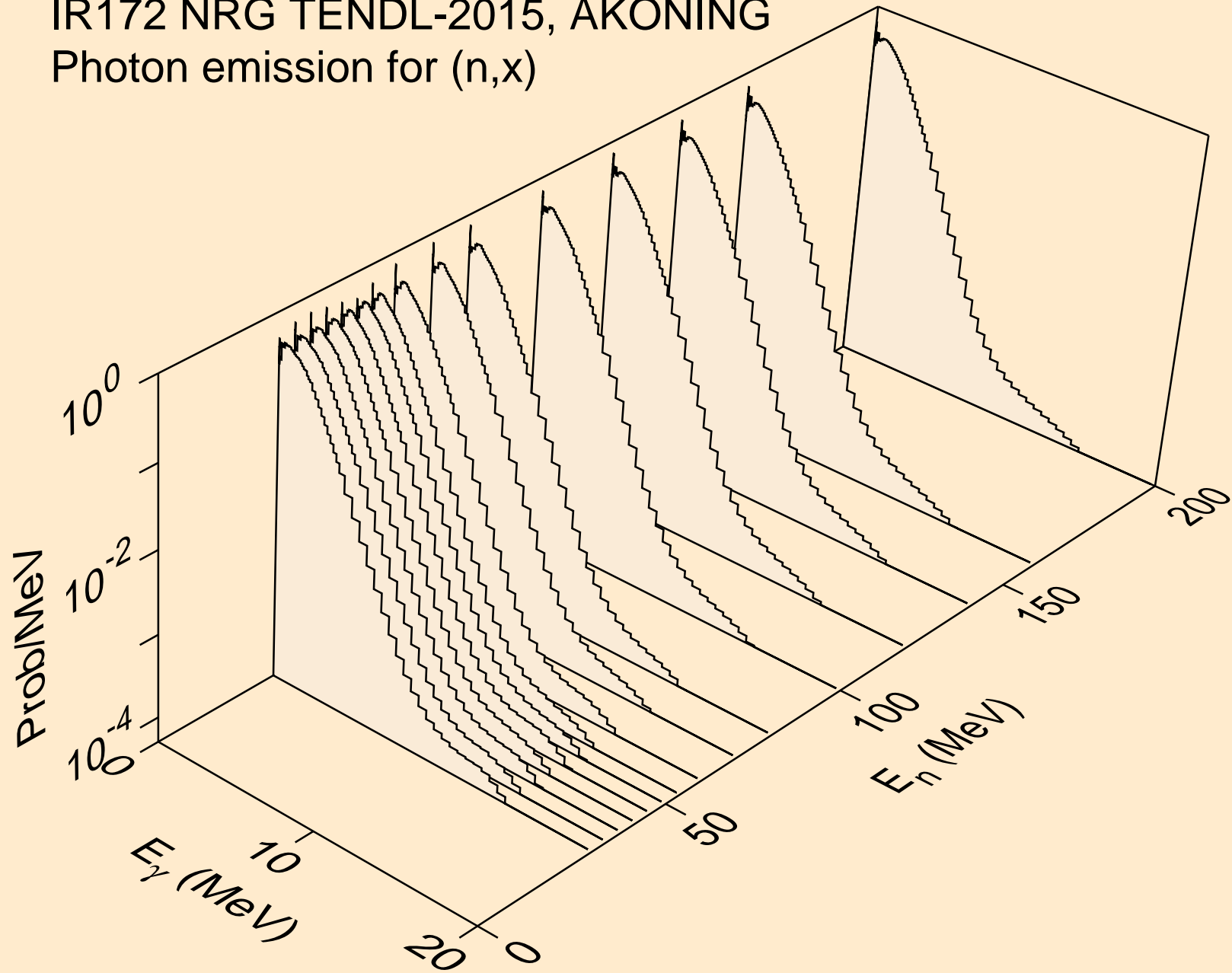

IR172 NRG TENDL-2015, AKONING
Photon emission for (n,2nd)

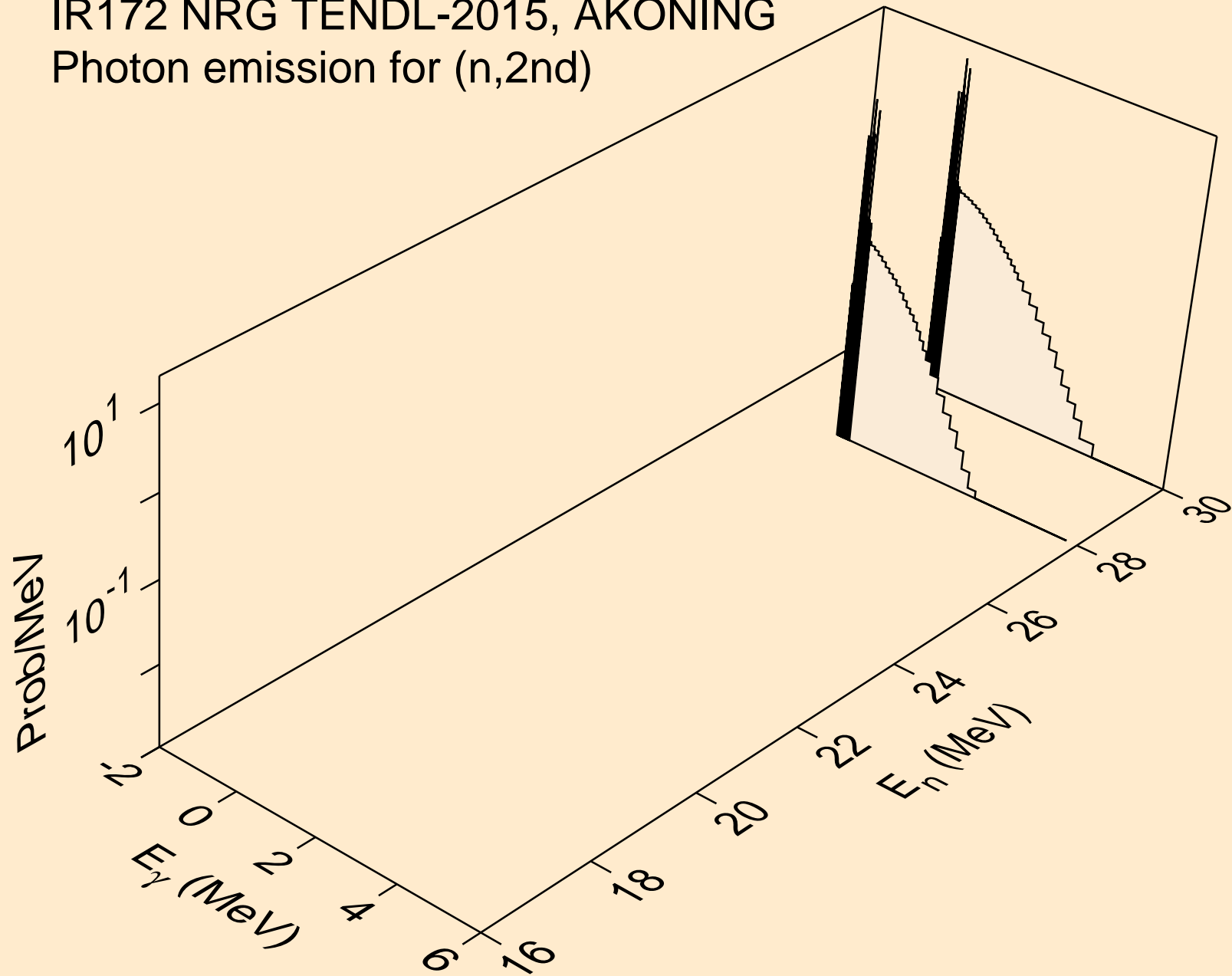

IR172 NRG TENDL-2015, AKONING
Photon emission for (n,2n)

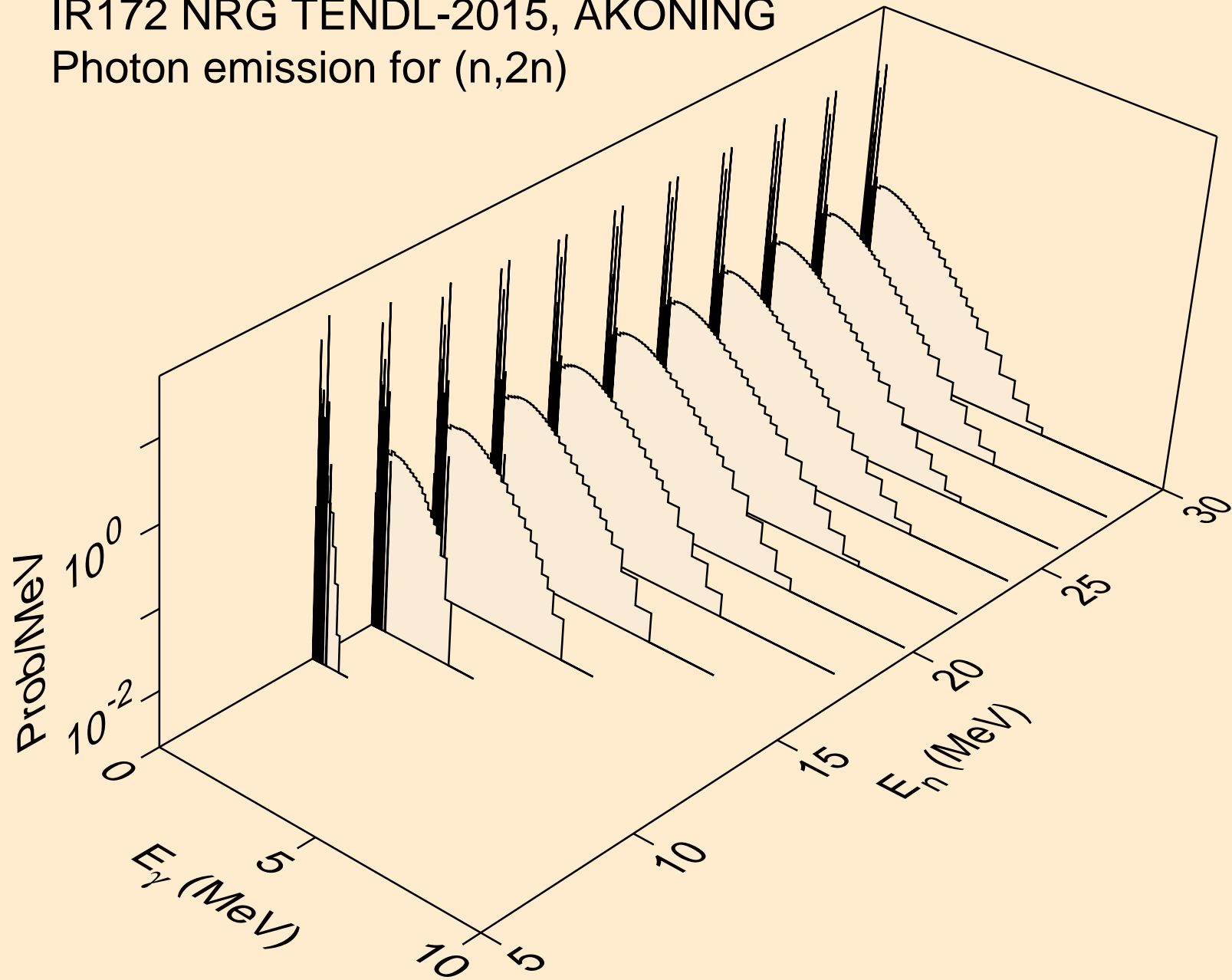

IR172 NRG TENDL-2015, AKONING
Photon emission for (n,3n)

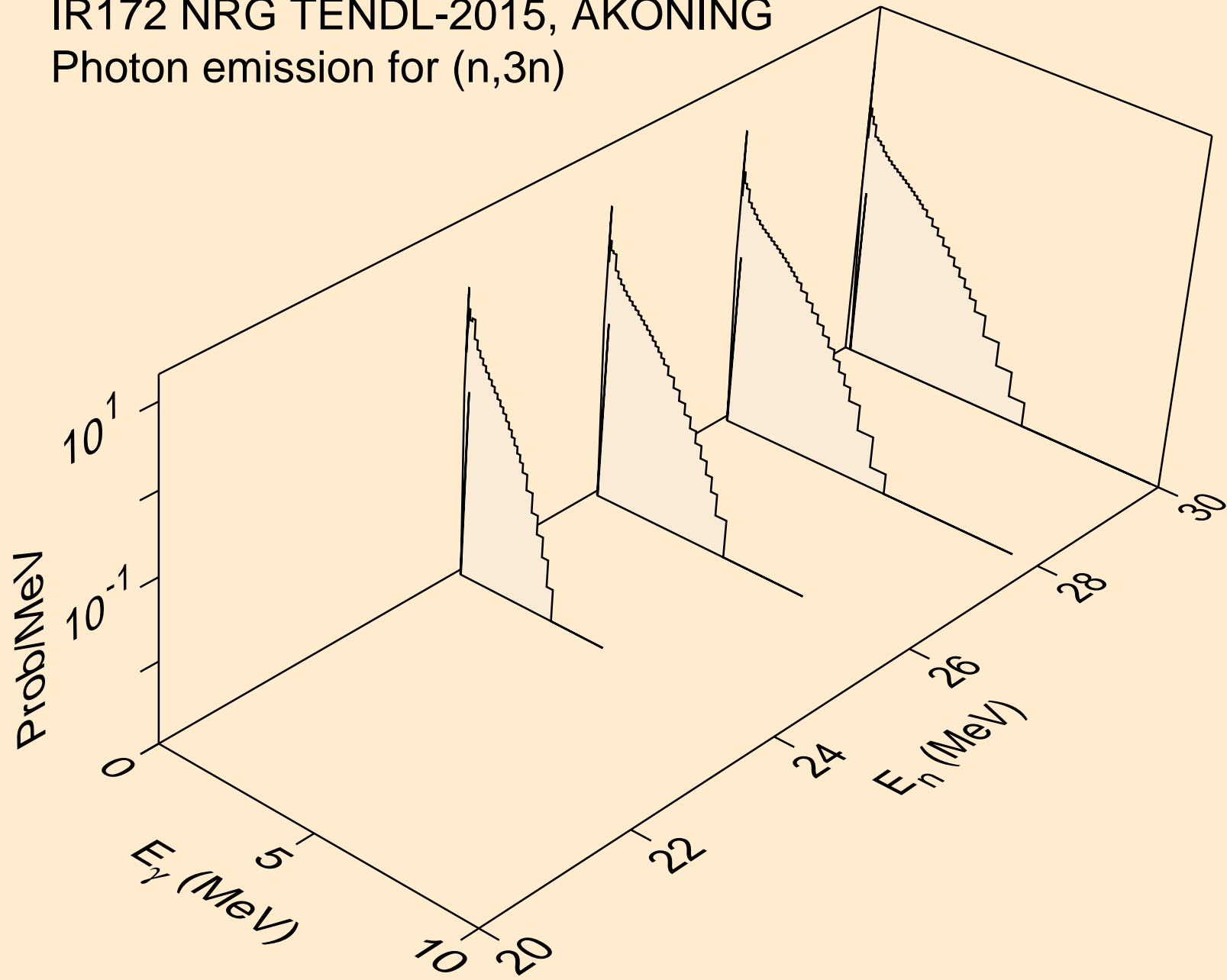

IR172 NRG TENDL-2015, AKONING
Photon emission for (n,n*)a

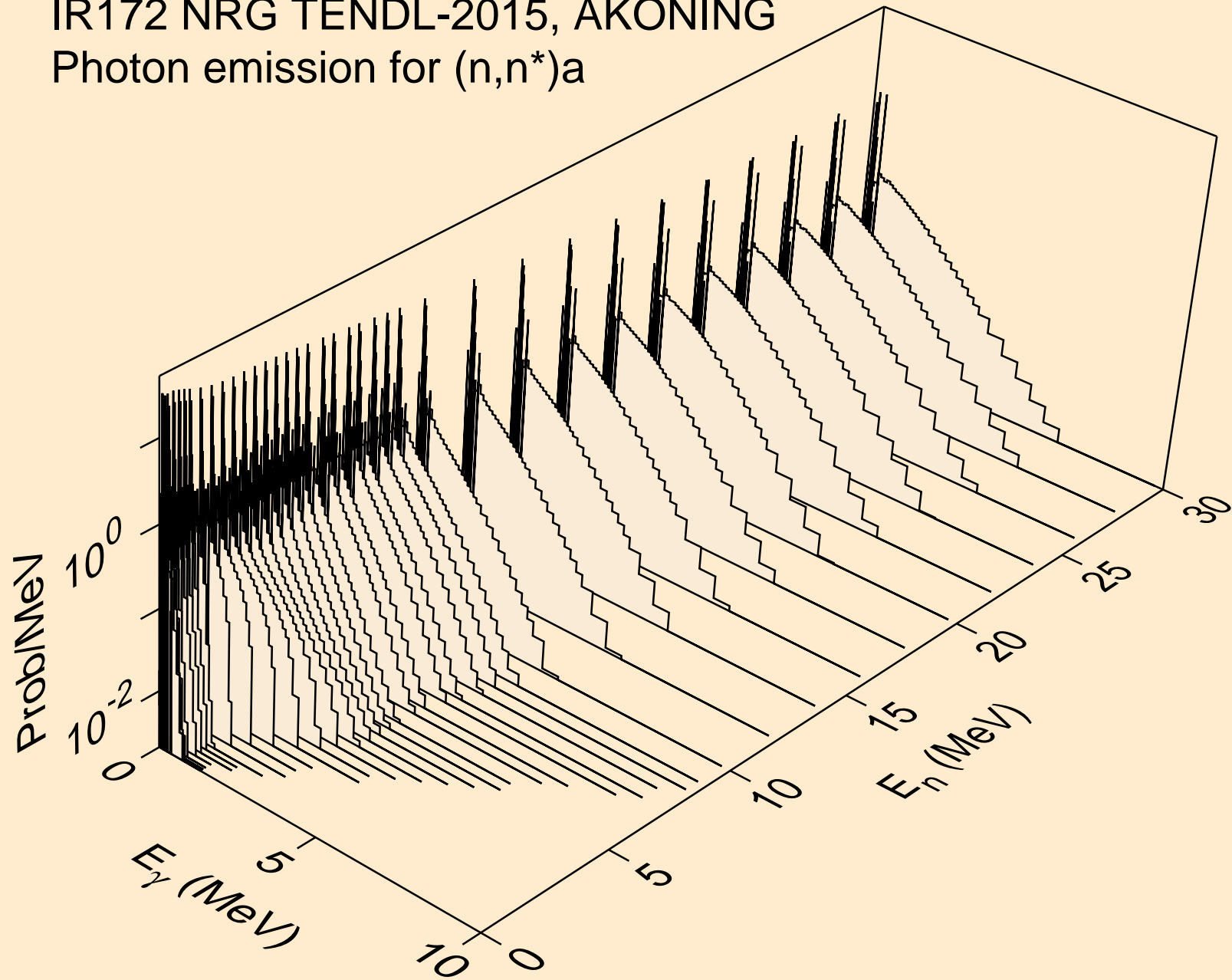

IR172 NRG TENDL-2015, AKONING
Photon emission for (n,n*)3a

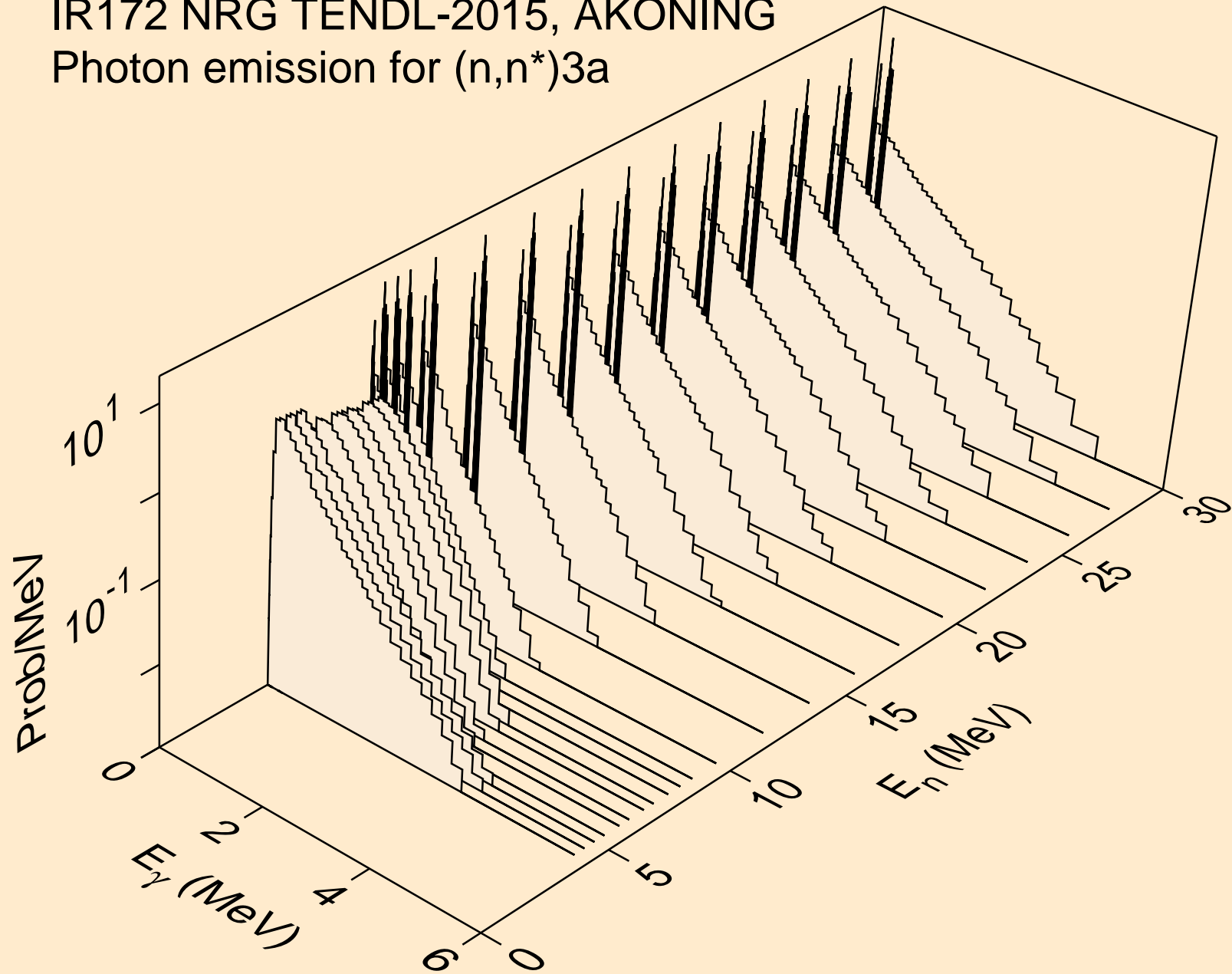

IR172 NRG TENDL-2015, AKONING
Photon emission for (n,2n)a

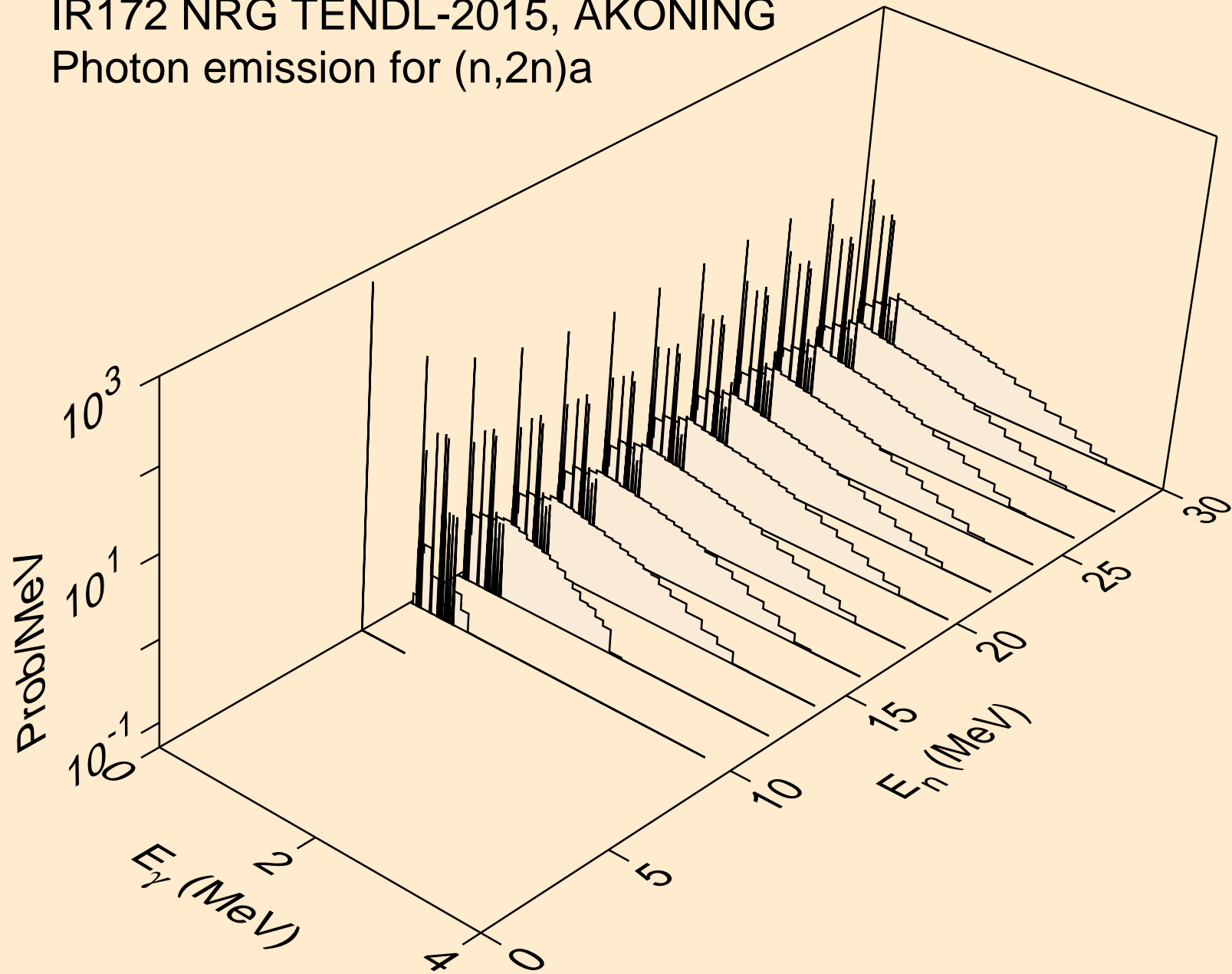

IR172 NRG TENDL-2015, AKONING
Photon emission for (n,3n)a

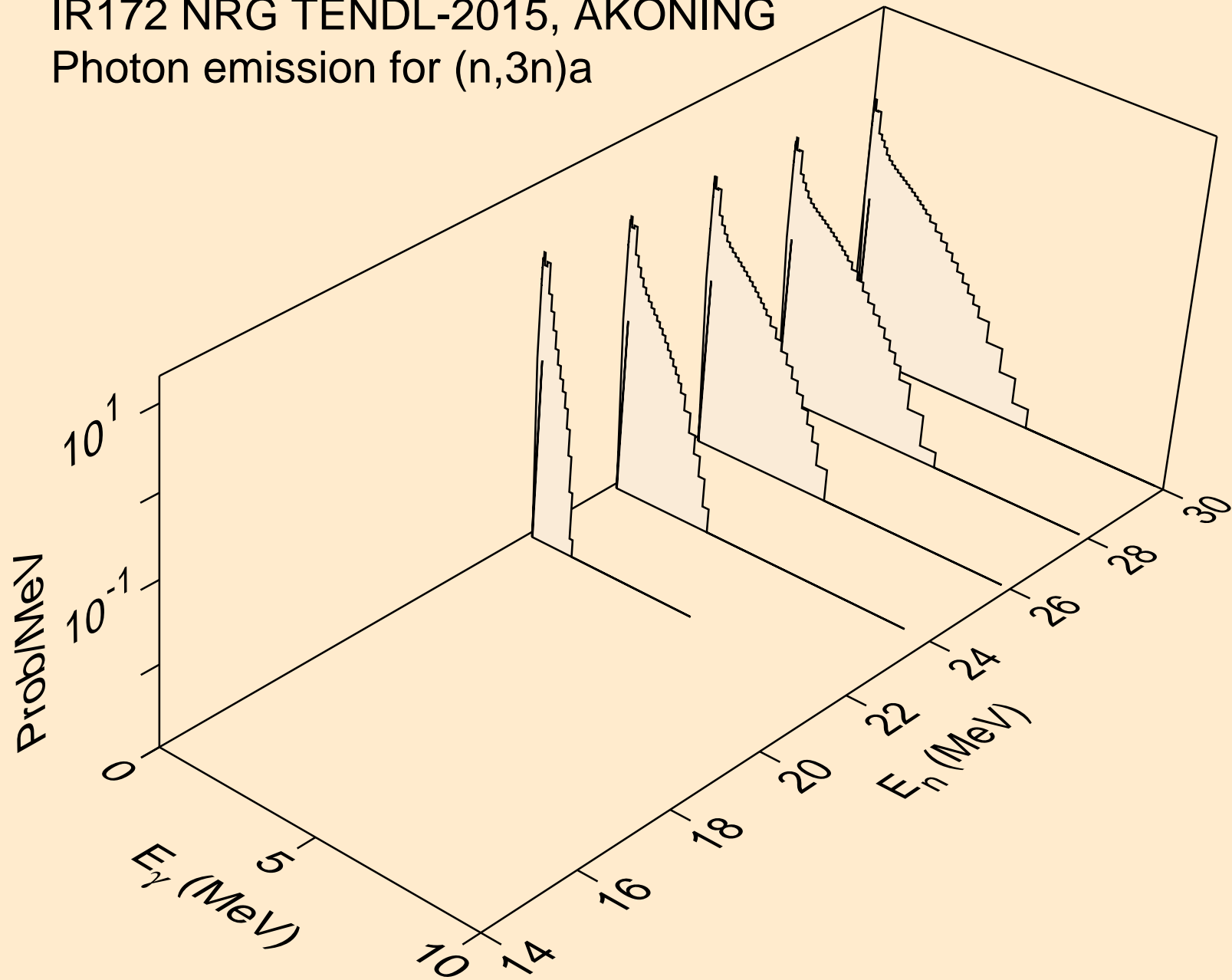

IR172 NRG TENDL-2015, AKONING
Photon emission for (n,n*)p

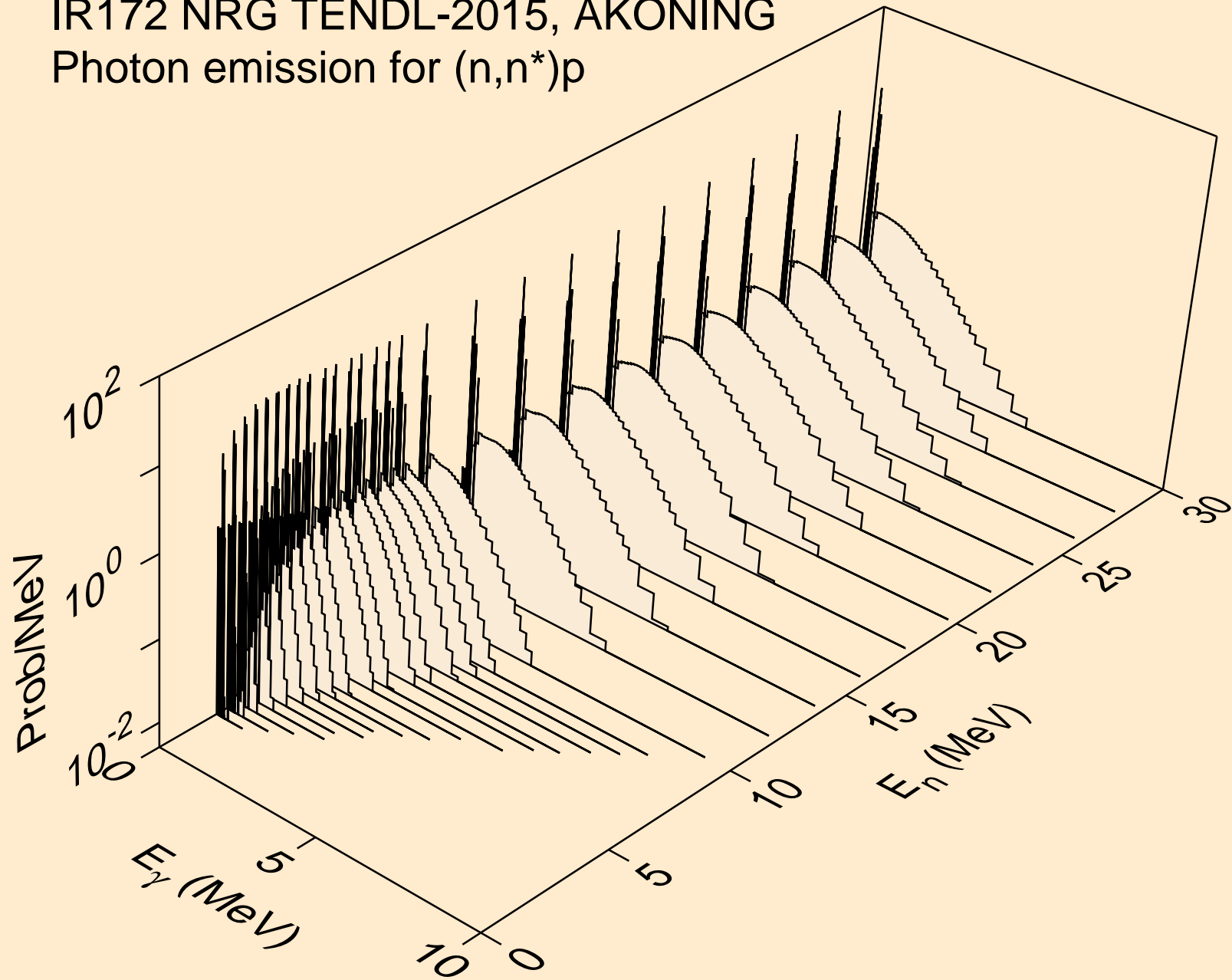

IR172 NRG TENDL-2015, AKONING
Photon emission for (n,n*)2a

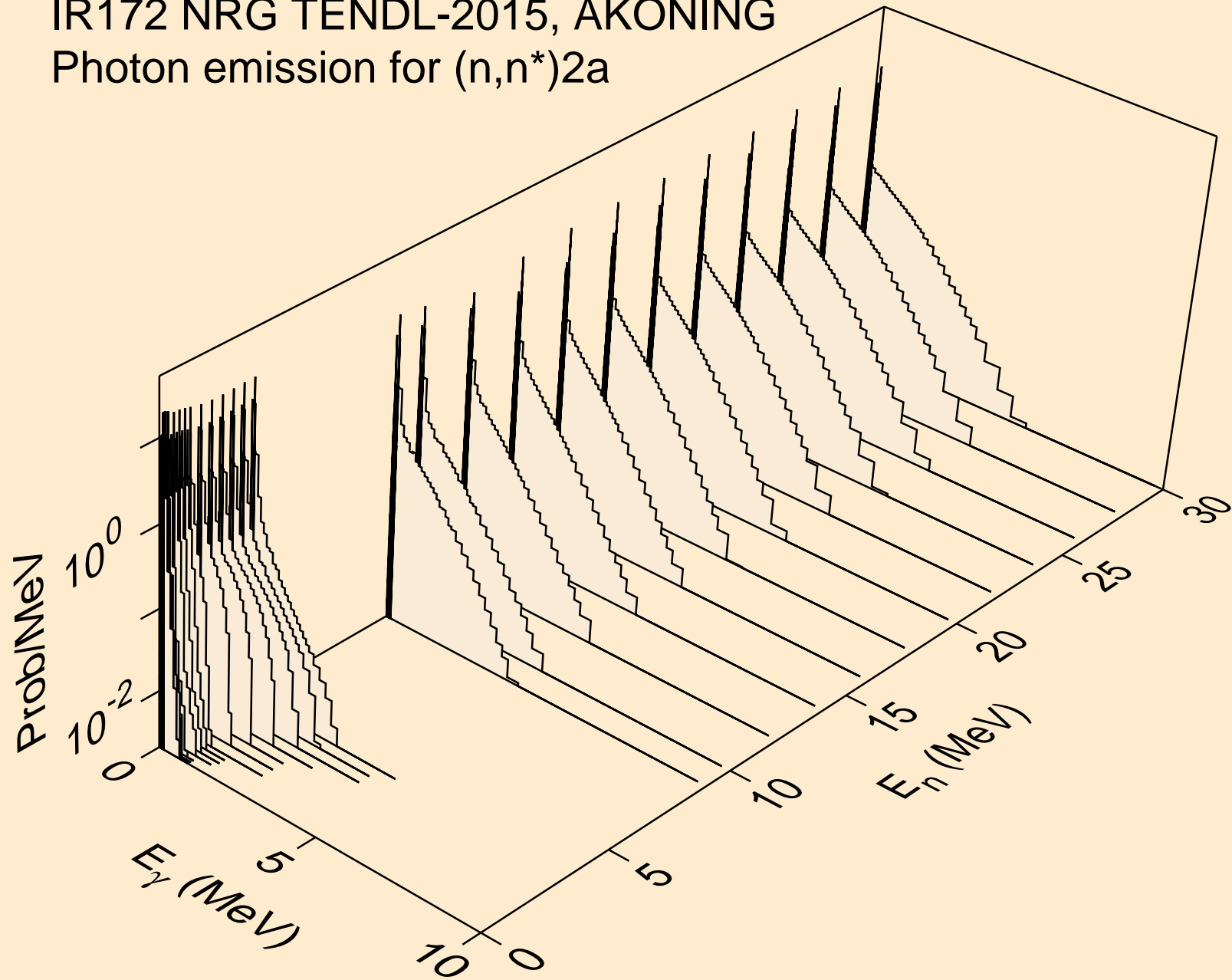

IR172 NRG TENDL-2015, AKONING
Photon emission for (n,2n)2a

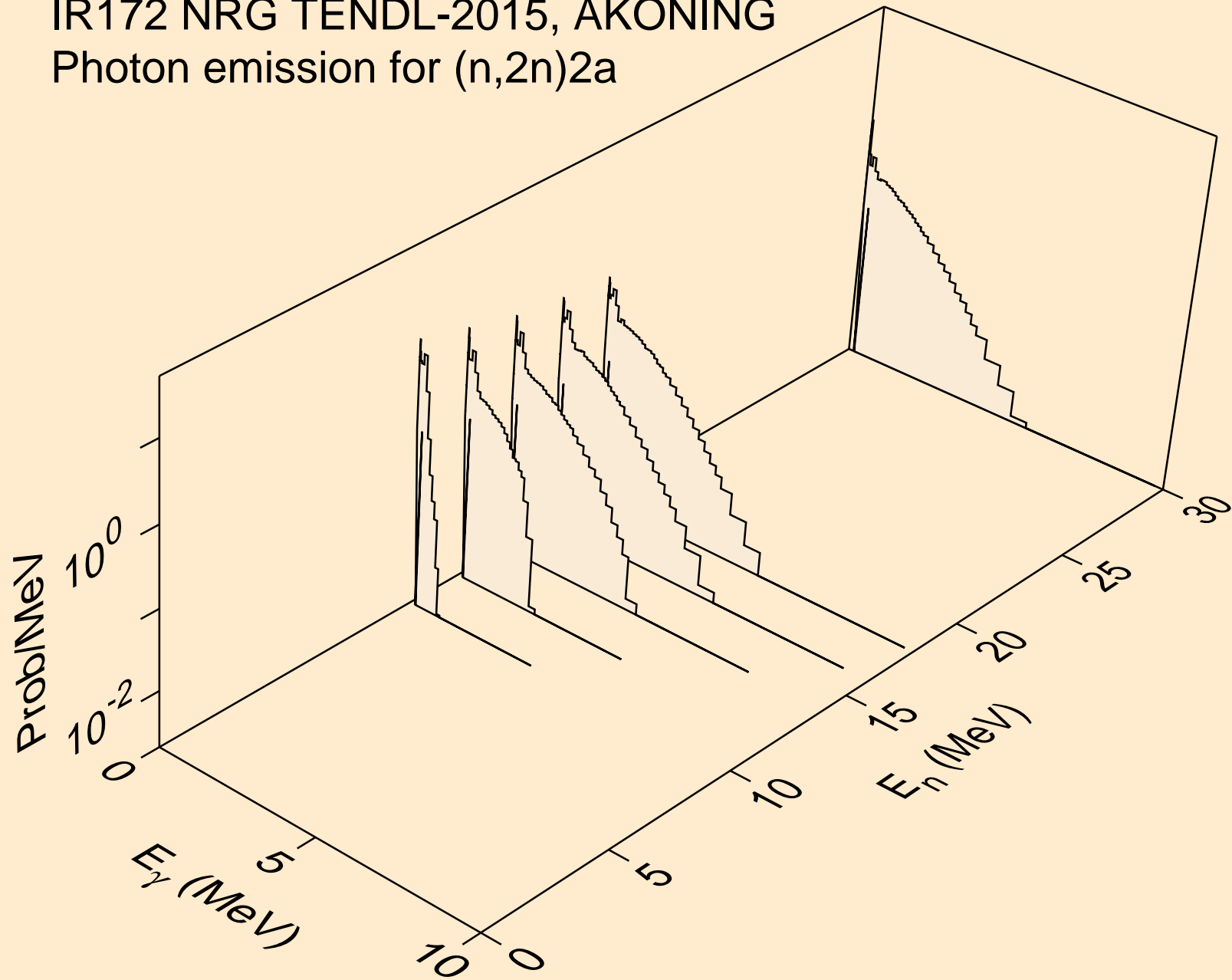

IR172 NRG TENDL-2015, AKONING
Photon emission for (n,n*)d

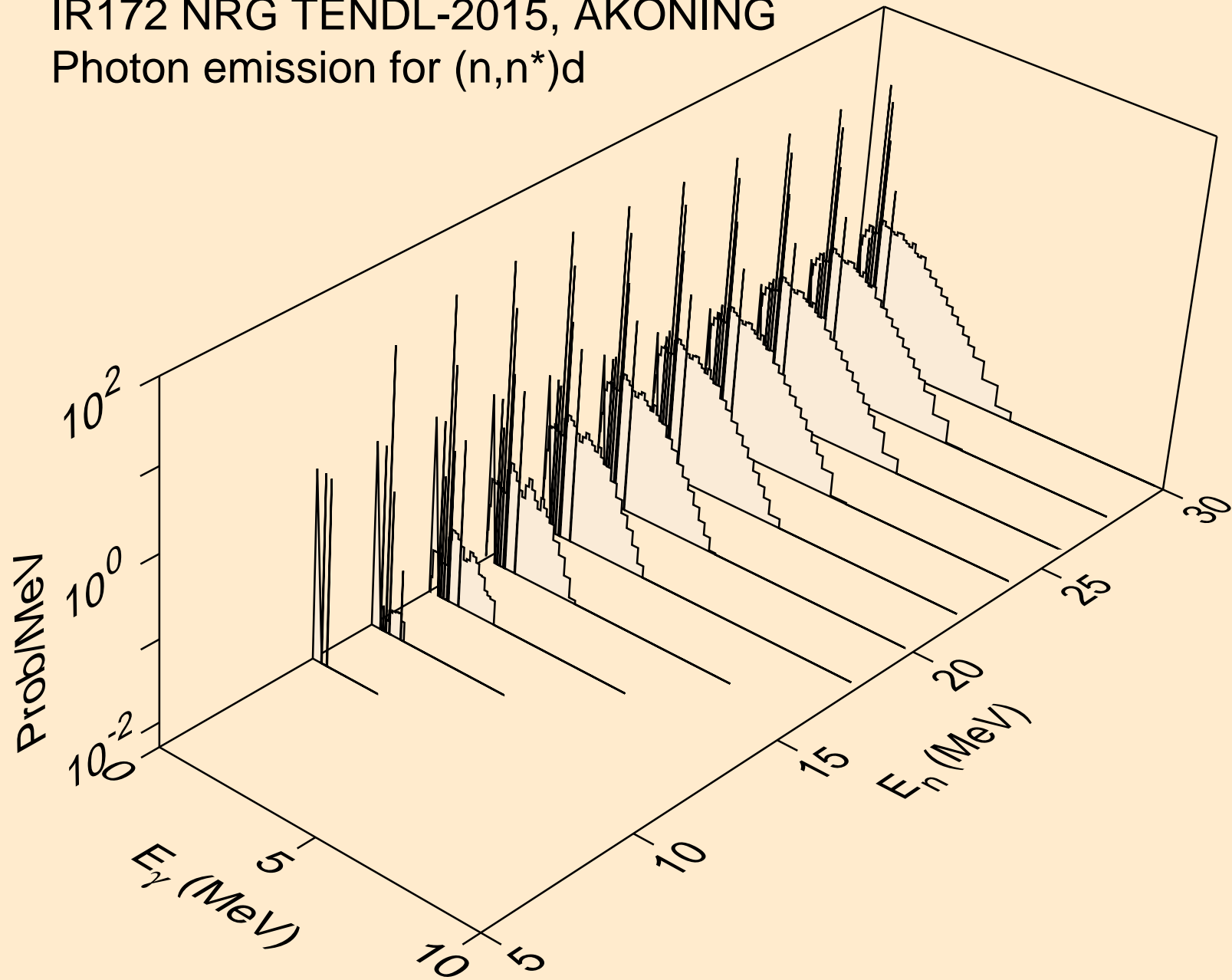

IR172 NRG TENDL-2015, AKONING
Photon emission for (n,n*)t

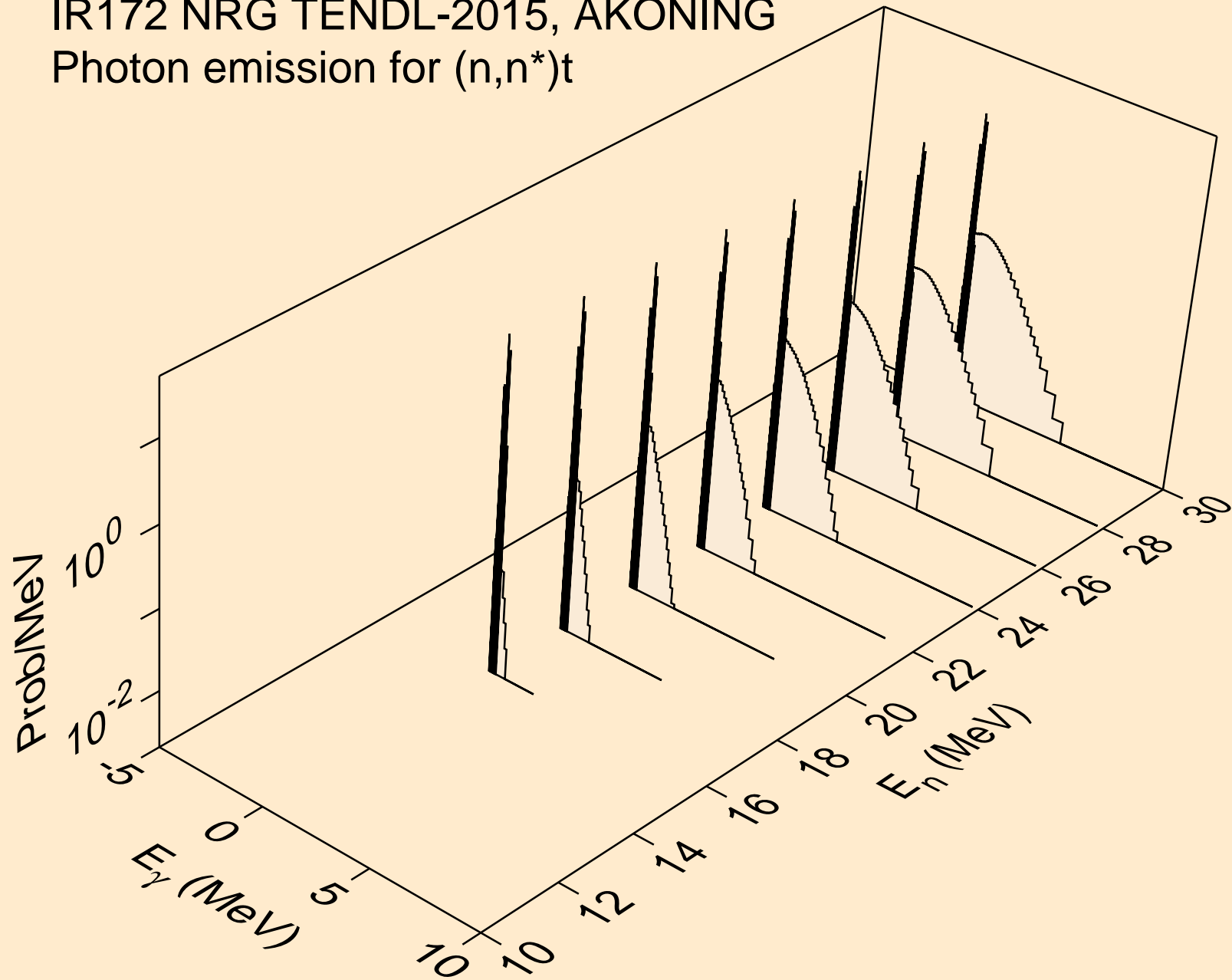

IR172 NRG TENDL-2015, AKONING
Photon emission for (n,n*)he3

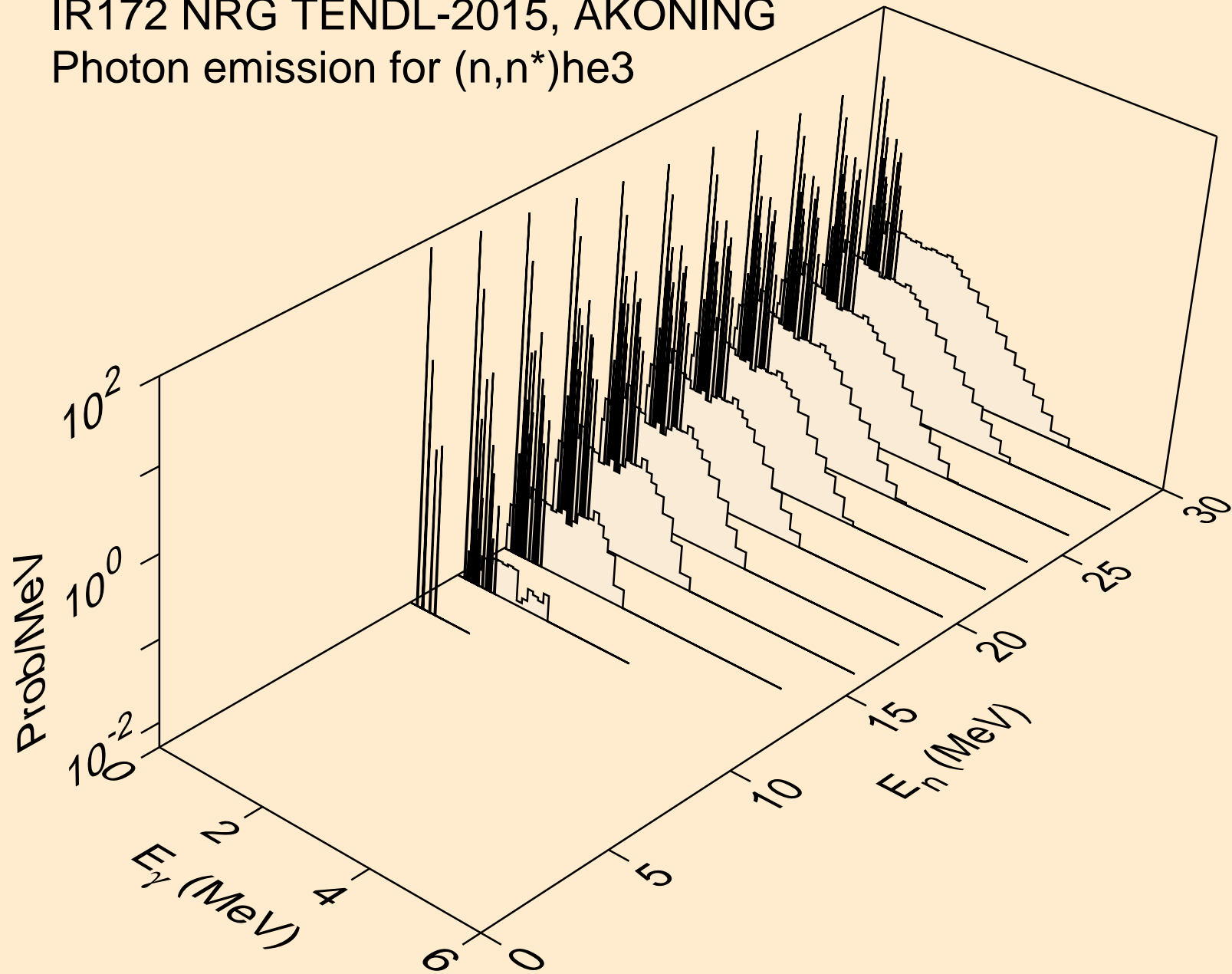

IR172 NRG TENDL-2015, AKONING
Photon emission for (n,n*)d2a

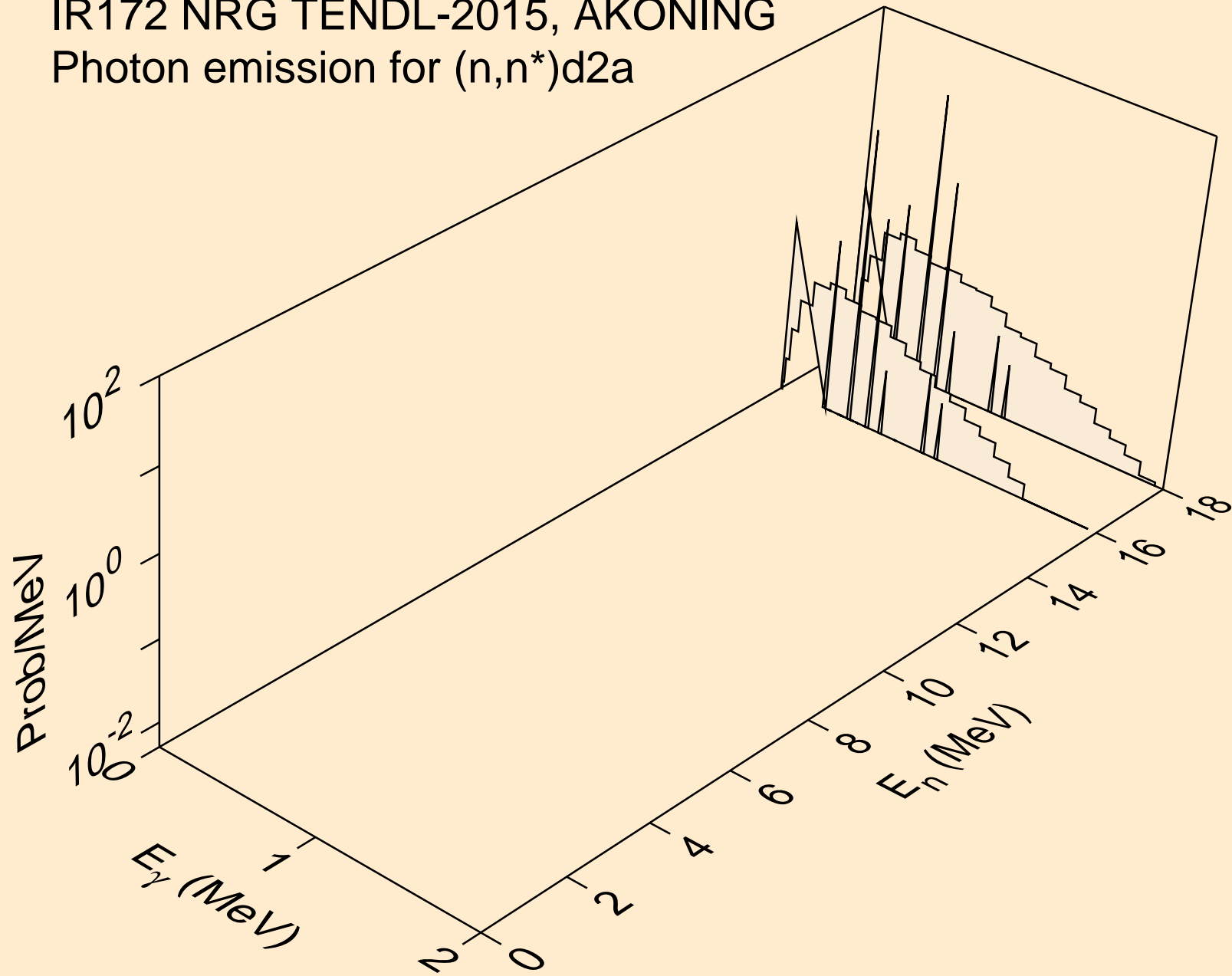

IR172 NRG TENDL-2015, AKONING
Photon emission for (n,n*)t2a

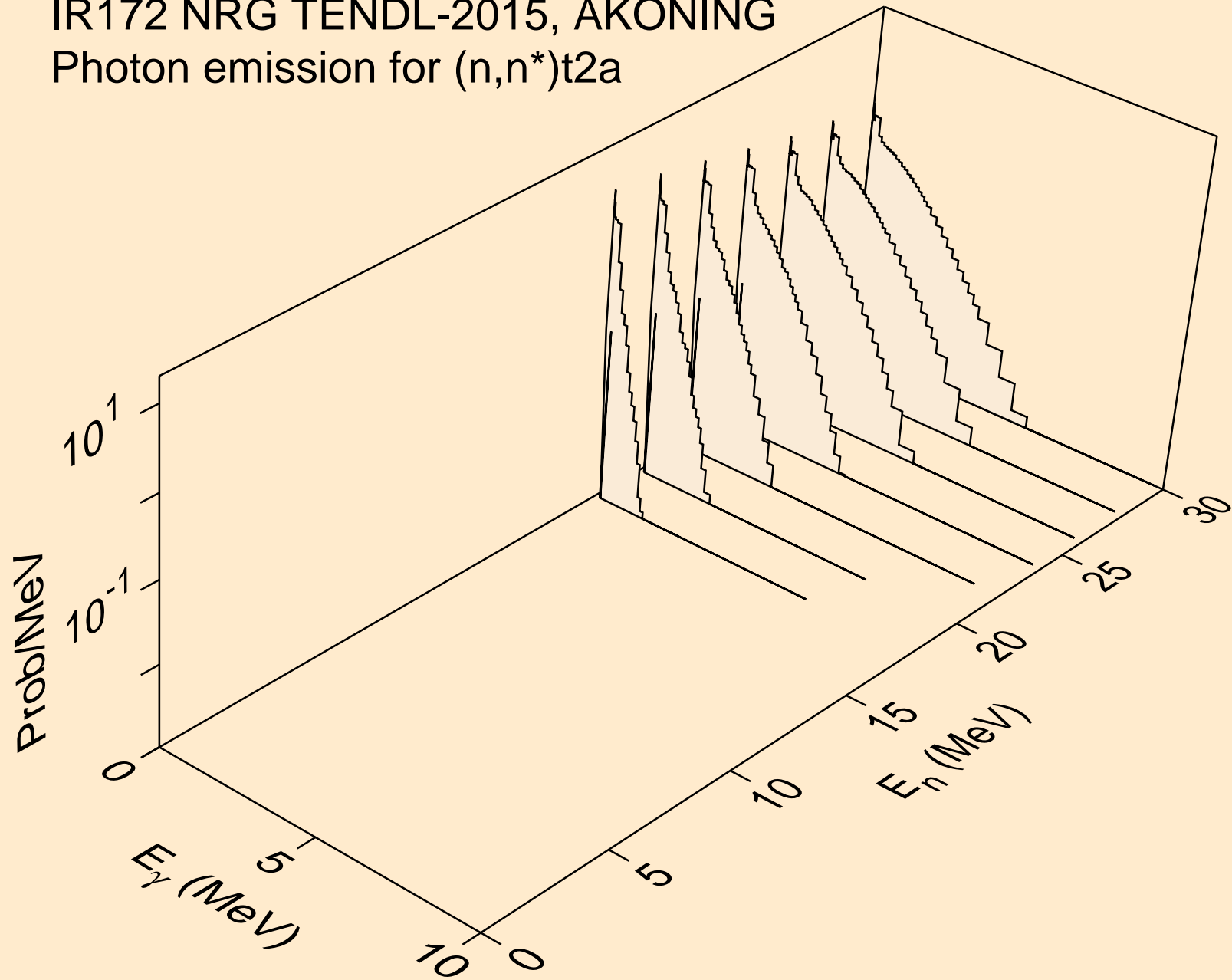

IR172 NRG TENDL-2015, AKONING
Photon emission for (n,2np)

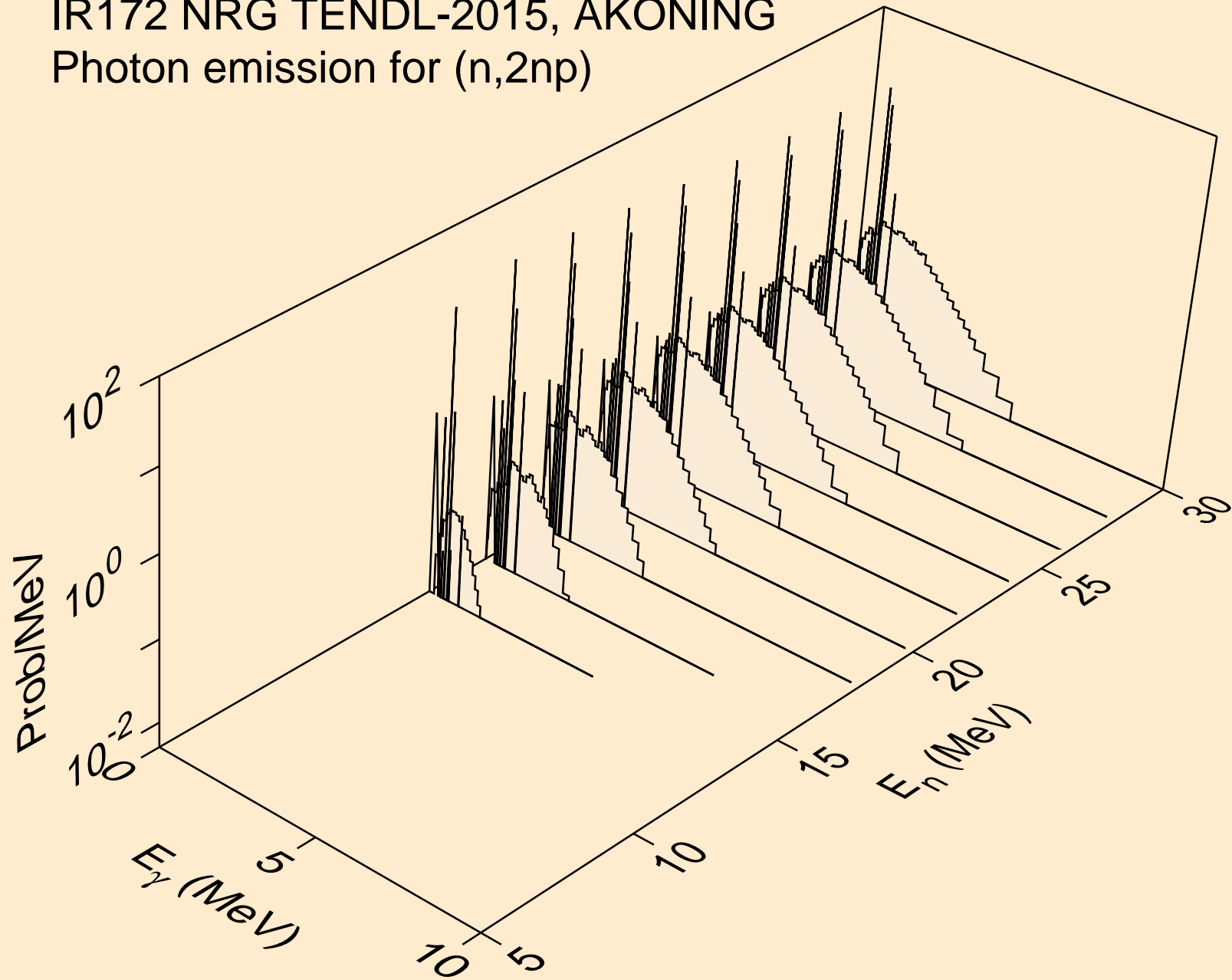

IR172 NRG TENDL-2015, AKONING
Photon emission for (n,3np)

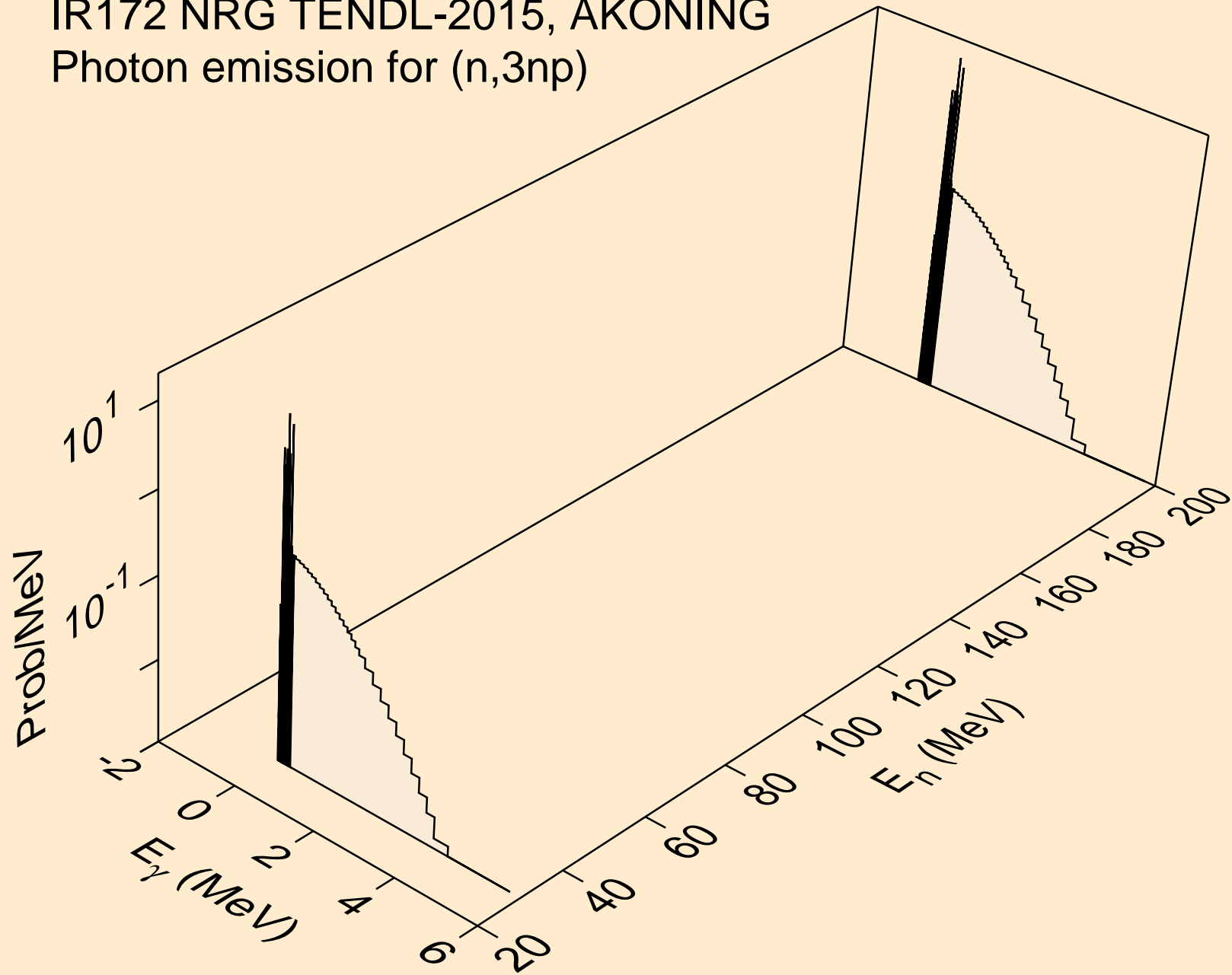

IR172 NRG TENDL-2015, AKONING
Photon emission for (n,2np)

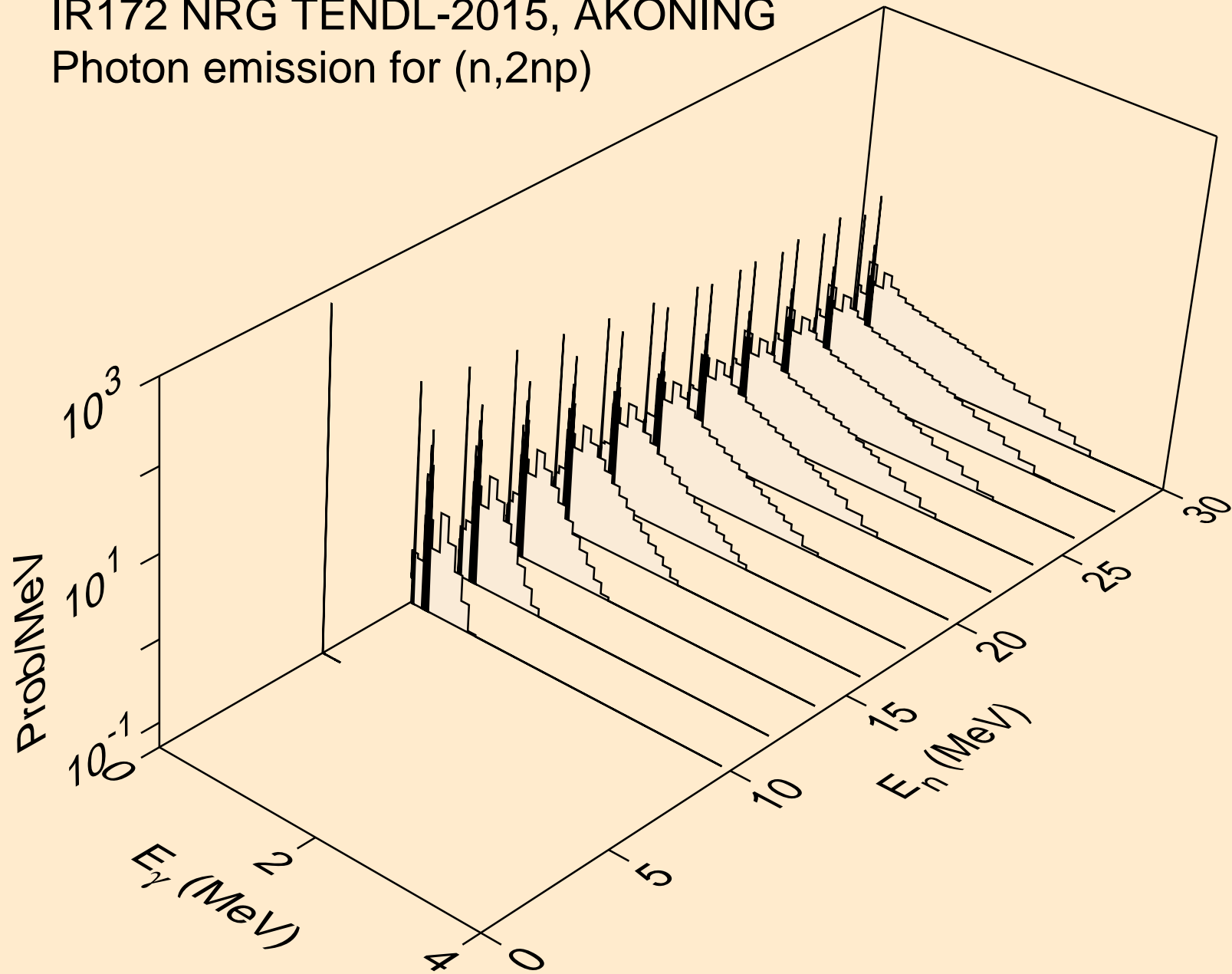

IR172 NRG TENDL-2015, AKONING
Photon emission for (n,npa)

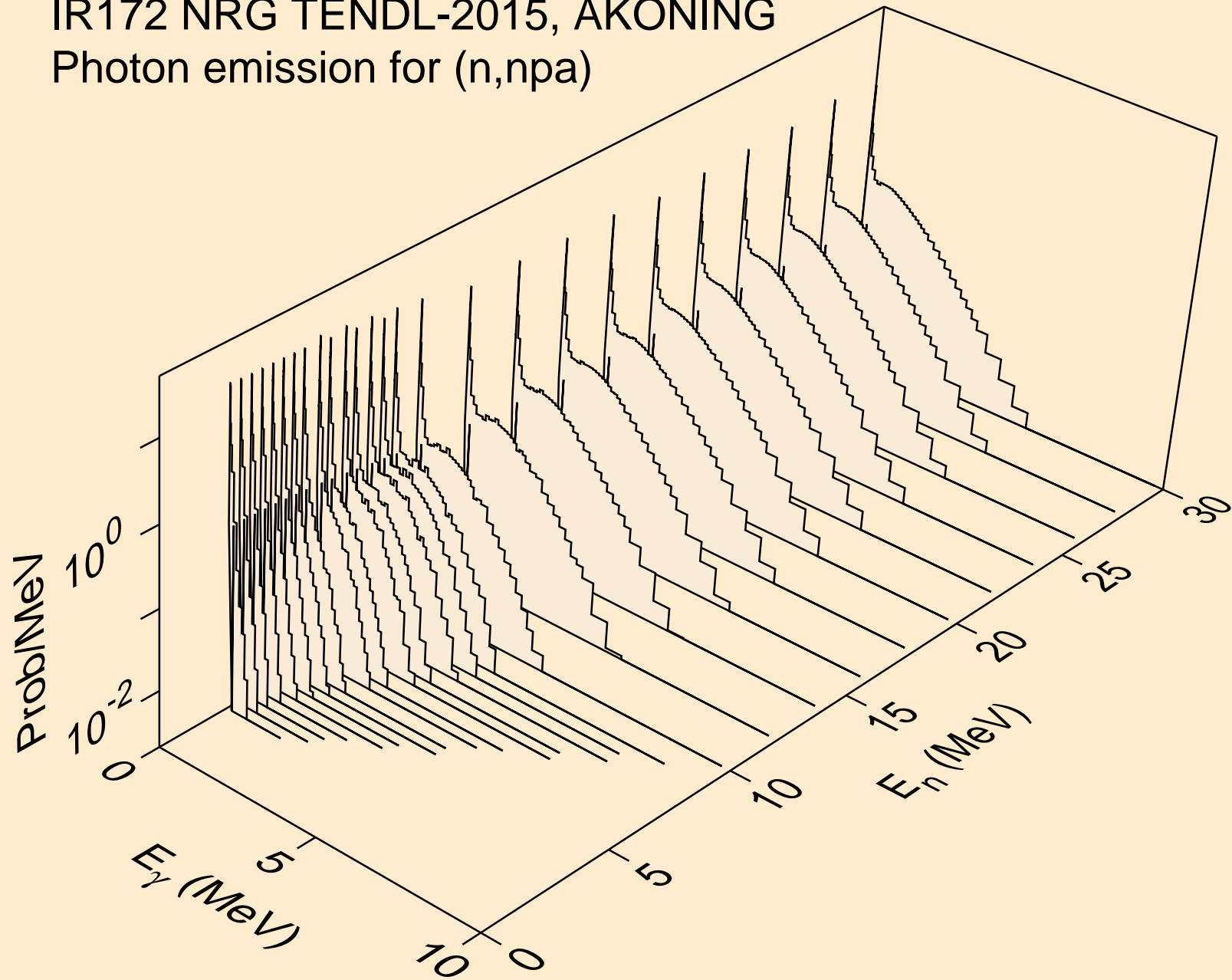

IR172 NRG TENDL-2015, AKONING
Photon emission for (n,n*c)

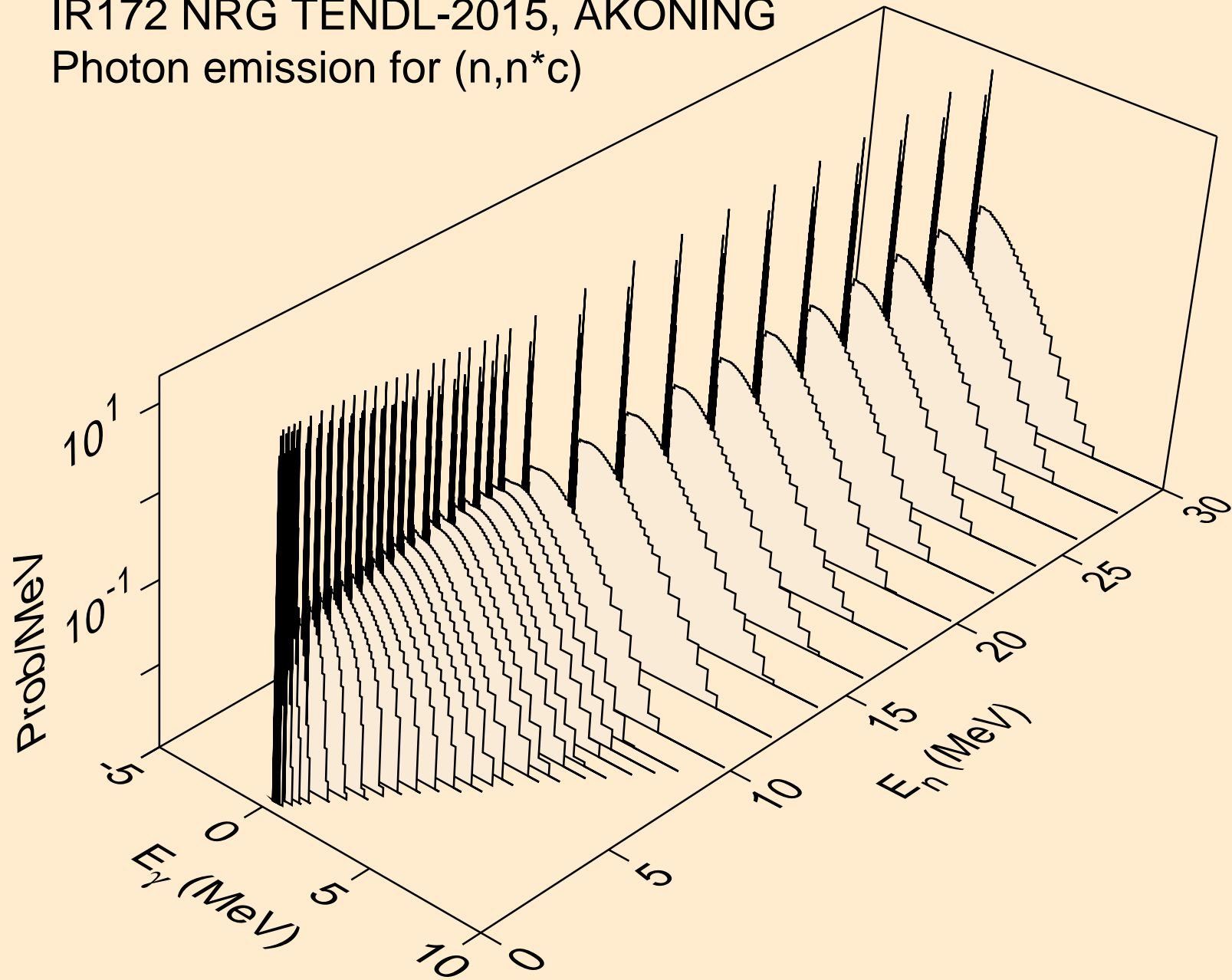

IR172 NRG TENDL-2015, AKONING
Photon emission for (n,gma)

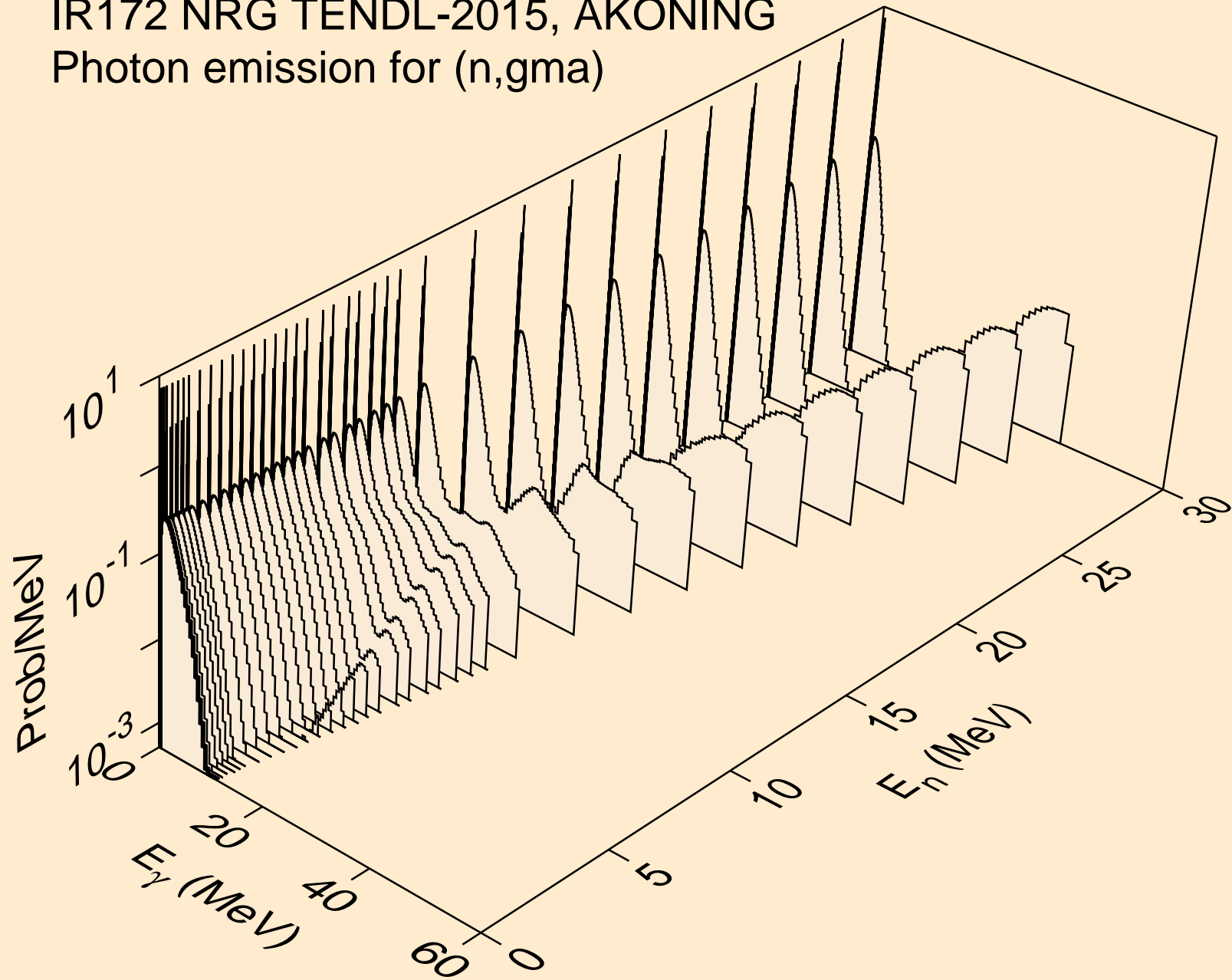

IR172 NRG TENDL-2015, AKONING
Photon emission for (n,p)

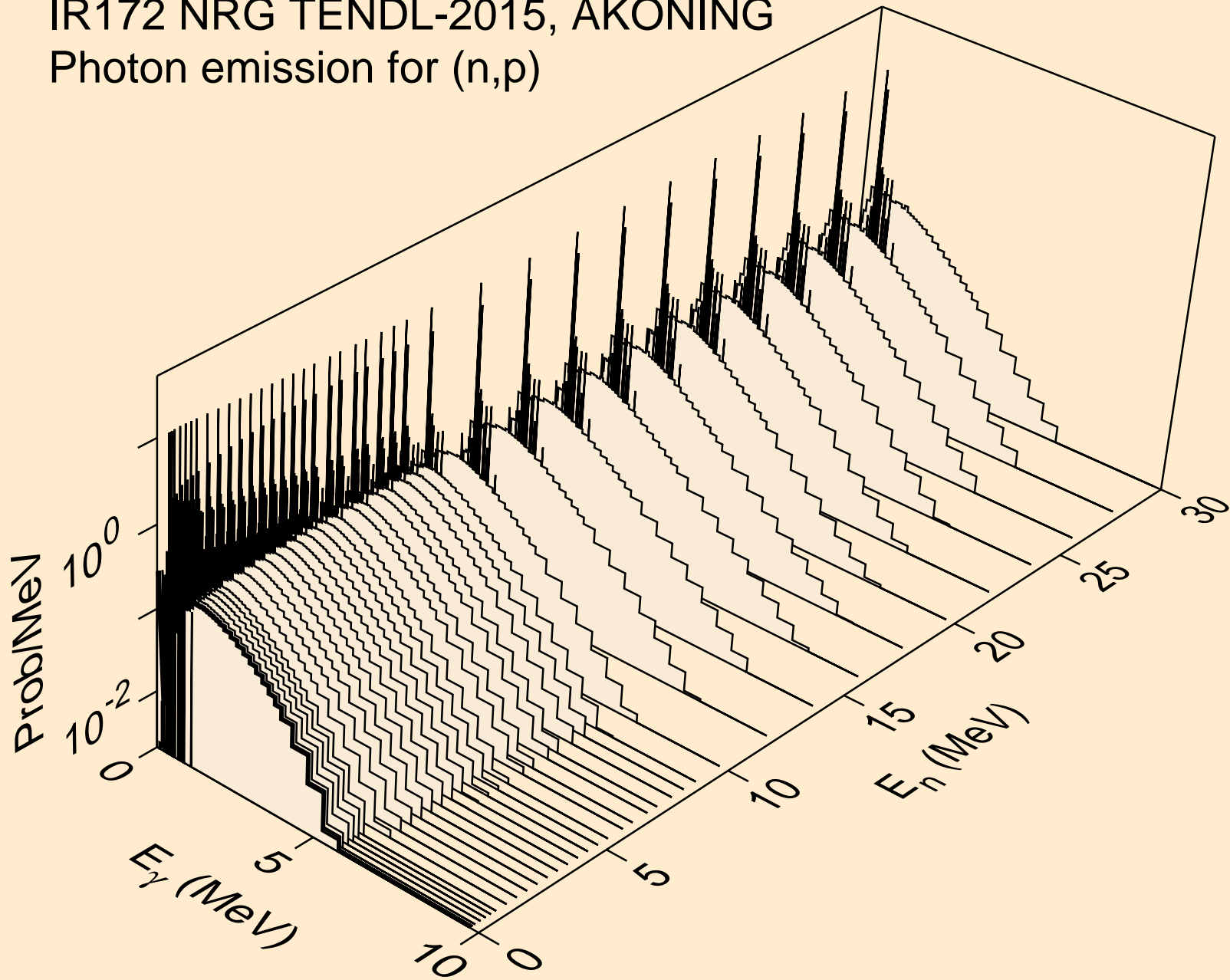

IR172 NRG TENDL-2015, AKONING
Photon emission for (n,d)

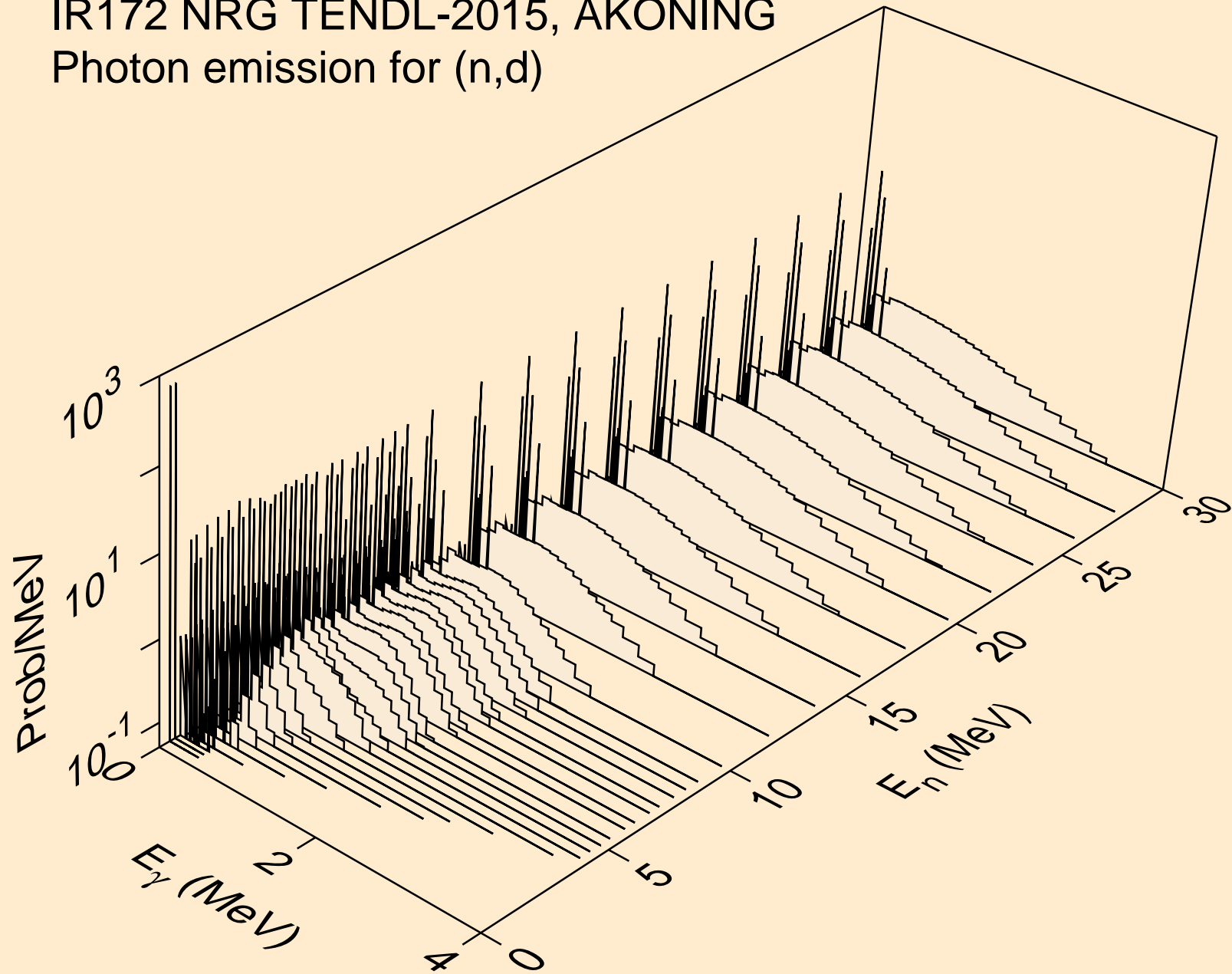

IR172 NRG TENDL-2015, AKONING
Photon emission for (n,t)

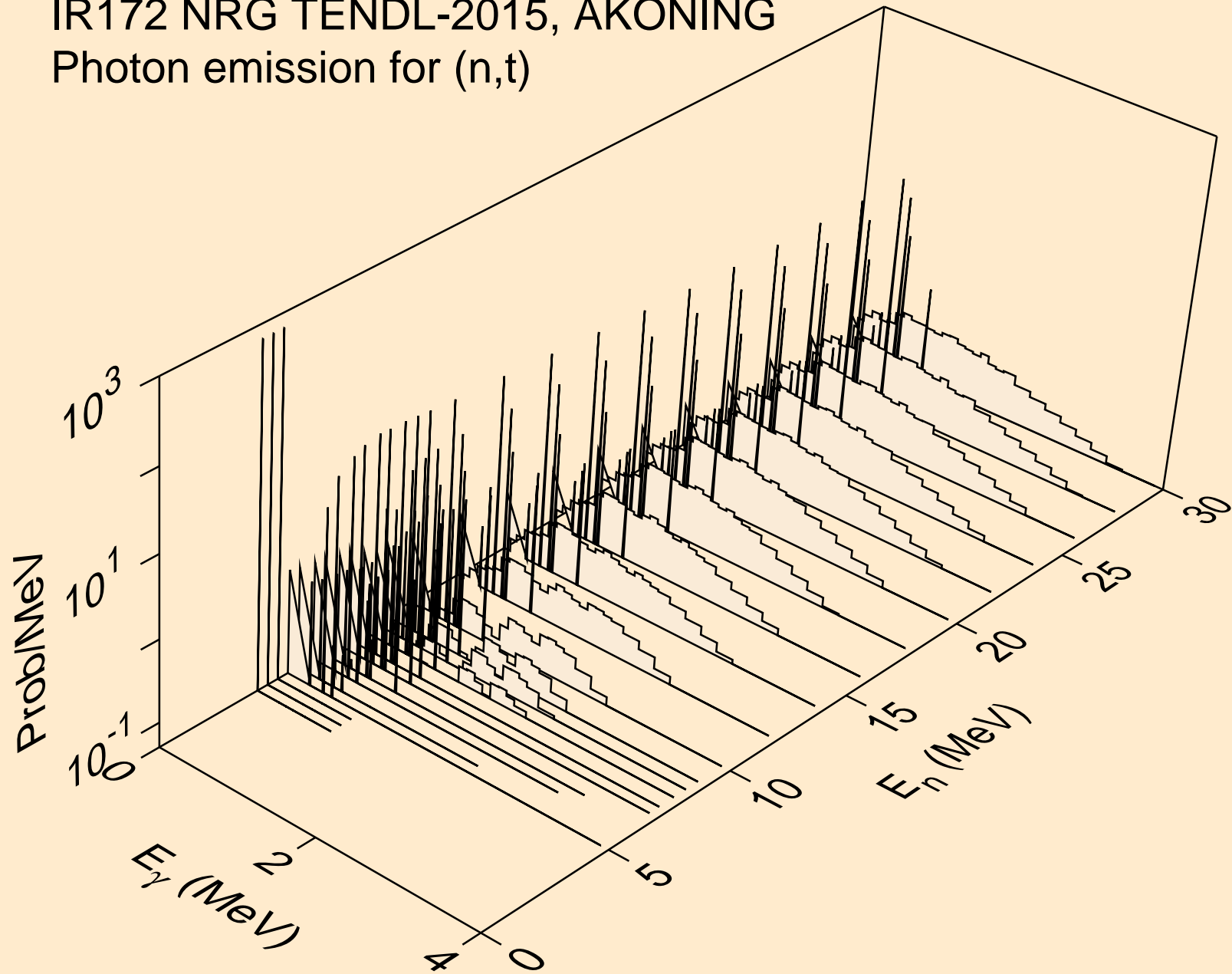

IR172 NRG TENDL-2015, AKONING
Photon emission for (n,he3)

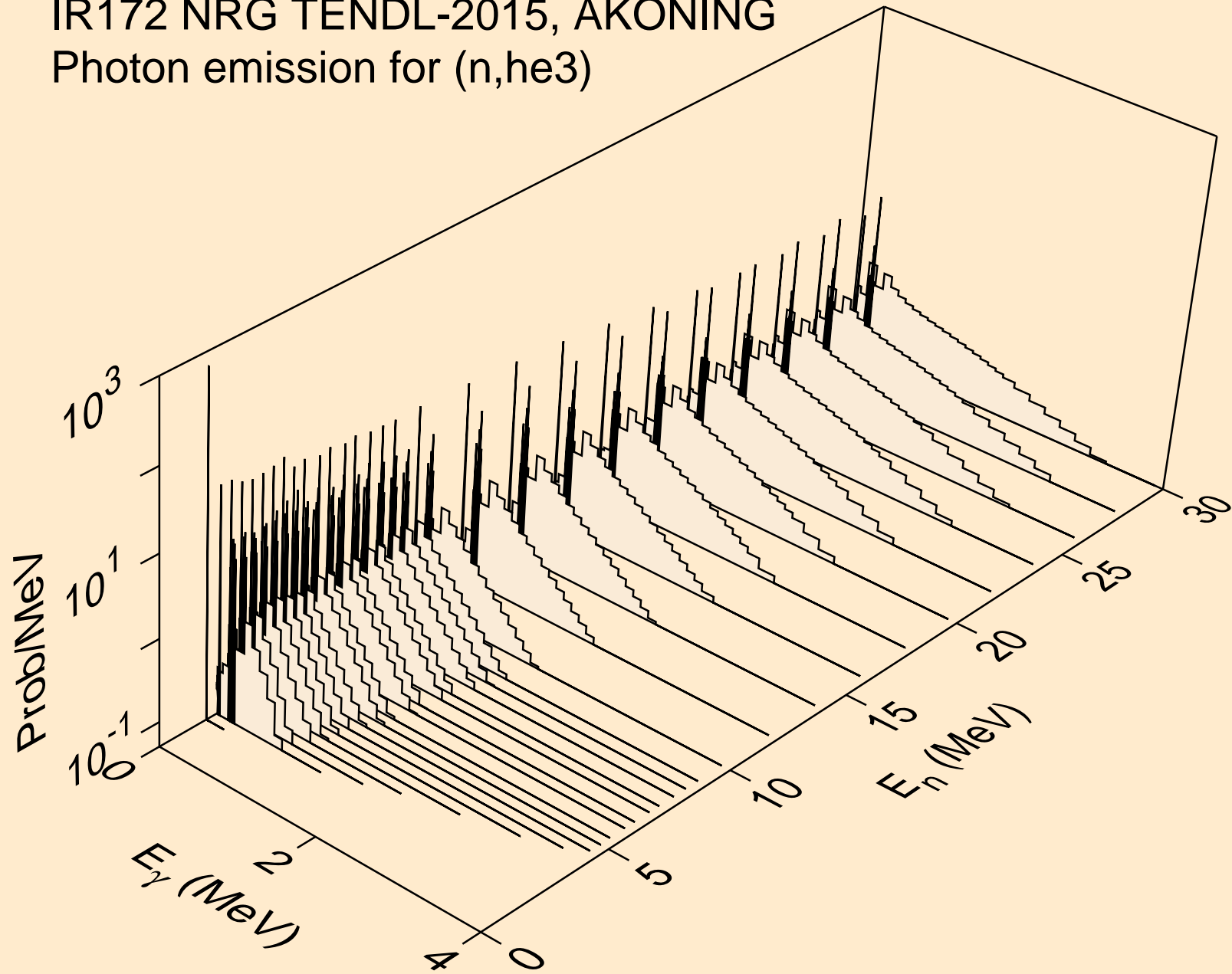

IR172 NRG TENDL-2015, AKONING
Photon emission for (n,a)

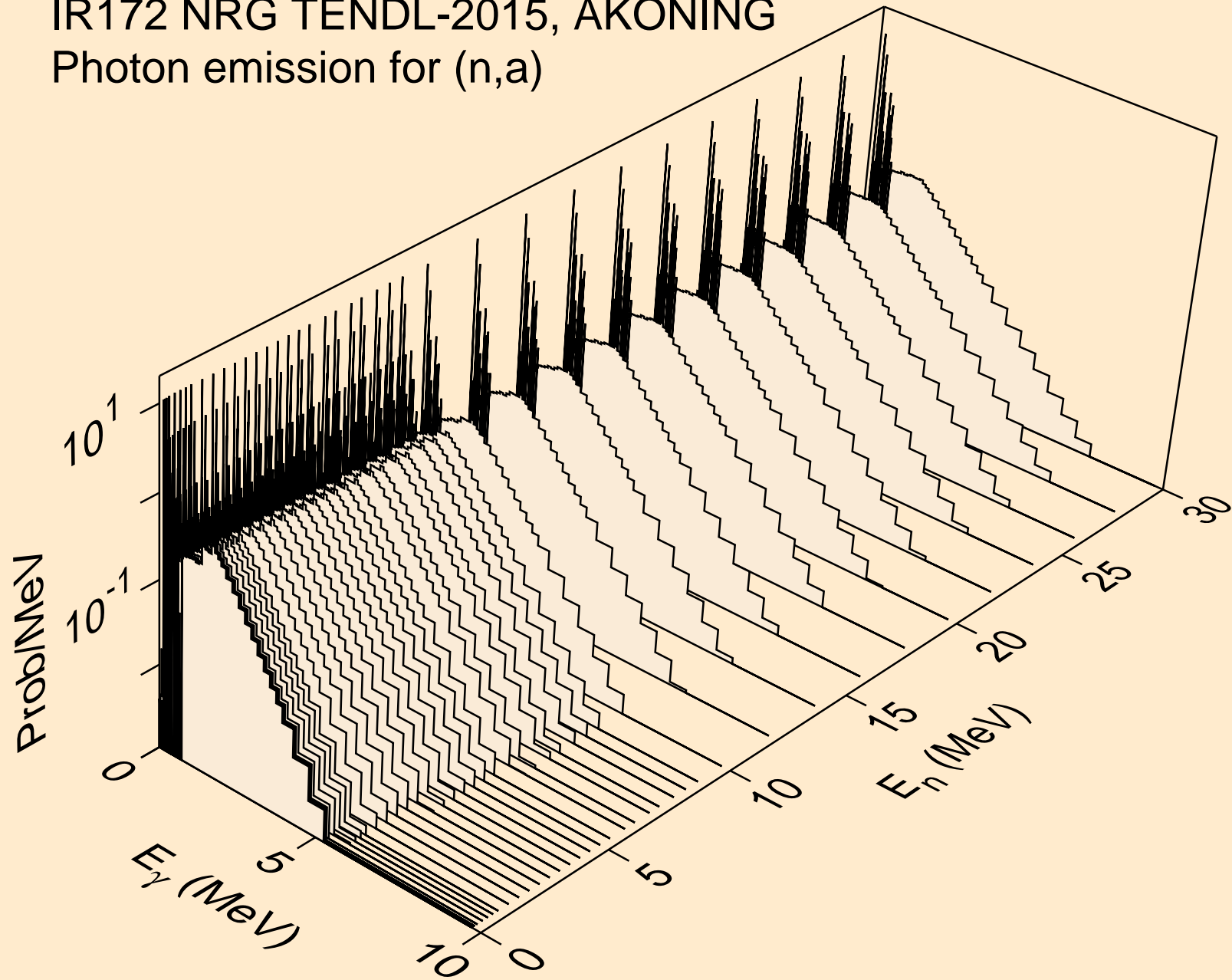

IR172 NRG TENDL-2015, AKONING
Photon emission for (n,2a)

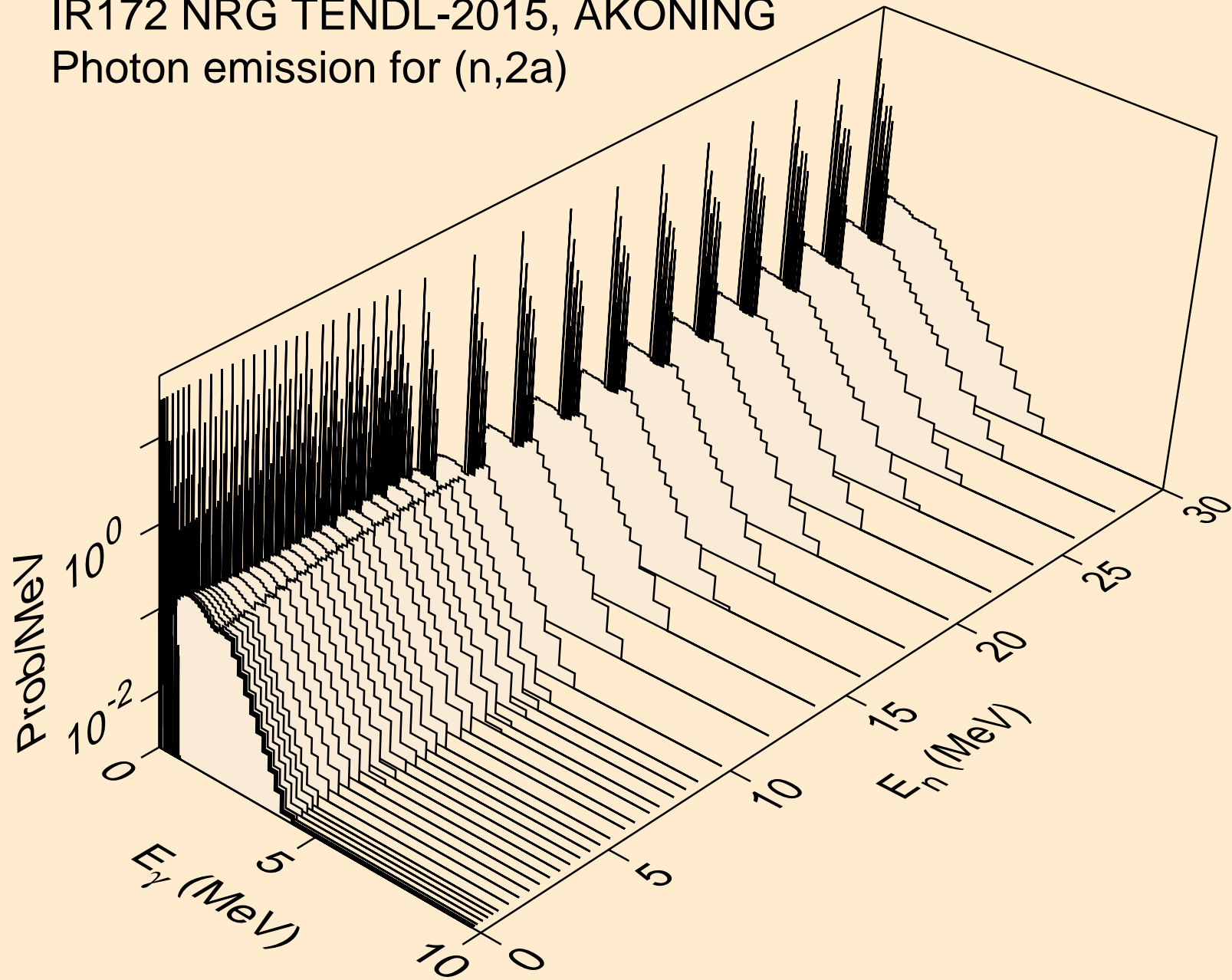

IR172 NRG TENDL-2015, AKONING
Photon emission for (n,3a)

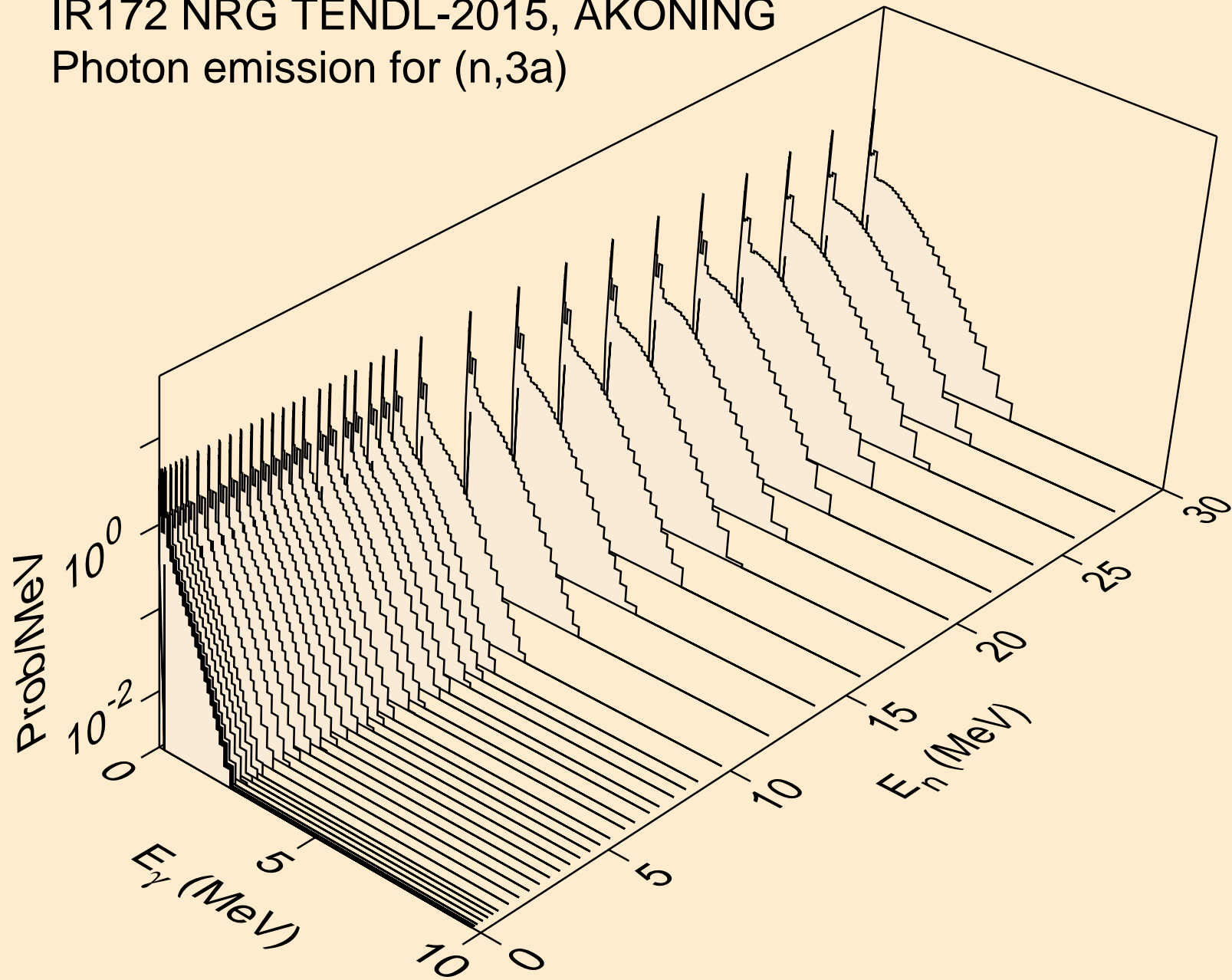

IR172 NRG TENDL-2015, AKONING
Photon emission for (n,2p)

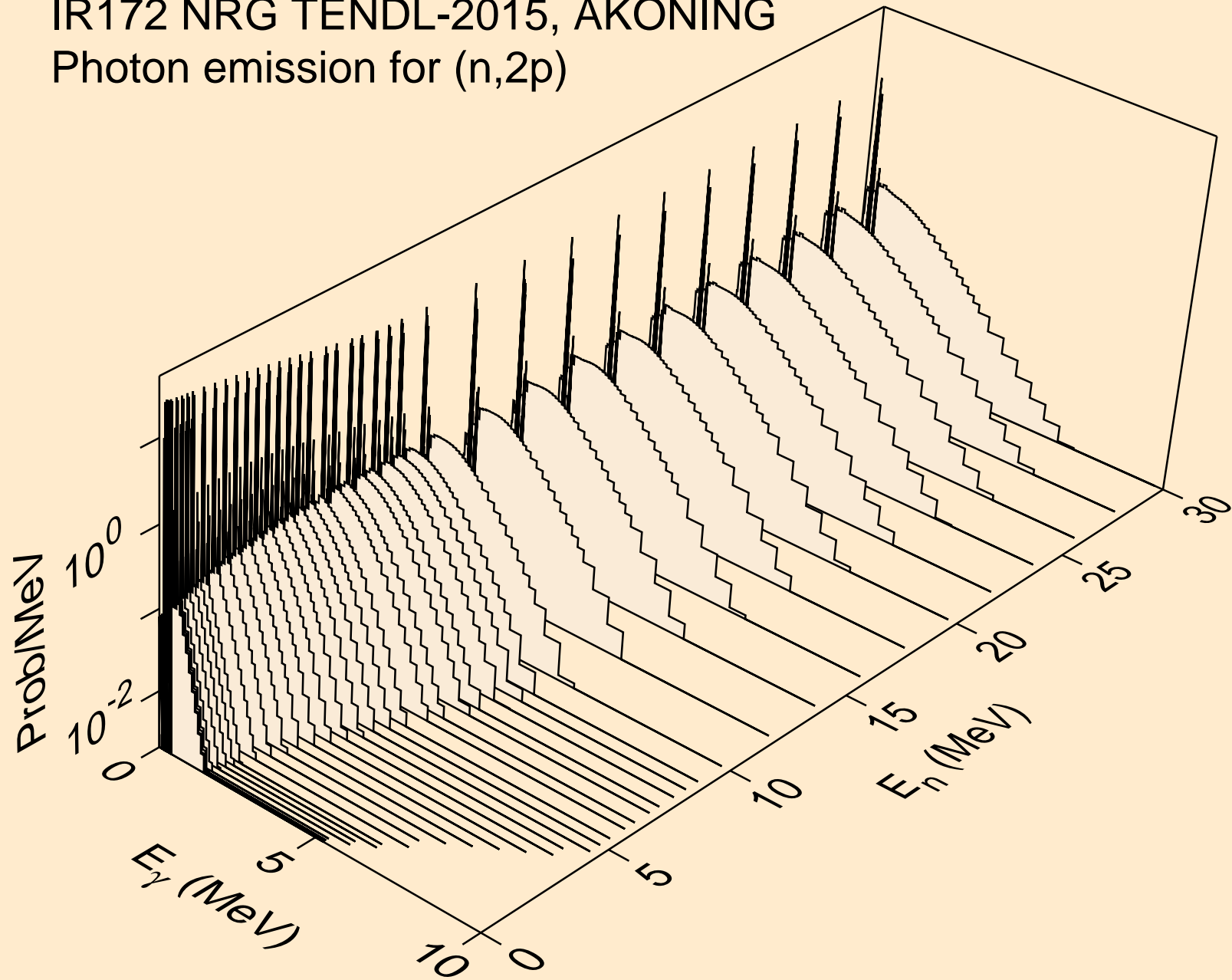

IR172 NRG TENDL-2015, AKONING
Photon emission for (n,p α)

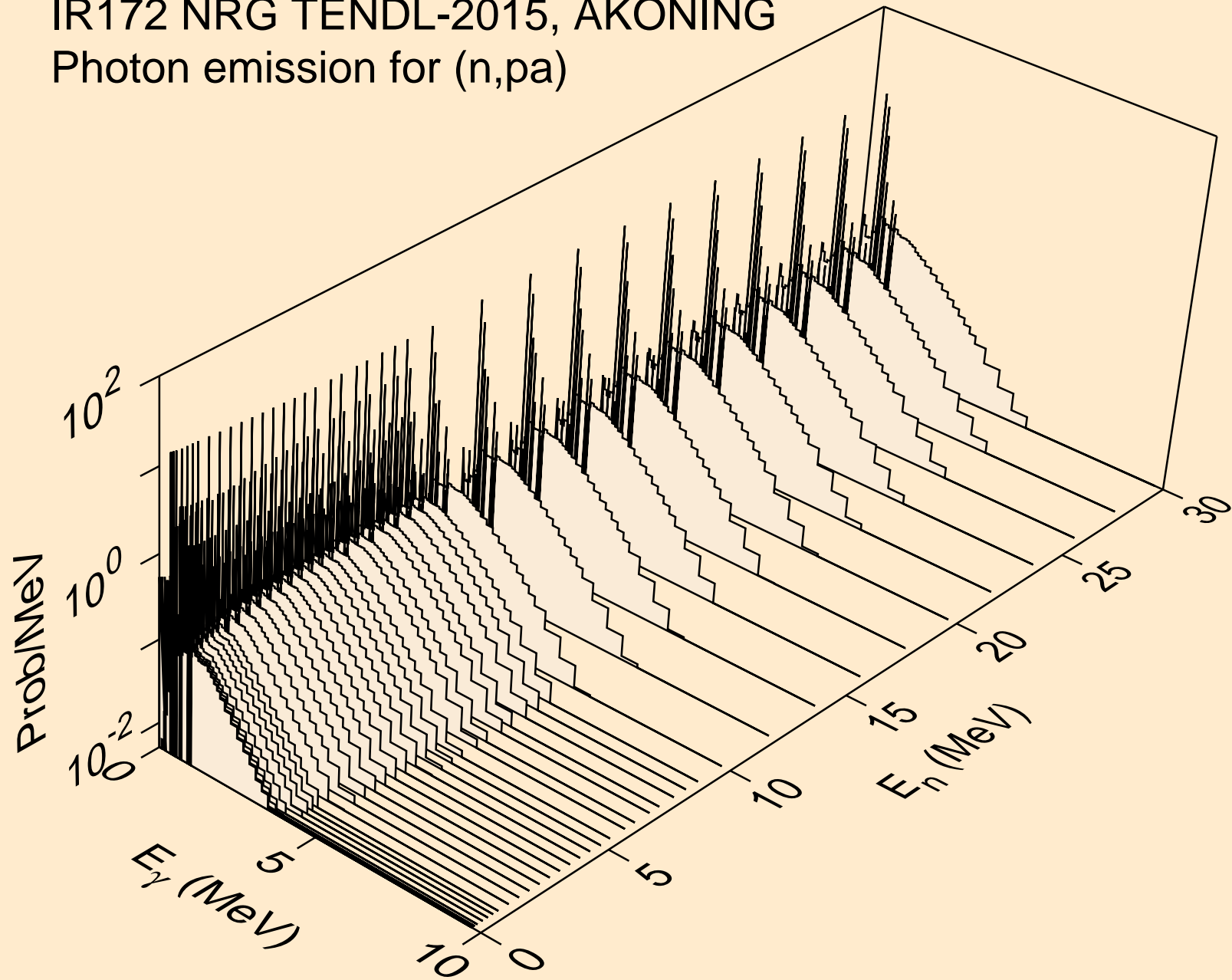

IR172 NRG TENDL-2015, AKONING
Photon emission for (n,t2a)

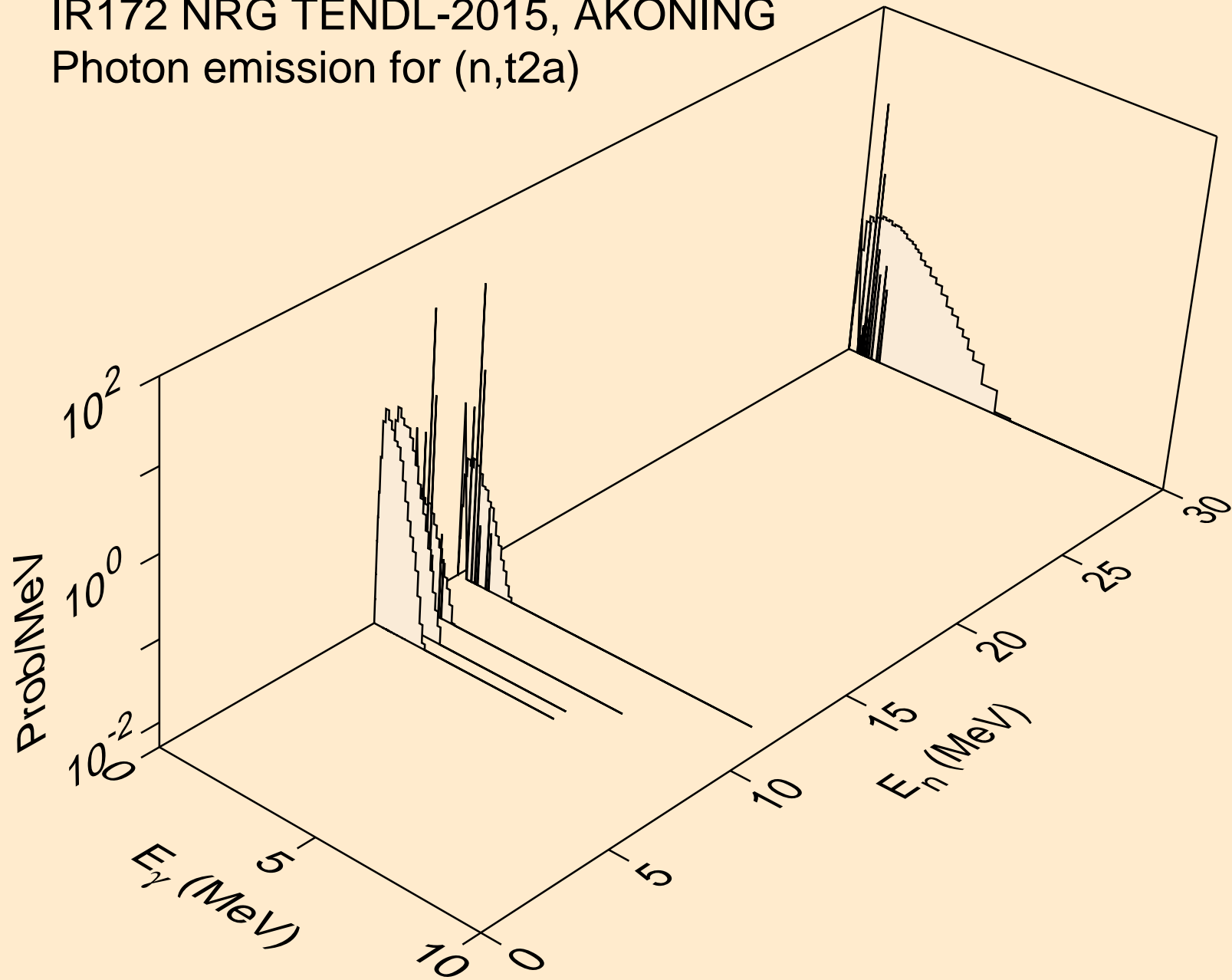

IR172 NRG TENDL-2015, AKONING
Photon emission for (n,d2a)

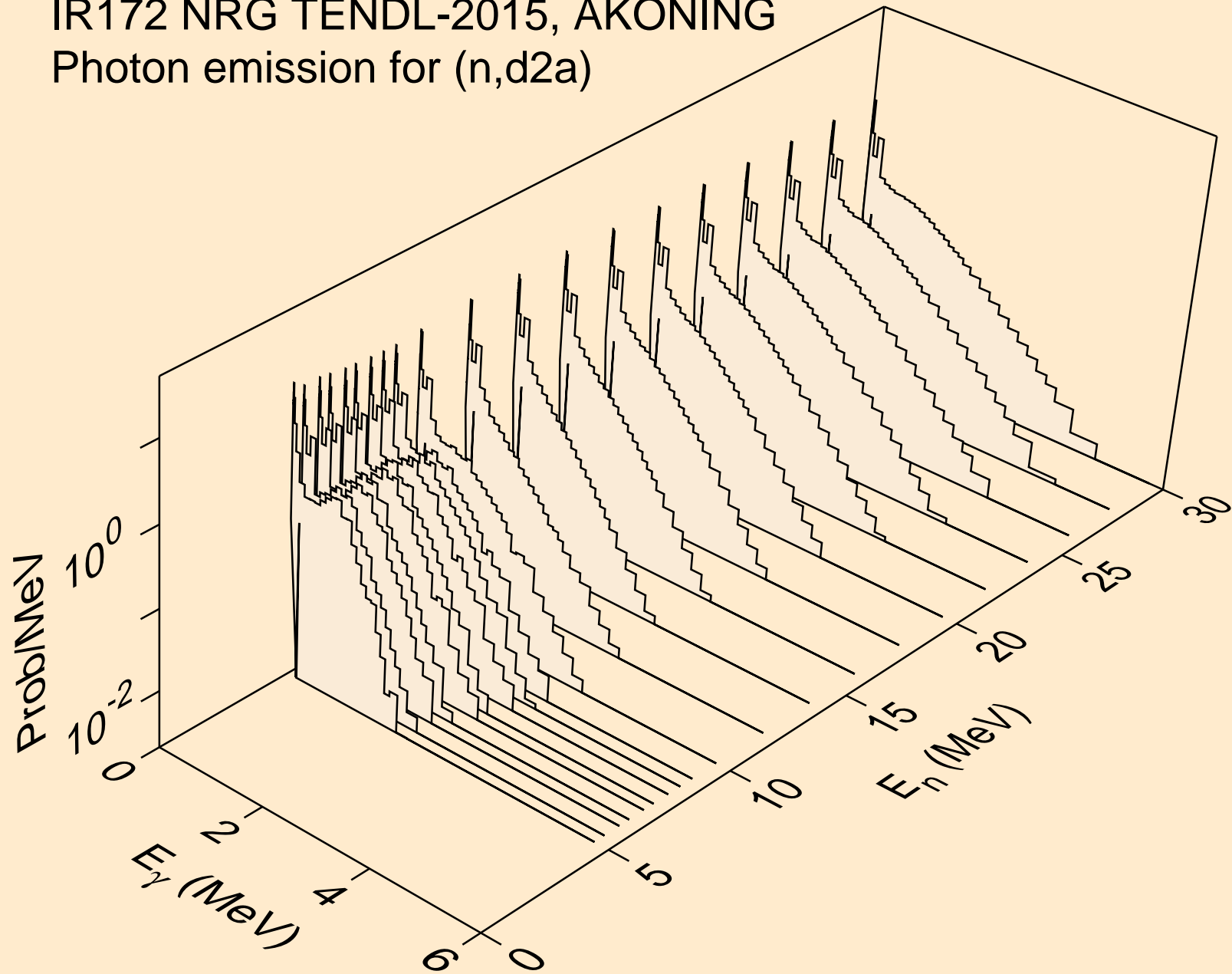

IR172 NRG TENDL-2015, AKONING
Photon emission for (n,pd)

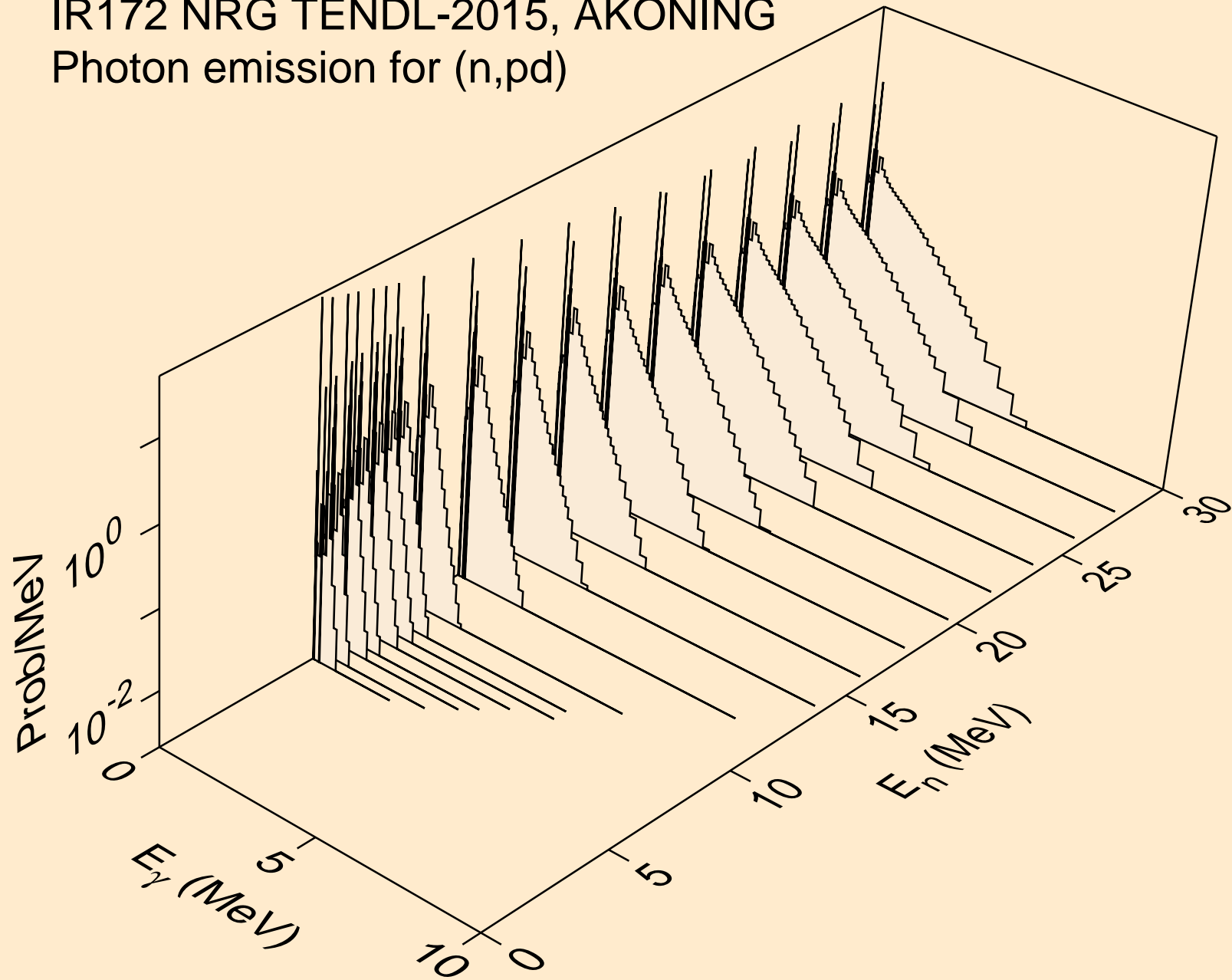

IR172 NRG TENDL-2015, AKONING
Photon emission for (n,pt)

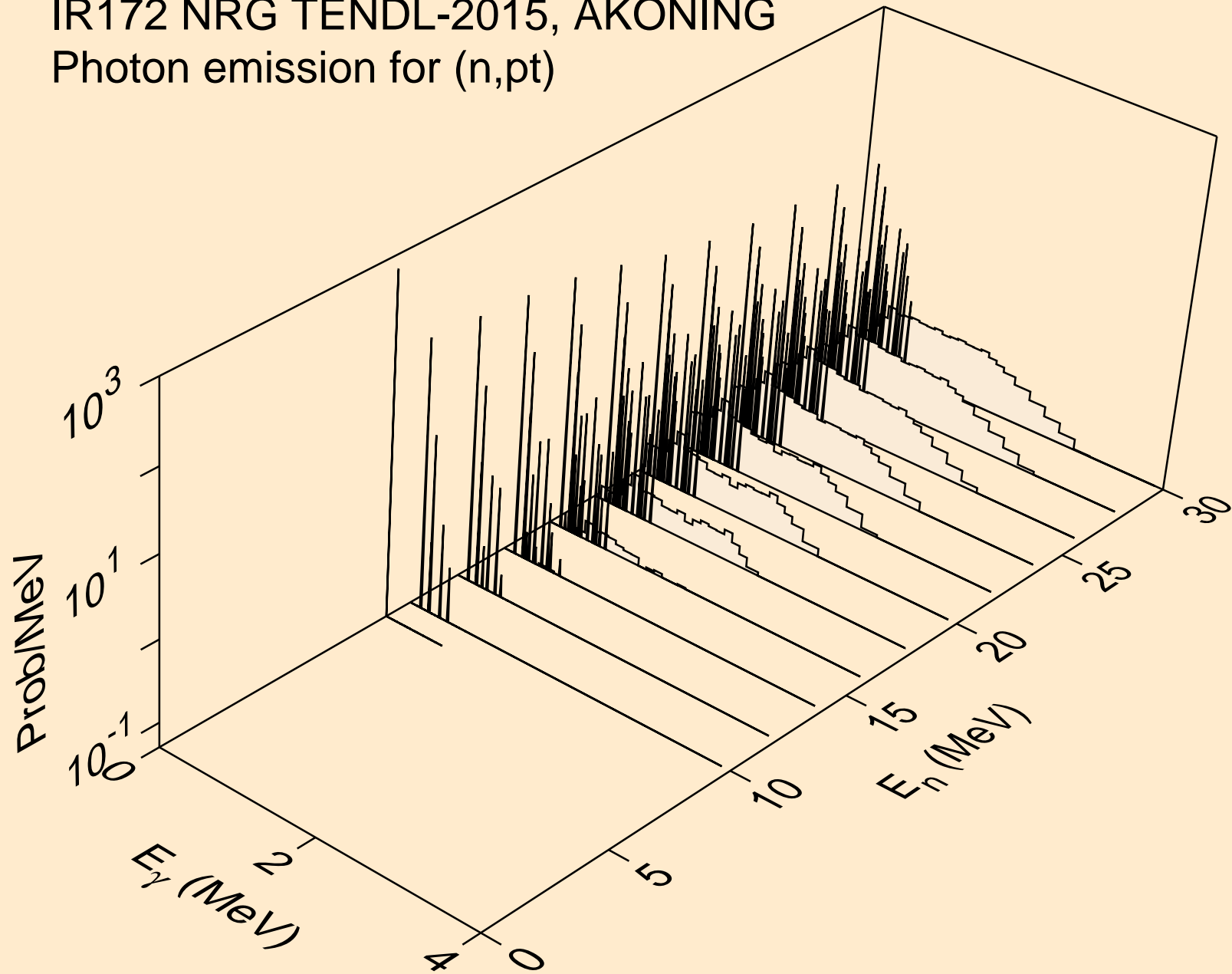

IR172 NRG TENDL-2015, AKONING
Photon emission for (n,da)

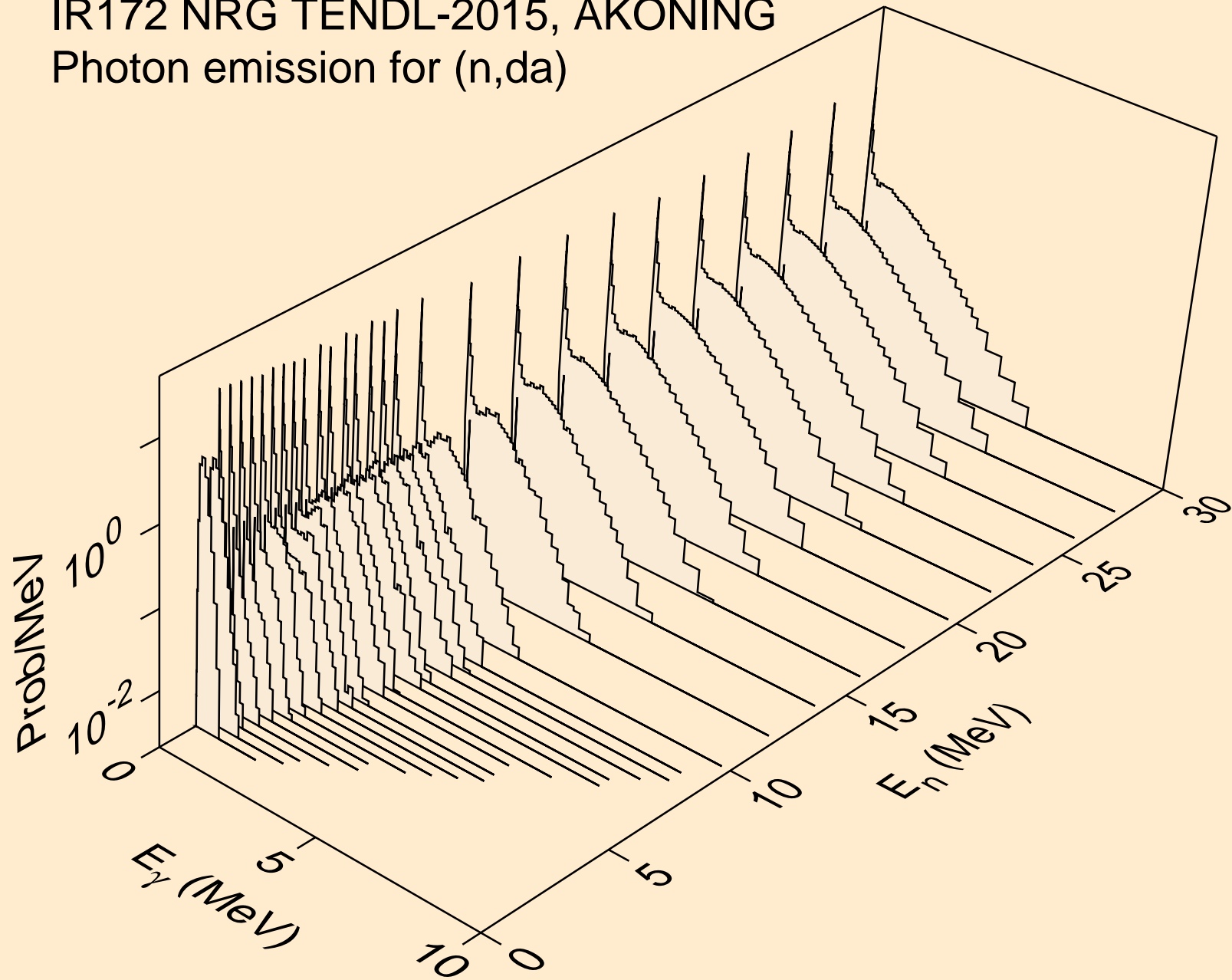

IR172 NRG TENDL-2015, AKONING
thermal capture photon spectrum

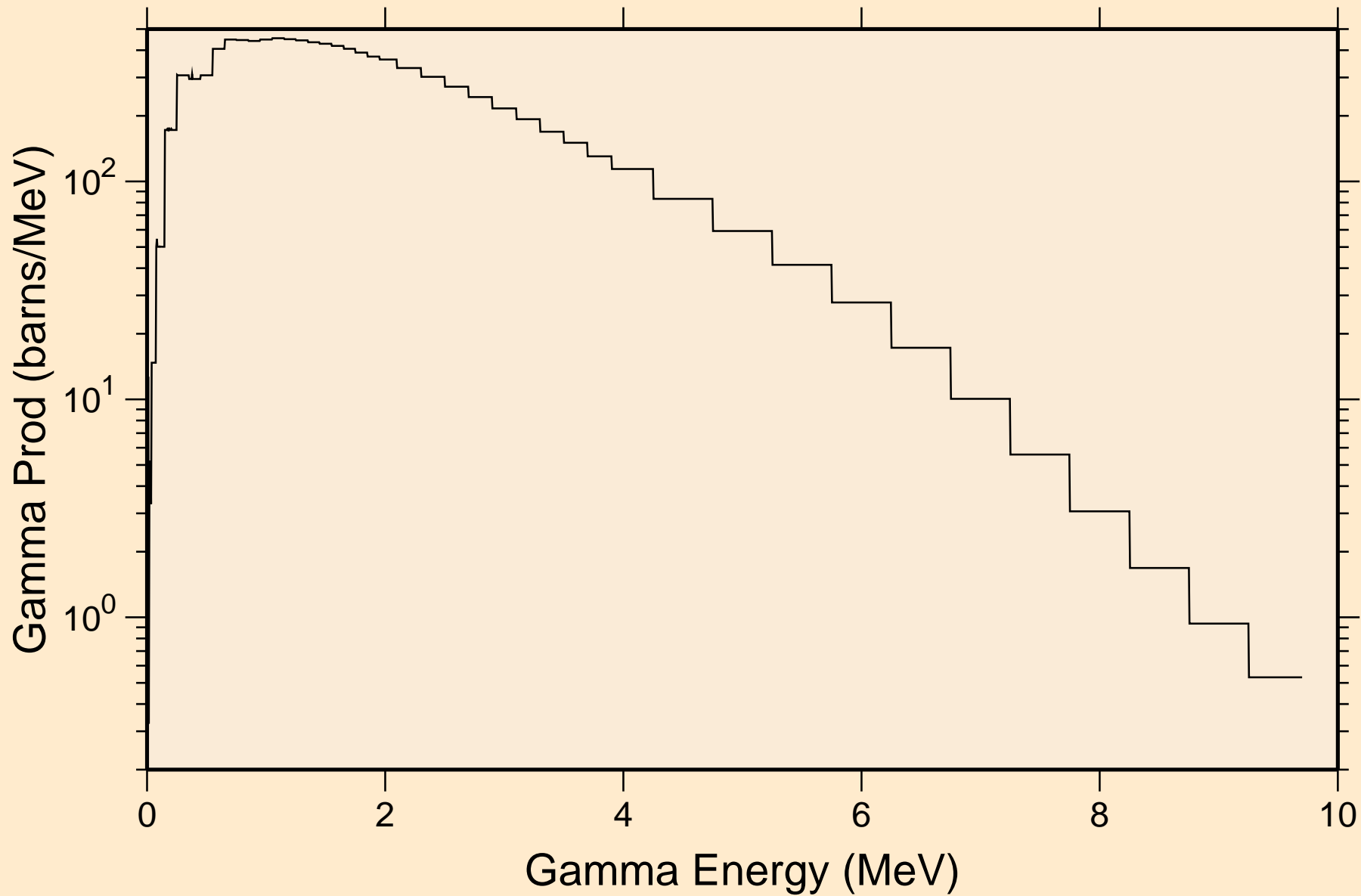

IR172 NRG TENDL-2015, AKONING
14 MeV photon spectrum

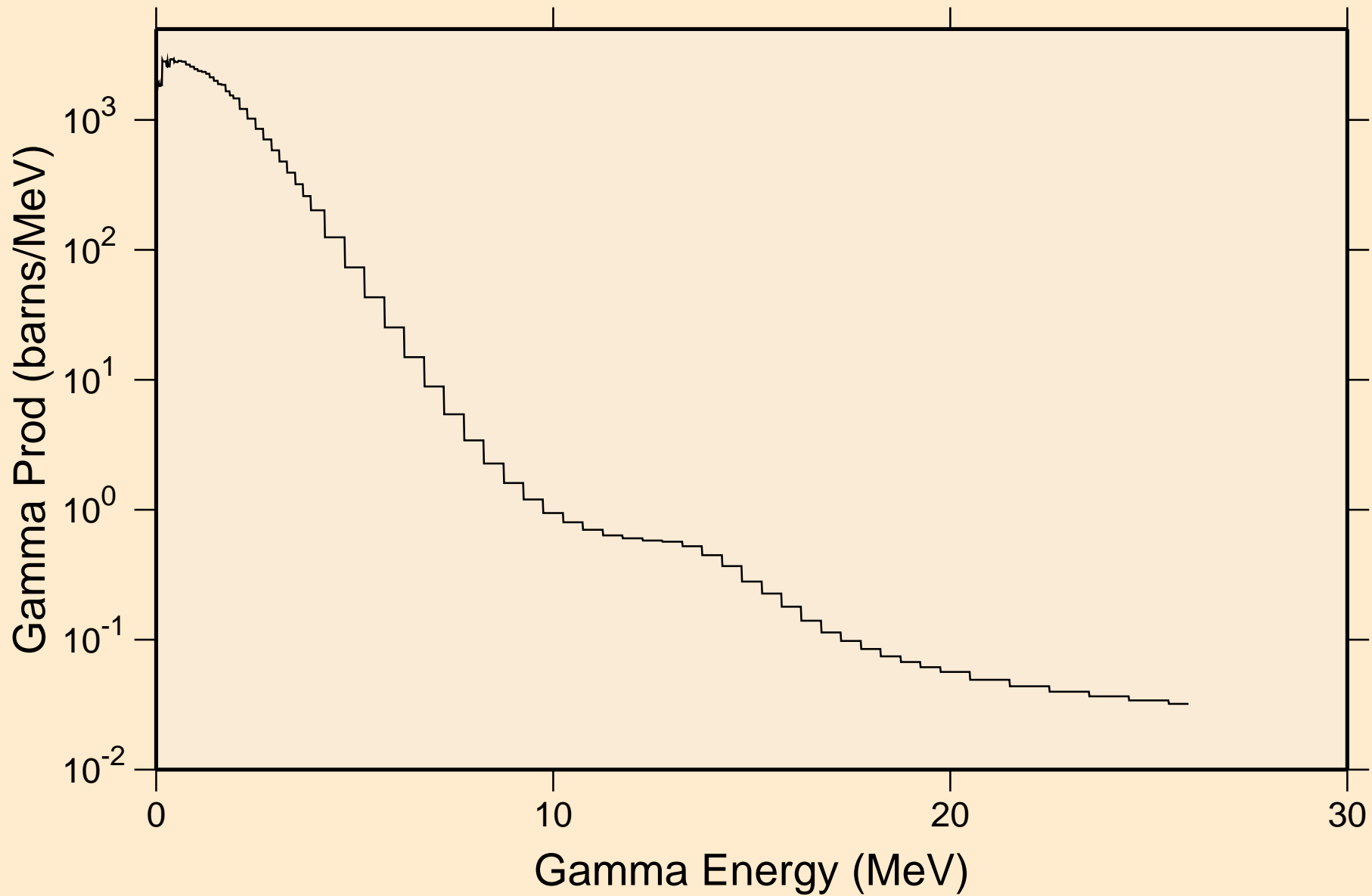

IR172 NRG TENDL-2015, AKONING

Particle heating contributions

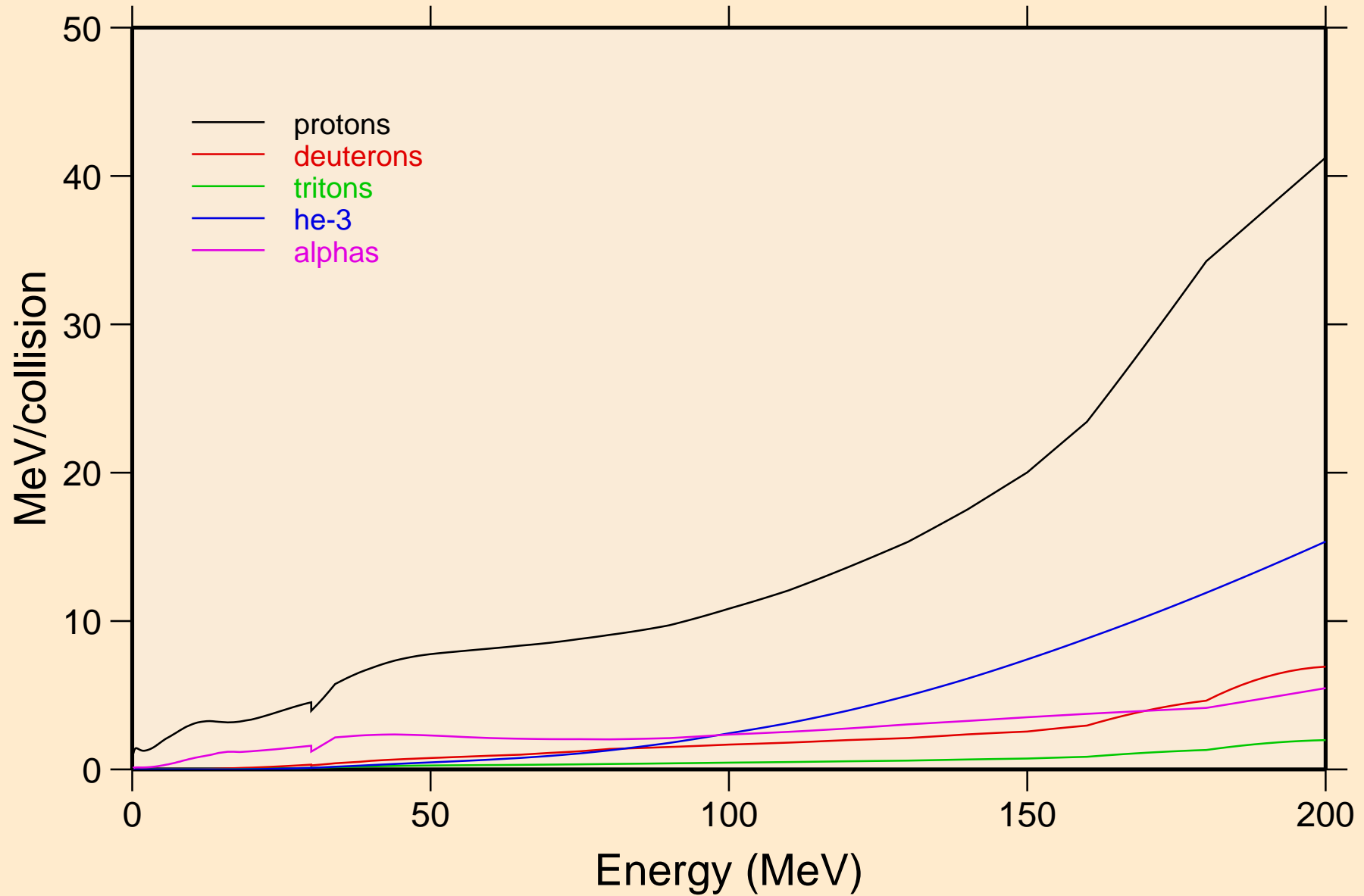

IR172 NRG TENDL-2015, AKONING

Recoil Heating

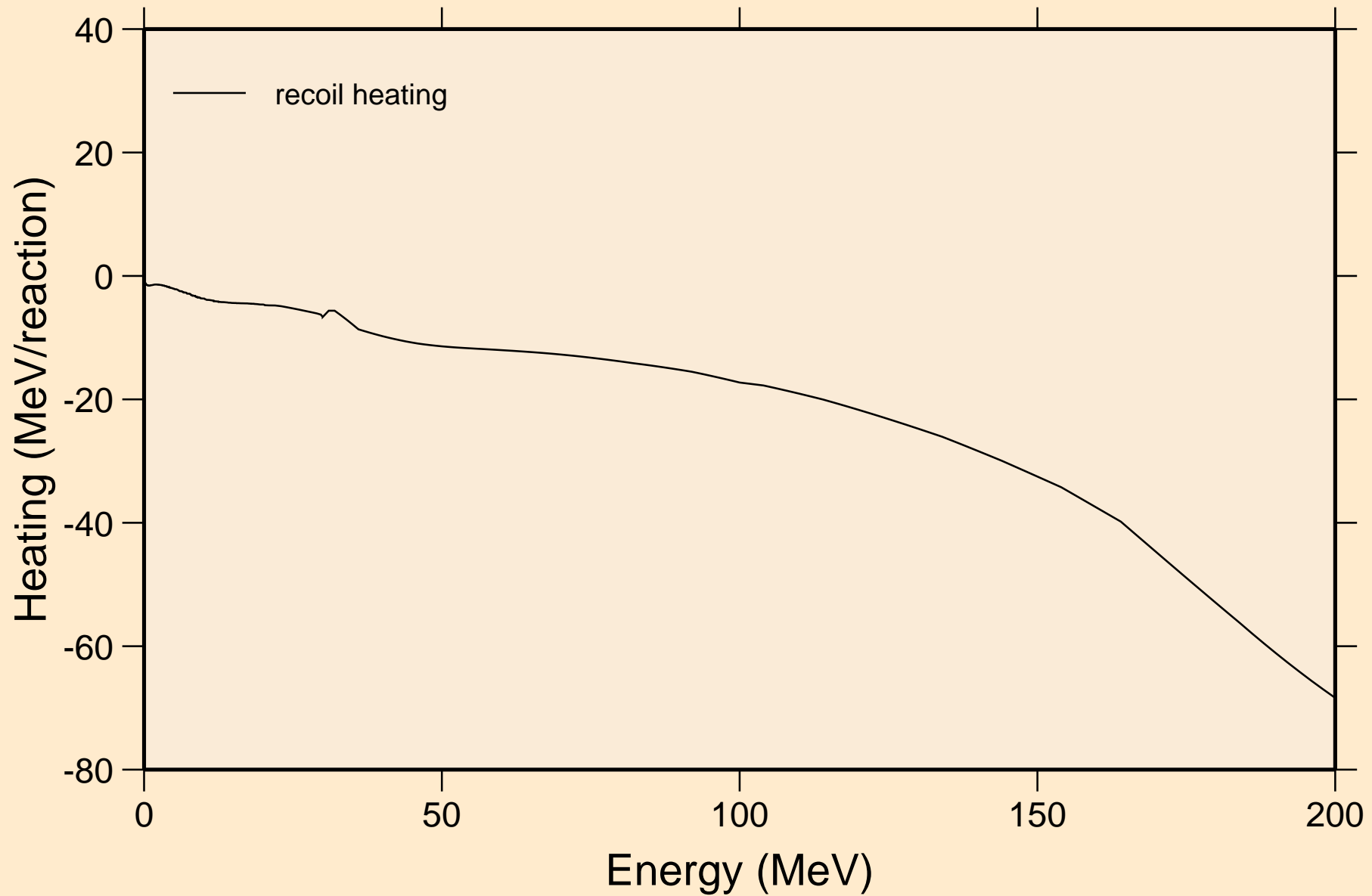

IR172 NRG TENDL-2015, AKONING

Particle production cross sections

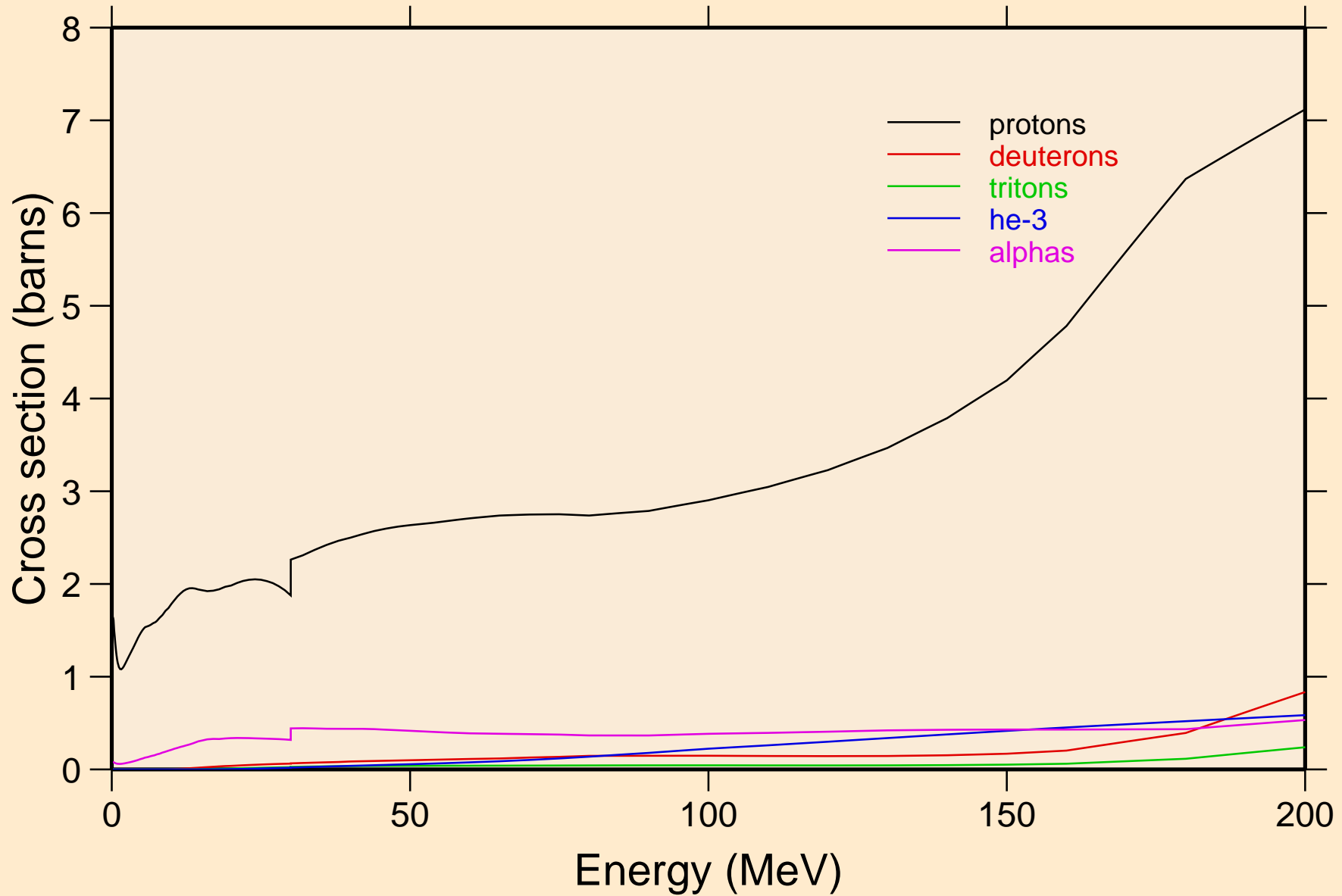

IR172 NRG TENDL-2015, AKONING
protons from (n,x)

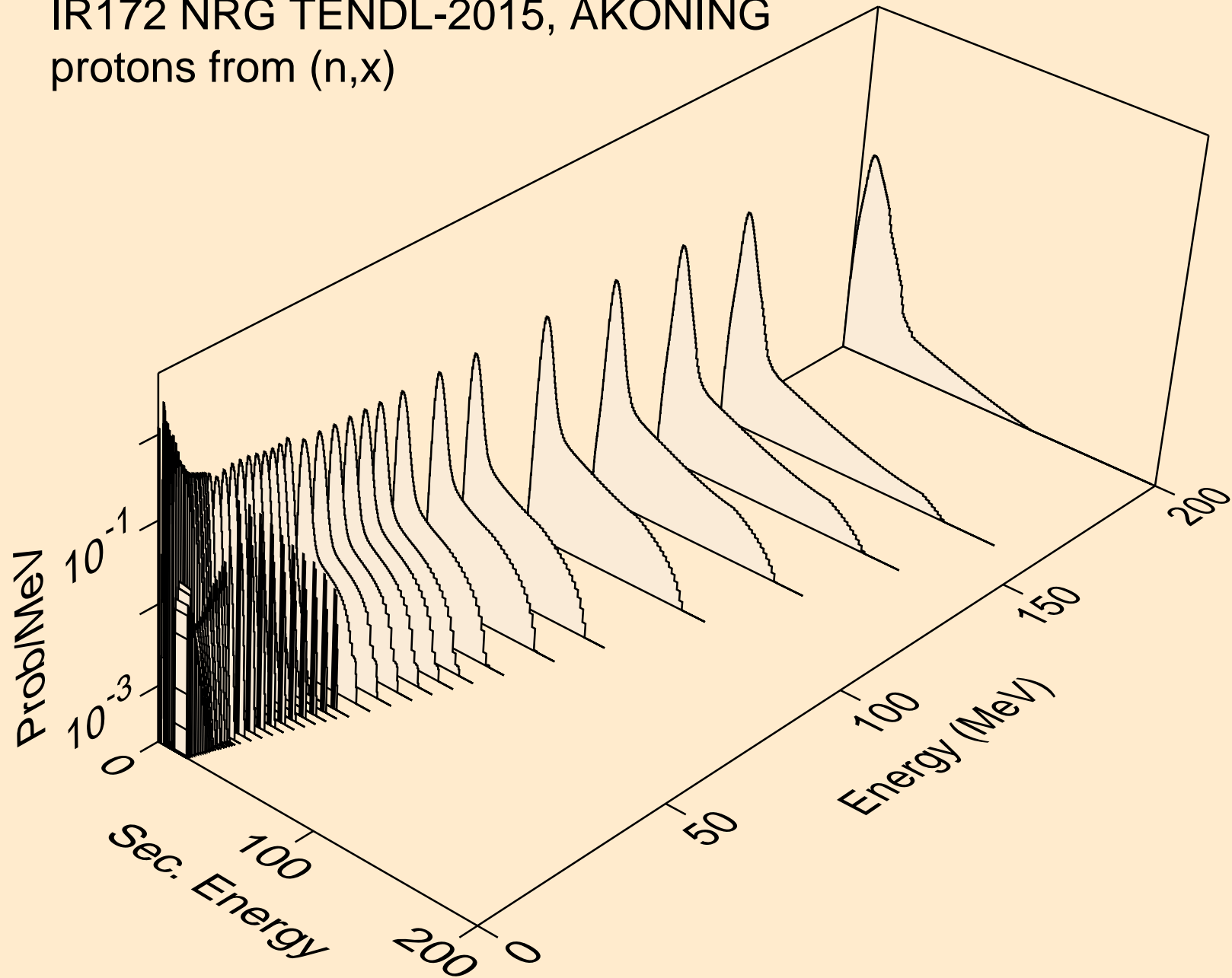

IR172 NRG TENDL-2015, AKONING
protons from (n,n*)p

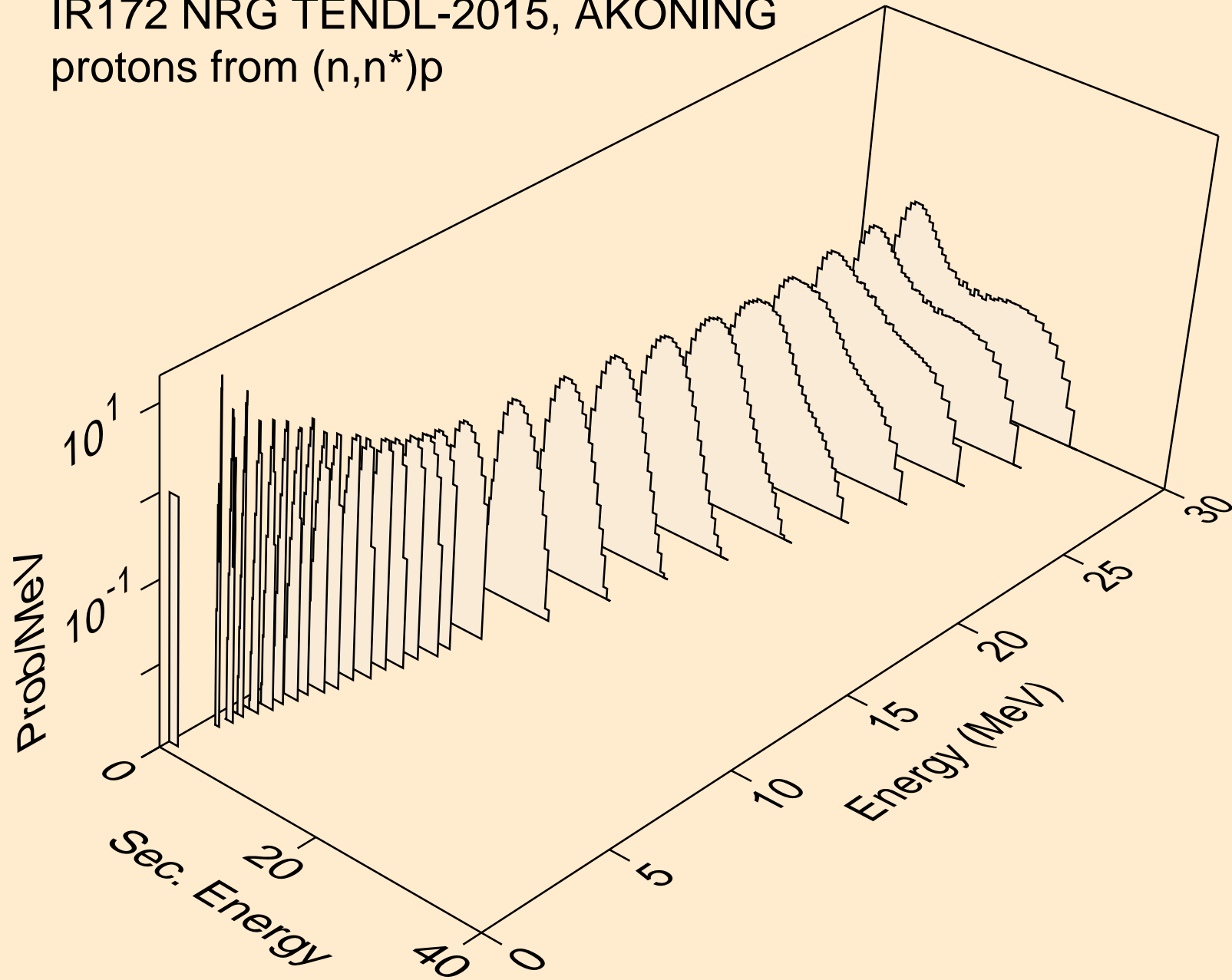

IR172 NRG TENDL-2015, AKONING
protons from (n,2np)

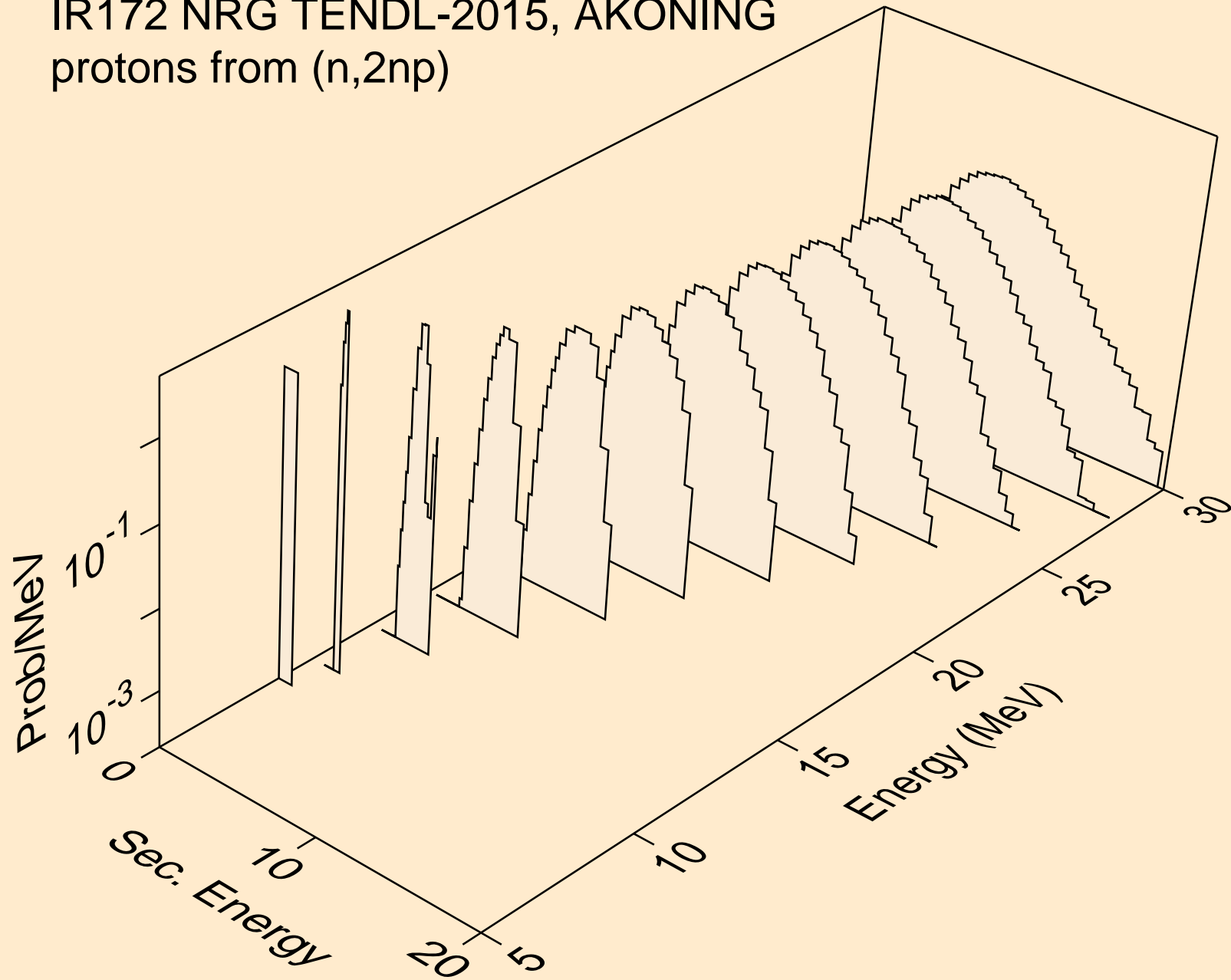

IR172 NRG TENDL-2015, AKONING
protons from (n,3np)

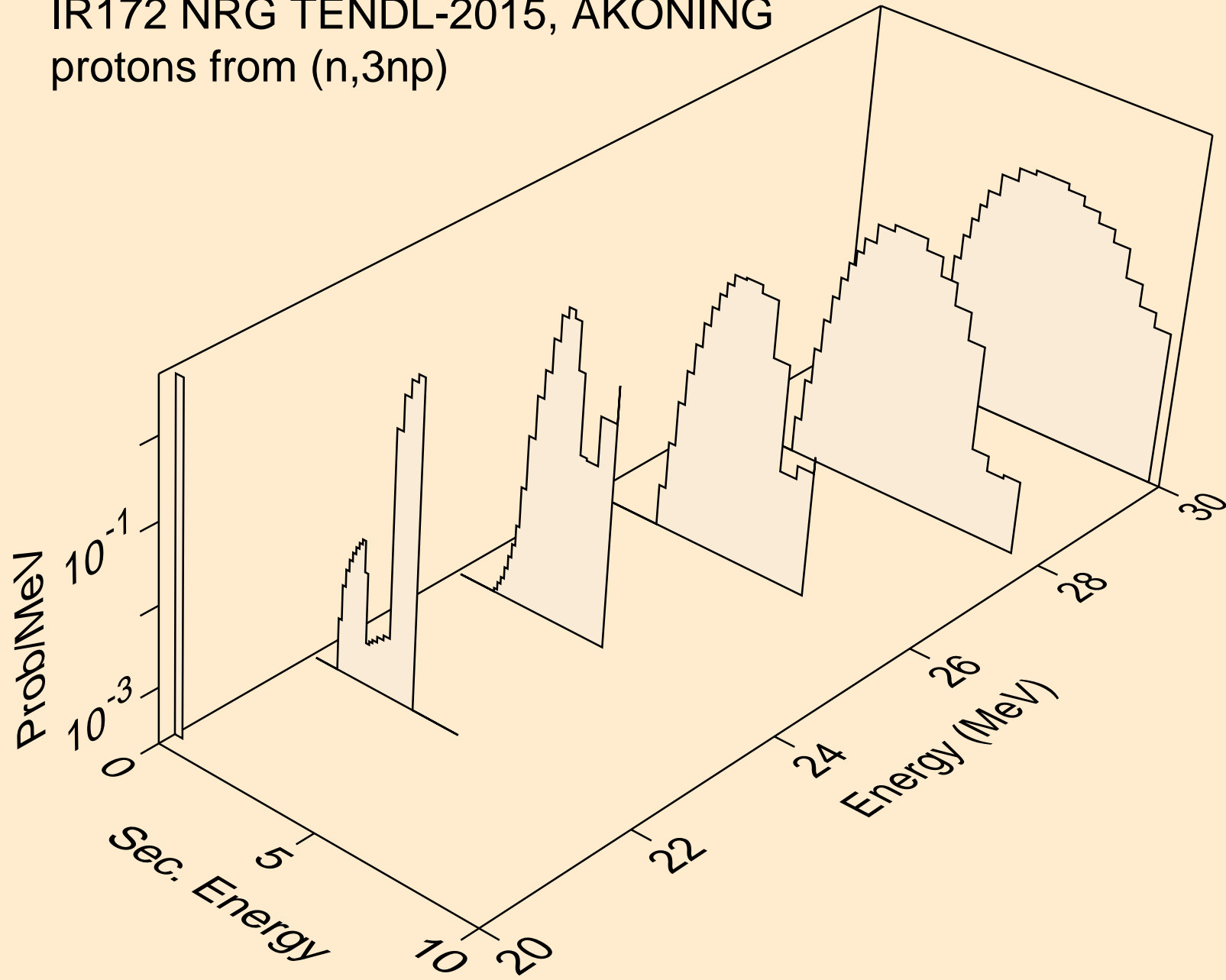

IR172 NRG TENDL-2015, AKONING
protons from (n,2np)

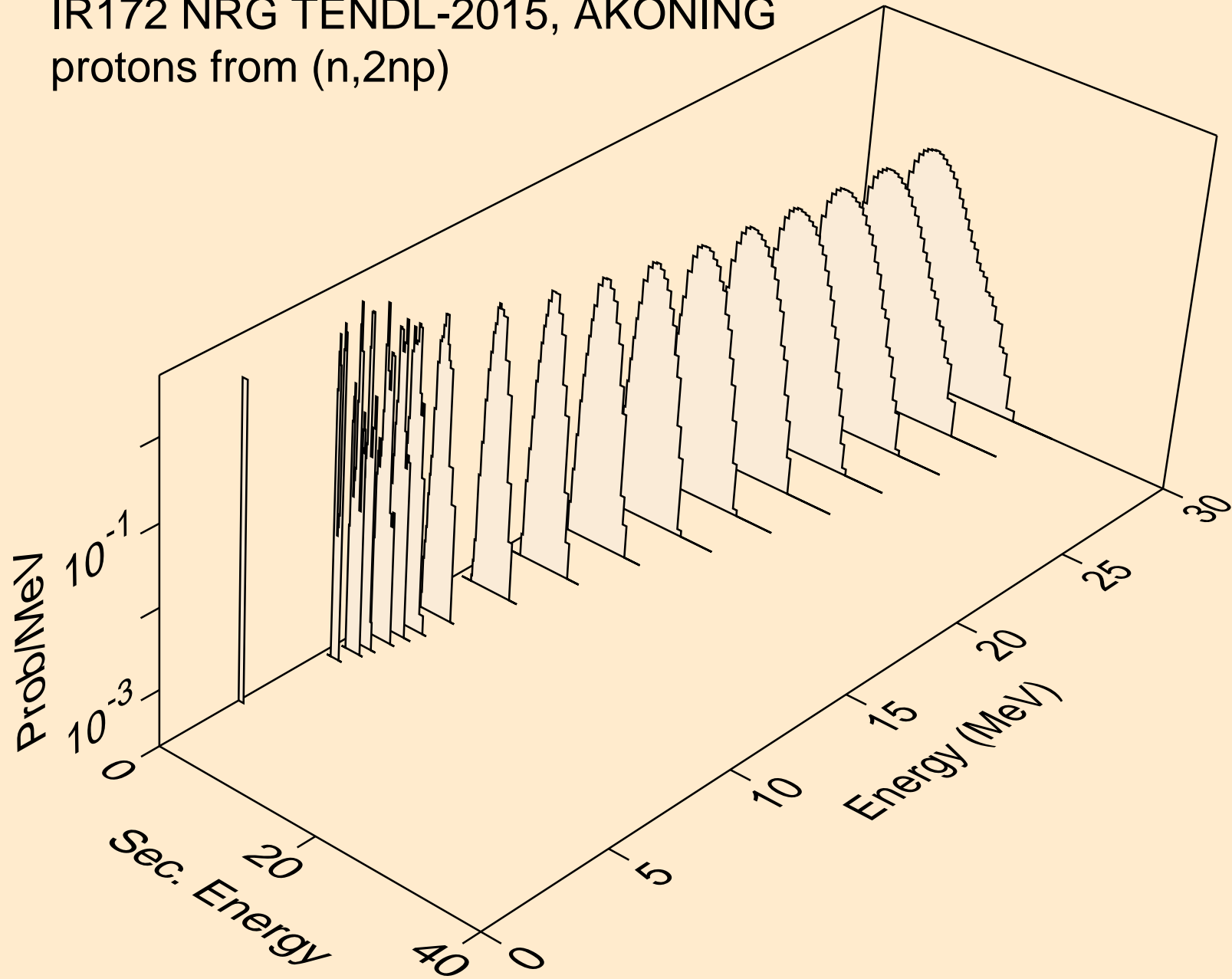

IR172 NRG TENDL-2015, AKONING
protons from (n,npa)

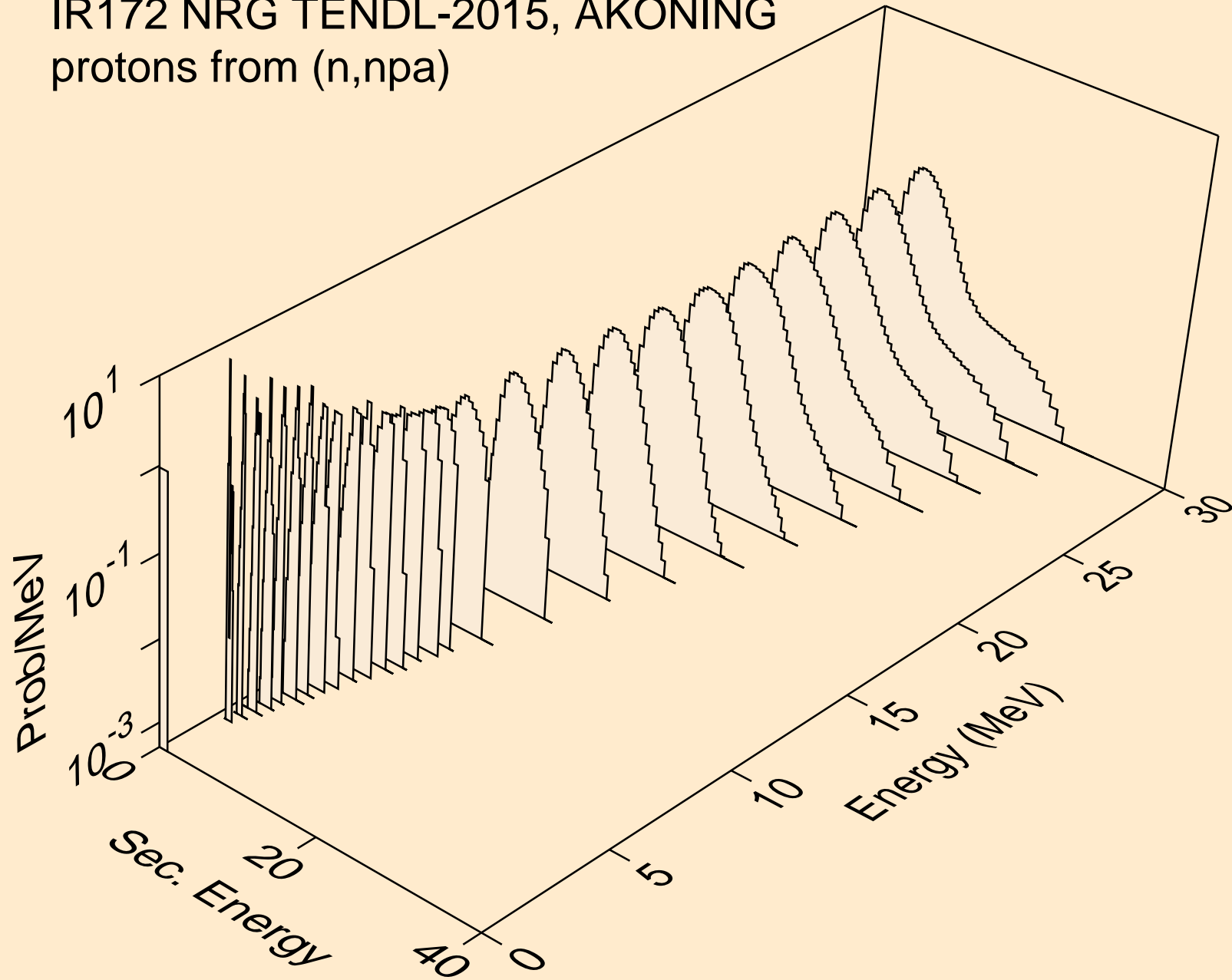

IR172 NRG TENDL-2015, AKONING
protons from (n,p)

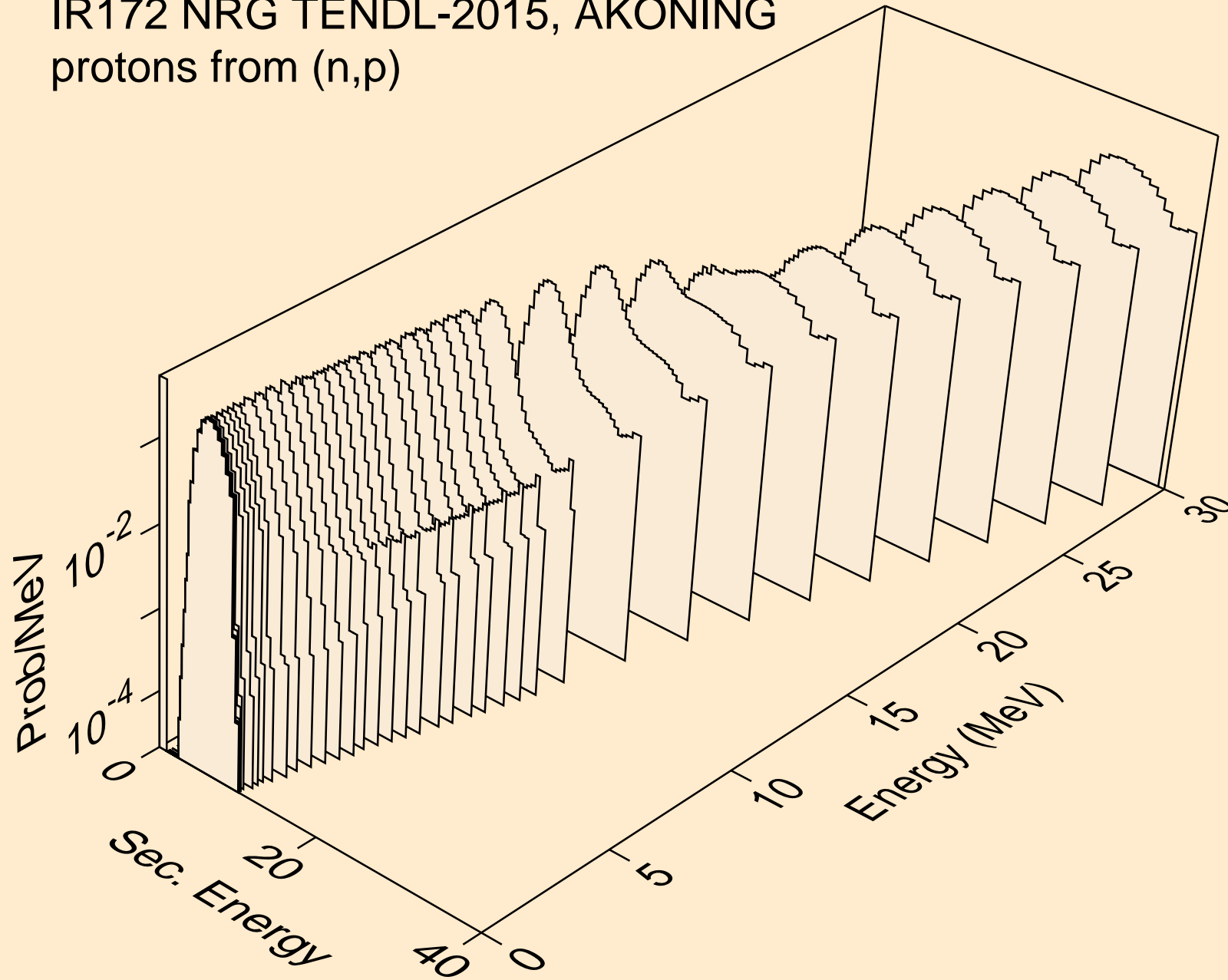

IR172 NRG TENDL-2015, AKONING
protons from (n,2p)

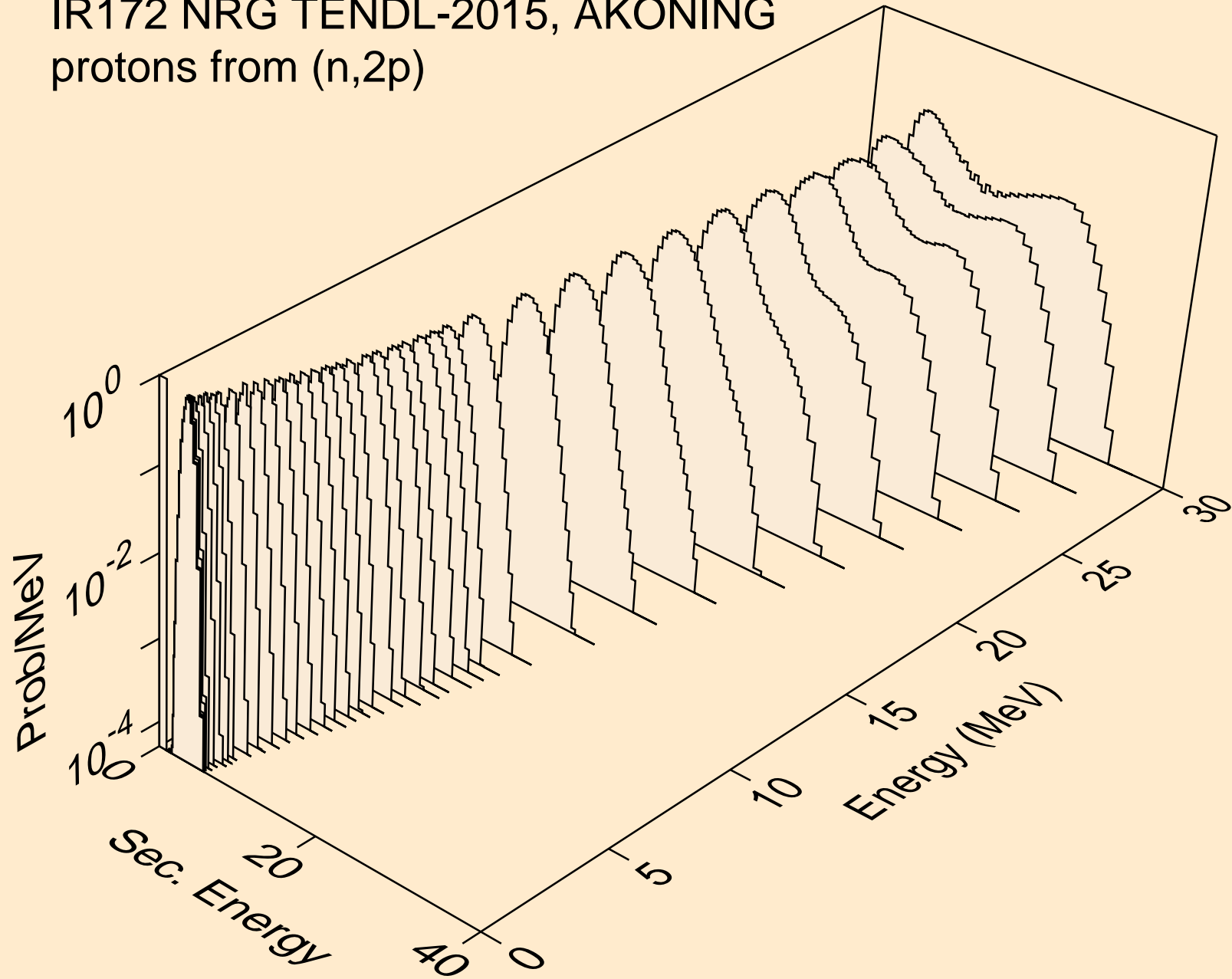

IR172 NRG TENDL-2015, AKONING
protons from (n,pa)

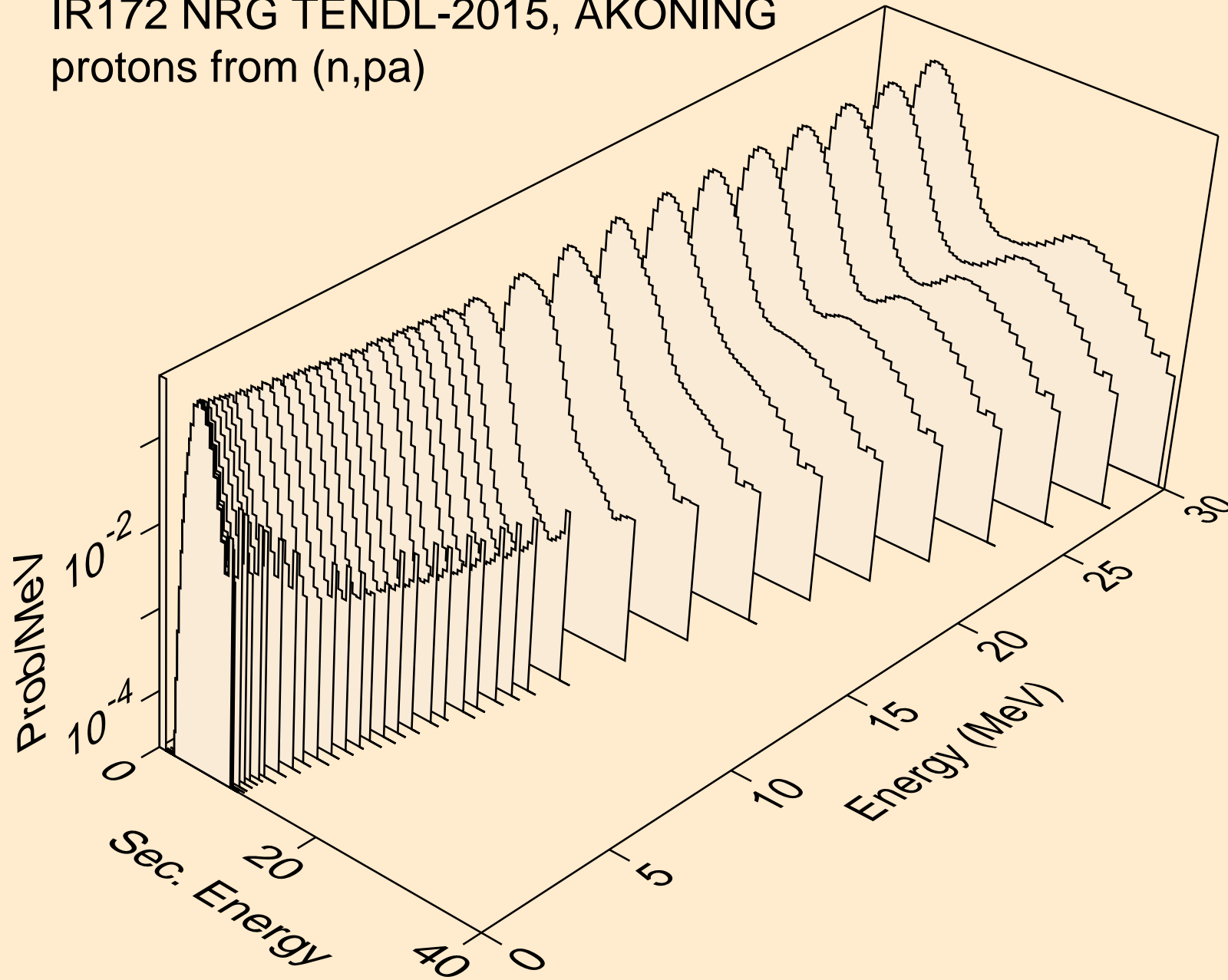

IR172 NRG TENDL-2015, AKONING
protons from (n,pd)

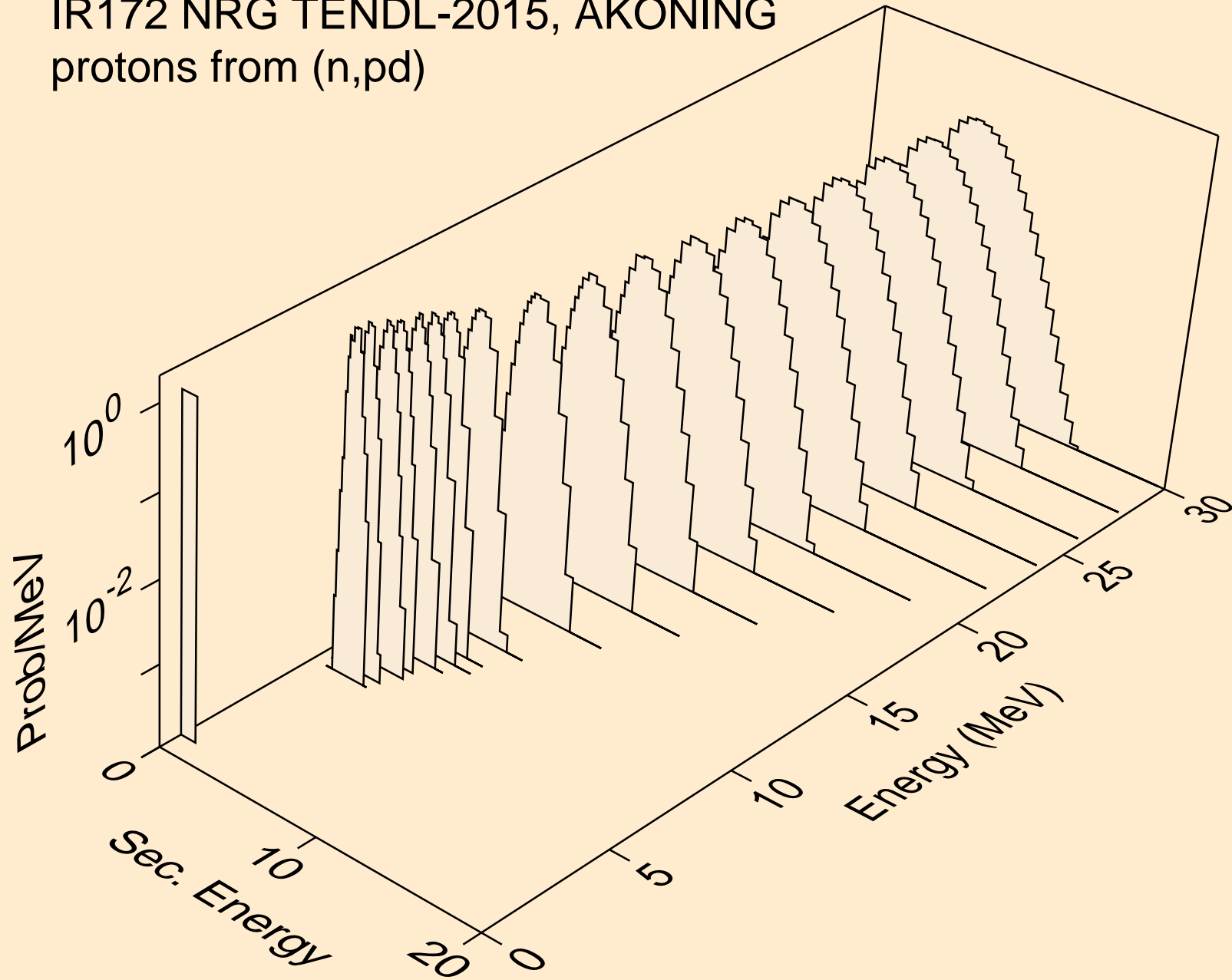

IR172 NRG TENDL-2015, AKONING
protons from (n,pt)

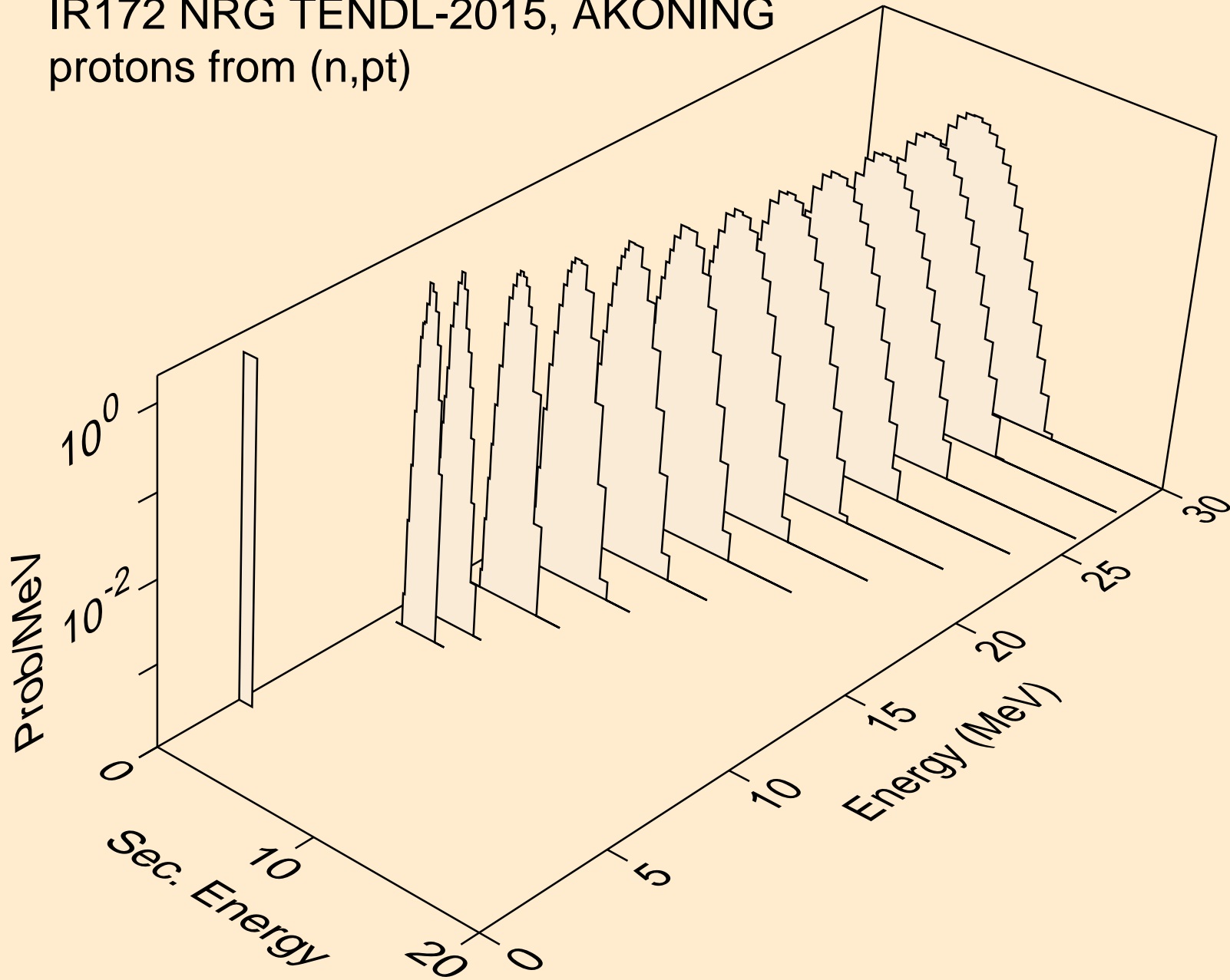

IR172 NRG TENDL-2015, AKONING
deuterons from (n,x)

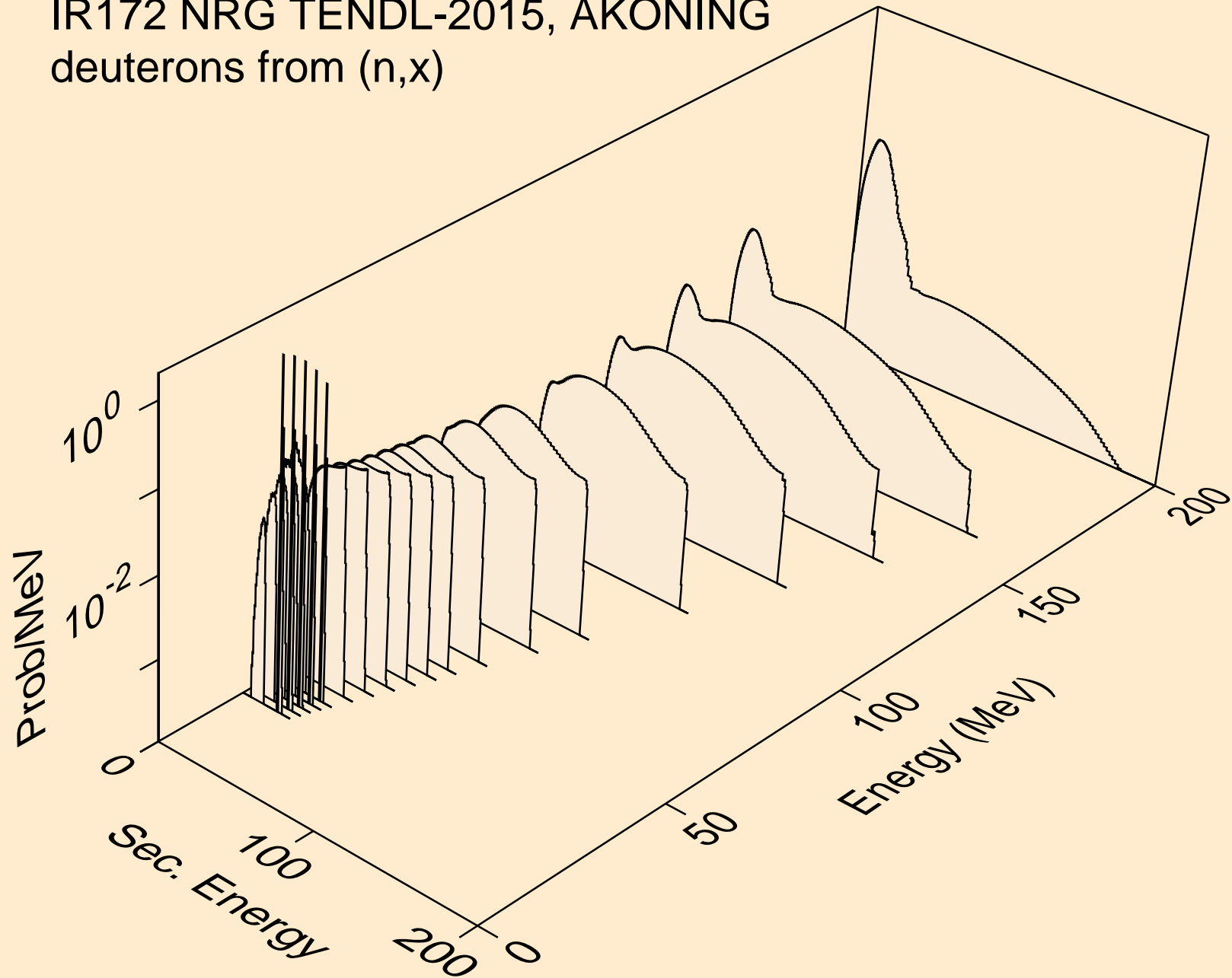

IR172 NRG TENDL-2015, AKONING
deuterons from (n,2nd)

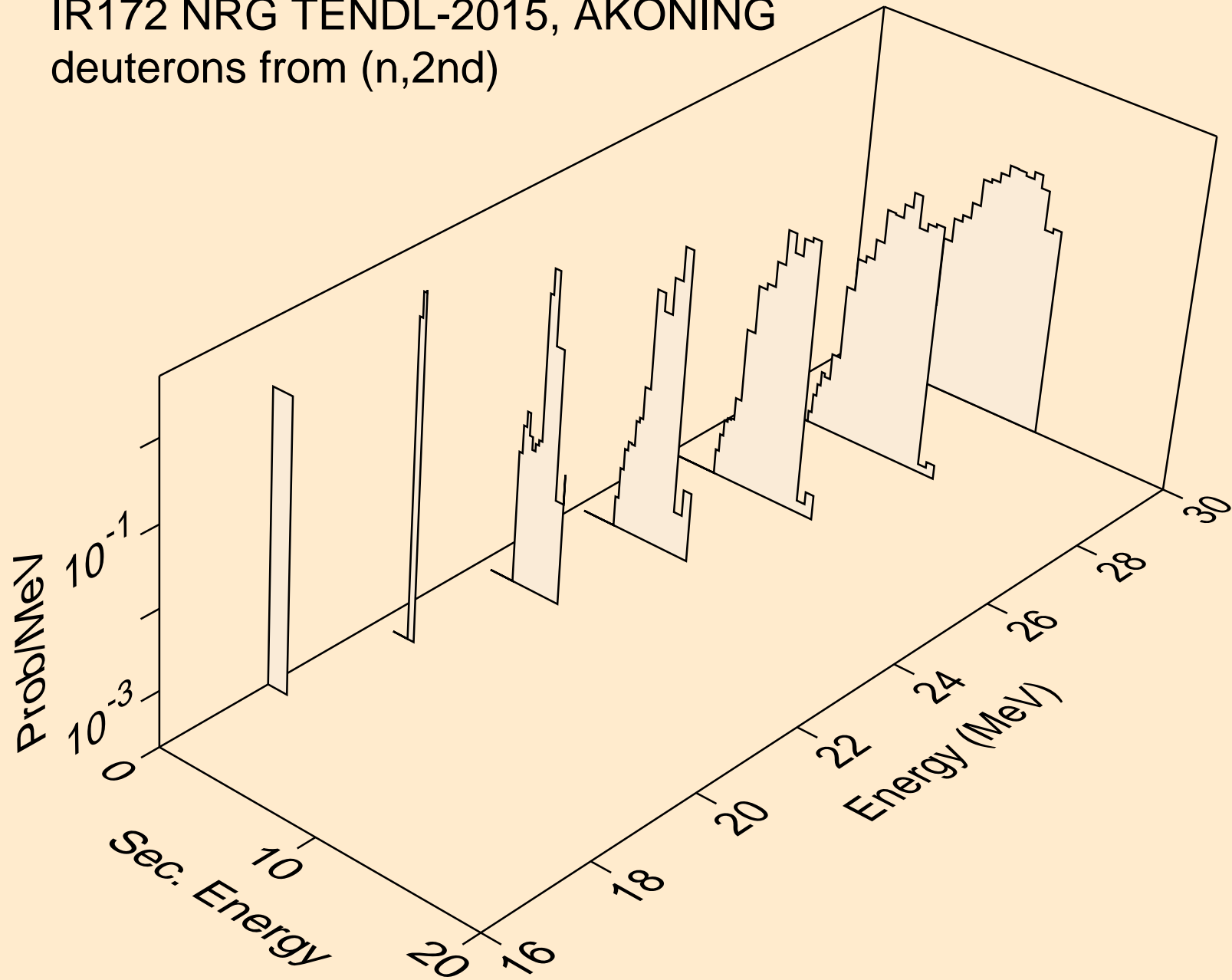

IR172 NRG TENDL-2015, AKONING
deuterons from (n,n*)d

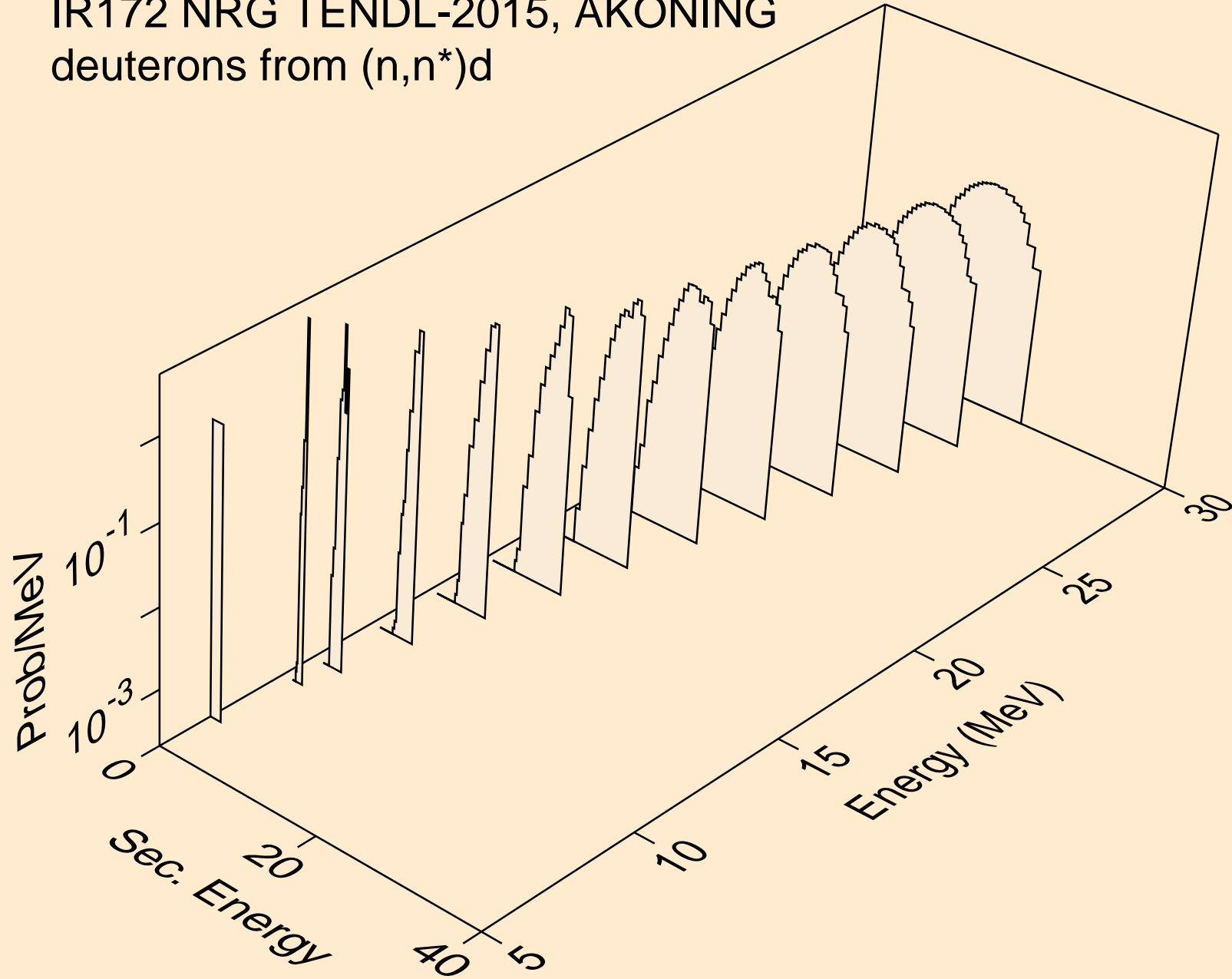

IR172 NRG TENDL-2015, AKONING
deuterons from (n,n*)d2a

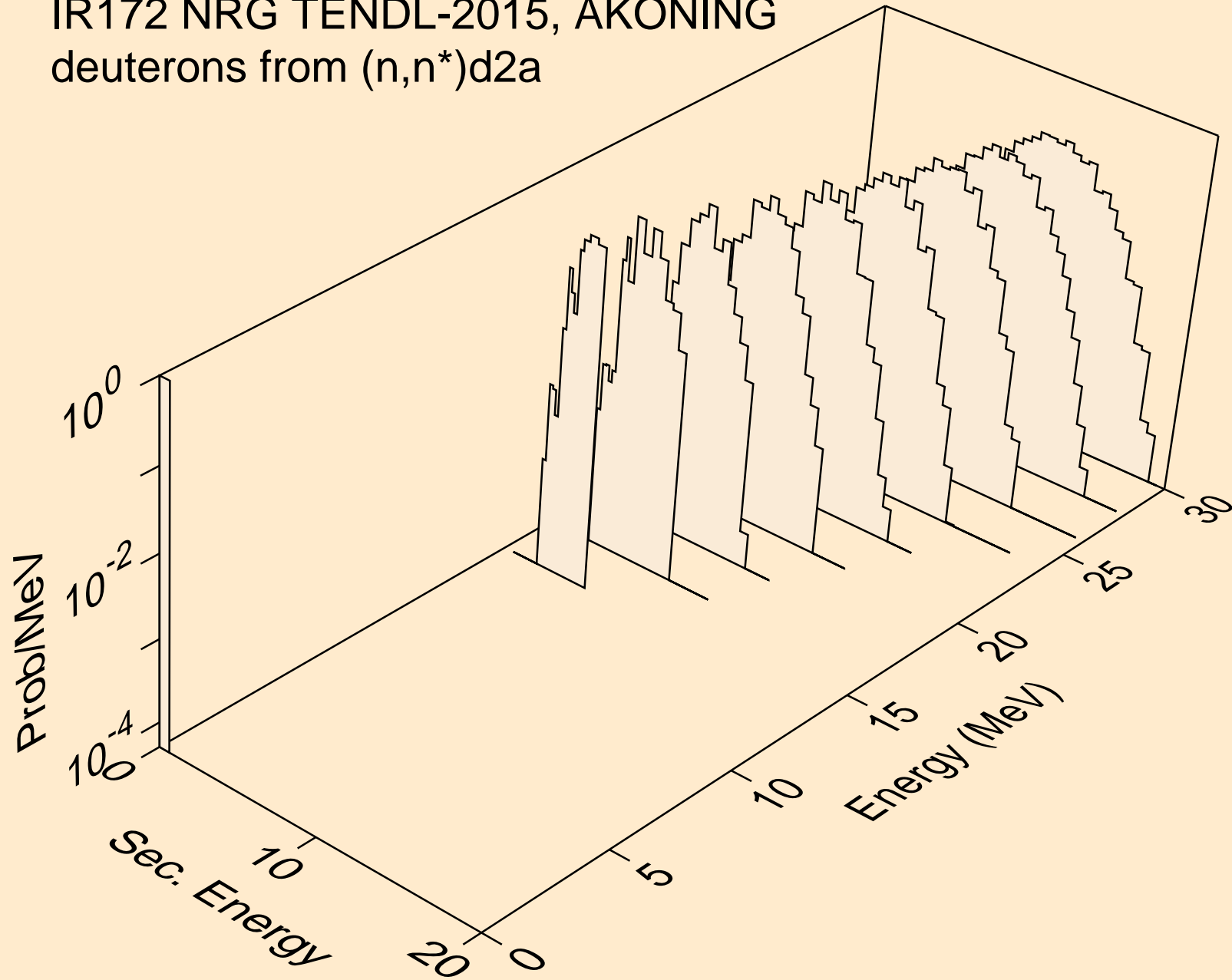

IR172 NRG TENDL-2015, AKONING
deuterons from (n,d)

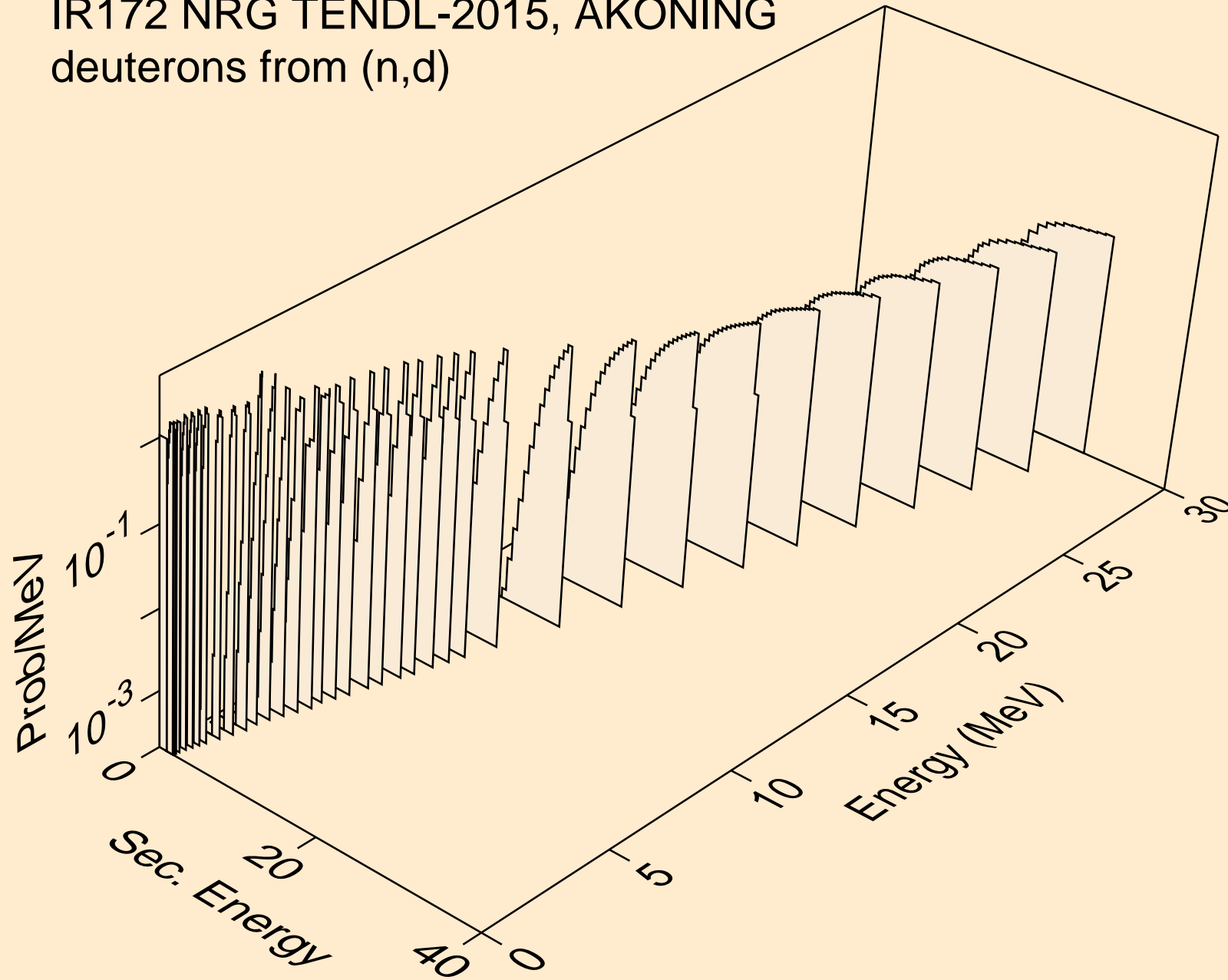

IR172 NRG TENDL-2015, AKONING
deuterons from (n,d2a)

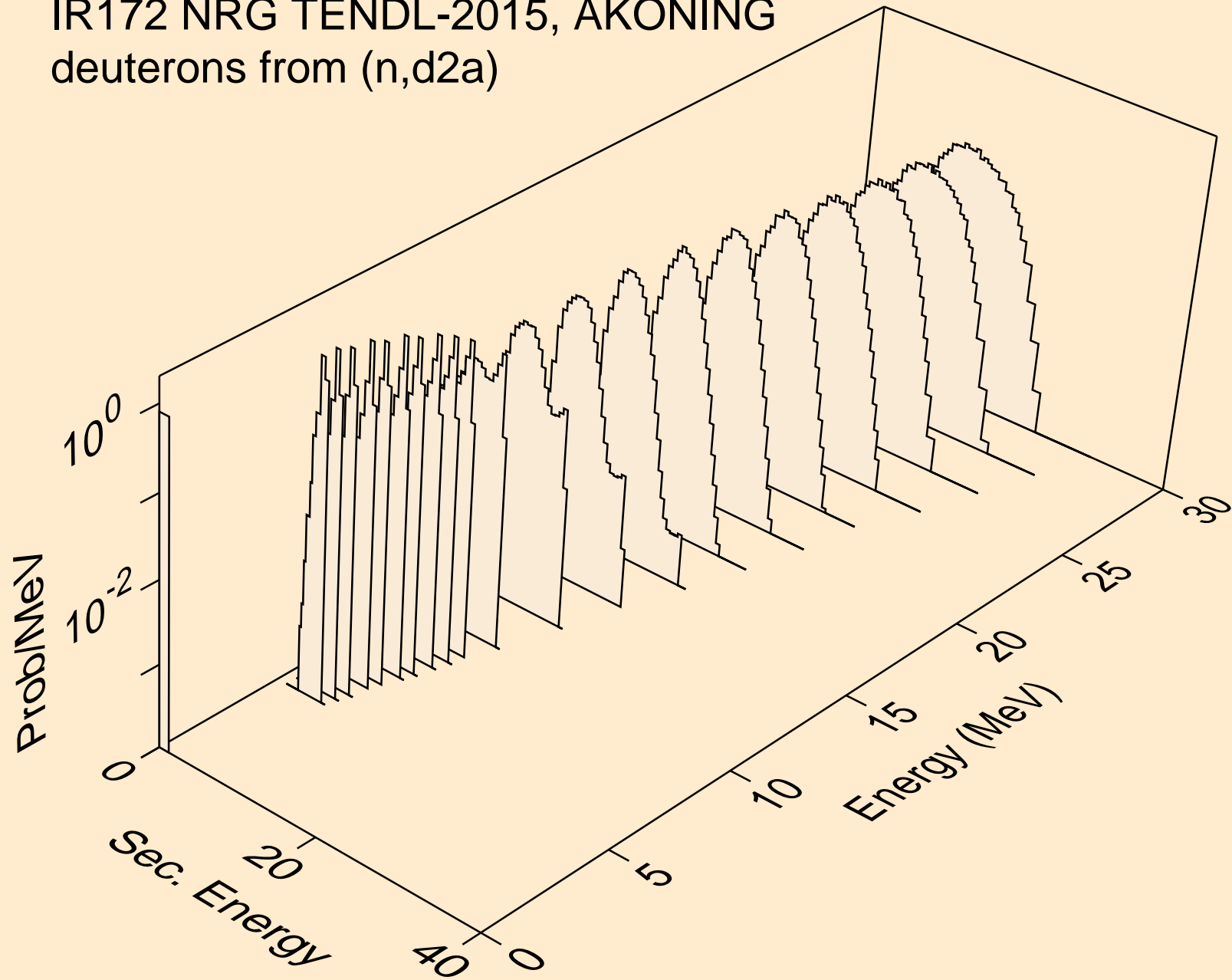

IR172 NRG TENDL-2015, AKONING
deuterons from (n,pd)

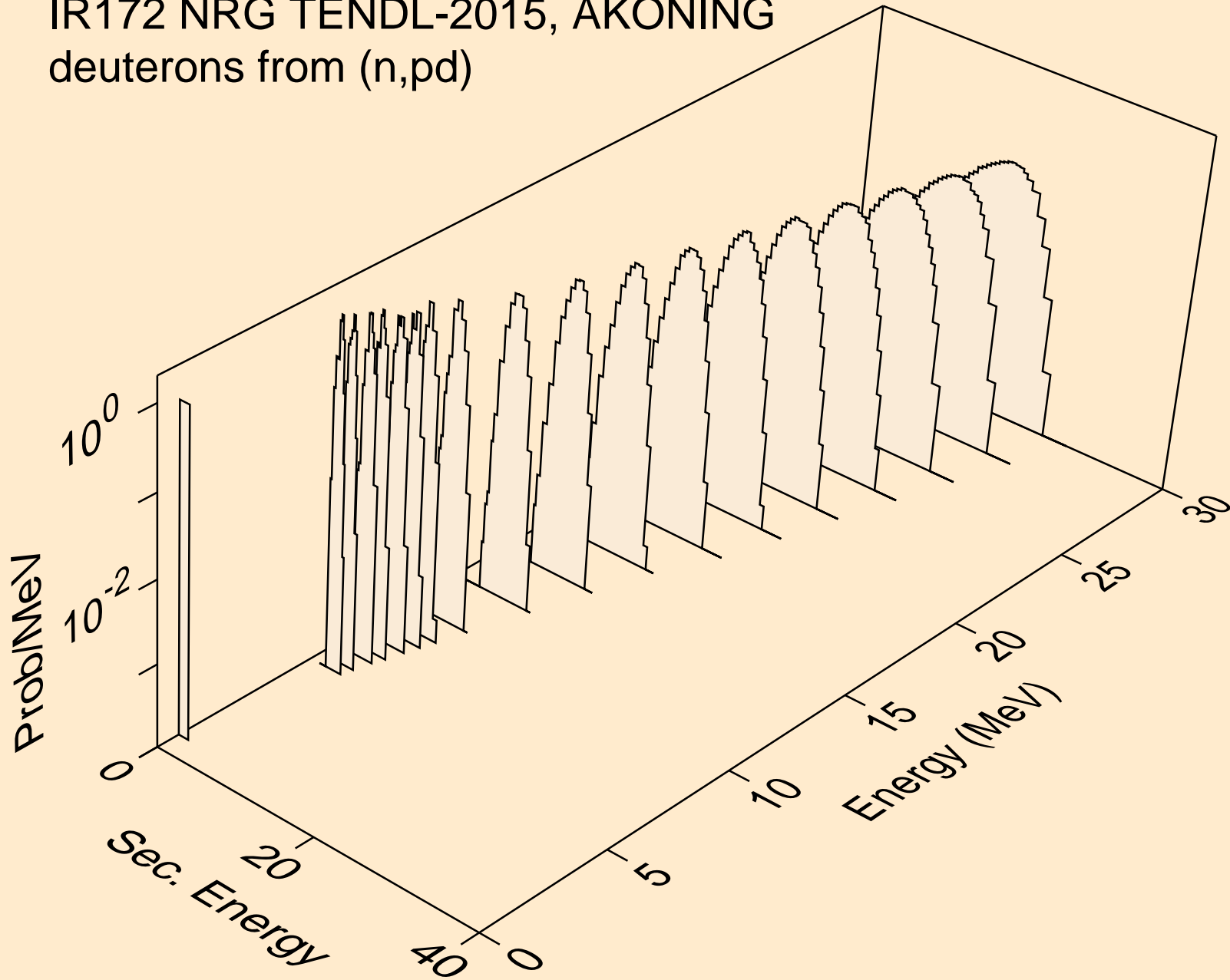

IR172 NRG TENDL-2015, AKONING
deuterons from (n,da)

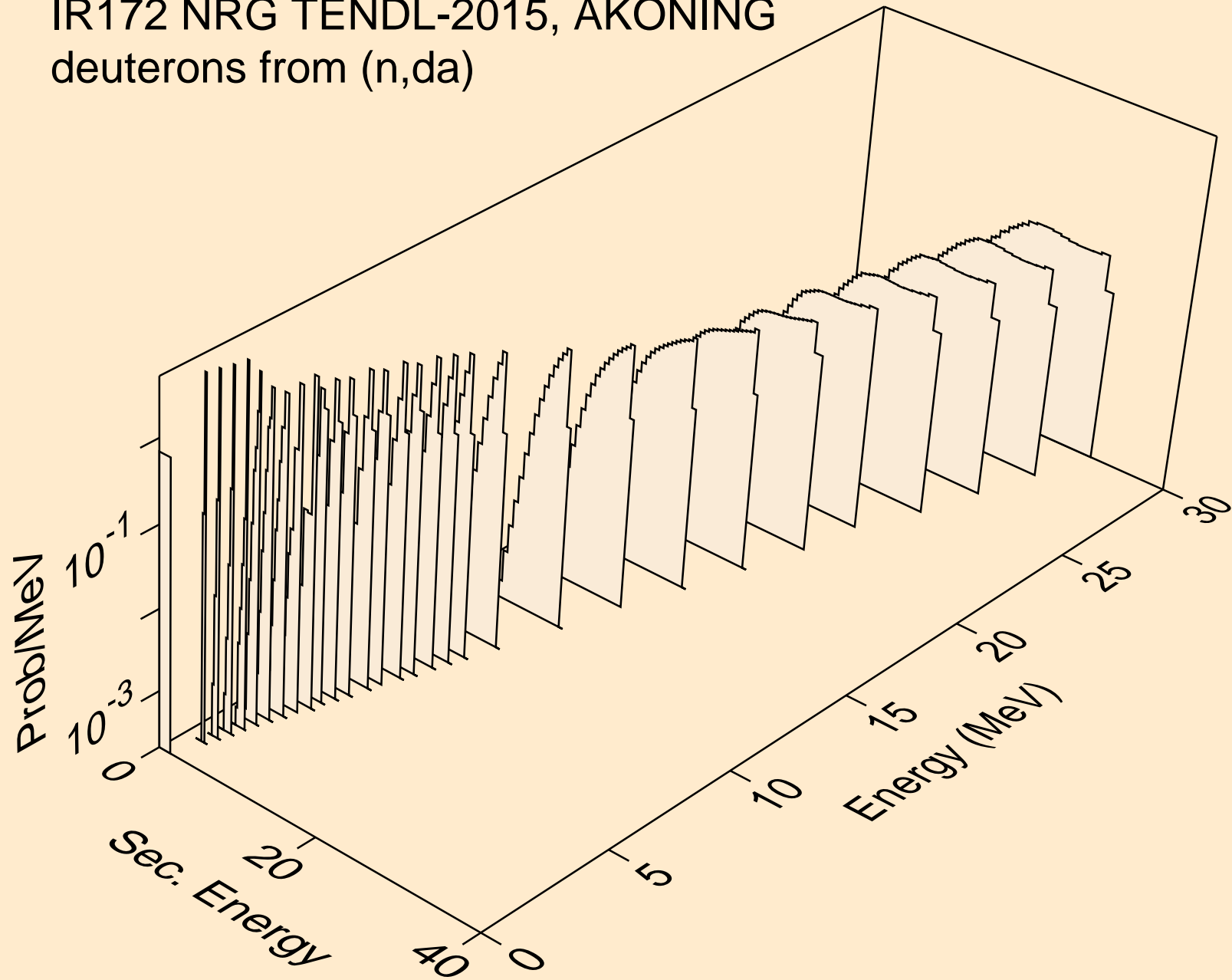

IR172 NRG TENDL-2015, AKONING
tritons from (n,x)

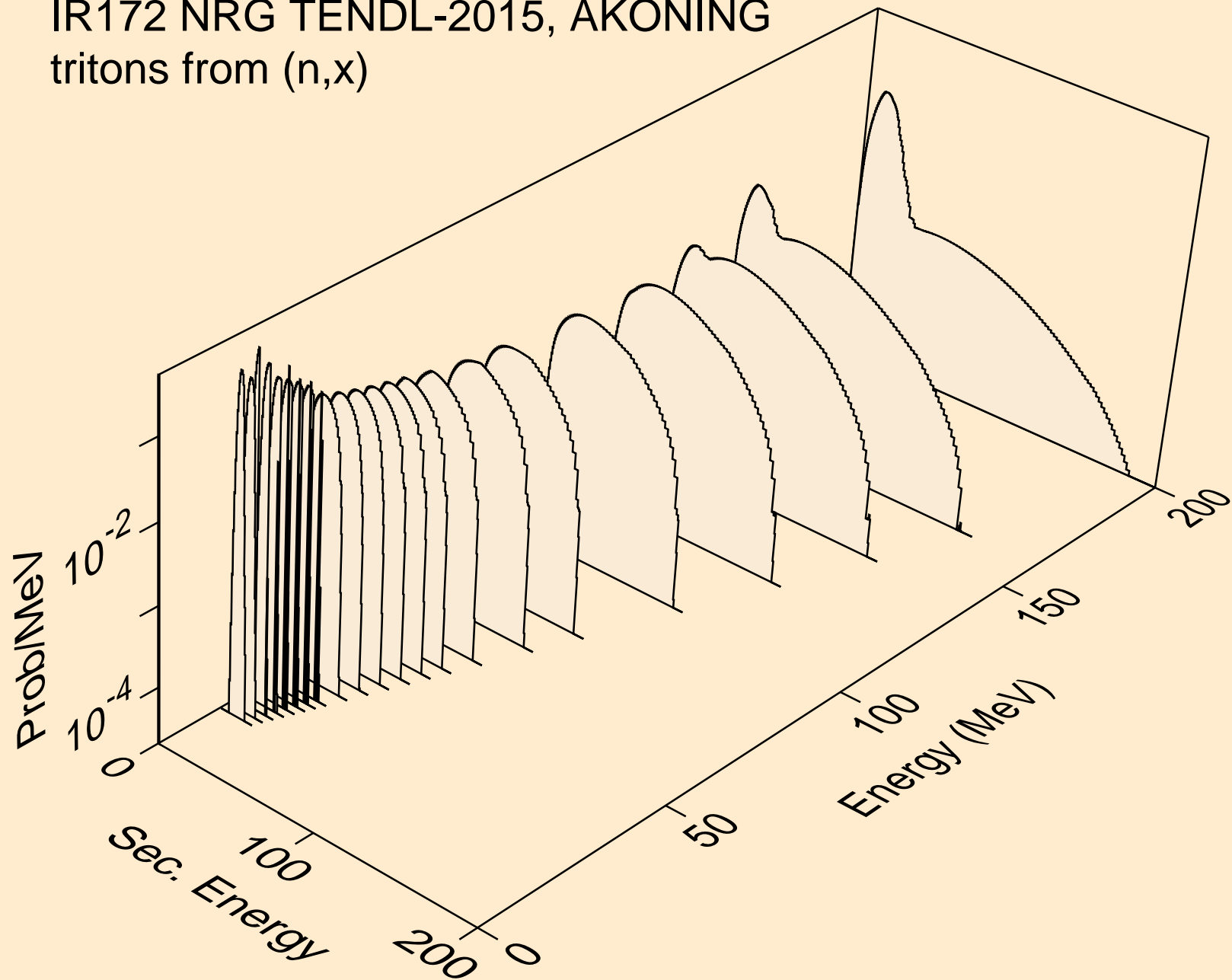

IR172 NRG TENDL-2015, AKONING
tritons from (n,n*)t

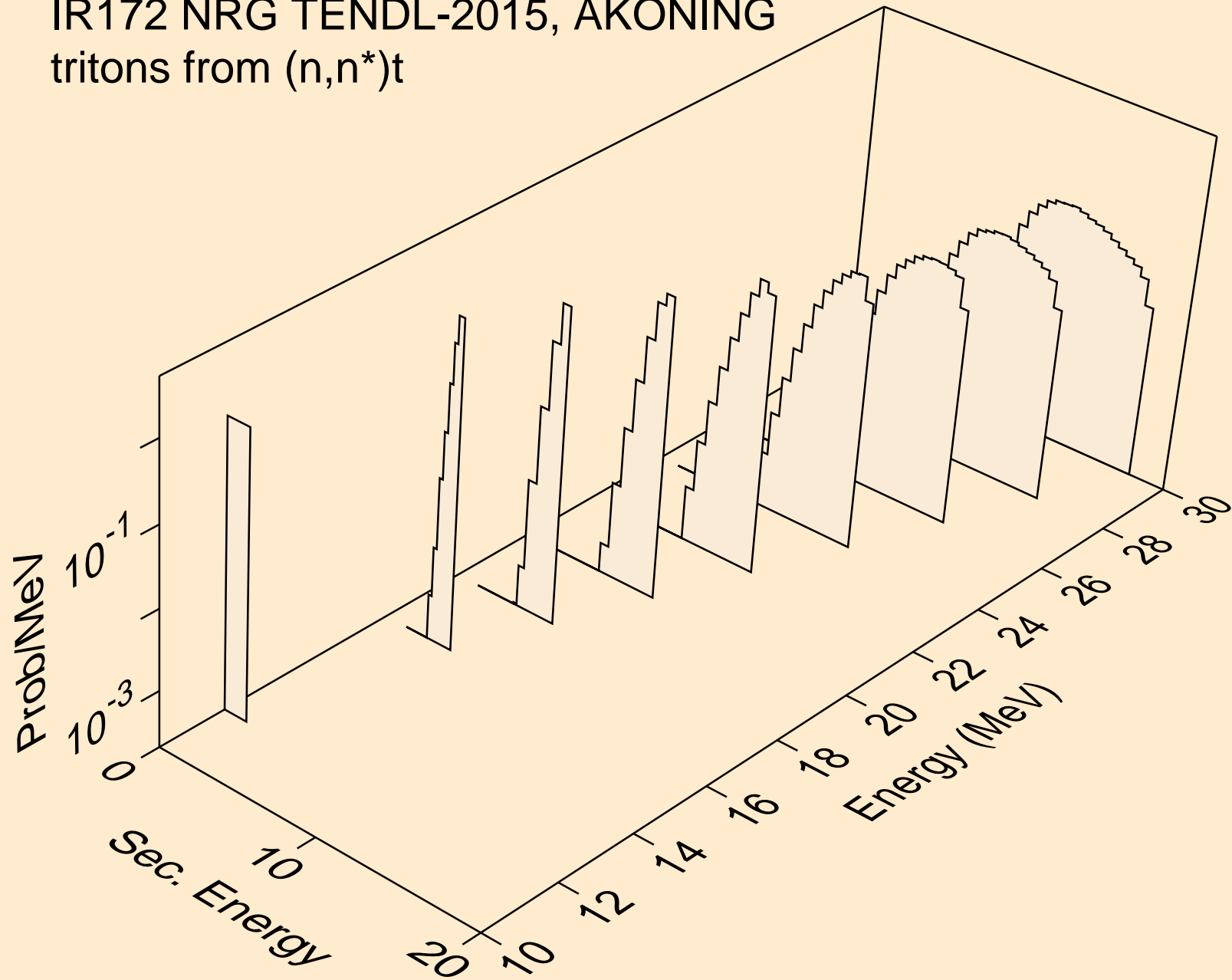

IR172 NRG TENDL-2015, AKONING
tritons from (n,n*)t2a

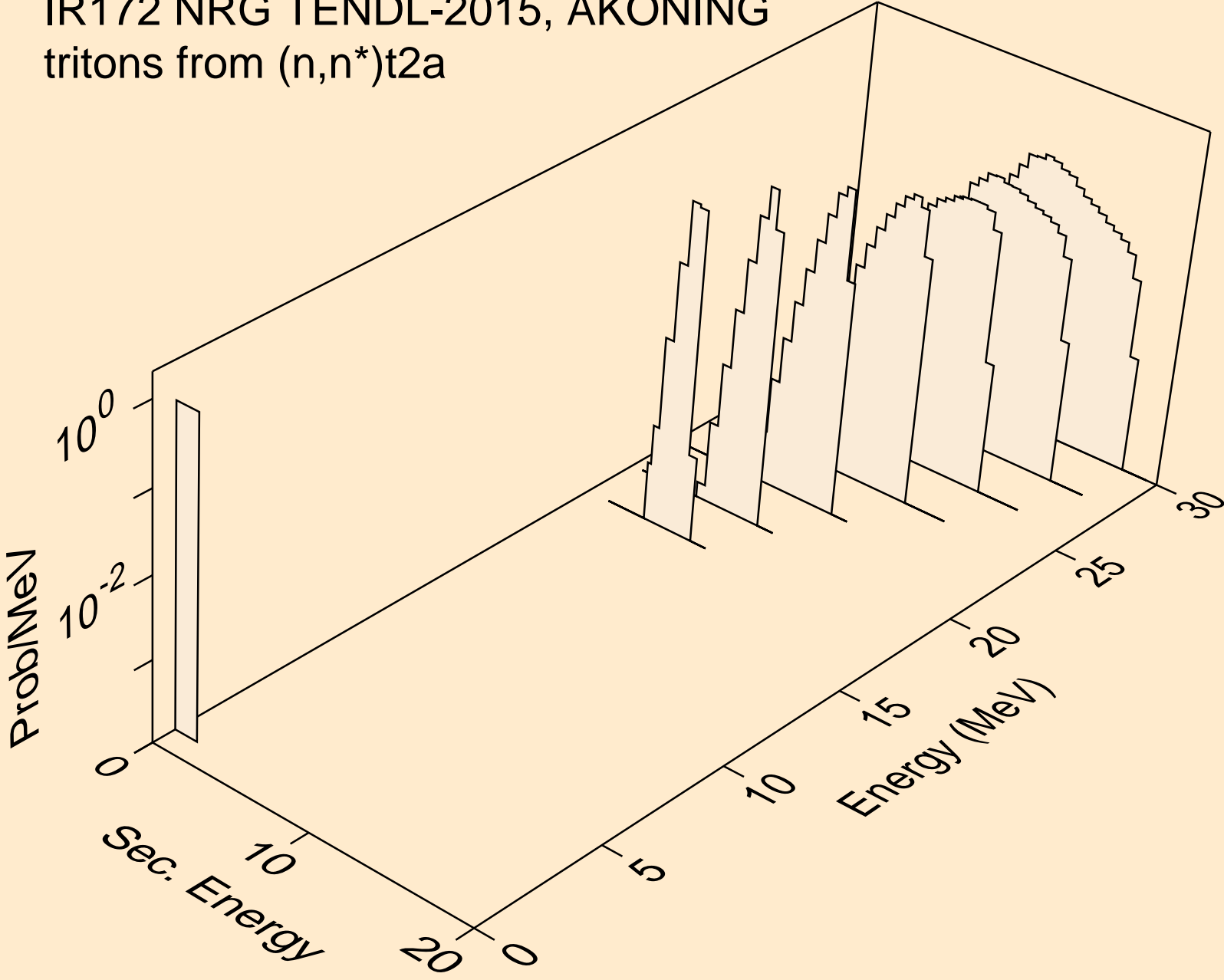

IR172 NRG TENDL-2015, AKONING
tritons from (n,t)

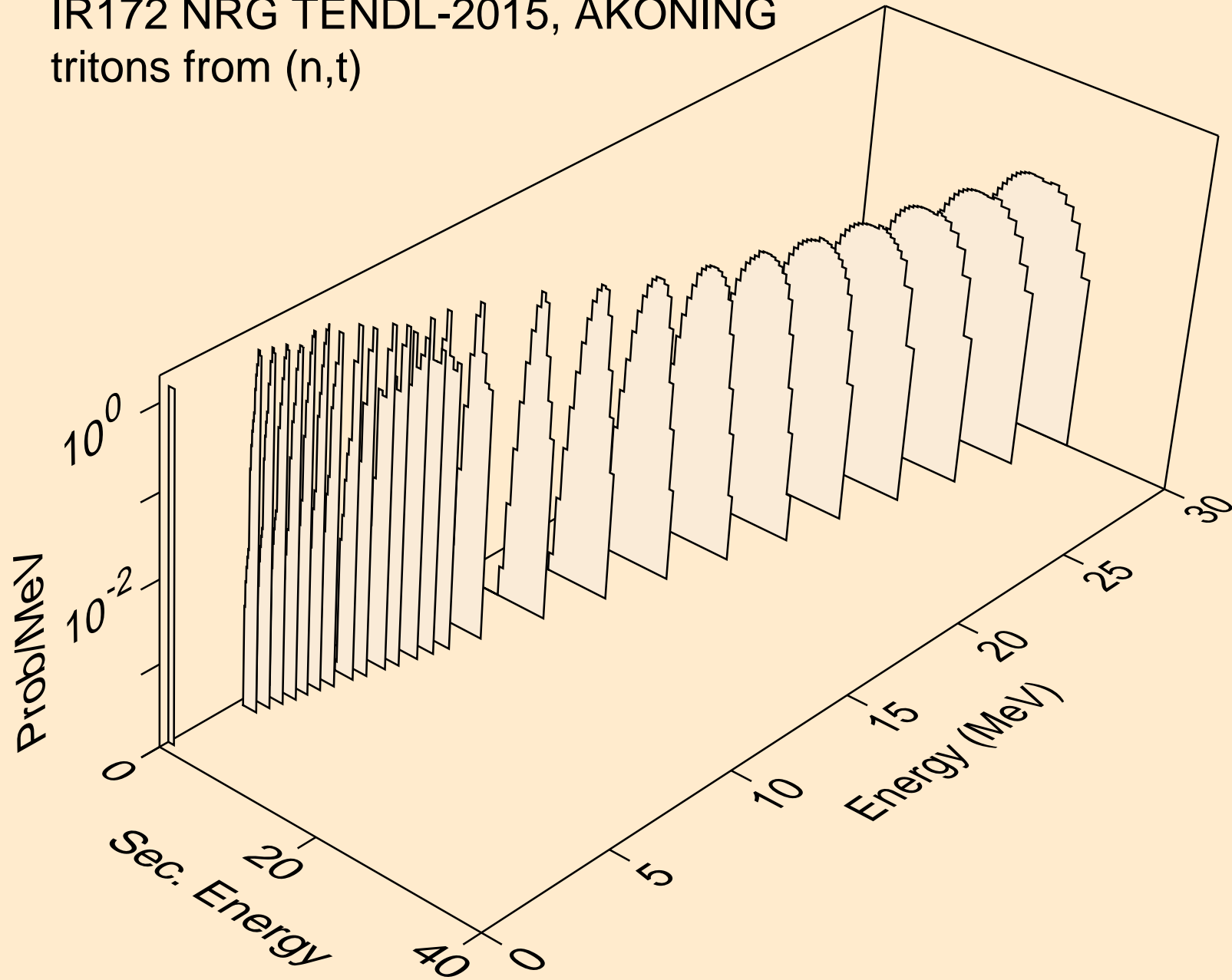

IR172 NRG TENDL-2015, AKONING
tritons from (n,t2a)

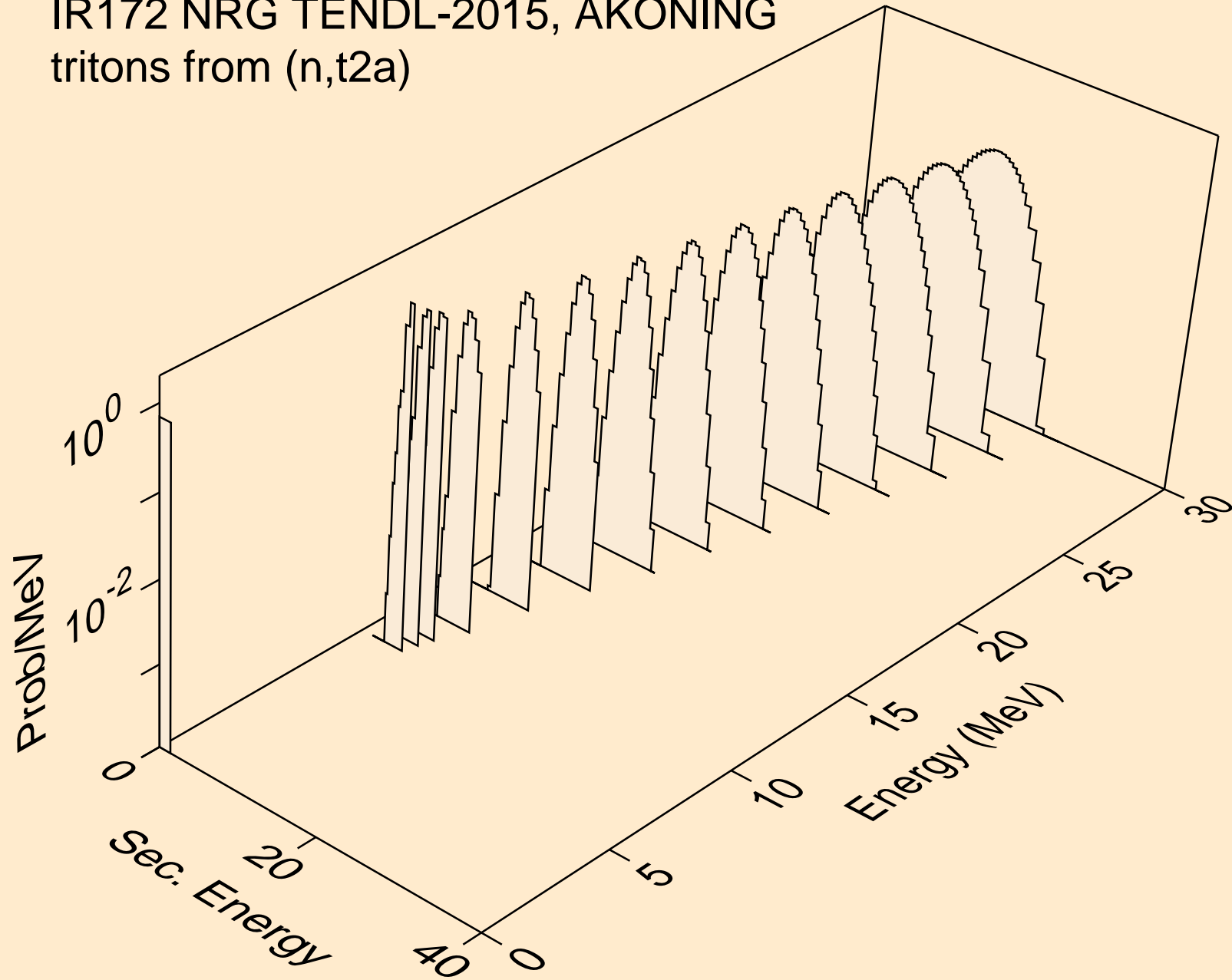

IR172 NRG TENDL-2015, AKONING
tritons from (n,pt)

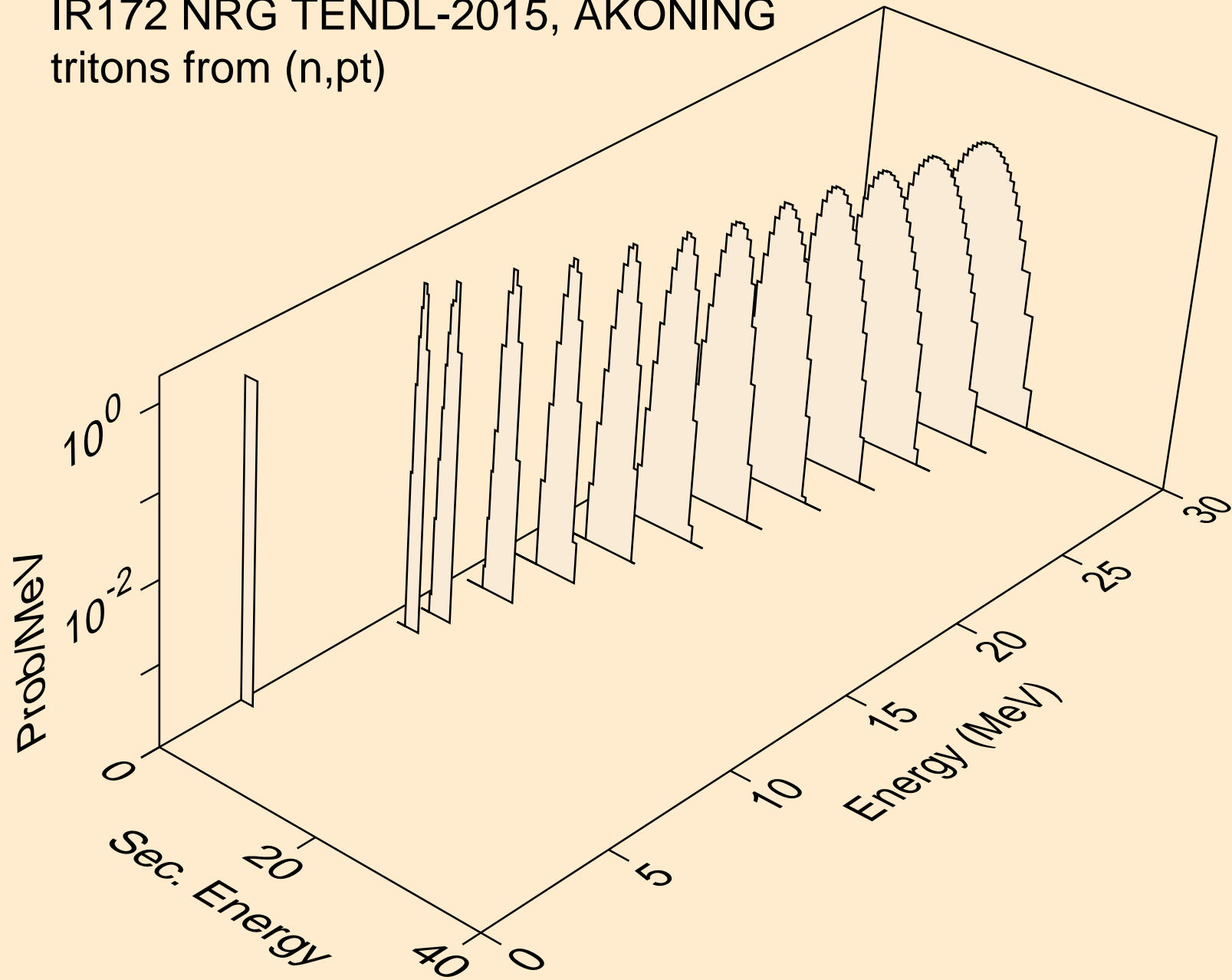

IR172 NRG TENDL-2015, AKONING
he3s from (n,x)

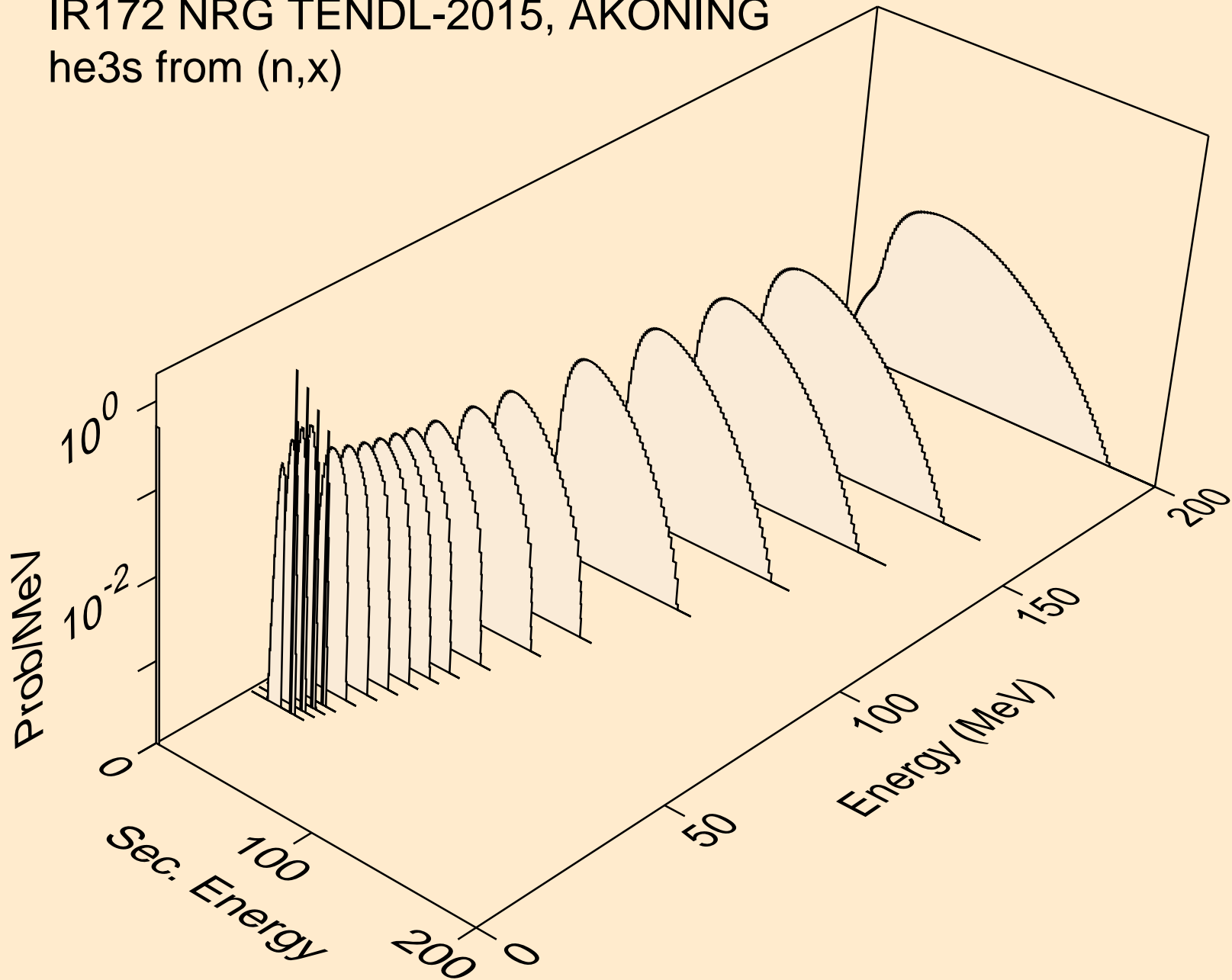

IR172 NRG TENDL-2015, AKONING
he3s from (n,n*)he3

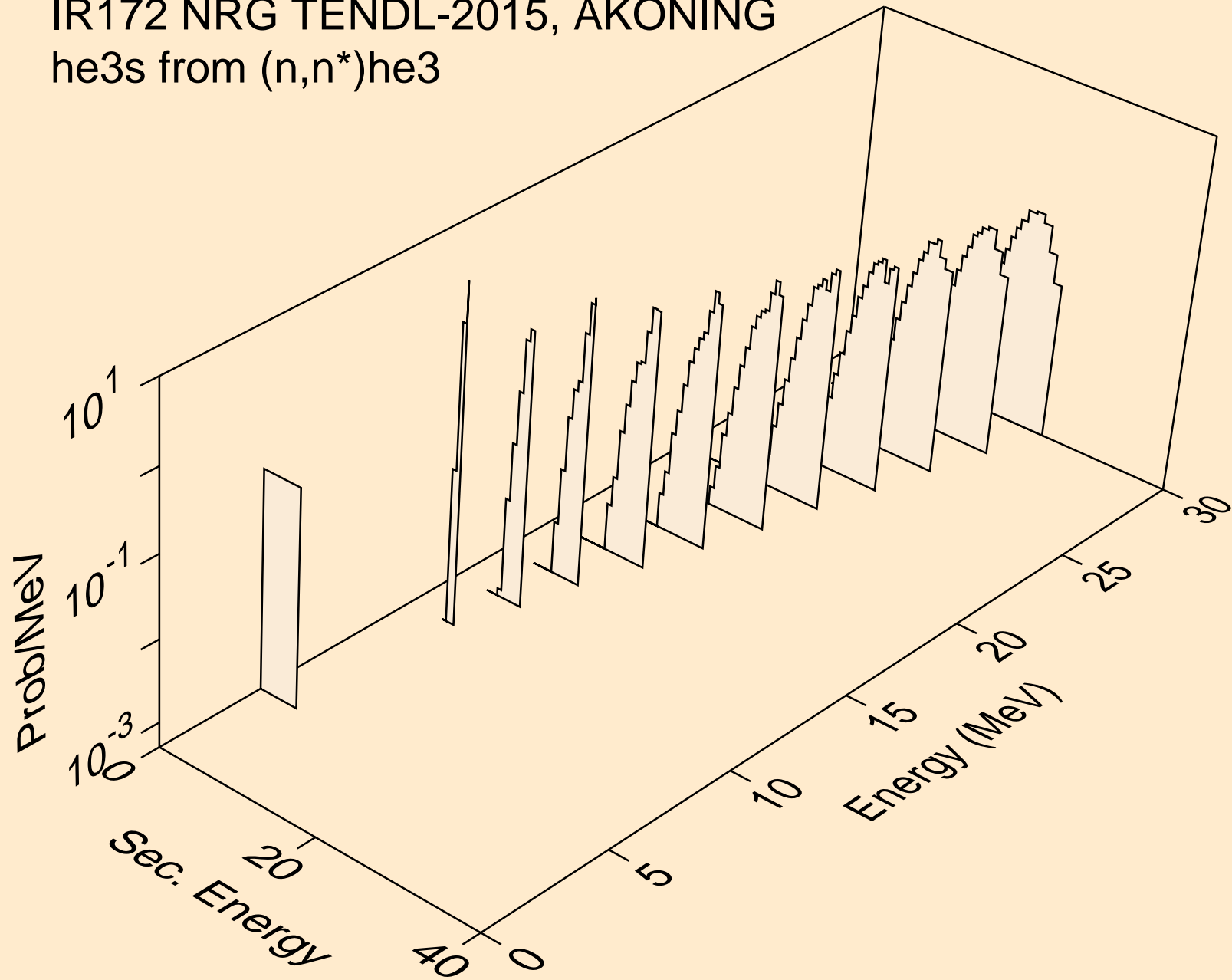

IR172 NRG TENDL-2015, AKONING
he3s from (n,he3)

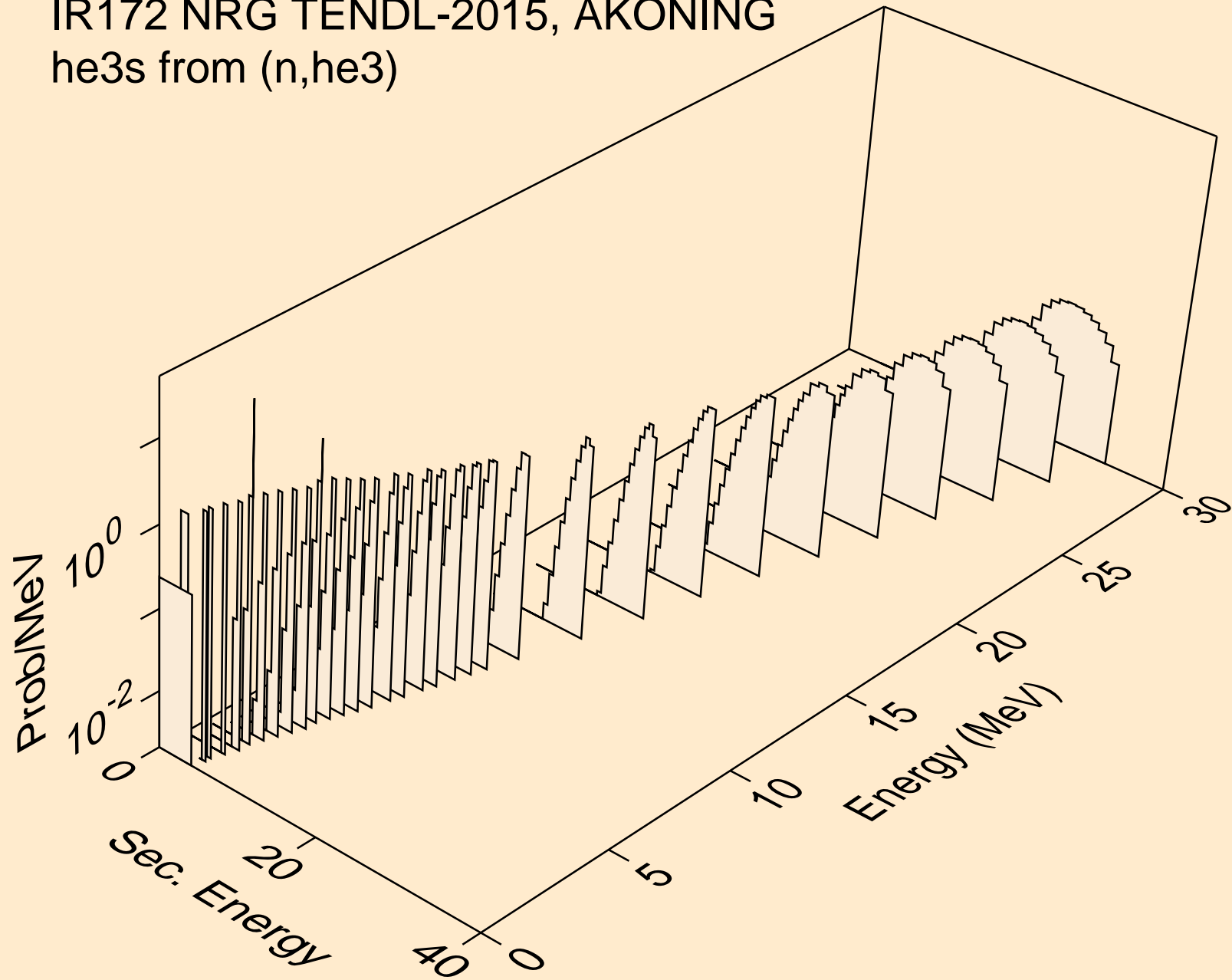

IR172 NRG TENDL-2015, AKONING
alphas from (n,x)

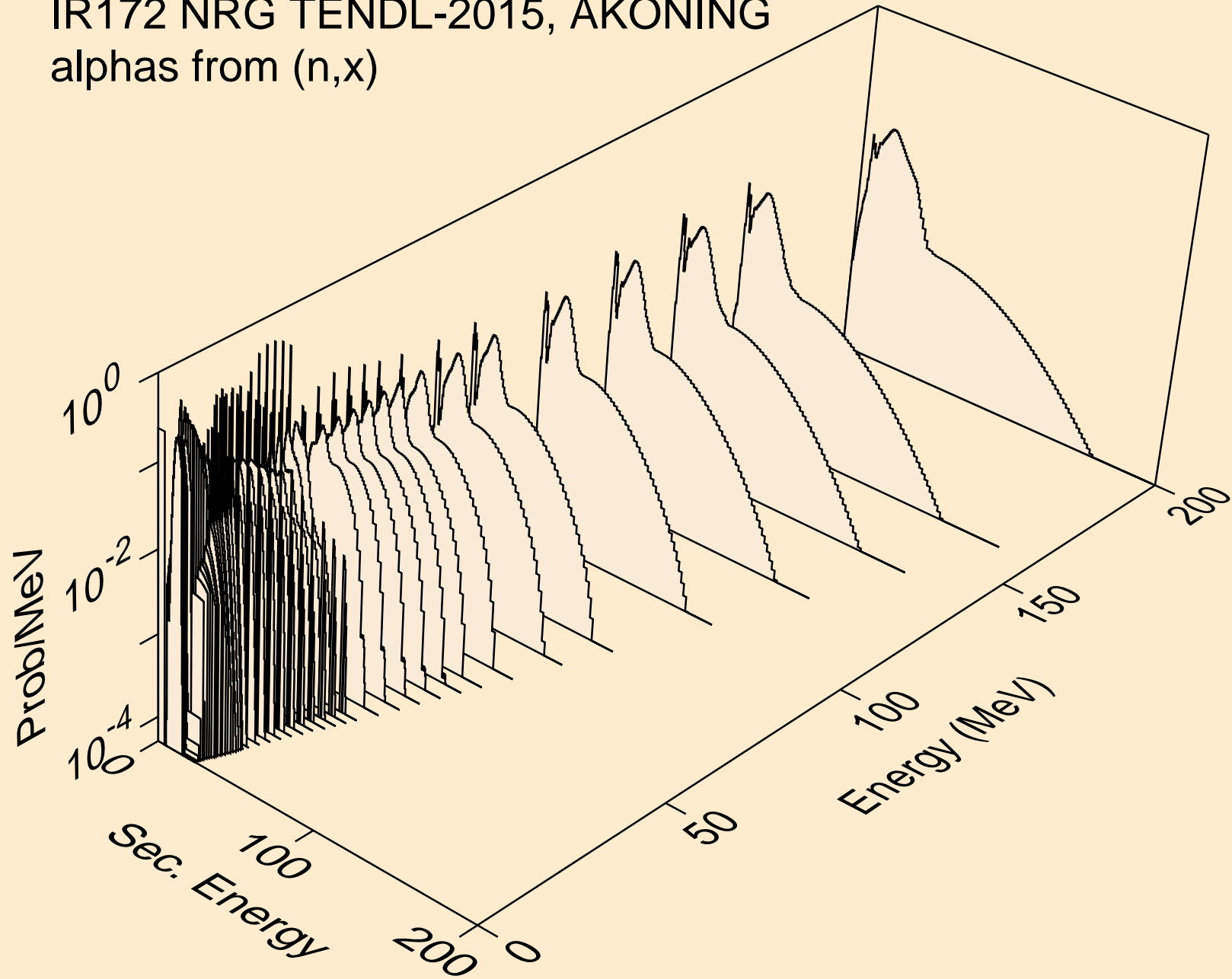

IR172 NRG TENDL-2015, AKONING
alphas from (n,n*)a

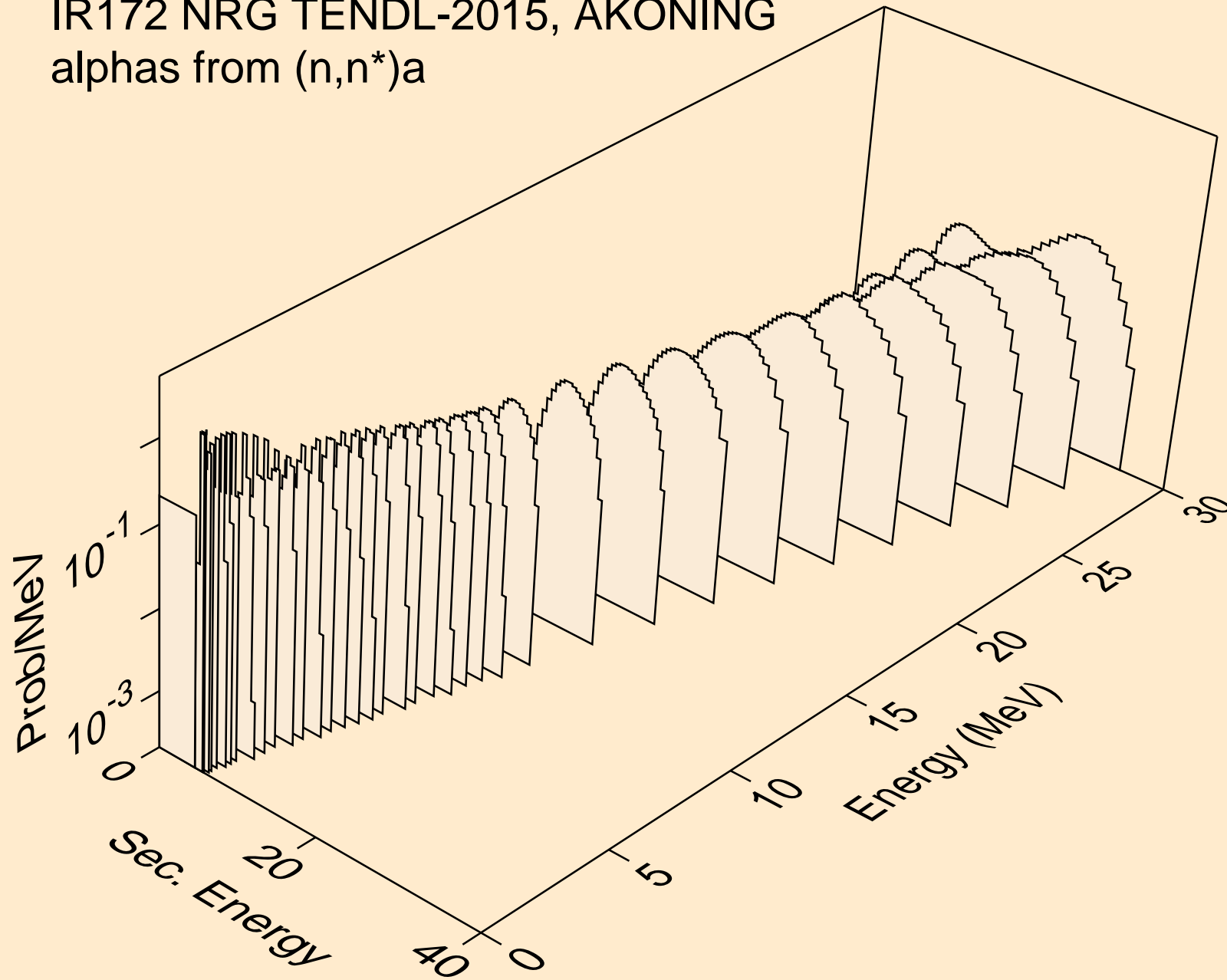

IR172 NRG TENDL-2015, AKONING
alphas from (n,n*)3a

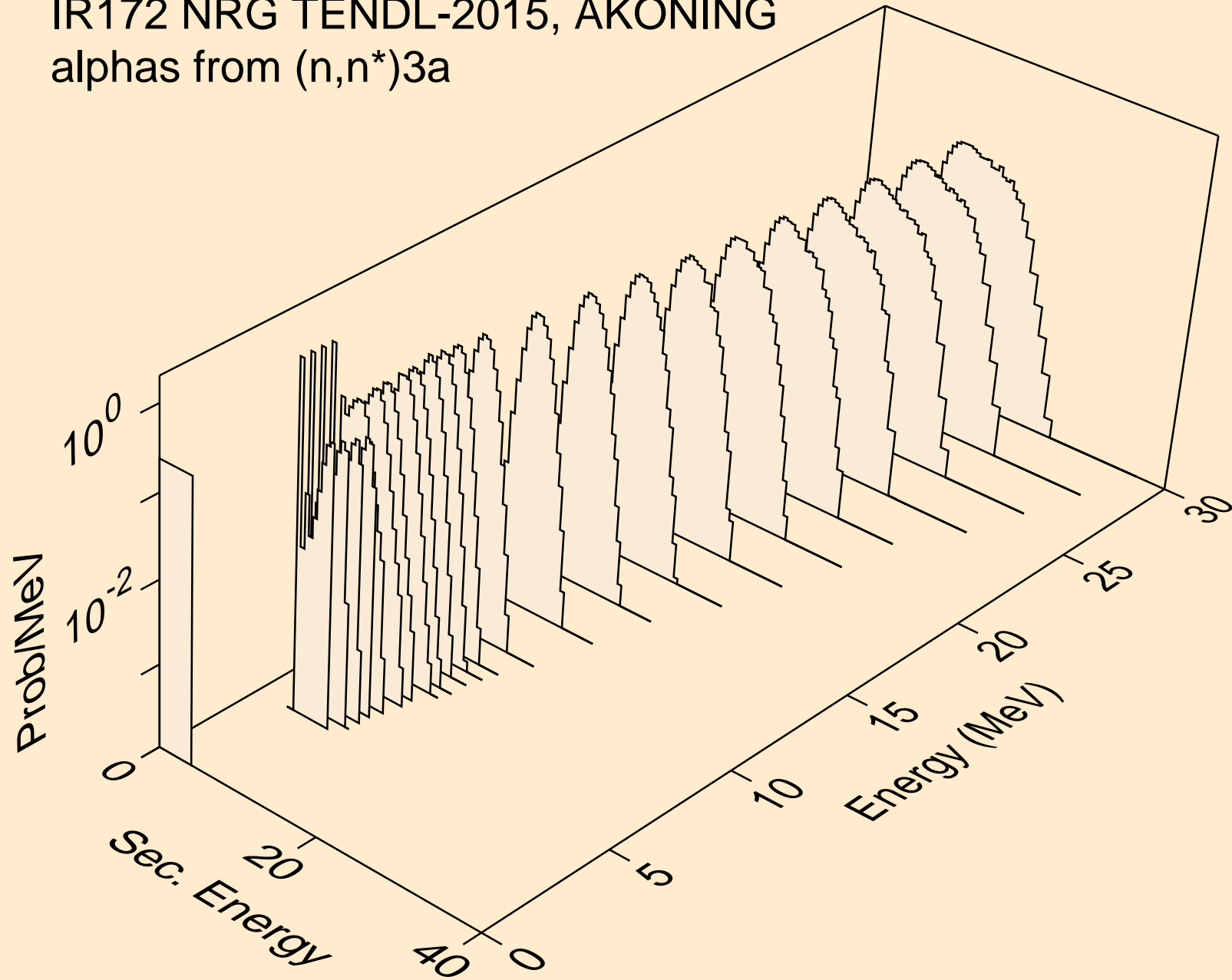

IR172 NRG TENDL-2015, AKONING
alphas from (n,2n)a

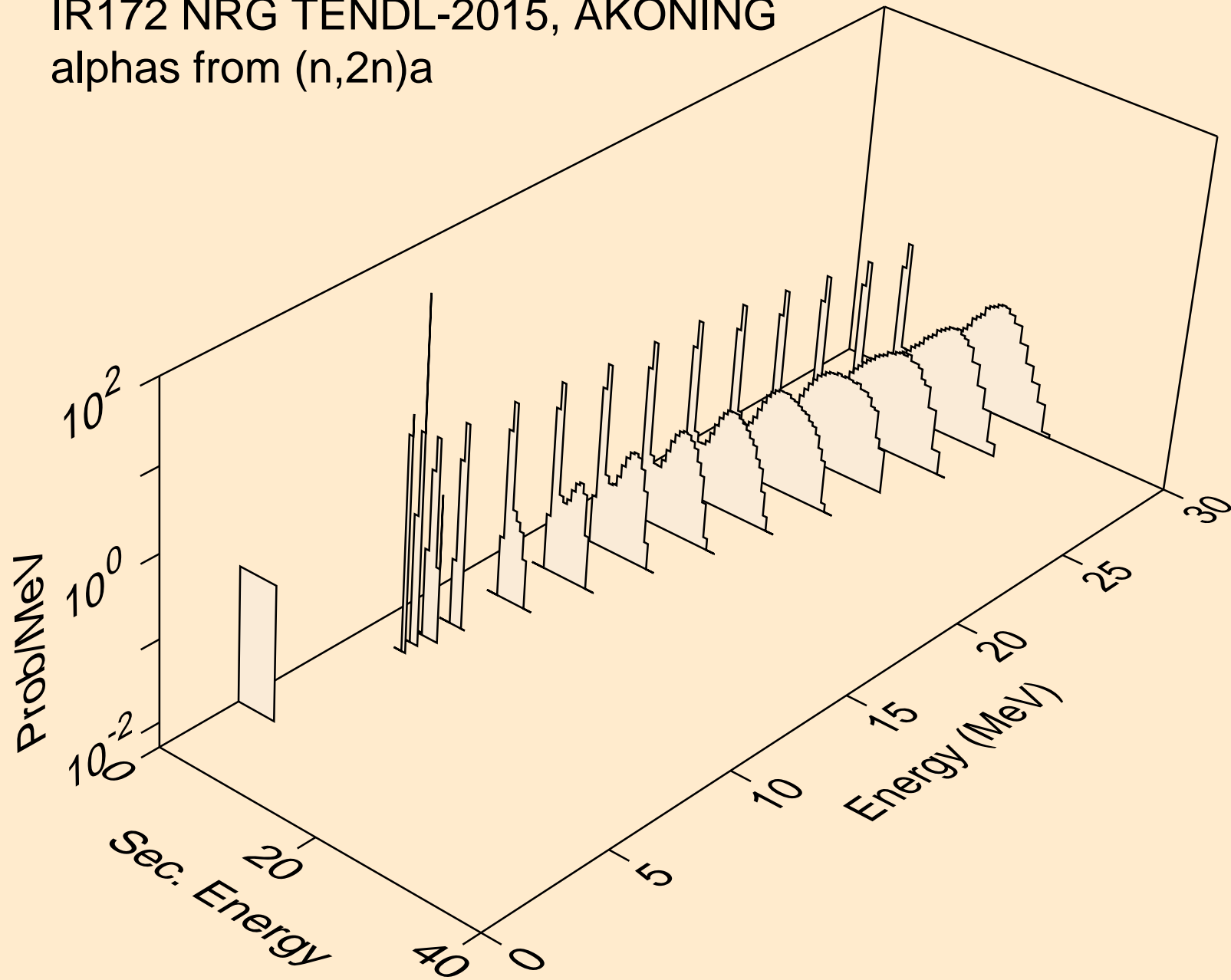

IR172 NRG TENDL-2015, AKONING
alphas from (n,3n)a

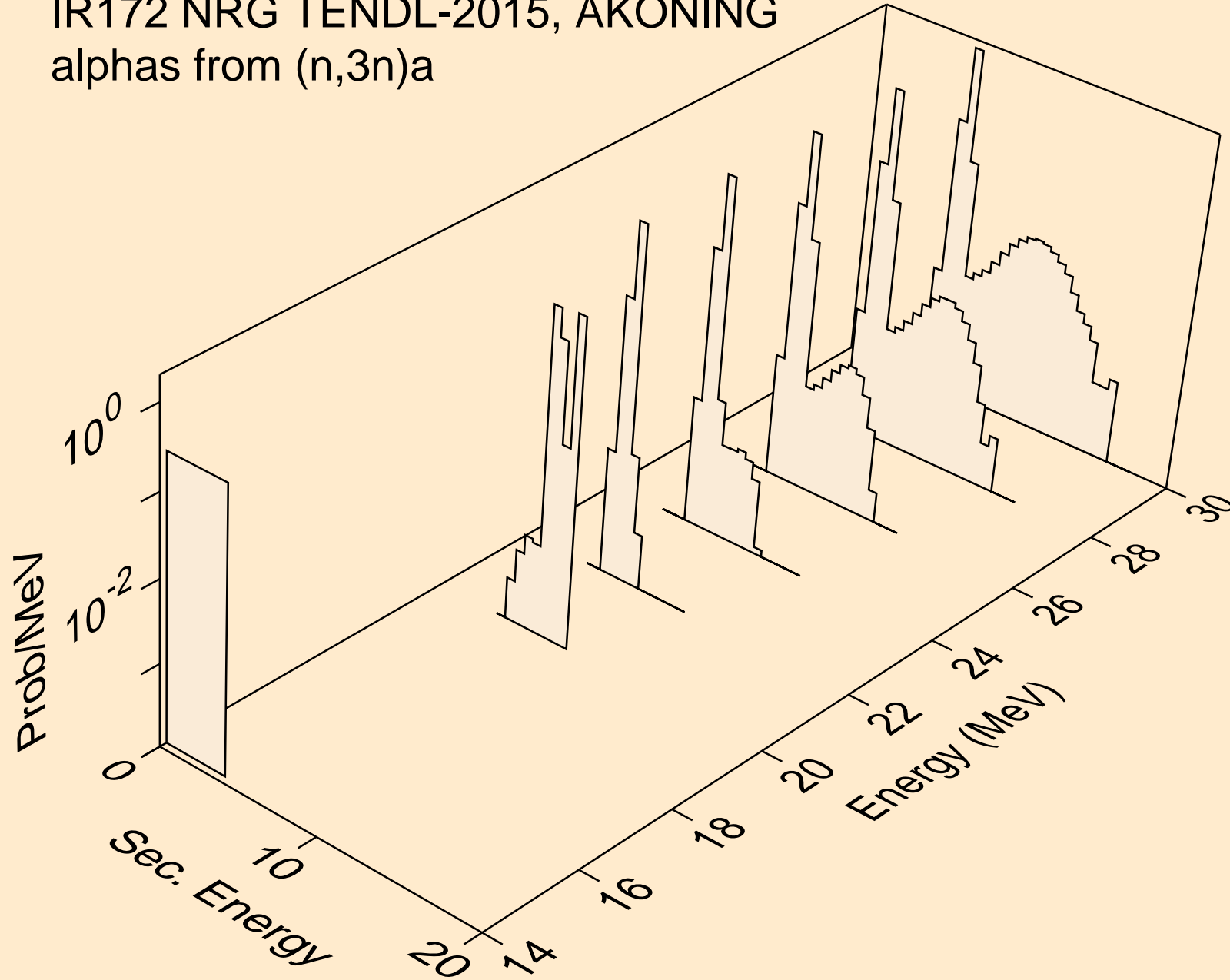

IR172 NRG TENDL-2015, AKONING
alphas from (n,n*)2a

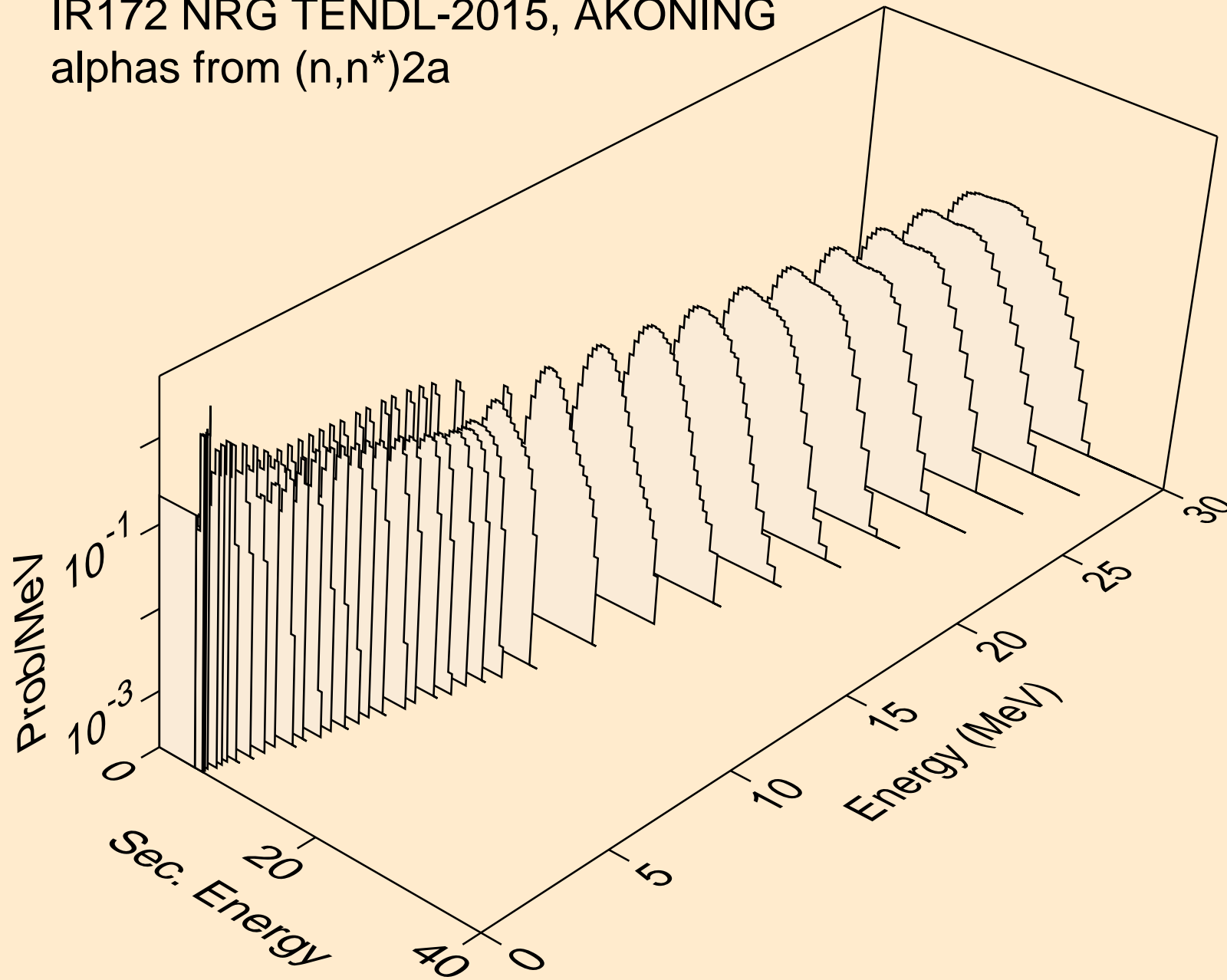

IR172 NRG TENDL-2015, AKONING
alphas from (n,2n)2a

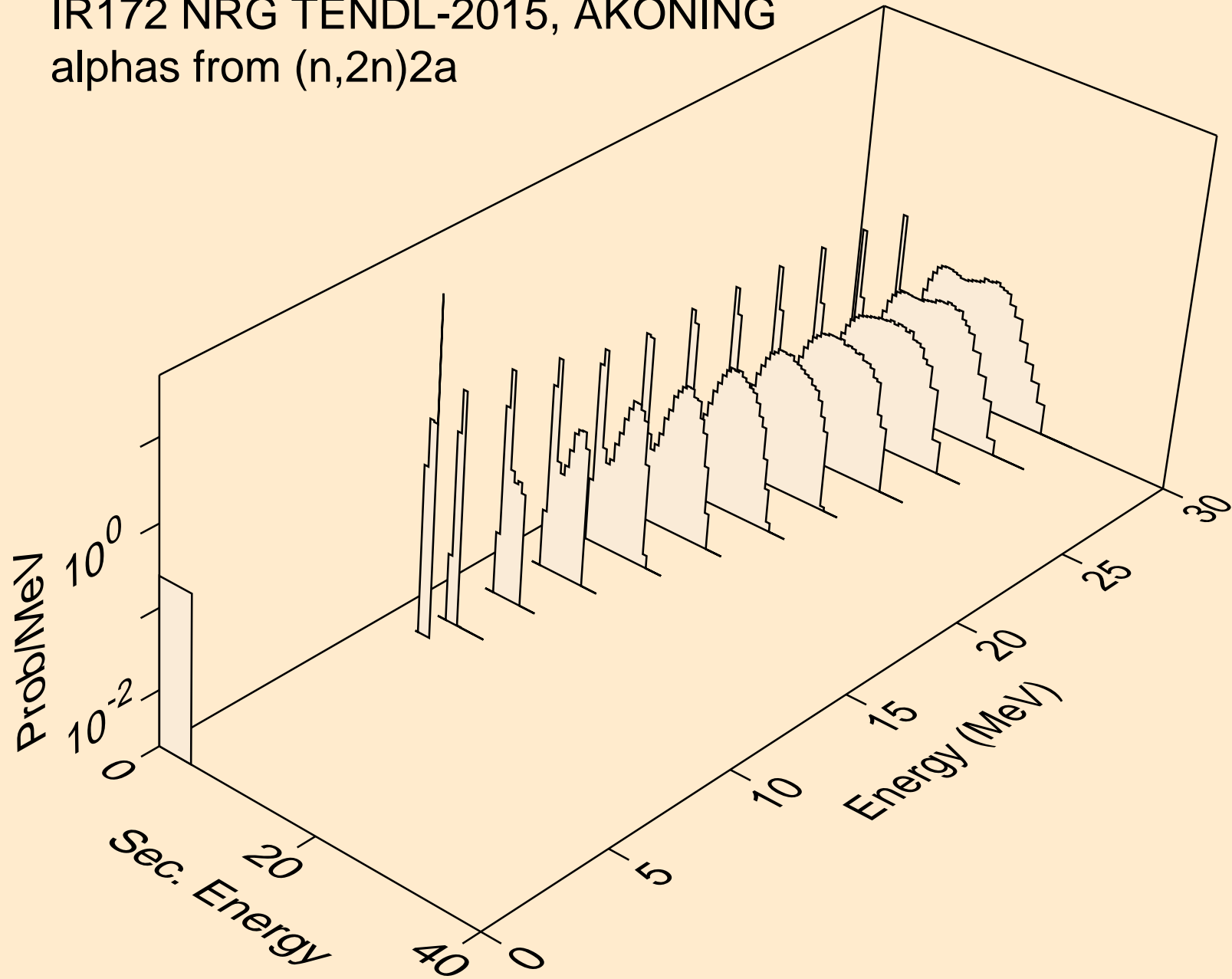

IR172 NRG TENDL-2015, AKONING
alphas from (n,n*)d2a

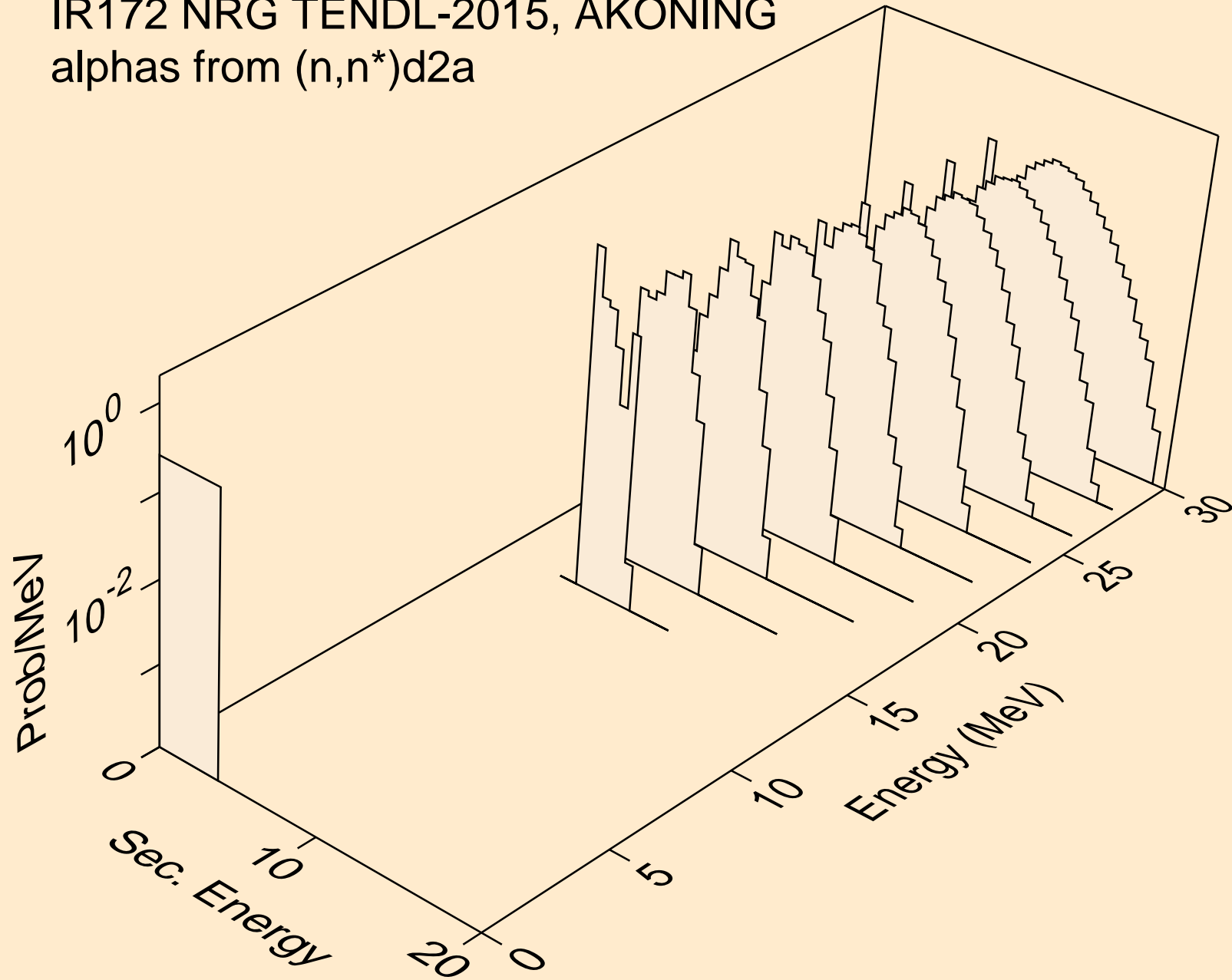

IR172 NRG TENDL-2015, AKONING
alphas from (n,n*)t2a

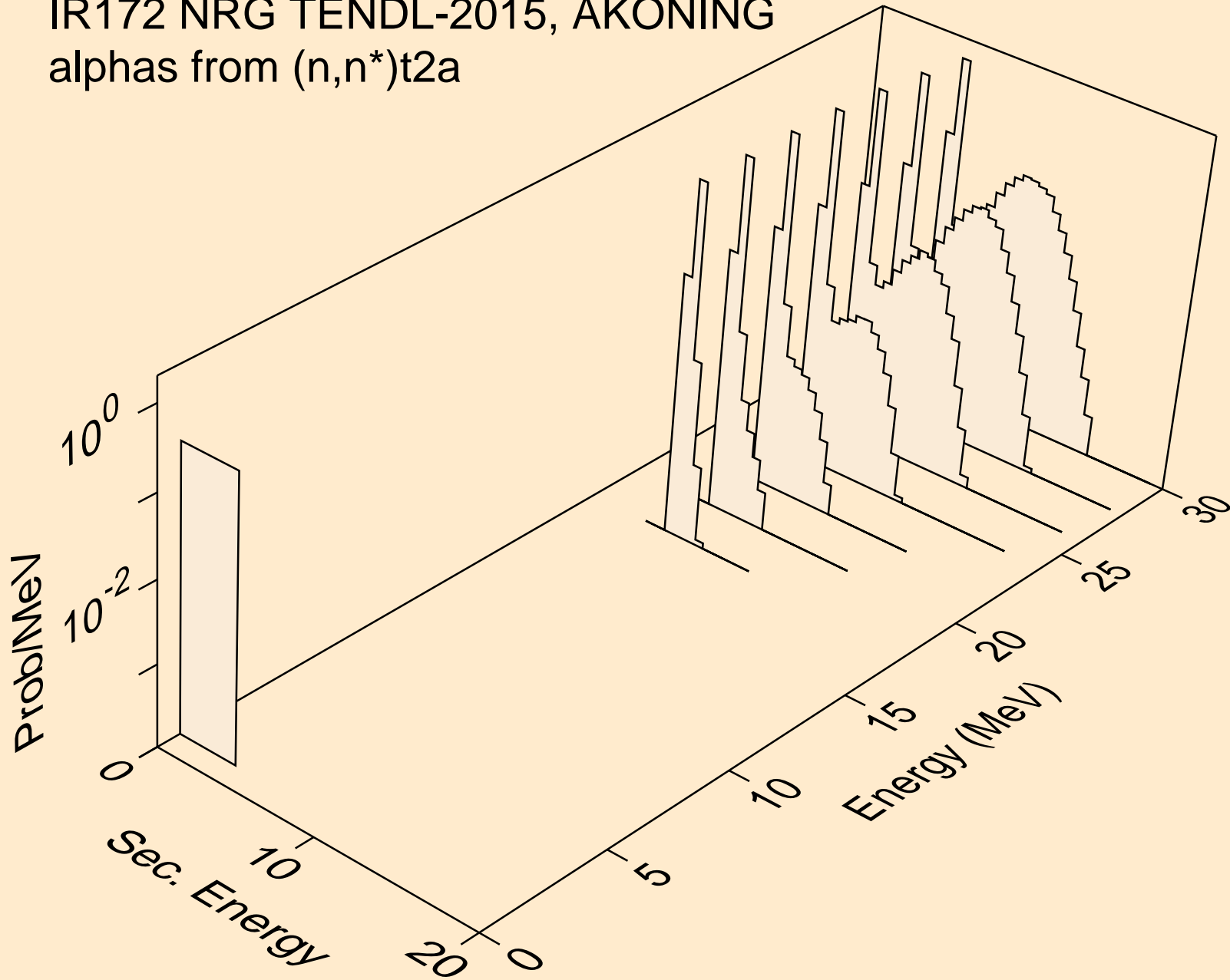

IR172 NRG TENDL-2015, AKONING
alphas from (n,npa)

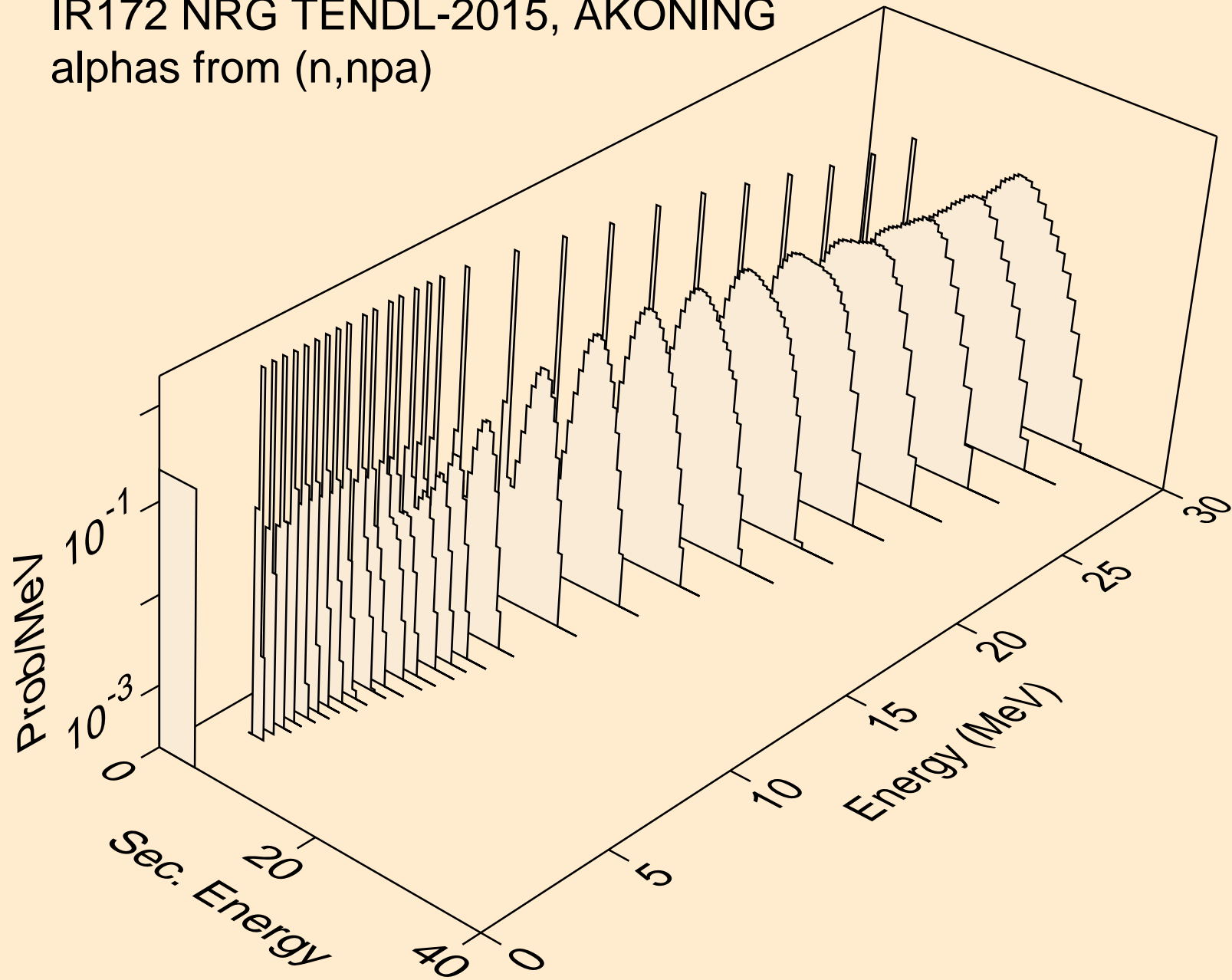

IR172 NRG TENDL-2015, AKONING
alphas from (n,a)

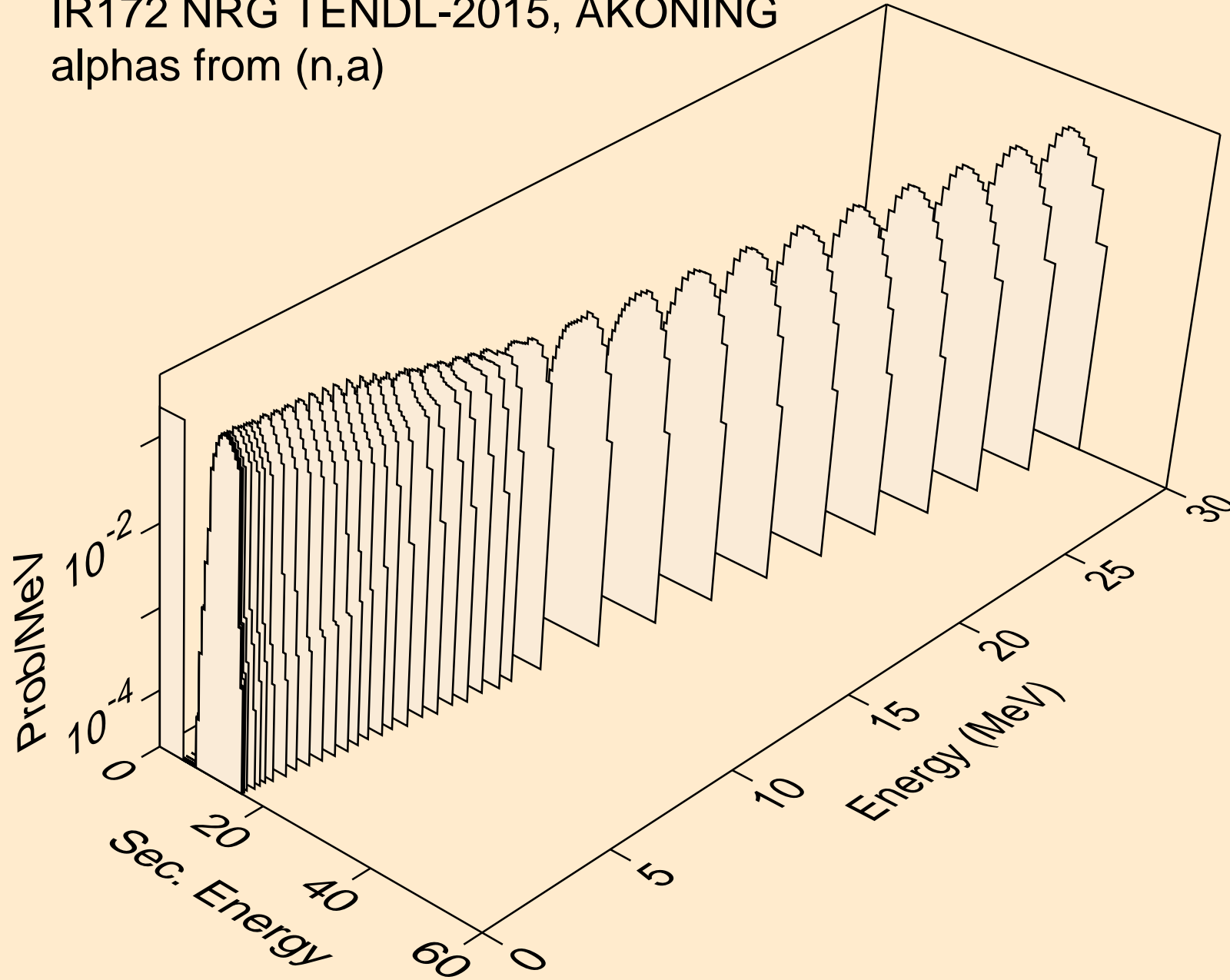

IR172 NRG TENDL-2015, AKONING
alphas from (n,2a)

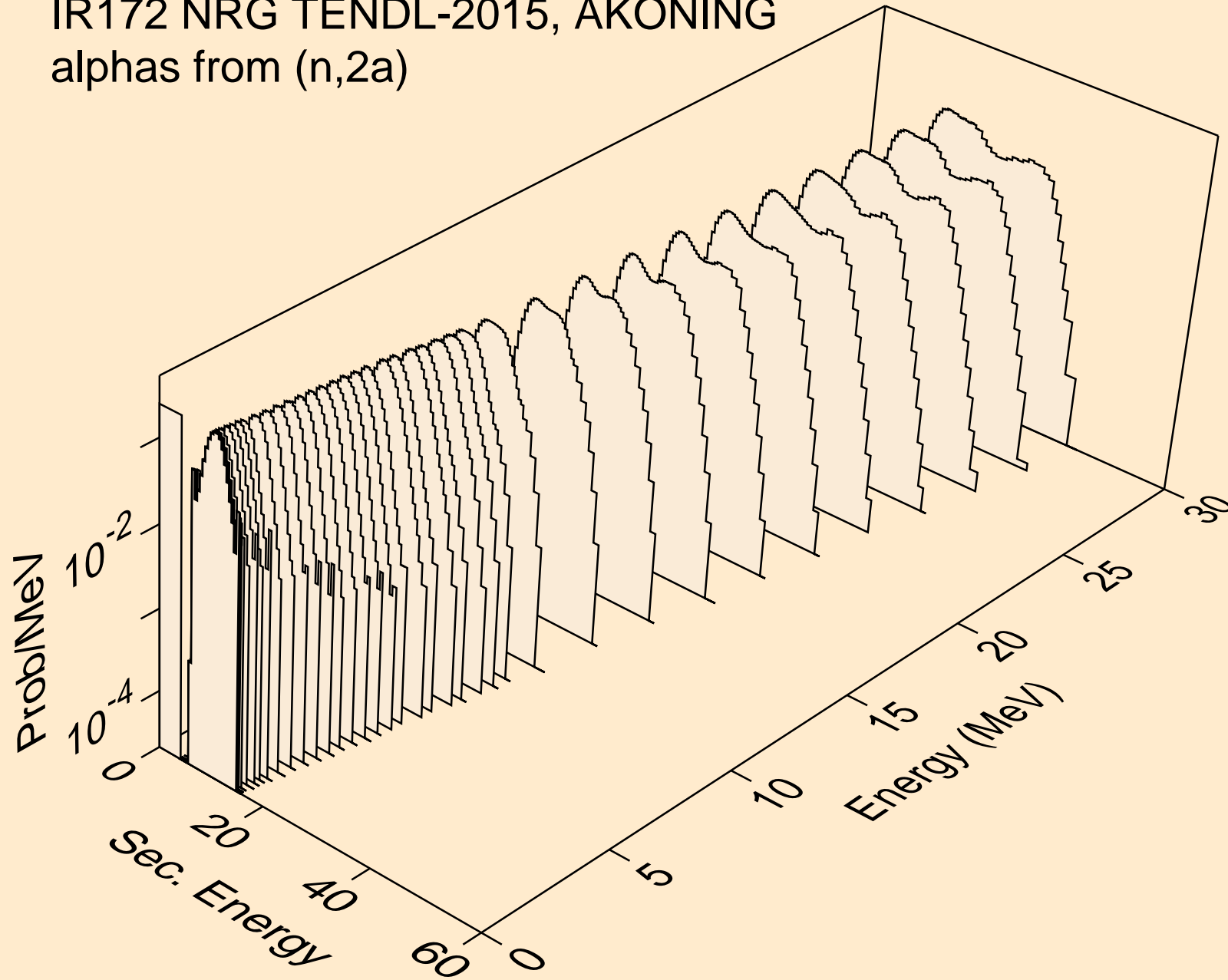

IR172 NRG TENDL-2015, AKONING
alphas from (n,3a)

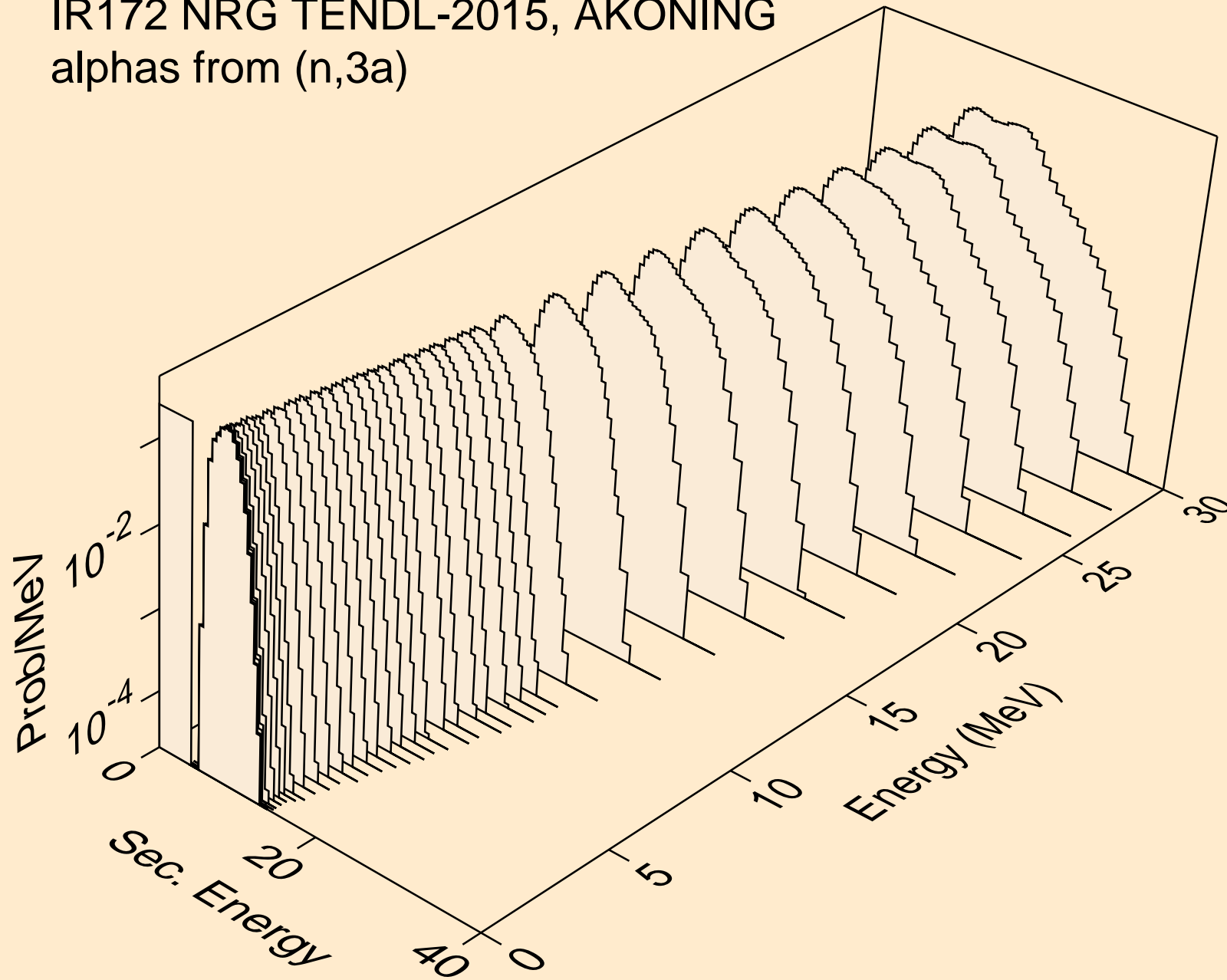

IR172 NRG TENDL-2015, AKONING
alphas from (n,pa)

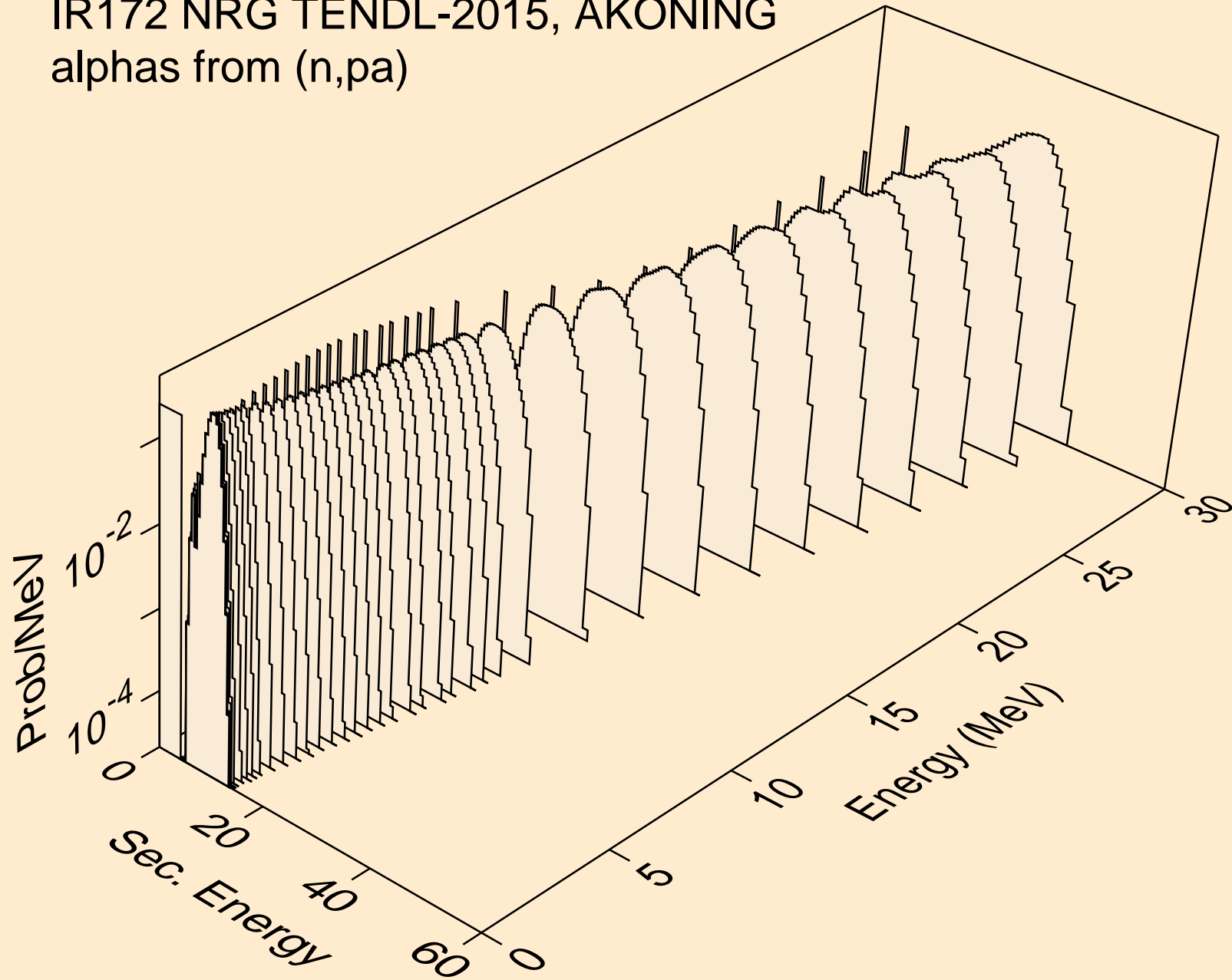

IR172 NRG TENDL-2015, AKONING
alphas from (n,t2a)

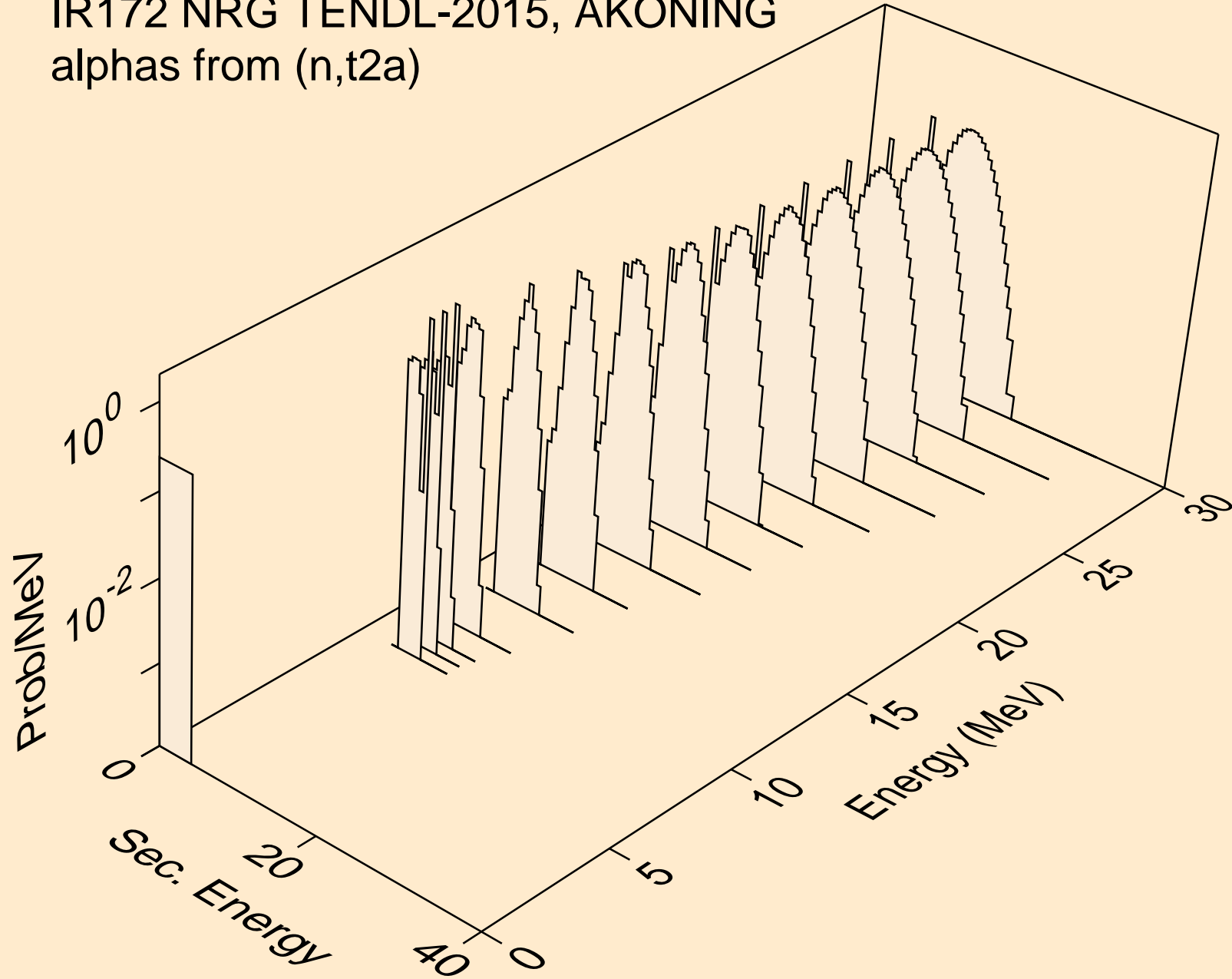

IR172 NRG TENDL-2015, AKONING
alphas from (n,d2a)

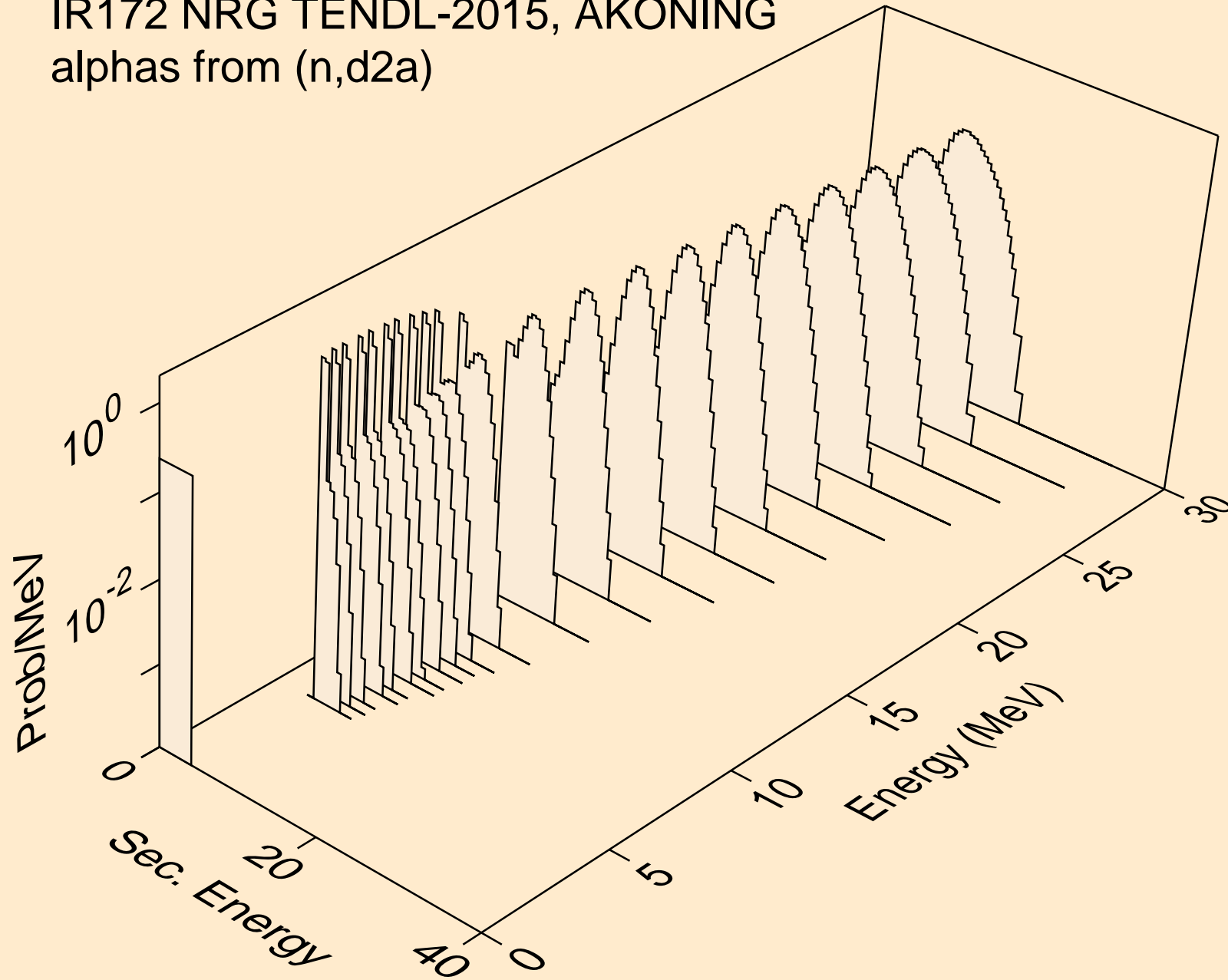

IR172 NRG TENDL-2015, AKONING
alphas from (n,da)

