

# IR177 NRG TENDL-2015, AKONING

## Principal cross sections

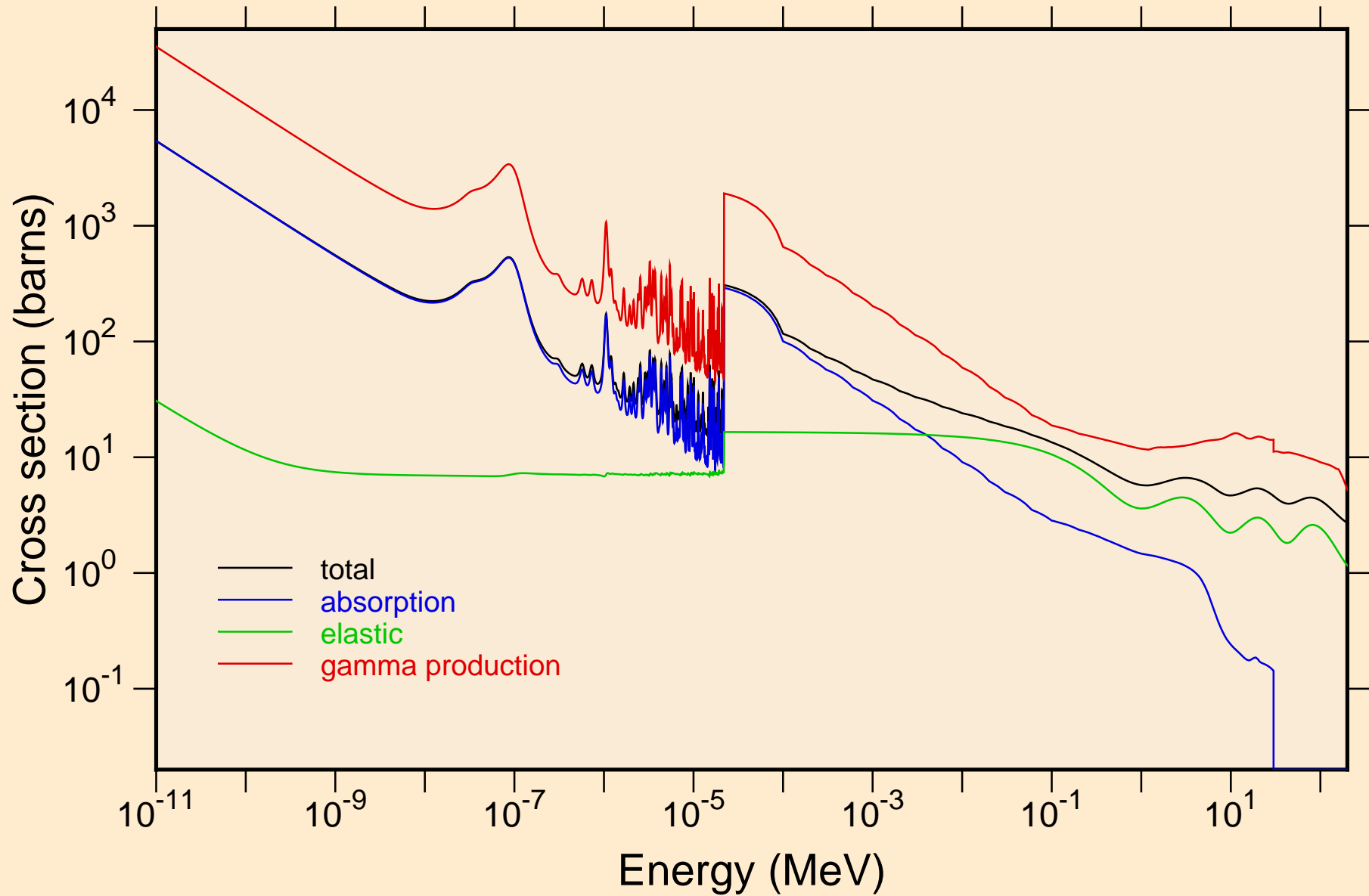

IR177 NRG TENDL-2015, AKONING  
resonance total cross section

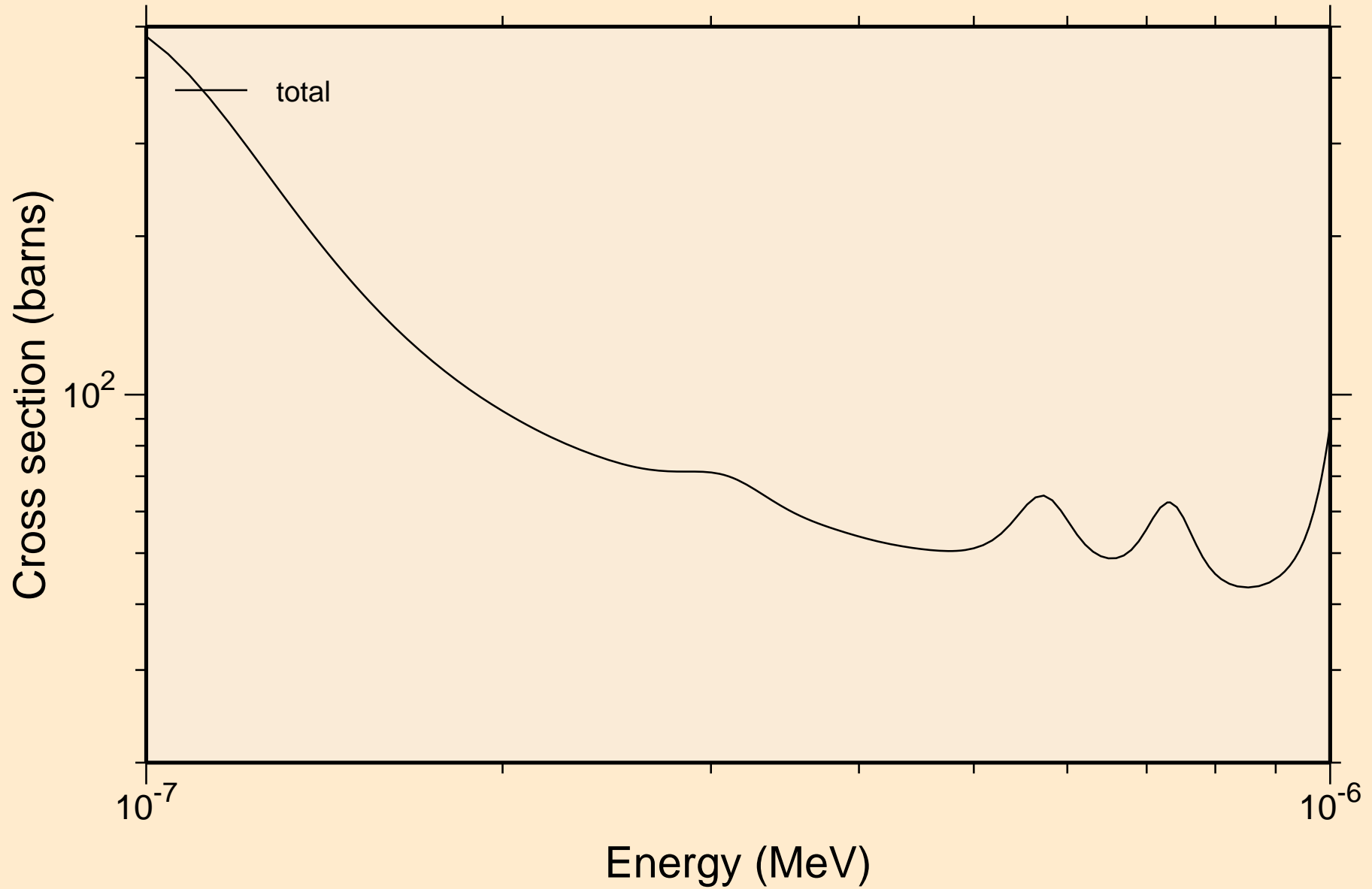

IR177 NRG TENDL-2015, AKONING  
resonance total cross section

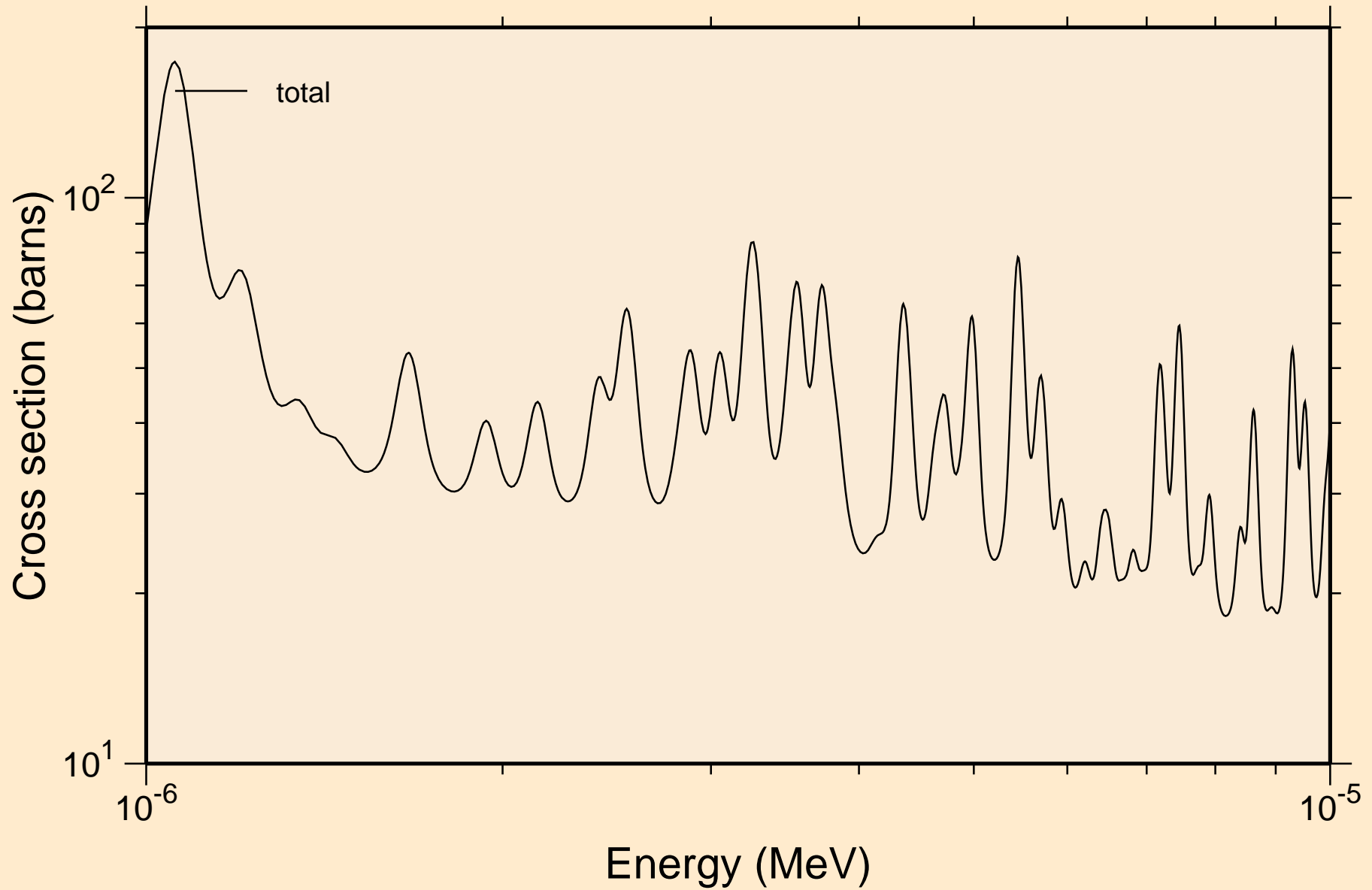

IR177 NRG TENDL-2015, AKONING  
resonance total cross section

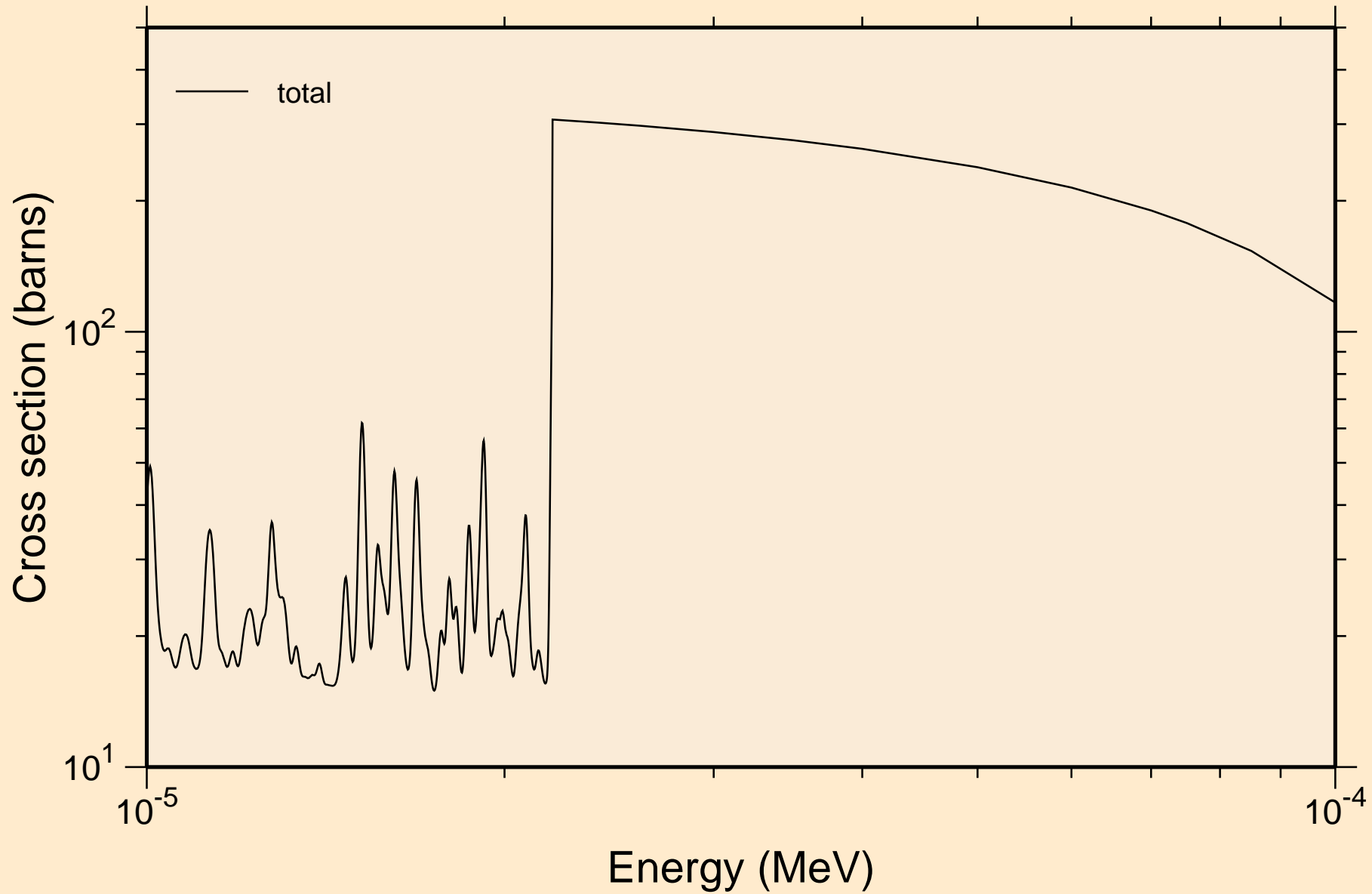

IR177 NRG TENDL-2015, AKONING  
resonance total cross section

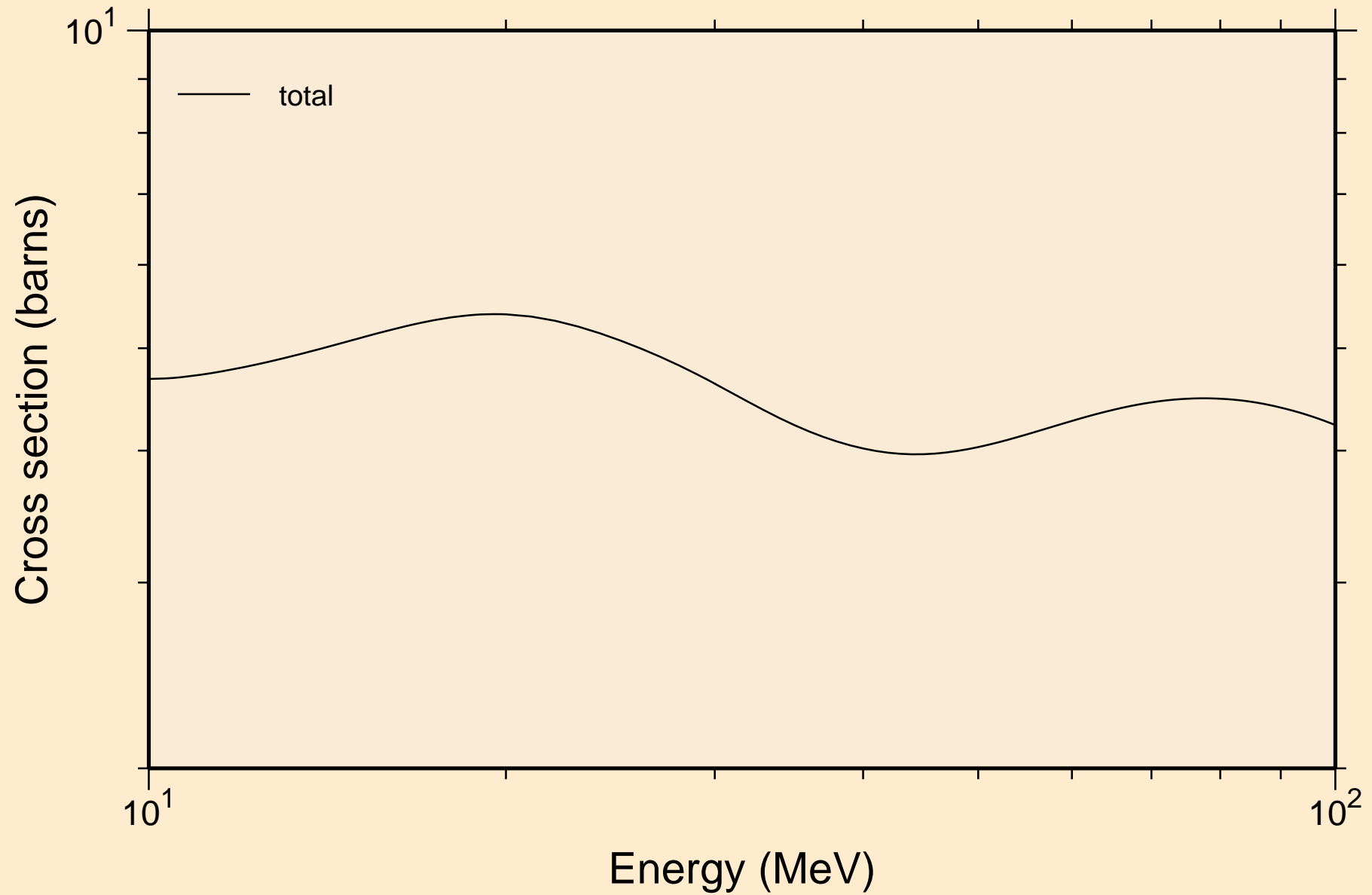

IR177 NRG TENDL-2015, AKONING  
resonance absorption cross sections

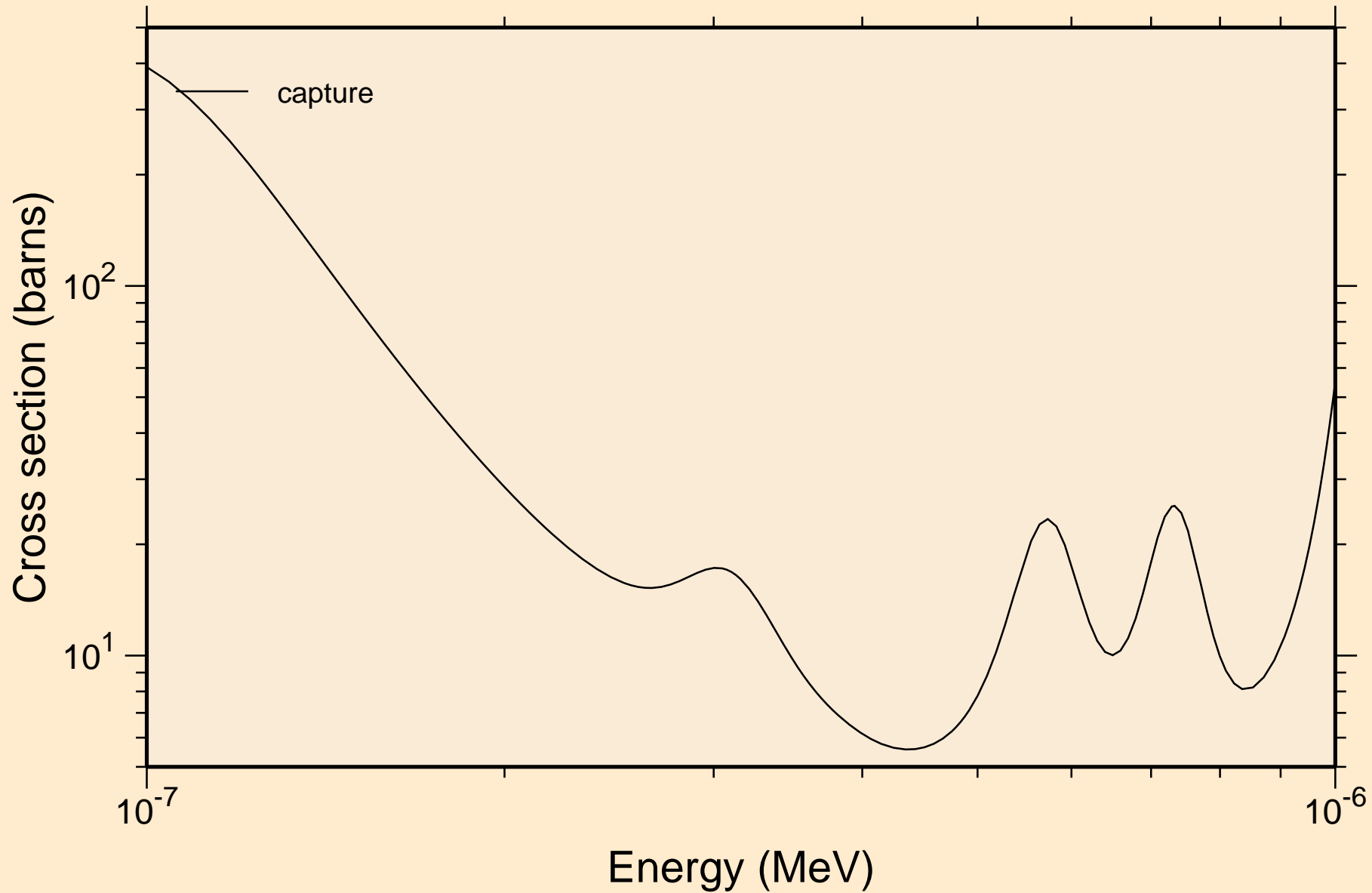

IR177 NRG TENDL-2015, AKONING  
resonance absorption cross sections

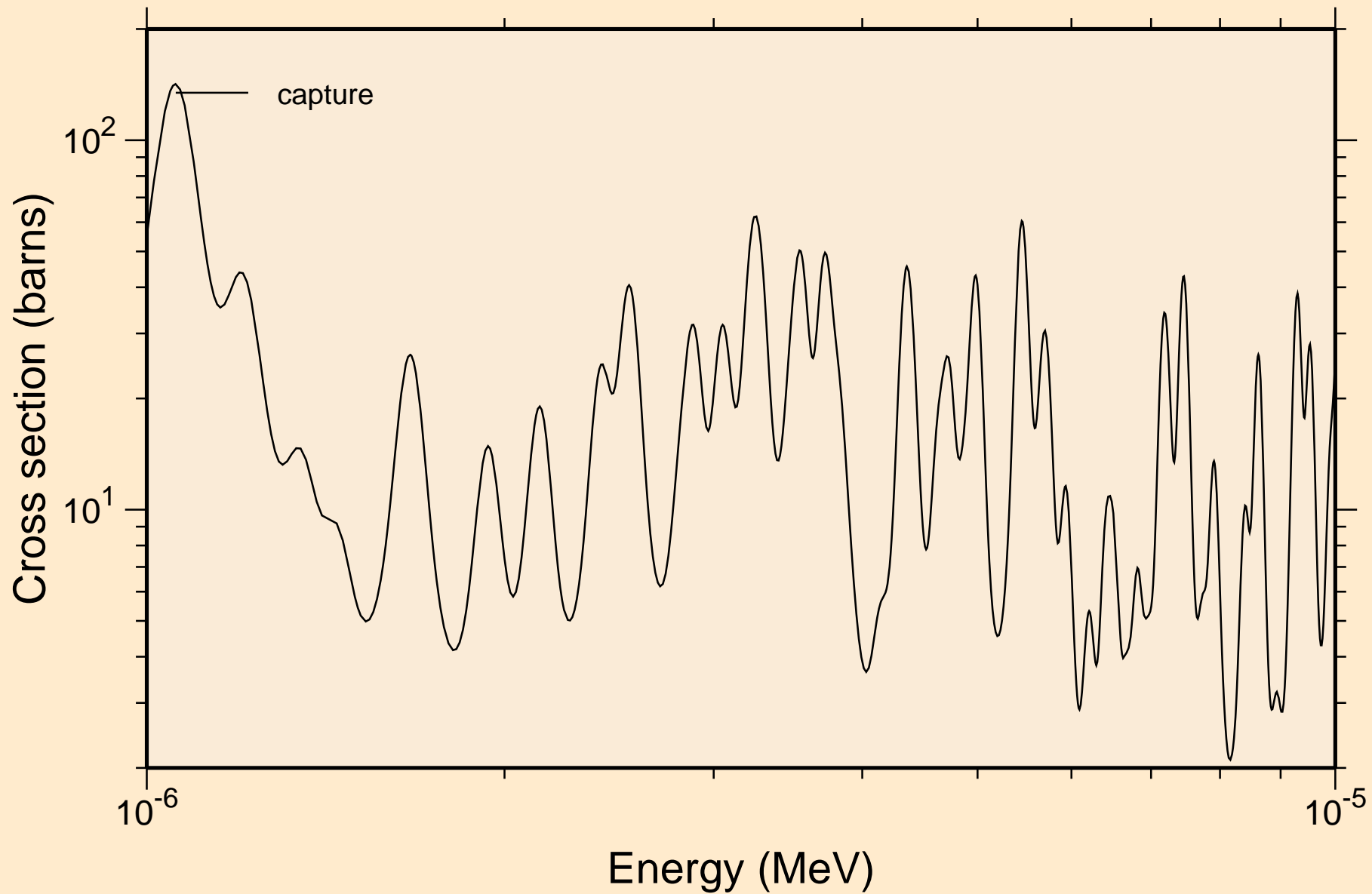

IR177 NRG TENDL-2015, AKONING  
resonance absorption cross sections

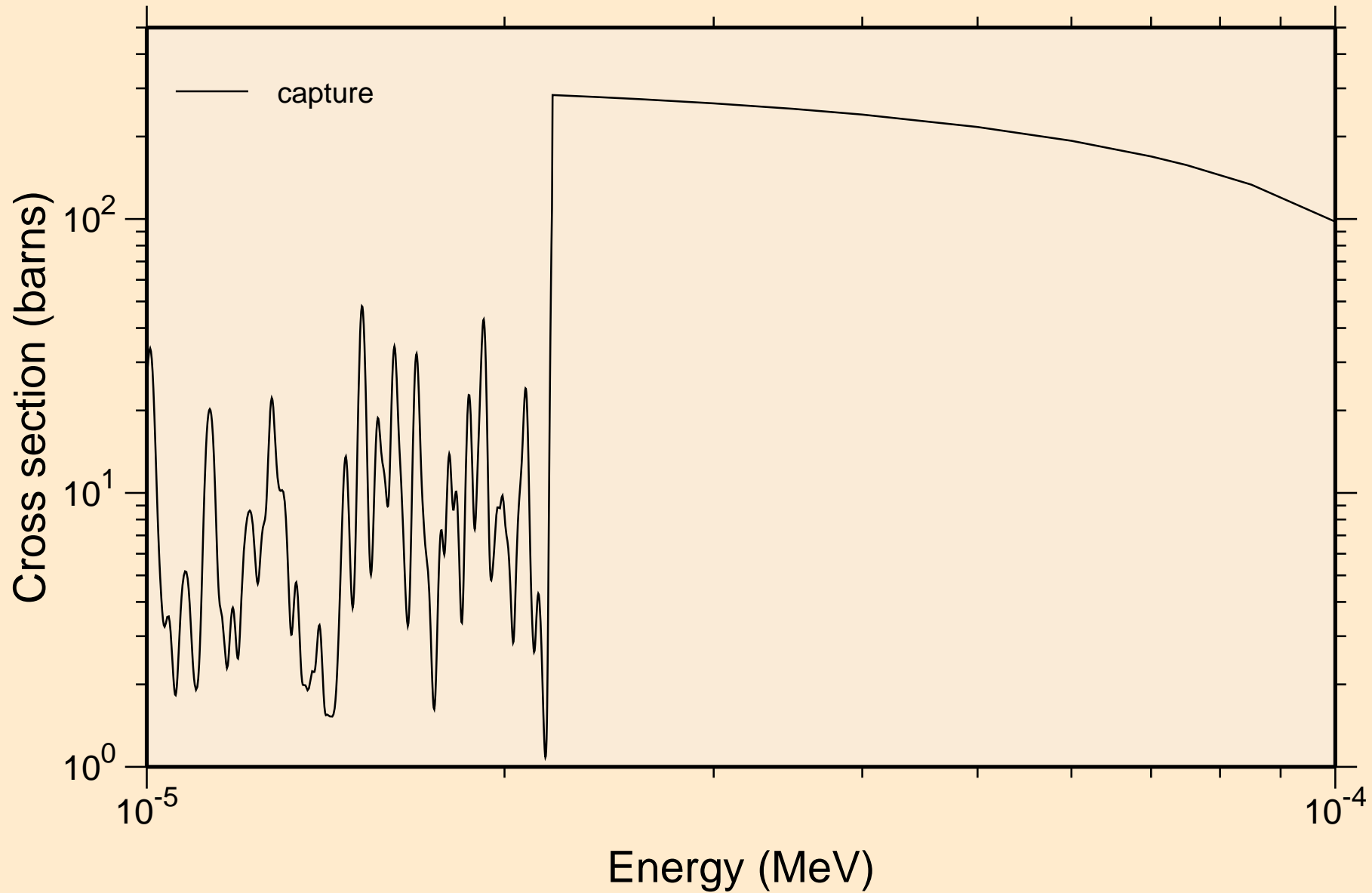



IR177 NRG TENDL-2015, AKONING  
resonance absorption cross sections

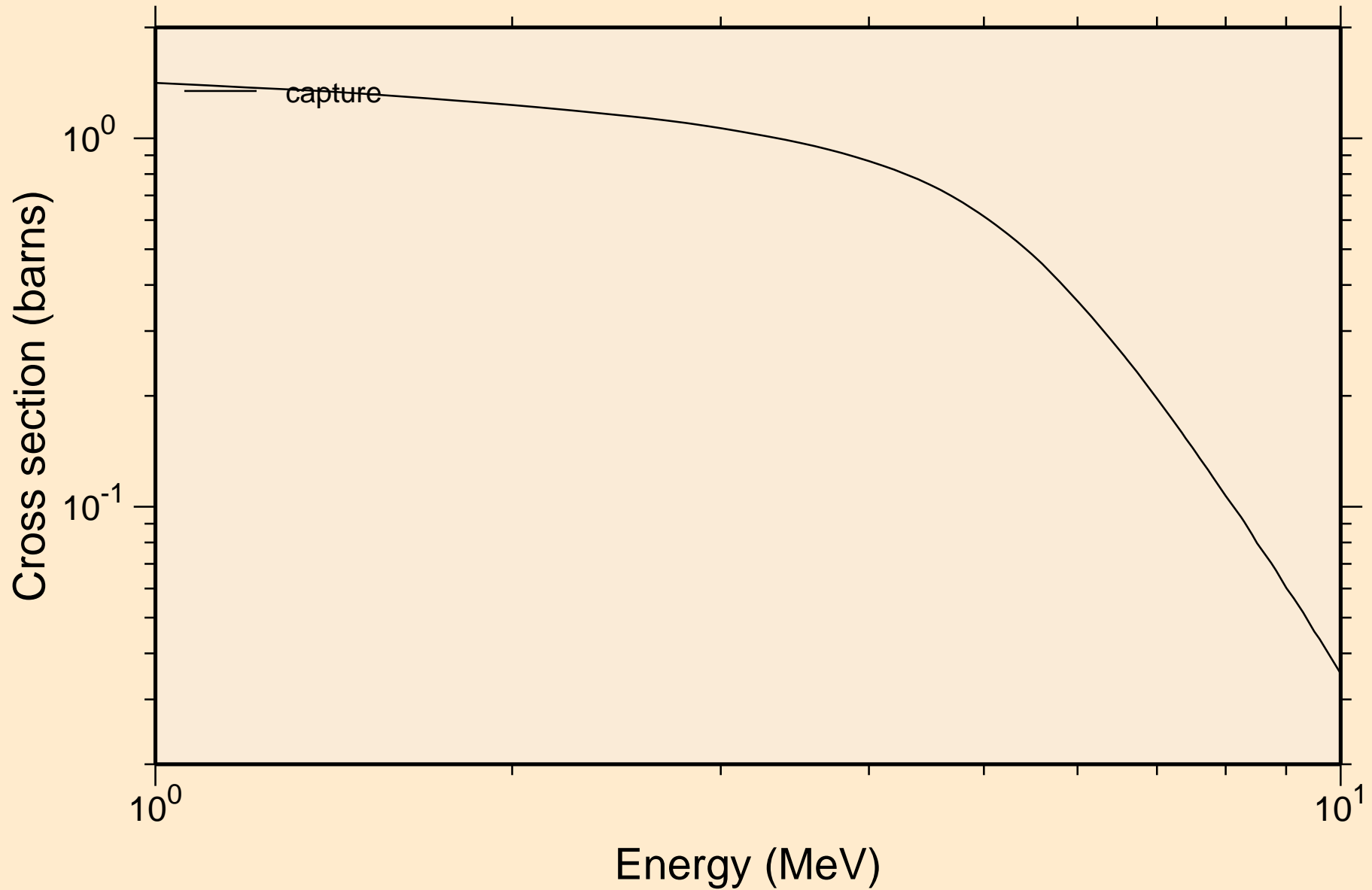

# IR177 NRG TENDL-2015, AKONING

## Non-threshold reactions

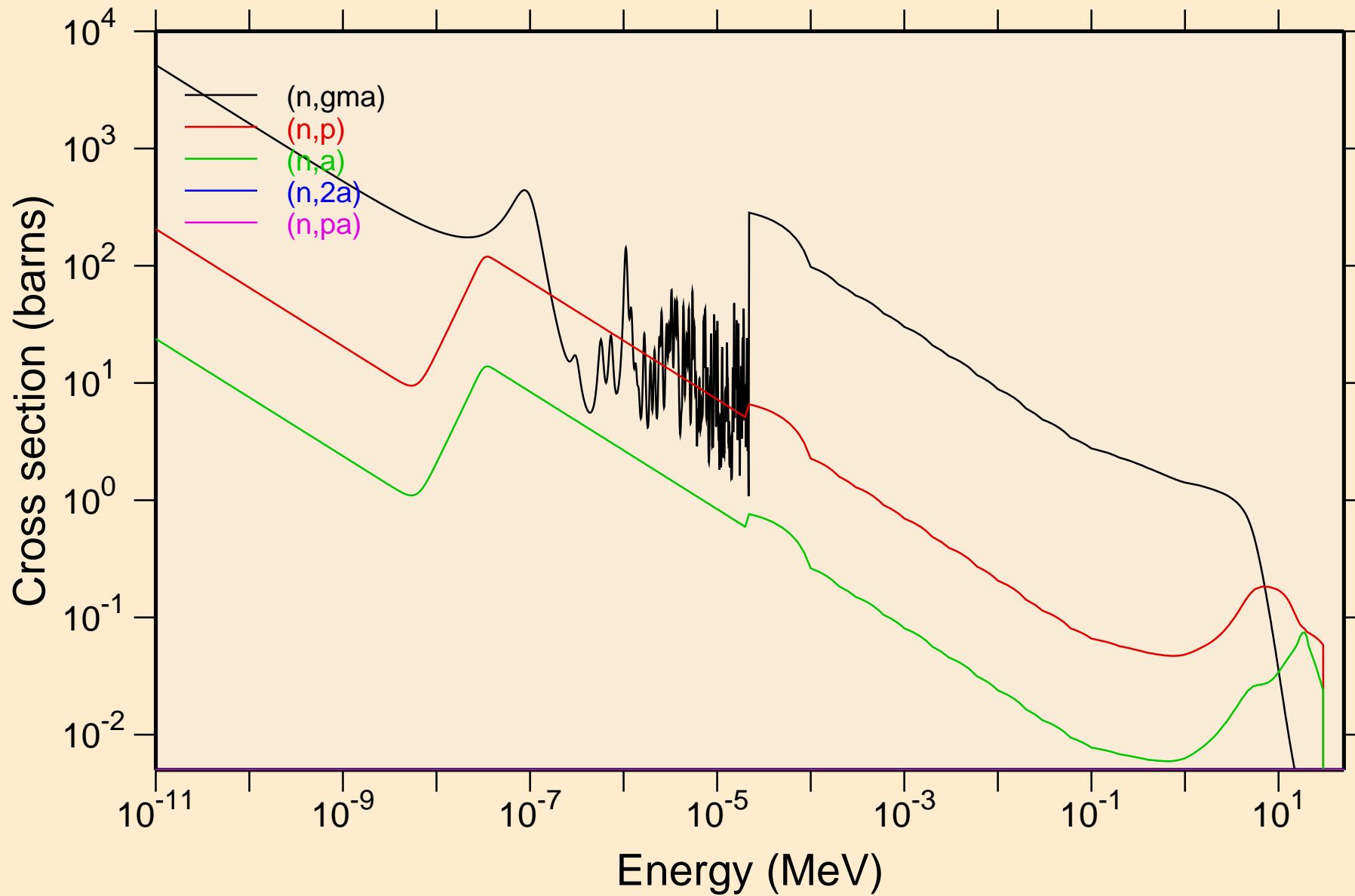

# IR177 NRG TENDL-2015, AKONING

## Principal cross sections

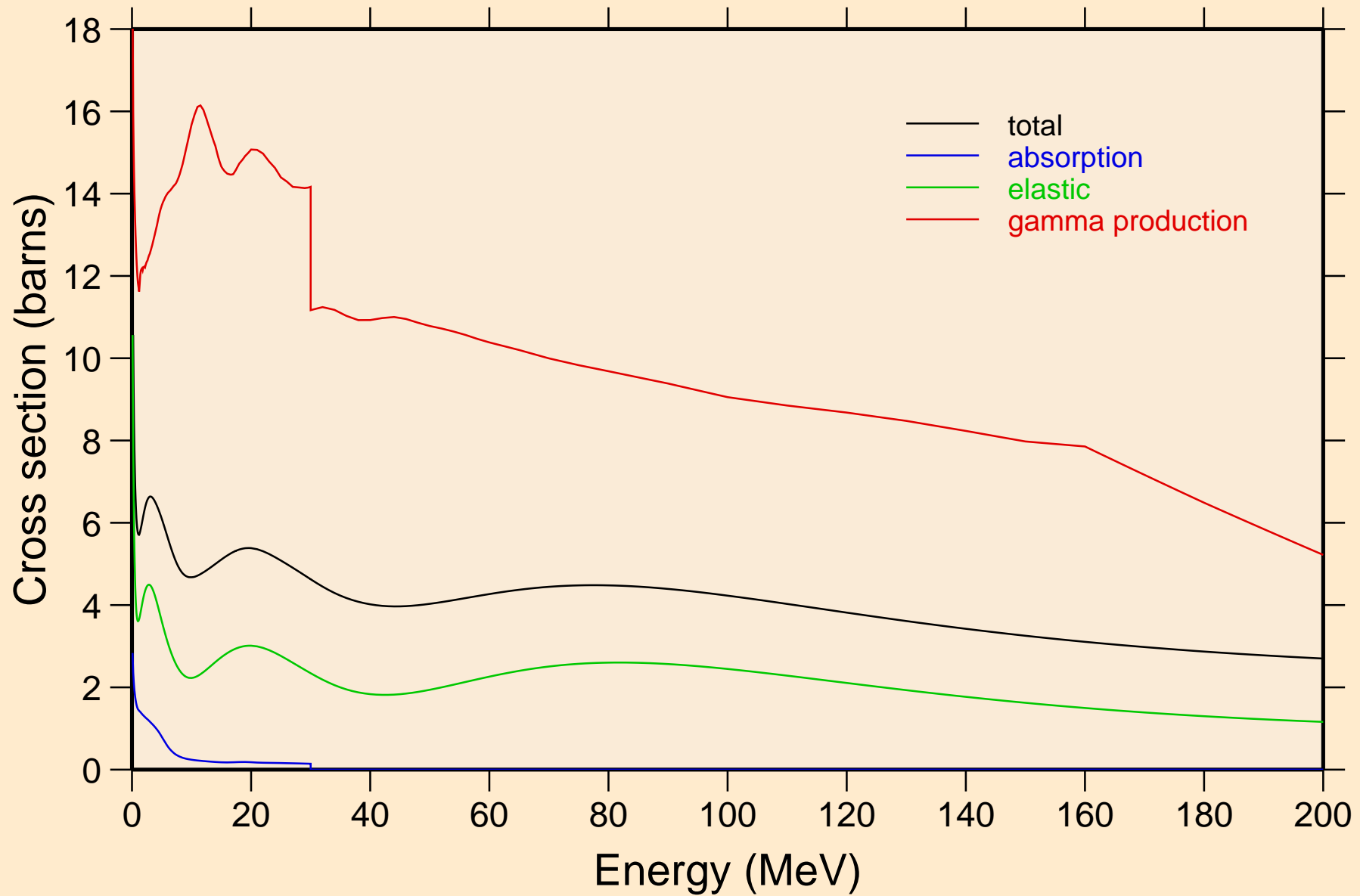

# IR177 NRG TENDL-2015, AKONING

## Non-threshold reactions

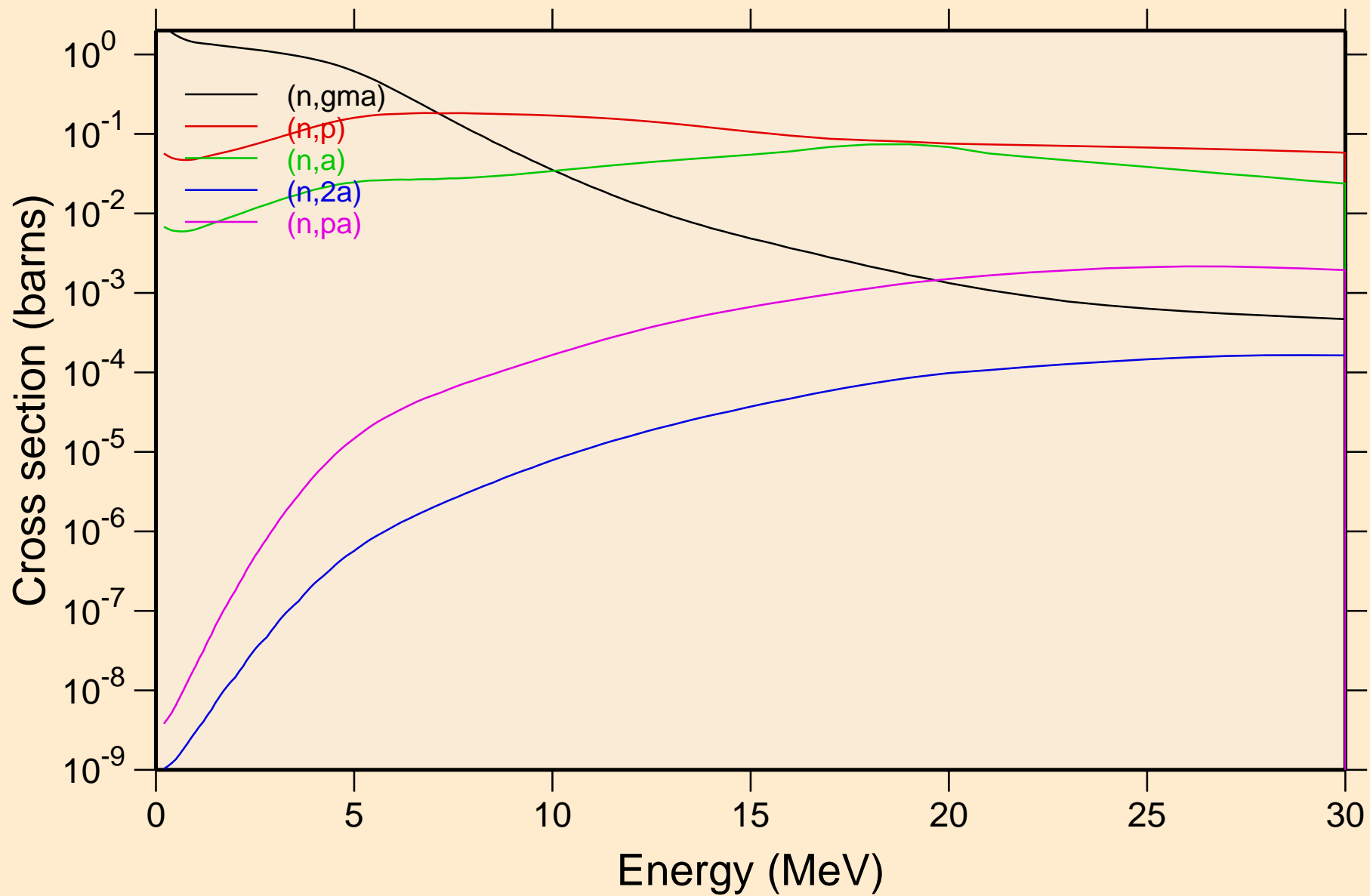

# IR177 NRG TENDL-2015, AKONING

## Inelastic levels

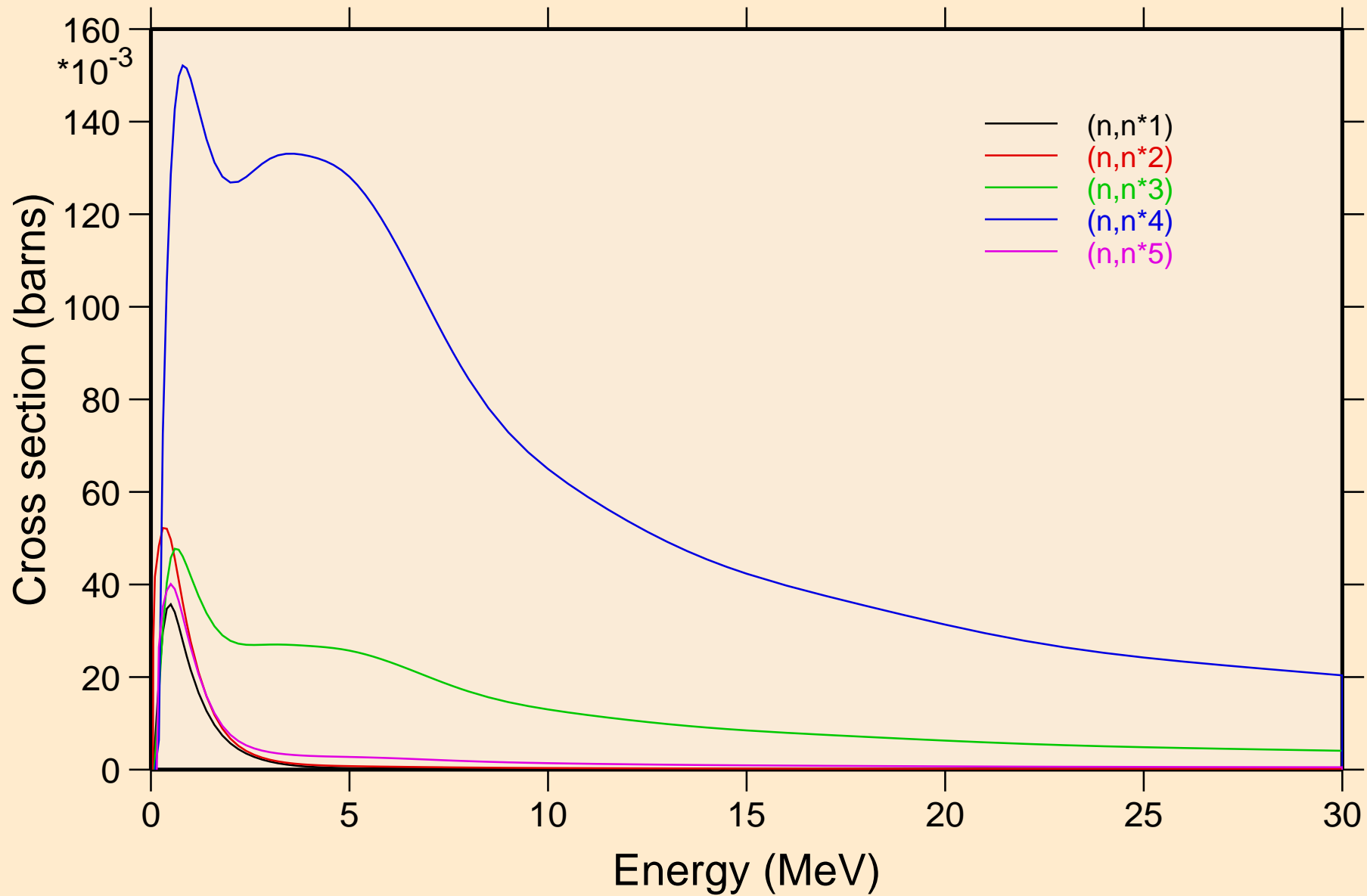

# IR177 NRG TENDL-2015, AKONING

## Inelastic levels

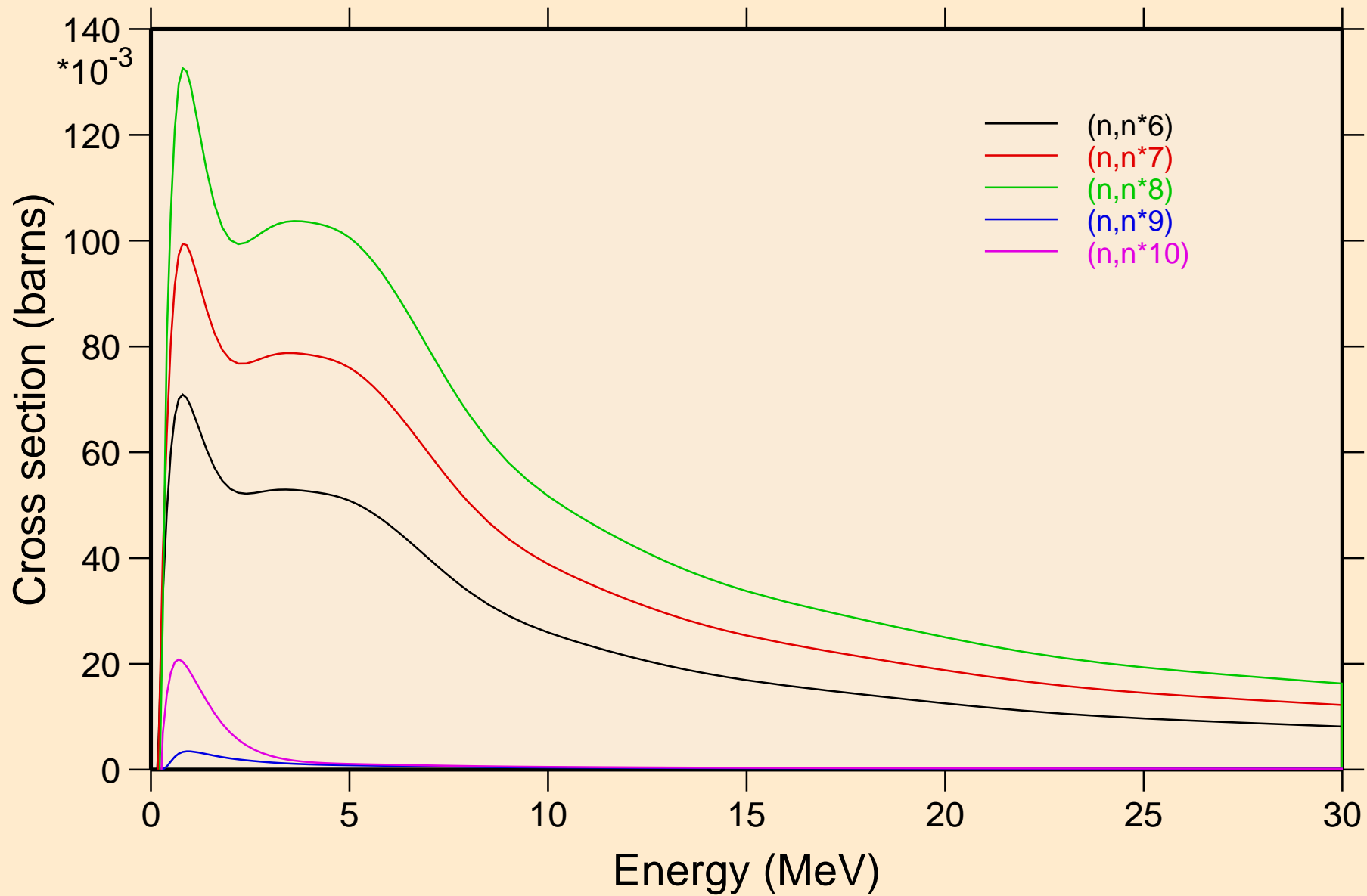

# IR177 NRG TENDL-2015, AKONING

## Inelastic levels

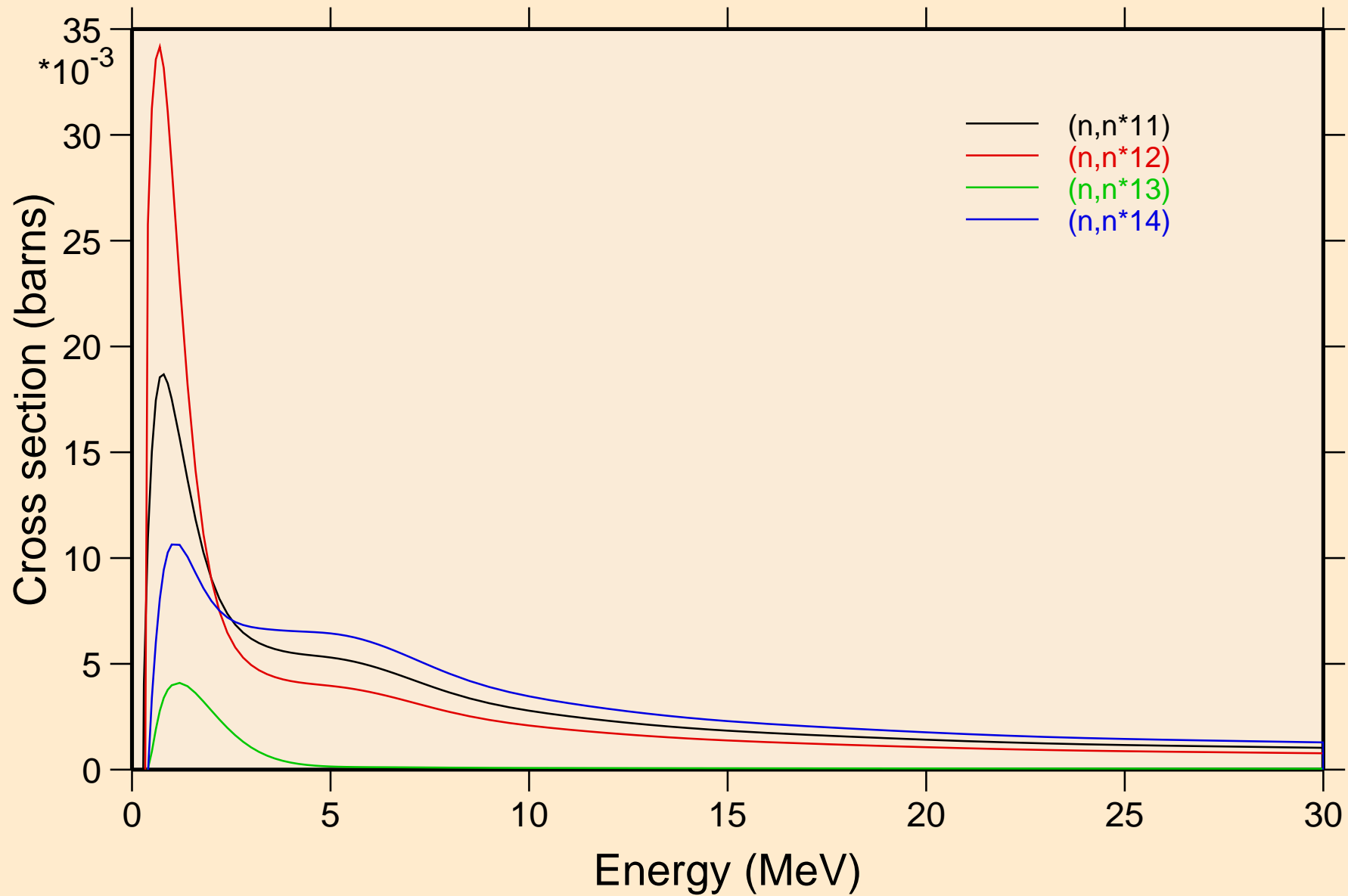

# IR177 NRG TENDL-2015, AKONING

## Threshold reactions

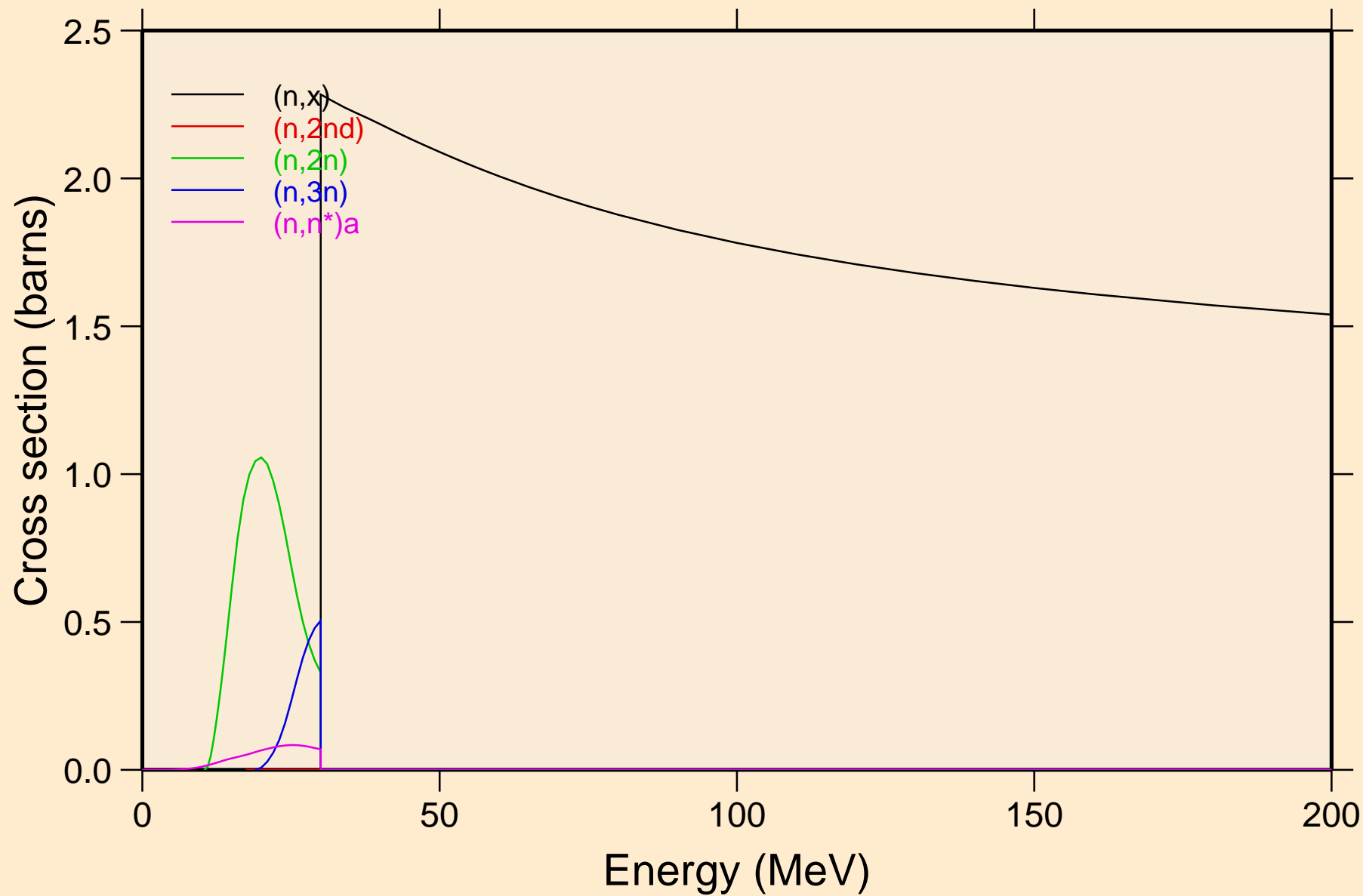



# IR177 NRG TENDL-2015, AKONING

## Threshold reactions

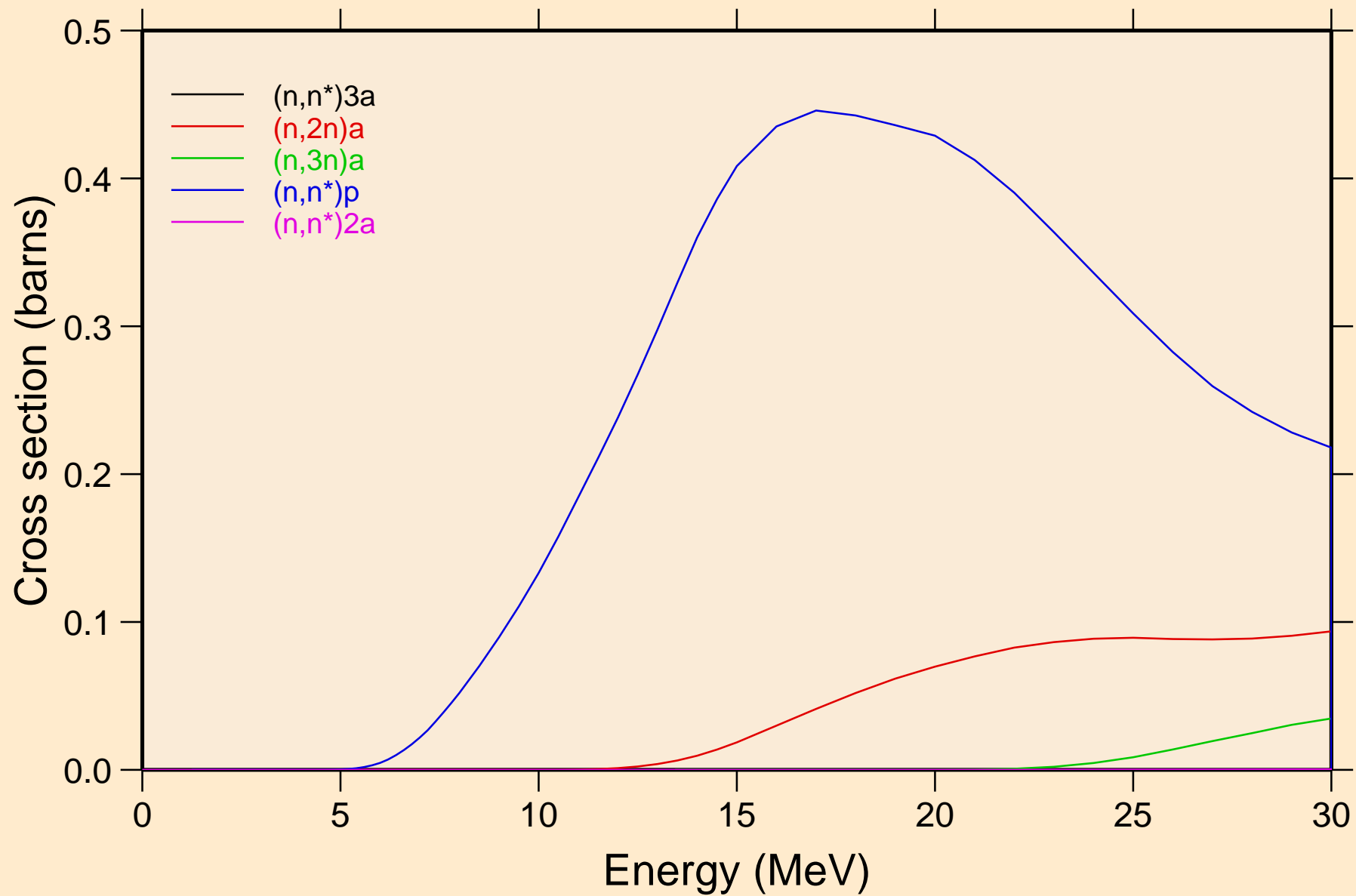

# IR177 NRG TENDL-2015, AKONING

## Threshold reactions

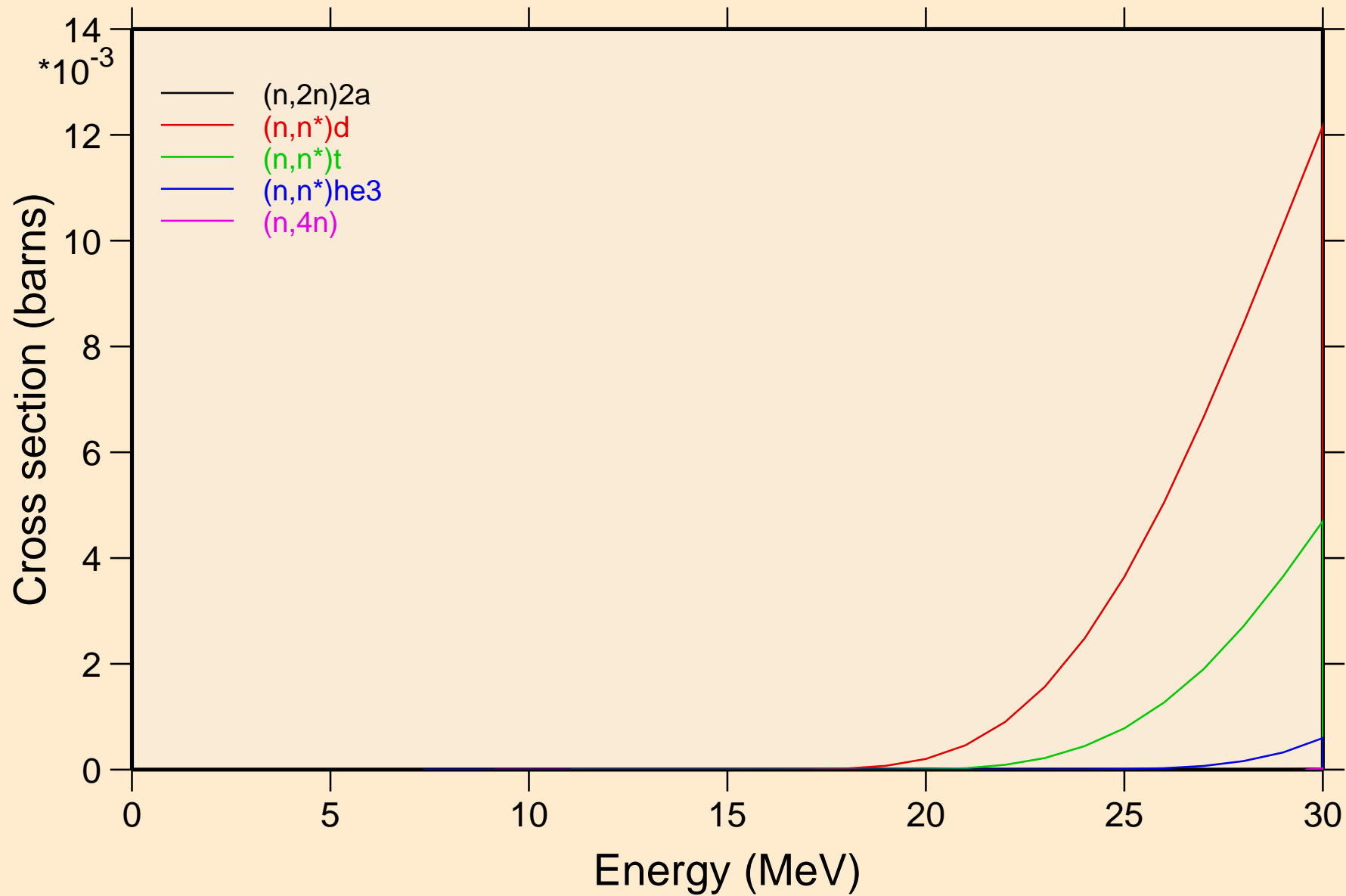

# IR177 NRG TENDL-2015, AKONING

## Threshold reactions

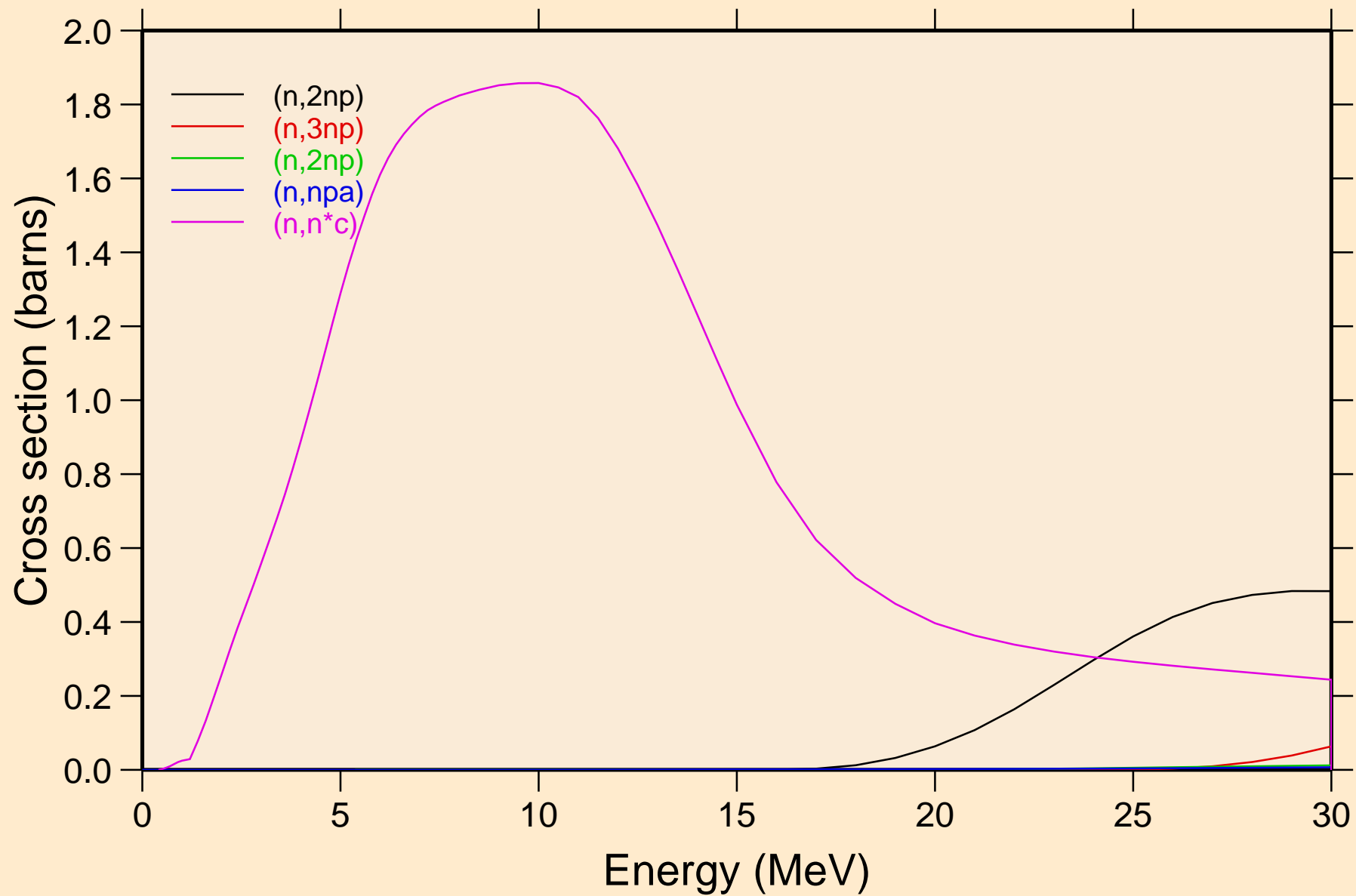

# IR177 NRG TENDL-2015, AKONING

## Threshold reactions

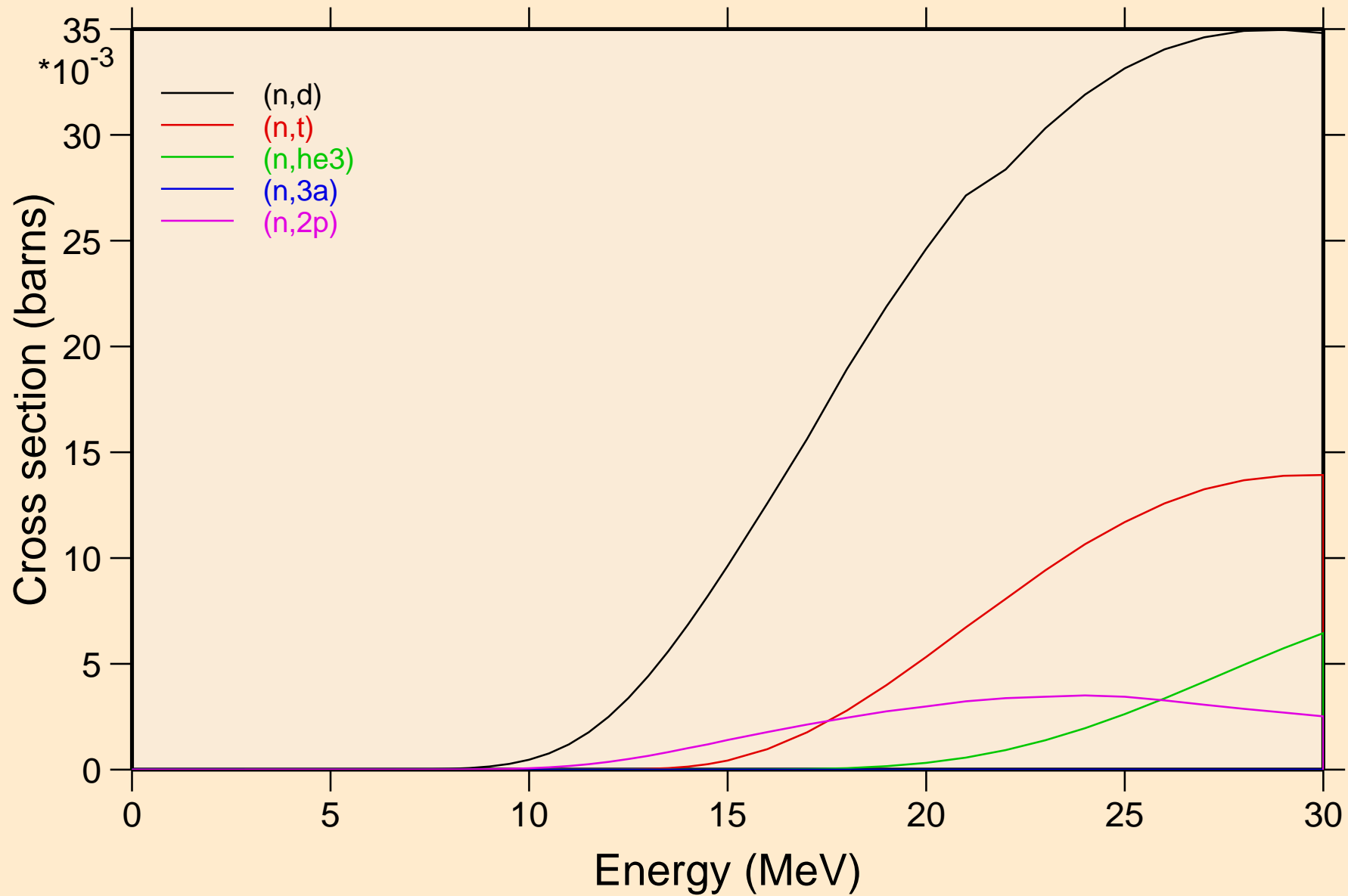

# IR177 NRG TENDL-2015, AKONING

## Threshold reactions

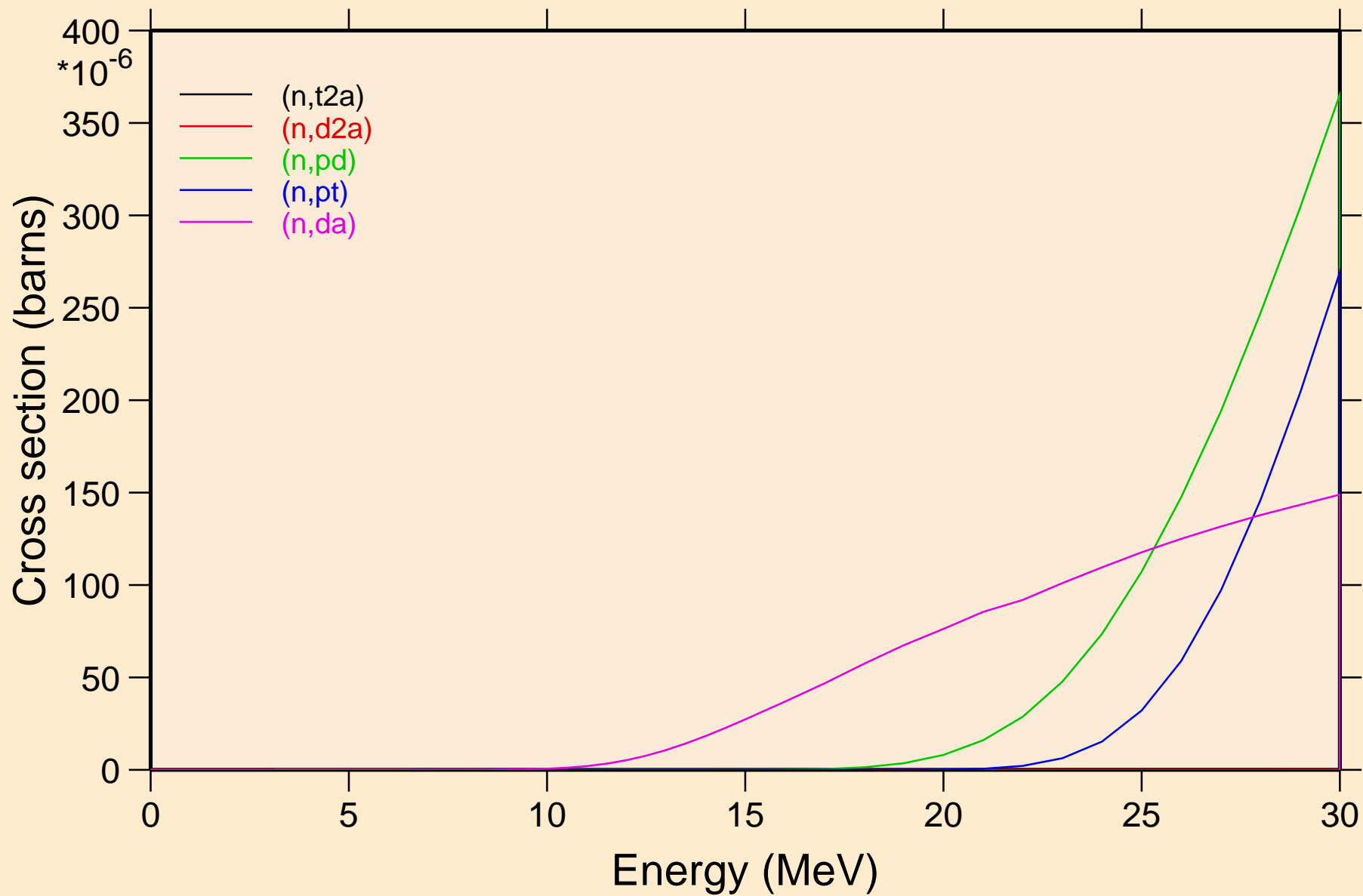

IR177 NRG TENDL-2015, AKONING  
angular distribution for elastic

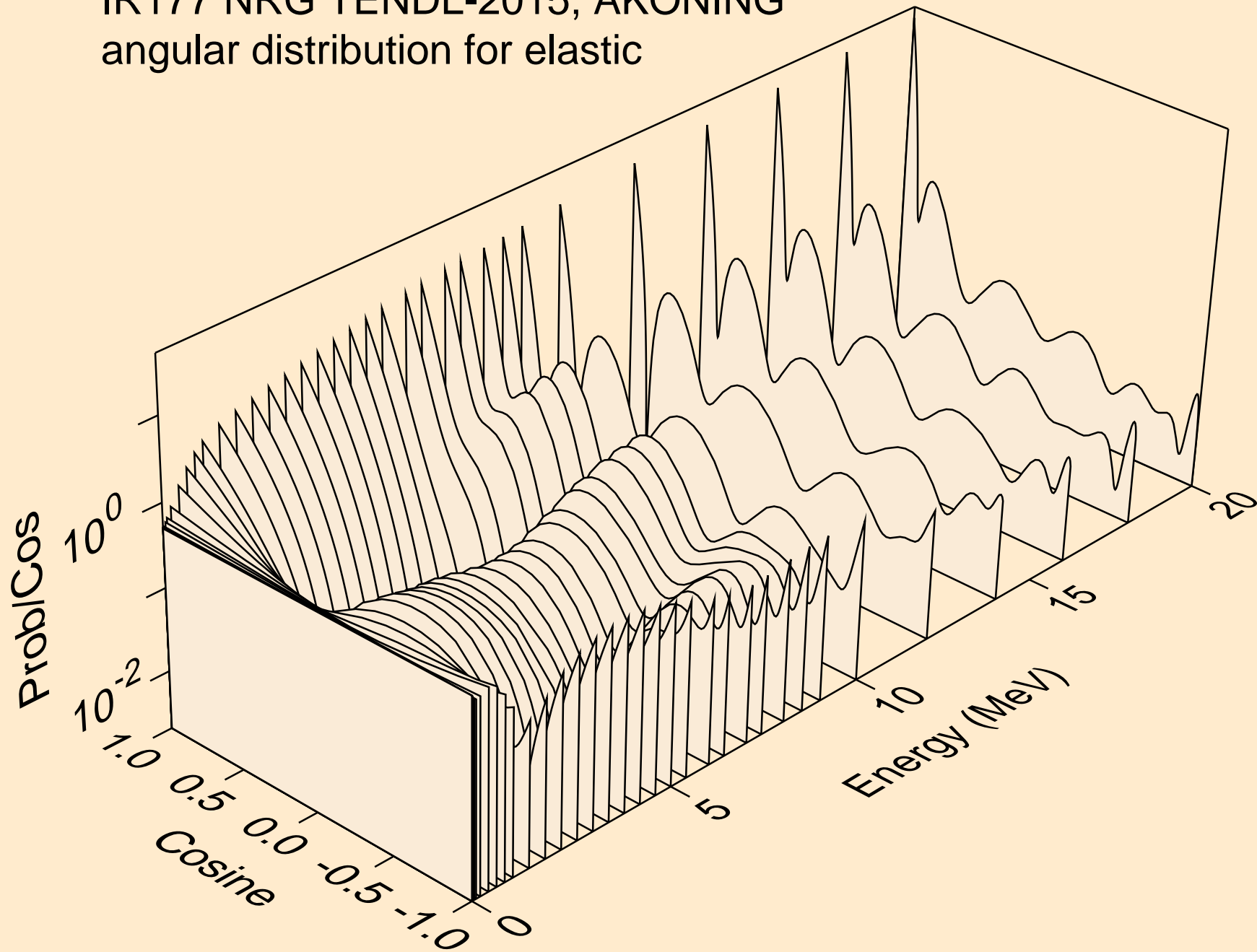

IR177 NRG TENDL-2015, AKONING  
angular distribution for elastic

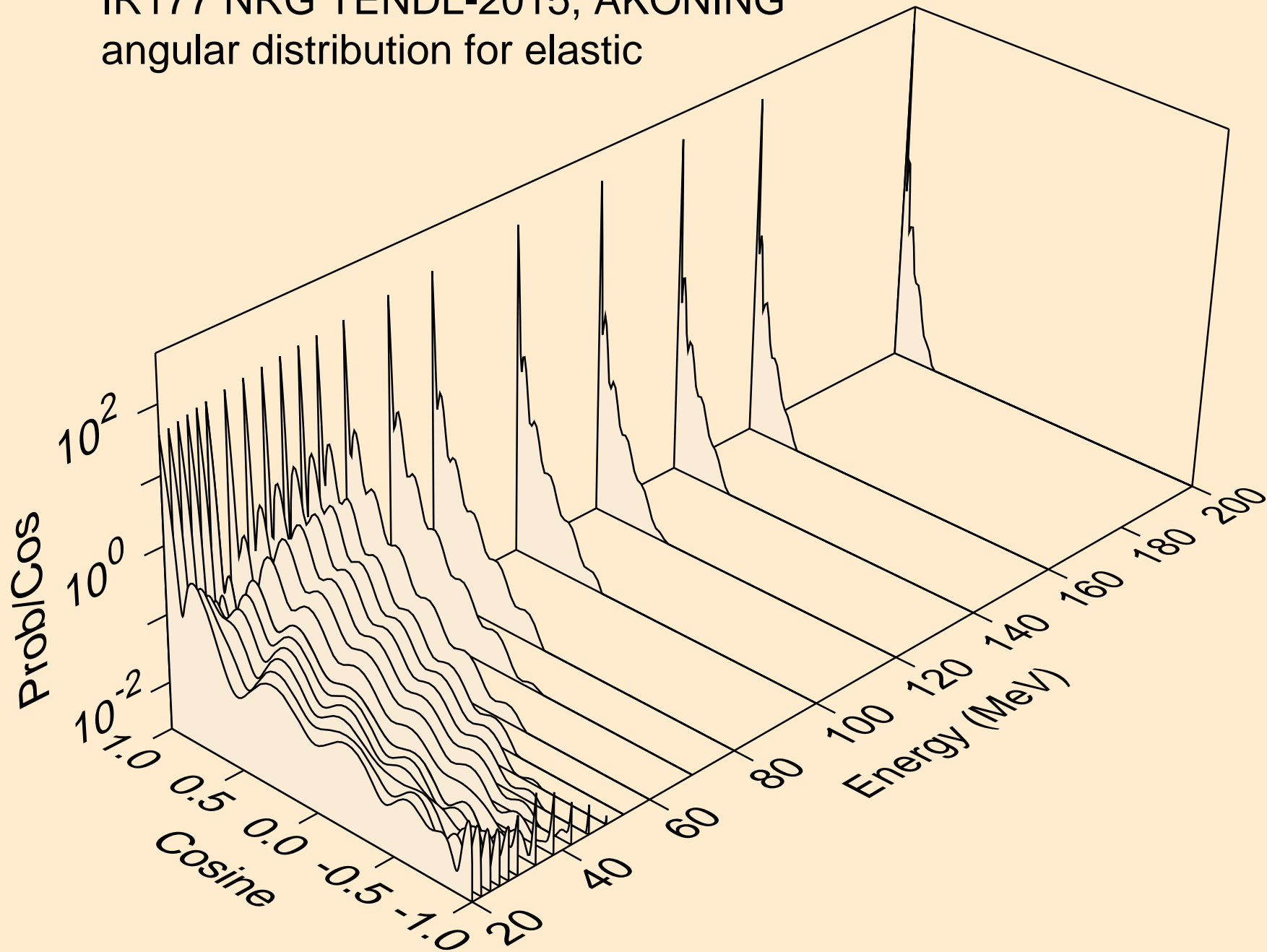

IR177 NRG TENDL-2015, AKONING  
angular distribution for (n,n\*1)

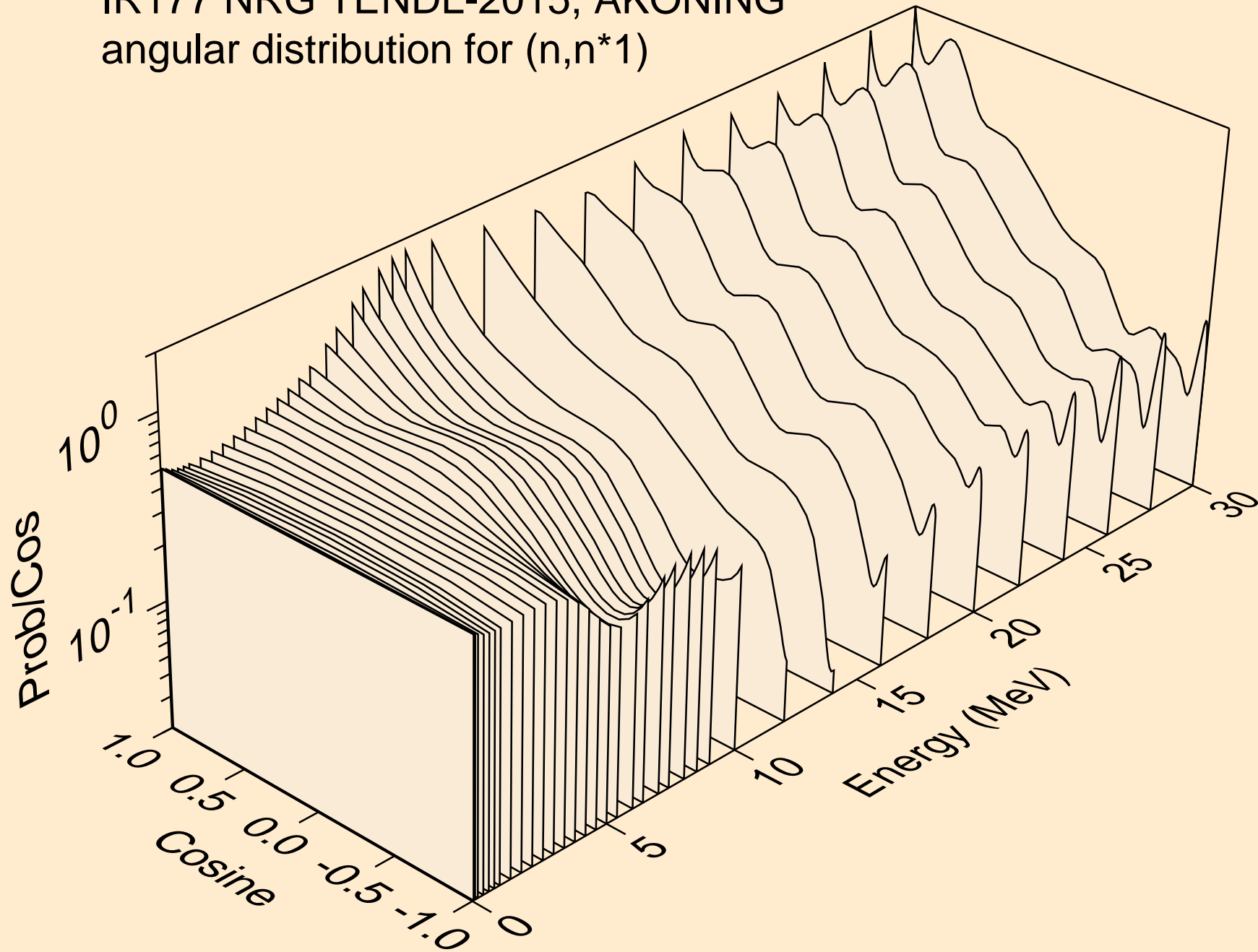



IR177 NRG TENDL-2015, AKONING  
angular distribution for (n,n\*2)

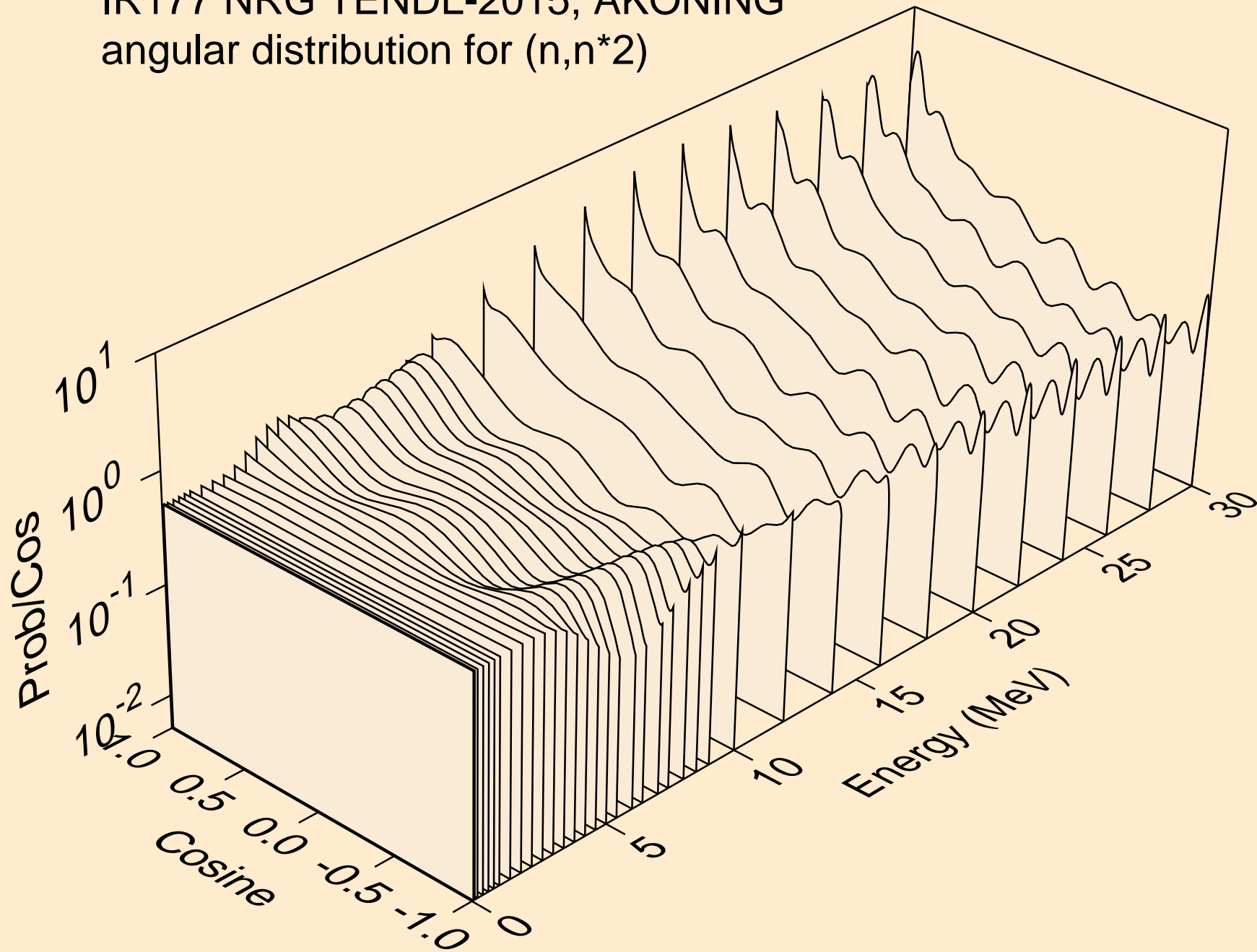

IR177 NRG TENDL-2015, AKONING  
angular distribution for (n,n\*3)

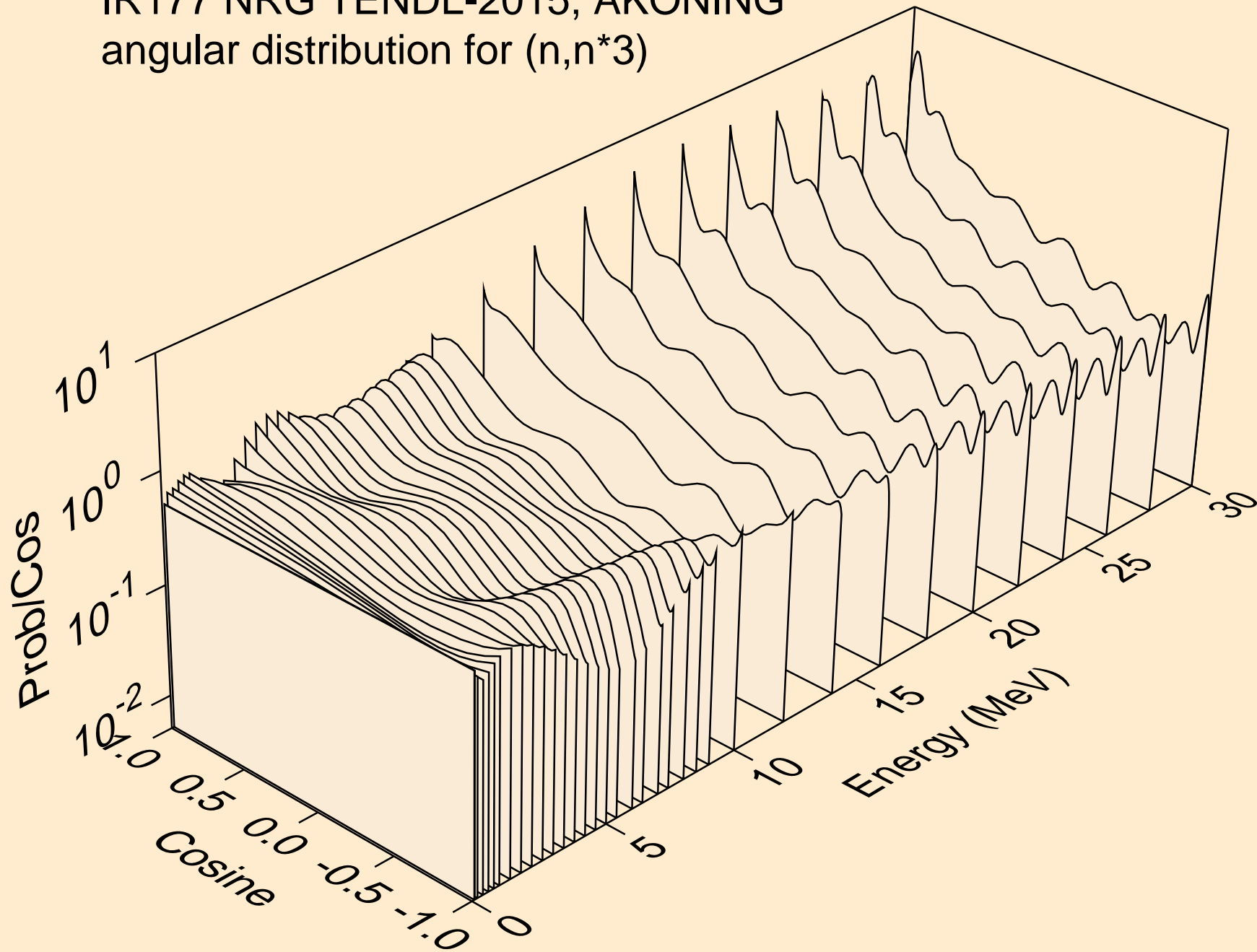

IR177 NRG TENDL-2015, AKONING  
angular distribution for (n,n\*4)

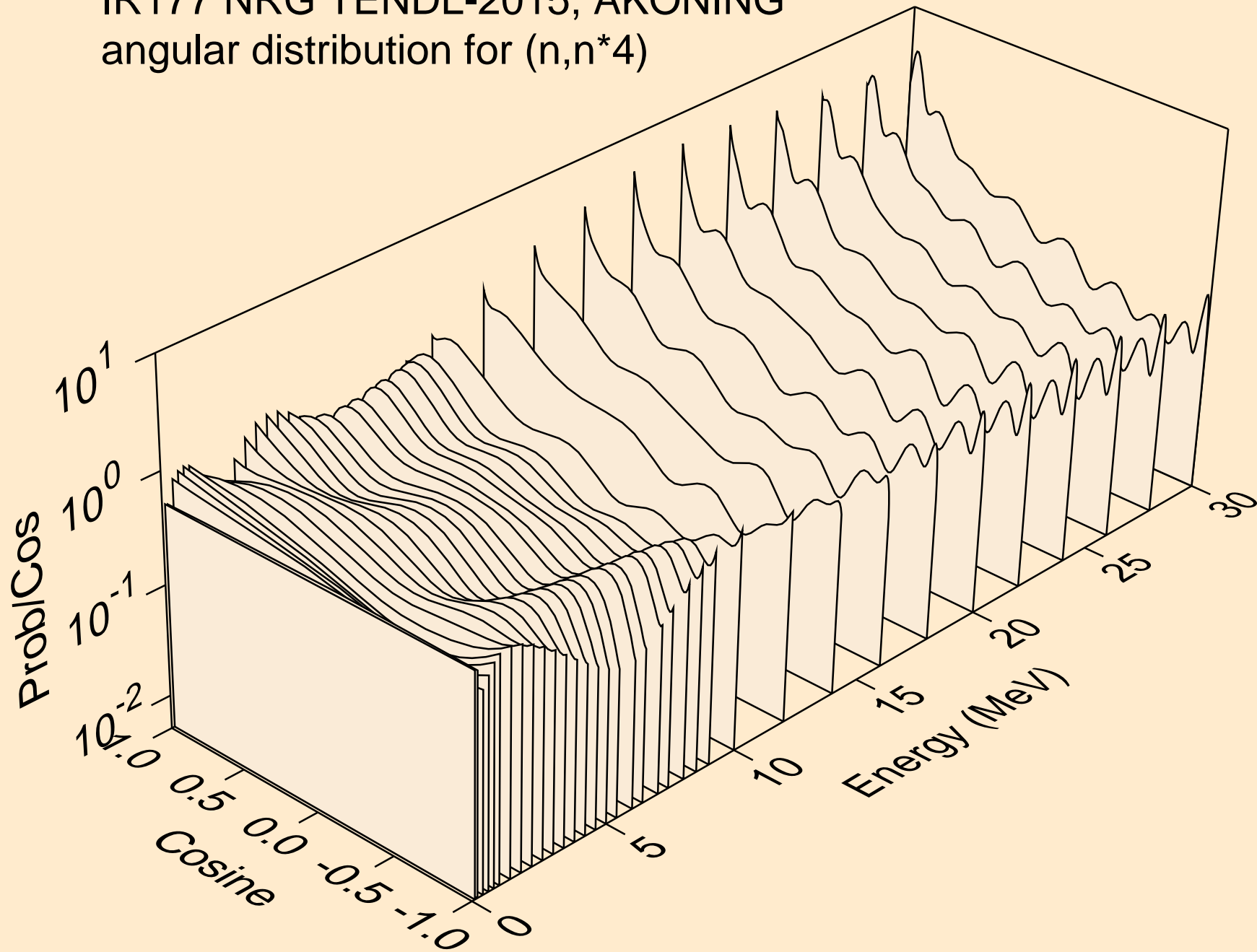

IR177 NRG TENDL-2015, AKONING  
angular distribution for (n,n\*5)

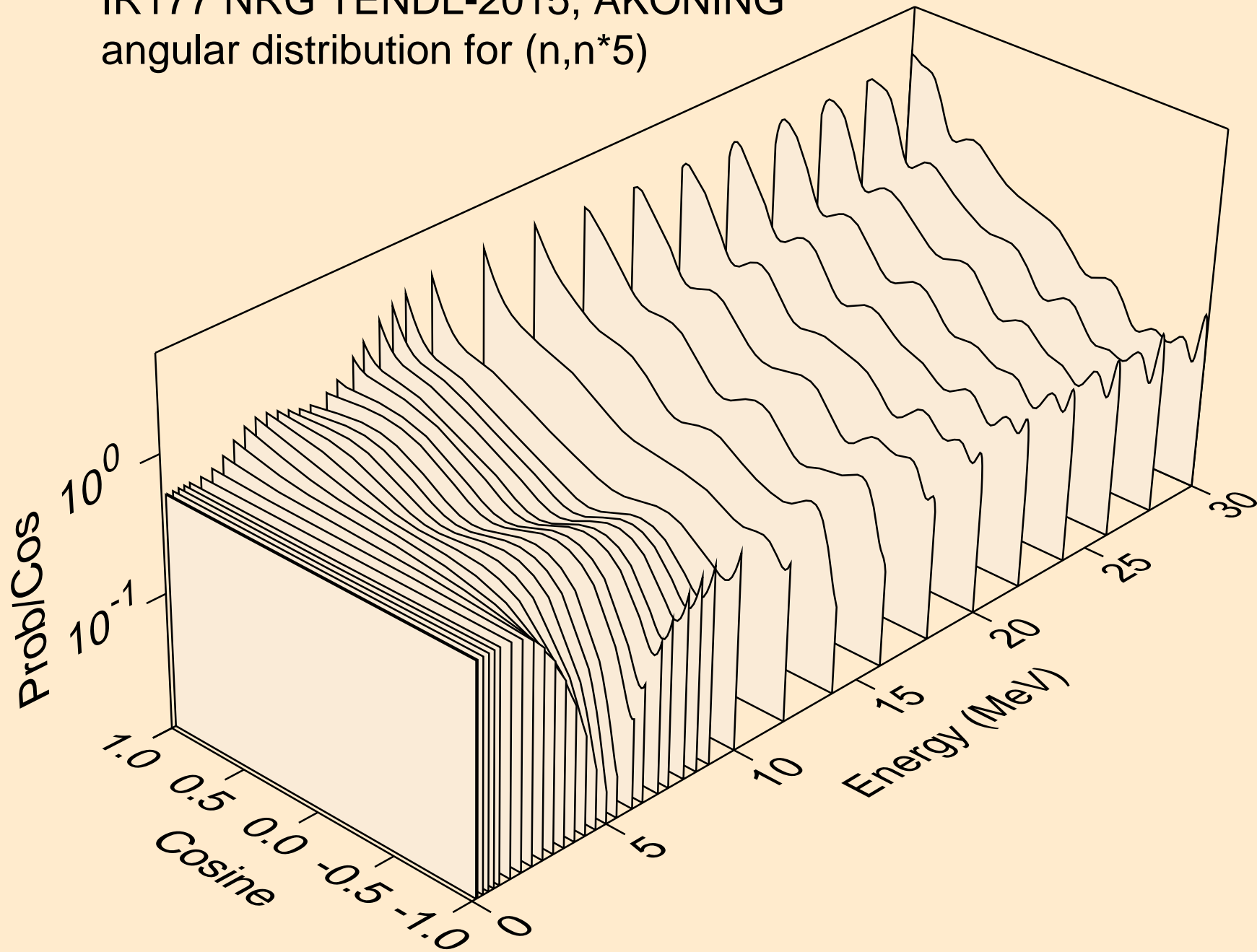

IR177 NRG TENDL-2015, AKONING  
angular distribution for (n,n\*6)

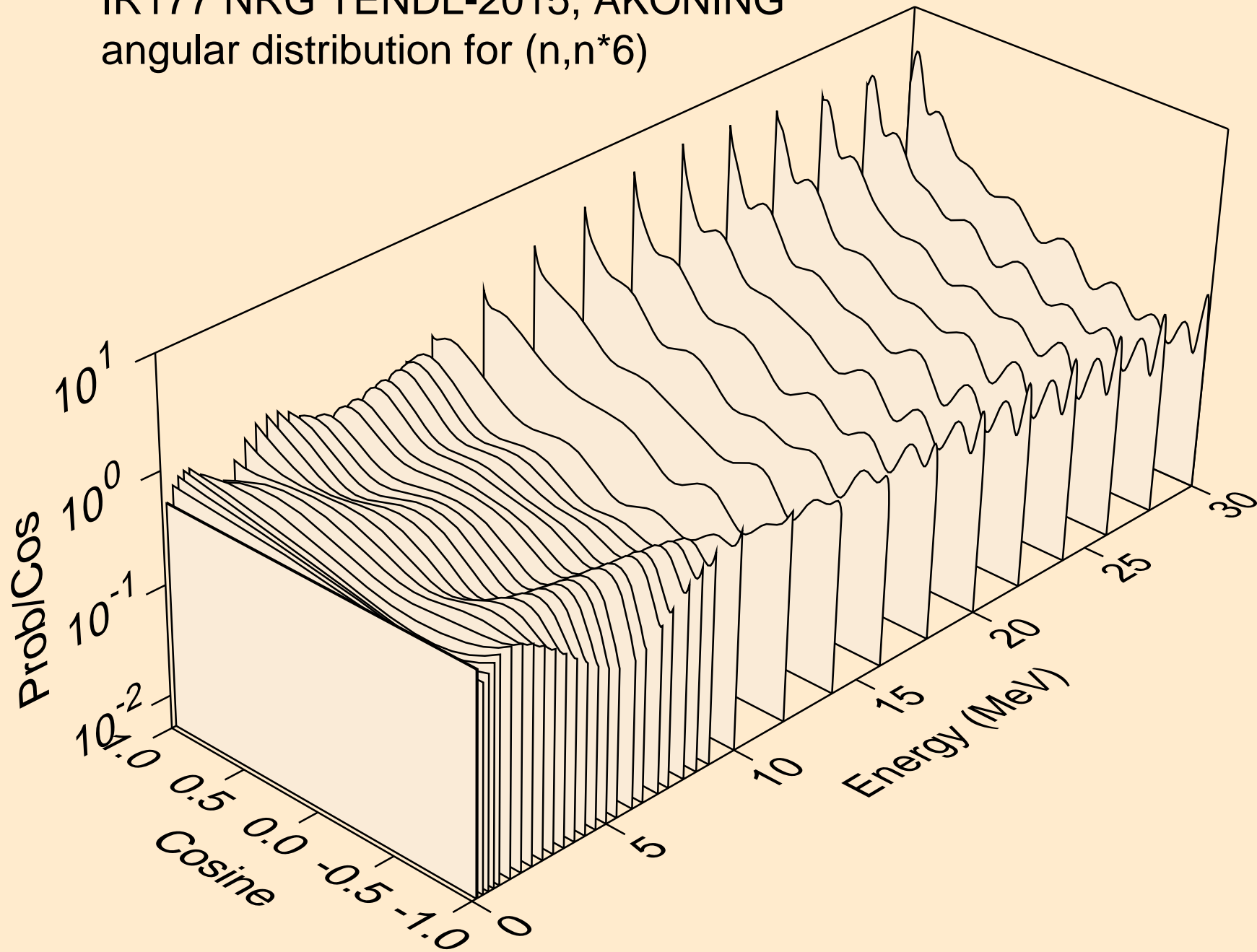

IR177 NRG TENDL-2015, AKONING  
angular distribution for (n,n\*7)

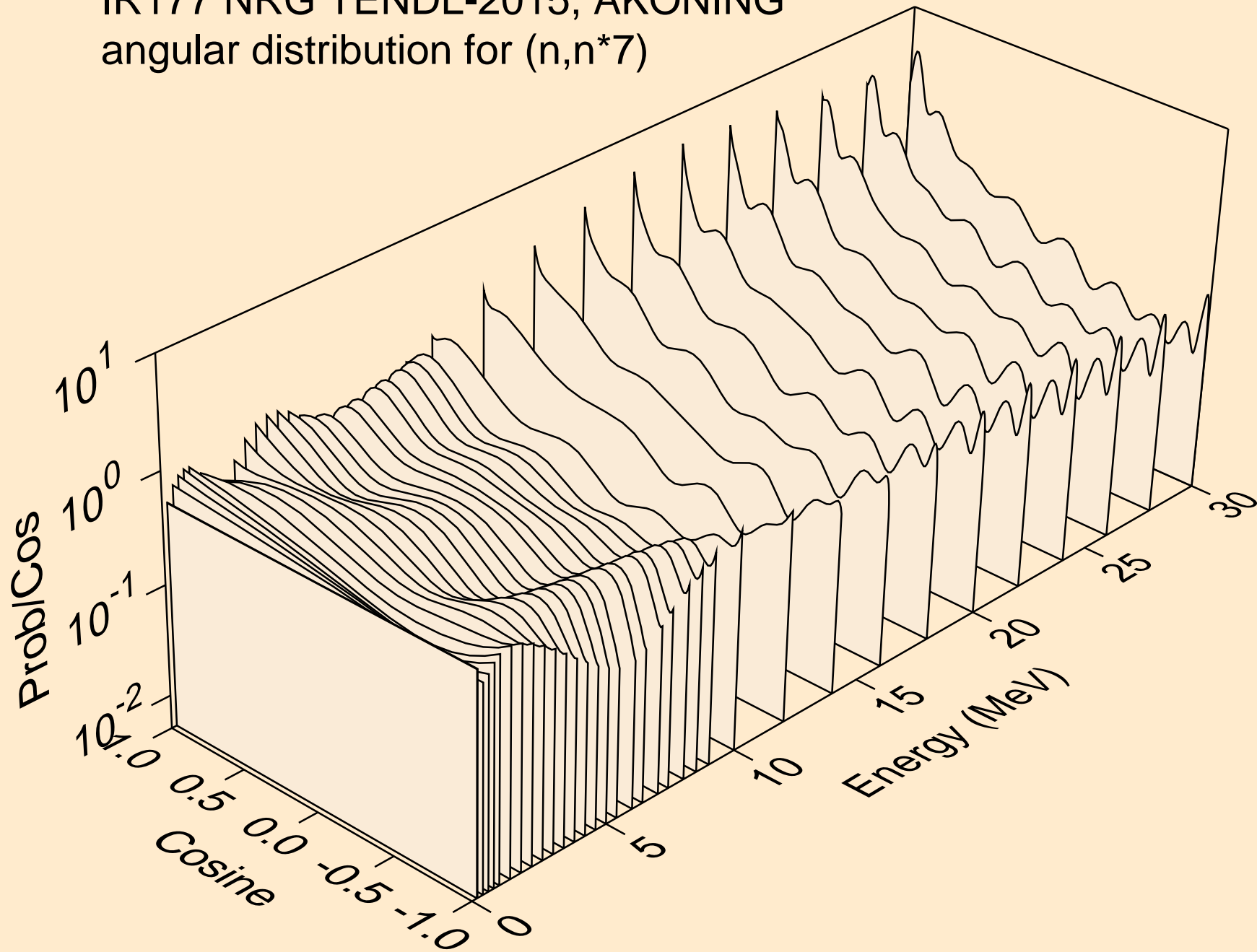

IR177 NRG TENDL-2015, AKONING  
angular distribution for (n,n\*8)

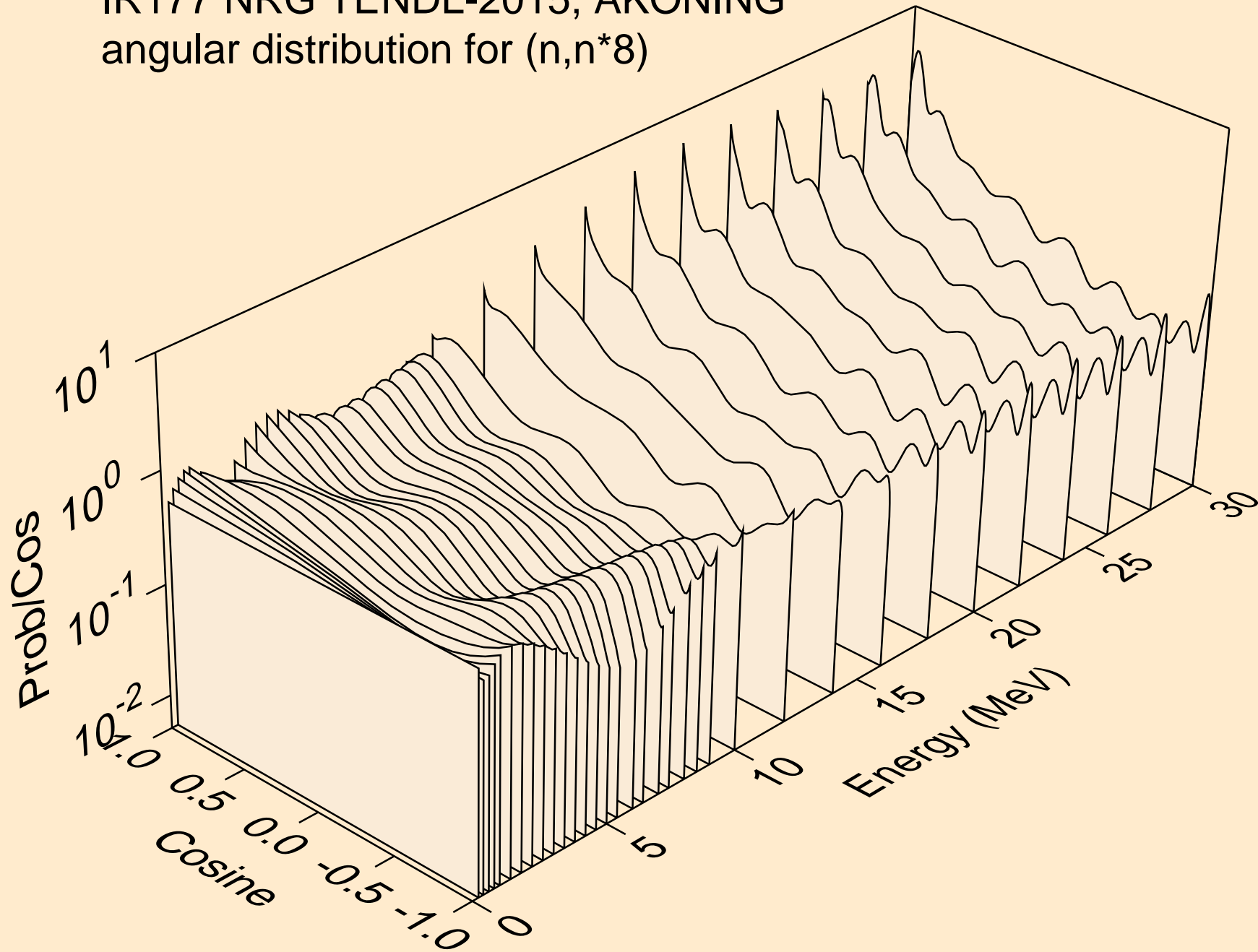



IR177 NRG TENDL-2015, AKONING  
angular distribution for (n,n\*9)

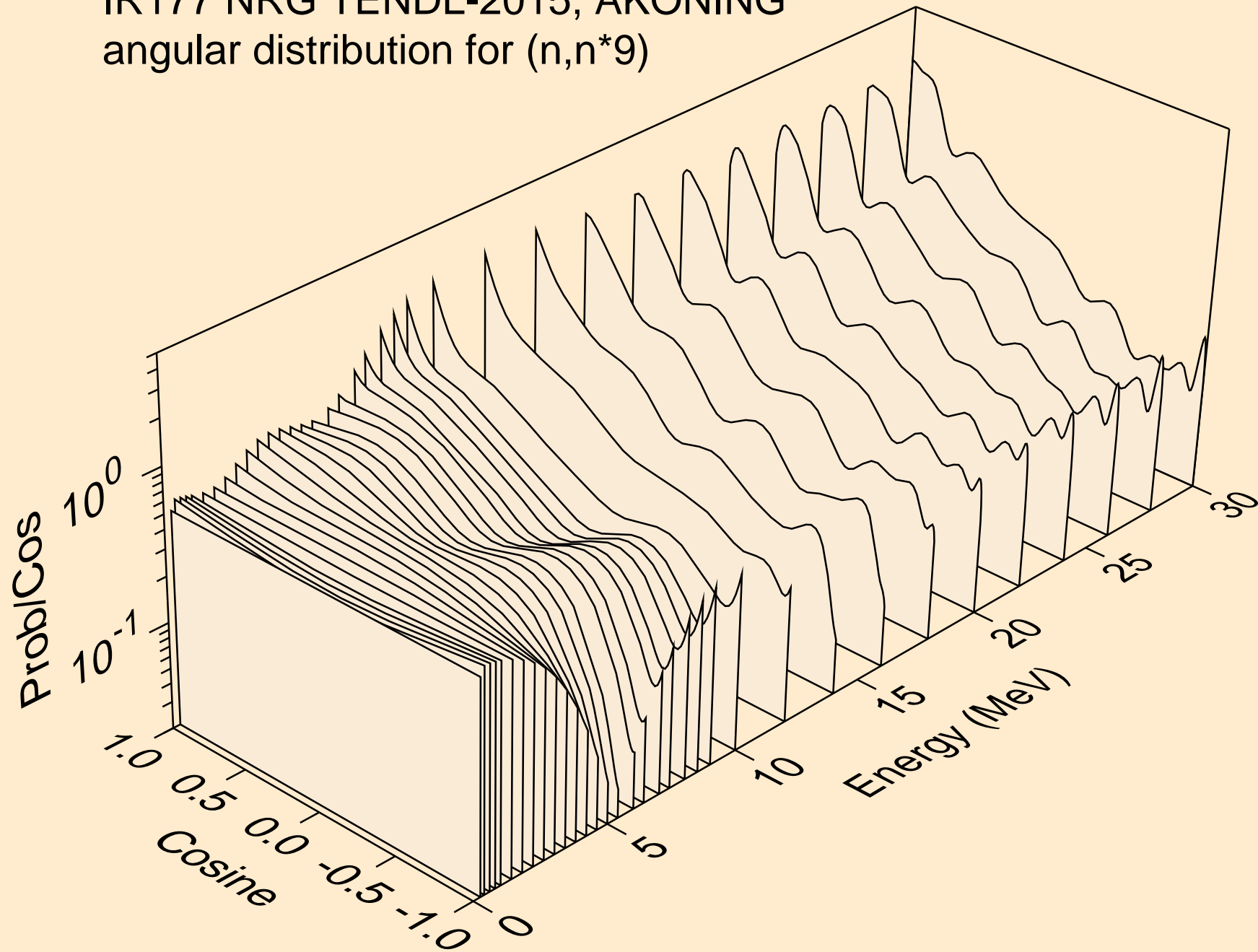



IR177 NRG TENDL-2015, AKONING  
angular distribution for (n,n\*10)

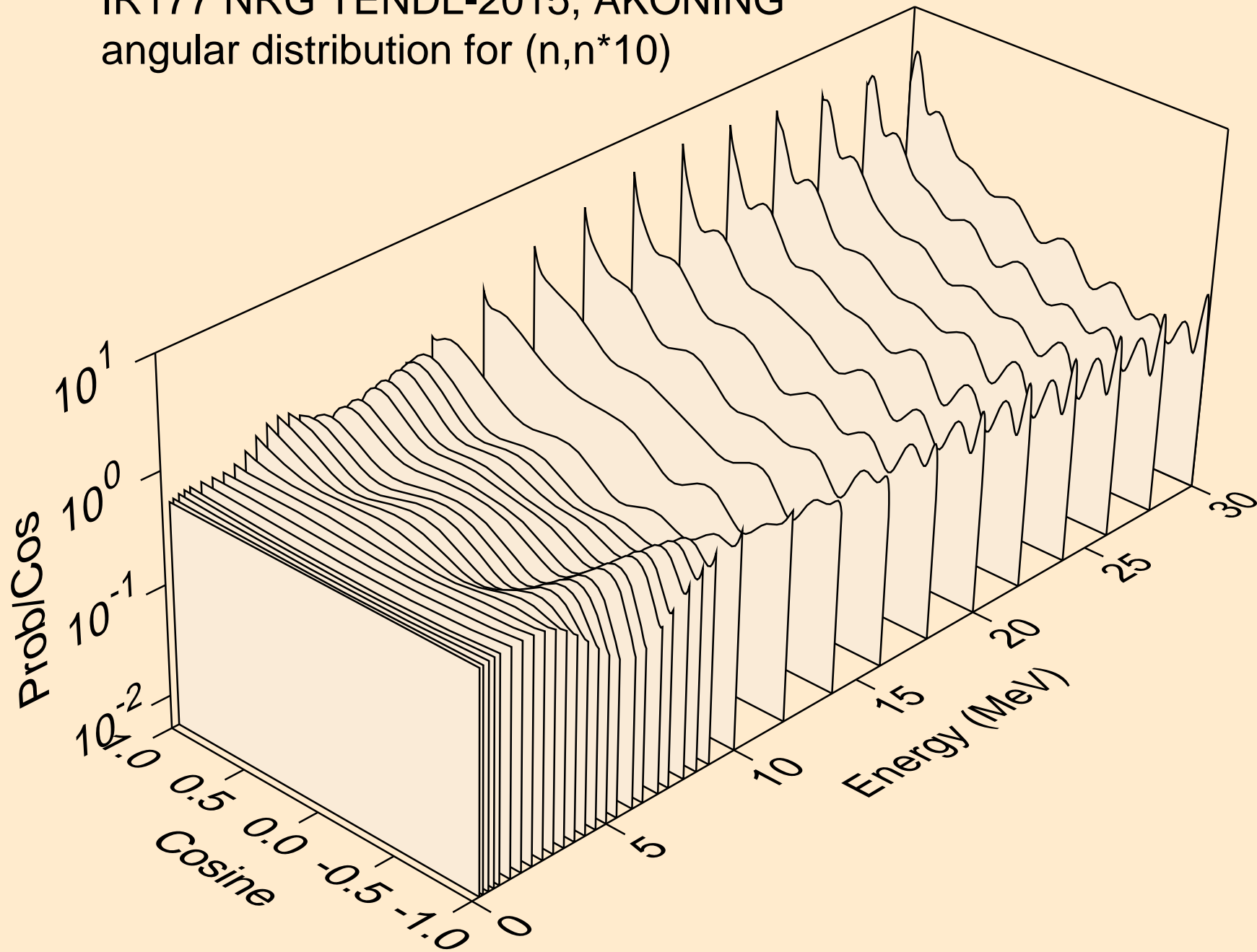

IR177 NRG TENDL-2015, AKONING  
angular distribution for (n,n\*11)

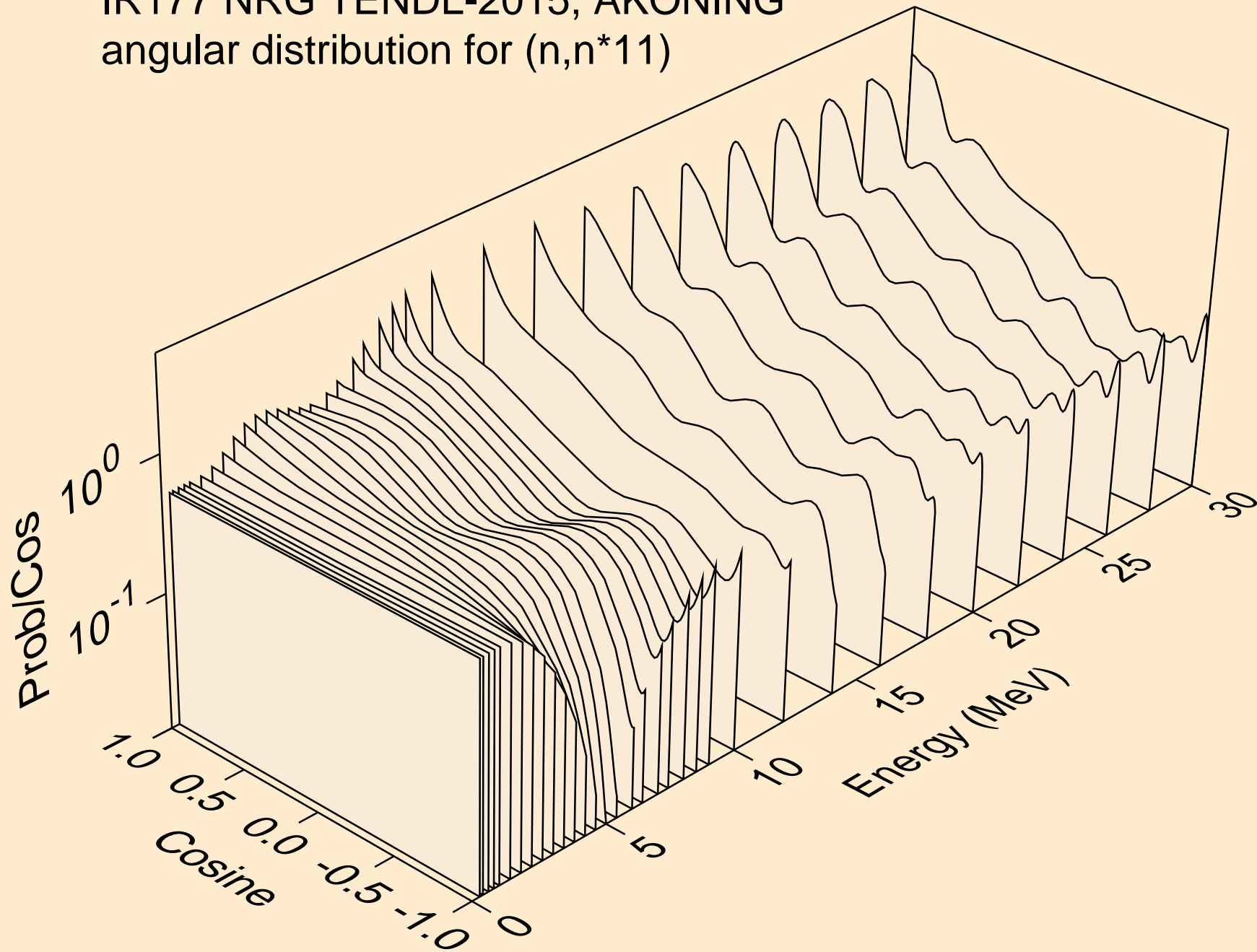

IR177 NRG TENDL-2015, AKONING  
angular distribution for (n,n\*12)

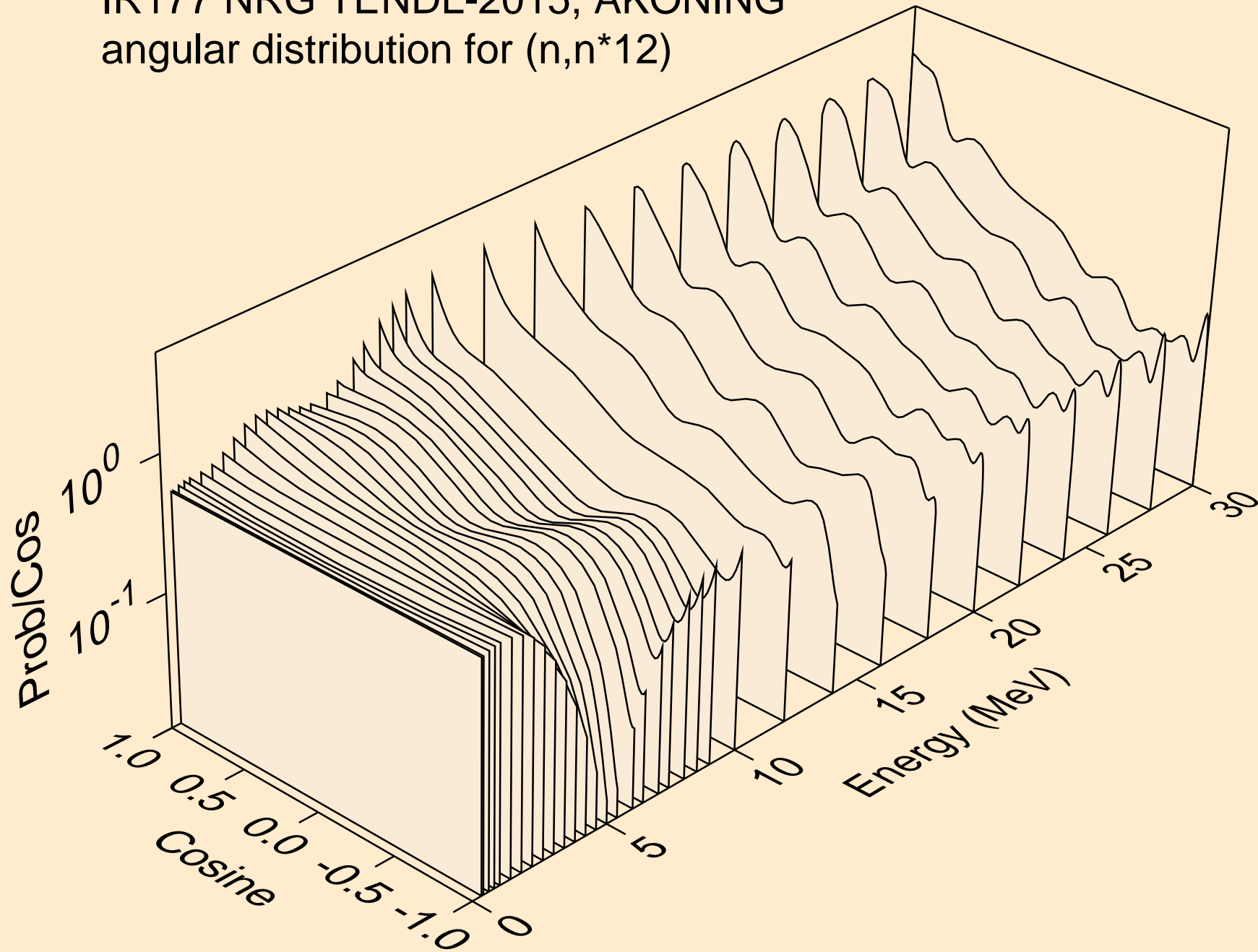

IR177 NRG TENDL-2015, AKONING  
angular distribution for (n,n\*13)

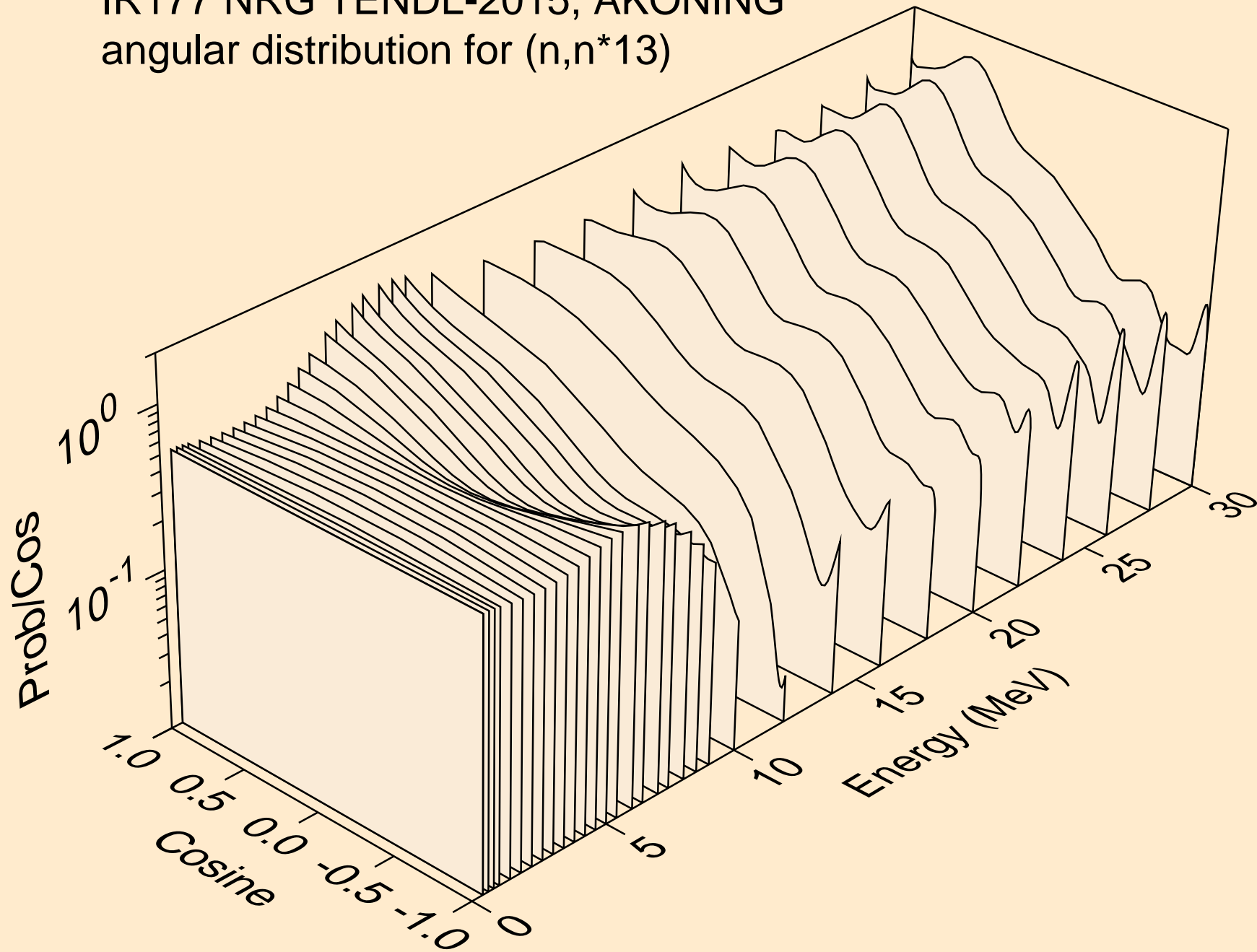

IR177 NRG TENDL-2015, AKONING  
angular distribution for (n,n\*14)

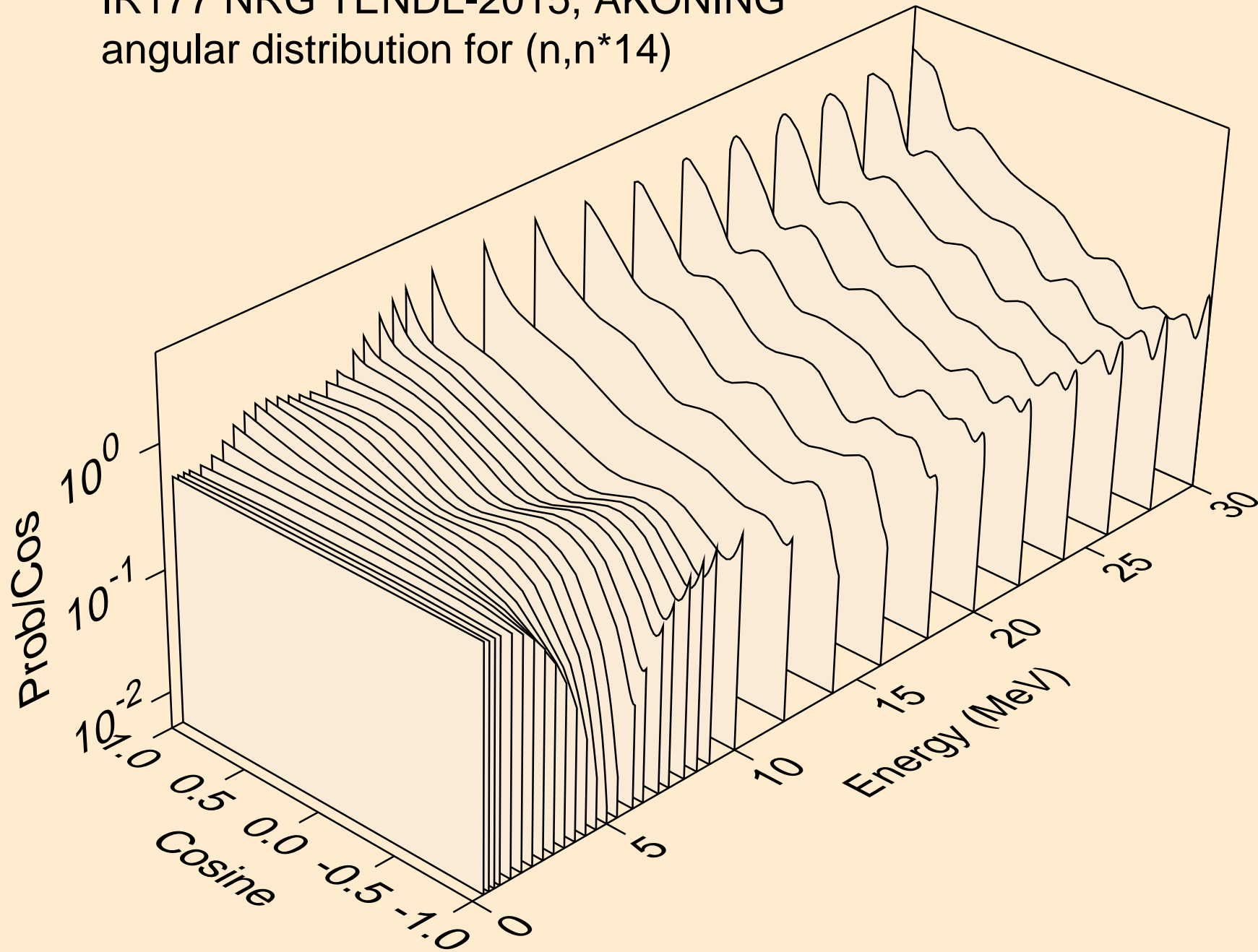

IR177 NRG TENDL-2015, AKONING  
Neutron emission for (n,x)

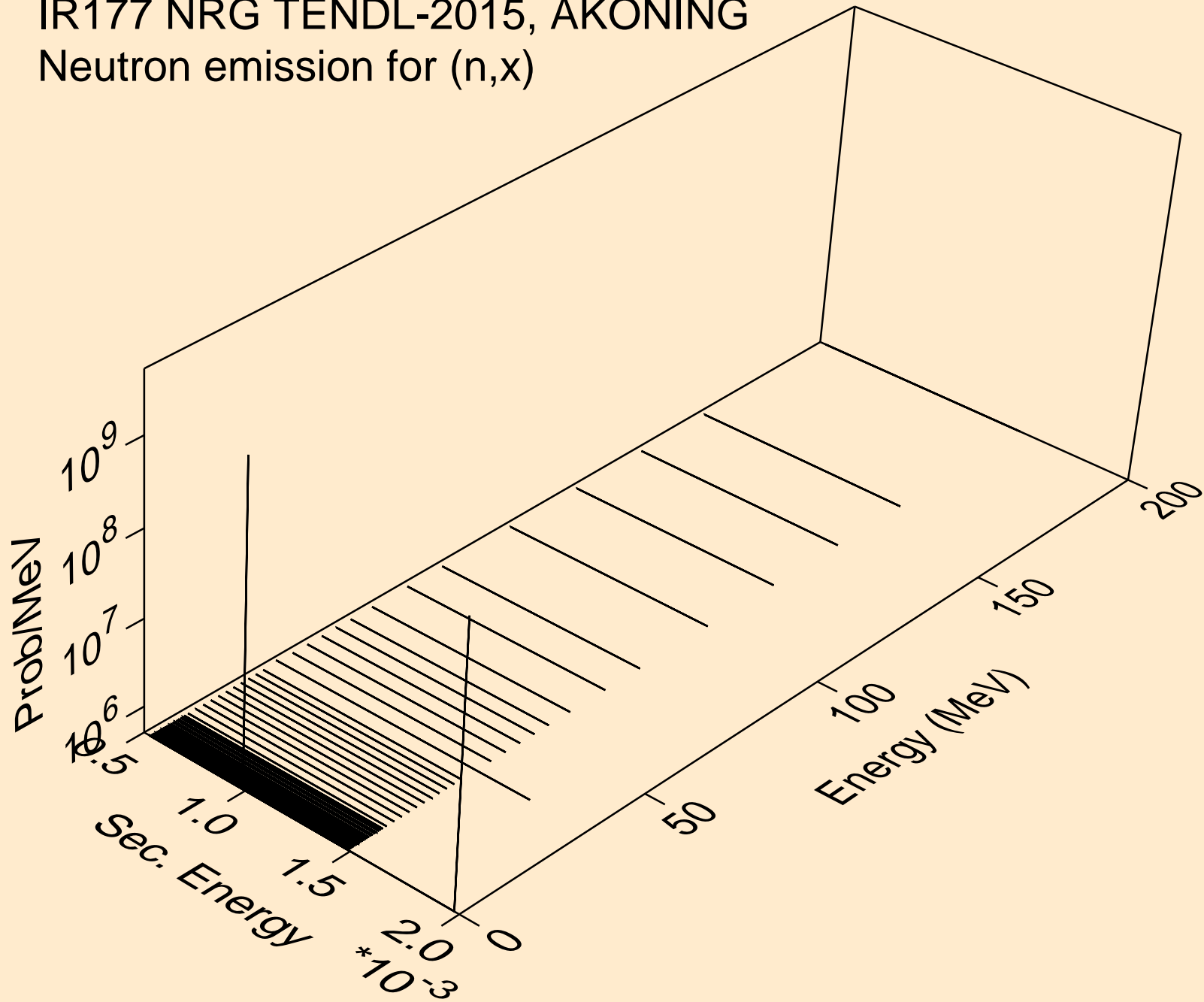

IR177 NRG TENDL-2015, AKONING  
Neutron emission for (n,2nd)

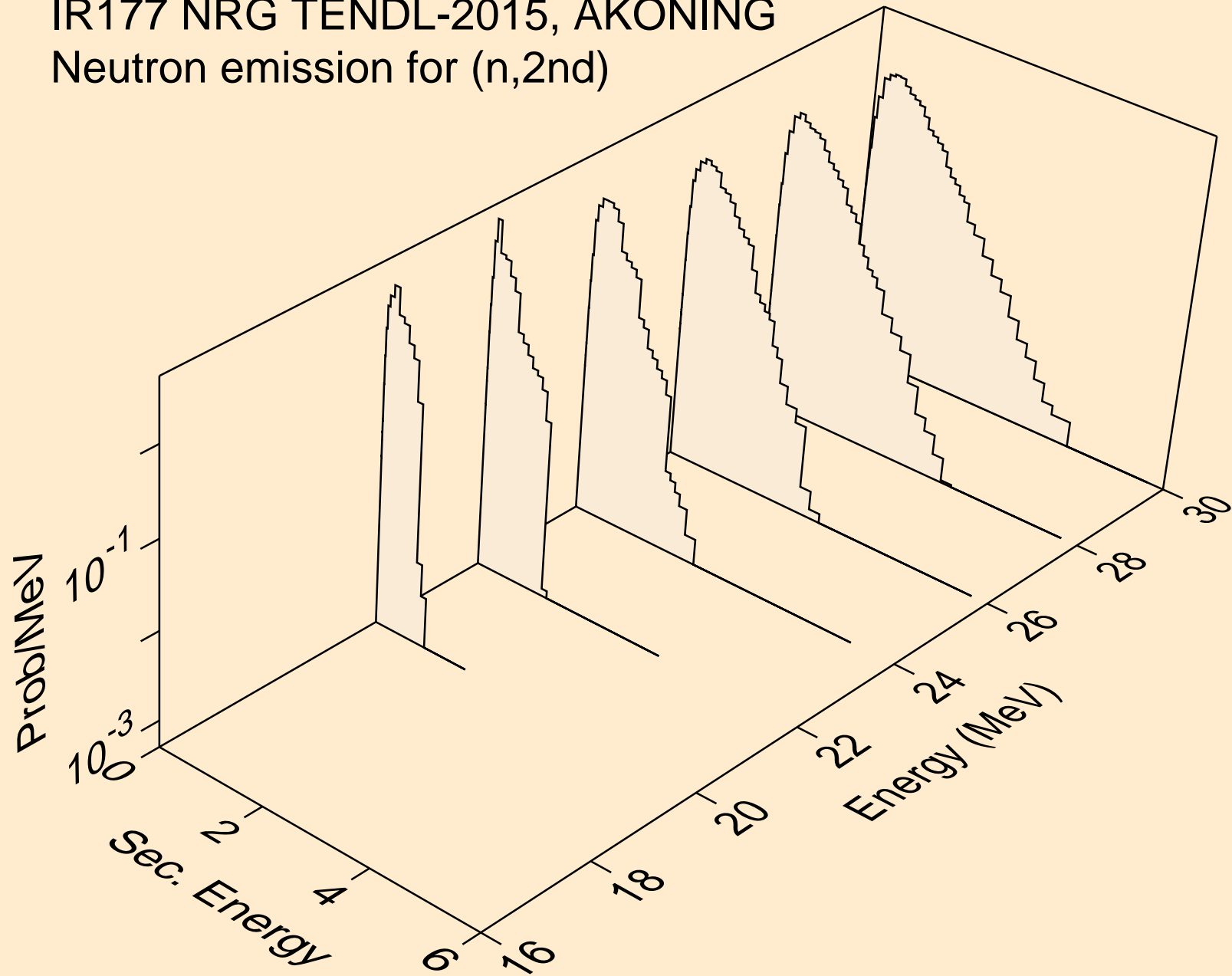

IR177 NRG TENDL-2015, AKONING  
Neutron emission for (n,2n)

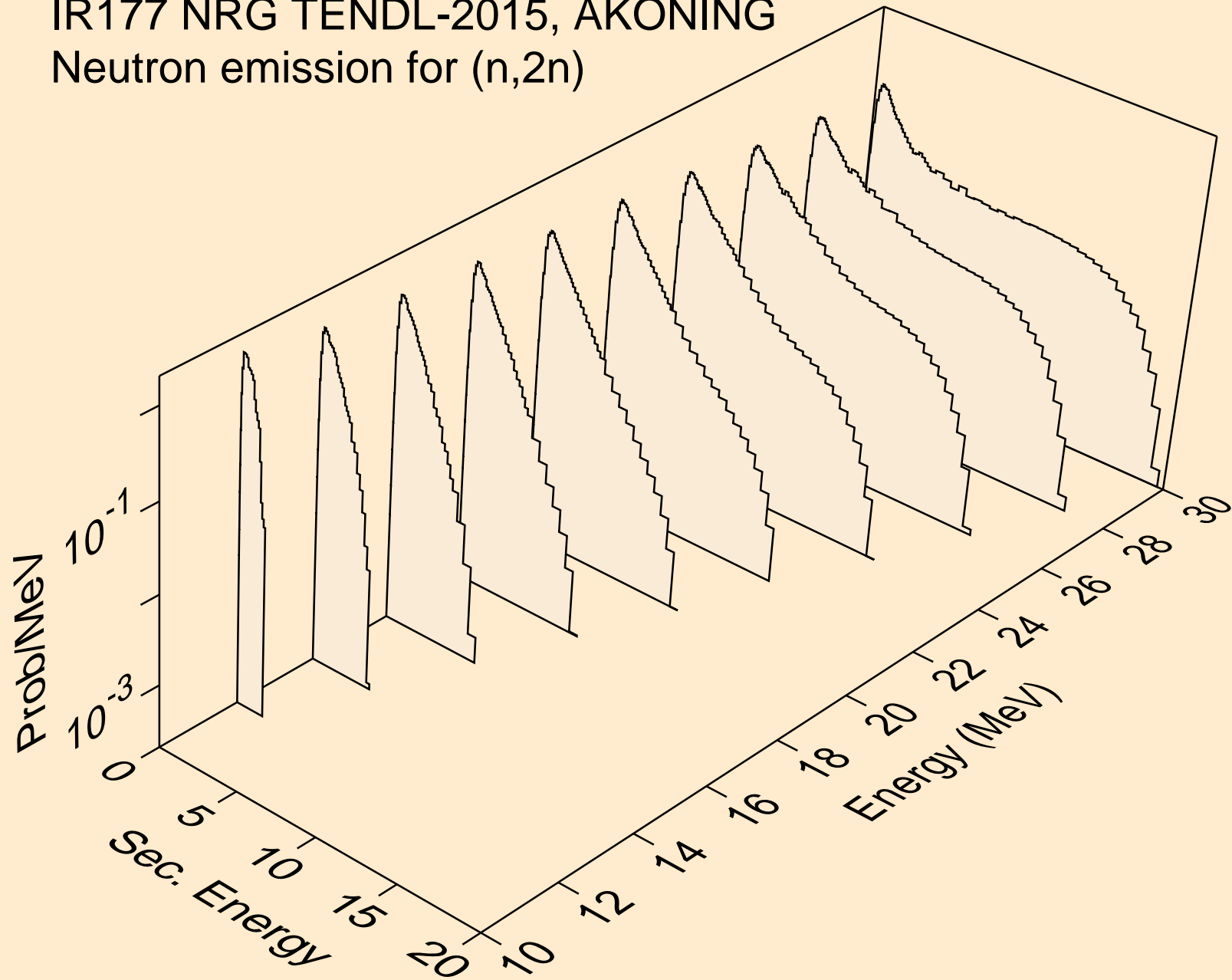



IR177 NRG TENDL-2015, AKONING  
Neutron emission for (n,3n)

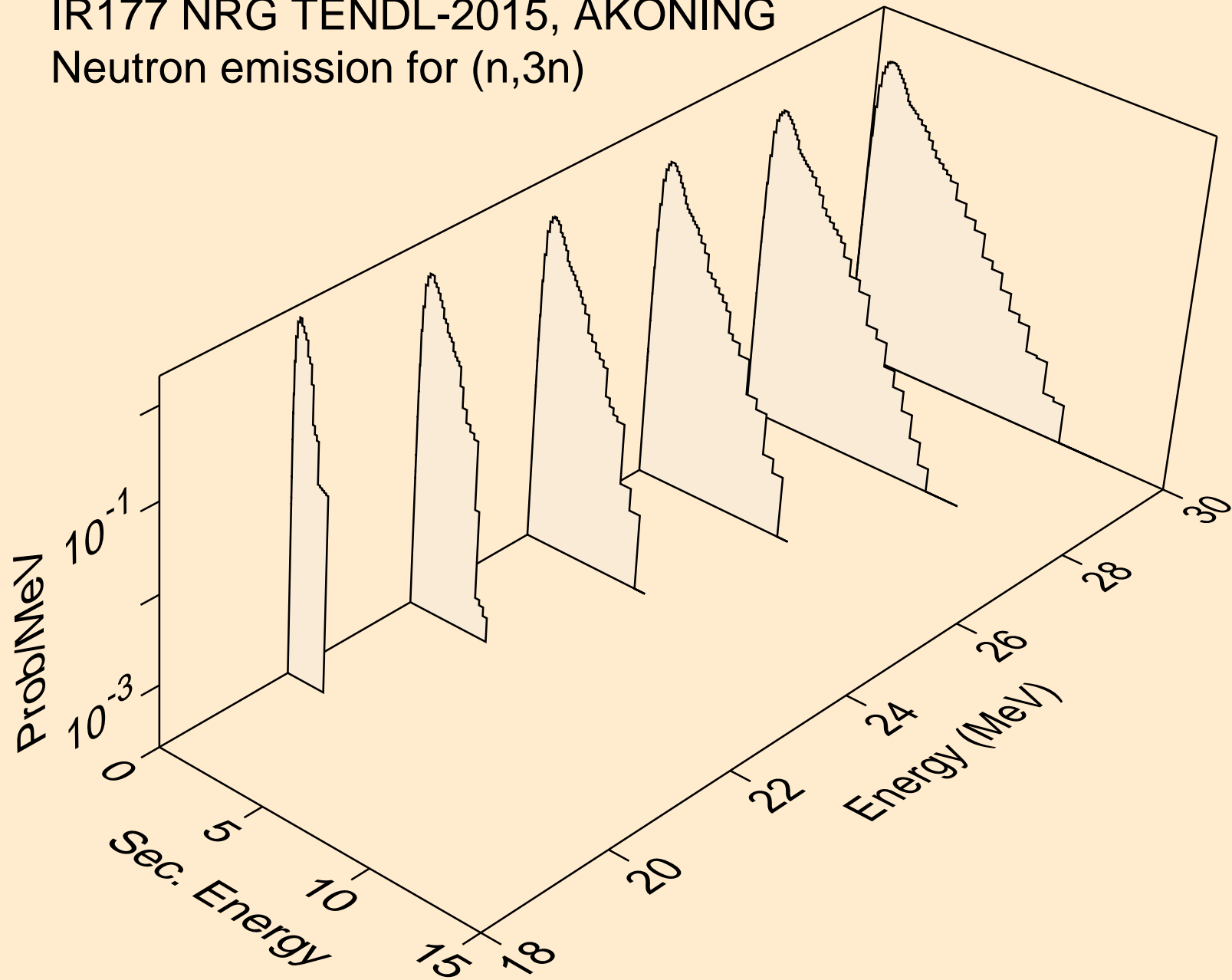

IR177 NRG TENDL-2015, AKONING  
Neutron emission for (n,n\*)a

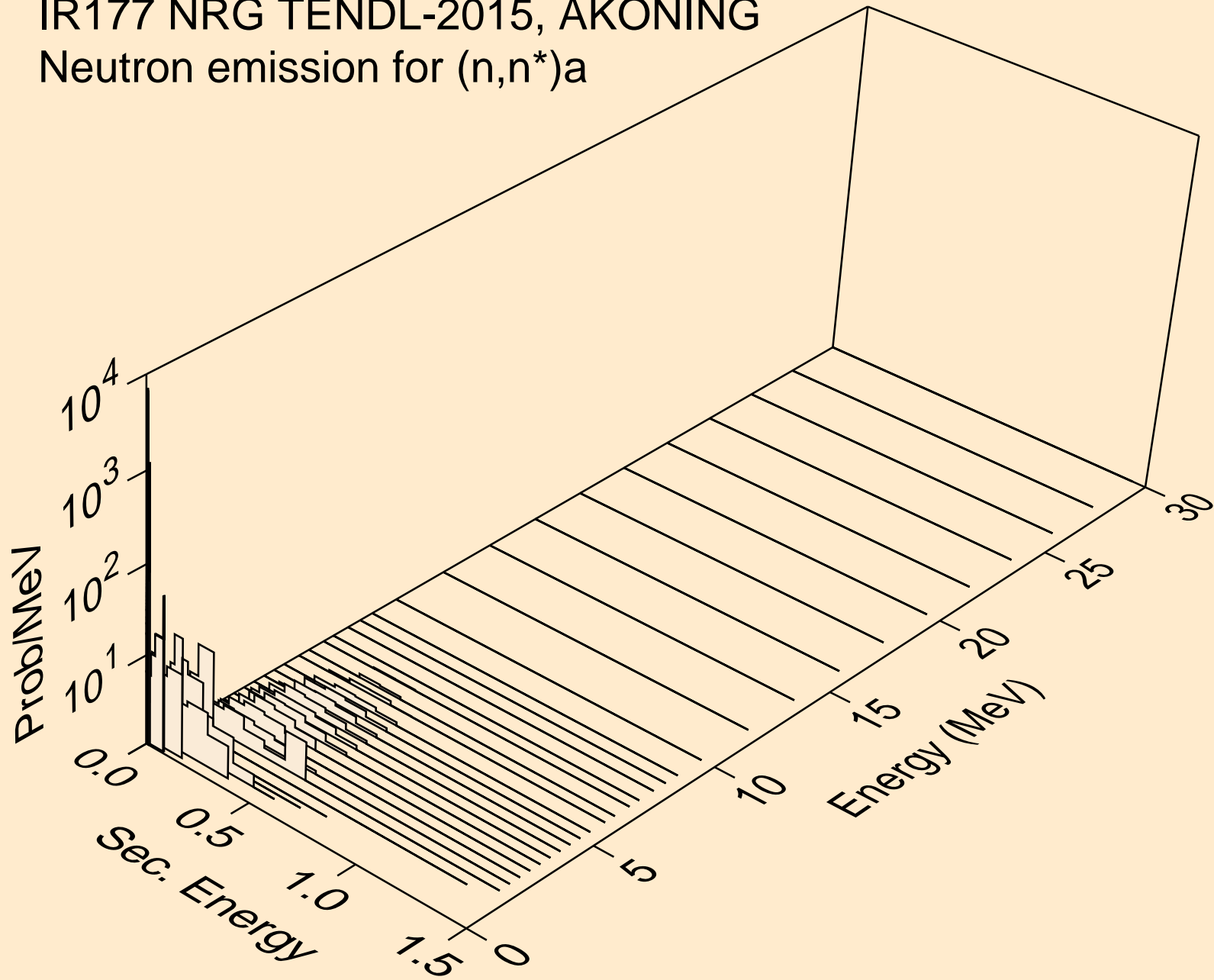

IR177 NRG TENDL-2015, AKONING  
Neutron emission for (n,n\*)3a

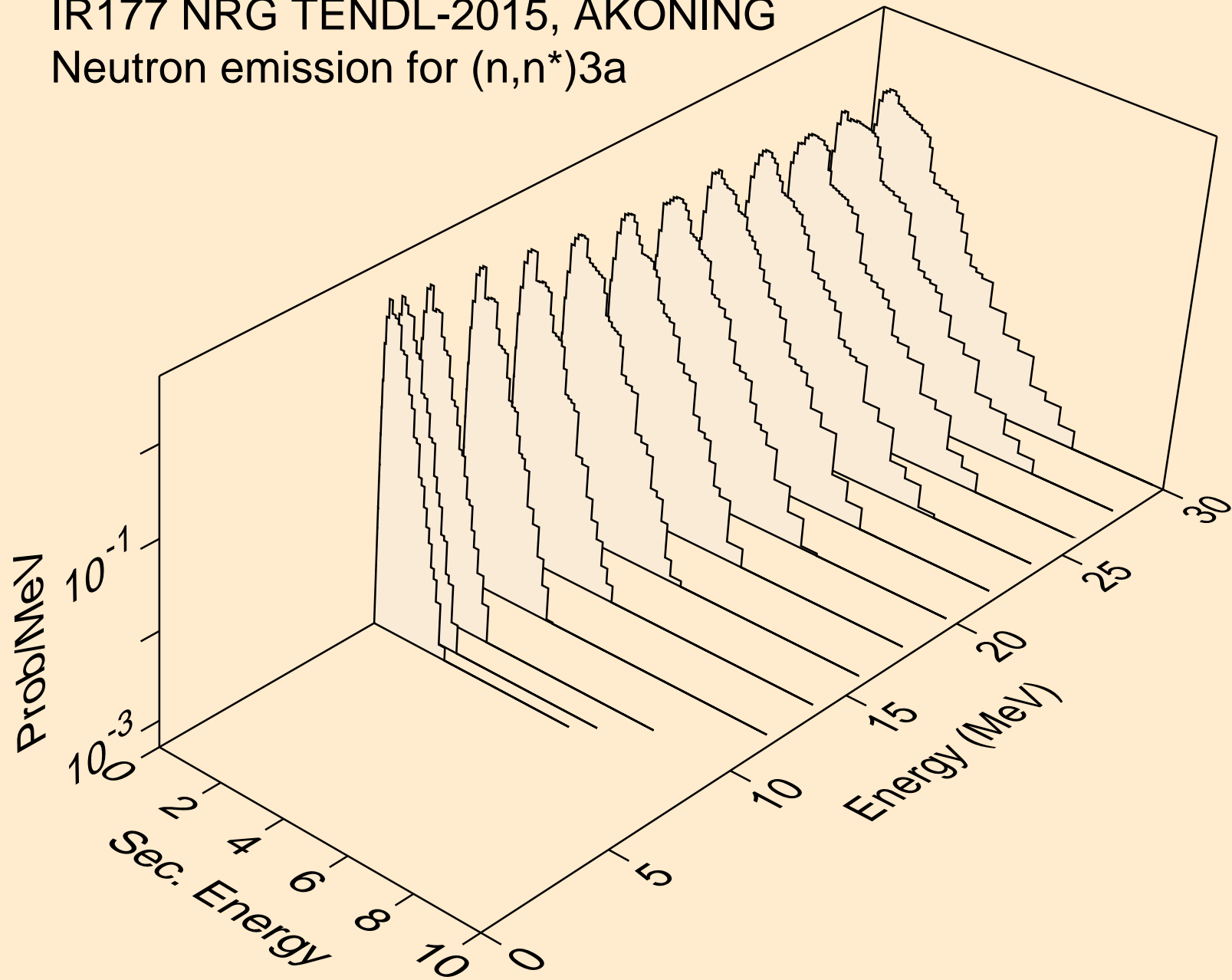

IR177 NRG TENDL-2015, AKONING  
Neutron emission for (n,2n)a

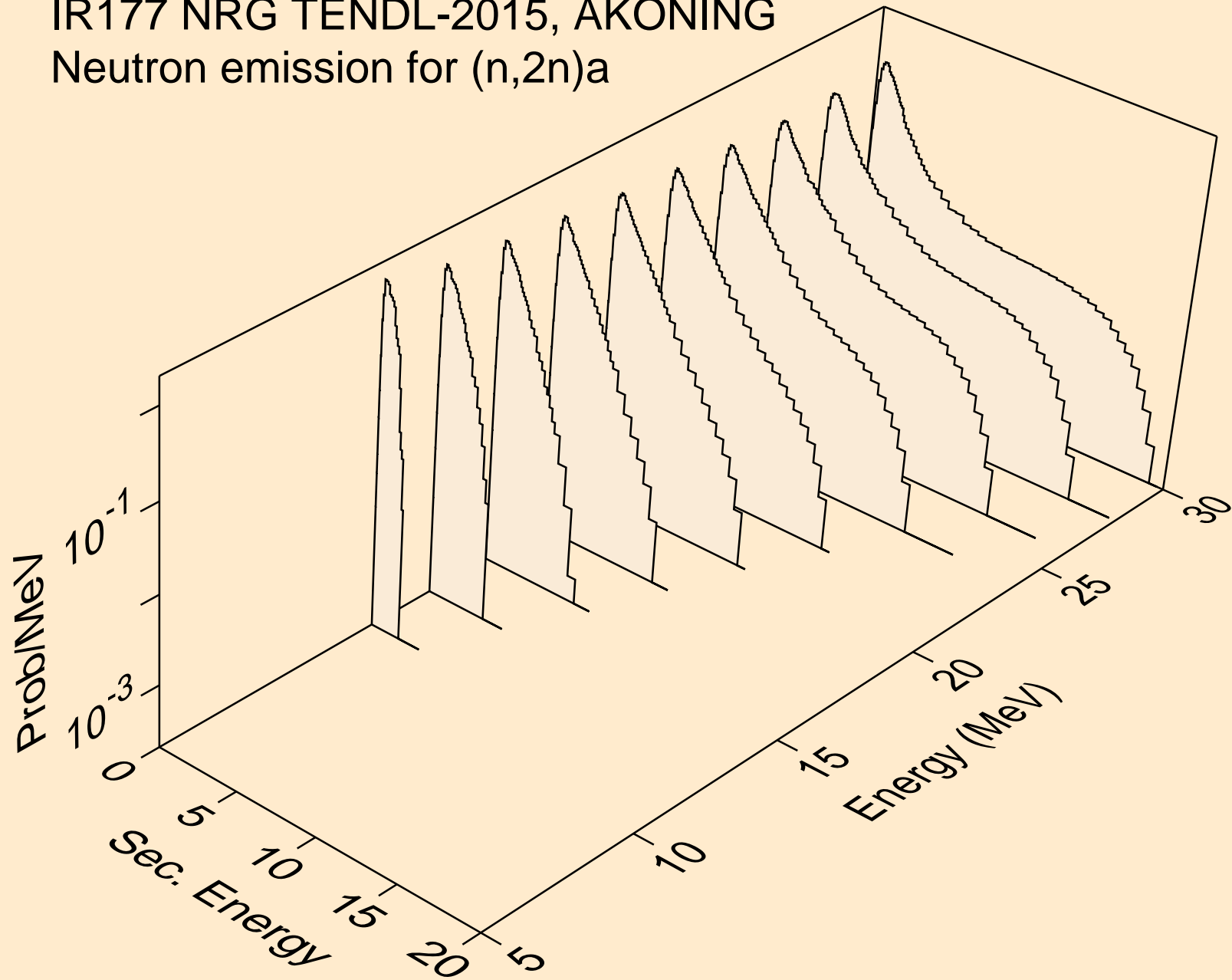

IR177 NRG TENDL-2015, AKONING  
Neutron emission for (n,3n)<sub>a</sub>

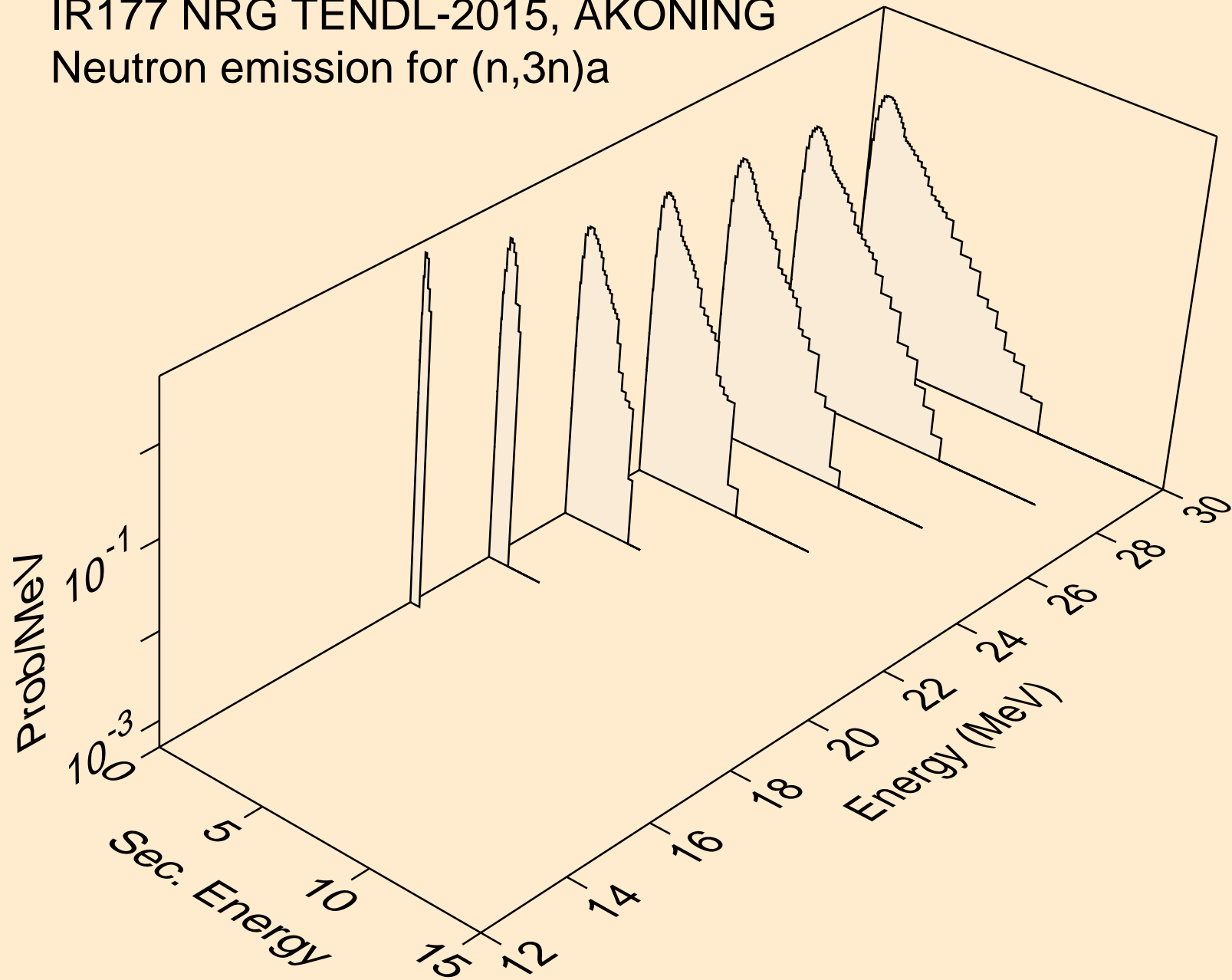

IR177 NRG TENDL-2015, AKONING  
Neutron emission for (n,n\*)p

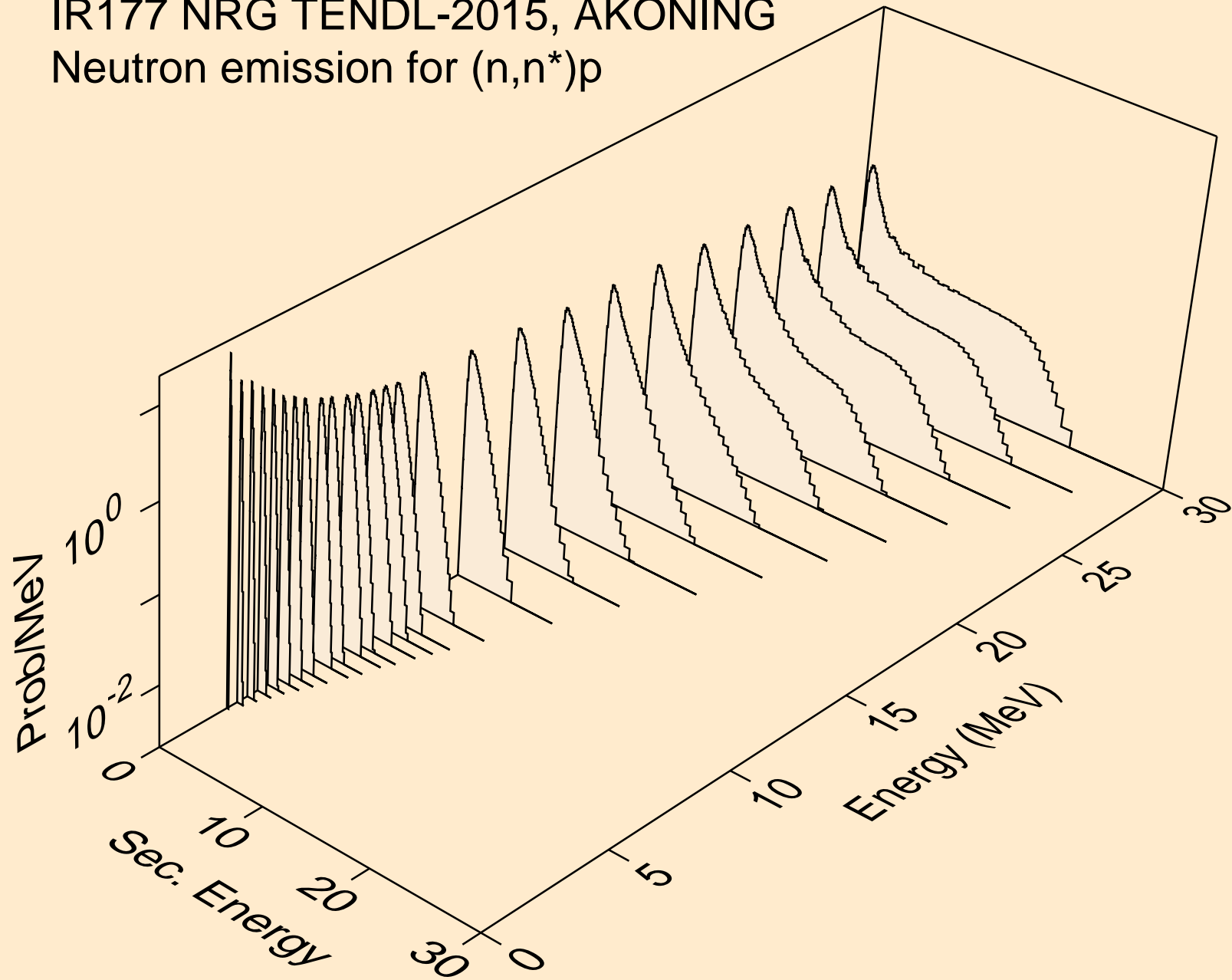

IR177 NRG TENDL-2015, AKONING  
Neutron emission for (n,n\*)2a

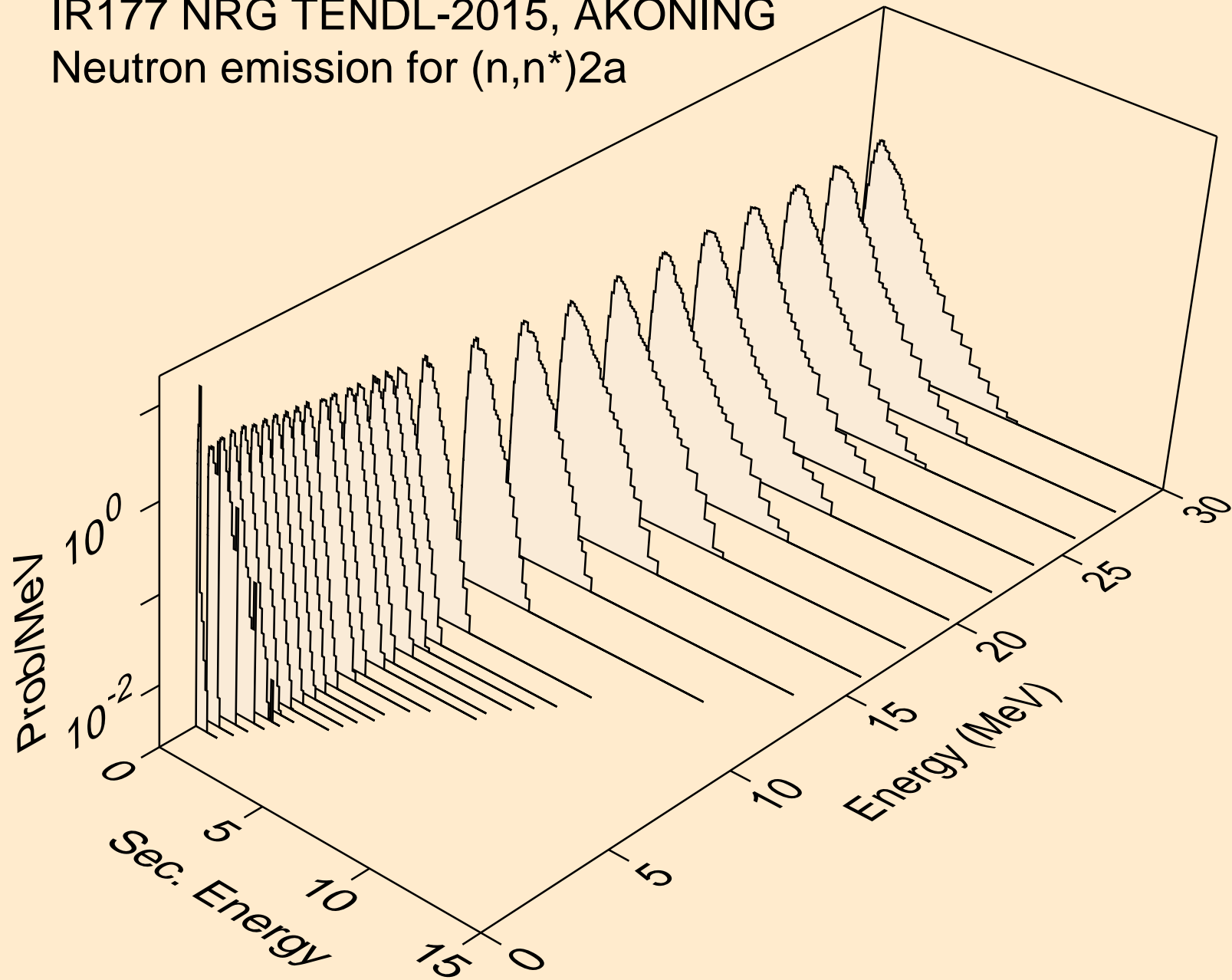

IR177 NRG TENDL-2015, AKONING  
Neutron emission for (n,2n)2a

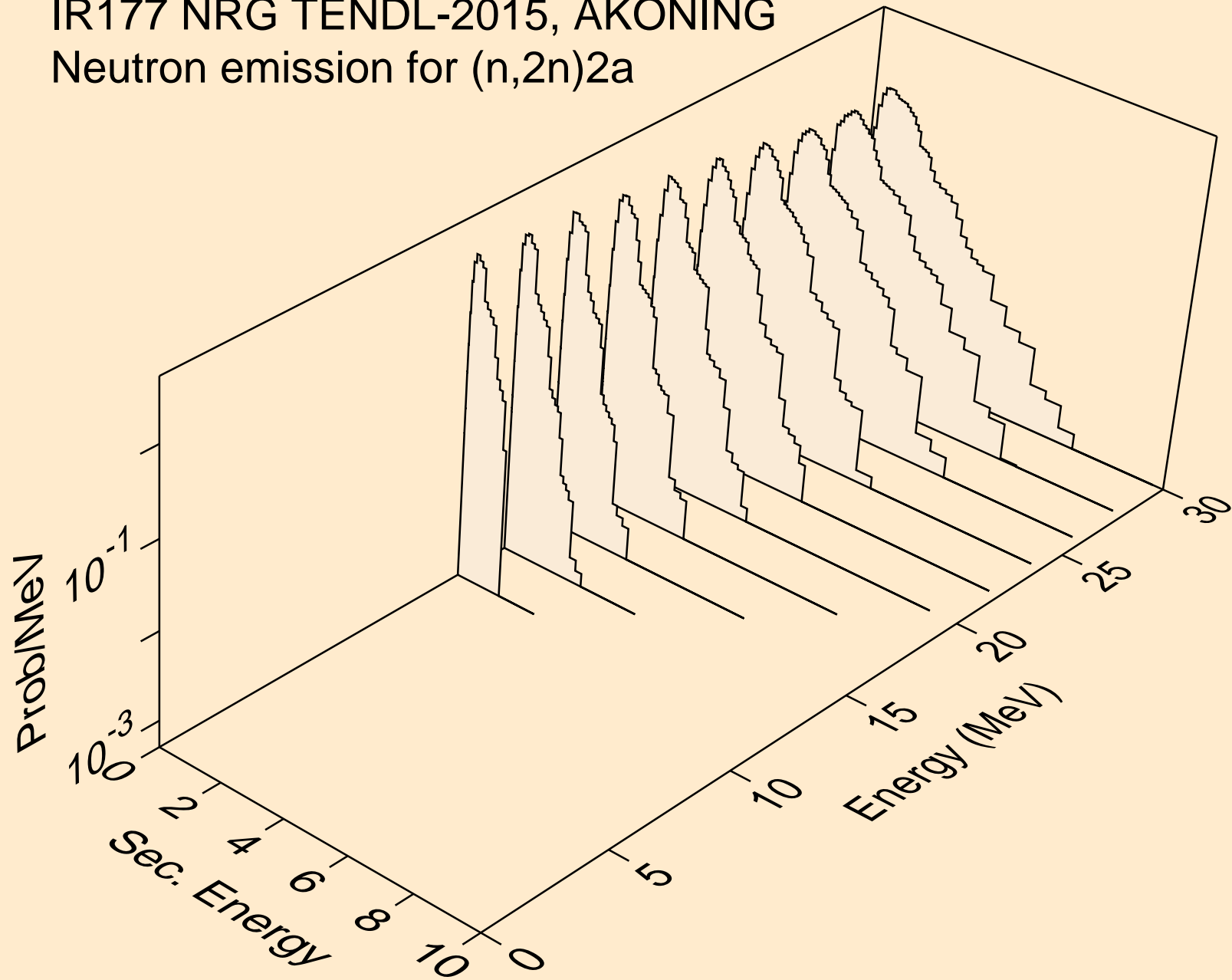



IR177 NRG TENDL-2015, AKONING  
Neutron emission for (n,n\*)d

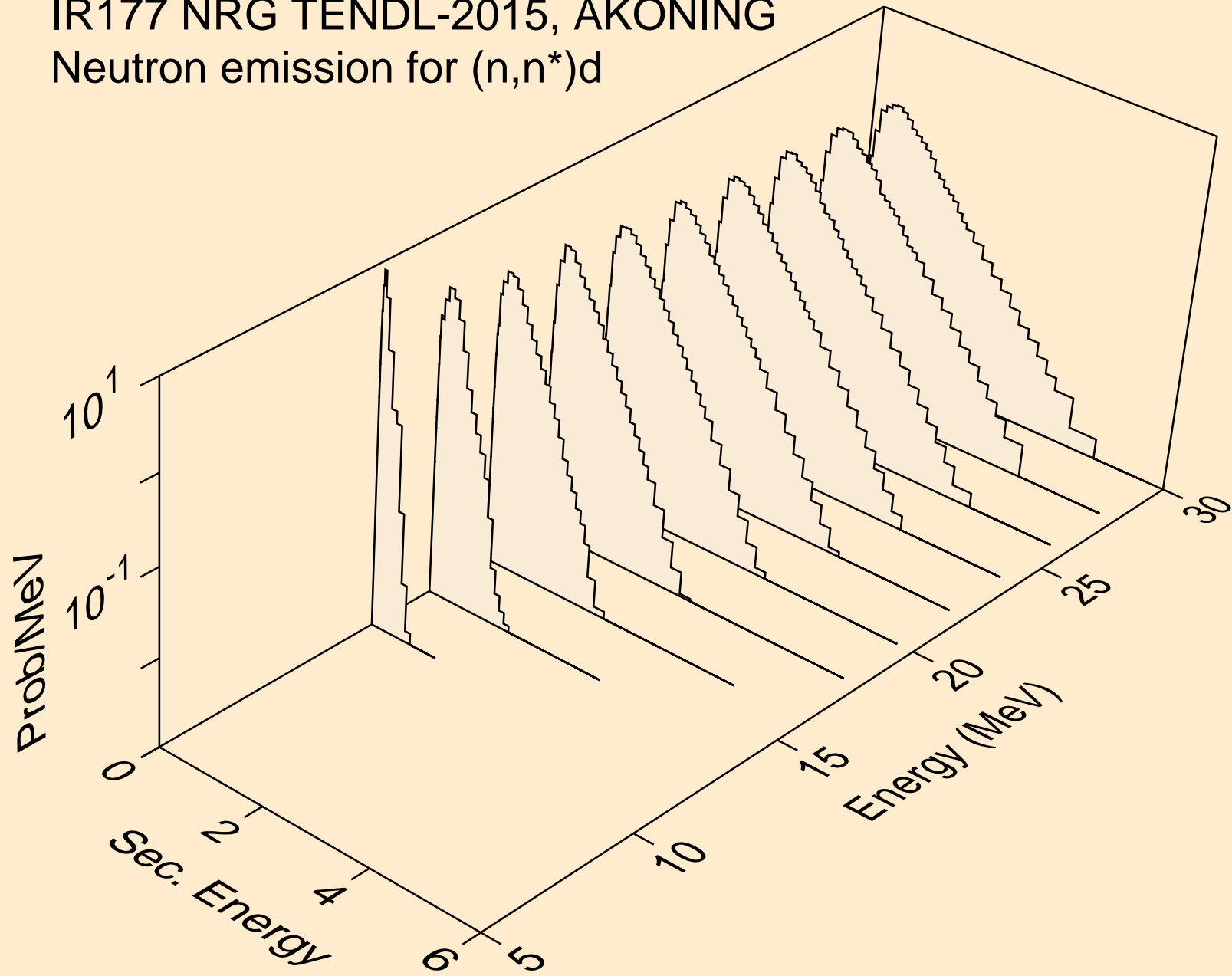

IR177 NRG TENDL-2015, AKONING  
Neutron emission for (n,n\*)t

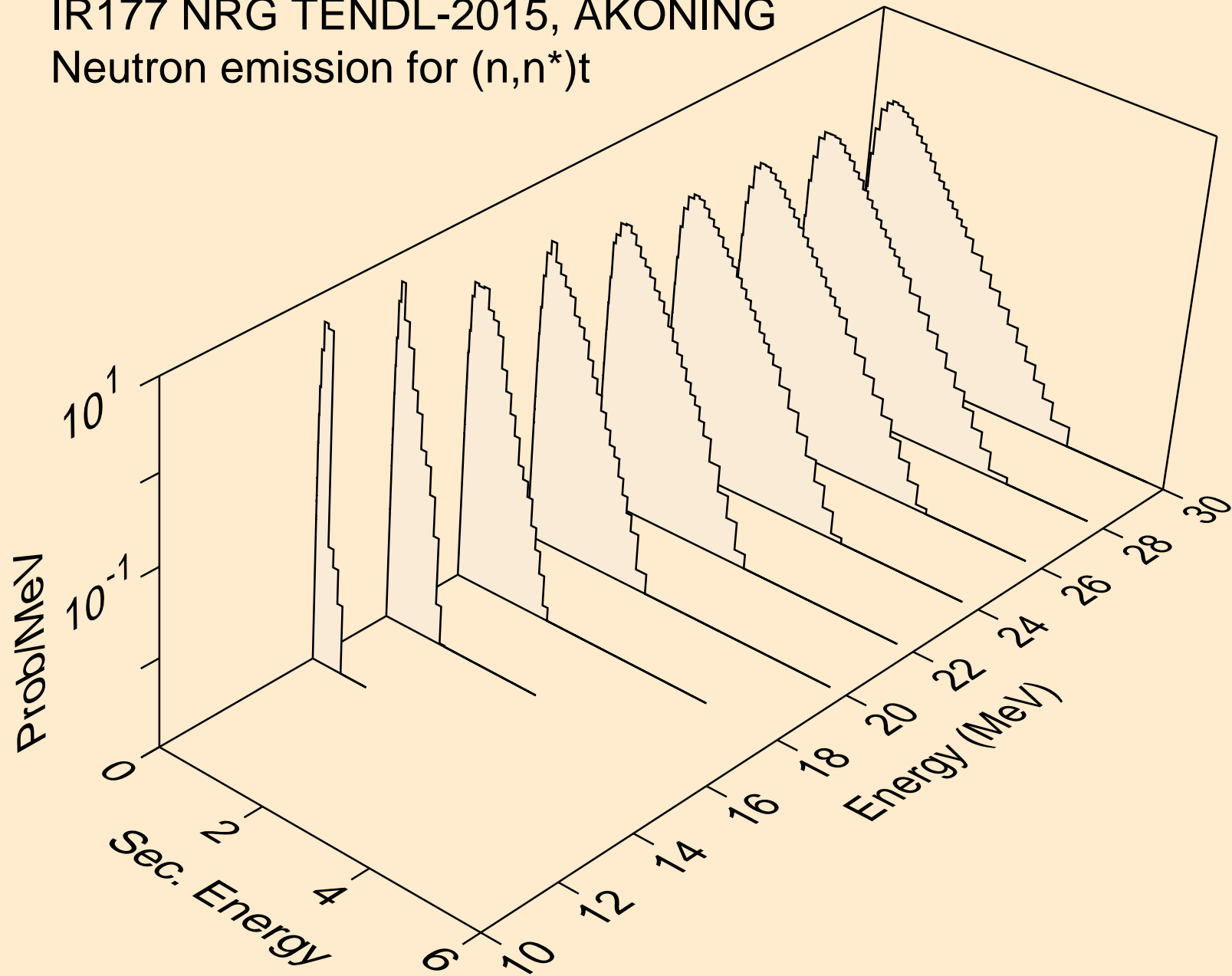

IR177 NRG TENDL-2015, AKONING  
Neutron emission for (n,n\*)he3

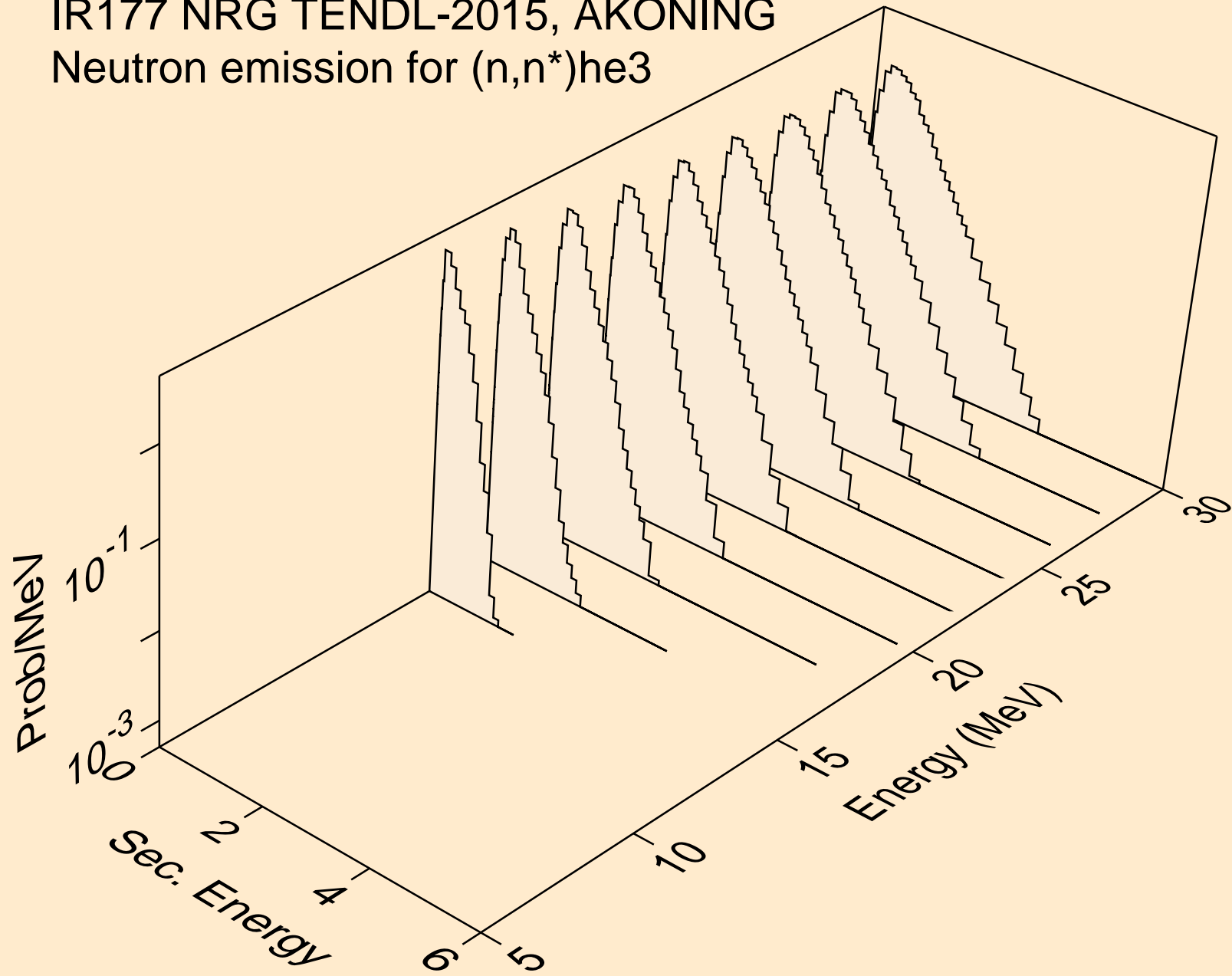

IR177 NRG TENDL-2015, AKONING  
Neutron emission for (n,4n)

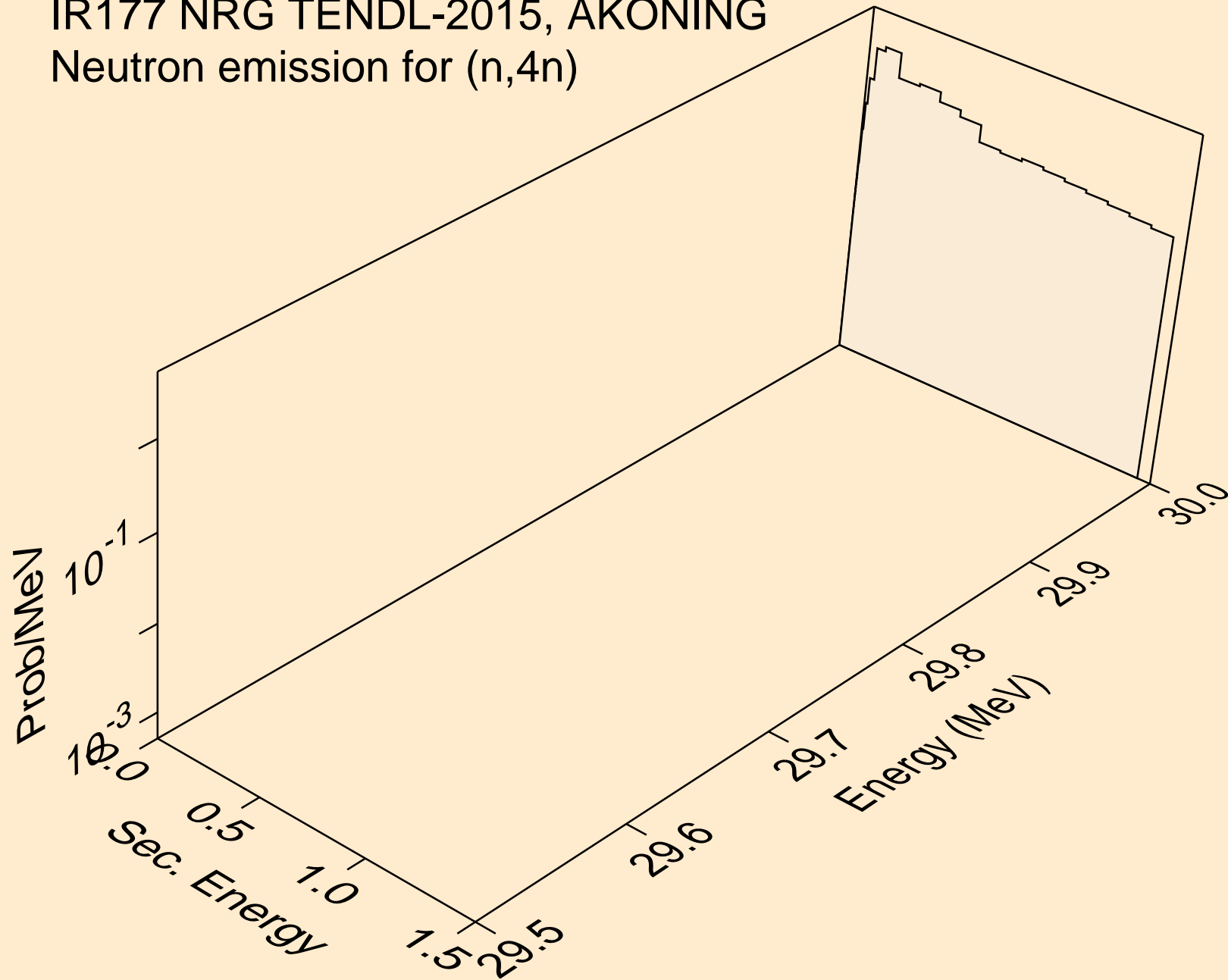

IR177 NRG TENDL-2015, AKONING  
Neutron emission for (n,2np)

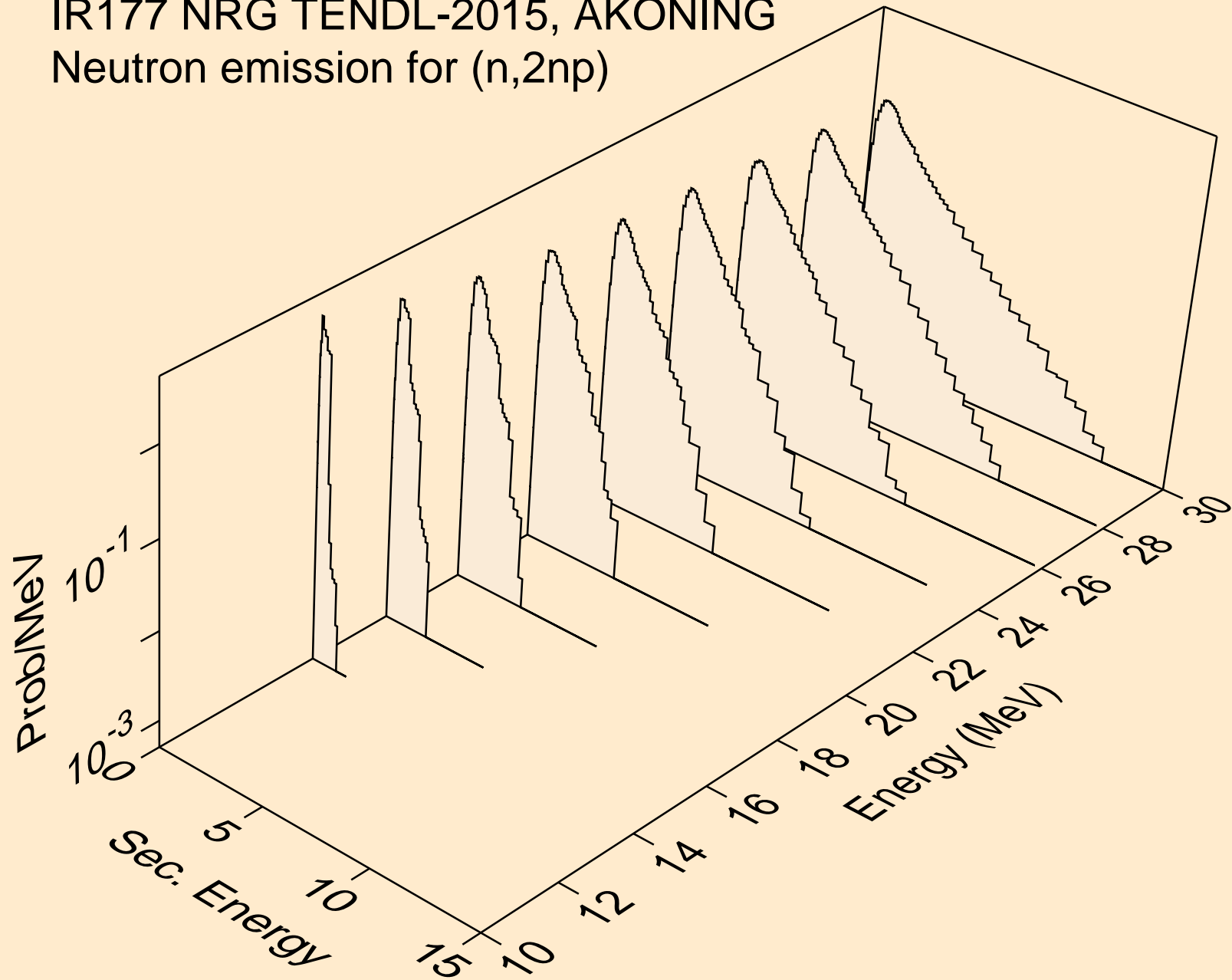

IR177 NRG TENDL-2015, AKONING  
Neutron emission for (n,3np)

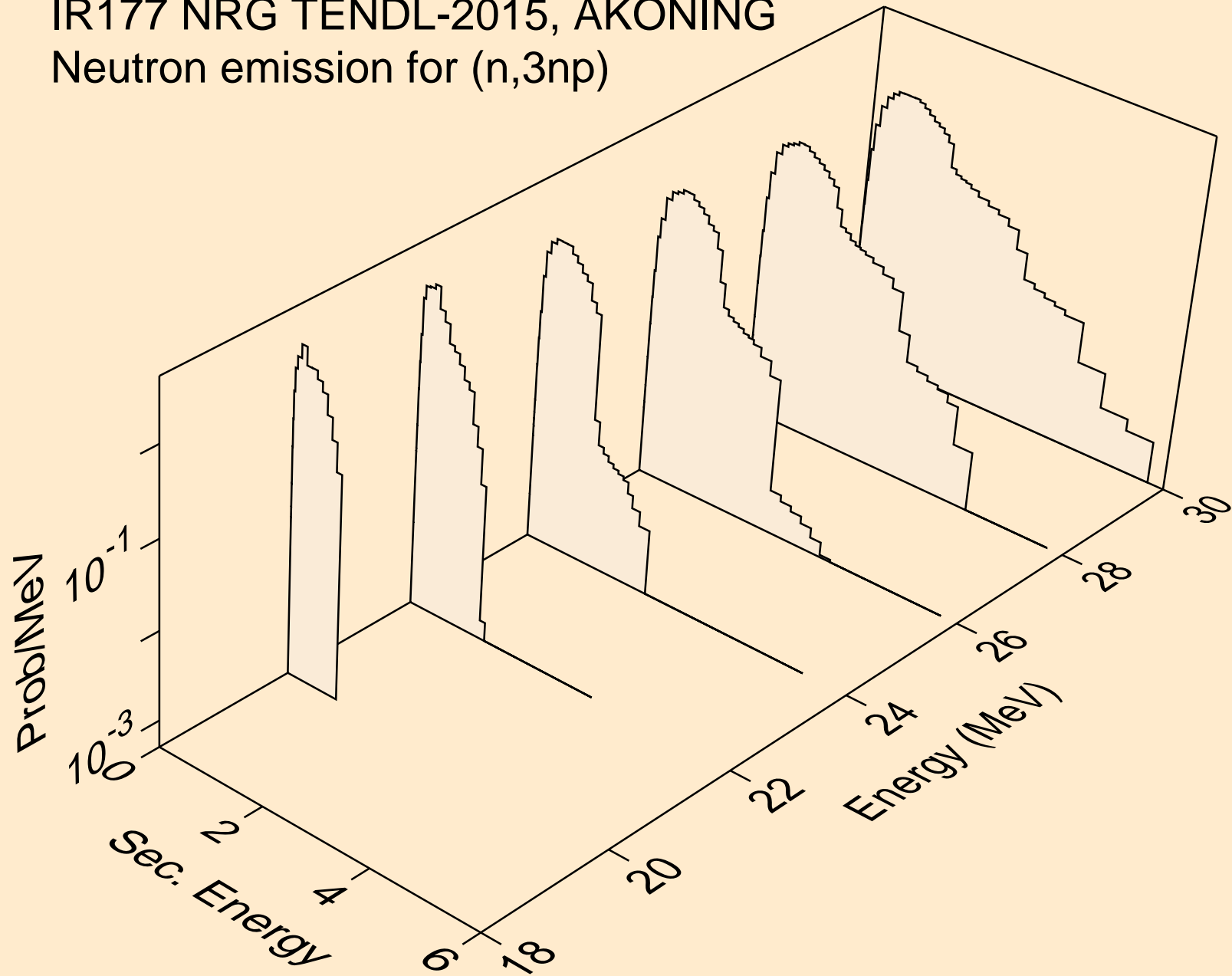

IR177 NRG TENDL-2015, AKONING  
Neutron emission for (n,2np)

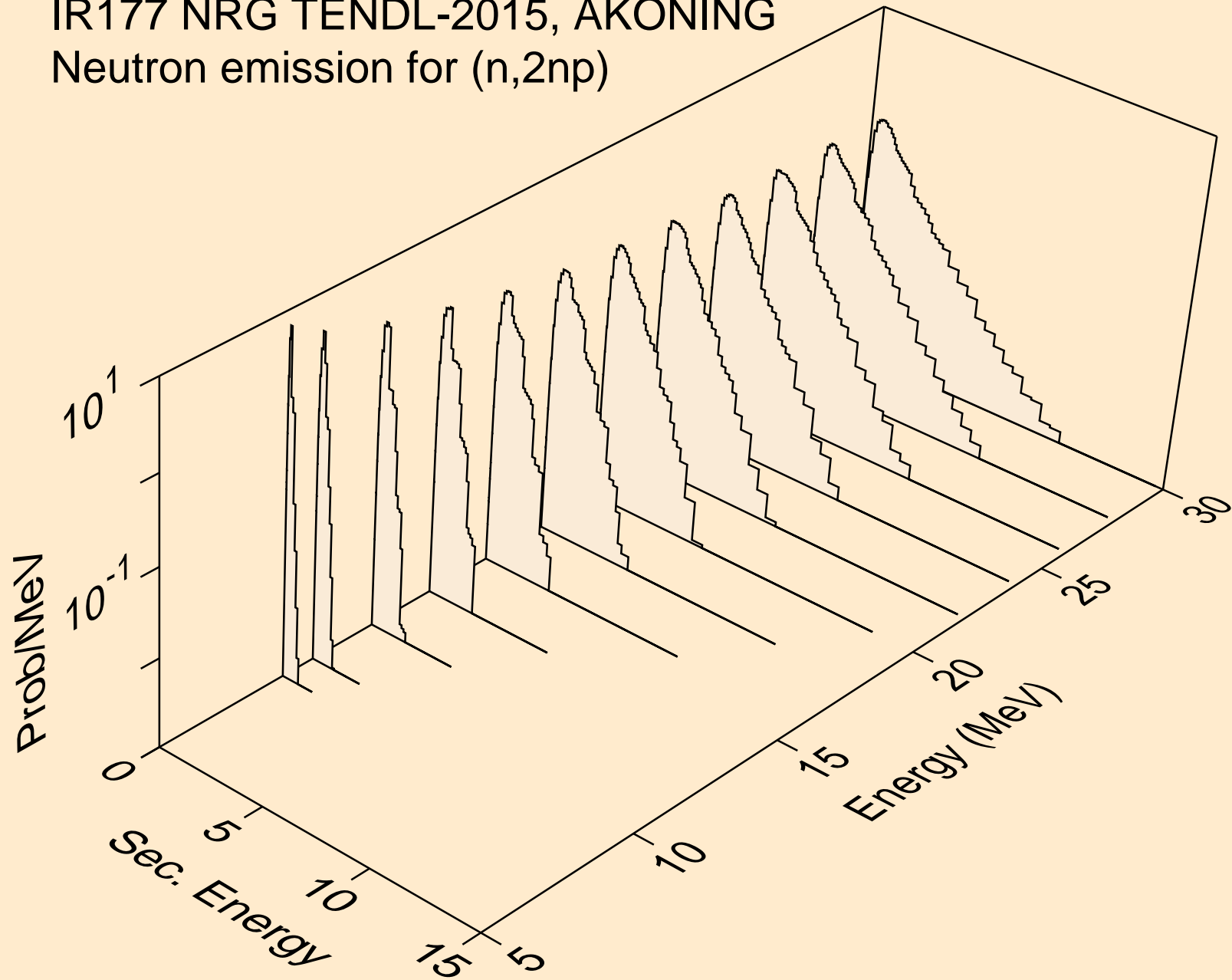

IR177 NRG TENDL-2015, AKONING  
Neutron emission for (n,npa)

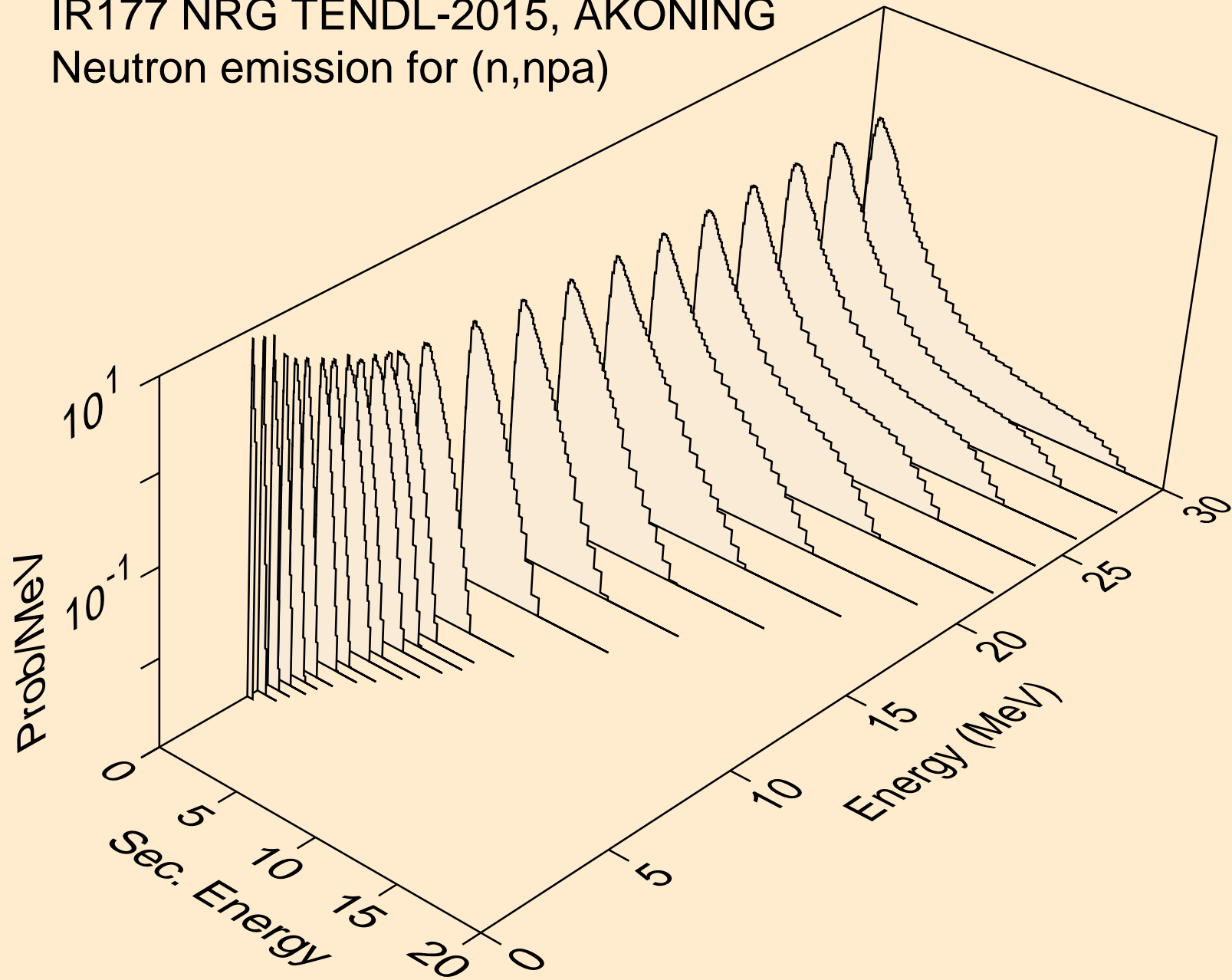



IR177 NRG TENDL-2015, AKONING  
Neutron emission for (n,n\*c)

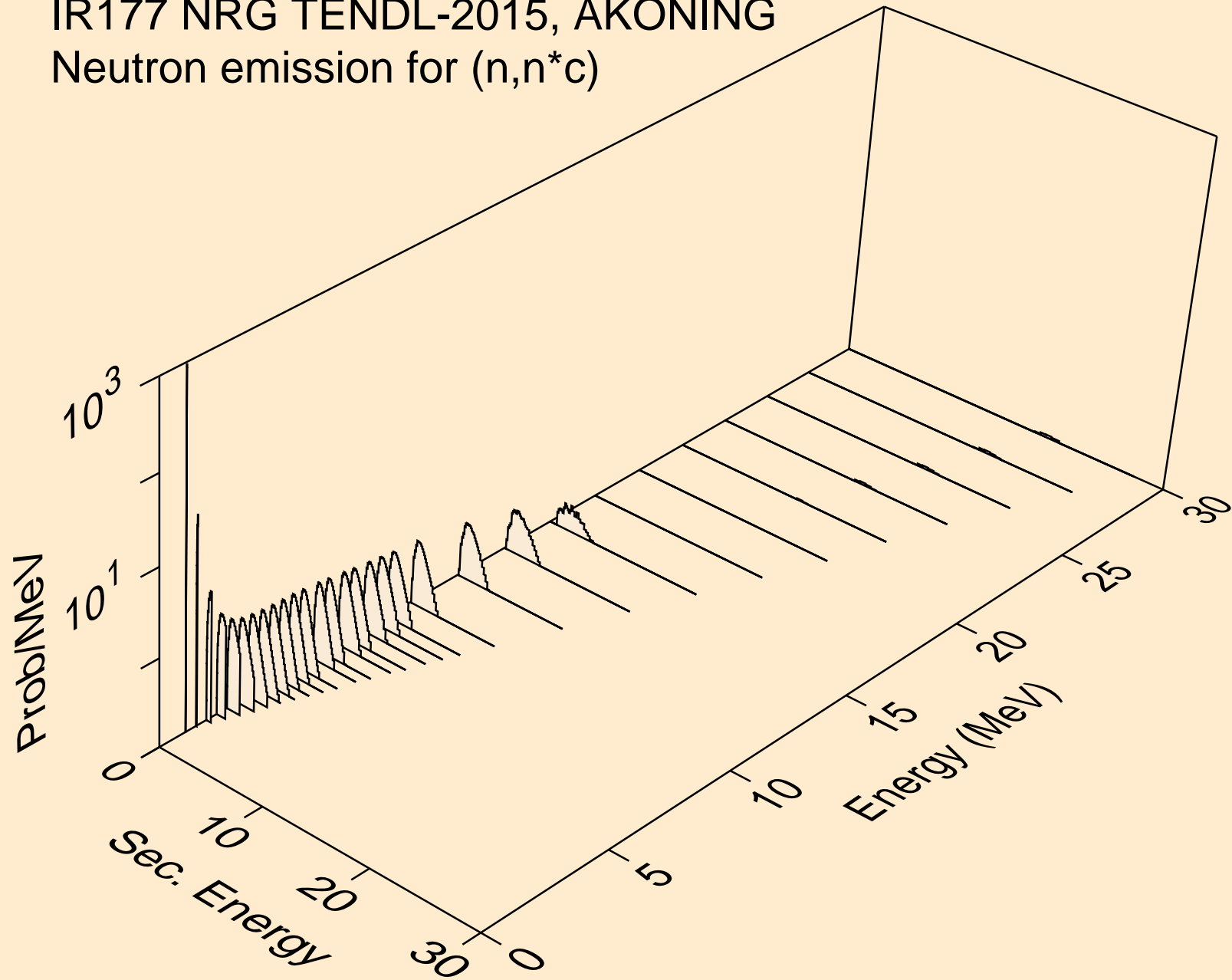

IR177 NRG TENDL-2015, AKONING  
Photon emission for (n,x)

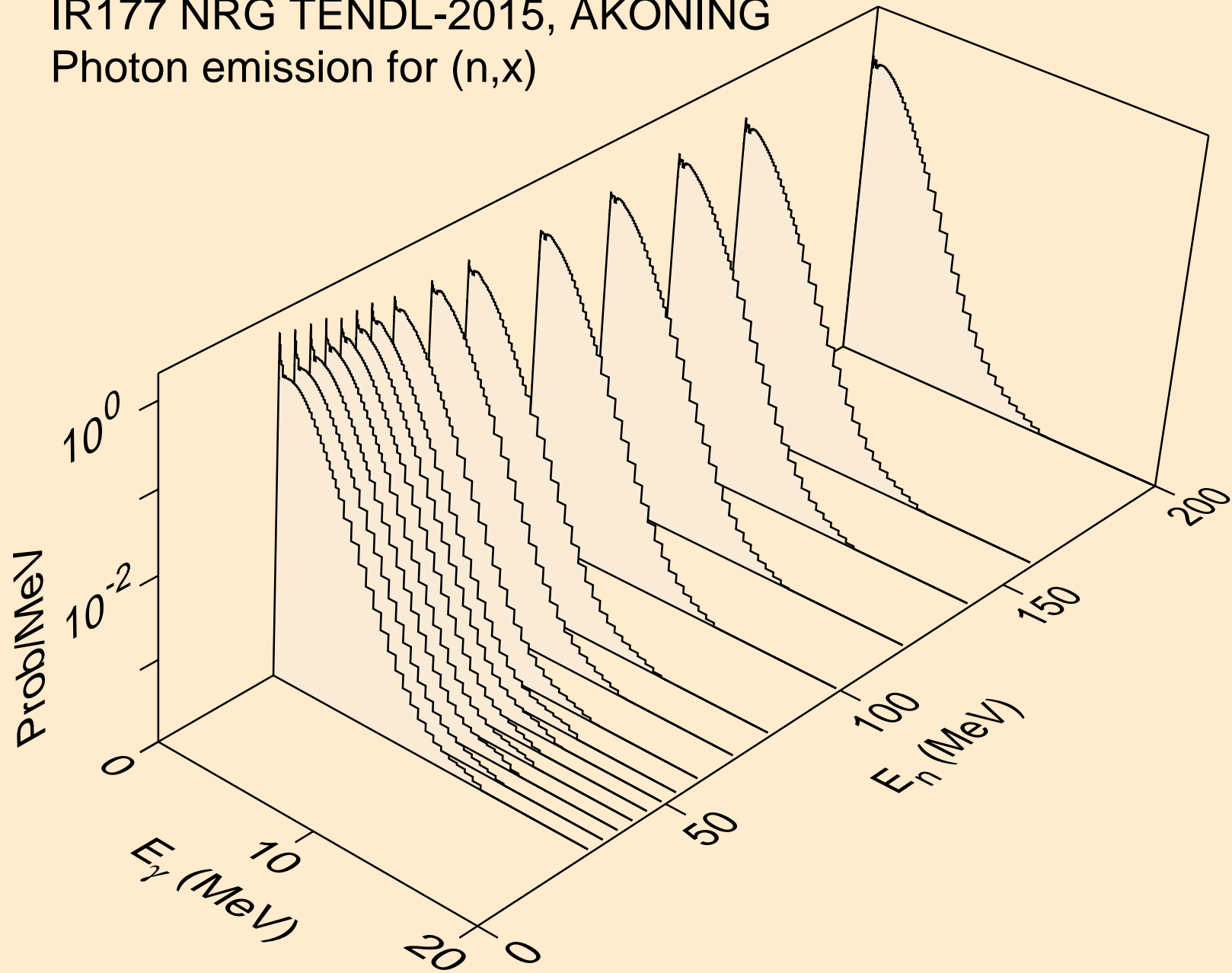

IR177 NRG TENDL-2015, AKONING  
Photon emission for (n,2nd)

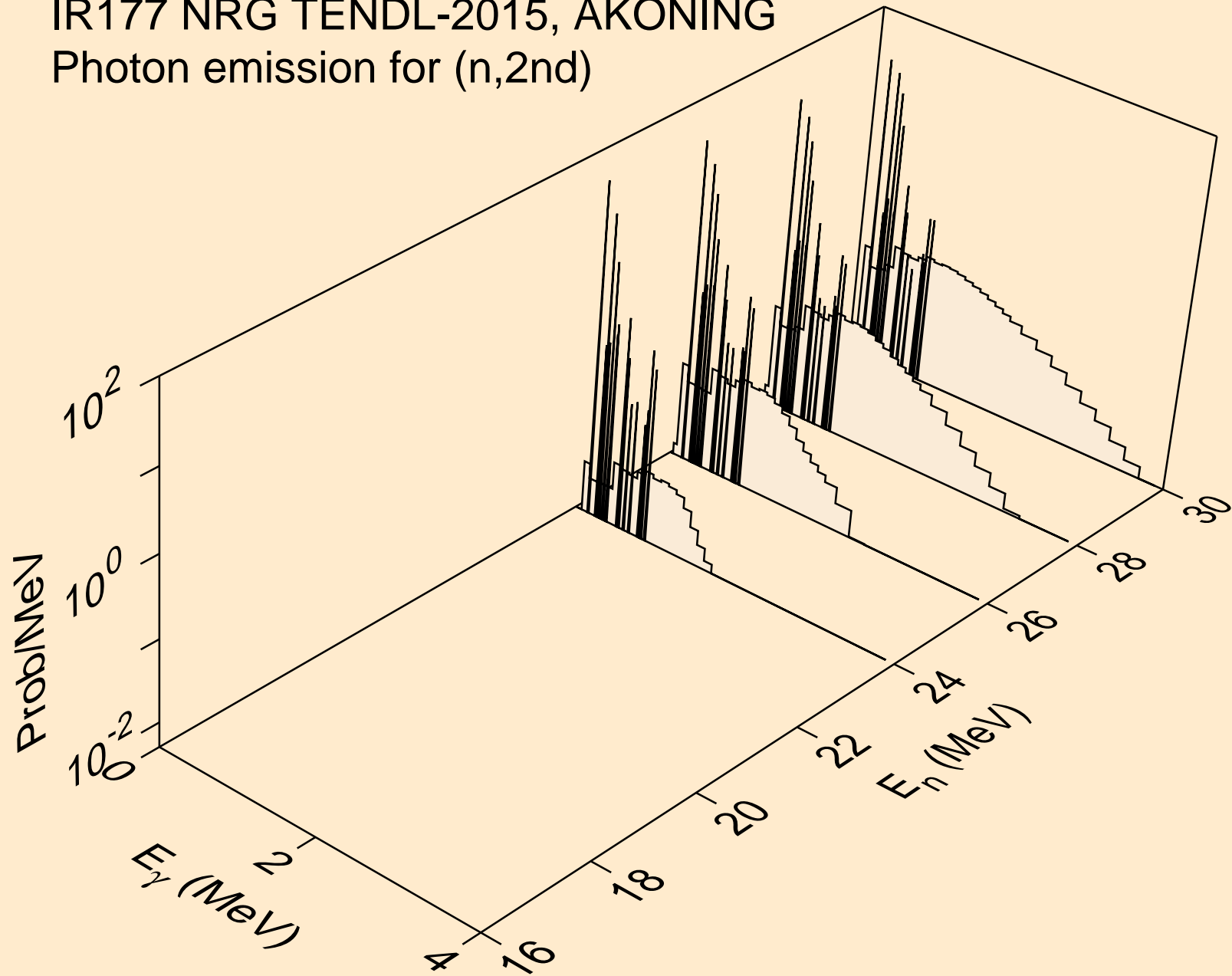

IR177 NRG TENDL-2015, AKONING  
Photon emission for (n,2n)

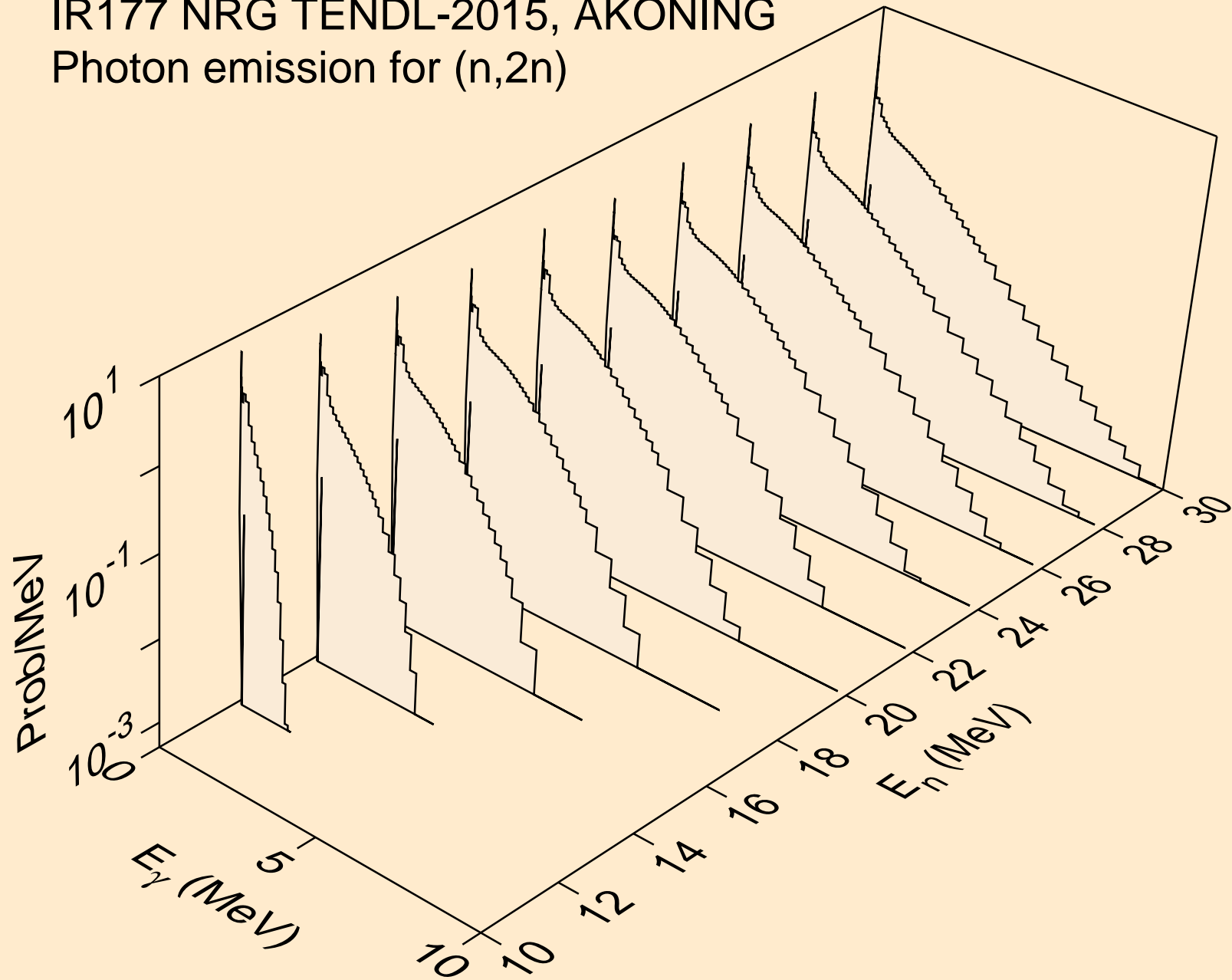

IR177 NRG TENDL-2015, AKONING  
Photon emission for (n,3n)

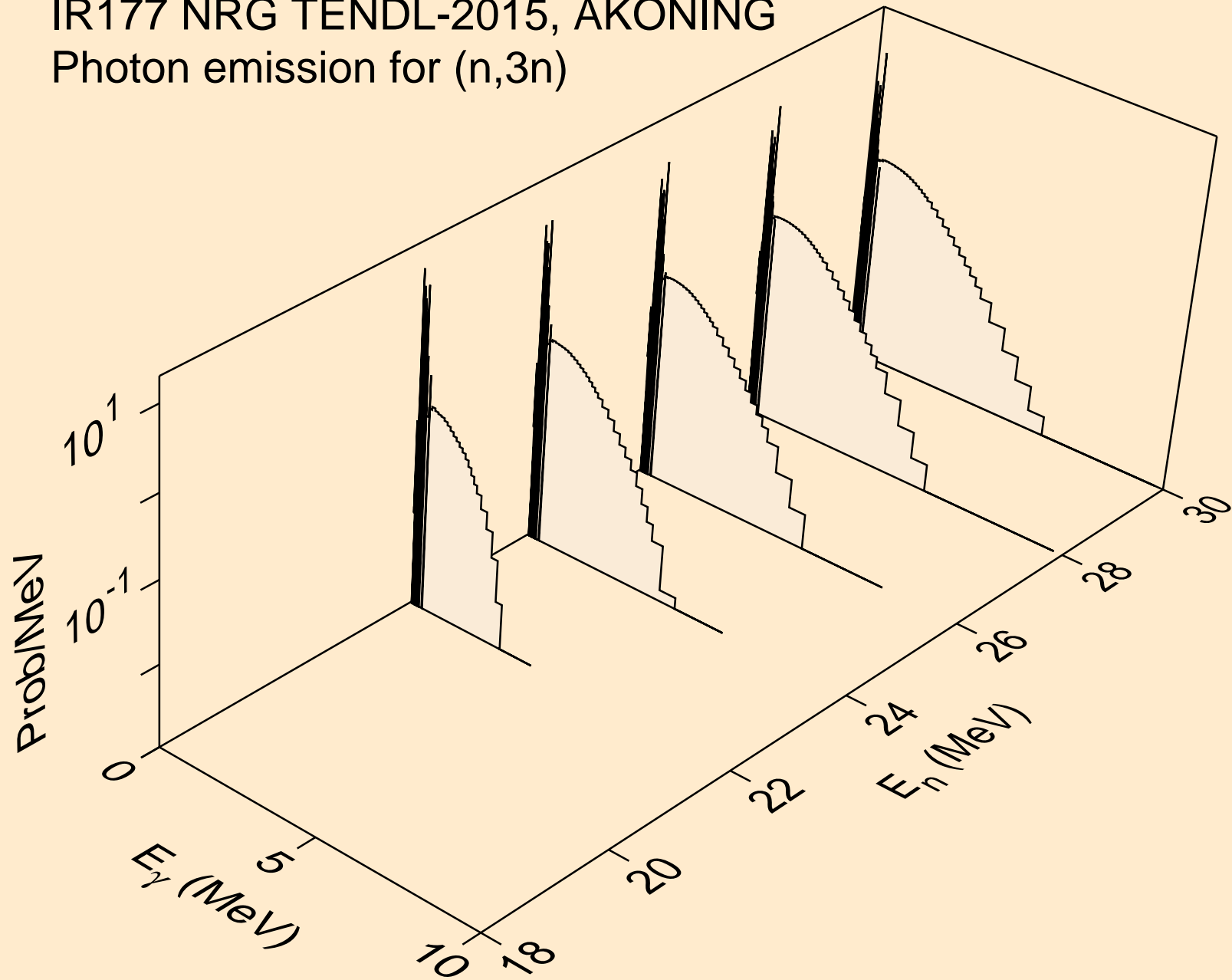

IR177 NRG TENDL-2015, AKONING  
Photon emission for (n,n\*)a

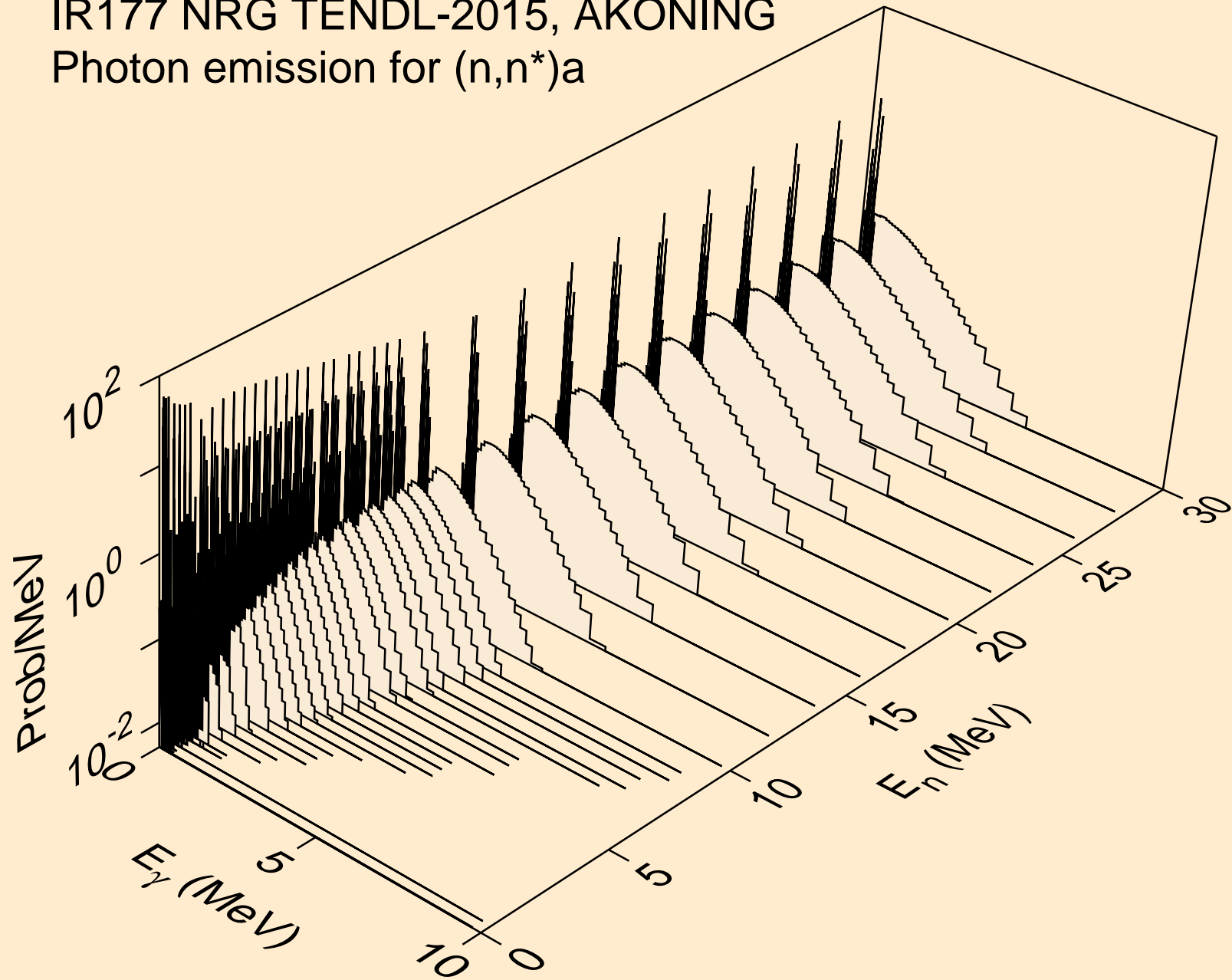

IR177 NRG TENDL-2015, AKONING  
Photon emission for (n,n\*)3a

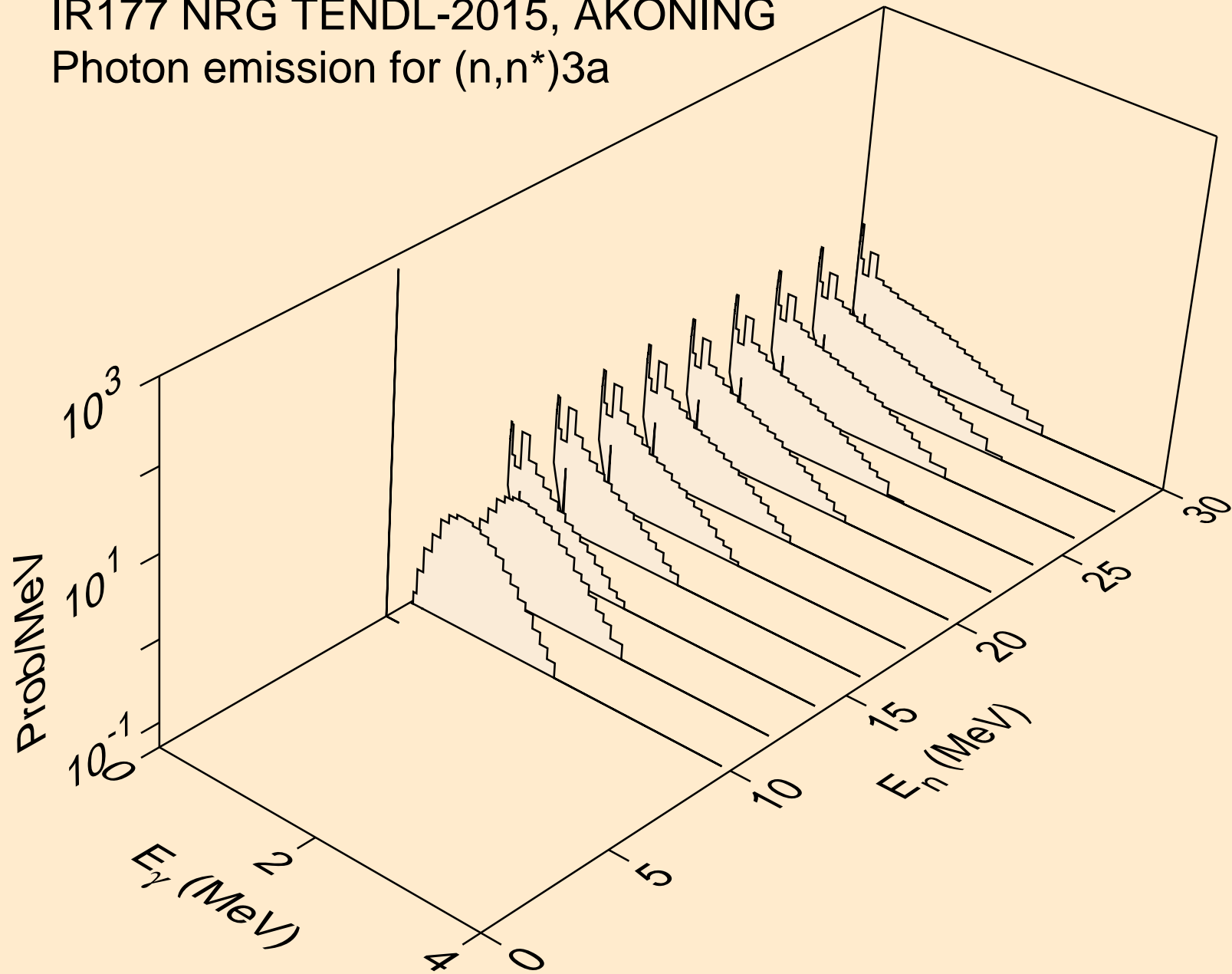

IR177 NRG TENDL-2015, AKONING  
Photon emission for (n,2n)a

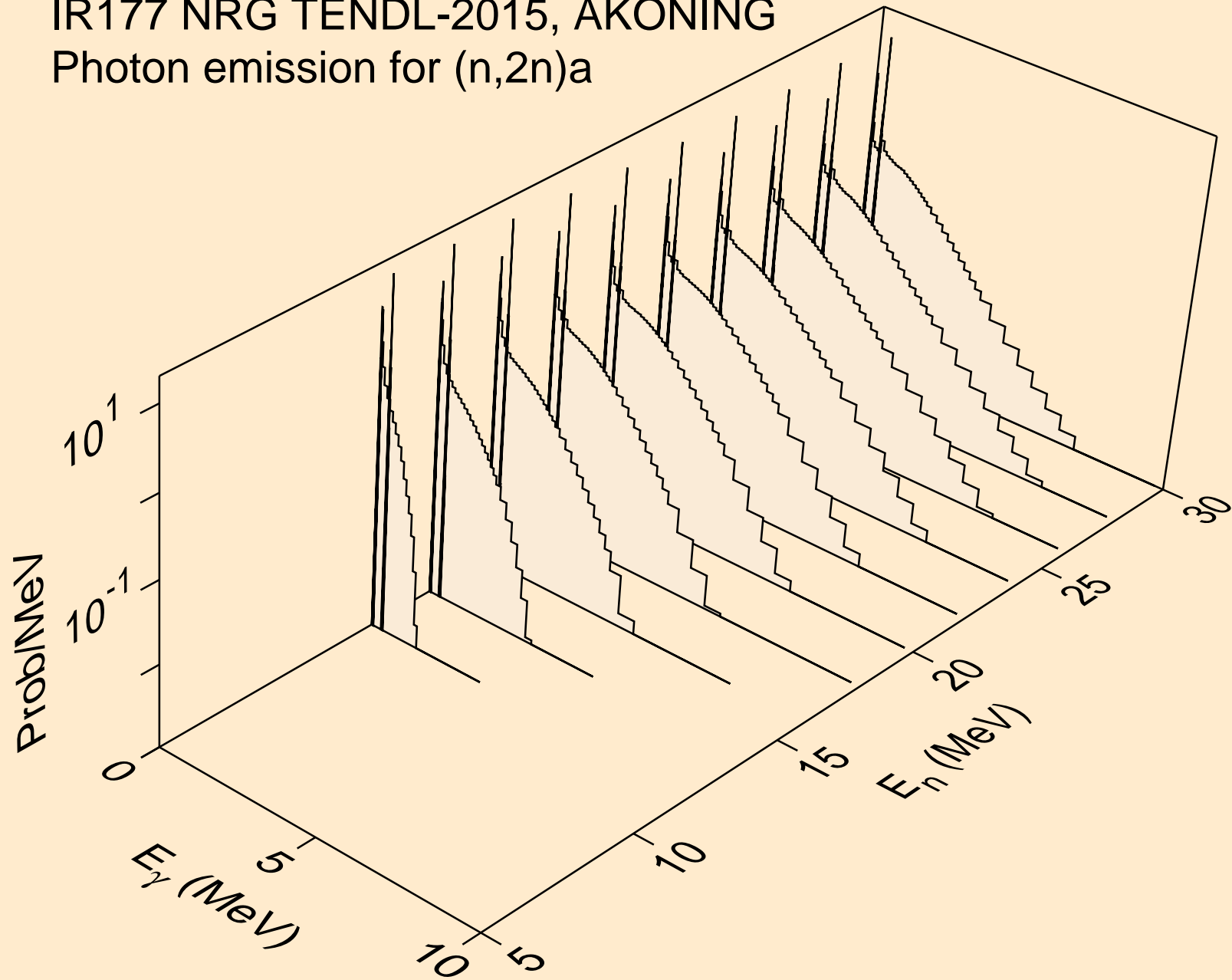



IR177 NRG TENDL-2015, AKONING  
Photon emission for (n,3n)a

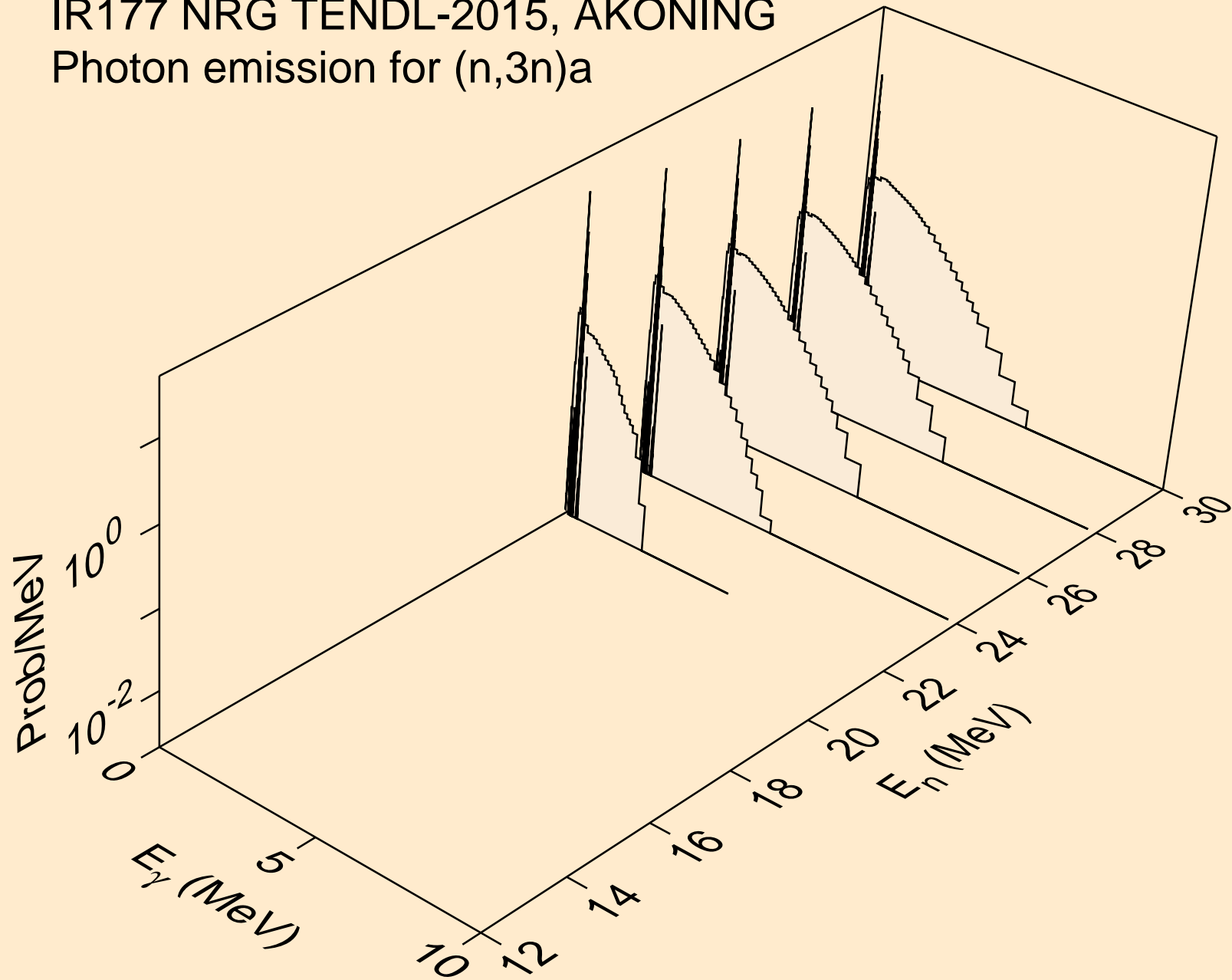

IR177 NRG TENDL-2015, AKONING  
Photon emission for (n,n\*)p

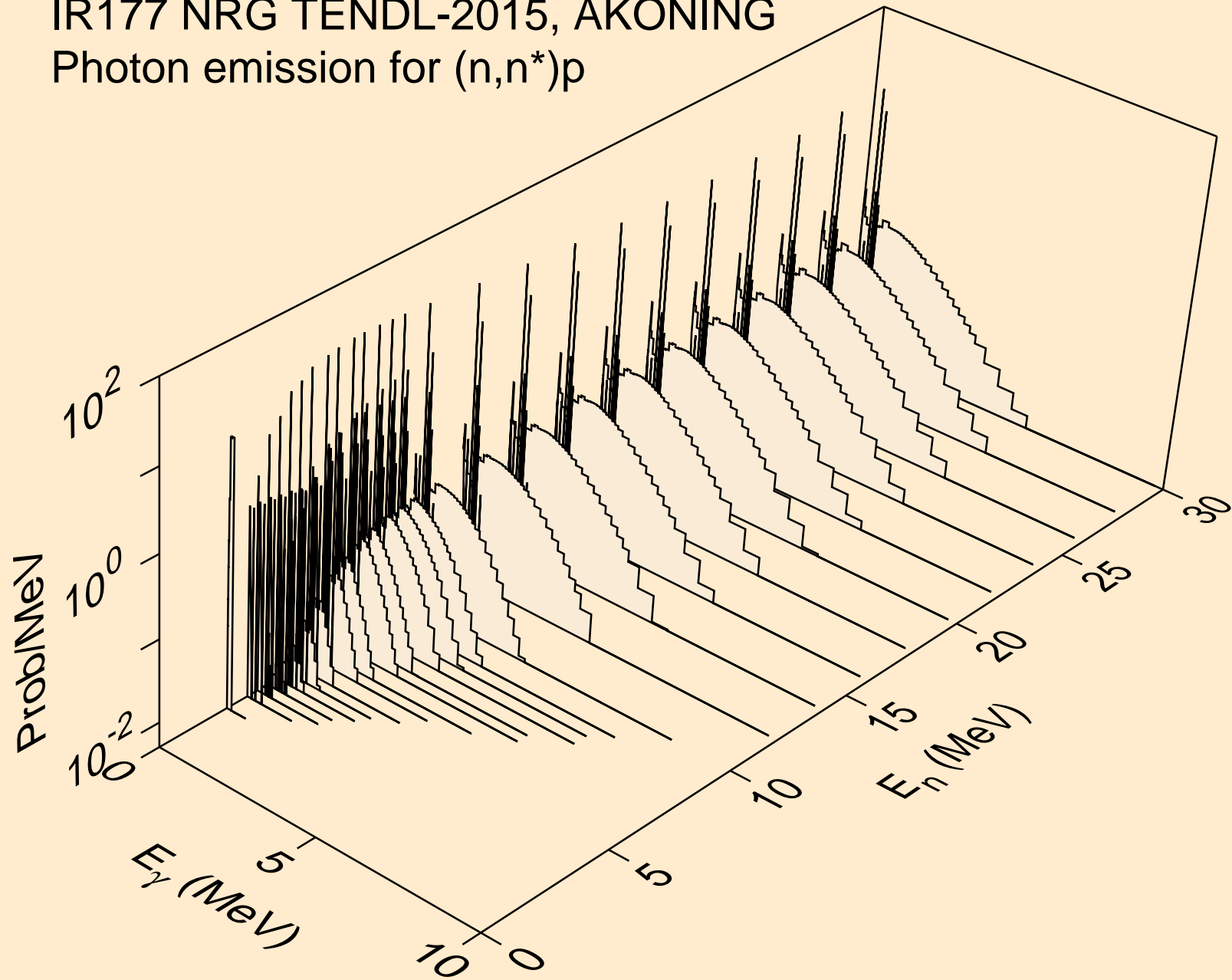

IR177 NRG TENDL-2015, AKONING  
Photon emission for (n,n\*)2a

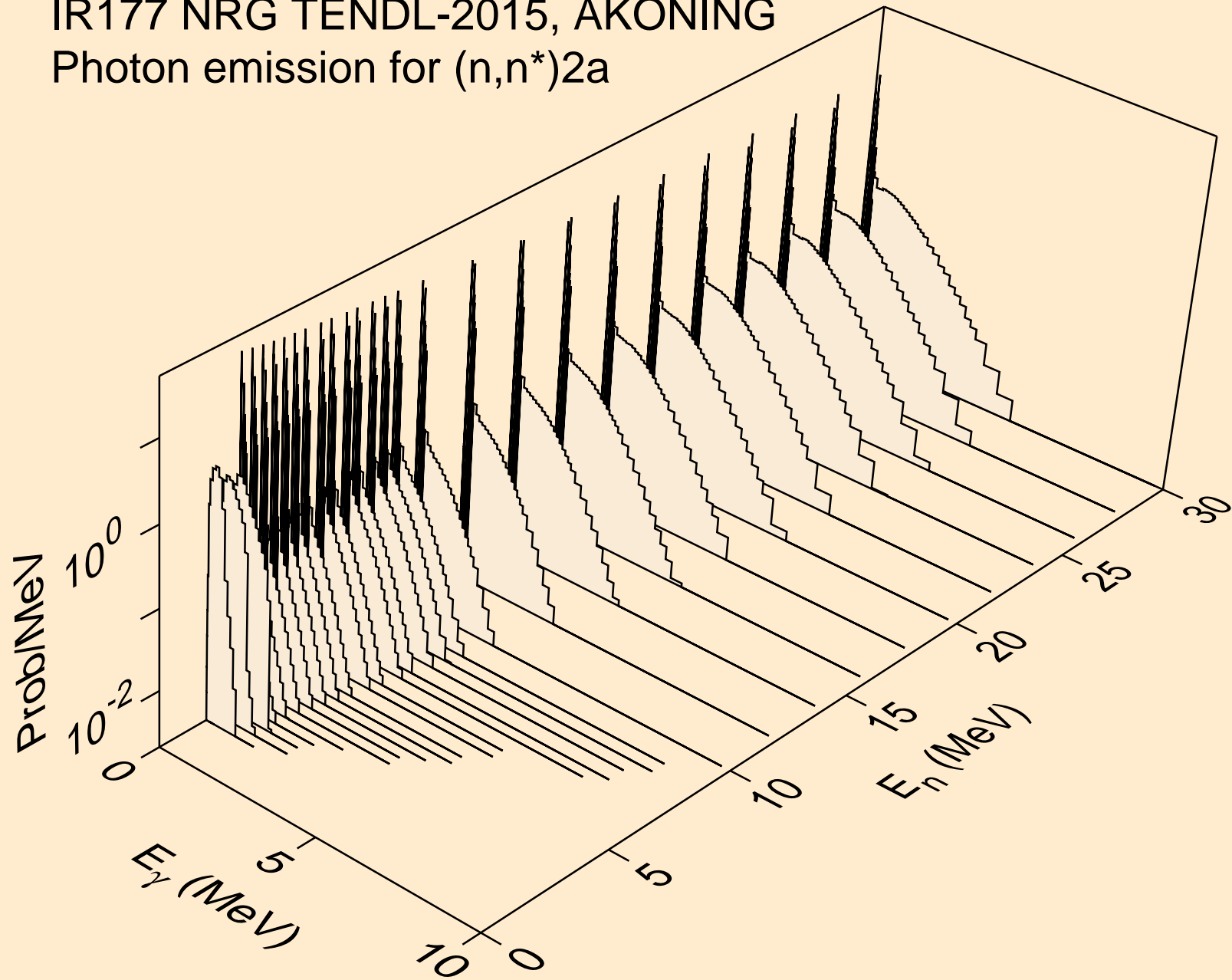

IR177 NRG TENDL-2015, AKONING  
Photon emission for (n,2n)2a

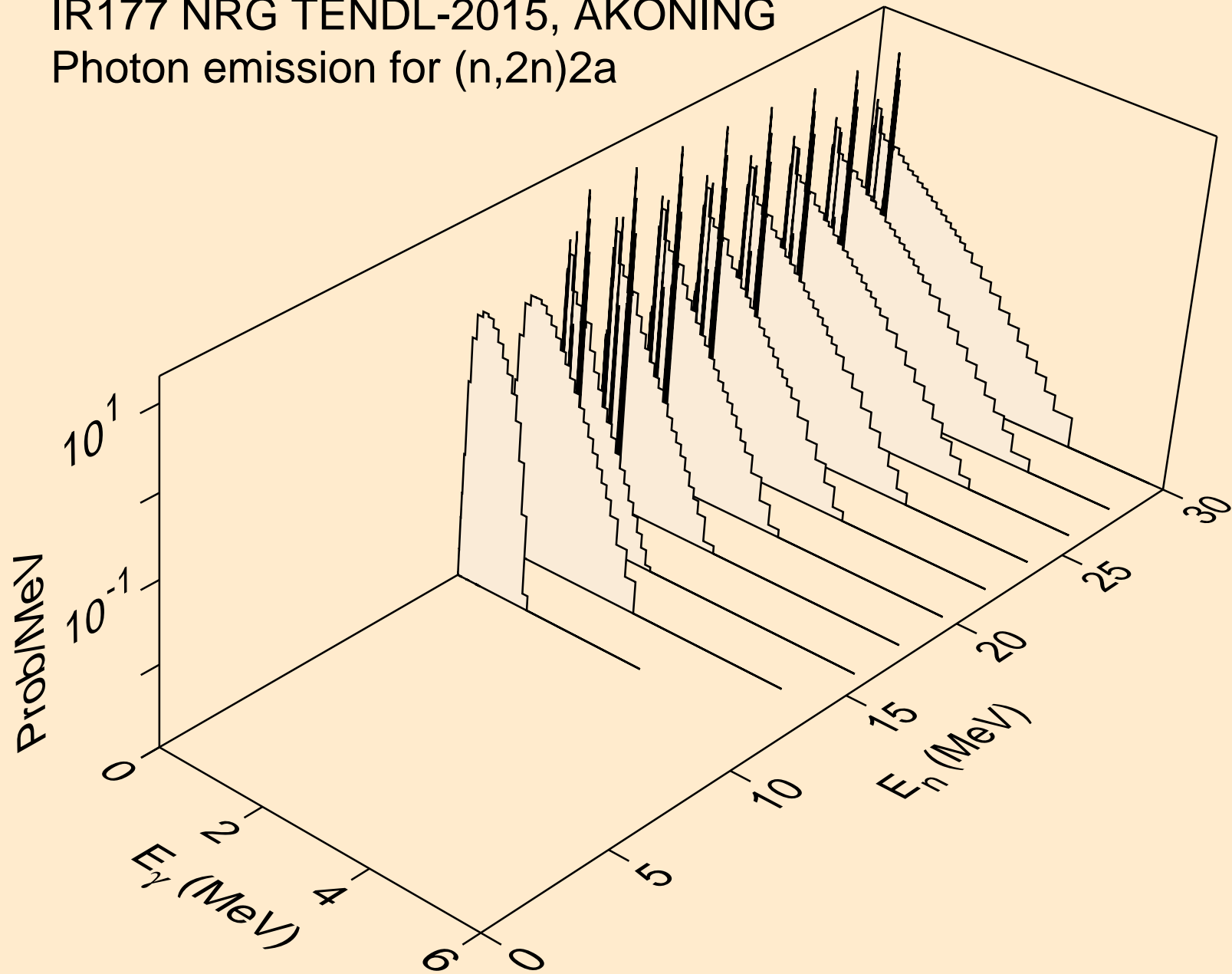

IR177 NRG TENDL-2015, AKONING  
Photon emission for (n,n\*)d

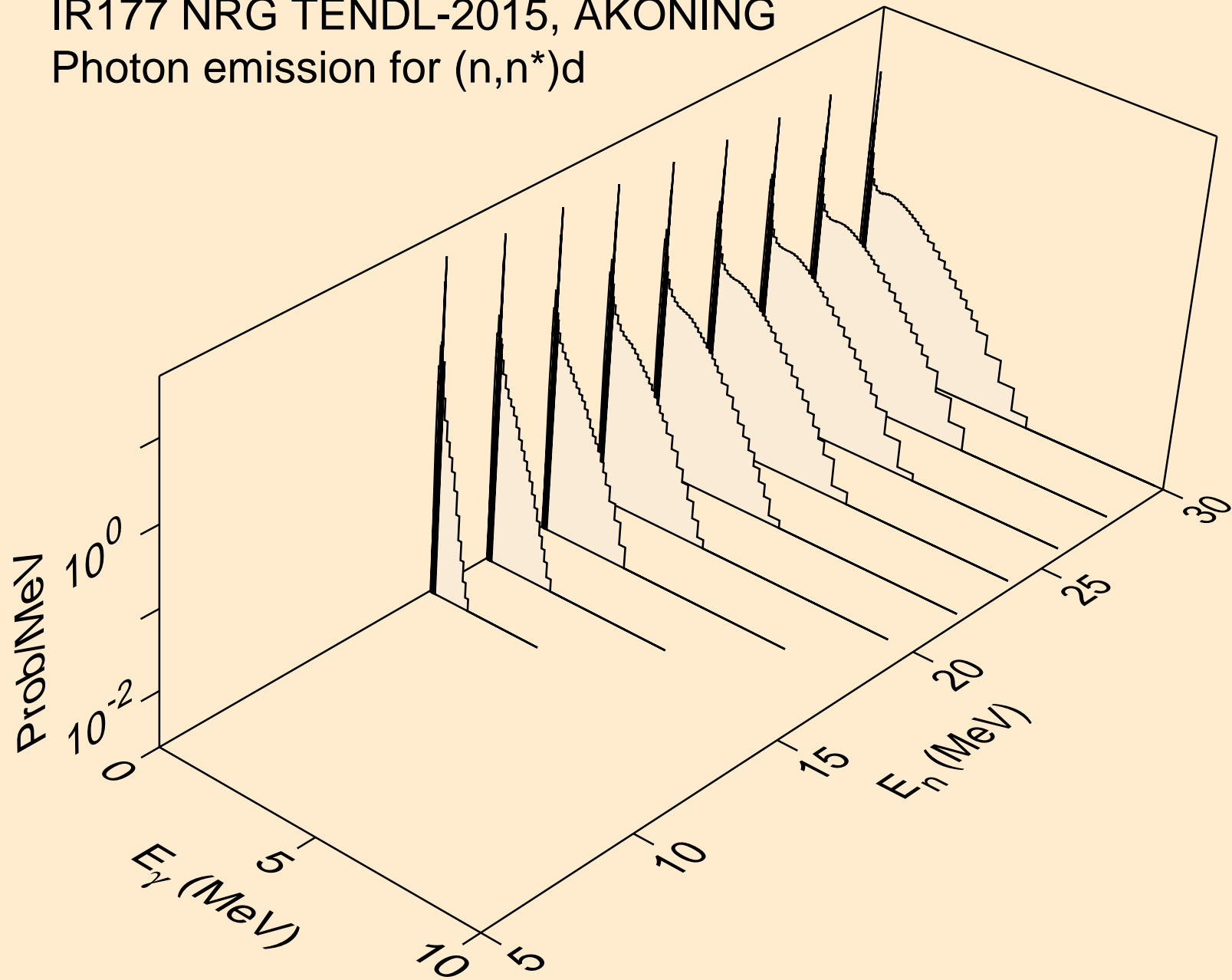

IR177 NRG TENDL-2015, AKONING  
Photon emission for (n,n\*)t

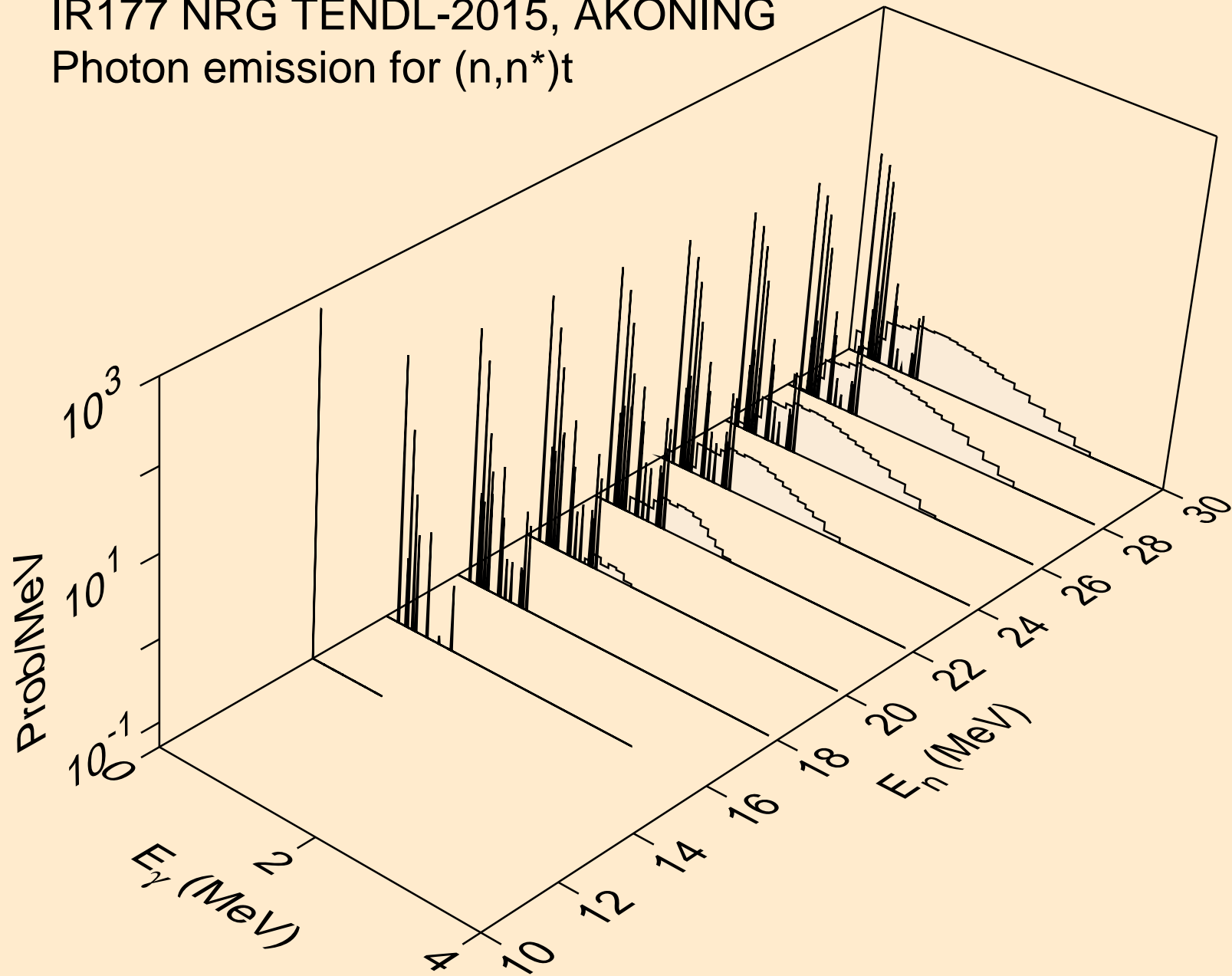

IR177 NRG TENDL-2015, AKONING  
Photon emission for (n,n\*)he3

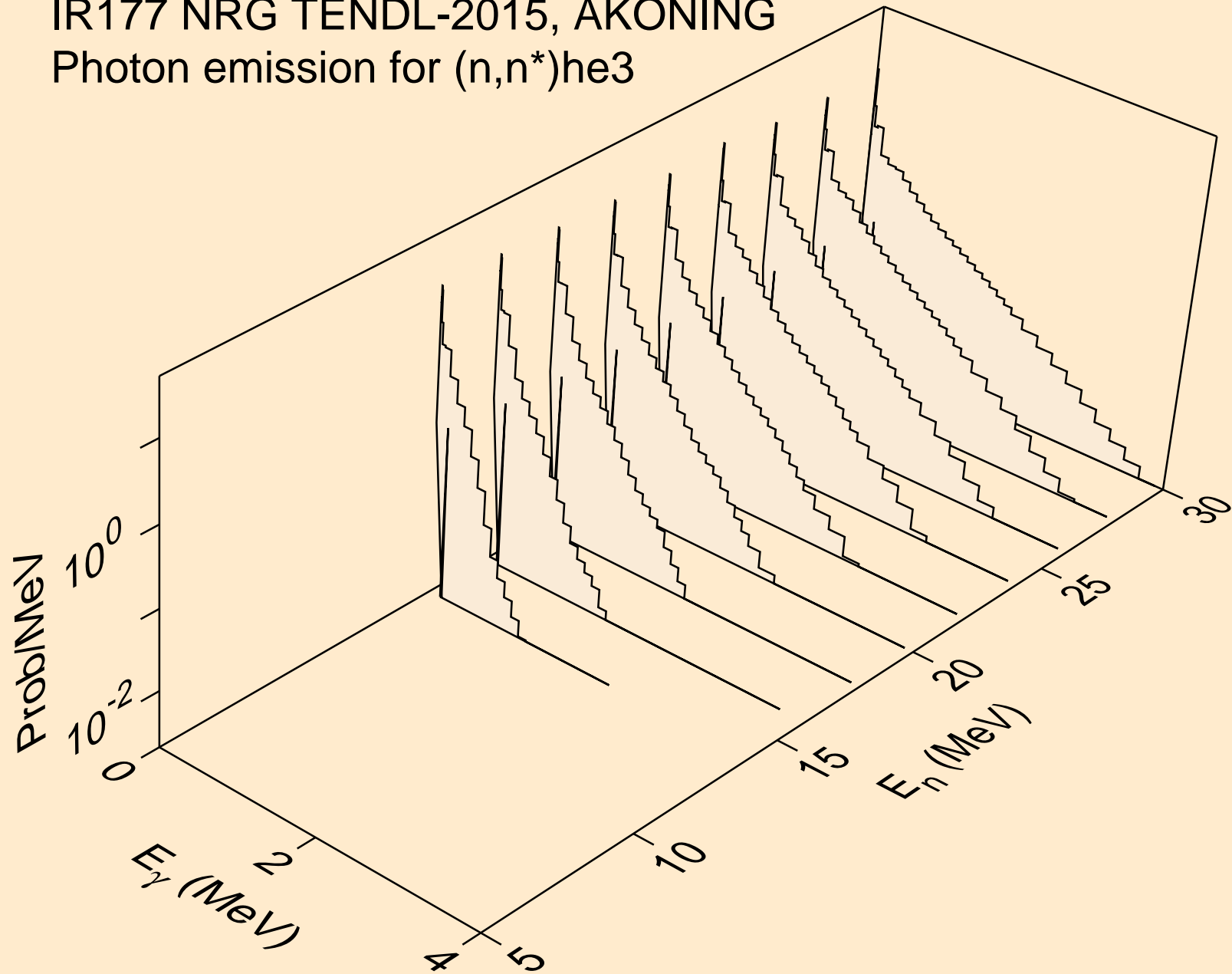

IR177 NRG TENDL-2015, AKONING  
Photon emission for (n,4n)

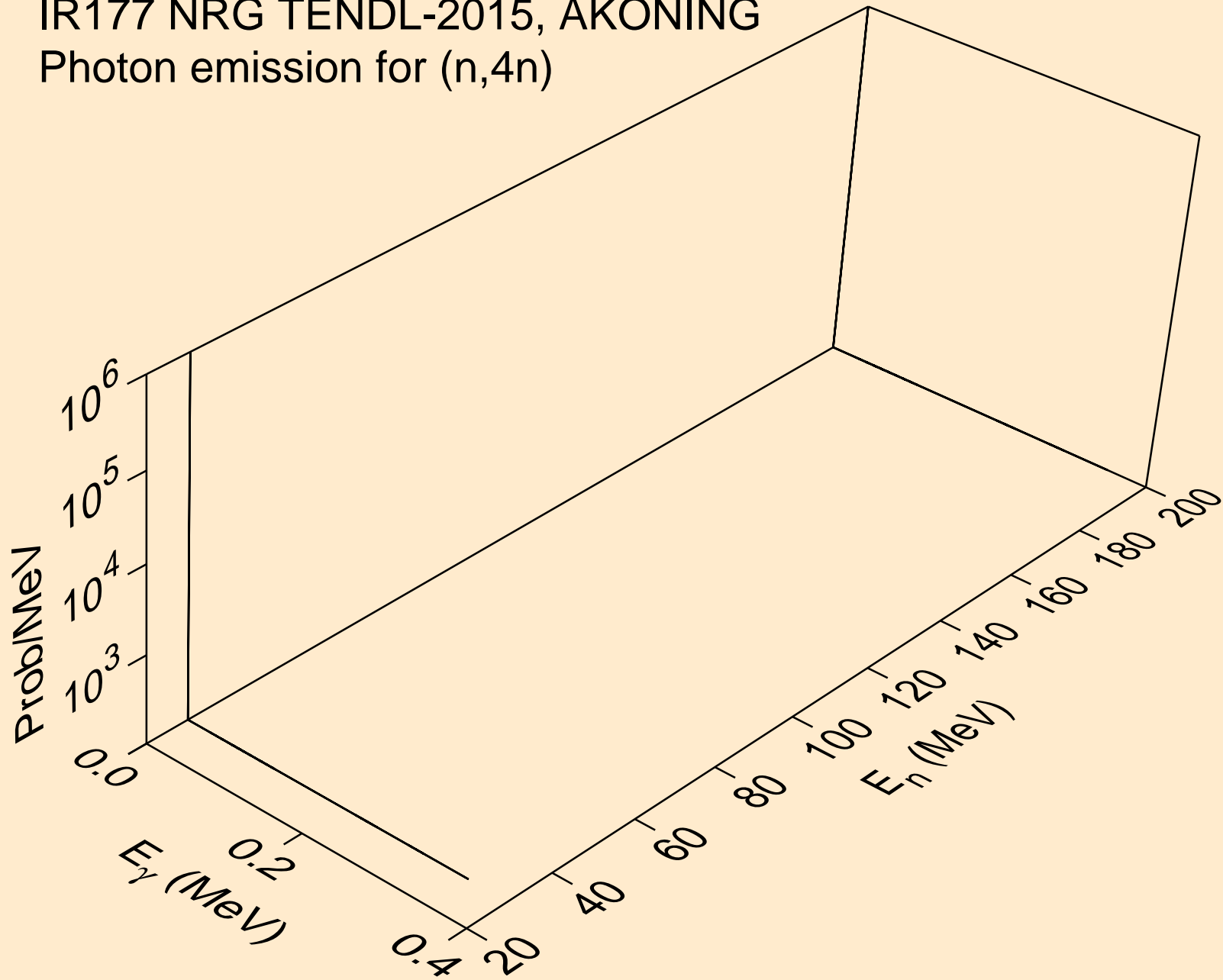



IR177 NRG TENDL-2015, AKONING  
Photon emission for (n,2np)

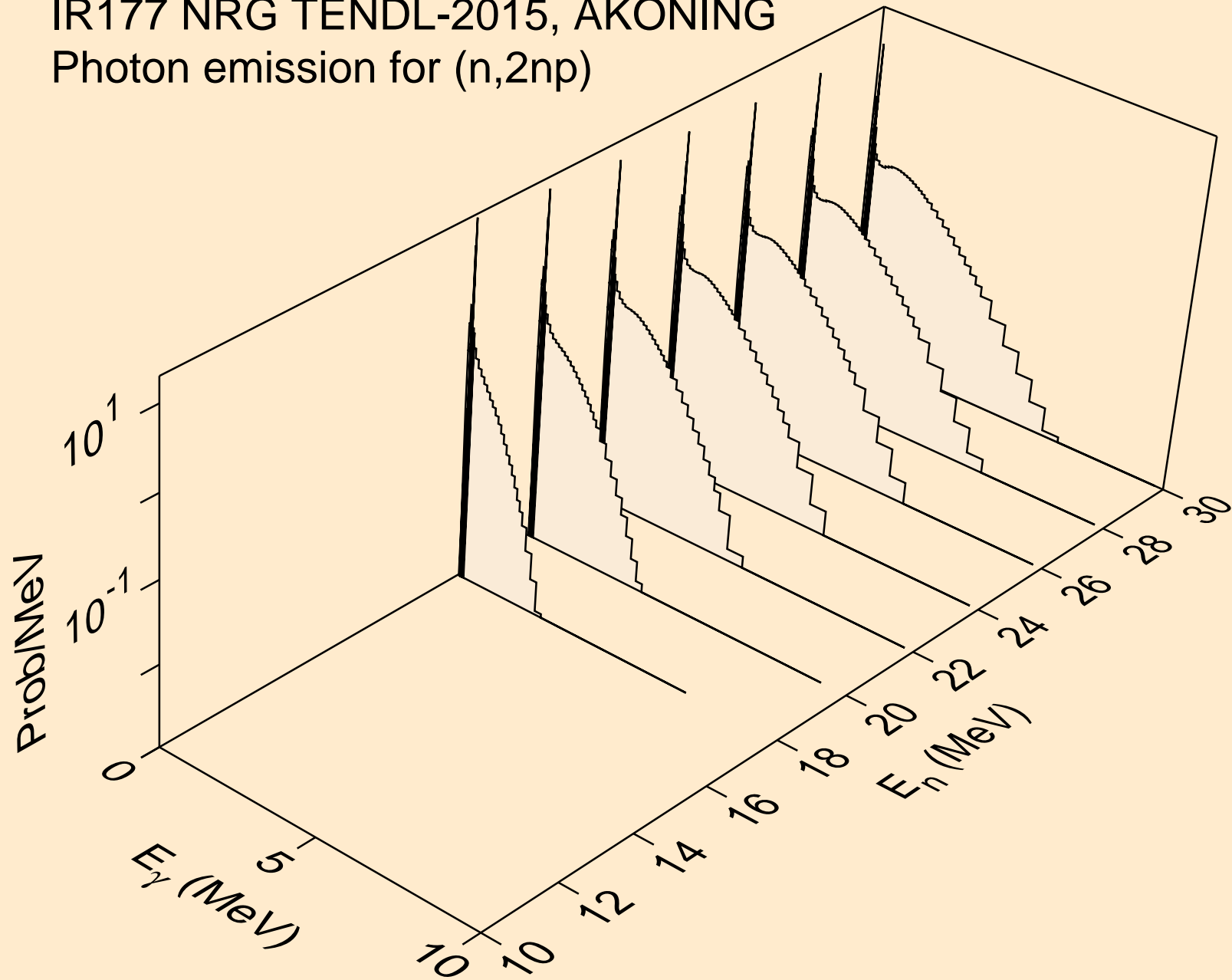

IR177 NRG TENDL-2015, AKONING  
Photon emission for (n,3np)

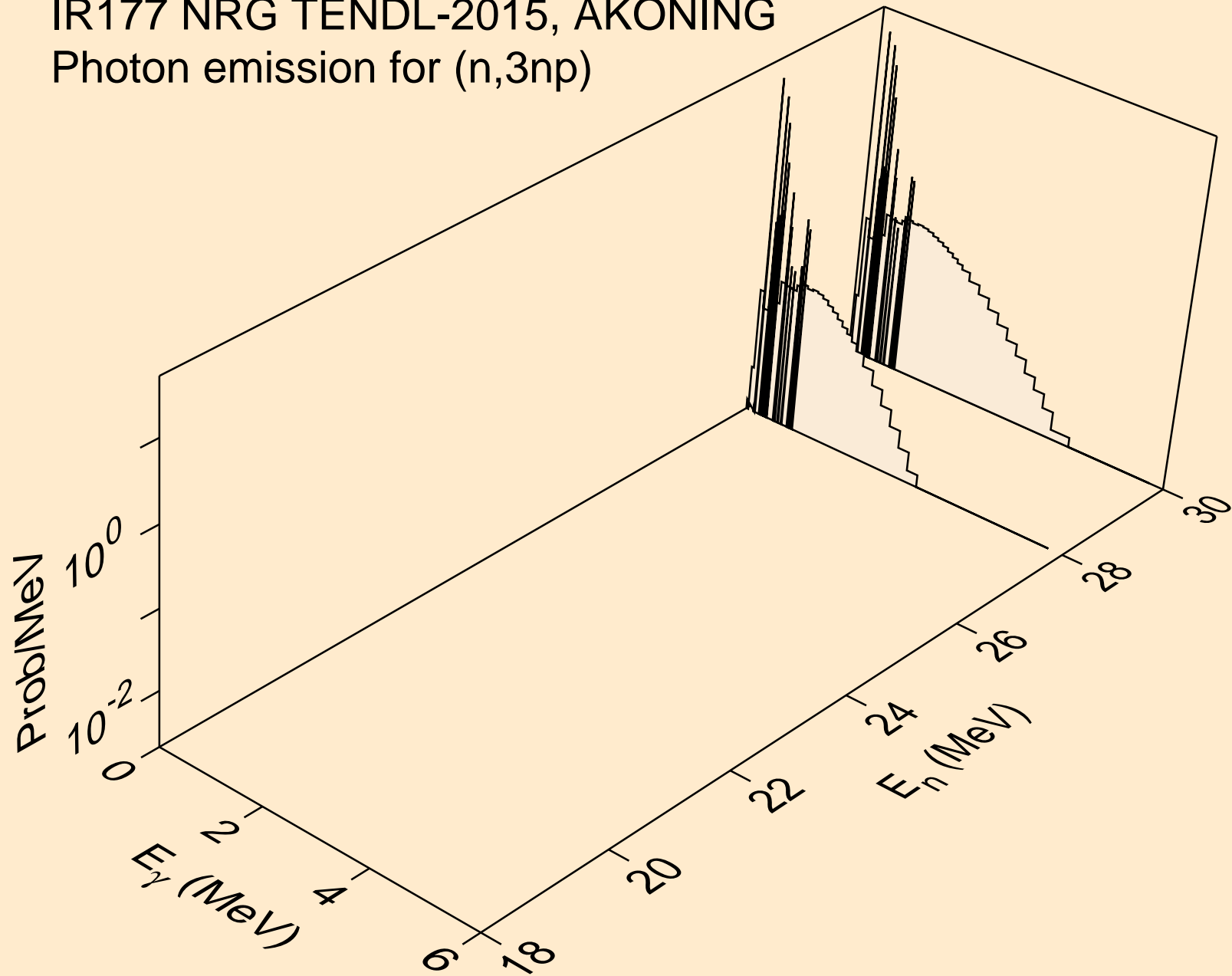

IR177 NRG TENDL-2015, AKONING  
Photon emission for (n,2np)

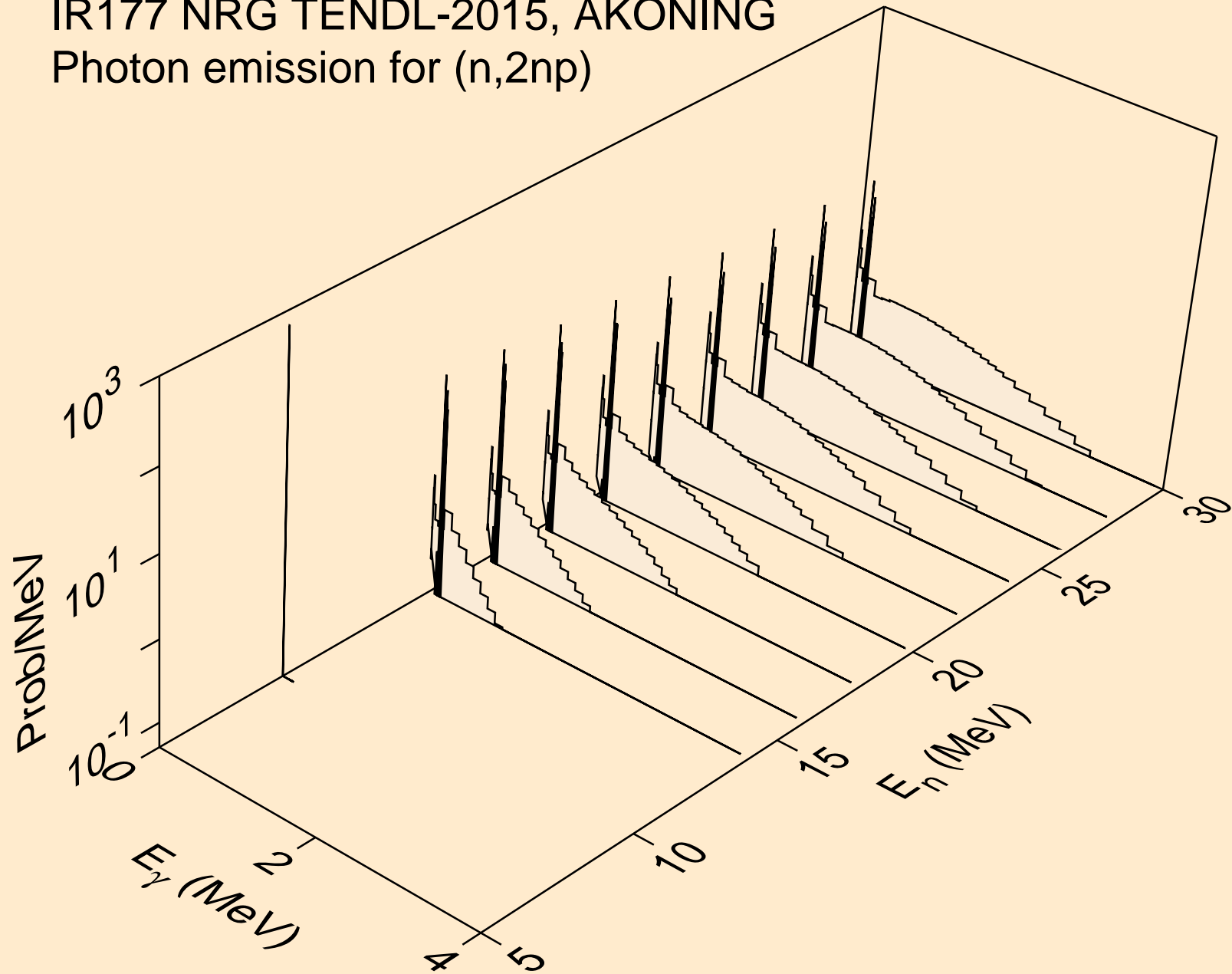

IR177 NRG TENDL-2015, AKONING  
Photon emission for (n,npa)

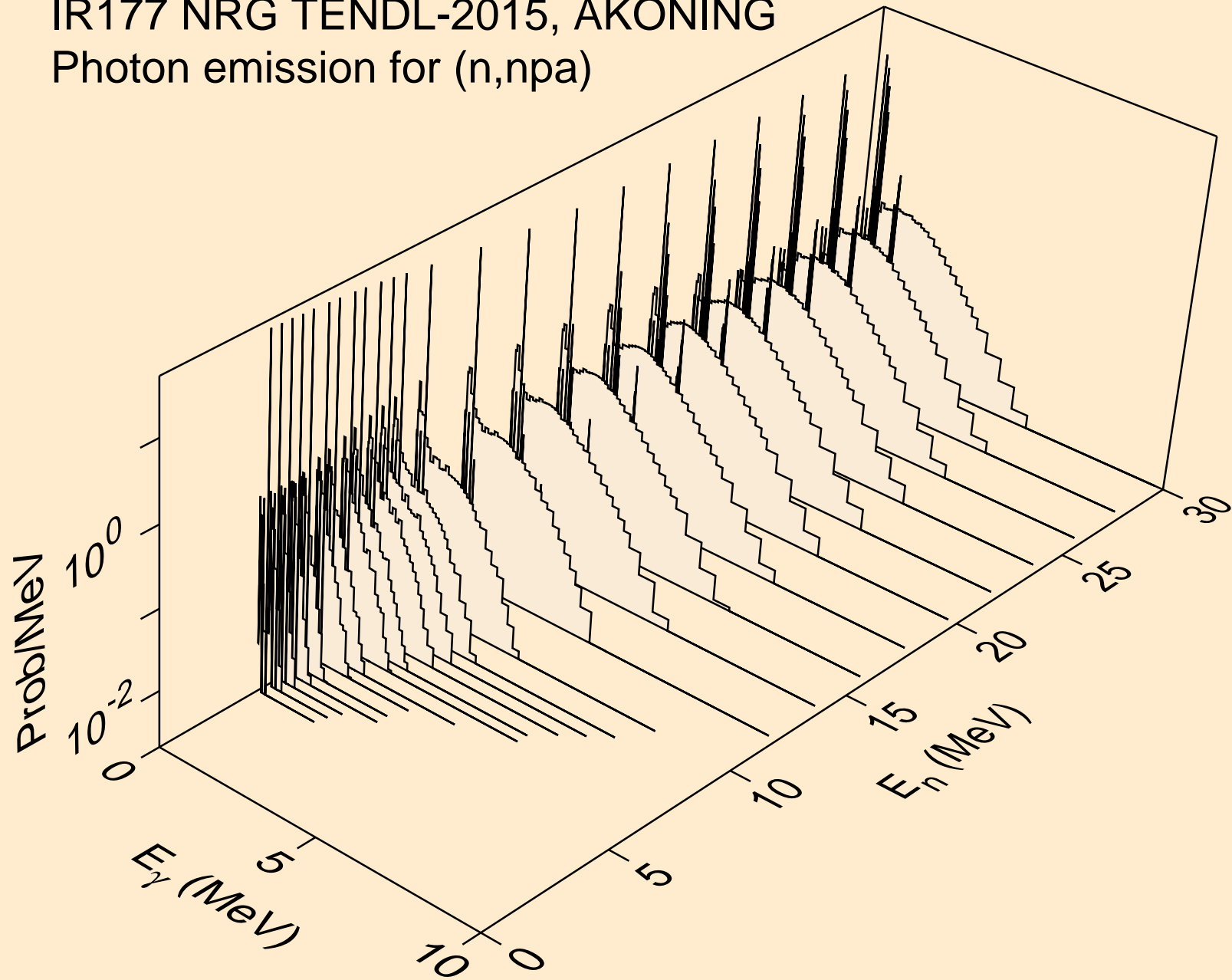

IR177 NRG TENDL-2015, AKONING  
Photon emission for (n,n\*c)

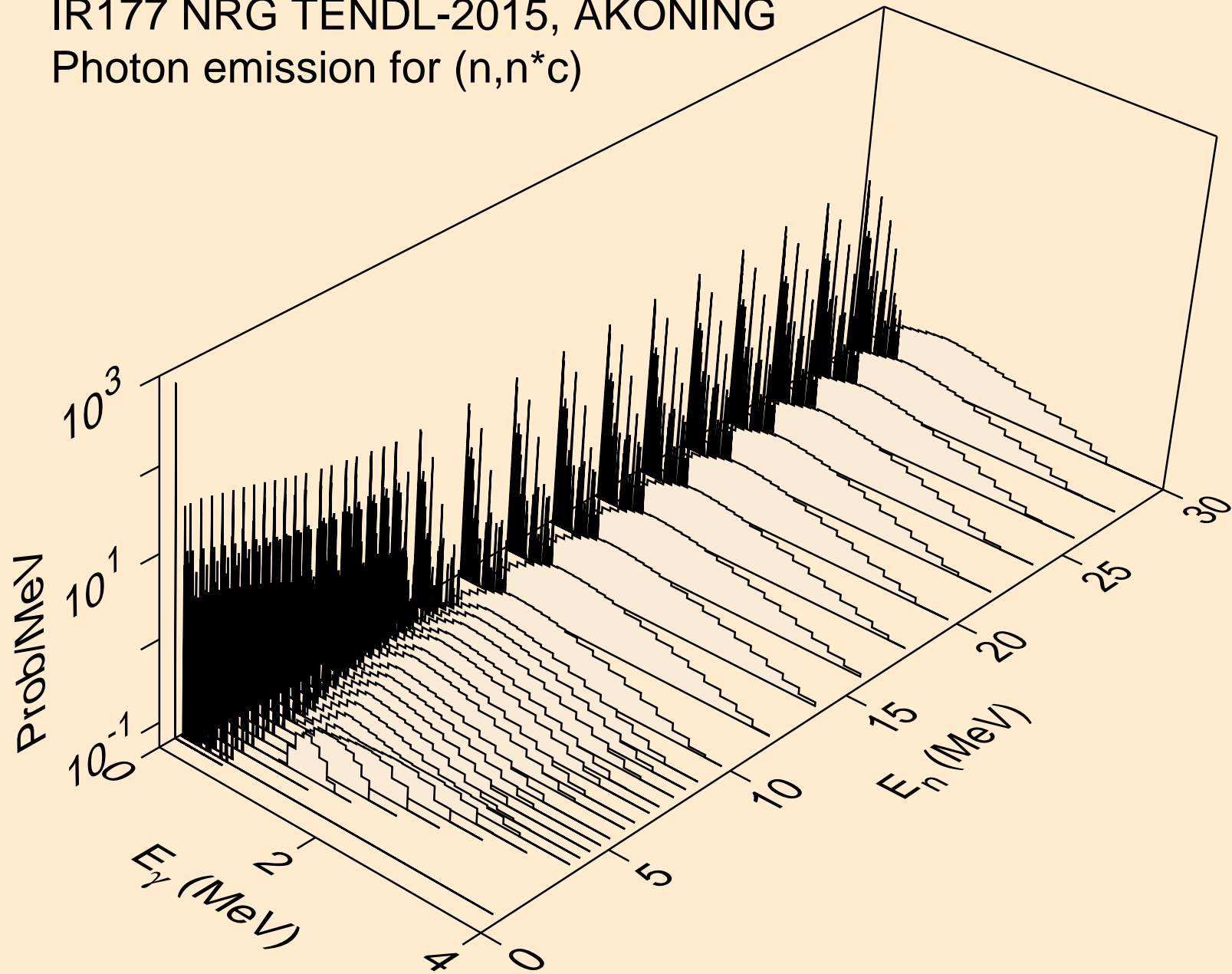

IR177 NRG TENDL-2015, AKONING  
Photon emission for (n,gma)

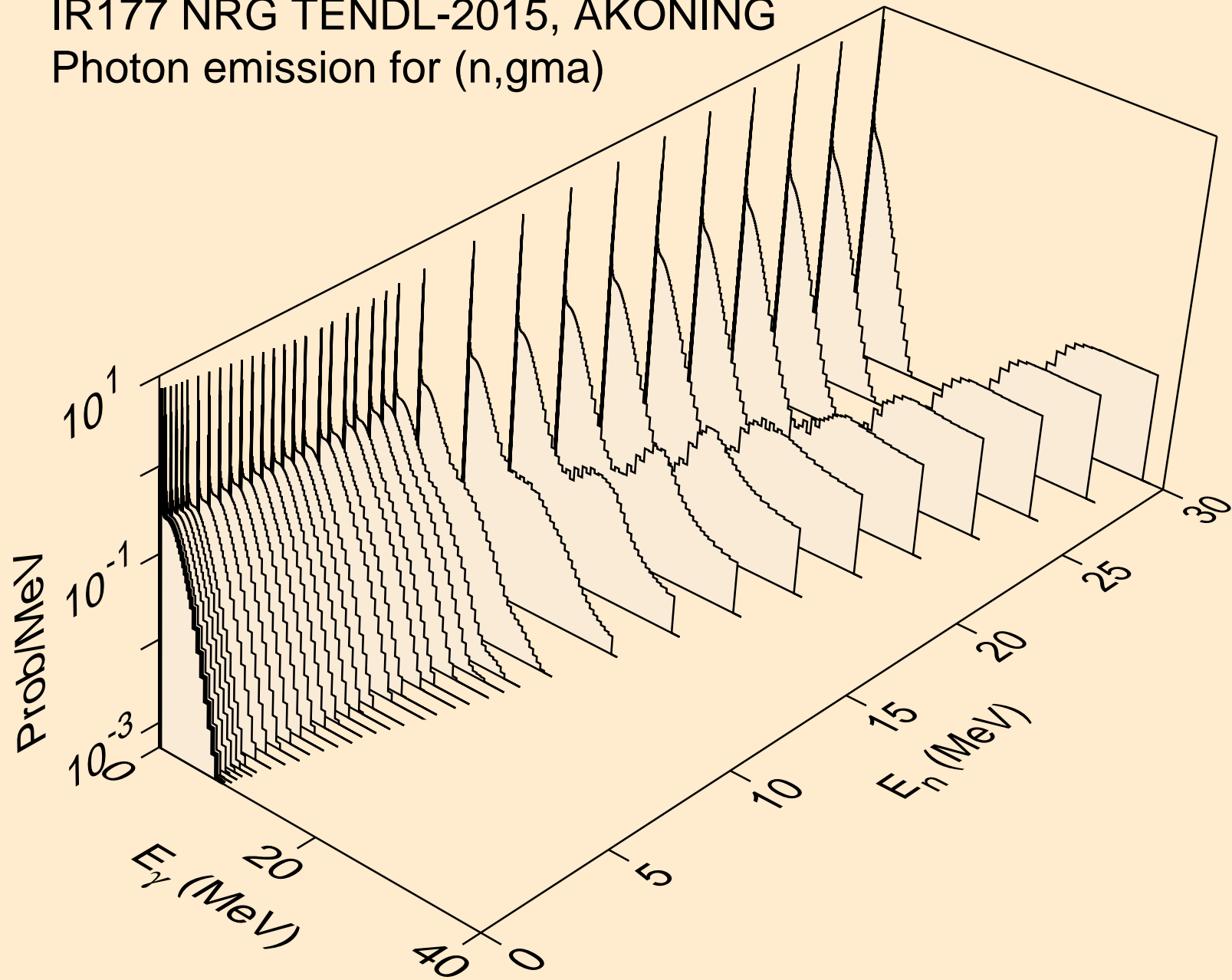

IR177 NRG TENDL-2015, AKONING  
Photon emission for (n,p)

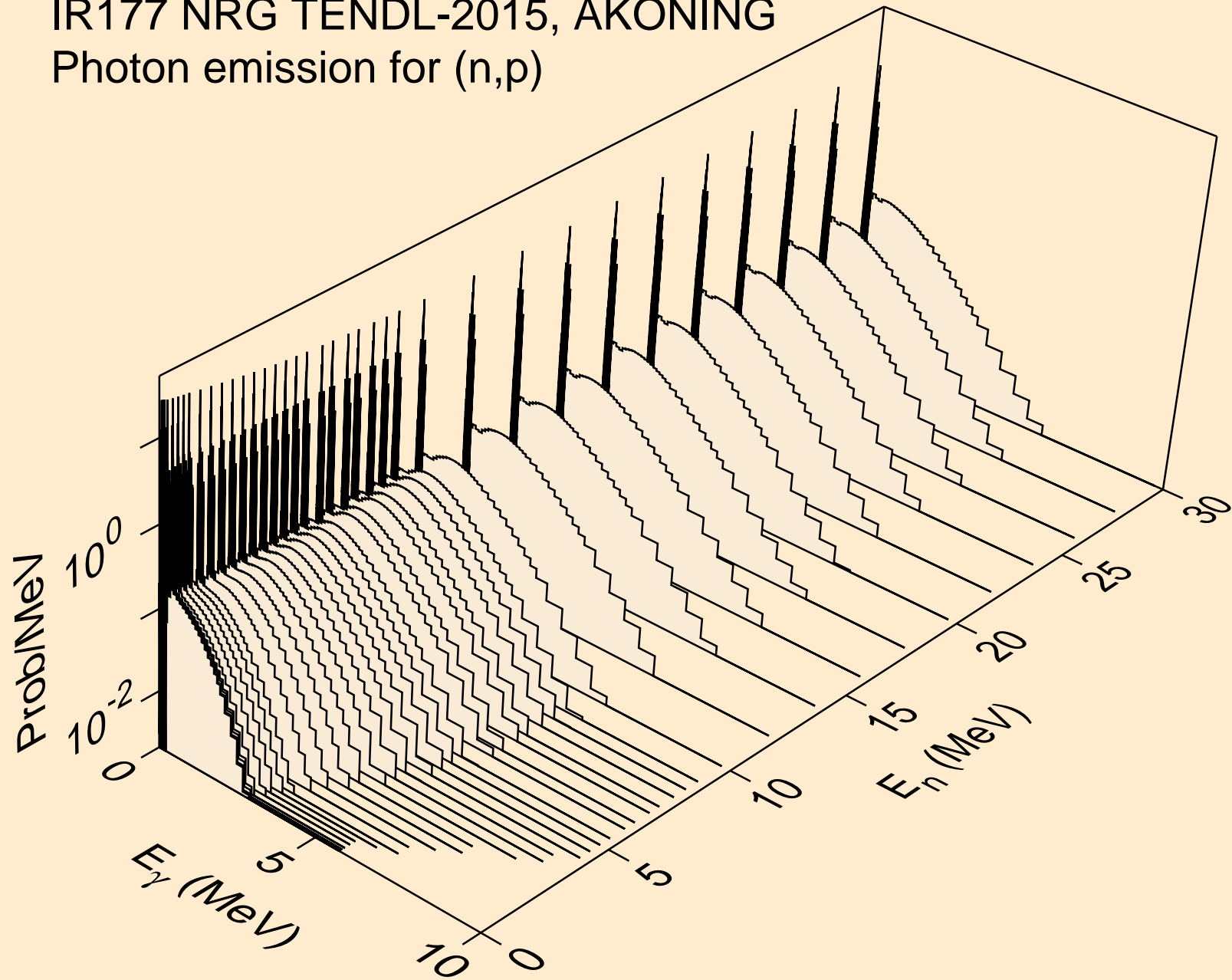

IR177 NRG TENDL-2015, AKONING  
Photon emission for (n,d)

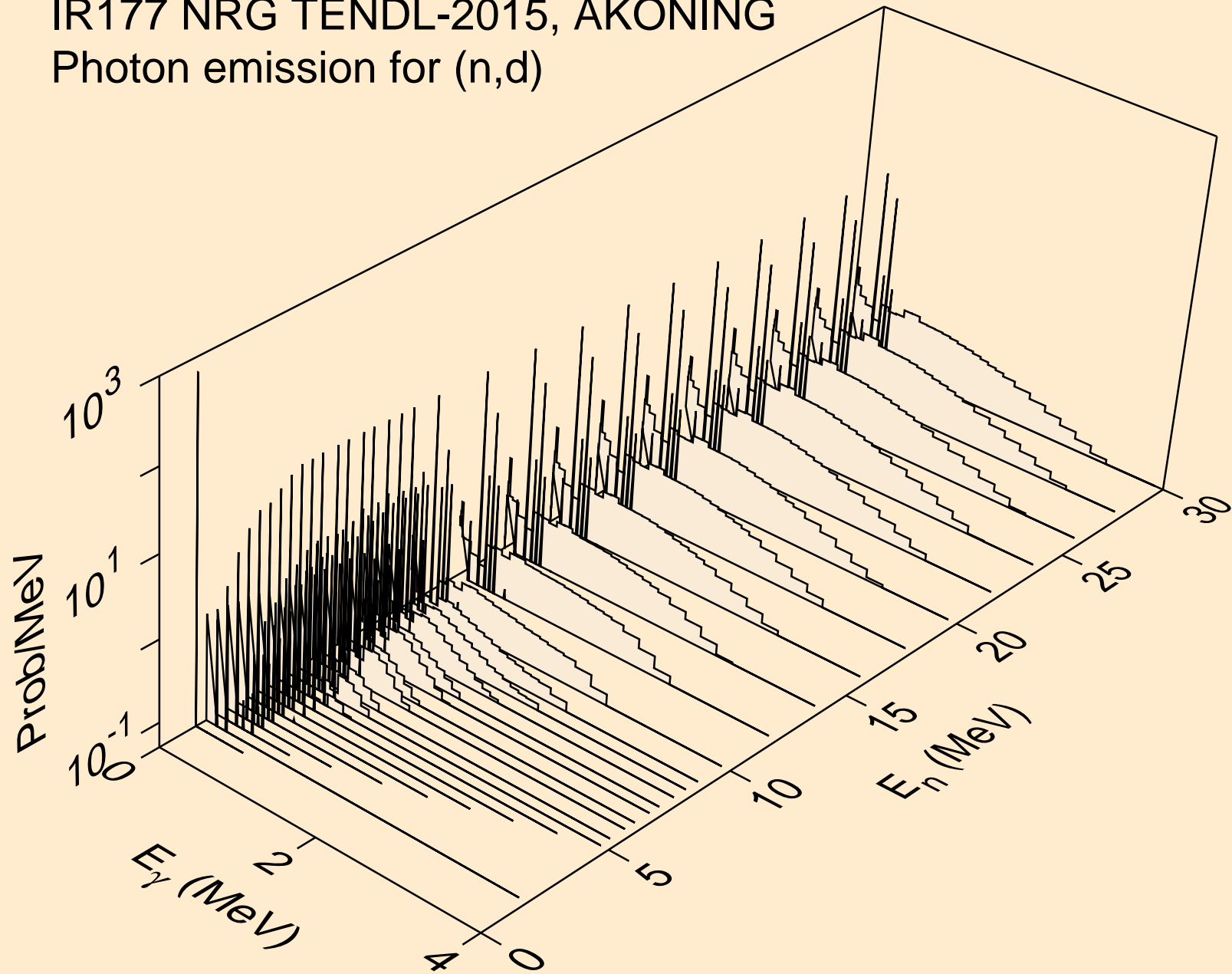



IR177 NRG TENDL-2015, AKONING  
Photon emission for (n,t)

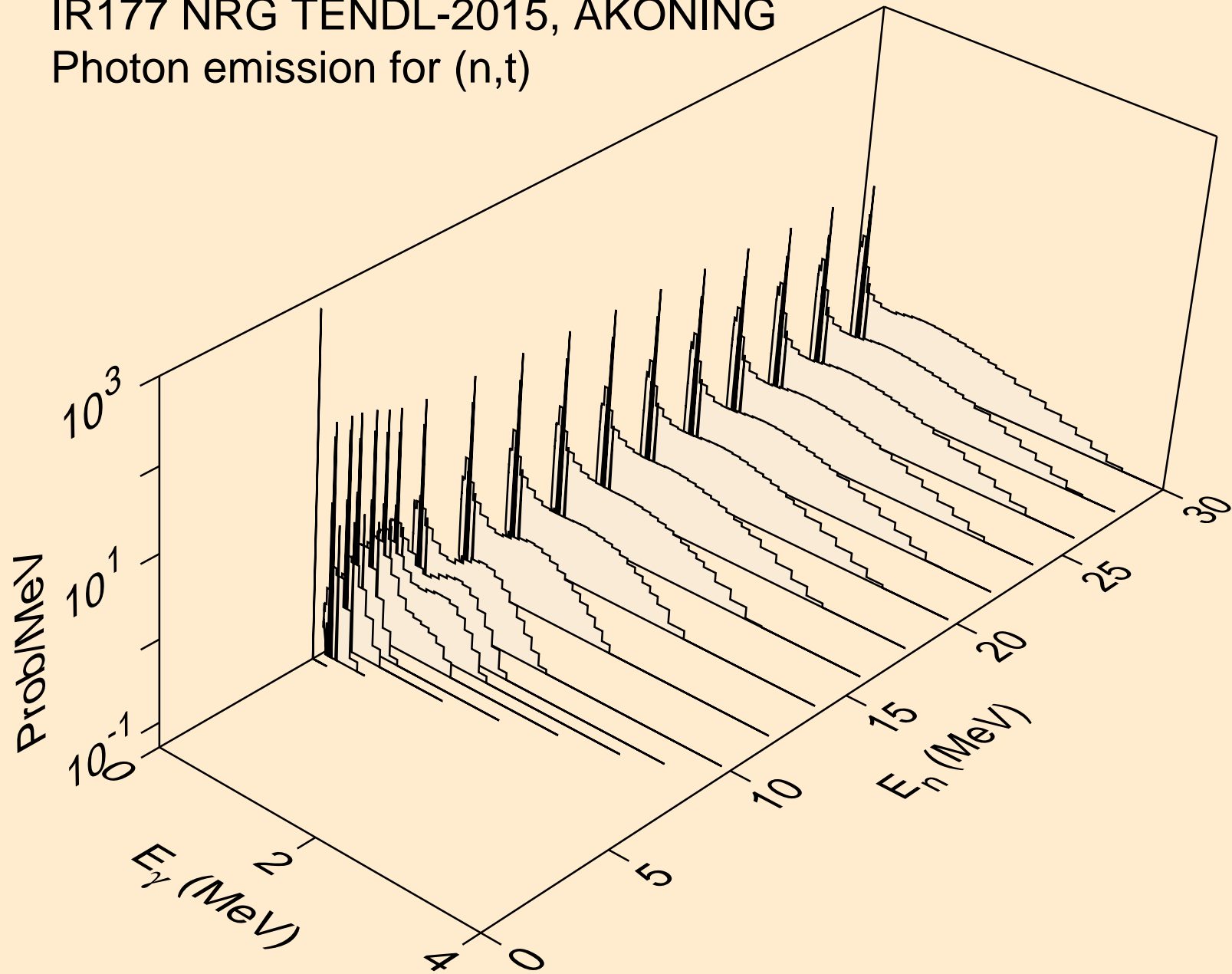

IR177 NRG TENDL-2015, AKONING  
Photon emission for (n,he3)

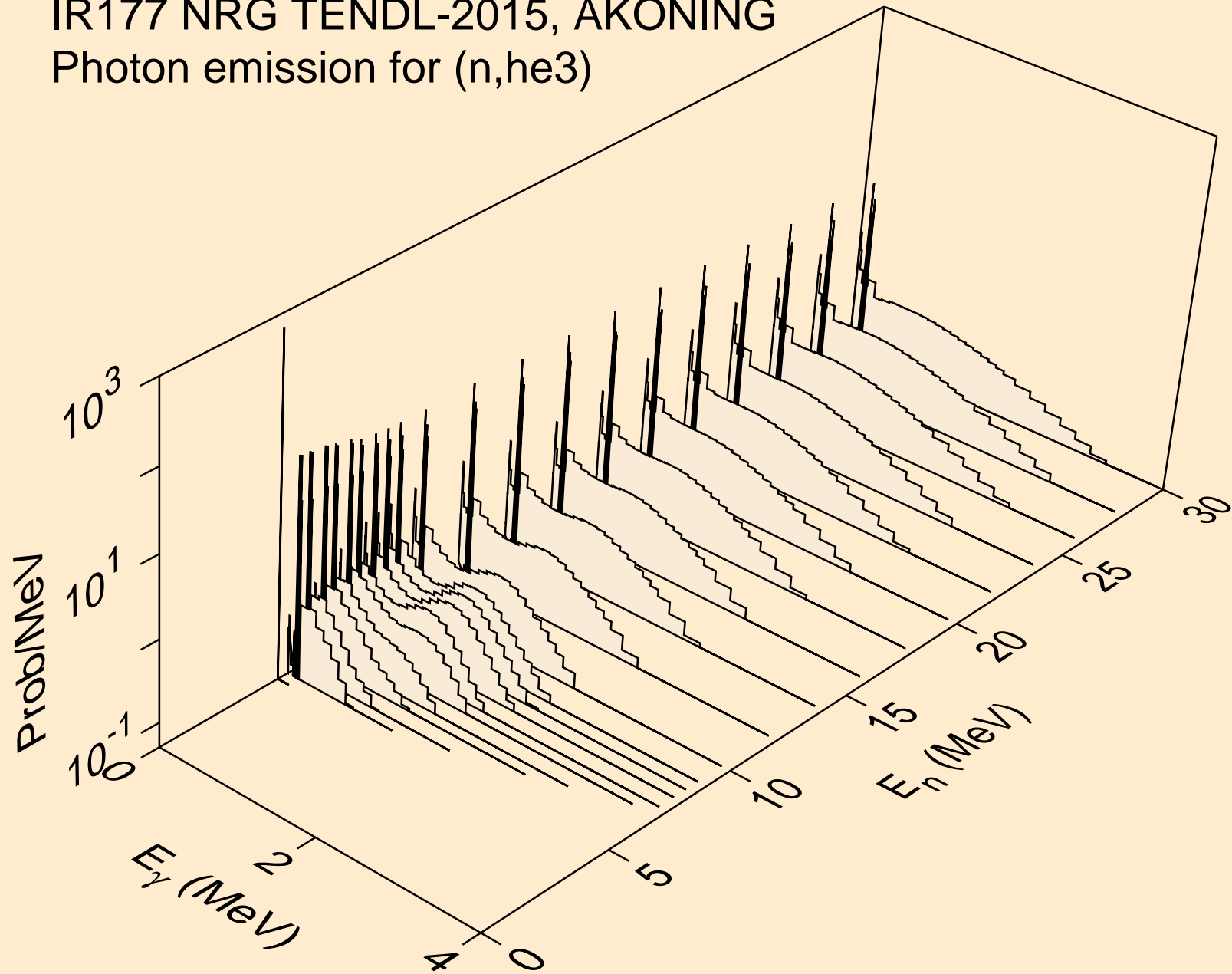

IR177 NRG TENDL-2015, AKONING  
Photon emission for (n,a)

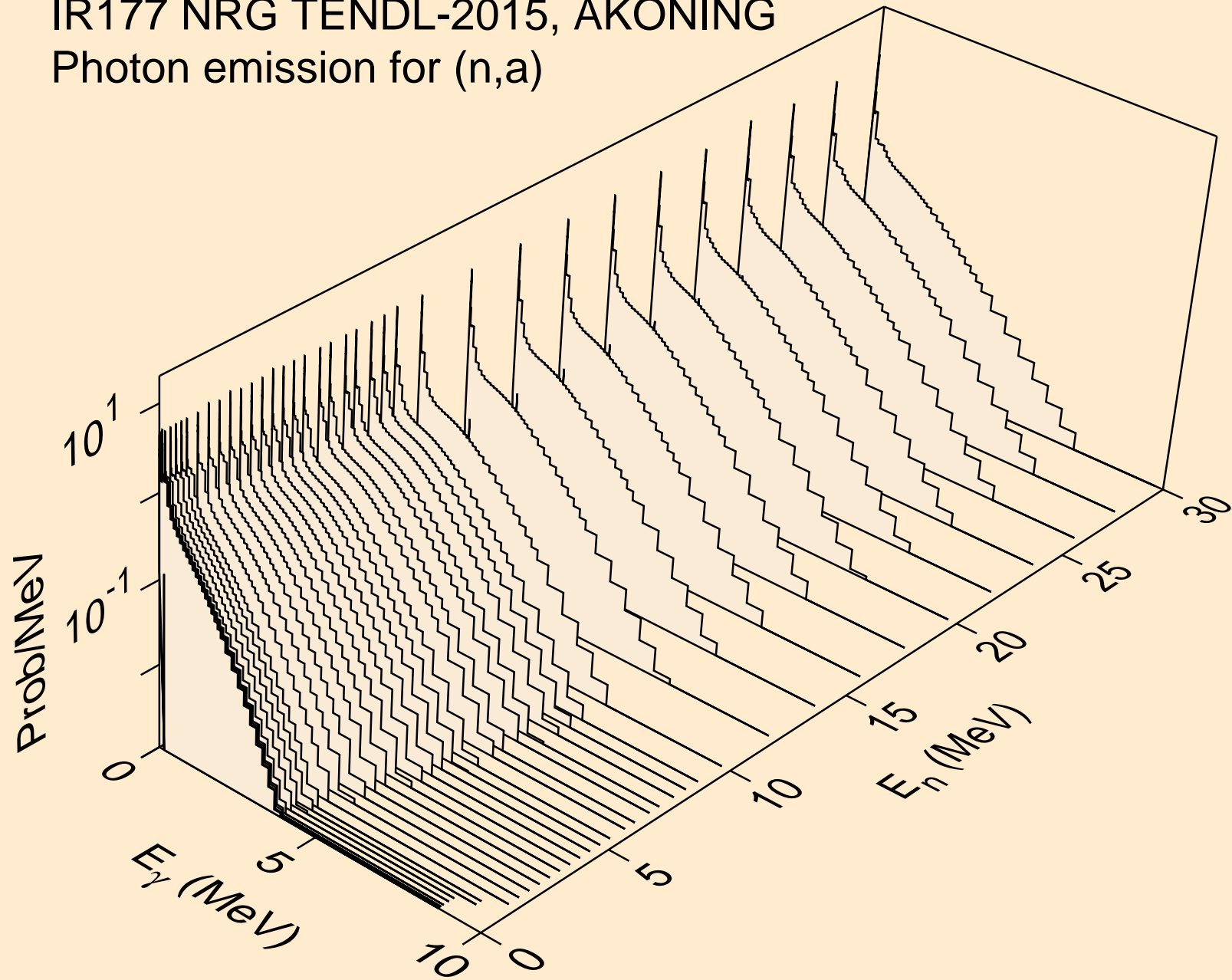

IR177 NRG TENDL-2015, AKONING  
Photon emission for (n,2a)

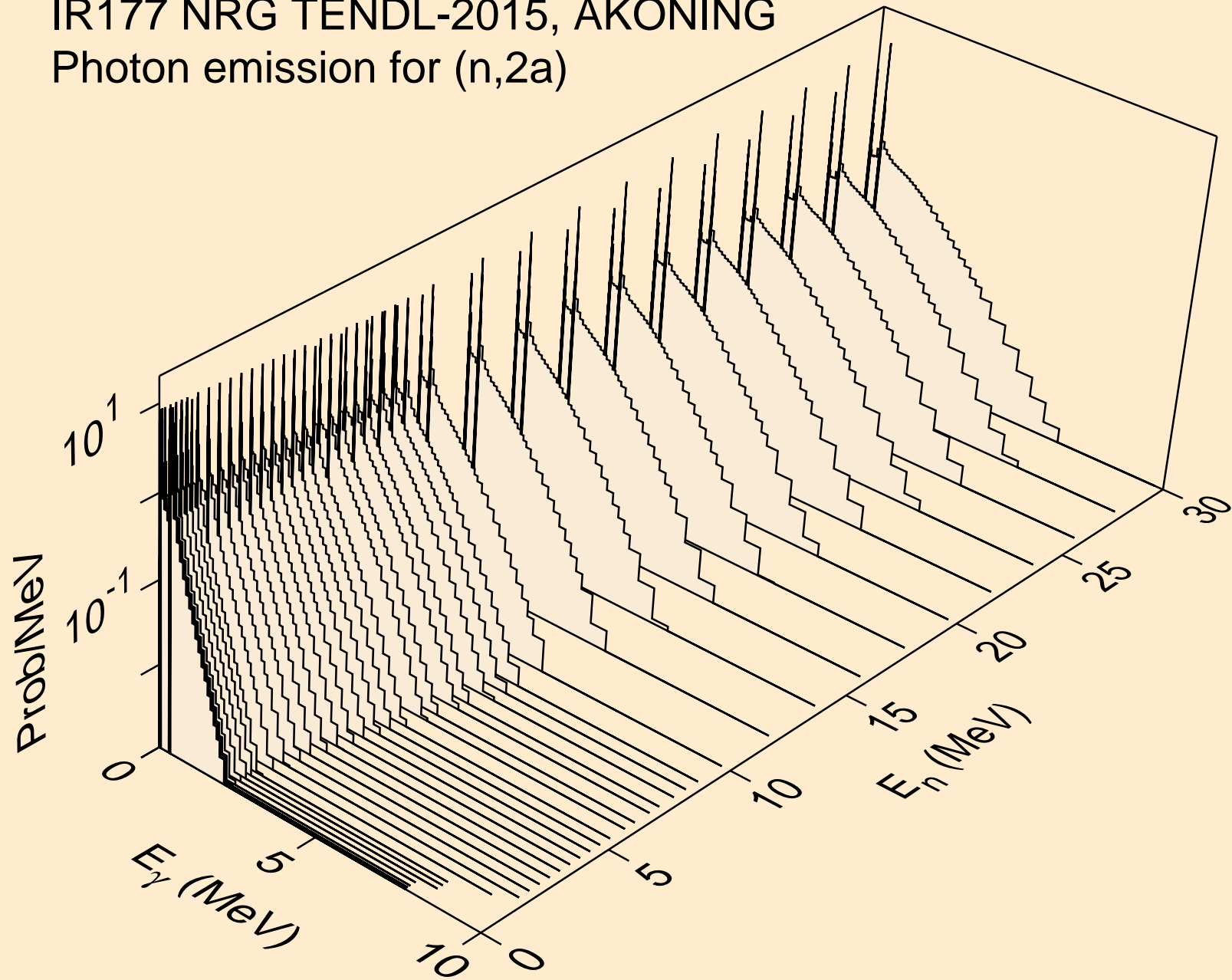

IR177 NRG TENDL-2015, AKONING  
Photon emission for (n,3a)

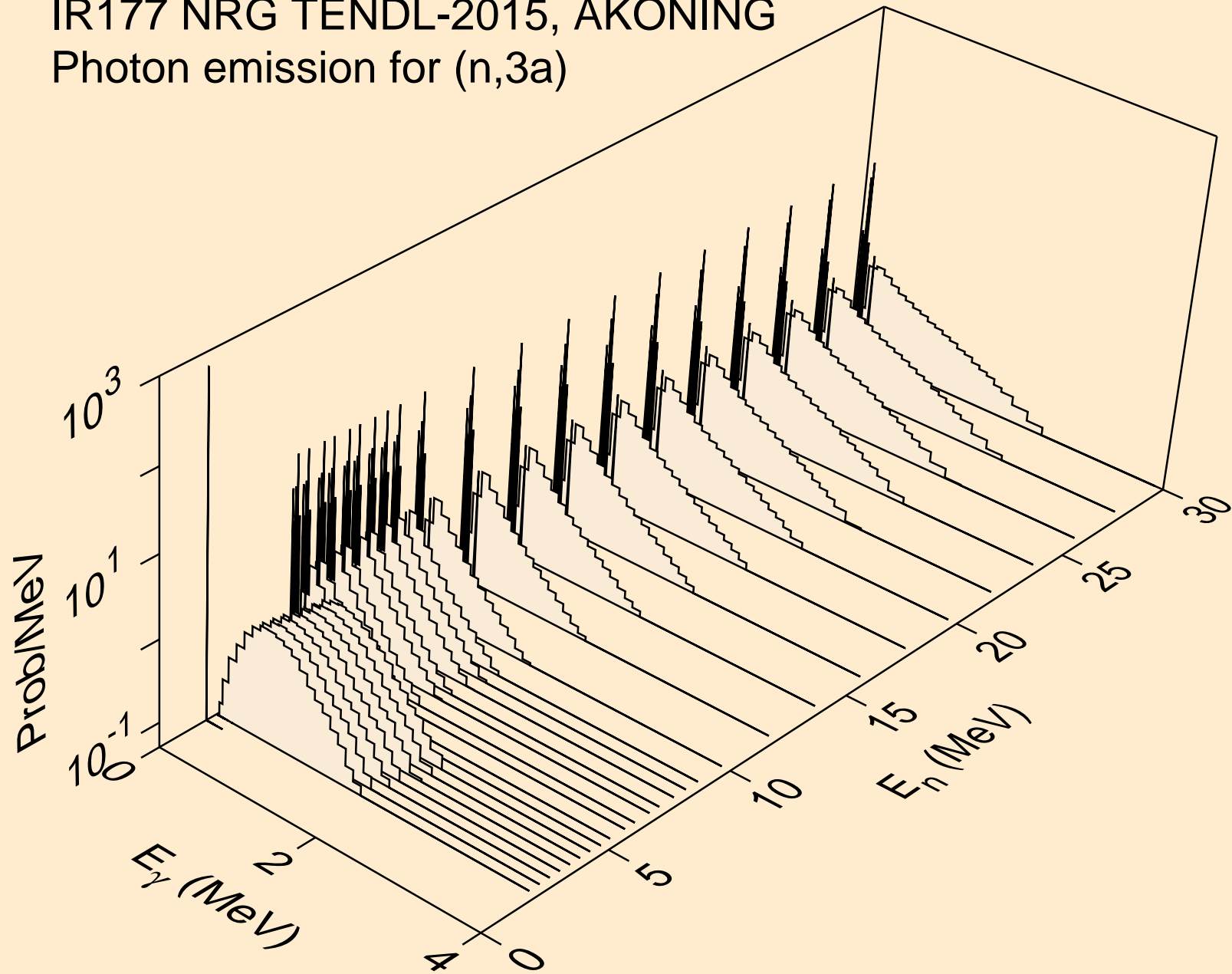

IR177 NRG TENDL-2015, AKONING  
Photon emission for (n,2p)

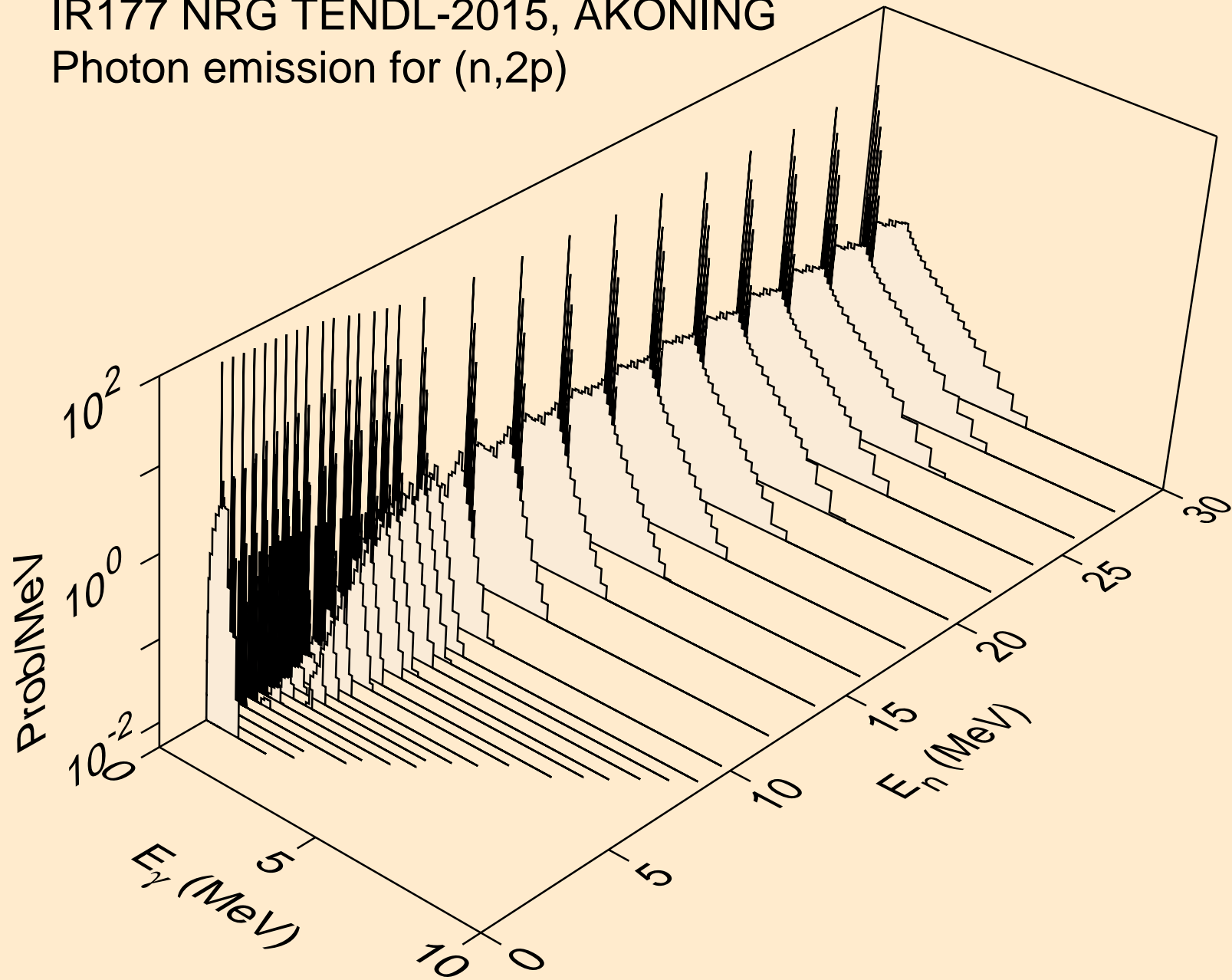

IR177 NRG TENDL-2015, AKONING  
Photon emission for (n,p $\alpha$ )

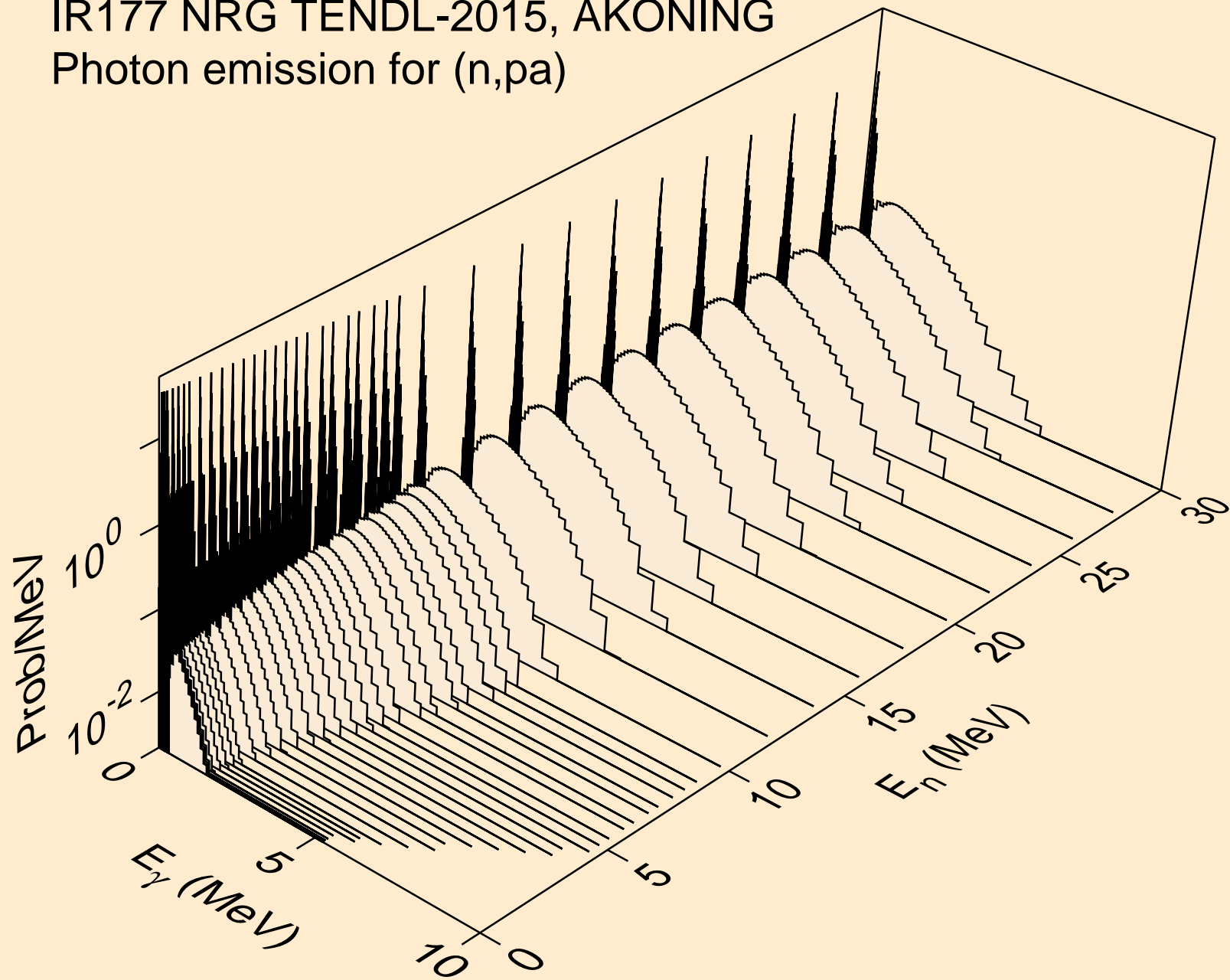

IR177 NRG TENDL-2015, AKONING  
Photon emission for (n,t2a)

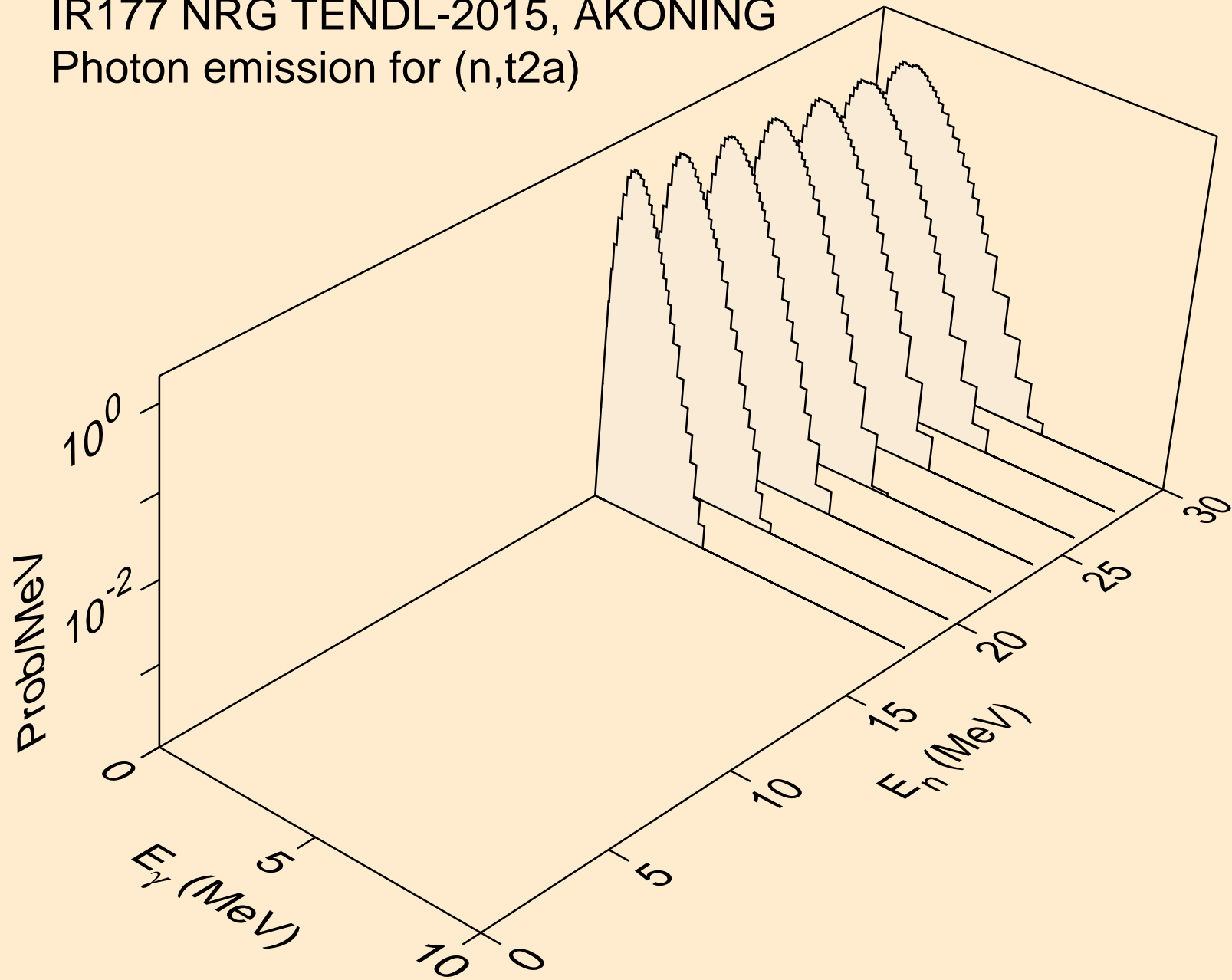



IR177 NRG TENDL-2015, AKONING  
Photon emission for (n,d2a)

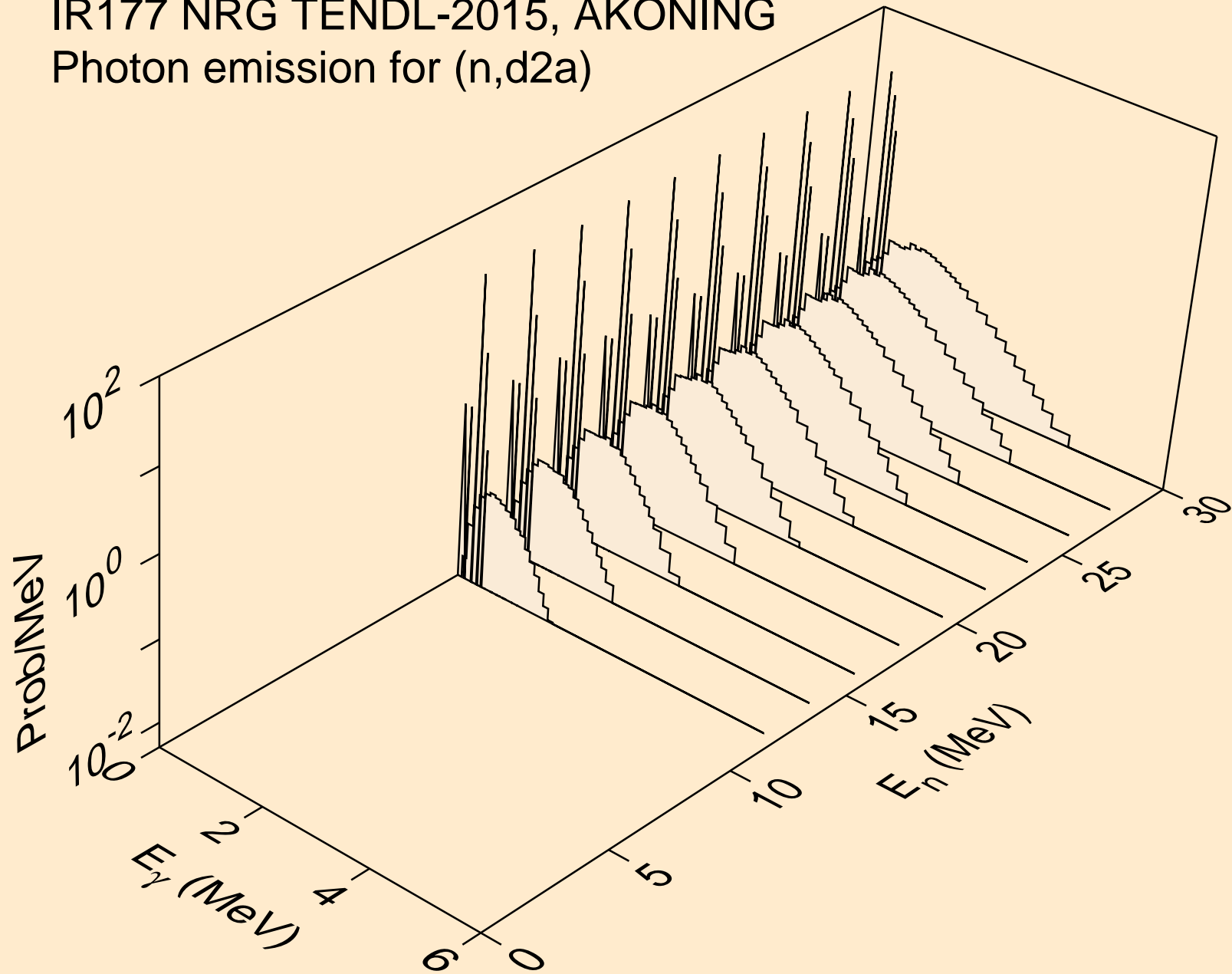

IR177 NRG TENDL-2015, AKONING  
Photon emission for (n,pd)

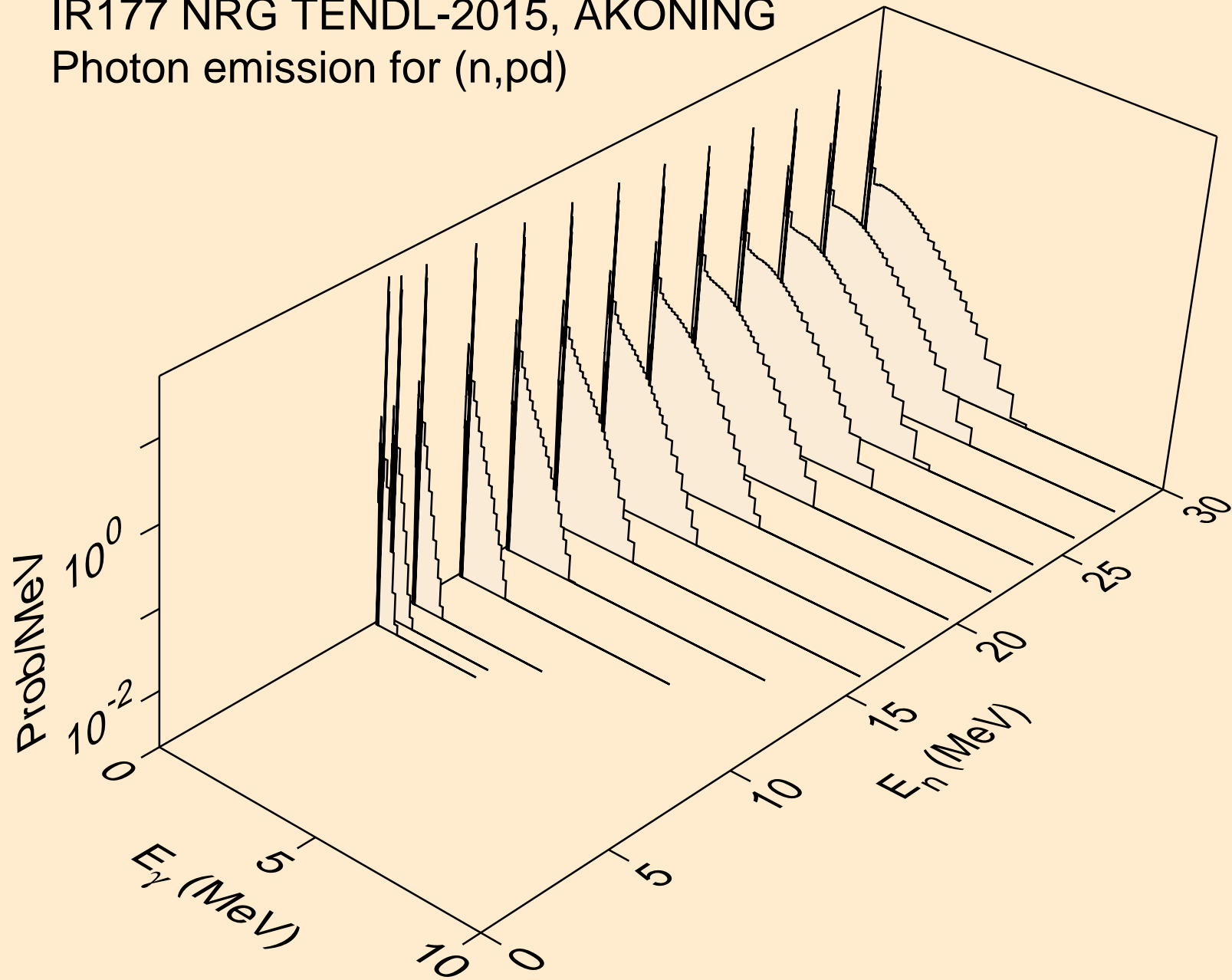

IR177 NRG TENDL-2015, AKONING  
Photon emission for (n,pt)

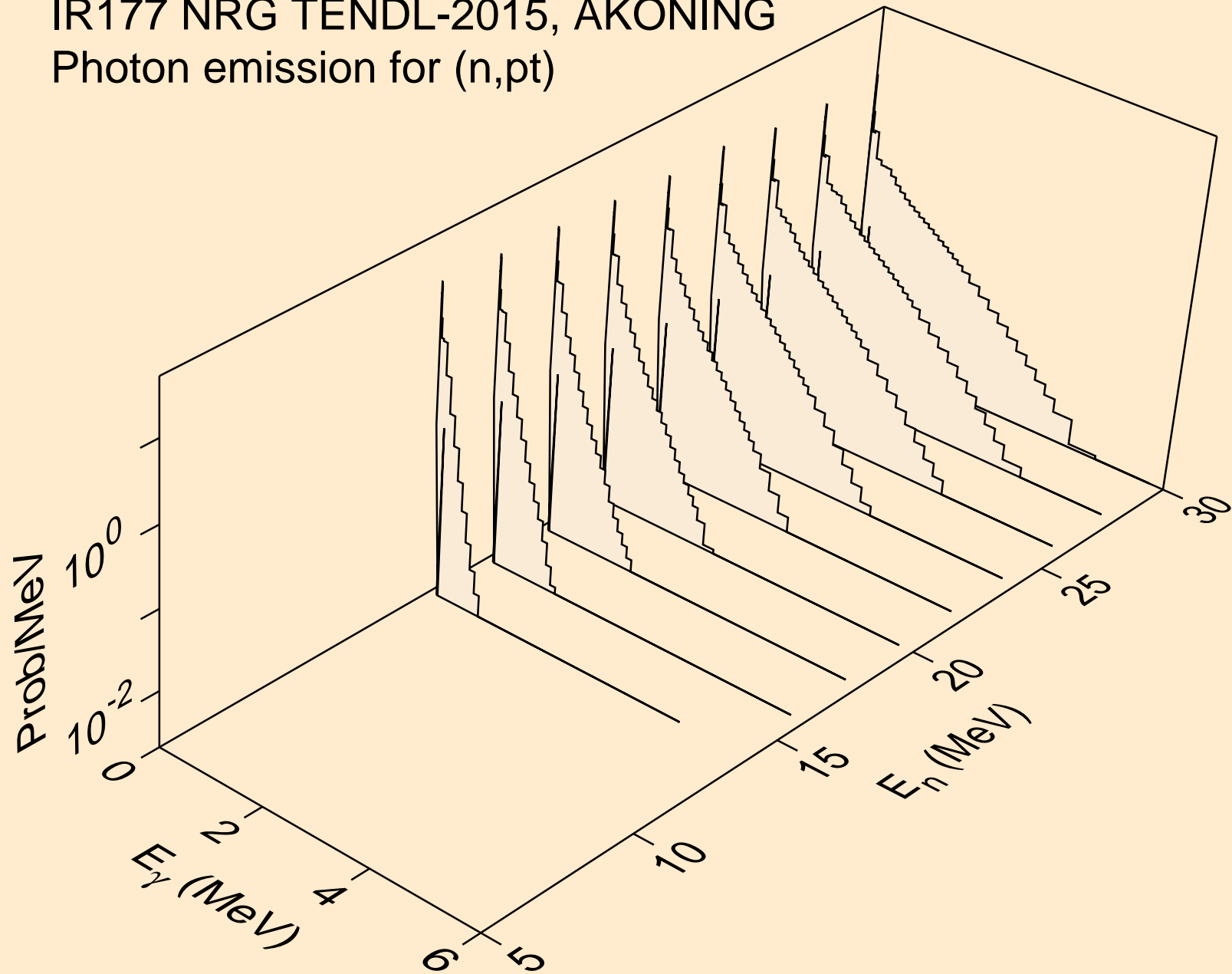

IR177 NRG TENDL-2015, AKONING  
Photon emission for (n,da)

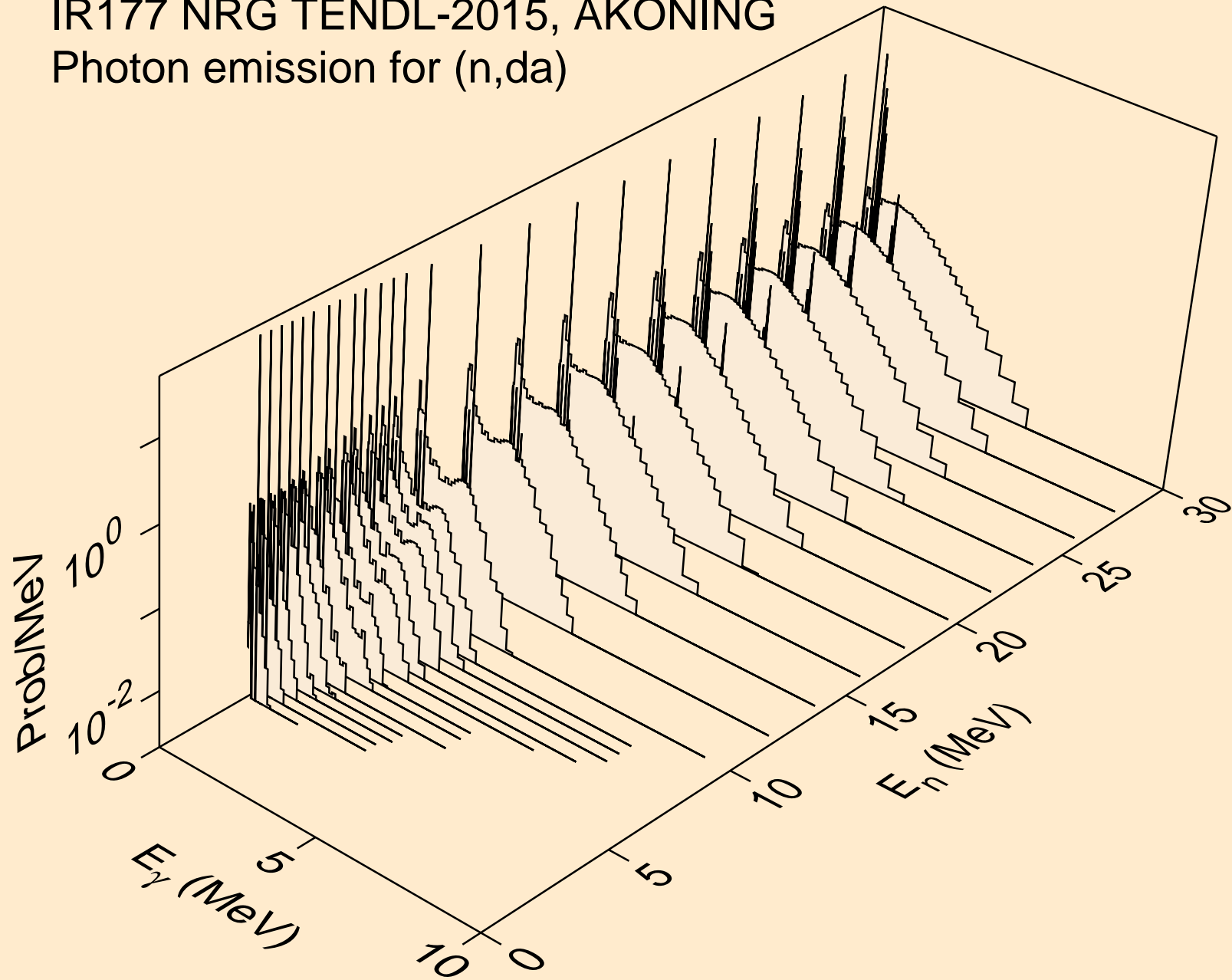

IR177 NRG TENDL-2015, AKONING  
thermal capture photon spectrum

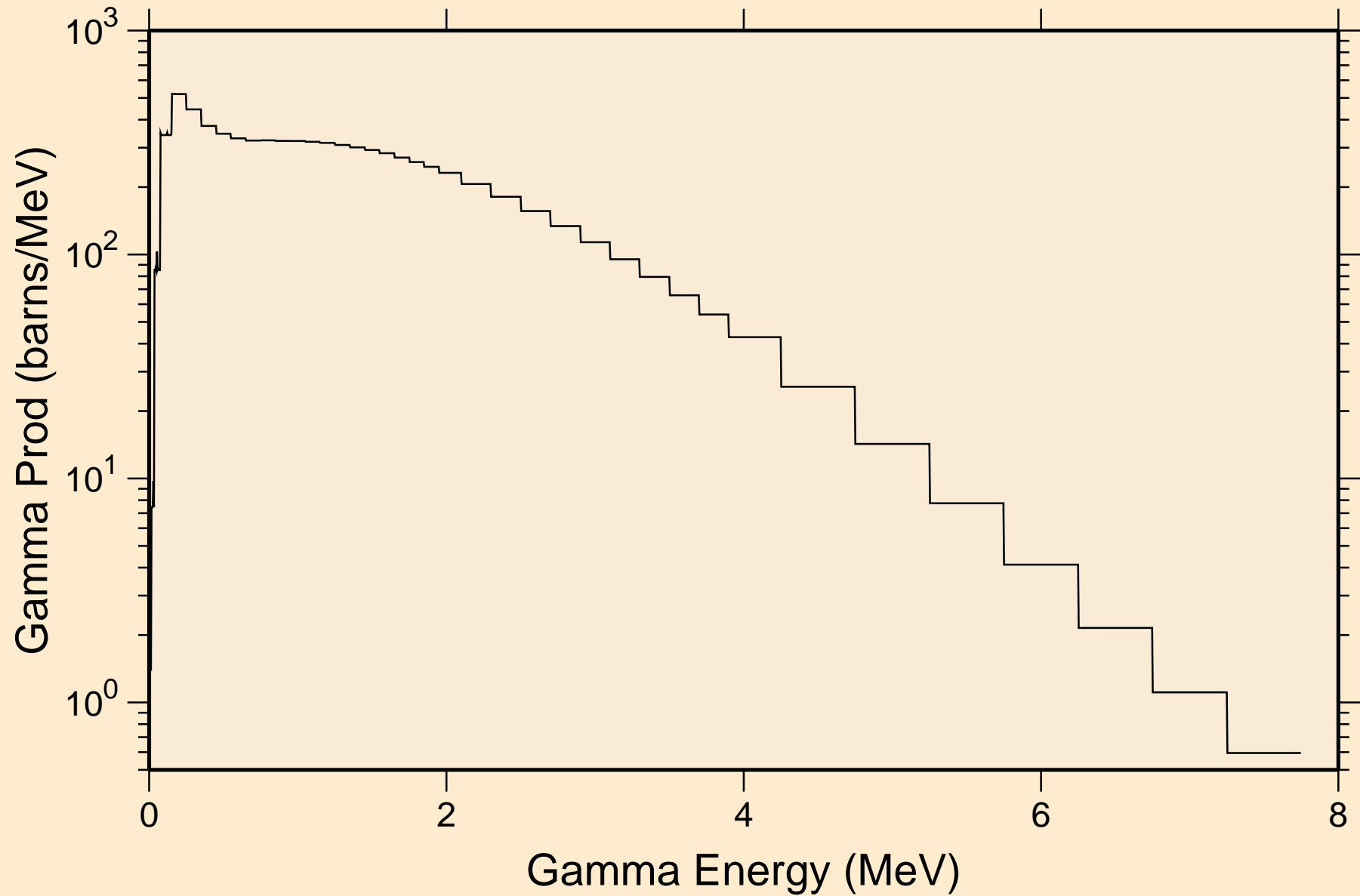

IR177 NRG TENDL-2015, AKONING  
14 MeV photon spectrum

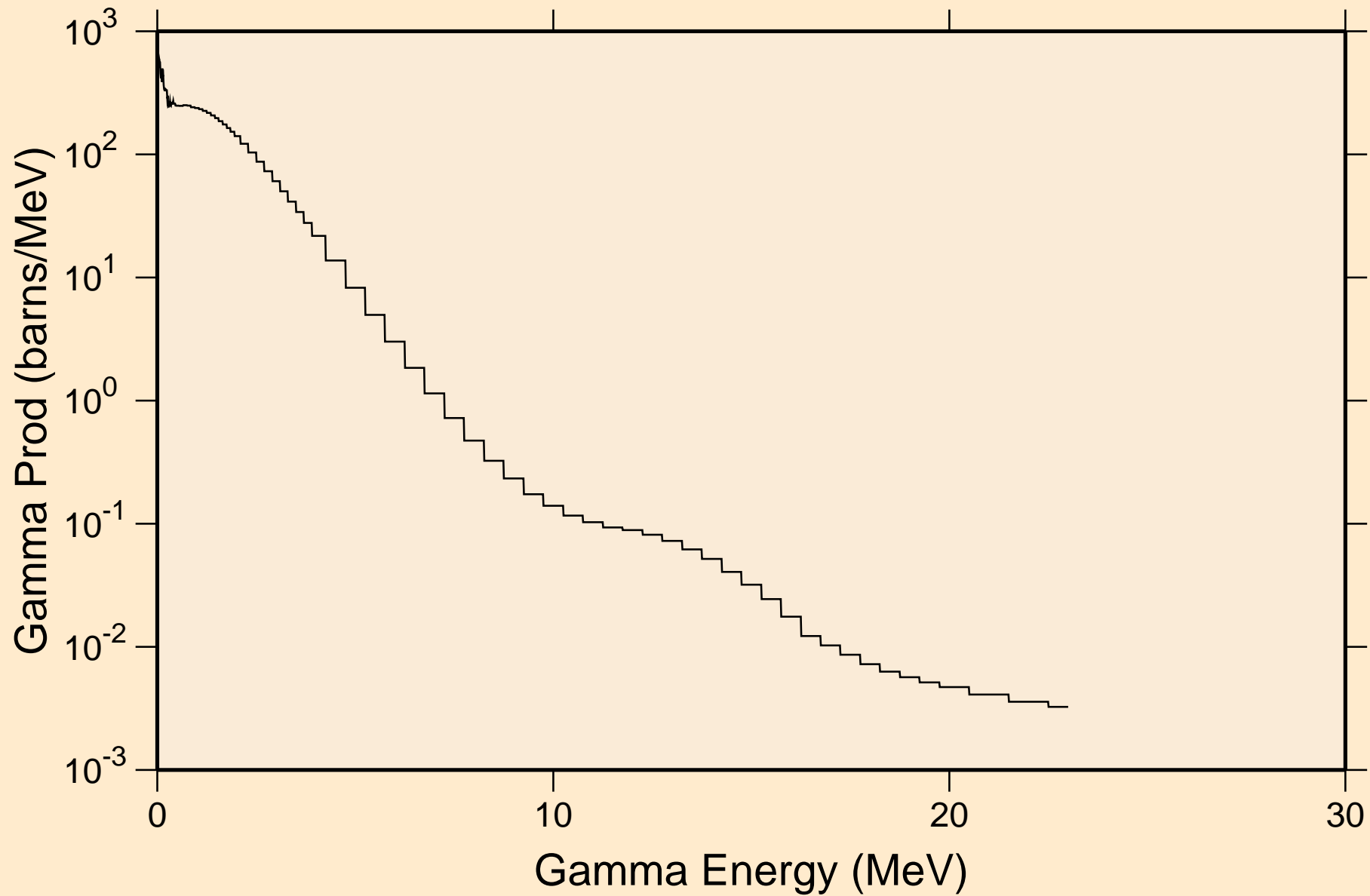

# IR177 NRG TENDL-2015, AKONING

## Particle heating contributions

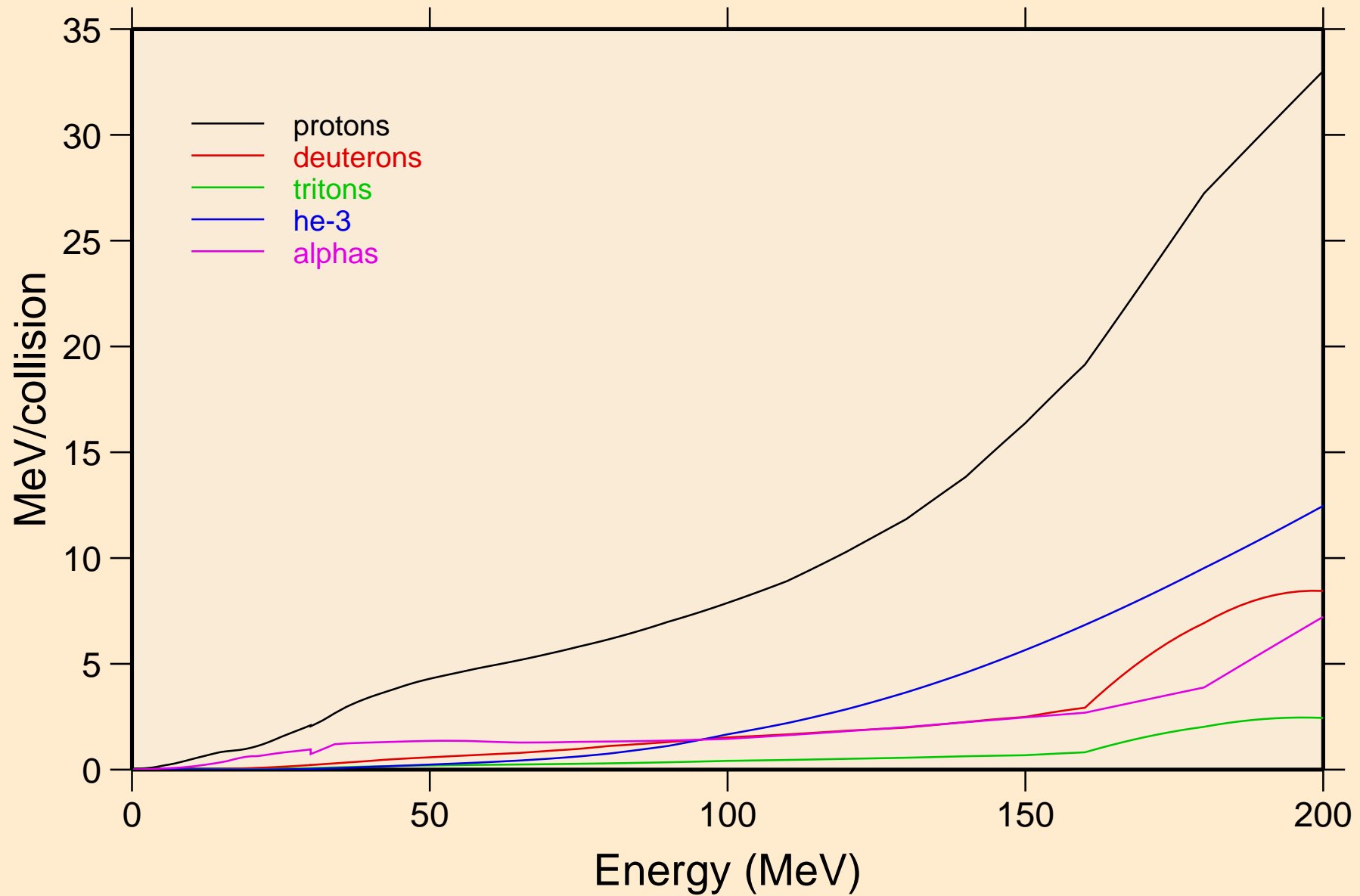

# IR177 NRG TENDL-2015, AKONING

## Recoil Heating

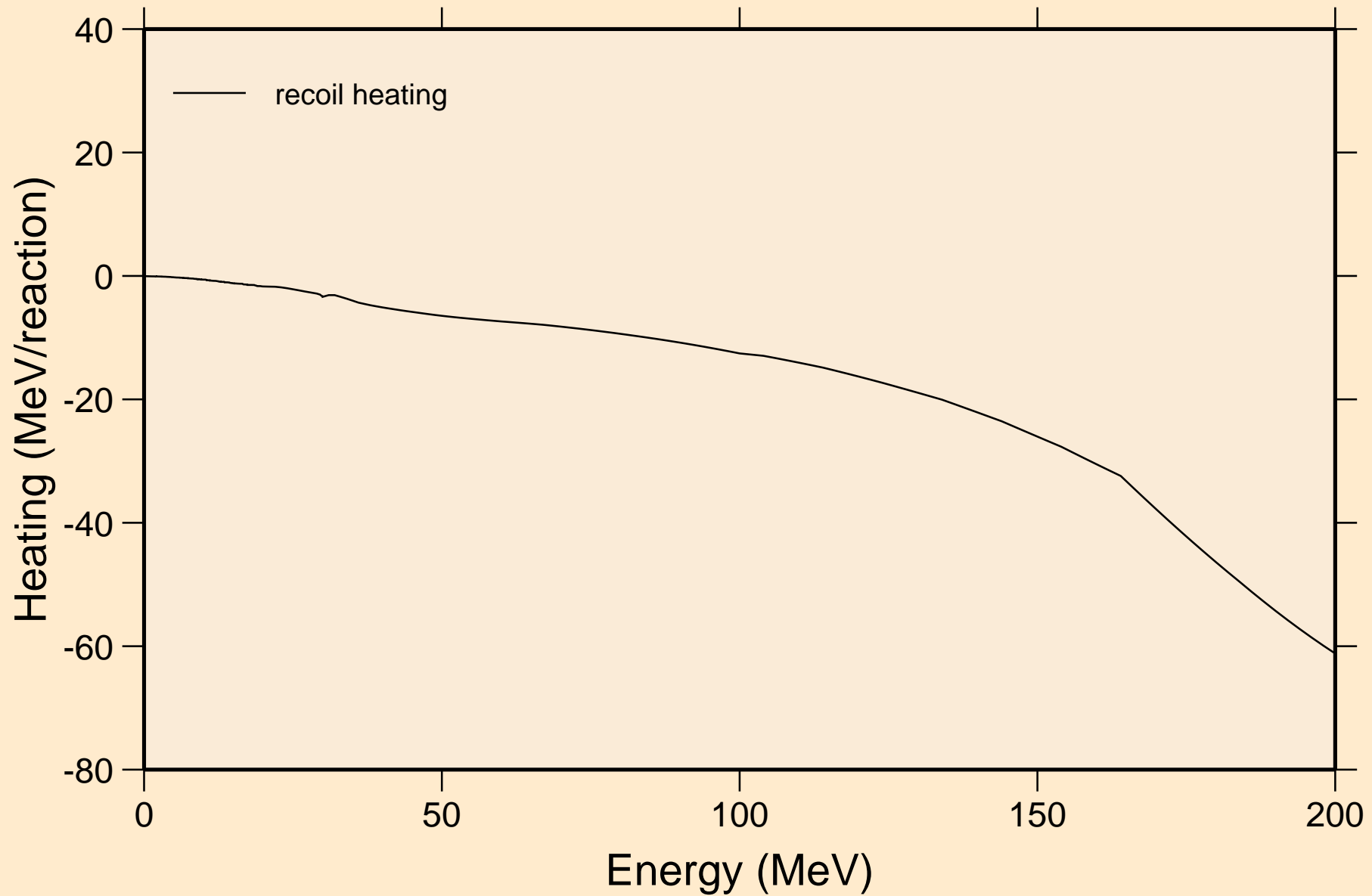



# IR177 NRG TENDL-2015, AKONING

## Particle production cross sections

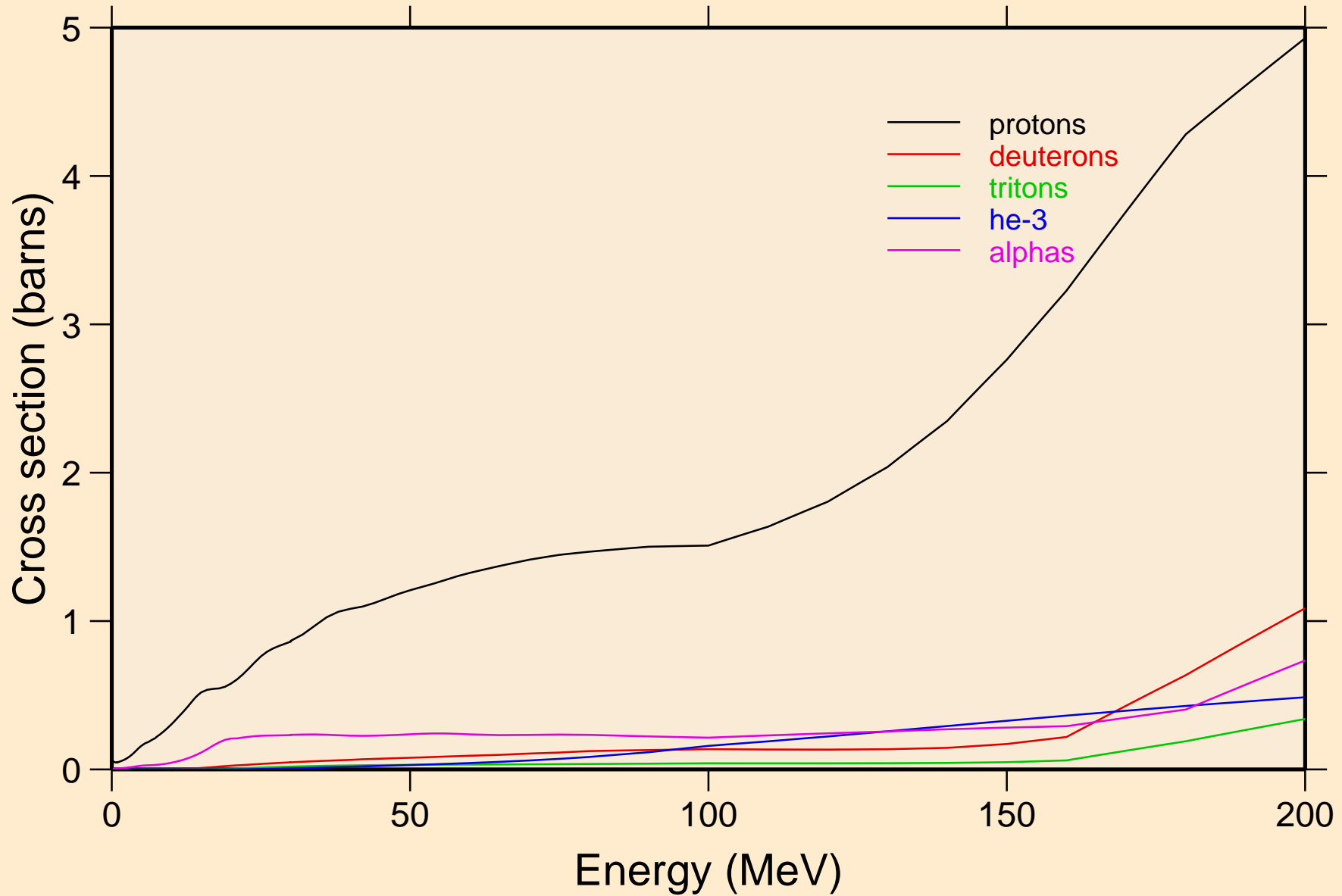

IR177 NRG TENDL-2015, AKONING  
protons from (n,x)

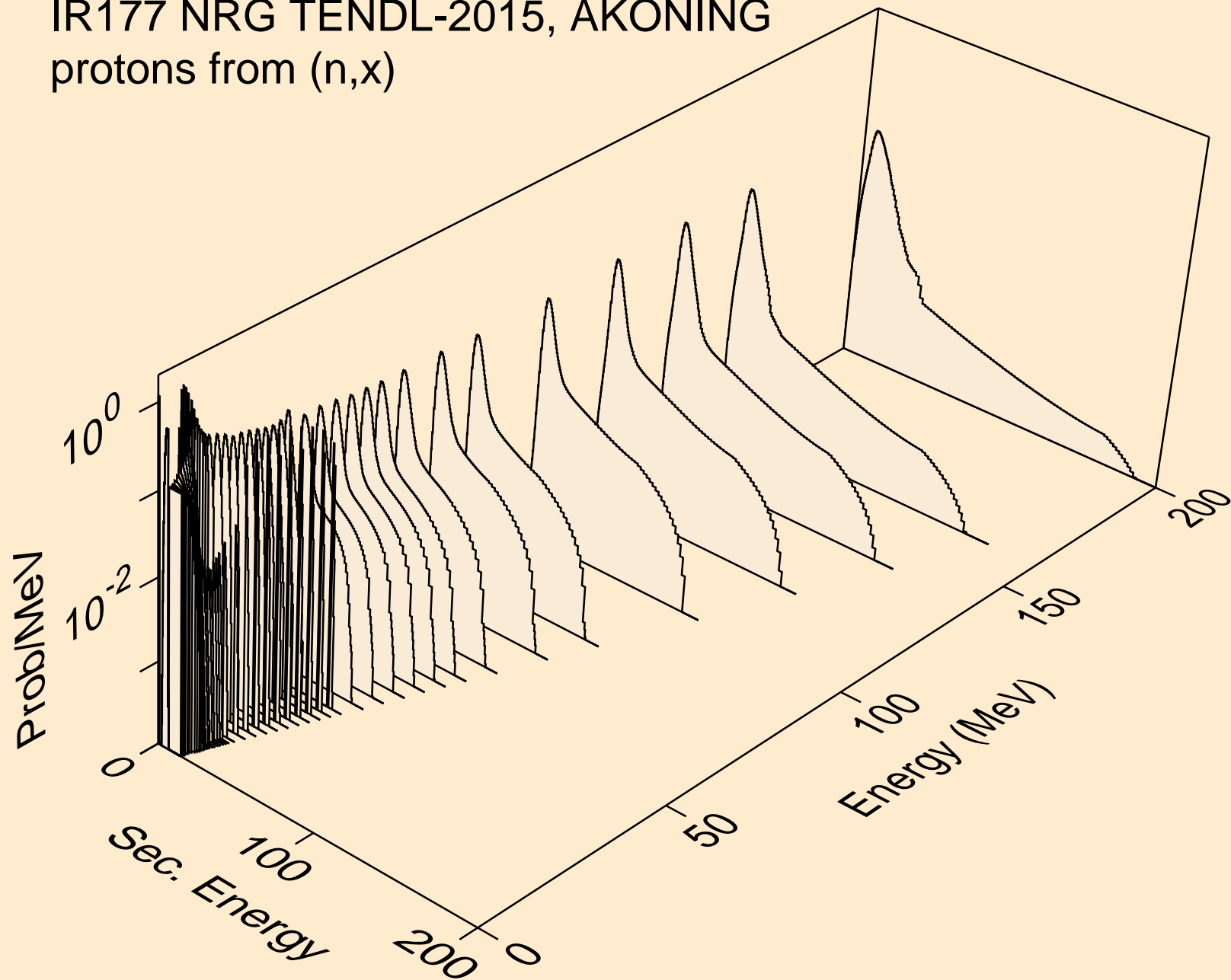

IR177 NRG TENDL-2015, AKONING  
protons from (n,n\*)p

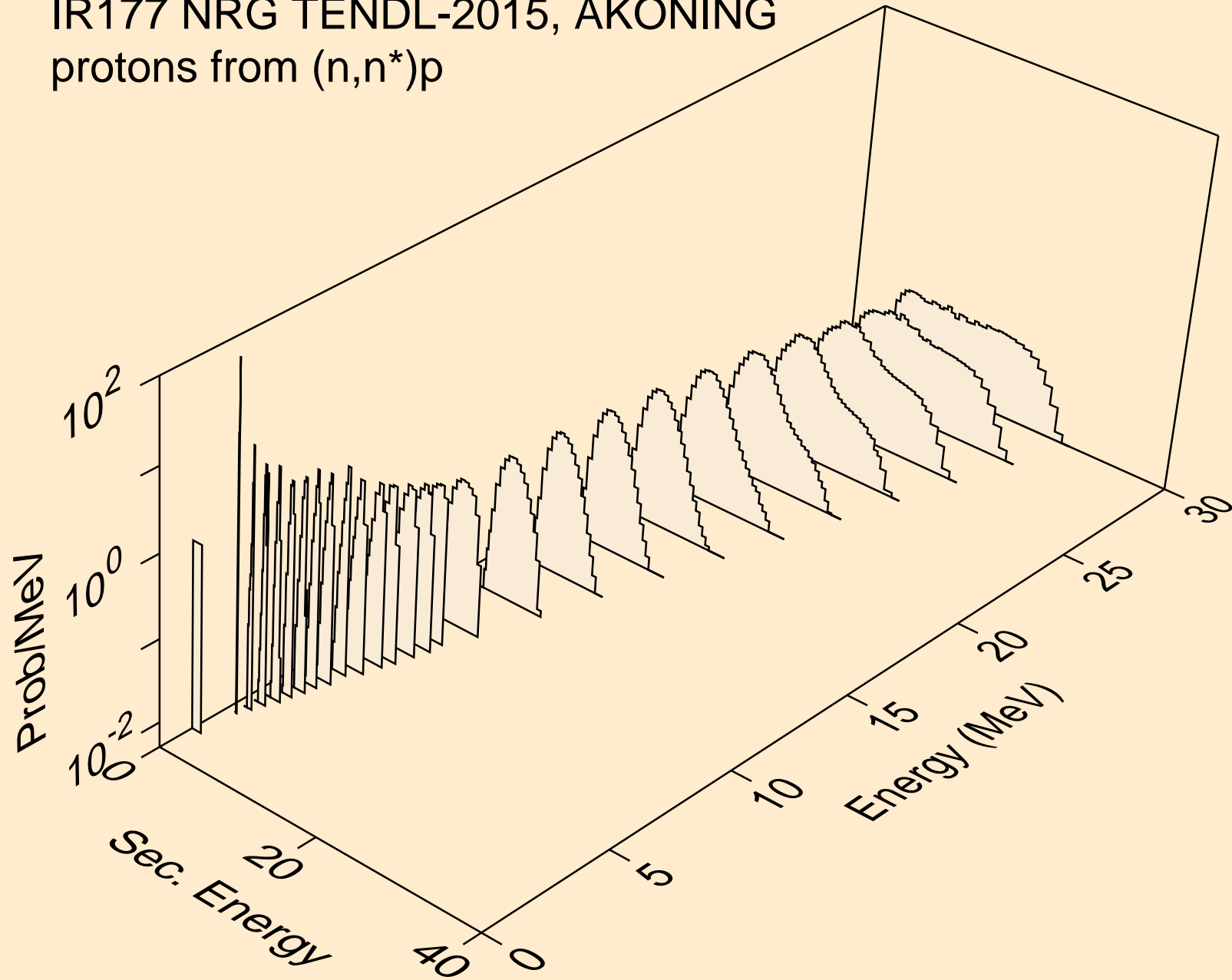

IR177 NRG TENDL-2015, AKONING  
protons from (n,2np)

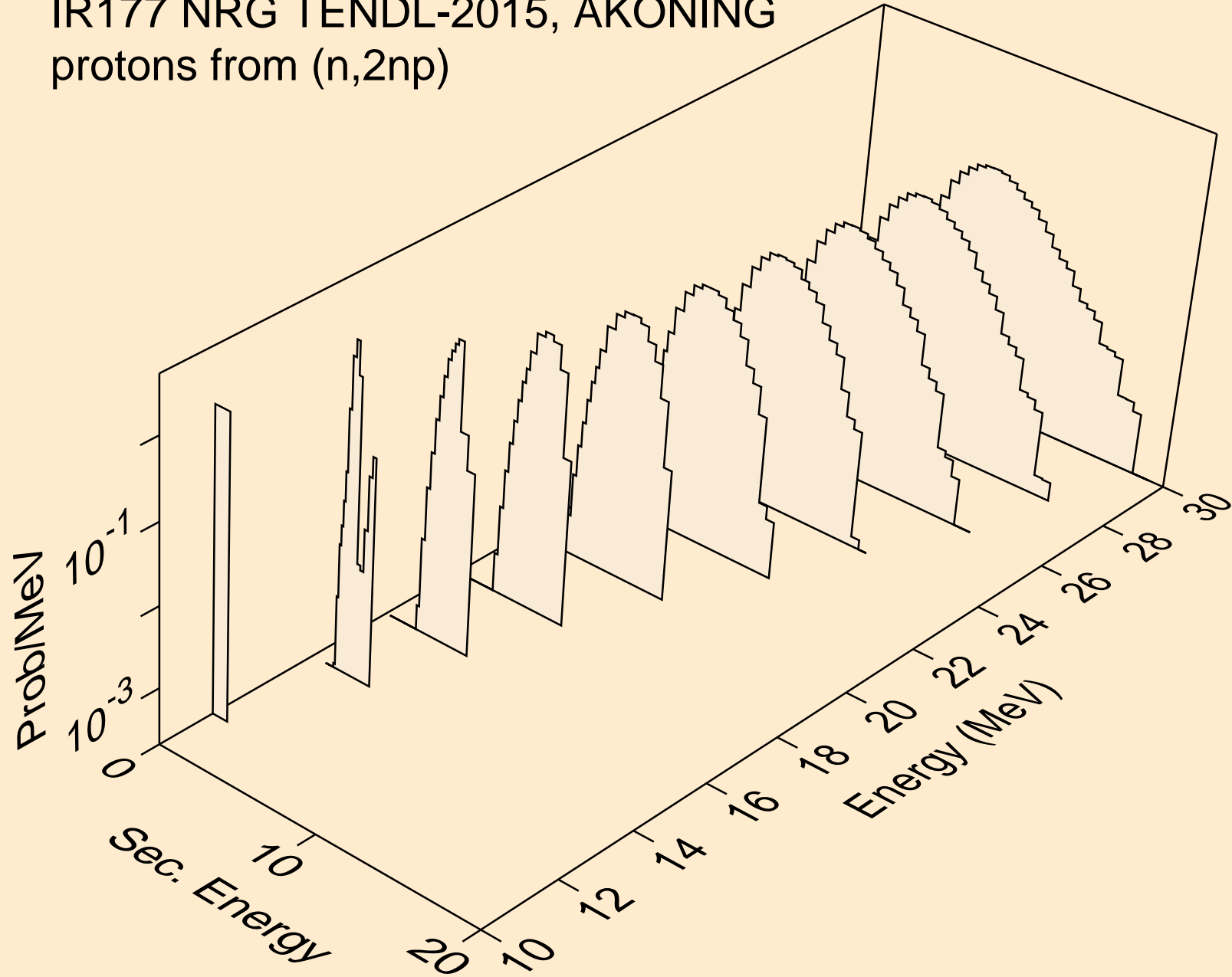

IR177 NRG TENDL-2015, AKONING  
protons from (n,3np)

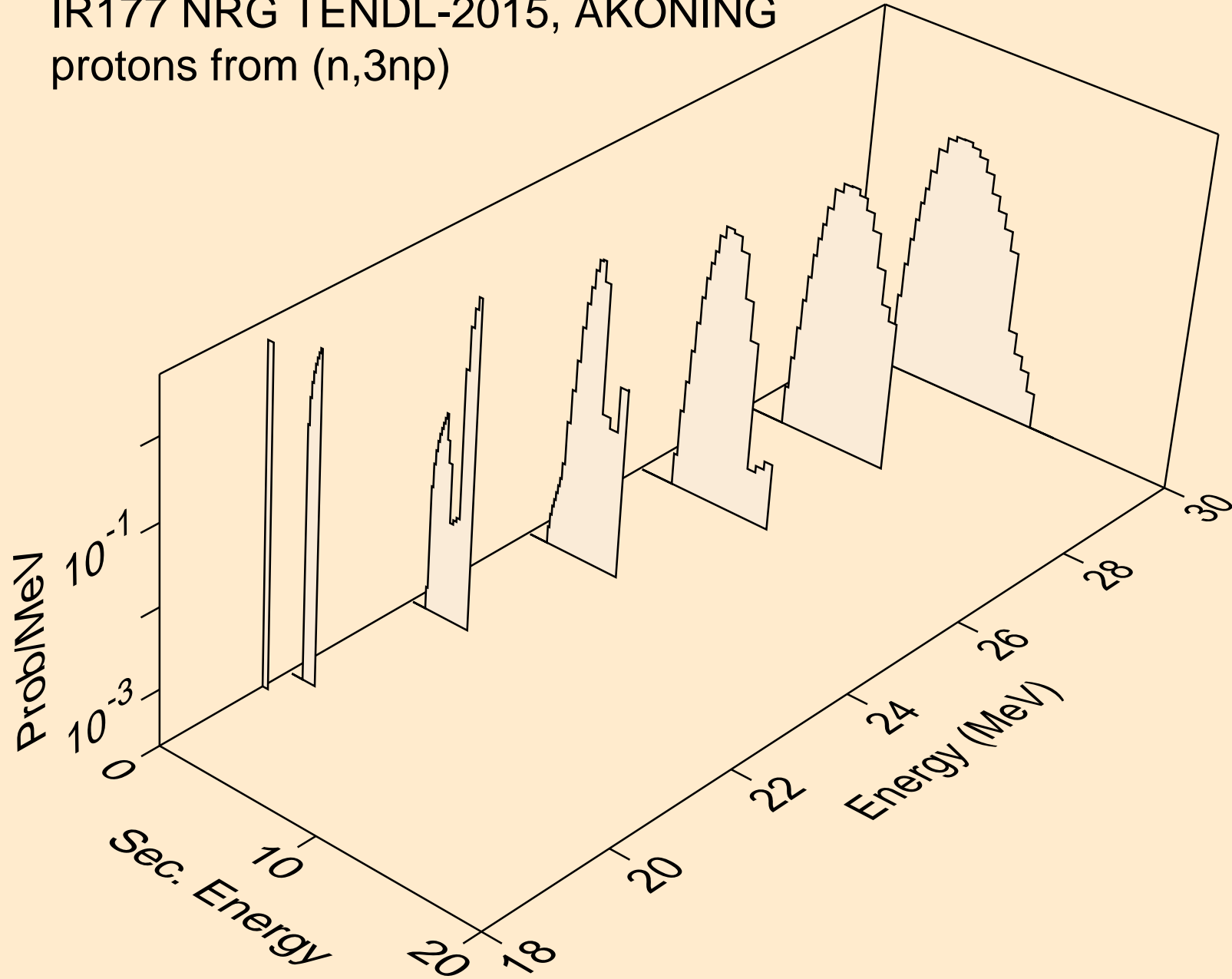

IR177 NRG TENDL-2015, AKONING  
protons from (n,2np)

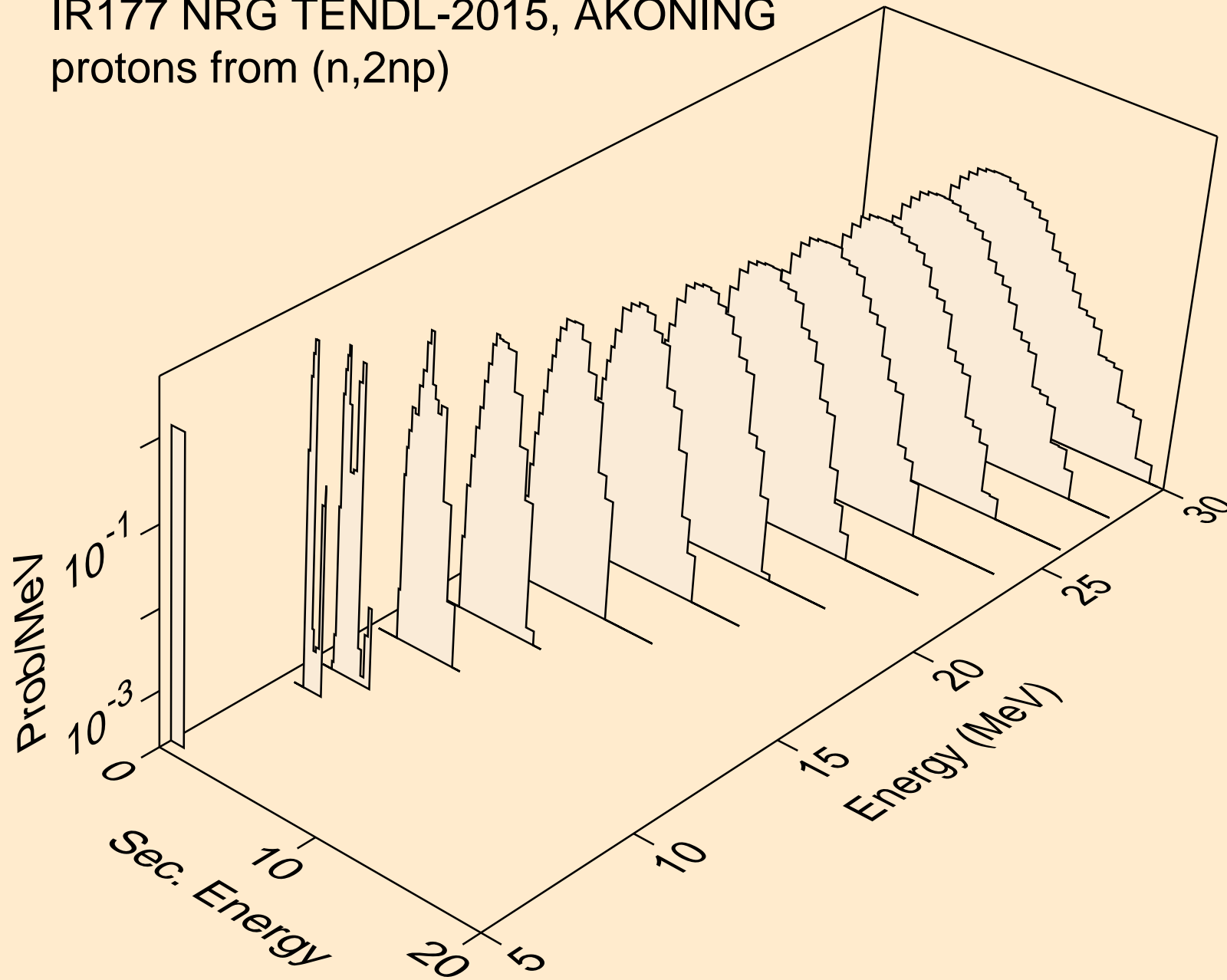

IR177 NRG TENDL-2015, AKONING  
protons from (n,npa)

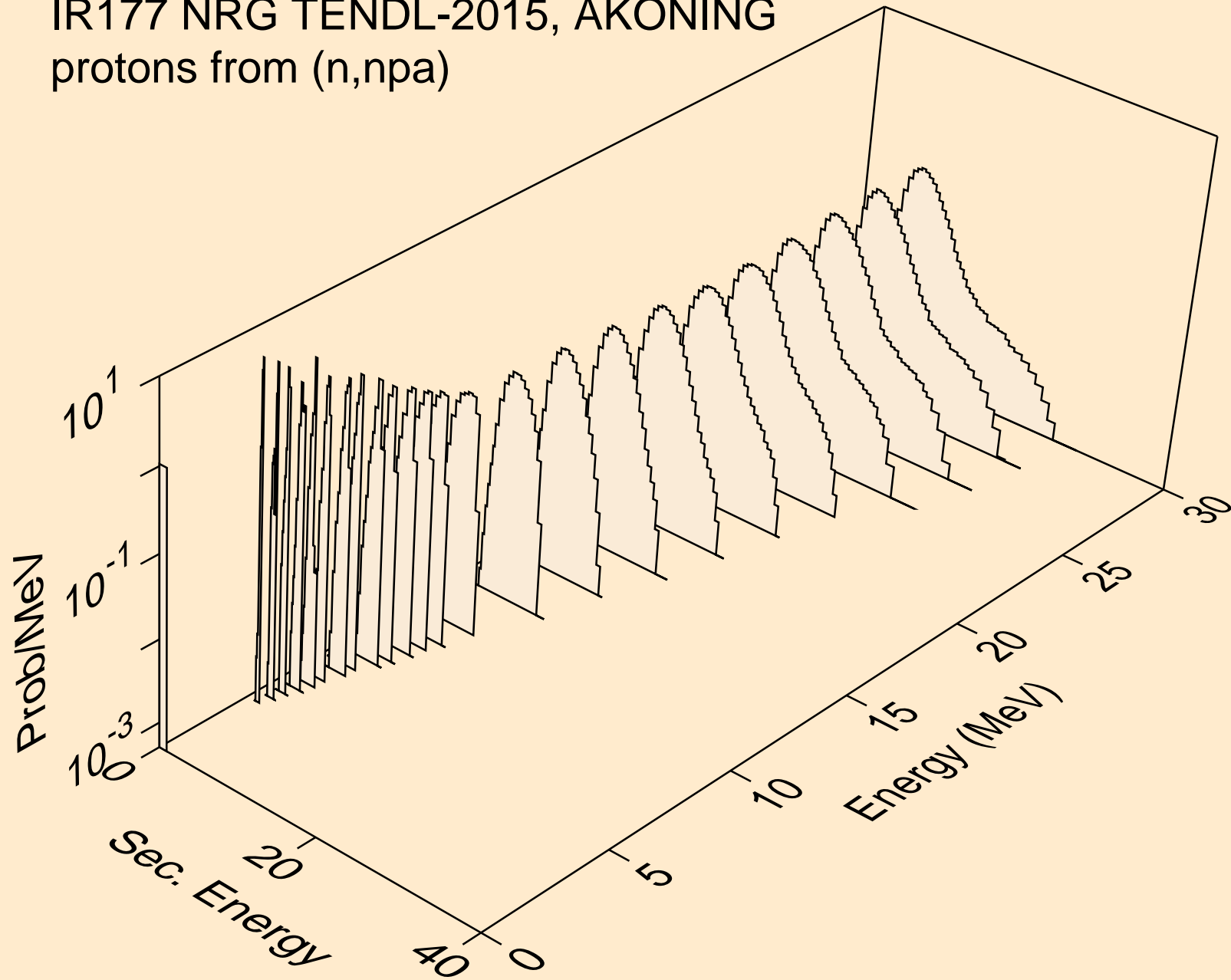

IR177 NRG TENDL-2015, AKONING  
protons from (n,p)

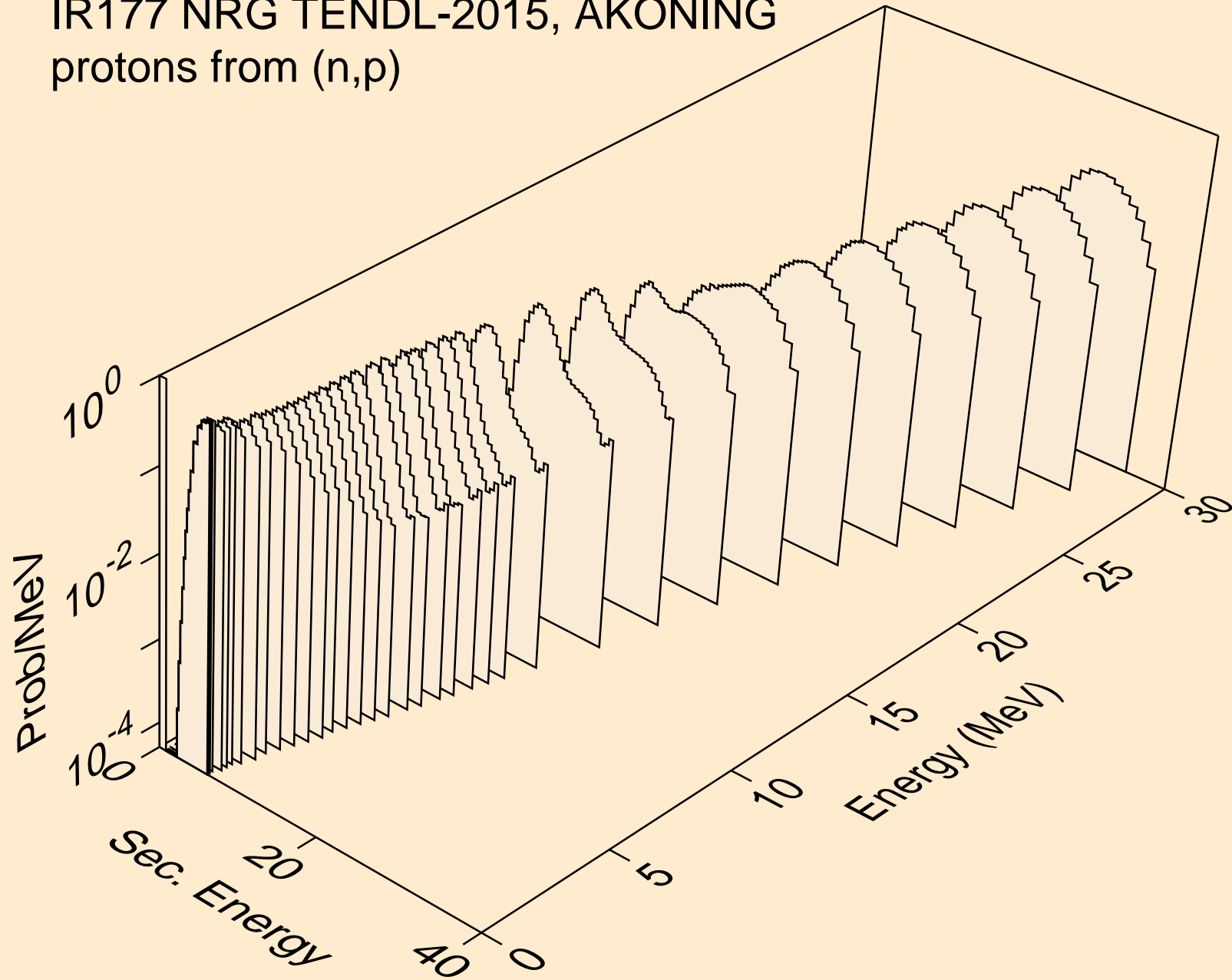



IR177 NRG TENDL-2015, AKONING  
protons from (n,2p)

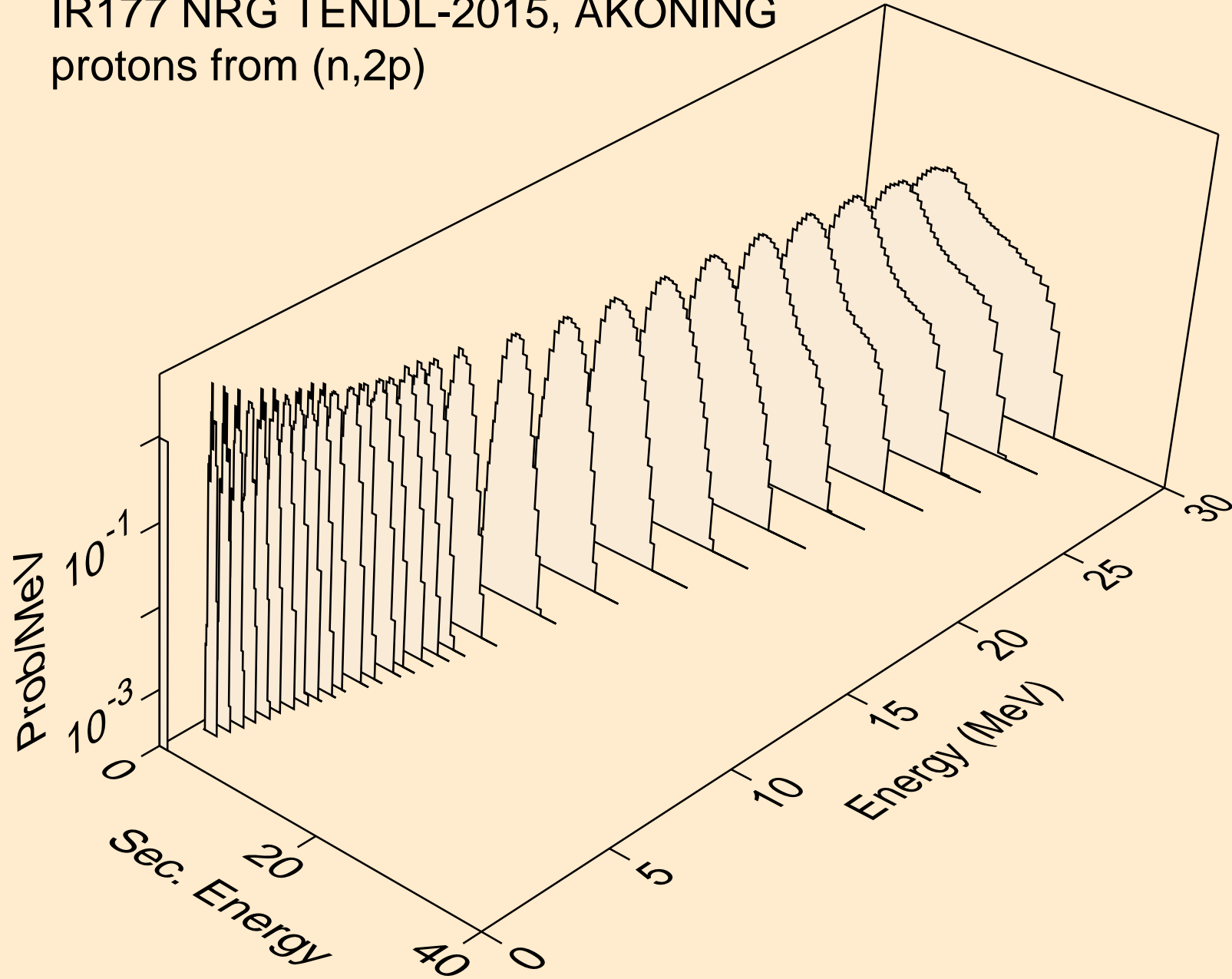

IR177 NRG TENDL-2015, AKONING  
protons from (n,pa)

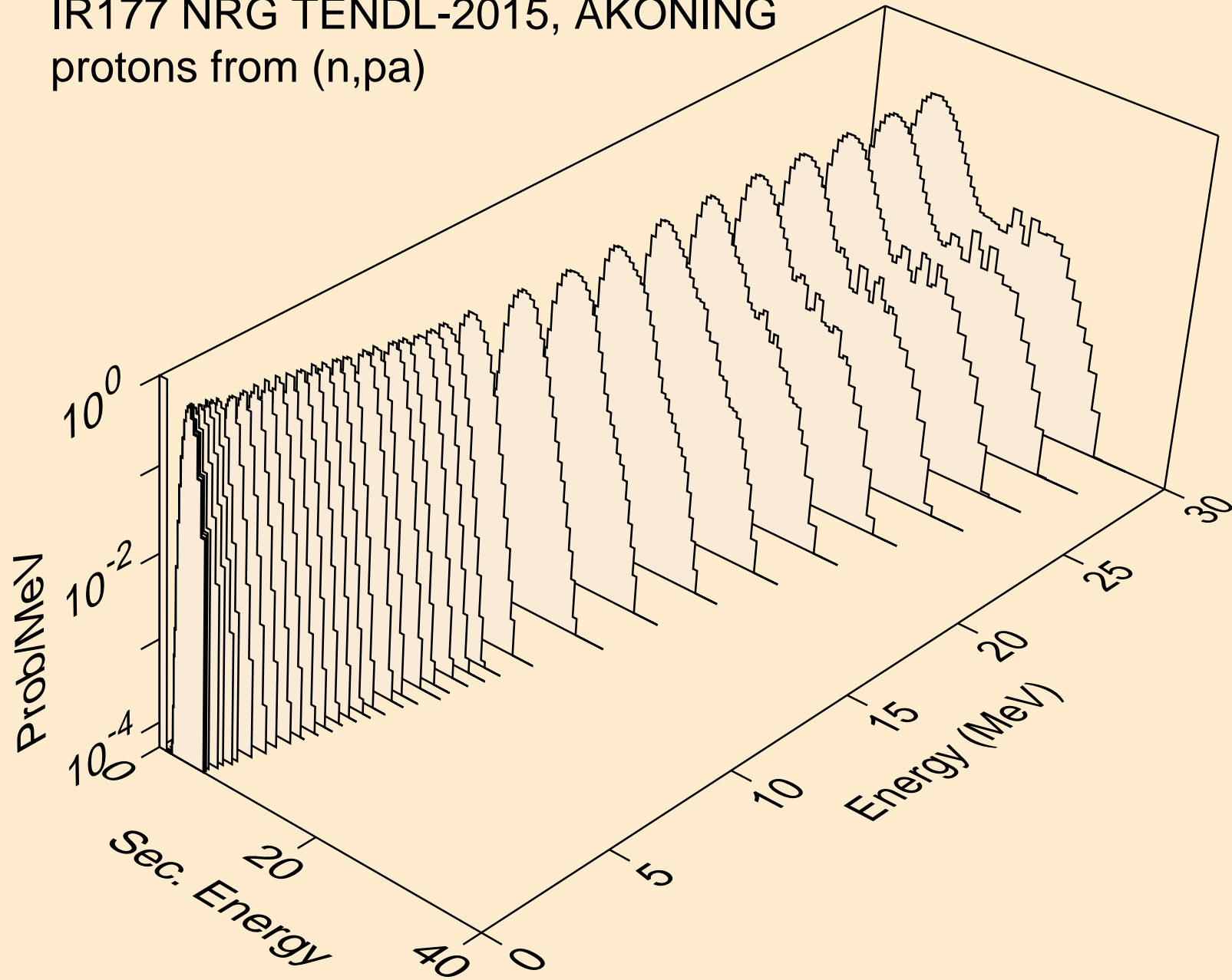

IR177 NRG TENDL-2015, AKONING  
protons from (n,pd)

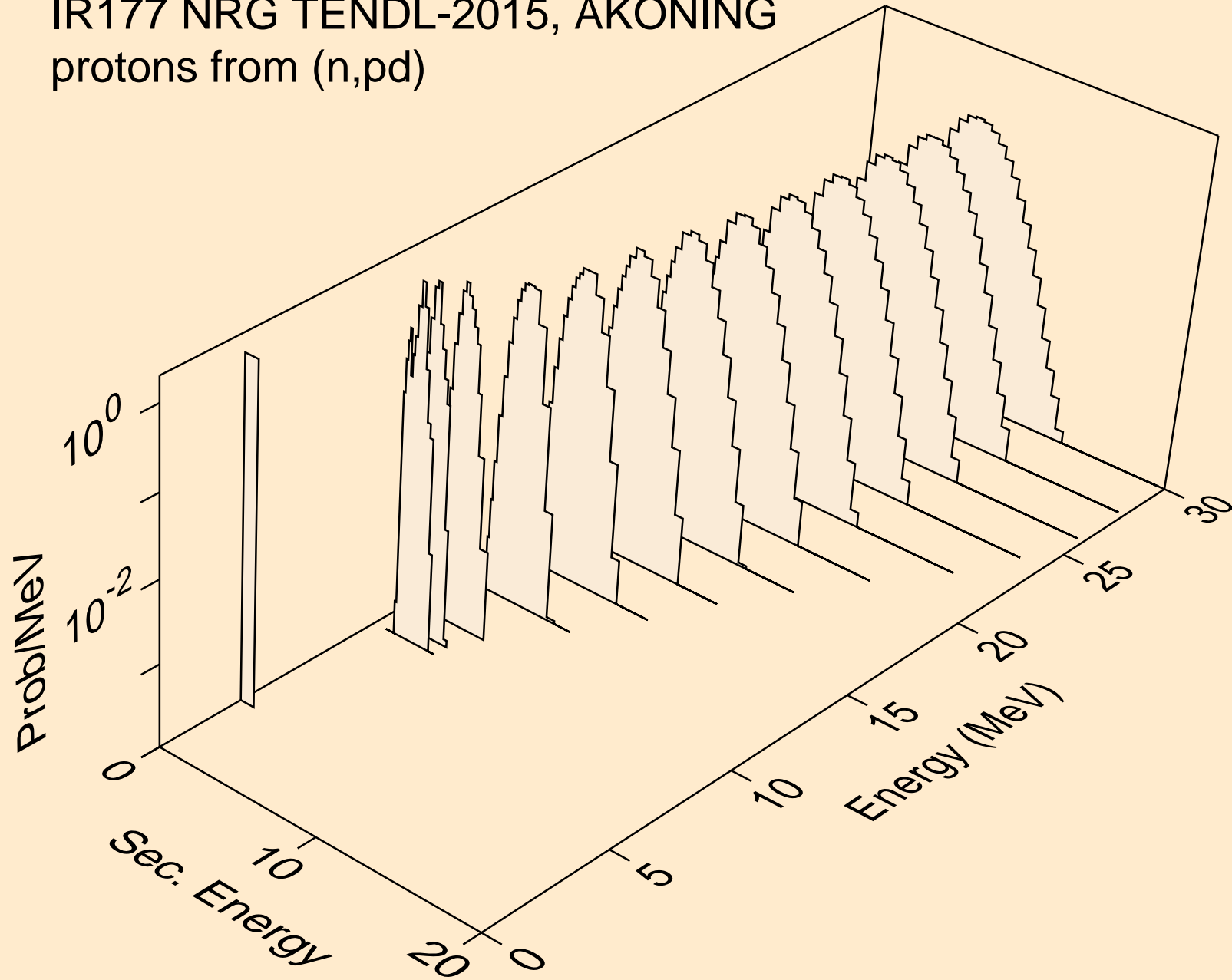

IR177 NRG TENDL-2015, AKONING  
protons from (n,pt)

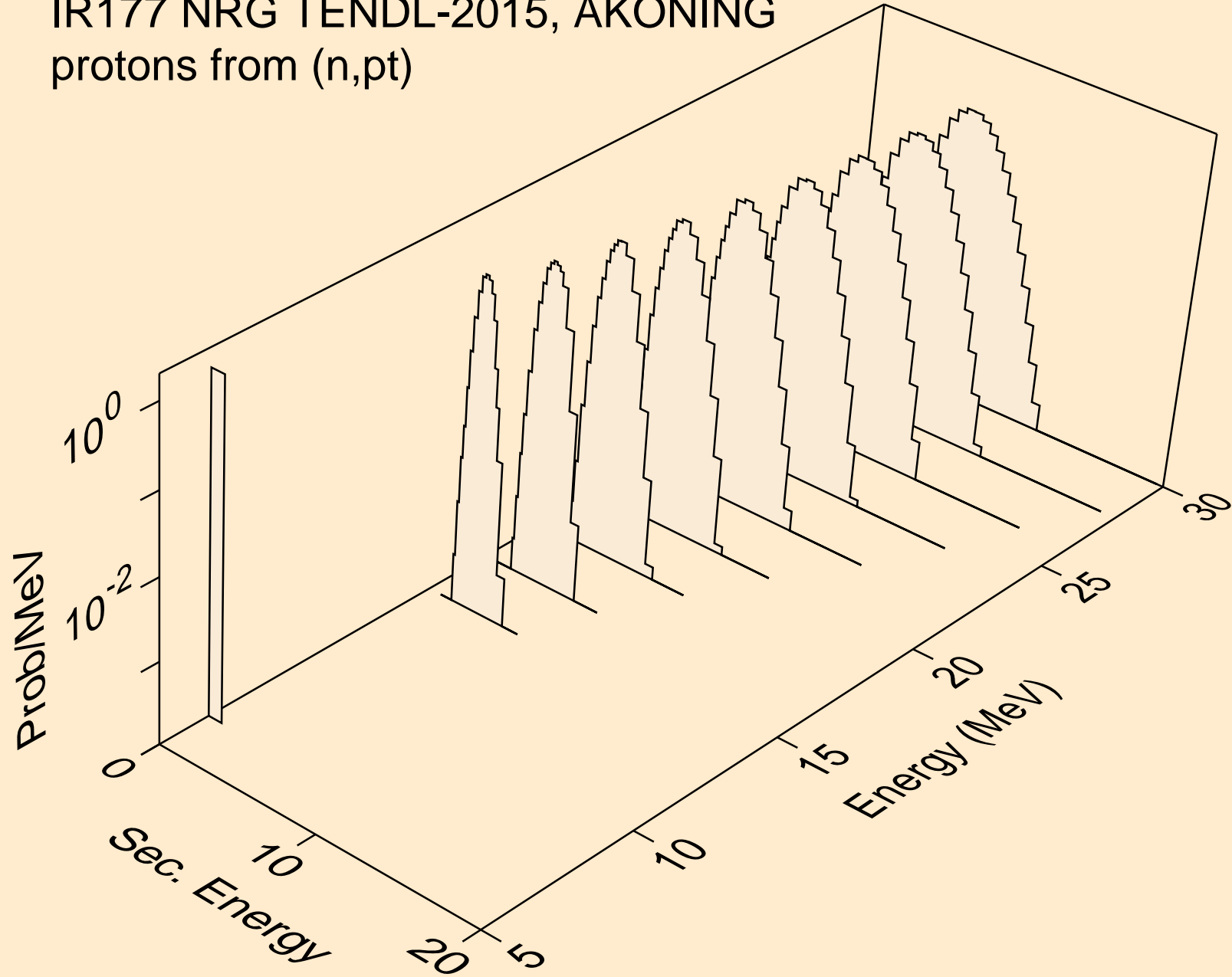

IR177 NRG TENDL-2015, AKONING  
deuterons from (n,x)

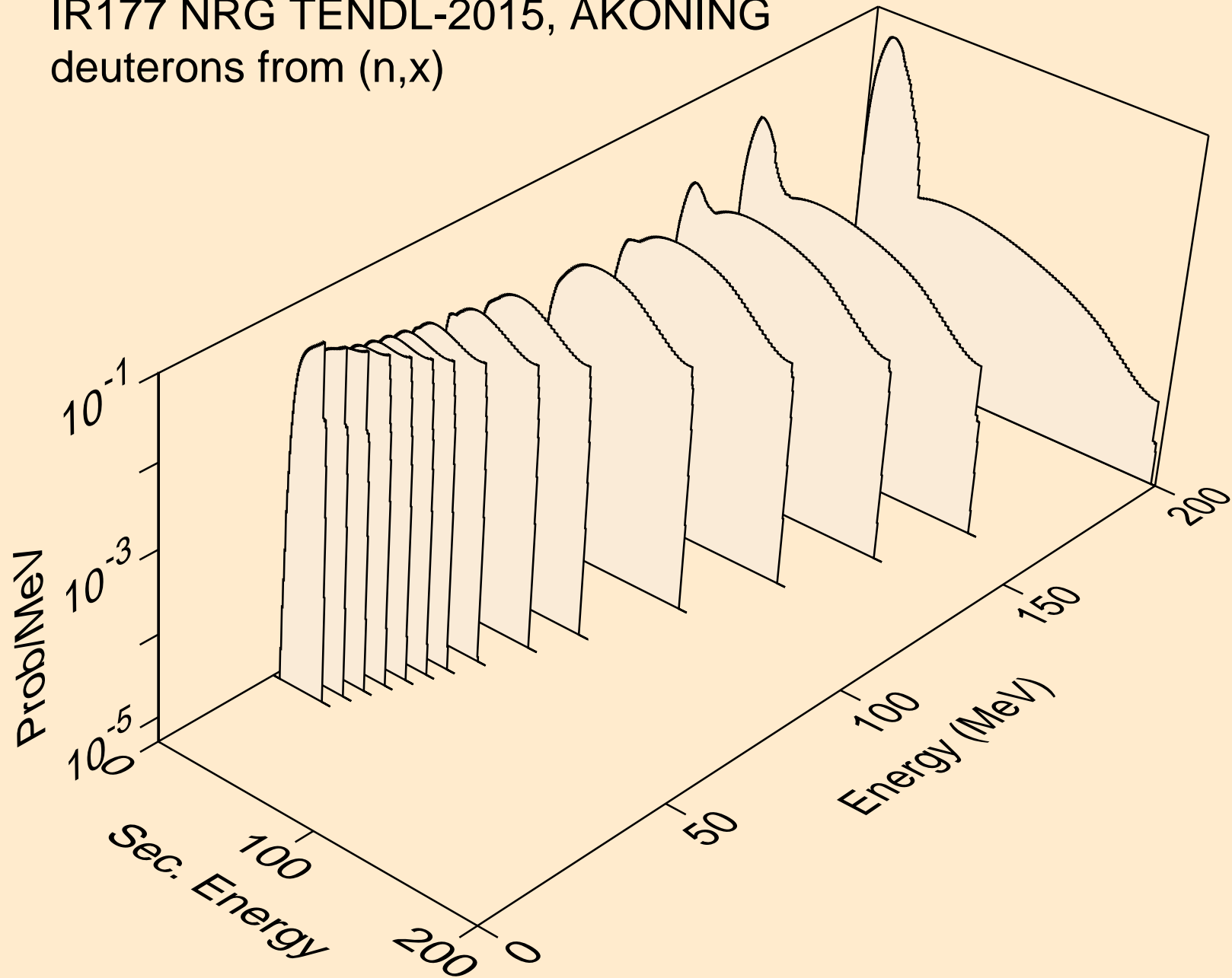

IR177 NRG TENDL-2015, AKONING  
deuterons from (n,2nd)

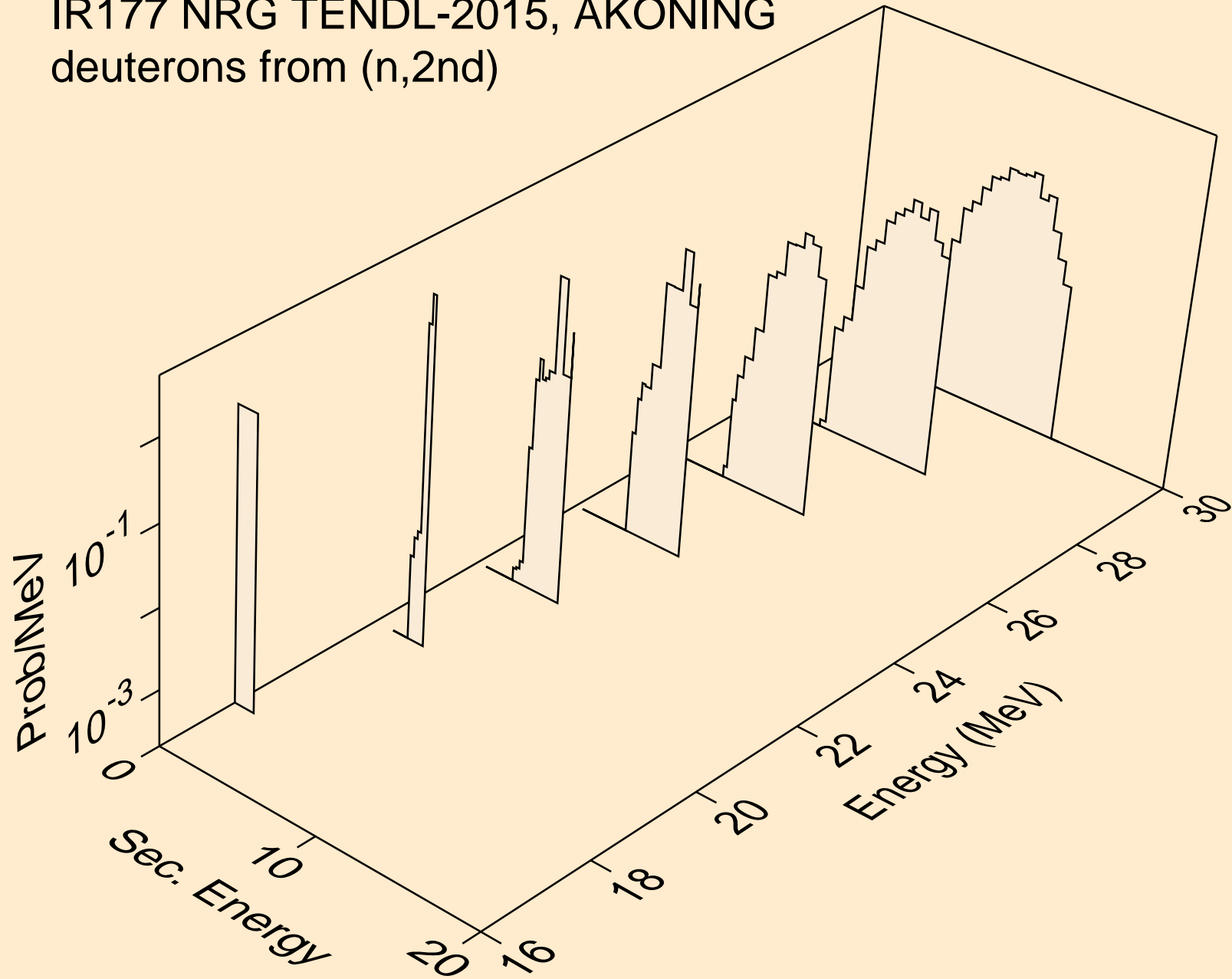

IR177 NRG TENDL-2015, AKONING  
deuterons from (n,n\*)d

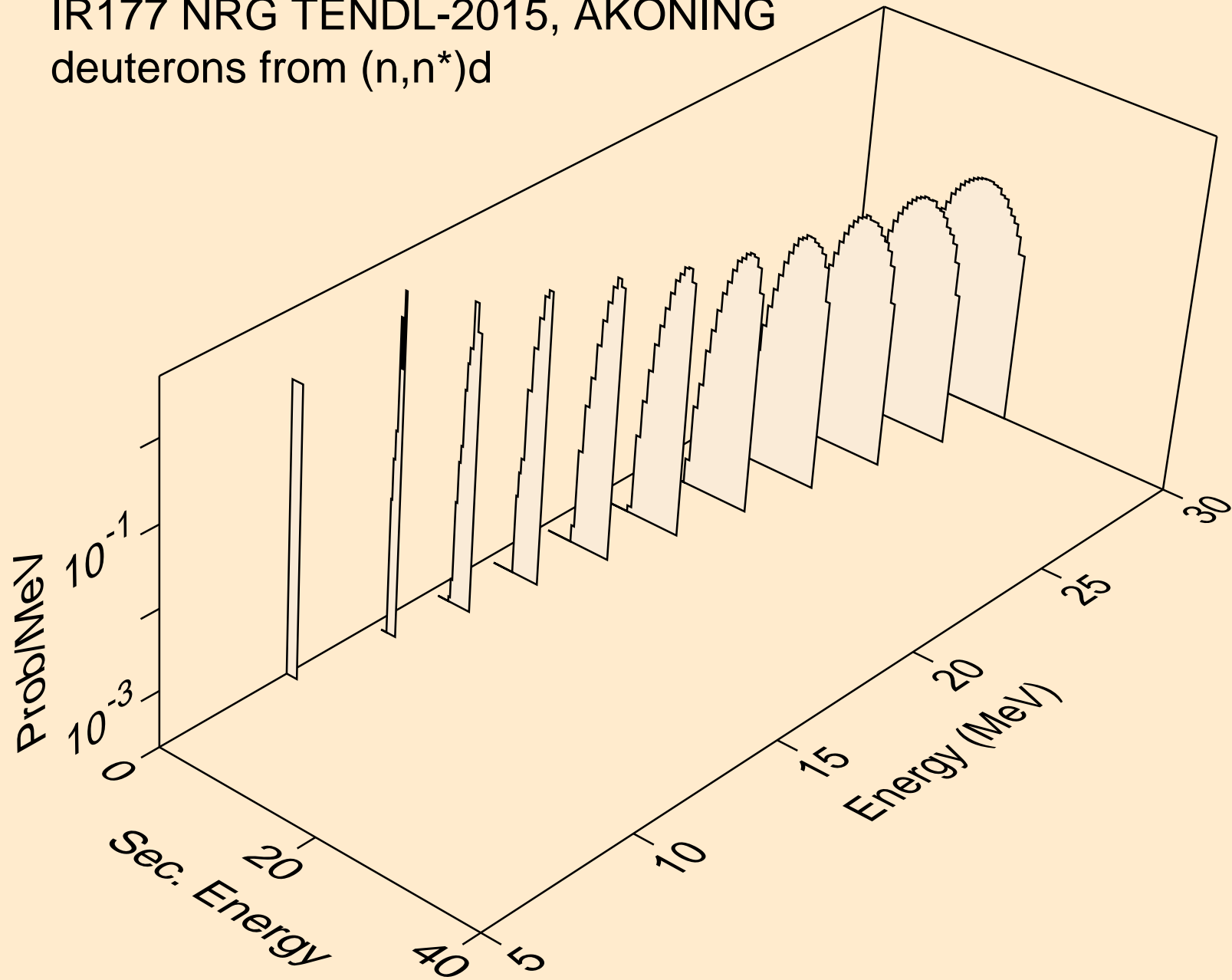

IR177 NRG TENDL-2015, AKONING  
deuterons from (n,d)

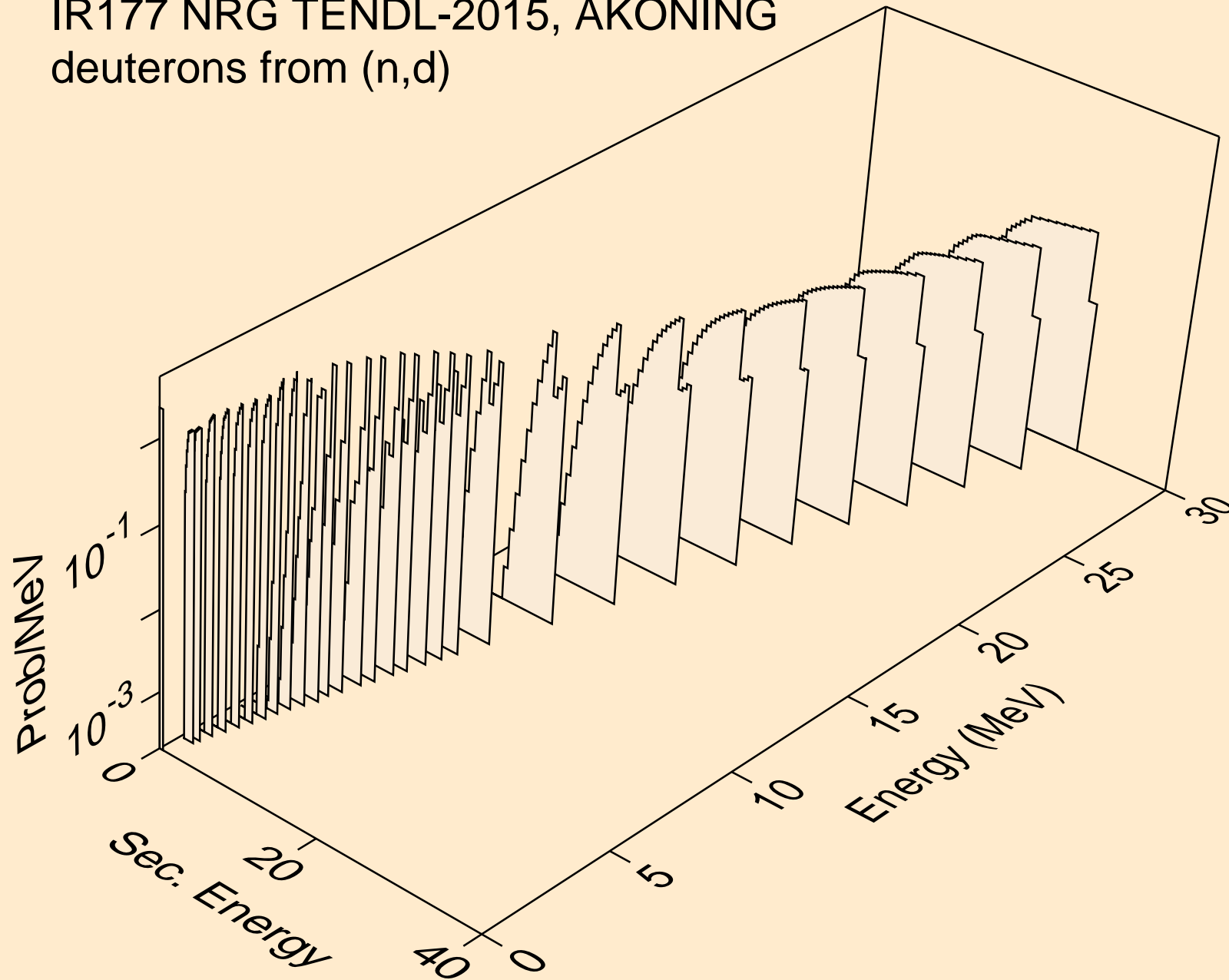



IR177 NRG TENDL-2015, AKONING  
deuterons from (n,d2a)

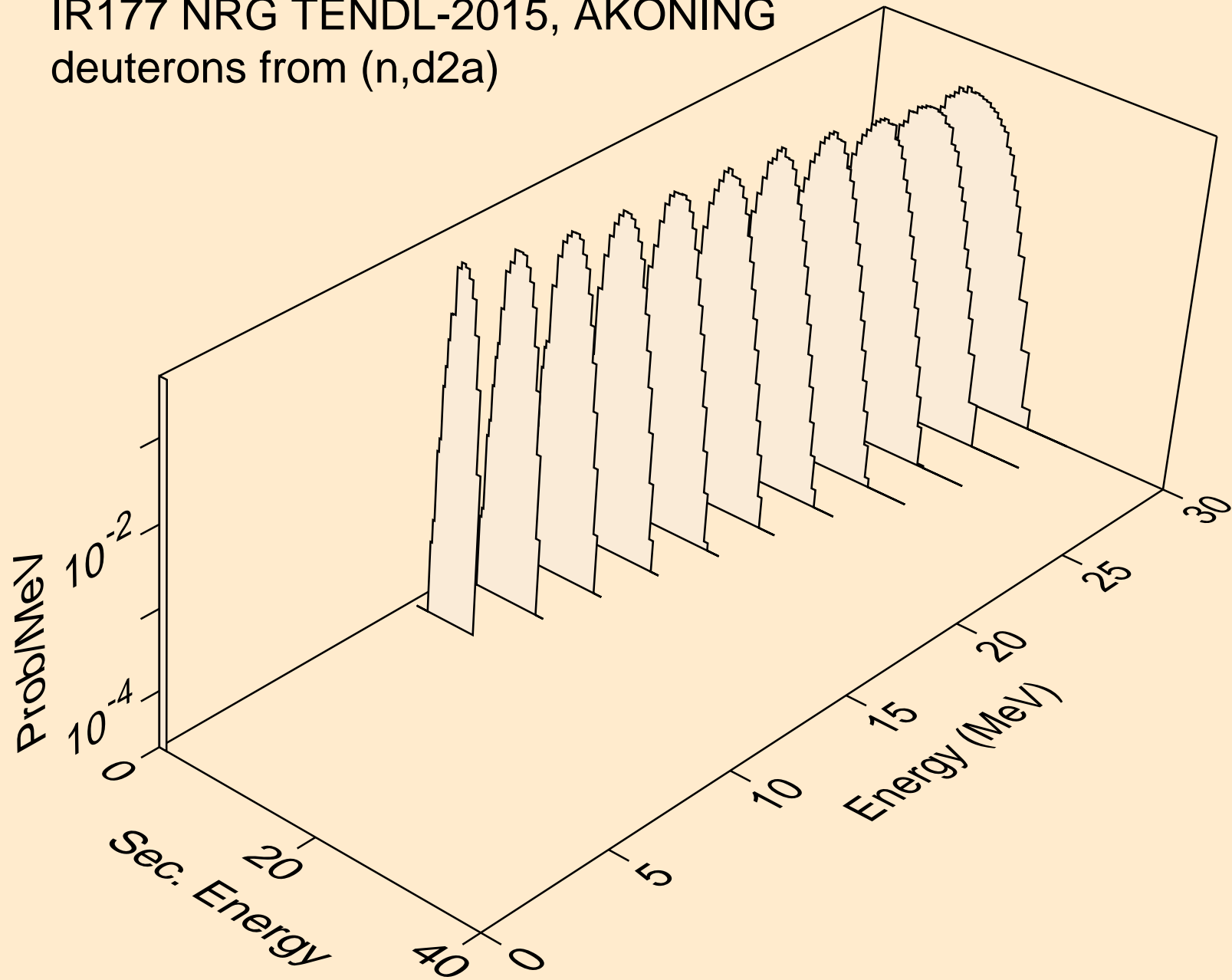

IR177 NRG TENDL-2015, AKONING  
deuterons from (n,pd)

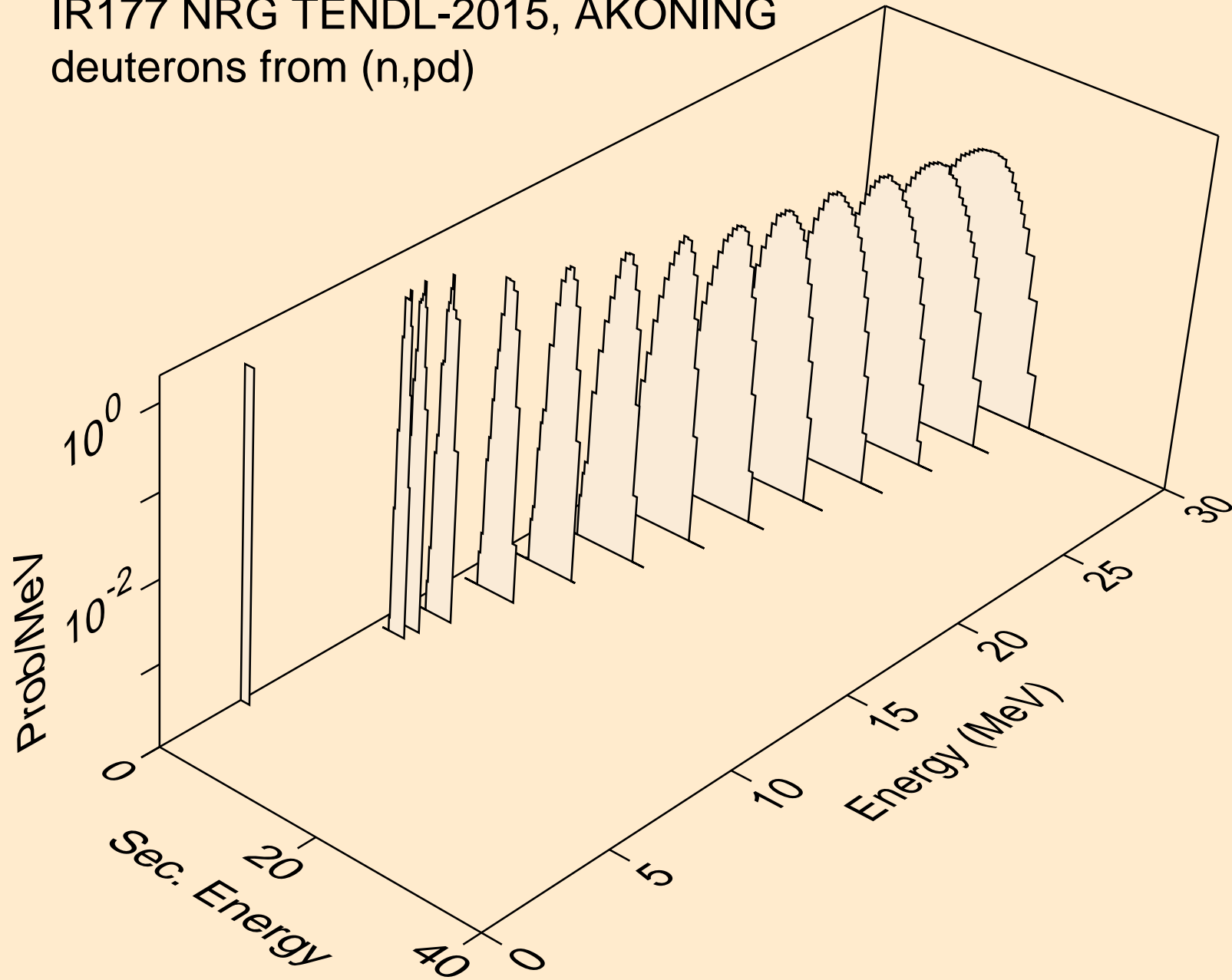

IR177 NRG TENDL-2015, AKONING  
deuterons from (n,da)

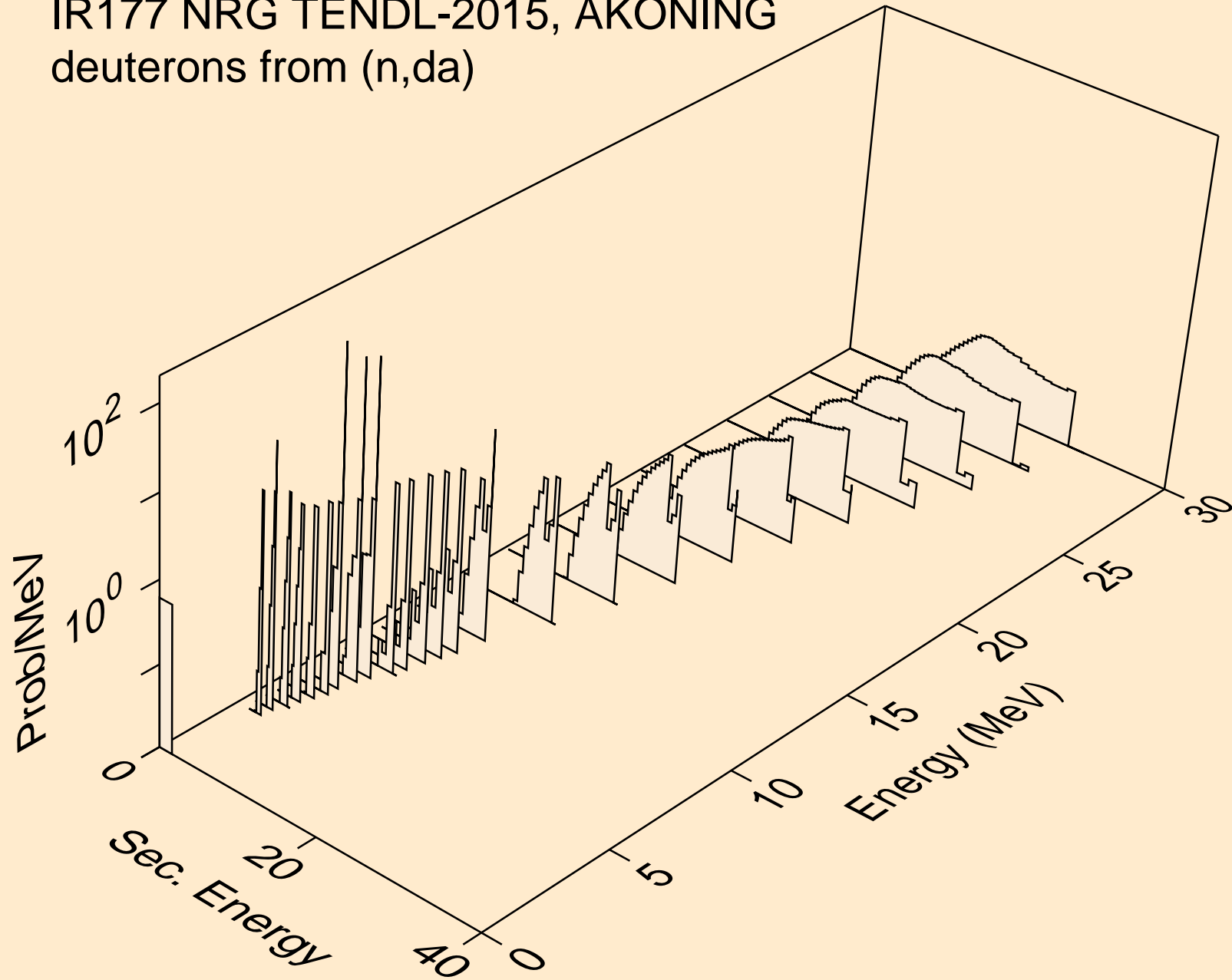

IR177 NRG TENDL-2015, AKONING  
tritons from (n,x)

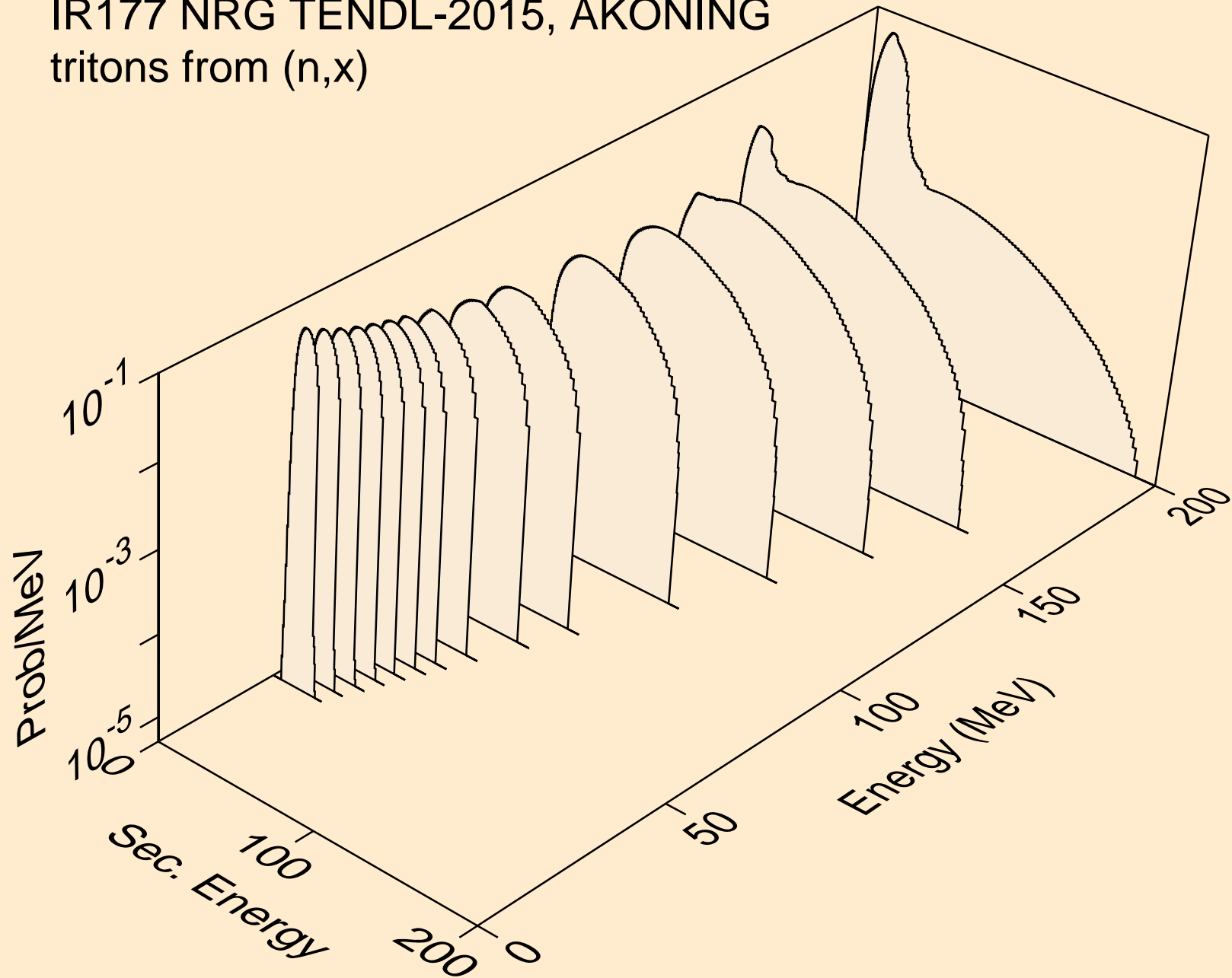

IR177 NRG TENDL-2015, AKONING  
tritons from (n,n\*)t

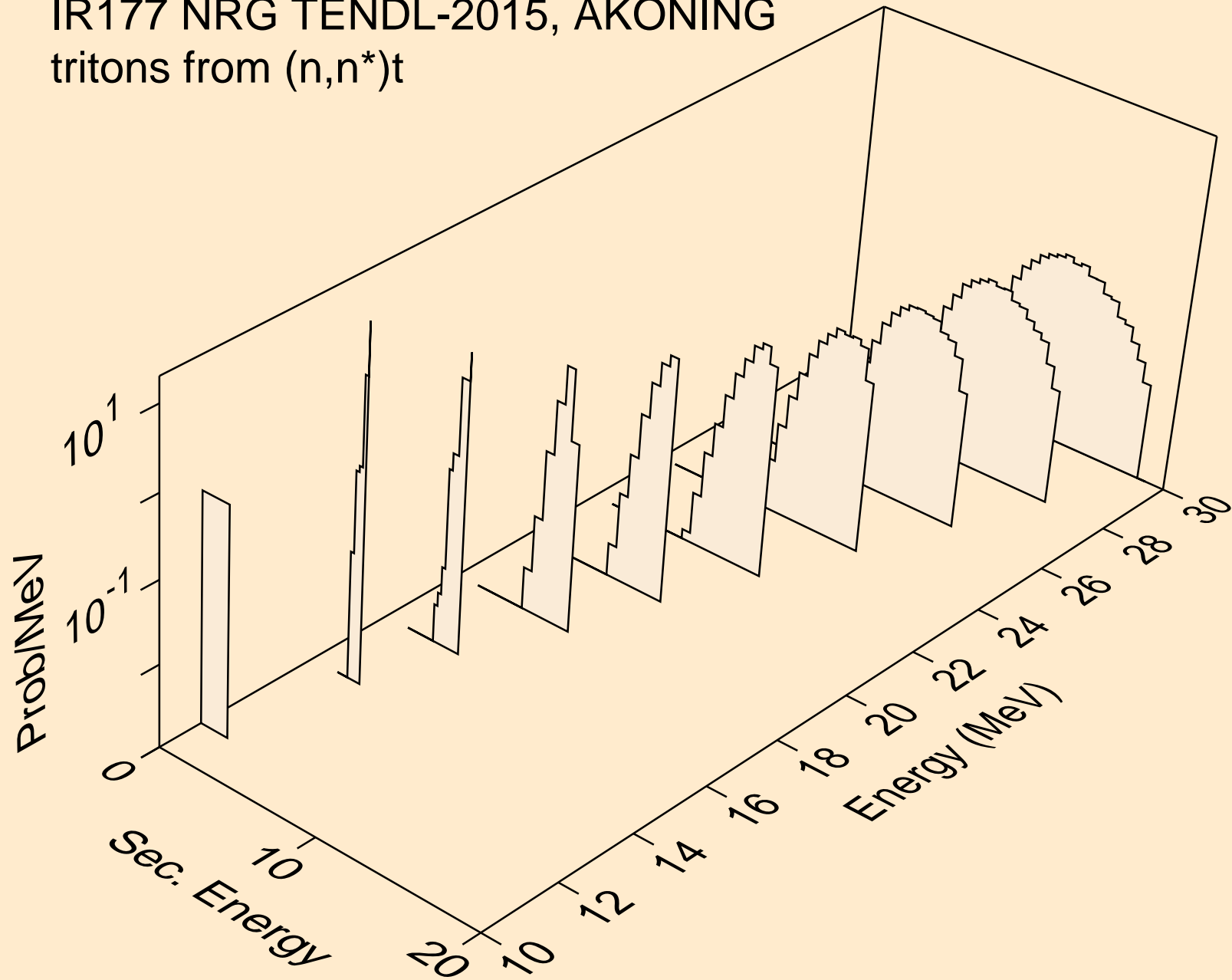

IR177 NRG TENDL-2015, AKONING  
tritons from (n,t)

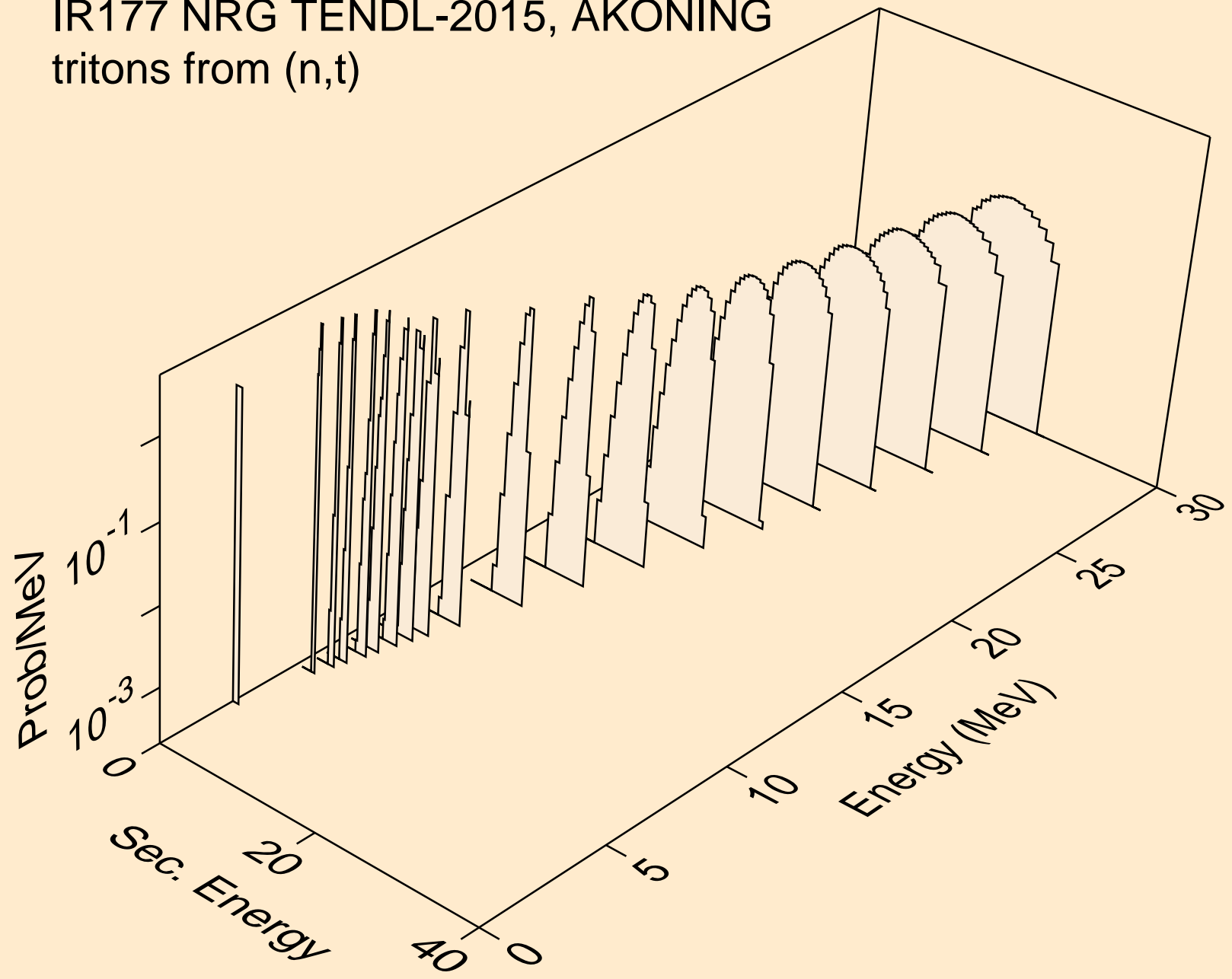

IR177 NRG TENDL-2015, AKONING  
tritons from (n,t2a)

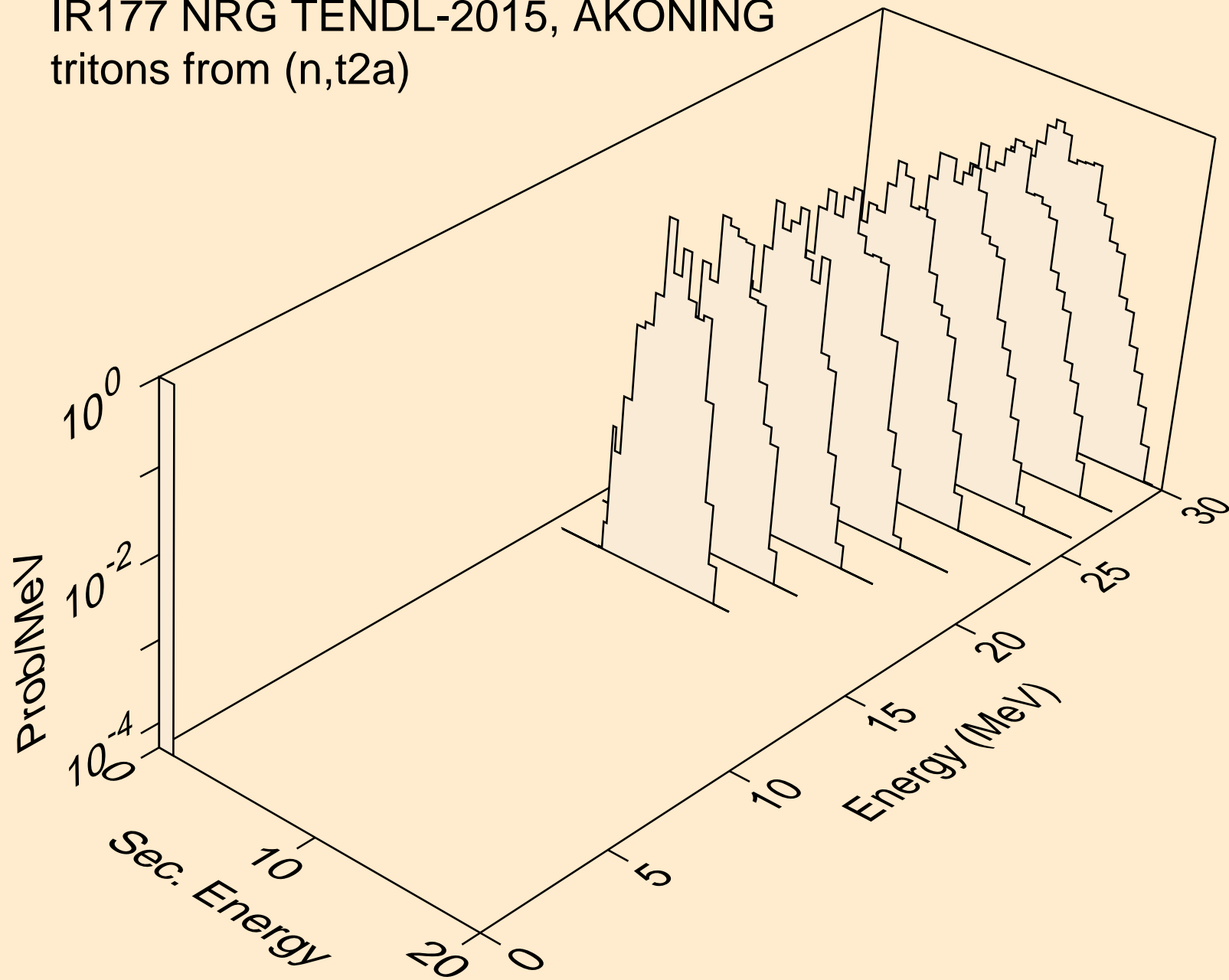

IR177 NRG TENDL-2015, AKONING  
tritons from (n,pt)

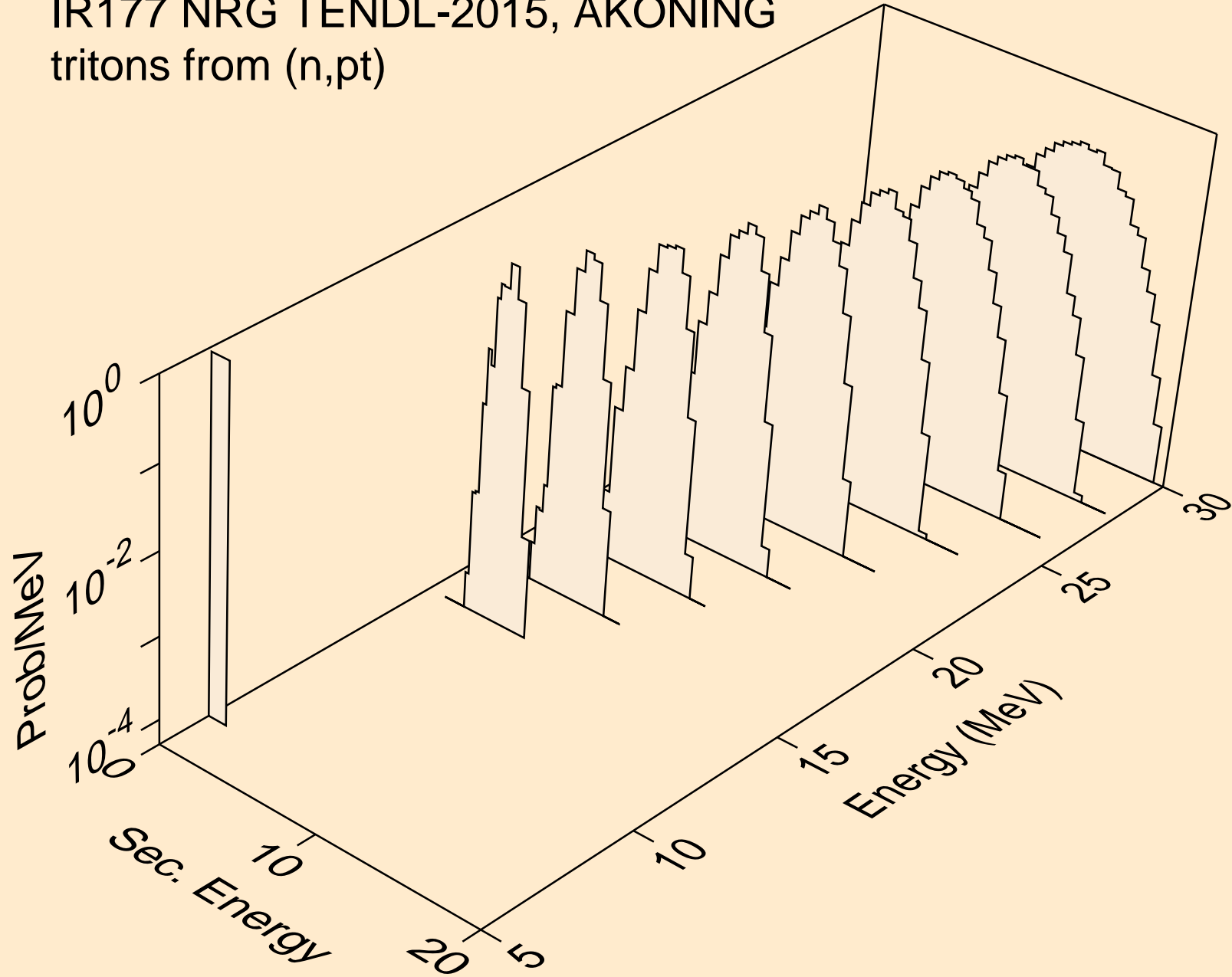



IR177 NRG TENDL-2015, AKONING  
he3s from (n,x)

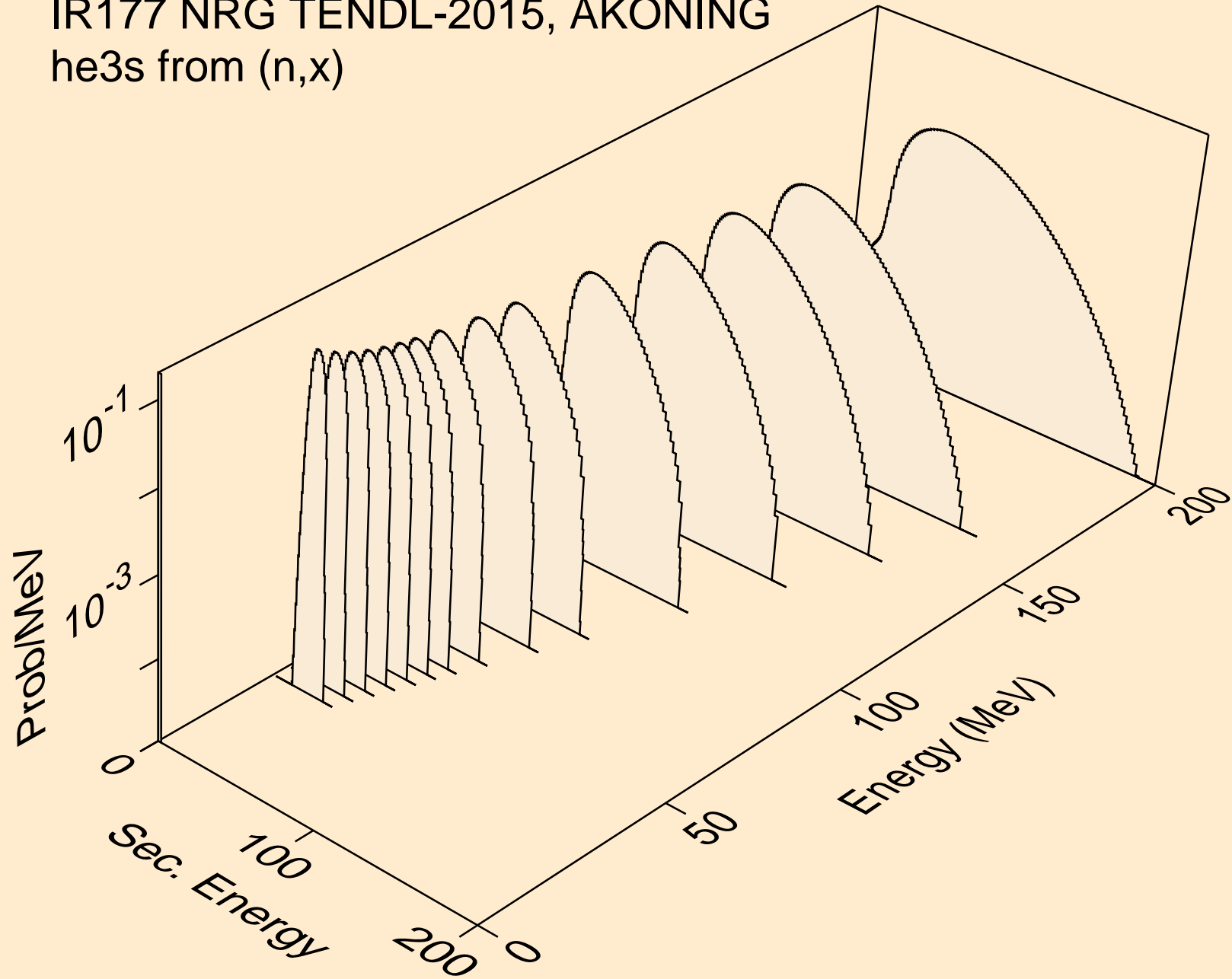

IR177 NRG TENDL-2015, AKONING  
he3s from (n,n\*)he3

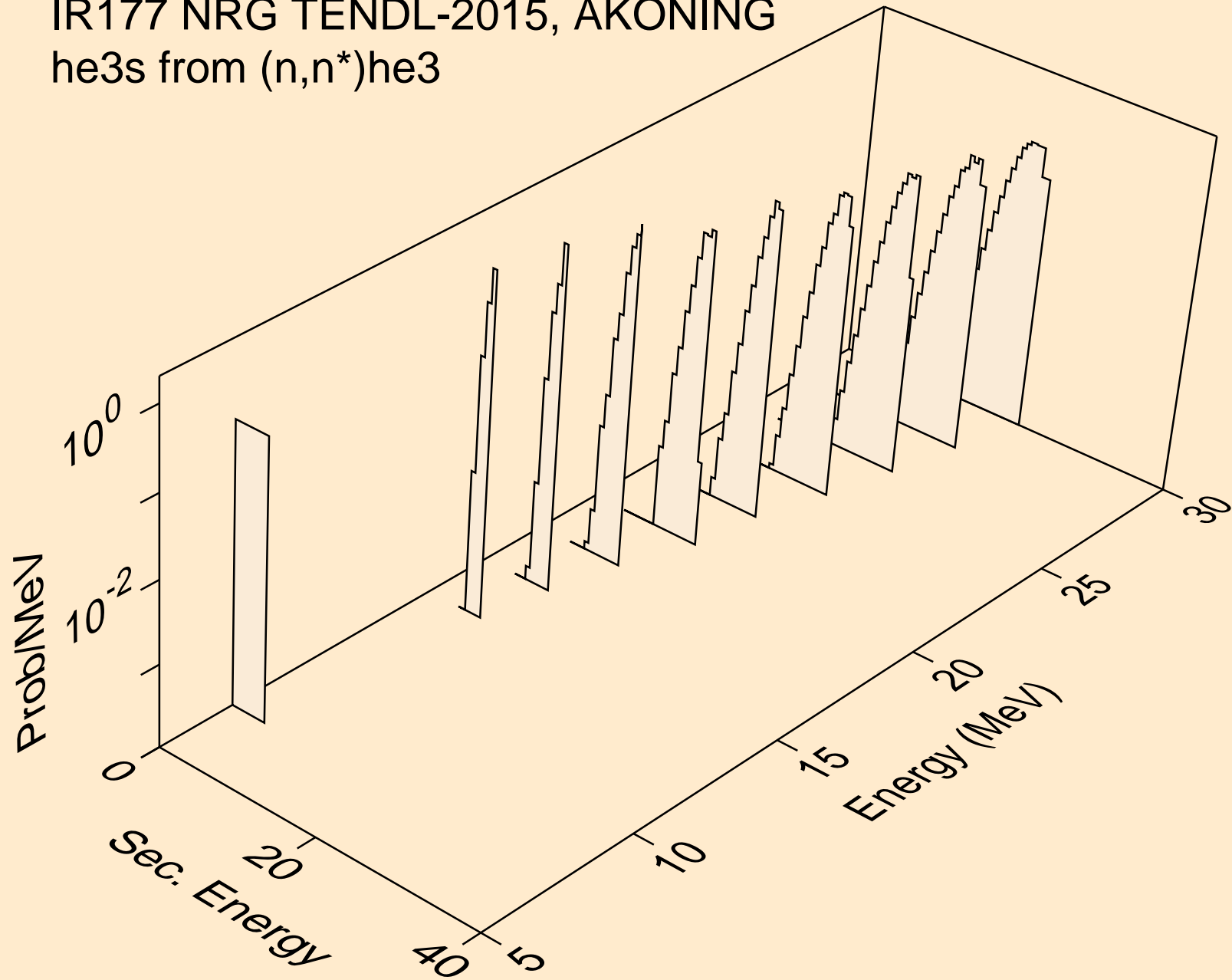

IR177 NRG TENDL-2015, AKONING  
he3s from (n,he3)

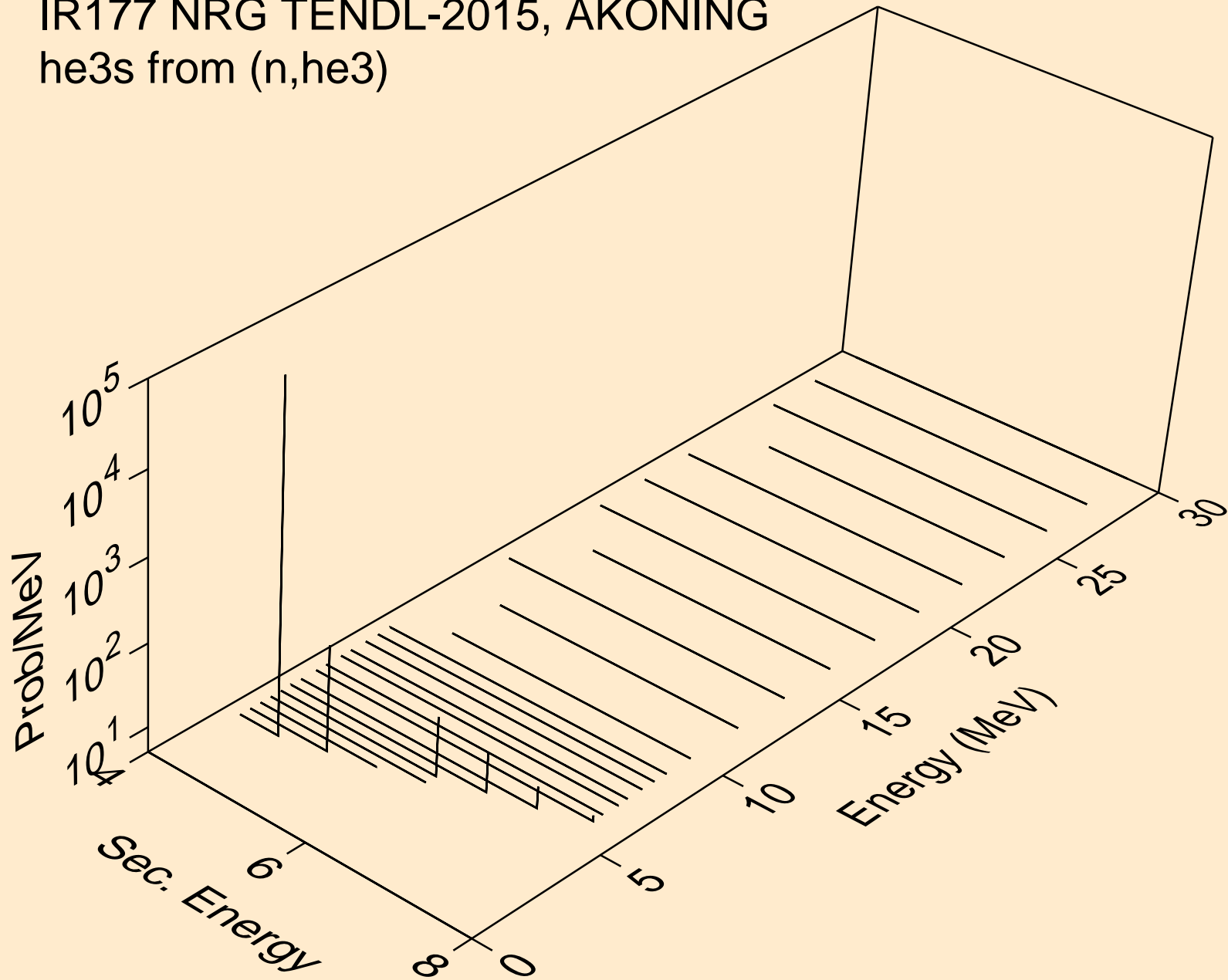

IR177 NRG TENDL-2015, AKONING  
alphas from (n,x)

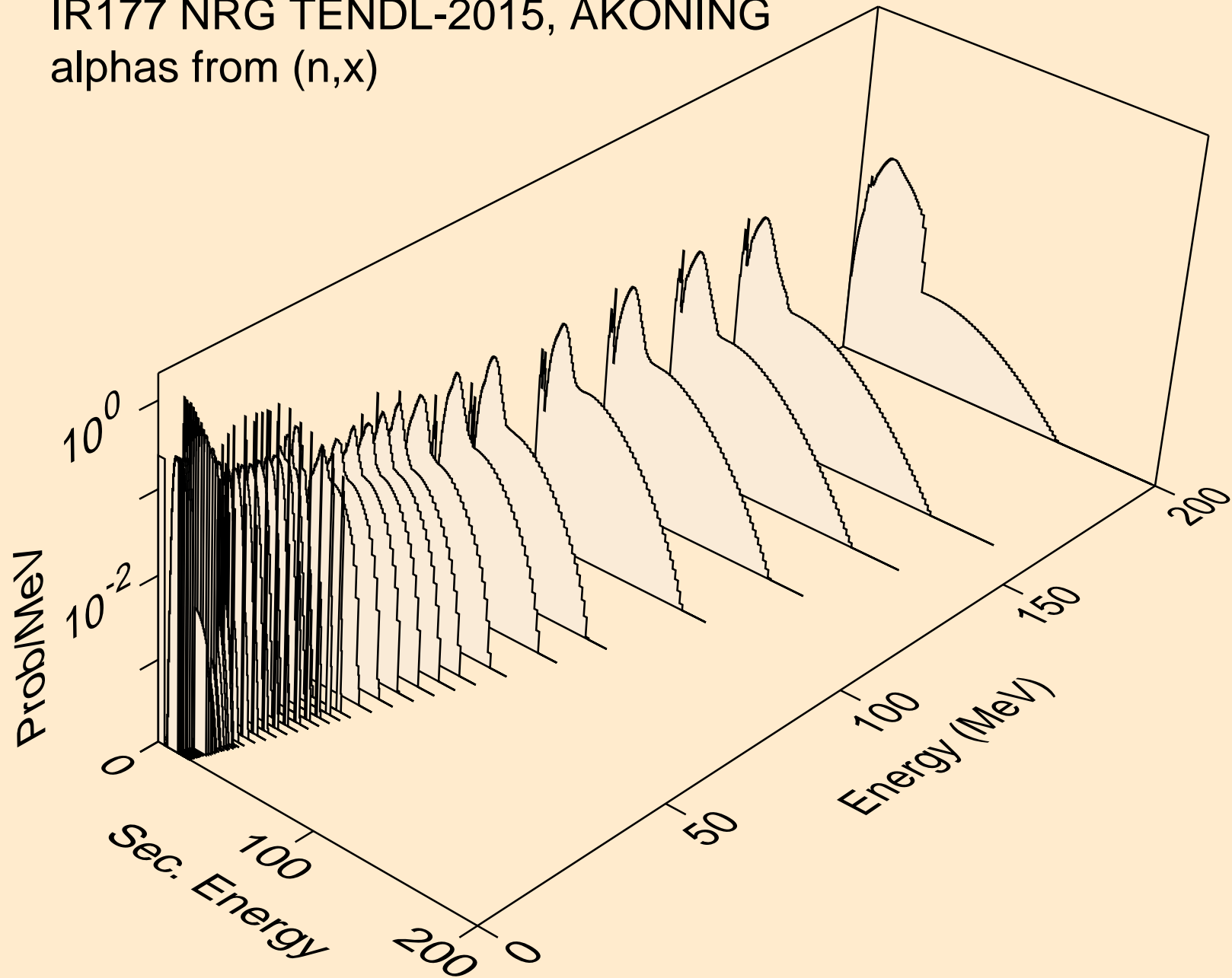

IR177 NRG TENDL-2015, AKONING  
alphas from (n,n\*)a

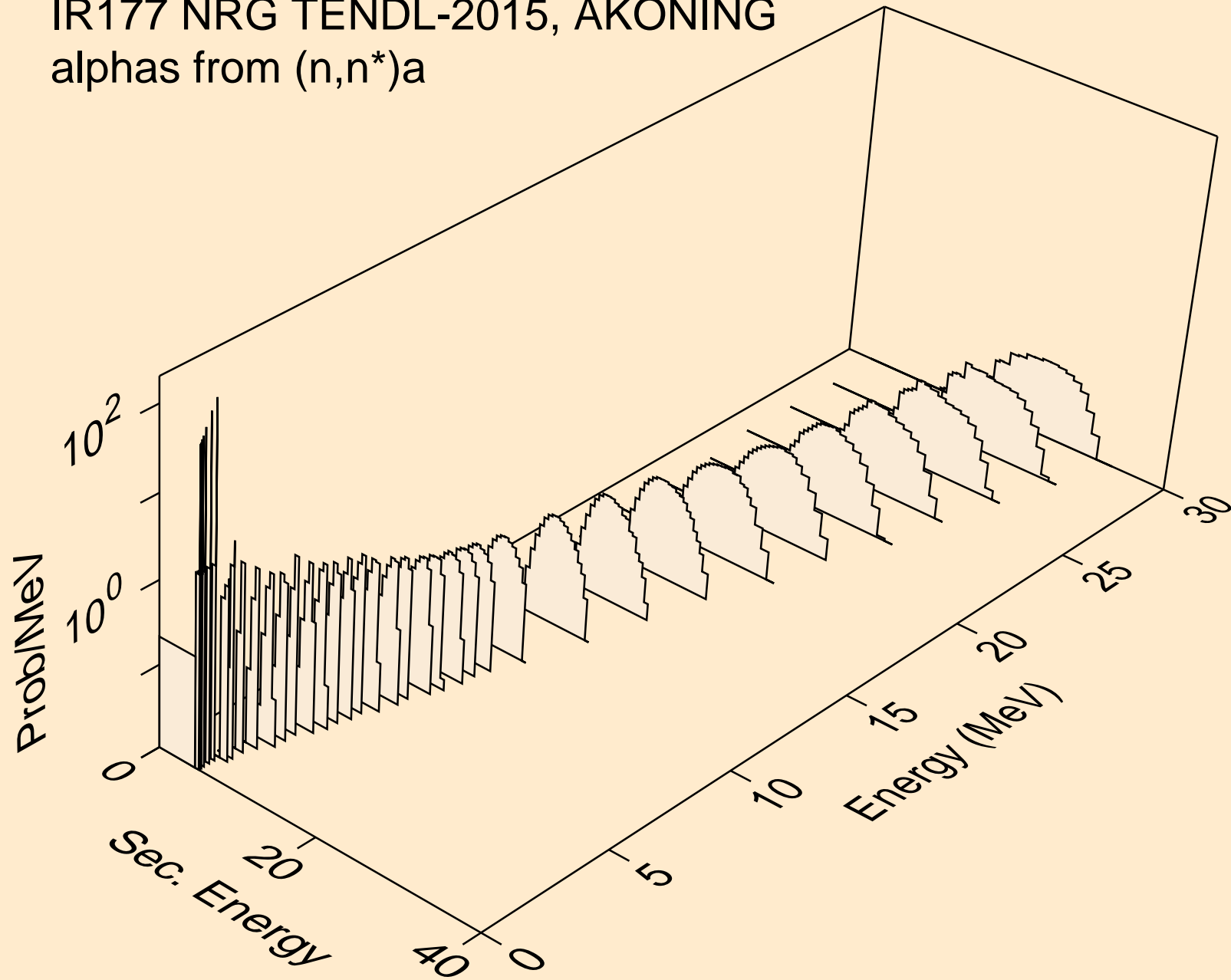

IR177 NRG TENDL-2015, AKONING  
alphas from (n,n\*)3a

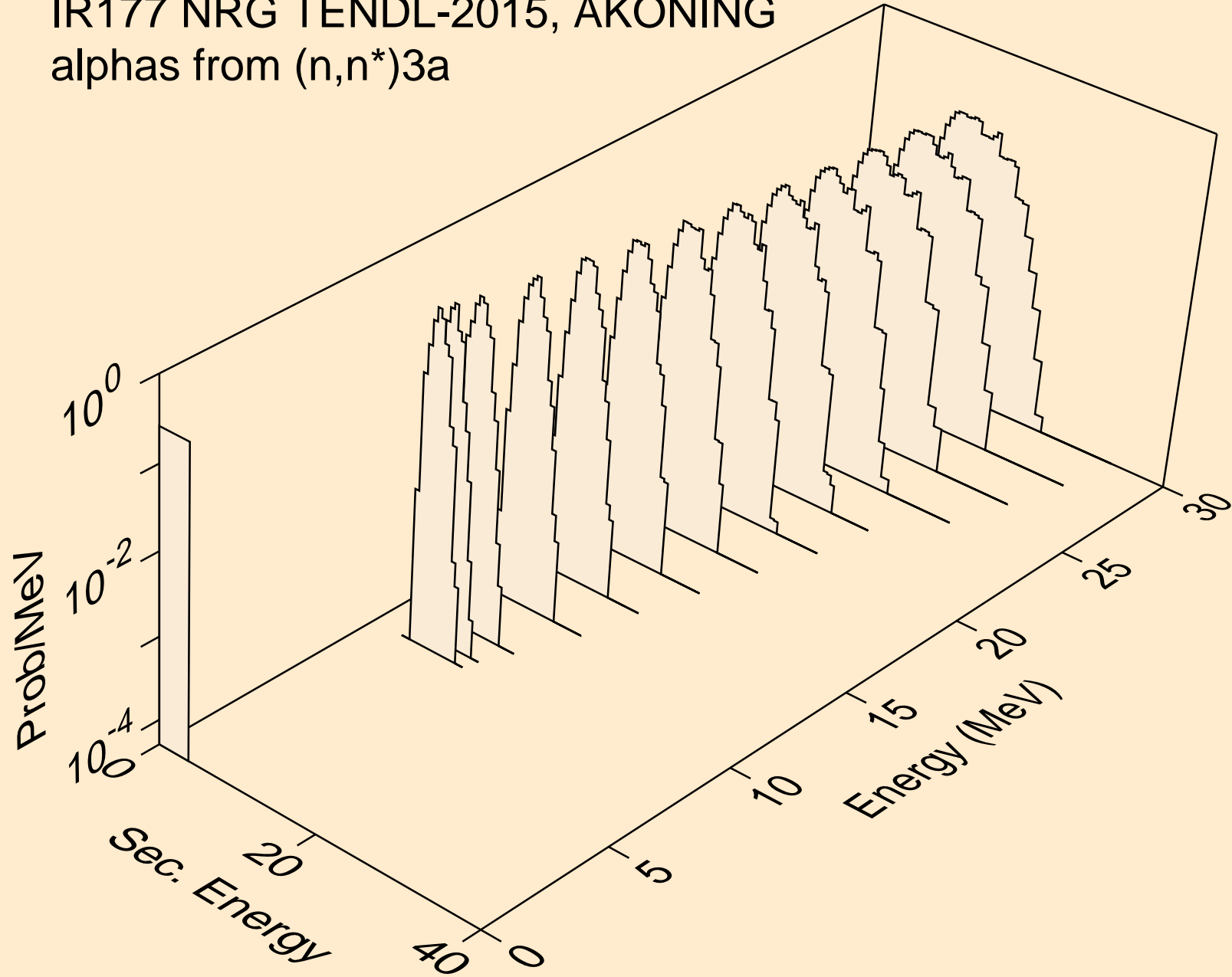

IR177 NRG TENDL-2015, AKONING  
alphas from (n,2n)a

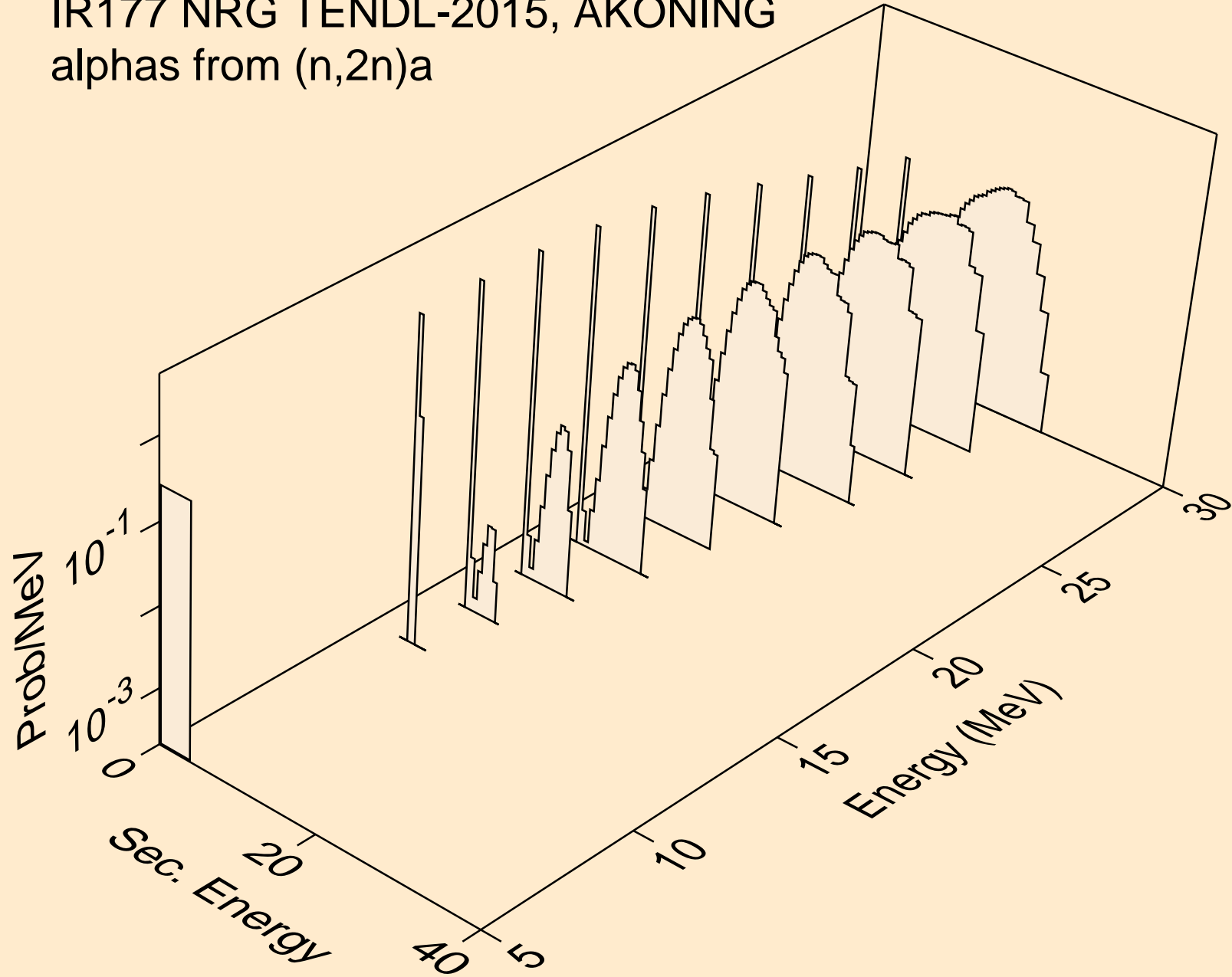

IR177 NRG TENDL-2015, AKONING  
alphas from (n,3n)a

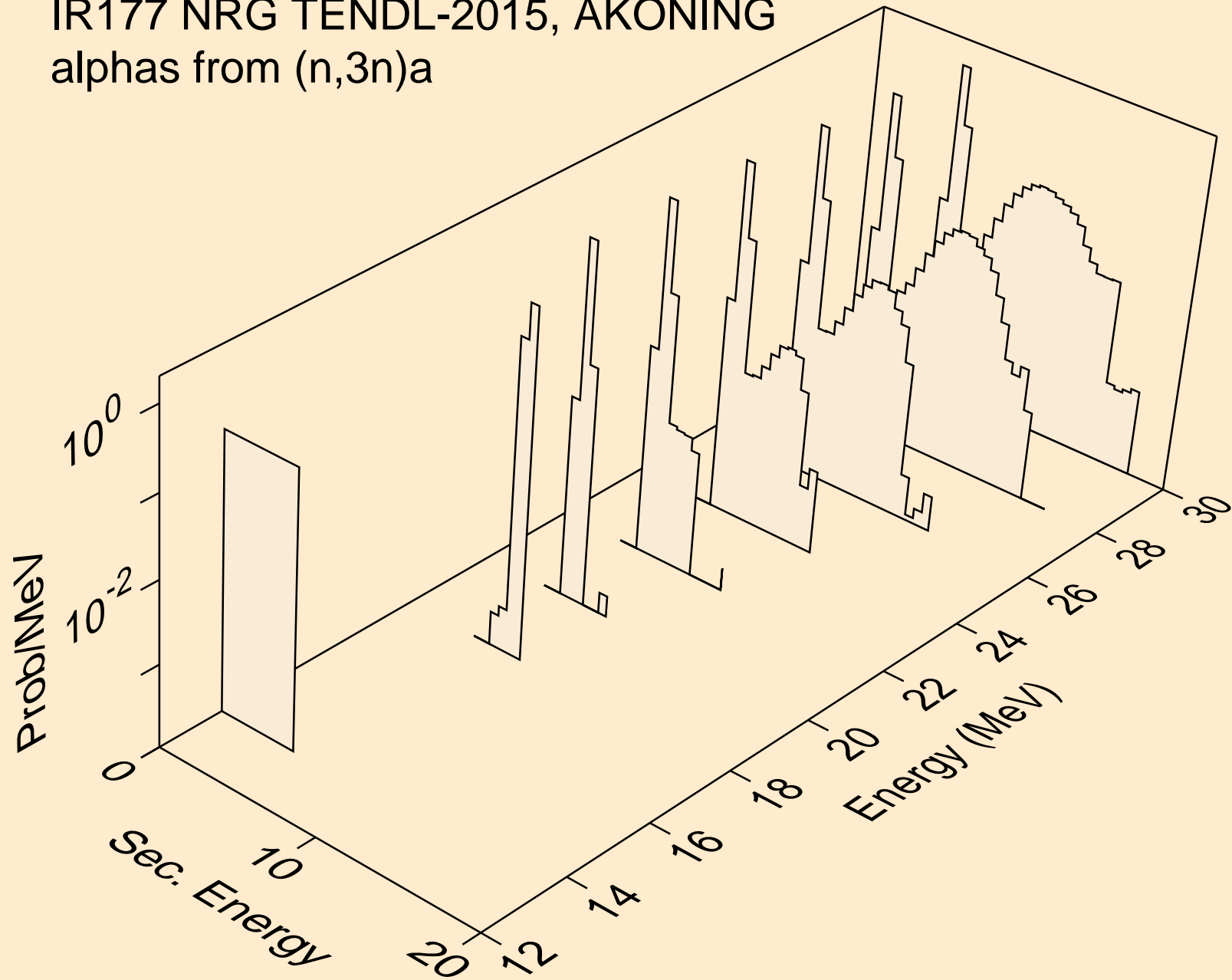



IR177 NRG TENDL-2015, AKONING  
alphas from (n,n\*)2a

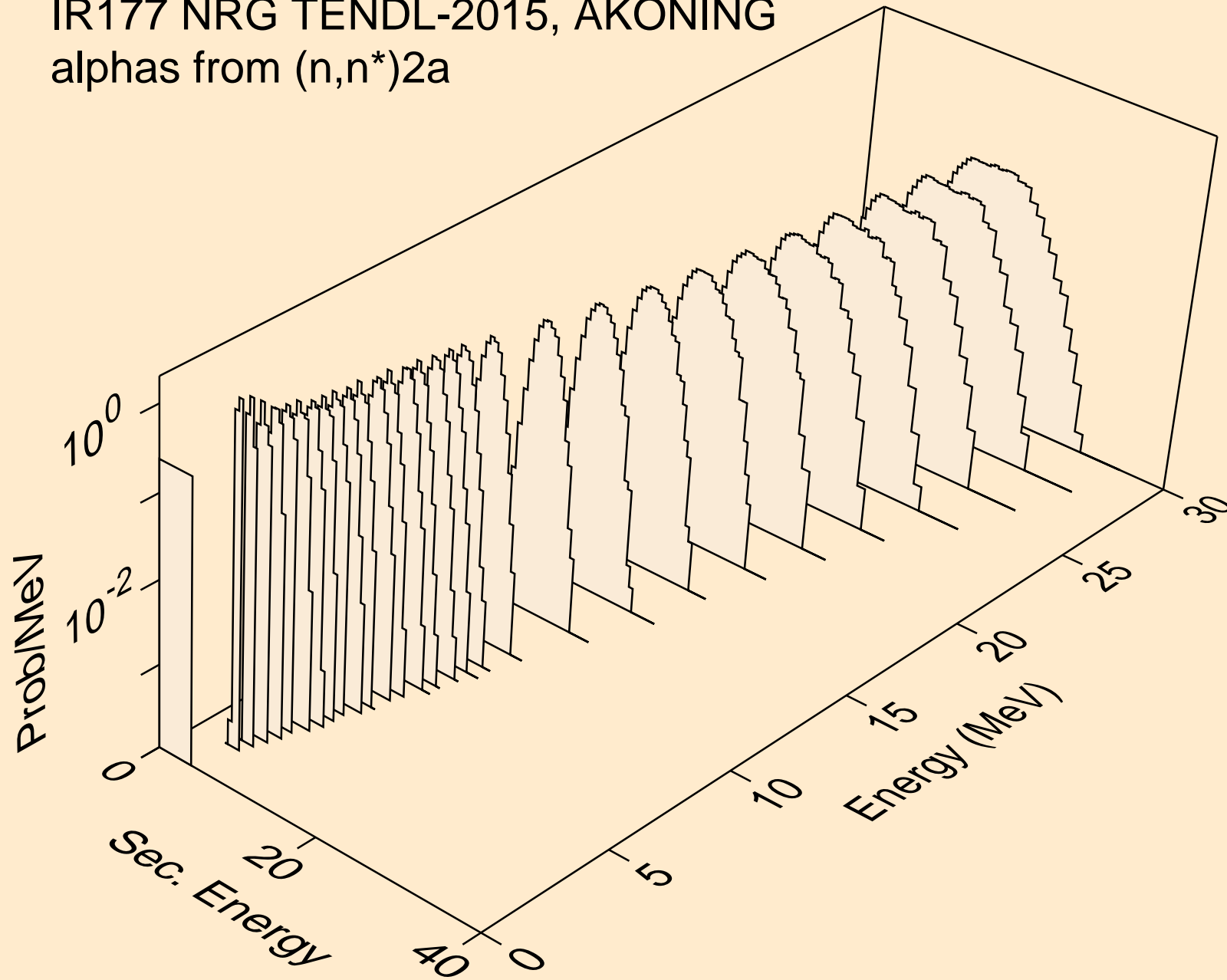

IR177 NRG TENDL-2015, AKONING  
alphas from (n,2n)2a

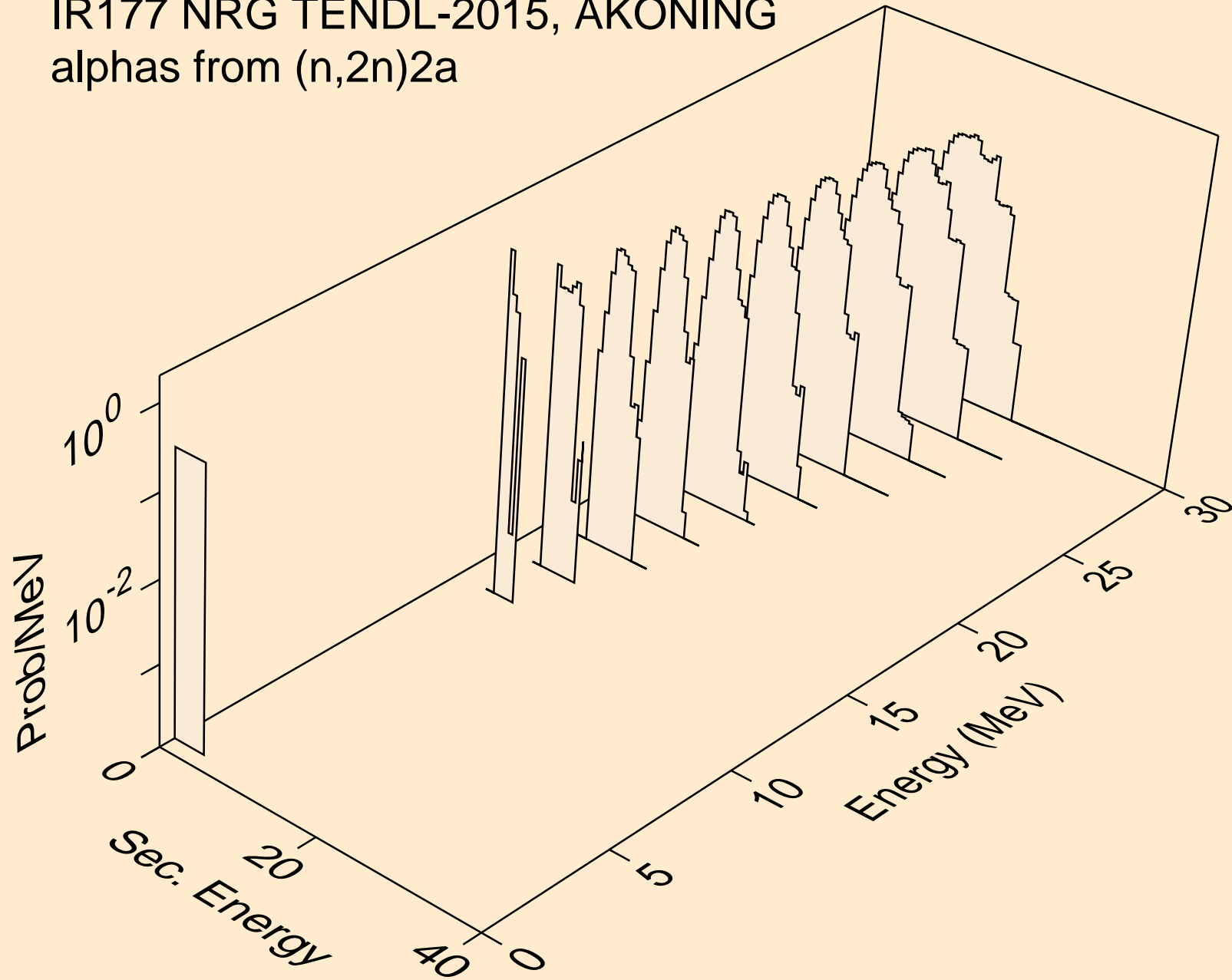

IR177 NRG TENDL-2015, AKONING  
alphas from (n,npa)

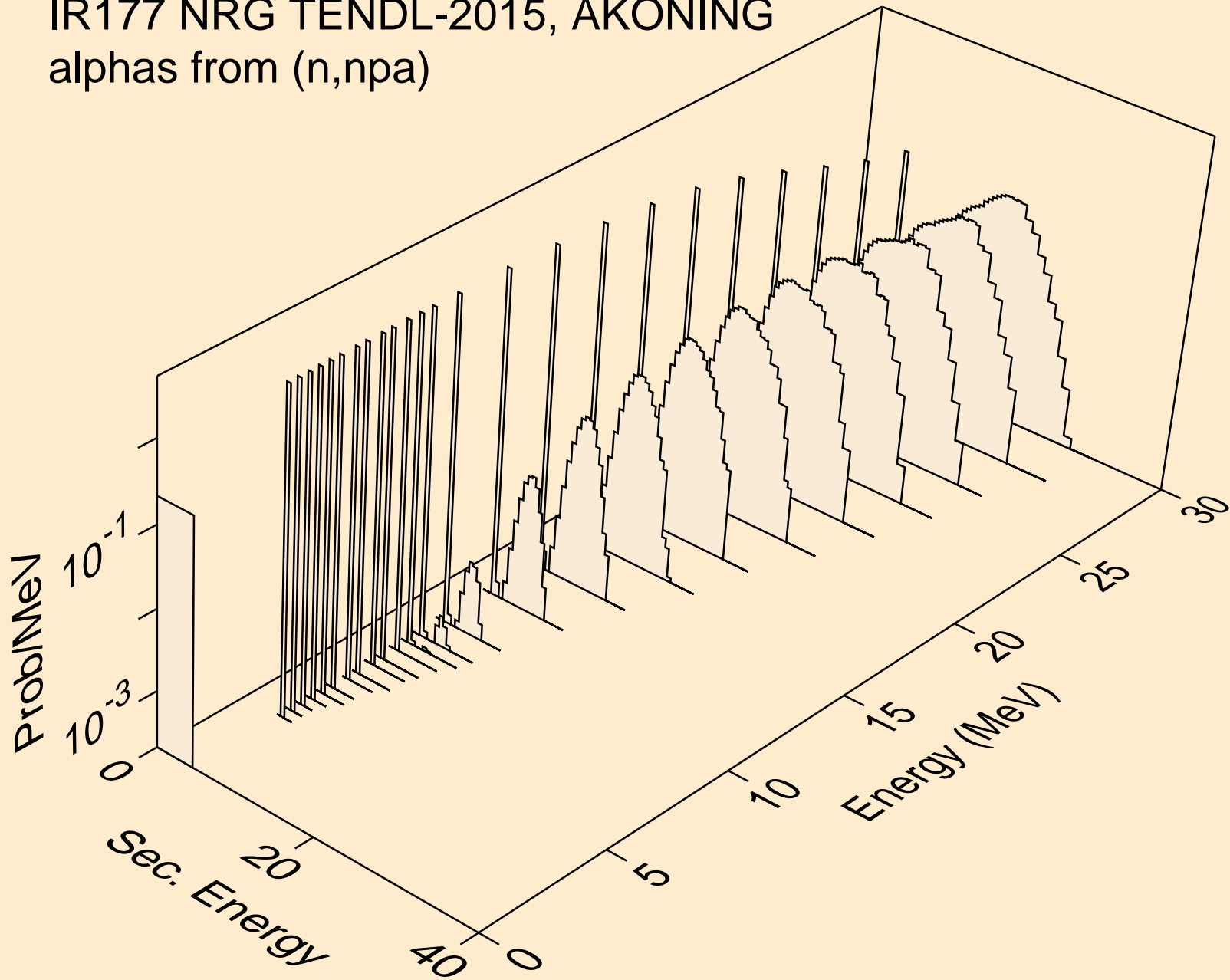

IR177 NRG TENDL-2015, AKONING  
alphas from (n,a)

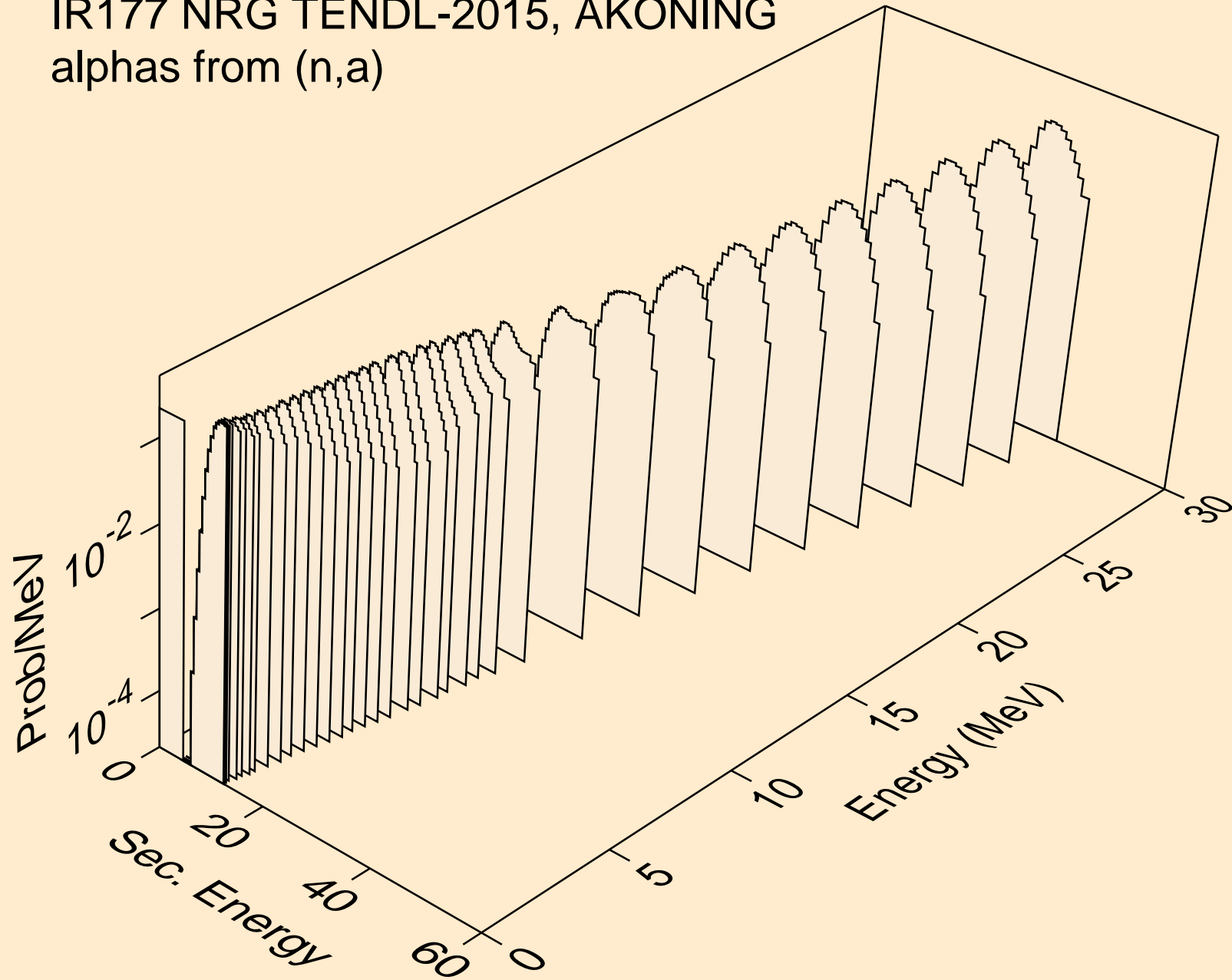

IR177 NRG TENDL-2015, AKONING  
alphas from (n,2a)

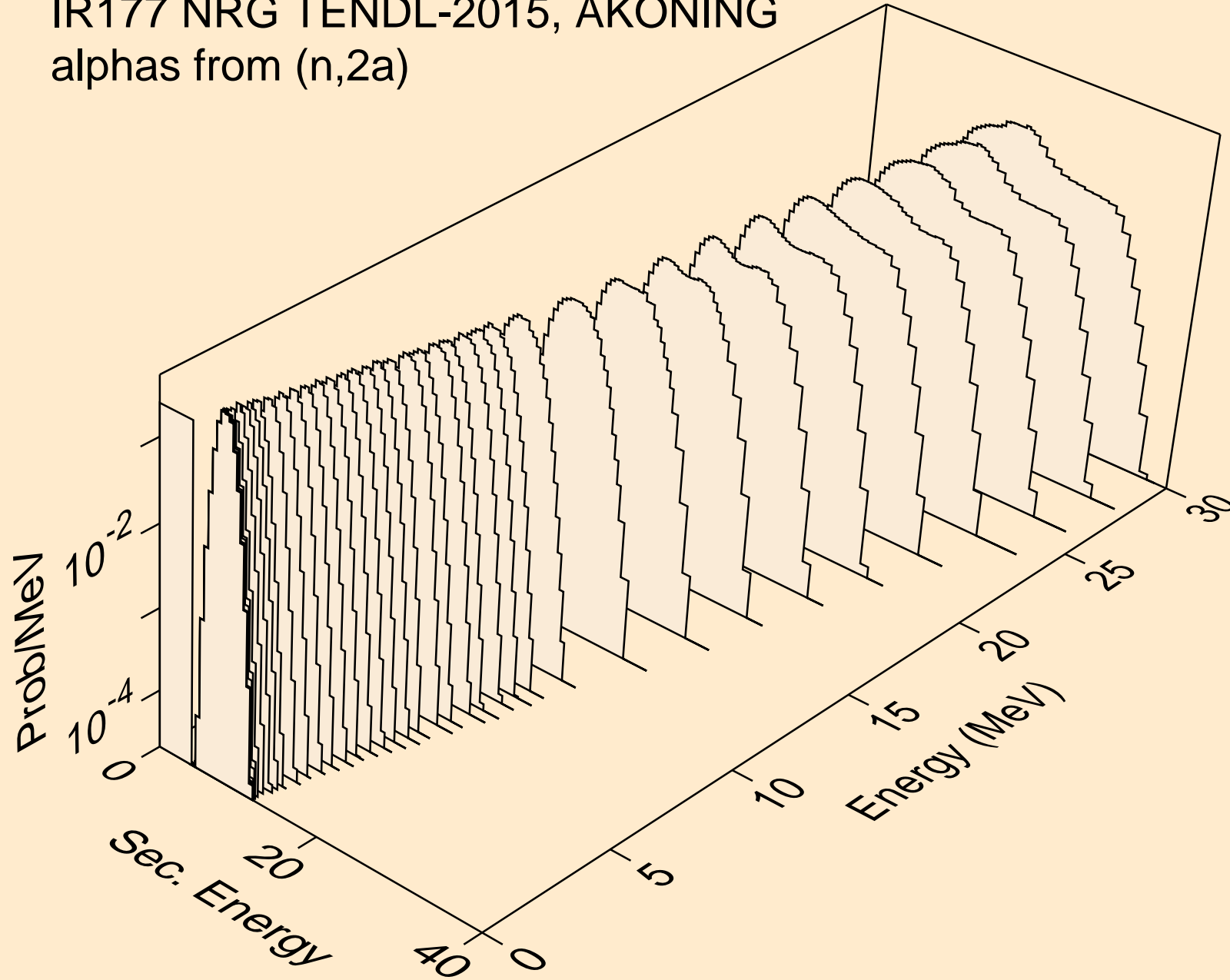

IR177 NRG TENDL-2015, AKONING  
alphas from (n,3a)

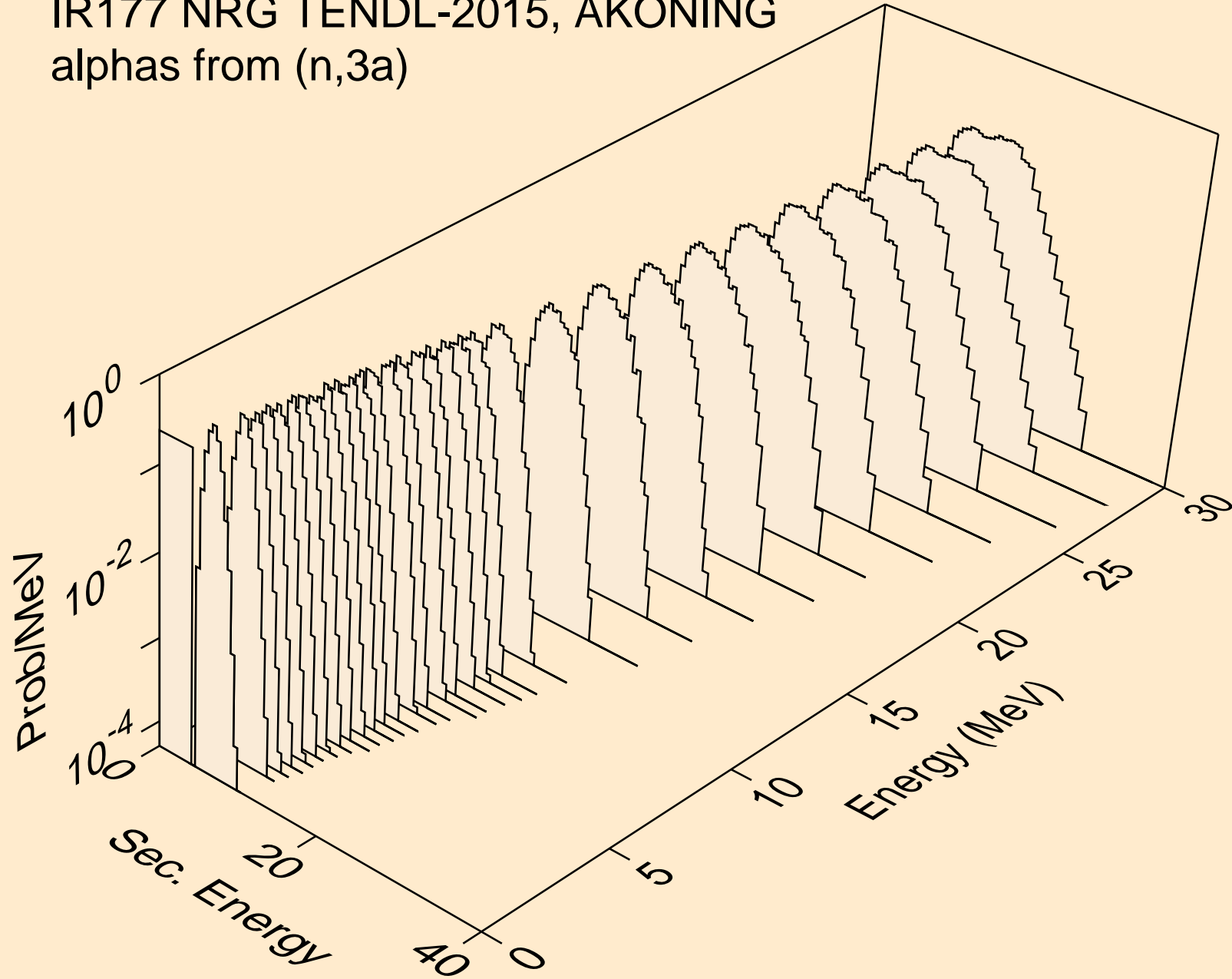

IR177 NRG TENDL-2015, AKONING  
alphas from (n,pa)

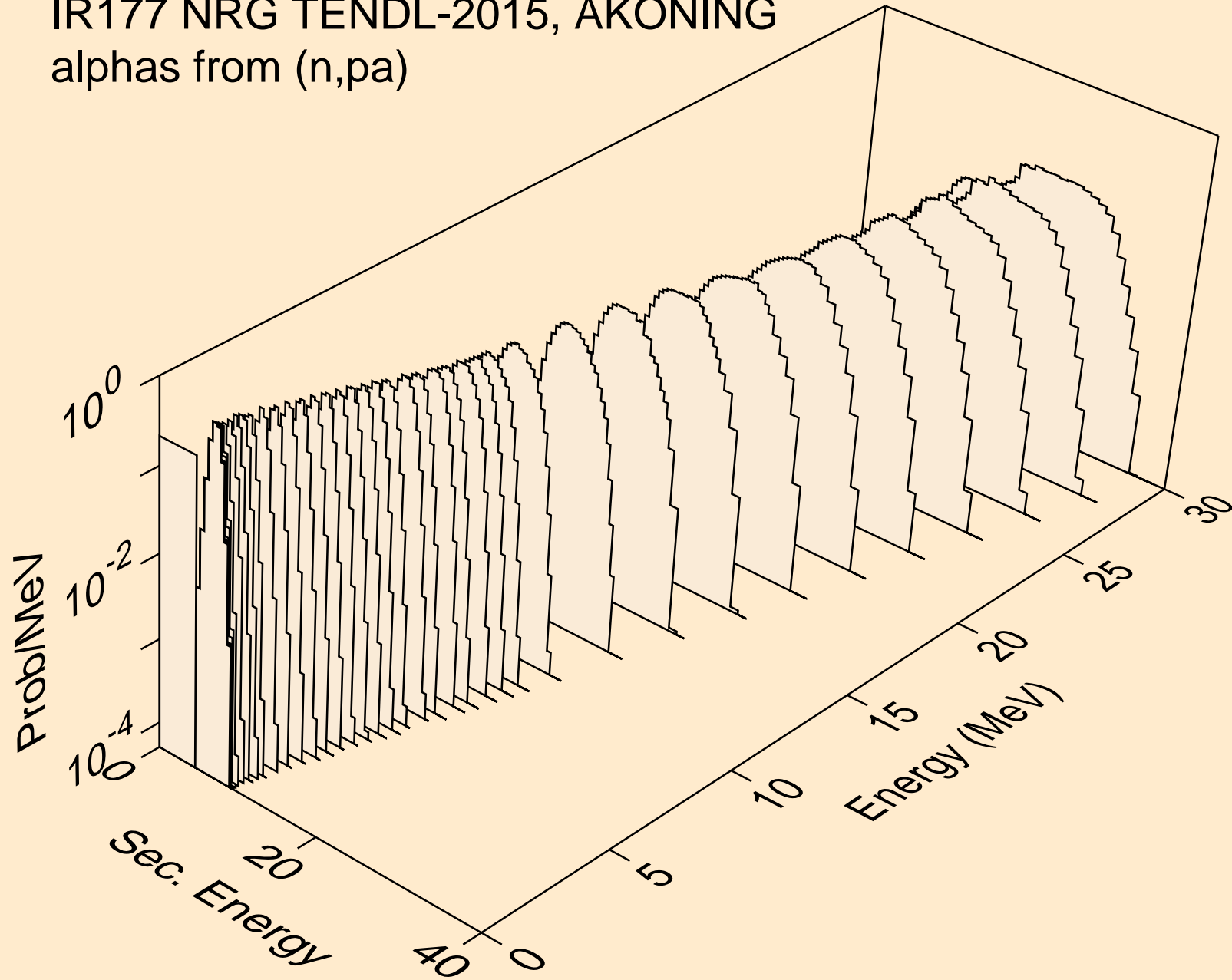

IR177 NRG TENDL-2015, AKONING  
alphas from (n,t2a)

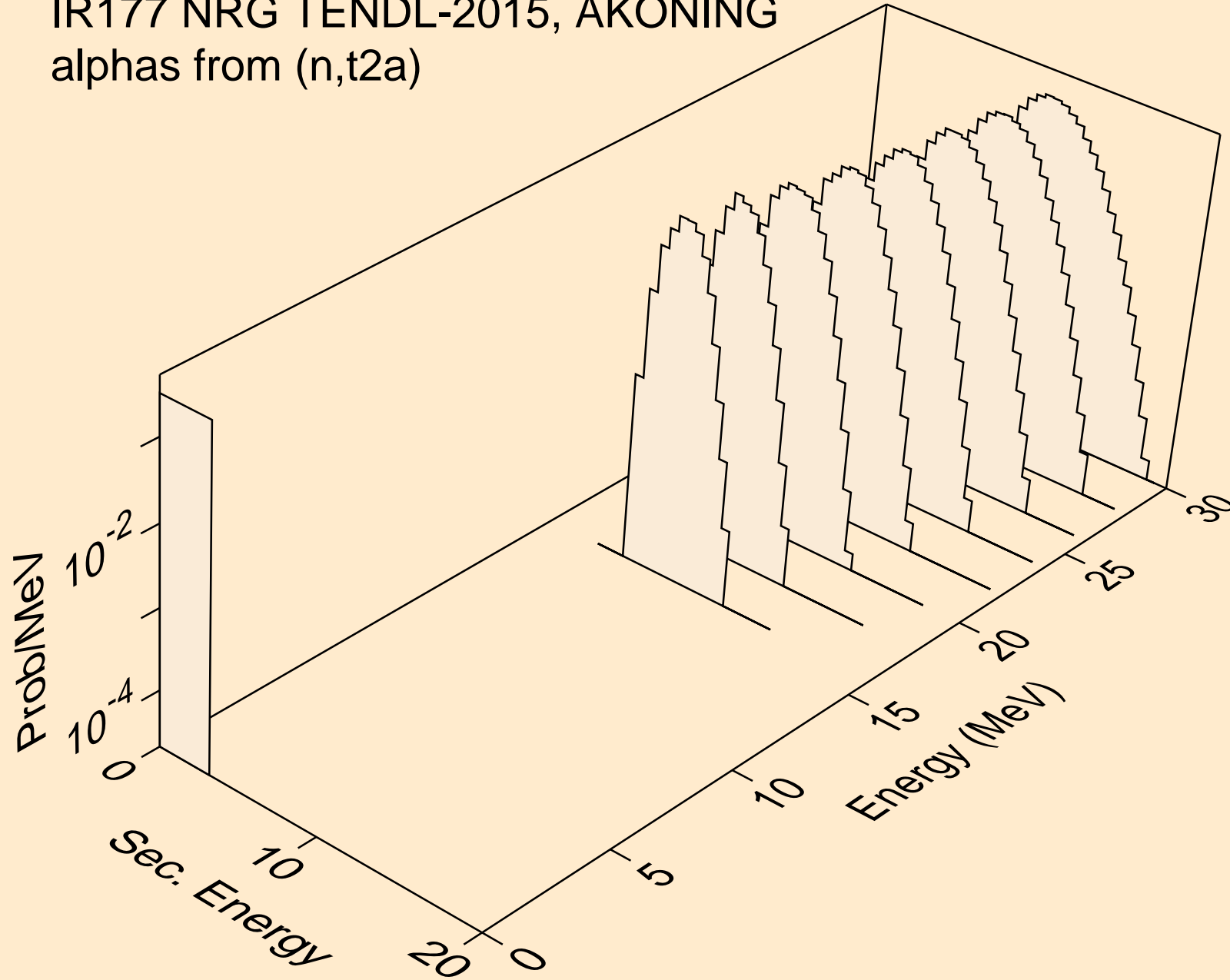



IR177 NRG TENDL-2015, AKONING  
alphas from (n,d2a)

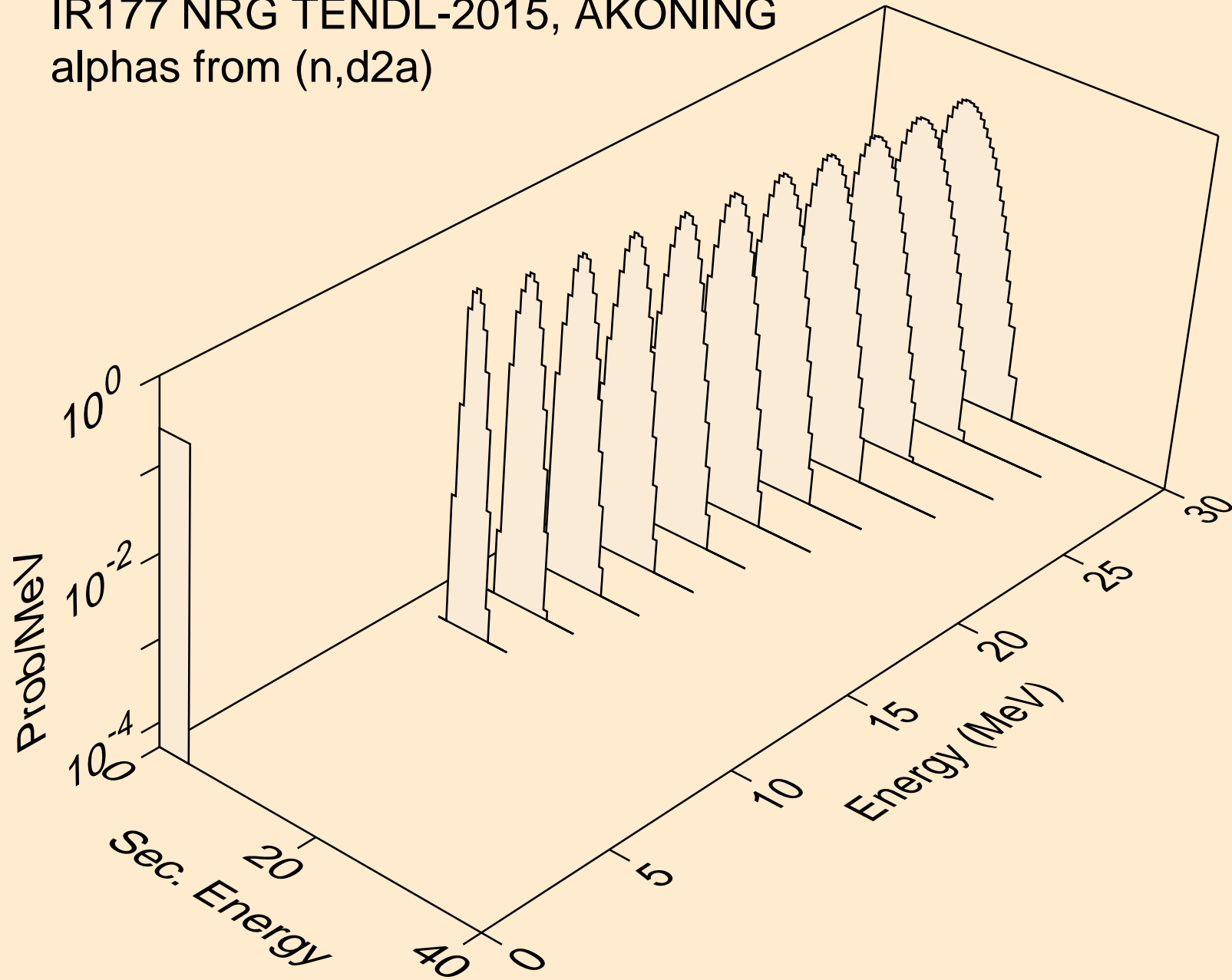

IR177 NRG TENDL-2015, AKONING  
alphas from (n,da)

