

# LA120 NRG TENDL-2015, AKONING

## Principal cross sections

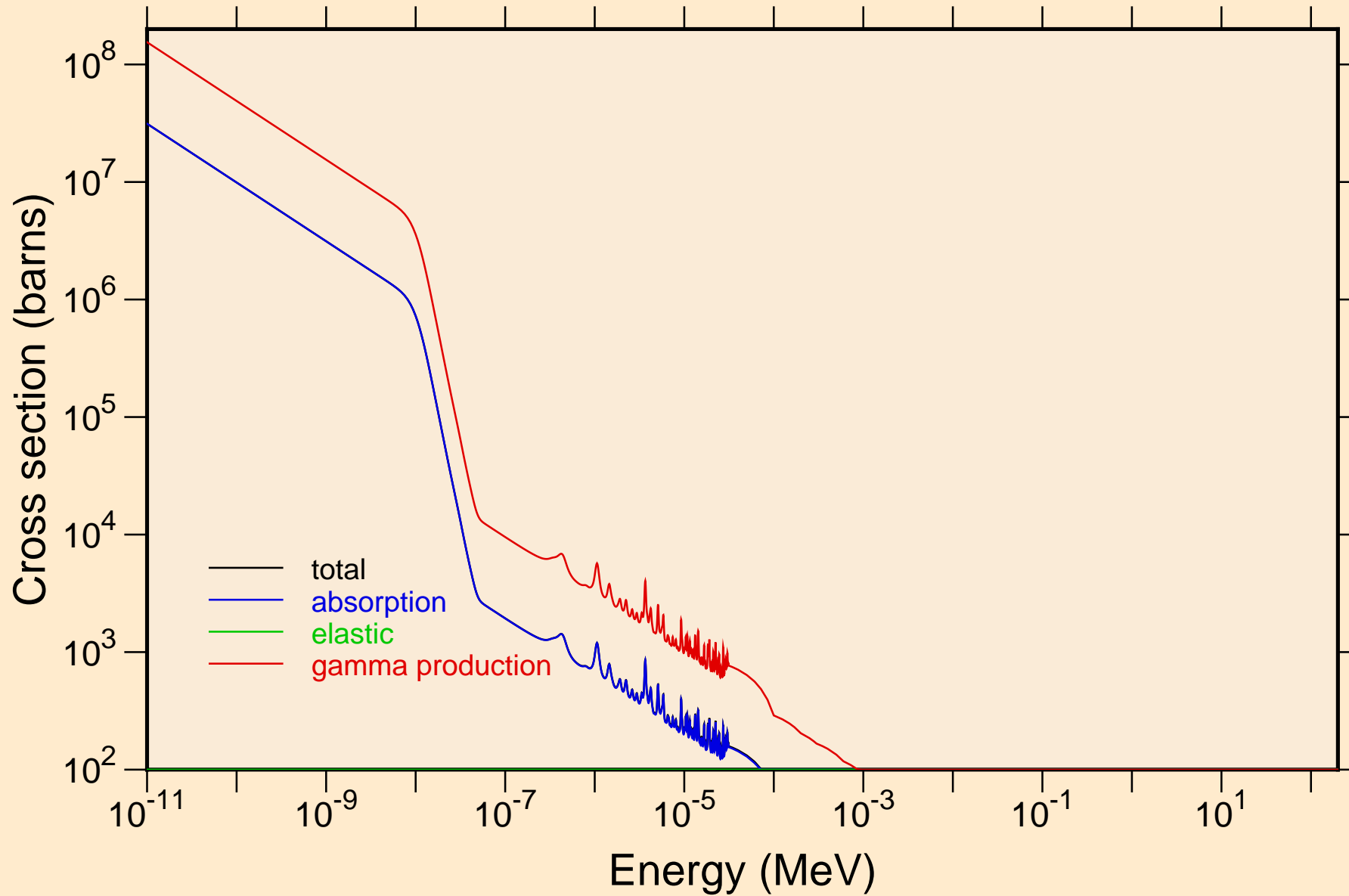

LA120 NRG TENDL-2015, AKONING  
resonance total cross section

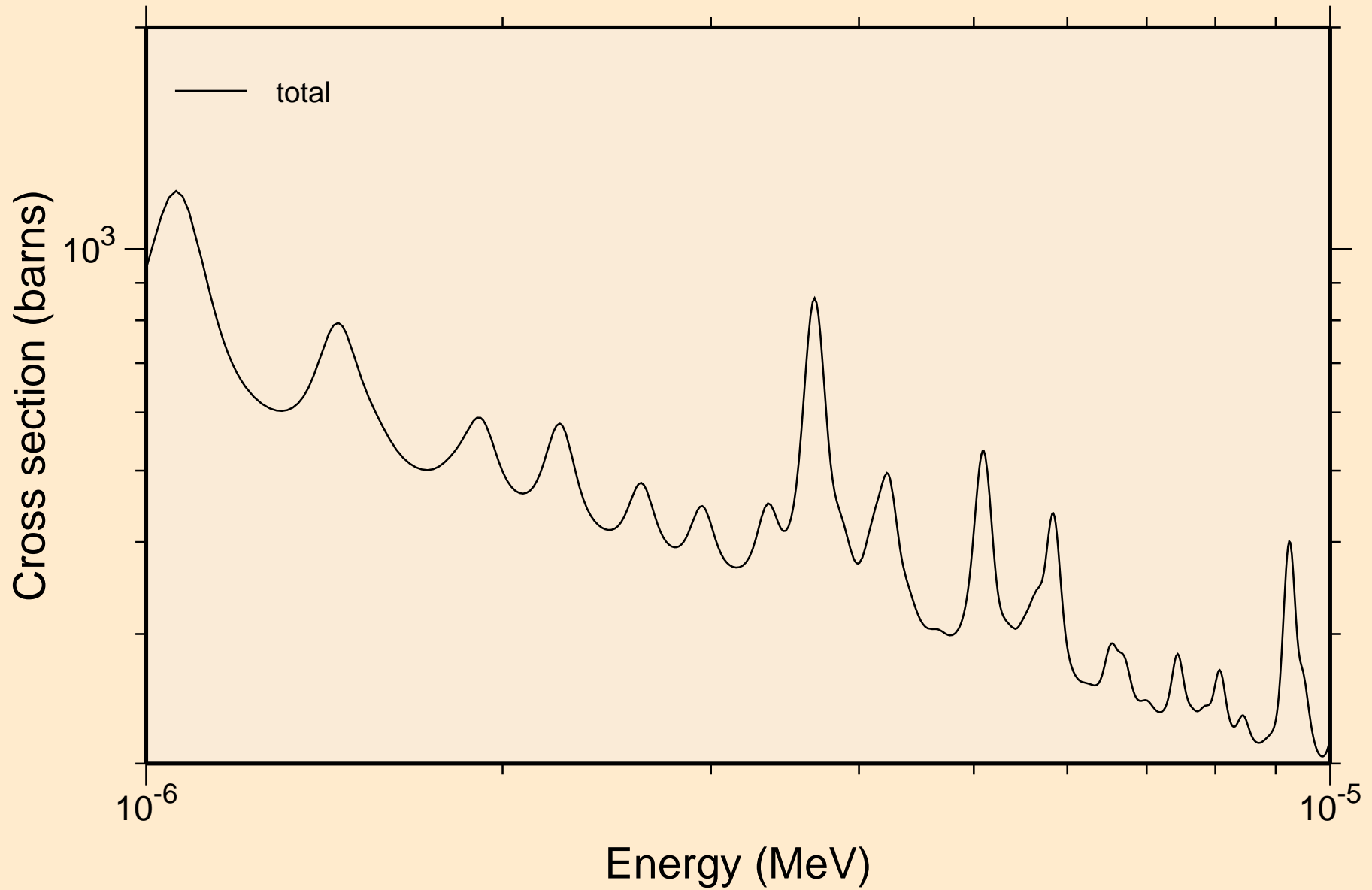

LA120 NRG TENDL-2015, AKONING  
resonance total cross section

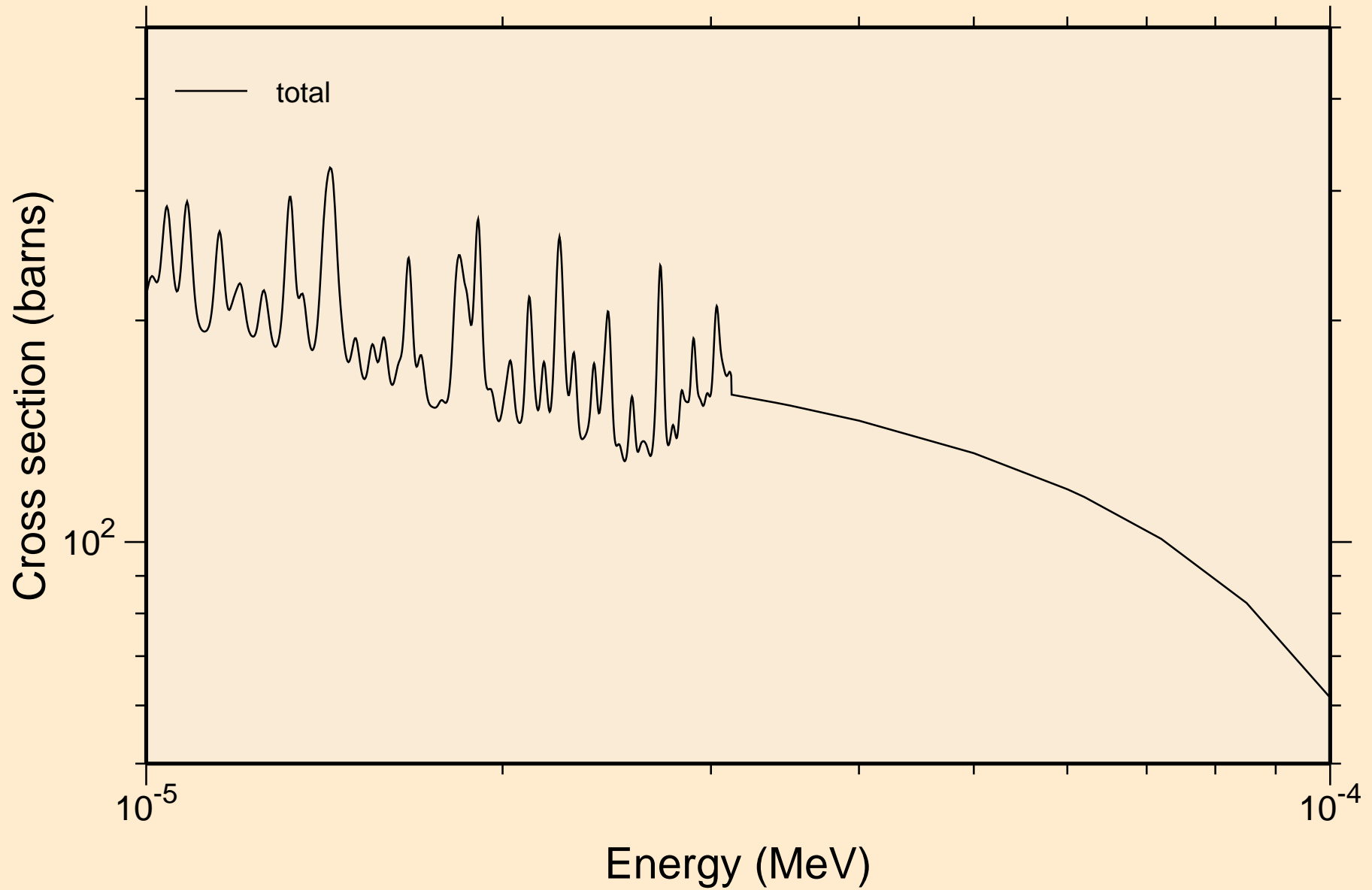

LÄ120 NRG TENDL-2015, AKONING  
resonance total cross section

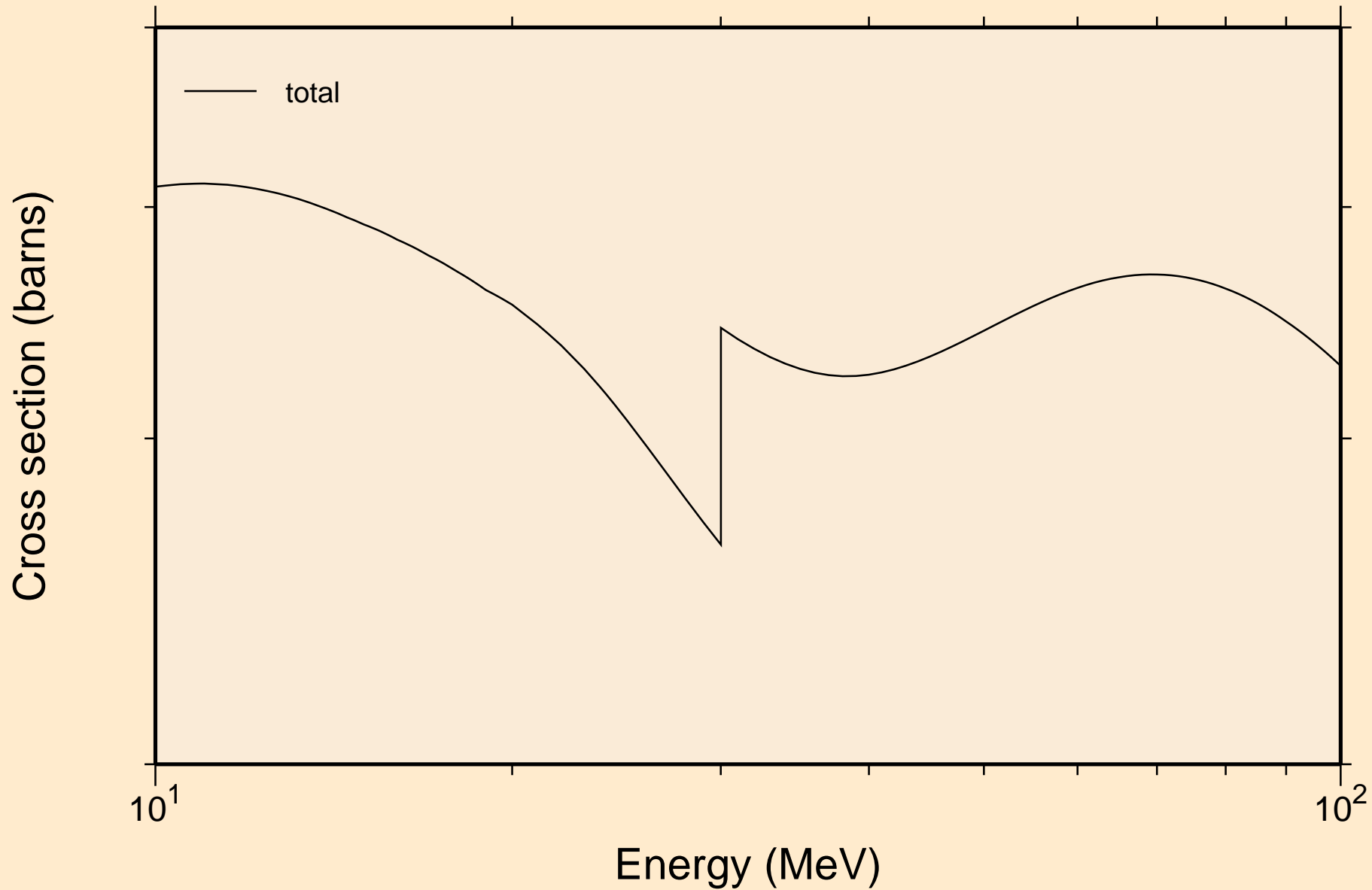

LA120 NRG TENDL-2015, AKONING  
resonance absorption cross sections

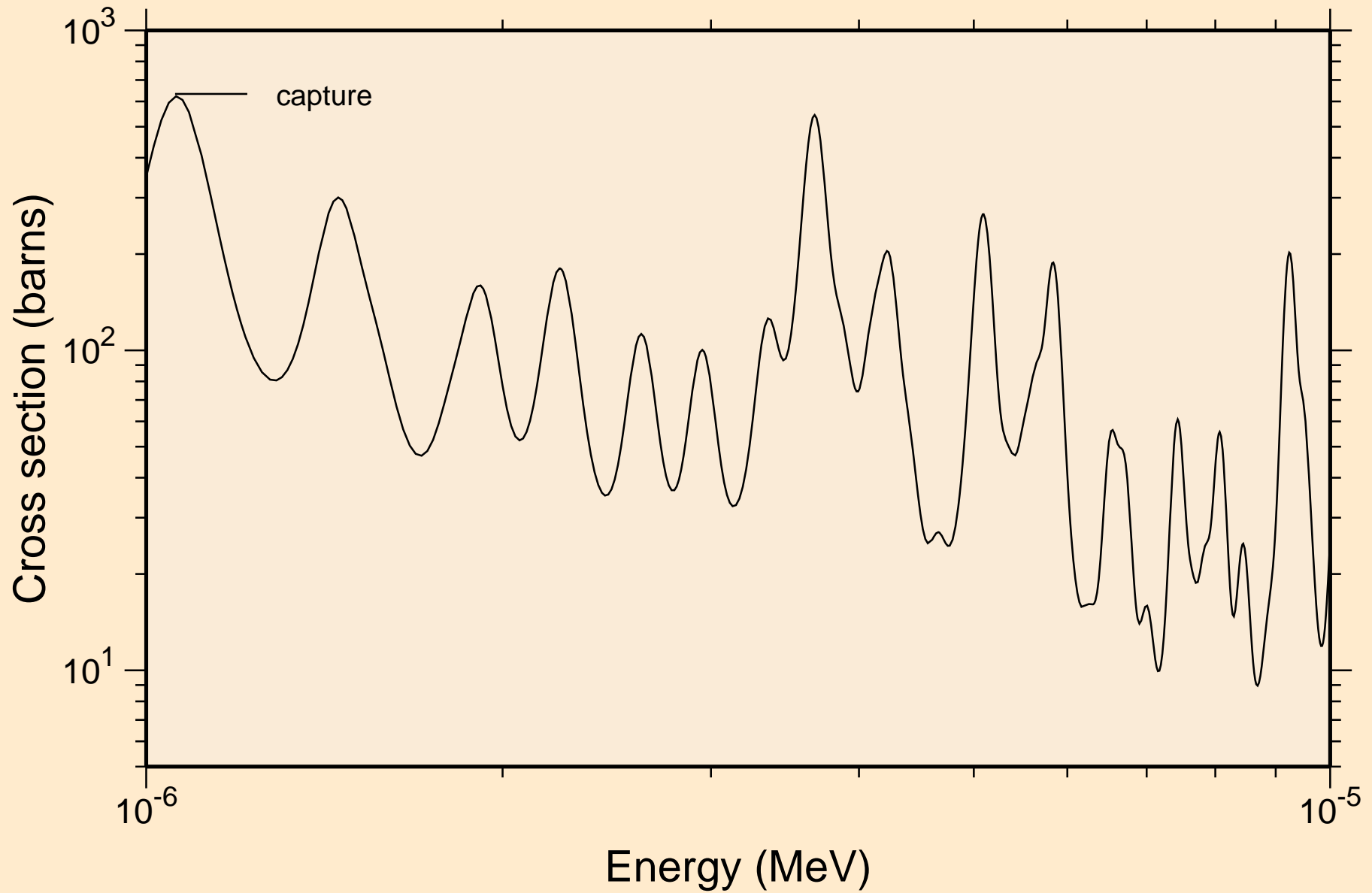

LA120 NRG TENDL-2015, AKONING  
resonance absorption cross sections

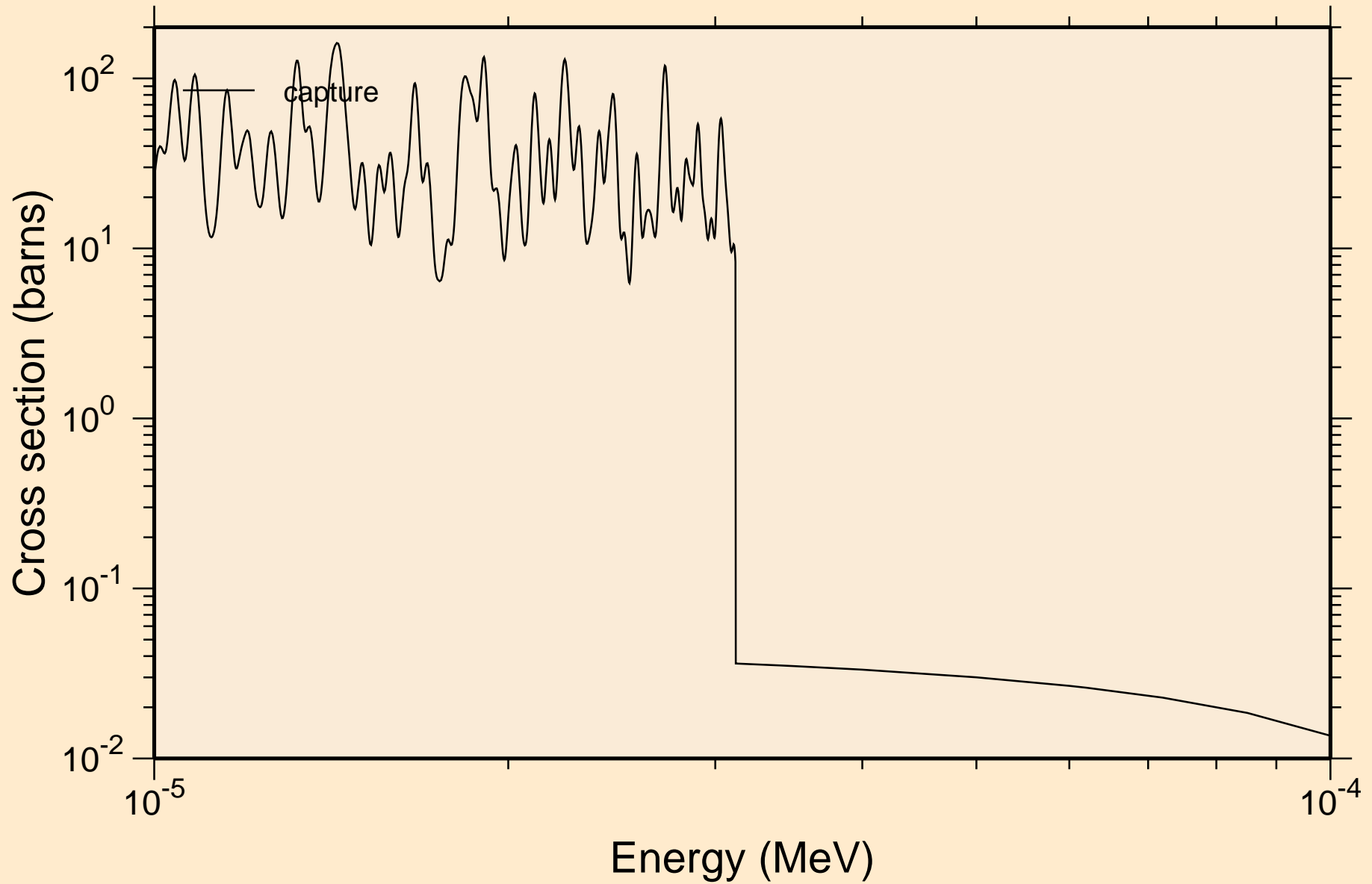

LA120 NRG TENDL-2015, AKONING  
resonance absorption cross sections

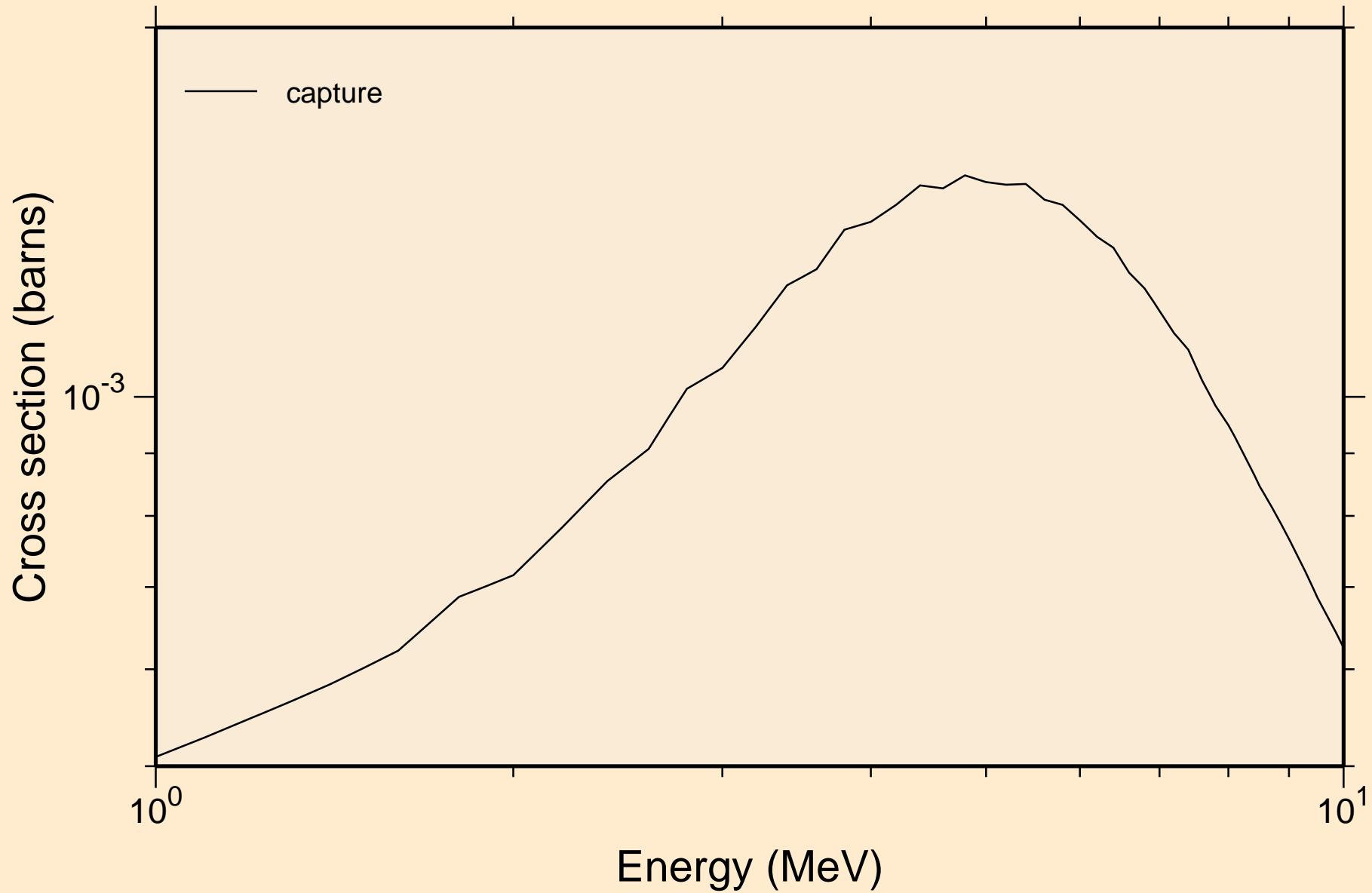

# LA120 NRG TENDL-2015, AKONING

## Non-threshold reactions

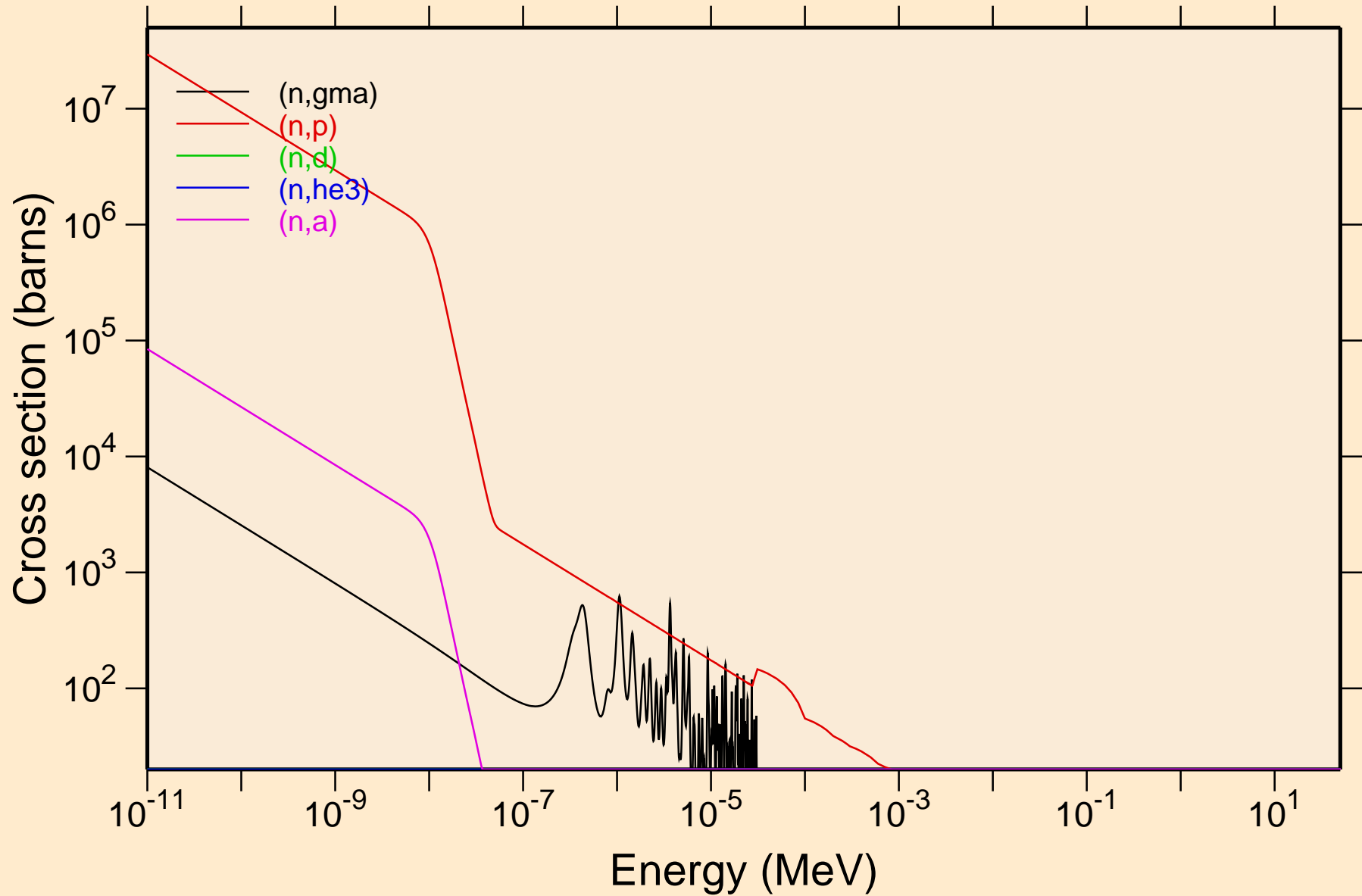



# LA120 NRG TENDL-2015, AKONING

## Non-threshold reactions

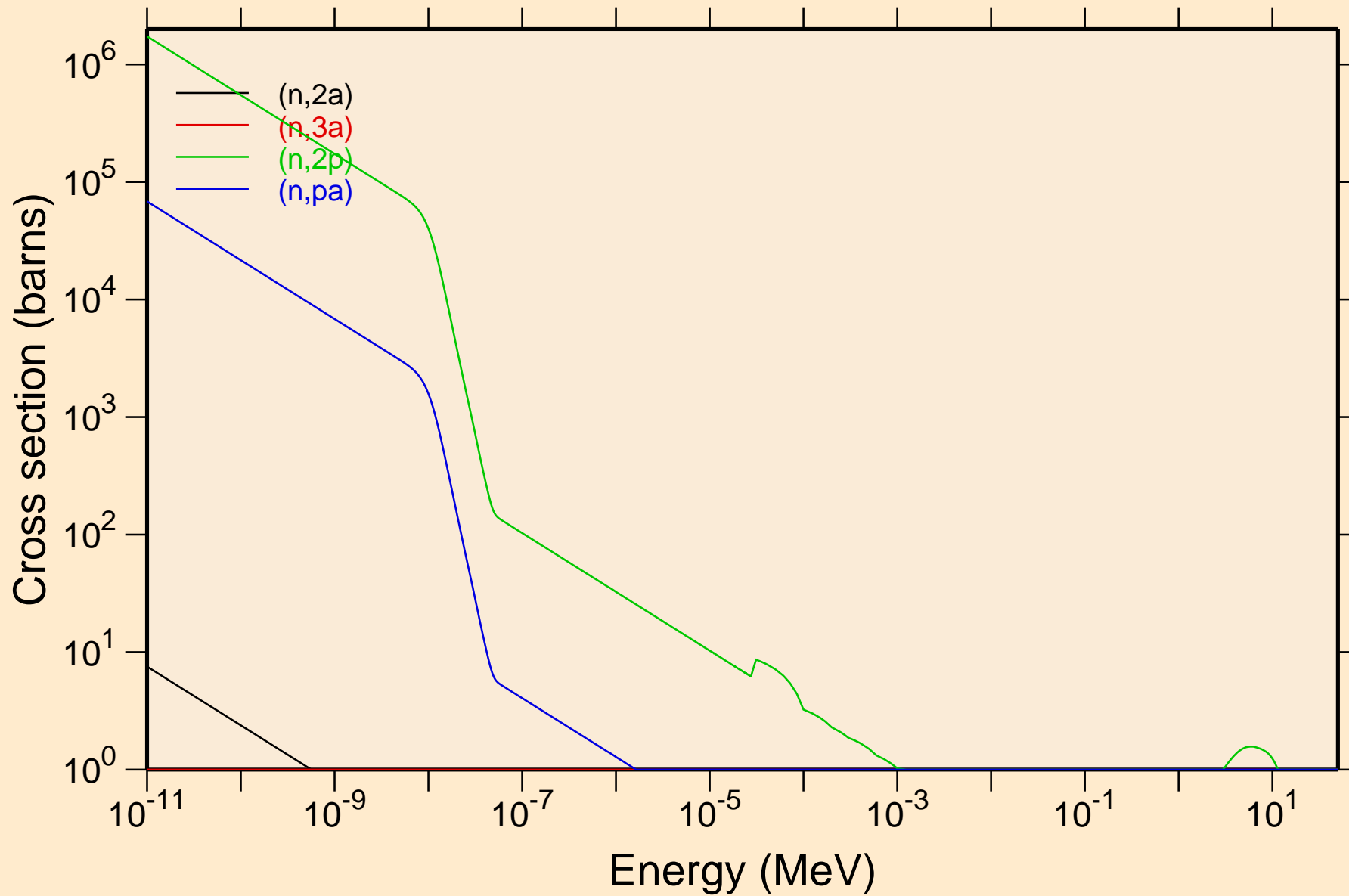

# LA120 NRG TENDL-2015, AKONING

## Principal cross sections

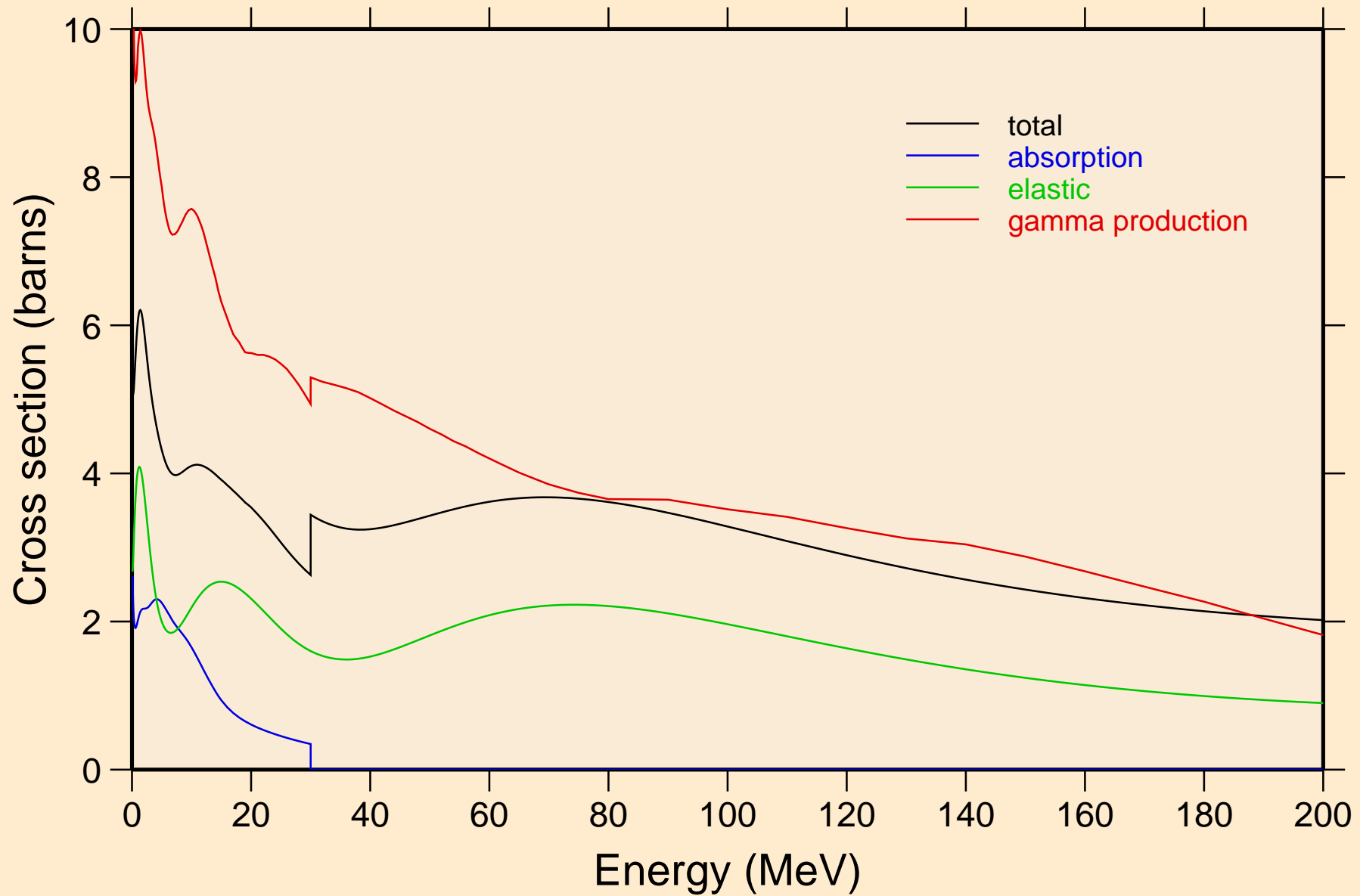

# LA120 NRG TENDL-2015, AKONING

## Non-threshold reactions

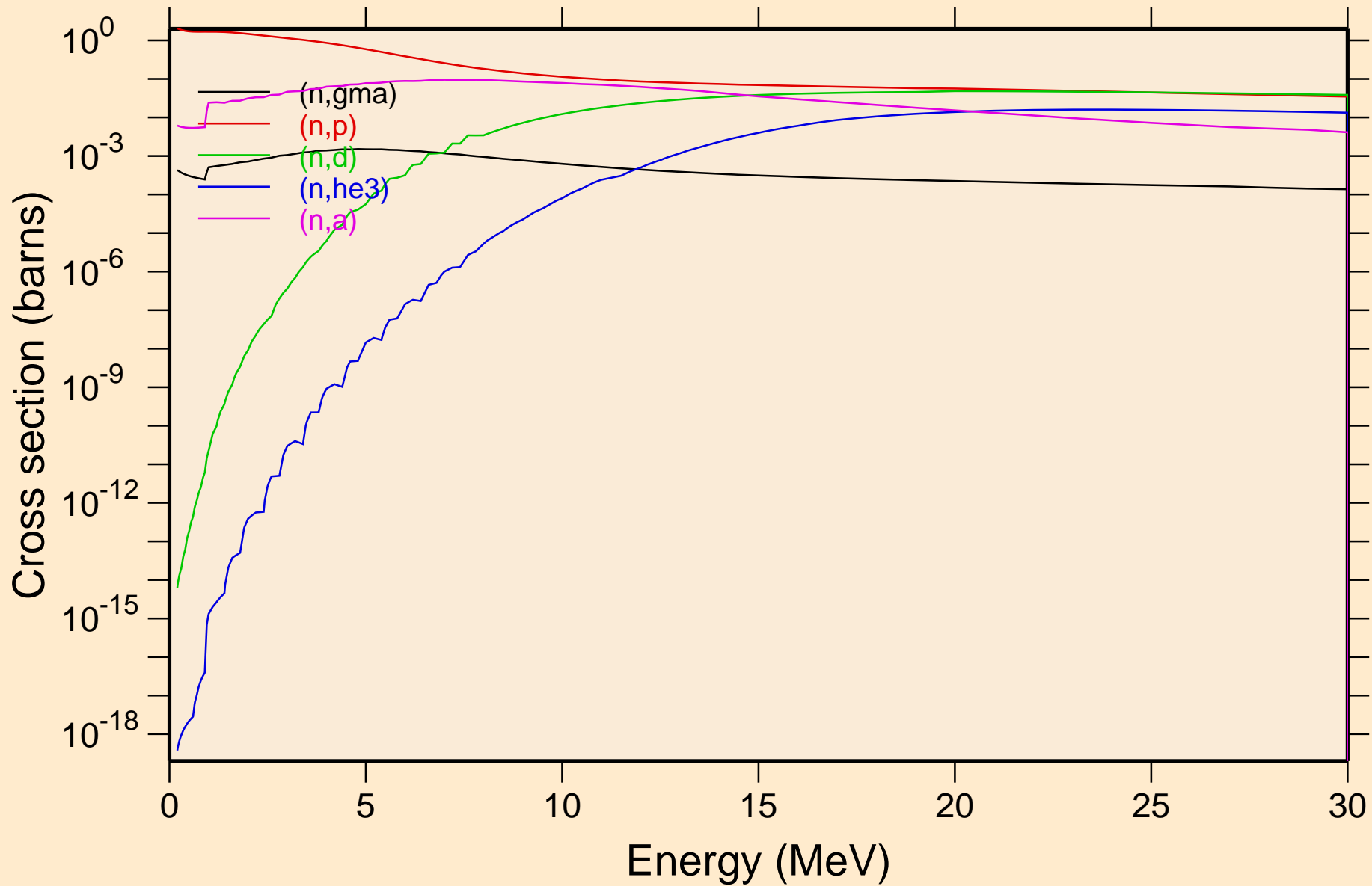

# LA120 NRG TENDL-2015, AKONING

## Non-threshold reactions

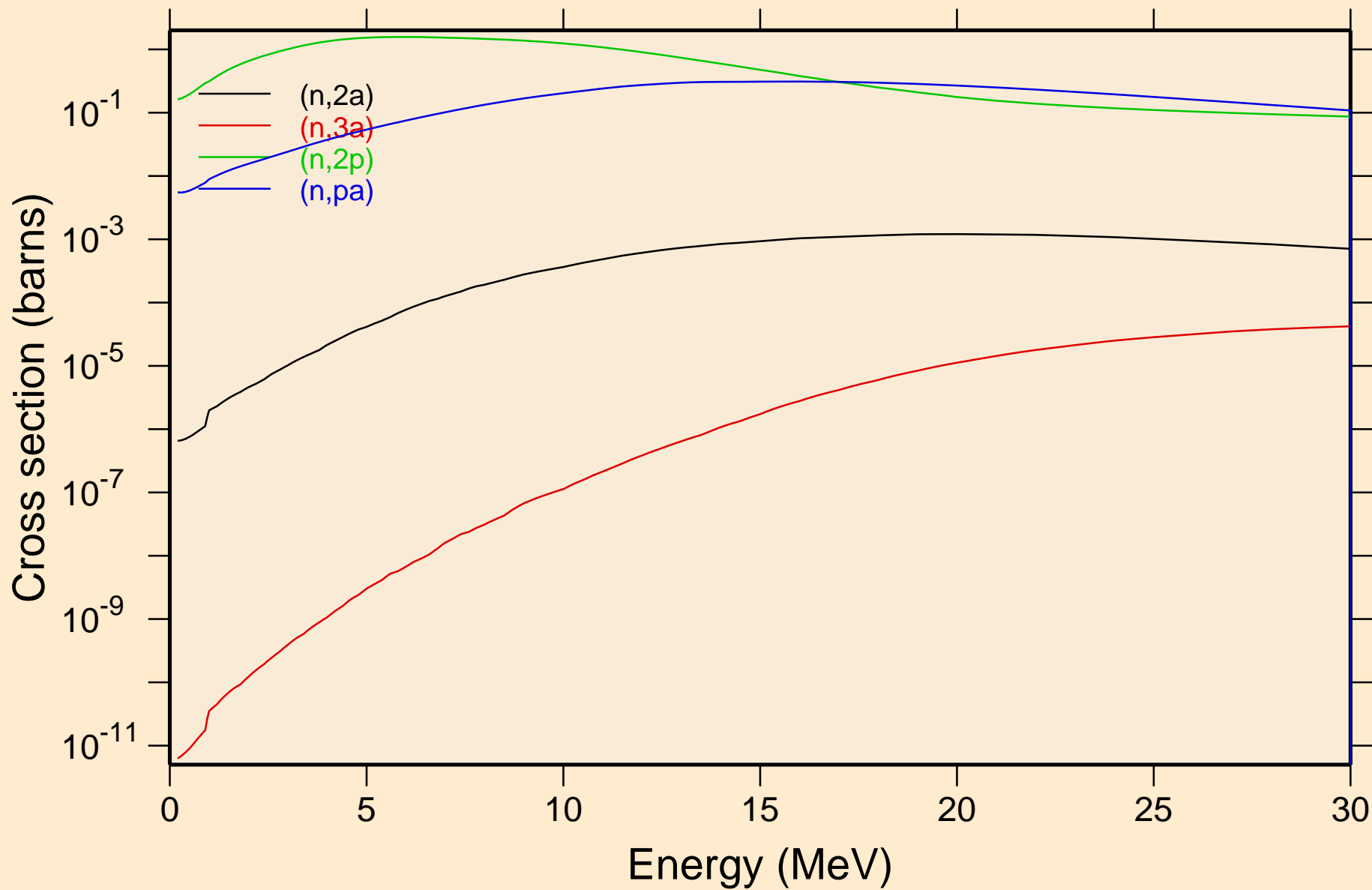

LA120 NRG TENDL-2015, AKONING  
Inelastic levels

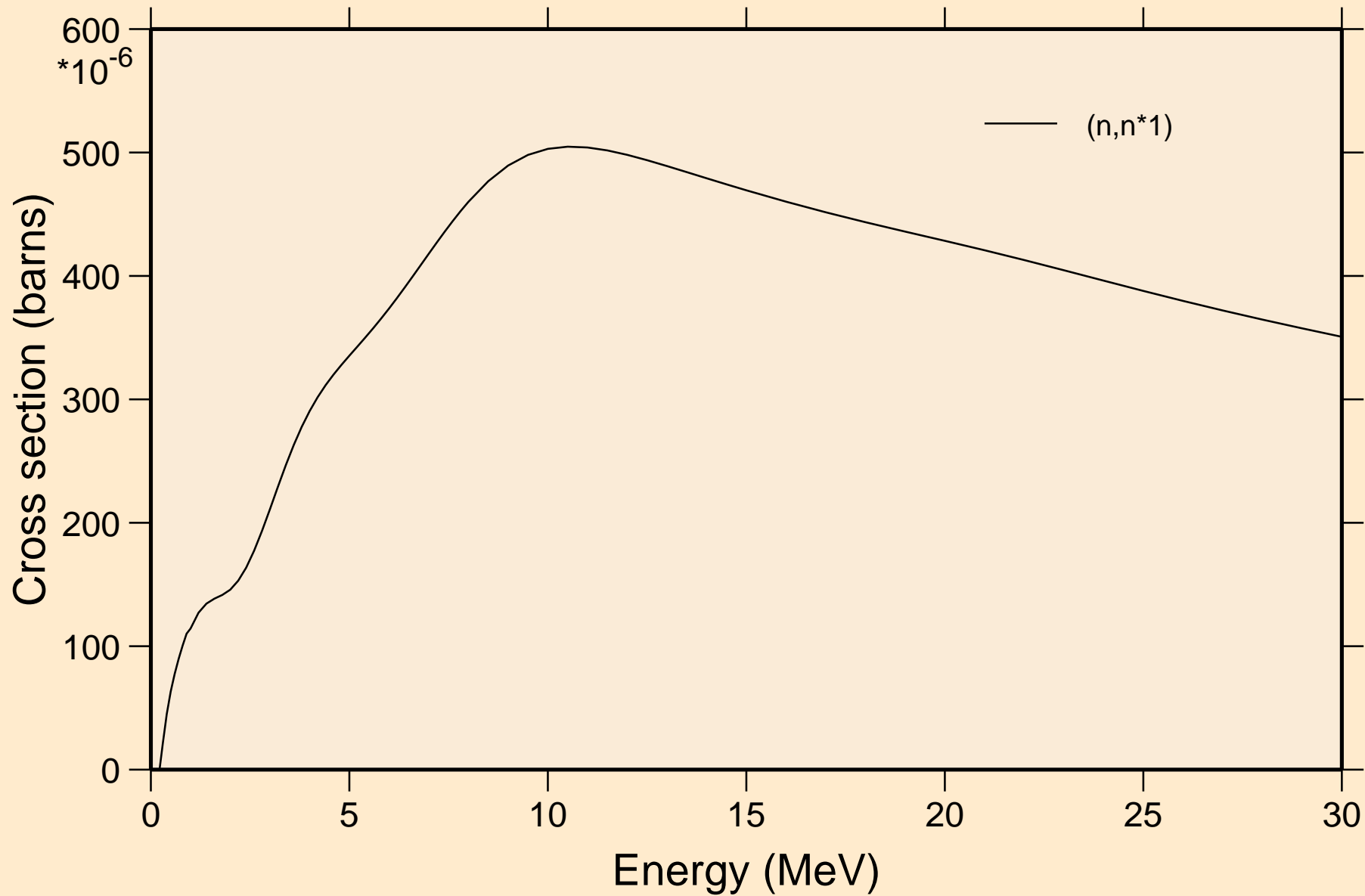

# LA120 NRG TENDL-2015, AKONING

## Threshold reactions

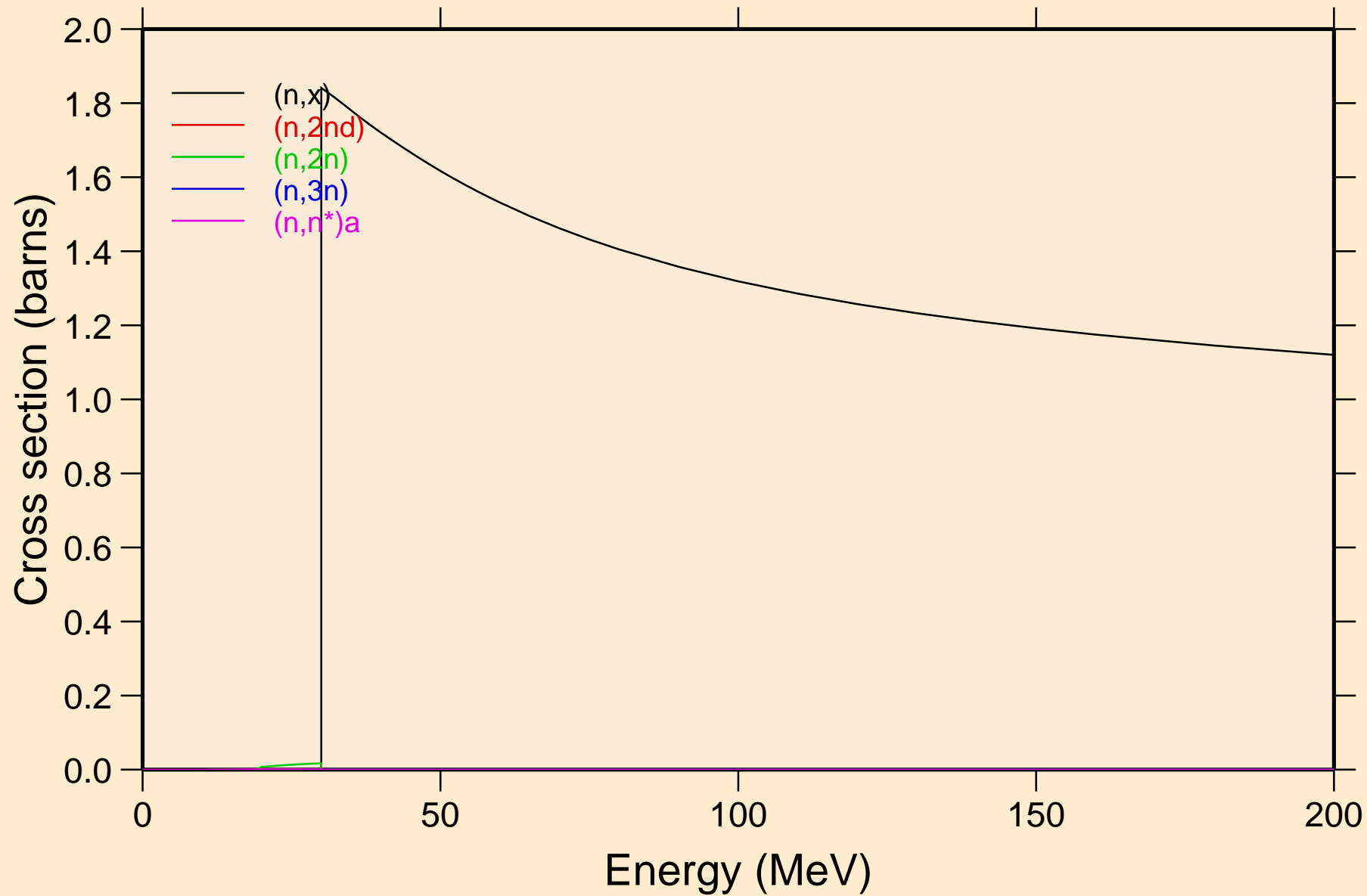

# LA120 NRG TENDL-2015, AKONING

## Threshold reactions

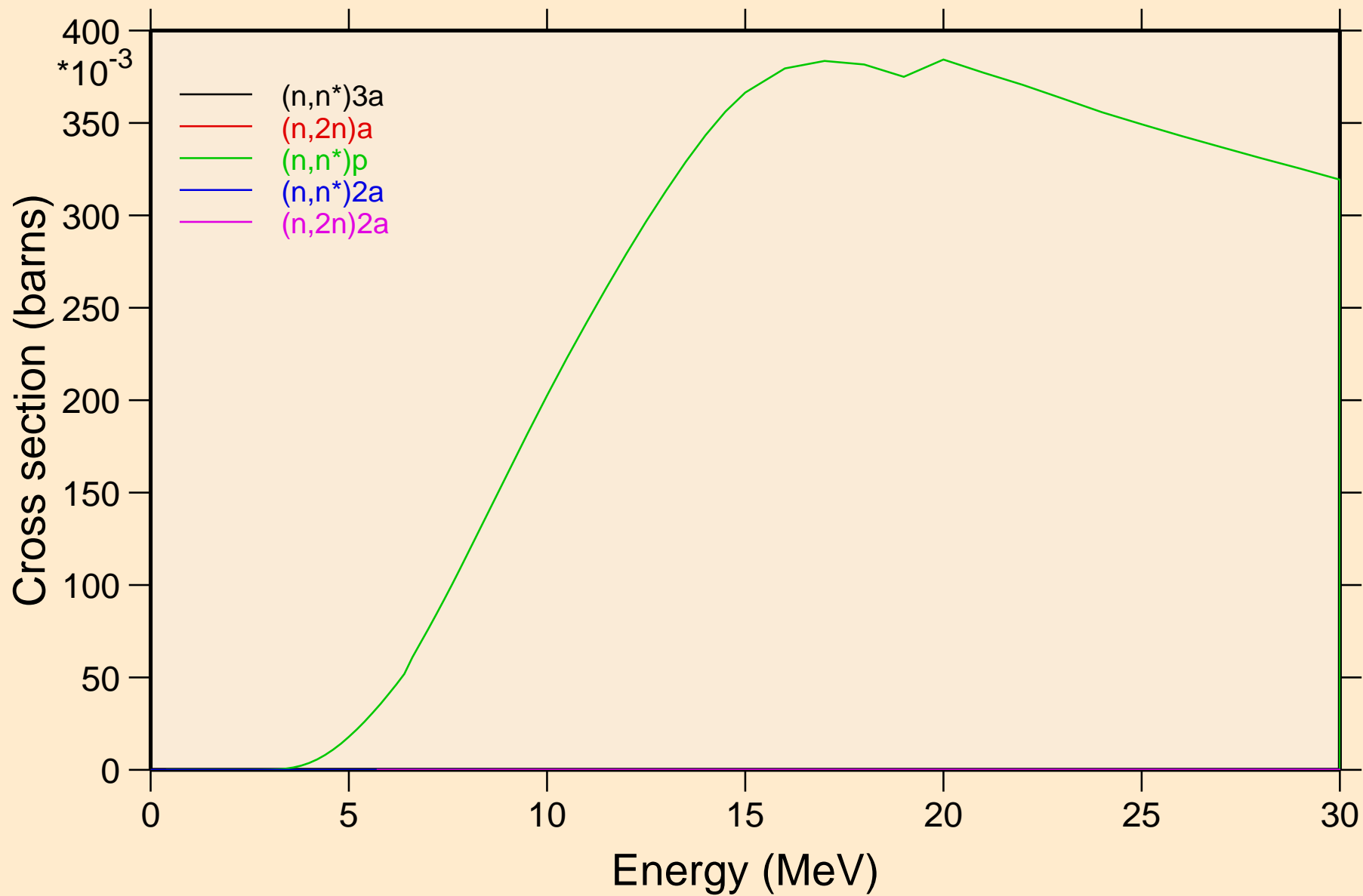

# LA120 NRG TENDL-2015, AKONING

## Threshold reactions

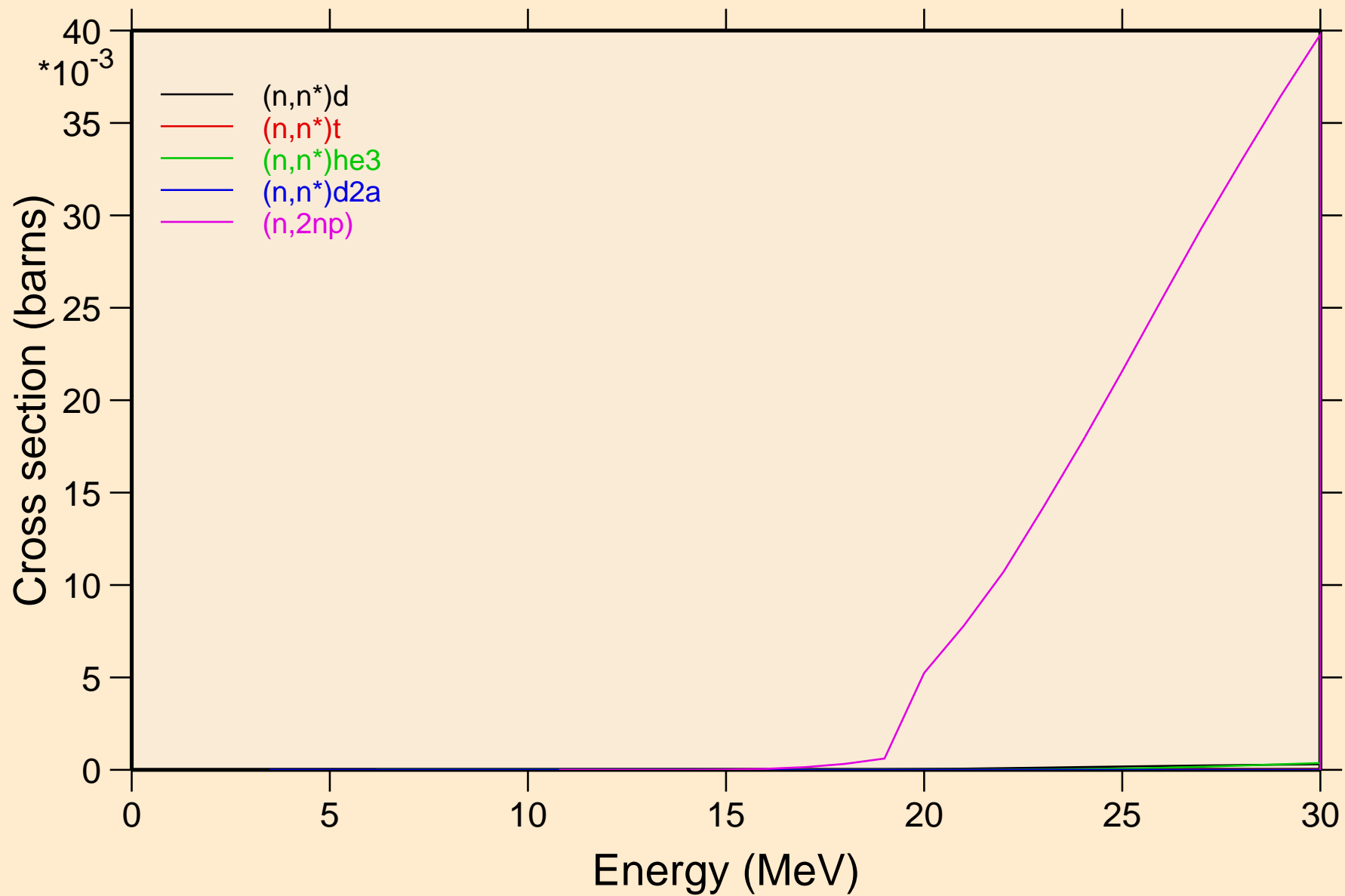



# LA120 NRG TENDL-2015, AKONING

## Threshold reactions

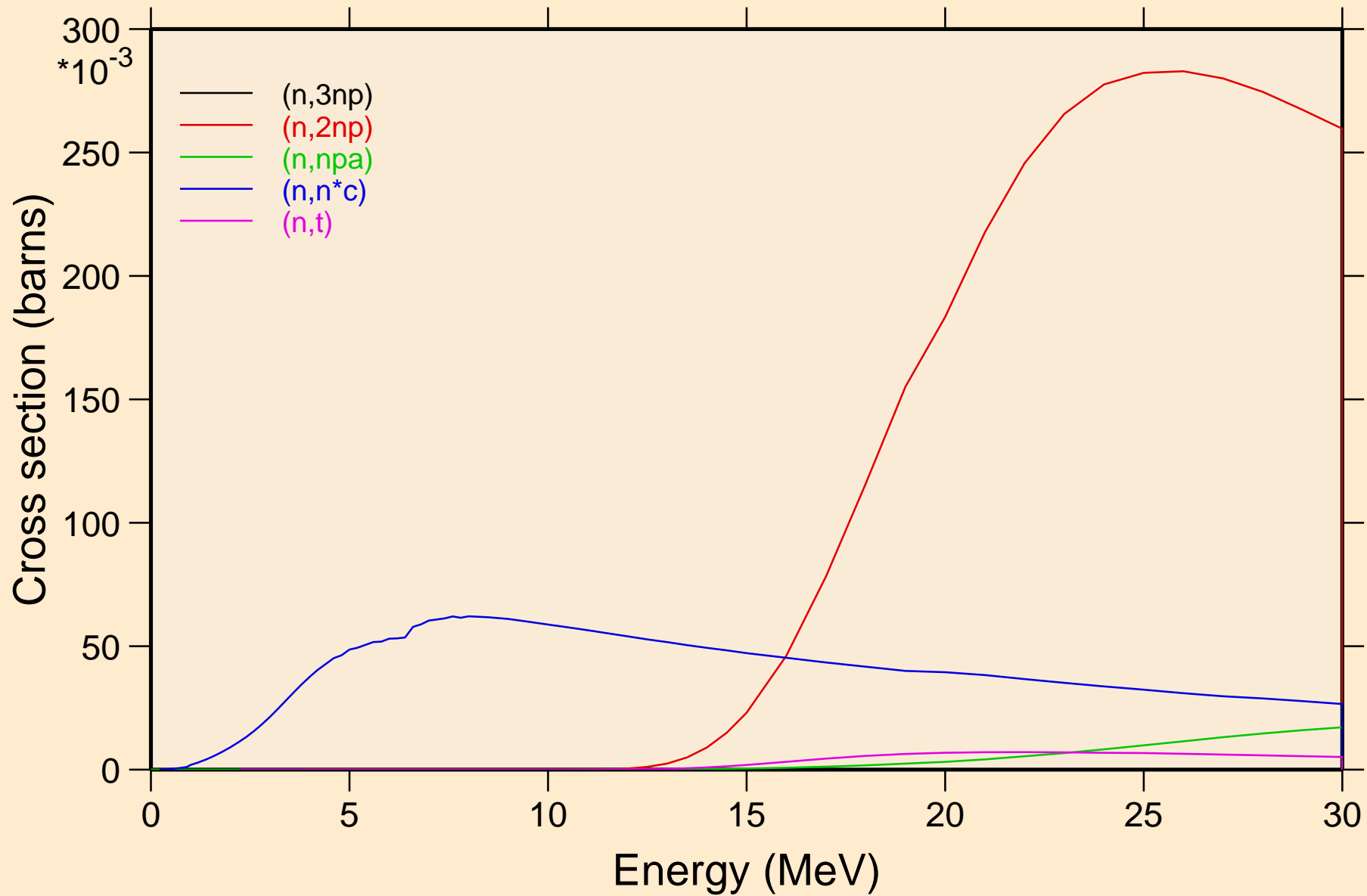

# LA120 NRG TENDL-2015, AKONING

## Threshold reactions

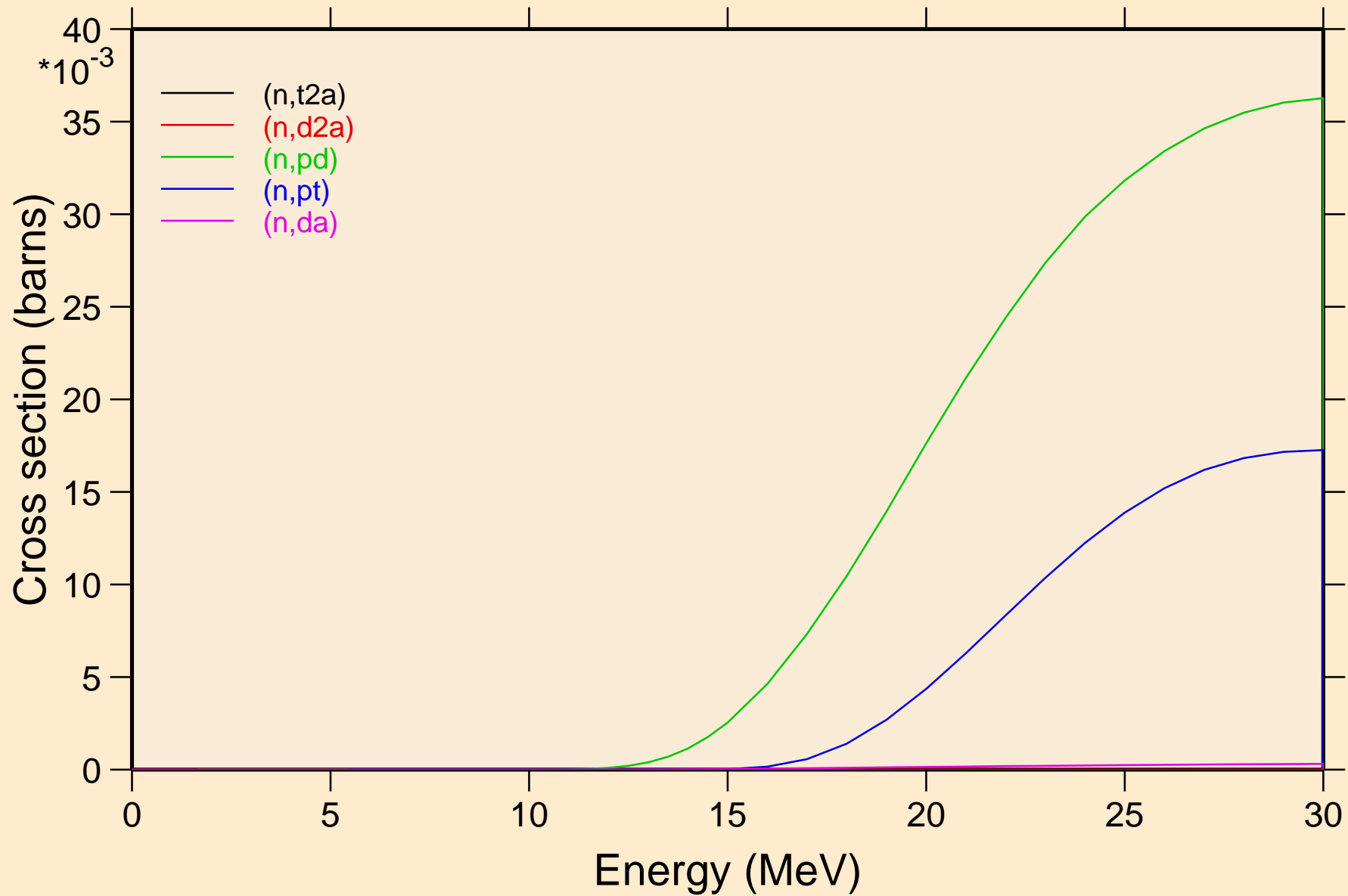

LA120 NRG TENDL-2015, AKONING  
angular distribution for elastic

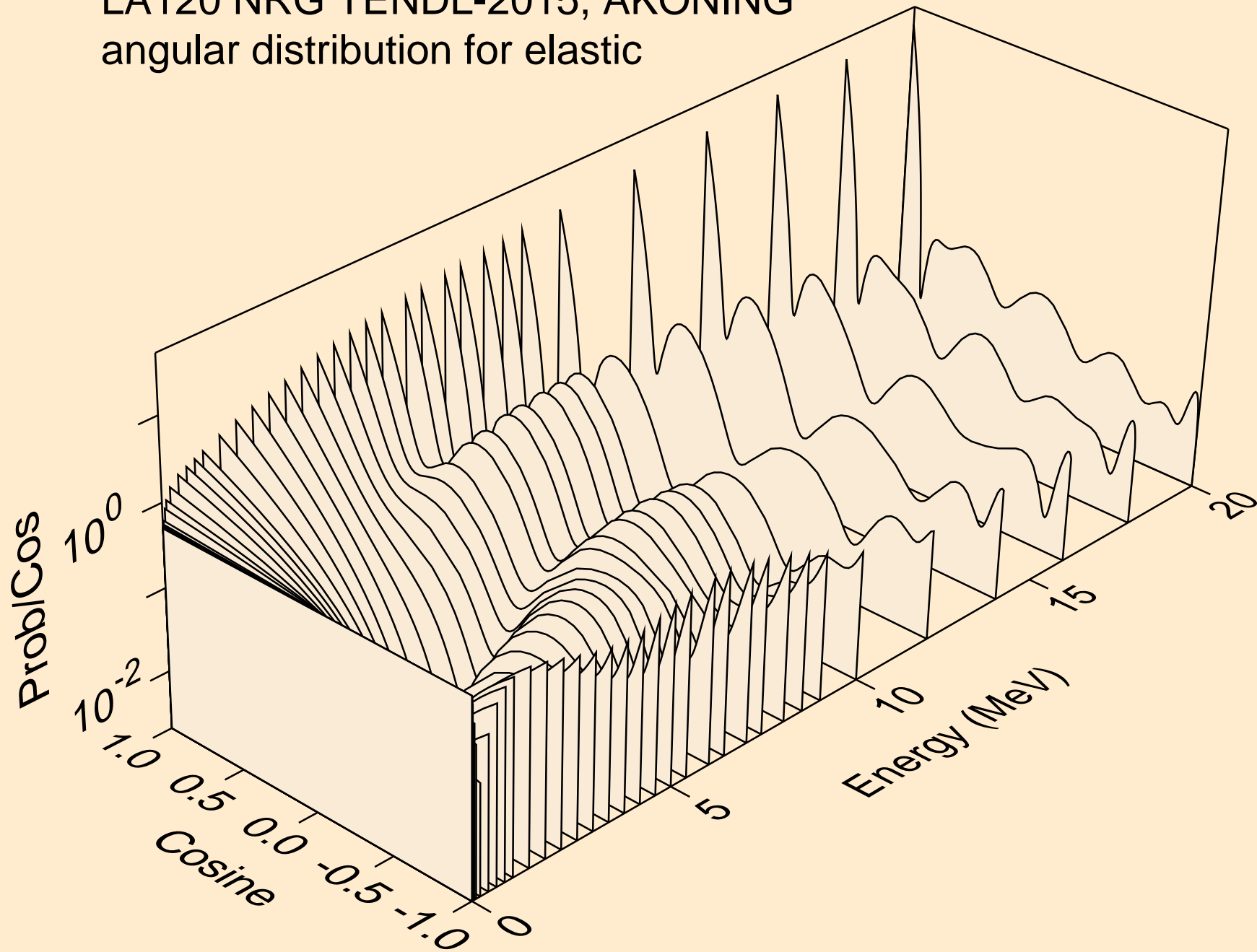

LA120 NRG TENDL-2015, AKONING  
angular distribution for elastic

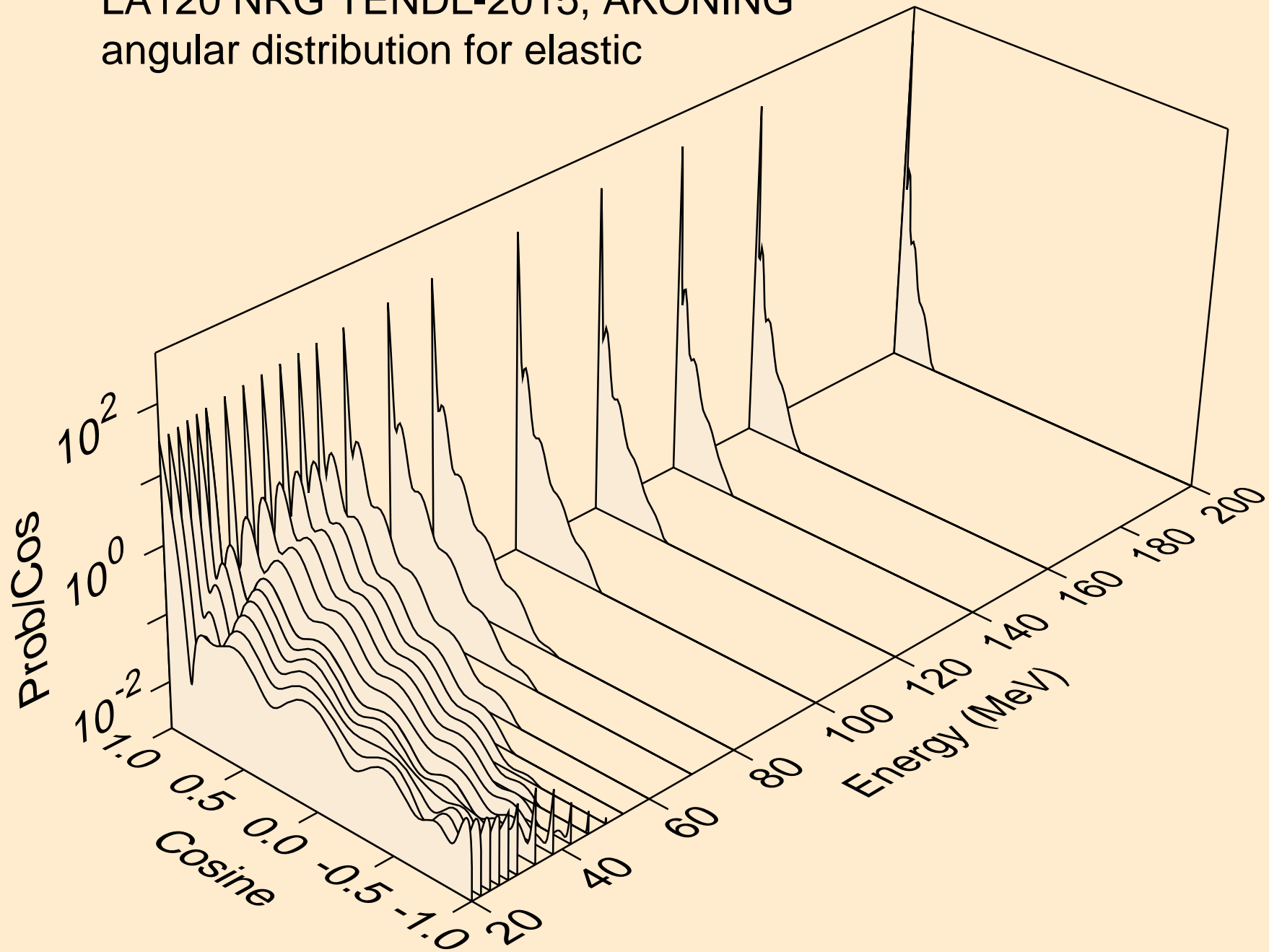

LA120 NRG TENDL-2015, AKONING  
angular distribution for (n,n\*1)

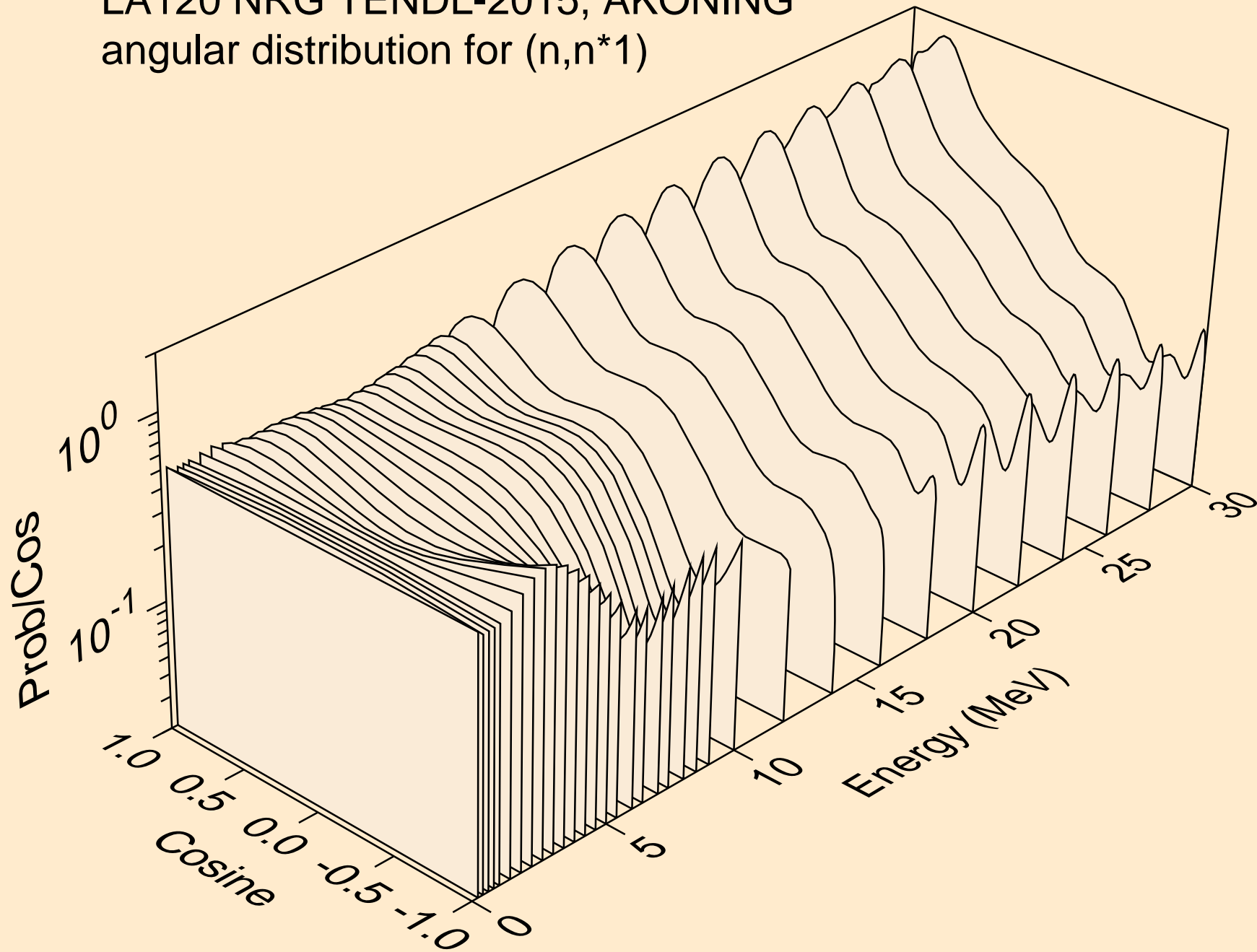

LA120 NRG TENDL-2015, AKONING  
Neutron emission for (n,x)

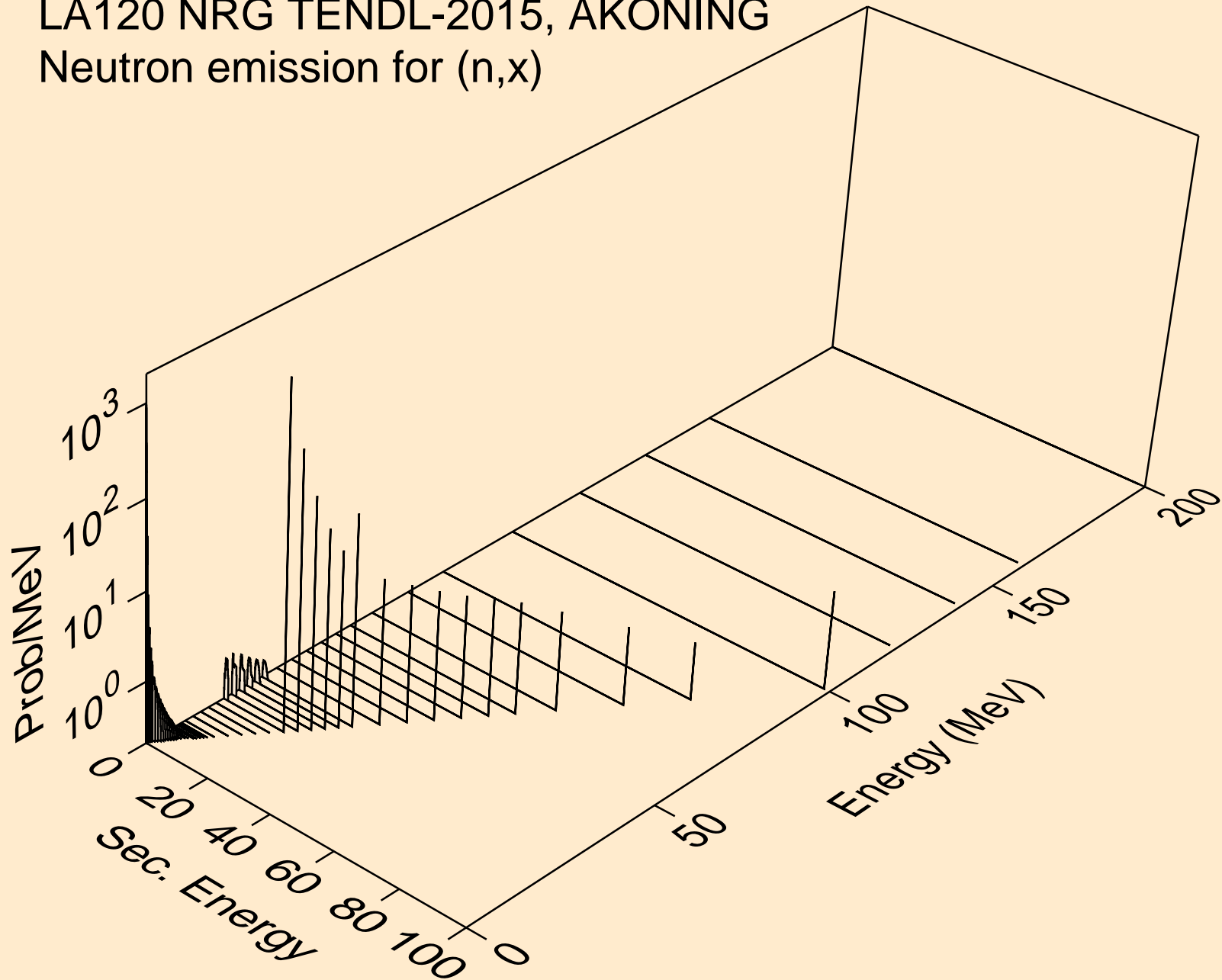

LA120 NRG TENDL-2015, AKONING  
Neutron emission for (n,2nd)

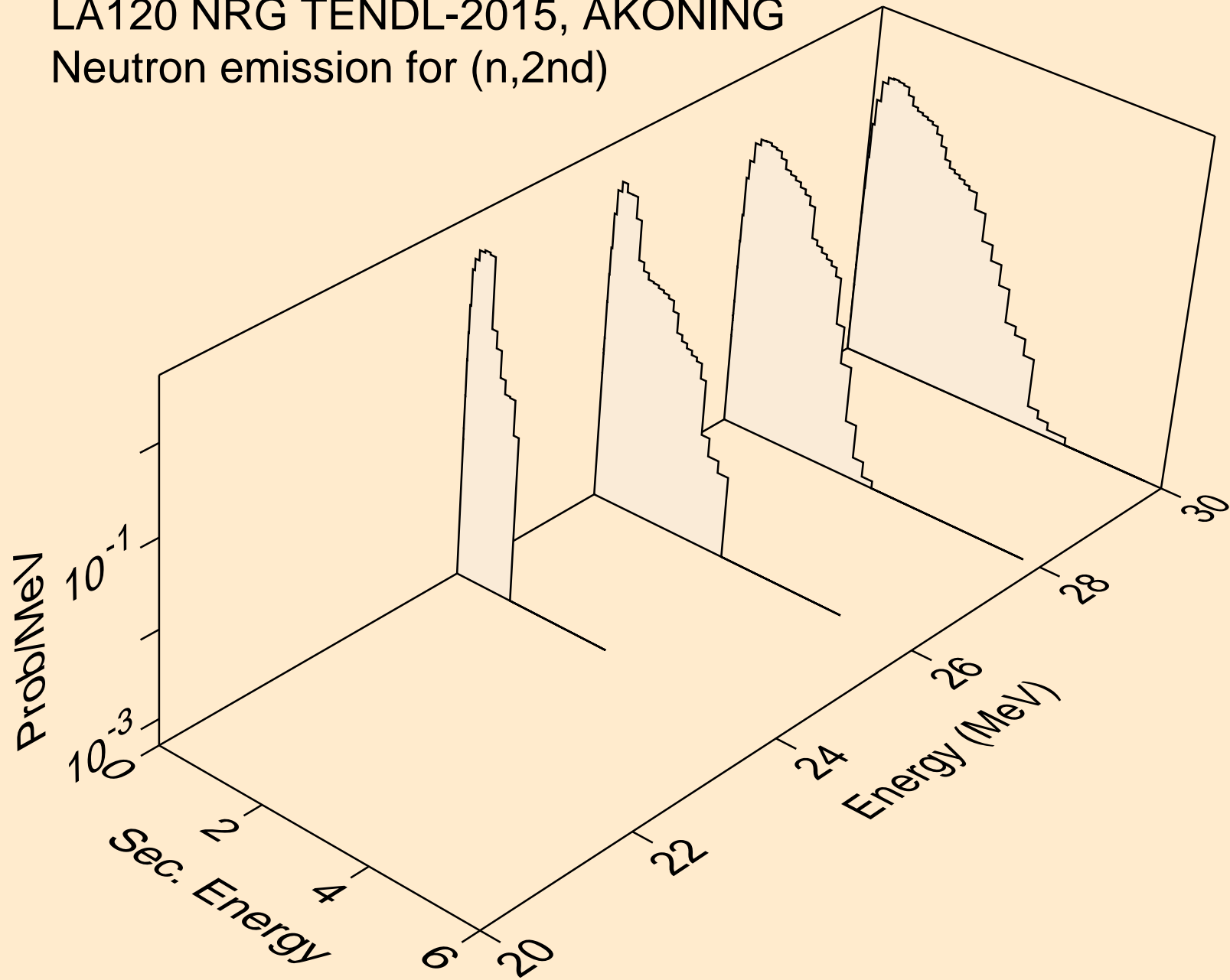

LA120 NRG TENDL-2015, AKONING  
Neutron emission for (n,2n)

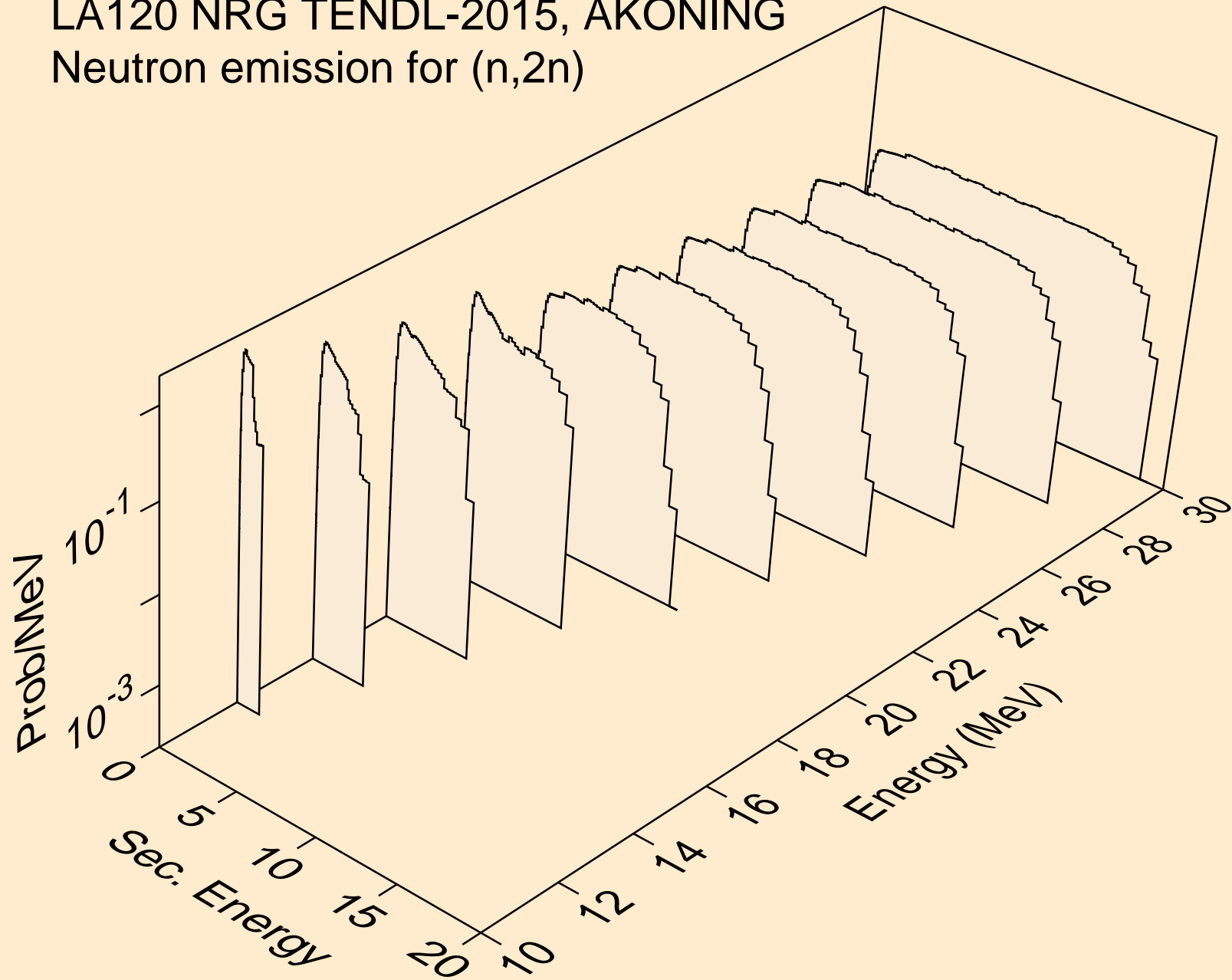



LA120 NRG TENDL-2015, AKONING  
Neutron emission for (n,3n)

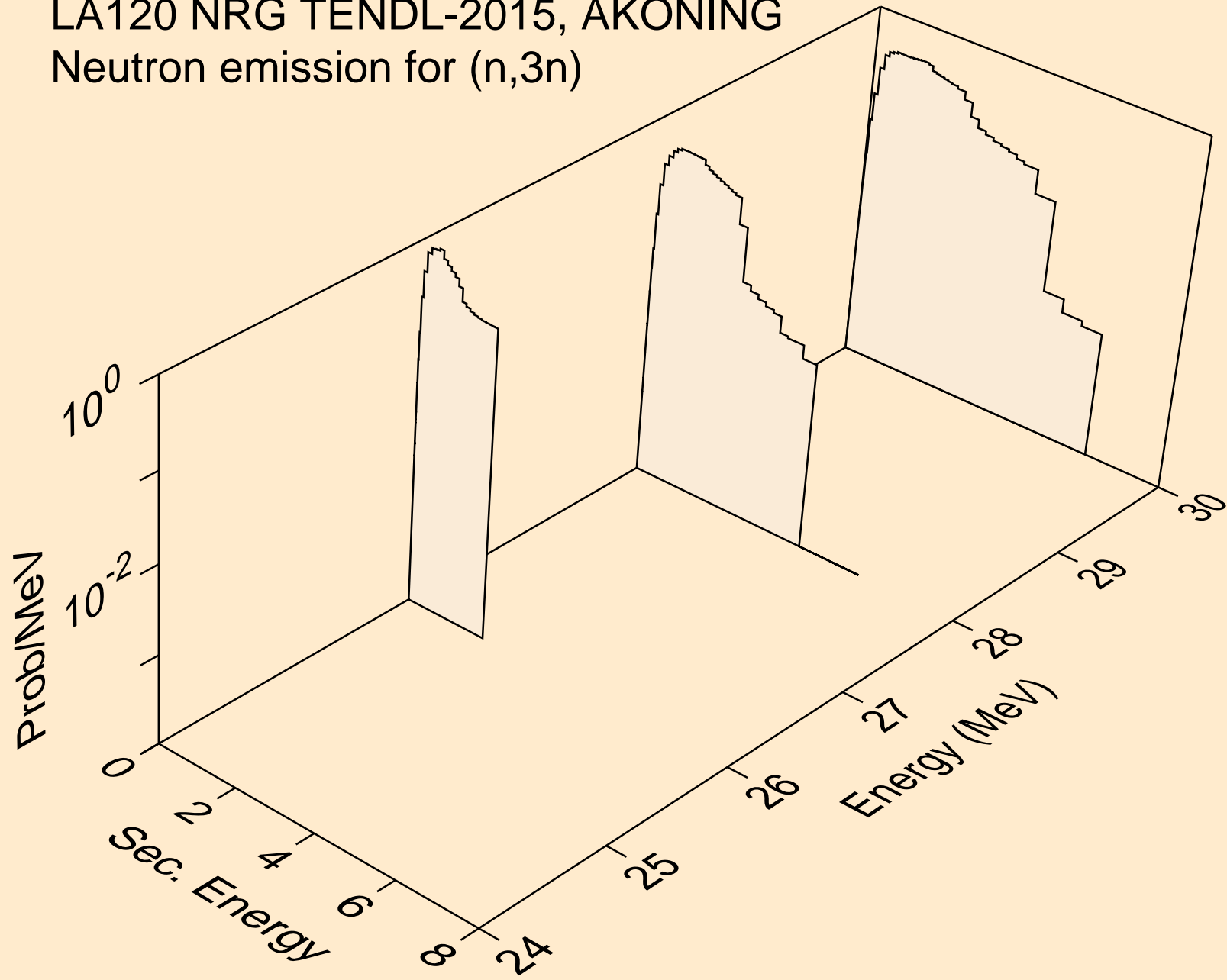

LA120 NRG TENDL-2015, AKONING  
Neutron emission for (n,n\*)a

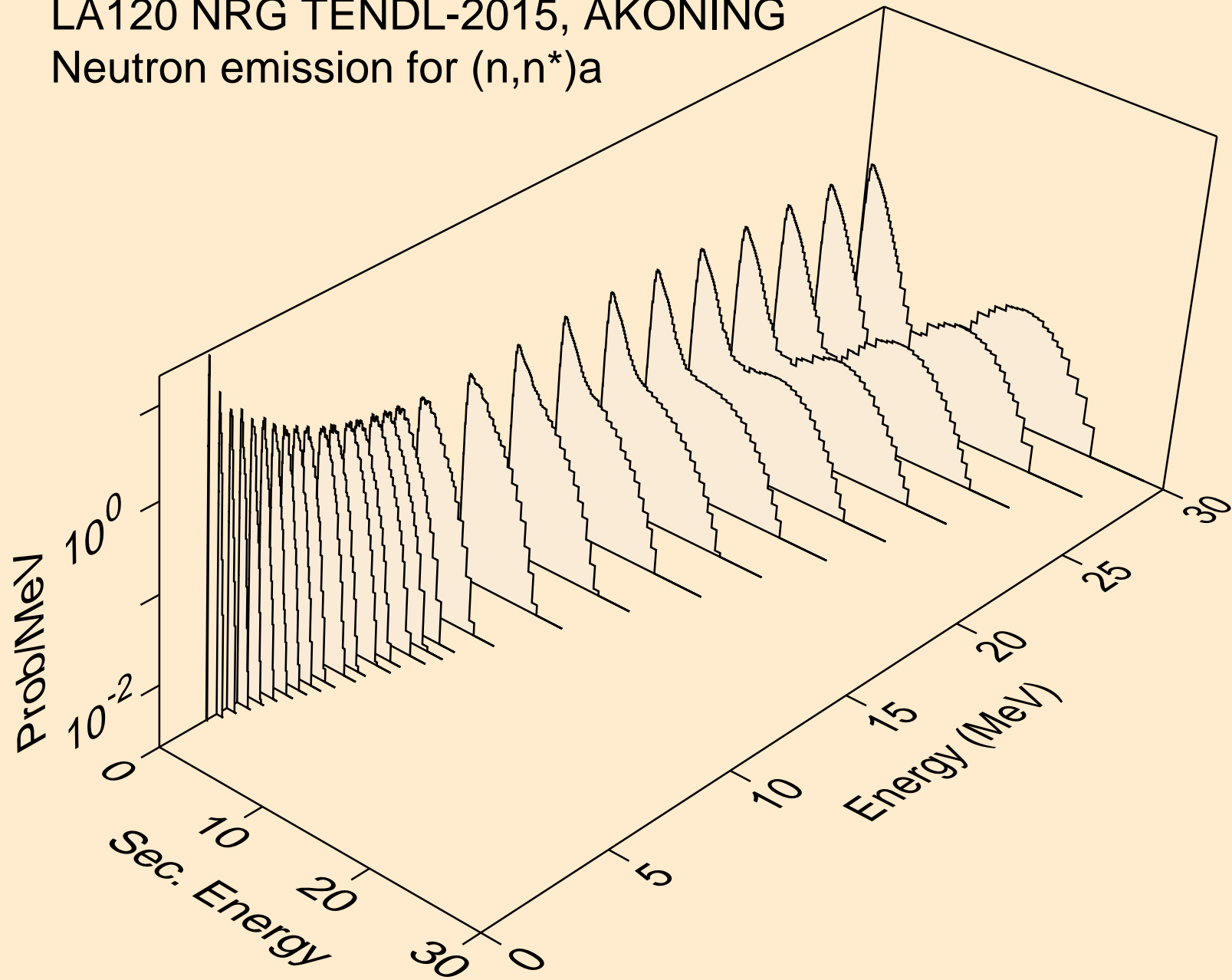

LA120 NRG TENDL-2015, AKONING  
Neutron emission for (n,n\*)3a

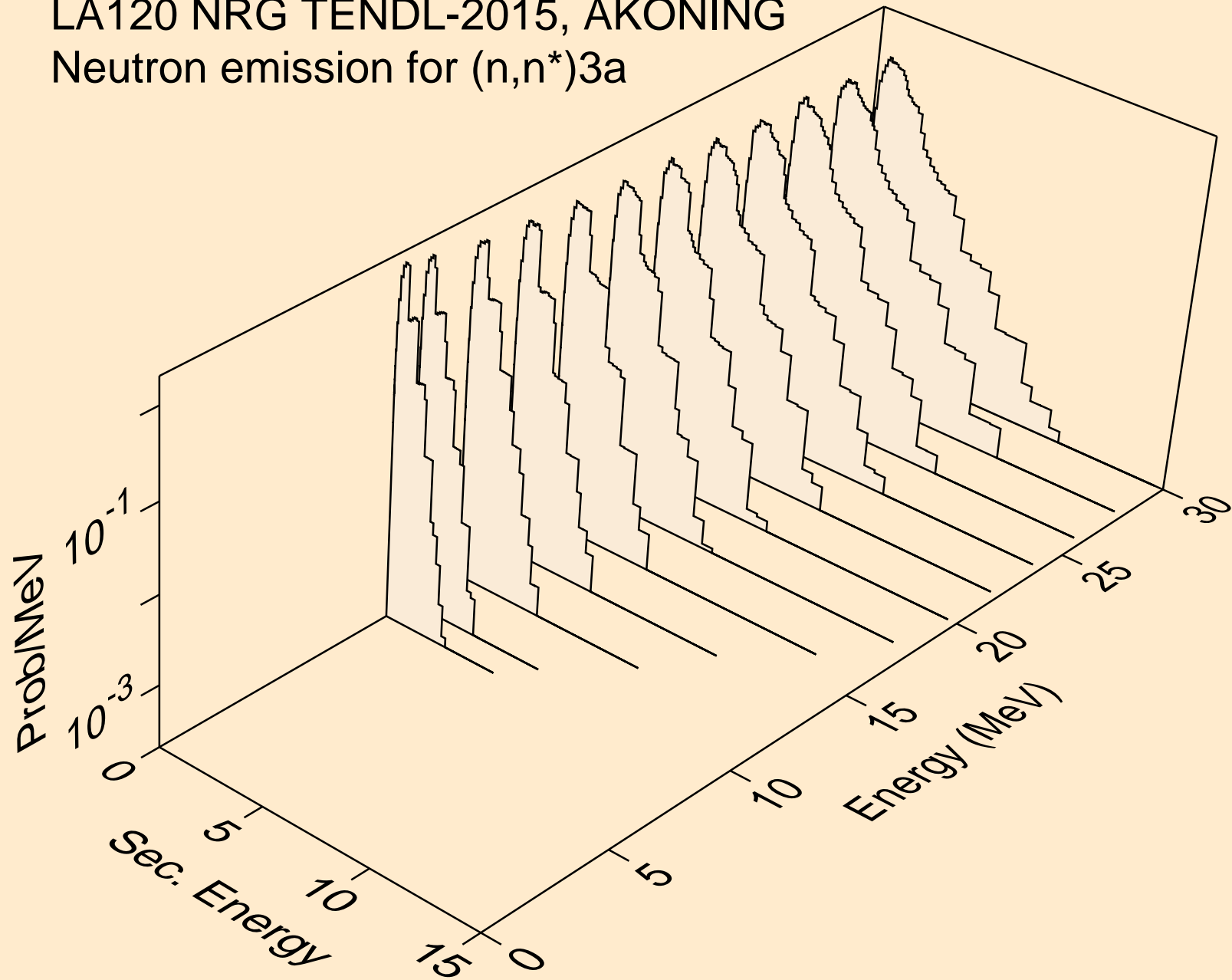

LA120 NRG TENDL-2015, AKONING  
Neutron emission for (n,2n)a

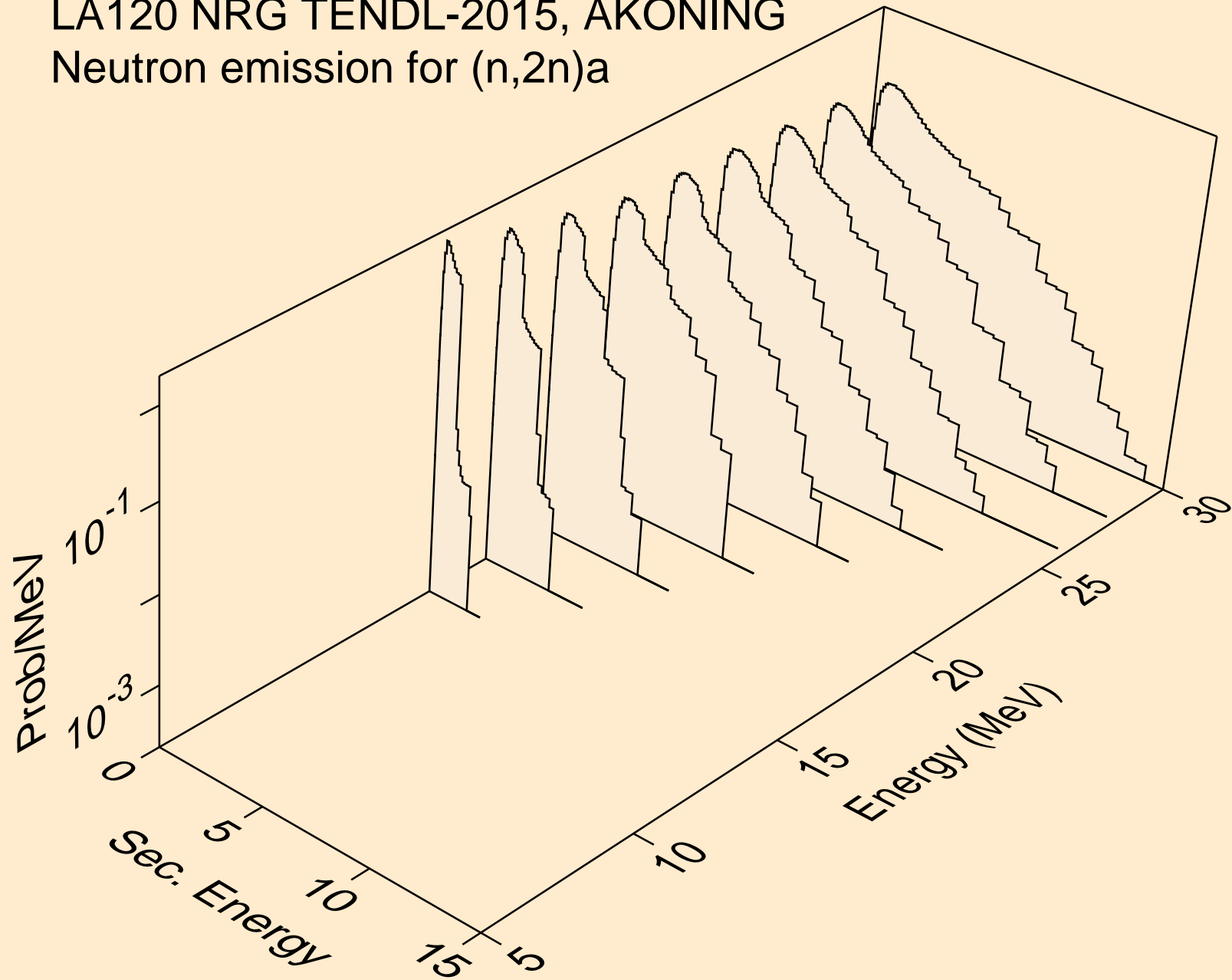

LA120 NRG TENDL-2015, AKONING  
Neutron emission for (n,n\*)p

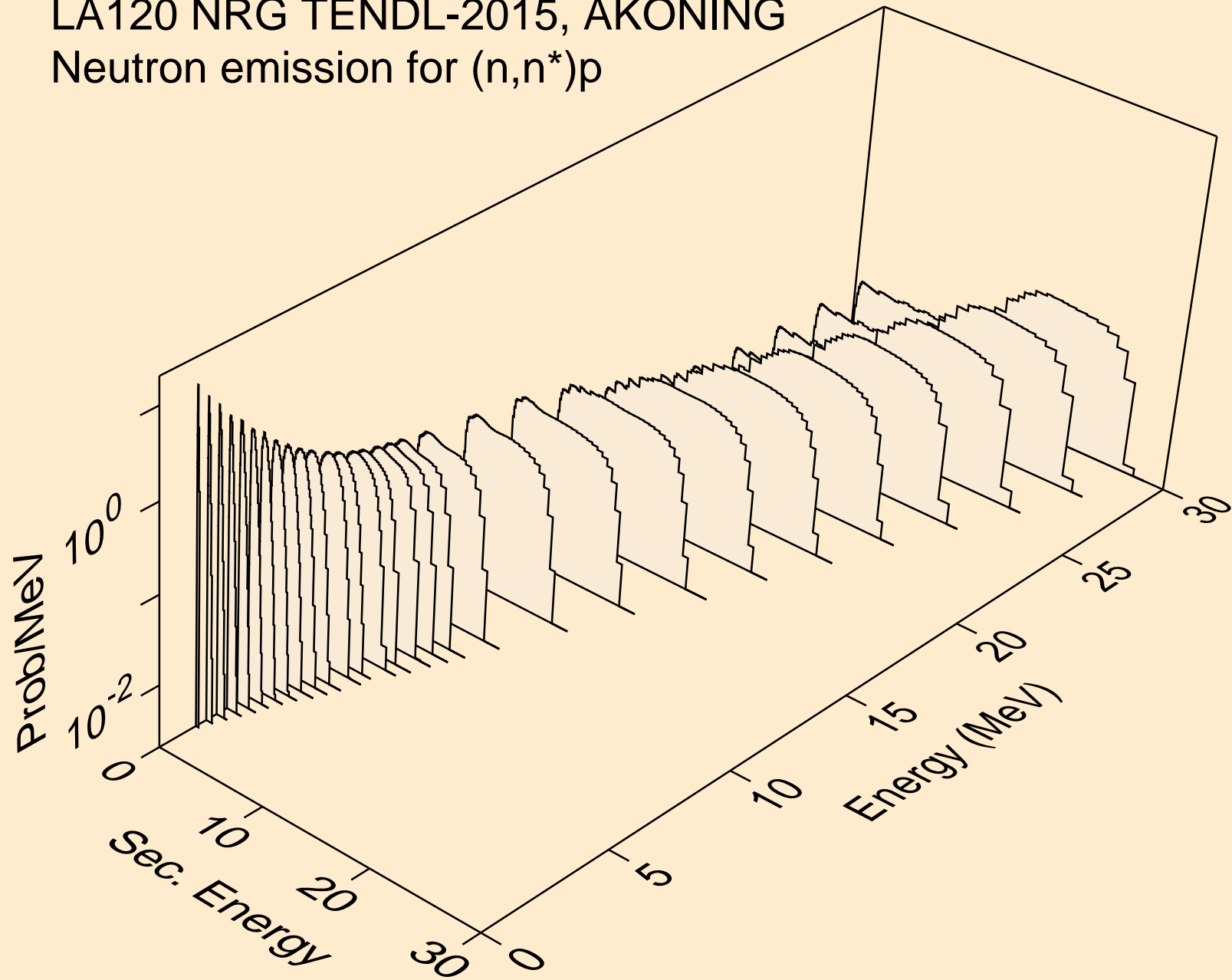

LA120 NRG TENDL-2015, AKONING  
Neutron emission for (n,n\*)2a

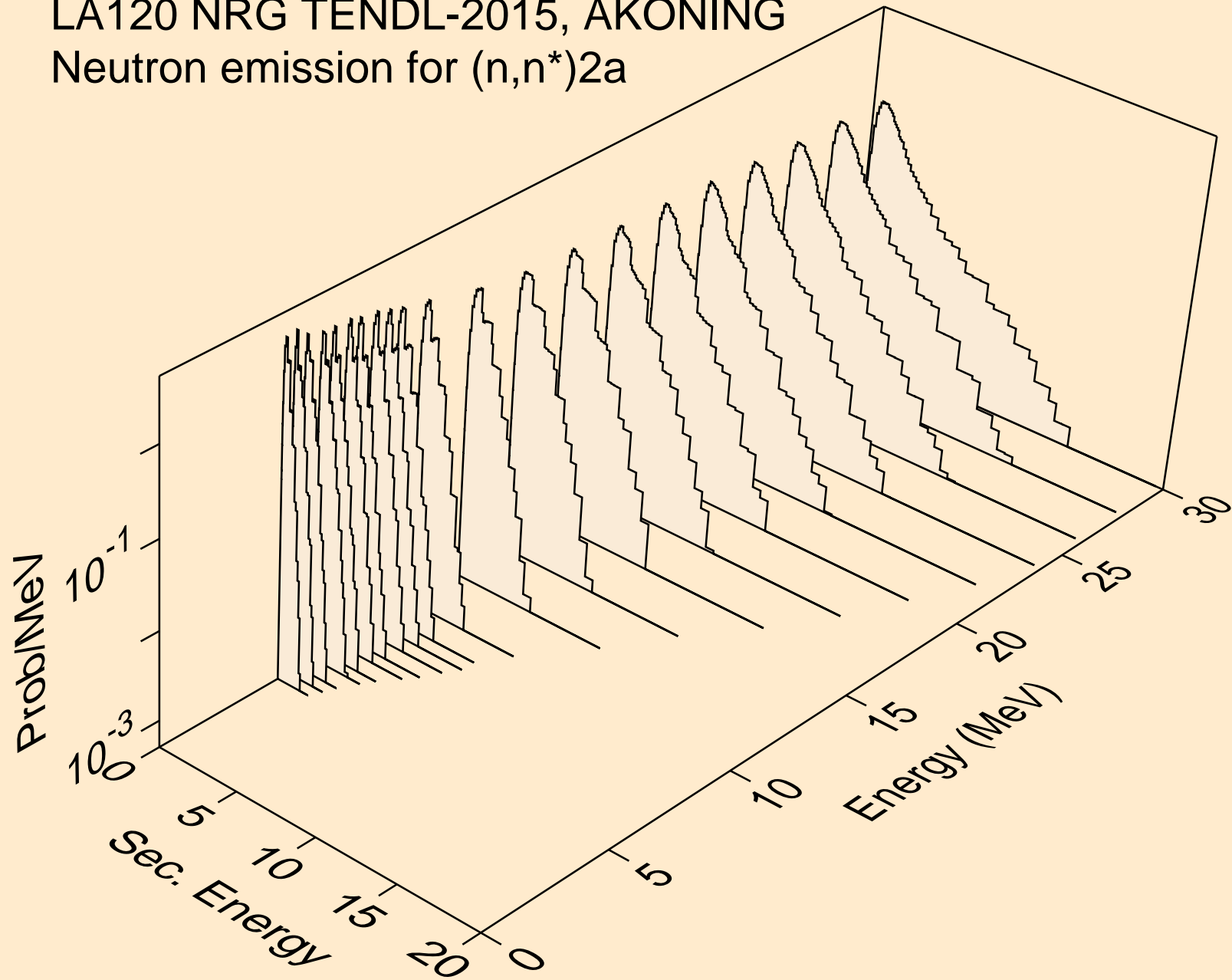

LA120 NRG TENDL-2015, AKONING  
Neutron emission for (n,2n)2a

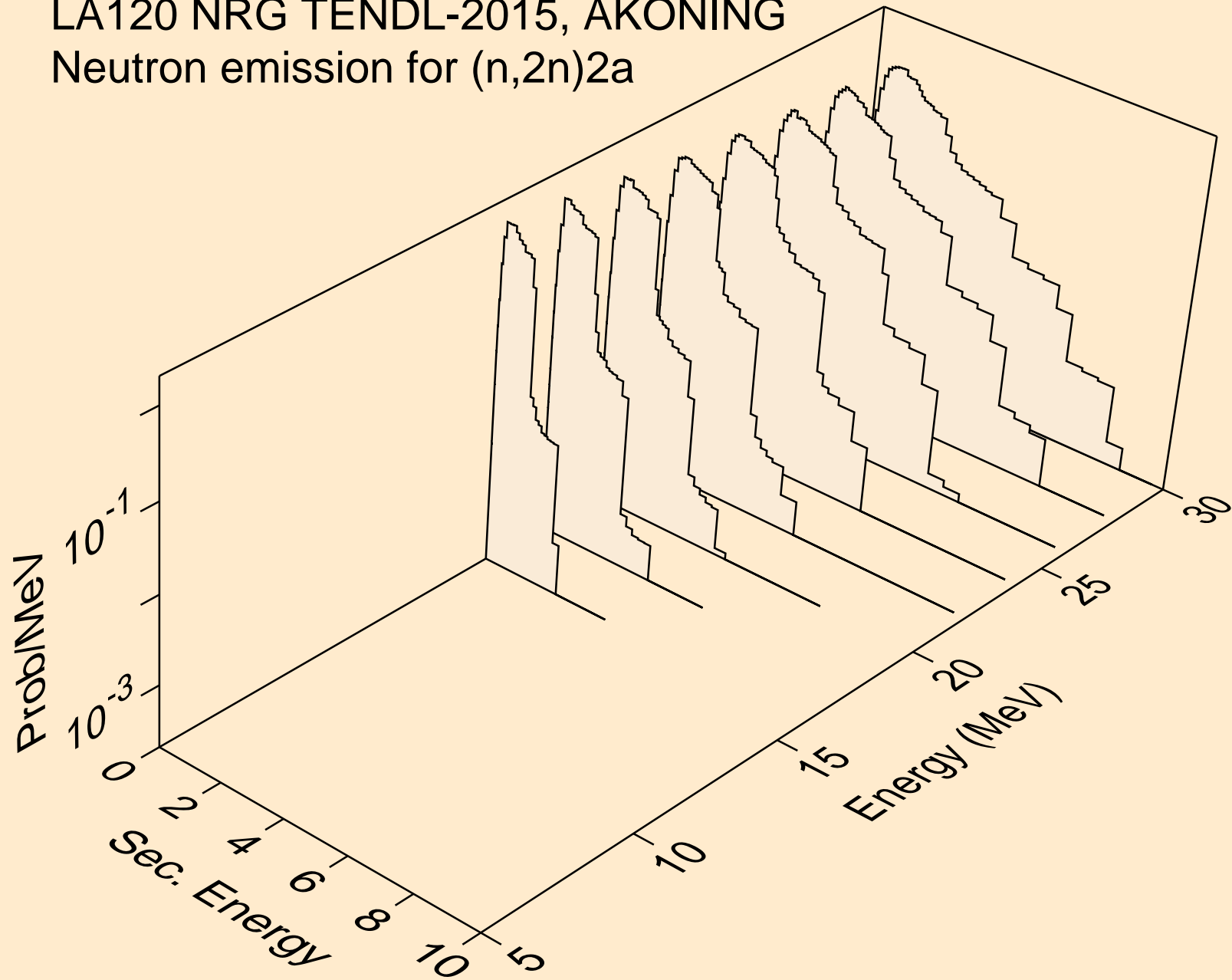

LA120 NRG TENDL-2015, AKONING  
Neutron emission for (n,n\*)d

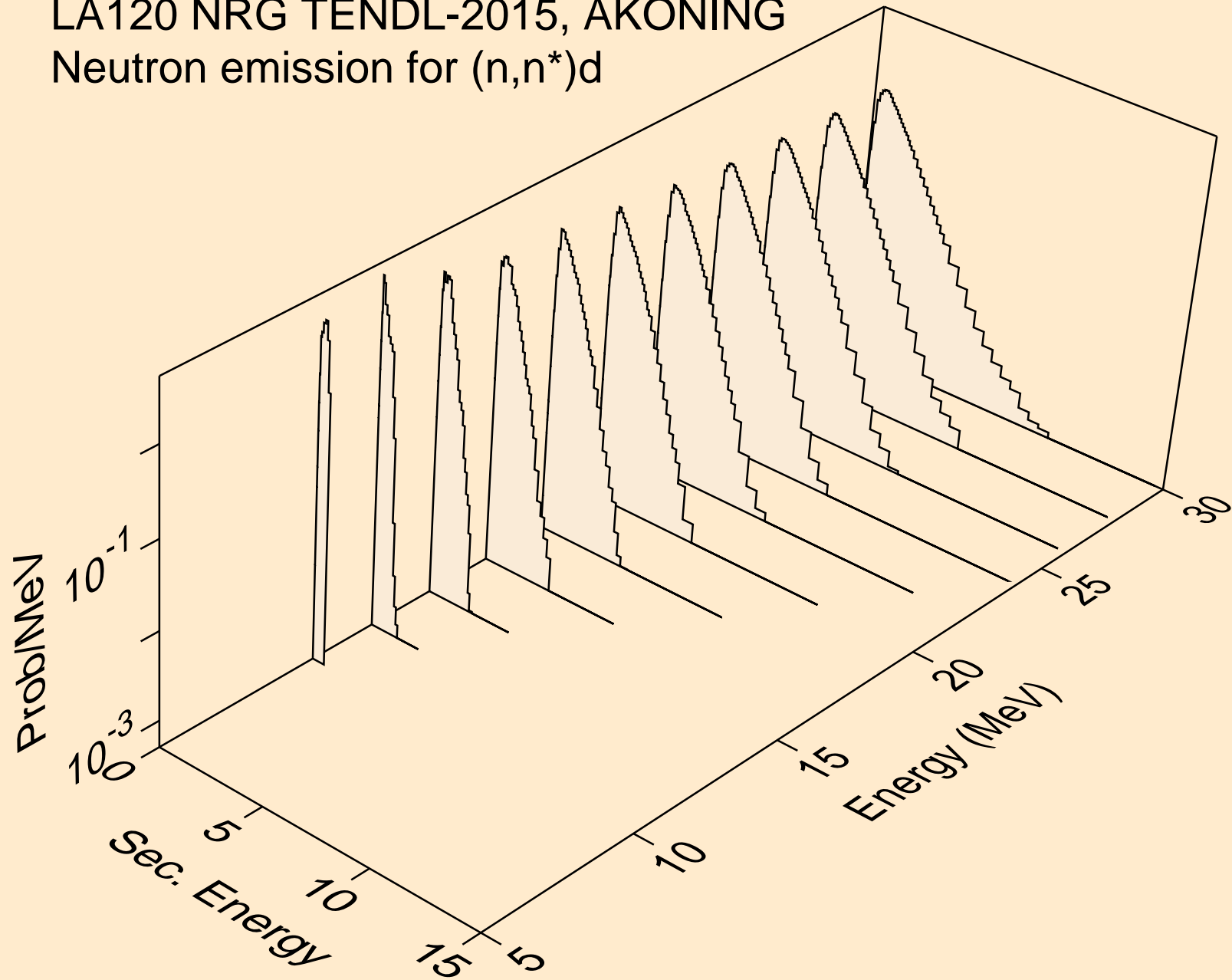



LA120 NRG TENDL-2015, AKONING  
Neutron emission for (n,n\*)t

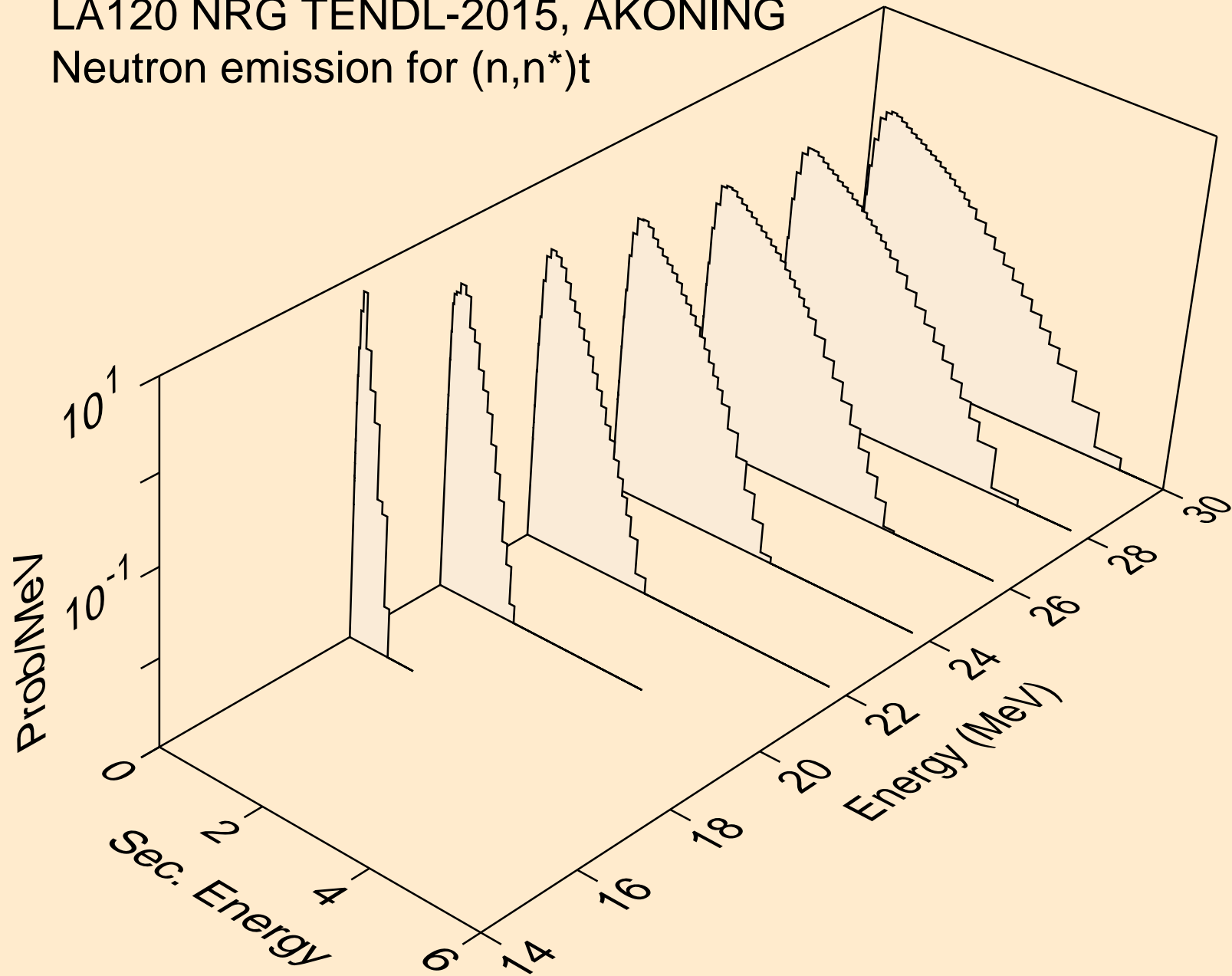

LA120 NRG TENDL-2015, AKONING  
Neutron emission for (n,n\*)he3

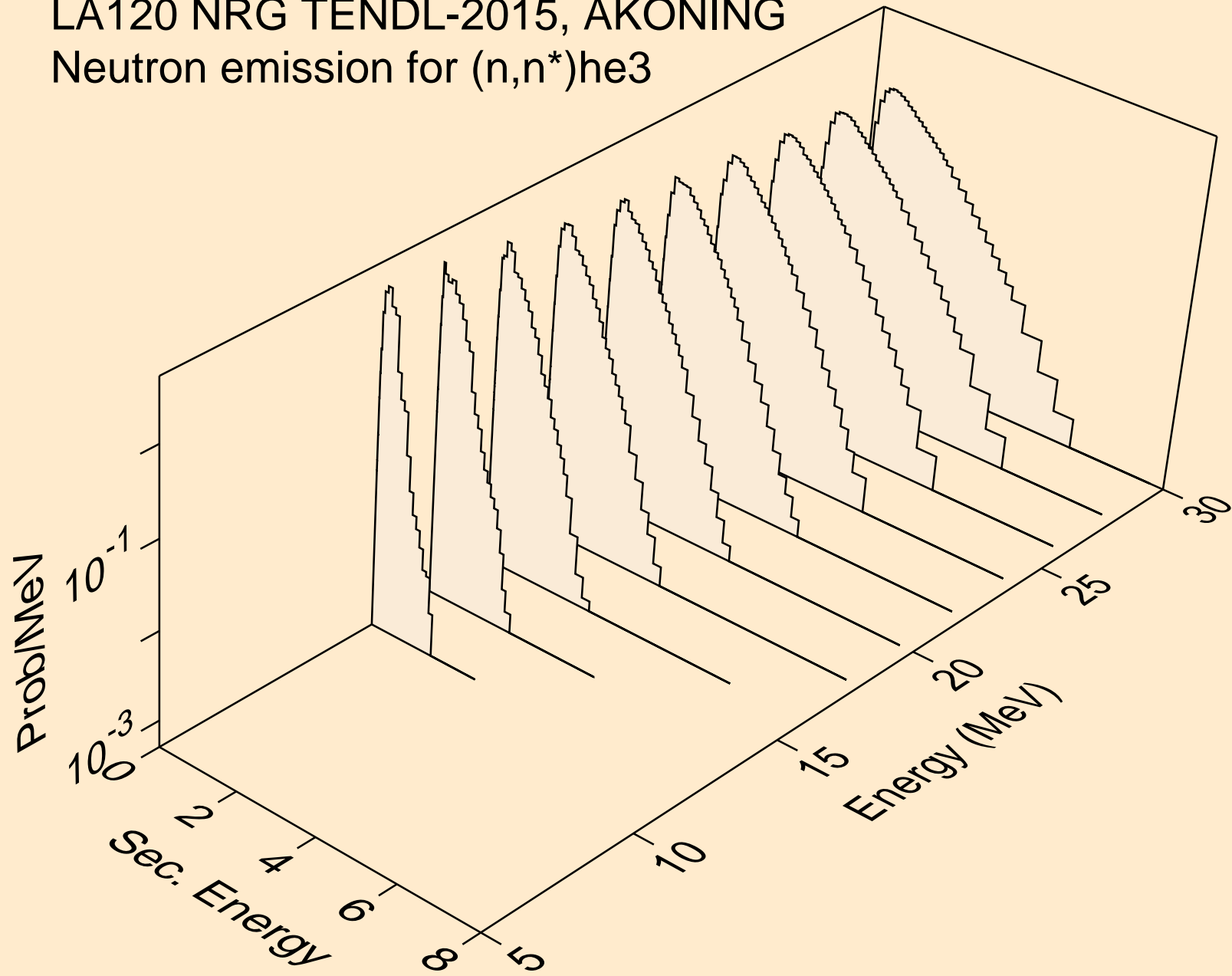

LA120 NRG TENDL-2015, AKONING  
Neutron emission for (n,n\*)d2a

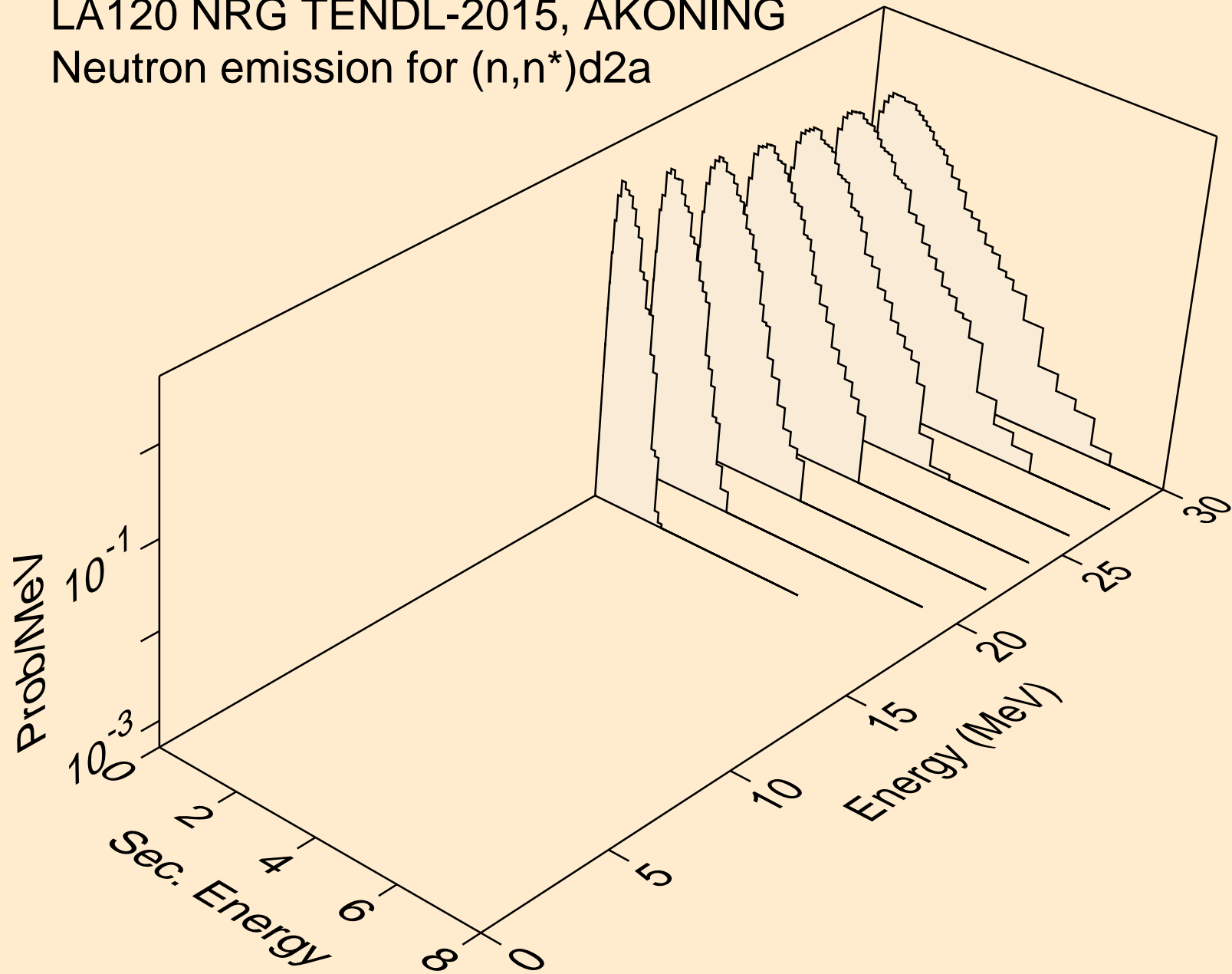

LA120 NRG TENDL-2015, AKONING  
Neutron emission for (n,2np)

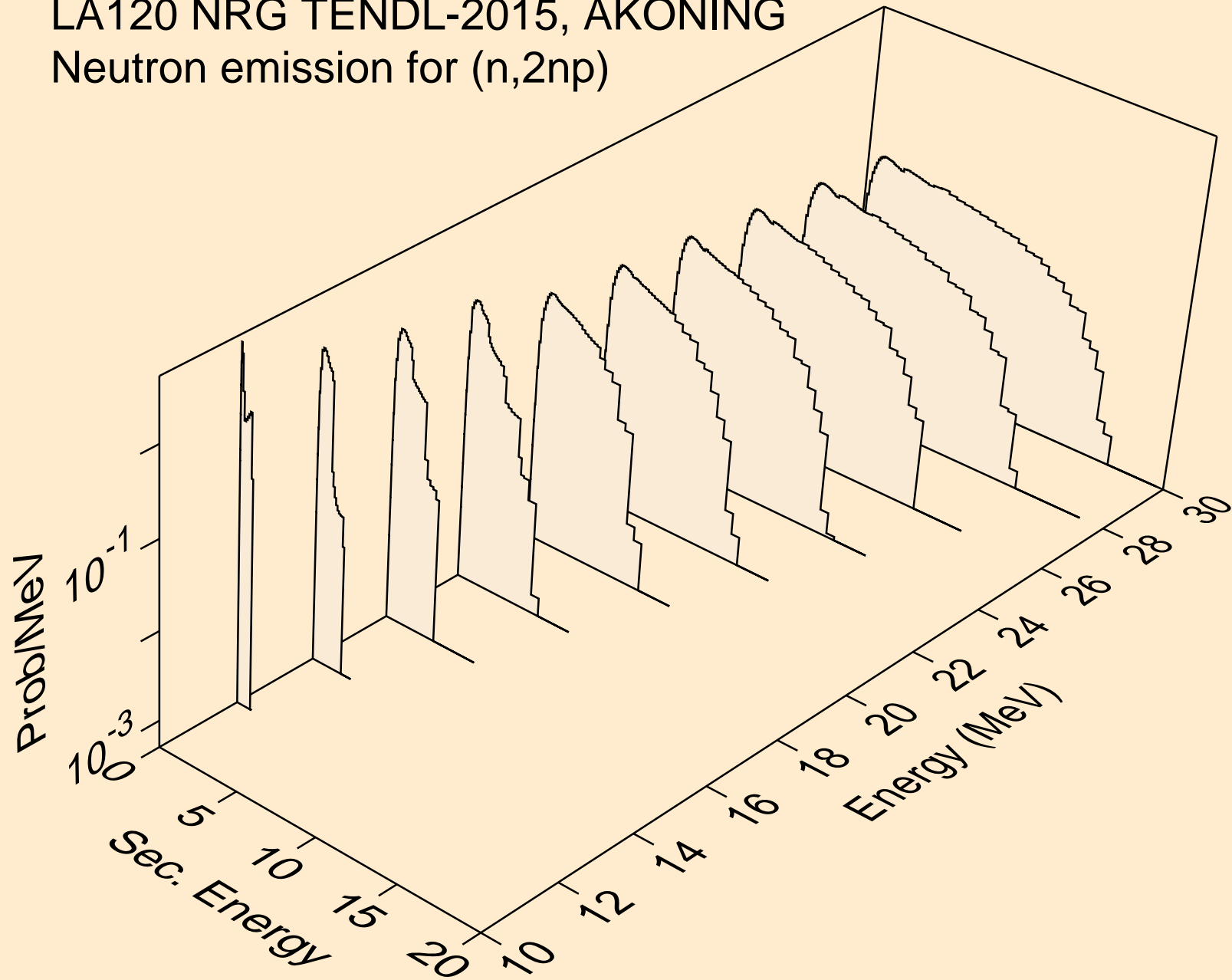

LA120 NRG TENDL-2015, AKONING  
Neutron emission for (n,3np)

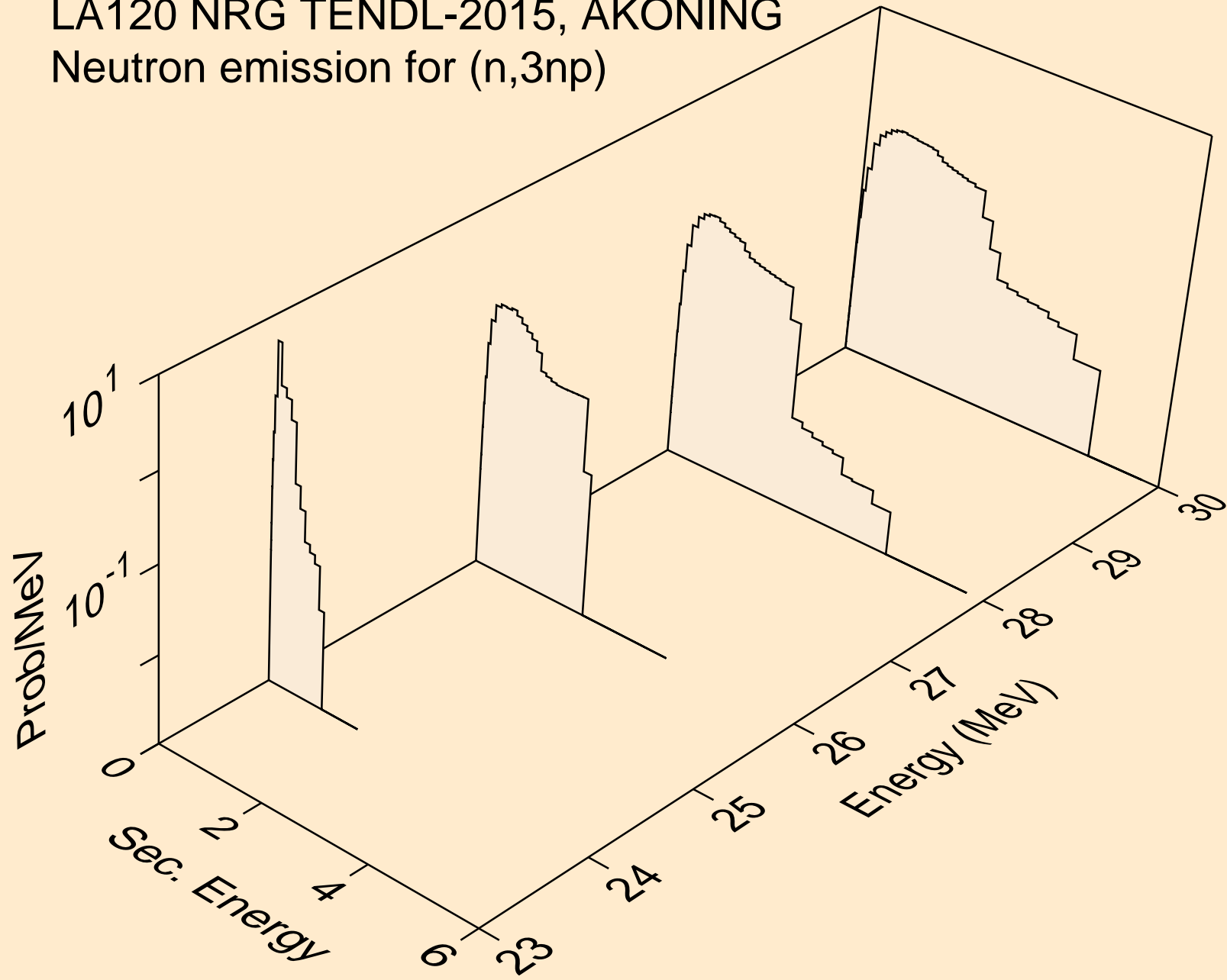

LA120 NRG TENDL-2015, AKONING  
Neutron emission for (n,2np)

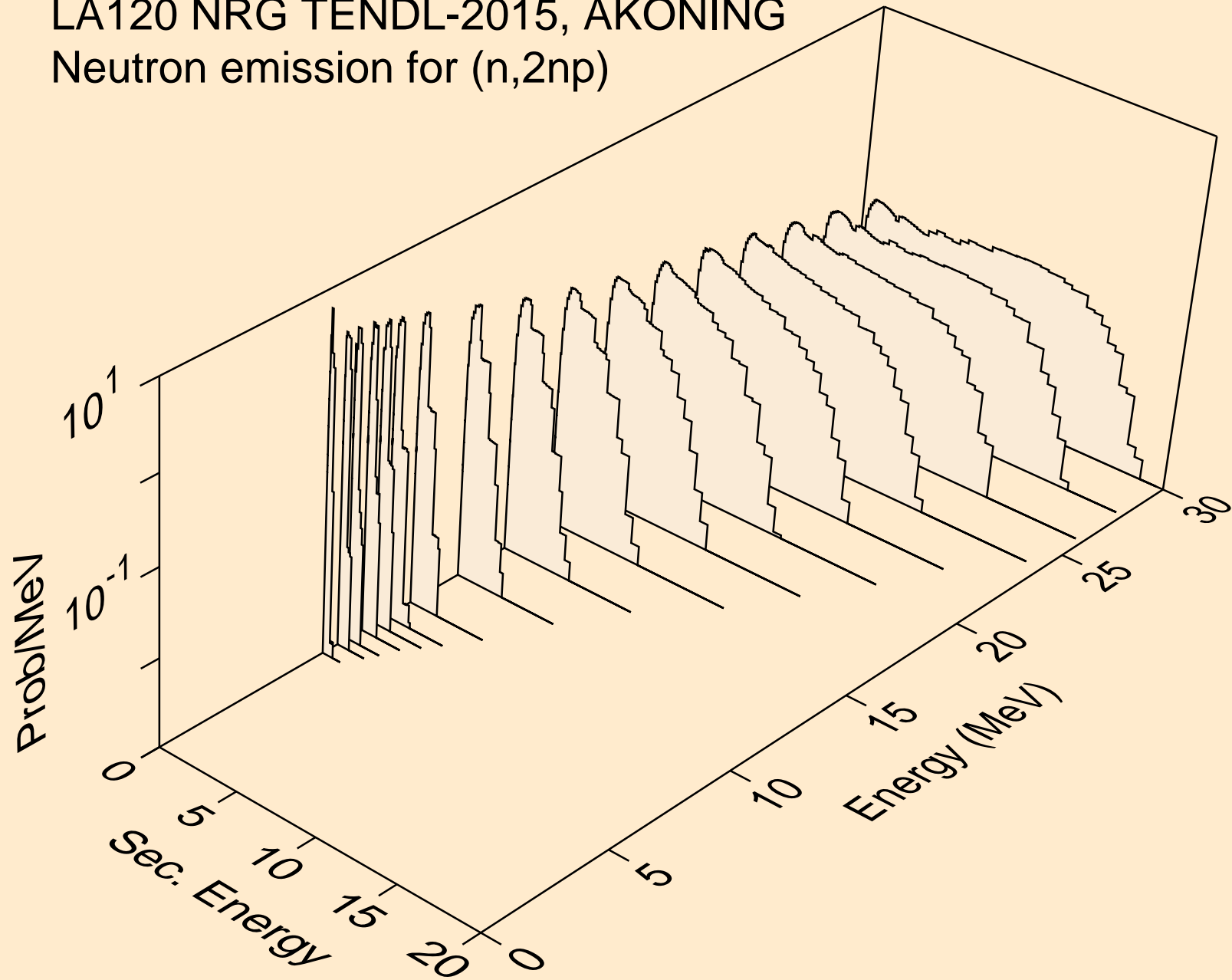

LA120 NRG TENDL-2015, AKONING  
Neutron emission for (n,npa)

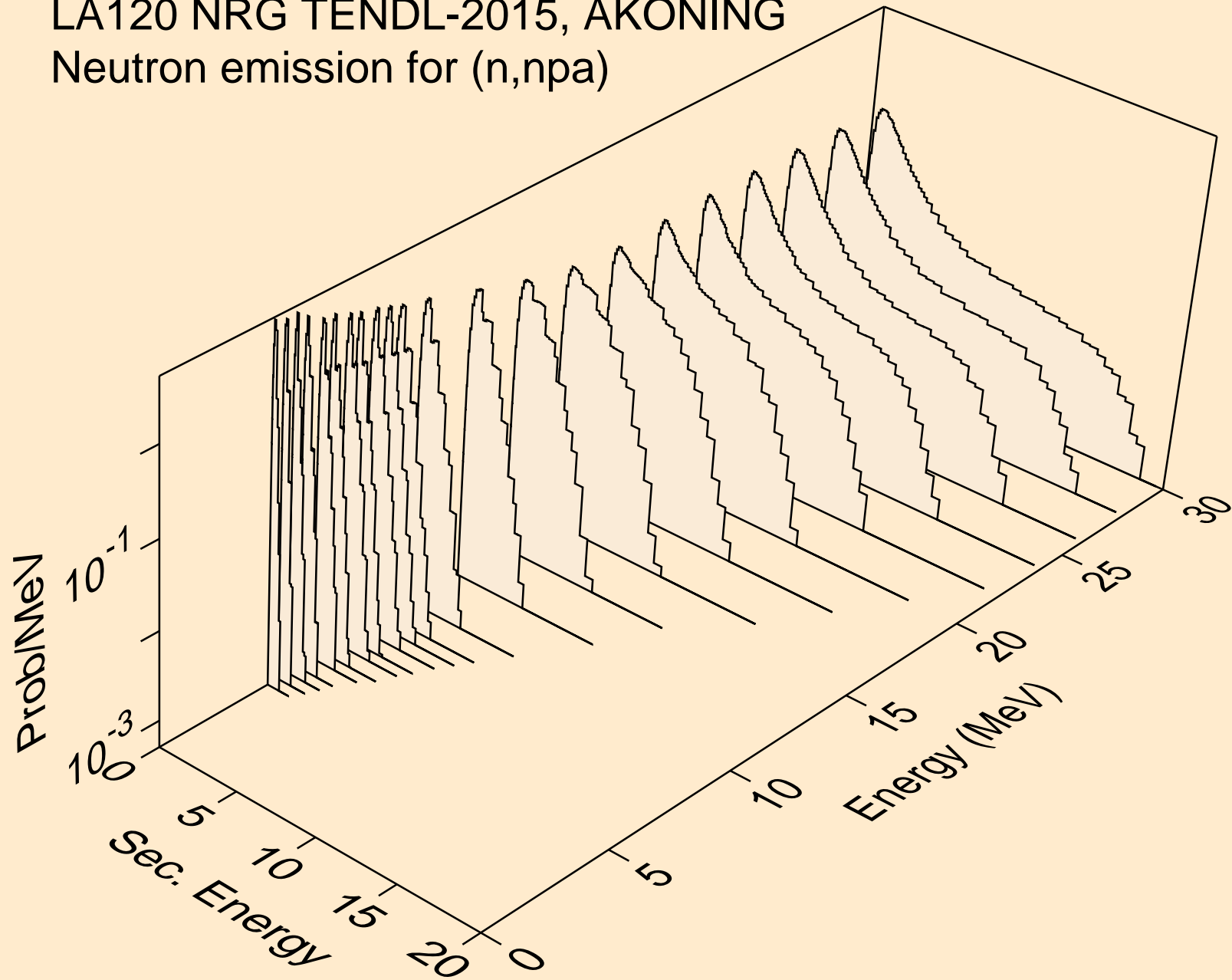

LA120 NRG TENDL-2015, AKONING  
Neutron emission for (n,n\*c)

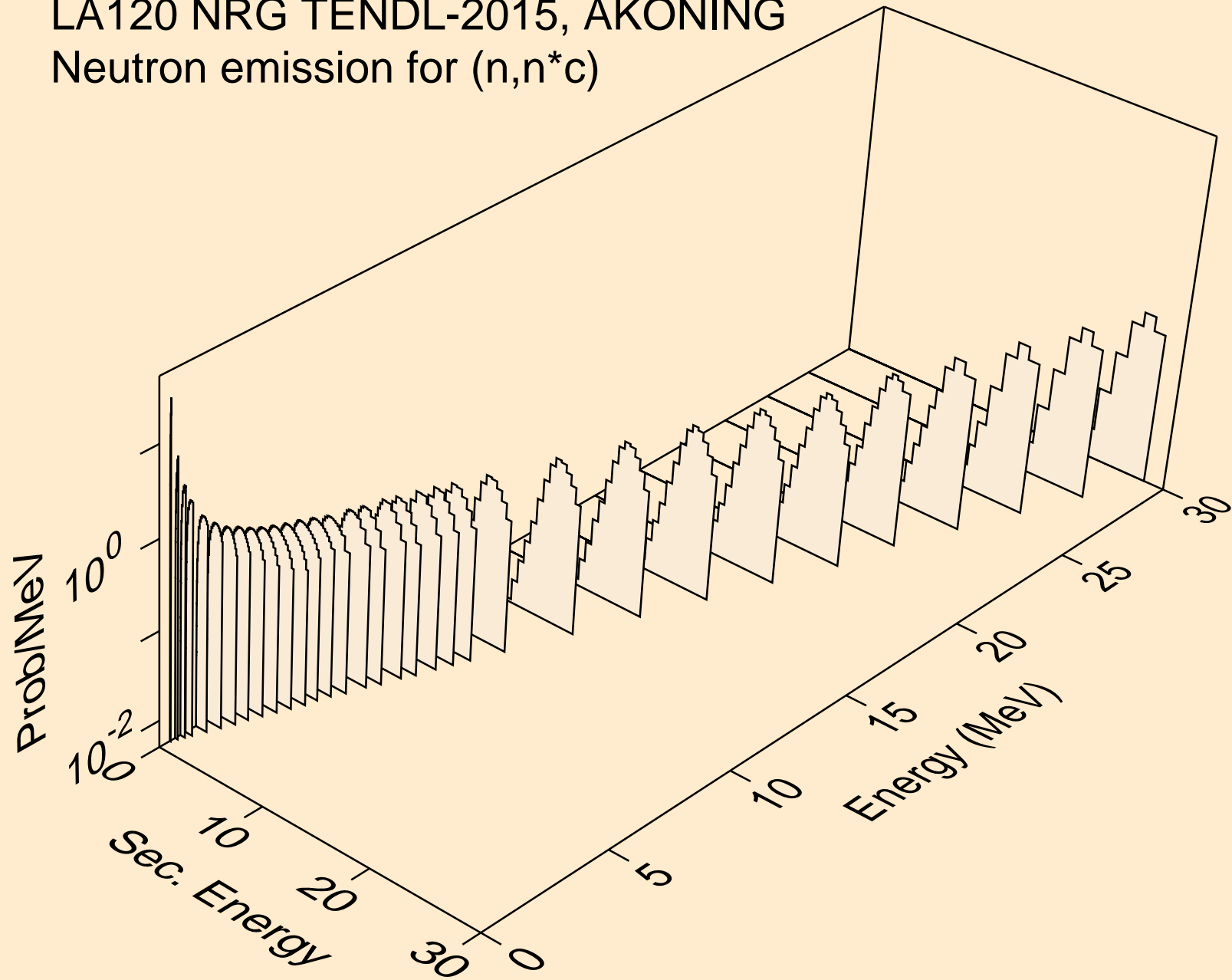



LA120 NRG TENDL-2015, AKONING  
Photon emission for (n,x)

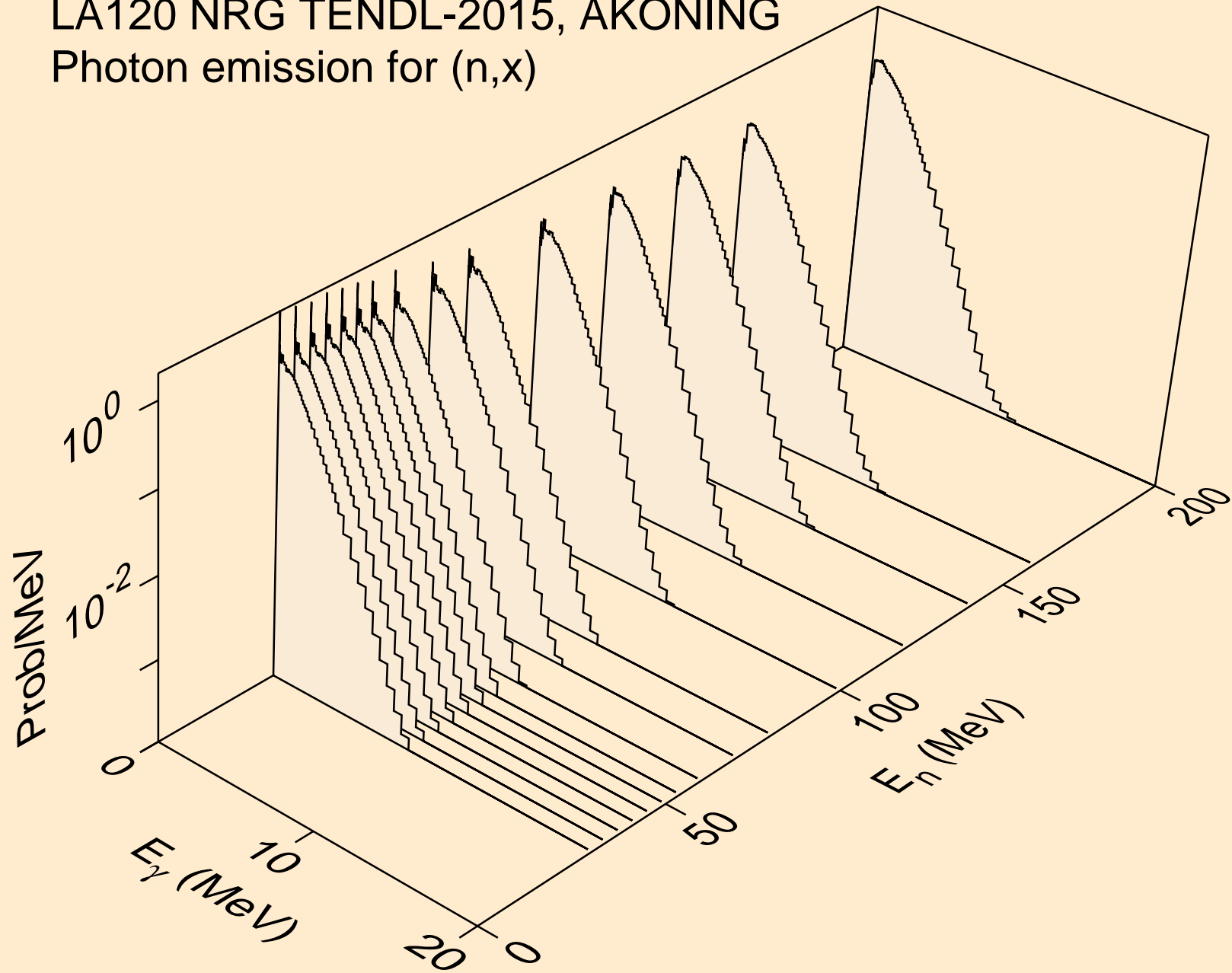

LA120 NRG TENDL-2015, AKONING  
Photon emission for (n,2nd)

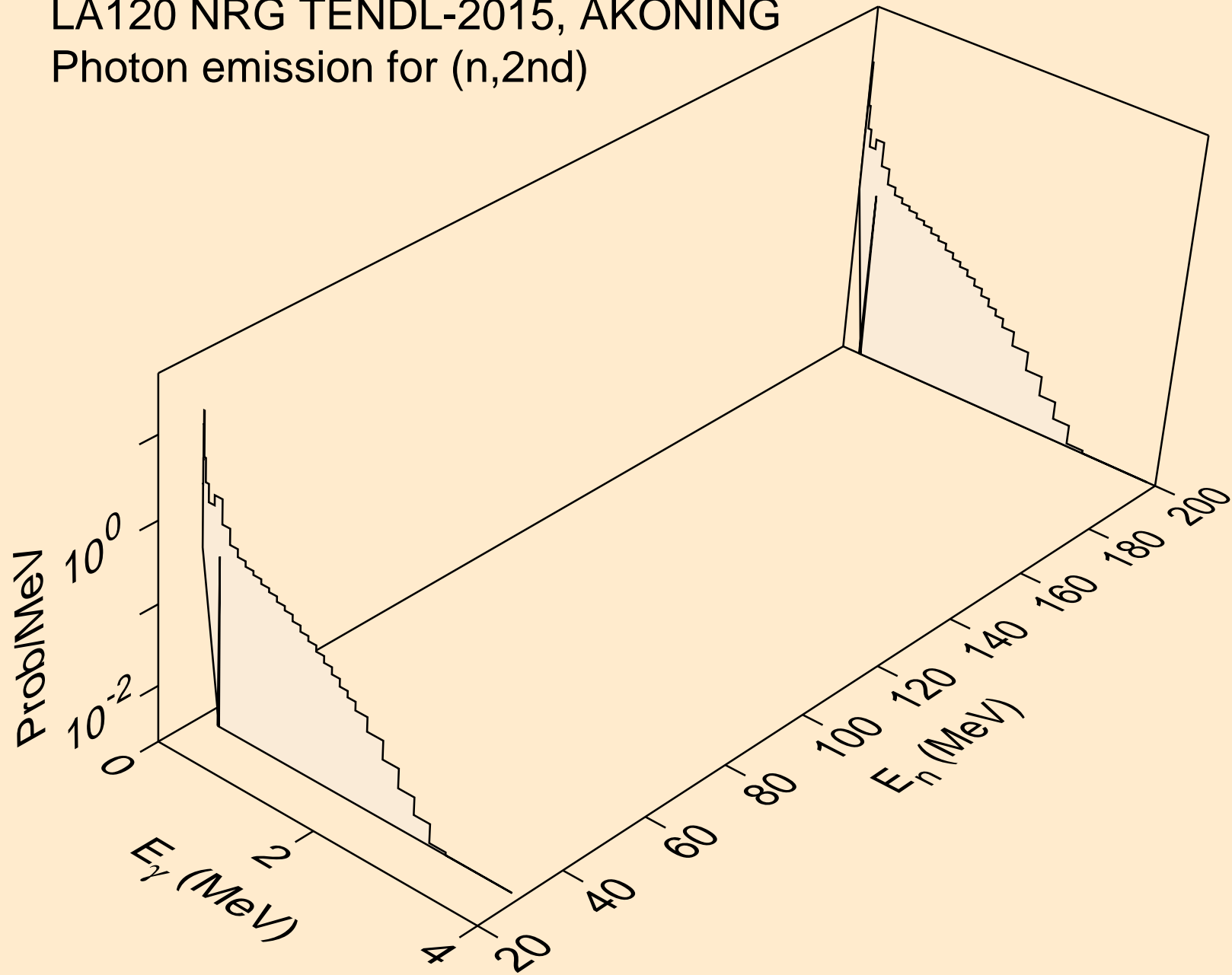

LA120 NRG TENDL-2015, AKONING  
Photon emission for (n,2n)

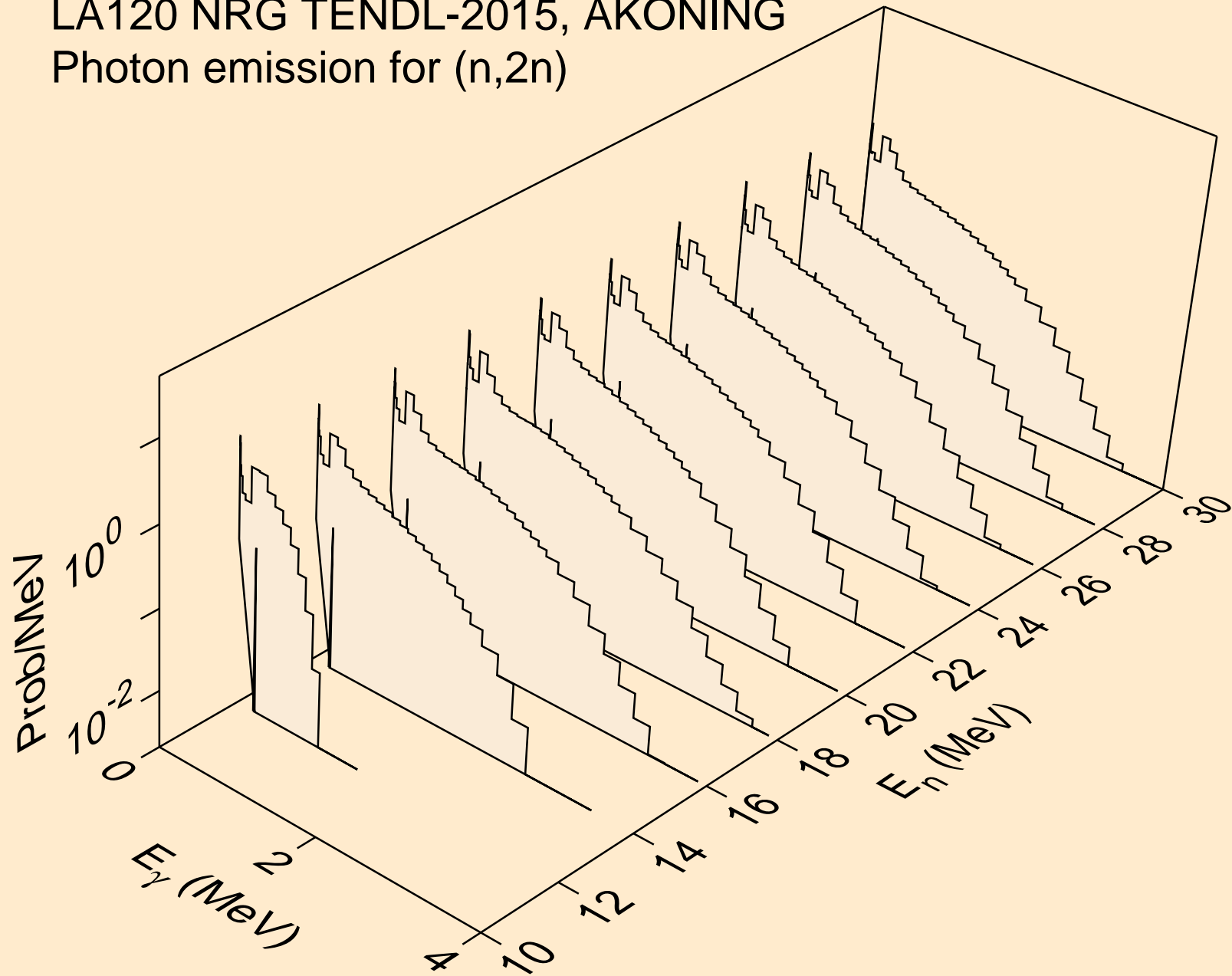

LA120 NRG TENDL-2015, AKONING  
Photon emission for (n,3n)

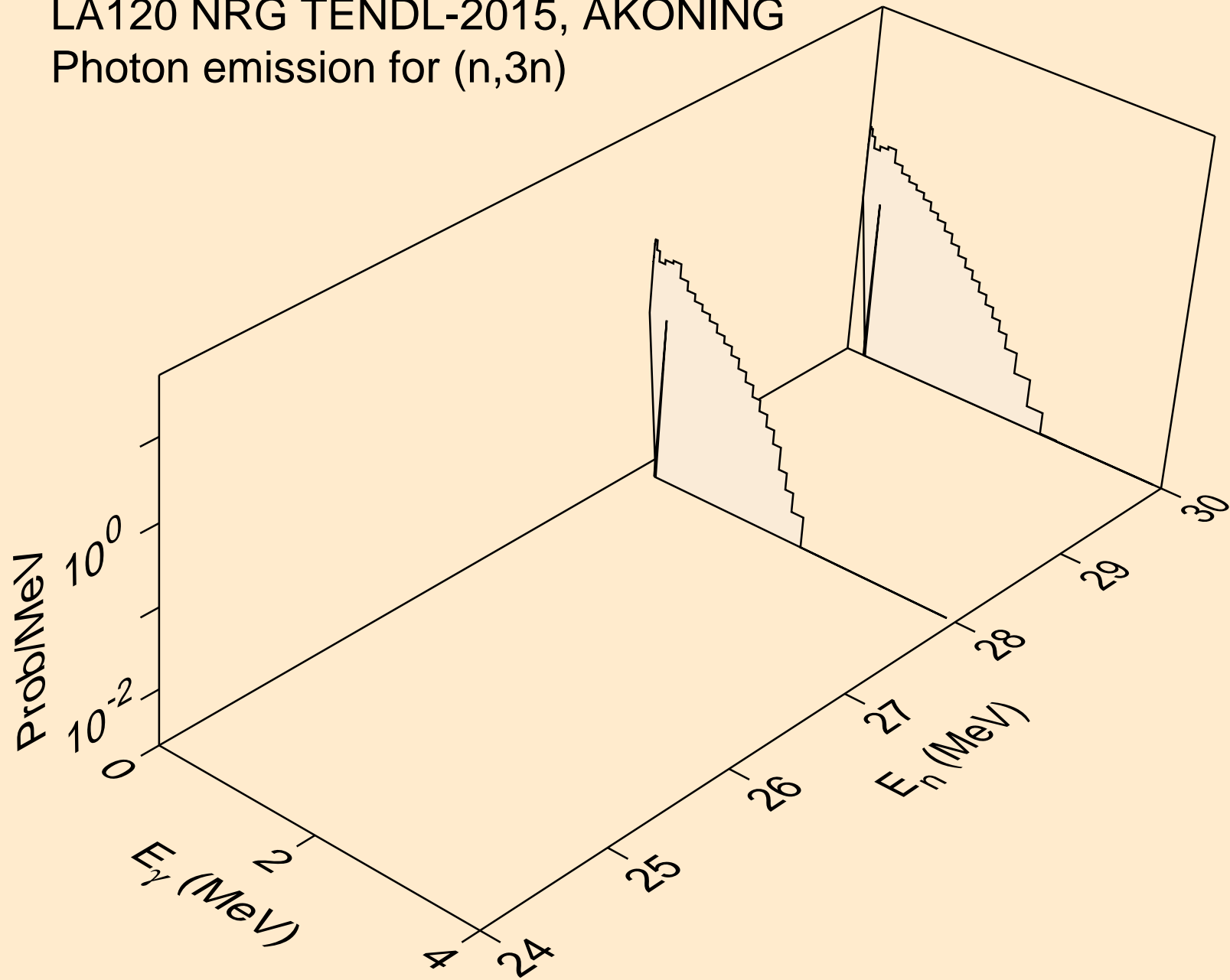

LA120 NRG TENDL-2015, AKONING  
Photon emission for (n,n\*)a

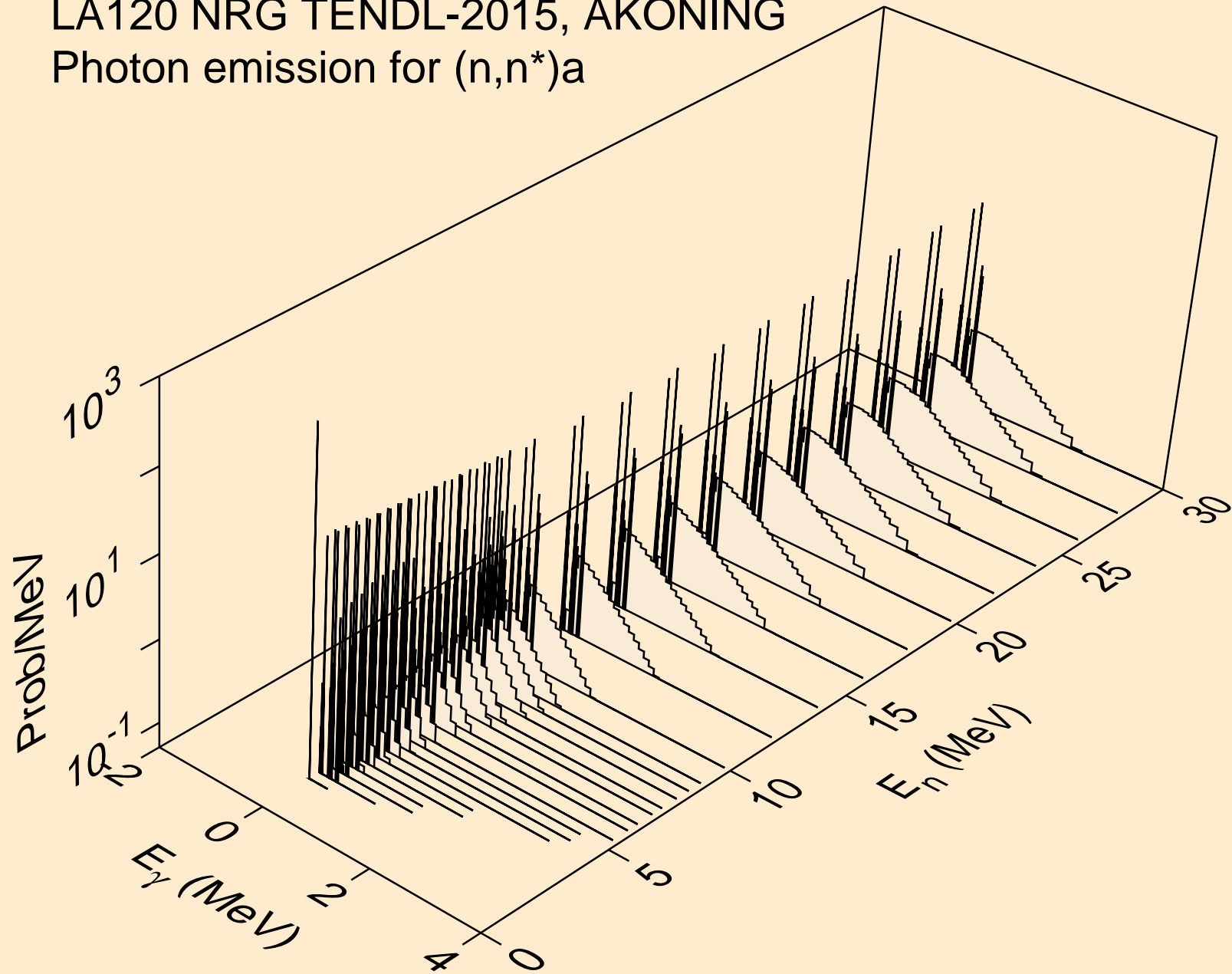

LA120 NRG TENDL-2015, AKONING  
Photon emission for (n,n\*)3a

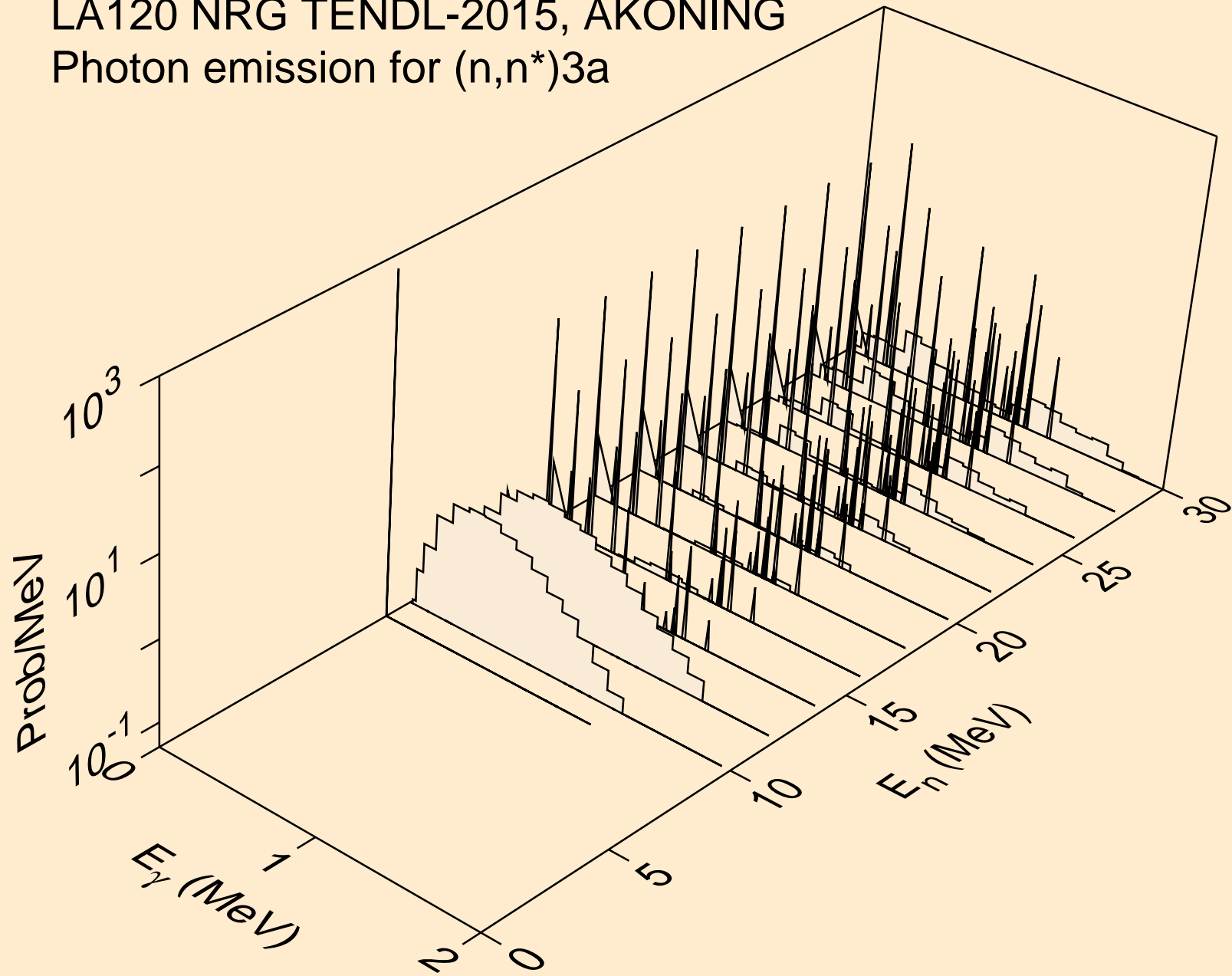

LA120 NRG TENDL-2015, AKONING  
Photon emission for (n,2n)a

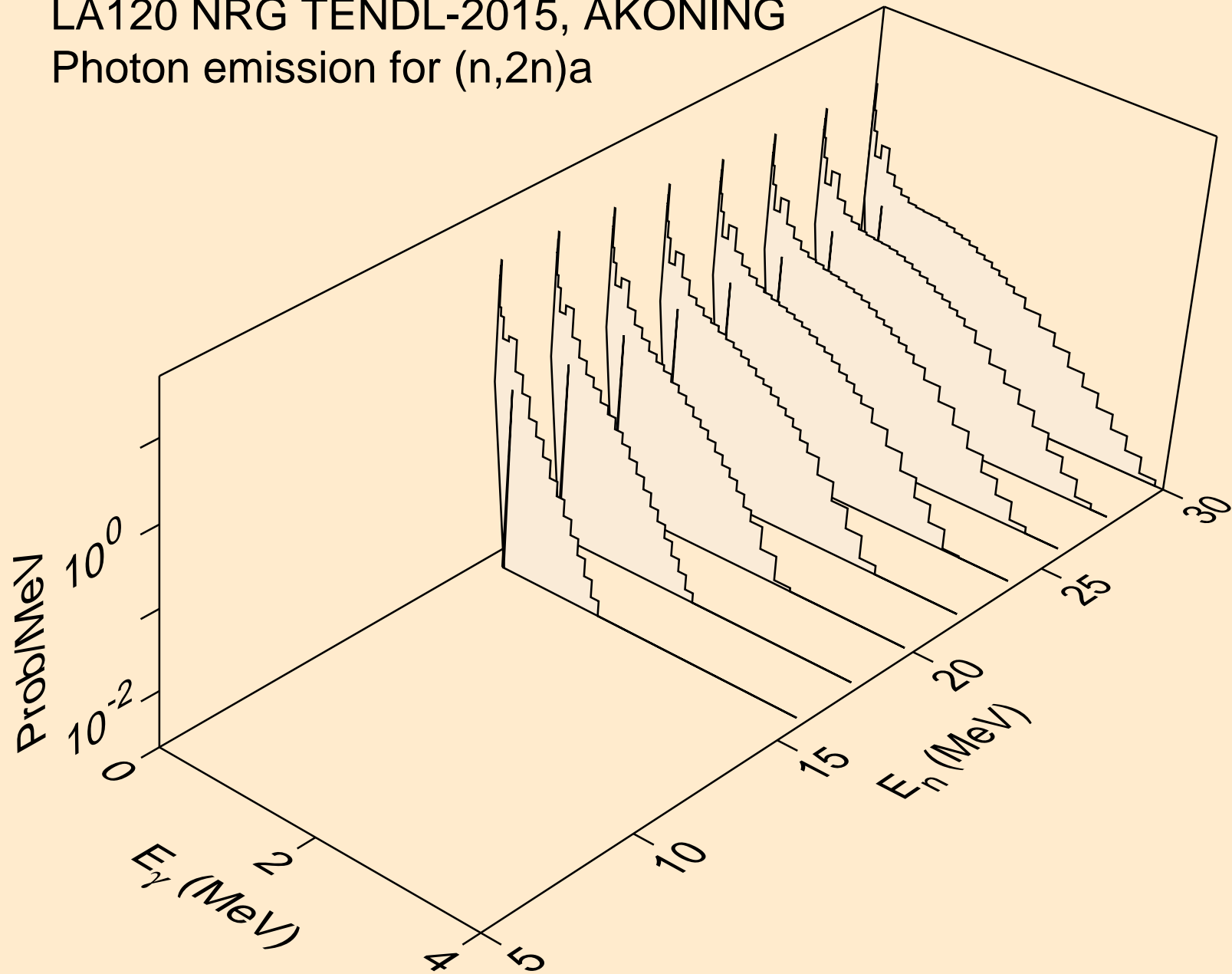

LA120 NRG TENDL-2015, AKONING  
Photon emission for (n,n\*)p

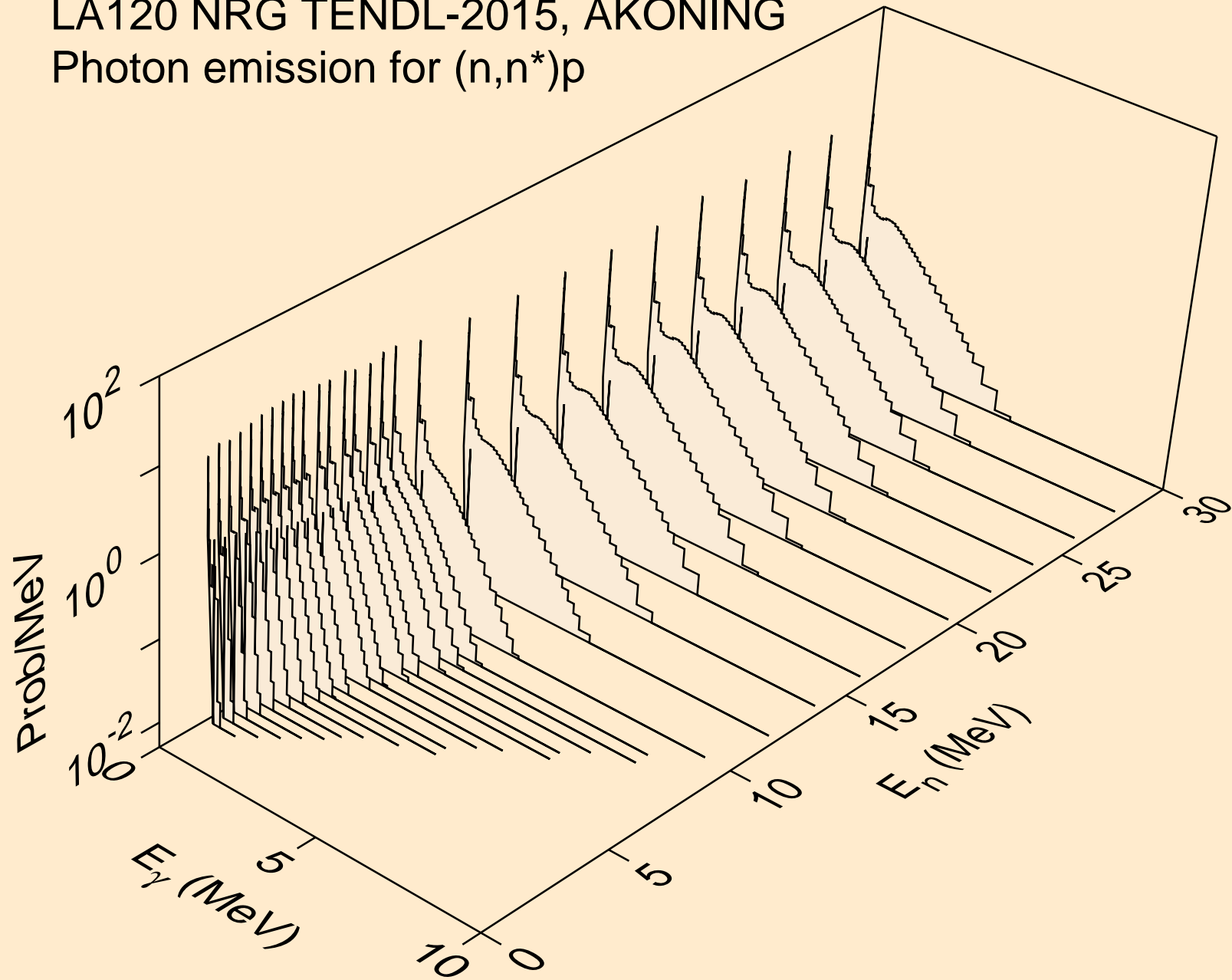



LA120 NRG TENDL-2015, AKONING  
Photon emission for (n,n\*)2a

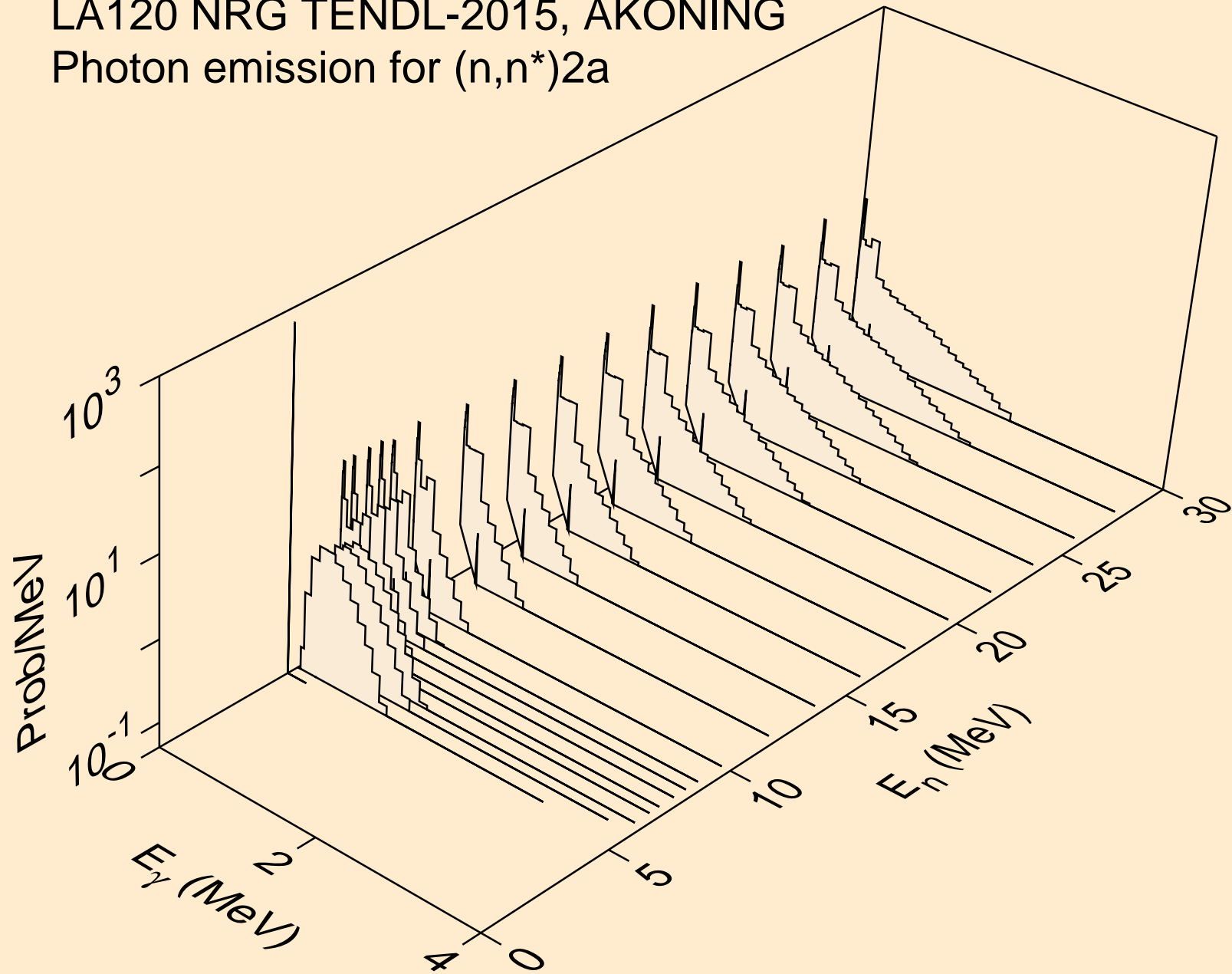

LA120 NRG TENDL-2015, AKONING  
Photon emission for (n,2n)2a

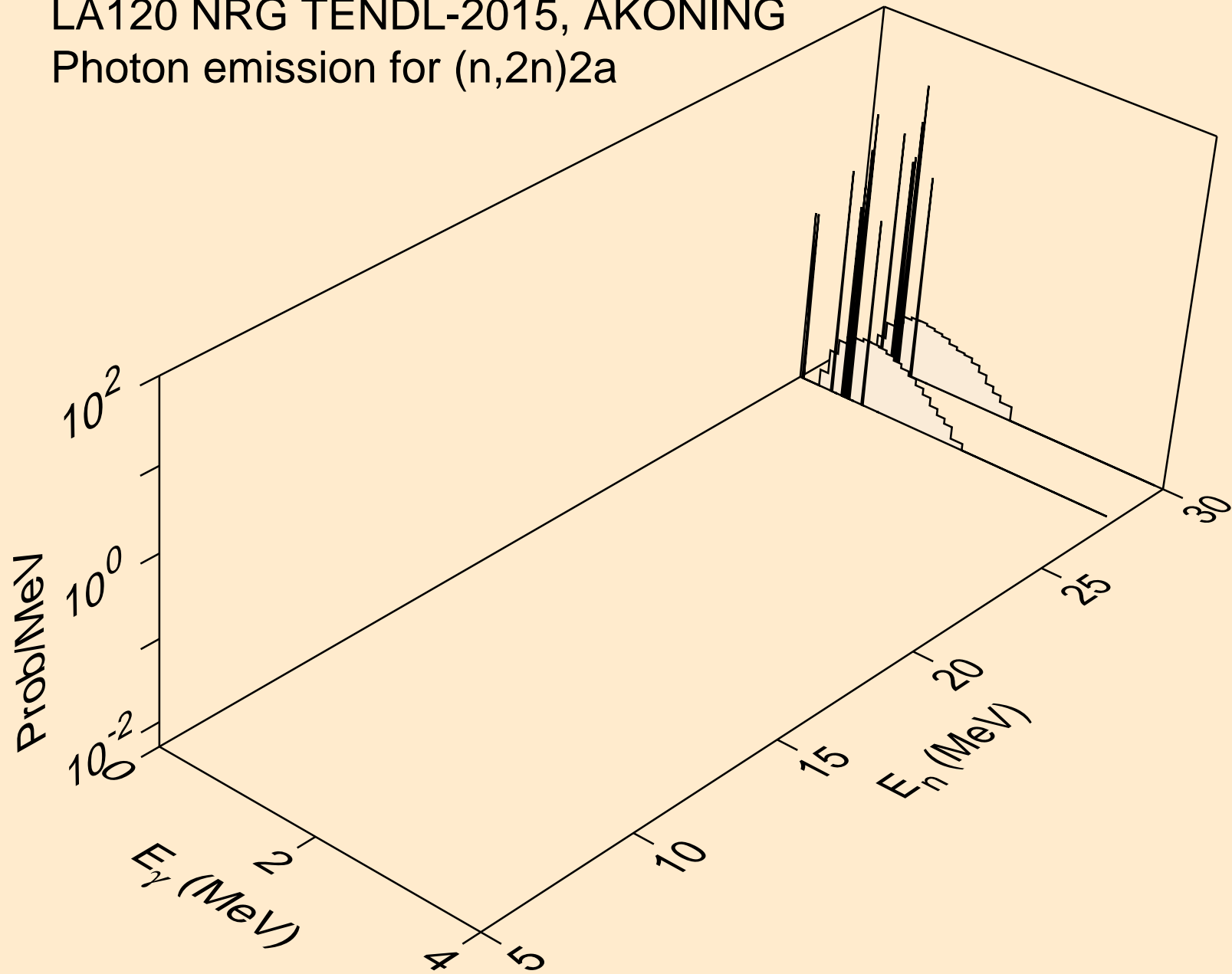

LA120 NRG TENDL-2015, AKONING  
Photon emission for (n,n\*)d

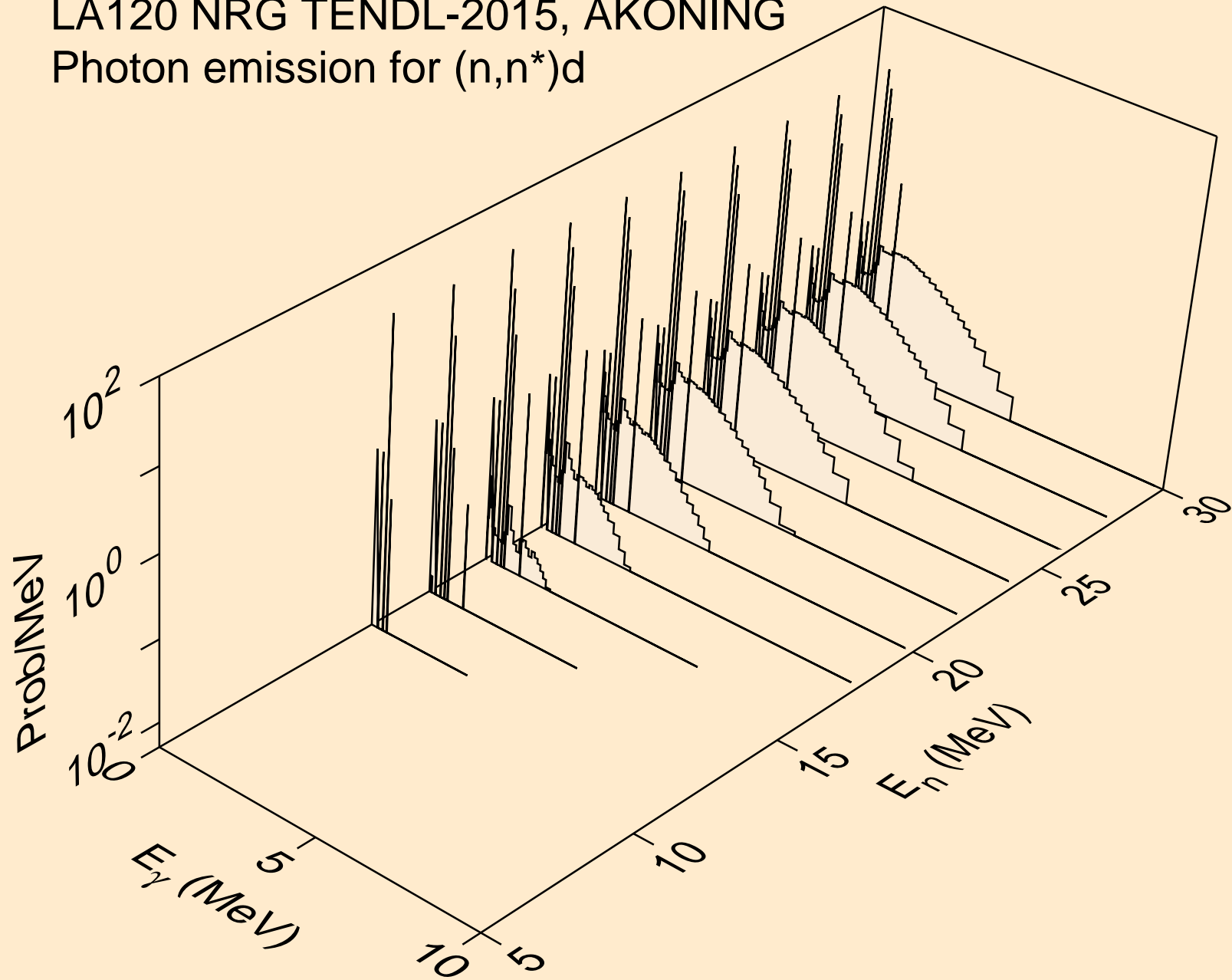

LA120 NRG TENDL-2015, AKONING  
Photon emission for (n,n\*)t

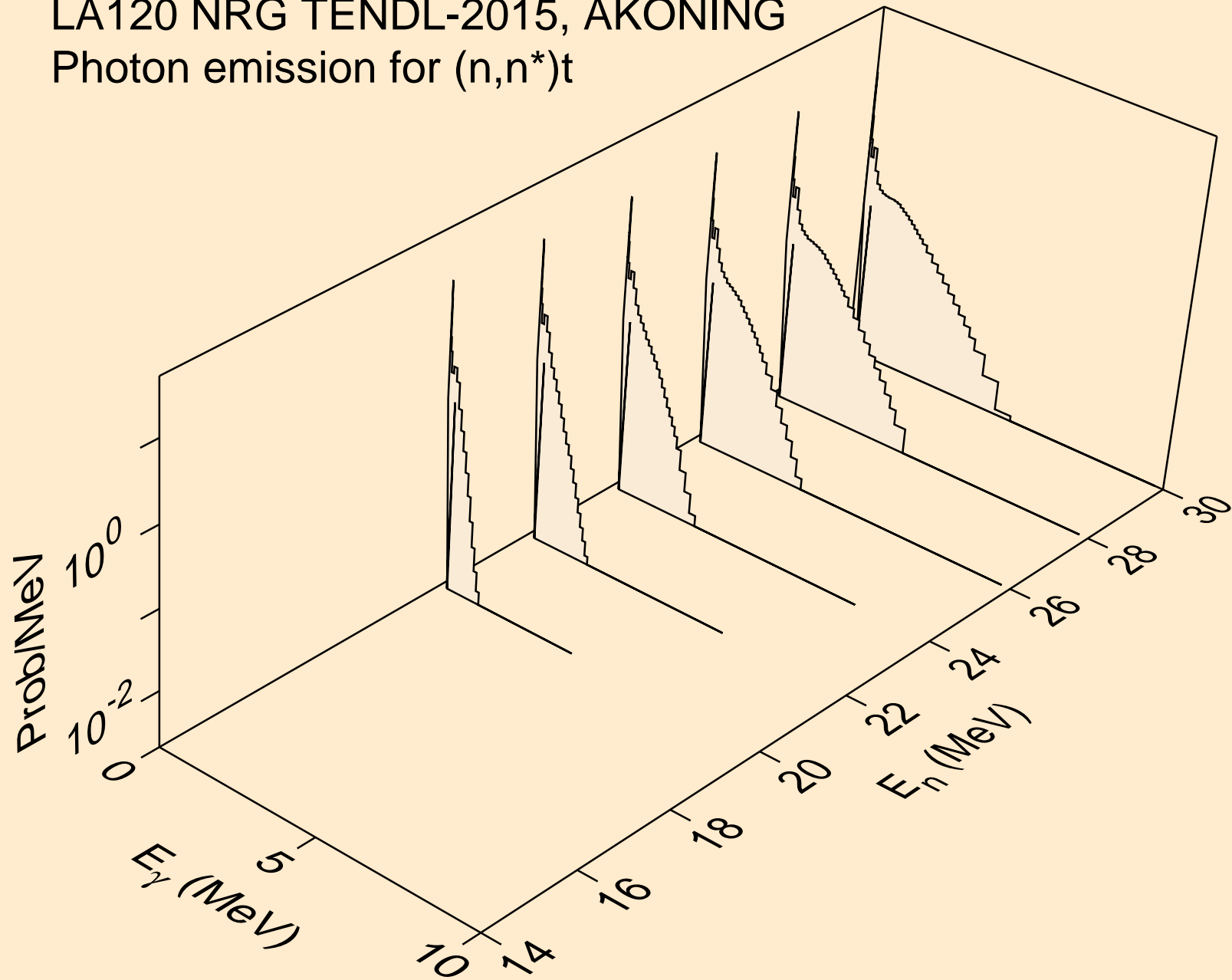

LA120 NRG TENDL-2015, AKONING  
Photon emission for (n,n\*)he3

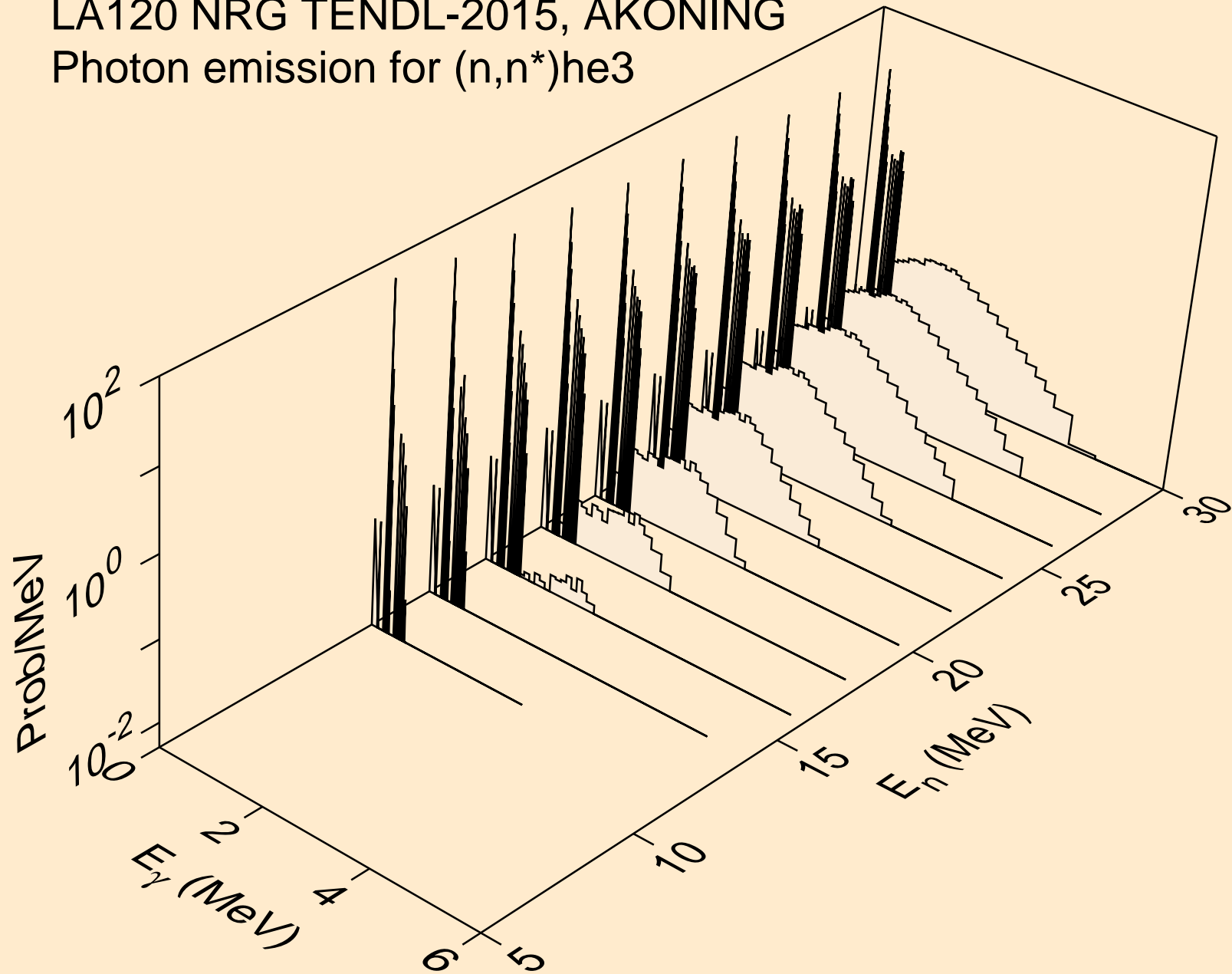

LA120 NRG TENDL-2015, AKONING  
Photon emission for (n,n\*)d2a

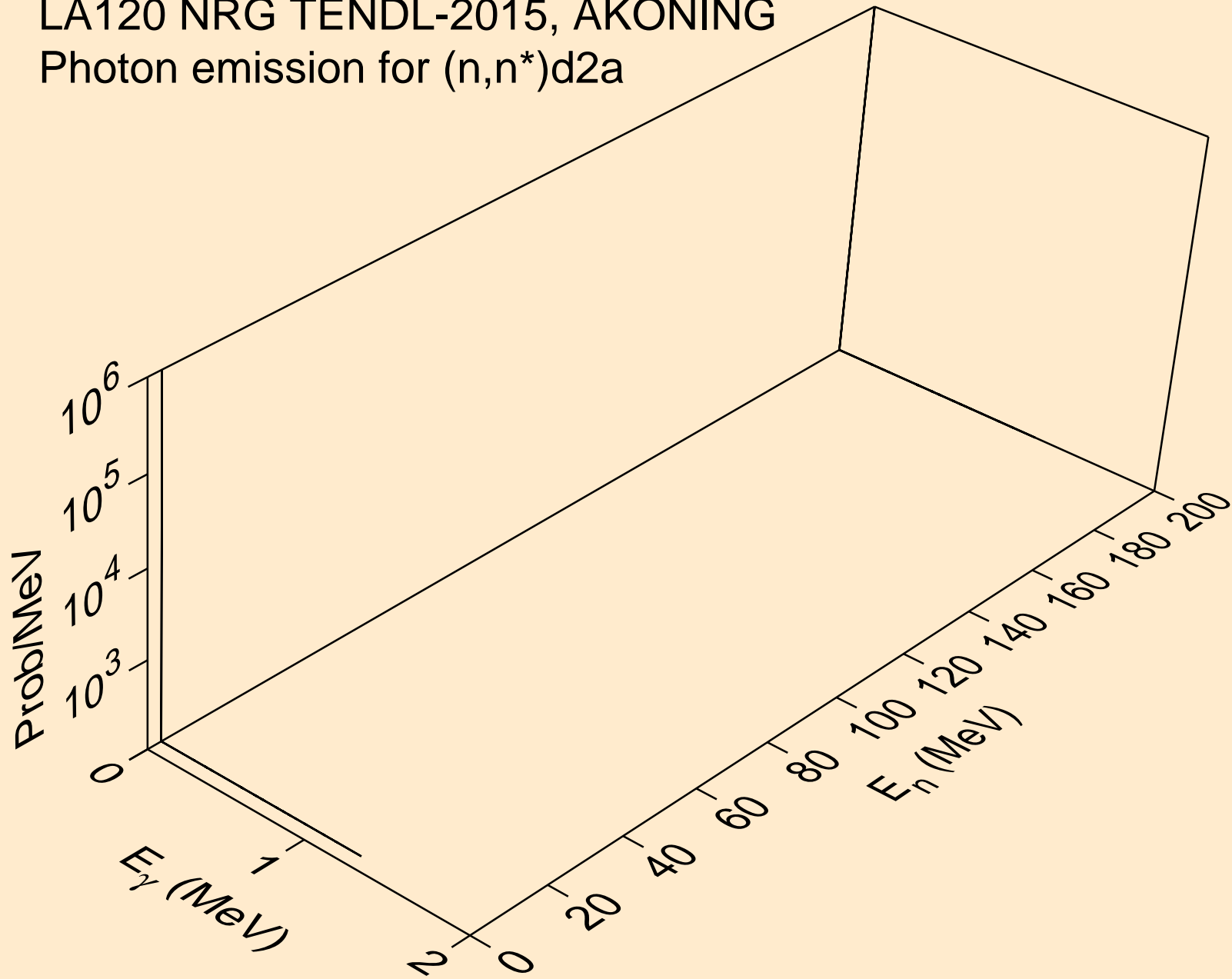

LA120 NRG TENDL-2015, AKONING  
Photon emission for (n,2np)

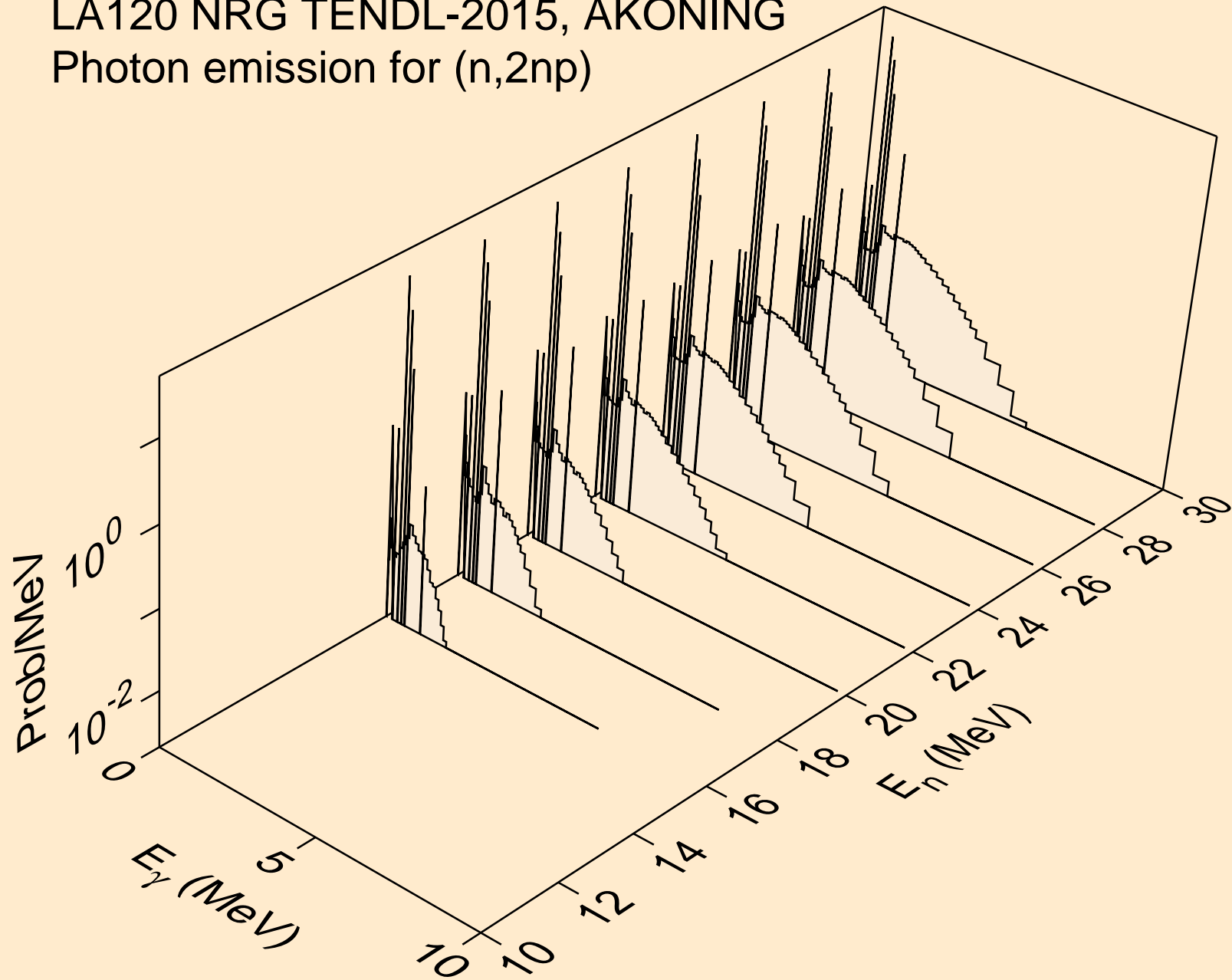

LA120 NRG TENDL-2015, AKONING  
Photon emission for (n,3np)

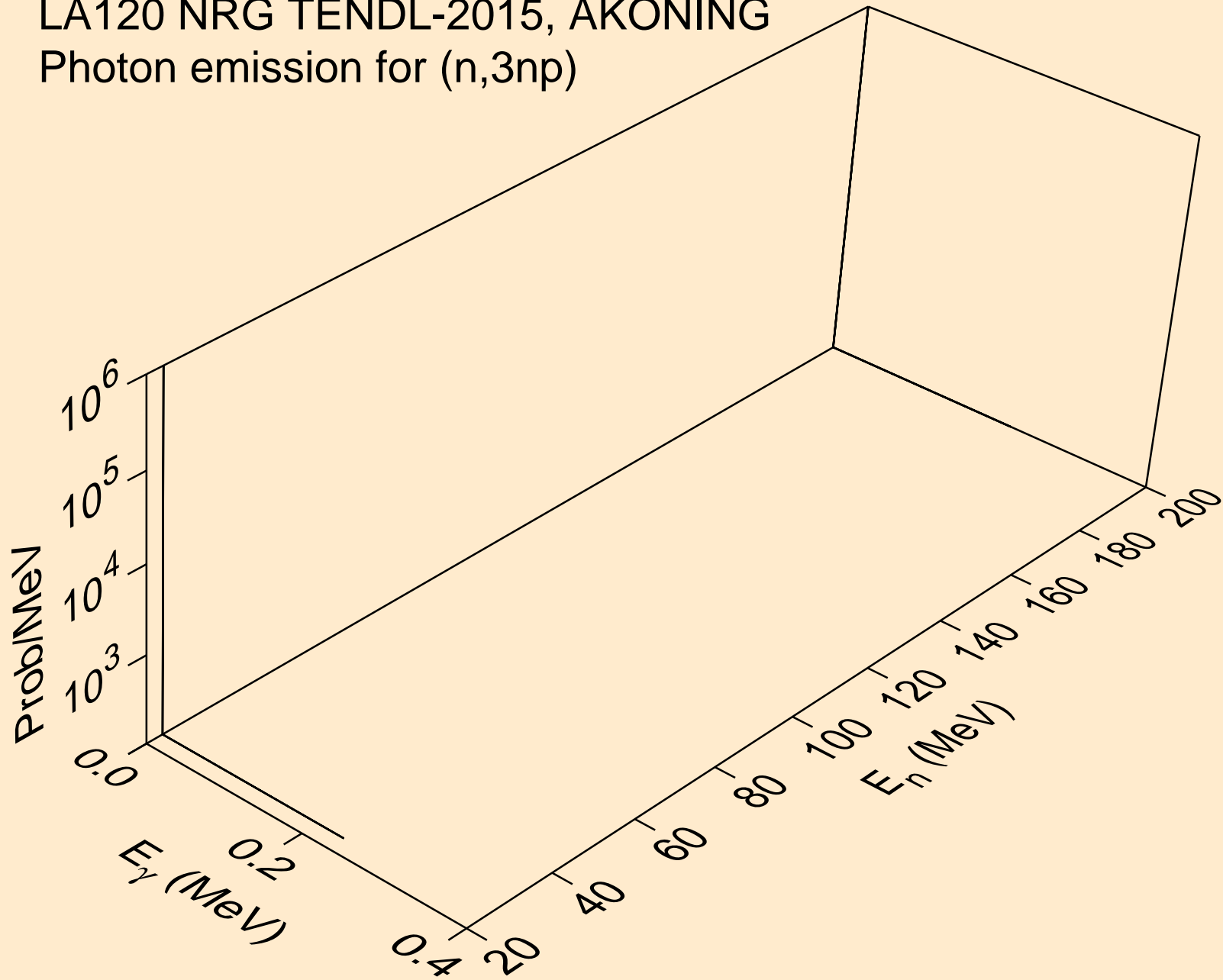



LA120 NRG TENDL-2015, AKONING  
Photon emission for (n,2np)

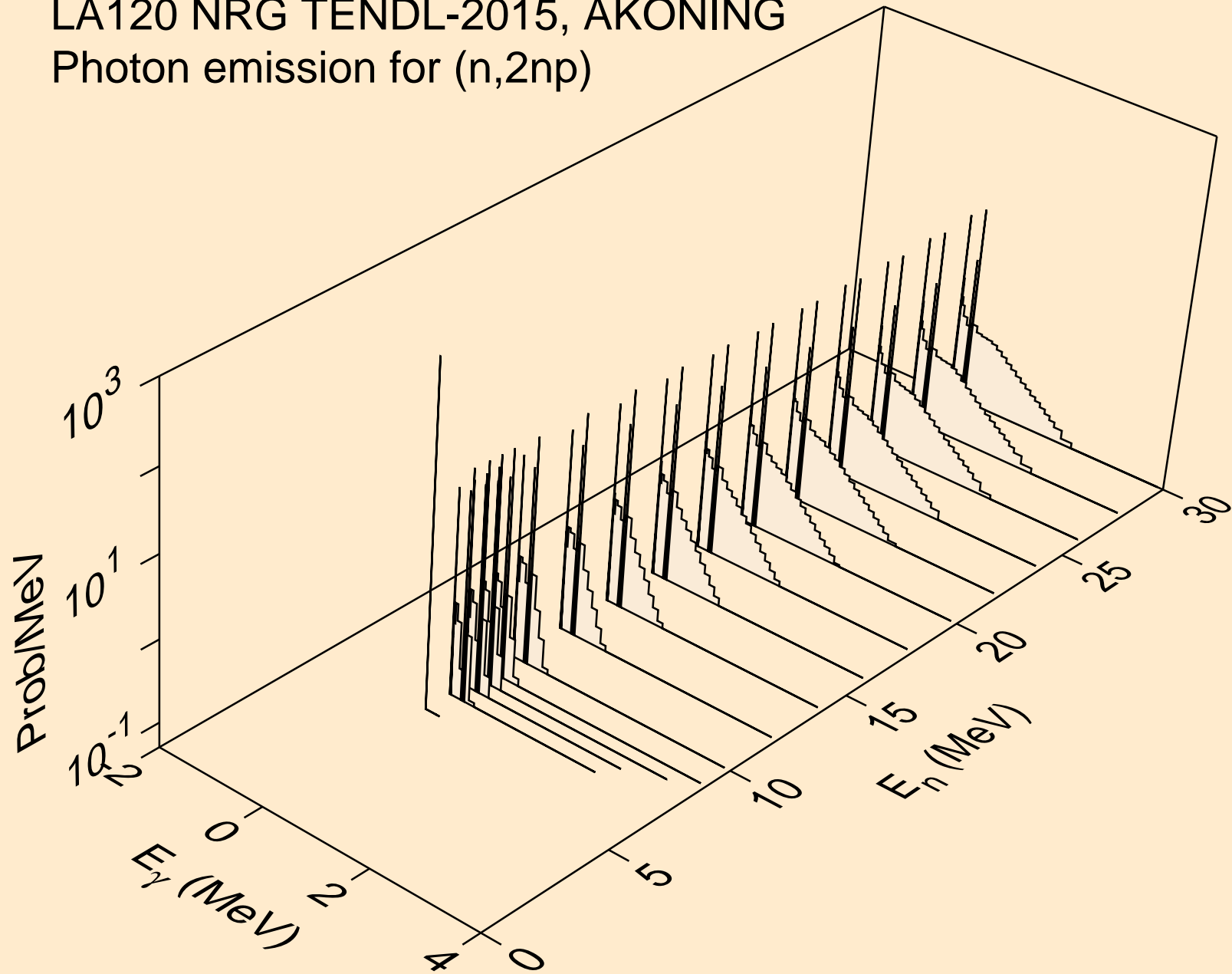

LA120 NRG TENDL-2015, AKONING  
Photon emission for (n,npa)

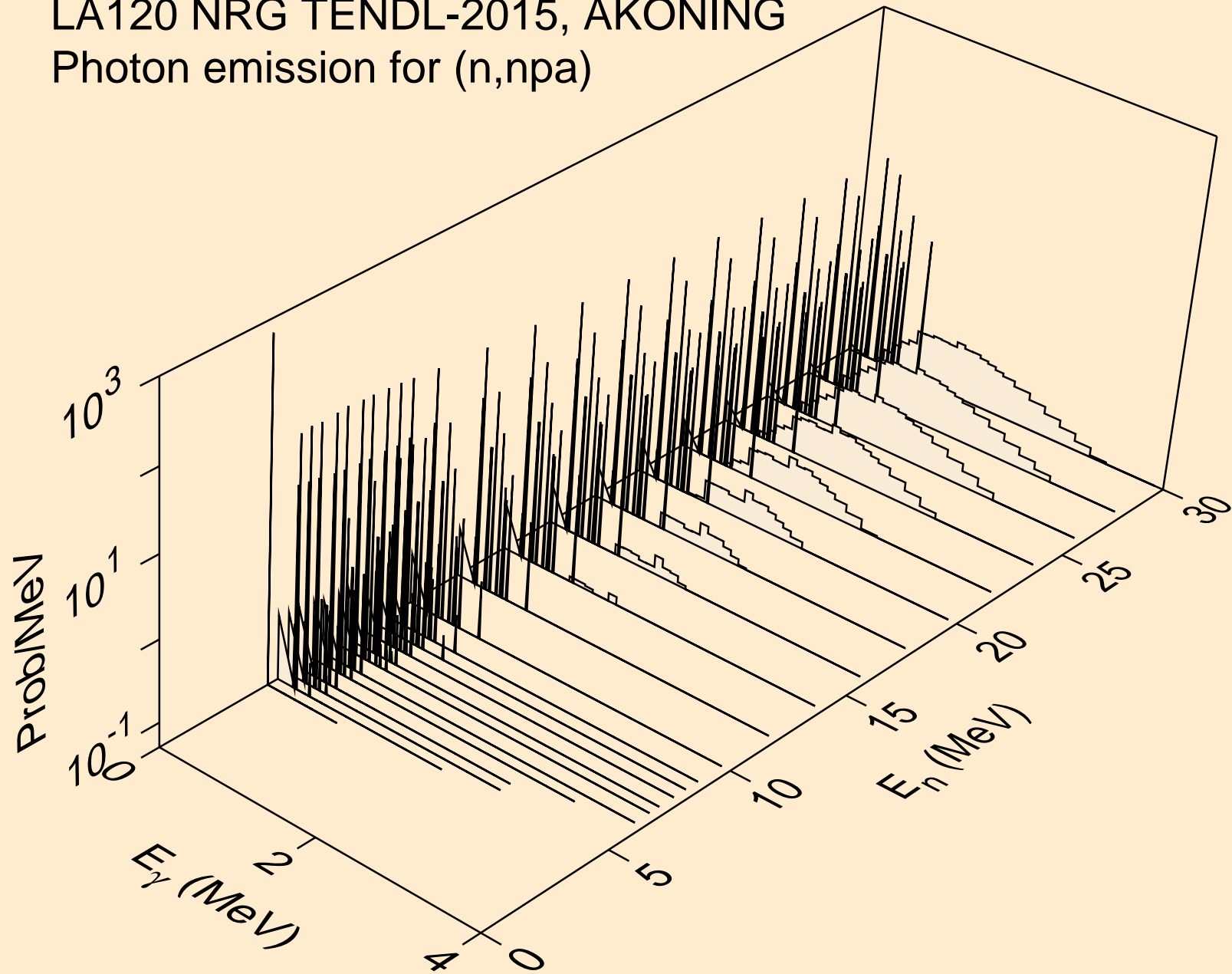

LA120 NRG TENDL-2015, AKONING  
Photon emission for (n,n\*c)

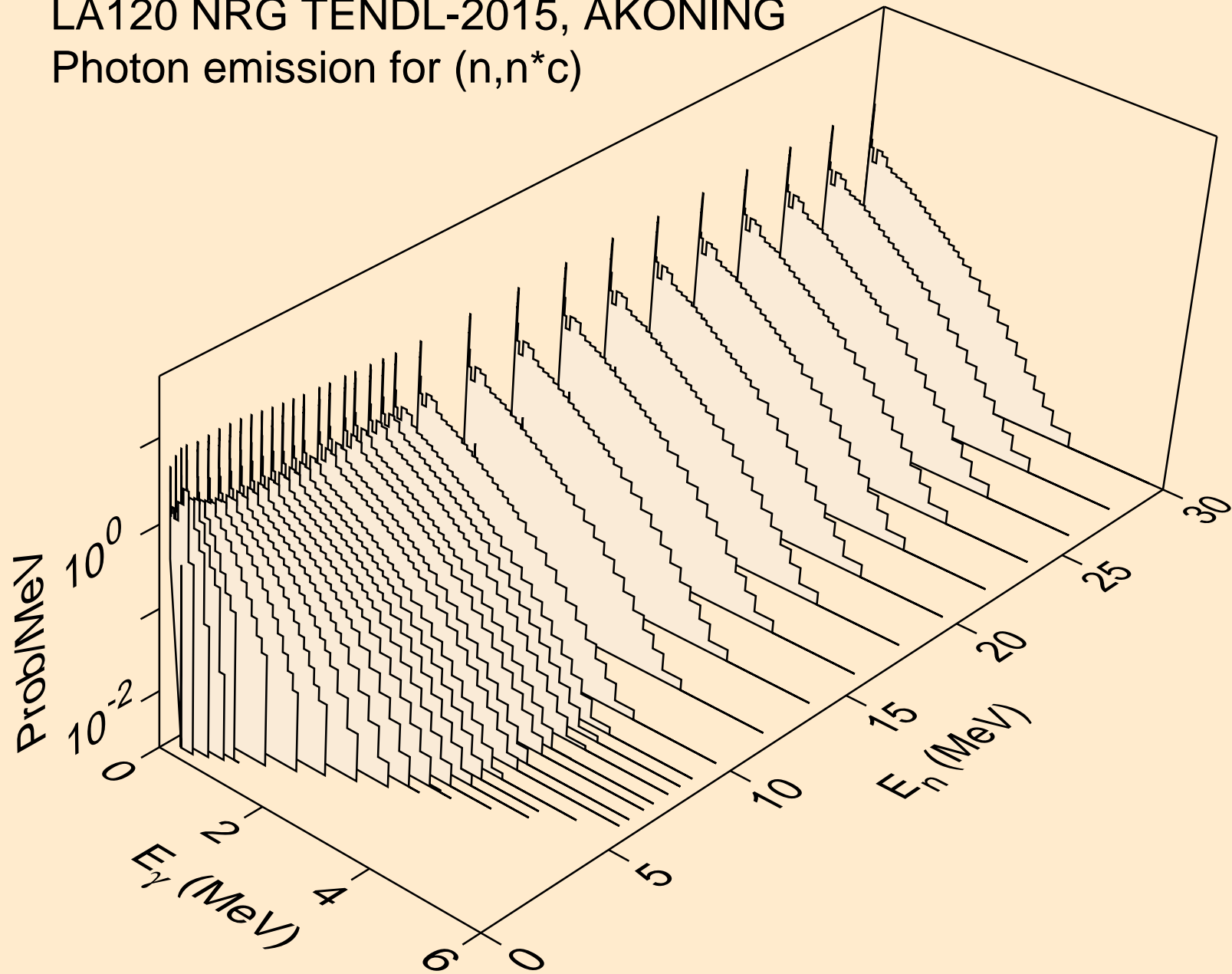

LA120 NRG TENDL-2015, AKONING  
Photon emission for (n,gma)

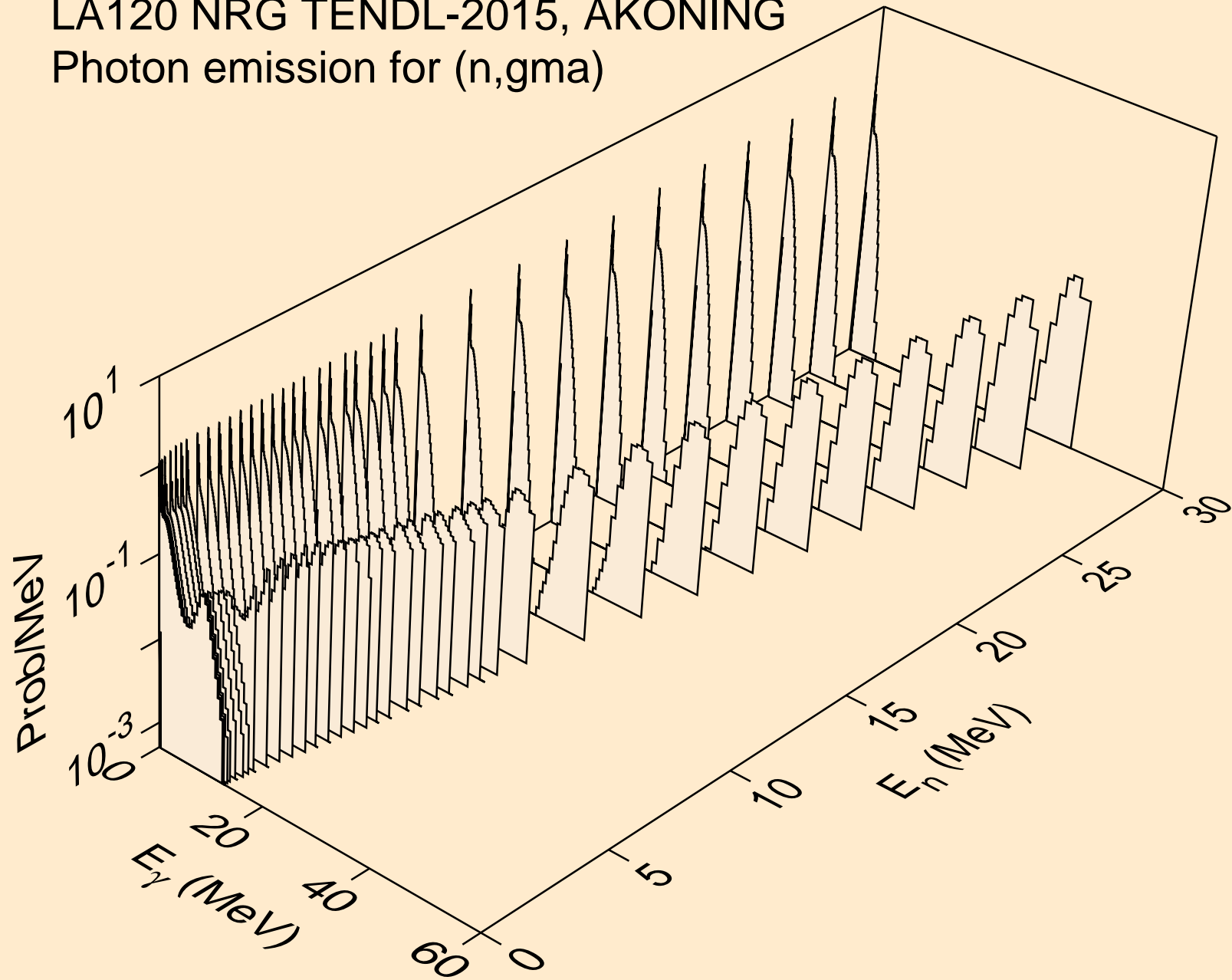

LA120 NRG TENDL-2015, AKONING  
Photon emission for (n,p)

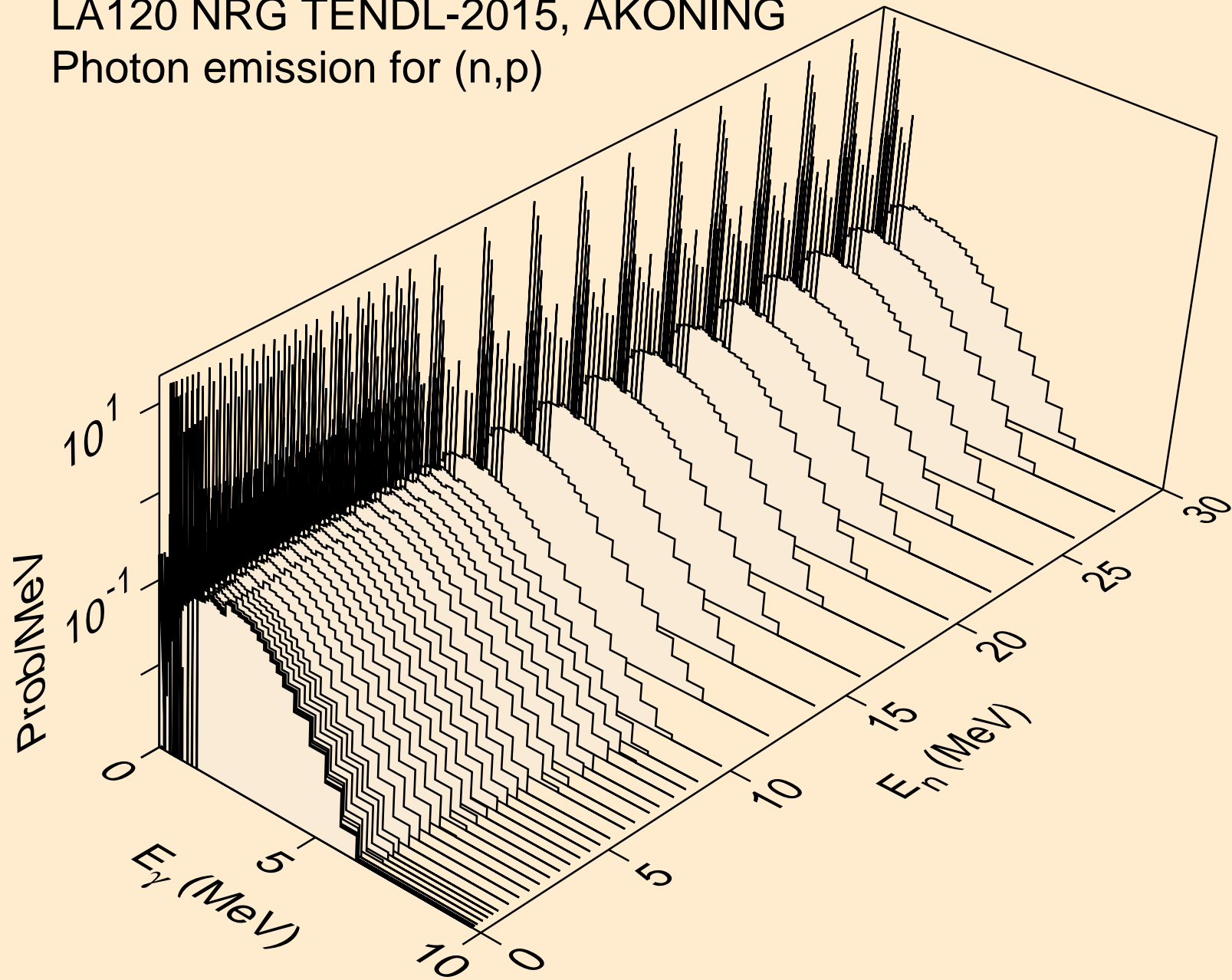

LA120 NRG TENDL-2015, AKONING  
Photon emission for (n,d)

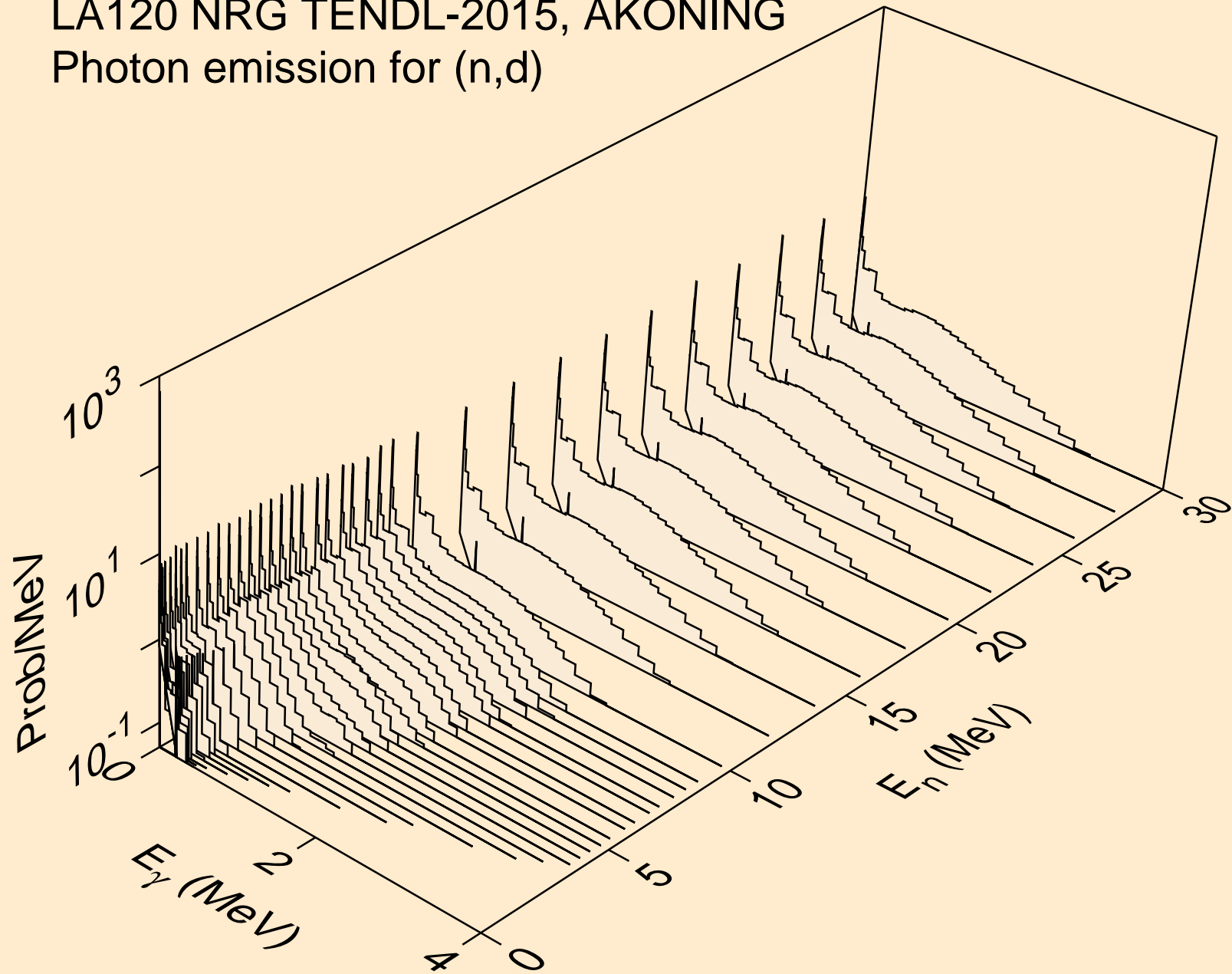

LA120 NRG TENDL-2015, AKONING  
Photon emission for (n,t)

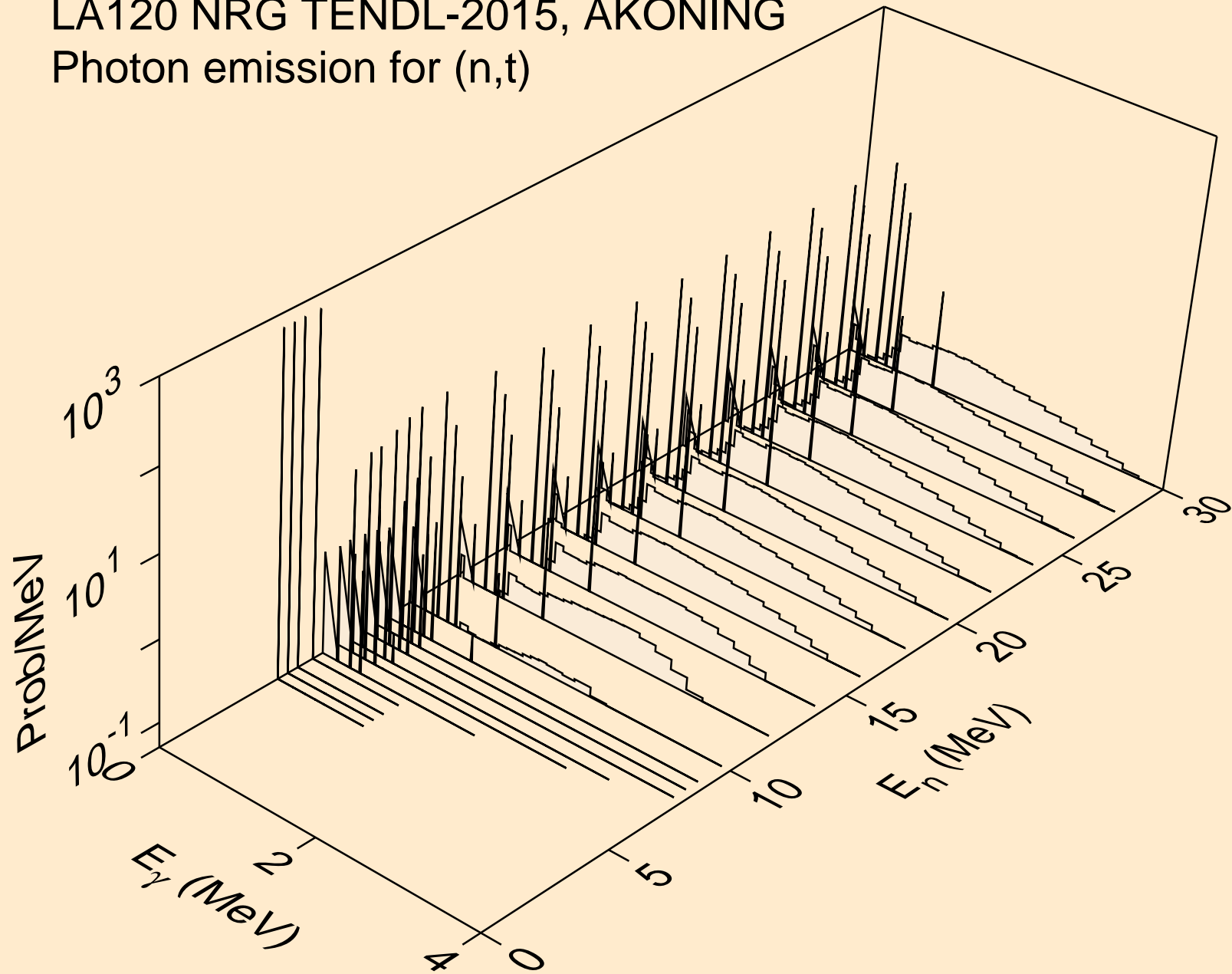

LA120 NRG TENDL-2015, AKONING  
Photon emission for (n,he3)

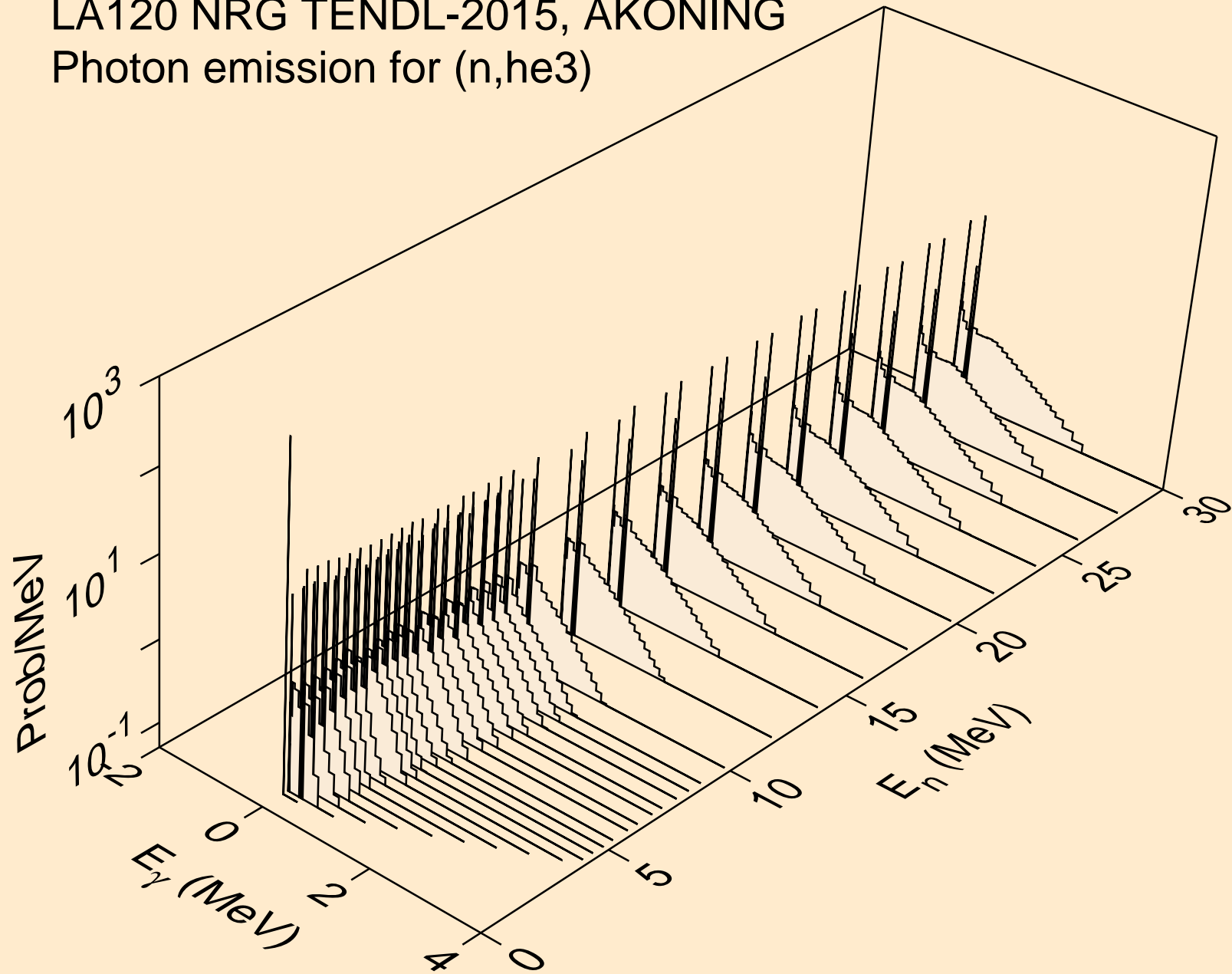



LA120 NRG TENDL-2015, AKONING  
Photon emission for (n,a)

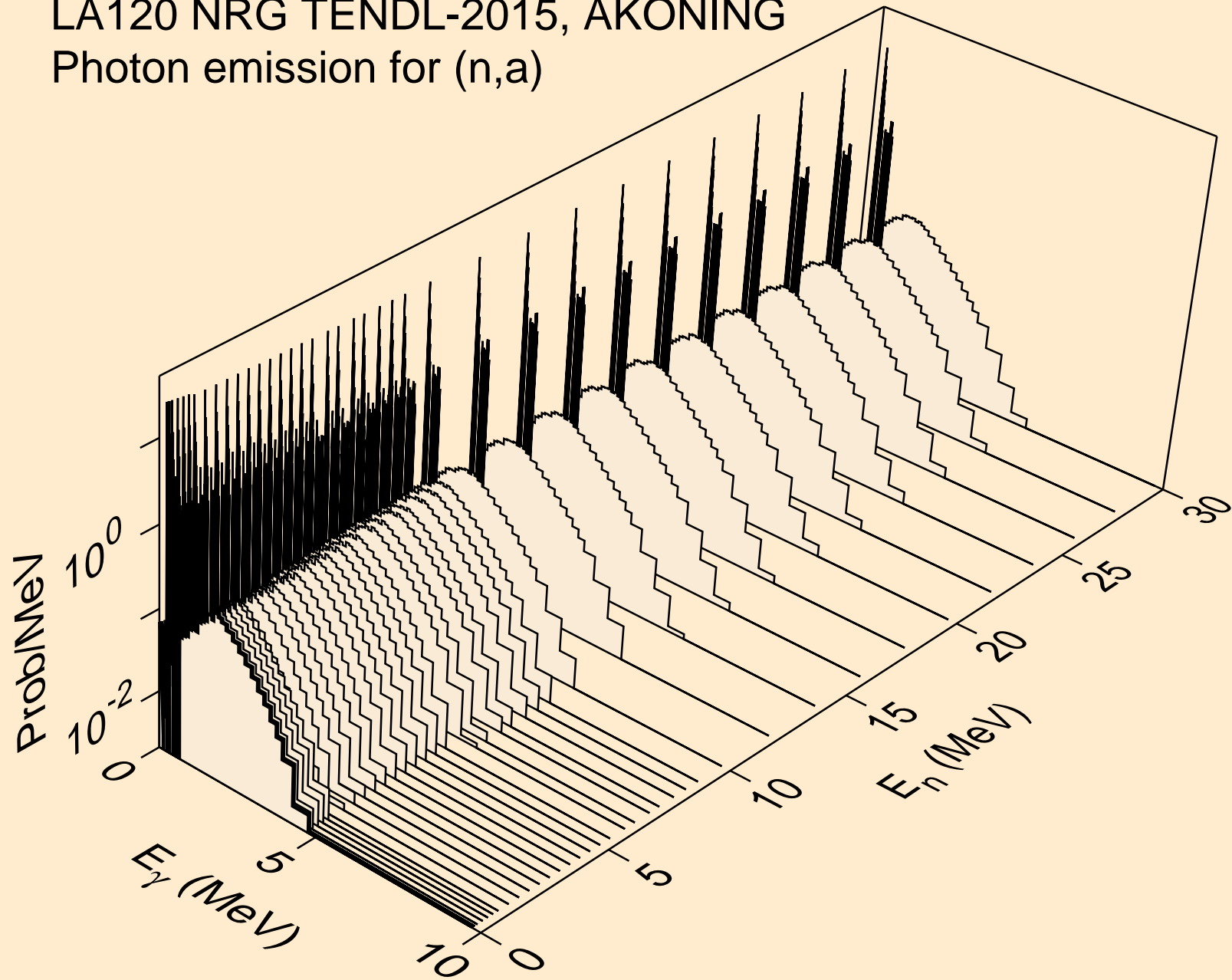

LA120 NRG TENDL-2015, AKONING  
Photon emission for (n,2a)

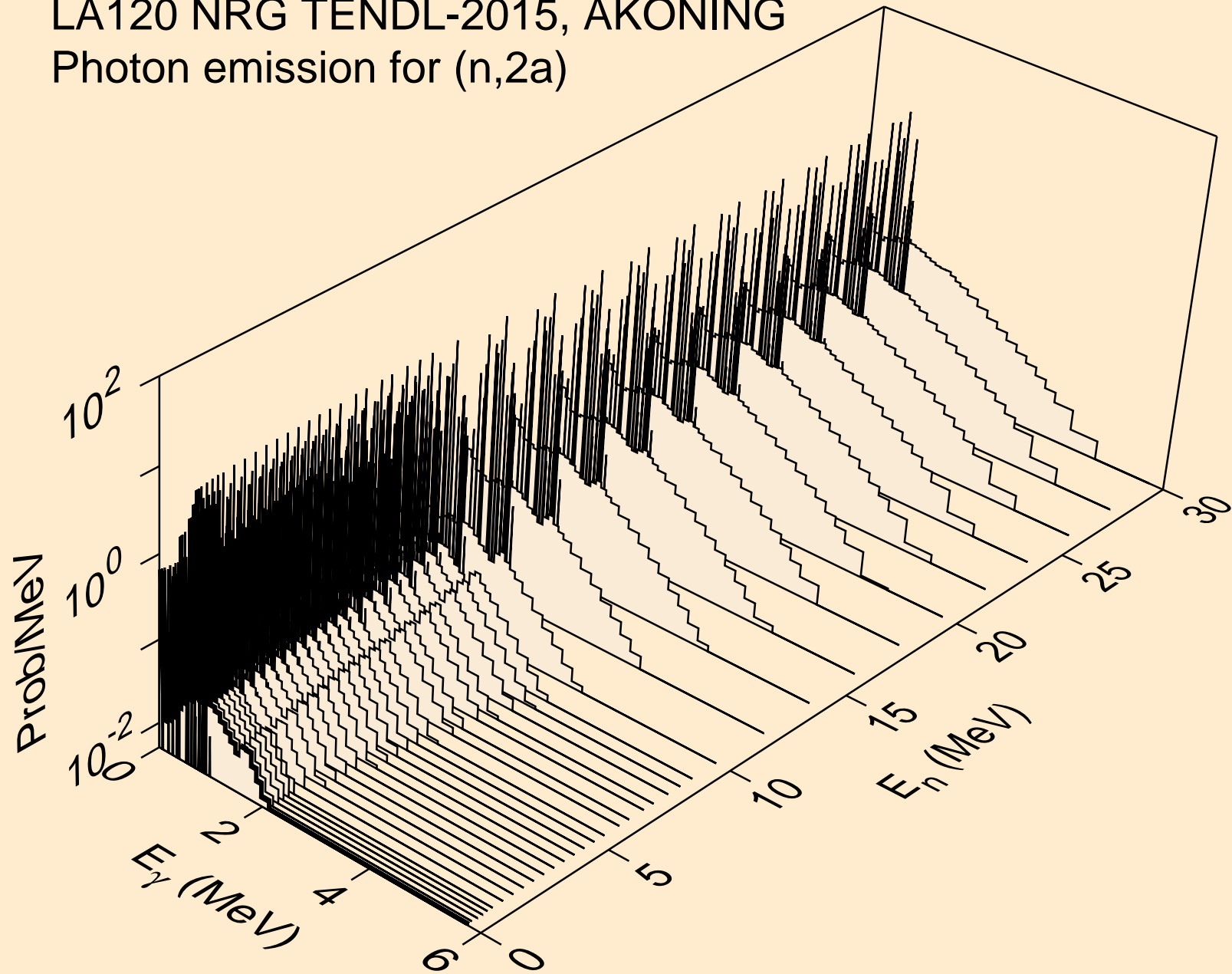

LA120 NRG TENDL-2015, AKONING  
Photon emission for (n,3a)

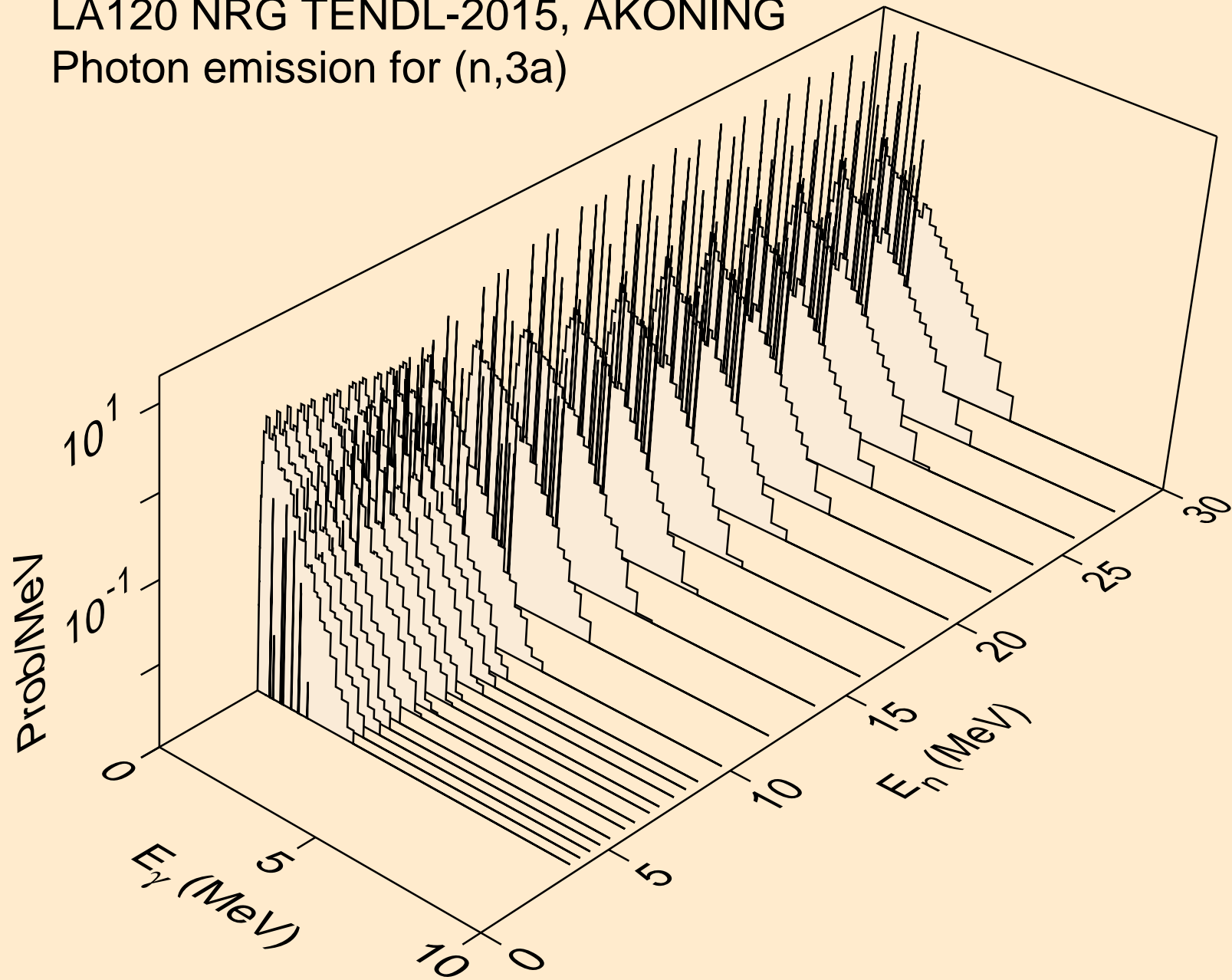

LA120 NRG TENDL-2015, AKONING  
Photon emission for (n,2p)

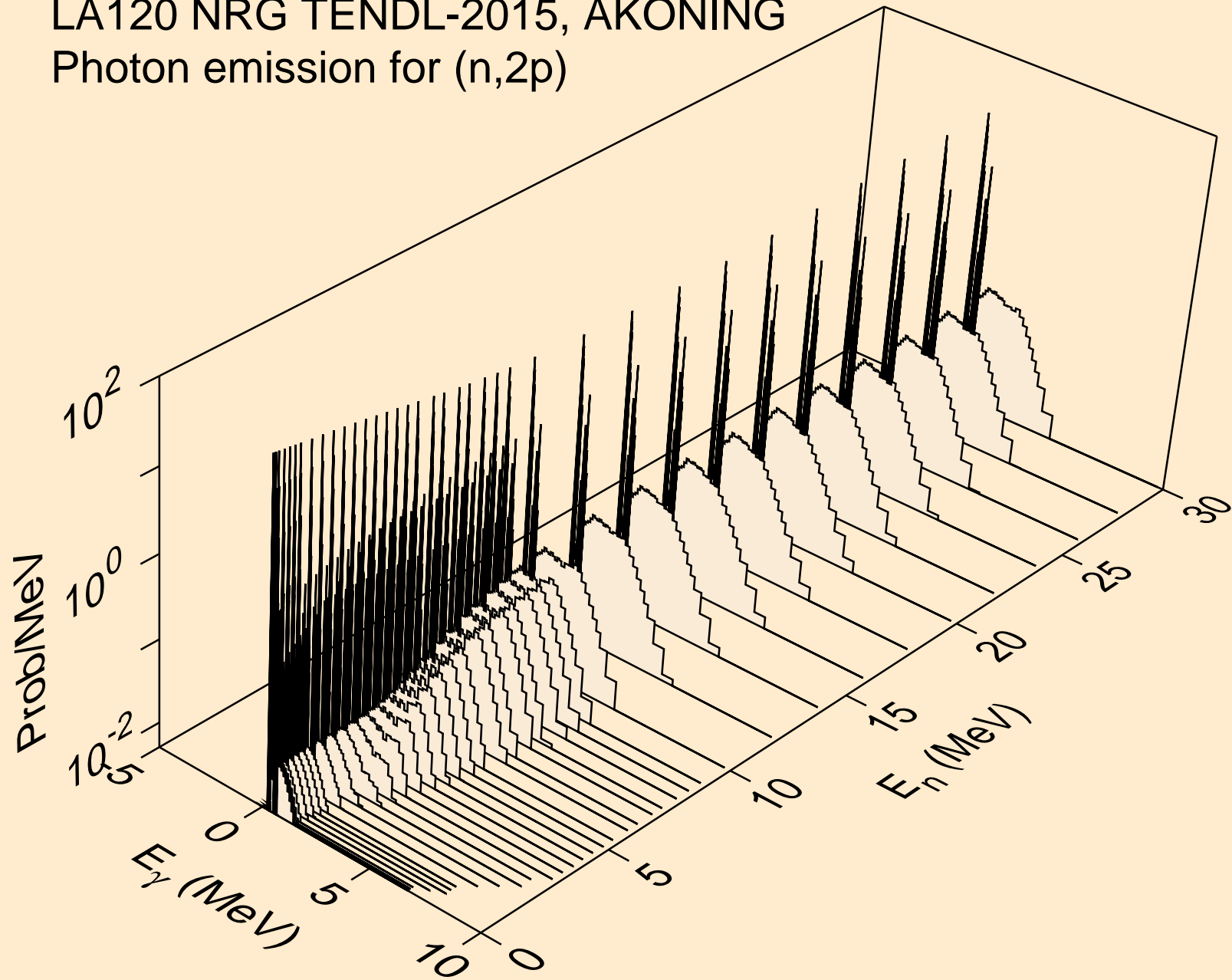

LA120 NRG TENDL-2015, AKONING  
Photon emission for (n,p $\alpha$ )

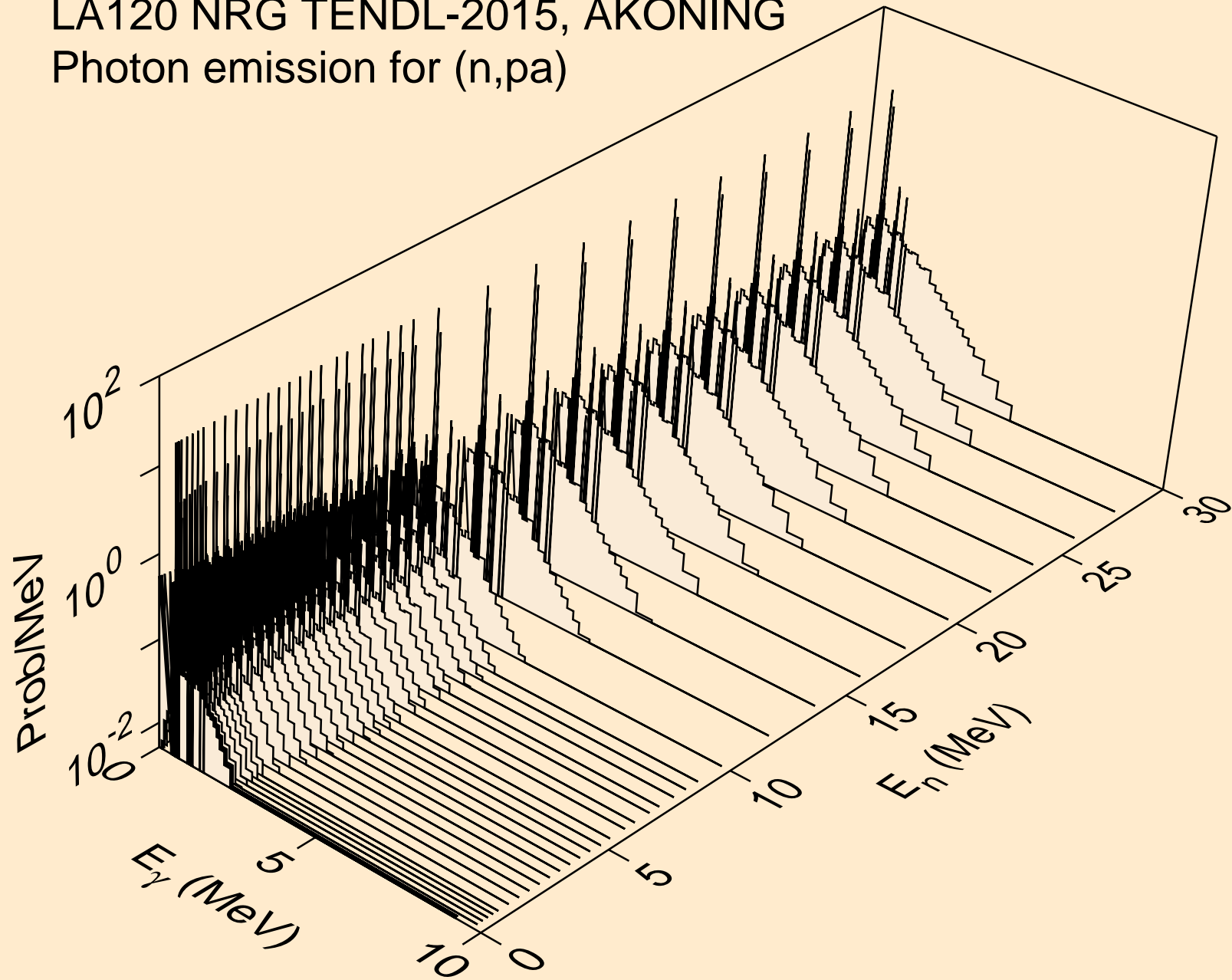

LA120 NRG TENDL-2015, AKONING  
Photon emission for (n,t2a)

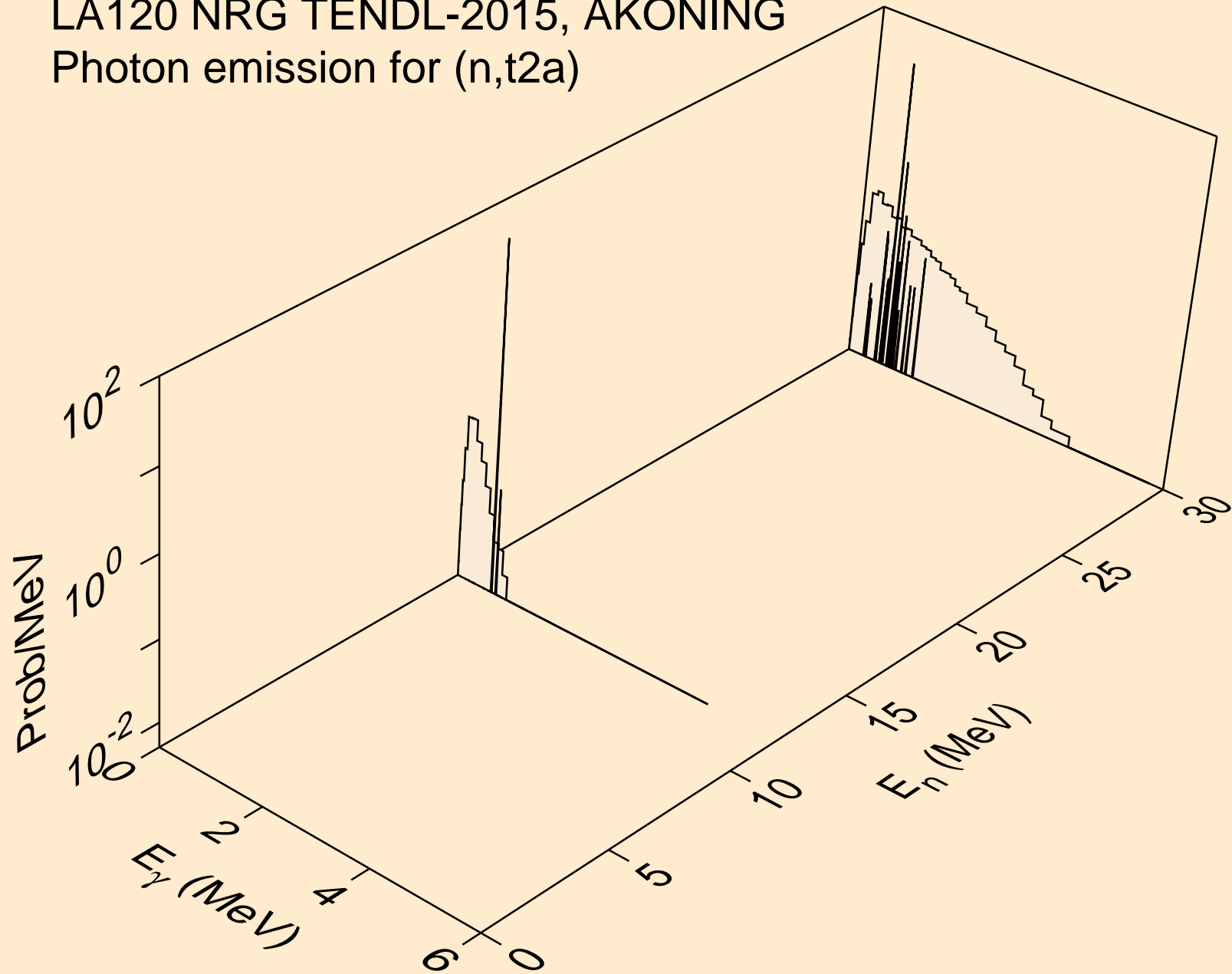

LA120 NRG TENDL-2015, AKONING  
Photon emission for (n,d2a)

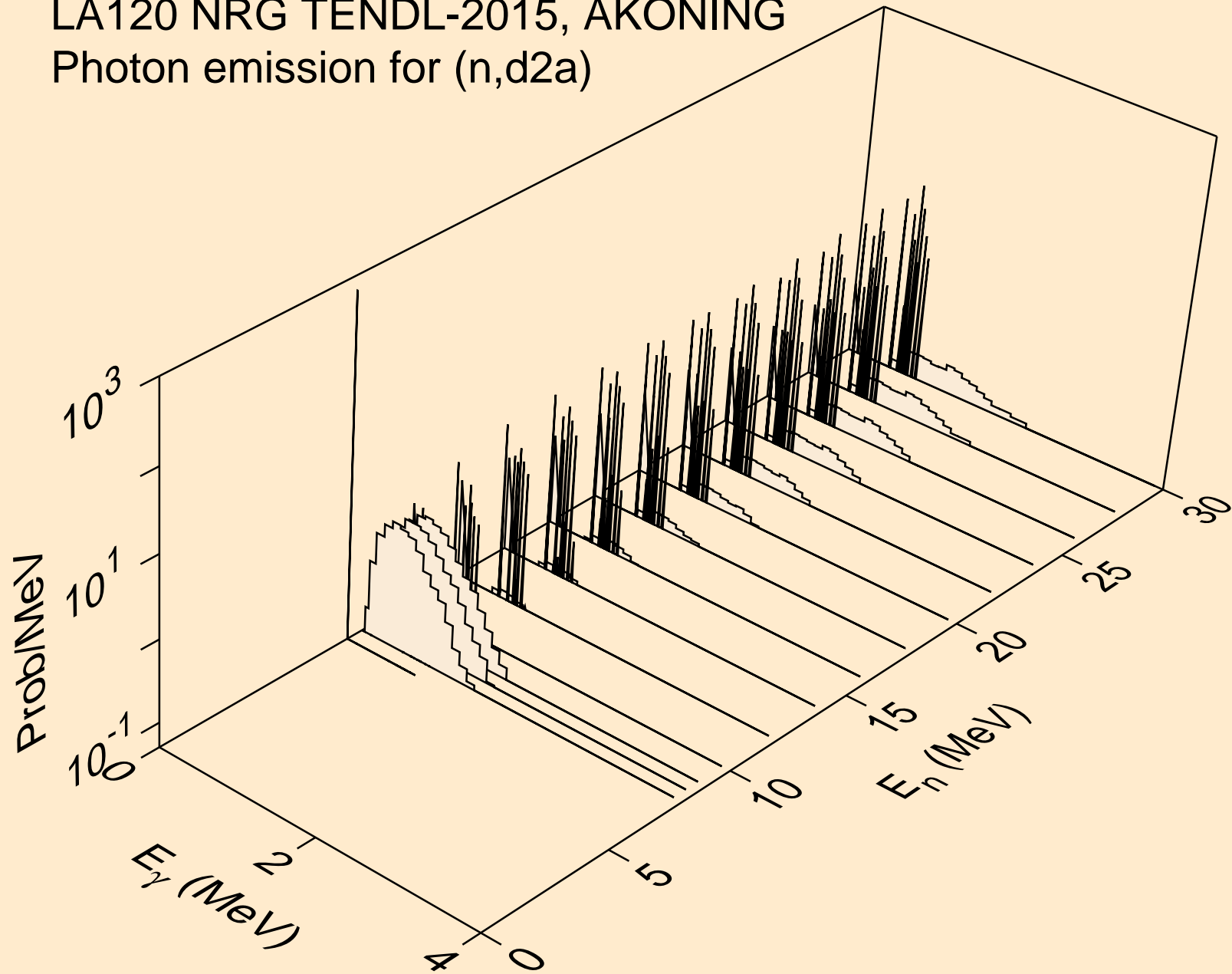

LA120 NRG TENDL-2015, AKONING  
Photon emission for (n,pd)

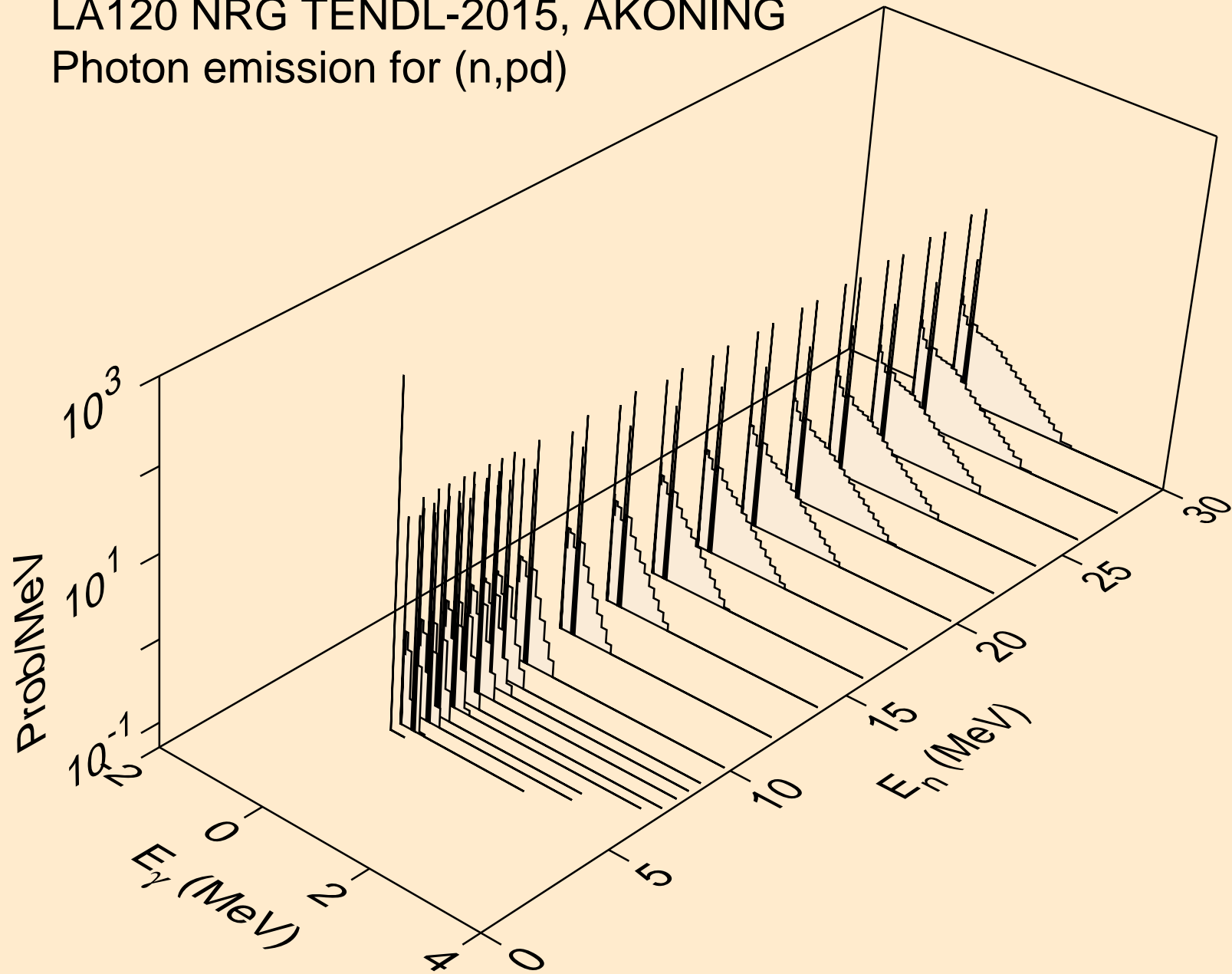



LA120 NRG TENDL-2015, AKONING  
Photon emission for (n,pt)

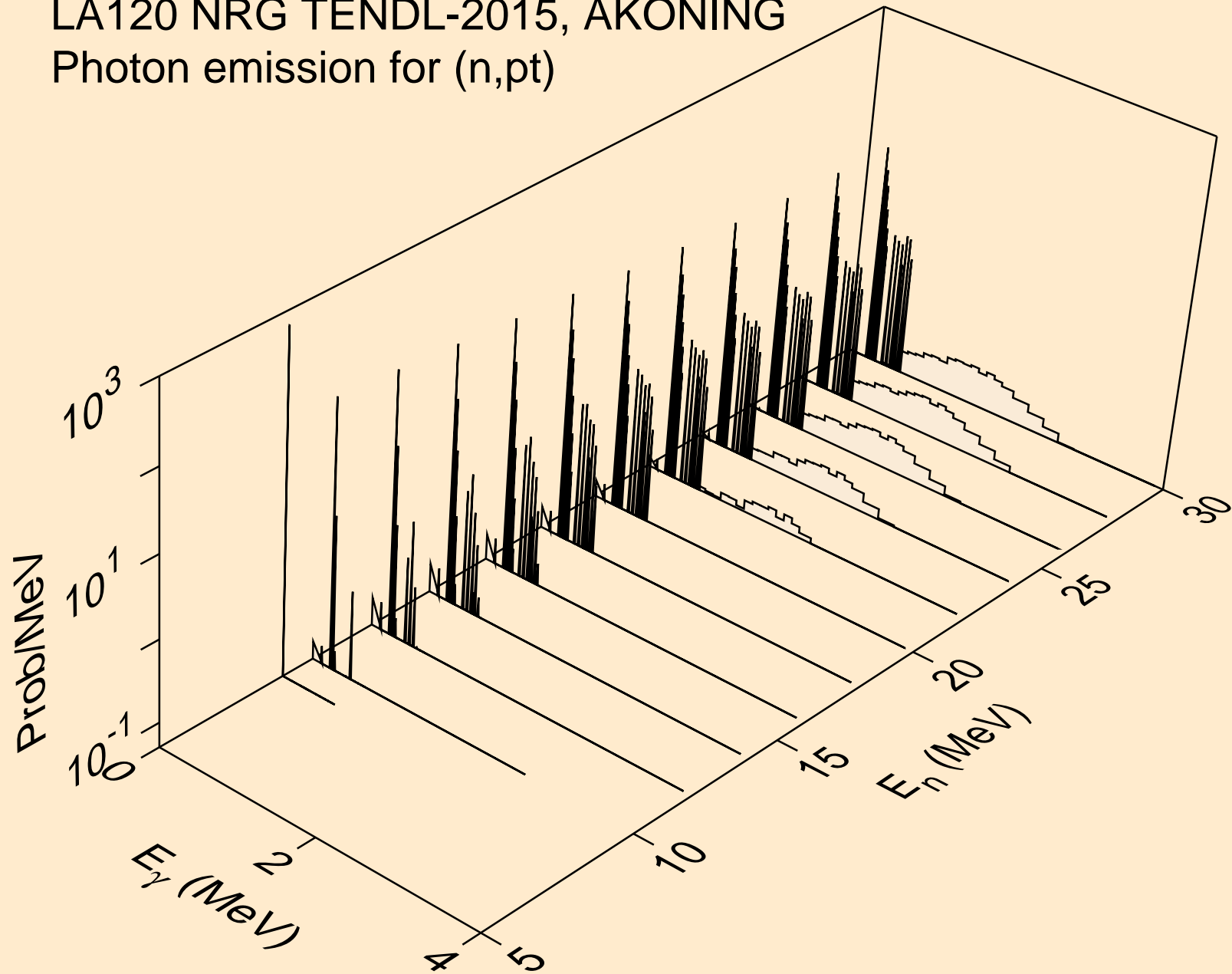

LA120 NRG TENDL-2015, AKONING  
Photon emission for (n,da)

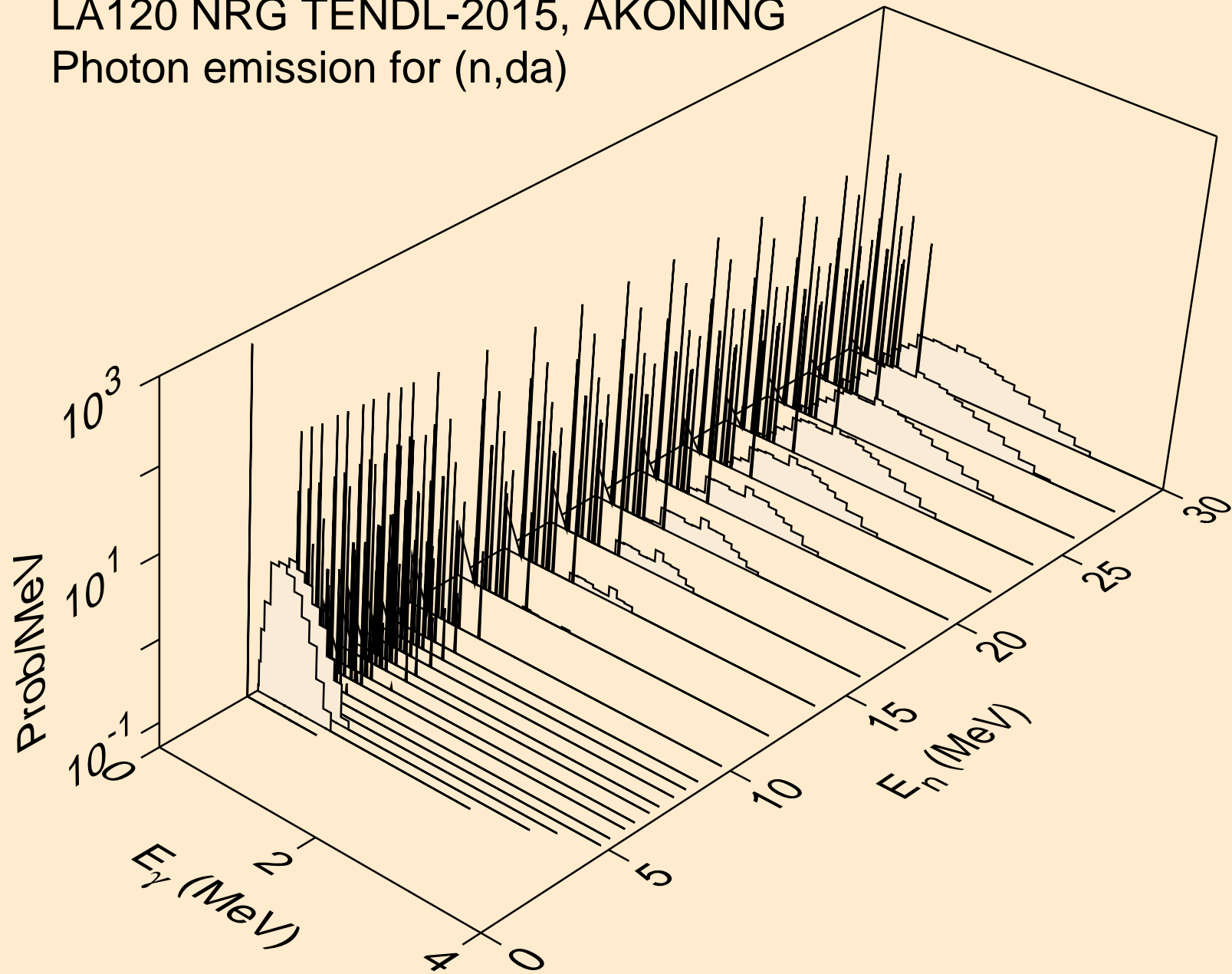

LA120 NRG TENDL-2015, AKONING  
thermal capture photon spectrum

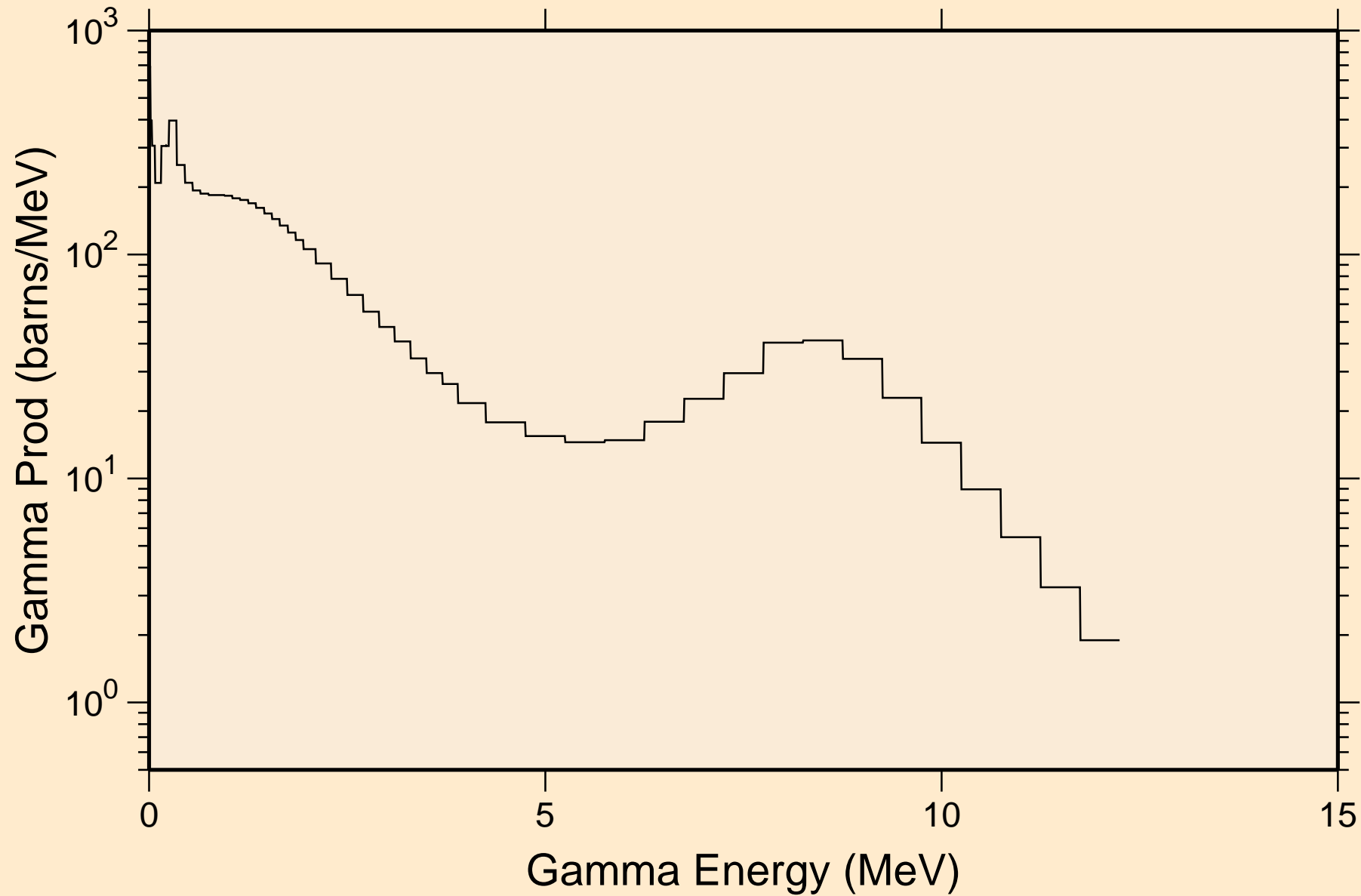

LA120 NRG TENDL-2015, AKONING  
14 MeV photon spectrum

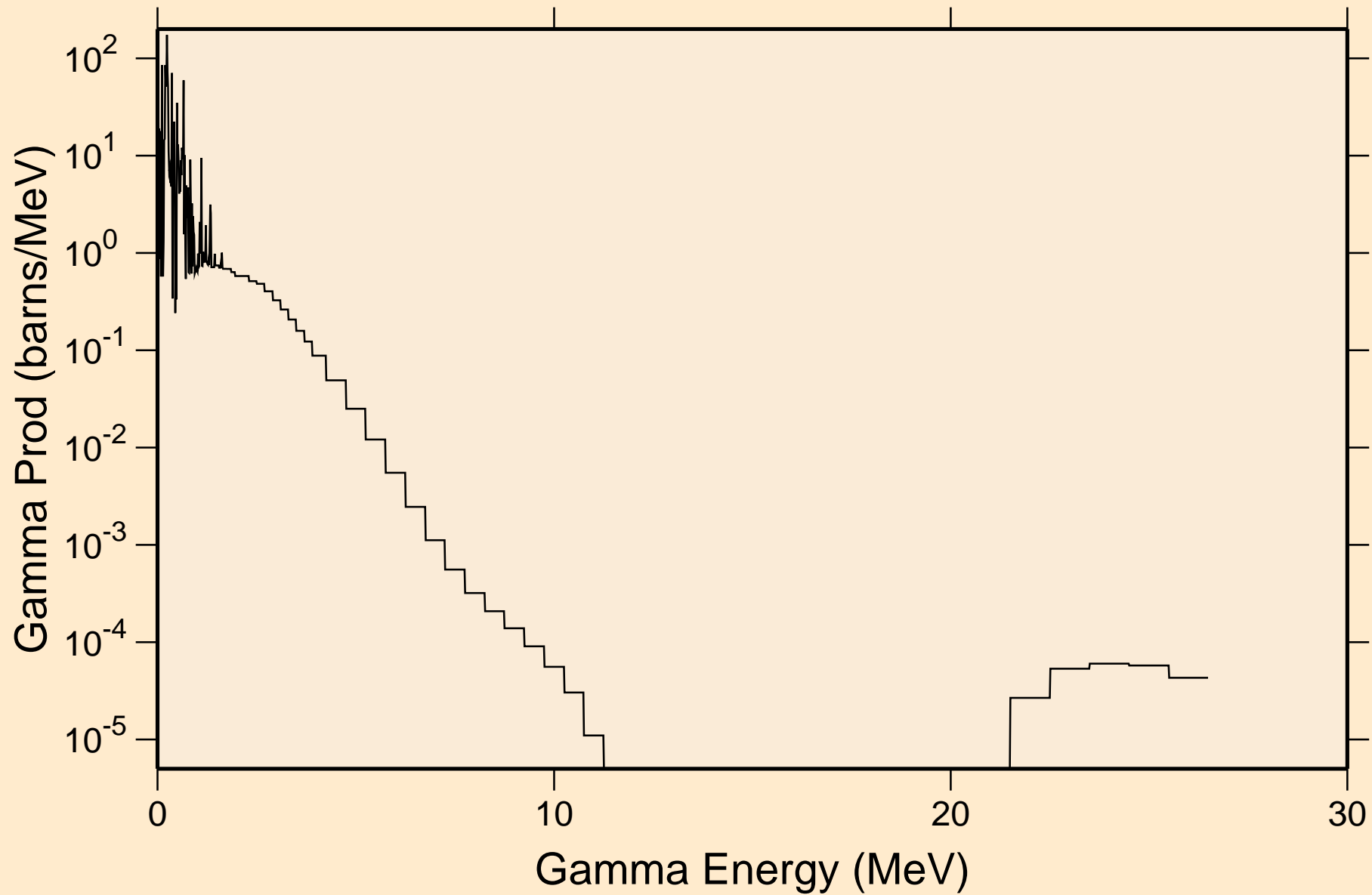

# LA120 NRG TENDL-2015, AKONING

## Particle heating contributions

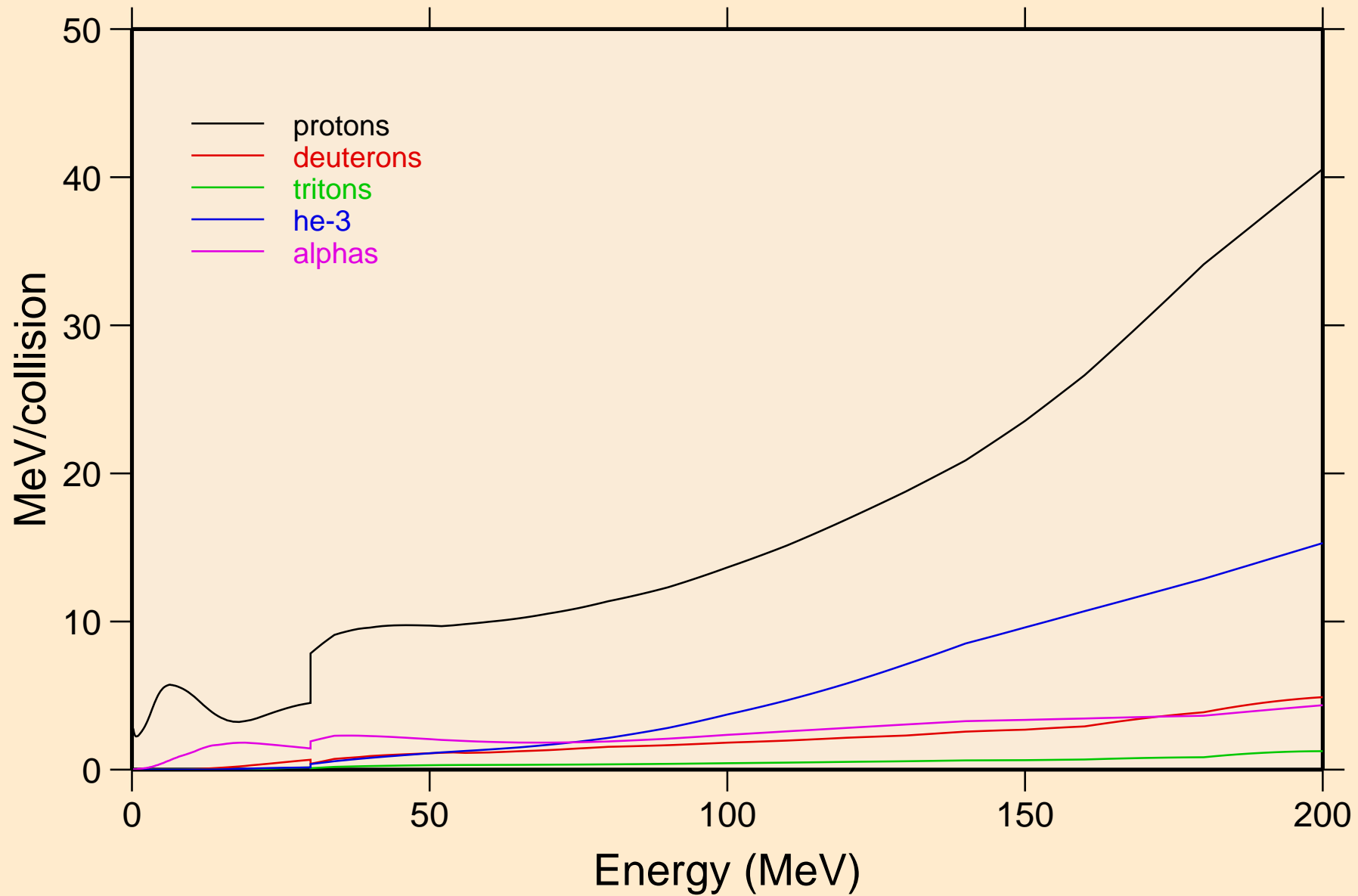

# LA120 NRG TENDL-2015, AKONING

## Recoil Heating

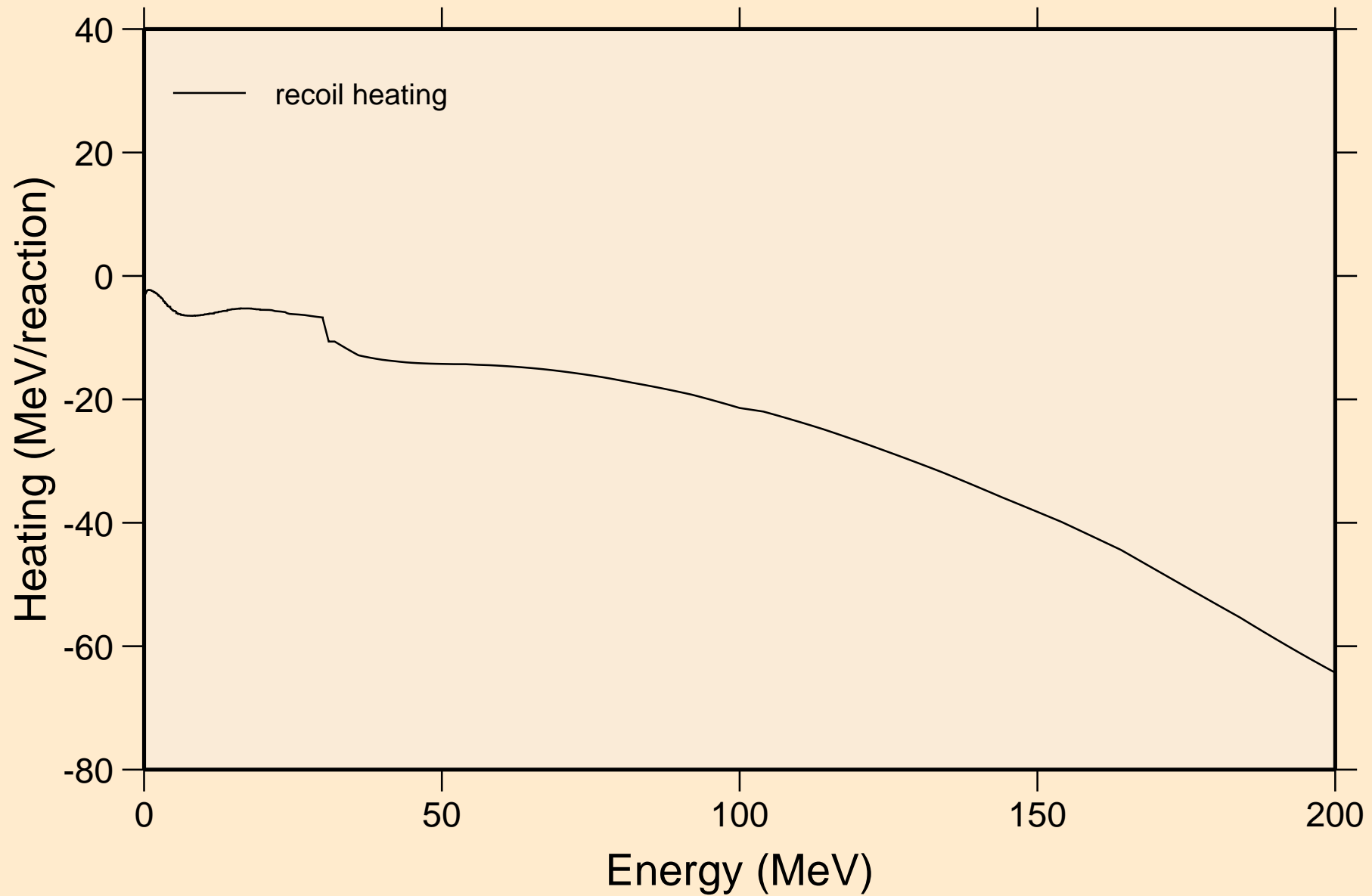

# LA120 NRG TENDL-2015, AKONING

## Particle production cross sections

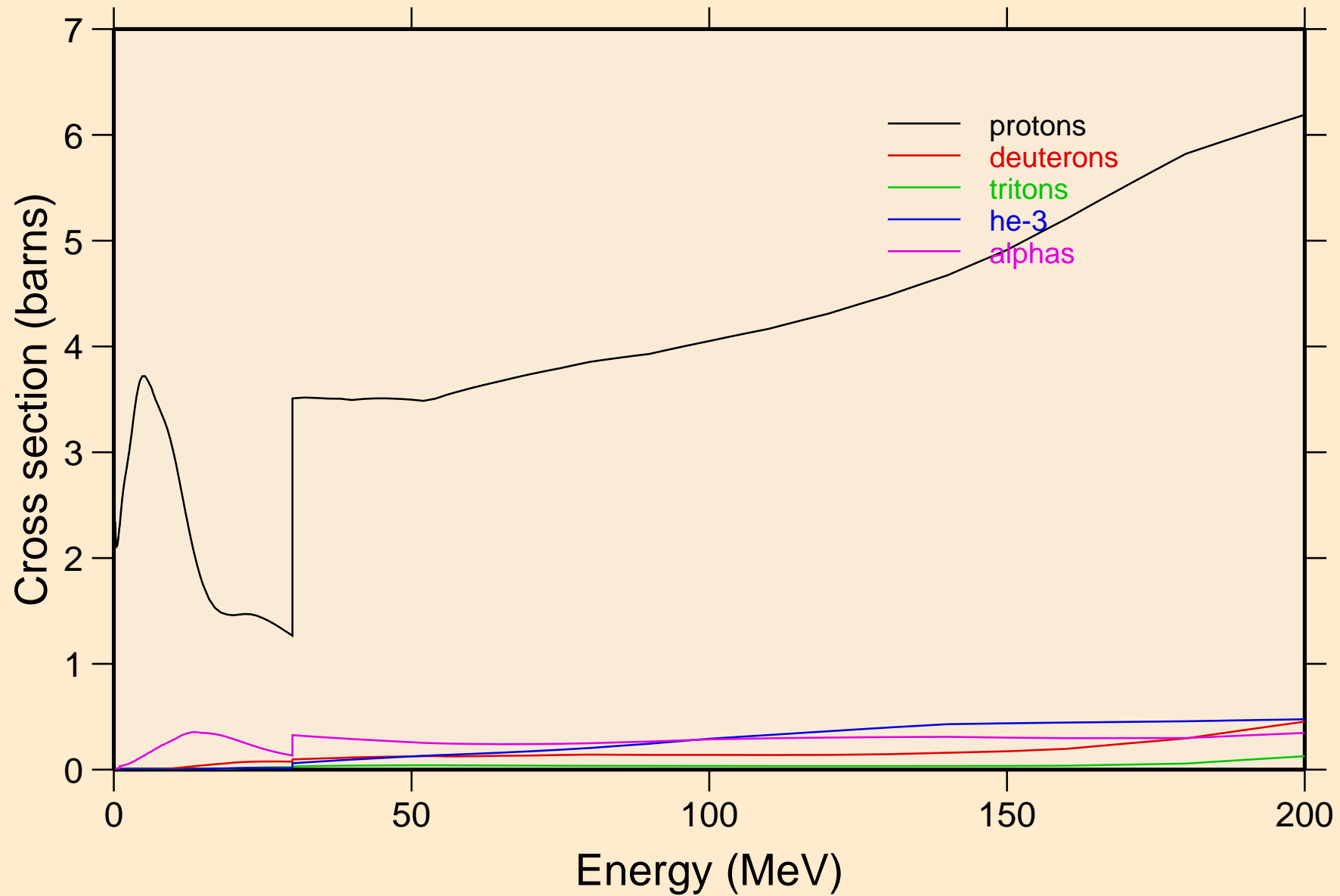

LA120 NRG TENDL-2015, AKONING  
protons from (n,x)

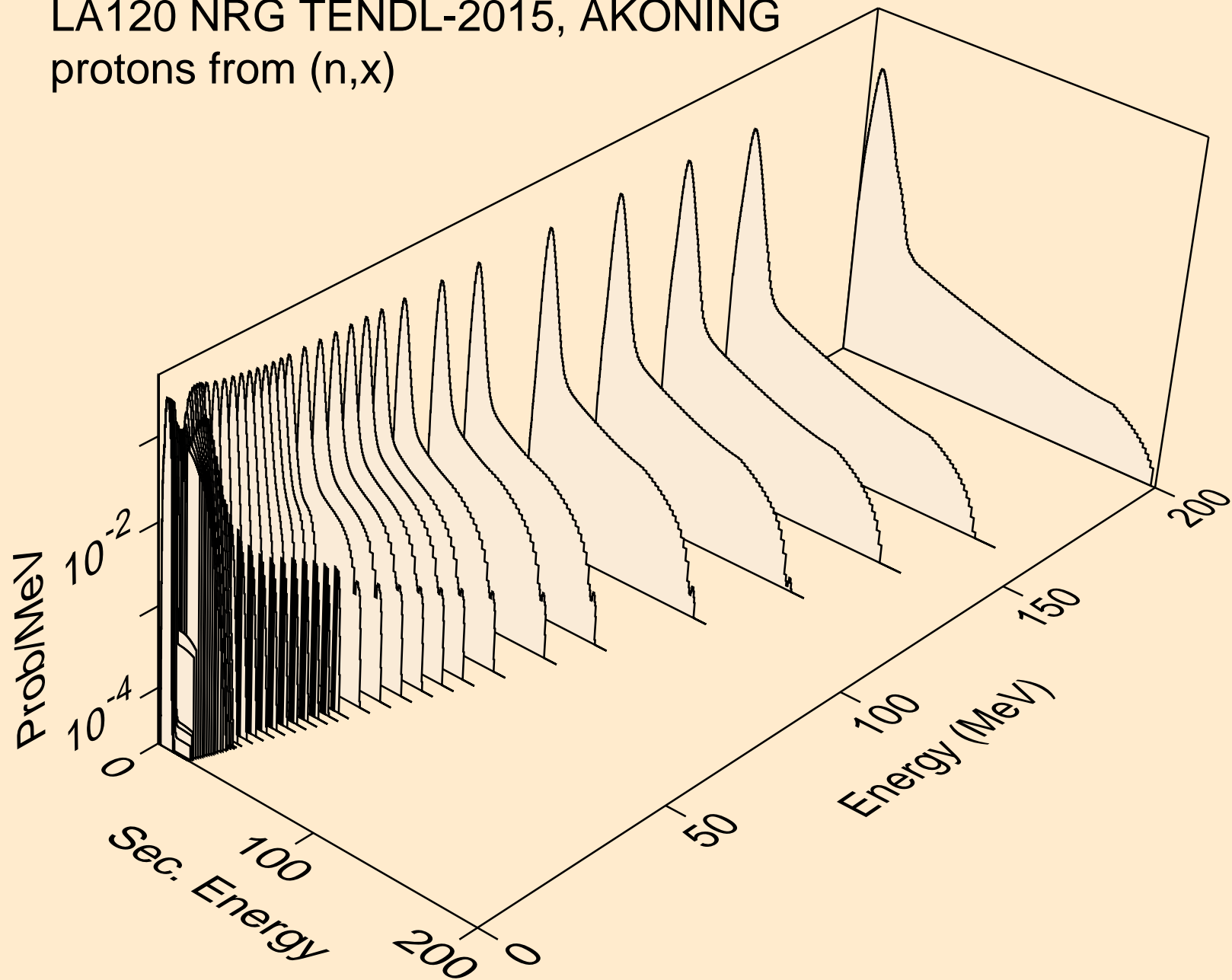



LA120 NRG TENDL-2015, AKONING  
protons from (n,n\*)p

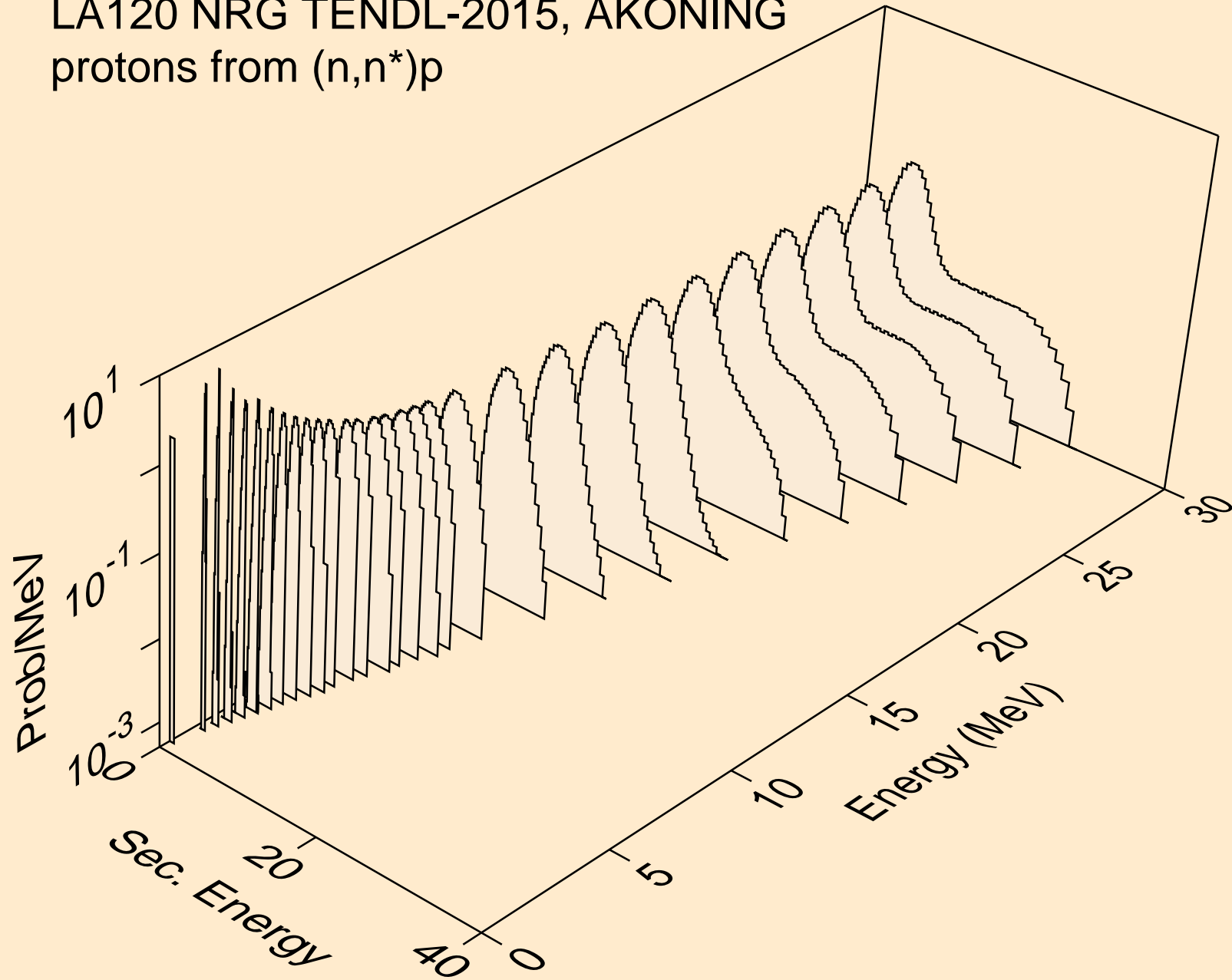

LA120 NRG TENDL-2015, AKONING  
protons from (n,2np)

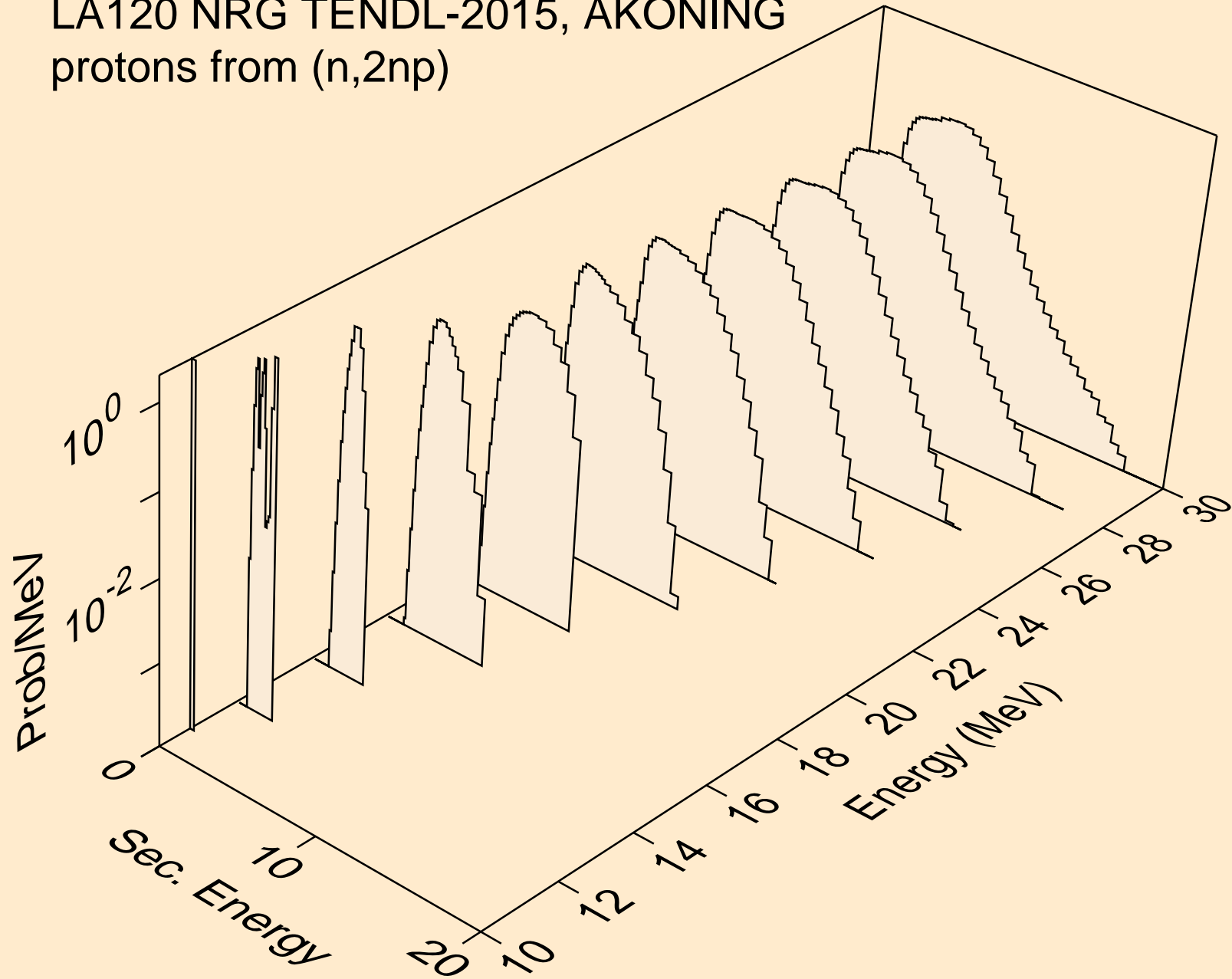

LA120 NRG TENDL-2015, AKONING  
protons from (n,3np)

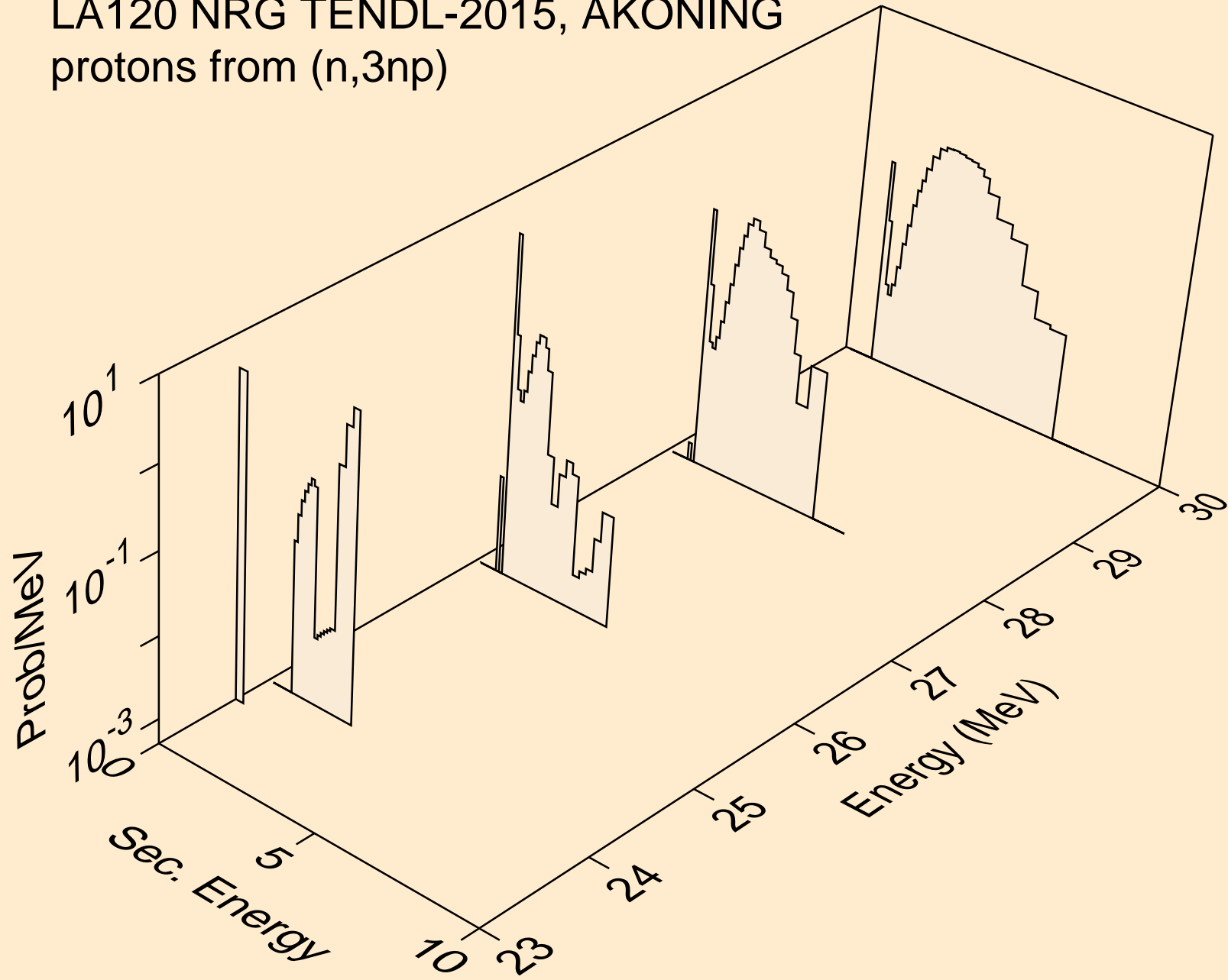

LA120 NRG TENDL-2015, AKONING  
protons from (n,2np)

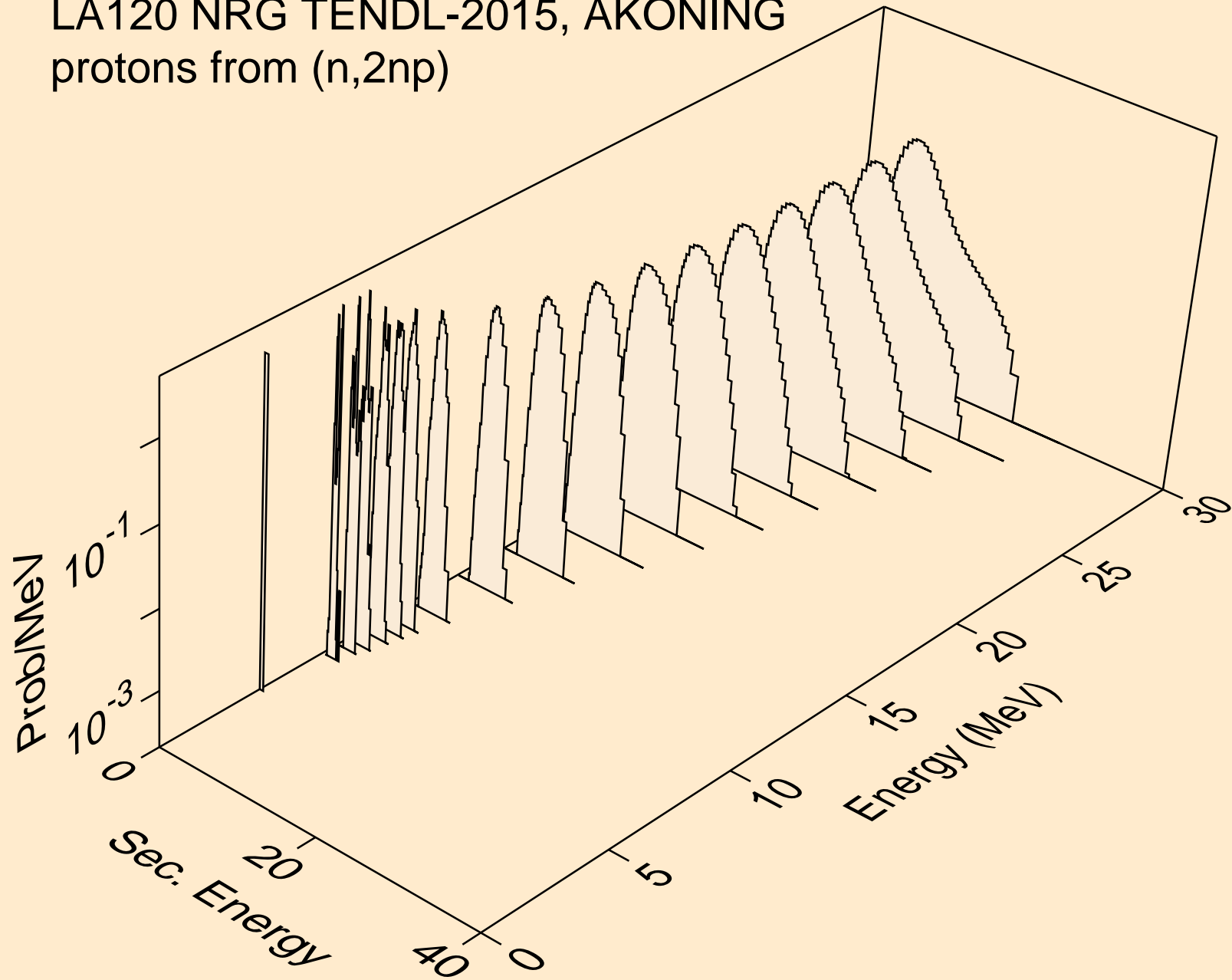

LA120 NRG TENDL-2015, AKONING  
protons from (n,npa)

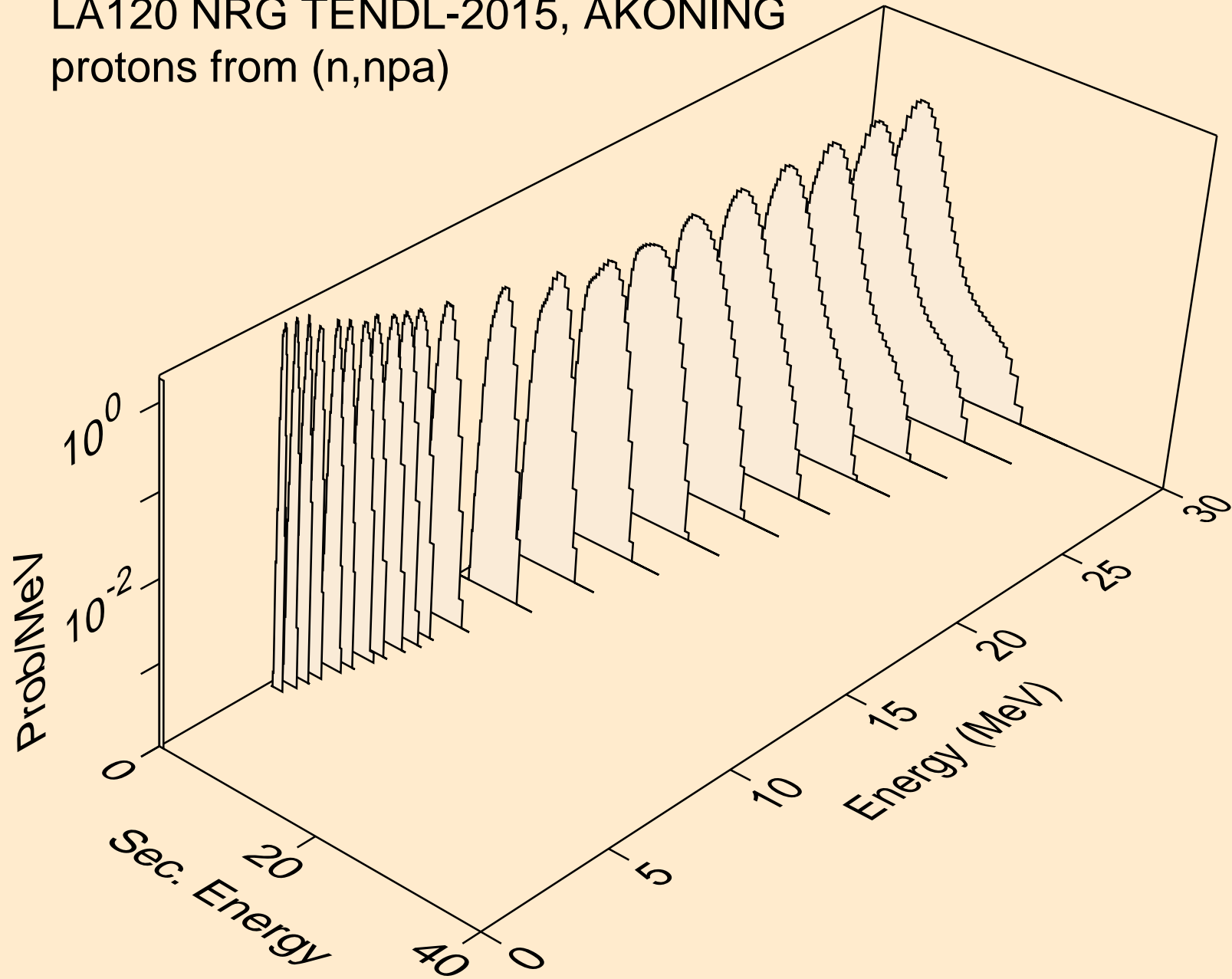

LA120 NRG TENDL-2015, AKONING  
protons from (n,p)

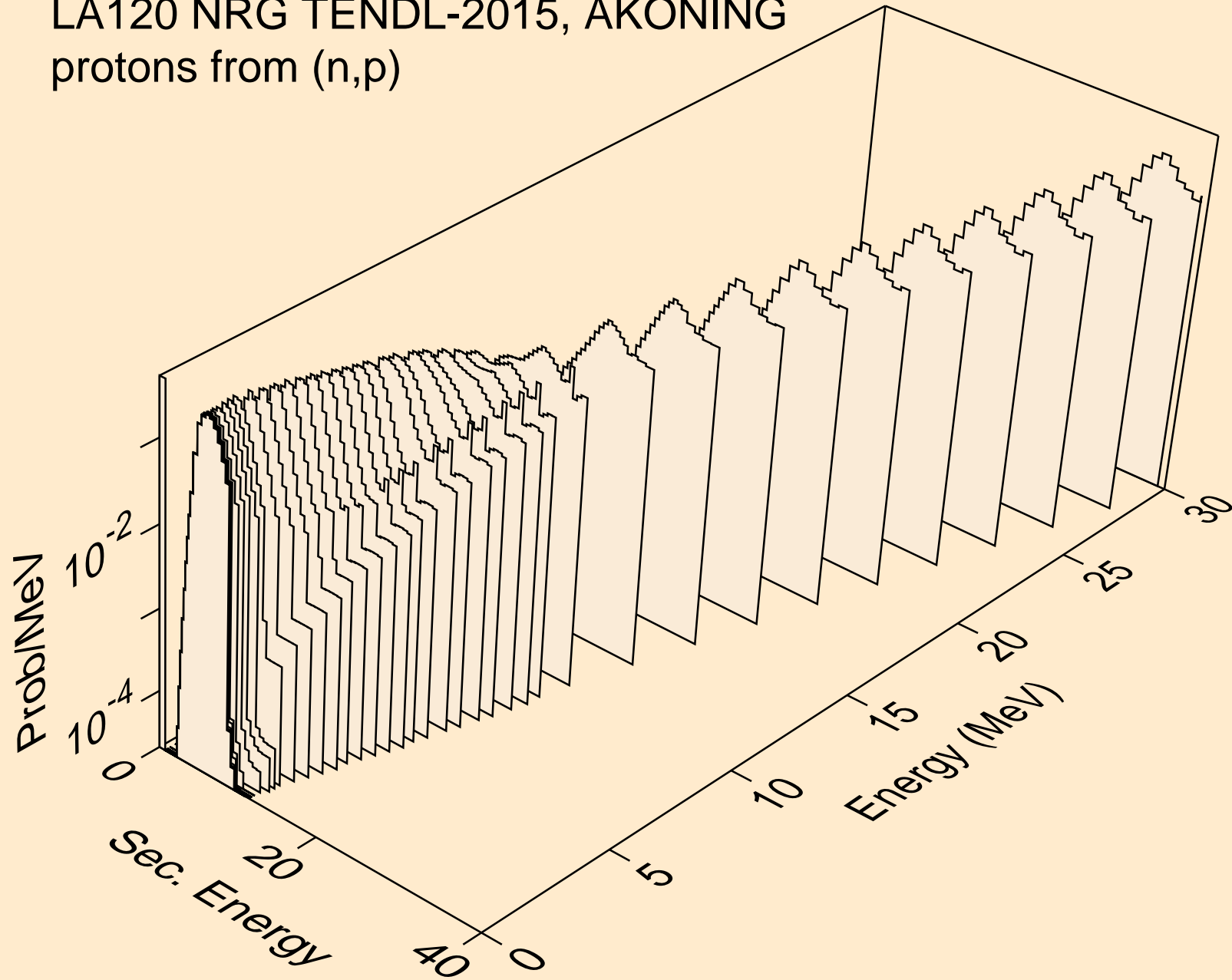

LA120 NRG TENDL-2015, AKONING  
protons from (n,2p)

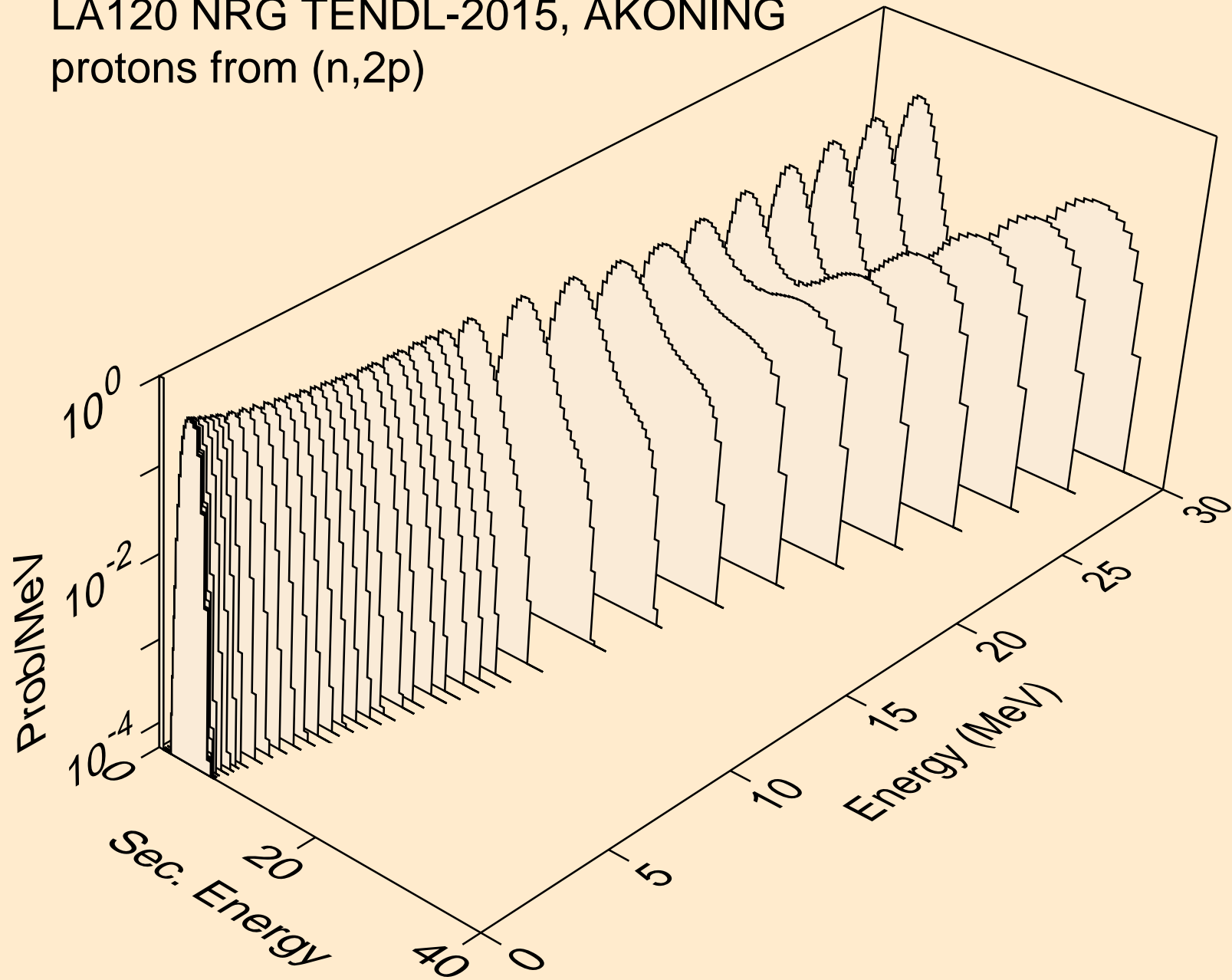

LA120 NRG TENDL-2015, AKONING  
protons from (n,pa)

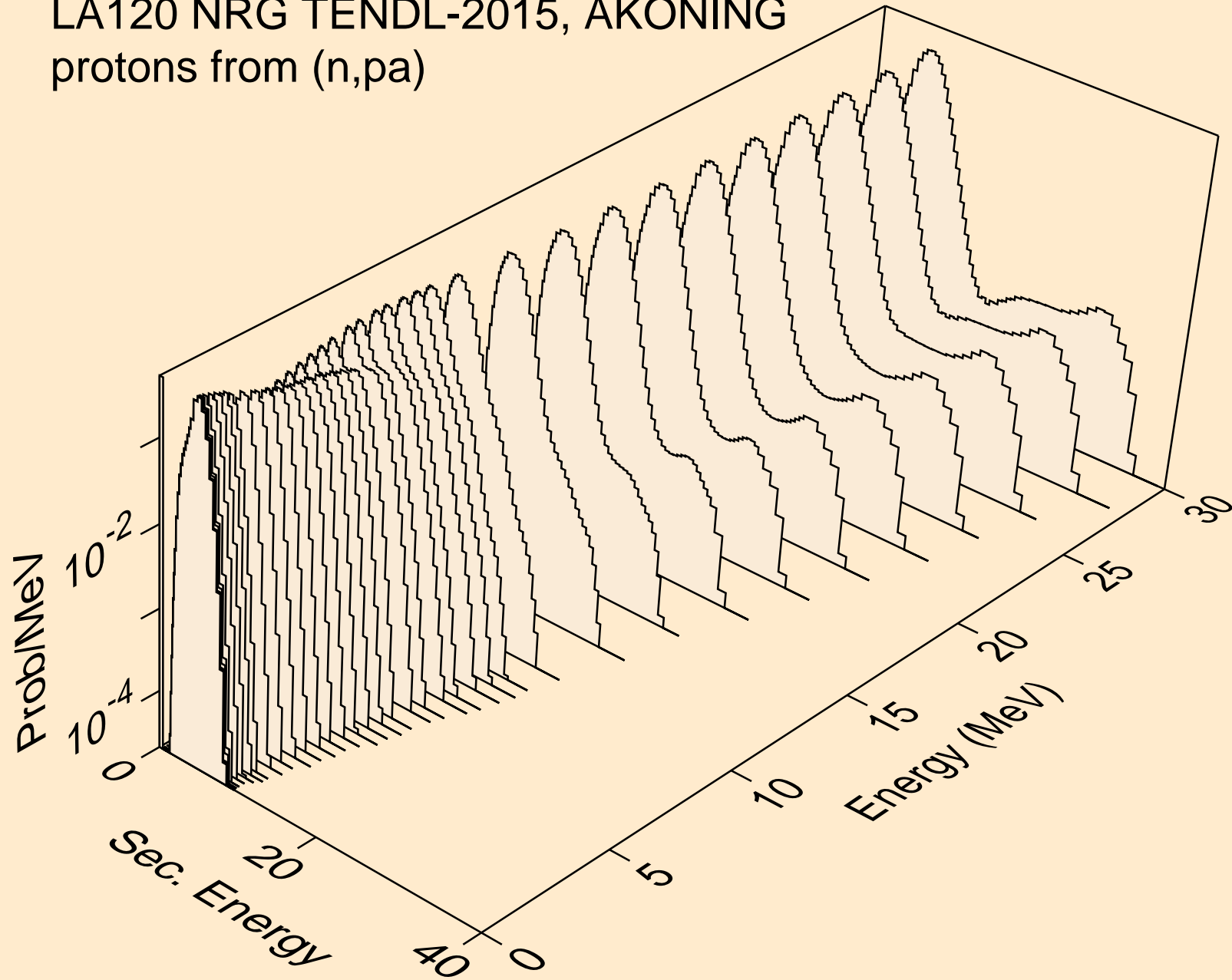



LA120 NRG TENDL-2015, AKONING  
protons from (n,pd)

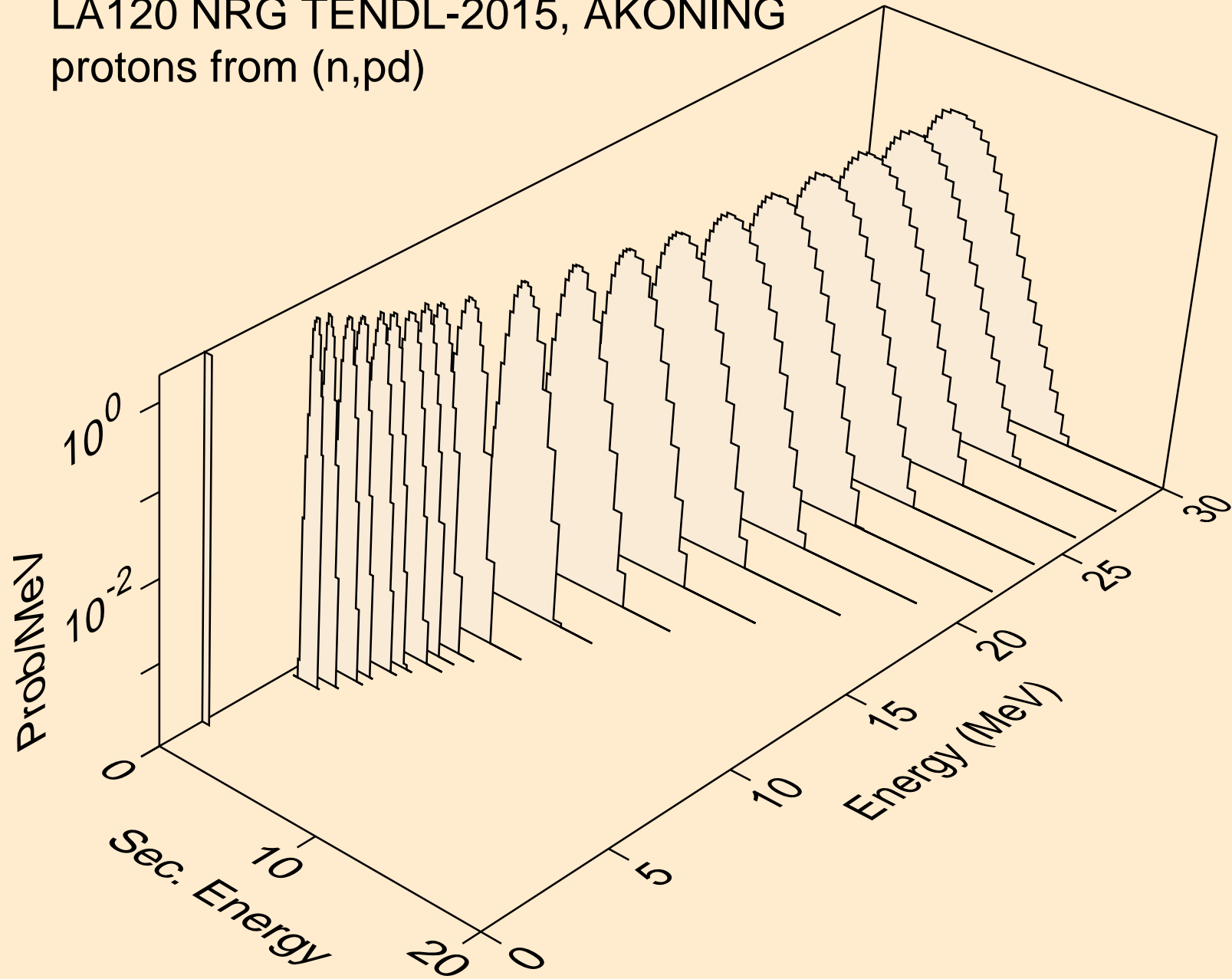

LA120 NRG TENDL-2015, AKONING  
protons from (n,pt)

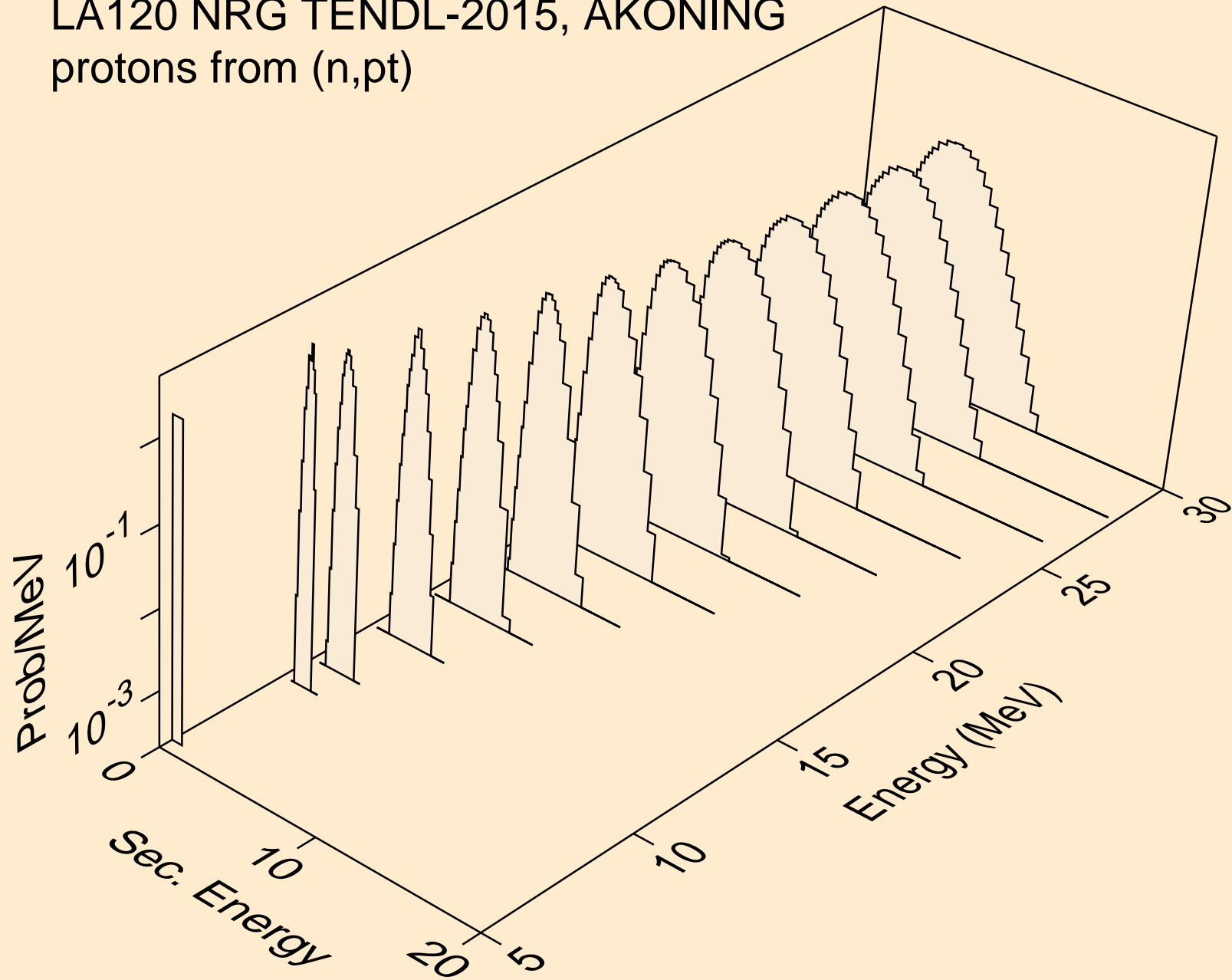

LA120 NRG TENDL-2015, AKONING  
deuterons from (n,x)

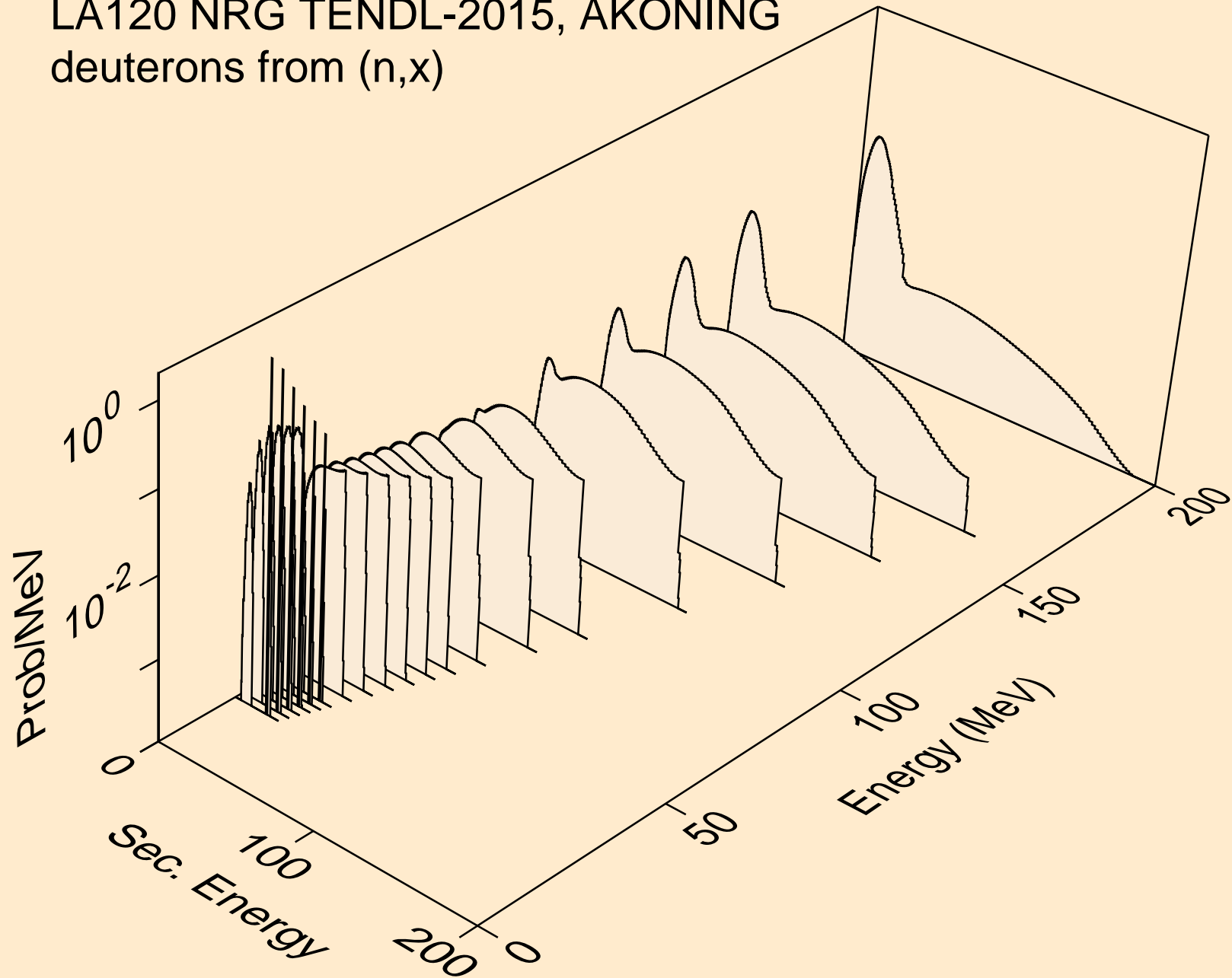

LA120 NRG TENDL-2015, AKONING  
deuterons from (n,2nd)

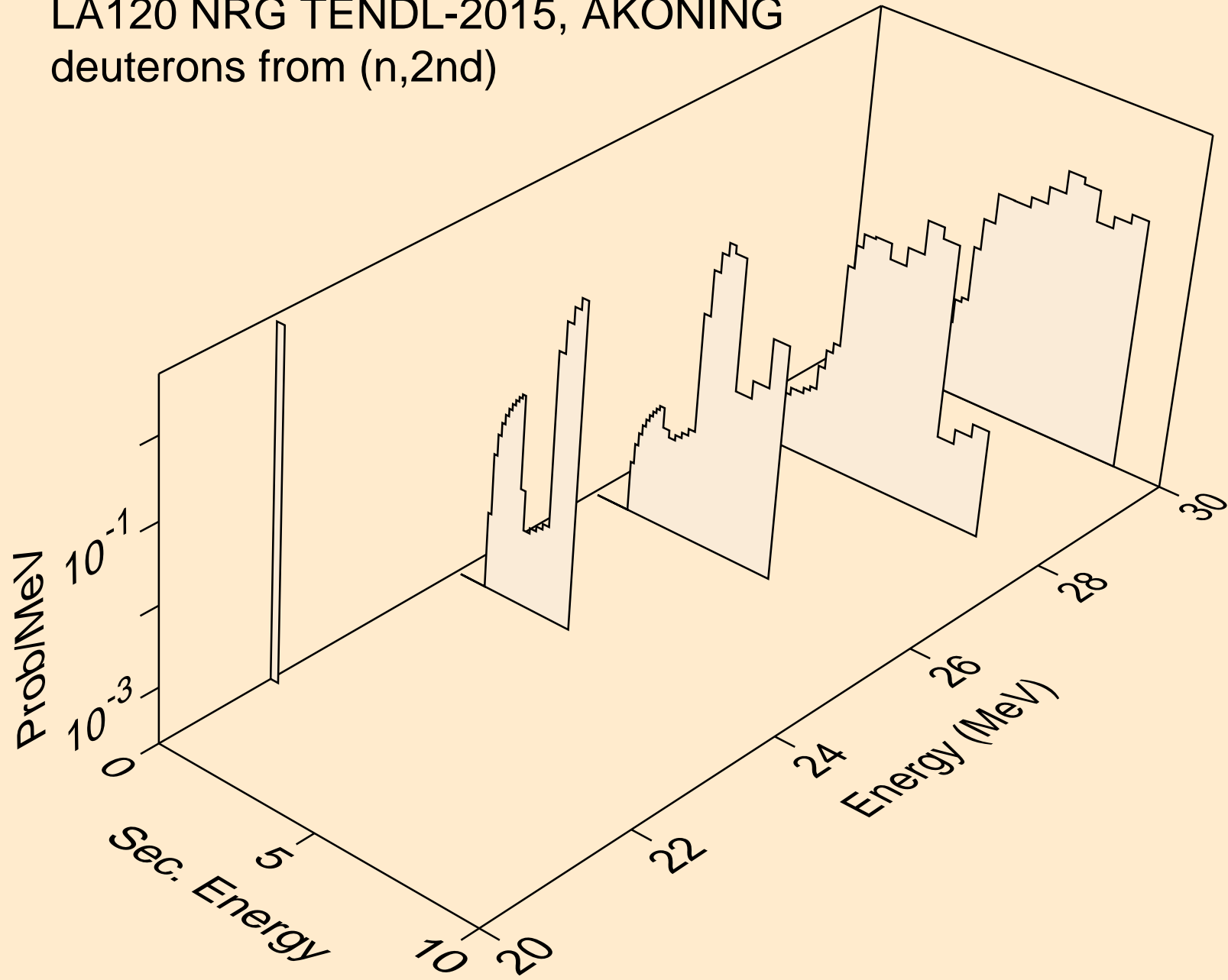

LA120 NRG TENDL-2015, AKONING  
deuterons from (n,n\*)d

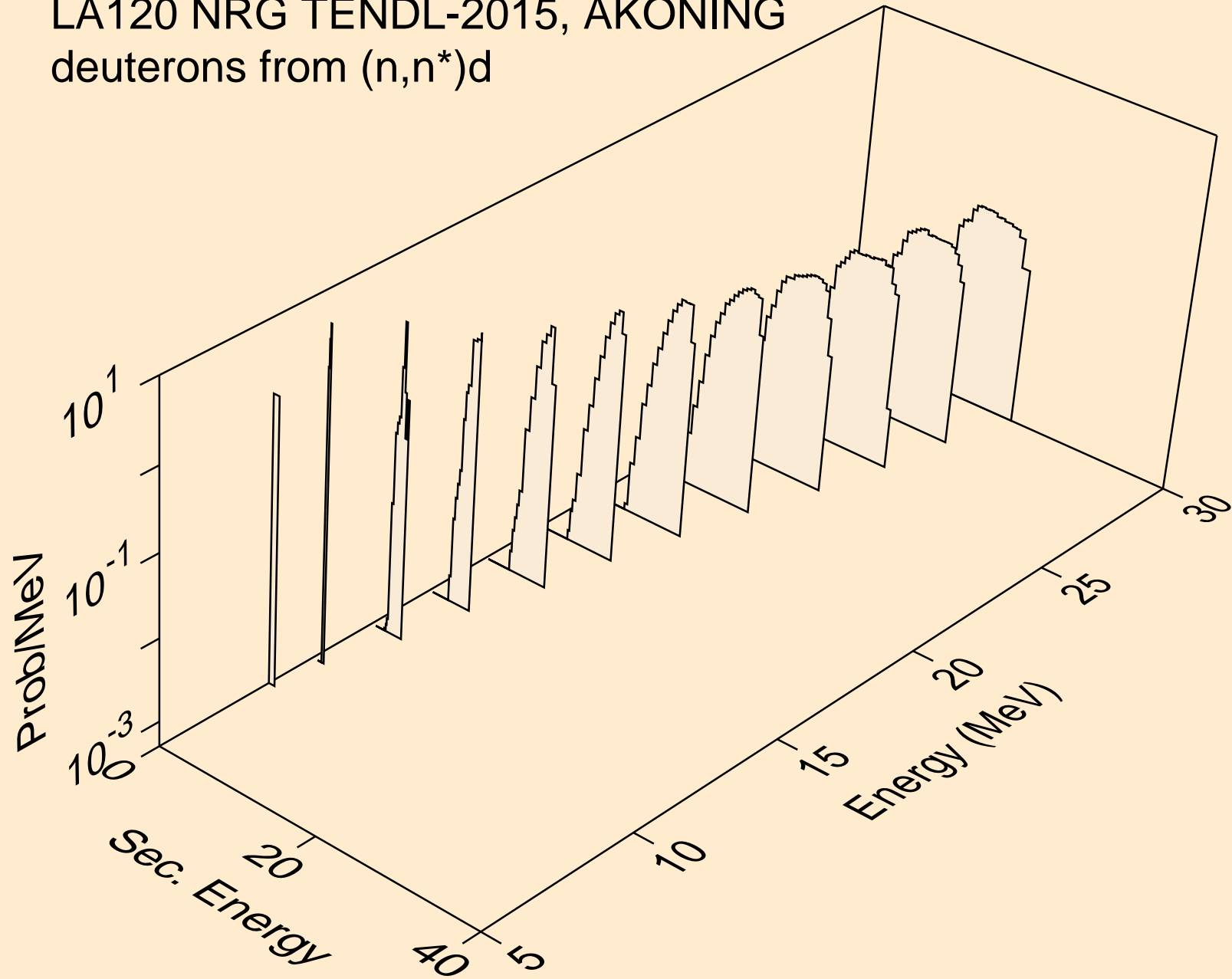

LA120 NRG TENDL-2015, AKONING  
deuterons from (n,n\*)d2a

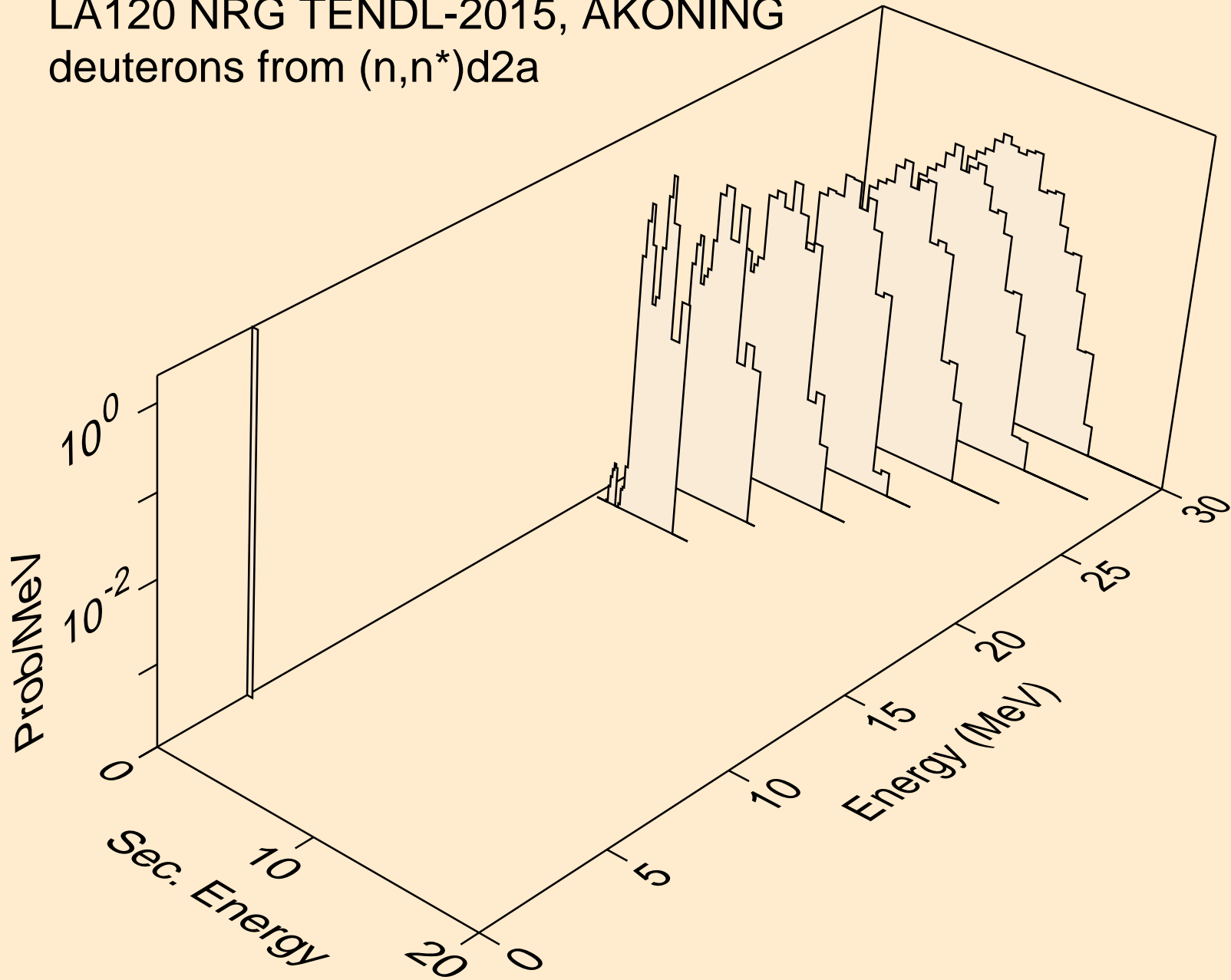

LA120 NRG TENDL-2015, AKONING  
deuterons from (n,d)

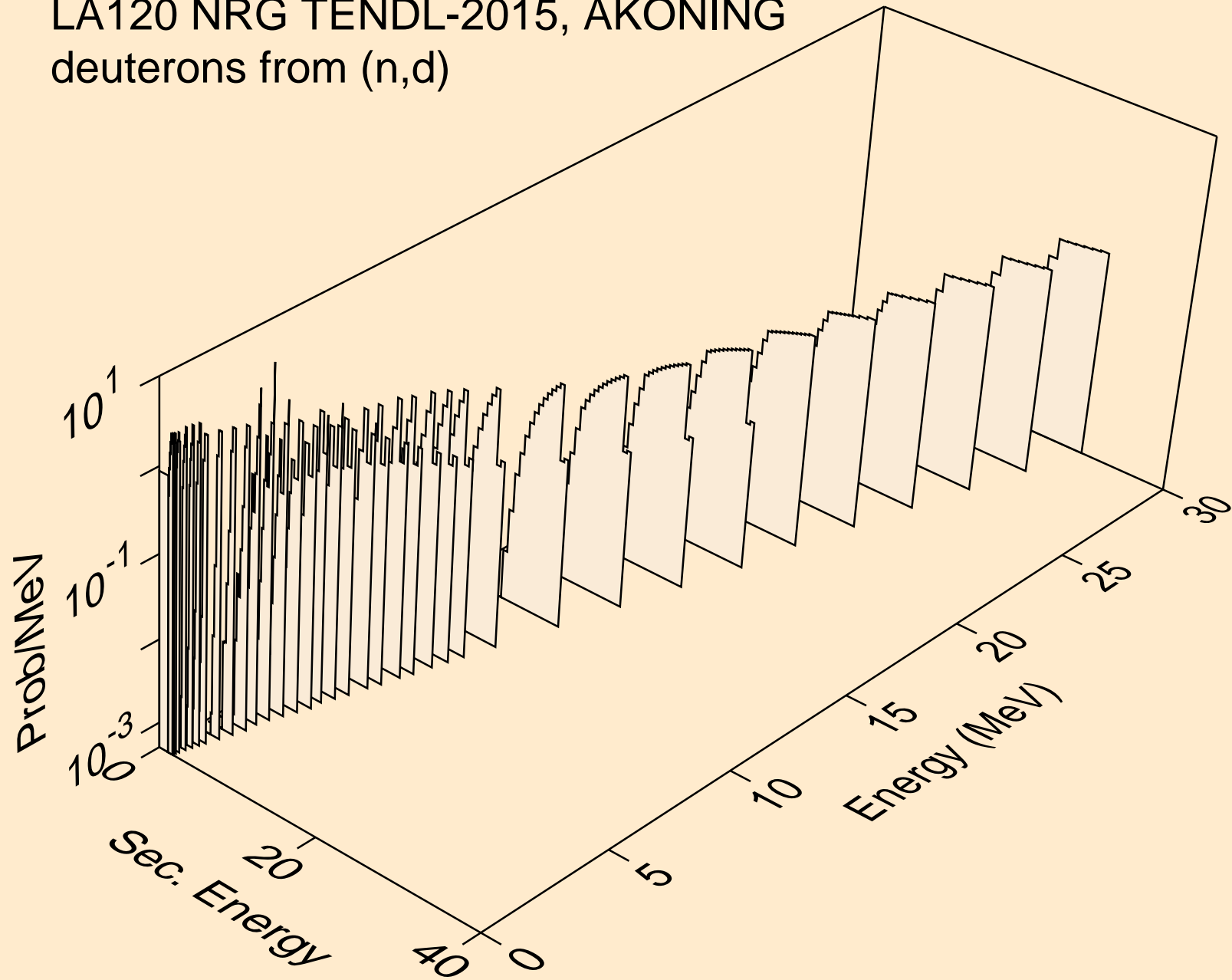

LA120 NRG TENDL-2015, AKONING  
deuterons from (n,d2a)

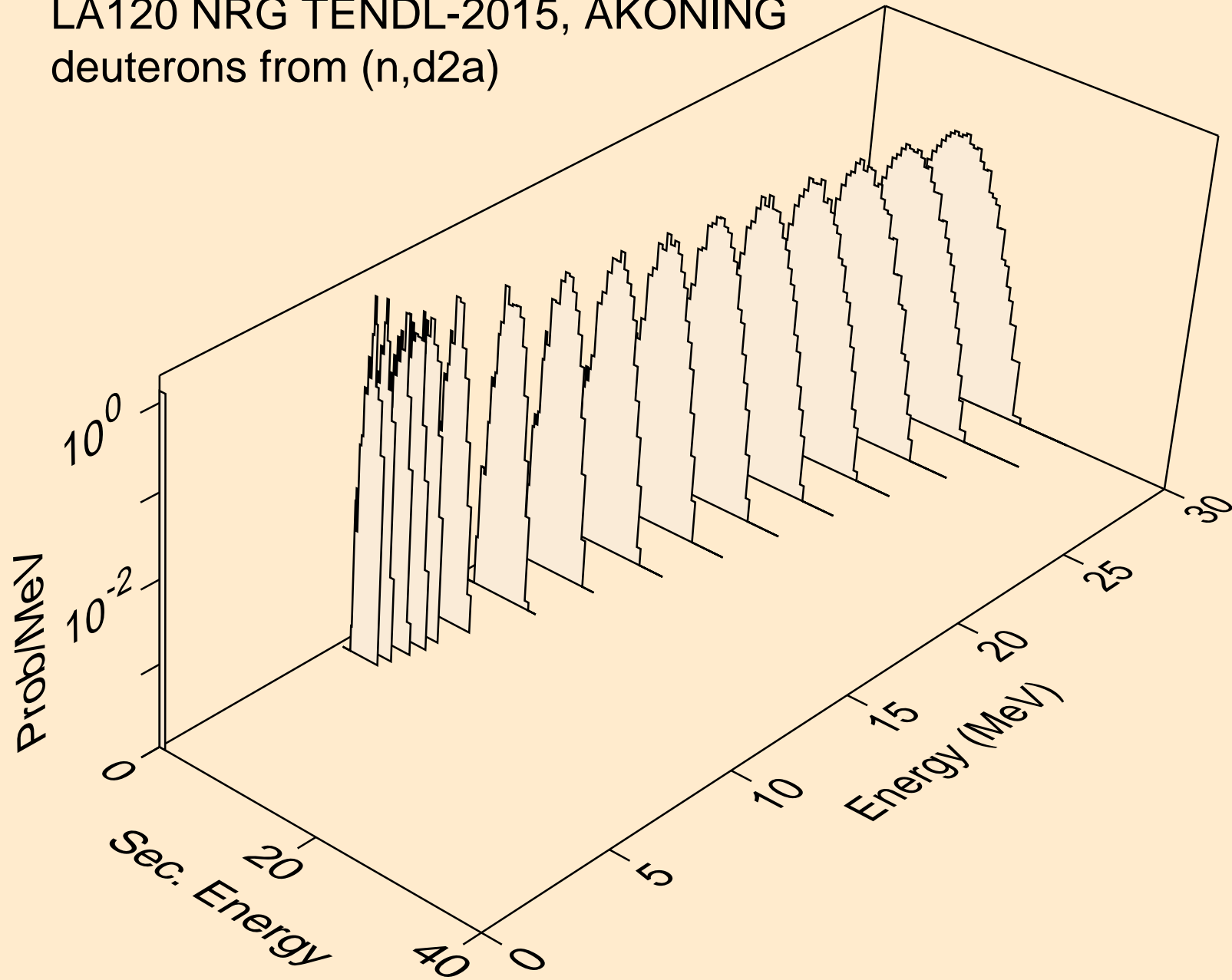



LA120 NRG TENDL-2015, AKONING  
deuterons from (n,pd)

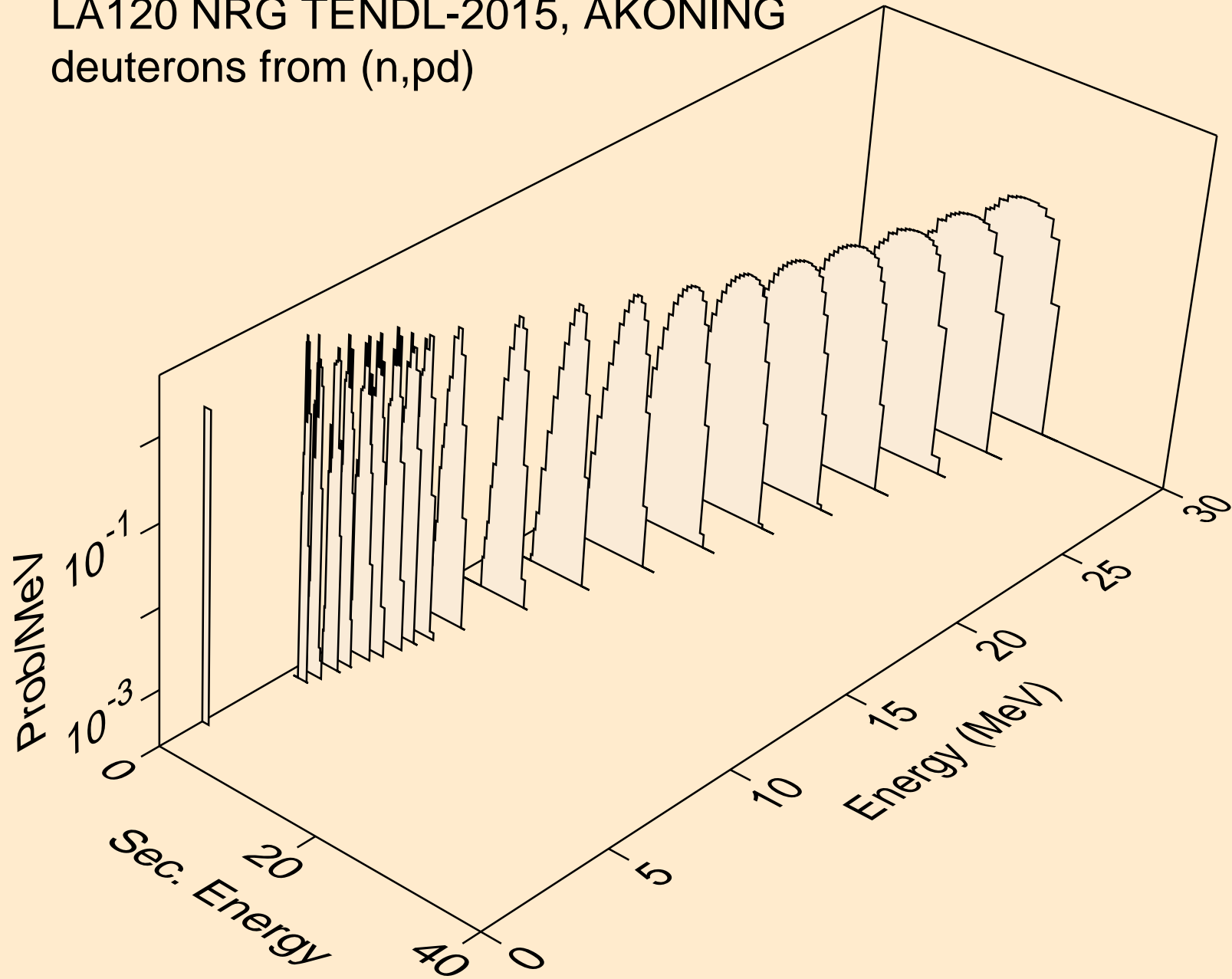

LA120 NRG TENDL-2015, AKONING  
deuterons from (n,da)

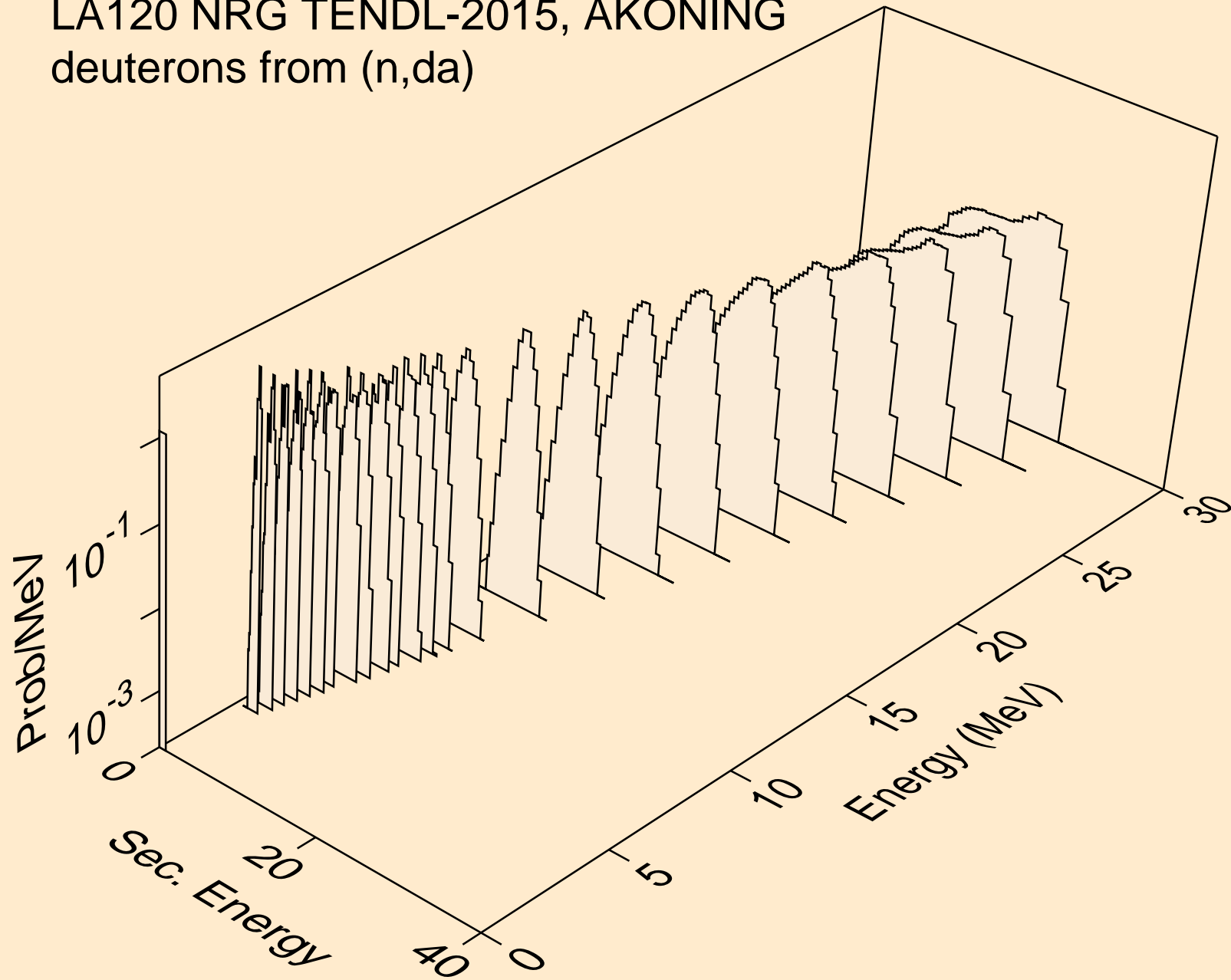

LA120 NRG TENDL-2015, AKONING  
tritons from (n,x)

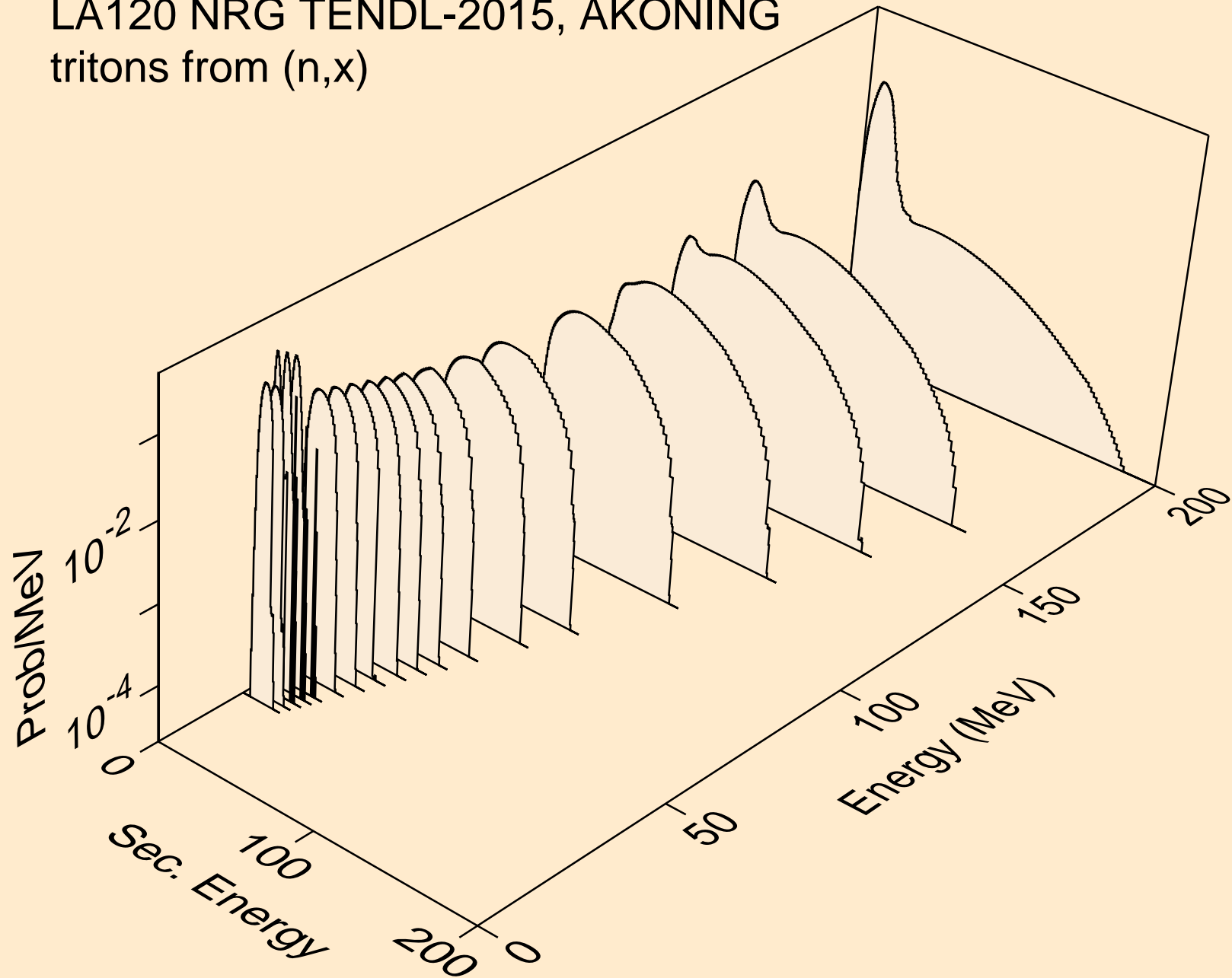

LA120 NRG TENDL-2015, AKONING  
tritons from (n,n\*)t

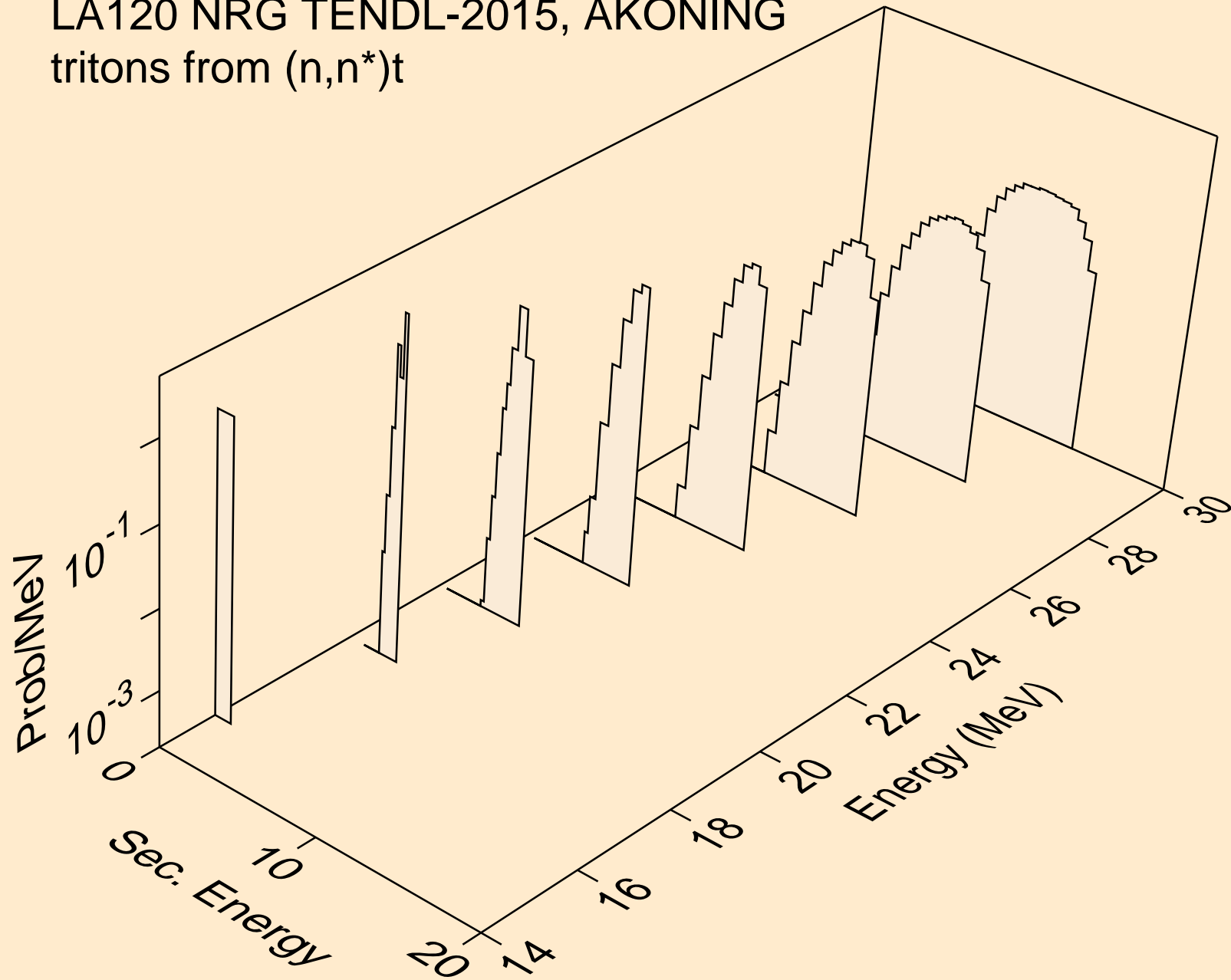

LA120 NRG TENDL-2015, AKONING  
tritons from (n,t)

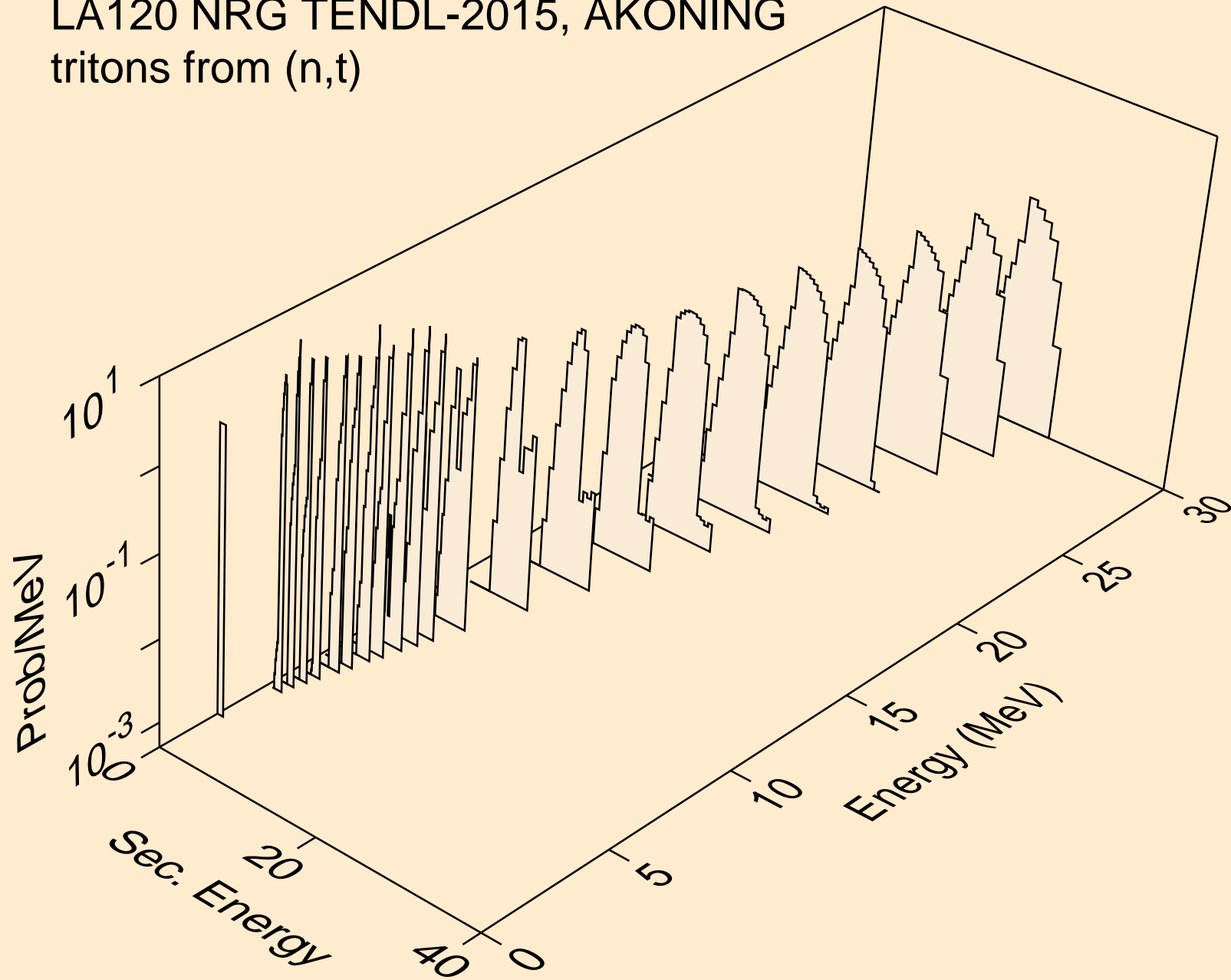

LA120 NRG TENDL-2015, AKONING  
tritons from (n,t2a)

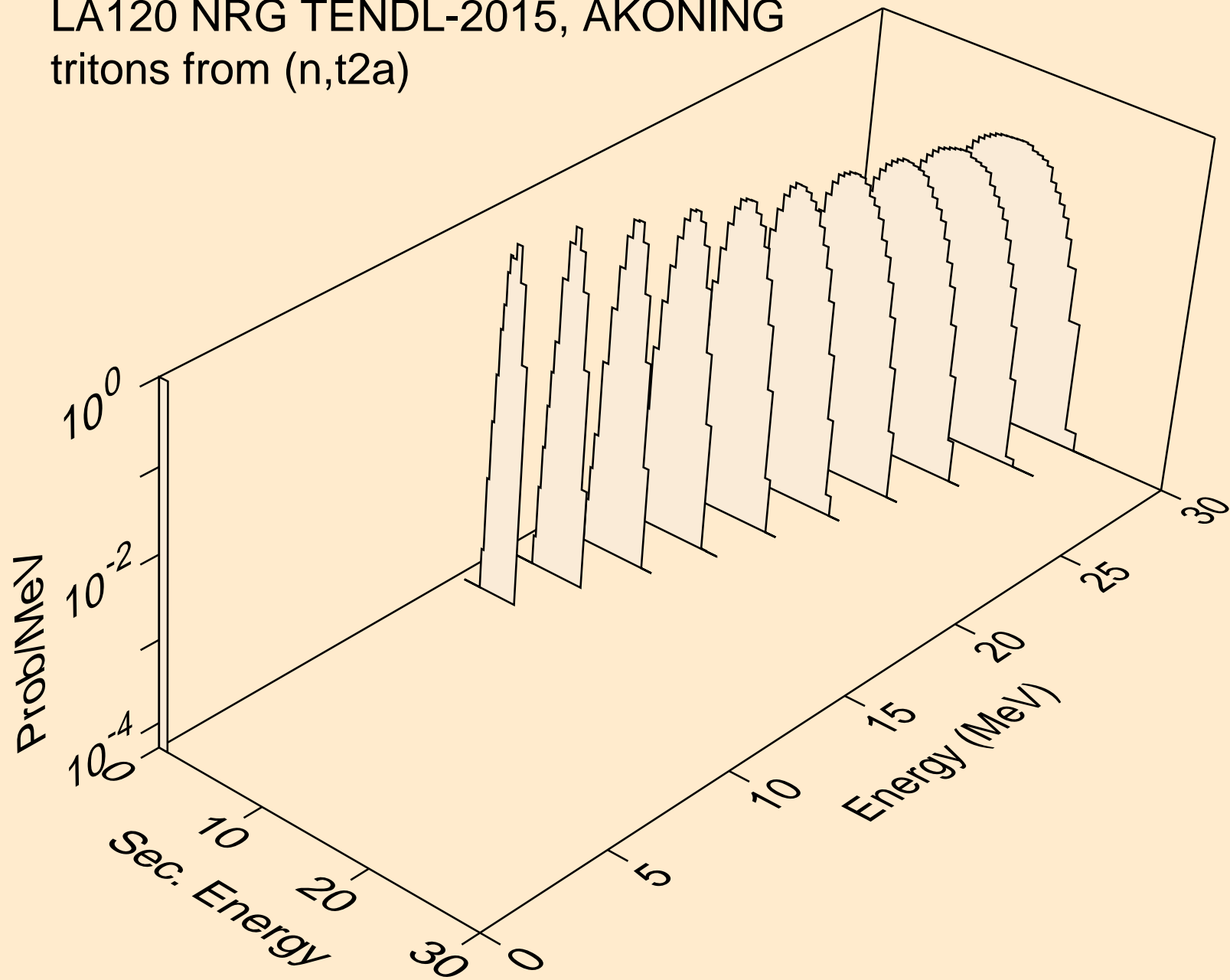

LA120 NRG TENDL-2015, AKONING  
tritons from (n,pt)

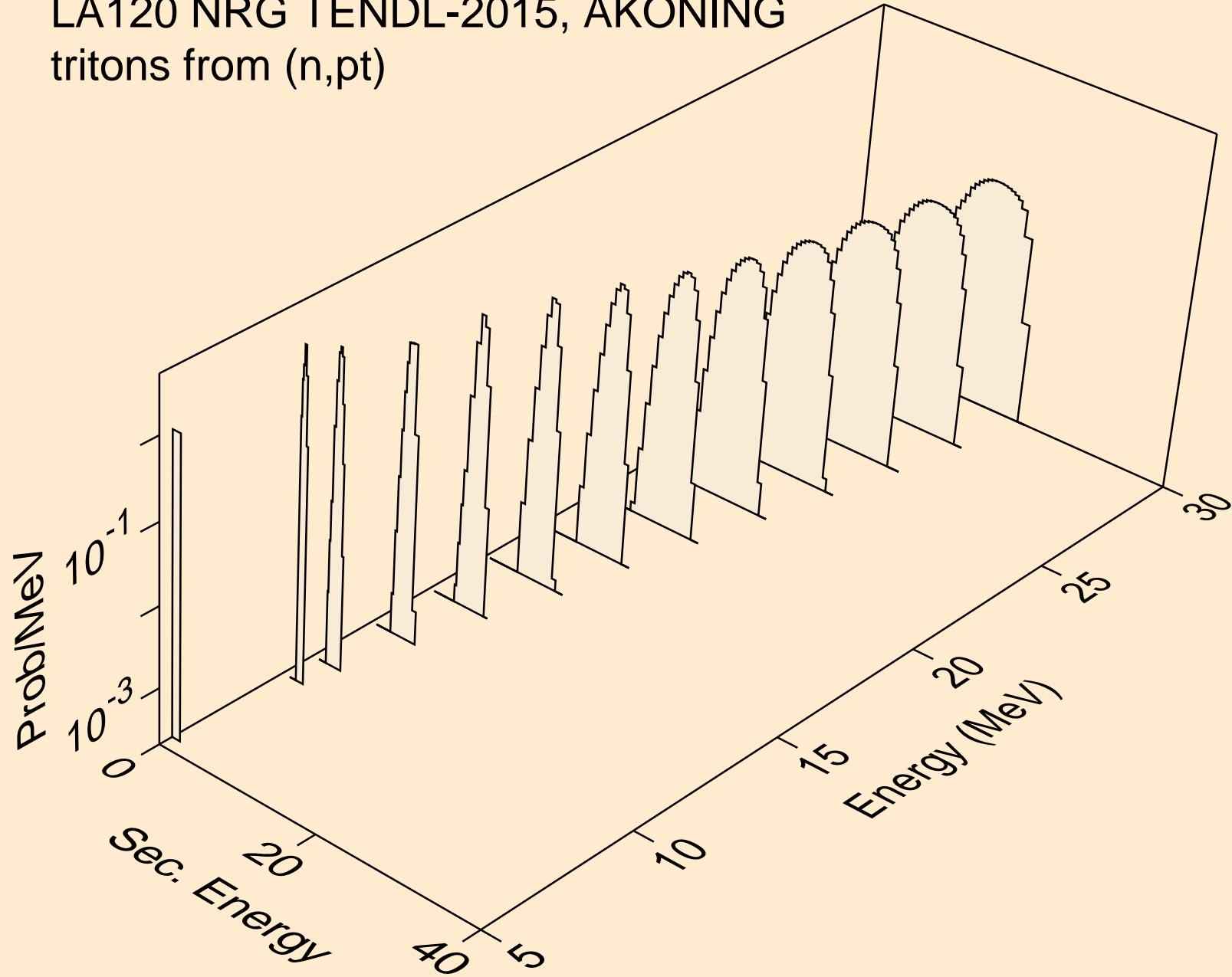

LA120 NRG TENDL-2015, AKONING  
he3s from (n,x)

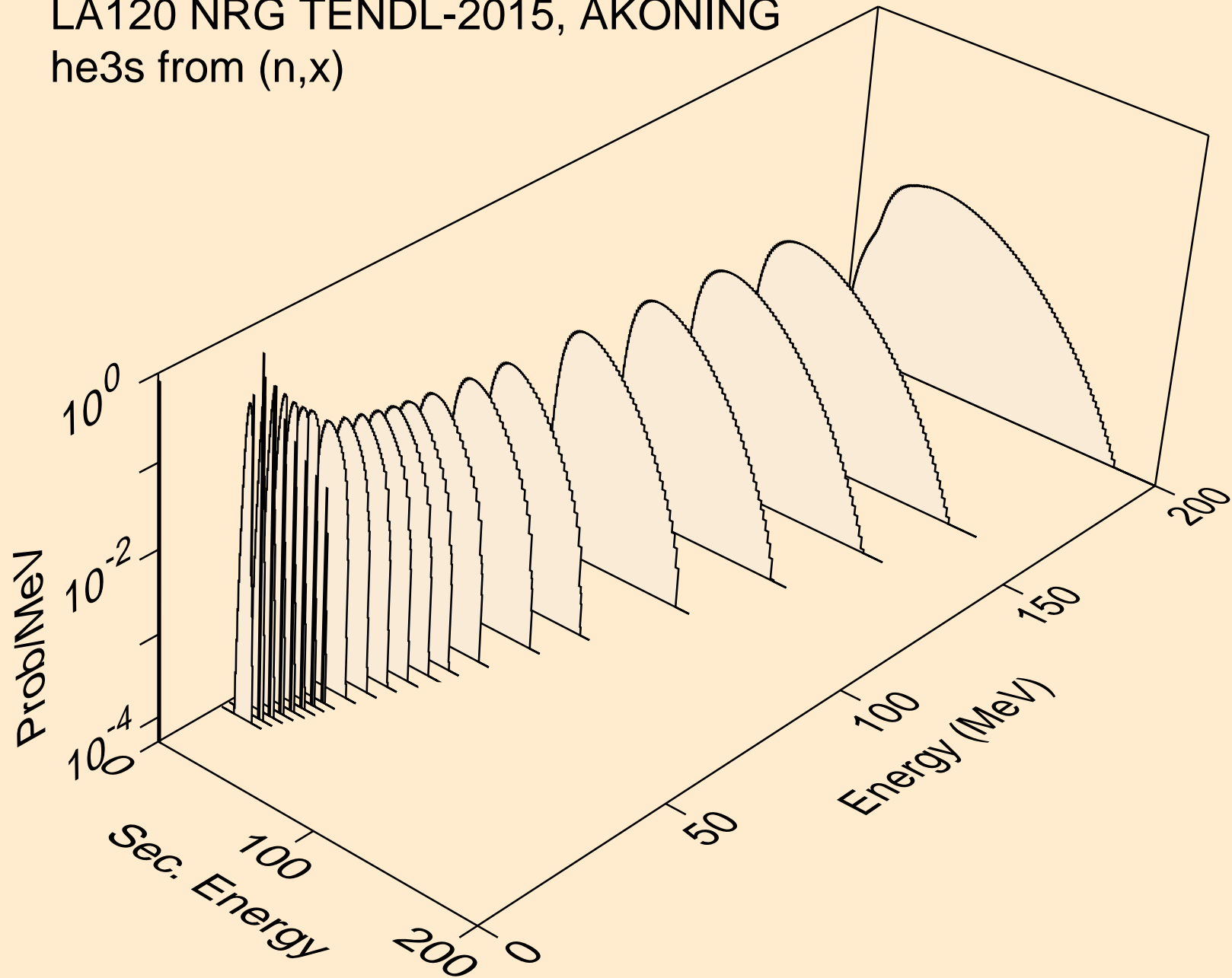



LA120 NRG TENDL-2015, AKONING  
he3s from (n,n\*)he3

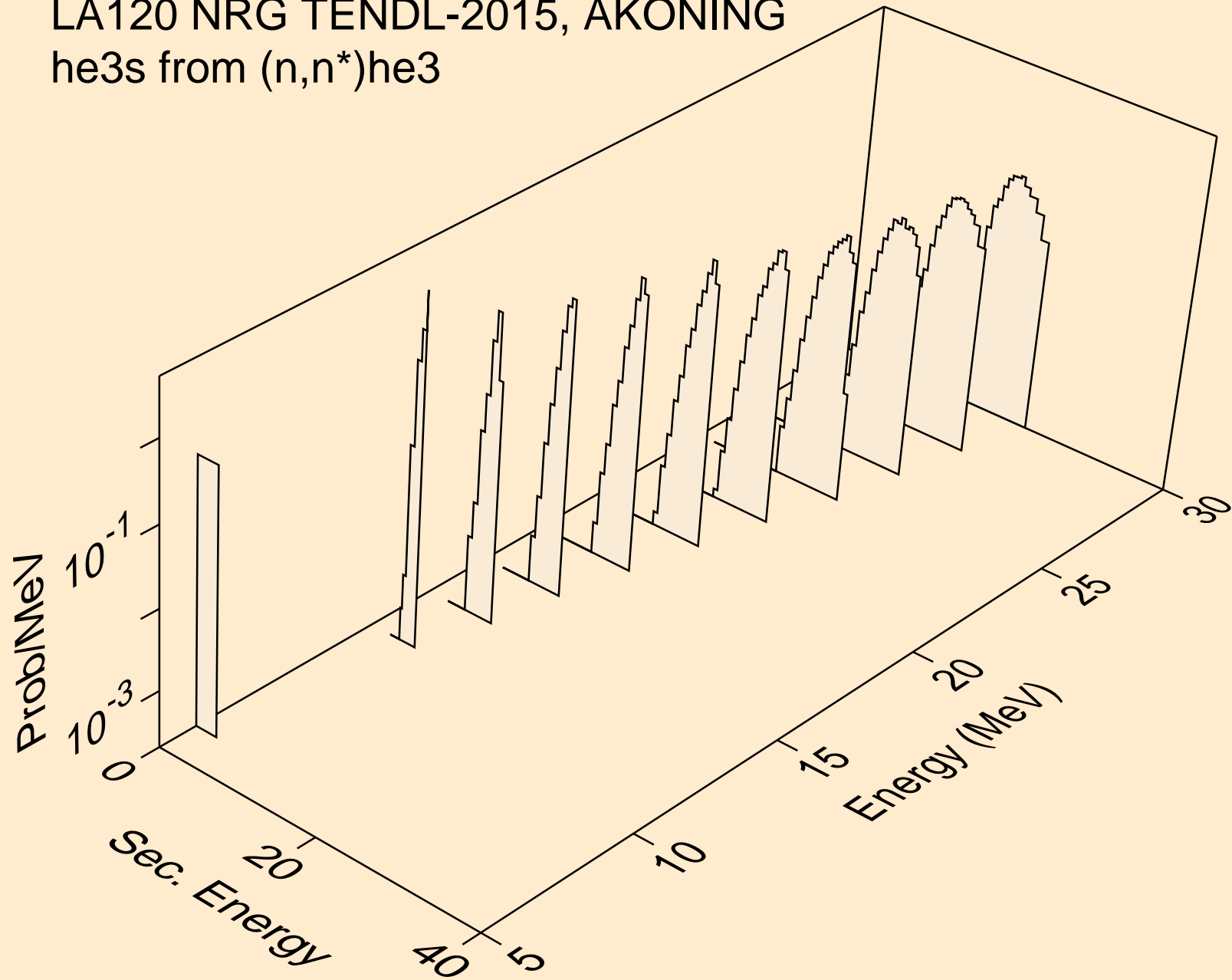

LA120 NRG TENDL-2015, AKONING  
he3s from (n,he3)

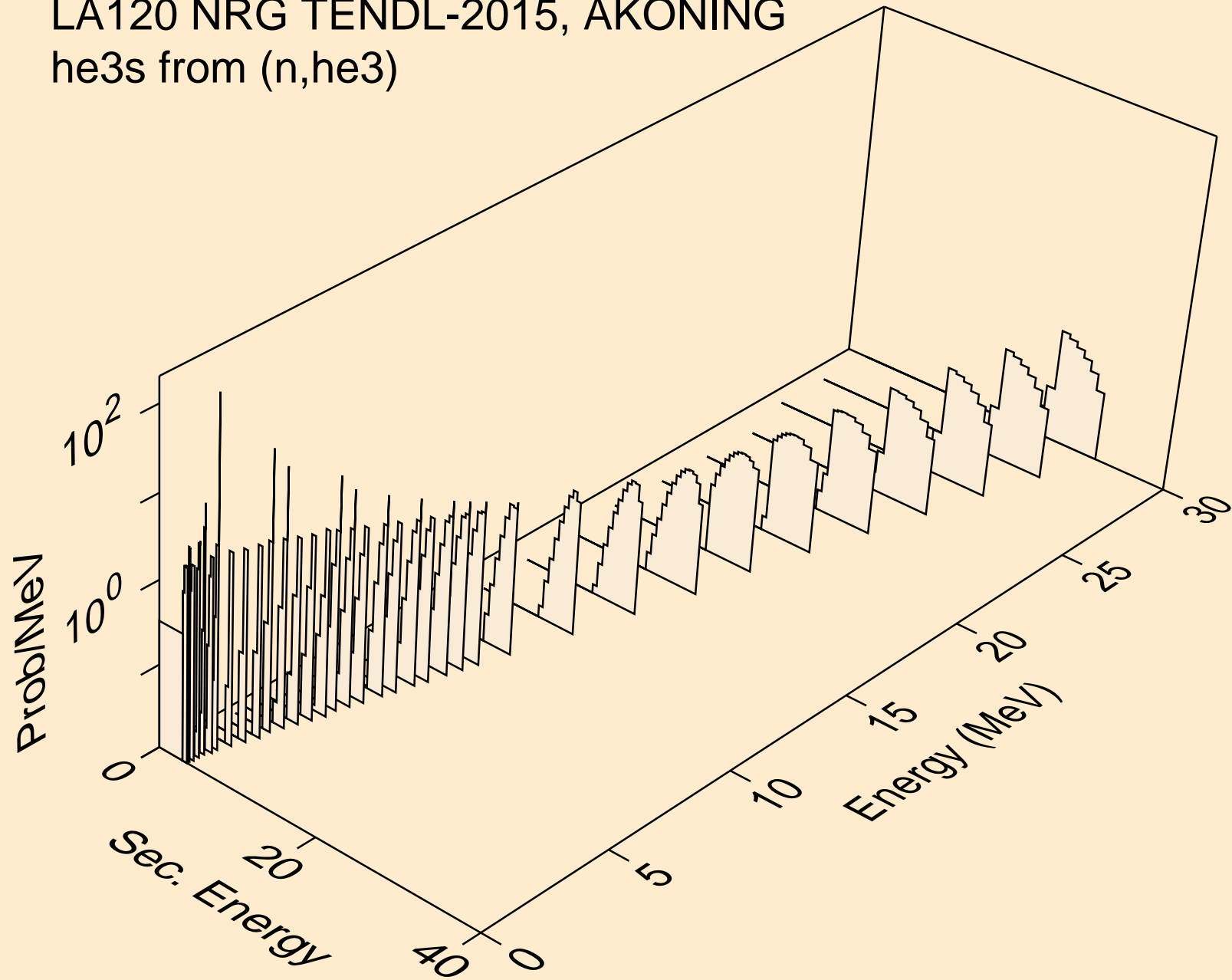

LA120 NRG TENDL-2015, AKONING  
alphas from (n,x)

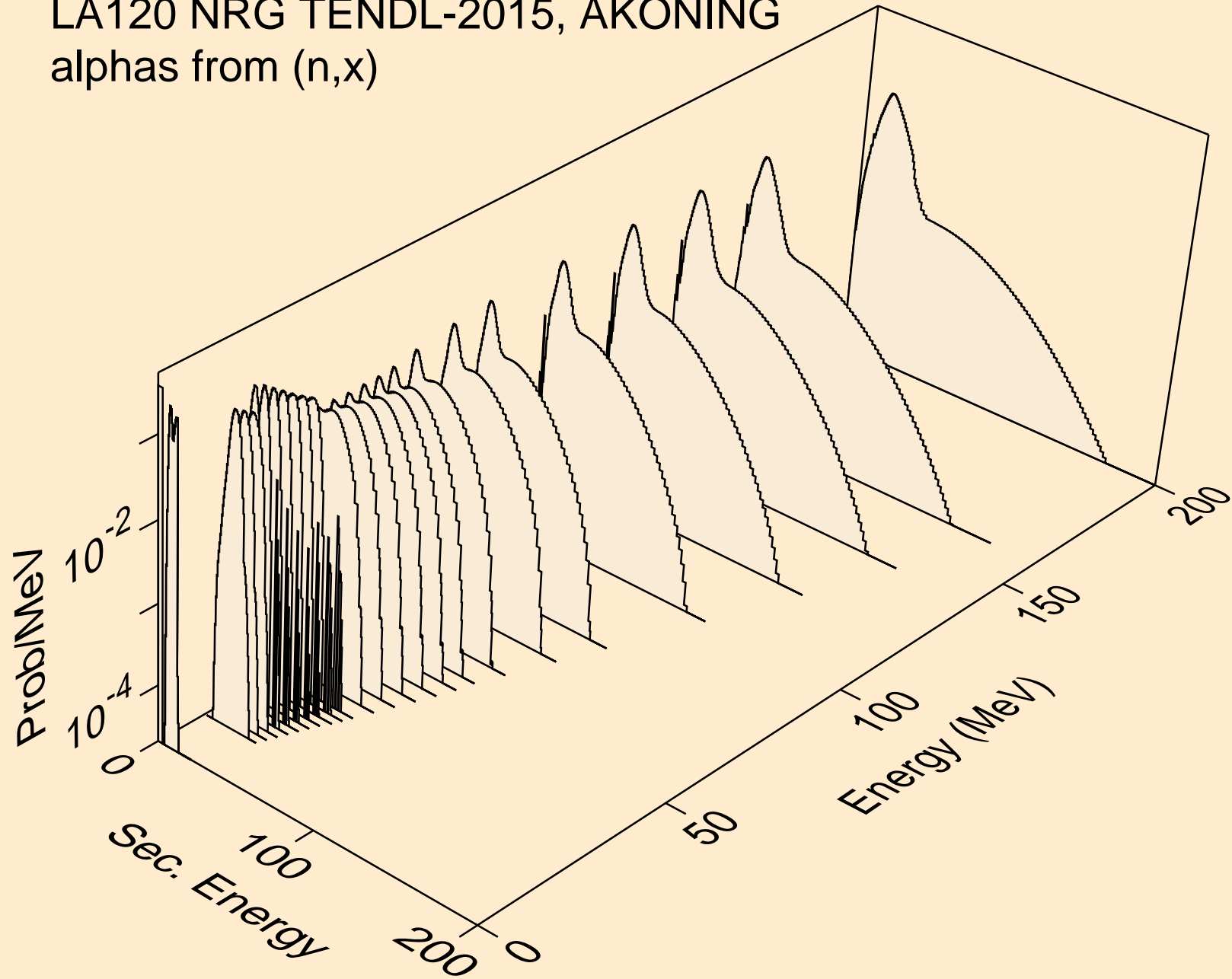

LA120 NRG TENDL-2015, AKONING  
alphas from (n,n\*)a

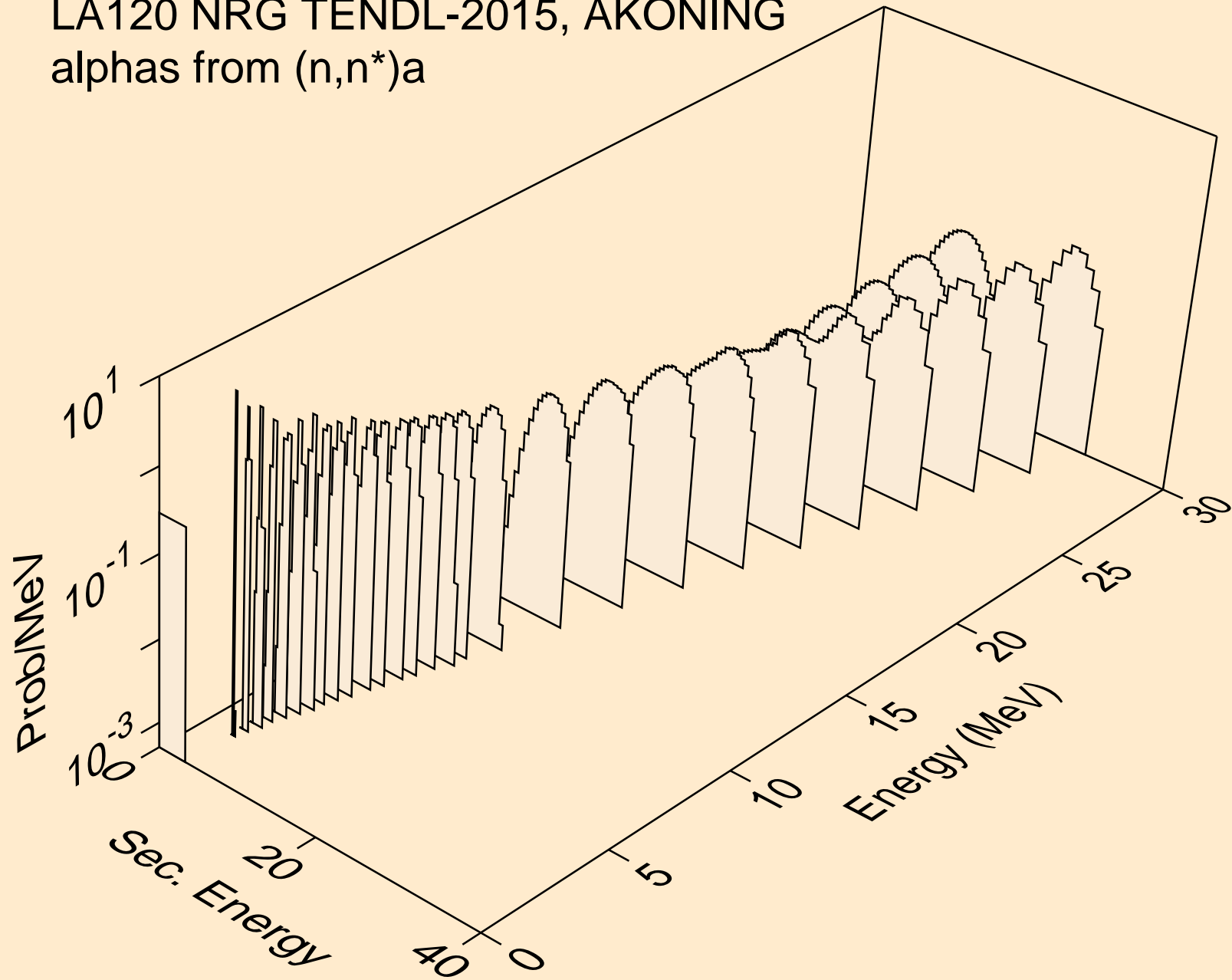

LA120 NRG TENDL-2015, AKONING  
alphas from (n,n\*)3a

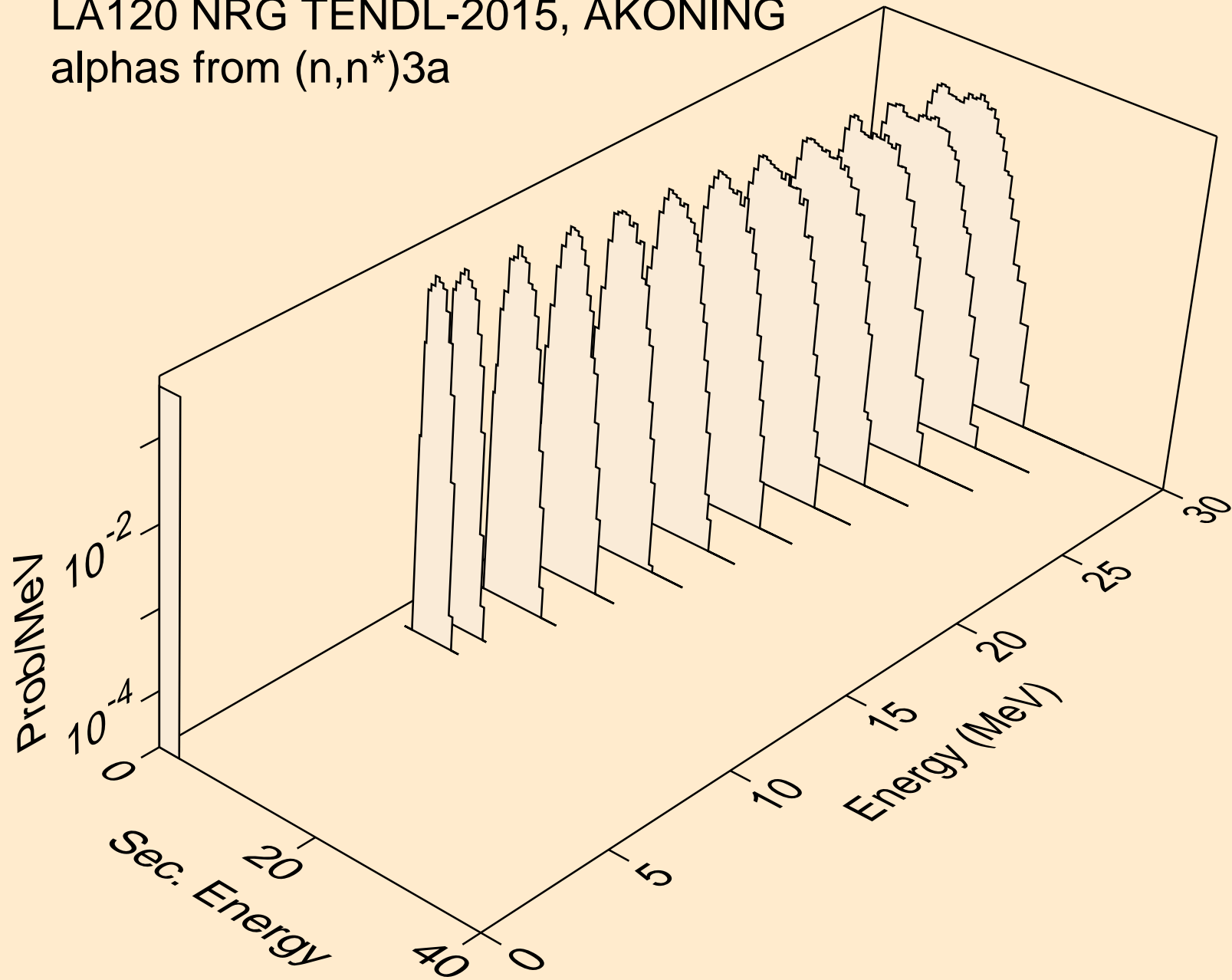

LA120 NRG TENDL-2015, AKONING  
alphas from (n,2n)a

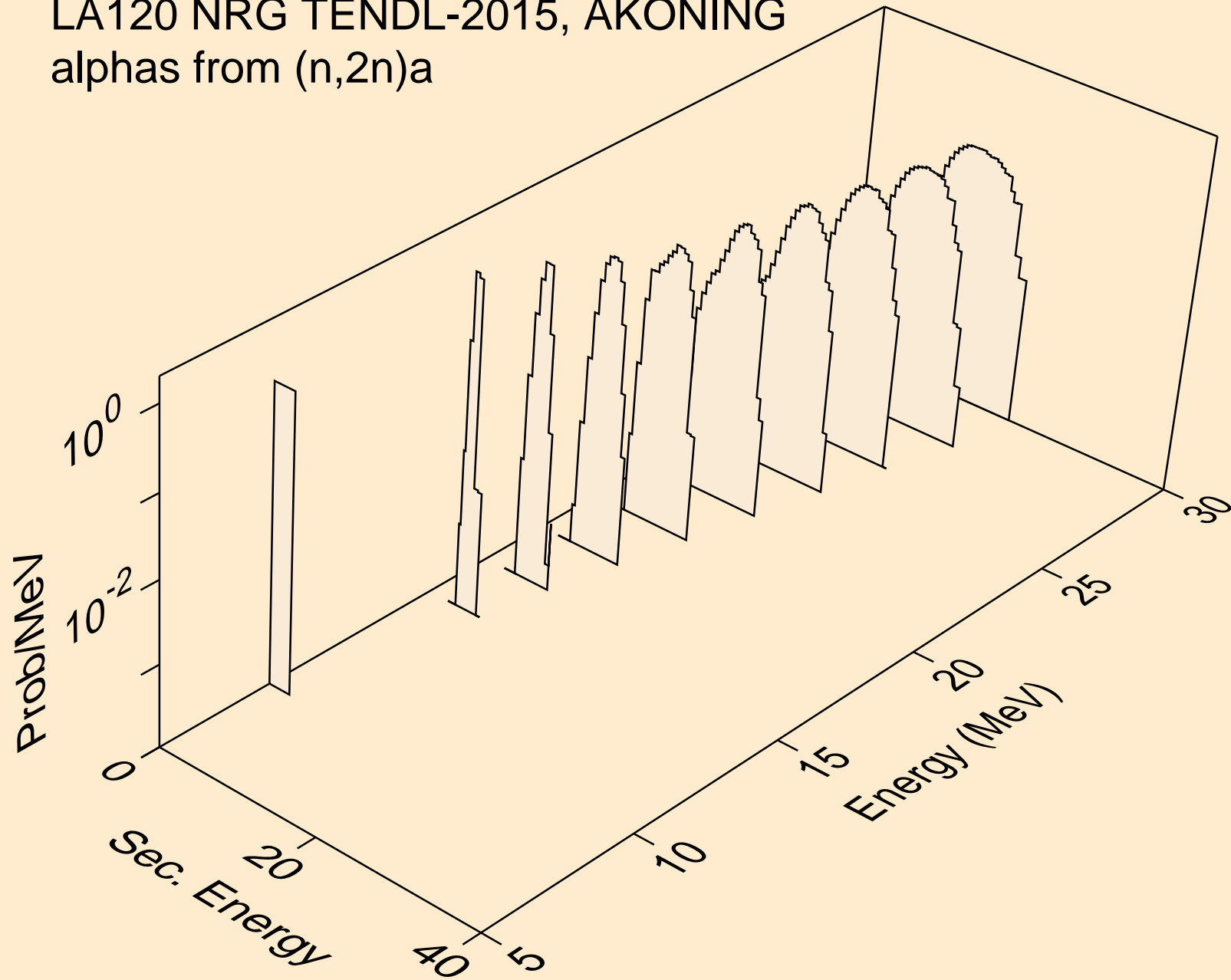

LA120 NRG TENDL-2015, AKONING  
alphas from (n,n\*)2a

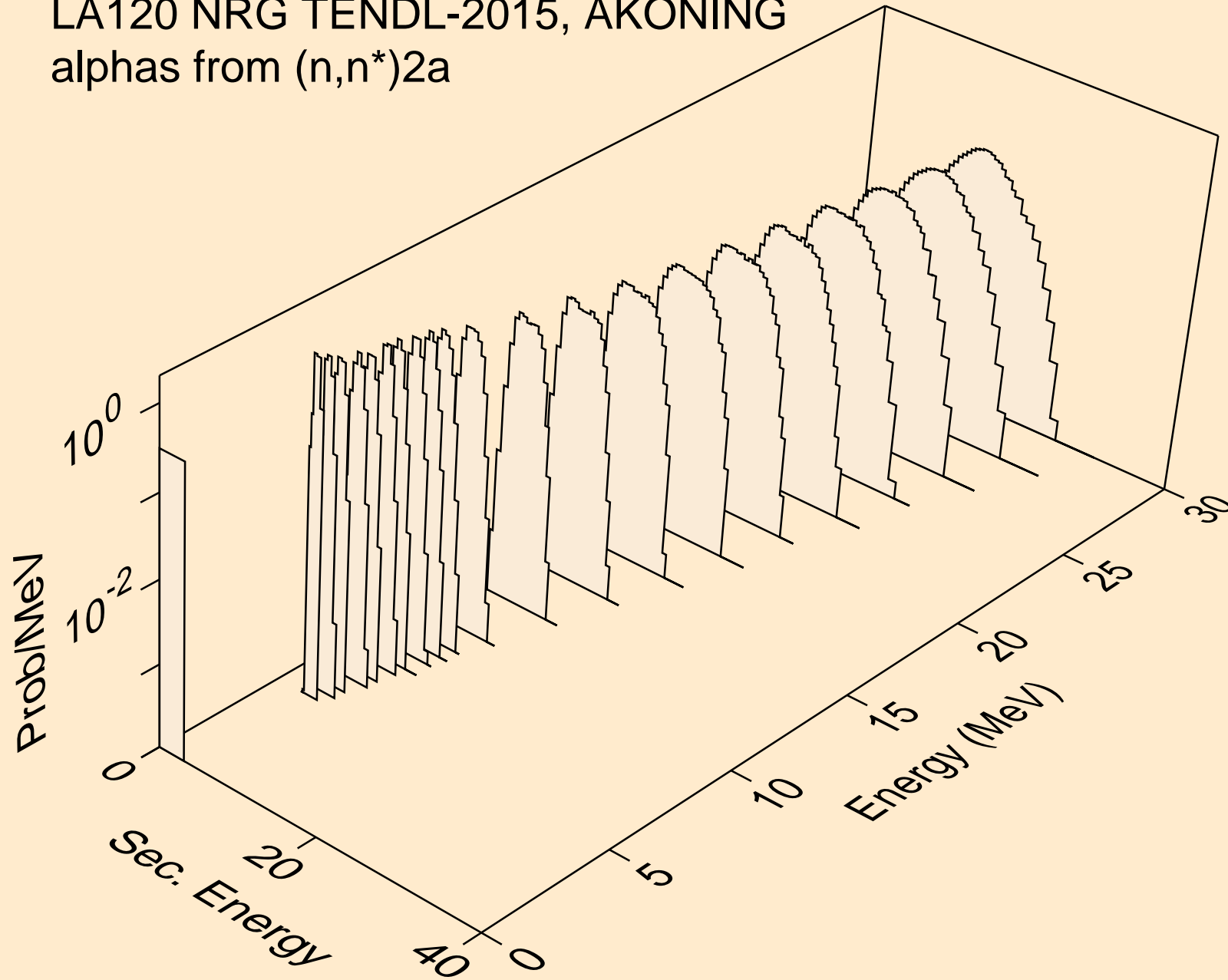

LA120 NRG TENDL-2015, AKONING  
alphas from (n,2n)2a

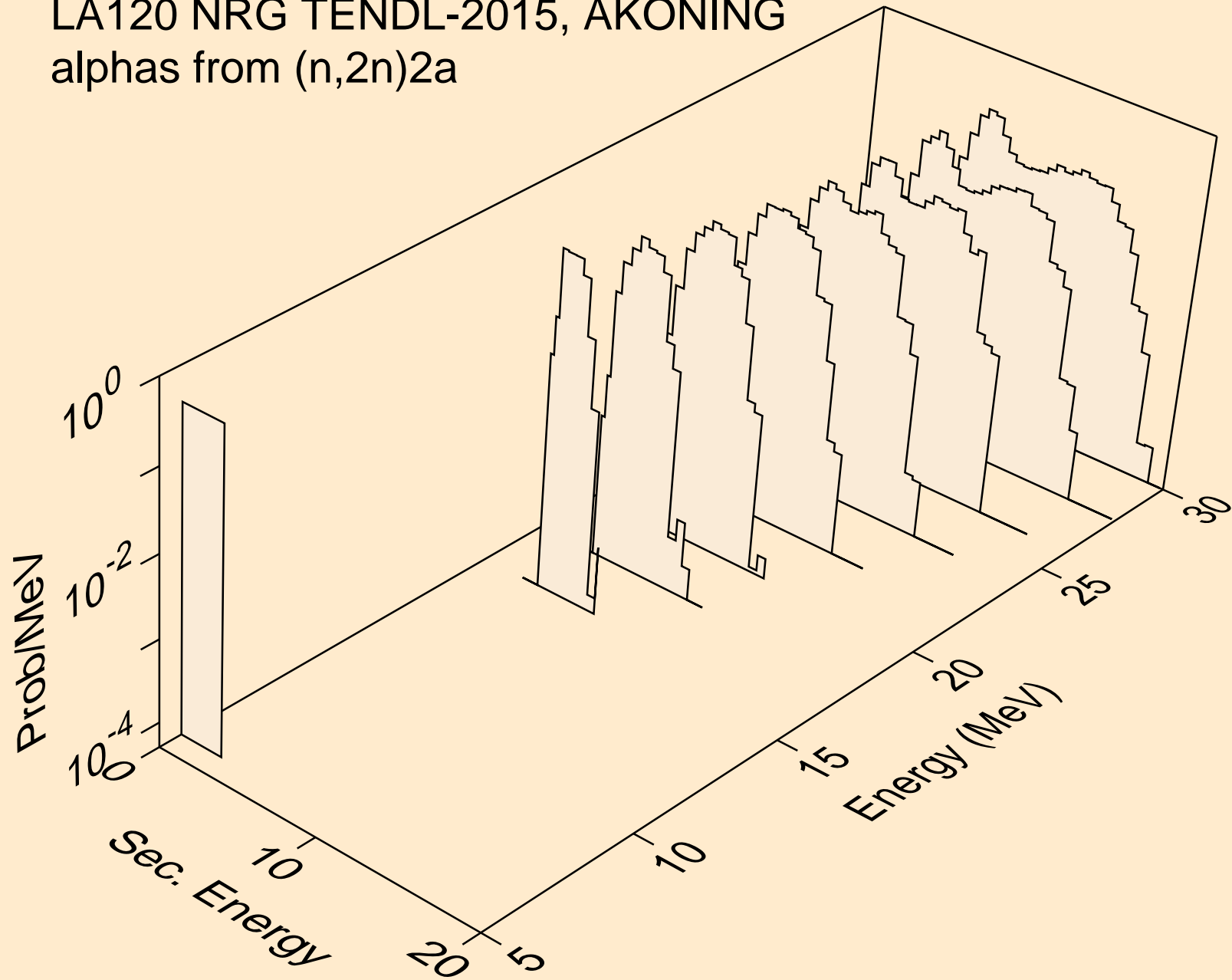



LA120 NRG TENDL-2015, AKONING  
alphas from (n,n\*)d2a

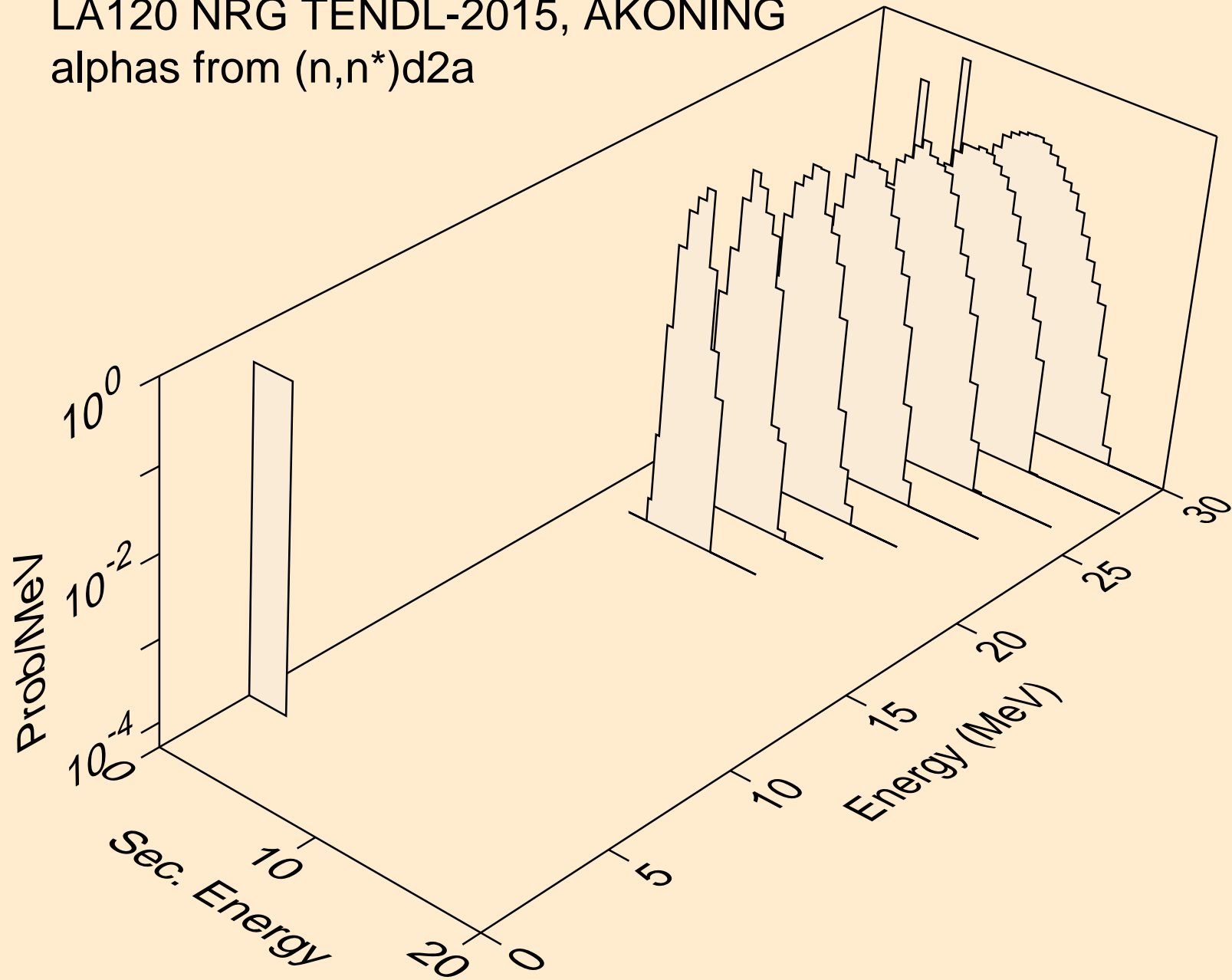

LA120 NRG TENDL-2015, AKONING  
alphas from (n,npa)

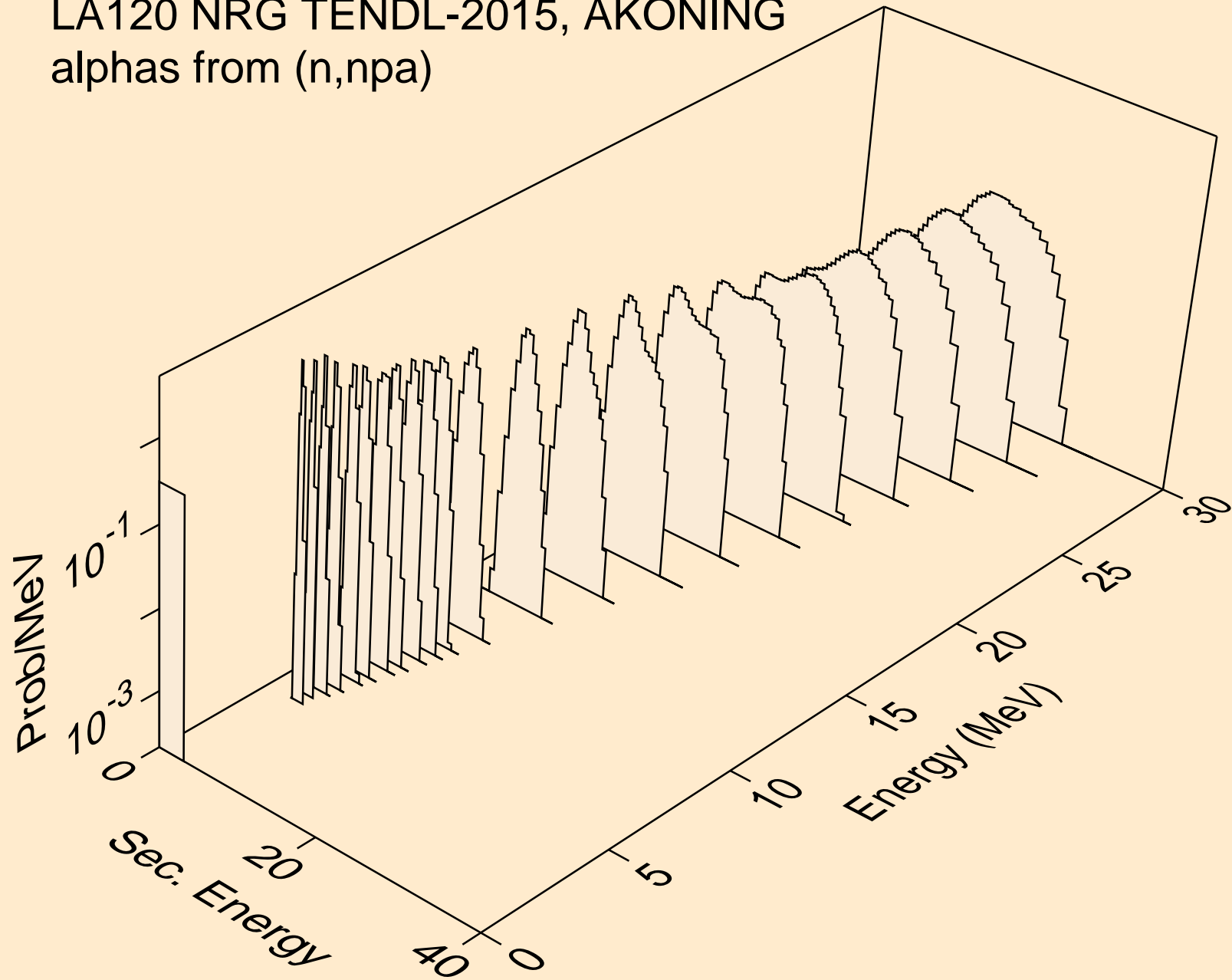

LA120 NRG TENDL-2015, AKONING  
alphas from (n,a)

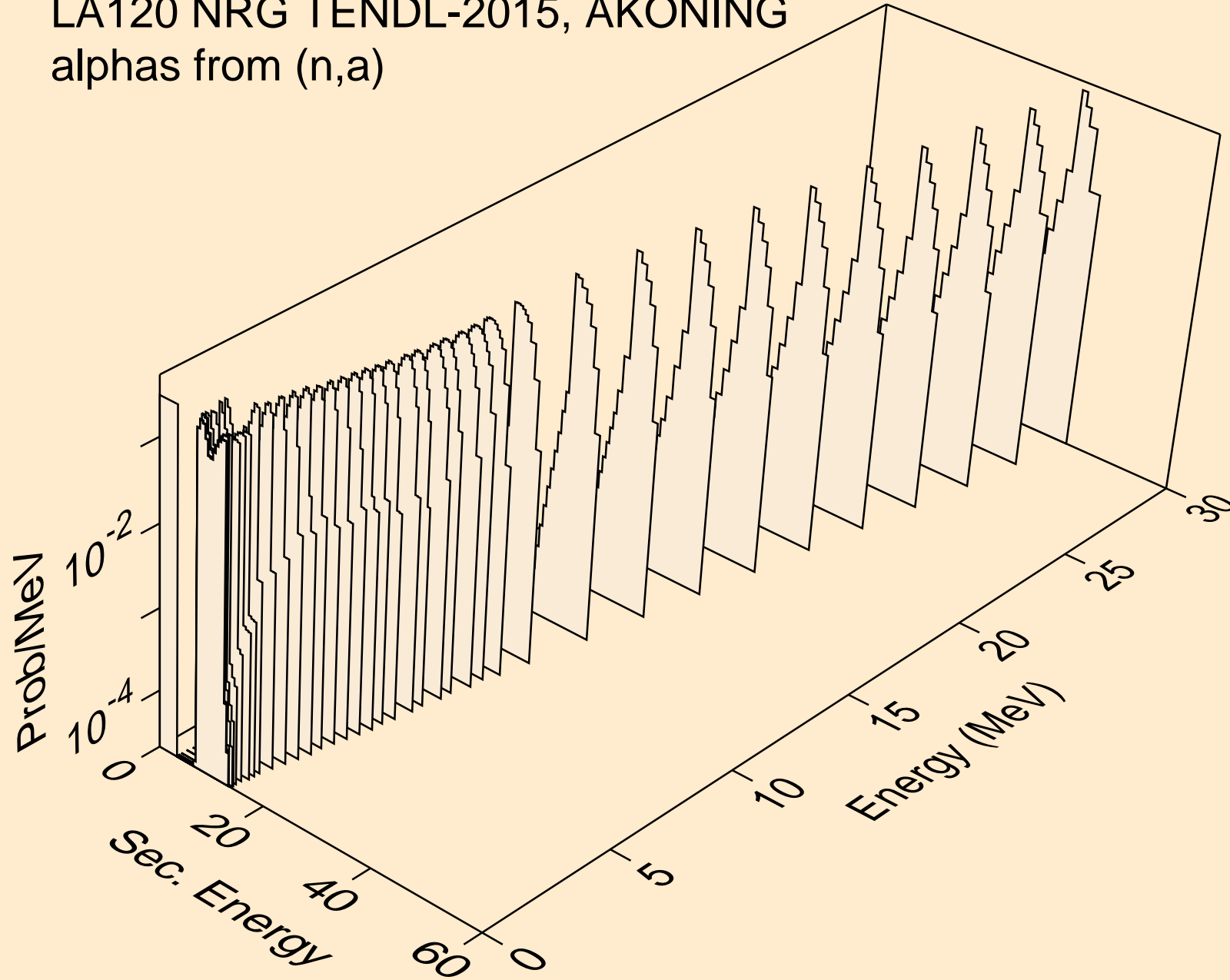

LA120 NRG TENDL-2015, AKONING  
alphas from (n,2a)

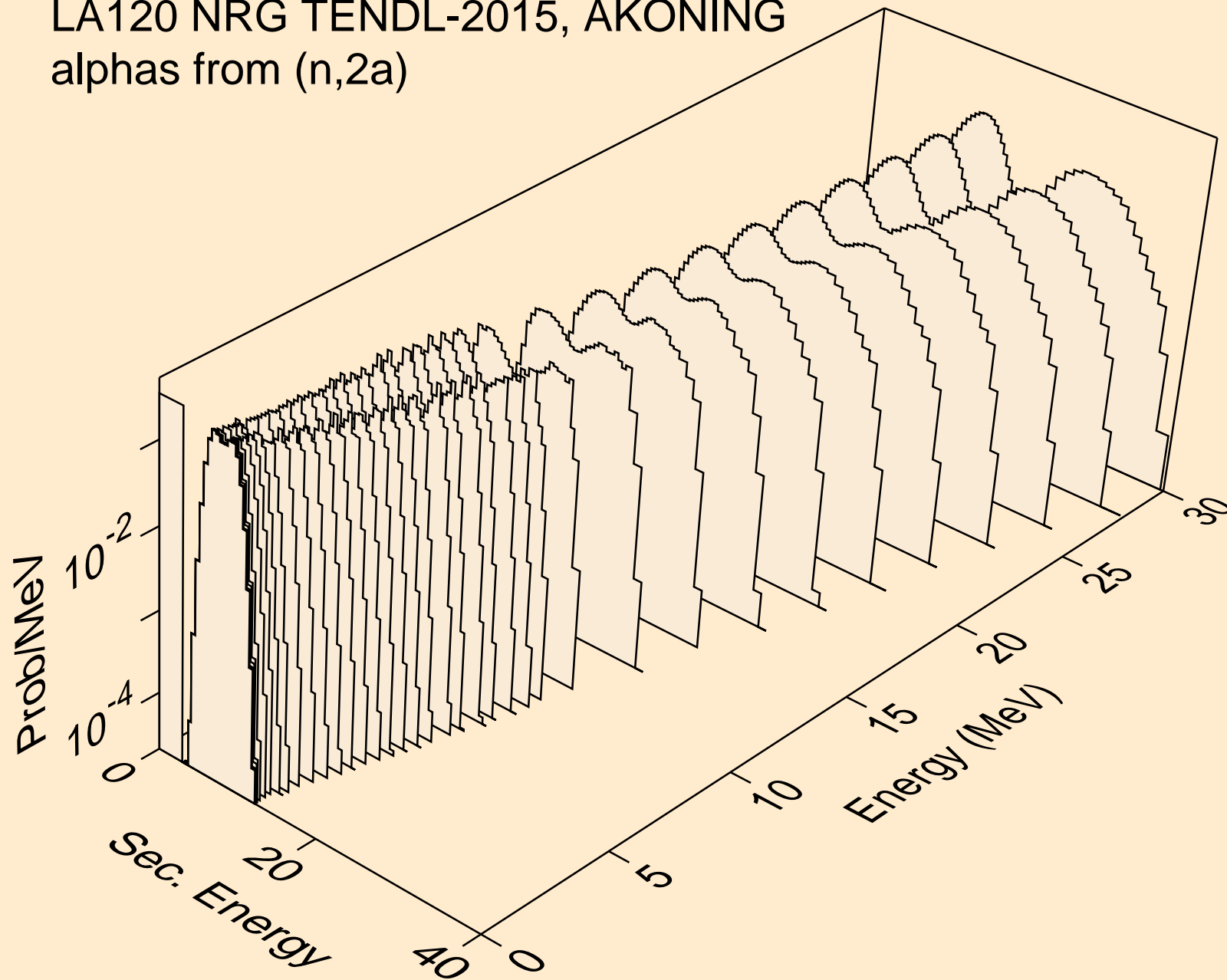

LA120 NRG TENDL-2015, AKONING  
alphas from (n,3a)

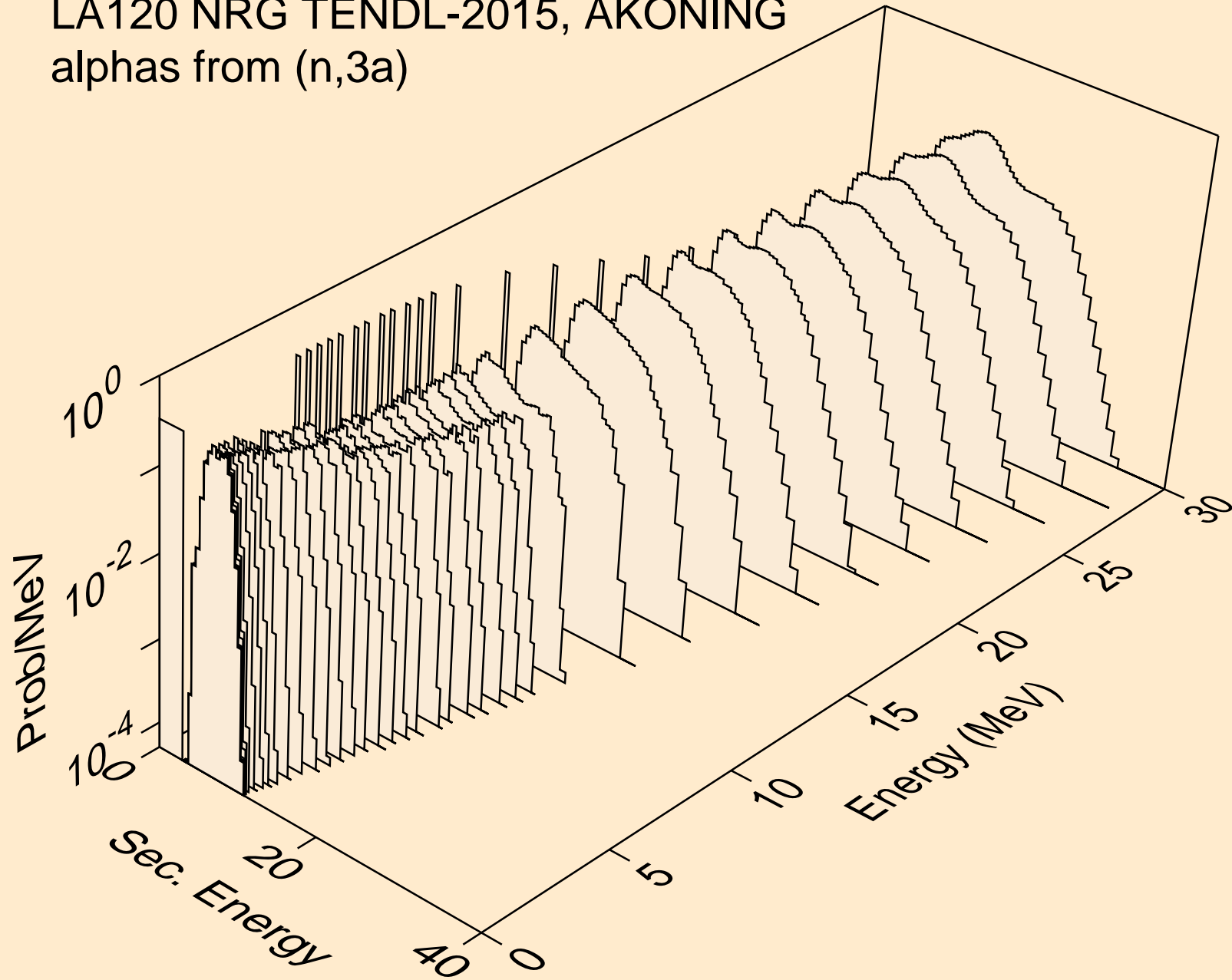

LA120 NRG TENDL-2015, AKONING  
alphas from (n,pa)

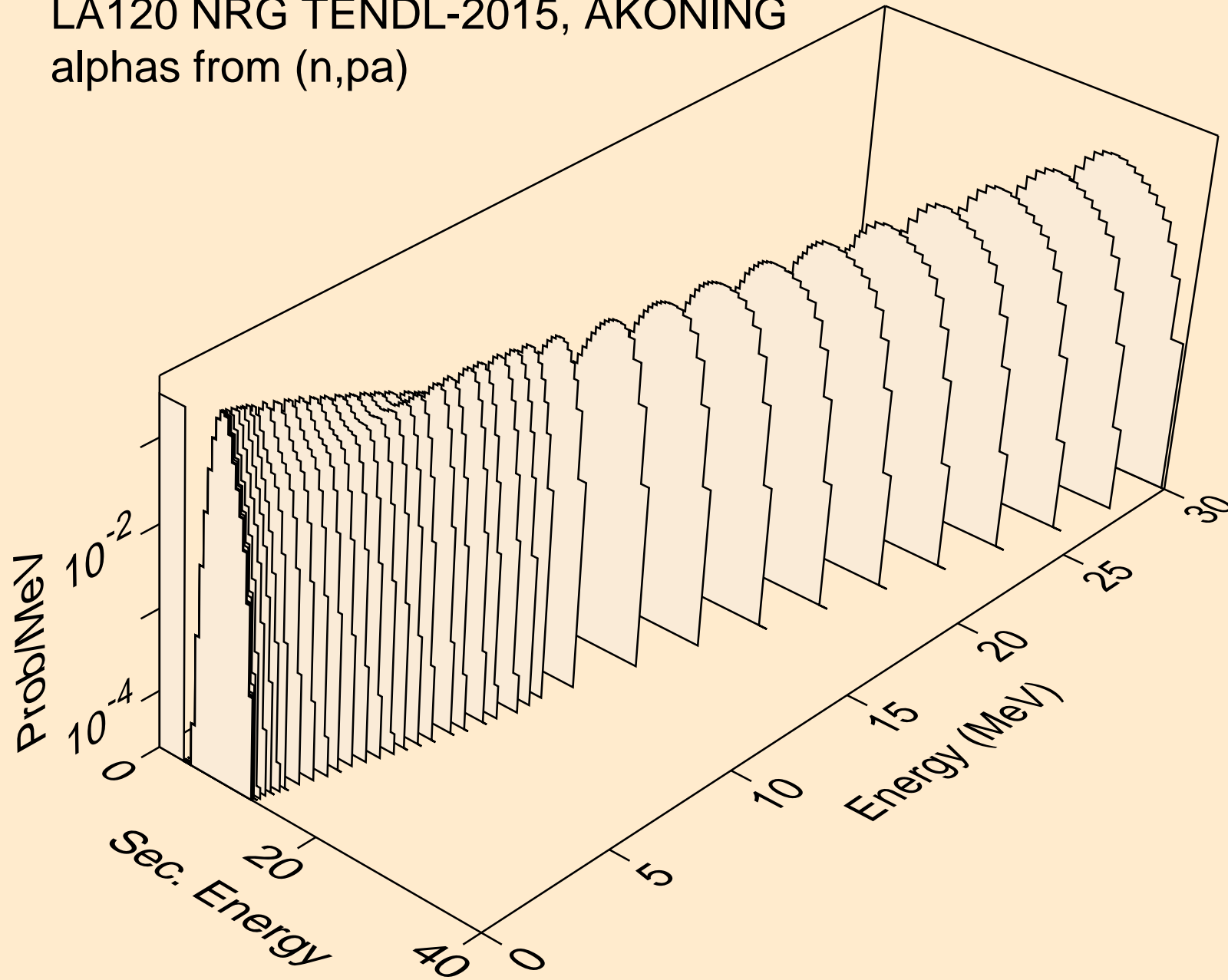

LA120 NRG TENDL-2015, AKONING  
alphas from (n,t2a)

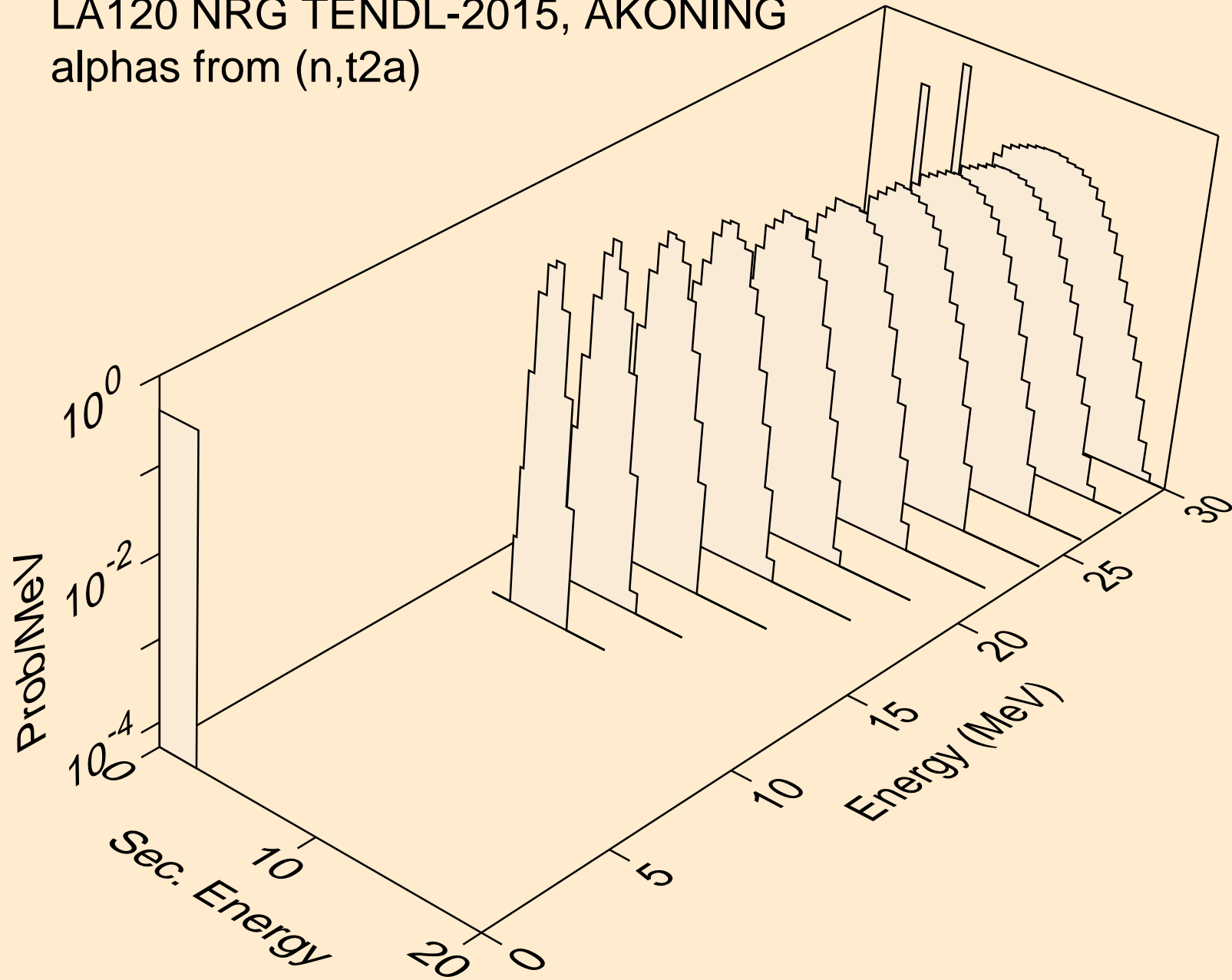

LA120 NRG TENDL-2015, AKONING  
alphas from (n,d2a)

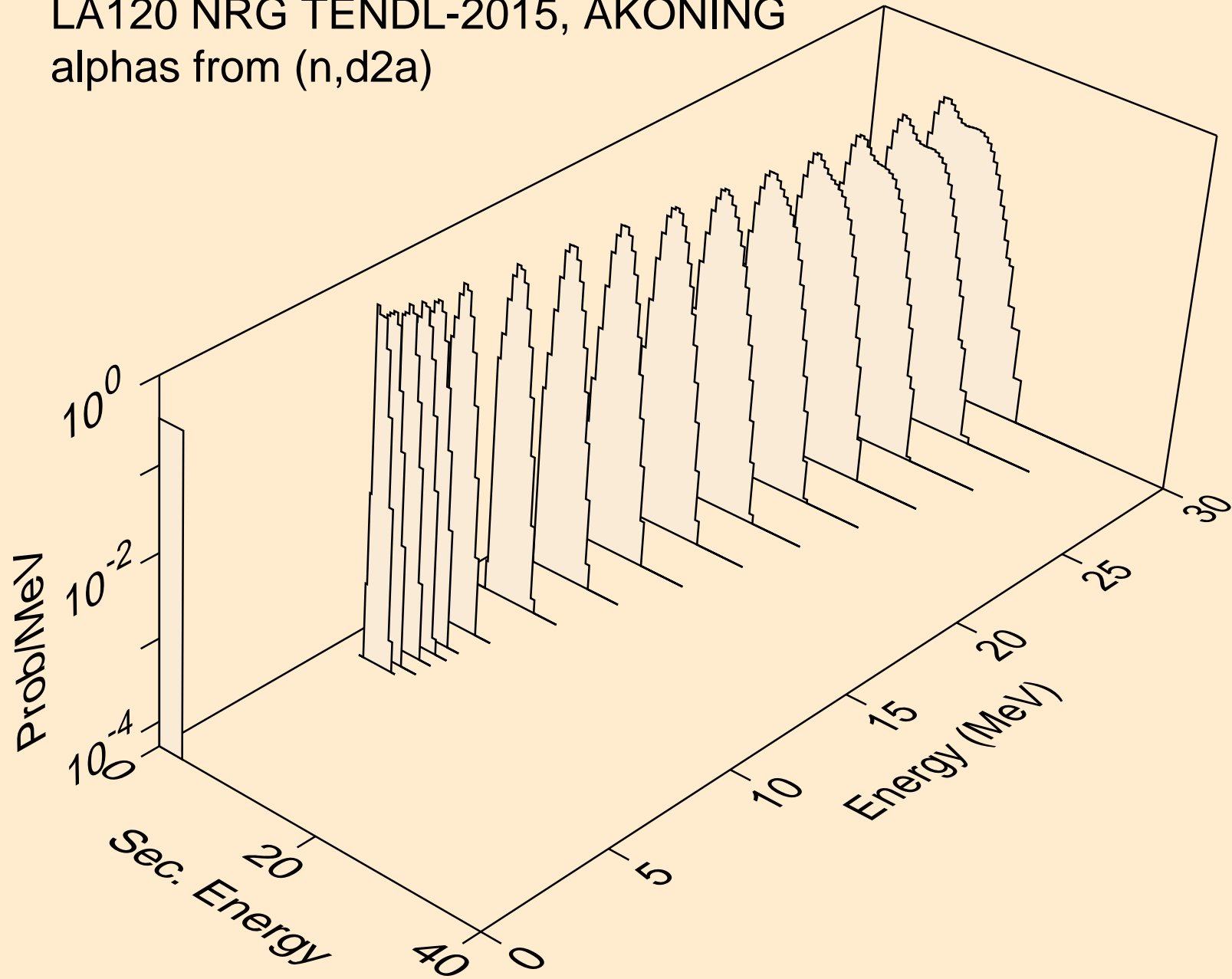



LA120 NRG TENDL-2015, AKONING  
alphas from (n,da)

