

LR254 NRG TENDL-2015, AKONING

Principal cross sections

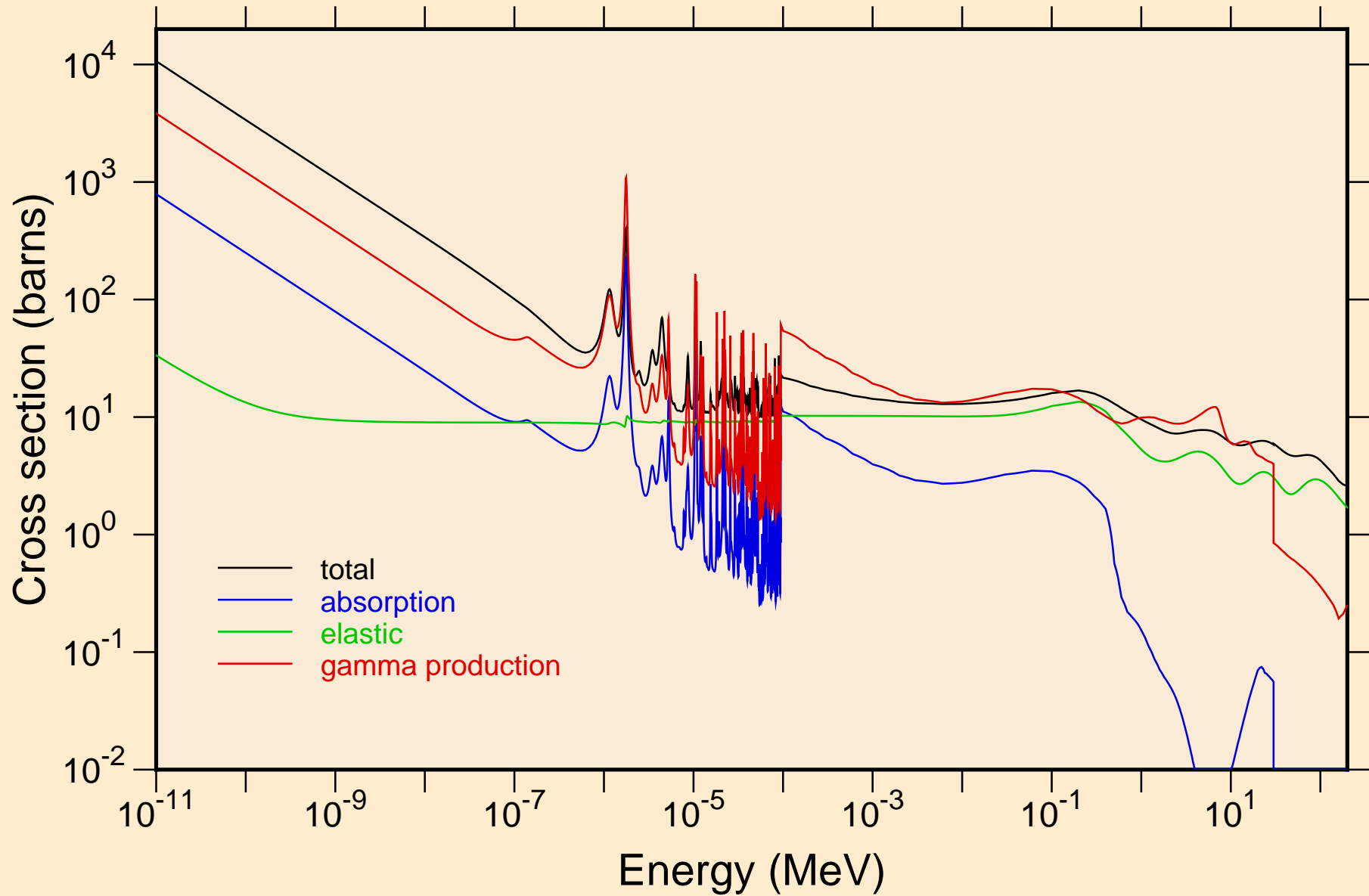

LR254 NRG TENDL-2015, AKONING
resonance total cross section

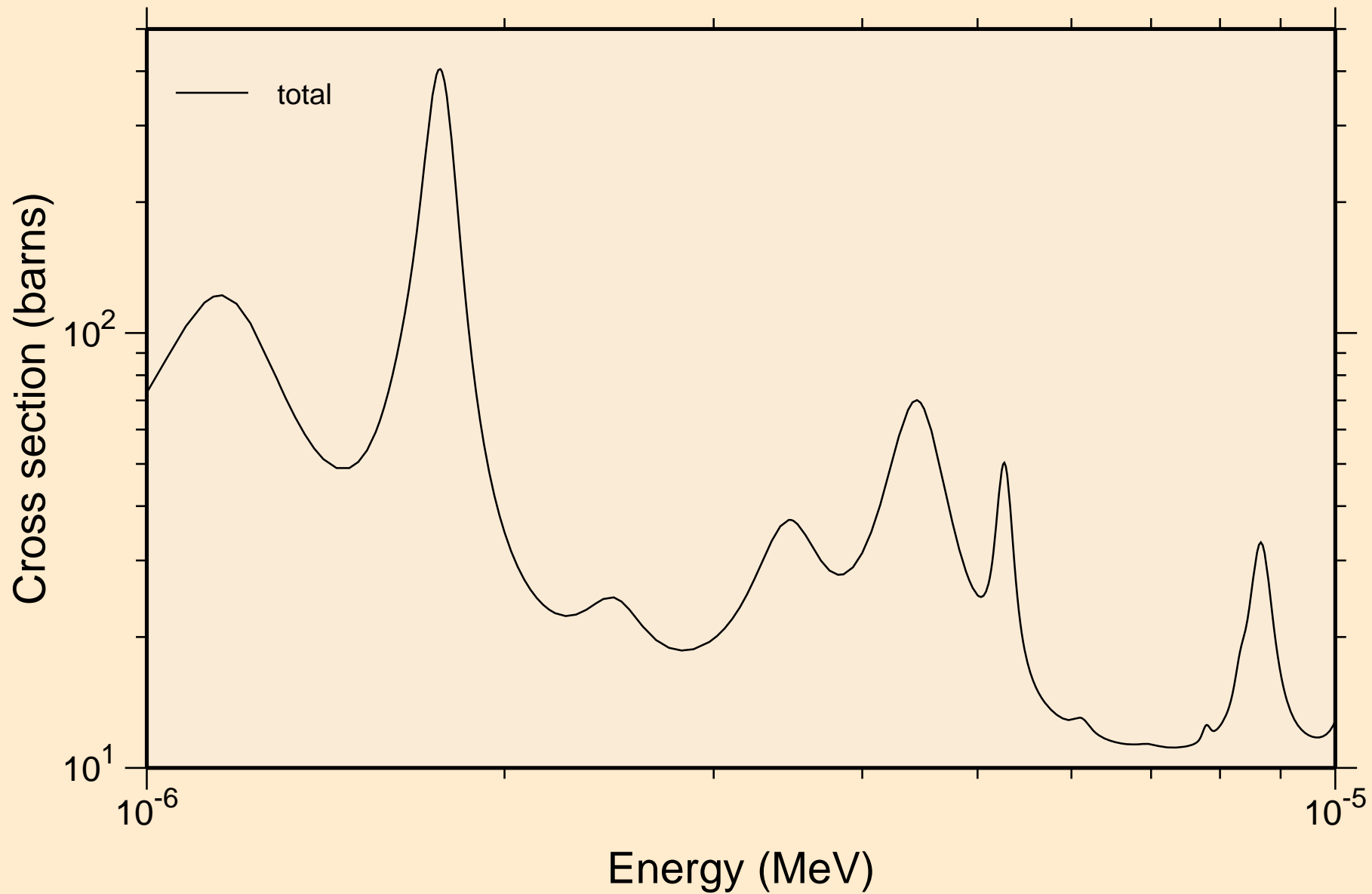

LR254 NRG TENDL-2015, AKONING
resonance total cross section

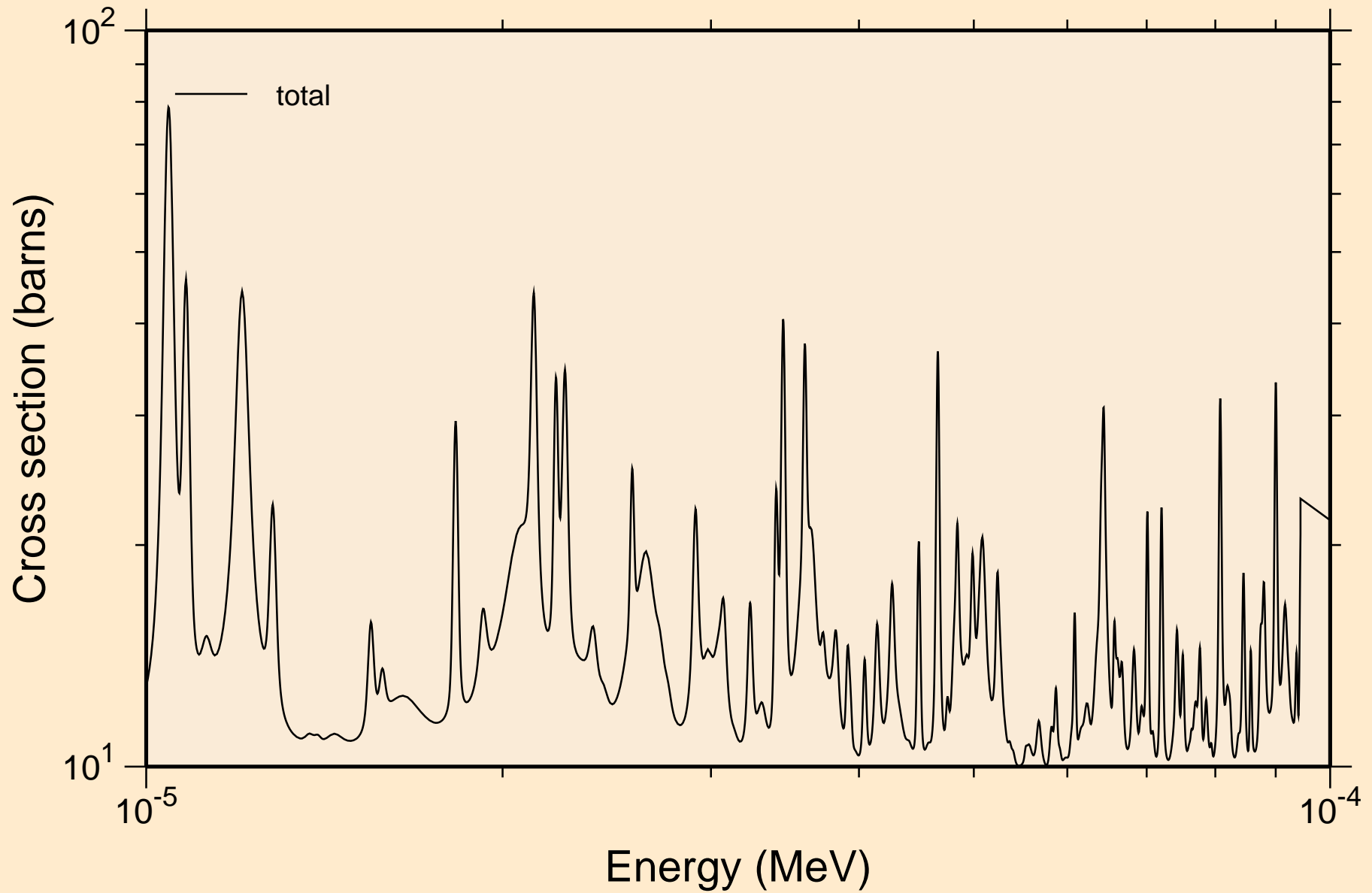

LR254 NRG TENDL-2015, AKONING
resonance total cross section

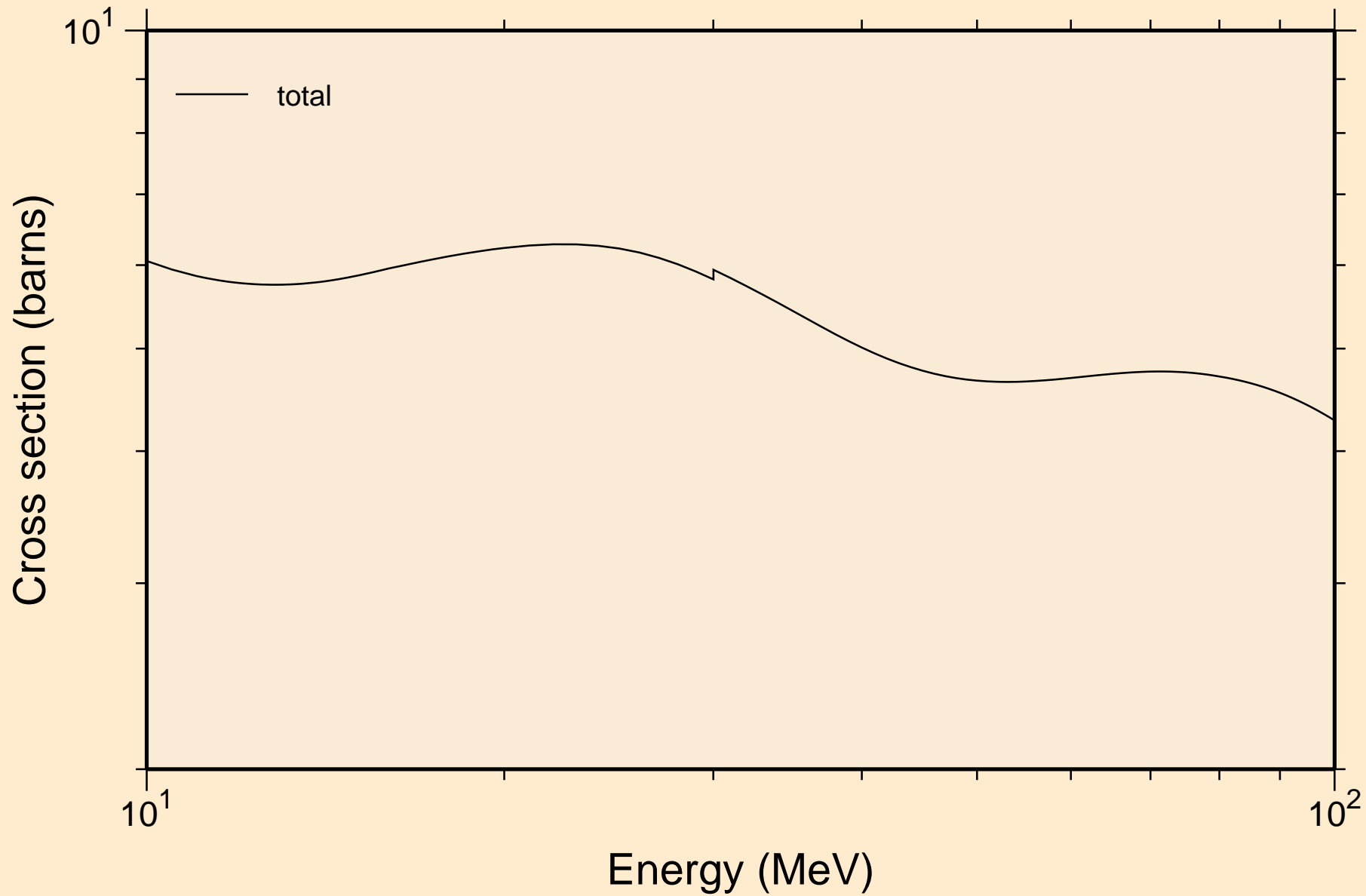

LR254 NRG TENDL-2015, AKONING
resonance absorption cross sections

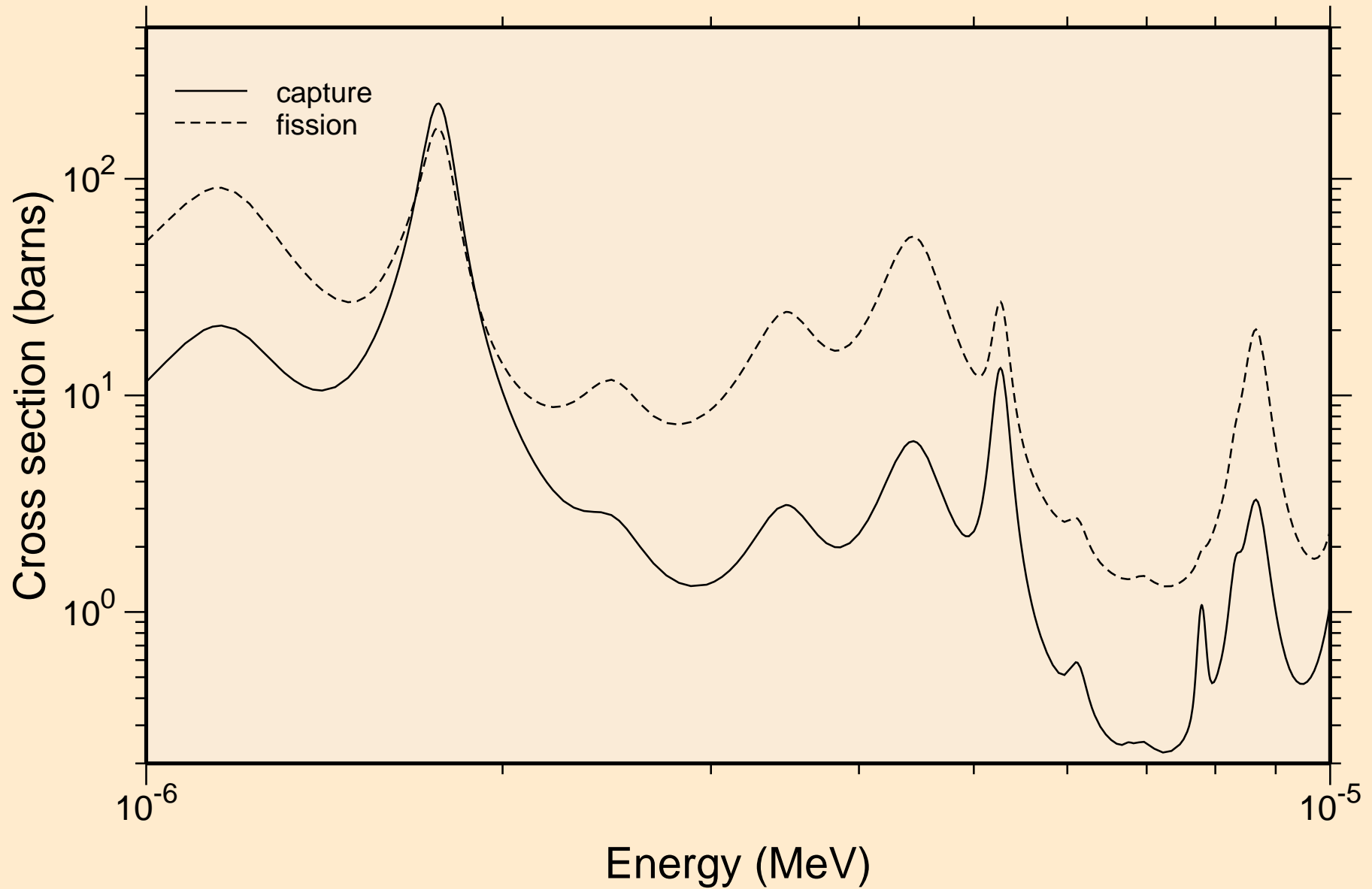

LR254 NRG TENDL-2015, AKONING
resonance absorption cross sections

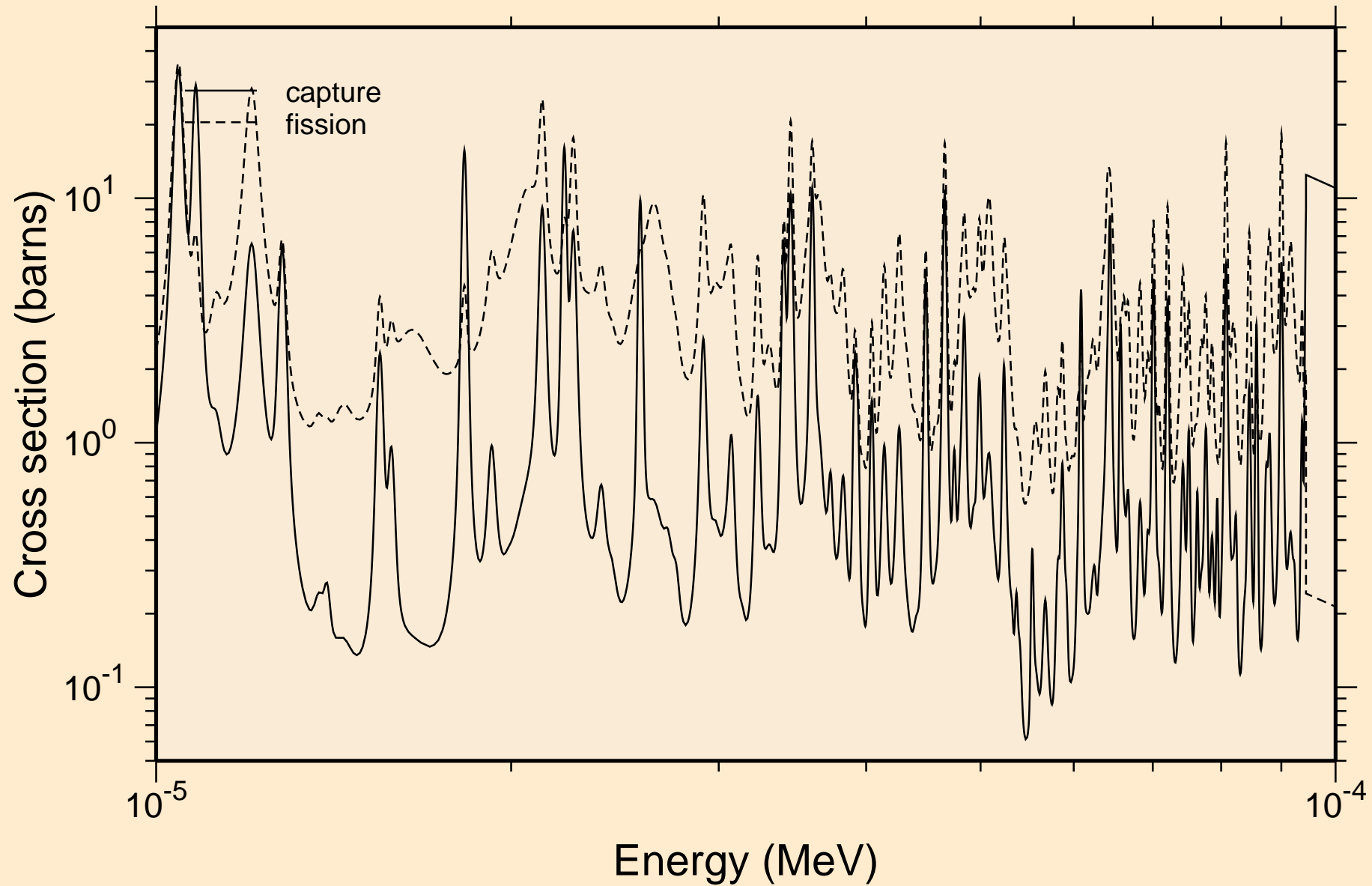

LR254 NRG TENDL-2015, AKONING
resonance absorption cross sections

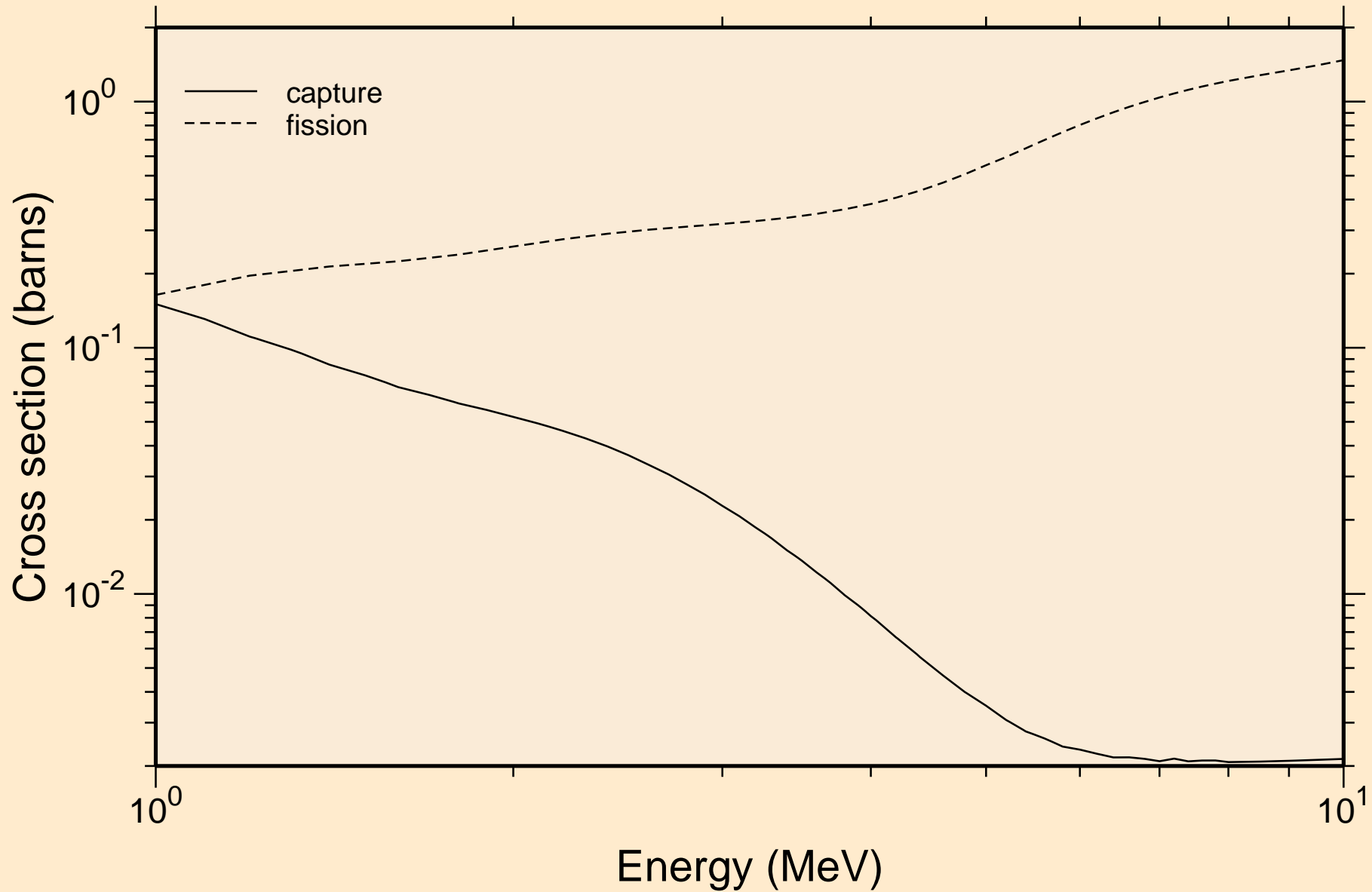

LR254 NRG TENDL-2015, AKONING

Non-threshold reactions

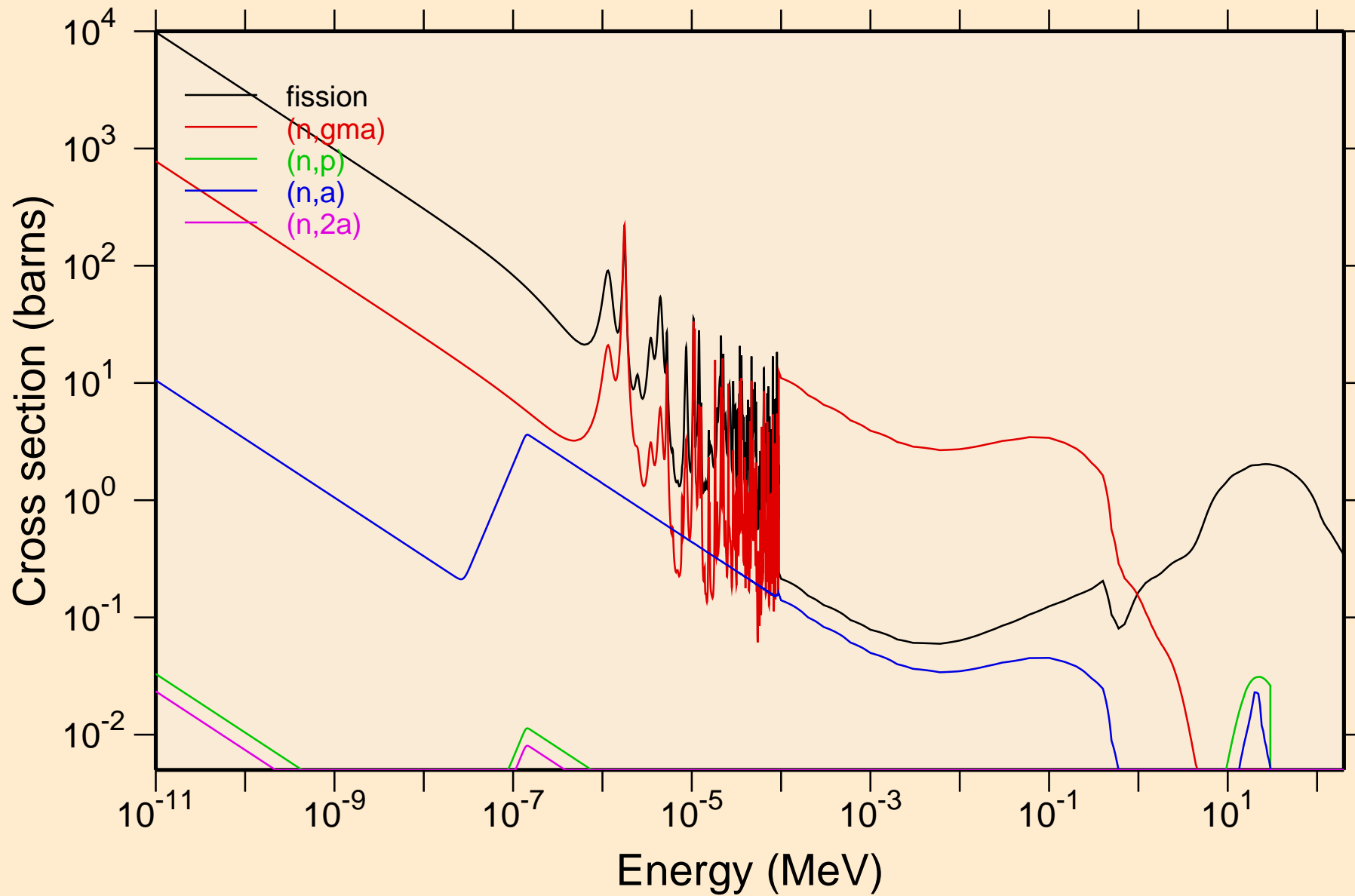

LR254 NRG TENDL-2015, AKONING
Non-threshold reactions

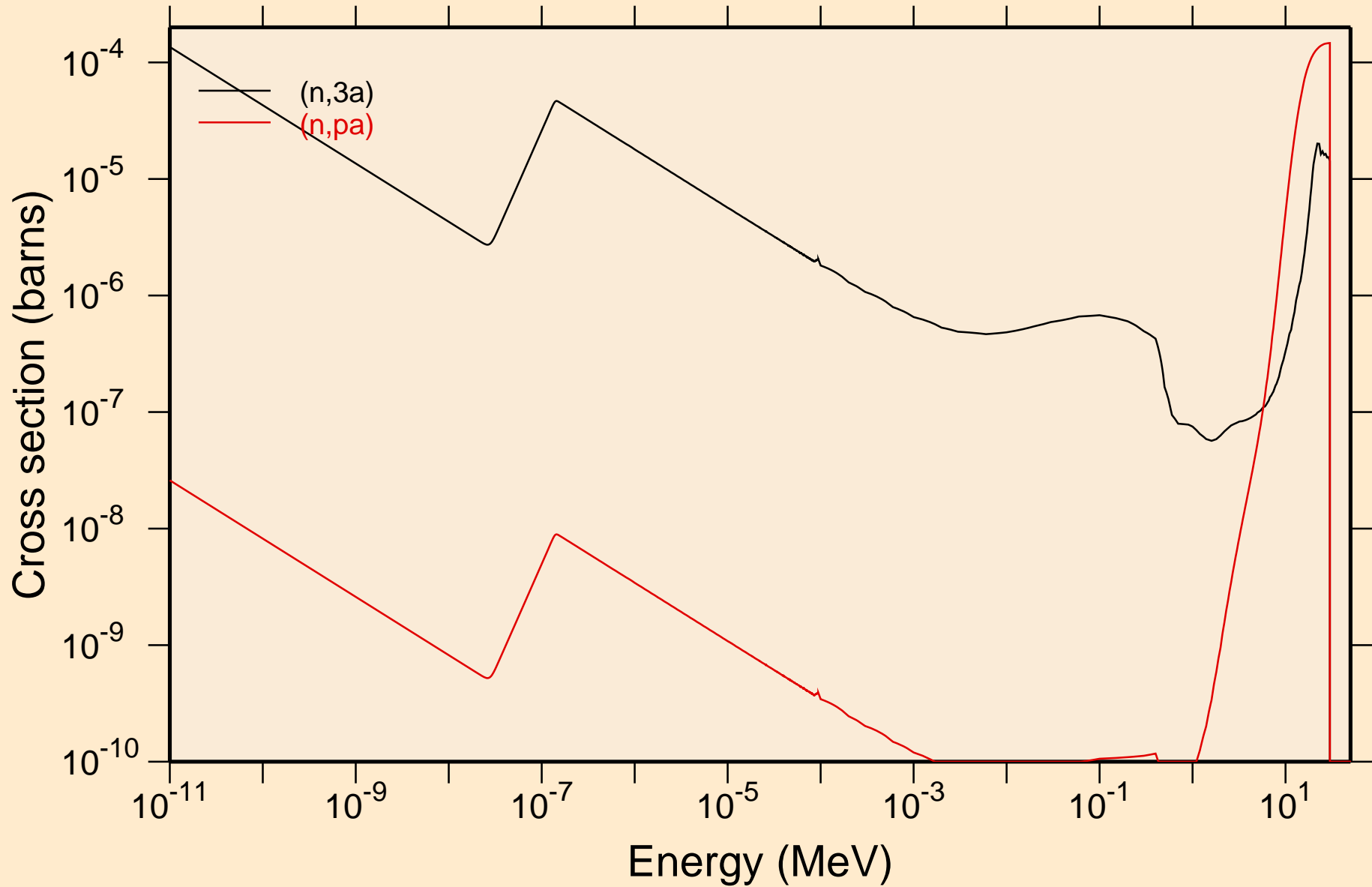

LR254 NRG TENDL-2015, AKONING

Principal cross sections

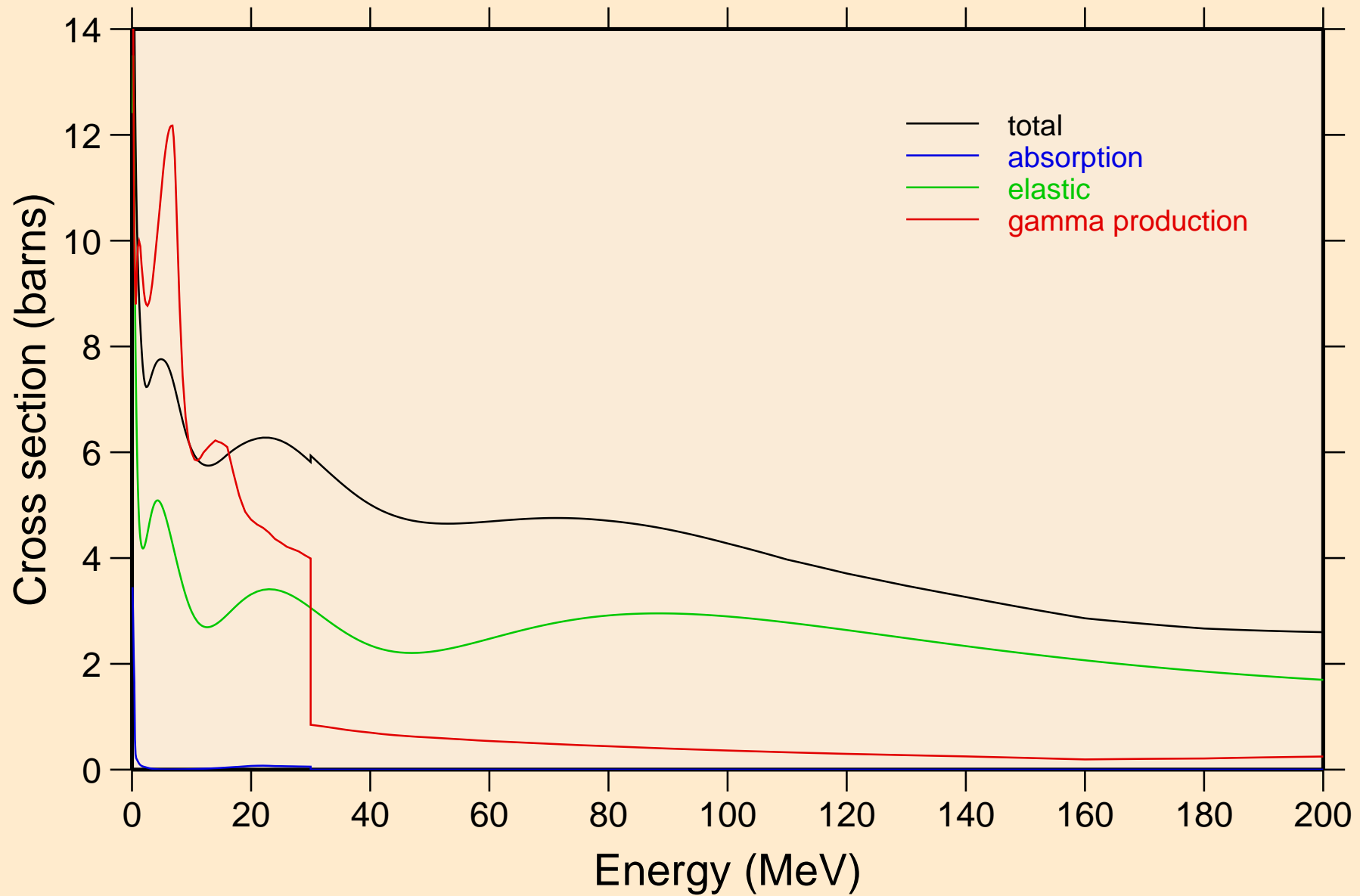

LR254 NRG TENDL-2015, AKONING

Non-threshold reactions

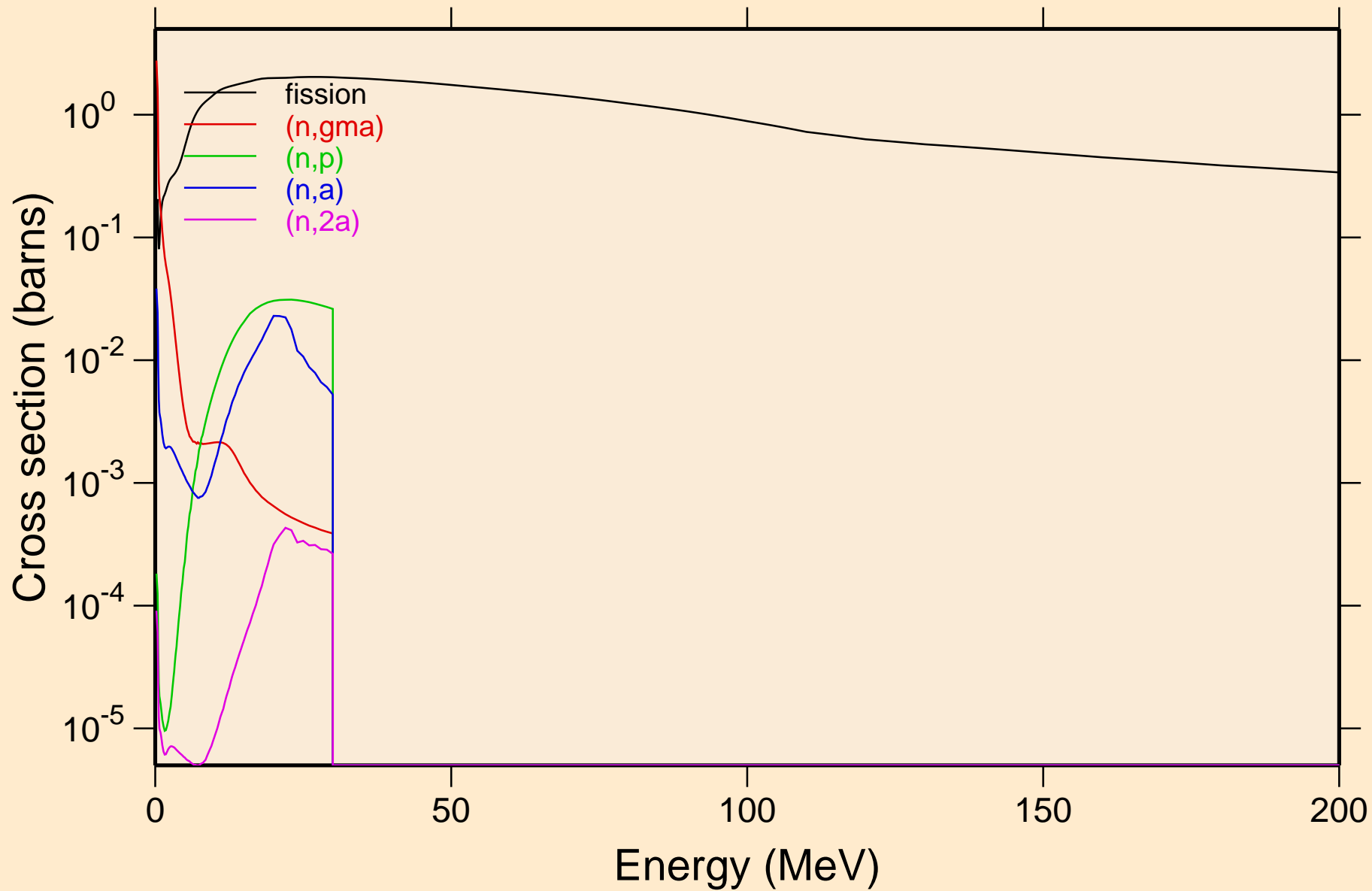

LR254 NRG TENDL-2015, AKONING
Non-threshold reactions

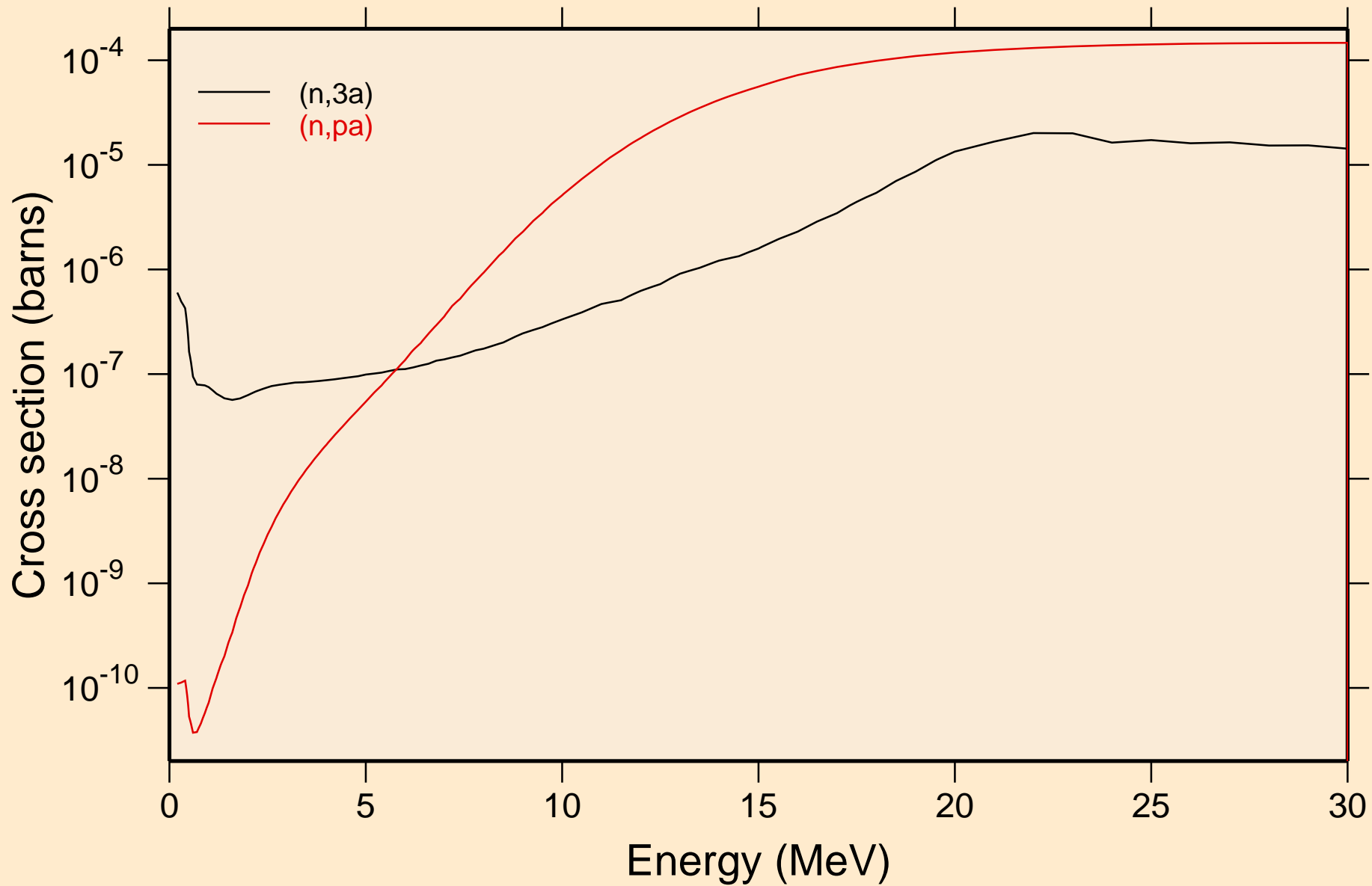

LR254 NRG TENDL-2015, AKONING

Inelastic levels

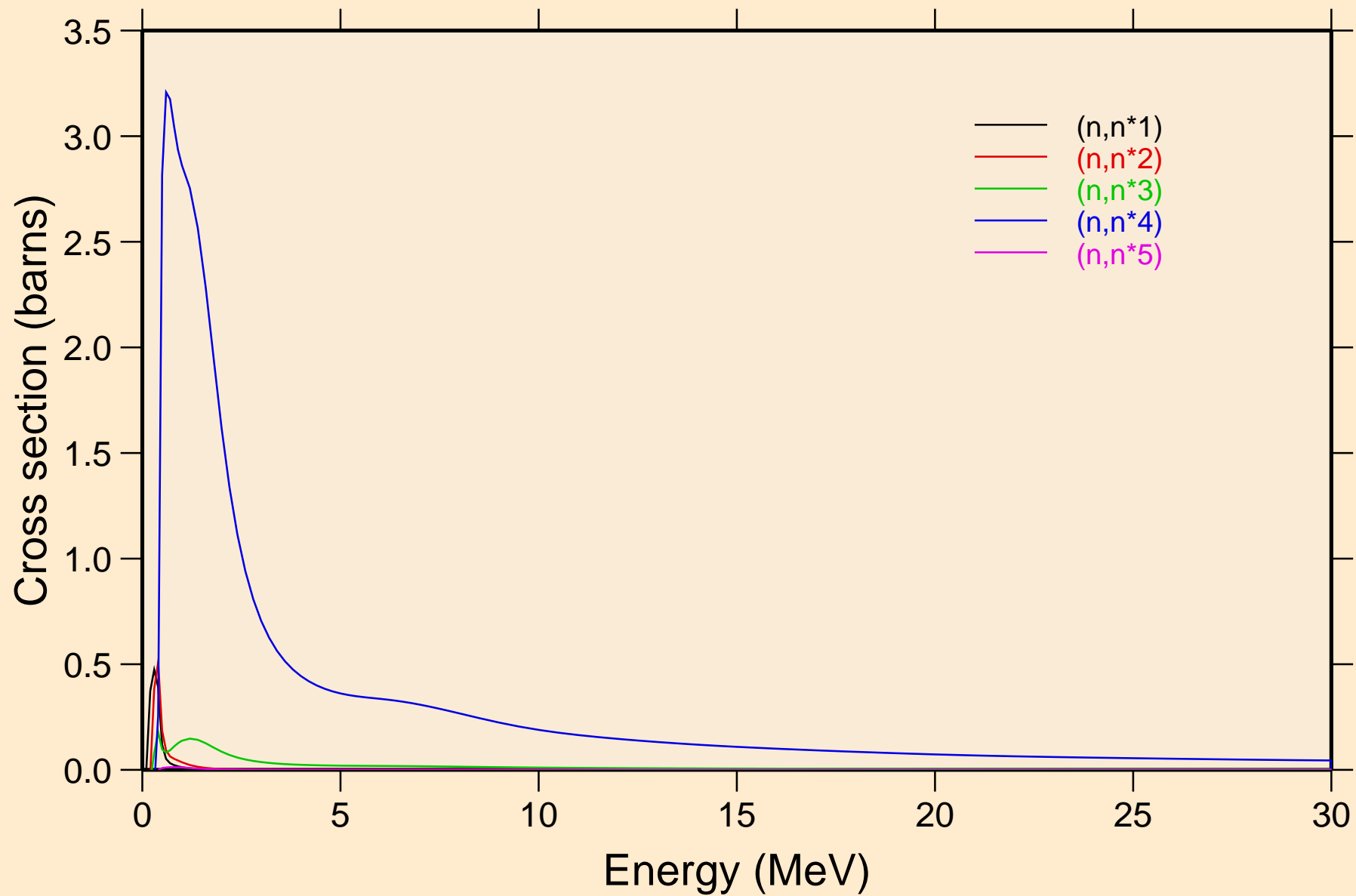

LR254 NRG TENDL-2015, AKONING

Inelastic levels

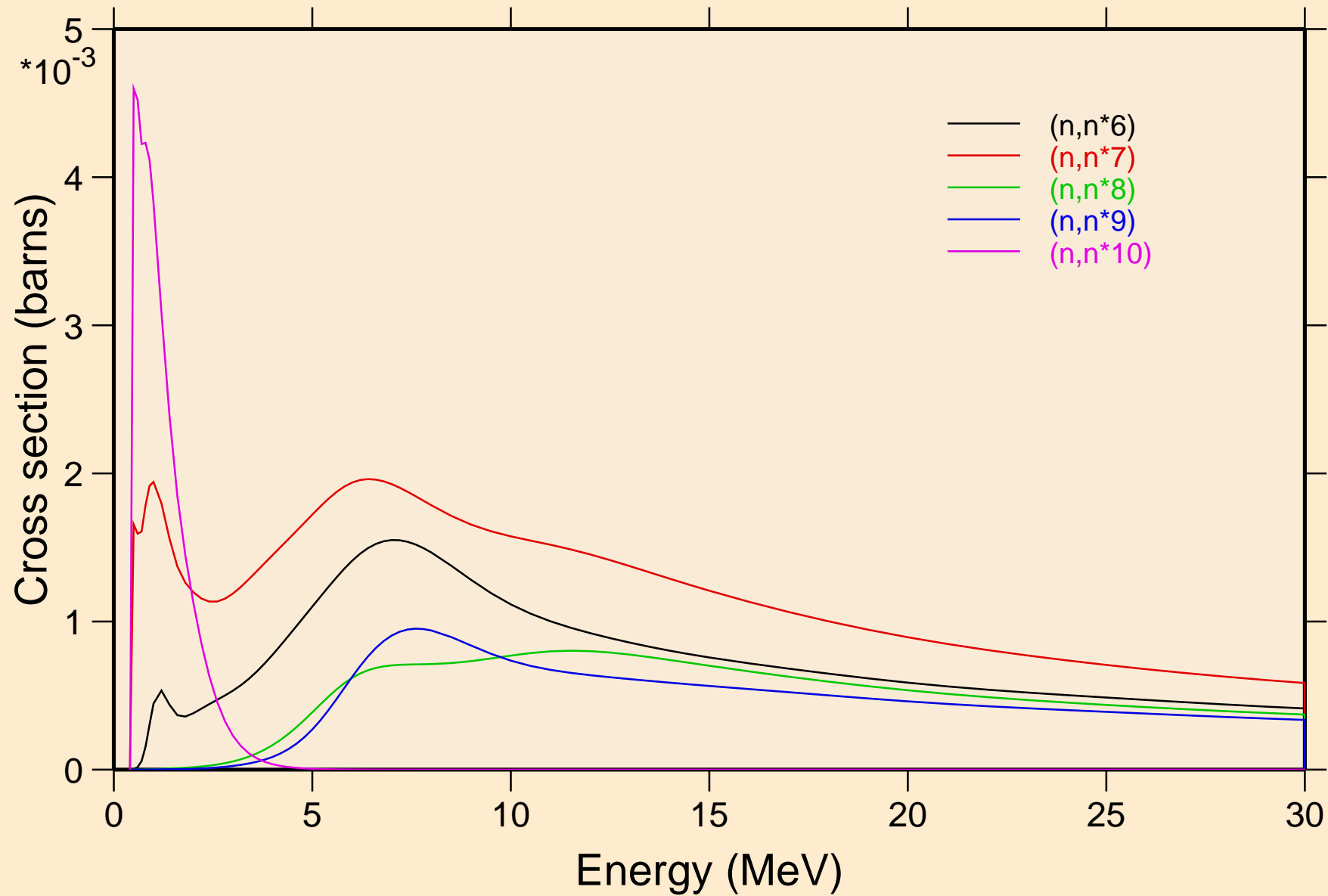

LR254 NRG TENDL-2015, AKONING

Inelastic levels

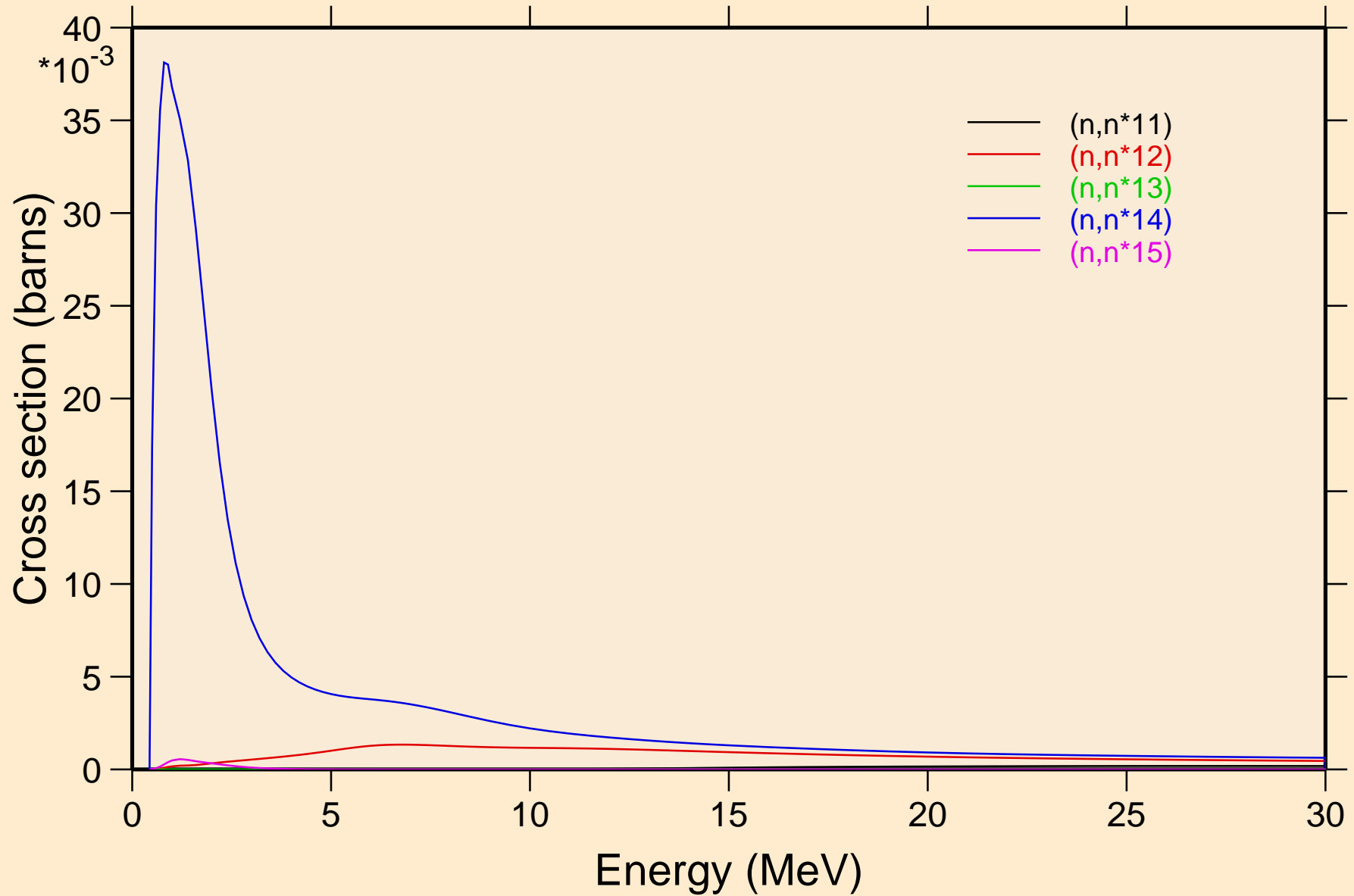

LR254 NRG TENDL-2015, AKONING

Inelastic levels

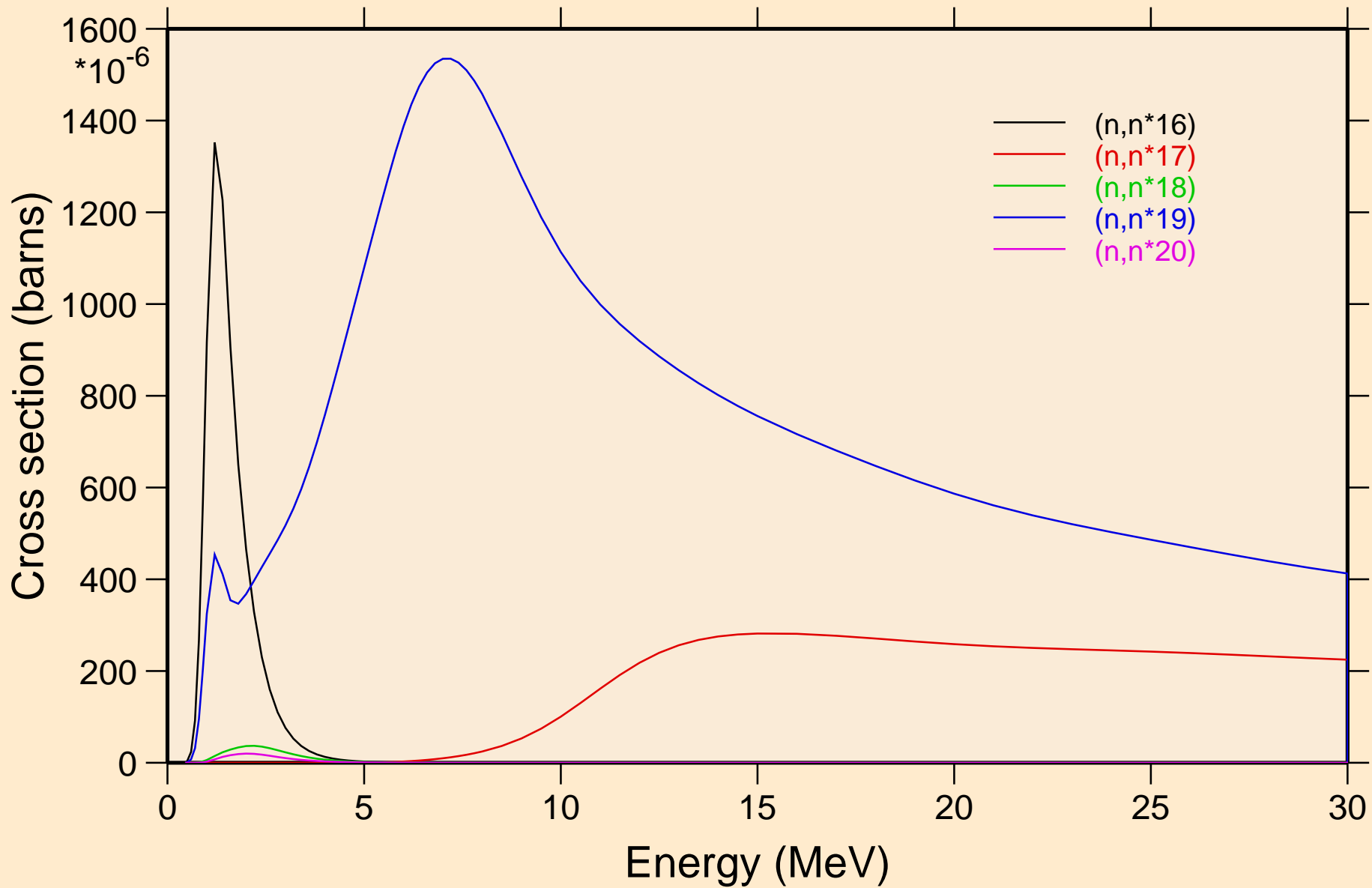

LR254 NRG TENDL-2015, AKONING

Inelastic levels

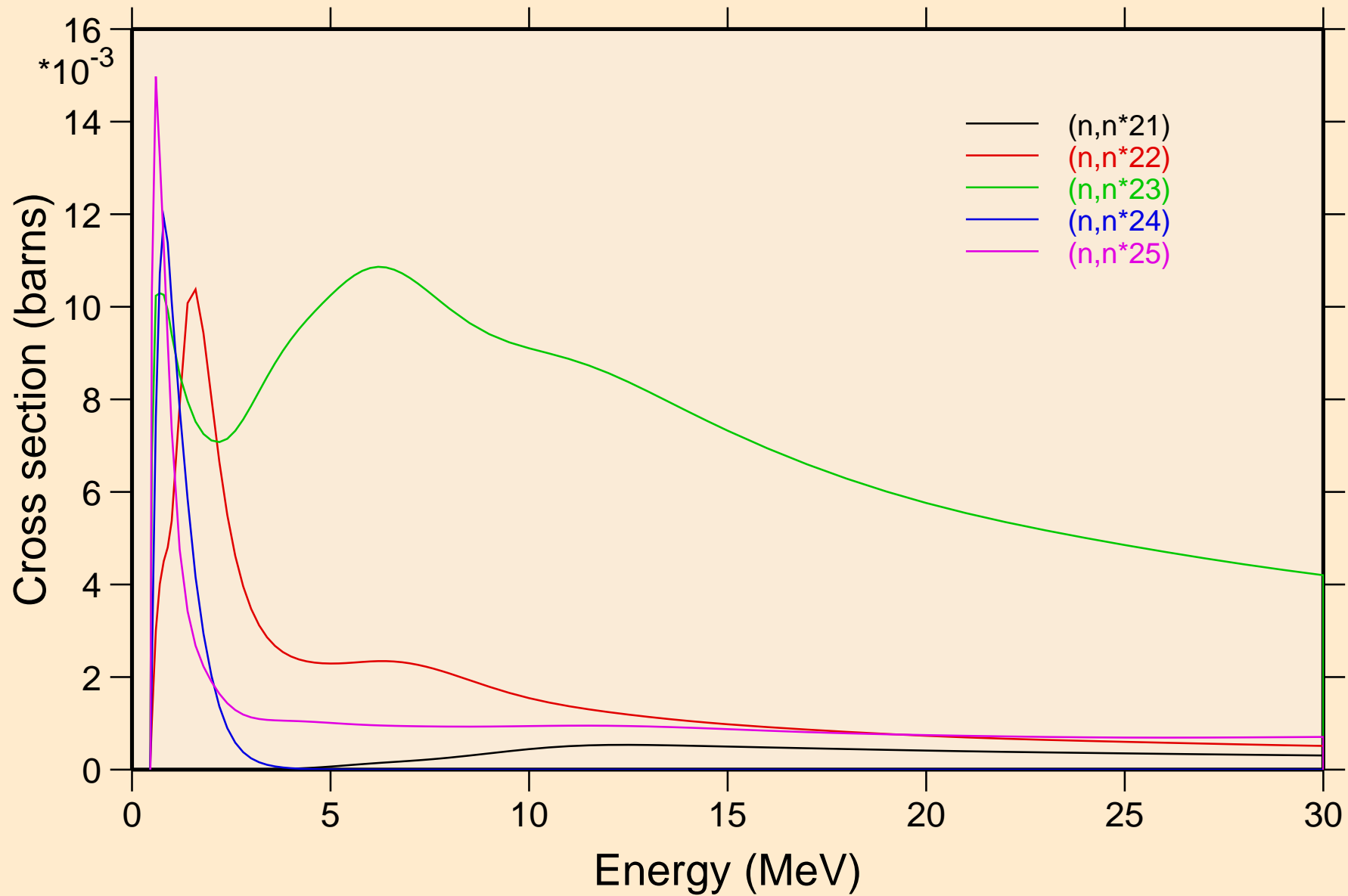

LR254 NRG TENDL-2015, AKONING

Threshold reactions

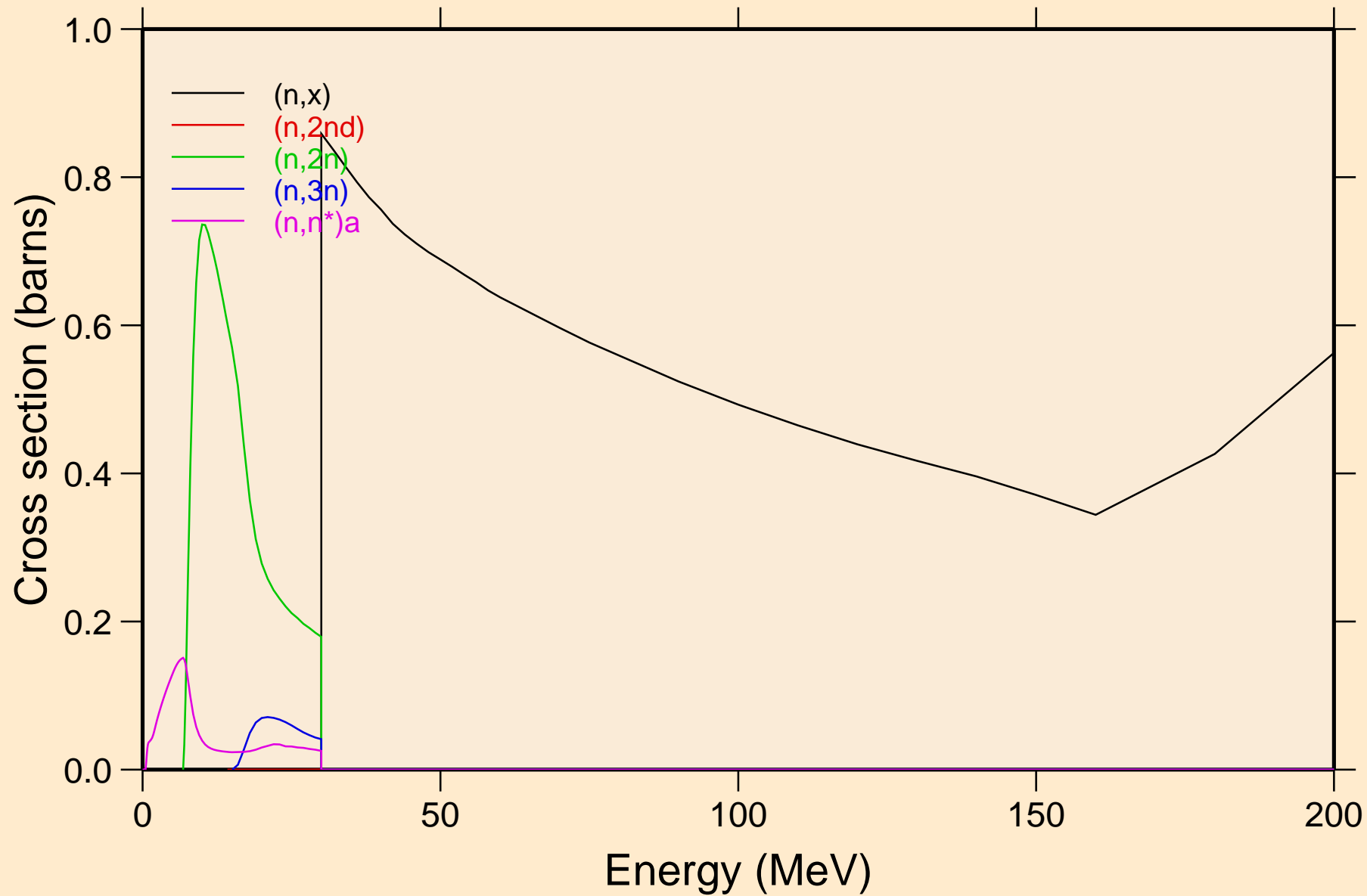

LR254 NRG TENDL-2015, AKONING

Threshold reactions

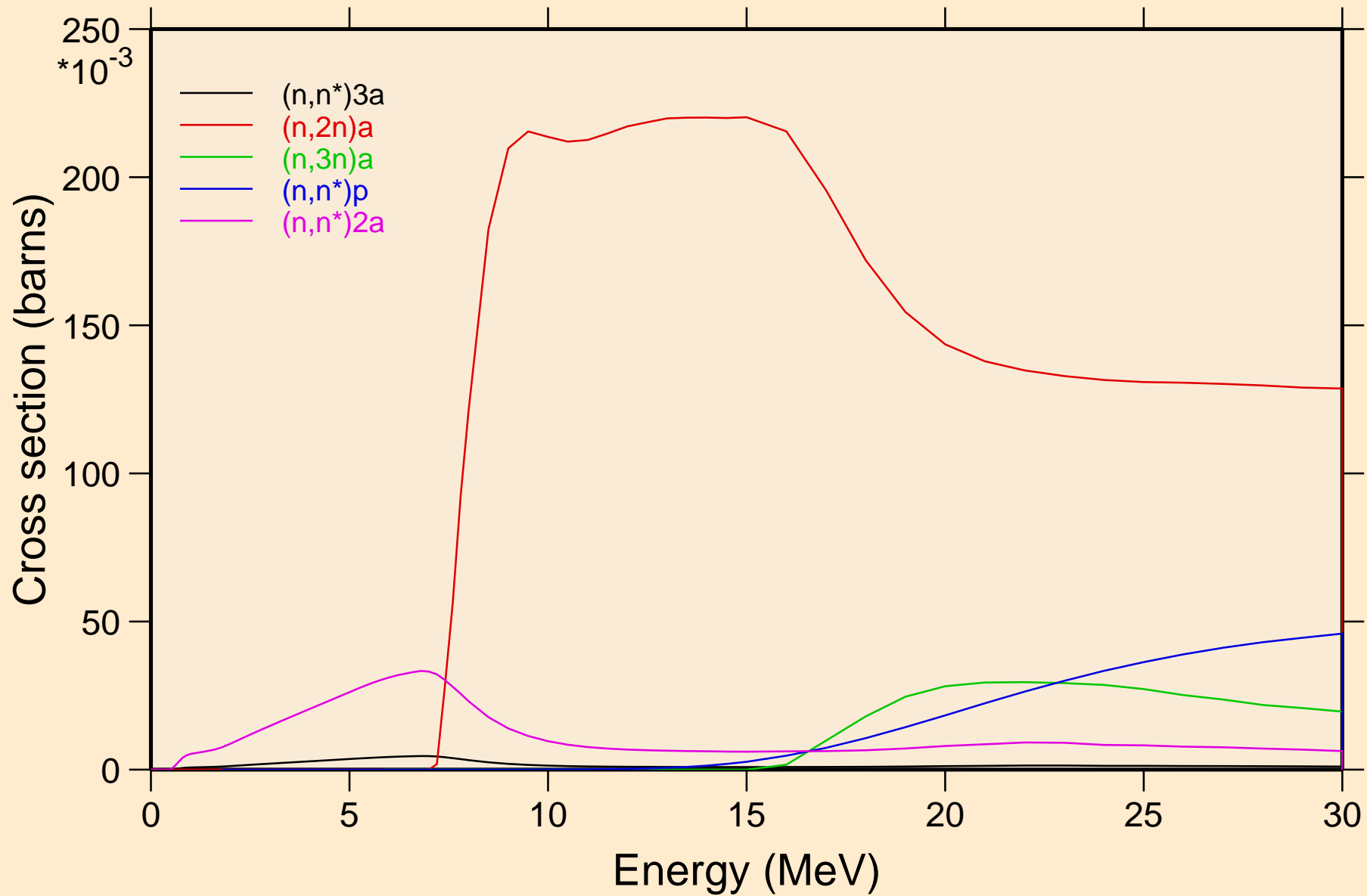

LR254 NRG TENDL-2015, AKONING

Threshold reactions

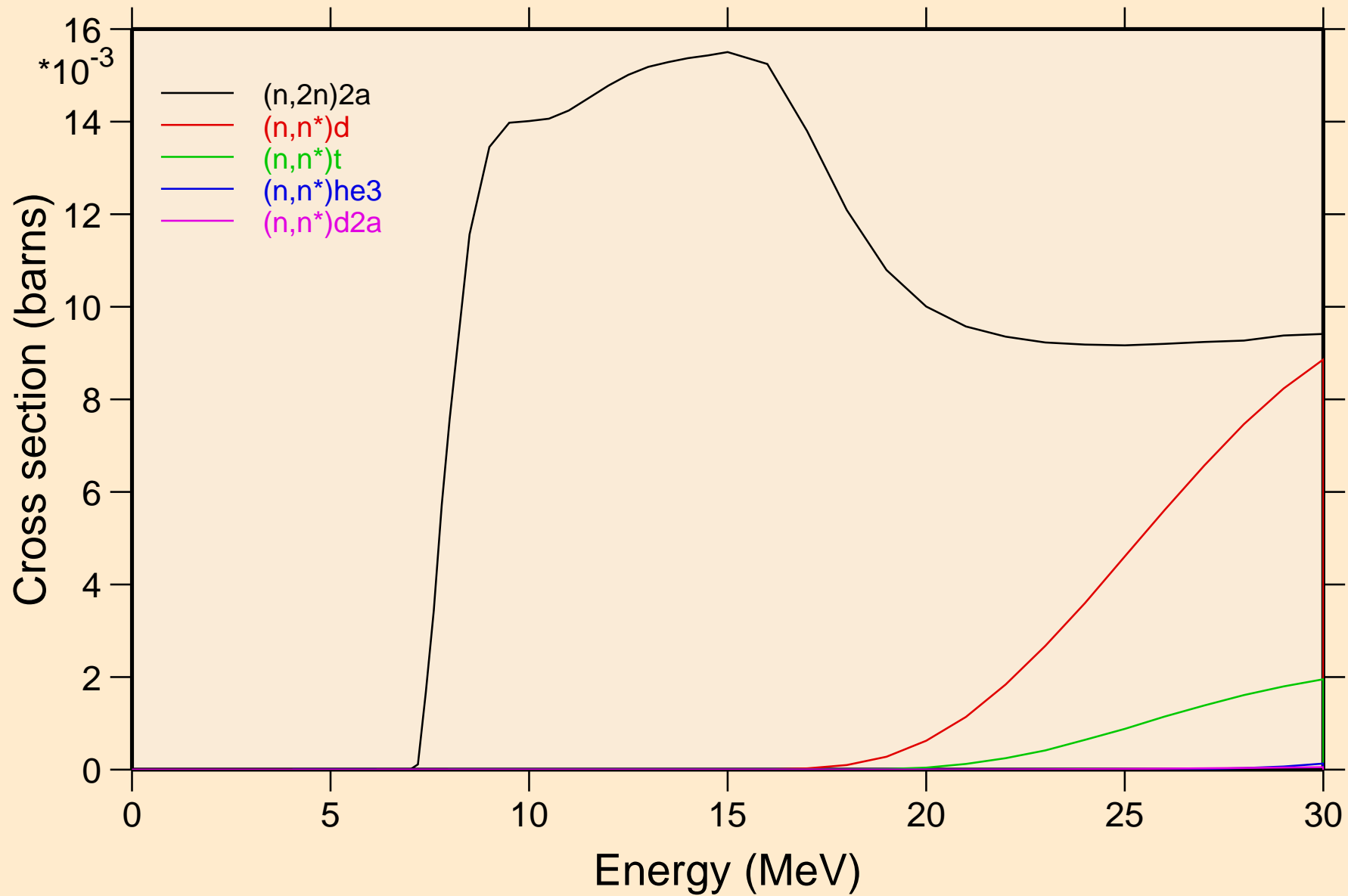

LR254 NRG TENDL-2015, AKONING

Threshold reactions

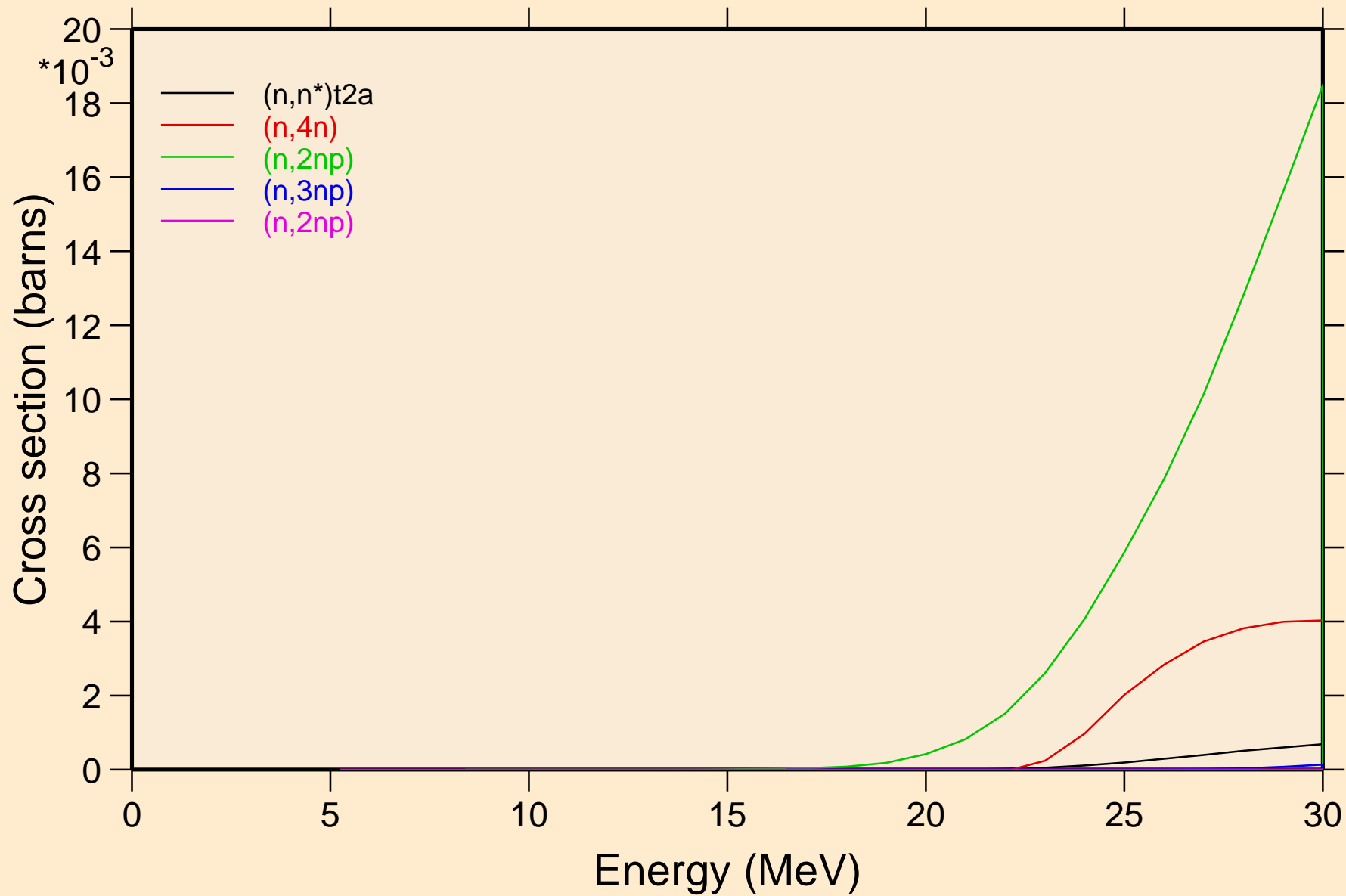

LR254 NRG TENDL-2015, AKONING

Threshold reactions

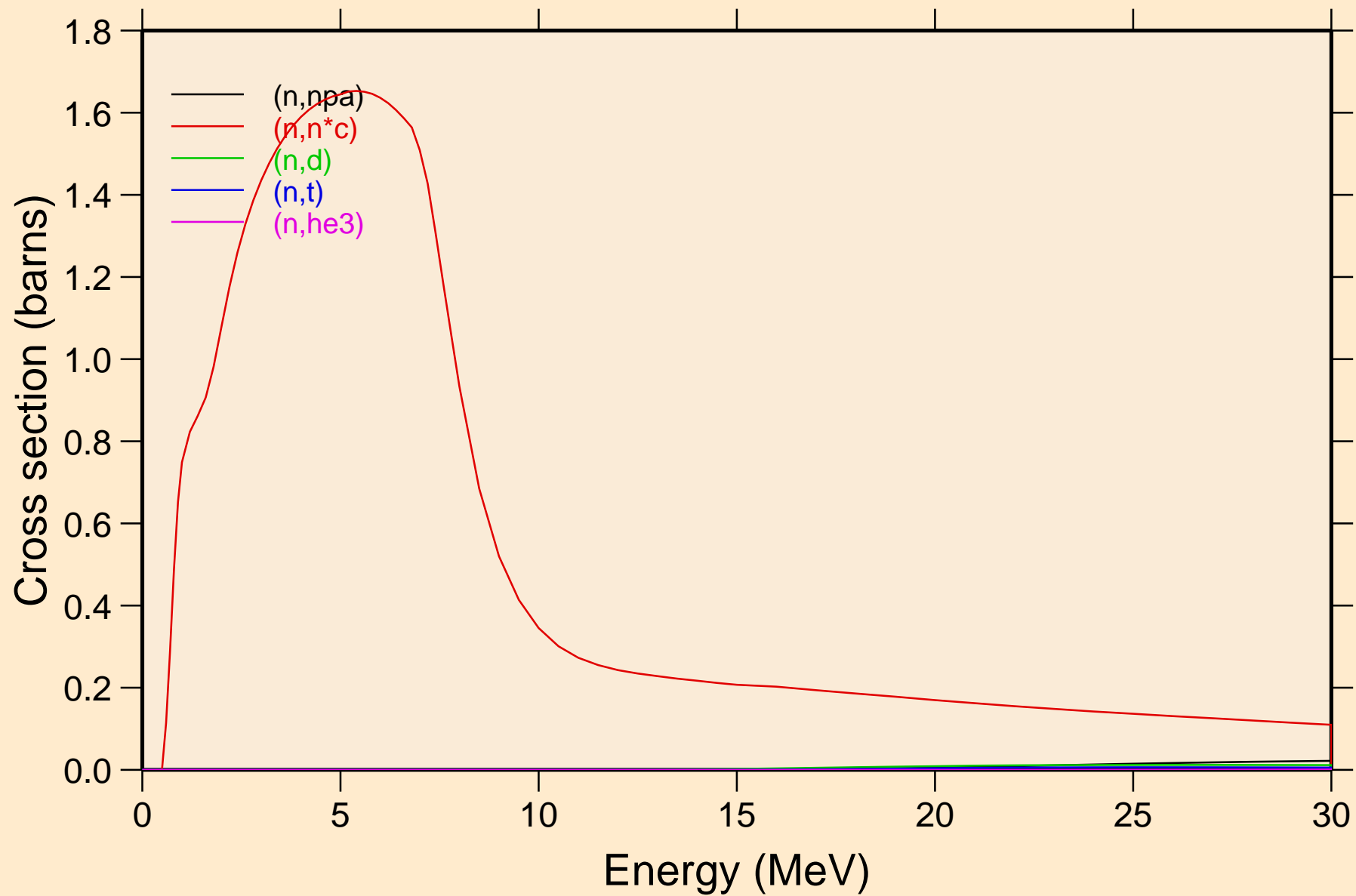

LR254 NRG TENDL-2015, AKONING

Threshold reactions

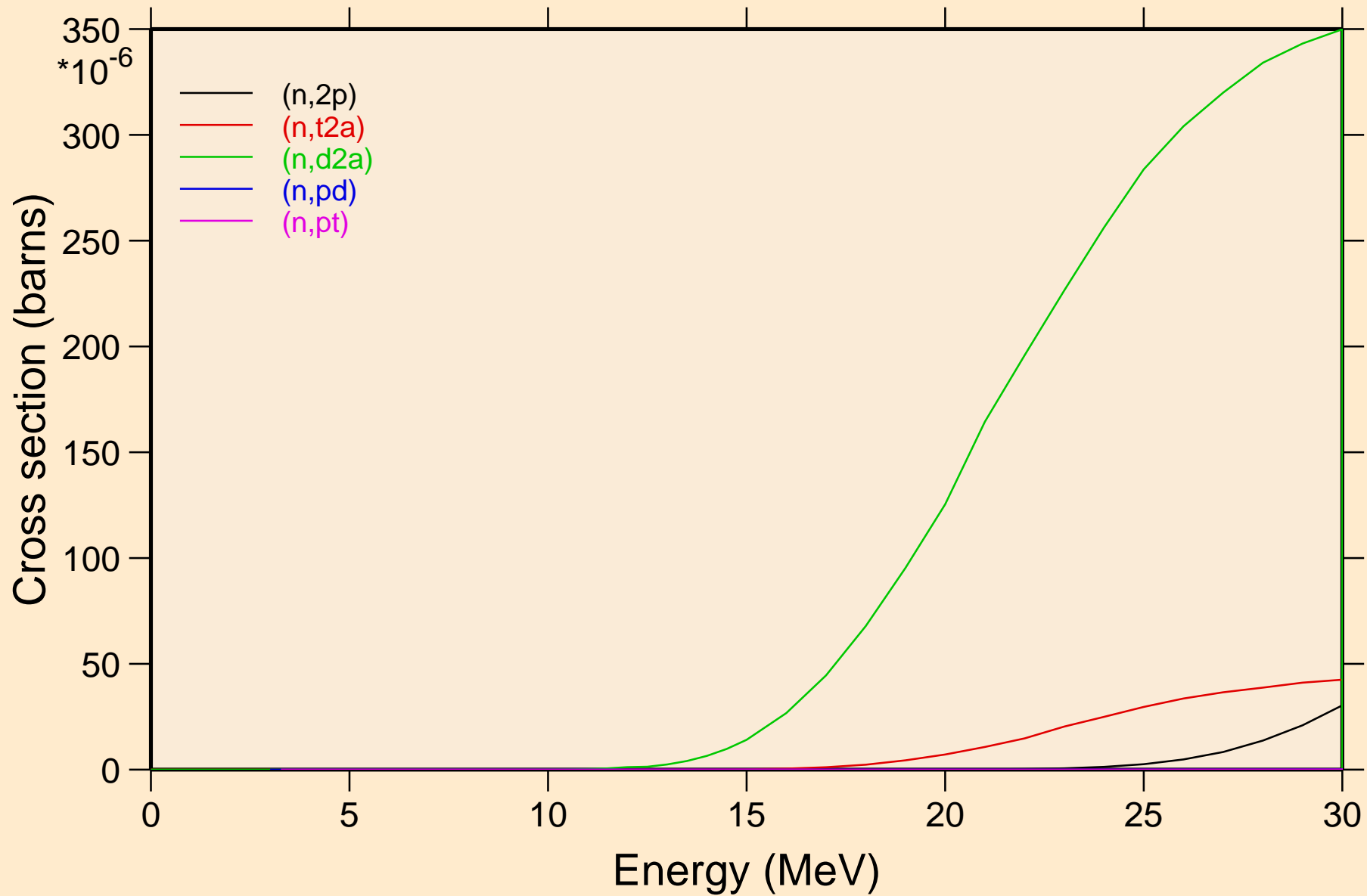

LR254 NRG TENDL-2015, AKONING
Threshold reactions

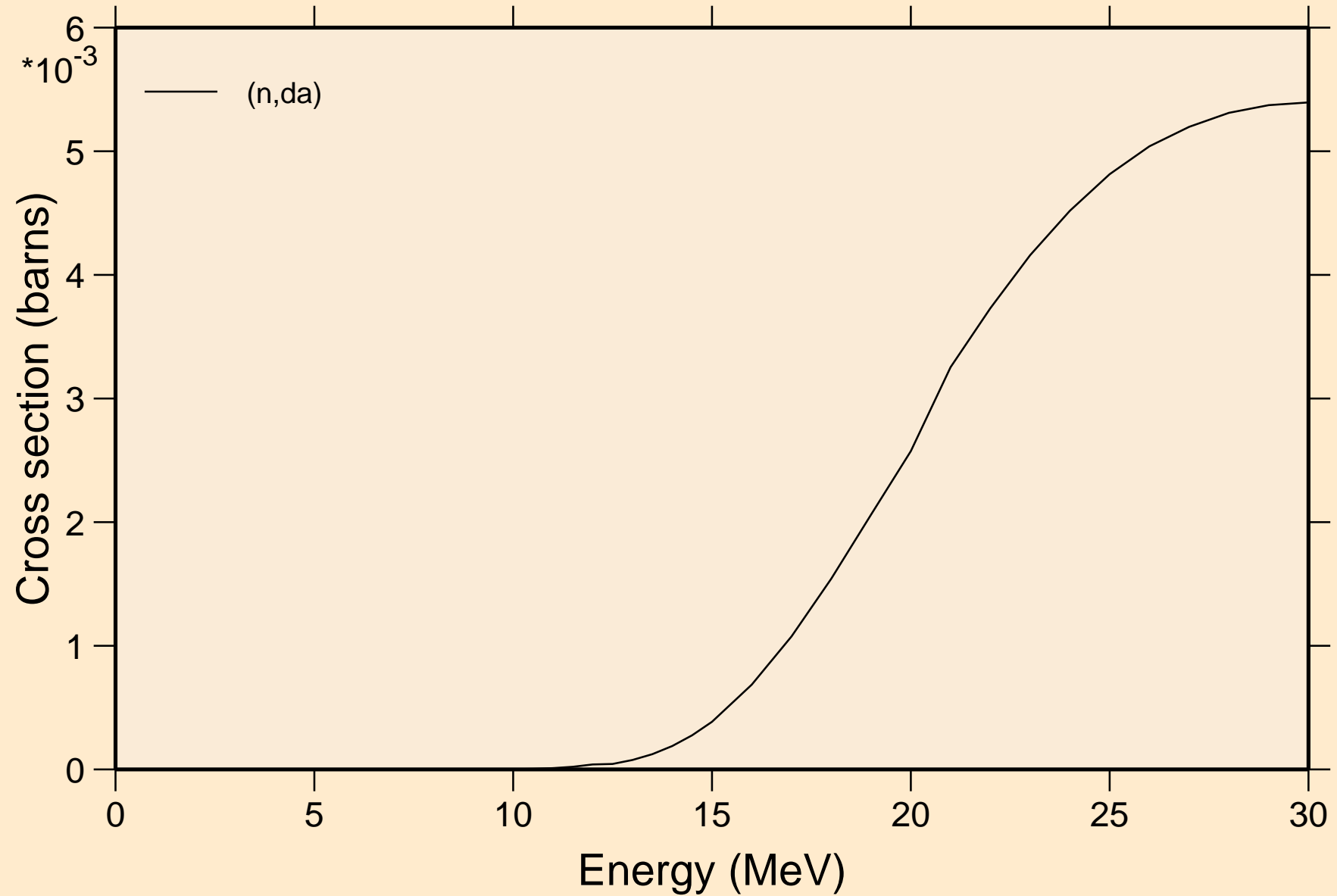

LR254 NRG TENDL-2015, AKONING
angular distribution for elastic

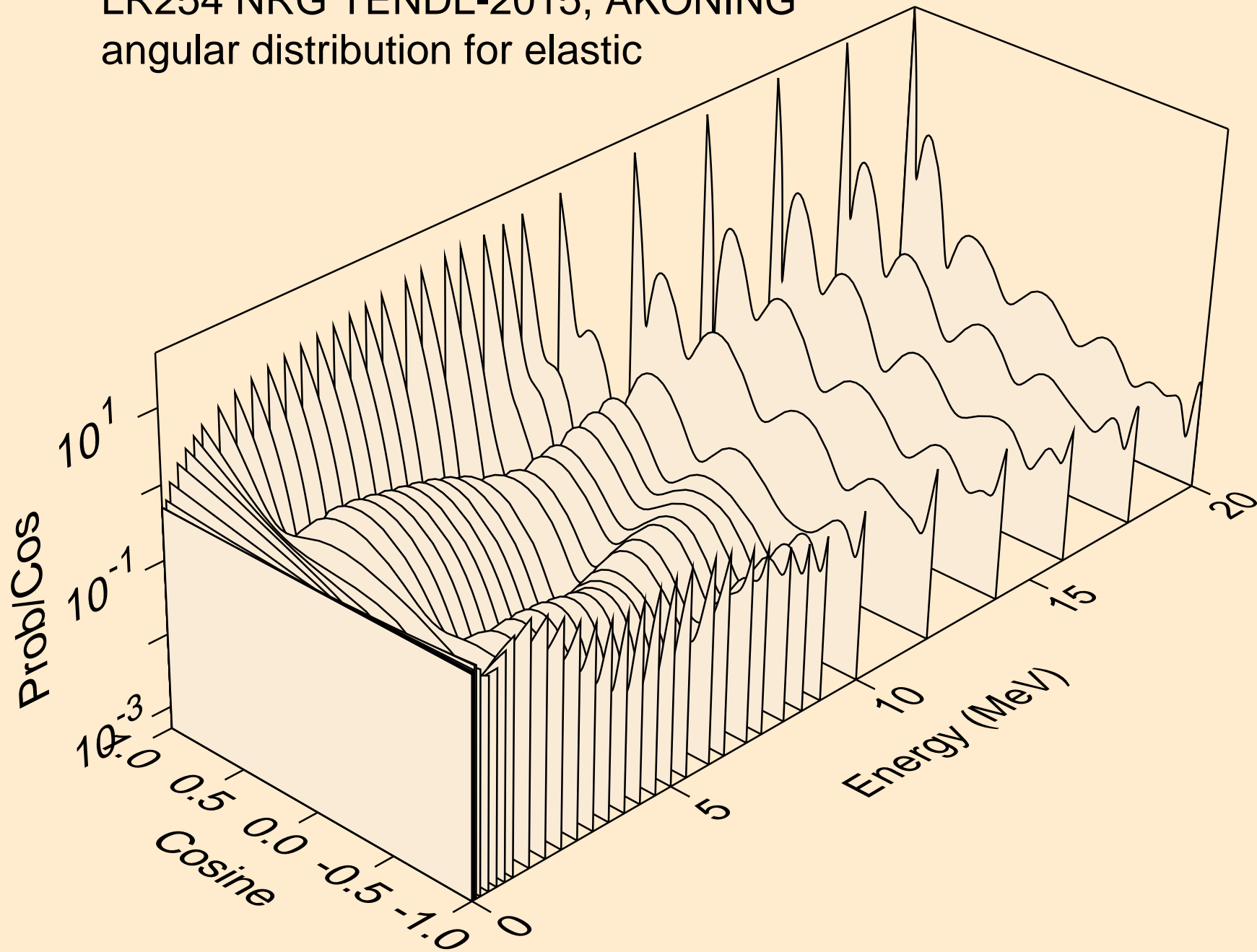

LR254 NRG TENDL-2015, AKONING
angular distribution for elastic

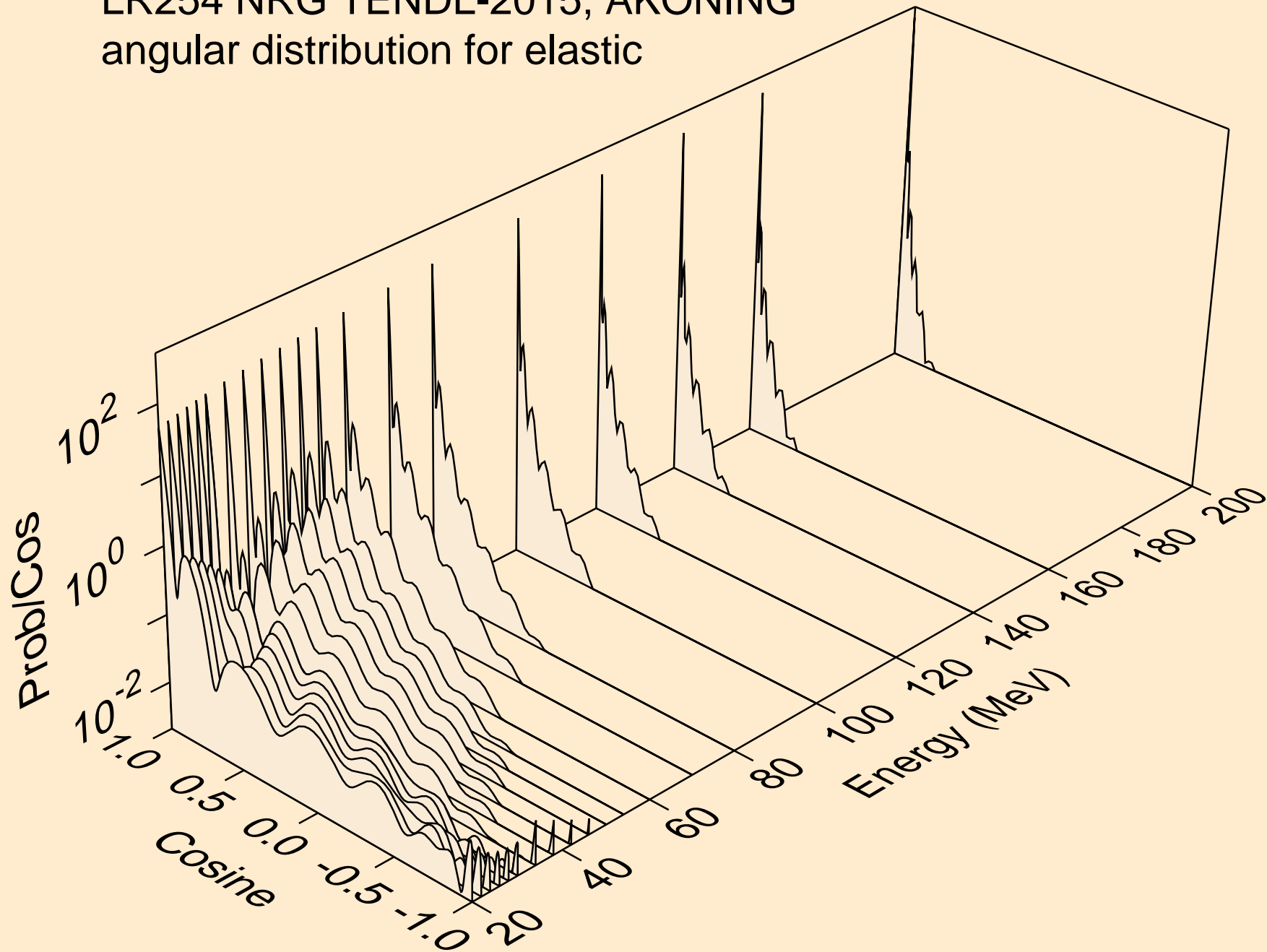

LR254 NRG TENDL-2015, AKONING
angular distribution for (n,n*1)

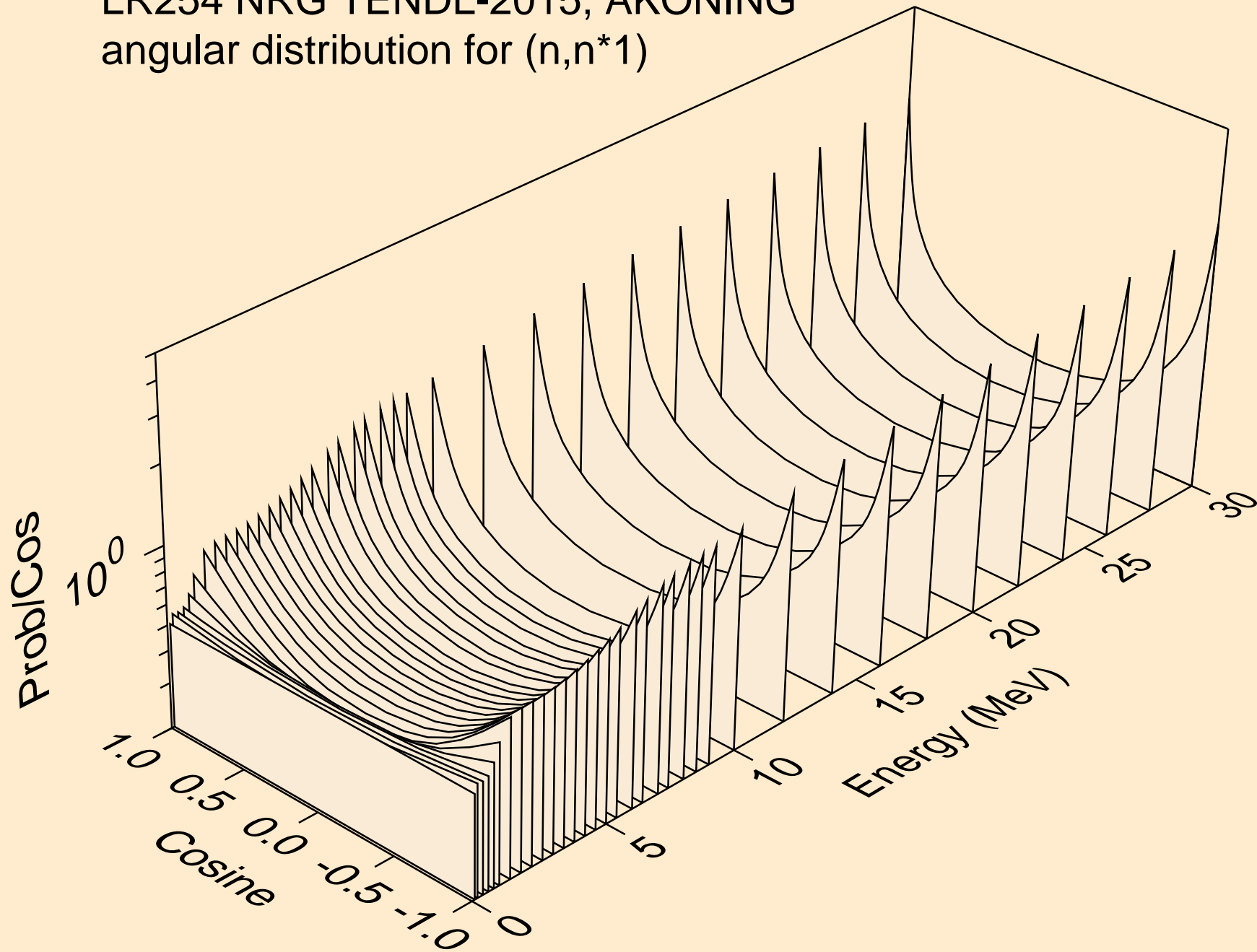

LR254 NRG TENDL-2015, AKONING
angular distribution for (n,n*2)

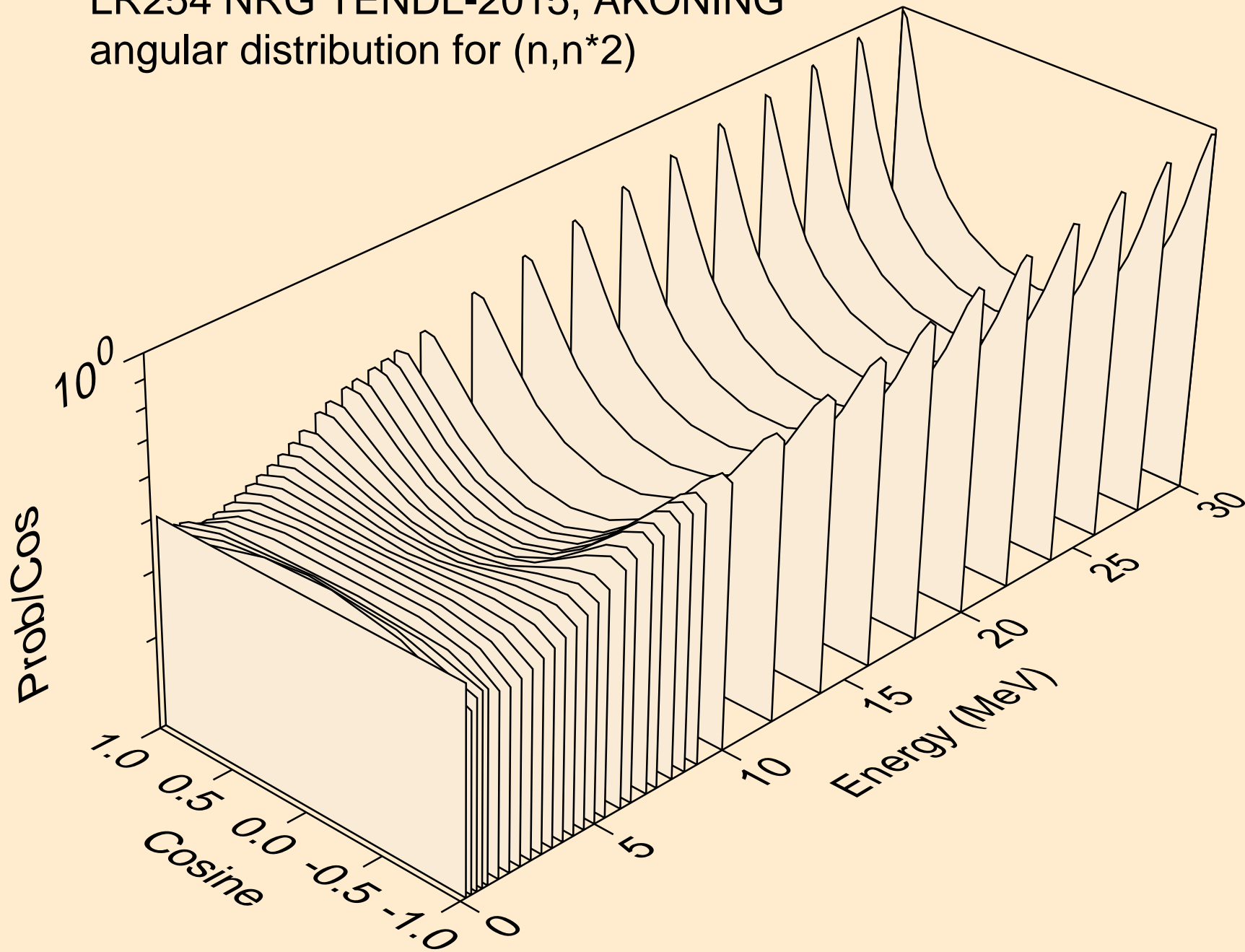

LR254 NRG TENDL-2015, AKONING
angular distribution for (n,n*3)

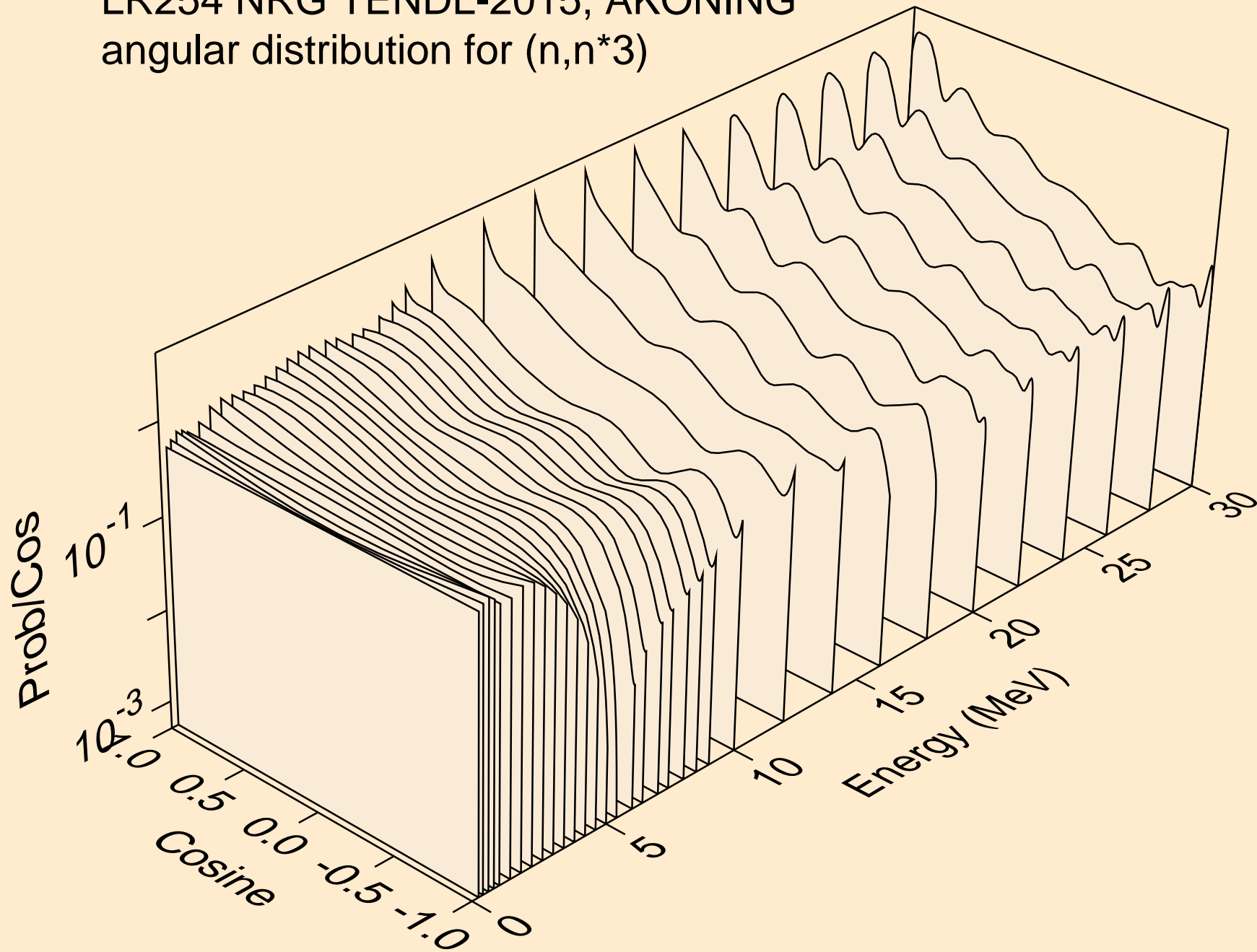

LR254 NRG TENDL-2015, AKONING
angular distribution for (n,n*4)

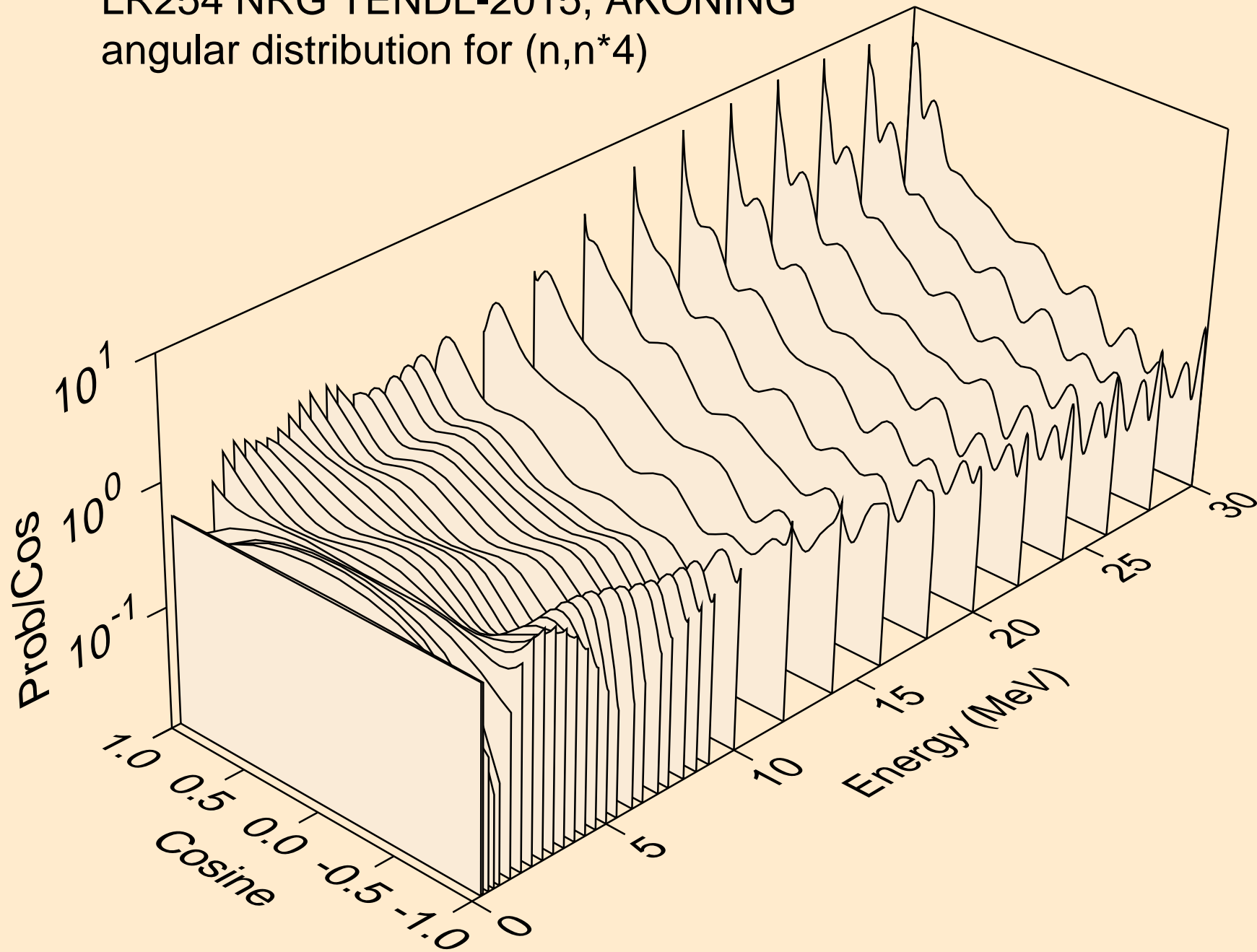

LR254 NRG TENDL-2015, AKONING
angular distribution for (n,n*5)

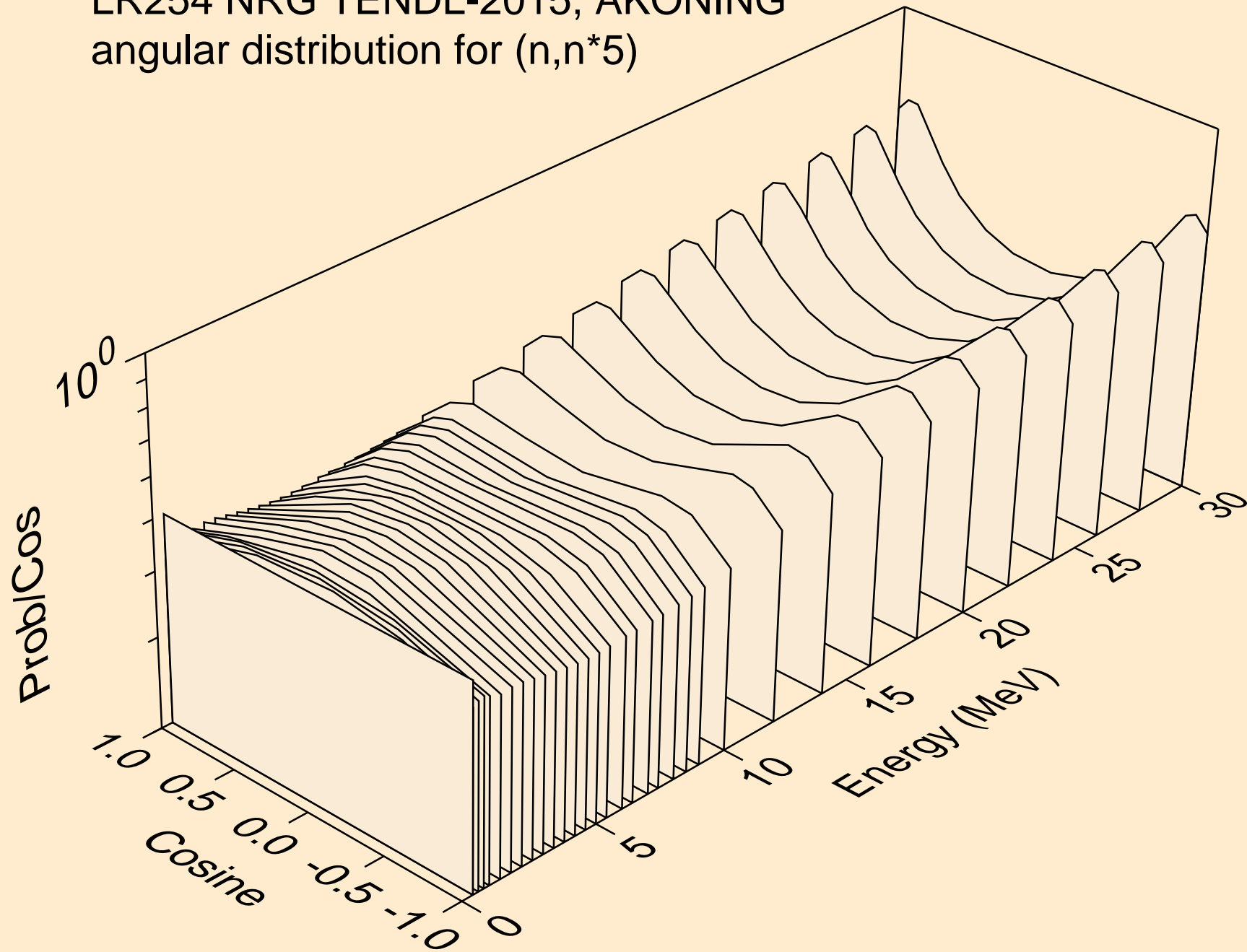

LR254 NRG TENDL-2015, AKONING
angular distribution for (n,n*6)

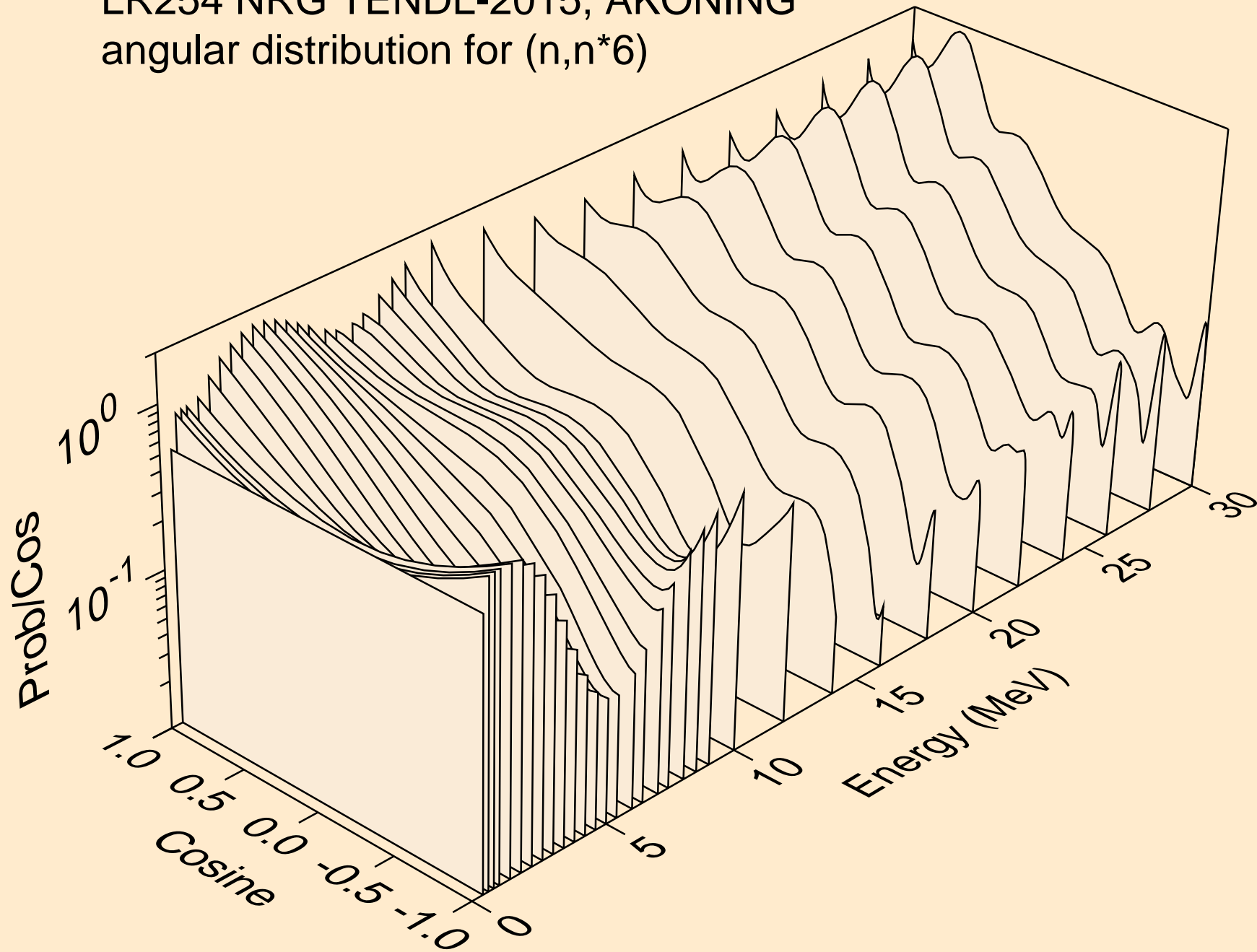

LR254 NRG TENDL-2015, AKONING
angular distribution for (n,n*7)

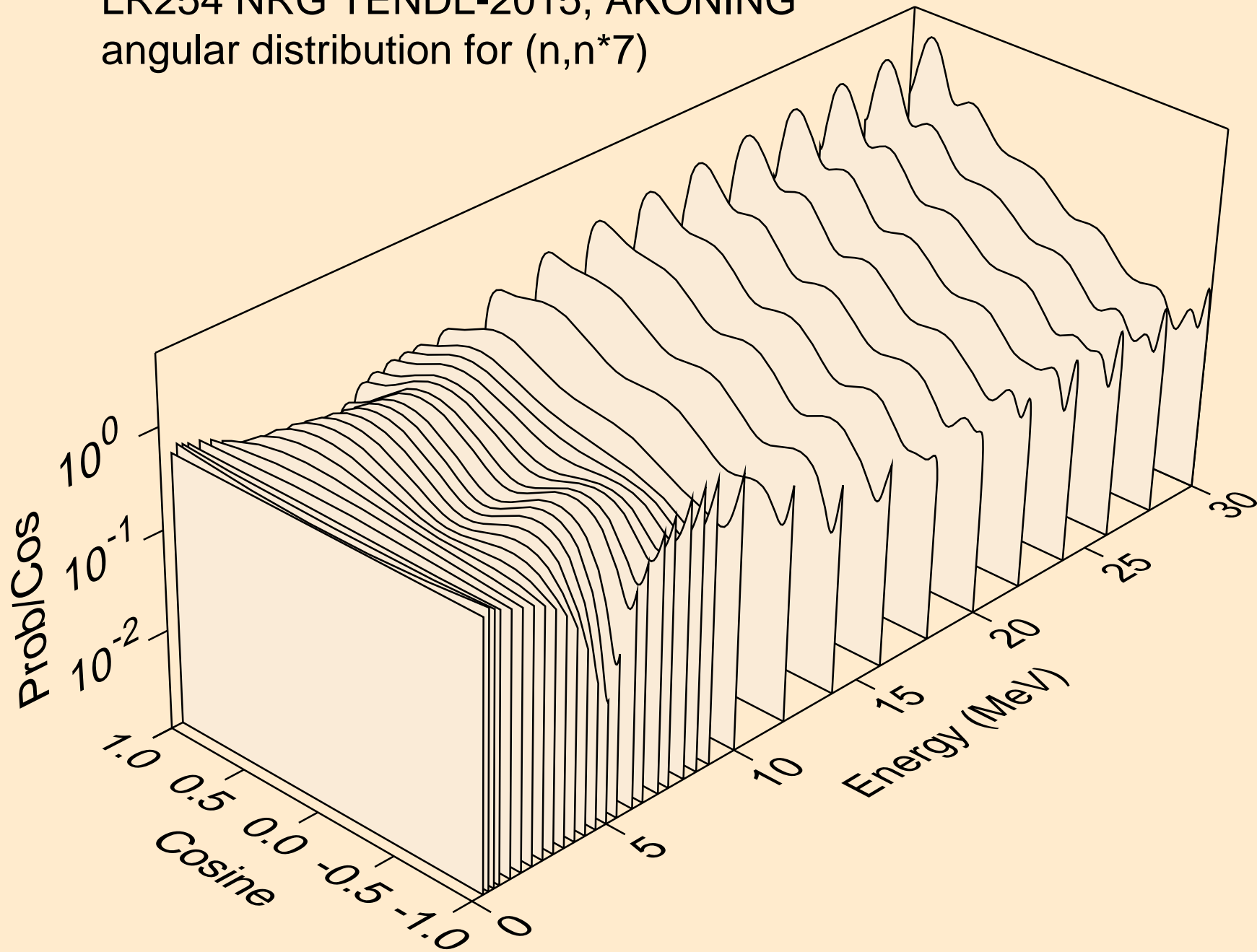

LR254 NRG TENDL-2015, AKONING
angular distribution for (n,n*8)

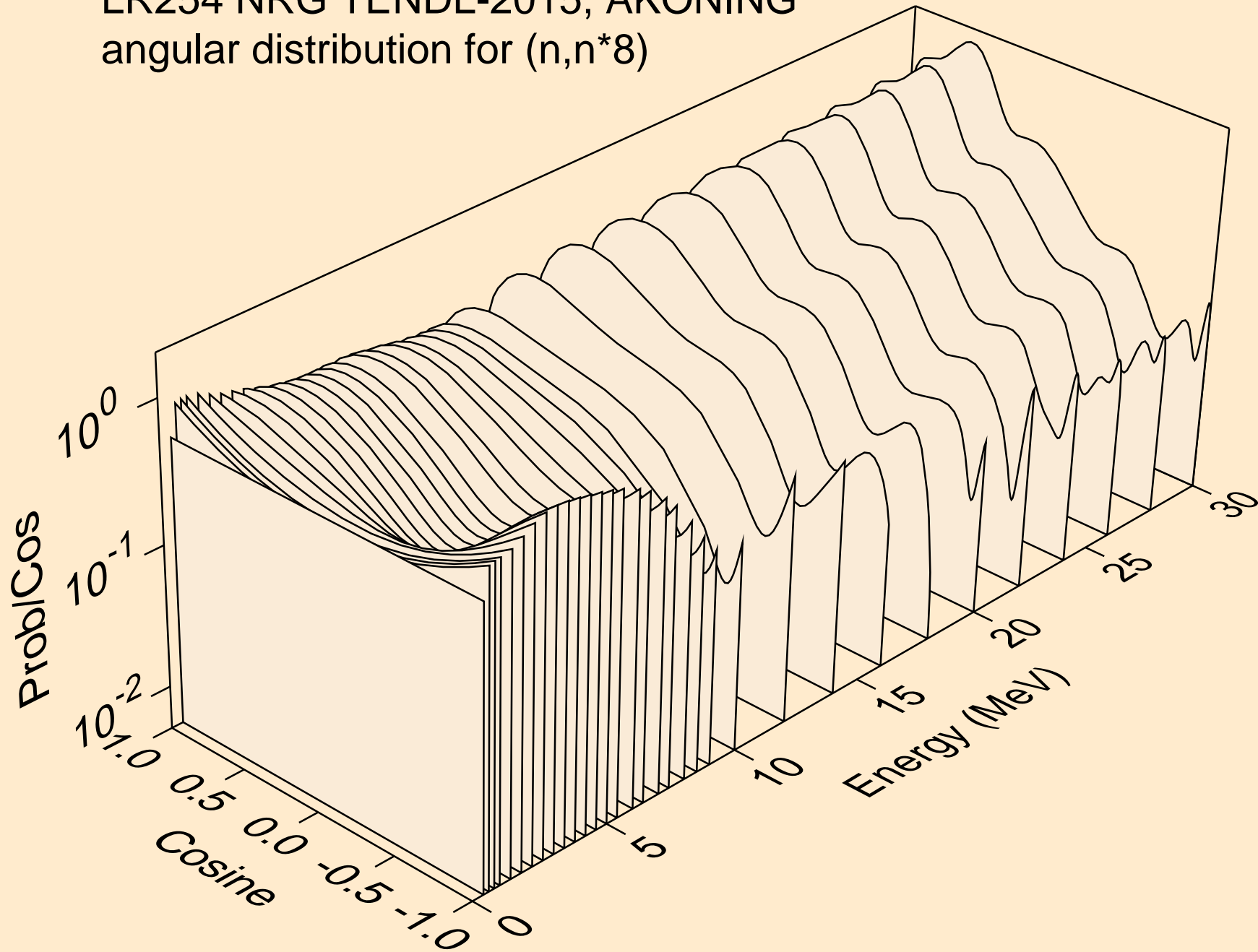

LR254 NRG TENDL-2015, AKONING
angular distribution for (n,n*9)

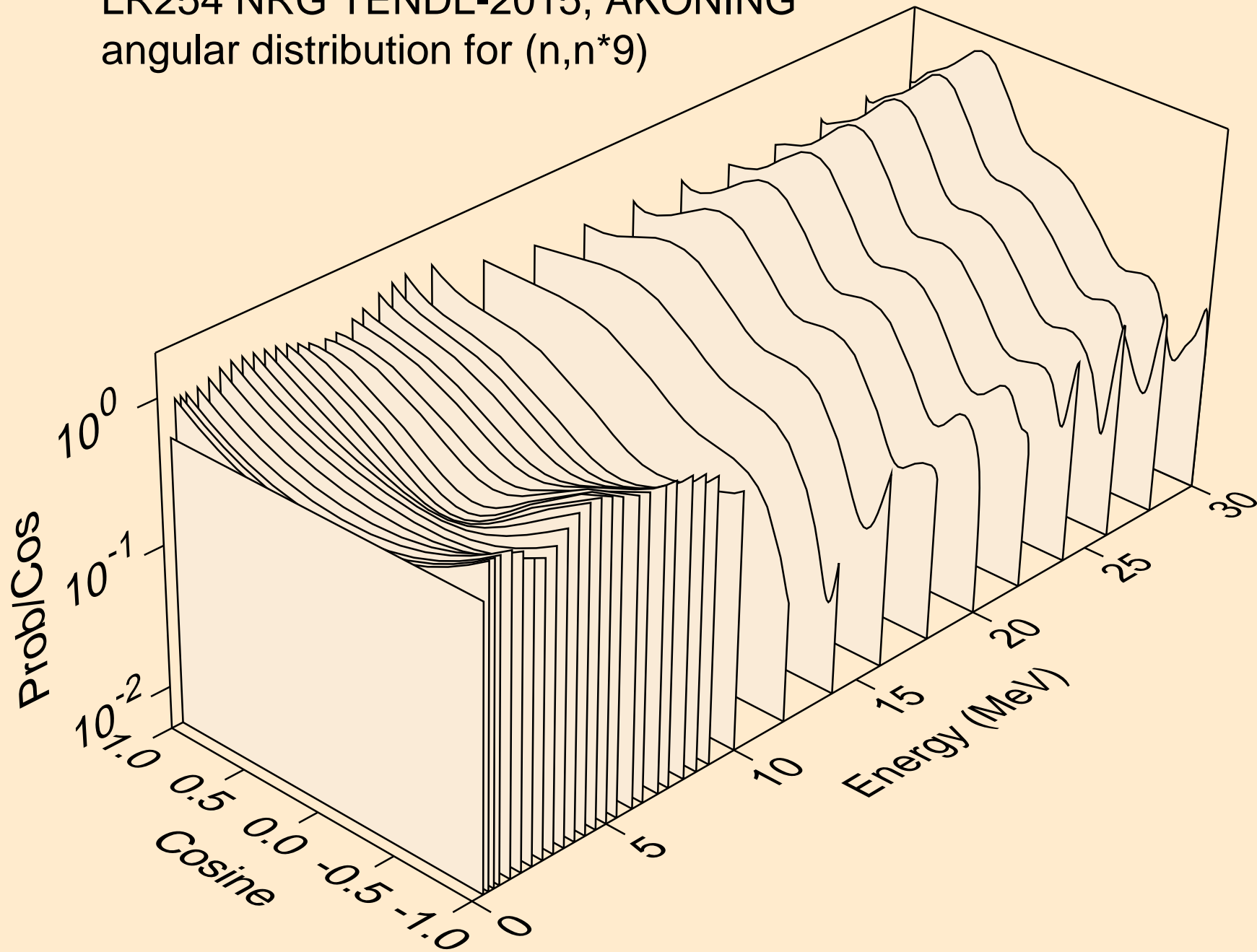

LR254 NRG TENDL-2015, AKONING
angular distribution for (n,n*10)

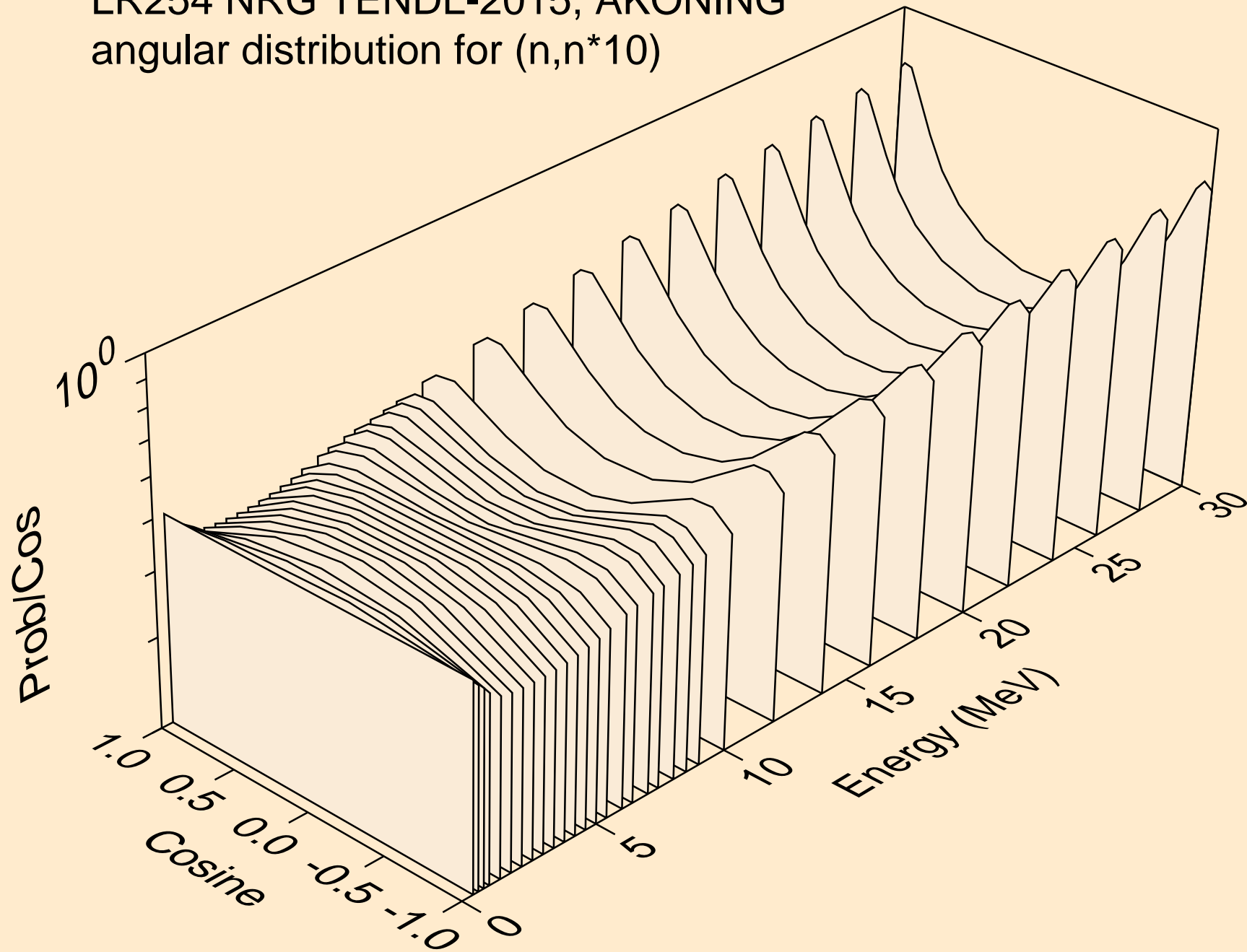

LR254 NRG TENDL-2015, AKONING
angular distribution for (n,n*11)

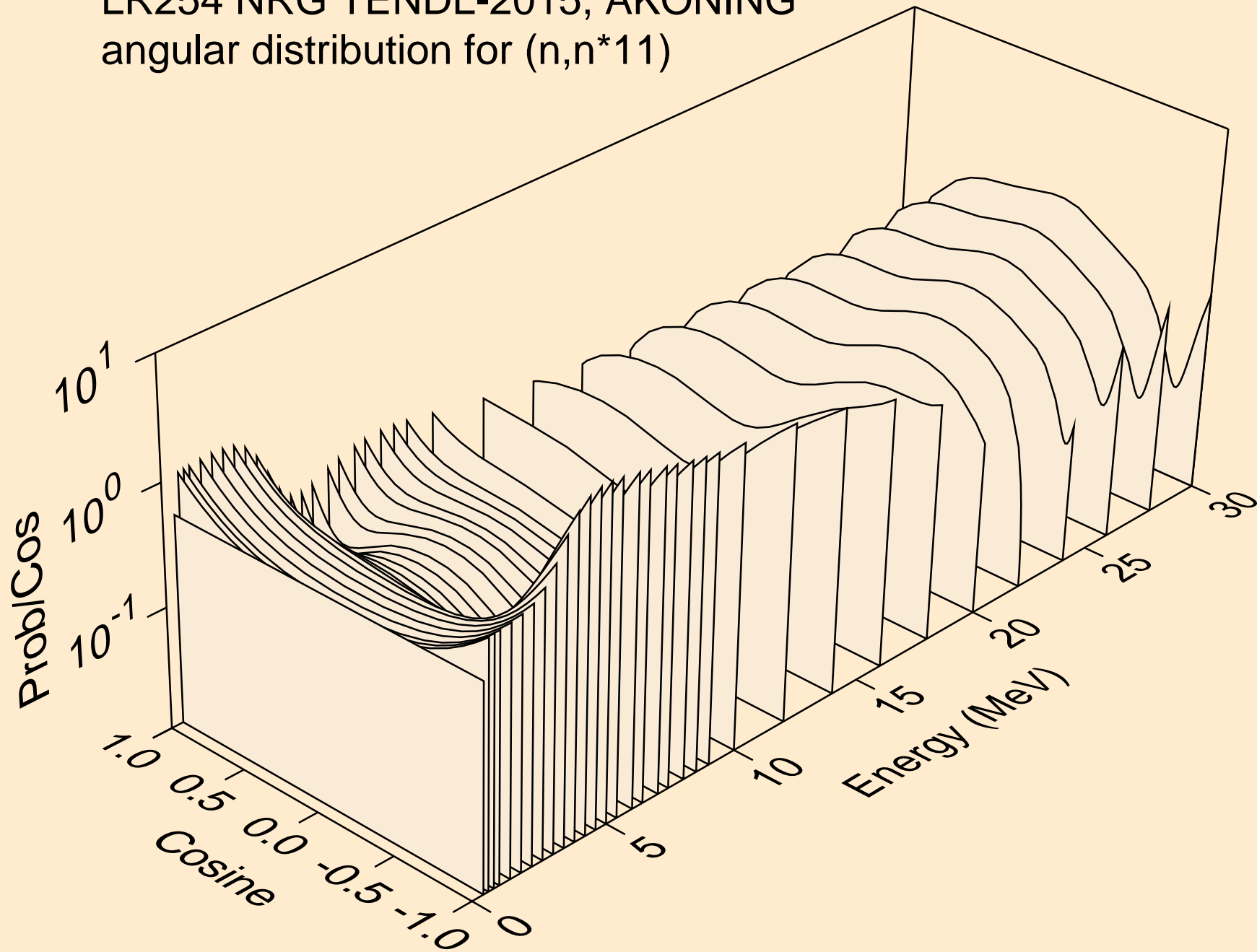

LR254 NRG TENDL-2015, AKONING
angular distribution for (n,n*12)

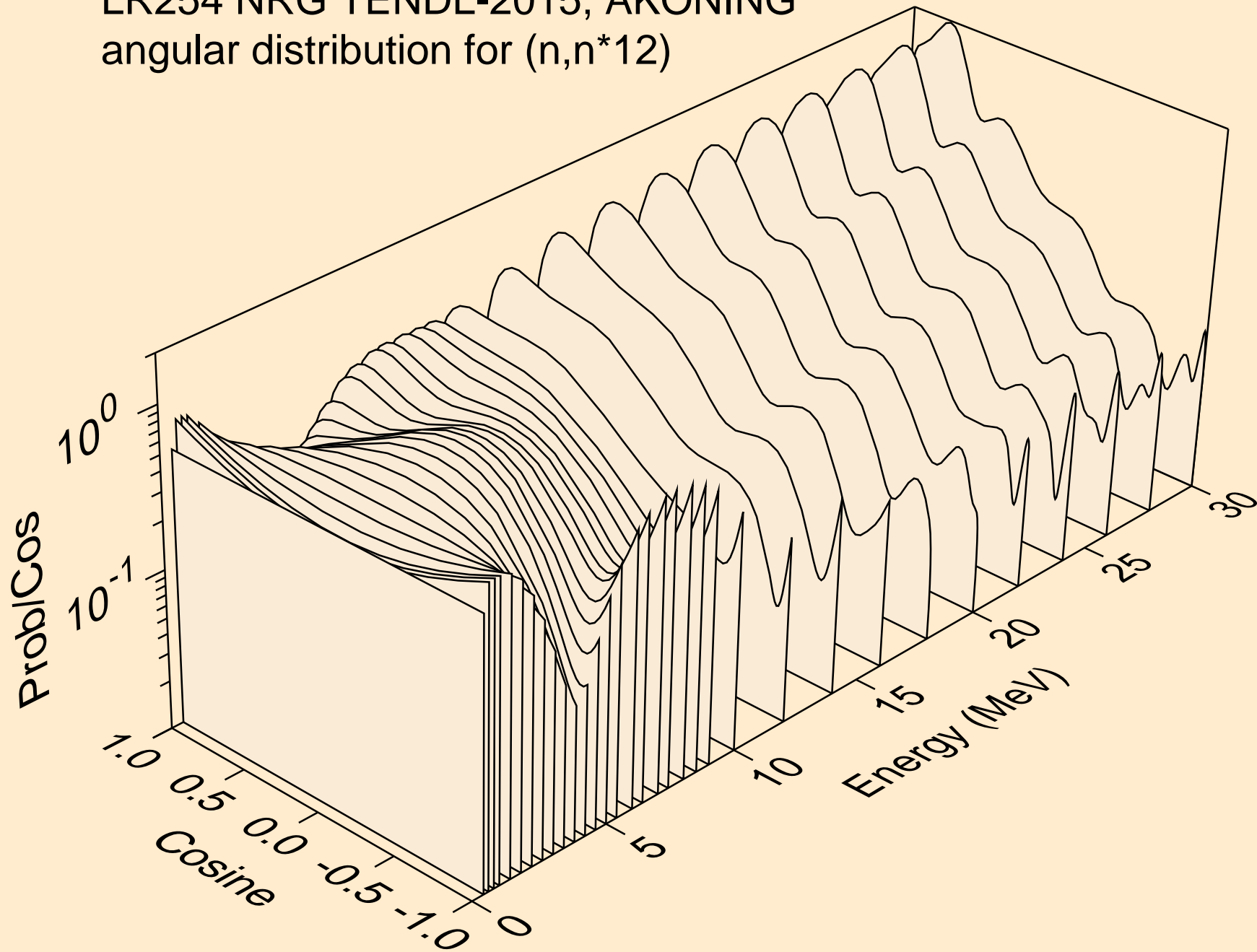

LR254 NRG TENDL-2015, AKONING
angular distribution for (n,n*13)

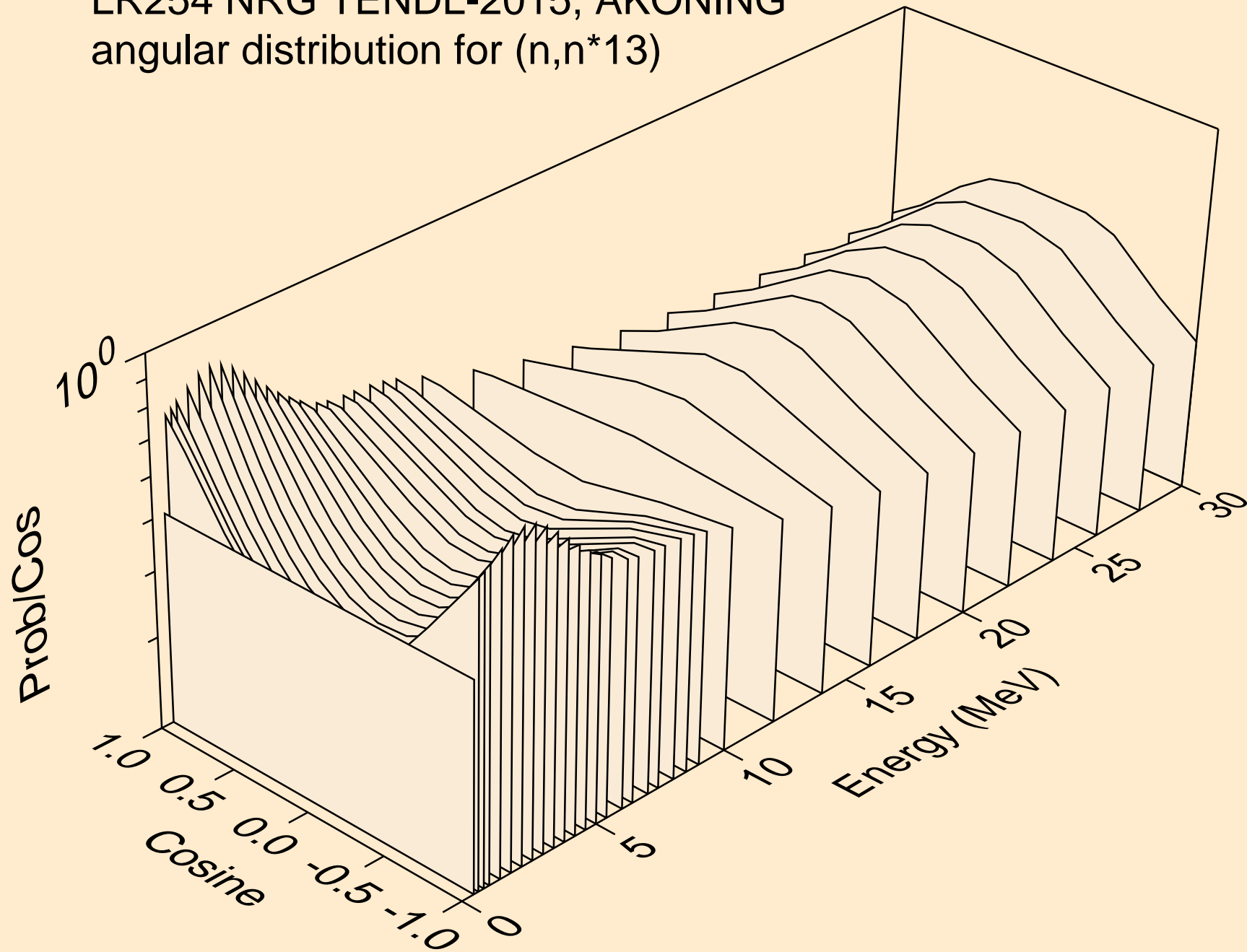

LR254 NRG TENDL-2015, AKONING
angular distribution for (n,n*14)

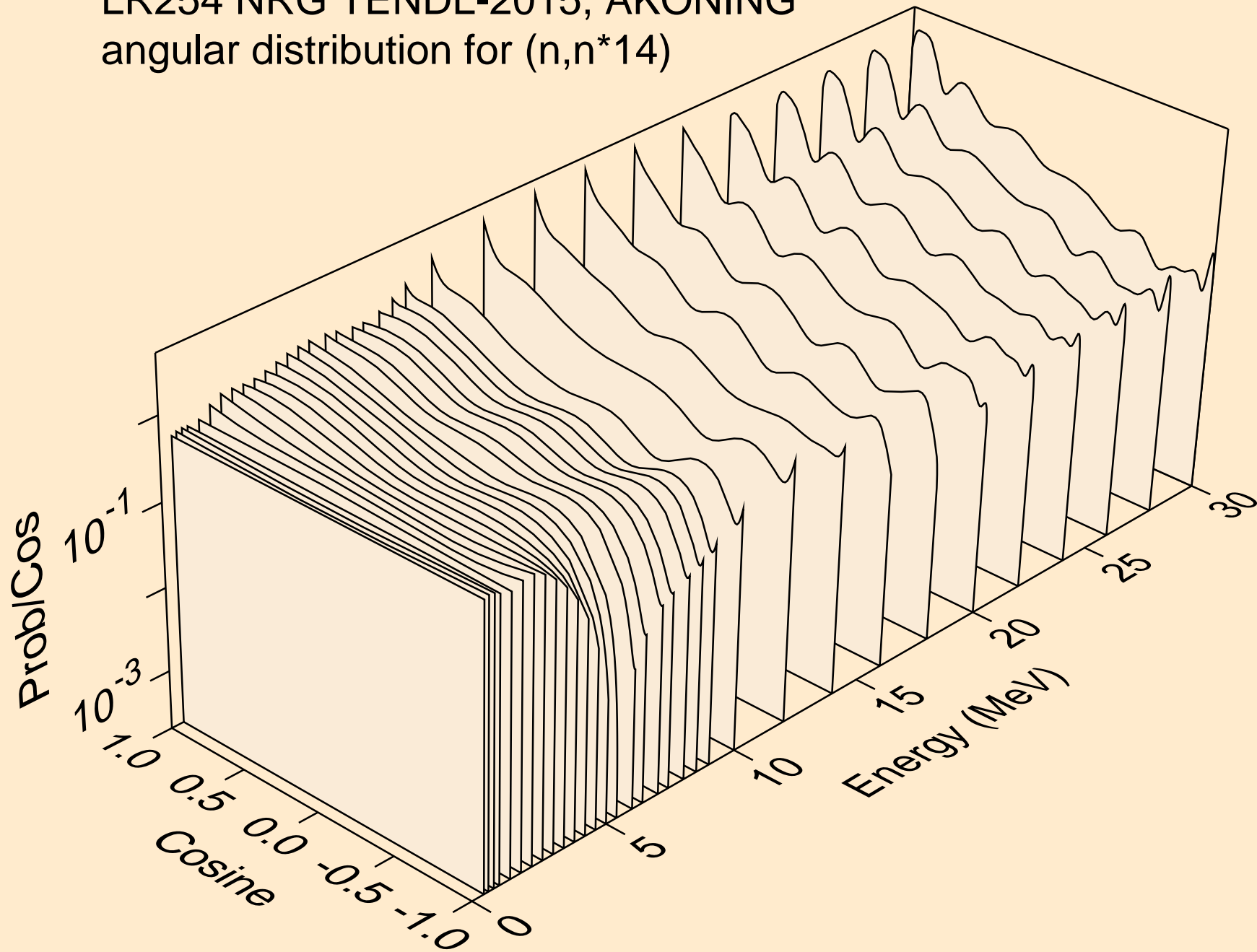

LR254 NRG TENDL-2015, AKONING
angular distribution for (n,n*15)

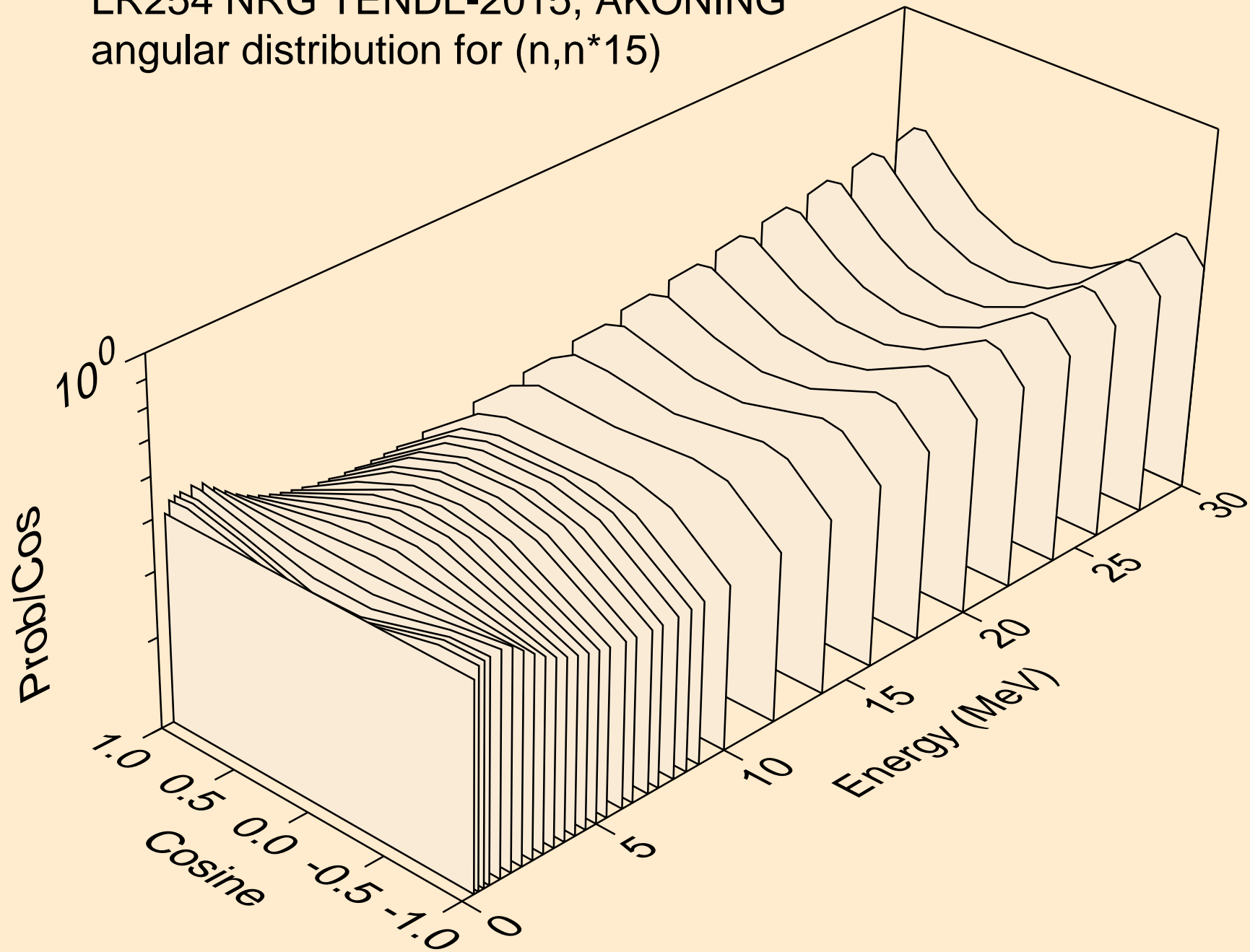

LR254 NRG TENDL-2015, AKONING
angular distribution for (n,n*16)

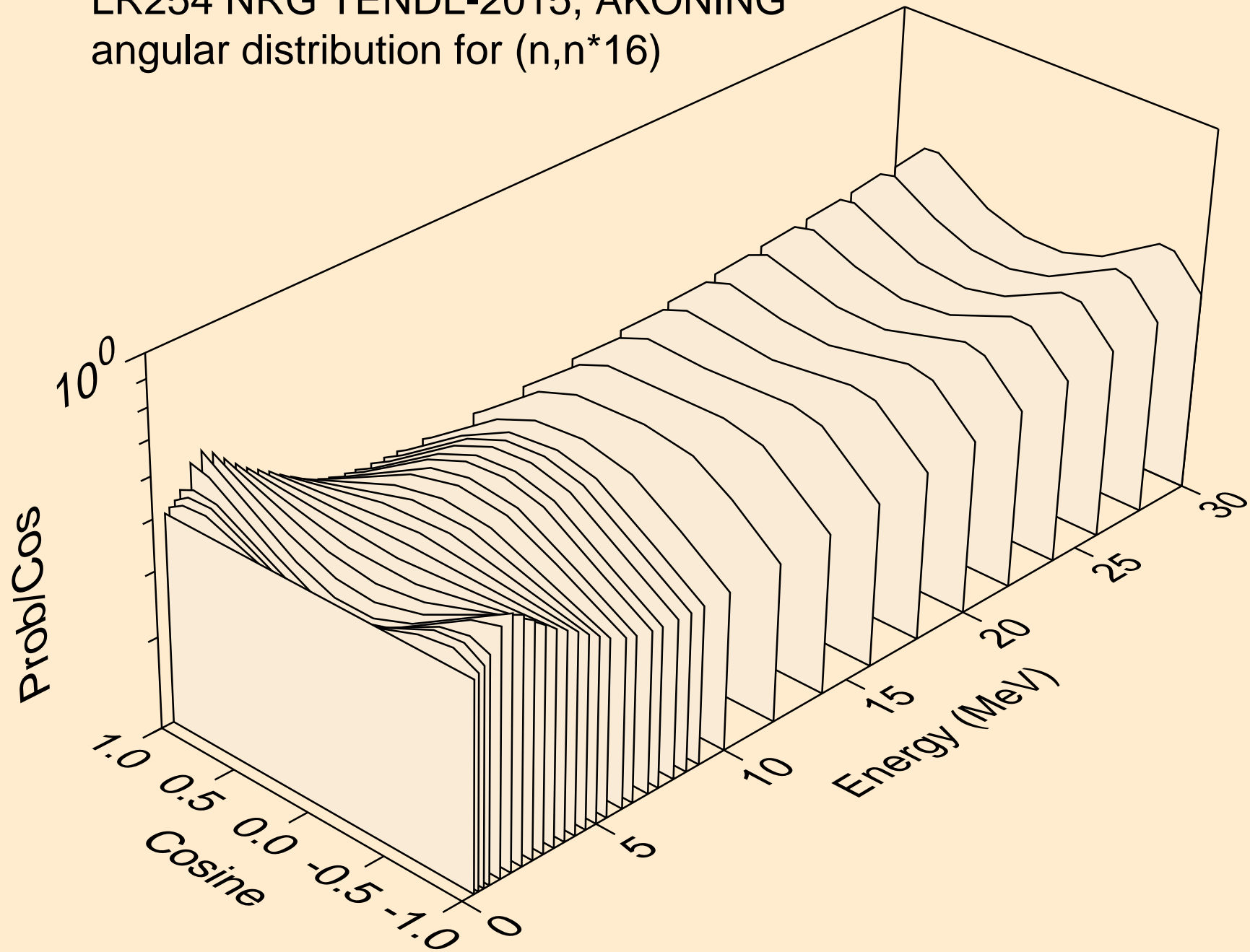

LR254 NRG TENDL-2015, AKONING
angular distribution for (n,n*17)

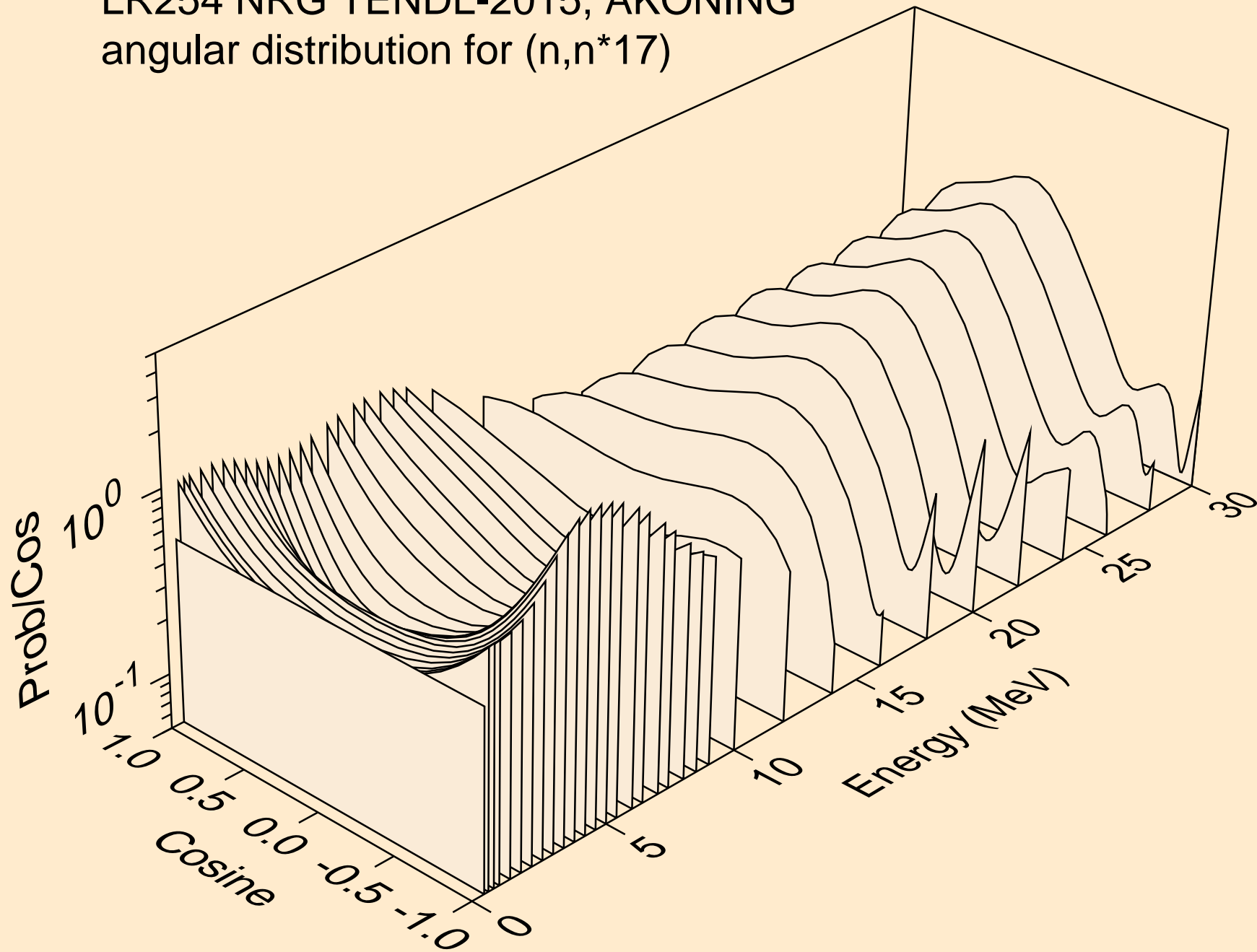

LR254 NRG TENDL-2015, AKONING
angular distribution for (n,n*18)

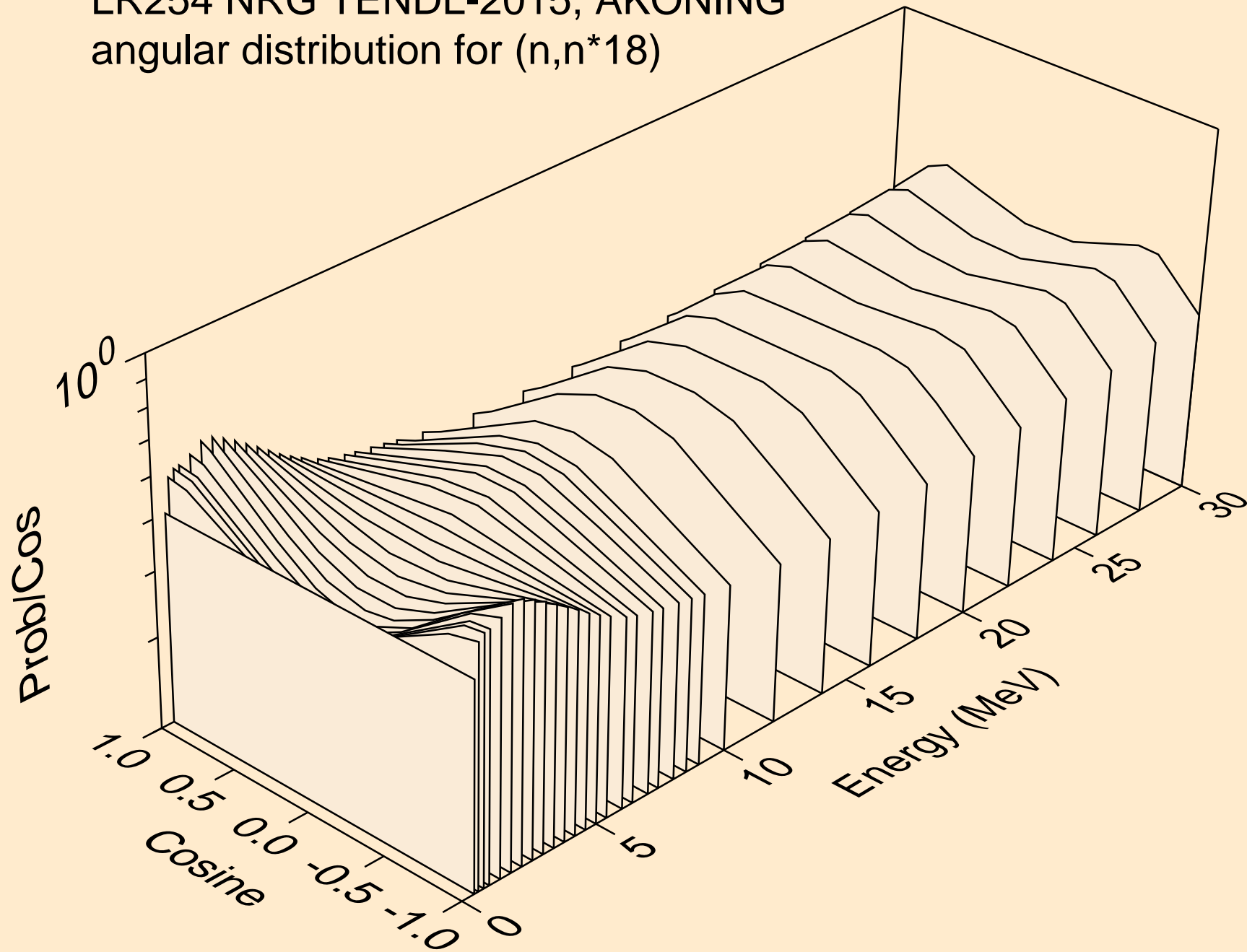

LR254 NRG TENDL-2015, AKONING
angular distribution for (n,n*19)

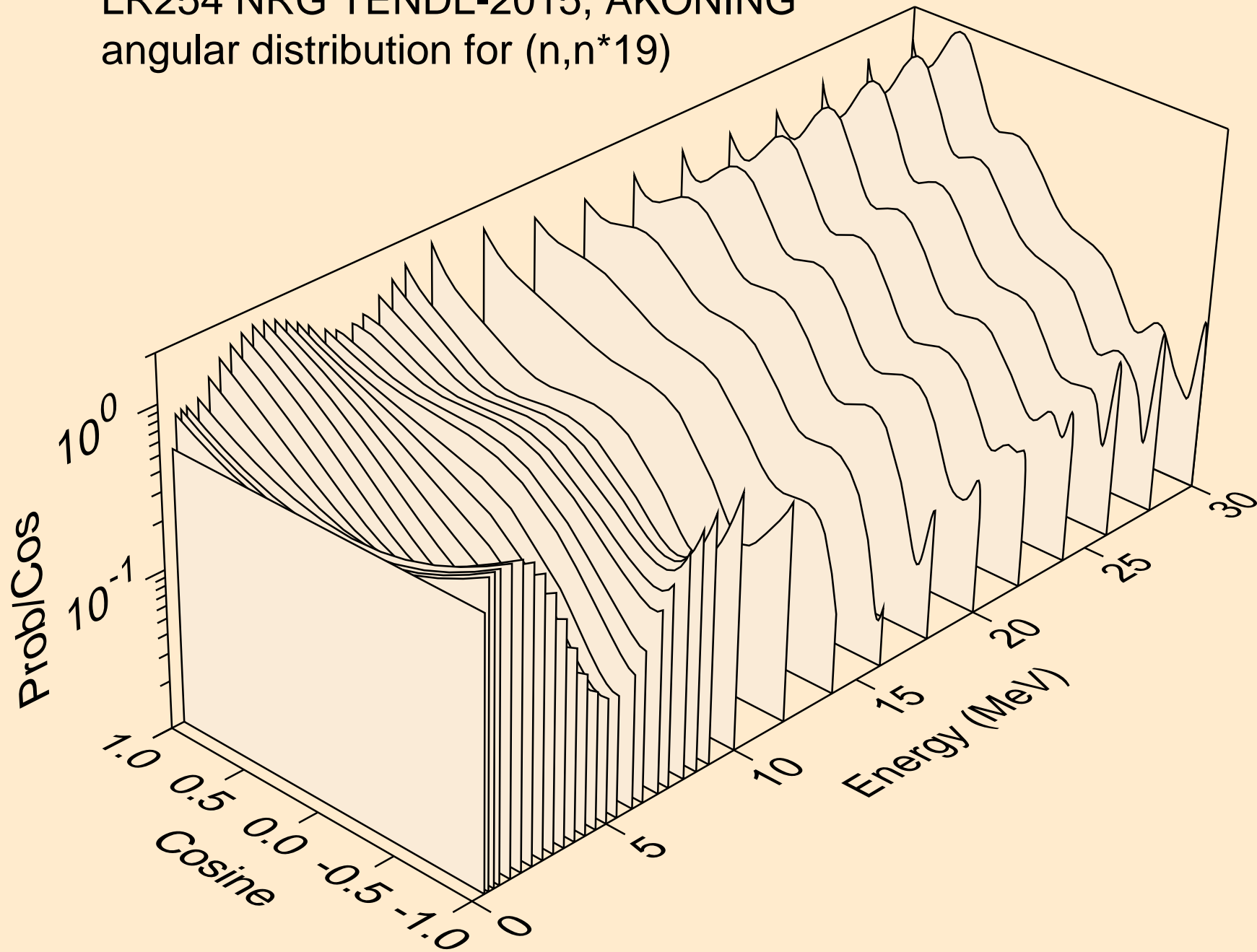

LR254 NRG TENDL-2015, AKONING
angular distribution for (n,n*20)

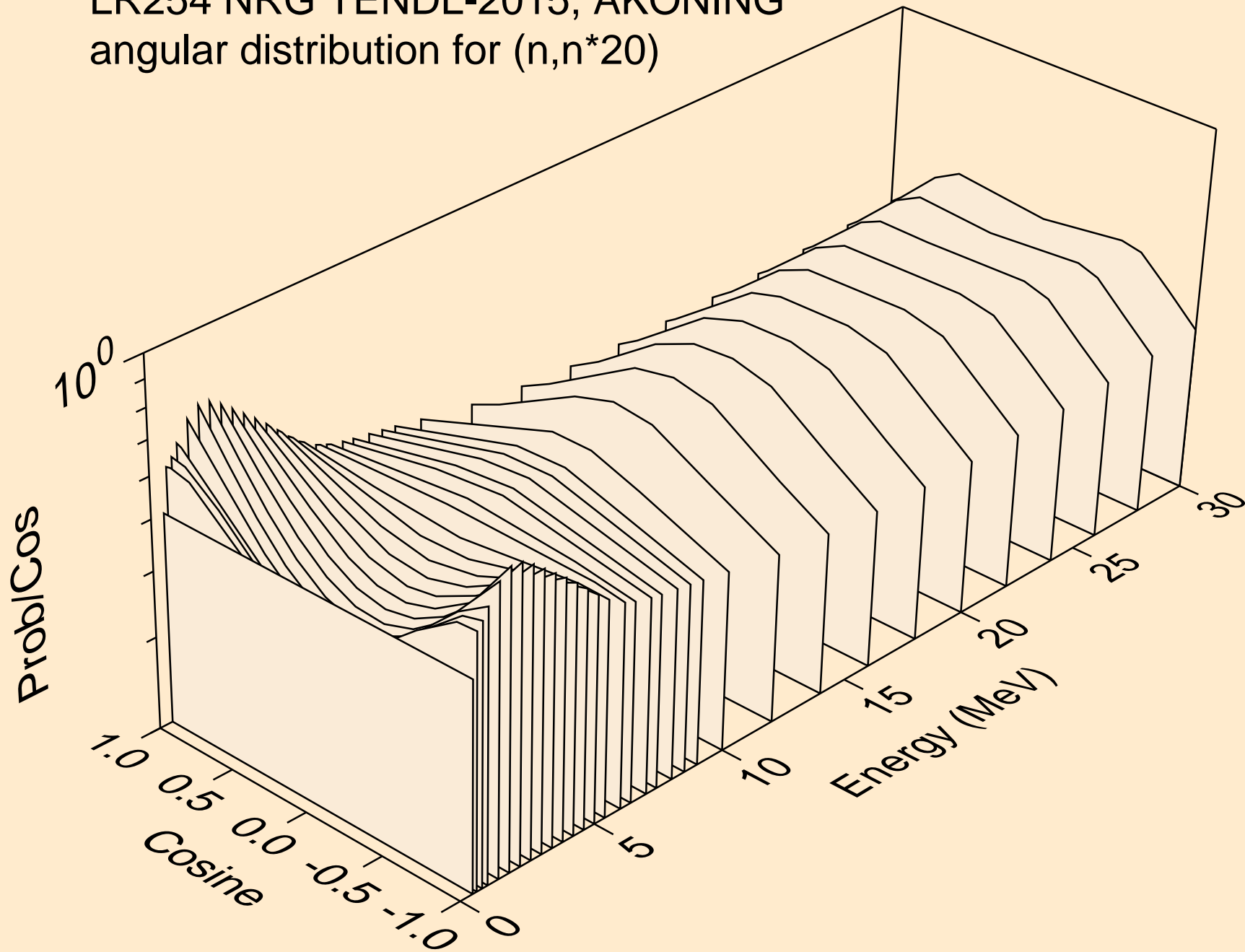

LR254 NRG TENDL-2015, AKONING
angular distribution for (n,n*21)

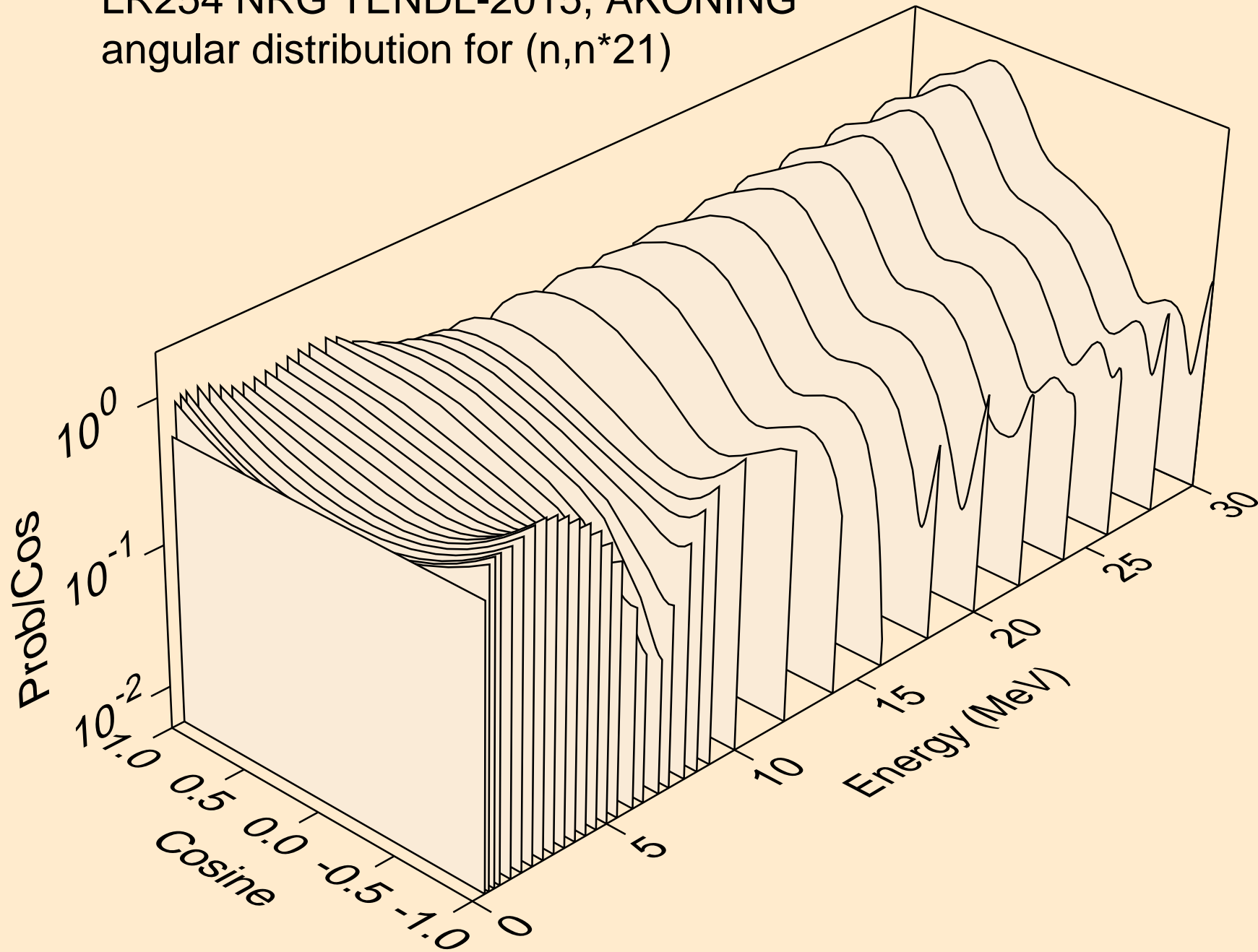

LR254 NRG TENDL-2015, AKONING
angular distribution for (n,n*22)

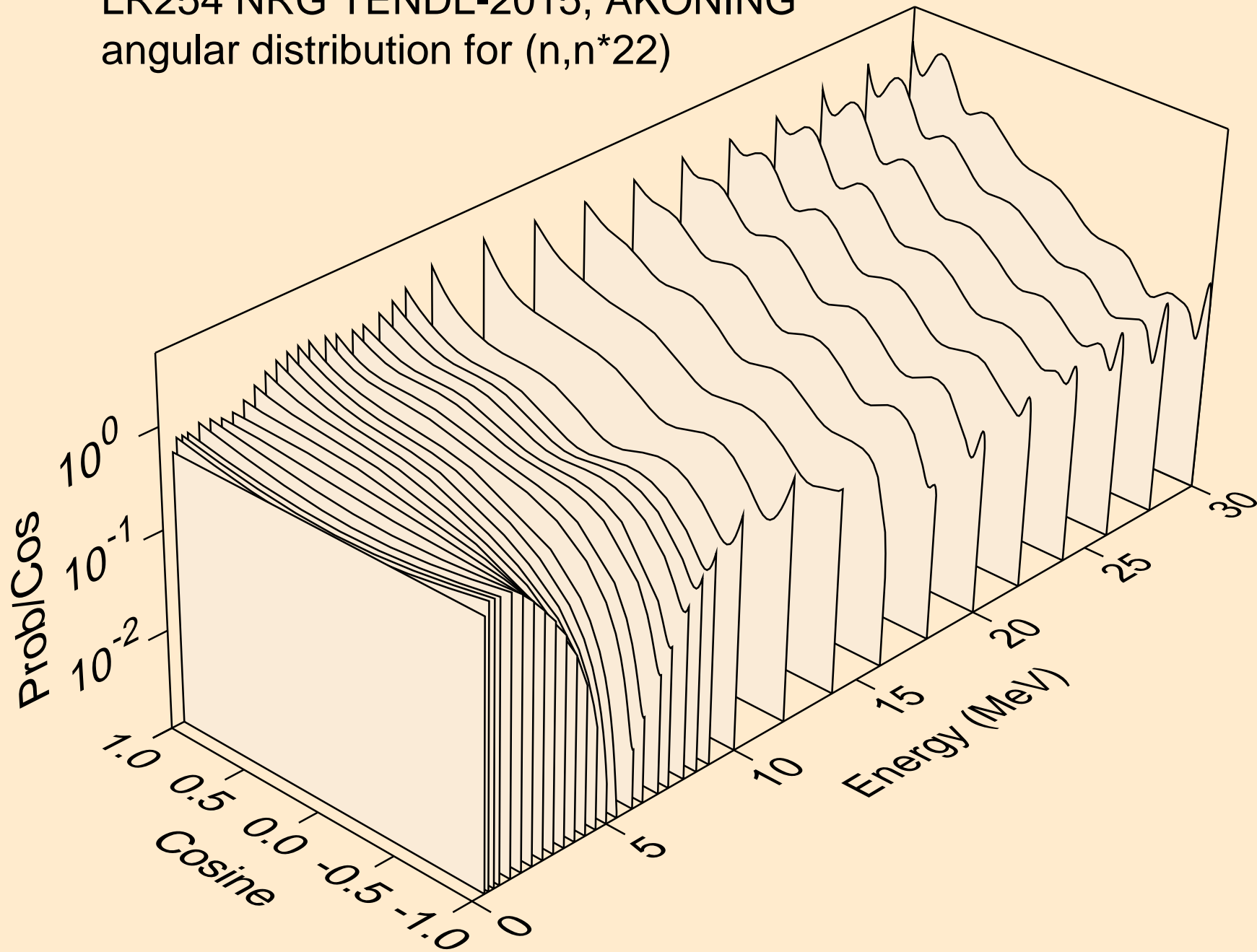

LR254 NRG TENDL-2015, AKONING
angular distribution for (n,n*23)

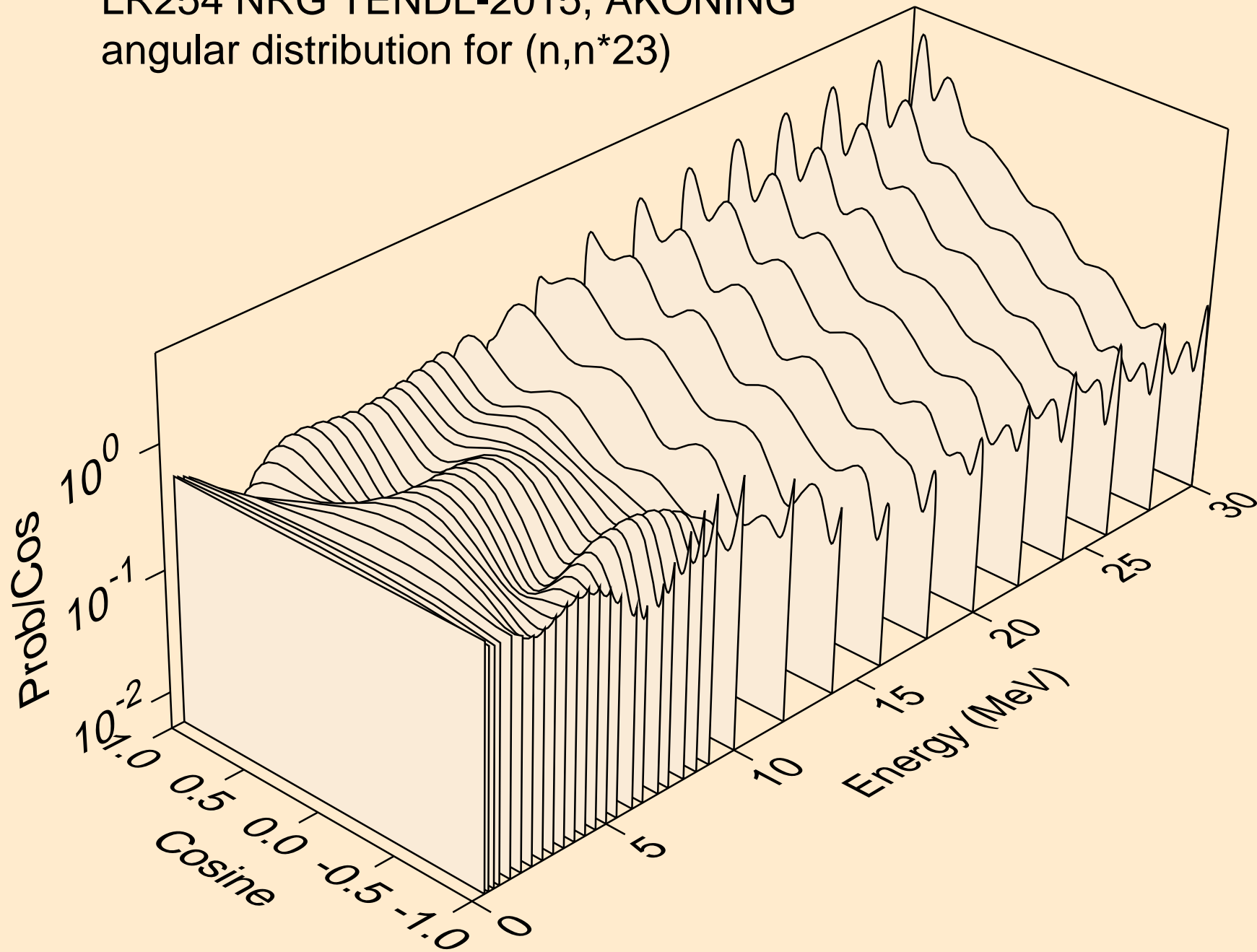

LR254 NRG TENDL-2015, AKONING
angular distribution for (n,n*24)

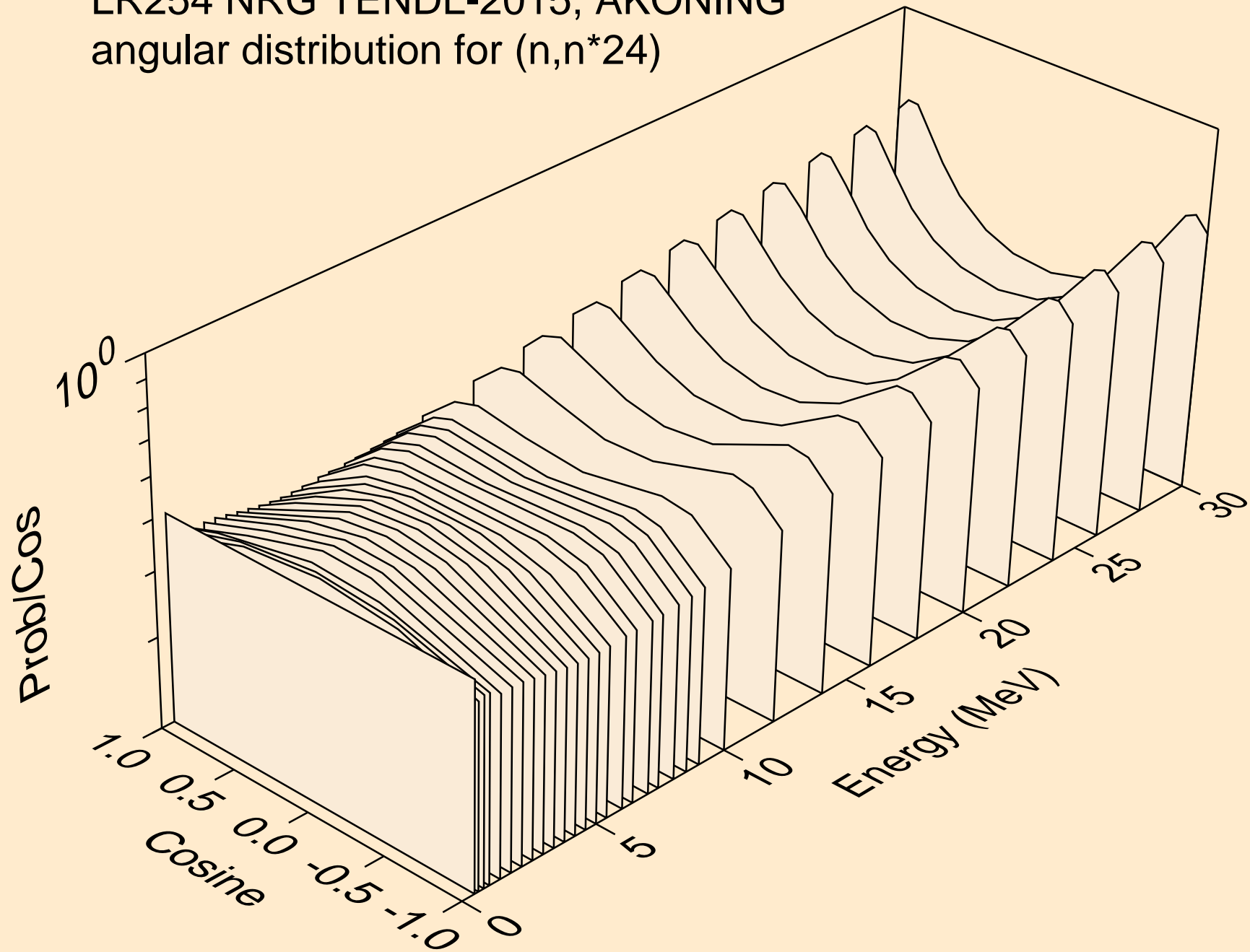

LR254 NRG TENDL-2015, AKONING
angular distribution for (n,n*25)

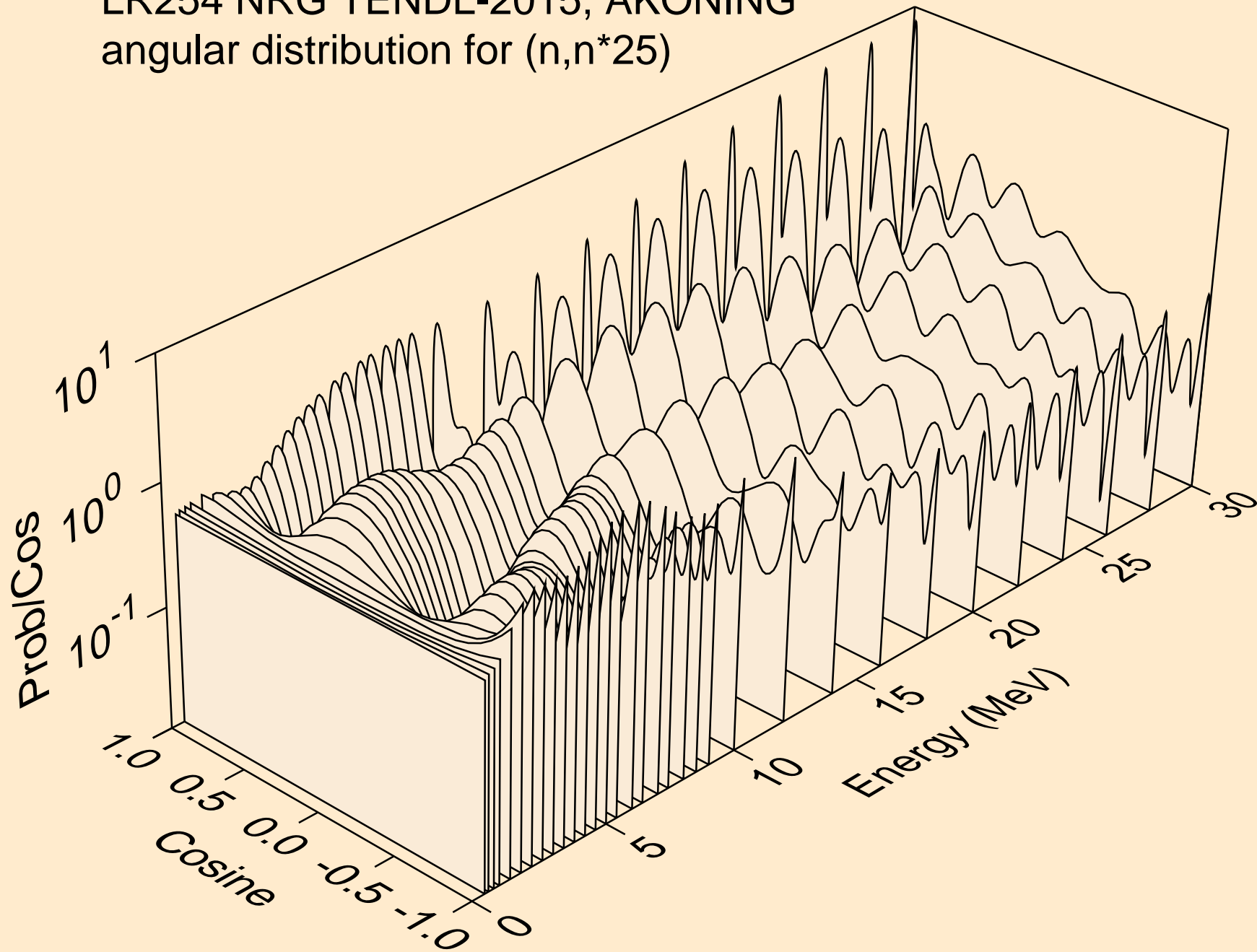

LR254 NRG TENDL-2015, AKONING

Total fission nubar

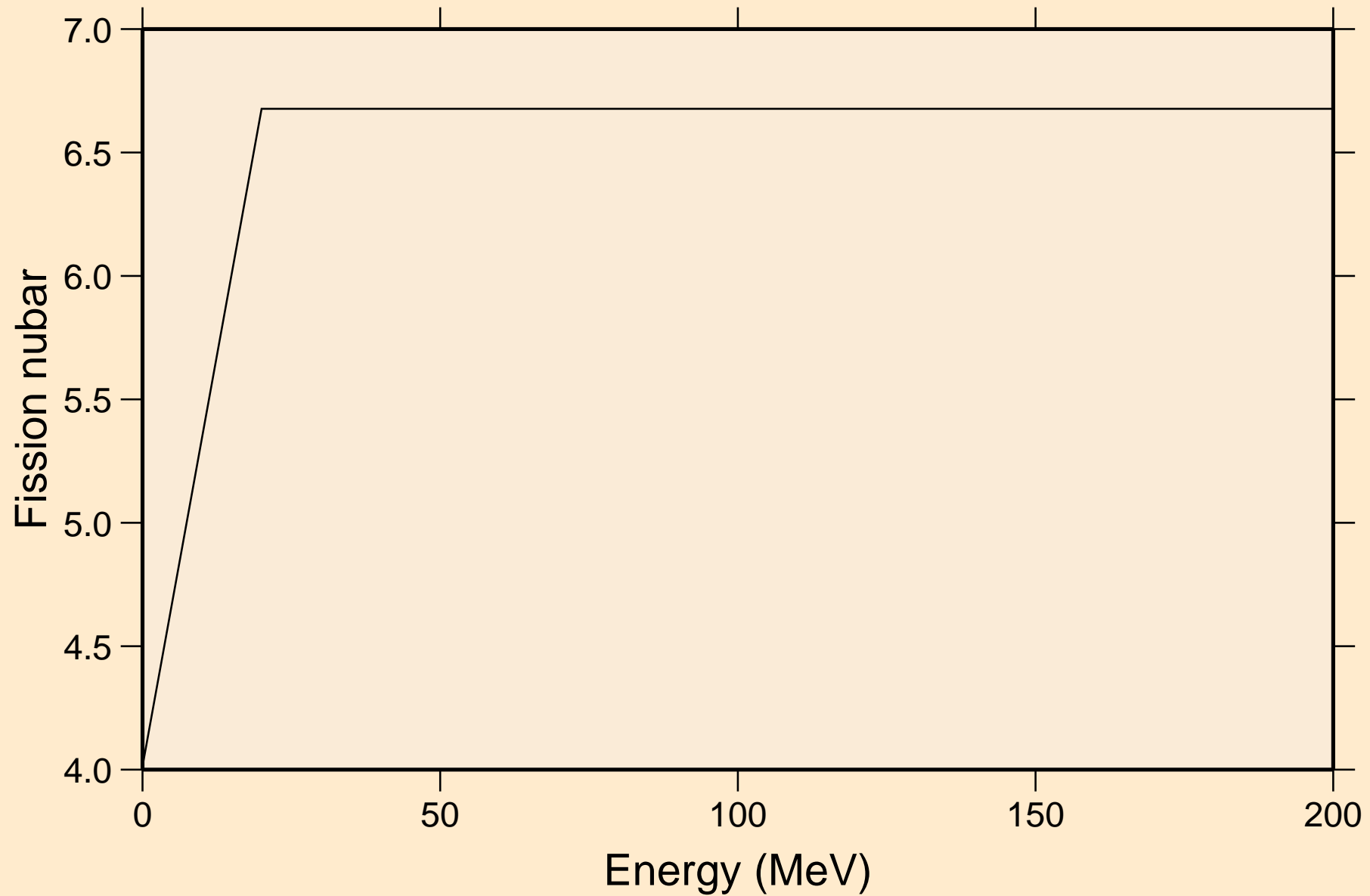

LR254 NRG TENDL-2015, AKONING
Neutron emission for (n,x)

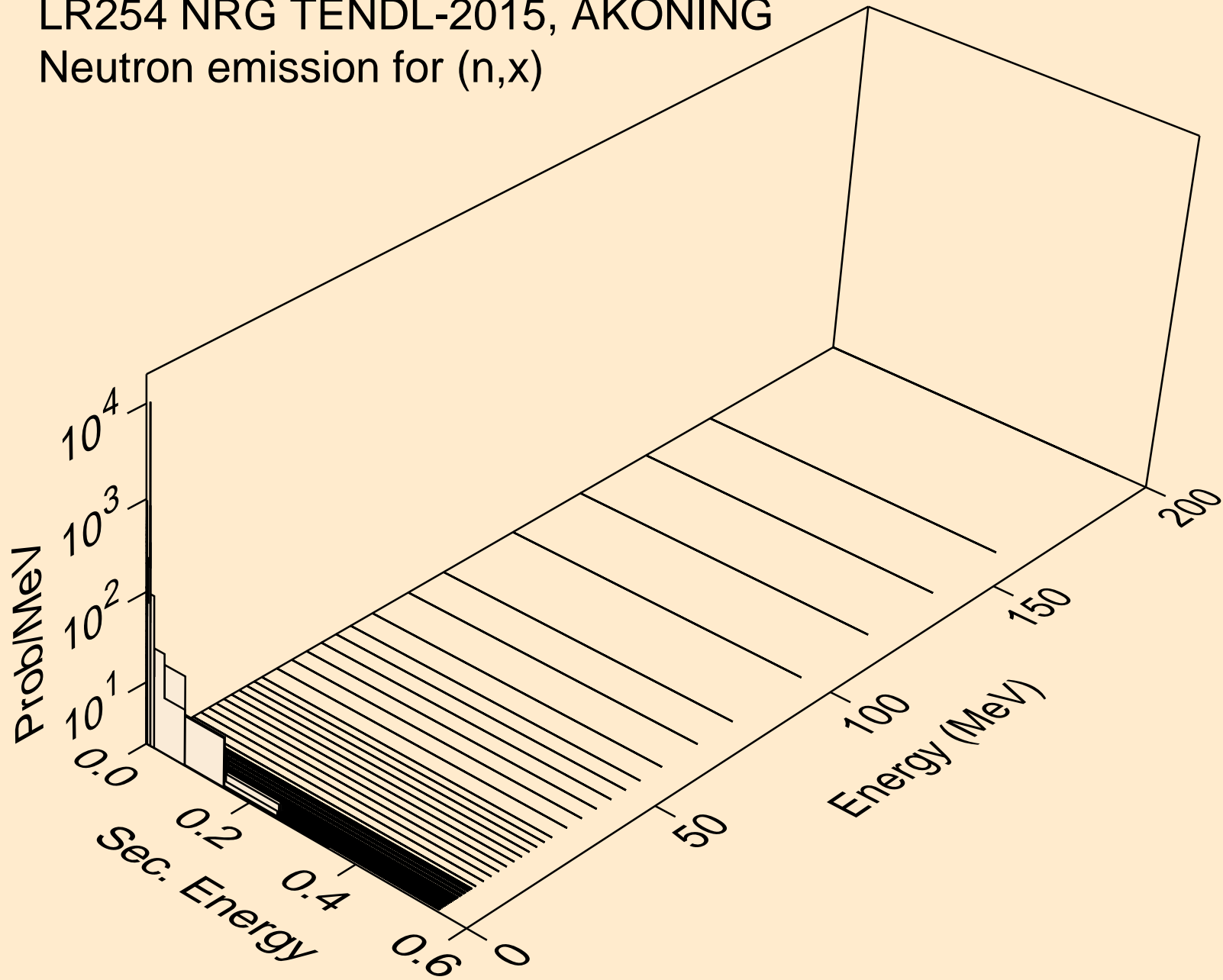

LR254 NRG TENDL-2015, AKONING
Neutron emission for (n,2nd)

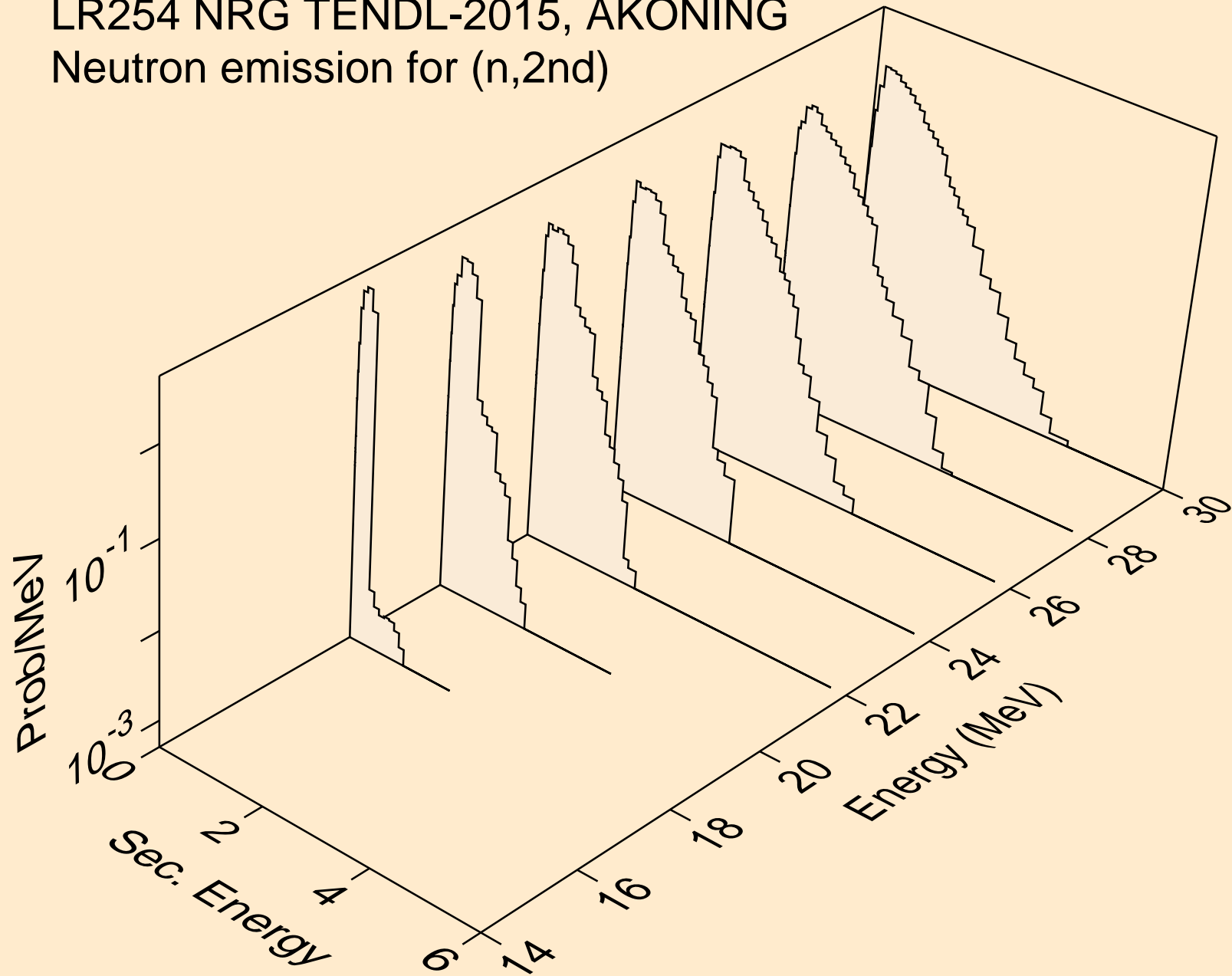

LR254 NRG TENDL-2015, AKONING
Neutron emission for (n,2n)

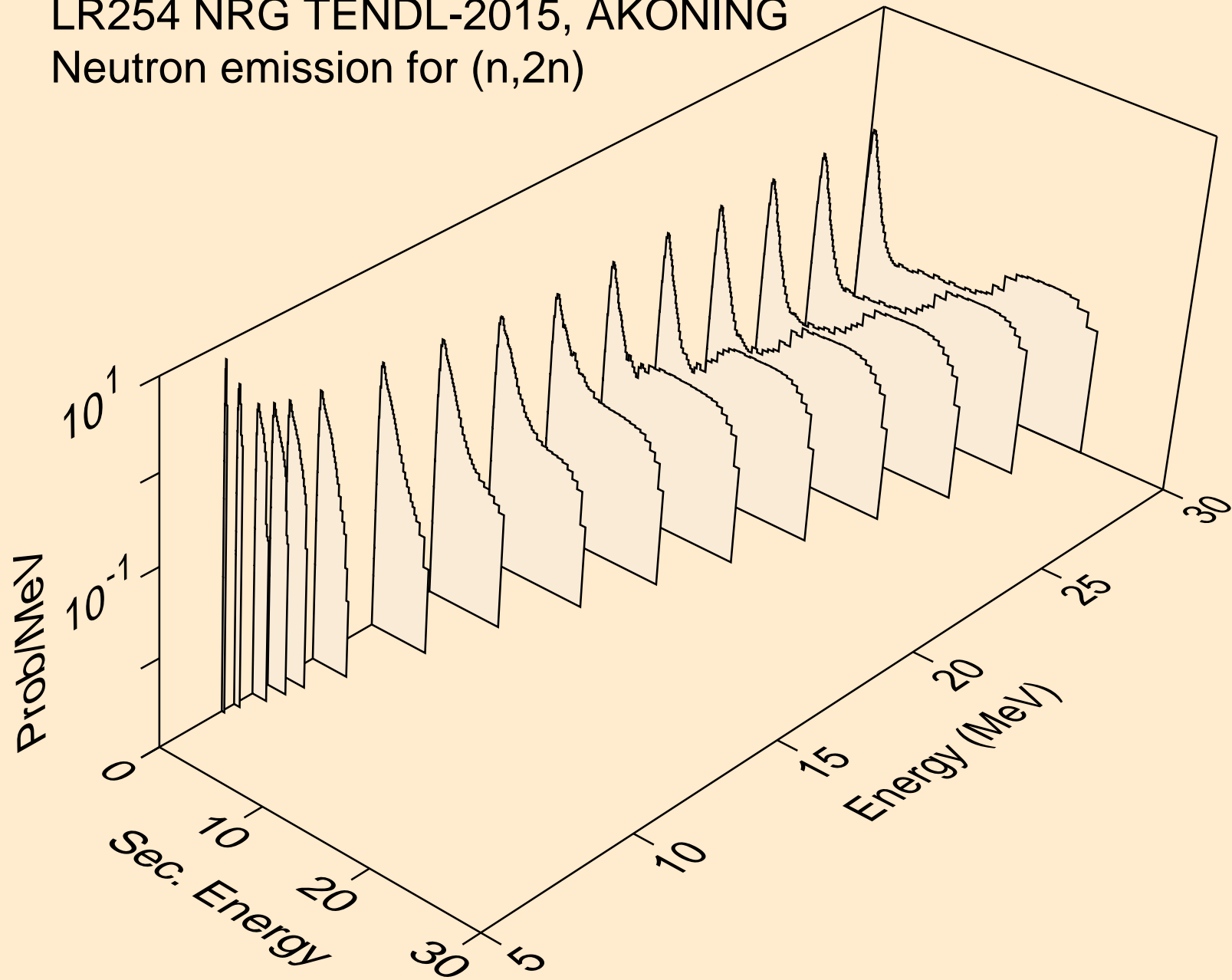

LR254 NRG TENDL-2015, AKONING
Neutron emission for (n,3n)

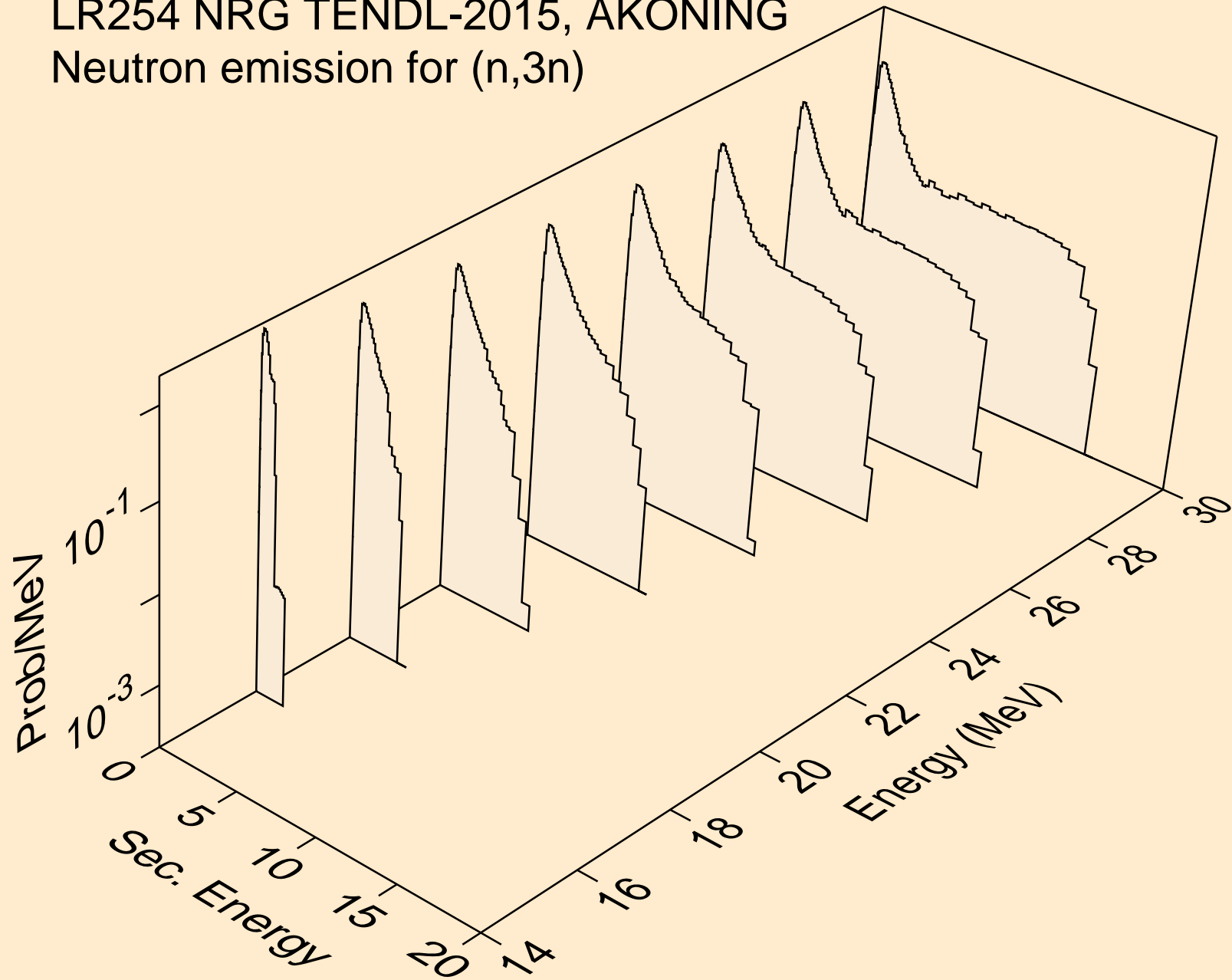

LR254 NRG TENDL-2015, AKONING
Neutron emission for fission

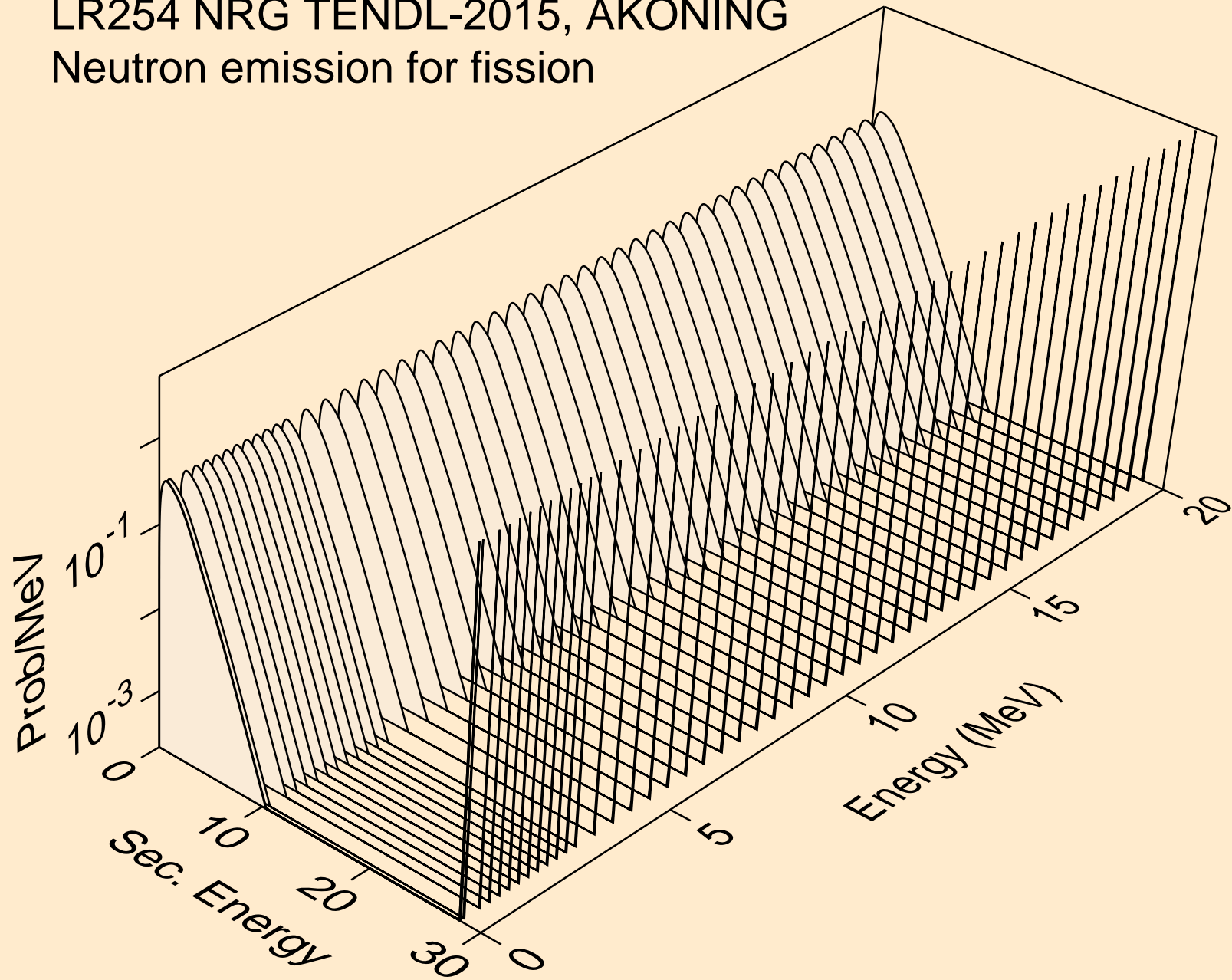

LR254 NRG TENDL-2015, AKONING
Neutron emission for (n,n*)a

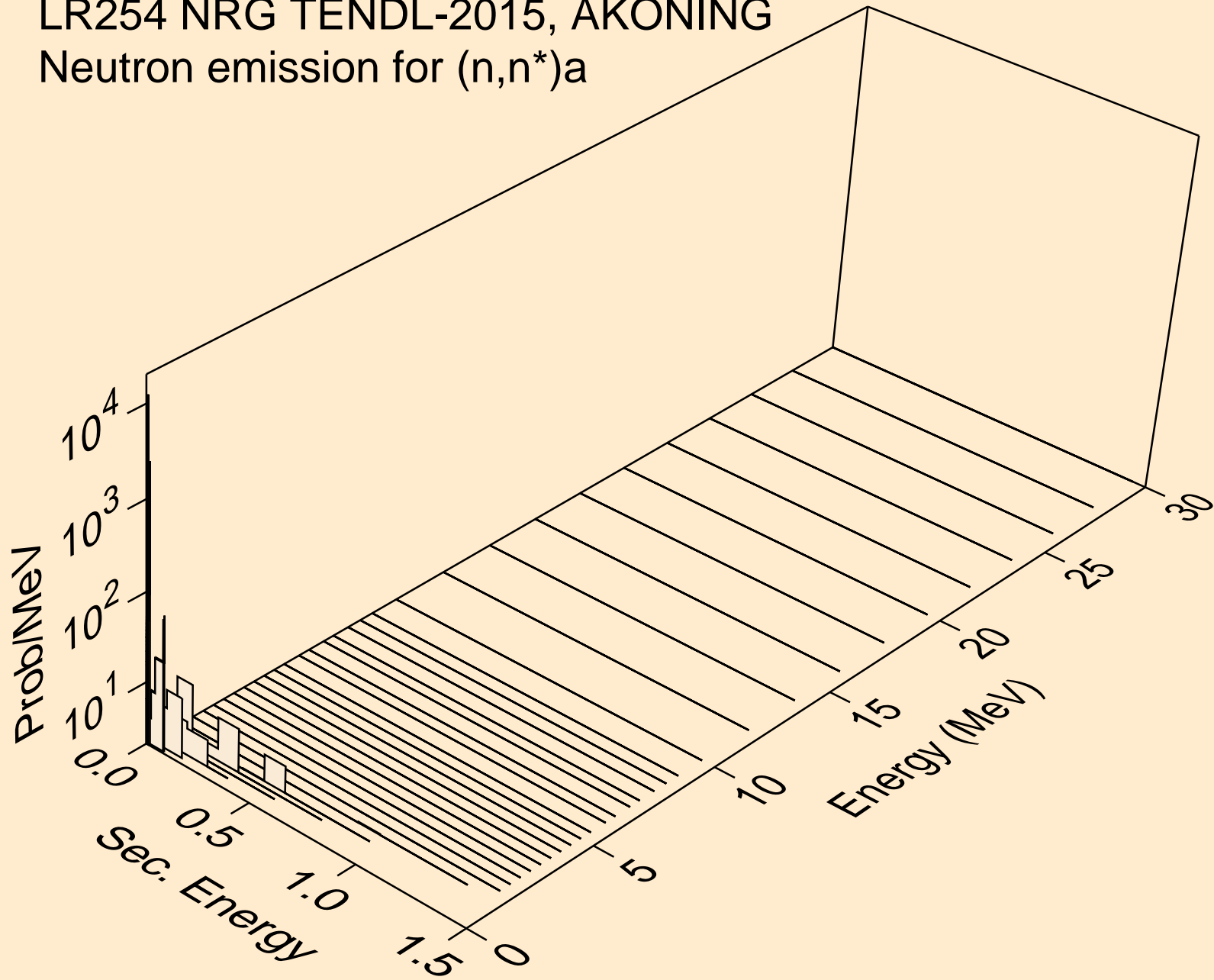

LR254 NRG TENDL-2015, AKONING
Neutron emission for (n,n*)3a

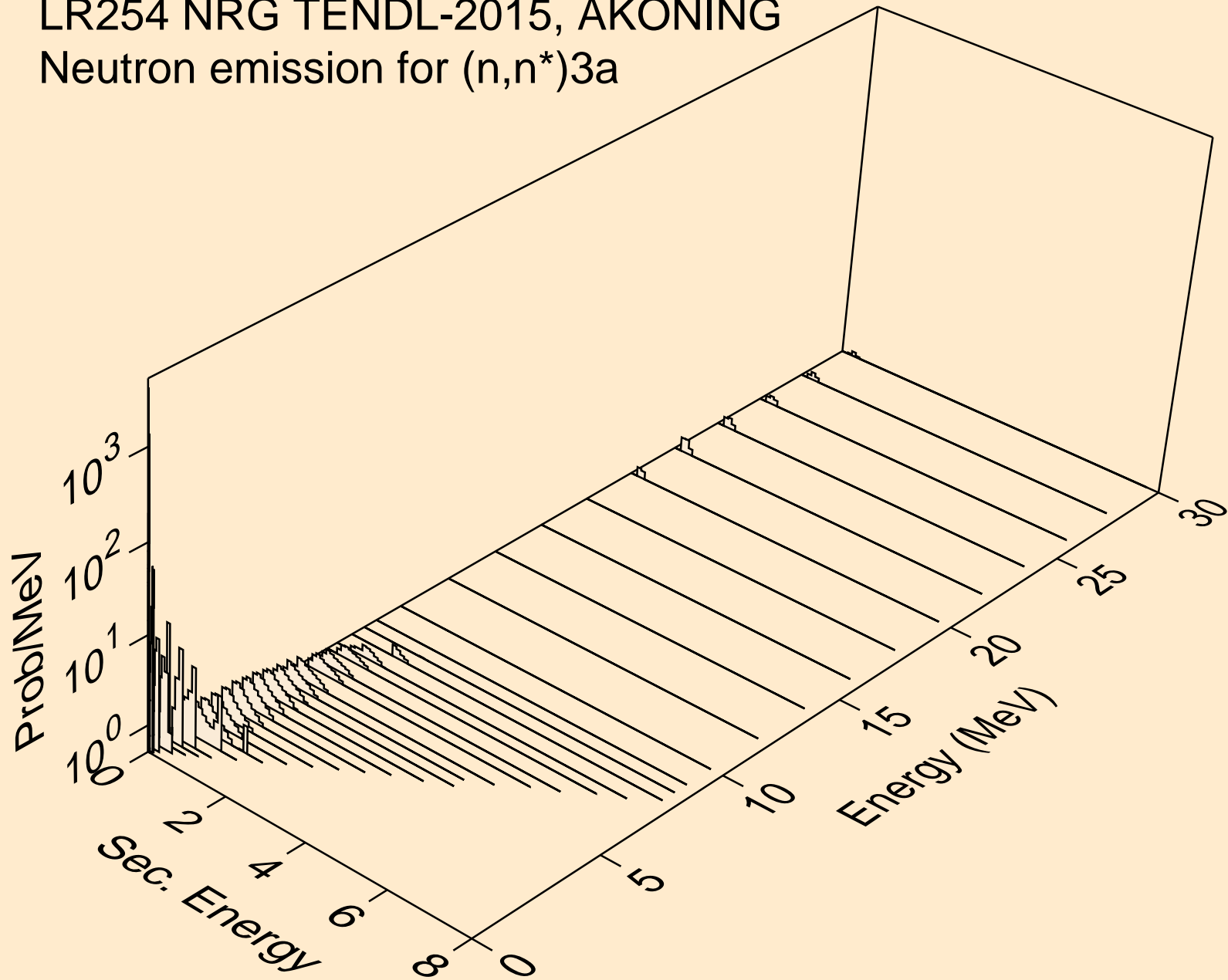

LR254 NRG TENDL-2015, AKONING
Neutron emission for (n,2n)a

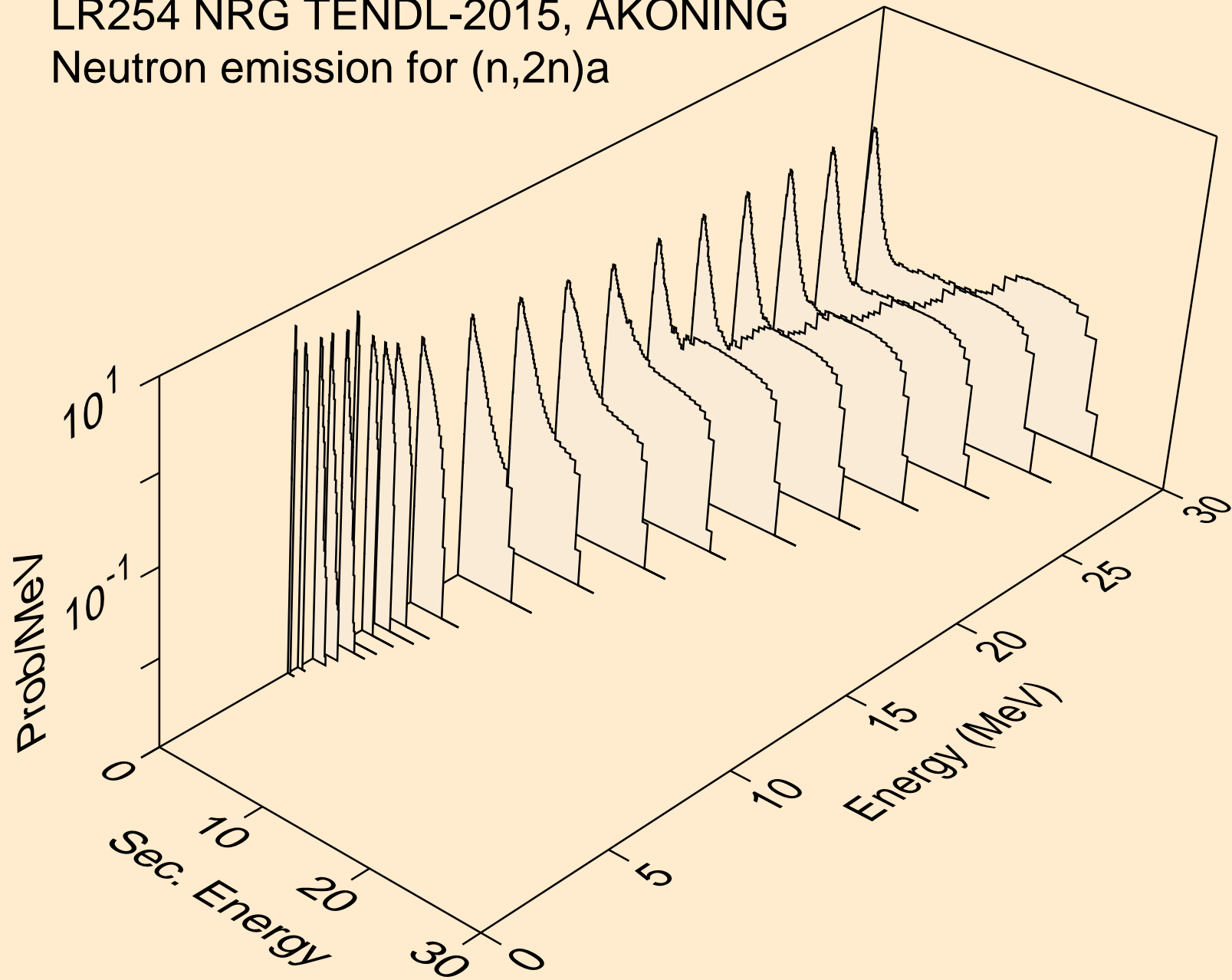

LR254 NRG TENDL-2015, AKONING
Neutron emission for (n,3n)a

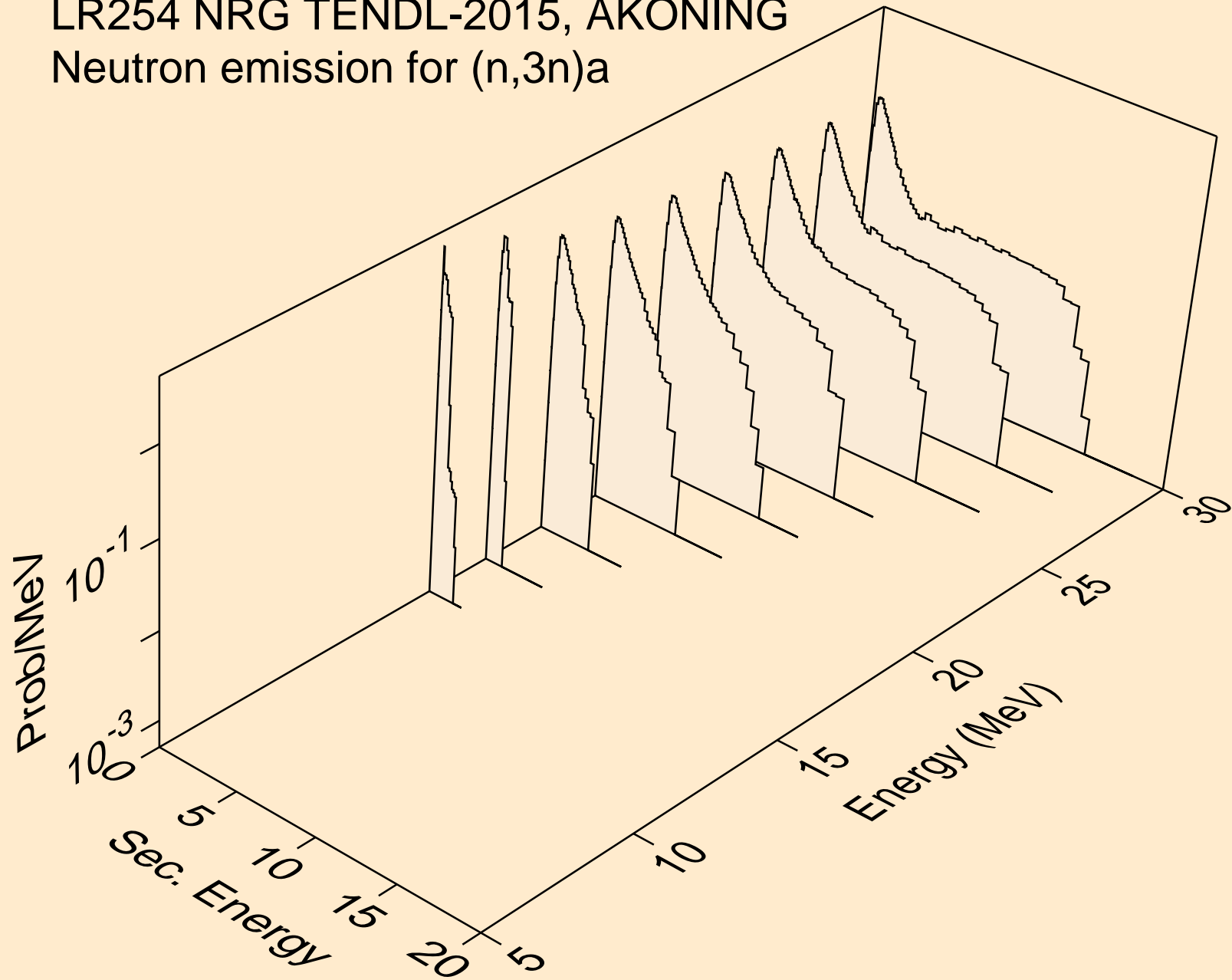

LR254 NRG TENDL-2015, AKONING
Neutron emission for (n,n*)p

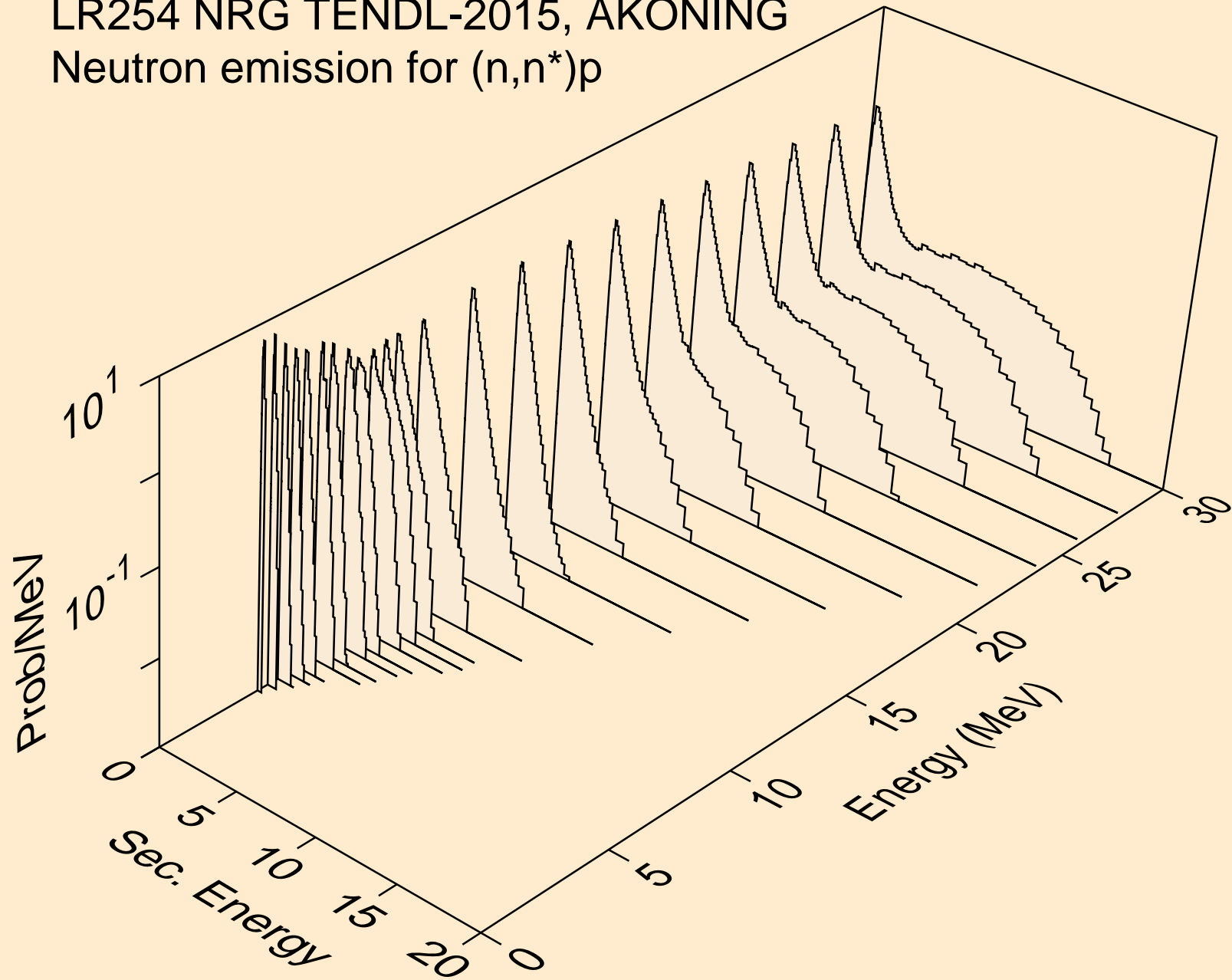

LR254 NRG TENDL-2015, AKONING
Neutron emission for (n,n*)2a

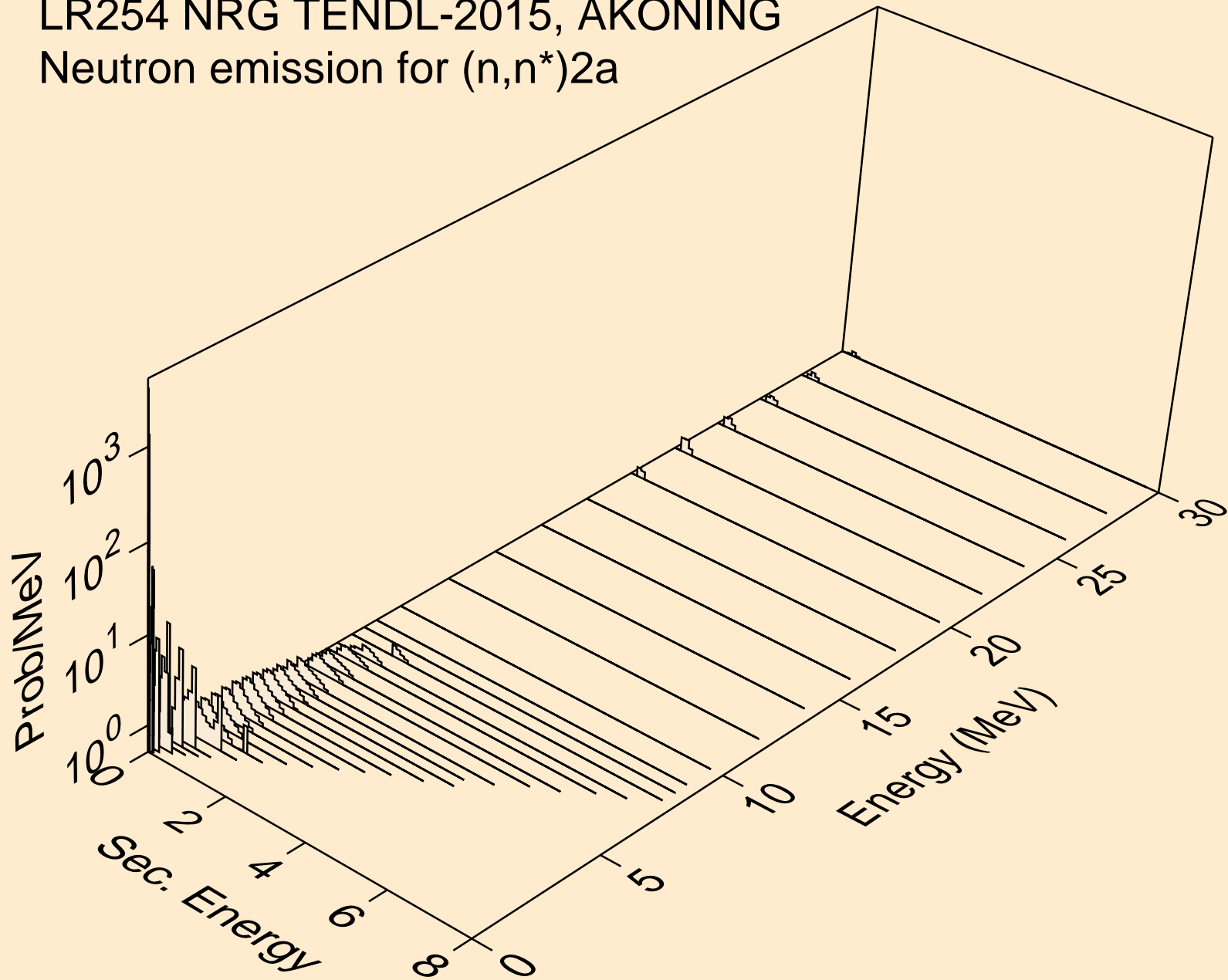

LR254 NRG TENDL-2015, AKONING
Neutron emission for (n,2n)2a

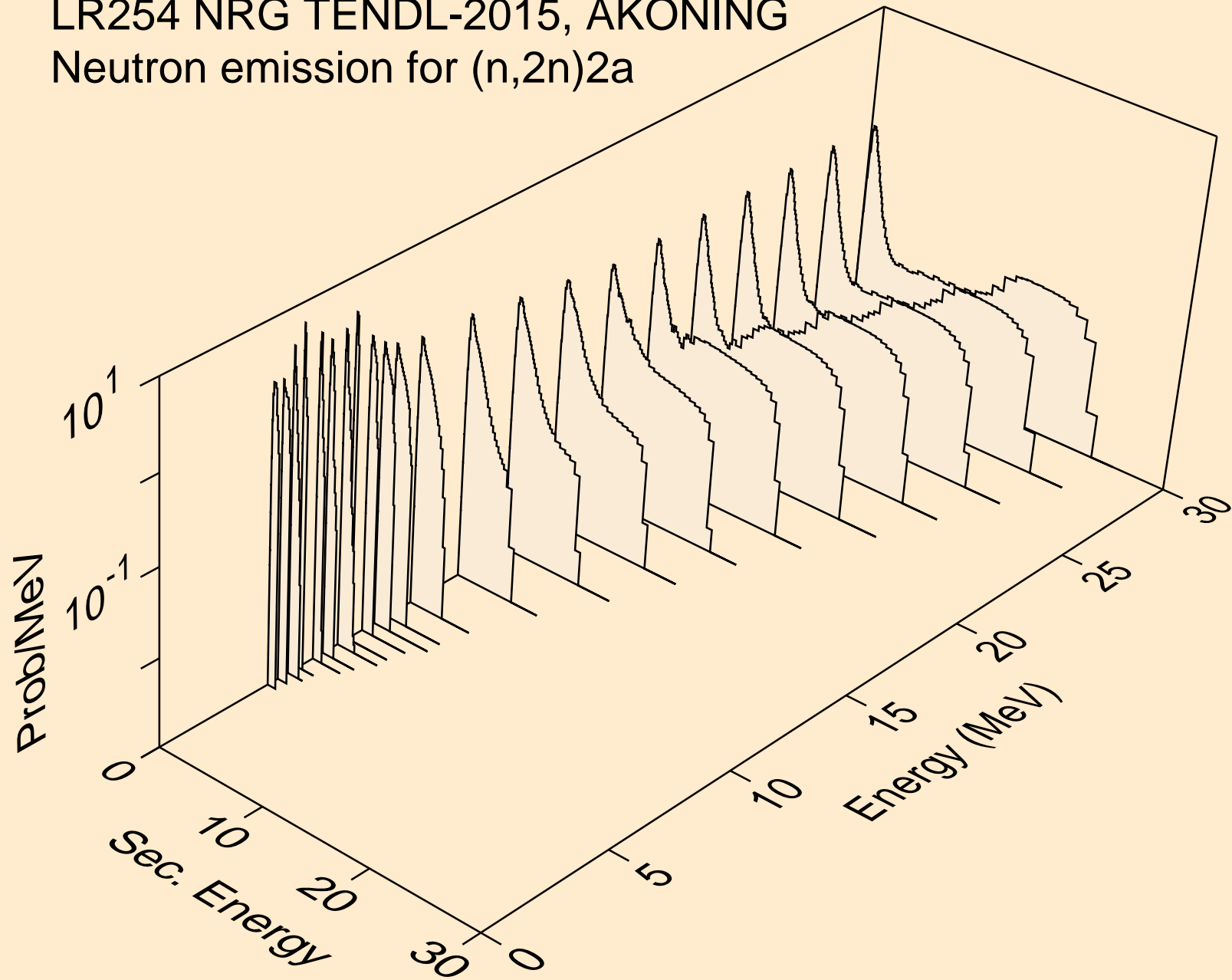

LR254 NRG TENDL-2015, AKONING
Neutron emission for (n,n*)d

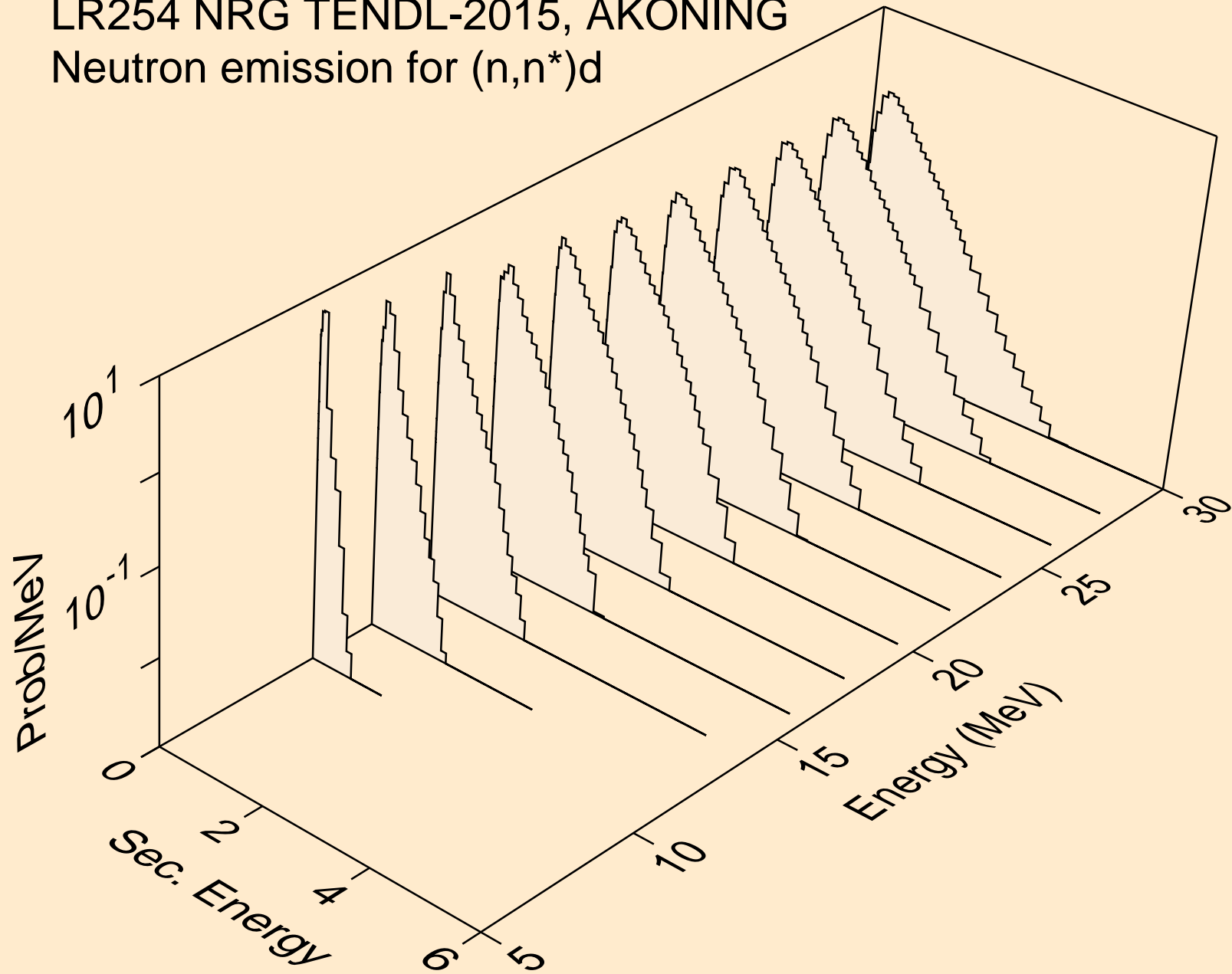

LR254 NRG TENDL-2015, AKONING
Neutron emission for (n,n*)t

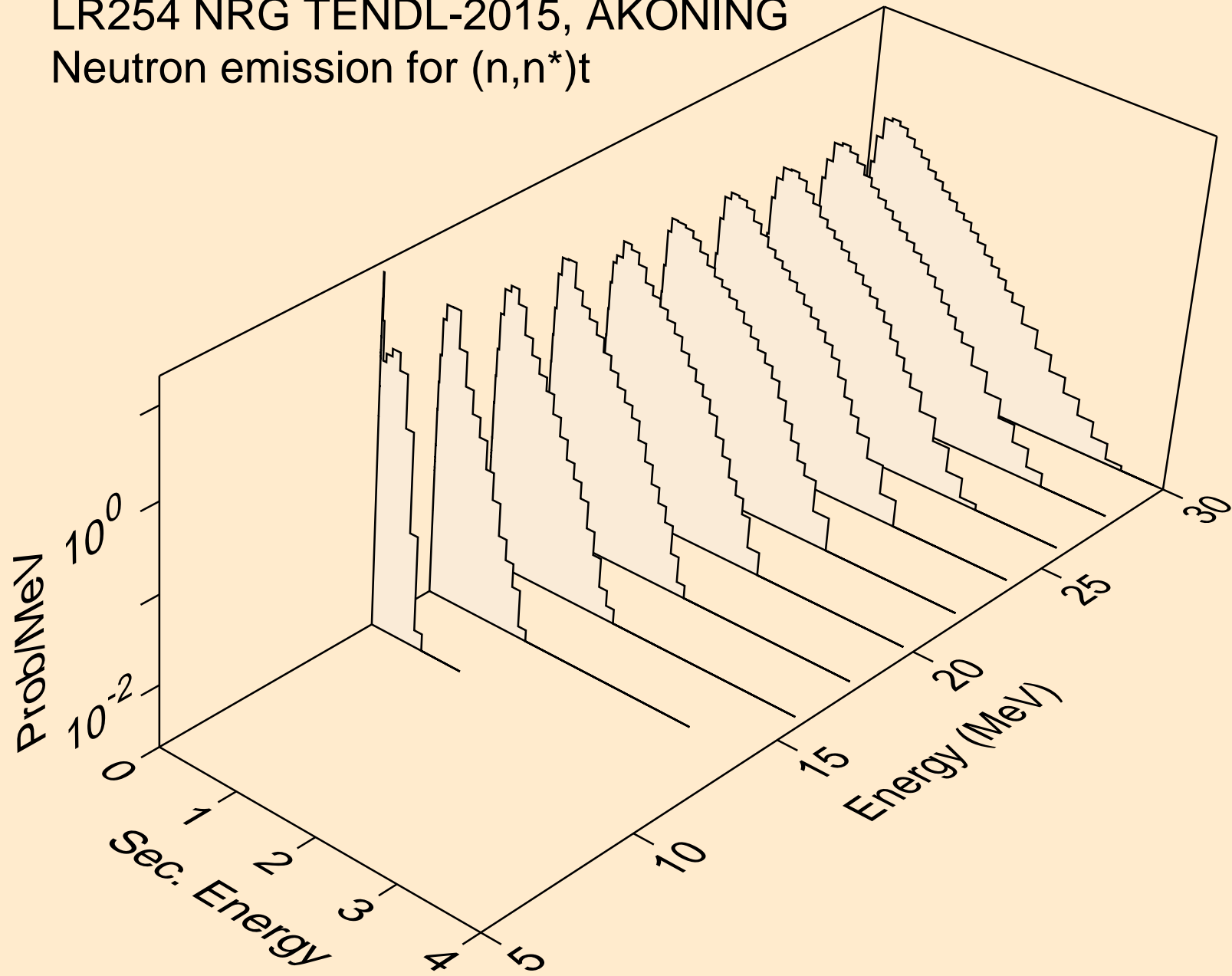

LR254 NRG TENDL-2015, AKONING
Neutron emission for (n,n*)he3

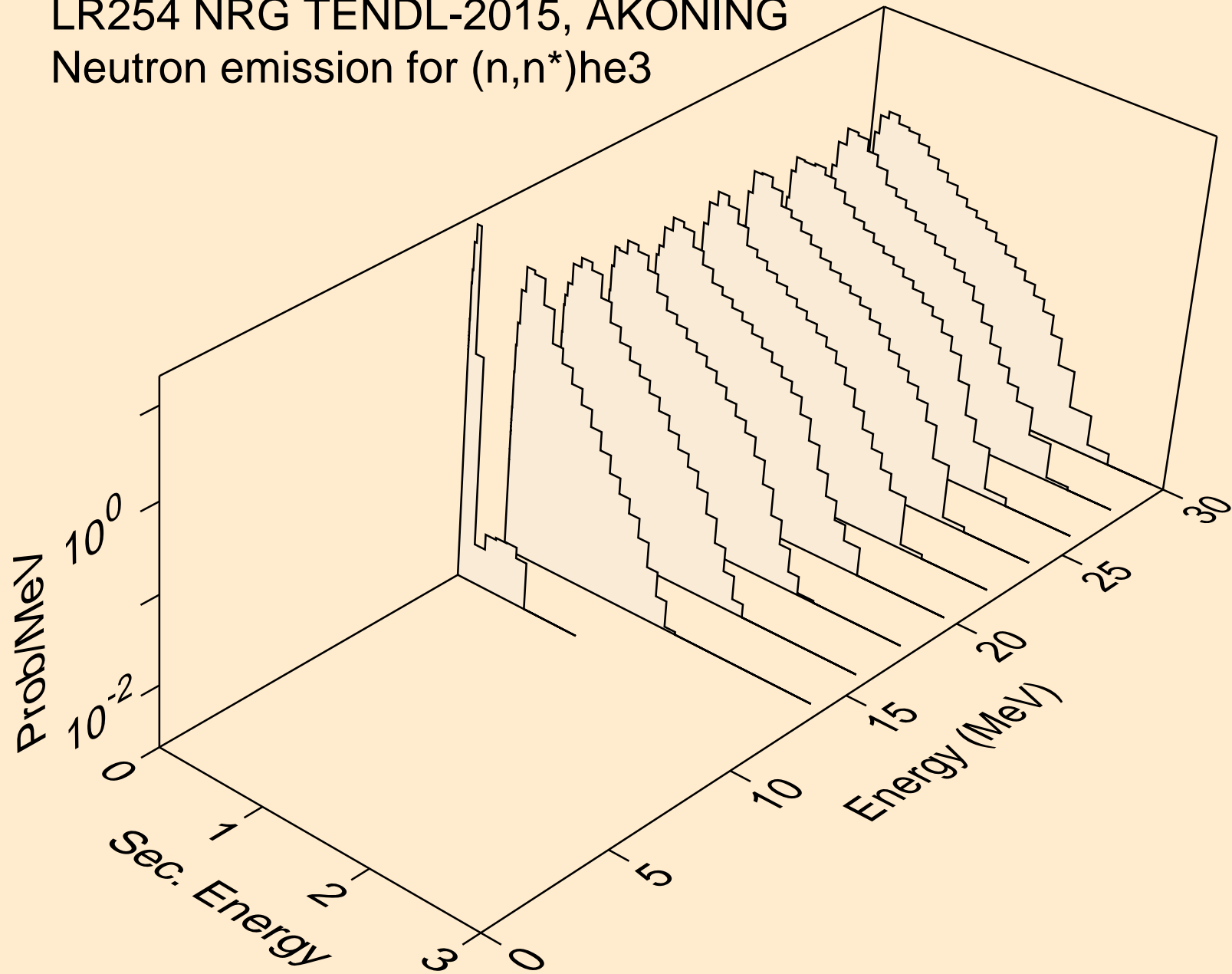

LR254 NRG TENDL-2015, AKONING
Neutron emission for (n,n*)d2a

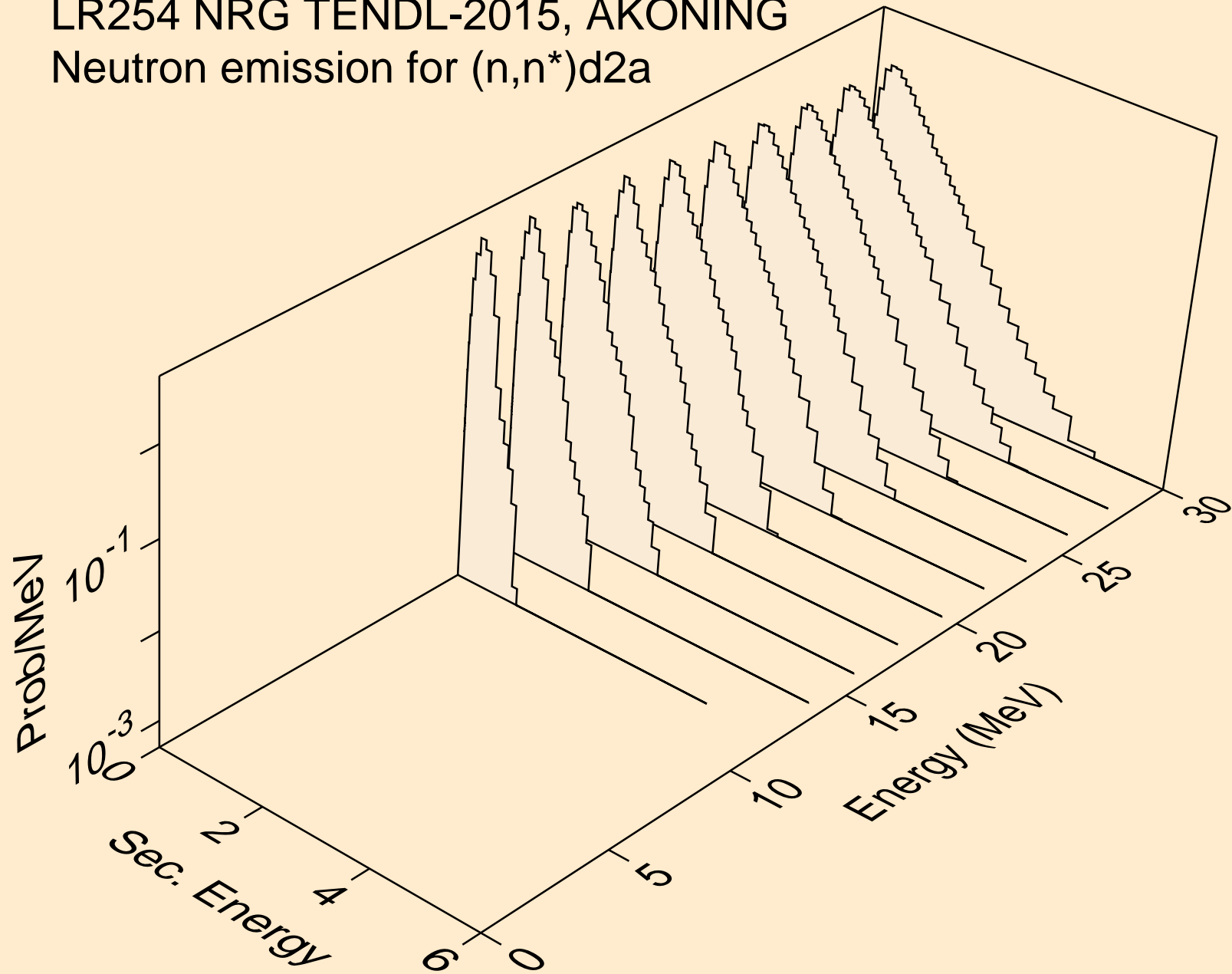

LR254 NRG TENDL-2015, AKONING
Neutron emission for (n,n*)t2a

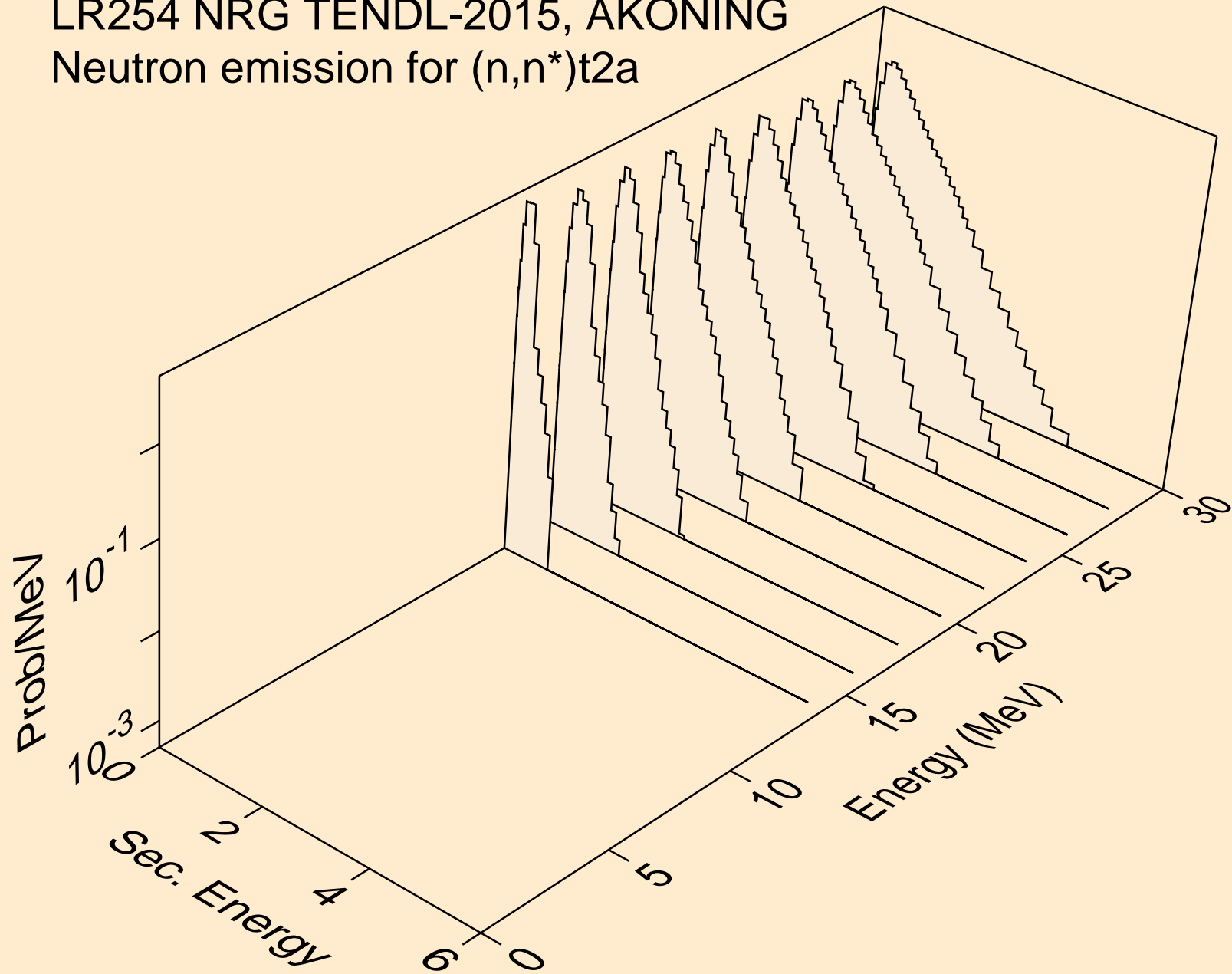

LR254 NRG TENDL-2015, AKONING
Neutron emission for (n,4n)

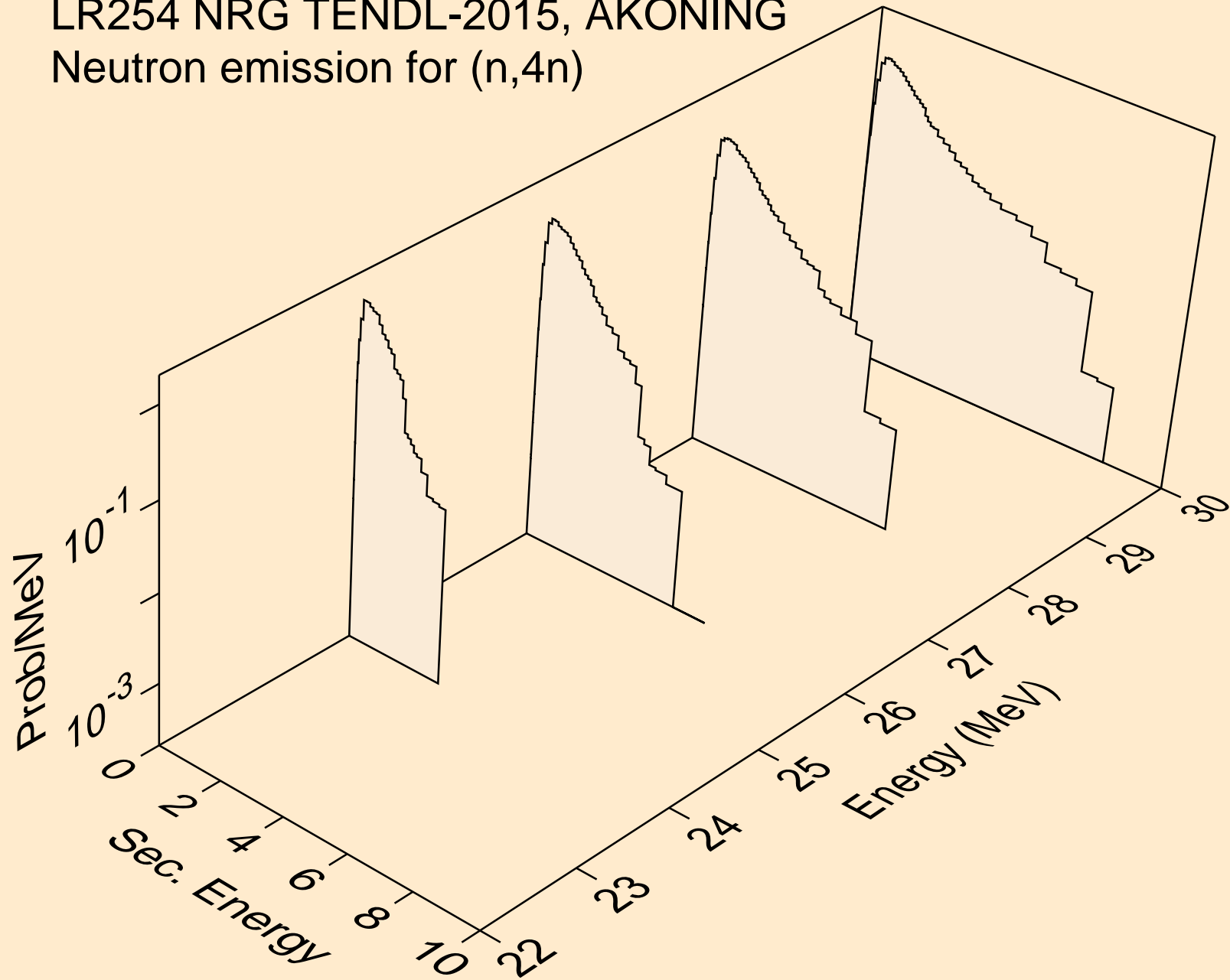

LR254 NRG TENDL-2015, AKONING
Neutron emission for (n,2np)

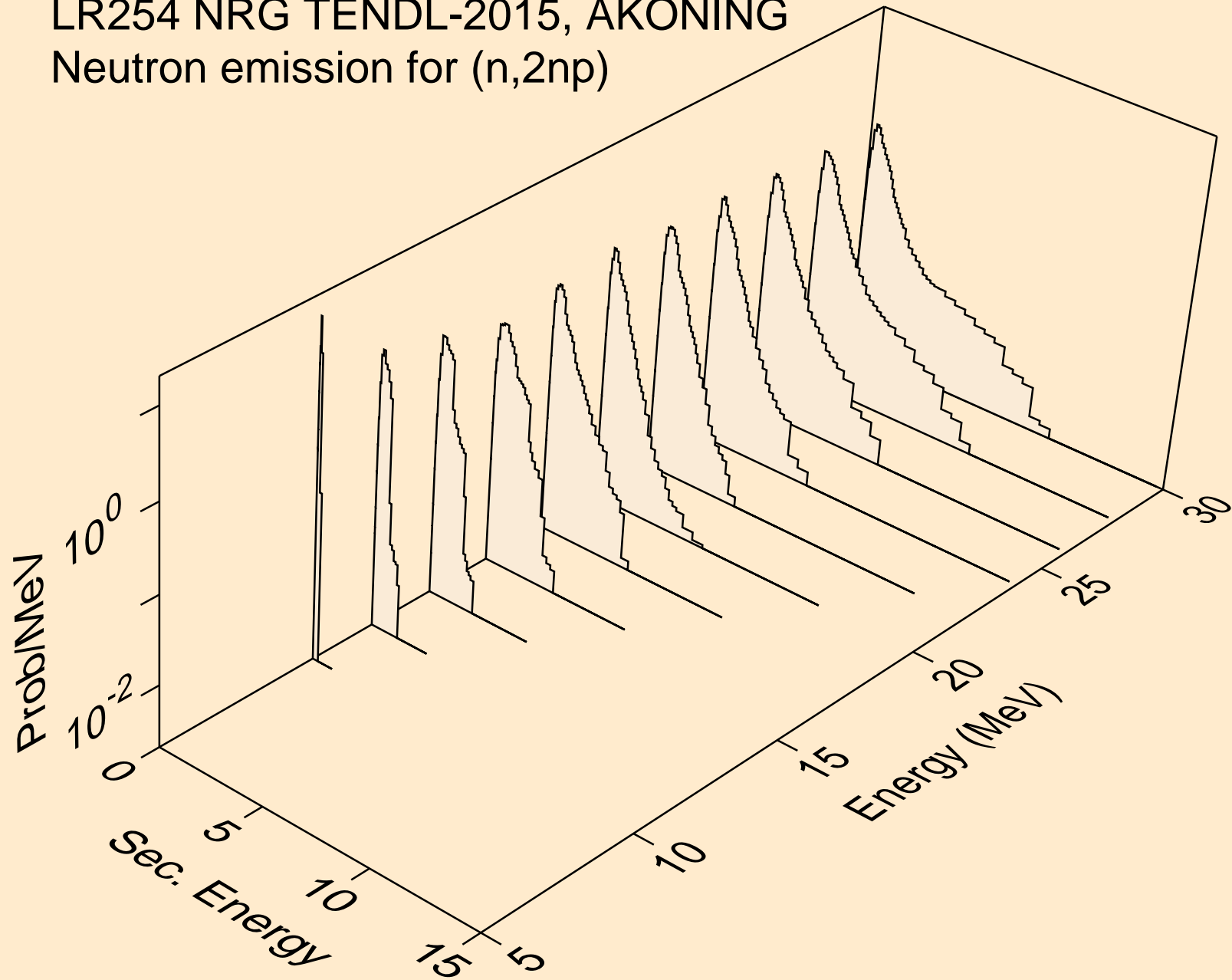

LR254 NRG TENDL-2015, AKONING
Neutron emission for (n,3np)

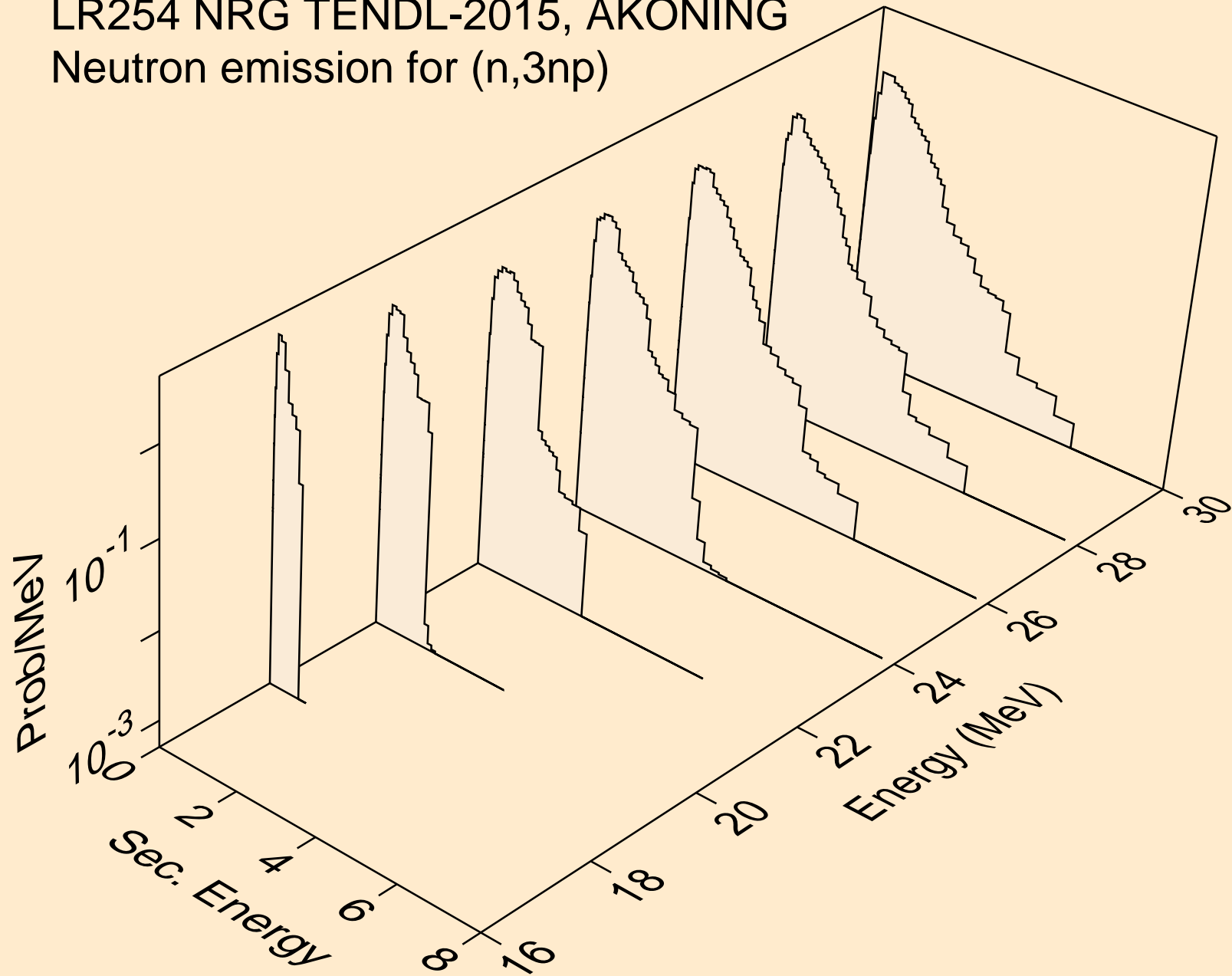

LR254 NRG TENDL-2015, AKONING
Neutron emission for (n,2np)

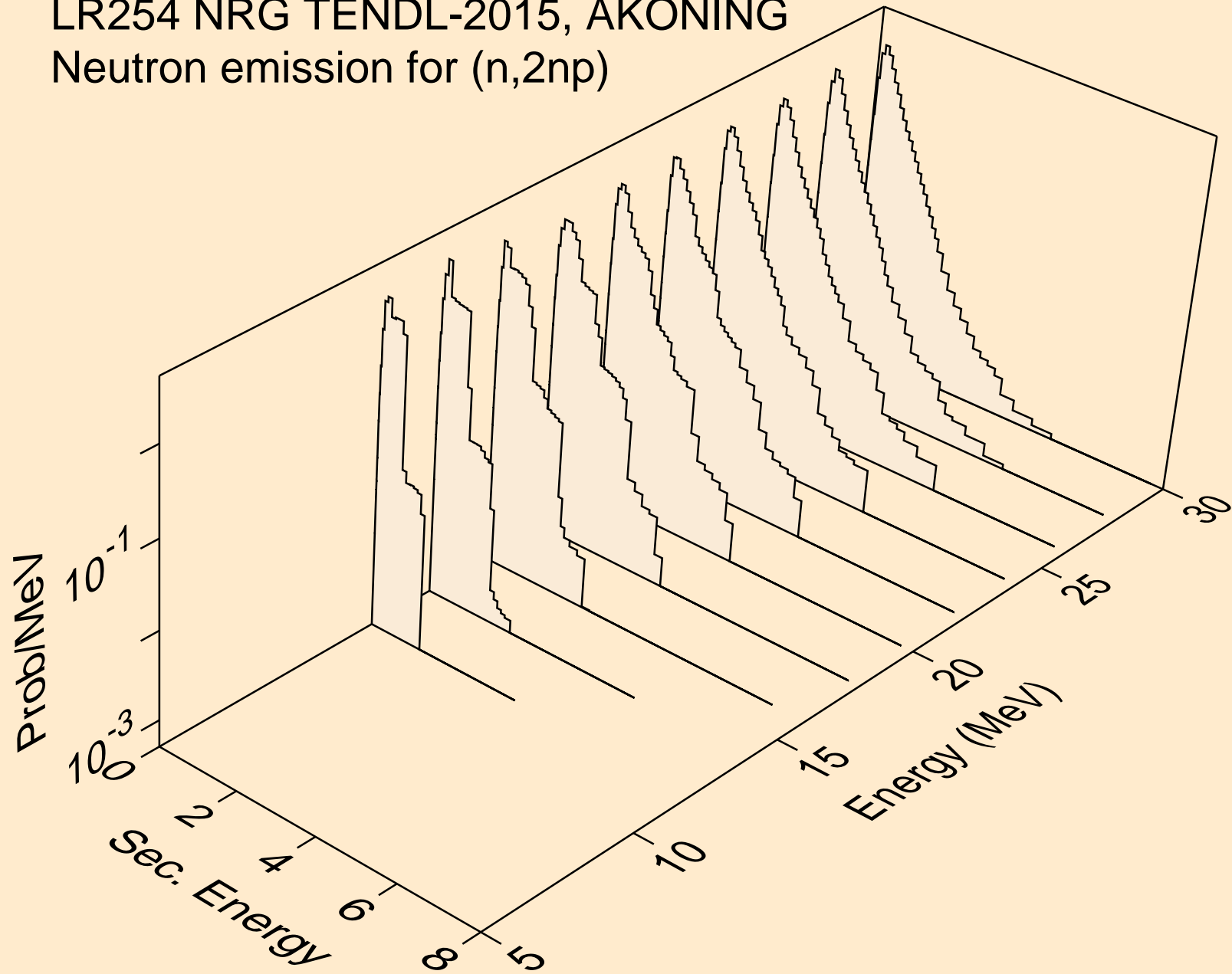

LR254 NRG TENDL-2015, AKONING
Neutron emission for (n,npa)

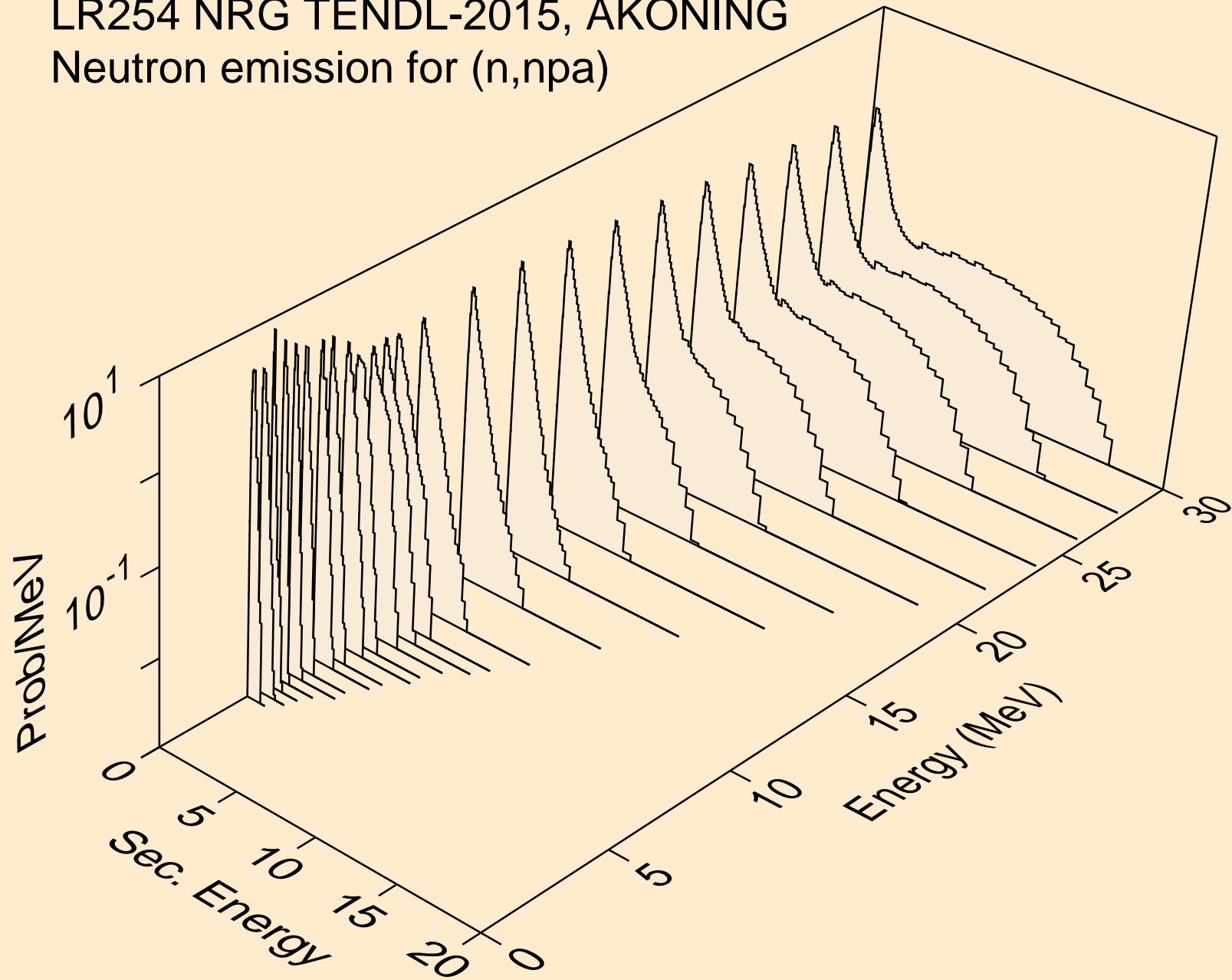

LR254 NRG TENDL-2015, AKONING
Neutron emission for (n,n*c)

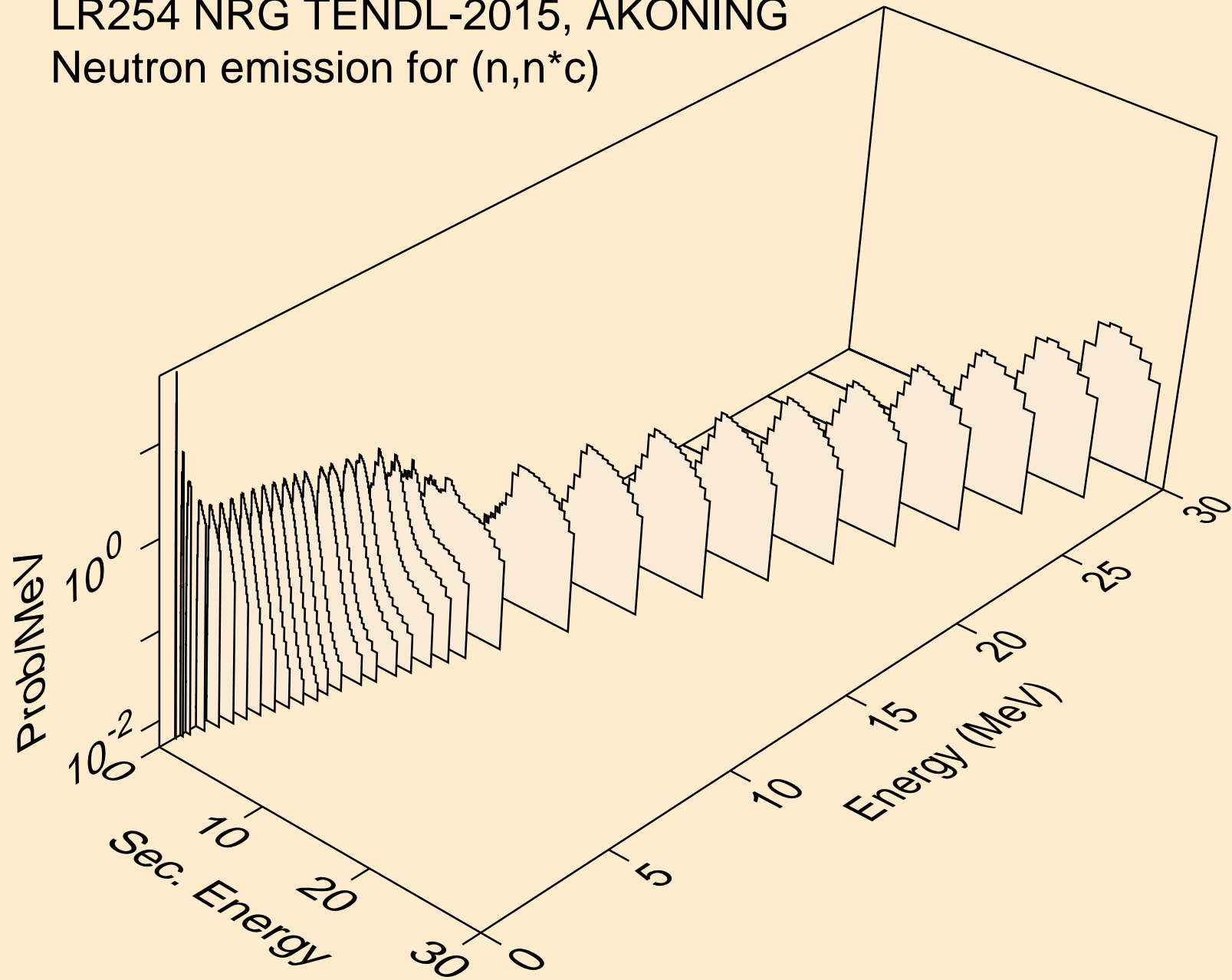

LR254 NRG TENDL-2015, AKONING

Delayed nubar

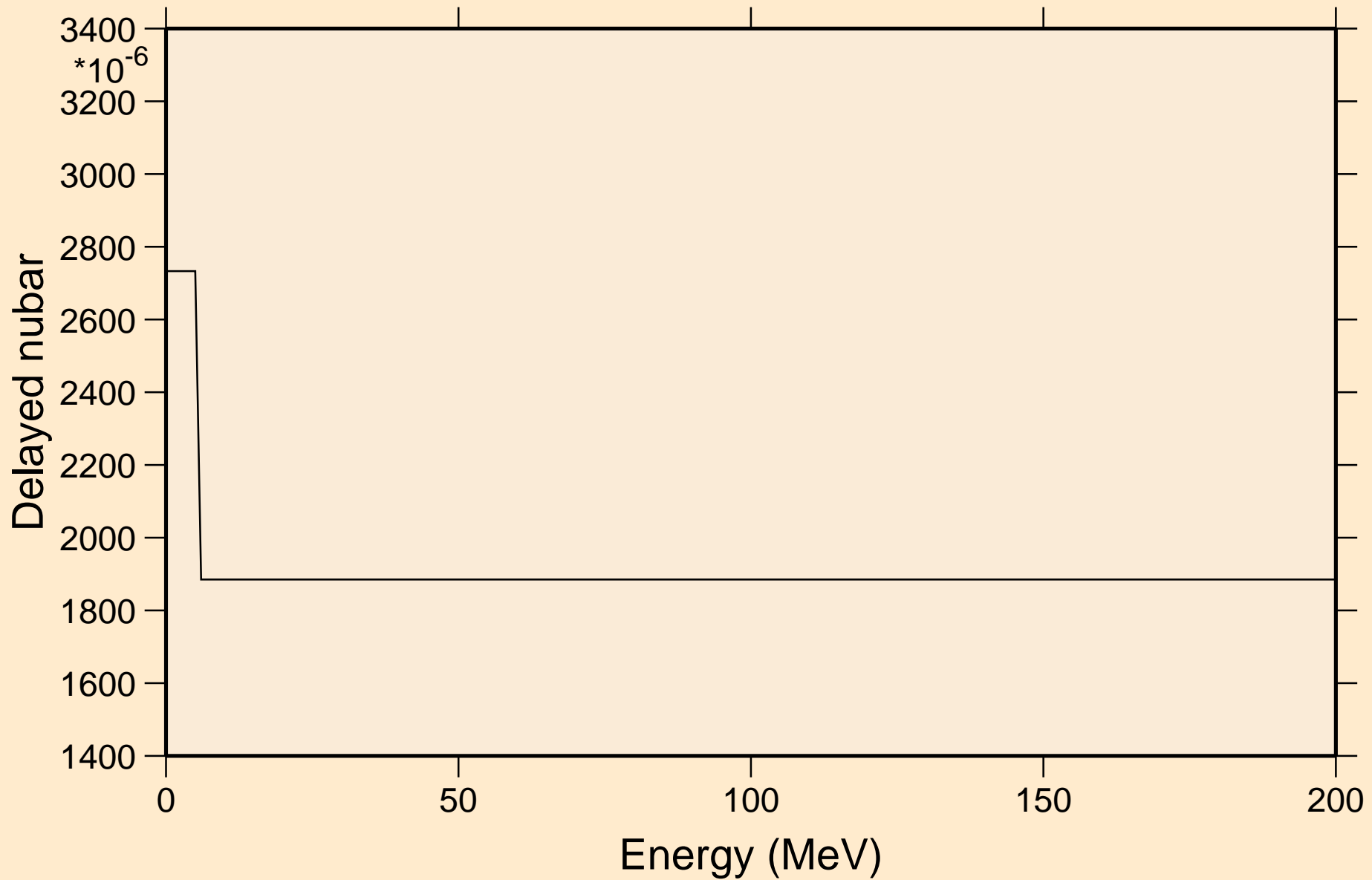

LR254 NRG TENDL-2015, AKONING

Delayed neutron spectra

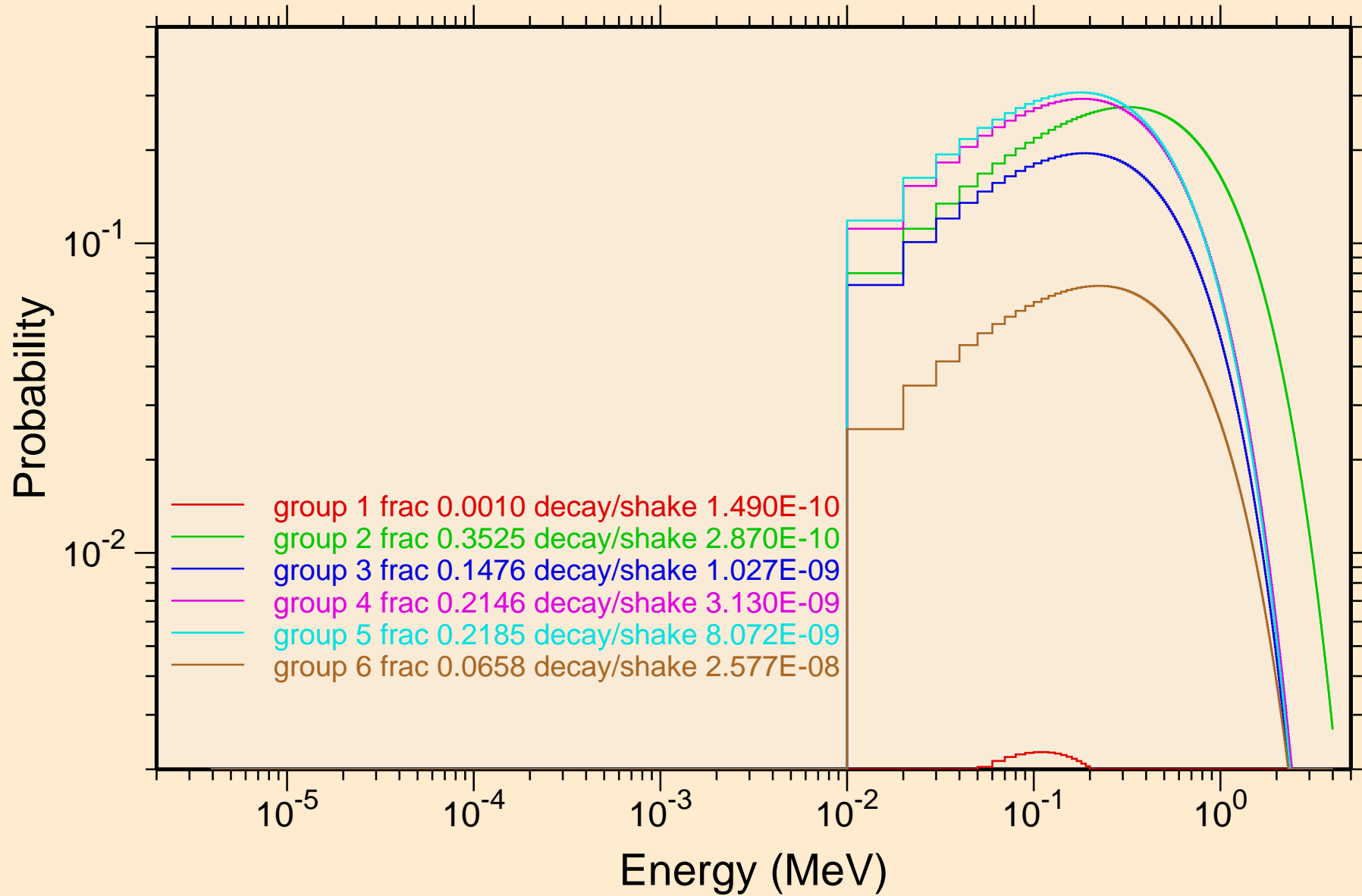

LR254 NRG TENDL-2015, AKONING
Photon emission for (n,x)

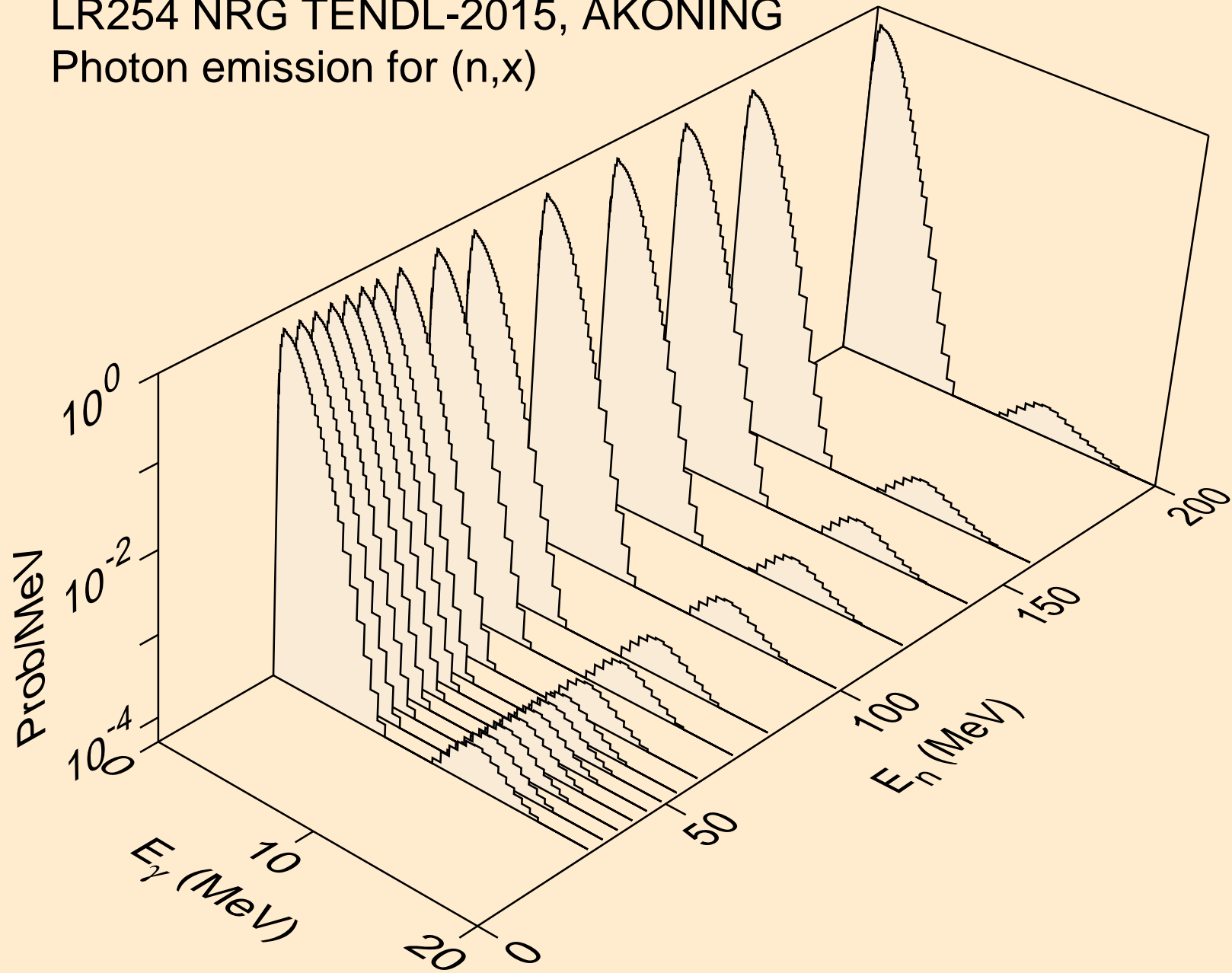

LR254 NRG TENDL-2015, AKONING
Photon emission for (n,2nd)

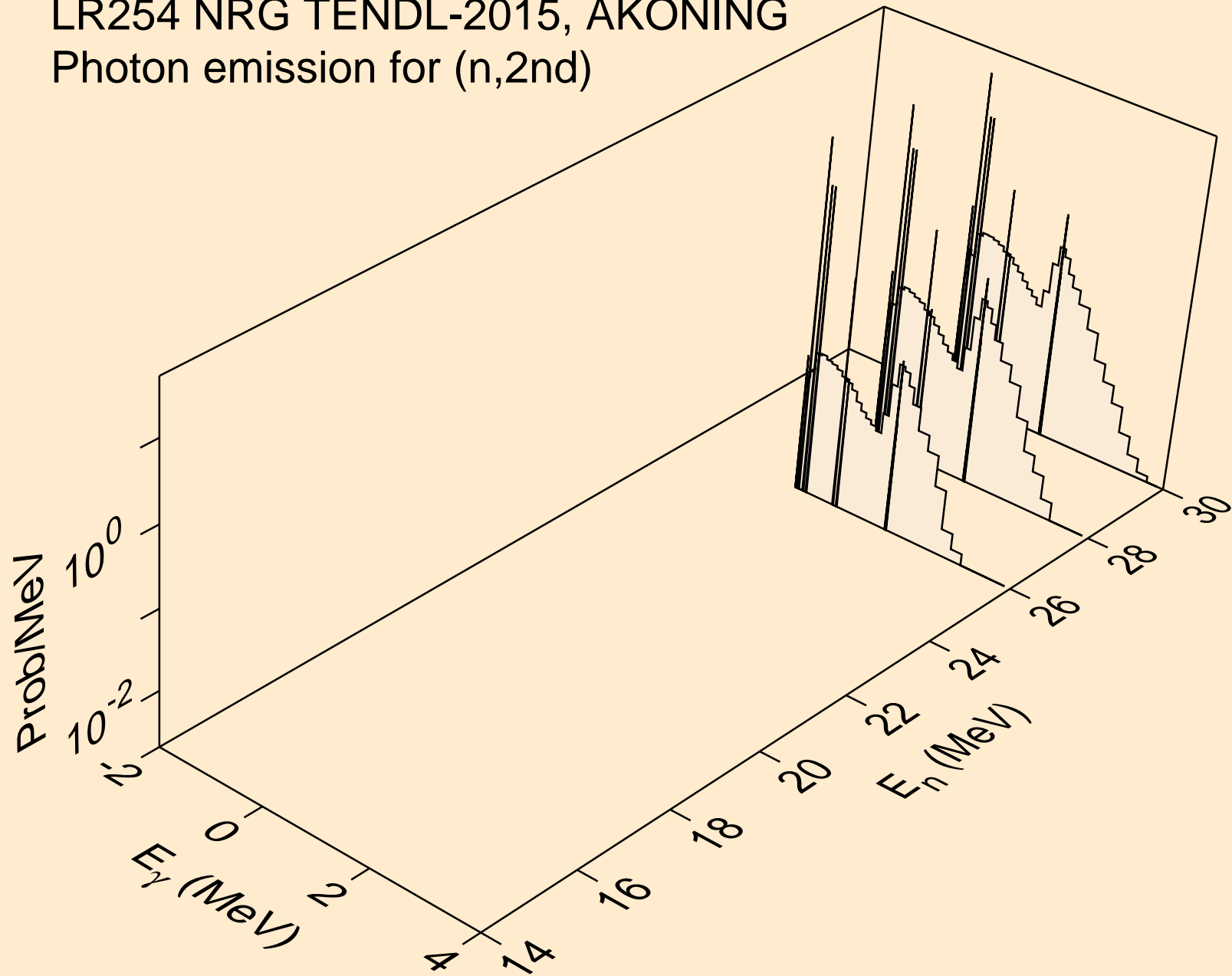

LR254 NRG TENDL-2015, AKONING
Photon emission for (n,2n)

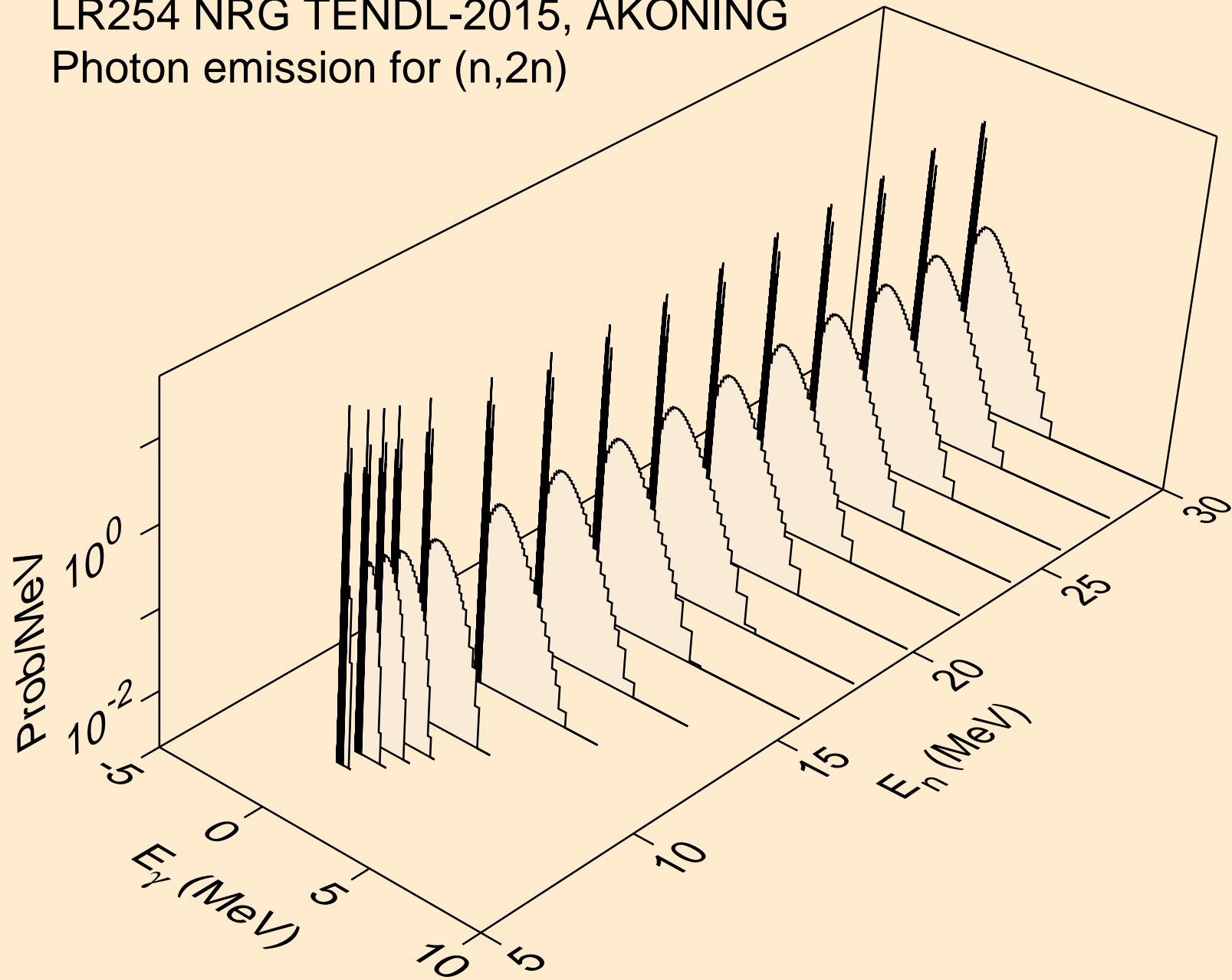

LR254 NRG TENDL-2015, AKONING
Photon emission for (n,3n)

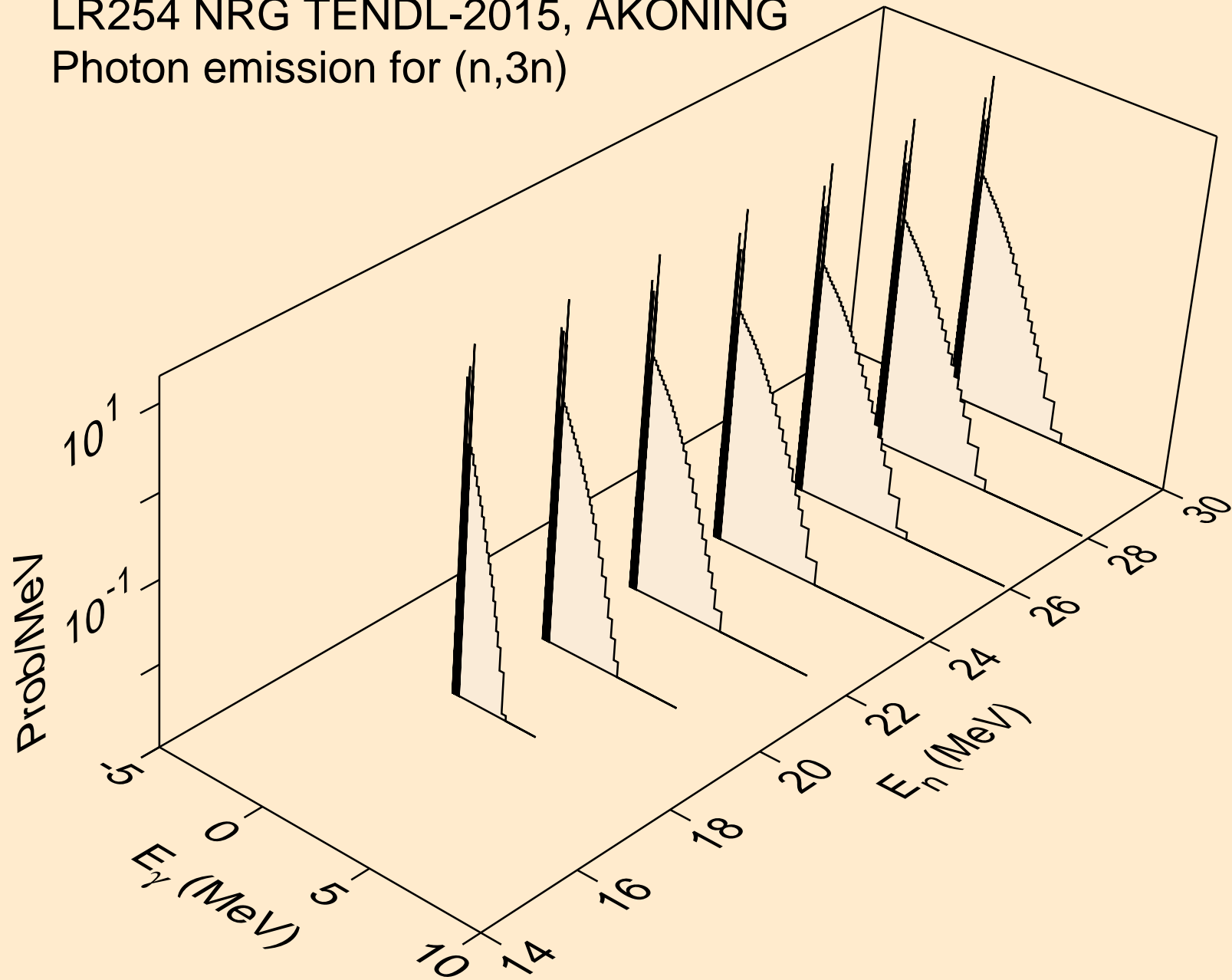

LR254 NRG TENDL-2015, AKONING
Photon emission for (n,n*)a

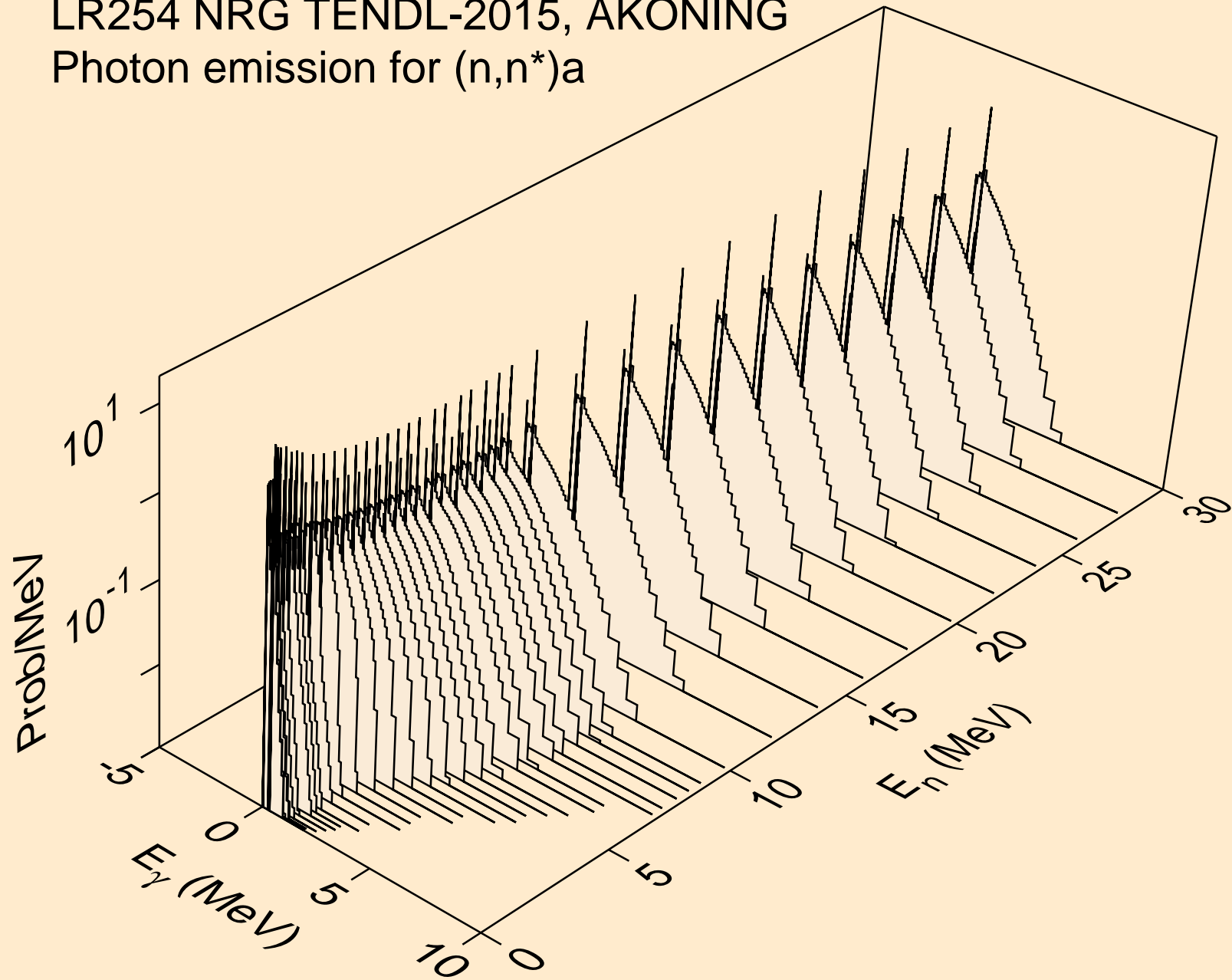

LR254 NRG TENDL-2015, AKONING
Photon emission for (n,n*)3a

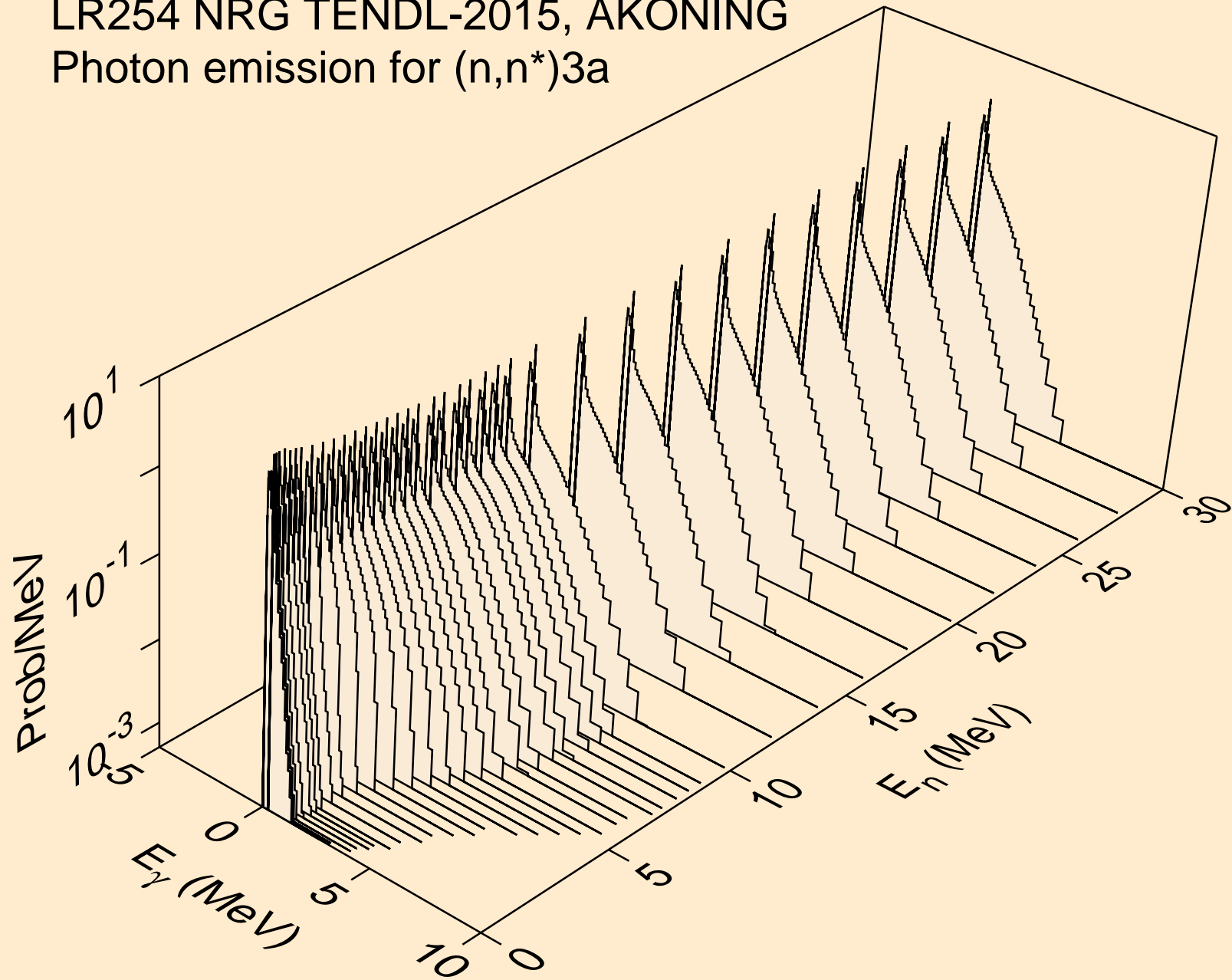

LR254 NRG TENDL-2015, AKONING
Photon emission for (n,2n)a

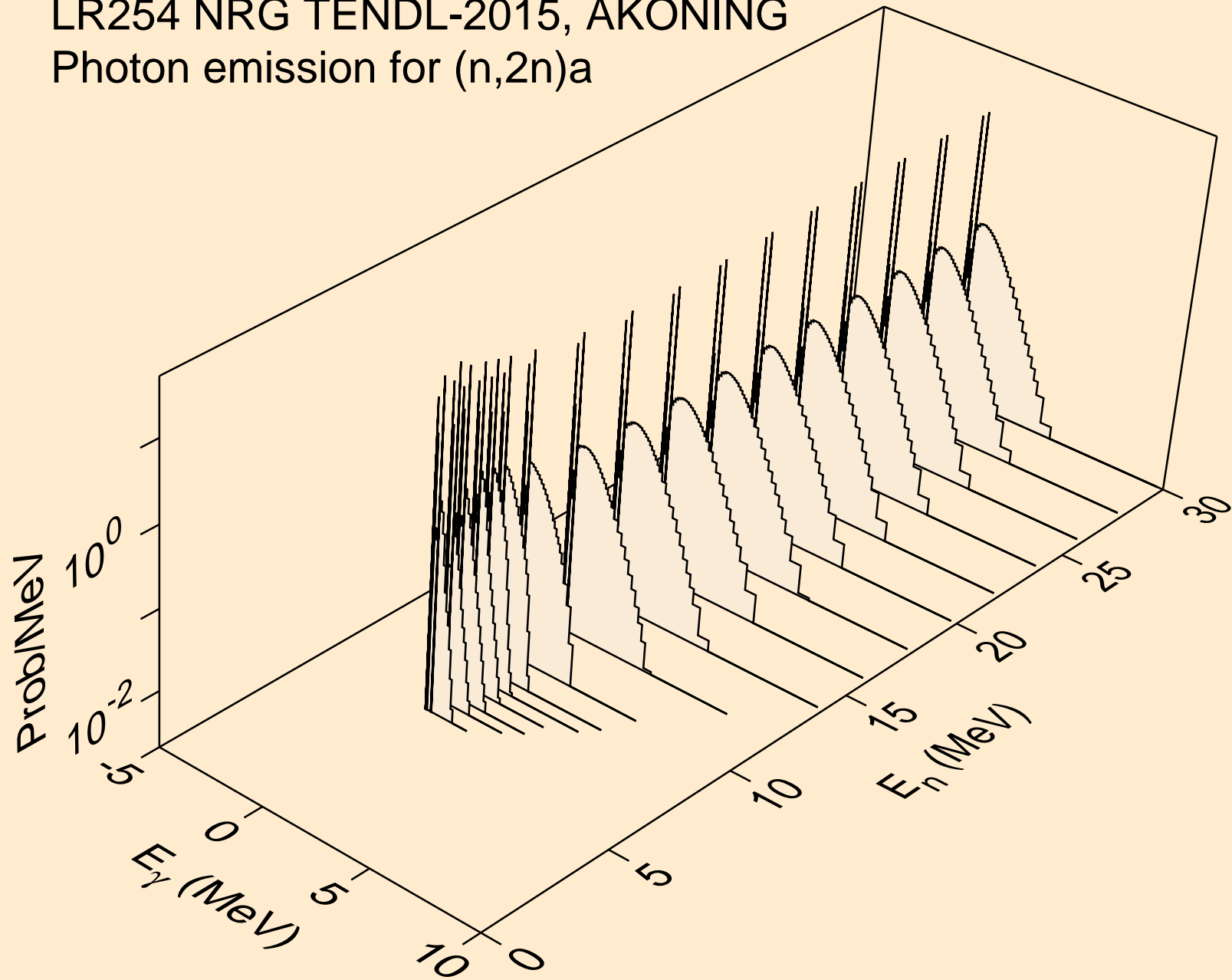

LR254 NRG TENDL-2015, AKONING
Photon emission for (n,3n)a

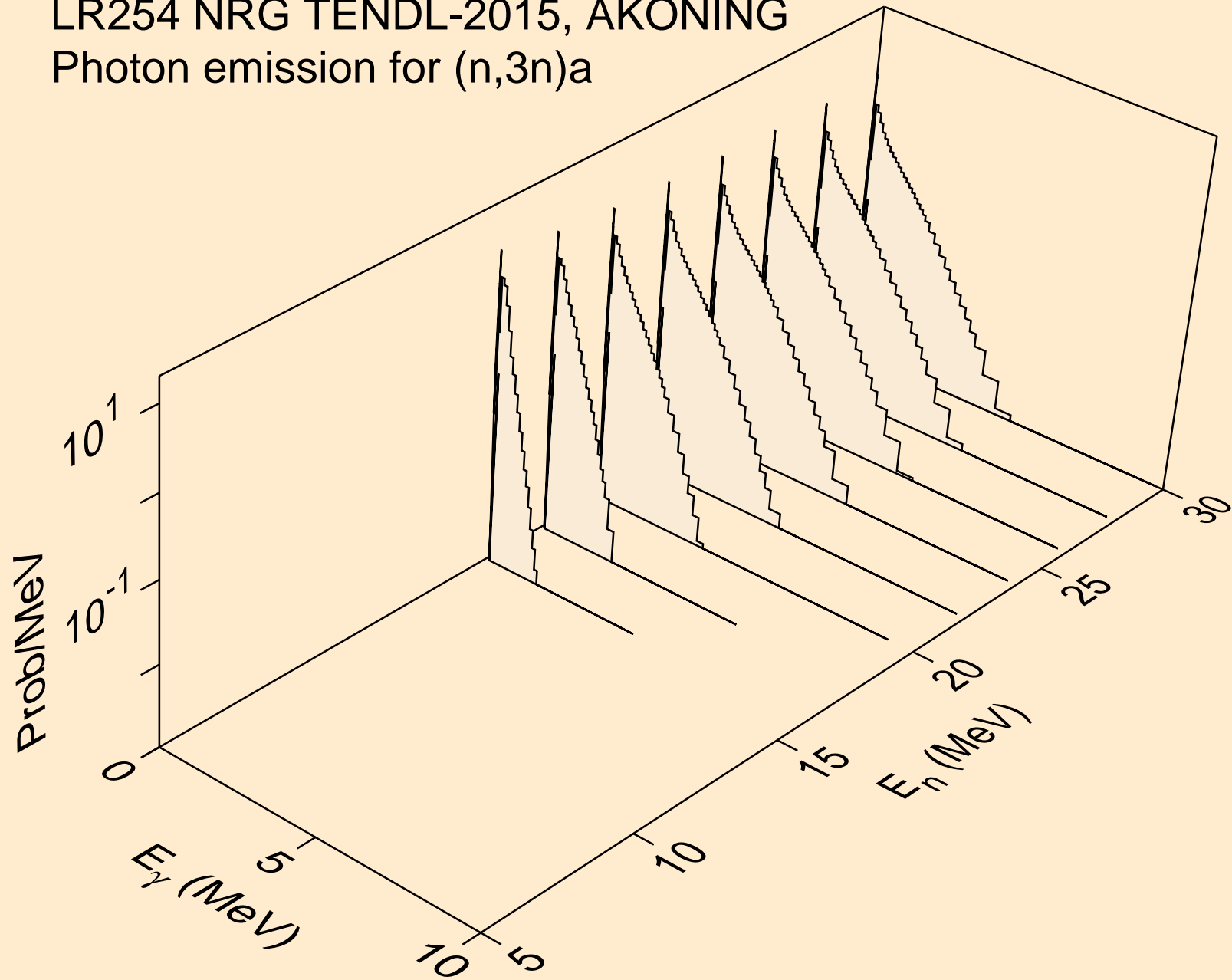

LR254 NRG TENDL-2015, AKONING
Photon emission for (n,n*)p

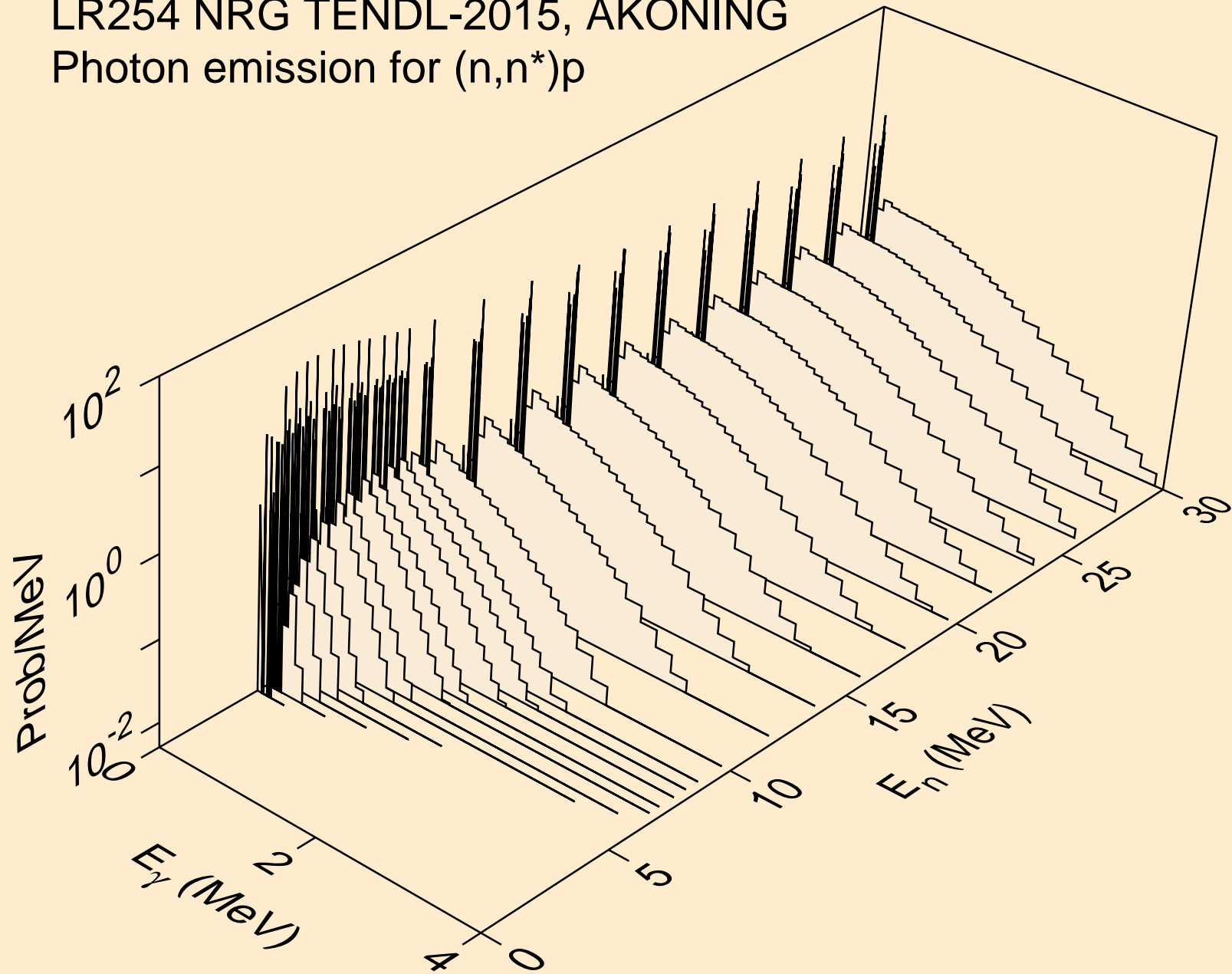

LR254 NRG TENDL-2015, AKONING
Photon emission for (n,n*)2a

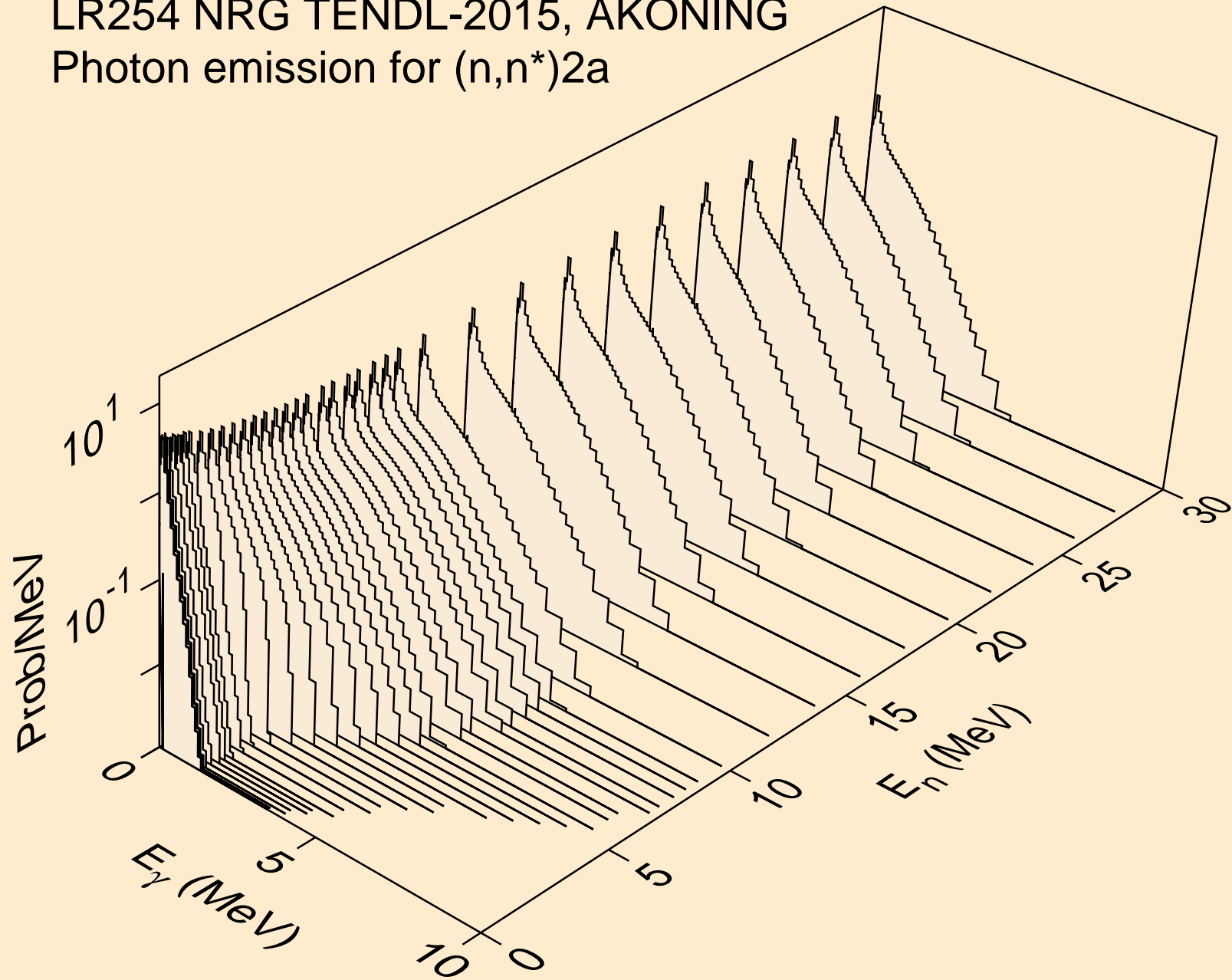

LR254 NRG TENDL-2015, AKONING
Photon emission for (n,2n)2a

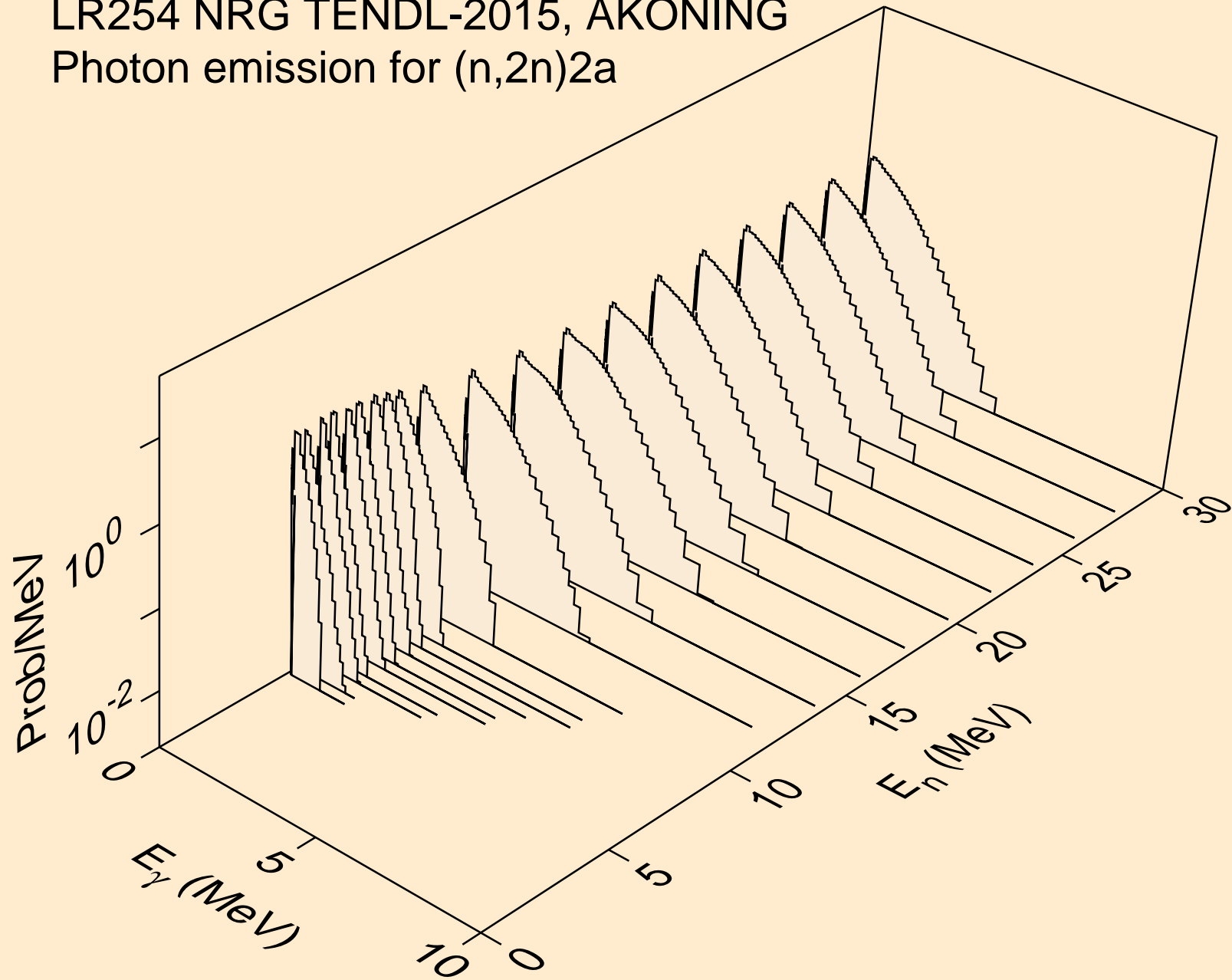

LR254 NRG TENDL-2015, AKONING
Photon emission for (n,n*)d

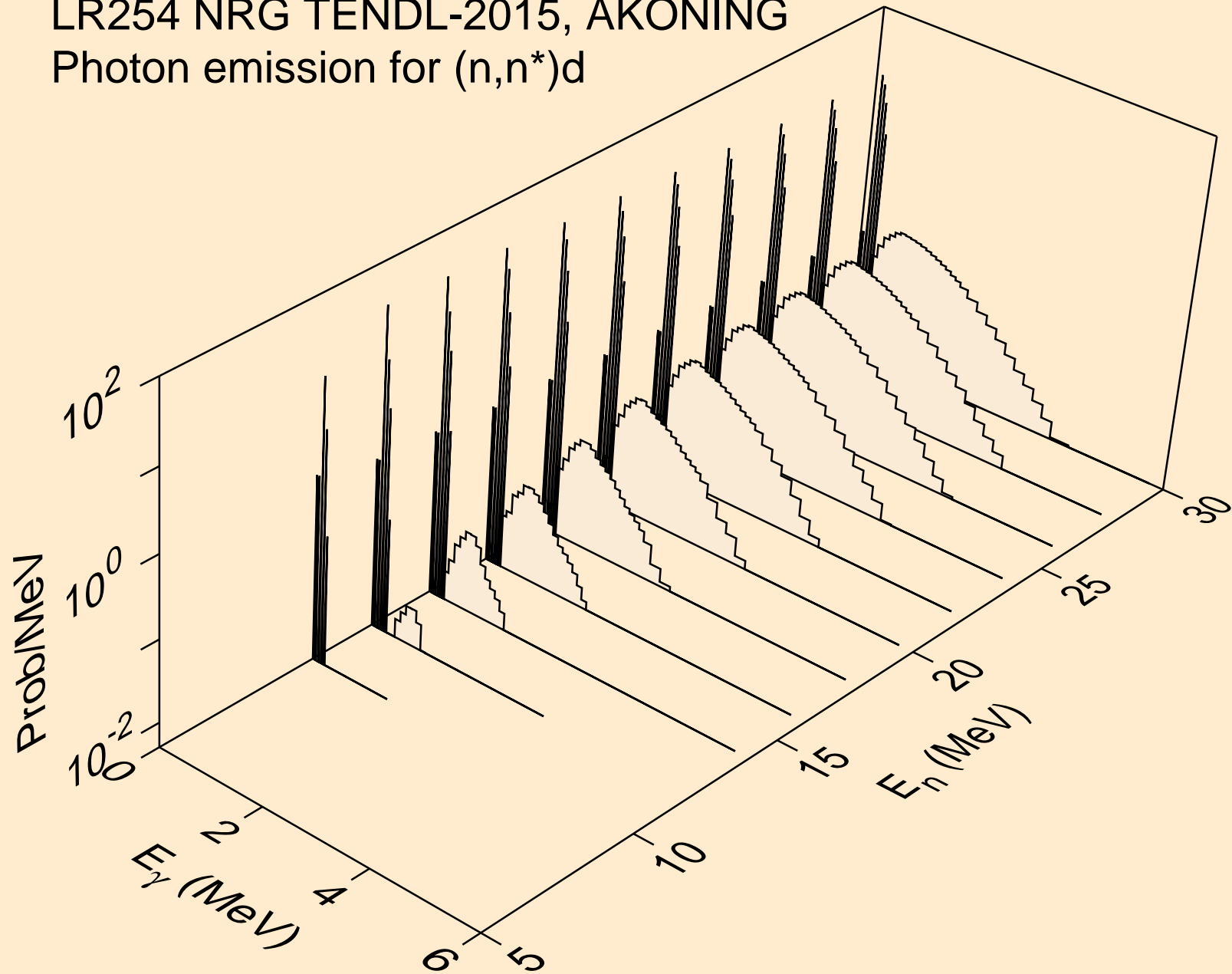

LR254 NRG TENDL-2015, AKONING
Photon emission for (n,n*)t

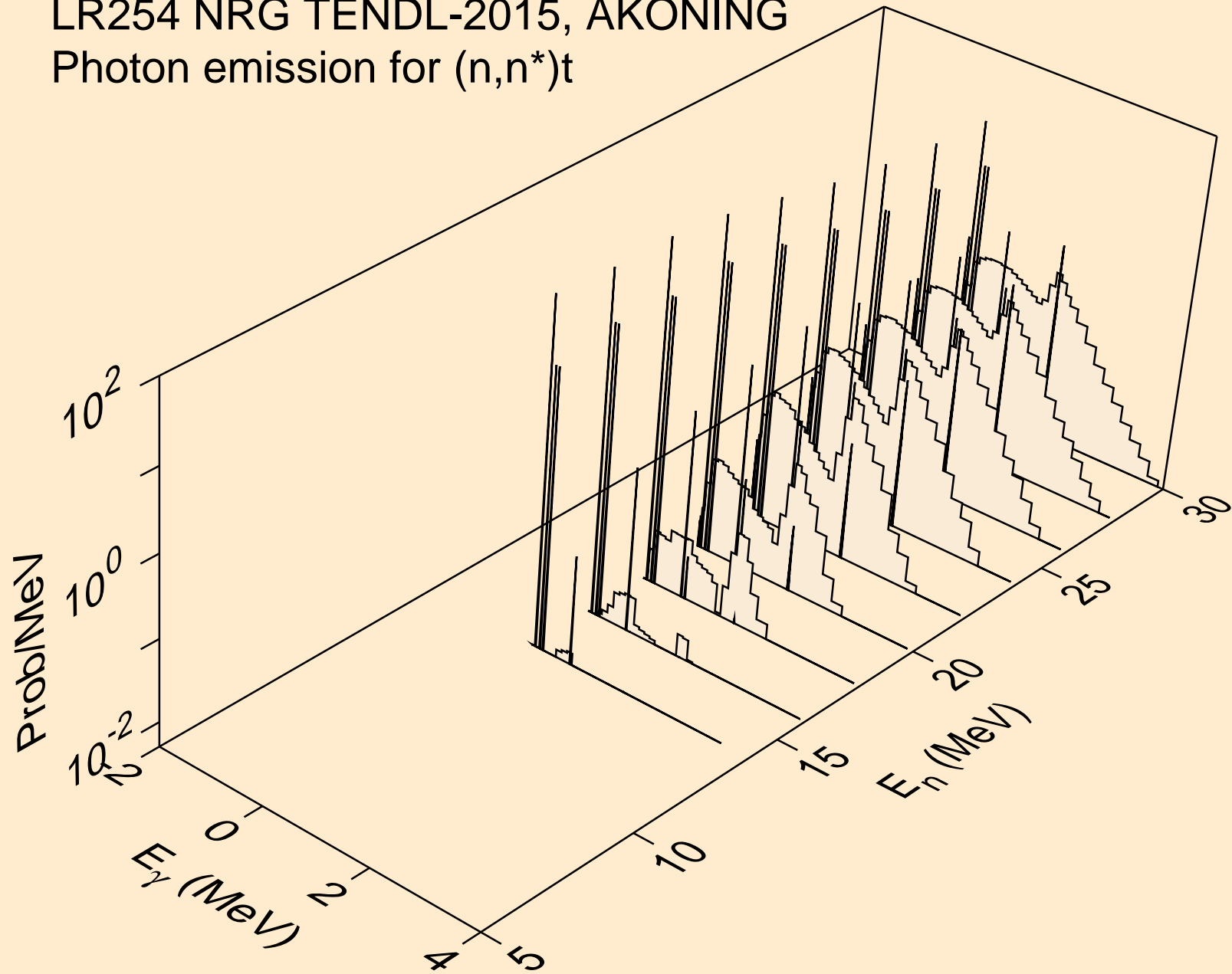

LR254 NRG TENDL-2015, AKONING
Photon emission for (n,n*)he3

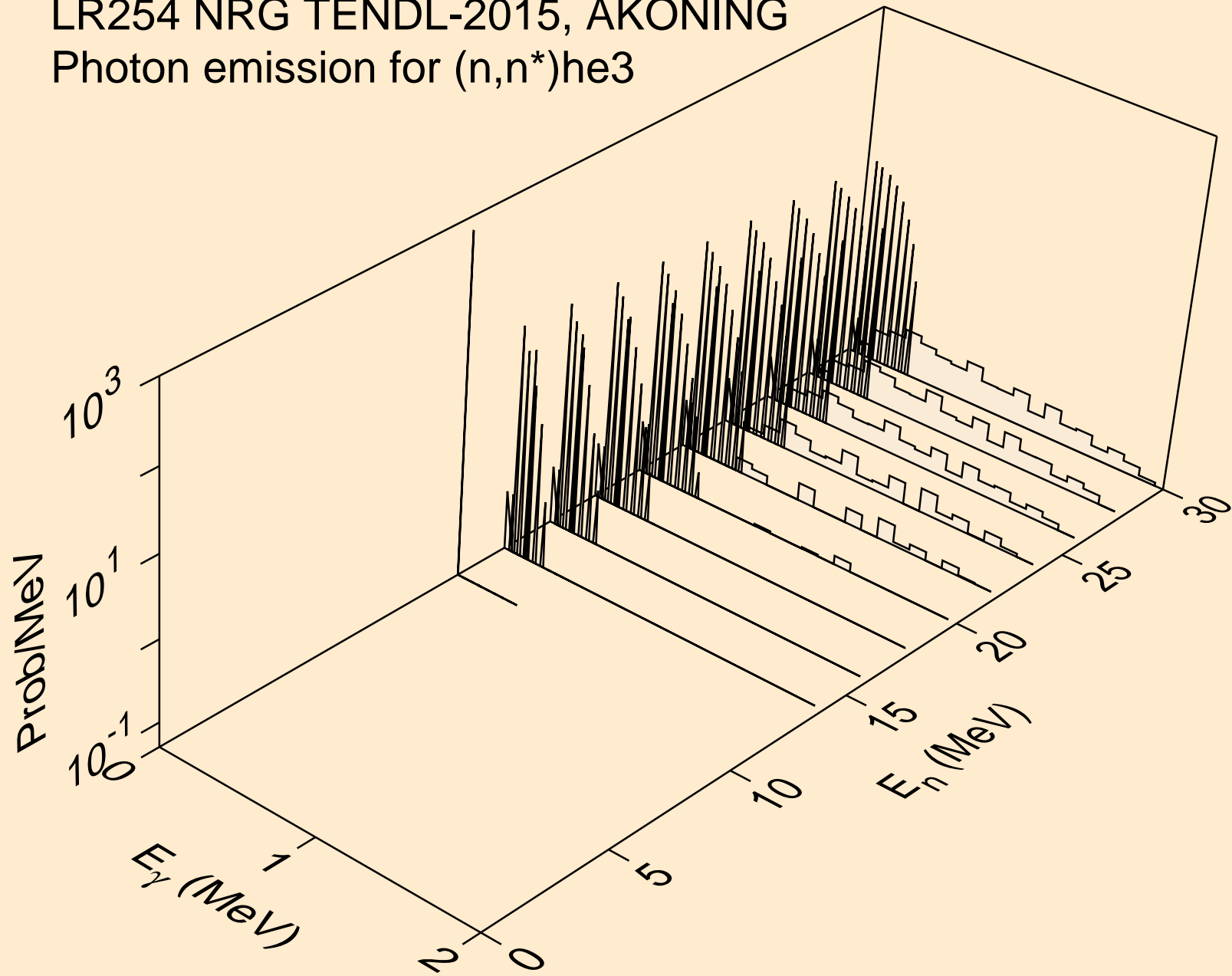

LR254 NRG TENDL-2015, AKONING
Photon emission for (n,n*)d2a

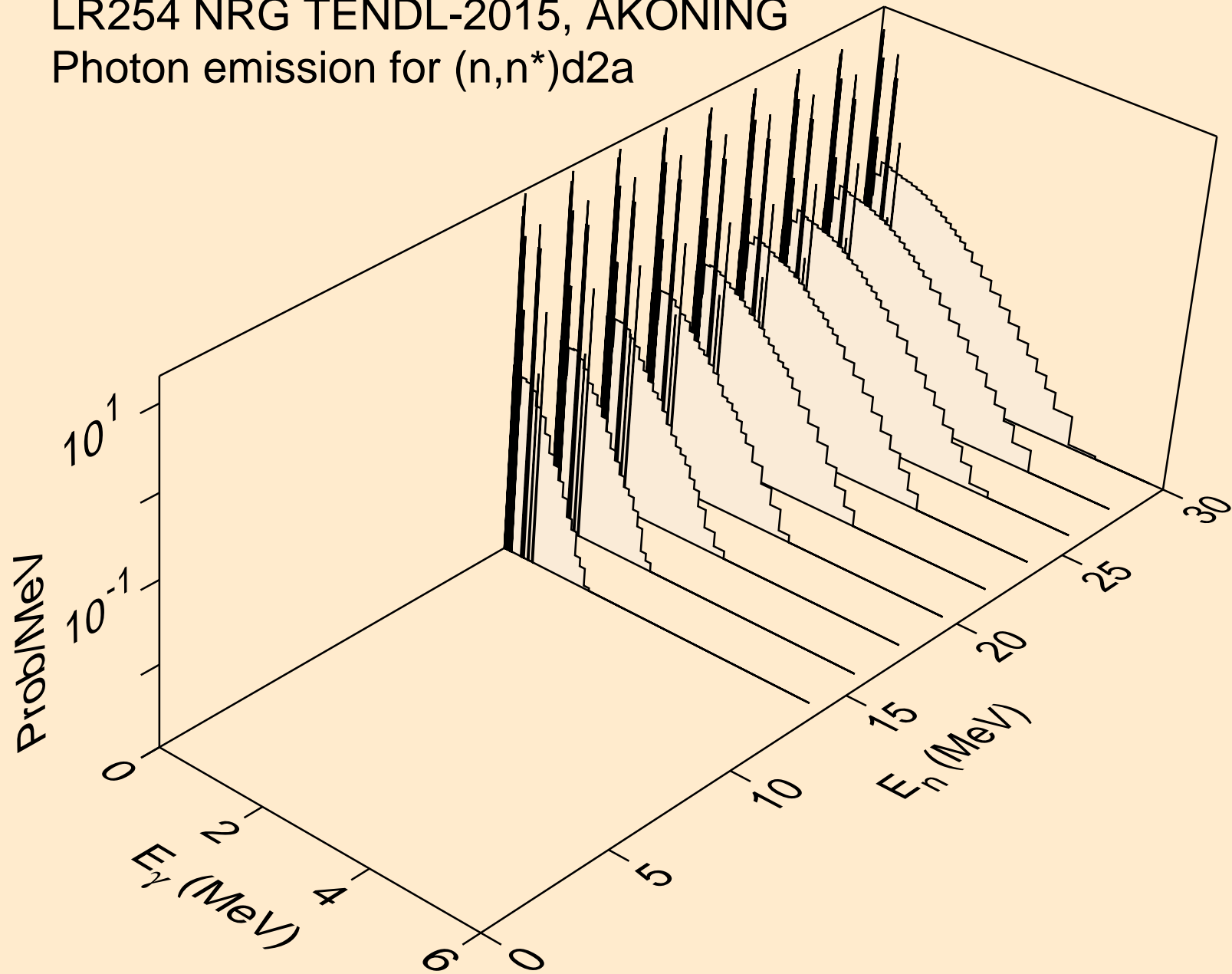

LR254 NRG TENDL-2015, AKONING
Photon emission for (n,n*)t2a

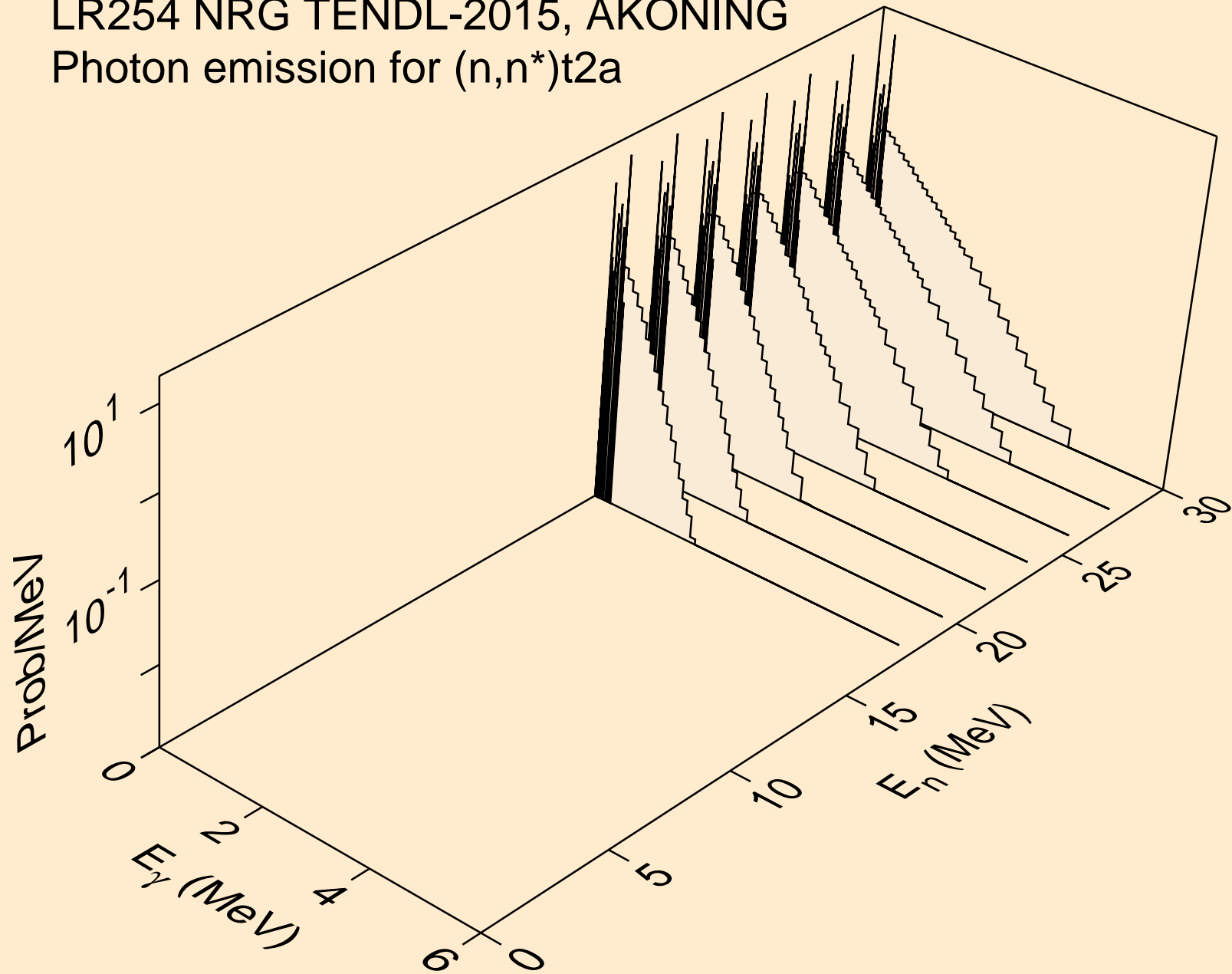

LR254 NRG TENDL-2015, AKONING
Photon emission for (n,4n)

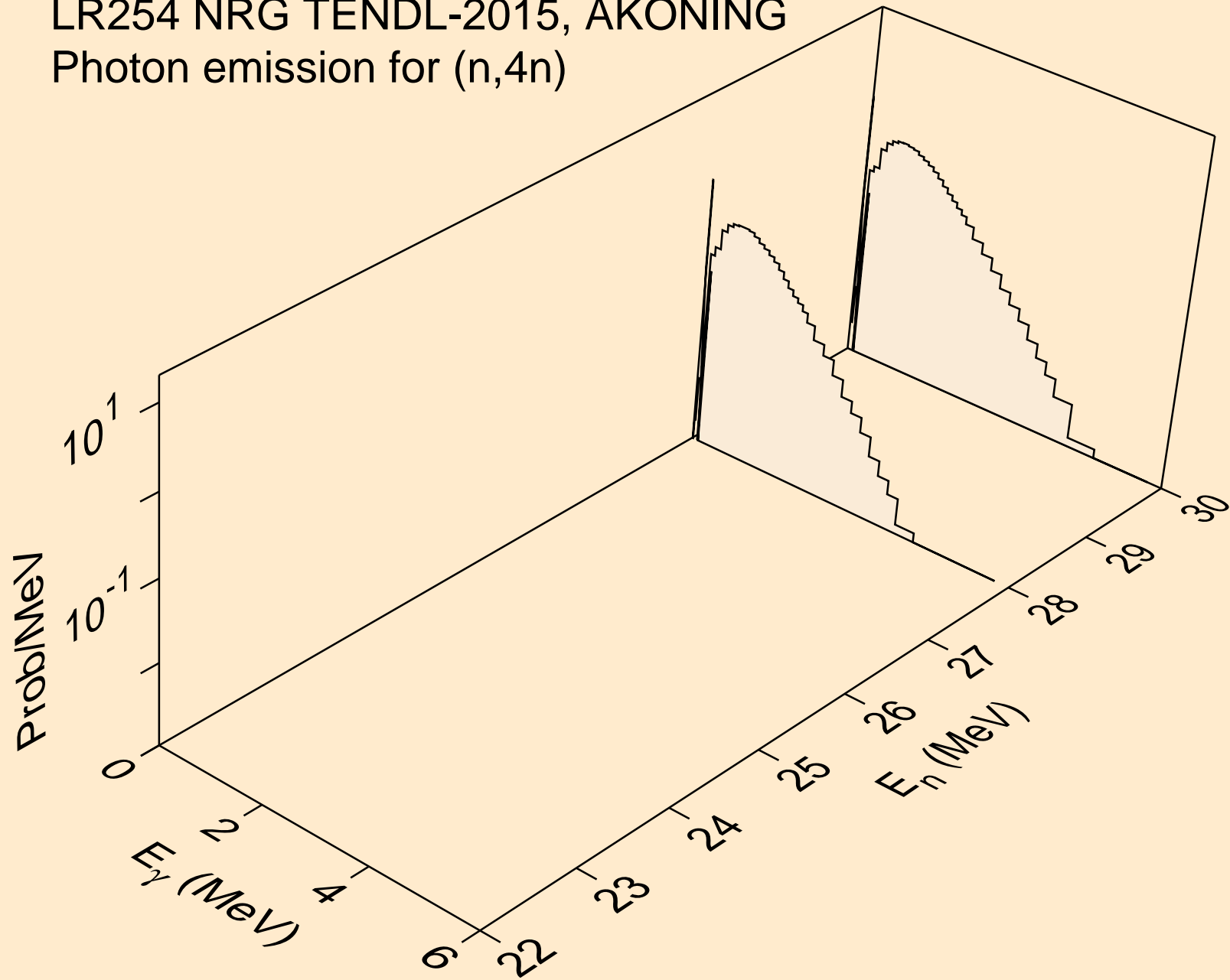

LR254 NRG TENDL-2015, AKONING
Photon emission for (n,2np)

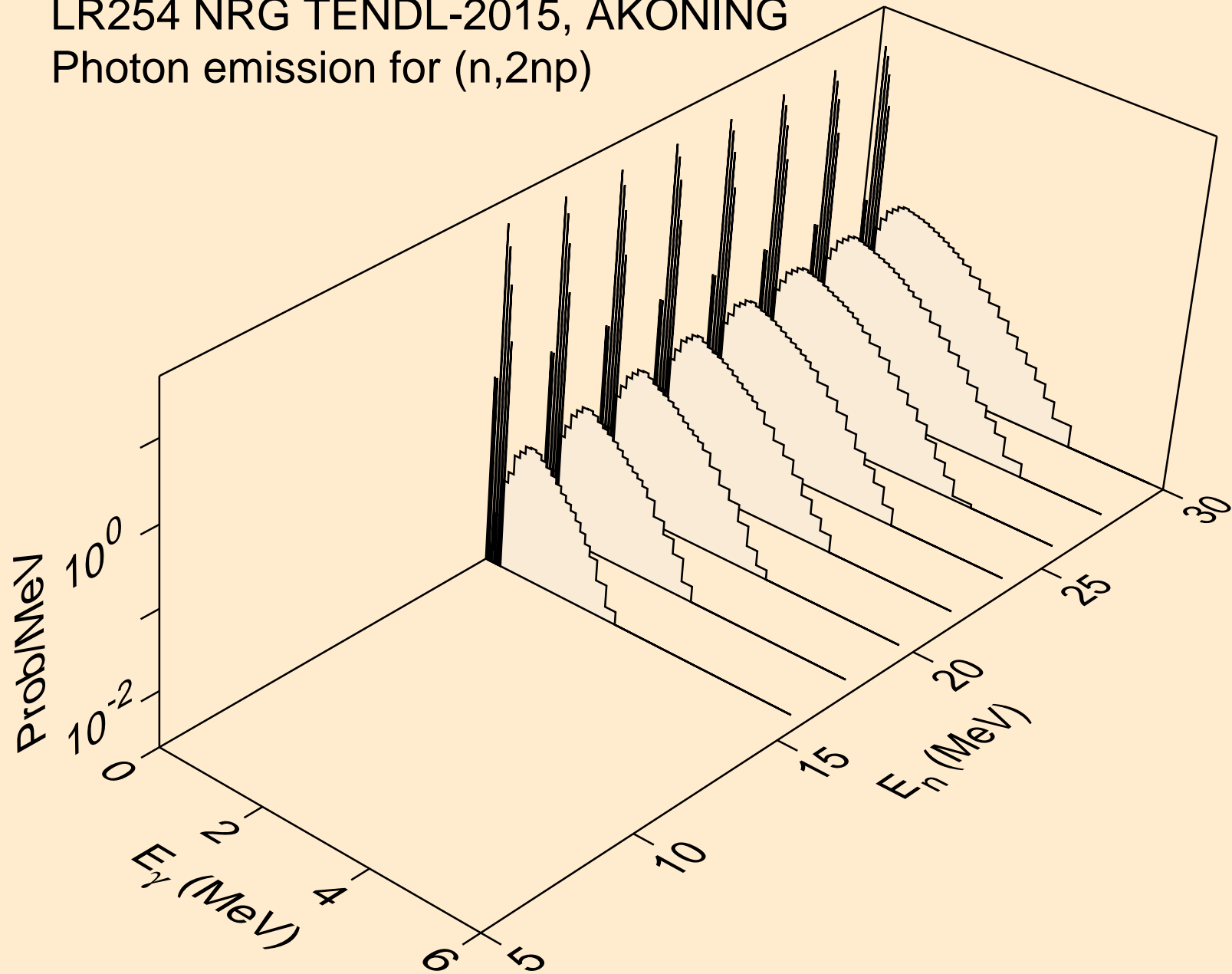

LR254 NRG TENDL-2015, AKONING
Photon emission for (n,3np)

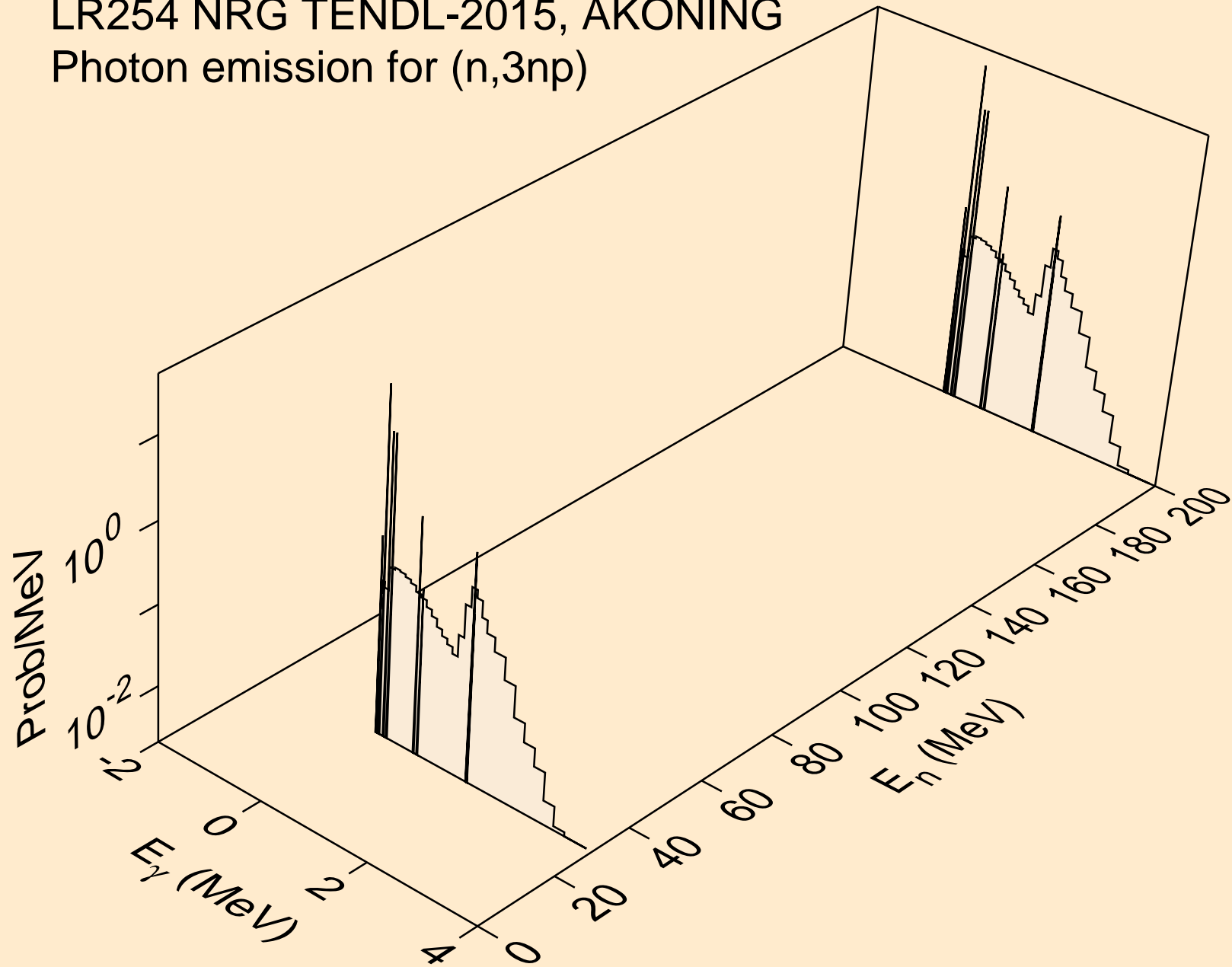

LR254 NRG TENDL-2015, AKONING
Photon emission for (n,2np)

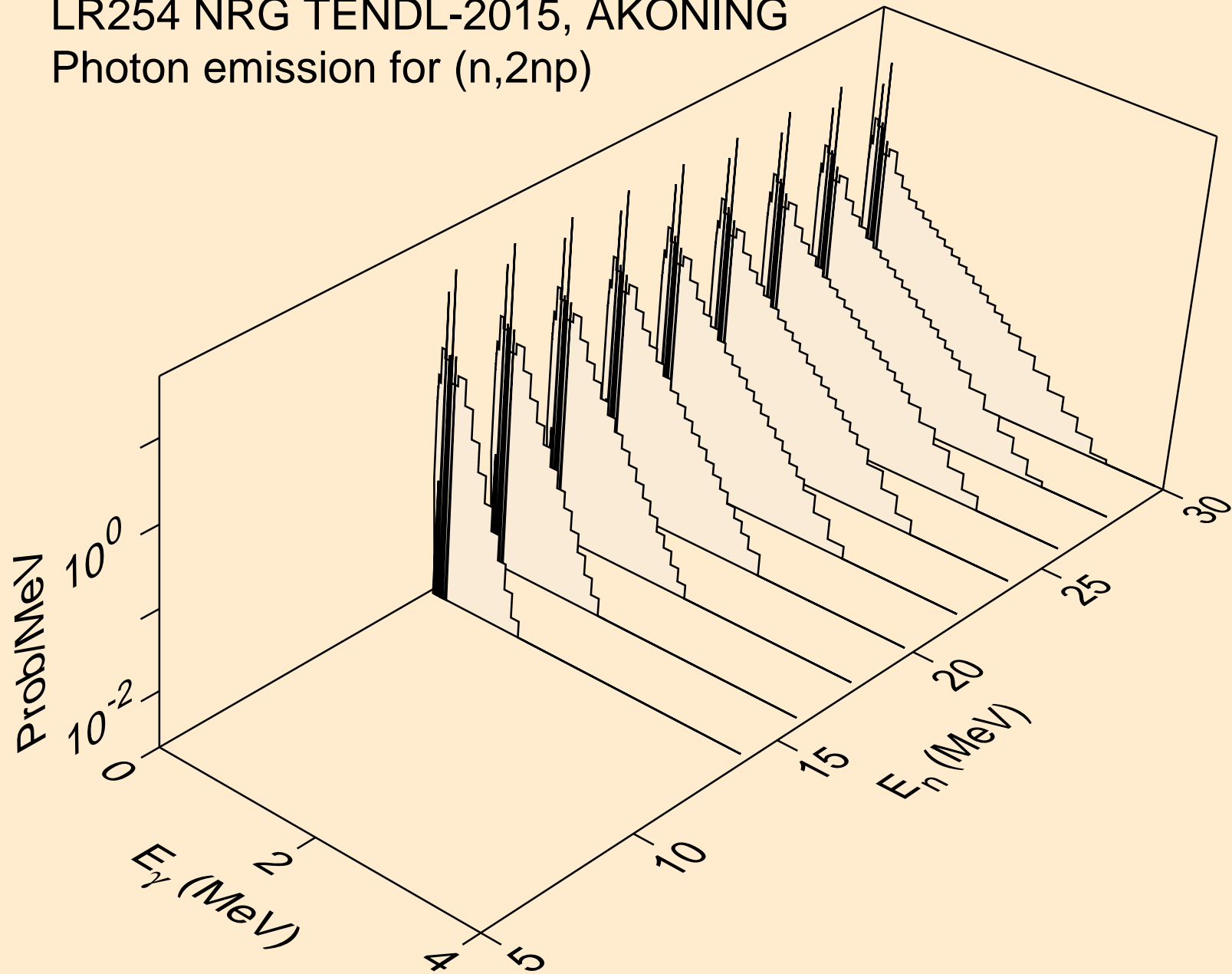

LR254 NRG TENDL-2015, AKONING
Photon emission for (n,npa)

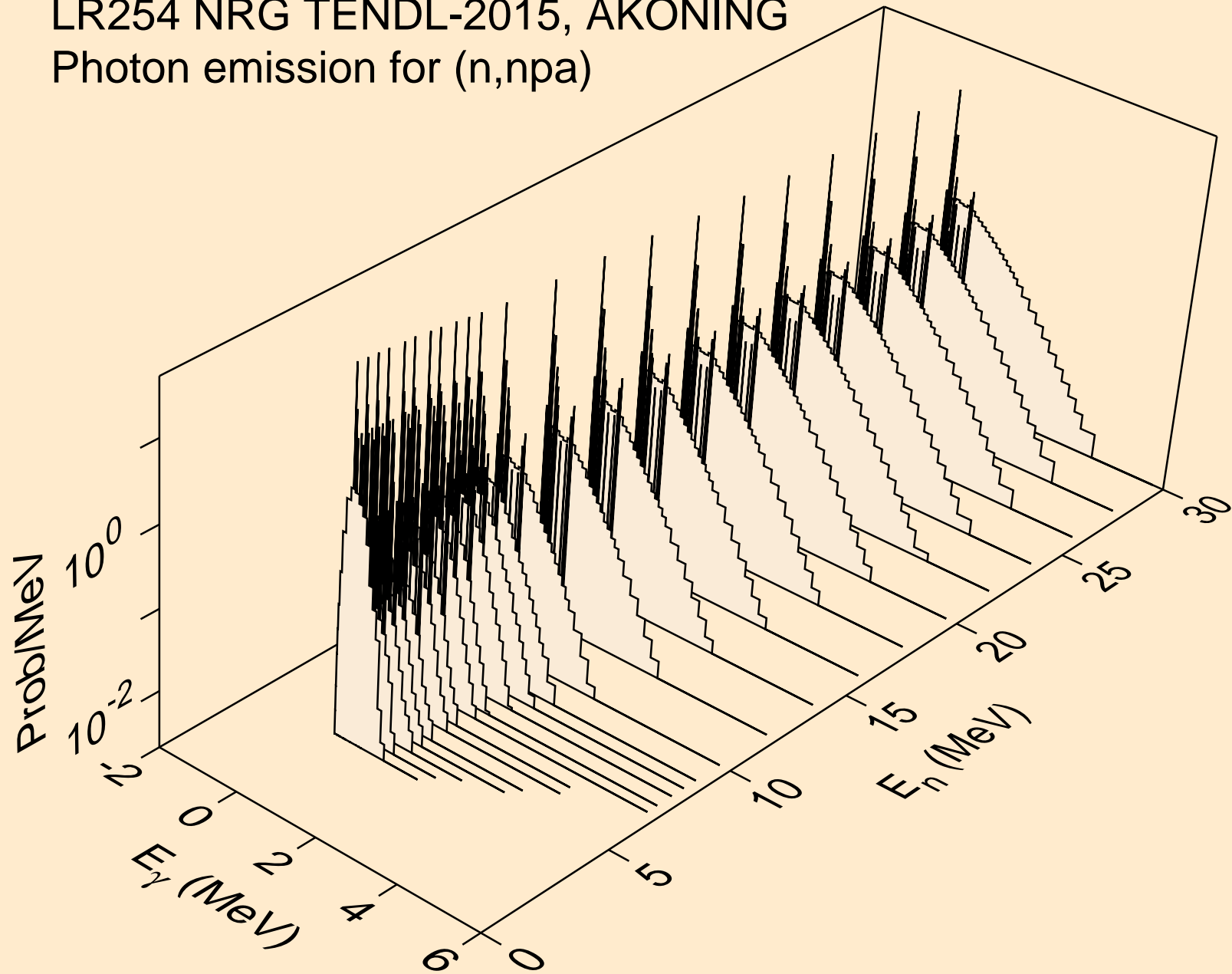

LR254 NRG TENDL-2015, AKONING
Photon emission for (n,n*c)

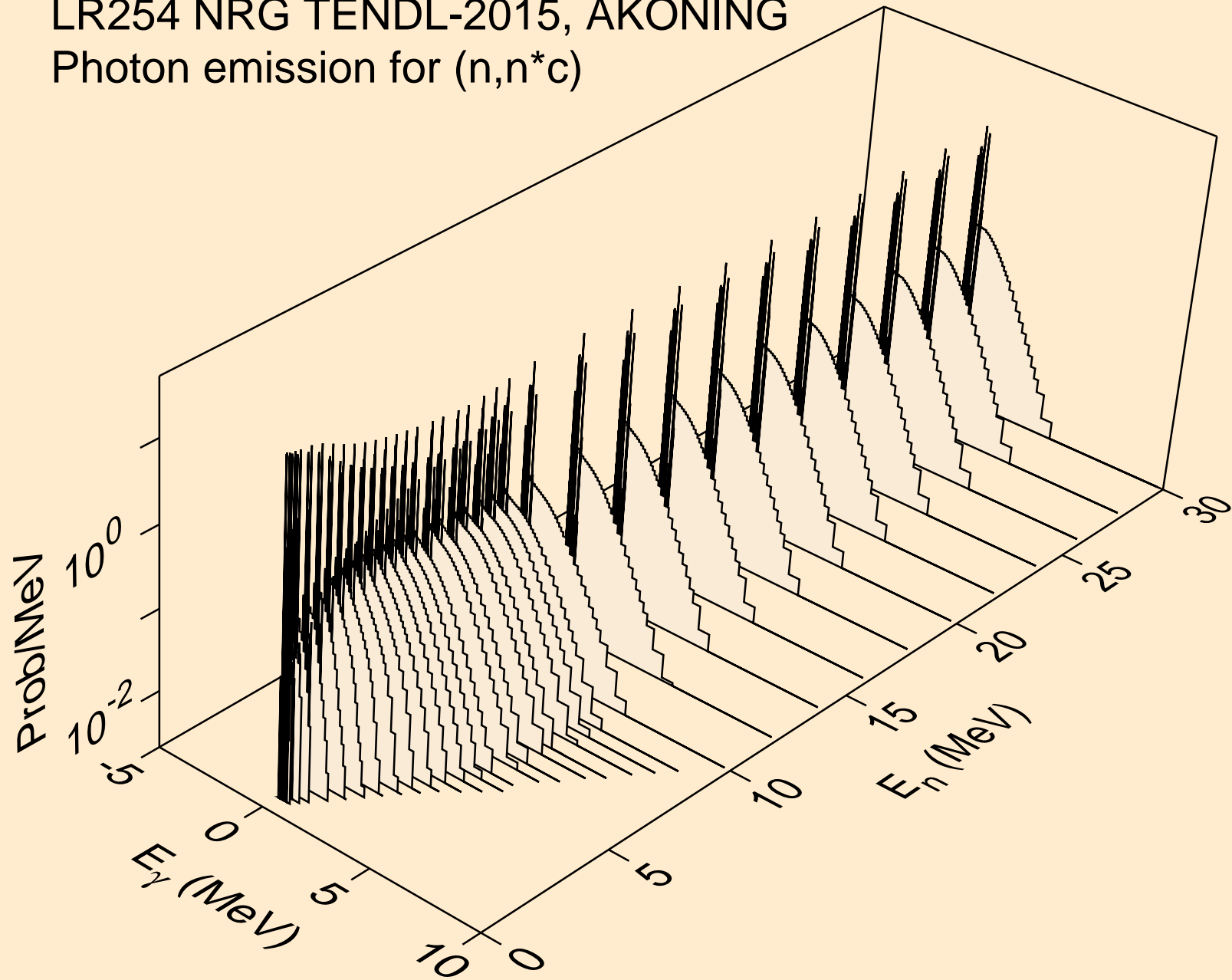

LR254 NRG TENDL-2015, AKONING
Photon emission for (n,gma)

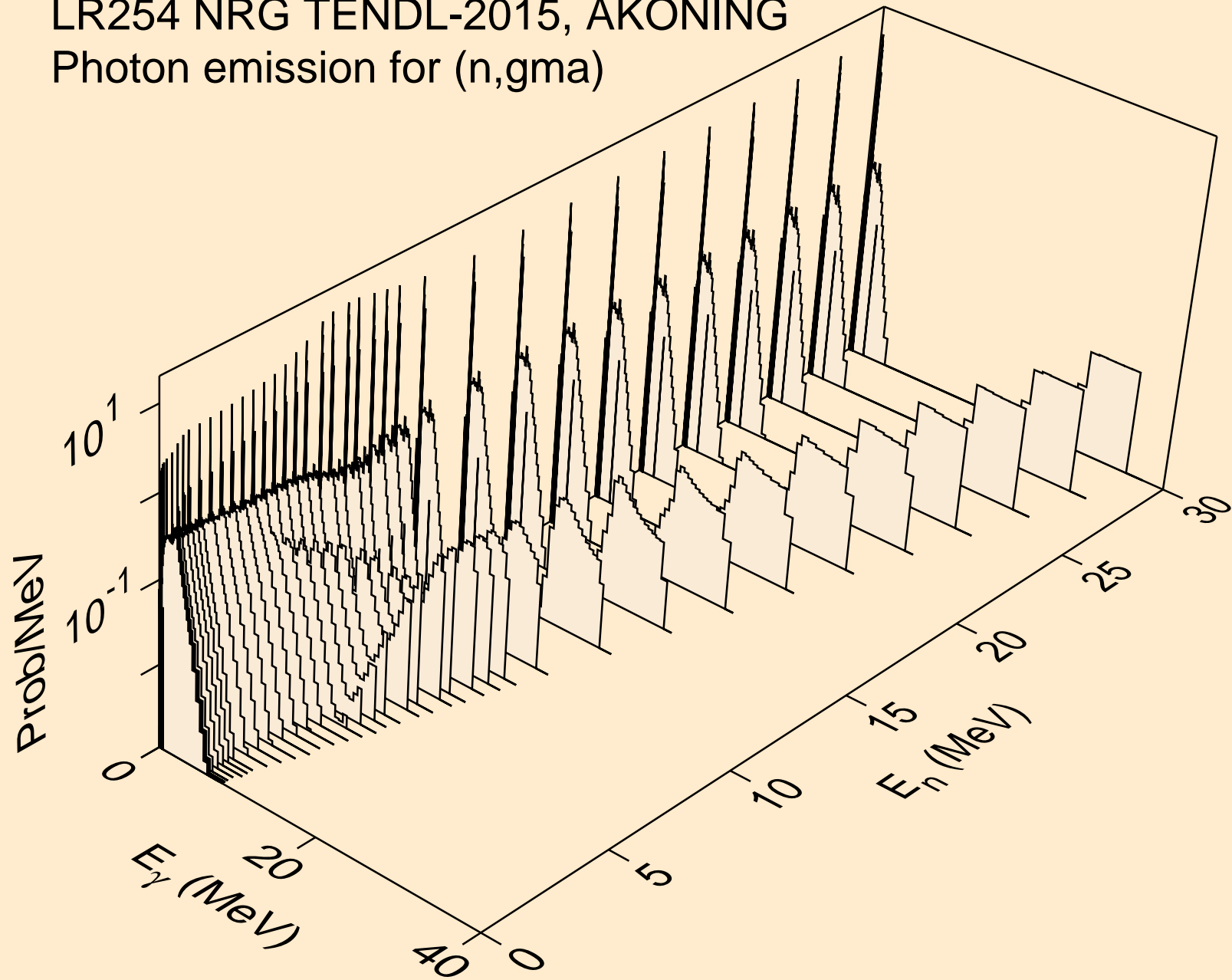

LR254 NRG TENDL-2015, AKONING
Photon emission for (n,p)

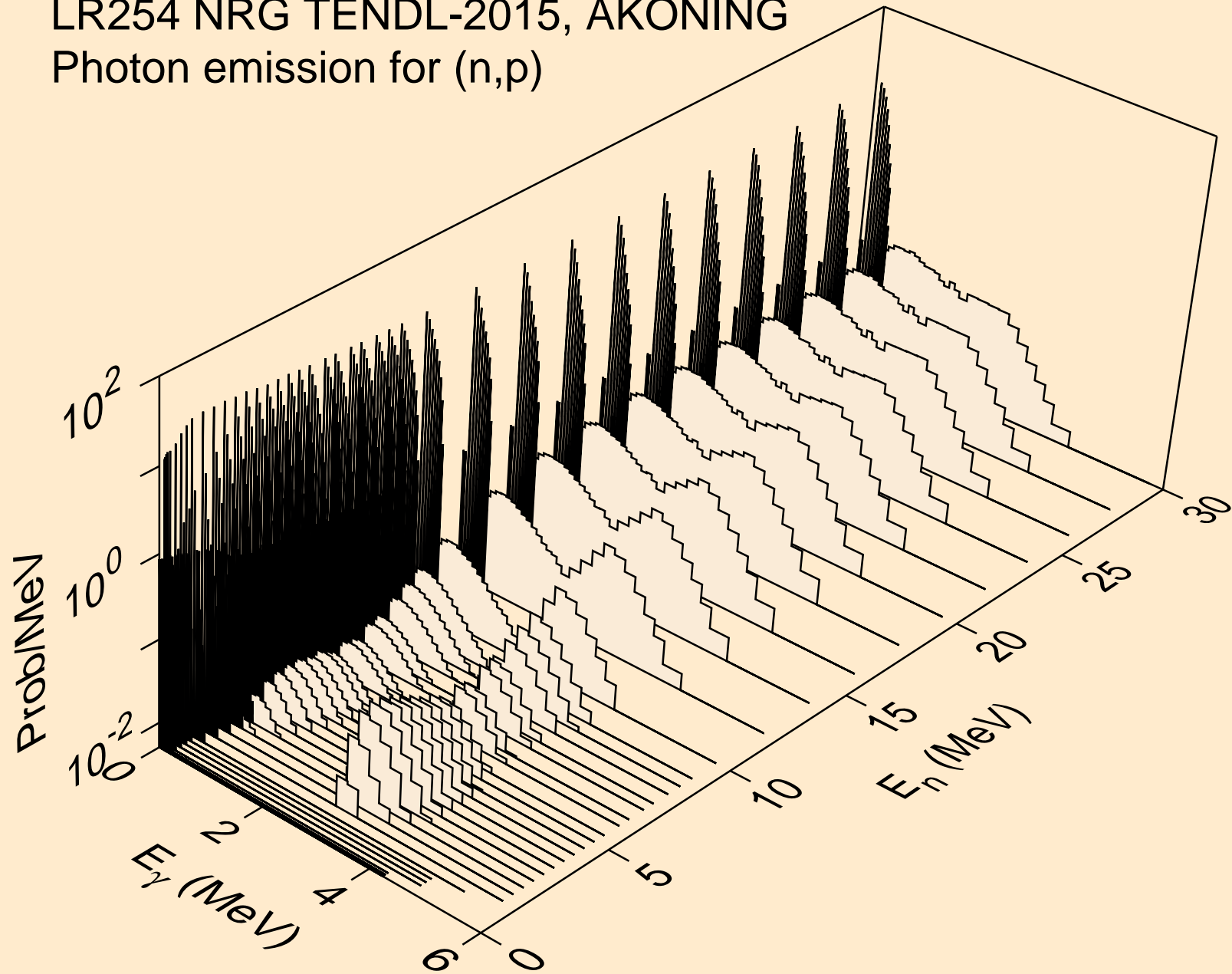

LR254 NRG TENDL-2015, AKONING
Photon emission for (n,d)

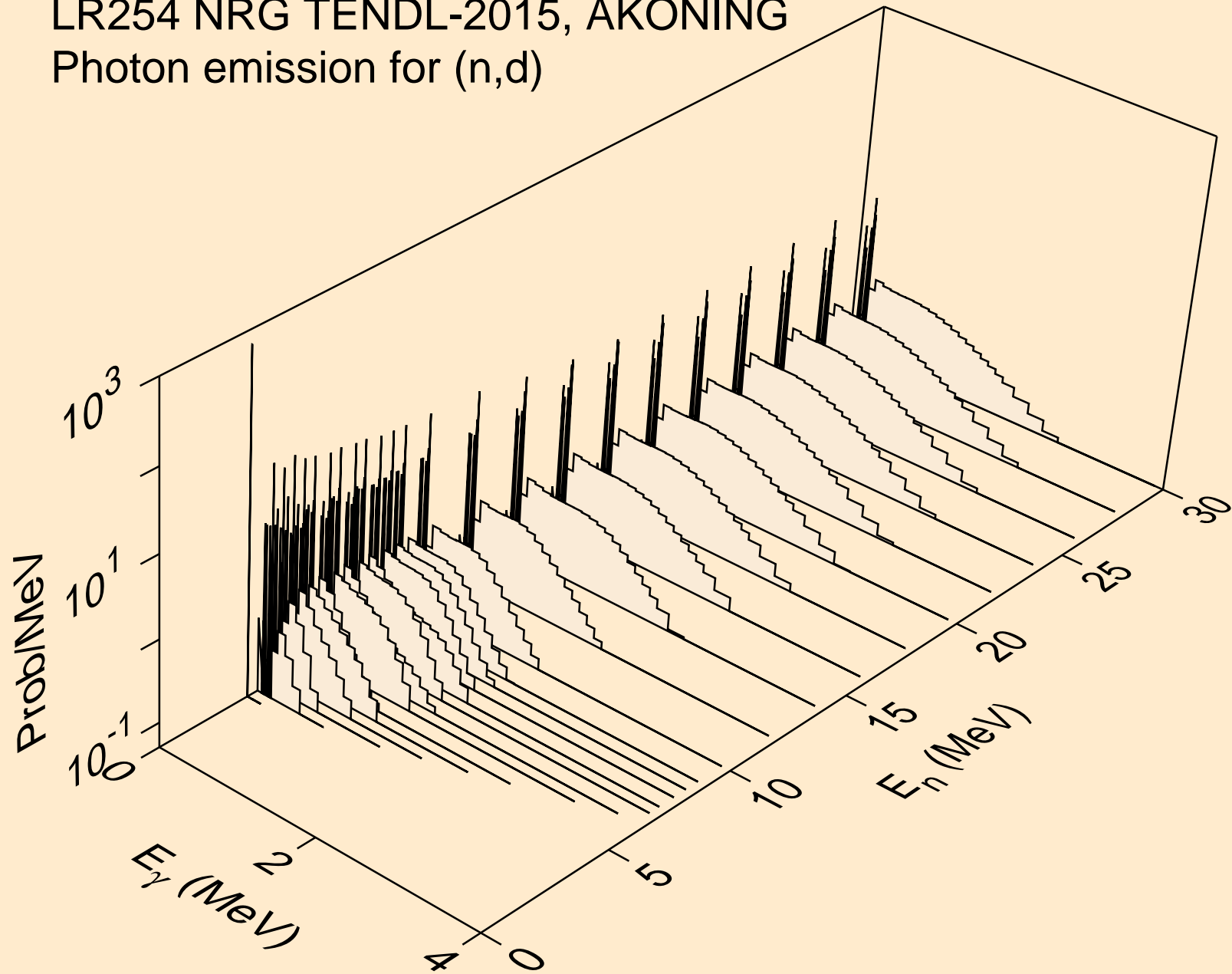

LR254 NRG TENDL-2015, AKONING
Photon emission for (n,t)

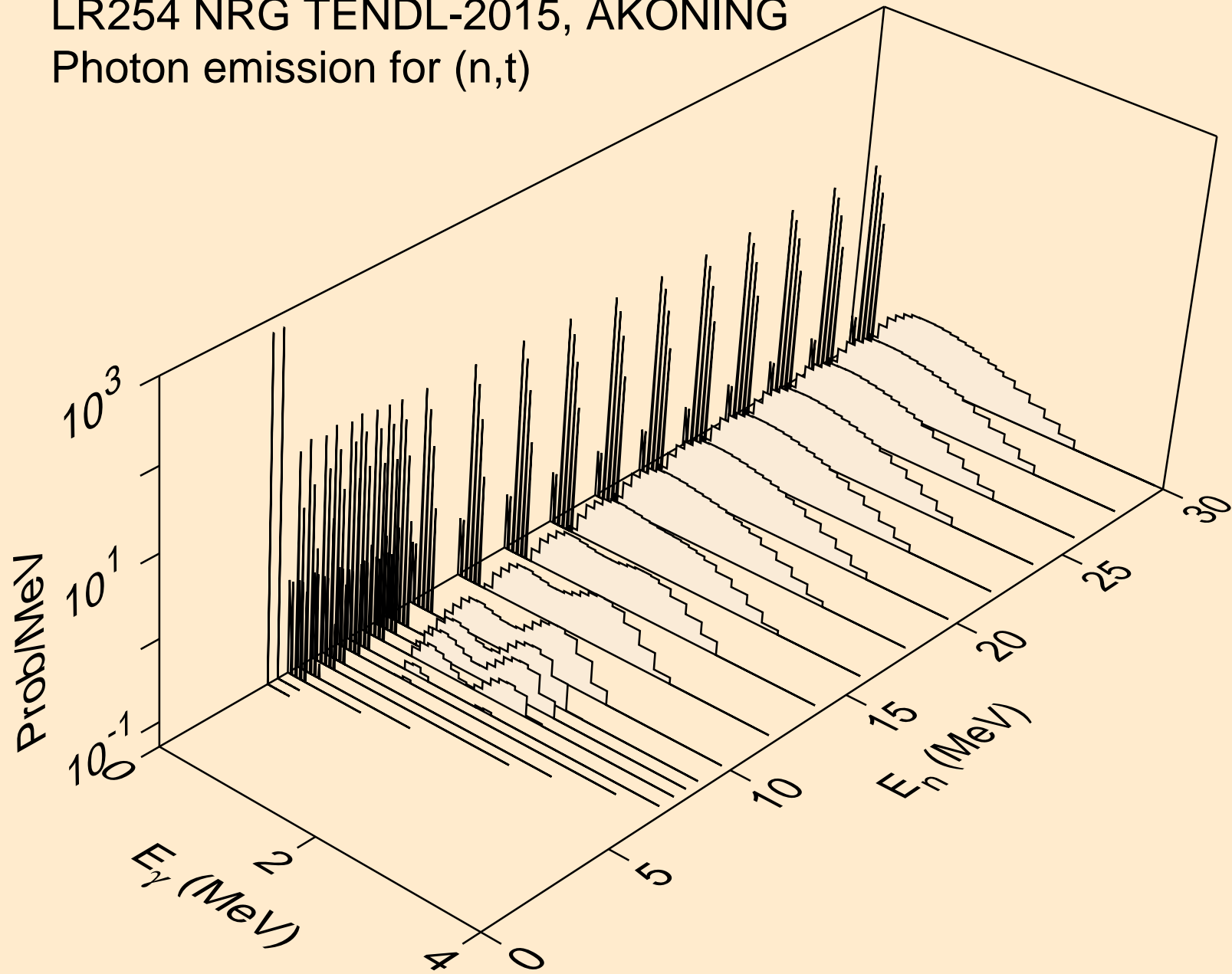

LR254 NRG TENDL-2015, AKONING
Photon emission for (n,he3)

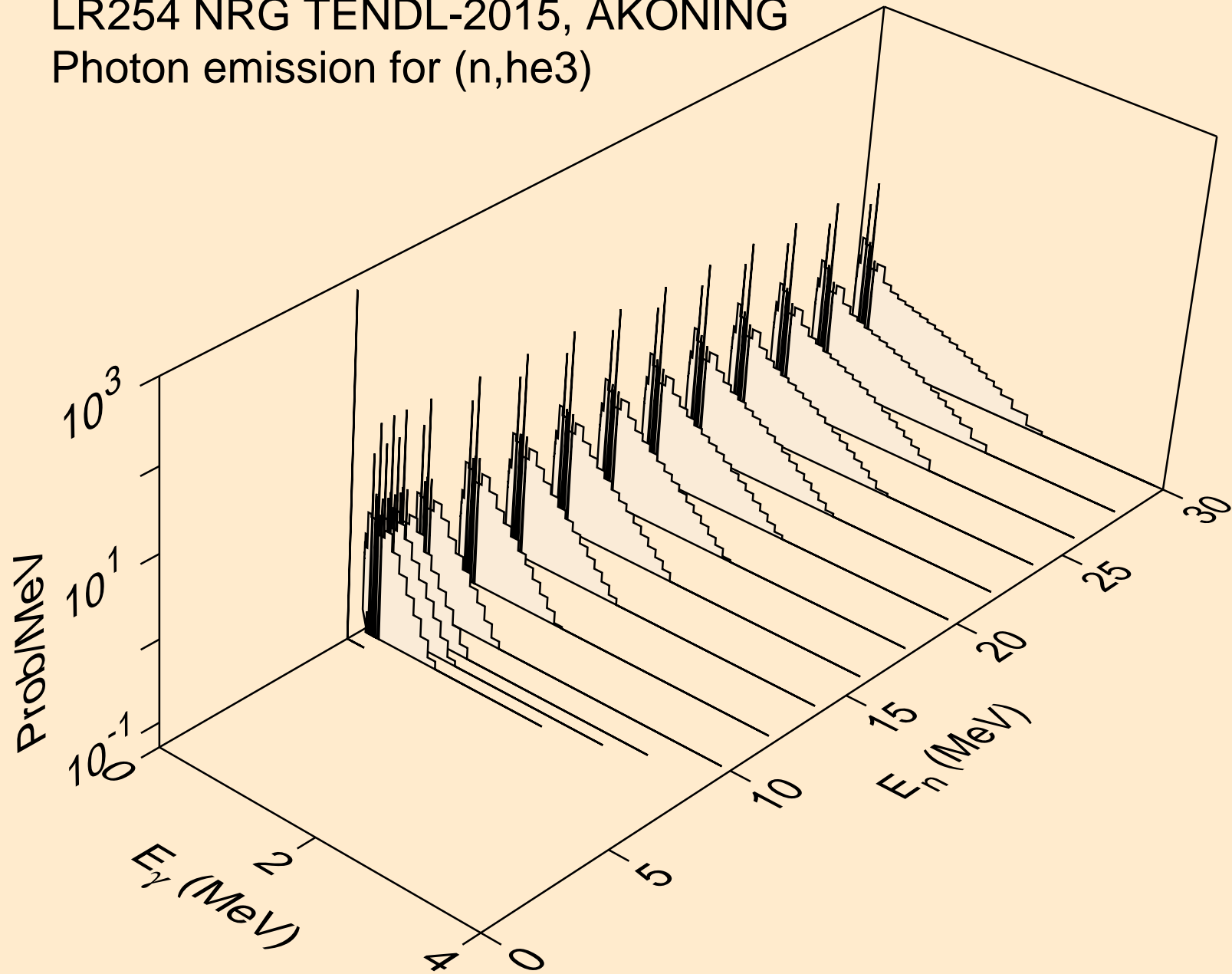

LR254 NRG TENDL-2015, AKONING
Photon emission for (n,a)

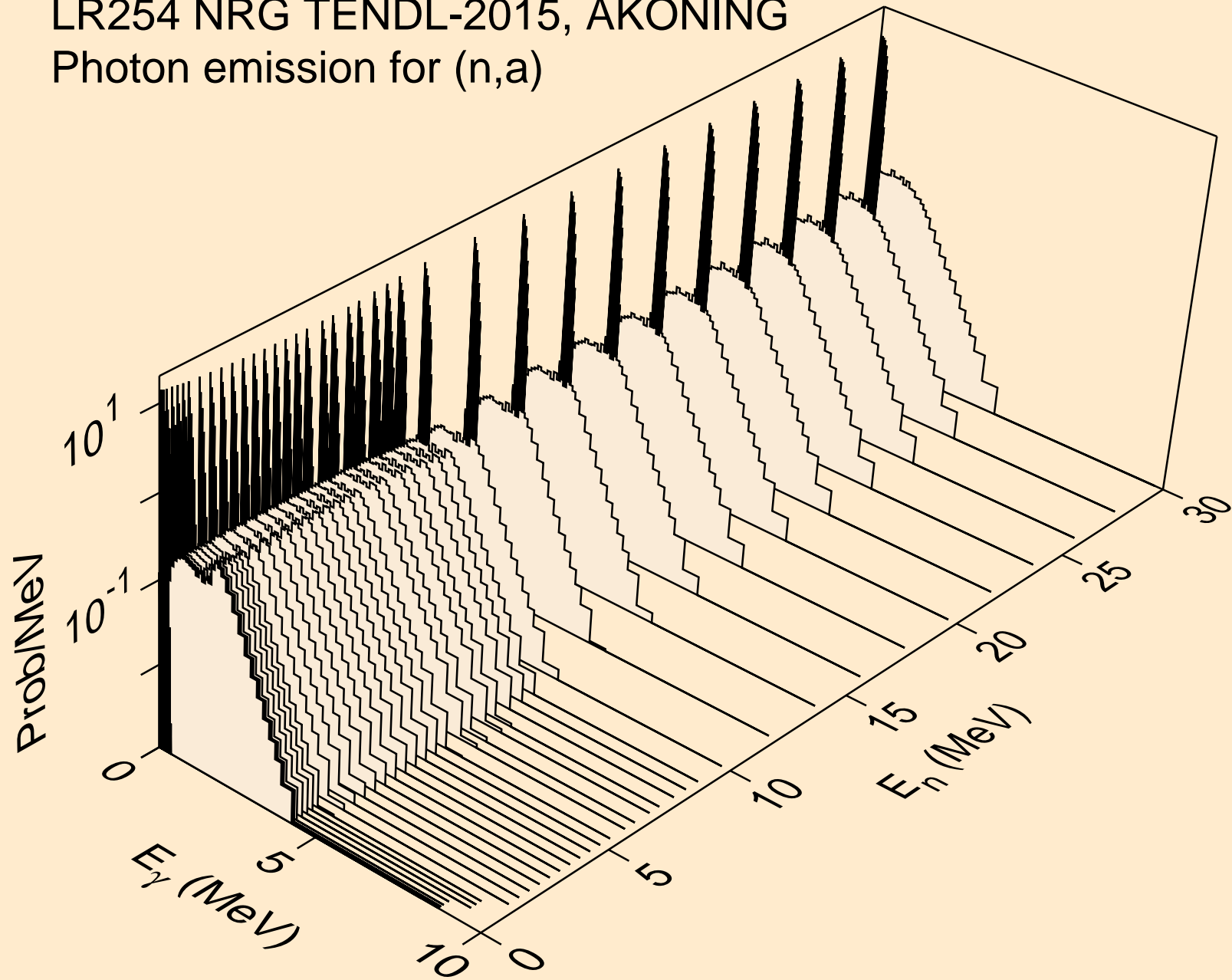

LR254 NRG TENDL-2015, AKONING
Photon emission for (n,2a)

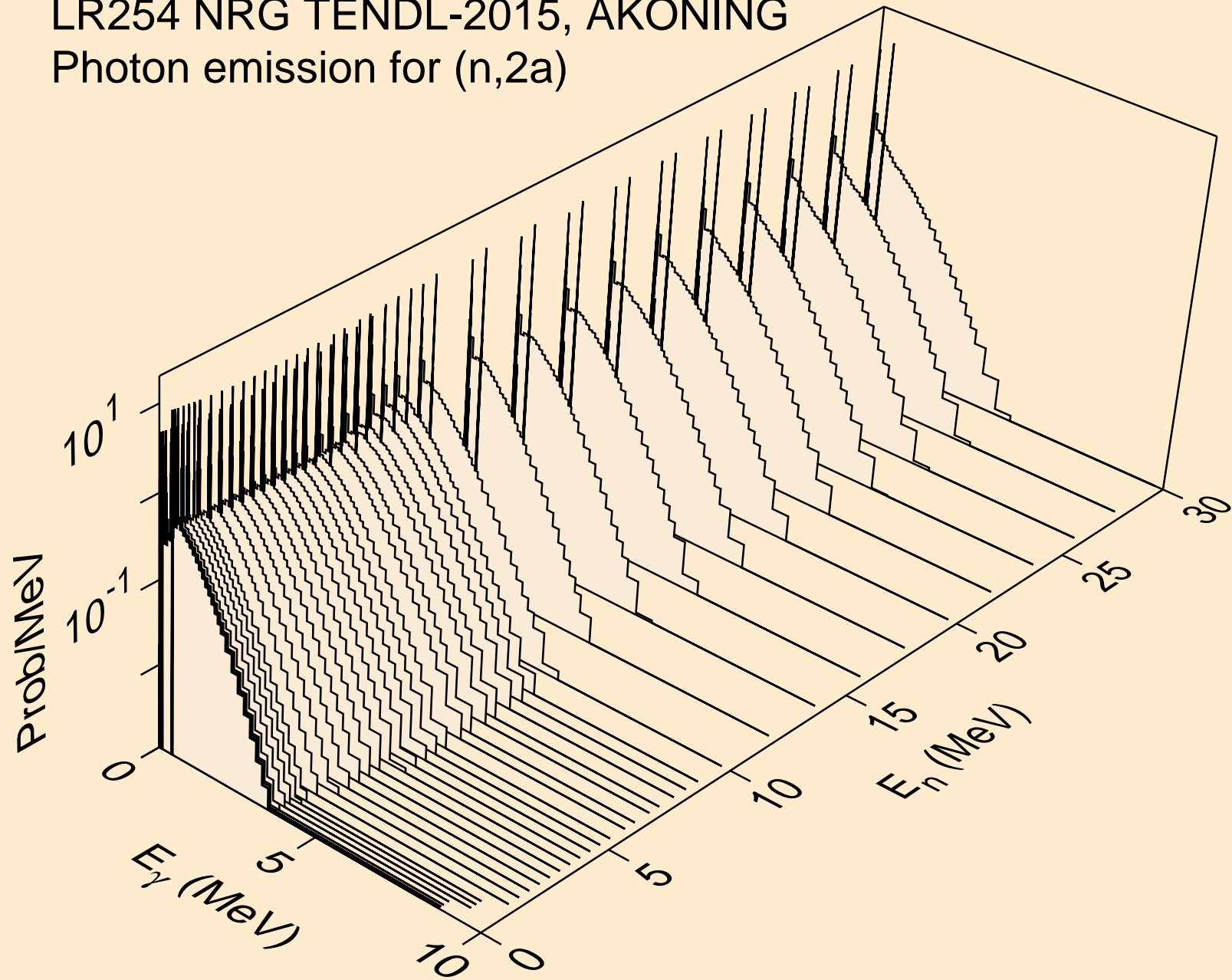

LR254 NRG TENDL-2015, AKONING
Photon emission for (n,3a)

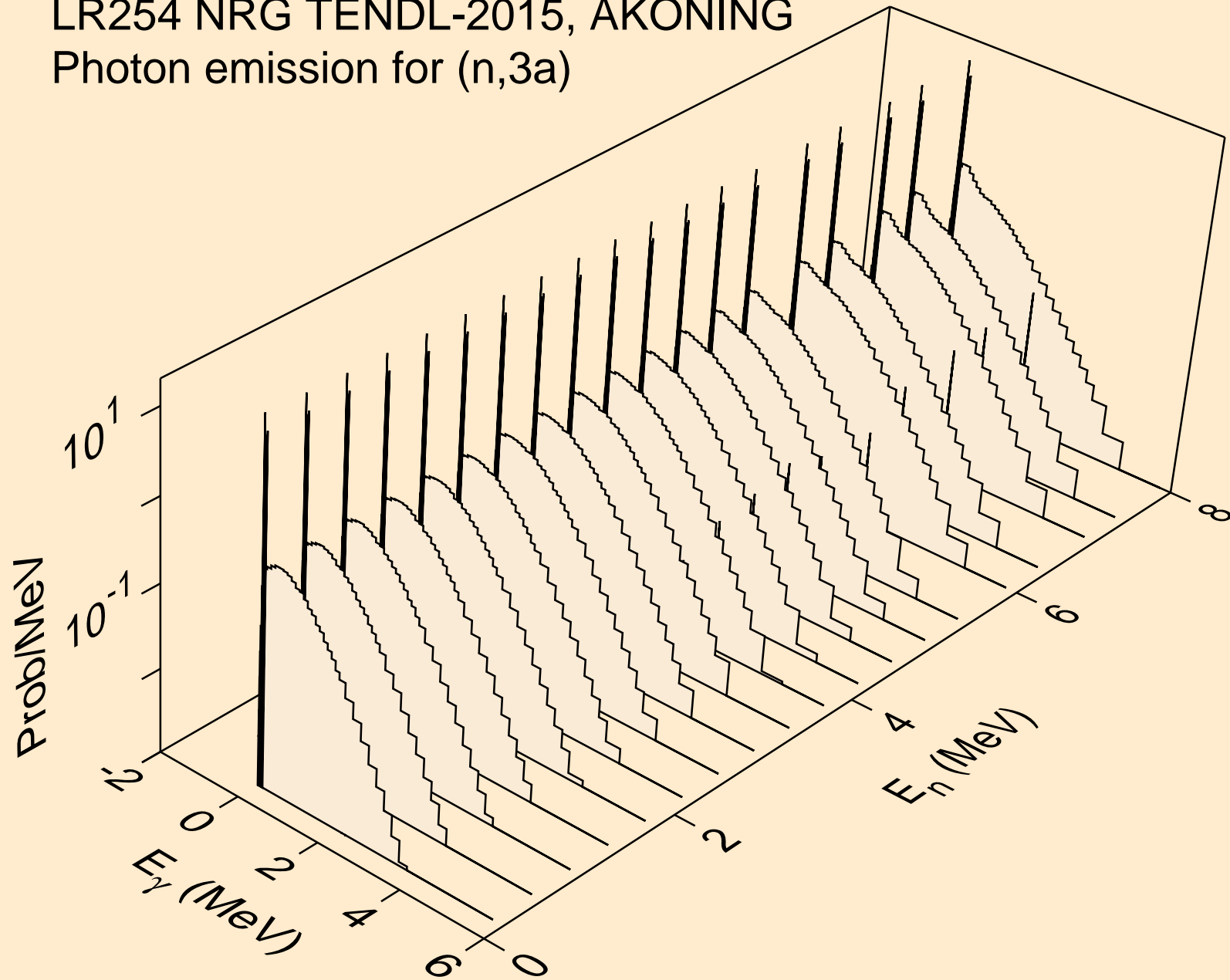

LR254 NRG TENDL-2015, AKONING
Photon emission for (n,2p)

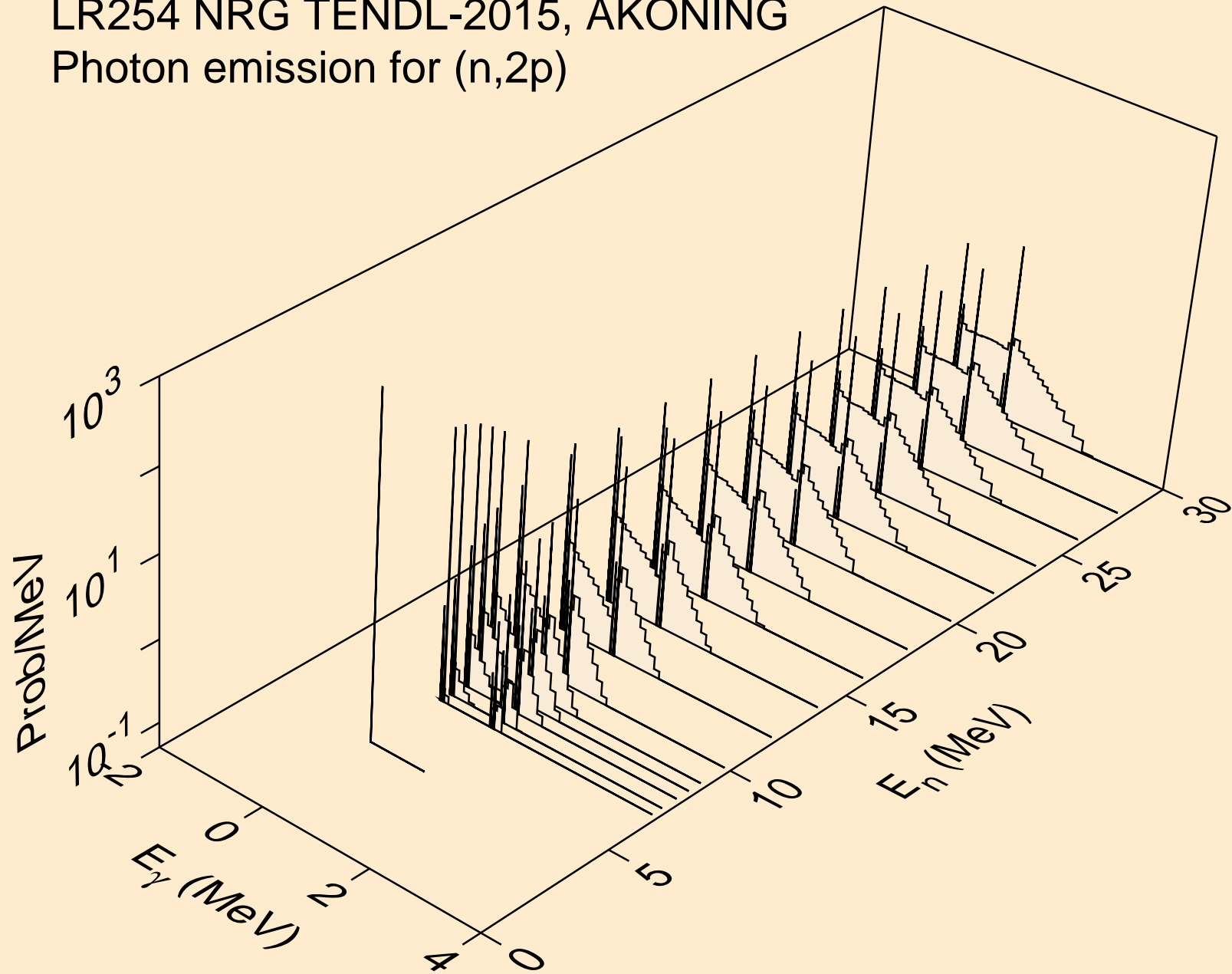

LR254 NRG TENDL-2015, AKONING
Photon emission for (n,p α)

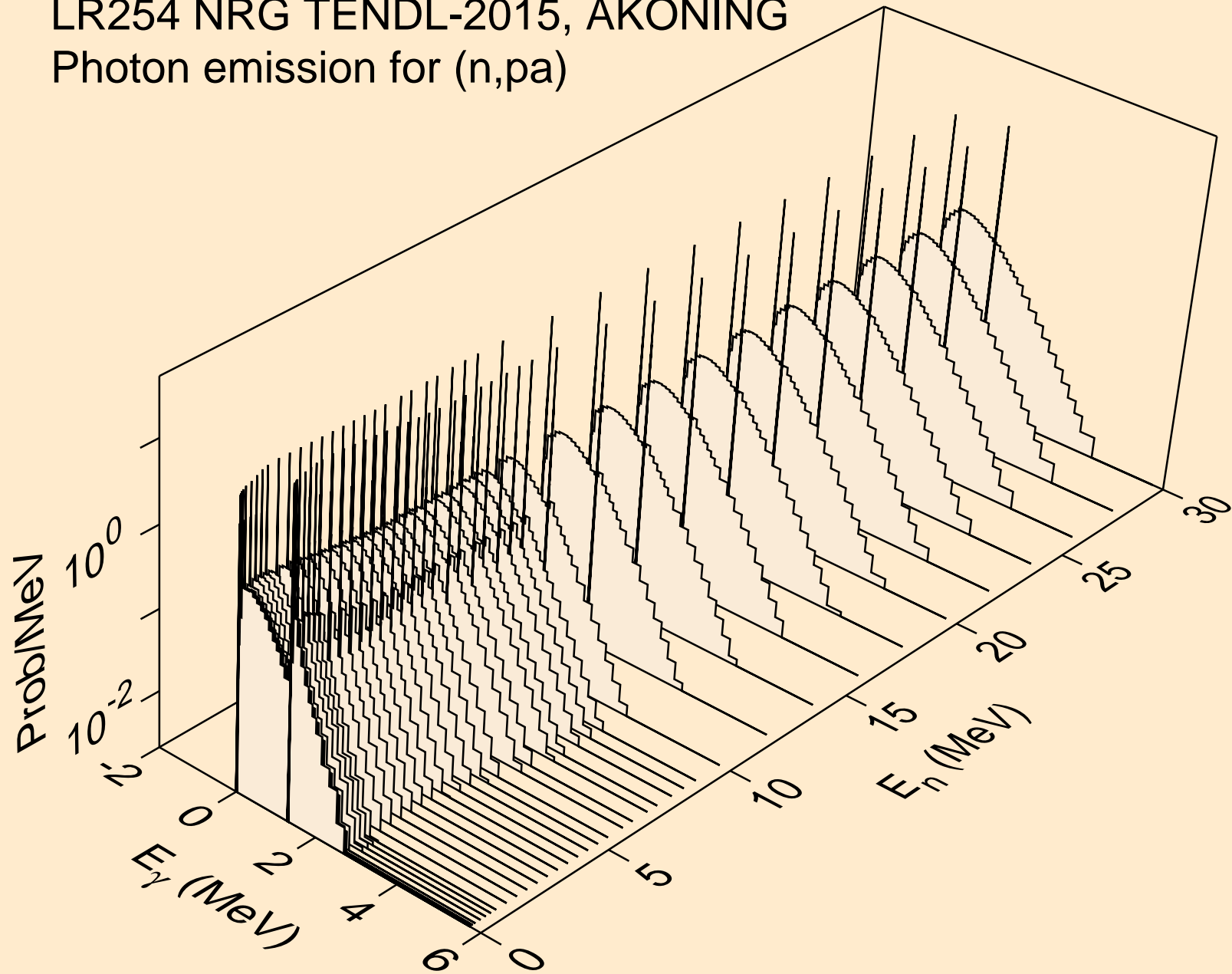

LR254 NRG TENDL-2015, AKONING
Photon emission for (n,t2a)

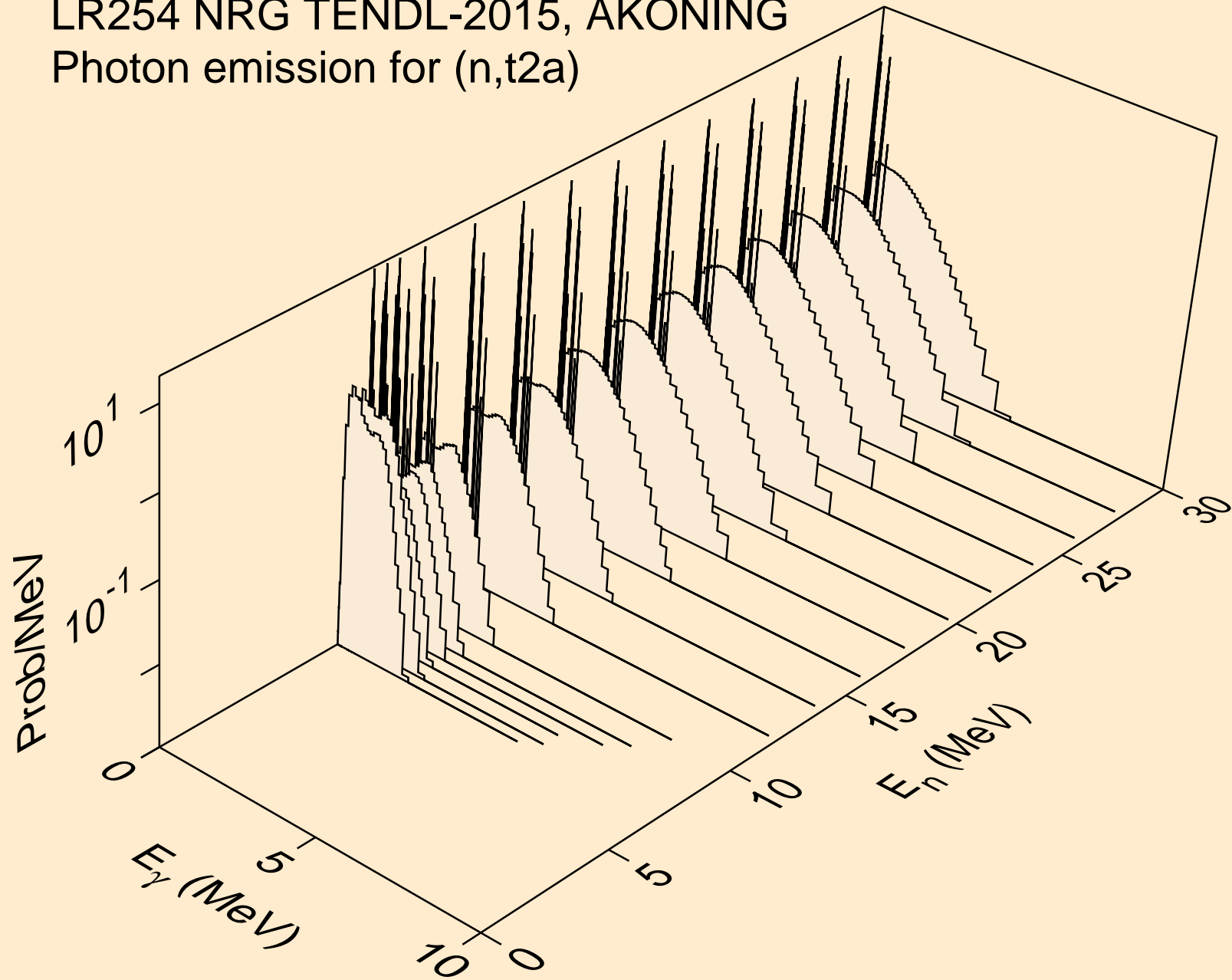

LR254 NRG TENDL-2015, AKONING
Photon emission for (n,d2a)

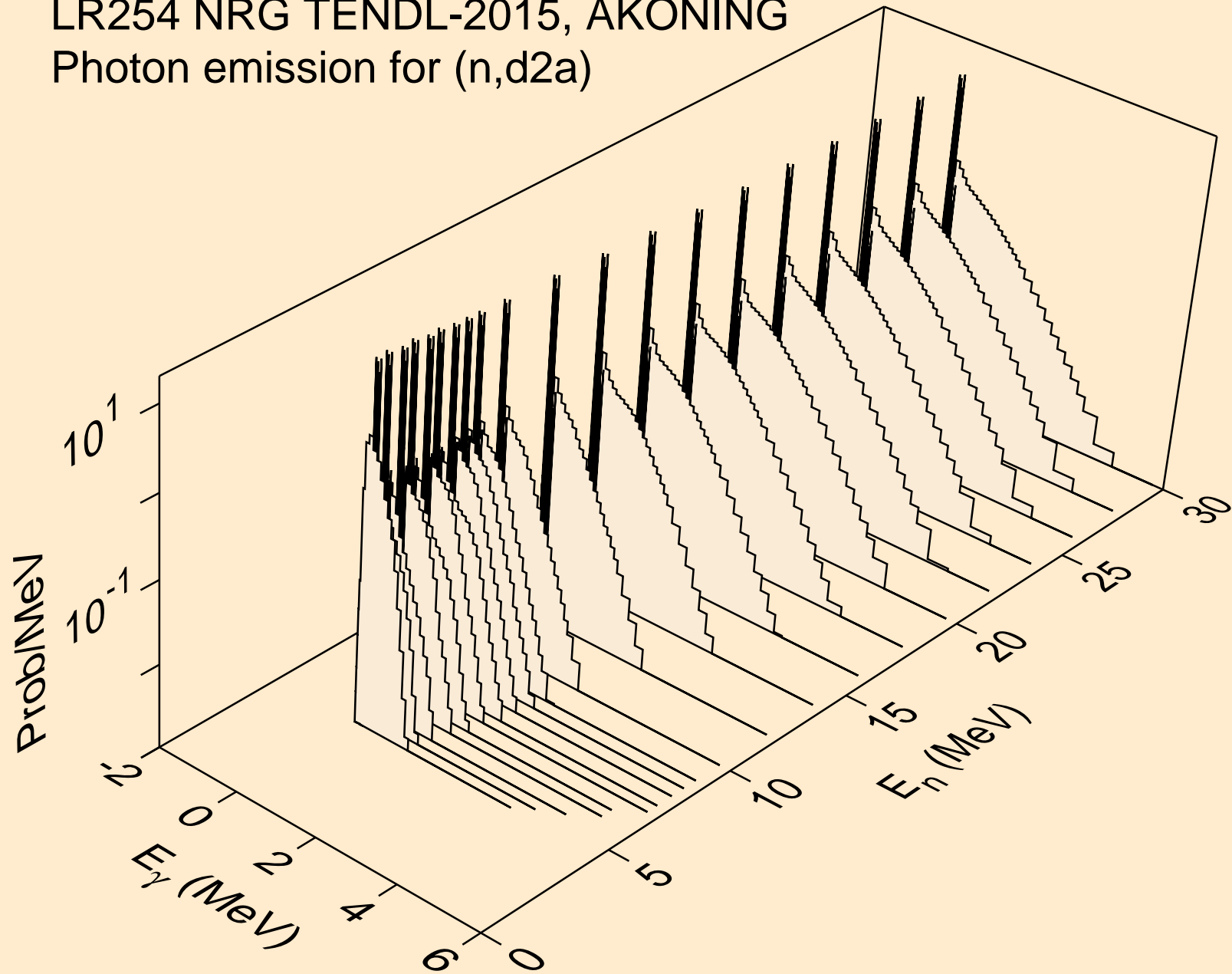

LR254 NRG TENDL-2015, AKONING
Photon emission for (n,pd)

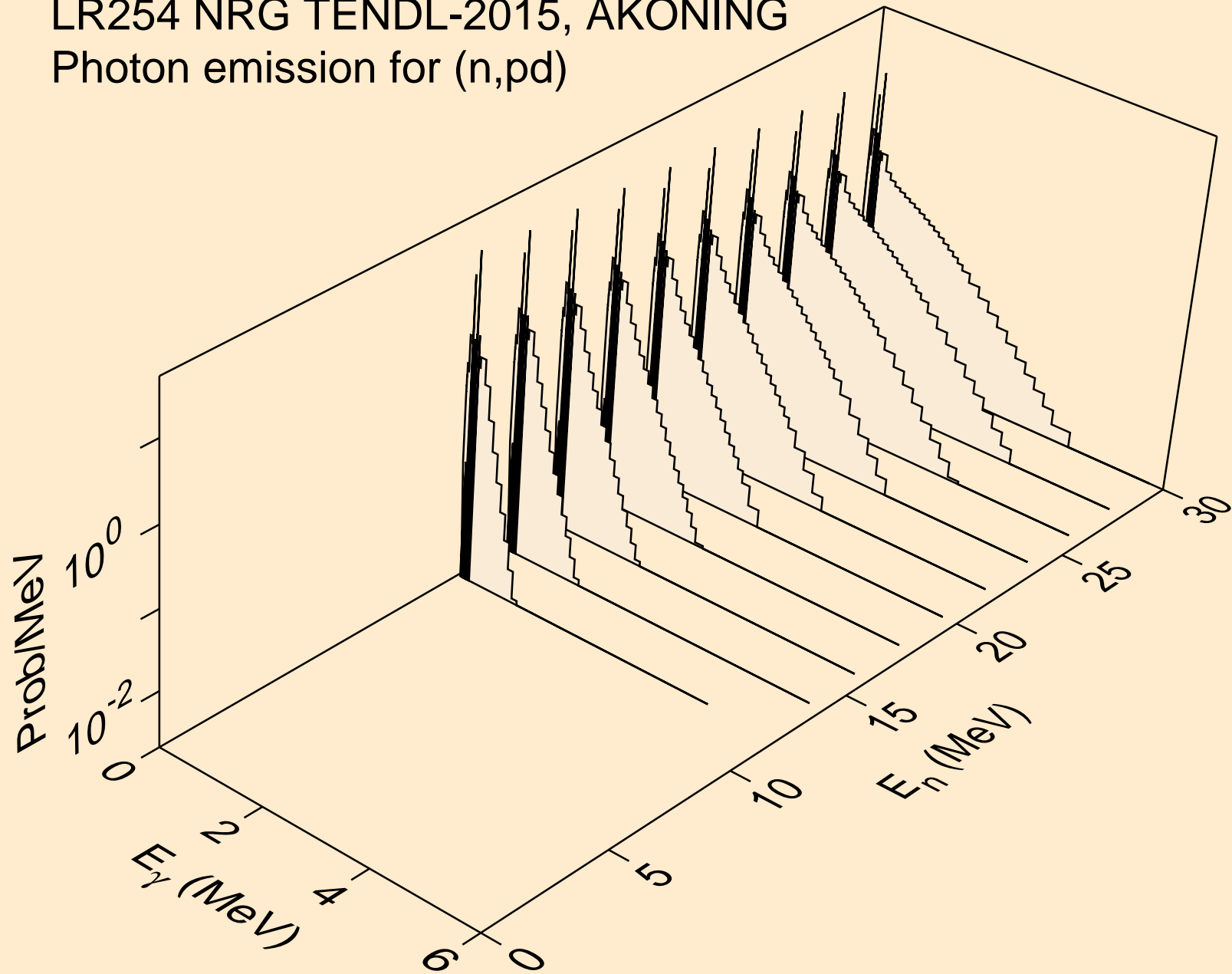

LR254 NRG TENDL-2015, AKONING
Photon emission for (n,pt)

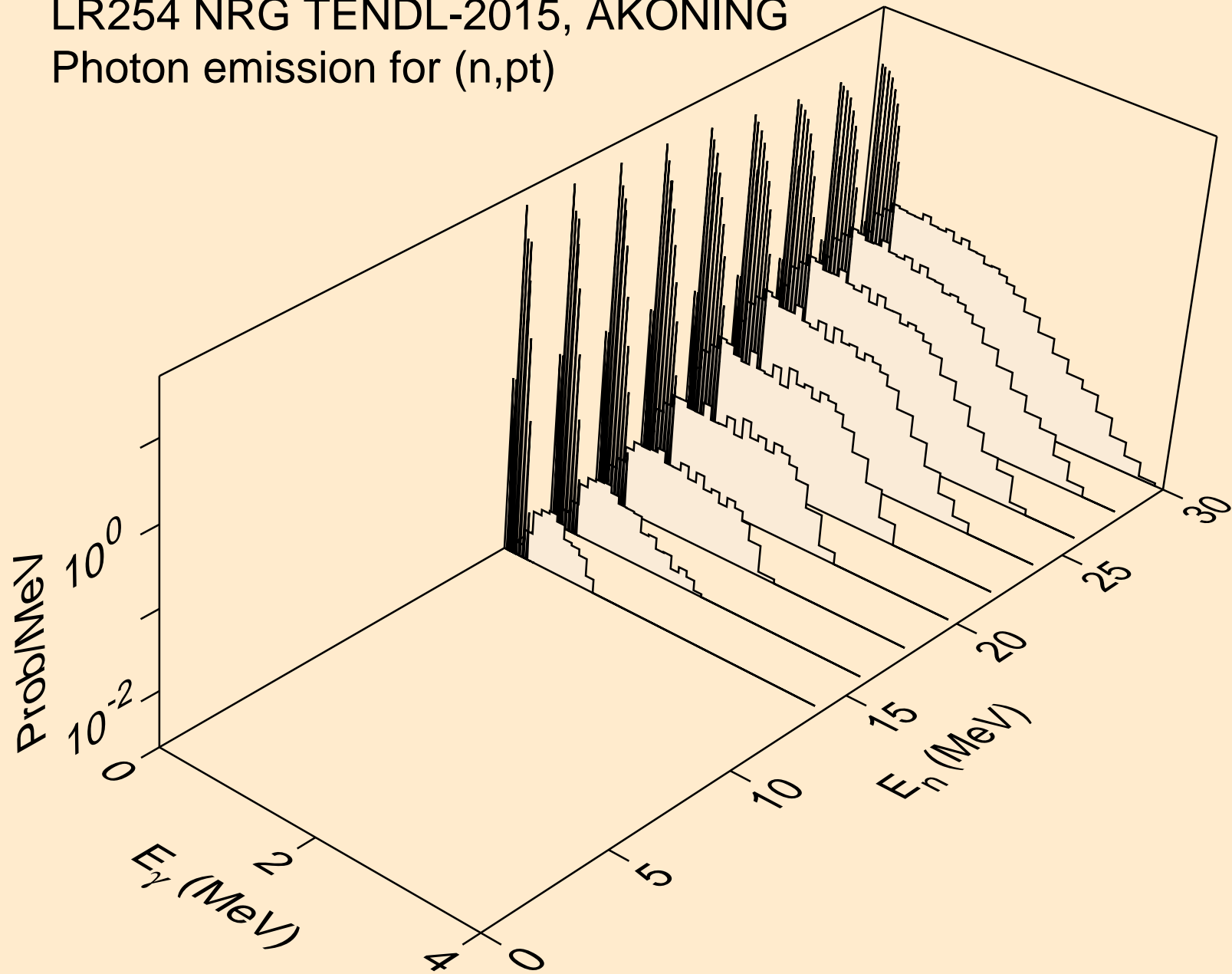

LR254 NRG TENDL-2015, AKONING
Photon emission for (n,da)

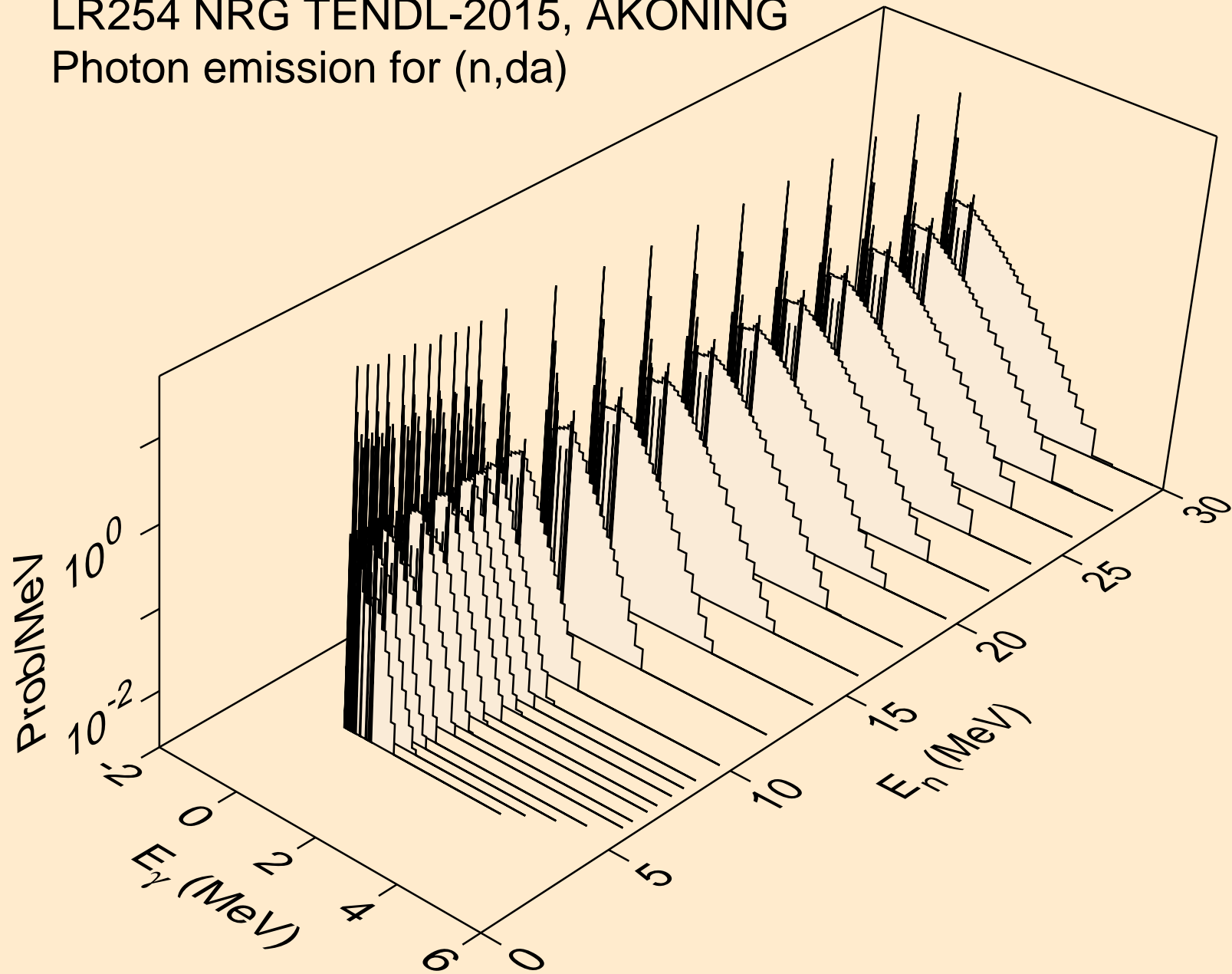

LR254 NRG TENDL-2015, AKONING
thermal capture photon spectrum

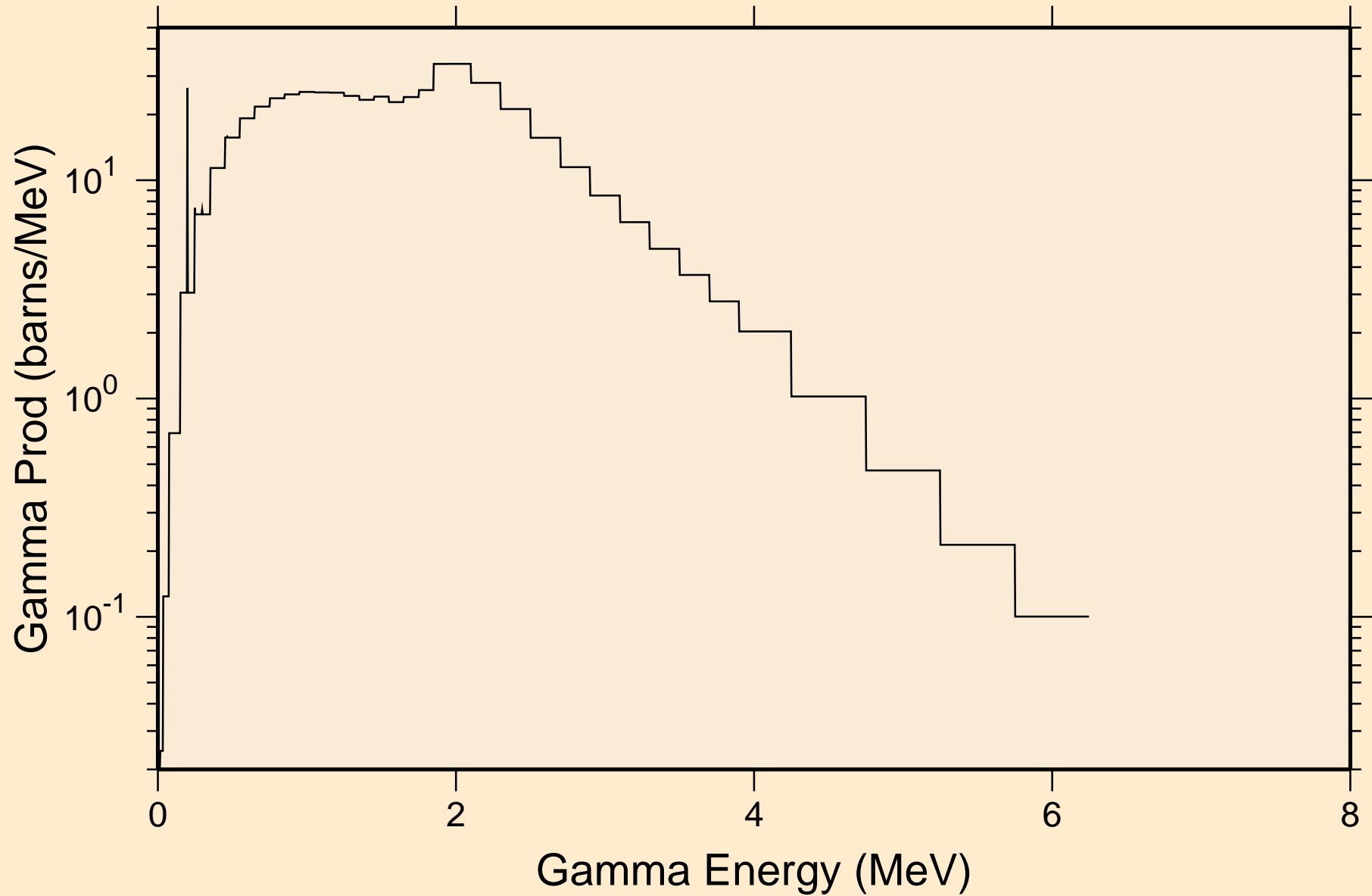

LR254 NRG TENDL-2015, AKONING
14 MeV photon spectrum

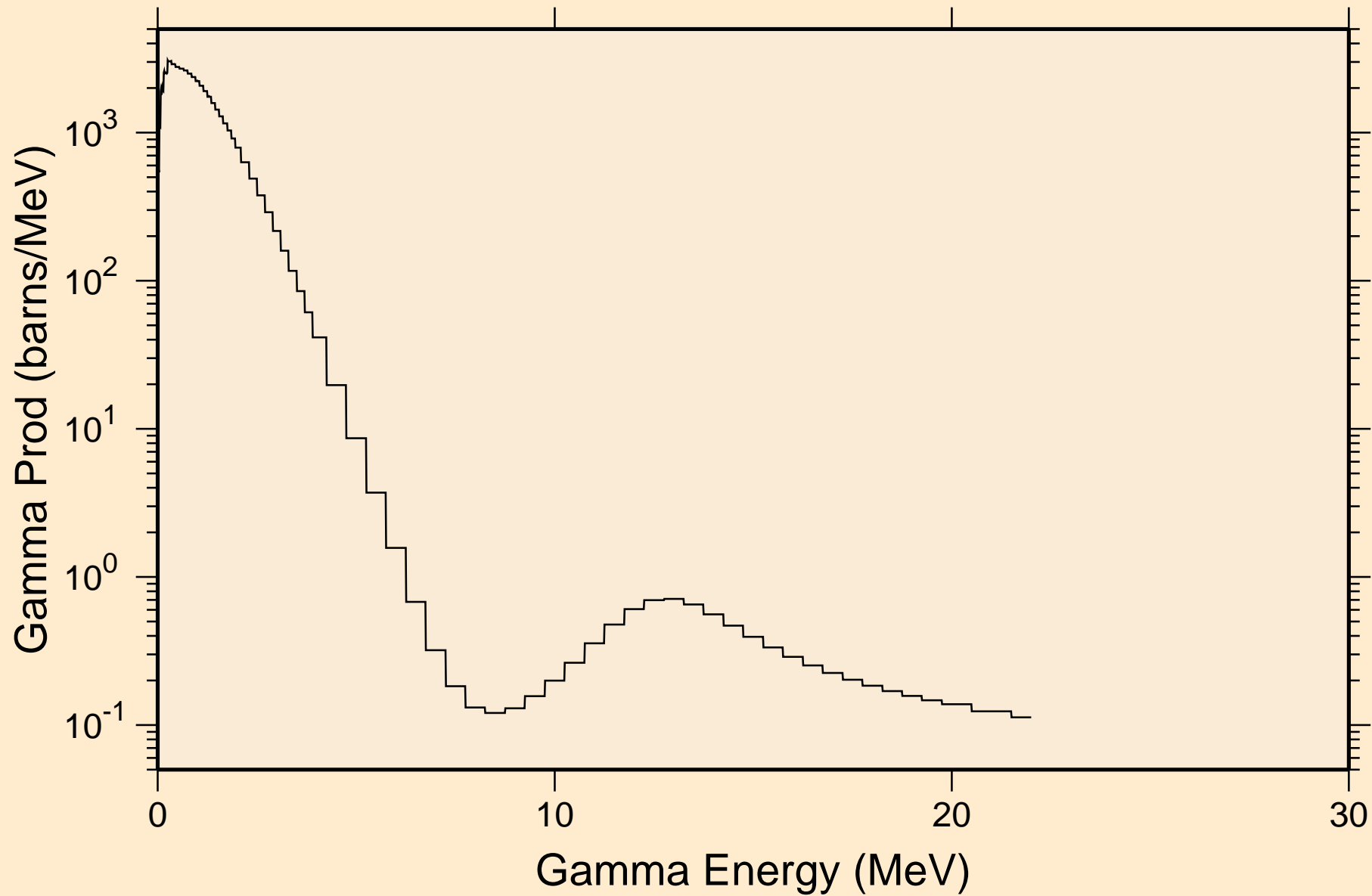

LR254 NRG TENDL-2015, AKONING

Particle heating contributions

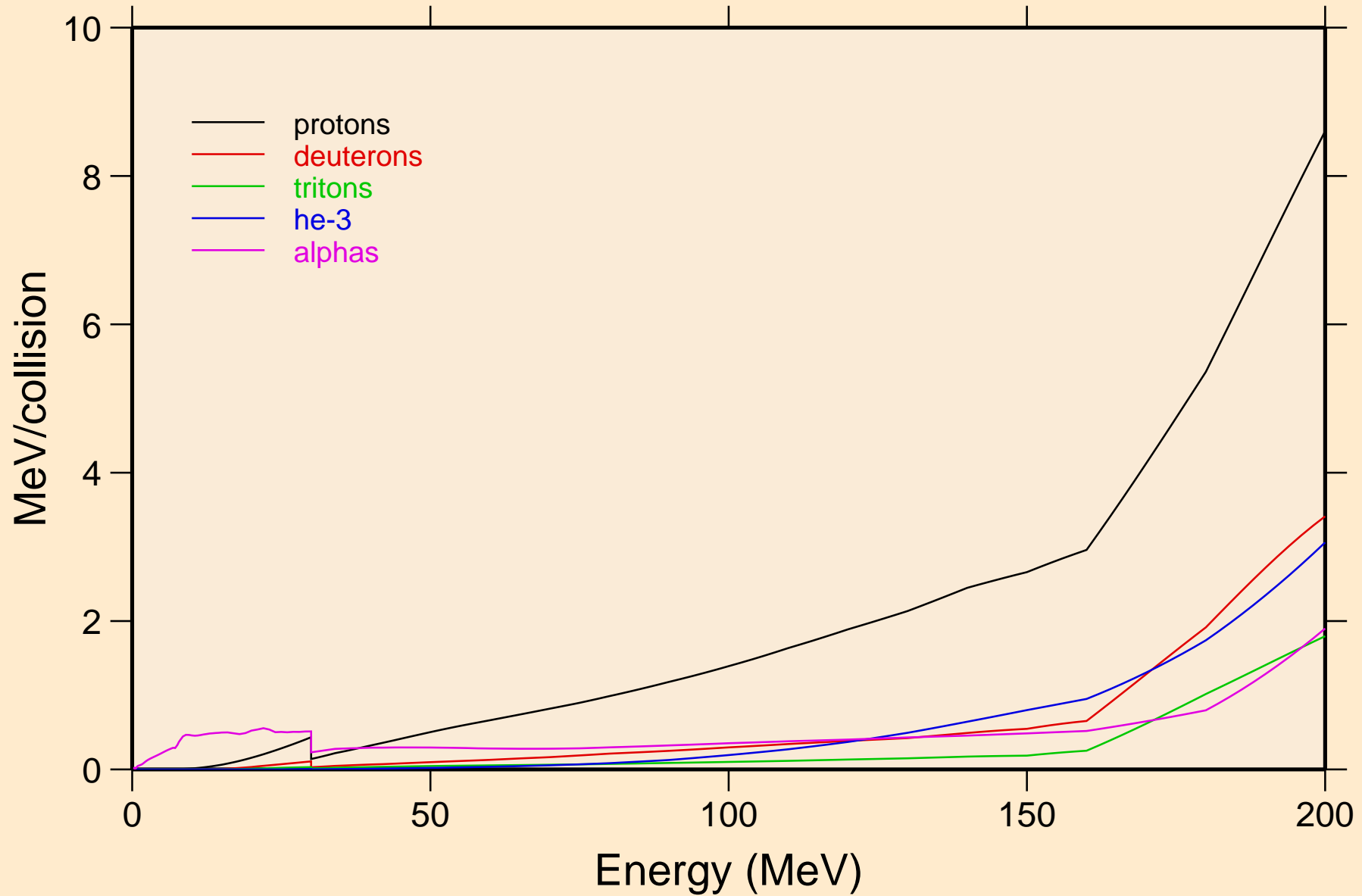

LR254 NRG TENDL-2015, AKONING

Recoil Heating

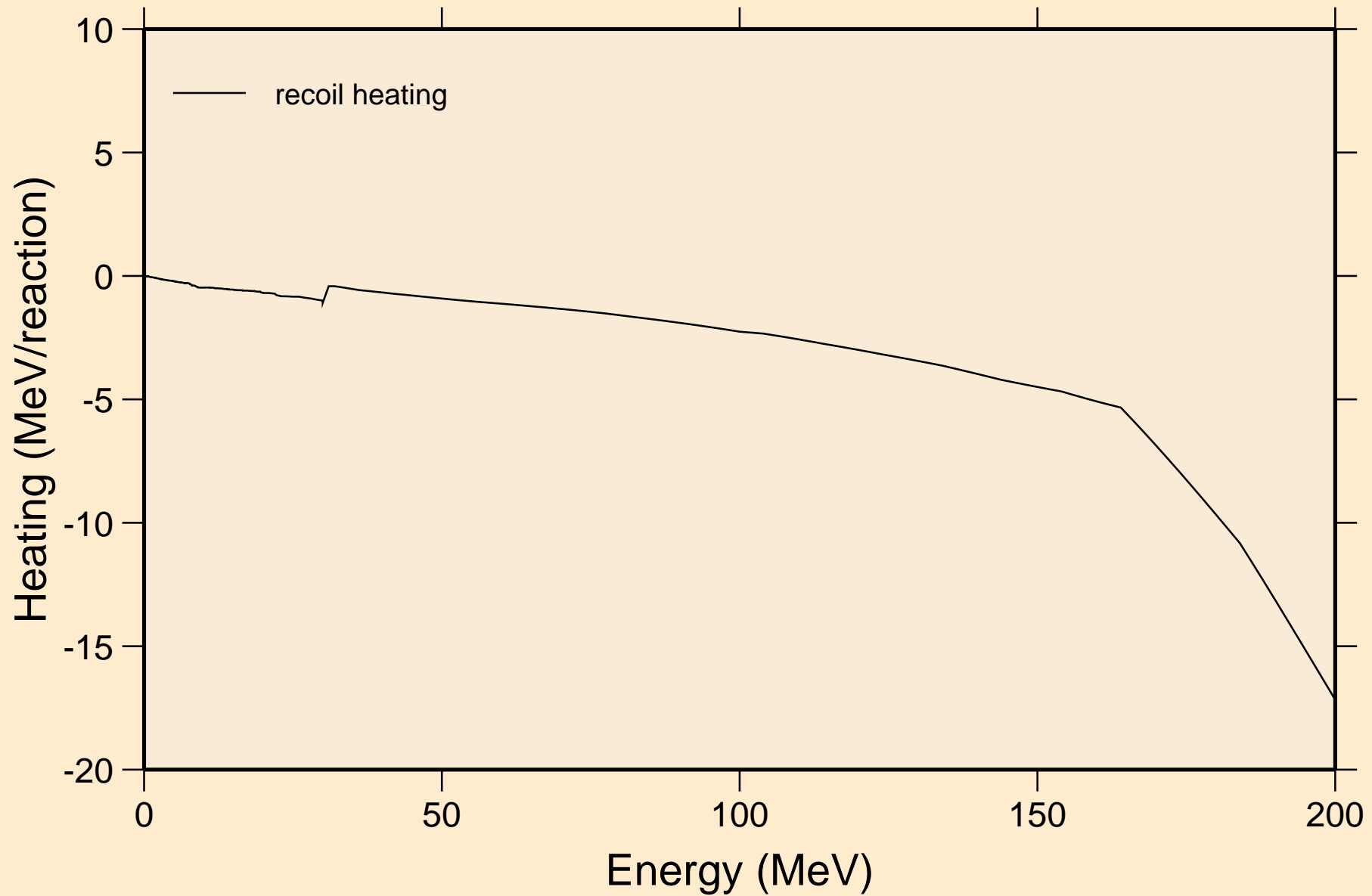

LR254 NRG TENDL-2015, AKONING

Particle production cross sections

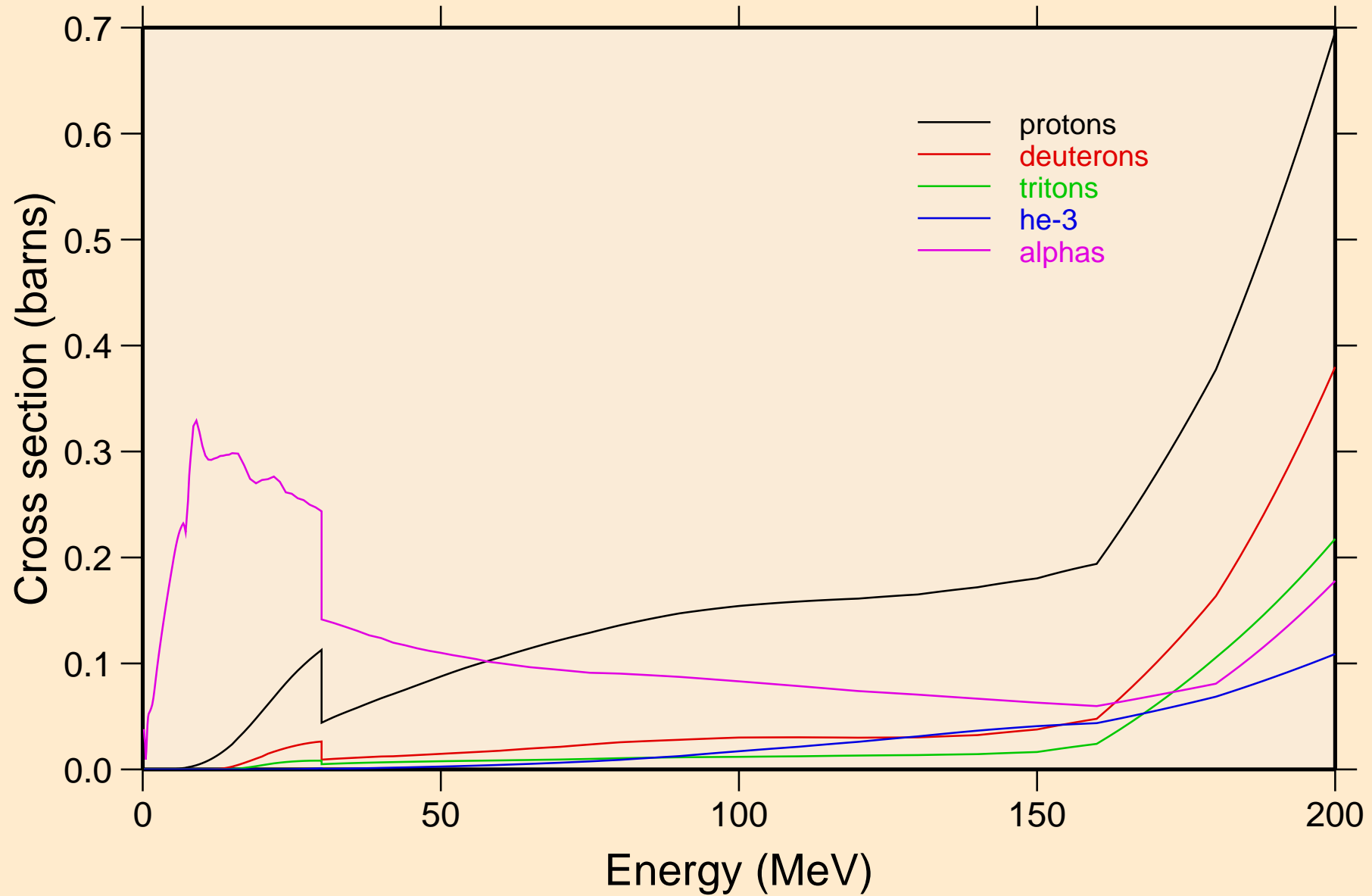

LR254 NRG TENDL-2015, AKONING
protons from (n,x)

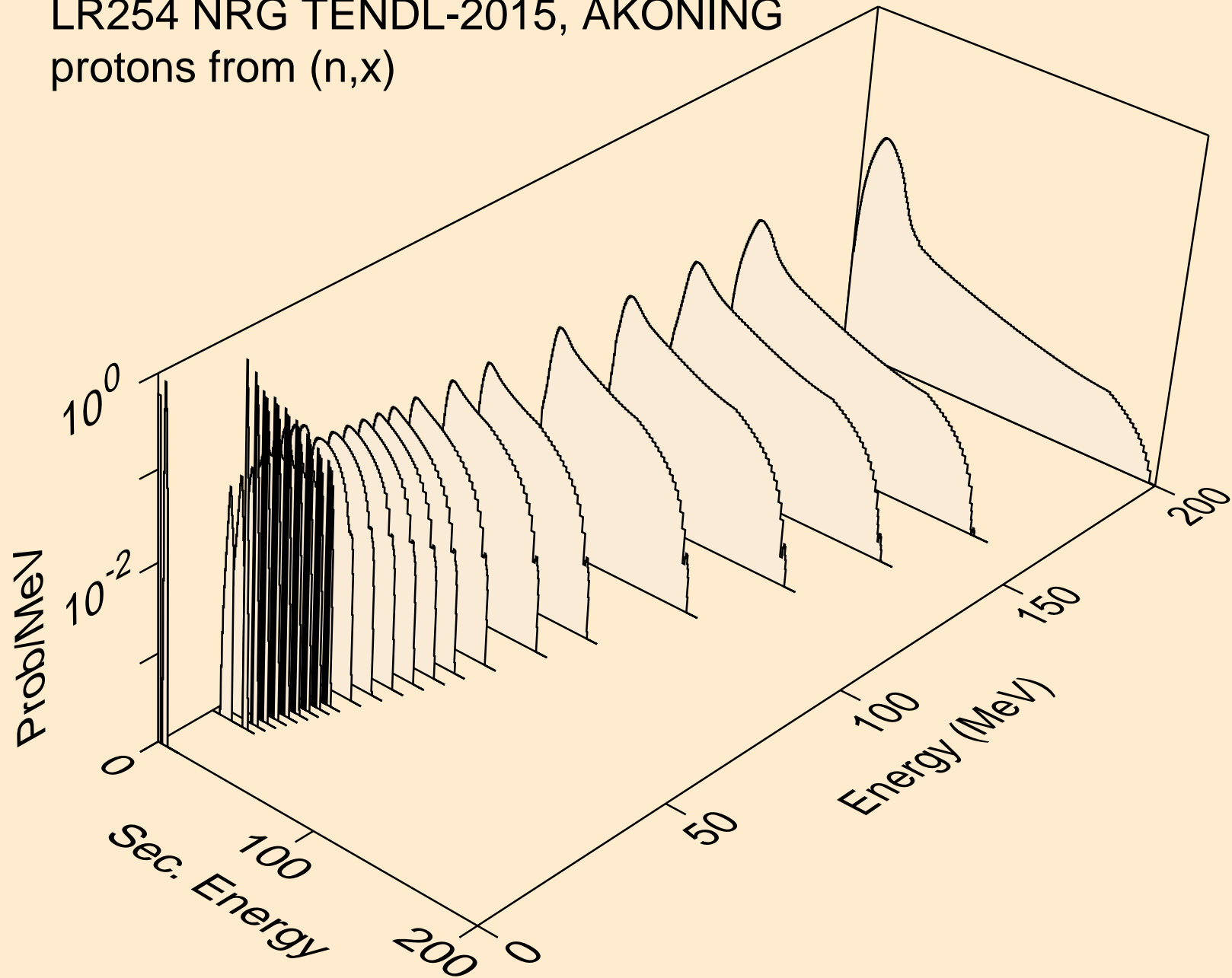

LR254 NRG TENDL-2015, AKONING
protons from (n,n*)p

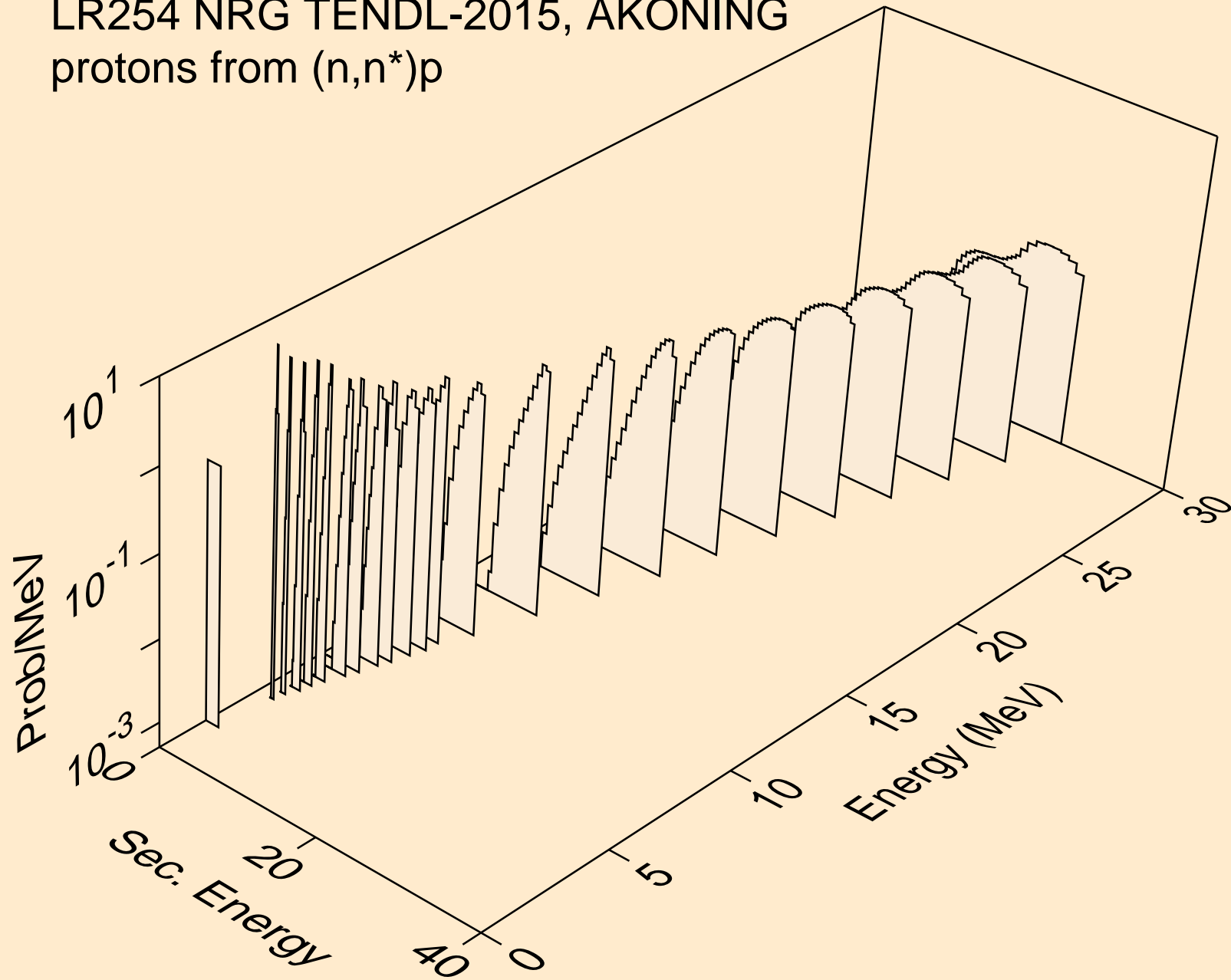

LR254 NRG TENDL-2015, AKONING
protons from (n,2np)

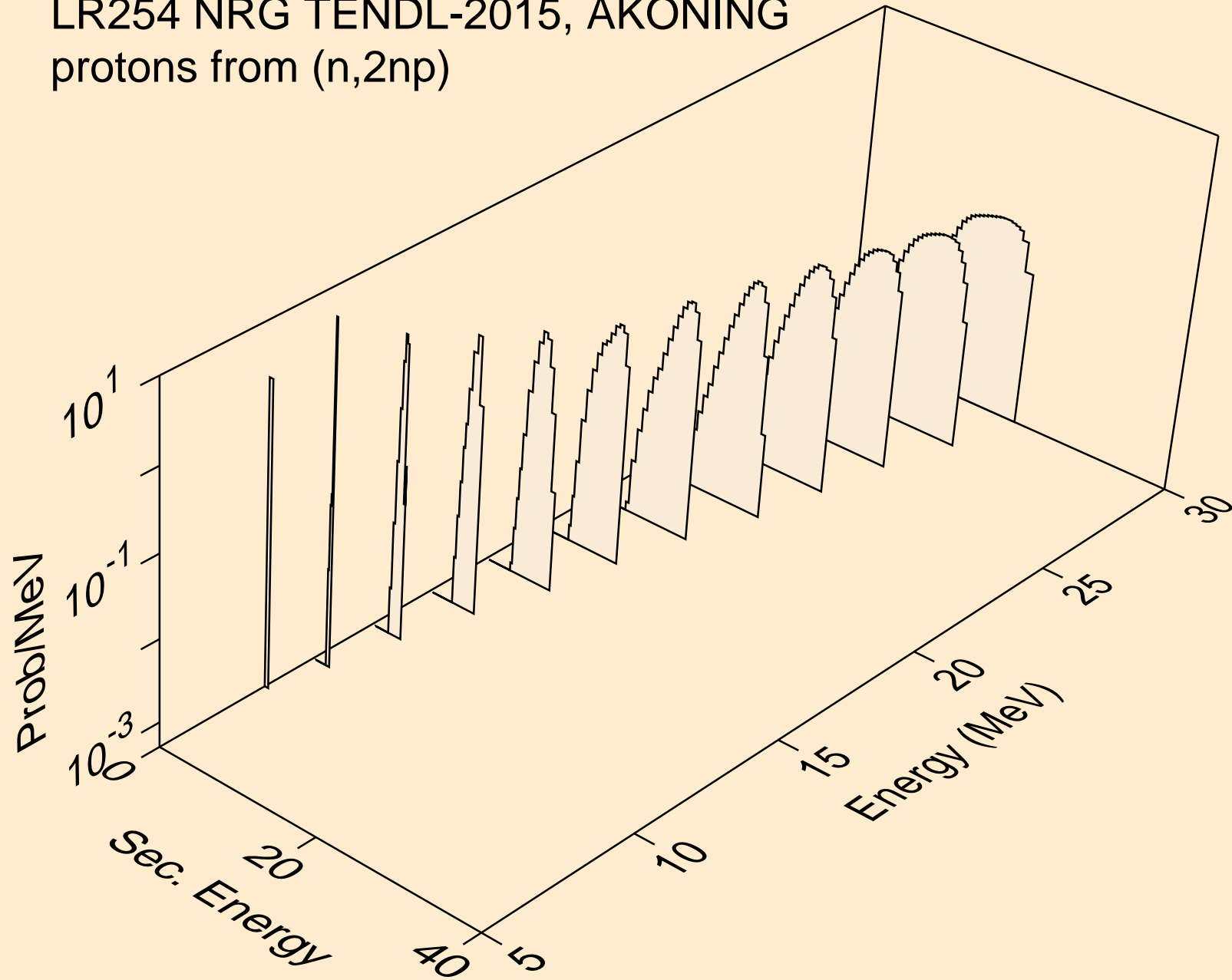

LR254 NRG TENDL-2015, AKONING
protons from (n,3np)

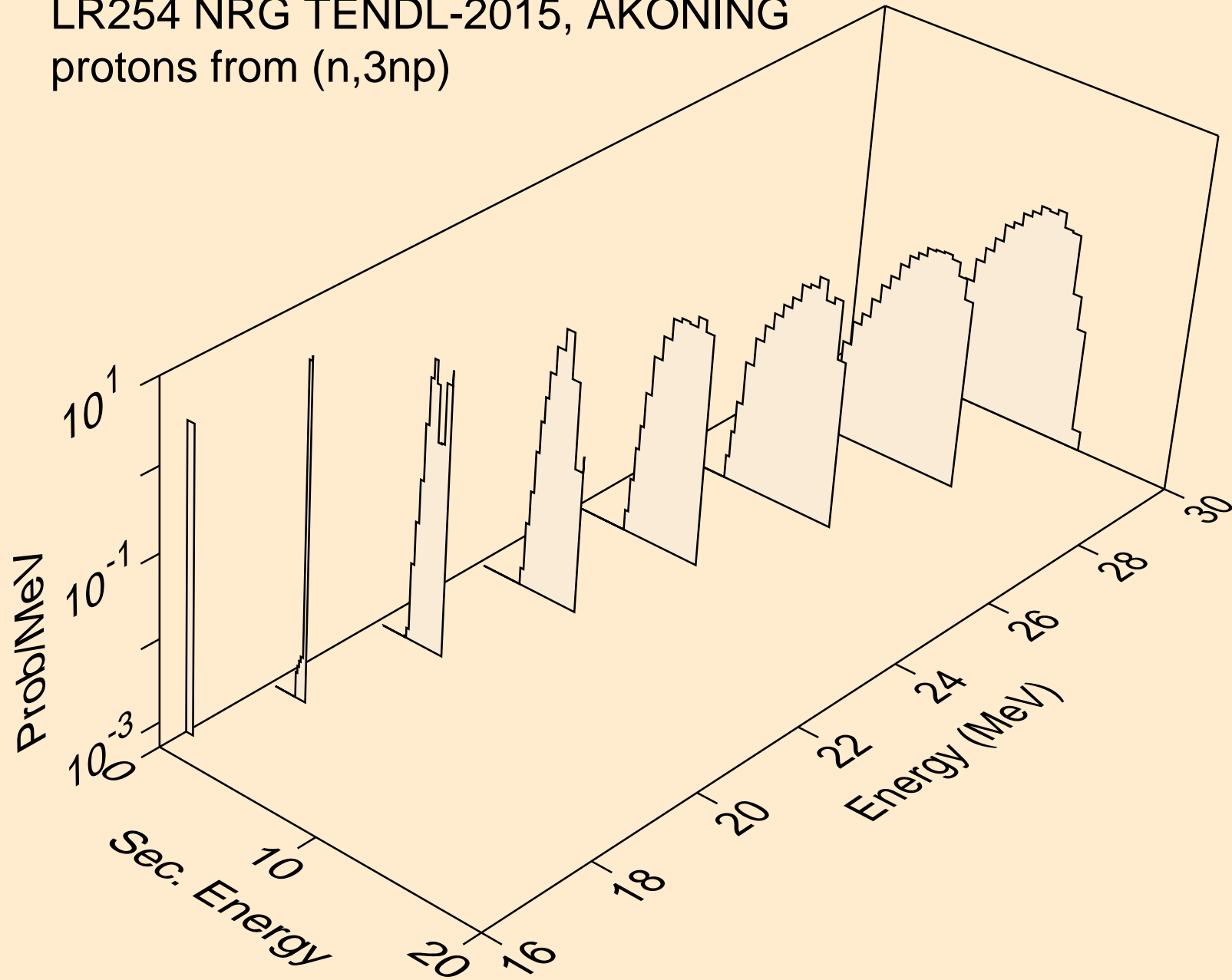

LR254 NRG TENDL-2015, AKONING
protons from (n,2np)

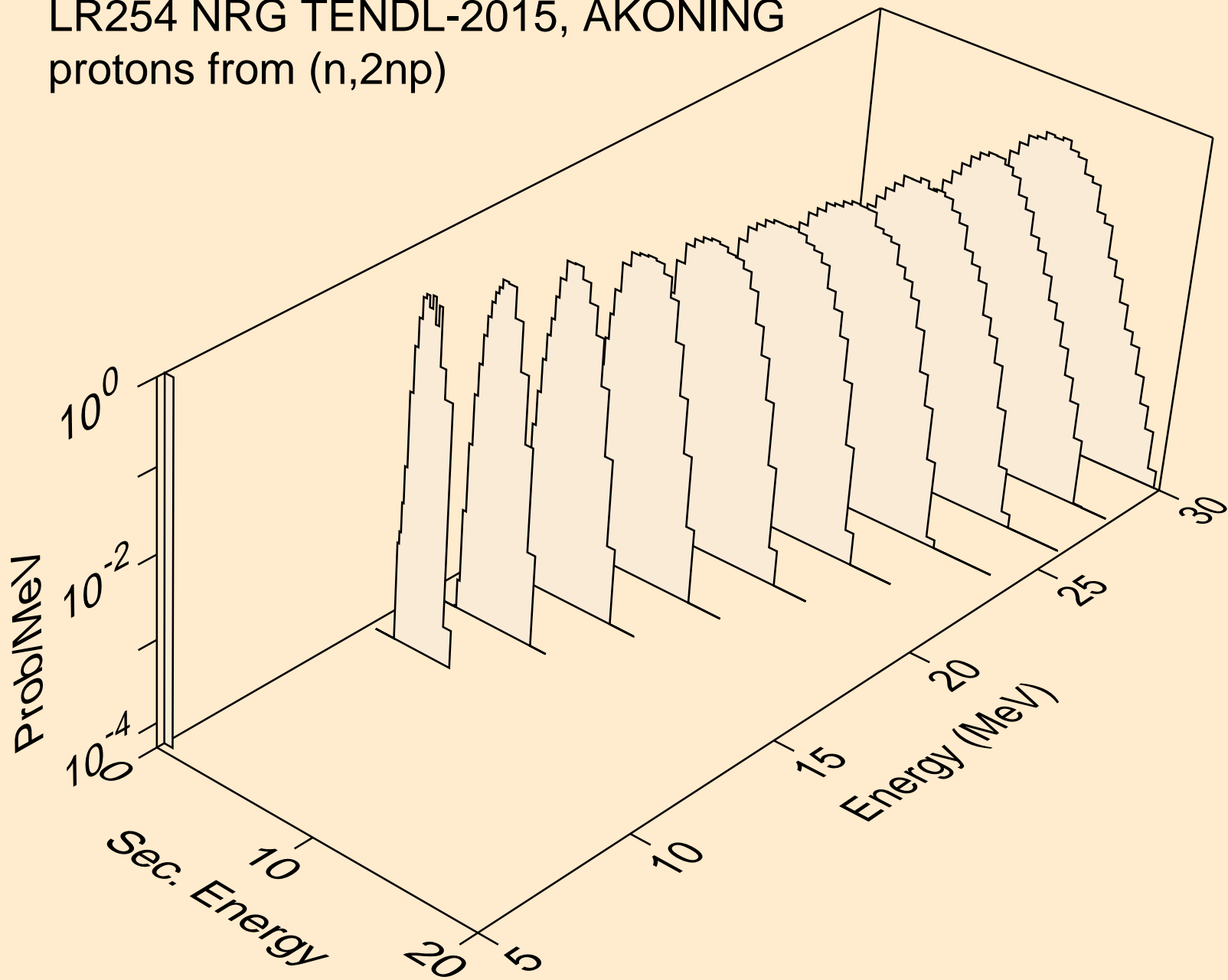

LR254 NRG TENDL-2015, AKONING
protons from (n,npa)

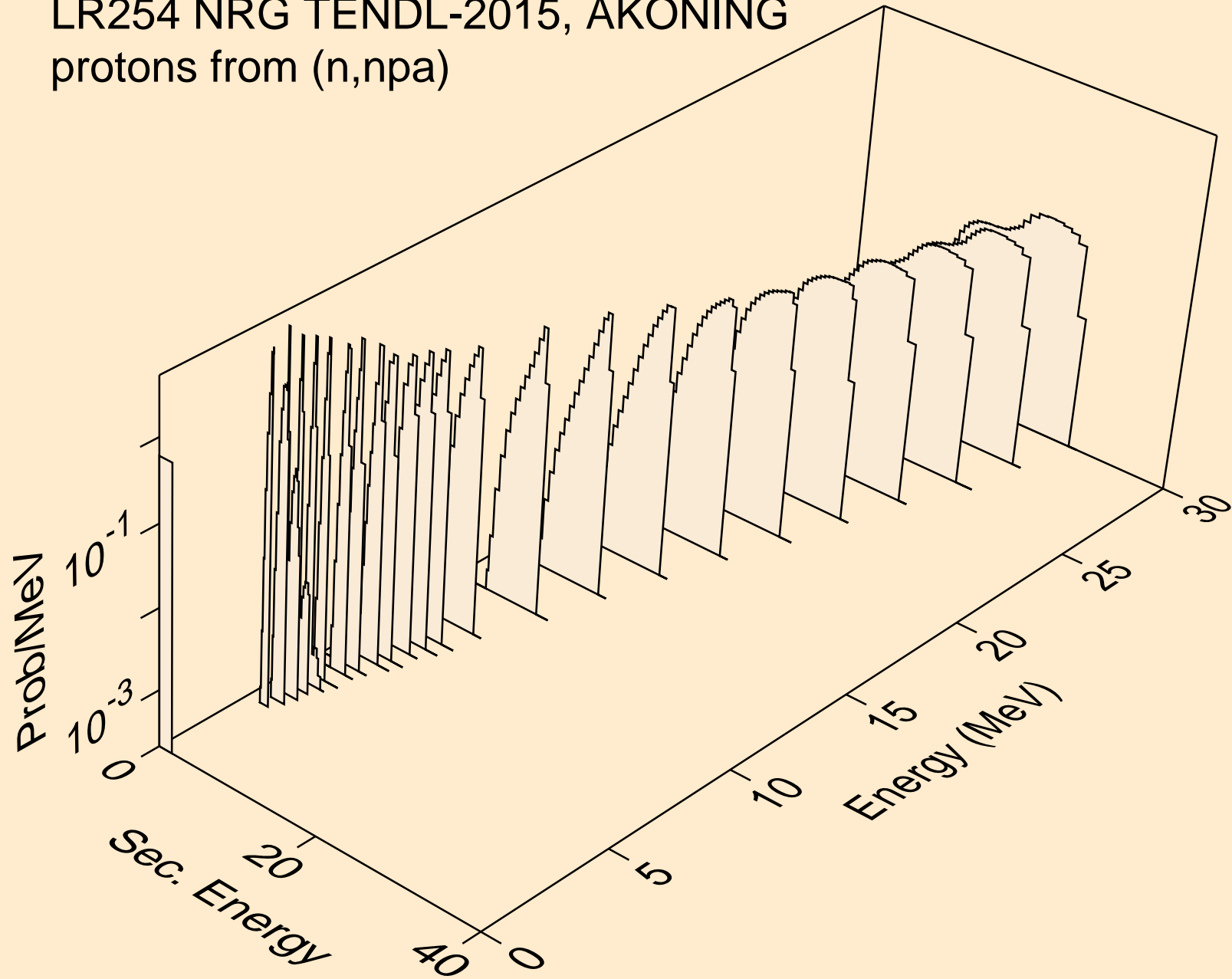

LR254 NRG TENDL-2015, AKONING
protons from (n,p)

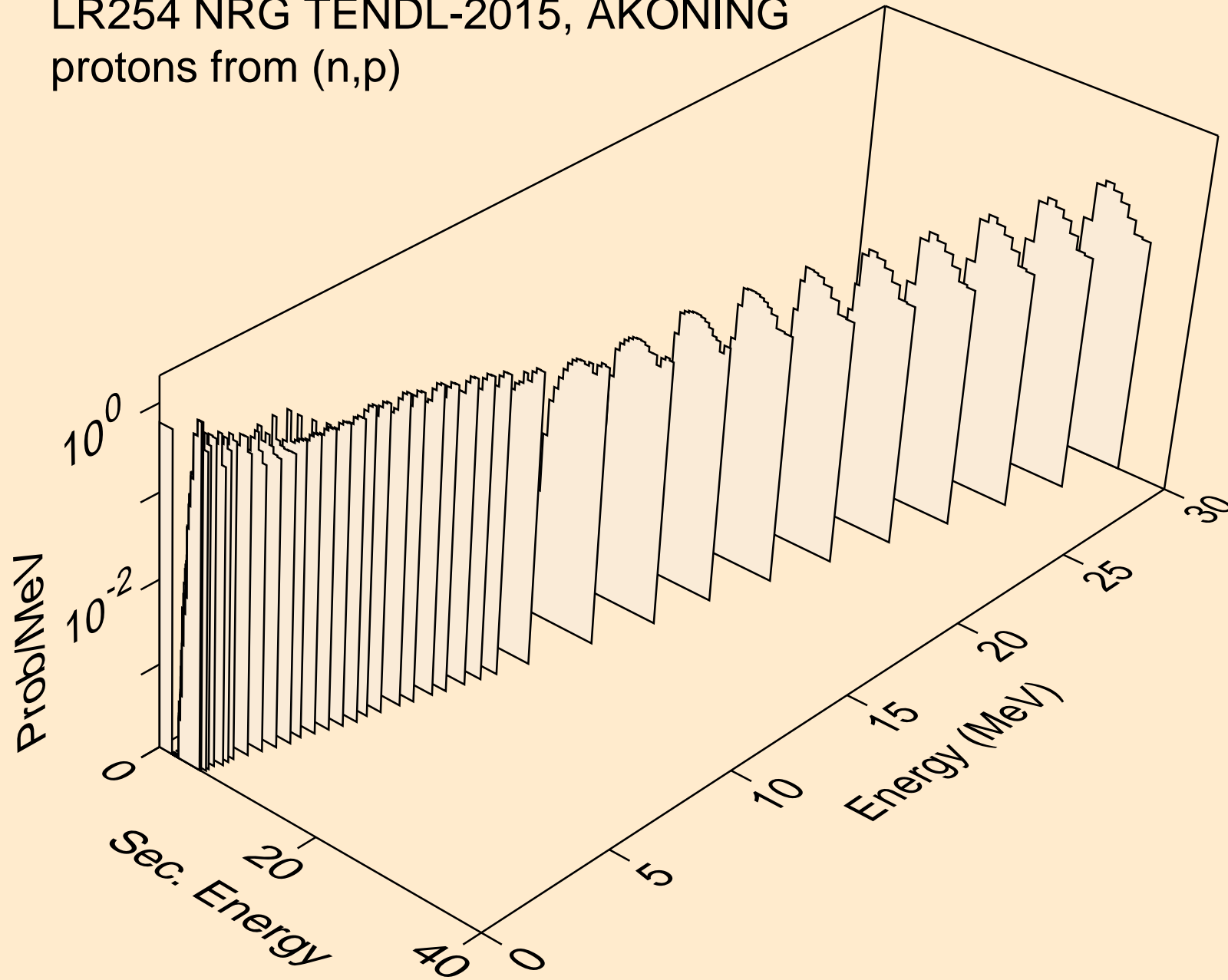

LR254 NRG TENDL-2015, AKONING
protons from (n,2p)

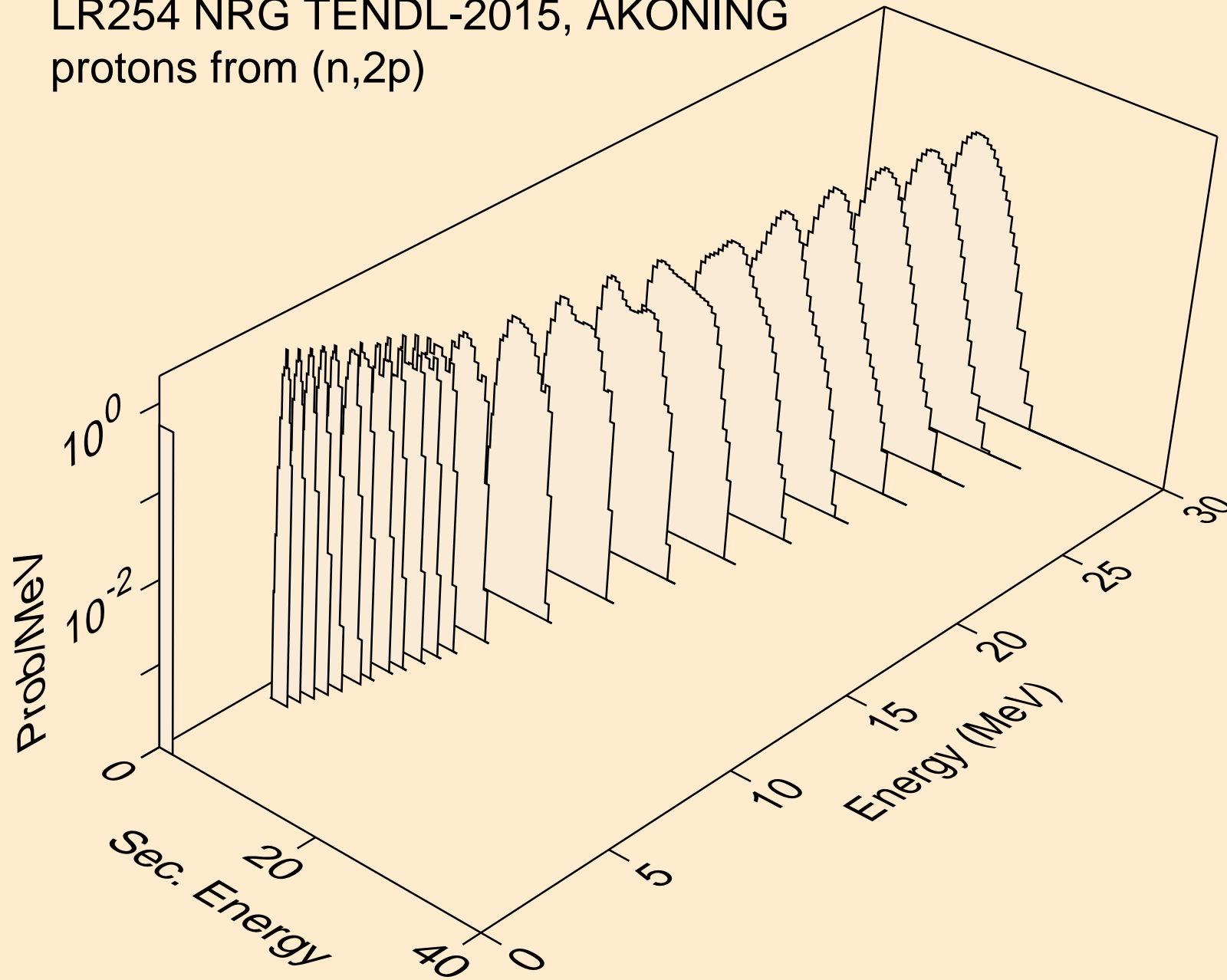

LR254 NRG TENDL-2015, AKONING
protons from (n,pa)

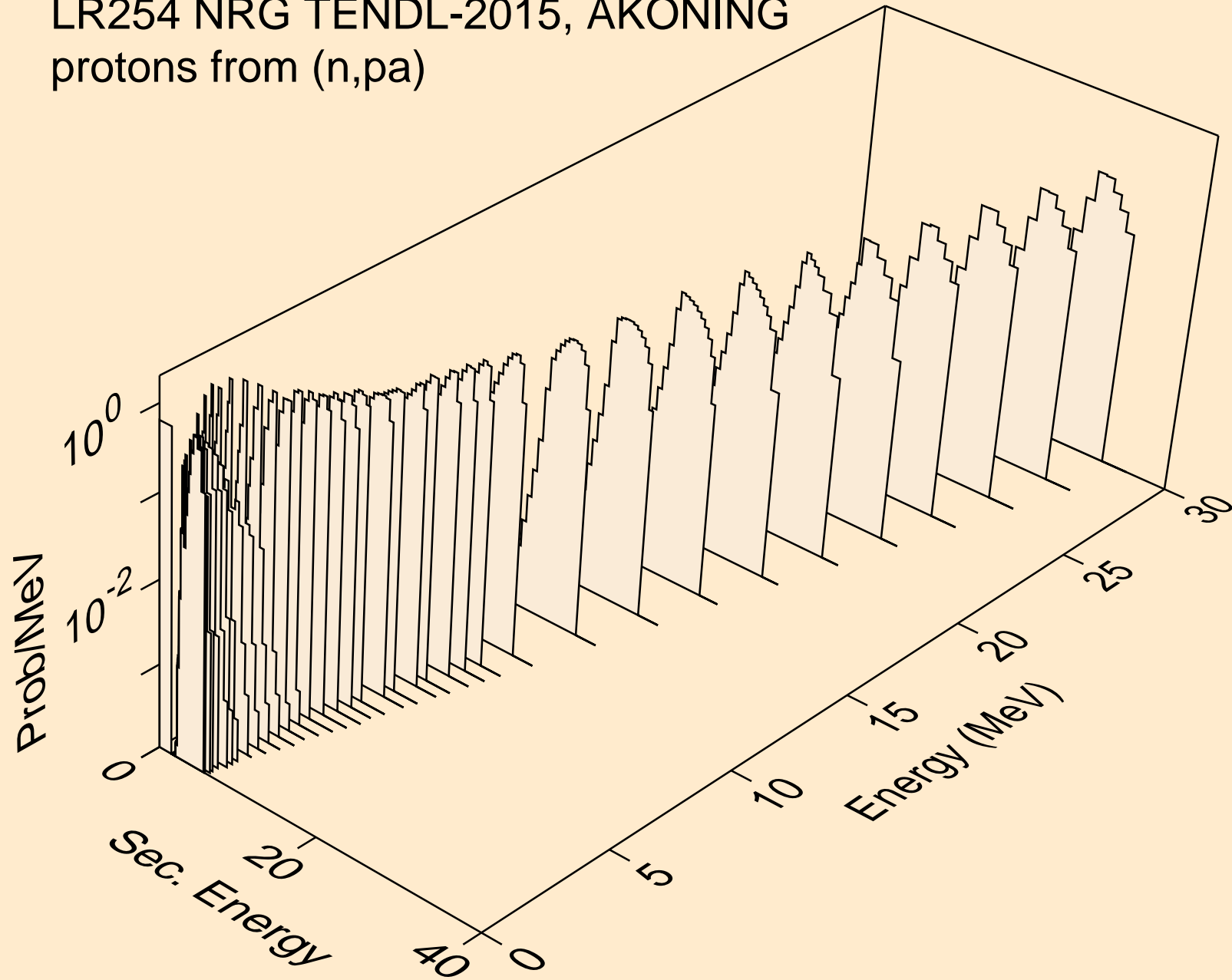

LR254 NRG TENDL-2015, AKONING
protons from (n,pd)

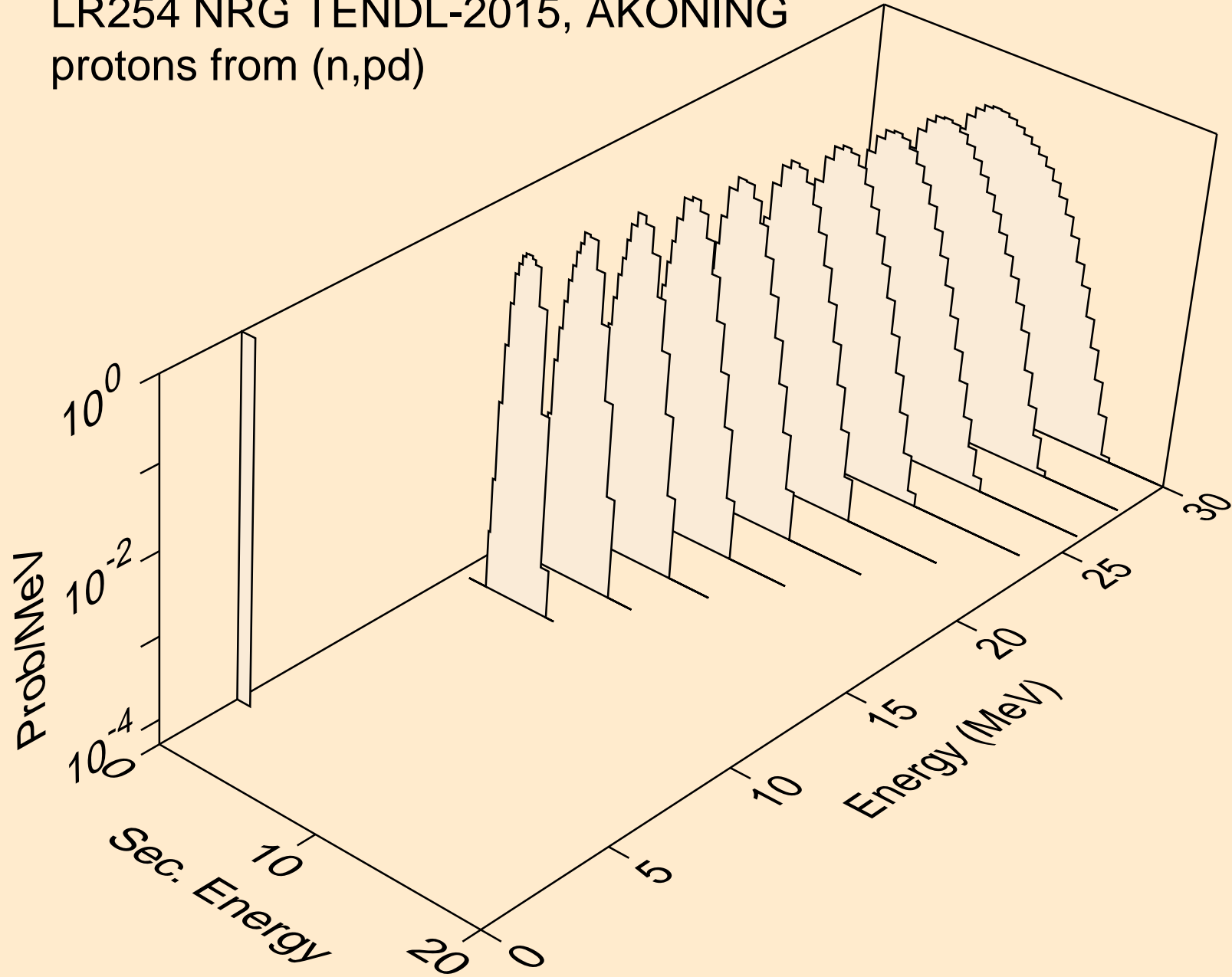

LR254 NRG TENDL-2015, AKONING
protons from (n,pt)

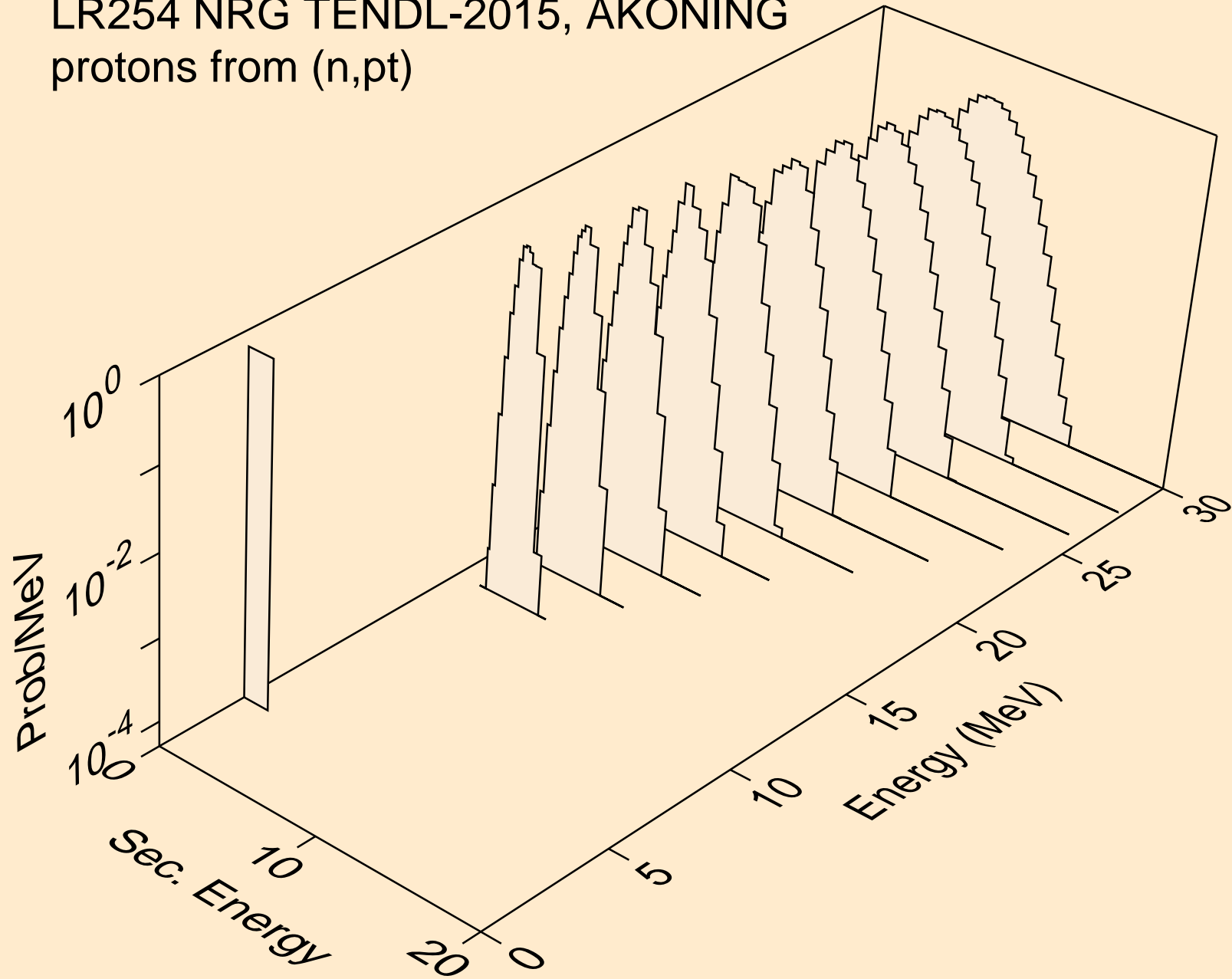

LR254 NRG TENDL-2015, AKONING
deuterons from (n,x)

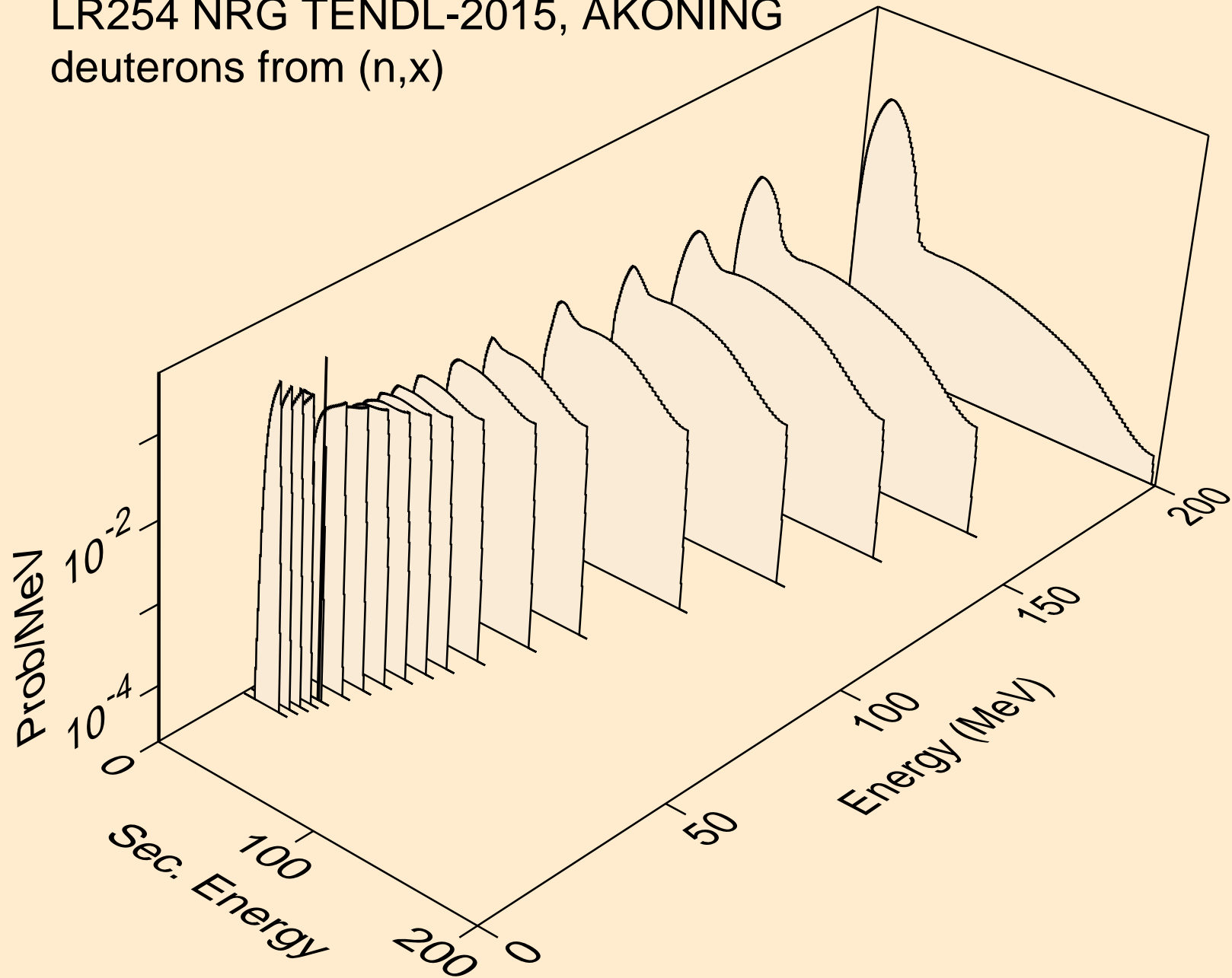

LR254 NRG TENDL-2015, AKONING
deuterons from (n,2nd)

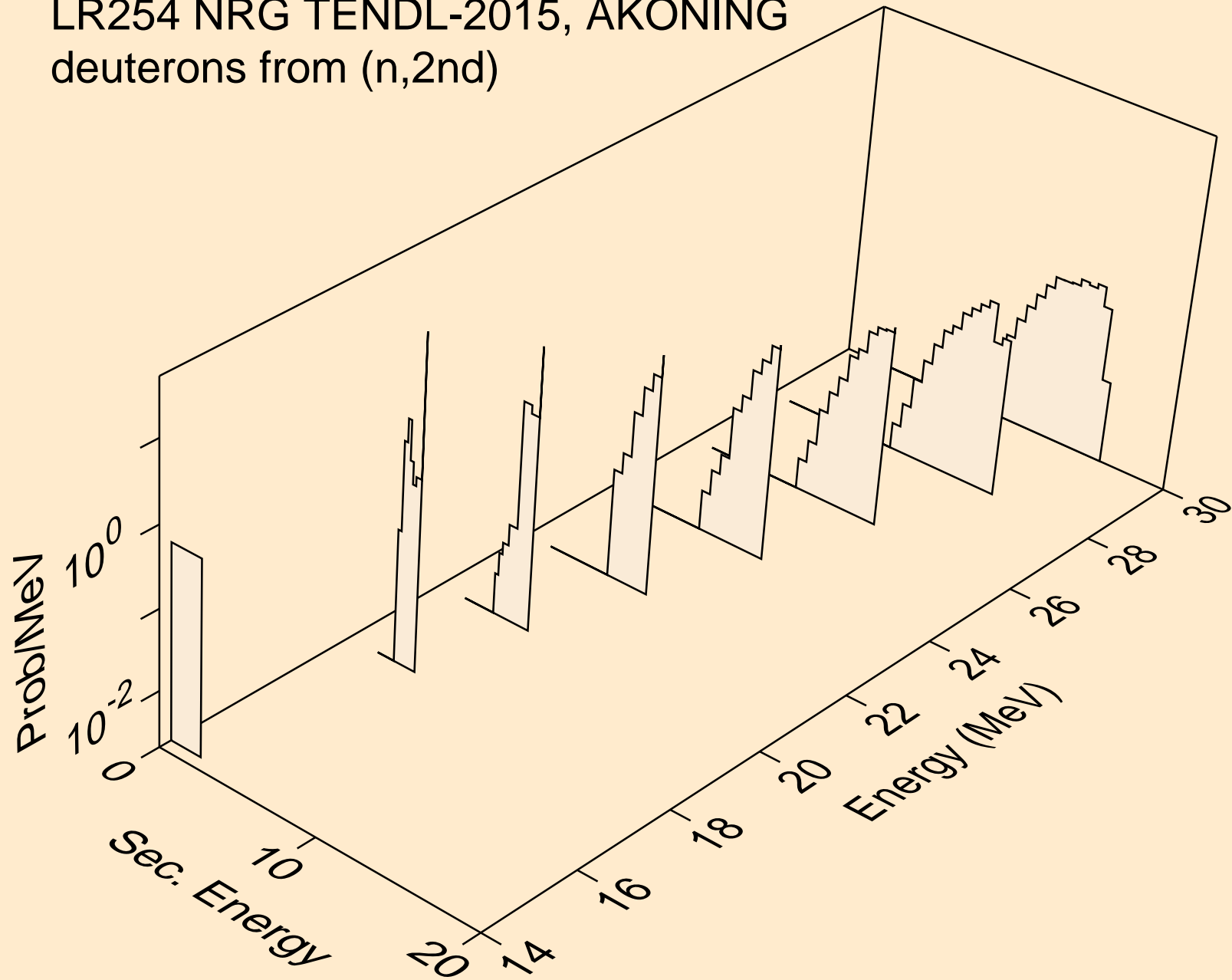

LR254 NRG TENDL-2015, AKONING
deuterons from (n,n*)d

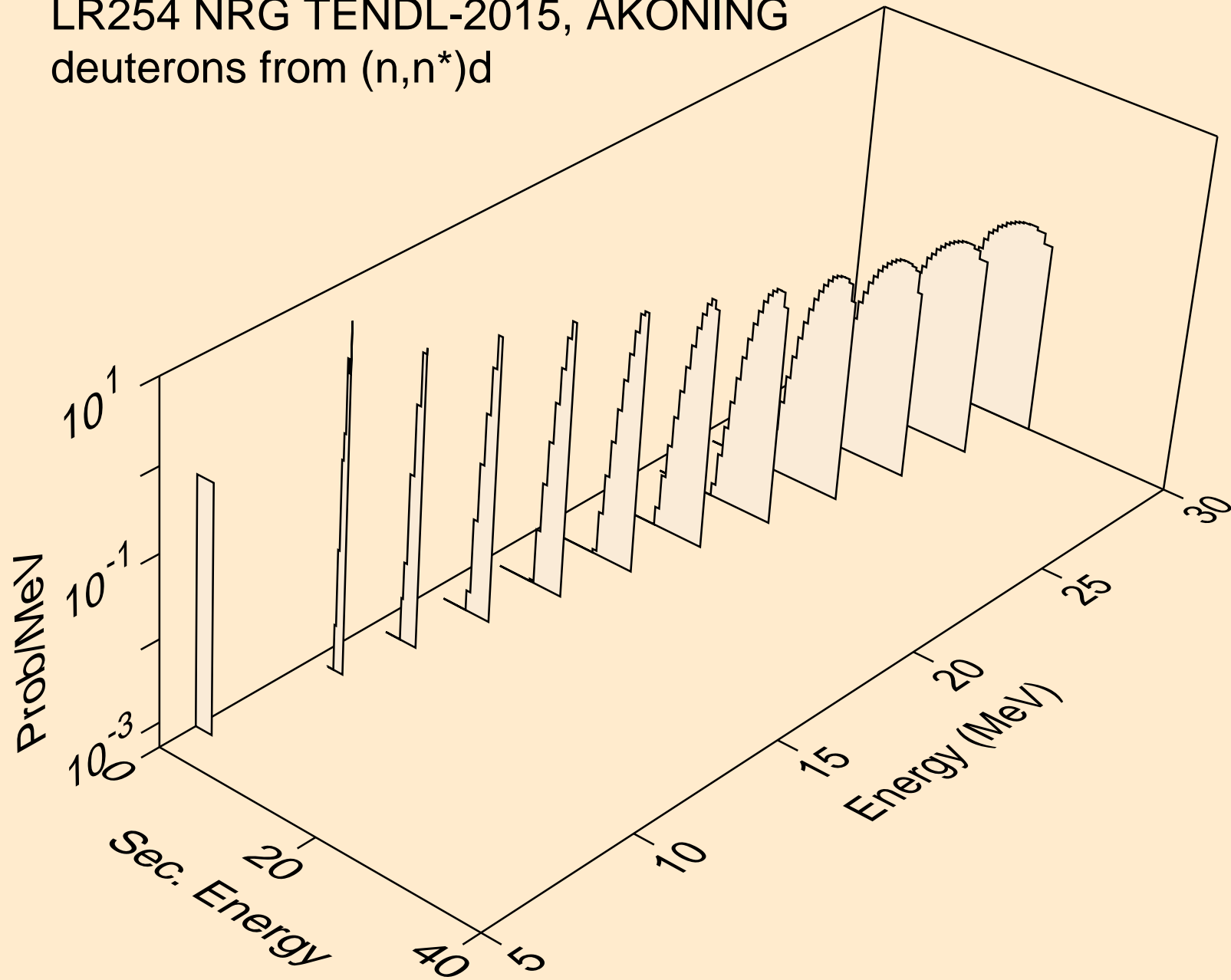

LR254 NRG TENDL-2015, AKONING
deuterons from (n,n*)d2a

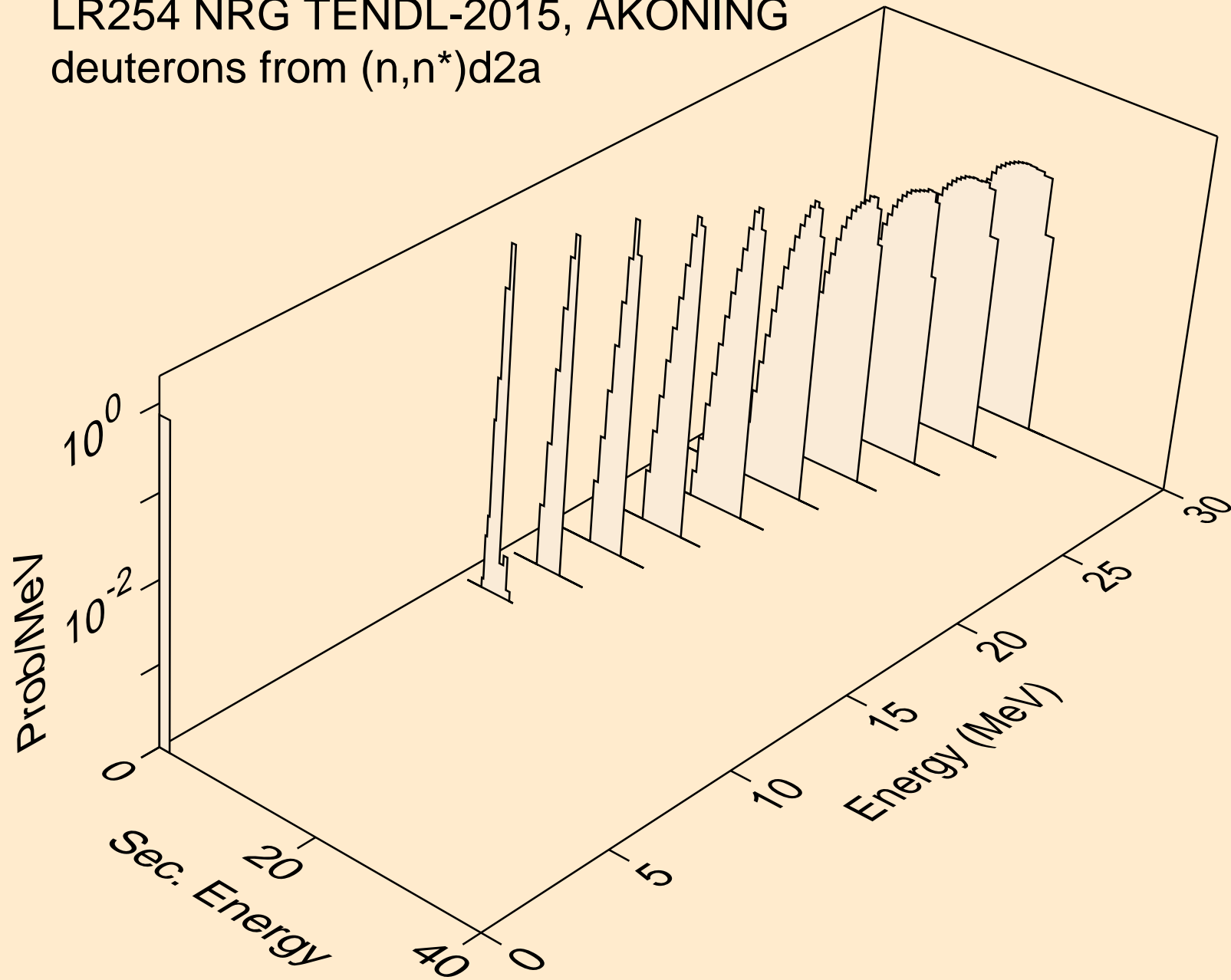

LR254 NRG TENDL-2015, AKONING
deuterons from (n,d)

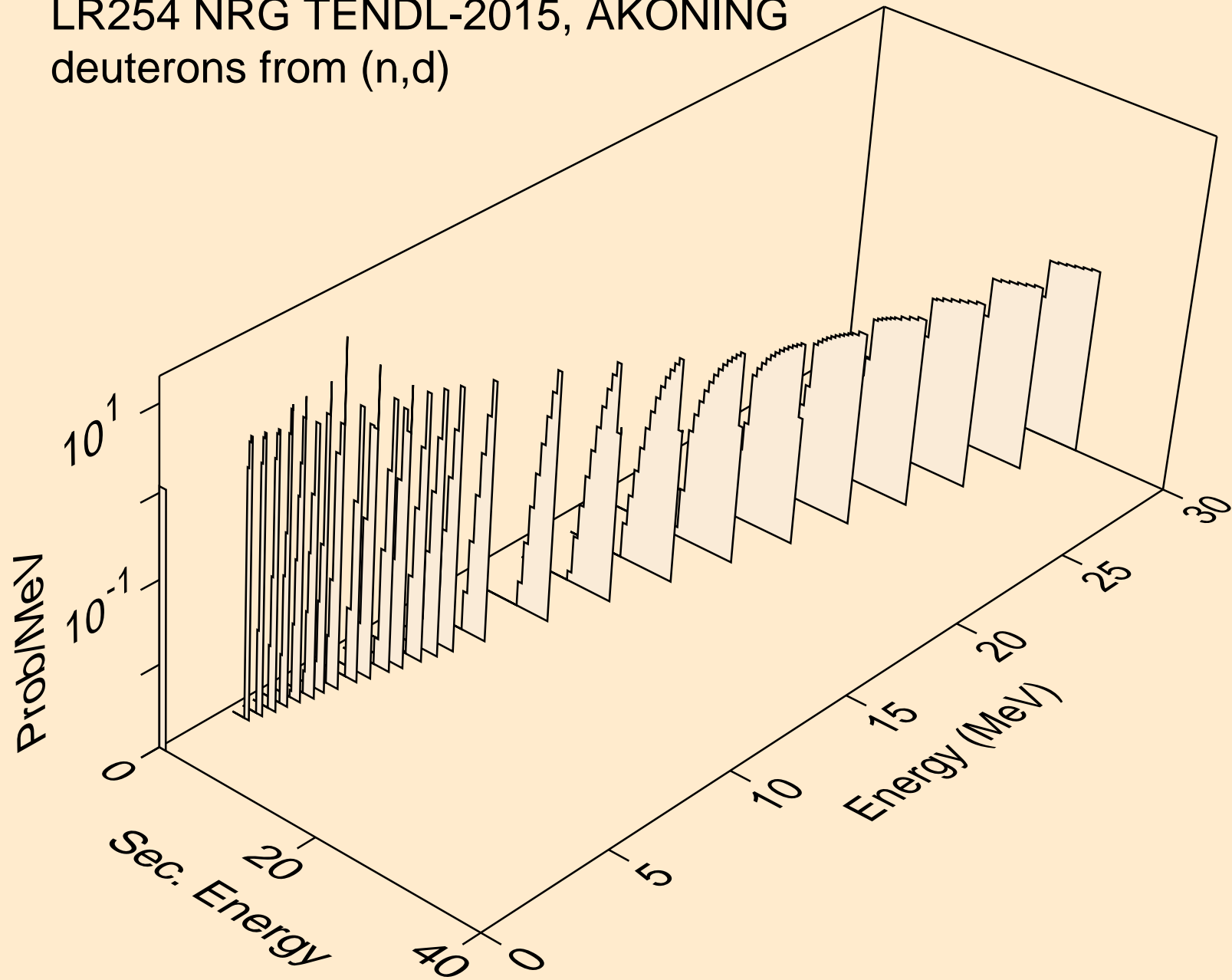

LR254 NRG TENDL-2015, AKONING
deuterons from (n,d2a)

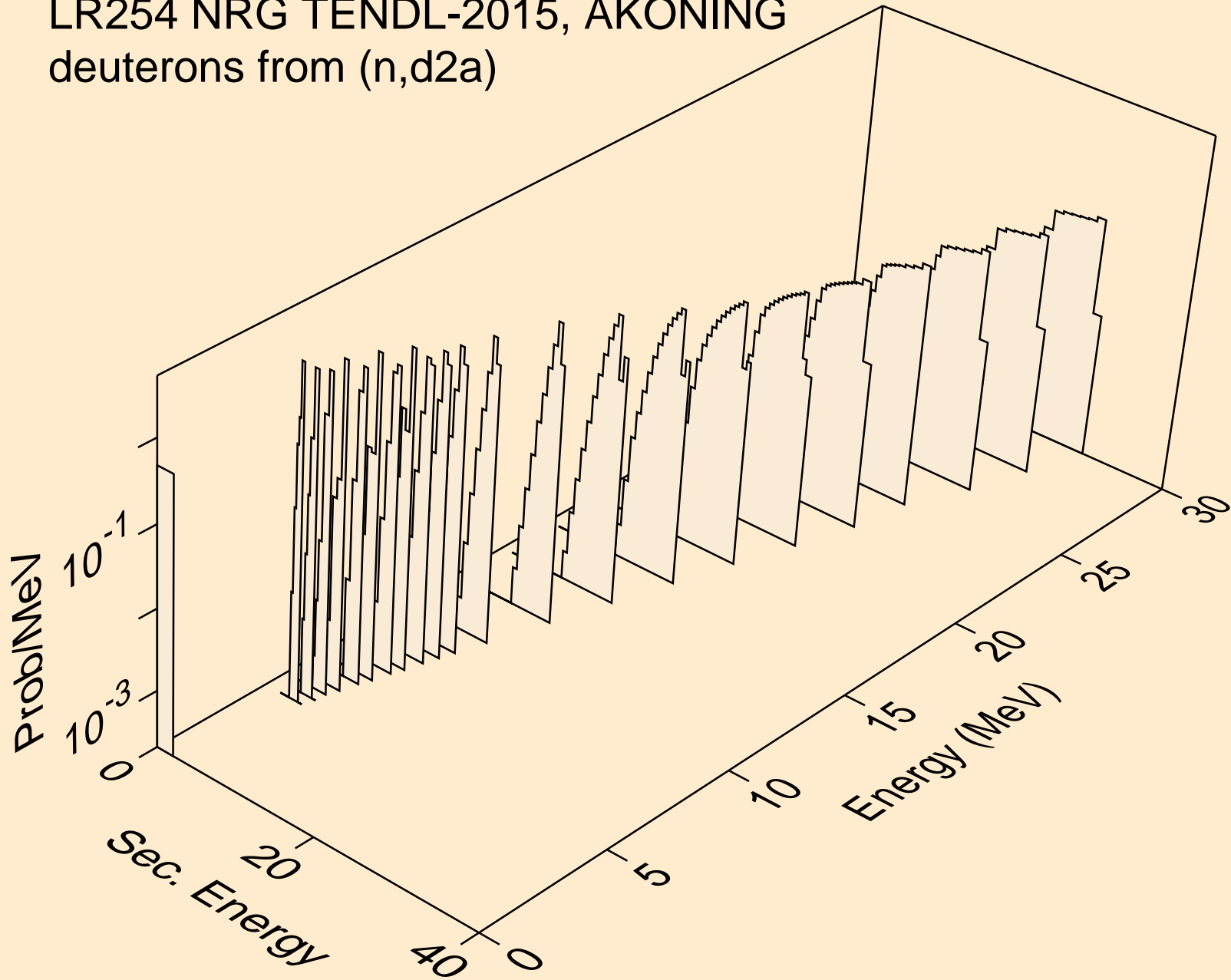

LR254 NRG TENDL-2015, AKONING
deuterons from (n,pd)

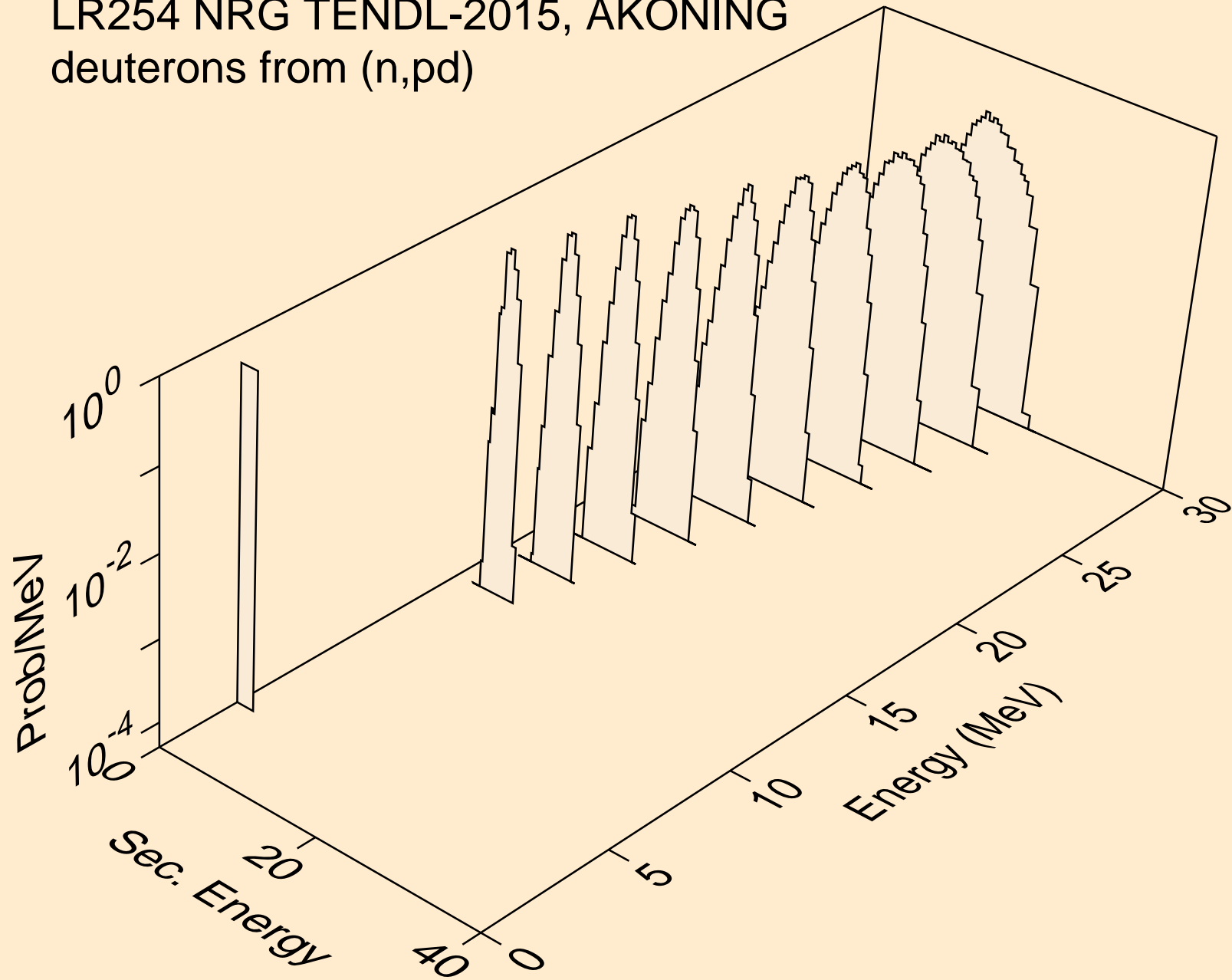

LR254 NRG TENDL-2015, AKONING
deuterons from (n,da)

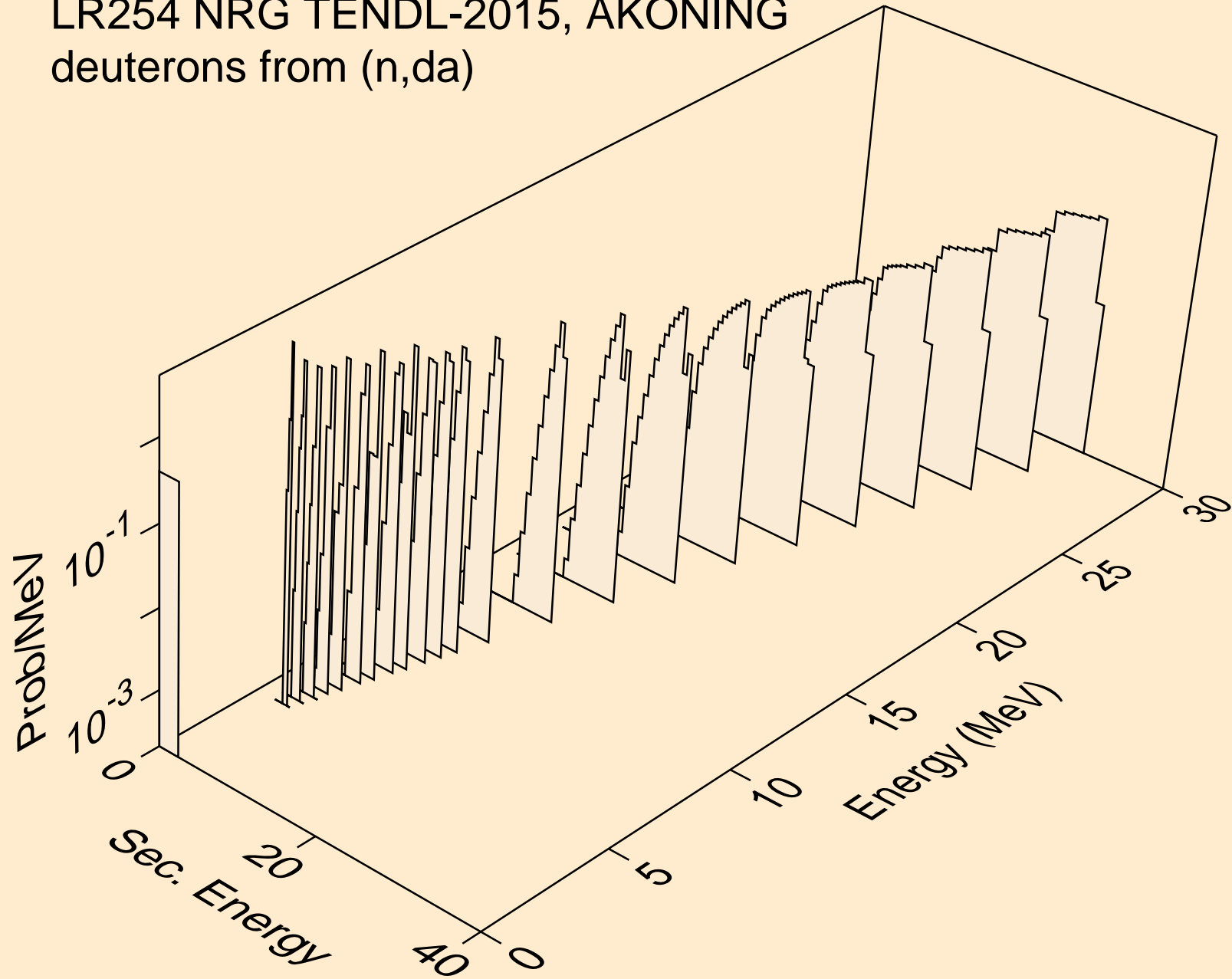

LR254 NRG TENDL-2015, AKONING
tritons from (n,x)

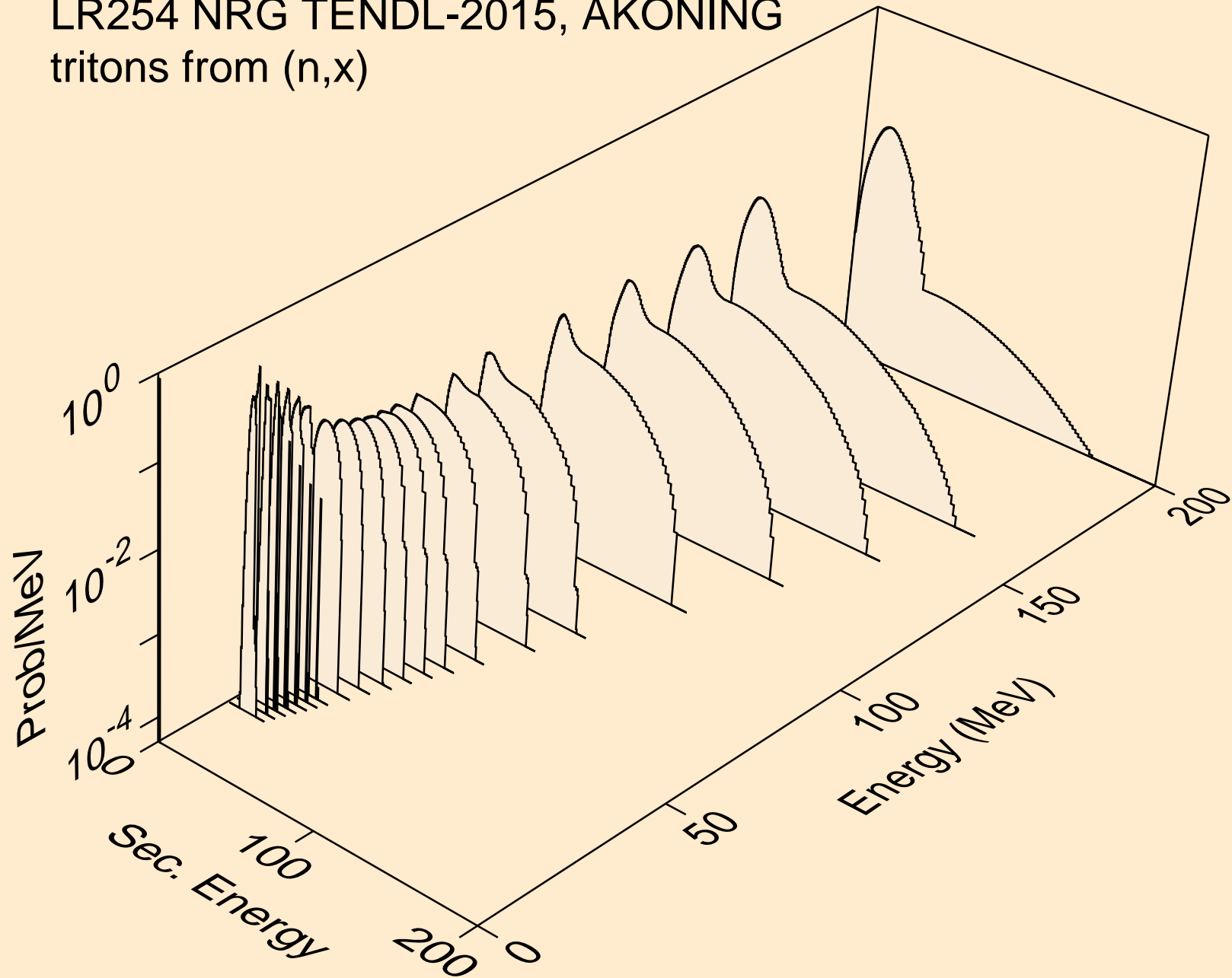

LR254 NRG TENDL-2015, AKONING
tritons from (n,n*)t

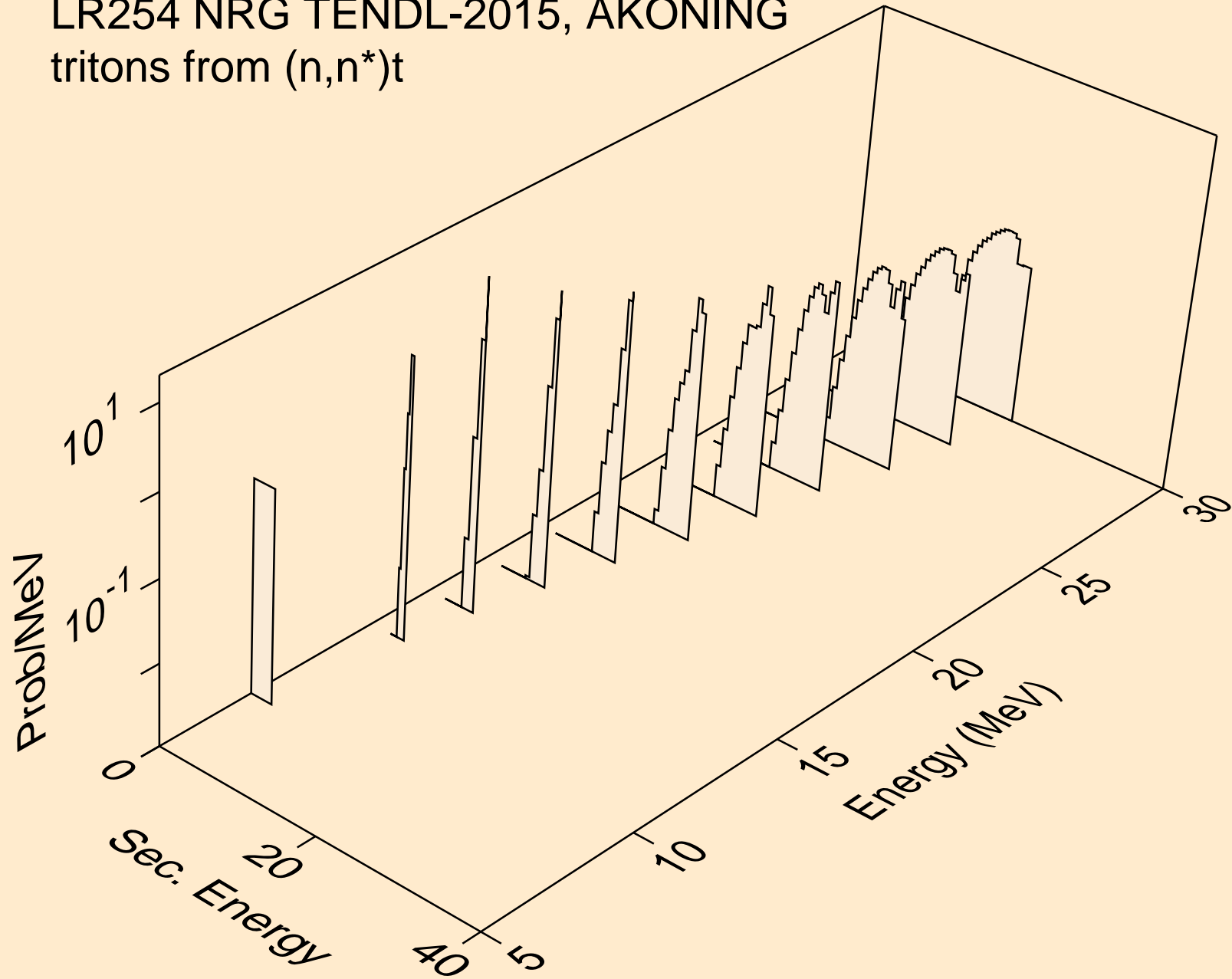

LR254 NRG TENDL-2015, AKONING
tritons from (n,n*)t2a

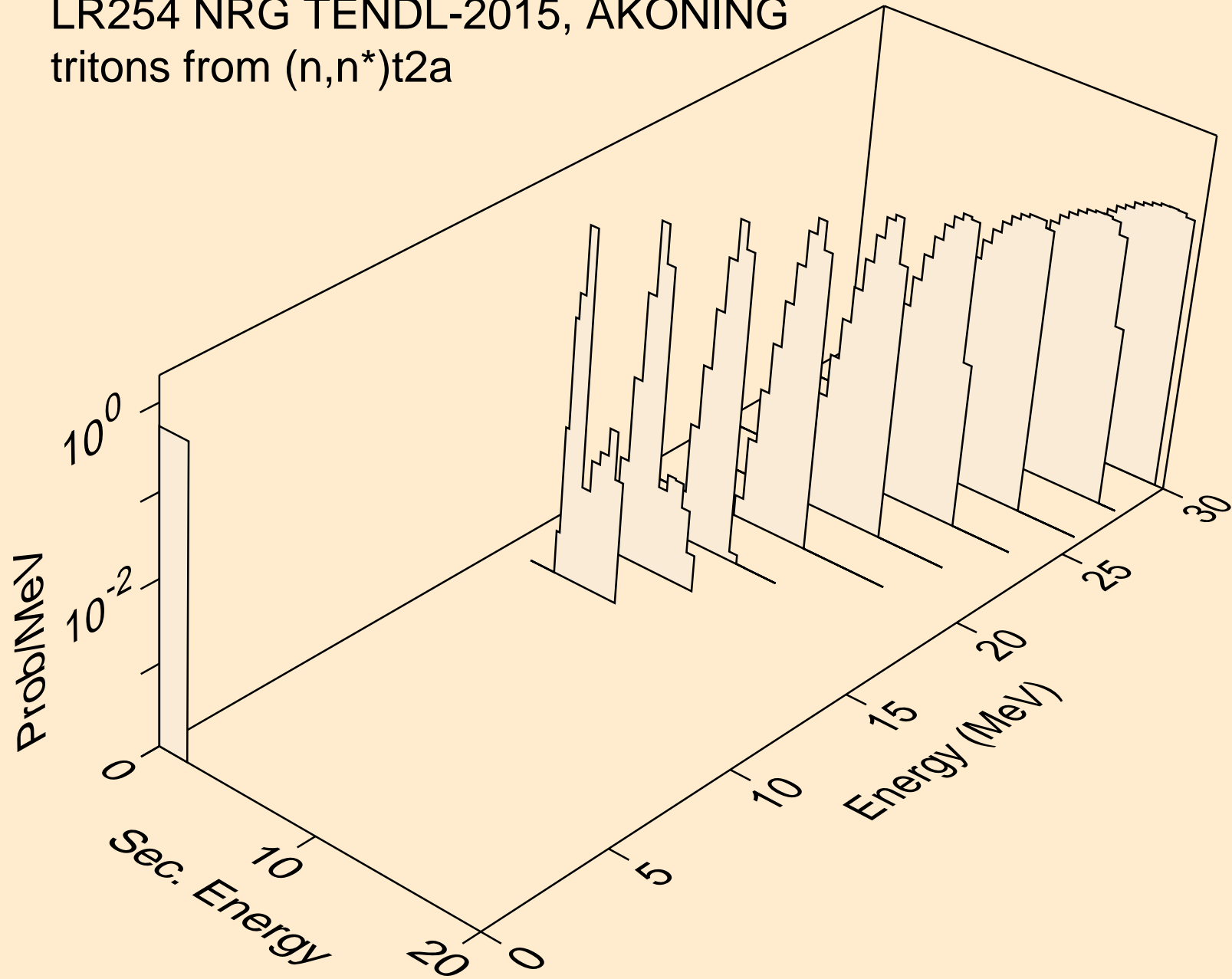

LR254 NRG TENDL-2015, AKONING
tritons from (n,t)

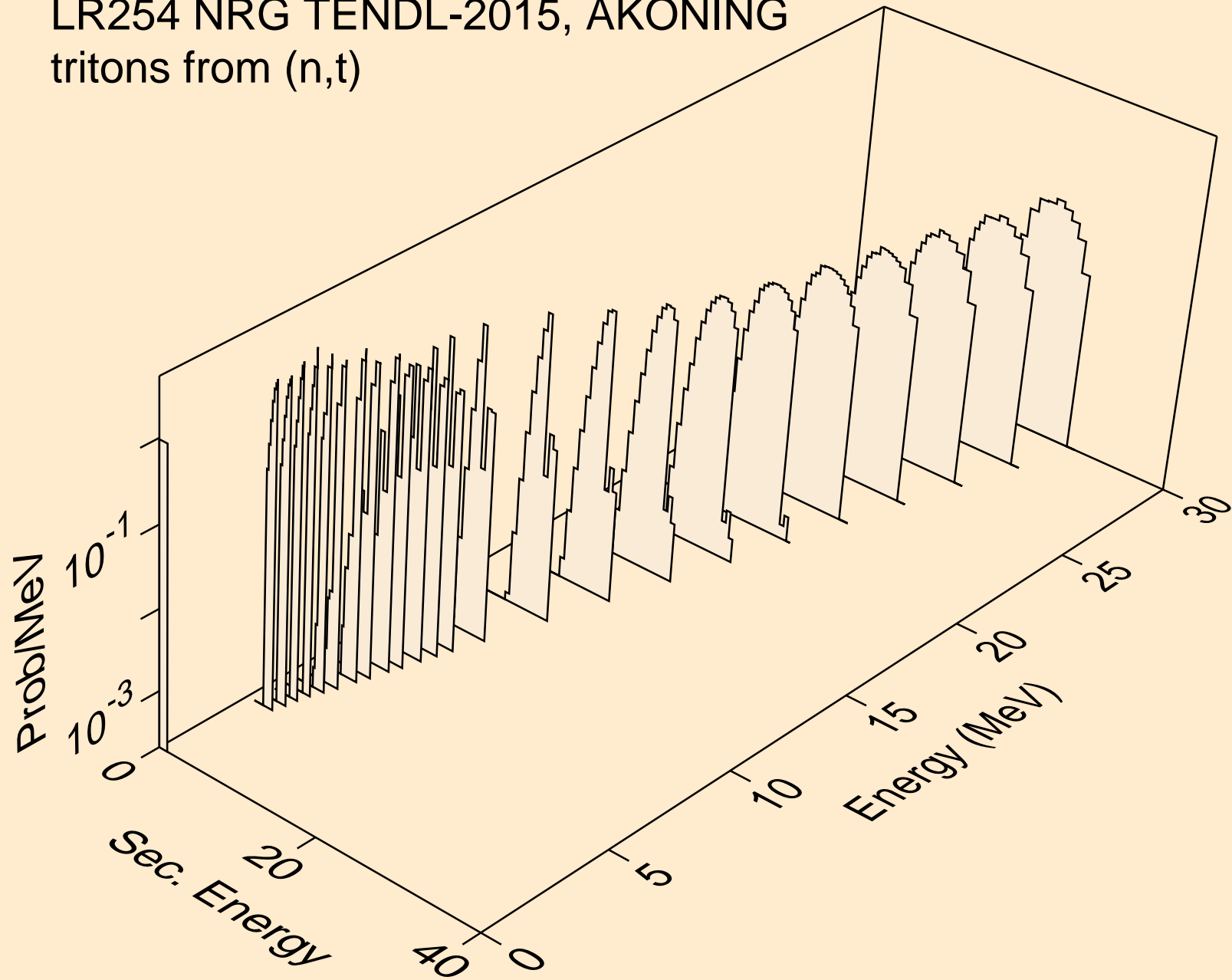

LR254 NRG TENDL-2015, AKONING
tritons from (n,t2a)

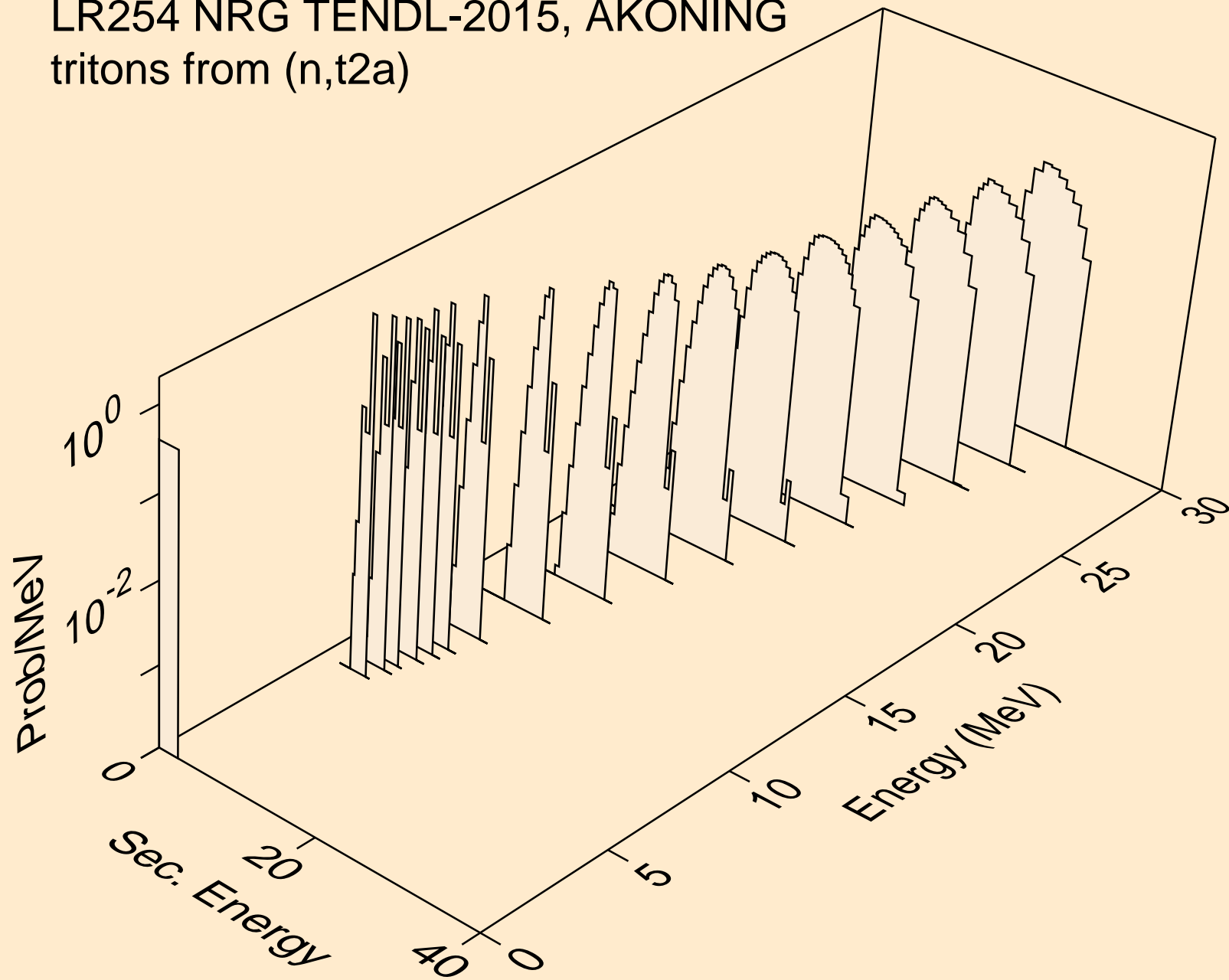

LR254 NRG TENDL-2015, AKONING
tritons from (n,pt)

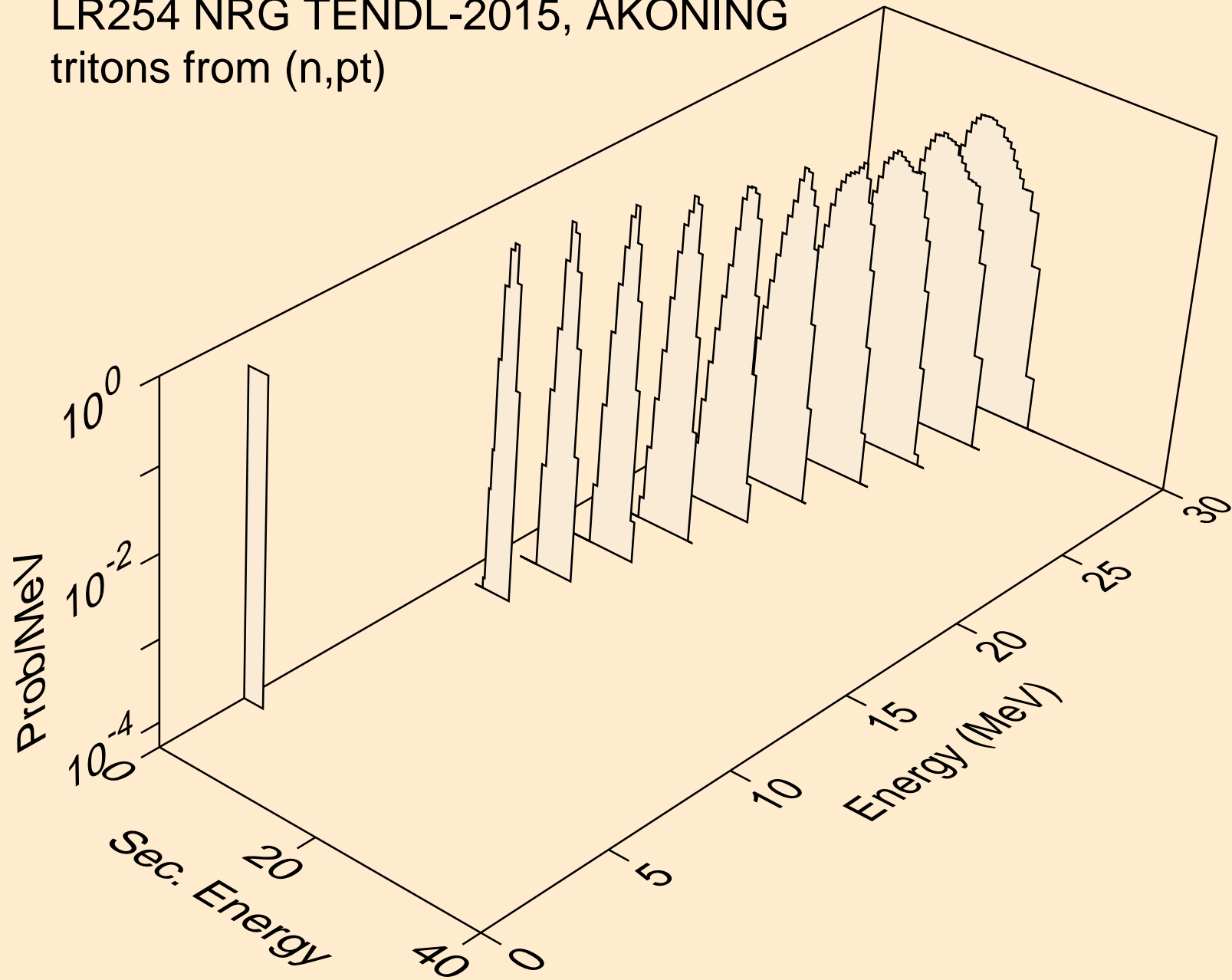

LR254 NRG TENDL-2015, AKONING
he3s from (n,x)

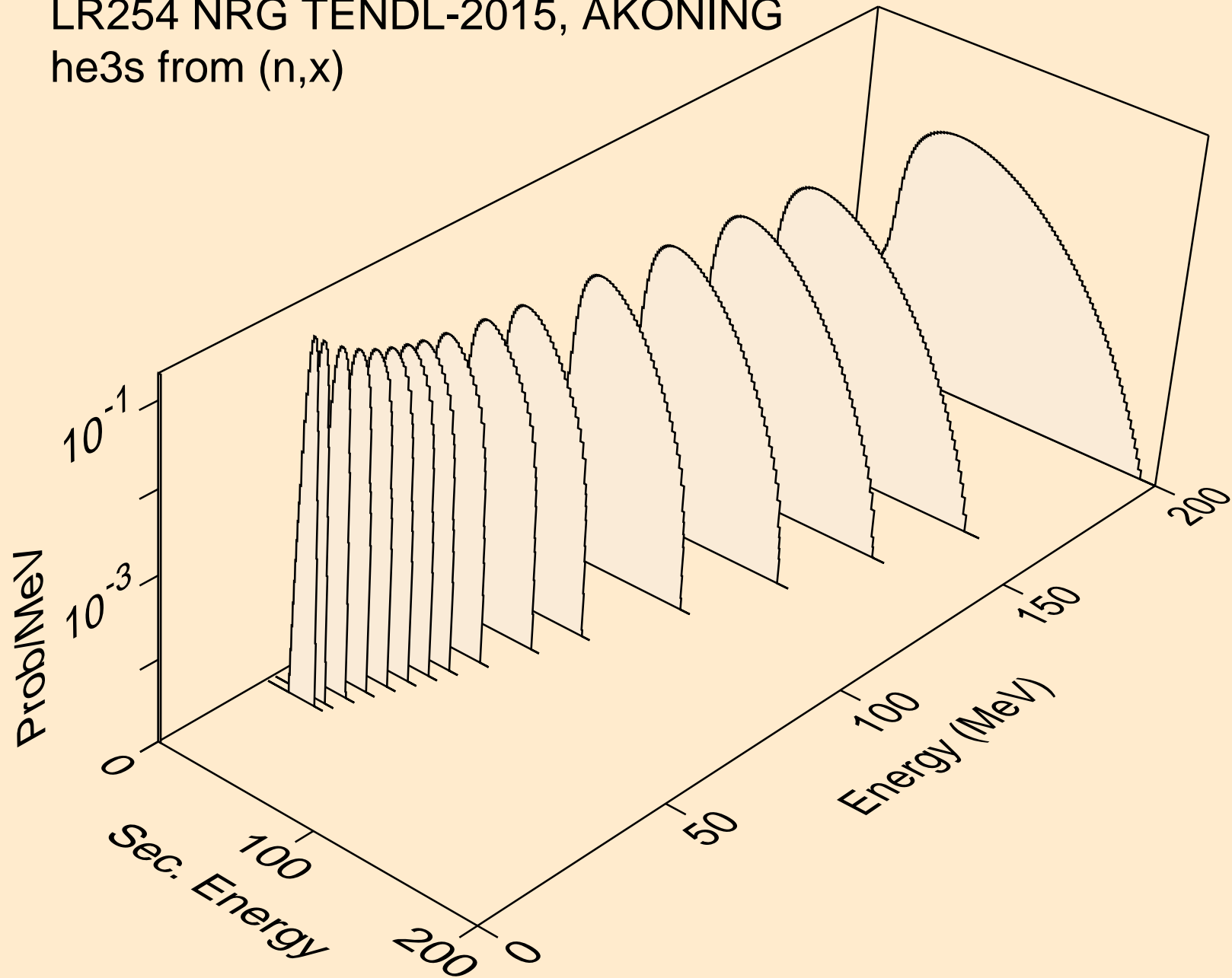

LR254 NRG TENDL-2015, AKONING
he3s from (n,n*)he3

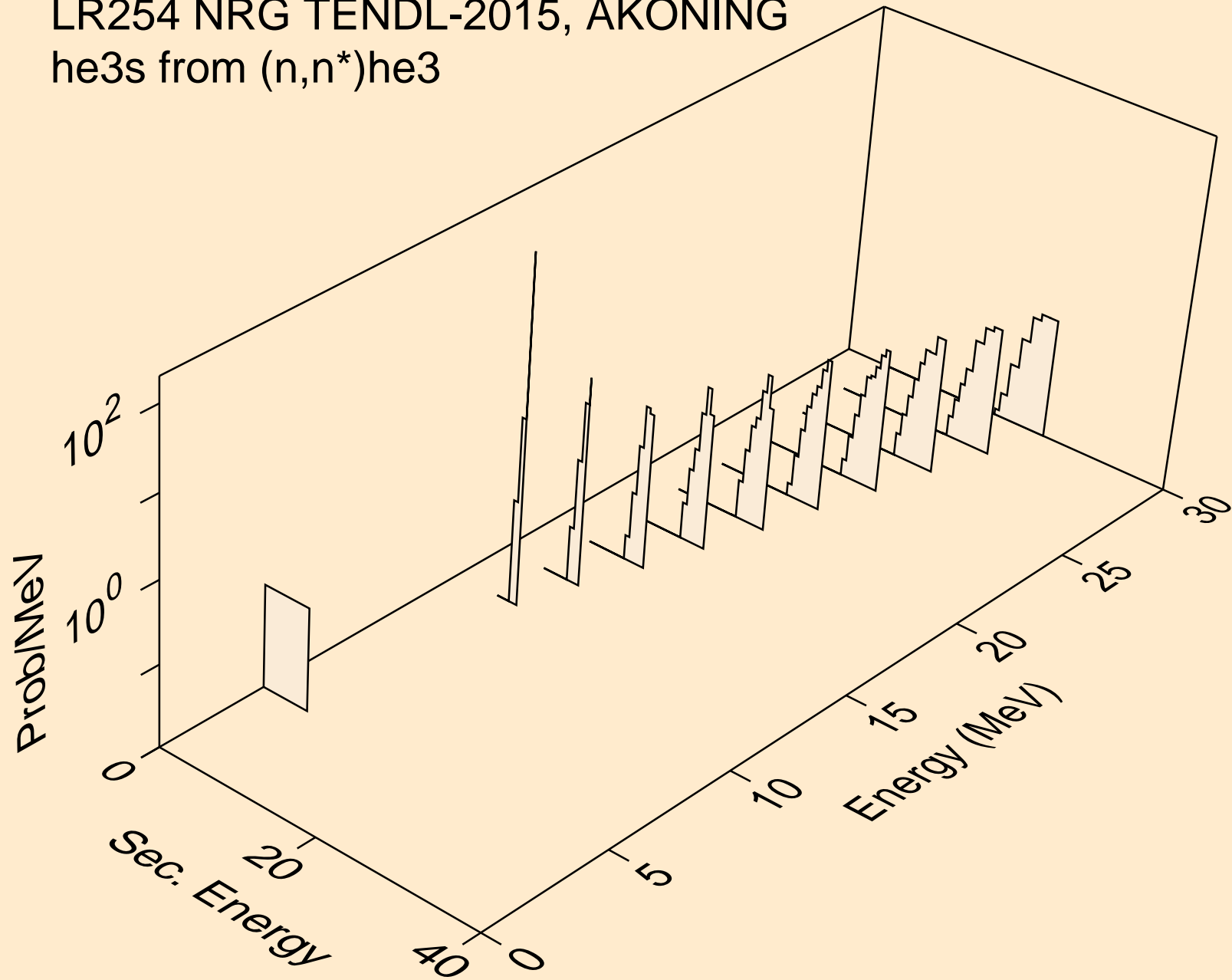

LR254 NRG TENDL-2015, AKONING
he3s from (n,he3)

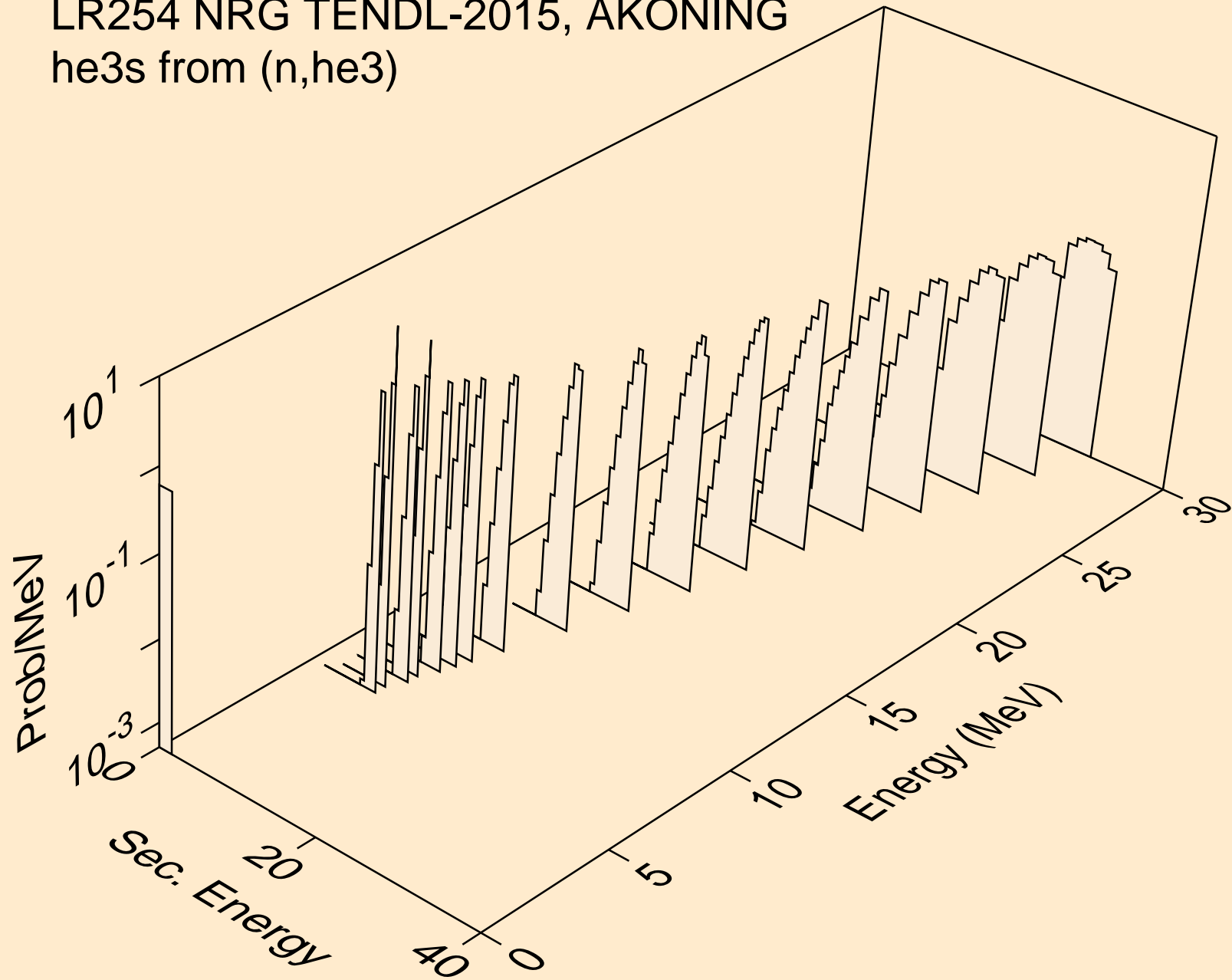

LR254 NRG TENDL-2015, AKONING
alphas from (n,x)

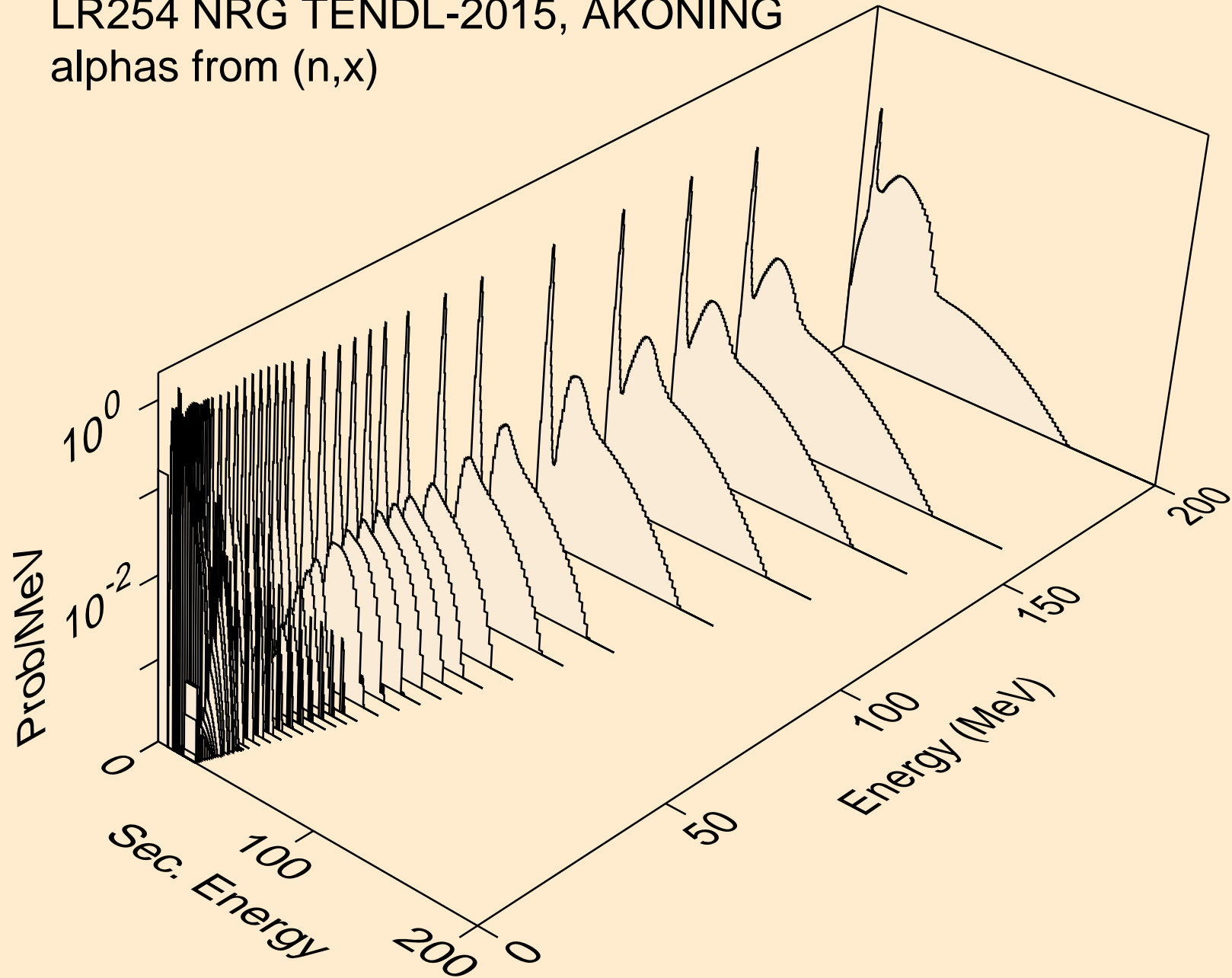

LR254 NRG TENDL-2015, AKONING
alphas from (n,n*)a

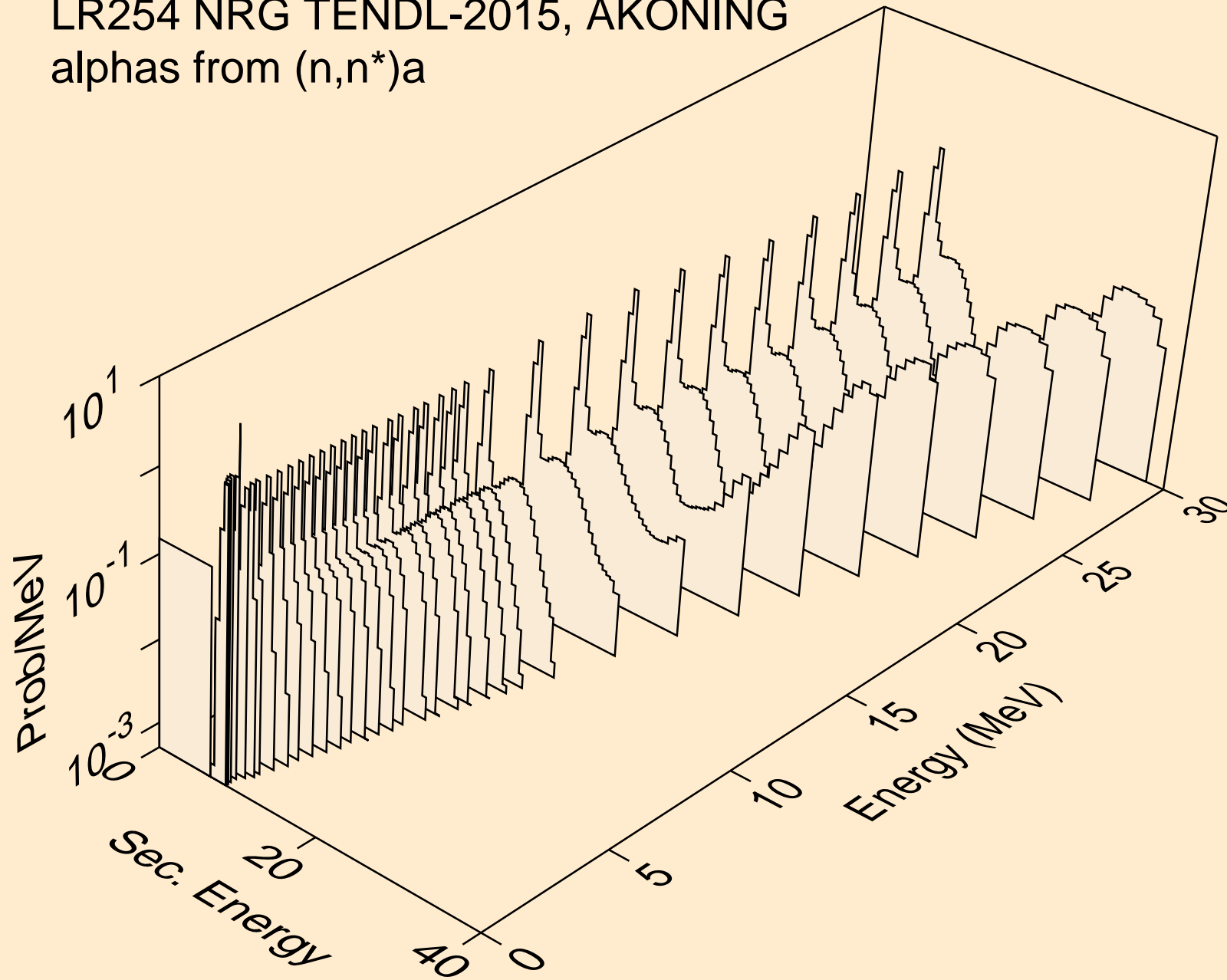

LR254 NRG TENDL-2015, AKONING
alphas from (n,n*)3a

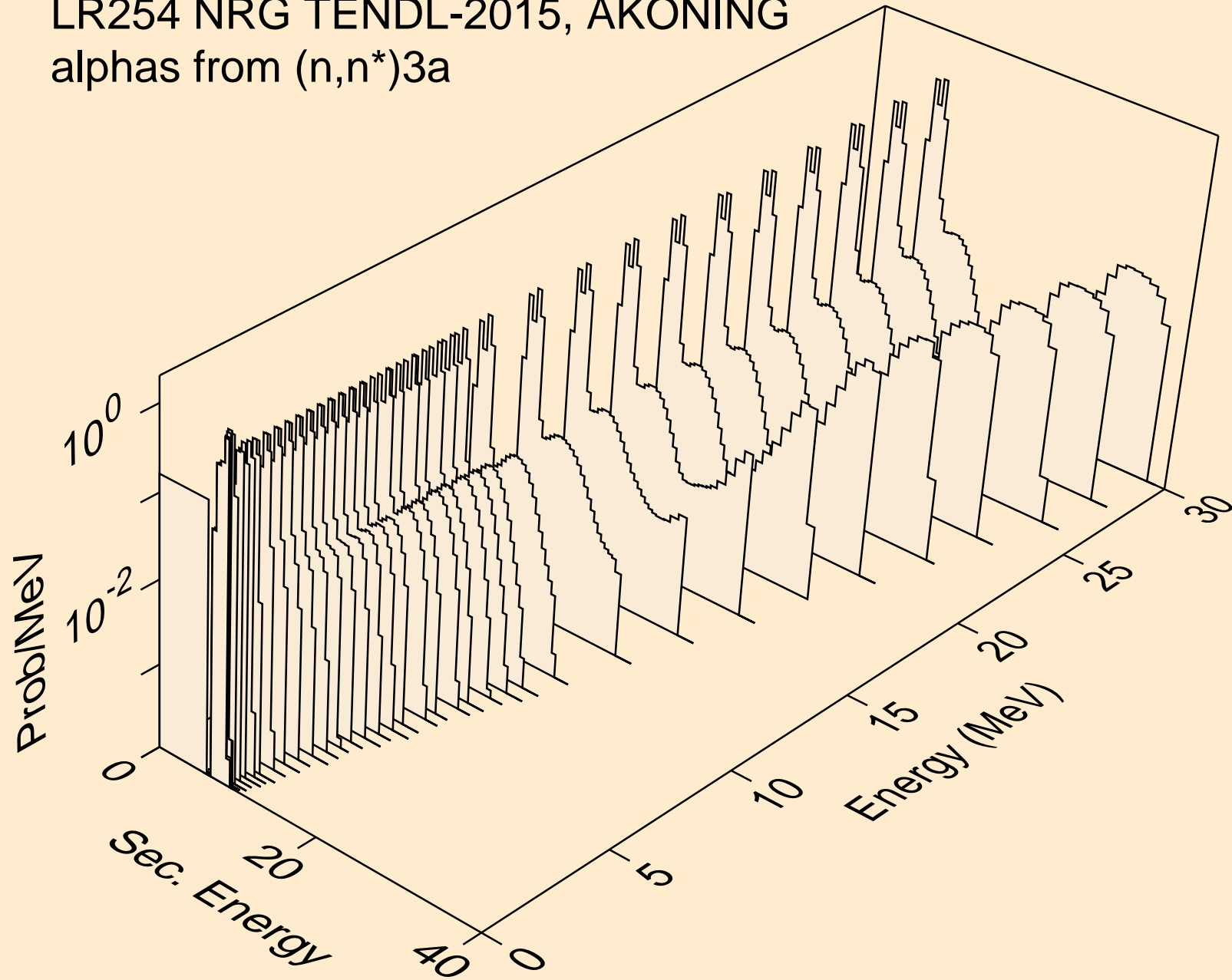

LR254 NRG TENDL-2015, AKONING
alphas from (n,2n)a

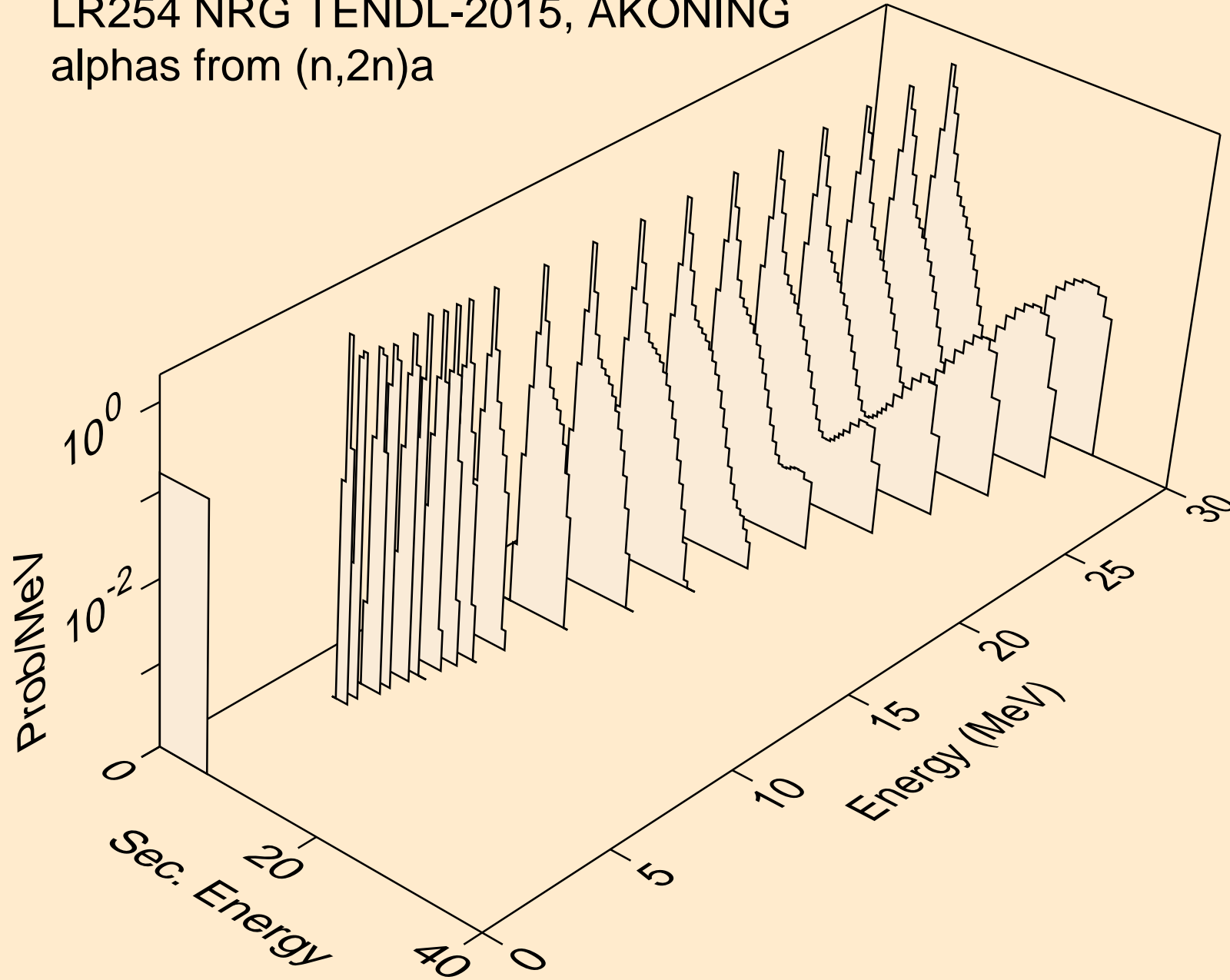

LR254 NRG TENDL-2015, AKONING
alphas from (n,3n)a

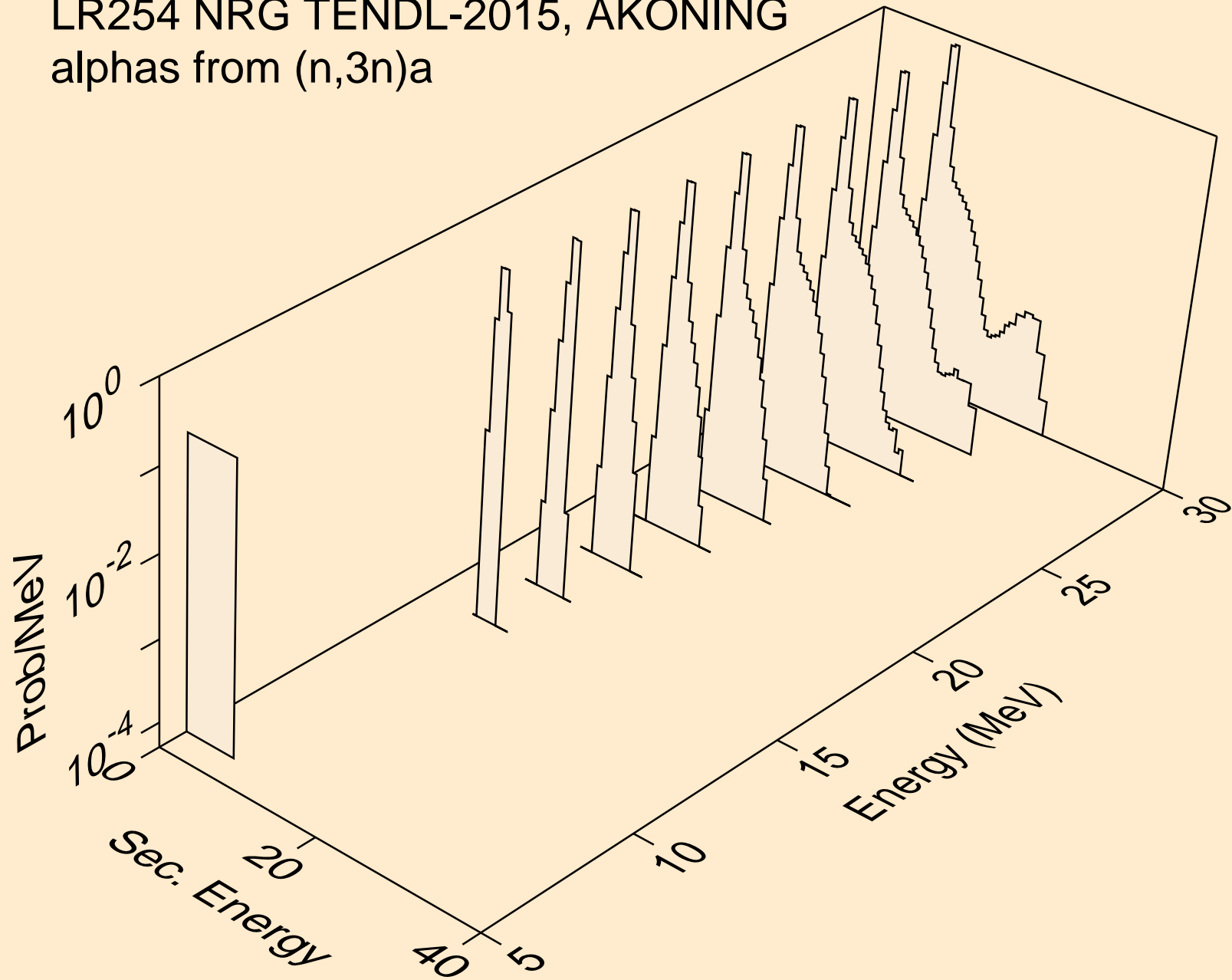

LR254 NRG TENDL-2015, AKONING
alphas from (n,n*)2a

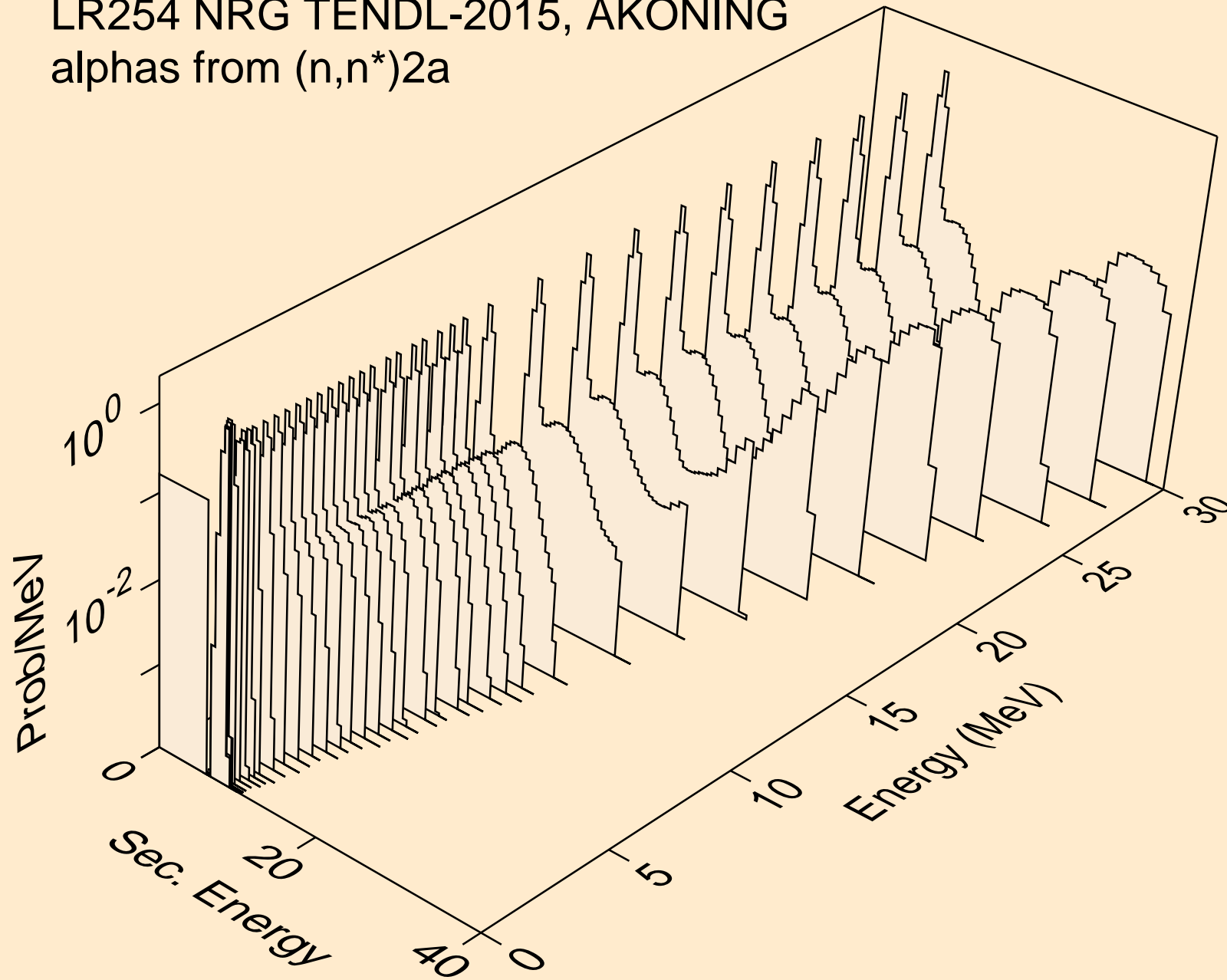

LR254 NRG TENDL-2015, AKONING
alphas from (n,2n)2a

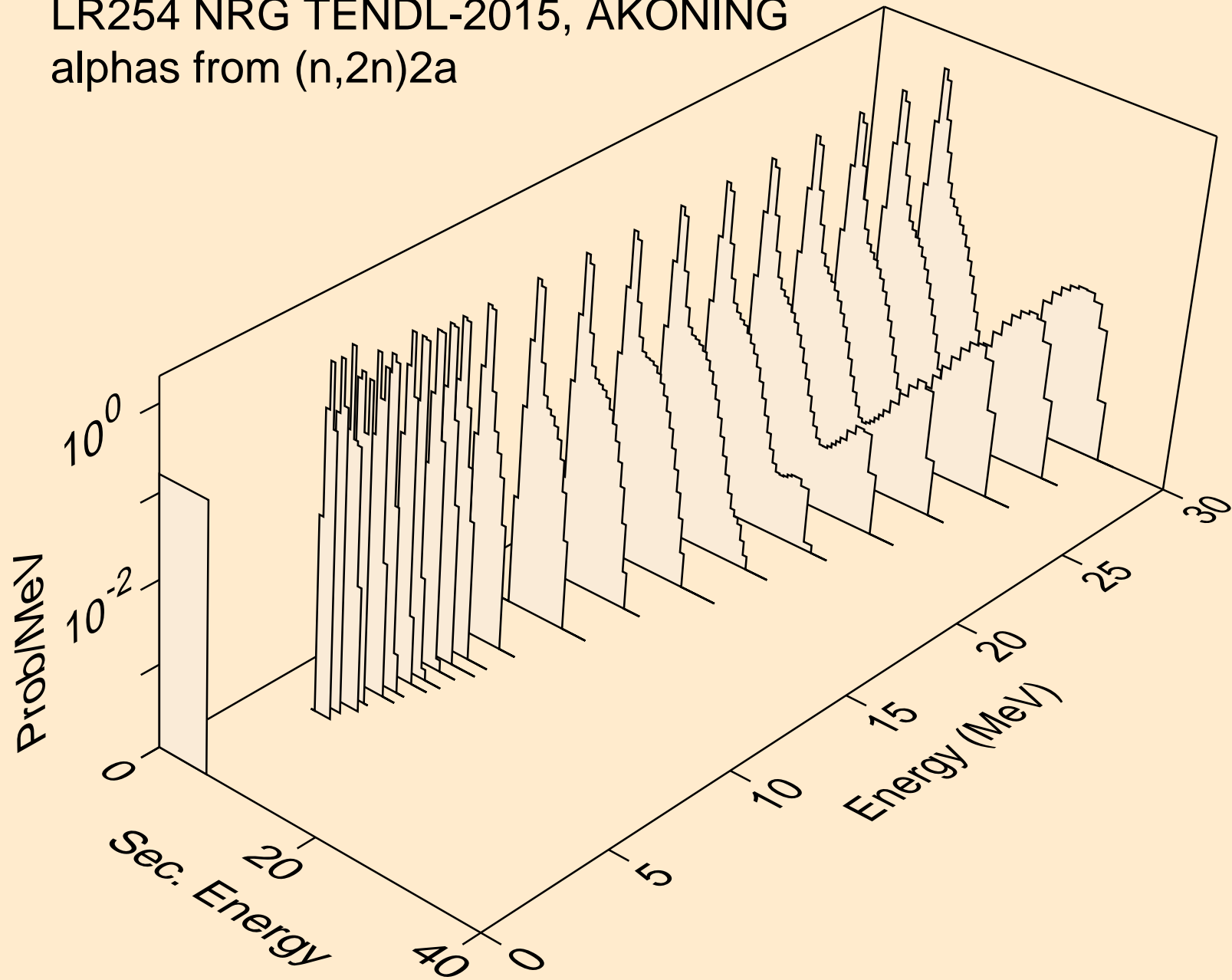

LR254 NRG TENDL-2015, AKONING
alphas from (n,n*)d2a

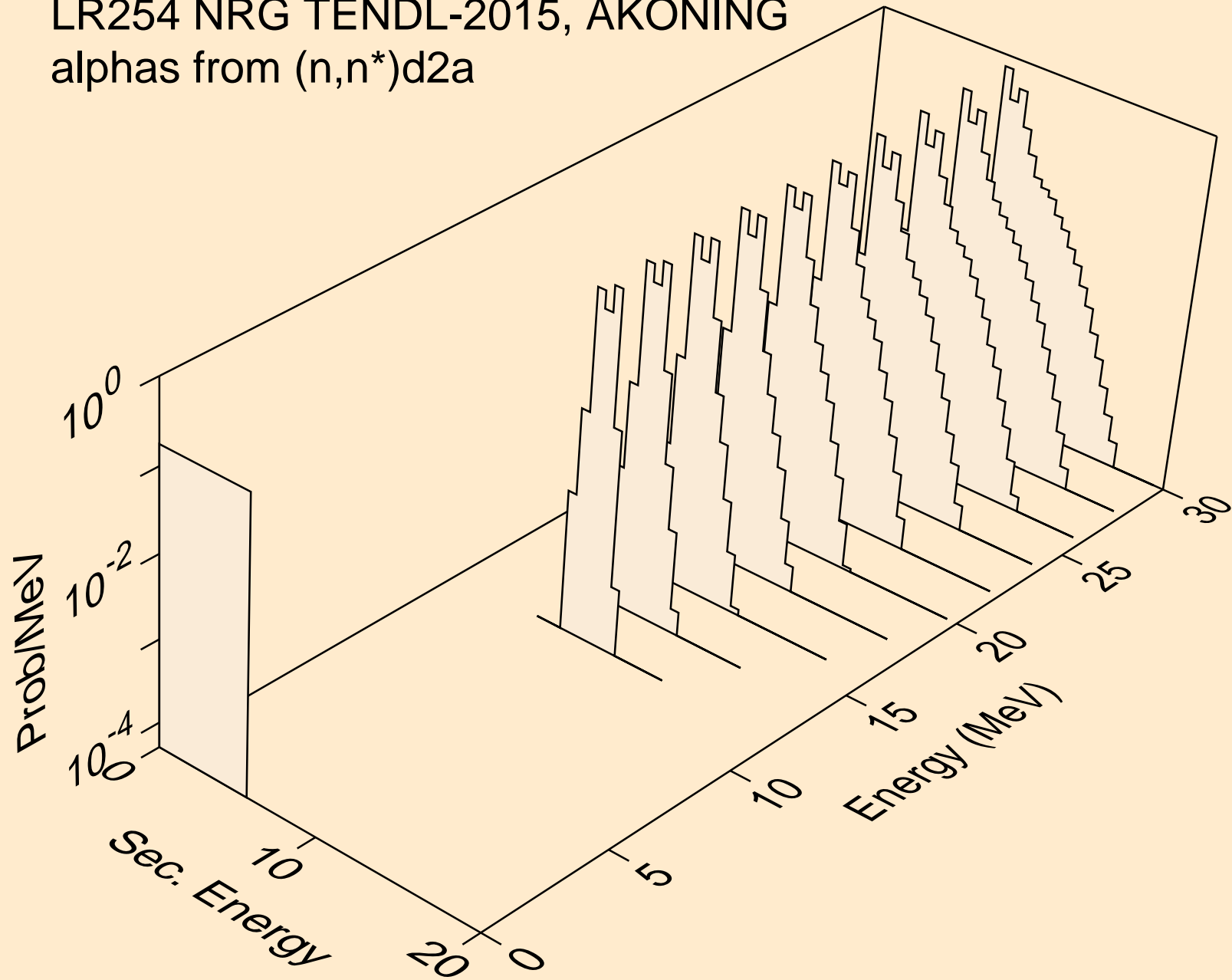

LR254 NRG TENDL-2015, AKONING
alphas from (n,n*)t2a

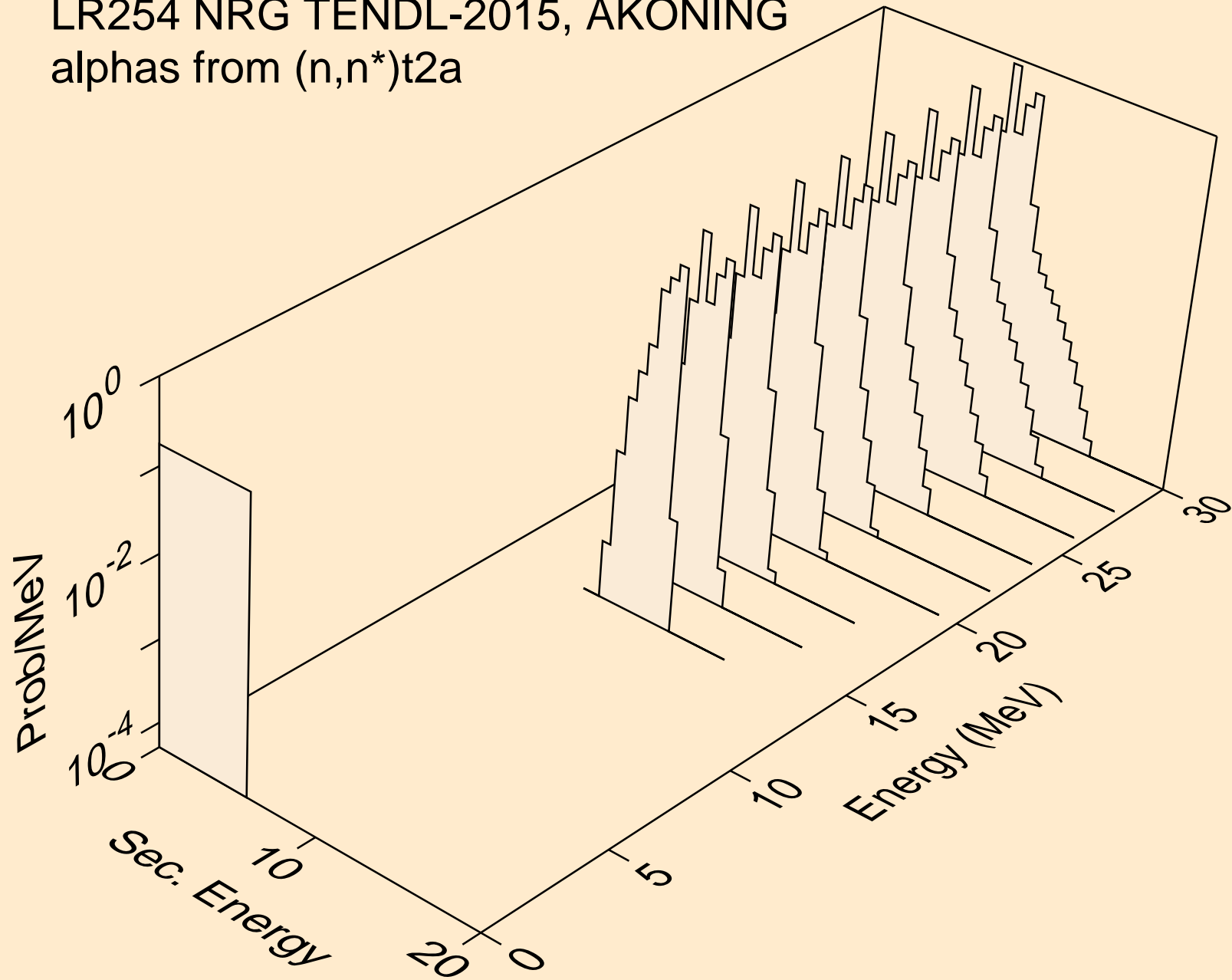

LR254 NRG TENDL-2015, AKONING
alphas from (n,npa)

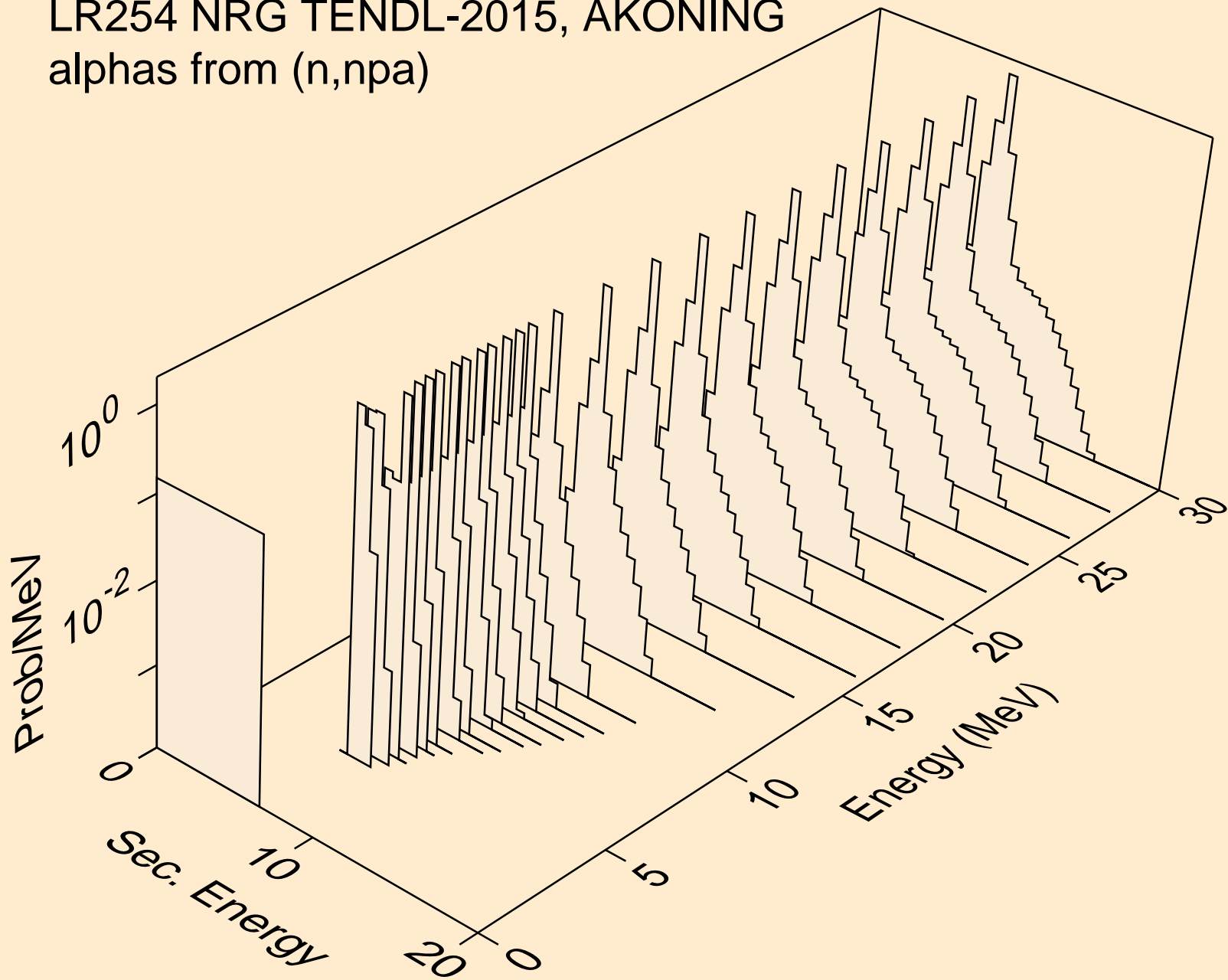

LR254 NRG TENDL-2015, AKONING
alphas from (n,a)

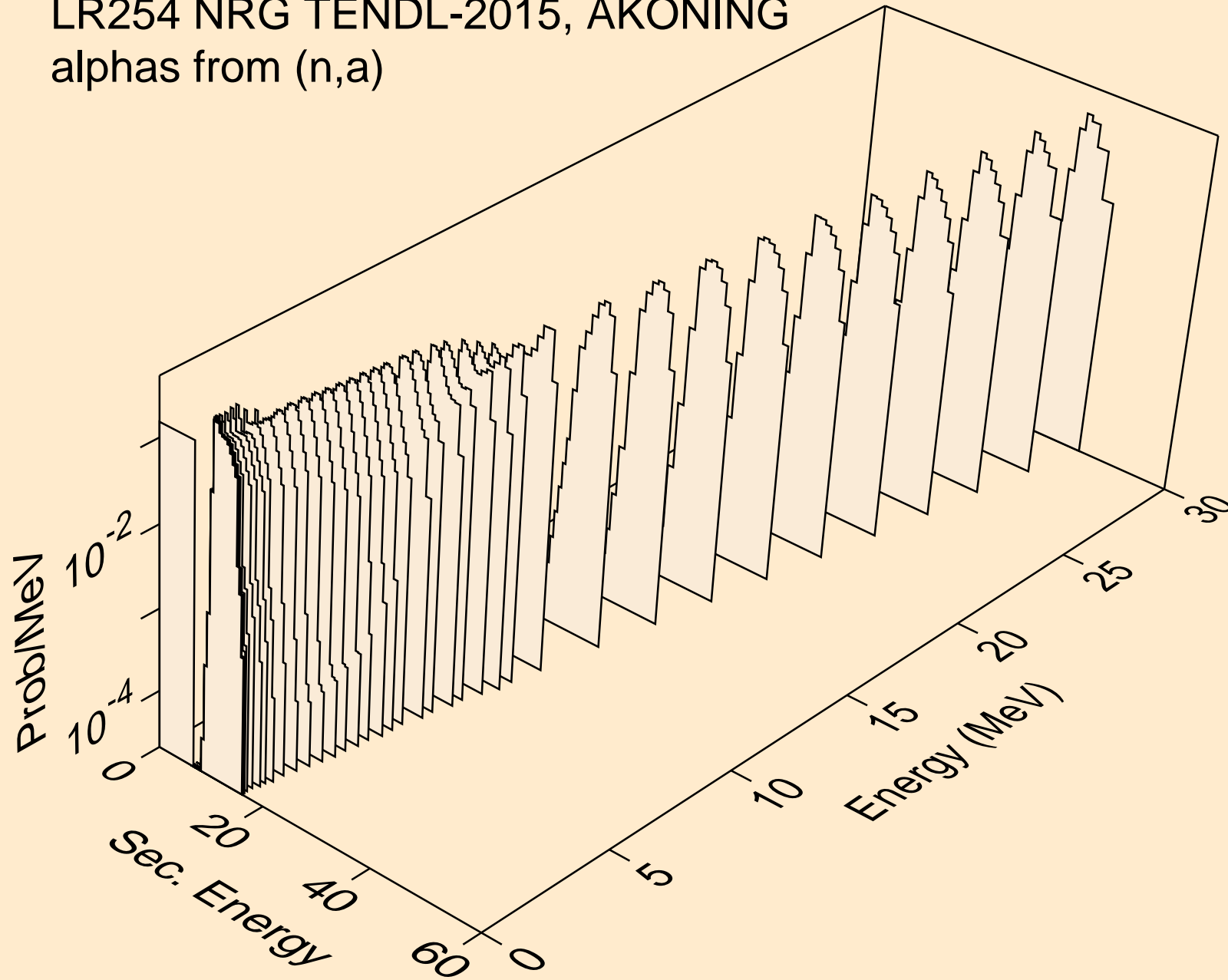

LR254 NRG TENDL-2015, AKONING
alphas from (n,2a)

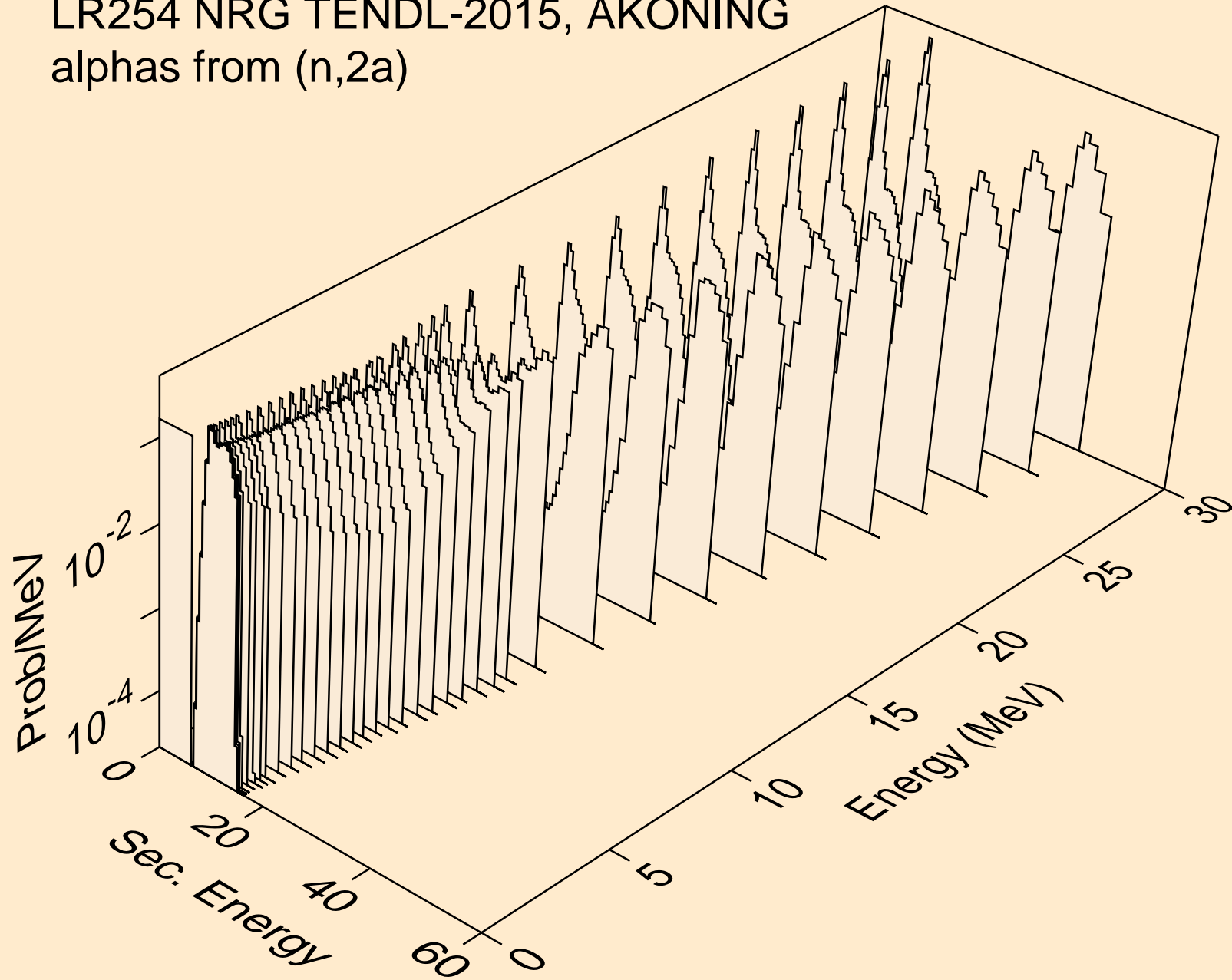

LR254 NRG TENDL-2015, AKONING
alphas from (n,3a)

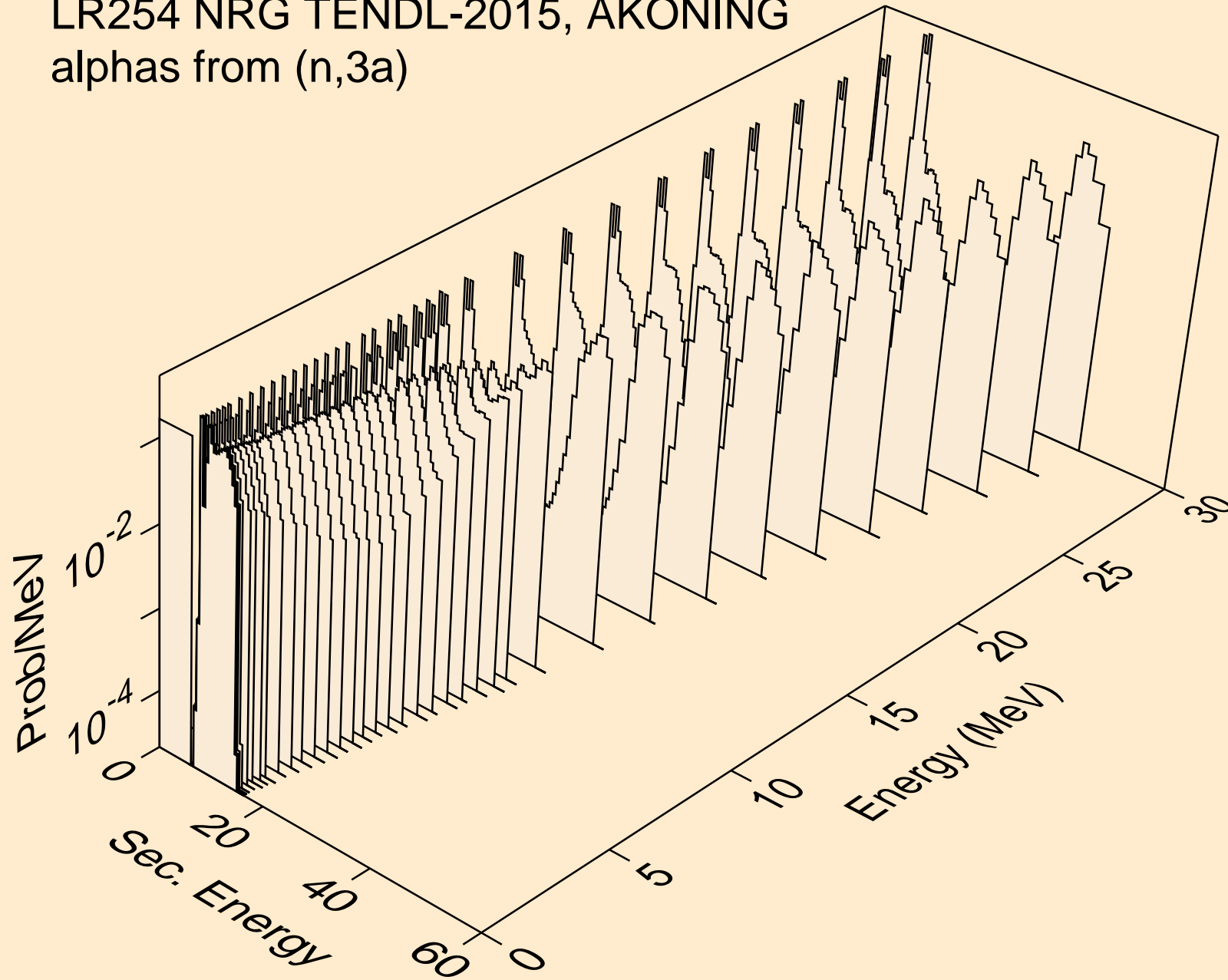

LR254 NRG TENDL-2015, AKONING
alphas from (n,pa)

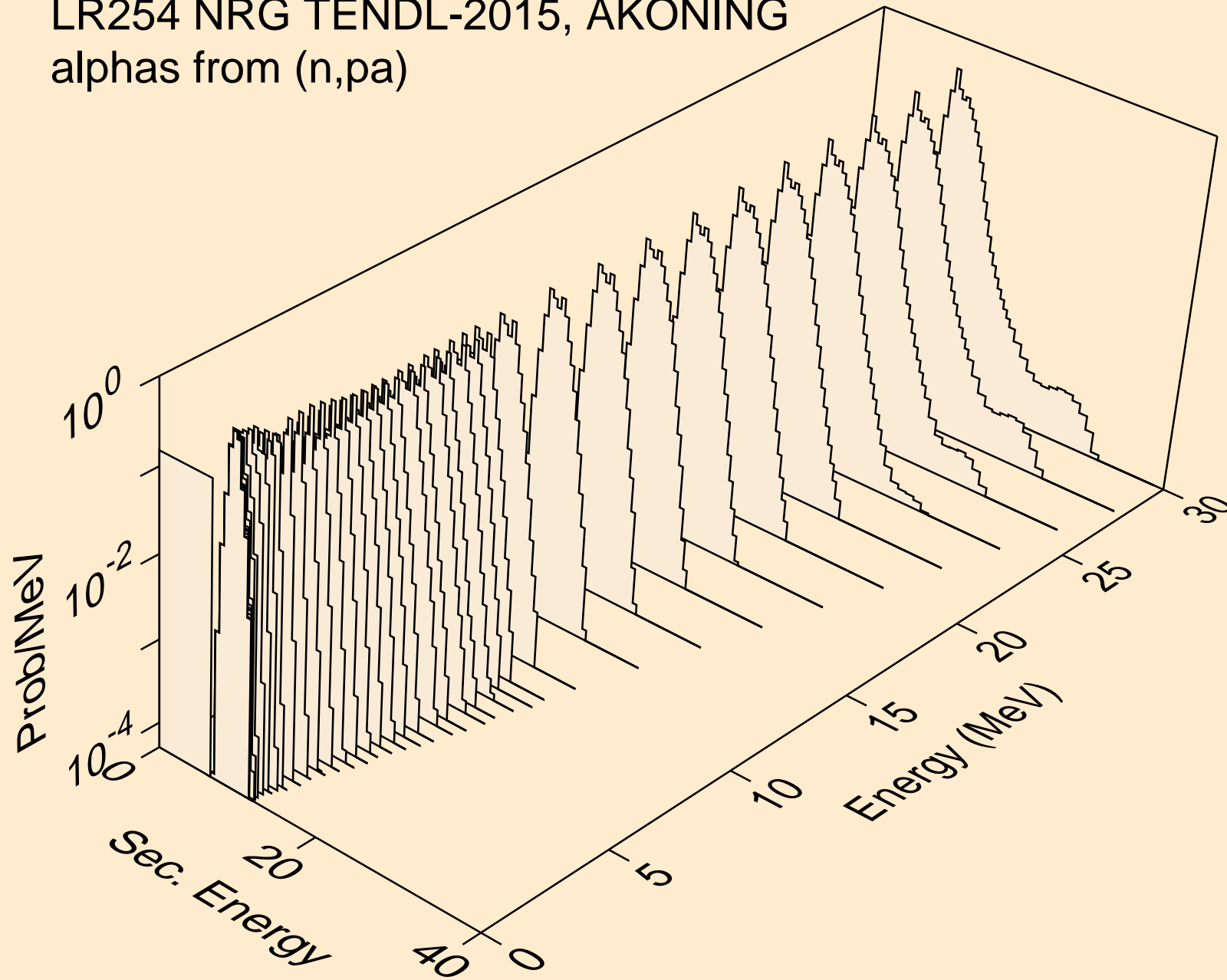

LR254 NRG TENDL-2015, AKONING
alphas from (n,t2a)

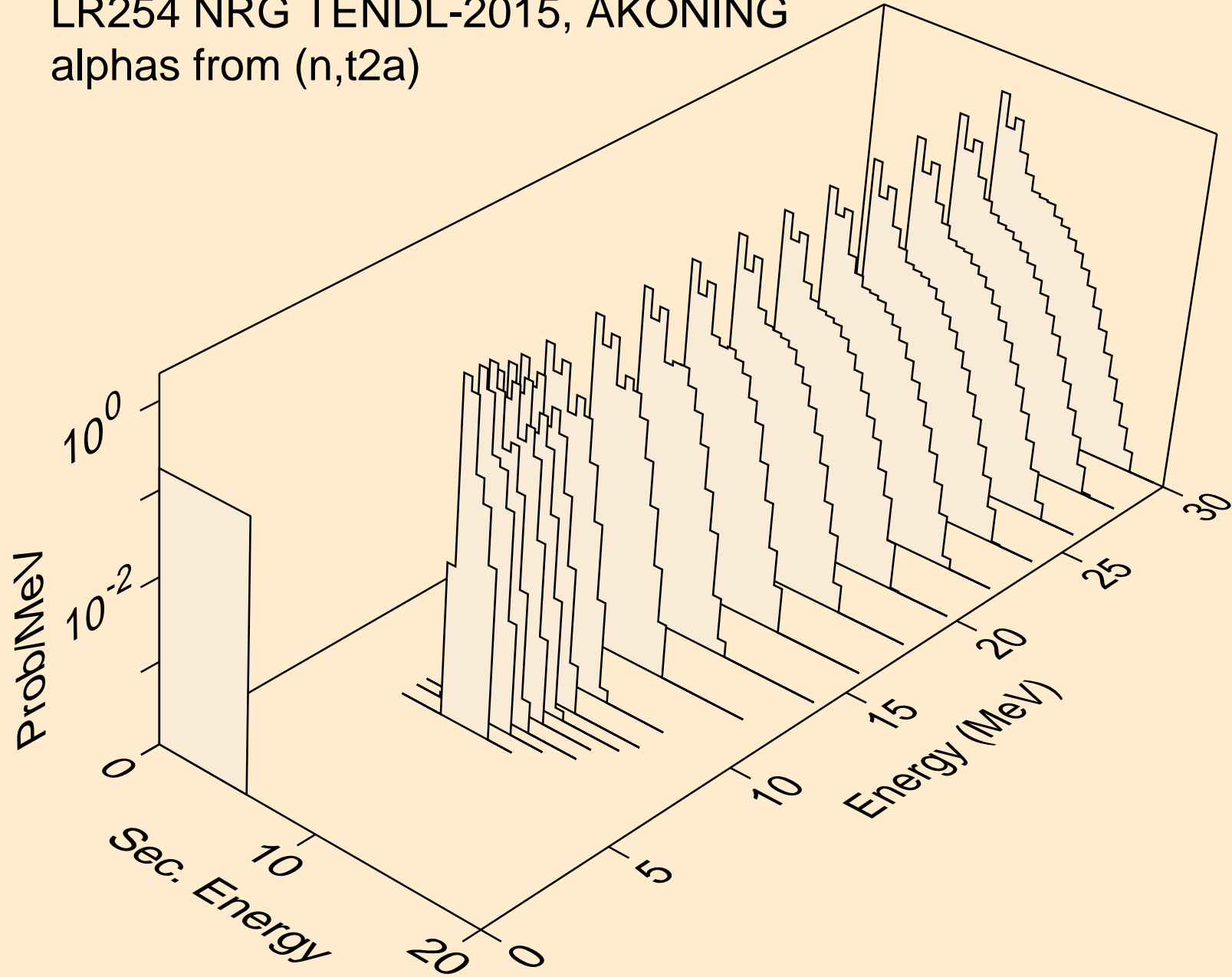

LR254 NRG TENDL-2015, AKONING
alphas from (n,d2a)

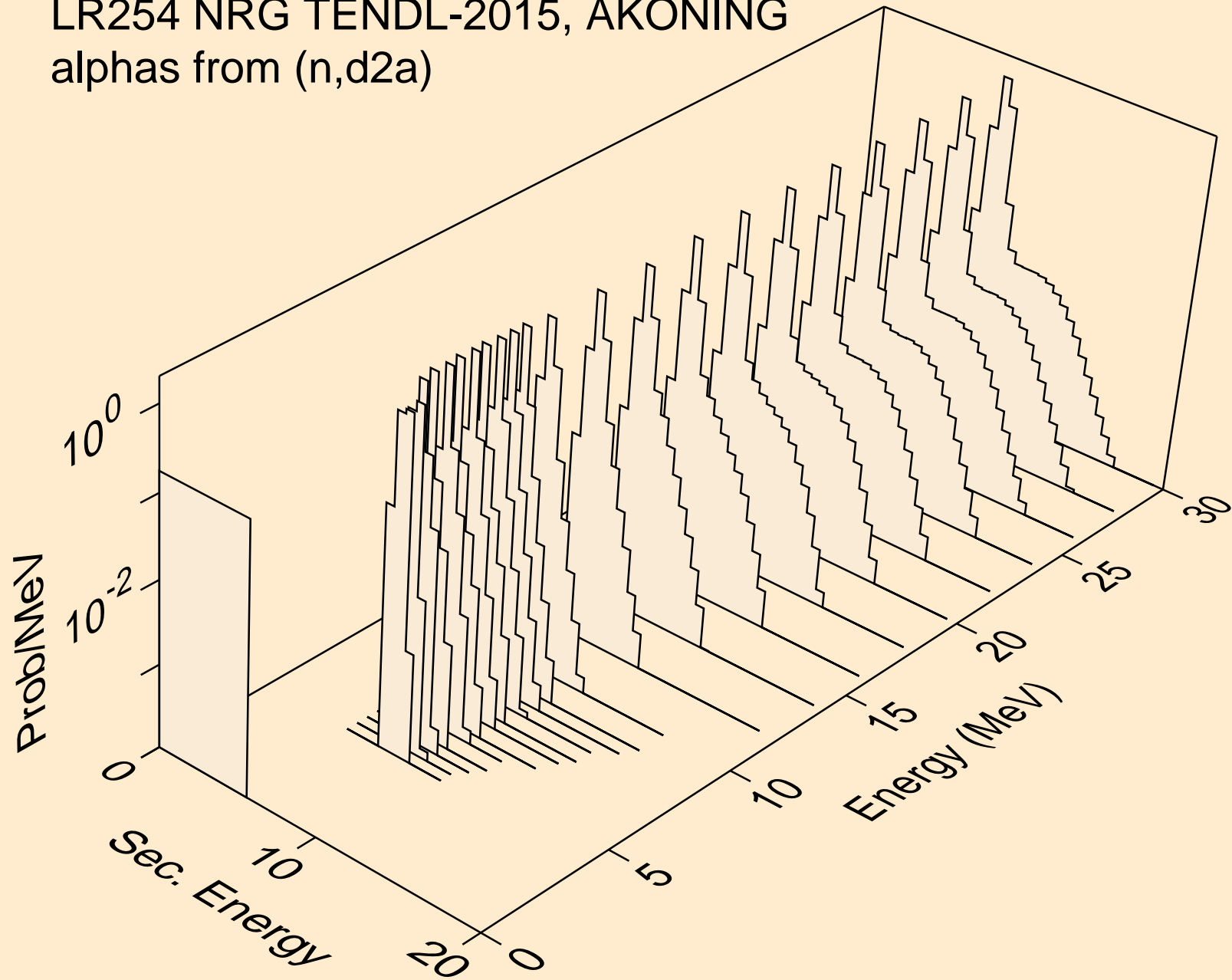

LR254 NRG TENDL-2015, AKONING
alphas from (n,da)

