

# LR262 NRG TENDL-2015, AKONING

## Principal cross sections

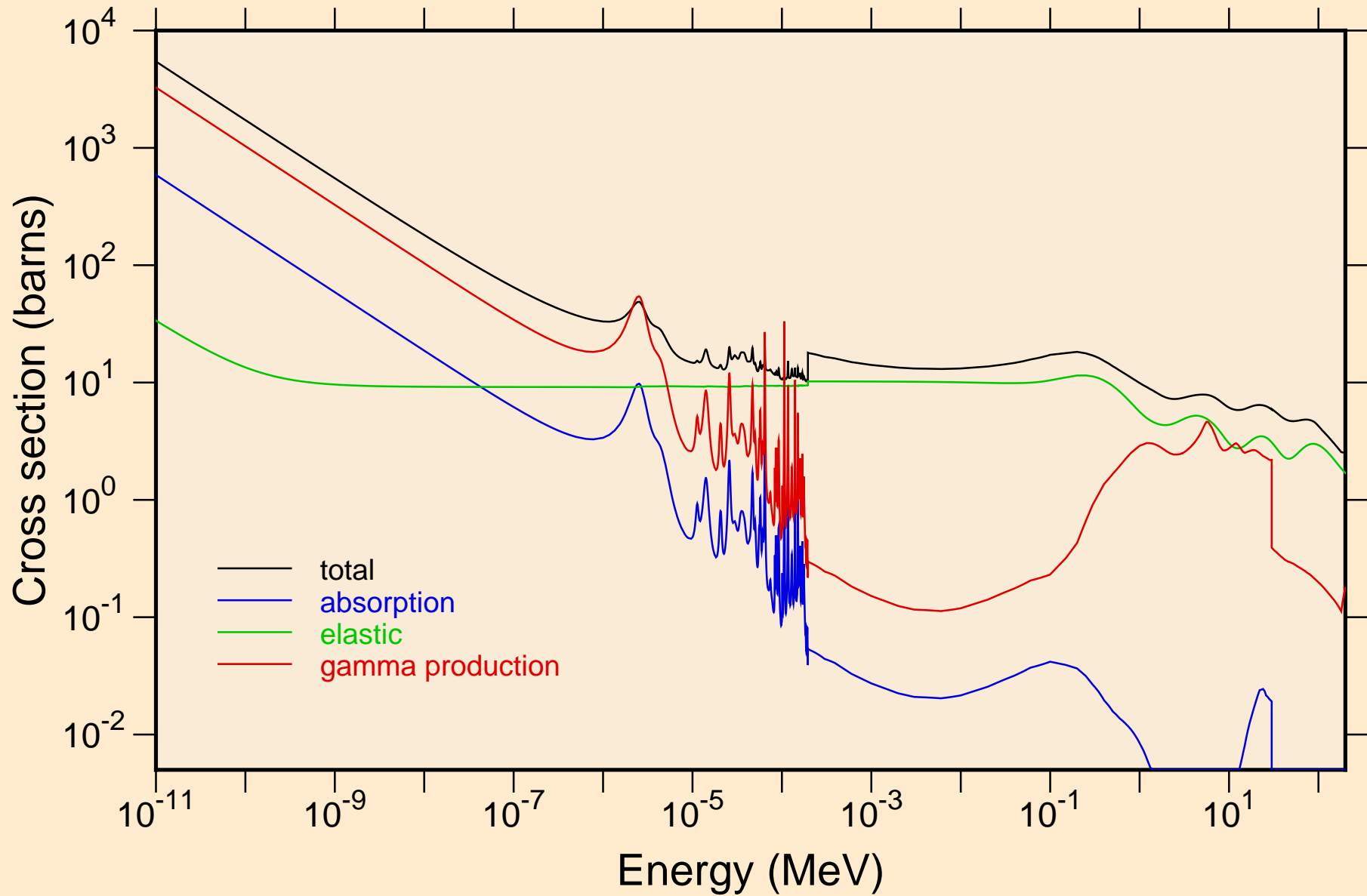

# LR262 NRG TENDL-2015, AKONING

## Non-threshold reactions

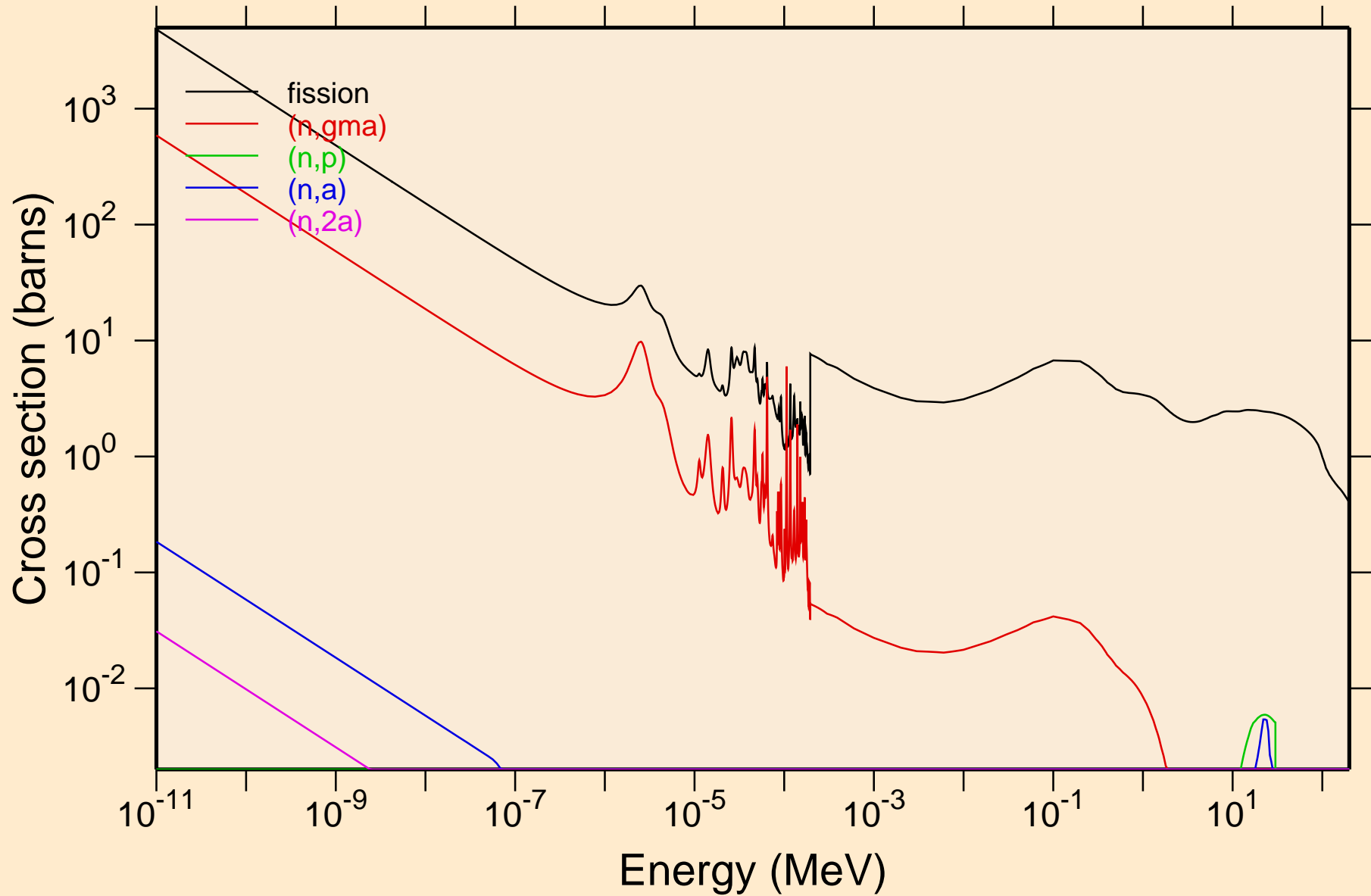

LR262 NRG TENDL-2015, AKONING  
Non-threshold reactions

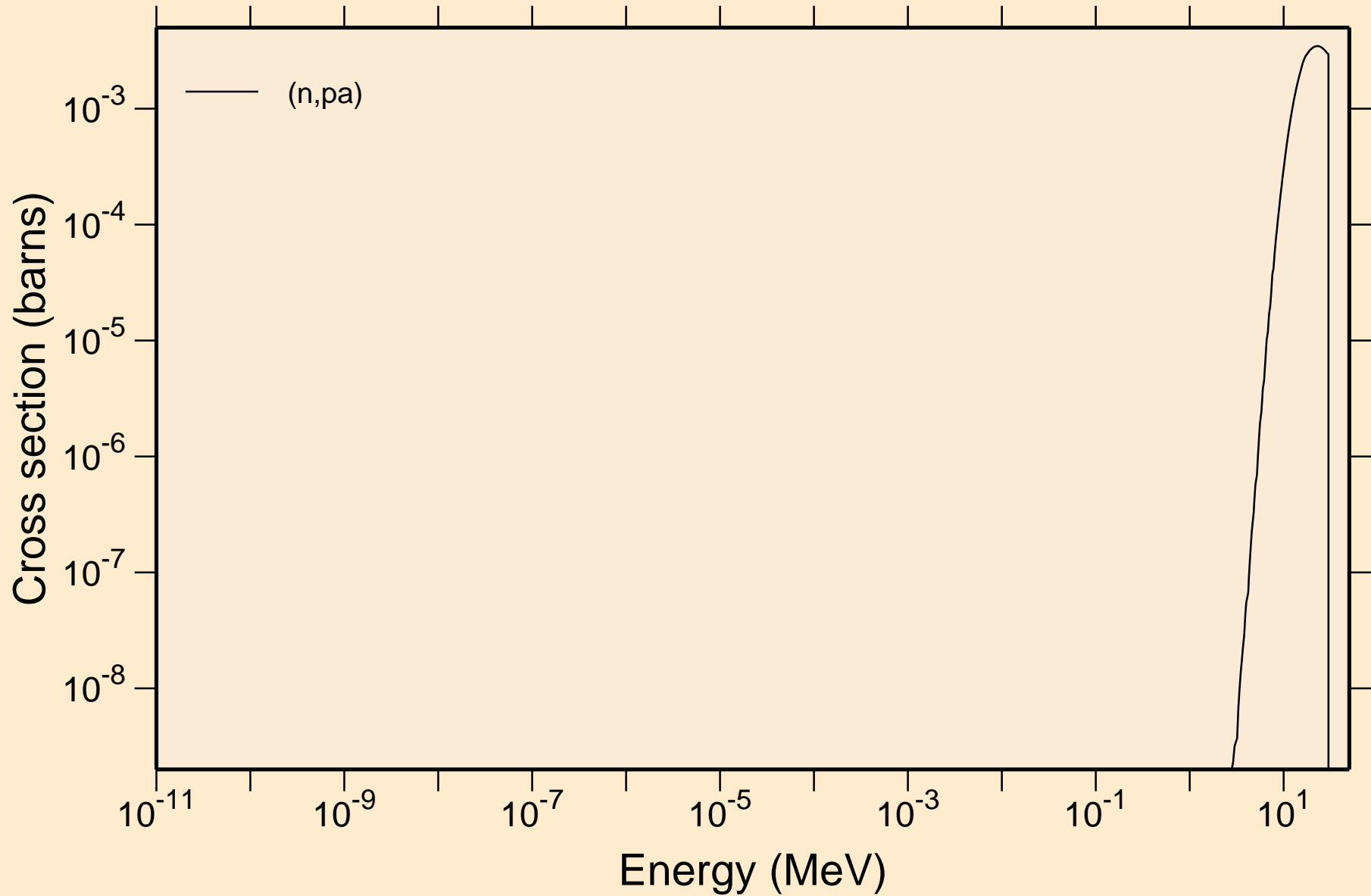

# LR262 NRG TENDL-2015, AKONING

## Principal cross sections

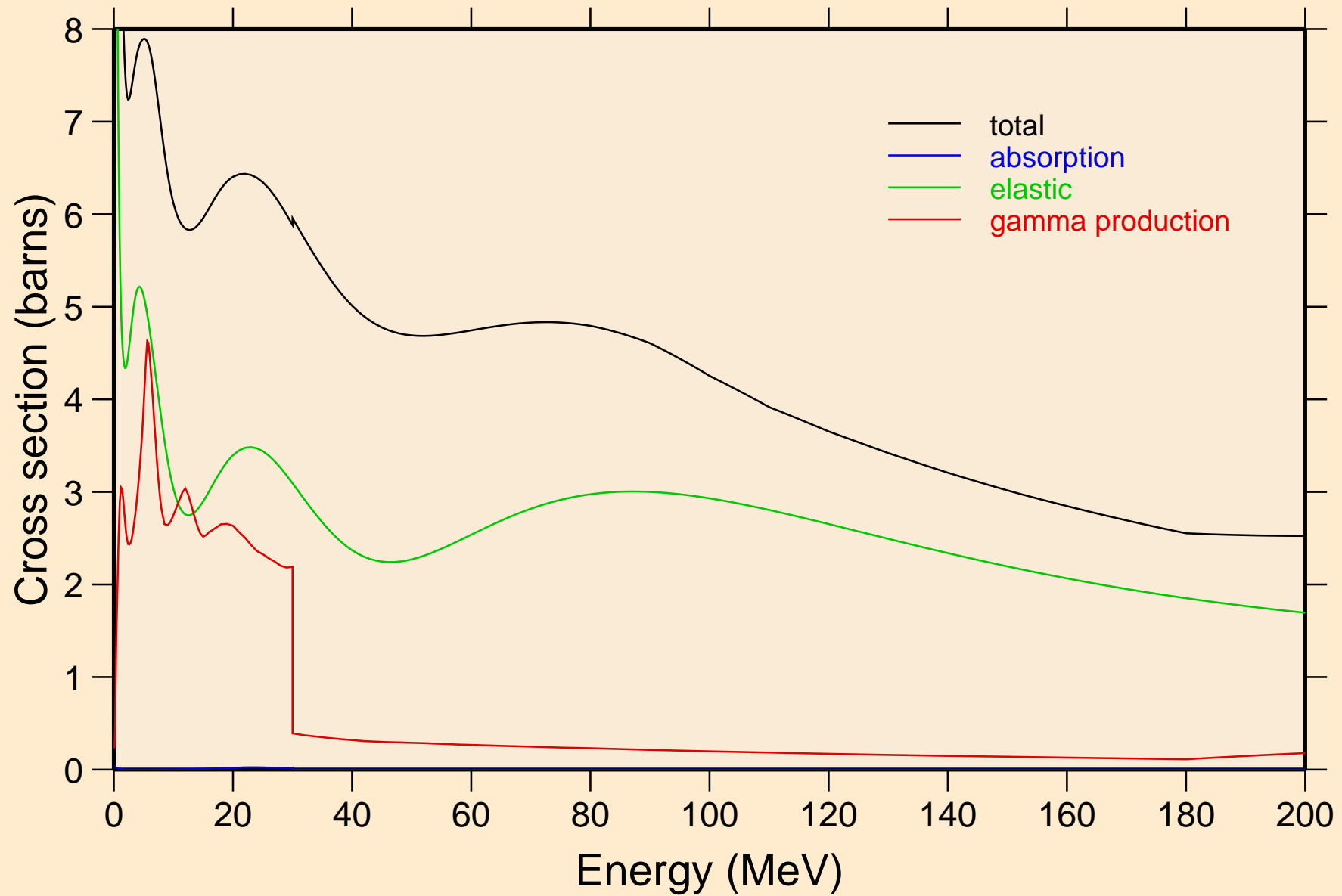

# LR262 NRG TENDL-2015, AKONING

## Non-threshold reactions

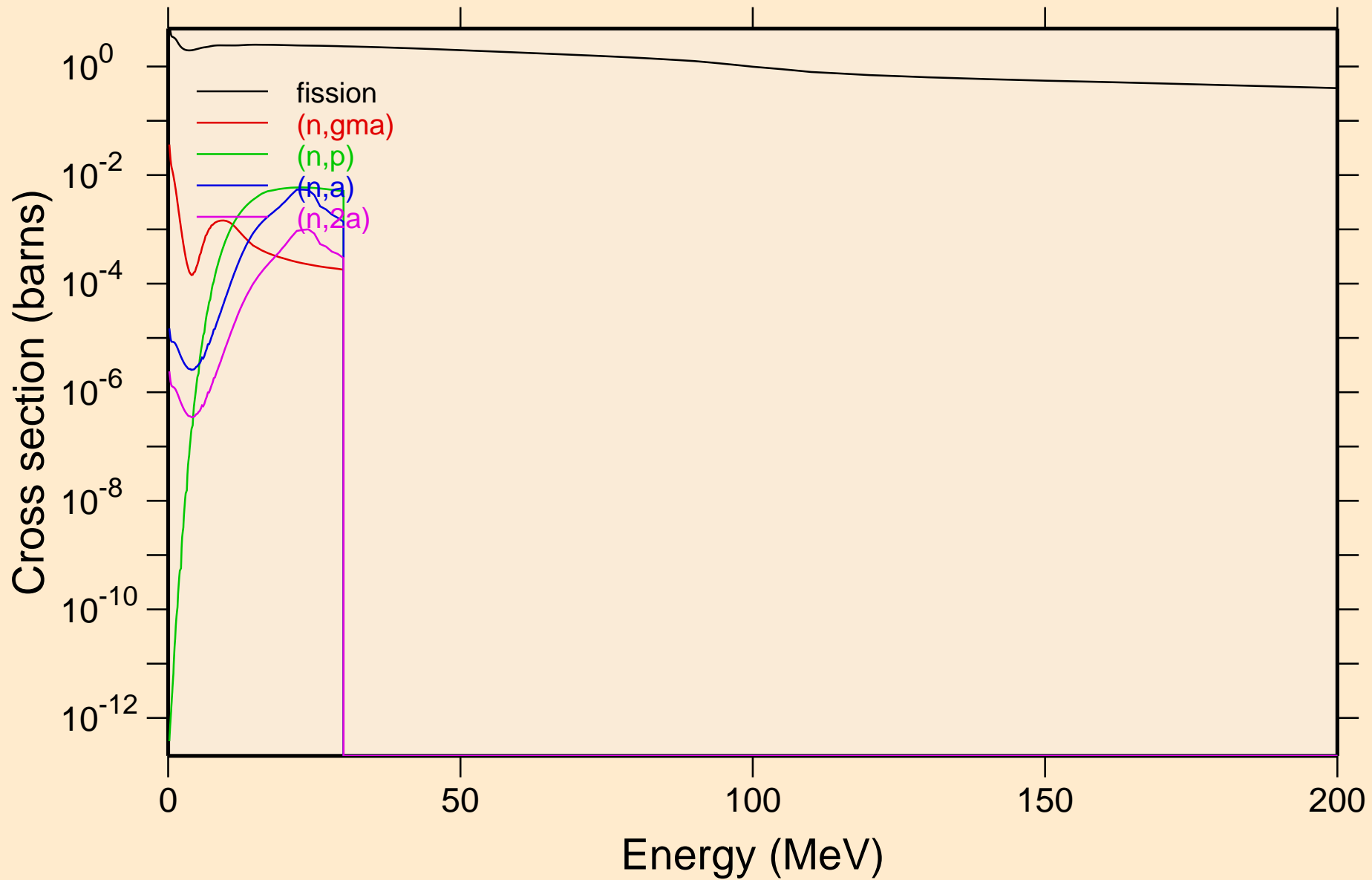

LR262 NRG TENDL-2015, AKONING  
Non-threshold reactions

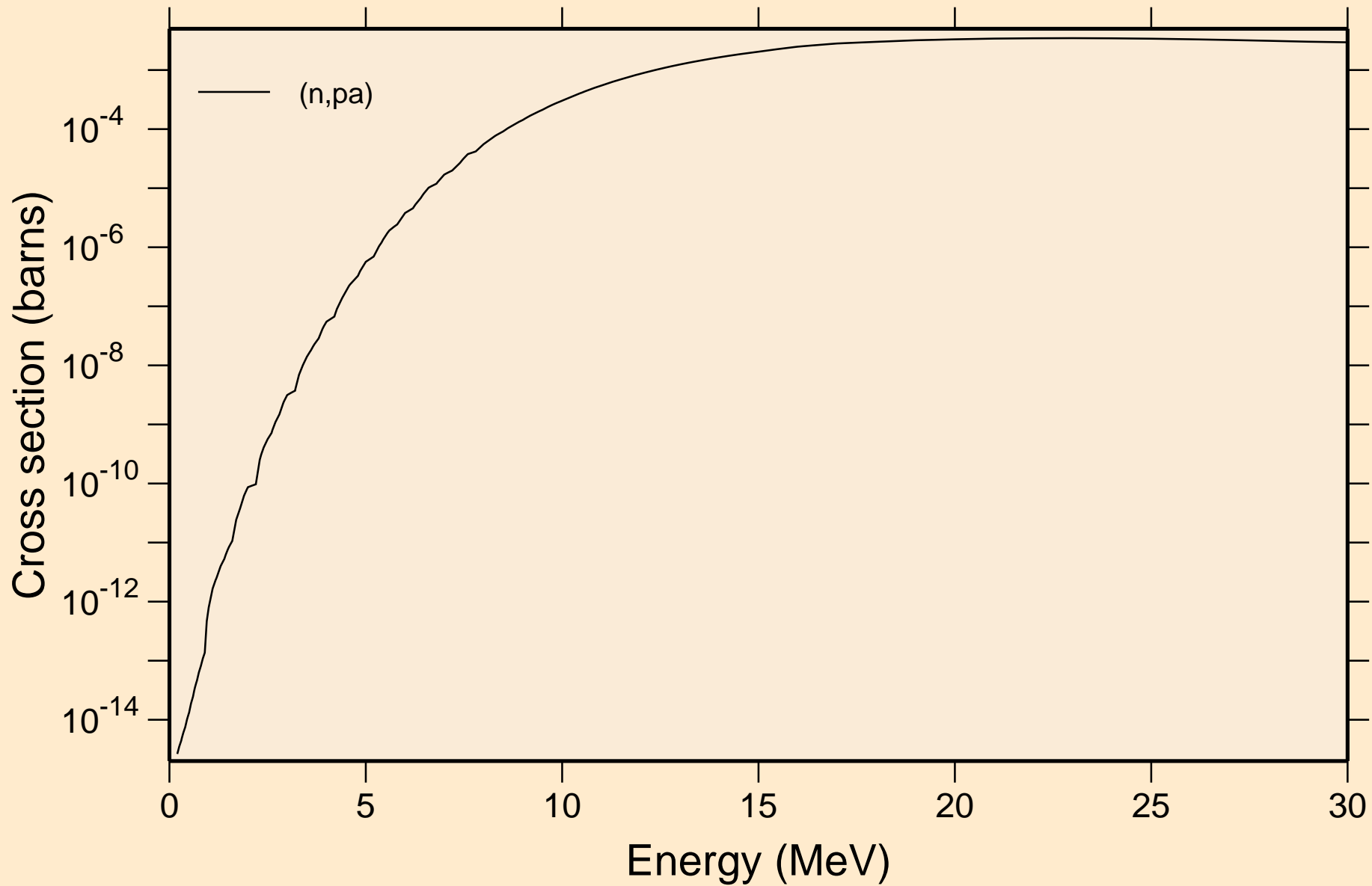

LR262 NRG TENDL-2015, AKONING  
Inelastic levels

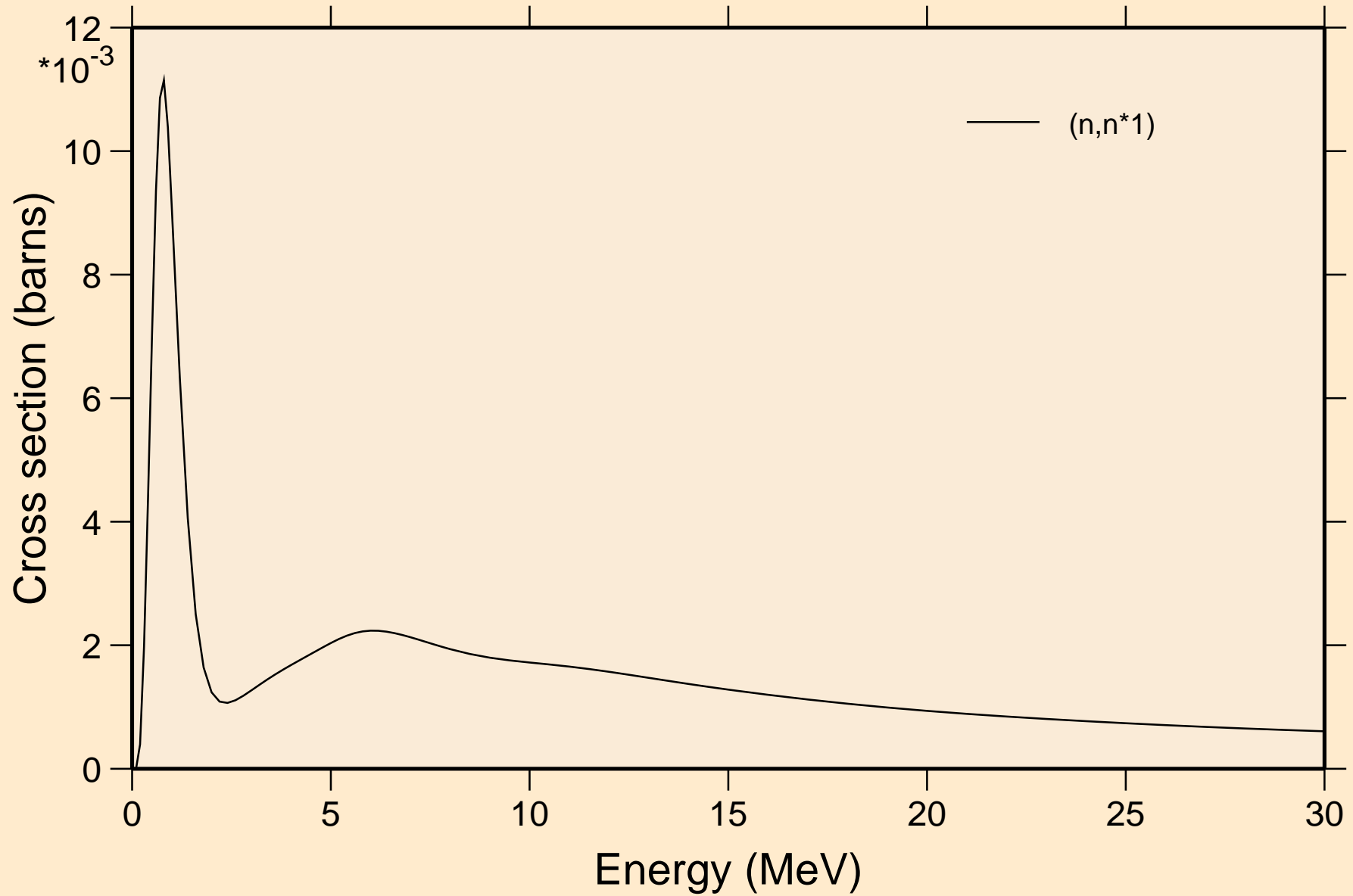

# LR262 NRG TENDL-2015, AKONING

## Threshold reactions

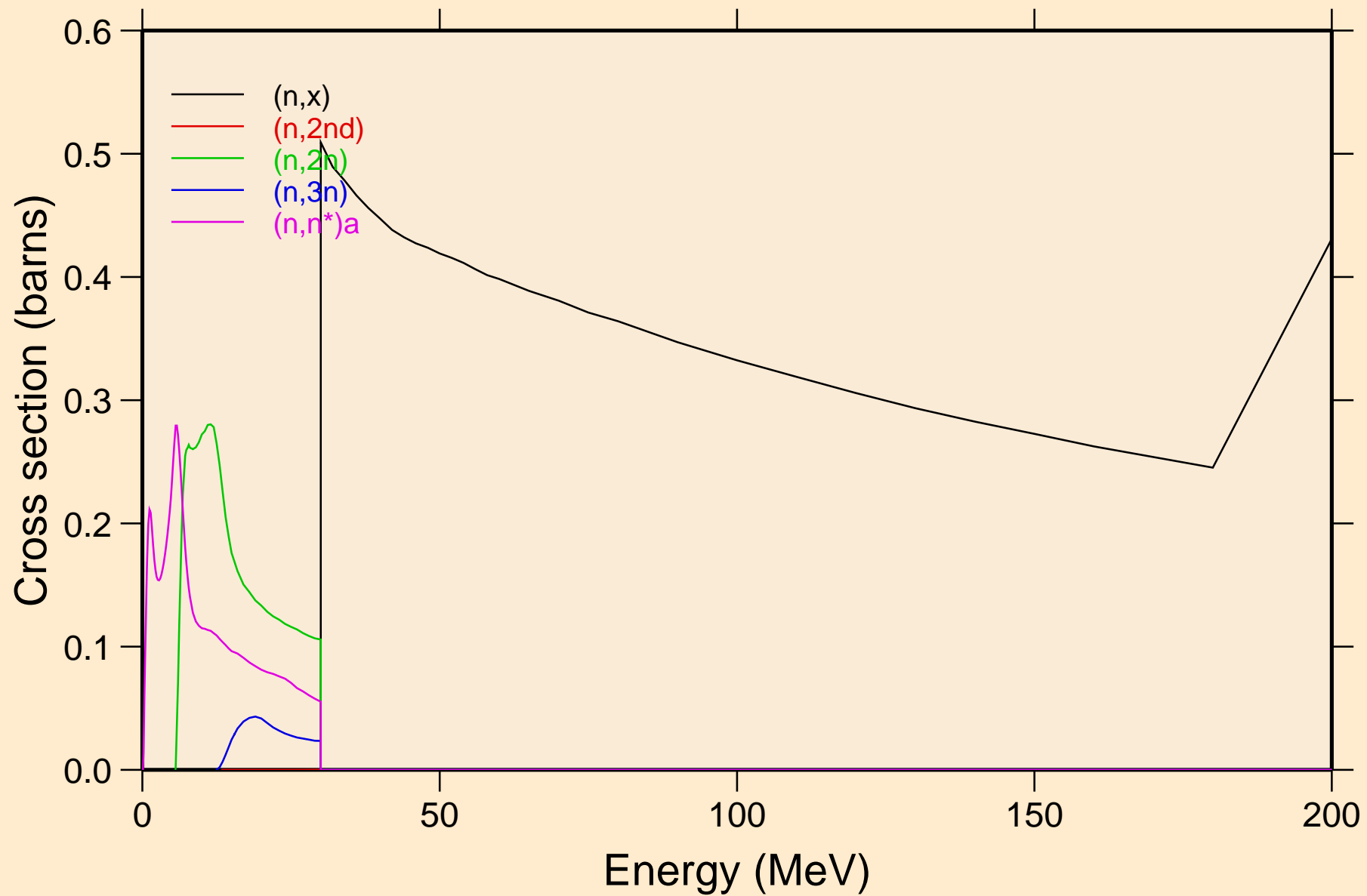



# LR262 NRG TENDL-2015, AKONING

## Threshold reactions

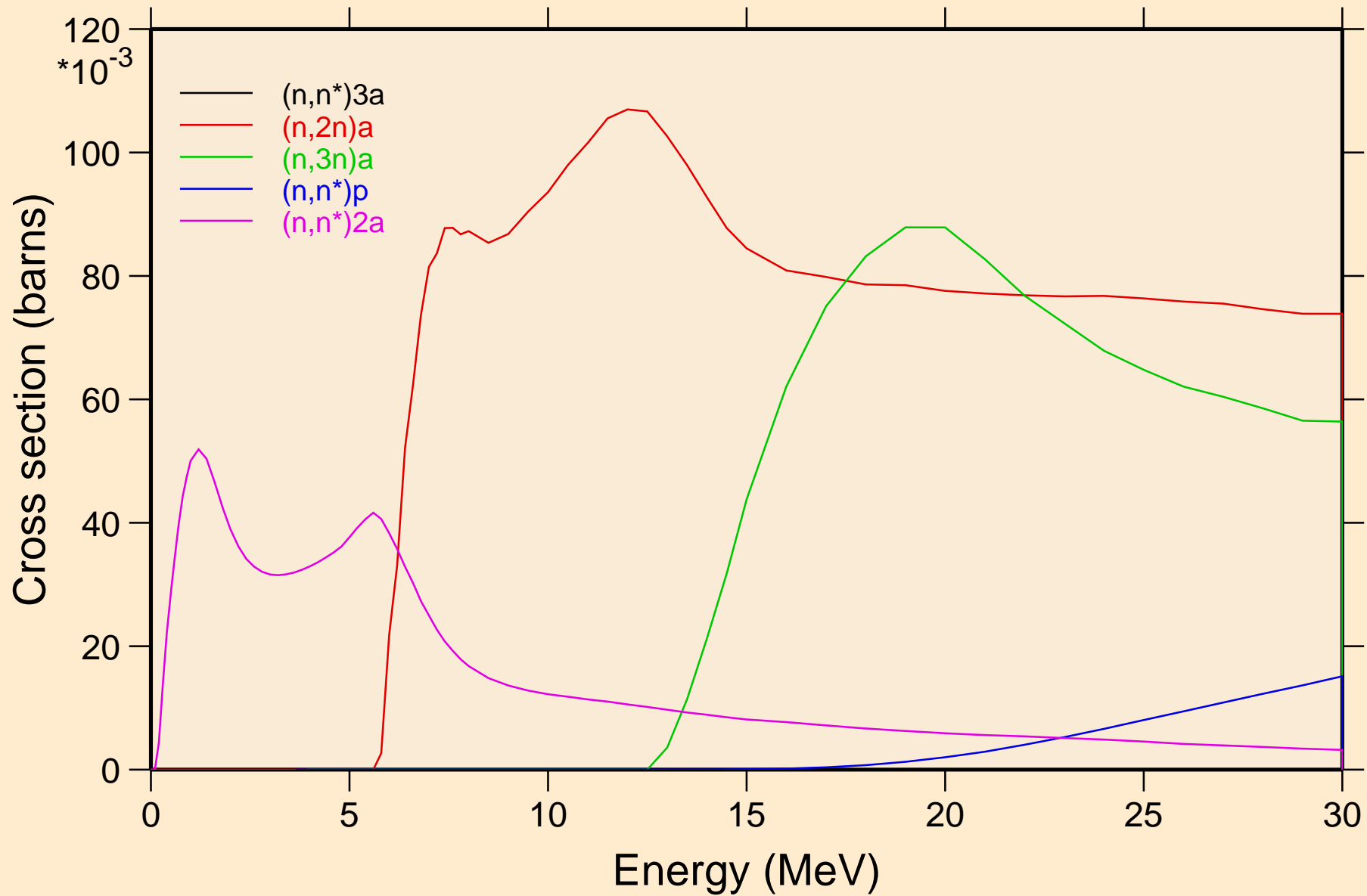

# LR262 NRG TENDL-2015, AKONING

## Threshold reactions

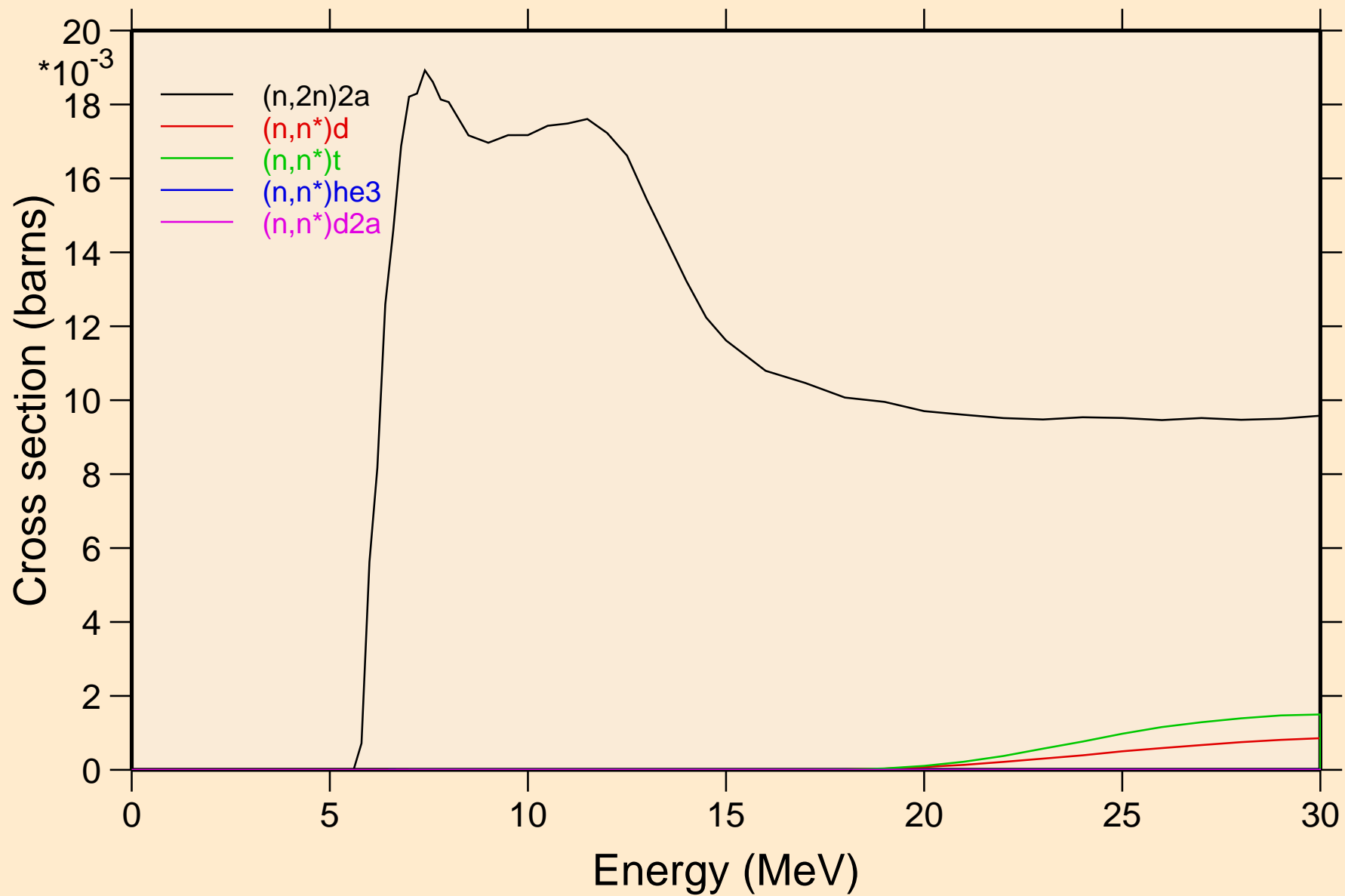

# LR262 NRG TENDL-2015, AKONING

## Threshold reactions

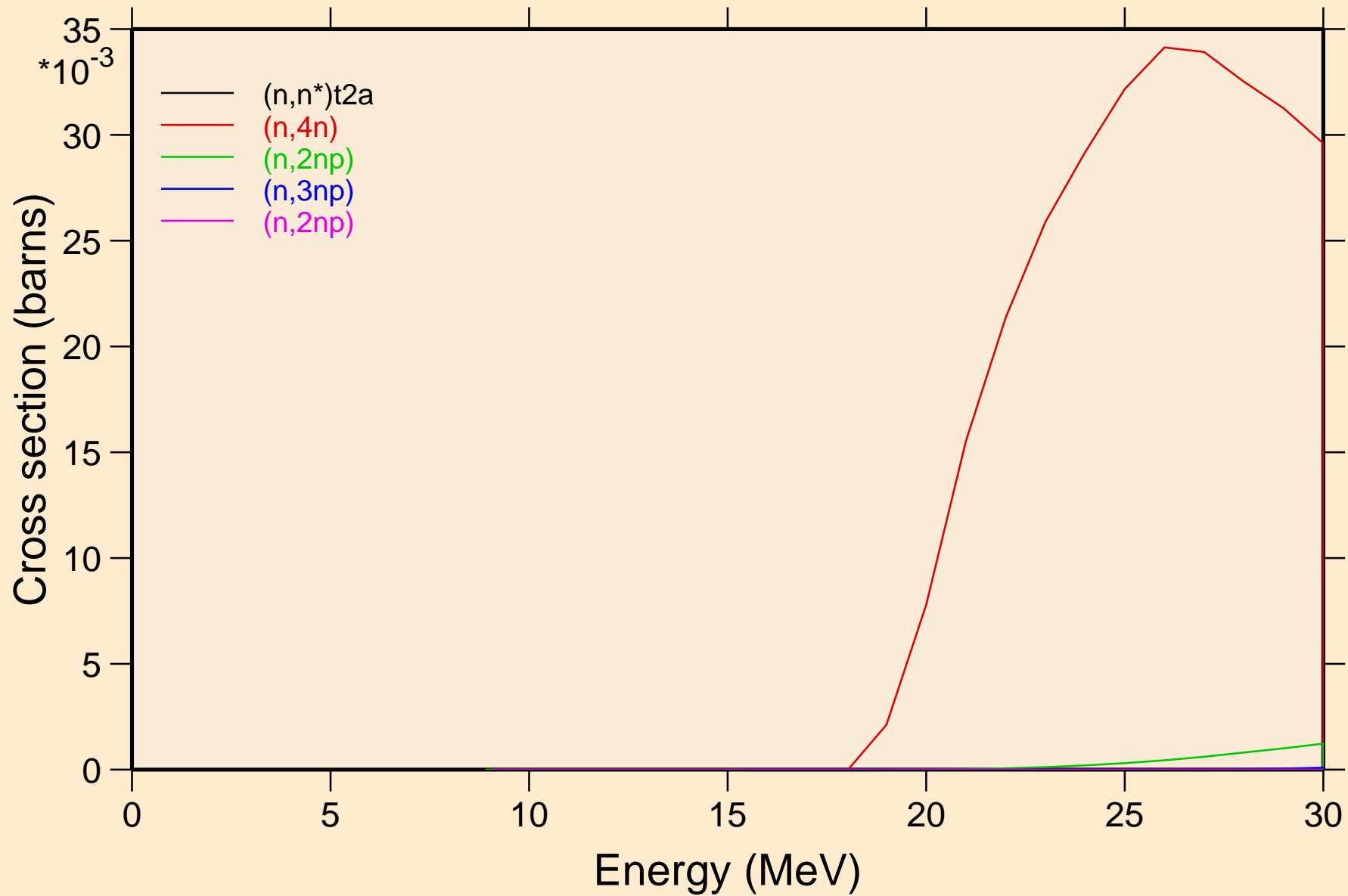

# LR262 NRG TENDL-2015, AKONING

## Threshold reactions

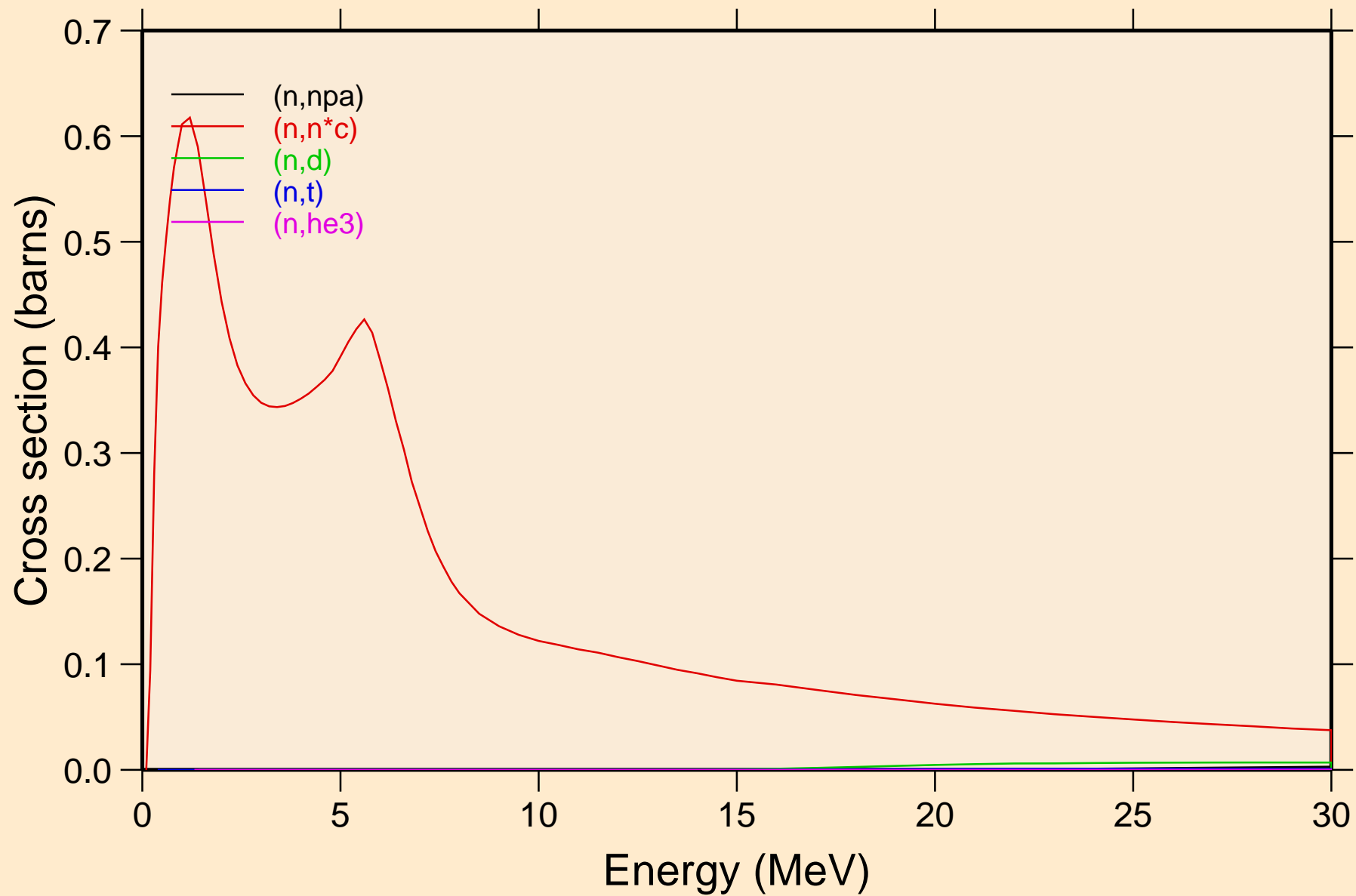

# LR262 NRG TENDL-2015, AKONING

## Threshold reactions

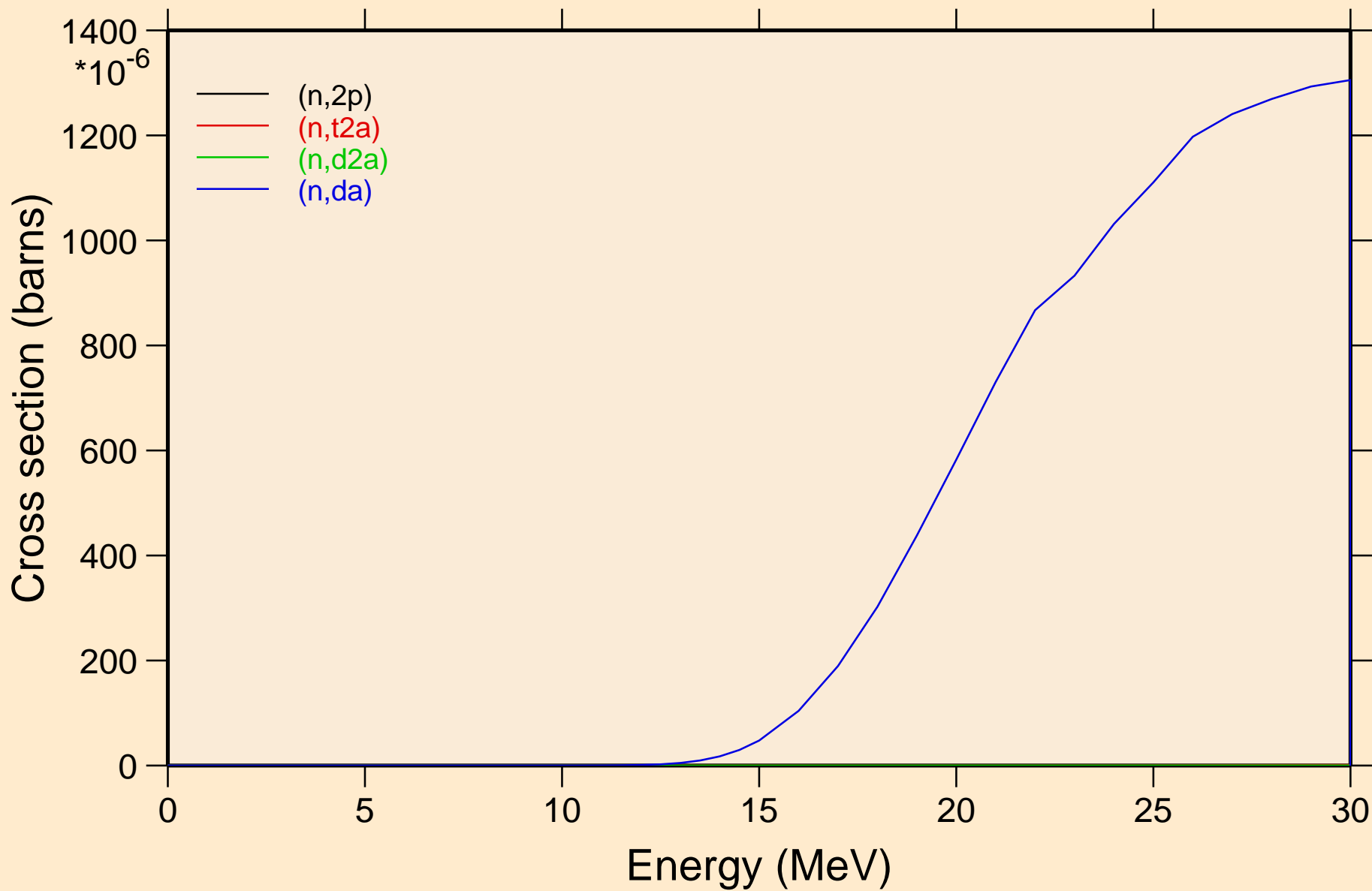

LR262 NRG TENDL-2015, AKONING  
angular distribution for elastic

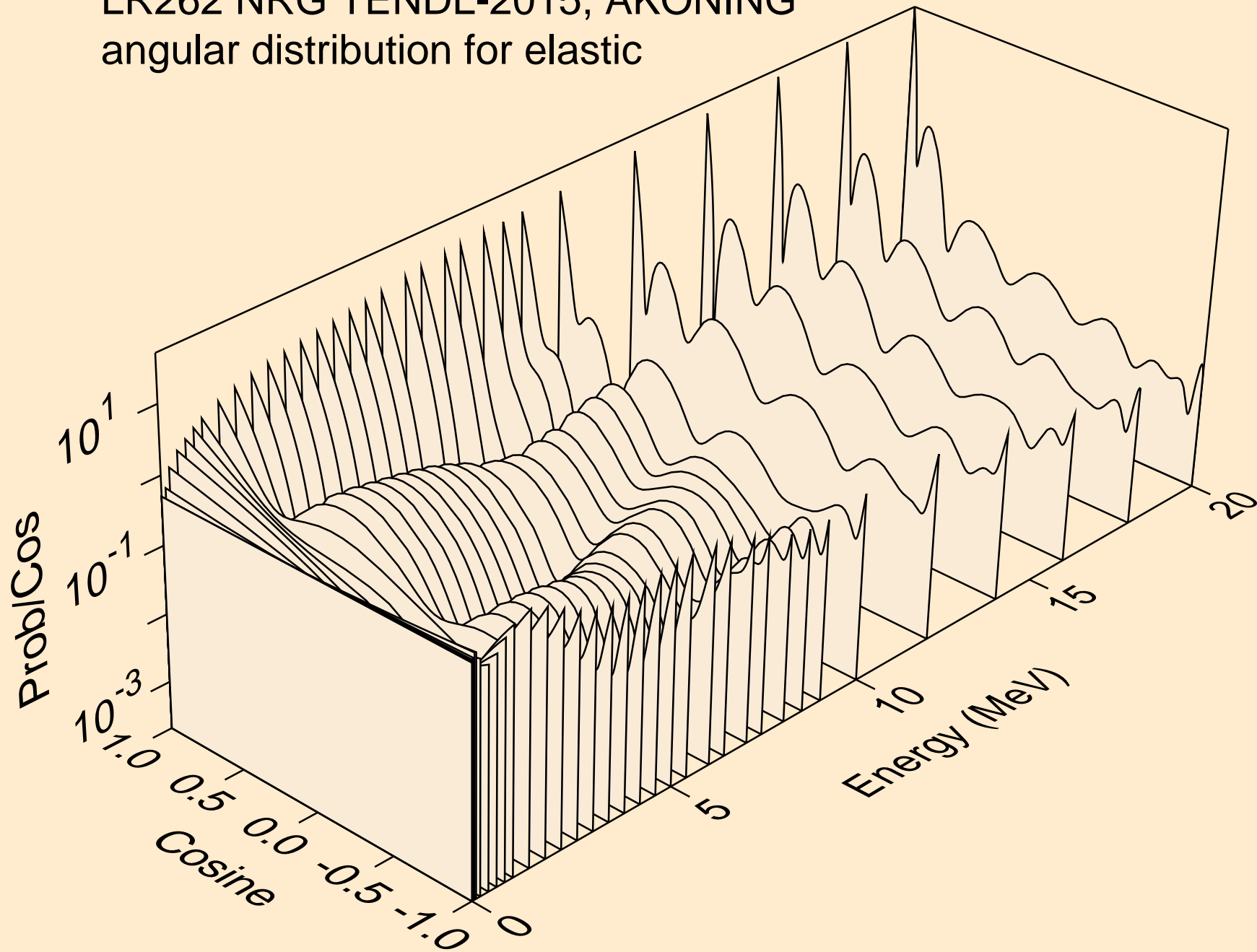

LR262 NRG TENDL-2015, AKONING  
angular distribution for elastic

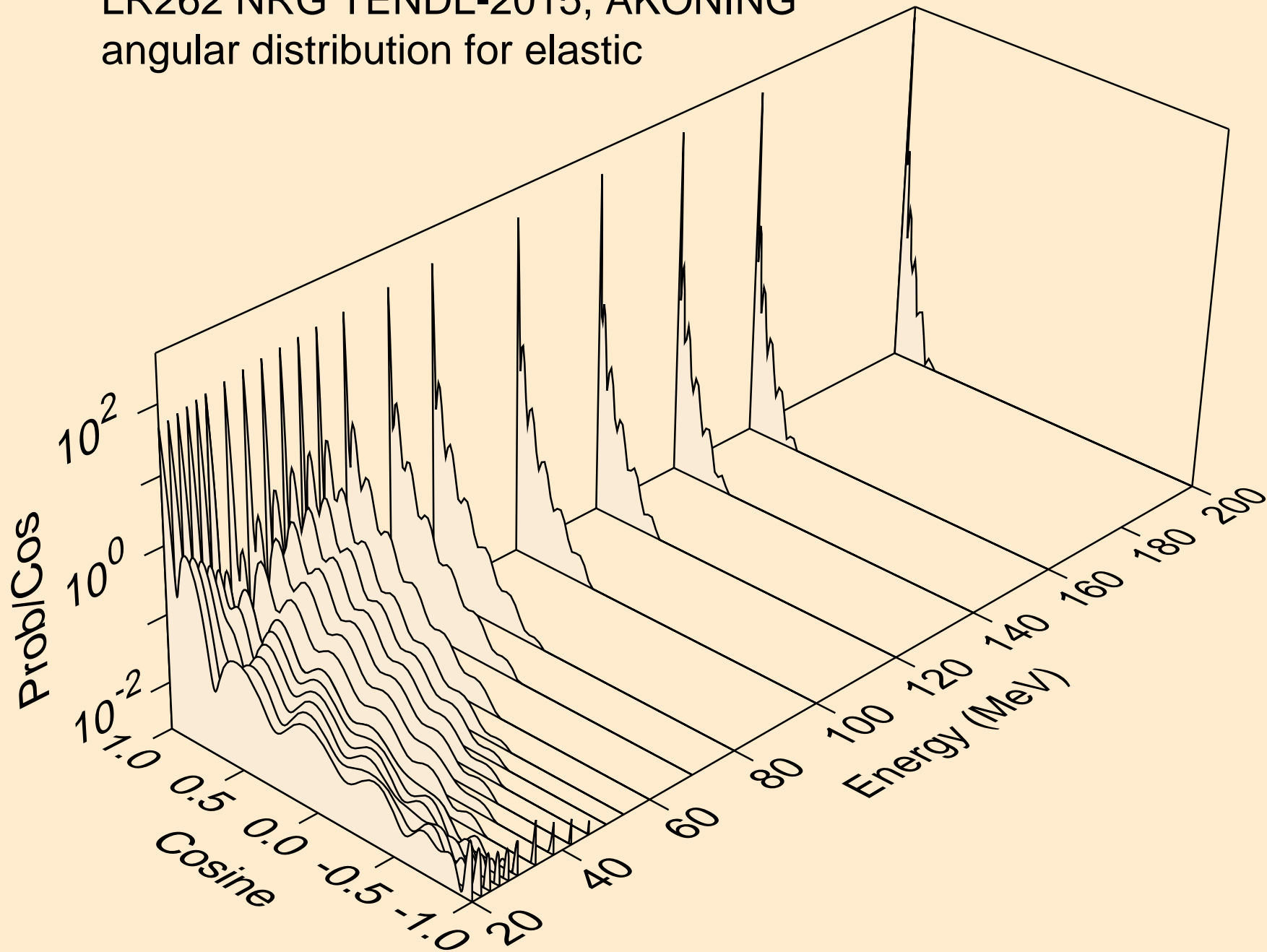

LR262 NRG TENDL-2015, AKONING  
angular distribution for (n,n\*1)

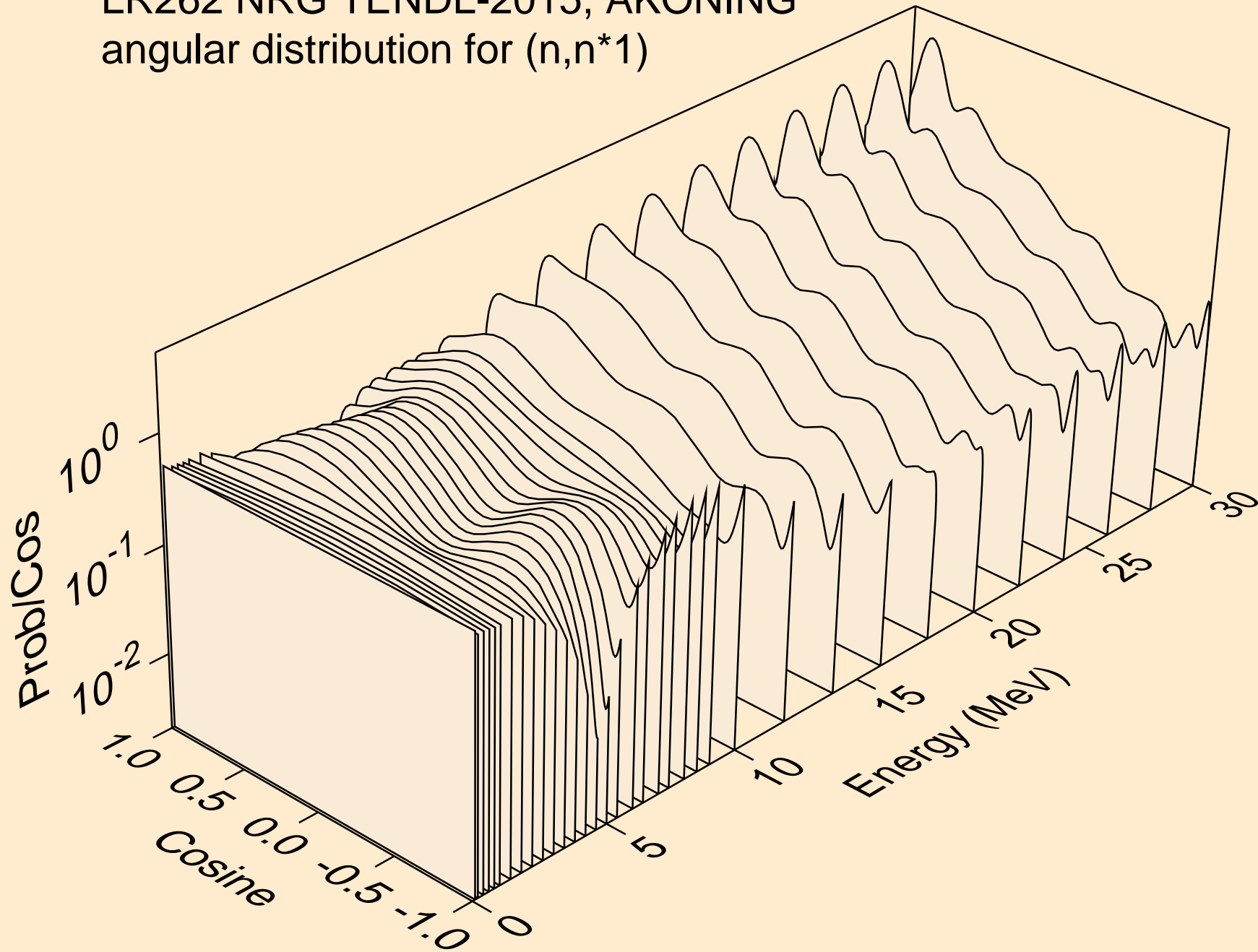



# LR262 NRG TENDL-2015, AKONING

Total fission nubar

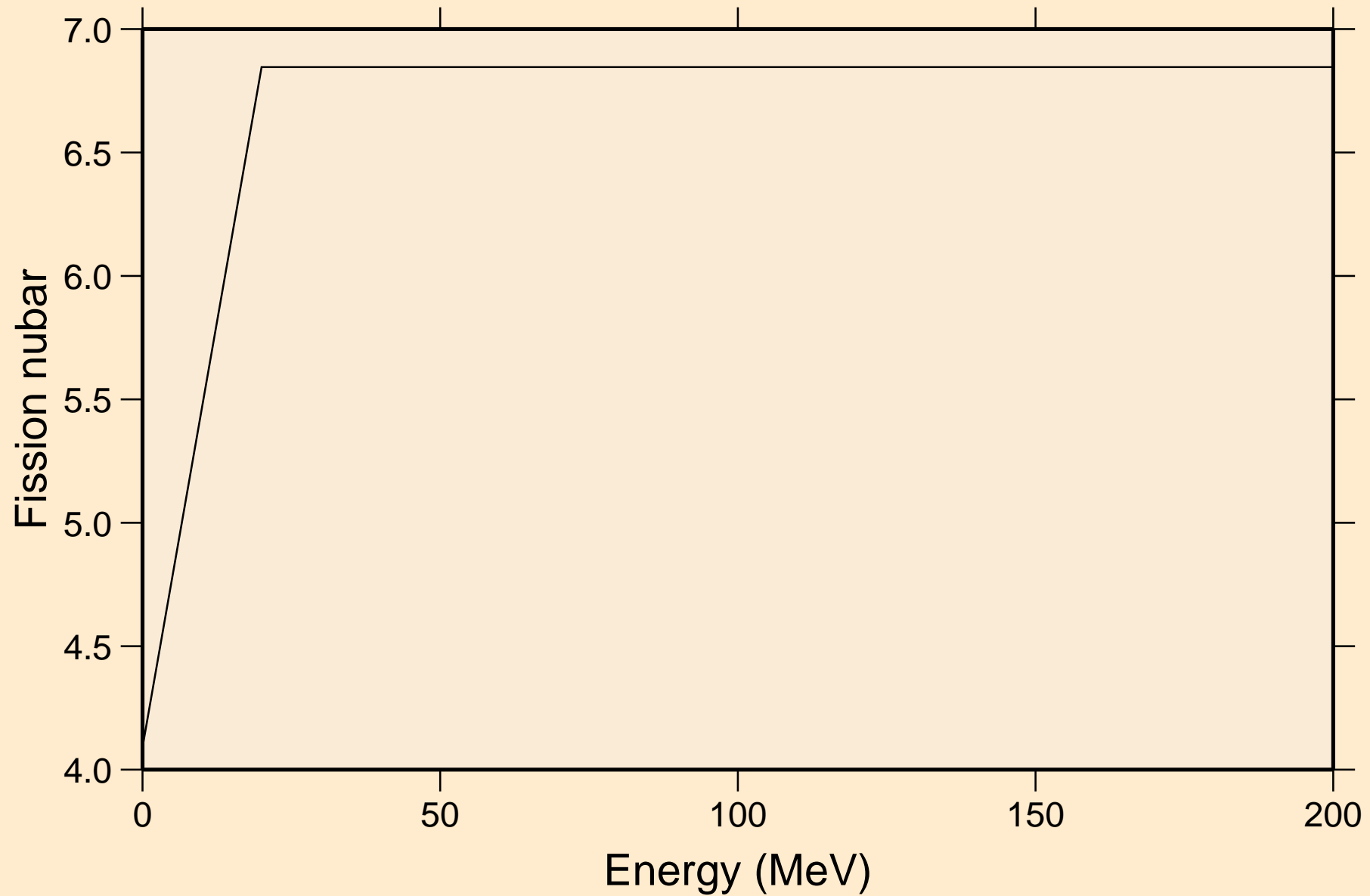

LR262 NRG TENDL-2015, AKONING  
Neutron emission for (n,x)

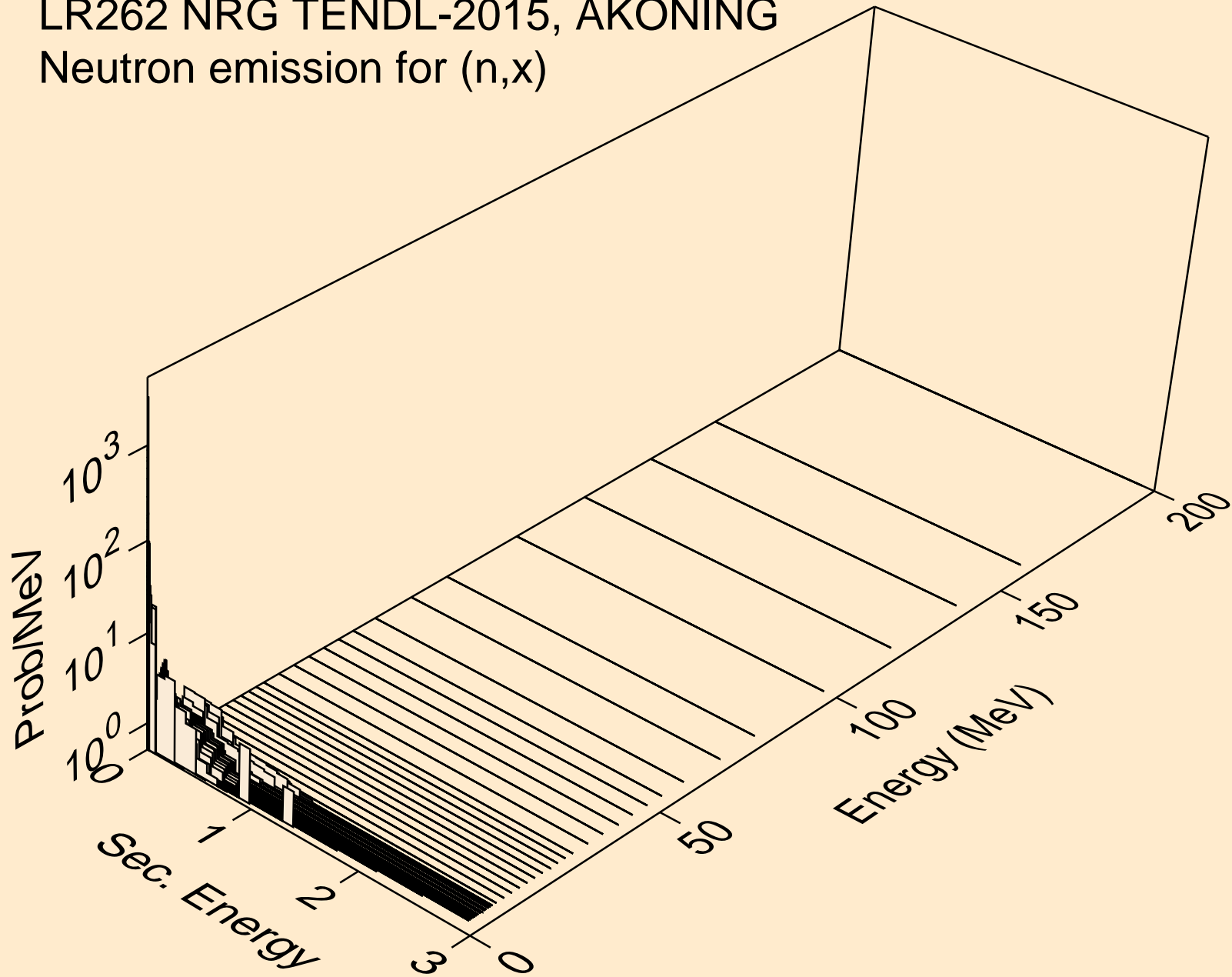

LR262 NRG TENDL-2015, AKONING  
Neutron emission for (n,2nd)

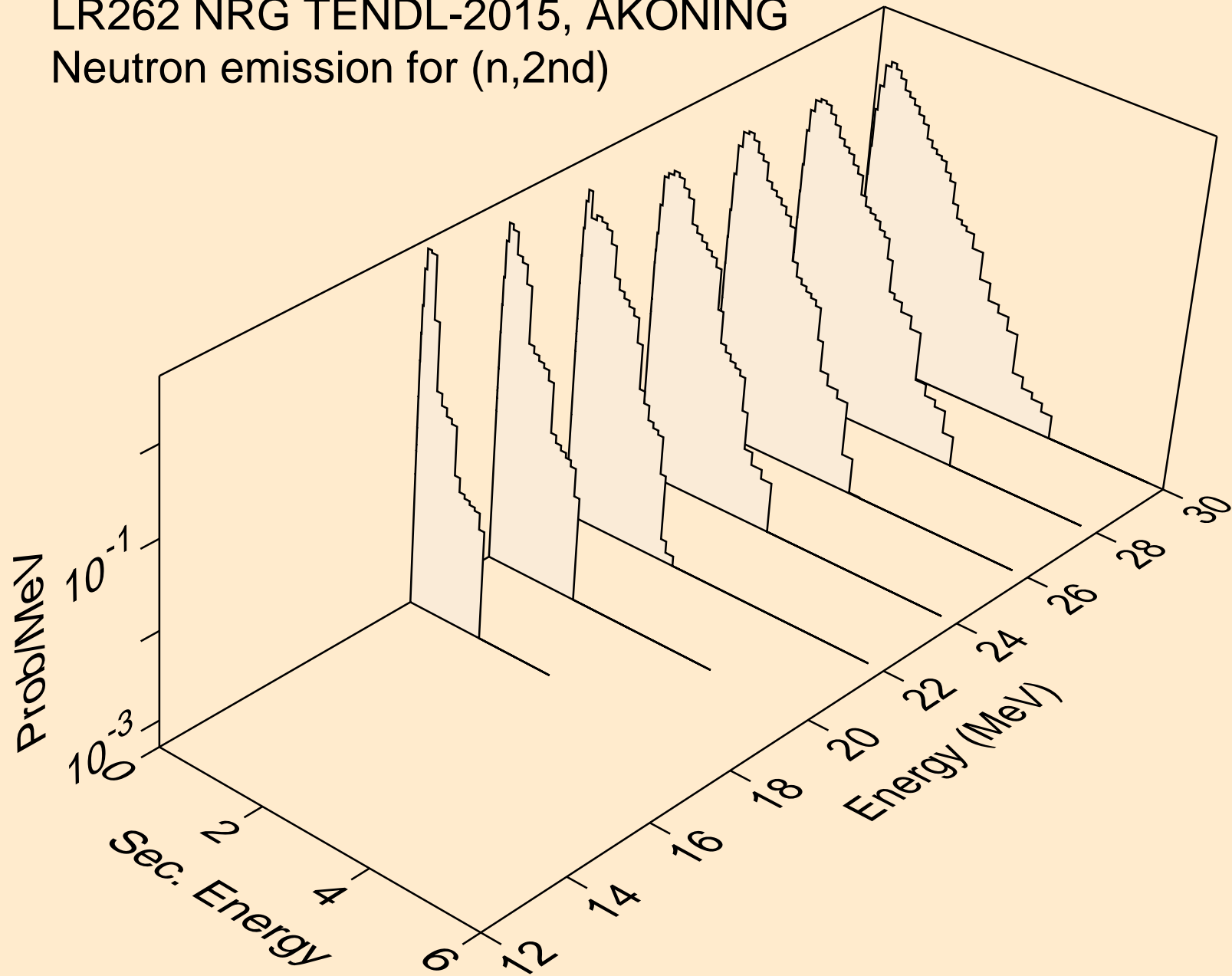

LR262 NRG TENDL-2015, AKONING  
Neutron emission for (n,2n)

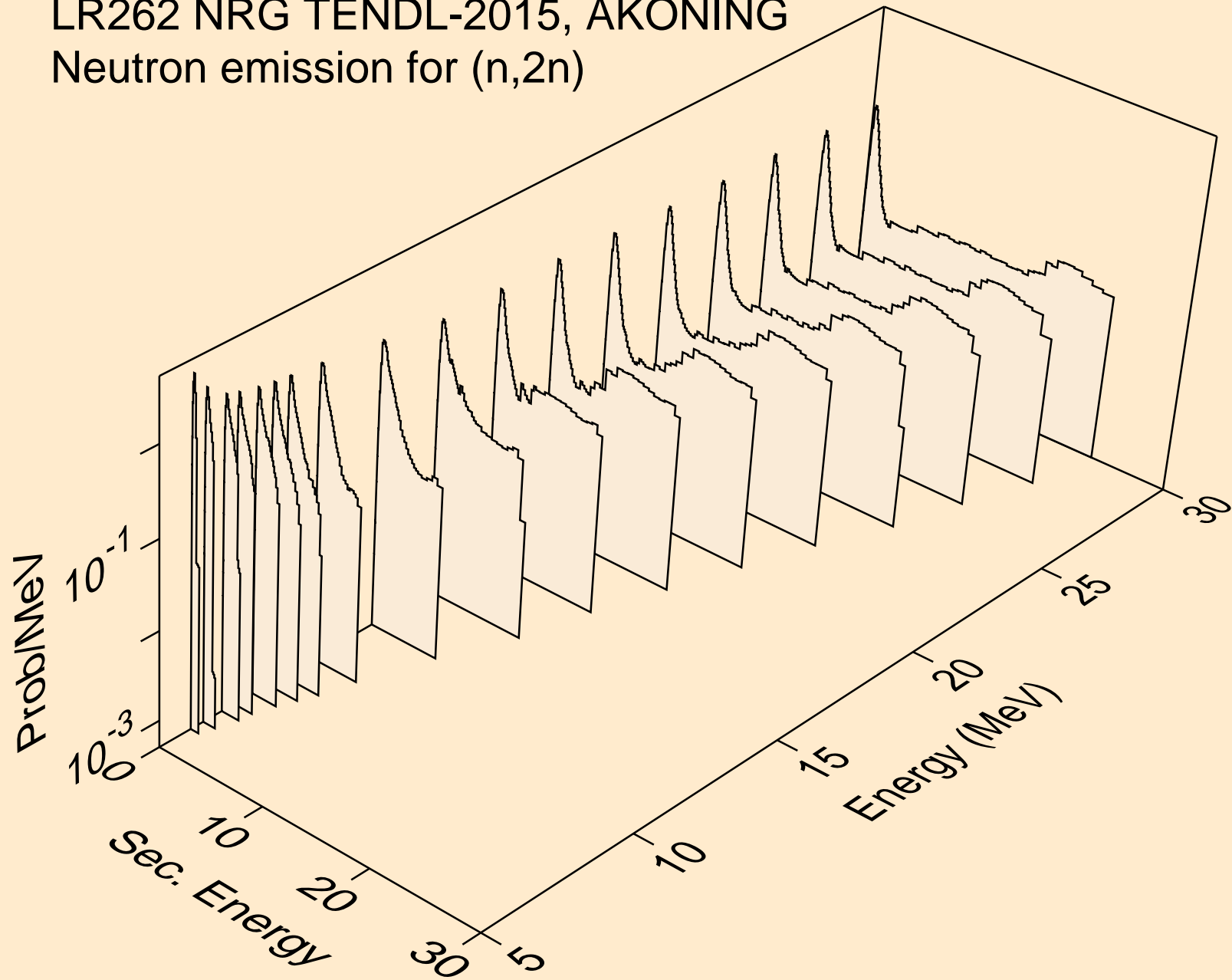

LR262 NRG TENDL-2015, AKONING  
Neutron emission for (n,3n)

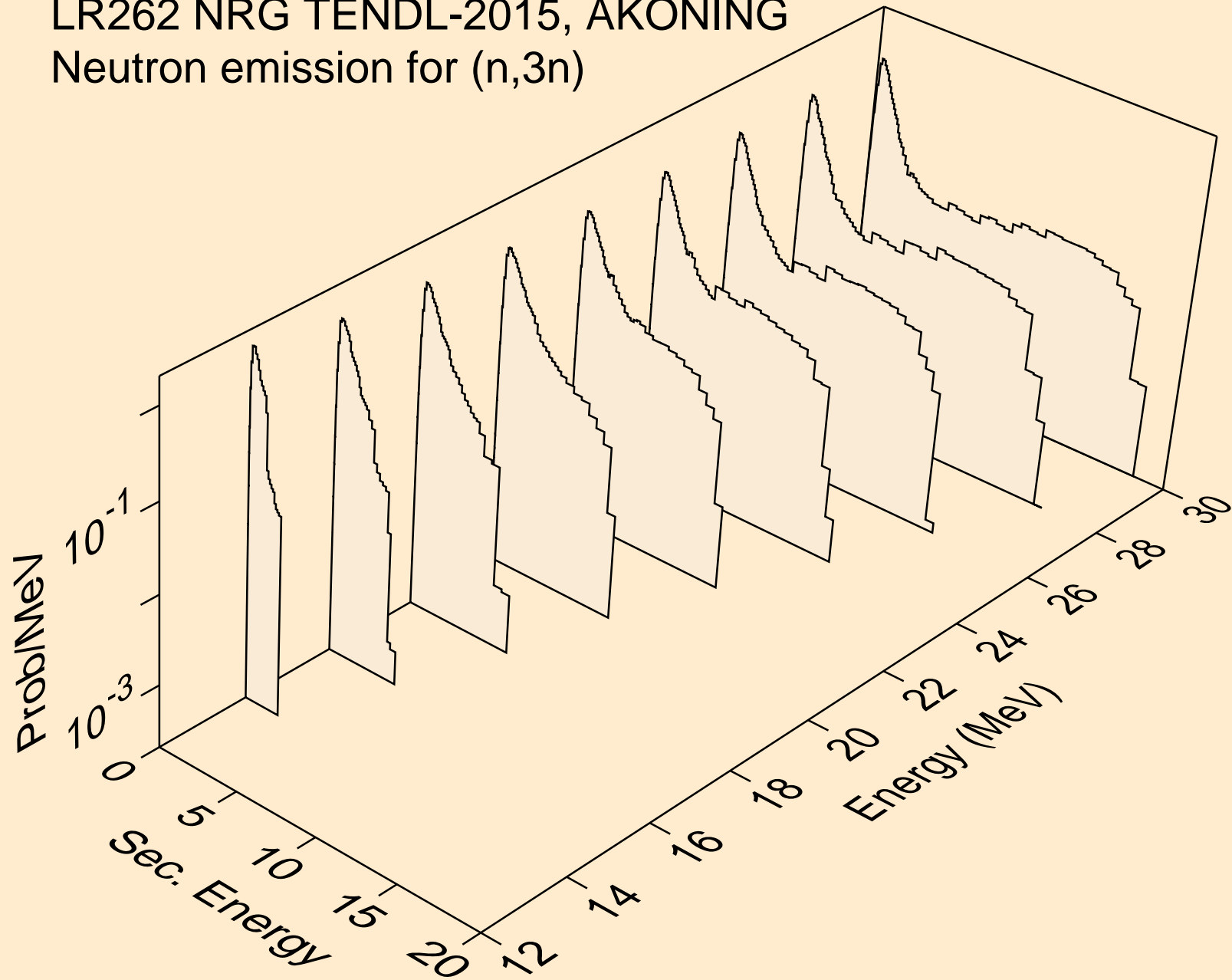

LR262 NRG TENDL-2015, AKONING  
Neutron emission for fission

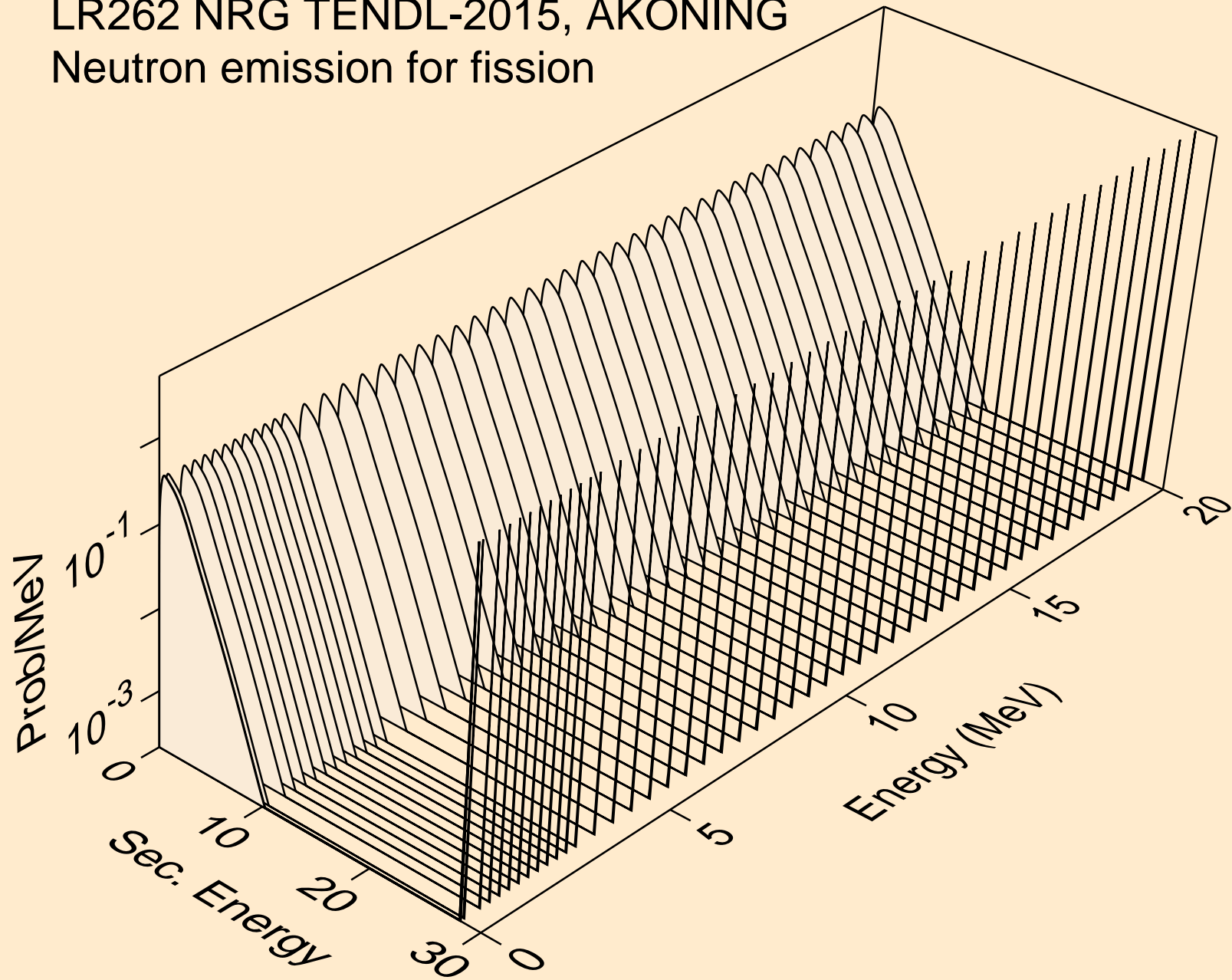

LR262 NRG TENDL-2015, AKONING  
Neutron emission for (n,n\*)a

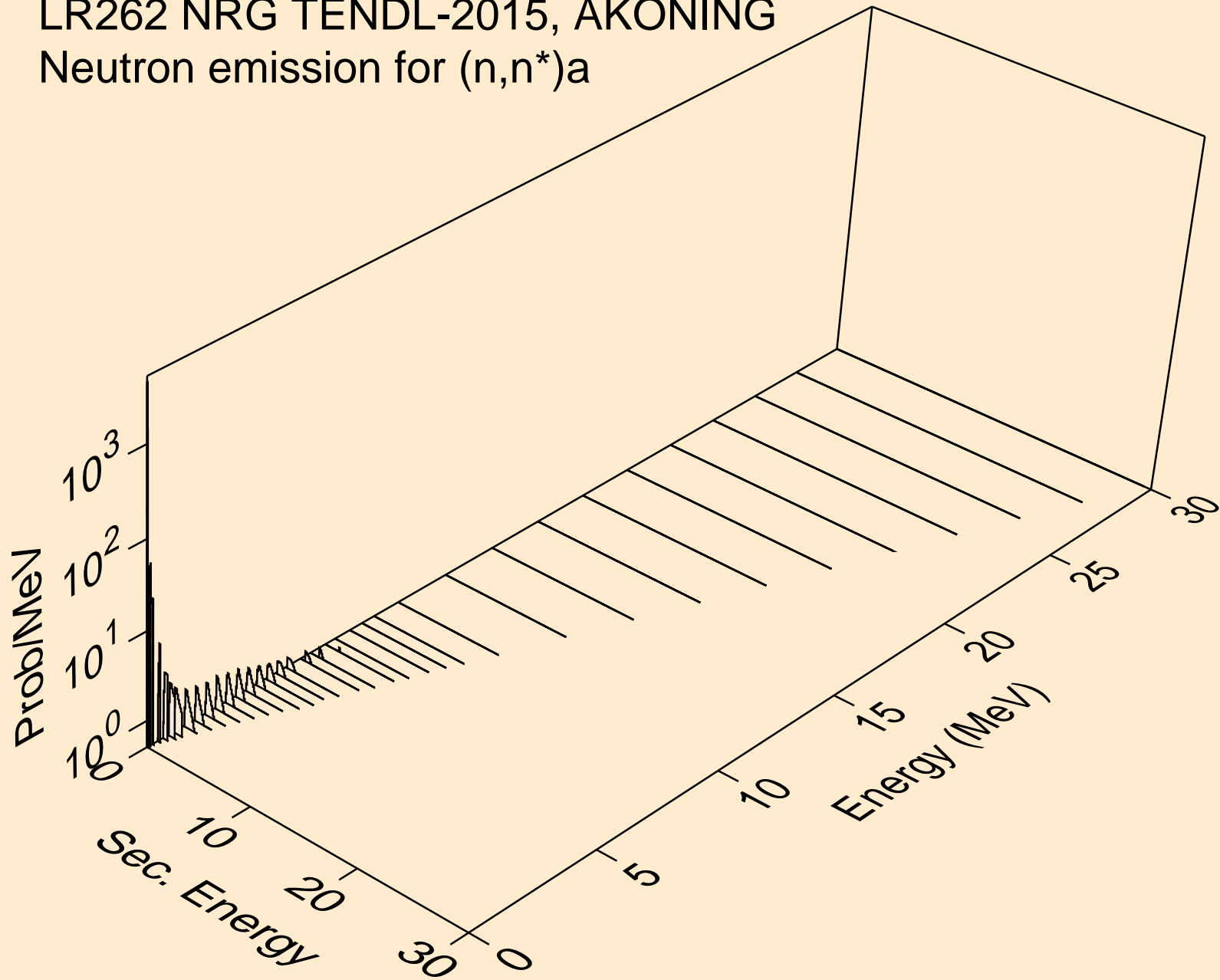

LR262 NRG TENDL-2015, AKONING  
Neutron emission for (n,n\*)3a

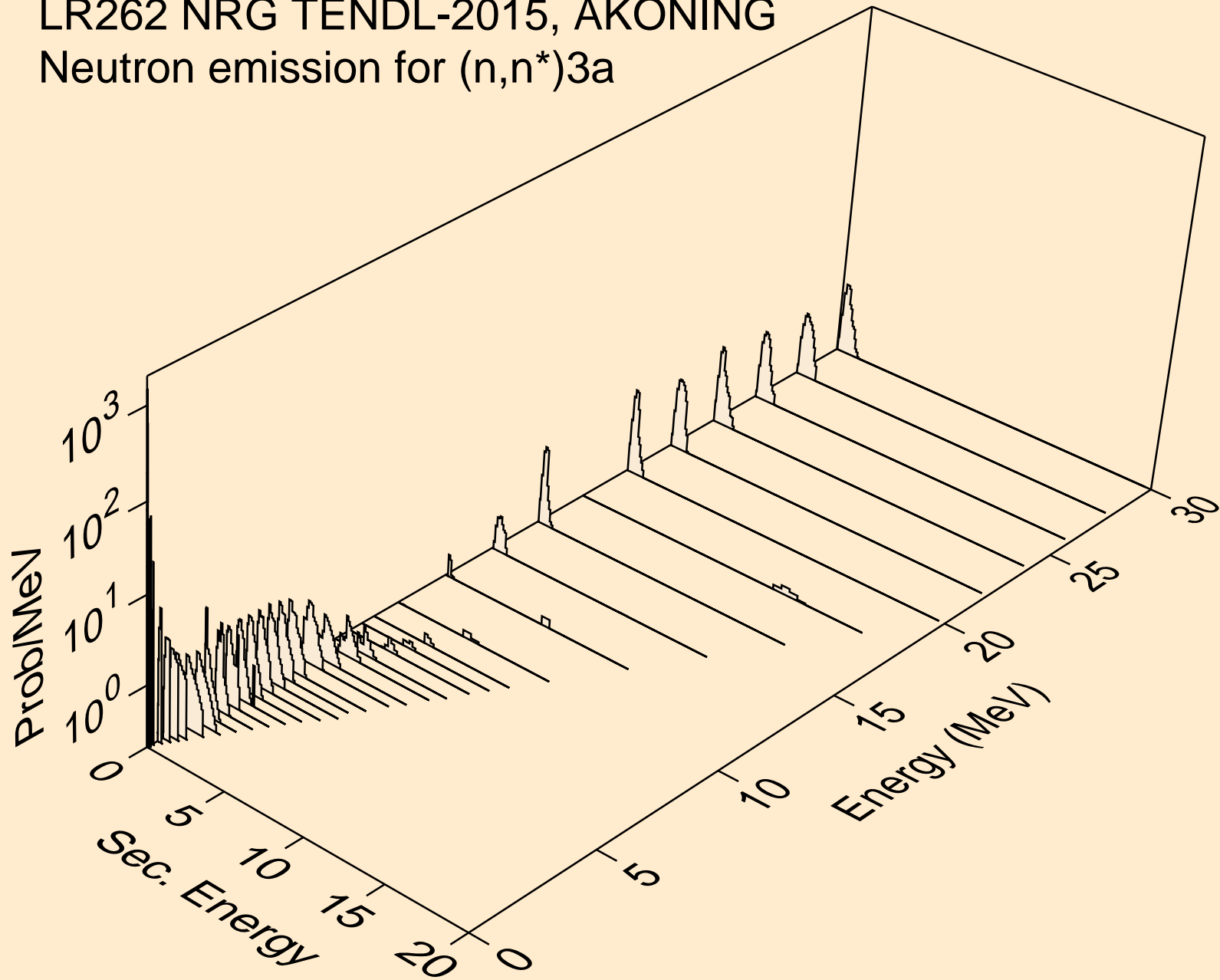



LR262 NRG TENDL-2015, AKONING  
Neutron emission for (n,2n)a

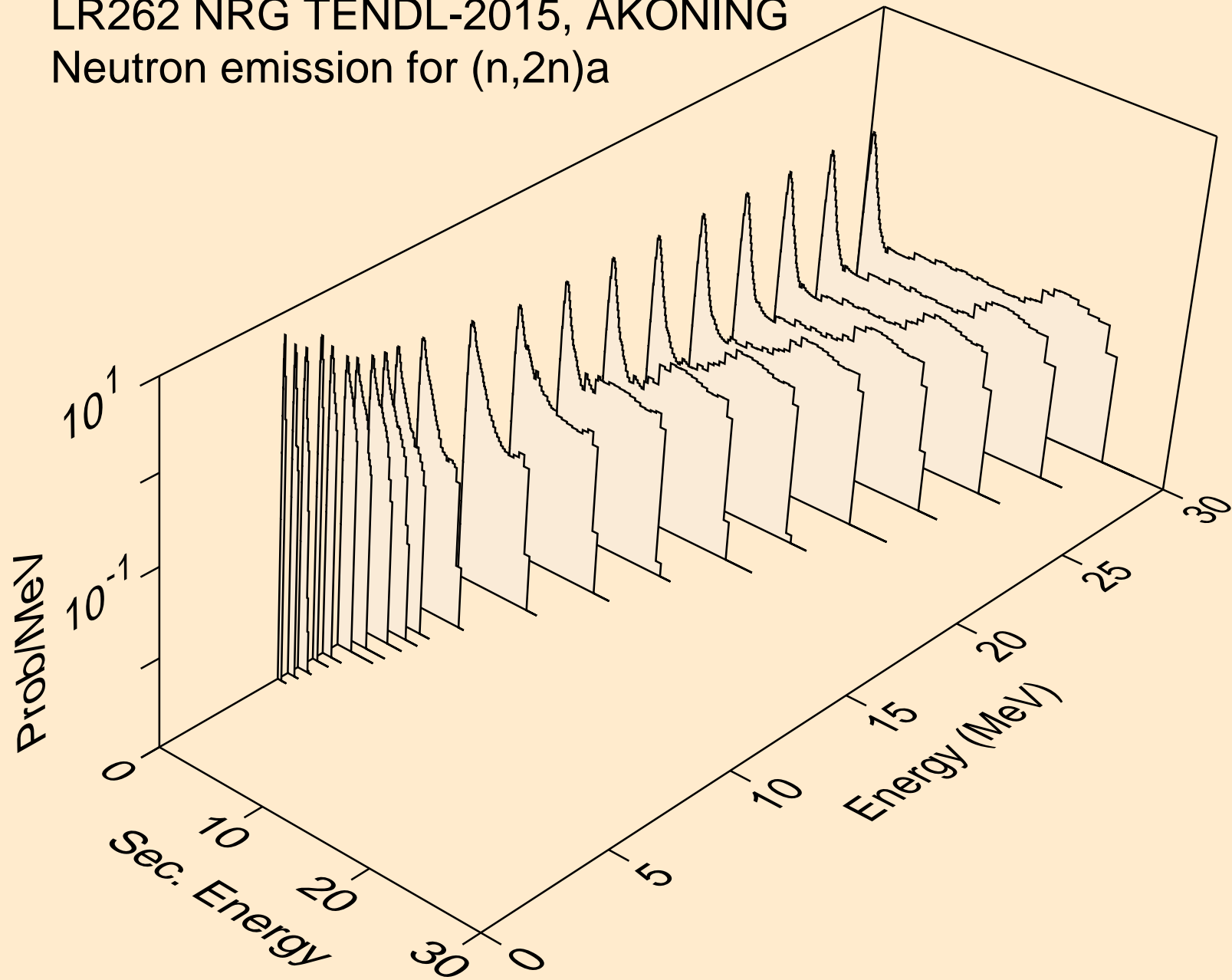

LR262 NRG TENDL-2015, AKONING  
Neutron emission for (n,3n)a

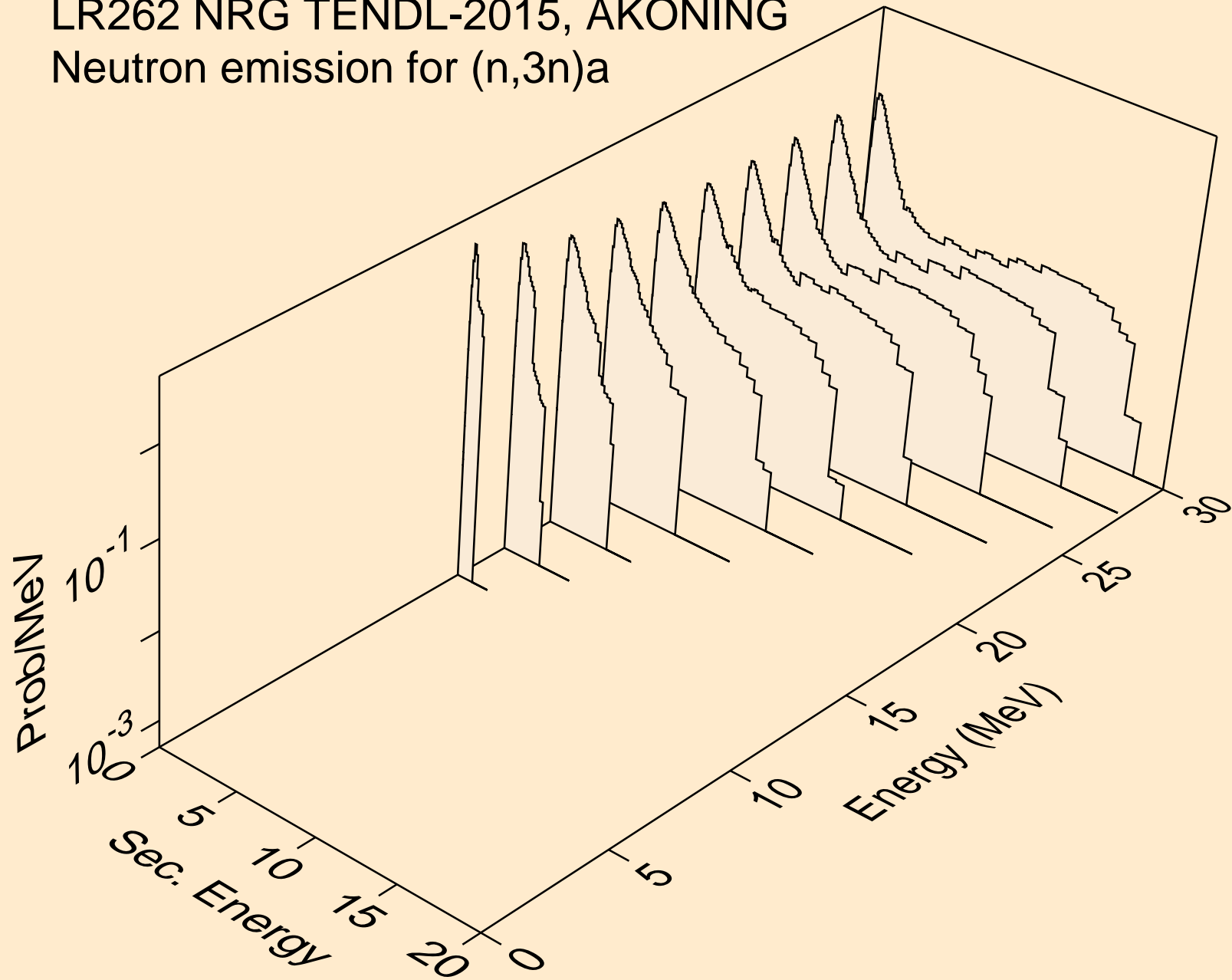

LR262 NRG TENDL-2015, AKONING  
Neutron emission for (n,n\*)p

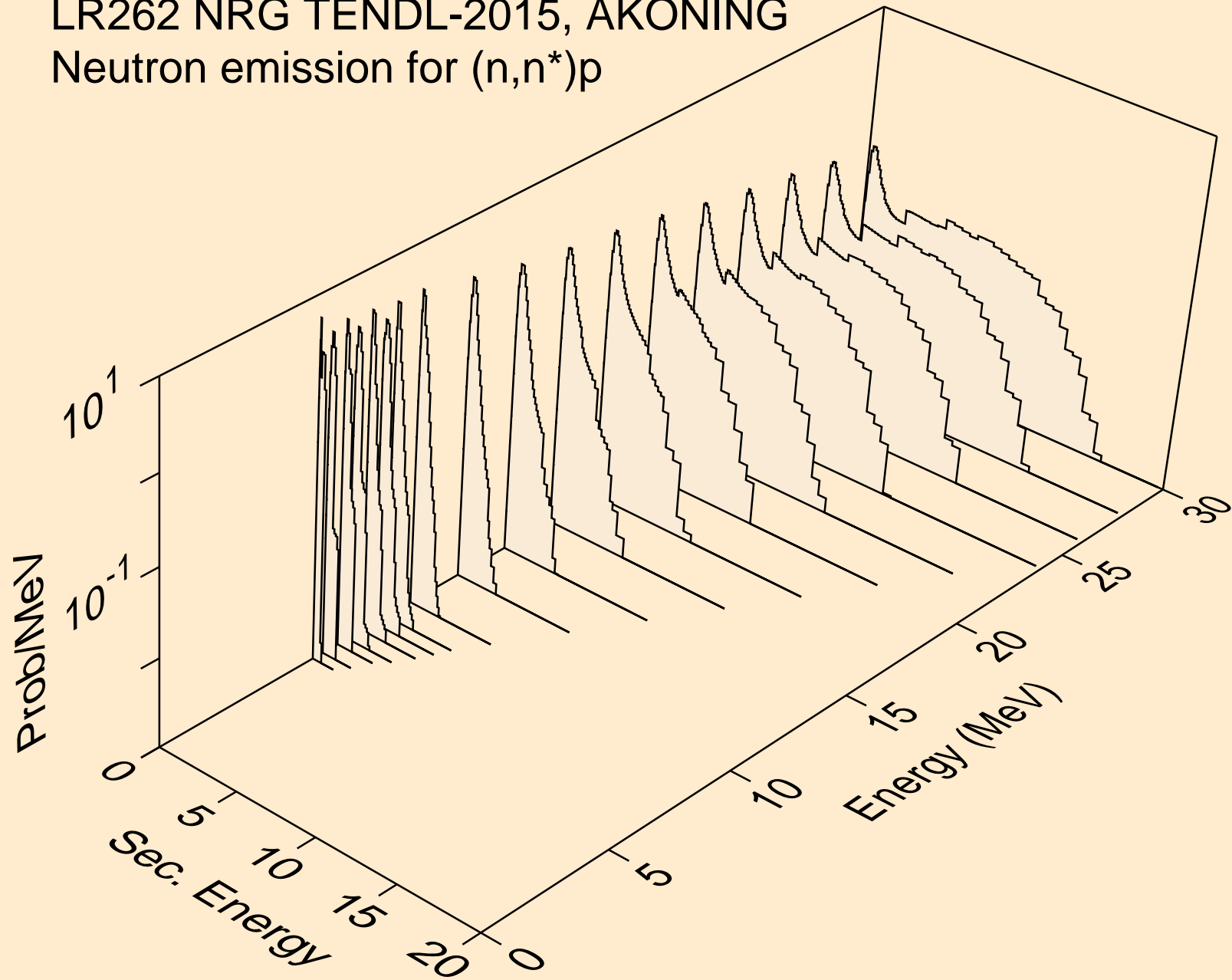

LR262 NRG TENDL-2015, AKONING  
Neutron emission for (n,n\*)2a

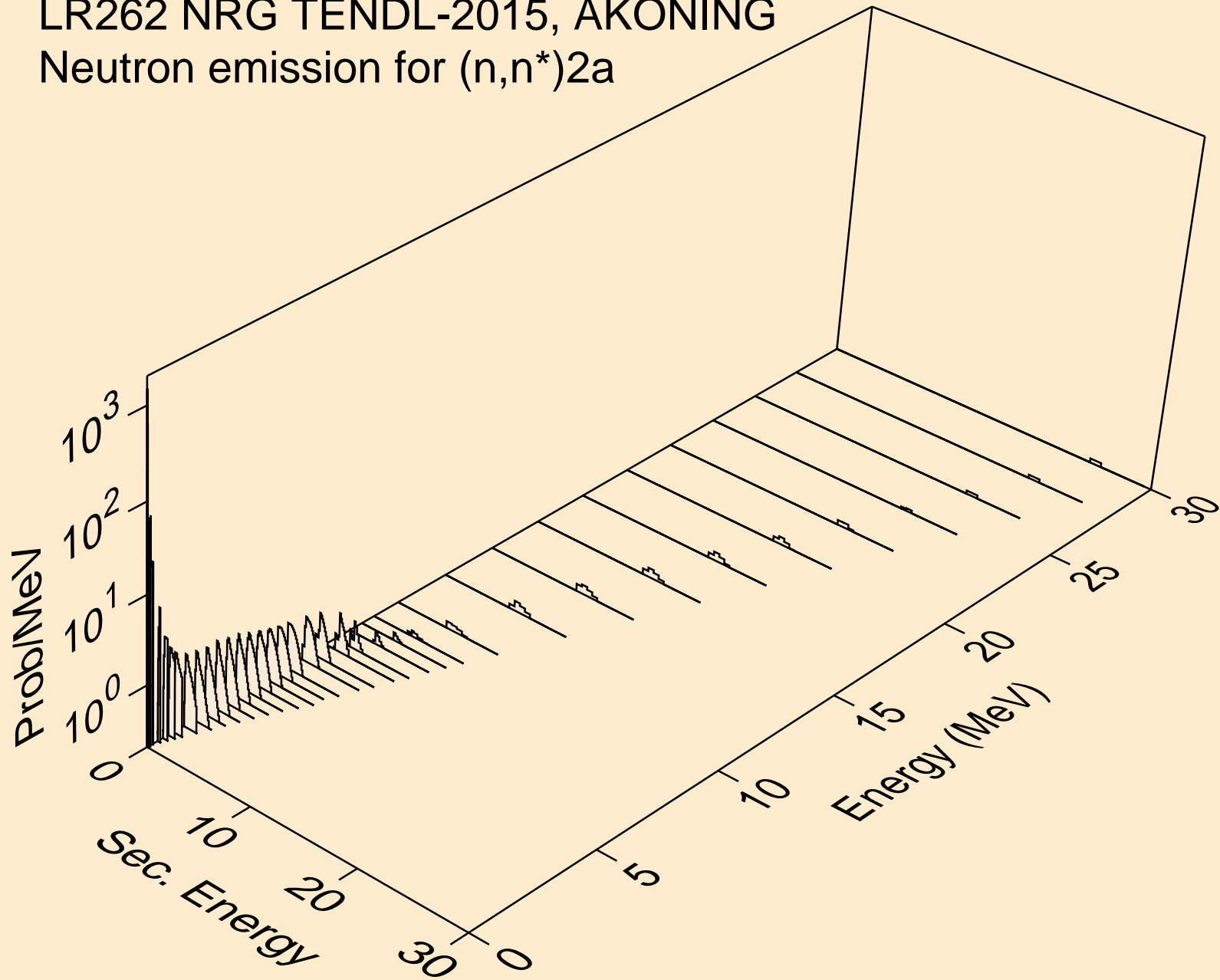

LR262 NRG TENDL-2015, AKONING  
Neutron emission for (n,2n)2a

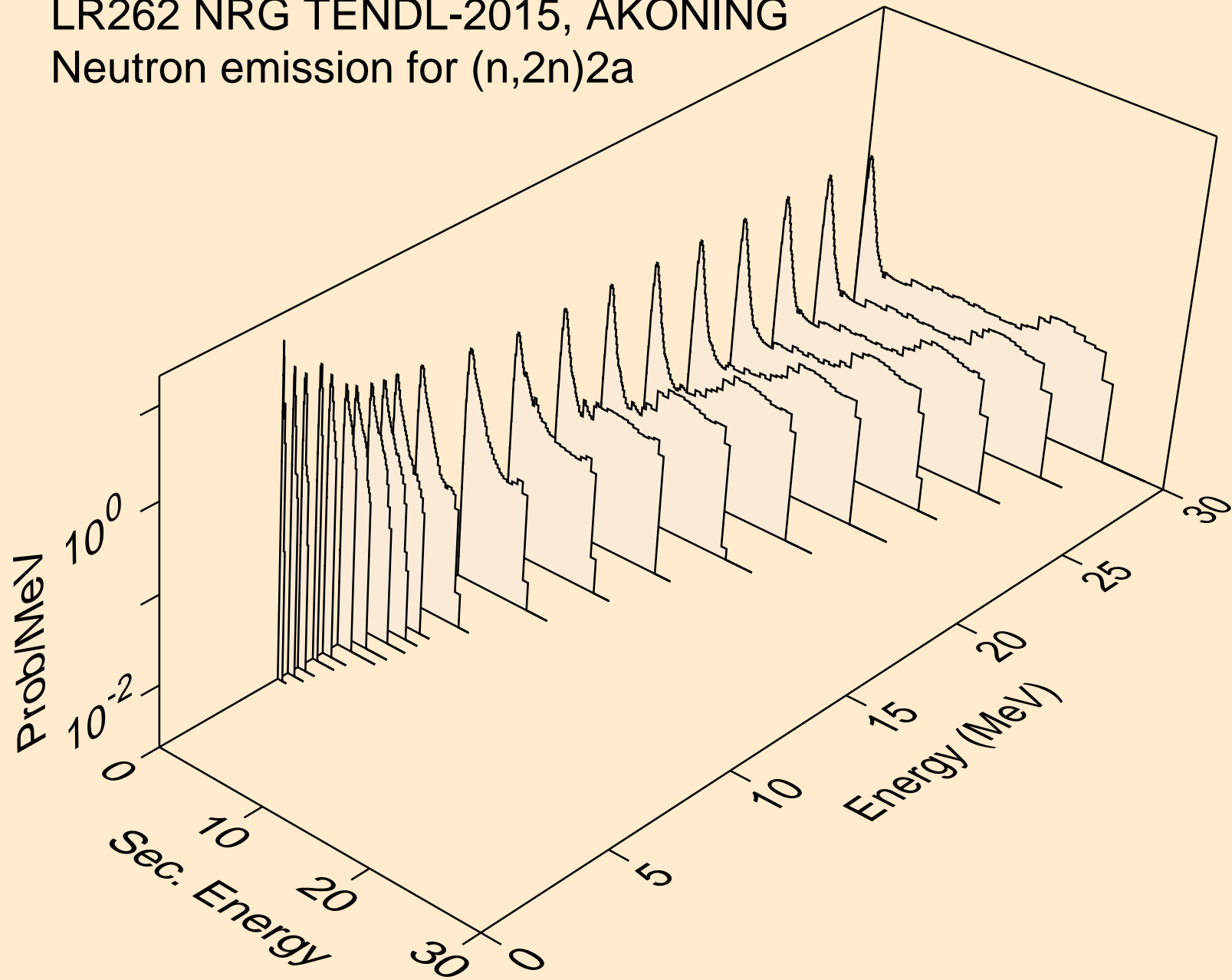

LR262 NRG TENDL-2015, AKONING  
Neutron emission for (n,n\*)d

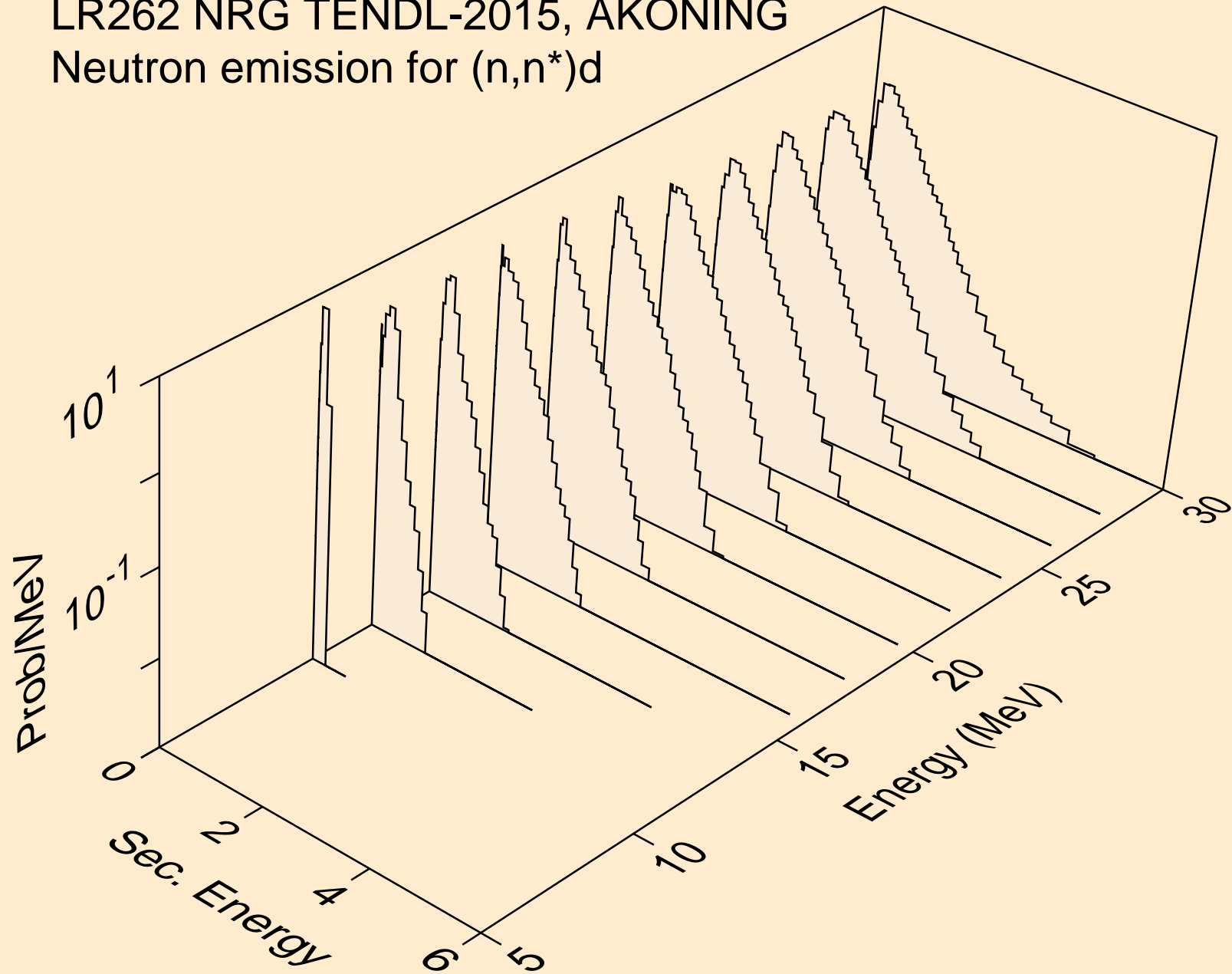

LR262 NRG TENDL-2015, AKONING  
Neutron emission for (n,n\*)t

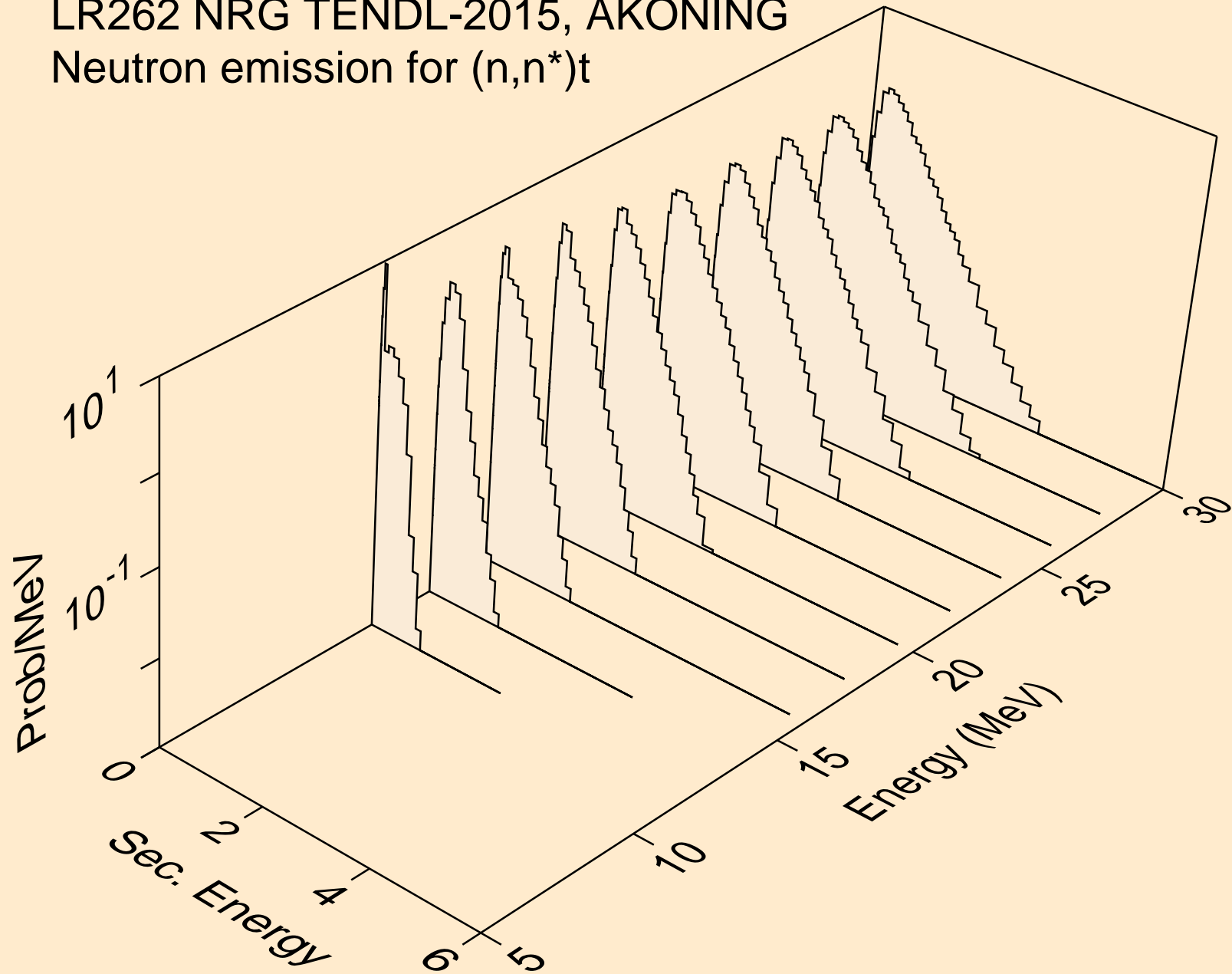

LR262 NRG TENDL-2015, AKONING  
Neutron emission for (n,n\*)he3

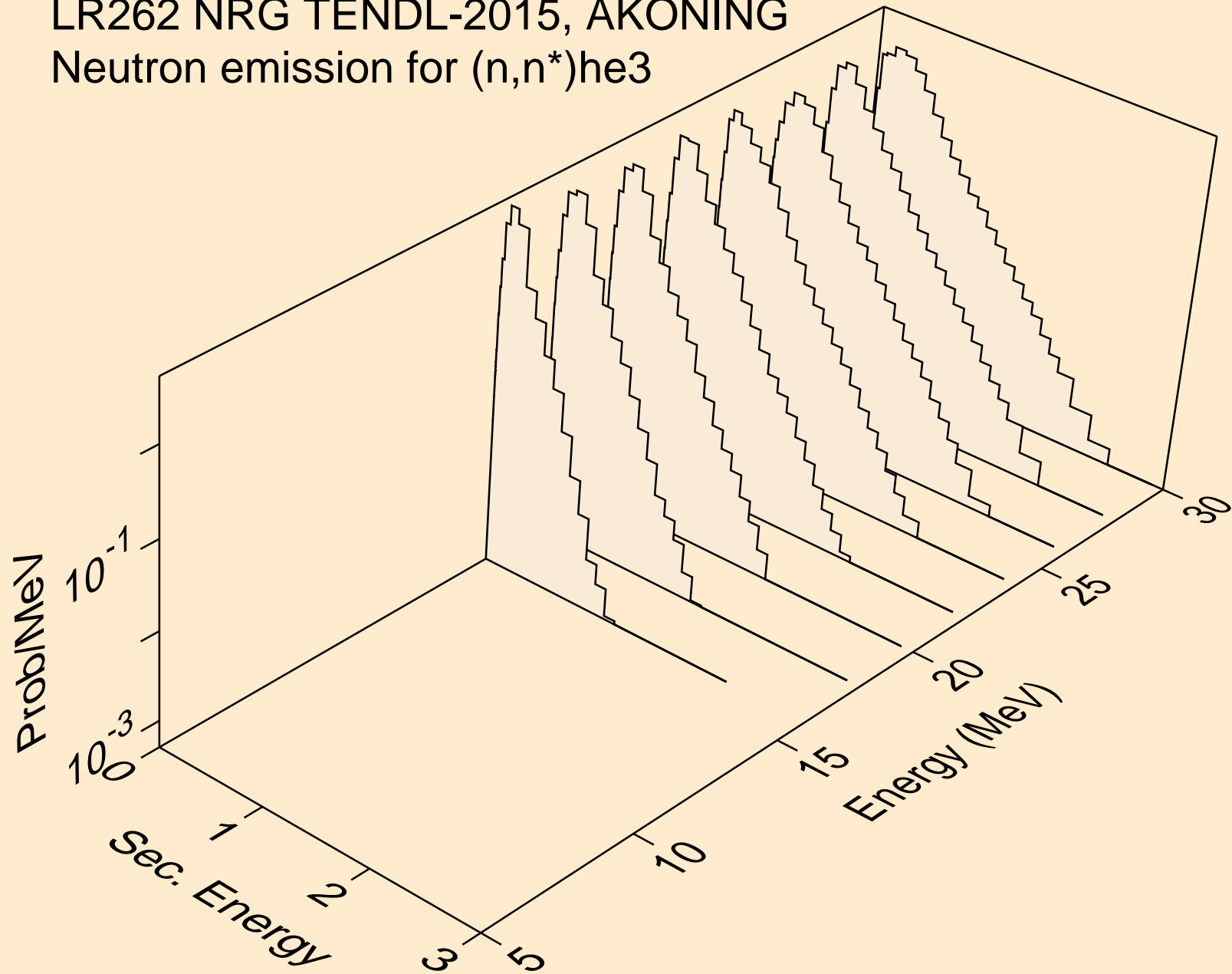



LR262 NRG TENDL-2015, AKONING  
Neutron emission for (n,n\*)d2a

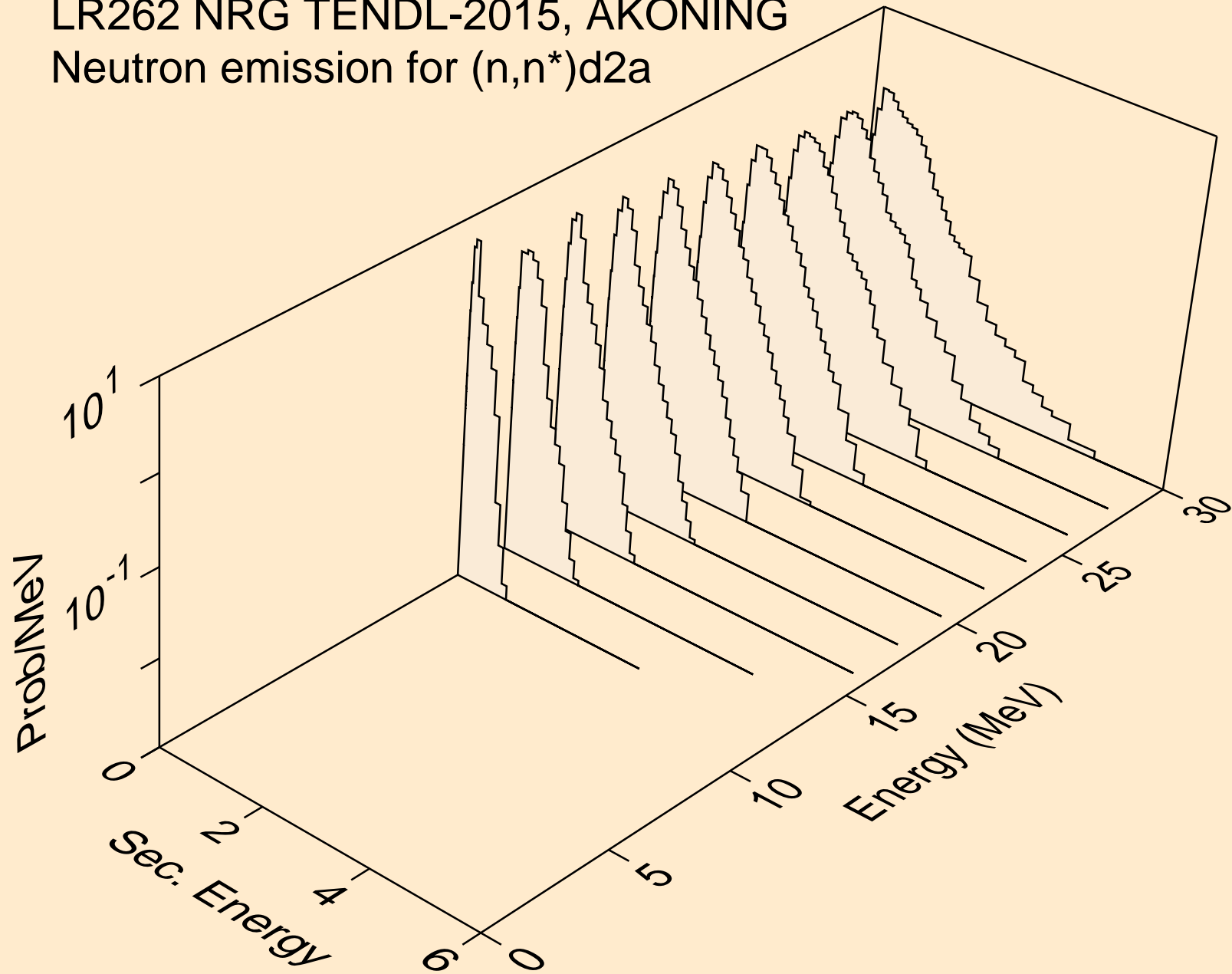

LR262 NRG TENDL-2015, AKONING  
Neutron emission for (n,n\*)t2a

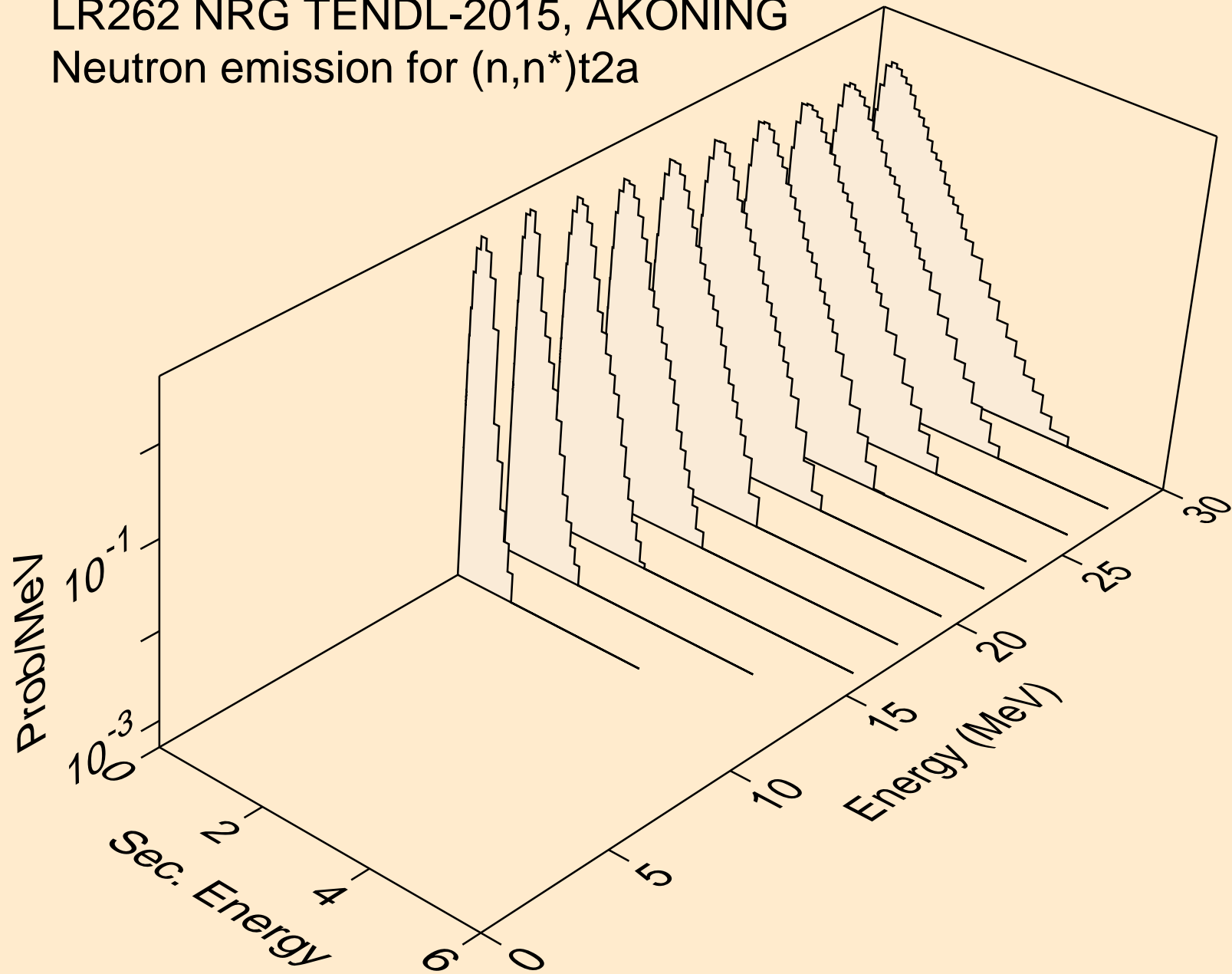

LR262 NRG TENDL-2015, AKONING  
Neutron emission for (n,4n)

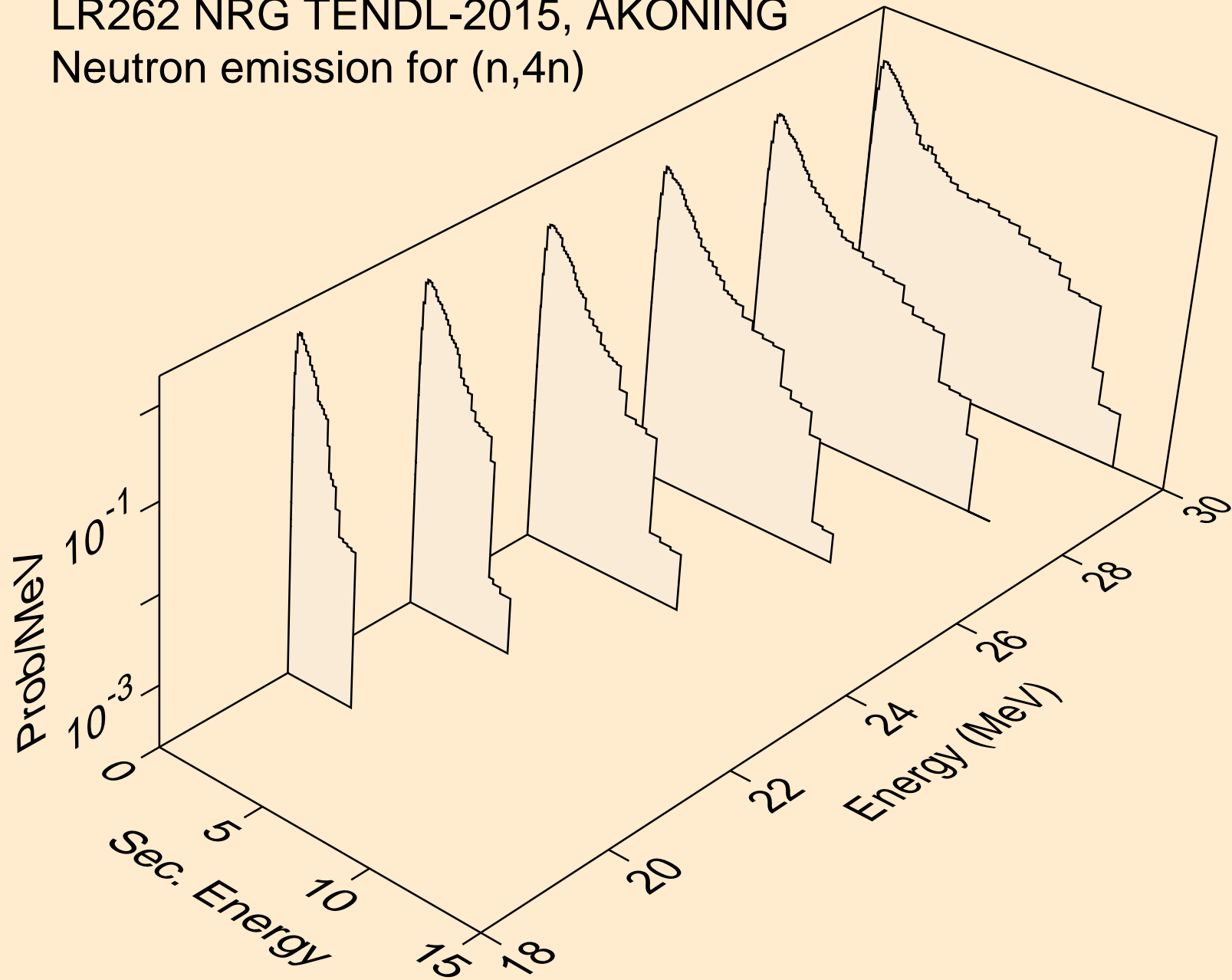

LR262 NRG TENDL-2015, AKONING  
Neutron emission for (n,2np)

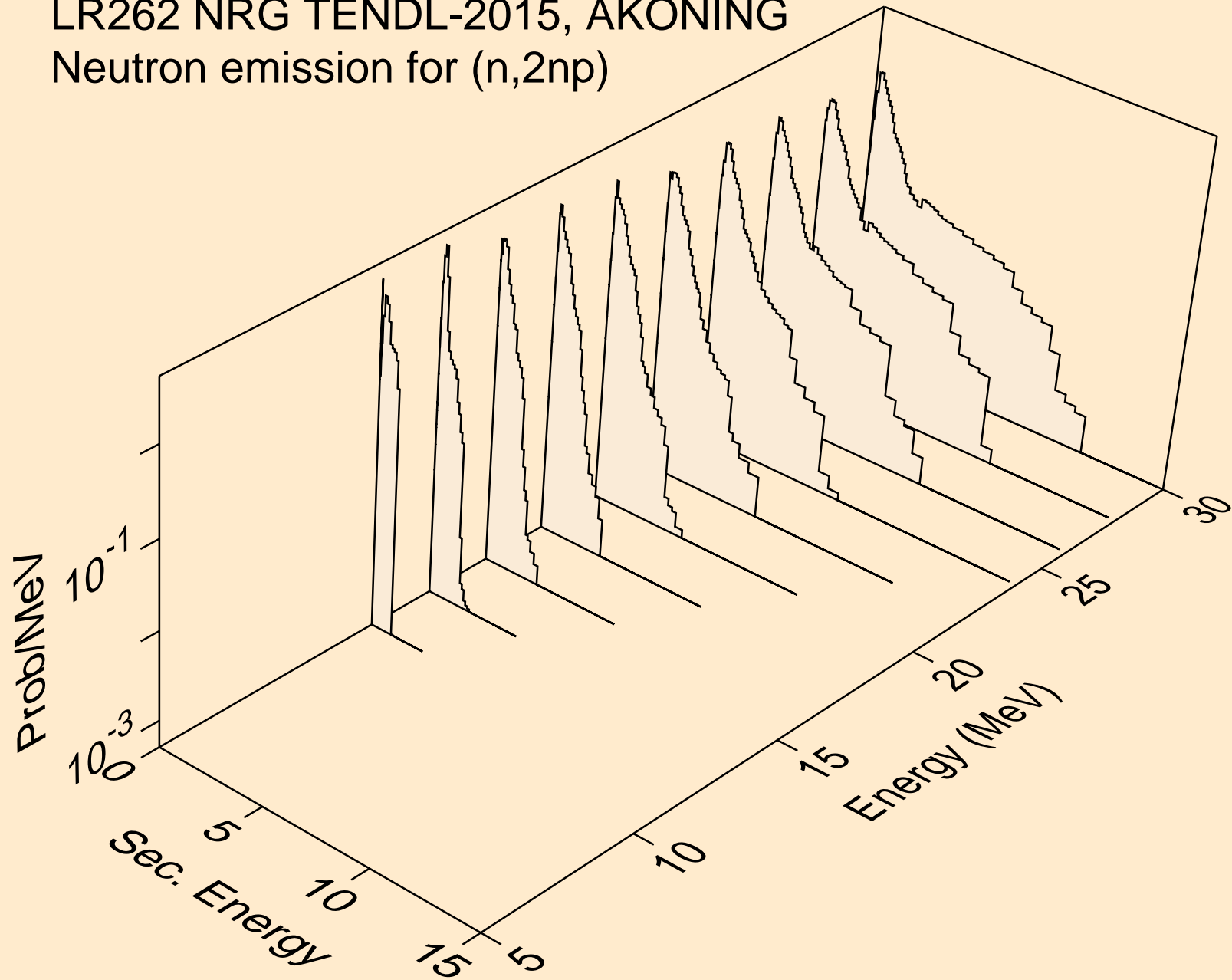

LR262 NRG TENDL-2015, AKONING  
Neutron emission for (n,3np)

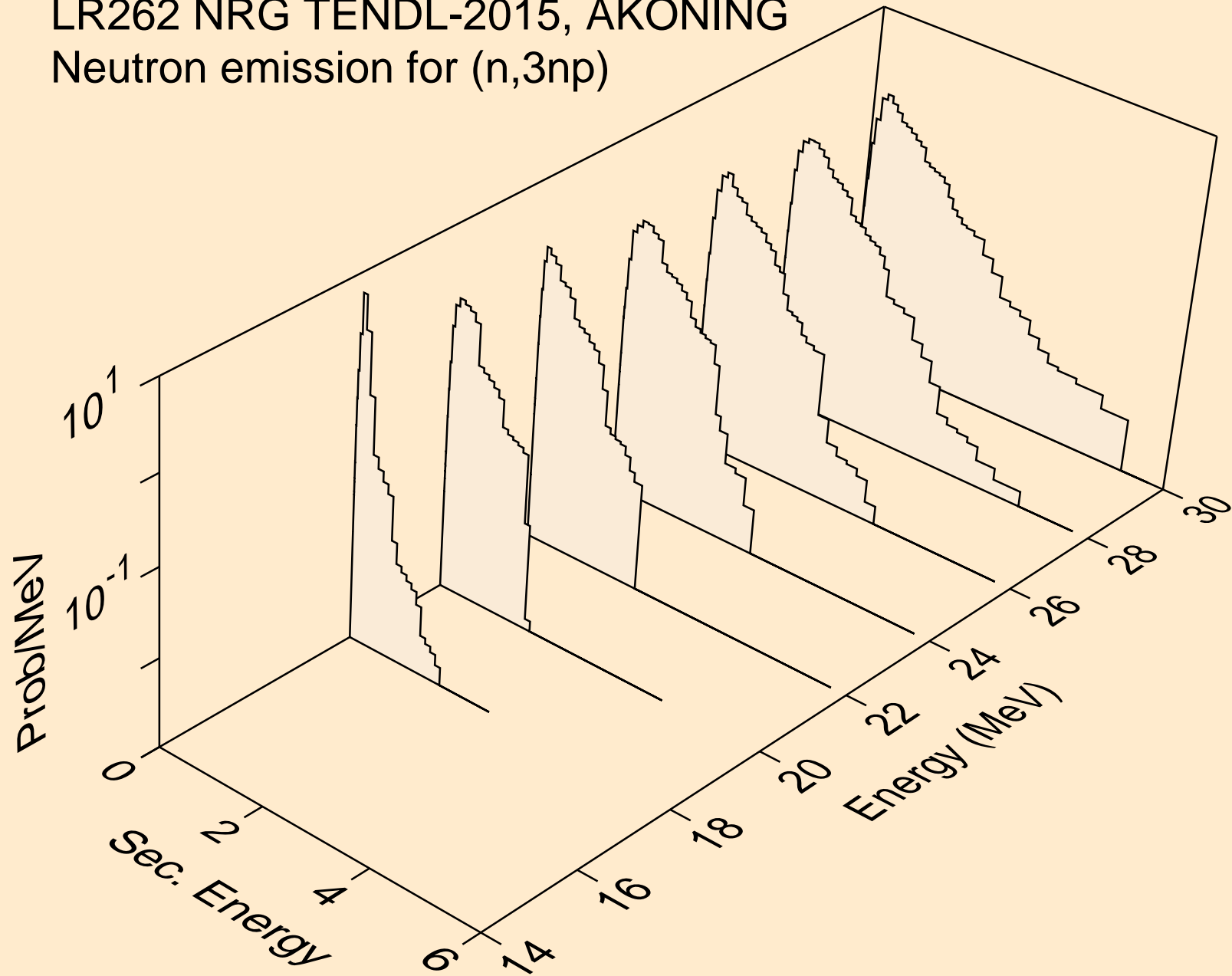

LR262 NRG TENDL-2015, AKONING  
Neutron emission for (n,2np)

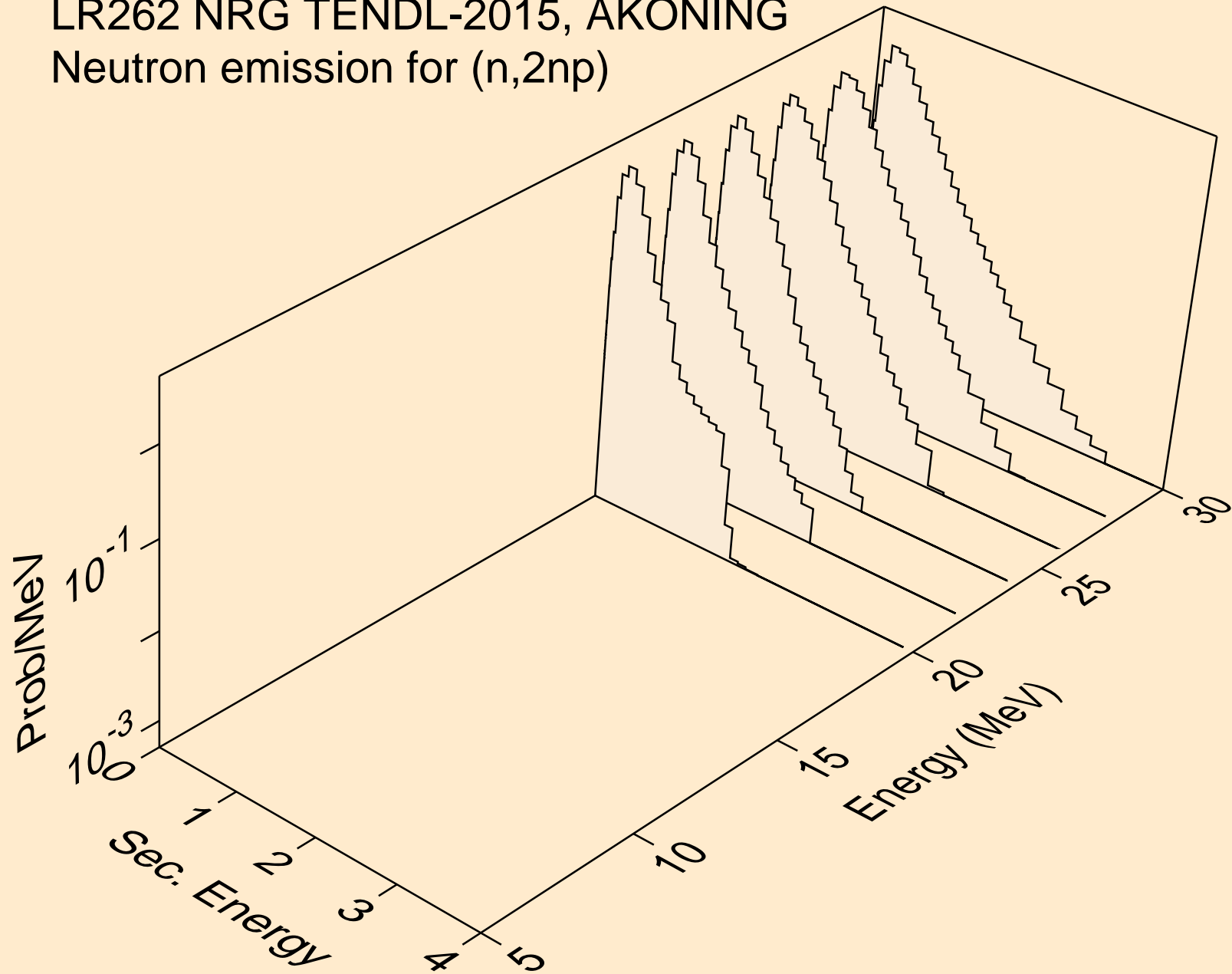

LR262 NRG TENDL-2015, AKONING  
Neutron emission for (n,npa)

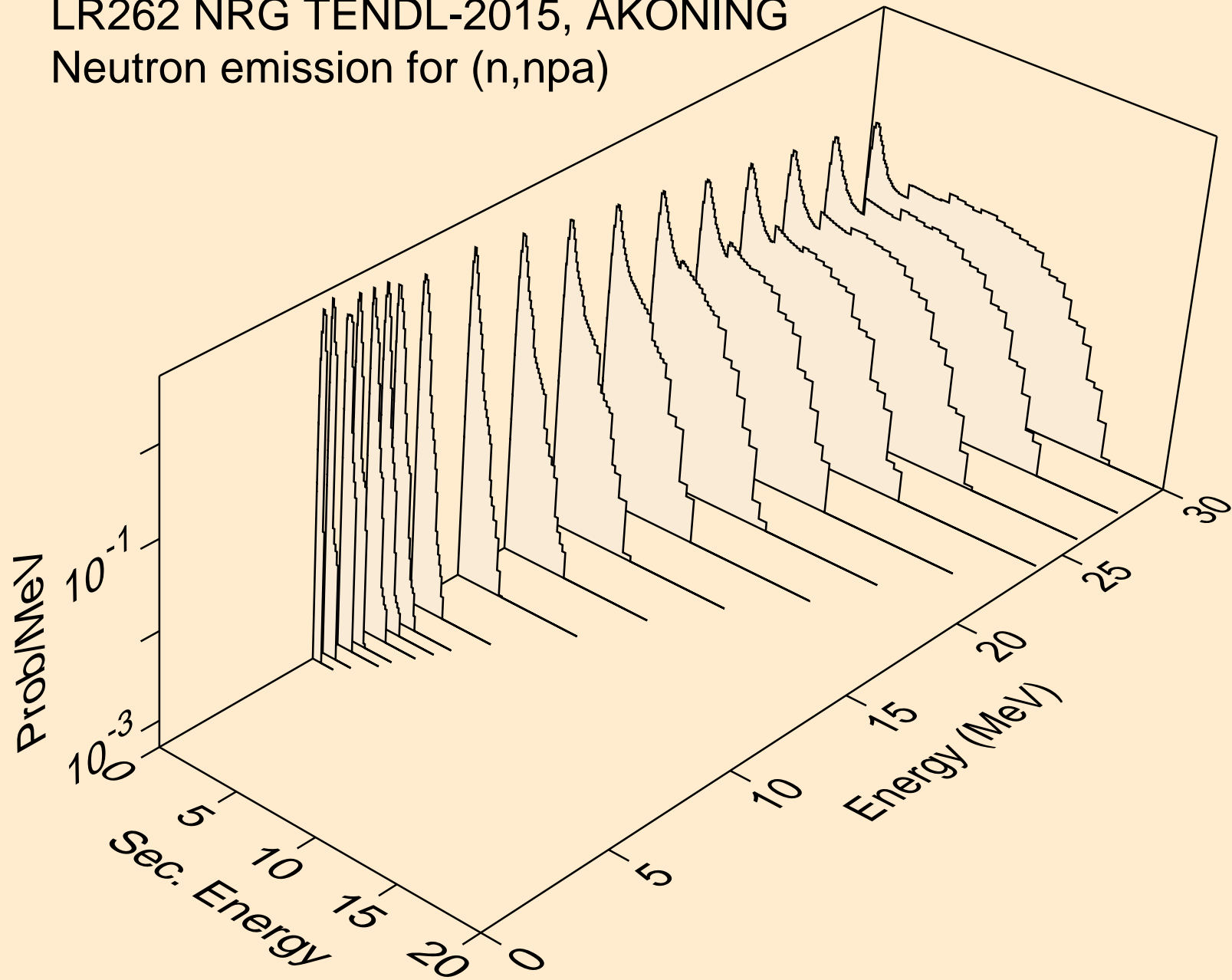

LR262 NRG TENDL-2015, AKONING  
Neutron emission for (n,n\*c)

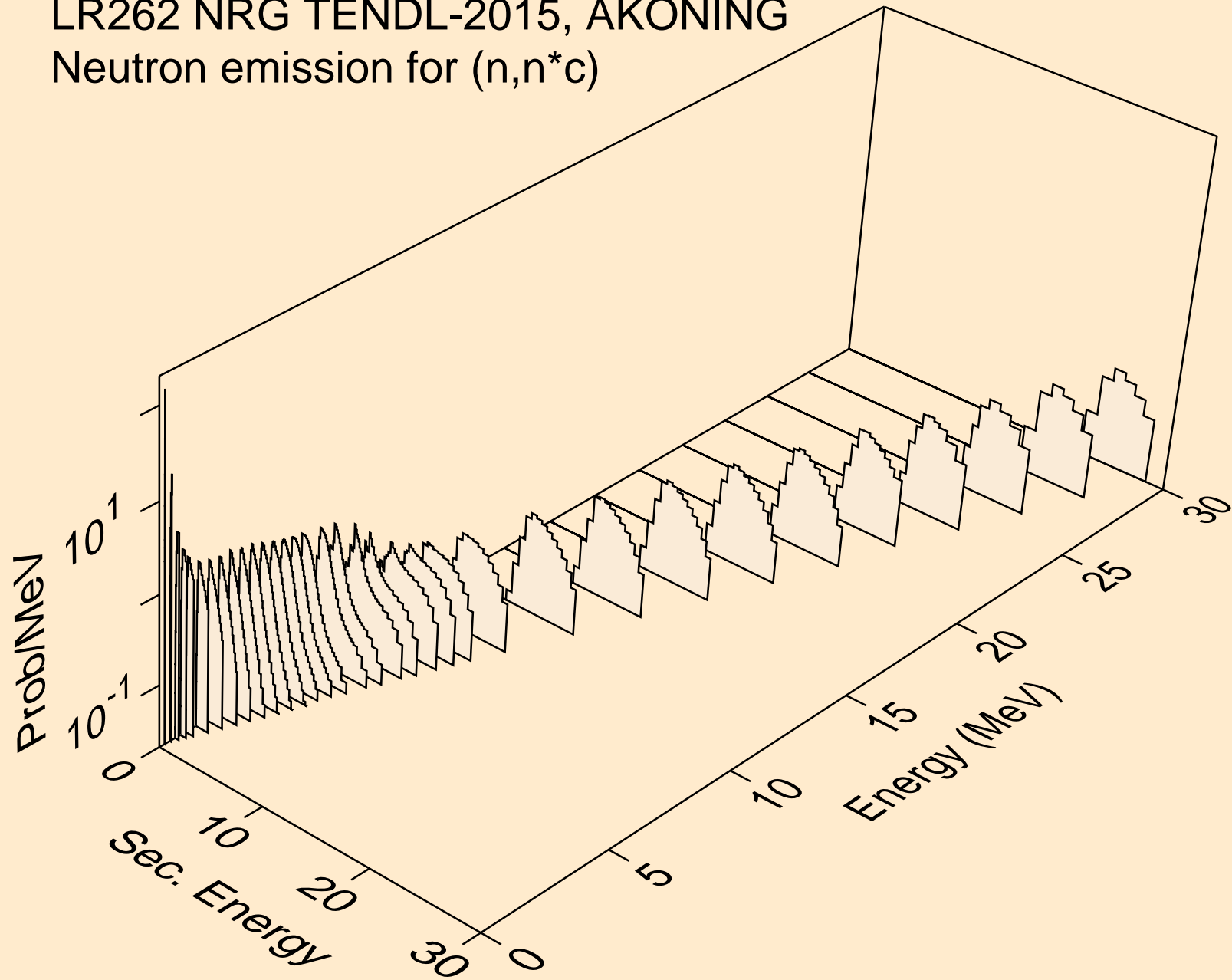



# LR262 NRG TENDL-2015, AKONING

Delayed nubar

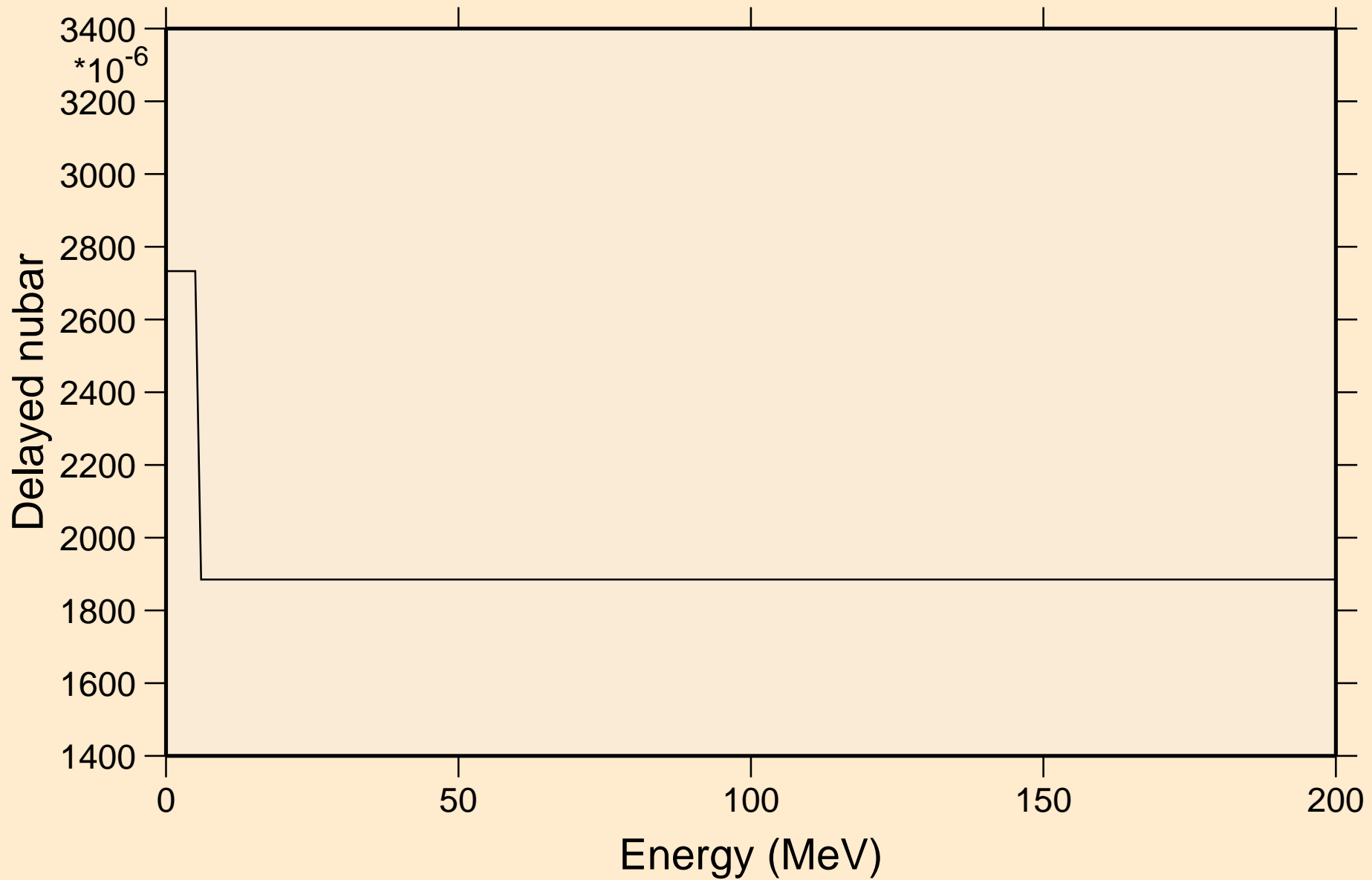

# LR262 NRG TENDL-2015, AKONING

## Delayed neutron spectra

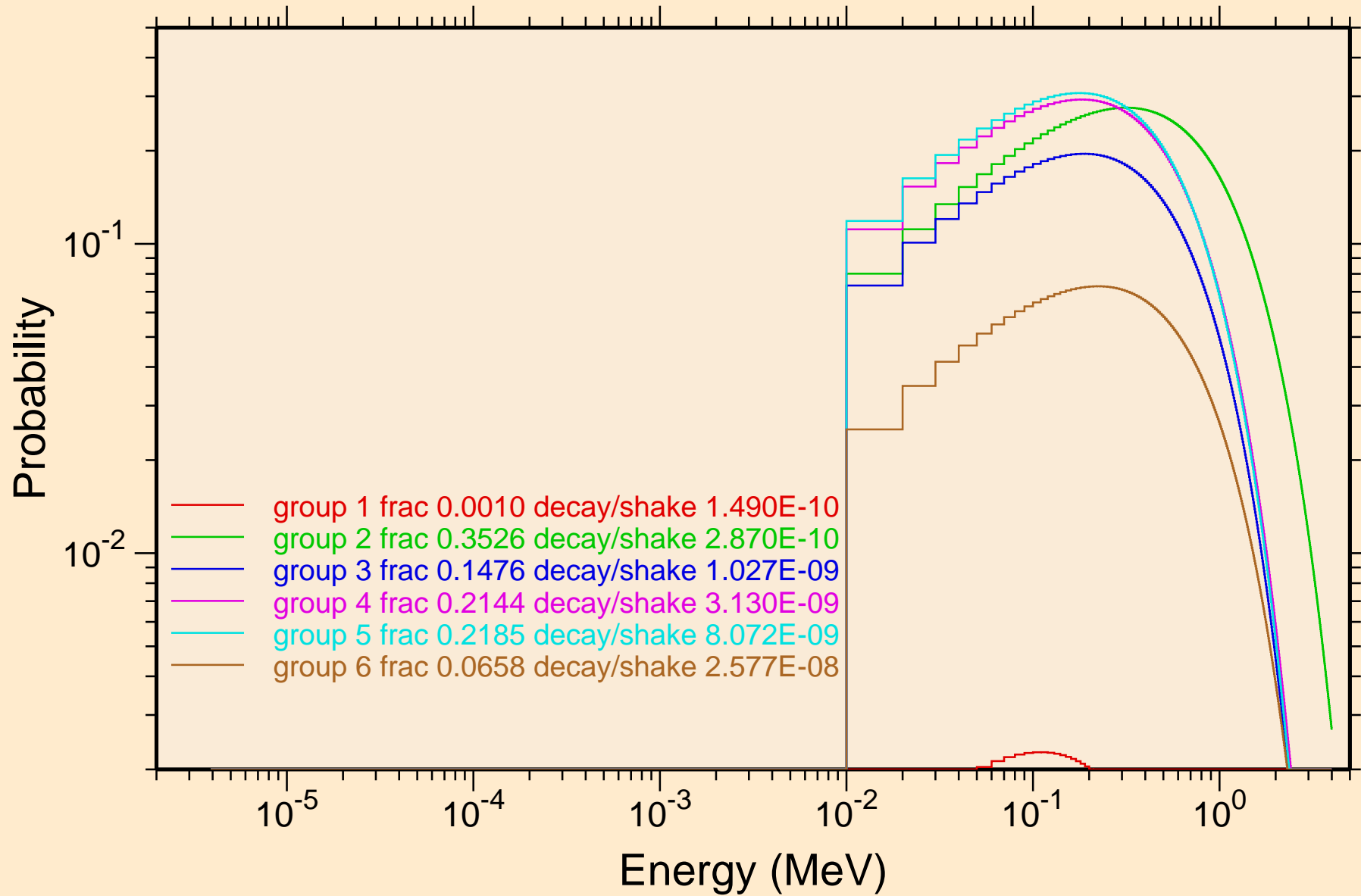

LR262 NRG TENDL-2015, AKONING  
Photon emission for (n,x)

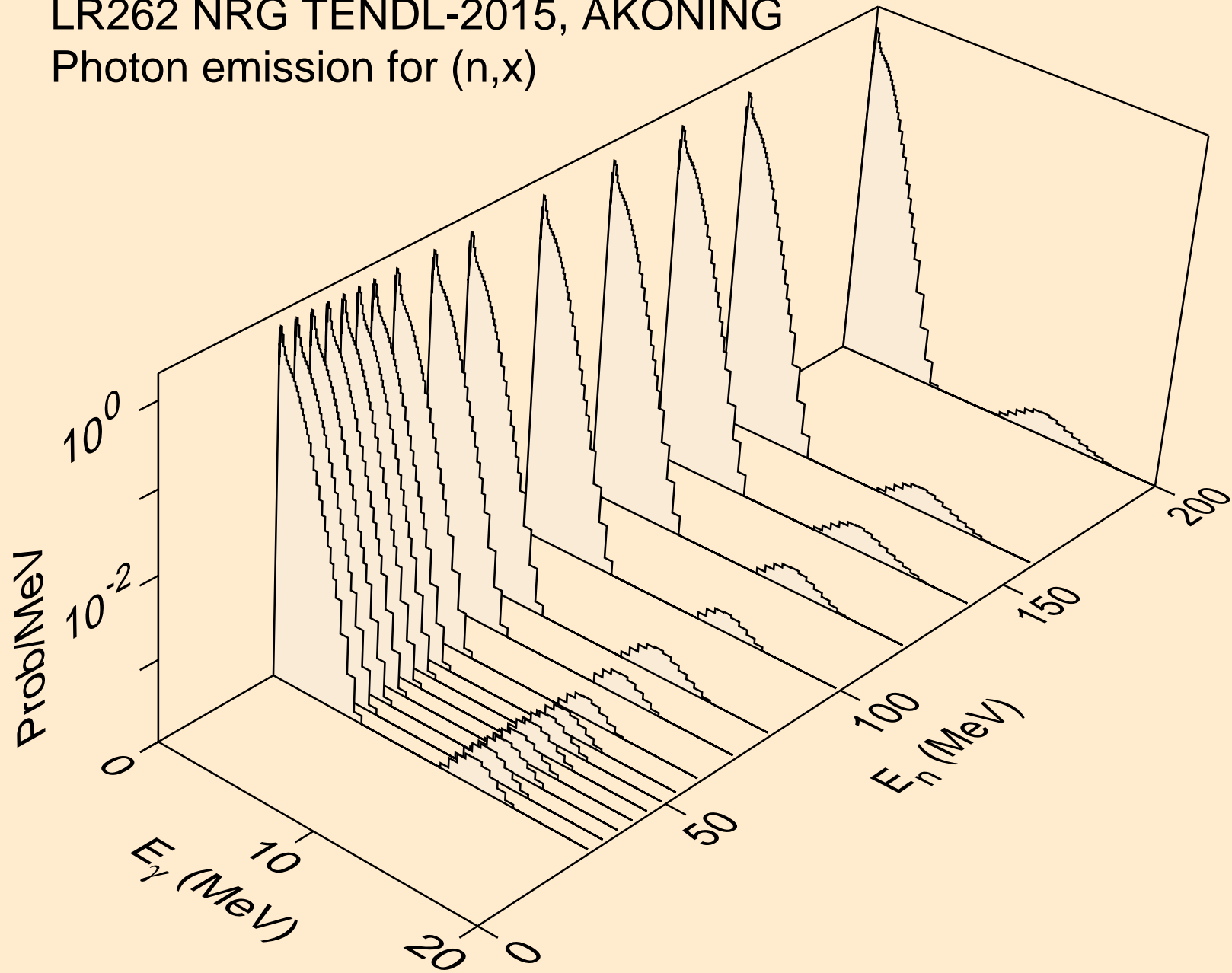

LR262 NRG TENDL-2015, AKONING  
Photon emission for (n,2nd)

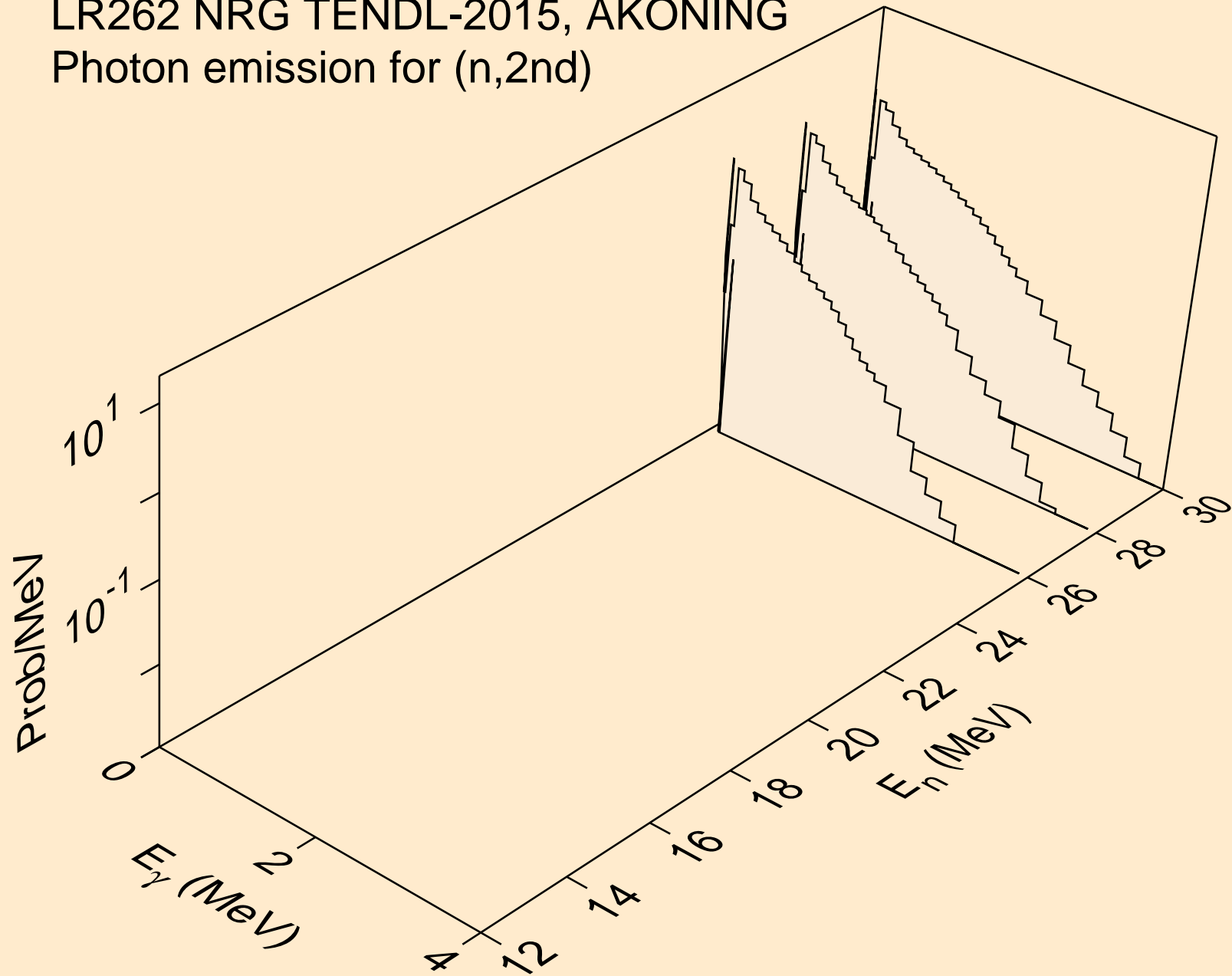

LR262 NRG TENDL-2015, AKONING  
Photon emission for (n,2n)

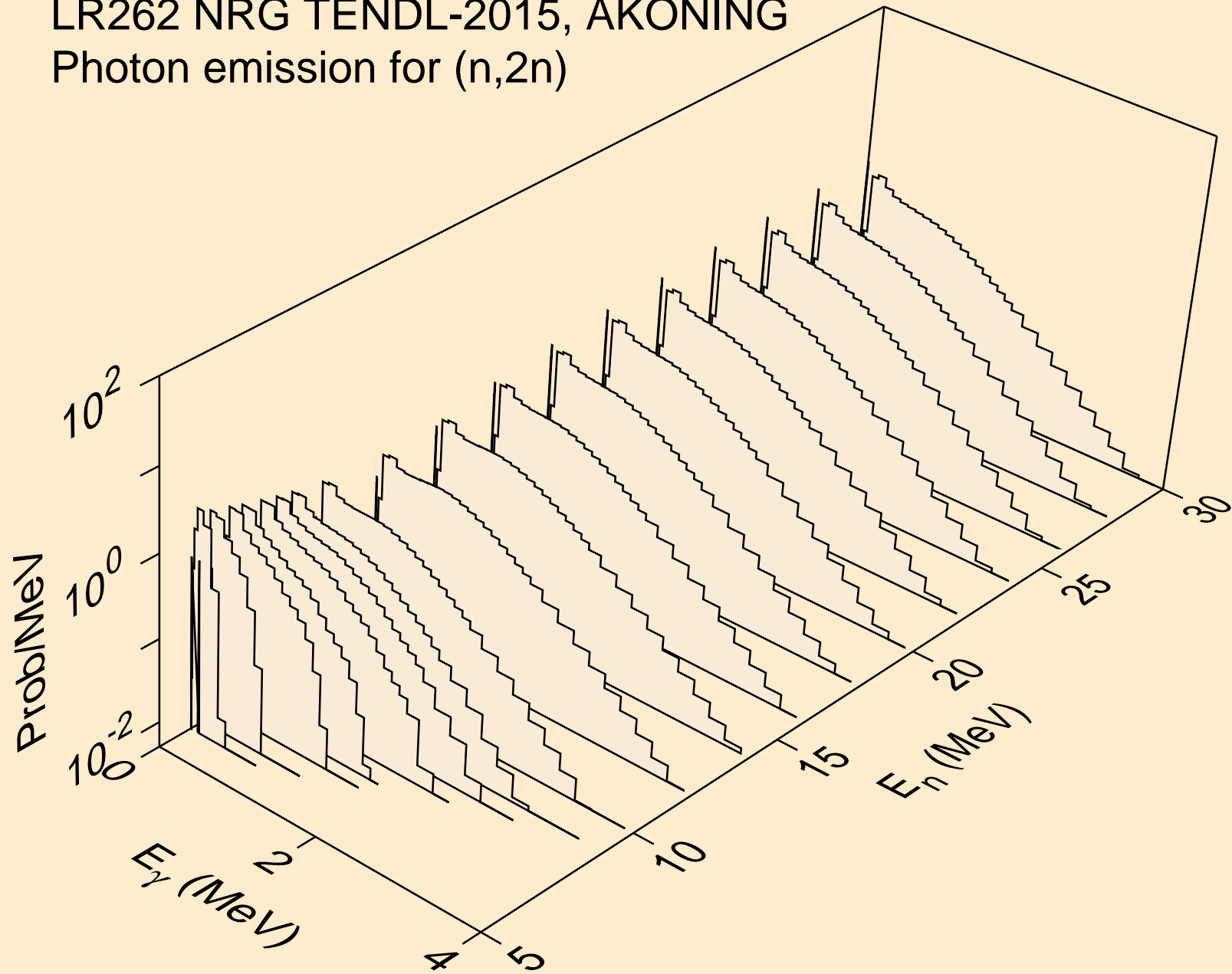

LR262 NRG TENDL-2015, AKONING  
Photon emission for (n,3n)

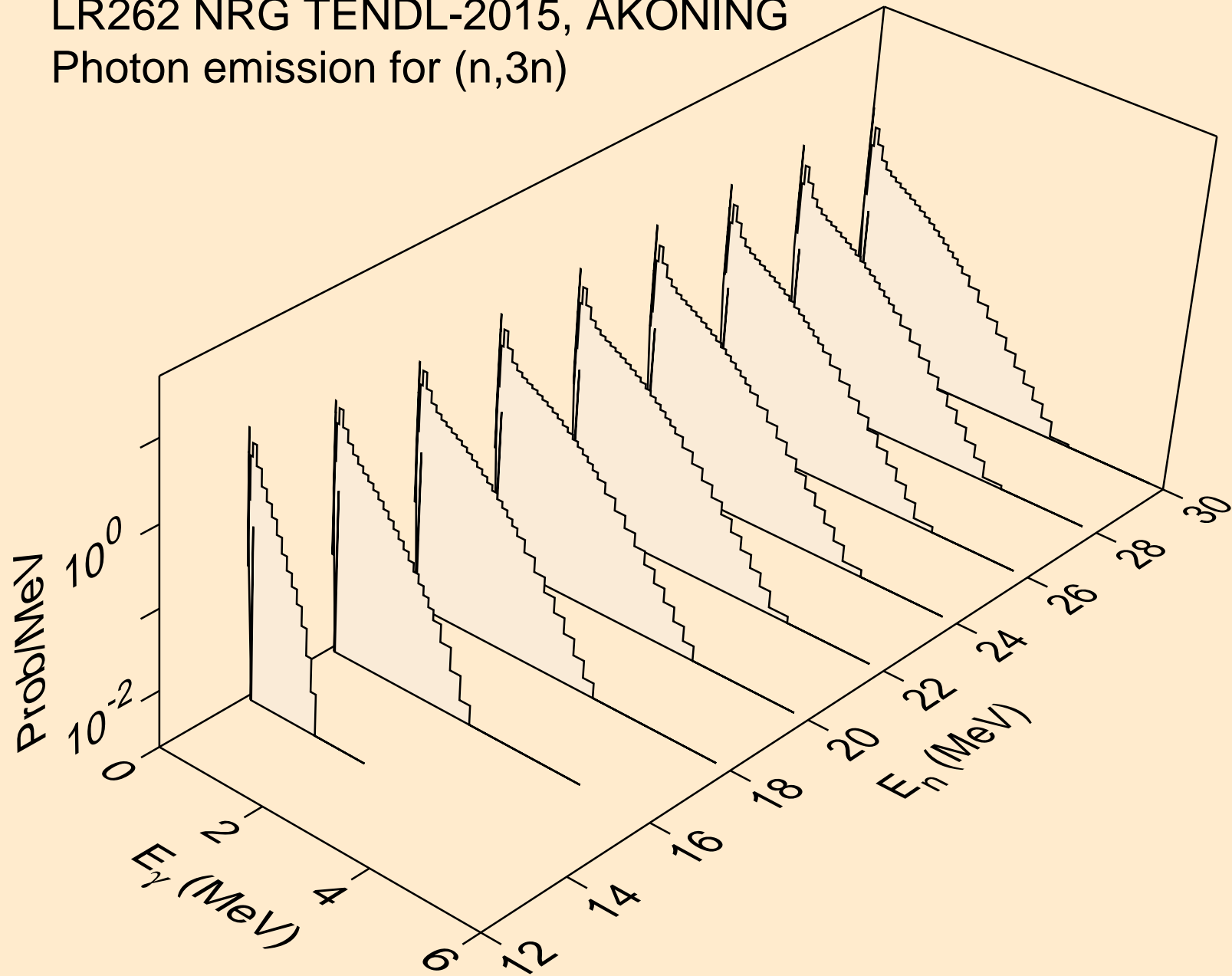

LR262 NRG TENDL-2015, AKONING  
Photon emission for (n,n\*)a

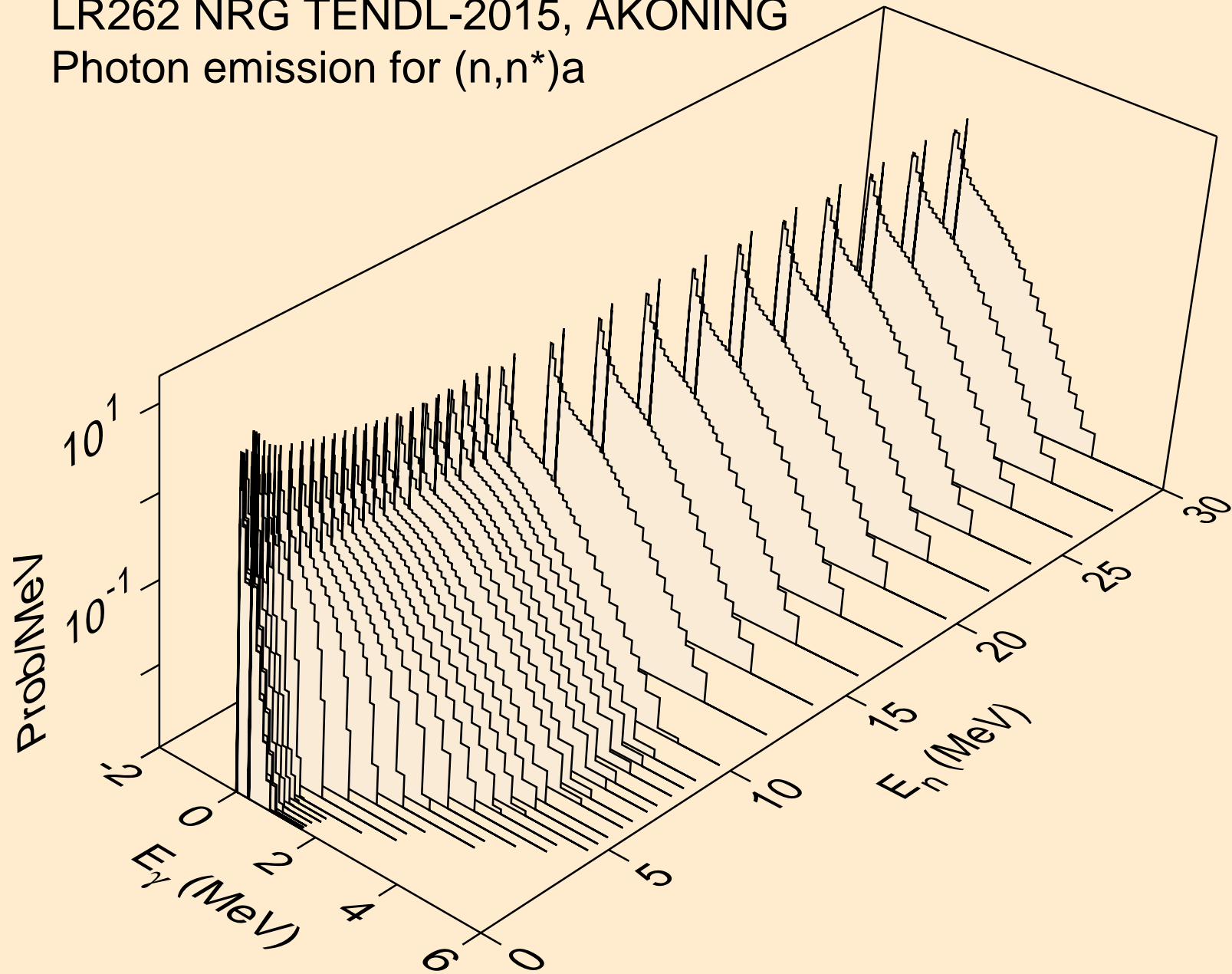

LR262 NRG TENDL-2015, AKONING  
Photon emission for (n,n\*)3a

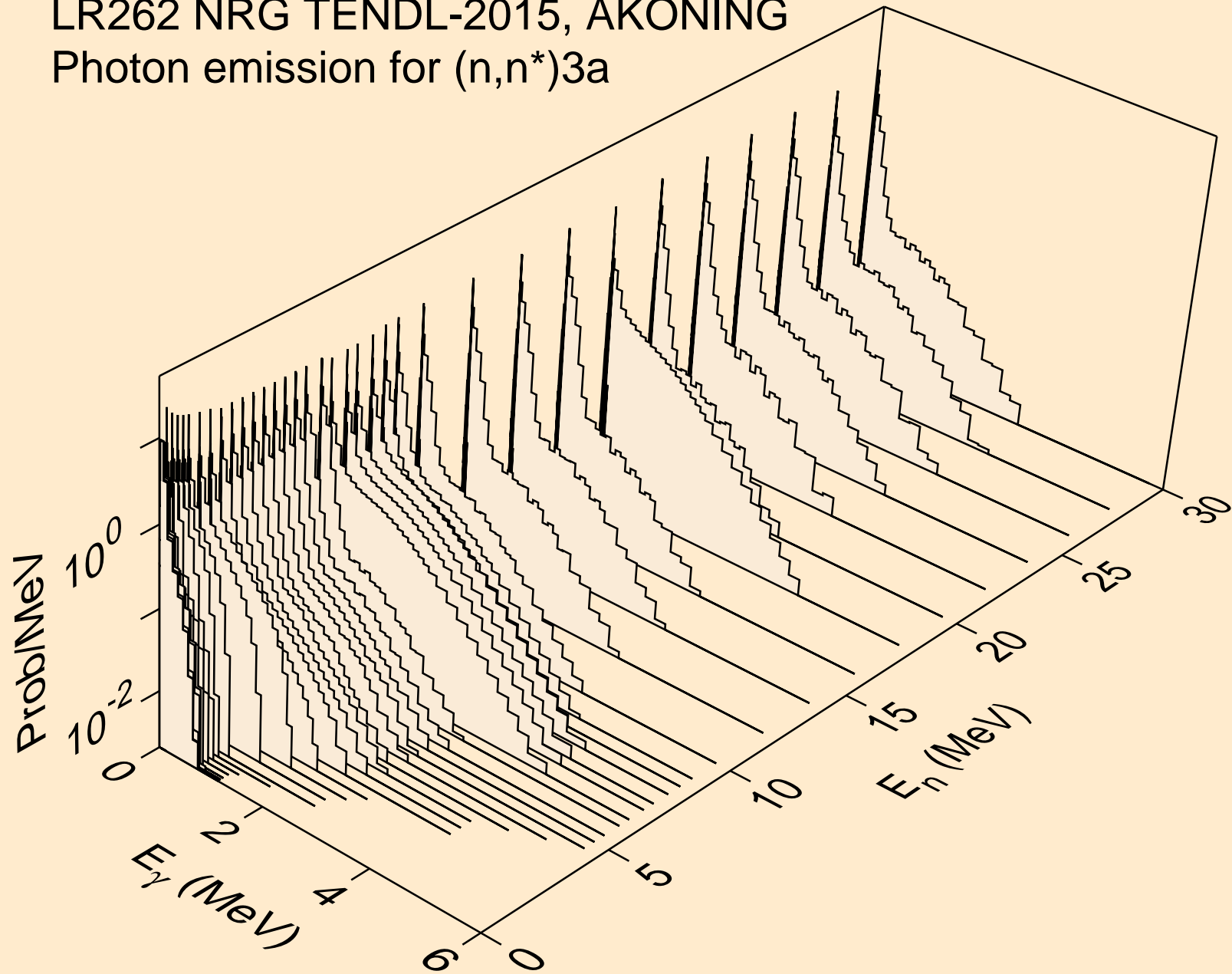



LR262 NRG TENDL-2015, AKONING  
Photon emission for (n,2n)a

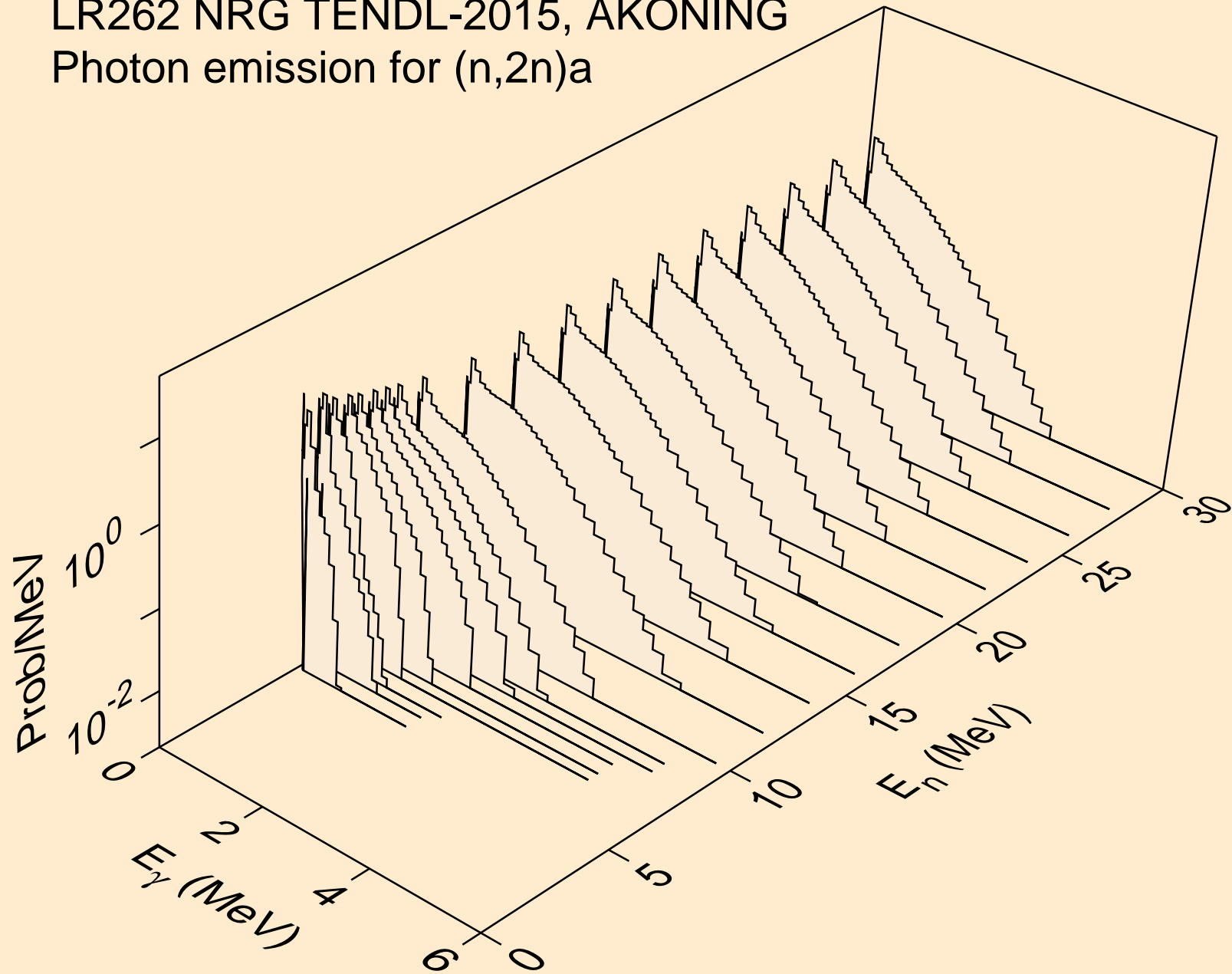

LR262 NRG TENDL-2015, AKONING  
Photon emission for (n,3n)a

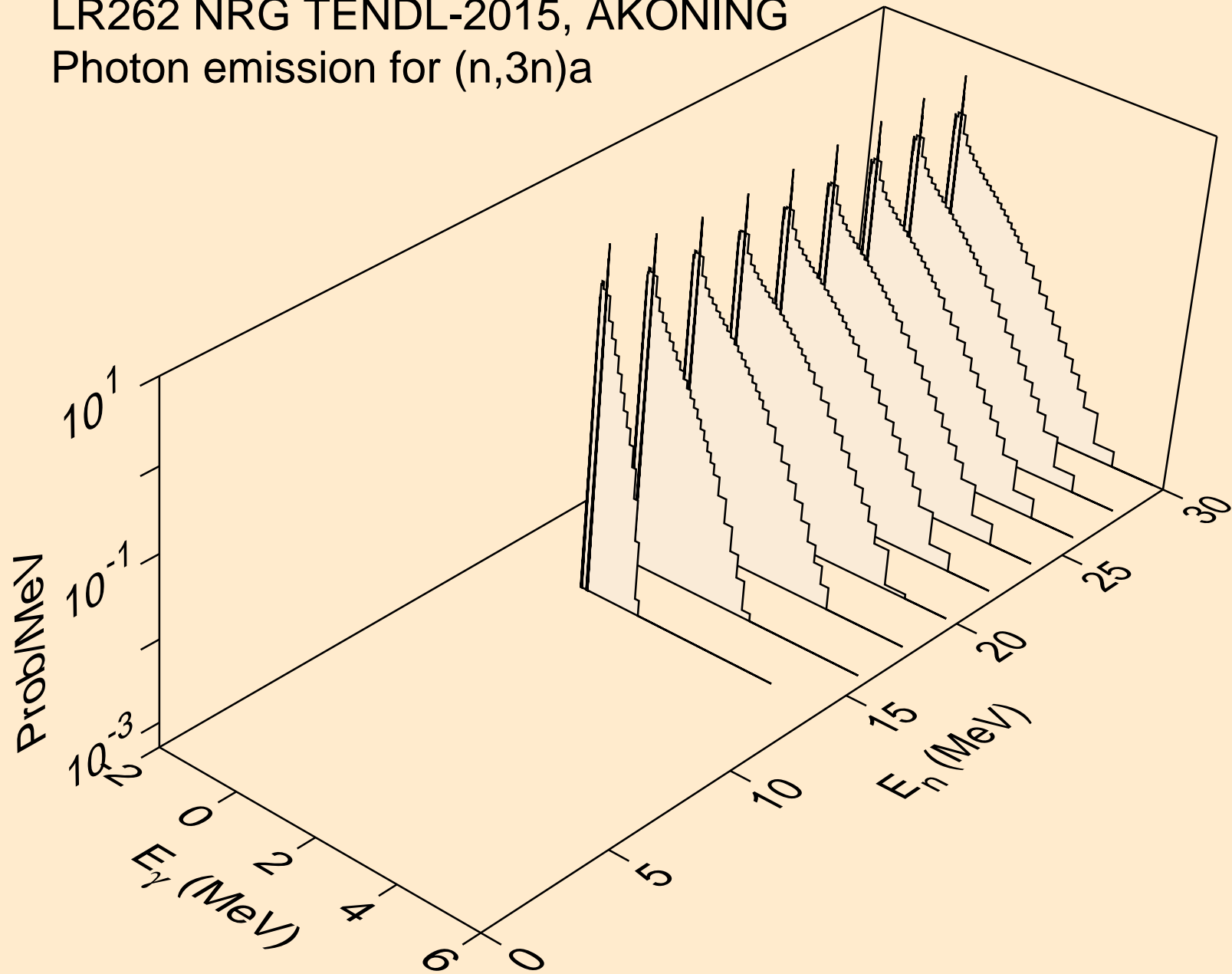

LR262 NRG TENDL-2015, AKONING  
Photon emission for (n,n\*)p

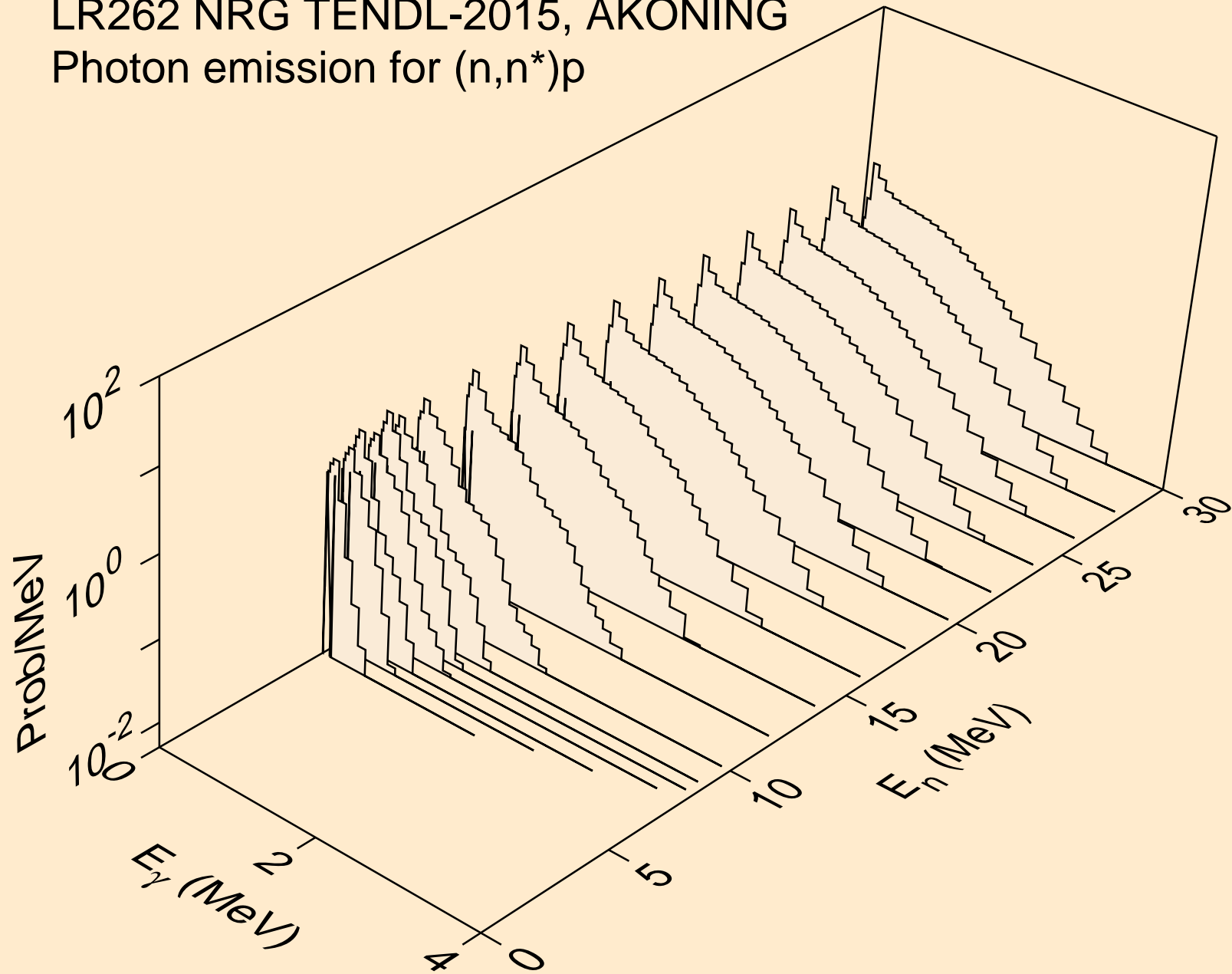

LR262 NRG TENDL-2015, AKONING  
Photon emission for (n,n\*)2a

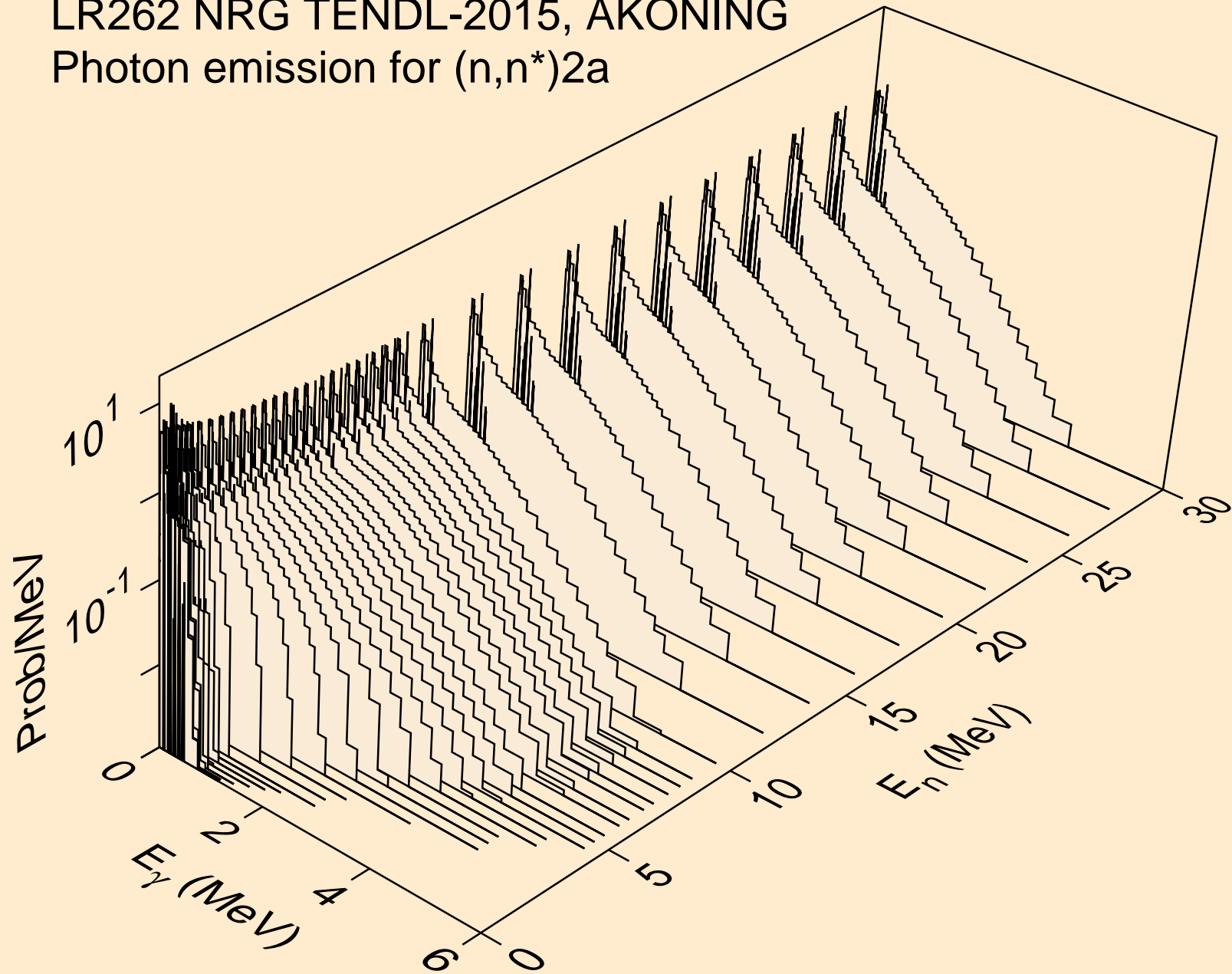

LR262 NRG TENDL-2015, AKONING  
Photon emission for (n,2n)2a

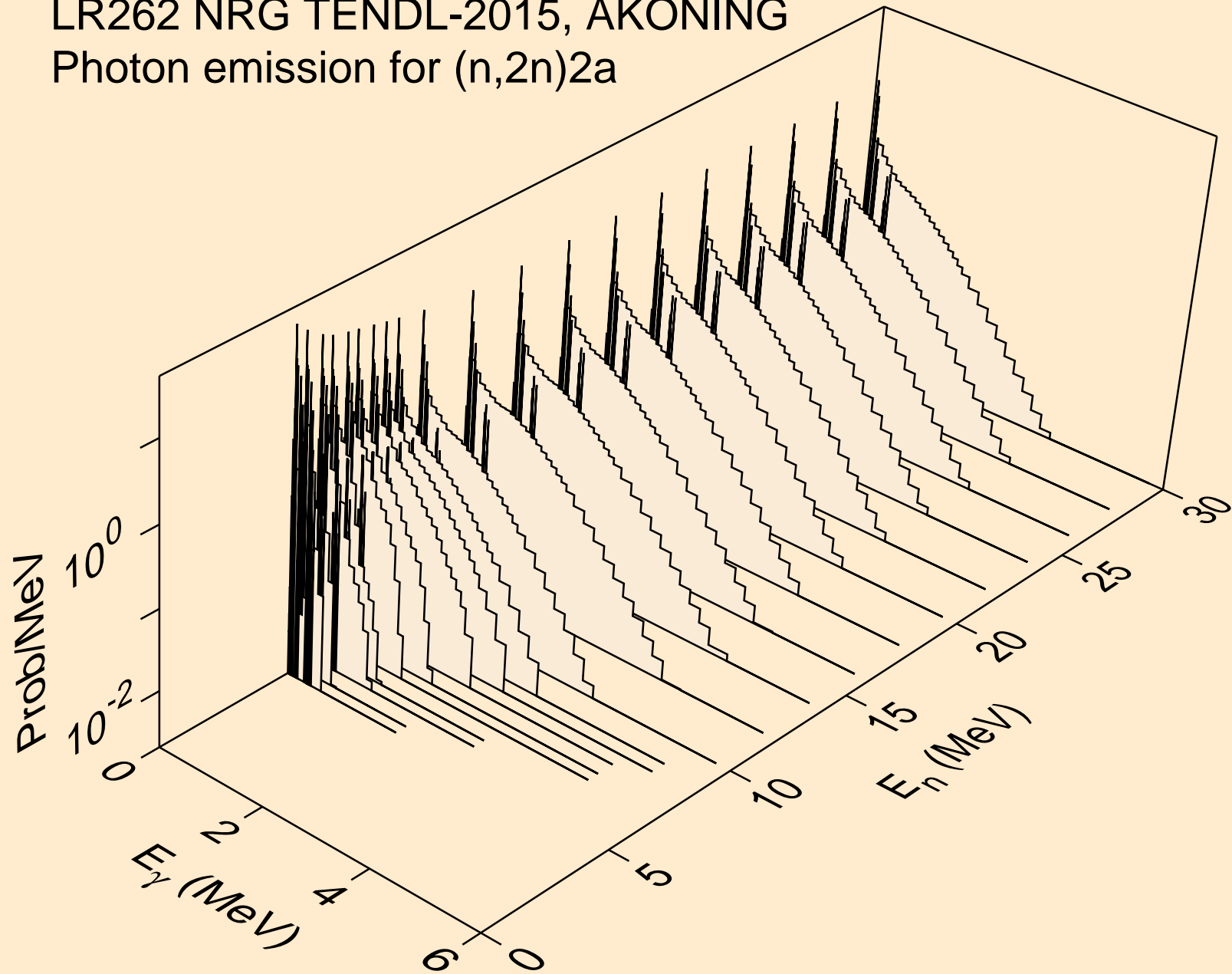

LR262 NRG TENDL-2015, AKONING  
Photon emission for (n,n\*)d

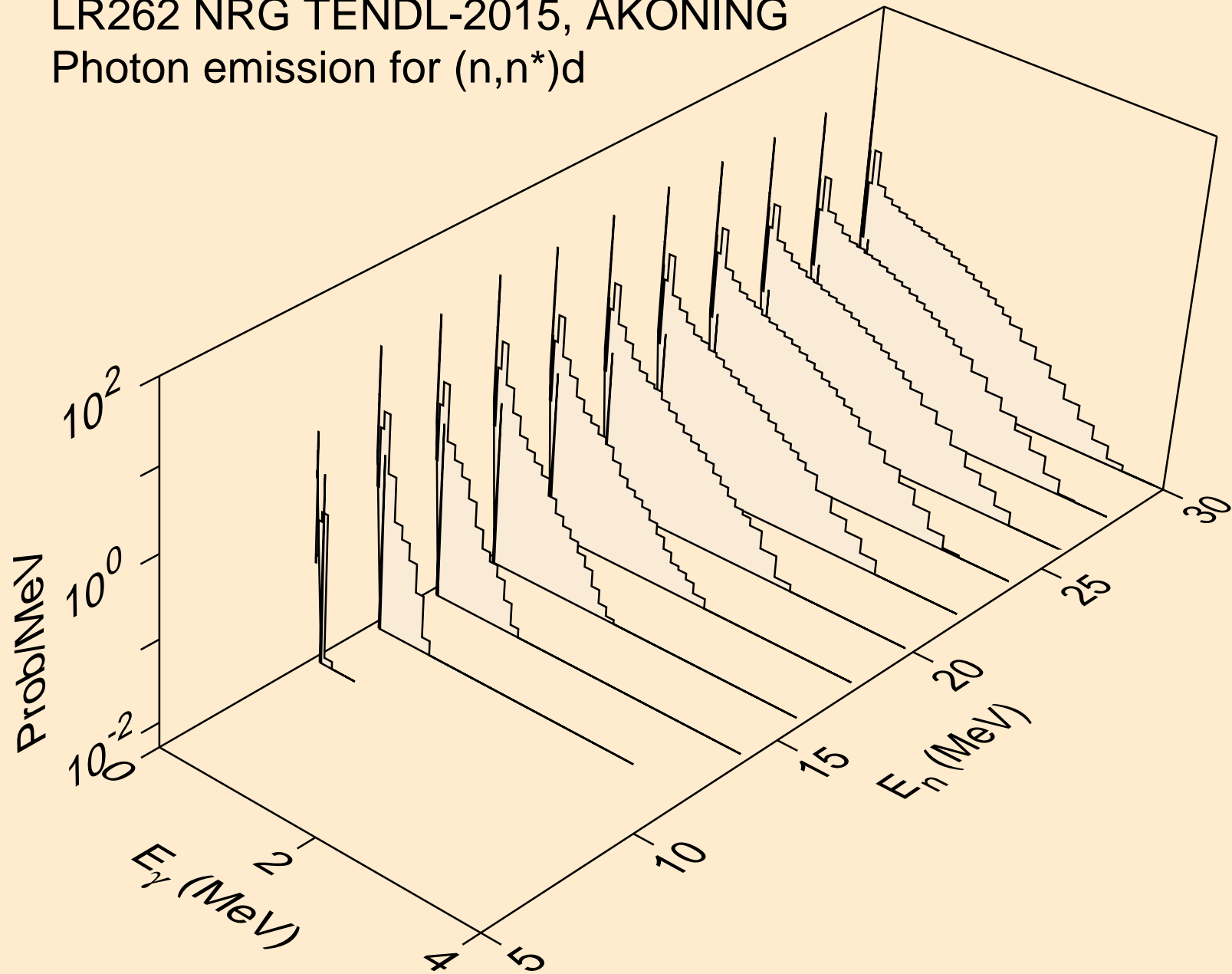

LR262 NRG TENDL-2015, AKONING  
Photon emission for (n,n\*)t

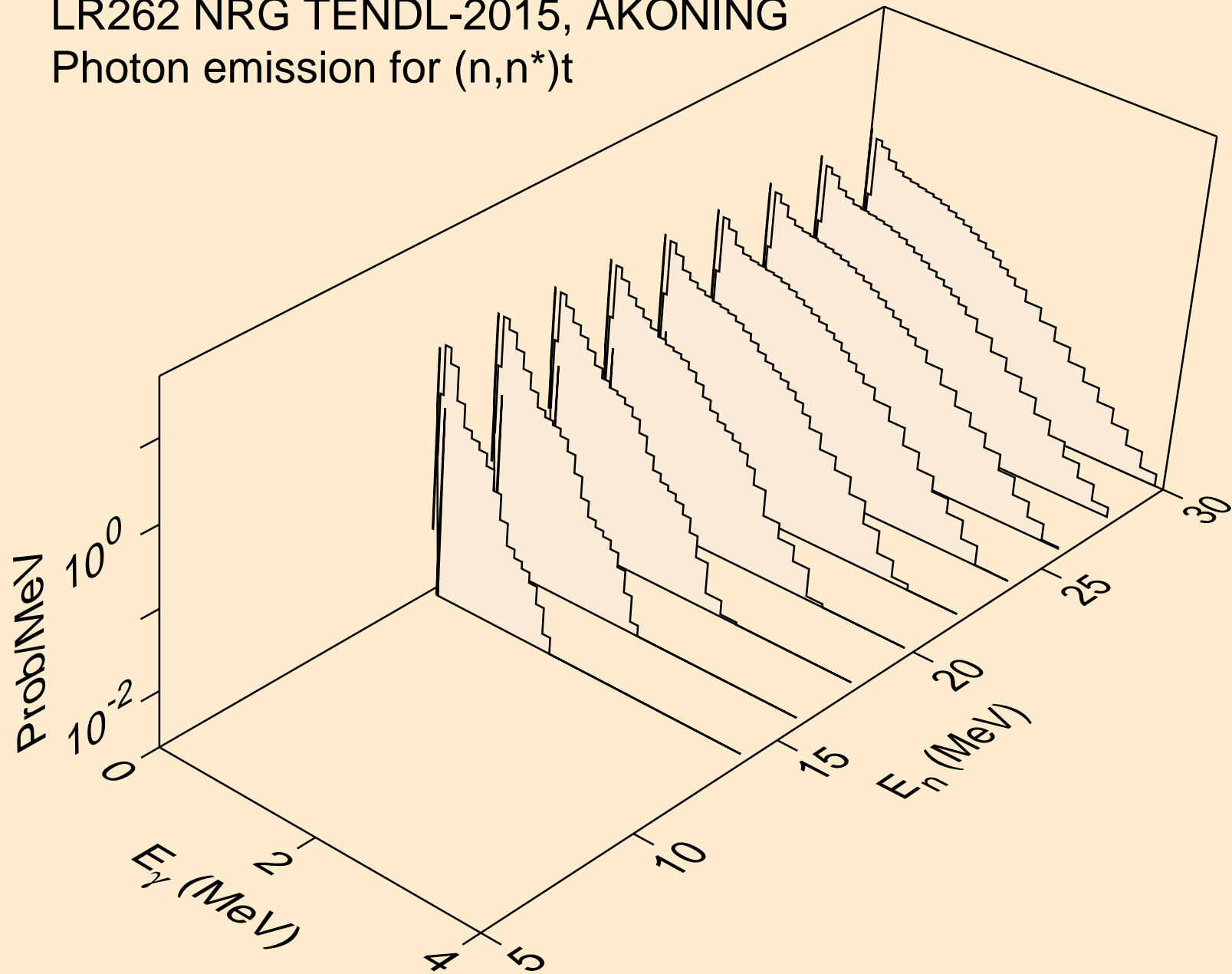

LR262 NRG TENDL-2015, AKONING  
Photon emission for (n,n\*)he3

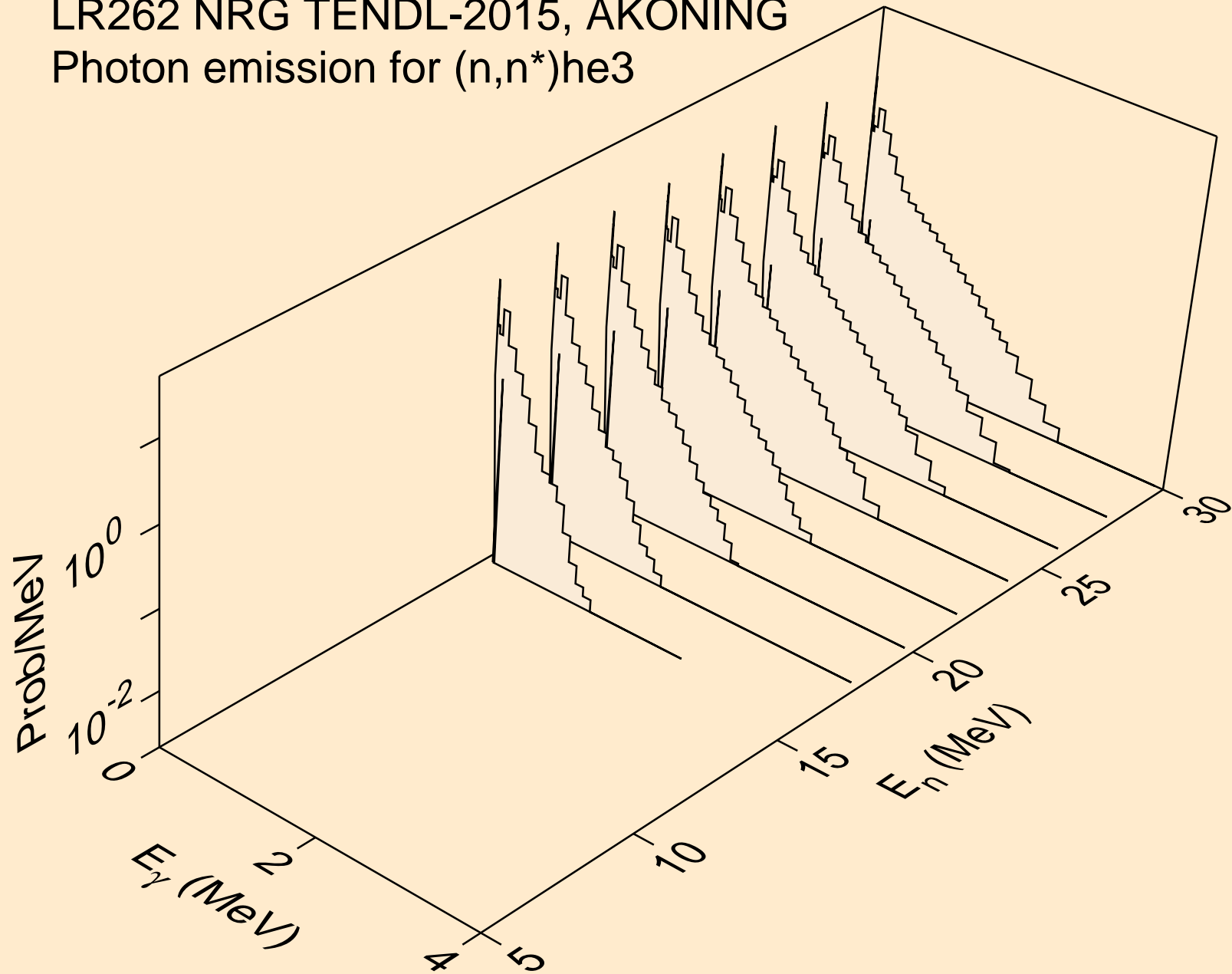



LR262 NRG TENDL-2015, AKONING  
Photon emission for (n,n\*)d2a

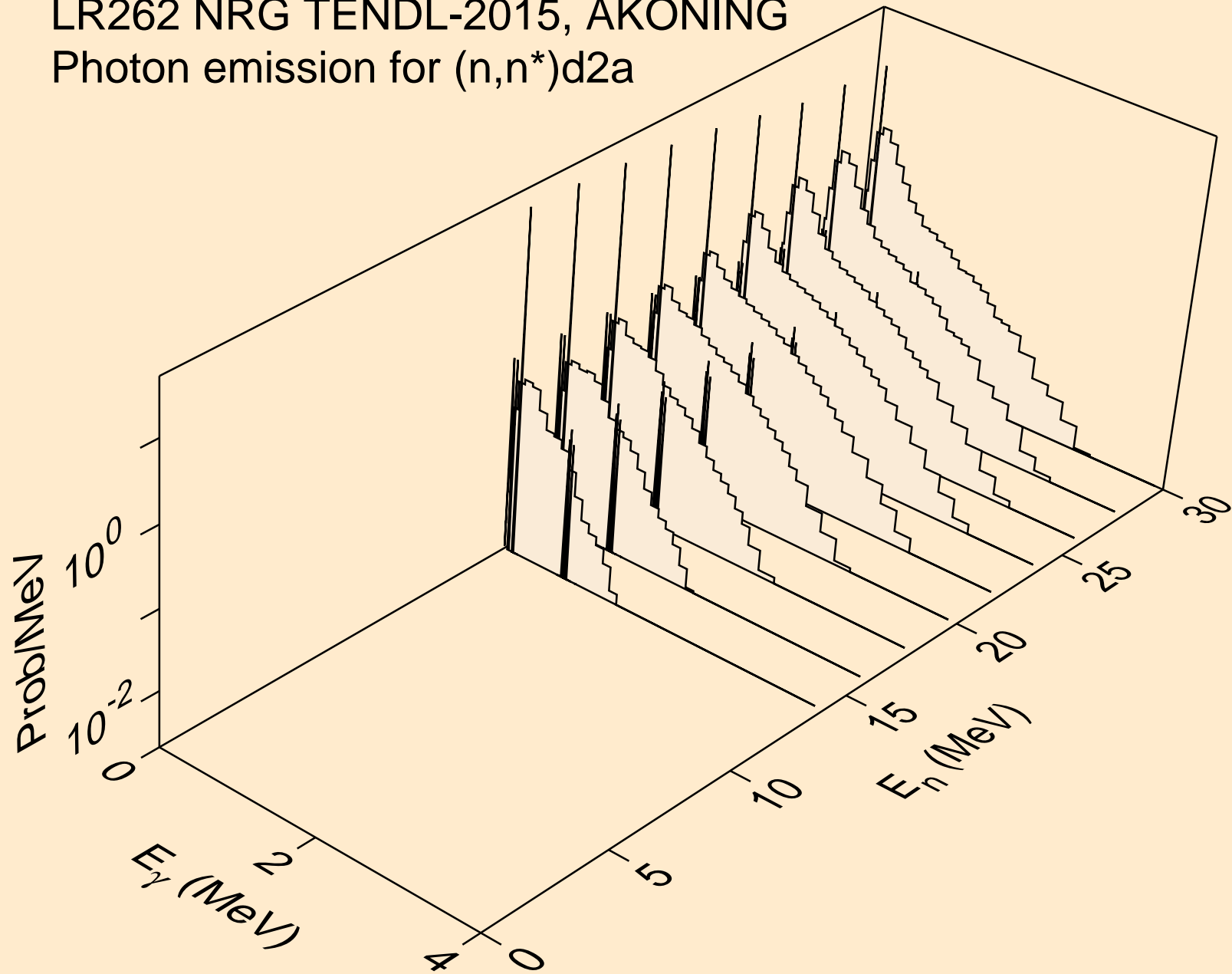

LR262 NRG TENDL-2015, AKONING  
Photon emission for (n,n\*)t2a

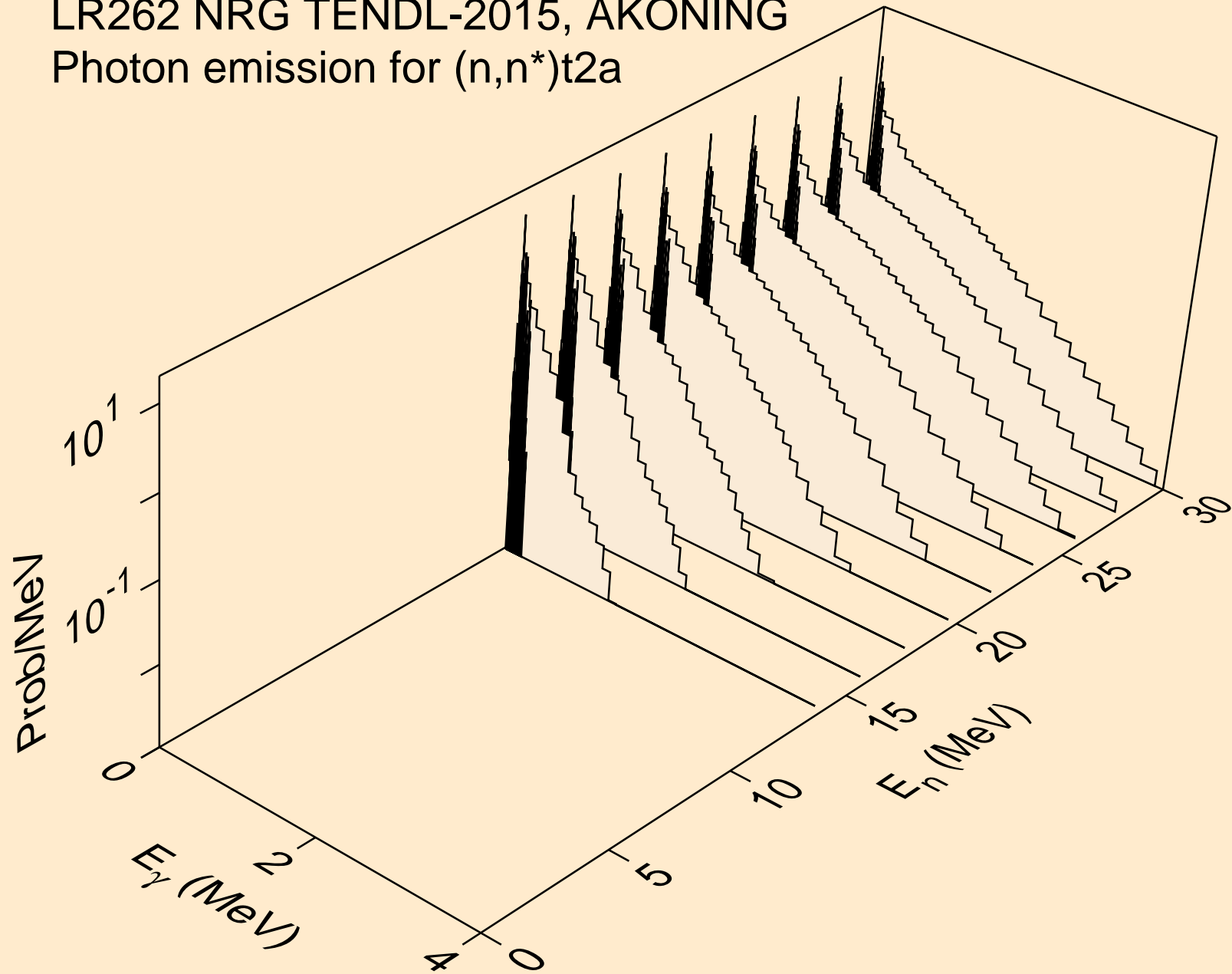

LR262 NRG TENDL-2015, AKONING  
Photon emission for (n,4n)

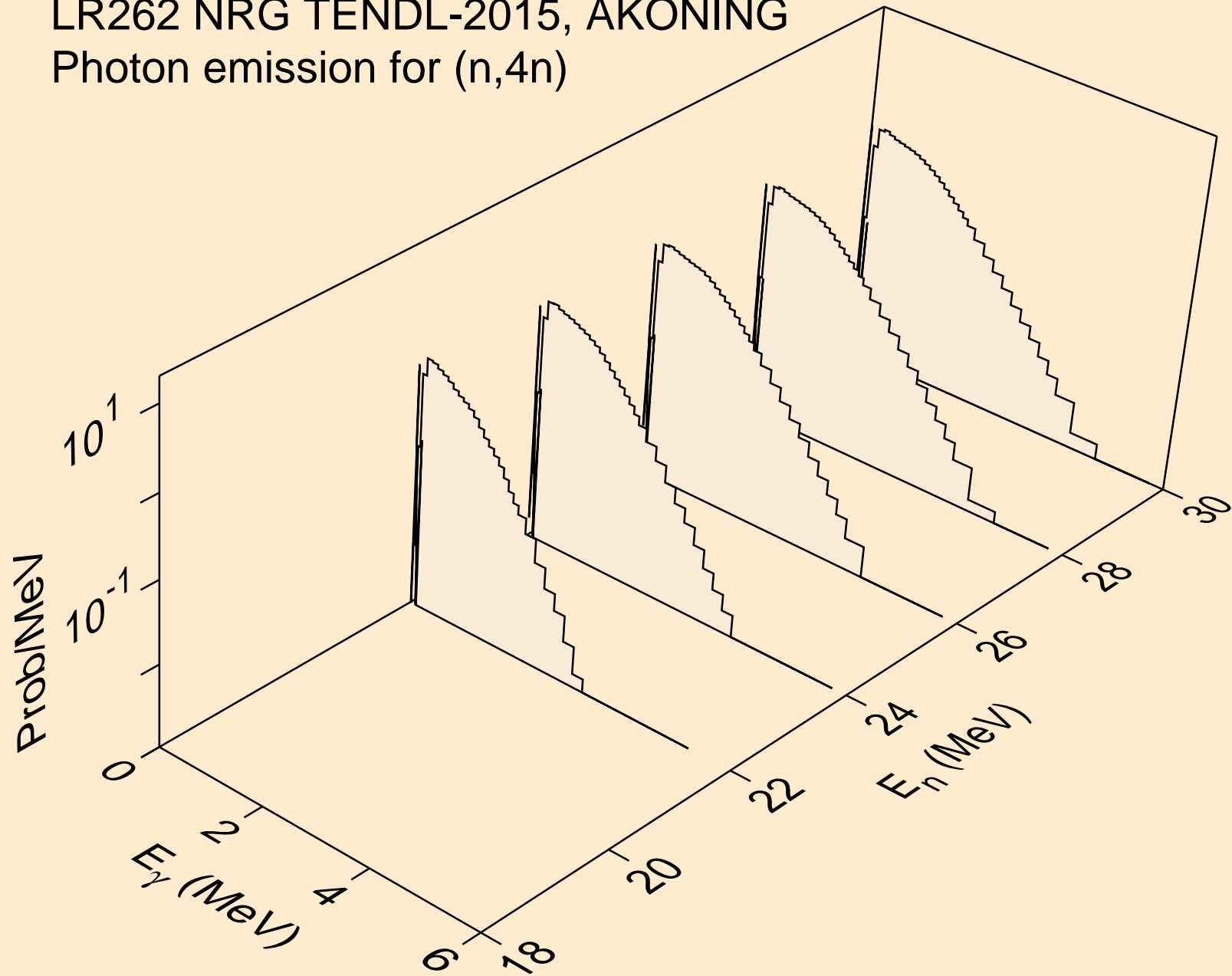

LR262 NRG TENDL-2015, AKONING  
Photon emission for (n,2np)

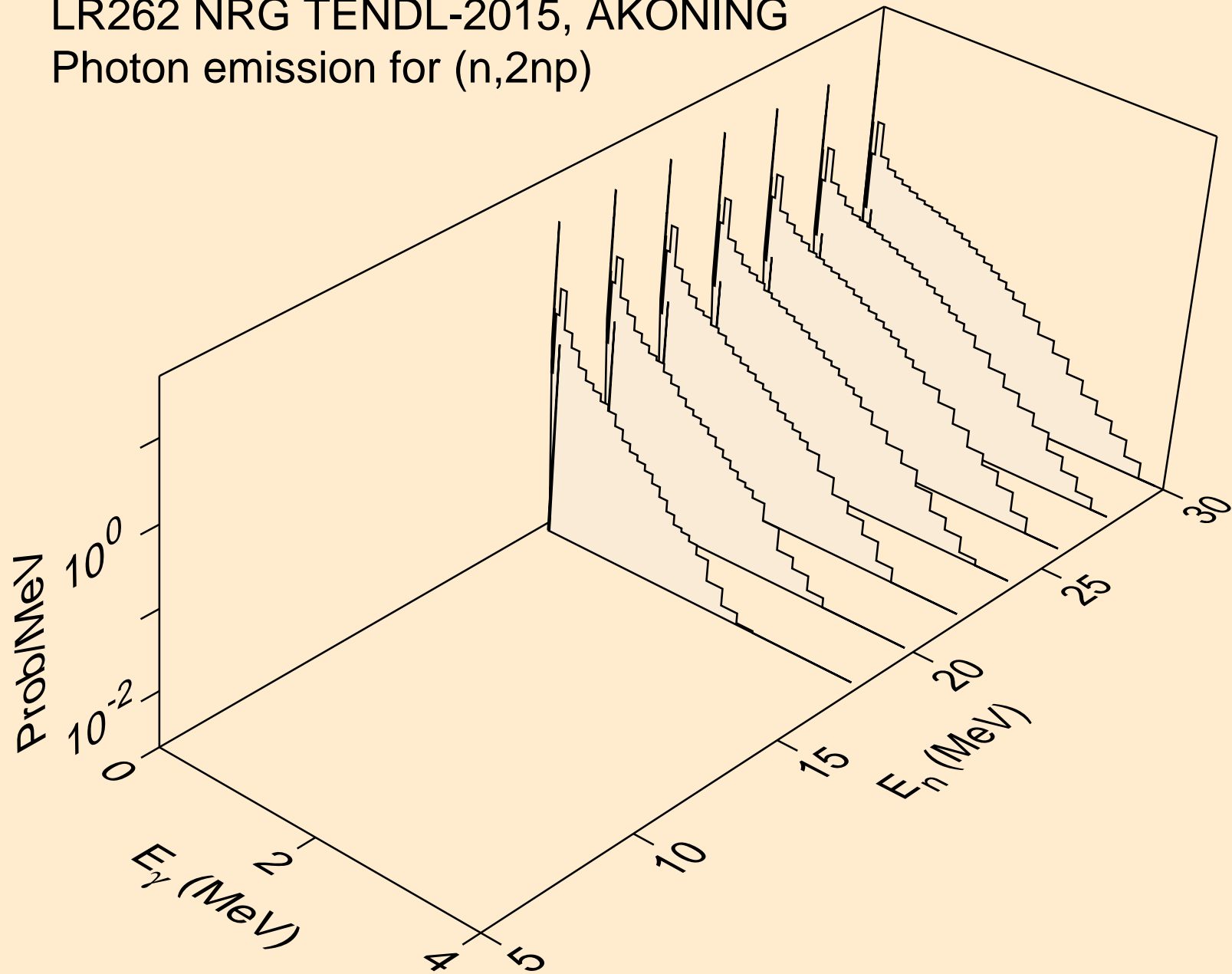

LR262 NRG TENDL-2015, AKONING  
Photon emission for (n,3np)

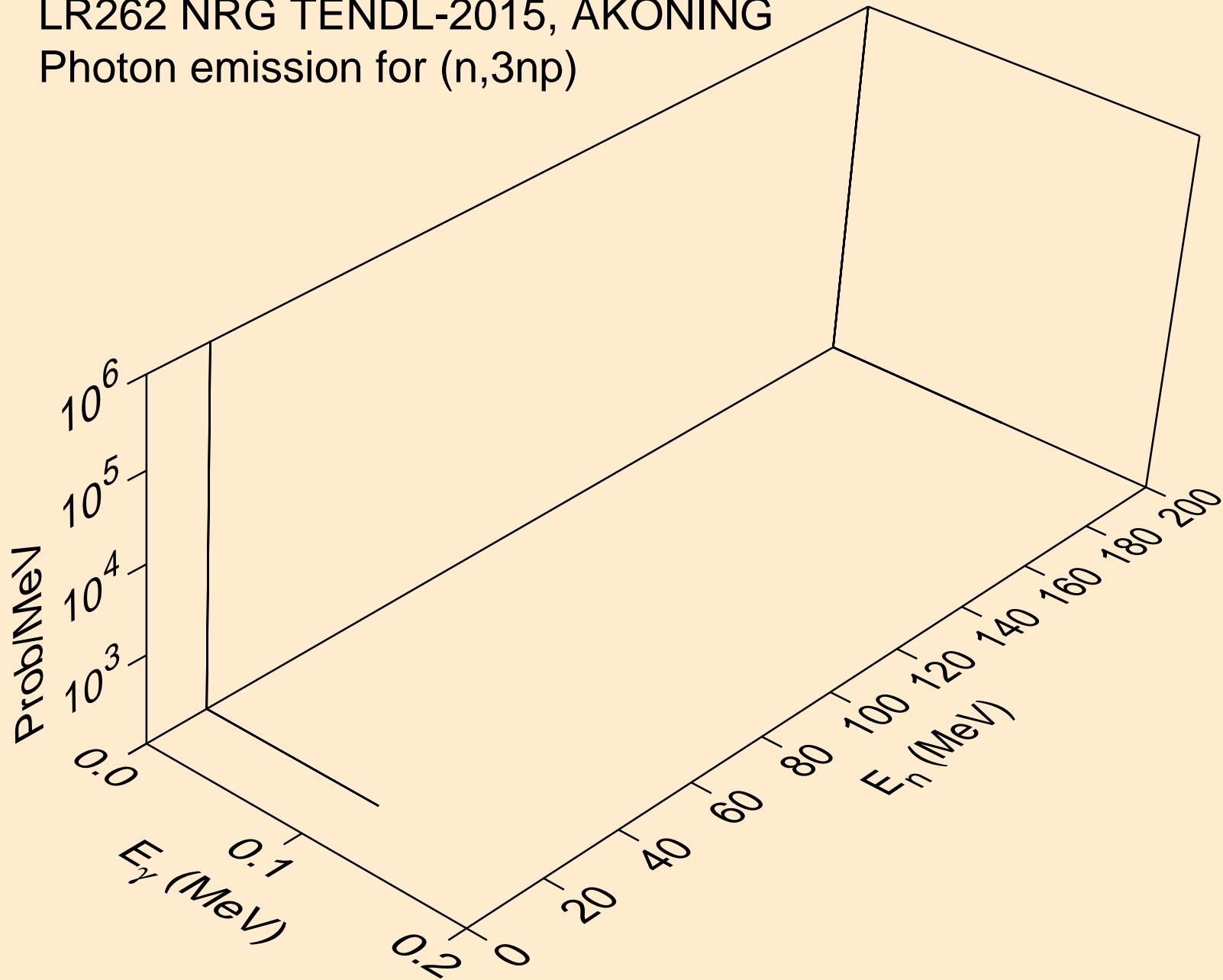

LR262 NRG TENDL-2015, AKONING  
Photon emission for (n,2np)

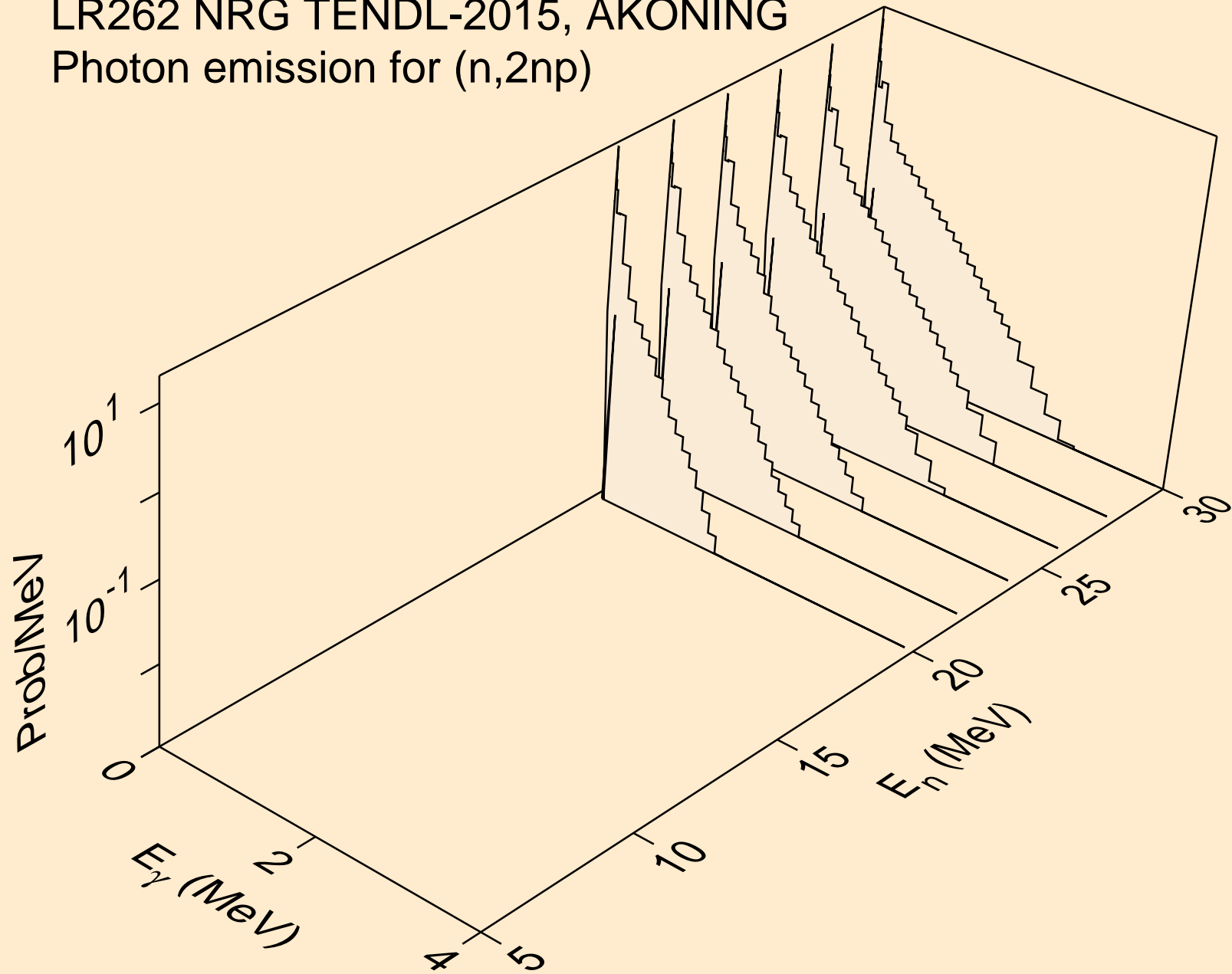

LR262 NRG TENDL-2015, AKONING  
Photon emission for (n,npa)

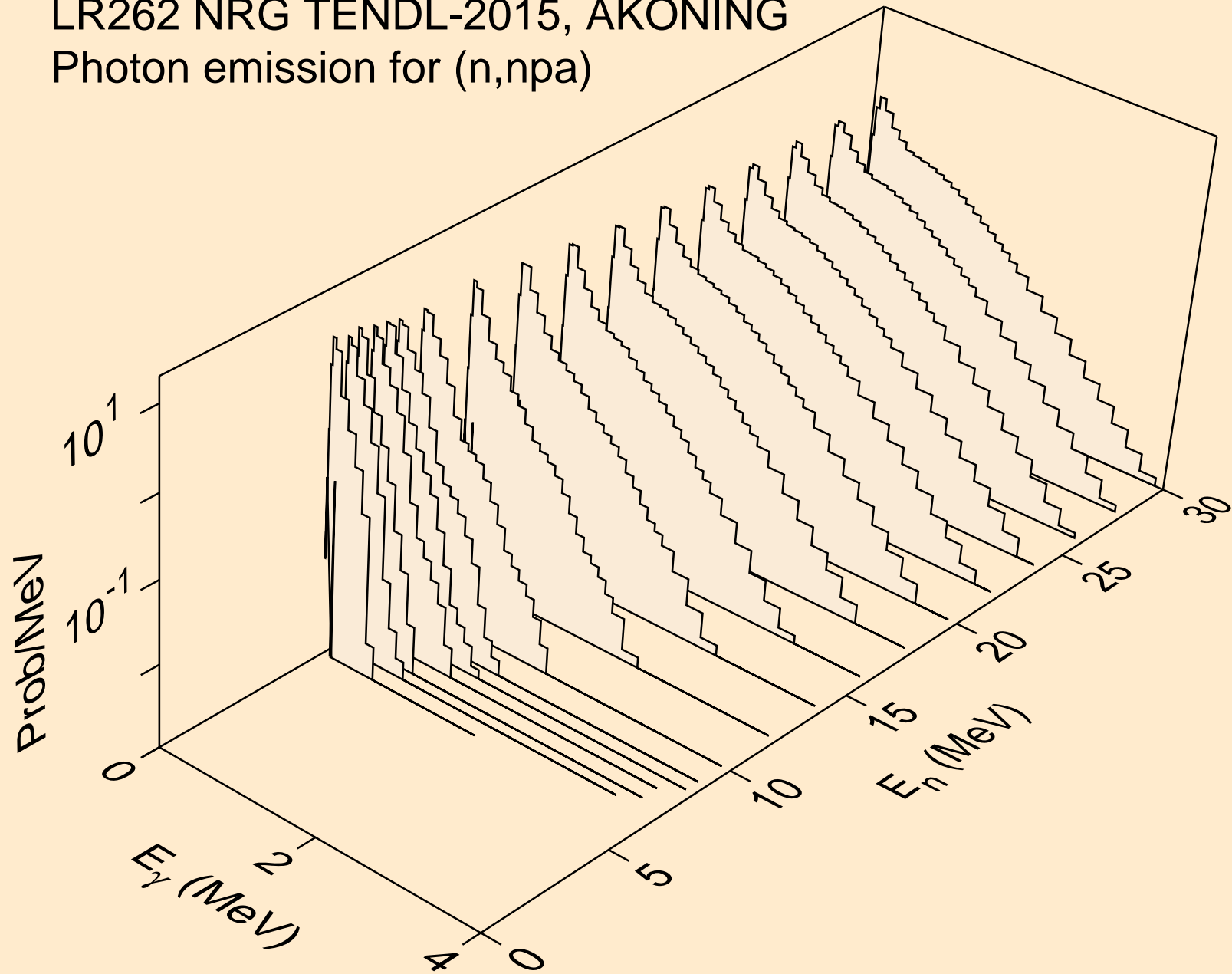

LR262 NRG TENDL-2015, AKONING  
Photon emission for (n,n\*c)

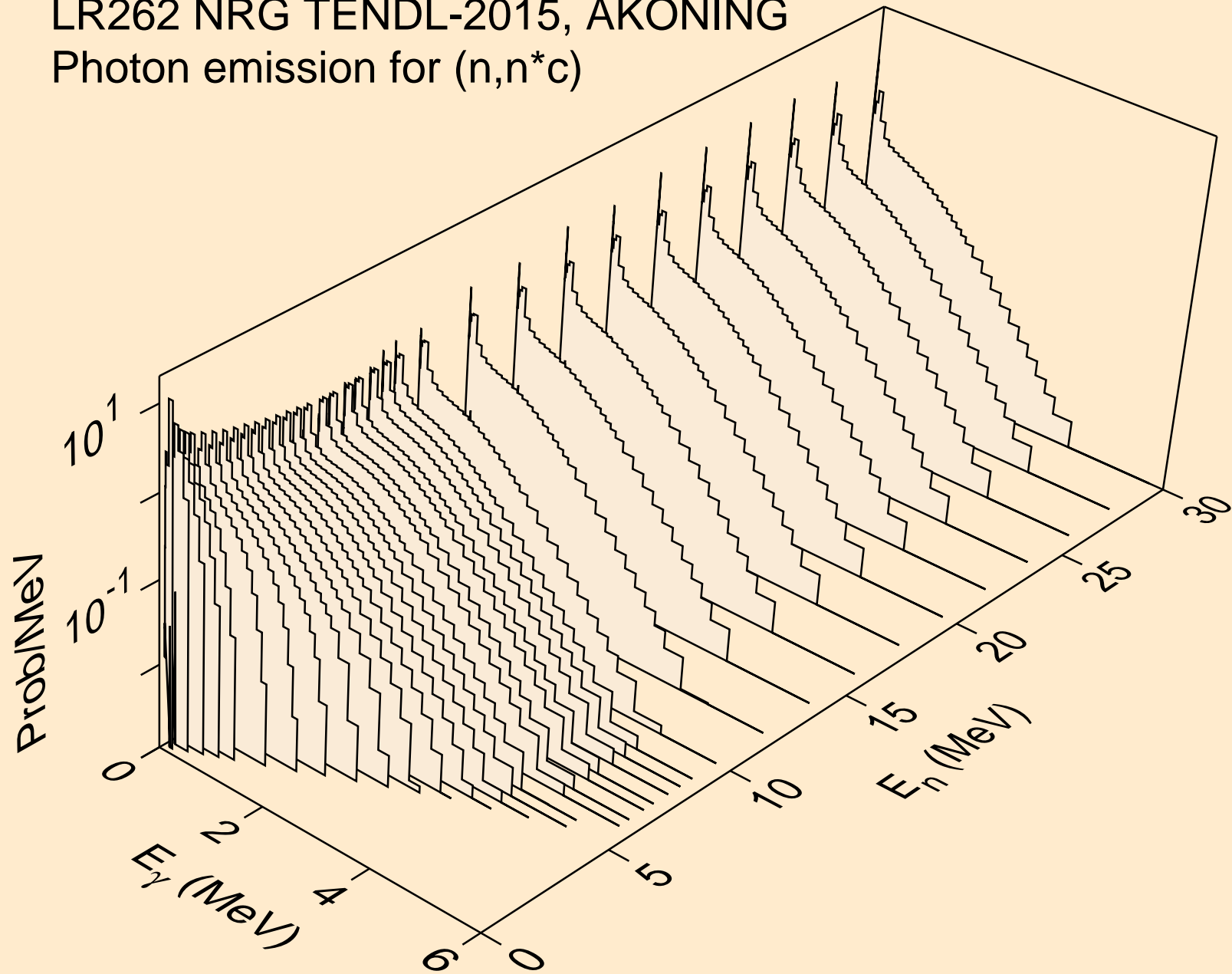



LR262 NRG TENDL-2015, AKONING  
Photon emission for (n,gma)

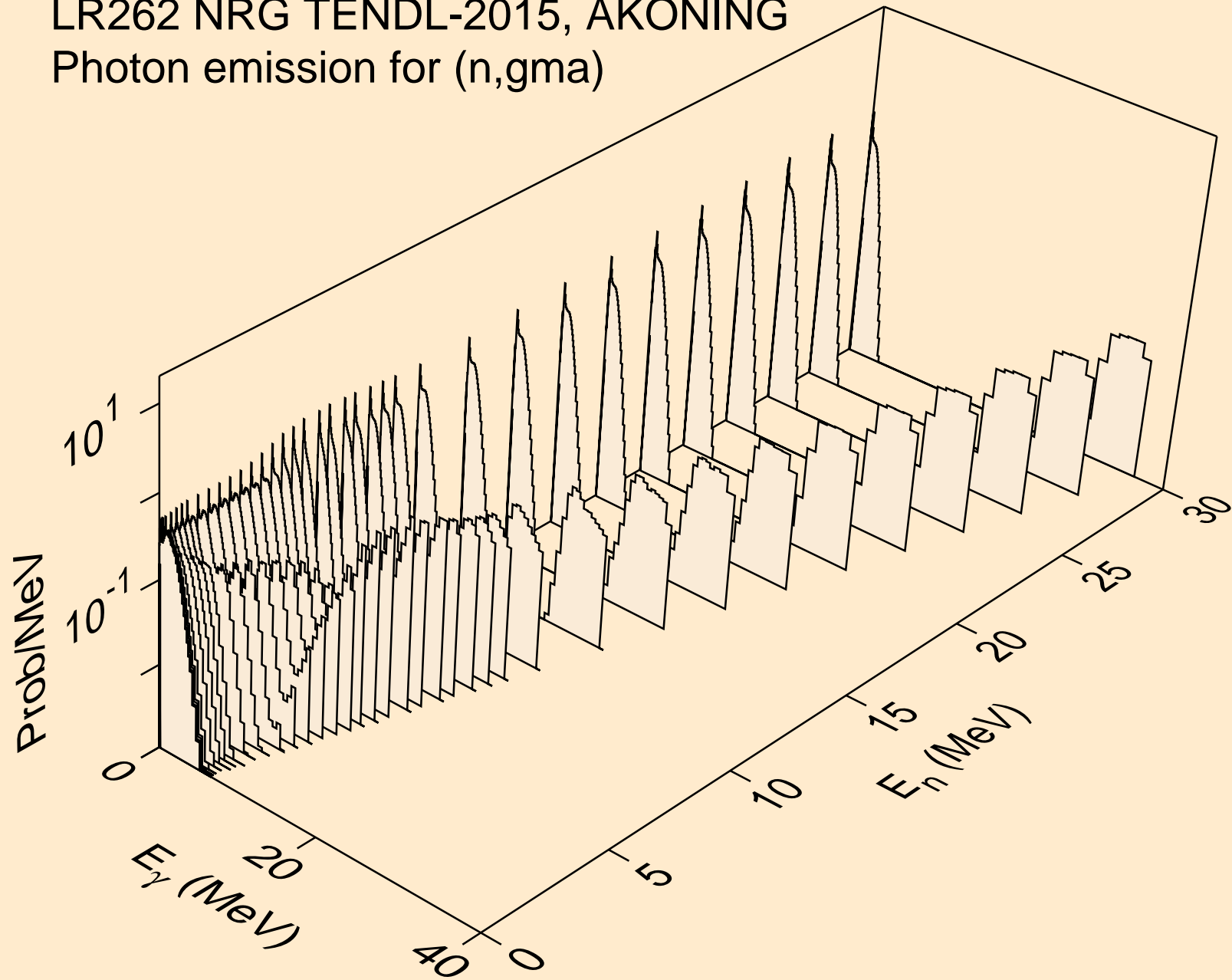

LR262 NRG TENDL-2015, AKONING  
Photon emission for (n,p)

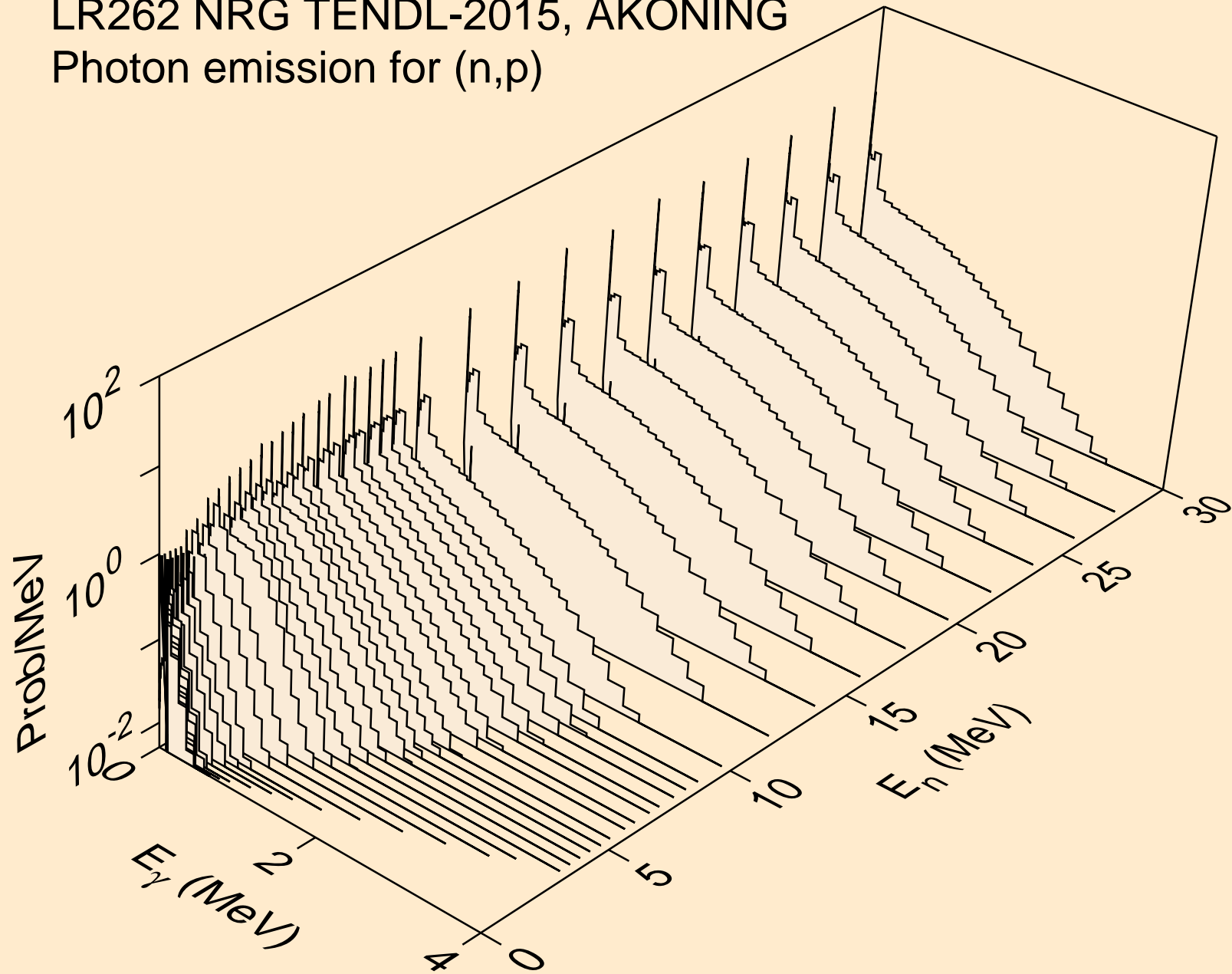

LR262 NRG TENDL-2015, AKONING  
Photon emission for (n,d)

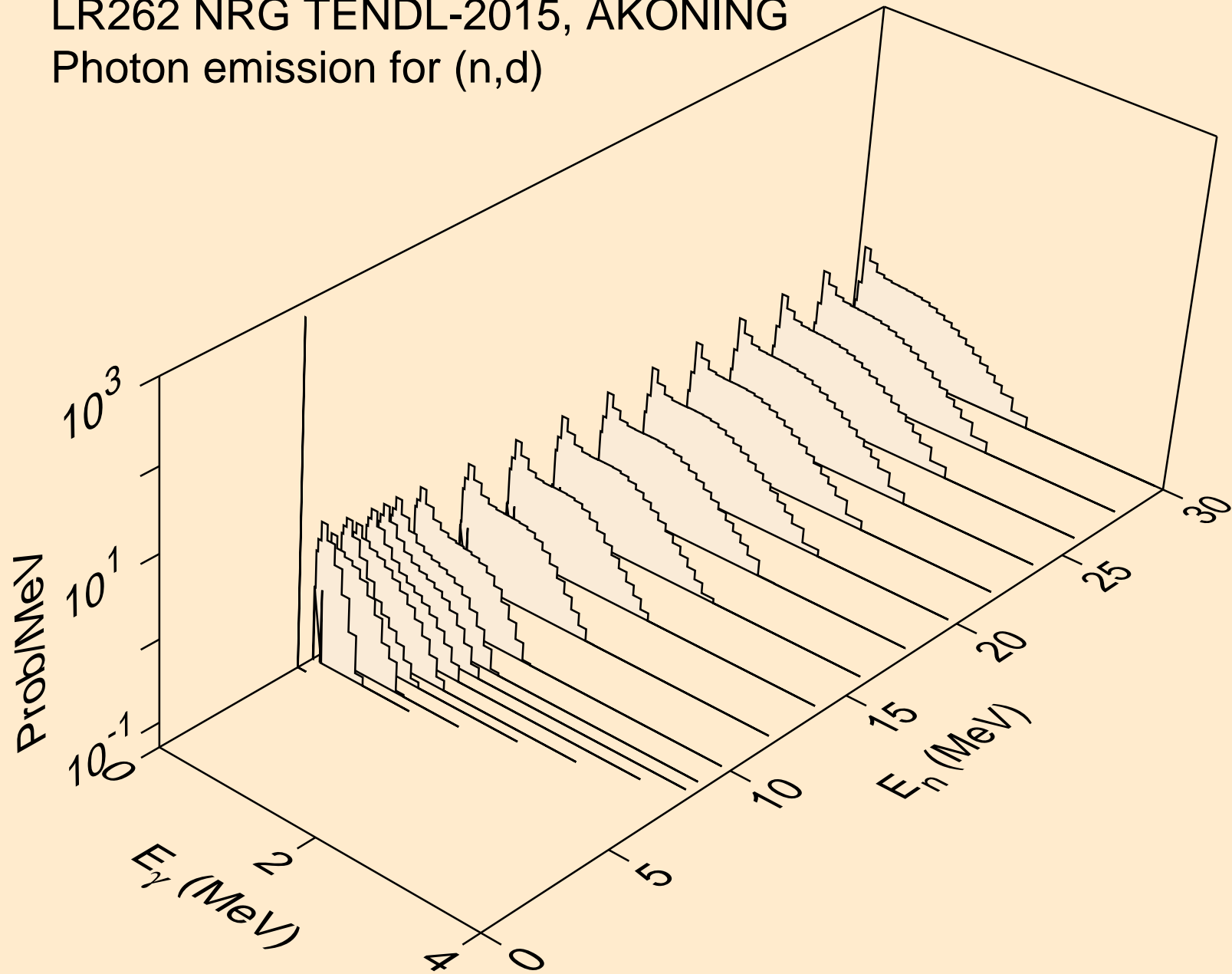

LR262 NRG TENDL-2015, AKONING  
Photon emission for (n,t)

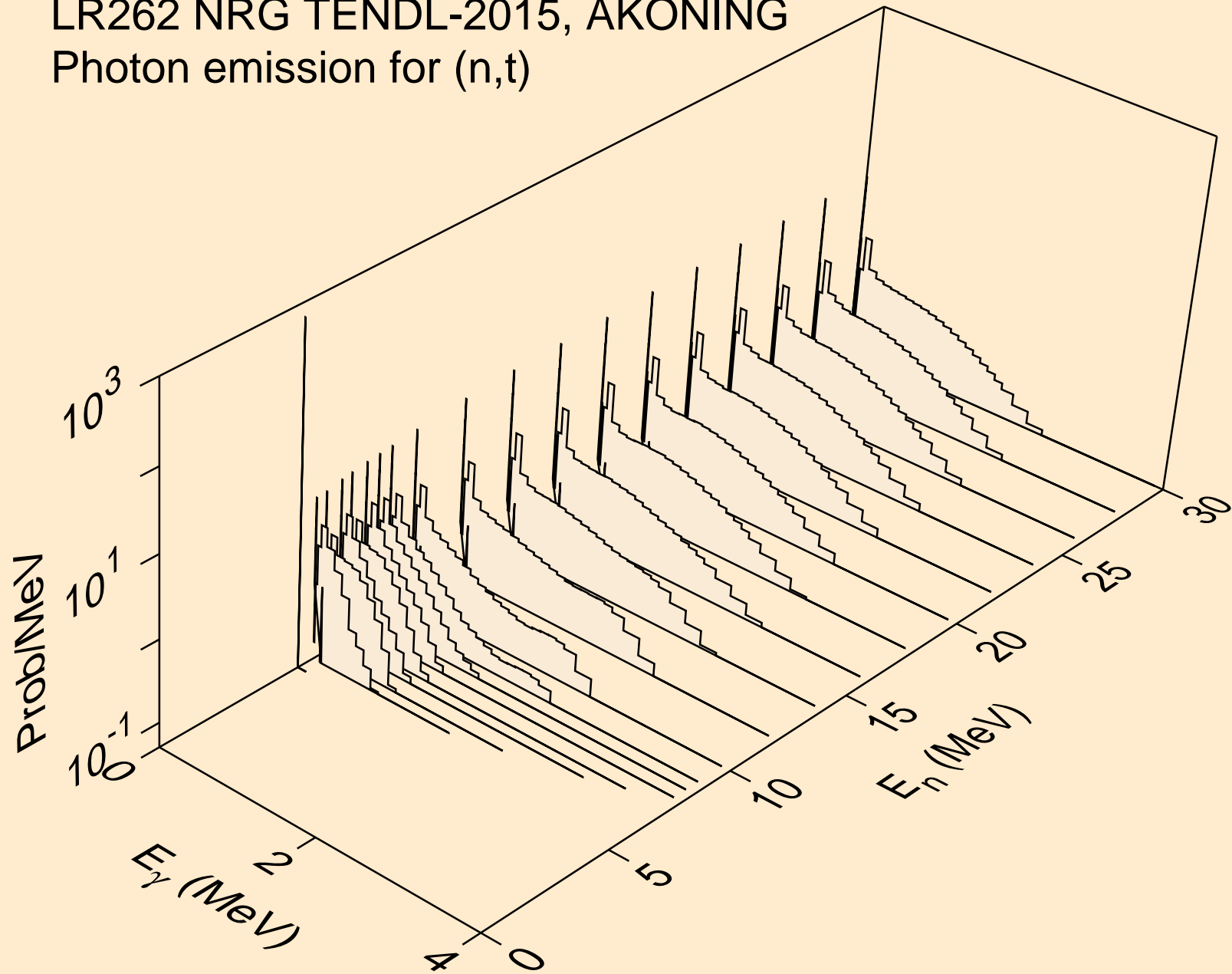

LR262 NRG TENDL-2015, AKONING  
Photon emission for (n,he3)

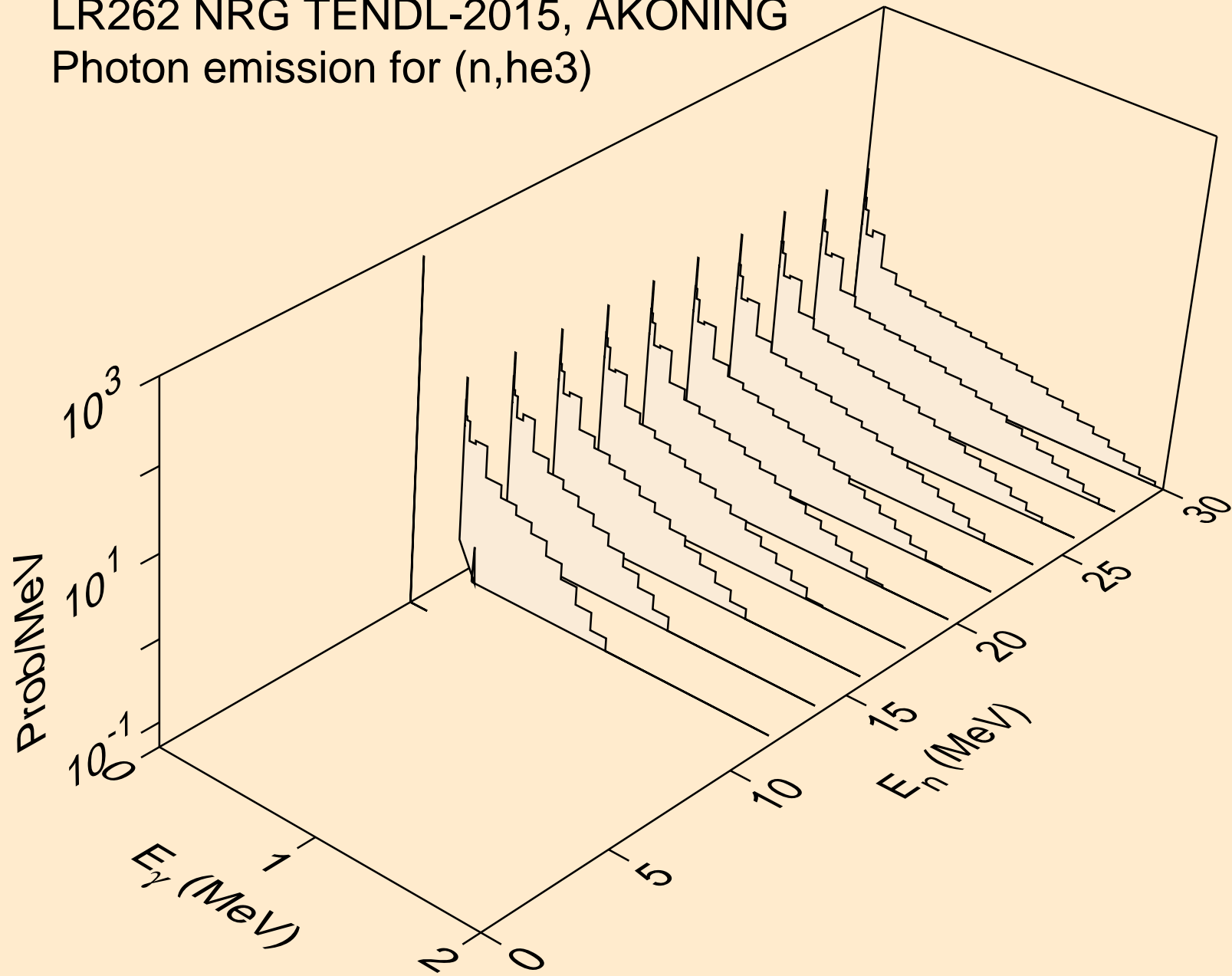

LR262 NRG TENDL-2015, AKONING  
Photon emission for (n,a)

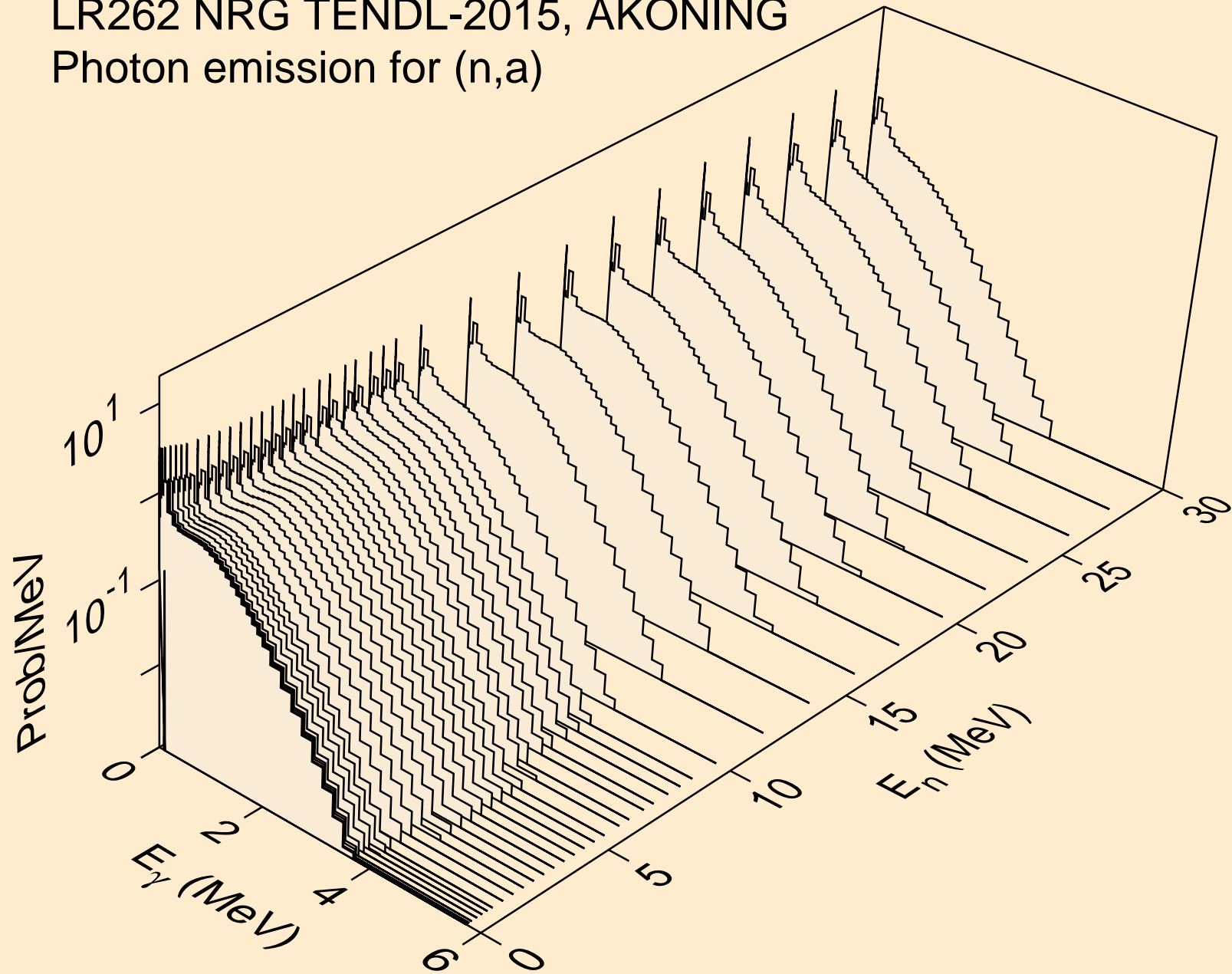

LR262 NRG TENDL-2015, AKONING  
Photon emission for (n,2a)

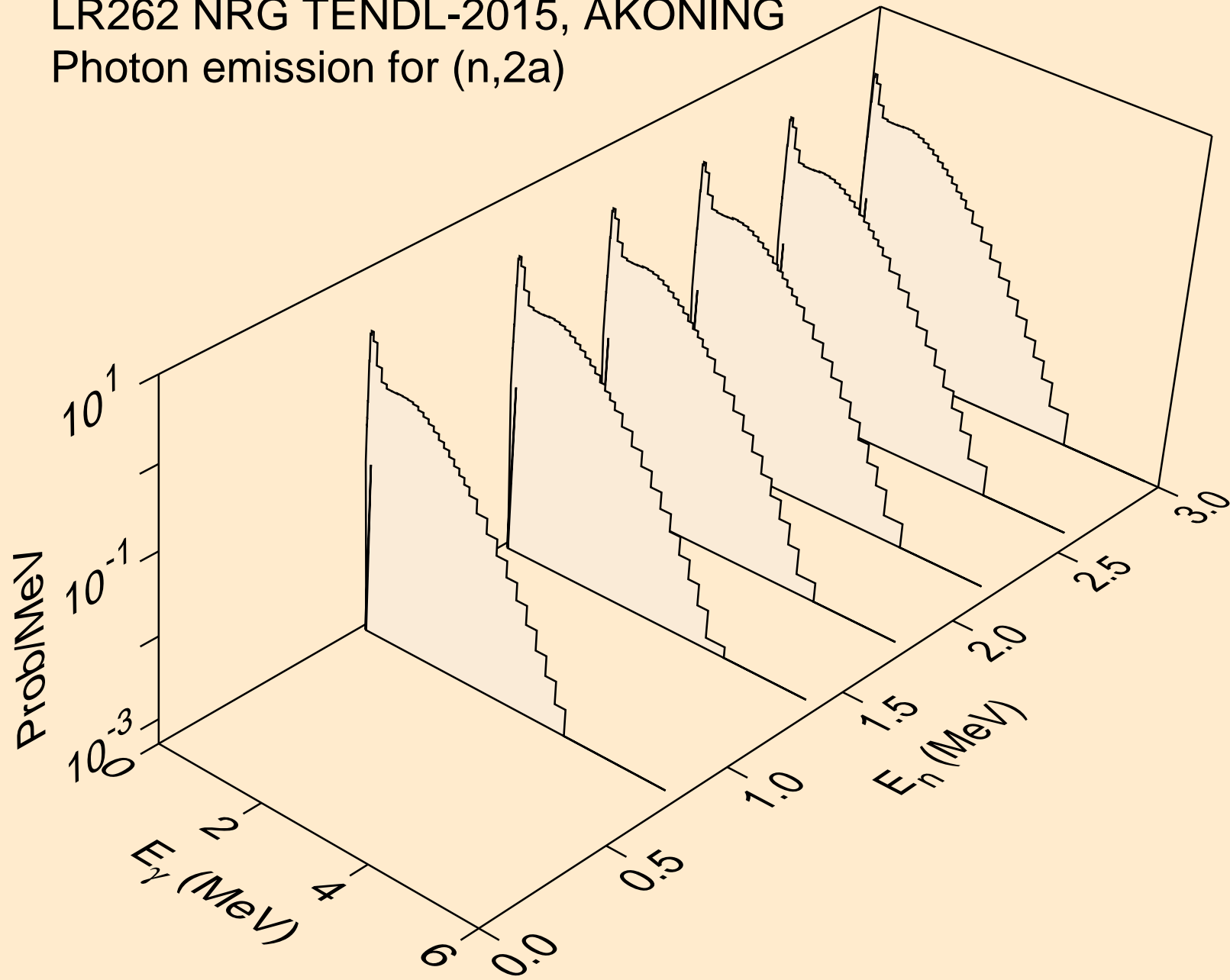

LR262 NRG TENDL-2015, AKONING  
Photon emission for (n,2p)

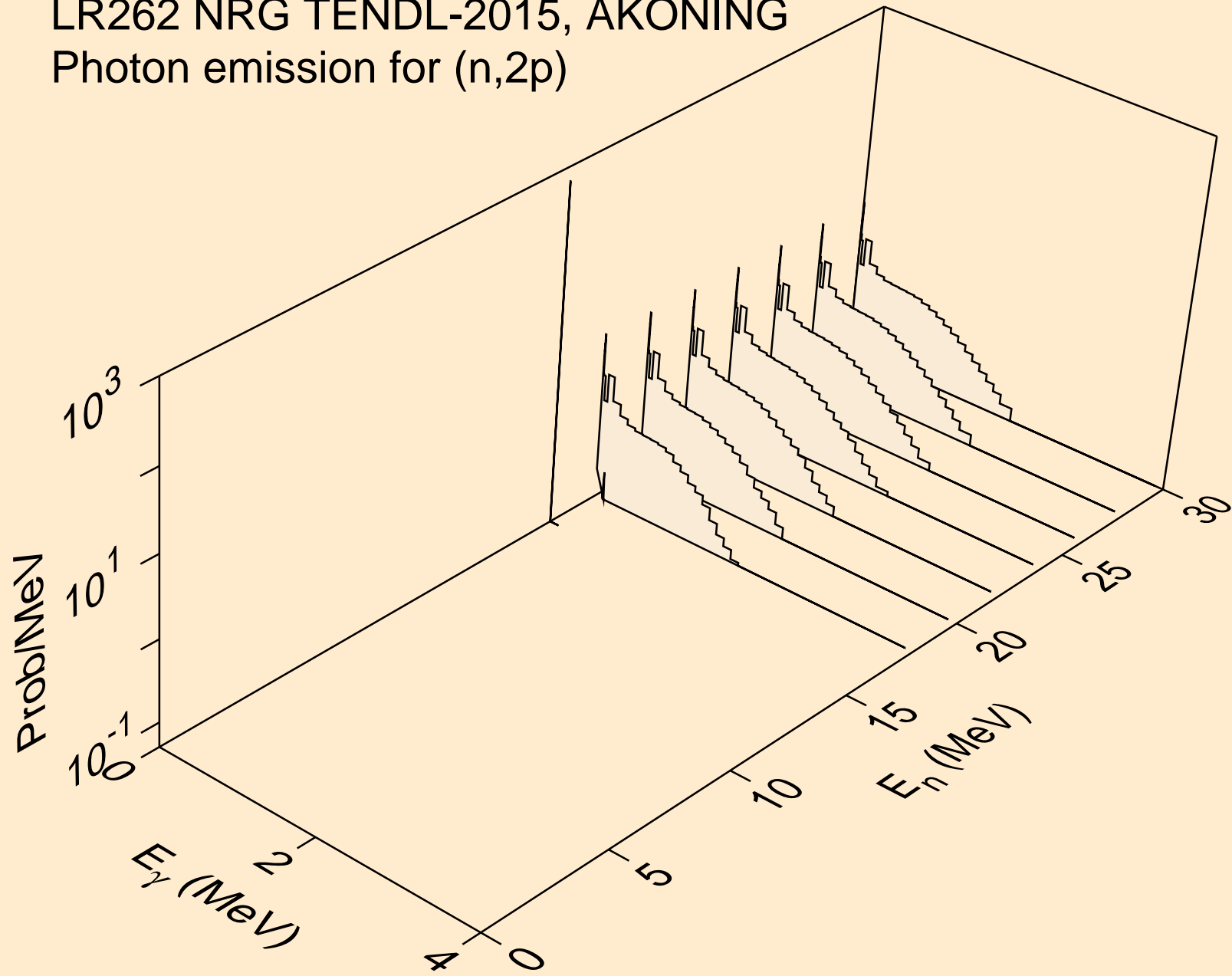



LR262 NRG TENDL-2015, AKONING  
Photon emission for (n,p $\alpha$ )

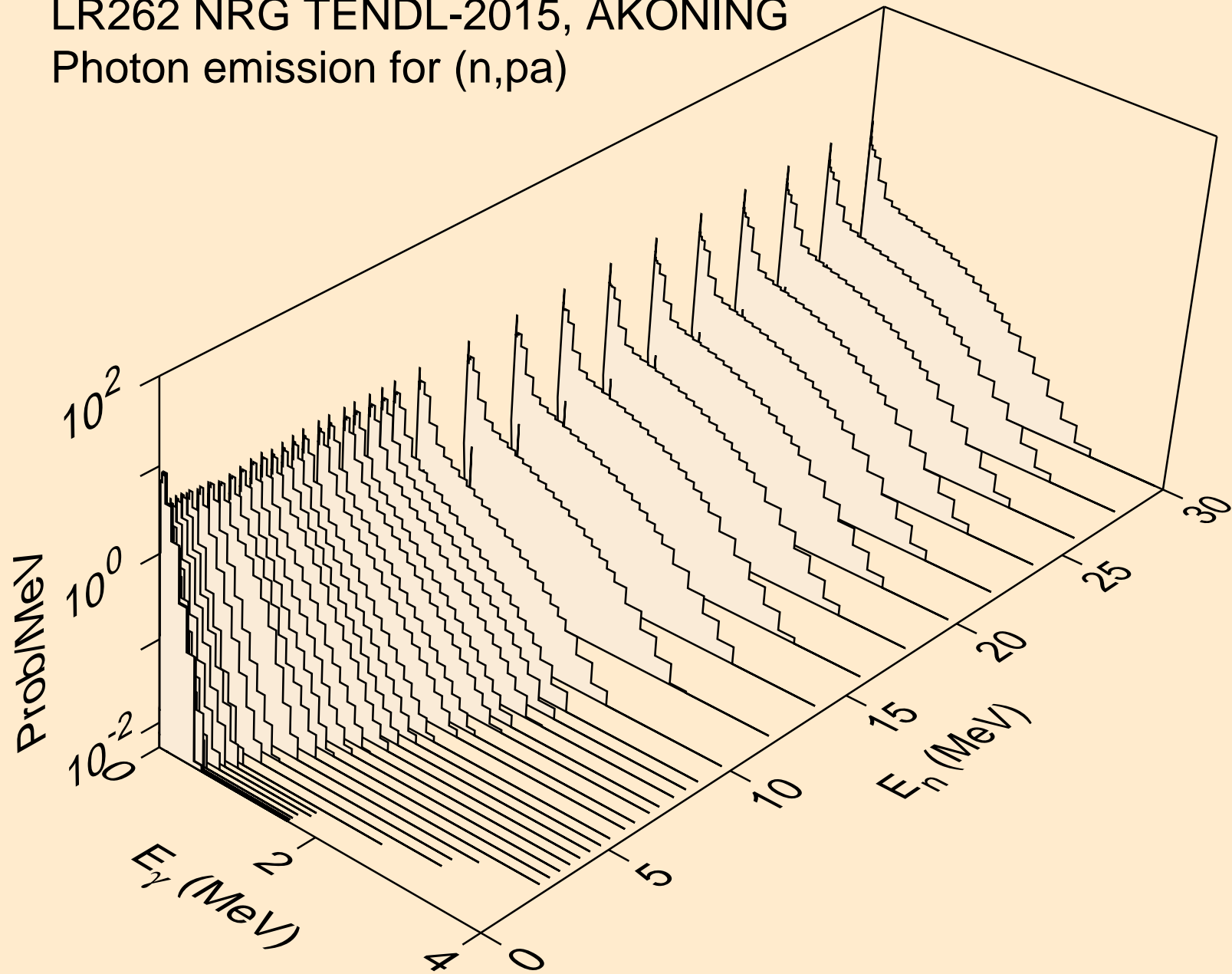

LR262 NRG TENDL-2015, AKONING  
Photon emission for (n,t2a)

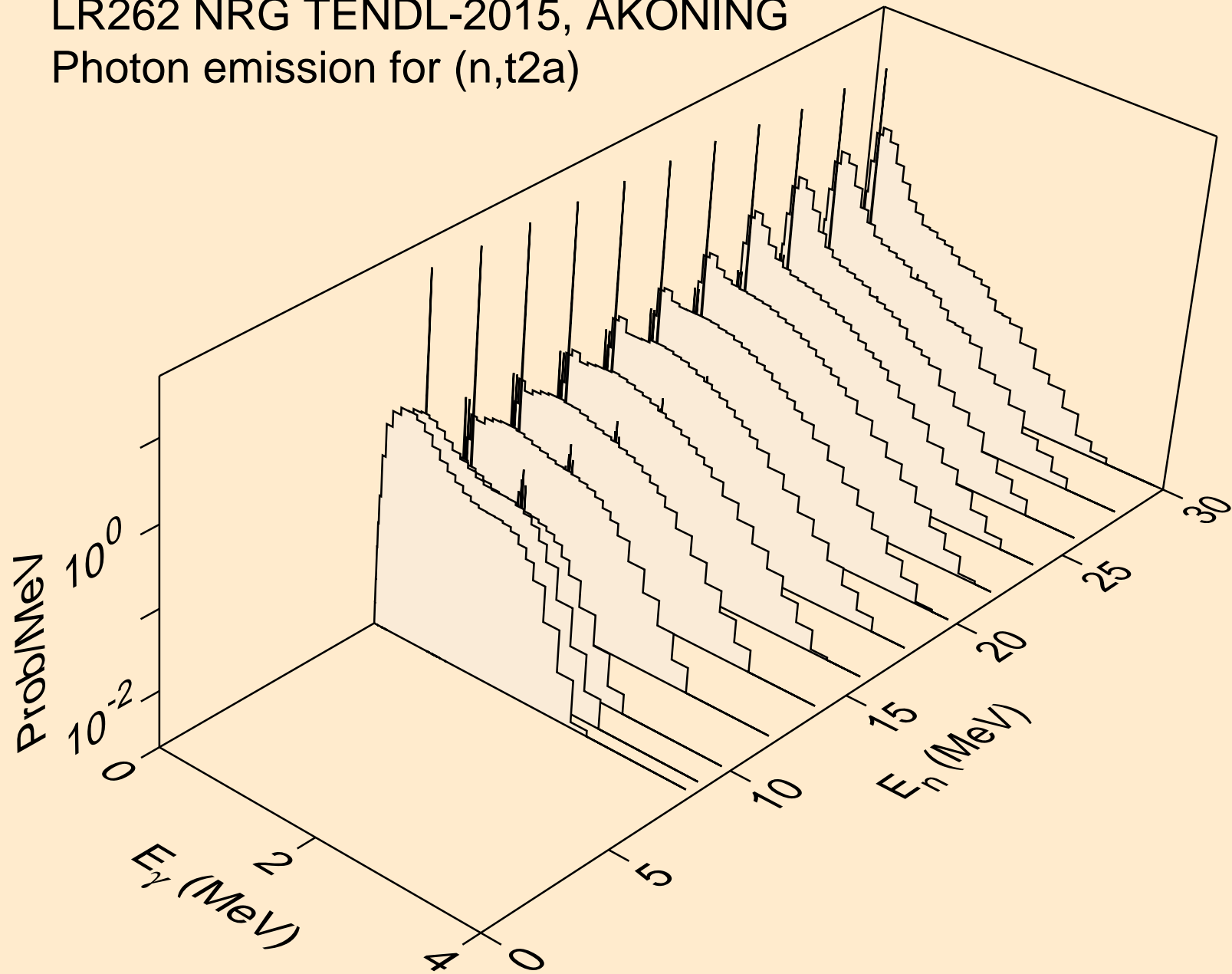

LR262 NRG TENDL-2015, AKONING  
Photon emission for (n,d2a)

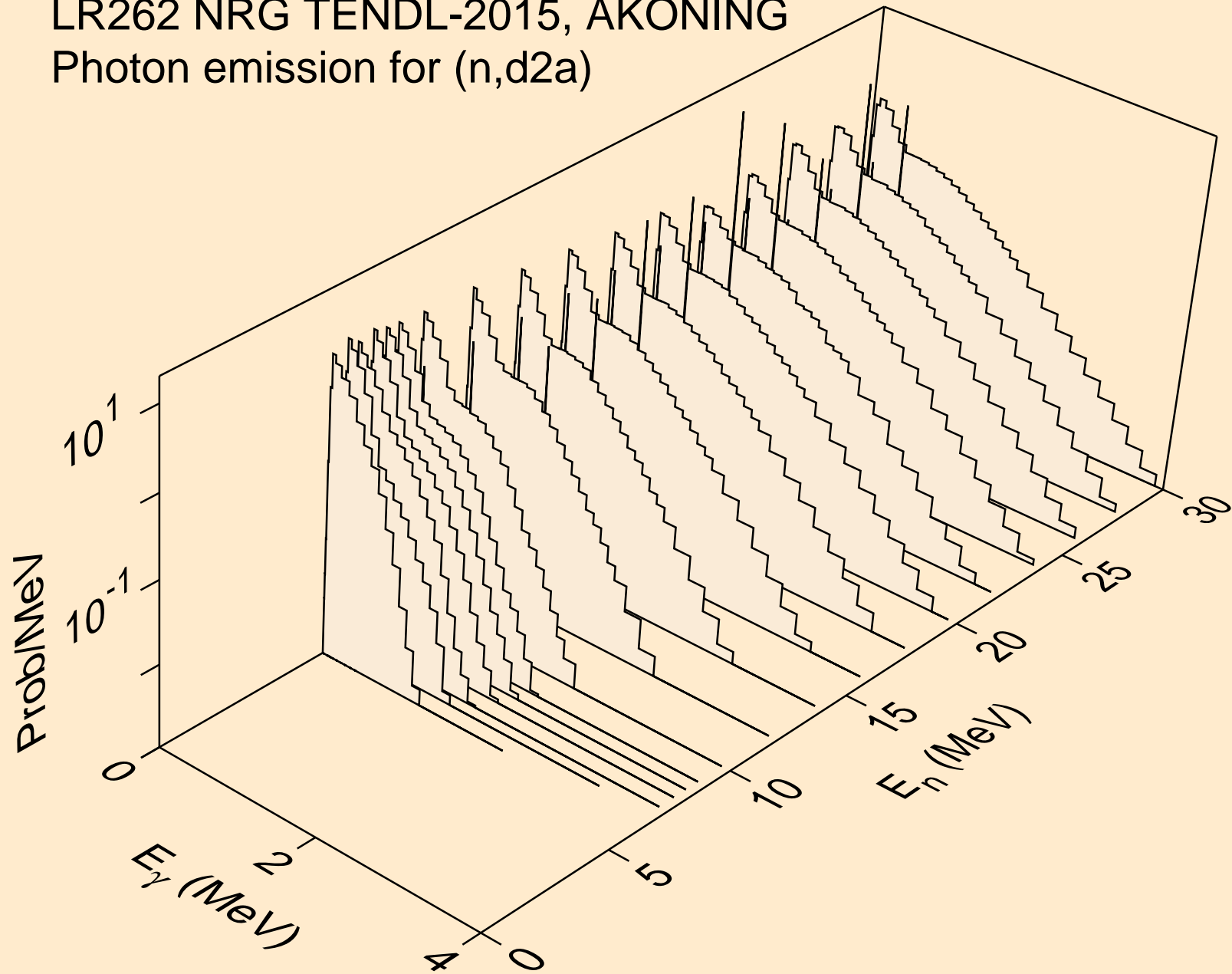

LR262 NRG TENDL-2015, AKONING  
Photon emission for (n,da)

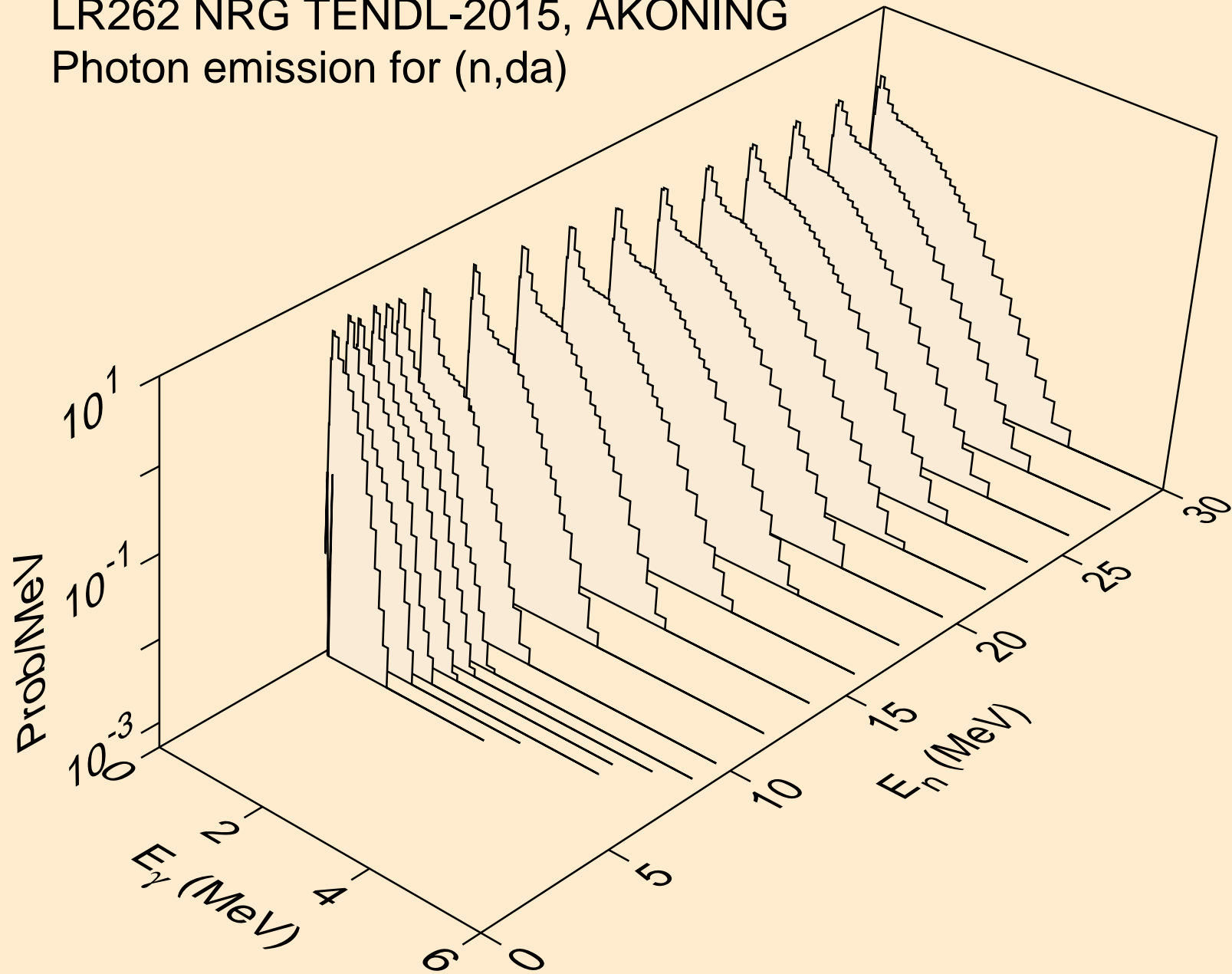

LR262 NRG TENDL-2015, AKONING  
thermal capture photon spectrum

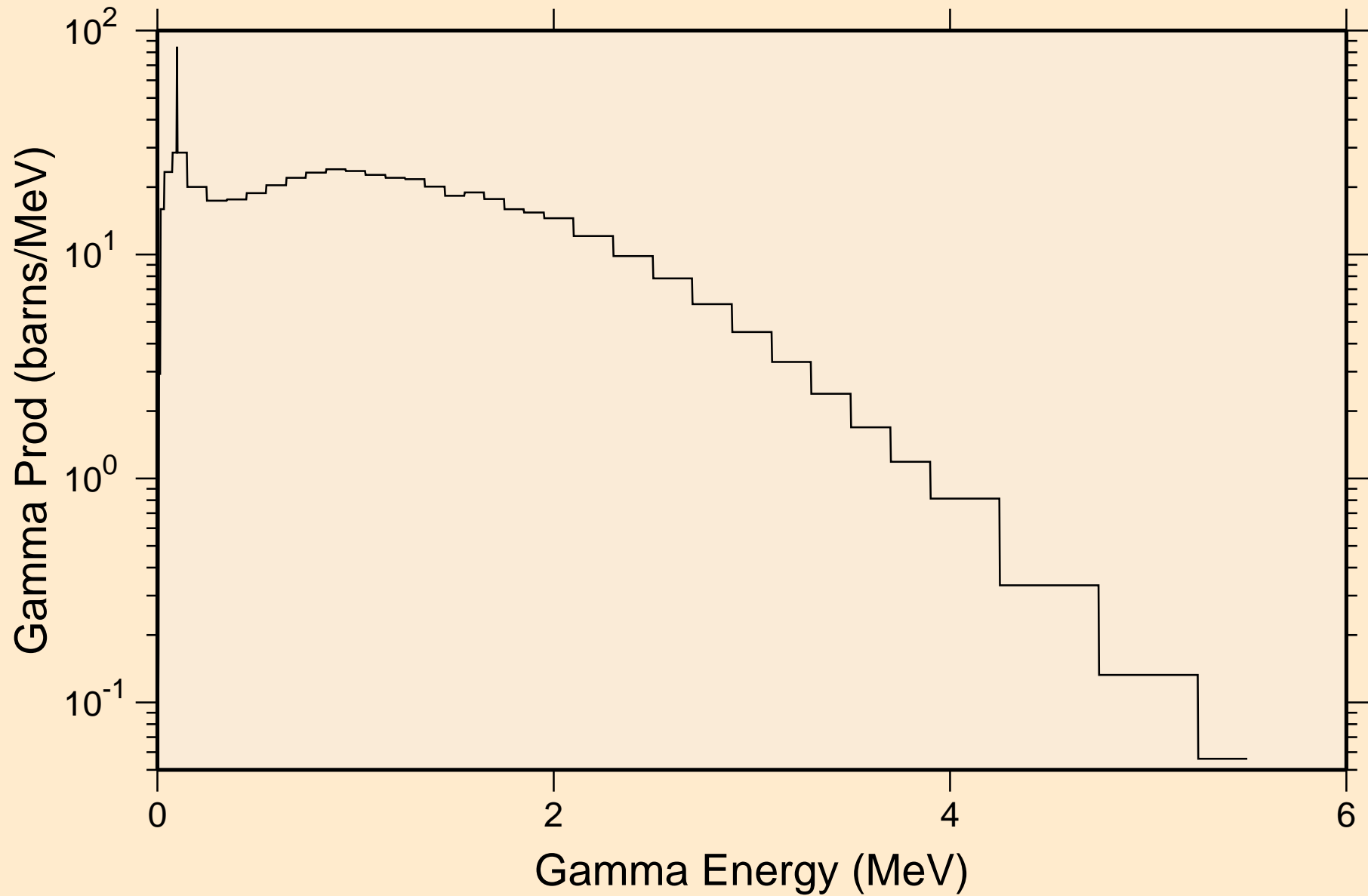

LR262 NRG TENDL-2015, AKONING  
14 MeV photon spectrum

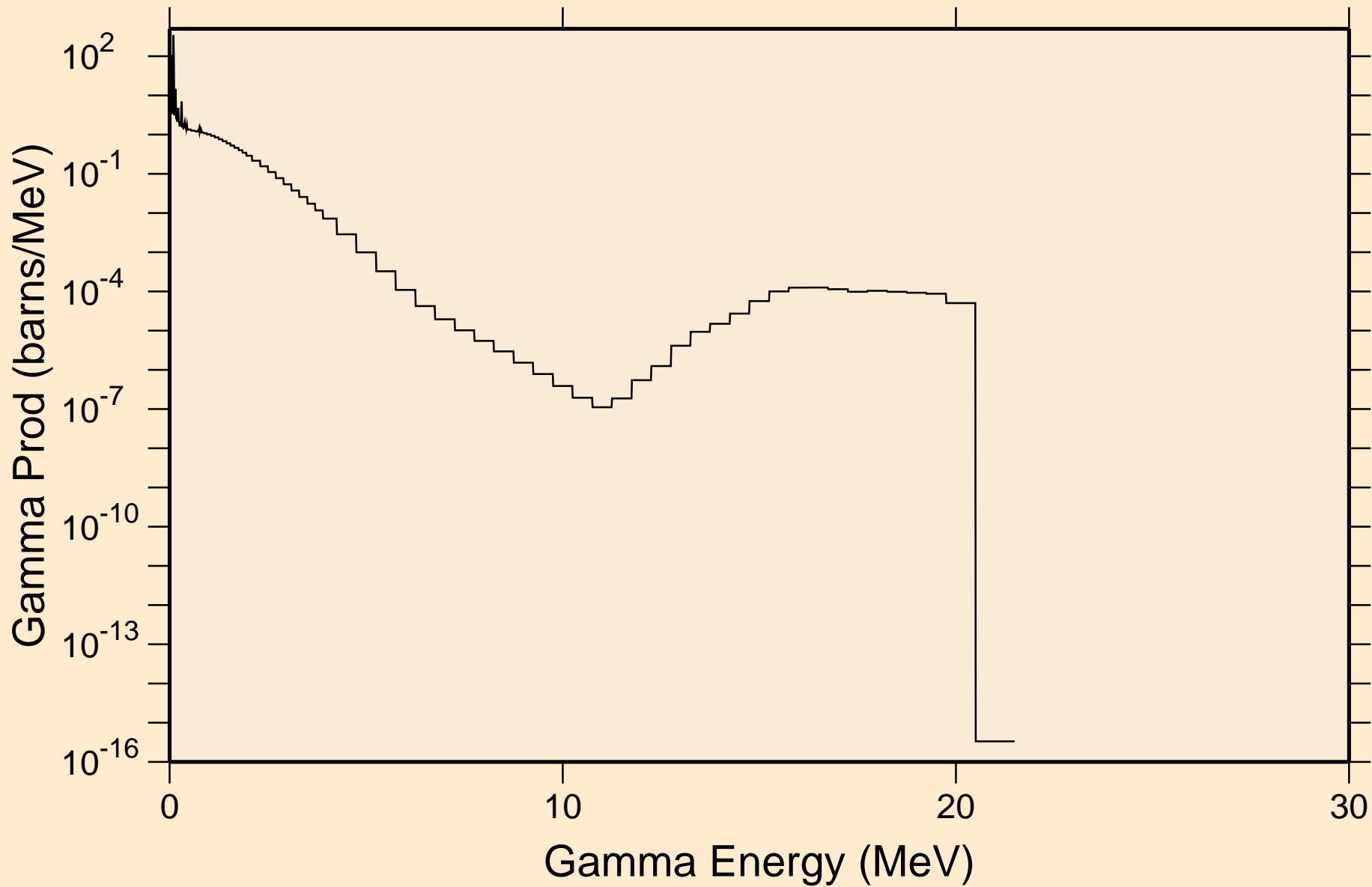

# LR262 NRG TENDL-2015, AKONING

## Particle heating contributions

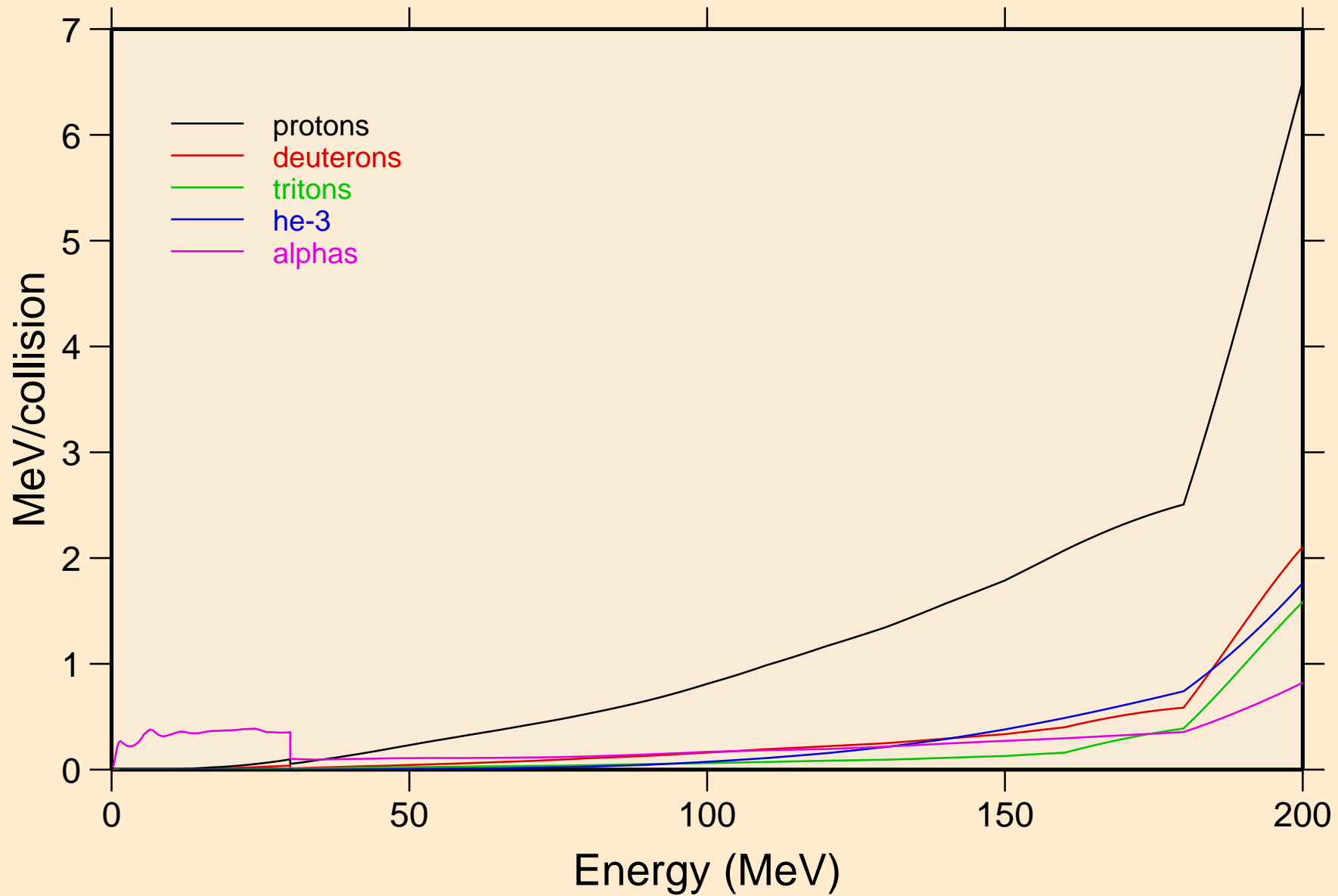

# LR262 NRG TENDL-2015, AKONING

## Recoil Heating

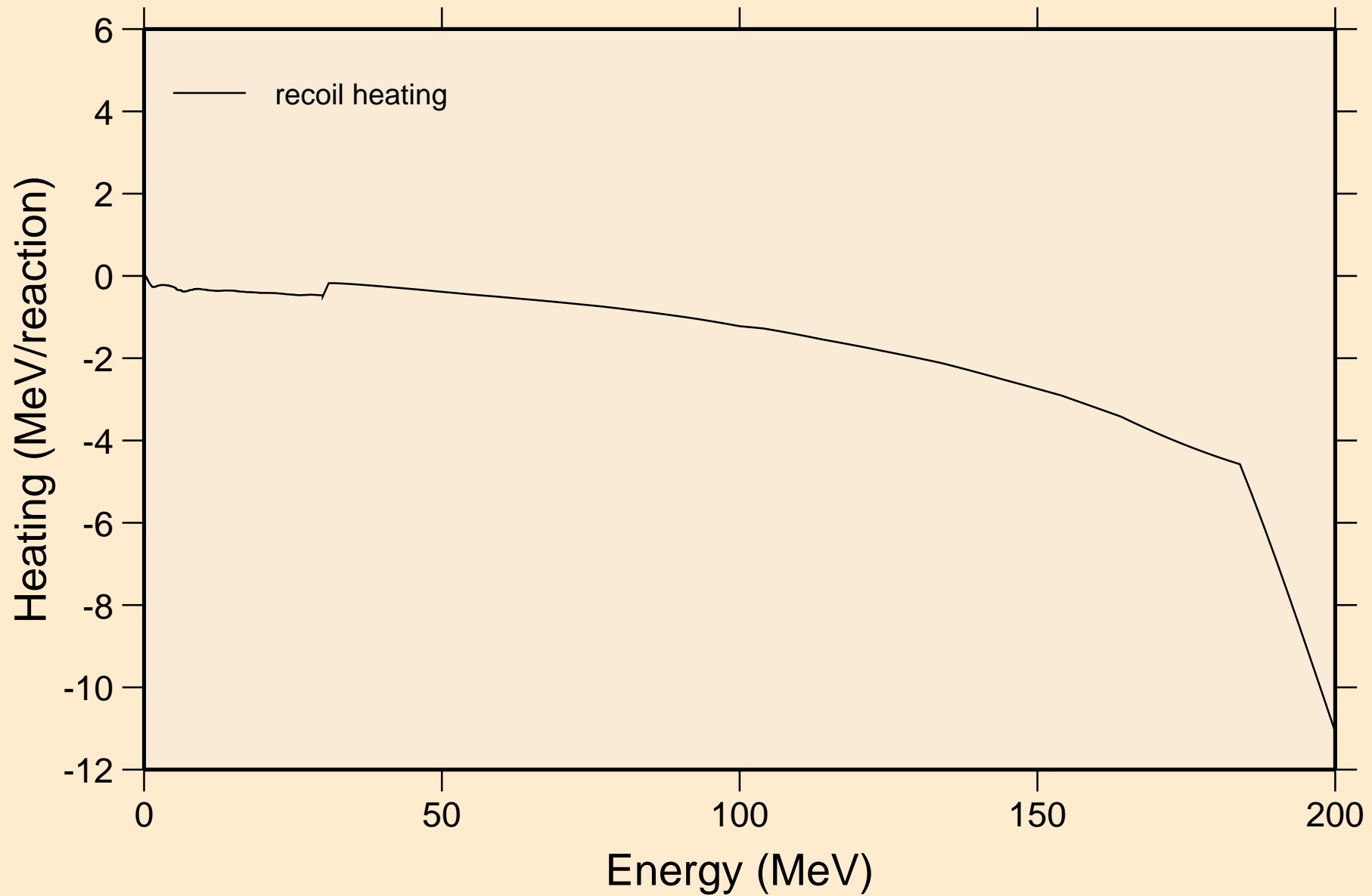



# LR262 NRG TENDL-2015, AKONING

## Particle production cross sections

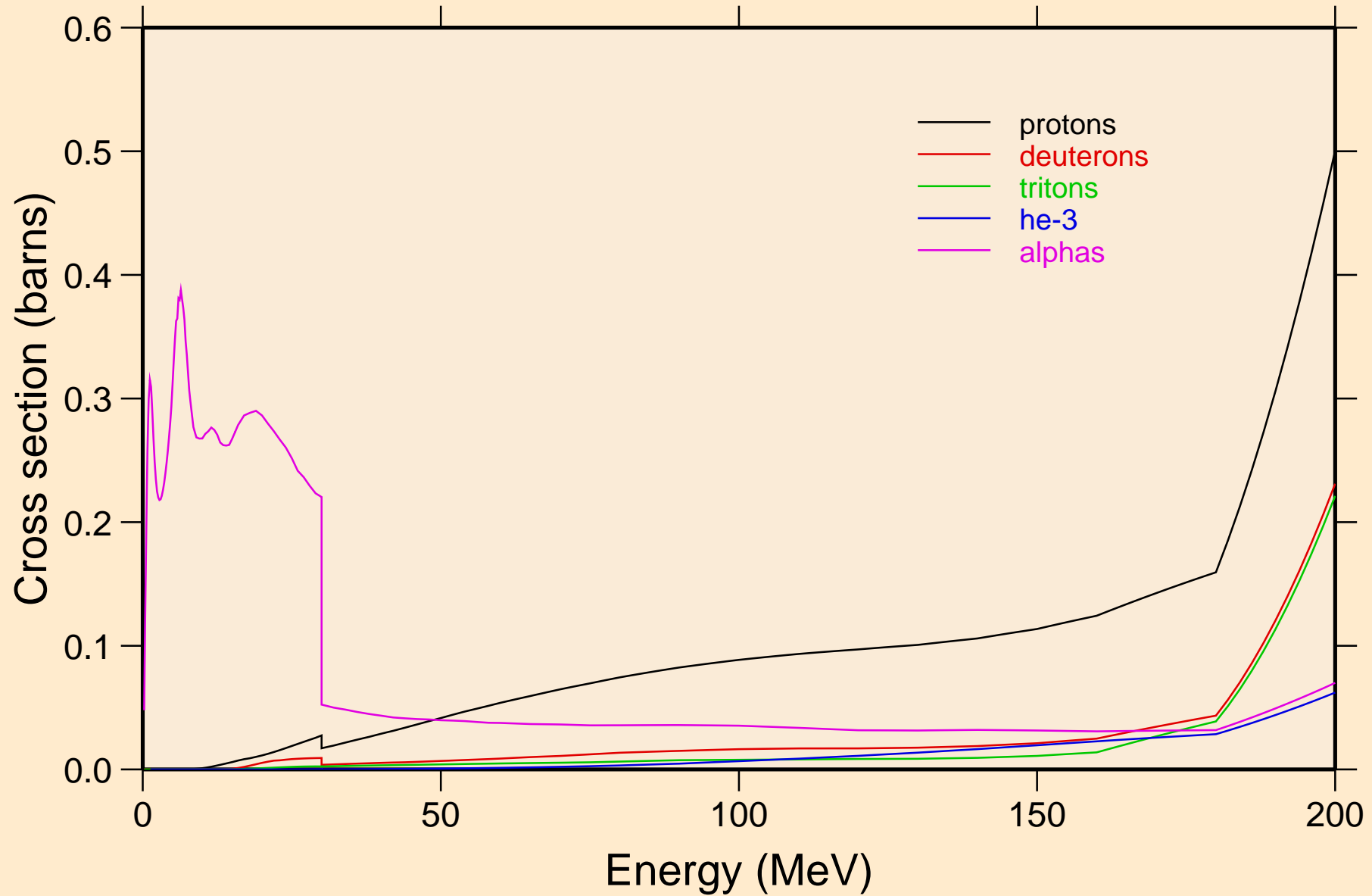

LR262 NRG TENDL-2015, AKONING  
protons from (n,x)

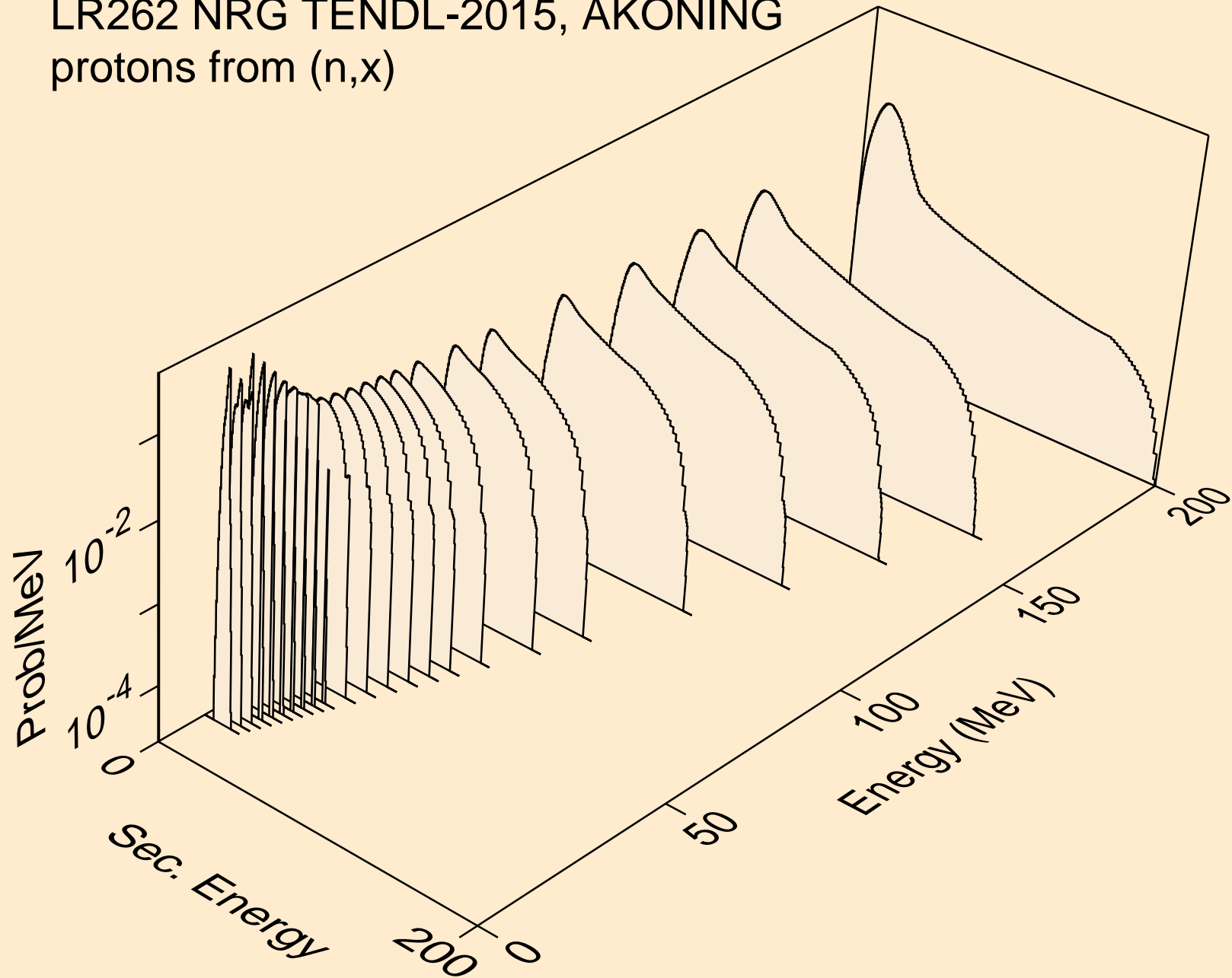

LR262 NRG TENDL-2015, AKONING  
protons from (n,n\*)p

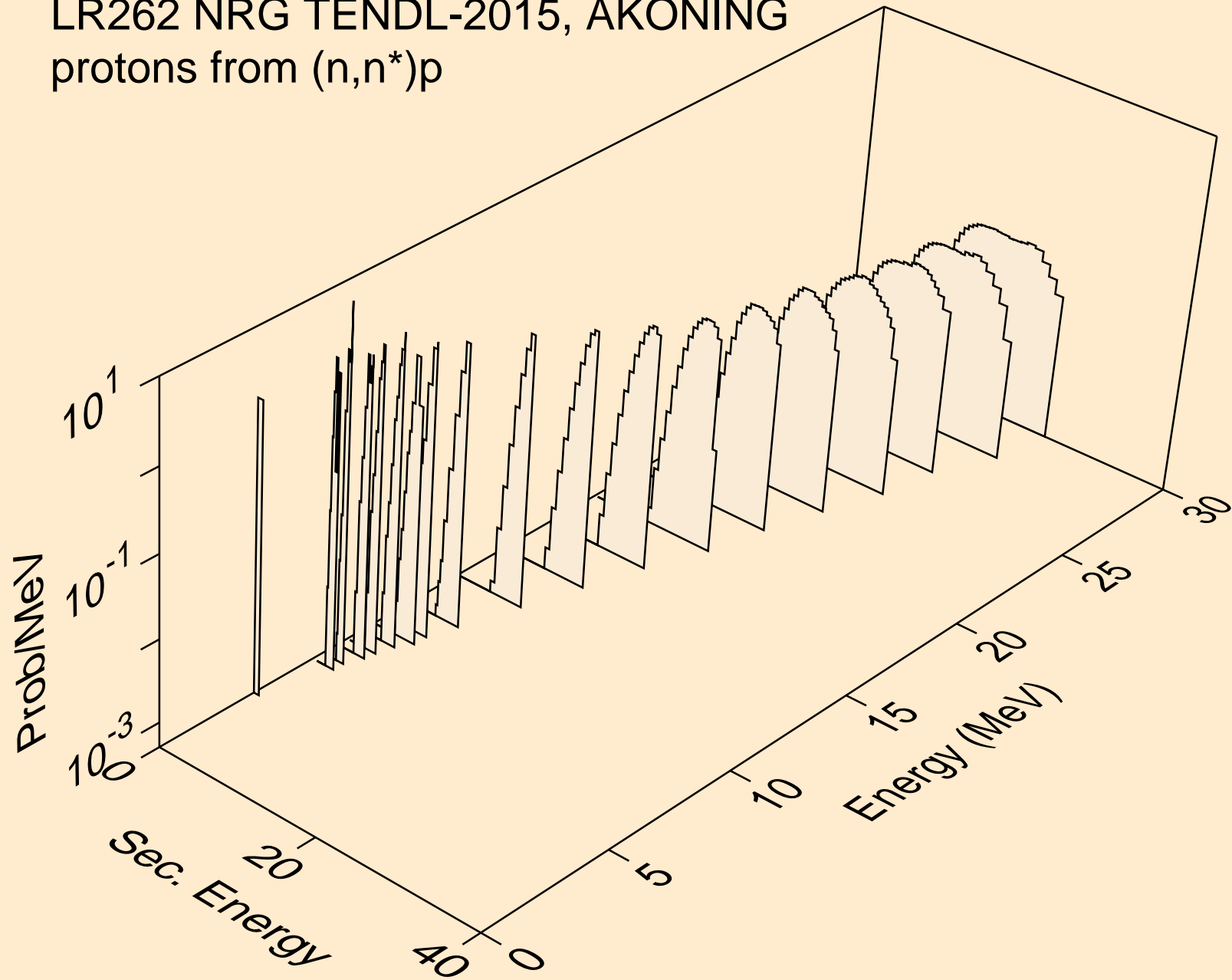

LR262 NRG TENDL-2015, AKONING  
protons from (n,2np)

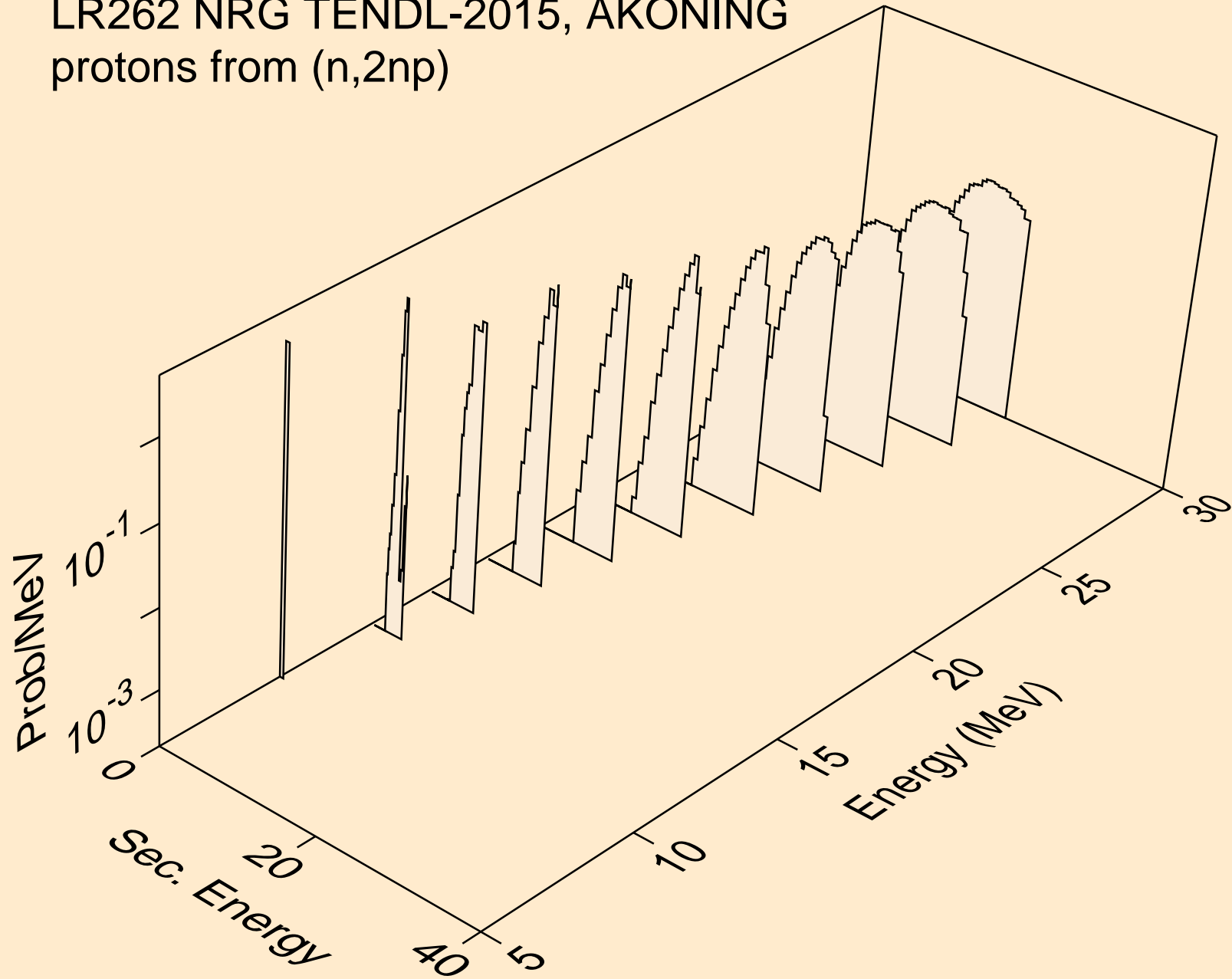

LR262 NRG TENDL-2015, AKONING  
protons from (n,3np)

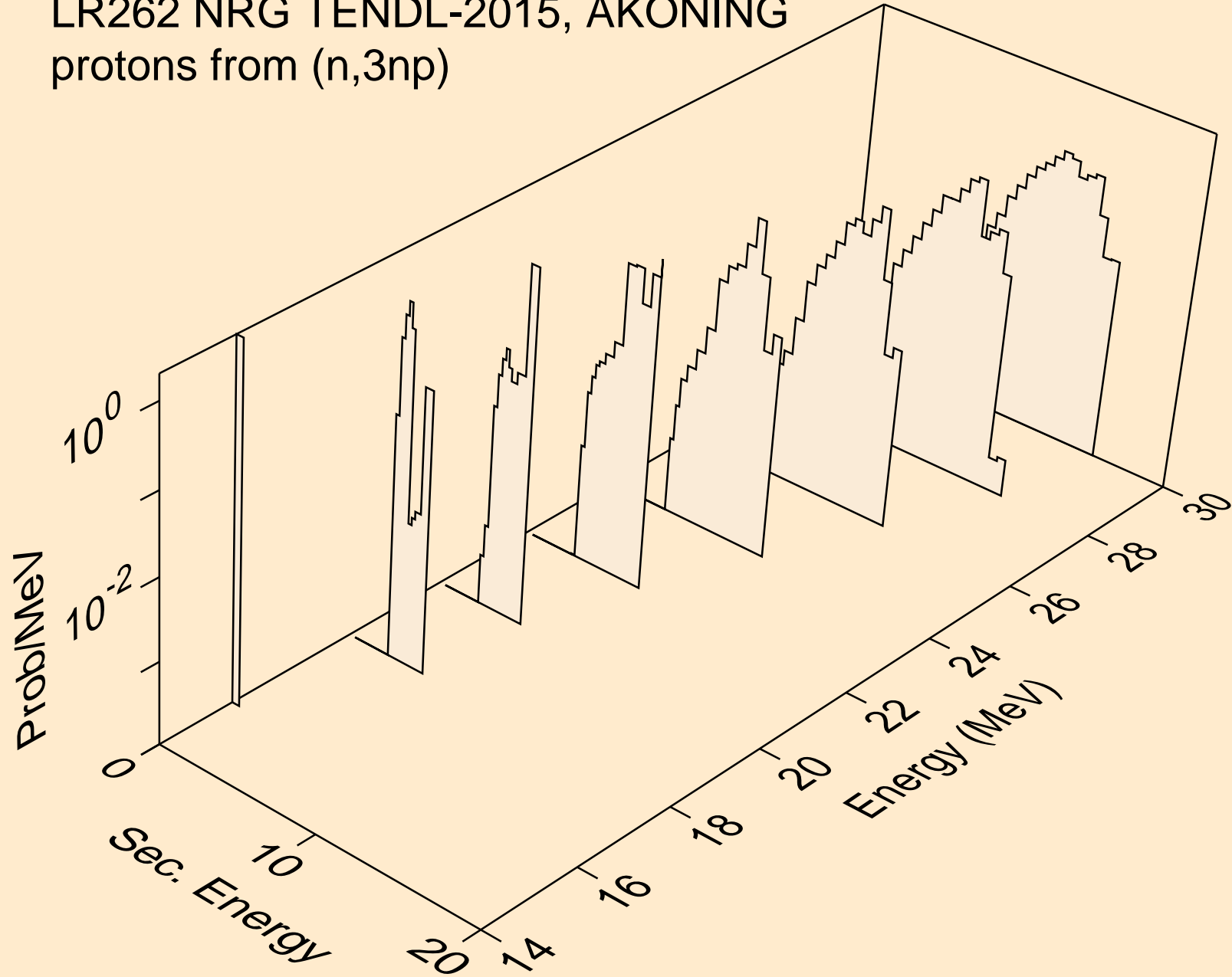

LR262 NRG TENDL-2015, AKONING  
protons from (n,2np)

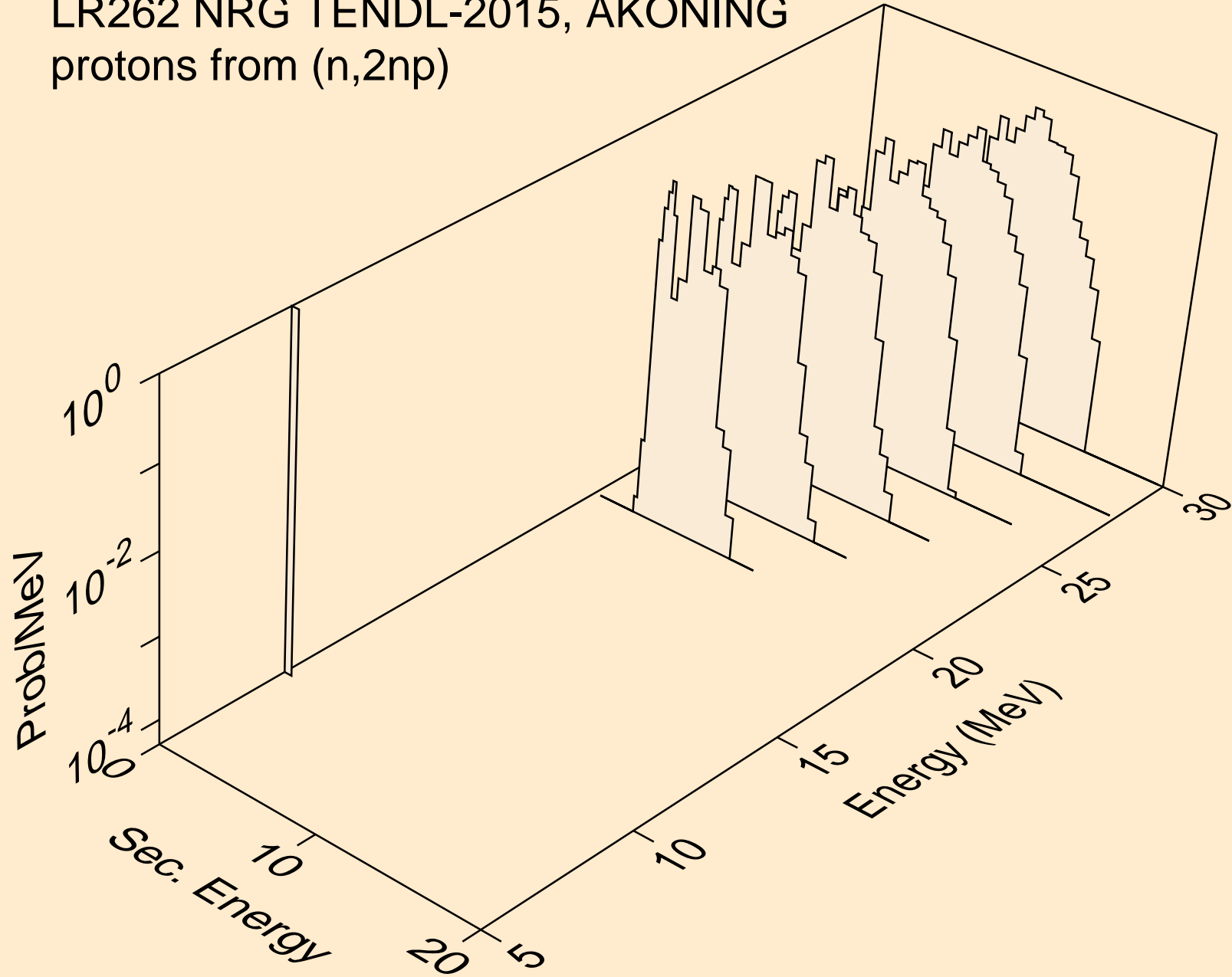

LR262 NRG TENDL-2015, AKONING  
protons from (n,npa)

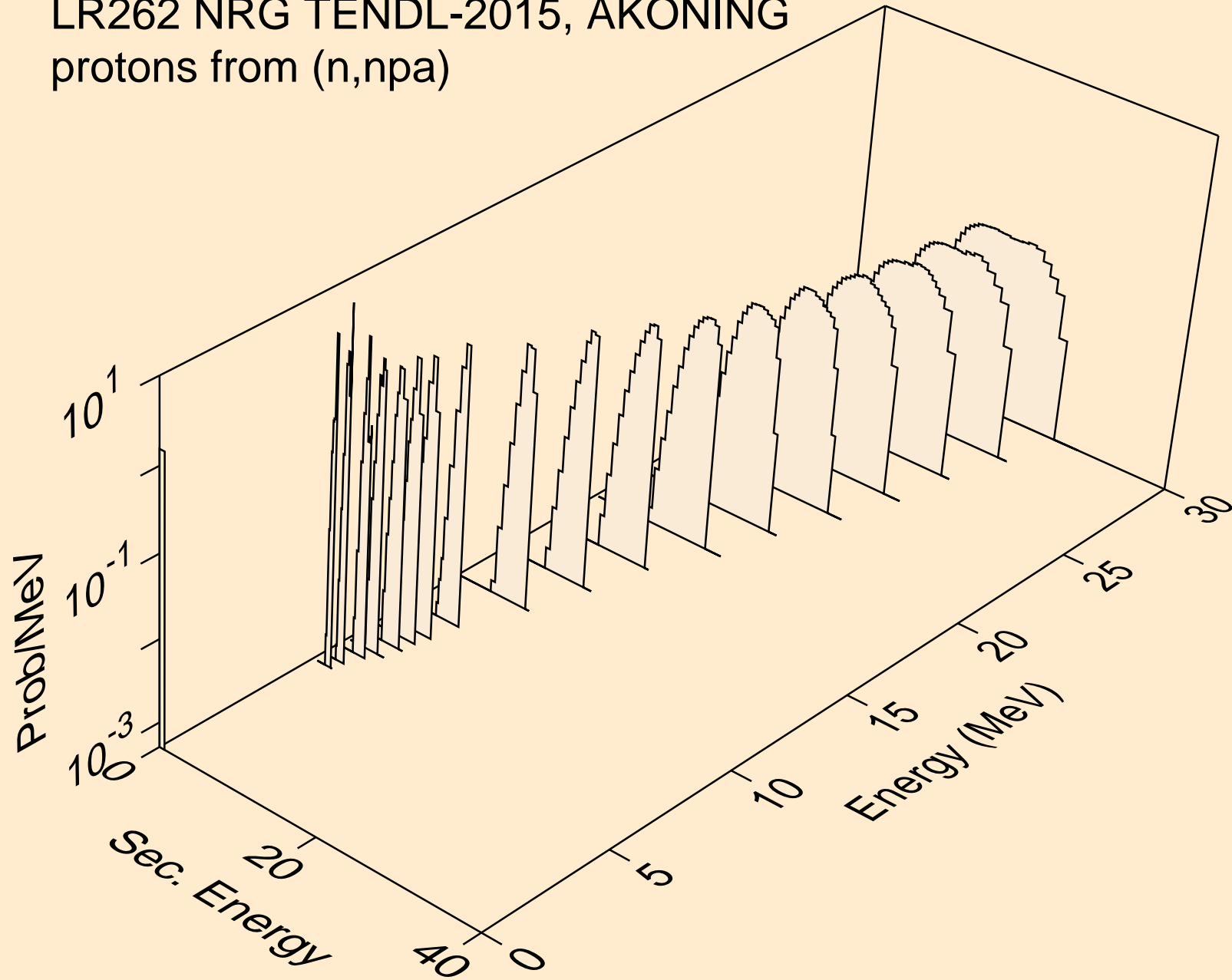

LR262 NRG TENDL-2015, AKONING  
protons from (n,p)

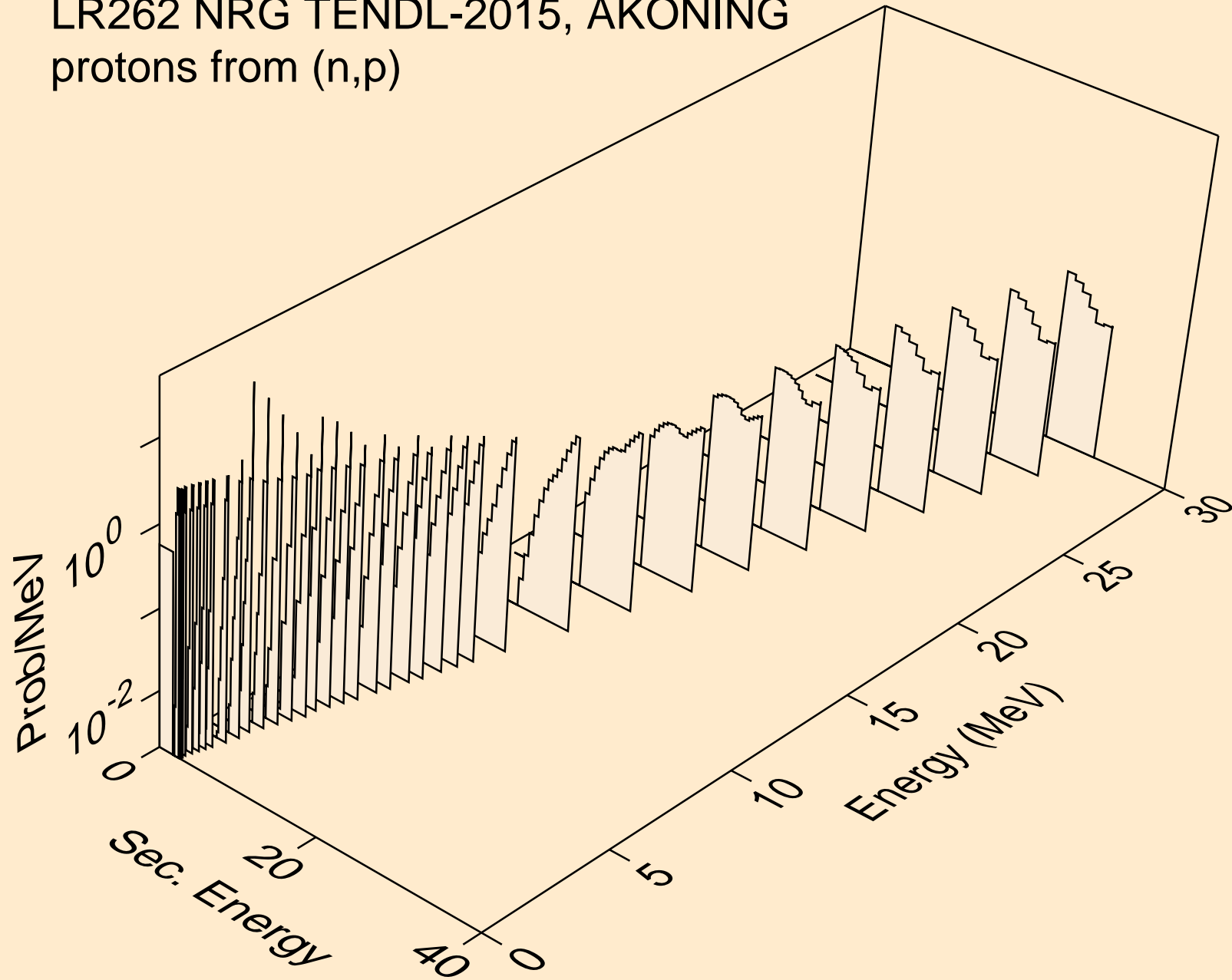



LR262 NRG TENDL-2015, AKONING  
protons from (n,2p)

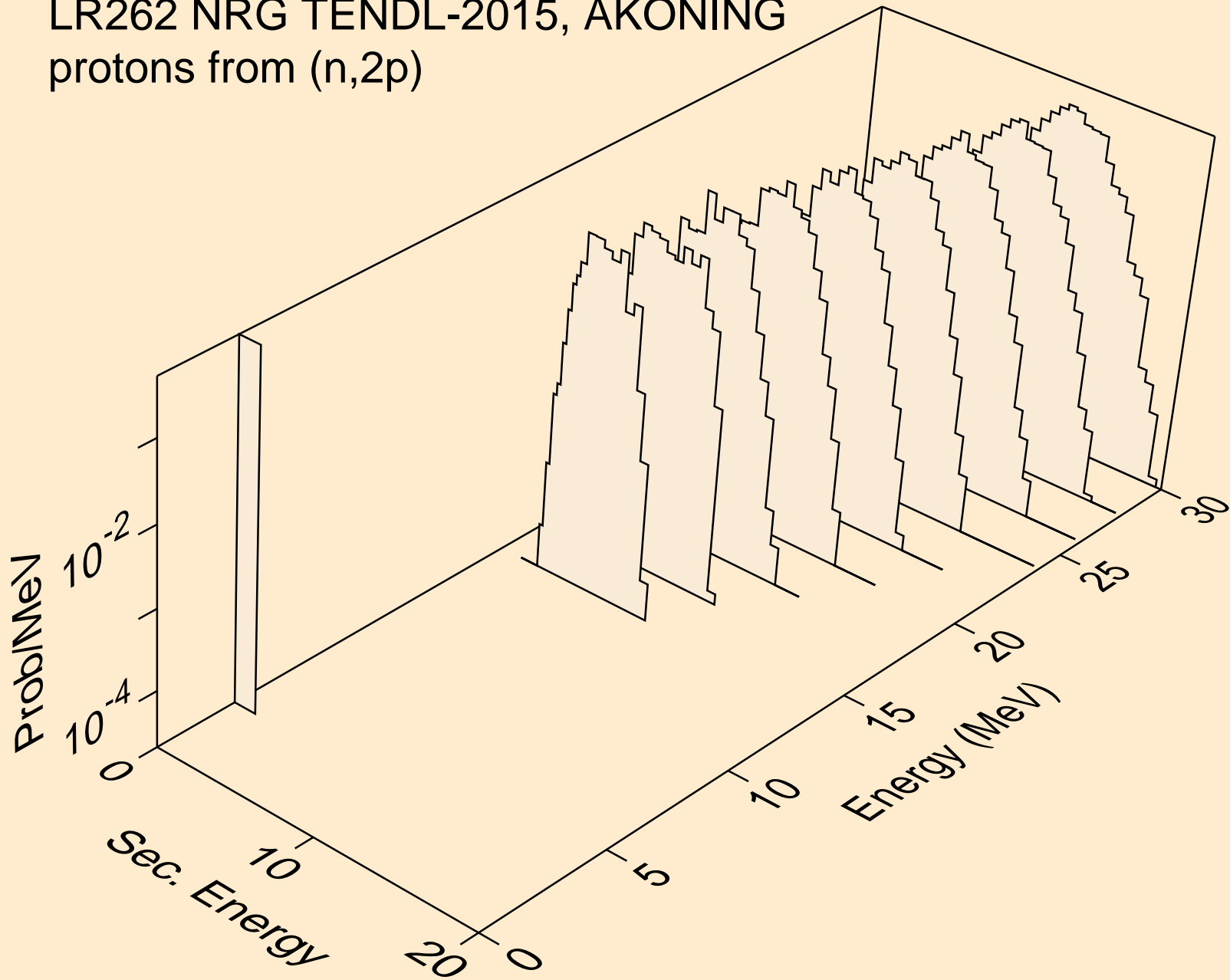

LR262 NRG TENDL-2015, AKONING  
protons from (n,pa)

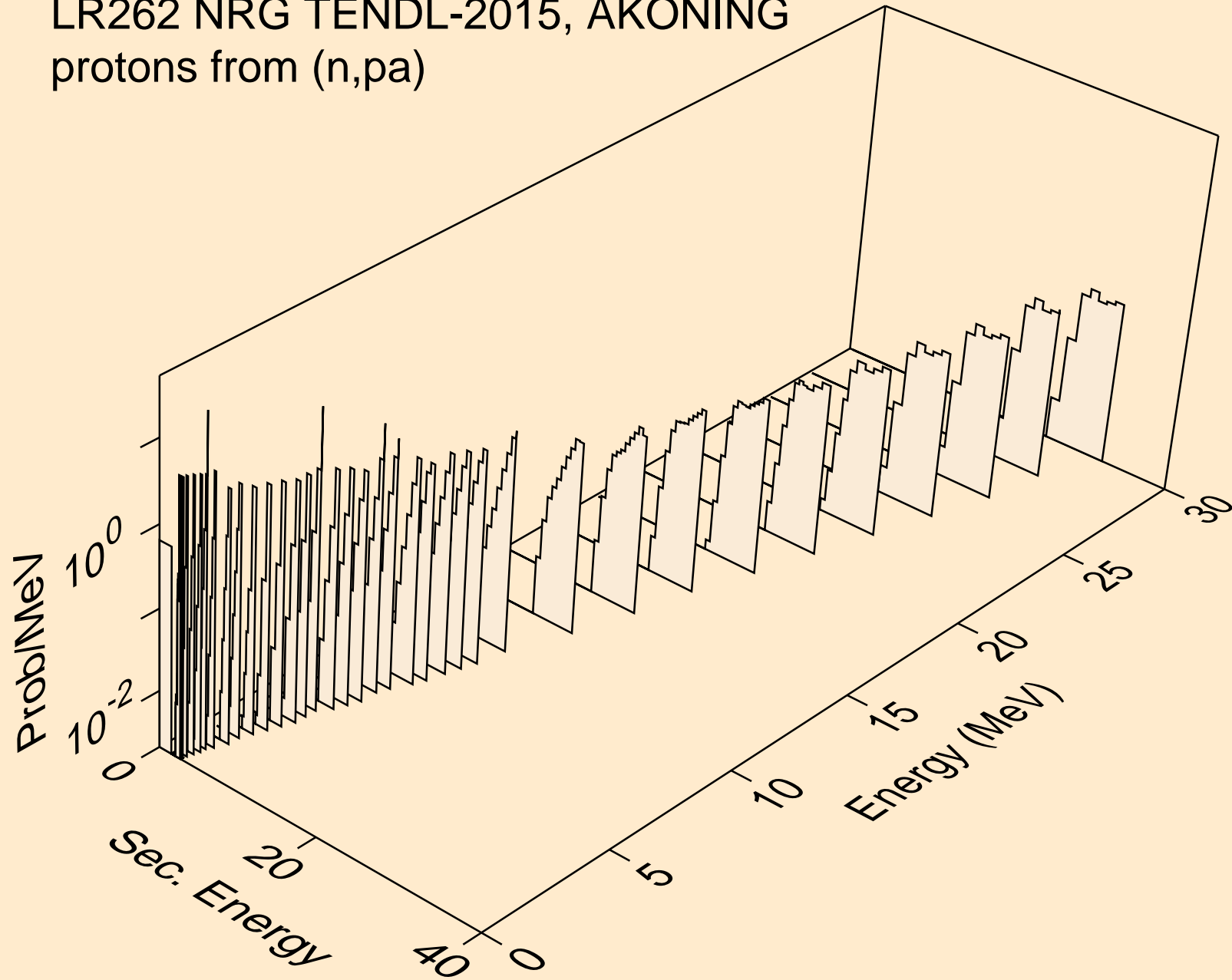

LR262 NRG TENDL-2015, AKONING  
deuterons from (n,x)

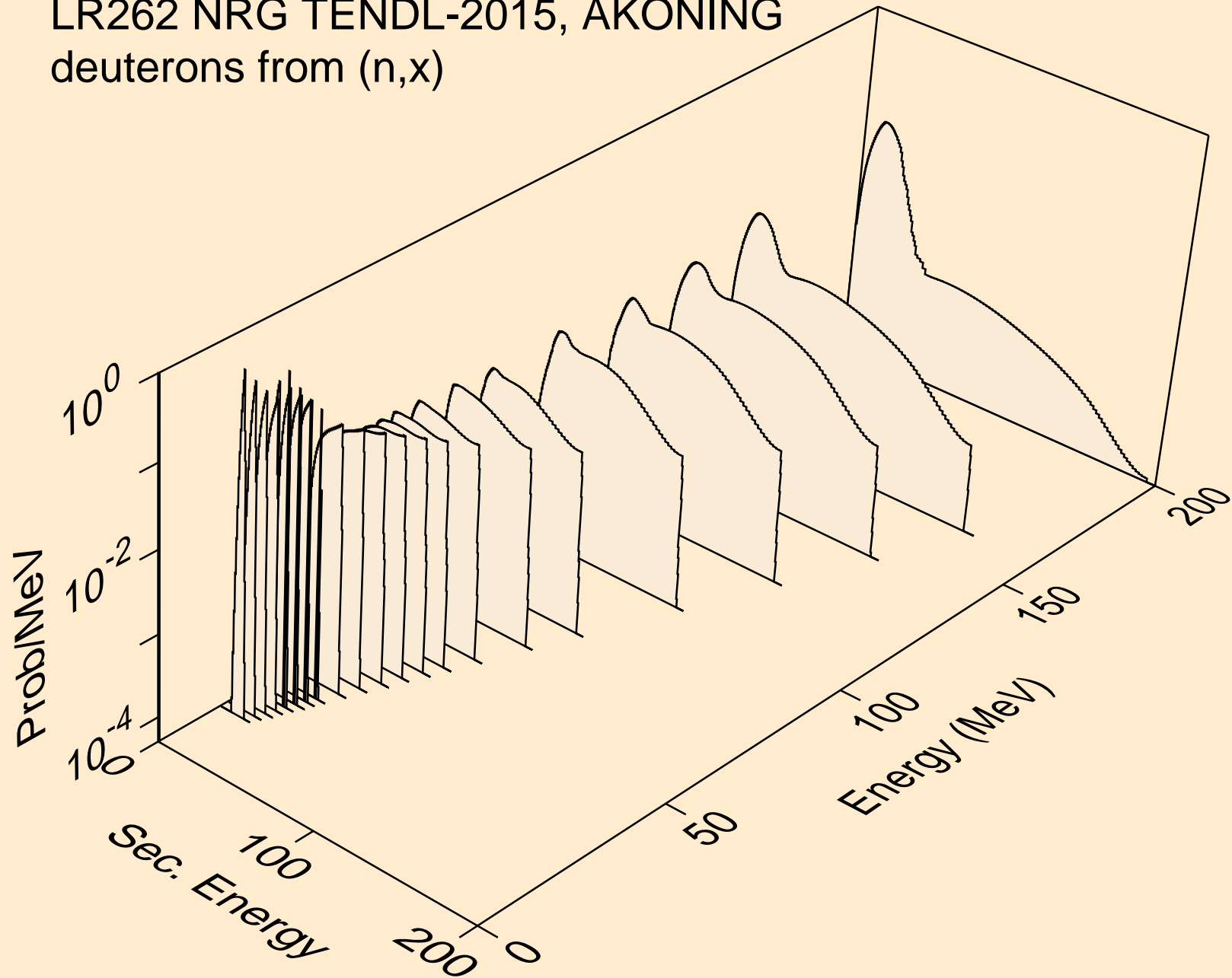

LR262 NRG TENDL-2015, AKONING  
deuterons from (n,2nd)

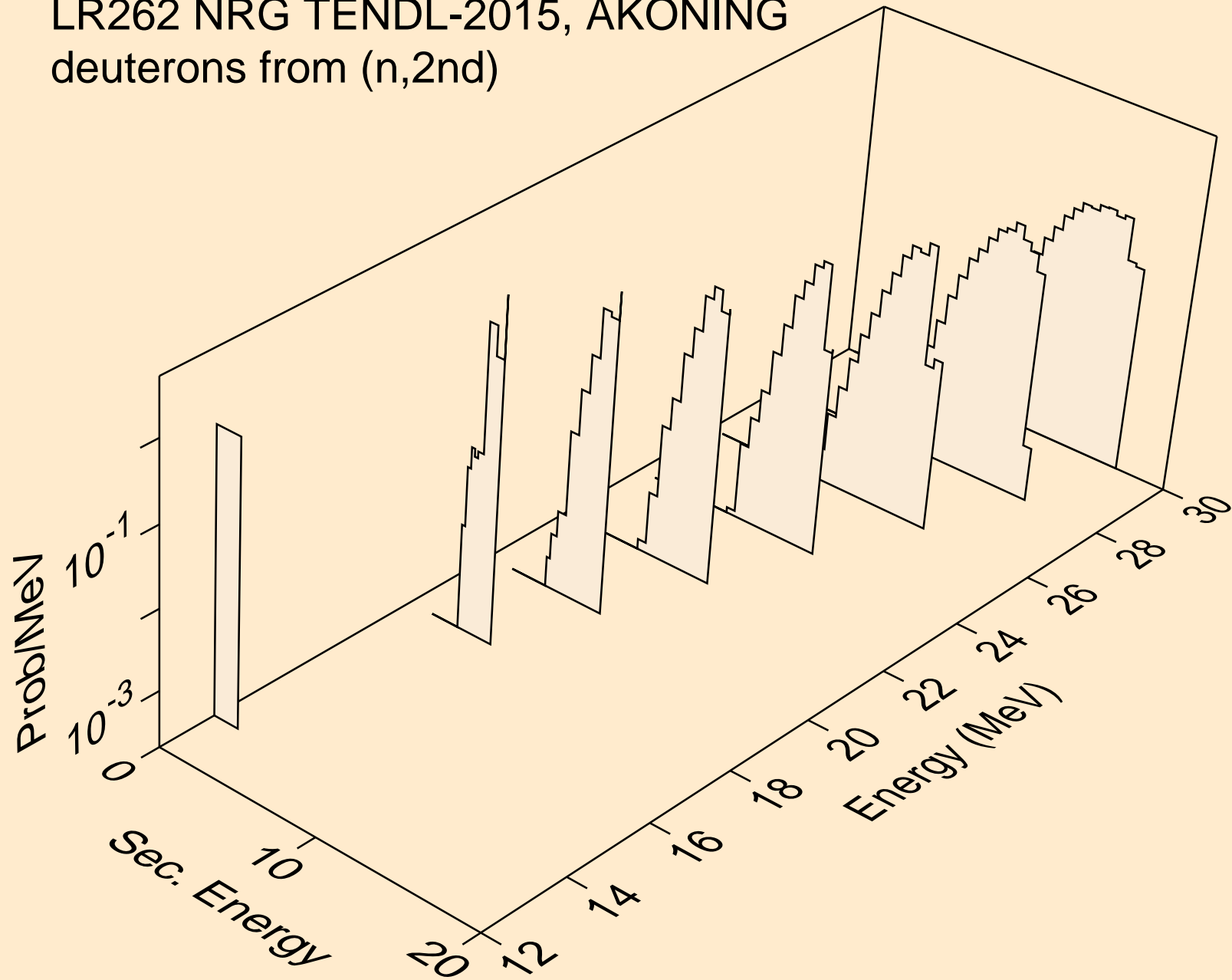

LR262 NRG TENDL-2015, AKONING  
deuterons from (n,n\*)d

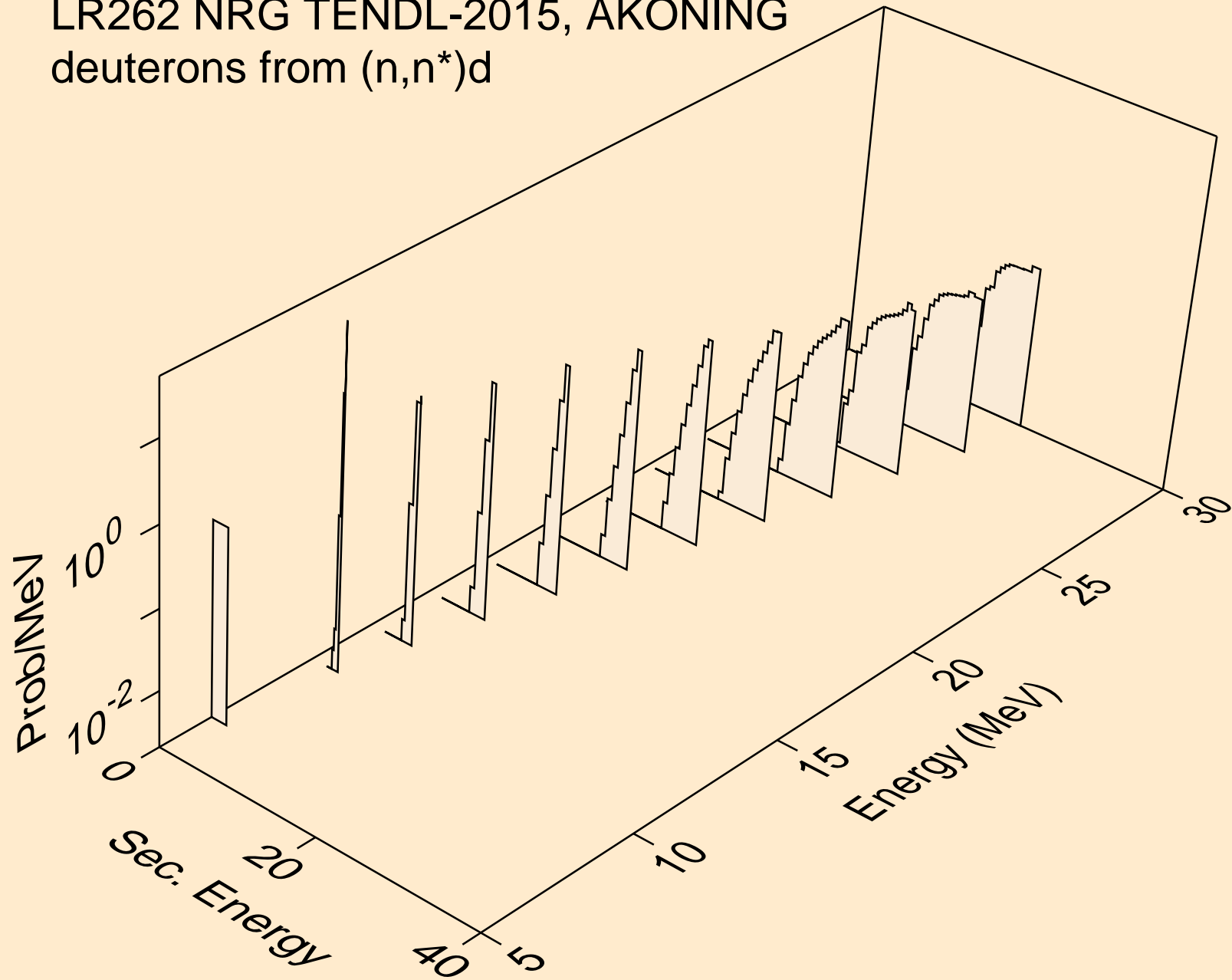

LR262 NRG TENDL-2015, AKONING  
deuterons from (n,n\*)d2a

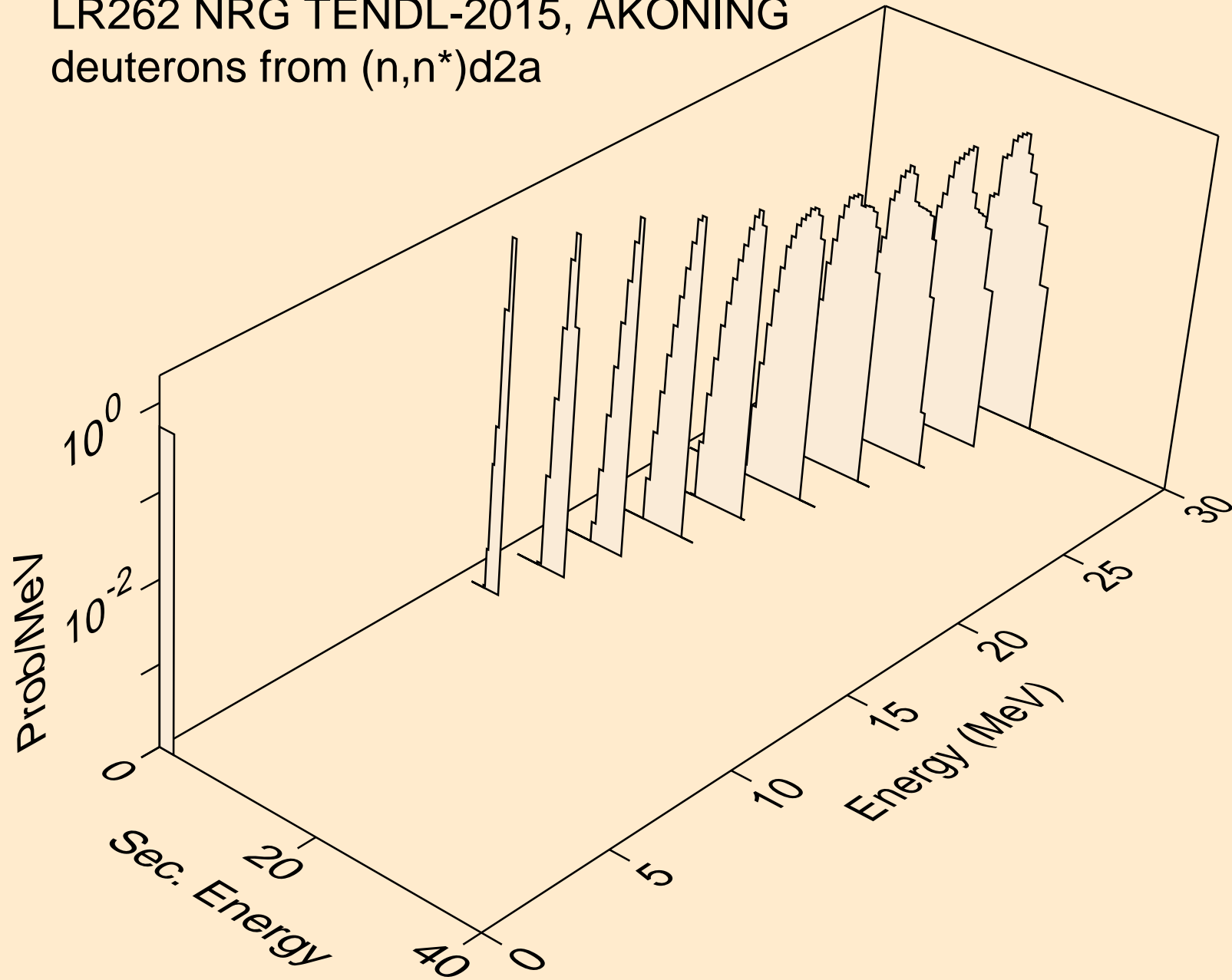

LR262 NRG TENDL-2015, AKONING  
deuterons from (n,d)

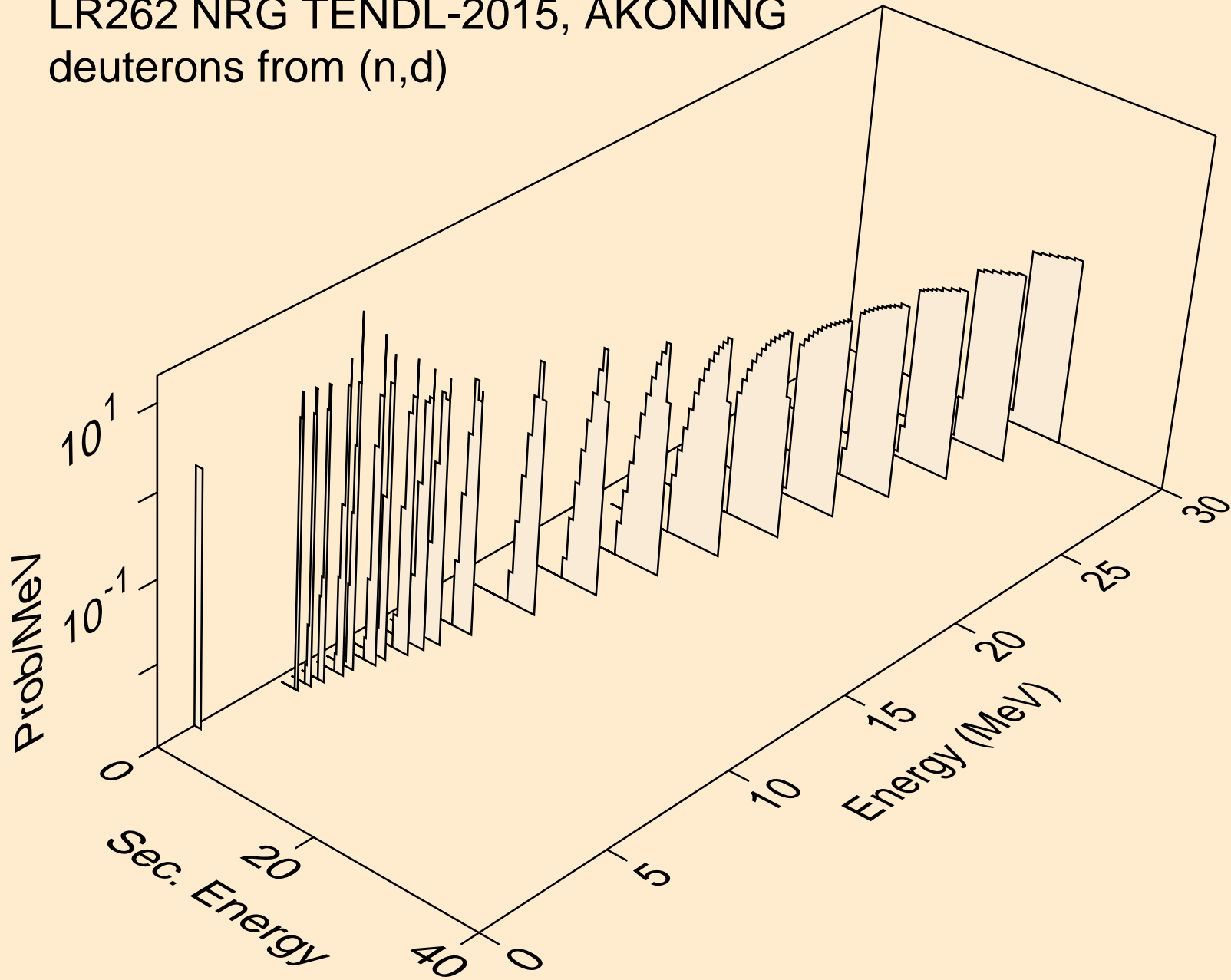

LR262 NRG TENDL-2015, AKONING  
deuterons from (n,d2a)

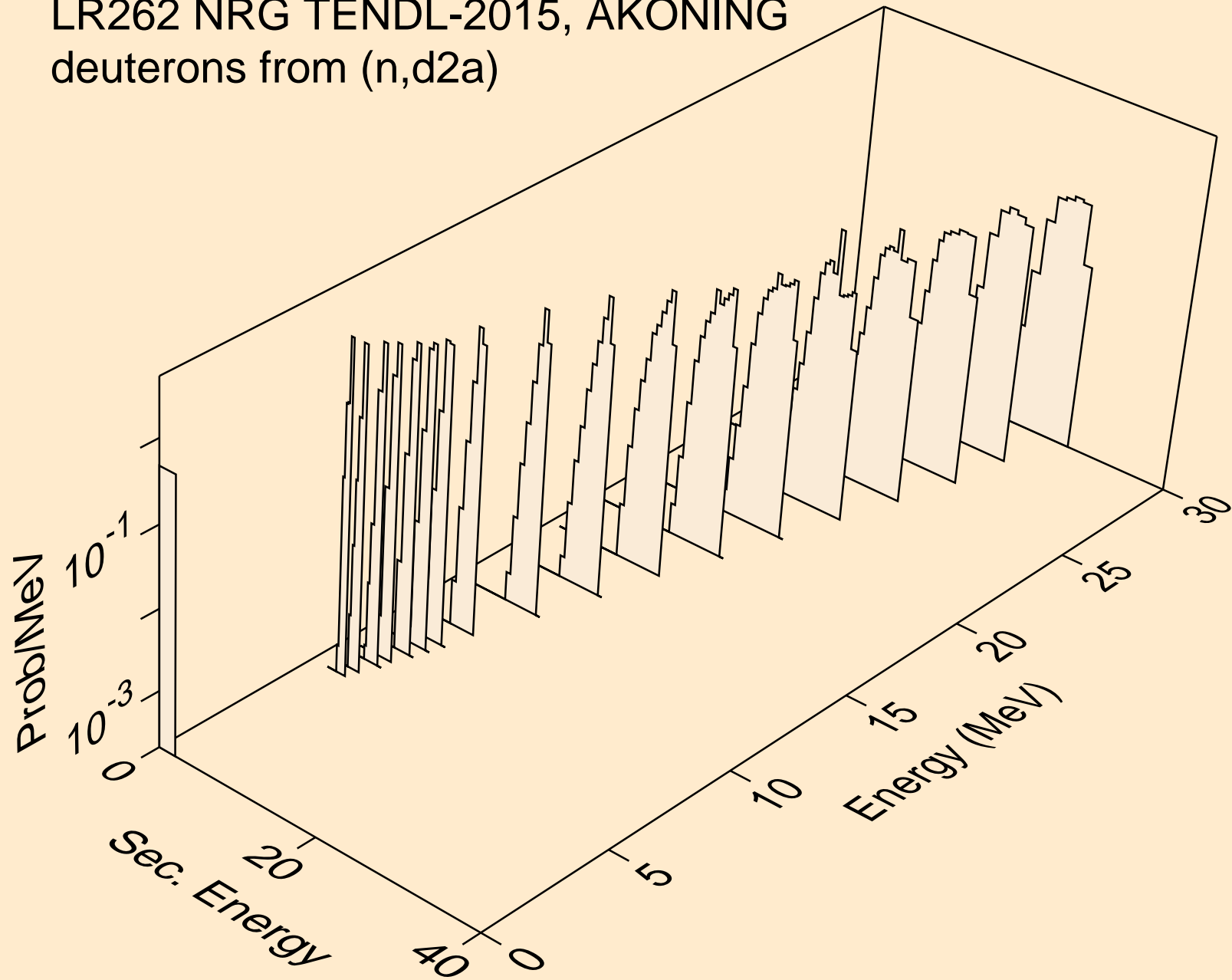



LR262 NRG TENDL-2015, AKONING  
deuterons from (n,da)

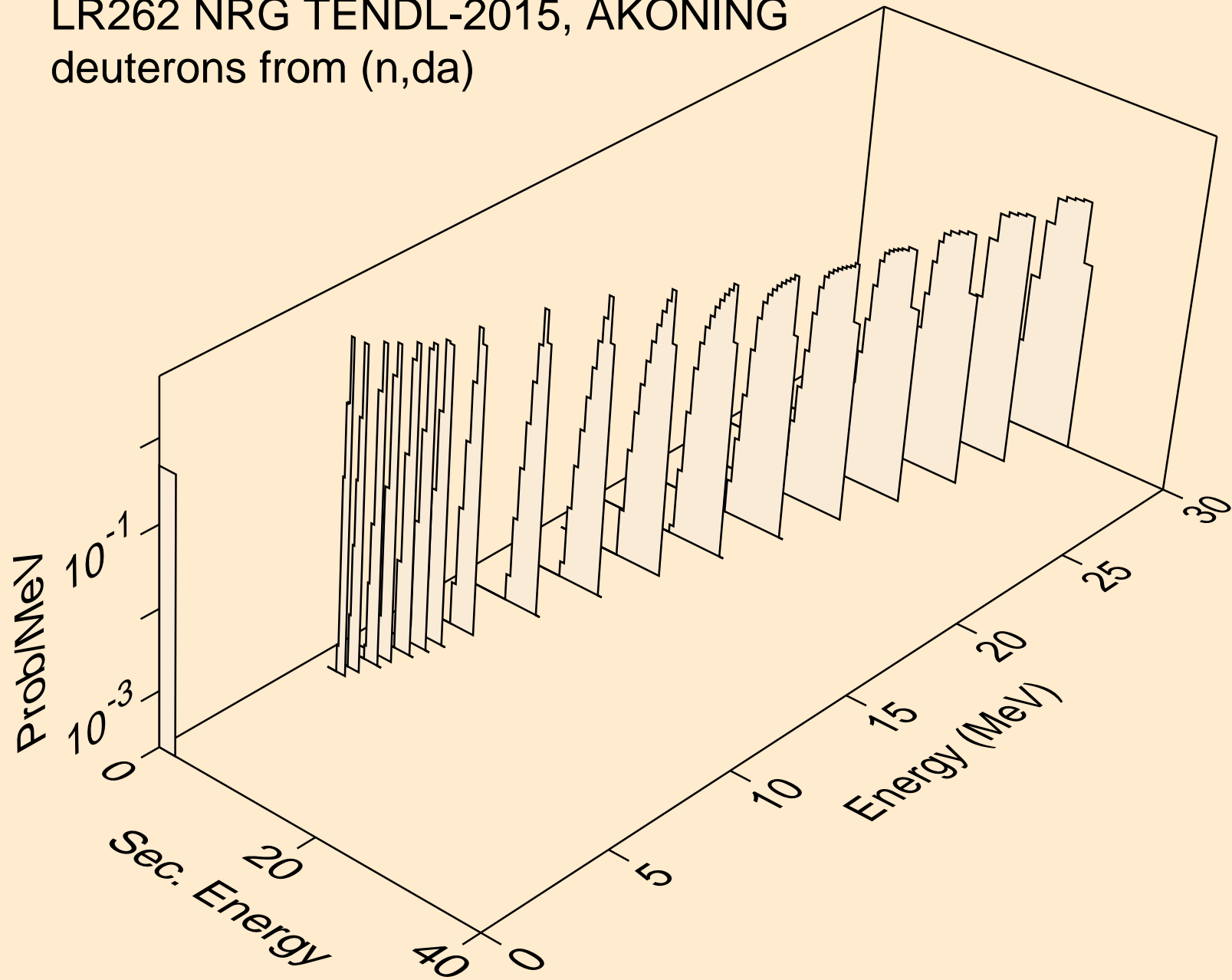

LR262 NRG TENDL-2015, AKONING  
tritons from (n,x)

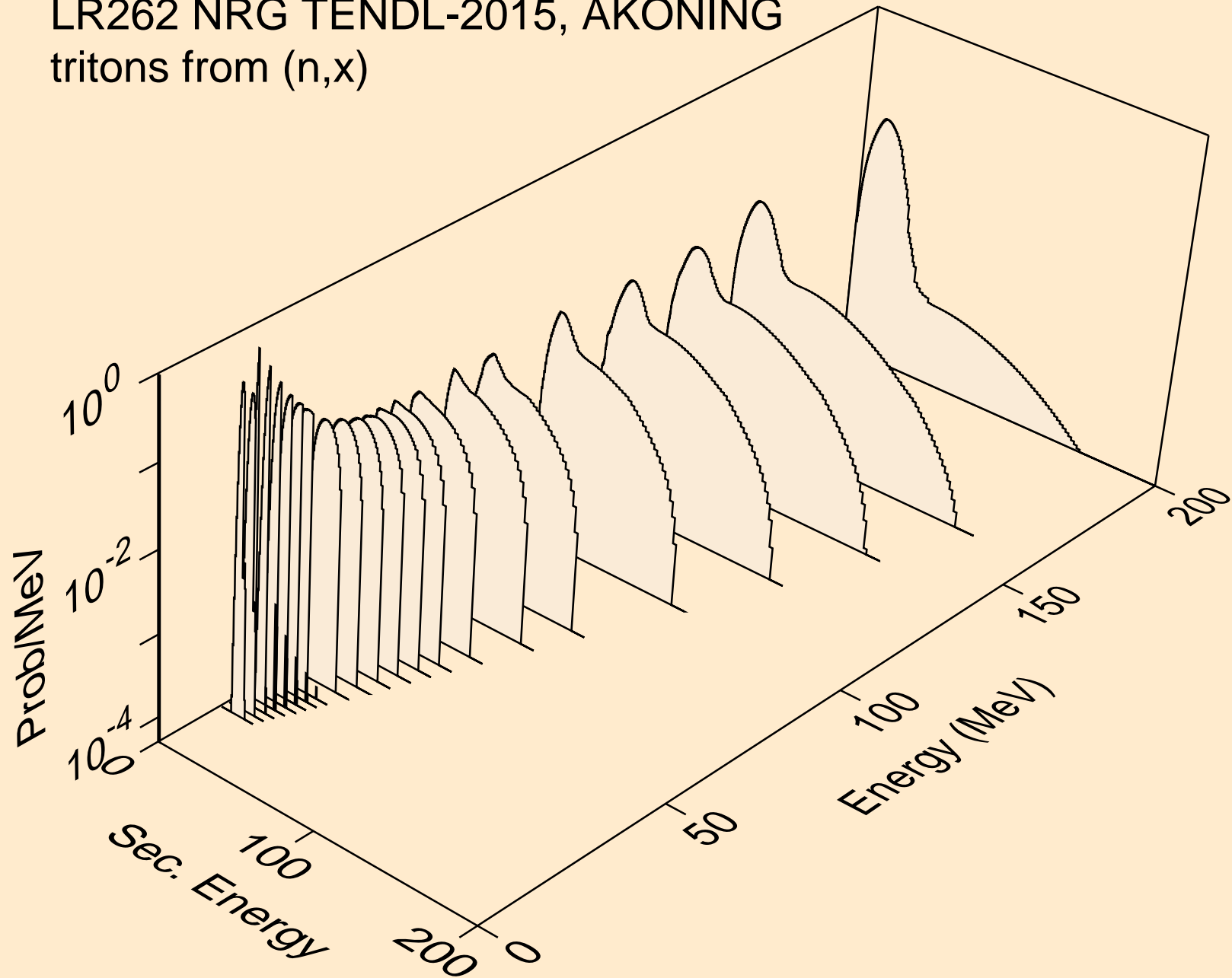

LR262 NRG TENDL-2015, AKONING  
tritons from (n,n\*)t

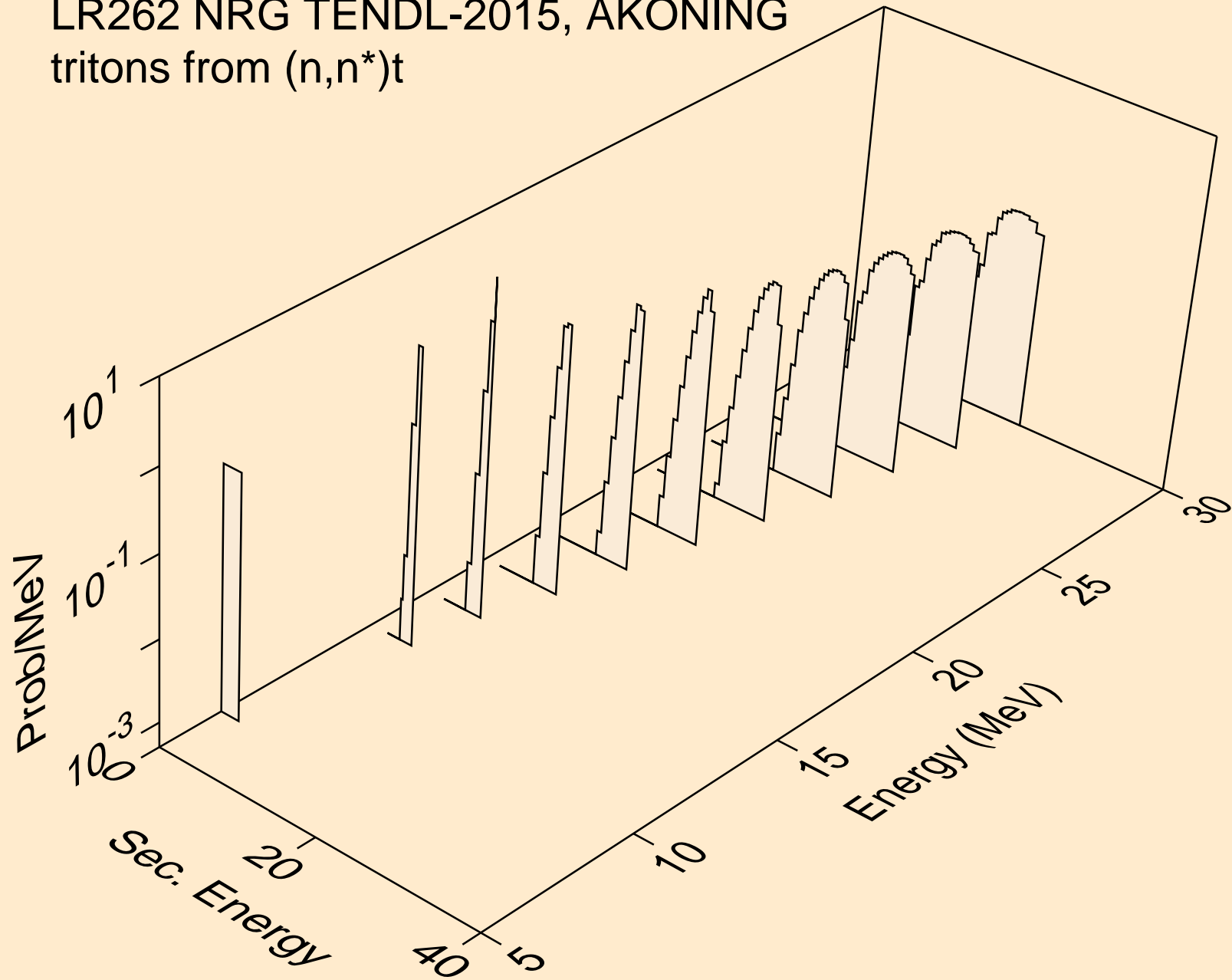

LR262 NRG TENDL-2015, AKONING  
tritons from (n,n\*)t2a

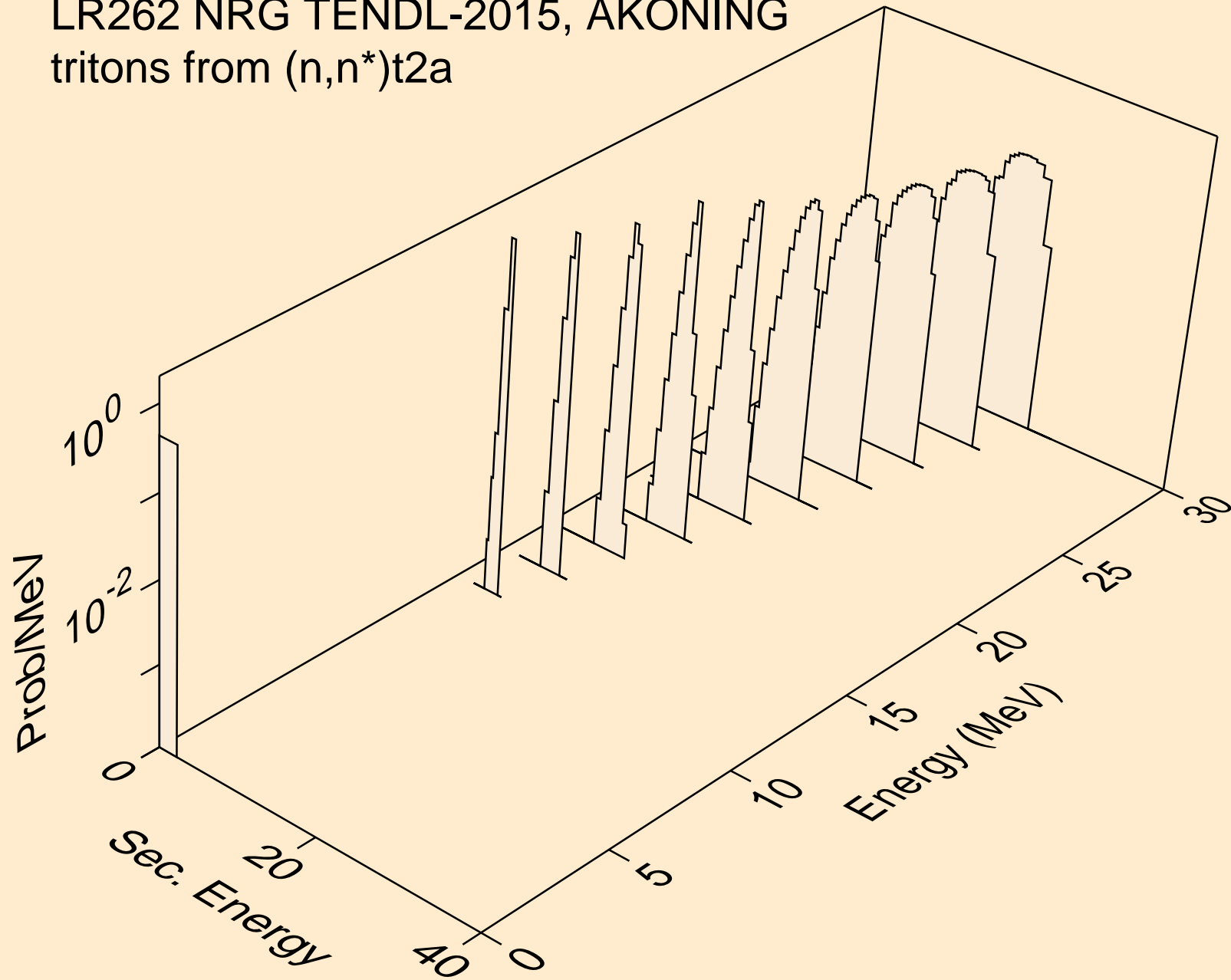

LR262 NRG TENDL-2015, AKONING  
tritons from (n,t)

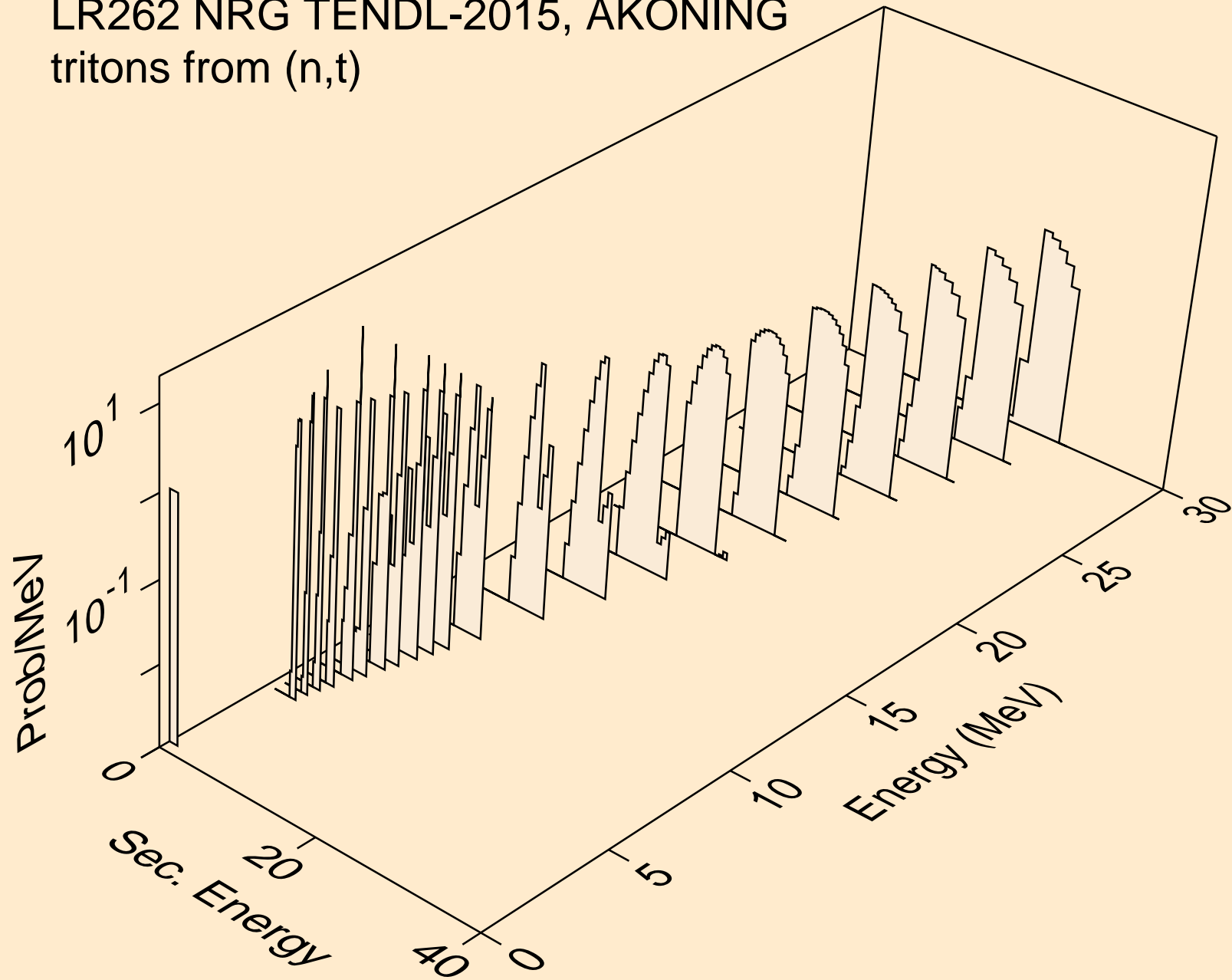

LR262 NRG TENDL-2015, AKONING  
tritons from (n,t2a)

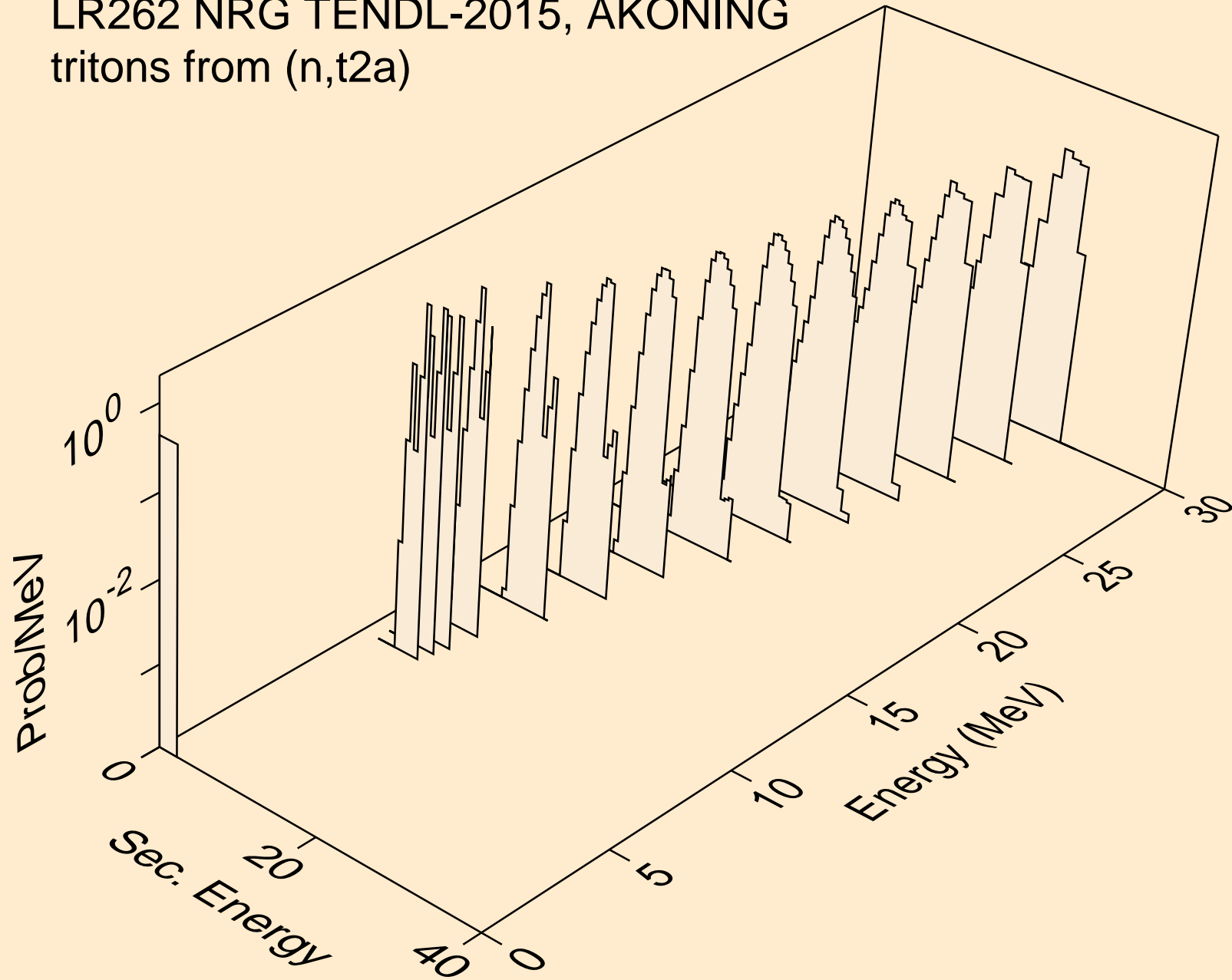

LR262 NRG TENDL-2015, AKONING  
he3s from (n,x)

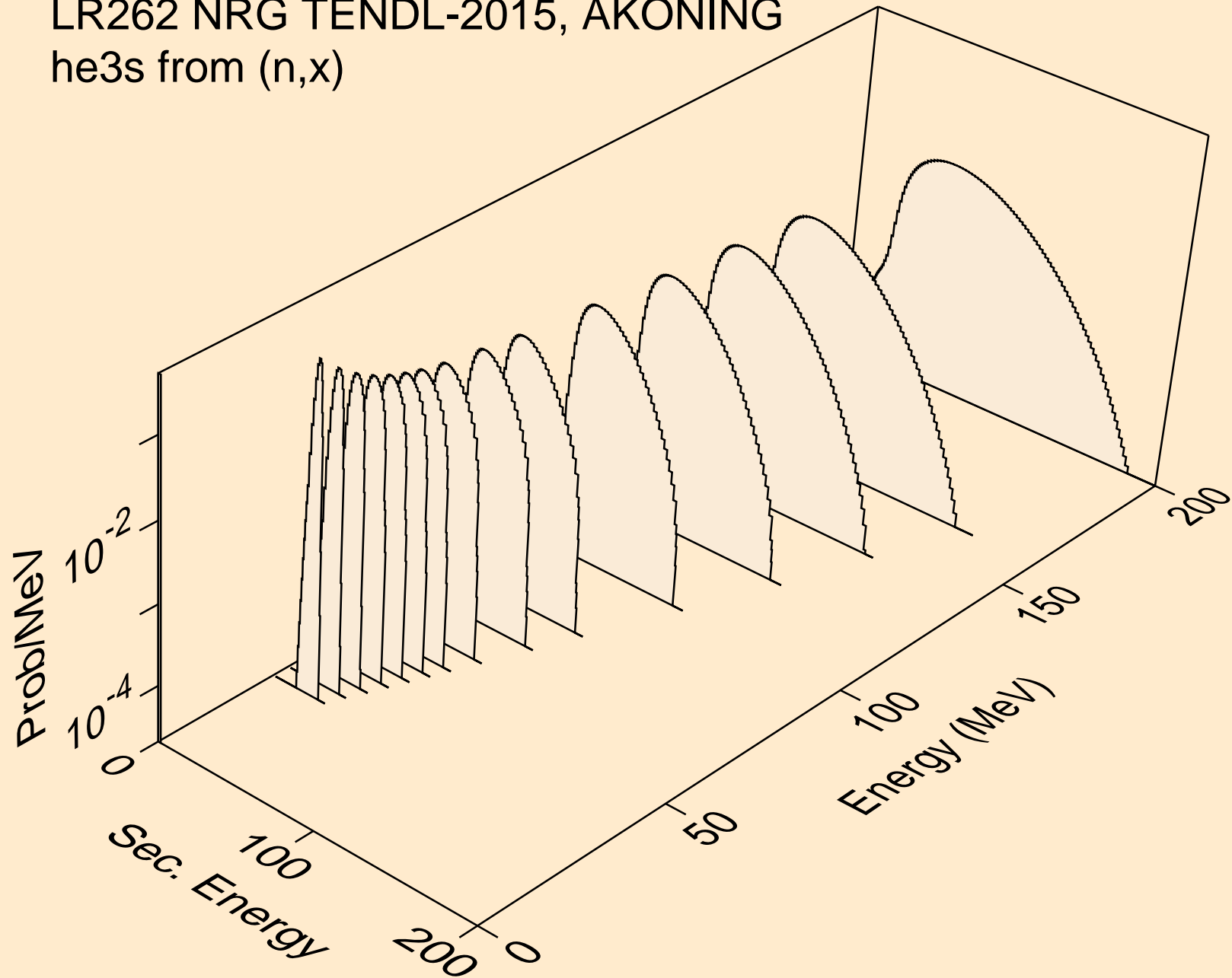

LR262 NRG TENDL-2015, AKONING  
he3s from (n,n\*)he3

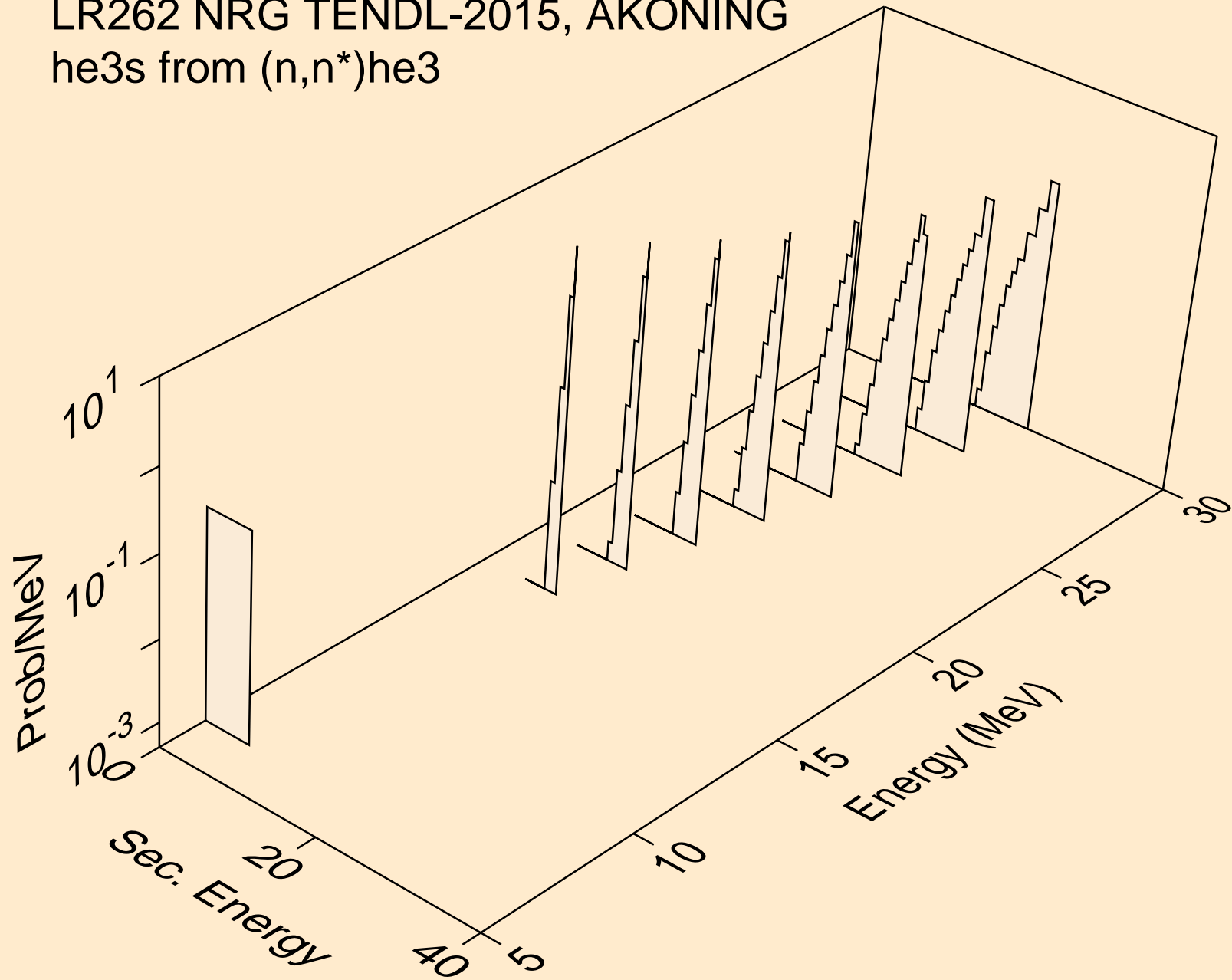



LR262 NRG TENDL-2015, AKONING  
he3s from (n,he3)

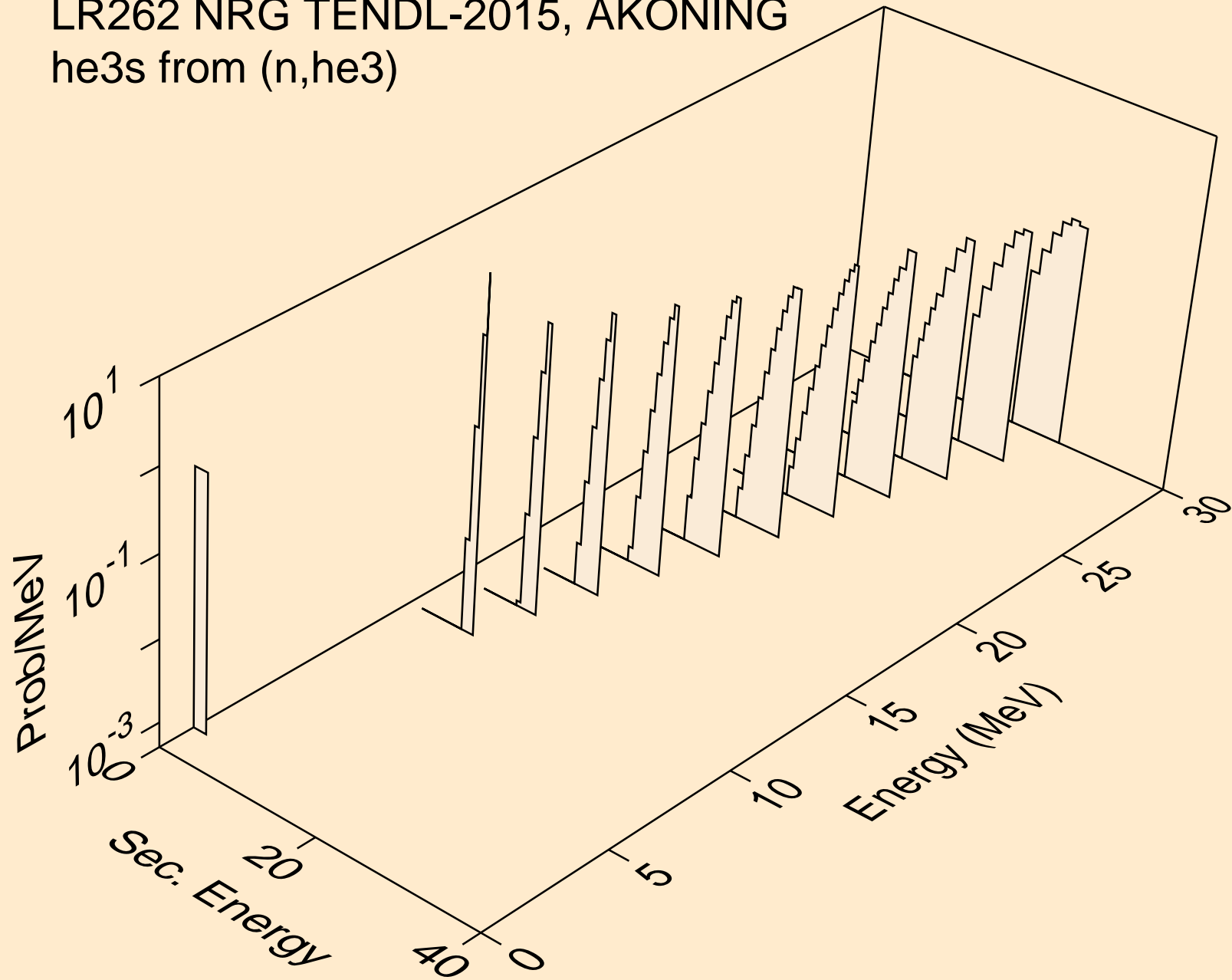

LR262 NRG TENDL-2015, AKONING  
alphas from (n,x)

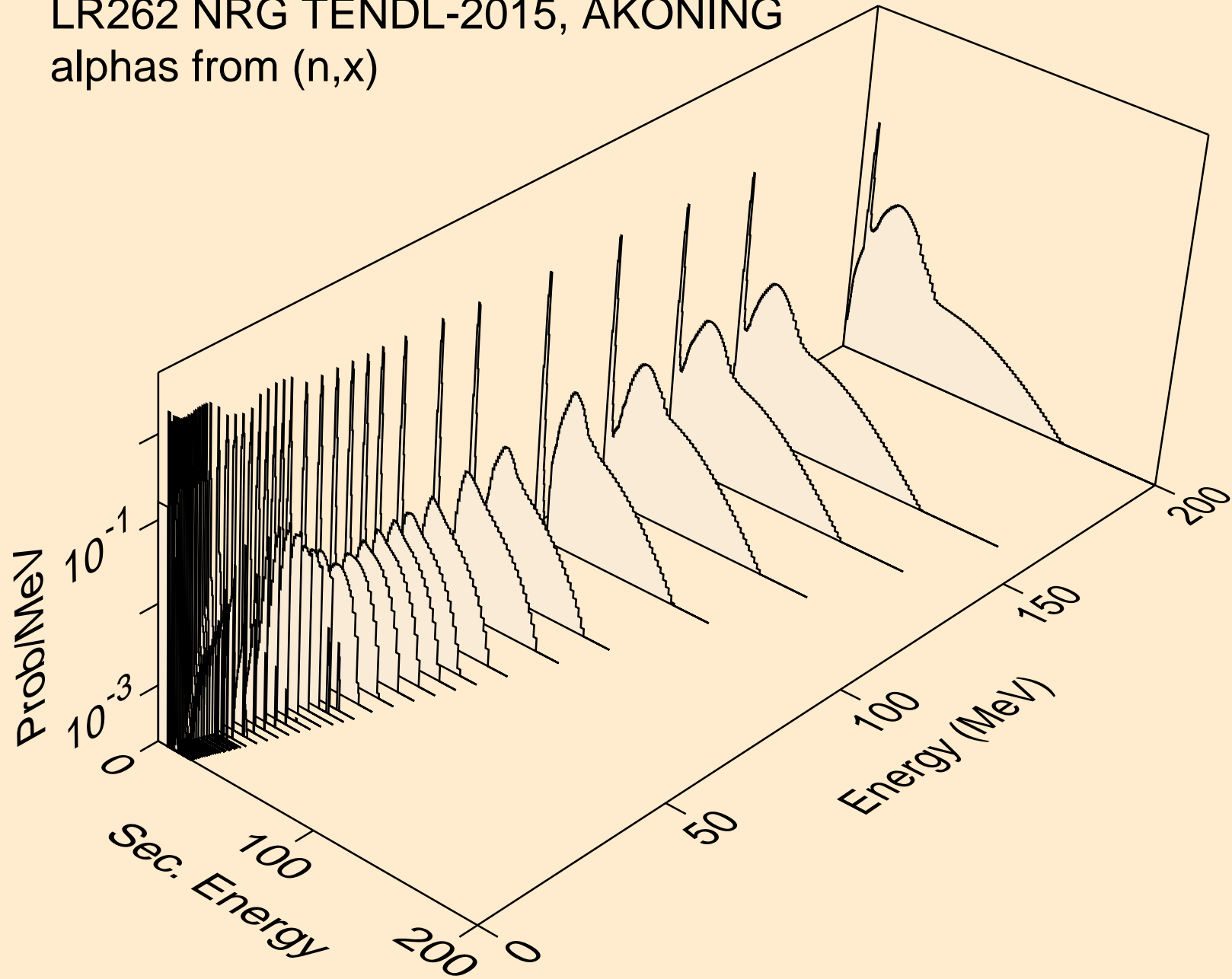

LR262 NRG TENDL-2015, AKONING  
alphas from (n,n\*)a

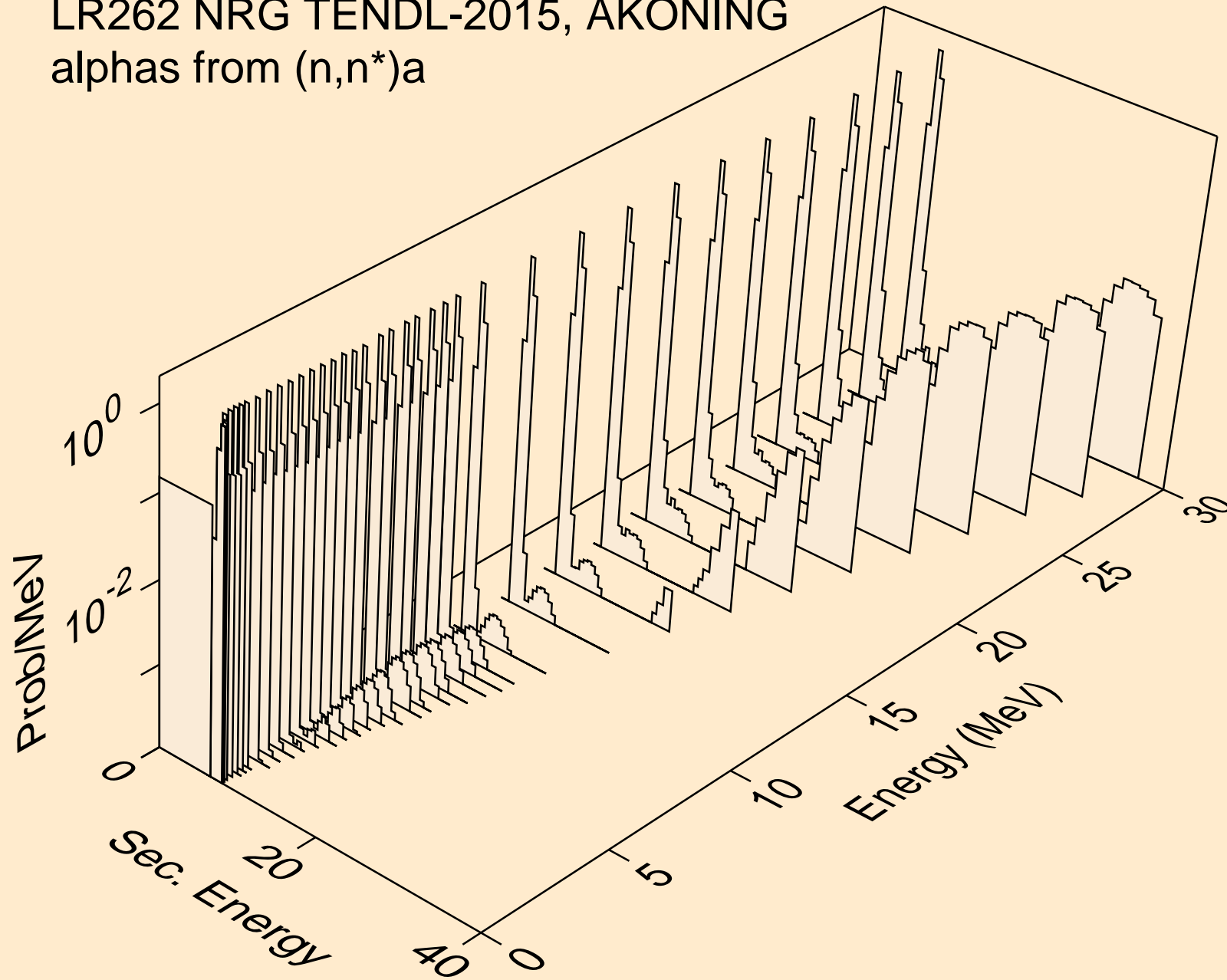

LR262 NRG TENDL-2015, AKONING  
alphas from (n,n\*)3a

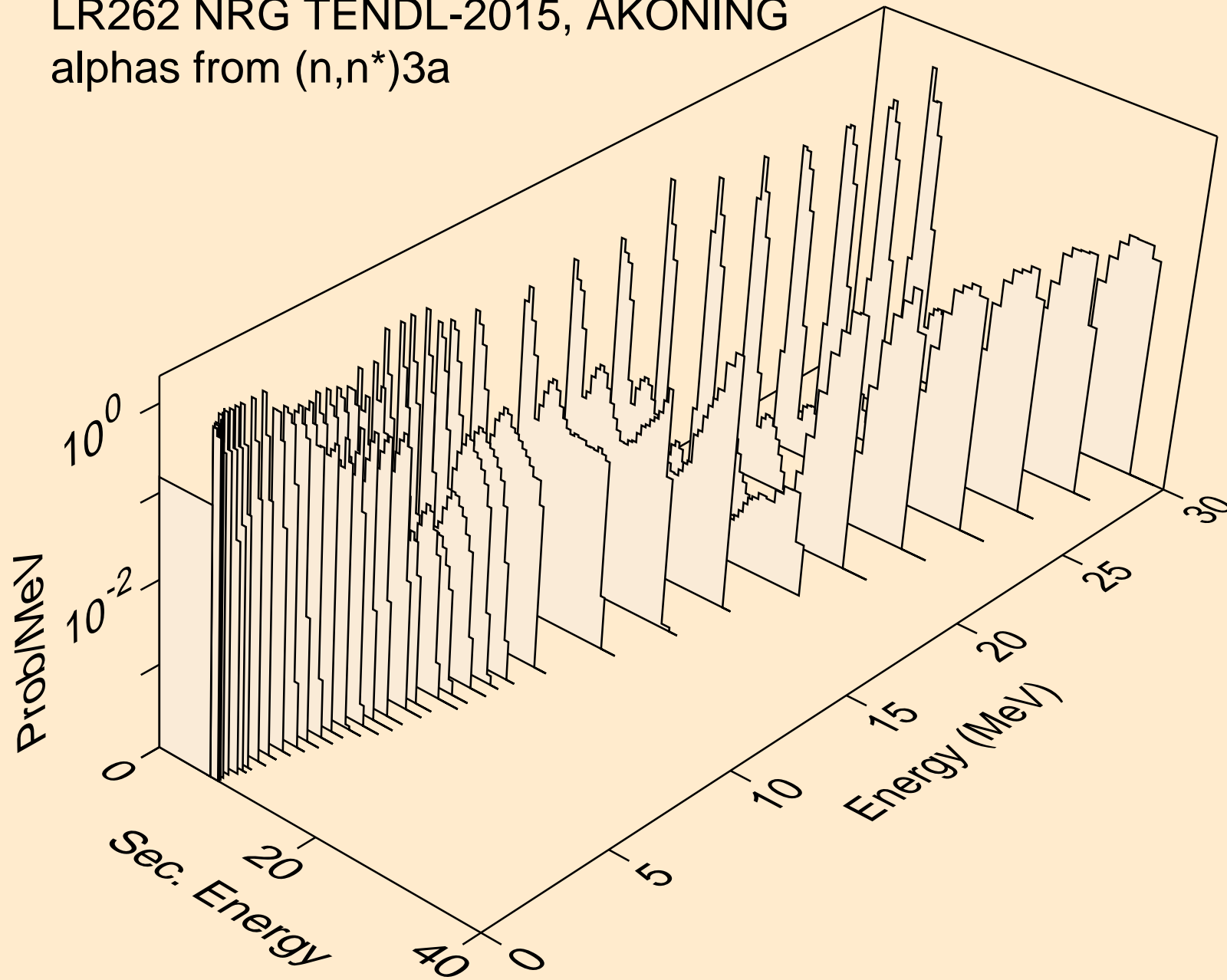

LR262 NRG TENDL-2015, AKONING  
alphas from (n,2n)a

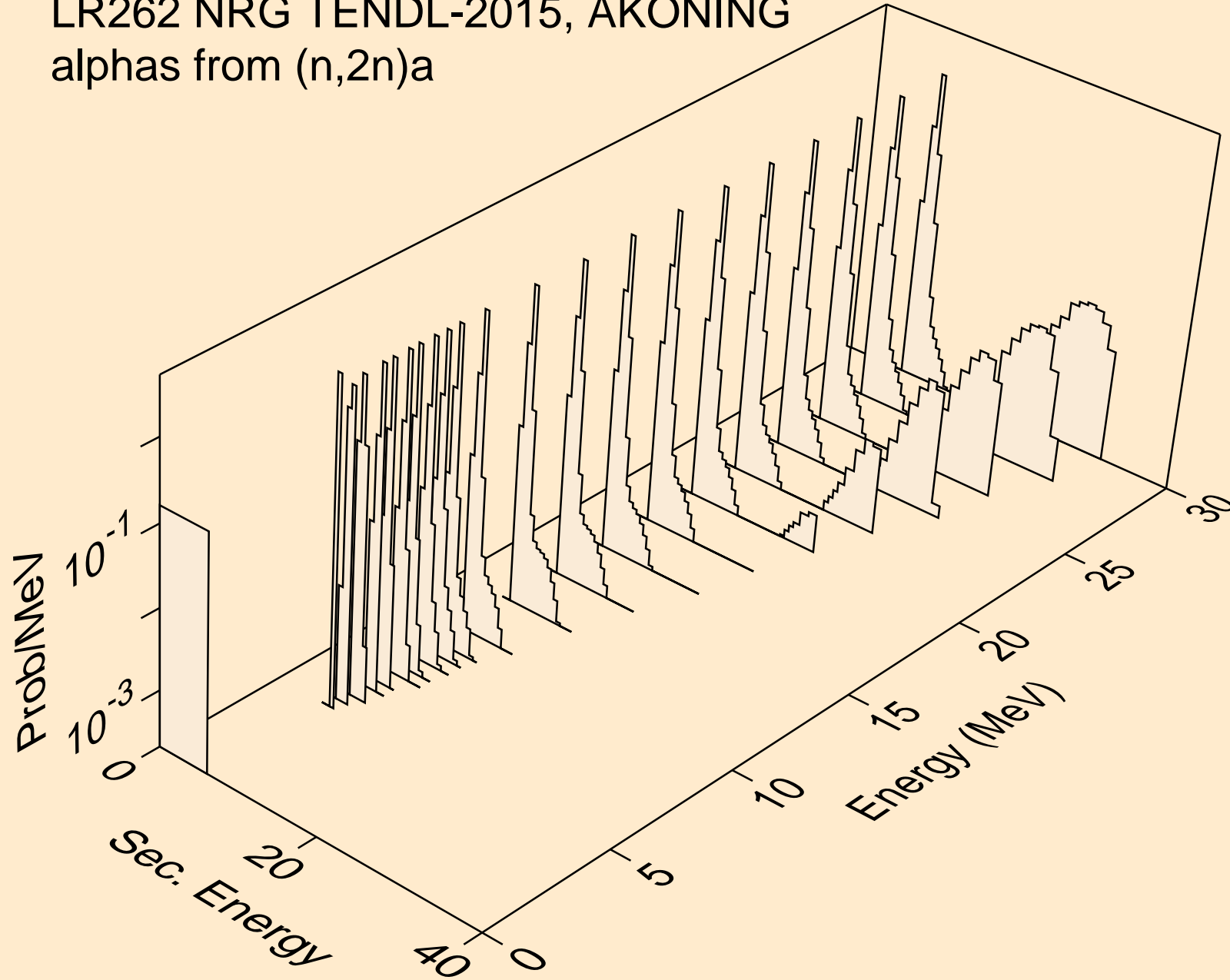

LR262 NRG TENDL-2015, AKONING  
alphas from (n,3n)a

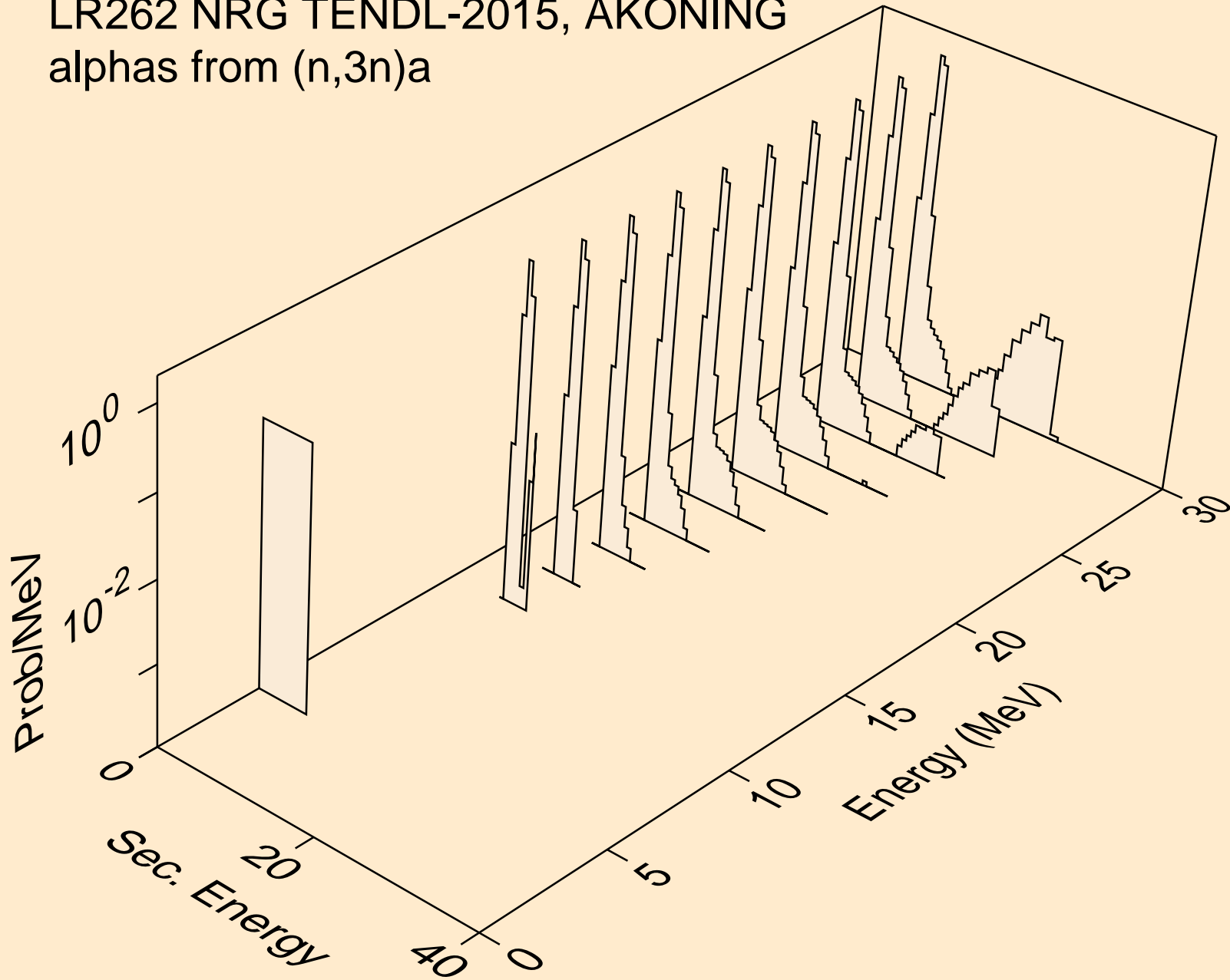

LR262 NRG TENDL-2015, AKONING  
alphas from (n,n\*)2a

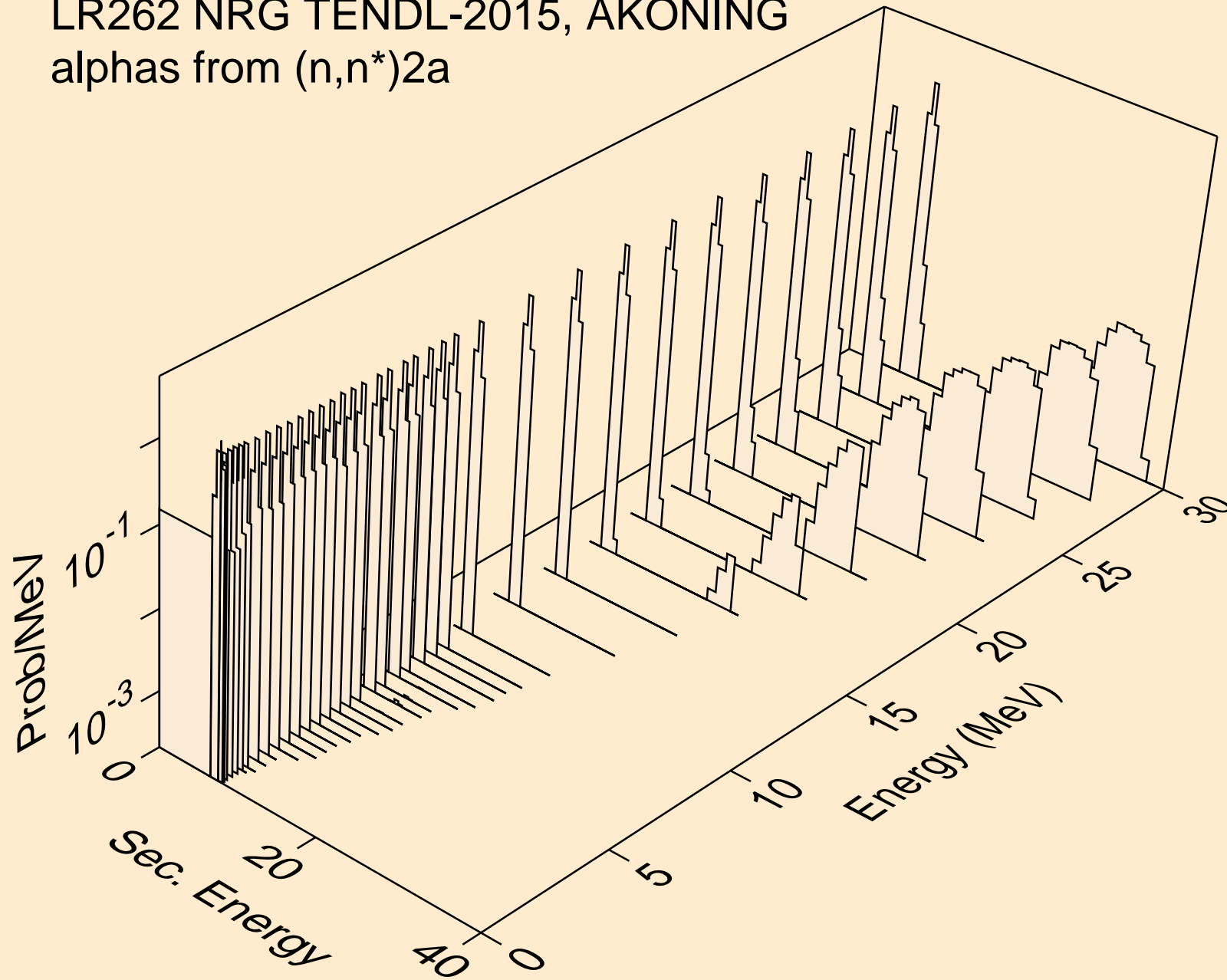

LR262 NRG TENDL-2015, AKONING  
alphas from (n,2n)2a

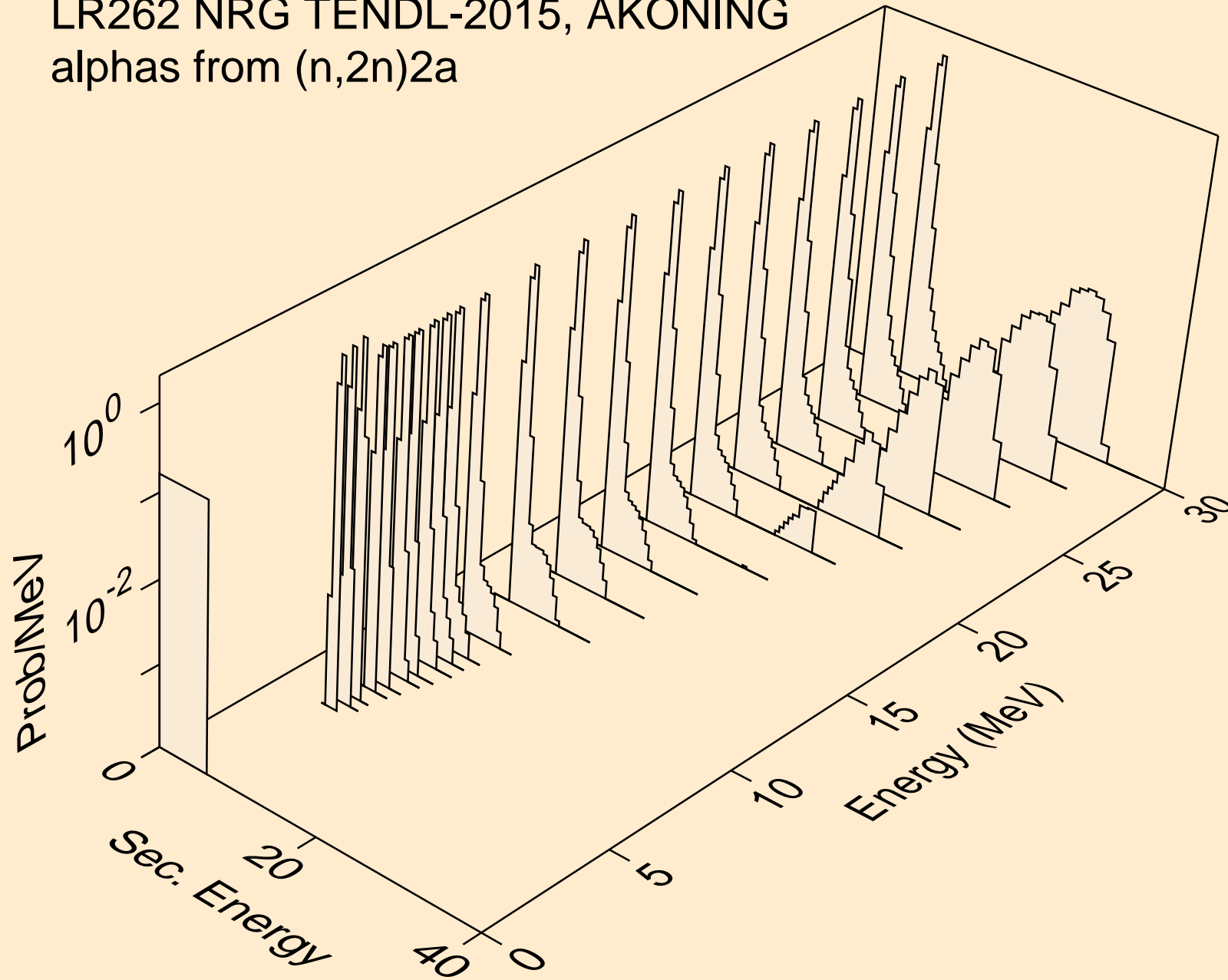



LR262 NRG TENDL-2015, AKONING  
alphas from (n,n\*)d2a

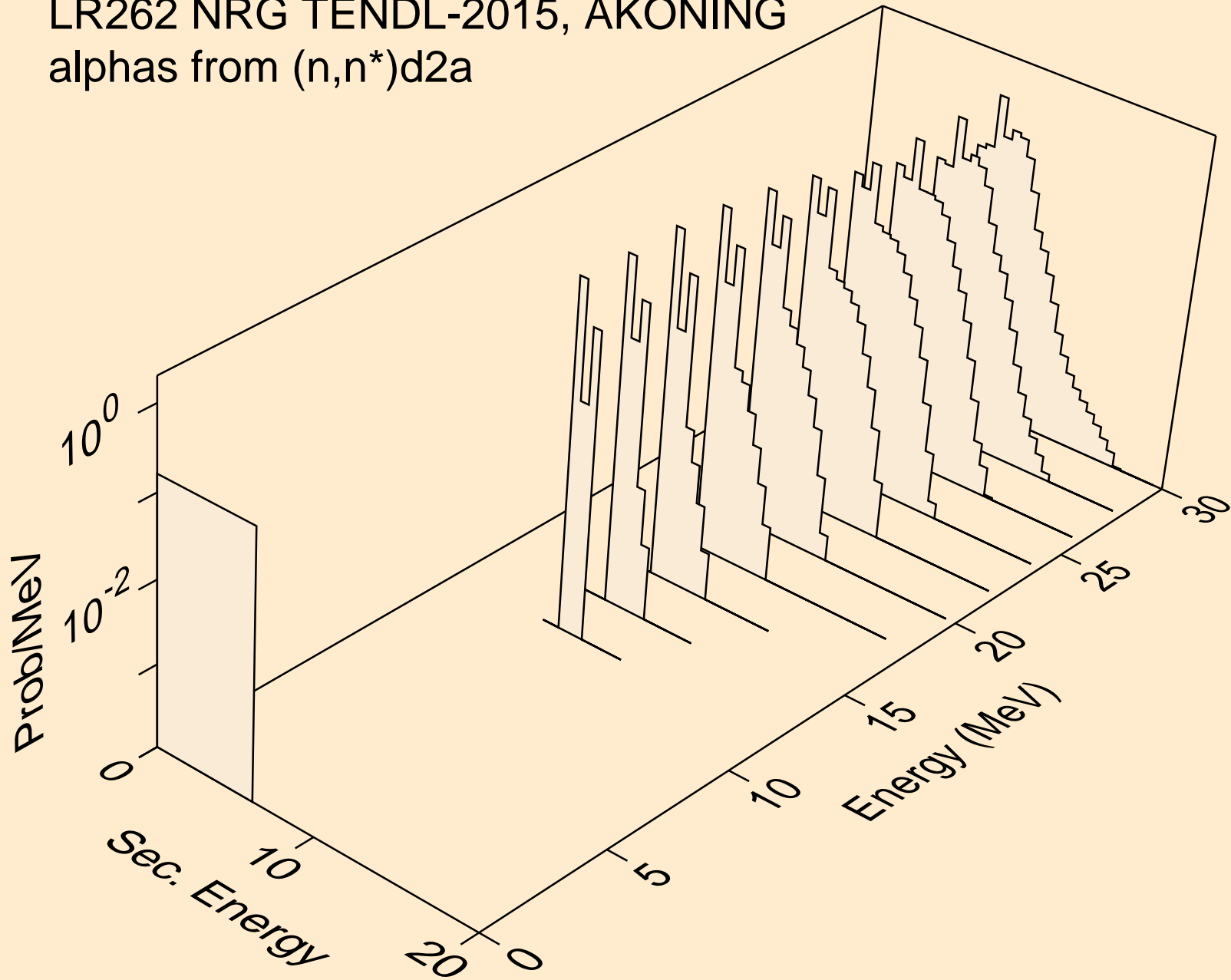

LR262 NRG TENDL-2015, AKONING  
alphas from (n,n\*)t2a

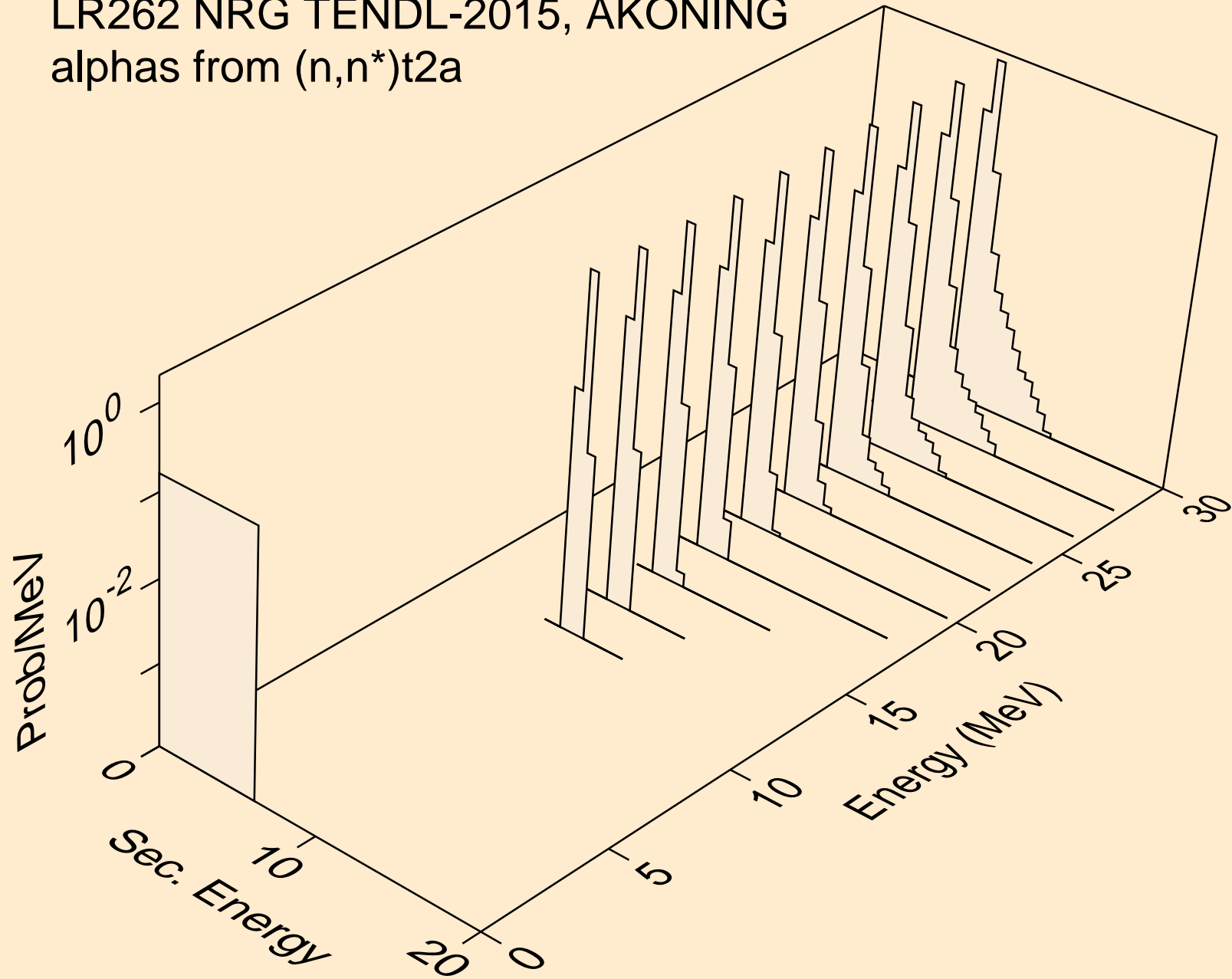

LR262 NRG TENDL-2015, AKONING  
alphas from (n,npa)

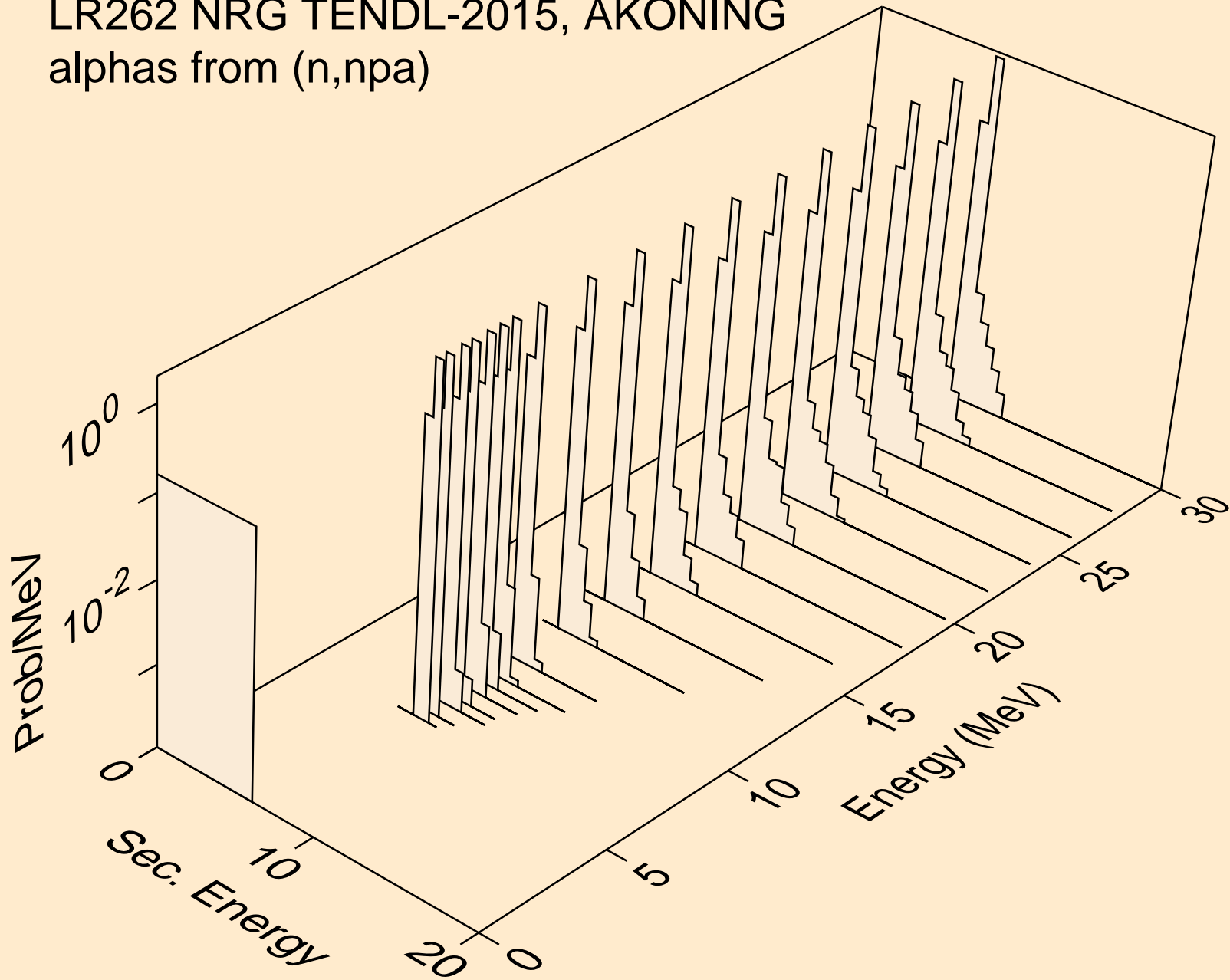

LR262 NRG TENDL-2015, AKONING  
alphas from (n,a)

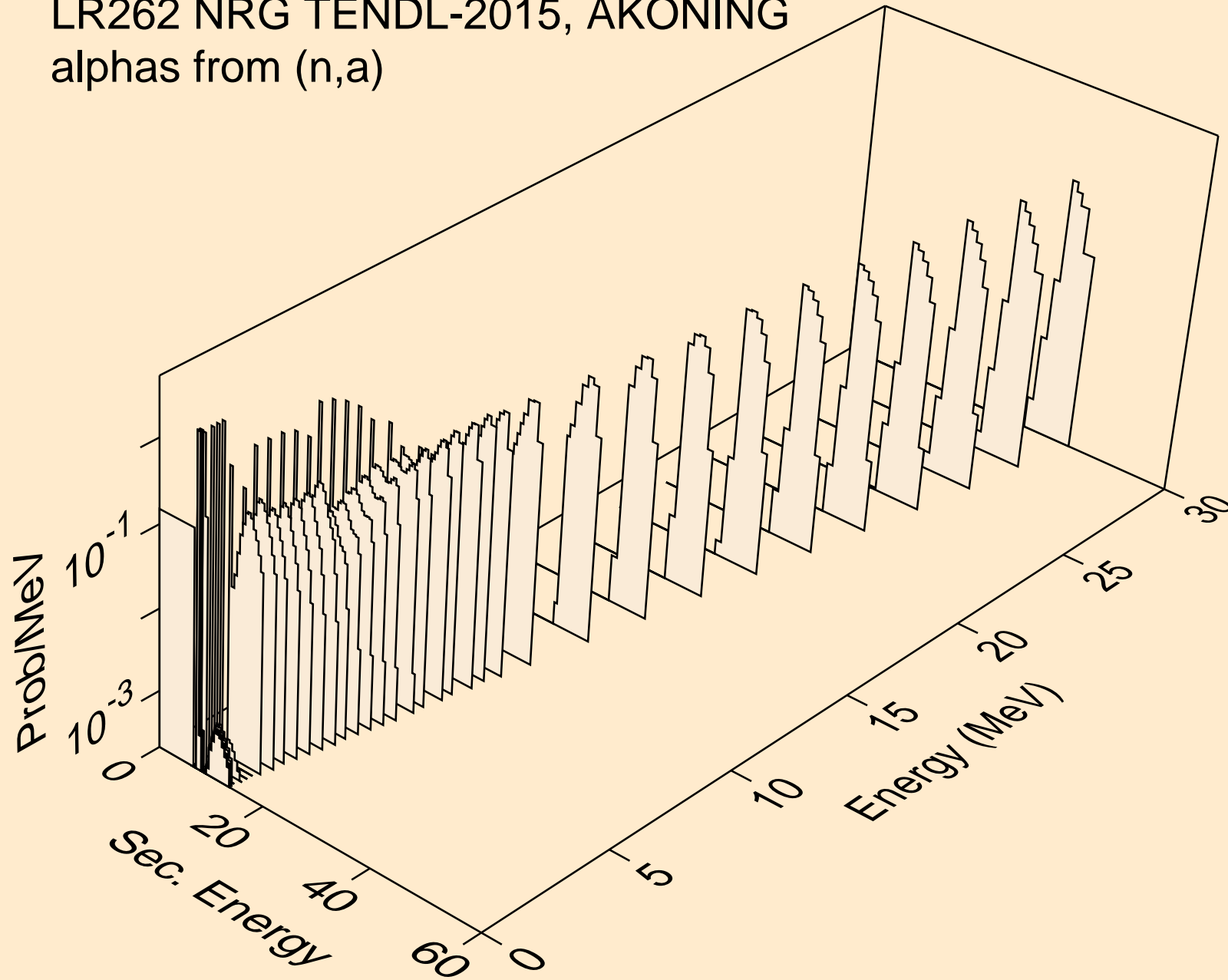

LR262 NRG TENDL-2015, AKONING  
alphas from (n,2a)

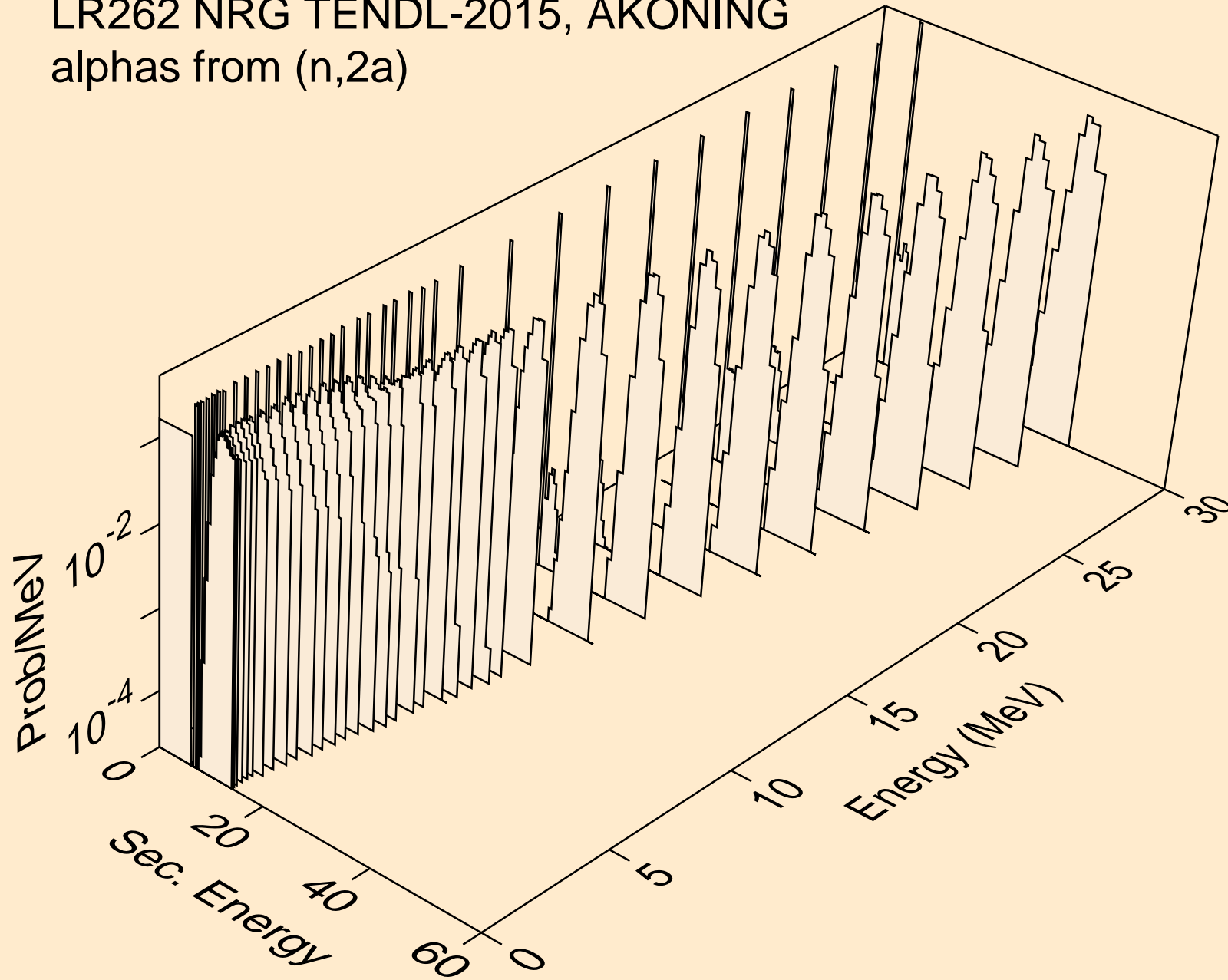

LR262 NRG TENDL-2015, AKONING  
alphas from (n,pa)

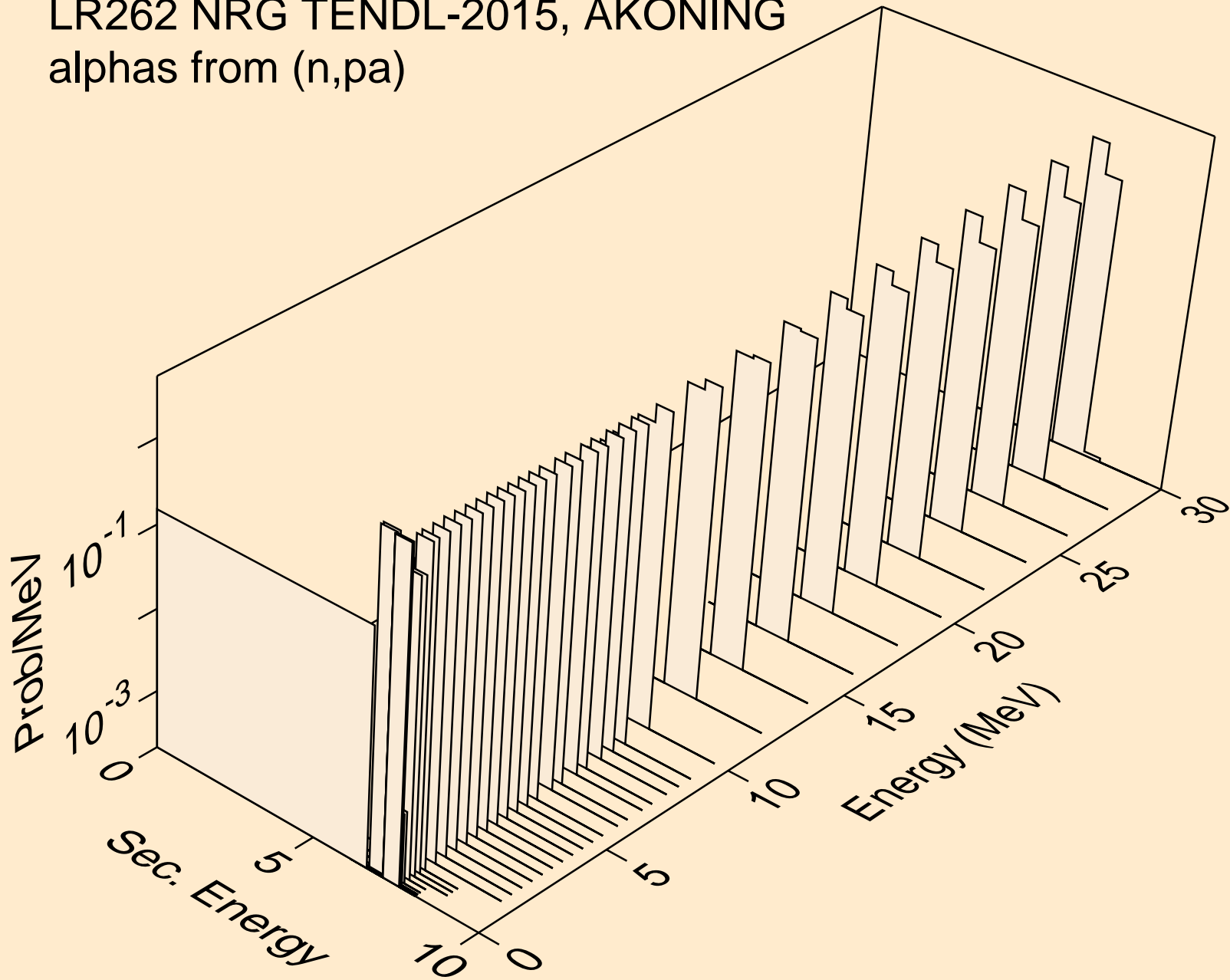

LR262 NRG TENDL-2015, AKONING  
alphas from (n,t2a)

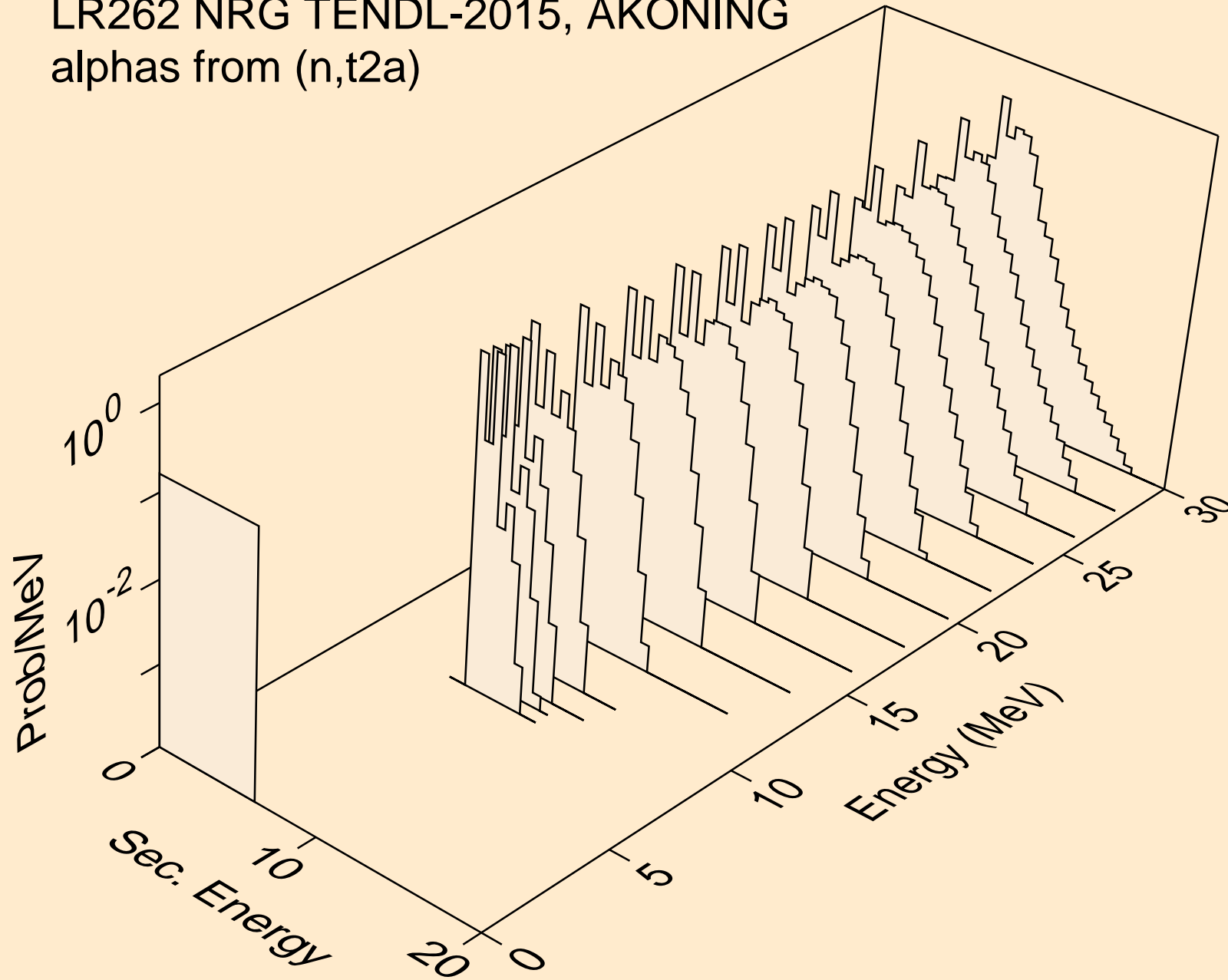

LR262 NRG TENDL-2015, AKONING  
alphas from (n,d2a)

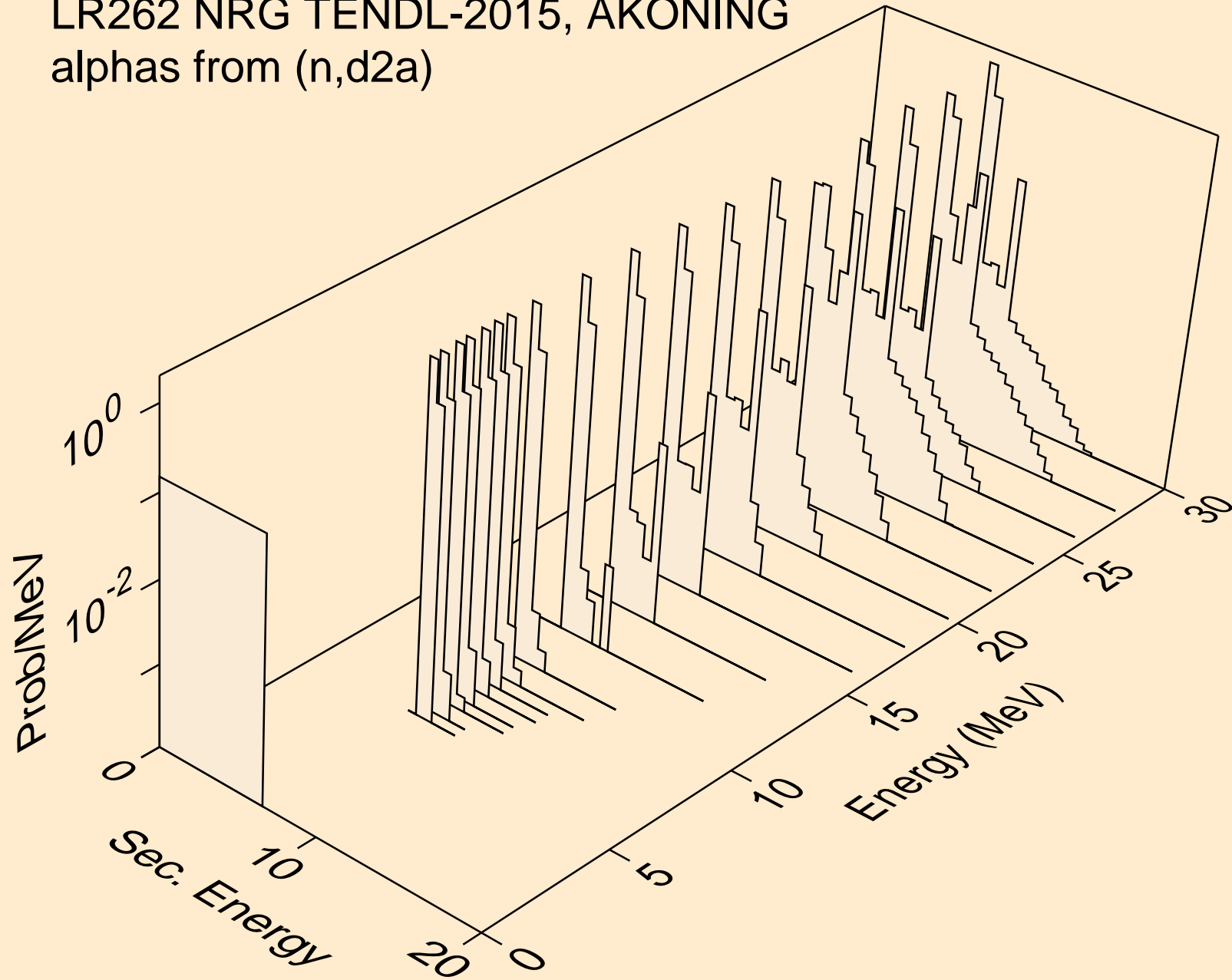



LR262 NRG TENDL-2015, AKONING  
alphas from (n,da)

